



Site Servicing and Stormwater
Management Brief – Mooney's Bay -
729 Ridgewood Avenue, Ottawa, ON

File: 160410536/83

June 9, 2021

Prepared for:

Brigil Homes

Prepared by:

Stantec Consulting Ltd.

Revision	Description	Author		Quality Check	
0	1 st submission	A. Paerez	09/06/2021	K. Kilborn	09/06/2021



SITE SERVICING AND STORMWATER MANAGEMENT BRIEF – MOONEY’S BAY - 729 RIDGEWOOD AVENUE, OTTAWA, ON

This document entitled Site Servicing and Stormwater Management Brief – Mooney’s Bay - 729 Ridgewood Avenue, Ottawa, ON was prepared by Stantec Consulting Ltd. (“Stantec”) for the account of Brigil Homes (the “Client”). Any reliance on this document by any third party is strictly prohibited. The material in it reflects Stantec’s professional judgment in light of the scope, schedule and other limitations stated in the document and in the contract between Stantec and the Client. The opinions in the document are based on conditions and information existing at the time the document was published and do not take into account any subsequent changes. In preparing the document, Stantec did not verify information supplied to it by others. Any use which a third party makes of this document is the responsibility of such third party. Such third party agrees that Stantec shall not be responsible for costs or damages of any kind, if any, suffered by it or any other third party as a result of decisions made or actions taken based on this document.

Prepared by  _____
(signature)

Ana M. Paerez, P. Eng.



Reviewed by  _____
(signature)

Kris Kilborn



Table of Contents

1.0	INTRODUCTION AND OBJECTIVE.....	1.1
1.1	OBJECTIVE.....	1.2
2.0	REFERENCES.....	2.1
3.0	WATER DISTRIBUTION.....	3.1
4.0	SANITARY SEWER.....	4.1
4.1	SANITARY SEWER DESIGN CRITERIA	4.2
5.0	STORMWATER MANAGEMENT	5.1
5.1	OBJECTIVES	5.1
5.2	EXISTING CONDITIONS.....	5.1
5.3	SWM CRITERIA AND CONSTRAINTS.....	5.1
5.4	STORMWATER MANAGEMENT DESIGN.....	5.2
5.4.1	Design Methodology	5.2
5.4.2	Water Quantity Control.....	5.3
5.4.3	Allowable Release Rate	5.3
5.4.4	Storage Requirements.....	5.3
5.4.5	Uncontrolled Area	5.4
5.4.6	Results	5.5
5.4.7	Water Quality Control.....	5.5
6.0	GRADING AND DRAINAGE.....	6.1
7.0	UTILITIES.....	7.1
8.0	EROSION CONTROL DURING CONSTRUCTION	8.1
9.0	GEOTECHNICAL INVESTIGATION AND ESA	9.1
9.1	GEOTECHNICAL INVESTIGATION	9.1
9.2	PHASE ONE ENVIRONMENTAL SITE ASSESSMENT	9.3
9.3	PHASE TWO ENVIRONMENTAL SITE ASSESSMENT.....	9.4
10.0	CONCLUSIONS.....	10.1
10.1	WATER SERVICING	10.1
10.2	SANITARY SERVICING	10.1
10.3	STORMWATER SERVICING	10.1
10.4	GRADING.....	10.1
10.5	UTILITIES.....	10.2
10.6	APPROVAL / PERMITS	10.2

LIST OF TABLES

Table 1: Estimated Water Demands.....	3.1
---------------------------------------	-----



Table 2: Boundary Conditions.....	3.2
Table 3: Estimated Wastewater Peak Flow.....	4.1
Table 4: Target Release Rate.....	5.3
Table 5 – 2-Year Summary of Roof Controls.....	5.3
Table 6 – 100-Year Summary of Roof Controls.....	5.4
Table 7: Peak Controlled (Cistern) 2-Year Release Rate.....	5.4
Table 8: Peak Controlled (Cistern) 100-Year Release Rate.....	5.4
Table 9: Peak Uncontrolled (Non-tributary) 2-Year Release Rate.....	5.4
Table 10: Peak Uncontrolled (Non-tributary) 100-Year Release Rate.....	5.5
Table 11: Estimated Discharge from Site (2-Year).....	5.5
Table 12: Estimated Discharge from Site (100-Year).....	5.5
Table 13: Recommended Parking Structure – Parking Areas.....	9.1
Table 14: Recommended Parking Structure – Local Roadways, Access Lanes and Heavy Vehicle Parking.....	9.2

LIST OF FIGURES

Figure 1: Site Location.....	1.2
------------------------------	-----

LIST OF APPENDICES

APPENDIX A	WATER CALCULATIONS.....	A.1
APPENDIX B	PROPOSED SITE PLAN.....	B.1
APPENDIX C	SANITARY SEWER CALCULATIONS.....	C.1
APPENDIX D	STORMWATER MANAGEMENT CALCULATIONS.....	D.1
APPENDIX E	GEOTECHNICAL REPORT AND ENVIRONMENTAL SITE ASSESSMENT.....	E.1
APPENDIX F	CITY OF OTTAWA SERVICING STUDY CHECKLIST.....	F.1
APPENDIX G	BACKGROUND CORRESPONDENCE.....	G.1
APPENDIX H	DRAWINGS.....	H.1



SITE SERVICING AND STORMWATER MANAGEMENT BRIEF – MOONEY’S BAY - 729 RIDGEWOOD AVENUE, OTTAWA, ON

Introduction and Objective

1.0 INTRODUCTION AND OBJECTIVE

Stantec Consulting Ltd. has been retained by Brigil Homes to prepare the following site servicing and stormwater management (SWM) brief to satisfy the City of Ottawa Site Plan Control Application process. The site is located at 729 Ridgewood Avenue, generally surrounded by residential and institutional developments in the city of Ottawa (see **Figure 1** below).

The site proposed for re-development measures 1.33 ha. The proposed re-development area was previously occupied by a commercial site and associated paved parking areas. The proposed development consists of five (5) multi-storey buildings with one of them consisting of commercial land uses on the ground floor and apartment buildings on the floors above. The five buildings will surround a common courtyard area, surface parking areas and an access road and will provide a total of 387 residential units, 856 m² of commercial area, two levels of underground parking and associated access and servicing infrastructure. The proposed buildings will include retail space within the ground floor of Building V, 254 one-bedroom apartments, 118 two-bedroom apartments, 15 three-bedroom apartments, underground parking and a bicycle storage room. The proposed site plan has been included in **Appendix B**.



SITE SERVICING AND STORMWATER MANAGEMENT BRIEF – MOONEY’S BAY - 729 RIDGEWOOD AVENUE, OTTAWA, ON

Introduction and Objective

Figure 1: Site Location



1.1 OBJECTIVE

This site servicing and SWM brief has been prepared to present a servicing scheme that is free of conflicts and which utilizes the existing infrastructure as obtained from available as-built drawings and in consultation with City of Ottawa staff. Infrastructure requirements for water supply, sanitary and storm sewer services are presented in this report.

Criteria and constraints provided by the City of Ottawa have been used as a basis for the conceptual servicing design of the proposed development. Specific elements and potential development constraints to be addressed are as follows:

- Prepare a grading plan in accordance with the proposed site plan and existing grades.
- Storm Sewer Servicing
 - Define major and minor conveyance systems in conjunction with the proposed grading plan
 - Determine the stormwater management storage requirements to meet the allowable release rate for the site



SITE SERVICING AND STORMWATER MANAGEMENT BRIEF – MOONEY’S BAY - 729 RIDGEWOOD AVENUE, OTTAWA, ON

Introduction and Objective

- Coordinate with mechanical engineer to convey drainage from roof tops, amenity areas, and private terrace areas to the internal cistern and discharge to the proposed storm service lateral at the allowable release rate.
- Define and size the proposed storm service lateral that will be connected to the existing 300 mm diameter storm sewer on Ridgewood Avenue.
- Wastewater Servicing
 - Define and size the sanitary service lateral which will be connected to the existing 225 mm diameter sanitary sewer on Ridgewood Avenue.
- Water Servicing
 - Estimate water demands to characterize the proposed feed for the development which will be serviced from the existing 305 mm diameter watermain on Ridgewood Avenue.
 - Watermain servicing for the development is to be able to provide average day and maximum day (including peak hour) demands (i.e., non-emergency conditions) at pressures within the acceptable range of 50 to 70 psi (350 to 480 kPa).
 - Under fire flow (emergency) conditions, the water distribution system is to maintain a minimum pressure greater than 20 psi (140 kPa).

The accompanying drawings included in the back of this report illustrate the proposed internal servicing scheme for the site.



SITE SERVICING AND STORMWATER MANAGEMENT BRIEF – MOONEY’S BAY - 729 RIDGEWOOD AVENUE, OTTAWA, ON

References

2.0 REFERENCES

The following background studies have been referenced during the preliminary servicing design of the proposed site:

- *City of Ottawa Design Guidelines – Water Distribution*, City of Ottawa, July 2010
- *City of Ottawa Sewer Design Guidelines*, City of Ottawa, October 2012
- *Technical Bulletin ISDTB-2014-01*, City of Ottawa, February 2014
- *Technical Bulletin ISTB-2018-01*, City of Ottawa, March 21, 2018
- *Technical Bulletin ISTB-2018-02*, City of Ottawa, March 21, 2018
- *Technical Bulletin ISTB-2018-03*, City of Ottawa, March 21, 2018
- *Technical Bulletin PI EDTB -2016-01*, City of Ottawa, September 6, 2016
- *Geotechnical Investigation Proposed Multi-Storey Building 729 Ridgewood Avenue – Ottawa*, Paterson Group, September 15, 2020
- *Sawmill Creek Subwatershed Study Update*, CH2MHILL, May 2003
- *Phase One Environmental Site Assessment – 729 Ridgewood Avenue, Ottawa, Ontario*, Lopers and Associates, July 27, 2020
- *Phase Two Environmental Site Assessment – 729 Ridgewood Avenue, Ottawa, Ontario*, Lopers and Associates, August 14, 2020



3.0 WATER DISTRIBUTION

The proposed development is located in Pressure Zone 2W2C of the City of Ottawa's Water Distribution System. The proposed development will be serviced through the existing 305 mm diameter watermain on Ridgewood Avenue as shown on the Site Servicing Plan (see **Drawing SSP-1**).

The proposed development encompasses four residential buildings, one mixed-use building with retail spaces on the ground floor and residential units on the higher floors, two levels of underground parking, landscaped amenity areas, surface parking areas and an access road. Tower I will consist of a 15-storey residential building with 73 one-bedroom apartments, 58 two-bedroom apartments and 10 three-bedroom apartments. Tower II is attached to Tower I and will consist of a 6-storey residential building with 36 one-bedroom apartments and 12 two-bedroom apartments. Tower III and Tower IV will each 4-storeys residential buildings with 40 one-bedroom apartments and 14 two-bedroom apartments. Tower V will consist of a 6-storey mixed-use building with 856 m² of commercial space on the ground floor and 65 one-bedroom apartments, 20 two-bedroom apartments and 5 three-bedroom apartments on the higher floors. The proposed site plan is included in **Appendix B**.

Water demands were calculated using the City of Ottawa Water Distribution Guidelines (July 2010) to determine the typical operating pressures to be expected at the proposed development (see detailed calculations in **Appendix A**). A daily rate of 350 L/cap/day has been applied for the population of the proposed site. The average daily (AVDY) residential demand was estimated for an occupancy of 1.4 persons per unit for a one-bedroom apartment, 2.1 persons per unit for a two-bedroom apartment and 3.1 persons per unit for a three-bedroom apartment. Water demands for the proposed retail space were estimated based on 28,000 L/ha/day. Maximum day (MXDY) demands were determined by multiplying the AVDY demands by a factor of 2.5 for residential areas and by a factor of 1.5 for commercial areas. Peak hourly (PKHR) demands were determined by multiplying the MXDY demands by a factor of 2.2 for residential areas and by a factor of 1.8 for commercial areas. The estimated demands are summarized in **Table 1**.

Table 1: Estimated Water Demands

	Population/Area	AVDY (L/s)	MXDY (L/s)	PKHR (L/s)
Residential	650 persons	2.63	6.58	14.48
Commercial	498 m ²	0.28	0.42	0.75
Total Site:		2.91	7.00	15.23

Given that the proposed site is a private site and that the proposed buildings will be serviced through direct connection to the mainline on Ridgewood Avenue, fire flow requirement



SITE SERVICING AND STORMWATER MANAGEMENT BRIEF – MOONEY’S BAY - 729 RIDGEWOOD AVENUE, OTTAWA, ON

Water Distribution

calculations for each building have been completed based on the Ontario Building Code (OBC) methodology. The OBC Fire Flow Calculations are included in **Appendix A**. The minimum required fire flow for this development has been determined to be 150 L/s (9,000L/min). Based on preliminary information obtained from the architect, non-combustible construction was assumed for Tower I & II and Tower V, while combustible construction was used for Tower III and Tower IV. Sprinkler systems conforming to NFPA13 will be provided within all buildings.

Table 2 outlines the boundary conditions provided by the City of Ottawa on April 27, 2021.

Table 2: Boundary Conditions

	Connection to Ridgewood Av.
Min. HGL (m)	123.7
Max. HGL (m)	131.9
Max. Day + Fire Flow (117 L/s)	125.6

1. Fire flow requirements for the proposed site have been revised to 150 L/s and as such, revised boundary conditions will be requested to the City and included in subsequent submissions.

The desired normal operating objective pressure range as per the City of Ottawa 2010 Water Distribution Design Guidelines is 350 kPa (50 psi) to 480kPa (70 psi) and no less than 275kPa (40 psi) at ground elevation. Furthermore, the maximum pressure at any point in the water distribution should not exceed 100 psi as per the Ontario Building/Plumbing Code; pressure reducing measures are required to service areas where pressures greater than 552kPa (80 psi) are anticipated.

The ground elevation along Ridgewood Avenue, approximately where the proposed building services are to be connected is approximately 82.43 m. With respect to the peak hour flow conditions, the resulting boundary condition HGL of 123.7 m corresponds to a peak hour pressure of 407 kPa (59 psi) at ground elevation. Since the proposed development consists of 4-storey, 6-storey and 15-storey towers, and an additional 34 kPa (5 psi) for every additional storey over two storeys is required to account for the change in elevation head and additional head loss, it is expected that booster pumps will be required for the 6-storey and 15-storey towers to maintain an acceptable level of service on the higher floors.

A maximum pressure check can be conducted using the buildings' lowest finished floor elevation (~83.45 m for Tower IV) and the maximum boundary condition HGL of 131.9 m. This results in a pressure of 476 kPa (69 psi). This value is below the limit of 80 psi for which pressure reducing valves would be required.

In regard to available fire flow, boundary conditions provided by the City confirm that a flow rate of 7,000 L/min (117 L/s) would have a residual pressure of 421 kPa (61 psi) on Ridgewood Avenue (ground elevation of 82.43 m). Based on the available boundary conditions, a fire flow rate of 7,000 L/min is achievable within the watermain at the connection location while maintaining a residual pressure above the minimum allowable pressure of 138kPa (20 psi).



SITE SERVICING AND STORMWATER MANAGEMENT BRIEF – MOONEY’S BAY - 729 RIDGEWOOD AVENUE, OTTAWA, ON

Water Distribution

However, as mentioned above, fire flow requirements for the proposed development have been revised to 9,000 L/min (150 L/s) and as such, revised boundary conditions will be requested, and the resulting residual pressure will be revised in subsequent submissions.

There are two hydrants along Ridgewood Avenue in close proximity to the site: one hydrant approximately 108 m west of the site and a second hydrant approximately 65 m east of the site. It is expected that approximately 7,000 L/min can be provided from the existing hydrants on Ridgewood Avenue to Towers I & II which are located at the northern edge of the proposed development and as a result, it is proposed to install a hydrant on-site as shown on **Drawing SSP-1** to achieve the fire flow requirements.

In conclusion, based on the boundary conditions available, the 305 mm diameter watermain on Ridgewood Avenue provide adequate fire flow capacity. In order to meet the City water supply objective that limits a single feed to 50 m³/d during basic day demands, two connections are required to service the proposed development. The service connections will be capable of providing anticipated demands at acceptable pressures to the lower storeys but will require booster pumps to maintain minimum required pressures for the higher floors of the proposed 6-storey and 15-storey towers.



Sanitary Sewer

4.0 SANITARY SEWER

As illustrated on **Drawing SSP-1**, sanitary servicing for the proposed development will be provided through a proposed 200 mm diameter service lateral connecting to the existing 225 mm diameter sanitary sewer running east on Ridgewood Avenue.

The proposed 1.33 ha re-development area will consist of five (5) multi-storey buildings with two levels of underground parking, a common courtyard area, surface parking areas and an access road. The proposed buildings will include retail space within the ground floor of Tower V (856 m²), 254 one-bedroom apartments, 118 two-bedroom apartments, 15 three-bedroom apartments, underground parking and a bicycle storage room. The anticipated wastewater peak flow generated from the proposed development is summarized in **Table 3** below while a sanitary sewer design sheet is included in **Appendix C**.

Table 3: Estimated Wastewater Peak Flow

Residential/Commercial Peak Flows					Infiltration Flow (L/s)	Total Peak Flow (L/s)
	# of Units/Area	Population	Peak Factor	Peak Flow (L/s)		
Residential	387 units	650	3.9	8.24	0.44	8.72
Commercial	0.086 ha	N/A	1.5	0.04		

1. Average residential flow based on 280 L/p/day
2. Peak factor for residential units calculated using Harmon's formula
3. Apartment population estimated based on 1.4 persons/unit for one-bedroom apartments, 2.1 persons/unit for two-bedroom apartments and 3.1 persons/unit for three-bedroom apartments
4. Commercial peak flows estimated based on 28,000 L/ha/day
5. Infiltration flow based on 0.33 L/s/ha.

The proposed sewage peak flows were provided to City of Ottawa staff to conduct a capacity analysis of the sanitary sewer system in the vicinity of the site and confirmation was received that there are no concerns with respect to adding the proposed sanitary peak flows to the existing sewers on Ridgewood Avenue (see correspondence in **Appendix C**).

Detailed sanitary sewage calculations are included in **Appendix C**. A backflow preventer will be required for the proposed building in accordance with the Ottawa Sewer Design Guidelines and will be coordinated with building mechanical engineers.

All underground parking drains should be connected to the building's internal plumbing. A sump pump will be required to drain the underground parking levels to the existing sanitary sewer on Ridgewood Avenue.



Sanitary Sewer

4.1 SANITARY SEWER DESIGN CRITERIA

As outlined in the City of Ottawa Sewer Design Guidelines and the MECP’s Design Guidelines for Sewage Works, the following criteria were used to calculate estimated wastewater flow rates and to size the sanitary sewer lateral:

- Minimum Velocity – 0.6 m/s (0.8 m/s for upstream sections)
- Maximum Velocity – 3.0 m/s
- Manning roughness coefficient for all smooth wall pipes – 0.013
- 1.4 persons/one-bedroom apartment
- 2.1 persons/two-bedroom apartment
- 3.1 persons/three-bedroom apartment
- 28,000 L/ha/day for commercial areas
- Harmon’s Formula for Residential Peak Factor – Max = 4.0
- Commercial Peak Factor of 1.5
- Extraneous Flow Allowance – 0.33 L/s/ha (conservative value)
- Manhole Spacing – 120 m
- Minimum Cover – 2.5 m



5.0 STORMWATER MANAGEMENT

5.1 OBJECTIVES

The objective of this stormwater management plan is to determine the measures necessary to control the quantity of stormwater released from the proposed development to the required levels and to provide sufficient detail for approval and construction.

5.2 EXISTING CONDITIONS

The proposed re-development area was previously occupied by two slab on grade commercial buildings, associated access roads and paved parking areas. A former mechanics garage which has been recently demolished was located on the east portion of the site. The previous site was serviced through the existing 300 mm diameter storm sewer on Ridgewood Avenue (see **Drawing EX-1**).

City of Ottawa staff recommended stormwater management peak flows from the proposed site be restricted to the 2-year storm with a runoff coefficient based on the Sawmill Creek Subwatershed Study (CH2MHILL, May 2003) and a minimum time of concentration (Tc) of 10 minutes (see pre-consultation meeting notes in **Appendix G**).

The Sawmill Creek Subwatershed Study (CH2MHILL, May 2003) assessed the hydrology and fluvial geomorphology of the creek under ultimate development conditions which considered the proposed site as a commercial site per the development conditions at the time of the report and as such, target peak outflows from the proposed development have been estimated using a runoff coefficient (C) of 0.80. The time of concentration of the existing development was assessed assuming a storm sewer network as per the storm sewer design sheet included in **Appendix D**, which resulted in a Tc of 12.38 minutes.

The proposed 729 Ridgewood Avenue re-development encompasses approximately 1.33 ha of land, which assuming a time of concentration (Tc) of 12.38 minutes results in an allowable peak outflow of $Q = 2.78 \times C \times I \times A = 2.78 \times 0.80 \times 68.73 \times 1.33 = \mathbf{203.3 \text{ L/s}}$.

5.3 SWM CRITERIA AND CONSTRAINTS

The stormwater management criteria for the proposed site are based on City of Ottawa Sewer Design Guidelines (2012) and on consultation with City of Ottawa Staff. The following summarizes the criteria used in the preparation of this stormwater management plan:

- Control post development peak flows up to the 100-year storm to the 2-year runoff with a runoff coefficient (C) of 0.80 which corresponds to **203.3 L/s**.



SITE SERVICING AND STORMWATER MANAGEMENT BRIEF – MOONEY’S BAY - 729 RIDGEWOOD AVENUE, OTTAWA, ON

Stormwater Management

- Size storm sewers using an inlet time of concentration (T_c) of 10 minutes
- Post-development runoff coefficient (C) value based on proposed impervious areas as per site plan drawing (see **Appendix D**)
- Provide 'Enhanced' level of quality control (i.e., 80% TSS removal)

5.4 STORMWATER MANAGEMENT DESIGN

The proposed 1.33 ha re-development area consists of five (5) multi-storey buildings with two levels of underground parking, a common courtyard area, surface parking areas, and associated access and servicing infrastructure. The imperviousness of the proposed site is 63% ($C = 0.64$).

The SWM strategy for the site is to use roof storage wherever possible and to provide a cistern in the underground parking to attenuate peak flows in the downstream system to the allowable release rate of 203.3 L/s. The proposed buildings will capture storm drainage through a combination of uncontrolled roof drains (Tower II), controlled roof drains (Towers I, III, IV and V), a trench drain that will capture runoff from the roundabout, amenity area drains and a trench drain at the end of the parking ramp that will direct peak flows to the cistern located in the underground parking for attenuation. Controlled peak flows from the cistern will be pumped from Tower 4 and ultimately discharged into the existing 300 mm diameter storm sewer on Ridgewood Avenue. Coordination with the mechanical consultant is on-going to size the internal plumbing system and the underground cistern.

The proposed site plan, drainage areas and proposed storm sewer infrastructure are shown on **Drawing SD-1**.

5.4.1 Design Methodology

The intent of the stormwater management plan presented herein is to mitigate any negative impact that the proposed development could have on the existing drainage and storm sewer infrastructure, while providing adequate capacity to service the proposed buildings, parking and access areas. The proposed stormwater management plan is designed to detain runoff on the roofs of buildings 1, 3, 4 and 5 and in an underground cistern to ensure that peak flows after construction from the proposed re-development area will not exceed the target release rate for the site.

A portion of the site could not be graded to enter the building's internal plumbing system and as such it will sheet drain uncontrolled. Runoff from this uncontrolled area is included in the overall site discharge calculations.



Stormwater Management

5.4.2 Water Quantity Control

The Modified Rational Method was used to assess the quantity and volume of runoff generated during post development conditions. The site was subdivided into subcatchments (subareas) tributary to storm sewer inlets, as defined by the location of catchbasins / inlet grates and used in the storm sewer design (see **Appendix D**). A summary of subareas and runoff coefficients is provided in **Appendix D**, and **Drawing SD-1** indicates the stormwater management subcatchments.

5.4.3 Allowable Release Rate

Site discharge rates up to the 100-year storm event are to be restricted to the 2-year storm event with a runoff coefficient ('C' value of 0.80) as outlined below in **Table 4**.

Table 4: Target Release Rate

Rational Method 'C'	Area (ha)	Time of Concentration (min)	Q _{Target} (L/s)
0.80	1.33	12.38	203.3

5.4.4 Storage Requirements

The site requires quantity control measures to meet the stormwater release criteria. Therefore, it is proposed to use roof storage and underground storage in a cistern located in the underground parking. Stormwater management calculations are provided in **Appendix D**.

5.4.4.1 Roof Storage

The roof of the proposed Building 2 will consist of a partial green roof with public amenity areas and as such it has been assumed to be uncontrolled (i.e., no roof storage). The following calculations assume the roofs of Buildings 1, 3, 4 and 5 will be equipped with standard Watts Modell R110 Accuflow Single Notch Roof Drains and that 80% of the roof areas are usable. **Table 5** and **Table 6** summarize the 2-year and 100-year roof release rates and storage requirements respectively.

Table 5 – 2-Year Summary of Roof Controls

Area ID	# of Drains	Usable Roof Area (m ²)	Depth (mm)	Discharge (L/s)	Drawdown Time (h)	Storage Volume (m ³)
ROOF1	4 drains – 75% open	720	93	4.2	0.7	9.1
ROOF3	4 drains – 75% open	880	97	4.3	0.9	12.1
ROOF4	4 drains – 50% open	880	100	3.8	1.1	13.0
ROOF5	6 drains – 75% open	1,280	96	6.4	0.9	17.3



Stormwater Management

Table 6 – 100-Year Summary of Roof Controls

Area ID	# of Drains	Usable Roof Area (m ²)	Depth (mm)	Discharge (L/s)	Drawdown Time (h)	Storage Volume (m ³)
ROOF1	4 drains – 75% open	720	141	6.0	1.7	30.8
ROOF3	4 drains – 75% open	880	145	6.1	2.3	40.4
ROOF4	4 drains – 50% open	880	149	5.0	2.8	43.6
ROOF5	6 drains – 75% open	1,280	145	9.2	2.2	58.2

5.4.4.2 Subsurface Storage

It is proposed to detain stormwater within a 52 m³ cistern below grade with a maximum controlled release rate of 177.3 L/s to the gravity service provided. The modified rational method was used to determine the peak volume requirement for the cistern. Site drainage areas are captured into the building plumbing directed to the cistern for additional control.

Table 7 and **Table 8** summarize the flow rates and storage from the cistern for the 2 and 100-year events, respectively.

Table 7: Peak Controlled (Cistern) 2-Year Release Rate

Area ID	Area (ha)	Runoff 'C'	Q _{release} (L/s)	V _{stored} (m ³)
ROOF1, ROOF2, ROOF2B, ROOF3, ROOF4, ROOF5, TANK1, TANK2, TANK3, TANK4, RAMP	1.18	0.69	100.51	0.00

Table 8: Peak Controlled (Cistern) 100-Year Release Rate

Area ID	Area (ha)	Runoff 'C'	Q _{release} (L/s)	V _{stored} (m ³)
ROOF1, ROOF2, ROOF2B, ROOF3, ROOF4, ROOF5, TANK1, TANK2, TANK3, TANK4, RAMP	1.18	0.86	177.25	49.8

5.4.5 Uncontrolled Area

A portion of the site around the buildings (see **Drawing SD-1**) could not be graded to enter the building’s internal plumbing system and as such it will sheet drain uncontrolled. **Table 9** and

Table 10 summarize the 2 and 100-year uncontrolled release rates from the proposed development.

Table 9: Peak Uncontrolled (Non-tributary) 2-Year Release Rate

Area ID	Area (ha)	Runoff 'C'	T _c (min)	Q _{release} (L/s)
UNC-1	0.15	0.28	10	9.0



Stormwater Management

Table 10: Peak Uncontrolled (Non-tributary) 100-Year Release Rate

Area ID	Area (ha)	Runoff 'C'	Tc (min)	Q _{release} (L/s)
UNC-1	0.15	0.35	10	26.1

5.4.6 Results

Table 11 and **Table 12** demonstrate that the proposed stormwater management plan provides adequate attenuation storage to meet the target peak outflow for the site.

Table 11: Estimated Discharge from Site (2-Year)

Area Type	Q _{release} (L/s)	Target (L/s)
Controlled Cistern Discharge	100.5	203.3
Uncontrolled Sheet Flow	9.0	
Total	109.5	

Table 12: Estimated Discharge from Site (100-Year)

Area Type	Q _{release} (L/s)	Target (L/s)
Controlled Cistern Discharge	177.3	203.3
Uncontrolled Sheet Flow	26.1	
Total	203.4	

5.4.7 Water Quality Control

The storm sewers on Ridgewood Avenue ultimately discharge into Sawmill Creek less than 1 km downstream of the proposed development. The Sawmill Creek watershed is within the Rideau Valley Conservation Authority (RVCA) that confirmed through correspondence that given that the proposed development consists of more than 6 surface parking spaces, onsite water quality treatment will be required to provide 'Enhanced' level of quality control, which is equivalent to 80% Total Suspended Solids (TSS) removal.

The online software available for Stormceptor sizing was used to size a unit capable of providing the required TSS removal. A drainage area of 0.72 ha (i.e., surface parking and access areas) with an imperviousness of 50% resulted in a Stormceptor EF4 which can provide 80% TSS removal. It should be noted that the Stormceptor Unit has been provided as an example and that an approved equivalent unit can be used during construction subject to approval. Stormceptor sizing information has been provided in **Appendix D**.



SITE SERVICING AND STORMWATER MANAGEMENT BRIEF – MOONEY’S BAY - 729 RIDGEWOOD AVENUE, OTTAWA, ON

Stormwater Management



Grading and Drainage

6.0 GRADING AND DRAINAGE

The proposed re-development site measures approximately 1.33 ha in area. A detailed grading plan (see **Drawing GP-1**) has been provided to satisfy stormwater management requirements and coordinated to accommodate architectural constraints.

The subject site maintains emergency overland flow routes to the back and to Ridgewood Avenue as depicted on **Drawings GP-1** and **SD-1**.



Utilities

7.0 UTILITIES

All utilities (Hydro Ottawa, Bell Canada, Rogers Ottawa, and Enbridge Gas) have existing plants in the area. The site will be serviced through connection to these existing services. Detailed design of the required utility services will be further investigated as part of the composite utility planning process following design circulation.



Erosion Control During Construction

8.0 EROSION CONTROL DURING CONSTRUCTION

Erosion and sediment controls must be in place during construction. The following recommendations to the contractor will be included in contract documents.

1. Implement best management practices to provide appropriate protection of the proposed drainage system and the receiving water course(s).
2. Limit extent of exposed soils at any given time.
3. Re-vegetate exposed areas as soon as possible.
4. Minimize the area to be cleared and grubbed.
5. Protect exposed slopes with plastic or synthetic mulches.
6. Provide sediment traps and basins during dewatering.
7. Install sediment traps (such as SiltSack® by Terrafix) between catch basins and frames.
8. Plan construction at proper time to avoid flooding.
9. Installation of a mud matt to prevent mud and debris from being transported off site.
10. Installation of a silt fence to prevent sediment runoff.

The contractor will, at every rainfall, complete inspections and guarantee proper performance. The inspection is to include:

1. Verification that water is not flowing under silt barriers.
2. Clean and change silt traps at catch basins.

Refer to **Drawing EC/DS-1** for the proposed location of silt fences, and other erosion control structures.



Geotechnical Investigation and ESA

9.0 GEOTECHNICAL INVESTIGATION AND ESA

9.1 GEOTECHNICAL INVESTIGATION

A geotechnical report for the site was prepared by Paterson Group in September 2020 (see **Appendix E**). As stated in the geotechnical report, the subsurface profile across the site generally consists of asphaltic concrete overlying a fill layer consisting of crushed stone and silty sand. The fill material is underlain by a stiff to hard layer of brown silty clay with sand seams. Glacial till was encountered below the above noted layers consisting of a compact to a very dense silty sand with clay, gravel, cobbles, and boulders. Seams of coarse sand were encountered in the glacial till layer at some test hole locations

Bedrock was cored at one borehole location to confirm refusal. Limestone bedrock was encountered at a depth of 9.7 m below the existing ground surface at BH6. Refusal was encountered in the other boreholes between a depth of 4.8 to 8.7 m. It should be noted that boulders are to be expected.

Groundwater levels were measured in July 2020 and were found to range between 1.9 m and 4.7 m below ground surface elevation. Long-term groundwater levels can also be determined based on observations of the recovered soil samples, such as moisture levels, colouring and consistency. Based on these observations, the long-term groundwater level is expected at a 5 to 6 m depth.

Bedrock removal can be accomplished by hoe ramming where only small quantity of the bedrock needs to be removed. Sound bedrock may be removed by line drilling and controlled blasting and/or hoe ramming.

Prior to considering blasting operations, the blasting effects on the existing services, buildings and other structures should be addressed. A pre-blast or pre-construction survey of the existing structures located in proximity of the blasting operations should be completed prior to commencing site activities. The extent of the survey should be determined by the blasting consultant and should be sufficient to respond to any inquiries/claims related to the blasting operations.

For design purposes, the flexible pavement structure presented in the following tables could be used for the design of car only parking areas in the lower level of the parking garage.

Table 13: Recommended Parking Structure – Parking Areas

Thickness (mm)	Material Description
50	Wear Course - HL 3 or Superpave 12.5 Asphaltic Concrete



SITE SERVICING AND STORMWATER MANAGEMENT BRIEF – MOONEY’S BAY - 729 RIDGEWOOD AVENUE, OTTAWA, ON

Geotechnical Investigation and ESA

Thickness (mm)	Material Description
150	BASE - OPSS Granular A Crushed Stone
300	SUBBASE - OPSS Granular B Type II
SUBGRADE - Either fill, in situ silty clay or sand or crushed stone material placed over in situ soil.	

Table 14: Recommended Parking Structure – Local Roadways, Access Lanes and Heavy Vehicle Parking

Thickness (mm)	Material Description
40	Wear Course - Superpave 12.5 Asphaltic Concrete
50	Binder Course - Superpave 19.0 Asphaltic Concrete
150	BASE - OPSS Granular A Crushed Stone
400	SUBBASE - OPSS Granular B Type II
SUBGRADE - Either fill, in situ silty clay or sand or crushed stone material placed over in situ soil.	

It is expected that the building foundation walls will be placed in close proximity to all the boundaries. It is expected that the foundation wall will be blind poured against a drainage system and waterproofing system fastened against the shoring system.

A waterproofing membrane will be required to lessen the effect of water infiltration for the lower P-2 basement level. The waterproofing membrane can be placed and fastened to the shoring system (soldier pile and timber lagging) and should extend to the bottom of the excavation at the founding level of the raft foundation.

It is recommended that the composite drainage system, such as Delta Drain 6000 or equivalent, extend from the exterior finished grade to the founding elevation (underside of raft slab). The purpose of the composite drainage system is to direct any water infiltration resulting from a breach of the waterproofing membrane to the building sump pit. It is recommended that 150 mm diameter sleeves at 3 m centres be cast in the foundation wall at the raft slab interface to allow the infiltration of water to flow to an interior perimeter underfloor drainage pipe. The perimeter drainage pipe should direct water to sump pit(s) within the lower basement area.

Underfloor drainage will be required to control water infiltration due to groundwater infiltration at the proposed founding elevation. For design purposes, we recommend that 150 mm in diameter perforated pipes be placed along the interior perimeter of the foundation wall and one drainage line within each bay. The spacing of the underfloor drainage system should be confirmed at the time of backfilling the floor completing the excavation when water infiltration can be better assessed.



SITE SERVICING AND STORMWATER MANAGEMENT BRIEF – MOONEY’S BAY - 729 RIDGEWOOD AVENUE, OTTAWA, ON

Geotechnical Investigation and ESA

It is anticipated that groundwater infiltration into the excavations should be controllable using open sumps. The contractor should be prepared to direct water away from all bearing surfaces and subgrades, regardless of the source, to prevent disturbance to the founding medium.

A temporary Ministry of Environment, Conservation and Parks (MECP) Category 3 Permit to Take Water (PTTW) may be required if more than 400,000 L/day are to be pumped during the construction phase. At least 4 to 5 months should be allowed for completion of the application and issuance of the permit by the MECP.

For typical ground or surface water volumes being pumped during the construction phase, typically between 50,000 to 400,000 L/day, it is required to register on the Environmental Activity and Sector Registry (EASR). A minimum of two to four weeks should be allotted for completion of the EASR registration and the Water Taking and Discharge Plan to be prepared by a Qualified Person as stipulated under O.Reg. 63/16. If a project qualifies for a PTTW based upon anticipated conditions, an EASR will not be allowed as a temporary dewatering measure while awaiting the MECP review of the PTTW application.

9.2 PHASE ONE ENVIRONMENTAL SITE ASSESSMENT

Lopers and Associates completed a Phase One Environmental Site Assessment of the existing commercial property in July 2020 (see **Appendix E**).

The Phase One Property was undeveloped prior to the 1950's when initial development was interpreted to have been for residential purposes. A commercial lease was registered at the Phase One Property in 1965 and it is inferred that commercial redevelopment of the Property occurred at this time. Demolition of the former residential building was completed prior to 1991. A retail fuel outlet and automotive service garage were present as part of the original commercial development at the Phase One Property and operated on the southeast portion of the Property until 2002 and 2018, respectively. The automotive garage moved to the south unit of the south commercial building in 2018 and has operated at that location on the Phase One Property since that time.

The presence of a former retail fuel outlet and automotive service garage on the southeast portion of the Phase One Property are a significant potentially contaminating activities (PCAs) which represent areas of potential environmental concern (APECs) for the Property. Given that previous reports were provided which document remnant petroleum hydrocarbon (PHC) and benzene, toluene, ethylbenzene and xylenes (BTEXs) soil contamination and that groundwater quality was not confirmed following the completion of a remediation program, further investigation is warranted. The contaminants of potential concern associated with retail fuelling are generally PHCs and BTEXs, and metals as this was an older facility and lead was historically present in gasoline. Based on historical soil analysis in this area of the Property, polycyclic aromatic hydrocarbons (PAH) and volatile organic compounds (VOCs) are also considered contaminants of potential concern associated with the former automotive garage operations.



SITE SERVICING AND STORMWATER MANAGEMENT BRIEF – MOONEY’S BAY - 729 RIDGEWOOD AVENUE, OTTAWA, ON

Geotechnical Investigation and ESA

The practice of backfilling following demolition activities at the Phase One Property is also a significant PCA which represents an APEC for the Property. Given that no reports were provided with analytical data to support the environmental quality of the backfill used to fill the former residential building footprint on the central-south portion of the Property, this area warrants further investigation. The contaminants of potential concern commonly found in poor environmental quality backfill are PHCs/BTEXs, PAHs and metals.

The presence of an active automotive service garage was observed during the site walk over on the central portion of the Phase One Property at the time of the Site Investigation. Although this garage has only been operating for a short time period (2018 to present), these operations are a PCA which represents an APEC for the Property. Based on the observations at this automotive garage, that contaminants of potential concern are considered to be PHCs and BTEXs.

Three active and/or historical fuel storage tank locations at neighbouring properties in the Phase One Study Area constitute PCAs. The PCAs at neighbouring properties in the Phase One Study Area are located significant distances and at down- or cross-gradient orientations with respect to the Phase One Property and are not considered to represent APECs for the Phase One Property.

Based on the identification of PCAs and APECs at the Phase One Property, it was recommended that a Phase Two Environmental Site Assessment be completed to assess the soil and groundwater quality in the vicinity of the four APECs.

9.3 PHASE TWO ENVIRONMENTAL SITE ASSESSMENT

Lopers & Associates (Lopers) completed a Phase Two Environmental Site Assessment (Phase Two ESA) of the existing commercial property in August 2020.

The scope of work for the Phase Two ESA included drilling seven boreholes at the Phase Two Property. Three of the boreholes were instrumented with groundwater monitoring wells with screens installed in the overburden.

Six soil samples, including one duplicate sample, were submitted for laboratory analysis for a combination of PHCs, BTEXs, volatile organic compounds (VOCs), PAHs, metals and inorganics. One sample was also submitted for toxicity leaching characteristic procedure (TCLP) for waste characterization purposes.

Groundwater sampling was completed of the newly installed monitoring wells and two existing groundwater monitoring wells at the Phase Two Property, which were installed as part of historical investigations. A total of seven groundwater samples, including a duplicate sample and a trip blank, were submitted for laboratory analysis for a combination of PHCs, BTEXs, VOCs, PAHs, metals and inorganics.



SITE SERVICING AND STORMWATER MANAGEMENT BRIEF – MOONEY’S BAY - 729 RIDGEWOOD AVENUE, OTTAWA, ON

Geotechnical Investigation and ESA

The applicable sites standard was determined to be the full depth generic site condition standard, in a non-potable groundwater condition, with coarse textured soil, for residential property use, as specified in Table 3 of the MECP Soil, Ground Water and Sediment Standards for Use Under Part XV.1 of the Environmental Protection Act, April 15, 2011.

At APEC #3 (placement of fill of unknown quality) the soil samples BH1-20-SS5 and BH11-20-SS5 (Duplicate of BH1-20-SS5), collected from a depth of approximately 3.1-3.7 m BGS, had reported concentrations of PHC F2 range (909 µg/g and 306 µg/g vs. 98 µg/g), Methylanthalene (7.61 µg/g and 2.26 µg/g vs. 0.99 µg/g) and reported concentrations of vanadium (101 µg/g and 104 µg/g vs. 86 µg/g). These samples also had respective cobalt concentrations of 20.1 µg/g and 22.5 µg/g compared to the site condition standard of 22 µg/g; since the average concentration of cobalt in these samples is less than the site condition standard, the marginal exceedance in the duplicate standard is not considered to exceed the site condition standard.

At APEC #1 (former retail fuel outlet) the soil sample BH3-20-SS6, collected from a depth of approximately 3.8-4.4 m BGS, had reported concentrations of PHC F1 range (117 µg/g vs. 55 µg/g), PHC F2 range (110 µg/g vs. 98 µg/g), benzene (3.02 µg/g vs. 0.21 µg/g), ethylbenzene (59 µg/g vs. 2 µg/g), toluene (73.5 µg/g vs. 2.3 µg/g) and xylenes (276 µg/g vs. 3.1 µg/g). Additionally, PAH exceedances from the same soil sample included Methylanthalene (1.95 µg/g vs. 0.99 µg/g) and Naphthalene (1.69 µg/g vs. 0.6 µg/g).

At APEC #1 (former retail fuel outlet), the groundwater samples BH3-20 and BH13-20 (Duplicate of BH3-20), collected from a screen depth of approximately 2.5-5.5 m BGS, had reported concentrations of PHC F1 range (3,600 µg/g and 3,790 µg/g vs. 750 µg/g), PHC F2 range (52,400 µg/g and 2,260 µg/g vs. 150 µg/g), PHC F3 range (3,940 µg/g vs. 500 µg/g), benzene (19,300 µg/g and 19,700 µg/g vs. 44 µg/g), ethylbenzene (3,800 µg/g and 3,700 µg/g vs. µg/g), toluene (65,200 µg/g and 60,900 µg/g vs. 18,000 µg/g) and xylenes (27,600 µg/g and 26,600 µg/g vs. 4,200 µg/g). Lead was also reported at concentrations of 51.6 µg/g and 54.6 µg/g vs. 25 µg/g.

All of the other soil and groundwater results for the Phase Two Property are in compliance with the applicable site condition standards. The Phase Two Property is not in compliance with the Table 3 site condition standards as of the certification date of June 30, 2020.

An environmental remediation program, including the bulk removal and off-site disposal of soil and groundwater in excess of the site condition standards is recommended for the Phase Two Property. Given the scope and timeline for the proposed redevelopment and the requirements for specialized construction techniques to complete remediation of the Phase Two Property to meet the site condition standards, it is recommended that remediation be completed in conjunction with redevelopment of the property. It should be noted that the proposed redevelopment includes excavation for at least two to three levels of underground parking, which is expected to be sufficient for remediation of the aforementioned environmental contamination at the Phase Two Property.



SITE SERVICING AND STORMWATER MANAGEMENT BRIEF – MOONEY’S BAY - 729 RIDGEWOOD AVENUE, OTTAWA, ON

Geotechnical Investigation and ESA

Further delineation and confirmation of remediation sampling will be required prior to the completion of an environmental remediation program and confirmation of compliance with the site condition standards; however, these tasks can be completed at the time decommissioning and demolition of existing structures at the Phase Two Property. The submission of a record of site condition would be required in the event of a change of zoning of the Phase Two Property; however, these tasks can be completed at the time decommissioning and demolition of existing structures at the Phase Two Property. The Phase Two ESA could be then updated at that time to show compliance with site condition standards.

Preparation of a soil management plan in accordance with O.Reg. 406/19 will be required as part of management of excess soil generated as part of construction activities. It was recommended that a remedial action plan be prepared to develop a strategy for remediation, including soil and groundwater management, during redevelopment.



Conclusions

10.0 CONCLUSIONS

10.1 WATER SERVICING

The existing 305 mm diameter watermain on Ridgewood Avenue will provide adequate fire flow capacity. In order to meet the City water supply objective that limits a single feed to 50 m³/d during basic day demands, two connections are required to service the proposed development. The service connections will be capable of providing anticipated demands at acceptable pressures to the lower storeys but will require booster pumps to maintain minimum required pressures for the higher floors of the proposed 6-storey and 15-storey towers.

10.2 SANITARY SERVICING

The proposed sanitary sewer lateral is sufficiently sized to provide gravity drainage for the site. The proposed site will be serviced by a 200 mm diameter service lateral directing wastewater flows to the existing 225 mm diameter sanitary sewer on Ridgewood Avenue. A backflow preventer will be required for the proposed building in accordance with the Ottawa sewer design guide and will be coordinated with building mechanical engineers.

All underground parking drains should be connected to the building's internal plumbing. A sump pump will be required to drain the underground parking levels to the existing sanitary sewer on Ridgewood Avenue.

10.3 STORMWATER SERVICING

The proposed stormwater management plan is in compliance with the goals specified through consultation with the City of Ottawa, as well as local standards. A combination of roof storage and underground storage within a cistern located in the underground parking will be provided to attenuate post development peak flows. Post development peak flows from the overall site up to the 100-year storm will be restricted to the target release rate. A sump pump will be required to direct flows from the internal building plumbing system to the proposed gravity service connected to the existing 300 mm diameter storm sewer running on Ridgewood Avenue.

10.4 GRADING

Erosion and sediment control measures will be implemented during construction to reduce the impact on existing infrastructure. The subject site will maintain emergency overland flow routes to the back and to Ridgewood Avenue.



Conclusions

10.5 UTILITIES

All utilities (Hydro Ottawa, Bell Canada, Rogers Ottawa, and Enbridge Gas) have existing plants in the subject area. Exact size, location and routing of utilities will be finalized after design circulation.

10.6 APPROVAL / PERMITS

Ministry of the Environment Conservation and Parks (MECP) Environmental Compliance Approvals (ECA) are not expected to be required for the subject site as the site is private and will remain under singular ownership. A Permit to Take Water may be required for pumping requirements for construction of underground parking level. No other approval requirements from other regulatory agencies are anticipated.



APPENDICES

**SITE SERVICING AND STORMWATER MANAGEMENT BRIEF – MOONEY’S BAY - 729
RIDGEWOOD AVENUE, OTTAWA, ON**

Appendix A Water Calculations

Appendix A WATER CALCULATIONS



From: [Rasool, Rubina](#)
To: [Mott, Peter](#)
Cc: [Kilborn, Kris](#)
Subject: RE: 729 Ridgewood Avenue - Boundary Conditions Request
Date: Tuesday, April 27, 2021 3:59:58 PM
Attachments: [729 Ridgewood April 2021.pdf](#)

Good afternoon,

The following are boundary conditions, HGL, for hydraulic analysis at 729 Ridgewood Ave (zone 2W2C) assumed to be connected to the 305 mm on Ridgewood Ave (see attached PDF for location).

Both Connections

Minimum HGL = 123.7 m

Maximum HGL = 131.9 m

Max Day + Fire Flow (117 L/s) = 125.6 m

These are for current conditions and are based on computer model simulation.

Disclaimer: The boundary condition information is based on current operation of the city water distribution system. The computer model simulation is based on the best information available at the time. The operation of the water distribution system can change on a regular basis, resulting in a variation in boundary conditions. The physical properties of watermains deteriorate over time, as such must be assumed in the absence of actual field test data. The variation in physical watermain properties can therefore alter the results of the computer model simulation.

Rubina

Rubina Rasool, E.I.T.

Project Manager

Planning, Infrastructure and Economic Development Department - Services de la planification, de l'infrastructure et du développement économique

Development Review – East Branch

City of Ottawa | Ville d'Ottawa

110 Laurier Avenue West Ottawa, ON | 110, avenue Laurier Ouest. Ottawa (Ontario) K1P 1J1

rubina.rasool@ottawa.ca

From: Mott, Peter <Peter.Mott@stantec.com>
Sent: April 13, 2021 9:33 AM
To: Rasool, Rubina <Rubina.Rasool@ottawa.ca>
Cc: Kilborn, Kris <kris.kilborn@stantec.com>
Subject: 729 Ridgewood Avenue - Boundary Conditions Request

CAUTION: This email originated from an External Sender. Please do not click links or open attachments unless you recognize the source.

ATTENTION : Ce courriel provient d'un expéditeur externe. Ne cliquez sur aucun lien et n'ouvrez pas de pièce jointe, excepté si vous connaissez l'expéditeur.

Hello Ms. Rasool,

I would like to request the hydraulic boundary conditions for the proposed 729 Ridgewood Avenue Development. Please find attached the concept plan, the key map showing the location of the proposed development, domestic water demand calculations, and fire flow calculations.

A summary of the proposed site is provided below:

We anticipate a minimum of two (2) connections to the existing watermain will be required to service the site. The following connections are expected for servicing:

➤Connections to the existing 305 mm (CI) watermain on Ridgewood Avenue.

*Existing hydrants on Ridgewood Avenue.

For the purpose of the boundary conditions request, may you please provide us with the boundary conditions for the following servicing options:

i. Watermain connections to the existing 305 mm (CI) watermain on Ridgewood Avenue; assuming a fire flow requirement of **7,000 L/min** for the site in addition to the domestic water demands provided below.

- The intended land use is a combination of commercial and residential, per the summary provided in the Domestic Demands spreadsheet. (See attached Concept Plan with project stats)
- Estimated fire flow demand per the FUS methodology: 7000 L/min (117 L/s) for the worst-case scenario (Tower I & Building II)
- Domestic water demands for the entire development:
 - **Average day: 172.5 L/min (2.87 L/s)**
 - **Maximum day: 414.3 L/min (6.91 L/s)**
 - **Peak hour: 901.3 L/min (15.02 L/s)**

Thank you for your time and please contact me at your earliest convenience if any additional information or clarification is required.

Best regards,

Peter Mott EIT

Engineering Intern, Community Development

Mobile: 613-897-0445

Peter.Mott@stantec.com

Stantec

400 - 1331 Clyde Avenue

Ottawa ON K2C 3G4



The content of this email is the confidential property of Stantec and should not be copied, modified, retransmitted, or used for any purpose except with Stantec's written authorization. If you are not the intended recipient, please delete all copies and notify us immediately.

,

This e-mail originates from the City of Ottawa e-mail system. Any distribution, use or copying of this e-mail or the information it contains by other than the intended recipient(s) is

unauthorized. Thank you.

Le présent courriel a été expédié par le système de courriels de la Ville d'Ottawa. Toute distribution, utilisation ou reproduction du courriel ou des renseignements qui s'y trouvent par une personne autre que son destinataire prévu est interdite. Je vous remercie de votre collaboration.

,

Boundary Condition for 729 Ridgewood

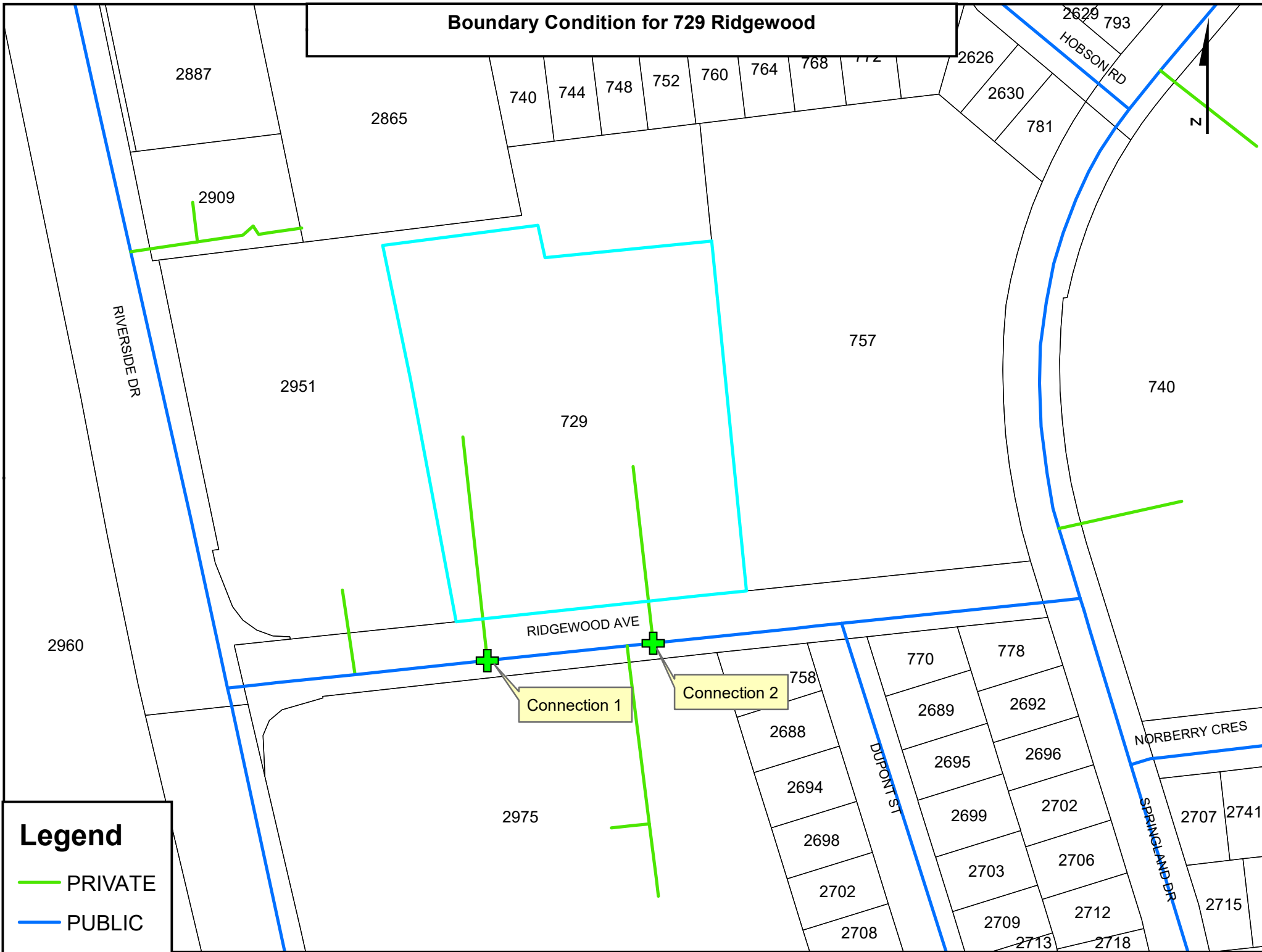

Legend

- PRIVATE
- PUBLIC

729 Ridgewood Avenue (Brigil Development) - Domestic Water Demand Estimates

Based on conceptual development plans from Neuf Architect(e)s (2021-05-14)
 Last updated on May 21, 2021

Ottawa Design Guidelines - Water Distribution

Table 4.1 Per Unit Populations		
Average Apt.	1.8	ppu
Bachelor	1.4	ppu
1 Bedroom	1.4	ppu
2 Bedroom	2.1	ppu
3 Bedroom	3.1	ppu

Development Block/Area ID	Commercial Area (m ²)	Number of Residential Units	Population	Daily Demand Rate (L/cap/day or L/ha/d)	Avg. Day Demand ^{1,2}		Max. Day Demand ^{1,2}		Peak Hour Demand ^{1,2}	
					(L/min)	(L/s)	(L/min)	(L/s)	(L/min)	(L/s)
Tower I (15 Storeys)										
<i>Bachelor</i>	-	20	28	350	6.8	0.11	17.0	0.28	37.4	0.62
<i>1 Bedroom</i>	-	53	74	350	18.0	0.30	45.1	0.75	99.2	1.65
<i>2 Bedroom</i>	-	58	122	350	29.6	0.49	74.0	1.23	162.8	2.71
<i>3 Bedroom</i>	-	10	31	350	7.5	0.13	18.8	0.31	41.4	0.69
Building II (6 Storeys)										
<i>Bachelor</i>	-	1	1	350	0.3	0.01	0.9	0.01	1.9	0.03
<i>1 Bedroom</i>	-	35	49	350	11.9	0.20	29.8	0.50	65.5	1.09
<i>2 Bedroom</i>	-	12	25	350	6.1	0.10	15.3	0.26	33.7	0.56
Building III (4 Storeys)										
<i>1 Bedroom</i>	-	40	56	350	13.6	0.23	34.0	0.57	74.9	1.25
<i>2 Bedroom</i>	-	14	29	350	7.1	0.12	17.9	0.30	39.3	0.66
Building IV (4 Storeys)										
<i>1 Bedroom</i>	-	40	56	350	13.6	0.23	34.0	0.57	74.9	1.25
<i>2 Bedroom</i>	-	14	29	350	7.1	0.1	17.9	0.3	39.3	0.66
Building V (6 Storeys)										
<i>Bachelor</i>	-	2	3	350	0.7	0.01	1.7	0.03	3.7	0.06
<i>1 Bedroom</i>	-	63	88	350	21.4	0.36	53.6	0.89	117.9	1.97
<i>2 Bedroom</i>	-	20	42	350	10.2	0.17	25.5	0.43	56.1	0.94
<i>3 Bedroom</i>	-	5	16	350	3.8	0.06	9.4	0.16	20.7	0.35
<i>Commercial</i>	856			28000	16.6	0.28	25.0	0.42	44.9	0.75
Total Site :	856	387	650	-	174.6	2.91	419.9	7.00	913.7	15.23

1 Water demand criteria used to estimate peak demand rates for residential areas are as follows:
 maximum daily demand rate = 2.5 x average day demand rate
 peak hour demand rate = 2.2 x maximum day demand rate

2 Water demand criteria used to estimate peak demand rates for commercial/amenity/lobby areas are as follows:
 maximum daily demand rate = 1.5 x average day demand rate
 peak hour demand rate = 1.8 x maximum day demand rate

3 Population density for all residential units based on an population densities provided in Table 4.1 - Per Unit Populations of the City of Ottawa Water Distribution Design Guidelines (July 2010).

Fire Flow Calculations as per Ontario Building Code 2006 (Appendix A)

Project # 160401536 (729 Ridgewood Avenue)
 Date 2021-05-28

Designed by: AMP
 Checked by:
 Description:

15-Storey (Tower I) High-rise Residential Building and 6-Storey (Building II) Mid-rise Residential Apartment Building

$$Q = KVS_{\text{tot}}$$

Q = Volume of water required (L)
 V = Total building volume (m³)
 K = Water supply coefficient from Table 1
 S_{tot} = Total of spatial coefficient values from property line exposures on all sides as obtained from the formula
 $S_{\text{tot}} = 1.0 + [S_{\text{side1}} + S_{\text{side2}} + S_{\text{side3}} + S_{\text{side4}}]$

1	Type of construction	Building Classification		Water Supply Coefficient	
	Non-Combustible with Fire-Resistance Ratings	A-2, B-1, B-2, B-3, C, D		10	
2	Area of one floor (m ²)	number of floors	height of ceiling (m)	Total Building Volume (m ³)	
	1058	17	3.05	54,857	Tower I
	647.12	8	3.05	15,790	Tower II
				70,647	Total
3	Side	Exposure Distance (m)	Spatial Coefficient	Total Spatial Coefficient	
	North	25	0	1.1	
	East	9	0.1		
	South	36	0		
	West	18	0		
4	Established Fire Safety Plan?	Reduction in Volume (%)		Total Volume Reduction	
	no	0%		0%	
5	Total Volume 'Q' (L)				
					777,117
	Minimum Required Fire Flow (L/min)				
					9,000

1. Tower I: Fifteen storey building with two levels of underground parking.
2. Tower II: Six storey building with two levels of underground parking.

Fire Flow Calculations as per Ontario Building Code 2006 (Appendix A)

Project # 160401536 (729 Ridgewood Avenue)
Date 2021-05-28

Designed by: AMP
Checked by:

Description:

Building III: 4-storey Residential apartment building. Building information from conceptual architectural drawings by Neuf Architects.

$$Q = KVS_{\text{tot}}$$

Q = Volume of water required (L)

V = Total building volume (m³)

K = Water supply coefficient from Table 1

S_{tot} = Total of spatial coefficient values from property line exposures on all sides as obtained from the formula

$$S_{\text{tot}} = 1.0 + [S_{\text{side1}} + S_{\text{side2}} + S_{\text{side3}} + S_{\text{side4}}]$$

1	Type of construction	Building Classification		Water Supply Coefficient
	combustible without Fire-Resistance Ratings	A-2, B-1, B-2, B-3, C, D		23
2	Area of one floor (m ²)	number of floors	height of ceiling (m)	Total Building Volume (m ³)
	1089	6	3.05	19,929
3	Side	Exposure Distance (m)	Spatial Coefficient	Total Spatial Coefficient
	North	52	0	1.1
	East	16	0	
	South	15	0	
	West	9	0.1	
4	Established Fire Safety Plan?	Reduction in Volume (%)		Total Volume Reduction
	no	0%		0%
5	Total Volume 'Q' (L)			
				504,204
	Minimum Required Fire Flow (L/min)			
			9,000	

1. Tower III: Four storey building with two levels of underground parking.

Fire Flow Calculations as per Ontario Building Code 2006 (Appendix A)

Project # 160401536 (729 Ridgewood Avenue)
 Date 2021-05-28

Designed by: AMP
 Checked by:

Description: **Building IV: Residential apartment building. Building information from conceptual architectural drawings by Neuf Architects.**

$$Q = KVS_{tot}$$

Q = Volume of water required (L)
 V = Total building volume (m³)
 K = Water supply coefficient from Table 1
 $S_{tot} =$ Total of spatial coefficient values from property line exposures on all sides as obtained from the formula
 $S_{tot} = 1.0 + [S_{side1} + S_{side2} + S_{side3} + S_{side4}]$

1	Type of construction	Building Classification		Water Supply Coefficient
	combustible without Fire-Resistance Ratings	A-2, B-1, B-2, B-3, C, D		23
2	Area of one floor (m ²)	number of floors	height of ceiling (m)	Total Building Volume (m ³)
	1074	6	3.05	19,654
3	Side	Exposure Distance (m)	Spatial Coefficient	Total Spatial Coefficient
	North	15	0	1
	East	16	0	
	South	52	0	
	West	20	0	
4	Established Fire Safety Plan?	Reduction in Volume (%)		Total Volume Reduction
	no	0%		0%
5	Total Volume 'Q' (L)			
				452,042
			Minimum Required Fire Flow (L/min)	
			9,000	

1. Tower IV: Four storey building with two levels of underground parking.

Fire Flow Calculations as per Ontario Building Code 2006 (Appendix A)

Project # 160401536 (729 Ridgewood Avenue)
 Date 2021-05-28

Designed by: AMP
 Checked by:

Description:

Building V: Commercial Areas on ground floor and apartments on higher floors. Building information from conceptual architectural drawings by Neuf Architects.

$$Q = KVS_{tot}$$

Q = Volume of water required (L)

V = Total building volume (m³)

K = Water supply coefficient from Table 1

S_{tot} = Total of spatial coefficient values from property line exposures on all sides as obtained from the formula

$$S_{tot} = 1.0 + [S_{side1} + S_{side2} + S_{side3} + S_{side4}]$$

1	Type of construction	Building Classification		Water Supply Coefficient
	Non-Combustible without Fire-Resistance Ratings	A-2, B-1, B-2, B-3, C, D		16
2	Area of one floor (m ²)	number of floors	height of ceiling (m)	Total Building Volume (m ³)
	1432	8	3.05	34,941
3	Side	Exposure Distance (m)	Spatial Coefficient	Total Spatial Coefficient
	North	36	0	1
	East	20	0	
	South	52	0	
	West	28	0	
4	Established Fire Safety Plan?	Reduction in Volume (%)		Total Volume Reduction
	no	0%		0%
5	Total Volume 'Q' (L)			
				559,056
	Minimum Required Fire Flow (L/min)			
			9,000	

1. Tower V: Six storey building with two levels of underground parking.

**SITE SERVICING AND STORMWATER MANAGEMENT BRIEF – MOONEY’S BAY - 729
RIDGEWOOD AVENUE, OTTAWA, ON**

Appendix B Proposed Site Plan

Appendix B PROPOSED SITE PLAN



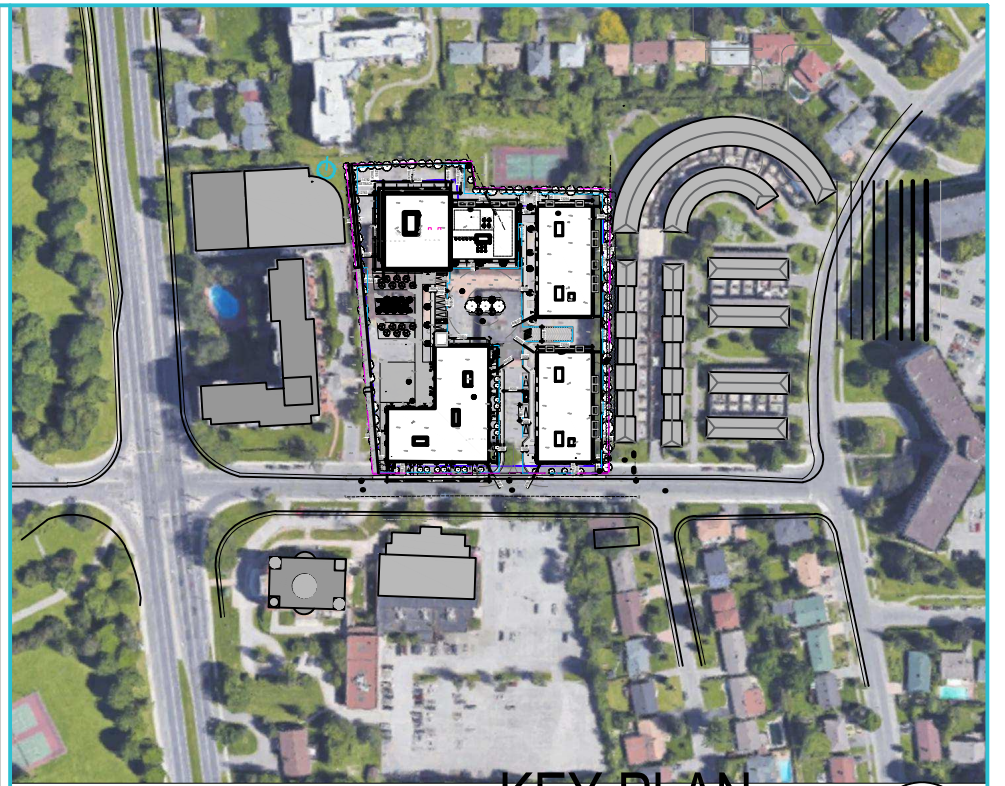
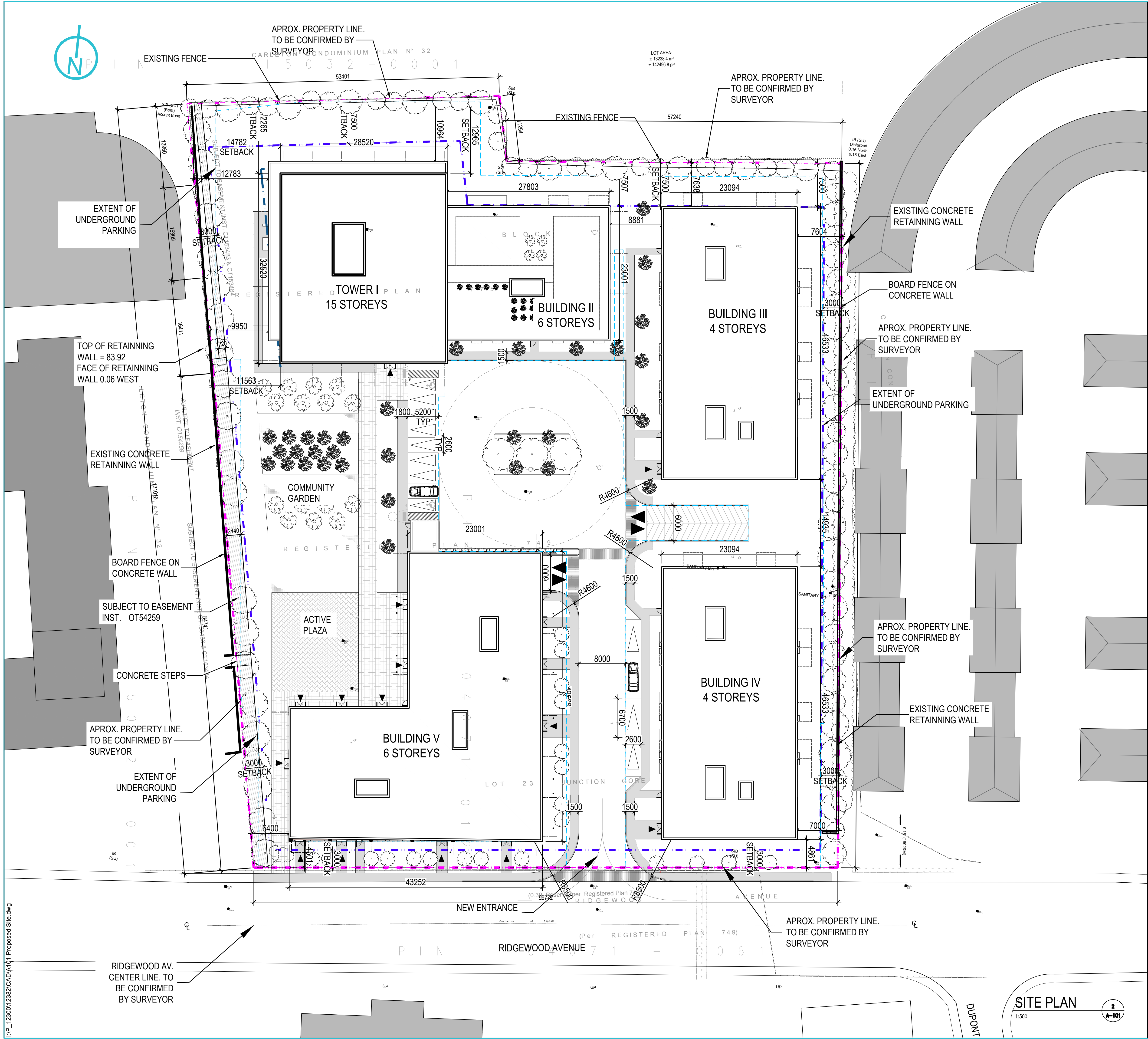

KEY PLAN
n/a
1
A-101

MOONEY'S BAY PROJECT - PROJECT INFORMATION			
PROJECT INFORMATION	CLIENT	DATE	SCALE
12382	FOTENN Planning and Urban design	2020.07.22	1:300
PREPARED BY	DATE	BY	SCALE
12382	2020.07.22	ANT, C.F.P.	1:300
PROJECT INFORMATION	CLIENT	DATE	SCALE
12382	FOTENN Planning and Urban design	2020.07.22	1:300
PREPARED BY	DATE	BY	SCALE
12382	2020.07.22	ANT, C.F.P.	1:300

MOONEY'S BAY			
PHASE / PHASE	ESTIMATED COST	ACTUAL COST	PERCENTAGE COMPLETED
12382	12382	12382	100%
PHASE / PHASE	ESTIMATED COST	ACTUAL COST	PERCENTAGE COMPLETED
12382	12382	12382	100%

LEGEND

- PROPERTY LINE
- RIGHT OF WAY
- EXISTING POWER LINE - SEE ENG
- 5.0m X 5.0m TRIANGLE
- EXISTING FENCE
- EXISTING BUILDING
- SNOW REMOVAL AREA
- CONCRETE SIDEWALKS
- FIRE ROUTE
- MAIN ENTRANCE
- LIGHT STANDARD - SEE ELEC. ENG.
- EXISTING CYCLE PATH
- BICYCLE PARKING

SIGNS

- STOP SIGN
- FIRE ROUTE SIGN
- PRIORITY TO PEDESTRIAN SIGN
- TWO LANES AHEAD

SIGNS

FOR ALL THE SIGNS FOLLOW THE SPECIFICATIONS OF THE CITY OF OTTAWA

THE PARKING SIGNS WILL BE LABELED AS:
"VISITOR ONLY"
"RESIDENT ONLY"
"ACCESSIBLE PARKING"
AND REINFORCED "UNAUTHORIZED VEHICLES TOWED AWAY"

SITE PLAN
1:300
2
A-101

GENERAL NOTE:
WHEN RETAINING WALL ARE GREATER THAN 1 MT. IN HEIGHT THE DESIGN WILL BE DONE BY A STRUCTURAL ENGINEER

NOTES GÉNÉRALES / General Notes

- Ces documents d'architecture sont la propriété exclusive de NEUF architectes et ne peuvent être utilisés, reproduits ou copiés sans autorisation écrite au préalable. / These architectural documents are the exclusive property of NEUF architectes and cannot be used, copied or reproduced without written pre-authorization.
- Les dimensions apparaissant aux documents devront être vérifiées par l'entrepreneur avant le début des travaux. / All dimensions which appear on the documents must be verified by the contractor before starting the work.
- Veuillez aviser l'architecte de toute dimension erreur et/ou divergences entre ses documents et ceux des autres professionnels. / The architect must be notified of all errors, omissions and discrepancies between these documents and those of other professionals.
- Les dimensions sur ces documents doivent être lues et non mesurées. / The dimensions on these documents must be read and not measured.

PLANIFICATEUR / Planner
FOTENN Planning and Urban design
398, Cooper Street, Ottawa, ON K2P 2H7
T 613 730 5709 www.fotenn.com

ARCHITECTURE DE PAYSAGE / Landscape architect
LEVSTEK CONSULTANTS Inc
5871, High Crescent, Ottawa, ON K1G 2W0
T 613 508 5515 www.landscapelevstek.com

INGÉNIEUR TRANSPORT / Engineering, Transportation
PARSONS
100-1232, Monnet Street Suite 100, Ottawa, ON K1J 1T2
T 613 738 4160 www.parsons.com

CIVIL / Civil
STANTEC
1331, Clyde Ave, Suite 400, Ottawa, ON K2C 3G4
T 613 722 4420 www.stantec.com

ARCHITECTES / Architect
NEUF architecte(s)
630, boul. René-Lévesque O. 32e étage, Montréal QC H5B 1S6
T 514 847 1117 NEUFarchitectes.com

GÉOTECHNIQUE / Geotechnical
PATERSON GROUP
154 Colonnade Rd S, Nepean, ON K2E 7J5
T 613 226 7381 www.me-eng.com

CONSERVATION DES ARBRES / Tree Conservation
BOWFIN
168 Montreal Rd., Cornwall, ON K6H 1E3
T 613 555 6139 www.bowfinenvironmental.ca

ENVIRONNEMENT / Environmental (ESA)
LOPERS ASSOCIATES

SCEAU / Seal

NEUF ARCHITECTE(S)

CLIENT / Client
brigil

98 Lois, Gatineau, Qc J8Y 3R7
T 819 243 7392 brigil.com

OUVRAGE / Project
MOONEY'S BAY

EMPLACEMENT / Location
OTTAWA, ON

NO / PROJET No
12382

NO / RÉVISION / DATE (aa.mm.jj)

A	For Comments	2020.07.22
B	For Comments	2020.07.31
C	For Comments	2020.08.13
D	For Comments	2020.08.20
E	For Coordination	2021.05.25

DESSIN PAR / Drawn by
O.C.

VÉRIFIÉ PAR / Checked by
ANT, C.F.P.

DATE (aa.mm.jj)
21.05.25

ECHELLE / Scale
1:300

TITRE DU DESSIN / Drawing Title
Proposed site

RÉVISION / Revision
E

NO. DESSIN / Dwg Number
A101

Appendix C SANITARY SEWER CALCULATIONS





SUBDIVISION:
Mooney's Bay - 729 Ridgewood Avenue

DATE: 6/2/2021
 REVISION: 0
 DESIGNED BY: AMP
 CHECKED BY:

SANITARY SEWER DESIGN SHEET (City of Ottawa)

FILE NUMBER: 160410536

DESIGN PARAMETERS			
MAX PEAK FACTOR (RES.)=	4.0	AVG. DAILY FLOW / PERSON	280 L/p/day
MIN PEAK FACTOR (RES.)=	2.0	COMMERCIAL	28,000 L/ha/day
PEAKING FACTOR (INDUSTRIAL):	2.4	INDUSTRIAL (HEAVY)	55,000 L/ha/day
PEAKING FACTOR (ICI >20%):	1.5	INDUSTRIAL (LIGHT)	35,000 L/ha/day
PERSONS / 1 BEDROOM	1.4	INSTITUTIONAL	28,000 L/ha/day
PERSONS / 2 BEDROOM	2.1		
PERSONS / 3 BEDROOM	3.1	INFILTRATION	0.33 L/s/ha
PERSONS / TOWNHOME	2.7		
MINIMUM VELOCITY	0.60 m/s		
MAXIMUM VELOCITY	3.00 m/s		
MANNINGS n	0.013		
BEDDING CLASS	B		
MINIMUM COVER	2.50 m		
HARMON CORRECTION FACTOR	0.8		

LOCATION			RESIDENTIAL AREA AND POPULATION										COMMERCIAL		INDUSTRIAL (L)		INDUSTRIAL (H)		INSTITUTIONAL		GREEN / UNUSED		C++	INFILTRATION			TOTAL	PIPE								
AREA ID NUMBER	FROM M.H.	TO M.H.	AREA (ha)	1 BEDROOM	2 BEDROOM	3 BEDROOM	TOWNHOME	POP.	CUMULATIVE AREA (ha)	POP.	PEAK FACT.	PEAK FLOW (L/s)	AREA (ha)	ACCU. AREA (ha)	AREA (ha)	ACCU. AREA (ha)	AREA (ha)	ACCU. AREA (ha)	AREA (ha)	ACCU. AREA (ha)	AREA (ha)	ACCU. AREA (ha)	PEAK FLOW (L/s)	TOTAL AREA (ha)	ACCU. AREA (ha)	INFILT. FLOW (L/s)	FLOW (L/s)	LENGTH (m)	DIA (mm)	MATERIAL	CLASS	SLOPE (%)	CAP. (FULL) (L/s)	CAP. V PEAK FLOW (%)	VEL. (FULL) (m/s)	VEL. (ACT.) (m/s)
Proposed Site	BLDG	SAN10	0.428	254	118	15	0	650	0.428	650	3.91	8.24	0.086	0.086	0.000	0.00	0.000	0.00	0.000	0.00	0.000	0.00	0.04	1.324	1.324	0.44	8.72	2.3	200	PVC	SDR 35	1.00	33.4	26.08%	1.05	0.74
	SAN10	EX. SANMH2	0.000	0	0	0	0	0	0.428	650	3.91	8.24	0.000	0.086	0.000	0.00	0.000	0.00	0.000	0.00	0.000	0.81	0.04	0.000	1.324	0.44	8.72	12.3	200	PVC	SDR 35	0.50	23.6	36.88%	0.74	0.58

From: [Rasool, Rubina](#)
To: [Paerez, Ana](#)
Cc: [Kilborn, Kris](#); [Sharp, Mike](#)
Subject: RE: 729 Ridgewood Avenue Site
Date: Wednesday, May 26, 2021 1:06:13 PM

The City has not identified concerns with the proposed flows.

Rubina

Rubina Rasool, E.I.T.

Project Manager

Planning, Infrastructure and Economic Development Department - Services de la planification, de l'infrastructure et du développement économique

Development Review – East Branch

City of Ottawa | Ville d'Ottawa

110 Laurier Avenue West Ottawa, ON | 110, avenue Laurier Ouest. Ottawa (Ontario) K1P 1J1

rubina.rasool@ottawa.ca

From: Rasool, Rubina

Sent: May 21, 2021 1:29 PM

To: Paerez, Ana <Ana.Paerez@stantec.com>

Cc: Kilborn, Kris <kris.kilborn@stantec.com>; Sharp, Mike <Mike.Sharp@stantec.com>

Subject: RE: 729 Ridgewood Avenue Site

Hi Ana,

I have forwarded your request to Asset Management and should receive a response next week.

Have a good long weekend

Rubina

Rubina Rasool, E.I.T.

Project Manager

Planning, Infrastructure and Economic Development Department - Services de la planification, de l'infrastructure et du développement économique

Development Review – East Branch

City of Ottawa | Ville d'Ottawa

110 Laurier Avenue West Ottawa, ON | 110, avenue Laurier Ouest. Ottawa (Ontario) K1P 1J1

rubina.rasool@ottawa.ca

From: Paerez, Ana <Ana.Paerez@stantec.com>

Sent: May 21, 2021 12:35 PM

To: Rasool, Rubina <Rubina.Rasool@ottawa.ca>

Cc: Kilborn, Kris <kris.kilborn@stantec.com>; Sharp, Mike <Mike.Sharp@stantec.com>

Subject: 729 Ridgewood Avenue Site

CAUTION: This email originated from an External Sender. Please do not click links or open attachments unless you recognize the source.

ATTENTION : Ce courriel provient d'un expéditeur externe. Ne cliquez sur aucun lien et n'ouvrez pas de pièce jointe, excepté si vous connaissez l'expéditeur.

Good afternoon Rubina,

We are working on a mixed-use (residential/commercial site) on 729 Ridgewood Avenue that will consist of 5 multi-storey buildings with 387 apartment units and retail area on the ground floor of one of the buildings fronting on Ridgewood Avenue.

The sanitary peak flows from the proposed site are approximately 8.72 L/s. Would it be possible for the City to confirm if the downstream sanitary sewers have sufficient capacity for the proposed flows.

Thank you very much for your feedback,

Ana Paerez P. Eng.

Water Resources Engineer

Direct: 506 204-5856

Fax: 506 858-8698

Ana.Paerez@stantec.com

Stantec



The content of this email is the confidential property of Stantec and should not be copied, modified, retransmitted, or used for any purpose except with Stantec's written authorization. If you are not the intended recipient, please delete all copies and notify us immediately.

This e-mail originates from the City of Ottawa e-mail system. Any distribution, use or copying of this e-mail or the information it contains by other than the intended recipient(s) is unauthorized. Thank you.

Le présent courriel a été expédié par le système de courriels de la Ville d'Ottawa. Toute distribution, utilisation ou reproduction du courriel ou des renseignements qui s'y trouvent par une personne autre que son destinataire prévu est interdite. Je vous remercie de votre collaboration.

Appendix D STORMWATER MANAGEMENT CALCULATIONS





729 Ridgewood Avenue - Brigid Homes

**STORM SEWER
DESIGN SHEET
(City of Ottawa)**

DESIGN PARAMETERS

$I = a / (t+b)^2$ (As per City of Ottawa Guidelines, 2012)

DATE: 2021-05-28
REVISION: 0
DESIGNED BY: AMP
CHECKED BY: -

Existing Development Conditions to estimate time of concentration
FILE NUMBER: 160404536

	1:2 yr	1.5 yr	1:10 yr	1:100 yr
a =	732.951	998.071	1174.184	1735.688
b =	6.199	6.053	6.014	6.014
c =	0.810	0.814	0.816	0.820

MANNING'S n = 0.013
MINIMUM COVER: 2.00 m
TIME OF ENTRY: 10 min
BEDDING CLASS = B

LOCATION			DRAINAGE AREA																	PIPE SELECTION																				
AREA ID NUMBER	FROM M.H.	TO M.H.	AREA (2-YEAR) (ha)	AREA (5-YEAR) (ha)	AREA (10-YEAR) (ha)	AREA (100-YEAR) (ha)	AREA (ROOF) (ha)	C (2-YEAR) (-)	C (5-YEAR) (-)	C (10-YEAR) (-)	C (100-YEAR) (-)	A x C (2-YEAR) (ha)	ACCUM A x C (2YR) (ha)	A x C (5-YEAR) (ha)	ACCUM A x C (5YR) (ha)	A x C (10-YEAR) (ha)	ACCUM A x C (10YR) (ha)	A x C (100-YEAR) (ha)	ACCUM A x C (100YR) (ha)	T of C (min)	I _{2-YEAR} (mm/h)	I _{5-YEAR} (mm/h)	I _{10-YEAR} (mm/h)	I _{100-YEAR} (mm/h)	Q _{CONTROL} (L/s)	ACCUM. Q _{CONTROL} (L/s)	Q _{ACT} (CIA/360) (L/s)	LENGTH (m)	PIPE WIDTH OR DIAMETE (mm)	PIPE HEIGHT (mm)	PIPE SHAPE (-)	MATERIAL (-)	CLASS (-)	SLOPE (%)	Q _{cap} (FULL) (L/s)	% FULL (-)	VEL (FULL) (m/s)	VEL (ACT) (m/s)	TIME OF FLOW (min)	
Half of existing Site	CB1	CB2	0.66	0.00	0.00	0.00	0.00	0.90	0.00	0.00	0.00	0.594	0.594	0.000	0.000	0.000	0.000	0.000	0.000	0.000	10.00	76.81	104.19	122.14	178.56	0.0	0.0	126.7	153.0	300	300	CIRCULAR	PVC	-	2.00	136.0	93.20%	1.93	1.99	1.28
Half of Existing Site	CB2	STM	0.66	0.00	0.00	0.00	0.00	0.90	0.00	0.00	0.00	0.594	1.188	0.000	0.000	0.000	0.000	0.000	0.000	0.000	11.28	72.21	97.88	114.70	167.63	0.0	0.0	238.3	86.0	300	300	CIRCULAR	PVC	-	2.00	136.0	175.24%	1.93	1.93	0.74
12.02																																								

Ridgewood Avenue
26-May-21

UNC-1

TOTAL AREA	1460.24
HARD	171.81
SOFT	1288.43
C=	0.28

TANK 1

TOTAL AREA	2871.63
HARD	546.94
SOFT	2324.69
C=	0.33

TANK 2

TOTAL AREA	1880.59
HARD	1444.14
SOFT	436.45
C=	0.74

TANK 3

TOTAL AREA	927.62
HARD	672.19
SOFT	255.43
C=	0.71

TANK 4

TOTAL AREA	231.09
HARD	0.00
SOFT	231.09
C=	0.20

RAMP

TOTAL AREA	452.25
HARD	134.60
SOFT	317.65
C=	0.41

Stormwater Management Calculations

File No: **160401536**
 Project: **729 Ridgewood Avenue - Brigil Homes**
 Date: **31-May-21**

SWM Approach: Restrict 100-year peak flows from entire site to 2-year storm as per existing development conditions

Post-Development Site Conditions:

Overall Runoff Coefficient for Site and Sub-Catchment Areas

Runoff Coefficient Table							
Catchment Type	Sub-catchment Area ID / Description		Area (ha) "A"	Runoff Coefficient "C"		"A x C"	Overall Runoff Coefficient
				Hard	Soft		
Tributary to Underground Tank Landscaped Area	TANK1	Hard	0.054	0.9	0.05	0.10	0.33
		Soft	0.236	0.2	0.05		
	Subtotal						
Controlled Roof Tower I - Roof Storage	ROOF 1	Hard	0.090	0.9	0.08	0.08	0.90
		Soft	0.000	0.2	0.00		
	Subtotal						
Tributary to Underground Tank Tower II - Green Roof - No Storage	ROOF 2A	Hard	0.060	0.9	0.05	0.05	0.90
		Soft	0.000	0.2	0.00		
	Subtotal						
Controlled Roof Tower III - Roof Storage	ROOF 3	Hard	0.110	0.9	0.10	0.10	0.90
		Soft	0.000	0.2	0.00		
	Subtotal						
Tributary to Underground Tank Cortyard Area	TANK2	Hard	0.147	0.9	0.13	0.14	0.74
		Soft	0.043	0.2	0.01		
	Subtotal						
Controlled Roof Tower IV - Roof Storage	ROOF 4	Hard	0.110	0.9	0.10	0.10	0.90
		Soft	0.000	0.2	0.00		
	Subtotal						
Tributary to Underground Tank Access Road	TANK3	Hard	0.066	0.9	0.06	0.06	0.71
		Soft	0.024	0.2	0.00		
	Subtotal						
Controlled Roof Tower V - Roof Storage	ROOF 5	Hard	0.160	0.9	0.14	0.14	0.90
		Soft	0.000	0.2	0.00		
	Subtotal						
Tributary to Underground Tank Tower I - Balcony - No Storage	ROOF 2B	Hard	0.010	0.9	0.01	0.009	0.90
		Soft	0.000	0.2	0.00		
	Subtotal						
Tributary to Underground Tank Underground Parking Ramp	RAMP	Hard	0.015	0.9	0.01	0.02	0.41
		Soft	0.035	0.2	0.01		
	Subtotal						
Tributary to Underground Tank Sideyard	TANK4	Hard	0.000	0.9	0.00	0.00	0.20
		Soft	0.020	0.2	0.00		
	Subtotal						
Uncontrolled to ridgewood Ave. Front Yard	UNC-1	Hard	0.017	0.9	0.02	0.04	0.28
		Soft	0.133	0.2	0.03		
	Subtotal						
Total			1.33			0.853	
Overall Runoff Coefficient= C:							0.64

Total Roof Storage (to underground tank)	0.47	ha	
Total Surface Areas to Underground Tank (to Storm Sewer)	0.71	ha	
Total to Underground Tank	<u>1.180</u>	<u>ha</u>	<u>0.69</u>
Total Uncontrolled Area	0.15	ha	

Stormwater Management Calculations

Project #160401536, 729 Ridgewood Avenue - Brillig Homes Modified Rational Method Calculations for Storage

Subdrainage Area: TANK2		Cortyard Area	
Area (ha): 0.19		Tributary to Underground Tank	
C:	0.74		

tc (min)	I (2 yr) (mm/hr)	Qactual (L/s)	Qrelease (L/s)	Qstored (L/s)	Vstored (m ³)
10	76.81	30.0	30.0		
20	52.03	20.3	20.3		
30	40.04	15.7	15.7		
40	32.86	12.8	12.8		
50	28.04	11.0	11.0		
60	24.56	9.6	9.6		
70	21.91	8.6	8.6		
80	19.83	7.8	7.8		
90	18.14	7.1	7.1		
100	16.75	6.5	6.5		
110	15.57	6.1	6.1		
120	14.56	5.7	5.7		

Subdrainage Area: ROOF 4		Controlled Roof	
Area (ha): 0.11		Maximum Storage Depth: 150 mm	
C:	0.90		

tc (min)	I (2 yr) (mm/hr)	Qactual (L/s)	Qrelease (L/s)	Qstored (L/s)	Vstored (m ³)	Depth (mm)
10	76.81	21.1	3.6	17.6	10.5	91.7
20	52.03	14.3	3.8	10.6	12.7	98.8
30	40.04	11.0	3.8	7.2	13.0	100.0
40	32.86	9.0	3.8	5.3	12.7	98.9
50	28.04	7.7	3.7	4.0	12.0	96.7
60	24.56	6.8	3.6	3.1	11.2	94.1
70	21.91	6.0	3.6	2.5	10.4	91.1
80	19.83	5.3	3.5	2.0	9.5	88.1
90	18.14	5.0	3.4	1.6	8.6	85.1
100	16.75	4.6	3.3	1.3	7.6	82.1
110	15.57	4.3	3.3	1.0	6.8	79.2
120	14.56	4.0	3.2	0.8	5.9	76.3

Storage: Roof Storage

Depth (mm)	Head (m)	Discharge (L/s)	Vreq (cu. m)	Vavail (cu. m)	Discharge Check	
2-year Water Level	100.0	0.10	3.8	13.0	44.0	0.0

Subdrainage Area: TANK3		Access Road	
Area (ha): 0.09		Tributary to Underground Tank	
C:	0.71		

tc (min)	I (2 yr) (mm/hr)	Qactual (L/s)	Qrelease (L/s)	Qstored (L/s)	Vstored (m ³)
10	76.81	13.6	13.6		
20	52.03	9.2	9.2		
30	40.04	7.1	7.1		
40	32.86	5.8	5.8		
50	28.04	5.0	5.0		
60	24.56	4.4	4.4		
70	21.91	3.9	3.9		
80	19.83	3.5	3.5		
90	18.14	3.2	3.2		
100	16.75	3.0	3.0		
110	15.57	2.8	2.8		
120	14.56	2.6	2.6		

Subdrainage Area: ROOF 5		Controlled Roof	
Area (ha): 0.16		Maximum Storage Depth: 150 mm	
C:	0.90		

tc (min)	I (2 yr) (mm/hr)	Qactual (L/s)	Qrelease (L/s)	Qstored (L/s)	Vstored (m ³)	Depth (mm)
10	76.81	30.7	6.1	24.7	14.8	90.5
20	52.03	20.8	6.4	14.4	17.3	96.2
30	40.04	16.0	6.4	9.6	17.3	96.2
40	32.86	13.2	6.3	6.9	16.5	94.3
50	28.04	11.2	6.1	5.1	15.2	91.5
60	24.56	9.8	6.0	3.9	13.9	88.5
70	21.91	8.8	5.8	3.0	12.5	85.3
80	19.83	7.9	5.6	2.3	11.2	82.2
90	18.14	7.3	5.4	1.8	9.8	79.2
100	16.75	6.7	5.3	1.4	8.6	76.3
110	15.57	6.2	5.1	1.1	7.5	73.0
120	14.56	5.8	4.9	0.9	6.8	69.5

Storage: Roof Storage

Depth (mm)	Head (m)	Discharge (L/s)	Vreq (cu. m)	Vavail (cu. m)	Discharge Check	
2-year Water Level	99.2	0.10	6.4	17.3	64.0	0.0

Project #160401536, 729 Ridgewood Avenue - Brillig Homes Modified Rational Method Calculations for Storage

Subdrainage Area: TANK2		Cortyard Area	
Area (ha): 0.19		Tributary to Underground Tank	
C:	0.93		

tc (min)	I (100 yr) (mm/hr)	Qactual (L/s)	Qrelease (L/s)	Qstored (L/s)	Vstored (m ³)
10	178.56	87.2	87.2		
20	119.95	58.6	58.6		
30	91.87	44.9	44.9		
40	75.15	36.7	36.7		
50	63.95	31.2	31.2		
60	55.89	27.3	27.3		
70	49.79	24.3	24.3		
80	44.99	22.0	22.0		
90	41.11	20.1	20.1		
100	37.90	18.5	18.5		
110	35.20	17.2	17.2		
120	32.89	16.1	16.1		

Subdrainage Area: ROOF 4		Controlled Roof	
Area (ha): 0.11		Maximum Storage Depth: 150 mm	
C:	1.00		

tc (min)	I (100 yr) (mm/hr)	Qactual (L/s)	Qrelease (L/s)	Qstored (L/s)	Vstored (m ³)	Depth (mm)
10	178.56	54.6	4.6	50.0	30.0	131.1
20	119.95	36.7	4.8	31.8	38.2	142.2
30	91.87	28.1	5.0	23.1	41.6	146.8
40	75.15	23.0	5.0	18.0	43.1	148.8
50	63.95	19.6	5.0	14.5	43.6	149.4
60	55.89	17.1	5.0	12.1	43.4	149.2
70	49.79	15.2	5.0	10.2	42.9	148.5
80	44.99	13.8	5.0	8.8	42.1	147.5
90	41.11	12.6	5.0	7.6	41.2	146.2
100	37.90	11.6	4.9	6.7	40.1	144.7
110	35.20	10.8	4.9	5.9	38.9	143.1
120	32.89	10.1	4.8	5.2	37.6	141.4

Storage: Roof Storage

Depth (mm)	Head (m)	Discharge (L/s)	Vreq (cu. m)	Vavail (cu. m)	Discharge Check	
100-year Water Level	149.4	0.15	5.0	43.6	44.0	0.0

Subdrainage Area: TANK3		Access Road	
Area (ha): 0.09		Tributary to Underground Tank	
C:	0.89		

tc (min)	I (100 yr) (mm/hr)	Qactual (L/s)	Qrelease (L/s)	Qstored (L/s)	Vstored (m ³)
10	178.56	39.6	39.6		
20	119.95	26.6	26.6		
30	91.87	20.4	20.4		
40	75.15	16.7	16.7		
50	63.95	14.2	14.2		
60	55.89	12.4	12.4		
70	49.79	11.1	11.1		
80	44.99	10.0	10.0		
90	41.11	9.1	9.1		
100	37.90	8.4	8.4		
110	35.20	7.8	7.8		
120	32.89	7.3	7.3		

Subdrainage Area: ROOF 5		Controlled Roof	
Area (ha): 0.16		Maximum Storage Depth: 150 mm	
C:	1.00		

tc (min)	I (100 yr) (mm/hr)	Qactual (L/s)	Qrelease (L/s)	Qstored (L/s)	Vstored (m ³)	Depth (mm)
10	178.56	79.4	8.3	71.1	42.7	130.2
20	119.95	53.4	8.9	44.5	53.3	140.1
30	91.87	40.9	9.1	31.8	57.2	143.7
40	75.15	33.4	9.2	24.3	58.2	144.7
50	63.95	28.4	9.1	19.3	57.9	144.4
60	55.89	24.9	9.1	15.8	56.8	143.3
70	49.79	22.1	9.0	13.1	55.2	141.9
80	44.99	20.0	8.9	11.1	53.3	140.1
90	41.11	18.3	8.8	9.5	51.3	138.2
100	37.90	16.9	8.7	8.2	49.1	136.2
110	35.20	15.7	8.6	7.1	46.8	134.1
120	32.89	14.6	8.4	6.2	44.6	132.0

Storage: Roof Storage

Depth (mm)	Head (m)	Discharge (L/s)	Vreq (cu. m)	Vavail (cu. m)	Discharge Check	
100-year Water Level	144.7	0.14	9.2	58.2	64.0	0.0

Stormwater Management Calculations

Project #160401536, 729 Ridgewood Avenue - Brillig Homes
Modified Rational Method Calculators for Storage

Subdrainage Area: ROOF 2B		Tower 1 - Balcony - No Storage Tributary to Underground Tank			
Area (ha): C:	0.01 0.90				
tc (min)	I (2 yr) (mm/hr)	Qactual (L/s)	Qrelease (L/s)	Qstored (L/s)	Vstored (m ³)
10	76.81	1.9	1.9		
20	52.03	1.3	1.3		
30	40.04	1.0	1.0		
40	32.86	0.8	0.8		
50	28.04	0.7	0.7		
60	24.56	0.6	0.6		
70	21.91	0.5	0.5		
80	19.83	0.5	0.5		
90	18.14	0.5	0.5		
100	16.75	0.4	0.4		
110	15.57	0.4	0.4		
120	14.56	0.4	0.4		

Subdrainage Area: RAMP		Tributary to Underground Tank Underground Parking Ramp			
Area (ha): C:	0.05 0.41				
tc (min)	I (2 yr) (mm/hr)	Qactual (L/s)	Qrelease (L/s)	Qstored (L/s)	Vstored (m ³)
10	76.81	4.4	4.4		
20	52.03	3.0	3.0		
30	40.04	2.3	2.3		
40	32.86	1.9	1.9		
50	28.04	1.6	1.6		
60	24.56	1.4	1.4		
70	21.91	1.2	1.2		
80	19.83	1.1	1.1		
90	18.14	1.0	1.0		
100	16.75	1.0	1.0		
110	15.57	0.9	0.9		
120	14.56	0.8	0.8		

Subdrainage Area: TANK4		Sideyard Tributary to Underground Tank			
Area (ha): C:	0.02 0.20				
tc (min)	I (2 yr) (mm/hr)	Qactual (L/s)	Qrelease (L/s)	Qstored (L/s)	Vstored (m ³)
10	76.81	0.9	0.9		
20	52.03	0.6	0.6		
30	40.04	0.4	0.4		
40	32.86	0.4	0.4		
50	28.04	0.3	0.3		
60	24.56	0.3	0.3		
70	21.91	0.2	0.2		
80	19.83	0.2	0.2		
90	18.14	0.2	0.2		
100	16.75	0.2	0.2		
110	15.57	0.2	0.2		
120	14.56	0.2	0.2		

Subdrainage Area: Site Area tributary to Underground Tank					
Area (ha):	1.16				
tc (min)	I (2 yr) (mm/hr)	Qactual (L/s)	Qrelease (L/s)	Qstored (L/s)	Vstored (m ³)
10	76.81	100.51	100.51	0.00	0.00
20	52.03	74.70	74.70	0.00	0.00
30	40.04	61.78	61.78	0.00	0.00
40	32.86	53.73	53.73	0.00	0.00
50	28.04	48.09	48.09	0.00	0.00
60	24.56	43.85	43.85	0.00	0.00
70	21.91	40.50	40.50	0.00	0.00
80	19.83	37.75	37.75	0.00	0.00
90	18.14	37.94	37.94	0.00	0.00
100	16.75	33.41	33.41	0.00	0.00
110	15.57	31.63	31.63	0.00	0.00
120	14.56	30.01	30.01	0.00	0.00

Project #160401536, 729 Ridgewood Avenue - Brillig Homes
Modified Rational Method Calculators for Storage

Subdrainage Area: ROOF 2B		Tower 1 - Balcony - No Storage Tributary to Underground Tank			
Area (ha): C:	0.01 1.00				
tc (min)	I (100 yr) (mm/hr)	Qactual (L/s)	Qrelease (L/s)	Qstored (L/s)	Vstored (m ³)
10	178.56	5.0	5.0		
20	119.95	3.3	3.3		
30	91.87	2.6	2.6		
40	75.15	2.1	2.1		
50	63.95	1.8	1.8		
60	55.89	1.6	1.6		
70	49.79	1.4	1.4		
80	44.99	1.3	1.3		
90	41.11	1.1	1.1		
100	37.90	1.1	1.1		
110	35.20	1.0	1.0		
120	32.89	0.9	0.9		

Subdrainage Area: RAMP		Tributary to Underground Tank Underground Parking Ramp			
Area (ha): C:	0.050 0.51				
tc (min)	I (100 yr) (mm/hr)	Qactual (L/s)	Qrelease (L/s)	Qstored (L/s)	Vstored (m ³)
10	178.56	12.7	12.7		
20	119.95	8.5	8.5		
30	91.87	6.5	6.5		
40	75.15	5.4	5.4		
50	63.95	4.6	4.6		
60	55.89	4.0	4.0		
70	49.79	3.5	3.5		
80	44.99	3.2	3.2		
90	41.11	2.9	2.9		
100	37.90	2.7	2.7		
110	35.20	2.5	2.5		
120	32.89	2.3	2.3		

Subdrainage Area: TANK4		Sideyard Tributary to Underground Tank			
Area (ha): C:	0.02 0.25				
tc (min)	I (100 yr) (mm/hr)	Qactual (L/s)	Qrelease (L/s)	Qstored (L/s)	Vstored (m ³)
10	178.56	2.5	2.5		
20	119.95	1.7	1.7		
30	91.87	1.3	1.3		
40	75.15	1.0	1.0		
50	63.95	0.9	0.9		
60	55.89	0.8	0.8		
70	49.79	0.7	0.7		
80	44.99	0.6	0.6		
90	41.11	0.6	0.6		
100	37.90	0.5	0.5		
110	35.20	0.5	0.5		
120	32.89	0.5	0.5		

Subdrainage Area: Site Area tributary to Underground Tank					
Area (ha):	1.16				
tc (min)	I (100 yr) (mm/hr)	Qactual (L/s)	Qrelease (L/s)	Qstored (L/s)	Vstored (m ³)
10	178.56	260.23	177.25	82.98	49.79
20	119.95	184.25	177.25	7.01	8.41
30	91.87	147.66	147.66	0.00	0.00
40	75.15	125.70	125.70	0.00	0.00
50	63.95	110.85	110.85	0.00	0.00
60	55.89	100.03	100.03	0.00	0.00
70	49.79	91.72	91.72	0.00	0.00
80	44.99	85.10	85.10	0.00	0.00
90	41.11	79.66	79.66	0.00	0.00
100	37.90	75.10	75.10	0.00	0.00
110	35.20	71.20	71.20	0.00	0.00
120	32.89	67.82	67.82	0.00	0.00

Stormwater Management Calculations

Project #160401536, 729 Ridgewood Avenue - Brigil Homes
Modified Rational Method Calculators for Storage

Subdrainage Area: UNC-1		Front Yard			
Area (ha): 0.15		Uncontrolled to ridgewood Ave.			
C: 0.28					
tc (min)	I (2 yr) (mm/hr)	Qactual (L/s)	Qrelease (L/s)	Qstored (L/s)	Vstored (m ³)
10	76.81	9.0	9.0		
20	52.03	6.1	6.1		
30	40.04	4.7	4.7		
40	32.86	3.8	3.8		
50	28.04	3.3	3.3		
60	24.56	2.9	2.9		
70	21.91	2.6	2.6		
80	19.83	2.3	2.3		
90	18.14	2.1	2.1		
100	16.75	2.0	2.0		
110	15.57	1.8	1.8		
120	14.56	1.7	1.7		

SUMMARY TO OUTLET					
Site Area to Underground Storage:	1.18 ha	Roof Storage Available:	188.0	Cistern Storage Available:	50 m ³
Cistern Release Rate:	100.51 L/s	Used:	51.5	Used:	0.0 m ³
Uncontrolled Area:	0.15 ha				
Uncontrolled Release Rate:	9.0 L/s				
Total Site Release Rate:	109.5 L/s				
Site Target Release Rate:	203.3 L/s				
	-93.8 L/s				

Project #160401536, 729 Ridgewood Avenue - Brigil Homes
Modified Rational Method Calculators for Storage

Subdrainage Area: UNC-1		Front Yard			
Area (ha): 0.15		Uncontrolled to ridgewood Ave.			
C: 0.35					
tc (min)	I (100 yr) (mm/hr)	Qactual (L/s)	Qrelease (L/s)	Qstored (L/s)	Vstored (m ³)
10	178.56	26.1	26.1		
20	119.95	17.5	17.5		
30	91.87	13.4	13.4		
40	75.15	11.0	11.0		
50	63.95	9.3	9.3		
60	55.89	8.2	8.2		
70	49.79	7.3	7.3		
80	44.99	6.6	6.6		
90	41.11	6.0	6.0		
100	37.90	5.5	5.5		
110	35.20	5.1	5.1		
120	32.89	4.8	4.8		

SUMMARY TO OUTLET					
Site Area to Underground Storage:	1.18 ha	Roof Storage Available:	188.0	Cistern Storage Available:	52 m ³
Cistern Release Rate:	177.25 L/s	Used:	173.0	Used:	49.8 m ³
Uncontrolled Area:	0.15 ha				
Uncontrolled Release Rate:	26.1 L/s				
Total Site Release Rate:	203.3 L/s				
Site Target Release Rate:	203.3 L/s				
	0.0 L/s				

Roof Drain Design Calculation Sheet

Project #160401536, 729 Ridgewood Avenue - Brigil Homes
Roof Drain Design Sheet, Estimated Roof Area in Block 1 (L103D-Roof)
Standard Watts Model R1100 Accuflow Roof Drain

Rating Curve				Volume Estimation				Water Depth (m)
Elevation (m)	Discharge Rate (cu.m/s)	Outlet Discharge (cu.m/s)	Storage (cu. m)	Elevation (m)	Area (sq. m)	Volume (cu. m)		
						Increment	Accumulated	
0.000	0.0000	0.0000	0	0.000	0	0	0	0.000
0.025	0.0003	0.0013	0	0.025	20	0	0	0.025
0.050	0.0006	0.0025	1	0.050	80	1	1	0.050
0.075	0.0009	0.0035	5	0.075	180	3	5	0.075
0.100	0.0011	0.0044	11	0.100	320	6	11	0.100
0.125	0.0013	0.0054	21	0.125	500	10	21	0.125
0.150	0.0016	0.0063	36	0.150	720	15	36	0.150

Drawdown Estimate			
Total Volume (cu.m)	Total Time (sec)	Vol (cu.m)	Detention Time (hr)
0.0	0.0	0.0	0
1.2	462.3	1.2	0.128417
4.3	912.6	3.2	0.381915
10.5	1396.3	6.2	0.769787
20.7	1895.8	10.2	1.296405
35.8	2404.0	15.2	1.964173

Rooftop Storage Summary

Total Building Area (sq.m)	900
Assume Available Roof Area (sq.m)	720
Roof Imperviousness	80%
Roof Drain Requirement (sq.m/Notch)	0.99
Number of Roof Notches*	232
Max. Allowable Depth of Roof Ponding (m)	4
Max. Allowable Storage (cu.m)	0.15
Estimated 100 Year Drawdown Time (h)	36
	1.7

* As per Ontario Building Code section OBC 7.4.10.4.(2)(c).

From Watts Drain Catalogue

Head (m)	L/s	Open	75%	50%	25%	Closed
0.025	0.31545	0.31545	0.31545	0.31545	0.31545	0.31545
0.050	0.6309	0.6309	0.6309	0.6309	0.6309	0.6309
0.075	0.94635	0.78863	0.86749	0.70976	0.6309	0.6309
0.100	1.2618	0.94635	1.10408	0.78863	0.6309	0.6309
0.125	1.57726	1.10408	1.34067	0.86749	0.6309	0.6309
0.150	1.89271	1.2618	1.57726	0.94635	0.6309	0.6309

* Note: Number of drains can be reduced if multiple-notch drain used.

Calculation Results

	5yr	100yr	Available
Qresult (cu.m/s)	0.004	0.006	-
Depth (m)	0.093	0.141	0.150
Volume (cu.m)	9.1	30.8	36.0
Drain time (hrs)	0.7	1.74	

Roof Drain Design Calculation Sheet

Project #160401536, 729 Ridgewood Avenue - Brigil Homes
Roof Drain Design Sheet, Estimated Roof Area in Block 2 (L103C-Roof)
Standard Watts Model R1100 Accuflow Roof Drain

Rating Curve				Volume Estimation				Water Depth (m)
Elevation (m)	Discharge Rate (cu.m/s)	Outlet Discharge (cu.m/s)	Storage (cu. m)	Elevation (m)	Area (sq. m)	Volume (cu. m)		
						Increment	Accumulated	
0.000	0.0000	0.0000	0	0.000	0	0	0	0.000
0.025	0.0003	0.0013	0	0.025	24	0	0	0.025
0.050	0.0006	0.0025	2	0.050	98	1	2	0.050
0.075	0.0009	0.0035	6	0.075	220	4	6	0.075
0.100	0.0011	0.0044	13	0.100	391	8	13	0.100
0.125	0.0013	0.0054	25	0.125	611	12	25	0.125
0.150	0.0016	0.0063	44	0.150	880	19	44	0.150

Drawdown Estimate			
Total Volume (cu.m)	Total Time (sec)	Total Vol (cu.m)	Detention Time (hr)
0.0	0.0	0.0	0
1.4	565.0	1.4	0.1569541
5.3	1115.4	3.9	0.4667855
12.8	1706.6	7.5	0.940851
25.3	2317.1	12.4	1.5844945
43.8	2938.2	18.5	2.4006556

Rooftop Storage Summary

Total Building Area (sq.m)	1100
Assume Available Roof Area (sq.n)	880
Roof Imperviousness	80%
Roof Drain Requirement (sq.m/Notch)	0.99
Number of Roof Notches*	232
Max. Allowable Depth of Roof Ponding (m)	4
Max. Allowable Storage (cu.m)	0.15
Estimated 100 Year Drawdown Time (h)	2.3

* As per Ontario Building Code section OBC 7.4.10.4.(2)(c).

From Watts Drain Catalogue

Head (m)	L/s	Open	75%	50%	25%	Closed
0.025	0.31545	0.31545	0.31545	0.31545	0.31545	0.31545
0.050	0.6309	0.6309	0.6309	0.6309	0.6309	0.630902
0.075	0.94635	0.94635	0.86749	0.78863	0.70976	0.630902
0.100	1.2618	1.2618	1.10408	0.94635	0.78863	0.630902
0.125	1.57726	1.57726	1.34067	1.10408	0.86749	0.630902
0.150	1.89271	1.89271	1.57726	1.2618	0.94635	0.630902

* Note: Number of drains can be reduced if multiple-notch drain used.

Calculation Results

	5yr	100yr	Available
Qresult (cu.m/s)	0.004	0.006	-
Depth (m)	0.097	0.145	0.150
Volume (cu.m)	12.1	40.4	44.0
Drain time (hrs)	0.9	2.3	

Roof Drain Design Calculation Sheet

Project #160401536, 729 Ridgewood Avenue - Brigil Homes
Roof Drain Design Sheet, Estimated Roof Area in Block 4 (L104B-Roof)
Standard Watts Model R1100 Accuflow Roof Drain

Rating Curve				Volume Estimation				Water Depth (m)
Elevation (m)	Discharge Rate (cu.m/s)	Outlet Discharge (cu.m/s)	Storage (cu. m)	Elevation (m)	Area (sq. m)	Volume (cu. m)		
						Increment	Accumulated	
0.000	0.0000	0.0000	0	0.000	0	0	0	0.000
0.025	0.0003	0.0013	0	0.025	24	0	0	0.025
0.050	0.0006	0.0025	2	0.050	98	1	2	0.050
0.075	0.0008	0.0032	6	0.075	220	4	6	0.075
0.100	0.0009	0.0038	13	0.100	391	8	13	0.100
0.125	0.0011	0.0044	25	0.125	611	12	25	0.125
0.150	0.0013	0.0050	44	0.150	880	19	44	0.150

Drawdown Estimate			
Total Volume (cu.m)	Total Time (sec)	Vol (cu.m)	Detention Time (hr)
0.0	0.0	0.0	0
1.4	565.0	1.4	0.156954
5.3	1226.9	3.9	0.497769
12.8	1991.1	7.5	1.050845
25.3	2813.6	12.4	1.832412
43.8	3672.7	18.5	2.852614

Rooftop Storage Summary

Total Building Area (sq.m)	1100
Assume Available Roof Area (sq.m)	880
Roof Imperviousness	80%
Roof Drain Requirement (sq.m/Notch)	0.99
Number of Roof Notches*	232
Max. Allowable Depth of Roof Ponding (m)	4
Max. Allowable Storage (cu.m)	0.15
Estimated 100 Year Drawdown Time (h)	2.8

* As per Ontario Building Code section OBC 7.4.10.4.(2)(c).

From Watts Drain Catalogue

Head (m)	L/s			
	Open	75%	50%	25% Closed
0.025	0.31545	0.31545	0.31545	0.31545
0.050	0.6309	0.6309	0.6309	0.6309
0.075	0.94635	0.86749	0.78863	0.6309
0.100	1.2618	1.10408	0.94635	0.6309
0.125	1.57726	1.34067	1.10408	0.6309
0.150	1.89271	1.57726	1.2618	0.6309

* Note: Number of drains can be reduced if multiple-notch drain used.

Calculation Results

	5yr	100yr	Available
Qresult (cu.m/s)	0.004	0.005	-
Depth (m)	0.100	0.149	0.150
Volume (cu.m)	13.0	43.6	44.0
Drain time (hrs)	1.1	2.8	

Roof Drain Design Calculation Sheet

Project #160401536, 729 Ridgewood Avenue - Brigil Homes
Roof Drain Design Sheet, Estimated Roof Area in Block 6 (L103B-Roof)
Standard Watts Model R1100 Accuflow Roof Drain

Rating Curve				Volume Estimation				Water Depth (m)
Elevation (m)	Discharge Rate (cu.m/s)	Outlet Discharge (cu.m/s)	Storage (cu. m)	Elevation (m)	Area (sq. m)	Volume (cu. m)		
						Increment	Accumulated	
0.000	0.0000	0.0000	0	0.000	0	0	0	0.000
0.025	0.0003	0.0019	0	0.025	36	0	0	0.025
0.050	0.0006	0.0038	2	0.050	142	2	2	0.050
0.075	0.0009	0.0052	8	0.075	320	6	8	0.075
0.100	0.0011	0.0066	19	0.100	569	11	19	0.100
0.125	0.0013	0.0080	37	0.125	889	18	37	0.125
0.150	0.0016	0.0095	64	0.150	1280	27	64	0.150

Drawdown Estimate			
Total Volume (cu.m)	Total Time (sec)	Vol (cu.m)	Detention Time (hr)
0.0	0.0	0.0	0
2.1	547.9	2.1	0.1521979
7.7	1081.6	5.6	0.4526405
18.7	1654.9	11.0	0.9123404
36.7	2246.9	18.1	1.5364795
63.7	2849.1	27.0	2.3279085

Rooftop Storage Summary

Total Building Area (sq.m)		1600	
Assume Available Roof Area (sq. m)	80%	1280	
Roof Imperviousness		0.99	
Roof Drain Requirement (sq.m/Notch)		232	
Number of Roof Notches*		6	
Max. Allowable Depth of Roof Ponding (m)		0.15	* As per Ontario Building Code section OBC 7.4.10.4.(2)(c).
Max. Allowable Storage (cu.m)		64	
Estimated 100 Year Drawdown Time (h)		2.2	

From Watts Drain Catalogue

Head (m)	L/s	Open	75%	50%	25%	Closed
0.025	0.31545	0.31545	0.31545	0.31545	0.31545	0.315451
0.050	0.6309	0.6309	0.6309	0.6309	0.6309	0.630902
0.075	0.94635	0.94635	0.78863	0.70976	0.630902	0.630902
0.100	1.2618	1.2618	0.94635	0.78863	0.630902	0.630902
0.125	1.57726	1.57726	1.10408	0.86749	0.630902	0.630902
0.150	1.89271	1.89271	1.2618	0.94635	0.630902	0.630902

* Note: Number of drains can be reduced if multiple-notch drain used.

Calculation Results	5yr	100yr	Available
Qresult (cu.m/s)	0.006	0.009	-
Depth (m)	0.096	0.145	0.150
Volume (cu.m)	17.3	58.2	64.0
Drain time (hrs)	0.9	2.2	

Stormceptor® EF Sizing Report

STORMCEPTOR®

ESTIMATED NET ANNUAL SEDIMENT (TSS) LOAD REDUCTION

06/02/2021

Province:	Ontario
City:	Ottawa
Nearest Rainfall Station:	OTTAWA MACDONALD-CARTIER INT'L AP
NCDC Rainfall Station Id:	6000
Years of Rainfall Data:	37

Project Name:	729 Ridgewood Avenue
Project Number:	160401536
Designer Name:	thakshika rathnasooriya
Designer Company:	stantec
Designer Email:	thakshika.rathnasooriya@stantec.com
Designer Phone:	613-724-4081
EOR Name:	
EOR Company:	
EOR Email:	
EOR Phone:	

Site Name:	729 Ridgewood Avenue
------------	----------------------

Drainage Area (ha):	0.72
---------------------	------

Runoff Coefficient 'c':	0.55
-------------------------	------

Particle Size Distribution:	Fine
-----------------------------	------

Target TSS Removal (%):	80.0
-------------------------	------

Required Water Quality Runoff Volume Capture (%):	90.00
---	-------

Estimated Water Quality Flow Rate (L/s):	14.31
--	-------

Oil / Fuel Spill Risk Site?	No
-----------------------------	----

Upstream Flow Control?	No
------------------------	----

Peak Conveyance (maximum) Flow Rate (L/s):	
--	--

Site Sediment Transport Rate (kg/ha/yr):	
--	--

Net Annual Sediment (TSS) Load Reduction Sizing Summary	
Stormceptor Model	TSS Removal Provided (%)
EF4	80
EF6	85
EF8	89
EF10	90
EF12	91

Recommended Stormceptor EF Model: EF4
Estimated Net Annual Sediment (TSS) Load Reduction (%): 80
Water Quality Runoff Volume Capture (%): > 90

Stormceptor® EF Sizing Report

THIRD-PARTY TESTING AND VERIFICATION

► **Stormceptor® EF and Stormceptor® EFO** are the latest evolutions in the Stormceptor® oil-grit separator (OGS) technology series, and are designed to remove a wide variety of pollutants from stormwater and snowmelt runoff. These technologies have been third-party tested in accordance with the Canadian ETV **Procedure for Laboratory Testing of Oil-Grit Separators** and performance has been third-party verified in accordance with the **ISO 14034 Environmental Technology Verification (ETV)** protocol.

PERFORMANCE

► **Stormceptor® EF and EFO** remove stormwater pollutants through gravity separation and floatation, and feature a patent-pending design that generates positive removal of total suspended solids (TSS) throughout each storm event, including high-intensity storms. Captured pollutants include sediment, free oils, and sediment-bound pollutants such as nutrients, heavy metals, and petroleum hydrocarbons. Stormceptor is sized to remove a high level of TSS from the frequent rainfall events that contribute the vast majority of annual runoff volume and pollutant load. The technology incorporates an internal bypass to convey excessive stormwater flows from high-intensity storms through the device without resuspension and washout (scour) of previously captured pollutants. Proper routine maintenance ensures high pollutant removal performance and protection of downstream waterways.

PARTICLE SIZE DISTRIBUTION (PSD)

► The **Canadian ETV PSD** shown in the table below was used, or in part, for this sizing. This is the identical PSD that is referenced in the Canadian ETV **Procedure for Laboratory Testing of Oil-Grit Separators** for both sediment removal testing and scour testing. The Canadian ETV PSD contains a wide range of particle sizes in the sand and silt fractions, and is considered reasonably representative of the particle size fractions found in typical urban stormwater runoff.

Particle Size (µm)	Percent Less Than	Particle Size Fraction (µm)	Percent
1000	100	500-1000	5
500	95	250-500	5
250	90	150-250	15
150	75	100-150	15
100	60	75-100	10
75	50	50-75	5
50	45	20-50	10
20	35	8-20	15
8	20	5-8	10
5	10	2-5	5
2	5	<2	5



Stormceptor[®] EF Sizing Report

Rainfall Intensity (mm / hr)	Percent Rainfall Volume (%)	Cumulative Rainfall Volume (%)	Flow Rate (L/s)	Flow Rate (L/min)	Surface Loading Rate (L/min/m ²)	Removal Efficiency (%)	Incremental Removal (%)	Cumulative Removal (%)
1	51.3	51.3	1.10	66.0	55.0	92	47.2	47.2
2	8.7	60.0	2.20	132.0	110.0	86	7.5	54.7
3	5.8	65.8	3.30	198.0	165.0	80	4.7	59.3
4	4.6	70.4	4.40	264.0	220.0	74	3.4	62.7
5	4.2	74.6	5.50	330.0	275.0	70	2.9	65.7
6	3.2	77.8	6.61	396.0	330.0	64	2.1	67.7
7	2.6	80.4	7.71	462.0	385.0	60	1.6	69.3
8	2.4	82.8	8.81	528.0	440.0	58	1.4	70.7
9	1.9	84.7	9.91	594.0	495.0	57	1.1	71.7
10	1.6	86.3	11.01	661.0	550.0	57	0.9	72.6
11	1.3	87.6	12.11	727.0	605.0	56	0.7	73.4
12	1.1	88.7	13.21	793.0	661.0	56	0.6	74.0
13	1.3	90.0	14.31	859.0	716.0	55	0.7	74.7
14	1.1	91.1	15.41	925.0	771.0	55	0.6	75.3
15	0.6	91.7	16.51	991.0	826.0	55	0.3	75.6
16	0.8	92.5	17.61	1057.0	881.0	55	0.4	76.1
17	0.7	93.2	18.71	1123.0	936.0	54	0.4	76.5
18	0.5	93.7	19.82	1189.0	991.0	54	0.3	76.7
19	0.6	94.3	20.92	1255.0	1046.0	55	0.3	77.1
20	0.5	94.8	22.02	1321.0	1101.0	55	0.3	77.3
21	0.2	95.0	23.12	1387.0	1156.0	56	0.1	77.4
22	0.4	95.4	24.22	1453.0	1211.0	57	0.2	77.7
23	0.5	95.9	25.32	1519.0	1266.0	57	0.3	78.0
24	0.4	96.3	26.42	1585.0	1321.0	58	0.2	78.2
25	0.1	96.4	27.52	1651.0	1376.0	59	0.1	78.2

Stormceptor[®] EF Sizing Report

Rainfall Intensity (mm / hr)	Percent Rainfall Volume (%)	Cumulative Rainfall Volume (%)	Flow Rate (L/s)	Flow Rate (L/min)	Surface Loading Rate (L/min/m ²)	Removal Efficiency (%)	Incremental Removal (%)	Cumulative Removal (%)
26	0.3	96.7	28.62	1717.0	1431.0	58	0.2	78.4
27	0.4	97.1	29.72	1783.0	1486.0	56	0.2	78.6
28	0.2	97.3	30.82	1849.0	1541.0	54	0.1	78.7
29	0.2	97.5	31.93	1916.0	1596.0	52	0.1	78.9
30	0.2	97.7	33.03	1982.0	1651.0	50	0.1	79.0
31	0.1	97.8	34.13	2048.0	1706.0	49	0.0	79.0
32	0.2	98.0	35.23	2114.0	1761.0	47	0.1	79.1
33	0.1	98.1	36.33	2180.0	1816.0	46	0.0	79.1
34	0.1	98.2	37.43	2246.0	1871.0	44	0.0	79.2
35	0.1	98.3	38.53	2312.0	1927.0	43	0.0	79.2
36	0.2	98.5	39.63	2378.0	1982.0	42	0.1	79.3
37	0.0	98.5	40.73	2444.0	2037.0	41	0.0	79.3
38	0.1	98.6	41.83	2510.0	2092.0	40	0.0	79.3
39	0.1	98.7	42.93	2576.0	2147.0	39	0.0	79.4
40	0.1	98.8	44.04	2642.0	2202.0	38	0.0	79.4
41	0.1	98.9	45.14	2708.0	2257.0	37	0.0	79.5
42	0.1	99.0	46.24	2774.0	2312.0	36	0.0	79.5
43	0.2	99.2	47.34	2840.0	2367.0	35	0.1	79.6
44	0.1	99.3	48.44	2906.0	2422.0	34	0.0	79.6
45	0.1	99.4	49.54	2972.0	2477.0	33	0.0	79.6
46	0.0	99.4	50.64	3038.0	2532.0	33	0.0	79.6
47	0.1	99.5	51.74	3104.0	2587.0	32	0.0	79.7
48	0.0	99.5	52.84	3171.0	2642.0	32	0.0	79.7
49	0.0	99.5	53.94	3237.0	2697.0	32	0.0	79.7
50	0.0	99.5	55.04	3303.0	2752.0	31	0.0	79.7
Estimated Net Annual Sediment (TSS) Load Reduction =								80 %

Stormceptor® EF Sizing Report

RAINFALL DATA FROM OTTAWA MACDONALD-CARTIER INT'L AP RAINFALL STATION

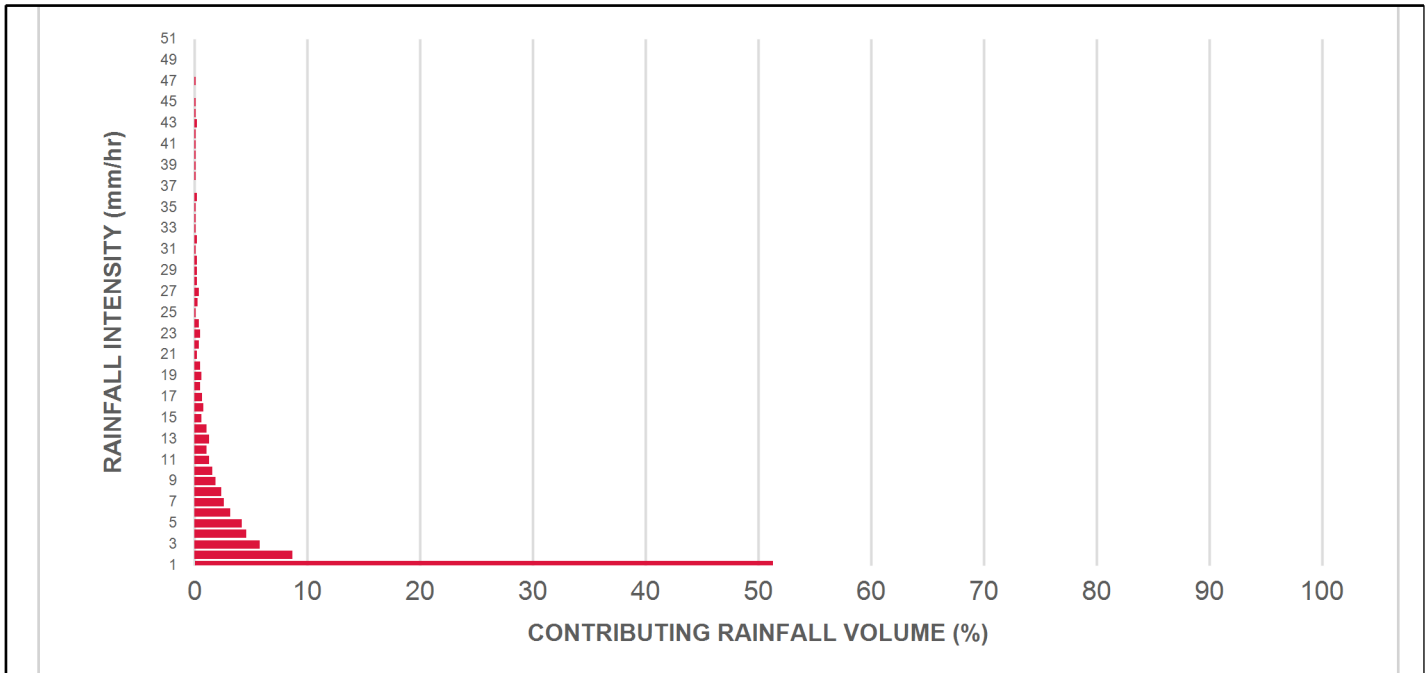

INCREMENTAL AND CUMULATIVE TSS REMOVAL FOR THE RECOMMENDED STORMCEPTOR® MODEL

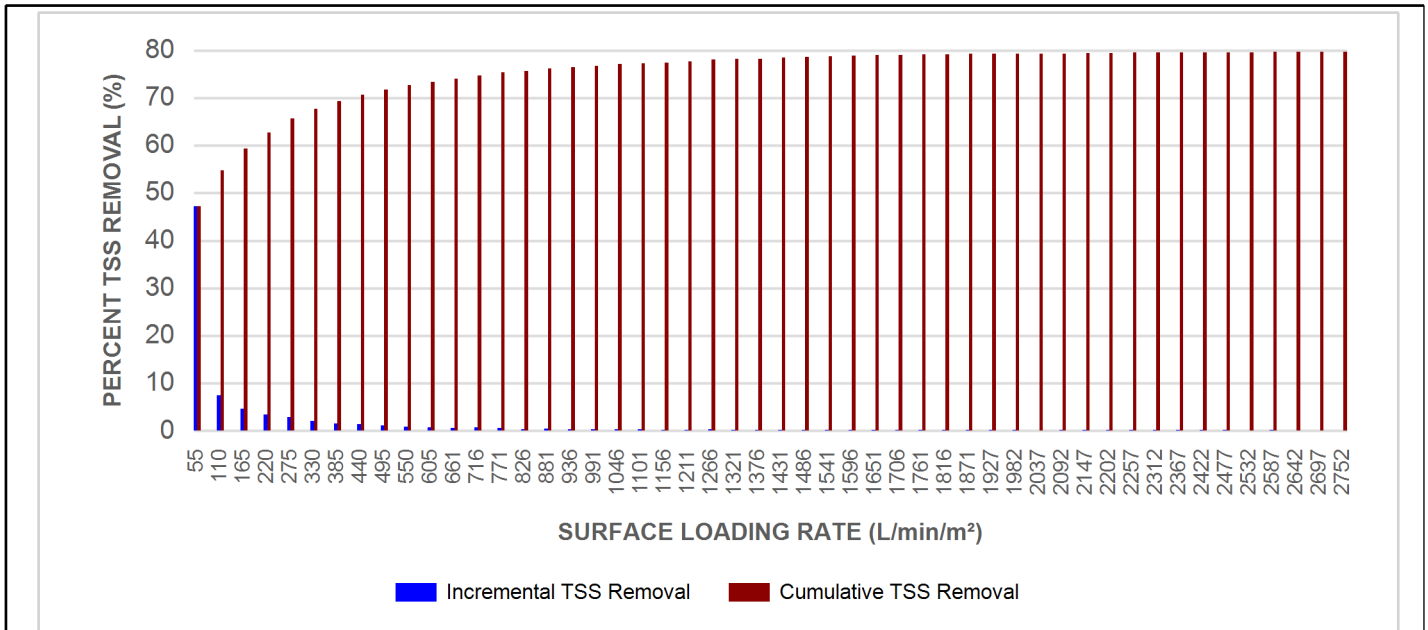

Stormceptor® EF Sizing Report

Maximum Pipe Diameter / Peak Conveyance

Stormceptor EF / EFO	Model Diameter		Min Angle Inlet / Outlet Pipes	Max Inlet Pipe Diameter		Max Outlet Pipe Diameter		Peak Conveyance Flow Rate	
	(m)	(ft)		(mm)	(in)	(mm)	(in)	(L/s)	(cfs)
EF4 / EFO4	1.2	4	90	609	24	609	24	425	15
EF6 / EFO6	1.8	6	90	914	36	914	36	990	35
EF8 / EFO8	2.4	8	90	1219	48	1219	48	1700	60
EF10 / EFO10	3.0	10	90	1828	72	1828	72	2830	100
EF12 / EFO12	3.6	12	90	1828	72	1828	72	2830	100

SCOUR PREVENTION AND ONLINE CONFIGURATION

► **Stormceptor® EF and EFO** feature an internal bypass and superior scour prevention technology that have been demonstrated in third-party testing according to the scour testing provisions of the Canadian ETV **Procedure for Laboratory Testing of Oil-Grit Separators**, and the exceptional scour test performance has been third-party verified in accordance with the ISO 14034 ETV protocol. As a result, Stormceptor EF and EFO are approved for online installation, eliminating the need for costly additional bypass structures, piping, and installation expense.

DESIGN FLEXIBILITY

► **Stormceptor® EF and EFO** offers design flexibility in one simplified platform, accepting stormwater flow from a single inlet pipe or multiple inlet pipes, and/or surface runoff through an inlet grate. The device can also serve as a junction structure, accommodate a 90-degree inlet-to-outlet bend angle, and can be modified to ensure performance in submerged conditions.

OIL CAPTURE AND RETENTION

► While Stormceptor® EF will capture and retain oil from dry weather spills and low intensity runoff, **Stormceptor® EFO** has demonstrated superior oil capture and greater than 99% oil retention in third-party testing according to the light liquid re-entrainment testing provisions of the Canadian ETV **Procedure for Laboratory Testing of Oil-Grit Separators**. Stormceptor EFO is recommended for sites where oil capture and retention is a requirement.

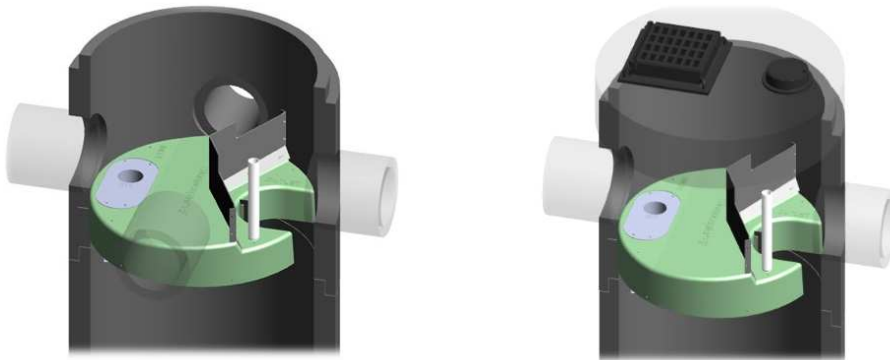

Stormceptor® EF Sizing Report

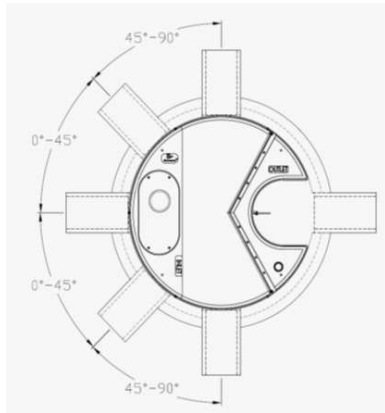

INLET-TO-OUTLET DROP

Elevation differential between inlet and outlet pipe inverts is dictated by the angle at which the inlet pipe(s) enters the unit.

0° - 45° : The inlet pipe is 1-inch (25mm) higher than the outlet pipe.

45° - 90° : The inlet pipe is 2-inches (50mm) higher than the outlet pipe.

HEAD LOSS

The head loss through Stormceptor EF is similar to that of a 60-degree bend structure. The applicable K value for calculating minor losses through the unit is 1.1.

For submerged conditions the applicable K value is 3.0.

Pollutant Capacity

Stormceptor EF / EFO	Model Diameter		Depth (Outlet Pipe Invert to Sump Floor)		Oil Volume		Recommended Sediment Maintenance Depth *		Maximum Sediment Volume *		Maximum Sediment Mass **	
	(m)	(ft)	(m)	(ft)	(L)	(Gal)	(mm)	(in)	(L)	(ft ³)	(kg)	(lb)
EF4 / EFO4	1.2	4	1.52	5.0	265	70	203	8	1190	42	1904	5250
EF6 / EFO6	1.8	6	1.93	6.3	610	160	305	12	3470	123	5552	15375
EF8 / EFO8	2.4	8	2.59	8.5	1070	280	610	24	8780	310	14048	38750
EF10 / EFO10	3.0	10	3.25	10.7	1670	440	610	24	17790	628	28464	78500
EF12 / EFO12	3.6	12	3.89	12.8	2475	655	610	24	31220	1103	49952	137875

*Increased sump depth may be added to increase sediment storage capacity

** Average density of wet packed sediment in sump = 1.6 kg/L (100 lb/ft³)

Feature	Benefit	Feature Appeals To
Patent-pending enhanced flow treatment and scour prevention technology	Superior, verified third-party performance	Regulator, Specifying & Design Engineer
Third-party verified light liquid capture and retention for EFO version	Proven performance for fuel/oil hotspot locations	Regulator, Specifying & Design Engineer, Site Owner
Functions as bend, junction or inlet structure	Design flexibility	Specifying & Design Engineer
Minimal drop between inlet and outlet	Site installation ease	Contractor
Large diameter outlet riser for inspection and maintenance	Easy maintenance access from grade	Maintenance Contractor & Site Owner

STANDARD STORMCEPTOR EF/EFO DRAWINGS

For standard details, please visit <http://www.imbrium.com/stormwater-treatment-solutions/stormceptor-ef>

STANDARD STORMCEPTOR EF/EFO SPECIFICATION

For specifications, please visit <http://www.imbrium.com/stormwater-treatment-solutions/stormceptor-ef>

Stormceptor[®] EF Sizing Report

STANDARD PERFORMANCE SPECIFICATION FOR “OIL GRIT SEPARATOR” (OGS) STORMWATER QUALITY TREATMENT DEVICE

PART 1 – GENERAL

1.1 WORK INCLUDED

This section specifies requirements for selecting, sizing, and designing an underground Oil Grit Separator (OGS) device for stormwater quality treatment, with third-party testing results and a Statement of Verification in accordance with ISO 14034 Environmental Management – Environmental Technology Verification (ETV).

1.2 REFERENCE STANDARDS & PROCEDURES

ISO 14034:2016 Environmental management – Environmental technology verification (ETV)

Canadian Environmental Technology Verification (ETV) Program’s **Procedure for Laboratory Testing of Oil-Grit Separators.**

1.3 SUBMITTALS

1.3.1 All submittals, including sizing reports & shop drawings, shall be submitted upon request with each order to the contractor then forwarded to the Engineer of Record for review and acceptance. Shop drawings shall detail all OGS components, elevations, and sequence of construction.

1.3.2 Alternative devices shall have features identical to or greater than the specified device, including: treatment chamber diameter, treatment chamber wet volume, sediment storage volume, and oil storage volume.

1.3.3 Unless directed otherwise by the Engineer of Record, OGS stormwater quality treatment product substitutions or alternatives submitted within ten days prior to project bid shall not be accepted. All alternatives or substitutions submitted shall be signed and sealed by a local registered Professional Engineer, based on the exact same criteria detailed in Section 3, in entirety, subject to review and approval by the Engineer of Record.

PART 2 – PRODUCTS

2.1 OGS POLLUTANT STORAGE

The OGS device shall include a sump for sediment storage, and a protected volume for the capture and storage of petroleum hydrocarbons and buoyant gross pollutants. The **minimum** sediment & petroleum hydrocarbon storage capacity shall be as follows:

2.1.1	4 ft (1219 mm) Diameter OGS Units:	1.19 m ³ sediment / 265 L oil
	6 ft (1829 mm) Diameter OGS Units:	3.48 m ³ sediment / 609 L oil
	8 ft (2438 mm) Diameter OGS Units:	8.78 m ³ sediment / 1,071 L oil
	10 ft (3048 mm) Diameter OGS Units:	17.78 m ³ sediment / 1,673 L oil
	12 ft (3657 mm) Diameter OGS Units:	31.23 m ³ sediment / 2,476 L oil

PART 3 – PERFORMANCE & DESIGN

3.1 GENERAL

Stormceptor[®] EF Sizing Report

The OGS stormwater quality treatment device shall be verified in accordance with ISO 14034:2016 Environmental management – Environmental technology verification (ETV). The OGS stormwater quality treatment device shall remove oil, sediment and gross pollutants from stormwater runoff during frequent wet weather events, and retain these pollutants during less frequent high flow wet weather events below the insert within the OGS for later removal during maintenance. The Manufacturer shall have at least ten (10) years of local experience, history and success in engineering design, manufacturing and production and supply of OGS stormwater quality treatment device systems, acceptable to the Engineer of Record.

3.2 SIZING METHODOLOGY

The OGS device shall be engineered, designed and sized to provide stormwater quality treatment based on treating a minimum of 90 percent of the average annual runoff volume and a minimum removal of an annual average 60% of the sediment (TSS) load based on the Particle Size Distribution (PSD) specified in the sizing report for the specified device. Sizing shall be determined using historical rainfall data and a sediment removal performance curve derived from the actual third-party verified laboratory testing data. The OGS device shall also have sufficient annual sediment storage capacity as specified and calculated in Section 2.1.

3.3 CANADIAN ETV or ISO 14034 ETV VERIFICATION OF SCOUR TESTING

The OGS device shall have Canadian ETV or ISO 14034 ETV Verification of third-party scour testing conducted in accordance with the Canadian ETV Program's **Procedure for Laboratory Testing of Oil-Grit Separators**.

3.3.1 To be acceptable for on-line installation, the OGS device must demonstrate an average scour test effluent concentration less than 10 mg/L at each surface loading rate tested, up to and including 2600 L/min/m².

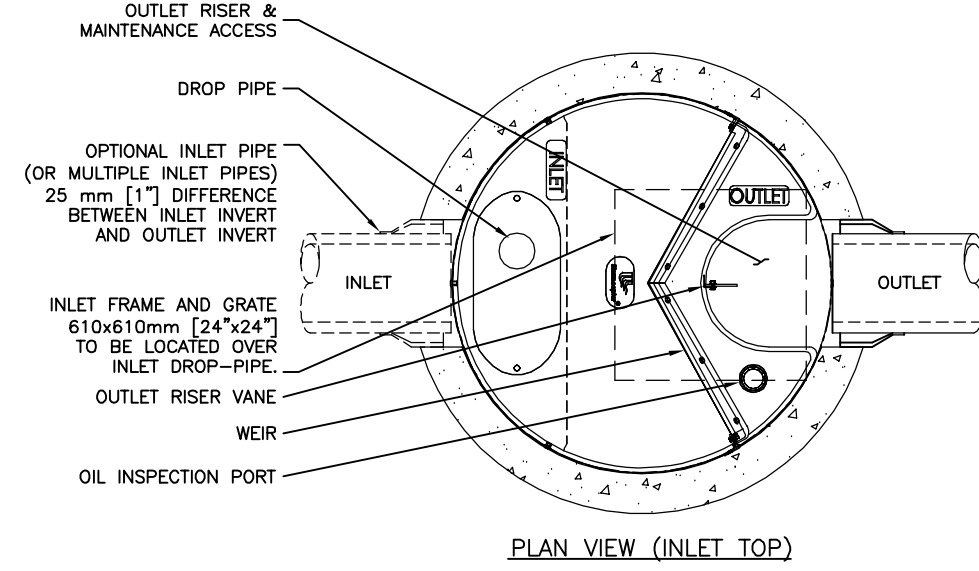
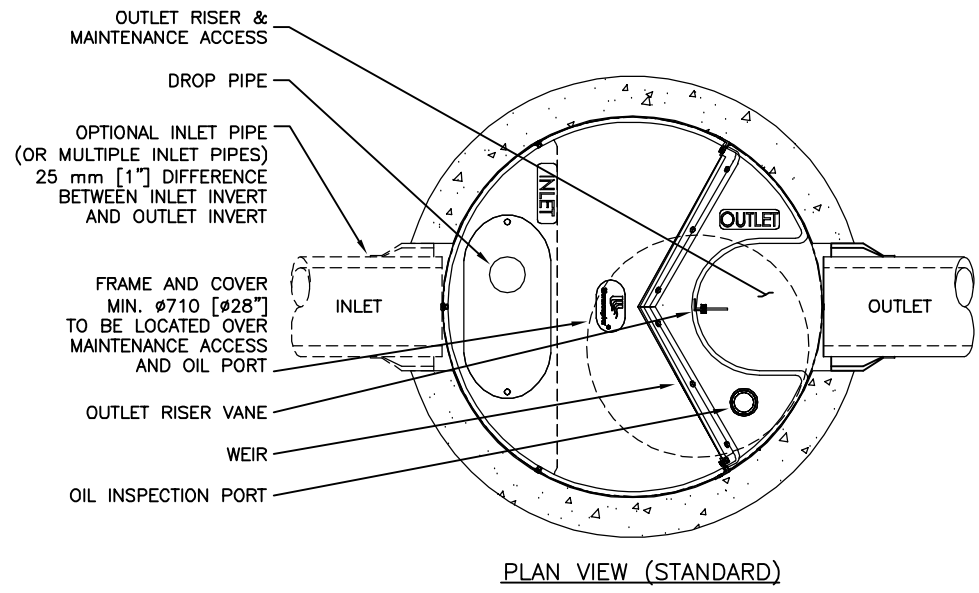
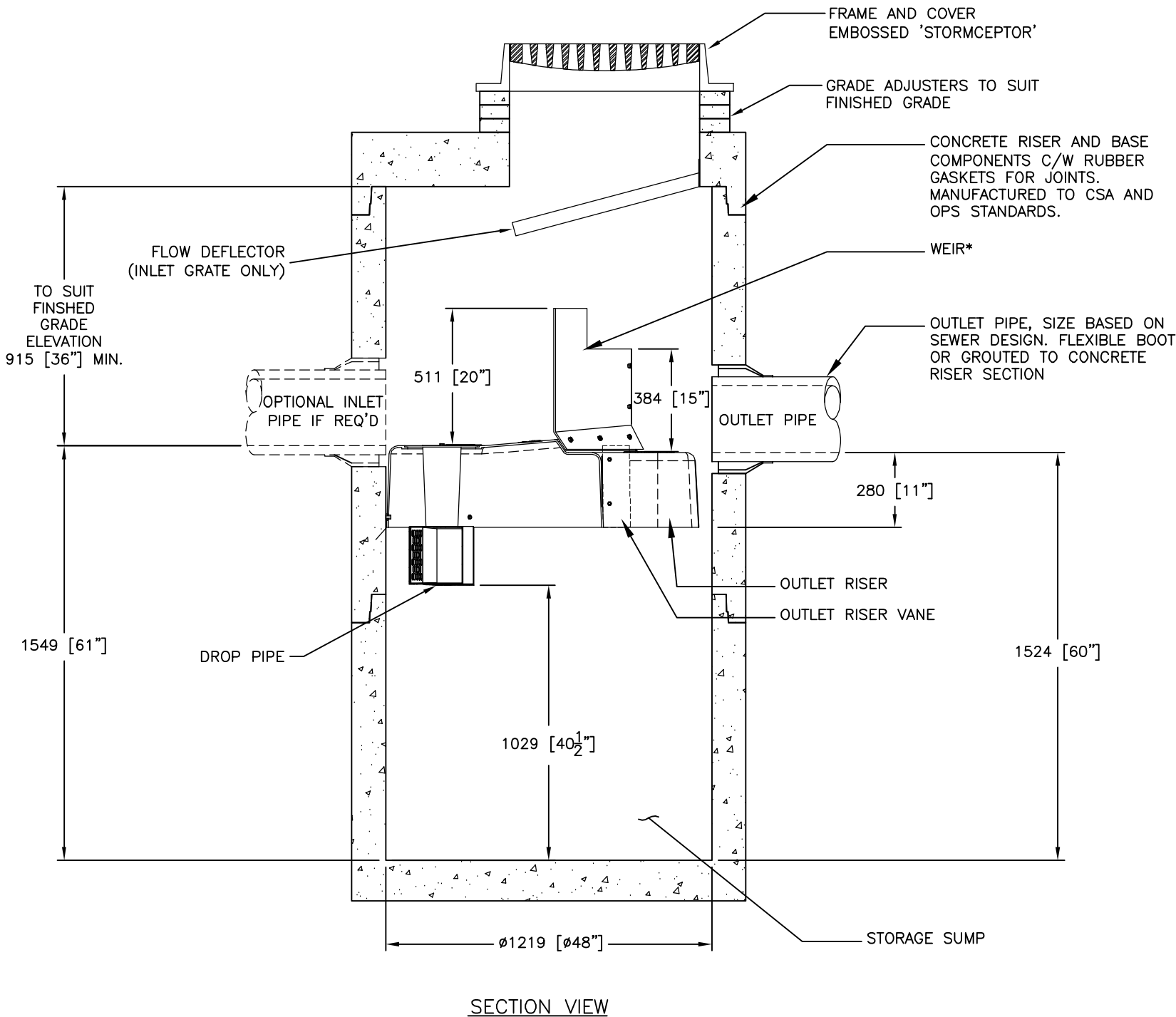

FOR SITE SPECIFIC DRAWINGS PLEASE CONTACT YOUR LOCAL STORMCEPTOR REPRESENTATIVE. SITE SPECIFIC DRAWINGS ARE BASED ON THE BEST AVAILABLE INFORMATION AT THE TIME. SOME FIELD REVISIONS TO THE SYSTEM LOCATION OR CONNECTION PIPING MAY BE NECESSARY BASED ON AVAILABLE SPACE OR SITE CONFIGURATION REVISIONS. ELEVATIONS SHOULD BE MAINTAINED EXCEPT WHERE NOTED ON BYPASS STRUCTURE (IF REQUIRED).

GENERAL NOTES:

- * MAXIMUM SURFACE LOADING RATE (SLR) INTO LOWER CHAMBER THROUGH DROP PIPE IS 1135 L/min/m² (27.9 gpm/ft²) FOR STORMCEPTOR EF4 AND 535 L/min/m² (13.1 gpm/ft²) FOR STORMCEPTOR EFO4 (OIL CAPTURE CONFIGURATION). WEIR HEIGHT IS 150 mm (6 INCH) FOR EF04.
- 1. ALL DIMENSIONS INDICATED ARE IN MILLIMETERS (INCHES) UNLESS OTHERWISE SPECIFIED.
- 2. STORMCEPTOR STRUCTURE INLET AND OUTLET PIPE SIZE AND ORIENTATION SHOWN FOR INFORMATIONAL PURPOSES ONLY.
- 3. UNLESS OTHERWISE NOTED, BYPASS INFRASTRUCTURE, SUCH AS ALL UPSTREAM DIVERSION STRUCTURES, CONNECTING STRUCTURES, OR PIPE CONDUITS CONNECTING TO COMPLETE THE STORMCEPTOR SYSTEM SHALL BE PROVIDED AND ADDRESSED SEPARATELY.
- 4. DRAWING FOR INFORMATIONAL PURPOSES ONLY. REFER TO ENGINEER'S SITE/UTILITY PLAN FOR STRUCTURE ORIENTATION.
- 5. NO PRODUCT SUBSTITUTIONS SHALL BE ACCEPTED UNLESS SUBMITTED 10 DAYS PRIOR TO PROJECT BID DATE, OR AS DIRECTED BY THE ENGINEER OF RECORD.

INSTALLATION NOTES

- A. ANY SUB-BASE, BACKFILL DEPTH, AND/OR ANTI-FLOTATION PROVISIONS ARE SITE-SPECIFIC DESIGN CONSIDERATIONS AND SHALL BE SPECIFIED BY ENGINEER OF RECORD.
- B. CONTRACTOR TO PROVIDE EQUIPMENT WITH SUFFICIENT LIFTING AND REACH CAPACITY TO LIFT AND SET THE STRUCTURE (LIFTING CLUTCHES PROVIDED)
- C. CONTRACTOR WILL INSTALL AND LEVEL THE STRUCTURE, SEALING THE JOINTS, LINE ENTRY AND EXIT POINTS (NON-SHRINK GROUT WITH APPROVED WATERSTOP OR FLEXIBLE BOOT)
- D. CONTRACTOR TO TAKE APPROPRIATE MEASURES TO PROTECT THE DEVICE FROM CONSTRUCTION-RELATED EROSION RUNOFF.
- E. DEVICE ACTIVATION, BY CONTRACTOR, SHALL OCCUR ONLY AFTER SITE HAS BEEN STABILIZED AND THE STORMCEPTOR UNIT IS CLEAN AND FREE OF DEBRIS.

STANDARD DETAIL NOT FOR CONSTRUCTION

SITE SPECIFIC DATA REQUIREMENTS						
STORMCEPTOR MODEL	EF4					
STRUCTURE ID	*					
WATER QUALITY FLOW RATE (L/s)	*					
PEAK FLOW RATE (L/s)	*					
RETURN PERIOD OF PEAK FLOW (yrs)	*					
DRAINAGE AREA (HA)	*					
DRAINAGE AREA IMPERVIOUSNESS (%)	*					
PIPE DATA:	I.E.	MAT'L	DIA	SLOPE %	HGL	
INLET #1	*	*	*	*	*	
INLET #2	*	*	*	*	*	
OUTLET	*	*	*	*	*	
* PER ENGINEER OF RECORD						

This design and information is provided as a service to the project owner. Engineer and contractor by Imbrium Systems ("Imbrium"). Neither the drawing, nor any part thereof, may be used for any purpose other than that intended, without the prior written consent of Imbrium. Imbrium expressly disclaims any liability or responsibility for such use.

If discrepancies between the supplied information upon which the drawing is based and actual field conditions are discovered, Imbrium Systems shall not be responsible for re-evaluation of the design. Imbrium accepts no liability for design based on missing, incomplete or inaccurate information supplied by others.

MARK	DATE	REVISION DESCRIPTION	BY
###	###	UPDATES	JSK
###	6/8/18	INITIAL RELEASE	JSK
###	5/26/17		

Stormceptor® EF

imbrium

7037 RIDGE ROAD, SUITE 300, HANOVER, MD 21076
USA 888-276-8828 CA 800-588-4801 INTL +1-410-960-9600

DATE: 5/26/2017

DESIGNED: JSK
DRAWN: JSK

CHECKED: BSF
APPROVED: SP

PROJECT No.: EF4
SEQUENCE No.: *

SHEET: 1 OF 1

SCALE = NTS

**SITE SERVICING AND STORMWATER MANAGEMENT BRIEF – MOONEY’S BAY - 729
RIDGEWOOD AVENUE, OTTAWA, ON**

Appendix E Geotechnical Report and Environmental Site Assessment

**Appendix E GEOTECHNICAL REPORT AND ENVIRONMENTAL
SITE ASSESSMENT**



Geotechnical
Engineering

Environmental
Engineering

Hydrogeology

Geological
Engineering

Materials Testing

Building Science

Archaeological Services

Geotechnical Investigation
Proposed Multi Storey Building
729 Ridgewood Avenue
Ottawa, Ontario

Prepared for

Brigil

Paterson Group Inc.

Consulting Engineers
154 Colonnade Road South
Ottawa, Ontario
Canada K2E 7J5

Tel: (613) 226-7381
Fax: (613) 226-6344
www.patersongroup.ca

September 15, 2020

Report PG5172-1

Table of Contents

		Page
1.0	Introduction	1
2.0	Proposed Development	1
3.0	Method of Investigation	
	3.1 Field Investigation	2
	3.2 Field Survey	3
	3.3 Laboratory Testing	3
	3.4 Analytical Testing	3
4.0	Observations	
	4.1 Surface Conditions	4
	4.2 Subsurface Profile	4
	4.3 Groundwater	5
5.0	Discussion	
	5.1 Geotechnical Assessment	6
	5.2 Site Grading and Preparation	6
	5.3 Foundation Design	9
	5.4 Design for Earthquakes	11
	5.5 Basement Slab	11
	5.6 Basement Wall	12
	5.7 Pavement Structure	13
6.0	Design and Construction Precautions	
	6.1 Foundation Drainage and Backfill	15
	6.2 Protection of Footings Against Frost Action	16
	6.3 Excavation Side Slopes	17
	6.4 Pipe Bedding and Backfill	20
	6.5 Groundwater Control	20
	6.6 Winter Construction	21
	6.7 Corrosion Potential and Sulphate	22
7.0	Recommendations	23
8.0	Statement of Limitations	24

Appendices

- Appendix 1** Soil Profile and Test Data Sheets
 Symbols and Terms
 Analytical Testing Results
- Appendix 2** Figure 1 - Key Plan
 Drawing PG5172-1 - Test Hole Location Plan

1.0 Introduction

Paterson Group (Paterson) was commissioned by Brigil to conduct a geotechnical investigation for the proposed mid-rise residential building to be located at 729 Ridgewood Avenue in the City of Ottawa, Ontario (refer to Figure 1 - Key Plan in Appendix 2 of this report).

The objectives of the current investigation were to:

- ❑ Determine the subsurface and groundwater conditions by means of boreholes and existing soils information.
- ❑ Provide geotechnical recommendations pertaining to design of the proposed development including construction considerations which may affect the design.

The following report has been prepared specifically and solely for the aforementioned project which is described herein. The report contains Paterson's findings and includes geotechnical recommendations pertaining to the design and construction of the subject development as understood at the time of writing this report.

2.0 Proposed Development

The development is understood to consist of a multi storey residential building with up to 2 levels of underground parking. It is further understood that the proposed building will encompass the majority of the subject site. Associated at-grade access lanes, car parking and landscaped areas are also anticipated. The proposed building is anticipated to be municipally serviced.

The subject property is presently occupied by a two slab on grade commercial buildings. It is expected that the existing buildings within the site will be demolished as part of the proposed project. A former mechanics garage was located on the east portion of the site. The building was recently demolished.

3.0 Method of Investigation

3.1 Field Investigation

Field Program

The field program for the current investigation was completed between June 25 and 26, 2020. At that time, 7 boreholes were advanced to a maximum depth of 9.7 m below existing grade. The borehole locations were distributed in a manner to provide general coverage of the proposed development taking into consideration existing site features and underground services. The borehole locations are shown on Drawing PG5172-1 - Test Hole Location Plan included in Appendix 2.

Sampling and In-Situ Testing

Soil samples were recovered with a 50 mm diameter split-spoon sample or from the auger flights. The split-spoon and auger samples were classified on site and placed in sealed plastic bags. All samples were transported to Paterson's laboratory. The depths at which the split-spoon and auger samples were recovered from the boreholes are presented as SS and AU, respectively, on the Soil Profile and Test Data sheets in Appendix 1.

The Standard Penetration Test (SPT) was conducted in conjunction with the recovery of the split-spoon samples. The SPT results are recorded as "N" values on the Soil Profile and Test Data sheets. The "N" value is the number of blows required to drive the split-spoon sampler 300 mm into the soil after a 150 mm initial penetration using a 63.5 kg hammer falling from a height of 760 mm.

Undrained shear strength testing was carried out in cohesive soils using a field vane apparatus.

The overburden thickness was evaluated by a dynamic cone penetration test (DCPT) completed at BH6. The DCPT consists of driving a steel drill rod, equipped with a 50 mm diameter cone at the tip, using a 63.5 kg hammer falling from a height of 760 mm. The number of blows required to drive the cone into the soil is recorded for each 300 mm increment.

Rock samples were recovered from BH7 using a core barrel and diamond drilling techniques. The bedrock samples were classified on site, placed in hard cardboard core boxes and transported to Paterson's laboratory. The depths at which rock core samples were recovered from the boreholes are presented as RC on the Soil Profile and Test Data sheets in Appendix 1.

The recovery value and a Rock Quality Designation (RQD) value were calculated for each drilled section of bedrock and are presented on the borehole logs. The recovery value is the length of the bedrock sample recovered over the length of the drilled section. The RQD value is the total length of intact rock pieces longer than 100 mm over the length of the core run. The values indicate the bedrock quality.

The subsurface conditions observed in the boreholes were recorded in detail in the field. The soil profiles are presented on the Soil Profile and Test Data sheets in Appendix 1.

Groundwater

Flexible piezometers were installed in all the boreholes to monitor the groundwater level subsequent to the completion of the sampling program. The groundwater observations are discussed in subsection 4.3 and presented in the Soil Profile and Test Data Sheets in Appendix 1.

3.2 Field Survey

The test hole locations were determined and located in the field by Paterson. All ground surface elevations reference a geodetic datum (NAD83). The locations of the boreholes and the ground surface elevations for each borehole location are presented on Drawing PG5172-1 -Test Hole Location Plan in Appendix 2.

3.3 Laboratory Testing

The soil samples and the bedrock core were recovered from the subject site and visually examined in Paterson's laboratory to review the field logs.

All samples will be stored in the laboratory for a period of one month after issuance of this report. The samples will then be discarded unless otherwise directed.

3.4 Analytical Testing

One soil sample was submitted for analytical testing to assess the corrosion potential for exposed ferrous metals and the potential of sulphate attacks against subsurface concrete structures. The sample was submitted to determine the concentration of sulphate and chloride, the resistivity and the pH of the sample. The results are presented in Appendix 1 and are discussed further in Subsection 6.7.

4.0 Observations

4.1 Surface Conditions

The subject property is presently occupied by two slab on grade commercial buildings. A former mechanical shop located on southeastern portion of the site was recently demolished. The area was backfilled with granular material. A parking lot and pavement structure covers the majority of the site. Some landscaped areas were noted along Ridgewood Avenue.

The ground surface across the subject site is relatively flat and slightly below grade from Ridgewood Avenue and the property to the west. The site is bordered to the west by a residential high rise structure, to the north and east by a residential and institutional development, and Ridgewood Avenue to the south.

4.2 Subsurface Profile

Overburden

Generally, the subsurface profile encountered at the boreholes consist of asphaltic concrete overlying a fill layer consisting of crushed stone and silty sand. The fill layer is underlain by a stiff to hard layer of brown silty clay with sand seams. Glacial till was encountered below the above noted layers consisting of a compact to a very dense silty sand with clay, gravel, cobbles, and boulders. Seams of coarse sand were encountered in the glacial till layer at some test hole locations. Reference should be made to the Soil Profile and Test Data sheets in Appendix 1 for the details of the soil profile encountered at each test hole location.

Bedrock

Bedrock was cored at one borehole location to confirm refusal. Limestone bedrock was encountered at a depth of 9.7 m below the existing ground surface at BH6. Refusal was encountered in the other boreholes between a depth of 4.8 to 8.7 m. It should be noted that boulders are to be expected.

Upon review of the core hole sample, the upper first meter of the bedrock was found to be of good quality.

Based on available geological mapping, the subject site is located in an area where the bedrock consists of limestone of the Bobcaygeon Formation. The overburden drift thickness is anticipated to be between 5 to 15 m in depth.

4.3 Groundwater

Flexible piezometers were installed as part of our geotechnical investigation. Groundwater level measurements were recorded at the borehole locations and our findings are presented in Table 1. It should also be noted that the groundwater level is subject to seasonal fluctuations. Therefore, groundwater could vary at the time of construction. It should be further noted that groundwater measurements at monitoring well locations can be influenced by surface water entering the backfilled borehole, which can lead to higher than normal groundwater level readings. Long-term groundwater levels can also be determined based on observations of the recovered soil samples, such as moisture levels, colouring and consistency. Based on these observations, the long-term groundwater level is expected at a 5 to 6 m depth.

Table 1 - Groundwater Measurements at Monitoring Well Locations				
Test Hole Location	Ground Surface Elevation (m)	GW Level Reading (m)	GW Level Elevation (m)	Date
BH 1	82.55	2.75	79.80	July 7, 2020
BH 2	81.92	3.54	78.38	July 7, 2020
BH 3	82.05	4.72	77.33	July 7, 2020
BH 4	81.35	4.01	77.34	July 7, 2020
BH 5	81.71	3.28	78.43	July 7, 2020
BH 6	82.02	1.88	80.14	July 7, 2020
BH 7	81.61	3.15	78.46	July 7, 2020

5.0 Discussion

5.1 Geotechnical Assessment

From a geotechnical perspective, the subject site is considered satisfactory for the proposed development. The proposed mid-rise residential building is anticipated to be founded on spread footings placed directly or indirectly by the use of a lean concrete in-filled trench on a clean, surface sounded bedrock bearing surface or compact glacial till bearing surface.

Bedrock removal may be required to complete the underground level. Hoe ramming is an option where only small quantities of bedrock need to be removed. Line drilling and controlled blasting where large quantities of bedrock need to be removed is recommended. The blasting operations should be planned and completed under the guidance of a professional engineer with experience in blasting operations.

The above and other considerations are further discussed in the following sections.

5.2 Site Grading and Preparation

Stripping Depth

Since the building will occupy the entire boundaries of the subject site, it is expected that most of the overburden will be removed to bedrock. Topsoil and deleterious fill, such as those containing organic materials, should be stripped from under any buildings, paved areas, pipe bedding and other settlement sensitive structures

Bedrock Removal

Bedrock removal can be accomplished by hoe ramming where only small quantity of the bedrock needs to be removed. Sound bedrock may be removed by line drilling and controlled blasting and/or hoe ramming.

Prior to considering blasting operations, the blasting effects on the existing services, buildings and other structures should be addressed. A pre-blast or pre-construction survey of the existing structures located in proximity of the blasting operations should be completed prior to commencing site activities. The extent of the survey should be determined by the blasting consultant and should be sufficient to respond to any inquiries/claims related to the blasting operations.

As a general guideline, peak particle velocities (measured at the structures) should not exceed 25 mm/s during the blasting program to reduce the risks of damage to the existing structures. The blasting operations should be planned and conducted under the supervision of a licensed professional engineer who is also an experienced blasting consultant.

Excavation side slopes in sound bedrock can be carried out using almost vertical side walls. A minimum 1 m horizontal ledge, should be left between the bottom of the overburden excavation and the top of the bedrock surface to provide an area to allow for potential sloughing or to provide a stable base for the overburden shoring system.

Lean Concrete In-Filled Trenches

Where bedrock is encountered below the design underside of footing elevation, consideration should be given to excavating vertical trenches to expose the underlying bedrock surface and backfilling with lean concrete (15 MPa 28-day compressive strength). Typically, the excavation sidewalls will be used as the form to support the concrete. The additional width of the concrete poured against an undisturbed trench sidewall will suffice in providing a direct transfer of the footing load to the underlying bedrock.

The effectiveness of this operation will depend on the ability of maintaining vertical trenches until the lean concrete can be poured. It is suggested that once the bottom of the excavation is exposed, an assessment should be completed to determine the water infiltration and stability of the excavation sidewalls extending to the bedrock surface.

The trench excavation should be at least 150 mm wider than all sides of the footing at the base of the excavation. The excavation bottom should be relatively clean using the hydraulic shovel only (workers will not be permitted in the excavation below a 1.5 m depth). Once approved by the geotechnical engineer, lean concrete can be poured up to the proposed founding elevation.

Footings placed on lean concrete filled trenches extending to the bedrock surface can be designed using a factored bearing resistance value at ultimate limit states (ULS) of 1,500 kPa.

Vibration Considerations

Construction operations are the cause of vibrations, and possibly, sources of nuisance to the community. Therefore, means to reduce the vibration levels as much as possible should be incorporated in the construction operations to maintain, as much as possible, a cooperative environment with the residents.

The following construction equipments could be the source of vibrations: hoe ram, compactor, dozer, crane, truck traffic, etc. Vibrations, whether caused by blasting operations or by construction operations, could be the source of detrimental vibrations on the nearby buildings and structures. Therefore, all vibrations are recommended to be limited.

Two parameters are used to determine the permissible vibrations, namely, the maximum peak particle velocity and the frequency. For low frequency vibrations, the maximum allowable peak particle velocity is less than that for high frequency vibrations. As a guideline, the peak particle velocity should be less than 15 mm/s between frequencies of 4 to 12 Hz, and 50 mm/s above a frequency of 40 Hz (interpolate between 12 and 40 Hz). The guidelines are for current construction standards. Considering that these guidelines are above perceptible human level and, in some cases, could be very disturbing to some people, a pre-construction survey is recommended be completed to minimize the risks of claims during or following the construction of the proposed building.

Fill Placement

Fill used for grading purposes beneath the proposed buildings should consist of clean imported granular fill, such as Ontario Provincial Standard Specifications (OPSS) Granular A or Granular B Type II. The fill should be tested and approved prior to delivery to the site. It should be placed in lifts no greater than 300 mm in thickness and compacted using suitable compaction equipment for the specified lift thickness. Fill placed beneath the building areas should be compacted to at least 98% of its standard Proctor maximum dry density (SPMDD).

Non-specified existing fill along with site-excavated soil can be used as general landscaping fill where settlement of the ground surface is of minor concern. These materials should be spread in thin lifts and be compacted at minimum by the tracks of the spreading equipment to minimize voids. If these materials are to be used to build up the subgrade level for areas to be paved, they should be compacted in thin lifts to a minimum density of 95% of their respective SPMDD. Non-specified existing fill and site-excavated soils are not suitable for use as backfill against foundation walls unless used in conjunction with a composite drainage membrane.

5.3 Foundation Design

Bearing Resistance Values

Footings placed on an undisturbed, **dense glacial till bearing surface** can be designed using a bearing resistance value at serviceability limit states (SLS) of **250 kPa** and a factored bearing resistance value at ultimate limit states (ULS) of **500 kPa**. A geotechnical resistance factor of 0.5 was applied to the above noted bearing resistance value at ULS. Footings designed using the above-noted bearing resistance value at SLS will be subjected to potential post-construction total and differential settlements of 25 and 20 mm, respectively.

Footings placed on the upper levels of the **fractured limestone** bedrock bearing surface can be designed using a factored bearing resistance value at ultimate limit states (ULS) of **1,500 kPa**, incorporating a geotechnical resistance factor of 0.5. Where the design underside of footing is slightly above the bedrock surface, footings can be placed over concrete in-filled (17 MPa). zero entry, near vertical trenches extended to a surface sounded bedrock bearing surface using the same bearing resistance values. The concrete in-filled trenches should extend a minimum 300 mm beyond the footing faces in all directions.

A factored bearing resistance value at ULS of **4,000 kPa**, incorporating a geotechnical resistance factor of 0.5 if founded on **clean, surface sounded limestone bedrock** and the bedrock is free of seams, fractures and voids within 1.5 m below the founding level. This could be verified by completing and probing 50 mm diameter drill holes to a depth of 1.5 m below the founding level within the footing footprint(s). One drill hole should be completed per footing. The drill hole inspection should be completed by the geotechnical consultant.

A clean, surface-sounded bedrock bearing surface should be free of loose materials, and have no near surface seams, voids, fissures or open joints which can be detected from surface sounding with a rock hammer.

Footings bearing on an acceptable bedrock bearing surface and designed using the bearing resistance values provided herein will be subjected to negligible potential post-construction total and differential settlements.

Soil/Bedrock Transition

It is expected that not all footings will be founded on bedrock. Where the building is founded on the glacial till deposit, it is recommended to decrease the soil bearing capacity by 25% for the footing placed on soil bearing media to reduce the potential long term total and differential settlements. Also, at the soil/bedrock and bedrock/soil transitions, it is recommended that a 2 m transition zone composed of 0.5 m layer of nominally compacted OPSS Granular A or Granular B type II be placed directly on sound bedrock. Steel reinforcement, extending at least 3 m on both sides of the 2 m long transition should be placed in the top part of the footing and foundation walls.

Raft Foundation

Alternatively, consideration can be given to a raft foundation if the building loads exceed the bearing resistance values provided for a conventional spread footing foundation. The following parameters may be used for raft design.

The amount of settlement of the raft slab will be dependent on the sustained raft contact pressure. The bearing resistance value at SLS (contact pressure) of **250 kPa** can be used for design purposes. The loading conditions for the contact pressure are based on sustained loads, that are generally taken to be 100% Dead Load and 50% Live Load. The contact pressure provided considers the stress relief associated with the soil removal associated with one underground parking level. The factored bearing resistance (contact pressure) at ULS can be taken as **400 kPa**. A geotechnical resistance factor of 0.5 was applied to the bearing resistance value at ULS.

Based on the following assumptions for the raft foundation, the proposed building can be designed using the above parameters with a total and differential settlement of 25 and 15 mm, respectively.

Base on a single underground parking level or more it is expected that the raft foundation will be installed on the glacial till deposit. The modulus of subgrade reaction was calculated to be **30 MPa/m** for a contact pressure of 250 kPa. The design of the raft foundation is required to consider the relative stiffness of the reinforced concrete slab and the supporting bearing medium.

Lateral Support

The bearing medium under footing-supported structures is required to be provided with adequate lateral support with respect to excavations and different foundation levels. Adequate lateral support is provided to a sound bedrock bearing medium when a plane extending down and out from the bottom edge of the footing at a minimum of 1H:6V (or flatter) passes only through sound bedrock or a material of the same or higher capacity as the bedrock, such as concrete. A weathered bedrock bearing medium will require a lateral support zone of 1H:1V (or flatter).

5.4 Design for Earthquakes

The site class for seismic site response can be taken as **Class C** for the foundations considered at this site. However, a higher site class (**Class A or B**) can be achieved. The higher site class will require a site specific shear wave velocity test to be completed in confirmation of the seismic site classification. The soils underlying the subject site are not susceptible to liquefaction. Refer to the latest revision of the Ontario Building Code for a full discussion of the earthquake design requirements.

5.5 Basement Slab

With the removal of all topsoil and deleterious fill, containing organic matter, within the footprints of the proposed building, the native soil surface, bedrock or approved engineered fill pad will be considered an acceptable subgrade on which to commence backfilling for floor slab construction.

Any soft areas should be removed and backfilled with appropriate backfill material. A clear crushed stone fill is recommended for backfilling below the floor slab for limited span slab-on-grade areas, such as front porch or garage footprints. It is recommended that the upper 200 mm of sub-slab fill consist of 19 mm clear crushed stone below basement floor slabs.

It is expected that the basement area will be mostly parking and a rigid pavement structure designed by a structural engineer will be applicable. However, if storage or other uses of the lower level where a concrete floor slab will be used it is recommended that the upper 200 mm of sub-slab fill consists of 19 mm clear crushed stone. All backfill material within the footprint of the proposed building should be placed in maximum 300 mm thick loose layers and compacted to at least 98% of its SPMDD.

5.6 Basement Wall

It is understood that the basement walls are to be poured against a dampproofing system, which will be placed against the exposed bedrock face. Below the bedrock surface, a nominal coefficient for at-rest earth pressure of 0.01 is recommended in conjunction with a bulk unit weight of 24.5 kN/m³ (effective 15.5 kN/m³). A seismic earth pressure component will not be applicable for the foundation wall, which is to be poured against the bedrock face. It is expected that the seismic earth pressure will be transferred to the underground floor slabs, which should be designed to accommodate these pressures. A hydrostatic groundwater pressure should be added for the portion below the groundwater level.

Where soil is to be retained, the conditions can be well-represented by assuming the retained soil consists of a material with an angle of internal friction of 30 degrees and a bulk (drained) unit weight of 20 kN/m³. Undrained conditions are anticipated (i.e. below the groundwater level). Therefore, the applicable effective (undrained) unit weight of the retained soil can be taken as 13 kN/m³, where applicable. A hydrostatic pressure should be added to the total static earth pressure when using the effective unit weight.

Two distinct conditions, static and seismic, must be reviewed for design calculations. The parameters for design calculations for the two conditions are presented below.

Static Conditions

The static horizontal earth pressure (p_o) can be calculated using a triangular earth pressure distribution equal to $K_o \cdot \gamma \cdot H$ where:

- K_o = at-rest earth pressure coefficient of the applicable retained soil, 0.5
- γ = unit weight of fill of the applicable retained soil (kN/m³)
- H = height of the wall (m)

An additional pressure having a magnitude equal to $K_o \cdot q$ and acting on the entire height of the wall should be added to the above diagram for any surcharge loading, q (kPa), that may be placed at ground surface adjacent to the wall. The surcharge pressure will only be applicable for static analyses and should not be used in conjunction with the seismic loading case.

Actual earth pressures could be higher than the “at-rest” case if care is not exercised during the compaction of the backfill materials to maintain a minimum separation of 0.3 m from the walls with the compaction equipment.

Seismic Conditions

The total seismic force (P_{AE}) includes both the earth force component (P_o) and the seismic component (ΔP_{AE}).

The seismic earth force (ΔP_{AE}) can be calculated using $0.375 \cdot a_c \cdot \gamma \cdot H^2/g$ where:

$$a_c = (1.45 - a_{max}/g) a_{max}$$

γ = unit weight of fill of the applicable retained soil (kN/m³)

H = height of the wall (m)

g = gravity, 9.81 m/s²

The peak ground acceleration, (a_{max}), for the Ottawa area is 0.32g according to OBC 2012. Note that the vertical seismic coefficient is assumed to be zero.

The earth force component (P_o) under seismic conditions can be calculated using $P_o = 0.5 K_o \gamma H^2$, where $K_o = 0.5$ for the soil conditions noted above.

The total earth force (P_{AE}) is considered to act at a height, h (m), from the base of the wall, where:

$$h = \{P_o \cdot (H/3) + \Delta P_{AE} \cdot (0.6 \cdot H)\} / P_{AE}$$

The earth forces calculated are unfactored. For the ULS case, the earth loads should be factored as live loads, as per OBC 2012.

5.7 Pavement Structure

For design purposes, the flexible pavement structure presented in the following table could be used for the design of car only parking areas in the lower level of the parking garage.

Table 4 - Recommended Pavement Structure - Parking Areas	
Thickness (mm)	Material Description
50	Wear Course - HL 3 or Superpave 12.5 Asphaltic Concrete
150	BASE - OPSS Granular A Crushed Stone
300	SUBBASE - OPSS Granular B Type II
SUBGRADE - Either fill, in situ silty clay or sand or crushed stone material placed over in situ soil.	

Table 5 - Recommended Pavement Structure - Local Roadways, Access Lanes and Heavy Vehicle Parking	
Thickness (mm)	Material Description
40	Wear Course - Superpave 12.5 Asphaltic Concrete
50	Binder Course - Superpave 19.0 Asphaltic Concrete
150	BASE - OPSS Granular A Crushed Stone
400	SUBBASE - OPSS Granular B Type II
SUBGRADE - Either fill, in situ silty clay or sand or crushed stone material placed over in situ soil.	

Minimum Performance Graded (PG) 58-34 asphalt cement should be used for parking areas and local roadways and PG 64-34 asphalt cement should be used for roadways with bus traffic. The pavement granular base and subbase should be placed in maximum 300 mm thick lifts and compacted to a minimum of 100% of the material's SPMDD using suitable vibratory equipment.

The proposed pavement structure, where it abuts the existing pavement, should match the existing pavement layers. It is recommended that a 300 mm wide and 50 mm deep stepped joint be provided where the new asphalt layer joins with the existing asphalt layer to provide more resistance to cracking at the joint.

6.0 Design and Construction Precautions

6.1 Foundation Drainage and Backfill

Foundation Drainage and Waterproofing

It is expected that the building foundation walls will be placed in close proximity to all the boundaries. It is expected that the foundation wall will be blind poured against a drainage system and waterproofing system fastened against the shoring system.

A waterproofing membrane will be required to lessen the effect of water infiltration for the lower P-2 basement level. The waterproofing membrane can be placed and fastened to the shoring system (soldier pile and timber lagging) and should extend to the bottom of the excavation at the founding level of the raft foundation.

It is recommended that the composite drainage system, such as Delta Drain 6000 or equivalent, extend from the exterior finished grade to the founding elevation (underside of raft slab). The purpose of the composite drainage system is to direct any water infiltration resulting from a breach of the waterproofing membrane to the building sump pit. It is recommended that 150 mm diameter sleeves at 3 m centres be cast in the foundation wall at the raft slab interface to allow the infiltration of water to flow to an interior perimeter underfloor drainage pipe. The perimeter drainage pipe should direct water to sump pit(s) within the lower basement area.

Foundation Raft Slab Construction Joints

If applicable, it is expected that the raft slab will be poured in sections. For the construction joint at each pour should incorporate a rubber water stop along with a chemical grout (Xypex or equivalent) applied to the entire vertical joint of the raft slab. Furthermore, a rubber water stop should be incorporated in the horizontal interface between the foundation wall and the raft slab.

Underfloor Drainage

Underfloor drainage will be required to control water infiltration due to groundwater infiltration at the proposed founding elevation. For design purposes, we recommend that 150 mm in diameter perforated pipes be placed along the interior perimeter of the foundation wall and one drainage line within each bay. The spacing of the underfloor drainage system should be confirmed at the time of backfilling the floor completing the excavation when water infiltration can be better assessed.

Adverse Effects of Dewatering on Adjacent Properties

It is understood that up to 2 underground parking levels are planned for the proposed development, with the lower portion of the foundation having a groundwater infiltration control system in place. The existing buildings along the west portion are expected to be founded over bedrock or within the glacial till above the bedrock surface.

Based on field observations and assessment, the groundwater level is anticipated at a 5 to 6 m depth below existing grade. A local groundwater lowering is expected under short-term conditions due to construction of the proposed building. It should be noted that the extent of any significant groundwater lowering will take place within a limited range of the subject site due to the minimal groundwater lowering. It should also be noted that the lower portion of the foundation walls will be waterproofed which will limit groundwater lowering within the subject site and surroundings.

Since the neighbouring structures are founded within native glacial till or directly over a bedrock bearing surface based on available soils information. No issues are expected with respect to groundwater lowering that would cause long term damage to adjacent structures surrounding the proposed building.

Foundation Backfill

Above the bedrock surface, backfill against the exterior sides of the foundation walls should consist of free-draining non frost susceptible granular materials. The greater part of the site excavated materials will be frost susceptible and, as such, are not recommended for re-use as backfill against the foundation walls, unless used in conjunction with a drainage geocomposite, such as Miradrain G100N or Delta Drain 6000, connected to the perimeter foundation drainage system. Imported granular materials, such as clean sand or OPSS Granular B Type I granular material, should otherwise be used for this purpose.

6.2 Protection of Footings Against Frost Action

The parking garage may require protection against frost action depending on the founding depth. Unheated structures, such as the access ramp wall footings, may be required to be insulated against the deleterious effect of frost action. A minimum of 2.1 m of soil cover alone, or a minimum of 0.6 m of soil cover, in conjunction with foundation insulation, should be provided.

Perimeter footings of heated structures are required to be insulated against the deleterious effects of frost action. A minimum of 1.5 m of soil cover alone, or a minimum of 0.6 m of soil cover, in conjunction with adequate foundation insulation, should be provided. More details regarding foundation insulation can be provided, if requested.

The effectiveness of this operation will depend on the ability of maintaining vertical trenches until the lean concrete can be poured. It is suggested that once the bottom of the excavation is exposed, an assessment should be completed to determine the water infiltration and stability of the excavation sidewalls extending to the bedrock surface.

Exterior unheated footings, such as those for isolated exterior piers, are more prone to deleterious movement associated with frost action than the exterior walls of the heated structure and require additional protection, such as soil cover of 2.1 m or an equivalent combination of soil cover and foundation insulation.

6.3 Excavation Side Slopes

Unsupported Side Slopes

The side slopes of excavations in the soil and fill overburden materials should either be excavated at acceptable slopes or should be retained by shoring systems from the beginning of the excavation until the structure is backfilled. Insufficient room is expected for majority of the excavation to be constructed by open-cut methods (i.e. unsupported excavations).

The excavation side slopes above the groundwater level extending to a maximum depth of 3 m should be excavated at 1H:1V or shallower. The shallower slope is required for excavation below groundwater level. The subsurface soils are considered to be a Type 2 and 3 soil according to the Occupational Health and Safety Act and Regulations for Construction Projects.

Excavated soil should not be stockpiled directly at the top of excavations and heavy equipment should be kept away from the excavation sides.

Slopes in excess of 3 m in height should be periodically inspected by the geotechnical consultant in order to detect if the slopes are exhibiting signs of distress. A trench box is recommended to protect personnel working in trenches with steep or vertical sides. Services are expected to be installed by "cut and cover" methods and excavations should not remain open for extended periods of time.

Temporary Shoring

Temporary shoring will be required to support the overburden soils. The design and implementation of these temporary systems will be the responsibility of the excavation contractor or the shoring contractor and their design team. Inspections and approval of the temporary system will also be the responsibility of the designer. Geotechnical information provided below is to assist the designer in completing a suitable and safe shoring system. The designer should take into account the impact of a significant precipitation event and designate design measures to ensure that a precipitation will not negatively impact the shoring system or soils supported by the system. Any changes to the approved shoring design system should be reported immediately to the owner’s representative prior to implementation.

Temporary shoring may be required to complete the required excavations where insufficient room is available for open cut methods. The shoring requirements will depend on the depth of the excavation, the proximity of the adjacent buildings and underground structures and the elevation of the adjacent building foundations and underground services. Additional information can be provided when the above details are known.

For design purposes, the temporary system may consist of soldier pile and lagging system or interlocking steel sheet piling. Any additional loading due to street traffic, construction equipment, adjacent structures and facilities, etc., should be added to the earth pressures described below. These systems can be cantilevered, anchored or braced. The earth pressures acting on the shoring system may be calculated using the following parameters.

Table 6 - Soil Parameters for Shoring System Design	
Parameters	Values
Active Earth Pressure Coefficient (K_a)	0.33
Passive Earth Pressure Coefficient (K_p)	3
At-Rest Earth Pressure Coefficient (K_o)	0.5
Unit Weight (γ), kN/m ³	20
Submerged Unit Weight (γ), kN/m ³	13

Generally, it is expected that the shoring systems will be provided with tie-back rock anchors to ensure their stability. It is further recommended that the toe of the shoring be adequately supported to resist toe failure.

The geotechnical design of grouted rock anchors in sedimentary bedrock is based upon two possible failure modes. The anchor can fail either by shear failure along the grout/rock interface or by pullout of a 60 to 90 degree cone of rock with the apex of the cone near the middle of the bonded length of the anchor.

The anchor derives its capacity from the bonded portion, or fixed anchor length, at the base of the anchor. An unbonded portion, or free anchor length, is also usually provided between the rock surface and the start of the bonded length. A factored tensile grout to rock bond resistance value at ULS of **1.0 MPa**, incorporating a resistance factor of 0.3, can be used. A minimum grout strength of 40 MPa is recommended.

It is recommended that the anchor drill hole diameter be within 1.5 to 2 times the rock anchor tendon diameter and the anchor drill holes be inspected by geotechnical personnel and should be flushed clean prior to grouting. The use of a grout tube to place grout from the bottom up in the anchor holes is further recommended.

The geotechnical capacity of each rock anchor should be proof tested at the time of construction. More information on testing can be provided upon request. Compressive strength testing is recommended to be completed for the rock anchor grout. A set of grout cubes should be tested for each day grout is prepared.

Soldier Pile and Lagging System

The active earth pressure acting on a soldier pile and lagging shoring system can be calculated using a rectangular earth pressure distribution with a maximum pressure of $0.65 K \gamma H$ for strutted or anchored shoring or a triangular earth pressure distribution with a maximum value of $K \gamma H$ for a cantilever shoring system. H is the height of the excavation.

The active earth pressure should be used where wall movements are permissible while the at-rest pressure should be used if no movement is permissible.

The total unit weight should be used above the groundwater level while the submerged unit weight should be used below the groundwater level.

The hydrostatic groundwater pressure should be added to the earth pressure distribution wherever the submerged unit weights are used for earth pressure calculations should the level on the groundwater not be lowered below the bottom of the excavation. If the groundwater level is lowered, the total unit weight for the soil should be used full weight, with no hydrostatic groundwater pressure component.

Concrete Underpinning

Based on proximity of existing adjacent buildings support in the form of concrete underpinning maybe required during excavation for the proposed building. It is expected that the founding elevations of the existing foundations will be in close proximity to the bedrock surface (less than 1.5 m) and conventional concrete underpinning may be used to support the full width and length of the foundation.

It is expected that the structural engineer along with the geotechnical engineer will review the site conditions at the time of construction and finalize the underpinning program based on their observations at that time.

6.4 Pipe Bedding and Backfill

Bedding and backfill materials should be in accordance with the most recent Material Specifications & Standard Detail Drawings from the Department of Public Works and Services, Infrastructure Services Branch of the City of Ottawa.

A minimum of 150 mm of OPSS Granular A should be placed for bedding for sewer or water pipes when placed on soil subgrade. If the bedding is placed on bedrock, the thickness of the bedding should be increased to 300 mm for sewer pipes. The bedding should extend to the spring line of the pipe. Cover material, from the spring line to a minimum of 300 mm above the obvert of the pipe should consist of OPSS Granular A (concrete or PSM PVC pipes) or sand (concrete pipe). The bedding and cover materials should be placed in maximum 225 mm thick lifts and compacted to 95% of the SPMDD.

Where hard surface areas are considered above the trench backfill, the trench backfill material within the frost zone (about 1.8 m below finished grade) should match the soils exposed at the trench walls to reduce the potential differential frost heaving. The trench backfill should be placed in maximum 300 mm thick loose lifts and compacted to a minimum of 95% of the SPMDD.

6.5 Groundwater Control

It is anticipated that groundwater infiltration into the excavations should be controllable using open sumps. The contractor should be prepared to direct water away from all bearing surfaces and subgrades, regardless of the source, to prevent disturbance to the founding medium.

A temporary Ministry of Environment, Conservation and Parks (MECP) Category 3 Permit to Take Water (PTTW) may be required if more than 400,000 L/day are to be pumped during the construction phase. At least 4 to 5 months should be allowed for completion of the application and issuance of the permit by the MECP.

For typical ground or surface water volumes being pumped during the construction phase, typically between 50,000 to 400,000 L/day, it is required to register on the Environmental Activity and Sector Registry (EASR). A minimum of two to four weeks should be allotted for completion of the EASR registration and the Water Taking and Discharge Plan to be prepared by a Qualified Person as stipulated under O.Reg. 63/16. If a project qualifies for a PTTW based upon anticipated conditions, an EASR will not be allowed as a temporary dewatering measure while awaiting the MECP review of the PTTW application.

6.6 Winter Construction

Precautions must be taken if winter construction is considered for this project. The subsoil conditions at this site mostly consist of frost susceptible materials. In presence of water and freezing conditions ice could form within the soil mass. Heaving and settlement upon thawing could occur.

In the event of construction during below zero temperatures, the founding stratum should be protected from freezing temperatures by the use of straw, propane heaters and tarpaulins or other suitable means. In this regard, the base of the excavations should be insulated from sub-zero temperatures immediately upon exposure and until such time as heat is adequately supplied to the building and the footings are protected with sufficient soil cover to prevent freezing at founding level.

The trench excavations should be carried out in a manner to avoid the introduction of frozen materials, snow or ice into the trenches. Precaution must be taken where excavations are carried in proximity of existing structures which may be adversely affected due to the freezing conditions. In particular, it should be recognized that where a shoring system is used, the soil behind the shoring system will be subjected to freezing conditions and could result in heaving of the structure(s) placed within or above frozen soil. Provisions should be made in the contract document to protect the walls of the excavations from freezing, if applicable.

6.7 Corrosion Potential and Sulphate

The analytical testing results indicate that the sulphate content is less than 0.1%. This result indicates that Type 10 Portland Cement (i.e. normal cement) would be appropriate for this site. The chloride content and pH of the samples indicate that they are not significant factors in creating a corrosive environment, whereas the resistivity is indicative of an aggressive corrosive environment.

7.0 Recommendations

A materials testing and observation services program is a requirement for the provided foundation design data to be applicable. The following aspects of the program should be performed by the geotechnical consultant:

- Review of the geotechnical aspects of the excavating contractor's shoring design, prior to construction.
- Review the bedrock stabilization and excavation requirements.
- Review proposed foundation drainage design and requirements.
- Observation of all bearing surfaces prior to the placement of concrete.
- Sampling and testing of the concrete and fill materials used.
- Observation of all subgrades prior to backfilling.
- Field density tests to determine the level of compaction achieved.

A report confirming that these works have been conducted in general accordance with our recommendations could be issued, upon request, following the completion of a satisfactory materials testing and observation program by the geotechnical consultant.

8.0 Statement of Limitations

The recommendations provided in this report are in accordance with our present understanding of the project. We request permission to review our recommendations when the drawings and specifications are completed.

A soils investigation is a limited sampling of a site. Should any conditions at the site be encountered which differ from those at the test locations, we request immediate notification to permit reassessment of our recommendations.

The recommendations provided herein should only be used by the design professionals associated with this project. They are not intended for contractors bidding on or undertaking the work. The latter should evaluate the factual information provided in this report and determine its suitability and completeness for their intended construction schedule and methods. Additional testing may be required for their purposes.

The present report applies only to the project described in this document. Use of this report for purposes other than those described herein or by person(s) other than Brigil or their agents is not authorized without review by Paterson for the applicability of our recommendations to the alternative use of the report.

Paterson Group Inc.



Joey R. Villeneuve, M.A.Sc., P.Eng.



David J. Gilbert, P.Eng.

Report Distribution

- Brigil
- Paterson Group

APPENDIX 1

SOIL PROFILE AND TEST DATA SHEETS

SYMBOLS AND TERMS

ANALYTICAL TESTING RESULTS

DATUM Geodetic

REMARKS

BORINGS BY CME-55 Low Clearance Drill

DATE June 25, 2020

FILE NO. **PG5172**

HOLE NO. **BH 1**

SOIL DESCRIPTION	STRATA PLOT	SAMPLE				DEPTH (m)	ELEV. (m)	Pen. Resist. Blows/0.3m ● 50 mm Dia. Cone				Piezometer Construction
		TYPE	NUMBER	RECOVERY %	N VALUE or RQD			○ Water Content %				
GROUND SURFACE							20	40	60	80		
Asphaltic concrete FILL: Brown silty sand with crushed stone	0.08 0.51	AU	1			0	82.55					
Hard to very stiff, brown SILTY CLAY		SS	2	67	10	1	81.55					
		SS	3	67	14	2	80.55					
		SS	4	100	10	3	79.55					
		SS	5	100	28	4	78.55					
GLACIAL TILL: Compact to dense, brown silty sand and gravel	3.05	SS	6	33	8	4	78.55					
		SS	7	33	4	5	77.55					
		SS	8	43	50+							
End of Borehole Practical refusal to augering at 5.84m depth. (GWL @ 2.75m - July 7, 2020)	5.84											

20 40 60 80 100
Shear Strength (kPa)
 ▲ Undisturbed △ Remoulded

DATUM Geodetic

REMARKS

BORINGS BY CME-55 Low Clearance Drill

DATE June 25, 2020

FILE NO. PG5172

HOLE NO. BH 2

SOIL DESCRIPTION	STRATA PLOT	SAMPLE				DEPTH (m)	ELEV. (m)	Pen. Resist. Blows/0.3m ● 50 mm Dia. Cone				Piezometer Construction	
		TYPE	NUMBER	RECOVERY %	N VALUE or RQD			○ Water Content %					
GROUND SURFACE								20	40	60	80		
Asphaltic concrete FILL: Brown silty sand with crushed stone	0.10 0.60	AU	1			0	81.92						
Very stiff, brown SILTY CLAY , trace sand	1.37	SS	2	29	11	1	80.92						
GLACIAL TILL: Compact to dense, brown silty sand with clay and gravel, some cobbles		SS	3	67	18	2	79.92						
		SS	4	33	19	3	78.92						
		SS	5	33	25	4	77.92						
		SS	6	25	16	5	76.92						
		SS	7	33	19	6	75.92						
		SS	8	83	4								
		SS	9	50	50+								
End of Borehole Practical refusal to augering at 6.35m depth. (GWL @ 3.54m - July 7, 2020)	6.35												

20 40 60 80 100
Shear Strength (kPa)
 ▲ Undisturbed △ Remoulded

DATUM Geodetic

REMARKS

BORINGS BY CME-55 Low Clearance Drill

DATE June 25, 2020

FILE NO. PG5172

HOLE NO. BH 3

SOIL DESCRIPTION	STRATA PLOT	SAMPLE				DEPTH (m)	ELEV. (m)	Pen. Resist. Blows/0.3m ● 50 mm Dia. Cone				Piezometer Construction	
		TYPE	NUMBER	RECOVERY %	N VALUE or RQD			○ Water Content %					
GROUND SURFACE								20	40	60	80		
Asphaltic concrete FILL: Brown silty sand with crushed stone	0.10 0.60	AU	1			0	82.05						
Very stiff, brown SILTY CLAY , trace sand		SS	2	75	12	1	81.05						
		SS	3	100	12	2	80.05						
		SS	4	100	11	3	79.05						
		SS	5	50	21	4	78.05						
GLACIAL TILL: Comapct to dense, brown silty sand, some clay and gravel, trace cobbles	2.90	SS	6	58	21	5	77.05						
		SS	7	58	8	6	76.05						
		SS	8	17	44	7	75.05						
		SS	9	8	8	8							
		SS	10	25	50+	9							
End of Borehole Practical refusal to augering at 7.26m depth. (GWL @ 4.72m - July 7, 2020)	7.26					7	75.05						

20 40 60 80 100
Shear Strength (kPa)
 ▲ Undisturbed △ Remoulded

DATUM Geodetic

FILE NO. PG5172

REMARKS

HOLE NO. BH 4

BORINGS BY CME-55 Low Clearance Drill

DATE June 25, 2020

SOIL DESCRIPTION	STRATA PLOT	SAMPLE				DEPTH (m)	ELEV. (m)	Pen. Resist. Blows/0.3m ● 50 mm Dia. Cone				Piezometer Construction
		TYPE	NUMBER	RECOVERY %	N VALUE or RQD			○ Water Content %				
GROUND SURFACE								20	40	60	80	
Asphaltic concrete	0.10	AU	1			0	81.35					
FILL: Brown silty sand with crushed stone, trace cobbles		SS	2	67	47	1	80.35					
		SS	3	8	8	2	79.35					
	2.29											
Very stiff, brown SILTY CLAY , trace sand		SS	4	100	11	3	78.35					
- sand seam at 3.4m depth		SS	5		11							
	3.81											
GLACIAL TILL: Dense, brown silty sand, some gravel, trace clay, cobbles and boulders		SS	6		41	4	77.35					
		SS	7		50+							
End of Borehole	4.80											
Practical refusal to augering at 4.80m depth. (GWL @ 4.01m - July 7, 2020)												

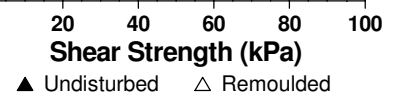

DATUM Geodetic

REMARKS

BORINGS BY CME-55 Low Clearance Drill

DATE June 25, 2020

FILE NO. PG5172

HOLE NO. BH 5

SOIL DESCRIPTION	STRATA PLOT	SAMPLE				DEPTH (m)	ELEV. (m)	Pen. Resist. Blows/0.3m ● 50 mm Dia. Cone				Piezometer Construction
		TYPE	NUMBER	RECOVERY %	N VALUE or RQD			○ Water Content %				
								20	40	60	80	
GROUND SURFACE												
Asphaltic concrete FILL: Brown silty sand with crushed stone	0.10 0.60	AU	1			0	81.71					
Hard to very stiff, brown SILTY CLAY		SS	2	100	8	1	80.71					
		SS	3	100	13	2	79.71					
		SS	4	100	9	3	78.71					
		SS	5	67	8	4	77.71					
GLACIAL TILL: Loose to compact, brown silty sand, some gravel, trace clay and cobbles - grey by 4.9m depth	2.90	SS	6	42	15	5	76.71					
		SS	7	67	12	6						
		SS	8	50	13	7						
End of Borehole Practical refusal to augering at 5.89m depth. (GWL @ 3.28m - July 7, 2020)	5.89											

20 40 60 80 100
Shear Strength (kPa)
 ▲ Undisturbed △ Remoulded

DATUM Geodetic

REMARKS

BORINGS BY CME-55 Low Clearance Drill

DATE June 26, 2020

FILE NO. PG5172

HOLE NO. BH 6

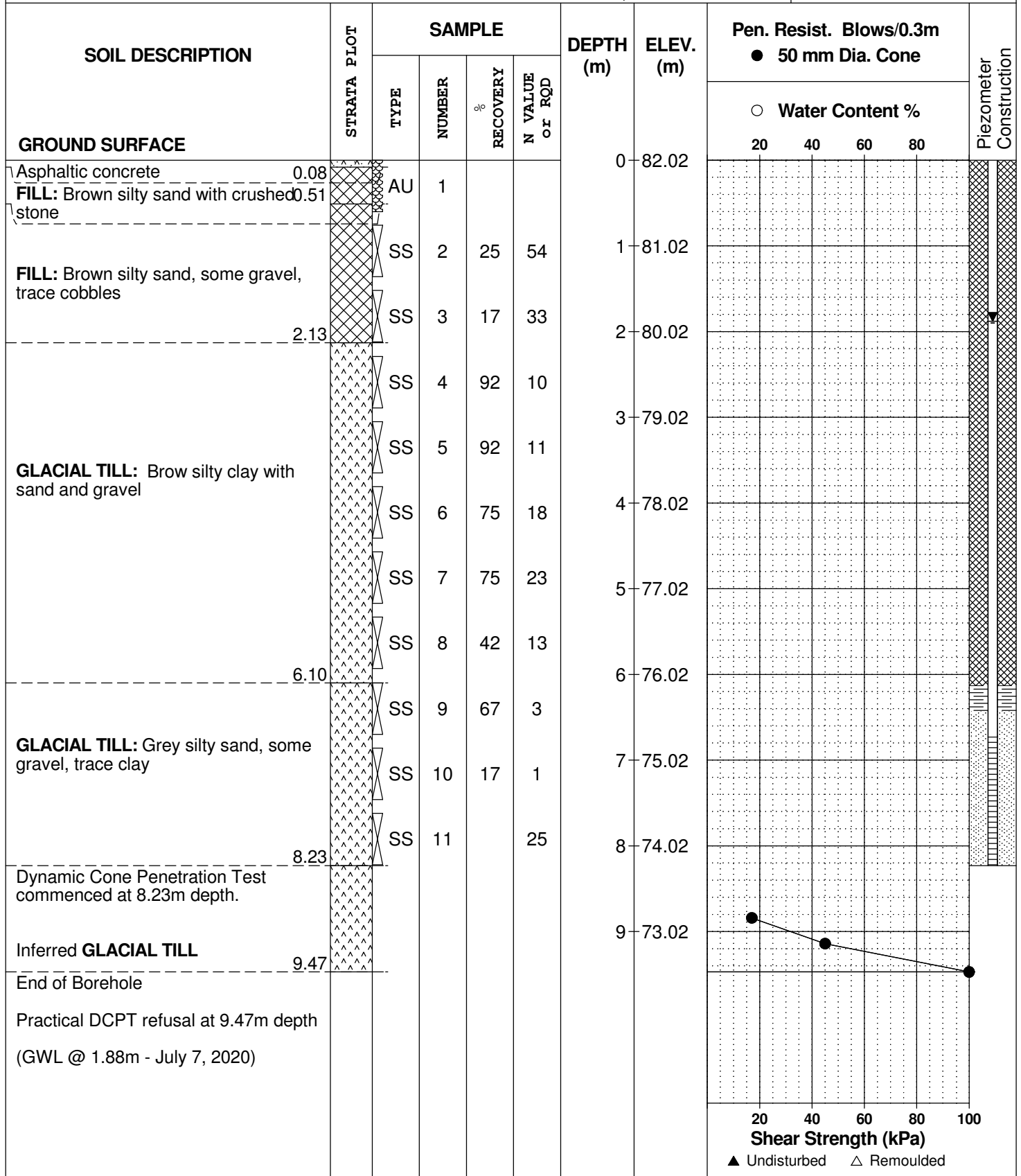

DATUM Geodetic

REMARKS

BORINGS BY CME-55 Low Clearance Drill

DATE June 25, 2020

FILE NO. PG5172

HOLE NO. BH 7

SOIL DESCRIPTION	STRATA PLOT	SAMPLE				DEPTH (m)	ELEV. (m)	Pen. Resist. Blows/0.3m ● 50 mm Dia. Cone				Piezometer Construction
		TYPE	NUMBER	RECOVERY %	N VALUE or RQD			○ Water Content %				
								20	40	60	80	
GROUND SURFACE												
Asphaltic concrete FILL: Brown silty sand with crushed stone	0.10 - 0.76	AU	1			0	81.61					
FILL: Brown silty clay, trace sand and gravel	0.76 - 1.37	SS	2	83	10	1	80.61					
FILL: Brown silty sand, trace gravel	1.37 - 1.68	SS	3	100	14	2	79.61					
FILL: Brown silty clay, trace sand	1.68 - 2.13	SS	4	83	22	3	78.61					
GLACIAL TILL: Brown silty clay with sand and gravel, trace cobbles		SS	5	92	39	4	77.61					
		SS	6	4	29	5	76.61					
		SS	7	33	15	6	75.61					
GLACIAL TILL: Grey silty sand, trace clay, gravel and cobbles	4.57 - 5.87	SS	8	38	19	7	74.61					
		SS	8	38	19	8	73.61					
BEDROCK: Fair to poor quality, grey limestone		RC	1	92	65	9	72.61					
		RC	2	100	48							
End of Borehole (GWL @ 3.15m - July 7, 2020)	9.04											

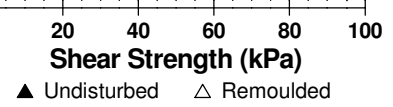

SYMBOLS AND TERMS

SOIL DESCRIPTION

Behavioural properties, such as structure and strength, take precedence over particle gradation in describing soils. Terminology describing soil structure are as follows:

Desiccated	-	having visible signs of weathering by oxidation of clay minerals, shrinkage cracks, etc.
Fissured	-	having cracks, and hence a blocky structure.
Varved	-	composed of regular alternating layers of silt and clay.
Stratified	-	composed of alternating layers of different soil types, e.g. silt and sand or silt and clay.
Well-Graded	-	Having wide range in grain sizes and substantial amounts of all intermediate particle sizes (see Grain Size Distribution).
Uniformly-Graded	-	Predominantly of one grain size (see Grain Size Distribution).

The standard terminology to describe the strength of cohesionless soils is the relative density, usually inferred from the results of the Standard Penetration Test (SPT) 'N' value. The SPT N value is the number of blows of a 63.5 kg hammer, falling 760 mm, required to drive a 51 mm O.D. split spoon sampler 300 mm into the soil after an initial penetration of 150 mm.

Relative Density	'N' Value	Relative Density %
Very Loose	<4	<15
Loose	4-10	15-35
Compact	10-30	35-65
Dense	30-50	65-85
Very Dense	>50	>85

The standard terminology to describe the strength of cohesive soils is the consistency, which is based on the undisturbed undrained shear strength as measured by the in situ or laboratory vane tests, penetrometer tests, unconfined compression tests, or occasionally by Standard Penetration Tests.

Consistency	Undrained Shear Strength (kPa)	'N' Value
Very Soft	<12	<2
Soft	12-25	2-4
Firm	25-50	4-8
Stiff	50-100	8-15
Very Stiff	100-200	15-30
Hard	>200	>30

SYMBOLS AND TERMS (continued)

SOIL DESCRIPTION (continued)

Cohesive soils can also be classified according to their "sensitivity". The sensitivity is the ratio between the undisturbed undrained shear strength and the remoulded undrained shear strength of the soil.

Terminology used for describing soil strata based upon texture, or the proportion of individual particle sizes present is provided on the Textural Soil Classification Chart at the end of this information package.

ROCK DESCRIPTION

The structural description of the bedrock mass is based on the Rock Quality Designation (RQD).

The RQD classification is based on a modified core recovery percentage in which all pieces of sound core over 100 mm long are counted as recovery. The smaller pieces are considered to be a result of closely-spaced discontinuities (resulting from shearing, jointing, faulting, or weathering) in the rock mass and are not counted. RQD is ideally determined from NXL size core. However, it can be used on smaller core sizes, such as BX, if the bulk of the fractures caused by drilling stresses (called "mechanical breaks") are easily distinguishable from the normal in situ fractures.

RQD %	ROCK QUALITY
90-100	Excellent, intact, very sound
75-90	Good, massive, moderately jointed or sound
50-75	Fair, blocky and seamy, fractured
25-50	Poor, shattered and very seamy or blocky, severely fractured
0-25	Very poor, crushed, very severely fractured

SAMPLE TYPES

SS	-	Split spoon sample (obtained in conjunction with the performing of the Standard Penetration Test (SPT))
TW	-	Thin wall tube or Shelby tube
PS	-	Piston sample
AU	-	Auger sample or bulk sample
WS	-	Wash sample
RC	-	Rock core sample (Core bit size AXT, BXL, etc.). Rock core samples are obtained with the use of standard diamond drilling bits.

SYMBOLS AND TERMS (continued)

GRAIN SIZE DISTRIBUTION

MC%	-	Natural moisture content or water content of sample, %
LL	-	Liquid Limit, % (water content above which soil behaves as a liquid)
PL	-	Plastic limit, % (water content above which soil behaves plastically)
PI	-	Plasticity index, % (difference between LL and PL)
Dxx	-	Grain size which xx% of the soil, by weight, is of finer grain sizes These grain size descriptions are not used below 0.075 mm grain size
D10	-	Grain size at which 10% of the soil is finer (effective grain size)
D60	-	Grain size at which 60% of the soil is finer
Cc	-	Concavity coefficient = $(D_{30})^2 / (D_{10} \times D_{60})$
Cu	-	Uniformity coefficient = D_{60} / D_{10}

Cc and Cu are used to assess the grading of sands and gravels:

Well-graded gravels have: $1 < Cc < 3$ and $Cu > 4$

Well-graded sands have: $1 < Cc < 3$ and $Cu > 6$

Sands and gravels not meeting the above requirements are poorly-graded or uniformly-graded.

Cc and Cu are not applicable for the description of soils with more than 10% silt and clay (more than 10% finer than 0.075 mm or the #200 sieve)

CONSOLIDATION TEST

p'_o	-	Present effective overburden pressure at sample depth
p'_c	-	Preconsolidation pressure of (maximum past pressure on) sample
Ccr	-	Recompression index (in effect at pressures below p'_c)
Cc	-	Compression index (in effect at pressures above p'_c)
OC Ratio		Overconsolidation ratio = p'_c / p'_o
Void Ratio		Initial sample void ratio = volume of voids / volume of solids
Wo	-	Initial water content (at start of consolidation test)

PERMEABILITY TEST

k	-	Coefficient of permeability or hydraulic conductivity is a measure of the ability of water to flow through the sample. The value of k is measured at a specified unit weight for (remoulded) cohesionless soil samples, because its value will vary with the unit weight or density of the sample during the test.
---	---	--

SYMBOLS AND TERMS (continued)

STRATA PLOT



Topsoil



Asphalt



Fill



Peat



Sand



Silty Sand

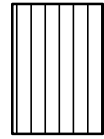

Silt



Sandy Silt



Clay



Silty Clay



Clayey Silty Sand



Glacial Till



Shale

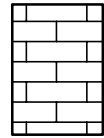

Bedrock

MONITORING WELL AND PIEZOMETER CONSTRUCTION

MONITORING WELL CONSTRUCTION

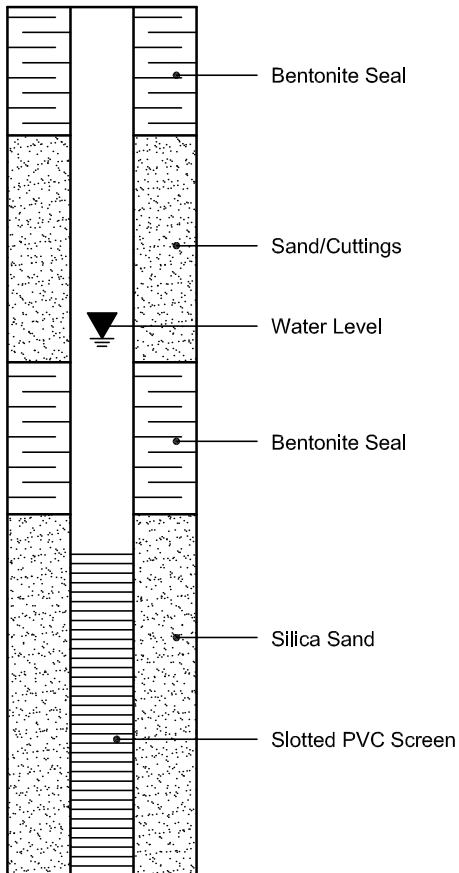

PIEZOMETER CONSTRUCTION

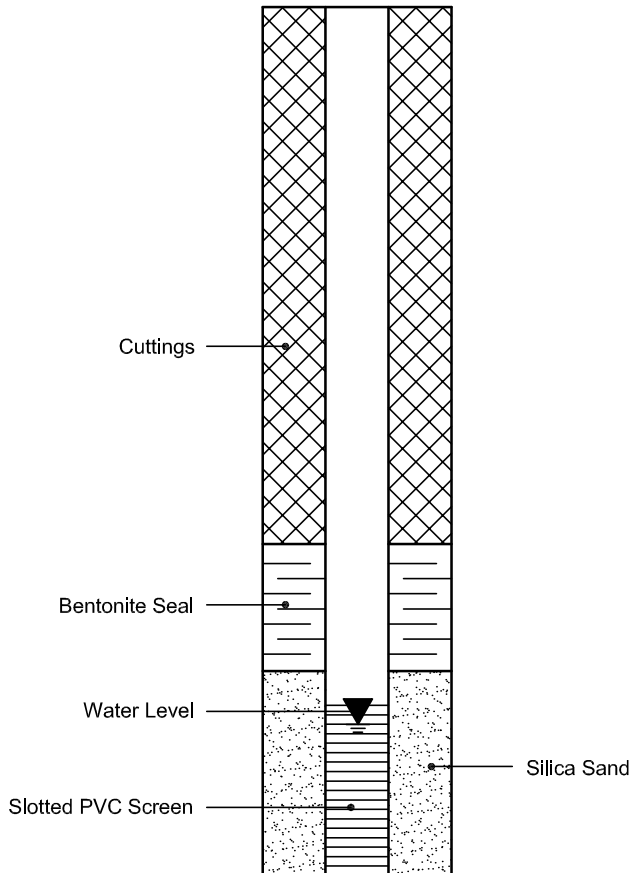

Certificate of Analysis

Report Date: 03-Jul-2020

Client: Paterson Group Consulting Engineers

Order Date: 26-Jun-2020

Client PO: 24713

Project Description: PG5172

Client ID:	BH3-SS3	-	-	-
Sample Date:	25-Jun-20 13:00	-	-	-
Sample ID:	2026529-01	-	-	-
MDL/Units	Soil	-	-	-

Physical Characteristics

% Solids	0.1 % by Wt.	74.6	-	-	-
----------	--------------	------	---	---	---

General Inorganics

pH	0.05 pH Units	7.58	-	-	-
Resistivity	0.10 Ohm.m	13.3	-	-	-

Anions

Chloride	5 ug/g dry	179	-	-	-
Sulphate	5 ug/g dry	389	-	-	-

APPENDIX 2

FIGURE 1 - KEY PLAN

DRAWING PG5172-1 - TEST HOLE LOCATION PLAN

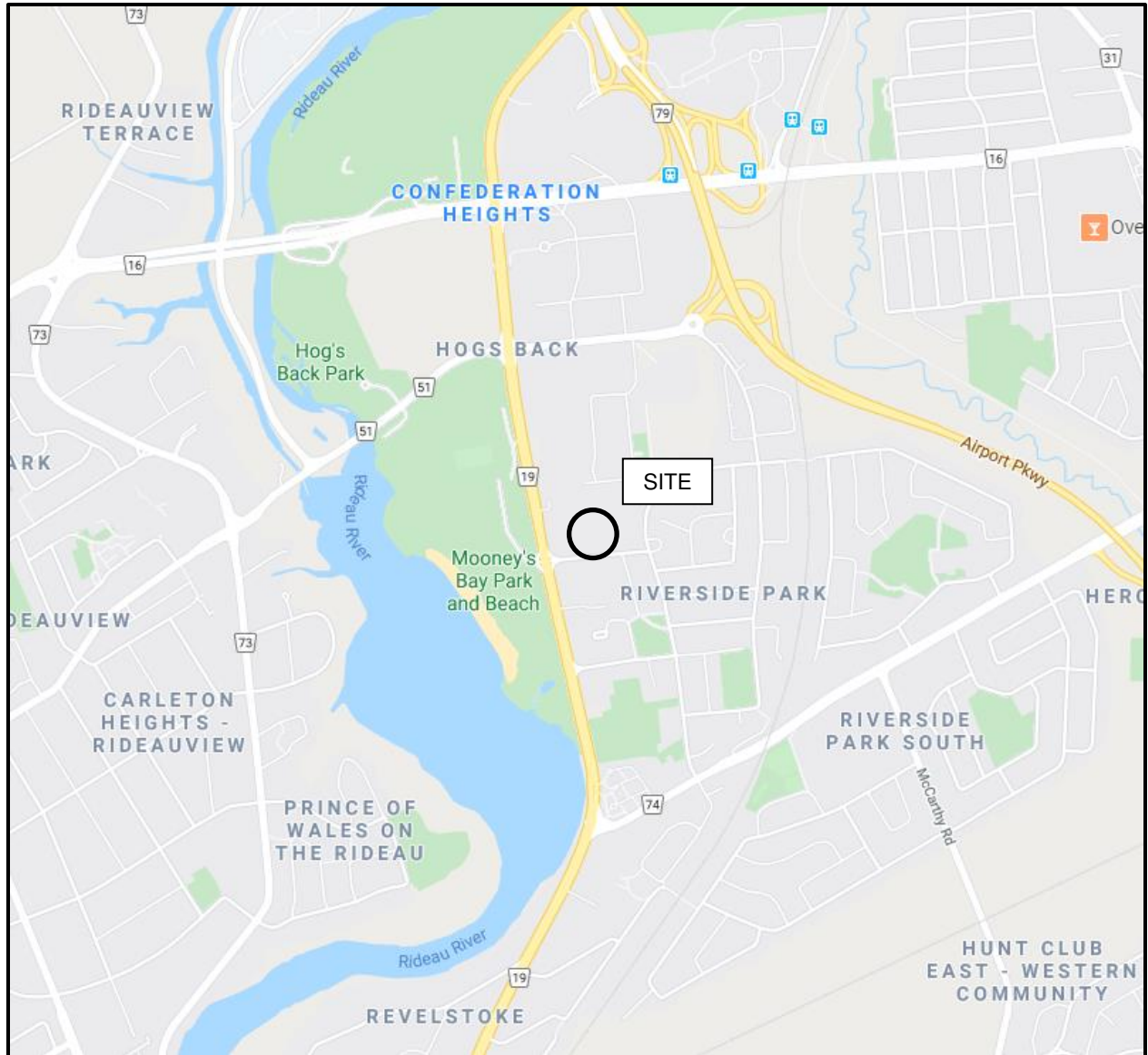
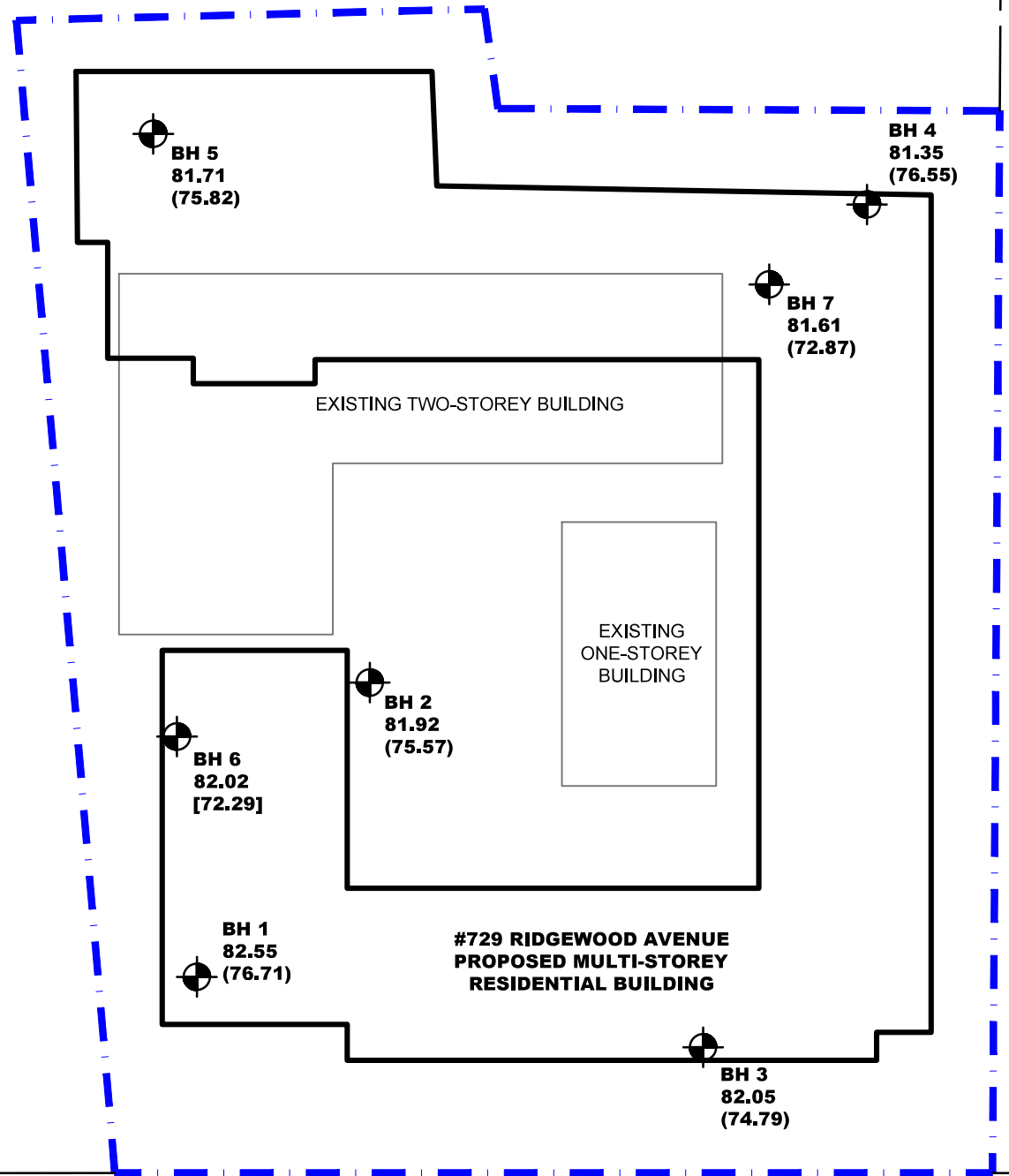

FIGURE 1

KEY PLAN



RIVERSIDE DRIVE



RIDGEWOOD AVENUE

LEGEND:

-  BOREHOLE LOCATION
- 82.05 GROUND SURFACE ELEVATION (m)
- (74.79) REFUSAL TO AUGERING ELEVATION (m)
- [72.29] BEDROCK SURFACE ELEVATION (m)

ALL GROUND SURFACE ELEVATIONS REFERENCE A GEODETIC DATUM (NAD83)

SCALE: 1:750



patersongroup
consulting engineers

154 Colonnade Road South
Ottawa, Ontario K2E 7J5
Tel: (613) 226-7381 Fax: (613) 226-6344

NO.	REVISIONS	DATE	INITIAL

BRIGIL
GEOTECHNICAL INVESTIGATION
729 RIDGEWOOD AVENUE

OTTAWA, ONTARIO

TEST HOLE LOCATION PLAN

Scale:	1:750	Date:	07/2020
Drawn by:	NFRV	Report No.:	PG5172-1
Checked by:	JV	Dwg. No.:	PG5172-1
Approved by:	DJG	Revision No.:	

c:\users\nicholas\desktop\pg5172_report\drafting\pg5172-1 test hole location plan.dwg

Phase One Environmental Site Assessment

729 Ridgewood
Avenue
Ottawa, Ontario

Prepared for:
11684663 Canada Inc.



July 27, 2020

Table of Contents

1. Executive Summary	1
2. Introduction	4
3. Scope of Investigation	5
4. Records Review.....	6
a) General.....	6
i. Phase One Study Area	6
ii. First Developed Use Determination.....	6
iii. Fire Insurance Plans.....	6
iv. Chain of Title.....	6
v. Environmental Reports.....	8
b) Environmental Source Information.....	10
c) Physical Setting Sources	16
i. Aerial Photographs	16
ii. Topography, Hydrology, Geology.....	18
iii. Fill Materials	19
iv. Water Bodies and Areas of Natural Significance & Ground Water Information	19
v. Well Records.....	19
d) Site Operating Records.....	20
5. Interviews.....	20
6. Site Reconnaissance.....	21
a) General Requirements.....	21
b) Specific Observations at Phase One Property.....	22
i. Enhanced Investigation Property.....	24
c) Land Use Observations of the Phase One Study Area	24
7. Review and Evaluation of Information.....	25
a) Current and Past Land Use	25
b) Potentially Contaminating Activity	26

c) Areas of Potential Environmental Concern.....	27
d) Phase One Conceptual Site Model.....	28
8. Conclusions.....	31
i. Whether Phase Two Environmental Site Assessment Required Before Record of Site Condition Submitted.....	31
ii. Record of Site Condition Based on Phase One Environmental Site Assessment Alone.....	31
iii. Signatures.....	32
iv. Limitations.....	32
9. References.....	33
10. Appendices.....	35

List of Figures

Figure 1:	Key Plan
Figure 2:	Site Plan
Figure 3:	Surrounding Land Use

List of Tables

Table 1: Potentially Contaminating Activities and Areas of Potential Environmental Concern.....	3
Table 2: Chain of Title Ownership Summary.....	7
Table 3: Building Occupants.....	22
Table 4: Current and Past Land Use.....	25
Table 5: Potentially Contaminating Activities at the Phase One Property.....	26
Table 6: Potentially Contaminating Activities in the Phase One Study Area.....	26
Table 7: Areas of Potential Environmental Concern.....	27

List of Appendices

Appendix A – Legal Survey Plan
Appendix B – Current Proposed Design Concept Plan
Appendix C - Chain of Title
Appendix D – Environmental Risk Information Systems (ERIS) database Search
Appendix E – Ministry of Environment, Conservation and Parks Freedom of Information (FOI) Request
Appendix F – Technical Standards and Safety Association Correspondence
Appendix G – City of Ottawa Historic Land Use Inventory (HLUI)
Appendix H – Aerial Photographs
Appendix I – Topographic Map
Appendix J – Photographic Log
Appendix K – Qualifications of Assessors

1. Executive Summary

Lopers & Associates (Lopers) was retained by 11684663 Canada Inc. (Brigil) to complete a Phase One Environmental Site Assessment (Phase One ESA) of the commercial property with Civic address No. 729 Ridgewood Avenue, Ottawa, Ontario ("Phase One Property", "Property" or "Site").

This Phase One ESA is being completed as part of due diligence requirements associated with the submission of a Development Application to the City of Ottawa Municipal Planning Department. This Phase One ESA can also be used to support the filing of a record of site condition for the Property.

The Phase One Property was undeveloped prior to the 1950's when initial development was interpreted to have been for residential purposes. A commercial lease was registered at the Phase One Property in 1965 and it is inferred that commercial redevelopment of the Property occurred at this time. Demolition of the former residential building was completed prior to 1991. A retail fuel outlet and automotive service garage were present as part of the original commercial development at the Phase One Property and operated on the southeast portion of the Property until 2002 and 2018, respectively. The automotive garage moved to the south unit of the south commercial building in 2018 and has operated at that location on the Phase One Property since that time.

The Property is currently used for commercial purposes and is zoned for mixed use. Brigil purchased the Phase One Property in November of 2019, and it is understood that the intended future use is for mixed use, with commercial ground floors and residential apartments on the subsequent levels. The Phase One Property is immediately surrounded by a municipal Right-of-Way to the south followed by a mixed institutional/commercial property and by residential properties to the north, east and west.

The presence of a former retail fuel outlet and automotive service garage on the southeast portion of the Phase One Property are a significant potentially contaminating activities (PCAs) which represent areas of potential environmental concern (APECs) for the Property. Given that previous reports were provided which document remnant petroleum hydrocarbon (PHC) and benzene, toluene, ethylbenzene and xylenes (BTEXs) soil contamination and that groundwater quality was not confirmed following the completion of a remediation program, further investigation is warranted. The contaminants of potential concern associated with retail fuelling are generally PHCs and BTEXs, and metals as this was an older facility and lead was historically present in gasoline. Based on historical soil analysis in this area of the Property, polycyclic aromatic hydrocarbons (PAH) and volatile organic compounds (VOCs) are also considered contaminants of potential concern associated with the former automotive garage operations.

The practice of backfilling following demolition activities at the Phase One Property is also a significant PCA which represents an APEC for the Property. Given that no reports were provided with analytical data to support the environmental quality of the backfill used to fill the former residential building footprint on the central-south portion of the Property, this area warrants further investigation. The contaminants of potential concern commonly found in poor environmental quality backfill are PHCs/BTEXs, PAHs and metals.

The presence of an active automotive service garage was observed during the Site walk over on the central portion of the Phase One Property at the time of the Site Investigation. Although this garage has only been operating for a short time period (2018 to present), these operations are a PCA which represents an APEC for the Property. Based on the observations at this automotive garage, that contaminants of potential concern are considered to be PHCs and BTEXs.

Three active and/or historical fuel storage tank locations at neighbouring properties in the Phase One Study Area constitute PCAs. The PCAs at neighbouring properties in the Phase One Study Area are located significant distances and at down- or cross-gradient orientations with respect to the Phase One Property and are not considered to represent APECs for the Phase One Property.

The PCAs identified at the Phase One Property and neighbouring properties in the Phase One Study Area and APECs at the Phase One Property are included in Table 1 below.

Table 1: Potentially Contaminating Activities and Areas of Potential Environmental Concern

PCA Report Reference No.	Potentially Contaminating Activity	Location	APEC Report Reference No.
1	Former retail fuel outlet (O.Reg. 153/04 PCA Item 28: Gasoline and Associated Products Storage in Fixed Tanks)	Southeast portion of the Phase One Property	APEC #1 / 2
2	Former automotive service garage (O.Reg. 153/04 PCA Item 52: Storage, Maintenance, Fuelling and Repair of Equipment, Vehicles, and Material used to Maintain Transportation Systems)	Southeast portion of the Phase One Property	APEC #1 / 2
3	Fill placement following demolition activities (O.Reg. 153/04 PCA Item 30: Importation of Fill Material of Unknown Quality)	Central-south portion of the Phase One Property	APEC #3
4	Active automotive service garage (O.Reg. 153/04 PCA Item 52: Storage, Maintenance, Fuelling and Repair of Equipment, Vehicles, and Material used to Maintain Transportation Systems)	Central portion of the Phase One Property (south unit in south commercial plaza building)	APEC #4
5	Suspected fuel (heating oil) storage tank, reported heating oil spill (O.Reg. 153/04 PCA Item 28: Gasoline and Associated Products Storage in Fixed Tanks)	2707 Springland Drive (Residential Dwelling), located approximately 160 m southeast	Not Applicable
6	Suspected fuel storage tank(s), waste generator (O.Reg. 153/04 PCA Item 28: Gasoline and Associated Products Storage in Fixed Tanks)	2960 Riverside Drive (Parkland), located approximately 200 m northwest	Not Applicable
7	Suspected former fuel storage tank(s), waste generator (O.Reg. 153/04 PCA Item 28: Gasoline and Associated Products Storage in Fixed Tanks)	2865 Riverside Drive (Residential property), located approximately 80 m north	Not Applicable

Based on the identification of PCAs and APECs at the Phase One Property, it is recommended that a Phase Two Environmental Site Assessment be completed to assess the soil and groundwater quality in the vicinity of the four APECs.

2. Introduction

Lopers & Associates (Lopers) was retained by 11684663 Canada Inc. (Brigil) to complete a Phase One Environmental Site Assessment (Phase One ESA) of the commercial property with Civic address No. 729 Ridgewood Avenue, Ottawa, Ontario (“Site” or “Phase One Property”).

The Phase One Property is legally described as Part of Block C, Registered Plan 749, Part of Block C, Registered Plan 775 and Part of Lot 23 Junction Gore, Township of Gloucester, now in the City of Ottawa and has a property identifier number of 04071-0125, as obtained from a Legal Survey completed by Fairhall, Moffatt & Woodland Limited, on January 8, 2018, provided by Brigil; a copy of the Legal Survey is presented in Appendix A.

Based on approximate dimensions obtained from the City of Ottawa’s GIS mapping software, the Phase One Property has an approximate area of 13,200 m² (1.32 Hectares) and a zoning designation of GM1 F(1.0), which signifies a general mixed use zone with a gross floor area restriction of 1 m² per m² of Property. The approximate elevation of the Phase One Property as indicated on the Legal Survey and confirmed through City of Ottawa mapping and Google Earth is between approximately 81 and 84 m above mean sea level (m AMSL). The approximate centre of the Phase One Property has Latitude and Longitude coordinates of 45° 22’ 06” N and 75° 41’ 16” W and Universal Transverse Mercator (UTM) coordinates of 446131 m E and 5024099 m N.

The Phase One Property is currently owned by 11684663 Canada Inc., a subsidiary company of Brigil Construction (“Brigil”). It is Lopers’ understanding that Brigil intends to redevelop the Phase One Property for mixed use (commercial and residential purposes), including the current concept for construction of one building with five adjoining segments ranging from seven to twenty storeys in height, with subgrade parking, commercial ground floors and residential units above. A copy of an artist’s rendering of the current Site development design concept plan, as provided by Brigil, is presented in Appendix B.

This Phase One ESA was commissioned by Mr. Jean-Luc Rivard, Director of Land Development and Infrastructure for Brigil Construction (Brigil), operating as 11684663 Canada Inc. Brigil has a business address of 98 Rue Lois, Gatineau, Quebec, J8Y 3R7 and a business telephone number of 819-243-7392.

3. Scope of Investigation

This Phase One ESA has been completed as per the details of scope presented in Lopers' Letter entitled "Proposal for Phase One Environmental Site Assessment and Phase Two Environmental Site Assessment, Proposed Residential Re-development, 729 Ridgewood Avenue, Ottawa, ON", dated May 8, 2020, reference No. PRO-002-20-Brigil.

The Phase One ESA has been prepared in accordance with the technical requirements and formatting guidance as presented by the Ministry of Environment, Conservation and Parks (MECP) in Ontario Regulation (O.Reg.)153/04, as amended July 1, 2020. This format is based on the provincial regulation for brownfields redevelopment and has been adopted as a standard by the City of Ottawa for development applications.

The scope of work for the Phase One ESA involved the following components:

- Historical Research (Review of available historical reports, public environmental databases, Fire Insurance Plans (FIPs), City Directories, Aerial Photographs, geological mapping and any other relevant environmental records which were readily accessible at the time of the Phase One ESA);
- Requests for Information from the MECP Freedom of Information (FOI), Technical Standards and Safety Authority (TSSA), and City of Ottawa Historical Land Use Inventory (HLUI);
- Subcontracted research of environmental databases through Environmental Risk Information Services (ERIS);
- Property Title Search (subcontracted through READ Abstracts Limited and reviewed herein)
- Physical Site inspection
- Interviews with persons knowledgeable about the Property and past uses
- Interpretation of findings
- Preparation of a Phase One ESA report

The specific objectives of the Phase One ESA are to:

- Provide an overview of the Phase One Environmental Site Assessment conducted with respect to the Phase One Property.
- Provide an environmental record of the Phase One Property, in a manner that can be assessed, tested and reconstructed, to document and demonstrate:
 - How the objectives of the Phase One ESA were achieved and how the requirements for the objectives were met;
 - Whether further investigation is required to submit a Record of Site Condition (RSC) for filing;
 - Whether there exists an adequate basis for further investigation; and,
 - The basis for required certifications.

4. Records Review

a) General

i. Phase One Study Area

The Phase One Study Area includes the Phase One Property and properties with the boundaries within 250 m of the Phase One Property limits. Based on a review of the Phase One Property and properties in the Phase One Study Area, their associated historical and/or current uses and operations and physical characteristics of the Phase One Study Area, it was determined that an assessment of properties within 250 m of the Phase One property was sufficient to meet the objectives of the scope of this investigation for a Phase One ESA.

ii. First Developed Use Determination

A land title search was completed by READ Abstracts Limited for the Phase One Property. The title search indicates that the Phase One Property was owned by individuals since at least 1904 until 1959 when ownership of the portions of the Property began to be transferred to Campeau Construction Company Limited. A commercial lease was registered at the Phase One Property in 1965.

Aerial photographs reviewed from 1933 and 1956 show that the Phase One Property use was agricultural use. The 1965 aerial photograph shows the presence of one small building on the central-south portion of the Phase One Property, which was interpreted to be used for residential purposes, and the rest of the Property is undeveloped. The 1976 aerial photograph shows full commercial development at the Phase One Property.

Based on the information reviewed as part of this Phase One ESA, specifically the title search and aerial photographs, the first developed use of the Phase One Property is considered to be 1959.

iii. Fire Insurance Plans

Fire insurance plans (FIPs), were reviewed where available, for the City of Ottawa as part of this Phase One ESA.

There was no coverage in the FIPs for the Phase One Property or for properties located in the Phase One Study Area as part of available FIPs.

iv. Chain of Title

A chronological chain of title was prepared by READ Abstracts Limited for the Phase One Property. The chain of title provides the names of historical owners, lessees and dates of ownership for the Phase One Property dating back to 1904. The legal description as obtained from the Chain of Title was Part of Block C, Registered Plan 749, Part of Block C, Registered Plan

775 and Part of Lot 23 Concession JG, Gloucester, with a property identifier number of 04071-0125.

Based on additional historical research completed as part of this Phase One ESA and a review of the chain of title, the Phase One Property was agricultural with no developed use prior to 1959. The Phase One Property ownership summary included the evolution of legal descriptions with additional references to Parts of Block C on Plans 749 and 775, respectively with time. A chain of title ownership summary was prepared dating back to 1904 and is presented in Table 2 below. A copy of the Chain of Title for the Phase One Property, as prepared by READ Abstracts Limited for the Phase One Property is provided in Appendix C.

Table 2: Chain of Title Ownership Summary

Year(s)	Phase One Property Ownership
Part of Lot 23, Concession JG	
Prior to September 7, 1904	Ed P. Gleason
1904 to 1925	Ellen Foran
1925 to 1938	Robert M. Graham and John H. Graham
1938 to 1944	John H. Graham
1944 to 1959	Mary E. Coombs
1959 to 1959	Norman H. Moody
1959 to 1963	Campeau Construction Company Limited
Part of Block C, Plan 749	
1904 to 1917	Ellen Foran
1917 to 1920	Thomas C. Bate, Robert S. Low, and Edward McMahon carrying on business as Bate, McMahon and Co.
1921 to 1926	Thomas C. Bate and Edward McMahon
1926 to 1943	Edward McMahon
1943 to 1945	Sidney Munro
1945 to 1949	Sidney Munro, John W. Lucas and Jessie J. Lucas
1949 to 1958	Sidney Munro, William Lucas
1958 to 1959	William Lucas and J. M. Patrick Kelly
1959 to 1961	William Lucas and Campeau Construction Company Limited
1961 to 1963	Campeau Construction Company Limited
Part of Block C, Plan 775	
1904 to 1926	Ellen Foran
1926 to 1930	Edward Rutledge

Year(s)	Phase One Property Ownership
1930 to 1947	John W. Dale
1947 to 1949	Yvonne Griffin
1949 to 1952	R. Walter Hamilton
1952 to 1955	James and Sarah Western
1955 to 1959	Frederick R. Francis
1959 to 1963	Joseph B. Kearney and Terrace Investments Limited
Entire Phase One Property	
1963 to 1983	Campeau Construction Company Limited
1983 to 2019	561266 Ontario Inc.
November 6, 2019 to Present	11684663 Canada Inc.

Five leases were registered at the Phase One Property including:

- OT67899 – Oct 20, 1965 – Supertest Petroleum Corporation Limited
- CT188136 – Feb 21, 1974 – B. P. Oil Products Limited
- CT209810 – May 15, 1975 - The Bank of Nova Scotia
- N297929 – Jul 31, 1985 – Petro-Canada Products Inc.
- N319366 0 Dec 20, 1985 – The Bank of Nova Scotia

Based on the chain of title ownership summary there was one Potentially Contaminating Activity (PCA) known to be associated with the ownership of the Phase One Property; the presence of a retail fuel outlet (operated by a sequence of companies), with associated Gasoline and Associated Products Storage in Fixed Tanks. This PCA represents Area of Potential Environmental Concern #1 (APEC #1) on the southeast portion of the Phase One Property. Additional research in subsequent sections of this assessment further reviews and identifies the location of APEC #1 on the Phase One Property.

v. Environmental Reports

Brigil provided the following two reports for review as part of this Phase One ESA:

1. "Phase II Environmental Site Assessment, 729 Ridgewood Avenue, Ottawa, Ontario", dated January 12, 2018, completed by Pinchin Ltd. for Canadian Rental Development Services Inc.
2. "Verification Soil Sampling Program, 729 Ridgewood Avenue, Ottawa, Ontario", dated October 19, 2018, completed by Pinchin Ltd. for 561226 Ontario Inc.

2018 Phase II Environmental Site Assessment by Pinchin (2018 Pinchin Phase II ESA)

The 2018 Pinchin Phase II Environmental Site Assessment (2018 Pinchin Phase II ESA) was completed to assess the APECs identified through a review of the 2005 Intera Phase II ESA, namely, the potential for residual soil and groundwater contamination in the vicinity of the former retail fuel outlet on the southeast portion of the Phase One Property following its decommissioning and underground storage tank (UST) and pump island removal.

Five boreholes, each instrumented with a groundwater monitoring well, were drilled on the former retail fuel outlet and automotive service garage portion of the Property as part of the 2018 Phase II ESA. Soil conditions were generally found to consist of a layer of sand and gravel fill, underlain by clayey silt, followed by silty sand till. Refusal on interpreted bedrock was encountered at depths ranging from 7.2 to 7.6 m below ground surface (m BGS). Groundwater was encountered at depths ranging from approximately 3.8 to 4.8 m BGS.

Soil and groundwater samples were submitted from each of the borehole/monitoring well locations, which were analyzed for petroleum hydrocarbons (PHCs), volatile organic compounds (VOCs) and polycyclic aromatic hydrocarbons (PAHs). All of the soil and groundwater samples had exceedances of the site condition standards, primarily with respect to PHCs and benzene, toluene, ethylbenzene and xylenes (BTEXs), which were associated with the storage and dispensing of fuel at the Phase One Property. Pinchin recommended a delineative investigation to determine the extents of the soil and groundwater contamination at the Property.

The 2018 Pinchin Phase II ESA report was completed as environmental due diligence of the Phase One Property prior to potential purchase by the Canadian Rental Development Services Inc. As part of the due diligence, Pinchin reviewed one previous environmental report for the Phase One Property:

3. "Phase II Environmental Site Assessment and UST Removal, 753 Ridgewood Avenue, Ottawa, Ontario" completed by INTERA Engineering Ltd. (Intera) for 561266 Ontario Inc. dated September 2005.

The aforementioned report was summarized by Pinchin, however it was not provided by Brigil as part of this Phase One ESA, so a summary of this report is based on information provided in the 2018 Pinchin Phase II ESA.

2005 Phase II Environmental Site Assessment by Intera (2005 Intera Phase II ESA)

This Phase II ESA was completed following the removal of five underground storage tanks (USTs) and associated pump islands for the former retail fuel outlet at the Phase One Property in approximately 2005. Based on the soil and groundwater analytical results from the 2005 Intera Phase II ESA and the introduction of new soil and groundwater standards by the MECP in 2011, Pinchin suspected that there was the potential for the soil and groundwater quality at the Phase One Property to exceed the current site condition standards. A Phase II ESA was subsequently

recommended to assess the soil and groundwater quality in the vicinity of the former retail fuel outlet.

2018 Versification Soil Sampling Program by Pinchin (2018 Pinchin VSSP)

The 2018 Pinchin Versification Soil Sampling Program (2018 Pinchin VSSP) was completed to address the residual soil and groundwater contamination in the vicinity of the former retail fuel outlet on the southeast portion of the Phase One Property following its decommissioning and UST/pump island removal.

An environmental remediation program, consisting of excavation and off-Site disposal of contaminated soil was completed in two separate excavation footprints on the southeast portion of the Property in 2018. A total of 4,078 tonnes of soil was excavated and removed from the Property as part of remediation work in 2018, while approximately 13,019 L of water were removed and transported off-Site from the excavation. Approximately 3,485 tonnes of clean granular fill was brought to the Property to backfill the excavation; five samples were analyzed from the backfill material and it was found to be in compliance with the site condition standards.

Following completion of the excavation work, Pinchin collected a total of 14 worst case soil samples from the south excavation (Excavation #1) and 19 worst case soil samples from the north excavation (Excavation #2). All of the confirmatory samples were in compliance with the site condition standards, with the exception of 5 samples collected from the south and east portions of Excavation #1. It was noted that these exceedances were present in locations which were not practical for remediation without specialized excavation procedures (i.e. shoring). Pinchin estimated that only a small volume of soil, estimated 5-10 m³ of contaminated soil remained in these areas. No further remediation work was recommended at that time and it was stated that residual contamination could be removed at the time of Site redevelopment. Pinchin recommended that passive remediation measures could be applied to address residual groundwater impacts at the Property.

The 2018 Pinchin VSSP reviewed and referenced a delineation study completed in 2018. No summary was provided for this study, however, the borehole and monitoring well locations completed as part of this study were inferred to have been presented on Figure 3 in the 2018 Pinchin VSSP. The delineation study, which was not provided by Brigil as part of this Phase One ESA was entitled:

4. "Supplemental Phase II Environmental Site Assessment, 753 Ridgewood Avenue, Ottawa, Ontario" dated March 2018, completed by Pinchin Ltd. for 561226 Ontario Inc.

The presence of a former retail fuel outlet at the Phase One Property was previously identified as APEC #1. The presence of residual soil contamination and unknown groundwater quality in 2018 in the vicinity of APEC #1 further reinforces that this APEC requires further investigation.

b) Environmental Source Information

A review of the readily available environmental source information records was completed as part of this Phase One ESA.

As part of environmental source information review, Environmental Risk Information Systems (ERIS) was also contracted to complete a search of their records of environmental data bases within 250 m of the Site. The pertinent search results to this Phase One ESA are presented in the following subsections. A copy of the ERIS database search is included as Appendix D.

National Pollutant Release Inventory

The National Pollutant Release Inventory (NPRI) is a database maintained by Environment and Climate Change Canada (ECCC). Reporting of releases of pollutants into the natural environment are reported annually by corporations and/or their representatives and posted for public record by ECCC. Presently, data is available and posted for the years 1994 through 2017. No records were identified within 250 m of the Phase One Property during a review of the posted NPRI data on the ECCC electronic website on June 18, 2020 and the results were confirmed through the subcontracted ERIS search, dated June 12, 2020.

Polychlorinated Biphenyl (PCB) Inventories

The MECP, formerly known as the Ministry of Environment and Energy, published the "Ontario Inventory of PCB Storage Sites". The inventory documented the company information, physical address, number of tonnes of liquid PCBs by region. No records were identified within 250 m of the Phase One Property during a review this document and the results were confirmed through the subcontracted ERIS search, dated June 12, 2020.

The ERIS search also reviewed the National PCB Inventory, which details in use PCB containing equipment in federal, provincial and private facilities; this database was last updated in 2008. No records were identified within 250 m of the Phase One Property during a review this database.

Environmental Instruments

Environmental Instruments, such as Environmental Compliance Approvals (ECAs), Certificates of Approval (CAs), Permits to Take Water (PTTWs), Risk Management Plans (RMPs), and Certificates of Property Use (CPUs) are maintained by the MECP on a property specific basis and can generally be obtained by submitting a Freedom of Information (FOI) request. If records exist, they can generally be obtained through the MECP through additional communications. The subcontracted ERIS search also confirms the filing of any such records associated with properties.

An FOI request was submitted to the MECP as part of this Phase One ESA; however, a response was not received in the timeframe permitted as part of this mandate; a copy of the FOI request is included as Appendix E. The ERIS search did not identify any records of environmental

instruments at the Phase One Property, however, three records of CAs were identified within 250 m of the Phase One Property. Two CAs were issued to Tamarack Developments Corp. at 2991 Riverside Drive, located approximately 160 m southwest of the Phase One Property, in October of 1990 for municipal water and municipal sewage. One CA was issued to The City of Ottawa at the intersection of Springland Drive and Hobson Road, located approximately 150 m northeast of the Phase One Property, in July of 1994 for municipal sewage. These activities associated with the aforementioned CAs are not PCAs and do not represent APECs for the Phase One Property.

Inventory of Coal Gasification Plants

The document "Inventory of Industrial Sites Producing or Using Coal Tar and Related Tars in Ontario, Volume II", produced by Intera Technologies Ltd. for the Ontario Ministry of the Environment, dated July 1988 was reviewed as part of this Phase One ESA. No records were identified within 250 m of the Phase One Property during a review of this document and the results were confirmed through the subcontracted ERIS search, dated June 12, 2020.

Environmental Records of Incidents, Orders, Offences, Spills, Discharges of Contaminants or Inspections maintained by the Ministry

Environmental records of incidents, orders, offences, spills, discharges of contaminants or inspections are maintained by the MECP on a property specific basis and can generally be obtained by submitting a Freedom of Information (FOI) request. If records exist, they can generally be obtained through the MECP through additional communications. The subcontracted ERIS search also confirms the filing of such records associated with properties.

An FOI request was submitted to the MECP as part of this Phase One ESA; however, a response was not received in the timeframe permitted as part of this mandate; a copy of the FOI request is included as Appendix E. The ERIS search did not identify any records of environmental records at the Phase One Property; however, two records of spills were identified within 250 m of the Phase One Property. A spill of hydraulic oil from an equipment hose break was recorded at 750 Ridgewood Avenue, approximately 20 m south of the Phase One Property, in June of 2018; the spill was reportedly contained and an environmental remediation contractor was engaged for the clean up; this spill is not a PCA as it was cleaned up immediately following its occurrence and therefore does not represent an APEC for the Phase One Property. A spill of heating oil was recorded at 2707 Springland Drive, approximately 160 m southeast of the Phase One Property, in January of 1992. The heating oil spill is associated with the PCA of "Gasoline and Associated Products Storage in Fixed Tanks" (PCA #5). Given the separation distance of this property with respect to the Phase One Property, this PCA #5 is not considered to represent an APEC for the Phase One Property.

Waste Management Records

Waste management records, including current and historical waste storage locations and waste generator and waste receiver information maintained pursuant to Regulation 347 of the Revised

Regulations of Ontario, 1990 (General — Waste Management) made under the Act, or its predecessors are maintained by the MECP on a property specific basis and can generally be obtained by submitting a Freedom of Information (FOI) request. If records exist, they can generally be obtained through the MECP through additional communications. The subcontracted ERIS search also confirms the filing of such records associated with properties.

An FOI request was submitted to the MECP as part of this Phase One ESA, however, a response was not received in the timeframe permitted as part of this mandate; a copy of the FOI request is included as Appendix E. The ERIS search identified five records of environmental waste generators at the Phase One Property; and two additional properties with records of waste generators were identified within 250 m of the Phase One Property.

561226 Ontario Inc., identified at the Phase One Property, was listed as a generator of Oil Skimmings and Sludges in 2005, 2016 and 2017. It is suspected that these waste registrations were associated with the former retail automotive service garage present on the southeast portion of the Phase One Property. The presence of an automotive service garage is associated with the PCA of "Storage, Maintenance, Fuelling and Repair of Equipment, Vehicles, and Material used to Maintain Transportation Systems" (PCA #2). This PCA #2, in conjunction with PCA #1 is considered to represent APEC #1/2 for the Phase One Property.

Rick McCloskey's Service, identified on the Phase One Property, was listed as a generator of light fuels in 2018. It is suspected that this waste registration is associated with waste generated at the active automotive service garage on the central portion of the Phase One Property. The presence of an operating automotive service garage is associated with the PCA of "Storage, Maintenance, Fuelling and Repair of Equipment, Vehicles, and Material used to Maintain Transportation Systems" (PCA #4). This PCA #4 is considered to represent APEC #4 for the Phase One Property.

Riverside Pharmacy, identified at the Phase One Property, was listed as a "Professional Organizations" in 2004, with no waste generator details provided. It is suspected that based on the nature of this business, waste generated may have included pharmaceutical waste, which is not a PCA and does not represent an APEC for the Phase One Property.

The City of Ottawa with a property at 2960 Riverside Drive, with property limits located approximately 110 m east of the Phase One Property, was listed as a generator of Oil Skimmings and Sludges and Light Fuels related to bulk liquids trucking in 2013, 2014, 2015, 2016, 2018 and 2019. It is suspected that the waste generated is related to the PCA of "Gasoline and Associated Products Storage in Fixed Tanks" PCA #6. It is suspected based on features at this property that PCA #6 is located approximately 200 m northwest of the Phase One Property. Given the separation distance of this property with respect to the Phase One Property and the inferred down- or cross-gradient orientation, this PCA #6 is not considered to represent an APEC for the Phase One Property.

St. Patrick's Home of Ottawa and Medical Arts Dispensary of Ottawa with a property at 2865 Riverside Drive, with property limits located approximately 10 m north of the Phase One Property was listed as a generator of pathological wastes and pharmaceuticals related to nursing/health care from 1992 through 2001 and 2015, 2016, 2018 and 2019. It is suspected that based on the nature of this facility, waste generated is not a PCA and does not represent an APEC for the Phase One Property. PCB waste was also registered at this facility in 2014, however, given the nature of the facility, it is suspected that this waste class is associated with decommissioning and replacement of older equipment, is not a PCA and does not represent an APEC for the Phase One Property. St. Patrick's Home of Ottawa Inc. was listed as a generator of Oil Skimmings and Sludges in 2009. It is suspected that the waste generated is related to the PCA of "Gasoline and Associated Products Storage in Fixed Tanks". It is suspected based on features at this property that PCA #7 was located approximately 80 m north of the Phase One Property. Given the inferred down- or cross-gradient orientation, this PCA #7 is not considered to represent an APEC for the Phase One Property.

The locations of these PCAs are depicted on Figure 3: Surrounding Land Use and are summarized in Table 6 in Section 7. (b).

MECP Property Specific Reports

Reports submitted to the Ministry related to environmental conditions are maintained by the MECP on a property specific basis and can generally be obtained by submitting a Freedom of Information (FOI) request. If records exist, they can generally be obtained through the MECP through additional communications. The subcontracted ERIS search also confirms the filing of such records associated with properties.

An FOI request was submitted to the MECP as part of this Phase One ESA; however, a response was not received in the timeframe permitted as part of this mandate; a copy of the FOI request is included as Appendix E. The ERIS search did not identify any records of environmental reports at the Phase One Property, or properties within 250 m of the Phase One Property.

Technical Standards and Safety Authority

Records of retail fuel storage tanks, retail fuel outlets, spills, releases, and other associated information is maintained by the Technical Standards and Safety Authority (TSSA). These records can be obtained through electronic communications with the TSSA. The subcontracted ERIS search also confirms the filing of such records associated with properties.

The TSSA was contacted by email to complete a search of available records associated with the current property address, the known former property address of the former retail fuel outlet and addresses of surrounding properties with historical environmental listings (based on other historical research). The TSSA response, received on June 12, 2020, identified the presence of an expired (decommissioned) gasoline service station and three expired underground fuel storage

tanks at 753 Ridgewood Avenue (a former address associated with the southeast portion of the Phase One Property). A copy of the TSSA response is included as Appendix F.

The subcontracted ERIS search identified records of an expired private and retail fuel outlet, three underground fuel storage tanks and fuel distribution piping at 753 Ridgewood Avenue. The ERIS search results indicate that the fuel dispensing facility and associated features expired in 2002.

As previously noted, the former presence of a retail fuel outlet at the Phase One Property is a PCA of "Gasoline and Associated Products Storage in Fixed Tanks" (PCA #1) and represents APEC #1 for the southeast portion of the Phase One Property.

Registry Filings

Records of notices and instruments, including records of site condition (RSC), which have been posted in the environmental registry, are maintained by the MECP. These records can be reviewed electronically on the MECP Environmental Site Registry (ESR) website. The subcontracted ERIS search also confirms the filing of such records associated with properties. The website was reviewed for RSCs filed at the Phase One Property and in the Phase One Study Area; no RSCs have been filed for the Phase One Property or for any properties in the Phase One Study Area.

Areas of Natural and Scientific Interest

Records of areas of natural and scientific interest (ANSIs) formerly referred to as areas of natural significance, are maintained by the Ministry of Natural Resources and Forestry (MNRF), and are available for review on the Ontario GeoHub website. The website was reviewed on June 18, 2020 for records of ANSIs in the Phase One Study Area. There were no ANSIs identified within 250 m of the Phase One Property.

Current and Historical Landfills

Records of historical and operating landfills is maintained by the MECP. The document "Waste Disposal Site Inventory", produced by the Ontario Ministry of the Environment, dated June 1991 was reviewed as part of this Phase One ESA. No records were identified within 250 m of the Phase One Property during a review of this document.

The City of Ottawa contracted Golder Associates Ltd. to conduct an inventory and assessment of former waste disposal sites in within the City of Ottawa. The document "Old Landfill Management Strategy, Phase 1 – Identification of Sites, City of Ottawa, Ontario", produced by Golder Associates Ltd., finalized October 2004, was reviewed as part of this Phase One ESA. No records of active or former landfills were identified within 250 m of the Phase One Property during a review of this document.

City of Ottawa Historical Land Use Inventory

The City of Ottawa's Planning, Infrastructure and Economic Development department was contacted to complete a search of the Historical Land Use Inventory (HLUI) maintained by the City. The response, received on July 28, 2020, indicated that the HLUI search identified five activities (of environmental significance) associated with the Phase One Property, including:

- Riverside Supertest Gas Station was present in 1960, 1970 and 1980 city directory listings. This listing was previously identified as PCA/APEC # 1.
- Rick McCloskey's Service Limited, identified in 2001 and 2005. This listing was previously identified as PCA/APEC # 2.
- Edwards Upholstery, identified in 2001 – this activity is not associated with a PCA.
- Fotomat was present in 1960, 1970 and 1980 city directory listings – this activity is not associated with a PCA.
- Mooney's Bay Electronics Inc., identified in 2001 – this activity is not associated with a PCA.

Additional activities were identified at properties in the HLUI study area; however, these activities were either located outside of the Phase One Study Area and/or are not associated with PCAs. None of the identified listed 'activities' at neighbouring properties are PCAs and no APECs were identified for the Phase One Property as part neighbouring land use during a review of the HLUI. A copy of the HLUI response letter is included in Appendix G.

c) Physical Setting Sources

i. Aerial Photographs

Aerial Photographs were reviewed for the Phase One Property and Phase One Study Area from available sources as part of the historical review. Aerial photographs were reviewed from historical research previously completed in the Phase One Study Area, Google Earth Aerial Imagery and from the City of Ottawa's geoOttawa GIS tool. Supplemental aerial photographs were ordered through (ERIS) and were reviewed. Aerial Photographs were reviewed over the period of 1933 through 2017, which depict development at the Phase One Property. A summary of the information gleaned from the aerial photographs is provided below. Copies of the aerial photographs reviewed are provided in Appendix H.

1933 Aerial Photograph

The Phase One Property appears to be undeveloped or used for agricultural purposes in the 1933 Aerial Photograph. What appears to be a gravel road (present day Ridgewood Avenue Right-of-Way) runs along the south limit of the Phase One Property. The Phase One Study Area appears to be used primarily for agricultural purposes, with some rural residential buildings present to the south and northwest of the Phase One Property. Riverside Drive has been constructed further west of the Phase One Property.

1956 Aerial Photograph

No significant changes appear to have been made to the Phase One Property. Some of the rural and/or agricultural buildings in the Phase One Study Area have been demolished and increased residential development is apparent along Riverside Drive, further southwest of the Phase One Property.

1965 Aerial Photograph

What appears to be a small (interpreted residential) building has been constructed on the central-south portion of the Phase One Property. No other significant changes appear to have been made at the Phase One Property. Ridgewood Avenue has been constructed to the south of the Phase One Property. Residential development, including single family residential dwellings and residential apartment buildings have been constructed to the northeast, southeast and east of the Phase One Property in the Phase One Study Area. Construction of Mooney's Bay beach and park appear to be on-going further west of the Phase One Property.

1976 Aerial Photograph

The Phase One Property has been developed with what appears to be the present-day commercial plaza buildings on the north portion of the Property. What appears to be a retail fuel outlet and automotive service garage has been constructed on the southeast portion of the Phase One Property. The majority of the undeveloped ground surface at the Property appears to have been surfaced with asphalt. The adjacent properties to the east and west of the Phase One Property have been developed with residential townhouses and a residential apartment building, respectively. A tennis court is present to the northeast of the Phase One Property. Increased residential development is apparent in the north portion of the Phase One Study Area.

1991 Aerial Photograph

The small, former (interpreted residential) building on the central-south portion of the Phase One Property has been demolished. The property to the south of Ridgewood Avenue, further south of the Phase One Property, has been developed with the present day institutional/commercial buildings. No other significant changes appear to have been made to the Phase One Property or neighbouring properties in the Phase One Study Area.

1999 Aerial Photograph

No significant changes appear to have been made to the Phase One Property or neighbouring properties in the Phase One Study Area.

2008 Aerial Photograph

No significant changes appear to have been made to the Phase One Property or neighbouring properties in the Phase One Study Area.

2017 Aerial Photograph

No significant changes appear to have been made to the Phase One Property or neighbouring properties in the Phase One Study Area.

As previously noted, the presence of a retail fuel outlet and automotive service garage at the Phase One Property are PCAs and represent APEC #1 / 2 for the southeast portion of the Phase One Property. The placement of fill material of unknown quality, associated with backfilling of the former inferred residential building's foundation at the Phase One Property also represents a PCA and APEC #2 for the central-south portion of the Phase One Property.

ii. Topography, Hydrology, Geology

The Ontario Ministry of Natural Resources and Forestry's (MNR's) Topographic Map GIS website was used to produce a topographic map showing the location of the Phase One Property, nearby water bodies and the regional topography of the Phase One Study Area. A copy of the Topographic Map is provided in Appendix I. The regional topography in the Phase One Study Area is undulating but generally slopes downward to the west-northwest, toward the Rideau River. The topography on the south portion of the Phase One Property slopes downward from west to east, with the neighbouring property to the east at an elevation approximately 1.5 m lower than the southeast Property limits. A local topographical high is present approximately 200 m west of the Phase One Property, which may be associated with local bedrock undulation. The Rideau River is located approximately 550 m west of the Phase One Property.

Information on the regional surficial soil was obtained from the Geological Survey of Canada map 1425A titled Surficial Materials and Terrain features Ottawa Hull. Based on a review of the map, the natural soil conditions in the Phase One Study Area consist of "Abandoned River Channel Deposits of silt and silty clay; commonly including lenses of sand and generally underlain at variable depth by unit 3. 7. Stratified, buff, medium grained sand; unfossiliferous; locally reworked into low dunes".

Information on the regional bedrock was obtained from the Ontario Geological Survey Map P2716 titled 'Paleozoic Geology Ottawa Area'. Based on a review of the map, the Phase One Study Area is underlain by bedrock of the Bobcaygeon Formation, described as a "two member formation that can be distinguished with the lower member consisting of sublithographic to fine crystalline limestone, and the upper member of calcarenite with interbeds of sublithographic to fine crystalline limestone and shale".

Well records and borehole logs, obtained from the MECP Water Well Records database, the subcontracted ERIS search and from historical investigations at the Phase One Property were reviewed. Based on these records, the general stratigraphy of the Phase One Property and Phase One Study Area consists of sand and gravel fill, underlain by silty clay, followed by silty sand and gravel (till). The overburden soil is underlain by interbedded shale and limestone bedrock.

iii. Fill Materials

The Phase One Property was historically developed with what was interpreted to be a small residential building on the central-south portion of the Property; this building was subsequently demolished and was suspected to have had its foundation backfilled; this activity is a PCA associated with "Importation of Fill Material of Unknown Quality" PCA #3. The importation of fill to the Phase One Property represents APEC #3 on the central-south portion of the Phase One Property.

The Property was developed with the present-day commercial plaza buildings and paved asphalt parking areas. Granular base fill material is expected to have been used as part of construction of the aforementioned features; this fill type is not considered to represent a PCA, as gravel does not meet the definition of soil.

Various remediation work has been completed for the former retail fuel outlet and automotive service garage, which included excavation and off-site disposal of soil, which were subsequently backfilled with imported granular material; this granular fill was analyzed as part of the backfilling process and was determined to be in compliance with the site condition standards.

iv. Water Bodies and Areas of Natural Significance & Ground Water Information

The closest significant water body to the Phase One Property is the Rideau River, located approximately 550 m to the west. There were no areas of natural and scientific interest (ANSIs or areas of natural significance) identified in the Phase One Study Area.

The Phase One Property and Study Area are not located in the vicinity of any well-head protection areas or other designation identified by the City of Ottawa in its official plan for the protection of ground water. The Phase One Study Area is serviced by municipally treated drinking water. No private or agricultural water supply wells are located within the Phase One Study Area.

v. Well Records

Well records and borehole logs, obtained from the MECP Water Well Records database, the subcontracted ERIS search and from historical investigations at the Phase One Property were reviewed. Monitoring well clusters (a total of 12 groundwater monitoring wells) are located on the southeast portion of the Phase One Property, in the vicinity of the former retail fuel outlet. Based on these records, the general stratigraphy of the Phase One Property and Phase One Study Area consists of sand and gravel fill, underlain by silty clay, underlain by silty sand. The approximate depth to bedrock is expected to range from 6 to 8 m below ground surface (m BGS) in the area of the existing monitoring wells at the Phase One Property, with a groundwater table at approximately 4 to 5 m BGS.

Three historic potable water supply wells were identified in the Phase One Study Area during a review of the MECP Water Well Records database, however, these wells were drilled in the early

1950s and were located at properties that have since been redeveloped. Additionally, the Phase One Study Area is provided with municipally treated non-potable water and as such it is not suspected that these wells remain in use.

d) Site Operating Records

Waste management, material orders and material safety data sheet records were available for Rick McCloskey's Automotive Service, which operates in the south unit of the east commercial plaza building. Since relocating to this commercial unit from the former automotive garage in 2018, this facility performs general repairs, oil changes, tire rotation/balancing. The presence of an operating automotive service garage, in a different location than the former automotive garage, is associated with the PCA of "Storage, Maintenance, Fuelling and Repair of Equipment, Vehicles, and Material used to Maintain Transportation Systems" (PCA #4). This PCA #4 is considered to represent APEC #4 for the Phase One Property.

Since it is known that there was a former retail fuel outlet and automotive service garage on the southeast portion of the Phase One Property and these are PCAs and are considered to represent APEC #1/2, the absence any such historical records from the former automotive service garage on the southeast portion of the Property is not expected to change the findings or the conclusions of this assessment.

5. Interviews

An in-person interview was completed on the day of the Site Investigation (June 19, 2020) with Mr. Philip Thibert, Project Manager – Land Development and Infrastructure for Brigil Construction. Mr. Thibert has been familiar with the Phase One Property since 2019 when Brigil purchased the Property. Mr. Thibert stated that Brigil purchased the property following the decommissioning of the former retail fuel outlet and automotive service garage on the southeast portion of the Property and the subsequent completion of an environmental remediation program by others in 2018. Mr. Thibert stated that the former tenants of the automotive service garage on the southeast portion of the Property relocated to the south unit of the south commercial building following decommissioning and demolition of the former garage building circa 2018. Mr. Thibert was not aware of any spills or poor environmental management practices associated with the current operation of the automotive service garage or any of the other tenants at the Phase One Property. Mr. Thibert stated that to the best of his knowledge, no dry-cleaning equipment has ever been operated at the Phase One Property. Mr. Thibert was not aware of any former building present on the central-south portion of the Phase One Property and was not aware of the year of demolition or backfilling procedures.

Mr. Rick McCloskey, manager of the active automotive service garage, was interviewed in person by Mr. Philip Thibert of Brigil on July 17, 2020. Mr. McCloskey has been familiar with the Phase

One Property for at least 40 years. Mr. McCloskey stated that the garage relocated to the south commercial unit following demolition of the former service garage building on the southeast portion of the Property circa 2018. Mr. McCloskey stated that the garage completes regular maintenance, repairs and oil changes. Mr. McCloskey stated that waste oil is stored in an aboveground storage tank inside the garage and that GFL Environmental Inc. currently handles removal of waste oil on an as needed basis. He stated that there are no underground tanks at this facility. Mr. McCloskey stated that there have not been any spills at the Property to his knowledge and the garage has good housekeeping practices including regular cleaning of the floors. Mr. McCloskey stated that no chlorinated solvents are used as part of operations. Mr. McCloskey stated that no dry cleaners have operated at the Phase One Property to his knowledge, however, he stated that a dry-cleaning drop off depot was located within the grocery store for a few years in the 1980's.

The interviews identified the presence of the former retail fuel outlet and automotive service garage in the southeast portion of the Phase One Property and the current operation of an automotive service garage on the central portion (south unit of south commercial building) of the Phase One Property. All of the aforementioned activities represent PCAs which are interpreted as APECs for the Phase One Property. The information gleaned through interviews is consistent other information sources reviewed as part of this Phase One ESA and information gleaned from the interviews is considered to be valid.

6. Site Reconnaissance

a) General Requirements

The Phase One Site Investigation was completed on June 19, 2020 between the hours of 10:00 AM and 1:00 PM. Weather conditions were sunny with an ambient air temperature of approximately 29 degrees Celsius. The Phase One Property was occupied by two commercial plaza style buildings at the time of the Site Investigation. The commercial plaza style buildings were partially occupied at the time of the Site Investigation. The Site Investigation was completed by Mr. Luke Lopers, who is a registered Professional Engineer (Environmental) in the province of Ontario and a Qualified Person (QP) for Environmental Site Assessments, and has been conducting Phase I/One Environmental Site Assessments and environmental reconnaissance since 2006. Mr. Lopers was accompanied by Mr. Philip Thibert, Project Manager – Land Development and Infrastructure for Brigil Construction.

Photographs were taken of the exterior of the Phase One Property, documenting any areas of potential environmental concern and areas of disturbed soils, including fill areas, and existing groundwater monitoring wells. A copy of the Photographic Log and written descriptions of the photos are provided in Appendix J.

b) Specific Observations at Phase One Property

The Phase One Property was developed with two multi-unit commercial buildings at the time of the Site Investigation.

The north commercial building is generally a single storey slab-on-grade building with a partial basement below the north portion of the building, and a partial second storey on the east portion of the building. The west commercial unit in the north commercial building, formerly a grocery store, has a partial mezzanine level. The exterior of this building is finished with brick, concrete block, or precast concrete panels, has a flat tar and gravel roof and steel or glass doors. One sump was identified in the northwest portion of this building. The sump extended approximately 1.2 m below the floor slab and was dry at the time of the Site Investigation; when active, this sump discharges to the municipal sanitary sewer system.

The south commercial building is a single storey slab-on-grade building. The exterior of this building is finished with brick, concrete block, or precast concrete panels, has a flat tar and gravel roof and steel or glass doors.

The north commercial building consists of six commercial units, while the south commercial building consists of four commercial units. The occupants of the buildings were observed as presented in Table 3 below. The occupant identifiers (A through J) in Table 3 below are depicted on Figure 2: Site Plan.

Table 3: Building Occupants

North Commercial Building		South Commercial Building	
A	Vacant (former grocery store)	G	Pharmasave
B	iCook Persian Cuisine	H	Picco Accounting Limited
C	Vacant (former Yoga studio)	I	Feras Barber Shop
D	Riverside Mall Hair Design	J	Rick McCloskey Auto Service (Automotive service garage)
E	Caiger Watson Insurance		
F	Vacant (former Doctor's office)		

One double-walled steel aboveground storage tank (AST) was present on the interior of the automotive service garage in the south commercial building. The AST was approximately 1,100 L in size, was used to store waste oil, was in good condition was not fixed in place, and was located above concrete floors which were free of visible cracks and staining. The exact age and dimensions of the AST could not be determined as there was mechanical equipment obscuring the specification tag (if present). No visual indications of the presence of underground storage tanks (USTs), such as vent and fill pipes or access hatches, were observed as part of the Site Investigation.

No potable water wells were observed at the Phase One Property during the Site Investigation. Two groundwater monitoring wells, associated with previous investigations by others at the Property were present on the southeast portion of the Phase One Property, in the vicinity of the former retail fuel outlet. The Phase One Property is provided with potable water by the City of Ottawa through two underground connections from Ridgewood Avenue to the south which connect to each of the commercial plaza buildings.

Underground utility corridors for sanitary and storm sewers, potable water, private electricity and natural gas lines lead to the commercial plaza buildings, generally from Ridgewood Avenue to the south. Underground electrical services are supplied to the commercial buildings through connections on the northwest portion of the Property.

The commercial plaza buildings are heated with natural gas fired furnaces and or heating, ventilating and air conditioning units. There were no details regarding former heating and cooling systems, including historical fuel sources for buildings at the Phase One Property, however, given the date of development of the Property, it is suspected that the current buildings have always been heated and cooled using natural gas or electricity. It is suspected that the former residential building, which was present on the central-south portion of the Property may have been historically heated using furnace oil.

There were no significant cracks or stains on the concrete or finished floors of the commercial plaza buildings. Some minor staining, associated with routine automotive service, was observed on the floor of the automotive service garage.

The commercial buildings are connected to the City of Ottawa municipal sanitary sewer system. There were no septic tanks or leaching beds observed at the Phase One Property as part of the Site Investigation. Given the approximate years (circa 1960s) of commercial development at the Phase One Property, and that paving of the entire undeveloped portion of the Property was completed, it is expected that any former sewage tank/bed (if present) associated with the inferred former residential building on the central-south portion of the property would have been removed during demolition/development.

Approximately 25% of the Phase One Property is developed with two commercial buildings, which the majority of the remainder of the Property is surfaced with asphalt. A small portion of the Property in the southeast corner (former retail fuel outlet remediation) is surfaced with granular fill.

There were no current or former railway lines, tracks or spurs identified at the Phase One Property or in the Phase One Study Area as part of the Site Investigation.

No surficial staining was observed on the asphalt or gravel covered surfaces of the Phase One Property during the Site Investigation. No stressed vegetation was observed.

The presence of an operating automotive service garage, in a different location as the former automotive garage, is associated with the PCA of "Storage, Maintenance, Fuelling and Repair of

Equipment, Vehicles, and Material used to Maintain Transportation Systems" (PCA #4). This PCA #4 is considered to represent APEC #4 for the Phase One Property.

i. Enhanced Investigation Property

The Phase One Property is currently operating as a garage and formerly had operated as a garage and as a bulk liquid dispensing facility in a different location. The Phase One Property is hence an enhanced investigation property.

Motor oil is used for automotive oil changes, and waste motor oil is generated in the process. No bulk storage of new motor oil or any other fluids were observed in the garage at the time of the Site Investigation; new motor oil is stored in 1L plastic containers provided by the manufacturer and is stored on shelves in the storage area of the automotive service garage. As noted above, waste oil is stored in an AST on the interior of the automotive garage unit.

The automotive garage unit was originally constructed as a retail commercial unit and was previously used as a bank, as such, there are no strip drains, sumps or oil/water separators present in this building. No spills have been reported at the automotive garage unit and none are known to have occurred through interviews with the Property owner and manager of the automotive service garage.

Three aboveground lifts are present in the automotive service garage, two of the lifts are hydraulic, while the third is electrically powered.

c) Land Use Observations of the Phase One Study Area

Properties in the Phase One Study Area were reviewed from publicly accessible Rights-of-Way as part of the Site Investigation on June 19, 2020. Uses of these lands were noted and any potential presence of PCAs was also assessed. Neighbouring land uses were recorded as follows:

North: Residential properties and a retirement residence.

East: Residential townhouses, followed by Springland Drive, followed by residential apartment buildings.

South: Ridgewood Avenue, followed by an institutional/commercial property (St. Elias Church and conference centre), followed by residential dwellings.

West: Residential apartment building, followed by Riverside Drive, followed by Parkland (Mooney's Bay Park).

Neighbouring land uses are shown on Figure 3: Surrounding Land Use. No indications of PCAs were observed during the review of land use in the Phase One Study Area. The current uses of the neighbouring properties are not considered to represent any APECs for the Phase One Property.

7. Review and Evaluation of Information

a) Current and Past Land Use

The current and past land use of the Phase One Property, dating back to the first developed use, is provided in Table 4 below.

Table 4: Current and Past Land Use

Year	Name of Owner	Description of Property Use	Property Use	Other observations from historical sources
1904 - 1959	Individuals	Unknown	Agricultural or other use	Property owned by individuals. 1933 and 1956 aerial photographs show Property in undeveloped condition.
1959 - 1963	Individuals & Campeau Construction Company Limited	Interpreted to have been partially used for residential purposes	Residential Use	Title search indicates a land developer started purchasing portions of the Property in 1959. Aerial photograph from 1965 shows the likely presence of a residential building, based on shape and location, on the central-south portion of the Property.
1963 - 1983	Campeau Construction Company Limited	Interpreted to have been used for residential purposes with commercial development commencing in the 1960s	Commercial Use and Residential Use	Commercial lease registered at the Property in 1965. Aerial photograph from 1976 shows the presence of commercial plaza buildings on north portion of Property and continued presence of inferred residential building on the central-south portion of the Property.
1983 - 2019	561266 Ontario Inc.	Commercial plazas and automotive service garage present at the Property and retail fuel outlet present until 2002.	Commercial Use	Aerial photographs from 1991 through 2017 show the presence of commercial plazas and automotive service garage. TSSA records indicated retail fuel outlet was decommissioned in 2002.
November 2019- Present	11684663 Canada Inc.	Commercial plazas and automotive service garage (within plaza building) present at the Property	Commercial Use	Site Investigation confirmed continued commercial use of the Property with automotive service on-going.

b) Potentially Contaminating Activity

Four Potentially Contaminating Activities were identified at the Phase One Property and are summarized in Table 5 below.

Table 5: Potentially Contaminating Activities at the Phase One Property

PCA Report Reference No.	Potentially Contaminating Activity	Location
1	Former retail fuel outlet (O.Reg. 153/04 PCA Item 28: Gasoline and Associated Products Storage in Fixed Tanks)	Southeast portion of the Phase One Property
2	Former automotive service garage (O.Reg. 153/04 PCA Item 52: Storage, Maintenance, Fuelling and Repair of Equipment, Vehicles, and Material used to Maintain Transportation Systems)	Southeast portion of the Phase One Property
3	Fill placement following demolition activities (O.Reg. 153/04 PCA Item 30: Importation of Fill Material of Unknown Quality)	Central-south portion of the Phase One Property
4	Active automotive service garage (O.Reg. 153/04 PCA Item 52: Storage, Maintenance, Fuelling and Repair of Equipment, Vehicles, and Material used to Maintain Transportation Systems)	Central portion of the Phase One Property (south unit in south commercial plaza building)

Additionally, three PCAs were identified at neighbouring properties in the Phase One Study Area and are summarized in Table 6 below.

Table 6: Potentially Contaminating Activities in the Phase One Study Area

PCA Report Reference No.	Potentially Contaminating Activity	Location
5	Suspected fuel (heating oil) storage tank, reported heating oil spill (O.Reg. 153/04 PCA Item 28: Gasoline and Associated Products Storage in Fixed Tanks)	2707 Springland Drive (Residential Dwelling), located approximately 160 m southeast
6	Suspected fuel storage tank(s), waste generator (O.Reg. 153/04 PCA Item 28: Gasoline and Associated Products Storage in Fixed Tanks)	2960 Riverside Drive (Parkland), located approximately 200 m northwest
7	Suspected former fuel storage tank(s), waste generator (O.Reg. 153/04 PCA Item 28: Gasoline and Associated Products Storage in Fixed Tanks)	2865 Riverside Drive (Residential property), located approximately 80 m north

The PCAs at neighbouring properties in the Phase One Study Area are located significant distances and/or at down- or cross-gradient orientations with respect to the Phase One Property and are not considered to represent APECs for the Phase One Property.

c) Areas of Potential Environmental Concern

Four PCAs identified are considered to represent APECs for the Phase One Property and are summarized in Table 7 below.

Table 7: Areas of Potential Environmental Concern

APEC Report Reference No.	Location of APEC on Phase One Property	PCA	Location of PCA (on-site or off-site)	Contaminants of Potential Concern	Media Potentially Impacted (Groundwater, soil and/or Sediment)
1	Southeast portion of the Phase One Property	PCA Item 28: Gasoline and Associated Products Storage in Fixed Tanks	On-site: associated with former retail fuel outlet	PHCs/BTEXs Metals	Soil Groundwater
2	Southeast portion of the Phase One Property	PCA Item 52: Storage, Maintenance, Fuelling and Repair of Equipment, Vehicles, and Material used to Maintain Transportation Systems	On-site: associated with fill placement following decommissioning, demolition and remediation activities	PHCs/VOCs PAHs Metals	Soil Groundwater
3	Central-south portion of Phase One Property	PCA Item 30: Importation of Fill Material of Unknown Quality	On-site: associated with fill placement following demolition activities	PHCs/BTEXs PAHs Metals	Soil Groundwater
4	Central portion of the Phase One Property (south unit of south commercial plaza building)	PCA Item 52: Storage, Maintenance, Fuelling and Repair of Equipment, Vehicles, and Material used to Maintain Transportation Systems	On-site: associated with a current active automotive garage	PHCs/BTEXs	Soil Groundwater

The presence of a former retail fuel outlet and automotive service garage on the southeast portion of the Phase One Property are a significant PCAs which represents APECs for the Property. Given that reports were provided which document remnant PHC/BTEXs soil contamination and that groundwater quality was not confirmed following the completion a remediation program, further investigation is warranted. The contaminants of potential concern

associated with retail fuelling are generally PHCs and BTEXs, with older facilities also having concerns associated with metals, as lead was historically present in gasoline. Based on historical soil analysis in this area of the Property, PAH and VOCs are also considered contaminants of potential concern associated with the former automotive garage operations.

The practice of backfilling following demolition activities at the Phase One Property is a significant PCA which represents an APEC for the Property. Given that no reports were provided with analytical data to support the environmental quality of the backfill used to fill the interpreted former residential building footprint on the central-south portion of the Property, this area warrants further investigation. The contaminants of potential concern commonly found in poor environmental quality backfill are PHCs/BTEXs, PAHs and metals.

The presence of an active automotive service garage was observed on the central portion of the Phase One Property at the time of the Site Investigation. Although this garage has only been operating for a short time period (2018 to present), these operations are a PCA which represents an APEC for the Property. Based on the observations at this automotive garage, the contaminants of potential concern are considered to be PHCs and BTEXs.

Given that PCAs, interpreted as APECs were identified at the Phase One Property, the uncertainty or absence of information obtained in each of the components of the Phase One ESA is not considered to affect the conclusions.

d) Phase One Conceptual Site Model

Three Figures are provided to visually depict the Conceptual Site Model. Figure 1: Key Plan shows the location of the Phase One Property within the City of Ottawa. Figure 2: Site Plan depicts the current and former structures and environmentally significant features at the Phase One Property; this figure is provided with an overlay of the 2017 aerial imagery, which depicts the current general conditions of the Phase One Property. Figure 3: Surrounding Land Use shows the current uses of properties in the Phase One Study Area, location of PCAs and the location of APECs.

The Phase One Property is located at Civic No. 729 Ridgewood Avenue, Ottawa, Ontario and has an approximate area of 1.32 Hectares.

The Phase One Property was undeveloped prior to the late 1950's when a single residential building appears to have been constructed on the central-south portion of the Phase One Property. Initial commercial development began circa 1965. The central and north portions of the Phase One Property have been occupied by two commercial plaza style buildings from circa 1965 to present. The southeast portion of the Phase One Property was formerly occupied by a retail fuel outlet and automotive service garage from 1965 to 2002 (retail fuel outlet) and the central portion of the Phase One Property has had an automotive service garage since 2018. Demolition of the former inferred residential building occurred between 1965 and 1991. The

remaining undeveloped areas of the Phase One Property are paved with asphalt and used for access or parking.

The Property is currently used for commercial purposes and is zoned for mixed use. 11684663 Canada Inc. (Brigil) purchased the Phase One Property in November of 2019, and it is understood that the intended future use is for residential purposes, with commercial use on the ground floor. The Phase One Property is immediately surrounded by a municipal Right-of-Way to the south followed by a mixed institutional/commercial property and by residential properties to the north, east and west.

The Phase One Study Area includes the Phase One Property and properties with the boundaries within 250 m of the Phase One Property limits. Based on a review of the Phase One Property and properties in the Phase One Study Area, their associated historical and/or current uses and operations and physical characteristics of the Phase One Study Area, it was determined that an assessment of properties within 250 m of the Phase One property was sufficient to meet the objectives of the scope of this investigation for a Phase One ESA.

No water bodies or areas of natural significance are located at the Phase One Property or in the Phase One Study Area. No drinking water wells are located at the Phase One Property and the Phase One Study Area is serviced by municipally treated non-potable water. Two existing groundwater monitoring wells were present at the Phase One Property; the locations of these wells are presented on Figure 2.

The regional topography in the Phase One Study Area is undulating but generally slopes downward to the west-northwest, toward the Rideau River. The topography on the south portion of the Phase One Property slopes downward from west to east, with the neighbouring property to the east at an elevation approximately 1.2 m lower than the southeast Property limits. A local topographical high is present approximately 200 m west of the Phase One Property, which may be associated with local bedrock undulation. The Rideau River is located approximately 550 m west of the Phase One Property.

Based on the historical research, the general stratigraphy of the Phase One Property and Phase One Study Area consists of sand and gravel fill, underlain by silty clay, followed by silty sand and gravel (till). Overburden soils are expected to be up to 8 m thick and underlain by interbedded shale and limestone bedrock. Groundwater is expected at a depth of approximately 4 to 5 m BGS and flow in a predominantly northwest direction.

The presence of a former retail fuel outlet and automotive service garage on the southeast portion of the Phase One Property are a significant PCAs which represent APECs for the Property. Given that reports were provided which document remnant PHC/BTEXs soil contamination and that groundwater quality was not confirmed following the completion a remediation program, further investigation is warranted. The contaminants of potential concern associated with retail fuelling are generally PHCs and BTEXs and metals as this was an older facilities and lead was historically present in gasoline. Based on historical soil analysis in this

area of the Property, PAH and VOCs are also considered contaminants of potential concern associated with the former automotive garage operations.

The practice of backfilling following demolition activities at the Phase One Property is a significant PCA which represents an APEC for the Property. Given that no reports were provided with analytical data to support the environmental quality of the backfill used to fill the former inferred residential building footprint on the central-south portion of the Property, this area warrants further investigation. The contaminants of potential concern commonly found in poor environmental quality backfill are PHCs/BTEXs, PAHs and metals.

The presence of an active automotive service garage was observed on the central portion of the Phase One Property at the time of the Site Investigation. Although this garage has only been operating for a short time period (2018 to present), these operations are a PCA which represents an APEC for the Property. Based on the observations at this automotive garage, that contaminants of potential concern are considered to be PHCs and BTEXs.

Three active and/or historical fuel storage tank locations at neighbouring properties in the Phase One Study Area constitute PCAs. The PCAs at neighbouring properties in the Phase One Study Area are located significant distances and/or at down- or cross-gradient orientations with respect to the Phase One Property and are not considered to represent APECs for the Phase One Property.

Underground utility service trenches are present at the Phase One Property. The underground utility corridors have the potential to affect contaminant distribution and transport, as they would create preferential pathways for lateral migration. It should be noted that the groundwater table is expected to be present approximately 4 to 5 m BGS, while the underground utilities are expected to be present at depths of 2 to 3 m BGS, therefore it is not suspected that significant migration of contaminants has occurred through underground utility corridors.

Given that APECs have been identified from several sources of information for the Phase One Property, any uncertainty or absence of information obtained in the components of this Phase One ESA are not expected to affect the validity of the conclusions or conceptual site model.

8. Conclusions

i. Whether Phase Two Environmental Site Assessment Required Before Record of Site Condition Submitted

The presence of a former retail fuel outlet and automotive service garage on the southeast portion of the Phase One Property are a significant PCAs which represent APECs for the Property. Given that reports were provided which document remnant PHC/BTEXs soil contamination and that groundwater quality was not confirmed following the completion a remediation program, further investigation is warranted. The contaminants of potential concern associated with retail fuelling are generally PHCs and BTEXs and metals as this was an older facility and lead was historically present in gasoline. Based on historical soil analysis in this area of the Property, PAH and VOCs are also considered contaminants of potential concern associated with the former automotive garage operations.

The practice of backfilling following demolition activities at the Phase One Property is a significant PCA which represents an APEC for the Property. Given that no reports were provided with analytical data to support the environmental quality of the backfill used to fill the former inferred residential building footprint on the central-south portion of the Property, this area warrants further investigation. The contaminants of potential concern commonly found in poor environmental quality backfill are PHCs/BTEXs, PAHs and metals.

The presence of an active automotive service garage was observed on the central portion of the Phase One Property at the time of the Site Investigation. Although this garage has only been operating for a short time period (2018 to present), these operations are a PCA which represents an APEC for the Property. Based on the observations at this automotive garage, that contaminants of potential concern are considered to be PHCs and BTEXs.

Based on the identification of APECs at the Phase One Property, it is recommended that a Phase Two Environmental Site Assessment be completed to assess the soil and/or groundwater quality in the vicinity of the APECs.

ii. Record of Site Condition Based on Phase One Environmental Site Assessment Alone

Given that there were APECs identified at the Phase One Property, a Phase Two Environmental Site Assessment is required before a record of site condition (RSC) may be submitted with respect to all or part of the Phase One Property.

iii. Signatures

The Qualified Person for this study is Mr. Luke Lopers, P. Eng. Mr. Lopers is a Professional Engineer registered in Ontario since 2012 and has been working on environmental site assessments since 2006. Mr. Lopers has been an author, project manager and/or peer reviewer for hundreds of Phase One ESAs and Phase Two ESAs as well as previously filed RSCs

The reviewer for this study is Mr. Don Plenderleith, P.Eng. Mr. Plenderleith is a Professional Engineer registered in Ontario since 1994 and has authored and/or reviewed hundreds of Phase One and Two ESAs in Ontario and the rest of Canada. The qualifications of the assessor/Qualified Person and reviewer are included in Appendix K.

Sincerely,



Luke Lopers, P.Eng., QP_{ESA}

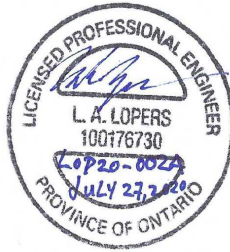

Don Plenderleith, P.Eng., QP_{ESA}

iv. Limitations

The findings and conclusions of this Phase One ESA are based on the information provided and/or reviewed as part of this study.

This Phase One ESA has been completed with the standard of care generally expected in the industry for a study of this nature.

This Phase One ESA has been prepared for the sole use of 11684663 Canada Inc. for the purposes of a due diligence assessment of the potential liabilities which may exist at the Phase One Property. No other party is permitted to rely on the conclusions or findings of this report without the written consent of Lopers & Associates and 11684663 Canada Inc..

There were no portions of the Phase One Property which were inaccessible, or components of this ESA where insufficient information was available to complete the interpretation.

Changes to the physical setting of the Phase One Property, Phase One Study Area and applicable regulations governing Phase One Environmental Site Assessments have the potential to influence the validity of the conclusions and opinions presented in this Phase One ESA.

9. References

Legal Survey Plan, Fairhall, Moffatt & Woodland Limited, dated January 8, 2018.

City of Ottawa, geoOttawa GIS mapping tool, Visited June through July, 2020.

<http://maps.ottawa.ca/geoottawa/>

City of Ottawa, Development Applications website, Visited July 22, 2020.

<http://ottwatch.ca/devapps?since=999>

Google Earth, Visited June through July, 2020.

Current Site Development Design Concept Plan, Brigil, 2020.

"Phase II Environmental Site Assessment, 729 Ridgewood Avenue, Ottawa, Ontario", dated January 12, 2018, completed by Pinchin Ltd. for Canadian Rental Development Services Inc.

"Verification Soil Sampling Program, 729 Ridgewood Avenue, Ottawa, Ontario", dated October 19, 2018, completed by Pinchin Ltd. for 561226 Ontario Inc.

National Pollutant Release Inventory – Environmental Climate Change Canada online website, visited June 18, 2020. <https://www.canada.ca/en/services/environment/pollution-waste-management/national-pollutant-release-inventory.html>

"Ontario Inventory of PCB Storage Sites", Ministry of Environment and Energy, dated January 1993.

"Inventory of Industrial Sites Producing or Using Coal Tar and Related Tars in Ontario, Volume II", produced by Intera Technologies Ltd. For the Ontario Ministry of the Environment, dated July 1988.

"Waste Disposal Site Inventory", produced by the Ontario Ministry of the Environment, dated June 1991.

"Inventory of Industrial Sites Producing or Using Coal Tar and Related Tars in Ontario, Volume II", produced by Intera Technologies Ltd. For the Ontario Ministry of the Environment, dated July 1988.

"Old Landfill Management Strategy, Phase 1 – Identification of Sites, City of Ottawa, Ontario", produced by Golder Associates Ltd., Dated October 2004.

Ministry of Environment, Conservation and Parks, Environmental Site Registry website, Visited June 18, 2020.

<https://www.lrcsde.lrc.gov.on.ca/BFISWebPublic/pub/viewDetail?submissionId=226318>

Ministry of Natural Resources and Forestry, Ontario GeoHub website, Visited June 18, 2020.

https://geohub.lio.gov.on.ca/datasets/b88037cdb71e4daf9445afa6fb999194_3?geometry=-75.706%2C45.443%2C-75.543%2C45.464

Ministry of Natural Resources and Forestry, Make a Topographic Map website, Visited July 22, 2020.

https://www.gisapplication.lrc.gov.on.ca/matm/Index.html?site=Make_A_Topographic_Map&viewer=MATM&locale=en-US

Ministry of Environment, Conservation and Parks, Water Well Records database website, Visited July 2, 2020. <https://www.ontario.ca/environment-and-energy/map-well-records>

10. Appendices

Appendix A – Legal Survey Plan

Appendix B – Site Development Design Concept Plan

Appendix C - Chain of Title

Appendix D – Environmental Risk Information Systems (ERIS) database Search

Appendix E – Ministry of Environment, Conservation and Parks Freedom of Information (FOI) Request

Appendix F – Technical Standards and Safety Association Correspondence

Appendix G – City of Ottawa Historic Land Use Inventory (HLUI)

Appendix H – Aerial Photographs

Appendix I – Topographic Map

Appendix J – Photographic Log

Appendix K – Qualifications of Assessors

Figures

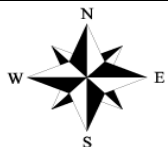
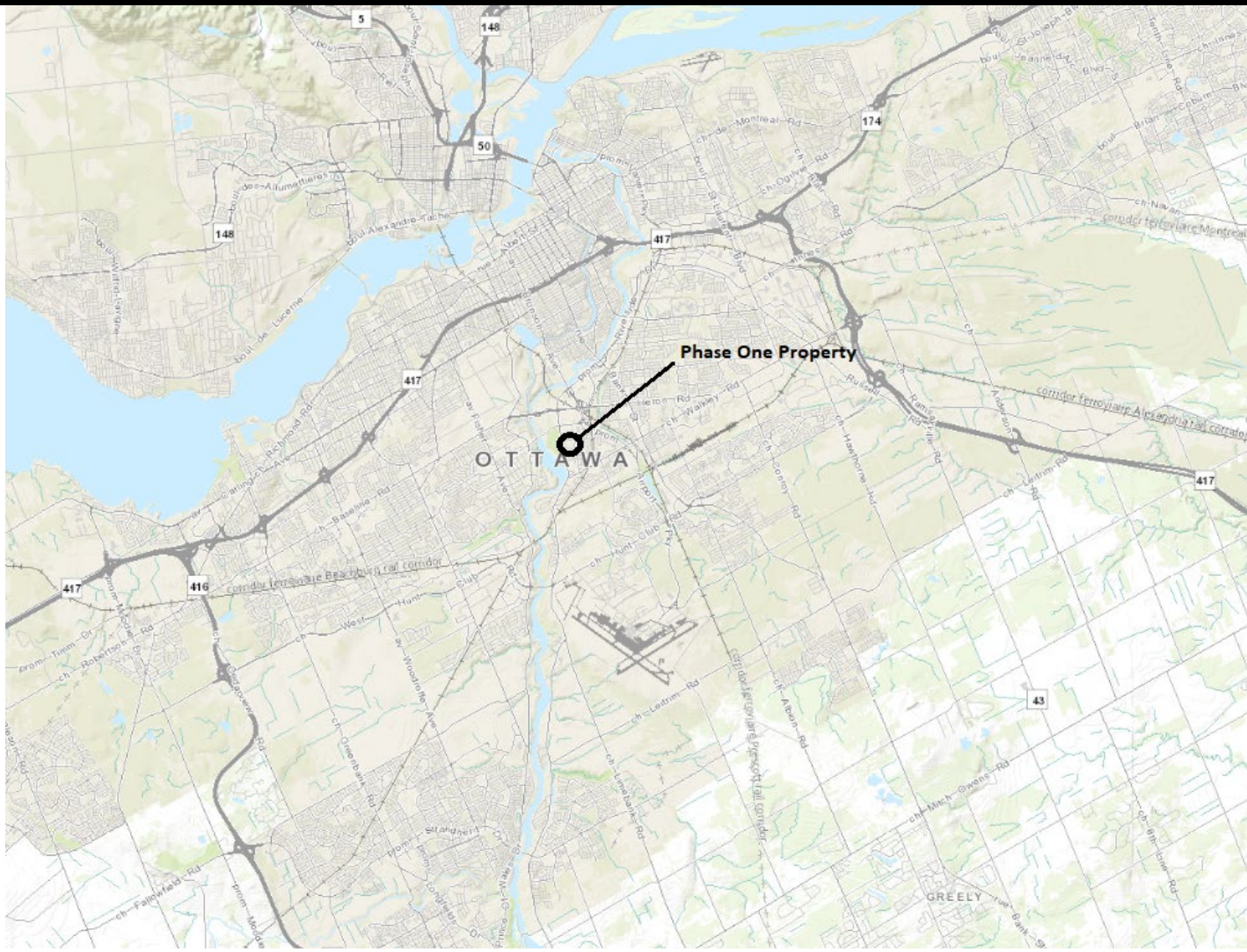

LOPERS & ASSOCIATES

Figure 1: Key Plan
 Phase One Environmental Site Assessment
 729 Ridgewood Avenue, Ottawa, Ontario
 11684663 Canada Inc.

Project Reference No: LOP20-002A
 Drawing No.: LOP20-002A-1
 Date: July 24, 2020
 Author: L. Lopers
 Source: geoOttawa, Base Mapping

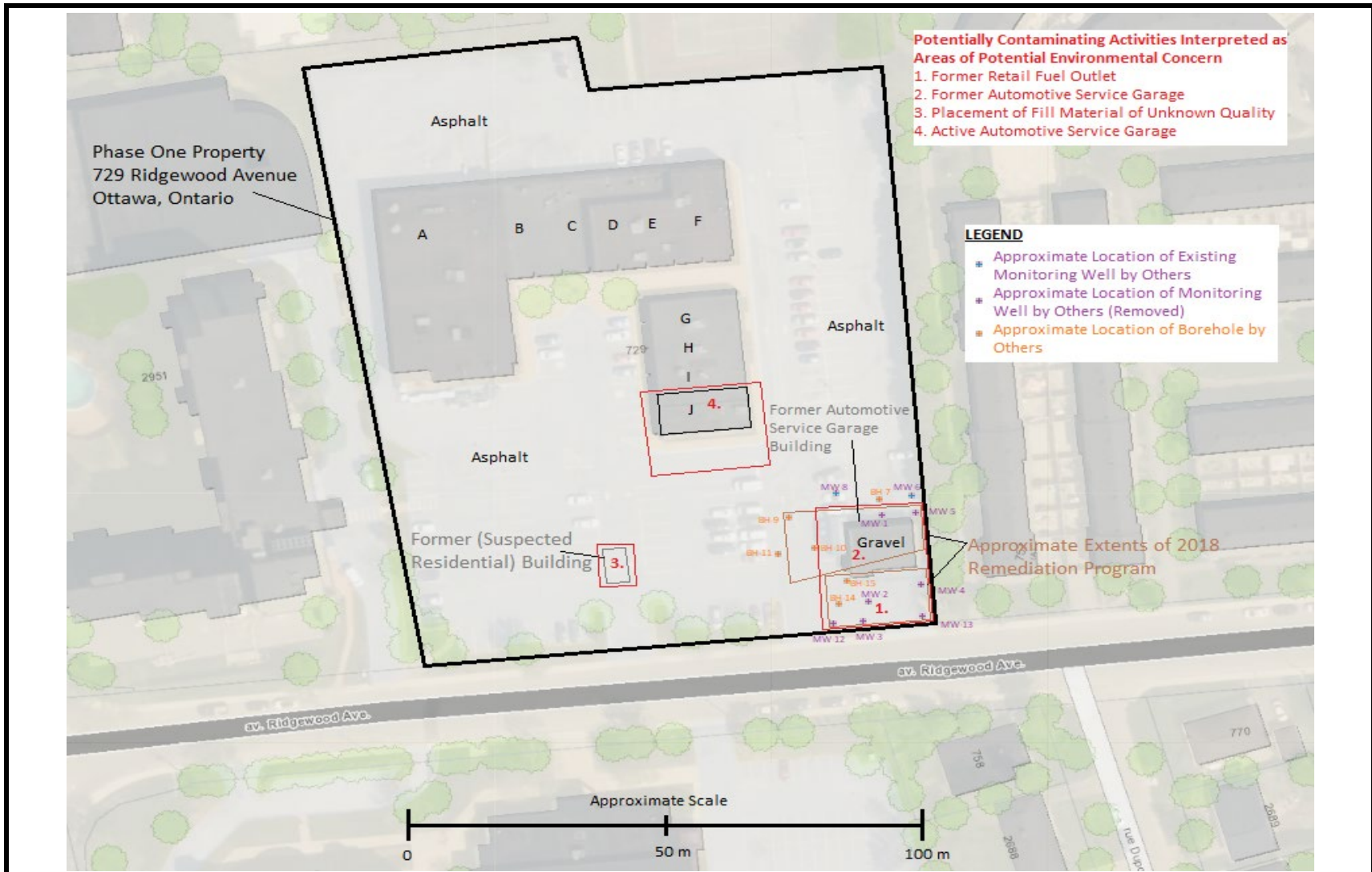

Figure 2: Site Plan
Phase One Environmental Site Assessment
729 Ridgewood Avenue, Ottawa, Ontario
11684663 Canada Inc.

Project Reference No: LOP20-002A
Drawing No.: LOP20-002A-2
Date: July 24, 2020
Author: L. Lopers
Source: geoOttawa, 2017 Aerial Imagery

Appendix A

Legal Survey Plan

Appendix B

Current Proposed Design Concept Plan

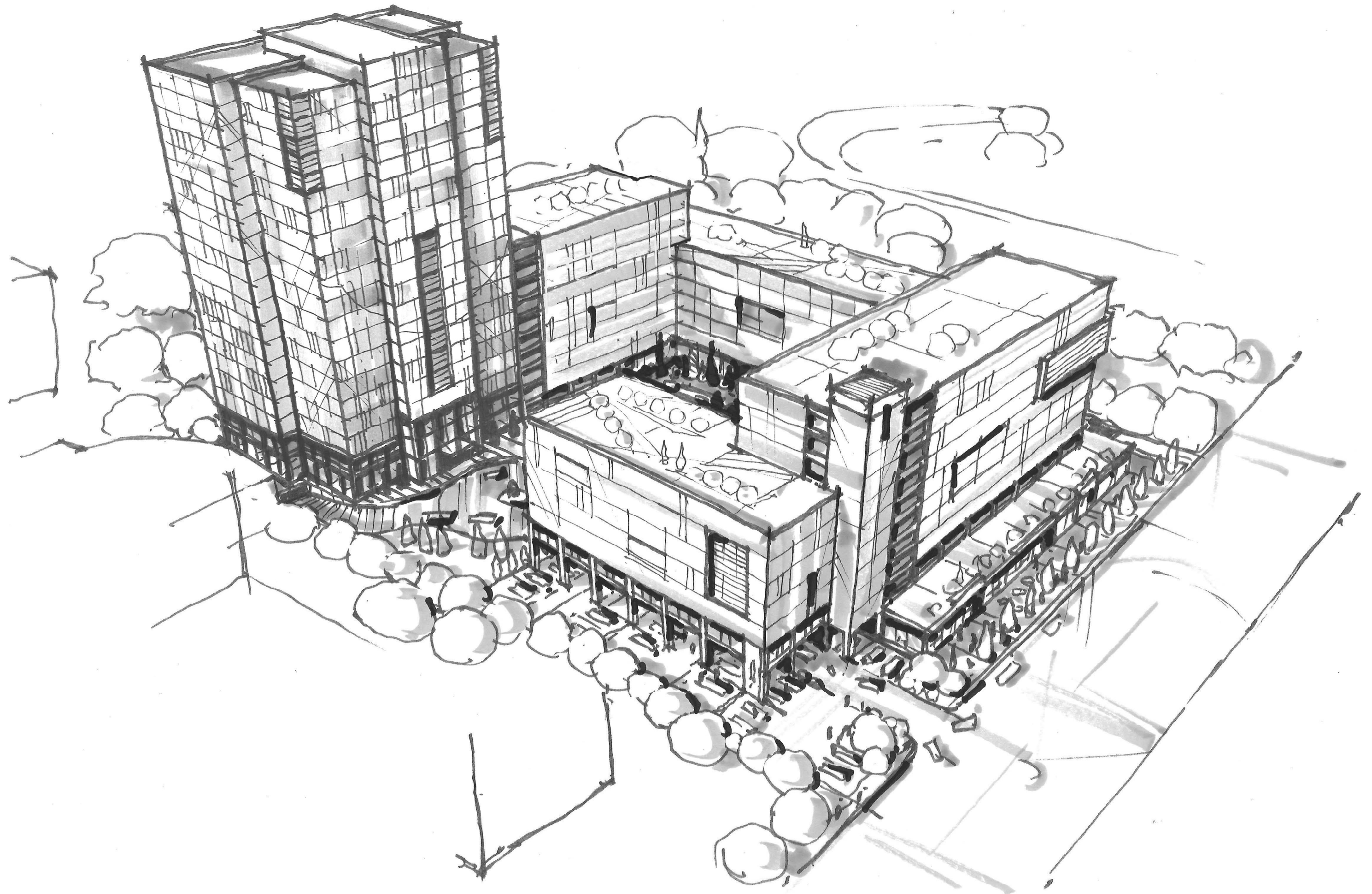

STATISTIQUES

- R.d.ch _____ = 36 UN.
- 2^e-7^e - 6^e x 62 = 372 .
- 8^e-10^e - 3^e x 35 = 105 .
- 11^e-20 - 10^e x 11 = 110 .

TOTAL 623 UN.

• STATIONNEMENT

- INT. 2 x 310 = 620 CASES
- EXT. _____ = 39 .

TOTAL 659 CASES.

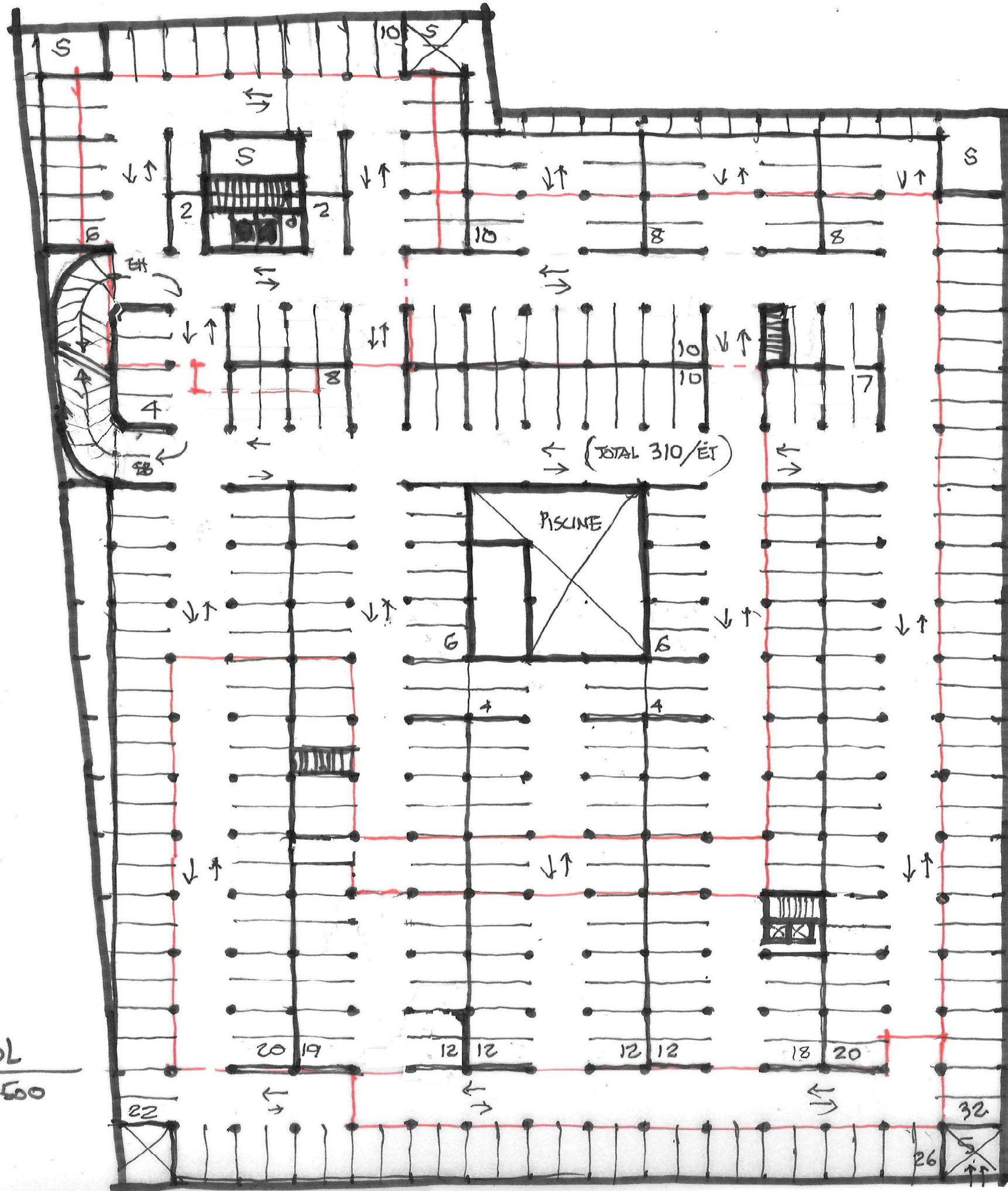

N ↑
 PLAN SOUS-SOL
 1:500
 310 CASES

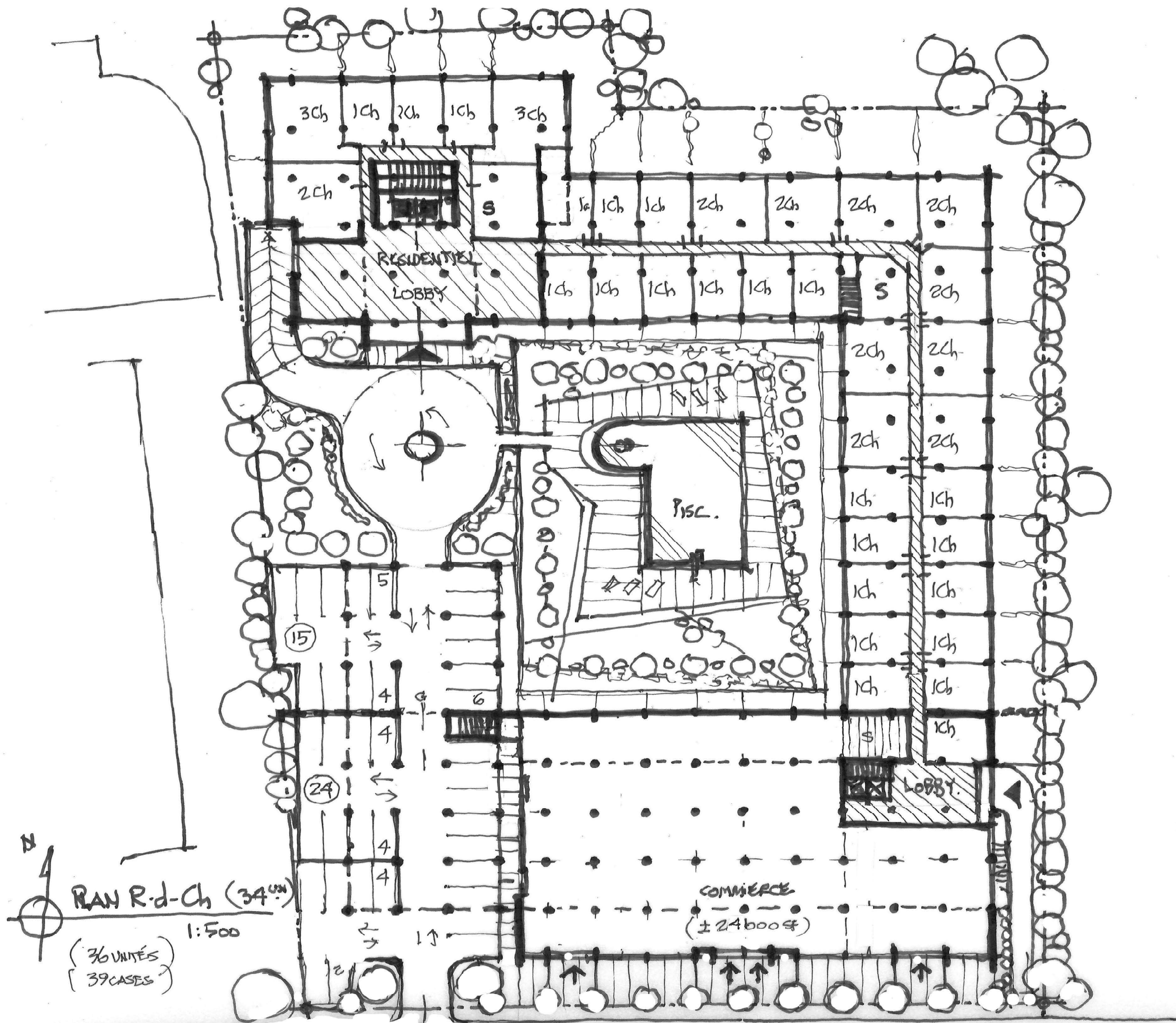

 ÉTAGE 2^e-7^e
 1:500
 (6x62 = 372 UNITÉS)

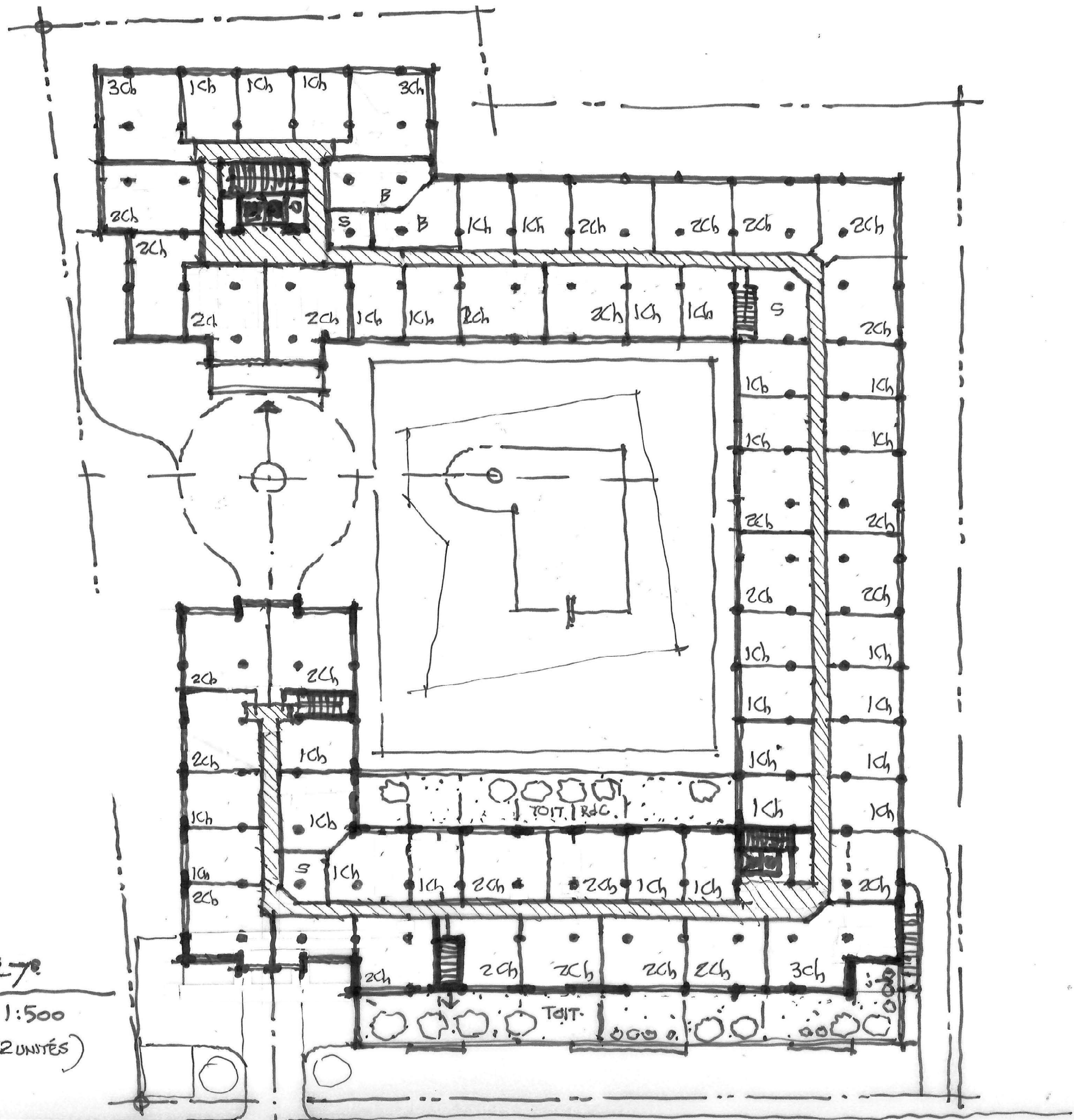

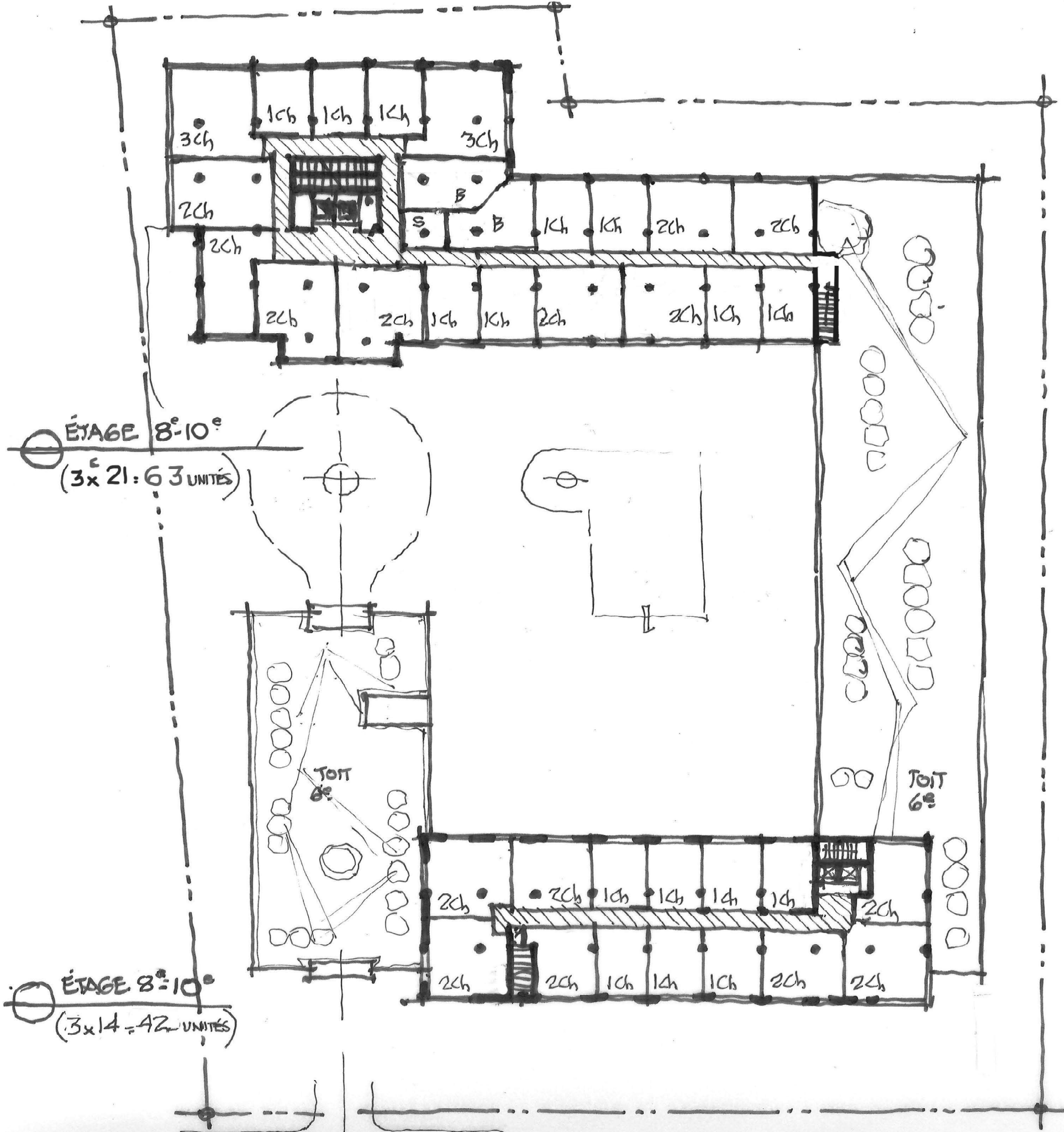

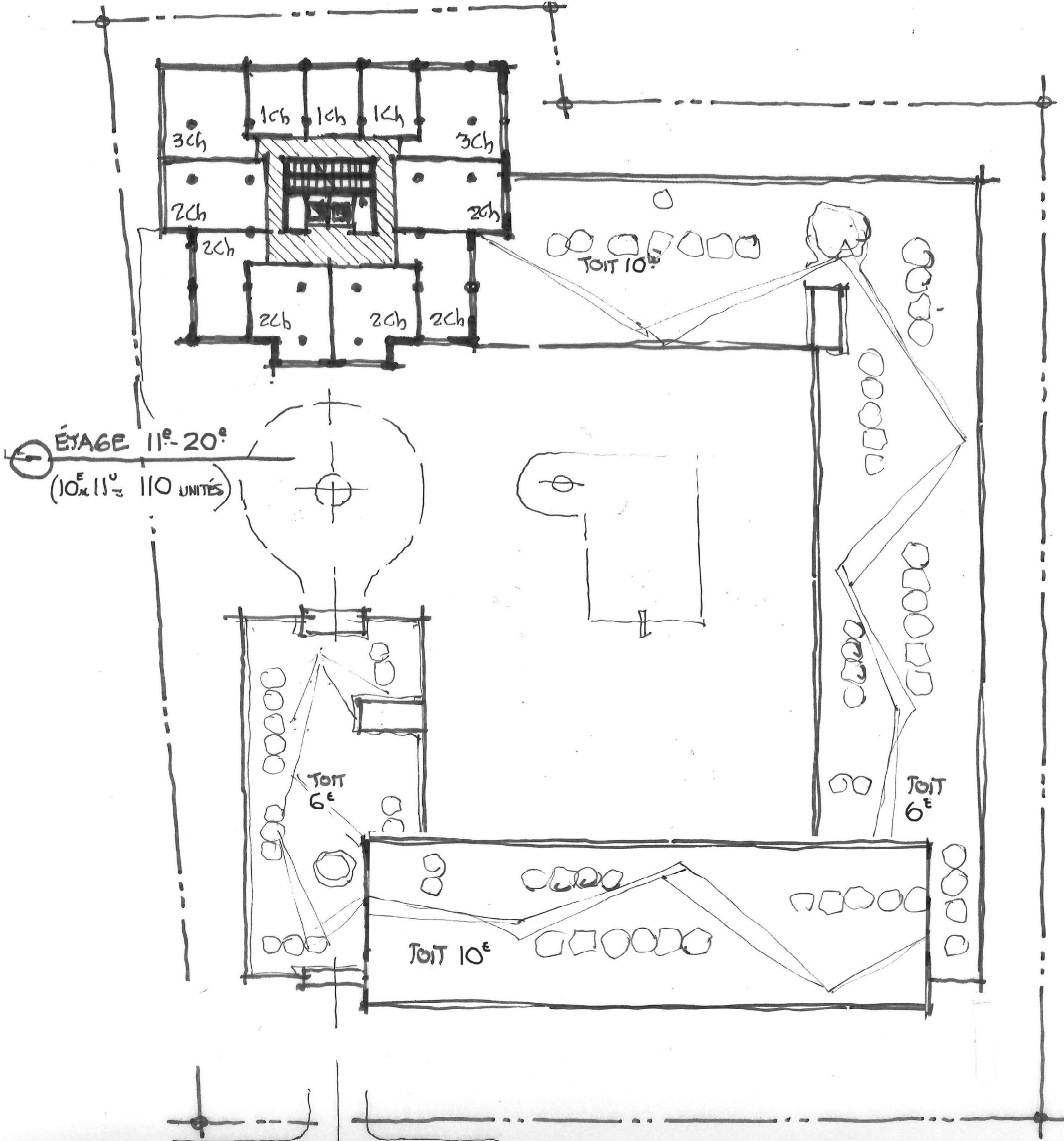

ÉYAGE 11^e-20^e

(10^e 11^u 110 UNITÉS)

3ch
1ch 1ch 1ch
2ch
2ch
2ch 2ch 2ch

TOIT 10^e

TOIT 6^e

TOIT 6^e

TOIT 10^e

Appendix C

Chain of Title



READ Abstracts Limited

331 Cooper Street, Suite 300, Ottawa, Ontario K2P 0A4

Email: search@readsearch.com

Tel.: 613-236-0664

Fax: 613-236-3677

ENVIRONMENTAL SEARCH

Lopers & Associates

Attn: Luke Lopers

BRIEF DESCRIPTION OF LAND:

729 Ridgewood Ave., Ottawa

Part Block C, Plan 775; Part Block C, Plan 749; Part Lot 23, Concession JG Gloucester

PIN: 04071-0125

LAST REGISTERED OWNER: 11684663 Canada Inc.

CHAIN OF TITLE:

Part Lot 23, Con JG.

Deed GL18011 registered Sep 7, 1904

From Ed P. Gleason to Ellen Foran

Vesting Order GL23147 registered Dec 18, 1917

To Thomas C. Bate, Robert S. Low, and Edward McMahon carrying on business as Bate, McMahon and Co.

Deed GL30343 registered April 13, 1920

From Thomas C. Bate and Edward McMahon surviving partners of Bate, McMahon and Co. to Thomas C. Bate and Edward McMahon

Deed GL31223 registered Oct 4, 1921

From Ellen Foran to Thomas C. Bate and Edward McMahon

Deed GL33374 registered Sep 5, 1925

From Ellen Foran to Robert M. Graham and John H. Graham

Deed GL33595 registered Feb 2, 1926

From Ellen Foran to Edward Rutledge

Deed GL33631 registered Mar 1, 1926
From Thomas C. Bate to Edward McMahon

Deed GL35202 registered Jan 3, 1930
From Edward Rutledge to John W. Dale

Deed GL37870 registered Jul 7, 1938
From estate of Robert M. Graham to John H. Graham

Deed GL40184 registered Sep 1943
From estate of Edward McMahon to Sidney Munro

Deed GL40430 registered Mar 9, 1944
From John H. Graham to Mary E. Coombs

Deed GL41671 registered Nov 21, 1945
From Sidney J. Munro to John W. Lucas and Jessie J. Lucas

Deed GL43757 registered Aug 16, 1947
From estate of John W. Dale to Robert and Yvonne Griffin

Deed GL46025 registered Apr 6, 1949
From John W. Lucas and Jessie J. Lucas to William Lucas

Foreclosure GL46822 registered Sep 7, 1949
From Robert and Yvonne Griffin to R. Walter Hamilton

Deed OT7066 registered Jul 3, 1952
From R. Walter Hamilton to James and Sarah Western

Deed OT9038 registered Jun 15, 1955
From James and Sarah Western to Frederick R. Francis

Deed OT31099 registered Jun 27, 1958
From estate of Sidney Munro to J. M. Patrick Kelly

Deed OT63114 registered Jun 4, 1959
From Mary E. Coombs to Norman H. Moody

Deed OT36513 registered Jun 30, 1959
From Frederick R. Francis to Joseph B. Kearney and Terrace Investments Limited

Deed OT37999 registered Oct 19, 1959
From Norman H. Moody to Campeau Construction Company Limited

Deed OT38000 registered Oct 19, 1959
From J. M. Patrick Kelly to Campeau Construction Company Limited

Deed OT40311 registered Jun 22, 1960
From estate of Ellen Foran and Frederick R. Francis to Joseph B. Kearney and Terrace Investments Limited

Deed OT42828 registered Jan 16, 1961
From William Lucas to Campeau Construction Company Limited

Deed OR42834 registered Jan 17, 1961
From Jessie J. Lucas and estate of John W. Lucas to Campeau Construction Company Limited

Plan 749 registered Jan 18, 1961
By Campeau Construction Company Limited

Plan 775 registered Dec 19, 1962
By Joseph B. Kearney and Terrace Investments Limited

Part Block C, Plan 775

Deed OT54279 registered Jan 9, 1963
From Joseph B. Kearney and Terrace Investments Limited to Campeau Construction Company Limited

Part Block C, Plan 775 and Part Block C, Plan 749 and Part Lot 23, Con. JG.

Deed NS223177 registered Dec 16, 1983
From Campeau Corporation to 561266 Ontario Inc.

Deed OC2162469 registered Nov 6, 2019
From 561266 Ontario Inc. to 11684663 Canada Inc.

Leases

OT67899 – Oct 20, 1965 – Supertest Petroleum Corporation Limited
CT188136 – Feb 21, 1974 – B. P. Oil Products Limited
CT209810 – May 15, 1975 - The Bank of Nova Scotia
N297929 – Jul 31, 1985 – Petro-Canada Products Inc.
N319366 0 Dec 20, 1985 – The Bank of Nova Scotia

Appendix D

Environmental Risk Information Systems (ERIS) database Search



DATABASE REPORT

Project Property: *Phase One Environmental Site Assessment
729 Ridgewood Avenue
Ottawa ON K1V 6M8*

Project No: *LOP20-002*

Report Type: *Standard Report*

Order No: *20200610241*

Requested by: *Lopers & Associates*

Date Completed: *June 12, 2020*

Table of Contents

Table of Contents.....	2
Executive Summary.....	3
Executive Summary: Report Summary.....	4
Executive Summary: Site Report Summary - Project Property.....	6
Executive Summary: Site Report Summary - Surrounding Properties.....	10
Executive Summary: Summary By Data Source.....	13
Map.....	21
Aerial.....	22
Topographic Map.....	23
Detail Report.....	24
Unplottable Summary.....	67
Unplottable Report.....	69
Appendix: Database Descriptions.....	76
Definitions.....	85

Notice: IMPORTANT LIMITATIONS and YOUR LIABILITY

Reliance on information in Report: This report DOES NOT replace a full Phase I Environmental Site Assessment but is solely intended to be used as a database review of environmental records.

License for use of information in Report: No page of this report can be used without this cover page, this notice and the project property identifier. The information in Report(s) may not be modified or re-sold.

Your Liability for misuse: Using this Service and/or its reports in a manner contrary to this Notice or your agreement will be in breach of copyright and contract and ERIS may obtain damages for such mis-use, including damages caused to third parties, and gives ERIS the right to terminate your account, rescind your license to any previous reports and to bar you from future use of the Service.

No warranty of Accuracy or Liability for ERIS: The information contained in this report has been produced by ERIS Information Limited Partnership ("ERIS") using various sources of information, including information provided by Federal and Provincial government departments. The report applies only to the address and up to the date specified on the cover of this report, and any alterations or deviation from this description will require a new report. This report and the data contained herein does not purport to be and does not constitute a guarantee of the accuracy of the information contained herein and does not constitute a legal opinion nor medical advice. Although ERIS has endeavored to present you with information that is accurate, ERIS disclaims, any and all liability for any errors, omissions, or inaccuracies in such information and data, whether attributable to inadvertence, negligence or otherwise, and for any consequences arising therefrom. Liability on the part of ERIS is limited to the monetary value paid for this report.

Trademark and Copyright: You may not use the ERIS trademarks or attribute any work to ERIS other than as outlined above. This Service and Report (s) are protected by copyright owned by ERIS Information Limited Partnership. Copyright in data used in the Service or Report(s) (the "Data") is owned by ERIS or its licensors. The Service, Report(s) and Data may not be copied or reproduced in whole or in any substantial part without prior written consent of ERIS.

Executive Summary

Property Information:

Project Property: *Phase One Environmental Site Assessment
729 Ridgewood Avenue Ottawa ON K1V 6M8*

Project No: *LOP20-002*

Coordinates:

Latitude: *45.3681874*
Longitude: *-75.6879375*
UTM Northing: *5,024,082.83*
UTM Easting: *446,128.39*
UTM Zone: *18T*

Elevation: *268 FT
81.82 M*

Order Information:

Order No: *20200610241*
Date Requested: *June 10, 2020*
Requested by: *Lopers & Associates*
Report Type: *Standard Report*

Historical/Products:

Aerial Photographs *Aerials - National Collection*
City Directory Search *CD - Subject Site plus 250m Radius*

Executive Summary: Report Summary

<i>Database</i>	<i>Name</i>	<i>Searched</i>	<i>Project Property</i>	<i>Within 0.25 km</i>	<i>Total</i>
AAGR	<i>Abandoned Aggregate Inventory</i>	Y	0	0	0
AGR	<i>Aggregate Inventory</i>	Y	0	0	0
AMIS	<i>Abandoned Mine Information System</i>	Y	0	0	0
ANDR	<i>Anderson's Waste Disposal Sites</i>	Y	0	0	0
AST	<i>Aboveground Storage Tanks</i>	Y	0	0	0
AUWR	<i>Automobile Wrecking & Supplies</i>	Y	0	0	0
BORE	<i>Borehole</i>	Y	1	0	1
CA	<i>Certificates of Approval</i>	Y	0	3	3
CDRY	<i>Dry Cleaning Facilities</i>	Y	0	0	0
CFOT	<i>Commercial Fuel Oil Tanks</i>	Y	0	0	0
CHEM	<i>Chemical Register</i>	Y	0	0	0
CNG	<i>Compressed Natural Gas Stations</i>	Y	0	0	0
COAL	<i>Inventory of Coal Gasification Plants and Coal Tar Sites</i>	Y	0	0	0
CONV	<i>Compliance and Convictions</i>	Y	0	0	0
CPU	<i>Certificates of Property Use</i>	Y	0	0	0
DRL	<i>Drill Hole Database</i>	Y	0	0	0
EASR	<i>Environmental Activity and Sector Registry</i>	Y	0	0	0
EBR	<i>Environmental Registry</i>	Y	0	0	0
ECA	<i>Environmental Compliance Approval</i>	Y	0	0	0
EEM	<i>Environmental Effects Monitoring</i>	Y	0	0	0
EHS	<i>ERIS Historical Searches</i>	Y	0	6	6
EIIS	<i>Environmental Issues Inventory System</i>	Y	0	0	0
EMHE	<i>Emergency Management Historical Event</i>	Y	0	0	0
EPAR	<i>Environmental Penalty Annual Report</i>	Y	0	0	0
EXP	<i>List of Expired Fuels Safety Facilities</i>	Y	11	0	11
FCON	<i>Federal Convictions</i>	Y	0	0	0
FCS	<i>Contaminated Sites on Federal Land</i>	Y	0	0	0
FOFT	<i>Fisheries & Oceans Fuel Tanks</i>	Y	0	0	0
FRST	<i>Federal Identification Registry for Storage Tank Systems (FIRSTS)</i>	Y	0	0	0
FST	<i>Fuel Storage Tank</i>	Y	0	0	0
FSTH	<i>Fuel Storage Tank - Historic</i>	Y	0	0	0
GEN	<i>Ontario Regulation 347 Waste Generators Summary</i>	Y	5	14	19
GHG	<i>Greenhouse Gas Emissions from Large Facilities</i>	Y	0	0	0
HINC	<i>TSSA Historic Incidents</i>	Y	0	0	0
IAFT	<i>Indian & Northern Affairs Fuel Tanks</i>	Y	0	0	0
INC	<i>Fuel Oil Spills and Leaks</i>	Y	0	0	0

Database	Name	Searched	Project Property	Within 0.25 km	Total
LIMO	Landfill Inventory Management Ontario	Y	0	0	0
MINE	Canadian Mine Locations	Y	0	0	0
MNR	Mineral Occurrences	Y	0	0	0
NATE	National Analysis of Trends in Emergencies System (NATES)	Y	0	0	0
NCPL	Non-Compliance Reports	Y	0	0	0
NDFT	National Defense & Canadian Forces Fuel Tanks	Y	0	0	0
NDSP	National Defense & Canadian Forces Spills	Y	0	0	0
NDWD	National Defence & Canadian Forces Waste Disposal Sites	Y	0	0	0
NEBI	National Energy Board Pipeline Incidents	Y	0	0	0
NEBP	National Energy Board Wells	Y	0	0	0
NEES	National Environmental Emergencies System (NEES)	Y	0	0	0
NPCB	National PCB Inventory	Y	0	0	0
NPRI	National Pollutant Release Inventory	Y	0	0	0
OGWE	Oil and Gas Wells	Y	0	0	0
OOGW	Ontario Oil and Gas Wells	Y	0	0	0
OPCB	Inventory of PCB Storage Sites	Y	0	0	0
ORD	Orders	Y	0	0	0
PAP	Canadian Pulp and Paper	Y	0	0	0
PCFT	Parks Canada Fuel Storage Tanks	Y	0	0	0
PES	Pesticide Register	Y	4	0	4
PINC	Pipeline Incidents	Y	0	0	0
PRT	Private and Retail Fuel Storage Tanks	Y	1	0	1
PTTW	Permit to Take Water	Y	0	0	0
REC	Ontario Regulation 347 Waste Receivers Summary	Y	0	0	0
RSC	Record of Site Condition	Y	0	0	0
RST	Retail Fuel Storage Tanks	Y	3	0	3
SCT	Scott's Manufacturing Directory	Y	0	1	1
SPL	Ontario Spills	Y	0	2	2
SRDS	Wastewater Discharger Registration Database	Y	0	0	0
TANK	Anderson's Storage Tanks	Y	0	0	0
TCFT	Transport Canada Fuel Storage Tanks	Y	0	0	0
VAR	Variances for Abandonment of Underground Storage Tanks	Y	0	0	0
WDS	Waste Disposal Sites - MOE CA Inventory	Y	0	0	0
WDSH	Waste Disposal Sites - MOE 1991 Historical Approval Inventory	Y	0	0	0
WWIS	Water Well Information System	Y	10	3	13
Total:			35	29	64

Executive Summary: Site Report Summary - Project Property

<i>Map Key</i>	<i>DB</i>	<i>Company/Site Name</i>	<i>Address</i>	<i>Dir/Dist (m)</i>	<i>Elev diff (m)</i>	<i>Page Number</i>
1	PES	THE COUNTRY GROCER INC. O/A COUNTRY GROCER FRESHMART	729 RIDGEWOOD AVENUE OTTAWA ON K1V 6M8	-/0.0	-0.25	24
1	PES	THE COUNTRY GROCER INC. O/A COUNTRY GROCER FRESHMART	729 RIDGEWOOD AVE OTTAWA ON K1V 6M8	-/0.0	-0.25	24
1	PES	THE COUNTRY GROCER INC. O/A COUNTRY GROCER FRESHMART	729 RIDGEWOOD AVE OTTAWA ON K1V 6M8	-/0.0	-0.25	24
1	GEN	561266 Ontario Inc.	729 Ridgewood Ottawa ON K1V 6M8	-/0.0	-0.25	25
1	GEN	561266 Ontario Inc.	729 Ridgewood Ottawa ON K1V 6M8	-/0.0	-0.25	25
1	PES	THE COUNTRY GROCER INC. O/A COUNTRY GROCER FRESHMART	729 RIDGEWOOD AVE OTTAWA ON K1V6M8	-/0.0	-0.25	25
2	BORE		ON	NNW/20.8	-0.71	26
3	WWIS		OTTAWA ON <i>Well ID:</i> 1535713	ESE/38.7	-0.92	27
4	WWIS		ON	ESE/45.3	-0.95	29

Map Key	DB	Company/Site Name	Address	Dir/Dist (m)	Elev diff (m)	Page Number
			Well ID: 7313098			
5	GEN	Riverside Pharmacy	737 Ridgewood Ave. Ottawa ON K1V 6M8	SSE/45.4	-0.64	30
6	WWIS		ON Well ID: 7303717	ESE/47.3	-0.95	30
7	WWIS		ON Well ID: 7313097	SE/53.4	-0.95	34
8	WWIS		ON Well ID: 7303718	ESE/54.2	-0.95	34
9	WWIS		ON Well ID: 7313096	E/54.7	-0.92	38
9	WWIS		ON Well ID: 7313099	E/54.7	-0.92	38
10	PRT	RICK MCCLOSKEYS SERVICE LTD	753 RIDGEWOOD AV OTTAWA ON K1V 6M8	ESE/55.4	-0.95	39
10	RST	MCCLOSKEY'S RICK SERVICE LTD	753 RIDGEWOOD AVE OTTAWA ON K1V6M8	ESE/55.4	-0.95	39
10	RST	MCCLOSKEY'S RICK SERVICE LTD	753 RIDGEWOOD AVE OTTAWA ON K1V 6M8	ESE/55.4	-0.95	39

<i>Map Key</i>	<i>DB</i>	<i>Company/Site Name</i>	<i>Address</i>	<i>Dir/Dist (m)</i>	<i>Elev diff (m)</i>	<i>Page Number</i>
10	RST	MCCLOSKEY'S RICK SERVICE LTD	OTTAWA ON K1V 6M8	ESE/55.4	-0.95	39
10	GEN	561266 ONT. INC.	753 RIDGEWOOD AVE OTTAWA ON K1V 6M8	ESE/55.4	-0.95	40
10	EXP	RICK MCCLOSKEYS SERVICE LTD	753 RIDGEWOOD AV OTTAWA ON K1V 6M8	ESE/55.4	-0.95	40
10	EXP	RICK MCCLOSKEYS SERVICE LTD	753 RIDGEWOOD AV OTTAWA ON	ESE/55.4	-0.95	40
10	EXP	RICK MCCLOSKEYS SERVICE LTD	753 RIDGEWOOD AV OTTAWA ON K1V 6M8	ESE/55.4	-0.95	40
10	EXP	RICK MCCLOSKEYS SERVICE LTD	753 RIDGEWOOD AV OTTAWA ON K1V 6M8	ESE/55.4	-0.95	41
10	EXP	RICK MCCLOSKEYS SERVICE LTD	753 RIDGEWOOD AV OTTAWA ON K1V 6M8	ESE/55.4	-0.95	41
10	EXP	RICK MCCLOSKEYS SERVICE LTD	753 RIDGEWOOD AV OTTAWA ON	ESE/55.4	-0.95	41
10	EXP	RICK MCCLOSKEYS SERVICE LTD	753 RIDGEWOOD AV OTTAWA ON	ESE/55.4	-0.95	41
10	EXP	RICK MCCLOSKEYS SERVICE LTD	753 RIDGEWOOD AV OTTAWA ON	ESE/55.4	-0.95	42

Map Key	DB	Company/Site Name	Address	Dir/Dist (m)	Elev diff (m)	Page Number
10	EXP	RICK MCCLOSKEYS SERVICE LTD	753 RIDGEWOOD AV OTTAWA ON K1V 6M8	ESE/55.4	-0.95	42
10	EXP	RICK MCCLOSKEYS SERVICE LTD	753 RIDGEWOOD AV OTTAWA ON K1V 6M8	ESE/55.4	-0.95	42
10	EXP	RICK MCCLOSKEYS SERVICE LTD	753 RIDGEWOOD AV OTTAWA ON K1V 6M8	ESE/55.4	-0.95	42
10	GEN	McCloskey's Rick Service	753 Ridgewood Ave Ottawa ON K1V 6M8	ESE/55.4	-0.95	43
11	WWIS		ON <i>Well ID: 7303720</i>	E/57.6	-2.10	43
12	WWIS		ON <i>Well ID: 7303719</i>	ESE/59.3	-0.95	46
13	WWIS		ON <i>Well ID: 7303721</i>	ESE/64.0	-1.25	48

Executive Summary: Site Report Summary - Surrounding Properties

Map Key	DB	Company/Site Name	Address	Dir/Dist (m)	Elev Diff (m)	Page Number
14	SPL	Clean Water Works Inc.	Ottawa ON	ESE/87.2	-1.15	51
15	WWIS		ON Well ID: 1508797	W/100.6	2.60	52
16	EHS		753 Springland Drive Ottawa ON K1V 6L9	ENE/116.2	-3.95	54
16	EHS		753 Springland Drive Ottawa ON K1V 6L9	ENE/116.2	-3.95	54
16	EHS		753 A Springland Dr Ottawa ON K1V6L9	ENE/116.2	-3.95	54
17	SCT	ITALIAN TELEPHONE DIRECTORY	770 RIDGEWOOD AVE OTTAWA ON K1V 6M9	ESE/137.1	-1.95	54
18	WWIS		ON Well ID: 1507898	W/188.7	5.76	55
19	EHS		2887 Riverside Dr Ottawa ON K1V8N4	NW/192.9	1.00	57
20	WWIS		Ottawa ON Well ID: 7285490	WNW/197.7	2.36	57
21	CA	TAMARACK DEVELOPMENTS CORP. - RIVERSIDE	2991 RIVERSIDE DR/BAYPORT PRIV OTTAWA CITY ON K1V 8N6	SSW/200.2	1.25	59
21	CA	TAMARACK DEVELOPMENTS CORP. - RIVERSIDE	2991 RIVERSIDE DR/BAYPORT PRIV OTTAWA CITY ON K1V 8N6	SSW/200.2	1.25	60
22	CA	OTTAWA CITY	SPRINGLAND DR./HOBSON RD. OTTAWA CITY ON	ENE/234.0	-5.92	60

Map Key	DB	Company/Site Name	Address	Dir/Dist (m)	Elev Diff (m)	Page Number
23	SPL	PRIVATE RESIDENCE	2707 SPRINGLAND DRIVE FURNACE OIL TANK OTTAWA CITY ON K1V 6M2	ESE/246.4	-3.89	60
24	GEN	City of Ottawa	2960 Riverside Dr. ottawa ON	WNW/249.5	5.11	61
24	GEN	City of Ottawa	2960 Riverside Dr. ottawa ON K2G 6J8	WNW/249.5	5.11	61
24	GEN	City of Ottawa	2960 Riverside Dr. ottawa ON K2G 6J8	WNW/249.5	5.11	62
24	GEN	City of Ottawa	2960 Riverside Dr. ottawa ON K2G 6J8	WNW/249.5	5.11	62
24	GEN	City of Ottawa RPAM	2960 Riverside Dr. ottawa ON K2G 6J8	WNW/249.5	5.11	62
24	GEN	City of Ottawa RPAM	2960 Riverside Dr. ottawa ON K2G 6J8	WNW/249.5	5.11	63
25	GEN	ST. PATRICK'S HOME OF OTTAWA 34-692	2865 RIVERSIDE DRIVE OTTAWA ON K1V 8N5	NNW/249.6	0.09	63
25	GEN	ST. PATRICK'S HOME OF OTTAWA	2865 RIVERSIDE DRIVE OTTAWA ON K1V 8N5	NNW/249.6	0.09	63
25	EHS		2865 Riverside Drive Ottawa ON K1V 8N5	NNW/249.6	0.09	63
25	EHS		2865 Riverside Drive Ottawa ON K1V 8N5	NNW/249.6	0.09	64
25	GEN	St. Patrick's Home of Ottawa Inc.	2865 Riverside Dr. Ottawa ON K1V 8N5	NNW/249.6	0.09	64
25	GEN	Medical Arts Dispensary of Ottawa	2865 Riverside Drive Ottawa ON K1V 8N5	NNW/249.6	0.09	64

<i>Map Key</i>	<i>DB</i>	<i>Company/Site Name</i>	<i>Address</i>	<i>Dir/Dist (m)</i>	<i>Elev Diff (m)</i>	<i>Page Number</i>
25	GEN	Medical Arts Dispensary of Ottawa	2865 Riverside Drive Ottawa ON K1V 8N5	NNW/249.6	0.09	64
25	GEN	St. Patrick's Home of Ottawa Inc.	2865 Riverside Dr. Ottawa ON K1V 8N5	NNW/249.6	0.09	65
25	GEN	Medical Arts Dispensary of Ottawa	2865 Riverside Drive Ottawa ON K1V 8N5	NNW/249.6	0.09	65
25	GEN	Medical Arts Dispensary of Ottawa	2865 Riverside Drive Ottawa ON K1V 8N5	NNW/249.6	0.09	65

Executive Summary: Summary By Data Source

BORE - Borehole

A search of the BORE database, dated 1875-Jul 2018 has found that there are 1 BORE site(s) within approximately 0.25 kilometers of the project property.

<u>Lower Elevation</u>	<u>Address</u>	<u>Direction</u>	<u>Distance (m)</u>	<u>Map Key</u>
	ON	NNW	20.83	2

CA - Certificates of Approval

A search of the CA database, dated 1985-Oct 30, 2011* has found that there are 3 CA site(s) within approximately 0.25 kilometers of the project property.

<u>Equal/Higher Elevation</u>	<u>Address</u>	<u>Direction</u>	<u>Distance (m)</u>	<u>Map Key</u>
TAMARACK DEVELOPMENTS CORP. - RIVERSIDE	2991 RIVERSIDE DR/BAYPORT PRIV OTTAWA CITY ON K1V 8N6	SSW	200.25	21

TAMARACK DEVELOPMENTS CORP. - RIVERSIDE	2991 RIVERSIDE DR/BAYPORT PRIV OTTAWA CITY ON K1V 8N6	SSW	200.25	21
---	--	-----	--------	--------------------

<u>Lower Elevation</u>	<u>Address</u>	<u>Direction</u>	<u>Distance (m)</u>	<u>Map Key</u>
OTTAWA CITY	SPRINGLAND DR./HOBSON RD. OTTAWA CITY ON	ENE	233.98	22

EHS - ERIS Historical Searches

A search of the EHS database, dated 1999-Jan 31, 2020 has found that there are 6 EHS site(s) within approximately 0.25 kilometers of the project property.

<u>Equal/Higher Elevation</u>	<u>Address</u>	<u>Direction</u>	<u>Distance (m)</u>	<u>Map Key</u>
	2887 Riverside Dr Ottawa ON K1V8N4	NW	192.93	19

	2865 Riverside Drive Ottawa ON K1V 8N5	NNW	249.56	25
--	---	-----	--------	--------------------

<u>Equal/Higher Elevation</u>	<u>Address</u>	<u>Direction</u>	<u>Distance (m)</u>	<u>Map Key</u>
	2865 Riverside Drive Ottawa ON K1V 8N5	NNW	249.56	25

<u>Lower Elevation</u>	<u>Address</u>	<u>Direction</u>	<u>Distance (m)</u>	<u>Map Key</u>
	753 Springland Drive Ottawa ON K1V 6L9	ENE	116.17	16
	753 A Springland Dr Ottawa ON K1V6L9	ENE	116.17	16
	753 Springland Drive Ottawa ON K1V 6L9	ENE	116.17	16

EXP - List of Expired Fuels Safety Facilities

A search of the EXP database, dated Feb 28, 2017 has found that there are 11 EXP site(s) within approximately 0.25 kilometers of the project property.

<u>Lower Elevation</u>	<u>Address</u>	<u>Direction</u>	<u>Distance (m)</u>	<u>Map Key</u>
RICK MCCLOSKEYS SERVICE LTD	753 RIDGEWOOD AV OTTAWA ON K1V 6M8	ESE	55.43	10
RICK MCCLOSKEYS SERVICE LTD	753 RIDGEWOOD AV OTTAWA ON	ESE	55.43	10
RICK MCCLOSKEYS SERVICE LTD	753 RIDGEWOOD AV OTTAWA ON K1V 6M8	ESE	55.43	10
RICK MCCLOSKEYS SERVICE LTD	753 RIDGEWOOD AV OTTAWA ON	ESE	55.43	10
RICK MCCLOSKEYS SERVICE LTD	753 RIDGEWOOD AV OTTAWA ON	ESE	55.43	10

RICK MCCLOSKEYS SERVICE LTD	753 RIDGEWOOD AV OTTAWA ON	ESE	55.43	10
RICK MCCLOSKEYS SERVICE LTD	753 RIDGEWOOD AV OTTAWA ON K1V 6M8	ESE	55.43	10
RICK MCCLOSKEYS SERVICE LTD	753 RIDGEWOOD AV OTTAWA ON K1V 6M8	ESE	55.43	10
RICK MCCLOSKEYS SERVICE LTD	753 RIDGEWOOD AV OTTAWA ON K1V 6M8	ESE	55.43	10
RICK MCCLOSKEYS SERVICE LTD	753 RIDGEWOOD AV OTTAWA ON K1V 6M8	ESE	55.43	10
RICK MCCLOSKEYS SERVICE LTD	753 RIDGEWOOD AV OTTAWA ON K1V 6M8	ESE	55.43	10

GEN - Ontario Regulation 347 Waste Generators Summary

A search of the GEN database, dated 1986-Jan 31, 2020 has found that there are 19 GEN site(s) within approximately 0.25 kilometers of the project property.

<u>Equal/Higher Elevation</u>	<u>Address</u>	<u>Direction</u>	<u>Distance (m)</u>	<u>Map Key</u>
City of Ottawa	2960 Riverside Dr. ottawa ON	WNW	249.51	24
City of Ottawa	2960 Riverside Dr. ottawa ON K2G 6J8	WNW	249.51	24
City of Ottawa	2960 Riverside Dr. ottawa ON K2G 6J8	WNW	249.51	24
City of Ottawa	2960 Riverside Dr. ottawa ON K2G 6J8	WNW	249.51	24
City of Ottawa RPAM	2960 Riverside Dr. ottawa ON K2G 6J8	WNW	249.51	24

<u>Equal/Higher Elevation</u>	<u>Address</u>	<u>Direction</u>	<u>Distance (m)</u>	<u>Map Key</u>
City of Ottawa RPAM	2960 Riverside Dr. ottawa ON K2G 6J8	WNW	249.51	24
ST. PATRICK'S HOME OF OTTAWA 34-692	2865 RIVERSIDE DRIVE OTTAWA ON K1V 8N5	NNW	249.56	25
ST. PATRICK'S HOME OF OTTAWA	2865 RIVERSIDE DRIVE OTTAWA ON K1V 8N5	NNW	249.56	25
St. Patrick's Home of Ottawa Inc.	2865 Riverside Dr. Ottawa ON K1V 8N5	NNW	249.56	25
Medical Arts Dispensary of Ottawa	2865 Riverside Drive Ottawa ON K1V 8N5	NNW	249.56	25
Medical Arts Dispensary of Ottawa	2865 Riverside Drive Ottawa ON K1V 8N5	NNW	249.56	25
St. Patrick's Home of Ottawa Inc.	2865 Riverside Dr. Ottawa ON K1V 8N5	NNW	249.56	25
Medical Arts Dispensary of Ottawa	2865 Riverside Drive Ottawa ON K1V 8N5	NNW	249.56	25
Medical Arts Dispensary of Ottawa	2865 Riverside Drive Ottawa ON K1V 8N5	NNW	249.56	25
<u>Lower Elevation</u>	<u>Address</u>	<u>Direction</u>	<u>Distance (m)</u>	<u>Map Key</u>
561266 Ontario INC.	729 Ridgewood Ottawa ON K1V 6M8	-	0.00	1
561266 Ontario INC.	729 Ridgewood Ottawa ON K1V 6M8	-	0.00	1

Riverside Pharmacy	737 Ridgewood Ave. Ottawa ON K1V 6M8	SSE	45.36	5
McCloskey's Rick Service	753 Ridgewood Ave Ottawa ON K1V 6M8	ESE	55.43	10
561266 ONT. INC.	753 RIDGEWOOD AVE OTTAWA ON K1V 6M8	ESE	55.43	10

PES - Pesticide Register

A search of the PES database, dated 1988 - Apr 2020 has found that there are 4 PES site(s) within approximately 0.25 kilometers of the project property.

<u>Lower Elevation</u>	<u>Address</u>	<u>Direction</u>	<u>Distance (m)</u>	<u>Map Key</u>
THE COUNTRY GROCER INC. O/A COUNTRY GROCER FRESHMART	729 RIDGEWOOD AVE OTTAWA ON K1V 6M8	-	0.00	1
THE COUNTRY GROCER INC. O/A COUNTRY GROCER FRESHMART	729 RIDGEWOOD AVENUE OTTAWA ON K1V 6M8	-	0.00	1
THE COUNTRY GROCER INC. O/A COUNTRY GROCER FRESHMART	729 RIDGEWOOD AVE OTTAWA ON K1V6M8	-	0.00	1
THE COUNTRY GROCER INC. O/A COUNTRY GROCER FRESHMART	729 RIDGEWOOD AVE OTTAWA ON K1V 6M8	-	0.00	1

PRT - Private and Retail Fuel Storage Tanks

A search of the PRT database, dated 1989-1996* has found that there are 1 PRT site(s) within approximately 0.25 kilometers of the project property.

<u>Lower Elevation</u>	<u>Address</u>	<u>Direction</u>	<u>Distance (m)</u>	<u>Map Key</u>
RICK MCCLOSKEYS SERVICE LTD	753 RIDGEWOOD AV OTTAWA ON K1V 6M8	ESE	55.43	10

RST - Retail Fuel Storage Tanks

A search of the RST database, dated 1999-Jan 31, 2020 has found that there are 3 RST site(s) within approximately 0.25 kilometers of the project property.

<u>Lower Elevation</u>	<u>Address</u>	<u>Direction</u>	<u>Distance (m)</u>	<u>Map Key</u>
MCCLOSKEY'S RICK SERVICE LTD	753 RIDGEWOOD AVE OTTAWA ON K1V6M8	ESE	55.43	10
MCCLOSKEY'S RICK SERVICE LTD	753 RIDGEWOOD AVE OTTAWA ON K1V 6M8	ESE	55.43	10
MCCLOSKEY'S RICK SERVICE LTD	OTTAWA ON K1V 6M8	ESE	55.43	10

SCT - Scott's Manufacturing Directory

A search of the SCT database, dated 1992-Mar 2011* has found that there are 1 SCT site(s) within approximately 0.25 kilometers of the project property.

<u>Lower Elevation</u>	<u>Address</u>	<u>Direction</u>	<u>Distance (m)</u>	<u>Map Key</u>
ITALIAN TELEPHONE DIRECTORY	770 RIDGEWOOD AVE OTTAWA ON K1V 6M9	ESE	137.10	17

SPL - Ontario Spills

A search of the SPL database, dated 1988-Nov 2019 has found that there are 2 SPL site(s) within approximately 0.25 kilometers of the project property.

<u>Lower Elevation</u>	<u>Address</u>	<u>Direction</u>	<u>Distance (m)</u>	<u>Map Key</u>
Clean Water Works Inc.	Ottawa ON	ESE	87.21	14
PRIVATE RESIDENCE	2707 SPRINGLAND DRIVE FURNACE OIL TANK OTTAWA CITY ON K1V 6M2	ESE	246.45	23

WWIS - Water Well Information System

A search of the WWIS database, dated Feb 28, 2019 has found that there are 13 WWIS site(s) within approximately 0.25 kilometers of the project property.

<u>Equal/Higher Elevation</u>	<u>Address</u>	<u>Direction</u>	<u>Distance (m)</u>	<u>Map Key</u>
	ON	W	100.64	15

<u>Equal/Higher Elevation</u>	<u>Address</u>	<u>Direction</u>	<u>Distance (m)</u>	<u>Map Key</u>
	<i>Well ID:</i> 1508797			
	ON	W	188.67	18
	<i>Well ID:</i> 1507898			
	Ottawa ON	WNW	197.74	20
	<i>Well ID:</i> 7285490			

<u>Lower Elevation</u>	<u>Address</u>	<u>Direction</u>	<u>Distance (m)</u>	<u>Map Key</u>
	OTTAWA ON	ESE	38.67	3
	<i>Well ID:</i> 1535713			
	ON	ESE	45.27	4
	<i>Well ID:</i> 7313098			
	ON	ESE	47.33	6
	<i>Well ID:</i> 7303717			
	ON	SE	53.37	7
	<i>Well ID:</i> 7313097			
	ON	ESE	54.23	8
	<i>Well ID:</i> 7303718			
	ON	E	54.66	9
	<i>Well ID:</i> 7313099			
	ON	E	54.66	9
	<i>Well ID:</i> 7313096			
	ON	E	57.63	11
	<i>Well ID:</i> 7303720			
	ON	ESE	59.26	12

Well ID: 7303719

ON

Well ID: 7303721

ESE

63.98

13



Map : 0.25 Kilometer Radius

Order Number: 20200610241

Address: 729 Ridgewood Avenue, Ottawa, ON



Project Property	Expressway	Industrial and Resource - Regions	National Park
Buffer Outline	Principal Highway	Main Line	Provincial or Territorial Park
Eris Sites with Higher Elevation	Secondary Highway	Sidetrack	Other Park
Eris Sites with Same Elevation	Major Road	Transit Line	Golf Course or Driving Range
Eris Sites with Lower Elevation	Local road	Abandoned Line	Park or Sports Field
Eris Sites with Unknown Elevation	Trail	Proposed Road	Other Recreation Area
	Ferry Route/Ice Road		

75°42'W

45°22'30"N

45°22'30"N



250 125 0 250 m

1:10000

Source: Esri, Maxar, GeoEye, Earthstar Geographics, CNES/Airbus DS, USDA, USGS, AeroGRID, IGN, and the GIS User Community

Aerial Year: 2019

Address: 729 Ridgewood Avenue, Ottawa, ON

Source: ESRI World Imagery

Order Number: 20200610241



© ERIS Information Limited Partnership

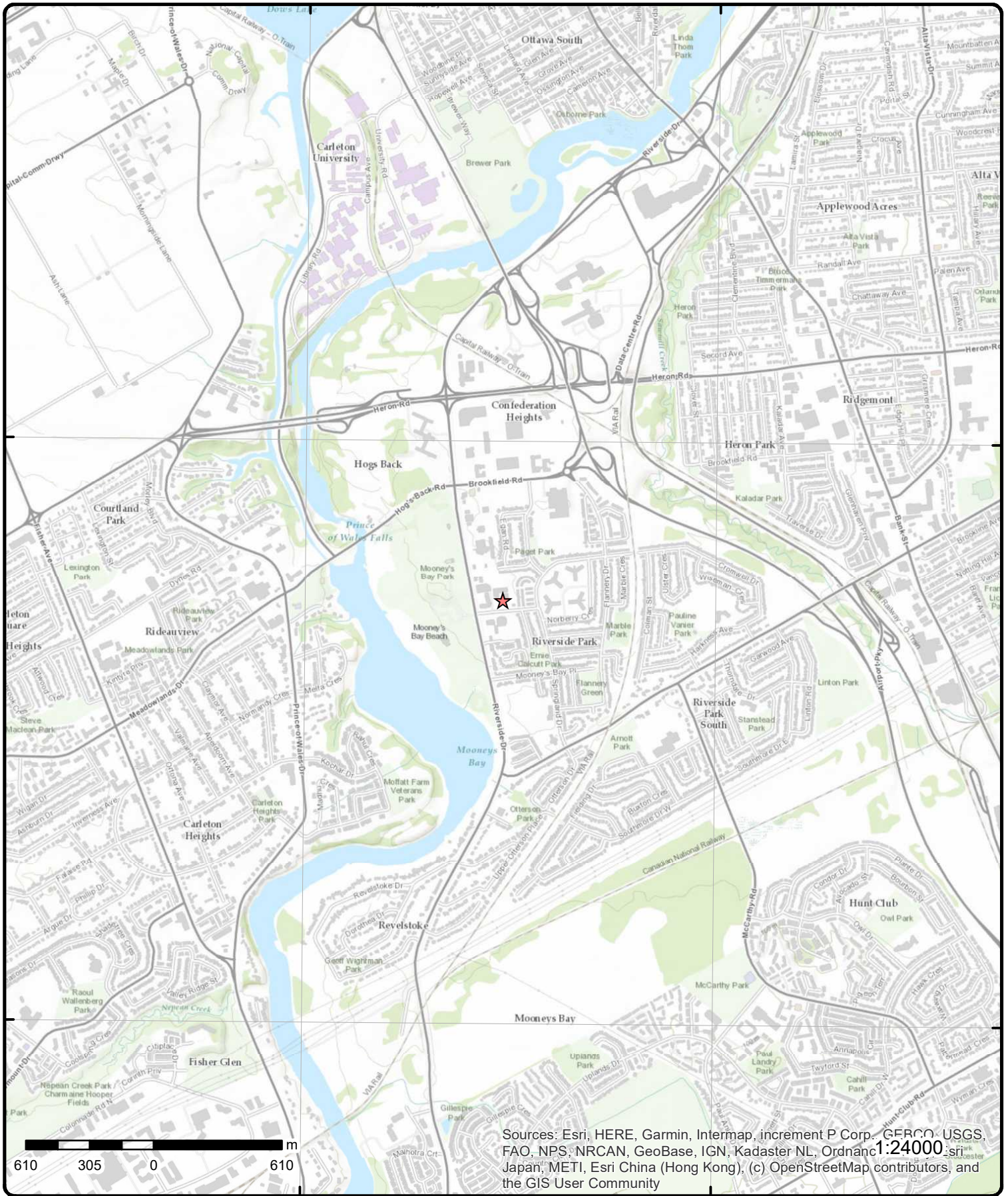

Sources: Esri, HERE, Garmin, Intermap, increment P Corp., GEBCO, USGS, FAO, NPS, NRCAN, GeoBase, IGN, Kadaster NL, Ordnance Survey, Esri Japan, METI, Esri China (Hong Kong), (c) OpenStreetMap contributors, and the GIS User Community

Topographic Map

Address: 729 Ridgewood Avenue, ON

Source: ESRI World Topographic Map

Order Number: 20200610241



© ERIS Information Limited Partnership

Detail Report

Map Key	Number of Records	Direction/ Distance (m)	Elev/Diff (m)	Site	DB
1	1 of 6	-/0.0	81.6 / -0.25	THE COUNTRY GROCER INC. O/A COUNTRY GROCER FRESHMART 729 RIDGEWOOD AVENUE OTTAWA ON K1V 6M8	PES
Detail Licence No: 23-01-11853-0 Licence No: 11853 Status: Approval Date: Report Source: Licence Type: Limited Vendor Licence Type Code: 23 Licence Class: 01 Licence Control: 0 Latitude: Longitude: Lot: Concession: Region: District: County: Trade Name: PDF Link:		Operator Box: Operator Class: Operator No: Operator Type: Oper Area Code: Oper Phone No: Operator Ext: Operator Lot: Oper Concession: Operator Region: 4 Operator District: 2 Operator County: 15 Op Municipality: Post Office Box: MOE District: SWP Area Name:			
1	2 of 6	-/0.0	81.6 / -0.25	THE COUNTRY GROCER INC. O/A COUNTRY GROCER FRESHMART 729 RIDGEWOOD AVE OTTAWA ON K1V 6M8	PES
Detail Licence No: Licence No: Status: Approval Date: Report Source: Licence Type: Limited Vendor Licence Type Code: 23 Licence Class: Licence Control: Latitude: Longitude: Lot: Concession: Region: District: County: Trade Name: PDF Link:		Operator Box: Operator Class: Operator No: Operator Type: Oper Area Code: Oper Phone No: Operator Ext: Operator Lot: Oper Concession: Operator Region: Operator District: Operator County: Op Municipality: Post Office Box: MOE District: SWP Area Name:			
1	3 of 6	-/0.0	81.6 / -0.25	THE COUNTRY GROCER INC. O/A COUNTRY GROCER FRESHMART 729 RIDGEWOOD AVE OTTAWA ON K1V 6M8	PES

Map Key	Number of Records	Direction/ Distance (m)	Elev/Diff (m)	Site	DB
---------	-------------------	-------------------------	---------------	------	----

Detail Licence No:
Licence No:
Status:
Approval Date:
Report Source:
Licence Type: Vendor
Licence Type Code:
Licence Class:
Licence Control:
Latitude:
Longitude:
Lot:
Concession:
Region:
District:
County:
Trade Name:
PDF Link:

Operator Box:
Operator Class:
Operator No:
Operator Type:
Oper Area Code:
Oper Phone No:
Operator Ext:
Operator Lot:
Oper Concession:
Operator Region:
Operator District:
Operator County:
Op Municipality:
Post Office Box:
MOE District:
SWP Area Name:

<u>1</u>	4 of 6	-/0.0	81.6 / -0.25	561266 Ontario Inc. 729 Ridgewood Ottawa ON K1V 6M8	GEN
----------	--------	-------	--------------	---	-----

Generator No: ON3535704
Status:
Approval Years: 2016
Contam. Facility: No
MHSW Facility: No
SIC Code: 531310
SIC Description: REAL ESTATE PROPERTY MANAGERS

PO Box No:
Country: Canada
Choice of Contact: CO_OFFICIAL
Co Admin: Brenda M Kennedy
Phone No Admin: 6132743742 Ext.223

Detail(s)

Waste Class: 251
Waste Class Desc: OIL SKIMMINGS & SLUDGES

<u>1</u>	5 of 6	-/0.0	81.6 / -0.25	561266 Ontario Inc. 729 Ridgewood Ottawa ON K1V 6M8	GEN
----------	--------	-------	--------------	---	-----

Generator No: ON3535704
Status: Registered
Approval Years: As of Dec 2017
Contam. Facility:
MHSW Facility:
SIC Code:
SIC Description:

PO Box No:
Country: Canada
Choice of Contact:
Co Admin:
Phone No Admin:

Detail(s)

Waste Class: 251 L
Waste Class Desc: Waste oils/sludges (petroleum based)

<u>1</u>	6 of 6	-/0.0	81.6 / -0.25	THE COUNTRY GROCER INC. O/A COUNTRY GROCER FRESHMART 729 RIDGEWOOD AVE OTTAWA ON K1V6M8	PES
----------	--------	-------	--------------	--	-----

Detail Licence No: 23-01-11853-0
Licence No: 11853

Operator Box:
Operator Class:

Map Key	Number of Records	Direction/ Distance (m)	Elev/Diff (m)	Site	DB
Status: Approval Date: Report Source: Legacy Licenses (Excluding TS) Licence Type: Limited Vendor Licence Type Code: 23 Licence Class: 01 Licence Control: 0 Latitude: Longitude: Lot: Concession: Region: District: County: Trade Name: PDF Link:				Operator No: Operator Type: Oper Area Code: 613 Oper Phone No: 7316883 Operator Ext: Operator Lot: Oper Concession: Operator Region: 4 Operator District: 2 Operator County: 15 Op Municipality: Post Office Box: MOE District: SWP Area Name:	

2	1 of 1	NNW/20.8	81.1 / -0.71	ON	BORE
Borehole ID: 612687 OGF ID: 215513993 Status: Type: Borehole Use: Completion Date: Static Water Level: Primary Water Use: Sec. Water Use: Total Depth m: -999 Depth Ref: Ground Surface Depth Elev: Drill Method: Orig Ground Elev m: 74.7 Elev Reliabil Note: DEM Ground Elev m: 82.4 Concession: Location D: Survey D: Comments:				Inclin FLG: No SP Status: Initial Entry Surv Elev: No Piezometer: No Primary Name: Municipality: Lot: Township: Latitude DD: 45.368361 Longitude DD: -75.688038 UTM Zone: 18 Easting: 446121 Northing: 5024102 Location Accuracy: Accuracy: Not Applicable	

Borehole Geology Stratum

Geology Stratum ID: 218392090 Top Depth: .6 Bottom Depth: .9 Material Color: Material 1: Gravel Material 2: Material 3: Material 4: Gsc Material Description: Stratum Description: GRAVEL.				Mat Consistency: Material Moisture: Material Texture: Non Geo Mat Type: Geologic Formation: Geologic Group: Geologic Period: Depositional Gen:	
Geology Stratum ID: 218392091 Top Depth: .9 Bottom Depth: Material Color: Material 1: Bedrock Material 2: Material 3: Material 4: Gsc Material Description:				Mat Consistency: Material Moisture: Material Texture: Non Geo Mat Type: Geologic Formation: Geologic Group: Geologic Period: Depositional Gen:	

Map Key	Number of Records	Direction/ Distance (m)	Elev/Diff (m)	Site	DB
Stratum Description:		BEDROCK. 0350093FEET.SAND. BEDROCK. ROCK. BEDROCK. 00000 040 00000009 000 **Note: Many records provided by the department have a truncated [Stratum Description] field.			
Geology Stratum ID:	218392089			Mat Consistency:	
Top Depth:	0			Material Moisture:	
Bottom Depth:	.6			Material Texture:	
Material Color:				Non Geo Mat Type:	
Material 1:	Silt			Geologic Formation:	
Material 2:				Geologic Group:	
Material 3:				Geologic Period:	
Material 4:				Depositional Gen:	
Gsc Material Description:					
Stratum Description:	SILT.				

Source

Source Type:	Data Survey	Source Appl:	Spatial/Tabular
Source Orig:	Geological Survey of Canada	Source Iden:	1
Source Date:	1956-1972	Scale or Res:	Varies
Confidence:	M	Horizontal:	NAD27
Observatio:		Verticalda:	Mean Average Sea Level
Source Name:	Urban Geology Automated Information System (UGAIS)		
Source Details:	File: OTTAWA2.txt RecordID: 051950 NTS_Sheet: 31G05B		
Confiden 1:	Logs are approximately correct. Lack of information. Doubtful terminology.		

Source List

Source Identifier:	1	Horizontal Datum:	NAD27
Source Type:	Data Survey	Vertical Datum:	Mean Average Sea Level
Source Date:	1956-1972	Projection Name:	Universal Transverse Mercator
Scale or Resolution:	Varies		
Source Name:	Urban Geology Automated Information System (UGAIS)		
Source Originators:	Geological Survey of Canada		

<u>3</u>	1 of 1	ESE/38.7	80.9 / -0.92	OTTAWA ON	WWIS
Well ID:	1535713			Data Entry Status:	
Construction Date:				Data Src:	
Primary Water Use:				Date Received:	8/16/2005
Sec. Water Use:				Selected Flag:	Yes
Final Well Status:	Observation Wells			Abandonment Rec:	
Water Type:				Contractor:	7241
Casing Material:				Form Version:	3
Audit No:	Z29930			Owner:	
Tag:	A027929			Street Name:	753 RIDGEWOOD DR
Construction Method:				County:	OTTAWA-CARLETON
Elevation (m):				Municipality:	OTTAWA CITY
Elevation Reliability:				Site Info:	
Depth to Bedrock:				Lot:	
Well Depth:				Concession:	
Overburden/Bedrock:				Concession Name:	
Pump Rate:				Easting NAD83:	
Static Water Level:				Northing NAD83:	
Flowing (Y/N):				Zone:	
Flow Rate:				UTM Reliability:	
Clear/Cloudy:					

Bore Hole Information

Bore Hole ID:	11316252	Elevation:	82.05619
----------------------	----------	-------------------	----------

Map Key	Number of Records	Direction/ Distance (m)	Elev/Diff (m)	Site	DB
DP2BR:				Elevrc:	
Spatial Status:				Zone:	18
Code OB:	0			East83:	446164.1
Code OB Desc:	Overburden			North83:	5024068
Open Hole:				Org CS:	G83a
Cluster Kind:				UTMRC:	4
Date Completed:	7/15/2005			UTMRC Desc:	margin of error : 30 m - 100 m
Remarks:				Location Method:	wwr
Elevrc Desc:					
Location Source Date:					
Improvement Location Source:					
Improvement Location Method:					
Source Revision Comment:					
Supplier Comment:					

Overburden and Bedrock

Materials Interval

Formation ID: 932996993
Layer: 3
Color: 2
General Color: GREY
Mat1: 05
Most Common Material: CLAY
Mat2: 28
Other Materials: SAND
Mat3:
Other Materials:
Formation Top Depth: 3
Formation End Depth: 5
Formation End Depth UOM: m

Overburden and Bedrock

Materials Interval

Formation ID: 932996991
Layer: 1
Color: 6
General Color: BROWN
Mat1: 28
Most Common Material: SAND
Mat2: 11
Other Materials: GRAVEL
Mat3:
Other Materials:
Formation Top Depth: 0
Formation End Depth: 1.2
Formation End Depth UOM: m

Overburden and Bedrock

Materials Interval

Formation ID: 932996992
Layer: 2
Color: 2
General Color: GREY
Mat1: 05
Most Common Material: CLAY
Mat2: 28
Other Materials: SAND
Mat3: 11
Other Materials: GRAVEL
Formation Top Depth: 1.2

Map Key	Number of Records	Direction/ Distance (m)	Elev/Diff (m)	Site	DB
Formation End Depth:	3				
Formation End Depth UOM:	m				
<u>Method of Construction & Well Use</u>					
Method Construction ID:					
Method Construction Code:	B				
Method Construction:	Other Method				
Other Method Construction:					
<u>Pipe Information</u>					
Pipe ID:	11331107				
Casing No:	1				
Comment:					
Alt Name:					
<u>Construction Record - Casing</u>					
Casing ID:	930855621				
Layer:	1				
Material:	5				
Open Hole or Material:	PLASTIC				
Depth From:	0				
Depth To:	1.83				
Casing Diameter:	1.25				
Casing Diameter UOM:	cm				
Casing Depth UOM:	m				
<u>Construction Record - Screen</u>					
Screen ID:	933414209				
Layer:	1				
Slot:	10				
Screen Top Depth:	1.83				
Screen End Depth:	5				
Screen Material:	5				
Screen Depth UOM:	m				
Screen Diameter UOM:	cm				
Screen Diameter:	3.17				
<u>Hole Diameter</u>					
Hole ID:	11533805				
Diameter:	8.89				
Depth From:	0				
Depth To:	3.96				
Hole Depth UOM:	m				
Hole Diameter UOM:	cm				

4

1 of 1

ESE/45.3

80.9 / -0.95

ON

WWIS

Well ID: 7313098
 Construction Date:
 Primary Water Use:
 Sec. Water Use:
 Final Well Status:
 Water Type:
 Casing Material:

Data Entry Status: Yes
 Data Src:
 Date Received: 6/19/2018
 Selected Flag: Yes
 Abandonment Rec:
 Contractor: 7241
 Form Version: 7

Map Key	Number of Records	Direction/ Distance (m)	Elev/Diff (m)	Site	DB
Audit No:	Z212322			Owner:	
Tag:	A189924			Street Name:	
Construction Method:				County:	OTTAWA-CARLETON
Elevation (m):				Municipality:	GLOUCESTER TOWNSHIP
Elevation Reliability:				Site Info:	
Depth to Bedrock:				Lot:	
Well Depth:				Concession:	
Overburden/Bedrock:				Concession Name:	
Pump Rate:				Easting NAD83:	
Static Water Level:				Northing NAD83:	
Flowing (Y/N):				Zone:	
Flow Rate:				UTM Reliability:	
Clear/Cloudy:					
<u>Bore Hole Information</u>					
Bore Hole ID:	1007115287			Elevation:	
DP2BR:				Elevrc:	
Spatial Status:				Zone:	18
Code OB:				East83:	446170
Code OB Desc:				North83:	5024065
Open Hole:				Org CS:	UTM83
Cluster Kind:				UTMRC:	4
Date Completed:	2/22/2018			UTMRC Desc:	margin of error : 30 m - 100 m
Remarks:				Location Method:	wwr
Elevrc Desc:					
Location Source Date:					
Improvement Location Source:					
Improvement Location Method:					
Source Revision Comment:					
Supplier Comment:					
5	1 of 1	SSE/45.4	81.2 / -0.64	Riverside Pharmacy 737 Ridgewood Ave. Ottawa ON K1V 6M8	GEN
Generator No:	ON7903814			PO Box No:	
Status:				Country:	
Approval Years:	04			Choice of Contact:	
Contam. Facility:				Co Admin:	
MHSW Facility:				Phone No Admin:	
SIC Code:	813920				
SIC Description:	Professional Organizations				
6	1 of 1	ESE/47.3	80.9 / -0.95	ON	WWIS
Well ID:	7303717			Data Entry Status:	
Construction Date:				Data Src:	
Primary Water Use:	Test Hole			Date Received:	1/19/2018
Sec. Water Use:	Monitoring			Selected Flag:	Yes
Final Well Status:	Observation Wells			Abandonment Rec:	
Water Type:				Contractor:	7241
Casing Material:				Form Version:	7
Audit No:	Z212364			Owner:	
Tag:	A182473			Street Name:	749 RIDGEWOOD AVENUE
Construction Method:				County:	OTTAWA-CARLETON
Elevation (m):				Municipality:	OTTAWA CITY
Elevation Reliability:				Site Info:	
Depth to Bedrock:				Lot:	
Well Depth:				Concession:	

Map Key	Number of Records	Direction/ Distance (m)	Elev/Diff (m)	Site	DB
---------	-------------------	----------------------------	------------------	------	----

Overburden/Bedrock:
Pump Rate:
Static Water Level:
Flowing (Y/N):
Flow Rate:
Clear/Cloudy:

Concession Name:
Easting NAD83:
Northing NAD83:
Zone:
UTM Reliability:

Bore Hole Information

Bore Hole ID: 1006972312
DP2BR:
Spatial Status:
Code OB:
Code OB Desc:
Open Hole:
Cluster Kind:
Date Completed: 11/27/2017
Remarks:
Elevrc Desc:
Location Source Date:
Improvement Location Source:
Improvement Location Method:
Source Revision Comment:
Supplier Comment:

Elevation:
Elevrc:
Zone: 18
East83: 446173
North83: 5024067
Org CS: UTM83
UTMRC: 4
UTMRC Desc: margin of error : 30 m - 100 m
Location Method: wwr

**Overburden and Bedrock
Materials Interval**

Formation ID: 1007122157
Layer: 1
Color: 6
General Color: BROWN
Mat1: 28
Most Common Material: SAND
Mat2: 11
Other Materials: GRAVEL
Mat3:
Other Materials:
Formation Top Depth: 0
Formation End Depth: 5
Formation End Depth UOM: m

**Overburden and Bedrock
Materials Interval**

Formation ID: 1007122160
Layer: 4
Color: 2
General Color: GREY
Mat1: 05
Most Common Material: CLAY
Mat2: 66
Other Materials: DENSE
Mat3:
Other Materials:
Formation Top Depth: 15
Formation End Depth: 20
Formation End Depth UOM: m

**Overburden and Bedrock
Materials Interval**

Map Key	Number of Records	Direction/ Distance (m)	Elev/Diff (m)	Site	DB
Formation ID:		1007122161			
Layer:		5			
Color:		2			
General Color:		GREY			
Mat1:		05			
Most Common Material:		CLAY			
Mat2:		66			
Other Materials:		DENSE			
Mat3:					
Other Materials:					
Formation Top Depth:		20			
Formation End Depth:		25			
Formation End Depth UOM:		m			
<u>Overburden and Bedrock</u>					
<u>Materials Interval</u>					
Formation ID:		1007122159			
Layer:		3			
Color:		2			
General Color:		GREY			
Mat1:		06			
Most Common Material:		SILT			
Mat2:		11			
Other Materials:		GRAVEL			
Mat3:					
Other Materials:					
Formation Top Depth:		10			
Formation End Depth:		15			
Formation End Depth UOM:		m			
<u>Overburden and Bedrock</u>					
<u>Materials Interval</u>					
Formation ID:		1007122158			
Layer:		2			
Color:		2			
General Color:		GREY			
Mat1:		28			
Most Common Material:		SAND			
Mat2:		11			
Other Materials:		GRAVEL			
Mat3:					
Other Materials:					
Formation Top Depth:		5			
Formation End Depth:		10			
Formation End Depth UOM:		m			
<u>Annular Space/Abandonment</u>					
<u>Sealing Record</u>					
Plug ID:		1007122171			
Layer:		3			
Plug From:		14			
Plug To:		25			
Plug Depth UOM:		m			
<u>Annular Space/Abandonment</u>					
<u>Sealing Record</u>					
Plug ID:		1007122169			
Layer:		1			

Map Key	Number of Records	Direction/ Distance (m)	Elev/Diff (m)	Site	DB
Plug From:		0			
Plug To:		1			
Plug Depth UOM:		m			
<u>Annular Space/Abandonment Sealing Record</u>					
Plug ID:		1007122170			
Layer:		2			
Plug From:		1			
Plug To:		14			
Plug Depth UOM:		m			
<u>Method of Construction & Well Use</u>					
Method Construction ID:					
Method Construction Code:		D			
Method Construction:		Direct Push			
Other Method Construction:					
<u>Pipe Information</u>					
Pipe ID:		1007122156			
Casing No:		0			
Comment:					
Alt Name:					
<u>Construction Record - Casing</u>					
Casing ID:		1007122164			
Layer:		1			
Material:		5			
Open Hole or Material:		PLASTIC			
Depth From:		0			
Depth To:		15			
Casing Diameter:		1.5			
Casing Diameter UOM:		cm			
Casing Depth UOM:		m			
<u>Construction Record - Screen</u>					
Screen ID:		1007122165			
Layer:		1			
Slot:		10			
Screen Top Depth:		15			
Screen End Depth:		25			
Screen Material:		5			
Screen Depth UOM:		m			
Screen Diameter UOM:		cm			
Screen Diameter:		1.9			
<u>Hole Diameter</u>					
Hole ID:		1007122162			
Diameter:		3.25			
Depth From:		0			
Depth To:		25			
Hole Depth UOM:		m			
Hole Diameter UOM:		cm			

Map Key	Number of Records	Direction/ Distance (m)	Elev/Diff (m)	Site	DB
7	1 of 1	SE/53.4	80.9 / -0.95	ON	WWIS
Well ID:	7313097			Data Entry Status:	Yes
Construction Date:				Data Src:	
Primary Water Use:				Date Received:	6/19/2018
Sec. Water Use:				Selected Flag:	Yes
Final Well Status:				Abandonment Rec:	
Water Type:				Contractor:	7241
Casing Material:				Form Version:	7
Audit No:	Z212323			Owner:	
Tag:	A182692			Street Name:	
Construction Method:				County:	OTTAWA-CARLETON
Elevation (m):				Municipality:	GLOUCESTER TOWNSHIP
Elevation Reliability:				Site Info:	
Depth to Bedrock:				Lot:	
Well Depth:				Concession:	
Overburden/Bedrock:				Concession Name:	
Pump Rate:				Easting NAD83:	
Static Water Level:				Northing NAD83:	
Flowing (Y/N):				Zone:	
Flow Rate:				UTM Reliability:	
Clear/Cloudy:					
<u>Bore Hole Information</u>					
Bore Hole ID:	1007115281			Elevation:	
DP2BR:				Elevrc:	
Spatial Status:				Zone:	18
Code OB:				East83:	446165
Code OB Desc:				North83:	5024044
Open Hole:				Org CS:	UTM83
Cluster Kind:				UTMRC:	4
Date Completed:	2/22/2018			UTMRC Desc:	margin of error : 30 m - 100 m
Remarks:				Location Method:	wwr
Elevrc Desc:					
Location Source Date:					
Improvement Location Source:					
Improvement Location Method:					
Source Revision Comment:					
Supplier Comment:					
8	1 of 1	ESE/54.2	80.9 / -0.95	ON	WWIS
Well ID:	7303718			Data Entry Status:	
Construction Date:				Data Src:	
Primary Water Use:	Test Hole			Date Received:	1/19/2018
Sec. Water Use:	Monitoring			Selected Flag:	Yes
Final Well Status:	Observation Wells			Abandonment Rec:	
Water Type:				Contractor:	7241
Casing Material:				Form Version:	7
Audit No:	Z212360			Owner:	
Tag:	A182474			Street Name:	749 RIDGEWOOD AVENUE
Construction Method:				County:	OTTAWA-CARLETON
Elevation (m):				Municipality:	OTTAWA CITY
Elevation Reliability:				Site Info:	
Depth to Bedrock:				Lot:	
Well Depth:				Concession:	
Overburden/Bedrock:				Concession Name:	
Pump Rate:				Easting NAD83:	

Map Key	Number of Records	Direction/ Distance (m)	Elev/Diff (m)	Site	DB											
Static Water Level: Flowing (Y/N): Flow Rate: Clear/Cloudy:				Northing NAD83: Zone: UTM Reliability:												
<u>Bore Hole Information</u>																
Bore Hole ID: DP2BR: Spatial Status: Code OB: Code OB Desc: Open Hole: Cluster Kind: Date Completed: Remarks: Elevrc Desc: Location Source Date: Improvement Location Source: Improvement Location Method: Source Revision Comment: Supplier Comment:	1006972315			Elevation: Elevrc: Zone: East83: North83: Org CS: UTMRC: UTMRC Desc: Location Method:	18 446173 5024052 UTM83 4 margin of error : 30 m - 100 m wwr											
<u>Overburden and Bedrock</u>																
<u>Materials Interval</u>																
Formation ID: Layer: Color: General Color: Mat1: Most Common Material: Mat2: Other Materials: Mat3: Other Materials: Formation Top Depth: Formation End Depth: Formation End Depth UOM:	1007122198	1	6	BROWN	28	SAND	85	SOFT								
<u>Overburden and Bedrock</u>																
<u>Materials Interval</u>																
Formation ID: Layer: Color: General Color: Mat1: Most Common Material: Mat2: Other Materials: Mat3: Other Materials: Formation Top Depth: Formation End Depth: Formation End Depth UOM:	1007122200	3	2	GREY	28	SAND	11	GRAVEL								
<u>Overburden and Bedrock</u>																
<u>Materials Interval</u>																
Formation ID: Layer:	1007122202	5														

Map Key	Number of Records	Direction/ Distance (m)	Elev/Diff (m)	Site	DB
Color:		2			
General Color:		GREY			
Mat1:		05			
Most Common Material:		CLAY			
Mat2:		66			
Other Materials:		DENSE			
Mat3:					
Other Materials:					
Formation Top Depth:		20			
Formation End Depth:		24			
Formation End Depth UOM:		m			
<u>Overburden and Bedrock</u>					
<u>Materials Interval</u>					
Formation ID:		1007122201			
Layer:		4			
Color:		2			
General Color:		GREY			
Mat1:		06			
Most Common Material:		SILT			
Mat2:		28			
Other Materials:		SAND			
Mat3:					
Other Materials:					
Formation Top Depth:		15			
Formation End Depth:		20			
Formation End Depth UOM:		m			
<u>Overburden and Bedrock</u>					
<u>Materials Interval</u>					
Formation ID:		1007122199			
Layer:		2			
Color:		2			
General Color:		GREY			
Mat1:		28			
Most Common Material:		SAND			
Mat2:		11			
Other Materials:		GRAVEL			
Mat3:					
Other Materials:					
Formation Top Depth:		5			
Formation End Depth:		10			
Formation End Depth UOM:		m			
<u>Annular Space/Abandonment</u>					
<u>Sealing Record</u>					
Plug ID:		1007122211			
Layer:		2			
Plug From:		1			
Plug To:		14			
Plug Depth UOM:		m			
<u>Annular Space/Abandonment</u>					
<u>Sealing Record</u>					
Plug ID:		1007122212			
Layer:		3			
Plug From:		14			
Plug To:		24			

Map Key	Number of Records	Direction/ Distance (m)	Elev/Diff (m)	Site	DB
Plug Depth UOM:		m			
<u>Annular Space/Abandonment Sealing Record</u>					
Plug ID:		1007122210			
Layer:		1			
Plug From:		0			
Plug To:		1			
Plug Depth UOM:		m			
<u>Method of Construction & Well Use</u>					
Method Construction ID:					
Method Construction Code:		D			
Method Construction:		Direct Push			
Other Method Construction:					
<u>Pipe Information</u>					
Pipe ID:		1007122197			
Casing No:		0			
Comment:					
Alt Name:					
<u>Construction Record - Casing</u>					
Casing ID:		1007122205			
Layer:		1			
Material:		5			
Open Hole or Material:		PLASTIC			
Depth From:		0			
Depth To:		14			
Casing Diameter:		1.5			
Casing Diameter UOM:		cm			
Casing Depth UOM:		m			
<u>Construction Record - Screen</u>					
Screen ID:		1007122206			
Layer:		1			
Slot:		10			
Screen Top Depth:		14			
Screen End Depth:		24			
Screen Material:		5			
Screen Depth UOM:		m			
Screen Diameter UOM:		cm			
Screen Diameter:		1.9			
<u>Hole Diameter</u>					
Hole ID:		1007122203			
Diameter:		3.25			
Depth From:		0			
Depth To:		24			
Hole Depth UOM:		m			
Hole Diameter UOM:		cm			

Map Key	Number of Records	Direction/ Distance (m)	Elev/Diff (m)	Site	DB
9	1 of 2	E/54.7	80.9 / -0.92	ON	WWIS
Well ID:	7313096			Data Entry Status:	Yes
Construction Date:				Data Src:	
Primary Water Use:				Date Received:	6/19/2018
Sec. Water Use:				Selected Flag:	Yes
Final Well Status:				Abandonment Rec:	
Water Type:				Contractor:	7241
Casing Material:				Form Version:	7
Audit No:	Z212321			Owner:	
Tag:	A199391			Street Name:	
Construction Method:				County:	OTTAWA-CARLETON
Elevation (m):				Municipality:	GLOUCESTER TOWNSHIP
Elevation Reliability:				Site Info:	
Depth to Bedrock:				Lot:	
Well Depth:				Concession:	
Overburden/Bedrock:				Concession Name:	
Pump Rate:				Easting NAD83:	
Static Water Level:				Northing NAD83:	
Flowing (Y/N):				Zone:	
Flow Rate:				UTM Reliability:	
Clear/Cloudy:					
<u>Bore Hole Information</u>					
Bore Hole ID:	1007115233			Elevation:	
DP2BR:				Elevrc:	
Spatial Status:				Zone:	18
Code OB:				East83:	446181
Code OB Desc:				North83:	5024068
Open Hole:				Org CS:	UTM83
Cluster Kind:				UTMRC:	4
Date Completed:	2/22/2018			UTMRC Desc:	margin of error : 30 m - 100 m
Remarks:				Location Method:	wwr
Elevrc Desc:					
Location Source Date:					
Improvement Location Source:					
Improvement Location Method:					
Source Revision Comment:					
Supplier Comment:					

9	2 of 2	E/54.7	80.9 / -0.92	ON	WWIS
Well ID:	7313099			Data Entry Status:	Yes
Construction Date:				Data Src:	
Primary Water Use:				Date Received:	6/19/2018
Sec. Water Use:				Selected Flag:	Yes
Final Well Status:				Abandonment Rec:	
Water Type:				Contractor:	7241
Casing Material:				Form Version:	7
Audit No:	Z212320			Owner:	
Tag:	A189923			Street Name:	
Construction Method:				County:	OTTAWA-CARLETON
Elevation (m):				Municipality:	GLOUCESTER TOWNSHIP
Elevation Reliability:				Site Info:	
Depth to Bedrock:				Lot:	
Well Depth:				Concession:	
Overburden/Bedrock:				Concession Name:	
Pump Rate:				Easting NAD83:	
Static Water Level:				Northing NAD83:	

Map Key	Number of Records	Direction/ Distance (m)	Elev/Diff (m)	Site	DB
Flowing (Y/N): Flow Rate: Clear/Cloudy:				Zone: UTM Reliability:	
<u>Bore Hole Information</u>					
Bore Hole ID: 1007115293 DP2BR: Spatial Status: Code OB: Code OB Desc: Open Hole: Cluster Kind: Date Completed: 2/22/2018 Remarks: Elevrc Desc: Location Source Date: Improvement Location Source: Improvement Location Method: Source Revision Comment: Supplier Comment:		Elevation: Elevrc: Zone: 18 East83: 446181 North83: 5024068 Org CS: UTM83 UTMRC: 4 UTMRC Desc: margin of error : 30 m - 100 m Location Method: wwr			
10	1 of 17	ESE/55.4	80.9 / -0.95	RICK MCCLOSKEYS SERVICE LTD 753 RIDGEWOOD AV OTTAWA ON K1V 6M8	PRT
Location ID: 11073 Type: retail Expiry Date: 1995-06-30 Capacity (L): 55000 Licence #: 0048045001					
10	2 of 17	ESE/55.4	80.9 / -0.95	MCCLOSKEY'S RICK SERVICE LTD 753 RIDGEWOOD AVE OTTAWA ON K1V6M8	RST
Headcode: 1186800 Headcode Desc: Service Stations-Gasoline, Oil & Natural Gas Phone: 6137330322 List Name: Description:					
10	3 of 17	ESE/55.4	80.9 / -0.95	MCCLOSKEY'S RICK SERVICE LTD 753 RIDGEWOOD AVE OTTAWA ON K1V 6M8	RST
Headcode: 1186800 Headcode Desc: Service Stations-Gasoline, Oil & Natural Gas Phone: 6137331749 List Name: Description:					
10	4 of 17	ESE/55.4	80.9 / -0.95	MCCLOSKEY'S RICK SERVICE LTD OTTAWA ON K1V 6M8	RST
Headcode: 1186800 Headcode Desc: Service Stations-Gasoline, Oil & Natural Gas					

Map Key	Number of Records	Direction/ Distance (m)	Elev/Diff (m)	Site	DB
Phone:		6137331749			
List Name:					
Description:					
10	5 of 17	ESE/55.4	80.9 / -0.95	561266 ONT. INC. 753 RIDGEWOOD AVE OTTAWA ON K1V 6M8	GEN
Generator No:	ON8776822			PO Box No:	
Status:				Country:	
Approval Years:	05			Choice of Contact:	
Contam. Facility:				Co Admin:	
MHSW Facility:				Phone No Admin:	
SIC Code:	447190				
SIC Description:	Other Gasoline Stations				
Detail(s)					
Waste Class:	251				
Waste Class Desc:	OIL SKIMMINGS & SLUDGES				
10	6 of 17	ESE/55.4	80.9 / -0.95	RICK MCCLOSKEYS SERVICE LTD 753 RIDGEWOOD AV OTTAWA ON K1V 6M8	EXP
Instance No:	9673997				
Instance ID:					
Instance Type:	FS Facility				
Description:					
Status:	EXPIRED				
TSSA Program Area:					
Maximum Hazard Rank:					
Facility Type:					
Expired Date:	4/13/2002				
10	7 of 17	ESE/55.4	80.9 / -0.95	RICK MCCLOSKEYS SERVICE LTD 753 RIDGEWOOD AV OTTAWA ON	EXP
Instance No:	10155239				
Instance ID:	12837				
Instance Type:	FS Facility				
Description:	FS Propane Cylr Handling Facility				
Status:	EXPIRED				
TSSA Program Area:					
Maximum Hazard Rank:					
Facility Type:					
Expired Date:					
10	8 of 17	ESE/55.4	80.9 / -0.95	RICK MCCLOSKEYS SERVICE LTD 753 RIDGEWOOD AV OTTAWA ON K1V 6M8	EXP
Instance No:	10906415				
Instance ID:					
Instance Type:	FS Liquid Fuel Tank				
Description:					
Status:	EXPIRED				

Map Key	Number of Records	Direction/ Distance (m)	Elev/Diff (m)	Site	DB
TSSA Program Area: Maximum Hazard Rank: Facility Type: Expired Date: 4/13/2002					
10	9 of 17	ESE/55.4	80.9 / -0.95	RICK MCCLOSKEYS SERVICE LTD 753 RIDGEWOOD AV OTTAWA ON K1V 6M8	EXP
Instance No: 10906439 Instance ID: Instance Type: FS Liquid Fuel Tank Description: Status: EXPIRED TSSA Program Area: Maximum Hazard Rank: Facility Type: Expired Date: 4/13/2002					
10	10 of 17	ESE/55.4	80.9 / -0.95	RICK MCCLOSKEYS SERVICE LTD 753 RIDGEWOOD AV OTTAWA ON K1V 6M8	EXP
Instance No: 10906455 Instance ID: Instance Type: FS Liquid Fuel Tank Description: Status: EXPIRED TSSA Program Area: Maximum Hazard Rank: Facility Type: Expired Date: 4/13/2002					
10	11 of 17	ESE/55.4	80.9 / -0.95	RICK MCCLOSKEYS SERVICE LTD 753 RIDGEWOOD AV OTTAWA ON	EXP
Instance No: 10906431 Instance ID: 51384 Instance Type: FS Piping Description: FS Piping Status: EXPIRED TSSA Program Area: Maximum Hazard Rank: Facility Type: Expired Date:					
10	12 of 17	ESE/55.4	80.9 / -0.95	RICK MCCLOSKEYS SERVICE LTD 753 RIDGEWOOD AV OTTAWA ON	EXP
Instance No: 10906446 Instance ID: 51538 Instance Type: FS Piping Description: FS Piping Status: EXPIRED TSSA Program Area: Maximum Hazard Rank:					

Map Key	Number of Records	Direction/ Distance (m)	Elev/Diff (m)	Site	DB
Facility Type:					
Expired Date:					
10	13 of 17	ESE/55.4	80.9 / -0.95	RICK MCCLOSKEYS SERVICE LTD 753 RIDGEWOOD AV OTTAWA ON	EXP
Instance No:		10906461			
Instance ID:		51967			
Instance Type:		FS Piping			
Description:		FS Piping			
Status:		EXPIRED			
TSSA Program Area:					
Maximum Hazard Rank:					
Facility Type:					
Expired Date:					
10	14 of 17	ESE/55.4	80.9 / -0.95	RICK MCCLOSKEYS SERVICE LTD 753 RIDGEWOOD AV OTTAWA ON K1V 6M8	EXP
Instance No:		10906415			
Instance ID:					
Instance Type:		FS Liquid Fuel Tank			
Description:		FS Gasoline Station - Full Serve			
Status:		EXPIRED			
TSSA Program Area:					
Maximum Hazard Rank:					
Facility Type:		FS Liquid Fuel Tank			
Expired Date:		4/13/2002			
10	15 of 17	ESE/55.4	80.9 / -0.95	RICK MCCLOSKEYS SERVICE LTD 753 RIDGEWOOD AV OTTAWA ON K1V 6M8	EXP
Instance No:		10906439			
Instance ID:					
Instance Type:		FS Liquid Fuel Tank			
Description:		FS Gasoline Station - Full Serve			
Status:		EXPIRED			
TSSA Program Area:					
Maximum Hazard Rank:					
Facility Type:		FS Liquid Fuel Tank			
Expired Date:		4/13/2002			
10	16 of 17	ESE/55.4	80.9 / -0.95	RICK MCCLOSKEYS SERVICE LTD 753 RIDGEWOOD AV OTTAWA ON K1V 6M8	EXP
Instance No:		10906455			
Instance ID:					
Instance Type:		FS Liquid Fuel Tank			
Description:		FS Gasoline Station - Full Serve			
Status:		EXPIRED			
TSSA Program Area:					
Maximum Hazard Rank:					
Facility Type:		FS Liquid Fuel Tank			
Expired Date:		4/13/2002			

Map Key	Number of Records	Direction/ Distance (m)	Elev/Diff (m)	Site	DB
10	17 of 17	ESE/55.4	80.9 / -0.95	McCloskey's Rick Service 753 Ridgewood Ave Ottawa ON K1V 6M8	GEN
Generator No: ON9824428 Status: Registered Approval Years: As of Dec 2018 Contam. Facility: MHSW Facility: SIC Code: SIC Description:				PO Box No: Country: Canada Choice of Contact: Co Admin: Phone No Admin:	
<u>Detail(s)</u>					
Waste Class:		221 L			
Waste Class Desc:		Light fuels			
11	1 of 1	E/57.6	79.7 / -2.10	ON	WWIS
Well ID: 7303720 Construction Date: Primary Water Use: Test Hole Sec. Water Use: Monitoring Final Well Status: Observation Wells Water Type: Casing Material: Audit No: Z212363 Tag: A182475 Construction Method: Elevation (m): Elevation Reliability: Depth to Bedrock: Well Depth: Overburden/Bedrock: Pump Rate: Static Water Level: Flowing (Y/N): Flow Rate: Clear/Cloudy:				Data Entry Status: Data Src: Date Received: 1/19/2018 Selected Flag: Yes Abandonment Rec: Contractor: 7241 Form Version: 7 Owner: Street Name: 749 RIDGEWOOD ROAD County: OTTAWA-CARLETON Municipality: OTTAWA CITY Site Info: Lot: Concession: Concession Name: Easting NAD83: Northing NAD83: Zone: UTM Reliability:	
<u>Bore Hole Information</u>					
Bore Hole ID: 1006972321 DP2BR: Spatial Status: Code OB: Code OB Desc: Open Hole: Cluster Kind: Date Completed: 11/27/2017 Remarks: Elevrc Desc: Location Source Date: Improvement Location Source: Improvement Location Method: Source Revision Comment: Supplier Comment:				Elevation: Elevrc: Zone: 18 East83: 446185 North83: 5024072 Org CS: UTM83 UTMRC: 4 UTMRC Desc: margin of error : 30 m - 100 m Location Method: wwr	

Map Key	Number of Records	Direction/ Distance (m)	Elev/Diff (m)	Site	DB
<u>Overburden and Bedrock Materials Interval</u>					
Formation ID:		1007122245			
Layer:		2			
Color:		2			
General Color:		GREY			
Mat1:		05			
Most Common Material:		CLAY			
Mat2:		06			
Other Materials:		SILT			
Mat3:					
Other Materials:					
Formation Top Depth:		2.43			
Formation End Depth:		4.57			
Formation End Depth UOM:		m			
<u>Overburden and Bedrock Materials Interval</u>					
Formation ID:		1007122246			
Layer:		3			
Color:		2			
General Color:		GREY			
Mat1:		06			
Most Common Material:		SILT			
Mat2:		11			
Other Materials:		GRAVEL			
Mat3:					
Other Materials:					
Formation Top Depth:		4.57			
Formation End Depth:		7.31			
Formation End Depth UOM:		m			
<u>Overburden and Bedrock Materials Interval</u>					
Formation ID:		1007122244			
Layer:		1			
Color:		6			
General Color:		BROWN			
Mat1:		28			
Most Common Material:		SAND			
Mat2:		11			
Other Materials:		GRAVEL			
Mat3:					
Other Materials:					
Formation Top Depth:		0			
Formation End Depth:		2.43			
Formation End Depth UOM:		m			
<u>Annular Space/Abandonment Sealing Record</u>					
Plug ID:		1007122254			
Layer:		1			
Plug From:		0			
Plug To:		0.31			
Plug Depth UOM:		m			
<u>Annular Space/Abandonment Sealing Record</u>					

<i>Map Key</i>	<i>Number of Records</i>	<i>Direction/ Distance (m)</i>	<i>Elev/Diff (m)</i>	<i>Site</i>	<i>DB</i>
Plug ID:		1007122256			
Layer:		3			
Plug From:		3.96			
Plug To:		7.31			
Plug Depth UOM:		m			
<u>Annular Space/Abandonment Sealing Record</u>					
Plug ID:		1007122255			
Layer:		2			
Plug From:		0.31			
Plug To:		3.96			
Plug Depth UOM:		m			
<u>Method of Construction & Well Use</u>					
Method Construction ID:					
Method Construction Code:		D			
Method Construction:		Direct Push			
Other Method Construction:					
<u>Pipe Information</u>					
Pipe ID:		1007122243			
Casing No:		0			
Comment:					
Alt Name:					
<u>Construction Record - Casing</u>					
Casing ID:		1007122249			
Layer:		1			
Material:		5			
Open Hole or Material:		PLASTIC			
Depth From:		0			
Depth To:		4.26			
Casing Diameter:		4.03			
Casing Diameter UOM:		cm			
Casing Depth UOM:		m			
<u>Construction Record - Screen</u>					
Screen ID:		1007122250			
Layer:		1			
Slot:		10			
Screen Top Depth:		4.26			
Screen End Depth:		7.31			
Screen Material:		5			
Screen Depth UOM:		m			
Screen Diameter UOM:		cm			
Screen Diameter:		4.82			
<u>Hole Diameter</u>					
Hole ID:		1007122247			
Diameter:		8.5			
Depth From:		0			
Depth To:		7.31			

Map Key	Number of Records	Direction/ Distance (m)	Elev/Diff (m)	Site	DB
Hole Depth UOM:		m			
Hole Diameter UOM:		cm			

12	1 of 1	ESE/59.3	80.9 / -0.95	ON	WWIS
Well ID:	7303719			Data Entry Status:	
Construction Date:				Data Src:	
Primary Water Use:	Test Hole			Date Received:	1/19/2018
Sec. Water Use:	Monitoring			Selected Flag:	Yes
Final Well Status:	Monitoring and Test Hole			Abandonment Rec:	
Water Type:				Contractor:	7241
Casing Material:				Form Version:	7
Audit No:	Z212362			Owner:	
Tag:	A182477			Street Name:	749 RIDGEWOOD ROAD
Construction Method:				County:	OTTAWA-CARLETON
Elevation (m):				Municipality:	OTTAWA CITY
Elevation Reliability:				Site Info:	
Depth to Bedrock:				Lot:	
Well Depth:				Concession:	
Overburden/Bedrock:				Concession Name:	
Pump Rate:				Easting NAD83:	
Static Water Level:				Northing NAD83:	
Flowing (Y/N):				Zone:	
Flow Rate:				UTM Reliability:	
Clear/Cloudy:					

Bore Hole Information

Bore Hole ID:	1006972318			Elevation:	
DP2BR:				Elevrc:	
Spatial Status:				Zone:	18
Code OB:				East83:	446174
Code OB Desc:				North83:	5024045
Open Hole:				Org CS:	UTM83
Cluster Kind:				UTMRC:	4
Date Completed:	11/27/2017			UTMRC Desc:	margin of error : 30 m - 100 m
Remarks:				Location Method:	wwr
Elevrc Desc:					
Location Source Date:					
Improvement Location Source:					
Improvement Location Method:					
Source Revision Comment:					
Supplier Comment:					

Overburden and Bedrock

Materials Interval

Formation ID:	1007122227
Layer:	1
Color:	6
General Color:	BROWN
Mat1:	28
Most Common Material:	SAND
Mat2:	11
Other Materials:	GRAVEL
Mat3:	
Other Materials:	
Formation Top Depth:	0
Formation End Depth:	2.43
Formation End Depth UOM:	m

Map Key	Number of Records	Direction/ Distance (m)	Elev/Diff (m)	Site	DB
<u>Overburden and Bedrock Materials Interval</u>					
Formation ID:		1007122229			
Layer:		3			
Color:		2			
General Color:		GREY			
Mat1:		06			
Most Common Material:		SILT			
Mat2:		11			
Other Materials:		GRAVEL			
Mat3:					
Other Materials:					
Formation Top Depth:		4.57			
Formation End Depth:		7.31			
Formation End Depth UOM:		m			
<u>Overburden and Bedrock Materials Interval</u>					
Formation ID:		1007122228			
Layer:		2			
Color:		2			
General Color:		GREY			
Mat1:		05			
Most Common Material:		CLAY			
Mat2:		06			
Other Materials:		SILT			
Mat3:					
Other Materials:					
Formation Top Depth:		2.43			
Formation End Depth:		4.57			
Formation End Depth UOM:		m			
<u>Annular Space/Abandonment Sealing Record</u>					
Plug ID:		1007122237			
Layer:		1			
Plug From:		0			
Plug To:		0.31			
Plug Depth UOM:		m			
<u>Annular Space/Abandonment Sealing Record</u>					
Plug ID:		1007122238			
Layer:		2			
Plug From:		0.31			
Plug To:		3.96			
Plug Depth UOM:		m			
<u>Annular Space/Abandonment Sealing Record</u>					
Plug ID:		1007122239			
Layer:		3			
Plug From:		3.96			
Plug To:		7.31			
Plug Depth UOM:		m			

Map Key	Number of Records	Direction/ Distance (m)	Elev/Diff (m)	Site	DB
<u>Method of Construction & Well Use</u>					
Method Construction ID:					
Method Construction Code:		D			
Method Construction:		Direct Push			
Other Method Construction:					
<u>Pipe Information</u>					
Pipe ID:		1007122226			
Casing No:		0			
Comment:					
Alt Name:					
<u>Construction Record - Casing</u>					
Casing ID:		1007122232			
Layer:		1			
Material:		5			
Open Hole or Material:		PLASTIC			
Depth From:		0			
Depth To:		4.26			
Casing Diameter:		4.03			
Casing Diameter UOM:		cm			
Casing Depth UOM:		m			
<u>Construction Record - Screen</u>					
Screen ID:		1007122233			
Layer:		1			
Slot:		10			
Screen Top Depth:		4.26			
Screen End Depth:		7.31			
Screen Material:		5			
Screen Depth UOM:		m			
Screen Diameter UOM:		cm			
Screen Diameter:		4.52			
<u>Hole Diameter</u>					
Hole ID:		1007122230			
Diameter:		8.5			
Depth From:		0			
Depth To:		7.31			
Hole Depth UOM:		m			
Hole Diameter UOM:		cm			

[13](#)

1 of 1

ESE/64.0

80.6 / -1.25

ON

WWIS

Well ID: 7303721
Construction Date:
Primary Water Use: Test Hole
Sec. Water Use: Monitoring
Final Well Status: Monitoring and Test Hole
Water Type:
Casing Material:
Audit No: Z212361
Tag: A182476
Construction

Data Entry Status:
Data Src:
Date Received: 1/19/2018
Selected Flag: Yes
Abandonment Rec:
Contractor: 7241
Form Version: 7
Owner:
Street Name: 749 RIDGEWOOD ROAD
County: OTTAWA-CARLETON

Map Key	Number of Records	Direction/ Distance (m)	Elev/Diff (m)	Site	DB
Method:					
Elevation (m):				Municipality:	OTTAWA CITY
Elevation Reliability:				Site Info:	
Depth to Bedrock:				Lot:	
Well Depth:				Concession:	
Overburden/Bedrock:				Concession Name:	
Pump Rate:				Easting NAD83:	
Static Water Level:				Northing NAD83:	
Flowing (Y/N):				Zone:	
Flow Rate:				UTM Reliability:	
Clear/Cloudy:					

Bore Hole Information

Bore Hole ID:	1006972324	Elevation:	
DP2BR:		Elevrc:	
Spatial Status:		Zone:	18
Code OB:		East83:	446186
Code OB Desc:		North83:	5024055
Open Hole:		Org CS:	UTM83
Cluster Kind:		UTMRC:	4
Date Completed:	11/27/2017	UTMRC Desc:	margin of error : 30 m - 100 m
Remarks:		Location Method:	wwr
Elevrc Desc:			
Location Source Date:			
Improvement Location Source:			
Improvement Location Method:			
Source Revision Comment:			
Supplier Comment:			

Overburden and Bedrock

Materials Interval

Formation ID:	1007122269
Layer:	3
Color:	2
General Color:	GREY
Mat1:	06
Most Common Material:	SILT
Mat2:	11
Other Materials:	GRAVEL
Mat3:	
Other Materials:	
Formation Top Depth:	4.57
Formation End Depth:	7.31
Formation End Depth UOM:	m

Overburden and Bedrock

Materials Interval

Formation ID:	1007122267
Layer:	1
Color:	6
General Color:	BROWN
Mat1:	28
Most Common Material:	SAND
Mat2:	11
Other Materials:	GRAVEL
Mat3:	
Other Materials:	
Formation Top Depth:	0
Formation End Depth:	2.43
Formation End Depth UOM:	m

Map Key	Number of Records	Direction/ Distance (m)	Elev/Diff (m)	Site	DB
<u>Overburden and Bedrock Materials Interval</u>					
Formation ID:		1007122268			
Layer:		2			
Color:		2			
General Color:		GREY			
Mat1:		05			
Most Common Material:		CLAY			
Mat2:		06			
Other Materials:		SILT			
Mat3:					
Other Materials:					
Formation Top Depth:		2.43			
Formation End Depth:		4.57			
Formation End Depth UOM:		m			
<u>Annular Space/Abandonment Sealing Record</u>					
Plug ID:		1007122279			
Layer:		3			
Plug From:		3.96			
Plug To:		7.31			
Plug Depth UOM:		m			
<u>Annular Space/Abandonment Sealing Record</u>					
Plug ID:		1007122277			
Layer:		1			
Plug From:		0			
Plug To:		0.31			
Plug Depth UOM:		m			
<u>Annular Space/Abandonment Sealing Record</u>					
Plug ID:		1007122278			
Layer:		2			
Plug From:		0.31			
Plug To:		3.96			
Plug Depth UOM:		m			
<u>Method of Construction & Well Use</u>					
Method Construction ID:					
Method Construction Code:		D			
Method Construction:		Direct Push			
Other Method Construction:					
<u>Pipe Information</u>					
Pipe ID:		1007122266			
Casing No:		0			
Comment:					
Alt Name:					

Map Key	Number of Records	Direction/ Distance (m)	Elev/Diff (m)	Site	DB
<u>Construction Record - Casing</u>					
Casing ID:		1007122272			
Layer:		1			
Material:		5			
Open Hole or Material:		PLASTIC			
Depth From:		0			
Depth To:		4.28			
Casing Diameter:		4.03			
Casing Diameter UOM:		cm			
Casing Depth UOM:		m			
<u>Construction Record - Screen</u>					
Screen ID:		1007122273			
Layer:		1			
Slot:		10			
Screen Top Depth:		4.26			
Screen End Depth:		7.31			
Screen Material:		5			
Screen Depth UOM:		m			
Screen Diameter UOM:		cm			
Screen Diameter:		4.82			
<u>Hole Diameter</u>					
Hole ID:		1007122270			
Diameter:		8.5			
Depth From:		0			
Depth To:		7.31			
Hole Depth UOM:		m			
Hole Diameter UOM:		cm			

14	1 of 1	ESE/87.2	80.7 / -1.15	Clean Water Works Inc.	SPL
				Ottawa ON	
Ref No:	3508-B23PFT			Discharger Report:	
Site No:	NA			Material Group:	
Incident Dt:	2018/06/25			Health/Env Conseq:	2 - Minor Environment Corporation
Year:				Client Type:	Miscellaneous Communal
Incident Cause:				Sector Type:	
Incident Event:	Leak/Break			Agency Involved:	
Contaminant Code:	15			Nearest Watercourse:	
Contaminant Name:	HYDRAULIC OIL			Site Address:	
Contaminant Limit 1:				Site District Office:	Ottawa
Contam Limit Freq 1:				Site Postal Code:	
Contaminant UN No 1:	n/a			Site Region:	Eastern
Environment Impact:				Site Municipality:	Ottawa
Nature of Impact:				Site Lot:	
Receiving Medium:				Site Conc:	
Receiving Env:	Land			Northing:	5024026.15
MOE Response:	No			Easting:	446194.67
Dt MOE Arvl on Scn:				Site Geo Ref Accu:	
MOE Reported Dt:	2018/06/25			Site Map Datum:	
Dt Document Closed:	2018/07/13			SAC Action Class:	Primary Assessment of Spills
Incident Reason:	Equipment Failure			Source Type:	Motor Vehicle
Site Name:	750 Ridgewood Dr<UNOFFICIAL>				
Site County/District:					
Site Geo Ref Meth:					
Incident Summary:	Clean Water Works: 50 gal hydraulic oil to asphalt, cntd				
Contaminant Qty:	50 gal-US				

Map Key	Number of Records	Direction/ Distance (m)	Elev/Diff (m)	Site	DB
15	1 of 1	W/100.6	84.4 / 2.60	ON	WWIS
Well ID: 1508797 Construction Date: Primary Water Use: Domestic Sec. Water Use: 0 Final Well Status: Water Supply Water Type: Casing Material: Audit No: Tag: Construction Method: Elevation (m): Elevation Reliability: Depth to Bedrock: Well Depth: Overburden/Bedrock: Pump Rate: Static Water Level: Flowing (Y/N): Flow Rate: Clear/Cloudy:		Data Entry Status: Data Src: 1 Date Received: 4/1/1952 Selected Flag: Yes Abandonment Rec: Contractor: 3725 Form Version: 1 Owner: Street Name: County: OTTAWA-CARLETON Municipality: OTTAWA CITY Site Info: Lot: Concession: Concession Name: Easting NAD83: Northing NAD83: Zone: UTM Reliability:			
<u>Bore Hole Information</u>					
Bore Hole ID: 10030831 DP2BR: 23 Spatial Status: Code OB: r Code OB Desc: Bedrock Open Hole: Cluster Kind: Date Completed: 10/25/1951 Remarks: Elevrc Desc: Location Source Date: Improvement Location Source: Improvement Location Method: Source Revision Comment: Supplier Comment:		Elevation: 84.175674 Elevrc: Zone: 18 East83: 446030.7 North83: 5024107 Org CS: UTMRC: 9 UTMRC Desc: unknown UTM Location Method: p9			
<u>Overburden and Bedrock</u>					
<u>Materials Interval</u>					
Formation ID: 931010616 Layer: 1 Color: General Color: Mat1: 05 Most Common Material: CLAY Mat2: 13 Other Materials: BOULDERS Mat3: Other Materials: Formation Top Depth: 0 Formation End Depth: 23 Formation End Depth UOM: ft					
<u>Overburden and Bedrock</u>					
<u>Materials Interval</u>					

Map Key	Number of Records	Direction/ Distance (m)	Elev/Diff (m)	Site	DB
Formation ID:		931010617			
Layer:		2			
Color:					
General Color:					
Mat1:		15			
Most Common Material:		LIMESTONE			
Mat2:					
Other Materials:					
Mat3:					
Other Materials:					
Formation Top Depth:		23			
Formation End Depth:		90			
Formation End Depth UOM:		ft			
<u>Method of Construction & Well Use</u>					
Method Construction ID:					
Method Construction Code:		1			
Method Construction:		Cable Tool			
Other Method Construction:					
<u>Pipe Information</u>					
Pipe ID:		10579401			
Casing No:		1			
Comment:					
Alt Name:					
<u>Construction Record - Casing</u>					
Casing ID:		930054296			
Layer:		2			
Material:		4			
Open Hole or Material:		OPEN HOLE			
Depth From:					
Depth To:		90			
Casing Diameter:		4			
Casing Diameter UOM:		inch			
Casing Depth UOM:		ft			
<u>Construction Record - Casing</u>					
Casing ID:		930054295			
Layer:		1			
Material:		1			
Open Hole or Material:		STEEL			
Depth From:					
Depth To:		31			
Casing Diameter:		4			
Casing Diameter UOM:		inch			
Casing Depth UOM:		ft			
<u>Results of Well Yield Testing</u>					
Pump Test ID:		991508797			
Pump Set At:					
Static Level:		12			
Final Level After Pumping:		50			
Recommended Pump Depth:					
Pumping Rate:					

Map Key	Number of Records	Direction/ Distance (m)	Elev/Diff (m)	Site	DB
Flowing Rate: Recommended Pump Rate: Levels UOM: ft Rate UOM: GPM Water State After Test Code: 1 Water State After Test: CLEAR Pumping Test Method: 1 Pumping Duration HR: Pumping Duration MIN: Flowing: N					
Water Details					
Water ID: 933463473 Layer: 1 Kind Code: 1 Kind: FRESH Water Found Depth: 60 Water Found Depth UOM: ft					
16	1 of 3	ENE/116.2	77.9 / -3.95	753 Springland Drive Ottawa ON K1V 6L9	EHS
Order No: 20040311001 Status: C Report Type: Complete Report Upgrade Report Date: 3/16/04 Date Received: 3/11/04 Previous Site Name: Lot/Building Size: Additional Info Ordered:					
Nearest Intersection: Municipality: Client Prov/State: ON Search Radius (km): 0.35 X: -75.686188 Y: 45.369211					
16	2 of 3	ENE/116.2	77.9 / -3.95	753 Springland Drive Ottawa ON K1V 6L9	EHS
Order No: 20040310012w Status: C Report Type: Online Mapless Report Date: 3/10/04 Date Received: 3/10/04 Previous Site Name: Lot/Building Size: Additional Info Ordered:					
Nearest Intersection: Municipality: Client Prov/State: ON Search Radius (km): 0.25 X: 0 Y: 0					
16	3 of 3	ENE/116.2	77.9 / -3.95	753 A Springland Dr Ottawa ON K1V6L9	EHS
Order No: 20170206030 Status: C Report Type: RSC Report (Urban) Report Date: 10-FEB-17 Date Received: 06-FEB-17 Previous Site Name: Lot/Building Size: Additional Info Ordered: Fire Insur. Maps and/or Site Plans; Aerial Photos					
Nearest Intersection: Municipality: Client Prov/State: ON Search Radius (km): .3 X: -75.686603 Y: 45.368644					
17	1 of 1	ESE/137.1	79.9 / -1.95	ITALIAN TELEPHONE DIRECTORY 770 RIDGEWOOD AVE OTTAWA ON K1V 6M9	SCT

Map Key	Number of Records	Direction/ Distance (m)	Elev/Diff (m)	Site	DB
Established:		1970			
Plant Size (ft²):		0			
Employment:		2			
--Details--					
Description:		Database and Directory Publishers			
SIC/NAICS Code:		511140			

18	1 of 1	W/188.7	87.6 / 5.76	ON	WWIS
--------------------	--------	---------	-------------	----	------

Well ID:	1507898	Data Entry Status:	
Construction Date:		Data Src:	1
Primary Water Use:	Domestic	Date Received:	11/16/1951
Sec. Water Use:	0	Selected Flag:	Yes
Final Well Status:	Water Supply	Abandonment Rec:	
Water Type:		Contractor:	3601
Casing Material:		Form Version:	1
Audit No:		Owner:	
Tag:		Street Name:	
Construction Method:		County:	OTTAWA-CARLETON
Elevation (m):		Municipality:	OTTAWA CITY
Elevation Reliability:		Site Info:	
Depth to Bedrock:		Lot:	
Well Depth:		Concession:	
Overburden/Bedrock:		Concession Name:	
Pump Rate:		Easting NAD83:	
Static Water Level:		Northing NAD83:	
Flowing (Y/N):		Zone:	
Flow Rate:		UTM Reliability:	
Clear/Cloudy:			

Bore Hole Information

Bore Hole ID:	10029933	Elevation:	87.029212
DP2BR:	14	Elevrc:	
Spatial Status:		Zone:	18
Code OB:	r	East83:	445940.7
Code OB Desc:	Bedrock	North83:	5024102
Open Hole:		Org CS:	
Cluster Kind:		UTMRC:	9
Date Completed:	8/18/1951	UTMRC Desc:	unknown UTM
Remarks:		Location Method:	p9
Elevrc Desc:			
Location Source Date:			
Improvement Location Source:			
Improvement Location Method:			
Source Revision Comment:			
Supplier Comment:			

**Overburden and Bedrock
Materials Interval**

Formation ID:	931008314
Layer:	3
Color:	
General Color:	
Mat1:	15
Most Common Material:	LIMESTONE
Mat2:	
Other Materials:	

Map Key	Number of Records	Direction/ Distance (m)	Elev/Diff (m)	Site	DB
Mat3:					
Other Materials:					
Formation Top Depth:		23			
Formation End Depth:		80			
Formation End Depth UOM:		ft			
<u>Overburden and Bedrock Materials Interval</u>					
Formation ID:		931008312			
Layer:		1			
Color:					
General Color:					
Mat1:		05			
Most Common Material:		CLAY			
Mat2:					
Other Materials:					
Mat3:					
Other Materials:					
Formation Top Depth:		0			
Formation End Depth:		14			
Formation End Depth UOM:		ft			
<u>Overburden and Bedrock Materials Interval</u>					
Formation ID:		931008313			
Layer:		2			
Color:					
General Color:					
Mat1:		17			
Most Common Material:		SHALE			
Mat2:					
Other Materials:					
Mat3:					
Other Materials:					
Formation Top Depth:		14			
Formation End Depth:		23			
Formation End Depth UOM:		ft			
<u>Method of Construction & Well Use</u>					
Method Construction ID:					
Method Construction Code:		1			
Method Construction:		Cable Tool			
Other Method Construction:					
<u>Pipe Information</u>					
Pipe ID:		10578503			
Casing No:		1			
Comment:					
Alt Name:					
<u>Construction Record - Casing</u>					
Casing ID:		930052520			
Layer:		2			
Material:		4			
Open Hole or Material:		OPEN HOLE			
Depth From:					

Map Key	Number of Records	Direction/ Distance (m)	Elev/Diff (m)	Site	DB
Depth To:		80			
Casing Diameter:		4			
Casing Diameter UOM:		inch			
Casing Depth UOM:		ft			
<u>Construction Record - Casing</u>					
Casing ID:		930052519			
Layer:		1			
Material:		1			
Open Hole or Material:		STEEL			
Depth From:					
Depth To:		16			
Casing Diameter:		4			
Casing Diameter UOM:		inch			
Casing Depth UOM:		ft			
<u>Results of Well Yield Testing</u>					
Pump Test ID:		991507898			
Pump Set At:					
Static Level:		8			
Final Level After Pumping:					
Recommended Pump Depth:					
Pumping Rate:					
Flowing Rate:					
Recommended Pump Rate:					
Levels UOM:		ft			
Rate UOM:		GPM			
Water State After Test Code:		1			
Water State After Test:		CLEAR			
Pumping Test Method:		1			
Pumping Duration HR:		1			
Pumping Duration MIN:		0			
Flowing:		N			
<u>Water Details</u>					
Water ID:		933462188			
Layer:		1			
Kind Code:		1			
Kind:		FRESH			
Water Found Depth:		50			
Water Found Depth UOM:		ft			

19	1 of 1	NW/192.9	82.8 / 1.00	2887 Riverside Dr Ottawa ON K1V8N4	EHS
Order No:	20170313066			Nearest Intersection:	
Status:	C			Municipality:	Ottawa
Report Type:	Standard Express Report			Client Prov/State:	ON
Report Date:	14-MAR-17			Search Radius (km):	.25
Date Received:	13-MAR-17			X:	-75.68957
Previous Site Name:				Y:	45.369488
Lot/Building Size:	0.45 Acres				
Additional Info Ordered:	Fire Insur. Maps and/or Site Plans; City Directory				

20	1 of 1	WNW/197.7	84.2 / 2.36	Ottawa ON	WWIS
Well ID:	7285490			Data Entry Status:	

Map Key	Number of Records	Direction/ Distance (m)	Elev/Diff (m)	Site	DB
Construction Date:				Data Src:	
Primary Water Use:	Test Hole			Date Received:	4/21/2017
Sec. Water Use:	Monitoring			Selected Flag:	Yes
Final Well Status:	Observation Wells			Abandonment Rec:	
Water Type:				Contractor:	7529
Casing Material:				Form Version:	7
Audit No:	Z245905			Owner:	
Tag:	A216094			Street Name:	2887 RIVERSIDE DR
Construction Method:				County:	OTTAWA-CARLETON
Elevation (m):				Municipality:	GLOUCESTER TOWNSHIP
Elevation Reliability:				Site Info:	
Depth to Bedrock:				Lot:	
Well Depth:				Concession:	
Overburden/Bedrock:				Concession Name:	
Pump Rate:				Easting NAD83:	
Static Water Level:				Northing NAD83:	
Flowing (Y/N):				Zone:	
Flow Rate:				UTM Reliability:	
Clear/Cloudy:					
<u>Bore Hole Information</u>					
Bore Hole ID:	1006383549			Elevation:	82.631134
DP2BR:				Elevrc:	
Spatial Status:				Zone:	18
Code OB:				East83:	445985
Code OB Desc:				North83:	5024219
Open Hole:				Org CS:	UTM83
Cluster Kind:				UTMRC:	4
Date Completed:	4/3/2017			UTMRC Desc:	margin of error : 30 m - 100 m
Remarks:				Location Method:	wwr
Elevrc Desc:					
Location Source Date:					
Improvement Location Source:					
Improvement Location Method:					
Source Revision Comment:					
Supplier Comment:					
<u>Overburden and Bedrock</u>					
<u>Materials Interval</u>					
Formation ID:	1006689984				
Layer:	1				
Color:	6				
General Color:	BROWN				
Mat1:	28				
Most Common Material:	SAND				
Mat2:	05				
Other Materials:	CLAY				
Mat3:	73				
Other Materials:	HARD				
Formation Top Depth:	0				
Formation End Depth:	15				
Formation End Depth UOM:	ft				
<u>Annular Space/Abandonment</u>					
<u>Sealing Record</u>					
Plug ID:	1006689993				
Layer:	2				
Plug From:	5				
Plug To:	15				
Plug Depth UOM:	ft				

Map Key	Number of Records	Direction/ Distance (m)	Elev/Diff (m)	Site	DB
---------	-------------------	----------------------------	------------------	------	----

**Annular Space/Abandonment
Sealing Record**

Plug ID: 1006689992
 Layer: 1
 Plug From: 0
 Plug To: 5
 Plug Depth UOM: ft

**Method of Construction & Well
Use**

Method Construction ID:
 Method Construction Code: 6
 Method Construction: Boring
 Other Method Construction:

Pipe Information

Pipe ID: 1006689983
 Casing No: 0
 Comment:
 Alt Name:

Construction Record - Casing

Casing ID: 1006689987
 Layer: 1
 Material: 5
 Open Hole or Material: PLASTIC
 Depth From: 0
 Depth To: 5
 Casing Diameter: 2
 Casing Diameter UOM: inch
 Casing Depth UOM: ft

Construction Record - Screen

Screen ID: 1006689988
 Layer: 1
 Slot:
 Screen Top Depth: 5
 Screen End Depth: 15
 Screen Material: 5
 Screen Depth UOM: ft
 Screen Diameter UOM: inch
 Screen Diameter: 2

Hole Diameter

Hole ID: 1006689985
 Diameter: 9
 Depth From: 0
 Depth To: 15
 Hole Depth UOM: ft
 Hole Diameter UOM: inch

Map Key	Number of Records	Direction/ Distance (m)	Elev/Diff (m)	Site	DB
				2991 RIVERSIDE DR/BAYPORT PRIV OTTAWA CITY ON K1V 8N6	
				Certificate #: 3-1919-90- Application Year: 90 Issue Date: 10/19/1990 Approval Type: Municipal sewage Status: Approved Application Type: Client Name: Client Address: Client City: Client Postal Code: Project Description: Contaminants: Emission Control:	
21	2 of 2	SSW/200.2	83.1 / 1.25	TAMARACK DEVELOPMENTS CORP. - RIVERSIDE 2991 RIVERSIDE DR/BAYPORT PRIV OTTAWA CITY ON K1V 8N6	CA
				Certificate #: 7-1571-90- Application Year: 90 Issue Date: 10/19/1990 Approval Type: Municipal water Status: Approved Application Type: Client Name: Client Address: Client City: Client Postal Code: Project Description: Contaminants: Emission Control:	
22	1 of 1	ENE/234.0	75.9 / -5.92	OTTAWA CITY SPRINGLAND DR./HOBSON RD. OTTAWA CITY ON	CA
				Certificate #: 3-0909-94- Application Year: 94 Issue Date: 7/22/1994 Approval Type: Municipal sewage Status: Approved Application Type: Client Name: Client Address: Client City: Client Postal Code: Project Description: Contaminants: Emission Control:	
23	1 of 1	ESE/246.4	77.9 / -3.89	PRIVATE RESIDENCE 2707 SPRINGLAND DRIVE FURNACE OIL TANK OTTAWA CITY ON K1V 6M2	SPL
				Ref No: 65843 Site No: Incident Dt: 1/3/1992 Discharger Report: Material Group: Health/Env Conseq:	

Map Key	Number of Records	Direction/ Distance (m)	Elev/Diff (m)	Site	DB
Year:				Client Type:	
Incident Cause:	PIPE/HOSE LEAK			Sector Type:	
Incident Event:				Agency Involved:	
Contaminant Code:				Nearest Watercourse:	
Contaminant Name:				Site Address:	
Contaminant Limit 1:				Site District Office:	
Contam Limit Freq 1:				Site Postal Code:	
Contaminant UN No 1:				Site Region:	
Environment Impact:	CONFIRMED			Site Municipality:	20101
Nature of Impact:	Multi-media Pollution			Site Lot:	
Receiving Medium:	LAND			Site Conc:	
Receiving Env:				Northing:	
MOE Response:				Easting:	MCCR
Dt MOE Arvl on Scn:				Site Geo Ref Accu:	
MOE Reported Dt:	1/3/1992			Site Map Datum:	
Dt Document Closed:				SAC Action Class:	
Incident Reason:	MATERIAL FAILURE			Source Type:	
Site Name:					
Site County/District:					
Site Geo Ref Meth:					
Incident Summary:	RESIDENCE: OIL LEAKING FROM FURNACE TANK OIL LINE UNDER BASEMENT SLAB				
Contaminant Qty:					

24	1 of 6	WNW/249.5	86.9 / 5.11	City of Ottawa 2960 Riverside Dr. ottawa ON	GEN
Generator No:	ON5939702			PO Box No:	
Status:				Country:	
Approval Years:	2013			Choice of Contact:	
Contam. Facility:				Co Admin:	
MHSW Facility:				Phone No Admin:	
SIC Code:	484221				
SIC Description:	BULK LIQUIDS TRUCKING, LOCAL				
Detail(s)					
Waste Class:	251				
Waste Class Desc:	OIL SKIMMINGS & SLUDGES				

24	2 of 6	WNW/249.5	86.9 / 5.11	City of Ottawa 2960 Riverside Dr. ottawa ON K2G 6J8	GEN
Generator No:	ON5939702			PO Box No:	
Status:				Country:	Canada
Approval Years:	2016			Choice of Contact:	CO_OFFICIAL
Contam. Facility:	No			Co Admin:	Mark Hennigar
MHSW Facility:	No			Phone No Admin:	613-580-2424 Ext.33331
SIC Code:	484221				
SIC Description:	BULK LIQUIDS TRUCKING, LOCAL				
Detail(s)					
Waste Class:	221				
Waste Class Desc:	LIGHT FUELS				
Waste Class:	251				
Waste Class Desc:	OIL SKIMMINGS & SLUDGES				

Map Key	Number of Records	Direction/ Distance (m)	Elev/Diff (m)	Site	DB
24	3 of 6	WNW/249.5	86.9 / 5.11	City of Ottawa 2960 Riverside Dr. ottawa ON K2G 6J8	GEN
Generator No:	ON5939702			PO Box No:	
Status:				Country:	Canada
Approval Years:	2015			Choice of Contact:	CO_OFFICIAL
Contam. Facility:	No			Co Admin:	Mark Hennigar
MHSW Facility:	No			Phone No Admin:	613-580-2424 Ext.33331
SIC Code:	484221				
SIC Description:	BULK LIQUIDS TRUCKING, LOCAL				
Detail(s)					
Waste Class:		251			
Waste Class Desc:	OIL SKIMMINGS & SLUDGES				
Waste Class:		221			
Waste Class Desc:	LIGHT FUELS				
24	4 of 6	WNW/249.5	86.9 / 5.11	City of Ottawa 2960 Riverside Dr. ottawa ON K2G 6J8	GEN
Generator No:	ON5939702			PO Box No:	
Status:				Country:	Canada
Approval Years:	2014			Choice of Contact:	CO_OFFICIAL
Contam. Facility:	No			Co Admin:	Mark Hennigar
MHSW Facility:	No			Phone No Admin:	613-580-2424 Ext.33331
SIC Code:	484221				
SIC Description:	BULK LIQUIDS TRUCKING, LOCAL				
Detail(s)					
Waste Class:		251			
Waste Class Desc:	OIL SKIMMINGS & SLUDGES				
Waste Class:		221			
Waste Class Desc:	LIGHT FUELS				
24	5 of 6	WNW/249.5	86.9 / 5.11	City of Ottawa RPAM 2960 Riverside Dr. ottawa ON K2G 6J8	GEN
Generator No:	ON5939702			PO Box No:	
Status:	Registered			Country:	Canada
Approval Years:	As of Dec 2018			Choice of Contact:	
Contam. Facility:				Co Admin:	
MHSW Facility:				Phone No Admin:	
SIC Code:					
SIC Description:					
Detail(s)					
Waste Class:		221 L			
Waste Class Desc:	Light fuels				
Waste Class:		251 L			
Waste Class Desc:	Waste oils/sludges (petroleum based)				

Map Key	Number of Records	Direction/ Distance (m)	Elev/Diff (m)	Site	DB
24	6 of 6	WNW/249.5	86.9 / 5.11	City of Ottawa RPAM 2960 Riverside Dr. ottawa ON K2G 6J8	GEN
Generator No:	ON5939702			PO Box No:	
Status:	Registered			Country:	Canada
Approval Years:	As of Oct 2019			Choice of Contact:	
Contam. Facility:				Co Admin:	
MHSW Facility:				Phone No Admin:	
SIC Code:					
SIC Description:					
<u>Detail(s)</u>					
Waste Class:	251 L				
Waste Class Desc:	Waste oils/sludges (petroleum based)				
Waste Class:	221 L				
Waste Class Desc:	Light fuels				
25	1 of 10	NNW/249.6	81.9 / 0.09	ST. PATRICK'S HOME OF OTTAWA 34-692 2865 RIVERSIDE DRIVE OTTAWA ON K1V 8N5	GEN
Generator No:	ON1668500			PO Box No:	
Status:				Country:	
Approval Years:	92,93,94,95,96,97,98			Choice of Contact:	
Contam. Facility:				Co Admin:	
MHSW Facility:				Phone No Admin:	
SIC Code:	8621				
SIC Description:	PERS./NURS. CARE H.				
<u>Detail(s)</u>					
Waste Class:	312				
Waste Class Desc:	PATHOLOGICAL WASTES				
25	2 of 10	NNW/249.6	81.9 / 0.09	ST. PATRICK'S HOME OF OTTAWA 2865 RIVERSIDE DRIVE OTTAWA ON K1V 8N5	GEN
Generator No:	ON1668500			PO Box No:	
Status:				Country:	
Approval Years:	99,00,01			Choice of Contact:	
Contam. Facility:				Co Admin:	
MHSW Facility:				Phone No Admin:	
SIC Code:	8621				
SIC Description:	PERS./NURS. CARE H.				
<u>Detail(s)</u>					
Waste Class:	312				
Waste Class Desc:	PATHOLOGICAL WASTES				
25	3 of 10	NNW/249.6	81.9 / 0.09	2865 Riverside Drive Ottawa ON K1V 8N5	EHS
Order No:	20081014031			Nearest Intersection:	Riverside Drive and Brookfield Road
Status:	C			Municipality:	Ottawa
Report Type:	Standard Report			Client Prov/State:	ON
Report Date:	10/23/2008			Search Radius (km):	0.25

Map Key	Number of Records	Direction/ Distance (m)	Elev/Diff (m)	Site	DB
Date Received: 10/14/2008 Previous Site Name: Lot/Building Size: approx. 5.9 acres Additional Info Ordered: City Directory					
25	4 of 10	NNW/249.6	81.9 / 0.09	2865 Riverside Drive Ottawa ON K1V 8N5	EHS
Order No: 20110412033 Status: C Report Type: Standard Select Report Report Date: 4/21/2011 Date Received: 4/12/2011 1:06:29 PM Previous Site Name: Lot/Building Size: Additional Info Ordered:					
Nearest Intersection: Municipality: Client Prov/State: ON Search Radius (km): 0.25 X: -75.689562 Y: 45.370416					
25	5 of 10	NNW/249.6	81.9 / 0.09	St. Patrick's Home of Ottawa Inc. 2865 Riverside Dr. Ottawa ON K1V 8N5	GEN
Generator No: ON4394512 Status: Approval Years: 2009 Contam. Facility: MHSW Facility: SIC Code: 623310 SIC Description: Community Care Facilities for the Elderly					
PO Box No: Country: Choice of Contact: Co Admin: Phone No Admin:					
Detail(s)					
Waste Class: 251 Waste Class Desc: OIL SKIMMINGS & SLUDGES					
25	6 of 10	NNW/249.6	81.9 / 0.09	Medical Arts Dispensary of Ottawa 2865 Riverside Drive Ottawa ON K1V 8N5	GEN
Generator No: ON4099831 Status: Approval Years: 2016 Contam. Facility: No MHSW Facility: No SIC Code: 621110 SIC Description: OFFICES OF PHYSICIANS					
PO Box No: Country: Canada Choice of Contact: CO_OFFICIAL Co Admin: Phone No Admin:					
Detail(s)					
Waste Class: 312 Waste Class Desc: PATHOLOGICAL WASTES					
Waste Class: 261 Waste Class Desc: PHARMACEUTICALS					
25	7 of 10	NNW/249.6	81.9 / 0.09	Medical Arts Dispensary of Ottawa 2865 Riverside Drive Ottawa ON K1V 8N5	GEN
Generator No: ON4099831 PO Box No:					

Map Key	Number of Records	Direction/ Distance (m)	Elev/Diff (m)	Site	DB
Status: Approval Years: 2015 Contam. Facility: No MHSW Facility: No SIC Code: 621110 SIC Description: OFFICES OF PHYSICIANS				Country: Canada Choice of Contact: CO_OFFICIAL Co Admin: Phone No Admin:	
<u>Detail(s)</u>					
Waste Class: 312 Waste Class Desc: PATHOLOGICAL WASTES					
Waste Class: 261 Waste Class Desc: PHARMACEUTICALS					
25	8 of 10	NNW/249.6	81.9 / 0.09	St. Patrick's Home of Ottawa Inc. 2865 Riverside Dr. Ottawa ON K1V 8N5	GEN
Generator No: ON7471928 Status: Approval Years: 2014 Contam. Facility: No MHSW Facility: No SIC Code: 623310 SIC Description: 623310				PO Box No: Country: Canada Choice of Contact: CO_OFFICIAL Co Admin: Phone No Admin:	
<u>Detail(s)</u>					
Waste Class: 243 Waste Class Desc: PCBS					
25	9 of 10	NNW/249.6	81.9 / 0.09	Medical Arts Dispensary of Ottawa 2865 Riverside Drive Ottawa ON K1V 8N5	GEN
Generator No: ON4099831 Status: Registered Approval Years: As of Dec 2018 Contam. Facility: MHSW Facility: SIC Code: SIC Description:				PO Box No: Country: Canada Choice of Contact: Co Admin: Phone No Admin:	
<u>Detail(s)</u>					
Waste Class: 261 A Waste Class Desc: Pharmaceuticals					
Waste Class: 261 I Waste Class Desc: Pharmaceuticals					
Waste Class: 312 P Waste Class Desc: Pathological wastes					
25	10 of 10	NNW/249.6	81.9 / 0.09	Medical Arts Dispensary of Ottawa 2865 Riverside Drive Ottawa ON K1V 8N5	GEN
Generator No: ON4099831 Status: Registered				PO Box No: Country: Canada	

Map Key	Number of Records	Direction/ Distance (m)	Elev/Diff (m)	Site	DB
Approval Years: Contam. Facility: MHSW Facility: SIC Code: SIC Description:	As of Oct 2019			Choice of Contact: Co Admin: Phone No Admin:	

Detail(s)

Waste Class:	261 I
Waste Class Desc:	Pharmaceuticals
Waste Class:	261 A
Waste Class Desc:	Pharmaceuticals
Waste Class:	312 P
Waste Class Desc:	Pathological wastes

Unplottable Summary

Total: 24 Unplottable sites

DB	Company Name/Site Name	Address	City	Postal
CA	1213225 Ontario Ltd. and Tamarack Developments Corporation	Block 165 of Registered Plan 4M-1224	Ottawa ON	
CA	1213225 Ontario Ltd. and Tamarack Developments Corporation	Block 167 - Reg. Plan 4M-1224	Ottawa ON	
CA	Clean Water Works Inc.		Ottawa ON	
CA	Clean Water Works Inc.		Ottawa ON	
CA	CLARIDGE HOMES (RIVERSIDE) INC.	ST.#1/RIVERSIDE DR/CUL-DE-SAC	OTTAWA CITY ON	
CA	CAMPEAU CORP.	RIVERSIDE DR.	OTTAWA ON	
CA	CAMPEAU CORP.	RIVERSIDE DR.	OTTAWA ON	
CA	CLARIDGE HOMES (RIVERSIDE) INC.	ST.#1/RIVERSIDE DR/CUL-DE-SAC	OTTAWA CITY ON	
CA	WEDGEWOOD BUILDING CORPORATION	RIDGEWOOD PRIVATE	OTTAWA CITY ON	
CA	PEREZ CORPORATION	STREET NO. 1 RIVERSIDE DR.	OTTAWA CITY ON	
CA	Clean Water Works Inc.		Ottawa ON	
CA	Clean Water Works Inc.		Ottawa ON	
CA	Clean Water Works Inc.	Mobile Unit	Ottawa ON	
CA	R.M. OF OTTAWA-CARL.S.E. TRANSITWAY ST. 1	E. SIDE OF RIVERSIDE DR.	OTTAWA CITY ON	
CA	WEDGEWOOD BUILDING CORPORATION	RIDGEWOOD PRIVATE	OTTAWA CITY ON	
CA	J. PEREZ CORPORATION STM MGN. 3-0842-87	STREET #1 RIVERSIDE DR.	OTTAWA CITY ON	
ECA	City of Ottawa	Cummings Ave., Norberry Cres., Rainbow Cres.	Ottawa ON	K1S 5K2

ECA	1213225 Ontario Ltd. and Tamarack Developments Corporation	Block 165 of Registered Plan 4M-1224	Ottawa ON	K2P 0G5
ECA	1213225 Ontario Ltd. and Tamarack Developments Corporation		Ottawa ON	K2P 0G5
ECA	Clean Water Works Inc.	Mobile Unit	Ottawa ON	K1B 5L6
ECA	City of Ottawa	Riverside Drive	Ottawa ON	K1S 5K2
RSC		Part Lot 23	Ottawa ON	
SPL	ULTRAMAR	RIVERSIDE DRIVE AT TRANSIT WAY (NEAR POST OFFICE) TANK TRUCK (CARGO)	OTTAWA CITY ON	
SPL	Clean Water Works Inc.		Ottawa ON	

Unplottable Report

Site: 1213225 Ontario Ltd. and Tamarack Developments Corporation
Block 165 of Registered Plan 4M-1224 Ottawa ON

Database:
CA

Certificate #: 2967-6DMNBF
Application Year: 2005
Issue Date: 6/24/2005
Approval Type: Municipal and Private Sewage Works
Status: Approved
Application Type:
Client Name:
Client Address:
Client City:
Client Postal Code:
Project Description:
Contaminants:
Emission Control:

Site: 1213225 Ontario Ltd. and Tamarack Developments Corporation
Block 167 - Reg. Plan 4M-1224 Ottawa ON

Database:
CA

Certificate #: 2786-6DNMQD
Application Year: 2005
Issue Date: 6/28/2005
Approval Type: Municipal and Private Sewage Works
Status: Approved
Application Type:
Client Name:
Client Address:
Client City:
Client Postal Code:
Project Description:
Contaminants:
Emission Control:

Site: Clean Water Works Inc.
Ottawa ON

Database:
CA

Certificate #: 3664-6GGPRM
Application Year: 2005
Issue Date: 10/3/2005
Approval Type: Waste Management Systems
Status: Revoked and/or Replaced
Application Type:
Client Name:
Client Address:
Client City:
Client Postal Code:
Project Description:
Contaminants:
Emission Control:

Site: Clean Water Works Inc.
Ottawa ON

Database:
CA

Certificate #: 3664-6GGPRM
Application Year: 2006

Issue Date: 1/20/2006
Approval Type: Waste Management Systems
Status: Approved
Application Type:
Client Name:
Client Address:
Client City:
Client Postal Code:
Project Description:
Contaminants:
Emission Control:

Site: CLARIDGE HOMES (RIVERSIDE) INC.
ST.#1/RIVERSIDE DR/CUL-DE-SAC OTTAWA CITY ON

Database:
CA

Certificate #: 3-1703-95-006
Application Year: 95
Issue Date: 12/11/95
Approval Type: Municipal sewage
Status: Approved
Application Type:
Client Name:
Client Address:
Client City:
Client Postal Code:
Project Description:
Contaminants:
Emission Control:

Site: CAMPEAU CORP.
RIVERSIDE DR. OTTAWA ON

Database:
CA

Certificate #: 7-0165-85-006
Application Year: 85
Issue Date: 3/29/85
Approval Type: Municipal water
Status: Approved
Application Type:
Client Name:
Client Address:
Client City:
Client Postal Code:
Project Description:
Contaminants:
Emission Control:

Site: CAMPEAU CORP.
RIVERSIDE DR. OTTAWA ON

Database:
CA

Certificate #: 3-0118-85-006
Application Year: 85
Issue Date: 3/1/85
Approval Type: Municipal sewage
Status: Approved
Application Type:
Client Name:
Client Address:
Client City:
Client Postal Code:
Project Description:
Contaminants:
Emission Control:

Site: CLARIDGE HOMES (RIVERSIDE) INC.
ST.#1/RIVERSIDE DR/CUL-DE-SAC OTTAWA CITY ON

Database:
CA

Certificate #: 7-1203-95-006
Application Year: 95
Issue Date: 12/11/95
Approval Type: Municipal water
Status: Approved
Application Type:
Client Name:
Client Address:
Client City:
Client Postal Code:
Project Description:
Contaminants:
Emission Control:

Site: WEDGEWOOD BUILDING CORPORATION
RIDGEWOOD PRIVATE OTTAWA CITY ON

Database:
CA

Certificate #: 7-1096-87-
Application Year: 87
Issue Date: 8/4/1987
Approval Type: Municipal water
Status: Approved
Application Type:
Client Name:
Client Address:
Client City:
Client Postal Code:
Project Description:
Contaminants:
Emission Control:

Site: PEREZ CORPORATION
STREET NO. 1 RIVERSIDE DR. OTTAWA CITY ON

Database:
CA

Certificate #: 7-0478-87-
Application Year: 87
Issue Date: 5/5/1987
Approval Type: Municipal water
Status: Approved
Application Type:
Client Name:
Client Address:
Client City:
Client Postal Code:
Project Description:
Contaminants:
Emission Control:

Site: Clean Water Works Inc.
Ottawa ON

Database:
CA

Certificate #: 6489-6GTPNX
Application Year: 2005
Issue Date: 10/5/2005
Approval Type: Waste Management Systems
Status: Revoked and/or Replaced
Application Type:
Client Name:
Client Address:
Client City:
Client Postal Code:
Project Description:

Contaminants:
Emission Control:

Site: Clean Water Works Inc.
Ottawa ON

Database:
CA

Certificate #: 6489-6GTPNX
Application Year: 2006
Issue Date: 3/3/2006
Approval Type: Waste Management Systems
Status: Approved
Application Type:
Client Name:
Client Address:
Client City:
Client Postal Code:
Project Description:
Contaminants:
Emission Control:

Site: Clean Water Works Inc.
Mobile Unit Ottawa ON

Database:
CA

Certificate #: 9392-8HTPQD
Application Year: 2011
Issue Date: 10/25/2011
Approval Type: Industrial Sewage Works
Status: Approved
Application Type:
Client Name:
Client Address:
Client City:
Client Postal Code:
Project Description:
Contaminants:
Emission Control:

Site: R.M. OF OTTAWA-CARL.S.E.TRANSITWAY ST. 1
E. SIDE OF RIVERSIDE DR. OTTAWA CITY ON

Database:
CA

Certificate #: 7-0818-89-
Application Year: 89
Issue Date: 5/29/1989
Approval Type: Municipal water
Status: Approved
Application Type:
Client Name:
Client Address:
Client City:
Client Postal Code:
Project Description:
Contaminants:
Emission Control:

Site: WEDGEWOOD BUILDING CORPORATION
RIDGEWOOD PRIVATE OTTAWA CITY ON

Database:
CA

Certificate #: 3-1320-87-
Application Year: 87
Issue Date: 8/4/1987
Approval Type: Municipal sewage
Status: Approved
Application Type:

Client Name:
Client Address:
Client City:
Client Postal Code:
Project Description:
Contaminants:
Emission Control:

Site: J. PEREZ CORPORATION STM MGN. 3-0842-87
STREET #1 RIVERSIDE DR. OTTAWA CITY ON

Database:
CA

Certificate #: 3-0563-87-
Application Year: 87
Issue Date: 5/5/1987
Approval Type: Municipal sewage
Status: Approved
Application Type:
Client Name:
Client Address:
Client City:
Client Postal Code:
Project Description:
Contaminants:
Emission Control:

Site: City of Ottawa
Cummings Ave., Norberry Cres., Rainbow Cres. Ottawa ON K1S 5K2

Database:
ECA

Approval No: 1904-5QCPU7
Approval Date: 2003-08-26
Status: Approved
Record Type: ECA
Link Source: IDS
SWP Area Name:
Approval Type: ECA-Municipal Drinking Water Systems
Project Type: Municipal Drinking Water Systems
Address: Cummings Ave., Norberry Cres., Rainbow Cres.
Full Address:
Full PDF Link:

MOE District:
City:
Longitude:
Latitude:
Geometry X:
Geometry Y:

Site: 1213225 Ontario Ltd. and Tamarack Developments Corporation
Block 165 of Registered Plan 4M-1224 Ottawa ON K2P 0G5

Database:
ECA

Approval No: 2967-6DMNBF
Approval Date: 2005-06-24
Status: Approved
Record Type: ECA
Link Source: IDS
SWP Area Name:
Approval Type: ECA-MUNICIPAL AND PRIVATE SEWAGE WORKS
Project Type: MUNICIPAL AND PRIVATE SEWAGE WORKS
Address: Block 165 of Registered Plan 4M-1224
Full Address:
Full PDF Link: <https://www.accessenvironment.ene.gov.on.ca/instruments/8345-6DKP82-14.pdf>

MOE District:
City:
Longitude:
Latitude:
Geometry X:
Geometry Y:

Site: 1213225 Ontario Ltd. and Tamarack Developments Corporation
Ottawa ON K2P 0G5

Database:
ECA

Approval No: 2786-6DNMQD
Approval Date: 2005-06-28
Status: Approved
Record Type: ECA
Link Source: IDS
MOE District:
City:
Longitude:
Latitude:
Geometry X:

SWP Area Name: **Geometry Y:**
Approval Type: ECA-MUNICIPAL AND PRIVATE SEWAGE WORKS
Project Type: MUNICIPAL AND PRIVATE SEWAGE WORKS
Address:
Full Address:
Full PDF Link: <https://www.accessenvironment.ene.gov.on.ca/instruments/6293-6DKPCR-14.pdf>

Site: **Clean Water Works Inc.**
Mobile Unit **Ottawa ON K1B 5L6**

Database:
ECA

Approval No: 9392-8HTPQD
Approval Date: 2011-10-25
Status: Approved
Record Type: ECA
Link Source: IDS
SWP Area Name:
Approval Type: ECA-INDUSTRIAL SEWAGE WORKS
Project Type: INDUSTRIAL SEWAGE WORKS
Address: Mobile Unit
Full Address:
Full PDF Link: <https://www.accessenvironment.ene.gov.on.ca/instruments/3319-8C7KZN-13.pdf>

MOE District:
City:
Longitude:
Latitude:
Geometry X:
Geometry Y:

Site: **City of Ottawa**
Riverside Drive **Ottawa ON K1S 5K2**

Database:
ECA

Approval No: 6330-5XEKCD
Approval Date: 2004-03-29
Status: Approved
Record Type: ECA
Link Source: IDS
SWP Area Name:
Approval Type: ECA-Municipal Drinking Water Systems
Project Type: Municipal Drinking Water Systems
Address: Riverside Drive
Full Address:
Full PDF Link:

MOE District:
City:
Longitude:
Latitude:
Geometry X:
Geometry Y:

Site: **Part Lot 23 Ottawa ON**

Database:
RSC

RSC ID:
RA No:
RSC Type:
Curr Property Use:
Ministry District: Ottawa
Filing Date: 07/05/01
Date Ack: 08/14/01
Date Returned:
Restoration Type: Generic
Soil Type: Medium/Fine
Criteria: Res/parkland + Nonpotable
CPU Issued Sect
1686:
Asmt Roll No:
Prop ID No (PIN):
Property Municipal Address:
Mailing Address:
Latitude & Latitude:
UTM Coordinates:
Consultant: DST Consulting Engineers Inc.
Legal Desc:
Measurement Method:
Applicable Standards:
RSC PDF:

Cert Date:
Cert Prop Use No:
Intended Prop Use:
Qual Person Name:
Stratified (Y/N): N
Audit (Y/N):
Entire Leg Prop. (Y/N):
Accuracy Estimate:
Telephone:
Fax:
Email:

Site: ULTRAMAR
RIVERSIDE DRIVE AT TRANSIT WAY (NEAR POST OFFICE) TANK TRUCK (CARGO) OTTAWA CITY ON

Database:
SPL

Ref No: 76621
Site No:
Incident Dt: 9/22/1992
Year:
Incident Cause: TRUCK/TRAILER OVERTURN
Incident Event:
Contaminant Code:
Contaminant Name:
Contaminant Limit 1:
Contam Limit Freq 1:
Contaminant UN No 1:
Environment Impact: NOT ANTICIPATED
Nature of Impact:
Receiving Medium: LAND
Receiving Env:
MOE Response:
Dt MOE Arvl on Scn:
MOE Reported Dt: 9/22/1992
Dt Document Closed:
Incident Reason: UNKNOWN
Site Name:
Site County/District:
Site Geo Ref Meth:
Incident Summary: ULTRAMAR GASOLINE TANKER - UNKNOWN QUANTITY GAS FROM MOTOR TO ROAD.
Contaminant Qty:

Discharger Report:
Material Group:
Health/Env Conseq:
Client Type:
Sector Type:
Agency Involved:
Nearest Watercourse:
Site Address:
Site District Office:
Site Postal Code:
Site Region:
Site Municipality: 20101
Site Lot:
Site Conc:
Northing:
Easting: F.D., FRANCIS WASTE MGT.
Site Geo Ref Accu:
Site Map Datum:
SAC Action Class:
Source Type:

Site: Clean Water Works Inc.
Ottawa ON

Database:
SPL

Ref No: 6517-B3EKFG
Site No: NA
Incident Dt: 2018/08/03
Year:
Incident Cause:
Incident Event: Leak/Break
Contaminant Code: 15
Contaminant Name: HYDRAULIC OIL
Contaminant Limit 1:
Contam Limit Freq 1:
Contaminant UN No 1: n/a
Environment Impact:
Nature of Impact:
Receiving Medium:
Receiving Env: Land
MOE Response: No
Dt MOE Arvl on Scn:
MOE Reported Dt: 2018/08/07
Dt Document Closed: 2018/09/04
Incident Reason: Equipment Failure
Site Name: 20 Marie Curie Drive (University of Ottawa)<UNOFFICIAL>
Site County/District:
Site Geo Ref Meth:
Incident Summary: Ottawa 25L of hydraulic oil to grnd
Contaminant Qty: 25 L

Discharger Report:
Material Group:
Health/Env Conseq: 2 - Minor Environment Corporation
Client Type: Miscellaneous Industrial
Sector Type:
Agency Involved:
Nearest Watercourse:
Site Address:
Site District Office: Ottawa
Site Postal Code:
Site Region: Eastern
Site Municipality: Ottawa
Site Lot:
Site Conc:
Northing:
Easting:
Site Geo Ref Accu:
Site Map Datum:
SAC Action Class: Land Spills
Source Type: Motor Vehicle

Appendix: Database Descriptions

Environmental Risk Information Services (ERIS) can search the following databases. The extent of historical information varies with each database and current information is determined by what is publicly available to ERIS at the time of update. **Note:** Databases denoted with " * " indicates that the database will no longer be updated. See the individual database description for more information.

Abandoned Aggregate Inventory:

Provincial

[AAGR](#)

The MAAP Program maintains a database of abandoned pits and quarries. Please note that the database is only referenced by lot and concession and city/town location. The database provides information regarding the location, type, size, land use, status and general comments.*

Government Publication Date: Sept 2002*

Aggregate Inventory:

Provincial

[AGR](#)

The Ontario Ministry of Natural Resources maintains a database of all active pits and quarries. The database provides information regarding the registered owner/operator, location name, operation type, approval type, and maximum annual tonnage.

Government Publication Date: Up to Sep 2019

Abandoned Mine Information System:

Provincial

[AMIS](#)

The Abandoned Mines Information System contains data on known abandoned and inactive mines located on both Crown and privately held lands. The information was provided by the Ministry of Northern Development and Mines (MNDM), with the following disclaimer: "the database provided has been compiled from various sources, and the Ministry of Northern Development and Mines makes no representation and takes no responsibility that such information is accurate, current or complete". Reported information includes official mine name, status, background information, mine start/end date, primary commodity, mine features, hazards and remediation.

Government Publication Date: 1800-Oct 2018

Anderson's Waste Disposal Sites:

Private

[ANDR](#)

The information provided in this database was collected by examining various historical documents which aimed to characterize the likely position of former waste disposal sites from 1860 to present. The research initiative behind the creation of this database was to identify those sites that are missing from the Ontario MOE Waste Disposal Site Inventory, as well as to provide revisions and corrections to the positions and descriptions of sites currently listed in the MOE inventory. In addition to historic waste disposal facilities, the database also identifies certain auto wreckers and scrap yards that have been extrapolated from documentary sources. Please note that the data is not warranted to be complete, exhaustive or authoritative. The information was collected for research purposes only.

Government Publication Date: 1860s-Present

Aboveground Storage Tanks:

Provincial

[AST](#)

Historical listing of aboveground storage tanks made available by the Department of Natural Resources and Forestry. Includes tanks used to hold water or petroleum. This dataset has been retired as of September 25, 2014 and will no longer be updated.

Government Publication Date: May 31, 2014

Automobile Wrecking & Supplies:

Private

[AUWR](#)

This database provides an inventory of known locations that are involved in the scrap metal, automobile wrecking/recycling, and automobile parts & supplies industry. Information is provided on the company name, location and business type.

Government Publication Date: 1999-Jan 31, 2020

Borehole:

Provincial

[BORE](#)

A borehole is the generalized term for any narrow shaft drilled in the ground, either vertically or horizontally. The information here includes geotechnical investigations or environmental site assessments, mineral exploration, or as a pilot hole for installing piers or underground utilities. Information is from many sources such as the Ministry of Transportation (MTO) boreholes from engineering reports and projects from the 1950 to 1990's in Southern Ontario. Boreholes from the Ontario Geological Survey (OGS) including The Urban Geology Analysis Information System (UGAIS) and the York Peel Durham Toronto (YPDT) database of the Conservation Authority Moraine Coalition. This database will include fields such as location, stratigraphy, depth, elevation, year drilled, etc. For all water well data or oil and gas well data for Ontario please refer to WWIS and OOGW.

Government Publication Date: 1875-Jul 2018

Certificates of Approval:

Provincial CA

This database contains the following types of approvals: Air & Noise, Industrial Sewage, Municipal & Private Sewage, Waste Management Systems and Renewable Energy Approvals. The MOE in Ontario states that any facility that releases emissions to the atmosphere, discharges contaminants to ground or surface water, provides potable water supplies, or stores, transports or disposes of waste, must have a Certificate of Approval before it can operate lawfully. Fields include approval number, business name, address, approval date, approval type and status. This database will no longer be updated, as CofA's have been replaced by either Environmental Activity and Sector Registry (EASR) or Environmental Compliance Approval (ECA). Please refer to those individual databases for any information after Oct.31, 2011.

Government Publication Date: 1985-Oct 30, 2011*

Dry Cleaning Facilities:

Federal CDRY

List of dry cleaning facilities made available by Environment and Climate Change Canada. Environment and Climate Change Canada's Tetrachloroethylene (Use in Dry Cleaning and Reporting Requirements) Regulations (SOR/2003-79) are intended to reduce releases of tetrachloroethylene to the environment from dry cleaning facilities.

Government Publication Date: Jan 2004-Dec 2017

Commercial Fuel Oil Tanks:

Provincial CFOT

Locations of commercial underground fuel oil tanks. This is not a comprehensive or complete inventory of commercial fuel tanks in the province; this listing is a copy of records of registered commercial underground fuel oil tanks obtained under Access to Public Information.

Note that the following types of tanks do not require registration: waste oil tanks in apartments, office buildings, residences, etc.; aboveground gas or diesel tanks. Records are not verified for accuracy or completeness.

Government Publication Date: Feb 28, 2017

Chemical Register:

Private CHEM

This database includes information from both a one time study conducted in 1992 and private source and is a listing of facilities that manufacture or distribute chemicals. The production of these chemical substances may involve one or more chemical reactions and/or chemical separation processes (i.e. fractionation, solvent extraction, crystallization, etc.).

Government Publication Date: 1999-Jan 31, 2020

Compressed Natural Gas Stations:

Private CNG

Canada has a network of public access compressed natural gas (CNG) refuelling stations. These stations dispense natural gas in compressed form at 3,000 pounds per square inch (psi), the pressure which is allowed within the current Canadian codes and standards. The majority of natural gas refuelling is located at existing retail gasoline that have a separate refuelling island for natural gas. This list of stations is made available by the Canadian Natural Gas Vehicle Alliance.

Government Publication Date: Dec 2012 - Feb 2020

Inventory of Coal Gasification Plants and Coal Tar Sites:

Provincial COAL

This inventory includes both the "Inventory of Coal Gasification Plant Waste Sites in Ontario-April 1987" and the Inventory of Industrial Sites Producing or Using Coal Tar and Related Tars in Ontario-November 1988) collected by the MOE. It identifies industrial sites that produced and continue to produce or use coal tar and other related tars. Detailed information is available and includes: facility type, size, land use, information on adjoining properties, soil condition, site operators/occupants, site description, potential environmental impacts and historic maps available. This was a one-time inventory.*

Government Publication Date: Apr 1987 and Nov 1988*

Compliance and Convictions:

Provincial CONV

This database summarizes the fines and convictions handed down by the Ontario courts beginning in 1989. Companies and individuals named here have been found guilty of environmental offenses in Ontario courts of law.

Government Publication Date: 1989-Dec 2019

Certificates of Property Use:

Provincial CPU

This is a subset taken from Ontario's Environmental Registry (EBR) database. It will include all CPU's on the registry such as (EPA s. 168.6) - Certificate of Property Use.

Government Publication Date: 1994-Apr 30, 2020

Drill Hole Database:

Provincial DRL

The Ontario Drill Hole Database contains information on more than 113,000 percussion, overburden, sonic and diamond drill holes from assessment files on record with the department of Mines and Minerals. Please note that limited data is available for southern Ontario, as it was the last area to be completed. The database was created when surveys submitted to the Ministry were converted in the Assessment File Research Image Database (AFRI) project. However, the degree of accuracy (coordinates) as to the exact location of drill holes is dependent upon the source document submitted to the MNDM. Levels of accuracy used to locate holes are: centering on the mining claim; a sketch of the mining claim; a 1:50,000 map; a detailed company map; or from submitted a "Report of Work".

Government Publication Date: 1886 - Sep 2019

Environmental Activity and Sector Registry:

Provincial [EASR](#)

On October 31, 2011, a smarter, faster environmental approvals system came into effect in Ontario. The EASR allows businesses to register certain activities with the ministry, rather than apply for an approval. The registry is available for common systems and processes, to which preset rules of operation can be applied. The EASR is currently available for: heating systems, standby power systems and automotive refinishing. Businesses whose activities aren't subject to the EASR may apply for an ECA (Environmental Compliance Approval), Please see our ECA database.

Government Publication Date: Oct 2011-Apr 30, 2020

Environmental Registry:

Provincial [EBR](#)

The Environmental Registry lists proposals, decisions and exceptions regarding policies, Acts, instruments, or regulations that could significantly affect the environment. Through the Registry, thirteen provincial ministries notify the public of upcoming proposals and invite their comments. For example, if a local business is requesting a permit, license, or certificate of approval to release substances into the air or water; these are notified on the registry. Data includes: Approval for discharge into the natural environment other than water (i.e. Air) - EPA s. 9, Approval for sewage works - OWRA s. 53(1), and EPA s. 27 - Approval for a waste disposal site. For information regarding Permit to Take Water (PTTW), Certificate of Property Use (CPU) and (ORD) Orders please refer to those individual databases.

Government Publication Date: 1994-Apr 30, 2020

Environmental Compliance Approval:

Provincial [ECA](#)

On October 31, 2011, a smarter, faster environmental approvals system came into effect in Ontario. In the past, a business had to apply for multiple approvals (known as certificates of approval) for individual processes and pieces of equipment. Today, a business either registers itself, or applies for a single approval, depending on the types of activities it conducts. Businesses whose activities aren't subject to the EASR may apply for an ECA. A single ECA addresses all of a business's emissions, discharges and wastes. Separate approvals for air, noise and waste are no longer required. This database will also include Renewable Energy Approvals. For certificates of approval prior to Nov 1st, 2011, please refer to the CA database. For all Waste Disposal Sites please refer to the WDS database.

Government Publication Date: Oct 2011-Apr 30, 2020

Environmental Effects Monitoring:

Federal [EEM](#)

The Environmental Effects Monitoring program assesses the effects of effluent from industrial or other sources on fish, fish habitat and human usage of fisheries resources. Since 1992, pulp and paper mills have been required to conduct EEM studies under the Pulp and Paper Effluent Regulations. This database provides information on the mill name, geographical location and sub-lethal toxicity data.

Government Publication Date: 1992-2007*

ERIS Historical Searches:

Private [EHS](#)

ERIS has compiled a database of all environmental risk reports completed since March 1999. Available fields for this database include: site location, date of report, type of report, and search radius. As per all other databases, the ERIS database can be referenced on both the map and "Statistical Profile" page.

Government Publication Date: 1999-Jan 31, 2020

Environmental Issues Inventory System:

Federal [EIS](#)

The Environmental Issues Inventory System was developed through the implementation of the Environmental Issues and Remediation Plan. This plan was established to determine the location and severity of contaminated sites on inhabited First Nation reserves, and where necessary, to remediate those that posed a risk to health and safety; and to prevent future environmental problems. The EIS provides information on the reserve under investigation, inventory number, name of site, environmental issue, site action (Remediation, Site Assessment), and date investigation completed.

Government Publication Date: 1992-2001*

Emergency Management Historical Event:

Provincial [EMHE](#)

List of locations of historical occurrences of emergency events, including those assigned to the Ministry of Natural Resources by Order-In-Council (OIC) under the Emergency Management and Civil Protection Act, as well as events where MNR provided requested emergency response assistance. Many of these events will have involved community evacuations, significant structural loss, and/or involvement of MNR emergency response staff. These events fall into one of ten (10) type categories: Dam Failure; Drought / Low Water; Erosion; Flood; Forest Fire; Soil and Bedrock Instability; Petroleum Resource Center Event, EMO Requested Assistance, Continuity of Operations Event, Other Requested Assistance. EMHE record details are reproduced by ERIS under License with the Ontario Ministry of Natural Resources © Queen's Printer for Ontario, 2017.

Government Publication Date: Dec 31, 2016

Environmental Penalty Annual Report:

Provincial [EPAR](#)

This database contains data from Ontario's annual environmental penalty report published by the Ministry of the Environment and Climate Change. These reports provide information on environmental penalties for land or water violations issued to companies in one of the nine industrial sectors covered by the Municipal Industrial Strategy for Abatement (MISA) regulations.

Government Publication Date: Jan 1, 2011 - Dec 31, 2019

List of Expired Fuels Safety Facilities:

Provincial EXP

List of facilities and tanks for which there was once a fuel registration. This is not a comprehensive or complete inventory of expired tanks/tank facilities in the province; this listing is a copy of previously registered tanks and facilities obtained under Access to Public Information. Includes private fuel outlets, bulk plants, fuel oil tanks, gasoline stations, marinas, propane filling stations, liquid fuel tanks, piping systems, etc; includes tanks which have been removed from the ground.

Notes: registration was not required for private fuel underground/aboveground storage tanks prior to January 1990, nor for furnace oil tanks prior to May 1, 2002; registration is not required for waste oil tanks in apartments, office buildings, residences, etc., or aboveground gas or diesel tanks. Records are not verified for accuracy or completeness.

Government Publication Date: Feb 28, 2017

Federal Convictions:

Federal FCON

Environment Canada maintains a database referred to as the "Environmental Registry" that details prosecutions under the Canadian Environmental Protection Act (CEPA) and the Fisheries Act (FA). Information is provided on the company name, location, charge date, offence and penalty.

Government Publication Date: 1988-Jun 2007*

Contaminated Sites on Federal Land:

Federal FCS

The Federal Contaminated Sites Inventory includes information on known federal contaminated sites under the custodianship of departments, agencies and consolidated Crown corporations as well as those that are being or have been investigated to determine whether they have contamination arising from past use that could pose a risk to human health or the environment. The inventory also includes non-federal contaminated sites for which the Government of Canada has accepted some or all financial responsibility. It does not include sites where contamination has been caused by, and which are under the control of, enterprise Crown corporations, private individuals, firms or other levels of government. Includes fire training sites and sites at which Per- and Polyfluoroalkyl Substances (PFAS) are a concern.

Government Publication Date: Jun 2000-Apr 2020

Fisheries & Oceans Fuel Tanks:

Federal FOFT

Fisheries & Oceans Canada maintains an inventory of aboveground & underground fuel storage tanks located on Fisheries & Oceans property or controlled by DFO. Our inventory provides information on the site name, location, tank owner, tank operator, facility type, storage tank location, tank contents & capacity, and date of tank installation.

Government Publication Date: 1964-Sep 2019

Federal Identification Registry for Storage Tank Systems (FIRSTS):

Federal FRST

A list of federally regulated Storage tanks from the Federal Identification Registry for Storage Tank Systems (FIRSTS). FIRSTS is Environment and Climate Change Canada's database of storage tank systems subject to the Storage Tank for Petroleum Products and Allied Petroleum Products Regulations. The main objective of the Regulations is to prevent soil and groundwater contamination from storage tank systems located on federal and aboriginal lands. Storage tank systems that do not have a valid identification number displayed in a readily visible location on or near the storage tank system may be refused product delivery.

Government Publication Date: May 31, 2018

Fuel Storage Tank:

Provincial FST

List of registered private and retail fuel storage tanks. This is not a comprehensive or complete inventory of private and retail fuel storage tanks in the province; this listing is a copy of registered private and retail fuel storage tanks, obtained under Access to Public Information.

Notes: registration was not required for private fuel underground/aboveground storage tanks prior to January 1990, nor for furnace oil tanks prior to May 1, 2002; registration is not required for waste oil tanks in apartments, office buildings, residences, etc., or aboveground gas or diesel tanks. Records are not verified for accuracy or completeness.

Government Publication Date: Feb 28, 2017

Fuel Storage Tank - Historic:

Provincial FSTH

The Fuels Safety Branch of the Ontario Ministry of Consumer and Commercial Relations maintained a database of all registered private fuel storage tanks. Public records of private fuel storage tanks are only available since the registration became effective in September 1989. This information is now collected by the Technical Standards and Safety Authority.

Government Publication Date: Pre-Jan 2010*

Ontario Regulation 347 Waste Generators Summary:

Provincial GEN

Regulation 347 of the Ontario EPA defines a waste generation site as any site, equipment and/or operation involved in the production, collection, handling and/or storage of regulated wastes. A generator of regulated waste is required to register the waste generation site and each waste produced, collected, handled, or stored at the site. This database contains the registration number, company name and address of registered generators including the types of hazardous wastes generated. It includes data on waste generating facilities such as: drycleaners, waste treatment and disposal facilities, machine shops, electric power distribution etc. This information is a summary of all years from 1986 including the most currently available data. Some records may contain, within the company name, the phrase "See & Use..." followed by a series of letters and numbers. This occurs when one company is amalgamated with or taken over by another registered company. The number listed as "See & Use", refers to the new ownership and the other identification number refers to the original ownership. This phrase serves as a link between the 2 companies until operations have been fully transferred.

Government Publication Date: 1986-Jan 31, 2020

Greenhouse Gas Emissions from Large Facilities:

Federal

GHG

List of greenhouse gas emissions from large facilities made available by Environment Canada. Greenhouse gas emissions in kilotonnes of carbon dioxide equivalents (kt CO2 eq).

Government Publication Date: 2013-Dec 2017

TSSA Historic Incidents:

Provincial

HINC

List of historic incidences of spills and leaks of diesel, fuel oil, gasoline, natural gas, propane, and hydrogen recorded by the TSSA in their previous incident tracking system. The TSSA's Fuels Safety Program administers the Technical Standards & Safety Act 2000, providing fuel-related safety services associated with the safe transportation, storage, handling and use of fuels such as gasoline, diesel, propane, natural gas and hydrogen. Under this Act, the TSSA regulates fuel suppliers, storage facilities, transport trucks, pipelines, contractors and equipment or appliances that use fuels. Records are not verified for accuracy or completeness. This is not a comprehensive or complete inventory of historical fuel spills and leaks in the province. This listing is a copy of the data captured at one moment in time and is hence limited by the record date provided here.

Government Publication Date: 2006-June 2009*

Indian & Northern Affairs Fuel Tanks:

Federal

IAFT

The Department of Indian & Northern Affairs Canada (INAC) maintains an inventory of aboveground & underground fuel storage tanks located on both federal and crown land. Our inventory provides information on the reserve name, location, facility type, site/facility name, tank type, material & ID number, tank contents & capacity, and date of tank installation.

Government Publication Date: 1950-Aug 2003*

Fuel Oil Spills and Leaks:

Provincial

INC

Listing of spills and leaks of diesel, fuel oil, gasoline, natural gas, propane, and hydrogen reported to the Spills Action Centre (SAC). This is not a comprehensive or complete inventory of fuel-related leaks, spills, and incidents in the province; this listing is a copy of incidents reported to the SAC, obtained under Access to Public Information. Includes incidents from fuel-related hazards such as spills, fires, and explosions. Records are not verified for accuracy or completeness.

Government Publication Date: Feb 28, 2017

Landfill Inventory Management Ontario:

Provincial

LIMO

The Landfill Inventory Management Ontario (LIMO) database is updated every year, as the ministry compiles new and updated information. The inventory will include small and large landfills. Additionally, each year the ministry will request operators of the larger landfills complete a landfill data collection form that will be used to update LIMO and will include the following information from the previous operating year. This will include additional information such as estimated amount of total waste received, landfill capacity, estimated total remaining landfill capacity, fill rates, engineering designs, reporting and monitoring details, size of location, service area, approved waste types, leachate of site treatment, contaminant attenuation zone and more. The small landfills will include information such as site owner, site location and certificate of approval # and status.

Government Publication Date: Feb 28, 2019

Canadian Mine Locations:

Private

MINE

This information is collected from the Canadian & American Mines Handbook. The Mines database is a national database that provides over 290 listings on mines (listed as public companies) dealing primarily with precious metals and hard rocks. Listed are mines that are currently in operation, closed, suspended, or are still being developed (advanced projects). Their locations are provided as geographic coordinates (x, y and/or longitude, latitude). As of 2002, data pertaining to Canadian smelters and refineries has been appended to this database.

Government Publication Date: 1998-2009*

Mineral Occurrences:

Provincial

MNR

In the early 70's, the Ministry of Northern Development and Mines created an inventory of approximately 19,000 mineral occurrences in Ontario, in regard to metallic and industrial minerals, as well as some information on building stones and aggregate deposits. Please note that the "Horizontal Positional Accuracy" is approximately +/- 200 m. Many reference elements for each record were derived from field sketches using pace or chain/tape measurements against claim posts or topographic features in the area. The primary limiting factor for the level of positional accuracy is the scale of the source material. The testing of horizontal accuracy of the source materials was accomplished by comparing the plan metric (X and Y) coordinates of that point with the coordinates of the same point as defined from a source of higher accuracy.

Government Publication Date: 1846-Jan 2020

National Analysis of Trends in Emergencies System (NATES):

Federal

NATE

In 1974 Environment Canada established the National Analysis of Trends in Emergencies System (NATES) database, for the voluntary reporting of significant spill incidents. The data was to be used to assist in directing the work of the emergencies program. NATES ran from 1974 to 1994. Extensive information is available within this database including company names, place where the spill occurred, date of spill, cause, reason and source of spill, damage incurred, and amount, concentration, and volume of materials released.

Government Publication Date: 1974-1994*

Non-Compliance Reports:

Provincial

NCPL

The Ministry of the Environment provides information about non-compliant discharges of contaminants to air and water that exceed legal allowable limits, from regulated industrial and municipal facilities. A reported non-compliance failure may be in regard to a Control Order, Certificate of Approval, Sectoral Regulation or specific regulation/act.

Government Publication Date: Dec 31, 2018

National Defense & Canadian Forces Fuel Tanks:

Federal

NDFT

The Department of National Defense and the Canadian Forces maintains an inventory of all aboveground & underground fuel storage tanks located on DND lands. Our inventory provides information on the base name, location, tank type & capacity, tank contents, tank class, date of tank installation, date tank last used, and status of tank as of May 2001. This database will no longer be updated due to the new National Security protocols which have prohibited any release of this database.

Government Publication Date: Up to May 2001*

National Defense & Canadian Forces Spills:

Federal

NDSP

The Department of National Defense and the Canadian Forces maintains an inventory of spills to land and water. All spill sites have been classified under the "Transportation of Dangerous Goods Act - 1992". Our inventory provides information on the facility name, location, spill ID #, spill date, type of spill, as well as the quantity of substance spilled & recovered.

Government Publication Date: Mar 1999-Apr 2018

National Defence & Canadian Forces Waste Disposal Sites:

Federal

NDWD

The Department of National Defence and the Canadian Forces maintains an inventory of waste disposal sites located on DND lands. Where available, our inventory provides information on the base name, location, type of waste received, area of site, depth of site, year site opened/closed and status.

Government Publication Date: 2001-Apr 2007*

National Energy Board Pipeline Incidents:

Federal

NEBI

Locations of pipeline incidents from 2008 to present, made available by the Canada Energy Regulator (CER) - previously the National Energy Board (NEB). Includes incidents reported under the Onshore Pipeline Regulations and the Processing Plant Regulations related to pipelines under federal jurisdiction, does not include incident data related to pipelines under provincial or territorial jurisdiction.

Government Publication Date: 2008-Mar 31, 2020

National Energy Board Wells:

Federal

NEBP

The NEBW database contains information on onshore & offshore oil and gas wells that are outside provincial jurisdiction(s) and are thereby regulated by the National Energy Board. Data is provided regarding the operator, well name, well ID No./UWI, status, classification, well depth, spud and release date.

Government Publication Date: 1920-Feb 2003*

National Environmental Emergencies System (NEES):

Federal

NEES

In 2000, the Emergencies program implemented NEES, a reporting system for spills of hazardous substances. For the most part, this system only captured data from the Atlantic Provinces, some from Quebec and Ontario and a portion from British Columbia. Data for Alberta, Saskatchewan, Manitoba and the Territories was not captured. However, NEES is also a repository for previous Environment Canada spill datasets. NEES is composed of the historic datasets ' or Trends ' which dates from approximately 1974 to present. NEES Trends is a compilation of historic databases, which were merged and includes data from NATES (National Analysis of Trends in Emergencies System), ARTS (Atlantic Regional Trends System), and NEES. In 2001, the Emergencies Program determined that variations in reporting regimes and requirements between federal and provincial agencies made national spill reporting and trend analysis difficult to achieve. As a consequence, the department has focused efforts on capturing data on spills of substances which fall under its legislative authority only (CEPA and FA). As such, the NEES database will be decommissioned in December 2004.

Government Publication Date: 1974-2003*

National PCB Inventory:

Federal

NPCB

Environment Canada's National PCB inventory includes information on in-use PCB containing equipment in Canada including federal, provincial and private facilities. Federal out-of-service PCB containing equipment and PCB waste owned by the federal government or by federally regulated industries such as airlines, railway companies, broadcasting companies, telephone and telecommunications companies, pipeline companies, etc. are also listed. Although it is not Environment Canada's mandate to collect data on non-federal PCB waste, the National PCB inventory includes some information on provincial and private PCB waste and storage sites. Some addresses provided may be Head Office addresses and are not necessarily the location of where the waste is being used or stored.

Government Publication Date: 1988-2008*

National Pollutant Release Inventory:

Federal

NPRI

Environment Canada has defined the National Pollutant Release Inventory ("NPRI") as a federal government initiative designed to collect comprehensive national data regarding releases to air, water, or land, and waste transfers for recycling for more than 300 listed substances.

Government Publication Date: 1993-May 2017

Oil and Gas Wells:

Private

[OGWE](#)

The Nickle's Energy Group (publisher of the Daily Oil Bulletin) collects information on drilling activity including operator and well statistics. The well information database includes name, location, class, status and depth. The main Nickle's database is updated on a daily basis, however, this database is updated on a monthly basis. More information is available at www.nickles.com.

Government Publication Date: 1988-Feb 29, 2020

Ontario Oil and Gas Wells:

Provincial

[OOGW](#)

In 1998, the MNR handed over to the Ontario Oil, Gas and Salt Resources Corporation, the responsibility of maintaining a database of oil and gas wells drilled in Ontario. The OGSR Library has over 20,000+ wells in their database. Information available for all wells in the ERIS database include well owner/operator, location, permit issue date, and well cap date, license No., status, depth and the primary target (rock unit) of the well being drilled. All geology/stratigraphy table information, plus all water table information is also provide for each well record.

Government Publication Date: 1800-Jun 2019

Inventory of PCB Storage Sites:

Provincial

[OPCB](#)

The Ontario Ministry of Environment, Waste Management Branch, maintains an inventory of PCB storage sites within the province. Ontario Regulation 11/82 (Waste Management - PCB) and Regulation 347 (Generator Waste Management) under the Ontario EPA requires the registration of inactive PCB storage equipment and/or disposal sites of PCB waste with the Ontario Ministry of Environment. This database contains information on: 1) waste quantities; 2) major and minor sites storing liquid or solid waste; and 3) a waste storage inventory.

Government Publication Date: 1987-Oct 2004; 2012-Dec 2013

Orders:

Provincial

[ORD](#)

This is a subset taken from Ontario's Environmental Registry (EBR) database. It will include all Orders on the registry such as (EPA s. 17) - Order for remedial work, (EPA s. 18) - Order for preventative measures, (EPA s. 43) - Order for removal of waste and restoration of site, (EPA s. 44) - Order for conformity with Act for waste disposal sites, (EPA s. 136) - Order for performance of environmental measures.

Government Publication Date: 1994-Apr 30, 2020

Canadian Pulp and Paper:

Private

[PAP](#)

This information is part of the Pulp and Paper Canada Directory. The Directory provides a comprehensive listing of the locations of pulp and paper mills and the products that they produce.

Government Publication Date: 1999, 2002, 2004, 2005, 2009-2014

Parks Canada Fuel Storage Tanks:

Federal

[PCFT](#)

Canadian Heritage maintains an inventory of known fuel storage tanks operated by Parks Canada, in both National Parks and at National Historic Sites. The database details information on site name, location, tank install/removal date, capacity, fuel type, facility type, tank design and owner/operator.

Government Publication Date: 1920-Jan 2005*

Pesticide Register:

Provincial

[PES](#)

The Ontario Ministry of the Environment and Climate Change maintains a database of licensed operators and vendors of registered pesticides.

Government Publication Date: 1988 - Apr 2020

Pipeline Incidents:

Provincial

[PINC](#)

List of pipeline incidents (strikes, leaks, spills). This is not a comprehensive or complete inventory of pipeline incidents in the province; this listing in an historical copy of records previously obtained under Access to Public Information. Records are not verified for accuracy or completeness.

Government Publication Date: Feb 28, 2017

Private and Retail Fuel Storage Tanks:

Provincial

[PRT](#)

The Fuels Safety Branch of the Ontario Ministry of Consumer and Commercial Relations maintained a database of all registered private fuel storage tanks and licensed retail fuel outlets. This database includes an inventory of locations that have gasoline, oil, waste oil, natural gas and/or propane storage tanks on their property. The MCCR no longer collects this information. This information is now collected by the Technical Standards and Safety Authority (TSSA).

Government Publication Date: 1989-1996*

Permit to Take Water:

Provincial

[PTTW](#)

This is a subset taken from Ontario's Environmental Registry (EBR) database. It will include all PTTW's on the registry such as OWRA s. 34 - Permit to take water.

Government Publication Date: 1994-Apr 30, 2020

Ontario Regulation 347 Waste Receivers Summary:

Provincial REC

Part V of the Ontario Environmental Protection Act ("EPA") regulates the disposal of regulated waste through an operating waste management system or a waste disposal site operated or used pursuant to the terms and conditions of a Certificate of Approval or a Provisional Certificate of Approval. Regulation 347 of the Ontario EPA defines a waste receiving site as any site or facility to which waste is transferred by a waste carrier. A receiver of regulated waste is required to register the waste receiving facility. This database represents registered receivers of regulated wastes, identified by registration number, company name and address, and includes receivers of waste such as: landfills, incinerators, transfer stations, PCB storage sites, sludge farms and water pollution control plants. This information is a summary of all years from 1986 including the most currently available data.

Government Publication Date: 1986-2016

Record of Site Condition:

Provincial RSC

The Record of Site Condition (RSC) is part of the Ministry of the Environment's Brownfields Environmental Site Registry. Protection from environmental clean-up orders for property owners is contingent upon documentation known as a record of site condition (RSC) being filed in the Environmental Site Registry. In order to file an RSC, the property must have been properly assessed and shown to meet the soil, sediment and groundwater standards appropriate for the use (such as residential) proposed to take place on the property. The Record of Site Condition Regulation (O. Reg. 153/04) details requirements related to site assessment and clean up.

RSCs filed after July 1, 2011 will also be included as part of the new (O.Reg. 511/09).

Government Publication Date: 1997-Sept 2001, Oct 2004-Mar 2020

Retail Fuel Storage Tanks:

Private RST

This database includes an inventory of retail fuel outlet locations (including marinas) that have on their property gasoline, oil, waste oil, natural gas and / or propane storage tanks.

Government Publication Date: 1999-Jan 31, 2020

Scott's Manufacturing Directory:

Private SCT

Scott's Directories is a data bank containing information on over 200,000 manufacturers across Canada. Even though Scott's listings are voluntary, it is the most comprehensive database of Canadian manufacturers available. Information concerning a company's address, plant size, and main products are included in this database.

Government Publication Date: 1992-Mar 2011*

Ontario Spills:

Provincial SPL

This database identifies information such as location (approximate), type and quantity of contaminant, date of spill, environmental impact, cause, nature of impact, etc. Information from 1988-2002 was part of the ORIS (Occurrence Reporting Information System). The SAC (Spills Action Centre) handles all spills reported in Ontario. Regulations for spills in Ontario are part of the MOE's Environmental Protection Act, Part X.

Government Publication Date: 1988-Nov 2019

Wastewater Discharger Registration Database:

Provincial SRDS

Information under this heading is combination of the following 2 programs. The Municipal/Industrial Strategy for Abatement (MISA) division of the Ontario Ministry of Environment maintained a database of all direct dischargers of toxic pollutants within nine sectors including: Electric Power Generation; Mining; Petroleum Refining; Organic Chemicals; Inorganic Chemicals; Pulp & Paper; Metal Casting; Iron & Steel; and Quarries. All sampling information is now collected and stored within the Sample Result Data Store (SRDS).

Government Publication Date: 1990-Dec 31, 2017

Anderson's Storage Tanks:

Private TANK

The information provided in this database was collected by examining various historical documents, which identified the location of former storage tanks, containing substances such as fuel, water, gas, oil, and other various types of miscellaneous products. Information is available in regard to business operating at tank site, tank location, permit year, permit & installation type, no. of tanks installed & configuration and tank capacity. Data contained within this database pertains only to the city of Toronto and is not warranted to be complete, exhaustive or authoritative. The information was collected for research purposes only.

Government Publication Date: 1915-1953*

Transport Canada Fuel Storage Tanks:

Federal TCFT

List of fuel storage tanks currently or previously owned or operated by Transport Canada. This inventory also includes tanks on The Pickering Lands, which refers to 7,530 hectares (18,600 acres) of land in Pickering, Markham, and Uxbridge owned by the Government of Canada since 1972; properties on this land has been leased by the government since 1975, and falls under the Site Management Policy of Transport Canada, but is administered by Public Works and Government Services Canada. This inventory provides information on the site name, location, tank age, capacity and fuel type.

Government Publication Date: 1970-Aug 2018

Variances for Abandonment of Underground Storage Tanks:

Provincial [VAR](#)

Listing of variances granted for storage tank abandonment. This is not a comprehensive or complete inventory of tank abandonment variances in the province; this listing is a copy of tank abandonment variance records previously obtained under Access to Public Information. In Ontario, registered underground storage tanks must be removed within two years of disuse; if removal of a tank is not feasible, an application may be sought for a variance from this code requirement.

Records are not verified for accuracy or completeness.

Government Publication Date: Feb 28, 2017

Waste Disposal Sites - MOE CA Inventory:

Provincial [WDS](#)

The Ontario Ministry of Environment, Waste Management Branch, maintains an inventory of known open (active or inactive) and closed disposal sites in the Province of Ontario. Active sites maintain a Certificate of Approval, are approved to receive and are receiving waste. Inactive sites maintain Certificate(s) of Approval but are not receiving waste. Closed sites are not receiving waste. The data contained within this database was compiled from the MOE's Certificate of Approval database. Locations of these sites may be cross-referenced to the Anderson database described under ERIS's Private Source Database section, by the CA number. All new Environmental Compliance Approvals handed out after Oct 31, 2011 for Waste Disposal Sites will still be found in this database.

Government Publication Date: Oct 2011-Apr 30, 2020

Waste Disposal Sites - MOE 1991 Historical Approval Inventory:

Provincial [WDSH](#)

In June 1991, the Ontario Ministry of Environment, Waste Management Branch, published the "June 1991 Waste Disposal Site Inventory", of all known active and closed waste disposal sites as of October 30st, 1990. For each "active" site as of October 31st 1990, information is provided on site location, site/CA number, waste type, site status and site classification. For each "closed" site as of October 31st 1990, information is provided on site location, site/CA number, closure date and site classification. Locations of these sites may be cross-referenced to the Anderson database described under ERIS's Private Source Database section, by the CA number.

Government Publication Date: Up to Oct 1990*

Water Well Information System:

Provincial [WWIS](#)

This database describes locations and characteristics of water wells found within Ontario in accordance with Regulation 903. It includes such information as coordinates, construction date, well depth, primary and secondary use, pump rate, static water level, well status, etc. Also included are detailed stratigraphy information, approximate depth to bedrock and the approximate depth to the water table.

Government Publication Date: Feb 28, 2019

Definitions

Database Descriptions: This section provides a detailed explanation for each database including: source, information available, time coverage, and acronyms used. They are listed in alphabetic order.

Detail Report: This is the section of the report which provides the most detail for each individual record. Records are summarized by location, starting with the project property followed by records in closest proximity.

Distance: The distance value is the distance between plotted points, not necessarily the distance between the sites' boundaries. All values are an approximation.

Direction: The direction value is the compass direction of the site in respect to the project property and/or center point of the report.

Elevation: The elevation value is taken from the location at which the records for the site address have been plotted. All values are an approximation. Source: Google Elevation API.

Executive Summary: This portion of the report is divided into 3 sections:

'Report Summary'- Displays a chart indicating how many records fall on the project property and, within the report search radii.

'Site Report Summary'-Project Property'- This section lists all the records which fall on the project property. For more details, see the 'Detail Report' section.

'Site Report Summary-Surrounding Properties'- This section summarizes all records on adjacent properties, listing them in order of proximity from the project property. For more details, see the 'Detail Report' section.

Map Key: The map key number is assigned according to closest proximity from the project property. Map Key numbers always start at #1. The project property will always have a map key of '1' if records are available. If there is a number in brackets beside the main number, this will indicate the number of records on that specific property. If there is no number in brackets, there is only one record for that property.

The symbol and colour used indicates 'elevation': the red inverted triangle will dictate 'ERIS Sites with Lower Elevation', the yellow triangle will dictate 'ERIS Sites with Higher Elevation' and the orange square will dictate 'ERIS Sites with Same Elevation.'

Unplottables: These are records that could not be mapped due to various reasons, including limited geographic information. These records may or may not be in your study area, and are included as reference.

Appendix E

Ministry of Environment, Conservation and Parks – Freedom of Information (FOI) Request

Freedom of Information and
Protection of Privacy Office
40 St. Clair Avenue West, 12th Floor
Toronto ON M4V 1M2
Telephone 416 314-4075

Instructions

Use this form to request records that are in the Ministry's files on environmental concerns related to properties. Our fax number is 416 314-4285.

For Ministry Use Only

FOI Request Number	Date Request Received (yyyy/mm/dd)
Fee Paid	<input type="checkbox"/> Cheque <input type="checkbox"/> VISA/MC <input type="checkbox"/> Cash/Money Order
<input type="checkbox"/> CNR <input type="checkbox"/> ER <input type="checkbox"/> NOR <input type="checkbox"/> SWR <input type="checkbox"/> WCR <input type="checkbox"/> IEB <input type="checkbox"/> EAA <input type="checkbox"/> EMR <input type="checkbox"/> SCB <input type="checkbox"/> SDW	

1. Requester Data

Last Name Lopers	First Name Luke	Middle Initial A
Title Principal	Company Name Lopers & Associates	

Mailing Address

Unit Number	Street Number 30	Street Name Lansfield Way	PO Box
City/Town Ottawa		Province Ontario	Postal Code K2G 3V8
Email Address Luke@Lopers.ca		Telephone Number 613 327-9073 ext.	Fax Number

Project/Reference Number LOP20-002	Signature of Requester 
--	--

2. Request Parameters

Municipal Address (Municipal address mandatory for cities, towns or regions)

Unit Number	Street Number 729	Street Name Ridgewood Avenue	PO Box
Lot Number	Concession	Geographic Township	
City/Town/Village Ottawa		Province Ontario	Postal Code K1V 6M8

Present Property

1. Owner 11684663 Canada Inc.	Date of Ownership (yyyy/mm/dd) 2019/11/06
Tenant (if applicable)	

Previous Property

1. Owner 561266 Ontario Inc.	Date of Ownership (yyyy/mm/dd) 1983/12/16
Tenant (if applicable)	

3. Search Parameters

Search Parameters	Specify Year(s) Requested
Environmental concerns (General correspondence, occurrence reports, abatement)	All
Orders	All
Spills	All
Investigations/prosecutions ► Owner and tenant information must be provided	All
Waste Generator number/classes	All

Files older than 2 years may require \$60.00 retrieval cost. There is no guarantee that records responsive to your request will be located.

4. Environmental Compliance Approvals/Certificates of Approval

Environmental Compliance Approvals/Certificates of Approval	SD	Specify Year(s) Requested
air - emissions	<input checked="" type="checkbox"/>	
renewable energy	<input checked="" type="checkbox"/>	
water - mains, treatment, ground level, standpipes & elevated storage, pumping stations (local & booster)	<input checked="" type="checkbox"/>	
sewage - sanitary, storm, treatment, stormwater, leachate & leachate treatment & sewage pump stations	<input checked="" type="checkbox"/>	
waste water - industrial discharge	<input checked="" type="checkbox"/>	
waste sites - disposal, landfill sites, transfer stations, processing sites, incinerator sites	<input checked="" type="checkbox"/>	
waste systems - haulers: sewage, non-hazardous & hazardous waste, mobile waste processing units, PCB destruction	<input checked="" type="checkbox"/>	

Proponent information must be provided and Environmental Compliance Approval/Certificate of Approval number(s) (if known). 1985 and prior records are searched manually. Search fees in excess of \$300.00 may be incurred, depending on the types and years to be searched. Specify Approval number(s) (if known). If supporting documents are also required, mark SD box and specify type e.g. maps, plans, reports, etc.

Appendix F

Technical Standards and Safety Authority Correspondence

From: [Public Information Services](#)
To: [Luke Lopers](#)
Subject: RE: TSSA Records Search Request - Environmental Research
Date: June 12, 2020 11:29:30 AM

Records Found

Hello,
Thank you for your request for confirmation of public information.

- We confirm the following **fuel storage tanks records** in our database at the subject address(es).

Inst Number	Context	Address	City	Province	Postal Code	Status
9673997	FS GASOLINE STATION - FULL SERVE	753 RIDGEWOOD AV	OTTAWA	ON	K1V 6M8	EXPIRED
10155239	FS PROPANE CYLR HANDLING FACILITY	753 RIDGEWOOD AV	OTTAWA	ON	K1V 6M8	EXPIRED
10906415	FS Liquid Fuel Tank	753 RIDGEWOOD AV	OTTAWA	ON	K1V 6M8	EXPIRED
10906439	FS Liquid Fuel Tank	753 RIDGEWOOD AV	OTTAWA	ON	K1V 6M8	EXPIRED
10906455	FS Liquid Fuel Tank	753 RIDGEWOOD AV	OTTAWA	ON	K1V 6M8	EXPIRED

For a further search in our archives please complete our release of public information form found at https://www.tssa.org/en/about-tssa/release-of-public-information.aspx?_mid_=392 and email the completed form to publicinformation@tssa.org or through mail along with a fee of \$56.50 (including HST) per location. The fee is payable with credit card (Visa or MasterCard) or with a Cheque made payable to TSSA.

Although TSSA believes the information provided pursuant to your request is accurate, please note that TSSA does not warrant this information in any way whatsoever.

Kind regards,
Gaya

From: Luke Lopers <Luke@lopers.ca>
Sent: June 12, 2020 11:02 AM
To: Public Information Services <publicinformation@tssa.org>
Subject: TSSA Records Search Request - Environmental Research

[CAUTION]: This email originated outside the organisation.
Please do not click links or open attachments unless you recognise the source of this email and know the content is safe.

Good morning,

Could you please search the TSSA database for records of fuel storage tanks, spills, incidents or infractions for the following addresses located in the City of Ottawa, ON:

- 729, 753, 757, 758, 770 Ridgewood Avenue
- 2865, 2909, 2951, 2975 Riverside Drive

Thank you for your time,

Luke Lopers, P.Eng.

Principal

LOPERS & ASSOCIATES

Cell: 613-327-9073 Email: Luke@Lopers.ca

30 Lansfield Way, Ottawa, Ontario K2G 3V8

This electronic message and any attached documents are intended only for the named recipients. This communication from the Technical Standards and Safety Authority may contain information that is privileged, confidential or otherwise protected from disclosure and it must not be disclosed, copied, forwarded or distributed without authorization. If you have received this message in error, please notify the sender immediately and delete the original message.

Appendix G

City of Ottawa Historic Land Use Inventory (HLUI)

July 28, 2020

Luke Lopers
Lopers & Associates
30 Lansfield Way, Ottawa

Sent via email [Luke@lopers.ca]

Dear Mr. Lopers,

Re: Information Request
729 Ridgewood Drive, **Ottawa, Ontario** (“Subject Property”)

Internal Department Circulation

The Planning, Infrastructure and Economic Development Department has the following information in response to your request for information regarding the Subject Property:

- No information was returned on the Subject Property from Departmental circulation.

Search of Historical Land Use Inventory

This acknowledges receipt of the signed Disclaimer regarding your request for information from the City’s Historical Land Use Inventory (HLUI 2005) database for the Subject Property.

A search of the HLUI database revealed the following information:

- There are five activities associated with the Subject Property; Activity Numbers 5134, 5948, 8806, 9038, and 12114.

The HLUI database was also searched for activity associated with properties located within 250m of the Subject Property. The search revealed the following:

- There are six activities associated with four properties located within 250m of the Subject Property; Activity Numbers 836, 6842, 10221, 12114, 13732, and 14215.

Please note that certain activities have been identified to have a PIN Certainty of “2”. This identifier acknowledges that there is some uncertainty about the exact location of the land use activity and that the activity may or may not have been located on the property. All database entries with a PIN Certainty of “2” require independent verification as to their precise location.

A **site map** and **table** have been included to show the location of the Subject Property as well as the location of all the activities noted above, including the HLUI database’s location of the Activity Numbers with a PIN Certainty of “2”.

Additional information may be obtained by contacting:

Ontario’s Environmental Registry

The Environmental Registry found at <http://www.ebr.gov.on.ca/ERS-WEB-External/> contains "public notices" about environmental matters being proposed by all government ministries covered by the Environmental Bill of Rights. The public notices may contain information about proposed new laws, regulations, policies and programs or about proposals to change or eliminate existing ones. By using keys words i.e. name of proponent/owner and the address one can ascertain if there is any information on the proponent and address under the following categories: Ministry, keywords, notice types, Notice Status, Acts, Instruments and published date (all years).

The Ontario Land Registry Office

Registration of real property is recorded in the Ontario Land Registry Office through the Land Titles Act or the Registry Act. Documents relating to title and other agreements that may affect your property are available to the public for a fee. It is recommended that a property search at the Land Registry Office be included in any investigation as to the historic use of your property. The City of Ottawa cannot comment on any documents to which it is not a party.

Court House
161 Elgin Street 4th Floor
Ottawa ON K2P 2K1
Tel: (613) 239-1230
Fax: (613) 239-1422

Please note, as per the HLUI Disclaimer, that the information contained in the HLUI database has been compiled from publicly available records and other sources of information. The HLUI may contain erroneous information given that the records used as sources of information may be flawed. For instance, changes in municipal addresses over time may introduce error. Accordingly, all information from the HLUI database is provided on an “as is” basis with no representation or warranty by the City with respect to the information’s accuracy or exhaustiveness in responding to the request.

Furthermore, the HLUI database and the results of this search in no way confirm the presence or absence of contamination or pollution of any kind. This information is provided on the assumption that it will not be relied upon by any person for any purpose whatsoever. The City of Ottawa denies all liability to any persons attempting to rely on any information provided from the HLUI database.

Please note that in responding to your request, the City of Ottawa does not guarantee or comment on the environmental condition of the Subject Property. You may wish to contact the Ontario Ministry of Environment and Climate Change for additional information.

If you have any further questions or comments, please contact Insert Your Name at 613-580-2424 ext. Insert Your Extension or HLUI@ottawa.ca

Sincerely,

A handwritten signature in black ink, appearing to read "Sarah Ezzio".

Sarah Ezzio

Per:

Michael Boughton, MCIP, RPP
Senior Planner
Development Review East
Planning Services
Planning, Infrastructure and Economic Development Department

cc: File no. D06-03-20-0086

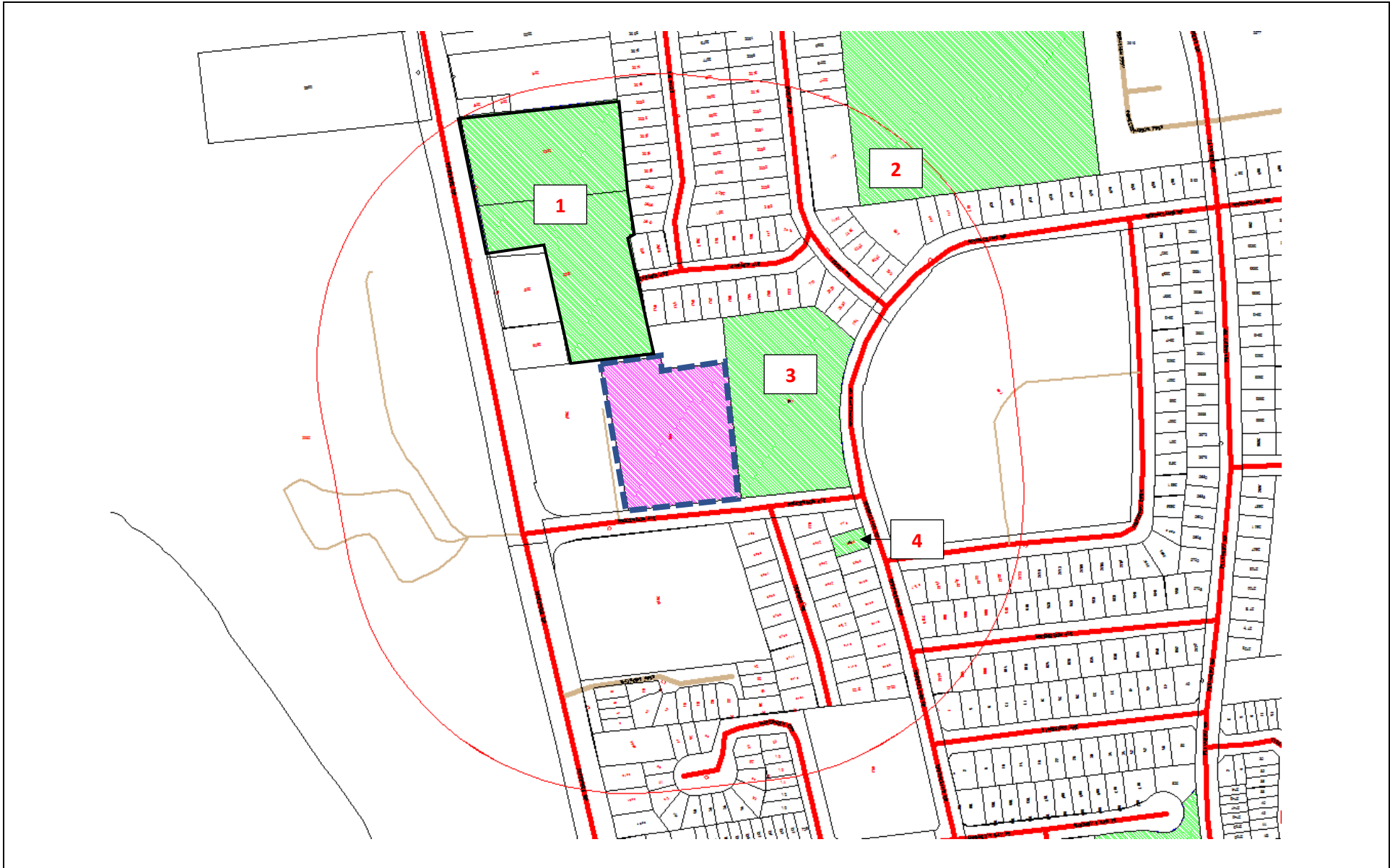

Address: 729 Ridgewood Ave
Ottawa, ON

File No.: D06-03-20-0086

Prepared By: Sarah Ezzio

Legend:

00	Area Number
 	Subject Site
 	250 m Buffer

Scale: 1 : 2176



Area	Associated HLUI Activities	Associated HLUI Activities with a PIN Certainty of "2" *
Subject Property	5134, 5948, 8806, 9038	12114
1	6842	14215
2	10221	
3		12114, 13732
4	836	

*This identifier acknowledges that there is some uncertainty about the exact location of the land use activity and that the activity may or may not have been located on the property. All database entries with a PIN Certainty of "2" require independent verification as to their precise location.



Historical Land Use Inventory

Subject Property

Activity Numbers



CITY OF OTTAWA
HLUI ID: __679G6H
AREA (Square Metres): 13220.778

Report: RPTC_OT_DEV0122
 Run On: 28 Jul 2020 at: 10:19:25

Study Year
1998

PIN
040710125

Multi-NAIC
Y

Multiple Activities
Y

Activity ID: 12114 **Multiple PINS:** Y
PIN Certainty: 2 **Previous Activity ID(s) :** 5563

Related PINS: 150960000

Name: RIVERSIDE SUPERTEST GAS STATION
Address: 753 RIDGEWOOD AVENUE, OTTAWA
Facility Type: Gasoline Service Stations
Comments 1:
Comments 2:

Generator Number:

Storage Tanks:

HL References 1: M.1960, M.1970, M.1980; SC98

HL References 2:

HL References 3:

NAICS	SIC
447190	633
811199	633
447110	633

Company Name	Year of Operation
McCloskey Supertest Gas Station	c. 1980-1998
Riverside Supertest Gas Station	c. 1970



CITY OF OTTAWA
HLUI ID: __679G6H
AREA (Square Metres): 13220.778

Report: RPTC_OT_DEV0122

Run On: 28 Jul 2020 at: 10:19:25

Study Year
1998

PIN
040710125

Multi-NAIC
Y

Multiple Activities
Y

Activity ID: 5134 **Multiple PINS:** N

PIN Certainty: 1 **Previous Activity ID(s) :**

Related PINS: 040710125

Name: EDWARDS UPHOLSTERY

Address: 747 RIDGEWOOD AVENUE, OTTAWA

Facility Type: Other Machinery, Equipment and Supplies, Wholesale

Comments 1:

Comments 2:

Generator Number:

Storage Tanks:

HL References 1:

HL References 2:

HL References 3: 2001 Employment Survey

NAICS	SIC
811420	0

Company Name

EDWARDS UPHOLSTERY

Year of Operation

c. 2001



CITY OF OTTAWA

HLUI ID: __679G6H

AREA (Square Metres): 13220.778

Report: RPTC_OT_DEV0122

Run On: 28 Jul 2020 at: 10:19:25

Study Year
1998

PIN
040710125

Multi-NAIC
Y

Multiple Activities
Y

Activity ID: 5948 Multiple PINS: N

PIN Certainty: 1 Previous Activity ID(s) : 5657

Related PINS: 040710125

Name: FOTOMAT

Address: 752 RIDGEWOOD AVENUE, OTTAWA

Facility Type: Platemaking, Typesetting and Bindery Industry

Comments 1:

Comments 2:

Generator Number:

Storage Tanks:

HL References 1: M.1960, M.1970, M.1980

HL References 2:

HL References 3:

NAICS	SIC
323120	282
812921	282

Company Name

Fotomat

Year of Operation

c. 1980



CITY OF OTTAWA

HLUI ID: __679G6H

AREA (Square Metres): 13220.778

Report: RPTC_OT_DEV0122

Run On: 28 Jul 2020 at: 10:19:25

Study Year
1998

PIN
040710125

Multi-NAIC
Y

Multiple Activities
Y

Activity ID: 8806 Multiple PINS: N

PIN Certainty: 1 Previous Activity ID(s) :

Related PINS: 040710125

Name: MOONEY'S BAY ELECTRONICS INC.

Address: 733 RIDGEWOOD AVENUE, OTTAWA

Facility Type: Electrical and Electronic Machinery, Equipment and Supplies, Wholesale

Comments 1:

Comments 2:

Generator Number:

Storage Tanks:

HL References 1:

HL References 2:

HL References 3: 2001 Employment Survey

NAICS	SIC
443120	0

Company Name

MOONEY'S BAY ELECTRONICS INC.

Year of Operation

c. 2001



CITY OF OTTAWA
HLUI ID: __679G6H
AREA (Square Metres): 13220.778

Report: RPTC_OT_DEV0122

Run On: 28 Jul 2020 at: 10:19:25

Study Year
1998

PIN
040710125

Multi-NAIC
Y

Multiple Activities
Y

Activity ID: 9038 **Multiple PINS:** N

PIN Certainty: 1 **Previous Activity ID(s) :**

Related PINS: 040710125

Name: MCCLOSKEY'S RICK SERVICE LIMITED

Address: 753 RIDGEWOOD AVENUE,

Facility Type: Motor Vehicles, Wholesale

Comments 1:

Comments 2:

Generator Number:

Storage Tanks:

HL References 1:

HL References 2:

HL References 3: 2005 Select Phone

NAICS	SIC
811111	0

Company Name	Year of Operation
MCCLOSKEY'S RICK SERVICE LIMITED	c. 2001
MCCLOSKEY'S RICK SERVICE LIMITED	c. 2005



Historical Land Use Inventory ***Adjacent Properties within 250m*** **Area & Activity Numbers**



Historical Land Use Inventory

Area 1 Activity Numbers



CITY OF OTTAWA

HLUI ID: __679GCT

AREA (Square Metres): 24278.332

Report: RPTC_OT_DEV0122

Run On: 28 Jul 2020 at: 10:20:56

Study Year
1998

PIN
040710122

Multi-NAIC
Y

Multiple Activities
Y

Activity ID: 14215 Multiple PINS: N

PIN Certainty: 2 Previous Activity ID(s) : 5044

Related PINS: 040710122

Name: TRANS TECH AUTO SERVICE
Address: 2805 RIVERSIDE DRIVE, OTTAWA
Facility Type: Gasoline Service Stations

Comments 1:
Comments 2:

Generator Number:

Storage Tanks:

HL References 1: M.1960, M.1970, M.1980; SC98

HL References 2:

HL References 3:

NAICS	SIC
811119	635
811112	635
447190	633
811199	633
447110	633
811121	635

Company Name	Year of Operation
Bob Tait's Service Station	c. 1960
Trans Tech Auto Service	c. 1998
Gerald McConnell Service Station	c. 1970
Beaver Service Centre	c. 1980



CITY OF OTTAWA
HLUI ID: __679GCT
AREA (Square Metres): 24278.332

Report: RPTC_OT_DEV0122

Run On: 28 Jul 2020 at: 10:20:56

Study Year
1998

PIN
040710122

Multi-NAIC
Y

Multiple Activities
Y

Activity ID: 6842 Multiple PINS: N
PIN Certainty: 1 Previous Activity ID(s) : 5043
Related PINS: 040710106
Name: PETRO-CANADA
Address: 2801 RIVERSIDE DRIVE, OTTAWA
Facility Type: Gasoline Service Stations
Comments 1:
Comments 2:
Generator Number:
Storage Tanks:
HL References 1: M.1960, M.1970, M.1980; SC98
HL References 2:
HL References 3: 2005 Property Assessment

NAICS	SIC
811112	635
447110	0
811121	635
447110	633
447190	633
811119	635
811199	633
447190	0
811111	0

Company Name	Year of Operation
PETRO-CANADA	c. 2005
Bud Tierney Service Station	c. 1970
HOGGS BACK SERVICE CENTRE	c. 2005
Bud Stephen's Garage	c. 1960
HOGGS BACK SERVICE CENTRE	c. 2001
Hog's Back Service Centre	c. 1998
H & D Lytle Gulf Station	c. 1980



Historical Land Use Inventory

Area 2 Activity Numbers



CITY OF OTTAWA

HLUI ID: __679087

AREA (Square Metres): 74354.836

Report: RPTC_OT_DEV0122

Run On: 28 Jul 2020 at: 10:23:14

Study Year
2005

PIN
040710124

Multi-NAIC
N

Multiple Activities
N

Activity ID: 10221 Multiple PINS: N

PIN Certainty: 1 Previous Activity ID(s) :

Related PINS: 040710124

Name: OTTAWA-CARLETON DISTRICT SCHOOL BOARD - BROOKFIELD HIGH SCHOOL

Address: 824 BROOKFIELD ROAD, OTTAWA

Facility Type: Elementary and Secondary Education

Comments 1: BROOKFIELD HIGH SCHOOL

Comments 2:

Generator Number: ON0375207

Storage Tanks:

HL References 1:

HL References 2:

HL References 3: 2000 PID

NAICS	SIC
611110	0

Company Name	Year of Operation
OTTAWA-CARLETON DISTRICT SCHOOL BOARD - BROOKFIELD HIGH SCHOOL	c. 2003
OTTAWA-CARLETON DISTRICT SCHOOL BOARD - BROOKFIELD HIGH SCHOOL	c. 2000
OTTAWA-CARLETON DISTRICT SCHOOL BOARD - BROOKFIELD HIGH SCHOOL	c. 2005



Historical Land Use Inventory

Area 3 Activity Numbers



CITY OF OTTAWA

HLUI ID: __679G8H

AREA (Square Metres): 15856.568

Report: RPTC_OT_DEV0122

Run On: 28 Jul 2020 at: 10:24:44

Study Year
1998

PIN
150960000

Multi-NAIC
Y

Multiple Activities
Y

Activity ID: 12114 Multiple PINS: Y

PIN Certainty: 2 Previous Activity ID(s) : 5563

Related PINS: 150960000

Name: RIVERSIDE SUPERTEST GAS STATION

Address: 753 RIDGEWOOD AVENUE, OTTAWA

Facility Type: Gasoline Service Stations

Comments 1:

Comments 2:

Generator Number:

Storage Tanks:

HL References 1: M.1960, M.1970, M.1980; SC98

HL References 2:

HL References 3:

NAICS	SIC
447190	633
811199	633
447110	633

Company Name

Year of Operation

McCloskey Supertest Gas Station

c. 1980-1998

Riverside Supertest Gas Station

c. 1970



CITY OF OTTAWA

HLUI ID: __679G8H

AREA (Square Metres): 15856.568

Report: RPTC_OT_DEV0122

Run On: 28 Jul 2020 at: 10:24:44

Study Year
1998

PIN
150960000

Multi-NAIC
Y

Multiple Activities
Y

Activity ID: 13732 Multiple PINS: N

PIN Certainty: 2 Previous Activity ID(s) : 5562

Related PINS: 150960000

Name: VAILS FABRIC CARE LIMITED
Address: 749 RIDGEWOOD AVENUE, OTTAWA
Facility Type: Laundries and Cleaners

Comments 1:

Comments 2:

Generator Number:

Storage Tanks:

HL References 1: M.1960, M.1970, M.1980

HL References 2:

HL References 3:

NAICS	SIC
812320	972
561740	972
812310	972
812330	972

Company Name	Year of Operation
Parker Clean	c. 1980
Vails Fabric Care Ltd.	c. 1970



Historical Land Use Inventory

Area 4 Activity Numbers



CITY OF OTTAWA

HLUI ID: __679AKD

AREA (Square Metres): 557.374

Report: RPTC_OT_DEV0122

Run On: 28 Jul 2020 at: 10:25:34

Study Year
2005

PIN
040730008

Multi-NAIC
N

Multiple Activities
N

Activity ID: 836 **Multiple PINS:** N

PIN Certainty: 1 **Previous Activity ID(s) :**

Related PINS: 040730008

Name: A-1 CARPET REPAIRS & INSTALL

Address: 2692 SPRINGLAND DRIVE,

Facility Type: Laundries and Cleaners

Comments 1:

Comments 2:

Generator Number:

Storage Tanks:

HL References 1:

HL References 2:

HL References 3: 2005 Select Phone

NAICS	SIC
561740	0

Company Name

A-1 CARPET REPAIRS & INSTALL

Year of Operation

c. 2005

Appendix H

Aerial Photographs



1933 Aerial Photograph



1956 Aerial Photograph



1965 Aerial Photograph

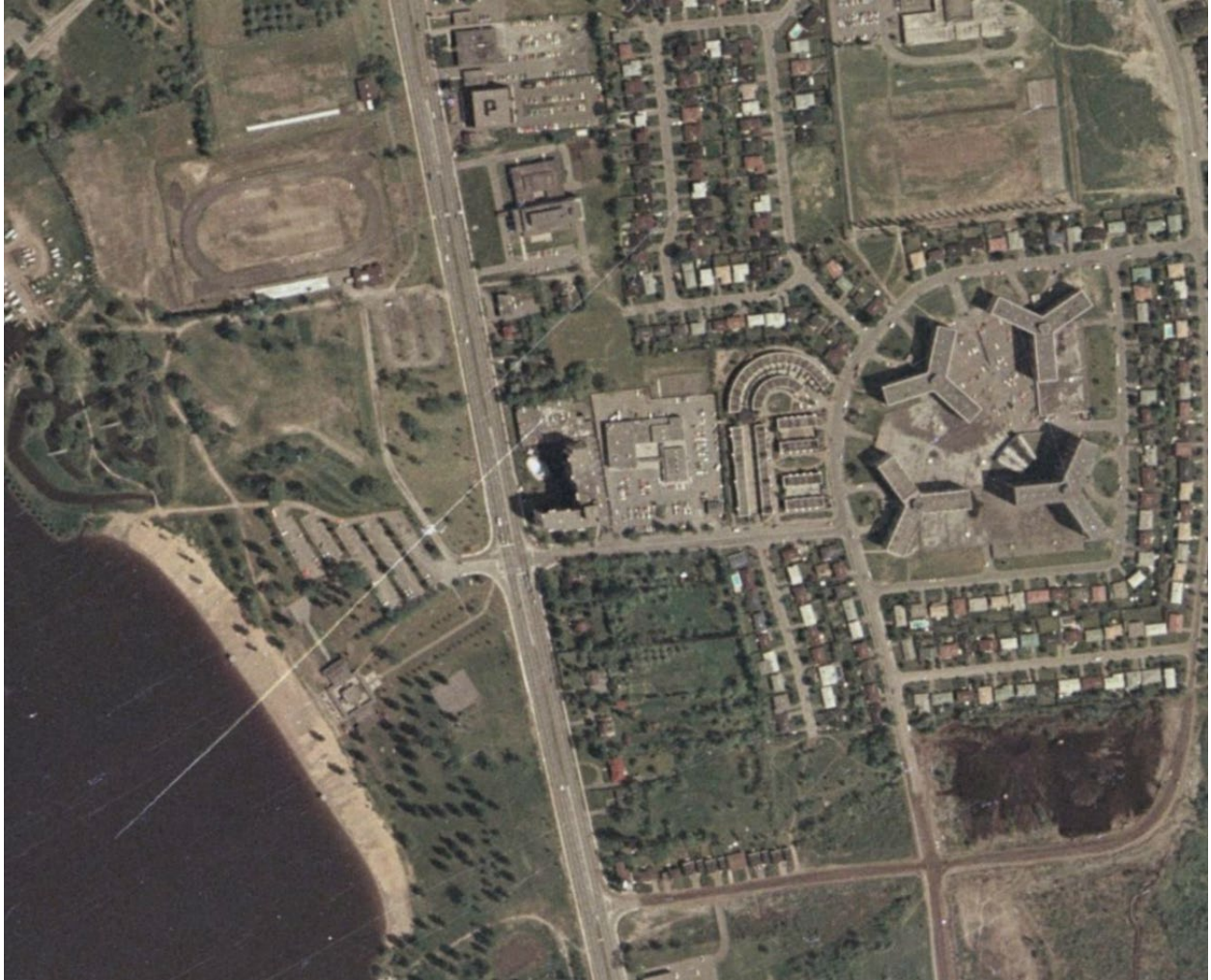

1976 Aerial Photograph



1991 Aerial Photograph



1999 Aerial Photograph



2008 Aerial Photograph



2017 Aerial Photograph

Appendix I

Topographic Map

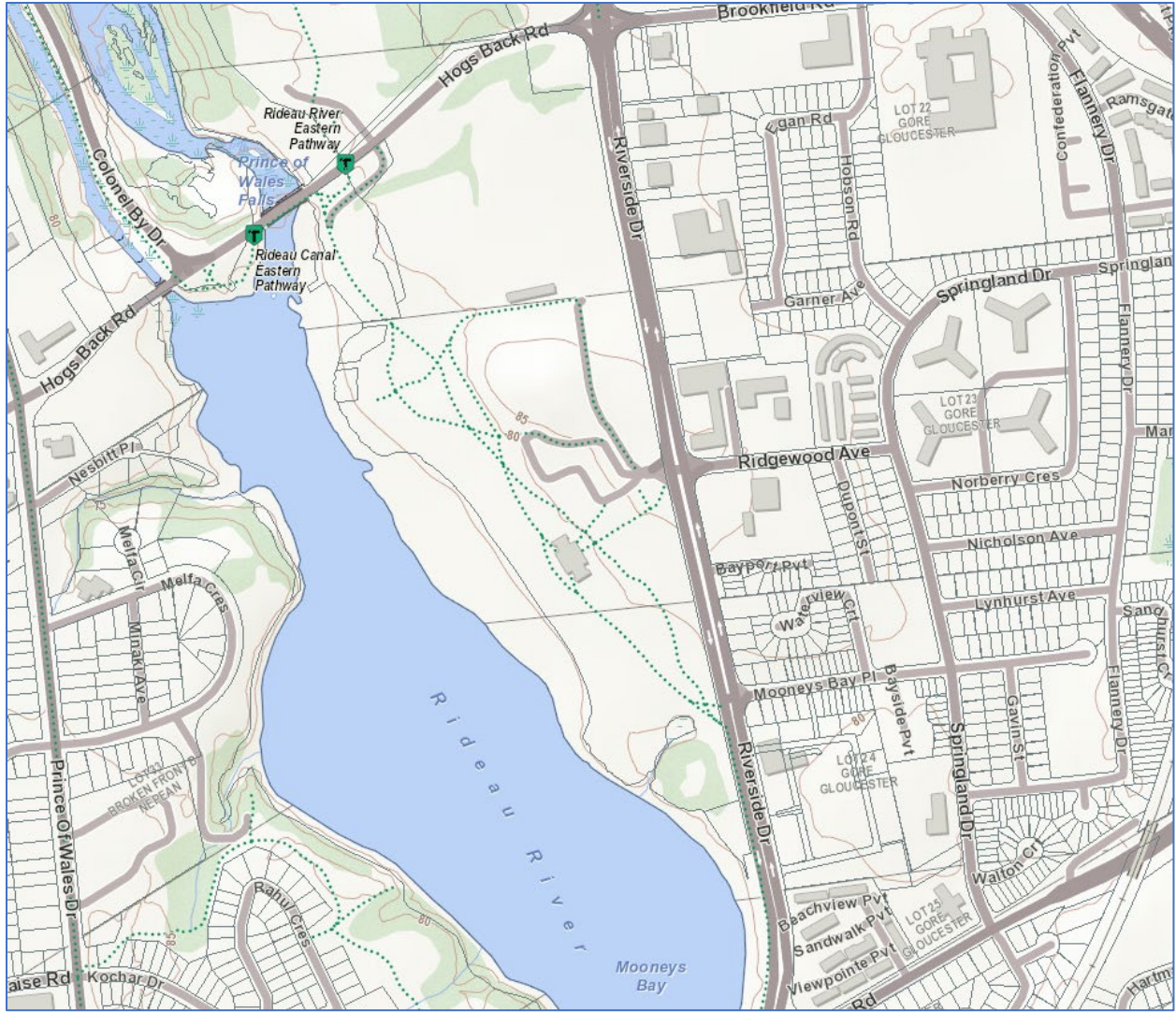

Topographic Map

Appendix J

Photographic Log



Photograph 1: View of Phase One Property looking north from Ridgewood Drive. View shows the north (right side) and south (left side) commercial buildings at the Property. The automotive service garage is visible in this view.



Photograph 2: View of Phase One Property looking northwest southeast corner of the Property. View shows former retail fuel outlet and automotive garage area in the southeast portion of the Site which has been backfilled with granular fill. The commercial buildings are also visible in this view.



Photograph 3: View of the north side of the Phase One Property looking southeast. View shows the north side of the north commercial building, including the loading dock for the former grocery store and the natural gas meters for the commercial units.



Photograph 4: View of the west side of the Phase One Property looking south. View shows the west side of the north commercial building.



Photograph 5: View of the east side of the Phase One Property looking south. View shows the east sides of the north and south commercial buildings.



Photograph 6: View of the interior of the automotive service garage in the south unit of the south commercial building. View shows a tire balancing machine and some equipment storage.



Photograph 7: View of the interior of the automotive service garage in the south unit of the south commercial building. View shows an aboveground hoist and some equipment storage.



Photograph 8: View of interior of the automotive service garage in the south unit of the south commercial building. View shows two of the aboveground hoists and general operations inside the garage.



Photograph 9: View of the basement electrical room in the north commercial plaza building.



Photograph 10: View of the refrigeration equipment in the penthouse level of the former grocery store in the northwest portion of the north commercial plaza building.



Photograph 11: View of interior of the former grocery store in the northwest portion of the north commercial plaza building.



Photograph 12: View of the interior (typical) of one of the commercial units in the north commercial plaza building.

Appendix K

Qualifications of Assessors



PROFILE

Mr. Lopers is an environmental engineer with over 12 years of experience in environmental engineering specializing in due diligence investigations. Mr. Lopers has extensive experience in Phase I and II Environmental Site Assessments; environmental remediation, and investigations; record of site condition submissions; asset inventory, designated substance surveys and abatement projects; environmental expertise on legal issues; and coordination of various monitoring programs (groundwater, surface water, air).

Mr. Lopers has participated in various Property Condition and Building Envelope mandates at various residential and commercial properties throughout Ontario.

Mr. Lopers has a strong commitment to health and safety, having experience leading a regional health and safety committee as a certified employee representative. Mr. Lopers has extensive training including OSHA 40-hour HAZWOPER, ASP Health and Safety on Construction Sites in Quebec, Ontario Working at Heights, Emergency First Aid/CPR and WHMIS.

CONTACT

EMAIL:
Luke@Lopers.ca

LUKE LOPERS

Principal

LOPERS & ASSOCIATES

EDUCATION

University of Waterloo,
B.A.Sc., Honours Environmental Engineering
Management Science Option Designation - 2002 - 2008

PROFESSIONAL EXPERIENCE

Lopers & Associates, Principal, Project Manager, Senior Environmental Engineer

Ottawa, Ontario - 2020–Present
Responsible for the management, coordination, supervision, completion and delivery of Phase I/1 and II/2 Environmental Site Assessments, Environmental Remediation Programs, Environmental litigation support, Designated Substance Surveys, scope of work development, cost estimates and proposals

GHD Limited, Project Manager, Senior Environmental Engineer

Ottawa, Ontario - 2013–2020
Responsible for the management, senior technical review, coordination, supervision, completion and delivery of Phase I/1 and II/2 Environmental Site Assessments, Environmental Remediation Programs, Environmental litigation support, Designated Substance Surveys, scope of work development, cost estimates and proposals
Office Safety Captain and Joint Health and Safety Committee team leader

Paterson Group Inc., Project Manager, Environmental Engineer

Ottawa, Ontario - 2009–2013
Responsible for supervision, completion and review for Phase I/1 and II/2 Environmental Site Assessments, Environmental Remediation Programs, Designated Substance Surveys

NEXT Environmental Inc., Site Investigation Staff

Burnaby, British Columbia - 2008–2009
Responsible for fieldwork and reporting for Stage/Phase I and II Environmental Site Assessments, Environmental Remediation Programs

PROFESSIONAL DESIGNATIONS

Licensed Professional Engineer (P.Eng.) with Professional Engineers Ontario (PEO) since 2012

Qualified Person (QP), Environmental Site Assessments with Ontario Ministry of the Environment, Conservation and Parks

PROJECT EXPERIENCE

Environmental Site Assessments

**Project Engineer/Manager
Phase 1 Environmental Site
Assessment | Various Clients |
Ontario, Quebec and British
Columbia | 2006-2020**

**Project Engineer/Manager
Phase Two Environmental Site
Assessments | Various Clients |
Various Locations | 2008-2020**

**Project Manager
Phase One, Phase Two
Environmental Site
Assessments, Environmental
Delineation Quality Assurance
Program | Costco Wholesale |
Ottawa, ON | 2014-2019**

Environmental Remediation Programs

**Project Engineer
Underground Fuel Storage
Tank Removals and
Environmental Remediation
Programs in Vicinity of Active
Underground Services |
Ottawa, ON | 2010, 2012**

Project Engineer/Manager for Phase I Environmental Site Assessments in support of acquisition/divestiture/regulatory requirements for various properties in Ontario, Quebec and British Columbia, including the following:

- Canadian Tire Retail Store and Gas Bar, CTR 417 - 2560 Princess Street, Kingston, Ontario
- Former Automotive Dealership and Service Garage, North Vancouver, British Columbia
- Former Philips Cable Plant, Brockville, Ontario
- Former Cornwall Cotton Mill, Cornwall, Ontario
- Retail Fuel Outlet and Automotive Service Garage, Ottawa, Ontario
- Jack Garland Airport Land, North Bay, Ontario
- Various Commercial/Residential Properties, Ontario and British Columbia
- Various Residential Properties, Ontario, Quebec and British Columbia
- Rochester Heights (811, 818 Gladstone Avenue), Ottawa, Ontario

Project Engineer/Manager for the following field investigation and/or regulatory reporting requirements for Phase II ESAs and other Site Investigations:

- Proposed Canadian Tire Development, CTR 693P - Terry Fox Drive at Eagleson Road, Stittsville, Ontario
- Former Retail/Private Fuel Outlets, Ottawa/North Bay/Vancouver, Canada
- Operational/Former Industrial Facilities, Ottawa/Cornwall/Sarnia/Brockville/Gananoque, Ontario
- Existing Dry Cleaning Facilities, Ottawa/Amprior, Ontario
- Automotive Service Garages, Ottawa/Vancouver, Canada
- Various Commercial/Residential Properties, Eastern Ontario
- Tetrachloroethylene Groundwater Plume, Commercial Property, Ottawa, Ontario
- Rochester Heights (811, 818 Gladstone Avenue), Ottawa, Ontario

Project Manager for the completion of a Phase One ESA for the potential acquisition of a commercial property. Upon discovery of APECs at the Site and significant data gaps in previous investigations, completed a Phase Two ESA to evaluate soil and groundwater quality at the Site. Further oversight of original owner's environmental consultants was completed to ensure adequate delineation and characterization of a dNAPL groundwater plume at the Site, present at significant depths in shale bedrock, which originated as a result of a former on-Site dry-cleaning operation.

Project Engineer for removal of underground heating oil storage tanks adjacent to residential buildings. Completed excavation supervision of contaminated soil around and below active underground services, including hydro, water and natural gas infrastructure at residential properties. Activities included oversight of removal of petroleum, impacted soil, and field screening and collection of confirmatory soil and groundwater samples for petroleum hydrocarbon analysis. Prepared Phase I, II and III Environmental Site Assessment reports.

**Project Engineer
Retail Fuel Outlet
Decommissioning and
Remediation | Ottawa, ON |
2012**

**Project Engineer/Manager
Former Fuel Outlet
Investigation and Remediation |
Merrickville, ON | 2016-2017**

Record of Site Conditions

**Project Manager/Engineer
Residential Redevelopment |
Environmental Remediation
Program and Record of Site
Condition Submission | Ottawa
| 2015**

**Project Manager/Engineer
Industrial Development |
Environmental Assessment and
Record of Site Condition
Submission | Township of
Edwardsburgh/Cardinal | 2015**

Excess Soil Management

**Project Engineer/Manager
Management of Excess Soil |
CTREL, Brigid, Ottawa
Community Housing
Corporation | Ottawa and
Pembroke, Ontario | 2016, 2018**

Designated Substance Surveys

**Project Manager
Designated Substance Surveys
and Hazardous Building
Materials Assessment |
Ottawa, Pembroke,
Southeastern Ontario | 2010-
2020**

Environmental Litigation Support

**Project Manager, Field
Engineer, Expert Witness
Ottawa, Ontario | 2014-2020**

Project Engineer for UST removal and confirmatory soil sampling at former ESSO gas station in Ottawa, Ontario. Activities included oversight of removal of USTs and product lines, oversight of removal of petroleum-impacted soil and groundwater encountered and backfilling operations, and field screening and collection of confirmatory soil and groundwater samples for petroleum hydrocarbon analysis.

Project Engineer for confirmatory soil and groundwater sampling following UST removal at former Shell gas station. Activities included oversight of removal of petroleum-impacted soil, pumping of groundwater encountered and backfilling operations, and field screening and collection of confirmatory soil and groundwater samples for petroleum hydrocarbon analysis. Additional borehole/monitoring well drilling also completed.

Project Manager for delineation of soil contamination and groundwater sampling for a former automotive garage and gas station property in Ottawa, Ontario. Presented and implemented remedial action plan to remediate on-site contamination. Directed staff in collection of post remediation confirmatory soil and groundwater samples for contaminants of concern. Prepared remediation closure report and record of site condition supporting documentation for submission to the Ministry of the Environment and Climate Change.

Project Manager for environmental assessments for a proposed industrial business park, in an existing industrial area within the Township of Edwardsburgh/Cardinal, Ontario. Prepared environmental assessment reports and record of site condition supporting documentation for submission to the Ministry of the Environment and Climate Change.

Project Engineer/Manager for sampling, analytical testing, development of soil management plans and monitoring during removal of excess soil generated as part of construction activities, including the following properties/facilities:

- Rochester Heights (811, 818 Gladstone Avenue), Ottawa, Ontario
- Residential redevelopment, 121 Parkdale Avenue, Ottawa, Ontario
- CTR 079, 1104 Pembroke Street East, Pembroke, Ontario
- CTR 297, 2010 Ogilvie Road, Ottawa, Ontario

Project Manager for asbestos containing material (ACM) surveys, designated substance surveys (DSSs), Hazardous Building Materials Assessments (HBMA) or mould assessments at the following sites:

- DSSs at various municipal facilities for the City of Pembroke, Pembroke, Ontario. Preparation of Asbestos Management Plan.
- HBMA at various institutional buildings for the Catholic District School Board of Eastern Ontario, Southeastern Ontario.
- DSSs and ACM surveys at various residential, buildings (dwellings and apartment buildings) for private residential clients, Ottawa, Ontario.
- DSS and abatement oversight during demolition, residential buildings (townhouses) for Ottawa Community Housing Corporation, 818 Gladstone Avenue, Ottawa, Ontario.

Project Manager, Field Engineer and Expert Witness for a fuel spill, remediation program, groundwater monitoring program and litigation review for redevelopment of a residential property adjacent to a central heating plant at an institutional facility.

Education

BEng Geological Engineering, École Polytechnique de Montreal, Montreal, Quebec, 1990

MSc Geophysics, University of British Columbia, Vancouver, British Columbia, 1983

BSc Geophysics, Honours, University of British Columbia, Vancouver, British Columbia, 1980

Certifications

Registered as PMP with Project Management Institute since 2012, requalified in 2018

Qualified Person (QP) for Environmental Site Assessments with Ontario Ministry of Environment and Conservation and Parks

Professional Affiliations

Licensed as P.Eng. with the Professional Engineers of Ontario (PEO) since 1994

Licensed as Ing. with l'Ordre des ingénieurs du Québec (OIQ), 1992

Licensed as P.Eng. with NAPEG (NWT and Nunavut), since 2009.

Licensed as P.Eng with Engineers Yukon since 2018

Federal Clearance Level

Secret ID # 95251065

DON PLENDERLEITH

Senior Environmental Engineer and Project Manager

PROFESSIONAL SUMMARY

Mr. Plenderleith has been an environmental engineer for 30 years. From 1990 to 2000 he worked at specialty firms in Montreal and Ottawa where he gained field and reporting experience in site assessment and remediation of retail fuel outlets and railway yards. In 1991 and 1992 he worked on a CIDA sponsored project to assess additional water resource potential in two provinces in Indonesia. He worked for Golder for 19 years on projects in Ottawa, the North and overseas.

His expertise covers all steps in contaminated site management: Phase I, II and III environmental site assessments (ESAs), risk assessments, remedial options evaluations, remedial action plans, tender plans and specifications, remediation project oversight, long-term monitoring and project closure. He has largely concentrated on federal sites since 2002 and was Golder's initial point of contact on the Environmental Standing Offer Agreement with PSPC in the National Capital over that time.

Don led Golder's national client service team for Federal government and was responsible to Golder's management for maintaining strong relations with the federal government. Locally, he provided project management and technical direction of a variety of environmental projects from the Ottawa office. Don mentored several junior professionals. His site portfolio included: military bases, Northern sites, navigational sites, correctional facilities, research labs, commercial buildings and Canadian embassies abroad. On several multi-year projects (Kingston Penitentiary and Connaught Ranges landfill) he directed all steps of site management from initial investigations, through to site closure.

Don is equally experienced at providing strategic and portfolio-level assistance to clients as well as site-specific level work. He has written contaminated sites management plans for several federal Departments. He helped to develop components of the FCSAP project manager's tool kit and has trained federal project managers in its use. He has provided program-level assistance to the FCSAP Secretariat for funding demand forecasting and long-term strategy and risk management. For nine years he led a multi-disciplinary team that performed contaminated site liability peer reviews for the Office of the Auditor General of Canada.

Don completed his engineering degree in French and is licensed to practice in Quebec. He frequently coordinates the French language component at bilingual meetings and workshops.

**Public Services and
Procurement Canada,
National Capital Region,
Environmental
Engineering Standing
Offer (2002-2019).**

PROJECT EXPERIENCE – STANDING OFFER MANAGER

Don managed Golder's Environmental Standing Offer Agreement (SOA) with PSPC in the National Capital Region from 2002 to 2019. He was the first point of contact with PSPC for new call-ups. He formed project teams from the approved resources and reviewed the work plans under each call-up. He was responsible and accountable for Golder's overall project performance to PSPC.

**Phase I, II, and III and
Remediation at Pittsburgh
Institution and Kingston
Penitentiary for PSPC/CSC
near Kingston, Ontario**

PROJECT EXPERIENCE – SENIOR PROJECT MANAGER

Environmental Site Assessment, Remediation Planning and Implementation for the Pittsburgh Institution and Kingston Penitentiary, Kingston, Ontario from 2007 to 2015 - Don was the Senior Project Manager and project reviewer for the Phase I, II and III of contaminated sites on two similar projects at these federal penitentiaries. Don performed project management and provided technical direction during the full suite of services from site assessment through to remediation. Federal project management tools, and FCSAP technical tools (GOST) were used to assist with procedural compliance. Don assisted PSPC with the tender specification for both remediation projects and performed on-site supervision during the fast-track remediation work at Pittsburgh. Don also performed senior review of the draft and final reports.

**Peer Review and Liability
Review of US Steel Site in
Hamilton Harbour for
PSPC and Transport
Canada (July-August 2016)**

Don was the Senior Project Manager for a Peer Review of reports pertaining to the US Steel site on Hamilton Harbour that the Hamilton Port Authority (HPA) was considering purchasing. TC requested the peer review and liability review in its oversight role over the HPA. Don brought a senior expert in at steel industry at Golder onto the project team. With his input some important gaps in the previous site assessments, management plans and liability estimates were identified to TC.

**Contaminated Site
Reporting and Review for
Department of National
Defence Ottawa, Ontario,
Canada**

Don has managed several projects for DND's Director General Environment, related to the financial reporting of DND's contaminated sites. He managed the EcoNet validation project in 2006, in which the systems and procedures by which site cost and liability information are input to DND's Contaminated Site database, Econet. Several of DND's major projects being run out of headquarters were reviewed in that exercise. In 2008 he assisted DND by producing the 2008 update of their Contaminated Sites Management Plan (CSMP) for Treasury Board submission. Nine divisional CSMPs were reviewed, summarized and incorporated into the departmental CSMP.

PROGRAM LEVEL WORK – FEDERAL CONTAMINATED SITES

Project Management Tools for Contaminated Sites, Ottawa, Ontario, Canada

Mr. Plenderleith developed two of the FCSAP Project Management Tools: Status Reporting and Project Risk Management. He has provided training in the tools to federal project managers country-wide. He has delivered training sessions at RPIC National Contaminated Sites workshops on several occasions on the PM Tools, the Sustainable Development Tool (SDAT), and Guidance Tool for Selection of Technologies Tools (GOST).

Assistance to FCSAP for program-level Risk Management, PWGSC/ECCC Ottawa, Ontario

Don has led a team at Golder that provided assistance to the FCSAP Secretariat from 2013 to 2019 in the areas of cost projections for funding demand estimates. He devised a method of projecting the costs of unassessed sites based on closure costs of similar sites. This tool was used to estimate the funding demand for FCSAP Phase III and past Phase III. Don assisted the Secretariat with Long-Term Strategic planning for FSCAP post 2020 when the 15-year program is due to sunset.

Secondments to Federal Departments

Mr. Plenderleith has been seconded from Golder to the Department of Foreign Affairs and International Trade (now Global Affairs Canada “GAC”) on three occasions to develop their Contaminated Sites Management Plans and to fill in while GAC was staffing their full-time environmental engineer position. Through these secondments he has developed a greater understanding of the role of federal custodians in managing their programs.

PROJECT EXPERIENCE – NORTHERN SITES

DEW Line Site Monitoring, Baffin Region, DND (2015-19)

Mr. Plenderleith was the project director of Golder’s DEW Line Monitoring contract with DND from four years 2015 to 2019. He was responsible for overall program quality and liaison with the client and management of Inuit subcontractors. The project was multi-disciplinary, involving geotechnical and environmental components. Mr. Plenderleith has developed a very positive working relationship with the hamlet of Qikiqtarjuaq and the Inuit staff from that community, many of whom have returned to work with Golder every year. All Inuit Participation Targets were exceeded.

Tundra Mine Remediation Monitoring PSPC/INAC (2016-2018)

Don was the Senior project director for Golder’s Remediation Monitoring of Tundra Mine (NWT) for PSPC and INAC. This project is multi-disciplinary involving surface water and groundwater environmental monitoring and aquatic monitoring for the final stages of the remediation of Tundra Mine. Don has reviewed the monthly and annual monitoring reports produced for the Water Licence. His earlier experience with the RAP for Tundra has been valuable on this project.

**Remedial Options Review
and Remedial Action
Planning Former Water
Tanker Base, Inuvik
Airport, NWT 2010-12**

From 2010 to 2012, Mr. Plenderleith was the technical director for the Phase III ESA detailed site assessment and remediation planning of the former Water Tanker Base at the Inuvik Airport in NWT. The work included determining the contaminants of concern, delineation of contaminated soil and seasonal groundwater areas, and assessing remedial options. The remedial action plan reviewed chemical oxidation and removal & disposal options within the constraints of northern work season, and the distance to a disposal facility. Descriptions, costs, advantages and limitations were provided for several options. GNWT performed the remediation with own forces.

Phase Two Environmental Site Assessment

729 Ridgewood
Avenue
Ottawa, Ontario

Prepared for:
11684663 Canada
Inc.



August 14, 2020

Table of Contents

1.	Executive Summary.....	1
2.	Introduction.....	4
	i. Site Description.....	4
	ii. Property Ownership.....	4
	iii. Current and Proposed Future Use.....	4
	iv. Applicable Site Condition Standard.....	5
3.	Background Information.....	6
	i. Physical Setting.....	6
	ii. Past Investigations.....	6
4.	Scope of Investigation.....	7
	i. Overview of Site Investigation.....	7
	ii. Media Investigation.....	10
	iii. Phase One Conceptual Site Model.....	11
	iv. Deviations from Sampling and Analysis Plan.....	12
	v. Impediments.....	13
5.	Investigation Method.....	13
	i. General.....	13
	ii. Drilling.....	13
	iii. Soil Sampling.....	14
	iv. Field Screening Measurements.....	16
	v. Groundwater: Monitoring Well Installation.....	16
	vi. Groundwater: Field Measurement of Water Quality Parameters.....	17
	vii. Groundwater: Sampling.....	17
	viii. Sediment: Sampling.....	18
	ix. Analytical Testing.....	18
	x. Residue Management Procedures.....	18
	xi. Elevation Surveying.....	18
	xii. Quality Assurance and Quality Control Measures.....	19
6.	Review and Evaluation.....	20

i.	Geology.....	20
ii.	Groundwater and Elevations and Flow Direction.....	22
iii.	Groundwater: Hydraulic Gradients.....	24
iv.	Fine-Medium Soil Texture	24
v.	Soil Field Screening	24
vi.	Soil Quality.....	25
vii.	Groundwater Quality	27
viii.	Sediment Quality.....	29
ix.	Quality Assurance and Quality Control Results	30
x.	Phase Two Conceptual Site Model	31
7.	Conclusions.....	35
i.	Signatures	37
8.	Limitations.....	38
9.	References.....	39
10.	Appendices	40

List of Figures

Figure 1: Key Plan

Figure 2: Site Plan

List of Tables

Table 1:	Monitoring Well Construction Details	22
Table 2:	Groundwater Table Elevations Measured on June 23, 2020	23
Table 3:	Soil Samples Selected for Laboratory Analysis.....	25
Table 4:	Groundwater Samples Selected for Laboratory Analysis	28
Table 5:	Soil Analytical Results.....	Following Text
Table 6:	TCLP Analytical Results.....	Following Text
Table 7:	Groundwater Analytical Results.....	Following Text

List of Appendices

- Appendix A – Sampling and Analysis Plan
- Appendix B – Underground Utility Locates
- Appendix C – Borehole Logs
- Appendix D – Certificates of Equipment Calibration
- Appendix E – Laboratory Certificates of Analysis
- Appendix F – Qualifications of Assessors

1. Executive Summary

Lopers & Associates (Lopers) was retained by 11684663 Canada Inc. (Brigil) to complete a Phase Two Environmental Site Assessment (Phase Two ESA) of the commercial property with Civic address No. 729 Ridgewood Avenue, Ottawa, Ontario ("Phase Two Property", "Property" or "Site").

This Phase Two ESA is being completed as part of due diligence requirements associated with the submission of a Development Application to the City of Ottawa Municipal Planning Department.

Lopers has previously completed a Phase One Environmental Site Assessment (Phase One ESA) (Reference No. LOP20-001A, dated July 27, 2020) for Brigil at the Property. The Phase One ESA identified the presence of four potentially contaminating activities (PCAs) at the Property which were interpreted to represent areas of potential environmental concern (APECs). The presence of a former retail fuel outlet and automotive service garage were identified on the southeast portion of the Phase One Property (APEC #1 / #2). The contaminants of potential concern associated with retail fuelling are petroleum hydrocarbons (PHCs) and benzene, toluene, ethylbenzene and xylenes (BTEX), and metals, since this was an older facility and lead was historically present in gasoline. Based on historical soil analysis in this area of the Property, polycyclic aromatic hydrocarbons (PAH) and volatile organic compounds (VOCs) are also considered contaminants of potential concern associated with the former automotive garage operations. The practice of backfilling following demolition activities was identified on the central-south portion of the Phase One Property (APEC #3). The contaminants of potential concern commonly found in poor environmental quality backfill are PHCs/BTEXs, polycyclic aromatic hydrocarbons (PAHs) and metals. Based on the operations observed at the active automotive service garage (APEC #4), the contaminants of concern associated with this activity are PHCs and BTEXs. A Phase Two ESA was recommended to assess the soil and groundwater quality in the vicinity of the identified APECs.

The scope of work for the Phase Two ESA included drilling seven boreholes at the Phase Two Property. Three of the boreholes were instrumented with groundwater monitoring wells with screens installed in the overburden.

Six soil samples, including one duplicate sample, were submitted for laboratory analysis for a combination of PHCs, BTEXs, volatile organic compounds (VOCs), PAHs, metals and inorganics. One sample was also submitted for toxicity leaching characteristic procedure (TCLP) for waste characterization purposes.

Groundwater sampling was completed of the newly installed monitoring wells and two existing groundwater monitoring wells at the Phase Two Property, which were installed as part of historical investigations. A total of seven groundwater samples, including a duplicate sample and a trip blank, were submitted for laboratory analysis for a combination of PHCs, BTEXs, VOCs, PAHs, metals and inorganics.

The applicable sites standard was determined to be the full depth generic site condition standard, in a non-potable groundwater condition, with coarse textured soil, for residential property use, as specified in Table 3 of the MECP Soil, Ground Water and Sediment Standards for Use Under Part XV.1 of the Environmental Protection Act, April 15, 2011.

At APEC #3 (placement of fill of unknown quality) the soil samples BH1-20-SS5 and BH11-20-SS5 (Duplicate of BH1-20-SS5), collected from a depth of approximately 3.1-3.7 m BGS, had reported concentrations of PHC F2 range (909 µg/g and 306 µg/g vs. 98 µg/g), Methylanthalene (7.61 µg/g and 2.26 µg/g vs. 0.99 µg/g) and reported concentrations of vanadium (101 µg/g and 104 µg/g vs. 86 µg/g). These samples also had respective cobalt concentrations of 20.1 µg/g and 22.5 µg/g compared to the site condition standard of 22 µg/g; since the average concentration of cobalt in these samples is less than the site condition standard, the marginal exceedance in the duplicate standard is not considered to exceed the site condition standard.

At APEC #1 (former retail fuel outlet) the soil sample BH3-20-SS6, collected from a depth of approximately 3.8-4.4 m BGS, had reported concentrations of PHC F1 range (117 µg/g vs. 55 µg/g), PHC F2 range (110 µg/g vs. 98 µg/g), benzene (3.02 µg/g vs. 0.21 µg/g), ethylbenzene (59 µg/g vs. 2 µg/g), toluene (73.5 µg/g vs. 2.3 µg/g) and xylenes (276 µg/g vs. 3.1 µg/g). Additionally, PAH exceedances from the same soil sample included Methylanthalene (1.95 µg/g vs. 0.99 µg/g) and Naphthalene (1.69 µg/g vs. 0.6 µg/g).

At APEC #1 (former retail fuel outlet), the groundwater samples BH3-20 and BH13-20 (Duplicate of BH3-20), collected from a screen depth of approximately 2.5-5.5 m BGS, had reported concentrations of PHC F1 range (3,600 µg/g and 3,790 µg/g vs. 750 µg/g), PHC F2 range (52,400 µg/g and 2,260 µg/g vs. 150 µg/g), PHC F3 range (3,940 µg/g vs. 500 µg/g), benzene (19,300 µg/g and 19,700 µg/g vs. 44 µg/g), ethylbenzene (3,800 µg/g and 3,700 µg/g vs. µg/g), toluene (65,200 µg/g and 60,900 µg/g vs. 18,000 µg/g) and xylenes (27,600 µg/g and 26,600 µg/g vs. 4,200 µg/g). Lead was also reported at concentrations of 51.6 µg/g and 54.6 µg/g vs. 25 µg/g.

All of the other soil and groundwater results for the Phase Two Property are in compliance with the applicable site condition standards. The Phase Two Property is not in compliance with the Table 3 site condition standards as of the certification date of June 30, 2020.

An environmental remediation program, including the bulk removal and off-site disposal of soil and groundwater in excess of the site condition standards is recommended for the Phase Two Property. Given the scope and timeline for the proposed redevelopment and the requirements for specialized construction techniques to complete remediation of the Phase Two Property to

meet the site condition standards, it is recommended that remediation be completed in conjunction with redevelopment of the Property. It should be noted that the proposed redevelopment includes excavation for at least two to three levels of underground parking, which is expected to be sufficient for remediation of the aforementioned environmental contamination at the Phase Two Property.

Further delineation and confirmation of remediation sampling will be required prior to the completion of an environmental remediation and program and confirmation of compliance with the site condition standards; however, these tasks can be completed at the time decommissioning and demolition of existing structures at the Phase Two Property. The submission of a record of site condition would be required in the event of a change of zoning of the Phase Two Property; however, these tasks can be completed at the time decommissioning and demolition of existing structures at the Phase Two Property. The Phase Two ESA could be then updated at that time to show compliance with site condition standards.

Preparation of a soil management plan in accordance with O.Reg. 406/19 will be required as part of management of excess soil generated as part of construction activities. It is recommended that a remedial action plan be prepared to develop a strategy for remediation, including soil and groundwater management, during redevelopment.

2. Introduction

Lopers & Associates (Lopers) was retained by 11684663 Canada Inc. (Brigil) to complete a Phase Two Environmental Site Assessment (Phase Two ESA) of the commercial property with Civic address No. 729 Ridgewood Avenue, Ottawa, Ontario (“Phase Two Property”, “Property” or “Site”). The location of the Phase Two Property within the City of Ottawa is presented on Figure 1: Key Plan.

i. Site Description

The Phase Two Property has a Civic address of 729 Ridgewood Avenue, Ottawa, Ontario. The Property is legally described as Part of Block C, Registered Plan 749, Part of Block C, Registered Plan 775 and Part of Lot 23 Junction Gore, Township of Gloucester, now in the City of Ottawa and has a property identifier number of 04071-0125. The boundaries of the Phase Two Property are presented on Figure 2: Site Plan.

Based on approximate dimensions obtained from the City of Ottawa’s GIS mapping tool, the Phase Two Property has an approximate area of 13,200 m² (1.32 Hectares). The Phase Two Property is immediately surrounded by a municipal Right-of-Way to the south followed by a mixed institutional/commercial property and by residential properties to the north, east and west.

ii. Property Ownership

The Phase Two Property is currently owned by 11684663 Canada Inc., a subsidiary company of Brigil Construction (“Brigil”). This Phase Two ESA was commissioned by Mr. Jean-Luc Rivard, Director of Land Development and Infrastructure for Brigil Construction (Brigil), operating as 11684663 Canada Inc. Brigil has a business address of 98 Rue Lois, Gatineau, Quebec, J8Y 3R7 and a business telephone number of 819-243-7392.

iii. Current and Proposed Future Use

It is Lopers’ understanding that Brigil intends to redevelop the Phase Two Property for mixed use (commercial and residential purposes), including the current concept for construction of one building with five adjoining segments ranging from seven to twenty storeys in height, with subgrade parking, commercial ground floors and residential units above.

The redevelopment plan for the Phase Two Property includes mixed use (residential and commercial), which is the current zoning of the Phase Two Property. A certified Planner should assist 11684663 Canada Inc. in determining whether a record of site condition (RSC) will be required to be filed with the Ministry of Environment, Conservation and Parks (MECP) for the Phase Two Property. If so, an update to this Phase Two ESA (post-remediation) can be used as supporting documentation as part of filing of an RSC.

iv. Applicable Site Condition Standard

Through Ontario Regulation 153/04 (O.Reg. 153/04) the Ministry of Environment, Conservation and Parks (MECP) prescribes the conditions to determine the applicable site condition standard for a property.

The proposed future use of the Phase Two Property is for mixed ground floor commercial and residential use, however residential land use standards have been applied for the purposes of this report as they represent the more environmentally sensitive land use conditions.

The Phase Two Property and all other properties within 250 m of the property boundaries are supplied by the municipal drinking water system. The RSC does not specify agricultural use and there are no wells within 250 m of the property boundaries that are intended for use as a source of water for human consumption or agriculture. As such, the designation of non-potable groundwater setting is determined to be applicable [O.Reg. 153/04, section 35].

The soil and groundwater quality over the full depth of overburden was considered for this Phase Two ESA. The full depth generic site condition standards were selected for comparison for the Phase Two Property [O.Reg. 153/04, sections 36, 37, 38, 39 and 40].

The Phase Two Property is not situated within or adjacent to an area of natural significance and does not include any land within 30 m of an area of natural significance. The pH of the soil was analyzed as part of this Phase Two ESA and was found to range from 7.14 to 7.40. As such, the Phase Two Property is not considered to be an environmentally sensitive area [O.Reg. 153/04, section 41].

A substantial layer of native glacial till, consisting of silty sand and gravel, which would be classified as coarse grained soil, is present underlying a silty clay unit to full depth to bedrock on the south and central portions of the Phase Two Property while sand and gravel fill is present near surface elsewhere at the Property. It is interpreted that greater than 1/3 of the Phase Two Property has coarse grained soil. For the purposes of this Phase Two ESA, the soil conditions are considered to be coarse grained, which provides a more conservative comparison to the MECP site condition standards than the fine-grained values [O.Reg. 153/04, section 42].

Review of the drilling program and borehole/monitoring well logs completed as part of this Phase Two ESA and previous investigations was completed. It was determined that greater than 2/3 of the Phase Two Property has greater than 2 m of overburden soil. The Phase Two Property is not considered a shallow soil property [O.Reg. 153/04, section 43.1].

The Phase Two Property does not include and does not have any land located within 30 m of a water body. The MECP site condition standards for use within 30 m of a water body do not apply [O.Reg. 153/04, section 43.1].

The full depth generic site condition standards, with non-potable groundwater, coarse textured soil, for residential/parkland/institutional property use, as specified in Table 3 of the MECP Soil,

Ground Water and Sediment Standards for Use Under Part XV.1 of the Environmental Protection Act, April 15, 2011 were determined to be the applicable site condition standards for the Phase Two Property as part of this Phase Two ESA.

3. Background Information

i. Physical Setting

No water bodies or areas of natural significance are located at the Phase Two Property or in the Phase One Study Area. There were no areas of natural and scientific interest (ANSIs) or areas of natural significance identified in the Phase One Study Area.

The regional topography in the Phase One Study Area is undulating but generally slopes downward to the west-northwest, toward the Rideau River. The topography on the south portion of the Phase Two Property slopes downward from west to east, with the neighbouring property to the east at an elevation approximately 1.5 m lower than the southeast Property limits. A local topographical high is present approximately 200 m west of the Phase Two Property, which may be associated with local bedrock undulation. The Rideau River is located approximately 550 m west of the Phase Two Property.

Surface water drainage at the Phase Two Property is by sheet drainage to catch basins located on the paved surfaces of the Property, which drain into the municipal stormwater sewer system.

No drinking water wells are located at the Phase Two Property and the Phase One Study Area are serviced by municipally treated drinking water. The Phase Two Property and Study Area are not located in the vicinity of any well-head protection areas or other designation identified by the City of Ottawa in its official plan for the protection of ground water. No private or agricultural water supply wells are located within the Phase One Study Area.

ii. Past Investigations

A Phase One ESA report was prepared concurrently with this Phase Two ESA: "Phase One Environmental Site Assessment, 729 Ridgewood Avenue, Ottawa, Ontario" dated July 27, 2020 prepared for 11684663 Canada Inc. by Lopers & Associates. The Phase One ESA identified four potentially contaminating activities (PCAs) at the Phase One Property, which include:

- The presence of a former retail fuel outlet and automotive service garage was identified on the southeast portion of the Phase One Property (O.Reg. PCA item #28 and #52). This former retail fuel outlet and automotive service garage are significant potentially contaminating activities (PCAs) which represent areas of potential environmental concern # 1 and #2 (APEC #1 / #2) for the Property. The contaminants of potential concern associated with retail fuelling are generally PHCs and BTEXs, with older facilities also having concerns associated with metals, as lead was historically present in gasoline. Based on historical soil

analysis in this area of the Property, PAH and VOCs are also considered contaminants of potential concern associated with the former automotive garage operations.

- The practice of backfilling following demolition activities was identified on the central-south portion of the Phase One Property (O.Reg. PCA item #30). Backfilling with fill of unknown environmental quality is a significant PCA which represents APEC #3 for the Property. The contaminants of potential concern commonly found in poor environmental quality backfill are PHCs/BTEXs, PAHs and metals.
- The presence of an active automotive service garage was observed on the central portion of the Phase One Property (O.Reg. PCA item #52). The active automotive service garage is a potentially contaminating activity (PCA) which represents area of potential environmental concern # 4 (APEC #4) for the Property. Based on the observations at this automotive garage, that contaminants of potential concern are considered to be PHCs and BTEXs.

Based on the identification of PCAs and APECs at the Phase One Property, a Phase Two Environmental Site Assessment was recommended to be completed to assess the soil groundwater quality in the vicinity of the APECs.

Additional reports and sources were reviewed and/or referenced as part of the aforementioned Phase One ESA, and included:

1. "Phase II Environmental Site Assessment, 729 Ridgewood Avenue, Ottawa, Ontario", dated January 12, 2018, completed by Pinchin Ltd. for Canadian Rental Development Services Inc.
2. "Verification Soil Sampling Program, 729 Ridgewood Avenue, Ottawa, Ontario", dated October 19, 2018, completed by Pinchin Ltd. for 561226 Ontario Inc.

These reports confirm the findings of the Phase One ESA completed by Lopers & Associates in 2020 and provide some additional detail of historical investigation and remediation work at the Phase Two Property.

There were no discrepancies identified in review of documentation, information or data from previous investigations. As such, previous investigations are considered to be of adequate quality such that they can be relied upon for the purposes of this Phase Two ESA.

4. Scope of Investigation

i. Overview of Site Investigation

This Phase Two ESA was designed to meet the general requirements of O.Reg. 153/04 as amended, with details of scope presented in Lopers' Letter entitled "Proposal for Phase One Environmental Site Assessment and Phase Two Environmental Site Assessment, Proposed Residential Re-development, 729 Ridgewood Avenue, Ottawa, ON", dated May 8, 2020,

reference, No. LOP-002-20-BRIGIL. The scope of work for investigation was discussed with Brigil and sampling and analysis plan (SAP) was prepared to achieve the objectives of the Phase Two ESA; the SAP is provided in Appendix A. In the event that an RSC is required for the Phase Two Property, additional effort, including delineation, remediation and reporting would be required.

Underground utility locates were completed through Ontario 1-Call to identify any active public services on the Phase Two Property. Following the completion of the public locates, USL-1 Underground Service Locators completed scanning of the Phase Two Property proposed drilling locations to locate privately owned underground services prior to initiating the field program. Various underground utility services, including natural gas, electricity, water and sewers were identified at the Phase Two Property. The natural gas, water and sewer services are present in underground trenches which enter the Property from Ridgewood Avenue to the south and lead to the commercial buildings. Electricity enters the property through an underground service trench to the north of the north commercial building. Copies of the underground locates are provided in Appendix B.

On June 24, 2020, a total of seven boreholes (BH1-20 through BH7-20) were drilled at the Phase Two Property. The boreholes were drilled using a truck mounted CME 55 drill rig operated by George Downing Estate Drilling. Soil samples were collected using stainless steel split spoons. Soil samples recovered during the sampling program were screened in the field for volatile vapour concentrations, as well as visual and olfactory observations.

A total of three groundwater monitoring wells (BH1-20, BH3-20, BH5-20) were installed on the central-south, southeast and central portions of the Phase Two Property. The boreholes which were instrumented with groundwater monitoring wells were drilled to the localized depths ranging from 5.9 to 6.7 m below ground surface (m BGS) and were screened to straddle the shallow groundwater table. When possible, these groundwater monitoring wells were developed on day of drilling by removing at least three well volumes or by purging the wells dry three times.

A total of two existing groundwater monitoring wells were present on the southeast portion of the Phase Two Property prior to undertaking the field program for this Phase Two ESA. The existing monitoring wells were installed as part of past investigations by others. Based on the depths of these wells and the depth to bedrock in boreholes in the vicinity of these wells which were drilled as part of this Phase Two ESA, the existing monitoring wells are suspected to have their screens set within the overburden and may also straddle the shallow groundwater table. Both of the existing groundwater monitoring wells were developed on day of drilling by removing at least three well volumes.

The locations of the boreholes/monitoring wells drilled/installed as part of this Phase Two ESA as well as existing monitoring wells at the Phase Two Property are presented on Figure 2: Site Plan. The rationale for the placement of the boreholes/monitoring wells is provided below:

BH1-20 was drilled in the vicinity of the former suspected residential building at the Phase Two Property. This borehole was placed in a location to assess fill quality in the footprint of this former building (APEC #3). This borehole was instrumented with a groundwater monitoring well, with its screen installed within soil which was observed to be wet during the drilling/soil sample collection in an attempt to straddle the shallow groundwater table.

BH2-20 was drilled in the southeast portion of the Phase Two Property, near the east Property limit. This borehole was placed in a location to assess potential remnant soil contamination from the former retail fuel outlet and automotive service garage (APEC #1 / #2).

BH3-20 was drilled in the southeast portion of the Phase Two Property, near the south Property limit. This borehole was placed in a location to assess potential remnant soil and groundwater contamination from the former retail fuel outlet and automotive service garage (APEC #1 / #2). This borehole was instrumented with a groundwater monitoring well, with its screen installed within soil which was observed to be wet during the drilling/soil sample collection in an attempt to straddle the shallow groundwater table.

BH4-20 was drilled in the southeast portion of the Phase Two Property, near footprint of the former automotive service garage. This borehole was placed in a location to assess potential remnant soil contamination from the former retail fuel outlet and automotive service garage (APEC #1 / #2).

BH5-20 was drilled in the central portion of the Phase Two Property, near the south side of the active automotive service garage. This borehole was placed in a location to assess potential soil and groundwater contamination from the active automotive service garage (APEC #4). This borehole was instrumented with a groundwater monitoring well, with its screen installed within soil which was observed to be wet during the drilling/soil sample collection in an attempt to straddle the shallow groundwater table.

BH6-20 was drilled approximately 5 m to the west of the former suspected residential building at the Phase Two Property. This borehole was placed in a location to delineate potential soil impacts suspected in BH1-20.

BH7-20 was drilled approximately 8 m to the east of the former suspected residential building at the Phase Two Property. This borehole was also placed in a location to delineate potential soil impacts suspected in BH1-20.

Soil samples were selected for laboratory analysis of select contaminants of potential concern (CPCs) based on APECs and CPCs identified in the Phase One ESA, as described in Section 3.ii. above as well as field screening observations.

A waste characterization sample was selected for laboratory analysis of toxicity characteristic leaching procedure (TCLP) analysis for flashpoint, leachate metals & inorganics, leachate VOCs and leachate organics (PAHs and polychlorinated biphenyls (PCBs)). This sample was comprised

of a composite of worst case samples, as determined by field screening parameters, from BH1-20 and BH3-20.

Groundwater monitoring and sampling of the monitoring wells installed as part of this Phase Two ESA (BH1-20, BH3-20, BH5-20) as well as both existing groundwater monitoring wells (MW-6 and MW-8, which were interpreted as being screened in overburden) was completed on June 30, 2020. Static groundwater levels were measured prior to disturbance of the water column. During purging, water quality parameters were measured at regular intervals to monitor groundwater quality stabilization; once groundwater quality parameters stabilized (were within approximately 10% on successive readings), groundwater samples were collected. Groundwater samples were selected for laboratory analysis of select CPCs based on APECs and CPCs identified in the Phase One ESA.

An elevation survey was completed of the boreholes/monitoring wells drilled as part of the Phase Two ESA as well as both existing monitoring wells at the Phase Two Property. The boreholes/monitoring wells were surveyed relative to a temporary benchmark of the top of spindle of the City of Ottawa fire hydrant located at the southwest corner of the Ridgewood Avenue and Dupont Street intersection; this benchmark was assigned a reference elevation of 100.000 m ("Site Datum") for the purposes of this Phase Two ESA.

ii. Media Investigation

Based on the finding of the Phase One ESA, the following APECs, and CPCs were identified for the following media:

The presence of a former retail fuel outlet and automotive service garage was identified on the southeast portion of the Phase One Property (O.Reg. PCA item #28 and #52). This former retail fuel outlet and automotive service garage are significant potentially contaminating activities (PCAs) which represent areas of potential environmental concern # 1 and #2 (APEC #1 / #2) for the Property. The contaminants of potential concern associated with retail fuelling are generally PHCs and BTEXs, with older facilities also having concerns associated with metals, as lead was historically present in gasoline. Based on historical soil analysis in this area of the Property, PAH and VOCs are also considered contaminants of potential concern associated with the former automotive garage operations.

The practice of backfilling following demolition activities was identified on the central-south portion of the Phase One Property (O.Reg. PCA item #30). Backfilling with fill of unknown environmental quality is a significant PCA which represents APEC #3 for the Property. The contaminants of potential concern commonly found in poor environmental quality backfill are PHCs/BTEXs, PAHs and metals.

The presence of an active automotive service garage was observed on the central portion of the Phase One Property (O.Reg. PCA item #52). The active automotive service garage is a potentially contaminating activity (PCA) which represents area of potential environmental

concern # 4 (APEC #4) for the Property. Based on the observations at this automotive garage, the contaminants of potential concern are considered to be PHCs and BTEXs.

Soil quality at the Phase Two Property was investigated through the collection of soil samples at varying depths facilitated by drilling using a truck mounted CME drill rig with stainless steel split spoon sampling.

Groundwater quality at the Phase Two Property was investigated through the installation and sampling of groundwater monitoring wells. The monitoring wells installed as part of the Phase Two ESA were drilled to the localized depths ranging from 5.9 to 6.7 m below ground surface (m BGS) and were screened to straddle the shallow groundwater table. The existing monitoring wells at the Phase Two Property were suspected to have monitoring well screens installed within the overburden. A bentonite seal was installed above the monitoring well screen's sand pack in each of the monitoring wells to prevent surface and precipitation water influence. Groundwater monitoring wells were sampled using a peristaltic pump.

There were no natural surface water bodies at the Phase Two Property, and as such no sediment sampling was completed as part of the Phase Two ESA.

iii. Phase One Conceptual Site Model

The Phase One Property, which has the same location orientation and property boundaries as the Phase Two Property, is located at Civic No. 729 Ridgewood Avenue, Ottawa, Ontario and has an approximate area of 1.32 Hectares.

The Phase One Property was undeveloped prior to the late 1950's when a suspected residential building was constructed on the central-south portion of the Phase One Property. Initial commercial development began circa 1965. The central and north portions of the Phase One Property have been occupied by two commercial plaza style buildings from circa 1965 to present. The southeast portion of the Phase One Property was formerly occupied by a retail fuel outlet and automotive service garage from 1965 to 2002 (retail fuel outlet) and 2017 (automotive service garage). Demolition of the former suspected residential building occurred prior to 1991. The remaining undeveloped areas of the Phase One Property are paved with asphalt and used for access or parking.

The Property is currently used for commercial purposes and is zoned for mixed use. 11684663 Canada Inc. (Brigil) purchased the Phase One Property in November of 2019, and it is understood that the intended future use is for mixed use, with commercial use on the ground floor and residential uses above the ground floor. The Phase One Property is immediately surrounded by a municipal Right-of-Way to the south followed by a mixed institutional/commercial property and by residential properties to the north, east and west.

The Phase One Study Area includes the Phase One Property and properties with the boundaries within 250 m of the Phase One Property limits. Based on a review of the Phase One Property and properties in the Phase One Study Area, their associated historical and/or current uses and

operations and physical characteristics of the Phase One Study Area, it was determined that an assessment of properties within 250 m of the Phase One property was sufficient to meet the objectives of the scope of this investigation for a Phase One ESA.

No water bodies or areas of natural significance are located at the Phase One Property or in the Phase One Study Area. No drinking water wells are located at the Phase One Property and the Phase One Study Area is serviced by municipally treated non-potable water. Two existing groundwater monitoring wells were present at the Phase One Property; the locations of these wells are presented on Figure 2.

The regional topography in the Phase One Study Area is undulating but generally slopes downward to the west-northwest, toward the Rideau River. The topography on the south portion of the Phase One Property slopes downward from west to east, with the neighbouring property to the east at an elevation approximately 1.2 m lower than the southeast Property limits. A local topographical high is present approximately 200 m west of the Phase One Property, which may be associated with local bedrock undulation. The Rideau River is located approximately 550 m west of the Phase One Property.

Based on the historical research, the general stratigraphy of the Phase One Property and Phase One Study Area consists of sand and gravel fill, underlain by silty clay, followed by silty sand and gravel (till). Overburden soils are expected to be up to 8 m thick and underlain by interbedded shale and limestone bedrock. Groundwater is expected at a depth of approximately 4 to 5 m BGS and flow in a predominantly northwest direction.

Three active and/or historical fuel storage tank locations at neighbouring properties in the Phase One Study Area were identified as PCAs. The PCAs at neighbouring properties in the Phase One Study Area are located significant distances and/or at down- or cross-gradient orientations with respect to the Phase One Property and are not considered to represent APECs for the Phase One Property.

Underground utility service trenches are present at the Phase One Property. The underground utility corridors do have the potential to affect contaminant distribution and transport, as they would create preferential pathways for lateral migration. It should be noted that the groundwater table is expected to be approximately 4 to 5 m BGS, while the underground utilities are expected to be present at depths of 2 to 3 m BGS, therefore it is not suspected that significant migration of contaminants has occurred through underground utility corridors.

iv. Deviations from Sampling and Analysis Plan

The Sampling and Analysis Plan (SAP) was designed to complete BH2-20 at the east Property limit, in the approximately location of remnant contaminated soil which was reported as part of historical sampling. The presence of fencing at the east Property limit prevented drilling with the CME 55 Tuck mounted drill within 3 m of the Property limit; BH2-20 was located as close as practical and safe drilling practices would permit.

v. Impediments

As noted above, the presence of fencing at the east Property limits, impeded the drilling investigation as planned in the SAP. It is suspected that remnant soil and/or groundwater contamination may be present in this area of the Phase Two Property based on historical sampling data, however, this could not be confirmed as part of this Phase Two ESA. Additional investigation and confirmation of soil and groundwater quality in this area of the Property is recommended at the time of excavation for site redevelopment.

5. Investigation Method

i. General

The investigation method for this Phase Two ESA involved an assessment of the soil and/or groundwater quality for the associated CPCs in the vicinity of the APECs identified during the Phase One ESA.

Investigation of soil was completed using a truck mounted CME drill rig, with stainless steel split spoons used to recover soil samples. Soil samples were screened in the field for volatile vapour concentrations, as well as visual and olfactory observations. Select soil samples were submitted based on all the indications mentioned above, as well as to capture representative soil and fill layers, for laboratory analysis for the CPCs.

Groundwater was assessed using groundwater monitoring wells which were installed as part of this Phase Two ESA drilling program and those which had been installed at the Phase Two Property as part of historical previous investigations. The wells selected for monitoring/sampling were purged during the drilling program. Static groundwater levels were measured in the monitoring wells prior to disturbance of the water column on the day of sampling. Groundwater samples were collected using a peristaltic pump using low-flow procedures and were submitted for laboratory analysis for the CPCs.

An elevation survey of the boreholes and groundwater monitoring wells was completed and was referenced to a temporary benchmark, the top of spindle of a fire hydrant located to the southeast of the Phase Two Property.

The following sections provide further detailed information regarding the investigation methodology completed as part of the Phase Two ESA.

ii. Drilling

The drilling field program was completed on June 24, 2020 under full time supervision of Lopers & Associates personnel. Seven boreholes were drilled for the Phase Two ESA by the drilling subcontractor George Downing Estate Drilling, located at 410 Principale Rue, Grenville-Sur-la-

Rouge, Quebec, J0V 1B0. The drill rig used for the Phase Two ESA was a truck mounted CME drill, equipped with hollow stem augers and stainless-steel split spoons. One of the seven boreholes was advanced to auger or cone refusal on suspected bedrock.

Samples were collected using stainless steel split spoons from the near surface to the full depth of drilling. Split spoon samples, collected in 0.6 m segments, were recovered at continuous 0.76 m intervals; the additional 0.16 m between split spoon samples was over-drilled to provide undisturbed field measurement of geotechnical parameters (blow counts) and to prevent cave in materials from stratigraphic units above the intended sampling intervals from being collected at unrepresentative depths during sampling.

The split spoons, which were the only media to come into contact with the soil samples, were washed using soap and water and a scrub brush between samples to minimize the potential for cross-contamination among samples. The field technician used sterile nitrile gloves, which were changed prior to the handling of each soil sample to further reduce the potential of cross-contamination. The flights of the hollow stem augers were cleaned manually following each borehole.

iii. Soil Sampling

As described above, soil samples were recovered using stainless steel split spoons.

Soil samples were initially collected in Ziploc bags for initial screening as part of sample selection. Soil samples selected for laboratory analysis were collected in dedicated clear glass jars prepared and provided by the analytical laboratory. Soil samples collected for BTEXs/VOCs and the F1 range of PHCs analysis were collected using a dedicated graduated syringe provided by the laboratory and placed directly into a glass vial with a known quantity of methanol preservative. Analytes and associated preservatives were specified on each jar/vial by the laboratory. Each jar/vial sample set was provided with a unique sample identifier, project number and date of sampling in the field.

Detailed soil descriptions of the stratigraphy for each borehole/monitoring are included on the borehole logs provided in Appendix C.

Based on the observations of soil samples collected during the Phase Two ESA field program, there were five stratigraphic units identified at the Phase Two Property, which include:

Asphalt

A layer of asphalt, approximately 0.10 to 0.13 m in thickness, was encountered at the ground surface in BH1-20, BH5-20, BH6-20 and BH7-20.

Silty Sand and Gravel (Fill)

A layer of silty sand and gravel fill material, ranging from approximately 0.1 to 2.2 m in thickness, was encountered from ground surface, immediately below the asphalt layer, or stratified with

the sand (fill) layer in boreholes BH2-20 through BH7-20 drilled as part of the Phase Two ESA. This material was identified to consist of silty sand and gravel, was loose to compact and generally grey. This layer was encountered at varying moisture conditions, generally moist to dry at shallow depths and was observed to be wet at approximately 1.8 m BGS in BH5-20.

Sand (Fill)

A layer of sand fill material, ranging from approximately 1.3 to 4.2 m in thickness, was encountered from near the ground surface, below a thin layer of silty sand and gravel (fill), in boreholes BH2-20 through BH4-20 drilled as part of the Phase Two ESA. This material was identified to consist of clean, poorly graded (uniform grain size) sand, was loose and brown. This layer was encountered at varying moisture conditions, generally moist to dry at shallow depths and was observed to be wet at approximately 2.4 m BGS in BH4-20.

Silty Clay

A layer of silty clay, ranging from approximately 0.6 to 3.1 m in thickness, was encountered immediately below the silty sand and gravel fill layer in all of the boreholes drilled as part of this Phase Two ESA, with the exception of BH4-20, which had a thick layer of sand fill. This material was identified to consist of silty clay, firm and was grey or brown-grey. This layer was encountered at varying moisture conditions, generally moist at shallow depths becoming wet at depths ranging from 3.2 to 3.8 m BGS.

Petroleum hydrocarbon odours, suspected to be associated with weathered heating oil were observed in BH1-20 in this unit from an approximate depth of 0.8 m BGS extending through to below the silty clay layer. Petroleum hydrocarbon odours, suspected to be associated with weathered gasoline were observed in BH3-20 in this unit from an approximate depth of 2.3 m BGS extending through to below the silty clay layer.

Silty Sand and Gravel (Till)

A layer of silty sand and gravel, at least 0.8 to 3.5 m in thickness, was encountered below the silty clay layer and right above refusal in BH1-20; actual auger refusal was only encountered in BH1-20, as deeper drilling was not required to investigate the contaminants of potential concern in the boreholes drilled as part of this Phase Two ESA. This material consisted of grey silty sand and gravel with some clay was compact and wet. Where present, this material was found or suspected to be underlain by bedrock.

Petroleum hydrocarbon odours, suspected to be associated with weathered heating oil were observed in BH1-20 in this unit extending from the silty clay layer above to an approximate depth of 5.2 m BGS. Petroleum hydrocarbon odours, suspected to be associated with weathered gasoline were observed in BH3-20 in this unit extending from the silty clay layer above to an approximate depth of 5.2 m BGS.

iv. Field Screening Measurements

Initial field screening of the soil samples consisted of visual and olfactory observations made at the time of sample collection during the drilling program.

Additional field screening of the soil samples was completed using an RKI Instruments Model Eagle-2 combustible gas detector ("RKI Eagle"). The RKI Eagle used for soil sample screening as part of this Phase Two ESA was obtained from Maxim Environmental and Safety Inc. and was calibrated by Maxim on June 23, 2020. The RKI Eagle is capable of measuring combustible vapours at concentrations ranging from 0 parts per million (PPM) to 50% of the lower explosive limit (LEL). The RKI Eagle is also capable of measuring VOC vapours at concentrations ranging from 0 ppm to 1000 ppm. Additional equipment and calibration information for the RKI Eagle is provided on the certificate of calibration included in Appendix D.

Where soil samples were selected in a borehole within an APEC and the SAP identified proposed soil analysis in that borehole, the field screening was used as follows to select the appropriate sample for laboratory analysis.

1. Select sample with evidence of visual and/or olfactory indications of suspected contamination, such as staining, PHC odours or deleterious fill material.
2. Select sample with most significant elevated soil vapour concentration.
3. Select sample based on stratigraphy and/or moisture content, as certain CPCs are generally expected to be found in these defined conditions (i.e. fill material at shallow depths or PHC impacts near the groundwater table interface).

v. Groundwater: Monitoring Well Installation

Installation of monitoring wells in BH1-20, BH3-20 and BH5-20 were completed by George Downing Estate Drilling. The wells were installed using slotted PVC No. 10 monitoring well screens, which were 51 mm in diameter; these screens were installed at depths intended to straddle the shallow groundwater table in each of the aforementioned boreholes. Well screens were 3.0 m in length in all three of the monitoring wells installed as part of this Phase Two ESA. The monitoring wells were extended to approximately 0.1 m below the surface grade with PVC riser, also 51 mm in diameter. A threaded PVC end cap was installed at the base of the screen to prevent sediment infiltration, while a J-Plug was installed at the top of the riser to prevent surface influence.

The annular space in each monitoring well was backfilled with clean silica sand to approximately 0.3 m above the monitoring well screens. A layer of bentonite chips was then used to make a hydraulic seal above the sand pack to near the ground surface. The monitoring wells were completed with aluminum flushmount protective casings, which were backfilled with sand to allow drainage of any surface water which may infiltrate into the casings.

Development of each of the monitoring wells was completed using dedicated Waterra low density polyethylene (LDPE) tubing and a Waterra footvalve. The monitoring wells were

developed on June 24, 2020 by purging the wells dry at least three times. The wells were left to stabilize for a period of six days prior to groundwater sampling.

vi. Groundwater: Field Measurement of Water Quality Parameters

Measurements of the groundwater quality field parameters were completed to determine stabilization of these parameters prior to sampling. These measurements were completed using Horiba U-52 groundwater quality measurement device ("Horiba"). The Horiba used for groundwater quality parameter stabilization measurements as part of this Phase Two ESA was obtained from Maxim Environmental and Safety Inc. and was calibrated on June 23, 2020. The Horiba is capable of measuring temperature, pH, conductivity, turbidity, dissolved oxygen and oxidation reduction potential. Additional equipment and calibration information for the Horiba is provided on the certificate of calibration included in Appendix D.

Field measurement of water quality parameters were collected at regular intervals (0 L, 0.5 well volumes, 1 well volume, 2 well volumes, etc.) during purging of the monitoring wells prior to sampling. The Horiba was placed in a flow-through cell and water quality parameters were measured until they were found to stabilize to within approximately 10% of the previous measurements prior to sample collection.

vii. Groundwater: Sampling

Groundwater sampling was completed on June 30, 2020 (six days after well installation). Groundwater samples were collected from monitoring wells BH1-20, BH3-20 and BH5-20, which were installed as part of this Phase Two ESA. Monitoring wells installed in MW-6 and MW-8, which were previously installed at the Phase Two Property within the APECs and in close proximity to APEC #1 / #2 were also sampled as part of this Phase Two ESA; it is suspected that these monitoring wells have their screens set in the overburden to straddle the shallow aquifer.

Stabilized groundwater levels were measured in each of the groundwater monitoring wells prior to disturbance of the water column prior to sampling. The dedicated Waterra LDPE tubing and footvalve was removed from each of the monitoring wells and 6 m Waterra LDPE tubing was placed in each of the monitoring wells. The LDPE tubing was connected to a dedicated length of silicon tubing, run through a peristaltic pump set to low flow (approximately 0.2-0.5 L/minute) during purging and sampling while monitoring groundwater level to minimize the drop in head. The monitoring wells were purged on the day of sampling while water quality parameters were measured as noted above.

Groundwater samples were collected in dedicated amber glass bottles and vials or plastic bottles prepared and provided by the analytical laboratory. Analytes and associated preservatives were specified on each bottle by the laboratory. Each bottle sample set was provided with a unique sample identifier, project number and date of sampling in the field. Samples for PHCs, BTEXs, VOCs, PAHs and general chemistry were unfiltered, while metals samples were field filtered using a dedicated 0.45 µm Waterra filter for each sample.

The field technician changed dedicated sterile nitrile gloves prior to initiating work at each monitoring well and changed gloves prior to sample collection to minimize the potential for cross-contamination.

viii. Sediment: Sampling

There were no natural surface water bodies at the Phase Two Property, and as such no sediment sampling was completed as part of the Phase Two ESA.

ix. Analytical Testing

Soil and groundwater analytical testing was conducted by Paracel Laboratories Ltd. (Paracel). Paracel is accredited by the Canadian Association for Laboratory Accreditation Inc. (CALA) and the National Institute of Standards and Technology (NIST), Standard Services Division, National Voluntary Laboratory Accreditation Program (NVLAP) for specific environmental and IAQ tests listed in the Scopes of Accreditation registered with each association. For the scope of accreditation under CALA Membership Number 1262, Paracel is accredited for analysis including, but not limited to, metals, organics, conventionals, bacteria, mold, and asbestos in various matrices.

x. Residue Management Procedures

Excess soil cuttings from drilling and monitoring well installations were containerized in steel 205 L drums, which were stored in the in the southeast portion of the Property. These drums were marked with a wax crayon indicating the origin location(s) of the cuttings containerized within each.

Groundwater from well development and purging was initially placed in a graduated plastic bucket for volume measurements and then was transferred to a dedicated plastic 205 L drum, which was stored in the southeast portion of the Property. This drum was marked with a wax crayon indicating the origin location(s) of the water containerized within.

Fluids from equipment cleaning and decontamination were containerized within the purge water drum.

xi. Elevation Surveying

An elevation survey was completed of the boreholes/monitoring wells drilled as part of the Phase Two ESA as well as the two existing monitoring wells at the Phase Two Property. The boreholes/monitoring wells were surveyed relative to a temporary benchmark of the top of spindle of the City of Ottawa fire hydrant located at the southwest corner of the Ridgewood Avenue and Dupont Street intersection; this benchmark was assigned a reference elevation of 100.000 m ("Site Datum") for the purposes of this Phase Two ESA. The reference elevations of each borehole/monitoring well are provided on the borehole logs in Appendix C.

xii. Quality Assurance and Quality Control Measures

Soil samples were collected in dedicated clear glass jars prepared and provided by the analytical laboratory. Soil samples collected for BTEXs/VOCs and the F1 range of PHCs analysis were collected using dedicated graduated syringes provided by the laboratory and placed directly into a glass vial with methanol preservative. Analytes and associated preservatives were specified on each jar/vial by the laboratory. Each jar/vial sample set was provided with a unique sample identifier, project number and date of sampling in the field.

Groundwater samples were collected in dedicated amber glass bottles and vials or plastic bottles prepared and provided by the analytical laboratory. Analytes and associated preservatives were specified on each bottle by the laboratory. Each bottle sample set was provided with a unique sample identifier, project number and date of sampling in the field.

Following sample collection, the soil and groundwater samples were stored in an ice pack chilled cooler to minimize volatilization and begin the cooling process on the day of sampling. On each day of sample collection, following completion of the fieldwork, samples were delivered directly to the analytical laboratory. Standard chain of custody procedures were used to maintain a custody record of soil and groundwater samples between the field technician and the analytical laboratory.

The split spoons, which were the only media to come into contact with the soil samples, were washed using soap and water and a scrub brush between samples to minimize the potential for cross contamination among samples. The field technician used sterile nitrile gloves, which were changed prior to the handling of each soil sample to prevent cross-contamination. The field technician changed dedicated sterile nitrile gloves prior to initiating work at each monitoring well and changed gloves prior to groundwater sample collection to minimize the potential for cross-contamination.

A trip blank water sample for VOCs was submitted for laboratory analysis from the groundwater sampling event completed on June 30, 2020. No detectable VOC concentrations were reported in the trip blank water sample.

The soil sample (BH11-20-SS5) was submitted to the laboratory as a blind field duplicate sample of BH1-20-SS5). The ratio of soil duplicate results to original sample results was generally 1 to 25%, which meets the required ratio. The soil duplicate ratios for PAHs and PHCs observed had higher degrees of variability, with ratios ranging from 33 to 120%; it should be noted that where exceedances of the site condition standards were observed, they were present in both samples and that the sample results for these parameters are comparable. Additionally, the high degree of heterogeneity in soil samples can attribute to higher levels of variability in analytical ratios. These samples were analyzed for PHCs, VOCs (including BTEXs), PAHs and metals & inorganics, which provide a blind quality assurance and quality control QA/QC validation for all soil parameters analyzed as part of this Phase Two ESA.

The groundwater sample (BH13-20) was submitted to the laboratory as a blind field duplicate sample of BH3-20. The ratio of groundwater duplicate results to original sample results was generally 1 to 5 or 18% which meets the required ratio. The groundwater duplicate ratios of PAH parameters were found to range from 5 to 120%; however, the instance of higher variability was with individual parameters which were detected at very low concentrations and close to the laboratory method detection limits. The PAH groundwater sample results are generally comparable. The groundwater sample duplicate comparison results for PHC-F1 and benzene, ethylbenzene, toluene and xylenes were between 2% and 7%, which indicates good reliability. The comparison results in the F2 and F3 ranges of PHCs, however, display a high degree of variability. The laboratory was asked to verify the results of the two samples and stated that the extract which was rerun confirmed the original results. Given the magnitude of the PHC-F2 results in the BH3-20 sample, the explanation may be that it contained droplets of product while the dissolved phase concentrations were in good agreement. Given that exceedances of the site condition standards for PHCs were detected in both samples, the variability of these sample results does not affect the validity of the conclusions with respect to these results. These samples were analyzed for PHCs, VOCs (including BTEXs), PAHs and metals & inorganics, which provide a blind quality assurance and quality control QA/QC validation for all groundwater parameters analyzed as part of this Phase Two ESA.

No equipment blank of groundwater was required since the groundwater samples were collected using dedicated tubing.

6. Review and Evaluation

i. Geology

Based on the observations of soil samples collected during the Phase Two ESA field program, there were five stratigraphic units identified at the Phase Two Property, which include:

Asphalt

A layer of asphalt, approximately 0.10 to 0.13 m in thickness, was encountered at the ground surface in BH1-20, BH5-20, BH6-20 and BH7-20.

Silty Sand and Gravel (Fill)

A layer of silty sand and gravel fill material, ranging from approximately 0.1 to 2.2 m in thickness, was encountered from ground surface, immediately below the asphalt layer, or stratified with the sand (fill) layer in boreholes BH2-20 through BH7-20 drilled as part of the Phase Two ESA. This material was identified to consist of silty sand and gravel, was loose to compact and generally grey. This layer was encountered at varying moisture conditions, generally moist to dry at shallow depths and was observed to be wet at approximately 1.8 m BGS in BH5-20.

Sand (Fill)

A layer of sand fill material, ranging from approximately 1.3 to 4.2 m in thickness, was encountered from near the ground surface, below a thin layer of silty sand and gravel (fill), in boreholes BH2-20 through BH4-20 drilled as part of the Phase Two ESA. This material was identified to consist of clean, poorly graded (uniform grain size) sand, was loose and brown. This layer was encountered at varying moisture conditions, generally moist to dry at shallow depths and was observed to be wet at approximately 2.4 m BGS in BH4-20.

Silty Clay

A layer of silty clay, ranging from approximately 0.6 to 3.1 m in thickness, was encountered immediately below the silty sand and gravel fill layer in all of the boreholes drilled as part of this Phase Two ESA, with the exception of BH4-20, which had a thick layer of sand fill. This material was identified to consist of silty clay, firm and was grey or brown-grey. This layer was encountered at varying moisture conditions, generally moist at shallow depths becoming wet at depths ranging from 3.2 to 3.8 m BGS.

Petroleum hydrocarbon odours, suspected to be associated with weathered heating oil were observed in BH1-20 in this unit from an approximate depth of 0.8 m BGS extending through to below the silty clay layer. Petroleum hydrocarbon odours, suspected to be associated with weathered gasoline were observed in BH3-20 in this unit from an approximate depth of 2.3 m BGS extending through to below the silty clay layer.

Silty Sand and Gravel (Till)

A layer of silty sand and gravel, at least 0.8 to 3.5 m in thickness, was encountered below the silty clay layer and right above refusal in BH1-20; practical refusal was only encountered in BH1-20, as deeper drilling was not required to investigate the contaminants of potential concern in the boreholes drilled as part of this Phase Two ESA. This material consisted of grey silty sand and gravel with some clay was compact and wet. Where present, this material was found or suspected to be underlain by suspected bedrock.

Petroleum hydrocarbon odours, suspected to be associated with weathered heating oil were observed in BH1-20 extending from the silty clay layer above this unit to an approximate depth of 5.2 m BGS. Petroleum hydrocarbon odours, suspected to be associated with weathered gasoline were observed in BH3-20 extending from the silty clay layer above to an approximate depth of 5.2 m BGS.

Aquifer

The shallow (unconfined) aquifer is the aquifer of interest based on the nature of APECs and PCAs identified for the Phase Two Property. It is present in several geological units, including the native silty clay and silty sand and gravel (till) layers, as well as in the sand and/or silty sand and gravel fill layers (where present in the former areas of excavation or backfilling).

Based on moisture contents observed in the soil samples collected as part of this Phase Two ESA it is expected that seasonal and annual variability affect the groundwater table elevation in the shallow aquifer.

ii. Groundwater and Elevations and Flow Direction

Based on the nature of the primary CPCs identified for groundwater at the Phase Two Property (including light non-aqueous phase liquids (LNAPLs)), the screened intervals for the groundwater monitoring wells installed as part of this Phase Two ESA were selected to straddle the shallow groundwater table within the overburden. Based on previous investigations, it was suspected that existing monitoring wells located within the APECs at the Phase Two Property had monitoring well screens that are also installed within the overburden and would be expected to straddle the shallow groundwater table, and are thus in same aquifer as the 2020 monitoring wells and could be used for supplemental sampling as part of this Phase Two ESA.

The boreholes/monitoring wells were surveyed relative to a temporary benchmark of the top of spindle of the City of Ottawa fire hydrant located at the southwest corner of the Ridgewood Avenue and Dupont Street intersection, southeast of the Phase Two Property; this benchmark was assigned a reference elevation of 100.000 m (“Site Datum”) for the purposes of this Phase Two ESA.

The shallow groundwater aquifer was present within the overburden on central, central-south and southeast portions of the Phase Two Property. Given the general consistency in depth of the groundwater table in different geological units at the Phase Two Property, it is suspected that the same shallow aquifer exists across these units and can be used for a determination of groundwater flow direction and hydraulic gradient. Monitoring well construction details are presented in Table 1 below.

Table 1: Monitoring Well Construction Details

Monitoring Well	Ground Surface Elevation (m RSD)	Top of Piezometer Elevation (m RSD)	Screen Elevation (m RSD)	Sand Pack Elevation (m RSD)	Bentonite Seal (m RSD)
BH1-20	100.93	100.80	95.45 – 98.50	95.45 – 98.80	98.80 – 100.63
BH3-20	100.15	99.91	94.61 – 97.66	94.61 – 97.96	97.96 – 99.85
BH5-20	100.39	100.31	95.01 – 98.06	95.01 – 98.36	98.36 – 100.09
MW-6	99.73	99.66	93.74 - unknown	unknown	unknown
MW-8	99.89	99.86	93.89 - unknown	unknown	unknown

m RSD – metres Referenced to Site Datum

On June 30, 2020, following a period of six days for stabilization after drilling and developing the monitoring wells, the groundwater levels were measured and are presented in Table 2 below. The groundwater table was measured at depths ranging between 3.15 and 3.90 m BGS on June 30, 2020.

Table 2: Groundwater Table Elevations Measured on June 30, 2020

Monitoring Well	Ground Surface Elevation (m RSD)	Top of Piezometer Elevation (m RSD)	Depth to Groundwater (m below TOP)	Groundwater Table Elevation (m RSD)	Depth to Groundwater (m BGS)
BH1-20	100.93	100.80	3.46	97.34	3.59
BH3-20	100.15	99.91	3.66	96.25	3.90
BH5-20	100.39	100.31	3.10	97.21	3.18
MW-6	99.73	99.66	3.80	95.86	3.87
MW-8	99.89	99.86	3.12	96.74	3.15

m RSD – meters Referenced to Site Datum

m BGS – metres below Ground Surface.

Three groundwater monitoring well water table elevations are required to triangulate groundwater elevations and determine an approximate groundwater flow direction. The groundwater table elevations in BH1-20, BH3-20 and BH5-20 were used for a determination of groundwater flow direction, while MW-8 was used to verify the accuracy of the model. Based on the measured groundwater table elevations in these monitoring wells, the local groundwater flow direction on the central and southeast portion of the Phase Two Property is towards the southeast. This interpreted local groundwater flow direction is reasonable based on the regional topography; however, it is expected that regional groundwater flow is toward the west in the direction of the nearest significant surface water body, the Rideau River, which is 550 m to the west of the Phase Two Property. The water table elevation in MW-8 was treated as an outlier, however, this measure elevation indicates that there is local influence in groundwater flow based on the lower elevation of the adjacent property to the east of the Phase Two Property.

No observations or indications of free product were observed in any of the monitoring wells accessed as part of this Phase Two ESA, as measured with an interface probe during water level measurements, and through observations of the purge water during development and sampling of the monitoring wells. A petroleum hydrocarbon odour, suspected to consist primarily of gasoline, was observed in the groundwater sample collected from BH3-20. Slight to moderate petroleum hydrocarbon odours were observed in the purge water recovered from BH1-20, MW-6 and MW-8

The underground utility corridors associated with the storm and sanitary sewers (exiting the southeast corner of the Phase Two Property) and east water service (accessing the Property on the southeast portion of the Property) do have the potential to affect contaminant distribution and transport, as they would create preferential pathways for lateral migration in the areas of historically identified contaminated soil and groundwater. Based on the depth to groundwater observed in the monitoring wells as part of this investigation, observed between 3.15 and 3.9 m BGS, the potential exists for migration of contaminants through underground utility service trenches (generally approximately 2 to 3 m BGS) during periods of seasonally high groundwater table elevations.

iii. Groundwater: Hydraulic Gradients

The horizontal hydraulic gradient was determined by plotting groundwater contours interpreted from groundwater elevations presented in Table 2 and then by dividing the difference in hydraulic head by the lateral separation distance in the groundwater contours. Based on the measured groundwater elevations in BH1-20, BH3-20 and BH5-20 the horizontal hydraulic gradient at the Phase Two Property is approximately 0.02 m/m.

iv. Course Grained Soil Texture

A substantial layer of native glacial till, consisting of silty sand and gravel, which would be classified as coarse grained soil, is present underlying a silty clay unit to full depth to bedrock on the south and central portions of the Phase Two Property while sand and gravel fill is present near surface elsewhere at the Property. It is interpreted that greater than 1/3 of the Phase Two Property has coarse grained soil. For the purposes of this Phase Two ESA, the soil conditions are considered to be coarse grained, which provides a more conservative comparison to the MECP site condition standards than the fine-grained values.

v. Soil Field Screening

Initial field screening of the soil samples consisted of visual and olfactory observations made at the time of sample collection during the drilling program. Petroleum hydrocarbon odours, suspected to be associated with weathered heating oil were observed in BH1-20 from an approximate depth of 0.8 m BGS extending to an approximate depth of 5.2 m BGS. Petroleum hydrocarbon odours, suspected to be associated with weathered gasoline were observed in BH3-20 from an approximate depth of 2.3 m BGS extending to an approximate depth of 5.2 m BGS.

Additional field screening of the soil samples was completed using an RKI Eagle gas detector. A combustible soil vapour screening concentration of 700 ppm was encountered in soil sample BH3-20-SS6, collected from a depth of 3.8 to 4.4 m BGS; this elevated concentration was suspected to be indicative of PHC contamination. Combustible soil vapour screening concentrations in the other soil samples were found to range from 0 to 55 ppm, which is low and generally not considered indicative of significant PHC contamination.

vi. Soil Quality

Location and Depth of Soil Samples

The following soil samples, which were collected from the boreholes drilled as part of this Phase Two ESA, were submitted for laboratory analysis.

Table 3: Soil Samples Selected for Laboratory Analysis

Sample Location	Sample ID	Sample Depth (m BGS)	Analytical Parameters
BH1-20	BH1-20-SS5	3.1 – 3.7	PHCs, VOCs, PAHs, Metals & Inorganics
Duplicate of BH1-20	BH11-20-SS5	3.1 – 3.7	PHCs, VOCs, PAHs, Metals & Inorganics
BH3-20	BH3-20-SS6	3.8 – 4.4	PHCs, BTEXs, PAHs
BH4-20	BH4-20-SS6	3.8 – 4.4	PHCs, BTEXs, PAHs, Metals & Inorganics
BH5-20	BH5-20-SS4	2.3 – 2.9	PHCs, BTEXs
BH5-20	BH5-20-SS7	4.6 – 5.2	PHCs, VOCs

Comparison of Soil Analytical Results to Applicable Site Conditions Standards

The analytical soil results were compared to the full depth generic site condition standards, with non-potable groundwater, coarse textured soil, for residential property use, as specified in Table 3 of the MECP Soil, Ground Water and Sediment Standards for Use Under Part XV.1 of the Environmental Protection Act, April 15, 2011.

The aforementioned soil samples selected for laboratory analysis were submitted to Paracel under chain of custody No. 54317 on June 24, 2020. The laboratory certificate of analysis (Paracel Report # 2026367) is provided in Appendix E. The following samples had exceedance concentrations reported compared to ('vs.') their respective site condition standards.

- BH1-20-SS5 and BH11-20-SS5 (Duplicate of BH1-20-SS5), collected from a depth of approximately 3.1-3.7 m BGS, had reported concentrations of PHC F2 range (909 µg/g and 306 µg/g vs. 98 µg/g), Methyl-naphthalene (7.61 µg/g and 2.26 µg/g vs. 0.99 µg/g) and reported concentrations of vanadium (101 µg/g and 104 µg/g vs. 86 µg/g). These samples also had respective cobalt concentrations of 20.1 µg/g and 22.5 µg/g compared to the site condition standard of 22 µg/g; since the average concentration of cobalt in these samples is less than the site condition standard, the marginal exceedance in the duplicate standard is not considered to exceed the site condition standard.
- BH3-20-SS6, collected from a depth of approximately 3.8-4.4 m BGS, had reported concentrations of PHC F1 range (117 µg/g vs. 55 µg/g), PHC F2 range (110 µg/g vs. 98 µg/g), benzene (3.02 µg/g vs. 0.21 µg/g), ethylbenzene (59 µg/g vs. 2 µg/g), toluene (73.5 µg/g vs.

2.3 µg/g) and xylenes (276 µg/g vs. 3.1 µg/g). Additionally, PAH exceedances from the same soil sample included Methyl-naphthalene (1.95 µg/g vs. 0.99 µg/g) and Naphthalene (1.69 µg/g vs. 0.6 µg/g).

All of the other analyzed soil samples were in compliance with the site condition standards. A full summary of the soil analytical results and comparison to the applicable site condition standards are presented in Table 1: Soil Analytical Results following the text of this report.

Comparison of TCLP Analytical Results to O.Reg. 558/00

A waste characterization sample was selected for laboratory analysis of toxicity characteristic leaching procedure (TCLP) analysis for flashpoint, leachate metals & inorganics, leachate VOCs and leachate organics (PAHs and polychlorinated biphenyls (PCBs)). This sample was comprised of a composite of worst-case samples, as determined by field screening parameters, from BH1-20 and BH3-20.

The aforementioned composite soil sample selected for TCLP laboratory analysis was submitted to Paracel under chain of custody No. 54317 on June 24, 2020. The laboratory certificate of analysis (Paracel Report # 2026368) is provided in Appendix E.

This composite sample was compared to the criteria specified in schedule IV of O.Reg. 558/00 and no measured parameter exceeded the toxicity criteria. Based on the analytical results and field screening, if excess soil generated from redevelopment of the Site cannot be reused as clean fill at an appropriate receiving site, it can be treated as solid non-hazardous waste.

A full summary of the soil analytical results and comparison to the Schedule IV of O.Reg. 558/00 standards are presented in Table 2: TCLP Analytical Results following the text of this report.

Contaminants of Concern

The presence of a former retail fuel outlet and automotive service garage were identified on the southeast portion of the Phase One Property (APEC #1 / #2). The contaminants of potential concern associated with retail fuelling are petroleum hydrocarbons (PHCs) and benzene, toluene, ethylbenzene and xylenes (BTEXs), and metals, since this was an older facility and lead was historically present in gasoline. Based on historical soil analysis in this area of the Property, PAH and VOCs are also considered contaminants of potential concern associated with the former automotive garage operations. The practice of backfilling following demolition activities was identified on the central-south portion of the Phase One Property (APEC #3). The contaminants of potential concern commonly found in poor environmental quality backfill are PHCs/BTEXs, polycyclic aromatic hydrocarbons (PAHs) and metals. Based on the operations observed at the active automotive service garage (APEC #4), the contaminants of concern associated with this activity are PHCs and BTEXs.

The contaminants of concern for a particular sample were based on the relative location and depth of the sample, visual and/or olfactory observations and combustible vapour screening concentrations.

Contaminants Related to Chemical and Biological Transformations

Contaminants related to chemical and biological transformations were not suspected to be present at the Phase Two Property and were not identified as part of the Phase Two ESA soil analysis.

Soil Serving as a Source of Contaminant Mass Contributing to Groundwater

Based on the analytical results, there may be soil that serves as a source of contaminant mass contributing to groundwater at the Phase Two Property. Soil contamination, namely PHCs and BTEXs were encountered at the southeast portion of the Phase Two Property (APEC #1 – former retail fuel outlet) and in the central-south portion of the Phase Two Property (APEC #3 – placement of fill material of unknown quality). There are detectable concentrations of PHCs and BTEXs in these areas of the Phase Two Property and it is suspected that soil serving as a source of contaminant mass is contributing to groundwater quality.

Light or Dense Non-Aqueous Phase Liquids

The analytical soil results indicate the potential presence of light non-aqueous phase liquids (LNAPLs) at the Phase Two Property, given that PHCs and BTEXs were identified in excess of the site condition standards. It should be noted that the concentrations of PHCs and BTEXs which exceed the site condition standards in the soil are not themselves indicative of the suspected presence of LNAPL free product at the Phase Two Property.

The analytical soil results do not indicate the suspected presence of dense non-aqueous phase liquids at the Phase to Property.

- vii. Groundwater Quality

Locations and Sample Depth Interval of Groundwater Samples

The groundwater samples were collected using a peristaltic pump with tubing lowered to between the top and approximate (vertical) center of the water column within each monitoring well and withdrawing the water at low flow rates. The groundwater sample locations, screen depths and parameters analyzed are presented in Table 4 below.

Table 4: Groundwater Samples Selected for Laboratory Analysis

Sample Location	Groundwater Level (m RSD)	Screen Depth (m RSD)	Analytical Parameters
BH1-20	97.34	95.45 – 98.50	PHCs, VOCs, PAHs, Metals & Inorganics
BH3-20	96.25	94.61 – 97.66	PHCs, VOCs, PAHs, Metals & Inorganics
BH13-20 (Duplicate of BH3-20)	96.25	94.61 – 97.66	PHCs, VOCs, PAHs, Metals & Inorganics
BH5-20	97.21	95.01 – 98.06	PHCs, BTEXs, PAHs
MW-6	95.86	93.74 - unknown	PHCs, BTEXs
MW-8	96.74	93.89 - unknown	PHCs, BTEXs

m RSD – metres Referenced to Site Datum

Field Filtering

Samples for PHCs, BTEXs, VOCs, PAHs and general chemistry were unfiltered, while metals samples were field filtered using a dedicated 0.45 µm Waterra filter for each sample.

Comparison of Groundwater Analytical Results to Applicable Site Conditions Standards

The analytical groundwater results were compared to the full depth generic site condition standards, with non-potable groundwater, coarse textured soil, as specified in Table 3 of the MECP Soil, Ground Water and Sediment Standards for Use Under Part XV.1 of the Environmental Protection Act, April 15, 2011.

The groundwater samples selected for laboratory analysis were submitted to Paracel under chain of custody No. 126519 on June 30, 2020. The laboratory certificate of analysis (Paracel Report # 2027199) is provided in Appendix E. The following samples had exceedance concentrations reported compared to ('vs.') their respective site condition standards.

- BH3-20 and BH13-20 (Duplicate of BH3-20), collected from a screen depth of approximately 2.5-5.5 m BGS, had reported concentrations of PHC F1 range (3,600 µg/g and 3,790 µg/g vs. 750 µg/g), PHC F2 range (52,400 µg/g and 2,260 µg/g vs. 150 µg/g), PHC F3 range (3,940 µg/g vs. 500 µg/g), benzene (19,300 µg/g and 19,700 µg/g vs. 44 µg/g), ethylbenzene (3,800 µg/g and 3,700 µg/g vs. µg/g), toluene (65,200 µg/g and 60,900 µg/g vs. 18,000 µg/g) and xylenes (27,600 µg/g and 26,600 µg/g vs. 4,200 µg/g). Lead was also reported at concentrations of 51.6 µg/g and 54.6 µg/g vs. 25 µg/g.

All of the other groundwater samples were in compliance with the site condition standards. A full summary of the groundwater analytical results and comparison to the applicable site

condition standards are presented in Table 3: Groundwater Analytical Results following the text of this report.

Contaminants of Concern

The contaminants of potential concern associated with retail fueling (APEC #1) are generally PHCs and BTEXs, and metals, since this was an older facility and lead was historically present in gasoline. Based on historical groundwater analysis at the Property, PAH and VOCs are limited contaminants of potential concern in selected areas of the Property and are suspected to have been associated with the former automotive garage operations (APEC #2). The contaminants of potential concern commonly found in poor environmental quality backfill (APEC #3) are PHCs/BTEXs, PAHs and metals. Based on the operations observed at the active automotive service garage (APEC #4), the contaminants of concern associated with this activity are PHCs and BTEXs.

The contaminants of concern for a particular sample were based on the relative location and depth of the sample, visual and/or olfactory observations of soil samples collected which could have come into contact with the groundwater table.

Contaminants Related to Chemical and Biological Transformations

Contaminants related to chemical and biological transformations were not suspected to be present at the Phase Two Property and were not identified as part of the Phase Two ESA groundwater analysis.

Soil Serving as a Source of Contaminant Mass Contributing to Groundwater

Based on the groundwater analytical results, there may be soil that serves as a source of contaminant mass contributing to groundwater at the Phase Two Property. Soil contamination, namely PHCs and BTEXs were encountered at the southeast portion of the Phase Two Property (APEC #1 – former retail fuel outlet) and in the central-south portion of the Phase Two Property (APEC #3 – placement of fill material of unknown quality). There are detectable concentrations of PHCs and BTEXs in soil in these areas of the Phase Two Property, and in the instance of APEC #1 there was identified groundwater contamination, and it is suspected that soil serving as a source of contaminant mass is contributing to groundwater quality.

Light or Dense Non-Aqueous Phase Liquids

The analytical groundwater results indicate the potential presence of light non-aqueous phase liquids (LNAPLs) at the Phase Two Property, given that PHCs and BTEXs were identified in excess of the site condition standards and at significant concentrations in the sample (and duplicate) from the monitoring well installed in BH3-20. It should be noted that the presence of measurable levels LNAPL free product were not observed at the Phase Two Property, as measured with an interface probe and with observations of the purge water recovered from the

monitoring wells. A light sheen was observed on the purge water recovered from the monitoring well installed in BH3-20.

The analytical groundwater results do not indicate the suspected presence of dense non-aqueous phase liquids at the Phase Two Property.

viii. Sediment Quality

There were no natural surface water bodies at the Phase Two Property, and as such no sediment sampling was completed as part of the Phase Two ESA.

ix. Quality Assurance and Quality Control Results

The soil sample (BH11-20-SS5) was submitted to the laboratory as a blind field duplicate sample of BH1-20-SS5). These samples were analyzed for PHCs, VOCs (including BTEXs), PAHs and metals & inorganics, which provide a blind quality assurance and quality control QA/QC validation for all soil parameters analyzed as part of this Phase Two ESA.

The groundwater sample (BH13-20) was submitted to the laboratory as a blind field duplicate sample of BH3-20. These samples were analyzed for PHCs, VOCs (including BTEXs), PAHs and metals & inorganics, which provide a blind quality assurance and quality control QA/QC validation for all groundwater parameters analyzed as part of this Phase Two ESA.

The soil sample (BH11-20-SS5) was submitted to the laboratory as a blind field duplicate sample of BH1-20-SS5). The ratio of soil duplicates to samples was generally 1 to 25%, which meets the required ratio. The soil duplicate ratios for PAHs and PHCs observed had higher degrees of variability, with ratios ranging from 33 to 120%; it should be noted that where exceedances of the site condition standards were observed, they were observed in both samples and that the sample results for these parameters are comparable. Additionally, the high degree of heterogeneity in soil samples can attribute to higher levels of variability in analytical ratios. These samples were analyzed for PHCs, VOCs (including BTEXs), PAHs and metals & inorganics, which provide a blind quality assurance and quality control QA/QC validation for all soil parameters analyzed as part of this Phase Two ESA.

The groundwater sample (BH13-20) was submitted to the laboratory as a blind field duplicate sample of BH3-20. The ratio of groundwater duplicates to samples was generally 1 to 5 or 18% which meets the required ratio. The groundwater duplicate ratios of PAH parameters were found to range from 5 to 120%; however, the instance of higher variability was with individual parameters which were detected at very low concentrations and close to the laboratory method detection limits. The PAH groundwater sample results are generally comparable. The groundwater sample duplicate comparison results for PHC-F1 and benzene, ethylbenzene, toluene and xylenes were between 2% and 7%, which indicates good reliability. The comparison results in the F2 and F3 ranges of PHCs however display a high degree of variability. The laboratory was asked to verify the results of the two samples and stated that the extract which was rerun confirmed the original results. Given the magnitude of the PHC-F2 results in the BH3-

20 sample, the explanation may be that it contained droplets of product while the dissolved phase concentrations were in good agreement. Given that exceedances of the site condition standards for PHCs were detected in both samples, the variability of these sample results does not affect the validity of the conclusions with respect to these results. These samples were analyzed for PHCs, VOCs (including BTEXs), PAHs and metals & inorganics, which provide a blind quality assurance and quality control QA/QC validation for all groundwater parameters analyzed as part of this Phase Two ESA. The QA/QC duplicate sample results demonstrate that the data are reliable, appropriate and accurate in the determination of whether the phase two property meets the applicable site condition standards.

The laboratory made qualifying statements for login criteria on several sample results due to the difference in naming convention on the soil jars and vials compared to what was presented on the chain of custody. In these circumstances, the labeling on the jar was made for simplicity and no concerns are present with respect to the validity of any of the laboratory results. The laboratory noted that elevated detection limits were presented for the duplicate groundwater sample from BH3-20 due to dilution required because of high target analyte concentration; it should be noted that the original sample did not have elevated detection limits. The qualifying remarks in certificates of analysis are not expected to impact the validity of any results qualified.

All certificates of analysis were received pursuant to clause 47 (2) (b) of O.Reg. 153/04 and comply with subsection 47 (3) of O.Reg. 153/04.

The overall quality of the field data from the investigation with respect to the data quality objectives, demonstrate that decision-making was not affected, and the overall objectives of the investigation and the assessment were met.

x. Phase Two Conceptual Site Model

The presence of a former retail fuel outlet and automotive service garage on the southeast portion of the Phase One Property are a significant PCAs which represent APEC #1 / #2 for the Property. Given that reports were provided which document remnant PHC/BTEXs soil contamination and that groundwater quality was not confirmed following the completion a remediation program, further investigation is warranted. The contaminants of potential concern associated with retail fuelling are generally PHCs and BTEXs, with older facilities also having concerns associated with metals, as lead was historically present in gasoline. Based on historical soil analysis in this area of the Property, PAH and VOCs are also considered contaminants of potential concern associated with the former automotive garage operations.

The practice of backfilling following demolition activities at the Phase One Property is a significant PCA which represents APEC #3 for the Property. Given that no reports were provided with analytical data to support the environmental quality of the backfill used to fill the former suspected residential building footprint on the central-south portion of the Property, this area warrants further investigation. The contaminants of potential concern commonly found in poor environmental quality backfill are PHCs/BTEXs, PAHs and metals.

The presence of an active automotive service garage was observed on the central portion of the Phase One Property at the time of the Site Investigation. Although this garage has only been operating for a short time period (2017 to present), these operations are a PCA which represents APEC #4 for the Property. Based on the observations at this automotive garage, that contaminants of potential concern are considered to be PHCs and BTEXs.

Various underground utility services, including natural gas, electricity, water and sewers were identified at the Phase Two Property. The natural gas, water and sewer services are present in underground trenches which enter the Property from Ridgewood Avenue to the south and lead to the commercial buildings. Electricity enters the property through an underground service trench to the north of the north commercial building. The underground utility corridors associated with the storm and sanitary sewers (exiting the southeast corner of the Phase Two Property) and east water service (accessing the Property on the southeast portion of the Property) do have the potential to affect contaminant distribution and transport, as they would create preferential pathways for lateral migration in the areas of historically identified contaminated soil and groundwater.

The overburden stratigraphy of the Phase Two Property is present in five geological units, including an asphalt layer at ground surface, silty sand and gravel (fill) layer, sand (fill) layer primarily present on the southeast portion of the Property, a native silty clay layer present across the Property and a native silty sand and gravel layer, found below the silty clay across the Property.

The shallow (unconfined) aquifer is the aquifer of interest based on the nature of APECs and PCAs identified for the Phase Two Property. It is present in across several geological units, including the native silty clay and silty sand and gravel (till) layers, as well as in the sand and/or silty sand and gravel fill layers (where present in the former areas of excavation or backfilling). The aquifer is expected to have higher permeability in more porous stratigraphic units such as the silty sand and gravel and sand fill, while the shallow aquifer in the silty clay layer is expected to have low permeability and restrict the movement of groundwater and associated contaminants.

The overburden soil is underlain by interbedded shale and limestone bedrock at depths ranging from approximately 6 to 8 m BGS.

The groundwater table was measured at depths ranging between 3.15 and 3.90 m BGS. The shallow groundwater aquifer was present within the overburden on central, central-south and southeast portions of the Phase Two Property. Given the general consistency in depth of the groundwater table in different geological units at the Phase Two Property, it is suspected that the same shallow aquifer exists across these units and can be used for a determination of groundwater flow direction and hydraulic gradient. The horizontal hydraulic gradient on the southeast portion of the Phase Two Property was calculated to be approximately 0.02 m/m with a localized groundwater flow direction towards the southeast.

The proposed redevelopment of the Phase Two Property includes construction of one building with five adjoining segments ranging from seven to twenty storeys in height, with subgrade parking, commercial ground floors and residential units above.

The Phase Two Property and all other properties within 250 m of the property boundaries are supplied by Ottawa's municipal potable water supply system. The RSC does not specify agricultural use and there are no wells within 250 m of the property boundaries that are intended for use as a source of water for human consumption or agriculture. As such, the designation of non-potable groundwater setting is determined to be applicable [O.Reg. 153/04, section 35].

The Phase Two Property is not situated within or adjacent to an area of natural significance and does not include any land within 30 m of an area of natural significance. The pH of the soil was analyzed as part of this Phase Two ESA and was found to range from 7.24 to 7.51. As such, the Phase Two Property is not considered to be an environmentally sensitive area [O.Reg. 153/04, section 41].

Review of the drilling program and borehole/monitoring well logs completed as part of this Phase Two ESA and previous investigations was completed. It was determined that greater than 2/3 of the Phase Two Property has greater than 2 m of overburden soil. The Phase Two Property is not considered a shallow soil property [O.Reg. 153/04, section 43.1].

The Phase Two Property does not include and does not have any land located within 30 m of a water body. The MECP site condition standards for use within 30 m of a water body do not apply [O.Reg. 153/04, section 43.1].

The full depth generic site condition standards, with non-potable groundwater, coarse textured soil, for residential property use, as specified in Table 3 of the MECP Soil, Ground Water and Sediment Standards for Use Under Part XV.1 of the Environmental Protection Act, April 15, 2011 were determined to be the applicable site condition standards for the Phase Two Property as part of this Phase Two ESA.

The soil samples BH1-20-SS5 and BH11-20-SS5 (Duplicate of BH1-20-SS5), collected from a depth of approximately 3.1-3.7 m BGS, had reported concentrations of PHC F2 range (909 µg/g and 306 µg/g vs. 98 µg/g), Methylnaphthalene (7.61 µg/g and 2.26 µg/g vs. 0.99 µg/g) and reported concentrations of vanadium (101 µg/g and 104 µg/g vs. 86 µg/g). These samples also had respective cobalt concentrations of 20.1 µg/g and 22.5 µg/g compared to the site condition standard of 22 µg/g; since the average concentration of cobalt in these samples is less than the site condition standard, the marginal exceedance in the duplicate standard is not considered to exceed the site condition standard. It should be noted that based on past investigations, it has been observed that both Cobalt and Vanadium are known to exceed MECP standards in Ottawa region natural soils, particularly clay.

The soil sample BH3-20-SS6, collected from a depth of approximately 3.8-4.4 m BGS, had reported concentrations of PHC F1 range (117 µg/g vs. 55 µg/g), PHC F2 range (110 µg/g vs. 98 µg/g), benzene (3.02 µg/g vs. 0.21 µg/g), ethylbenzene (59 µg/g vs. 2 µg/g), toluene (73.5 µg/g vs. 2.3 µg/g) and xylenes (276 µg/g vs. 3.1 µg/g). Additionally, PAH exceedances from the same soil sample included Methylnaphthalene (1.95 µg/g vs. 0.99 µg/g) and Naphthalene (1.69 µg/g vs. 0.6 µg/g).

The groundwater samples BH3-20 and BH13-20 (Duplicate of BH3-20), collected from a screen depth of approximately 2.5-5.5 m BGS, had reported concentrations of PHC F1 range (3,600 µg/g and 3,790 µg/g vs. 750 µg/g), PHC F2 range (52,400 µg/g and 2,260 µg/g vs. 150 µg/g), PHC F3 range (3,940 µg/g vs. 500 µg/g), benzene (19,300 µg/g and 19,700 µg/g vs. 44 µg/g), ethylbenzene (3,800 µg/g and 3,700 µg/g vs. µg/g), toluene (65,200 µg/g and 60,900 µg/g vs. 18,000 µg/g) and xylenes (27,600 µg/g and 26,600 µg/g vs. 4,200 µg/g). Lead was also reported at concentrations of 51.6 µg/g and 54.6 µg/g vs. 25 µg/g.

All of the other soil and groundwater results for the Phase Two Property are in compliance with the applicable site condition standards. The Phase Two Property is not in compliance with the site condition standards as of the certification date of June 30, 2020.

7. Conclusions

The soil samples BH1-20-SS5 and BH11-20-SS5 (Duplicate of BH1-20-SS5), collected from a depth of approximately 3.1-3.7 m BGS, had reported concentrations of PHC F2 range (909 µg/g and 306 µg/g vs. 98 µg/g), Methylnaphthalene (7.61 µg/g and 2.26 µg/g vs. 0.99 µg/g) and reported concentrations of vanadium (101 µg/g and 104 µg/g vs. 86 µg/g). These samples also had respective cobalt concentrations of 20.1 µg/g and 22.5 µg/g compared to the site condition standard of 22 µg/g; since the average concentration of cobalt in these samples is less than the site condition standard, the marginal exceedance in the duplicate standard is not considered to exceed the site condition standard. It should be noted that based on past investigations, it has been observed that both Cobalt and Vanadium are known to exceed MECP standards in Ottawa region natural soils, particularly clay.

The soil sample BH3-20-SS6, collected from a depth of approximately 3.8-4.4 m BGS, had reported concentrations of PHC F1 range (117 µg/g vs. 55 µg/g), PHC F2 range (110 µg/g vs. 98 µg/g), benzene (3.02 µg/g vs. 0.21 µg/g), ethylbenzene (59 µg/g vs. 2 µg/g), toluene (73.5 µg/g vs. 2.3 µg/g) and xylenes (276 µg/g vs. 3.1 µg/g). Additionally, PAH exceedances from the same soil sample included Methylnaphthalene (1.95 µg/g vs. 0.99 µg/g) and Naphthalene (1.69 µg/g vs. 0.6 µg/g).

The groundwater samples BH3-20 and BH13-20 (Duplicate of BH3-20), collected from a screen depth of approximately 2.5-5.5 m BGS, had reported concentrations of PHC F1 range (3,600 µg/g and 3,790 µg/g vs. 750 µg/g), PHC F2 range (52,400 µg/g and 2,260 µg/g vs. 150 µg/g), PHC F3 range (3,940 µg/g vs. 500 µg/g), benzene (19,300 µg/g and 19,700 µg/g vs. 44 µg/g), ethylbenzene (3,800 µg/g and 3,700 µg/g vs. µg/g), toluene (65,200 µg/g and 60,900 µg/g vs. 18,000 µg/g) and xylenes (27,600 µg/g and 26,600 µg/g vs. 4,200 µg/g). Lead was also reported at concentrations of 51.6 µg/g and 54.6 µg/g vs. 25 µg/g.

All of the other soil and groundwater results for the Phase Two Property are in compliance with the applicable site condition standards. The Phase Two Property is not in compliance with the site condition standards as of the certification date of June 30, 2020.

It is suspected that remnant soil and/or groundwater contamination may be present near the east Property limits of the Phase Two Property based on historical sampling data, however, this could not be confirmed as part of this Phase Two ESA due to physical impediments (fencing) during the drilling program. Additional investigation and confirmation of soil and groundwater quality in this area of the Property is recommended at the time of excavation for site redevelopment. It should be noted that the proposed redevelopment includes excavation for at least two to three levels of underground parking, which is expected to be sufficient for remediation of the aforementioned environmental contamination at the Phase Two Property.

An environmental remediation program, including the bulk removal and off-site disposal of soil and groundwater in excess of the site condition standards is recommended for the Phase Two Property. Given the scope and timeline for the proposed redevelopment and the requirements for specialized construction techniques to complete remediation of the Phase Two Property to meet the site condition standards, it is recommended that remediation be completed in conjunction with redevelopment of the Property.

Further delineation and confirmation of remediation sampling will be required prior to the completion of an environmental remediation and program and confirmation of compliance with the site condition standards; however, these tasks can be completed at the time decommissioning and demolition of existing structures at the Phase Two Property. The submission of a record of site condition would be required in the event of a change of zoning of the Phase Two Property; however, these tasks can be completed at the time decommissioning and demolition of existing structures at the Phase Two Property. The Phase Two ESA could be then updated at that time to show compliance with site condition standards.

Preparation of a soil management plan in accordance with O.Reg. 406/19 will be required as part of management of excess soil generated as part of construction activities. It is recommended that a remedial action plan be prepared to develop a strategy for remediation, including soil and groundwater management, during redevelopment.

i. Signatures

The Qualified Person for this study is Mr. Luke Lopers, P. Eng. Mr. Lopers has been a Professional Engineer, registered in Ontario since 2012 and has been working on environmental site assessments since 2006. Mr. Lopers has been an author, project manager and/or peer reviewer for hundreds of Phase One ESAs and Phase Two ESAs as well as previously filed RSCs.

The reviewer for this study is Mr. Don Plenderleith, P.Eng. Mr. Plenderleith is a Professional Engineer registered in Ontario since 1994 and has authored and/or reviewed hundreds of Phase One and Two ESAs in Ontario and the rest of Canada. The qualifications of the assessor/Qualified Person and reviewer are included in Appendix F.

Sincerely,



Luke Lopers, P.Eng., QP_{ESA}



Don Plenderleith, P.Eng., QP_{ESA}

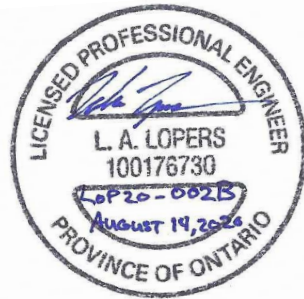

8. Limitations

The findings and conclusions of this Phase Two ESA are based on the information provided and/or reviewed as part of this study.

This Phase Two ESA has been completed with the standard of care generally expected in the industry for a study of this nature.

This Phase Two ESA has been prepared for the sole use of 11684663 Canada Inc. for the purposes of a due diligence assessment of the potential liabilities which may exist at the Phase Two Property. No other party is permitted to rely on the conclusions or findings of this report without the written consent of Lopers & Associates and 11684663 Canada Inc.

Changes to the physical setting of the Phase Two Property, Phase One Study Area and applicable regulations governing Phase One and Two Environmental Site Assessments have the potential to influence the validity of the conclusions and opinions presented in this Phase Two ESA.

9. References

Legal Survey Plan, Fairhall, Moffatt & Woodland Limited, dated January 8, 2018.

City of Ottawa, geoOttawa mapping website, Visited June through July, 2020.

<http://maps.ottawa.ca/geottawa/>

Google Earth, Visited June through July, 2020.

"Soil, Ground Water and Sediment Standards for Use Under Part XV.1 of the Environmental Protection Act", produced by the Ontario Ministry of the Environment, dated April 15, 2011.

"Phase One Environmental Site Assessment, 729 Ridgewood Avenue, Ottawa, Ontario" dated July 27, 2020 prepared for 11684663 Canada Inc. by Lopers & Associates.

"Phase II Environmental Site Assessment, 729 Ridgewood Avenue, Ottawa, Ontario", dated January 12, 2018, completed by Pinchin Ltd. for Canadian Rental Development Services Inc.

"Verification Soil Sampling Program, 729 Ridgewood Avenue, Ottawa, Ontario", dated October 19, 2018, completed by Pinchin Ltd. for 561226 Ontario Inc.

Parcel Certificate of Analysis – Report # 2026367 - Soil Sample Submission June 24, 2020

Parcel Certificate of Analysis – Report # 2026368 - TCLP Sample Submission June 24, 2020

Parcel Certificate of Analysis – Report # 2027199 - Groundwater Sample Submission June 30, 2020

10. Appendices

Appendix A – Sampling and Analysis Plan

Appendix B – Underground Utility Locates

Appendix C – Borehole Logs

Appendix D – Certificates of Equipment Calibration

Appendix E – Laboratory Certificates of Analysis

Appendix F – Qualifications of Assessors

Figures

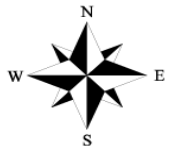

LOPERS & ASSOCIATES

Figure 1: Key Plan
 Phase Two Environmental Site Assessment
 729 Ridgewood Avenue, Ottawa, Ontario
 11684663 Canada Inc.

Project Reference No: LOP20-002B
 Drawing No.: LOP20-002B-1
 Date: July 24, 2020
 Author: L. Lopers
 Source: geoOttawa, Base Mapping

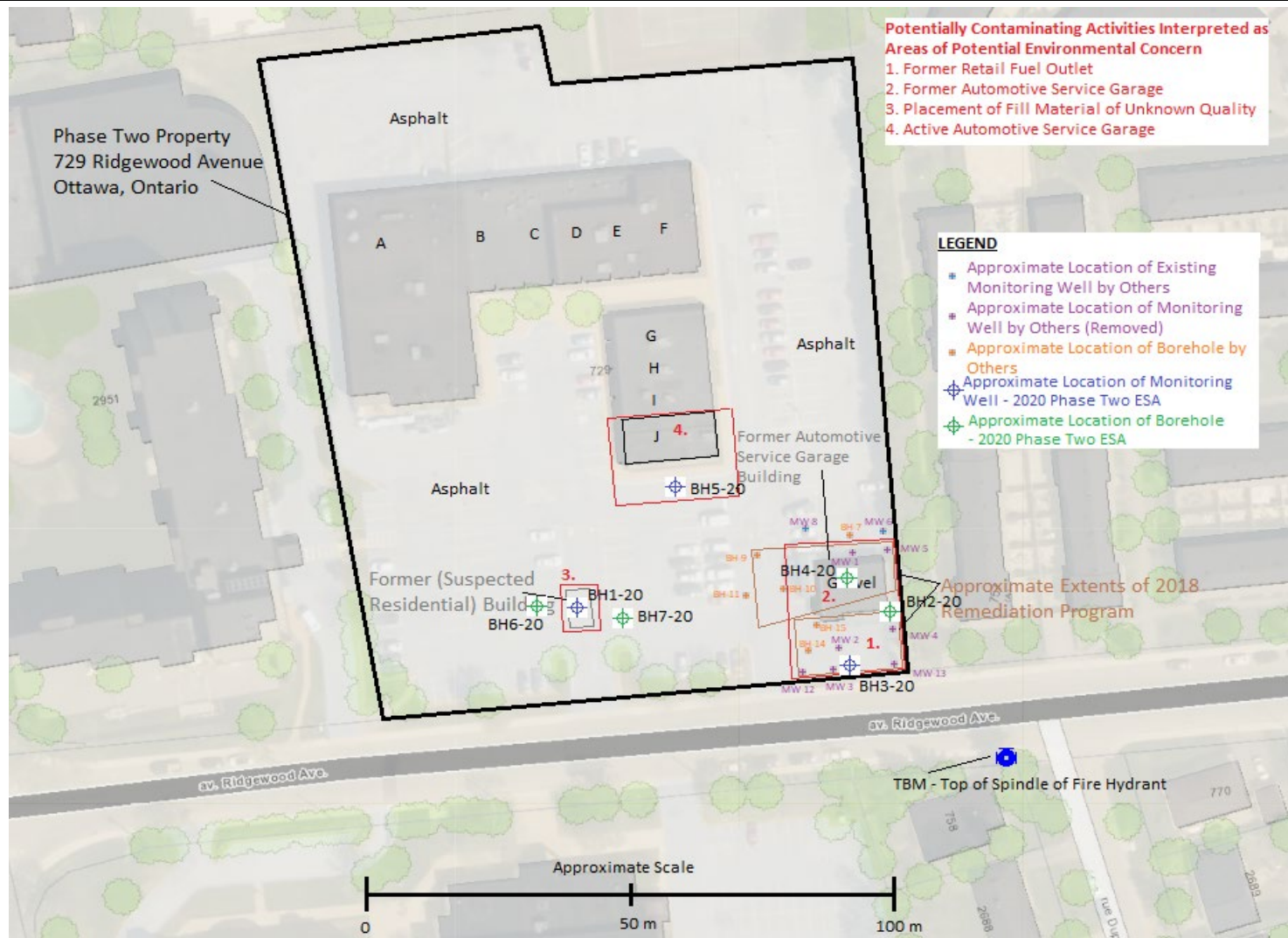

Figure 2: Site Plan
 Phase Two Environmental Site Assessment
 729 Ridgewood Avenue, Ottawa, Ontario
 11684663 Canada Inc.

Project Reference No: LOP20-002B
 Drawing No.: LOP20-002B-2
 Date: July 27, 2020
 Author: L. Lopers
 Source: geoOttawa, Base Mapping

Tables

Table 5: Soil Analytical Results

729 Ridgewood Avenue, Ottawa, Ontario

		Sample Location:		BH1-20-SS5	BH11-20-SS5	BH3-20-SS6	BH4-20-SS6	BH5-20-SS4	BH5-20-SS7
		Sample Depth:		3.1-3.7 m BGS	3.1-3.7 m BGS	3.8-4.4 m BGS	3.8-4.4 m BGS	2.3-2.9 m BGS	4.6-5.2 m BGS
		Sample Date:		June 24, 2020	June 24, 2020	June 24, 2020	June 24, 2020	June 24, 2020	June 24, 2020
		Laboratory Sample ID:		2026367-01	2026367-06	2026367-02	2026367-03	2026367-04	2026367-05
Parameter	Units	Method Detection Limit (MDL)	MECP Table 3: Residential Property Use Standard Coarse Grain Soil						
Petroleum Hydrocarbons (PHCs)									
F1 PHCs (C6-C10)	ug/g	7	55	22	34	117	ND	ND	ND
F2 PHCs (C10-C16)	ug/g	4	98	909	306	110	ND	ND	ND
F3 PHCs (C16-C34)	ug/g	8	300	102	25	11	ND	ND	ND
F4 PHCs (C34-C50)	ug/g	6	2800	ND	ND	ND	ND	ND	ND
F4G PHCs (gravimetric)	ug/g	50	2800	-	-	-	-	-	-
Volatile Organic Compounds (VOCs)									
Acetone	ug/g	0.50	16	ND	ND	-	-	-	ND
Benzene	ug/g	0.02	0.21	ND	ND	3.02	ND	ND	ND
Bromodichloromethane	ug/g	0.05	13	ND	ND	-	-	-	ND
Bromoform	ug/g	0.05	0.27	ND	ND	-	-	-	ND
Bromomethane	ug/g	0.05	0.05	ND	ND	-	-	-	ND
Carbon Tetrachloride	ug/g	0.05	0.05	ND	ND	-	-	-	ND
Chlorobenzene	ug/g	0.05	2.4	ND	ND	-	-	-	ND
Chloroform	ug/g	0.05	0.05	ND	ND	-	-	-	ND
Dibromochloromethane	ug/g	0.05	9.4	ND	ND	-	-	-	ND
Dichlorodifluoromethane	ug/g	0.05	16	ND	ND	-	-	-	ND
1,2-Dichlorobenzene	ug/g	0.05	3.4	ND	ND	-	-	-	ND
1,3-Dichlorobenzene	ug/g	0.05	4.8	ND	ND	-	-	-	ND
1,4-Dichlorobenzene	ug/g	0.05	0.083	ND	ND	-	-	-	ND
1,1-Dichloroethane	ug/g	0.05	3.5	ND	ND	-	-	-	ND
1,2-Dichloroethane	ug/g	0.05	0.05	ND	ND	-	-	-	ND
1,1-Dichloroethylene	ug/g	0.05	0.05	ND	ND	-	-	-	ND
cis-1,2-Dichloroethylene	ug/g	0.05	3.4	ND	ND	-	-	-	ND
trans-1,2-Dichloroethylene	ug/g	0.05	0.084	ND	ND	-	-	-	ND
1,2-Dichloropropane	ug/g	0.05	0.05	ND	ND	-	-	-	ND
cis-1,3-Dichloropropylene	ug/g	0.05	ND	ND	ND	-	-	-	ND
trans-1,3-Dichloropropylene	ug/g	0.05	ND	ND	ND	-	-	-	ND
1,3-Dichloropropene, total	ug/g	0.05	0.05	ND	ND	-	-	-	ND
Ethylbenzene	ug/g	0.05	2	ND	ND	59	ND	ND	ND
Ethylene dibromide (dibromoethane, 1,2-)	ug/g	0.05	0.05	ND	ND	-	-	-	ND
Hexane	ug/g	0.05	2.8	ND	ND	-	-	-	ND
Methyl Ethyl Ketone (2-Butanone)	ug/g	0.50	16	ND	ND	-	-	-	ND
Methyl Isobutyl Ketone	ug/g	0.50	1.7	ND	ND	-	-	-	ND
Methyl tert-butyl ether	ug/g	0.05	0.75	ND	ND	-	-	-	ND
Methylene Chloride	ug/g	0.05	0.1	ND	ND	-	-	-	ND
Styrene	ug/g	0.05	0.7	ND	ND	-	-	-	ND
1,1,1,2-Tetrachloroethane	ug/g	0.05	0.058	ND	ND	-	-	-	ND
1,1,2,2-Tetrachloroethane	ug/g	0.05	0.05	ND	ND	-	-	-	ND
Tetrachloroethylene	ug/g	0.05	0.28	ND	ND	-	-	-	ND
Toluene	ug/g	0.05	2.3	ND	ND	73.5	ND	ND	ND
1,1,1-Trichloroethane	ug/g	0.05	0.38	ND	ND	-	-	-	ND
1,1,2-Trichloroethane	ug/g	0.05	0.05	ND	ND	-	-	-	ND
Trichloroethylene	ug/g	0.05	0.061	ND	ND	-	-	-	ND
Trichlorofluoromethane	ug/g	0.05	4	ND	ND	-	-	-	ND
Vinyl Chloride	ug/g	0.02	0.02	ND	ND	-	-	-	ND
m/p-Xylene	ug/g	0.05	NV	ND	0.08	196	ND	ND	ND
o-Xylene	ug/g	0.05	NV	ND	ND	80.3	ND	ND	ND
Xylenes, total	ug/g	0.05	3.1	ND	0.08	276	ND	ND	ND
Polycyclic Aromatic Hydrocarbons									
Acenaphthene	ug/g	0.02	7.9	0.07	0.05	ND	ND	-	-
Acenaphthylene	ug/g	0.02	0.15	0.11	0.03	ND	ND	-	-
Anthracene	ug/g	0.02	0.67	ND	ND	ND	ND	-	-
Benzo[a]anthracene	ug/g	0.02	0.5	ND	ND	ND	ND	-	-
Benzo[a]pyrene	ug/g	0.02	0.3	ND	ND	ND	ND	-	-
Benzo[b]fluoranthene	ug/g	0.02	0.78	ND	ND	ND	ND	-	-
Benzo[g,h,i]perylene	ug/g	0.02	6.6	ND	ND	ND	ND	-	-
Benzo[k]fluoranthene	ug/g	0.02	0.78	ND	ND	ND	ND	-	-
Chrysene	ug/g	0.02	7	ND	ND	ND	ND	-	-
Dibenzo[a,h]anthracene	ug/g	0.02	0.1	ND	ND	ND	ND	-	-
Fluoranthene	ug/g	0.02	0.69	ND	ND	ND	ND	-	-
Fluorene	ug/g	0.02	62	0.26	0.1	ND	ND	-	-
Indeno[1,2,3-cd]pyrene	ug/g	0.02	0.38	ND	ND	ND	ND	-	-
1-Methylnaphthalene	ug/g	0.02	0.99	3.02	0.89	0.58	ND	-	-
2-Methylnaphthalene	ug/g	0.02	0.99	4.58	1.38	1.37	ND	-	-
Methylnaphthalene (1&2)	ug/g	0.04	0.99	7.61	2.26	1.95	ND	-	-
Naphthalene	ug/g	0.01	0.6	0.5	0.26	1.69	ND	-	-
Phenanthrene	ug/g	0.02	6.2	0.13	0.07	ND	ND	-	-
Pyrene	ug/g	0.02	78	ND	ND	ND	ND	-	-
Metals									
Boron, available	ug/g	0.5	1.5	ND	ND	-	ND	-	-
Chromium (VI)	ug/g	0.2	8	0.3	0.3	-	ND	-	-
Mercury	ug/g	0.1	0.27	ND	ND	-	ND	-	-
Antimony	ug/g	1.0	7.5	ND	ND	-	ND	-	-
Arsenic	ug/g	1.0	18	3.9	4	-	3.7	-	-
Barium	ug/g	1.0	390	284	327	-	46.3	-	-
Beryllium	ug/g	0.5	4	0.7	0.9	-	ND	-	-
Boron	ug/g	5.0	120	5.8	7.2	-	6.5	-	-
Cadmium	ug/g	0.5	1.2	ND	ND	-	ND	-	-
Chromium	ug/g	5.0	160	104	126	-	13.1	-	-
Cobalt	ug/g	1.0	22	20.1	22.5	-	5.6	-	-
Copper	ug/g	5.0	140	45.5	49	-	12.4	-	-
Lead	ug/g	1.0	120	6.1	6.8	-	5.2	-	-
Molybdenum	ug/g	1.0	6.9	ND	ND	-	ND	-	-
Nickel	ug/g	5.0	100	56.1	65.4	-	10.6	-	-
Selenium	ug/g	1.0	2.4	ND	ND	-	ND	-	-
Silver	ug/g	0.3	20	ND	ND	-	ND	-	-
Thallium	ug/g	1.0	1	ND	ND	-	ND	-	-
Uranium	ug/g	1.0	23	ND	ND	-	ND	-	-
Vanadium	ug/g	10.0	86	101	104	-	23.5	-	-
Zinc	ug/g	20.0	340	92.7	114	-	ND	-	-
General Inorganics									
SAR	N/A	0.01	5	0.76	0.81	-	1.12	-	-
Conductivity	uS/cm	5	700	636	670	-	627	-	-
Cyanide, free	ug/g	0.03	0.051	ND	ND	-	ND	-	-
pH	pH Units	0.05	NV	7.14	7.33	-	7.4	-	-

NV - No value listed in MECP site condition standards
 - - Not Analyzed
 ND - Not detected above laboratory method detection limits
 Exceeds MECP site condition standards

Table 6: TCLP Analytical Results
729 Ridgewood Avenue, Ottawa, Ontario

Parameter	Units	Method Detection Limit (MDL)	Sample ID: TCLP	
			Laboratory Sample ID: 2026368-01	Sample Date: June 24, 2020
			Reg 558 Schedule IV	
Physical Characteristics				
Flashpoint	°C			>70
TCLP Leachate Inorganics				
Fluoride	mg/L	0.05	150	0.32
Nitrate as N	mg/L	1	1000	ND
Nitrite as N	mg/L	1	1000	ND
Cyanide, free	mg/L	0.02	20	ND
TCLP Leachate Metals				
Mercury	mg/L	0.005	0.1	ND
Arsenic	mg/L	0.05	2.5	ND
Barium	mg/L	0.05	100	0.97
Boron	mg/L	0.05	500	0.05
Cadmium	mg/L	0.01	0.5	ND
Chromium	mg/L	0.05	5	ND
Lead	mg/L	0.05	5	ND
Selenium	mg/L	0.05	1	ND
Silver	mg/L	0.05	5	ND
Uranium	mg/L	0.05	10	ND
TCLP Leachate Volatiles				
Benzene	mg/L	0.005	0.5	ND
Carbon Tetrachloride	mg/L	0.005	0.5	ND
Chlorobenzene	mg/L	0.004	8	ND
Chloroform	mg/L	0.006	10	ND
1,2-Dichlorobenzene	mg/L	0.004	20	ND
1,4-Dichlorobenzene	mg/L	0.004	0.5	ND
1,2-Dichloroethane	mg/L	0.005	0.5	ND
1,1-Dichloroethylene	mg/L	0.006	1.4	ND
Methyl Ethyl Ketone (2-Butanone)	mg/L	0.30	200	ND
Methylene Chloride	mg/L	0.04	5	ND
Tetrachloroethylene	mg/L	0.005	3	ND
Trichloroethylene	mg/L	0.004	5	ND
Vinyl Chloride	mg/L	0.005	0.2	ND
TCLP Leachate Organics				
Benzo[a]pyrene	mg/L	0.0001	0.13	ND
Benzo[a]pyrene	mg/L	0.0001	0.001	ND
Nitrobenzene	mg/L	0.001	2	ND
Hexachloroethane	mg/L	0.001	3	ND
Hexachlorobenzene	mg/L	0.050	0.13	ND
Hexachlorobutadiene	mg/L	0.001	-	ND
2,3,4,6-Tetrachlorophenol	mg/L	0.002	10	ND
2,4,5-Trichlorophenol	mg/L	0.001	400	ND
2,4,6-Trichlorophenol	mg/L	0.001	0.5	ND
2,4-Dichlorophenol	mg/L	0.001	90	ND
2-Methylphenol	mg/L	0.001	200	ND
3/4-Methylphenol	mg/L	0.001	200	ND
Pentachlorophenol	mg/L	0.005	6	ND
PCBs, total	mg/L	0.003	0.3	ND

ND - Not detected above laboratory method detection limits

Table 7: Groundwater Analytical Results

729 Ridgewood Avenue, Ottawa, Ontario

Parameter	Units	Method Detection Limit (MDL)	MECP Table 3 Standards Coarse Grain Soil	Sample Location:				MW-6	MW-8	Trip Blank
				BH1-20	BH3-20	BH13-20 Duplicate of BH3-20	BH5-20			
				Sample Date: Laboratory Sample ID:	Sample Date: Laboratory Sample ID:	Sample Date: Laboratory Sample ID:	Sample Date: Laboratory Sample ID:			
				June 30, 2020 2027199-01	June 30, 2020 2027199-02	June 30, 2020 2027199-04	June 30, 2020 2027199-03	June 30, 2020 2027199-05	June 30, 2020 2027199-06	June 30, 2020 2027199-07
Petroleum Hydrocarbons (PHCs)										
F1 PHCs (C6-C10)	ug/L	25	750	123	3600	3790	ND	ND	ND	-
F2 PHCs (C10-C16)	ug/L	100	150	ND	52400	2260	ND	ND	ND	-
F3 PHCs (C16-C34)	ug/L	100	500	ND	3940	ND	ND	ND	ND	-
F4 PHCs (C34-C50)	ug/L	100	500	ND	ND	ND	ND	ND	ND	-
Volatile Organic Compounds (VOCs)										
Acetone	ug/L	5.0	130000	ND	ND (2500)	ND (2500)	-	-	-	ND
Benzene	ug/L	0.5	44	ND	19300	19700	-	-	-	ND
Bromodichloromethane	ug/L	0.5	85000	ND	ND (250)	ND (250)	-	-	-	ND
Bromoform	ug/L	0.5	380	ND	ND (250)	ND (250)	-	-	-	ND
Bromomethane	ug/L	0.5	5.6	ND	ND (250)	ND (250)	-	-	-	ND
Carbon Tetrachloride	ug/L	0.2	0.79	ND	ND (100)	ND (100)	-	-	-	ND
Chlorobenzene	ug/L	0.5	630	ND	ND (250)	ND (250)	-	-	-	ND
Chloroform	ug/L	0.5	2.4	ND	ND (250)	ND (250)	-	-	-	ND
Dibromochloromethane	ug/L	0.5	82000	ND	ND (250)	ND (250)	-	-	-	ND
Dichlorodifluoromethane	ug/L	1.0	4400	ND	ND (500)	ND (500)	-	-	-	ND
1,2-Dichlorobenzene	ug/L	0.5	4600	ND	ND (250)	ND (250)	-	-	-	ND
1,3-Dichlorobenzene	ug/L	0.5	9600	ND	ND (250)	ND (250)	-	-	-	ND
1,4-Dichlorobenzene	ug/L	0.5	8	ND	ND (250)	ND (250)	-	-	-	ND
1,1-Dichloroethane	ug/L	0.5	320	ND	ND (250)	ND (250)	-	-	-	ND
1,2-Dichloroethane	ug/L	0.5	1.6	ND	ND (250)	ND (250)	-	-	-	ND
1,1-Dichloroethylene	ug/L	0.5	1.6	ND	ND (250)	ND (250)	-	-	-	ND
cis-1,2-Dichloroethylene	ug/L	0.5	1.6	ND	ND (250)	ND (250)	-	-	-	ND
trans-1,2-Dichloroethylene	ug/L	0.5	1.6	ND	ND (250)	ND (250)	-	-	-	ND
1,2-Dichloropropane	ug/L	0.5	16	ND	ND (250)	ND (250)	-	-	-	ND
cis-1,3-Dichloropropylene	ug/L	0.5	NV	ND	ND (250)	ND (250)	-	-	-	ND
trans-1,3-Dichloropropylene	ug/L	0.5	NV	ND	ND (250)	ND (250)	-	-	-	ND
1,3-Dichloropropene, total	ug/L	0.5	5.2	ND	ND (250)	ND (250)	-	-	-	ND
Ethylbenzene	ug/L	0.5	2300	ND	3800	3700	-	-	-	ND
Ethylene dibromide (dibromoethane, 1,2)	ug/L	0.2	0.25	ND	ND (100)	ND (100)	-	-	-	ND
Hexane	ug/L	1.0	51	ND	ND (500)	ND (500)	-	-	-	ND
Methyl Ethyl Ketone (2-Butanone)	ug/L	5.0	470000	ND	ND (2500)	ND (2500)	-	-	-	ND
Methyl Isobutyl Ketone	ug/L	5.0	140000	ND	ND (2500)	ND (2500)	-	-	-	ND
Methyl tert-butyl ether	ug/L	2.0	190	ND	ND (1000)	ND (1000)	-	-	-	ND
Methylene Chloride	ug/L	5.0	610	ND	ND (2500)	ND (2500)	-	-	-	ND
Styrene	ug/L	0.5	1300	ND	ND (250)	ND (250)	-	-	-	ND
1,1,1,2-Tetrachloroethane	ug/L	0.5	3.3	ND	ND (250)	ND (250)	-	-	-	ND
1,1,1,2,2-Tetrachloroethane	ug/L	0.5	3.2	ND	ND (250)	ND (250)	-	-	-	ND
Tetrachloroethylene	ug/L	0.5	1.6	ND	ND (250)	ND (250)	-	-	-	ND
Toluene	ug/L	0.5	18000	ND	65200	60900	-	-	-	ND
1,1,1-Trichloroethane	ug/L	0.5	640	ND	ND (250)	ND (250)	-	-	-	ND
1,1,2-Trichloroethane	ug/L	0.5	4.7	ND	ND (250)	ND (250)	-	-	-	ND
Trichloroethylene	ug/L	0.5	1.6	ND	ND (250)	ND (250)	-	-	-	ND
Trichlorofluoromethane	ug/L	1.0	2500	ND	ND (500)	ND (500)	-	-	-	ND
Vinyl Chloride	ug/L	0.5	0.5	ND	ND (250)	ND (250)	-	-	-	ND
m/p-Xylene	ug/L	0.5	NV	ND	19200	18200	-	-	-	ND
o-Xylene	ug/L	0.5	NV	ND	8400	8320	-	-	-	ND
Xylenes, total	ug/L	0.5	4200	ND	27600	26600	-	-	-	ND
Polycyclic Aromatic Hydrocarbons										
Acenaphthene	ug/L	0.05	600	0.12	0.29	0.21	ND	-	-	-
Acenaphthylene	ug/L	0.05	1.8	0.06	0.08	ND	ND	-	-	-
Anthracene	ug/L	0.01	2.4	ND	0.04	0.03	ND	-	-	-
Benzo[a]anthracene	ug/L	0.01	4.7	0.02	ND	ND	ND	-	-	-
Benzo[a]pyrene	ug/L	0.01	0.81	ND	ND	ND	ND	-	-	-
Benzo[b]fluoranthene	ug/L	0.05	0.75	ND	ND	ND	ND	-	-	-
Benzo[g,h,i]perylene	ug/L	0.05	0.2	ND	ND	ND	ND	-	-	-
Benzo[k]fluoranthene	ug/L	0.05	0.4	ND	ND	ND	ND	-	-	-
Chrysene	ug/L	0.05	1	ND	ND	ND	ND	-	-	-
Dibenzo[a,h]anthracene	ug/L	0.05	0.52	ND	ND	ND	ND	-	-	-
Fluoranthene	ug/L	0.01	130	0.21	0.04	0.01	0.19	-	-	-
Fluorene	ug/L	0.05	400	0.28	0.41	0.27	ND	-	-	-
Indeno[1,2,3-cd]pyrene	ug/L	0.05	0.2	ND	ND	ND	ND	-	-	-
1-Methylnaphthalene	ug/L	0.05	1800	18.2	50.8	37.8	ND	-	-	-
2-Methylnaphthalene	ug/L	0.05	1800	10.4	87.3	79.7	ND	-	-	-
Methylnaphthalene (1&2)	ug/L	0.10	1800	28.6	138	118	ND	-	-	-
Naphthalene	ug/L	0.05	1400	11.3	419	392	0.08	-	-	-
Phenanthrene	ug/L	0.05	580	0.69	0.34	0.19	0.43	-	-	-
Pyrene	ug/L	0.01	68	0.4	0.07	0.03	0.37	-	-	-
Metals										
Mercury	ug/L	0.1	0.29	ND	ND	ND	-	-	-	-
Antimony	ug/L	0.5	20000	ND	ND	ND	-	-	-	-
Arsenic	ug/L	1	1900	1	1	1	-	-	-	-
Barium	ug/L	1	29000	874	1880	1880	-	-	-	-
Beryllium	ug/L	0.5	67	ND	ND	ND	-	-	-	-
Boron	ug/L	10	45000	27	25	26	-	-	-	-
Cadmium	ug/L	0.1	2.7	ND	ND	ND	-	-	-	-
Chromium	ug/L	1	810	ND	ND	ND	-	-	-	-
Chromium (VI)	ug/L	10	140	ND	ND	ND	-	-	-	-
Cobalt	ug/L	0.5	66	11.3	6.5	6.8	-	-	-	-
Copper	ug/L	0.5	87	1.2	1	1.2	-	-	-	-
Lead	ug/L	0.1	25	ND	51.2	54.6	-	-	-	-
Molybdenum	ug/L	0.5	9200	1.2	1.4	1.4	-	-	-	-
Nickel	ug/L	1	490	23	12	13	-	-	-	-
Selenium	ug/L	1	63	ND	3	3	-	-	-	-
Silver	ug/L	0.1	1.5	ND	ND	ND	-	-	-	-
Sodium	ug/L	200	2300000	174000	202000	209000	-	-	-	-
Thallium	ug/L	0.1	510	ND	ND	ND	-	-	-	-
Uranium	ug/L	0.1	420	9.2	11.2	11.2	-	-	-	-
Vanadium	ug/L	0.5	250	1.2	1.1	1.2	-	-	-	-
Zinc	ug/L	5	1100	ND	7	ND	-	-	-	-
General Inorganics										
Cyanide, free	ug/L	2	66	ND	ND	ND	-	-	-	-
pH	pH Units	0.1	NV	7	7.2	7.2	-	-	-	-
Chloride	mg/L	1	2300	918	833	828	-	-	-	-

NV - No value listed in MECP site condition standards

- - Not Analyzed

ND - Not detected above laboratory method detection limits

ND(250) - Not detected above elevated laboratory method detection limits due to high analyte concentrations. Elevated MDL listed in "()"

Exceeds MECP site condition standards

Appendix A

Sampling and Analysis Plan

Sampling and Analysis Plan

729 Ridgewood Avenue
Ottawa, Ontario

Prepared for:
11684663 Canada Inc.



Table of Contents

1. Background	1
2. Planning Site Investigation - Specific Objectives	2
3. Underground Utility Service Locates	2
4. Planning Site Investigation - Specific Requirements	3
i. Media for Investigation	3
ii. Locations and Depths for Sampling	3
iii. Parameters for Laboratory Analysis	3
5. Quality Assurance and Quality Control	4
5.1 Field Equipment Decontamination	4
5.2 Trip Blanks	5
5.3 Field Duplicates	5
5.4 Equipment Calibration	5
5.5 Data Quality Objectives.....	5
6. Standard Operating Procedures	6
6.1 Borehole Drilling	6
6.2 Soil Sampling.....	6
6.3 Field Soil Screening Measurements.....	6
6.4 Monitoring Well Installation.....	7
6.5 Elevation Survey	7
6.6 Monitoring Well Development;.....	7
6.7 Field Measurement of Water Quality Indicators.....	8
6.8 Groundwater Sampling	8

1. Background

Lopers & Associates (Lopers) was retained by 11684663 Canada Inc. (Brigil) to complete a Phase Two Environmental Site Assessment (Phase Two ESA) of the commercial property with Civic address No. 729 Ridgewood Avenue, Ottawa, Ontario ("Phase Two Property", "Property" or "Site").

Lopers has previously completed a Phase One Environmental Site Assessment (Phase One ESA) for Brigil at the Property. The Phase One ESA identified the presence of four potentially contaminating activities (PCAs) at the Property which were interpreted to represent areas of potential environmental concern (APECs).

The presence of a former retail fuel outlet and automotive service garage on the southeast portion of the Phase One Property are a significant potentially contaminating activities (PCAs) which represents areas of potential environmental concern (APECs) for the Property. Given that previous reports were provided which document remnant petroleum hydrocarbon (PHC) and benzene, toluene, ethylbenzene and xylenes (BTEX) soil contamination and that groundwater quality was not confirmed following the completion of a remediation program, further investigation is warranted. The contaminants of potential concern associated with retail fuelling are generally PHCs and BTEXs, and metals as this was an older facility and lead was historically present in gasoline. Based on historical soil analysis in this area of the Property, polycyclic aromatic hydrocarbons (PAH) and volatile organic compounds (VOCs) are also considered contaminants of potential concern associated with the former automotive garage operations.

The practice of backfilling following demolition activities at the Phase One Property is also a significant PCA which represents an APEC for the Property. Given that no reports were provided with analytical data to support the environmental quality of the backfill used to fill the former residential building footprint on the central-south portion of the Property, this area warrants further investigation. The contaminants of potential concern commonly found in poor environmental quality backfill are PHCs/BTEXs, PAHs and metals.

The presence of an active automotive service garage was observed during the Site walk over on the central portion of the Phase One Property at the time of the Site Investigation. Although this garage has only been operating for a short time period (2017 to present), these operations are a PCA which represents an APEC for the Property. Based on the observations at this automotive garage, that contaminants of potential concern are considered to be PHCs and BTEXs.

The scope of work for the Phase Two ESA includes drilling 5 boreholes at the Phase Two Property.

Three of the boreholes will be instrumented with groundwater monitoring wells with screens installed in the overburden. The two existing groundwater monitoring wells at the Phase Two Property, which were installed as part of historical investigations, may also be accessed and sampled to supplement the groundwater quality assessment.

In the event that additional contaminants of APECs are identified during the drilling or sampling fieldwork, additional scope of work will be discussed with Brigil to complete the Phase Two ESA.

2. Planning Site Investigation - Specific Objectives

The following are the specific objectives for planning a site investigation of the Phase Two Environmental Site Assessment, as defined in O.Reg. 153/04.

1. To plan an investigation that will achieve the general objectives of a Phase Two Environmental Site Assessment,
 - i. through the use of an appropriate and complete information base concerning the Phase Two Property, and
 - ii. through the conduct of an investigation based both on information obtained before the Phase Two Environmental Site Assessment begins and on the incorporation of information obtained during the Phase Two Environmental Site Assessment.
2. To develop a sampling and analysis plan that will adequately assess all areas of the Phase Two Property where contaminants may be present in land or water on, in or under the Property.
3. To develop a quality assurance program that is designed to effectively limit errors and bias in sampling and analysis through implementation of assessment and control measures that will ensure data are useful, appropriate and accurate in the determination of whether the Phase Two Property, or any record of site condition (RSC) property within it, meets applicable site condition standards and any standards specified in a risk assessment.

3. Underground Utility Service Locates

Prior to completing the Phase Two ESA field investigation activities, public underground locates will be coordinated through Ontario One Call. Privately owned underground services and infrastructure are present at the Phase Two Property, as such, private locates were undertaken by USL-1 Underground Service Locators Inc.

The locations of the proposed boreholes will be reviewed in relation to the public underground locates and locations will be modified accordingly if conflicts exist between any location or if the location is in close proximity to an active underground service.

A copy of the public and private underground locates will be retained by Lopers' field personnel during all excavation components of the fieldwork.

4. Planning Site Investigation - Specific Requirements

The qualified person has ensured the following requirements were met in planning a site investigation. The Phase One conceptual site model for the Phase One Environmental Site Assessment report was used in conjunction with other information in determining:

i. Media for Investigation

Soil and groundwater sampling and analysis for the purpose of assessing environmental quality will be completed as part of the Phase Two ESA.

There are no surface water bodies at the Phase Two Property, as such, sediment and surface water quality sampling and analysis will not be completed as part of this Phase Two ESA.

ii. Locations and Depths for Sampling

A total of three borehole locations have been proposed to provide coverage of the APECs identified at the Phase Two Property. Boreholes will be located in the southeast portion of the Property to assess APEC #1 /2. One borehole has been proposed in the central-south portion of the Property to assess APEC #3. One borehole has been proposed in the central portion of the Phase Two Property to assess APEC #4.

Sampling depths will include as a minimum, collection of samples in 0.6 m intervals from the ground surface to native soil conditions within the groundwater table. Borehole/monitoring wells depths are proposed to be drilled to approximately 4 m to 6 m BGS to intercept the groundwater table in APECs where groundwater quality assessment is required.

iii. Parameters for Laboratory Analysis.

The parameters for laboratory analysis will be selected based on the contaminants of potential concern for each APEC as well as the field screening observations.

The contaminants of potential concern associated with retail fueling and a former automotive service garage (APEC #1 / 2) are generally PHCs and BTEXs, with older facilities also having concerns associated with metals, as lead was historically present in gasoline. Based on historical

soil analysis in this area of the Property, PAH and VOCs are also considered contaminants of potential concern associated with the former automotive garage operations.

The contaminants of potential concern commonly found in poor environmental quality backfill (APEC #3) are PHCs/BTEXs, PAHs and metals.

Based on the observations at the active automotive garage (APEC #4), the contaminants of potential concern are considered to be PHCs and BTEXs.

The contaminants of concern for a particular sample will be based on the relative location and depth of the sample, visual and/or olfactory observations and combustible vapour screening concentrations.

Information obtained after the completion of the phase one environmental site assessment shall be used to modify the investigation, as appropriate.

5. Quality Assurance and Quality Control

The qualified person has ensured that there is a quality assurance and quality control program, data quality objectives, standard operating procedures and a description of any physical impediments that interfere with or limit the ability to conduct sampling and analysis.

The quality assurance and quality control program includes the following requirements:

5.1 Field Equipment Decontamination

All non-dedicated sampling and monitoring equipment must be cleaned following each use.

The split spoons, which are the only media to come into contact with the soil samples, will be washed using soap and water and a scrub brush between samples to minimize the potential for cross-contamination among samples. The field technician will use sterile nitrile gloves, which are to be changed prior to the handling of each soil sample to further reduce the potential of cross-contamination. The flights of the hollow stem augers are to be cleaned manually following each borehole.

Water level monitoring equipment, including water level meters and interface probes will be decontaminated with an environmentally safe cleaning solution and rinsed with deionized water between water level readings to prevent cross contamination.

The field technician will change dedicated sterile nitrile gloves prior to initiating work at each monitoring well and change gloves prior to sample collection to minimize the potential for cross-contamination.

5.2 Trip Blanks

Since groundwater samples are to be analyzed for benzene, toluene, ethylbenzene and xylenes (BTEXs), which are components of volatile organic compounds (VOCs), one trip blank sample shall be submitted for laboratory analysis with each laboratory submission of groundwater samples.

5.3 Field Duplicates

Sufficient field duplicate samples shall be collected in each medium (soil and groundwater) being sampled, so that at least one field duplicate sample can be submitted for laboratory analysis for every ten samples submitted for laboratory analysis.

At least one field duplicate sample shall be submitted for laboratory analysis for every ten samples submitted for laboratory analysis.

One field duplicate will be submitted from each medium sampled for each parameter suite analyzed as part of this Phase Two ESA.

5.4 Equipment Calibration

Field screening of the soil samples will be completed using an RKI Instruments Model Eagle-2 combustible gas detector ("RKI Eagle"). The RKI Eagle used for soil sample screening as part of this Phase Two ESA will be obtained from Maxim Environmental and Safety Inc. and will be calibrated prior to use.

Measurements of the groundwater quality field parameters will be completed to determine stabilization of these parameters prior to sampling. These measurements will be completed using Horiba U-52 groundwater quality measurement device ("Horiba"). The Horiba used for groundwater quality parameter stabilization measurements as part of this Phase Two ESA will be obtained from Maxim Environmental and Safety Inc. and will be calibrated prior to use.

5.5 Data Quality Objectives

The data quality objectives for all types of field data collected during the Phase Two Environmental Site Assessment field investigation that set the level of uncertainty in environmental data shall be such that,

- (a) the decision-making is not affected; and
- (b) the overall objectives of the investigation are met.

6. Standard Operating Procedures

Standard operating procedures were developed for all of the following field investigation methods used in the field investigation.

6.1 Borehole Drilling

The drilling field program will be completed under full time supervision of Lopers & Associates personnel. The drilling subcontractor retained for the Phase Two ESA is George Downing Estate Drilling, located at 410 Principale Rue, Grenville-Sur-la-Rouge, Quebec, J0V 1B0. The drill rig used for the Phase Two ESA will be a track mounted CME drill, equipped with hollow stem augers and stainless steel split spoons. Operation of the drilling equipment is the responsibility of the drilling subcontractor, who is trained and competent in the operation of this equipment.

The field technician logs the drilling and recovery of soil samples from each borehole, noting the soil type, physical and environmental characteristics at each borehole location on the field borehole logs.

6.2 Soil Sampling

Samples are to be collected from auger cuttings at the ground surface for surficial samples (0-0.6 m below ground surface (m BGS)) and then using split spoons for subsequent samples. Split spoon samples are generally not collected from surficial depths, as poor recovery of loose packed fill material does not yield sufficient volume of samples required for field screening or laboratory analysis. Split spoon samples, collected in 0.6 m segments, are to be recovered at continuous 0.76 m intervals; the additional 0.16 m between split spoon samples will be over-drilled to provide undisturbed field measurement of geotechnical parameters (blow counts) and to prevent cave in materials from stratigraphic units above the intended sampling intervals from being collected at unrepresentative depths during sampling.

Soil samples are initially collected in Ziploc bags for initial screening as part of sample selection. Soil samples selected for laboratory analysis are collected in dedicated clear glass jars prepared and provided by the analytical laboratory. Soil samples collected for BTEXs/VOCs and the F1 range of PHCs analysis are collected using a dedicated graduated syringe provided by the laboratory and placed directly into a glass vial with methanol preservative. Analytes and associated preservatives are specified on each jar/vial by the laboratory. Each jar/vial sample set is provided with a unique sample identifier, project number and date of sampling in the field.

6.3 Field Soil Screening Measurements

Initial field screening of the soil samples will consist of visual and olfactory observations made at the time of sample collection during the drilling program.

Additional field screening of the soil samples will be completed using an RKI Instruments Model Eagle-2 combustible gas detector ("RKI Eagle"). The RKI Eagle is capable of measuring combustible vapours at concentrations ranging from 0 parts per million (PPM) to 50% of the lower explosive limit (LEL). The RKI Eagle is also capable of measuring VOC vapours at concentrations ranging from 0 ppm to 1000 ppm.

6.4 Monitoring Well Installation

Installation of monitoring wells in selected boreholes is to be completed by George Downing Estate Drilling, who is a licensed well driller in accordance with O.Reg. 903. The wells will be installed using slotted PVC No. 10 monitoring well screens, which are 51 mm in diameter; these screens are to be installed at the base of each of the aforementioned boreholes, directly above the bedrock surface. Well screens can range from 1.5 m to 4.5 m in length. The monitoring wells are extended to approximately 1.0 m above the surface grade with PVC riser, also 51 mm in diameter. A threaded PVC end cap should be installed at the base of the screen to prevent sediment infiltration, while a J-Plug is installed at the top of the riser to prevent surface influence.

The annular space in each monitoring well is to be backfill with clean silica sand to approximately 0.3 m above the monitoring well screens. A layer of bentonite chips is then used to make a hydraulic seal above the sand pack to near the ground surface. The monitoring wells are to be completed with steel stickup protective casings, which were backfilled with sand to provide stability to the casing and PVC riser.

6.5 Elevation Survey

An elevation survey of all boreholes and monitoring wells will be conducted following the completion of the drilling program. A fixed temporary benchmark should be used as a reference elevation; the top of the spindle of a fire hydrant is preferred for this purpose as geodetic elevations can be obtained for these points. The reference benchmark should be assigned a field site datum of 100.00 m for the purposes of the elevation survey. The ground surface elevation of all boreholes should be surveyed. The top of piezometer of each monitoring well should also be surveyed; this allows for higher accuracy in the interpretation of groundwater elevations.

6.6 Monitoring Well Development;

Groundwater monitoring wells will be developed on the day of drilling using LDPE tubing and a footvalve. At least three and up to ten well volumes will be removed from the monitoring wells in order to remove as much sediment as possible from the wells. In cases where the monitoring well goes dry prior to purging three well volumes, the well should be purged dry a minimum of three times, waiting at least one hour between purging events. The LDPE tubing should be removed from the monitoring wells following well development.

6.7 Field Measurement of Water Quality Indicators

Field measurement of water quality parameters were collected at regular intervals (0 L, 0.5 well volumes, 1 well volume, 2 well volumes, etc.) during purging of the monitoring wells prior to sampling. The Horiba was placed in a flow-through cell and water quality parameters were measured until they were found to stabilize to within approximately 10% of the previous measurements prior to sample collection.

6.8 Groundwater Sampling

Follow a period of stabilization after drilling and monitoring well development (1 week recommended), static groundwater elevations are measured relative to the top of piezometer at each groundwater monitoring well on the day of sampling, prior to disturbance of the water column.

Following static groundwater elevation measurements, 6 mm LDPE tubing is placed in each of the monitoring wells. The LDPE tubing is connected to silicon tubing, run through a peristaltic pump set to low flow (approximately 0.2-0.5 L/minute) during purging and sampling. The peristaltic pump is used to avoid mixture of sediment into the groundwater column and prevent volatilization during sample collection. The monitoring wells are purged on the day of sampling while water quality parameters were measured and stabilize as noted above.

Groundwater samples are collected in dedicated amber glass bottles and vials or plastic bottles prepared and provided by the analytical laboratory. Analytes and associated preservatives are specified on each bottle by the laboratory. Each bottle sample set will be provided with a unique sample identifier, project number and date of sampling in the field. Samples for PHCs, BTEXs, VOCs, PAHs and general chemistry are unfiltered, while metals samples are to be field filtered using a dedicated 0.45 µm filter for each sample.

Appendix B

Underground Utility Locates

*** PLEASE NOTE THAT THERE ARE A LOT OF CUTOUTS AROUND THE SITE AND LIKELY MANY ABANDONED UTILITIES. I ALSO CAN'T TELL IF THE SANITARY SERVICE TO THE MECHANIC SHOP COMES IN FROM THE NORTH OR EAST SIDE OF THE BUILDING. THE SANITARY SERVICE FOR THE SMALLER STRIP MALL BUILDING IS ALSO UNKNOWN ***

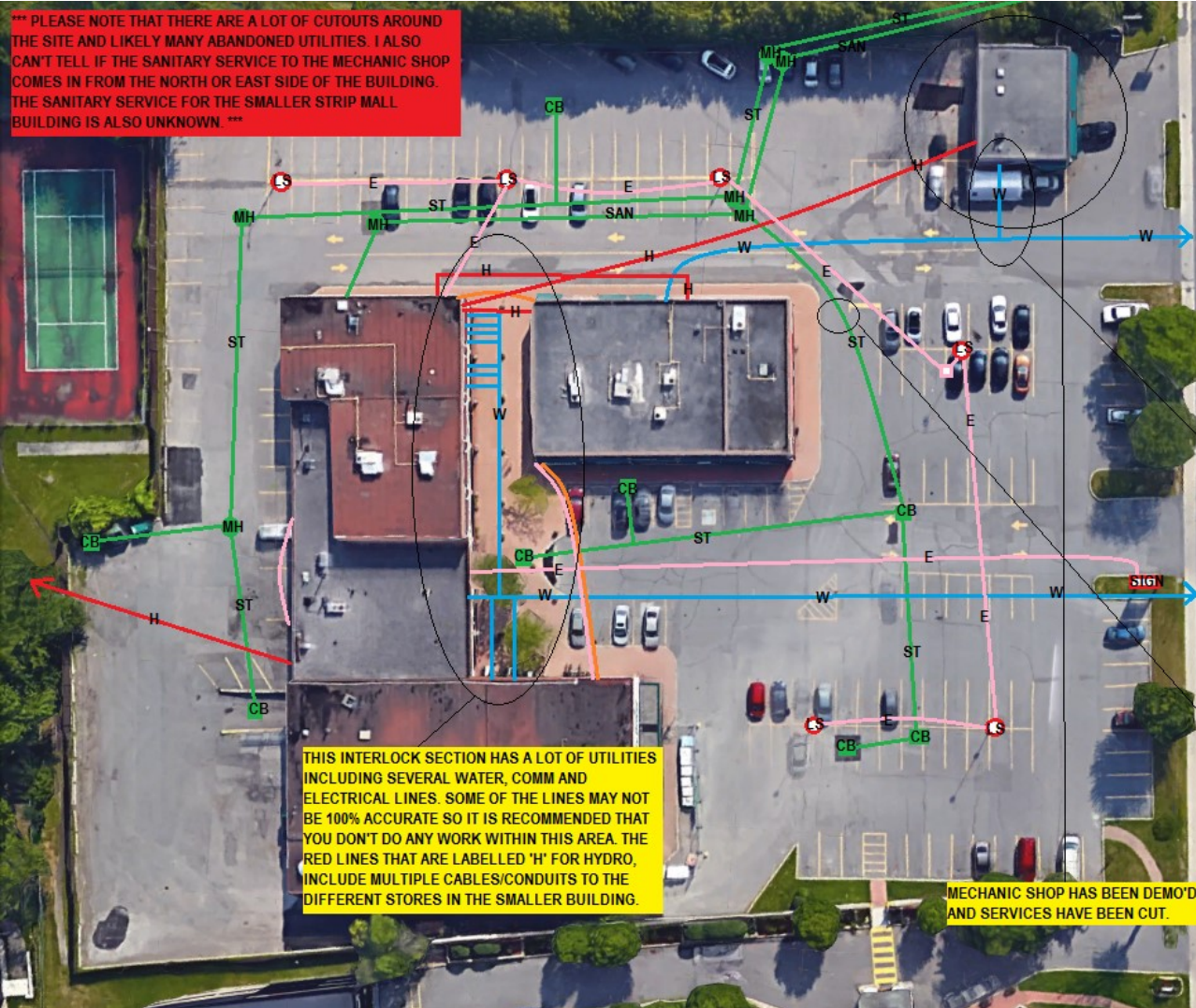

THIS INTERLOCK SECTION HAS A LOT OF UTILITIES INCLUDING SEVERAL WATER, COMM AND ELECTRICAL LINES. SOME OF THE LINES MAY NOT BE 100% ACCURATE SO IT IS RECOMMENDED THAT YOU DON'T DO ANY WORK WITHIN THIS AREA. THE RED LINES THAT ARE LABELLED 'H' FOR HYDRO, INCLUDE MULTIPLE CABLES/CONDUITS TO THE DIFFERENT STORES IN THE SMALLER BUILDING.

MECHANIC SHOP HAS BEEN DEMO'D AND SERVICES HAVE BEEN CUT.

USL-1 UNDERGROUND SERVICE LOCATORS INC.
 CLIENT: LOPERS & ASSOCIATES
 SITE: 729 RIDGEWOOD AVE.
 WORK: BOREHOLES
 LOCATOR: MATT MOREAU
 JUNE 19, 2020

*** THIS IS YOUR VALID PRIVATE LOCATE SKETCH, PLEASE VIEW/PRINT IN COLOUR. PLEASE NOTE THAT NOT ALL PUBLIC UTILITIES ARE SHOWN ON THIS MAP, REFER TO PROMARK SHEETS FOR GAS, BELL, HYDRO (MAIN FEEDER). REVIEW ALL NOTES ON THIS SKETCH AND PLACE THE HOLES ACCORDINGLY.

THIS WATER SERVICE HAS BEEN BROKEN AND REPAIRED, ACCORDING TO THE OWNER. COULD NOT GET A PROPER TRACE ON IT, BUT THE OWNER SAID IT CONNECTED WEST OF THE BUILDING AT THE WATER MAIN. THE METER IS WHERE INDICATED.

THE CATCH BASIN CONNECTS TO THE STORM MANHOLE BUT THERE MAY BE AN ELBOW OR SLIGHT BEND IN THE PIPE AS A DIRECT LINE MAY BE TOO CLOSE TO THE BUILDING FOOTING. CAN'T TRACE IT EXACTLY UNLESS THE PIPE IS SONDED/FISHED. BEST NOT TO PUT A HOLE ALONG THAT LINE.



UNDERGROUND ● SERVICE LOCATORS INC.

USL-1 UNDERGROUND SERVICE LOCATORS INC.

100 - 1704 CARLING AVE. - OTTAWA, ON - K2H 1H3

613-226-8750 - WWW.USL-1.COM

COVER SHEET

DATE: JUNE 19/20

TO: LUKE -

RE: 753 RIDGEWOOD AVE.

PAGES (INCLUDING COVER): 24

FROM: MATT MOREAU

613-218-7751 - MATTM@USL-1.COM

IF YOU DID NOT RECEIVE ALL OF THE PAGES FOR THIS REPORT, OR IF ANY PART OF IT IS UNCLEAR, PLEASE CONTACT ME. THANK YOU AND HAVE A GREAT DAY!



UNDERGROUND SERVICE LOCATORS INC.

DATE: JUNE 19/20

CLIENT: LOPERS & ASSOC.

JOB LOCATION: 753 RIDGEWOOD AVE.

WORK: BHS

PUBLIC UTILITY LOCATE REPORT

UTILITY	LOCATED BY	MARKED / CLEAR
① BELL, GAS, HYDRO	PROMARK	MARKED
② WATER, SEWER	CITY	CLEAR
③ TOLLERS, TELLS	CU	CLEAR
④ STREET LIGHTS	BLACK & MAC	CLEAR
NOTES: <u>BELL & GAS MARKED</u>		

PRIVATE UTILITY LOCATE REPORT

UTILITY	MARKED / CLEAR or N/A	UTILITY	MARKED / CLEAR or N/A
HYDRO / ELECTRICAL	<u>MARKED</u>	STORM SEWER	<u>CLEAR</u>
COMMS / FOC	<u>CLEAR</u>	SANITARY SEWER	<u>↓</u>
GAS / PROPANE / FUEL	<u>↓</u>	STEAM / TUNNELS	<u>N/A -</u>
WATER	<u>MARKED</u>	OTHER	
NOTES: <u> </u>			

AS-BUILT OR UTILITY PLANS PROVIDED? YES / (NO) - WORK AREA MARKED? (YES) / NO

Sara S

From: solutions@on1call.com
Sent: Monday, June 1, 2020 1:08 PM
To: Locates
Subject: Request 2020234213



LOCATE REQUEST CONFIRMATION

TICKET #:
2020234213

REQUEST PRIORITY:
STANDARD

REQUEST TYPE: REGULAR

WORK TO BEGIN DATE:
06/08/2020

Update of Ticket #

Project #

Transmit date: 06/01/2020
01:03:13 PM

REQUESTOR'S CONTACT INFORMATION

Contractor ID#: 202

Contact Name: Sara Staniszewski

Alternate Contact Name: JACQUES DESJARDINS

Company name: U S L

Address: 1704 Carling

Company Phone #: (613) 226-8750

Cell #:

Fax #: (613) 226-8677

Email: locates@usl-1.com

Alternate Contact #:

DIG INFORMATION

Region/County: OTTAWA

Community:

City: OTTAWA

Address: 729, RIDGEWOOD AVE To 753

Intersecting Street 1: SPRINGLAND DR

Intersecting Street 2: RIVERSIDE DR

Type of work: BORE HOLES

Max Depth: 100.00 FT

Machine Dig: YES

Hand Dig: NO

Directional Drilling: NO

Public Property: YES

Private Property: YES

Mark & Fax: NO

Area is not marked: NO

Area is marked: YES

Site Meet Req.: NO

Work being done for: Lopers
and Associates

DETAILED DESCRIPTION OF WORK

CORLOT=U Drilling throughout property. Clear entire property and to sidewalk along Ridgewood Ave. Includes property known as 753 Ridgewood.

REMARKS

Civic # 729, 753.

MEMBERS NOTIFIED: The following owners of underground infrastructure in the area of your excavation site have been notified.

Member name	Station Code	Initial Status
HYDRO OTTAWA (HOT1)	HOT1	Notification sent
PROMARK FOR ENBRIDGE GAS (ENOE01)	ENOE01	Notification sent
TELUS (TELUSON3)	TELUSON3	Notification sent
CLI FOR ROGERS (ROGOTT01)	ROGOTT01	Notification sent
CITY OF OTTAWA WATER/SEWER (OTWAWS01)	OTWAWS01	Notification sent
BLACK AND MC DONALD FOR CITY OF OTTAWA STREET LIGHTS (OTWASL01)	OTWASL01	Notification sent
PROMARK FOR BELL CANADA (BCOE01)	BCOE01	Notification sent

MAP SELECTION: Map Selection provided by the excavator through Ontario One Call's map tool or through agent interpretation by



IMPORTANT INFORMATION: Please read.

Defining "NC" - Non-Compliant

- Non-compliant members have not met their obligations under section 5 of the Ontario Underground Infrastructure Notification Act. ON1Call has notified these members to ensure they are aware of your excavation. In this circumstance, should the member not respond, the excavator should contact the member directly to obtain their locates or request a status. ON1Call will not be provided with a locate status from the member regarding this ticket and therefore, cannot provide further information at this time. For locate status contact information please refer to our website.

You have a valid locate when...

- You have reviewed your locate request information for accuracy. CONTACT Ontario One Call (ON1Call) IMMEDIATELY if changes are needed and obtain a corrected locate request confirmation.
- You have obtained locates or clearances from all ON1Call members listed in this ticket before beginning your dig.

You've met your obligations when...

- In addition to this locate request, you have DIRECTLY contacted all owners of infrastructure who ARE NOT current members of ON1Call (such as owned buried infrastructure on private property), as well as arranged for contract locates for your private lines on your private property - where applicable. For a list of locate status contacts visit www.on1call.com.
- You respect the marks and instructions provided by the locators and dig with care; the marks and locator instructions MUST MATCH.
- You have obtained any necessary permits from the municipality in which you are excavating.

What does "Cleared" mean in the "Initial Status" section?

1. The information that you have provided about your dig will not affect that member's underground infrastructure and they have provided you with a clearance, if anything about your excavation changes, please ensure that you update your ticket immediately.

What are the images under "Map Selection":

1. A drawing created by an excavator directly within Ontario One Call's web ticket tool, this is expected to be an accurate rendition of the dig site, and it is the excavator's responsibility to ensure the location matches the information they provide under the 'Dig Location' section OR;
2. A drawing created by an Ontario One Call agent, this drawing is based on a verbal description by phone of the area by the excavator. Agents may create drawings that are larger than the proposed dig to minimize risk of interpretation. It is the excavator's responsibility to review these map selections for accuracy. Changes can be made by the excavator through the web ticket tool, to learn how visit www.on1call.com/contractors.
3. All drawings dictate which members are notified.



Primary Locate Sheet

UNION GAS EMERGENCY #
1-877-969-0999

Fax: 613-723-9277

Toll free: 1-800-371-8866

Email:

Request #
2020234213
NORMAL

Utilities Located: <input checked="" type="radio"/> Bell <input checked="" type="radio"/> Gas <input checked="" type="radio"/> Hydro Ottawa <input type="checkbox"/> Hydro One <input type="checkbox"/> Zayo <input type="checkbox"/> Videotron <input type="checkbox"/> Lakefront Utilities <input type="checkbox"/> Elexicon Energy		Revised Excavation Date N/A mm/dd/yyyy	Excavation Date 06/12/2020 00:00:00 N/A mm/dd/yyyy	Status STANDARD
Requested by: SARA STANISZEWSKI	Company: U S L	Phone: (613)-226-8750 ext.	Fax/email: (613)-226-8677 ext. N/A	Homeowner <input type="checkbox"/> Contractor <input checked="" type="checkbox"/> Project <input type="checkbox"/>

Appt Date: N/A mm/dd/yyyy	Received Date: 06/01/2020 mm/dd/yyyy	Locate Address: 729 to 753, RIDGEWOOD AVE 1st Inters.: SPRINGLAND DR 2nd Inters.: RIVERSIDE DR
------------------------------	---	---

Type of work: BORE HOLES	City: OTTAWA
-----------------------------	-----------------

Caller's Remarks:
CIVIC # 729, 753.
MACH. DIG
CORLOT=U DRILLING THROUGHOUT PROPERTY. CLEAR ENTIRE PROPERTY AND TO SIDEWALK ALONG RIDGEWOOD AVE. INCLUDES PROPERTY KNOWN AS 753 RIDGEWOOD.
-75.687939, 45.368339, NB_SEGMENTS::1, NO_PLAN::613 737, BCOE01, OTWASL01, OTWAWS01, ROGOTT01, TELUSON3, ENOE01, HOT1

Bell Mark Clear 1	Gas Mark Clear 1	Hydro Ottawa Mark Clear 1	Street Lighting Mark Clear N/A	Lakefront Mark Clear N/A	Hydro One Mark Clear N/A	Zayo Mark Clear N/A	Elexicon Energy Mark Clear N/A	Videotron Mark Clear N/A
------------------------	-----------------------	--------------------------------	-------------------------------------	-------------------------------	-------------------------------	--------------------------	-------------------------------------	-------------------------------

LOCATED AREA: EXCAVATOR SHALL NOT WORK OUTSIDE THE LOCATED AREA WITHOUT OBTAINING ANOTHER LOCATE.

Records Reference:
 Map Network X #
 Byers Datapak PMOTT190081
 Field Notes: LAC Multiviewer
 Other: GL38, FN-3871-1
 DPT Remarks:

— Third Party Notification _____

*****DANGER DO NOT PROCEED*****
 BURIED HIGH VOLTAGE CABLES WITHIN THE LOCATED AREA. YOU MUST SEND LOCATE TO HOLsupervisions@hydroottawa.com
 OR CONTACT HYDRO OTTAWA AT 613-738-6418 FOR FURTHER INFORMATION
 "EMERGENCY" NUMBER IS 613-738-0188

Apply Sticker Here if Required

Excavator shall notify & receive a clearance from Utility prior to excavation for the following:

Telecon <input type="checkbox"/> High Priority Cable <input type="checkbox"/> Central Office Vicinity	Gas Material Type: <input type="checkbox"/> Steel(st) <input type="checkbox"/> Plastic(PE) <input type="checkbox"/> Copper(CO)
---	---

Method of Field Marking: Paint Stakes Flags Offset Flags Other (Telecom=Orange, Gas=Yellow, Hydro Ott. =Red)

Caution: Bell locate valid for life of excavation see attached document. Hydro One - Hydro Ottawa - Enbridge Gas - Lakefront Utilities - Elexicon Energy valid for 60 days, 360 valid for life of excavation. See disclaimer for Facility Owner Guidelines.

Caution: Any changes to location or nature of work require new locate. The Excavator must not work outside the Located Area without a new locate. Privately owned services within the located area have not been marked - check with service / property owner. For all Locate requests including remarks contact: Ontario One Call at 1-800-400-2255 or www.on1call.com

Locator Name: MAIN CULLEN	Start Time: 12:00	— Mark & Fax — Left on Site <input checked="" type="radio"/> Emailed
ID #: 10879 1849	End Time: 16:00	Print:
Date Jun 12 2020	Total Hours: 4	Signature:

A copy of this Primary Locate Sheet and Auxiliary Locate Sheet(s) must be on site and in the hands of the machine operator during work operations. If sketch and markings do not coincide, the Excavator must obtain a new locate.



Auxiliary Locate Sheet

Union Gas Emergency #
1-877-969-0999

Fax:
613-723-9277

Toll free:
1-800-371-8866

Email

Utilities Located: Bell Gas HydroOttawa Hydro One
 Videotron Peel Fibre Elexicon Energy

Date Located:
mm/dd/yyyy 06/12/2020

Request #
2020234213

Number of Services marked: (Specify building/house numbers) (1) 729-751 Ridgewood Avenue

LOCATED AREA: EXCAVATOR SHALL NOT WORK OUTSIDE THE LOCATED AREA WITHOUT OBTAINING ANOTHER LOCATE

FROM: 3M N of N.FC Ridgewood Avenue

TO: S.BL of 751 Ridgewood Avenue

FROM: E.BL of 751 Ridgewood Avenue

TO: E.FL of 751 Ridgewood Avenue

- Legend
- Building Line - BL -
 - Fence Line - FL -
 - Face of Curb - FC -
 - Asphalt Edge - AE -
 - Sidewalk - SW -
 - Driveway - DW -
 - Manhole
 - Pedestal
 - Flush to Grade Pedestal
 - Buried Service Wire - BSW -
 - Buried Cable - B -
 - Conduit - C -
 - Fiber Optic Cable - FO -
 - Bell Hydro Service - BH -
 - Gas Valve
 - Gas Service - GS -
 - Gas Main - GM -
 - Transformer
 - Demarcation
 - Hydro - H -
 - Hydro Primary - HP -
 - Hydro Secondary - HS -
 - Catch Basin
 - Sewer Manhole
 - Water Valve
 - Hydrant
 - Water Valve Chamber
 - Hydro / Bell Pole
 - Railway
 - End Cap
 - Traffic Manhole
 - Street Light Cable - SL -
 - Street Light
 - North N.
 - East E.
 - West W.
 - South S.

CAUTION: Hand dig within 1 M as measured horizontally from the field markings to avoid damaging the underground utilities. If you damage the plant, you may be held liable. If you damage underground plant, contact the facility owner immediately. Depth varies and MUST be verified by hand digging or vacuum excavation. LOCATED AREA HAS BEEN ALTERED AS PER: Luke F.

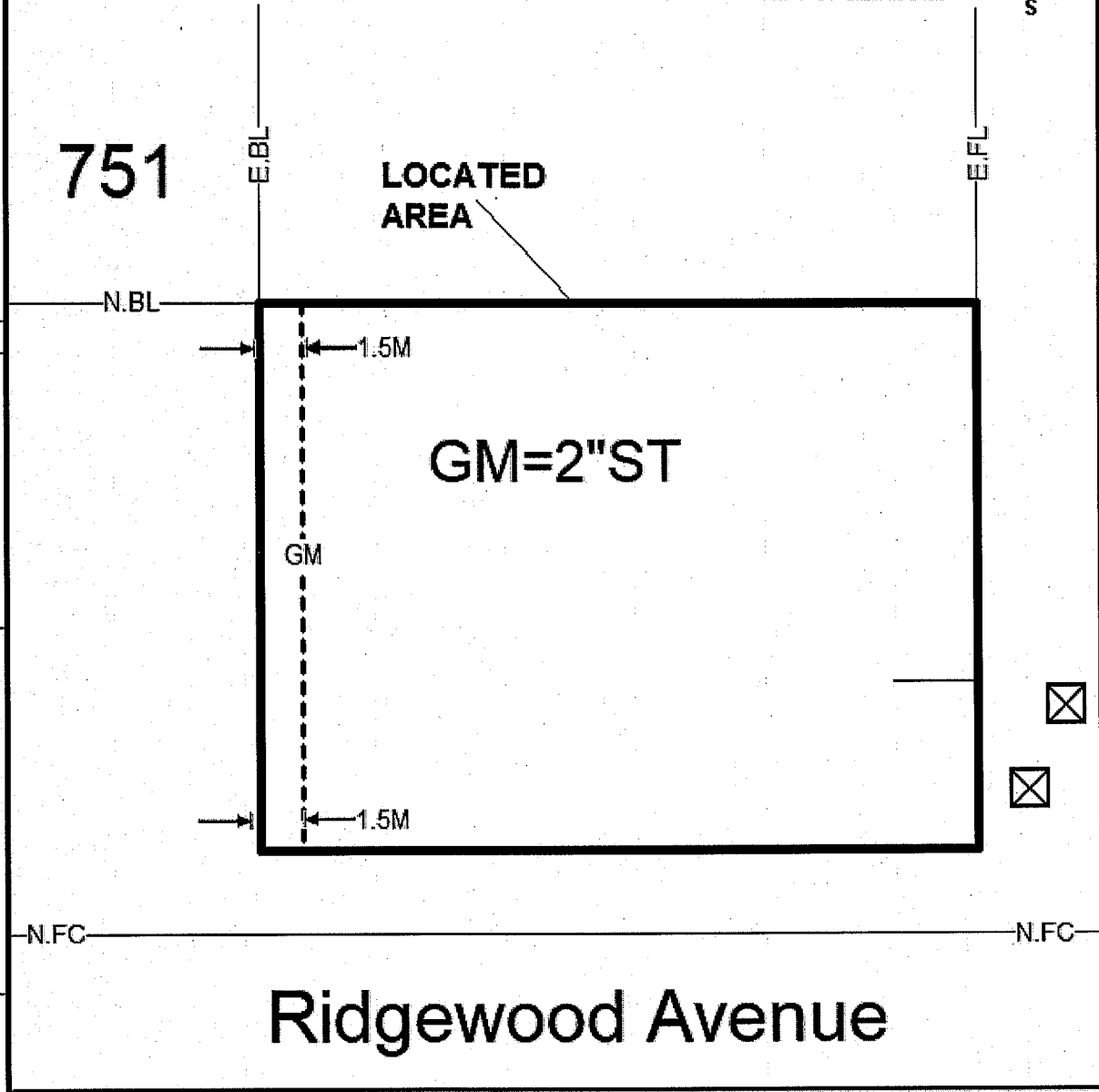

THIS FORM VALID ONLY WITH Primary Locate Form. This sketch is not to scale. Any privately owned services within the located area have not been marked- check with service/property owner.

A copy of this Auxiliary Locate Sheet(s) and the Primary Locate Sheet must be on site and in the hands of the machine operator during work operations. If sketch and markings do not coincide, the Excavator must obtain a new locate.



Auxiliary Locate Sheet

Union Gas Emergency #
1-877-969-0999

Fax:
613-723-9277

Toll free:
1-800-371-8866

Email

Utilities Located: Bell Gas HydroOttawa Hydro One Videotron Peel Fibre Elexicon Energy

Date Located:
mm/dd/yyyy 06/12/2020

Request #
2020234213

Number of Services marked: (Specify building/house numbers) N/A

LOCATED AREA: EXCAVATOR SHALL NOT WORK OUTSIDE THE LOCATED AREA WITHOUT OBTAINING ANOTHER LOCATE

FROM: 3M N of N.FC Ridgewood Avenue

TO: S.BL of 751 Ridgewood Avenue

FROM: E.BL of 751 Ridgewood Avenue

TO: E.FL of 751 Ridgewood Avenue

- Legend
- Building Line - BL -
 - Fence Line - FL -
 - Face of Curb - FC -
 - Asphalt Edge - AE -
 - Sidewalk - SW -
 - Driveway - DW -
 - Manhole
 - Pedestal
 - Flush to Grade Pedestal
 - Buried Service Wire - BSW -
 - Buried Cable - B -
 - Conduit - C -
 - Fiber Optic Cable - FO -
 - Bell Hydro Service - BH -
 - Gas Valve
 - Gas Service - GS -
 - Gas Main - GM -
 - Transformer
 - Demarcation
 - Hydro - H -
 - Hydro Primary - HP -
 - Hydro Secondary - HS -
 - Catch Basin
 - Sewer Manhole
 - Water Valve
 - Hydrant
 - Water Valve Chamber
 - Hydro / Bell Pole
 - Railway
 - End Cap
 - Traffic Manhole
 - Street Light Cable - SL -
 - Street Light
 - North N.
 - East E.
 - West W.
 - South S.

CAUTION: Hand dig within 1 M as measured horizontally from the field markings to avoid damaging the underground utilities. If you damage the plant, you may be held liable. If you damage underground plant, contact the facility owner immediately. Depth varies and **MUST** be verified by hand digging or vacuum excavation. LOCATED AREA HAS BEEN ALTERED AS PER: Luke F.



751

LOCATED AREA

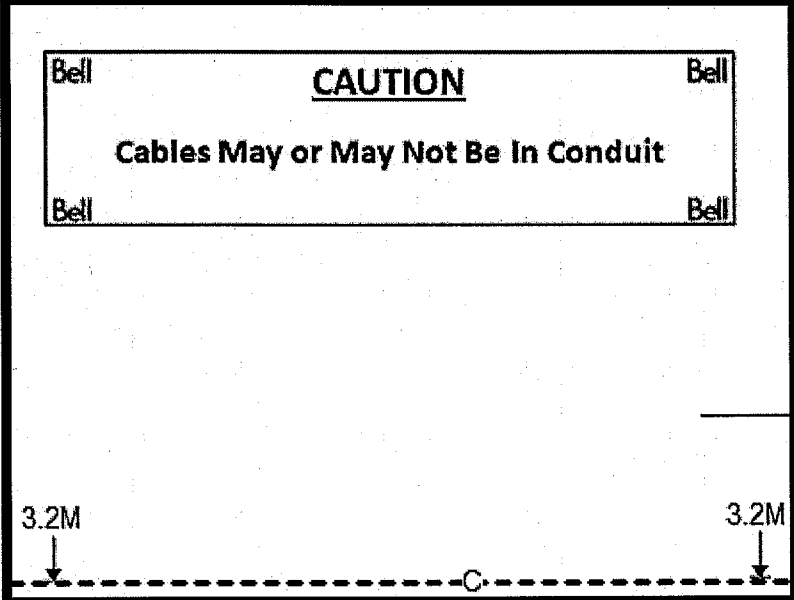

Ridgewood Avenue

THIS FORM VALID ONLY WITH Primary Locate Form. This sketch is not to scale. Any privately owned services within the located area have not been marked- check with service/property owner.

A copy of this Auxillary Locate Sheet(s) and the Primary Locate Sheet must be on site and in the hands of the machine operator during work operations. If sketch and markings do not coincide, the Excavator must obtain a new locate.



Auxiliary Locate Sheet

Union Gas Emergency #
1-877-969-0999

Fax:
613-723-9277

Toll free:
1-800-371-8866

Email

Utilities Bell Gas HydroOttawa Street Lighting
 Located: Bellink Peel Fibre

Date Located:
mm/dd/yyyy 06/12/2020

Request # 2020234213

Number of Services marked: (Specify building/house numbers) N/A

LOCATED AREA: EXCAVATOR SHALL NOT WORK OUTSIDE THE LOCATED AREA WITHOUT OBTAINING ANOTHER LOCATE.

FROM: 3M N of N.FC Ridgewood Avenue

TO: S.BL of 751 Ridgewood Avenue

FROM: E.BL of 751 Ridgewood Avenue

TO: E.FL of 751 Ridgewood Avenue

- Legend**
- Building Line - BL -
 - Fence Line - FL -
 - Face of Curb - FC -
 - Asphalt Edge - AE -
 - Sidewalk - SW -
 - Driveway - DW -
 - Manhole
 - Pedestal
 - Flush to Grade Pedestal
 - Buried Service Wire - BSW -
 - Buried Cable - B -
 - Conduit - C -
 - Fiber Optic Cable - FO -
 - Bell Hydro Service - BH -
 - Gas Valve
 - Gas Service - GS -
 - Gas Main - GM -
 - Transformer
 - Demarcation
 - Hydro - H -
 - Hydro Primary - HP -
 - Hydro Secondary - HS -
 - Catch Basin
 - Sewer Manhole
 - Water Valve
 - Hydrant
 - Water Valve Chamber
 - Hydro / Bell Pole
 - Railway
 - End Cap
 - Traffic Manhole
 - Street Light Cable - SL -
 - Street Light
 - North N.
 - East E.
 - West W.
 - South S.

CAUTION: Hand dig within 1.5M as measured horizontally from the field markings to avoid damaging the underground utilities. If you damage the plant, you may be held liable. If you damage underground plant, contact the facility owner immediately. Depth varies and **MUST** be verified by hand digging or vacuum excavation. LOCATED AREA HAS BEEN ALTERED AS PER: Luke F.



751

LOCATED AREA

NO BURIED HYDRO OTTAWA NETWORK IN THE LOCATED AREA

Ridgewood Avenue

THIS FORM VALID ONLY WITH Primary Locate Form. This sketch is not to scale. Any privately owned services within the located area have not been marked- check with service/property owner.

A copy of this Auxiliary Locate Sheet(s) and the Primary Locate Sheet must be on site and in the hands of the machine operator during work operations. If sketch and markings do not coincide, the Excavator must obtain a new locate.



Auxiliary Locate Sheet

Union Gas Emergency #
1-877-969-0999

Fax:
613-723-9277

Toll free:
1-800-371-8866

Email

Utilities Located: Bell Gas HydroOttawa Hydro One
 Videotron Paerl Fibre El Exxon Energy

Date Located:
mm/dd/yyyy 06/12/2020

Request #
2020234213

Number of Services marked: (Specify building/house numbers) 0

















LOCATED AREA: EXCAVATOR SHALL NOT WORK OUTSIDE THE LOCATED AREA WITHOUT OBTAINING ANOTHER LOCATE

FROM: 5M N of N.FC Ridgewood Avenue

TO: S.BL2 of 729-751 Ridgewood Avenue

FROM: 5M W of W.BL 729-751 Ridgewood Avenue

TO: E.BL of 729-751 Ridgewood Avenue

- Legend**
- Building Line - BL -
 - Fence Line - FL -
 - Face of Curb - FC -
 - Asphalt Edge - AE -
 - Sidewalk - SW -
 - Driveway - DW -
 - Manhole 
 - Pedestal 
 - Flush to Grade Pedestal 
 - Buried Service Wire - BSW -
 - Buried Cable - B -
 - Conduit - C -
 - Fiber Optic Cable - FO -
 - Bell Hydro Service - BH -
 - Gas Valve 
 - Gas Service - GS -
 - Gas Main - GM -
 - Transformer 
 - Demarcation 
 - Hydro - H -
 - Hydro Primary - HP -
 - Hydro Secondary - HS -
 - Catch Basin 
 - Sewer Manhole 
 - Water Valve 
 - Hydrant 
 - Water Valve Chamber 
 - Hydro / Bell Pole 
 - Railway 
 - End Cap 
 - Traffic Manhole 
 - Street Light Cable - SL -
 - Street Light 
 - North N.
 - East E.
 - West W.
 - South S.

CAUTION: Hand dig within 1 M as measured horizontally from the field markings to avoid damaging the underground utilities. If you damage the plant, you may be held liable.

If you damage underground plant, contact the facility owner immediately.

Depth varies and MUST be verified by hand digging or vacuum excavation.

LOCATED AREA HAS BEEN ALTERED AS PER: Luke F.



729-751

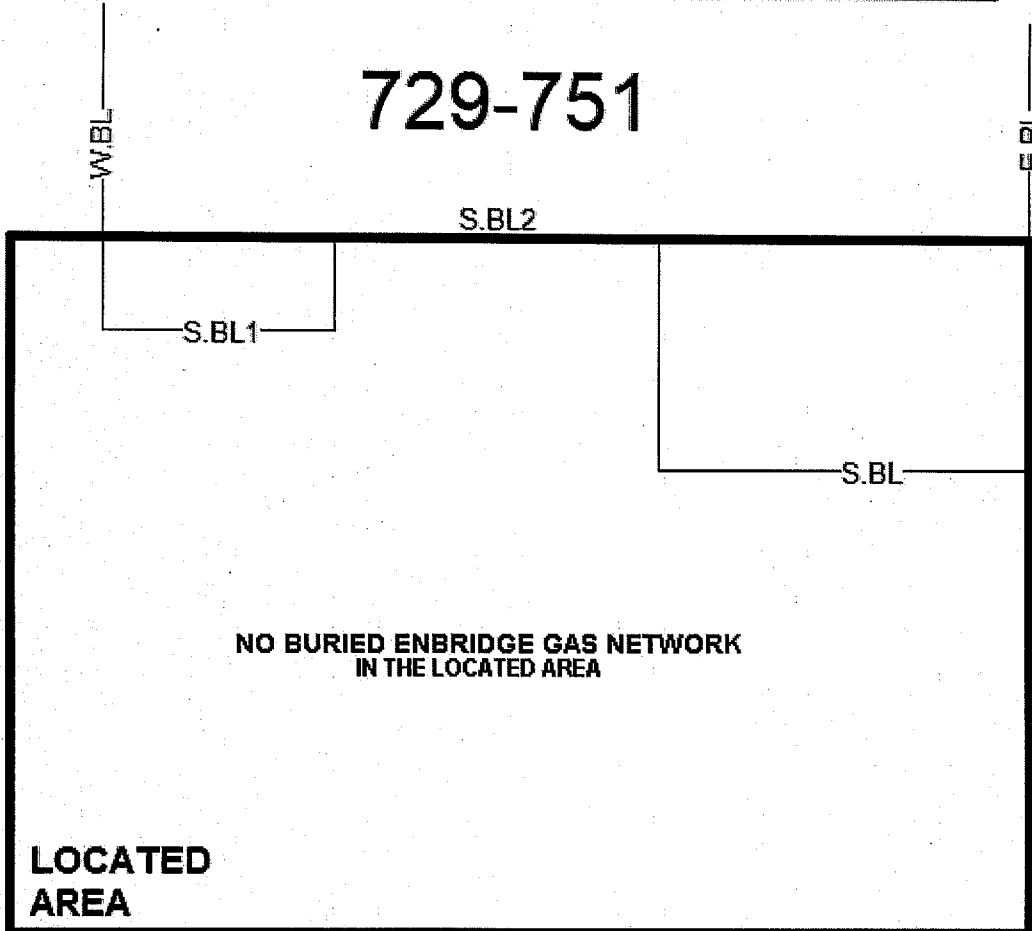

**NO BURIED ENBRIDGE GAS NETWORK
IN THE LOCATED AREA**

**LOCATED
AREA**

N.FC

N.FC

Ridgewood Avenue

THIS FORM VALID ONLY WITH Primary Locate Form. This sketch is not to scale.

Any privately owned services within the located area have not been marked- check with service/property owner.

A copy of this Auxiliary Locate Sheet(s) and the Primary Locate Sheet must be on site and in the hands of the machine operator during work operations. If sketch and markings do not coincide, the Excavator must obtain a new locate.



Auxiliary Locate Sheet

Union Gas Emergency #
1-877-969-0999

Fax:
613-723-9277

Toll free:
1-800-371-8866

Email

Utilities Located: Bell Gas HydroOttawa Hydro One
 Videotron Peel Fibre El Exxon Energy

Date Located:
mm/dd/yyyy 06/12/2020

Request #
2020234213

Number of Services marked: (Specify building/house numbers) N/A

LOCATED AREA: EXCAVATOR SHALL NOT WORK OUTSIDE THE LOCATED AREA WITHOUT OBTAINING ANOTHER LOCATE

FROM: 5M N of N.FC Ridgewood Avenue

TO: S.BL2 of 729-751 Ridgewood Avenue

FROM: 5M W of W.BL 729-751 Ridgewood Avenue

TO: E.BL of 729-751 Ridgewood Avenue

- Legend**
- Building Line --BL--
 - Fence Line --FL--
 - Face of Curb --FC--
 - Asphalt Edge --AE--
 - Sidewalk --SW--
 - Driveway --DW--
 - Manhole
 - Pedestal
 - Flush to Grade Pedestal
 - Buried Service Wire --BSW--
 - Buried Cable --B--
 - Conduit --C--
 - Fiber Optic Cable --FO--
 - Bell Hydro Service --BH--
 - Gas Valve
 - Gas Service --GS--
 - Gas Main --GM--
 - Transformer
 - Demarcation
 - Hydro --H--
 - Hydro Primary --HP--
 - Hydro Secondary --HS--
 - Catch Basin
 - Sewer Manhole
 - Water Valve
 - Hydrant
 - Water Valve Chamber
 - Hydro / Bell Pole
 - Railway
 - End Cap
 - Traffic Manhole
 - Street Light Cable --SL--
 - Street Light
 - North N.
 - East E.
 - West W.
 - South S.

CAUTION: Hand dig within 1 M as measured horizontally from the field markings to avoid damaging the underground utilities. If you damage the plant, you may be held liable. If you damage underground plant, contact the facility owner immediately. Depth varies and **MUST** be verified by hand digging or vacuum excavation.

LOCATED AREA HAS BEEN ALTERED AS PER: Luke F.

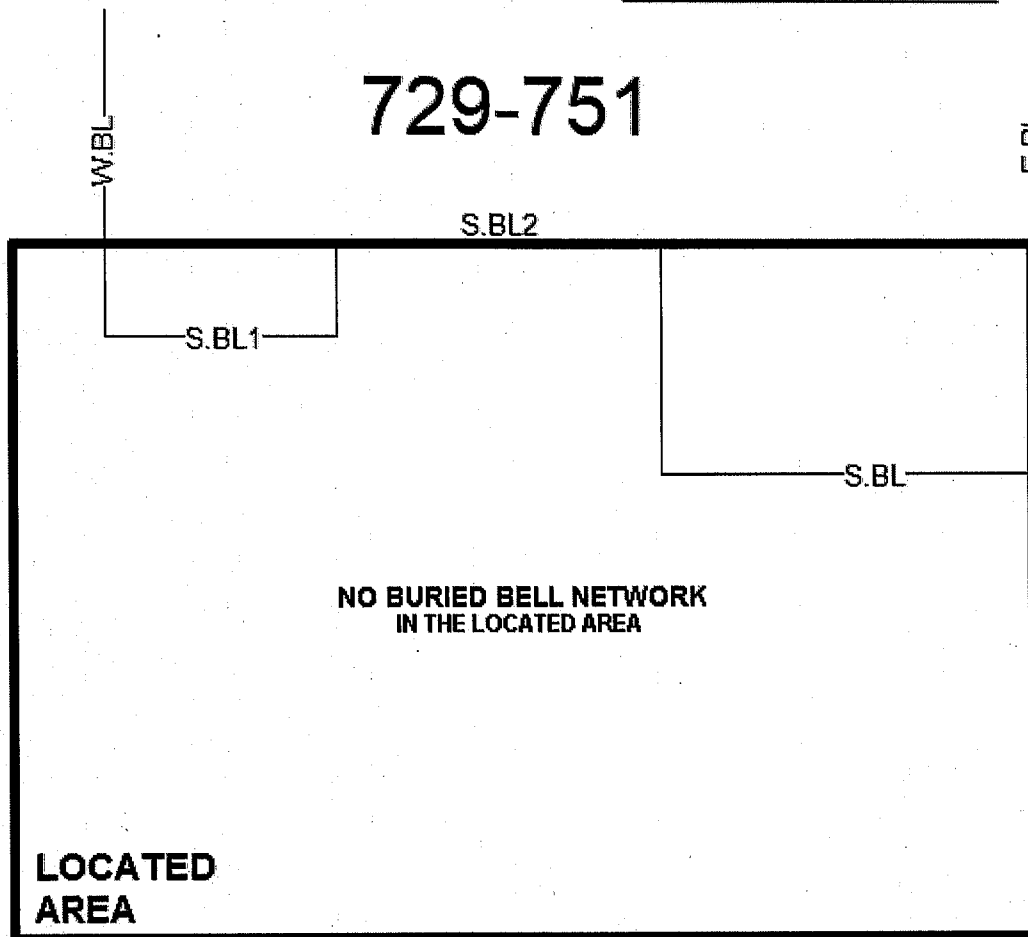

N.FC _____ N.FC

Ridgewood Avenue

THIS FORM VALID ONLY WITH Primary Locate Form. This sketch is not to scale.
Any privately owned services within the located area have not been marked- check with service/property owner.

A copy of this Auxillary Locate Sheet(s) and the Primary Locate Sheet must be on site and in the hands of the machine operator during work operations. If sketch and markings do not coincide, the Excavator must obtain a new locate.



Auxiliary Locate Sheet

Union Gas Emergency #
1-877-969-0999

Fax:
613-723-9277

Toll free:
1-800-371-8866

Email

Utilities Bell Gas HydroOttawa Street Lighting
 Located: BLink Peel Fibre

Date Located:
mm/dd/yyyy 06/12/2020

Request # 2020234213

Number of Services marked: (Specify building/house numbers) N/A

LOCATED AREA: EXCAVATOR SHALL NOT WORK OUTSIDE THE LOCATED AREA WITHOUT OBTAINING ANOTHER LOCATE.

FROM: 5M N of N.FC Ridgewood Avenue

TO: S.BL2 of 729-751 Ridgewood Avenue

FROM: 5M W of W.BL 729-751 Ridgewood Avenue

TO: E.BL of 729-751 Ridgewood Avenue

- Legend**
- Building Line -- BL --
 - Fence Line -- FL --
 - Face of Curb -- FC --
 - Asphalt Edge -- AE --
 - Sidewalk -- SW --
 - Driveway -- DW --
 - Manhole
 - Pedestal
 - Flush to Grade Pedestal
 - Buried Service Wire -- BSW --
 - Buried Cable -- B --
 - Conduit -- C --
 - Fiber Optic Cable -- FO --
 - Bell Hydro Service -- BH --
 - Gas Valve
 - Gas Service -- GS --
 - Gas Main -- GM --
 - Transformer
 - Demarcation
 - Hydro -- H --
 - Hydro Primary -- HP --
 - Hydro Secondary -- HS --
 - Catch Basin
 - Sewer Manhole
 - Water Valve
 - Hydrant
 - Water Valve Chamber
 - Hydro / Bell Pole
 - Railway
 - End Cap
 - Traffic Manhole
 - Street Light Cable -- SL --
 - Street Light
 - North N.
 - East E.
 - West W.
 - South S.

CAUTION: Hand dig within 1.5M as measured horizontally from the field markings to avoid damaging the underground utilities. If you damage the plant, you may be held liable. If you damage underground plant, contact the facility owner immediately. Depth varies and **MUST** be verified by hand digging or vacuum excavation.

LOCATED AREA HAS BEEN ALTERED AS PER: Luke F.

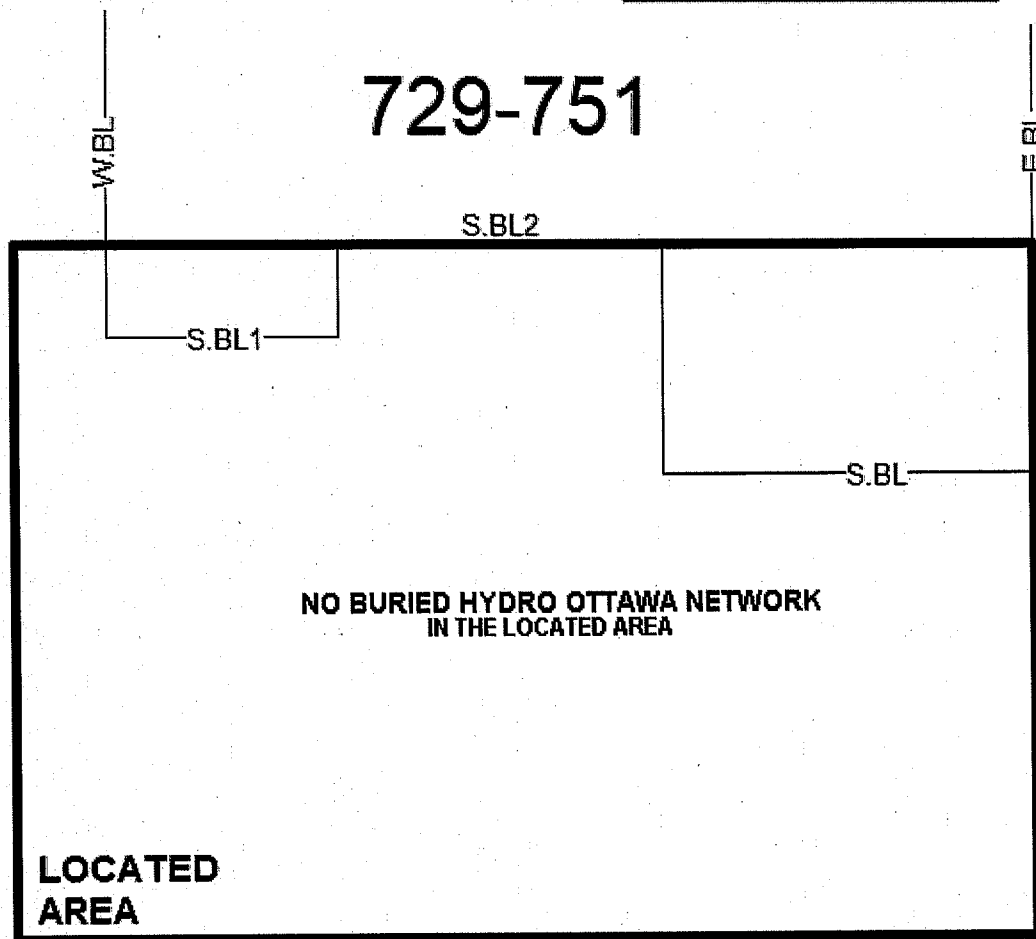
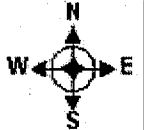

Ridgewood Avenue

THIS FORM VALID ONLY WITH Primary Locate Form. This sketch is not to scale. Any privately owned services within the located area have not been marked- check with service/property owner.

A copy of this Auxiliary Locate Sheet(s) and the Primary Locate Sheet must be on site and in the hands of the machine operator during work operations. If sketch and markings do not coincide, the Excavator must obtain a new locate.



Auxiliary Locate Sheet

Union Gas Emergency # 1-877-969-0999

Fax: 613-723-9277

Toll free: 1-800-371-8866

Email

Utilities Located: Bell Gas HydroOttawa Hydro One Videotron Peel Fibra Elexicon Energy

Date Located: mm/dd/yyyy 06/12/2020

Request # 2020234213

Number of Services marked: (Specify building/house numbers) 0

LOCATED AREA: EXCAVATOR SHALL NOT WORK OUTSIDE THE LOCATED AREA WITHOUT OBTAINING ANOTHER LOCATE

FROM: 5M N of N.BL 729-751 Ridgewood Avenue

TO: N.FL of 729-751 Ridgewood Avenue

FROM: W.FL of 729-751 Ridgewood Avenue

TO: E.BL of 729-751 Ridgewood Avenue

- Legend
- Building Line -BL-
 - Fence Line -FL-
 - Face of Curb -FC-
 - Asphalt Edge -AE-
 - Sidewalk -SW-
 - Driveway -DW-
 - Manhole
 - Pedestal
 - Flush to Grade Pedestal
 - Buried Service Wire -BSW-
 - Buried Cable -B-
 - Conduit -C-
 - Fiber Optic Cable -FO-
 - Bell Hydro Service -BH-
 - Gas Valve
 - Gas Service -GS-
 - Gas Main -GM-
 - Transformer
 - Demarcation
 - Hydro -H-
 - Hydro Primary -HP-
 - Hydro Secondary -HS-
 - Catch Basin
 - Sewer Manhole
 - Water Valve
 - Hydrant
 - Water Valve Chamber
 - Hydro / Bell Pole
 - Railway
 - End Cap
 - Traffic Manhole
 - Street Light Cable -SL-
 - Street Light
 - North N.
 - East E.
 - West W.
 - South S.

CAUTION: Hand dig within 1 M as measured horizontally from the field markings to avoid damaging the underground utilities. If you damage the plant, you may be held liable. If you damage underground plant, contact the facility owner immediately. Depth varies and MUST be verified by hand digging or vacuum excavation. LOCATED AREA HAS BEEN ALTERED AS PER: Luke F.

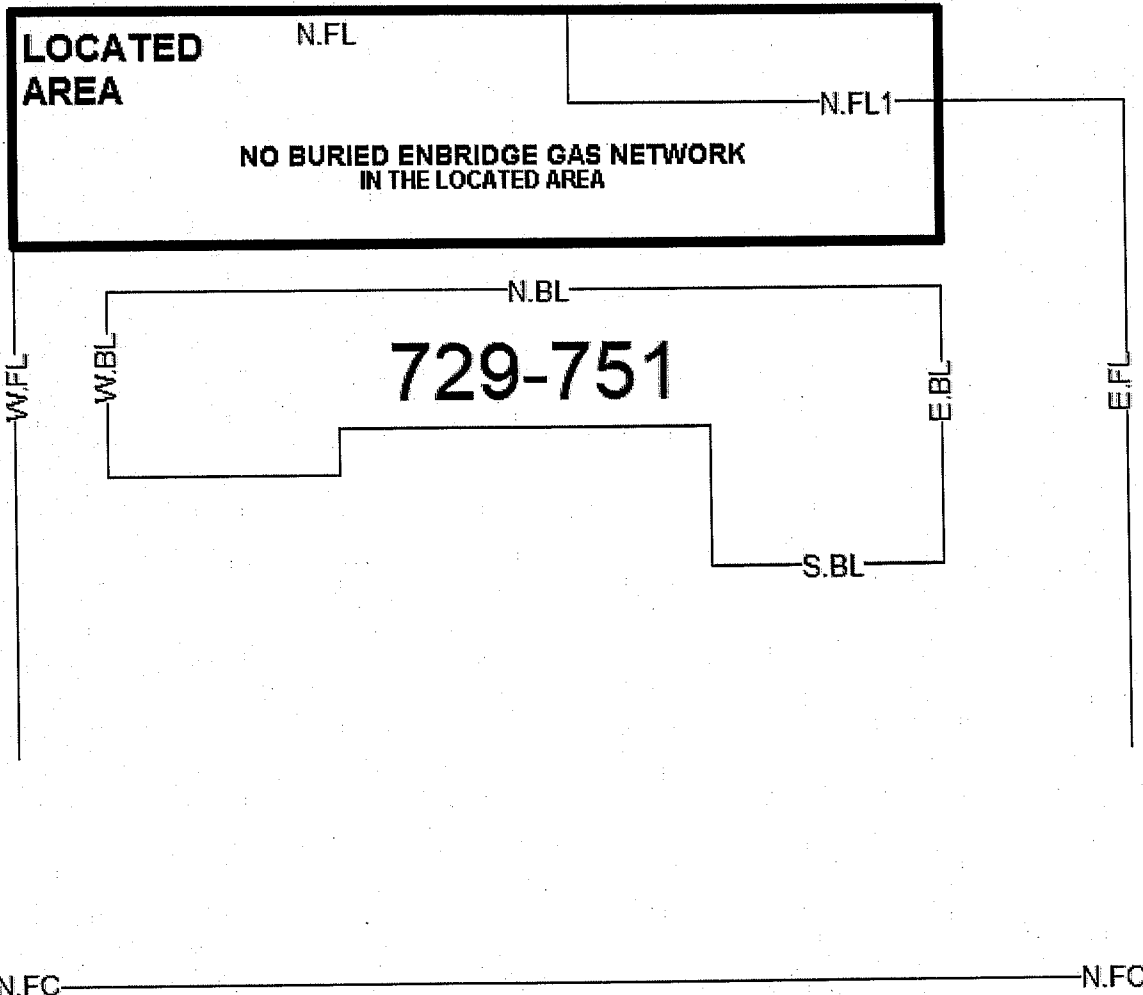
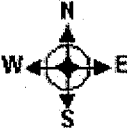

Ridgewood Avenue

THIS FORM VALID ONLY WITH Primary Locate Form. This sketch is not to scale. Any privately owned services within the located area have not been marked- check with service/property owner.

A copy of this Auxiliary Locate Sheet(s) and the Primary Locate Sheet must be on site and in the hands of the machine operator during work operations. If sketch and markings do not coincide, the Excavator must obtain a new locate.



Auxiliary Locate Sheet

Union Gas Emergency # 1-877-969-0999

Fax: 613-723-9277

Toll free: 1-800-371-8866

Email

Utilities Located: Bell Gas HydroOttawa Hydro One Videotron Peel Fibre El Exxon Energy

Date Located: mm/dd/yyyy 06/12/2020

Request # 2020234213

Number of Services marked: (Specify building/house numbers) N/A

LOCATED AREA: EXCAVATOR SHALL NOT WORK OUTSIDE THE LOCATED AREA WITHOUT OBTAINING ANOTHER LOCATE

FROM: 5M N of N.BL 729-751 Ridgewood Avenue

TO: N.FL of 729-751 Ridgewood Avenue

FROM: W.FL of 729-751 Ridgewood Avenue

TO: E.BL of 729-751 Ridgewood Avenue

- Legend
- Building Line -BL-
 - Fence Line -FL-
 - Face of Curb -FC-
 - Asphalt Edge -AE-
 - Sidewalk -SW-
 - Driveway -DW-
 - Manhole
 - Pedestal
 - Flush to Grade Pedestal
 - Buried Service Wire -BSW-
 - Buried Cable -B-
 - Conduit -C-
 - Fiber Optic Cable -FO-
 - Bell Hydro Service -BH-
 - Gas Valve
 - Gas Service -GS-
 - Gas Main -GM-
 - Transformer
 - Demarcation
 - Hydro -H-
 - Hydro Primary -HP-
 - Hydro Secondary -HS-
 - Catch Basin
 - Sewer Manhole
 - Water Valve
 - Hydrant
 - Water Valve Chamber
 - Hydro / Bell Pole
 - Railway
 - End Cap
 - Traffic Manhole
 - Street Light Cable -SL-
 - Street Light
 - North N.
 - East E.
 - West W.
 - South S.

CAUTION: Hand dig within 1 M as measured horizontally from the field markings to avoid damaging the underground utilities. If you damage the plant, you may be held liable. If you damage underground plant, contact the facility owner immediately. Depth varies and MUST be verified by hand digging or vacuum excavation. LOCATED AREA HAS BEEN ALTERED AS PER: Luke F.

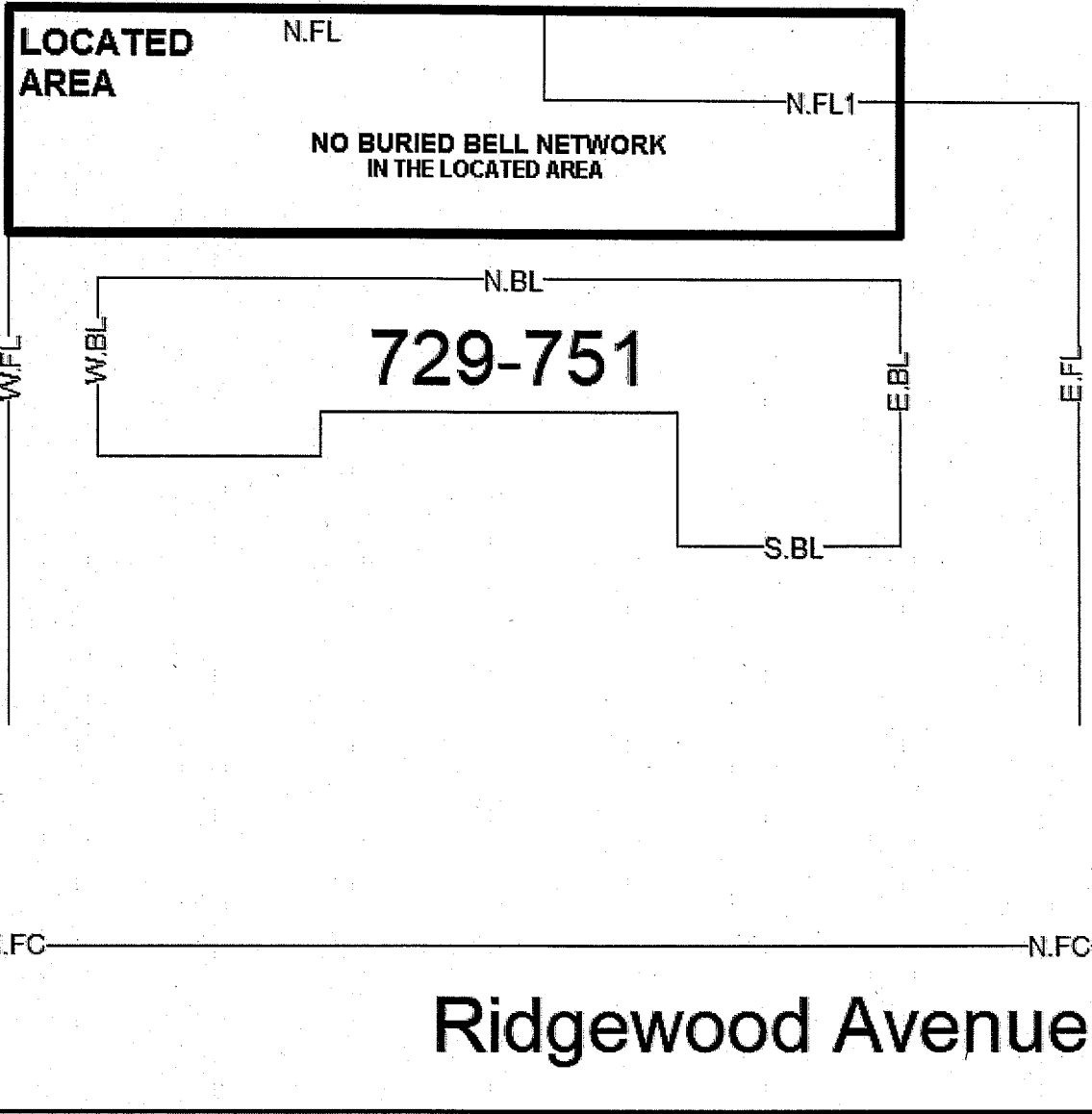

THIS FORM VALID ONLY WITH Primary Locate Form. This sketch is not to scale. Any privately owned services within the located area have not been marked- check with service/property owner.

A copy of this Auxillary Locate Sheet(s) and the Primary Locate Sheet must be on site and in the hands of the machine operator during work operations. If sketch and markings do not coincide, the Excavator must obtain a new locate.



Auxiliary Locate Sheet

Union Gas Emergency #
1-877-969-0999

Fax:
613-723-9277

Toll free:
1-800-371-8866

Email

Utilities Bell Gas HydroOttawa Street Lighting
 Located: Blink Peel Fibre

Date Located:
mm/dd/yyyy 06/12/2020

Request # 2020234213

Number of Services marked: (Specify building/house numbers) N/A

LOCATED AREA: EXCAVATOR SHALL NOT WORK OUTSIDE THE LOCATED AREA WITHOUT OBTAINING ANOTHER LOCATE.

FROM: 5M N of N.BL 729-751 Ridgewood Avenue

TO: N.FL of 729-751 Ridgewood Avenue

FROM: W.FL of 729-751 Ridgewood Avenue

TO: E.BL of 729-751 Ridgewood Avenue

- Legend**
- Building Line - BL -
 - Fence Line - FL -
 - Face of Curb - FC -
 - Asphalt Edge - AE -
 - Sidewalk - SW -
 - Driveway - DW -
 - Manhole
 - Pedestal
 - Flush to Grade Pedestal
 - Buried Service Wire - BSW -
 - Buried Cable - B -
 - Conduit - C -
 - Fiber Optic Cable - FO -
 - Bell Hydro Service - BH -
 - Gas Valve
 - Gas Service - GS -
 - Gas Main - GM -
 - Transformer
 - Demarcation
 - Hydro - H -
 - Hydro Primary - HP -
 - Hydro Secondary - HS -
 - Catch Basin
 - Sewer Manhole
 - Water Valve
 - Hydrant
 - Water Valve Chamber
 - Hydro / Bell Pole
 - Railway
 - End Cap
 - Traffic Manhole
 - Street Light Cable - SL -
 - Street Light
 - North N.
 - East E.
 - West W.
 - South S.

CAUTION: Hand dig within 1.5M as measured horizontally from the field markings to avoid damaging the underground utilities. If you damage the plant, you may be held liable. If you damage underground plant, contact the facility owner immediately. Depth varies and **MUST** be verified by hand digging or vacuum excavation. LOCATED AREA HAS BEEN ALTERED AS PER: Luke F.

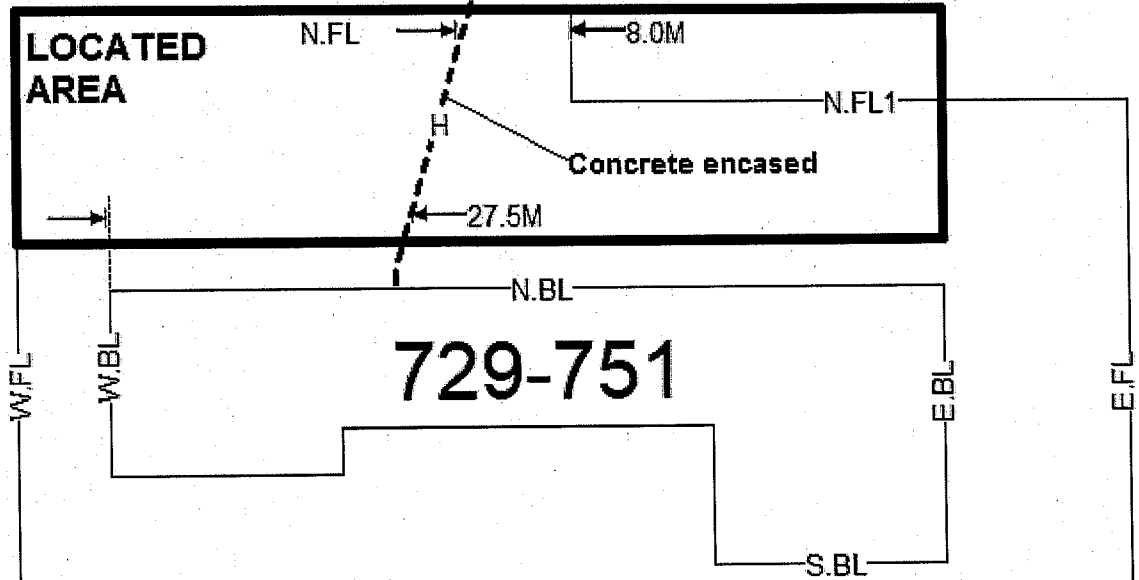
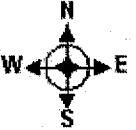

*****DANGER DO NOT PROCEED*****
 BURIED HIGH VOLTAGE CABLES WITHIN THE LOCATED AREA. YOU MUST SEND LOCATE TO HOLsupervisions@hydroottawa.com OR CONTACT HYDRO OTTAWA AT 613-738-6418 FOR FURTHER INFORMATION
 "EMERGENCY" NUMBER IS 613-738-0188

Ridgewood Avenue

THIS FORM VALID ONLY WITH Primary Locate Form. This sketch is not to scale.
 Any privately owned services within the located area have not been marked- check with service/property owner.

A copy of this Auxiliary Locate Sheet(s) and the Primary Locate Sheet must be on site and in the hands of the machine operator during work operations. If sketch and markings do not coincide, the Excavator must obtain a new locate.

ENBRIDGE GAS INC.

Thank you for calling for a locate prior to starting your project.

Please note Enbridge Gas Inc has changed the locate validity period for station codes **ENOE01** and **EN2OE01** and this completed locate is valid for a period of **60 days** from the completion date on the Primary Locate Sheet.

You must adhere to the following:

- You must follow all STOP letters associated with your locate if provided in your locate package.
- You should always review the Primary and all the Auxiliary Sheets of your locate package and understand the validity period for all utilities / infrastructure owners.
- It is the responsibility of Excavators to protect and preserve the original yellow paint markings. White paint can be used to preserve/maintain the markings but should be placed beside or at the top / bottom of the original markings ensuring not to replace the yellow paint.

When winter conditions exist, such as snow, pink paint and stakes or flags can be used.

Please be aware new gas services or mains can be installed after this locate was completed. Newly buried gas plant flags will be installed as visual identifier if this occurs.



If flags are present, please contact Enbridge Gas Damage Prevention at 1-866-922-3622

For station code – **ENOE01** or *Legacy Enbridge Gas Distribution* please refer to the Third Party Requirements in the Vicinity of Natural Gas Facilities must always be followed.

<https://www.enbridgegas.com/~media/Extranet-Pages/Safety/Before-you-dig/Third-Party-Requirements-in-the-Vicinity-of-Natural-Gas-Facilities>

For station code **EN2OE01** or *Legacy Union Gas* please refer to

<https://www.uniongas.com/about-us/safety/safe-digging-practices>

Thank you



February 9 2015

To all Excavators:

Bell locates are now valid for the life of the excavation project and will not automatically be relocated every 60 days.

Please note the following for the above to apply:

- a) Construction within the located area begins within 60 days of the "locate completed" date on the original ticket.
- b) The construction company named on the locate remains active on the site.

Bell expects excavators will protect and preserve the paint marks put down on the original locate ticket. If markings are removed due to weather or excavation work the excavator is expected to recreate the markings based on the tie-in measurements provided on the original locate ticket.

If an excavator would like their markings freshened up they can contact Promark (the Bell Canada Locate Service Provider in this area) directly to arrange for them to place fresh markings on the ground however this will be at the excavators expense. Promark can be reached at 613-723-9888.

The locate will be considered officially expired one day after the final day of construction.

Thank you.

Bell Canada

Service Request Details

Service Request

1360829

Lagan Case ID: 20202342131

Source: Contractor

Created By: Ga Maxpur

Priority:

Reported By:

Status: RESOLVED

Initiated: 2020-Jun-01 1:05 PM

Location Information

Address: RIDGEWOOD AVE

Range: 729-753

Unit:

Between Streets: SPRINGLAND DR / RIVERSIDE DR

Municipality: OO

Description:

Street Range:729-753
 Street:RIDGEWOOD AVE
 Intersect 1:SPRINGLAND DR
 Intersect 2:RIVERSIDE DR
 Door Numbers:-
 Municipality:

The work area is clear of underground water and sewer pipes owned by The City of Ottawa if the excavation is not in the road. The service pipes within the property are privately owned by the property owner and are not the responsibility of The City of Ottawa. Attached is an ArcView.

Please note: City of Ottawa locates are valid for sixty (60) days. | S'il-vous-plaît notez: les localisations de la ville d'Ottawa sont valables pendant soixante (60) jours.

Requestor Information

Name: Sara Staniszewski

Phones

Address: 1704 CARLING AVE

Res:

Cell:

City: OTTAWA

Bus: 6132268750

Ext:

Postal Code: K2A1C7

Unit:

Fax: 6132268677

Call Back & Other Assignments

Responsibilities

Service Request

Work Order #

Work Order

Request Details

Start Date:

Appointment Time:

Service: ESD

Finish Date: 2020-Jun-04

Classification: LOCATES - PROVIDE

Amount Charge to Customer:

Category:

Structures

Structure ID	District	Description	Location	Qualifier	Unit
--------------	----------	-------------	----------	-----------	------

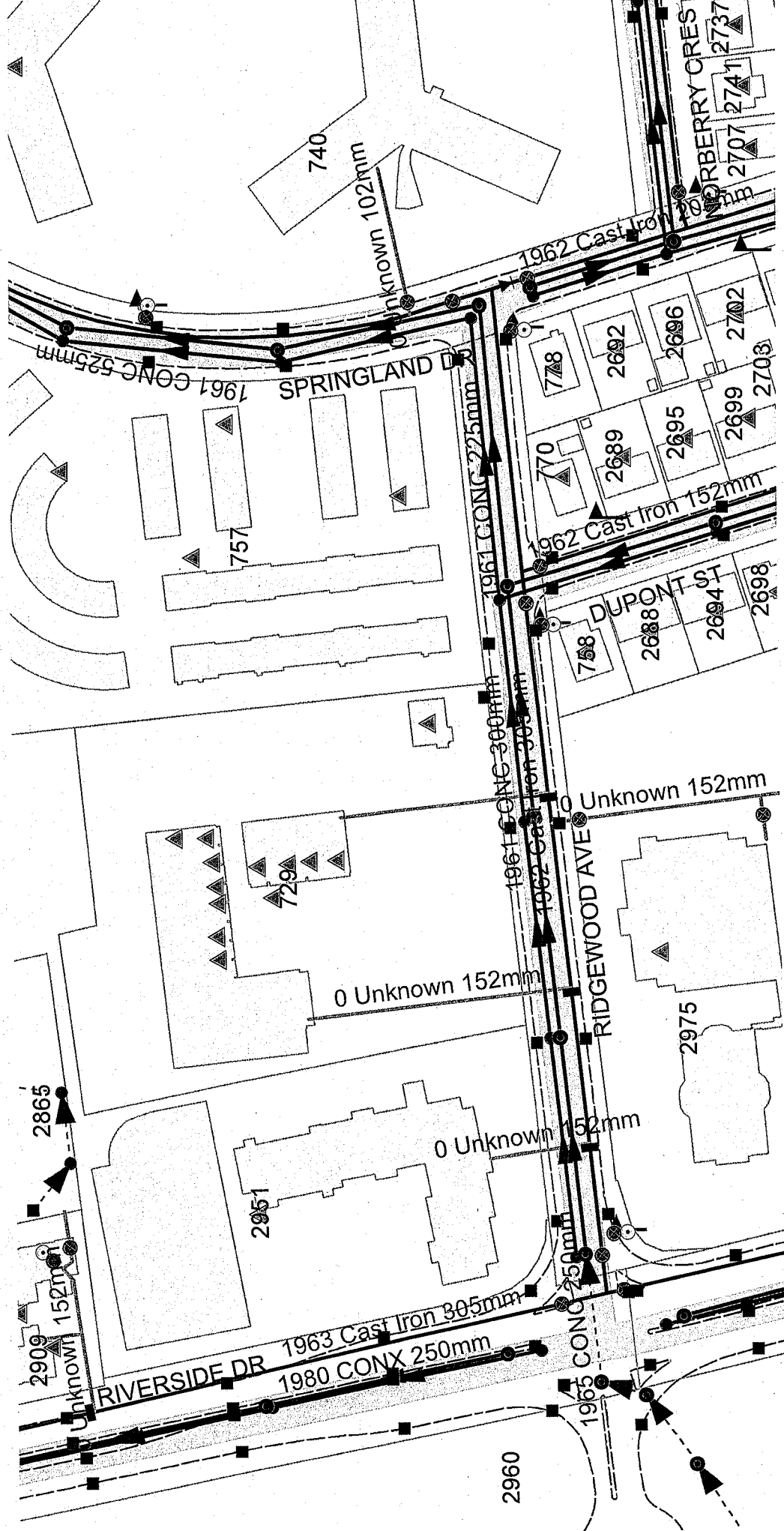

Ph: (905) 479-5674 Email: ontario@canadianlocators.com

Contractor / Excavator : U S L		Contact Name : Sara Staniszewski	
Tel : 613-226-8750	Alt. Phone :	Email : locates@usl-1.com	
Received Date : Jun 2 2020	Excavation Date : Jun 8 2020	Revised Excavation Date :	Type of Work : BORE HOLES
Locate Address : 729-753 RIDGEWOOD AVE		City / Municipality : OTTAWA, ONTARIO	
Nearest Intersection : SPRINGLAND DR & RIVERSIDE DR			
Method of Field Marking : <input type="checkbox"/> Paint <input type="checkbox"/> Stakes <input type="checkbox"/> Flags			

Caller's Remarks (Additional Info):
 CORLOT=U Drilling throughout property. Clear entire property and to sidewalk along Ridgewood Ave. Includes property known as 753 Ridgewood.//Civic # 729, 753.

Utilities Marked :	<input type="checkbox"/> Coaxial Plant	<input type="checkbox"/> Fibre Optics Plant			This locate has multiple work areas which are greater than 100 m apart : <input type="checkbox"/> Yes <input type="checkbox"/> No
Total Length :	m.	Total Length :	m.		

Field sketch and Located Area shown on auxiliary locate sheet(s)

This locate is for ROGERS plant/ infrastructure ONLY!

Apply sticker here if required

CAUTION : Locate is VOID after 60 days !

CAUTION : Hand dig within one (1) meter or 3.28 feet of markings. The Located Area defined on the Auxiliary Locate Sheet(s) contains all known ROGERS infrastructure. Any changes to excavation area or nature of work requires a new locate.

**For all cut cable, please call :
 1-800-265-9501**

Locator's Comments :
 ROGERS CABLES CLEAR IN LOCATED AREA

Locator's Name : (Please Print)
 Courtney Stoddard

Date : Jun 4 2020	Start Time : 5:30 PM	End Time : 5:40 PM
----------------------	-------------------------	-----------------------

A copy of this Primary Locate Sheet and Auxiliary Locate Sheet(s) must be on site and in the hands of the machine operator during work operations. Should sketch and markings not coincide, a new locate MUST be obtained.

Ph: (905) 479-5674 Email: ontario@canadianlocators.com

Utilities Marked :

Coaxial Plant m Fibre Optics Plant m

Number of Services Marked : (specify building/house numbers)

NA

LOCATED AREA CONTAINS ALL KNOWN ROGERS INFRASTRUCTURE

FROM :
 30M N OF N BL OF 729 - 753 RIDGEWOOD AVE.

TO :
 N FC OF RIDGEWOOD AVE.

FROM :
 10M W OF W BL OF 729 - 753 RIDGEWOOD AVE.

TO :
 35M E OF E BL OF 729 - 753 RIDGEWOOD AVE

Hand dig within 1 meter or 3.28 feet as measured horizontally from the field markings to avoid damaging the underground utilities.
 If you damage the utilities, you may be held liable. For all cut cable, please call: 1-800-265-9501 immediately!
 Depth of cable plant varies and MUST be determined by hand digging or vacuum excavation.
 LOCATED AREA ALTERED AS PER :



ROGERS CABLES CLEAR IN LOCATED AREA

LOCATED AREA

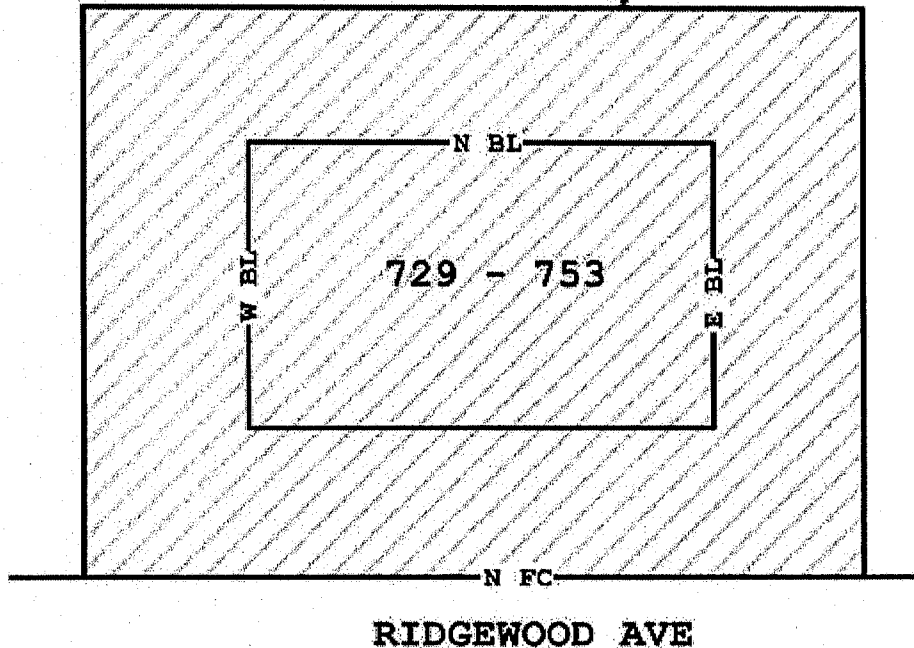

RIDGEWOOD AVE

Sketch not drawn to scale

LEGEND :

Fibre Optic — FQ —
 Cable / T.V. — CATV —
 Conduit — C —
 Railway — [|||||] —
 Work Area — [diagonal lines] —

Road Edge — RE —
 Bldg Line — BL —
 North Direction — N —
 Sidewalk — SW —
 Measurement — [arrow] —

Property Line — PL —
 Lot Line — LL —
 Face of Curb — FC —
 Driveway — DW —
 Fence Line — FL —

Tree — [circle with dot] —
 Pedestal — [square with X] —
 Pole — [circle with X] —
 Valve — [circle with arrow] —
 Vault — [square with V] —

Transformer — [square with T] —
 Manhole — [circle with M] —
 Catch Basin — [square with CB] —
 North — N —
 South — S —

Streetlight — [circle with SL] —
 Hand Hole — [square with HH] —
 Hydrant — [circle with H] —
 East — E —
 West — W —

A copy of this Auxiliary Locate Sheet(s) and the Primary Locate Sheet must be on site and in the hands of the machine operator during work operations. Should sketch and markings not coincide, a new locate MUST be obtained.

Sara S

From: agt_comm@irth.com
Sent: Monday, June 1, 2020 2:20 PM
To: Locates
Subject: Ticket 2020234213 - TELUS Facility Locate Request: Results/Information
Attachments: 2020234213.PNG; 2020234213_1.PNG

=====
To: U S L Attn: Sara Staniszewski
Voice: 6132268750 **Fax:** 6132268677
Re: TELUS Facility Locate Request: Results/Information

****This is an important Safety Message from TELUS Communications Company regarding your Provincial One-Call Locate Request** PLEASE REVIEW THIS ENTIRE MESSAGE!** We are responding to your request to locate TELUS underground facilities in the specific area of excavation listed on this One-Call ticket.
Your locate request has been reviewed and its status is explained below*:

=====
Ticket: 2020234213
County: ONTARIO **Place:** OTTAWA
Address: 729 to 753 RIDGEWOOD AVE

TELUSON3:

Upon review of the information and the work area specified on this locate request, we will not be marking TELUS lines at this time for the following reason: Additional information below ***NOTE* TELUS N/R, OUR RECORDS SHOW NO TELUS FACILITIES LOCATED AT THE LOCATION LISTED ON YOUR LOCATE REQUEST.**

=====
If you have any questions or concerns regarding this response, please contact the Cable Locate Support Centre for AB,BC,SK, MB & ON, by calling, 1-800-980-0030. Any damage to TELUS facilities **MUST** be reported as a "Dig Up" to your Provincial One-Call Center ASAP. We ask, that while excavating, you dig with caution. Thank You for using your local Dial / Click Before You Dig process!

=====
This message was generated by an automated system. Please do not reply to this email.

On1 Call #	2020234213
Date Requested	06/01/2020 1:03:33 PM

City of Ottawa Street Light Locate

Dispatcher: Melissa Dowdell
Phone: 613-526-1226



Company	U S L
Name	SARA STANISZEWSKI
Phone	(613)-226-8750 ext.
FAX	(613)-226-8677 ext.
Site Contact	JACQUES DESJARDINS
Phone	

Instructions
 729 to 753, RIDGEWOOD AVE
 CIVIC # 729, 753. CORLOT=U DRILLING THROUGHOUT PROPERTY. CLEAR ENTIRE PROPERTY AND TO SIDEWALK ALONG RIDGEWOOD AVE. INCLUDES PROPERTY KNOWN AS 753 RIDGEWOOD. NO_PLAN:613 737

LOCATOR SKETCH

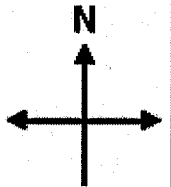

Clear

No City of Ottawa Street
Light assets in dig area

- SL** Underground Street Light Cable
- OH** Overhead/Aerial Wires
- △** Source/Transformer
- ⊗** Street Light
- ⊗** Globe/Decorative Light
- Hydro Pole

Locator Notes/Comments:

Locate is valid for 60 days. If sketch is different from markings, location or nature of work changes, a new locate must be requested. Hand dig within 1m (3.28ft) on either side of markings. Depth of buried plant varies. Cette fiche n'est pas valide 60 jours de calendrier apres le reperege. Si les marques ne concordent pas avec celles sur le croquis, un nouveau reperege est requis. Tout changement a l'emplacement ou a la nature du travail necessite un nouveau reperege. Creuser a la main un metre (3.28 pieds) du repere. La profondeur des installation varie d'un endroit a l'autre.	Date Located	06/03/2020
	Time of day	
	Located by	JUSTIN VAVROS
	Signature	
	Page 2	of 2

USL-1 DISCLAIMER - FORM 101

- It is our Clients responsibility to fully read and understand this document, prior to any ground disturbance taking place. Should any questions or clarifications be required, contact USL-1 before commencing work
- Locate is VOID after 30 days from the date the locate was completed. Contact USL-1 for remarks and/or new ticket requests, with a minimum notice of 5 business days
- If the scope of work, locate area, or site information changes, contact USL-1 before continuing work. In certain instances, a new ticket request may be required
- Any work within 1.5 metres laterally of a marked utility, must be hand dug or daylighted. Utility depths vary, as does the accuracy of the locate equipment, and therefore depths are typically not provided and should not be used for excavation purposes. Depth of utilities should also be verified by hand digging or daylighting. The best information is provided at the time of the locate, however the accuracy of field markings can vary with regard to equipment accuracy and external interference
- If the paint markings or flags on site differ from that of the sketch provided, please contact USL-1 before commencing work. If possible, the issue will be clarified by USL-1 and/or a site meet may be requested with the appropriate parties
- The "Excavator" is responsible for keeping a current copy of the locates on site, with the operators and in/on the excavation equipment AT ALL TIMES
- It is the "Excavator/Contractor's" responsibility to read ALL locate sheets, both public and private, to ensure they understand what potential hazards or buried utilities exist in their work area
- Special purpose locates such as sewer sondeing, locate surveys, tunnel identification, conduit identification, ground fault detections, ground penetrating radar, well cap location, concrete scanning, or anything else that requires use of more than Radiodetection equipment, must be identified at the time of the original locate request. Should a USL-1 locator identify any special needs services during a normal Private utility locate, the client will be notified for the appropriate course of action
- Not all buried utilities can be traced. In many instances, water and sewer lines, irrigation systems, grounding cables, fibre optic cables, heating cables, protection cables, and communication cables may not be traceable. Typically, sewer lines will be painted and lined up directionally from manhole to manhole where possible. It may not be possible to detect bends in the sewer lines between manholes. If tracer wires have been buried with the utility, they will be used to locate the buried utility where possible. If a buried utility cannot be traced, it will be noted on the USL-1 report. USL-1 is not liable for damage to untraceable utilities
- Public utility locators have maps, plans and as-built diagrams for reference to work from. Private utility locators, for the most part, do not. USL-1 will attempt to locate any Private utilities on a site, using as-built plans provided to them. Building access is mandatory and must be arranged by our client. Any conduits or utilities noted entering or exiting a building will be traced if possible, as well as any other visible utilities observed on site. It is the responsibility of the contractor to provide any and all buried utility information and site contacts that they have. There is no guarantee that USL-1 can find all buried utilities if the property owner does not have records or information regarding their own buried utilities
- USL-1 cannot be held liable for damage to Private water and/or sewer laterals unless building access is granted, and the utility is locatable
- Thick snow and ice, frozen manhole lids, live traffic, parked cars, construction debris and activities etc, are all factors that can interfere with USL-1's ability to perform Private utility locates. USL-1 cannot guaranty location of all buried utilities when such factors impede the locate process. It is the contractor's responsibility to ensure that the work areas are safe and accessible for locates, prior to USL-1's arrival to site
- USL-1 as a Private utility locator, is not permitted to locate Publicly owned utilities. In some cases, Public utilities may be noted on a sketch, but are FOR REFERENCE ONLY, and under no circumstances shall be used for excavation purposes. It is the contractor's responsibility to verify any Public utilities noted on the USL-1 sketch by referring to the Public utility locate sheets for physical LOCATION AND ACCURACY. USL-1 DOES NOT ASSUME LIABILITY FOR PUBLIC LOCATE INNACCURACIES
- If the proposed work area is on Private property, it does NOT mean that all buried utilities are Private. Regardless of where you are digging, and what the proposed depth of excavation is, it is the law to notify Ontario One Call (or Info-Excavation in Quebec) to obtain Public utility locates
- NCC PROPERTY - assuming the contractor has been issued a Land Access Permit from the NCC, it is typically indicated within the permit that it is the contractor's responsibility to contact NCC for utility locates of their buried utilities

Appendix C

Borehole Logs

CLIENT 11684663 Canada Inc. **PROJECT NAME** Phase Two Environmental Site Assessment
PROJECT NUMBER LOP20-002B **PROJECT LOCATION** 729 Ridgewood Avenue, Ottawa, Ontario
DATE STARTED 6-24-20 **COMPLETED** 6-24-20 **GROUND ELEVATION** 100.93 m **HOLE SIZE** 20 cm
DRILLING CONTRACTOR George Downing Estate Drilling **GROUND WATER LEVELS:**
DRILLING METHOD Truck Mounted CME 55 **AFTER DRILLING** 3.59 m / Elev 97.34 m
LOGGED BY L. Lopers **CHECKED BY** D. Plenderleith
NOTES Site Datum = 100.00 m Top of Spindle of Fire Hydrant SE of Property

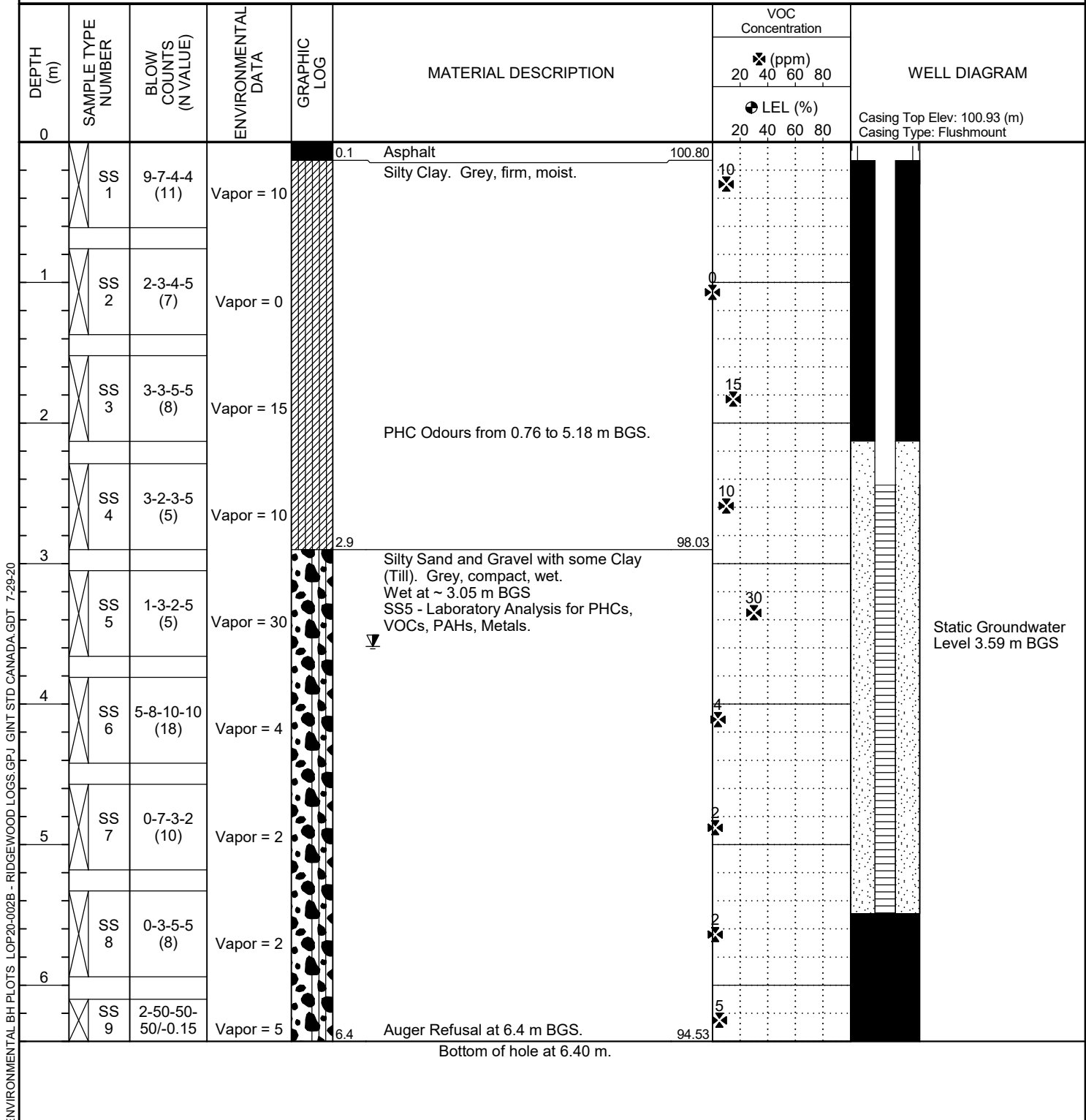

ENVIRONMENTAL BH PLOTS - RIDGEWOOD LOGS.GPJ GINT STD CANADA.GDT 7-29-20

CLIENT 11684663 Canada Inc. **PROJECT NAME** Phase Two Environmental Site Assessment
PROJECT NUMBER LOP20-002B **PROJECT LOCATION** 729 Ridgewood Avenue, Ottawa, Ontario
DATE STARTED 6-24-20 **COMPLETED** 6-24-20 **GROUND ELEVATION** 99.63 m **HOLE SIZE** 20 cm
DRILLING CONTRACTOR George Downing Estate Drilling **GROUND WATER LEVELS:**
DRILLING METHOD Track Mounted CME 55 **AFTER DRILLING** ---
LOGGED BY L. Lopers **CHECKED BY** D. Plenderleith
NOTES Site Datum = 100.00 m Top of Spindle of Fire Hydrant SE of Property

DEPTH (m)	SAMPLE TYPE NUMBER	BLOW COUNTS (N VALUE)	ENVIRONMENTAL DATA	GRAPHIC LOG	MATERIAL DESCRIPTION	VOC Concentration				WELL DIAGRAM
						✕ (ppm)				
						20	40	60	80	
0						☉ LEL (%)				
						20	40	60	80	
						20	40	60	80	
0.1	SS 1	2-5-5-6 (10)	Vapor = 0		Silty Sand and gravel (Fill). Grey, compact, moist. Sand (Fill). Brown, loose, moist.					99.50
1.4	SS 2	4-6-50-50 (56)	Vapor = 0		Silty Sand and gravel (Fill). Grey, compact, moist.					98.26
2.3	SS 3	8-9-11-9 (20)	Vapor = 0		Silty Clay. Brown/grey, firm, moist.					97.33
2.9	SS 4	3-8-10-50 (18)	Vapor = 0		Silty Sand and Gravel (Till). Grey, compact, wet. Wet at 3.05 m BGS.					96.73
3.05	SS 5	3-8-12-10 (20)	Vapor = 5							5
4.4	SS 6	3-4-4-4 (8)	Vapor = 0							95.21

Bottom of hole at 4.42 m.

ENVIRONMENTAL BH PLOTS LOP20-002B - RIDGEWOOD LOGS.GPJ GINT STD CANADA.GDT 7-29-20

CLIENT 11684663 Canada Inc. **PROJECT NAME** Phase Two Environmental Site Assessment
PROJECT NUMBER LOP20-002B **PROJECT LOCATION** 729 Ridgewood Avenue, Ottawa, Ontario
DATE STARTED 6-24-20 **COMPLETED** 6-24-20 **GROUND ELEVATION** 100.15 m **HOLE SIZE** 20 cm
DRILLING CONTRACTOR George Downing Estate Drilling **GROUND WATER LEVELS:**
DRILLING METHOD Truck Mounted CME 55 **AFTER DRILLING** 3.90 m / Elev 96.25 m
LOGGED BY L. Lopers **CHECKED BY** D. Plenderleith
NOTES Site Datum = 100.00 m Top of Spindle of Fire Hydrant SE of Property

DEPTH (m)	SAMPLE TYPE NUMBER	BLOW COUNTS (N VALUE)	ENVIRONMENTAL DATA	GRAPHIC LOG	MATERIAL DESCRIPTION	VOC Concentration		WELL DIAGRAM
						✕ (ppm)		
						⊕ LEL (%)		
0						20 40 60 80	20 40 60 80	Casing Top Elev: 100.15 (m) Casing Type: Flushmount Static Groundwater Level 3.90 m BGS
0.1	SS 1	3-8-9-5 (17)	Vapor = 0	Silty Sand and gravel (Fill). Grey, compact, moist. Sand (Fill). Brown, loose, moist.	0	0		
1	SS 2	2-2-2-1 (4)	Vapor = 0			0	0	
1.4	SS 3	1-2-2-3 (4)	Vapor = 0	Silty Sand and gravel (Fill). Grey, compact, moist.		0	0	
2.3	SS 4	3-4-3-5 (7)	Vapor = 5	Silty Clay. Brown/grey, firm, moist.	5			
2.9	SS 5	40-36-25-18 (61)	Vapor = 2	Silty Sand and Gravel (Till). Grey, compact, wet. PHC Odours from 2.3 to 5.18 m BGS. Wet at ~ 3.81 m BGS.	2			
3.81	SS 6	16-12-12-11 (24)	Vapor = 700	Very strong gasoline odour at 3.81 m BGS. SS6 - Laboratory Analysis for PHCs, BTEXs, PAHs.	>>>			
5.18	SS 7	4-6-10-10 (16)	Vapor = 7		7			
5.94	SS 8	2-6-10-10 (16)	Vapor = 13		13			

Bottom of hole at 5.94 m.

ENVIRONMENTAL BH PLOTS LOP20-002B - RIDGEWOOD LOGS.GPJ GINT STD CANADA.GDT 7-29-20

CLIENT 11684663 Canada Inc. **PROJECT NAME** Phase Two Environmental Site Assessment
PROJECT NUMBER LOP20-002B **PROJECT LOCATION** 729 Ridgewood Avenue, Ottawa, Ontario
DATE STARTED 6-24-20 **COMPLETED** 6-24-20 **GROUND ELEVATION** 99.88 m **HOLE SIZE** 20 cm
DRILLING CONTRACTOR George Downing Estate Drilling **GROUND WATER LEVELS:**
DRILLING METHOD Truck Mounted CME 55 **AFTER DRILLING** ---
LOGGED BY L. Lopers **CHECKED BY** D. Plenderleith
NOTES Site Datum = 100.00 m Top of Spindle of Fire Hydrant SE of Property

DEPTH (m)	SAMPLE TYPE NUMBER	BLOW COUNTS (N VALUE)	ENVIRONMENTAL DATA	GRAPHIC LOG	MATERIAL DESCRIPTION	VOC Concentration				WELL DIAGRAM
						✕ (ppm)				
						20	40	60	80	
0						☉ LEL (%)				
						20	40	60	80	
0						20	40	60	80	
0.2	SS 1	4-6-6-6 (12)	Vapor = 0		Silty Sand and gravel (Fill). Grey, compact, moist.					99.73
					Sand (Fill). Brown, loose, moist.					
1	SS 2	4-5-5-4 (10)	Vapor = 0							
2	SS 3	3-2-2-1 (4)	Vapor = 0							
3	SS 4	1-0-1-0 (1)	Vapor = 5		Wet at 2.44 m BGS.					5
4	SS 5	0-0-0-0 (0)	Vapor = 15							15
4	SS 6	0-0-0-0 (0)	Vapor = 55		SS6 - Laboratory Analysis for PHCs, BTEXs, PAHs, Metals.					55
4.4					Silty Sand and Gravel (Till). Grey, compact, wet.					95.46
5	SS 7	0-1-1-1 (2)	Vapor = 0							
5.2										94.70

Bottom of hole at 5.18 m.

ENVIRONMENTAL BH PLOTS - RIDGEWOOD LOGS.GPJ GINT STD CANADA.GDT 7-29-20

CLIENT 11684663 Canada Inc. **PROJECT NAME** Phase Two Environmental Site Assessment
PROJECT NUMBER LOP20-002B **PROJECT LOCATION** 729 Ridgewood Avenue, Ottawa, Ontario
DATE STARTED 6-24-20 **COMPLETED** 6-24-20 **GROUND ELEVATION** 100.39 m **HOLE SIZE** 20 cm
DRILLING CONTRACTOR George Downing Estate Drilling **GROUND WATER LEVELS:**
DRILLING METHOD Truck Mounted CME 55 **AFTER DRILLING** 3.18 m / Elev 97.21 m
LOGGED BY L. Lopers **CHECKED BY** D. Plenderleith
NOTES Site Datum = 100.00 m Top of Spindle of Fire Hydrant SE of Property

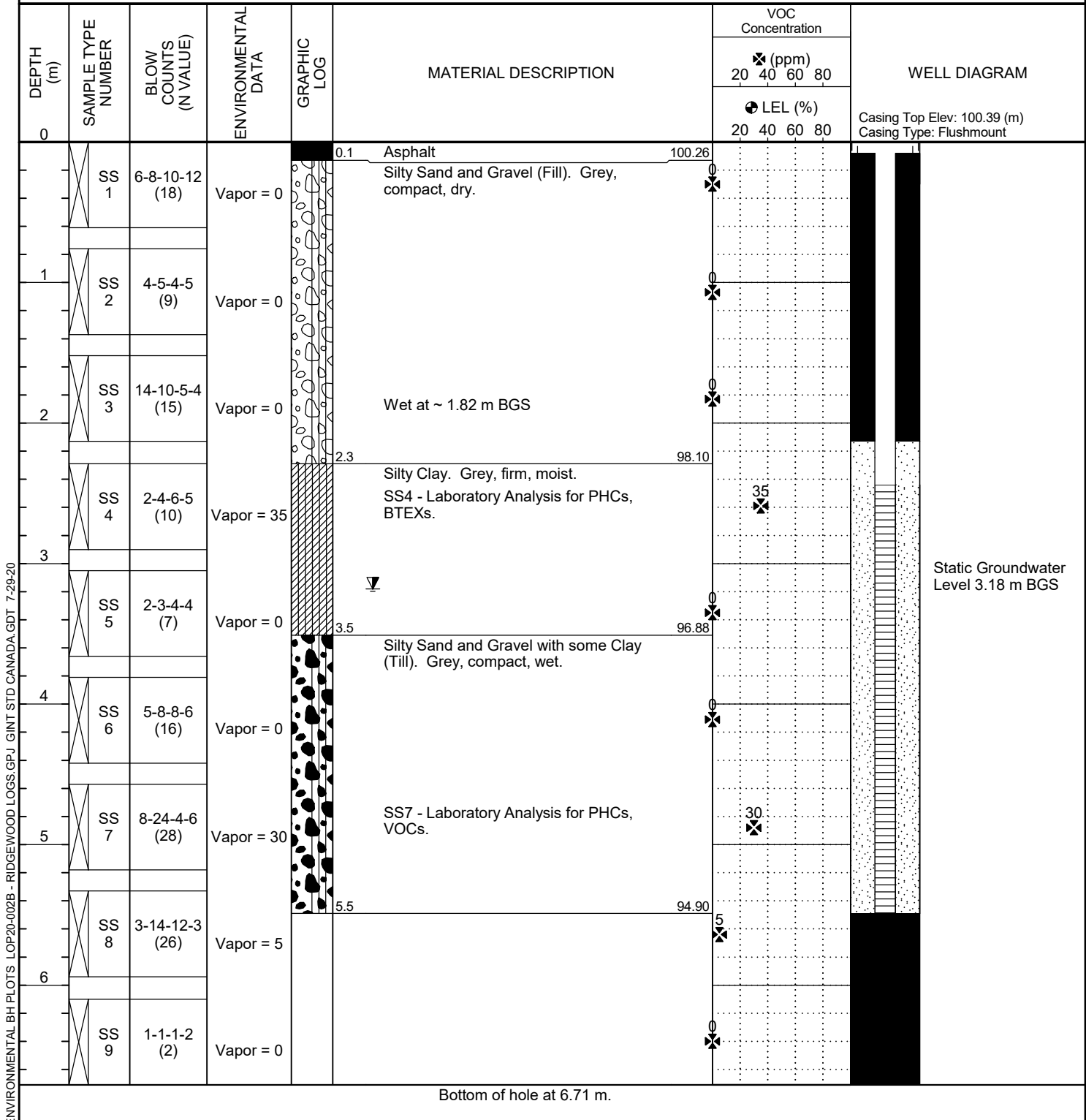













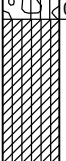

ENVIRONMENTAL BH PLOTS LOP20-002B - RIDGEWOOD LOGS.GPJ GINT STD CANADA.GDT 7-29-20

CLIENT 11684663 Canada Inc. **PROJECT NAME** Phase Two Environmental Site Assessment
PROJECT NUMBER LOP20-002B **PROJECT LOCATION** 729 Ridgewood Avenue, Ottawa, Ontario
DATE STARTED 6-24-20 **COMPLETED** 6-24-20 **GROUND ELEVATION** 100.99 m **HOLE SIZE** 20 cm
DRILLING CONTRACTOR George Downing Estate Drilling **GROUND WATER LEVELS:**
DRILLING METHOD Truck Mounted CME 55 **AFTER DRILLING** ---
LOGGED BY L. Lopers **CHECKED BY** D. Plenderleith
NOTES Site Datum = 100.00 m Top of Spindle of Fire Hydrant SE of Property

DEPTH (m)	SAMPLE TYPE NUMBER	BLOW COUNTS (N VALUE)	ENVIRONMENTAL DATA	GRAPHIC LOG	MATERIAL DESCRIPTION	VOC Concentration				WELL DIAGRAM
						✕ (ppm)				
						20	40	60	80	
0						☉ LEL (%)				
						20	40	60	80	
0					0.1 Asphalt 100.86					
	AU 1		Vapor = 0		Silty Sand and gravel (Fill). Grey, compact, moist.					✕
1					0.8 Silty Clay. Grey, firm, moist. 100.23					
	SS 2	2-3-5-7 (8)	Vapor = 0							✕
2										
	SS 3	4-4-6-5 (10)	Vapor = 5							✕ 5
3										
	SS 4	3-3-4-5 (7)	Vapor = 15							✕ 15
4										
	SS 5	2-3-4-4 (7)	Vapor = 0		Wet at ~ 3.3 m BGS					✕
5										
	SS 6	21-12-8-7 (20)			3.8 Silty Sand and Gravel with some Clay (Till). Grey, compact, wet. 97.18					
5										
	SS 7	10-7-12-10 (19)	Vapor = 0							✕
					5.2 Bottom of hole at 5.18 m. 95.81					

ENVIRONMENTAL BH PLOTS LOP20-002B - RIDGEWOOD LOGS.GPJ GINT STD CANADA.GDT 7-29-20

CLIENT 11684663 Canada Inc. **PROJECT NAME** Phase Two Environmental Site Assessment
PROJECT NUMBER LOP20-002B **PROJECT LOCATION** 729 Ridgewood Avenue, Ottawa, Ontario
DATE STARTED 6-24-20 **COMPLETED** 6-24-20 **GROUND ELEVATION** 101.07 m **HOLE SIZE** 20 cm
DRILLING CONTRACTOR George Downing Estate Drilling **GROUND WATER LEVELS:**
DRILLING METHOD Truck Mounted CME 55 **AFTER DRILLING** ---
LOGGED BY L. Lopers **CHECKED BY** D. Plenderleith
NOTES Site Datum = 100.00 m Top of Spindle of Fire Hydrant SE of Property

DEPTH (m)	SAMPLE TYPE NUMBER	BLOW COUNTS (N VALUE)	ENVIRONMENTAL DATA	GRAPHIC LOG	MATERIAL DESCRIPTION	VOC Concentration				WELL DIAGRAM
						✕ (ppm)				
						⊕ LEL (%)				
0										
	AU 1		Vapor = 0		0.1 Asphalt 100.97					
			Vapor = 0		Silty Sand and gravel (Fill). Grey, compact, moist.					
1	SS 2	2-3-5-8 (8)	Vapor = 0		0.8 Silty Clay. Grey, firm, moist. 100.31					
			Vapor = 0							
2	SS 3	4-5-7-7 (12)	Vapor = 0							
			Vapor = 0							
3	SS 4	1-3-4-5 (7)	Vapor = 0							
			Vapor = 0							
4	SS 5	1-2-2-3 (4)	Vapor = 0							
			Vapor = 0							
5	SS 6	8-12-15-8 (27)	Vapor = 0		3.8 Wet at ~ 3.81 m BGS 97.26					
			Vapor = 0		Silty Sand and Gravel with some Clay (Till). Grey, compact, wet.					
			Vapor = 0							
	SS 7	7-24-18-19 (42)	Vapor = 0		5.2 95.89					

Bottom of hole at 5.18 m.

ENVIRONMENTAL BH PLOTS LOP20-002B - RIDGEWOOD LOGS.GPJ GINT STD CANADA.GDT 7-29-20

Appendix D

Certificates of Equipment Calibration



ENVIRONMENTAL AND SAFETY INC.
 "Exceptional Customer Service!"

Certificate of Calibration

HORIBA U-52 Serial Number *YH3406FIT* has been calibrated per the Manufacturers published instructions, using NIST traceable solutions and

2, 2-Point pH	Cond.	Turb,	DO	ORP
4.00, 7.00, 10.0	4.49uS/cm	0, 100 NTU	<i>8.62</i> mg/L@ <i>22.75</i> DegC	240mV
pH 4.0 Lot #9GD684 Exp05/21	zero checked	Zero checked	Sodium Sulfite Zero	
pH 7.0 Lot# 9GK721 Exp.11/21	Cond.Standard Lot#9GC1263	StableCal Standard, 100 NTU	Oakton Zero Oxygen Solution Lot# 639901	ORP Test Solution 240 mV
pH 10.0 Lot#9GD483 Exp. 04/21	Exp. 04/2021	Lot#A9151 Exp.06/21		
				Lot # 4318 Exp 06/2024

Solutions ref. to NIST SRM's

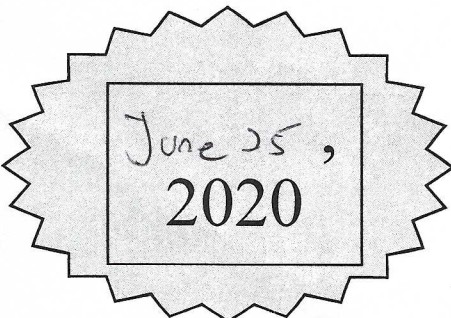

Calibrated

RENTALS, SALES, SERVICE, SUPPORT

MAXIM ENVIRONMENTAL AND SAFETY INC.

148 Colonnade Rd, UNIT # 9
Nepean, Ontario, K2E 7R4

Phone: (613)224-4747

CERTIFICATE OF CALIBRATION

The RKI Instruments **Model EAGLE-2** as listed below has been inspected and calibrated following the Manufacturer's published specifications and methods.

Instrument Model: **EAGLE-2**

Serial Number: *E2F801*

Date of Calibration: *June 23/2020*

<u>SENSOR</u>	<u>CALIBRATION GAS STANDARD</u>	<u>CALIBRATION GAS CONCENTRATION</u>	<u>READING PRIOR TO ADJUSTMENT</u>	<u>INSTRUMENT SPAN SETTING</u>	<u>ALARM LEVEL SETTINGS</u>
Combustible	Hexane lot # 1189063	15% LEL	1650 ppm	15% LEL "Methane Elimination" Mode	10 & 50% LEL
Combustible	Methane lot # 1013148	50% LEL	<500 PPM	Verification Only "Methane Elimination" Mode	
Combustible	Hexane lot # 1189063	15% LEL	1650 ppm	15% LEL "Methane Response Enabled" Mode	10 & 50% LEL
VOC	Isobutylene lot # 1278604	100 PPM	100 PPM	100 PPM	400 & 1000 PPM

The calibration gas standard used is considered to be a certified standard and is traceable to the National Institute of Standards and Technology (NIST). Certificate of Analysis is available upon request.

The instrument indicated above is now certified to be operating within the Manufacturer's specifications. **This does not preclude the requirement for regular maintenance and pre-use sensor response checks in order to ensure continued complete and accurate operating condition.**

Certified: *[Signature]*

Appendix E

Laboratory Certificates of Analysis

Certificate of Analysis

Lopers & Associates

30 Lansfield Way
Ottawa, ONT K2G 3V8
Attn: Luke Lopers

Client PO: LOP20-002B
Project: LOP20-002B
Custody: 54317

Report Date: 7-Jul-2020
Order Date: 24-Jun-2020

Revised Report

Order #: 2026367

This Certificate of Analysis contains analytical data applicable to the following samples as submitted:

Parcel ID	Client ID
2026367-01	BH1-20-SS5
2026367-02	BH3-20-SS6
2026367-03	BH4-20-SS6
2026367-04	BH5-20-SS4
2026367-05	BH5-20-SS7
2026367-06	BH11-20-SS5

Approved By:



Dale Robertson, BSc
Laboratory Director

Certificate of Analysis

Report Date: 07-Jul-2020

Client: Lopers & Associates

Order Date: 24-Jun-2020

Client PO: LOP20-002B

Project Description: LOP20-002B

Analysis Summary Table

Analysis	Method Reference/Description	Extraction Date	Analysis Date
Boron, available	MOE (HWE), EPA 200.8 - ICP-MS	3-Jul-20	3-Jul-20
BTEX by P&T GC-MS	EPA 8260 - P&T GC-MS	26-Jun-20	29-Jun-20
Chromium, hexavalent - soil	MOE E3056 - Extraction, colourimetric	25-Jun-20	27-Jun-20
Conductivity	MOE E3138 - probe @25 °C, water ext	30-Jun-20	30-Jun-20
Cyanide, free	MOE E3015 - Auto Colour, water extraction	25-Jun-20	26-Jun-20
Mercury by CVAA	EPA 7471B - CVAA, digestion	30-Jun-20	30-Jun-20
pH, soil	EPA 150.1 - pH probe @ 25 °C, CaCl buffered ext.	25-Jun-20	26-Jun-20
PHC F1	CWS Tier 1 - P&T GC-FID	26-Jun-20	26-Jun-20
PHCs F2 to F4	CWS Tier 1 - GC-FID, extraction	25-Jun-20	30-Jun-20
REG 153: Metals by ICP/MS, soil	EPA 6020 - Digestion - ICP-MS	29-Jun-20	7-Jul-20
REG 153: PAHs by GC-MS	EPA 8270 - GC-MS, extraction	25-Jun-20	29-Jun-20
REG 153: VOCs by P&T GC/MS	EPA 8260 - P&T GC-MS	26-Jun-20	26-Jun-20
SAR	Calculated	2-Jul-20	2-Jul-20
Solids, %	Gravimetric, calculation	26-Jun-20	27-Jun-20

Certificate of Analysis

Report Date: 07-Jul-2020

Client: Lopers & Associates

Order Date: 24-Jun-2020

Client PO: LOP20-002B

Project Description: LOP20-002B

Client ID:	BH1-20-SS5	BH3-20-SS6	BH4-20-SS6	BH5-20-SS4
Sample Date:	24-Jun-20 09:00	24-Jun-20 09:00	24-Jun-20 09:00	24-Jun-20 09:00
Sample ID:	2026367-01	2026367-02	2026367-03	2026367-04
MDL/Units	Soil	Soil	Soil	Soil

Physical Characteristics

% Solids	0.1 % by Wt.	71.5	92.5	87.1	79.5
----------	--------------	------	------	------	------

General Inorganics

SAR	0.01 N/A	0.76	-	1.12	-
Conductivity	5 uS/cm	636	-	627	-
Cyanide, free	0.03 ug/g dry	<0.03	-	<0.03	-
pH	0.05 pH Units	7.14	-	7.40	-

Metals

Antimony	1.0 ug/g dry	<1.0	-	<1.0	-
Arsenic	1.0 ug/g dry	3.9	-	3.7	-
Barium	1.0 ug/g dry	284	-	46.3	-
Beryllium	0.5 ug/g dry	0.7	-	<0.5	-
Boron	5.0 ug/g dry	5.8	-	6.5	-
Boron, available	0.5 ug/g dry	<0.5	-	<0.5	-
Cadmium	0.5 ug/g dry	<0.5	-	<0.5	-
Chromium	5.0 ug/g dry	104	-	13.1	-
Chromium (VI)	0.2 ug/g dry	0.3	-	<0.2	-
Cobalt	1.0 ug/g dry	20.1	-	5.6	-
Copper	5.0 ug/g dry	45.5	-	12.4	-
Lead	1.0 ug/g dry	6.1	-	5.2	-
Mercury	0.1 ug/g dry	<0.1	-	<0.1	-
Molybdenum	1.0 ug/g dry	<1.0	-	<1.0	-
Nickel	5.0 ug/g dry	56.1	-	10.6	-
Selenium	1.0 ug/g dry	<1.0	-	<1.0	-
Silver	0.3 ug/g dry	<0.3	-	<0.3	-
Thallium	1.0 ug/g dry	<1.0	-	<1.0	-
Uranium	1.0 ug/g dry	<1.0	-	<1.0	-
Vanadium	10.0 ug/g dry	101	-	23.5	-
Zinc	20.0 ug/g dry	92.7	-	<20.0	-

Volatiles

Acetone	0.50 ug/g dry	<0.50	-	-	-
Benzene	0.02 ug/g dry	<0.02	-	-	-
Bromodichloromethane	0.05 ug/g dry	<0.05	-	-	-
Bromoform	0.05 ug/g dry	<0.05	-	-	-
Bromomethane	0.05 ug/g dry	<0.05	-	-	-
Carbon Tetrachloride	0.05 ug/g dry	<0.05	-	-	-

Certificate of Analysis

Report Date: 07-Jul-2020

Client: Lopers & Associates

Order Date: 24-Jun-2020

Client PO: LOP20-002B

Project Description: LOP20-002B

	Client ID:	BH1-20-SS5	BH3-20-SS6	BH4-20-SS6	BH5-20-SS4
	Sample Date:	24-Jun-20 09:00	24-Jun-20 09:00	24-Jun-20 09:00	24-Jun-20 09:00
	Sample ID:	2026367-01	2026367-02	2026367-03	2026367-04
	MDL/Units	Soil	Soil	Soil	Soil
Chlorobenzene	0.05 ug/g dry	<0.05	-	-	-
Chloroform	0.05 ug/g dry	<0.05	-	-	-
Dibromochloromethane	0.05 ug/g dry	<0.05	-	-	-
Dichlorodifluoromethane	0.05 ug/g dry	<0.05	-	-	-
1,2-Dichlorobenzene	0.05 ug/g dry	<0.05	-	-	-
1,3-Dichlorobenzene	0.05 ug/g dry	<0.05	-	-	-
1,4-Dichlorobenzene	0.05 ug/g dry	<0.05	-	-	-
1,1-Dichloroethane	0.05 ug/g dry	<0.05	-	-	-
1,2-Dichloroethane	0.05 ug/g dry	<0.05	-	-	-
1,1-Dichloroethylene	0.05 ug/g dry	<0.05	-	-	-
cis-1,2-Dichloroethylene	0.05 ug/g dry	<0.05	-	-	-
trans-1,2-Dichloroethylene	0.05 ug/g dry	<0.05	-	-	-
1,2-Dichloropropane	0.05 ug/g dry	<0.05	-	-	-
cis-1,3-Dichloropropylene	0.05 ug/g dry	<0.05	-	-	-
trans-1,3-Dichloropropylene	0.05 ug/g dry	<0.05	-	-	-
1,3-Dichloropropene, total	0.05 ug/g dry	<0.05	-	-	-
Ethylbenzene	0.05 ug/g dry	<0.05	-	-	-
Ethylene dibromide (dibromoethane, 1,2-)	0.05 ug/g dry	<0.05	-	-	-
Hexane	0.05 ug/g dry	<0.05	-	-	-
Methyl Ethyl Ketone (2-Butanone)	0.50 ug/g dry	<0.50	-	-	-
Methyl Isobutyl Ketone	0.50 ug/g dry	<0.50	-	-	-
Methyl tert-butyl ether	0.05 ug/g dry	<0.05	-	-	-
Methylene Chloride	0.05 ug/g dry	<0.05	-	-	-
Styrene	0.05 ug/g dry	<0.05	-	-	-
1,1,1,2-Tetrachloroethane	0.05 ug/g dry	<0.05	-	-	-
1,1,1,2,2-Tetrachloroethane	0.05 ug/g dry	<0.05	-	-	-
Tetrachloroethylene	0.05 ug/g dry	<0.05	-	-	-
Toluene	0.05 ug/g dry	<0.05	-	-	-
1,1,1-Trichloroethane	0.05 ug/g dry	<0.05	-	-	-
1,1,2-Trichloroethane	0.05 ug/g dry	<0.05	-	-	-
Trichloroethylene	0.05 ug/g dry	<0.05	-	-	-
Trichlorofluoromethane	0.05 ug/g dry	<0.05	-	-	-
Vinyl chloride	0.02 ug/g dry	<0.02	-	-	-
m,p-Xylenes	0.05 ug/g dry	<0.05	-	-	-
o-Xylene	0.05 ug/g dry	<0.05	-	-	-

Certificate of Analysis

Report Date: 07-Jul-2020

Client: Lopers & Associates

Order Date: 24-Jun-2020

Client PO: LOP20-002B

Project Description: LOP20-002B

	Client ID:	BH1-20-SS5	BH3-20-SS6	BH4-20-SS6	BH5-20-SS4
	Sample Date:	24-Jun-20 09:00	24-Jun-20 09:00	24-Jun-20 09:00	24-Jun-20 09:00
	Sample ID:	2026367-01	2026367-02	2026367-03	2026367-04
	MDL/Units	Soil	Soil	Soil	Soil
Xylenes, total	0.05 ug/g dry	<0.05	-	-	-
4-Bromofluorobenzene	Surrogate	98.3%	-	-	-
Dibromofluoromethane	Surrogate	116%	-	-	-
Toluene-d8	Surrogate	104%	-	-	-
Benzene	0.02 ug/g dry	-	3.02	<0.02	<0.02
Ethylbenzene	0.05 ug/g dry	-	59.0	<0.05	<0.05
Toluene	0.05 ug/g dry	-	73.5	<0.05	<0.05
m,p-Xylenes	0.05 ug/g dry	-	196	<0.05	<0.05
o-Xylene	0.05 ug/g dry	-	80.3	<0.05	<0.05
Xylenes, total	0.05 ug/g dry	-	276	<0.05	<0.05
Toluene-d8	Surrogate	-	100%	104%	102%

Hydrocarbons

F1 PHCs (C6-C10)	7 ug/g dry	22	117	<7	<7
F2 PHCs (C10-C16)	4 ug/g dry	909	110	<4	<4
F3 PHCs (C16-C34)	8 ug/g dry	102	11	<8	<8
F4 PHCs (C34-C50)	6 ug/g dry	<6	<6	<6	<6

Semi-Volatiles

Acenaphthene	0.02 ug/g dry	0.07	<0.02	<0.02	-
Acenaphthylene	0.02 ug/g dry	0.11	<0.02	<0.02	-
Anthracene	0.02 ug/g dry	<0.02	<0.02	<0.02	-
Benzo [a] anthracene	0.02 ug/g dry	<0.02	<0.02	<0.02	-
Benzo [a] pyrene	0.02 ug/g dry	<0.02	<0.02	<0.02	-
Benzo [b] fluoranthene	0.02 ug/g dry	<0.02	<0.02	<0.02	-
Benzo [g,h,i] perylene	0.02 ug/g dry	<0.02	<0.02	<0.02	-
Benzo [k] fluoranthene	0.02 ug/g dry	<0.02	<0.02	<0.02	-
Chrysene	0.02 ug/g dry	<0.02	<0.02	<0.02	-
Dibenzo [a,h] anthracene	0.02 ug/g dry	<0.02	<0.02	<0.02	-
Fluoranthene	0.02 ug/g dry	<0.02	<0.02	<0.02	-
Fluorene	0.02 ug/g dry	0.26	<0.02	<0.02	-
Indeno [1,2,3-cd] pyrene	0.02 ug/g dry	<0.02	<0.02	<0.02	-
1-Methylnaphthalene	0.02 ug/g dry	3.02	0.58	<0.02	-
2-Methylnaphthalene	0.02 ug/g dry	4.58	1.37	<0.02	-
Methylnaphthalene (1&2)	0.04 ug/g dry	7.61	1.95	<0.04	-
Naphthalene	0.01 ug/g dry	0.50	1.69	<0.01	-
Phenanthrene	0.02 ug/g dry	0.13	0.03	<0.02	-
Pyrene	0.02 ug/g dry	<0.02	<0.02	<0.02	-
2-Fluorobiphenyl	Surrogate	67.4%	91.3%	88.2%	-

Certificate of Analysis

Report Date: 07-Jul-2020

Client: **Lopers & Associates**

Order Date: 24-Jun-2020

Client PO: **LOP20-002B**

Project Description: **LOP20-002B**

	Client ID:	BH1-20-SS5	BH3-20-SS6	BH4-20-SS6	BH5-20-SS4
	Sample Date:	24-Jun-20 09:00	24-Jun-20 09:00	24-Jun-20 09:00	24-Jun-20 09:00
	Sample ID:	2026367-01	2026367-02	2026367-03	2026367-04
	MDL/Units	Soil	Soil	Soil	Soil
Terphenyl-d14	Surrogate	75.7%	97.2%	116%	-

Certificate of Analysis
 Client: Lopers & Associates
 Client PO: LOP20-002B

Report Date: 07-Jul-2020

Order Date: 24-Jun-2020

Project Description: LOP20-002B

Client ID:	BH5-20-SS7	BH11-20-SS5	-	-
Sample Date:	24-Jun-20 09:00	24-Jun-20 09:00	-	-
Sample ID:	2026367-05	2026367-06	-	-
MDL/Units	Soil	Soil	-	-

Physical Characteristics

% Solids	0.1 % by Wt.	92.8	70.6	-	-
----------	--------------	------	------	---	---

General Inorganics

SAR	0.01 N/A	-	0.81	-	-
Conductivity	5 uS/cm	-	670	-	-
Cyanide, free	0.03 ug/g dry	-	<0.03	-	-
pH	0.05 pH Units	-	7.33	-	-

Metals

Antimony	1.0 ug/g dry	-	<1.0	-	-
Arsenic	1.0 ug/g dry	-	4.0	-	-
Barium	1.0 ug/g dry	-	327	-	-
Beryllium	0.5 ug/g dry	-	0.9	-	-
Boron	5.0 ug/g dry	-	7.2	-	-
Boron, available	0.5 ug/g dry	-	<0.5	-	-
Cadmium	0.5 ug/g dry	-	<0.5	-	-
Chromium	5.0 ug/g dry	-	126	-	-
Chromium (VI)	0.2 ug/g dry	-	0.3	-	-
Cobalt	1.0 ug/g dry	-	22.5	-	-
Copper	5.0 ug/g dry	-	49.0	-	-
Lead	1.0 ug/g dry	-	6.8	-	-
Mercury	0.1 ug/g dry	-	<0.1	-	-
Molybdenum	1.0 ug/g dry	-	<1.0	-	-
Nickel	5.0 ug/g dry	-	65.4	-	-
Selenium	1.0 ug/g dry	-	<1.0	-	-
Silver	0.3 ug/g dry	-	<0.3	-	-
Thallium	1.0 ug/g dry	-	<1.0	-	-
Uranium	1.0 ug/g dry	-	<1.0	-	-
Vanadium	10.0 ug/g dry	-	104	-	-
Zinc	20.0 ug/g dry	-	114	-	-

Volatiles

Acetone	0.50 ug/g dry	<0.50	<0.50	-	-
Benzene	0.02 ug/g dry	<0.02	<0.02	-	-
Bromodichloromethane	0.05 ug/g dry	<0.05	<0.05	-	-
Bromoform	0.05 ug/g dry	<0.05	<0.05	-	-
Bromomethane	0.05 ug/g dry	<0.05	<0.05	-	-
Carbon Tetrachloride	0.05 ug/g dry	<0.05	<0.05	-	-

Certificate of Analysis
 Client: **Lopers & Associates**
 Client PO: **LOP20-002B**

Report Date: 07-Jul-2020

Order Date: 24-Jun-2020

 Project Description: **LOP20-002B**

	MDL/Units	Client ID: Sample Date: Sample ID: Soil	BH5-20-SS7 24-Jun-20 09:00 2026367-05 Soil	BH11-20-SS5 24-Jun-20 09:00 2026367-06 Soil	-	-
Chlorobenzene	0.05 ug/g dry	<0.05	<0.05	-	-	
Chloroform	0.05 ug/g dry	<0.05	<0.05	-	-	
Dibromochloromethane	0.05 ug/g dry	<0.05	<0.05	-	-	
Dichlorodifluoromethane	0.05 ug/g dry	<0.05	<0.05	-	-	
1,2-Dichlorobenzene	0.05 ug/g dry	<0.05	<0.05	-	-	
1,3-Dichlorobenzene	0.05 ug/g dry	<0.05	<0.05	-	-	
1,4-Dichlorobenzene	0.05 ug/g dry	<0.05	<0.05	-	-	
1,1-Dichloroethane	0.05 ug/g dry	<0.05	<0.05	-	-	
1,2-Dichloroethane	0.05 ug/g dry	<0.05	<0.05	-	-	
1,1-Dichloroethylene	0.05 ug/g dry	<0.05	<0.05	-	-	
cis-1,2-Dichloroethylene	0.05 ug/g dry	<0.05	<0.05	-	-	
trans-1,2-Dichloroethylene	0.05 ug/g dry	<0.05	<0.05	-	-	
1,2-Dichloropropane	0.05 ug/g dry	<0.05	<0.05	-	-	
cis-1,3-Dichloropropylene	0.05 ug/g dry	<0.05	<0.05	-	-	
trans-1,3-Dichloropropylene	0.05 ug/g dry	<0.05	<0.05	-	-	
1,3-Dichloropropene, total	0.05 ug/g dry	<0.05	<0.05	-	-	
Ethylbenzene	0.05 ug/g dry	<0.05	<0.05	-	-	
Ethylene dibromide (dibromoethane, 1	0.05 ug/g dry	<0.05	<0.05	-	-	
Hexane	0.05 ug/g dry	<0.05	<0.05	-	-	
Methyl Ethyl Ketone (2-Butanone)	0.50 ug/g dry	<0.50	<0.50	-	-	
Methyl Isobutyl Ketone	0.50 ug/g dry	<0.50	<0.50	-	-	
Methyl tert-butyl ether	0.05 ug/g dry	<0.05	<0.05	-	-	
Methylene Chloride	0.05 ug/g dry	<0.05	<0.05	-	-	
Styrene	0.05 ug/g dry	<0.05	<0.05	-	-	
1,1,1,2-Tetrachloroethane	0.05 ug/g dry	<0.05	<0.05	-	-	
1,1,1,2,2-Tetrachloroethane	0.05 ug/g dry	<0.05	<0.05	-	-	
Tetrachloroethylene	0.05 ug/g dry	<0.05	<0.05	-	-	
Toluene	0.05 ug/g dry	<0.05	<0.05	-	-	
1,1,1-Trichloroethane	0.05 ug/g dry	<0.05	<0.05	-	-	
1,1,2-Trichloroethane	0.05 ug/g dry	<0.05	<0.05	-	-	
Trichloroethylene	0.05 ug/g dry	<0.05	<0.05	-	-	
Trichlorofluoromethane	0.05 ug/g dry	<0.05	<0.05	-	-	
Vinyl chloride	0.02 ug/g dry	<0.02	<0.02	-	-	
m,p-Xylenes	0.05 ug/g dry	<0.05	0.08	-	-	
o-Xylene	0.05 ug/g dry	<0.05	<0.05	-	-	

Certificate of Analysis

Report Date: 07-Jul-2020

Client: Lopers & Associates

Order Date: 24-Jun-2020

Client PO: LOP20-002B

Project Description: LOP20-002B

	Client ID:	BH5-20-SS7	BH11-20-SS5	-	-
	Sample Date:	24-Jun-20 09:00	24-Jun-20 09:00	-	-
	Sample ID:	2026367-05	2026367-06	-	-
	MDL/Units	Soil	Soil	-	-
Xylenes, total	0.05 ug/g dry	<0.05	0.08	-	-
4-Bromofluorobenzene	Surrogate	101%	101%	-	-
Dibromofluoromethane	Surrogate	110%	111%	-	-
Toluene-d8	Surrogate	103%	102%	-	-

Hydrocarbons

F1 PHCs (C6-C10)	7 ug/g dry	<7	34	-	-
F2 PHCs (C10-C16)	4 ug/g dry	<4	306	-	-
F3 PHCs (C16-C34)	8 ug/g dry	<8	25	-	-
F4 PHCs (C34-C50)	6 ug/g dry	<6	<6	-	-

Semi-Volatiles

Acenaphthene	0.02 ug/g dry	-	0.05	-	-
Acenaphthylene	0.02 ug/g dry	-	0.03	-	-
Anthracene	0.02 ug/g dry	-	<0.02	-	-
Benzo [a] anthracene	0.02 ug/g dry	-	<0.02	-	-
Benzo [a] pyrene	0.02 ug/g dry	-	<0.02	-	-
Benzo [b] fluoranthene	0.02 ug/g dry	-	<0.02	-	-
Benzo [g,h,i] perylene	0.02 ug/g dry	-	<0.02	-	-
Benzo [k] fluoranthene	0.02 ug/g dry	-	<0.02	-	-
Chrysene	0.02 ug/g dry	-	<0.02	-	-
Dibenzo [a,h] anthracene	0.02 ug/g dry	-	<0.02	-	-
Fluoranthene	0.02 ug/g dry	-	<0.02	-	-
Fluorene	0.02 ug/g dry	-	0.10	-	-
Indeno [1,2,3-cd] pyrene	0.02 ug/g dry	-	<0.02	-	-
1-Methylnaphthalene	0.02 ug/g dry	-	0.89	-	-
2-Methylnaphthalene	0.02 ug/g dry	-	1.38	-	-
Methylnaphthalene (1&2)	0.04 ug/g dry	-	2.26	-	-
Naphthalene	0.01 ug/g dry	-	0.26	-	-
Phenanthrene	0.02 ug/g dry	-	0.07	-	-
Pyrene	0.02 ug/g dry	-	<0.02	-	-
2-Fluorobiphenyl	Surrogate	-	79.7%	-	-
Terphenyl-d14	Surrogate	-	75.2%	-	-

Certificate of Analysis

Report Date: 07-Jul-2020

Client: Lopers & Associates

Order Date: 24-Jun-2020

Client PO: LOP20-002B

Project Description: LOP20-002B

Method Quality Control: Blank

Analyte	Result	Reporting Limit	Units	Source Result	%REC	%REC Limit	RPD	RPD Limit	Notes
General Inorganics									
Conductivity	ND	5	uS/cm						
Cyanide, free	ND	0.03	ug/g						
Hydrocarbons									
F1 PHCs (C6-C10)	ND	7	ug/g						
F2 PHCs (C10-C16)	ND	4	ug/g						
F3 PHCs (C16-C34)	ND	8	ug/g						
F4 PHCs (C34-C50)	ND	6	ug/g						
Metals									
Antimony	ND	1.0	ug/g						
Arsenic	ND	1.0	ug/g						
Barium	ND	1.0	ug/g						
Beryllium	ND	0.5	ug/g						
Boron, available	ND	0.5	ug/g						
Boron	ND	5.0	ug/g						
Cadmium	ND	0.5	ug/g						
Chromium (VI)	ND	0.2	ug/g						
Chromium	ND	5.0	ug/g						
Cobalt	ND	1.0	ug/g						
Copper	ND	5.0	ug/g						
Lead	ND	1.0	ug/g						
Mercury	ND	0.1	ug/g						
Molybdenum	ND	1.0	ug/g						
Nickel	ND	5.0	ug/g						
Selenium	ND	1.0	ug/g						
Silver	ND	0.3	ug/g						
Thallium	ND	1.0	ug/g						
Uranium	ND	1.0	ug/g						
Vanadium	ND	10.0	ug/g						
Zinc	ND	20.0	ug/g						
Semi-Volatiles									
Acenaphthene	ND	0.02	ug/g						
Acenaphthylene	ND	0.02	ug/g						
Anthracene	ND	0.02	ug/g						
Benzo [a] anthracene	ND	0.02	ug/g						
Benzo [a] pyrene	ND	0.02	ug/g						
Benzo [b] fluoranthene	ND	0.02	ug/g						
Benzo [g,h,i] perylene	ND	0.02	ug/g						
Benzo [k] fluoranthene	ND	0.02	ug/g						
Chrysene	ND	0.02	ug/g						
Dibenzo [a,h] anthracene	ND	0.02	ug/g						
Fluoranthene	ND	0.02	ug/g						
Fluorene	ND	0.02	ug/g						
Indeno [1,2,3-cd] pyrene	ND	0.02	ug/g						
1-Methylnaphthalene	ND	0.02	ug/g						
2-Methylnaphthalene	ND	0.02	ug/g						
Methylnaphthalene (1&2)	ND	0.04	ug/g						
Naphthalene	ND	0.01	ug/g						
Phenanthrene	ND	0.02	ug/g						
Pyrene	ND	0.02	ug/g						
Surrogate: 2-Fluorobiphenyl	1.30		ug/g		97.5	50-140			
Surrogate: Terphenyl-d14	1.31		ug/g		97.9	50-140			
Volatiles									
Acetone	ND	0.50	ug/g						
Benzene	ND	0.02	ug/g						
Bromodichloromethane	ND	0.05	ug/g						
Bromoform	ND	0.05	ug/g						
Bromomethane	ND	0.05	ug/g						

Certificate of Analysis

Report Date: 07-Jul-2020

Client: Lopers & Associates

Order Date: 24-Jun-2020

Client PO: LOP20-002B

Project Description: LOP20-002B

Method Quality Control: Blank

Analyte	Result	Reporting Limit	Units	Source Result	%REC	%REC Limit	RPD	RPD Limit	Notes
Carbon Tetrachloride	ND	0.05	ug/g						
Chlorobenzene	ND	0.05	ug/g						
Chloroform	ND	0.05	ug/g						
Dibromochloromethane	ND	0.05	ug/g						
Dichlorodifluoromethane	ND	0.05	ug/g						
1,2-Dichlorobenzene	ND	0.05	ug/g						
1,3-Dichlorobenzene	ND	0.05	ug/g						
1,4-Dichlorobenzene	ND	0.05	ug/g						
1,1-Dichloroethane	ND	0.05	ug/g						
1,2-Dichloroethane	ND	0.05	ug/g						
1,1-Dichloroethylene	ND	0.05	ug/g						
cis-1,2-Dichloroethylene	ND	0.05	ug/g						
trans-1,2-Dichloroethylene	ND	0.05	ug/g						
1,2-Dichloropropane	ND	0.05	ug/g						
cis-1,3-Dichloropropylene	ND	0.05	ug/g						
trans-1,3-Dichloropropylene	ND	0.05	ug/g						
1,3-Dichloropropene, total	ND	0.05	ug/g						
Ethylbenzene	ND	0.05	ug/g						
Ethylene dibromide (dibromoethane, 1,2-	ND	0.05	ug/g						
Hexane	ND	0.05	ug/g						
Methyl Ethyl Ketone (2-Butanone)	ND	0.50	ug/g						
Methyl Isobutyl Ketone	ND	0.50	ug/g						
Methyl tert-butyl ether	ND	0.05	ug/g						
Methylene Chloride	ND	0.05	ug/g						
Styrene	ND	0.05	ug/g						
1,1,1,2-Tetrachloroethane	ND	0.05	ug/g						
1,1,2,2-Tetrachloroethane	ND	0.05	ug/g						
Tetrachloroethylene	ND	0.05	ug/g						
Toluene	ND	0.05	ug/g						
1,1,1-Trichloroethane	ND	0.05	ug/g						
1,1,2-Trichloroethane	ND	0.05	ug/g						
Trichloroethylene	ND	0.05	ug/g						
Trichlorofluoromethane	ND	0.05	ug/g						
Vinyl chloride	ND	0.02	ug/g						
m,p-Xylenes	ND	0.05	ug/g						
o-Xylene	ND	0.05	ug/g						
Xylenes, total	ND	0.05	ug/g						
Surrogate: 4-Bromofluorobenzene	8.40		ug/g		105	50-140			
Surrogate: Dibromofluoromethane	9.45		ug/g		118	50-140			
Surrogate: Toluene-d8	6.94		ug/g		86.7	50-140			
Benzene	ND	0.02	ug/g						
Ethylbenzene	ND	0.05	ug/g						
Toluene	ND	0.05	ug/g						
m,p-Xylenes	ND	0.05	ug/g						
o-Xylene	ND	0.05	ug/g						
Xylenes, total	ND	0.05	ug/g						
Surrogate: Toluene-d8	6.94		ug/g		86.7	50-140			

Certificate of Analysis

Report Date: 07-Jul-2020

Client: Lopers & Associates

Order Date: 24-Jun-2020

Client PO: LOP20-002B

Project Description: LOP20-002B

Method Quality Control: Duplicate

Analyte	Result	Reporting Limit	Units	Source Result	%REC	%REC Limit	RPD	RPD Limit	Notes
General Inorganics									
Conductivity	626	5	uS/cm	627			0.2	5	
Cyanide, free	ND	0.03	ug/g dry	ND			NC	35	
pH	7.37	0.05	pH Units	7.38			0.1	2.3	
Hydrocarbons									
F1 PHCs (C6-C10)	30	7	ug/g dry	22			30.6	40	
F2 PHCs (C10-C16)	ND	4	ug/g dry	ND			NC	30	
F3 PHCs (C16-C34)	ND	8	ug/g dry	ND			NC	30	
F4 PHCs (C34-C50)	ND	6	ug/g dry	ND			NC	30	
Metals									
Antimony	1.0	1.0	ug/g dry	ND			NC	30	
Arsenic	2.2	1.0	ug/g dry	2.1			NC	30	
Barium	12.5	1.0	ug/g dry	11.4			9.6	30	
Beryllium	ND	0.5	ug/g dry	ND			NC	30	
Boron, available	ND	0.5	ug/g dry	ND			NC	35	
Boron	ND	5.0	ug/g dry	ND			NC	30	
Cadmium	ND	0.5	ug/g dry	ND			NC	30	
Chromium (VI)	ND	0.2	ug/g dry	ND			NC	35	
Chromium	8.9	5.0	ug/g dry	8.4			6.0	30	
Cobalt	3.7	1.0	ug/g dry	3.6			NC	30	
Copper	8.3	5.0	ug/g dry	8.5			NC	30	
Lead	2.3	1.0	ug/g dry	2.1			6.2	30	
Mercury	ND	0.1	ug/g dry	ND			NC	30	
Molybdenum	ND	1.0	ug/g dry	ND			NC	30	
Nickel	6.2	5.0	ug/g dry	6.4			2.8	30	
Selenium	ND	1.0	ug/g dry	ND			NC	30	
Silver	ND	0.3	ug/g dry	ND			NC	30	
Thallium	ND	1.0	ug/g dry	ND			NC	30	
Uranium	ND	1.0	ug/g dry	ND			NC	30	
Vanadium	17.4	10.0	ug/g dry	16.2			7.2	30	
Zinc	ND	20.0	ug/g dry	ND			NC	30	
Physical Characteristics									
% Solids	78.6	0.1	% by Wt.	68.7			13.5	25	
Semi-Volatiles									
Acenaphthene	ND	0.02	ug/g dry	ND			NC	40	
Acenaphthylene	ND	0.02	ug/g dry	ND			NC	40	
Anthracene	ND	0.02	ug/g dry	ND			NC	40	
Benzo [a] anthracene	ND	0.02	ug/g dry	ND			NC	40	
Benzo [a] pyrene	ND	0.02	ug/g dry	ND			NC	40	
Benzo [b] fluoranthene	ND	0.02	ug/g dry	ND			NC	40	
Benzo [g,h,i] perylene	ND	0.02	ug/g dry	ND			NC	40	
Benzo [k] fluoranthene	ND	0.02	ug/g dry	ND			NC	40	
Chrysene	ND	0.02	ug/g dry	ND			NC	40	
Dibenzo [a,h] anthracene	ND	0.02	ug/g dry	ND			NC	40	
Fluoranthene	ND	0.02	ug/g dry	ND			NC	40	
Fluorene	ND	0.02	ug/g dry	ND			NC	40	
Indeno [1,2,3-cd] pyrene	ND	0.02	ug/g dry	ND			NC	40	
1-Methylnaphthalene	ND	0.02	ug/g dry	ND			NC	40	
2-Methylnaphthalene	ND	0.02	ug/g dry	ND			NC	40	
Naphthalene	ND	0.01	ug/g dry	ND			NC	40	
Phenanthrene	ND	0.02	ug/g dry	ND			NC	40	
Pyrene	ND	0.02	ug/g dry	ND			NC	40	
Surrogate: 2-Fluorobiphenyl	1.07		ug/g dry		67.2	50-140			
Surrogate: Terphenyl-d14	1.36		ug/g dry		85.5	50-140			
Volatiles									
Acetone	ND	0.50	ug/g dry	ND			NC	50	

Certificate of Analysis

Report Date: 07-Jul-2020

Client: Lopers & Associates

Order Date: 24-Jun-2020

Client PO: LOP20-002B

Project Description: LOP20-002B

Method Quality Control: Duplicate

Analyte	Result	Reporting Limit	Units	Source Result	%REC	%REC Limit	RPD	RPD Limit	Notes
Benzene	ND	0.02	ug/g dry	ND			NC	50	
Bromodichloromethane	ND	0.05	ug/g dry	ND			NC	50	
Bromoform	ND	0.05	ug/g dry	ND			NC	50	
Bromomethane	ND	0.05	ug/g dry	ND			NC	50	
Carbon Tetrachloride	ND	0.05	ug/g dry	ND			NC	50	
Chlorobenzene	ND	0.05	ug/g dry	ND			NC	50	
Chloroform	ND	0.05	ug/g dry	ND			NC	50	
Dibromochloromethane	ND	0.05	ug/g dry	ND			NC	50	
Dichlorodifluoromethane	ND	0.05	ug/g dry	ND			NC	50	
1,2-Dichlorobenzene	ND	0.05	ug/g dry	ND			NC	50	
1,3-Dichlorobenzene	ND	0.05	ug/g dry	ND			NC	50	
1,4-Dichlorobenzene	ND	0.05	ug/g dry	ND			NC	50	
1,1-Dichloroethane	ND	0.05	ug/g dry	ND			NC	50	
1,2-Dichloroethane	ND	0.05	ug/g dry	ND			NC	50	
1,1-Dichloroethylene	ND	0.05	ug/g dry	ND			NC	50	
cis-1,2-Dichloroethylene	ND	0.05	ug/g dry	ND			NC	50	
trans-1,2-Dichloroethylene	ND	0.05	ug/g dry	ND			NC	50	
1,2-Dichloropropane	ND	0.05	ug/g dry	ND			NC	50	
cis-1,3-Dichloropropylene	ND	0.05	ug/g dry	ND			NC	50	
trans-1,3-Dichloropropylene	ND	0.05	ug/g dry	ND			NC	50	
Ethylbenzene	ND	0.05	ug/g dry	ND			NC	50	
Ethylene dibromide (dibromoethane, 1,2-	ND	0.05	ug/g dry	ND			NC	50	
Hexane	ND	0.05	ug/g dry	ND			NC	50	
Methyl Ethyl Ketone (2-Butanone)	ND	0.50	ug/g dry	ND			NC	50	
Methyl Isobutyl Ketone	ND	0.50	ug/g dry	ND			NC	50	
Methyl tert-butyl ether	ND	0.05	ug/g dry	ND			NC	50	
Methylene Chloride	ND	0.05	ug/g dry	ND			NC	50	
Styrene	ND	0.05	ug/g dry	ND			NC	50	
1,1,1,2-Tetrachloroethane	ND	0.05	ug/g dry	ND			NC	50	
1,1,2,2-Tetrachloroethane	ND	0.05	ug/g dry	ND			NC	50	
Tetrachloroethylene	ND	0.05	ug/g dry	ND			NC	50	
Toluene	ND	0.05	ug/g dry	ND			NC	50	
1,1,1-Trichloroethane	ND	0.05	ug/g dry	ND			NC	50	
1,1,2-Trichloroethane	ND	0.05	ug/g dry	ND			NC	50	
Trichloroethylene	ND	0.05	ug/g dry	ND			NC	50	
Trichlorofluoromethane	ND	0.05	ug/g dry	ND			NC	50	
Vinyl chloride	ND	0.02	ug/g dry	ND			NC	50	
m,p-Xylenes	ND	0.05	ug/g dry	ND			NC	50	
o-Xylene	ND	0.05	ug/g dry	ND			NC	50	
<i>Surrogate: 4-Bromofluorobenzene</i>	<i>11.1</i>		<i>ug/g dry</i>		<i>99.1</i>	<i>50-140</i>			
<i>Surrogate: Dibromofluoromethane</i>	<i>12.4</i>		<i>ug/g dry</i>		<i>111</i>	<i>50-140</i>			
<i>Surrogate: Toluene-d8</i>	<i>11.5</i>		<i>ug/g dry</i>		<i>103</i>	<i>50-140</i>			
Benzene	ND	0.02	ug/g dry	ND			NC	50	
Ethylbenzene	ND	0.05	ug/g dry	ND			NC	50	
Toluene	ND	0.05	ug/g dry	ND			NC	50	
m,p-Xylenes	ND	0.05	ug/g dry	ND			NC	50	
o-Xylene	ND	0.05	ug/g dry	ND			NC	50	
<i>Surrogate: Toluene-d8</i>	<i>11.5</i>		<i>ug/g dry</i>		<i>103</i>	<i>50-140</i>			

Certificate of Analysis

Report Date: 07-Jul-2020

Client: Lopers & Associates

Order Date: 24-Jun-2020

Client PO: LOP20-002B

Project Description: LOP20-002B

Method Quality Control: Spike

Analyte	Result	Reporting Limit	Units	Source Result	%REC	%REC Limit	RPD	RPD Limit	Notes
General Inorganics									
Cyanide, free	0.210	0.03	ug/g	ND	70.1	70-130			
Hydrocarbons									
F1 PHCs (C6-C10)	187	7	ug/g	ND	93.6	80-120			
F2 PHCs (C10-C16)	119	4	ug/g	ND	129	60-140			
F3 PHCs (C16-C34)	292	8	ug/g	ND	129	60-140			
F4 PHCs (C34-C50)	164	6	ug/g	ND	115	60-140			
Metals									
Antimony	38.9	1.0	ug/g	ND	77.7	70-130			
Arsenic	44.9	1.0	ug/g	ND	88.1	70-130			
Barium	46.6	1.0	ug/g	4.6	84.2	70-130			
Beryllium	46.3	0.5	ug/g	ND	92.4	70-130			
Boron, available	3.73	0.5	ug/g	ND	74.5	70-122			
Boron	42.6	5.0	ug/g	ND	82.9	70-130			
Cadmium	43.1	0.5	ug/g	ND	86.2	70-130			
Chromium (VI)	0.1	0.2	ug/g	ND	74.5	70-130			
Chromium	47.9	5.0	ug/g	ND	89.1	70-130			
Cobalt	44.9	1.0	ug/g	1.5	86.9	70-130			
Copper	45.1	5.0	ug/g	ND	83.5	70-130			
Lead	41.9	1.0	ug/g	ND	82.1	70-130			
Mercury	1.42	0.1	ug/g	ND	94.9	70-130			
Molybdenum	42.4	1.0	ug/g	ND	84.7	70-130			
Nickel	45.2	5.0	ug/g	ND	85.3	70-130			
Selenium	44.2	1.0	ug/g	ND	88.2	70-130			
Silver	51.6	0.3	ug/g	ND	103	70-130			
Thallium	46.2	1.0	ug/g	ND	92.4	70-130			
Uranium	44.1	1.0	ug/g	ND	87.8	70-130			
Vanadium	49.2	10.0	ug/g	ND	85.5	70-130			QM-07
Zinc	46.6	20.0	ug/g	ND	83.6	70-130			
Semi-Volatiles									
Acenaphthene	0.141	0.02	ug/g	ND	71.2	50-140			
Acenaphthylene	0.132	0.02	ug/g	ND	66.4	50-140			
Anthracene	0.145	0.02	ug/g	ND	73.2	50-140			
Benzo [a] anthracene	0.131	0.02	ug/g	ND	66.0	50-140			
Benzo [a] pyrene	0.136	0.02	ug/g	ND	68.5	50-140			
Benzo [b] fluoranthene	0.155	0.02	ug/g	ND	77.9	50-140			
Benzo [g,h,i] perylene	0.129	0.02	ug/g	ND	65.2	50-140			
Benzo [k] fluoranthene	0.149	0.02	ug/g	ND	74.8	50-140			
Chrysene	0.148	0.02	ug/g	ND	74.4	50-140			
Dibenzo [a,h] anthracene	0.118	0.02	ug/g	ND	59.4	50-140			
Fluoranthene	0.142	0.02	ug/g	ND	71.6	50-140			
Fluorene	0.138	0.02	ug/g	ND	69.7	50-140			
Indeno [1,2,3-cd] pyrene	0.122	0.02	ug/g	ND	61.5	50-140			
1-Methylnaphthalene	0.138	0.02	ug/g	ND	69.4	50-140			
2-Methylnaphthalene	0.158	0.02	ug/g	ND	79.7	50-140			
Naphthalene	0.162	0.01	ug/g	ND	81.3	50-140			
Phenanthrene	0.140	0.02	ug/g	ND	70.4	50-140			
Pyrene	0.144	0.02	ug/g	ND	72.7	50-140			
Surrogate: 2-Fluorobiphenyl	0.959		ug/g		60.3	50-140			

Certificate of Analysis

Report Date: 07-Jul-2020

Client: Lopers & Associates

Order Date: 24-Jun-2020

Client PO: LOP20-002B

Project Description: LOP20-002B

Method Quality Control: Spike

Analyte	Result	Reporting Limit	Units	Source Result	%REC	%REC Limit	RPD	RPD Limit	Notes
<i>Surrogate: Terphenyl-d14</i>	1.23		ug/g		77.4	50-140			
Volatiles									
Acetone	11.2	0.50	ug/g	ND	112	50-140			
Benzene	4.57	0.02	ug/g	ND	114	60-130			
Bromodichloromethane	4.45	0.05	ug/g	ND	111	60-130			
Bromoform	4.54	0.05	ug/g	ND	113	60-130			
Bromomethane	3.15	0.05	ug/g	ND	78.7	50-140			
Carbon Tetrachloride	4.29	0.05	ug/g	ND	107	60-130			
Chlorobenzene	4.27	0.05	ug/g	ND	107	60-130			
Chloroform	4.66	0.05	ug/g	ND	116	60-130			
Dibromochloromethane	4.62	0.05	ug/g	ND	116	60-130			
Dichlorodifluoromethane	2.44	0.05	ug/g	ND	60.9	50-140			
1,2-Dichlorobenzene	4.35	0.05	ug/g	ND	109	60-130			
1,3-Dichlorobenzene	4.30	0.05	ug/g	ND	108	60-130			
1,4-Dichlorobenzene	4.14	0.05	ug/g	ND	104	60-130			
1,1-Dichloroethane	5.00	0.05	ug/g	ND	125	60-130			
1,2-Dichloroethane	4.88	0.05	ug/g	ND	122	60-130			
1,1-Dichloroethylene	3.74	0.05	ug/g	ND	93.4	60-130			
cis-1,2-Dichloroethylene	4.67	0.05	ug/g	ND	117	60-130			
trans-1,2-Dichloroethylene	3.59	0.05	ug/g	ND	89.7	60-130			
1,2-Dichloropropane	4.79	0.05	ug/g	ND	120	60-130			
cis-1,3-Dichloropropylene	5.01	0.05	ug/g	ND	125	60-130			
trans-1,3-Dichloropropylene	5.12	0.05	ug/g	ND	128	60-130			
Ethylbenzene	4.41	0.05	ug/g	ND	110	60-130			
Ethylene dibromide (dibromoethane, 1,2-	4.73	0.05	ug/g	ND	118	60-130			
Hexane	3.33	0.05	ug/g	ND	83.1	60-130			
Methyl Ethyl Ketone (2-Butanone)	11.9	0.50	ug/g	ND	119	50-140			
Methyl Isobutyl Ketone	12.8	0.50	ug/g	ND	128	50-140			
Methyl tert-butyl ether	13.0	0.05	ug/g	ND	130	50-140			
Methylene Chloride	4.82	0.05	ug/g	ND	121	60-130			
Styrene	4.33	0.05	ug/g	ND	108	60-130			
1,1,1,2-Tetrachloroethane	4.58	0.05	ug/g	ND	114	60-130			
1,1,2,2-Tetrachloroethane	5.00	0.05	ug/g	ND	125	60-130			
Tetrachloroethylene	3.70	0.05	ug/g	ND	92.5	60-130			
Toluene	3.82	0.05	ug/g	ND	95.5	60-130			
1,1,1-Trichloroethane	4.80	0.05	ug/g	ND	120	60-130			
1,1,2-Trichloroethane	4.87	0.05	ug/g	ND	122	60-130			
Trichloroethylene	4.09	0.05	ug/g	ND	102	60-130			
Trichlorofluoromethane	3.96	0.05	ug/g	ND	99.0	50-140			
Vinyl chloride	2.47	0.02	ug/g	ND	61.9	50-140			
m,p-Xylenes	8.65	0.05	ug/g	ND	108	60-130			
o-Xylene	4.60	0.05	ug/g	ND	115	60-130			
<i>Surrogate: 4-Bromofluorobenzene</i>	7.77		ug/g		97.1	50-140			
<i>Surrogate: Dibromofluoromethane</i>	10.4		ug/g		130	50-140			
<i>Surrogate: Toluene-d8</i>	7.57		ug/g		94.7	50-140			
Benzene	4.57	0.02	ug/g	ND	114	60-130			
Ethylbenzene	4.41	0.05	ug/g	ND	110	60-130			
Toluene	3.82	0.05	ug/g	ND	95.5	60-130			
m,p-Xylenes	8.65	0.05	ug/g	ND	108	60-130			
o-Xylene	4.60	0.05	ug/g	ND	115	60-130			

Certificate of Analysis

Report Date: 07-Jul-2020

Client: **Lopers & Associates**

Order Date: 24-Jun-2020

Client PO: **LOP20-002B**

Project Description: LOP20-002B

Method Quality Control: Spike

Analyte	Result	Reporting Limit	Units	Source Result	%REC	%REC Limit	RPD	RPD Limit	Notes
<i>Surrogate: Toluene-d8</i>	7.57		ug/g		94.7	50-140			

Certificate of Analysis
Client: **Lopers & Associates**
Client PO: **LOP20-002B**

Report Date: 07-Jul-2020
Order Date: 24-Jun-2020
Project Description: **LOP20-002B**

Qualifier Notes:

Login Qualifiers :

Container(s) - Labeled improperly/insufficient information - Date reads 23 on Jar

Applies to samples: BH3-20-SS6, BH4-20-SS6

Container(s) - Labeled improperly/insufficient information - Date reads 23 on Vial

Applies to samples: BH5-20-SS4

Container(s) - Bottle and COC sample ID don't match - ID missing -20- on jars

Applies to samples: BH1-20-SS5, BH3-20-SS6, BH4-20-SS6, BH5-20-SS4, BH5-20-SS7, BH11-20-SS5

QC Qualifiers :

QM-07 : The spike recovery was outside acceptance limits for the MS and/or MSD. The batch was accepted based on other acceptable QC.

Sample Data Revisions

None

Work Order Revisions / Comments:

Revision 1 - This report includes updated data for metals due to preparation error

Other Report Notes:

n/a: not applicable

ND: Not Detected

MDL: Method Detection Limit

Source Result: Data used as source for matrix and duplicate samples

%REC: Percent recovery.

RPD: Relative percent difference.

NC: Not Calculated

Soil results are reported on a dry weight basis when the units are denoted with 'dry'.
Where %Solids is reported, moisture loss includes the loss of volatile hydrocarbons.

CCME PHC additional information:

- The method for the analysis of PHCs complies with the Reference Method for the CWS PHC and is validated for use in the laboratory. All prescribed quality criteria identified in the method has been met.
- F1 range corrected for BTEX.
- F2 to F3 ranges corrected for appropriate PAHs where available.
- The gravimetric heavy hydrocarbons (F4G) are not to be added to C6 to C50 hydrocarbons.
- In the case where F4 and F4G are both reported, the greater of the two results is to be used for comparison to CWS PHC criteria.
- When reported, data for F4G has been processed using a silica gel cleanup.



ent Blvd.
1G 4J8
labs.com
.com

Paracel Order Number (Lab Use Only) 2026367-PUM 2026368-TCH	Chain Of Custody (Lab Use Only) No: 54317
--	--

Client Name: LOPERS & ASSOCIATES	Project Ref: LOP20-002B	Page <u> </u> of <u> </u>
Contact Name: Luke Lopers	Quote #:	Turnaround Time <input type="checkbox"/> 1 day <input type="checkbox"/> 3 day <input type="checkbox"/> 2 day <input checked="" type="checkbox"/> Regular
Address: 30 Lansfield Way, Ottawa, ON	PO #: LOP20-002B	
Telephone: 613-327-9073	E-mail: Luke@Lopers.ca	
Date Required: _____		

Regulation 153/04		Other Regulation		Matrix Type: S (Soil/Sed.) GW (Ground Water) SW (Surface Water) SS (Storm/Sanitary Sewer) P (Paint) A (Air) O (Other)		Required Analysis							
<input type="checkbox"/> Table 1	<input type="checkbox"/> Res/Park	<input type="checkbox"/> Med/Fine	<input type="checkbox"/> REG 558	<input type="checkbox"/> PWQO	Matrix	Air Volume	# of Containers	Sample Taken	PAHs/BTEX	VOCs	Metals & Inorganics	PATE	Reg 558 Infill on Lower Pick-up on Package
<input type="checkbox"/> Table 2	<input type="checkbox"/> Ind/Comm	<input type="checkbox"/> Coarse	<input type="checkbox"/> CCME	<input type="checkbox"/> MISA									
<input type="checkbox"/> Table 3	<input type="checkbox"/> Agri/Other		<input type="checkbox"/> SU - Sani	<input type="checkbox"/> SU - Storm									
<input type="checkbox"/> Table _____			Mun: _____										
For RSC: <input type="checkbox"/> Yes <input type="checkbox"/> No		<input type="checkbox"/> Other: _____											
Sample ID/Location Name				Date	Time								
1	BH1-20-SS5			S	2	June 24, 2020			X	X	X	X	
2	BH3-20-SS6			S	2				X			X	
3	BH4-20-SS6			S	2				X		X	X	
4	BH5-20-SS4			S	2				X				
5	BH5-20-SS7			S	2				X	X			
6	BH11-20-SS5			S	2				X	X	X	X	
7	TCLP			S	2							X	
8													
9													
10													

Comments:		Method of Delivery: D/B	
Relinquished By (Sign):	Received By Driver/Depot:	Received at Lab:	Verified By:
Relinquished By (Print): Luke Lopers	Date/Time:	Date/Time: 06-24-20/17:56	Date/Time: 06-25-20/12:19
Date/Time: June 24, 2020/5:30 PM	Temperature: _____ °C	Temperature: 21.9 °C	pH Verified: <input type="checkbox"/> By: _____

Certificate of Analysis

Lopers & Associates

30 Lansfield Way
Ottawa, ONT K2G 3V8
Attn: Luke Lopers

Client PO: LOP20-002B
Project: LOP20-002B
Custody: 54317

Report Date: 6-Jul-2020
Order Date: 24-Jun-2020

Order #: 2026368

This Certificate of Analysis contains analytical data applicable to the following samples as submitted:

Parcel ID	Client ID	Parcel ID	Client ID
2026368-01	TCLP		

Approved By:



Dale Robertson, BSc
Laboratory Director

Certificate of Analysis
Client: **Lopers & Associates**
Client PO: **LOP20-002B**

Report Date: 06-Jul-2020

Order Date: 24-Jun-2020

Project Description: **LOP20-002B**

Analysis Summary Table

Analysis	Method Reference/Description	Extraction Date	Analysis Date
Flashpoint	ASTM D93 - Pensky-Martens Closed Cup	29-Jun-20	29-Jun-20
REG 558 - Cyanide	MOE E3015- Auto Colour	6-Jul-20	6-Jul-20
REG 558 - Fluoride	EPA 340.2 - ISE	30-Jun-20	30-Jun-20
REG 558 - Mercury by CVAA	EPA 7470A - Cold Vapour AA	29-Jun-20	29-Jun-20
REG 558 - Metals, ICP-MS	TCLP EPA 6020 - Digestion - ICP-MS	30-Jun-20	30-Jun-20
REG 558 - NO3/NO2	EPA 300.1 - IC	30-Jun-20	30-Jun-20
REG 558 - PCBs	EPA 608 - GC-ECD	29-Jun-20	29-Jun-20
REG 558 - SVOCs	EPA 625 - GC-MS	29-Jun-20	30-Jun-20
REG 558 - VOCs	EPA 624 - P&T GC-MS	30-Jun-20	30-Jun-20
Solids, %	Gravimetric, calculation	30-Jun-20	30-Jun-20

Certificate of Analysis
Client: Lopers & Associates
Client PO: LOP20-002B

Report Date: 06-Jul-2020
 Order Date: 24-Jun-2020
Project Description: LOP20-002B

Summary of Exceedances

(If this page is blank then there are no exceedances)

Only those criteria that a sample exceeds will be highlighted in red

Regulatory Comparison:

Paracel Laboratories has provided regulatory guidelines on this report for informational purposes only and makes no representations or warranties that the data is accurate or reflects the current regulatory values. The user is advised to consult with the appropriate official regulations to evaluate compliance. Sample results that are highlighted have exceeded the selected regulatory limit. Calculated uncertainty estimations have not been applied for determining regulatory exceedances. Regulatory limits displayed in brackets, (), applies to medium and fine textured soils.

Criteria:

Client ID	Analyte	MDL / Units	Result	Reg 558 Schedule 4
-----------	---------	-------------	--------	--------------------

Certificate of Analysis
 Client: Lopers & Associates
 Client PO: LOP20-002B

Report Date: 06-Jul-2020

Order Date: 24-Jun-2020

Project Description: LOP20-002B

Client ID:	TCLP	-	-	-	Criteria: Reg 558 Schedule 4
Sample Date:	24-Jun-2020	-	-	-	
Sample ID:	2026368-01	-	-	-	
Matrix:	Soil	-	-	-	
MDL/Units					

Physical Characteristics

% Solids	0.1 % by Wt.	91.8	-	-	-
Flashpoint	°C	>70	-	-	-

EPA 1311 - TCLP Leachate Inorganics

Fluoride	0.05 mg/L	0.32	-	-	-	150	mg/L
Nitrate as N	1 mg/L	<1	-	-	-	1,000	mg/L
Nitrite as N	1 mg/L	<1	-	-	-	1,000	mg/L
Cyanide, free	0.02 mg/L	<0.02	-	-	-	20	mg/L

EPA 1311 - TCLP Leachate Metals

Arsenic	0.05 mg/L	<0.05	-	-	-	2.5	mg/L
Barium	0.05 mg/L	0.97	-	-	-	100	mg/L
Boron	0.05 mg/L	0.05	-	-	-	500	mg/L
Cadmium	0.01 mg/L	<0.01	-	-	-	0.5	mg/L
Chromium	0.05 mg/L	<0.05	-	-	-	5	mg/L
Lead	0.05 mg/L	<0.05	-	-	-	5	mg/L
Mercury	0.005 mg/L	<0.005	-	-	-	0.1	mg/L
Selenium	0.05 mg/L	<0.05	-	-	-	1	mg/L
Silver	0.05 mg/L	<0.05	-	-	-	5	mg/L
Uranium	0.05 mg/L	<0.05	-	-	-	10	mg/L

EPA 1311 - TCLP Leachate Volatiles

Benzene	0.005 mg/L	<0.005	-	-	-	0.5	mg/L
Carbon Tetrachloride	0.005 mg/L	<0.005	-	-	-	0.5	mg/L
Chlorobenzene	0.004 mg/L	<0.004	-	-	-	8	mg/L
Chloroform	0.006 mg/L	<0.006	-	-	-	10	mg/L

Certificate of Analysis
Client: **Lopers & Associates**
Client PO: **LOP20-002B**

Report Date: 06-Jul-2020

Order Date: 24-Jun-2020

Project Description: **LOP20-002B**

		Client ID:	TCLP	-	-	-	Criteria: Reg 558 Schedule 4	
		Sample Date:	24-Jun-2020	-	-	-		
		Sample ID:	2026368-01	-	-	-		
		Matrix:	Soil	-	-	-		
		MDL/Units						
1,2-Dichlorobenzene	0.004 mg/L	<0.004	-	-	-	20	mg/L	
1,4-Dichlorobenzene	0.004 mg/L	<0.004	-	-	-	0.5	mg/L	
1,2-Dichloroethane	0.005 mg/L	<0.005	-	-	-	0.5	mg/L	
1,1-Dichloroethylene	0.006 mg/L	<0.006	-	-	-	1.4	mg/L	
Methyl Ethyl Ketone (2-Butanone)	0.30 mg/L	<0.30	-	-	-	200	mg/L	
Methylene Chloride	0.04 mg/L	<0.04	-	-	-	5	mg/L	
Tetrachloroethylene	0.005 mg/L	<0.005	-	-	-	3	mg/L	
Trichloroethylene	0.004 mg/L	<0.004	-	-	-	5	mg/L	
Vinyl chloride	0.005 mg/L	<0.005	-	-	-	0.2	mg/L	
4-Bromofluorobenzene	Surrogate	115%	-	-	-			
Dibromofluoromethane	Surrogate	112%	-	-	-			
Toluene-d8	Surrogate	101%	-	-	-			

EPA 1311 - TCLP Leachate Organics

2,4-Dinitrotoluene	0.001 mg/L	<0.001	-	-	-	0.13	mg/L
Benzo [a] pyrene	0.001 mg/L	<0.001	-	-	-	0.001	mg/L
Nitrobenzene	0.001 mg/L	<0.001	-	-	-	2	mg/L
Hexachloroethane	0.001 mg/L	<0.001	-	-	-	3	mg/L
Hexachlorobenzene	0.050 mg/L	<0.050	-	-	-	0.13	mg/L
Hexachlorobutadiene	0.001 mg/L	<0.001	-	-	-		
2,3,4,6-Tetrachlorophenol	0.002 mg/L	<0.002	-	-	-	10	mg/L
2,4,5-Trichlorophenol	0.001 mg/L	<0.001	-	-	-	400	mg/L
2,4,6-Trichlorophenol	0.001 mg/L	<0.001	-	-	-	0.5	mg/L
2,4-Dichlorophenol	0.001 mg/L	<0.001	-	-	-	90	mg/L
2-Methylphenol	0.001 mg/L	<0.001	-	-	-	200	mg/L

Certificate of Analysis
Client: **Lopers & Associates**
Client PO: **LOP20-002B**

Report Date: 06-Jul-2020

Order Date: 24-Jun-2020

Project Description: **LOP20-002B**

		Client ID:	TCLP	-	-	-	Criteria: Reg 558 Schedule 4	
		Sample Date:	24-Jun-2020	-	-	-		
		Sample ID:	2026368-01	-	-	-		
		Matrix:	Soil	-	-	-		
		MDL/Units						
3/4-Methylphenol	0.001 mg/L	<0.001	-	-	-	200	mg/L	
Pentachlorophenol	0.005 mg/L	<0.005	-	-	-	6	mg/L	
2,4,6-Tribromophenol	Surrogate	50.0%	-	-	-			
2-Fluorobiphenyl	Surrogate	66.4%	-	-	-			
2-Fluorophenol	Surrogate	12.8% [2]	-	-	-			
Terphenyl-d14	Surrogate	94.8%	-	-	-			
PCBs, total	0.003 mg/L	<0.003	-	-	-	0.3	mg/L	
Decachlorobiphenyl	Surrogate	90.0%	-	-	-			

Certificate of Analysis
Client: **Lopers & Associates**
Client PO: **LOP20-002B**

Report Date: 06-Jul-2020
Order Date: 24-Jun-2020
Project Description: **LOP20-002B**

Method Quality Control: Blank

Analyte	Result	Reporting Limit	Units	Source Result	%REC	%REC Limit	RPD	RPD Limit	Notes
EPA 1311 - TCLP Leachate Inorganics									
Fluoride	ND	0.05	mg/L						
Nitrate as N	ND	1	mg/L						
Nitrite as N	ND	1	mg/L						
Cyanide, free	ND	0.02	mg/L						
EPA 1311 - TCLP Leachate Metals									
Arsenic	ND	0.05	mg/L						
Barium	ND	0.05	mg/L						
Boron	ND	0.05	mg/L						
Cadmium	ND	0.01	mg/L						
Chromium	ND	0.05	mg/L						
Lead	ND	0.05	mg/L						
Mercury	ND	0.005	mg/L						
Selenium	ND	0.05	mg/L						
Silver	ND	0.05	mg/L						
Uranium	ND	0.05	mg/L						
EPA 1311 - TCLP Leachate Organics									
2,4-Dinitrotoluene	ND	0.001	mg/L						
Benzo [a] pyrene	ND	0.001	mg/L						
Nitrobenzene	ND	0.001	mg/L						
Hexachloroethane	ND	0.001	mg/L						
Hexachlorobenzene	ND	0.050	mg/L						
Hexachlorobutadiene	ND	0.001	mg/L						
2,3,4,6-Tetrachlorophenol	ND	0.002	mg/L						
2,4,5-Trichlorophenol	ND	0.001	mg/L						
2,4,6-Trichlorophenol	ND	0.001	mg/L						
2,4-Dichlorophenol	ND	0.001	mg/L						
2-Methylphenol	ND	0.001	mg/L						
3/4-Methylphenol	ND	0.001	mg/L						
Pentachlorophenol	ND	0.005	mg/L						
Surrogate: 2,4,6-Tribromophenol	0.019		mg/L		46.7	40-150			
Surrogate: 2-Fluorobiphenyl	0.013		mg/L		62.8	40-150			
Surrogate: 2-Fluorophenol	0.0053		mg/L		13.2	40-150			S-GC
Surrogate: Terphenyl-d14	0.021		mg/L		107	40-150			
PCBs, total	ND	0.003	mg/L						
Surrogate: Decachlorobiphenyl	0.0080		mg/L		80.4	62-138			
EPA 1311 - TCLP Leachate Volatiles									
Benzene	ND	0.005	mg/L						
Carbon Tetrachloride	ND	0.005	mg/L						
Chlorobenzene	ND	0.004	mg/L						

Certificate of Analysis
Client: **Lopers & Associates**
Client PO: **LOP20-002B**

Report Date: 06-Jul-2020
Order Date: 24-Jun-2020
Project Description: **LOP20-002B**

Method Quality Control: Blank

Analyte	Result	Reporting Limit	Units	Source Result	%REC	%REC Limit	RPD	RPD Limit	Notes
Chloroform	ND	0.006	mg/L						
1,2-Dichlorobenzene	ND	0.004	mg/L						
1,4-Dichlorobenzene	ND	0.004	mg/L						
1,2-Dichloroethane	ND	0.005	mg/L						
1,1-Dichloroethylene	ND	0.006	mg/L						
Methyl Ethyl Ketone (2-Butanone)	ND	0.30	mg/L						
Methylene Chloride	ND	0.04	mg/L						
Tetrachloroethylene	ND	0.005	mg/L						
Trichloroethylene	ND	0.004	mg/L						
Vinyl chloride	ND	0.005	mg/L						
Surrogate: 4-Bromofluorobenzene	0.851		mg/L		124	83-134			
Surrogate: Dibromofluoromethane	0.796		mg/L		116	78-124			
Surrogate: Toluene-d8	0.767		mg/L		111	76-118			

Certificate of Analysis
Client: **Lopers & Associates**
Client PO: **LOP20-002B**

Report Date: 06-Jul-2020

Order Date: 24-Jun-2020

Project Description: **LOP20-002B**

Method Quality Control: Duplicate

Analyte	Result	Reporting Limit	Units	Source Result	%REC	%REC Limit	RPD	RPD Limit	Notes
EPA 1311 - TCLP Leachate Inorganics									
Fluoride	0.32	0.05	mg/L	0.32			0.4	20	
Nitrate as N	ND	1	mg/L	ND			NC	20	
Nitrite as N	ND	1	mg/L	ND			NC	20	
Cyanide, free	ND	0.02	mg/L	ND			NC	20	
EPA 1311 - TCLP Leachate Metals									
Arsenic	ND	0.05	mg/L	ND			NC	29	
Barium	0.960	0.05	mg/L	0.969			0.9	34	
Boron	0.055	0.05	mg/L	0.055			1.4	33	
Cadmium	ND	0.01	mg/L	ND			NC	33	
Chromium	ND	0.05	mg/L	ND			NC	32	
Lead	ND	0.05	mg/L	ND			NC	32	
Mercury	ND	0.005	mg/L	ND			NC	30	
Selenium	ND	0.05	mg/L	ND			NC	28	
Silver	ND	0.05	mg/L	ND			NC	28	
Uranium	ND	0.05	mg/L	ND			NC	27	
EPA 1311 - TCLP Leachate Organics									
PCBs, total	ND	0.003	mg/L	ND			NC	30	
<i>Surrogate: Decachlorobiphenyl</i>	0.0090		mg/L		89.7	62-138			
EPA 1311 - TCLP Leachate Volatiles									
Benzene	ND	0.005	mg/L	ND			NC	25	
Carbon Tetrachloride	ND	0.005	mg/L	ND			NC	25	
Chlorobenzene	ND	0.004	mg/L	ND			NC	25	
Chloroform	ND	0.006	mg/L	ND			NC	25	
1,2-Dichlorobenzene	ND	0.004	mg/L	ND			NC	25	
1,4-Dichlorobenzene	ND	0.004	mg/L	ND			NC	25	
1,2-Dichloroethane	ND	0.005	mg/L	ND			NC	25	
1,1-Dichloroethylene	ND	0.006	mg/L	ND			NC	25	
Methyl Ethyl Ketone (2-Butanone)	ND	0.30	mg/L	ND			NC	25	
Methylene Chloride	ND	0.04	mg/L	ND			NC	25	
Tetrachloroethylene	ND	0.005	mg/L	ND			NC	25	
Trichloroethylene	ND	0.004	mg/L	ND			NC	25	
Vinyl chloride	ND	0.005	mg/L	ND			NC	25	
<i>Surrogate: 4-Bromofluorobenzene</i>	0.788		mg/L		114	83-134			
<i>Surrogate: Dibromofluoromethane</i>	0.730		mg/L		106	78-124			
<i>Surrogate: Toluene-d8</i>	0.690		mg/L		100	76-118			
Physical Characteristics									
% Solids	77.6	0.1	% by Wt.	75.9			2.2	25	

Certificate of Analysis
Client: **Lopers & Associates**
Client PO: **LOP20-002B**

Report Date: 06-Jul-2020

Order Date: 24-Jun-2020

Project Description: **LOP20-002B**

Method Quality Control: Spike

Analyte	Result	Reporting Limit	Units	Source Result	%REC	%REC Limit	RPD	RPD Limit	Notes
EPA 1311 - TCLP Leachate Inorganics									
Fluoride	0.71	0.05	mg/L	0.32	78.3	70-130			
Nitrate as N	10	1	mg/L	ND	99.6	81-112			
Nitrite as N	10	1	mg/L	ND	100	76-107			
Cyanide, free	0.042	0.02	mg/L	ND	84.4	60-136			
EPA 1311 - TCLP Leachate Metals									
Arsenic	52.0	0.05	mg/L	0.450	103	83-119			
Barium	155	0.05	mg/L	96.9	117	83-116			QM-07
Boron	44.4	0.05	mg/L	5.45	78.0	71-128			
Cadmium	47.0	0.01	mg/L	0.050	93.9	78-119			
Chromium	59.5	0.05	mg/L	0.460	118	80-124			
Lead	47.5	0.05	mg/L	2.63	89.8	77-126			
Mercury	0.0305	0.005	mg/L	ND	102	70-130			
Selenium	44.8	0.05	mg/L	0.864	87.8	81-125			
Silver	49.1	0.05	mg/L	ND	98.2	70-128			
Uranium	48.7	0.05	mg/L	0.765	95.8	70-131			
EPA 1311 - TCLP Leachate Organics									
2,4-Dinitrotoluene	0.006	0.001	mg/L	ND	63.9	50-140			
Benzo [a] pyrene	0.009	0.001	mg/L	ND	93.1	50-140			
Nitrobenzene	0.013	0.001	mg/L	ND	129	50-140			
Hexachloroethane	0.011	0.001	mg/L	ND	109	50-140			
Hexachlorobutadiene	0.006	0.001	mg/L	ND	57.3	50-140			
2,3,4,6-Tetrachlorophenol	0.006	0.002	mg/L	ND	60.6	51-140			
2,4,5-Trichlorophenol	0.007	0.001	mg/L	ND	66.6	50-140			
2,4,6-Trichlorophenol	0.006	0.001	mg/L	ND	64.9	50-140			
2,4-Dichlorophenol	0.009	0.001	mg/L	ND	94.3	50-140			
2-Methylphenol	0.006	0.001	mg/L	ND	58.0	50-140			
3/4-Methylphenol	0.006	0.001	mg/L	ND	64.0	50-140			
Pentachlorophenol	0.005	0.005	mg/L	ND	50.6	50-140			
Surrogate: 2,4,6-Tribromophenol	0.021		mg/L		53.4	40-150			
Surrogate: 2-Fluorobiphenyl	0.014		mg/L		67.6	40-150			
Surrogate: 2-Fluorophenol	0.0030		mg/L		7.55	40-150			S-GC
Surrogate: Terphenyl-d14	0.018		mg/L		87.7	40-150			
PCBs, total	0.035	0.003	mg/L	ND	87.0	86-145			
Surrogate: Decachlorobiphenyl	0.0085		mg/L		84.8	62-138			

Certificate of Analysis
Client: **Lopers & Associates**
Client PO: **LOP20-002B**

Report Date: 06-Jul-2020

Order Date: 24-Jun-2020

Project Description: **LOP20-002B**

Method Quality Control: Spike

Analyte	Result	Reporting Limit	Units	Source Result	%REC	%REC Limit	RPD	RPD Limit	Notes
---------	--------	-----------------	-------	---------------	------	------------	-----	-----------	-------

EPA 1311 - TCLP Leachate Volatiles

Benzene	0.314	0.005	mg/L	ND	91.3	55-141			
Carbon Tetrachloride	0.391	0.005	mg/L	ND	114	49-149			
Chlorobenzene	0.340	0.004	mg/L	ND	98.8	64-137			
Chloroform	0.397	0.006	mg/L	ND	115	58-138			
1,2-Dichlorobenzene	0.409	0.004	mg/L	ND	119	60-150			
1,4-Dichlorobenzene	0.330	0.004	mg/L	ND	96.0	63-132			
1,2-Dichloroethane	0.383	0.005	mg/L	ND	111	50-140			
1,1-Dichloroethylene	0.404	0.006	mg/L	ND	118	43-153			
Methyl Ethyl Ketone (2-Butanone)	1.00	0.30	mg/L	ND	117	26-153			
Methylene Chloride	0.357	0.04	mg/L	ND	104	58-149			
Tetrachloroethylene	0.415	0.005	mg/L	ND	121	51-145			
Trichloroethylene	0.411	0.004	mg/L	ND	120	52-135			
Vinyl chloride	0.351	0.005	mg/L	ND	102	31-159			
Surrogate: 4-Bromofluorobenzene	0.740		mg/L		107	83-134			
Surrogate: Dibromofluoromethane	0.655		mg/L		95.2	78-124			
Surrogate: Toluene-d8	0.628		mg/L		91.4	76-118			

Certificate of Analysis
Client: **Lopers & Associates**
Client PO: **LOP20-002B**

Report Date: 06-Jul-2020

Order Date: 24-Jun-2020

Project Description: LOP20-002B

Qualifier Notes:

2 : Surrogate recovery outside of control limits. The data was accepted based on valid recovery of the remaining surrogate.

QC Qualifiers :

QM-07 : The spike recovery was outside acceptance limits for the MS and/or MSD. The batch was accepted based on other acceptable QC.

S-GC : Surrogate recovery outside of control limits. The data was accepted based on valid recovery of the remaining surrogate.

Sample Data Revisions

None

Work Order Revisions / Comments:

None

Other Report Notes:

n/a: not applicable

ND: Not Detected

MDL: Method Detection Limit

Source Result: Data used as source for matrix and duplicate samples

%REC: Percent recovery.

RPD: Relative percent difference.

NC: Not Calculated

Soil/Solid results are reported on a dry weight basis unless otherwise indicated

Where %Solids is reported, moisture loss includes the loss of volatile hydrocarbons.

Any use of these results implies your agreement that our total liability in connection with this work, however arising, shall be limited to the amount paid by you for this work, and that our employees or agents shall not under any circumstances be liable to you in connection with this work.



Parcel ID: 2026368



ent Blvd.
1G 4JB
ilabs.com
com

Parcel Order Number (Lab Use Only) 2026368-Bulk	Chain Of Custody (Lab Use Only) No: 54317
2026368-TC	

Client Name: LOPERS ASSOCIATES
 Contact Name: Luke Lopers
 Address: 30 Lansfield Way, Ottawa, ON
 Telephone: 613-327-9073

Quote #: LOP20-002B
 PO #: LOP20-002B
 E-mail: Luke@Lopers.ca

Page of
 Turnaround Time
 1 day 3 day
 2 day Regular
 Date Required:

Regulation 153/04		Other Regulation		Matrix Type: S (Soil/Sed.) GW (Ground Water) SW (Surface Water) SS (Storm/Sanitary Sewer) P (Paint) A (Air) O (Other)		Required Analysis														
<input type="checkbox"/> Table 1	<input type="checkbox"/> Res/Park	<input type="checkbox"/> Med/Fine	<input type="checkbox"/> REG 558	<input type="checkbox"/> PWCO	Matrix	Air Volume	# of Containers	Sample Taken	PAHs/BTEX	VOCs	Metals & Inorganics	PAHs	Reg 558 Infiltrate Leachate Pesticides							
<input type="checkbox"/> Table 2	<input type="checkbox"/> Ind/Comm	<input type="checkbox"/> Coarse	<input type="checkbox"/> CCME	<input type="checkbox"/> MISA																Date
<input type="checkbox"/> Table 3	<input type="checkbox"/> Agri/Other		<input type="checkbox"/> SU - Sani	<input type="checkbox"/> SU - Storm																
<input type="checkbox"/> Table			Mun: <u> </u>	<input type="checkbox"/> Other: <u> </u>																
For RSC: <input type="checkbox"/> Yes <input type="checkbox"/> No																				
1	BH1-20-SS5			S		2	June 24, 2020		X	X	X	X								
2	BH3-20-SS6			S		2			X			X								
3	BH4-20-SS6			S		2			X		X	X								
4	BH5-20-SS4			S		2			X											
5	BH5-20-SS7			S		2			X	X										
6	BH11-20-SS5			S		2			X	X	X	X								
7	TCLP			S		2							X							
8																				
9																				
10																				

Comments: Method of Delivery: D/B

Relinquished By (Sign): <u>[Signature]</u>	Received By Driver/Depot:	Received at Lab: <u>[Signature]</u>	Verified By: <u>[Signature]</u>
Relinquished By (Print): <u>Luke Lopers</u>	Date/Time:	Date/Time: <u>06-24-2017 18</u>	Date/Time: <u>06-25-2017 19</u>
Date/Time: <u>June 24, 2020 / 5:30 PM</u>	Temperature: <u> </u> °C	Temperature: <u>21.9</u> °C	pH Verified: <input type="checkbox"/> By: <u> </u>

Certificate of Analysis

Lopers & Associates

30 Lansfield Way
Ottawa, ON K2G 3V8
Attn: Luke Lopers

Client PO: LOP20-002B
Project: LOP20-002B
Custody: 126519

Report Date: 9-Jul-2020
Order Date: 30-Jun-2020

Order #: 2027199

This Certificate of Analysis contains analytical data applicable to the following samples as submitted:

Parcel ID	Client ID
2027199-01	BH1-20
2027199-02	BH3-20
2027199-03	BH5-20
2027199-04	BH13-20
2027199-05	MW-6
2027199-06	MW-8
2027199-07	Trip Blank

Approved By:



Dale Robertson, BSc
Laboratory Director

Certificate of Analysis

Report Date: 09-Jul-2020

Client: Lopers & Associates

Order Date: 30-Jun-2020

Client PO: LOP20-002B

Project Description: LOP20-002B

Analysis Summary Table

Analysis	Method Reference/Description	Extraction Date	Analysis Date
Anions	EPA 300.1 - IC	2-Jul-20	2-Jul-20
BTEX by P&T GC-MS	EPA 624 - P&T GC-MS	2-Jul-20	2-Jul-20
Chromium, hexavalent - water	MOE E3056 - colourimetric	6-Jul-20	6-Jul-20
Cyanide, free	MOE E3015 - Auto Colour	6-Jul-20	6-Jul-20
Mercury by CVAA	EPA 245.2 - Cold Vapour AA	3-Jul-20	3-Jul-20
Metals, ICP-MS	EPA 200.8 - ICP-MS	30-Jun-20	30-Jun-20
pH	EPA 150.1 - pH probe @25 °C	6-Jul-20	6-Jul-20
PHC F1	CWS Tier 1 - P&T GC-FID	30-Jun-20	2-Jul-20
PHCs F2 to F4	CWS Tier 1 - GC-FID, extraction	7-Jul-20	7-Jul-20
REG 153: PAHs by GC-MS	EPA 625 - GC-MS, extraction	7-Jul-20	7-Jul-20
REG 153: VOCs by P&T GC/MS	EPA 624 - P&T GC-MS	30-Jun-20	2-Jul-20

Certificate of Analysis

Report Date: 09-Jul-2020

Client: Lopers & Associates

Order Date: 30-Jun-2020

Client PO: LOP20-002B

Project Description: LOP20-002B

	Client ID:	BH1-20	BH3-20	BH5-20	BH13-20
	Sample Date:	30-Jun-20 09:00	30-Jun-20 09:00	30-Jun-20 09:00	30-Jun-20 09:00
	Sample ID:	2027199-01	2027199-02	2027199-03	2027199-04
	MDL/Units	Water	Water	Water	Water

General Inorganics

	MDL/Units	BH1-20	BH3-20	BH5-20	BH13-20
Cyanide, free	2 ug/L	<2	<2	-	<2
pH	0.1 pH Units	7.0	7.2	-	7.2

Anions

	MDL/Units	BH1-20	BH3-20	BH5-20	BH13-20
Chloride	1 mg/L	918	833	-	828

Metals

	MDL/Units	BH1-20	BH3-20	BH5-20	BH13-20
Mercury	0.1 ug/L	<0.1	<0.1	-	<0.1
Antimony	0.5 ug/L	<0.5	<0.5	-	<0.5
Arsenic	1 ug/L	1	1	-	1
Barium	1 ug/L	874	1880	-	1880
Beryllium	0.5 ug/L	<0.5	<0.5	-	<0.5
Boron	10 ug/L	27	25	-	26
Cadmium	0.1 ug/L	<0.1	<0.1	-	<0.1
Chromium	1 ug/L	<1	<1	-	<1
Chromium (VI)	10 ug/L	<10	<10	-	<10
Cobalt	0.5 ug/L	11.3	6.5	-	6.8
Copper	0.5 ug/L	1.2	1.0	-	1.2
Lead	0.1 ug/L	<0.1	51.2	-	54.6
Molybdenum	0.5 ug/L	1.2	1.4	-	1.4
Nickel	1 ug/L	23	12	-	13
Selenium	1 ug/L	<1	3	-	3
Silver	0.1 ug/L	<0.1	<0.1	-	<0.1
Sodium	200 ug/L	174000	202000	-	209000
Thallium	0.1 ug/L	<0.1	<0.1	-	<0.1
Uranium	0.1 ug/L	9.2	11.2	-	11.2
Vanadium	0.5 ug/L	1.2	1.1	-	1.2
Zinc	5 ug/L	<5	7	-	<5

Volatiles

	MDL/Units	BH1-20	BH3-20	BH5-20	BH13-20
Acetone	5.0 ug/L	<5.0	<2500 [1]	-	<2500 [1]
Benzene	0.5 ug/L	<0.5	19300 [1]	-	19700 [1]
Bromodichloromethane	0.5 ug/L	<0.5	<250 [1]	-	<250 [1]
Bromoform	0.5 ug/L	<0.5	<250 [1]	-	<250 [1]
Bromomethane	0.5 ug/L	<0.5	<250 [1]	-	<250 [1]
Carbon Tetrachloride	0.2 ug/L	<0.2	<100 [1]	-	<100 [1]
Chlorobenzene	0.5 ug/L	<0.5	<250 [1]	-	<250 [1]
Chloroform	0.5 ug/L	<0.5	<250 [1]	-	<250 [1]

Certificate of Analysis

Report Date: 09-Jul-2020

Client: Lopers & Associates

Order Date: 30-Jun-2020

Client PO: LOP20-002B

Project Description: LOP20-002B

	Client ID:	BH1-20	BH3-20	BH5-20	BH13-20
	Sample Date:	30-Jun-20 09:00	30-Jun-20 09:00	30-Jun-20 09:00	30-Jun-20 09:00
	Sample ID:	2027199-01	2027199-02	2027199-03	2027199-04
	MDL/Units	Water	Water	Water	Water
Dibromochloromethane	0.5 ug/L	<0.5	<250 [1]	-	<250 [1]
Dichlorodifluoromethane	1.0 ug/L	<1.0	<500 [1]	-	<500 [1]
1,2-Dichlorobenzene	0.5 ug/L	<0.5	<250 [1]	-	<250 [1]
1,3-Dichlorobenzene	0.5 ug/L	<0.5	<250 [1]	-	<250 [1]
1,4-Dichlorobenzene	0.5 ug/L	<0.5	<250 [1]	-	<250 [1]
1,1-Dichloroethane	0.5 ug/L	<0.5	<250 [1]	-	<250 [1]
1,2-Dichloroethane	0.5 ug/L	<0.5	<250 [1]	-	<250 [1]
1,1-Dichloroethylene	0.5 ug/L	<0.5	<250 [1]	-	<250 [1]
cis-1,2-Dichloroethylene	0.5 ug/L	<0.5	<250 [1]	-	<250 [1]
trans-1,2-Dichloroethylene	0.5 ug/L	<0.5	<250 [1]	-	<250 [1]
1,2-Dichloropropane	0.5 ug/L	<0.5	<250 [1]	-	<250 [1]
cis-1,3-Dichloropropylene	0.5 ug/L	<0.5	<250 [1]	-	<250 [1]
trans-1,3-Dichloropropylene	0.5 ug/L	<0.5	<250 [1]	-	<250 [1]
1,3-Dichloropropene, total	0.5 ug/L	<0.5	<250 [1]	-	<250 [1]
Ethylbenzene	0.5 ug/L	<0.5	3800 [1]	-	3700 [1]
Ethylene dibromide (dibromoethane, 1,2-)	0.2 ug/L	<0.2	<100 [1]	-	<100 [1]
Hexane	1.0 ug/L	<1.0	<500 [1]	-	<500 [1]
Methyl Ethyl Ketone (2-Butanone)	5.0 ug/L	<5.0	<2500 [1]	-	<2500 [1]
Methyl Isobutyl Ketone	5.0 ug/L	<5.0	<2500 [1]	-	<2500 [1]
Methyl tert-butyl ether	2.0 ug/L	<2.0	<1000 [1]	-	<1000 [1]
Methylene Chloride	5.0 ug/L	<5.0	<2500 [1]	-	<2500 [1]
Styrene	0.5 ug/L	<0.5	<250 [1]	-	<250 [1]
1,1,1,2-Tetrachloroethane	0.5 ug/L	<0.5	<250 [1]	-	<250 [1]
1,1,1,2,2-Tetrachloroethane	0.5 ug/L	<0.5	<250 [1]	-	<250 [1]
Tetrachloroethylene	0.5 ug/L	<0.5	<250 [1]	-	<250 [1]
Toluene	0.5 ug/L	<0.5	65200 [1]	-	60900 [1]
1,1,1-Trichloroethane	0.5 ug/L	<0.5	<250 [1]	-	<250 [1]
1,1,2-Trichloroethane	0.5 ug/L	<0.5	<250 [1]	-	<250 [1]
Trichloroethylene	0.5 ug/L	<0.5	<250 [1]	-	<250 [1]
Trichlorofluoromethane	1.0 ug/L	<1.0	<500 [1]	-	<500 [1]
Vinyl chloride	0.5 ug/L	<0.5	<250 [1]	-	<250 [1]
m,p-Xylenes	0.5 ug/L	<0.5	19200 [1]	-	18200 [1]
o-Xylene	0.5 ug/L	<0.5	8400 [1]	-	8320 [1]
Xylenes, total	0.5 ug/L	<0.5	27600 [1]	-	26600 [1]
4-Bromofluorobenzene	Surrogate	90.7%	118% [1]	-	119% [1]
Dibromofluoromethane	Surrogate	102%	91.9% [1]	-	93.1% [1]

Certificate of Analysis

Report Date: 09-Jul-2020

Client: Lopers & Associates

Order Date: 30-Jun-2020

Client PO: LOP20-002B

Project Description: LOP20-002B

	MDL/Units	Client ID:	BH1-20	BH3-20	BH5-20	BH13-20
		Sample Date:	30-Jun-20 09:00	30-Jun-20 09:00	30-Jun-20 09:00	30-Jun-20 09:00
		Sample ID:	2027199-01	2027199-02	2027199-03	2027199-04
			Water	Water	Water	Water
Toluene-d8	Surrogate		106%	108% [1]	-	106% [1]
Benzene	0.5 ug/L		-	-	<0.5	-
Ethylbenzene	0.5 ug/L		-	-	<0.5	-
Toluene	0.5 ug/L		-	-	<0.5	-
m,p-Xylenes	0.5 ug/L		-	-	<0.5	-
o-Xylene	0.5 ug/L		-	-	<0.5	-
Xylenes, total	0.5 ug/L		-	-	<0.5	-
Toluene-d8	Surrogate		-	-	98.9%	-

Hydrocarbons

	MDL/Units	BH1-20	BH3-20	BH5-20	BH13-20
F1 PHCs (C6-C10)	25 ug/L	123	3600	<25	3790
F2 PHCs (C10-C16)	100 ug/L	<100	52400	<100	2260
F3 PHCs (C16-C34)	100 ug/L	<100	3940	<100	<100
F4 PHCs (C34-C50)	100 ug/L	<100	<1000 [1]	<100	<100

Semi-Volatiles

	MDL/Units	BH1-20	BH3-20	BH5-20	BH13-20
Acenaphthene	0.05 ug/L	0.12	0.29	<0.05	0.21
Acenaphthylene	0.05 ug/L	0.06	0.08	<0.05	<0.05
Anthracene	0.01 ug/L	<0.01	0.04	<0.01	0.03
Benzo [a] anthracene	0.01 ug/L	0.02	<0.01	<0.01	<0.01
Benzo [a] pyrene	0.01 ug/L	<0.01	<0.01	<0.01	<0.01
Benzo [b] fluoranthene	0.05 ug/L	<0.05	<0.05	<0.05	<0.05
Benzo [g,h,i] perylene	0.05 ug/L	<0.05	<0.05	<0.05	<0.05
Benzo [k] fluoranthene	0.05 ug/L	<0.05	<0.05	<0.05	<0.05
Chrysene	0.05 ug/L	<0.05	<0.05	<0.05	<0.05
Dibenzo [a,h] anthracene	0.05 ug/L	<0.05	<0.05	<0.05	<0.05
Fluoranthene	0.01 ug/L	0.21	0.04	0.19	0.01
Fluorene	0.05 ug/L	0.28	0.41	<0.05	0.27
Indeno [1,2,3-cd] pyrene	0.05 ug/L	<0.05	<0.05	<0.05	<0.05
1-Methylnaphthalene	0.05 ug/L	18.2	50.8	<0.05	37.8
2-Methylnaphthalene	0.05 ug/L	10.4	87.3	<0.05	79.7
Methylnaphthalene (1&2)	0.10 ug/L	28.6	138	<0.10	118
Naphthalene	0.05 ug/L	11.3	419	0.08	392
Phenanthrene	0.05 ug/L	0.69	0.34	0.43	0.19
Pyrene	0.01 ug/L	0.40	0.07	0.37	0.03
2-Fluorobiphenyl	Surrogate	90.9%	75.2%	90.3%	88.0%
Terphenyl-d14	Surrogate	98.8%	114%	95.5%	103%

Certificate of Analysis

Report Date: 09-Jul-2020

Client: Lopers & Associates

Order Date: 30-Jun-2020

Client PO: LOP20-002B

Project Description: LOP20-002B

Client ID:	MW-6	MW-8	Trip Blank	-
Sample Date:	30-Jun-20 09:00	30-Jun-20 09:00	29-Jun-20 09:00	-
Sample ID:	2027199-05	2027199-06	2027199-07	-
MDL/Units	Water	Water	Water	-

Volatiles					
	MDL/Units	MW-6	MW-8	Trip Blank	
Acetone	5.0 ug/L	-	-	<5.0	-
Benzene	0.5 ug/L	-	-	<0.5	-
Bromodichloromethane	0.5 ug/L	-	-	<0.5	-
Bromoform	0.5 ug/L	-	-	<0.5	-
Bromomethane	0.5 ug/L	-	-	<0.5	-
Carbon Tetrachloride	0.2 ug/L	-	-	<0.2	-
Chlorobenzene	0.5 ug/L	-	-	<0.5	-
Chloroform	0.5 ug/L	-	-	<0.5	-
Dibromochloromethane	0.5 ug/L	-	-	<0.5	-
Dichlorodifluoromethane	1.0 ug/L	-	-	<1.0	-
1,2-Dichlorobenzene	0.5 ug/L	-	-	<0.5	-
1,3-Dichlorobenzene	0.5 ug/L	-	-	<0.5	-
1,4-Dichlorobenzene	0.5 ug/L	-	-	<0.5	-
1,1-Dichloroethane	0.5 ug/L	-	-	<0.5	-
1,2-Dichloroethane	0.5 ug/L	-	-	<0.5	-
1,1-Dichloroethylene	0.5 ug/L	-	-	<0.5	-
cis-1,2-Dichloroethylene	0.5 ug/L	-	-	<0.5	-
trans-1,2-Dichloroethylene	0.5 ug/L	-	-	<0.5	-
1,2-Dichloropropane	0.5 ug/L	-	-	<0.5	-
cis-1,3-Dichloropropylene	0.5 ug/L	-	-	<0.5	-
trans-1,3-Dichloropropylene	0.5 ug/L	-	-	<0.5	-
1,3-Dichloropropene, total	0.5 ug/L	-	-	<0.5	-
Ethylbenzene	0.5 ug/L	-	-	<0.5	-
Ethylene dibromide (dibromoethane, 1	0.2 ug/L	-	-	<0.2	-
Hexane	1.0 ug/L	-	-	<1.0	-
Methyl Ethyl Ketone (2-Butanone)	5.0 ug/L	-	-	<5.0	-
Methyl Isobutyl Ketone	5.0 ug/L	-	-	<5.0	-
Methyl tert-butyl ether	2.0 ug/L	-	-	<2.0	-
Methylene Chloride	5.0 ug/L	-	-	<5.0	-
Styrene	0.5 ug/L	-	-	<0.5	-
1,1,1,2-Tetrachloroethane	0.5 ug/L	-	-	<0.5	-
1,1,2,2-Tetrachloroethane	0.5 ug/L	-	-	<0.5	-
Tetrachloroethylene	0.5 ug/L	-	-	<0.5	-
Toluene	0.5 ug/L	-	-	<0.5	-

Certificate of Analysis

Report Date: 09-Jul-2020

Client: Lopers & Associates

Order Date: 30-Jun-2020

Client PO: LOP20-002B

Project Description: LOP20-002B

	Client ID:	MW-6	MW-8	Trip Blank	-
	Sample Date:	30-Jun-20 09:00	30-Jun-20 09:00	29-Jun-20 09:00	-
	Sample ID:	2027199-05	2027199-06	2027199-07	-
	MDL/Units	Water	Water	Water	-
1,1,1-Trichloroethane	0.5 ug/L	-	-	<0.5	-
1,1,2-Trichloroethane	0.5 ug/L	-	-	<0.5	-
Trichloroethylene	0.5 ug/L	-	-	<0.5	-
Trichlorofluoromethane	1.0 ug/L	-	-	<1.0	-
Vinyl chloride	0.5 ug/L	-	-	<0.5	-
m,p-Xylenes	0.5 ug/L	-	-	<0.5	-
o-Xylene	0.5 ug/L	-	-	<0.5	-
Xylenes, total	0.5 ug/L	-	-	<0.5	-
4-Bromofluorobenzene	Surrogate	-	-	116%	-
Dibromofluoromethane	Surrogate	-	-	99.4%	-
Toluene-d8	Surrogate	-	-	108%	-
Benzene	0.5 ug/L	<0.5	<0.5	-	-
Ethylbenzene	0.5 ug/L	<0.5	<0.5	-	-
Toluene	0.5 ug/L	<0.5	<0.5	-	-
m,p-Xylenes	0.5 ug/L	<0.5	<0.5	-	-
o-Xylene	0.5 ug/L	<0.5	<0.5	-	-
Xylenes, total	0.5 ug/L	<0.5	<0.5	-	-
Toluene-d8	Surrogate	95.0%	101%	-	-
Hydrocarbons					
F1 PHCs (C6-C10)	25 ug/L	<25	<25	-	-
F2 PHCs (C10-C16)	100 ug/L	<100	<100	-	-
F3 PHCs (C16-C34)	100 ug/L	<100	<100	-	-
F4 PHCs (C34-C50)	100 ug/L	<100	<100	-	-

Certificate of Analysis

Report Date: 09-Jul-2020

Client: Lopers & Associates

Order Date: 30-Jun-2020

Client PO: LOP20-002B

Project Description: LOP20-002B

Method Quality Control: Blank

Analyte	Result	Reporting Limit	Units	Source Result	%REC	%REC Limit	RPD	RPD Limit	Notes
Anions									
Chloride	ND	1	mg/L						
General Inorganics									
Cyanide, free	ND	2	ug/L						
Hydrocarbons									
F1 PHCs (C6-C10)	ND	25	ug/L						
F2 PHCs (C10-C16)	ND	100	ug/L						
F3 PHCs (C16-C34)	ND	100	ug/L						
F4 PHCs (C34-C50)	ND	100	ug/L						
Metals									
Mercury	ND	0.1	ug/L						
Antimony	ND	0.5	ug/L						
Arsenic	ND	1	ug/L						
Barium	ND	1	ug/L						
Beryllium	ND	0.5	ug/L						
Boron	ND	10	ug/L						
Cadmium	ND	0.1	ug/L						
Chromium (VI)	ND	10	ug/L						
Chromium	ND	1	ug/L						
Cobalt	ND	0.5	ug/L						
Copper	ND	0.5	ug/L						
Lead	ND	0.1	ug/L						
Molybdenum	ND	0.5	ug/L						
Nickel	ND	1	ug/L						
Selenium	ND	1	ug/L						
Silver	ND	0.1	ug/L						
Sodium	ND	200	ug/L						
Thallium	ND	0.1	ug/L						
Uranium	ND	0.1	ug/L						
Vanadium	ND	0.5	ug/L						
Zinc	ND	5	ug/L						
Semi-Volatiles									
Acenaphthene	ND	0.05	ug/L						
Acenaphthylene	ND	0.05	ug/L						
Anthracene	ND	0.01	ug/L						
Benzo [a] anthracene	ND	0.01	ug/L						
Benzo [a] pyrene	ND	0.01	ug/L						
Benzo [b] fluoranthene	ND	0.05	ug/L						
Benzo [g,h,i] perylene	ND	0.05	ug/L						
Benzo [k] fluoranthene	ND	0.05	ug/L						
Chrysene	ND	0.05	ug/L						
Dibenzo [a,h] anthracene	ND	0.05	ug/L						
Fluoranthene	ND	0.01	ug/L						
Fluorene	ND	0.05	ug/L						
Indeno [1,2,3-cd] pyrene	ND	0.05	ug/L						
1-Methylnaphthalene	ND	0.05	ug/L						
2-Methylnaphthalene	ND	0.05	ug/L						
Methylnaphthalene (1&2)	ND	0.10	ug/L						
Naphthalene	ND	0.05	ug/L						
Phenanthrene	ND	0.05	ug/L						
Pyrene	ND	0.01	ug/L						
Surrogate: 2-Fluorobiphenyl	19.0		ug/L		95.0	50-140			
Surrogate: Terphenyl-d14	22.8		ug/L		114	50-140			
Volatiles									
Acetone	ND	5.0	ug/L						
Benzene	ND	0.5	ug/L						
Bromodichloromethane	ND	0.5	ug/L						
Bromoform	ND	0.5	ug/L						

Certificate of Analysis

Report Date: 09-Jul-2020

Client: Lopers & Associates

Order Date: 30-Jun-2020

Client PO: LOP20-002B

Project Description: LOP20-002B

Method Quality Control: Blank

Analyte	Result	Reporting Limit	Units	Source Result	%REC	%REC Limit	RPD	RPD Limit	Notes
Bromomethane	ND	0.5	ug/L						
Carbon Tetrachloride	ND	0.2	ug/L						
Chlorobenzene	ND	0.5	ug/L						
Chloroform	ND	0.5	ug/L						
Dibromochloromethane	ND	0.5	ug/L						
Dichlorodifluoromethane	ND	1.0	ug/L						
1,2-Dichlorobenzene	ND	0.5	ug/L						
1,3-Dichlorobenzene	ND	0.5	ug/L						
1,4-Dichlorobenzene	ND	0.5	ug/L						
1,1-Dichloroethane	ND	0.5	ug/L						
1,2-Dichloroethane	ND	0.5	ug/L						
1,1-Dichloroethylene	ND	0.5	ug/L						
cis-1,2-Dichloroethylene	ND	0.5	ug/L						
trans-1,2-Dichloroethylene	ND	0.5	ug/L						
1,2-Dichloropropane	ND	0.5	ug/L						
cis-1,3-Dichloropropylene	ND	0.5	ug/L						
trans-1,3-Dichloropropylene	ND	0.5	ug/L						
1,3-Dichloropropene, total	ND	0.5	ug/L						
Ethylbenzene	ND	0.5	ug/L						
Ethylene dibromide (dibromoethane, 1,2-	ND	0.2	ug/L						
Hexane	ND	1.0	ug/L						
Methyl Ethyl Ketone (2-Butanone)	ND	5.0	ug/L						
Methyl Isobutyl Ketone	ND	5.0	ug/L						
Methyl tert-butyl ether	ND	2.0	ug/L						
Methylene Chloride	ND	5.0	ug/L						
Styrene	ND	0.5	ug/L						
1,1,1,2-Tetrachloroethane	ND	0.5	ug/L						
1,1,2,2-Tetrachloroethane	ND	0.5	ug/L						
Tetrachloroethylene	ND	0.5	ug/L						
Toluene	ND	0.5	ug/L						
1,1,1-Trichloroethane	ND	0.5	ug/L						
1,1,2-Trichloroethane	ND	0.5	ug/L						
Trichloroethylene	ND	0.5	ug/L						
Trichlorofluoromethane	ND	1.0	ug/L						
Vinyl chloride	ND	0.5	ug/L						
m,p-Xylenes	ND	0.5	ug/L						
o-Xylene	ND	0.5	ug/L						
Xylenes, total	ND	0.5	ug/L						
<i>Surrogate: 4-Bromofluorobenzene</i>	95.5		ug/L		119	50-140			
<i>Surrogate: Dibromofluoromethane</i>	90.2		ug/L		113	50-140			
<i>Surrogate: Toluene-d8</i>	79.1		ug/L		98.9	50-140			
Benzene	ND	0.5	ug/L						
Ethylbenzene	ND	0.5	ug/L						
Toluene	ND	0.5	ug/L						
m,p-Xylenes	ND	0.5	ug/L						
o-Xylene	ND	0.5	ug/L						
Xylenes, total	ND	0.5	ug/L						
<i>Surrogate: Toluene-d8</i>	79.1		ug/L		98.9	50-140			

Certificate of Analysis

Report Date: 09-Jul-2020

Client: Lopers & Associates

Order Date: 30-Jun-2020

Client PO: LOP20-002B

Project Description: LOP20-002B

Method Quality Control: Duplicate

Analyte	Result	Reporting Limit	Units	Source Result	%REC	%REC Limit	RPD	RPD Limit	Notes
Anions									
Chloride	17.0	1	mg/L	17.0			0.3	10	
General Inorganics									
Cyanide, free	ND	2	ug/L	ND			NC	20	
pH	8.0	0.1	pH Units	8.0			0.1	3.3	
Hydrocarbons									
F1 PHCs (C6-C10)	ND	25	ug/L	ND			NC	30	
Metals									
Mercury	ND	0.1	ug/L	ND			NC	20	
Antimony	ND	0.5	ug/L	ND			NC	20	
Arsenic	ND	1	ug/L	ND			NC	20	
Barium	47.3	1	ug/L	48.0			1.6	20	
Beryllium	ND	0.5	ug/L	ND			NC	20	
Boron	141	10	ug/L	142			0.8	20	
Cadmium	ND	0.1	ug/L	ND			NC	20	
Chromium (VI)	ND	10	ug/L	ND			NC	20	
Chromium	ND	1	ug/L	ND			NC	20	
Cobalt	ND	0.5	ug/L	ND			NC	20	
Copper	0.82	0.5	ug/L	0.85			3.6	20	
Lead	ND	0.1	ug/L	ND			NC	20	
Molybdenum	4.14	0.5	ug/L	4.19			1.2	20	
Nickel	3.0	1	ug/L	3.1			3.8	20	
Selenium	ND	1	ug/L	ND			NC	20	
Silver	ND	0.1	ug/L	ND			NC	20	
Sodium	32100	200	ug/L	32300			0.9	20	
Thallium	0.10	0.1	ug/L	0.11			2.3	20	
Uranium	3.5	0.1	ug/L	3.3			3.3	20	
Vanadium	0.64	0.5	ug/L	0.65			1.8	20	
Zinc	ND	5	ug/L	ND			NC	20	
Volatiles									
Acetone	ND	5.0	ug/L	ND			NC	30	
Benzene	ND	0.5	ug/L	ND			NC	30	
Bromodichloromethane	ND	0.5	ug/L	ND			NC	30	
Bromoform	ND	0.5	ug/L	ND			NC	30	
Bromomethane	ND	0.5	ug/L	ND			NC	30	
Carbon Tetrachloride	ND	0.2	ug/L	ND			NC	30	
Chlorobenzene	ND	0.5	ug/L	ND			NC	30	
Chloroform	ND	0.5	ug/L	ND			NC	30	
Dibromochloromethane	ND	0.5	ug/L	ND			NC	30	
Dichlorodifluoromethane	ND	1.0	ug/L	ND			NC	30	
1,2-Dichlorobenzene	ND	0.5	ug/L	ND			NC	30	
1,3-Dichlorobenzene	ND	0.5	ug/L	ND			NC	30	
1,4-Dichlorobenzene	ND	0.5	ug/L	ND			NC	30	
1,1-Dichloroethane	ND	0.5	ug/L	ND			NC	30	
1,2-Dichloroethane	ND	0.5	ug/L	ND			NC	30	
1,1-Dichloroethylene	ND	0.5	ug/L	ND			NC	30	
cis-1,2-Dichloroethylene	ND	0.5	ug/L	ND			NC	30	
trans-1,2-Dichloroethylene	ND	0.5	ug/L	ND			NC	30	
1,2-Dichloropropane	ND	0.5	ug/L	ND			NC	30	
cis-1,3-Dichloropropylene	ND	0.5	ug/L	ND			NC	30	
trans-1,3-Dichloropropylene	ND	0.5	ug/L	ND			NC	30	
Ethylbenzene	ND	0.5	ug/L	ND			NC	30	
Ethylene dibromide (dibromoethane, 1,2)	ND	0.2	ug/L	ND			NC	30	
Hexane	ND	1.0	ug/L	ND			NC	30	
Methyl Ethyl Ketone (2-Butanone)	ND	5.0	ug/L	ND			NC	30	
Methyl Isobutyl Ketone	ND	5.0	ug/L	ND			NC	30	
Methyl tert-butyl ether	ND	2.0	ug/L	ND			NC	30	

Certificate of Analysis

Report Date: 09-Jul-2020

Client: Lopers & Associates

Order Date: 30-Jun-2020

Client PO: LOP20-002B

Project Description: LOP20-002B

Method Quality Control: Duplicate

Analyte	Result	Reporting Limit	Units	Source Result	%REC	%REC Limit	RPD	RPD Limit	Notes
Methylene Chloride	ND	5.0	ug/L	ND			NC	30	
Styrene	ND	0.5	ug/L	ND			NC	30	
1,1,1,2-Tetrachloroethane	ND	0.5	ug/L	ND			NC	30	
1,1,2,2-Tetrachloroethane	ND	0.5	ug/L	ND			NC	30	
Tetrachloroethylene	ND	0.5	ug/L	ND			NC	30	
Toluene	ND	0.5	ug/L	ND			NC	30	
1,1,1-Trichloroethane	ND	0.5	ug/L	ND			NC	30	
1,1,2-Trichloroethane	ND	0.5	ug/L	ND			NC	30	
Trichloroethylene	ND	0.5	ug/L	ND			NC	30	
Trichlorofluoromethane	ND	1.0	ug/L	ND			NC	30	
Vinyl chloride	ND	0.5	ug/L	ND			NC	30	
m,p-Xylenes	ND	0.5	ug/L	ND			NC	30	
o-Xylene	ND	0.5	ug/L	ND			NC	30	
<i>Surrogate: 4-Bromofluorobenzene</i>	<i>94.1</i>		<i>ug/L</i>		<i>118</i>	<i>50-140</i>			
<i>Surrogate: Dibromofluoromethane</i>	<i>83.4</i>		<i>ug/L</i>		<i>104</i>	<i>50-140</i>			
<i>Surrogate: Toluene-d8</i>	<i>71.4</i>		<i>ug/L</i>		<i>89.3</i>	<i>50-140</i>			
Benzene	ND	0.5	ug/L	ND			NC	30	
Ethylbenzene	ND	0.5	ug/L	ND			NC	30	
Toluene	ND	0.5	ug/L	ND			NC	30	
m,p-Xylenes	ND	0.5	ug/L	ND			NC	30	
o-Xylene	ND	0.5	ug/L	ND			NC	30	
<i>Surrogate: Toluene-d8</i>	<i>71.4</i>		<i>ug/L</i>		<i>89.3</i>	<i>50-140</i>			

Certificate of Analysis

Report Date: 09-Jul-2020

Client: Lopers & Associates

Order Date: 30-Jun-2020

Client PO: LOP20-002B

Project Description: LOP20-002B

Method Quality Control: Spike

Analyte	Result	Reporting Limit	Units	Source Result	%REC	%REC Limit	RPD	RPD Limit	Notes
Anions									
Chloride	26.5	1	mg/L	17.0	95.0	77-123			
General Inorganics									
Cyanide, free	25.2	2	ug/L	ND	83.9	70-130			
Hydrocarbons									
F1 PHCs (C6-C10)	1990	25	ug/L	ND	99.7	68-117			
F2 PHCs (C10-C16)	1670	100	ug/L	ND	105	60-140			
F3 PHCs (C16-C34)	4580	100	ug/L	ND	117	60-140			
F4 PHCs (C34-C50)	2690	100	ug/L	ND	109	60-140			
Metals									
Mercury	3.48	0.1	ug/L	ND	116	70-130			
Antimony	49.5	0.5	ug/L	ND	98.3	80-120			
Arsenic	56.4	1	ug/L	ND	112	80-120			
Barium	102	1	ug/L	48.0	108	80-120			
Beryllium	54.7	0.5	ug/L	ND	109	80-120			
Boron	49	10	ug/L	ND	97.2	80-120			
Cadmium	53.0	0.1	ug/L	ND	106	80-120			
Chromium (VI)	191	10	ug/L	ND	95.5	70-130			
Chromium	59.4	1	ug/L	ND	118	80-120			
Cobalt	53.0	0.5	ug/L	ND	105	80-120			
Copper	52.9	0.5	ug/L	0.85	104	80-120			
Lead	45.7	0.1	ug/L	ND	91.4	80-120			
Molybdenum	54.4	0.5	ug/L	4.19	100	80-120			
Nickel	56.4	1	ug/L	3.1	107	80-120			
Selenium	51.2	1	ug/L	ND	102	80-120			
Silver	50.9	0.1	ug/L	ND	102	80-120			
Sodium	40400	200	ug/L	32300	81.0	80-120			
Thallium	50.8	0.1	ug/L	0.11	101	80-120			
Uranium	44.6	0.1	ug/L	3.3	82.4	80-120			
Vanadium	60.0	0.5	ug/L	0.65	119	80-120			
Zinc	53	5	ug/L	ND	99.6	80-120			
Semi-Volatiles									
Acenaphthene	4.21	0.05	ug/L	ND	84.3	50-140			
Acenaphthylene	3.32	0.05	ug/L	ND	66.3	50-140			
Anthracene	4.02	0.01	ug/L	ND	80.5	50-140			
Benzo [a] anthracene	4.51	0.01	ug/L	ND	90.2	50-140			
Benzo [a] pyrene	5.22	0.01	ug/L	ND	104	50-140			
Benzo [b] fluoranthene	5.79	0.05	ug/L	ND	116	50-140			
Benzo [g,h,i] perylene	5.11	0.05	ug/L	ND	102	50-140			
Benzo [k] fluoranthene	5.43	0.05	ug/L	ND	109	50-140			
Chrysene	5.22	0.05	ug/L	ND	104	50-140			
Dibenzo [a,h] anthracene	5.17	0.05	ug/L	ND	103	50-140			
Fluoranthene	4.22	0.01	ug/L	ND	84.3	50-140			
Fluorene	4.00	0.05	ug/L	ND	79.9	50-140			
Indeno [1,2,3-cd] pyrene	5.15	0.05	ug/L	ND	103	50-140			
1-Methylnaphthalene	5.35	0.05	ug/L	ND	107	50-140			
2-Methylnaphthalene	5.93	0.05	ug/L	ND	119	50-140			
Naphthalene	5.29	0.05	ug/L	ND	106	50-140			

Certificate of Analysis

Report Date: 09-Jul-2020

Client: Lopers & Associates

Order Date: 30-Jun-2020

Client PO: LOP20-002B

Project Description: LOP20-002B

Method Quality Control: Spike

Analyte	Result	Reporting Limit	Units	Source Result	%REC	%REC Limit	RPD	RPD Limit	Notes
Phenanthrene	4.26	0.05	ug/L	ND	85.2	50-140			
Pyrene	4.27	0.01	ug/L	ND	85.4	50-140			
<i>Surrogate: 2-Fluorobiphenyl</i>	20.3		ug/L		101	50-140			
<i>Surrogate: Terphenyl-d14</i>	20.9		ug/L		105	50-140			
Volatiles									
Acetone	126	5.0	ug/L	ND	126	50-140			
Benzene	44.5	0.5	ug/L	ND	111	60-130			
Bromodichloromethane	46.6	0.5	ug/L	ND	117	60-130			
Bromoform	46.9	0.5	ug/L	ND	117	60-130			
Bromomethane	47.5	0.5	ug/L	ND	119	50-140			
Carbon Tetrachloride	48.1	0.2	ug/L	ND	120	60-130			
Chlorobenzene	44.4	0.5	ug/L	ND	111	60-130			
Chloroform	47.5	0.5	ug/L	ND	119	60-130			
Dibromochloromethane	42.2	0.5	ug/L	ND	106	60-130			
Dichlorodifluoromethane	46.7	1.0	ug/L	ND	117	50-140			
1,2-Dichlorobenzene	49.8	0.5	ug/L	ND	124	60-130			
1,3-Dichlorobenzene	40.1	0.5	ug/L	ND	100	60-130			
1,4-Dichlorobenzene	43.7	0.5	ug/L	ND	109	60-130			
1,1-Dichloroethane	45.8	0.5	ug/L	ND	115	60-130			
1,2-Dichloroethane	44.2	0.5	ug/L	ND	111	60-130			
1,1-Dichloroethylene	37.0	0.5	ug/L	ND	92.5	60-130			
cis-1,2-Dichloroethylene	49.2	0.5	ug/L	ND	123	60-130			
trans-1,2-Dichloroethylene	34.8	0.5	ug/L	ND	87.1	60-130			
1,2-Dichloropropane	39.2	0.5	ug/L	ND	97.9	60-130			
cis-1,3-Dichloropropylene	42.3	0.5	ug/L	ND	106	60-130			
trans-1,3-Dichloropropylene	46.6	0.5	ug/L	ND	116	60-130			
Ethylbenzene	43.9	0.5	ug/L	ND	110	60-130			
Ethylene dibromide (dibromoethane, 1,2)	40.5	0.2	ug/L	ND	101	60-130			
Hexane	44.0	1.0	ug/L	ND	110	60-130			
Methyl Ethyl Ketone (2-Butanone)	126	5.0	ug/L	ND	126	50-140			
Methyl Isobutyl Ketone	104	5.0	ug/L	ND	104	50-140			
Methyl tert-butyl ether	114	2.0	ug/L	ND	114	50-140			
Methylene Chloride	43.8	5.0	ug/L	ND	110	60-130			
Styrene	43.5	0.5	ug/L	ND	109	60-130			
1,1,1,2-Tetrachloroethane	44.5	0.5	ug/L	ND	111	60-130			
1,1,2,2-Tetrachloroethane	43.3	0.5	ug/L	ND	108	60-130			
Tetrachloroethylene	34.7	0.5	ug/L	ND	86.7	60-130			
Toluene	45.9	0.5	ug/L	ND	115	60-130			
1,1,1-Trichloroethane	41.8	0.5	ug/L	ND	105	60-130			
1,1,2-Trichloroethane	46.7	0.5	ug/L	ND	117	60-130			
Trichloroethylene	42.5	0.5	ug/L	ND	106	60-130			
Trichlorofluoromethane	43.6	1.0	ug/L	ND	109	60-130			
Vinyl chloride	49.0	0.5	ug/L	ND	122	50-140			
m,p-Xylenes	79.2	0.5	ug/L	ND	98.9	60-130			
o-Xylene	44.0	0.5	ug/L	ND	110	60-130			
<i>Surrogate: 4-Bromofluorobenzene</i>	86.1		ug/L		108	50-140			
<i>Surrogate: Dibromofluoromethane</i>	85.9		ug/L		107	50-140			
<i>Surrogate: Toluene-d8</i>	69.3		ug/L		86.6	50-140			
Benzene	44.5	0.5	ug/L	ND	111	60-130			
Ethylbenzene	43.9	0.5	ug/L	ND	110	60-130			

Certificate of Analysis

Report Date: 09-Jul-2020

Client: **Lopers & Associates**

Order Date: 30-Jun-2020

Client PO: **LOP20-002B**

Project Description: LOP20-002B

Method Quality Control: Spike

Analyte	Result	Reporting Limit	Units	Source Result	%REC	%REC Limit	RPD	RPD Limit	Notes
Toluene	45.9	0.5	ug/L	ND	115	60-130			
m,p-Xylenes	79.2	0.5	ug/L	ND	98.9	60-130			
o-Xylene	44.0	0.5	ug/L	ND	110	60-130			
<i>Surrogate: Toluene-d8</i>	69.3		<i>ug/L</i>		86.6	50-140			

Certificate of Analysis

Report Date: 09-Jul-2020

Client: **Lopers & Associates**

Order Date: 30-Jun-2020

Client PO: **LOP20-002B**

Project Description: **LOP20-002B**

Qualifier Notes:

Sample Qualifiers :

1 : Elevated detection limit due to dilution required because of high target analyte concentration.

Sample Data Revisions

None

Work Order Revisions / Comments:

None

Other Report Notes:

n/a: not applicable

ND: Not Detected

MDL: Method Detection Limit

Source Result: Data used as source for matrix and duplicate samples

%REC: Percent recovery.

RPD: Relative percent difference.

NC: Not Calculated

CCME PHC additional information:

- The method for the analysis of PHCs complies with the Reference Method for the CWS PHC and is validated for use in the laboratory. All prescribed quality criteria identified in the method has been met.
- F1 range corrected for BTEX.
- F2 to F3 ranges corrected for appropriate PAHs where available.
- The gravimetric heavy hydrocarbons (F4G) are not to be added to C6 to C50 hydrocarbons.
- In the case where F4 and F4G are both reported, the greater of the two results is to be used for comparison to CWS PHC criteria.
- When reported, data for F4G has been processed using a silica gel cleanup.

Appendix F

Qualifications of Assessors



PROFILE

Mr. Lopers is an environmental engineer with over 12 years of experience in environmental engineering specializing in due diligence investigations. Mr. Lopers has extensive experience in Phase I and II Environmental Site Assessments; environmental remediation, and investigations; record of site condition submissions; asset inventory, designated substance surveys and abatement projects; environmental expertise on legal issues; and coordination of various monitoring programs (groundwater, surface water, air).

Mr. Lopers has participated in various Property Condition and Building Envelope mandates at various residential and commercial properties throughout Ontario.

Mr. Lopers has a strong commitment to health and safety, having experience leading a regional health and safety committee as a certified employee representative. Mr. Lopers has extensive training including OSHA 40-hour HAZWOPER, ASP Health and Safety on Construction Sites in Quebec, Ontario Working at Heights, Emergency First Aid/CPR and WHMIS.

CONTACT

EMAIL:
Luke@Lopers.ca

LUKE LOPERS

Principal

LOPERS & ASSOCIATES

EDUCATION

University of Waterloo,
B.A.Sc., Honours Environmental Engineering
Management Science Option Designation - 2002 - 2008

PROFESSIONAL EXPERIENCE

Lopers & Associates, Principal, Project Manager, Senior Environmental Engineer

Ottawa, Ontario - 2020–Present
Responsible for the management, coordination, supervision, completion and delivery of Phase I/1 and II/2 Environmental Site Assessments, Environmental Remediation Programs, Environmental litigation support, Designated Substance Surveys, scope of work development, cost estimates and proposals

GHD Limited, Project Manager, Senior Environmental Engineer

Ottawa, Ontario - 2013–2020
Responsible for the management, senior technical review, coordination, supervision, completion and delivery of Phase I/1 and II/2 Environmental Site Assessments, Environmental Remediation Programs, Environmental litigation support, Designated Substance Surveys, scope of work development, cost estimates and proposals
Office Safety Captain and Joint Health and Safety Committee team leader

Paterson Group Inc., Project Manager, Environmental Engineer

Ottawa, Ontario - 2009–2013
Responsible for supervision, completion and review for Phase I/1 and II/2 Environmental Site Assessments, Environmental Remediation Programs, Designated Substance Surveys

NEXT Environmental Inc., Site Investigation Staff

Burnaby, British Columbia - 2008–2009
Responsible for fieldwork and reporting for Stage/Phase I and II Environmental Site Assessments, Environmental Remediation Programs

PROFESSIONAL DESIGNATIONS

Licensed Professional Engineer (P.Eng.) with Professional Engineers Ontario (PEO) since 2012

Qualified Person (QP), Environmental Site Assessments with Ontario Ministry of the Environment, Conservation and Parks

PROJECT EXPERIENCE

Environmental Site Assessments

**Project Engineer/Manager
Phase 1 Environmental Site
Assessment | Various Clients |
Ontario, Quebec and British
Columbia | 2006-2020**

**Project Engineer/Manager
Phase Two Environmental Site
Assessments | Various Clients |
Various Locations | 2008-2020**

**Project Manager
Phase One, Phase Two
Environmental Site
Assessments, Environmental
Delineation Quality Assurance
Program | Costco Wholesale |
Ottawa, ON | 2014-2019**

Environmental Remediation Programs

**Project Engineer
Underground Fuel Storage
Tank Removals and
Environmental Remediation
Programs in Vicinity of Active
Underground Services |
Ottawa, ON | 2010, 2012**

Project Engineer/Manager for Phase I Environmental Site Assessments in support of acquisition/divestiture/regulatory requirements for various properties in Ontario, Quebec and British Columbia, including the following:

- Canadian Tire Retail Store and Gas Bar, CTR 417 - 2560 Princess Street, Kingston, Ontario
- Former Automotive Dealership and Service Garage, North Vancouver, British Columbia
- Former Philips Cable Plant, Brockville, Ontario
- Former Cornwall Cotton Mill, Cornwall, Ontario
- Retail Fuel Outlet and Automotive Service Garage, Ottawa, Ontario
- Jack Garland Airport Land, North Bay, Ontario
- Various Commercial/Residential Properties, Ontario and British Columbia
- Various Residential Properties, Ontario, Quebec and British Columbia
- Rochester Heights (811, 818 Gladstone Avenue), Ottawa, Ontario

Project Engineer/Manager for the following field investigation and/or regulatory reporting requirements for Phase II ESAs and other Site Investigations:

- Proposed Canadian Tire Development, CTR 693P - Terry Fox Drive at Eagleson Road, Stittsville, Ontario
- Former Retail/Private Fuel Outlets, Ottawa/North Bay/Vancouver, Canada
- Operational/Former Industrial Facilities, Ottawa/Cornwall/Sarnia/Brockville/Gananoque, Ontario
- Existing Dry Cleaning Facilities, Ottawa/Amprior, Ontario
- Automotive Service Garages, Ottawa/Vancouver, Canada
- Various Commercial/Residential Properties, Eastern Ontario
- Tetrachloroethylene Groundwater Plume, Commercial Property, Ottawa, Ontario
- Rochester Heights (811, 818 Gladstone Avenue), Ottawa, Ontario

Project Manager for the completion of a Phase One ESA for the potential acquisition of a commercial property. Upon discovery of APECs at the Site and significant data gaps in previous investigations, completed a Phase Two ESA to evaluate soil and groundwater quality at the Site. Further oversight of original owner's environmental consultants was completed to ensure adequate delineation and characterization of a dNAPL groundwater plume at the Site, present at significant depths in shale bedrock, which originated as a result of a former on-Site dry-cleaning operation.

Project Engineer for removal of underground heating oil storage tanks adjacent to residential buildings. Completed excavation supervision of contaminated soil around and below active underground services, including hydro, water and natural gas infrastructure at residential properties. Activities included oversight of removal of petroleum, impacted soil, and field screening and collection of confirmatory soil and groundwater samples for petroleum hydrocarbon analysis. Prepared Phase I, II and III Environmental Site Assessment reports.

**Project Engineer
Retail Fuel Outlet
Decommissioning and
Remediation | Ottawa, ON |
2012**

**Project Engineer/Manager
Former Fuel Outlet
Investigation and Remediation |
Merrickville, ON | 2016-2017**

Record of Site Conditions

**Project Manager/Engineer
Residential Redevelopment |
Environmental Remediation
Program and Record of Site
Condition Submission | Ottawa
| 2015**

**Project Manager/Engineer
Industrial Development |
Environmental Assessment and
Record of Site Condition
Submission | Township of
Edwardsburgh/Cardinal | 2015**

Excess Soil Management

**Project Engineer/Manager
Management of Excess Soil |
CTREL, Brigid, Ottawa
Community Housing
Corporation | Ottawa and
Pembroke, Ontario | 2016, 2018**

Designated Substance Surveys

**Project Manager
Designated Substance Surveys
and Hazardous Building
Materials Assessment |
Ottawa, Pembroke,
Southeastern Ontario | 2010-
2020**

Environmental Litigation Support

**Project Manager, Field
Engineer, Expert Witness
Ottawa, Ontario | 2014-2020**

Project Engineer for UST removal and confirmatory soil sampling at former ESSO gas station in Ottawa, Ontario. Activities included oversight of removal of USTs and product lines, oversight of removal of petroleum-impacted soil and groundwater encountered and backfilling operations, and field screening and collection of confirmatory soil and groundwater samples for petroleum hydrocarbon analysis.

Project Engineer for confirmatory soil and groundwater sampling following UST removal at former Shell gas station. Activities included oversight of removal of petroleum-impacted soil, pumping of groundwater encountered and backfilling operations, and field screening and collection of confirmatory soil and groundwater samples for petroleum hydrocarbon analysis. Additional borehole/monitoring well drilling also completed.

Project Manager for delineation of soil contamination and groundwater sampling for a former automotive garage and gas station property in Ottawa, Ontario. Presented and implemented remedial action plan to remediate on-site contamination. Directed staff in collection of post remediation confirmatory soil and groundwater samples for contaminants of concern. Prepared remediation closure report and record of site condition supporting documentation for submission to the Ministry of the Environment and Climate Change.

Project Manager for environmental assessments for a proposed industrial business park, in an existing industrial area within the Township of Edwardsburgh/Cardinal, Ontario. Prepared environmental assessment reports and record of site condition supporting documentation for submission to the Ministry of the Environment and Climate Change.

Project Engineer/Manager for sampling, analytical testing, development of soil management plans and monitoring during removal of excess soil generated as part of construction activities, including the following properties/facilities:

- Rochester Heights (811, 818 Gladstone Avenue), Ottawa, Ontario
- Residential redevelopment, 121 Parkdale Avenue, Ottawa, Ontario
- CTR 079, 1104 Pembroke Street East, Pembroke, Ontario
- CTR 297, 2010 Ogilvie Road, Ottawa, Ontario

Project Manager for asbestos containing material (ACM) surveys, designated substance surveys (DSSs), Hazardous Building Materials Assessments (HBMA) or mould assessments at the following sites:

- DSSs at various municipal facilities for the City of Pembroke, Pembroke, Ontario. Preparation of Asbestos Management Plan.
- HBMA at various institutional buildings for the Catholic District School Board of Eastern Ontario, Southeastern Ontario.
- DSSs and ACM surveys at various residential, buildings (dwellings and apartment buildings) for private residential clients, Ottawa, Ontario.
- DSS and abatement oversight during demolition, residential buildings (townhouses) for Ottawa Community Housing Corporation, 818 Gladstone Avenue, Ottawa, Ontario.

Project Manager, Field Engineer and Expert Witness for a fuel spill, remediation program, groundwater monitoring program and litigation review for redevelopment of a residential property adjacent to a central heating plant at an institutional facility.

Education

BEng Geological Engineering, École Polytechnique de Montreal, Montreal, Quebec, 1990

MSc Geophysics, University of British Columbia, Vancouver, British Columbia, 1983

BSc Geophysics, Honours, University of British Columbia, Vancouver, British Columbia, 1980

Certifications

Registered as PMP with Project Management Institute since 2012, requalified in 2018

Qualified Person (QP) for Environmental Site Assessments with Ontario Ministry of Environment and Conservation and Parks

Professional Affiliations

Licensed as P.Eng. with the Professional Engineers of Ontario (PEO) since 1994

Licensed as Ing. with l'Ordre des ingénieurs du Québec (OIQ), 1992

Licensed as P.Eng. with NAPEG (NWT and Nunavut), since 2009.

Licensed as P.Eng with Engineers Yukon since 2018

Federal Clearance Level

Secret ID # 95251065

DON PLENDERLEITH

Senior Environmental Engineer and Project Manager

PROFESSIONAL SUMMARY

Mr. Plenderleith has been an environmental engineer for 30 years. From 1990 to 2000 he worked at specialty firms in Montreal and Ottawa where he gained field and reporting experience in site assessment and remediation of retail fuel outlets and railway yards. In 1991 and 1992 he worked on a CIDA sponsored project to assess additional water resource potential in two provinces in Indonesia. He worked for Golder for 19 years on projects in Ottawa, the North and overseas.

His expertise covers all steps in contaminated site management: Phase I, II and III environmental site assessments (ESAs), risk assessments, remedial options evaluations, remedial action plans, tender plans and specifications, remediation project oversight, long-term monitoring and project closure. He has largely concentrated on federal sites since 2002 and was Golder's initial point of contact on the Environmental Standing Offer Agreement with PSPC in the National Capital over that time.

Don led Golder's national client service team for Federal government and was responsible to Golder's management for maintaining strong relations with the federal government. Locally, he provided project management and technical direction of a variety of environmental projects from the Ottawa office. Don mentored several junior professionals. His site portfolio included: military bases, Northern sites, navigational sites, correctional facilities, research labs, commercial buildings and Canadian embassies abroad. On several multi-year projects (Kingston Penitentiary and Connaught Ranges landfill) he directed all steps of site management from initial investigations, through to site closure.

Don is equally experienced at providing strategic and portfolio-level assistance to clients as well as site-specific level work. He has written contaminated sites management plans for several federal Departments. He helped to develop components of the FCSAP project manager's tool kit and has trained federal project managers in its use. He has provided program-level assistance to the FCSAP Secretariat for funding demand forecasting and long-term strategy and risk management. For nine years he led a multi-disciplinary team that performed contaminated site liability peer reviews for the Office of the Auditor General of Canada.

Don completed his engineering degree in French and is licensed to practice in Quebec. He frequently coordinates the French language component at bilingual meetings and workshops.

**Public Services and
Procurement Canada,
National Capital Region,
Environmental
Engineering Standing
Offer (2002-2019).**

PROJECT EXPERIENCE – STANDING OFFER MANAGER

Don managed Golder's Environmental Standing Offer Agreement (SOA) with PSPC in the National Capital Region from 2002 to 2019. He was the first point of contact with PSPC for new call-ups. He formed project teams from the approved resources and reviewed the work plans under each call-up. He was responsible and accountable for Golder's overall project performance to PSPC.

**Phase I, II, and III and
Remediation at Pittsburgh
Institution and Kingston
Penitentiary for PSPC/CSC
near Kingston, Ontario**

PROJECT EXPERIENCE – SENIOR PROJECT MANAGER

Environmental Site Assessment, Remediation Planning and Implementation for the Pittsburgh Institution and Kingston Penitentiary, Kingston, Ontario from 2007 to 2015 - Don was the Senior Project Manager and project reviewer for the Phase I, II and III of contaminated sites on two similar projects at these federal penitentiaries. Don performed project management and provided technical direction during the full suite of services from site assessment through to remediation. Federal project management tools, and FCSAP technical tools (GOST) were used to assist with procedural compliance. Don assisted PSPC with the tender specification for both remediation projects and performed on-site supervision during the fast-track remediation work at Pittsburgh. Don also performed senior review of the draft and final reports.

**Peer Review and Liability
Review of US Steel Site in
Hamilton Harbour for
PSPC and Transport
Canada (July-August 2016)**

Don was the Senior Project Manager for a Peer Review of reports pertaining to the US Steel site on Hamilton Harbour that the Hamilton Port Authority (HPA) was considering purchasing. TC requested the peer review and liability review in its oversight role over the HPA. Don brought a senior expert in at steel industry at Golder onto the project team. With his input some important gaps in the previous site assessments, management plans and liability estimates were identified to TC.

**Contaminated Site
Reporting and Review for
Department of National
Defence Ottawa, Ontario,
Canada**

Don has managed several projects for DND's Director General Environment, related to the financial reporting of DND's contaminated sites. He managed the EcoNet validation project in 2006, in which the systems and procedures by which site cost and liability information are input to DND's Contaminated Site database, Econet. Several of DND's major projects being run out of headquarters were reviewed in that exercise. In 2008 he assisted DND by producing the 2008 update of their Contaminated Sites Management Plan (CSMP) for Treasury Board submission. Nine divisional CSMPs were reviewed, summarized and incorporated into the departmental CSMP.

PROGRAM LEVEL WORK – FEDERAL CONTAMINATED SITES

Project Management Tools for Contaminated Sites, Ottawa, Ontario, Canada

Mr. Plenderleith developed two of the FCSAP Project Management Tools: Status Reporting and Project Risk Management. He has provided training in the tools to federal project managers country-wide. He has delivered training sessions at RPIC National Contaminated Sites workshops on several occasions on the PM Tools, the Sustainable Development Tool (SDAT), and Guidance Tool for Selection of Technologies Tools (GOST).

Assistance to FCSAP for program-level Risk Management, PWGSC/ECCC Ottawa, Ontario

Don has led a team at Golder that provided assistance to the FCSAP Secretariat from 2013 to 2019 in the areas of cost projections for funding demand estimates. He devised a method of projecting the costs of unassessed sites based on closure costs of similar sites. This tool was used to estimate the funding demand for FCSAP Phase III and past Phase III. Don assisted the Secretariat with Long-Term Strategic planning for FSCAP post 2020 when the 15-year program is due to sunset.

Secondments to Federal Departments

Mr. Plenderleith has been seconded from Golder to the Department of Foreign Affairs and International Trade (now Global Affairs Canada “GAC”) on three occasions to develop their Contaminated Sites Management Plans and to fill in while GAC was staffing their full-time environmental engineer position. Through these secondments he has developed a greater understanding of the role of federal custodians in managing their programs.

PROJECT EXPERIENCE – NORTHERN SITES

DEW Line Site Monitoring, Baffin Region, DND (2015-19)

Mr. Plenderleith was the project director of Golder’s DEW Line Monitoring contract with DND from four years 2015 to 2019. He was responsible for overall program quality and liaison with the client and management of Inuit subcontractors. The project was multi-disciplinary, involving geotechnical and environmental components. Mr. Plenderleith has developed a very positive working relationship with the hamlet of Qikiqtarjuaq and the Inuit staff from that community, many of whom have returned to work with Golder every year. All Inuit Participation Targets were exceeded.

Tundra Mine Remediation Monitoring PSPC/INAC (2016-2018)

Don was the Senior project director for Golder’s Remediation Monitoring of Tundra Mine (NWT) for PSPC and INAC. This project is multi-disciplinary involving surface water and groundwater environmental monitoring and aquatic monitoring for the final stages of the remediation of Tundra Mine. Don has reviewed the monthly and annual monitoring reports produced for the Water Licence. His earlier experience with the RAP for Tundra has been valuable on this project.

**Remedial Options Review
and Remedial Action
Planning Former Water
Tanker Base, Inuvik
Airport, NWT 2010-12**

From 2010 to 2012, Mr. Plenderleith was the technical director for the Phase III ESA detailed site assessment and remediation planning of the former Water Tanker Base at the Inuvik Airport in NWT. The work included determining the contaminants of concern, delineation of contaminated soil and seasonal groundwater areas, and assessing remedial options. The remedial action plan reviewed chemical oxidation and removal & disposal options within the constraints of northern work season, and the distance to a disposal facility. Descriptions, costs, advantages and limitations were provided for several options. GNWT performed the remediation with own forces.

**SITE SERVICING AND STORMWATER MANAGEMENT BRIEF – MOONEY’S BAY - 729
RIDGEWOOD AVENUE, OTTAWA, ON**

Appendix F City of Ottawa Servicing Study Checklist

Appendix F CITY OF OTTAWA SERVICING STUDY CHECKLIST





APPLICANT'S STUDY AND PLAN IDENTIFICATION LIST - Draft

Legend: **S** indicates that the study or plan is required with application submission.

A indicates that the study or plan may be required to satisfy a condition of approval/draft approval.

For information and guidance on preparing required studies and plans refer to:

<http://ottawa.ca/en/development-application-review-process-0/guide-preparing-studies-and-plans>

S/A	Number of copies	ENGINEERING		S/A	Number of copies
S		1. Site Servicing Plan	2. Assessment of Adequacy of Public Services / Site Servicing Study / Brief	S	
S		3. Grade Control and Drainage Plan	4. Geotechnical Study / Slope Stability Study	S	
		5. Composite Utility Plan	6. Groundwater Impact Study		
		7. Servicing Options Report	8. Wellhead Protection Study		
S		9. Community Transportation Study and / or Transportation Impact Study / Brief	10. Erosion and Sediment Control Plan / Brief	S	
S		11. Storm water Management Report / Brief	12. Hydro geological and Terrain Analysis		
		13. Hydraulic Water main Analysis	14. Noise / Vibration Study	S	
		15. Roadway Modification Design Plan	16. Confederation Line Proximity Study		

S/A	Number of copies	PLANNING / DESIGN / SURVEY		S/A	Number of copies
		17. Draft Plan of Subdivision	18. Plan Showing Layout of Parking Garage	S	
		19. Draft Plan of Condominium	20. Planning Rationale	S	
S		21. Site Plan	22. Minimum Distance Separation (MDS)		
		23. Concept Plan Showing Proposed Land Uses and Landscaping	24. Agrology and Soil Capability Study		
		25. Concept Plan Showing Ultimate Use of Land	26. Cultural Heritage Impact Statement		
S		27. Landscape Plan	28. Archaeological Resource Assessment Requirements: S (site plan) A (subdivision, condo)		
S		29. Survey Plan	30. Shadow Analysis		
S		31. Architectural Building Elevation Drawings (dimensioned)	32. Design Brief (includes the Design Review Panel Submission Requirements)		
		33. Wind Analysis			

S/A	Number of copies	ENVIRONMENTAL		S/A	Number of copies
S		34. Phase 1 Environmental Site Assessment	35. Impact Assessment of Adjacent Waste Disposal/Former Landfill Site		
A		36. Phase 2 Environmental Site Assessment (depends on the outcome of Phase 1)	37. Assessment of Landform Features		
A		38. Record of Site Condition	39. Mineral Resource Impact Assessment		
S		40. Tree Conservation Report	41. Environmental Impact Statement / Impact Assessment of Endangered Species		
		42. Mine Hazard Study / Abandoned Pit or Quarry Study	43. Integrated Environmental Review (Draft, as part of Planning Rationale)		

Number of copies

***Reports require 3 copies; Plans require 3 copies + Digital versions of all submissions**

Meeting Date: TBD

Application Type: TBD

File Lead (Assigned Planner): Kelby Lodoen Unseth

Infrastructure Approvals Project Manager: Rubina Rasool

Site Address (Municipal Address): 729 Ridgewood Ave.

*Preliminary Assessment: 1 2 3 4 5

*One (1) indicates that considerable major revisions are required before a planning application is submitted, while five (5) suggests that proposal appears to meet the City's key land use policies and guidelines. **This assessment is purely advisory and does not consider technical aspects of the proposal or in any way guarantee application approval.**

It is important to note that the need for additional studies and plans may result during application review. If following the submission of your application, it is determined that material that is not identified in this checklist is required to achieve complete application status, in accordance with the Planning Act and Official Plan requirements, the Planning, Infrastructure and Economic Development Department will notify you of outstanding material required within the required 30 day period. Mandatory pre-application consultation will not shorten the City's standard processing timelines, or guarantee that an application will be approved. It is intended to help educate and inform the applicant about submission requirements as well as municipal processes, policies, and key issues in advance of submitting a formal development application. This list is valid for one year following the meeting date. If the application is not submitted within this timeframe the applicant must again pre-consult with the Planning, Infrastructure and Economic Development Department.

Appendix G Background Correspondence

Appendix G BACKGROUND CORRESPONDENCE



Site Plan Pre- Application Consultation Notes

Date: Wednesday , May 6, 2020.

Site Location: 729 Ridgewood Avenue

Type of Development: Residential (townhomes, stacked, singles, apartments), Office Space, Commercial, Retail, Institutional, Industrial, Other: N/A

Project Manager: Sharif Golam

Assigned Planner: Kelby Lodoen Unseth

Infrastructure

Water

Water District Plan No: 368-025

Existing public services:

- Ridgewood Avenue – 305mm CI



Watermain Frontage Fees to be paid (\$190.00 per metre) Yes No

- Existing on-site water service must be shown on the plans. The existing on-site water services will be blanked at the watermain if it will not be reused.
- Service areas with a basic demand greater than 50 m³/day shall be connected with a minimum of two water services, separated by an isolation valve, to avoid creation of vulnerable service area.
- A water meter sizing questionnaire [water card] will have to be completed prior to receiving a water permit (water card will be provided post approval)

Boundary conditions:

Civil consultant must request boundary conditions from the City's assigned Project Manager prior to first submission.

- Water boundary condition requests must include the location of the service(s) and the expected loads required by the proposed developments. Please provide all the following information:
 - Location of service(s)
 - Type of development and the amount of fire flow required (as per FUS, 1999).
 - Average daily demand: ___ l/s.
 - Maximum daily demand: ___ l/s.
 - Maximum hourly daily demand: ___ l/s.
- Fire protection (Fire demand, Hydrant Locations)
- A water meter sizing questionnaire [water card] will have to be completed prior to receiving a water permit (water card will be provided post approval)

Sanitary Sewer

Existing public services:

- Ridgewood Avenue – 225mm Conc.



Is a monitoring manhole required on private property? Yes No

- The sanitary sewer design has assumed a population density for the area. The sewer design should demonstrate that the proposed development is within that design criteria or that additional demand can be accommodated.

Storm Sewer

Existing public services:

- Ridgewood Avenue – 300mm Conc.

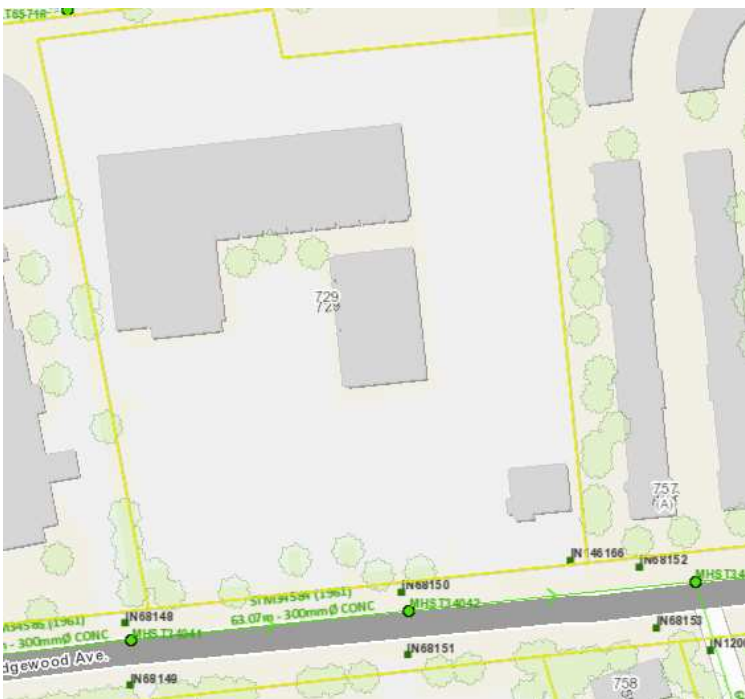

Stormwater Management

Quality Control:

- Rideau Valley Conservation Authority to confirm quality control requirements.

Quantity Control:

- Master Servicing Study:
 - Sawmills Creek Subwatershed Study
- Allowable Run-off Coefficient: to be calculated as per the Sawmills Creek Subwatershed Study
- Time of concentration (Tc): Tc = pre-development; maximum Tc = 10 min

- Allowable flowrate: Control the 100-year storm events to the 2-year storm event

Ministry of Environment, Conservation and Parks (MECEP)

All development applications should be considered for an Environmental Compliance Approval, under MECP regulations.

- a. Consultant determines if an approval for sewage works under Section 53 of OWRA is required. Consultant determines what type of application is required and the City's project manager confirms. (If the consultant is not clear if an ECA is required, they will work with the City to determine what is required. If unclear or there is a difference of opinion the City Project Manager will coordinate requirements with MECP).
- b. The project will be either transfer of review (standard), transfer of review (additional), direct submission, or exempt as per O. Reg. 525/98.
- c. Pre-consultation is not required if applying for standard or additional works (Schedule A of the Agreement) under Transfer Review.
- d. Pre-consultation with local District office of MECP is recommended for direct submission.
- e. Consultant completes an MECP request form for a pre-consultation. Sends request to moeccottawasewage@ontario.ca
- f. ECA applications are required to be submitted online through the MECP portal. A business account required to submit ECA application. For more information visit <https://www.ontario.ca/page/environmental-compliance-approval>

NOTE: Site Plan Approval, or Draft Approval, is required before any Ministry of the Environment and Climate Change (MOECC) application is signed

General Service Design Comments

- Ensure that the proposed drive lane entrance to the underground parking garage is protected from the major overland flow route within Ridgewood Avenue.
- The City of Ottawa requests that all new services be located within the existing service trench to minimize necessary road cuts.
- Monitoring manholes should be located within the property near the property line in an accessible location to City forces and free from obstruction (i.e. not a parking).
- Where service length is greater than 30 m between the building and the first maintenance hole / connection, a cleanout is required.
- The City of Ottawa Standard Detail Drawings should be referenced where possible for all work within the Public Right-of-Way.
- The upstream and downstream manhole top of grate and invert elevations are required for all new sewer connections.
- Services crossing the existing watermain or sewers need to clearly provide the obvert/invert elevations to demonstrate minimum separation distances. A watermain crossing table may be provided.

Other

Are there are Capital Works Projects scheduled that will impact the application? Yes No

References and Resources

- As per section 53 of the Professional Engineers Act, O. Reg 941/40, R.S.O. 1990, all documents prepared by engineers must be signed and dated on the seal.
- All required plans are to be submitted on standard A1 size sheets (594mm x 841mm) sheets, utilizing a reasonable and appropriate metric scale as per City of Ottawa Servicing and Grading Plan Requirements: title blocks are to be placed on the right of the sheets and not along the bottom. Engineering plans may be combined, but the Site Plans must be provided separately. Plans shall include the survey monument used to confirm datum. Information shall be provided to enable a non-surveyor to locate the survey monument presented by the consultant.
- All required plans & reports are to be provided in *.pdf format (at application submission and for any, and all, re-submissions)
- Please find relevant City of Ottawa Links to Preparing Studies and Plans below:

<https://ottawa.ca/en/city-hall/planning-and-development/information-developers/development-application-review-process/development-application-submission/guide-preparing-studies-and-plans#standards-policies-and-guidelines>

- To request City of Ottawa plan(s) or report information please contact the City of Ottawa Information Centre:
InformationCentre@ottawa.ca<<mailto:InformationCentre@ottawa.ca>>
(613) 580-2424 ext. 44455
- geoOttawa
<http://maps.ottawa.ca/geoOttawa/>

SITE PLAN APPLICATION – Municipal servicing

For information on preparing required studies and plans refer to:

<http://ottawa.ca/en/development-application-review-process-0/guide-preparing-studies-and-plans>

S/A	Number of copies	ENGINEERING		S/A	Number of copies
S		1. Site Servicing Plan	2. Site Servicing Study	S	
S		3. Grade Control and Drainage Plan	4. Geotechnical Study	S	
		5. Composite Utility Plan	6. Groundwater Impact Study		
		7. Servicing Options Report	8. Wellhead Protection Study		
		9. Community Transportation Study and/or Transportation Impact Study / Brief	10. Erosion and Sediment Control Plan / Brief	S	
S		11. Storm water Management Report	12. Hydro-geological and Terrain Analysis		
		13. Water main Analysis	14. Noise / Vibration Study	S	
		15. Roadway Modification Design Plan	16. Confederation Line Proximity Study		

S/A	Number of copies	ENVIRONMENTAL		S/A	Number of copies
S		17. Phase 1 Environmental Site Assessment	18. Impact Assessment of adjacent Waste Disposal/Former Landfill Site		
		19. Phase 2 Environmental Site Assessment (depends on the outcome of Phase 1)	20. Assessment of Landform Features		
		21. Record of Site Condition	22. Mineral Resource Impact Assessment		
		23. Tree Conservation Report	24. Environmental Impact Statement / Impact Assessment of Endangered Species		
		25. Mine Hazard Study / Abandoned Pit or Quarry Study			

It is important to note that the need for additional studies and plans may result during application review. If following the submission of your application, it is determined that material that is not identified in this checklist is required to achieve complete application status, in accordance with the Planning Act and Official Plan requirements, City Planning will notify you of outstanding material required within the required 30 day period. Mandatory pre-application consultation will not shorten the City's standard processing timelines, or guarantee that an application will be approved. It is intended to help educate and inform the applicant about submission requirements as well as municipal processes, policies, and key issues in advance of submitting a formal development application. This list is valid for one year following the meeting date. If the application is not submitted within this timeframe the applicant must again pre-consult with the City.

Notes:

4. Geotechnical Study / Slope Stability Study – required as per Official Plan section 4.8.3. All site plan applications need to demonstrate the soils are suitable for development. A Slope Stability Study may be required with unique circumstances (Schedule K or topography may define slope stability concerns).

10. Erosion and Sediment Control Plan – required with all site plan applications as per Official Plan section 4.7.3.

11. Stormwater Management Report/Brief - required with all site plan applications as per Official Plan section 4.7.6.

14. Noise and Vibration Study – a Noise Study will be required if the noise sensitive development is proposed within 250 metres of an existing or proposed highway or a railway right-of-way, or 100 metres of an arterial or collector roadway or rapid-transit corridor. A Vibration Study will be required if the proposed development is within 75 metres of either an existing or proposed railway ROW. A Noise Study may also be required if the proposed development is adjacent to an existing or proposed stationary noise source.

**SITE SERVICING AND STORMWATER MANAGEMENT BRIEF – MOONEY’S BAY - 729
RIDGEWOOD AVENUE, OTTAWA, ON**

Appendix H Drawings

Appendix H DRAWINGS

