

# 265 Centrum Boulevard

## Transportation Impact Assessment

Step 1 Screening Report

Step 2 Scoping Report

Step 3 Forecasting Report

Step 4 Strategy Report (Rev #1)

Prepared for:

Bayview Orleans Inc.  
108 Chestnut Street  
Toronto ON M5G 1R3

Prepared by:



6 Plaza Court  
Ottawa, ON K2H 7W1

February 2024

PN: 2023-013

## Table of Contents

1	Screening .....	1
2	Existing and Planned Conditions .....	1
2.1	Proposed Development.....	1
2.2	Existing Conditions .....	3
2.2.1	Area Road Network.....	3
2.2.2	Existing Intersections .....	3
2.2.3	Existing Driveways .....	4
2.2.4	Cycling and Pedestrian Facilities.....	4
2.2.5	Existing Transit.....	7
2.2.6	Existing Area Traffic Management Measures.....	8
2.2.7	Existing Peak Hour Travel Demand.....	8
2.2.8	Collision Analysis.....	10
2.3	Planned Conditions.....	12
2.3.1	Changes to the Area Transportation Network .....	12
2.3.2	Other Study Area Developments .....	13
3	Study Area and Periods .....	13
3.1	Study Area .....	13
3.2	Time Periods .....	14
3.3	Horizon Years.....	14
4	Exemption Review .....	14
4.1	TIA Stepped Process .....	14
5	Development-Generated Travel Demand .....	15
5.1	Mode Shares.....	15
5.2	Trip Generation .....	15
5.3	Trip Distribution.....	17
5.4	Trip Assignment.....	17
6	Background Network Travel Demands.....	19
6.1	Transportation Network Plans .....	19
6.2	Background Growth.....	19
6.3	Other Developments .....	20
7	Demand Rationalization .....	20
7.1	2028 Future Background Operations .....	20
7.2	2033 Future Background Operations .....	21
7.3	2028 Future Total Operations .....	23
7.4	2033 Future Total Operations .....	25
7.5	Modal Share Sensitivity and Demand Rationalization Conclusions .....	26
7.5.1	Network Rationalization .....	26
7.5.2	Development Rationalization .....	26
8	Development Design .....	27
8.1	Design for Sustainable Modes.....	27
8.2	Circulation and Access.....	27
9	Parking.....	27

9.1 Parking Supply ..... 27

10 Boundary Street Design..... 28

11 Access Intersections Design ..... 28

    11.1 Location and Design of Access..... 28

    11.2 Intersection Control..... 28

    11.3 Access Intersection Design ..... 29

        11.3.1 Future Access Intersection Operations ..... 29

        11.3.2 Access Intersection MMLOS..... 29

        11.3.3 Recommended Design Elements..... 29

12 Transportation Demand Management ..... 29

    12.1 Context for TDM ..... 29

    12.2 Need and Opportunity..... 29

    12.3 TDM Program ..... 29

13 Neighbourhood Traffic Management..... 29

14 Transit..... 30

    14.1 Route Capacity..... 30

    14.2 Transit Priority ..... 30

15 Network Concept..... 30

16 Network Intersection Design..... 30

    16.1 Network Intersection Control..... 30

    16.2 Network Intersection Design..... 30

        16.2.1 2028 & 2033 Future Total Network Intersection Operations ..... 30

        16.2.2 Network Intersection Multi-Modal Level of Service (MMLOS)..... 31

        16.2.3 Recommended Design Elements..... 31

17 Summary of Improvements Indicated and Modifications Options..... 31

18 Conclusion ..... 35

List of Figures

Figure 1: Area Context Plan ..... 1

Figure 2: Concept Plan..... 2

Figure 3: Existing Driveways ..... 4

Figure 4: Study Area Pedestrian Facilities ..... 5

Figure 5: Study Area Cycling Facilities ..... 5

Figure 6: Existing Pedestrian Volumes ..... 6

Figure 7: Existing Cyclist Volumes ..... 6

Figure 8: Existing Study Area Transit Service..... 7

Figure 9: Existing Study Area Transit Stops ..... 8

Figure 10: Existing Traffic Counts ..... 9

Figure 11: Study Area Collision Records..... 11

Figure 12: New Site Generation Auto Volumes..... 18

Figure 13: Pass-by Auto Volumes ..... 19

Figure 14: 2028 Future Background Volumes ..... 20

Figure 15: 2033 Future Background Volumes ..... 22

Figure 16: 2028 Future Total Volumes ..... 23  
 Figure 17: 2033 Future Total Volumes ..... 25

### Table of Tables

Table 1: Intersection Count Date..... 8  
 Table 2: Existing Intersection Operations..... 9  
 Table 3: Study Area Collision Summary, 2016-2020 ..... 10  
 Table 4: Summary of Collision Locations, 2016-2020 ..... 11  
 Table 5: St Joseph Boulevard at Prestone Drive Collision Summary ..... 12  
 Table 6: Exemption Review ..... 14  
 Table 7: TRANS Trip Generation Manual Recommended Mode Shares – Orleans..... 15  
 Table 8: Proposed Development Mode Shares ..... 15  
 Table 9: Trip Generation Person Trip Rates ..... 15  
 Table 10: Total Person Trip Generation ..... 16  
 Table 11: Internal Capture Rates..... 16  
 Table 12: Trip Generation by Mode ..... 16  
 Table 13: OD Survey Distribution – Orleans ..... 17  
 Table 14: Trip Assignment ..... 17  
 Table 15: TRANS Regional Model Projections – Study Area Growth Rates..... 19  
 Table 16: Recommended Area Growth Rates ..... 20  
 Table 17: 2028 Future Background Intersection Operations ..... 21  
 Table 18: 2033 Future Background Intersection Operations ..... 22  
 Table 19: 2028 Future Total Intersection Operations ..... 24  
 Table 20: 2033 Future Total Intersection Operations ..... 25  
 Table 21: Boundary Street MMLOS Analysis ..... 28  
 Table 22: Trip Generation by Transit Mode ..... 30  
 Table 23: Forecasted Site-Generated Transit Ridership..... 30  
 Table 24: Study Area Intersection MMLOS Analysis ..... 31

### List of Appendices

- Appendix A – TIA Screening Form and Certification Form
- Appendix B – Turning Movement Count Data
- Appendix C – Synchro Intersection Worksheets – Existing Conditions
- Appendix D – Collision Data
- Appendix E – St. Joseph Boulevard Concept Plan
- Appendix F – TRANS Plot
- Appendix G – Background Volumes
- Appendix H – Synchro Intersection Worksheets – 2028 Future Background Conditions
- Appendix I – Synchro Intersection Worksheets – 2033 Future Background Conditions
- Appendix J – Synchro Intersection Worksheets – 2028 Future Total Conditions
- Appendix K – Synchro Intersection Worksheets – 2033 Future Total Conditions
- Appendix L – TDM Checklist
- Appendix M – Turning Templates

Appendix N – MMLOS Analysis

# 1 Screening

This study has been prepared according to the City of Ottawa’s 2017 Transportation Impact Assessment (TIA) Guidelines, prior to the June 2023 updates. Accordingly, a Step 1 Screening Form has been prepared and is included as Appendix A, along with the Certification Form for the TIA Study PM. As shown in the Screening Form, a TIA is required including the Design Review component and the Network Impact Component. This study has been prepared to support a zoning bylaw amendment and site plan applications.

# 2 Existing and Planned Conditions

## 2.1 Proposed Development

The development site is located at 265 Centrum Boulevard within the Mixed-Use Centre Zone (MC14[1520] S152), Place d’Orleans Protected Major Transit Station Area (PMTSA) and design priority area. The existing site was a YMCA, now closed, and it will be replaced with three towers, two residential towers including 764 units, and one mix-used tower including 363 residential units, 8,967 sq. ft retail space, and 31,570 sq. ft office space. The site plan proposes a total of 516 vehicle parking spaces and 1,256 bicycle parking spaces. The existing perpendicular street parking spaces along Brisebois Crescent are proposed to be replaced with parallel street parking spaces. The preliminary accesses are proposed to include three along Brisebois Crescent, and the existing two accesses on Brisebois Crescent will be removed. Build-out is anticipated to occur in a single phase by 2028. Figure 1 illustrates the study area context. Figure 2 illustrates the proposed concept plan.

Figure 1: Area Context Plan

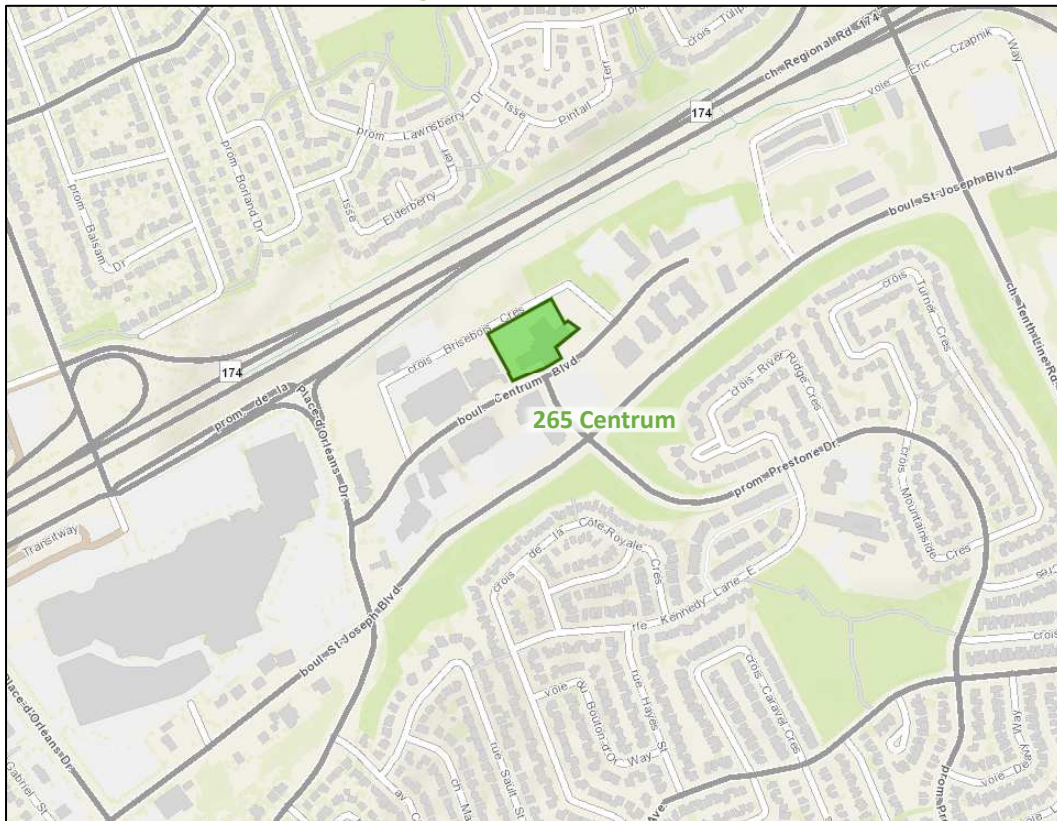

Source: <http://maps.ottawa.ca/geoOttawa/> Accessed: January 31, 2023

Figure 2: Concept Plan

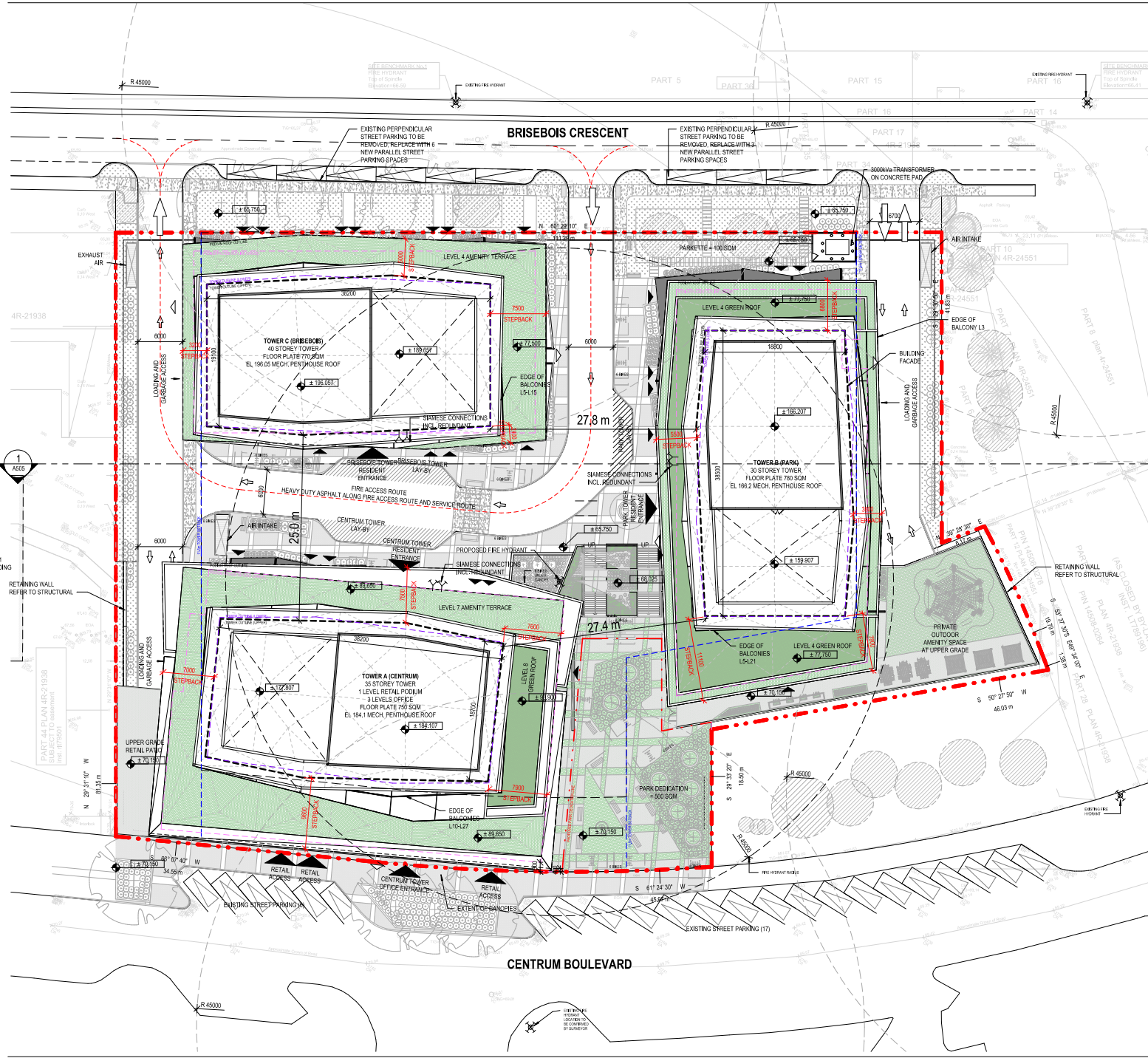

PART OF BLOCK 6 AND PART OF COMMERCIAL DRIVE  
(As Closed by By-Law 90-42, Int. L178196), REGISTERED  
PLAN S34545  
CITY OF OTTAWA

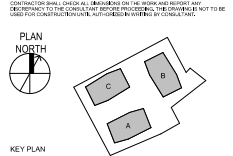

- NOTES
1. TO BE READ IN CONJUNCTION WITH DRAWINGS PREPARED BY SITE SERVING ENGINEER AND LANDSCAPE ARCHITECT. REFER TO SITE SERVICES/GRADING DRAWINGS FOR GRADING INFORMATION AND DRAINAGE.
  2. FIRE ROUTES SHALL BE DESIGNED IN ACCORDANCE WITH APPLICABLE CBC REQUIREMENTS: MIN. WIDTH 6m AND MIN. TURNING RADIUS OF 7m; INTERIOR TURNING RADIUS OF 9m AND OUTSIDE TURNING RADIUS OF 15m.
  3. FIRE ROUTES OVER PARKING GARAGE SHALL BE DESIGNED TO SUPPORT THE 500 KPA LOADING REQUIREMENT IDENTIFIED IN NFPA 1901.
  4. FIRE ROUTES SHALL BE DESIGNED TO SUPPORT EXPECTED LOADS IMPOSED BY FIREFIGHTING EQUIPMENT AND MEET THE REQUIREMENTS OF THE CANADIAN HIGHWAY BRIDGE CODE, AND SHALL BE SURFACED IN ORDER TO BE ACCESSIBLE UNDER ALL CLIMATIC CONDITIONS.

REVISION		
NO.	DATE	DESCRIPTION
1	23-03-24	ISSUED FOR SITE PLAN APPROVAL
2	24-02-06	ISSUED FOR SPA REVISIONS

- LEGEND
- MAIN PEDESTRIAN ENTRY
  - PEDESTRIAN ENTRY
  - PEDESTRIAN EGRESS
  - VEHICULAR ENTRY
  - PROPOSED ELEVATION
  - SIAMSE CONNECTION
  - FIRE HYDRANT
  - LIGHT POST
  - CATCH BASIN / MANHOLE COVER
  - FIRE ACCESS ROUTE
  - OUTLINE OF UPPER TOWER FACADE
  - OUTLINE OF LOWER TOWER FACADE
  - OUTLINE OF PODIUM FACADE

**B+H Architects**  
330 Bloor Street, Suite 100  
Toronto, ON M5H 4A6  
Tel: 416-598-2299 Fax: 416-598-0599

SEAL:

- BIKE PARKING DIAGRAMS
- STACKED

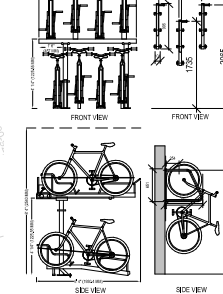

- STRUCTURAL ENGINEER:  
**Art Engineering**  
171 Midland Rd  
Ottawa, ON K1P 1J1  
Tel: 613-436-0632
- ELECTRICAL ENGINEER:  
**Mechanical Consultant**  
Street Address  
City: Postal Code  
Tel: Fax: Email
- ELECTRICAL ENGINEER:  
**Electrical Consultant**  
Street Address  
City: Postal Code  
Tel: Fax: Email
- WIND + NOISE CONSULTANT:  
**Gradient Wind**  
127 Midland Rd  
Ottawa, ON K1P 1J1  
Tel: 613-562-0284
- LANDSCAPE ARCHITECT:  
**J. Lennox and Associates**  
1000 Carleton Place  
North York, ON M2H 5A8  
Tel: 416-223-6168
- SITE SERVICES/CIVIL ENGINEER:  
**McIntosh Perry**  
115 Midland Rd  
Ottawa, ON K1P 1J1  
Tel: 613-562-0284
- PLANNING CONSULTANT:  
**Fotenn**  
198 Dundas St. Suite 300  
Ottawa, K2P 2P7  
Tel: 613-243-0799
- TRAFFIC CONSULTANT:  
**CGH**  
13 Markham Ave  
Ottawa, K2C 3T1  
Tel: 613-496-2623
- OWNER:  
**BAYVIEW GROUP**  
188 Chestnut Street  
Toronto, ON M5H 1R3  
Tel: 416-597-4368

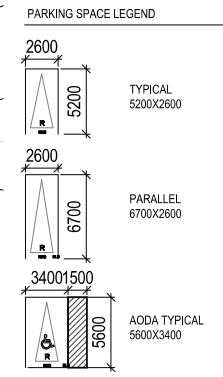

PROJECT:  
**CENTRUM**

265 CENTRUM BLVD  
OTTAWA, ON  
K1E 3X7

SHEET CONTENTS:  
**SITE PLAN**

PROJECT NUMBER:  
2211080

DRAWING SCALE:  
As indicated

DRAWN BY: Author  
CHECKED BY: Checker  
DATE: 01/19/23

SHEET NO:  
**A010**

REV: 2

BIM: 28/02/2021 10:05 - Centrum Blvd Ottawa 2211080-014-ARCH-ARCH-MASTER-02/21-14  
 SITE PLAN  
 28/02/2024 10:41:08 AM  
 A010

## 2.2 Existing Conditions

### 2.2.1 Area Road Network

*Place d'Orleans Drive:* Place d'Orleans Drive is a City of Ottawa arterial road with a four-lane cross-section. The posted speed limit is 60km/h. Sidewalks are present on both sides of the road. The Official Plan reserves a right-of-way of 37.5 metres within the study area. Place d'Orleans Drive is a designated truck route.

*St Joseph Boulevard:* St Joseph Boulevard is a City of Ottawa arterial road with a divided, four-lane cross-section. The posted speed limit is 50km/h west of Prestone Drive and 60km/h east of Prestone Drive. Sidewalks are present on both sides of the road. The Official Plan reserves a right-of-way of 32.0 metres from Gabriel Street to 130 m west of Duford Drive and 37.5 metres east to Trim Road. St Joseph Boulevard is a designated truck route.

*Centrum Boulevard:* Centrum Boulevard is a City of Ottawa collector road with a two-lane cross-section. The posted speed limit is 40km/h. Sidewalks and angle parking are provided on both sides of the road. The existing right-of-way is 26.0 metres within the study area.

*Prestone Drive:* Prestone Drive is a City of Ottawa collector road with a divided four-lane cross-section north of St Joseph Boulevard, and a major collector road south of St Joseph Boulevard with an undivided two-lane cross-section. The posted speed limit is 40km/h. Sidewalks are present on both sides of the road. Within the study area, the existing right-of-way is 24.5 metres north of St Joseph Boulevard and 26.0 metres south of St Joseph Boulevard within the study area.

*Brisebois Crescent:* Brisebois Crescent is a City of Ottawa local road with a two-lane cross-section. The unposted speed limit is assumed to be 50km/h. Sidewalks are present on one side of the road, and perpendicular parking is provided on the south side of the road. The existing right-of-way is 18.0 metres within the study area.

### 2.2.2 Existing Intersections

The existing key area intersections within 400 metres of the site have been summarized below:

*Centrum Boulevard at Place d'Orleans Drive* The intersection of Centrum Boulevard at Place d'Orleans Drive is a signalized intersection. The northbound and southbound approaches each consist of a shared left-turn/through lane and a shared through/right-turn lane. The eastbound approach consists of an auxiliary left-turn lane, a through lane, and an auxiliary channelized right-turn lane, and the westbound approach consists of a left-turn lane and a shared through/channelized right-turn lane. No turn restrictions were noted.

*Centrum Boulevard at Brisebois Crescent West* The intersection of Centrum Boulevard at Brisebois Crescent West is an unsignalized intersection with stop control on the minor approaches of Brisebois Crescent West. All approaches consist of a shared all-movements lane. No turn restrictions were noted.

*Centrum Boulevard at Prestone Drive* The intersection of Centrum Boulevard at Prestone Drive is an unsignalized T-intersection with all-way stop control. The northbound approach consists of a left-turn lane and a right-turn lane. The eastbound approach consists of a shared through/right-turn lane, and the westbound approach consists of a shared left-turn/through lane. No turn restrictions were noted.



*Centrum Boulevard at Brisebois Crescent East*

The intersection of Centrum Boulevard at Brisebois Crescent East is an unsignalized T-intersection with stop control on the minor approach of Brisebois Crescent East. All approaches consist of a shared all-movements lane. No turn restrictions were noted.

*St Joseph Boulevard at Prestone Drive*

The intersection of St Joseph Boulevard at Prestone Drive is a signalized intersection. The northbound approach consists of an auxiliary left-turn lane and a shared through/channelized right-turn lane, and the southbound approach consists of a left-turn lane and a shared through/channelized right-turn lane. The eastbound and westbound approaches each consist of an auxiliary left-turn lane, two through lanes, and an auxiliary channelized right-turn lane. No turn restrictions were noted.

2.2.3 Existing Driveways

Within 200 metres of the site accesses, three driveways to an office, three driveways to an art school, and one driveway to a library are on Brisebois Crescent. One driveway to a retail plaza, one to a parking lot, three to condominiums, and one to townhouses are present on Centrum Boulevard. On Prestone Drive, one driveway to a retail plaza and one to a parking lot are present. Figure 3 illustrates the existing driveways.

Figure 3: Existing Driveways

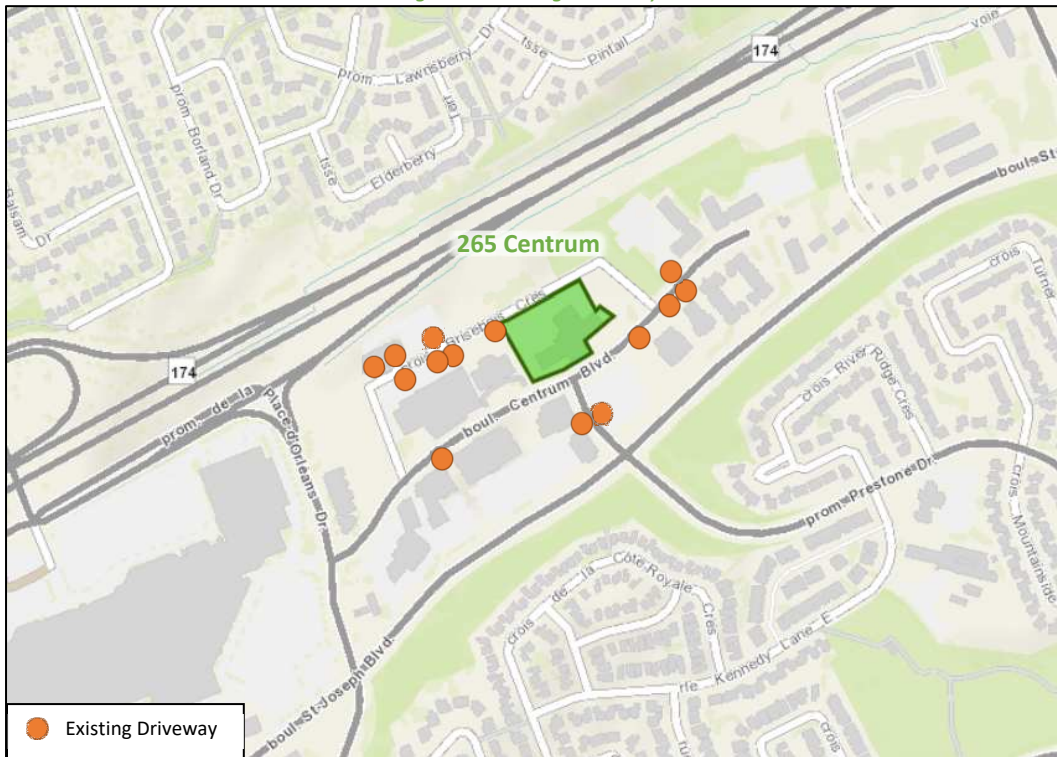

Source: <http://maps.ottawa.ca/geoOttawa/> Accessed: January 31, 2023

2.2.4 Cycling and Pedestrian Facilities

Figure 4 illustrates the pedestrian facilities in the study area and Figure 5 illustrates the cycling facilities.

Sidewalks are provided on both sides of Place d’Orleans Drive, St Joseph Boulevard, Centrum Boulevard, and Prestone Drive. Sidewalks are also provided on one side of Brisebois Crescent.

No existing cycling facility is within the study area. St Joseph Boulevard is identified as crosstown bikeways as part of the 2023 Transportation Master Plan – Part 1.

Figure 4: Study Area Pedestrian Facilities

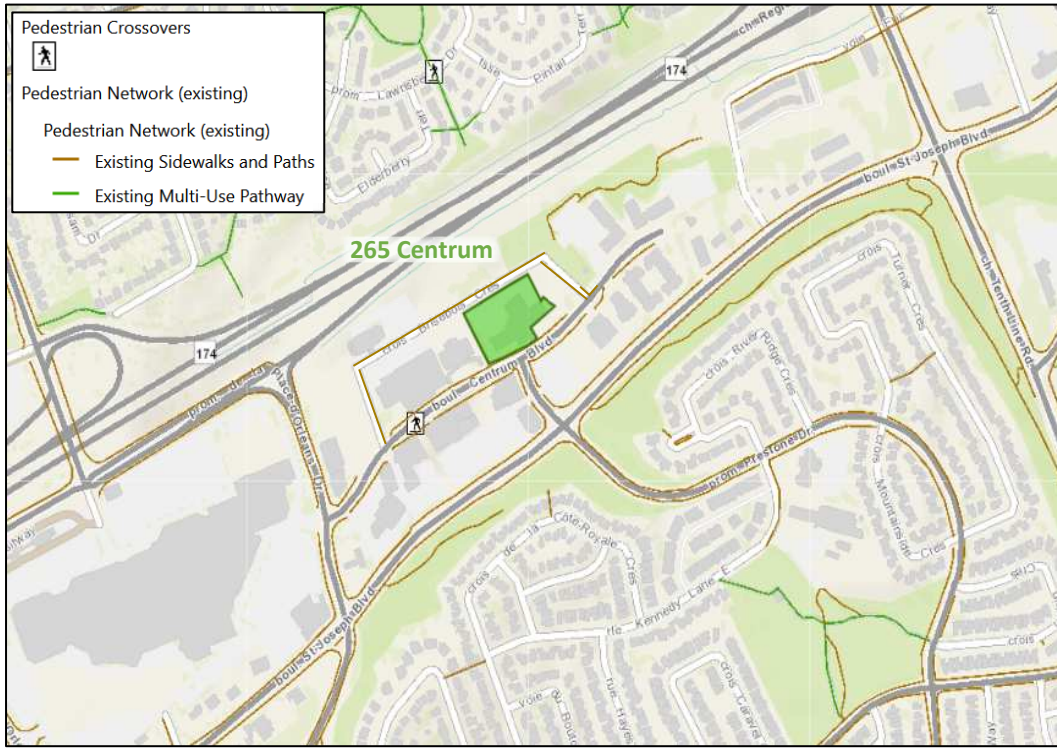

Source: <http://maps.ottawa.ca/geoOttawa/> Accessed: February 27, 2024

Figure 5: Study Area Cycling Facilities

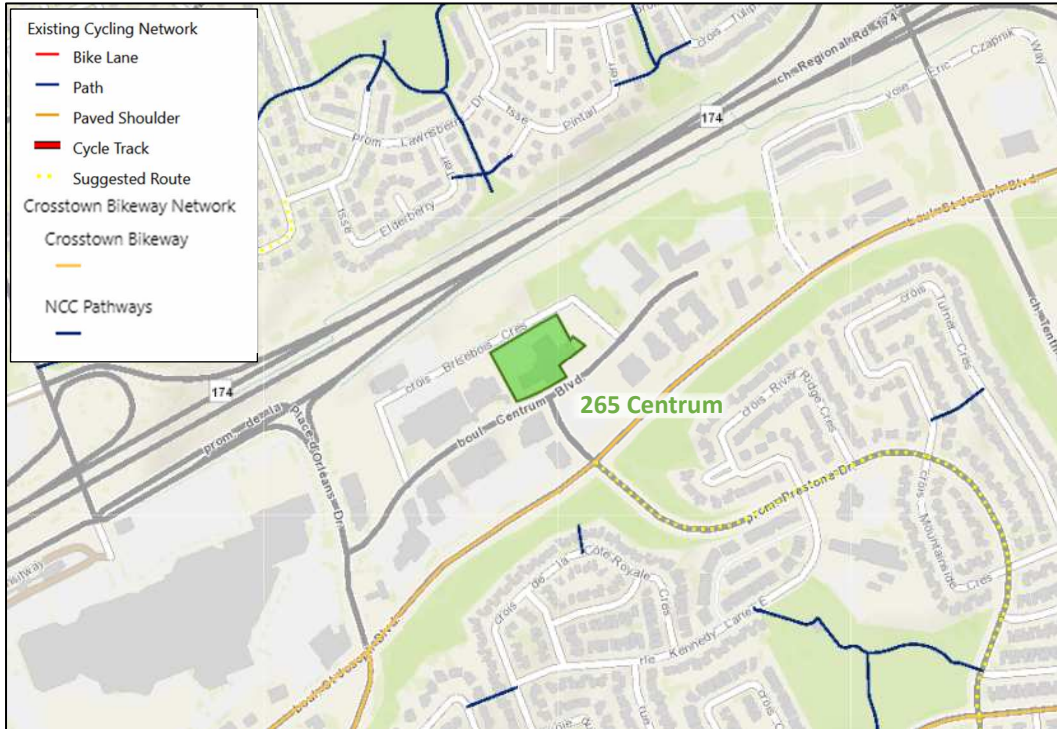

Source: <http://maps.ottawa.ca/geoOttawa/> Accessed: February 27, 2024

Pedestrian and cyclist volumes included in study area intersection counts, presented in Section 2.2.7, have been compiled and are illustrated in Figure 6 and Figure 7, respectively.

Figure 6: Existing Pedestrian Volumes

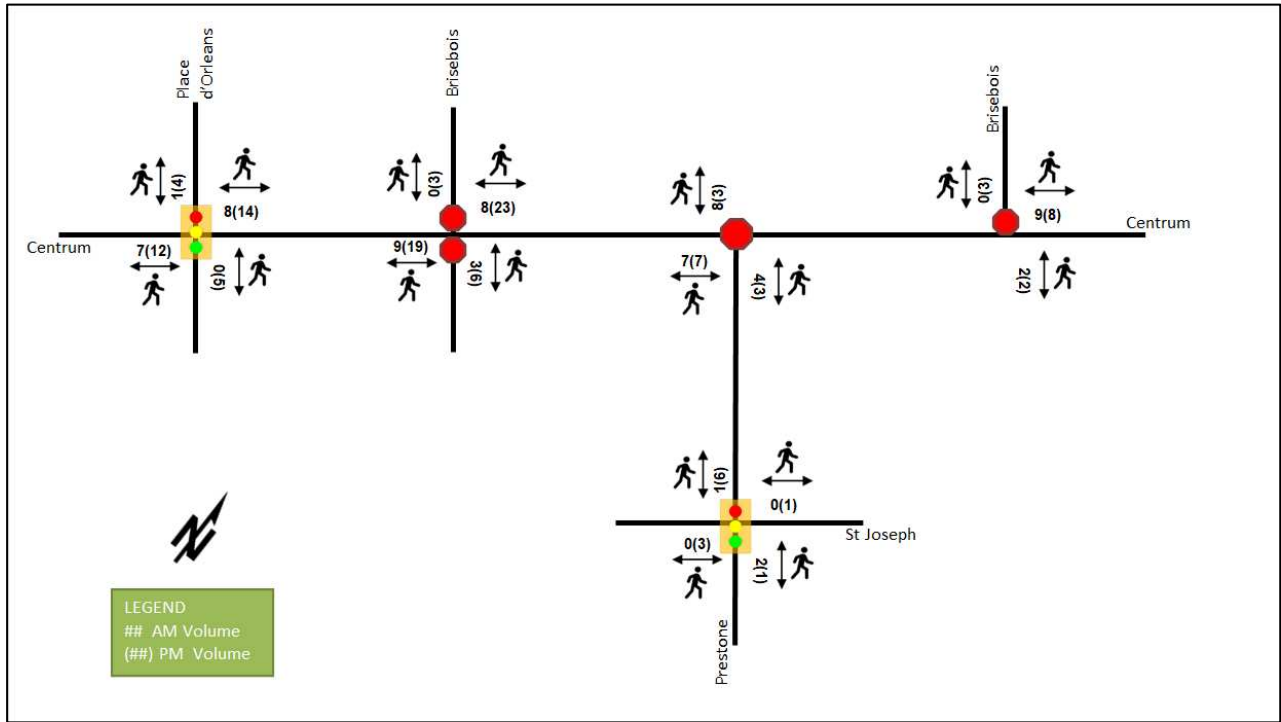
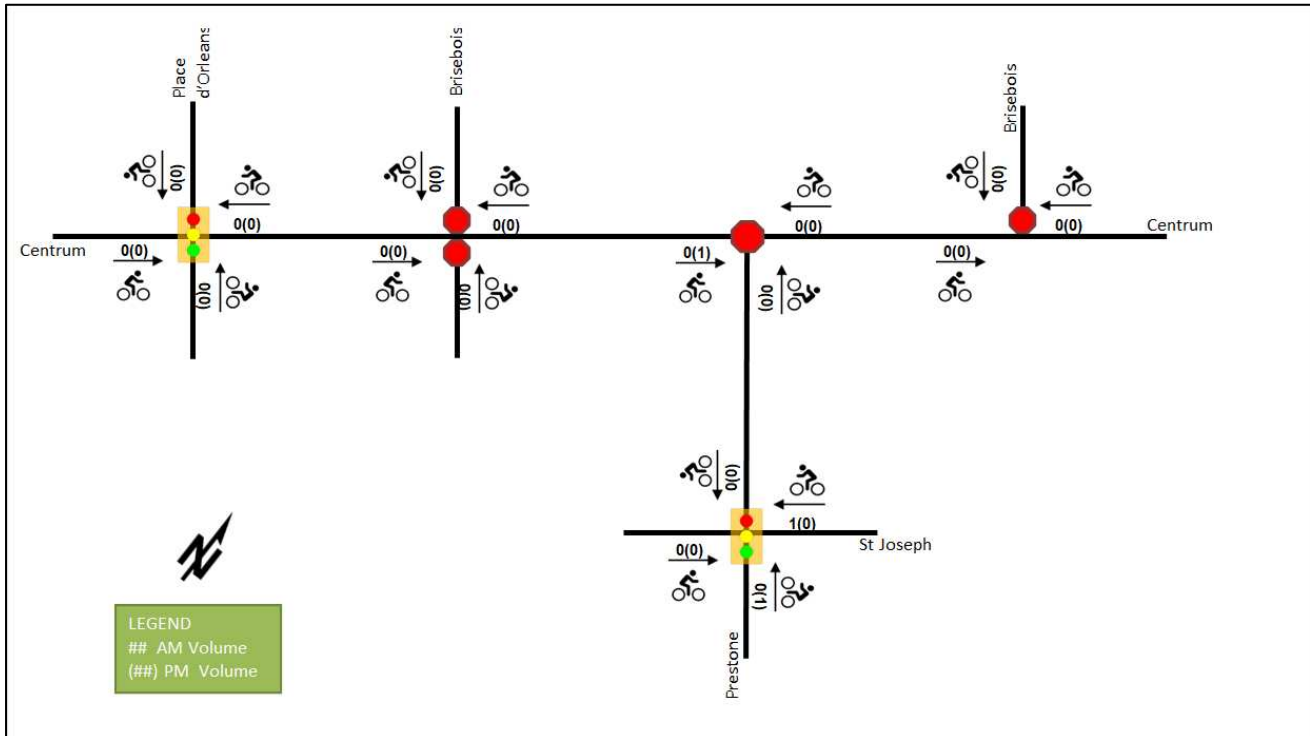

Figure 7: Existing Cyclist Volumes



2.2.5 Existing Transit

Figure 8 illustrates the transit system map in the study area and Figure 9 illustrates nearby transit stops and stations. All transit information is from January 31, 2023, and is included for general information purposes and context to the surrounding area.

Within the study area, routes #33, #35, #37, #232, and #302 travel along Centrum Boulevard and Prestone Drive, and routes #37, #131, and #234 travel along Place d’Orleans Drive. The frequency of these routes within proximity of the proposed site based on January 31, 2023 service levels are:

- Route # 33 – 30-minute service all day
- Route # 35 – 30-minute service all day
- Route # 37 – 30-minute service all day until 8:00 PM
- Route # 232 – 30-minute service in the peak period/direction
- Route # 302 – One bus in the peak period/direction
- Route # 131 – 30-minute service all day, 1-hr service after 9:00 PM
- Route # 234 – 30-minute service in the peak period/direction

Place d’Orléans station is located within 800 metres from the site. The bus station serves bus routes #33, #35, #37, #38, #39, #131, #221, #232, #234, #236, #302, #639, and #678.

Place d’Orléans station will be converted to accommodate LRT, and the future Place d’Orléans station is located within 800 metres from the site. The completion of the future Place d’Orléans station is anticipated by the end of 2024. Future Orleans Town Centre LRT is noted to be located within 400 metres from the site, however, the timeline is unknown.

Figure 8: Existing Study Area Transit Service

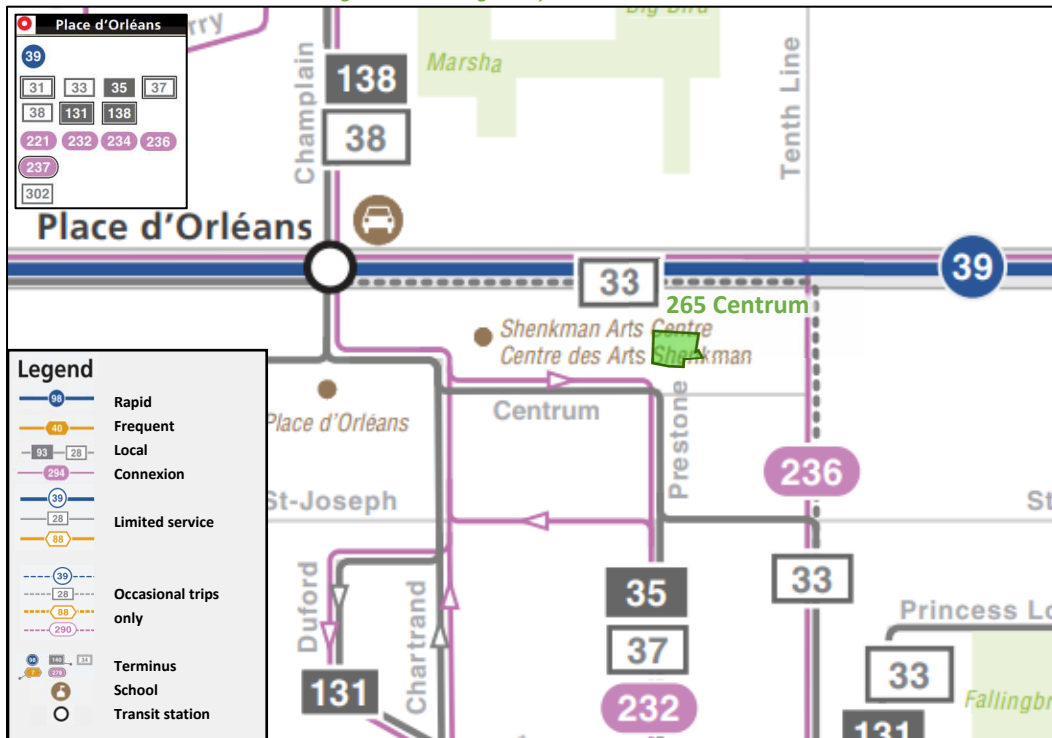

Source: <http://www.octranspo.com/> Accessed: January 31, 2023

Figure 9: Existing Study Area Transit Stops

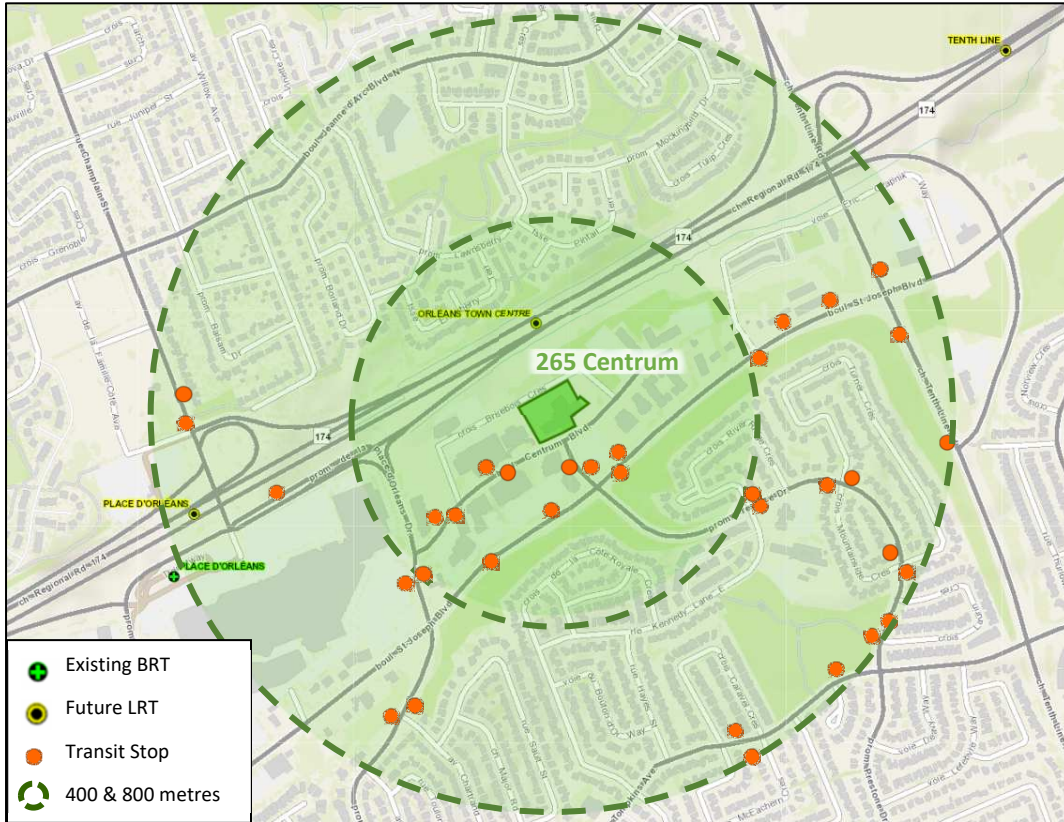

Source: <http://maps.ottawa.ca/geoOttawa/> Accessed: March 23, 2023

2.2.6 Existing Area Traffic Management Measures

An on-road messaging of the maximum speed limit of 40 km/h is present on Prestone Drive.

2.2.7 Existing Peak Hour Travel Demand

Existing turning movement counts were acquired from the City of Ottawa and The Traffic Specialist for the existing study area key intersections. Table 1 summarizes the intersection count dates.

Table 1: Intersection Count Date

Intersection	Count Date	Source
Centrum Boulevard at Place d’Orleans Drive	Thursday, January 31, 2019	City of Ottawa
Centrum Boulevard at Brisebois Crescent West	Thursday, 12 March, 2020	The Traffic Specialist
Centrum Boulevard at Prestone Drive	Tuesday, February 14, 2023	The Traffic Specialist
Centrum Boulevard at Brisebois Crescent East	Wednesday, February 08, 2023	The Traffic Specialist
St Joseph Boulevard at Prestone Drive	Tuesday, March 20, 2018	City of Ottawa

Figure 10 illustrates the existing traffic counts and Table 2 summarizes the existing intersection operations. The level of service for signalized intersections is based on volume to capacity ratio (v/c) calculations for individual lane movements and HCM 2000 v/c calculations for the overall intersection, and average delay for unsignalized intersections. Detailed turning movement count data is included in Appendix B and the Synchro worksheets are provided in Appendix C.

Figure 10: Existing Traffic Counts

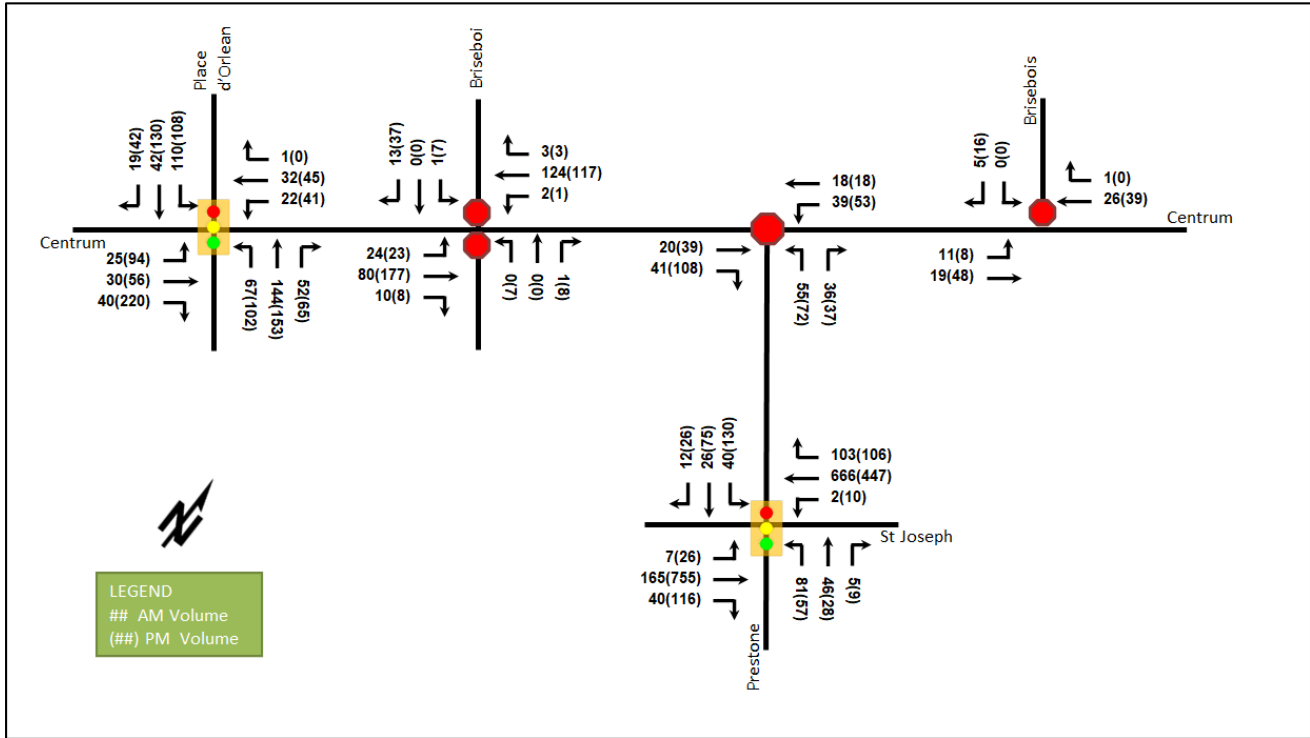

Table 2: Existing Intersection Operations

Intersection	Lane	AM Peak Hour				PM Peak Hour			
		LOS	V/C	Delay (s)	Q (95 <sup>th</sup> )	LOS	V/C	Delay (s)	Q (95 <sup>th</sup> )
Centrum Boulevard at Place d'Orleans Drive <i>Signalized</i>	EBL	A	0.11	20.2	7.8	A	0.49	38.4	25.9
	EBT	A	0.09	19.6	8.5	A	0.21	29.7	16.1
	EBR	A	0.14	7.6	6.1	A	0.54	8.5	15.7
	WBL	A	0.09	19.7	7.0	A	0.22	30.4	13.3
	WBT/R	A	0.11	19.4	9.1	A	0.17	28.9	13.8
	NB	A	0.14	4.8	15.3	A	0.22	5.2	18.7
	SB	A	0.12	5.4	11.6	A	0.20	5.4	17.4
	<b>Overall</b>	<b>A</b>	<b>0.15</b>	<b>8.0</b>	-	<b>A</b>	<b>0.26</b>	<b>12.2</b>	-
Centrum Boulevard at Brisebois Crescent West <i>Unsignalized</i>	EB	A	0.02	7.6	0.8	A	0.02	7.6	0.8
	WB	A	0.00	7.5	0.0	A	0.00	7.7	0.0
	NB	A	0.00	9.9	0.0	B	0.03	11.0	0.8
	SB	A	0.02	9.2	0.8	A	0.06	9.9	1.5
	<b>Overall</b>	<b>A</b>	-	<b>1.3</b>	-	<b>A</b>	-	<b>2.0</b>	-
Centrum Boulevard at Prestone Drive <i>Unsignalized</i>	EB	A	0.07	7.2	1.5	A	0.18	7.8	4.5
	WB	A	0.08	7.8	1.5	A	0.10	8.1	2.3
	NBL	A	0.09	8.7	2.3	A	0.13	9.3	3.0
	NBR	A	0.05	7.0	0.8	A	0.05	7.3	1.5
	<b>Overall</b>	<b>A</b>	-	<b>7.7</b>	-	<b>A</b>	-	<b>8.1</b>	-
Centrum Boulevard at Brisebois Crescent East <i>Unsignalized</i>	EB	A	0.01	7.4	0.0	A	0.01	7.3	0.0
	WB	-	-	-	-	-	-	-	-
	SB	A	0.01	8.6	0.0	A	0.02	8.6	0.8
	<b>Overall</b>	<b>A</b>	-	<b>2.0</b>	-	<b>A</b>	-	<b>1.7</b>	-

Intersection	Lane	AM Peak Hour				PM Peak Hour			
		LOS	V/C	Delay (s)	Q (95 <sup>th</sup> )	LOS	V/C	Delay (s)	Q (95 <sup>th</sup> )
<b>St Joseph Boulevard at Prestone Drive Signalized</b>	EBL	A	0.05	11.9	2.6	A	0.05	6.7	5.3
	EBT	A	0.17	12.2	11.3	A	0.39	7.5	48.6
	EBR	A	0.09	4.7	4.7	A	0.13	1.9	6.5
	WBL	A	0.01	11.0	1.1	A	0.03	6.9	2.8
	WBT	B	0.67	18.0	44.4	A	0.23	6.4	26.7
	WBR	A	0.21	3.9	7.4	A	0.12	1.9	6.2
	NBL	A	0.16	11.3	14.1	A	0.28	26.7	16.5
	NBT/R	A	0.08	9.6	9.0	A	0.13	19.2	10.4
	SBL	A	0.08	10.7	8.2	A	0.59	36.1	33.2
	SBT/R	A	0.07	8.3	6.8	A	0.35	22.2	22.5
<b>Overall</b>	<b>A</b>	<b>0.38</b>	<b>14.1</b>	<b>-</b>	<b>-</b>	<b>A</b>	<b>0.43</b>	<b>10.3</b>	<b>-</b>

Notes: Saturation flow rate of 1800 veh/h/lane  
Queue is measured in metres  
Peak Hour Factor = 0.90

Delay = average vehicle delay in seconds  
m = metered queue  
# = volume for the 95<sup>th</sup> %ile cycle exceeds capacity

During both the AM and PM peak hours, the study area intersections operate well. No capacity issues are noted.

### 2.2.8 Collision Analysis

Collision data have been acquired from the City of Ottawa open data website (data.ottawa.ca) for five years prior to the commencement of this TIA for the surrounding study area road network. Table 3 summarizes the collision types and conditions in the study area, Figure 11 illustrates the intersections and segments analyzed, and Table 4 summarizes the total collisions for each of these locations. Collision data are included in Appendix D.

Table 3: Study Area Collision Summary, 2016-2020

		Number	%
<b>Total Collisions</b>		<b>32</b>	<b>100%</b>
<b>Classification</b>	<b>Fatality</b>	0	0%
	<b>Non-Fatal Injury</b>	8	25%
	<b>Property Damage Only</b>	24	75%
<b>Initial Impact Type</b>	<b>Approaching</b>	1	3%
	<b>Angle</b>	13	41%
	<b>Rear end</b>	4	13%
	<b>Sideswipe</b>	2	6%
	<b>Turning Movement</b>	6	19%
	<b>SMV Other</b>	6	19%
<b>Road Surface Condition</b>	<b>Dry</b>	21	66%
	<b>Wet</b>	3	9%
	<b>Loose Snow</b>	6	19%
	<b>Packed Snow</b>	2	6%
<b>Pedestrian Involved</b>		3	9%
<b>Cyclists Involved</b>		0	0%

Figure 11: Study Area Collision Records

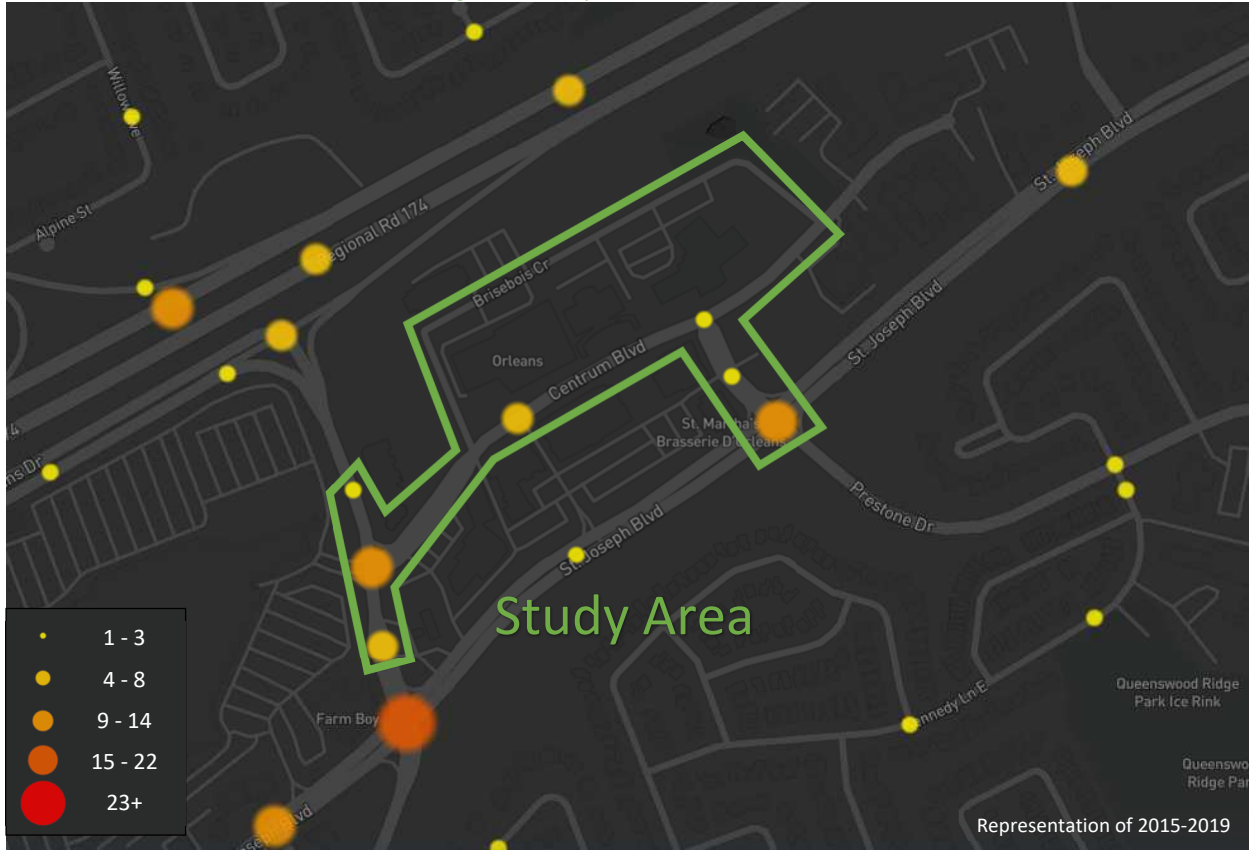

Table 4: Summary of Collision Locations, 2016-2020

Intersections / Segments	Number	%
<b>Intersections / Segments</b>	<b>32</b>	<b>100%</b>
St. Joseph Blvd @ Prestone Dr	11	34%
Place D'orleans Dr btwn Centrum Blvd & St. Joseph Blvd	7	22%
Place D'orleans @ Centrum Blvd/Place D'orleans	6	19%
Centrum Blvd btwn Place D'orleans Dr & Prestone Dr	5	16%
Centrum Blvd @ Prestone Dr	2	6%
Place D'orleans Dr btwn Turn Lane & Centrum Blvd	1	3%

Within the study area, the intersection of St Joseph Boulevard at Prestone Drive is noted to have experienced higher collisions than other locations. Table 5 summarizes the collision types and conditions for the location.



Table 5: St Joseph Boulevard at Prestone Drive Collision Summary

		Number	%
<b>Total Collisions</b>		<b>11</b>	<b>100%</b>
<b>Classification</b>	<b>Fatality</b>	0	0%
	<b>Non-Fatal Injury</b>	4	36%
	<b>Property Damage Only</b>	7	64%
<b>Initial Impact Type</b>	<b>Angle</b>	4	36%
	<b>Rear end</b>	2	18%
	<b>Turning Movement</b>	3	27%
	<b>SMV Other</b>	2	18%
<b>Road Surface Condition</b>	<b>Dry</b>	7	64%
	<b>Wet</b>	2	18%
	<b>Loose Snow</b>	2	18%
<b>Pedestrian Involved</b>		1	9%
<b>Cyclists Involved</b>		0	0%

The St Joseph Boulevard at Prestone Drive intersection had a total of eleven collisions during the 2016-2020 time period, with seven involving property damage only and the remaining four having non-fatal injuries. The collision types are most represented by angle with four collisions, followed by three turning movement collisions, and the remaining collisions split between the rear end and SMV (other). The majority of the collisions (7 of 11) occurred during 2017 and 2018 when there was resurfacing operations occurred through the intersection, which is assumed to be the cause of the elevated collision rate during these two years. Weather conditions do not affect collisions at this location. No further examination is required as part of this study.

## 2.3 Planned Conditions

### 2.3.1 Changes to the Area Transportation Network

#### 2.3.1.1 Official Plan (2021)

Within the Official Plan, the ultimate transit network diagram shows the O-train along Regional Road 174, with a station located at Place d'Orleans connecting to the existing park and ride/station, and a future station north of the site, currently called 'Orleans Town Centre'. This station is unfunded and will not be considered in this study.

Within the Official Plan, the development site is within the Place d'Orleans Protected Major Transit Station Area (PMTSA) and design priority area. St Joseph Boulevard is identified as mainstreet corridor within design priority area.

#### 2.3.1.2 Stage 2 Light Rail Transit (LRT) project

Place d'Orleans station, which is located approximately 800 metres from the site, is identified as one of the east extension stations in the Stage 2 Light Rail Transit (LRT) project and will be converted to accommodate LRT. Multi-Use Pathways (MUPs) are planned to be along the south side of Highway 174 and along Place d'Orléans Drive south to Centrum Boulevard. A new fare-paid pedestrian bridge is also planned from bus loop to station for non-transit users. The completion of the east extension is anticipated by the end of 2024.

#### 2.3.1.3 Orleans Corridor Secondary Plan

The extension of Centrum Boulevard to Vieux Silo Street has been identified in the Orleans Corridor Secondary Plan. No property has been acquired and will not be included in this study. The Official Plan (2021) identified the Orleans Corridor Secondary Plan area as Outer East Line 1 and 3 Stations secondary plan area, and the plan is currently in progress.

The St. Joseph Boulevard Concept Plan in the Orleans Corridor Secondary Plan is to transform the road right-of-way into a pedestrian-oriented mainstreet, including a reduction in vehicle travel lanes from four to three in order to accommodate cycling facilities and bus transit improvements and opportunities for on-street parking on St. Joseph Boulevard. Since none of the improvements is confirmed, these will not be included in the analysis. Conceptually, these improvements would all be supportive of redevelopment along St Joseph Boulevard. The St. Joseph Boulevard Concept Plan is included in Appendix E.

The feasibility study of cycling facilities on St-Joseph Boulevard between Forest Valley Drive and Tenth Line Road are identified in the Active Transportation Project Lists as part of the Orléans Corridor Secondary Plan Study.

### 2.3.2 Other Study Area Developments

#### *280 Eric Czapnik Way*

The proposed development application includes a site plan application to include two apartment buildings for a total of 72 dwellings. No TIA is expected to be warranted for this development.

#### *3277 St Joseph Boulevard*

The proposed development application includes a site plan application to include two apartment buildings for a total of 274 dwellings. The development is predicted to generate 58 AM and 60 new PM two-way peak-hour auto trips. The anticipated build-out horizon is 2024. (Novatech, 2021)

#### *3459 & 3479 St Joseph Boulevard*

The proposed development application includes a zoning by-law amendment to allow 326 apartment units. The development is predicted to generate 141 new AM and 179 new PM two-way peak-hour auto trips. The build-out horizon is assumed to be 2023. (Novatech, 2021)

#### *360 Kennedy Lane East*

The proposed development application includes a zoning by-law amendment and site plan application to include 81 residential dwelling units. No TIA is expected to be warranted for this development.

#### *211 Centrum Boulevard*

The proposed development application includes a site plan application to include 394 retirement home units. The development is predicted to generate 46 new AM and 57 new PM two-way peak-hour auto trips. The build-out horizon is assumed to be 2024. (CGH, 2021)

## 3 Study Area and Periods

### 3.1 Study Area

The study area will include the intersections of:

- Centrum Boulevard at:
  - Place d’Orleans Drive
  - Brisebois Crescent West
  - Prestone Drive
  - Brisebois Crescent East
- St Joseph Boulevard at:
  - Prestone Drive

The boundary road will be Brisebois Crescent and Centrum Boulevard, and the SL-45 screenline is located to the west of the Place d’Orleans Mall. The screenline will not be assessed as part of this study.

While within 1 km of the site, other development sites in the area have excluded the intersections along Place d’Orleans Drive at Champlain Street and the Place d’Orleans at Regional Road 174 offramp. The Place d’Orleans Drive and Regional Road 174 on-ramp intersection has been reviewed in other area studies and operates well during existing conditions and future projections. This is similar to the existing conditions intersections examined within Section 2.2.7. Therefore, these intersections have been excluded from the scope of this study going forward. If undue impacts are noted at the intersections in proximity to the site, such as Place d’Orleans Drive or Prestone Drive at St Joseph Boulevard, these intersections may be re-incorporated into the study.

### 3.2 Time Periods

As the proposed development is composed mainly of residential units, the AM and PM peak hours will be examined.

### 3.3 Horizon Years

The anticipated build-out year is 2028. As a result, the full build-out plus five years horizon year is 2033.

## 4 Exemption Review

Table 6 summarizes the exemptions for this TIA.

*Table 6: Exemption Review*

Module	Element	Explanation	Exempt/Required
<b>Design Review Component</b>			
<b>4.1 Development Design</b>	4.1.2 Circulation and Access	Only required for site plans	Required
	4.1.3 New Street Networks	Only required for plans of subdivision	Exempt
<b>4.2 Parking</b>	4.2.1 Parking Supply	Only required for site plans	Required
	4.2.2 Spillover Parking	Only required for site plans where parking supply is 15% below unconstrained demand	Exempt
<b>Network Impact Component</b>			
<b>4.5 Transportation Demand Management</b>	All Elements	Not required for site plans expected to have fewer than 60 employees and/or students on location at any given time	Required
<b>4.6 Neighbourhood Traffic Management</b>	4.6.1 Adjacent Neighbourhoods	Only required when the development relies on local or collector streets for access and total volumes exceed ATM capacity thresholds	Required
<b>4.8 Network Concept</b>		Only required when proposed development generates more than 200 person-trips during the peak hour in excess of equivalent volume permitted by established zoning	Required

### 4.1 TIA Stepped Process

The removal of the existing YMCA site, and transit-oriented design of the subject site confirmed by the City of Ottawa during the pre-consultation meeting and notes, the expected increase in area trips will be much lower than a typical site on redevelopment land. No operational constraints are noted at the area intersections for the

existing conditions, all movements at LOS A or B. Due to the above factors, future Steps 3 and 4 are combined into a single submission.

## 5 Development-Generated Travel Demand

### 5.1 Mode Shares

Examining the mode shares recommended in the TRANS Trip Generation Manual (2020) for the subject district, derived from the most recent National Capital Region Origin-Destination survey (OD Survey), the existing average district mode shares by land use for Orleans have been summarized in Table 7.

*Table 7: TRANS Trip Generation Manual Recommended Mode Shares – Orleans*

Travel Mode	Multi-Unit (High-Rise)		Commercial Generator		Employment Generator
	AM	PM	AM	PM	AM and PM
<b>Auto Driver</b>	54%	61%	77%	71%	71%
<b>Auto Passenger</b>	7%	13%	14%	20%	7%
<b>Transit</b>	29%	21%	3%	2%	13%
<b>Cycling</b>	0%	0%	0%	1%	1%
<b>Walking</b>	10%	6%	6%	5%	8%
<b>Total</b>	<b>100%</b>	<b>100%</b>	<b>100%</b>	<b>100%</b>	<b>100%</b>

It is noted that the future Place d’Orleans LRT station will be located approximately 800 metres from the site, and completion is anticipated by the end of 2024. In addition, transit-oriented design of the subject site is confirmed by the City of Ottawa during the pre-consultation meeting and notes to the consultant team. A 15% shift to transit mode from the auto mode for residential land use and a 10% percent shift to transit mode from the auto mode for commercial and office land use are proposed. The modified mode share targets are summarized in Table 8.

*Table 8: Proposed Development Mode Shares*

Travel Mode	Multi-Unit (High-Rise)		Commercial Generator		Employment Generator
	AM	PM	AM	PM	AM and PM
<b>Auto Driver</b>	39%	46%	67%	61%	61%
<b>Auto Passenger</b>	7%	13%	14%	20%	7%
<b>Transit</b>	44%	36%	13%	12%	23%
<b>Cycling</b>	0%	0%	0%	1%	1%
<b>Walking</b>	10%	6%	6%	5%	8%
<b>Total</b>	<b>100%</b>	<b>100%</b>	<b>100%</b>	<b>100%</b>	<b>100%</b>

### 5.2 Trip Generation

This TIA has been prepared using the vehicle and person trip rates for the residential dwellings using the TRANS Trip Generation Manual (2020) and the vehicle trip rates and derived person trip rates for commercial components from the ITE Trip Generation Manual 11th Edition (2021) using the City-prescribed conversion factor of 1.28. Table 9 summarizes the person trip rates for the proposed residential land uses for each peak period and the person trip rates for the non-residential land uses by peak hour.

*Table 9: Trip Generation Person Trip Rates*

Land Use	Land Use Code	Peak	Peak Period		Peak Hour	
			Vehicle Trip Rate	Person Trip Rates	Vehicle Trip Rate	Person Trip Rates
<b>Multi-Unit (High-Rise)</b>	221 & 222 (TRANS)	AM	-	0.80	-	-
		PM	-	0.90	-	-
<b>General Office Building</b>	710 (ITE)	AM	-	-	1.52	1.95
		PM	-	-	1.44	1.84

Land Use	Land Use Code	Peak	Peak Period		Peak Hour	
			Vehicle Trip Rate	Person Trip Rates	Vehicle Trip Rate	Person Trip Rates
Strip Retail Plaza (<40k)	822 (ITE)	AM	-	-	2.36	3.02
		PM	-	-	6.59	8.44

Using the above person trip rates, the total person trip generation has been estimated. Table 10 summarizes the total person trip generation for the residential land uses and for the non-residential land uses.

Table 10: Total Person Trip Generation

Land Use	Units	AM Peak Period			PM Peak Period		
		In	Out	Total	In	Out	Total
Multi-Unit (High-Rise)	1,127	280	622	902	588	426	1014

Land Use	Units / GFA	AM Peak Hour			PM Peak Hour		
		In	Out	Total	In	Out	Total
General Office Building	31,570 sq. ft	55	7	62	10	48	58
Strip Retail Plaza (<40k)	8,967 sq. ft	16	11	27	38	38	76

Internal capture rates from the ITE Trip Generation Handbook 3<sup>rd</sup> Edition have been assigned to the development’s retail and office components for mixed-use developments. The rates summarized in Table 11 represent the percentage of trips to/from retail and office use based on the residential component.

Table 11: Internal Capture Rates

Land Use	AM		PM	
	In	Out	In	Out
Residential to/from Shopping Centre	17%	14%	10%	26%
Residential to/from Office	3%	1%	57%	2%

Pass-by reductions applied to the retail trip generation at a rate of 40% have been included using the recommended value presented in the ITE Trip Generation Manual 11th Edition (2021) for the most similar land use with a recommended rate, “Retail (40k – 150k sq. ft.)”.

Using the above mode share targets for the LRT area, the internal capture and pass-by rates, and the person trip rates, the person trips by mode have been projected. Trip generation by peak hour has been forecasted using the prescribed peak period conversion factors presented in the TRANS Trip Generation Manual (2020) for the residential component. Table 12 summarizes the residential trip generation and the non-residential trip generation by mode and peak hour.

Table 12: Trip Generation by Mode

Travel Mode		AM Peak Hour				PM Peak Hour			
		Mode Share	In	Out	Total	Mode Share	In	Out	Total
Multi-Unit (High-Rise)	Auto Driver	39%	52	117	169	46%	119	86	205
	Auto Passenger	7%	10	21	31	13%	33	24	58
	Transit	44%	68	151	219	36%	100	72	172
	Cycling	0%	0	0	0	0%	0	0	0
	Walking	10%	16	36	52	6%	18	14	32
	<b>Total</b>	<b>100%</b>	<b>146</b>	<b>325</b>	<b>471</b>	<b>100%</b>	<b>270</b>	<b>196</b>	<b>466</b>
General Office	Auto Driver	61%	32	4	36	61%	2	29	31
	Auto Passenger	7%	4	0	4	7%	0	3	3

Travel Mode	AM Peak Hour				PM Peak Hour				
	Mode Share	In	Out	Total	Mode Share	In	Out	Total	
Transit	23%	12	2	14	23%	1	11	12	
Cycling	1%	1	0	1	1%	0	0	0	
Walking	8%	4	1	5	8%	0	4	4	
Internal Capture	varies	-2	0	-2	varies	-6	-1	-7	
<b>Total</b>	<b>100%</b>	<b>53</b>	<b>7</b>	<b>60</b>	<b>100%</b>	<b>3</b>	<b>47</b>	<b>50</b>	
Strip Retail Plaza (<40k)	Auto Driver	67%	3	2	5	61%	7	5	12
	Auto Passenger	14%	2	1	3	20%	7	7	14
	Transit	13%	2	1	3	12%	4	4	8
	Cycling	0%	0	0	0	1%	0	0	0
	Walking	6%	1	1	2	5%	2	2	4
	Internal Capture	varies	-2	-1	-3	varies	-2	-6	-8
	Pass-by	40%	-6	-4	-10	40%	-15	-16	-31
	<b>Total</b>	<b>100%</b>	<b>8</b>	<b>5</b>	<b>13</b>	<b>100%</b>	<b>20</b>	<b>18</b>	<b>38</b>
Total	Auto Driver	-	87	123	210	-	128	120	248
	Auto Passenger	-	16	22	38	-	40	34	74
	Transit	-	82	154	236	-	105	87	192
	Cycling	-	1	0	1	-	0	0	0
	Walking	-	21	38	59	-	20	20	40
	Internal Capture	varies	-4	-1	-5	varies	-8	-7	-15
	Pass-by	varies	-6	-4	-10	varies	-15	-16	-31
	<b>Total</b>	<b>100%</b>	<b>207</b>	<b>337</b>	<b>544</b>	<b>100%</b>	<b>293</b>	<b>261</b>	<b>554</b>

As shown above, a total of 210 AM and 248 PM new peak hour two-way vehicle trips are projected as a result of the proposed development.

### 5.3 Trip Distribution

To understand the travel patterns of the subject development, the OD Survey has been reviewed to determine the travel for the residential component, and these patterns were applied based on the build-out of Orleans Table 13 below summarizes the distributions.

Table 13: OD Survey Distribution – Orleans

To/From	Residential % of Trips
North	5%
South	30%
East	25%
West	40%
<b>Total</b>	<b>100%</b>

### 5.4 Trip Assignment

Using the distribution outlined above, turning movement splits, and access to major transportation infrastructure, the trips generated by the site have been assigned to the study area road network. Table 14 summarizes the proportional assignment to the study area roadways. Figure 12 illustrates the new site-generated volumes, and Figure 13 illustrates the pass-by volumes.

Table 14: Trip Assignment

To/From	Via
North	3% St Joseph (E) 2% Place d’Orleans (N)

To/From	Via
South	20% Prestone Drive (S)
	10% Place d'Orleans (S)
East	25% St Joseph (E)
West	20% Regional 174 (W)
	(via Place d'Orléans (N))
	10% St Joseph (W)
Total	(via Place d'Orléans Drive) (S)
	<b>100%</b>

Figure 12: New Site Generation Auto Volumes

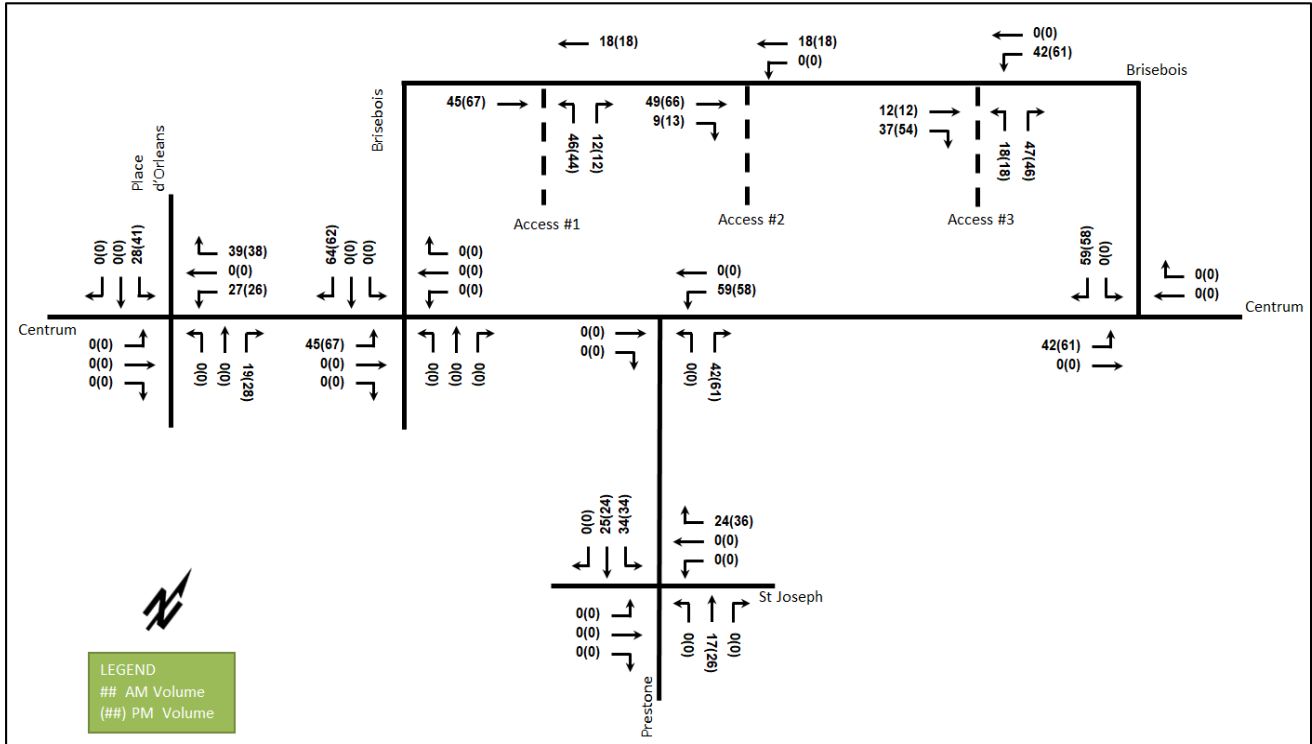
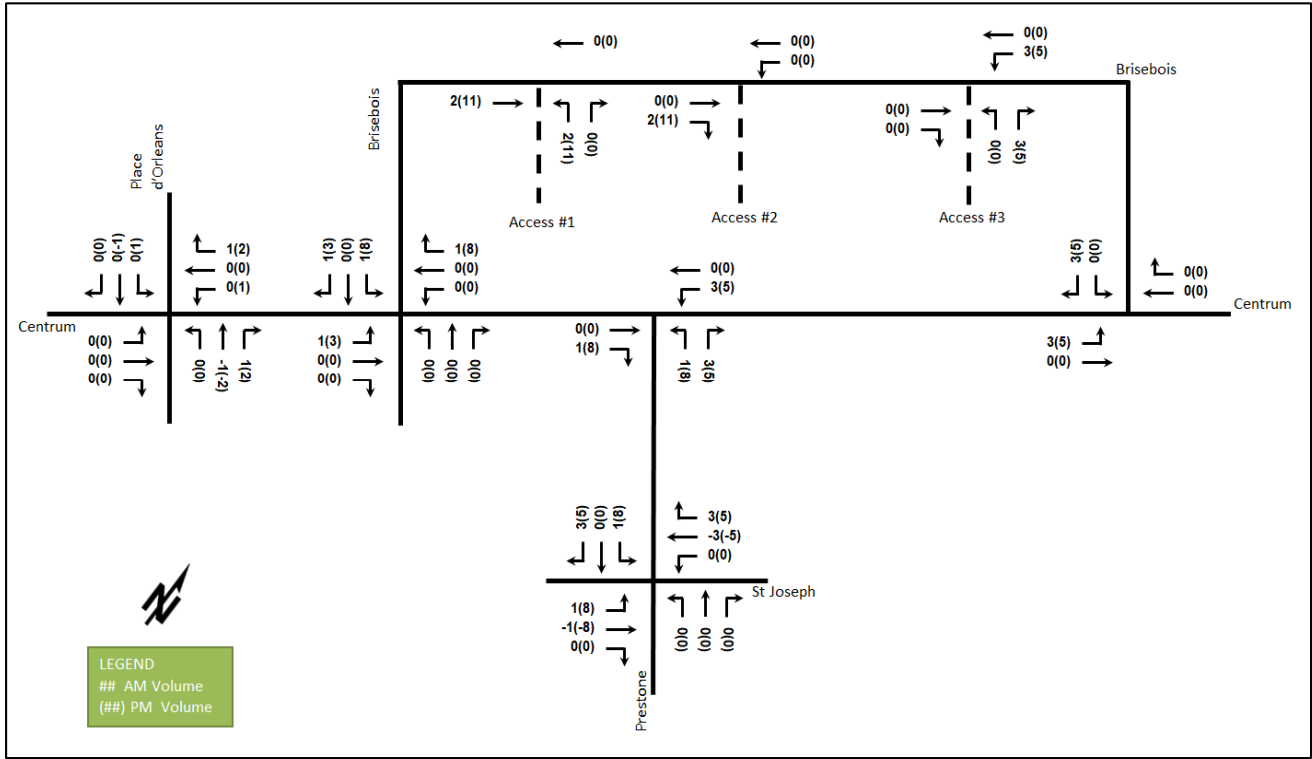

Figure 13: Pass-by Auto Volumes



## 6 Background Network Travel Demands

### 6.1 Transportation Network Plans

The transportation network plans were discussed in Section 2.3. The Place d'Orleans station Light Rail Transit (LRT) project is the only confirmed project within the study horizons and has been included.

### 6.2 Background Growth

A review of the background projections from the City's TRANS Regional Model for the 2011 and 2031 horizons was completed to determine the background growth for each of the study area roadways. The background TRANS model growth rates are summarized in Table 15 and the TRANS model plots are provided in Appendix F.

Table 15: TRANS Regional Model Projections – Study Area Growth Rates

Street	TRANS Rate		2011 to Existing		Existing to 2031	
	Eastbound	Westbound	Eastbound	Westbound	Eastbound	Westbound
Centrum Blvd	0.21%	0.34%	7.74%	-6.68%	-10.10%	11.89%
St Joseph Blvd	0.17%	3.06%	7.71%	3.27%	-10.17%	2.74%
	Northbound	Southbound	Northbound	Southbound	Northbound	Southbound
Prestone Dr	-0.46%	-0.53%	-8.12%	0.97%	12.25%	-2.73%
Place d'Orleans Dr	3.71%	-0.24%	4.08%	23.91%	3.15%	-27.94%

A comparison of the TRANS volumes and the existing volumes, the eastbound movement along Centrum Boulevard and the southbound moment along Place d'Orleans Drive show negative growth rates which are likely to have been underestimated and development may not have progressed linearly. Table 16 summarizes the recommended growth rates to be considered within the study area.



Table 16: Recommended Area Growth Rates

Street	AM Peak Hour		PM Peak Hour	
	Eastbound	Westbound	Eastbound	Westbound
Centrum Blvd	0.25%	0.25%	0.25%	0.25%
St Joseph Blvd	0.25%	2.00%	2.00%	0.25%
	Northbound	Southbound	Northbound	Southbound
Prestone Dr	-	-	-	-
Place d'Orleans Dr	2.00%	-	-	2.00%

### 6.3 Other Developments

The background developments explicitly considered in the background conditions (Section 6.2) include:

- 3277 St Joseph Boulevard
- 3459 & 3479 St Joseph Boulevard
- 211 Centrum Boulevard

The background development volumes within the study area have been provided in Appendix G.

## 7 Demand Rationalization

### 7.1 2028 Future Background Operations

Figure 14 illustrates the 2028 background volumes and Table 17 summarizes the 2028 background intersection operations. The level of service for signalized intersections is based on v/c calculations for individual lane movements and HCM 2000 v/c calculations for the overall intersection, and average delay for unsignalized intersections. The synchro worksheets for the 2028 future background horizon are provided in Appendix H.

Figure 14: 2028 Future Background Volumes

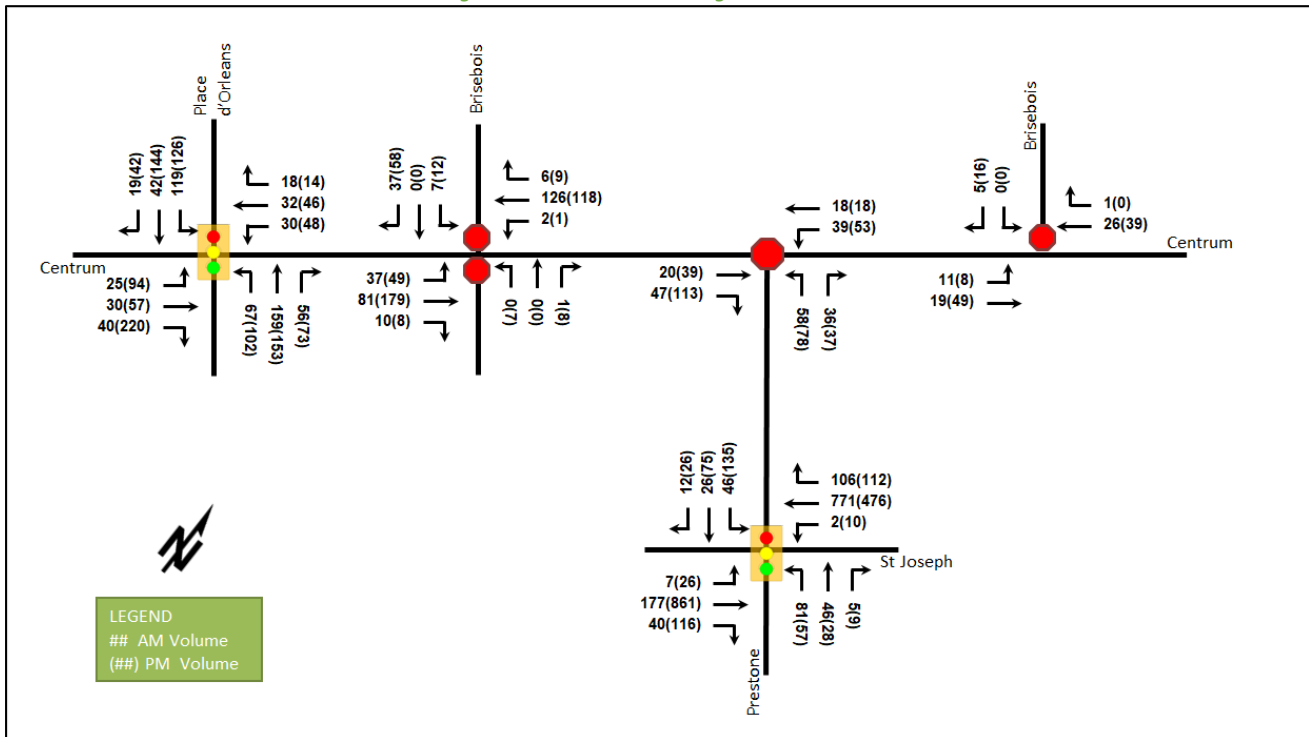

Table 17: 2028 Future Background Intersection Operations

Intersection	Lane	AM Peak Hour				PM Peak Hour			
		LOS	V/C	Delay (s)	Q (95 <sup>th</sup> )	LOS	V/C	Delay (s)	Q (95 <sup>th</sup> )
Centrum Boulevard at Place d'Orleans Drive <i>Signalized</i>	EBL	A	0.10	20.0	7.2	A	0.46	37.6	23.7
	EBT	A	0.08	19.5	8.0	A	0.20	29.8	15.2
	EBR	A	0.13	7.0	5.5	A	0.52	8.6	15.1
	WBL	A	0.11	20.1	8.2	A	0.23	31.1	13.8
	WBT/R	A	0.14	14.7	9.7	A	0.21	24.3	14.1
	NB	A	0.14	4.8	14.8	A	0.20	4.8	16.6
	SB	A	0.11	5.4	11.2	A	0.20	5.4	17.7
<b>Overall</b>	<b>A</b>	<b>0.15</b>	<b>7.9</b>	-	-	<b>A</b>	<b>0.24</b>	<b>11.9</b>	-
Centrum Boulevard at Brisebois Crescent West <i>Unsignalized</i>	EB	A	0.03	7.6	0.8	A	0.04	7.7	0.8
	WB	A	0.00	7.4	0.0	A	0.00	7.7	0.0
	NB	A	0.00	9.9	0.0	B	0.03	11.2	0.8
	SB	A	0.05	9.5	1.5	B	0.09	10.1	2.3
	<b>Overall</b>	<b>A</b>	-	<b>2.4</b>	-	-	<b>A</b>	-	<b>2.8</b>
Centrum Boulevard at Prestone Drive <i>Unsignalized</i>	EB	A	0.07	7.2	1.5	A	0.16	7.6	4.5
	WB	A	0.07	7.7	1.5	A	0.09	8.0	2.3
	NBL	A	0.09	8.6	2.3	A	0.12	9.2	3.0
	NBR	A	0.04	7.0	0.8	A	0.04	7.2	0.8
	<b>Overall</b>	<b>A</b>	-	<b>7.7</b>	-	-	<b>A</b>	-	<b>8.0</b>
Centrum Boulevard at Brisebois Crescent East <i>Unsignalized</i>	EB	A	0.01	7.3	0.0	A	0.01	7.3	0.0
	WB	-	-	-	-	-	-	-	-
	SB	A	0.01	8.6	0.0	A	0.02	8.5	0.0
	<b>Overall</b>	<b>A</b>	-	<b>2.0</b>	-	-	<b>A</b>	-	<b>1.7</b>
St Joseph Boulevard at Prestone Drive <i>Signalized</i>	EBL	A	0.04	11.6	2.4	A	0.05	6.6	4.9
	EBT	A	0.16	12.0	11.0	A	0.40	7.5	50.2
	EBR	A	0.08	4.6	4.3	A	0.12	1.9	6.2
	WBL	A	0.01	10.5	1.1	A	0.03	6.7	2.7
	WBT	B	0.68	18.2	46.5	A	0.22	6.3	25.5
	WBR	A	0.19	3.9	7.1	A	0.11	1.9	6.1
	NBL	A	0.15	11.5	13.1	A	0.25	26.3	15.2
	NBT/R	A	0.07	9.9	8.5	A	0.12	19.2	9.7
	SBL	A	0.09	11.0	8.6	A	0.56	35.0	31.4
	SBT/R	A	0.07	8.6	6.4	A	0.32	21.6	20.5
	<b>Overall</b>	<b>A</b>	<b>0.38</b>	<b>14.5</b>	-	-	<b>A</b>	<b>0.43</b>	<b>10.0</b>

**Notes:** Saturation flow rate of 1800 veh/h/lane  
Queue is measured in metres  
Peak Hour Factor = 1.00

Delay = average vehicle delay in seconds  
m = metered queue  
# = volume for the 95th %ile cycle exceeds capacity

During both peak hours, the study area intersections operate similar to the existing condition. No capacity issues are noted.

### 7.2 2033 Future Background Operations

Figure 15 illustrates the 2033 background volumes and Table 18 summarizes the 2033 background intersection operations. The level of service for signalized intersections is based on v/c calculations for individual lane movements and HCM 2000 v/c calculations for the overall intersection, and average delay for unsignalized intersections. The synchro worksheets for the 2033 future background horizon are provided in Appendix I.

Figure 15: 2033 Future Background Volumes

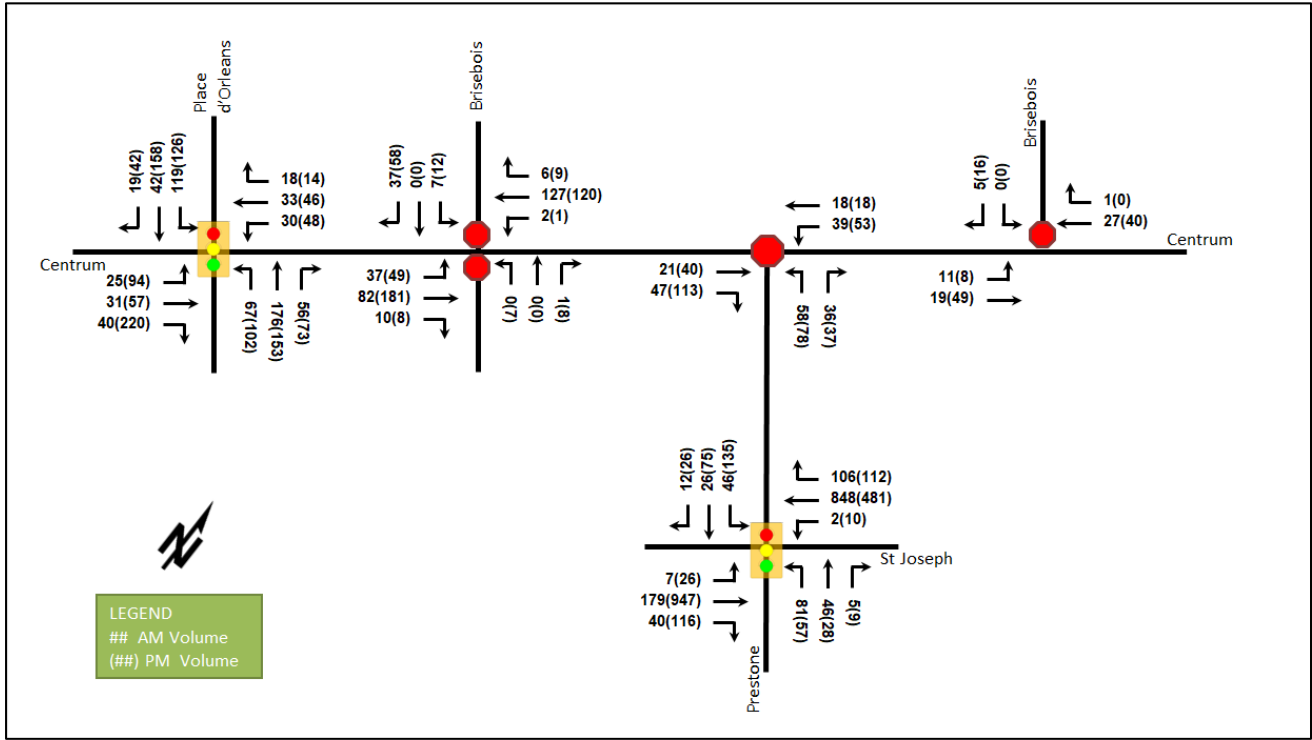

Table 18: 2033 Future Background Intersection Operations

Intersection	Lane	AM Peak Hour				PM Peak Hour			
		LOS	V/C	Delay (s)	Q (95 <sup>th</sup> )	LOS	V/C	Delay (s)	Q (95 <sup>th</sup> )
Centrum Boulevard at Place d'Orleans Drive <i>Signalized</i>	EBL	A	0.10	20.0	7.2	A	0.46	37.6	23.7
	EBT	A	0.09	19.5	8.2	A	0.20	29.8	15.2
	EBR	A	0.13	7.0	5.5	A	0.52	8.6	15.1
	WBL	A	0.11	20.1	8.2	A	0.23	31.1	13.8
	WBT/R	A	0.15	14.9	9.9	A	0.21	24.3	14.1
	NB	A	0.15	4.9	15.8	A	0.20	4.8	16.6
	SB	A	0.11	5.5	11.2	A	0.21	5.5	18.6
	<b>Overall</b>	<b>A</b>	<b>0.16</b>	<b>7.9</b>	-	<b>A</b>	<b>0.25</b>	<b>11.8</b>	-
Centrum Boulevard at Brisebois Crescent West <i>Unsignalized</i>	EB	A	0.03	7.6	0.8	A	0.04	7.7	0.8
	WB	A	0.00	7.4	0.0	A	0.00	7.7	0.0
	NB	A	0.00	9.9	0.0	B	0.03	11.2	0.8
	SB	A	0.05	9.5	1.5	B	0.09	10.1	2.3
	<b>Overall</b>	<b>A</b>	-	<b>2.3</b>	-	<b>A</b>	-	<b>2.8</b>	-
Centrum Boulevard at Prestone Drive <i>Unsignalized</i>	EB	A	0.07	7.2	1.5	A	0.17	7.7	4.5
	WB	A	0.07	7.7	1.5	A	0.09	8.0	2.3
	NBL	A	0.09	8.6	2.3	A	0.12	9.2	3.0
	NBR	A	0.04	7.0	0.8	A	0.04	7.2	0.8
	<b>Overall</b>	<b>A</b>	-	<b>7.7</b>	-	<b>A</b>	-	<b>8.1</b>	-
Centrum Boulevard at Brisebois Crescent East <i>Unsignalized</i>	EB	A	0.01	7.4	0.0	A	0.01	7.3	0.0
	WB	-	-	-	-	-	-	-	-
	SB	A	0.01	8.6	0.0	A	0.02	8.5	0.0
	<b>Overall</b>	<b>A</b>	-	<b>2.0</b>	-	<b>A</b>	-	<b>1.7</b>	-

Intersection	Lane	AM Peak Hour				PM Peak Hour			
		LOS	V/C	Delay (s)	Q (95 <sup>th</sup> )	LOS	V/C	Delay (s)	Q (95 <sup>th</sup> )
<b>St Joseph Boulevard at Prestone Drive Signalized</b>	EBL	A	0.05	11.4	2.4	A	0.05	6.6	4.9
	EBT	A	0.15	11.6	11.0	A	0.44	7.8	56.7
	EBR	A	0.08	4.3	4.3	A	0.12	1.9	6.2
	WBL	A	0.00	10.5	1.1	A	0.03	6.8	2.7
	WBT	C	0.71	18.3	52.0	A	0.22	6.3	25.8
	WBR	A	0.18	3.6	7.0	A	0.11	1.9	6.1
	NBL	A	0.15	12.4	14.0	A	0.25	26.3	15.2
	NBT/R	A	0.07	10.7	9.1	A	0.12	19.2	9.7
	SBL	A	0.09	11.9	9.0	A	0.56	35.0	31.4
	SBT/R	A	0.07	9.3	6.8	A	0.32	21.6	20.5
<b>Overall</b>	<b>A</b>	<b>0.41</b>	<b>14.8</b>	<b>-</b>	<b>A</b>	<b>0.46</b>	<b>10.0</b>	<b>-</b>	

**Notes:** Saturation flow rate of 1800 veh/h/lane  
 Queue is measured in metres  
 Peak Hour Factor = 1.00

Delay = average vehicle delay in seconds  
 m = metered queue  
 # = volume for the 95th %ile cycle exceeds capacity

During both peak hours, the study area intersections operate similar to the existing condition. No capacity issues are noted.

### 7.3 2028 Future Total Operations

Figure 16 illustrates the 2028 total volumes and Table 19 summarizes the 2028 total intersection operations. The level of service for signalized intersections is based on v/c calculations for individual lane movements and HCM 2000 v/c calculations for the overall intersection. The synchro worksheets for the 2028 total horizon are provided in Appendix J.

Figure 16: 2028 Future Total Volumes

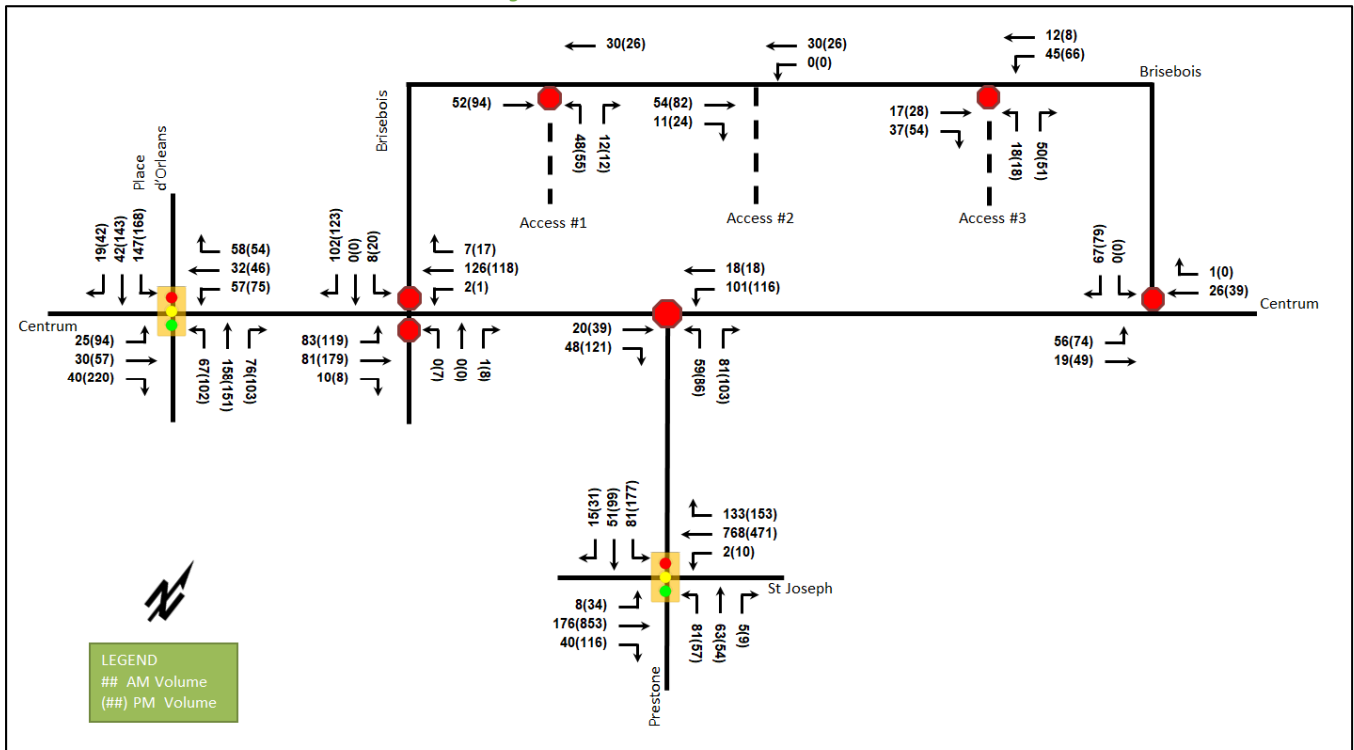

Table 19: 2028 Future Total Intersection Operations

Intersection	Lane	AM Peak Hour				PM Peak Hour			
		LOS	V/C	Delay (s)	Q (95 <sup>th</sup> )	LOS	V/C	Delay (s)	Q (95 <sup>th</sup> )
Centrum Boulevard at Place d'Orleans Drive <i>Signalized</i>	EBL	A	0.11	20.2	7.2	A	0.47	38.1	23.9
	EBT	A	0.08	19.6	8.0	A	0.20	29.6	15.2
	EBR	A	0.13	7.0	5.5	A	0.52	8.5	15.1
	WBL	A	0.22	22.1	13.1	A	0.36	34.2	19.6
	WBT/R	A	0.25	11.2	11.9	A	0.32	17.4	16.4
	NB	A	0.16	5.0	15.0	A	0.22	4.4	16.6
	SB	A	0.15	6.1	12.8	A	0.24	5.9	21.0
	<b>Overall</b>	<b>A</b>	<b>0.18</b>	<b>8.5</b>	-	<b>A</b>	<b>0.28</b>	<b>12.0</b>	-
Centrum Boulevard at Brisebois Crescent West <i>Unsignalized</i>	EB	A	0.06	7.7	1.5	A	0.08	7.8	2.3
	WB	A	0.00	7.4	0.0	A	0.00	7.7	0.0
	NB	A	0.00	9.9	0.0	B	0.03	13.1	0.8
	SB	A	0.13	9.8	3.0	B	0.19	11.0	5.3
	<b>Overall</b>	<b>A</b>	-	<b>4.2</b>	-	<b>A</b>	-	<b>4.5</b>	-
Centrum Boulevard at Prestone Drive <i>Unsignalized</i>	EB	A	0.08	7.4	1.5	A	0.18	8.1	5.3
	WB	A	0.15	8.3	3.8	A	0.18	8.8	4.5
	NBL	A	0.09	8.8	2.3	A	0.14	9.5	3.8
	NBR	A	0.10	7.4	2.3	A	0.13	7.9	3.0
	<b>Overall</b>	<b>A</b>	-	<b>8.0</b>	-	<b>A</b>	-	<b>8.5</b>	-
Centrum Boulevard at Brisebois Crescent East <i>Unsignalized</i>	EB	A	0.04	7.4	0.8	A	0.05	7.4	0.8
	WB	-	-	-	-	-	-	-	-
	SB	A	0.07	8.9	1.5	A	0.08	8.8	1.5
	<b>Overall</b>	<b>A</b>	-	<b>6.0</b>	-	<b>A</b>	-	<b>5.2</b>	-
St Joseph Boulevard at Prestone Drive <i>Signalized</i>	EBL	A	0.05	11.8	2.7	A	0.06	7.2	6.0
	EBT	A	0.16	12.0	10.9	A	0.41	8.2	49.5
	EBR	A	0.08	4.6	4.3	A	0.12	2.0	6.2
	WBL	A	0.01	10.5	1.1	A	0.03	7.2	2.7
	WBT	B	0.68	18.1	46.4	A	0.22	6.9	25.2
	WBR	A	0.23	3.8	8.0	A	0.16	1.8	7.0
	NBL	A	0.15	11.5	13.2	A	0.23	25.3	15.2
	NBT/R	A	0.09	10.1	10.7	A	0.19	21.2	14.9
	SBL	A	0.16	11.6	13.3	B	0.68	40.0	41.1
	SBT/R	A	0.11	9.3	9.9	A	0.38	23.4	26.2
	<b>Overall</b>	<b>A</b>	<b>0.39</b>	<b>14.1</b>	-	<b>A</b>	<b>0.47</b>	<b>11.6</b>	-
Access #1 at Brisebois Crescent <i>Unsignalized</i>	EB	-	-	-	-	-	-	-	-
	WB	-	-	-	-	-	-	-	-
	NB	A	0.06	9.1	1.5	A	0.08	9.4	1.5
	<b>Overall</b>	<b>A</b>	-	<b>3.8</b>	-	<b>A</b>	-	<b>3.4</b>	-
Access #2 at Brisebois Crescent <i>Unsignalized</i>	EB	Low volumes do not return operational results.							
	WB								
	<b>Overall</b>								
Access #3 at Brisebois Crescent <i>Unsignalized</i>	EB	-	-	-	-	-	-	-	-
	WB	A	0.03	7.4	0.8	A	0.04	7.5	0.8
	NB	A	0.07	9.0	1.5	A	0.07	9.2	1.5
	<b>Overall</b>	<b>A</b>	-	<b>5.3</b>	-	<b>A</b>	-	<b>5.0</b>	-

Notes: Saturation flow rate of 1800 veh/h/lane  
 Queue is measured in metres  
 Peak Hour Factor = 1.00

Delay = average vehicle delay in seconds  
 m = metered queue  
 # = volume for the 95th %ile cycle exceeds capacity

During both peak hours, the study area intersections operate similar to the 2028 future background condition. No capacity issues are noted.

### 7.4 2033 Future Total Operations

Figure 17 illustrates the 2033 total volumes and Table 20 summarizes the 2033 total intersection operations. The level of service for signalized intersections is based on v/c calculations for individual lane movements and HCM 2000 v/c calculations for the overall intersection. The synchro worksheets for the 2033 future total horizon are provided in Appendix K.

Figure 17: 2033 Future Total Volumes

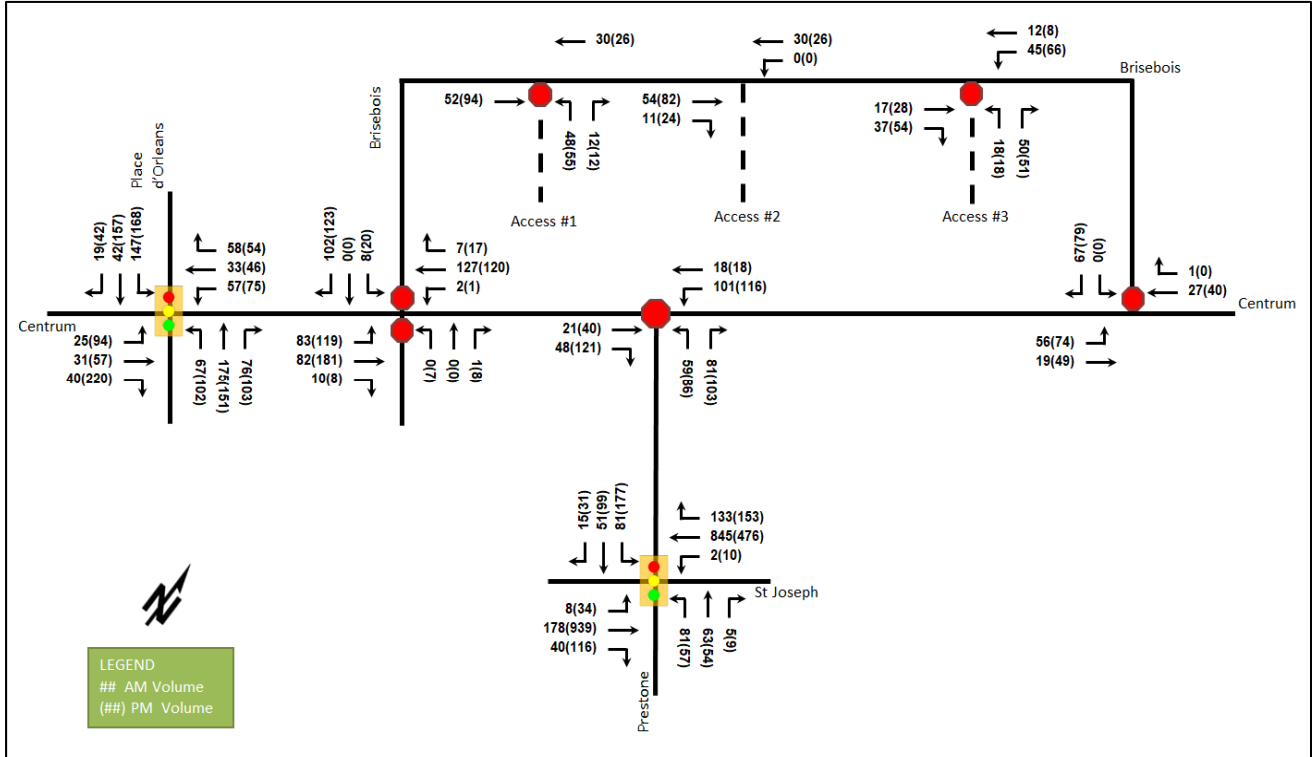

Table 20: 2033 Future Total Intersection Operations

Intersection	Lane	AM Peak Hour				PM Peak Hour			
		LOS	V/C	Delay (s)	Q (95 <sup>th</sup> )	LOS	V/C	Delay (s)	Q (95 <sup>th</sup> )
<b>Centrum Boulevard at Place d'Orleans Drive</b> <i>Signalized</i>	EBL	A	0.11	20.2	7.2	A	0.47	38.1	23.9
	EBT	A	0.09	19.6	8.2	A	0.20	29.6	15.2
	EBR	A	0.13	7.0	5.5	A	0.52	8.5	15.1
	WBL	A	0.22	22.1	13.1	A	0.36	34.2	19.6
	WBT/R	A	0.25	11.3	12.0	A	0.32	17.4	16.4
	NB	A	0.17	5.1	15.9	A	0.22	4.4	16.6
	SB	A	0.15	6.1	12.9	A	0.25	5.9	21.9
<b>Overall</b>	<b>A</b>	<b>0.19</b>	<b>8.5</b>	-	-	<b>A</b>	<b>0.29</b>	<b>12.0</b>	-
<b>Centrum Boulevard at Brisebois Crescent West</b> <i>Unsignalized</i>	EB	A	0.06	7.7	1.5	A	0.08	7.8	2.3
	WB	A	0.00	7.4	0.0	A	0.00	7.7	0.0
	NB	A	0.00	9.9	0.0	B	0.03	13.1	0.8
	SB	A	0.13	9.8	3.0	B	0.19	11.0	5.3
	<b>Overall</b>	<b>A</b>	-	<b>4.1</b>	-	-	<b>A</b>	-	<b>4.5</b>

Intersection	Lane	AM Peak Hour				PM Peak Hour			
		LOS	V/C	Delay (s)	Q (95 <sup>th</sup> )	LOS	V/C	Delay (s)	Q (95 <sup>th</sup> )
<b>Centrum Boulevard at Prestone Drive</b> <i>Unsignalized</i>	EB	A	0.08	7.4	1.5	A	0.18	8.1	5.3
	WB	A	0.15	8.3	3.8	A	0.18	8.8	4.5
	NBL	A	0.09	8.8	2.3	A	0.14	9.5	3.8
	NBR	A	0.10	7.4	2.3	A	0.13	7.9	3.0
	<b>Overall</b>	<b>A</b>	-	<b>8.0</b>	-	<b>A</b>	-	<b>8.5</b>	-
<b>Centrum Boulevard at Brisebois Crescent East</b> <i>Unsignalized</i>	EB	A	0.04	7.4	0.8	A	0.05	7.4	0.8
	WB	-	-	-	-	-	-	-	-
	SB	A	0.07	8.9	1.5	A	0.08	8.8	1.5
	<b>Overall</b>	<b>A</b>	-	<b>5.9</b>	-	<b>A</b>	-	<b>5.2</b>	-
<b>St Joseph Boulevard at Prestone Drive</b> <i>Signalized</i>	EBL	A	0.05	11.6	2.7	A	0.06	7.2	6.0
	EBT	A	0.15	11.6	10.9	A	0.45	8.6	56.1
	EBR	A	0.08	4.3	4.3	A	0.12	2.0	6.2
	WBL	A	0.00	10.5	1.1	A	0.03	7.3	2.7
	WBT	B	0.70	18.3	51.7	A	0.23	6.9	25.5
	WBR	A	0.22	3.5	7.7	A	0.16	1.8	7.0
	NBL	A	0.16	12.4	14.0	A	0.23	25.3	15.2
	NBT/R	A	0.09	11.0	11.3	A	0.19	21.2	14.9
	SBL	A	0.16	12.6	14.1	B	0.68	40.0	41.1
	SBT/R	A	0.12	10.0	10.4	A	0.38	23.4	26.2
	<b>Overall</b>	<b>A</b>	<b>0.41</b>	<b>14.5</b>	-	<b>A</b>	<b>0.50</b>	<b>11.6</b>	-
	<b>Access #1 at Brisebois Crescent</b> <i>Unsignalized</i>	EB	-	-	-	-	-	-	-
WB		-	-	-	-	-	-	-	-
NB		A	0.06	9.1	1.5	A	0.08	9.4	1.5
<b>Overall</b>		<b>A</b>	-	<b>3.8</b>	-	<b>A</b>	-	<b>3.4</b>	-
<b>Access #2 at Brisebois Crescent</b> <i>Unsignalized</i>	EB	Low volumes do not return operational results.							
	WB								
	<b>Overall</b>								
<b>Access #3 at Brisebois Crescent</b> <i>Unsignalized</i>	EB	-	-	-	-	-	-	-	-
	WB	A	0.03	7.4	0.8	A	0.04	7.5	0.8
	NB	A	0.07	9.0	1.5	A	0.07	9.2	1.5
	<b>Overall</b>	<b>A</b>	-	<b>5.3</b>	-	<b>A</b>	-	<b>5.0</b>	-

**Notes:** Saturation flow rate of 1800 veh/h/lane  
Queue is measured in metres  
Peak Hour Factor = 1.00

Delay = average vehicle delay in seconds  
m = metered queue  
# = volume for the 95th %ile cycle exceeds capacity

During both peak hours, the study area intersections operate similar to the 2033 future background condition. No capacity issues are noted.

### 7.5 Modal Share Sensitivity and Demand Rationalization Conclusions

#### 7.5.1 Network Rationalization

No capacity constraints are noted in the background conditions. No further rationalization for background travel demand is required for this study.

#### 7.5.2 Development Rationalization

The proposed trip generation rates and modal shares have been updated to match the surrounding area context and do not unduly impact the surrounding road network. No site-specific demand rationalization is considered necessary as part of this TIA.

The network intersection exemptions noted in Section 3.1 are validated in the low impact of the development on intersections in close proximity to the site.

## 8 Development Design

### 8.1 Design for Sustainable Modes

The proposed development includes two residential towers and a mixed-use tower. The site plan proposes a total of 1,184 internal bicycle parking and 72 external bicycle parking spaces. Hard surface connections between building entrances and internal pedestrian crossing are proposed. Local bus stops are located within 400 metres of the site entrances at Centrum Boulevard and Prestone Drive, and Place d'Orléans station located approximately one-kilometre walking distance from the site. The sidewalks along Brisebois Crescent, Centrum Boulevard, and the MUPs along the Highway 174 and Place d'Orléans Drive will provide connections from the site to the nearby transit stops and station.

Along Brisebois Crescent, the removal of the perpendicular parking is likely to permit a sidewalk to be added along the south side of the road.

The infrastructure TDM checklist is provided in Appendix L.

### 8.2 Circulation and Access

The proposed development will remove two existing accesses on Brisebois Crescent and propose three accesses on Brisebois Crescent. A one-way loop around Tower C will form the inbound Access #2 and outbound Access #1, and Access #3 will be a two-way access with a connection to the underground parking levels on the east side of Tower B. The one-way loop will permit temporary parking for deliveries, ubers, etc. and internal loading bays will be provided for each building for move-in operations. At the southwestern corner of the site, two-way operation is permitted to access the garbage collection and loading zone for Tower A from the one-way loop. The garbage collection is expected to occur within the internal aisle. Para Transpo vehicles can access the Tower A and Tower C lay-bys.

The turning templates are provided in Appendix M.

The Brisebois Crescent modifications have been noted on the site plan in a conceptual manner. Future design work will be required to meet City standards.

## 9 Parking

### 9.1 Parking Supply

The proposed development will provide 516 vehicle parking spaces, including 70 office spaces, 356 residential spaces, and 90 visitor spaces. According to the zoning by-law, specifically within Area Z on Schedule 1A, there is no minimum off-street motor vehicle parking required to be provided, and the minimum visitor parking required for the site is 90 vehicle spaces. The zoning by-law allows a maximum of 1,973 vehicle parking spaces for the site based on its proximity to rapid transit and within Area C on Schedule 1. The minimum visitor parking and the maximum vehicle parking requirements outlined in the zoning by-law are met.

The existing 30 perpendicular street parking along the Brisebois Crescent are proposed to be removed and replaced with nine parallel street parking spaces, and 23 existing street parking will remain along the Centrum Boulevard frontage.



It is noted that off-site parking is available along Brisebois Crescent and Centrum Boulevard, and it provides potential additional parking spaces in close proximity to the site.

Based on the Traffic and Parking (By-law No. 2017-301), the proposed parking falls within the range of 500 or more spaces, with a minimum requirement of six accessible parking spaces. The site proposes a total of 22 accessible parking spaces, and it meets the by-law requirements.

A total of 1,256 bicycle parking spaces are proposed, including 1,184 internal bicycle parking and 72 external bicycle parking spaces. According to the zoning by-law, the minimum bicycle parking provision is 564 at a ratio of 0.5 spaces per unit, and the proposed bicycle parking exceeds the minimum by-law requirement.

## 10 Boundary Street Design

Table 21 summarizes the Multi-Modal Level of Service (MMLOS) analysis for the boundary streets of Brisebois Crescent and Centrum Boulevard. The existing and future conditions for Centrum Boulevard will be the same and are considered in one row. The boundary street analysis is based on the land-use of the “General Urban Area”. The MMLOS worksheets have been provided in Appendix N.

Table 21: Boundary Street MMLOS Analysis

Segment	Pedestrian LOS		Bicycle LOS		Transit LOS		Truck LOS	
	PLOS	Target	BLOS	Target	TLOS	Target	TrLOS	Target
<b>Brisebois Crescent (Existing)</b>	<b>C</b>	B	D	D	N/A	N/A	N/A	N/A
<b>Brisebois Crescent (Future)</b>	<b>C</b>	B	D	D	N/A	N/A	N/A	N/A
<b>Centrum Boulevard</b>	B	B	B	D	N/A	N/A	N/A	N/A

The pedestrian LOS will not be met along the segment of Brisebois Crescent with the sidewalk along the north side of the roadway. A sidewalk along the boundary of the site will not improve the pedestrian LOS. Nonetheless, if the perpendicular on street parking is removed, a sidewalk should be considered along the south side. To meet the theoretical pedestrian LOS targets, the boulevards would need to be at least 0.5 metres or the operating speed would need to be less than 50 km/h along the boundary street of Brisebois Crescent.

Brisebois Crescent meets local road requirements for a sidewalk on one side of the road. An additional sidewalk is contemplated as part of the site plan should the perpendicular parking is removed. It is recommended that the City explore reducing the speed limit along Brisebois Crescent to help improve the PLOS. (e.g. 40 km/h would become PLOS B).

## 11 Access Intersections Design

### 11.1 Location and Design of Access

The development proposed three accesses to Brisebois Crescent and complies with the private approach bylaw for the number and operation of the permitted accesses. Access #1 and Access #2 are one-way access are 6.0 metres wide, operating as a one-way loop, inbound on Access #1 and outbound on Access #2. Access #3 is a two-way access with a 6.7-metre width and connects to the ground-level parking and underground garage. The throat length for each access meets the private approach bylaw requirements.

### 11.2 Intersection Control

Based upon the projected volumes, Accesses #1 and #3 will have stop-control each on the minor approach and Access #2 will have no control as it is inbound only.

### 11.3 Access Intersection Design

#### 11.3.1 Future Access Intersection Operations

The operations are noted in Section 7.4 and no mitigation is required for the development.

#### 11.3.2 Access Intersection MMLOS

All accesses are unsignalized and do not require MMLOS review.

#### 11.3.3 Recommended Design Elements

The Brisebois Crescent frontage is expected to be modified to remove the perpendicular on-street parking with a sidewalk in the new boulevard. The sidewalk would tie into the existing sidewalk at the corner of Brisebois Crescent as it bends towards Centrum Boulevard. The proposed accesses will be constructed to comply with the City standard SC7.1, and any bulb-out features will comply with the City standard R8.

## 12 Transportation Demand Management

### 12.1 Context for TDM

The subject site has been assumed to rely predominantly on auto driver and transit mode shares due to the conversion of the Place d'Orleans LRT station. The convenience of the transit station should provide the opportunity to reach the forecast transit mode share.

### 12.2 Need and Opportunity

The subject site has been assumed to rely predominantly on auto travel with an increase in transit ridership with the proximity to the Place d'Orleans LRT station, and those assumptions have been carried through the analysis.. The study area intersections are anticipated to have residual capacity and the increase in transit ridership from the LRT convenience is achievable.

### 12.3 TDM Program

The “suite of post occupancy TDM measures” has been summarized in the TDM checklists for the residential land uses. The checklist is provided in Appendix L. Transit-oriented design of the subject site is confirmed by the City of Ottawa during the pre-consultation meeting, and the key TDM measures recommended include:

- Designate an internal coordinator, or contract with an external coordinator
- Display local area maps with walking/cycling access routes and key destinations at major entrances
- Display relevant transit schedules and route maps at entrances
- Provide online links to OC Transpo and STO information
- Provide a dedicated ridematching portal at OttawaRideMatch.com
- Provide a multimodal travel option information package to new/relocating employees, students, and new residents
- Unbundle parking costs from lease rates at multi-tenant sites, purchase or rental costs
- Offer personalized trip planning to new/relocating employees

## 13 Neighbourhood Traffic Management

The proposed development will connect to the arterial network via Brisebois Crescent (a local road), Centrum Boulevard (a collector road), and Prestone Drive (a collector road). In general, Brisebois Crescent will range between 153 to 257 vehicles during peak hours west of the proposed Access #1 and 84 to 143 vehicles during peak hours east of the proposed Access #1. Centrum Boulevard will range between 110 to 337 vehicles west of

Prestone Drive and 221 to 289 vehicles east of Prestone Drive during peak hours. Prestone Drive is anticipated to convey between 289 to 426 vehicles north of St. Joseph Boulevard during peak hours.

The roadways are functioning as intended within the network and no change to the roadway classifications or proposed road network are required to support the site.

## 14 Transit

### 14.1 Route Capacity

In Section 5.1 the trip generation by mode was estimated, including an estimate of the number of transit trips that will be generated by the proposed development. Table 22 summarizes the transit trip generation.

Table 22: Trip Generation by Transit Mode

Travel Mode	Mode Share	AM Peak Hour			PM Peak Hour		
		In	Out	Total	In	Out	Total
Transit	varies	82	154	236	105	87	192

The proposed development is anticipated to generate an additional 236 AM and 192 PM peak hour two-way transit trips. From the trip distribution found in section 5.3, these values can be further broken down. Table 23 summarizes forecasted site-generated transit ridership trips by direction and the equivalent bus loads.

Table 23: Forecasted Site-Generated Transit Ridership

Direction	AM Peak Hour		PM Peak Hour		Service Type	Approximate Equivalent Peak Hour/Direction Bus Loads
	In	Out	In	Out		
North	4	8	5	4	Bus	Negligible
South	25	46	32	26	Bus	Half of a standard bus
East	21	39	26	22	Bus, LRT	Half of a standard bus
West	32	61	42	35	Bus, LRT	A standard bus

### 14.2 Transit Priority

Examining the study area intersection delays, negligible impacts are noted on the transit movements at the study area intersections. No change in transit LOS is noted throughout the study area. No specific transit priority measures were considered as part of this development.

## 15 Network Concept

The background and forecasted site trips do not exceed the anticipated lane capacities on the boundary road network. The transit modal share is likely to be achieved and the site has negligible impact on the road network. No future network changes are required to support the subject development.

## 16 Network Intersection Design

### 16.1 Network Intersection Control

No change to the existing signalized control is recommended for the network intersections.

### 16.2 Network Intersection Design

#### 16.2.1 2028 & 2033 Future Total Network Intersection Operations

The operations are noted in Section 7.4 and no mitigation of conditions is required for the subject site traffic.

16.2.2 Network Intersection Multi-Modal Level of Service (MMLOS)

Table 24 summarizes the MMLOS analysis for the network intersections of Centrum Boulevard at Place d’Orleans Drive and St Joseph Boulevard at Prestone Drive.

A Multi-Use Pathway (MUP) is planned to be along Place d’Orléans Drive south to Centrum Boulevard, and the St. Joseph Boulevard Concept Plan includes cycling facilities along St. Joseph Boulevard. These improvements were included in the future conditions. The intersection analysis is based on the policy area of the “Within 600m of a rapid transit station”. The MMLOS worksheets have been provided in Appendix N.

Table 24: Study Area Intersection MMLOS Analysis

Intersection	Pedestrian LOS		Bicycle LOS		Transit LOS		Truck LOS		Auto LOS	
	PLOS	Target	BLOS	Target	TLOS	Target	TrLOS	Target	ALOS	Target
Centrum Boulevard at Place d’Orleans Drive (Existing)	F	A	F	A	N/A	N/A	N/A	N/A	A	D
Centrum Boulevard at Place d’Orleans Drive (Future)	F	A	F	A	N/A	N/A	N/A	N/A	A	D
St Joseph Boulevard at Prestone Drive (Existing)	F	A	F	B	N/A	N/A	N/A	N/A	A	D
St Joseph Boulevard at Prestone Drive (Future)	F	A	E	B	N/A	N/A	N/A	N/A	A	D

The pedestrian LOS targets will not be met at the study area intersections. As typical for arterial roads, the crossing distance does not permit the targets to be met. To meet pedestrian LOS targets, the maximum crossing distance on all pedestrian crossings would need to be reduced to three lane-widths.

The bicycle LOS targets will not be met at the study area intersections, and two-stage left turns or left-turn boxes would be required to meet LOS targets on all below-target approaches.

The feasibility study of cycling facilities on St-Joseph Boulevard between Forest Valley Drive and Tenth Line Road are identified as part of the Orléans Corridor Secondary Plan Study, and the bicycle LOS on the east and west approaches at the intersection of St Joseph Boulevard at Prestone Drive may be improved beyond the study horizons.

It is expected that the City will review and propose improvements along St Joseph Boulevard and explore options to address the area PLOS and BLOS deficiencies, given they are arterial road intersections and may require greater network improvements beyond the localized intersection upgrades.

16.2.3 Recommended Design Elements

No study area intersection design elements are proposed as part of this study.

17 Summary of Improvements Indicated and Modifications Options

The following summarizes the analysis and results presented in this TIA report:

### Proposed Site and Screening

- The proposed site includes 1,127 residential units, 8,967 sq. ft retail space, and 31,570 sq. ft office space
- The development site is located within the Place d’Orleans Protected Major Transit Station Area (PMTSA) and design priority area
- The site plan proposes a total of 516 vehicle parking spaces and 1,256 bicycle parking space
- The preliminary accesses are proposed to include three along Brisebois Crescent, and the existing two accesses on Brisebois Crescent will be removed
- The existing perpendicular street parking spaces along Brisebois Crescent are proposed to be replaced with parallel street parking spaces
- The development is proposed to be completed as a single phase by 2028
- The Trip Generation and safety triggers were met for the TIA Screening

### Existing Conditions

- Place d’Orleans Drive and St Joseph Boulevard are arterial roads, and Centrum Boulevard and Prestone Drive are collector roads in the study area
- Sidewalks are provided on both sides of Place d’Orleans Drive, St Joseph Boulevard, Centrum Boulevard, and Prestone Drive, and one side of Brisebois Crescent
- St Joseph Boulevard is a cross-town bikeway identified as part of the 2023 Transportation Master Plan – Part 1
- Within the study area, the intersection of St Joseph Boulevard at Prestone Drive is noted to have experienced higher collisions than other locations (11 of 32)
- The majority of the collisions (7 of 11) occurred during 2017 and 2018 at the intersection of St Joseph Boulevard at Prestone Drive when there was resurfacing operations occurred through the intersection, which is assumed to be the cause of the elevated collision rate during these two years

### Development Generated Travel Demand

- A 15% shift to transit mode from the auto mode for residential land use and a 10% shift to transit mode from the auto mode for commercial land use are proposed because of the conversion of the future Place d’Orleans LRT station and being design priority area with good access to transit
- The proposed development is forecasted to produce 544 two-way people trips during the AM peak hour and 554 two-way people trips during the PM peak hour
- Of the forecasted people trips, 210 two-way trips will be vehicle trips during the AM peak hour and 248 two-way trips will be vehicle trips during the PM peak hour
- Of the forecasted trips, 5 % are anticipated to travel north, 30% to the south, 25% to the east, and 40 % to the west

### Background Conditions

- The background developments were explicitly included in the background conditions, along with background growths per annum applied along the mainline directions/volumes on Centrum Boulevard, St Joseph Boulevard, and Place d’Orleans Drive
- The study area intersections at the 2028 and 2033 background conditions will operate similar to the existing conditions
- Place d’Orleans station, which is located approximately 800 metres from the site, will be converted to accommodate LRT by the end of 2024

### Development Design

- The site plan proposes a total of 1,184 internal bicycle parking and 72 external bicycle parking spaces
- Hard surface connections between building entrances and internal pedestrian crossing are proposed, and a sidewalk is also proposed along the frontage of Brisebois Crescent in conjunction with the removal of the perpendicular on-street parking
- Local bus stops, situated within 400 meters of the site entrances, and the Place d'Orléans station, approximately one kilometer away, are accessible via the existing and future pedestrian facilities
- A one-way loop around Tower C will form the inbound Access #2 and outbound Access #1, and Access #3 will be a two-way access with a connection to the underground parking levels on the east side of Tower B
- The one-way loop will permit temporary parking for deliveries, ubers, etc. and internal loading bays will be provided for each building for the move-in truck operations
- Two-way operation is permitted to the loading bay and garbage collection for Tower A from the one-way loop
- The garbage collection is expected to occur within the internal aisle
- Para Transpo vehicles can access the Tower A and Tower C lay-bys

### Parking

- The proposed development will provide 516 vehicle parking spaces, including 70 office spaces, 356 residential spaces, and 90 visitor spaces
- The site proposes a total of 22 accessible parking spaces
- The site meets the minimum visitor vehicle parking, maximum vehicle parking, and accessible parking requirements
- A total of 1,184 internal bicycle parking and 72 external bicycle parking spaces are proposed, and the proposed bicycle parking exceeds the minimum requirement
- Off-site parking along Brisebois Crescent and Centrum Boulevard provides potential additional parking spaces in close proximity to the site
- The existing 30 perpendicular street parking along the Brisebois Crescent are proposed to be removed and replaced with nine parallel street parking spaces, and 23 existing street parking will remain along the Centrum Boulevard frontage

### Boundary Street Design

- The pedestrian LOS will not be met along the segment of Brisebois Crescent, and at least 0.5 metres of boulevards or less than 50 km/h of operating speed would need to meet the target
- While it does not impact the pedestrian LOS, a sidewalk will be provided along the south side of Brisebois Crescent, in conjunction with the removal of the perpendicular on-street parking
- The City should reduce the speed limit to at least 40 km/h to help improve the PLOS results and meet the target

### Access Intersections Design

- The Access #1 and Access #2 are one-way access are 6.0 metres wide, operating as a one-way loop, inbound on Access #2 and outbound on Access #1
- The Access #3 is a two-way access with a 6.7 metre width and connects to the ground level parking and underground garage
- The throat length for each access meets the private approach bylaw requirements

- Accesses #1 and #3 will have stop-control each on the minor approach and Access #2 will have no control as it is inbound only
- The Brisebois Crescent frontage is proposed to be formalized to a local road standard with the perpendicular parking being removed and replaced by a sidewalk and grass boulevard

#### **TDM**

- Supportive TDM measures to be included within the proposed development should include:
  - Designate an internal coordinator, or contract with an external coordinator
  - Display local area maps with walking/cycling access routes and key destinations at major entrances
  - Display relevant transit schedules and route maps at entrances
  - Provide online links to OC Transpo and STO information
  - Provide a dedicated ridematching portal at OttawaRideMatch.com
  - Provide a multimodal travel option information package to new/relocating employees, students, and new residents
  - Unbundle parking costs from lease rates at multi-tenant sites, purchase or rental costs
  - Offer personalized trip planning to new/relocating employees

#### **NTM**

- The proposed development will connect to the arterial network via Brisebois Crescent (a local road), Centrum Boulevard (a collector road), and Prestone Drive (a collector road)
- No changes to the roadway classifications or proposed road network are required to support the site

#### **Transit**

- The forecasted transit trips will include 236 two-way trips during the AM peak and 192 two-way trips during the PM peak
- Peak hour increases in transit ridership resulting from the site equate to half of a standard bus load southerly and easterly of the site, a standard bus load westerly of the site, and negligible impact northerly of the site
- Negligible impacts are noted on the transit movements at the study area intersections
- No specific transit priority measures were considered as part of this development

#### **Network Concept**

- The transit modal share is likely to be achieved and the site has negligible impact on the road network
- No future network changes are required to support the subject development

#### **Network Intersection Design**

- No change to the existing signalized control is recommended for the network intersections
- Generally, the network intersections are expected to operate similarly to the background conditions
- The pedestrian LOS targets will not be met at the study area intersections, and the maximum crossing distance on all pedestrian crossings are required to be reduced to three lane-widths
- The bicycle LOS targets will not be met at the study area intersections, and two-stage left turns or left-turn boxes would be required to meet LOS targets on all below-target approaches

- Improvements along St. Joseph Boulevard are anticipated beyond the study horizons, and the PLOS and BLOS may be improved on the east and west approaches at the intersection of St Joseph Boulevard at Prestone Drive
- The City of Ottawa will be responsible for exploring options to address the area PLOS and BLOS deficiencies, given they are arterial road intersections and may require greater network improvements beyond the localized intersection upgrades

## 18 Conclusion

It is recommended that, from a transportation perspective, the proposed development applications proceed.

Prepared By:



Yu-Chu Chen, EIT  
Transportation Engineering-Intern

Reviewed By:



Andrew Harte, P.Eng.  
Senior Transportation Engineer



# Appendix A

TIA Screening Form and PM Certification Form

City of Ottawa 2017 TIA Guidelines  
Step 1 - Screening Form

Date: 23-Mar-23  
Project Number: 2023-013  
Project Reference: 265 Centrum

1.1 Description of Proposed Development	
Municipal Address	265 Centrum Boulevard
Description of Location	Existing YMCA site. Bounded by Centrum Boulevard to the south, Brisebois Crescent to the north and east, and the Shenkman Arts Centre to the west
Land Use Classification	Mixed-Use Centre Zone (MC14[1520] S152)
Development Size	Three (3) towers with a total of 1,127 residential units, 8,970 sq. ft retail space, and 31,570 sq. ft office space
Accesses	Three accesses on Brisebois Crescent
Phase of Development	Single
Buildout Year	2028
TIA Requirement	Full TIA Required

1.2 Trip Generation Trigger	
Land Use Type	Townhomes or apartments
Development Size	1093 Units
Trip Generation Trigger	Yes

1.3 Location Triggers	
Does the development propose a new driveway to a boundary street that is designated as part of the City's Transit Priority, Rapid Transit or Spine Bicycle Networks?	No
Is the development in a Design Priority Area (DPA) or Transit-oriented Development (TOD) zone?	No Heart of Orleans BIA
Location Trigger	No

1.4. Safety Triggers	
Are posted speed limits on a boundary street 80 km/hr or greater?	No
Are there any horizontal/vertical curvatures on a boundary street limits sight lines at a proposed driveway?	Yes Brisebois curvature. It's a local with low volumes. No issue.
Is the proposed driveway within the area of influence of an adjacent traffic signal or roundabout (i.e. within 300 m of intersection in rural conditions, or within 150 m of intersection in urban/ suburban conditions)?	No
Is the proposed driveway within auxiliary lanes of an intersection?	No
Does the proposed driveway make use of an existing median break that serves an existing site?	No
Is there is a documented history of traffic operations or safety concerns on the boundary streets within 500 m of the development?	No
Does the development include a drive-thru facility?	No
Safety Trigger	Yes



## **TIA Plan Reports**

On 14 June 2017, the Council of the City of Ottawa adopted new Transportation Impact Assessment (TIA) Guidelines. In adopting the guidelines, Council established a requirement for those preparing and delivering transportation impact assessments and reports to sign a letter of certification.

Individuals submitting TIA reports will be responsible for all aspects of development-related transportation assessment and reporting, and undertaking such work, in accordance and compliance with the City of Ottawa's Official Plan, the Transportation Master Plan and the Transportation Impact Assessment (2017) Guidelines.

By submitting the attached TIA report (and any associated documents) and signing this document, the individual acknowledges that s/he meets the four criteria listed below.

### **CERTIFICATION**

1. I have reviewed and have a sound understanding of the objectives, needs and requirements of the City of Ottawa's Official Plan, Transportation Master Plan and the Transportation Impact Assessment (2017) Guidelines;
2. I have a sound knowledge of industry standard practice with respect to the preparation of transportation impact assessment reports, including multi modal level of service review;
3. I have substantial experience (more than 5 years) in undertaking and delivering transportation impact studies (analysis, reporting and geometric design) with strong background knowledge in transportation planning, engineering or traffic operations; and
4. I am either a licensed<sup>1</sup> or registered<sup>2</sup> professional in good standing, whose field of expertise [check  appropriate field(s)] is either transportation engineering  or transportation planning .

**1,2 License of registration body that oversees the profession is required to have a code of conduct and ethics guidelines that will ensure appropriate conduct and representation for transportation planning and/or transportation engineering works.**

City Of Ottawa  
Infrastructure Services and Community  
Sustainability  
Planning and Growth Management  
110 Laurier Avenue West, 4th fl.  
Ottawa, ON K1P 1J1  
Tel. : 613-580-2424  
Fax: 613-560-6006

Ville d'Ottawa  
Services d'infrastructure et Viabilité des  
collectivités  
Urbanisme et Gestion de la croissance  
110, avenue Laurier Ouest  
Ottawa (Ontario) K1P 1J1  
Tél. : 613-580-2424  
Télécopieur: 613-560-6006

Dated at Ottawa this 20 day of September, 2018.  
(City)

Name: Andrew Harte  
(Please Print)

Professional Title: Professional Engineer

  
Signature of Individual certifier that s/he meets the above four criteria

<b>Office Contact Information (Please Print)</b>
Address: 6 Plaza Court
City / Postal Code: Ottawa / K2H 7W1
Telephone / Extension: (613) 697-3797
E-Mail Address: Andrew.Harte@CGHTransportation.com



# Appendix B

Turning Movement Counts



# Transportation Services - Traffic Services

## Turning Movement Count - Study Results

### PLACE D'ORLEANS @ CENTRUM BLVD/PLACE D'ORLEANS

Survey Date: Thursday, January 31, 2019

WO No: 38321

Start Time: 07:00

Device: Miovision

#### Full Study Diagram

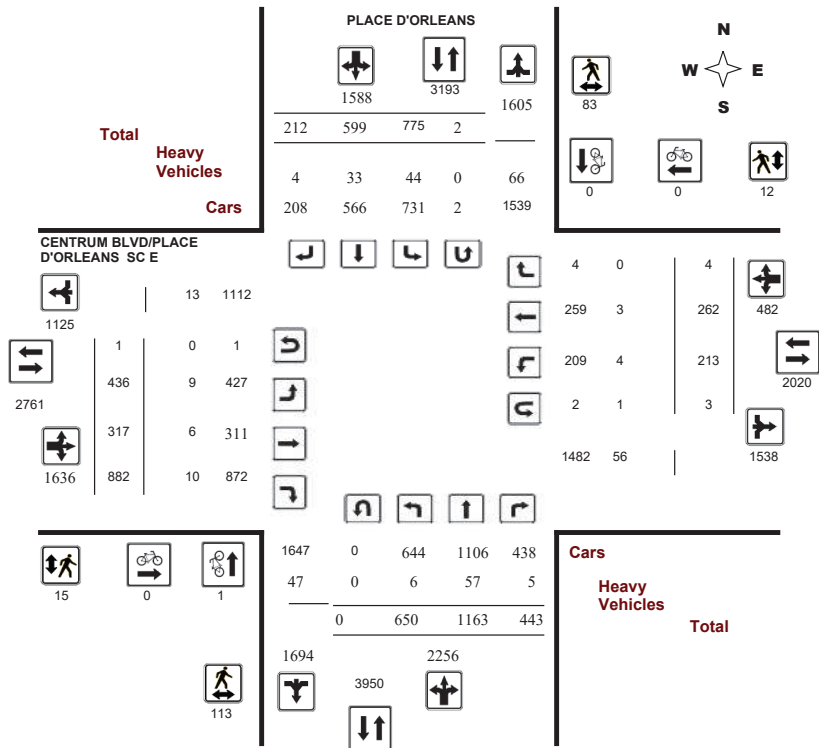

# Transportation Services - Traffic Services

## Turning Movement Count - Study Results

### PLACE D'ORLEANS @ CENTRUM BLVD/PLACE D'ORLEANS

Survey Date: Thursday, January 31, 2019

WO No: 38321

Start Time: 07:00

Device: Miovision

#### Full Study Peak Hour Diagram

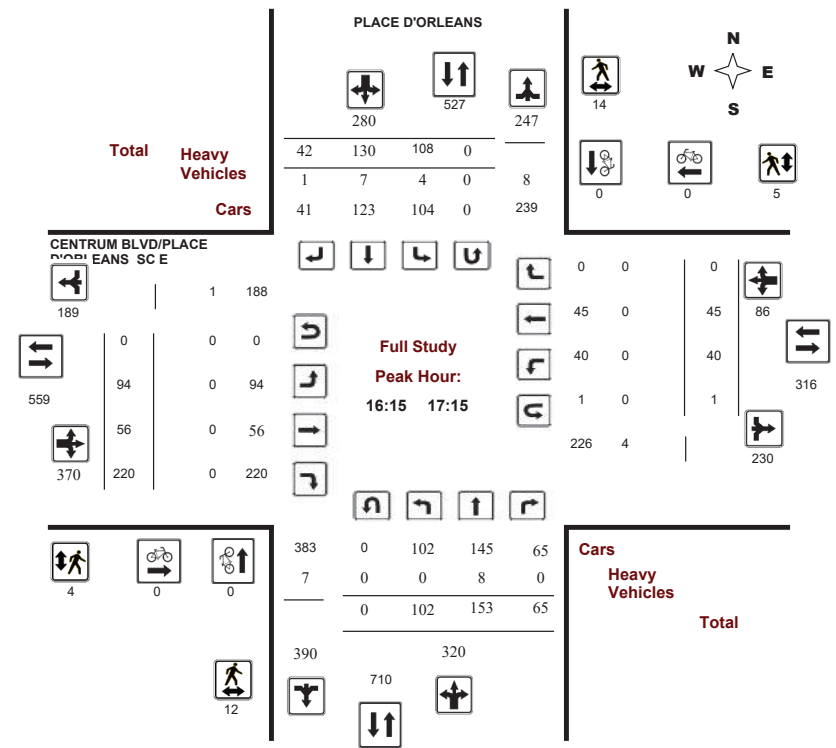



### Transportation Services - Traffic Services

#### Turning Movement Count - Peak Hour Diagram

#### PLACE D'ORLEANS @ CENTRUM BLVD/PLACE D'ORLEANS

Survey Date: Thursday, January 31, 2019  
Start Time: 07:00

WO No: 38321  
Device: Miovision

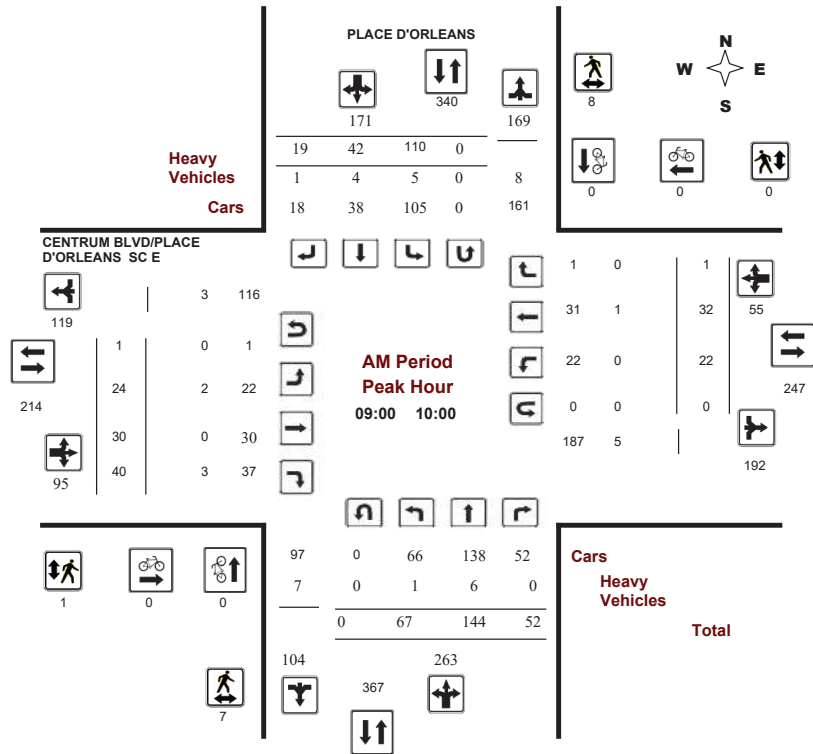

Comments



### Transportation Services - Traffic Services

#### Turning Movement Count - Peak Hour Diagram

#### PLACE D'ORLEANS @ CENTRUM BLVD/PLACE D'ORLEANS

Survey Date: Thursday, January 31, 2019  
Start Time: 07:00

WO No: 38321  
Device: Miovision

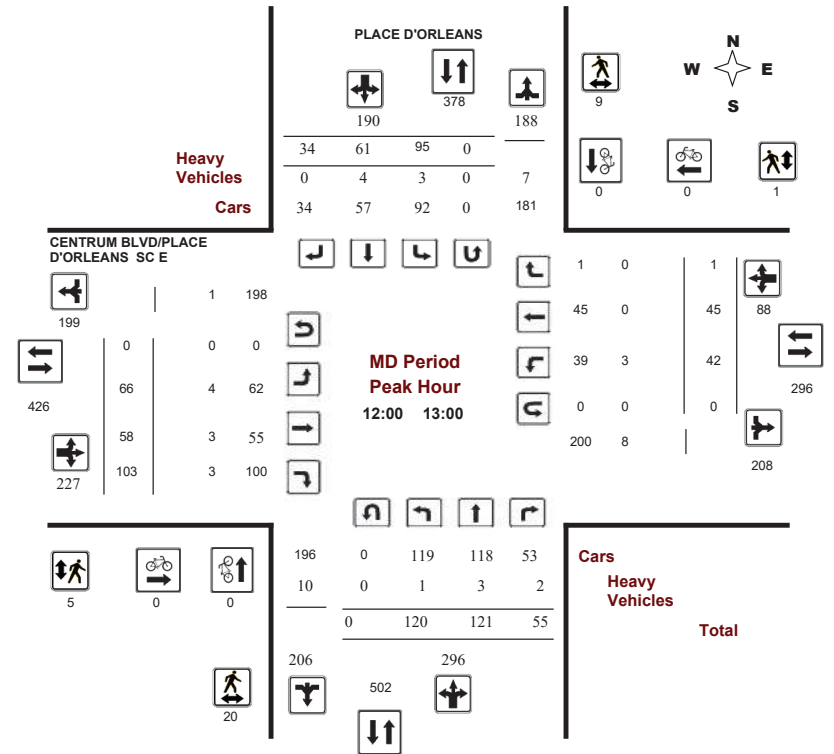

Comments



Transportation Services - Traffic Services

Turning Movement Count - Peak Hour Diagram

PLACE D'ORLEANS @ CENTRUM BLVD/PLACE D'ORLEANS

Survey Date: Thursday, January 31, 2019  
Start Time: 07:00

WO No: 38321  
Device: Miovision

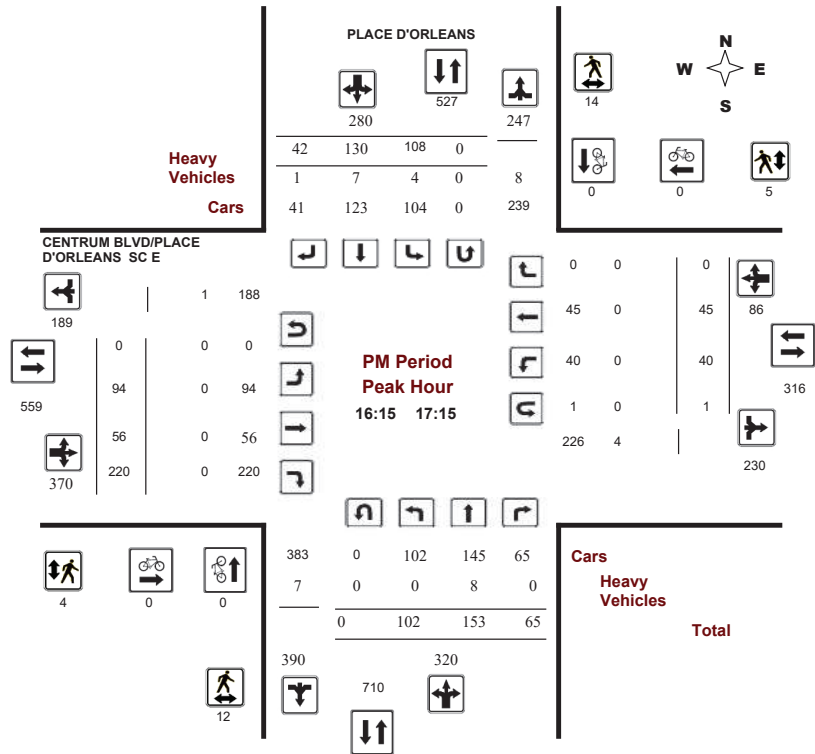

Comments



Transportation Services - Traffic Services

Turning Movement Count - Study Results

PLACE D'ORLEANS @ CENTRUM BLVD/PLACE D'ORLEANS

Survey Date: Thursday, January 31, 2019  
Start Time: 07:00

WO No: 38321  
Device: Miovision

Full Study Summary (8 HR Standard)

Survey Date: Thursday, January 31, 2019

**Total Observed U-Turns**  
Northbound: 0 Southbound: 2  
Eastbound: 1 Westbound: 3

**AADT Factor**  
1.39

Period	PLACE D'ORLEANS								CENTRUM BLVD/PLACE D'ORLEANS SC E								Grand Total			
	Northbound				Southbound				Eastbound				Westbound							
	LT	ST	RT	NB TOT	LT	ST	RT	SB TOT	LT	ST	RT	EB TOT	LT	ST	RT	WB TOT				
07:00-08:00	38	182	24	244	35	47	7	89	333	4	6	15	25	12	5	0	17	42	375	
08:00-09:00	54	183	55	292	88	47	11	146	438	16	11	23	50	12	19	0	31	81	519	
09:00-10:00	67	144	52	263	110	42	19	171	434	24	30	40	94	22	32	1	55	149	583	
11:30-12:30	117	120	65	302	84	55	31	170	472	55	53	106	214	36	38	0	74	288	760	
12:30-13:30	97	105	48	250	94	60	26	180	430	74	54	103	231	29	48	1	78	309	739	
15:00-16:00	75	129	62	266	130	111	36	277	543	87	61	167	315	34	45	0	79	394	937	
16:00-17:00	108	156	60	324	114	128	46	288	612	81	53	202	336	43	47	1	91	427	1039	
17:00-18:00	94	144	77	315	120	109	36	265	580	95	49	226	370	25	28	1	54	424	1004	
<b>Sub Total</b>	<b>650</b>	<b>1163</b>	<b>443</b>	<b>2256</b>	<b>775</b>	<b>599</b>	<b>212</b>	<b>1586</b>	<b>3844</b>	<b>436</b>	<b>317</b>	<b>882</b>	<b>1635</b>	<b>213</b>	<b>262</b>	<b>4</b>	<b>479</b>	<b>2114</b>	<b>5956</b>	
<b>U Turns</b>				<b>0</b>				<b>2</b>	<b>2</b>				<b>1</b>				<b>3</b>	<b>4</b>	<b>6</b>	
<b>Total</b>	<b>650</b>	<b>1163</b>	<b>443</b>	<b>2256</b>	<b>775</b>	<b>599</b>	<b>212</b>	<b>1588</b>	<b>3844</b>	<b>436</b>	<b>317</b>	<b>882</b>	<b>1636</b>	<b>213</b>	<b>262</b>	<b>4</b>	<b>482</b>	<b>2118</b>	<b>5962</b>	
<b>EQ 12Hr</b>	<b>903</b>	<b>1617</b>	<b>616</b>	<b>3136</b>	<b>1077</b>	<b>833</b>	<b>295</b>	<b>2207</b>	<b>5343</b>	<b>606</b>	<b>441</b>	<b>1226</b>	<b>2274</b>	<b>296</b>	<b>364</b>	<b>6</b>	<b>670</b>	<b>2944</b>	<b>8287</b>	
Note: These values are calculated by multiplying the totals by the appropriate expansion factor.																				<b>1.39</b>
<b>AVG 12Hr</b>	<b>903</b>	<b>1617</b>	<b>616</b>	<b>3136</b>	<b>1077</b>	<b>833</b>	<b>295</b>	<b>2207</b>	<b>5343</b>	<b>606</b>	<b>441</b>	<b>1226</b>	<b>2274</b>	<b>296</b>	<b>364</b>	<b>6</b>	<b>670</b>	<b>2944</b>	<b>8287</b>	
Note: These volumes are calculated by multiplying the Equivalent 12 hr. totals by the AADT factor.																				<b>1</b>
<b>AVG 24Hr</b>	<b>1184</b>	<b>2118</b>	<b>807</b>	<b>4108</b>	<b>1411</b>	<b>1091</b>	<b>386</b>	<b>2892</b>	<b>7000</b>	<b>794</b>	<b>577</b>	<b>1606</b>	<b>2979</b>	<b>388</b>	<b>477</b>	<b>7</b>	<b>878</b>	<b>3857</b>	<b>10857</b>	
Note: These volumes are calculated by multiplying the Average Daily 12 hr. totals by 12 to 24 expansion factor.																				<b>1.31</b>
Note: U-Turns provided for approach totals. Refer to 'U-Turn' Report for specific breakdown.																				





Transportation Services - Traffic Services

Turning Movement Count - Study Results

PLACE D'ORLEANS @ CENTRUM BLVD/PLACE D'ORLEANS

Survey Date: Thursday, January 31, 2019

WO No: 38321

Start Time: 07:00

Device: Miovision

Full Study 15 Minute Increments

PLACE D'ORLEANS

CENTRUM BLVD/PLACE D'ORLEANS SC E

Table with columns for Time Period, Northbound (LT, ST, RT, N TOT), Southbound (LT, ST, RT, S TOT), Eastbound (LT, ST, RT, E TOT), Westbound (LT, ST, RT, W TOT), and Grand Total. Rows represent 15-minute intervals from 07:00 to 18:00.

Note: U-Turns are included in Totals.



Transportation Services - Traffic Services

Turning Movement Count - Study Results

PLACE D'ORLEANS @ CENTRUM BLVD/PLACE D'ORLEANS

Survey Date: Thursday, January 31, 2019

WO No: 38321

Start Time: 07:00

Device: Miovision

Full Study Cyclist Volume

PLACE D'ORLEANS

CENTRUM BLVD/PLACE D'ORLEANS SC E

Table with columns for Time Period, Northbound, Southbound, Street Total, Eastbound, Westbound, Street Total, and Grand Total. Rows represent 15-minute intervals from 07:00 to 18:00.



Transportation Services - Traffic Services

Turning Movement Count - Study Results

PLACE D'ORLEANS @ CENTRUM BLVD/PLACE D'ORLEANS

Survey Date: Thursday, January 31, 2019

WO No: 38321

Start Time: 07:00

Device: Miovision

Full Study Pedestrian Volume

PLACE D'ORLEANS

CENTRUM BLVD/PLACE D'ORLEANS SC E

Table with columns: Time Period, NB Approach (E or W Crossing), SB Approach (E or W Crossing), Total, EB Approach (N or S Crossing), WB Approach (N or S Crossing), Total, Grand Total. Rows show pedestrian counts from 07:00 to 18:00.



Transportation Services - Traffic Services

Turning Movement Count - Study Results

PLACE D'ORLEANS @ CENTRUM BLVD/PLACE D'ORLEANS

Survey Date: Thursday, January 31, 2019

WO No: 38321

Start Time: 07:00

Device: Miovision

Full Study Heavy Vehicles

PLACE D'ORLEANS

CENTRUM BLVD/PLACE D'ORLEANS SC E

Table with columns: Time Period, Northbound (LT, ST, RT, N TOT), Southbound (LT, ST, RT, S TOT, STR TOT), Eastbound (LT, ST, RT, E TOT), Westbound (LT, ST, RT, W TOT, STR TOT), Grand Total. Rows show heavy vehicle counts from 07:00 to 18:00.



# Transportation Services - Traffic Services

## Turning Movement Count - Study Results

### PLACE D'ORLEANS @ CENTRUM BLVD/PLACE D'ORLEANS

Survey Date: Thursday, January 31, 2019

WO No: 38321

Start Time: 07:00

Device: Miovision

#### Full Study 15 Minute U-Turn Total

Time Period	PLACE D'ORLEANS		CENTRUM BLVD/PLACE D'ORLEANS		Total
	Northbound U-Turn Total	Southbound U-Turn Total	Eastbound U-Turn Total	Westbound U-Turn Total	
07:00 - 07:15	0	2	0	0	2
07:15 - 07:30	0	0	0	0	0
07:30 - 07:45	0	0	0	1	1
07:45 - 08:00	0	0	0	0	0
08:00 - 08:15	0	0	0	0	0
08:15 - 08:30	0	0	0	0	0
08:30 - 08:45	0	0	0	0	0
08:45 - 09:00	0	0	0	0	0
09:00 - 09:15	0	0	0	0	0
09:15 - 09:30	0	0	1	0	1
09:30 - 09:45	0	0	0	0	0
09:45 - 10:00	0	0	0	0	0
11:30 - 11:45	0	0	0	1	1
11:45 - 12:00	0	0	0	0	0
12:00 - 12:15	0	0	0	0	0
12:15 - 12:30	0	0	0	0	0
12:30 - 12:45	0	0	0	0	0
12:45 - 13:00	0	0	0	0	0
13:00 - 13:15	0	0	0	0	0
13:15 - 13:30	0	0	0	0	0
15:00 - 15:15	0	0	0	0	0
15:15 - 15:30	0	0	0	0	0
15:30 - 15:45	0	0	0	0	0
15:45 - 16:00	0	0	0	0	0
16:00 - 16:15	0	0	0	0	0
16:15 - 16:30	0	0	0	0	0
16:30 - 16:45	0	0	0	1	1
16:45 - 17:00	0	0	0	0	0
17:00 - 17:15	0	0	0	0	0
17:15 - 17:30	0	0	0	0	0
17:30 - 17:45	0	0	0	0	0
17:45 - 18:00	0	0	0	0	0
<b>Total</b>	<b>0</b>	<b>2</b>	<b>1</b>	<b>3</b>	<b>6</b>



## Turning Movement Count Summary, AM and PM Peak Hour Flow Diagrams

Automobiles, Taxis, Light Trucks, Vans, SUVs, Motorcycles, Heavy Trucks, Buses, and School Buses

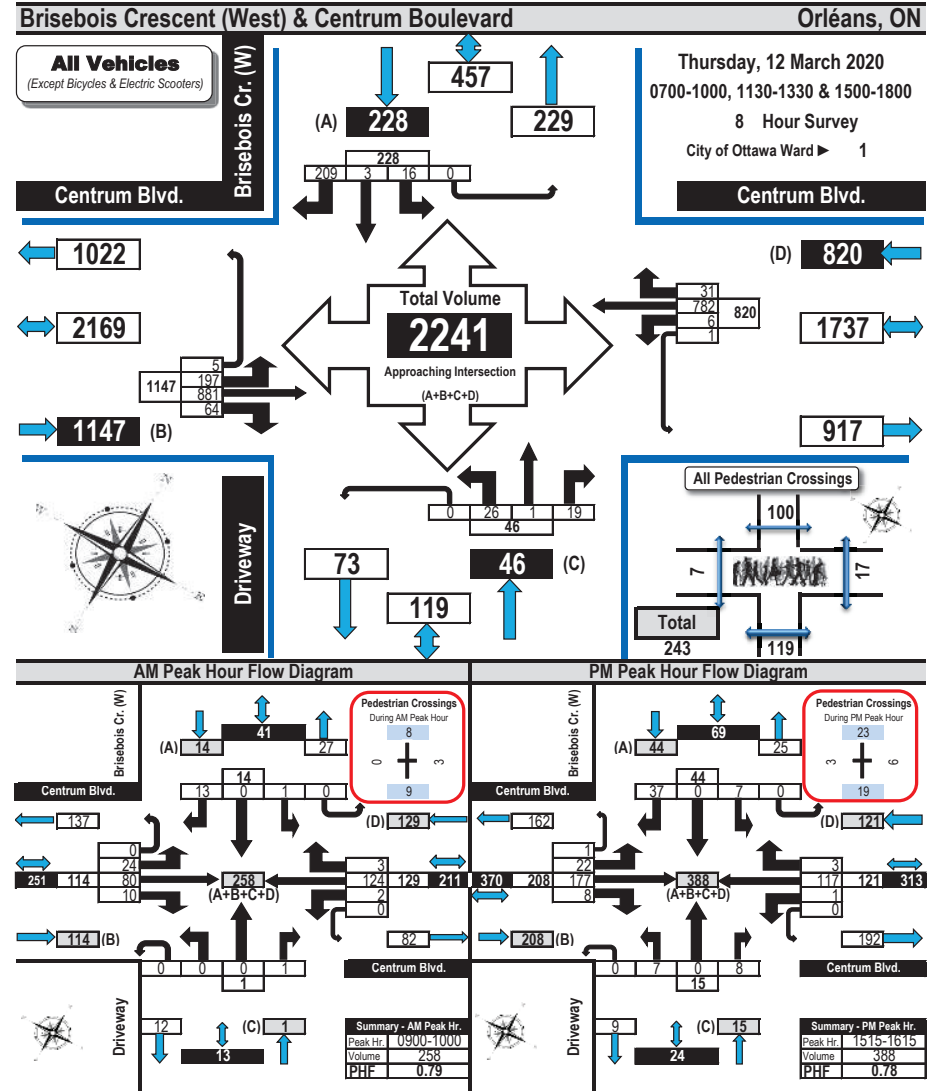



### Turning Movement Count Heavy Vehicle Summary Flow Diagram

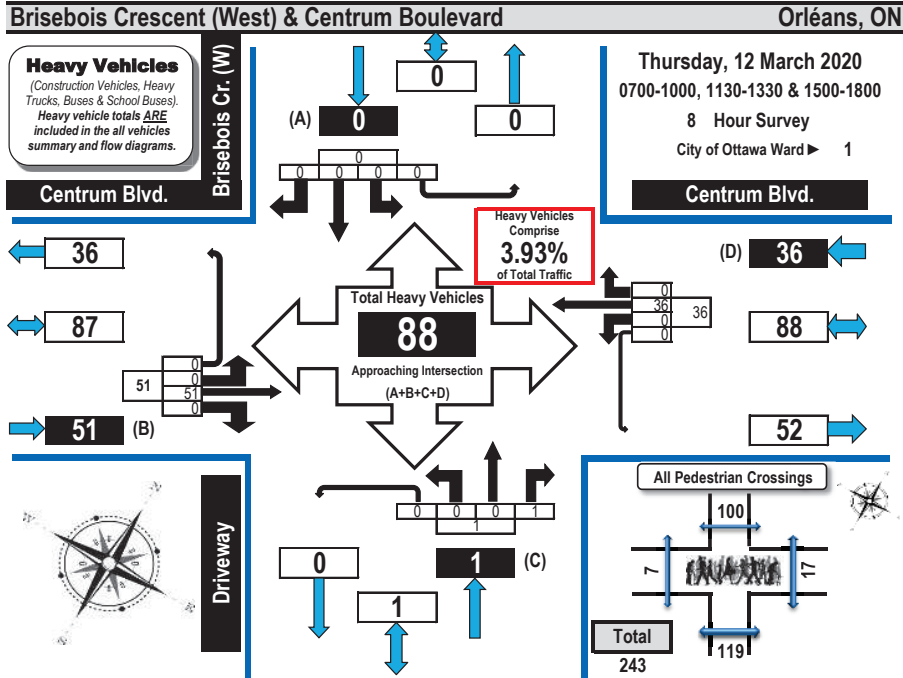

Time Period	Centrum Blvd. Eastbound					Centrum Blvd. Westbound					Driveway Northbound					Brisebois Cr. (W) Southbound					S. Tot	G. Tot	
	LT	ST	RT	UT	S. Tot	LT	ST	RT	UT	S. Tot	LT	ST	RT	UT	S. Tot	LT	ST	RT	UT	S. Tot			
	0700-0800	0	8	0	0	8	0	1	0	0	1	0	0	0	0	0	0	0	0	0			0
0800-0900	0	12	0	0	12	0	2	0	0	2	0	0	0	0	0	0	0	0	0	0	0	14	14
0900-1000	0	4	0	0	4	0	4	0	0	4	0	0	1	0	1	0	0	0	0	0	0	9	9
1130-1230	0	6	0	0	6	0	5	0	0	5	0	0	0	0	0	0	0	0	0	0	0	11	11
1230-1330	0	4	0	0	4	0	4	0	0	4	0	0	0	0	0	0	0	0	0	0	0	8	8
1500-1600	0	5	0	0	5	0	6	0	0	6	0	0	0	0	0	0	0	0	0	0	0	11	11
1600-1700	0	7	0	0	7	0	9	0	0	9	0	0	0	0	0	0	0	0	0	0	0	16	16
1700-1800	0	5	0	0	5	0	5	0	0	5	0	0	0	0	0	0	0	0	0	0	0	10	10
<b>Totals</b>	0	51	0	0	51	0	36	0	0	36	0	0	1	0	1	0	0	0	0	0	0	88	88

**Comments:**  
OC Transpo buses and school buses comprise the majority of the heavy vehicle traffic.



### Turning Movement Count Pedestrian Crossings Summary and Flow Diagram

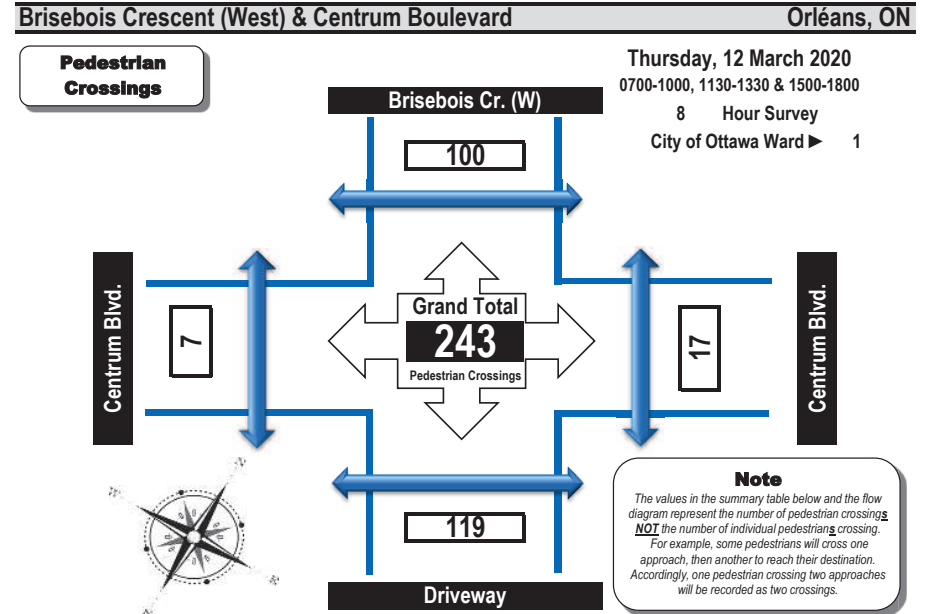

Time Period	West Side Crossing Centrum Blvd.	East Side Crossing Centrum Blvd.	Street Total	South Side Crossing Driveway	North Side Crossing Brisebois Cr. (W)	Street Total	Grand Total
0700-0800	1	2	3	8	3	11	14
0800-0900	0	0	0	11	8	19	19
0900-1000	0	3	3	9	8	17	20
1130-1230	1	0	1	16	13	29	30
1230-1330	1	2	3	16	7	23	26
1500-1600	2	6	8	22	30	52	60
1600-1700	2	1	3	14	18	32	35
1700-1800	0	3	3	23	13	36	39
<b>Totals</b>	7	17	24	119	100	219	243

**Comments:**  
OC Transpo buses and school buses comprise the majority of the heavy vehicle traffic.



## Turning Movement Count Bicycle Summary Flow Diagram



### Brisebois Crescent (West) & Centrum Boulevard Orléans, ON

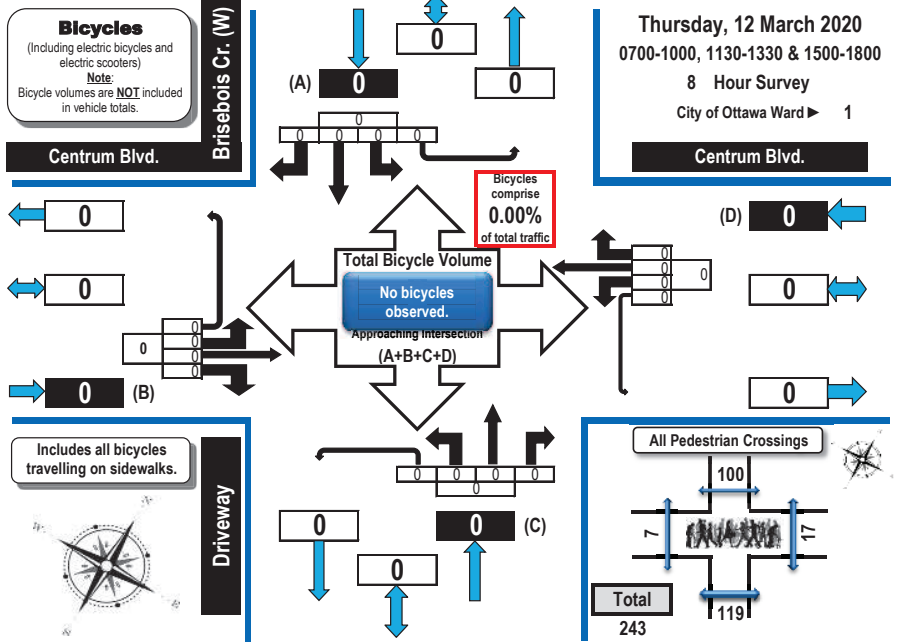

Time Period	Centrum Blvd. Eastbound					Centrum Blvd. Westbound					Driveway Northbound					Brisebois Cr. (W) Southbound					S.Tot	G.Tot
	LT	ST	RT	UT	S.Tot	LT	ST	RT	UT	S.Tot	LT	ST	RT	UT	S.Tot	LT	ST	RT	UT	S.Tot		
0700-0800	0	0	0	0	0	0	0	0	0	0	0	0	0	0	0	0	0	0	0	0	0	0
0800-0900	0	0	0	0	0	0	0	0	0	0	0	0	0	0	0	0	0	0	0	0	0	0
0900-1000	0	0	0	0	0	0	0	0	0	0	0	0	0	0	0	0	0	0	0	0	0	0
1130-1230	0	0	0	0	0	0	0	0	0	0	0	0	0	0	0	0	0	0	0	0	0	0
1230-1330	0	0	0	0	0	0	0	0	0	0	0	0	0	0	0	0	0	0	0	0	0	0
1500-1600	0	0	0	0	0	0	0	0	0	0	0	0	0	0	0	0	0	0	0	0	0	0
1600-1700	0	0	0	0	0	0	0	0	0	0	0	0	0	0	0	0	0	0	0	0	0	0
1700-1800	0	0	0	0	0	0	0	0	0	0	0	0	0	0	0	0	0	0	0	0	0	0
<b>Totals</b>	0	0	0	0	0	0	0	0	0	0	0	0	0	0	0	0	0	0	0	0	0	0

**Comments:**  
 OC Transpo buses and school buses comprise the majority of the heavy vehicle traffic.



## Turning Movement Count Summary Report AADT and Expansion Factors

Automobiles, Taxis,  
 Light Trucks, Vans,  
 SUV's, Motorcycles,  
 Heavy Trucks, Buses,  
 and School Buses

### Brisebois Crescent (West) & Centrum Boulevard Orléans, ON

Survey Date: Thursday, 12 March 2020      Start Time: 0700      AADT Factor: 1.0  
 Weather AM: Cloudy -2° C      Survey Duration: 8 Hrs.      Survey Hours: 0700-1000, 1130-1330 & 1500-1800  
 Weather PM: Partly Cloudy +1° C      Surveyor(s): T. Carmody

Time Period	Centrum Blvd. Eastbound					Centrum Blvd. Westbound					Driveway Northbound					Brisebois Cr. (W) Southbound					S/B Tot	Street Total	Grand Total
	LT	ST	RT	UT	E/B Tot	LT	ST	RT	UT	W/B Tot	LT	ST	RT	UT	N/B Tot	LT	ST	RT	UT	S.Tot			
0700-0800	30	28	0	0	58	0	56	6	0	62	120	0	1	0	0	1	2	0	19	0	21	22	142
0800-0900	29	66	10	1	106	2	95	2	0	99	205	1	0	1	0	2	0	1	23	0	24	26	231
0900-1000	24	80	10	0	114	2	124	3	0	129	243	0	0	1	0	1	1	0	13	0	14	15	258
1130-1230	16	105	11	2	134	0	90	4	0	94	228	8	0	3	0	11	1	0	38	0	39	50	278
1230-1330	31	122	16	0	169	0	123	5	0	128	297	2	0	2	0	4	1	1	23	0	25	29	326
1500-1600	23	155	8	1	187	1	113	1	0	115	302	5	0	5	0	10	3	0	28	0	31	41	343
1600-1700	16	159	2	0	177	0	94	8	0	102	279	9	0	7	0	16	7	1	38	0	46	62	341
1700-1800	28	166	7	1	202	1	87	2	1	91	293	1	0	0	0	1	1	0	27	0	28	29	322
<b>Totals</b>	197	881	64	5	1147	6	782	31	1	820	1967	26	1	19	0	46	16	3	209	0	228	274	2241

**Equivalent 12 & 24-hour Vehicle Volumes Including the Annual Average Daily Traffic (AADT) Factor**  
 Applicable to the Day and Month of the Turning Movement Count  
**Expansion factors are applied exclusively to standard weekday 8-hour turning movement counts**  
**conducted during the hours of 0700h - 1000h, 1130h - 1330h and 1500h - 1800h**

Equivalent 12-hour vehicle volumes. These volumes are calculated by multiplying the 8-hour totals by the 8 → 12 expansion factor of 1.39																							
Equ. 12 Hr	274	1225	89	7	1594	8	1087	43	1	1140	2734	36	1	26	0	64	22	4	291	0	317	381	3115
Average daily 12-hour vehicle volumes. These volumes are calculated by multiplying the equivalent 12-hour totals by the AADT factor of: 1.0																							
AADT 12-hr	274	1225	89	7	1594	8	1087	43	1	1140	2734	36	1	26	0	64	22	4	291	0	317	381	3115
24-Hour AADT. These volumes are calculated by multiplying the average daily 12-hour vehicle volumes by the 12 → 24 expansion factor of 1.31																							
AADT 24 Hr	359	1604	117	9	2089	11	1424	56	2	1493	3582	47	2	35	0	84	29	5	381	0	415	499	4081

#### AADT and expansion factors provided by the City of Ottawa

AM Peak Hour Factor →	0.79	<b>Highest Hourly Vehicle Volume Between 0700h &amp; 1000h</b>																					
AM Peak Hr	LT	ST	RT	UT	TOT	LT	ST	RT	UT	TOT	LT	ST	RT	UT	TOT	LT	ST	RT	UT	TOT	S.TOT	G.TOT	
0900-1000	24	80	10	0	114	2	124	3	0	129	243	0	0	1	0	1	1	0	13	0	14	15	258
OFF Peak Hour Factor →	0.91	<b>Highest Hourly Vehicle Volume Between 1130h &amp; 1330h</b>																					
OFF Peak Hr	LT	ST	RT	UT	TOT	LT	ST	RT	UT	TOT	LT	ST	RT	UT	TOT	LT	ST	RT	UT	TOT	S.TOT	G.TOT	
1215-1315	27	128	15	1	171	0	116	6	0	122	293	3	0	1	0	4	1	1	29	0	31	35	328
PM Peak Hour Factor →	0.78	<b>Highest Hourly Vehicle Volume Between 1500h &amp; 1800h</b>																					
PM Peak Hr	LT	ST	RT	UT	TOT	LT	ST	RT	UT	TOT	LT	ST	RT	UT	TOT	LT	ST	RT	UT	TOT	S.TOT	G.TOT	
1515-1615	22	177	8	1	208	1	117	3	0	121	329	7	0	8	0	15	7	0	37	0	44	59	388

**Comments:**  
 OC Transpo buses and school buses comprise the majority of the heavy vehicle traffic.

- Notes:**
- Includes all vehicle types except bicycles, electric bicycles, and electric scooters.
  - When expansion and AADT factors are applied, the results will differ slightly due to rounding.



# Transportation Services - Traffic Services

## Turning Movement Count - Study Results

### PRESTONE DR @ ST. JOSEPH BLVD

Survey Date: Tuesday, March 20, 2018

WO No: 37614

Start Time: 07:00

Device: Miovision

#### Full Study Diagram

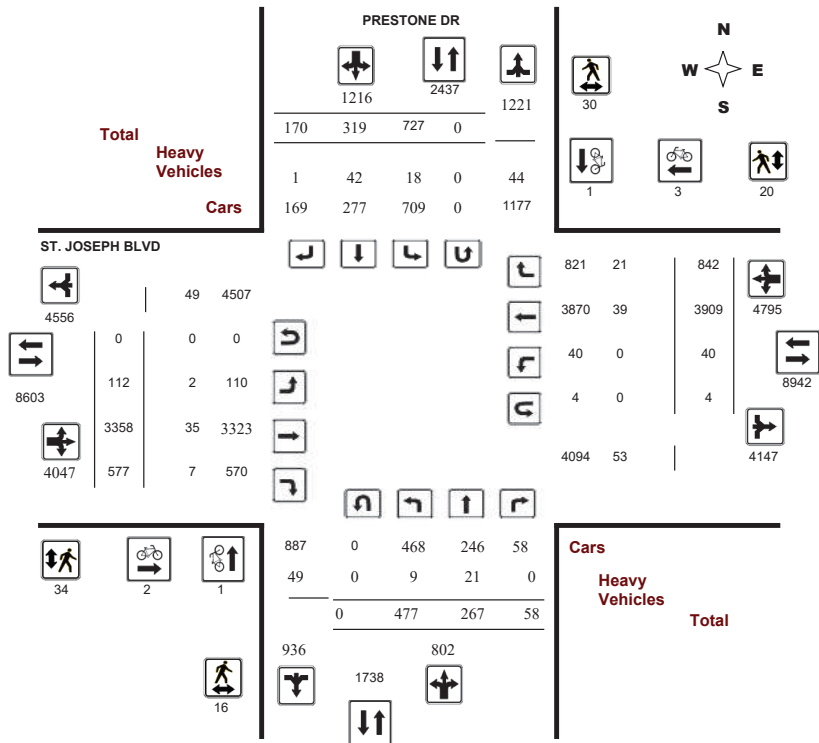

# Transportation Services - Traffic Services

## Turning Movement Count - Study Results

### PRESTONE DR @ ST. JOSEPH BLVD

Survey Date: Tuesday, March 20, 2018

WO No: 37614

Start Time: 07:00

Device: Miovision

#### Full Study Peak Hour Diagram

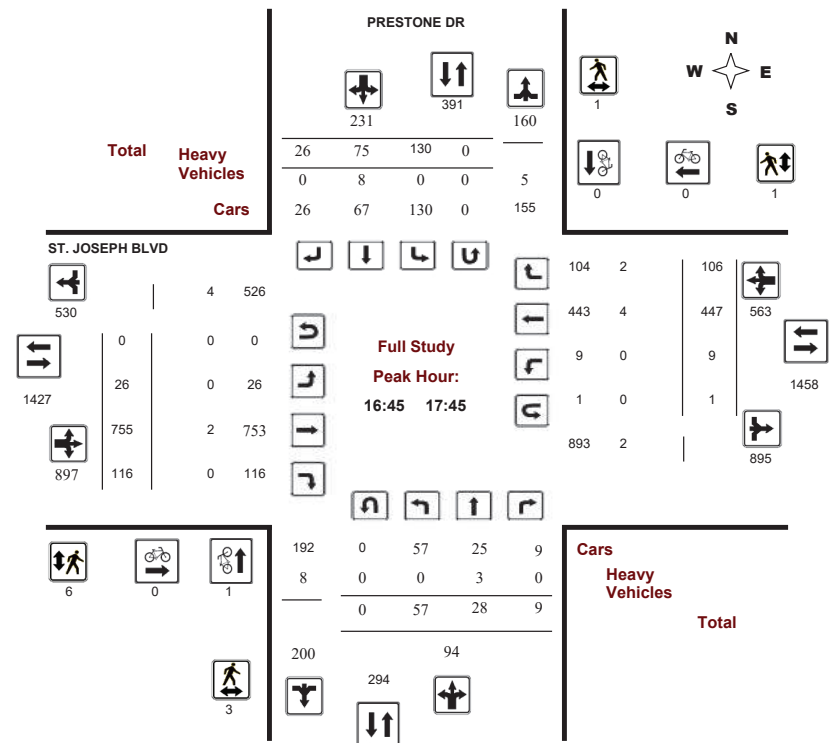



# Transportation Services - Traffic Services

## Turning Movement Count - Peak Hour Diagram

### PRESTONE DR @ ST. JOSEPH BLVD

Survey Date: Tuesday, March 20, 2018  
Start Time: 07:00

WO No: 37614  
Device: Miovision

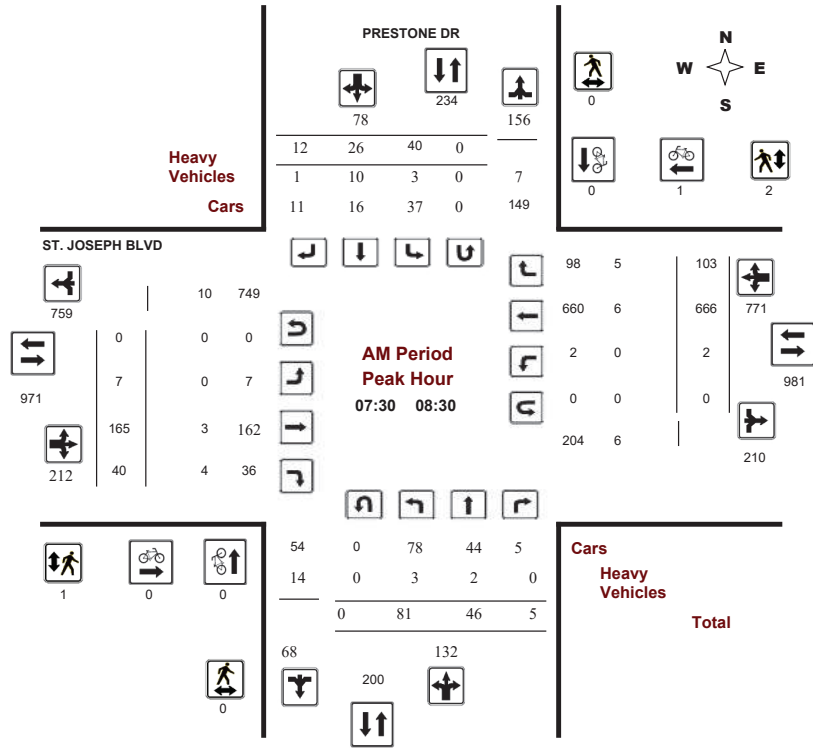

Comments



# Transportation Services - Traffic Services

## Turning Movement Count - Peak Hour Diagram

### PRESTONE DR @ ST. JOSEPH BLVD

Survey Date: Tuesday, March 20, 2018  
Start Time: 07:00

WO No: 37614  
Device: Miovision

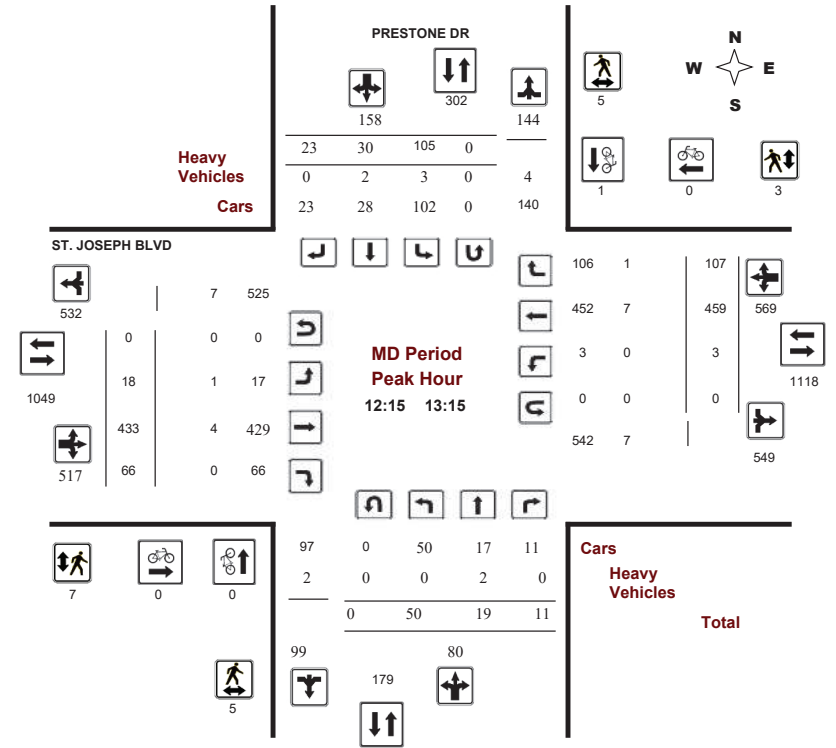

Comments



### Transportation Services - Traffic Services

#### Turning Movement Count - Peak Hour Diagram

#### PRESTONE DR @ ST. JOSEPH BLVD

Survey Date: Tuesday, March 20, 2018  
Start Time: 07:00

WO No: 37614  
Device: Miovision

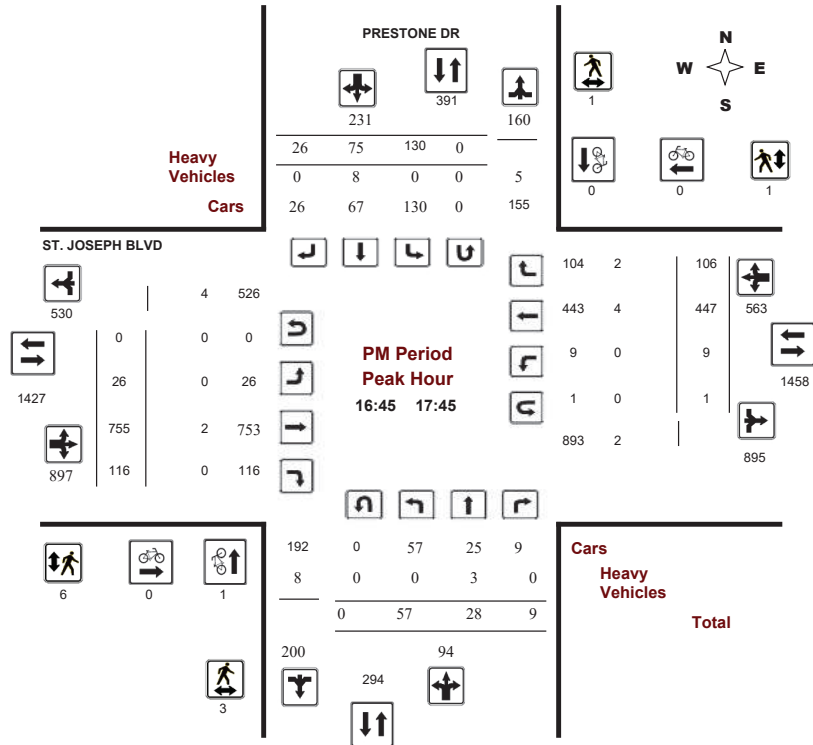

Comments



### Transportation Services - Traffic Services

#### Turning Movement Count - Study Results

#### PRESTONE DR @ ST. JOSEPH BLVD

Survey Date: Tuesday, March 20, 2018  
Start Time: 07:00

WO No: 37614  
Device: Miovision

#### Full Study Summary (8 HR Standard)

Survey Date: Tuesday, March 20, 2018

Total Observed U-Turns  
Northbound: 0 Southbound: 0  
Eastbound: 0 Westbound: 4

AADT Factor  
1.39

Period	PRESTONE DR								ST. JOSEPH BLVD								WB TOT	STR TOT	Grand Total	
	Northbound				Southbound				Eastbound				Westbound							
	LT	ST	RT	NB TOT	LT	ST	RT	SB TOT	LT	ST	RT	EB TOT	LT	ST	RT	WB TOT				
07:00-08:00	101	45	4	150	40	14	16	70	220	6	126	26	158	1	676	83	760	918	1138	
08:00-09:00	69	46	5	120	38	32	14	84	204	9	187	33	229	2	573	130	705	934	1138	
09:00-10:00	55	36	7	98	50	27	20	97	195	10	232	34	276	3	437	104	544	820	1015	
11:30-12:30	55	31	7	93	110	35	28	173	266	2	401	77	480	7	442	104	553	1033	1299	
12:30-13:30	55	17	13	85	91	28	25	144	229	22	422	54	498	3	463	107	573	1071	1300	
15:00-16:00	42	30	6	78	118	48	22	188	266	23	562	111	696	7	441	92	540	1236	1502	
16:00-17:00	44	29	4	77	157	71	24	252	329	16	712	127	855	10	416	111	537	1392	1721	
17:00-18:00	56	33	12	101	123	64	21	208	309	24	716	115	855	7	461	111	579	1434	1743	
<b>Sub Total</b>	<b>477</b>	<b>267</b>	<b>58</b>	<b>802</b>	<b>727</b>	<b>319</b>	<b>170</b>	<b>1216</b>	<b>2018</b>	<b>112</b>	<b>3358</b>	<b>577</b>	<b>4047</b>	<b>40</b>	<b>3909</b>	<b>842</b>	<b>4791</b>	<b>8838</b>	<b>10856</b>	
<b>U Turns</b>	<b>0</b>								<b>0</b>								<b>4</b>		<b>4</b>	<b>4</b>
<b>Total</b>	<b>477</b>	<b>267</b>	<b>58</b>	<b>802</b>	<b>727</b>	<b>319</b>	<b>170</b>	<b>1216</b>	<b>2018</b>	<b>112</b>	<b>3358</b>	<b>577</b>	<b>4047</b>	<b>40</b>	<b>3909</b>	<b>842</b>	<b>4795</b>	<b>8842</b>	<b>10860</b>	
<b>EQ 12Hr</b>	<b>663</b>	<b>371</b>	<b>81</b>	<b>1115</b>	<b>1011</b>	<b>443</b>	<b>236</b>	<b>1690</b>	<b>2805</b>	<b>156</b>	<b>4668</b>	<b>802</b>	<b>5625</b>	<b>56</b>	<b>5434</b>	<b>1170</b>	<b>6665</b>	<b>12290</b>	<b>15095</b>	
Note: These values are calculated by multiplying the totals by the appropriate expansion factor.														<b>1.39</b>						
<b>AVG 12Hr</b>	<b>663</b>	<b>371</b>	<b>81</b>	<b>1115</b>	<b>1011</b>	<b>443</b>	<b>236</b>	<b>1690</b>	<b>2805</b>	<b>156</b>	<b>4668</b>	<b>802</b>	<b>5625</b>	<b>56</b>	<b>5434</b>	<b>1170</b>	<b>6665</b>	<b>12290</b>	<b>15095</b>	
Note: These volumes are calculated by multiplying the Equivalent 12 hr. totals by the AADT factor.														<b>1</b>						
<b>AVG 24Hr</b>	<b>869</b>	<b>486</b>	<b>106</b>	<b>1460</b>	<b>1324</b>	<b>581</b>	<b>310</b>	<b>2214</b>	<b>3674</b>	<b>204</b>	<b>6115</b>	<b>1051</b>	<b>7369</b>	<b>73</b>	<b>7118</b>	<b>1533</b>	<b>8731</b>	<b>16100</b>	<b>19774</b>	
Note: These volumes are calculated by multiplying the Average Daily 12 hr. totals by 12 to 24 expansion factor.														<b>1.31</b>						
Note: U-Turns provided for approach totals. Refer to 'U-Turn' Report for specific breakdown.																				





Transportation Services - Traffic Services

Turning Movement Count - Study Results

PRESTONE DR @ ST. JOSEPH BLVD

Survey Date: Tuesday, March 20, 2018

WO No: 37614

Start Time: 07:00

Device: Miovision

Full Study 15 Minute Increments

PRESTONE DR ST. JOSEPH BLVD

Table with columns for Time Period, Northbound (LT, ST, RT, N TOT, STR TOT), Southbound (LT, ST, RT, S TOT, STR TOT), Eastbound (LT, ST, RT, E TOT), Westbound (LT, ST, RT, W TOT, STR TOT), and Grand Total. Rows represent 15-minute intervals from 07:00 to 18:00.

Note: U-Turns are included in Totals.



Transportation Services - Traffic Services

Turning Movement Count - Study Results

PRESTONE DR @ ST. JOSEPH BLVD

Survey Date: Tuesday, March 20, 2018

WO No: 37614

Start Time: 07:00

Device: Miovision

Full Study Cyclist Volume

PRESTONE DR ST. JOSEPH BLVD

Table with columns for Time Period, Northbound (Street Total), Southbound (Street Total), Eastbound (Street Total), Westbound (Street Total), and Grand Total. Rows represent 15-minute intervals from 07:00 to 18:00.



Transportation Services - Traffic Services

Turning Movement Count - Study Results

PRESTONE DR @ ST. JOSEPH BLVD

Survey Date: Tuesday, March 20, 2018

WO No: 37614

Start Time: 07:00

Device: Miovision

Full Study Pedestrian Volume

PRESTONE DR

ST. JOSEPH BLVD

Table with columns: Time Period, NB Approach (E or W Crossing), SB Approach (E or W Crossing), Total, EB Approach (N or S Crossing), WB Approach (N or S Crossing), Total, Grand Total. Rows show pedestrian counts from 07:00 to 18:00.



Transportation Services - Traffic Services

Turning Movement Count - Study Results

PRESTONE DR @ ST. JOSEPH BLVD

Survey Date: Tuesday, March 20, 2018

WO No: 37614

Start Time: 07:00

Device: Miovision

Full Study Heavy Vehicles

PRESTONE DR

ST. JOSEPH BLVD

Table with columns: Time Period, Northbound (LT, ST, RT, N TOT), Southbound (LT, ST, RT, S TOT, STR TOT), Eastbound (LT, ST, RT, E TOT), Westbound (LT, ST, RT, W TOT, STR TOT), Grand Total. Rows show heavy vehicle counts from 07:00 to 18:00.



Transportation Services - Traffic Services

Turning Movement Count - Study Results

PRESTONE DR @ ST. JOSEPH BLVD

Survey Date: Tuesday, March 20, 2018

WO No: 37614

Start Time: 07:00

Device: Miovision

Full Study 15 Minute U-Turn Total

PRESTONE DR

ST. JOSEPH BLVD

Time Period	Northbound U-Turn Total	Southbound U-Turn Total	Eastbound U-Turn Total	Westbound U-Turn Total	Total
07:00 07:15	0	0	0	0	0
07:15 07:30	0	0	0	0	0
07:30 07:45	0	0	0	0	0
07:45 08:00	0	0	0	0	0
08:00 08:15	0	0	0	0	0
08:15 08:30	0	0	0	0	0
08:30 08:45	0	0	0	0	0
08:45 09:00	0	0	0	0	0
09:00 09:15	0	0	0	1	1
09:15 09:30	0	0	0	0	0
09:30 09:45	0	0	0	0	0
09:45 10:00	0	0	0	0	0
11:30 11:45	0	0	0	0	0
11:45 12:00	0	0	0	0	0
12:00 12:15	0	0	0	0	0
12:15 12:30	0	0	0	0	0
12:30 12:45	0	0	0	0	0
12:45 13:00	0	0	0	0	0
13:00 13:15	0	0	0	0	0
13:15 13:30	0	0	0	0	0
15:00 15:15	0	0	0	0	0
15:15 15:30	0	0	0	0	0
15:30 15:45	0	0	0	0	0
15:45 16:00	0	0	0	1	1
16:00 16:15	0	0	0	0	0
16:15 16:30	0	0	0	0	0
16:30 16:45	0	0	0	1	1
16:45 17:00	0	0	0	0	0
17:00 17:15	0	0	0	0	0
17:15 17:30	0	0	0	1	1
17:30 17:45	0	0	0	0	0
17:45 18:00	0	0	0	0	0
Total	0	0	0	4	4

# Appendix C

Synchro Intersection Worksheets – Existing Conditions

Lanes, Volumes, Timings  
1: Place d'Orleans & Centrum

AM Peak Hour  
Existing

Lane Group	EBL	EBT	EBR	WBL	WBT	WBR	NBL	NBT	NBR	SBL	SBT	SBR
Lane Configurations	↔	↔	↔	↔	↔	↔	↔	↔	↔	↔	↔	↔
Traffic Volume (vph)	25	30	40	22	32	1	67	144	52	110	42	19
Future Volume (vph)	25	30	40	22	32	1	67	144	52	110	42	19
Satd. Flow (prot)	1566	1745	1401	1658	1721	0	0	3141	0	0	3025	0
Fit Permitted	0.733			0.736				0.840			0.682	
Satd. Flow (perm)	1200	1745	1375	1277	1721	0	0	2672	0	0	2129	0
Satd. Flow (RTOR)			44		1			57			21	
Lane Group Flow (vph)	28	33	44	24	37	0	0	292	0	0	190	0
Turn Type	Perm	NA	Perm	Perm	NA	Perm	NA	Perm	NA	Perm	NA	
Protected Phases	4			8			2	2		6		6
Permitted Phases	4		4	8			2			6		6
Detector Phase	4	4	4	8	8		2	2		6	6	
Switch Phase												
Minimum Initial (s)	10.0	10.0	10.0	10.0	10.0		10.0	10.0		10.0	10.0	
Minimum Split (s)	31.0	31.0	31.0	31.0	31.0		36.0	36.0		36.0	36.0	
Total Split (s)	32.0	32.0	32.0	32.0	32.0		43.0	43.0		43.0	43.0	
Total Split (%)	42.7%	42.7%	42.7%	42.7%	42.7%		57.3%	57.3%		57.3%	57.3%	
Yellow Time (s)	3.3	3.3	3.3	3.3	3.3		3.3	3.3		3.3	3.3	
All-Red Time (s)	2.7	2.7	2.7	2.7	2.7		2.7	2.7		2.7	2.7	
Lost Time Adjust (s)	0.0	0.0	0.0	0.0	0.0		0.0	0.0		0.0	0.0	
Total Lost Time (s)	6.0	6.0	6.0	6.0	6.0		6.0	6.0		6.0	6.0	
Lead/Lag												
Lead-Lag Optimize?												
Recall Mode	None	None	None	None	None		Max	Max		Max	Max	
Act Effct Green (s)	12.6	12.6	12.6	12.6	12.6		46.3	46.3		46.3	46.3	
Actuated g/C Ratio	0.20	0.20	0.20	0.20	0.20		0.75	0.75		0.75	0.75	
v/c Ratio	0.11	0.09	0.14	0.09	0.11		0.14	0.11		0.12	0.11	
Control Delay	20.2	19.6	7.6	19.7	19.4		4.8	5.4		4.8	5.4	
Queue Delay	0.0	0.0	0.0	0.0	0.0		0.0	0.0		0.0	0.0	
Total Delay	20.2	19.6	7.6	19.7	19.4		4.8	5.4		4.8	5.4	
LOS	C	B	A	B	B		A	A		A	A	
Approach Delay		14.7			19.5		4.8	5.4		4.8	5.4	
Approach LOS		B			B		A	A		A	A	
Queue Length 50th (m)	2.6	3.1	0.0	2.2	3.4		4.5	3.2		4.5	3.2	
Queue Length 95th (m)	7.8	8.5	6.1	7.0	9.1		15.3	11.6		15.3	11.6	
Internal Link Dist (m)		55.7			119.8		103.0	90.8		103.0	90.8	
Turn Bay Length (m)	52.0		20.0									
Base Capacity (vph)	510	743	610	543	733		2020	1603		2020	1603	
Starvation Cap Reductn	0	0	0	0	0		0	0		0	0	
Spillback Cap Reductn	0	0	0	0	0		0	0		0	0	
Storage Cap Reductn	0	0	0	0	0		0	0		0	0	
Reduced v/c Ratio	0.05	0.04	0.07	0.04	0.05		0.14	0.12		0.14	0.12	

Intersection Summary

Cycle Length: 75  
Actuated Cycle Length: 61.6  
Natural Cycle: 70  
Control Type: Actuated-Uncoordinated  
Maximum v/c Ratio: 0.14

Lanes, Volumes, Timings  
1: Place d'Orleans & Centrum

AM Peak Hour  
Existing

Intersection Signal Delay: 8.0 Intersection LOS: A  
Intersection Capacity Utilization 59.6% ICU Level of Service B  
Analysis Period (min) 15

Splits and Phases: 1: Place d'Orleans & Centrum

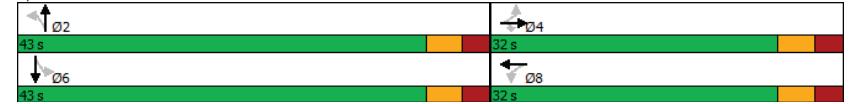

HCM 2010 TWSC  
2: Centrum & Brisebois W

AM Peak Hour  
Existing

Intersection												
Int Delay, s/veh	1.3											
Movement	EBL	EBT	EBR	WBL	WBT	WBR	NBL	NBT	NBR	SBL	SBT	SBR
Lane Configurations	↔			↔			↔			↔		
Traffic Vol, veh/h	24	80	10	2	124	3	0	0	1	1	0	13
Future Vol, veh/h	24	80	10	2	124	3	0	0	1	1	0	13
Conflicting Peds, #/hr	8	0	9	9	0	8	0	0	3	3	0	0
Sign Control	Free	Free	Free	Free	Free	Free	Stop	Stop	Stop	Stop	Stop	Stop
RT Channelized	-	-	None	-	-	None	-	-	None	-	-	None
Storage Length	-	-	-	-	-	-	-	-	-	-	-	-
Veh in Median Storage, #	-	0	-	-	0	-	-	0	-	-	0	-
Grade, %	-	0	-	-	0	-	-	0	-	-	0	-
Peak Hour Factor	90	90	90	90	90	90	90	90	90	90	90	90
Heavy Vehicles, %	2	5	2	2	3	2	2	2	100	2	2	2
Mvmt Flow	27	89	11	2	138	3	0	0	1	1	0	14
Major/Minor	Major1	Major2			Minor1			Minor2				
Conflicting Flow All	149	0	0	109	0	0	309	311	107	304	315	148
Stage 1	-	-	-	-	-	-	158	158	-	152	152	-
Stage 2	-	-	-	-	-	-	151	153	-	152	163	-
Critical Hdwy	4.12	-	-	4.12	-	-	7.12	6.52	7.2	7.12	6.52	6.22
Critical Hdwy Stg 1	-	-	-	-	-	-	6.12	5.52	-	6.12	5.52	-
Critical Hdwy Stg 2	-	-	-	-	-	-	6.12	5.52	-	6.12	5.52	-
Follow-up Hdwy	2.218	-	-	2.218	-	-	3.518	4.018	4.2	3.518	4.018	3.318
Pot Cap-1 Maneuver	1432	-	-	1481	-	-	643	604	736	648	601	899
Stage 1	-	-	-	-	-	-	844	767	-	850	772	-
Stage 2	-	-	-	-	-	-	851	771	-	850	763	-
Platoon blocked, %	-	-	-	-	-	-	-	-	-	-	-	-
Mov Cap-1 Maneuver	1423	-	-	1471	-	-	618	583	729	631	581	893
Mov Cap-2 Maneuver	-	-	-	-	-	-	618	583	-	631	581	-
Stage 1	-	-	-	-	-	-	821	746	-	828	767	-
Stage 2	-	-	-	-	-	-	836	766	-	830	742	-
Approach	EB	WB			NB			SB				
HCM Control Delay, s	1.6	0.1			9.9			9.2				
HCM LOS	A			A			A					
Minor Lane/Major Mvmt	NBLn1	EBL	EBT	EBR	WBL	WBT	WBR	SBLn1				
Capacity (veh/h)	729	1423	-	-	1471	-	-	867				
HCM Lane V/C Ratio	0.002	0.019	-	-	0.002	-	-	0.018				
HCM Control Delay (s)	9.9	7.6	0	-	7.5	0	-	9.2				
HCM Lane LOS	A	A	A	-	A	A	-	A				
HCM 95th %tile Q(veh)	0	0.1	-	-	0	-	-	0.1				

HCM 2010 AWSC  
3: Prestone & Centrum

AM Peak Hour  
Existing

Intersection						
Intersection Delay, s/veh	7.7					
Intersection LOS	A					
Movement	EBT	EBR	WBL	WBT	NBL	NBR
Lane Configurations	↔			↔	↔	↔
Traffic Vol, veh/h	20	41	39	18	55	36
Future Vol, veh/h	20	41	39	18	55	36
Peak Hour Factor	0.90	0.90	0.90	0.90	0.90	0.90
Heavy Vehicles, %	5	17	2	6	7	2
Mvmt Flow	22	46	43	20	61	40
Number of Lanes	1	0	0	1	1	1
Approach	EB	WB		NB		
Opposing Approach	WB	EB				
Opposing Lanes	1	1		0		
Conflicting Approach Left		NB		EB		
Conflicting Lanes Left	0	2		1		
Conflicting Approach Right	NB			WB		
Conflicting Lanes Right	2	0		1		
HCM Control Delay	7.2	7.8		8		
HCM LOS	A	A		A		
Lane	NBLn1	NBLn2	EBLn1	WBLn1		
Vol Left, %	100%	0%	0%	68%		
Vol Thru, %	0%	0%	33%	32%		
Vol Right, %	0%	100%	67%	0%		
Sign Control	Stop	Stop	Stop	Stop		
Traffic Vol by Lane	55	36	61	57		
LT Vol	55	0	0	39		
Through Vol	0	0	20	18		
RT Vol	0	36	41	0		
Lane Flow Rate	61	40	68	63		
Geometry Grp	7	7	2	2		
Degree of Util (X)	0.091	0.045	0.074	0.076		
Departure Headway (Hd)	5.345	4.058	3.906	4.295		
Convergence, Y/N	Yes	Yes	Yes	Yes		
Cap	666	874	922	820		
Service Time	3.111	1.823	1.906	2.394		
HCM Lane V/C Ratio	0.092	0.046	0.074	0.077		
HCM Control Delay	8.7	7	7.2	7.8		
HCM Lane LOS	A	A	A	A		
HCM 95th %tile Q	0.3	0.1	0.2	0.2		

HCM 2010 TWSC  
4: Centrum & Brisebois E

AM Peak Hour  
Existing

Intersection						
Int Delay, s/veh	2					
Movement	EBL	EBT	WBT	WBR	SBL	SBR
Lane Configurations		↕	↕		↕	↕
Traffic Vol, veh/h	11	19	26	1	0	5
Future Vol, veh/h	11	19	26	1	0	5
Conflicting Peds, #/hr	0	0	0	0	0	0
Sign Control	Free	Free	Free	Free	Stop	Stop
RT Channelized	-	None	-	None	-	None
Storage Length	-	-	-	-	0	-
Veh in Median Storage, #	-	0	0	-	0	-
Grade, %	-	0	0	-	0	-
Peak Hour Factor	90	90	90	90	90	90
Heavy Vehicles, %	9	2	2	2	2	20
Mvmt Flow	12	21	29	1	0	6
Major/Minor	Major1	Major2	Minor2			
Conflicting Flow All	30	0	0	75	30	
Stage 1	-	-	-	30	-	
Stage 2	-	-	-	45	-	
Critical Hdwy	4.19	-	-	6.42	6.4	
Critical Hdwy Stg 1	-	-	-	5.42	-	
Critical Hdwy Stg 2	-	-	-	5.42	-	
Follow-up Hdwy	2.281	-	-	3.518	3.48	
Pot Cap-1 Maneuver	1539	-	-	928	995	
Stage 1	-	-	-	993	-	
Stage 2	-	-	-	977	-	
Platoon blocked, %	-	-	-	-	-	
Mov Cap-1 Maneuver	1539	-	-	921	995	
Mov Cap-2 Maneuver	-	-	-	921	-	
Stage 1	-	-	-	985	-	
Stage 2	-	-	-	977	-	
Approach	EB	WB	SB			
HCM Control Delay, s	2.7	0	8.6			
HCM LOS			A			
Minor Lane/Major Mvmt	EBL	EBT	WBT	WBR	SBLn1	
Capacity (veh/h)	1539	-	-	-	995	
HCM Lane V/C Ratio	0.008	-	-	-	0.006	
HCM Control Delay (s)	7.4	0	-	-	8.6	
HCM Lane LOS	A	A	-	-	A	
HCM 95th %tile Q(veh)	0	-	-	-	0	

Lanes, Volumes, Timings  
5: Prestone & St Joseph

AM Peak Hour  
Existing

Lane Group	EBL	EBT	EBR	WBL	WBT	WBR	NBL	NBT	NBR	SBL	SBT	SBR
Lane Configurations	↕	↕	↕	↕	↕	↕	↕	↕	↕	↕	↕	↕
Traffic Volume (vph)	7	165	40	2	666	103	81	46	5	40	26	12
Future Volume (vph)	7	165	40	2	666	103	81	46	5	40	26	12
Satd. Flow (prot)	1658	3316	1375	1658	3316	1441	1626	1685	0	1566	1314	0
Fit Permitted	0.288			0.636			0.730			0.720		
Satd. Flow (perm)	503	3316	1375	1110	3316	1423	1248	1685	0	1184	1314	0
Satd. Flow (RTOR)			44			114		6			13	
Lane Group Flow (vph)	8	183	44	2	740	114	90	57	0	44	42	0
Turn Type	Perm	NA	Perm	Perm	NA	Perm	Perm	NA		Perm	NA	
Protected Phases		2			6			8			4	
Permitted Phases	2		2	6		6	8			4		
Detector Phase	2	2	2	6	6	6	8	8		4	4	
Switch Phase												
Minimum Initial (s)	10.0	10.0	10.0	10.0	10.0	10.0	10.0	10.0		10.0	10.0	
Minimum Split (s)	23.7	23.7	23.7	23.7	23.7	23.7	29.0	29.0		29.0	29.0	
Total Split (s)	51.0	51.0	51.0	51.0	51.0	51.0	29.0	29.0		29.0	29.0	
Total Split (%)	63.8%	63.8%	63.8%	63.8%	63.8%	63.8%	36.3%	36.3%		36.3%	36.3%	
Yellow Time (s)	3.3	3.3	3.3	3.3	3.3	3.3	3.3	3.3		3.3	3.3	
All-Red Time (s)	2.4	2.4	2.4	2.4	2.4	2.4	2.7	2.7		2.7	2.7	
Lost Time Adjust (s)	0.0	0.0	0.0	0.0	0.0	0.0	0.0	0.0		0.0	0.0	
Total Lost Time (s)	5.7	5.7	5.7	5.7	5.7	5.7	6.0	6.0		6.0	6.0	
Lead/Lag												
Lead-Lag Optimize?												
Recall Mode	None	None	None	None	None	None	Max	Max		Max	Max	
Act Effct Green (s)	17.5	17.5	17.5	17.5	17.5	17.5	23.1	23.1		23.1	23.1	
Actuated g/C Ratio	0.33	0.33	0.33	0.33	0.33	0.33	0.44	0.44		0.44	0.44	
v/c Ratio	0.05	0.17	0.09	0.01	0.67	0.21	0.16	0.08		0.08	0.07	
Control Delay	11.9	12.2	4.7	11.0	18.0	3.9	11.3	9.6		10.7	8.3	
Queue Delay	0.0	0.0	0.0	0.0	0.0	0.0	0.0	0.0		0.0	0.0	
Total Delay	11.9	12.2	4.7	11.0	18.0	3.9	11.3	9.6		10.7	8.3	
LOS	B	B	A	B	B	A	B	A		B	A	
Approach Delay		10.8			16.1			10.6			9.5	
Approach LOS		B			B			B			A	
Queue Length 50th (m)	0.5	6.2	0.0	0.1	30.3	0.0	4.7	2.6		2.2	1.4	
Queue Length 95th (m)	2.6	11.3	4.7	1.1	44.4	7.4	14.1	9.0		8.2	6.8	
Internal Link Dist (m)		163.5			149.6			92.4			92.1	
Turn Bay Length (m)	50.0		105.0	62.5		120.0	47.5					
Base Capacity (vph)	437	2883	1201	965	2883	1252	550	747		522	587	
Starvation Cap Reductn	0	0	0	0	0	0	0	0		0	0	
Spillback Cap Reductn	0	0	0	0	0	0	0	0		0	0	
Storage Cap Reductn	0	0	0	0	0	0	0	0		0	0	
Reduced v/c Ratio	0.02	0.06	0.04	0.00	0.26	0.09	0.16	0.08		0.08	0.07	

Intersection Summary												
Cycle Length: 80												
Actuated Cycle Length: 52.4												
Natural Cycle: 55												
Control Type: Actuated-Uncoordinated												
Maximum v/c Ratio: 0.67												

Lanes, Volumes, Timings  
5: Prestone & St Joseph

AM Peak Hour  
Existing

Intersection Signal Delay: 14.1	Intersection LOS: B
Intersection Capacity Utilization 50.3%	ICU Level of Service A
Analysis Period (min) 15	

Splits and Phases: 5: Prestone & St Joseph

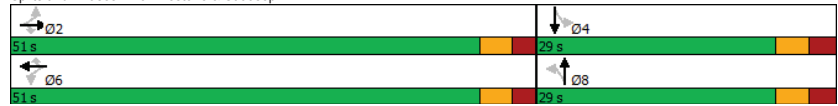

Lanes, Volumes, Timings  
1: Place d'Orleans & Centrum

PM Peak Hour  
Existing

Lane Group	EBL	EBT	EBR	WBL	WBT	WBR	NBL	NBT	NBR	SBL	SBT	SBR
Lane Configurations	↔	↕	↗	↖	↖	↗	↕	↕	↗	↖	↖	↗
Traffic Volume (vph)	94	56	220	41	45	0	102	153	65	108	130	42
Future Volume (vph)	94	56	220	41	45	0	102	153	65	108	130	42
Satd. Flow (prot)	1658	1745	1483	1658	1745	0	0	3104	0	0	3100	0
Fit Permitted	0.724			0.717				0.751			0.711	
Satd. Flow (perm)	1247	1745	1448	1237	1745	0	0	2366	0	0	2243	0
Satd. Flow (RTOR)			244					59			38	
Lane Group Flow (vph)	104	62	244	46	50	0	0	355	0	0	311	0
Turn Type	Perm	NA	Perm	Perm	NA		Perm	NA		Perm	NA	
Protected Phases		4			8			2			6	
Permitted Phases	4		4	8			2			6		
Detector Phase	4	4	4	8	8		2	2		6	6	
Switch Phase												
Minimum Initial (s)	10.0	10.0	10.0	10.0	10.0		10.0	10.0		10.0	10.0	
Minimum Split (s)	31.0	31.0	31.0	31.0	31.0		36.0	36.0		36.0	36.0	
Total Split (s)	32.0	32.0	32.0	32.0	32.0		53.0	53.0		53.0	53.0	
Total Split (%)	37.6%	37.6%	37.6%	37.6%	37.6%		62.4%	62.4%		62.4%	62.4%	
Yellow Time (s)	3.3	3.3	3.3	3.3	3.3		3.3	3.3		3.3	3.3	
All-Red Time (s)	2.7	2.7	2.7	2.7	2.7		2.7	2.7		2.7	2.7	
Lost Time Adjust (s)	0.0	0.0	0.0	0.0	0.0		0.0	0.0		0.0	0.0	
Total Lost Time (s)	6.0	6.0	6.0	6.0	6.0		6.0	6.0		6.0	6.0	
Lead/Lag												
Lead-Lag Optimize?												
Recall Mode	None	None	None	None	None		C-Max	C-Max		C-Max	C-Max	
Act Effct Green (s)	14.4	14.4	14.4	14.4	14.4		58.6	58.6		58.6	58.6	
Actuated g/C Ratio	0.17	0.17	0.17	0.17	0.17		0.69	0.69		0.69	0.69	
v/c Ratio	0.49	0.21	0.54	0.22	0.17		0.22	0.20		0.20	0.20	
Control Delay	38.4	29.7	8.5	30.4	28.9		5.2	5.4		5.4	5.4	
Queue Delay	0.0	0.0	0.0	0.0	0.0		0.0	0.0		0.0	0.0	
Total Delay	38.4	29.7	8.5	30.4	28.9		5.2	5.4		5.4	5.4	
LOS	D	C	A	C	C		A	A		A	A	
Approach Delay		19.3			29.6		5.2	5.4		5.4	5.4	
Approach LOS		B			C		A	A		A	A	
Queue Length 50th (m)	16.0	9.0	0.0	6.7	7.3		6.9	6.3		6.3	6.3	
Queue Length 95th (m)	25.9	16.1	15.7	13.3	13.8		18.7	17.4		17.4	17.4	
Internal Link Dist (m)		55.7			119.8		103.0	90.8		90.8	90.8	
Turn Bay Length (m)	52.0		20.0									
Base Capacity (vph)	381	533	612	378	533		1648	1557		1557	1557	
Starvation Cap Reductn	0	0	0	0	0		0	0		0	0	
Spillback Cap Reductn	0	0	0	0	0		0	0		0	0	
Storage Cap Reductn	0	0	0	0	0		0	0		0	0	
Reduced v/c Ratio	0.27	0.12	0.40	0.12	0.09		0.22	0.20		0.20	0.20	

Intersection Summary

Cycle Length: 85
Actuated Cycle Length: 85
Offset: 0 (0%), Referenced to phase 2:NBTL and 6:SBTL, Start of Green
Natural Cycle: 70
Control Type: Actuated-Coordinated



Lanes, Volumes, Timings  
1: Place d'Orleans & Centrum

PM Peak Hour  
Existing

Maximum v/c Ratio: 0.54	Intersection LOS: B
Intersection Signal Delay: 12.2	ICU Level of Service D
Intersection Capacity Utilization 80.0%	
Analysis Period (min) 15	

Splits and Phases: 1: Place d'Orleans & Centrum

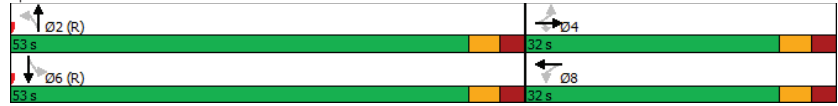

HCM 2010 TWSC  
2: Centrum & Brisebois W

PM Peak Hour  
Existing

Intersection												
Int Delay, s/veh	2											

Movement	EBL	EBT	EBR	WBL	WBT	WBR	NBL	NBT	NBR	SBL	SBT	SBR
Lane Configurations	↔			↔			↔			↔		
Traffic Vol, veh/h	23	177	8	1	117	3	7	0	8	7	0	37
Future Vol, veh/h	23	177	8	1	117	3	7	0	8	7	0	37
Conflicting Peds, #/hr	23	0	19	19	0	23	3	0	6	6	0	3
Sign Control	Free	Free	Free	Free	Free	Free	Stop	Stop	Stop	Stop	Stop	Stop
RT Channelized	-	-	None	-	-	None	-	-	None	-	-	None
Storage Length	-	-	-	-	-	-	-	-	-	-	-	-
Veh in Median Storage, #	-	0	-	-	0	-	-	0	-	-	0	-
Grade, %	-	0	-	-	0	-	-	0	-	-	0	-
Peak Hour Factor	90	90	90	90	90	90	90	90	90	90	90	90
Heavy Vehicles, %	2	3	2	2	5	2	2	2	2	2	2	2
Mvmt Flow	26	197	9	1	130	3	8	0	9	8	0	41

Major/Minor	Major1			Major2			Minor1			Minor2		
Conflicting Flow All	156	0	0	225	0	0	430	431	227	421	434	158
Stage 1	-	-	-	-	-	-	273	273	-	157	157	-
Stage 2	-	-	-	-	-	-	157	158	-	264	277	-
Critical Hdwy	4.12	-	-	4.12	-	-	7.12	6.52	6.22	7.12	6.52	6.22
Critical Hdwy Stg 1	-	-	-	-	-	-	6.12	5.52	-	6.12	5.52	-
Critical Hdwy Stg 2	-	-	-	-	-	-	6.12	5.52	-	6.12	5.52	-
Follow-up Hdwy	2,218	-	-	2,218	-	-	3,518	4,018	3,318	3,518	4,018	3,318
Pot Cap-1 Maneuver	1424	-	-	1344	-	-	535	517	812	543	515	887
Stage 1	-	-	-	-	-	-	733	684	-	845	768	-
Stage 2	-	-	-	-	-	-	845	767	-	741	681	-
Platoon blocked, %	-	-	-	-	-	-	-	-	-	-	-	-
Mov Cap-1 Maneuver	1399	-	-	1324	-	-	493	489	796	516	487	869
Mov Cap-2 Maneuver	-	-	-	-	-	-	493	489	-	516	487	-
Stage 1	-	-	-	-	-	-	707	659	-	813	753	-
Stage 2	-	-	-	-	-	-	802	752	-	714	656	-

Approach	EB	WB	NB	SB
HCM Control Delay, s	0.8	0.1	11	9.9
HCM LOS			B	A

Minor Lane/Major Mvmt	NBLn1	EBL	EBT	EBR	WBL	WBT	WBR	SBLn1
Capacity (veh/h)	619	1399	-	-	1324	-	-	784
HCM Lane V/C Ratio	0.027	0.018	-	-	0.001	-	-	0.062
HCM Control Delay (s)	11	7.6	0	-	7.7	0	-	9.9
HCM Lane LOS	B	A	A	-	A	A	-	A
HCM 95th %tile Q(veh)	0.1	0.1	-	-	0	-	-	0.2

HCM 2010 AWSC  
3: Prestone & Centrum

PM Peak Hour  
Existing

Intersection						
Intersection Delay, s/veh	8.1					
Intersection LOS	A					
Movement						
	EBT	EBR	WBL	WBT	NBL	NBR
Lane Configurations	↔	↔	↔	↔	↔	↔
Traffic Vol, veh/h	39	108	53	18	72	37
Future Vol, veh/h	39	108	53	18	72	37
Peak Hour Factor	0.90	0.90	0.90	0.90	0.90	0.90
Heavy Vehicles, %	2	6	2	2	11	2
Mvmt Flow	43	120	59	20	80	41
Number of Lanes	1	0	0	1	1	1
Approach						
	EB	WB		NB		
Opposing Approach	WB	EB				
Opposing Lanes	1	1		0		
Conflicting Approach Left		NB		EB		
Conflicting Lanes Left	0	2		1		
Conflicting Approach Right	NB			WB		
Conflicting Lanes Right	2	0		1		
HCM Control Delay	7.8	8.1		8.6		
HCM LOS	A	A		A		
Lane						
	NBLn1	NBLn2	EBLn1	WBLn1		
Vol Left, %	100%	0%	0%	75%		
Vol Thru, %	0%	0%	27%	25%		
Vol Right, %	0%	100%	73%	0%		
Sign Control	Stop	Stop	Stop	Stop		
Traffic Vol by Lane	72	37	147	71		
LT Vol	72	0	0	53		
Through Vol	0	0	39	18		
RT Vol	0	37	108	0		
Lane Flow Rate	80	41	163	79		
Geometry Grp	7	7	2	2		
Degree of Util (X)	0.127	0.05	0.177	0.1		
Departure Headway (Hd)	5.705	4.363	3.905	4.565		
Convergence, Y/N	Yes	Yes	Yes	Yes		
Cap	630	826	921	788		
Service Time	3.422	2.063	1.915	2.577		
HCM Lane V/C Ratio	0.127	0.05	0.177	0.1		
HCM Control Delay	9.3	7.3	7.8	8.1		
HCM Lane LOS	A	A	A	A		
HCM 95th-tile Q	0.4	0.2	0.6	0.3		

HCM 2010 TWSC  
4: Centrum & Brisebois E

PM Peak Hour  
Existing

Intersection						
Int Delay, s/veh	1.7					
Movement						
	EBL	EBT	WBT	WBR	SBL	SBR
Lane Configurations		↔	↔	↔	↔	↔
Traffic Vol, veh/h	8	48	39	0	0	16
Future Vol, veh/h	8	48	39	0	0	16
Conflicting Peds, #/hr	0	0	0	0	0	0
Sign Control	Free	Free	Free	Free	Stop	Stop
RT Channelized	-	None	-	None	-	None
Storage Length	-	-	-	-	0	-
Veh in Median Storage, #	-	0	0	-	0	-
Grade, %	-	0	0	-	0	-
Peak Hour Factor	90	90	90	90	90	90
Heavy Vehicles, %	2	2	2	2	2	2
Mvmt Flow	9	53	43	0	0	18
Major/Minor						
	Major1	Major2		Minor2		
Conflicting Flow All	43	0	-	0	114	43
Stage 1	-	-	-	-	43	-
Stage 2	-	-	-	-	71	-
Critical Hdwy	4.12	-	-	-	6.42	6.22
Critical Hdwy Stg 1	-	-	-	-	5.42	-
Critical Hdwy Stg 2	-	-	-	-	5.42	-
Follow-up Hdwy	2,218	-	-	-	3,518	3,318
Pot Cap-1 Maneuver	1566	-	-	-	882	1027
Stage 1	-	-	-	-	979	-
Stage 2	-	-	-	-	952	-
Platoon blocked, %	-	-	-	-	-	-
Mov Cap-1 Maneuver	1566	-	-	-	877	1027
Mov Cap-2 Maneuver	-	-	-	-	877	-
Stage 1	-	-	-	-	973	-
Stage 2	-	-	-	-	952	-
Approach						
	EB	WB		SB		
HCM Control Delay, s	1	0		8.6		
HCM LOS				A		
Minor Lane/Major Mvmt						
	EBL	EBT	WBT	WBR	SBLn1	
Capacity (veh/h)	1566	-	-	-	-	1027
HCM Lane V/C Ratio	0.006	-	-	-	-	0.017
HCM Control Delay (s)	7.3	0	-	-	-	8.6
HCM Lane LOS	A	A	-	-	-	A
HCM 95th %tile Q(veh)	0	-	-	-	-	0.1

Lanes, Volumes, Timings  
5: Prestone & St Joseph

PM Peak Hour  
Existing

Lane Group	EBL	EBT	EBR	WBL	WBT	WBR	NBL	NBT	NBR	SBL	SBT	SBR
Lane Configurations	↔	↕	↕	↕	↕	↕	↕	↕	↕	↕	↕	↕
Traffic Volume (vph)	26	755	116	10	447	106	57	28	9	130	75	26
Future Volume (vph)	26	755	116	10	447	106	57	28	9	130	75	26
Satd. Flow (prot)	1658	3316	1483	1658	3316	1483	1658	1570	0	1658	1567	0
Fit Permitted	0.470			0.317			0.685			0.730		
Satd. Flow (perm)	820	3316	1444	552	3316	1464	1189	1570	0	1273	1567	0
Satd. Flow (RTOR)			129				118		10			22
Lane Group Flow (vph)	29	839	129	11	497	118	63	41	0	144	112	0
Turn Type	Perm	NA	Perm	Perm	NA	Perm	Perm	NA	NA	Perm	NA	
Protected Phases		2			6		8		8		4	
Permitted Phases	2		2	6		6	8			4		
Detector Phase	2	2	2	6	6	6	8	8		4	4	
Switch Phase												
Minimum Initial (s)	10.0	10.0	10.0	10.0	10.0	10.0	10.0	10.0		10.0	10.0	
Minimum Split (s)	23.7	23.7	23.7	23.7	23.7	23.7	29.0	29.0		29.0	29.0	
Total Split (s)	51.0	51.0	51.0	51.0	51.0	51.0	29.0	29.0		29.0	29.0	
Total Split (%)	63.8%	63.8%	63.8%	63.8%	63.8%	63.8%	36.3%	36.3%		36.3%	36.3%	
Yellow Time (s)	3.3	3.3	3.3	3.3	3.3	3.3	3.3	3.3		3.3	3.3	
All-Red Time (s)	2.4	2.4	2.4	2.4	2.4	2.4	2.7	2.7		2.7	2.7	
Lost Time Adjust (s)	0.0	0.0	0.0	0.0	0.0	0.0	0.0	0.0		0.0	0.0	
Total Lost Time (s)	5.7	5.7	5.7	5.7	5.7	5.7	6.0	6.0		6.0	6.0	
Lead/Lag												
Lead-Lag Optimize?												
Recall Mode	Max	Max	Max	Max	Max	Max	None	None		None	None	
Act Effct Green (s)	48.3	48.3	48.3	48.3	48.3	48.3	14.4	14.4		14.4	14.4	
Actuated g/C Ratio	0.65	0.65	0.65	0.65	0.65	0.65	0.19	0.19		0.19	0.19	
v/c Ratio	0.05	0.39	0.13	0.03	0.23	0.12	0.28	0.13		0.59	0.35	
Control Delay	6.7	7.5	1.9	6.9	6.4	1.9	26.7	19.2		36.1	22.2	
Queue Delay	0.0	0.0	0.0	0.0	0.0	0.0	0.0	0.0		0.0	0.0	
Total Delay	6.7	7.5	1.9	6.9	6.4	1.9	26.7	19.2		36.1	22.2	
LOS	A	A	A	A	A	A	C	B		D	C	
Approach Delay		6.8			5.6			23.7			30.0	
Approach LOS		A			A			C			C	
Queue Length 50th (m)	1.2	23.3	0.0	0.5	12.1	0.0	7.2	3.4		17.5	10.3	
Queue Length 95th (m)	5.3	48.6	6.5	2.8	26.7	6.2	16.5	10.4		33.2	22.5	
Internal Link Dist (m)		163.5			149.6			92.4			92.1	
Turn Bay Length (m)	50.0		105.0	62.5		120.0	47.5					
Base Capacity (vph)	531	2150	981	357	2150	990	369	494		395	502	
Starvation Cap Reductn	0	0	0	0	0	0	0	0		0	0	
Spillback Cap Reductn	0	0	0	0	0	0	0	0		0	0	
Storage Cap Reductn	0	0	0	0	0	0	0	0		0	0	
Reduced v/c Ratio	0.05	0.39	0.13	0.03	0.23	0.12	0.17	0.08		0.36	0.22	

Intersection Summary	
Cycle Length:	80
Actuated Cycle Length:	74.4
Natural Cycle:	55
Control Type:	Actuated-Uncoordinated
Maximum v/c Ratio:	0.59

Lanes, Volumes, Timings  
5: Prestone & St Joseph

PM Peak Hour  
Existing

Intersection Signal Delay: 10.3	Intersection LOS: B
Intersection Capacity Utilization 48.1%	ICU Level of Service A
Analysis Period (min) 15	

Splits and Phases: 5: Prestone & St Joseph



# Appendix D

Collision Data

Accident Date	Accident Year	Accident Time	Location	Environment Condition	Light	Traffic Control	Traffic Control Condition	Classification Of Accident	Initial Impact Type	Road Surface Condition	# Vehicles	# Motorcycles	# Bicycles	# Pedestrians
1/13/2016	2016	14:50	CENTRUM BLVD @ PRESTONE DR (0012922)	03 - Snow	01 - Daylight	02 - Stop sign	01 - Functioning	02 - Non-fatal injury	07 - SMV other	03 - Loose snow	1	0	0	1
2/2/2019	2019	16:11	CENTRUM BLVD @ PRESTONE DR (0012922)	03 - Snow	01 - Daylight	02 - Stop sign	01 - Functioning	03 - P.D. only	03 - Rear end	05 - Packed snow	2	0	0	0
3/10/2016	2016	15:18	CENTRUM BLVD btwn PLACE D'ORLEANS DR & PRESTONE DR ( _32AS2B)	01 - Clear	01 - Daylight	10 - No control	0	03 - P.D. only	04 - Sideswipe	01 - Dry	2	0	0	0
10/10/2018	2018	12:22	CENTRUM BLVD btwn PLACE D'ORLEANS DR & PRESTONE DR ( _32AS2B)	01 - Clear	01 - Daylight	10 - No control	0	02 - Non-fatal injury	07 - SMV other	01 - Dry	1	0	0	0
11/12/2019	2019	10:30	CENTRUM BLVD btwn PLACE D'ORLEANS DR & PRESTONE DR ( _32AS2B)	03 - Snow	01 - Daylight	10 - No control	0	03 - P.D. only	02 - Angle	03 - Loose snow	2	0	0	0
12/4/2019	2019	11:46	CENTRUM BLVD btwn PLACE D'ORLEANS DR & PRESTONE DR ( _32AS2B)	04 - Freezing Rain	01 - Daylight	10 - No control	0	03 - P.D. only	02 - Angle	03 - Loose snow	2	0	0	0
2/5/2020	2020	9:35	CENTRUM BLVD btwn PLACE D'ORLEANS DR & PRESTONE DR ( _32AS2B)	01 - Clear	01 - Daylight	10 - No control	0	03 - P.D. only	01 - Approaching	01 - Dry	2	0	0	0
4/6/2016	2016	18:25	PLACE D'ORLEANS @ CENTRUM BLVD/PLACE D'ORLEANS (0004167)	03 - Snow	01 - Daylight	01 - Traffic signal	01 - Functioning	03 - P.D. only	03 - Rear end	03 - Loose snow	2	0	0	0
5/31/2016	2016	11:42	PLACE D'ORLEANS @ CENTRUM BLVD/PLACE D'ORLEANS (0004167)	01 - Clear	01 - Daylight	01 - Traffic signal	01 - Functioning	03 - P.D. only	07 - SMV other	01 - Dry	1	0	0	1
9/28/2018	2018	11:54	PLACE D'ORLEANS @ CENTRUM BLVD/PLACE D'ORLEANS (0004167)	01 - Clear	01 - Daylight	01 - Traffic signal	01 - Functioning	03 - P.D. only	02 - Angle	01 - Dry	2	0	0	0
3/27/2018	2018	12:30	PLACE D'ORLEANS @ CENTRUM BLVD/PLACE D'ORLEANS (0004167)	01 - Clear	01 - Daylight	01 - Traffic signal	01 - Functioning	03 - P.D. only	05 - Turning movement	01 - Dry	2	0	0	0
1/15/2018	2018	11:58	PLACE D'ORLEANS @ CENTRUM BLVD/PLACE D'ORLEANS (0004167)	01 - Clear	01 - Daylight	01 - Traffic signal	01 - Functioning	03 - P.D. only	02 - Angle	05 - Packed snow	2	0	0	0
1/31/2019	2019	13:44	PLACE D'ORLEANS @ CENTRUM BLVD/PLACE D'ORLEANS (0004167)	01 - Clear	01 - Daylight	01 - Traffic signal	01 - Functioning	03 - P.D. only	02 - Angle	01 - Dry	2	0	0	0
8/29/2016	2016	12:11	PLACE D'ORLEANS DR btwn TURN LANE & CENTRUM BLVD ( _3ZBP94)	01 - Clear	01 - Daylight	10 - No control	0	03 - P.D. only	04 - Sideswipe	01 - Dry	2	0	0	0
8/30/2016	2016	21:55	PLACE D'ORLEANS DR btwn CENTRUM BLVD & ST. JOSEPH BLVD ( _3ZA2FM)	01 - Clear	07 - Dark	10 - No control	0	02 - Non-fatal injury	05 - Turning movement	01 - Dry	2	1	0	0
1/28/2017	2017	18:36	PLACE D'ORLEANS DR btwn CENTRUM BLVD & ST. JOSEPH BLVD ( _3ZA2FM)	01 - Clear	07 - Dark	10 - No control	0	03 - P.D. only	05 - Turning movement	02 - Wet	2	0	0	0
11/1/2018	2018	7:11	PLACE D'ORLEANS DR btwn CENTRUM BLVD & ST. JOSEPH BLVD ( _3ZA2FM)	07 - Fog, mist, smoke, dust	03 - Dawn	10 - No control	0	02 - Non-fatal injury	07 - SMV other	01 - Dry	1	0	0	0
3/25/2018	2018	23:11	PLACE D'ORLEANS DR btwn CENTRUM BLVD & ST. JOSEPH BLVD ( _3ZA2FM)	01 - Clear	07 - Dark	10 - No control	0	03 - P.D. only	02 - Angle	01 - Dry	2	0	0	0
5/29/2018	2018	14:39	PLACE D'ORLEANS DR btwn CENTRUM BLVD & ST. JOSEPH BLVD ( _3ZA2FM)	01 - Clear	01 - Daylight	10 - No control	0	03 - P.D. only	02 - Angle	01 - Dry	2	0	0	0
10/23/2019	2019	16:36	PLACE D'ORLEANS DR btwn CENTRUM BLVD & ST. JOSEPH BLVD ( _3ZA2FM)	01 - Clear	01 - Daylight	10 - No control	0	03 - P.D. only	02 - Angle	01 - Dry	2	0	0	0
4/22/2020	2020	10:10	PLACE D'ORLEANS DR btwn CENTRUM BLVD & ST. JOSEPH BLVD ( _3ZA2FM)	01 - Clear	01 - Daylight	10 - No control	0	03 - P.D. only	02 - Angle	01 - Dry	2	0	0	0
3/13/2016	2016	14:12	PRESTONE DR @ ST. JOSEPH BLVD (0003551)	01 - Clear	01 - Daylight	01 - Traffic signal	01 - Functioning	03 - P.D. only	02 - Angle	02 - Wet	2	0	0	0
4/23/2017	2017	13:57	PRESTONE DR @ ST. JOSEPH BLVD (0003551)	01 - Clear	01 - Daylight	01 - Traffic signal	01 - Functioning	02 - Non-fatal injury	02 - Angle	01 - Dry	2	0	0	0
6/24/2017	2017	11:00	PRESTONE DR @ ST. JOSEPH BLVD (0003551)	01 - Clear	01 - Daylight	01 - Traffic signal	01 - Functioning	02 - Non-fatal injury	05 - Turning movement	01 - Dry	2	0	0	0
10/25/2018	2018	19:15	PRESTONE DR @ ST. JOSEPH BLVD (0003551)	01 - Clear	07 - Dark	01 - Traffic signal	01 - Functioning	03 - P.D. only	03 - Rear end	01 - Dry	2	0	0	0
7/31/2018	2018	7:50	PRESTONE DR @ ST. JOSEPH BLVD (0003551)	01 - Clear	01 - Daylight	01 - Traffic signal	01 - Functioning	03 - P.D. only	03 - Rear end	01 - Dry	2	0	0	0
8/21/2018	2018	16:00	PRESTONE DR @ ST. JOSEPH BLVD (0003551)	02 - Rain	01 - Daylight	01 - Traffic signal	01 - Functioning	03 - P.D. only	05 - Turning movement	02 - Wet	2	0	0	0
8/28/2018	2018	16:56	PRESTONE DR @ ST. JOSEPH BLVD (0003551)	01 - Clear	01 - Daylight	01 - Traffic signal	01 - Functioning	03 - P.D. only	05 - Turning movement	01 - Dry	2	0	0	0
1/23/2019	2019	12:18	PRESTONE DR @ ST. JOSEPH BLVD (0003551)	03 - Snow	01 - Daylight	01 - Traffic signal	01 - Functioning	02 - Non-fatal injury	02 - Angle	03 - Loose snow	2	0	0	0
1/27/2019	2019	5:30	PRESTONE DR @ ST. JOSEPH BLVD (0003551)	03 - Snow	07 - Dark	01 - Traffic signal	01 - Functioning	03 - P.D. only	07 - SMV other	03 - Loose snow	1	0	0	0
2/19/2019	2019	10:34	PRESTONE DR @ ST. JOSEPH BLVD (0003551)	01 - Clear	01 - Daylight	01 - Traffic signal	01 - Functioning	03 - P.D. only	02 - Angle	01 - Dry	2	0	0	0
1/17/2020	2020	9:13	PRESTONE DR @ ST. JOSEPH BLVD (0003551)	01 - Clear	01 - Daylight	01 - Traffic signal	01 - Functioning	02 - Non-fatal injury	07 - SMV other	01 - Dry	1	0	0	1

# Appendix E

St. Joseph Boulevard Concept Plan

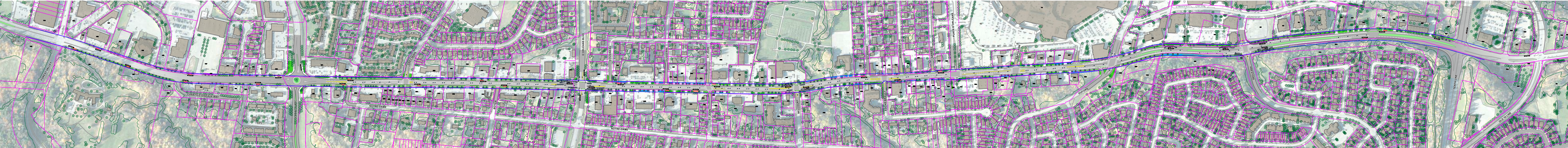

- Legend**
- Potential Street Tree in Existing ROW
  - Potential Street Tree in Future ROW
  - Existing Tree
  - Existing ROW Improvement Area
  - Future ROW Improvement Area
  - Bus Stop Place-Making Area (Behind Sidewalk)
  - Future Public Park
  - Property Lines
  - Official Plan Protection Limits

# Appendix F

TRANS Plot



# TRANS Regional Model

Version 2.15 - Assigned June 16, 2020

## AM Peak Hour Total Traffic Volume

### 265 Centrum Boulevard

2011 Model - Basecase

N/A

User Initials: TIMW

Plot Prepared: January, 2023

EMME Scenario: 21713



## Legend

AM Peak Hour Total Traffic Volume

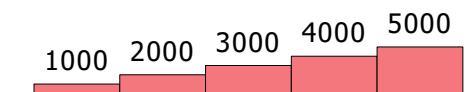

Distance (m)

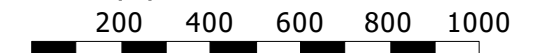

The TRANS model is continuously refined & maintained, and all information is provided in good faith. However, model outputs are provided "as is", and no warranty or guarantee is provided as to the accuracy, reliability or reasonableness of the results. In using this data, you agree to accept any and all risks arising from any incorrect, incomplete, or misleading information.

Recipients are required to use caution and professional judgement in using and interpreting model outputs. In particular, caution should be used when focusing on a geographically limited area (such as a single road or intersection), as the model is primarily designed to simulate regional-scale phenomena and has been calibrated at a regional level.

As general good practice, it is recommended that the user confirm the network coding within the area of interest, and compare base year forecasts against traffic count data to assess the extent to which the model may be over- or under-estimating the travel demand.

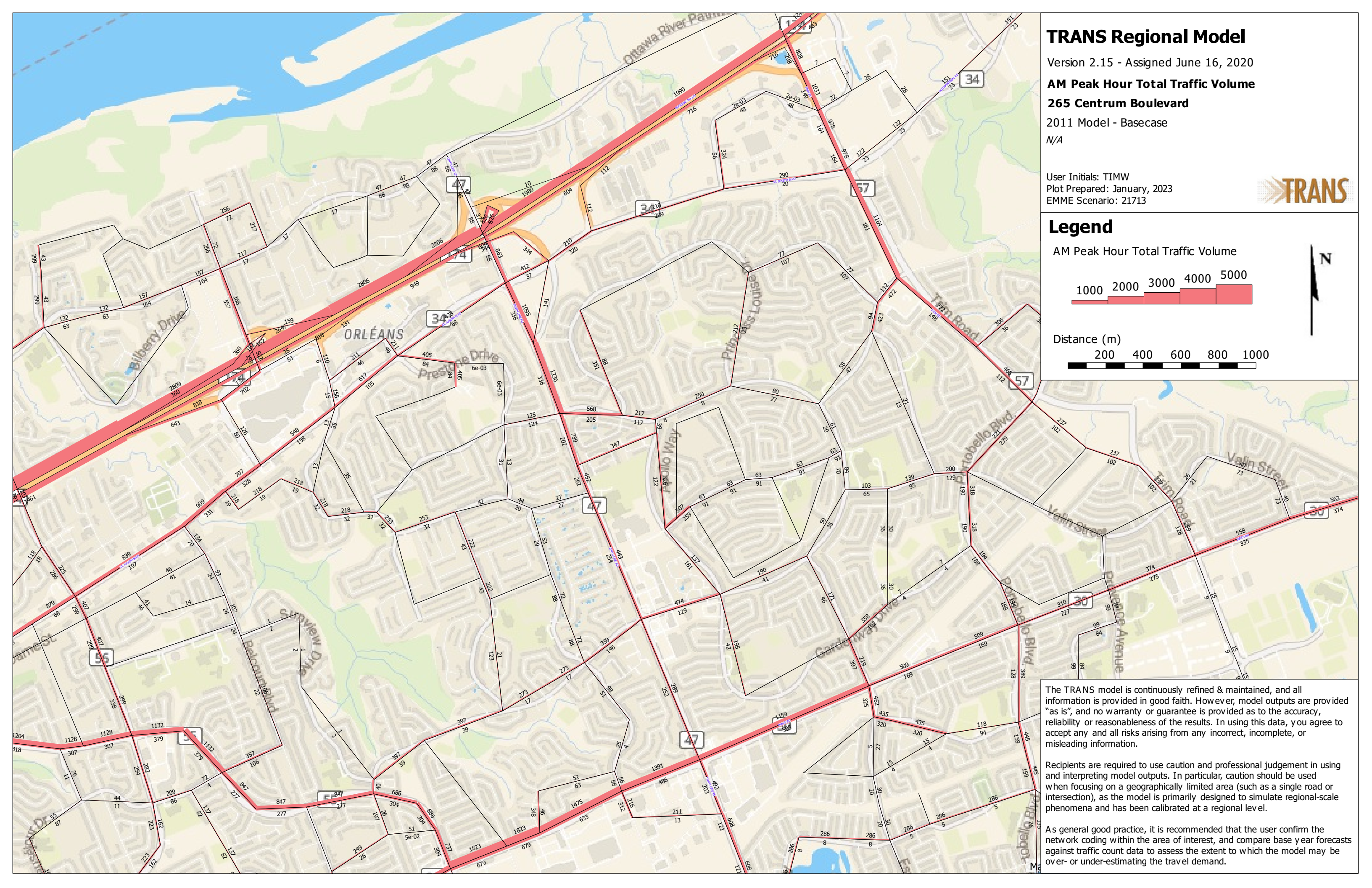

# TRANS Regional Model

Version 2.15 - Assigned June 16, 2020

## AM Peak Hour Total Traffic Volume

### 265 Centrum Boulevard

2031 Model - Basecase

N/A

User Initials: TIMW

Plot Prepared: January, 2023

EMME Scenario: 21715



## Legend

AM Peak Hour Total Traffic Volume

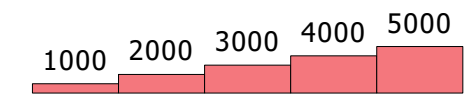

Distance (m)

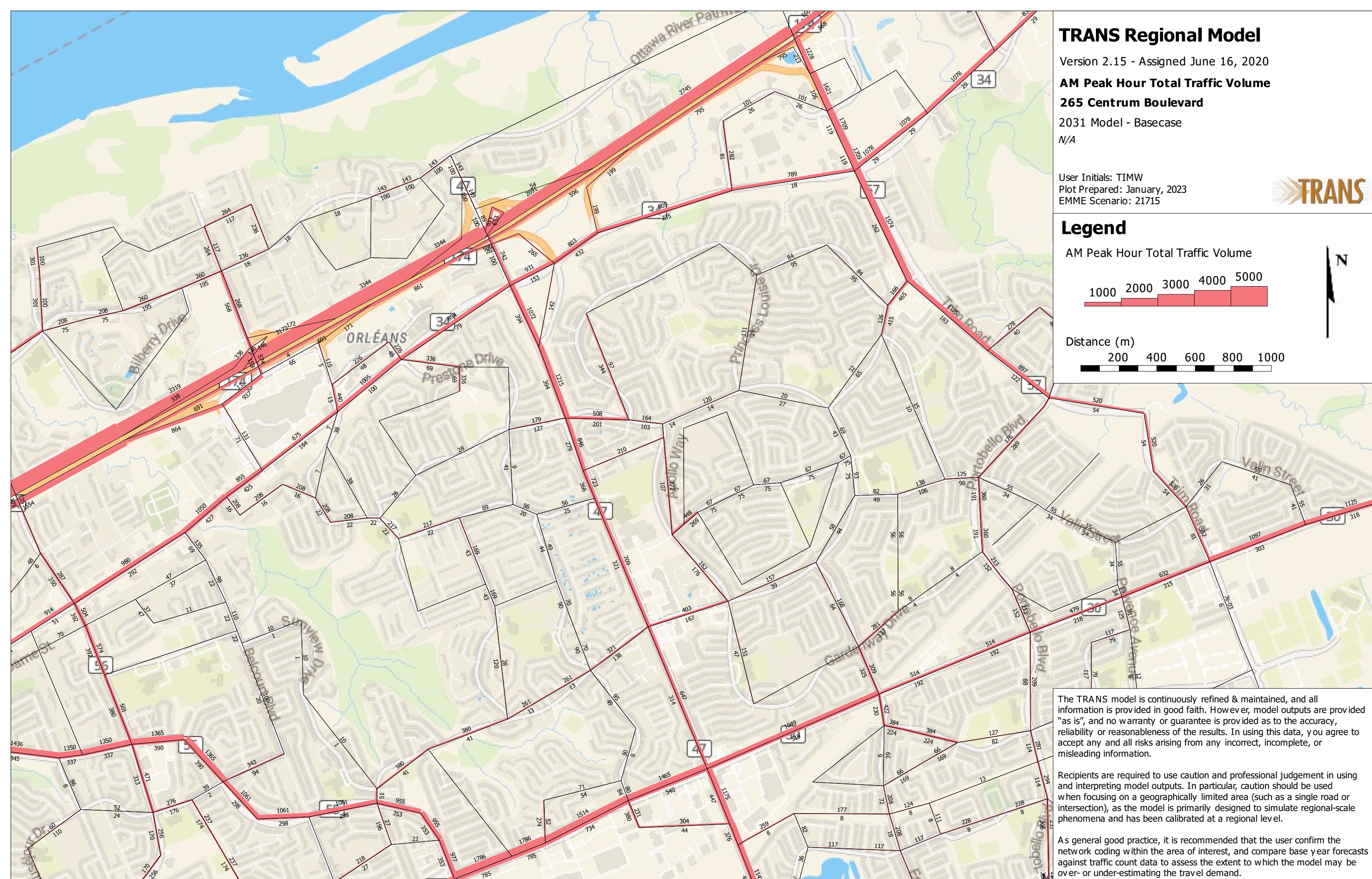
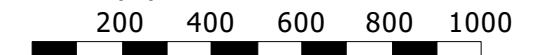

The TRANS model is continuously refined & maintained, and all information is provided in good faith. However, model outputs are provided "as is", and no warranty or guarantee is provided as to the accuracy, reliability or reasonableness of the results. In using this data, you agree to accept any and all risks arising from any incorrect, incomplete, or misleading information.

Recipients are required to use caution and professional judgement in using and interpreting model outputs. In particular, caution should be used when focusing on a geographically limited area (such as a single road or intersection), as the model is primarily designed to simulate regional-scale phenomena and has been calibrated at a regional level.

As a general good practice, it is recommended that the user confirm the network coding within the area of interest, and compare base year forecasts against traffic count data to assess the extent to which the model may be over- or under-estimating the travel demand.

# Appendix G

Background Volumes

Figure 5: Assignment of Site Trips

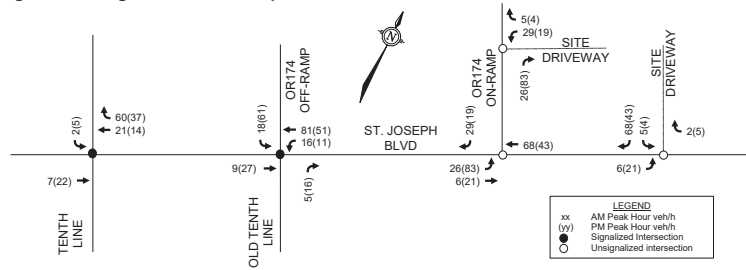
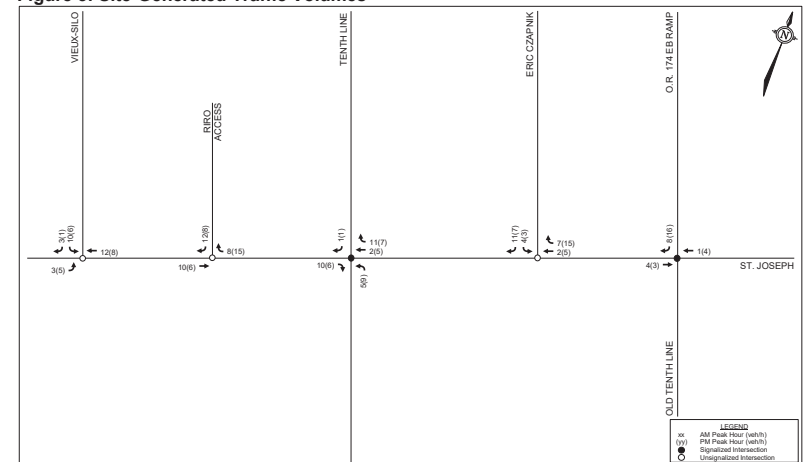

Figure 5: Site-Generated Traffic Volumes



# Appendix H

Synchro Intersection Worksheets – 2028 Future Background Conditions

Lanes, Volumes, Timings  
1: Place d'Orleans & Centrum

AM Peak Hour  
2028 Future Background

Lane Group	EBL	EBT	EBR	WBL	WBT	WBR	NBL	NBT	NBR	SBL	SBT	SBR
Lane Configurations	↖	↗	↘	↖	↗	↘	↖	↗	↘	↖	↗	↘
Traffic Volume (vph)	25	30	40	30	32	18	67	159	56	119	42	19
Future Volume (vph)	25	30	40	30	32	18	67	159	56	119	42	19
Satd. Flow (prot)	1566	1745	1401	1658	1629	0	0	3143	0	0	3027	0
Fit Permitted	0.724			0.738				0.852			0.684	
Satd. Flow (perm)	1185	1745	1375	1280	1629	0	0	2710	0	0	2139	0
Satd. Flow (RTOR)			44		18			56			19	
Lane Group Flow (vph)	25	30	40	30	50	0	0	282	0	0	180	0
Turn Type	Perm	NA	Perm	Perm	NA		Perm	NA		Perm	NA	
Protected Phases	4			8			8	2			6	
Permitted Phases	4		4	8			2			6		
Detector Phase	4	4	4	8	8		2	2		6	6	
Switch Phase												
Minimum Initial (s)	10.0	10.0	10.0	10.0	10.0		10.0	10.0		10.0	10.0	
Minimum Split (s)	31.0	31.0	31.0	31.0	31.0		36.0	36.0		36.0	36.0	
Total Split (s)	32.0	32.0	32.0	32.0	32.0		43.0	43.0		43.0	43.0	
Total Split (%)	42.7%	42.7%	42.7%	42.7%	42.7%		57.3%	57.3%		57.3%	57.3%	
Yellow Time (s)	3.3	3.3	3.3	3.3	3.3		3.3	3.3		3.3	3.3	
All-Red Time (s)	2.7	2.7	2.7	2.7	2.7		2.7	2.7		2.7	2.7	
Lost Time Adjust (s)	0.0	0.0	0.0	0.0	0.0		0.0	0.0		0.0	0.0	
Total Lost Time (s)	6.0	6.0	6.0	6.0	6.0		6.0	6.0		6.0	6.0	
Lead/Lag												
Lead-Lag Optimize?												
Recall Mode	None	None	None	None	None		Max	Max		Max	Max	
Act Effct Green (s)	12.6	12.6	12.6	12.6	12.6		46.3	46.3		46.3	46.3	
Actuated g/C Ratio	0.20	0.20	0.20	0.20	0.20		0.75	0.75		0.75	0.75	
v/c Ratio	0.10	0.08	0.13	0.11	0.14		0.14	0.14		0.11	0.11	
Control Delay	20.0	19.5	7.0	20.1	14.7		4.8	4.8		5.4	5.4	
Queue Delay	0.0	0.0	0.0	0.0	0.0		0.0	0.0		0.0	0.0	
Total Delay	20.0	19.5	7.0	20.1	14.7		4.8	4.8		5.4	5.4	
LOS	B	B	A	C	B		A	A		A	A	
Approach Delay	14.4				16.8		4.8	4.8		5.4	5.4	
Approach LOS	B				B		A	A		A	A	
Queue Length 50th (m)	2.3	2.8	0.0	2.8	3.0		4.3	4.3		3.1	3.1	
Queue Length 95th (m)	7.2	8.0	5.5	8.2	9.7		14.8	14.8		11.2	11.2	
Internal Link Dist (m)		55.7			119.8		103.0	103.0		90.8	90.8	
Turn Bay Length (m)	52.0		20.0									
Base Capacity (vph)	504	743	610	545	704		2049	2049		1611	1611	
Starvation Cap Reductn	0	0	0	0	0		0	0		0	0	
Spillback Cap Reductn	0	0	0	0	0		0	0		0	0	
Storage Cap Reductn	0	0	0	0	0		0	0		0	0	
Reduced v/c Ratio	0.05	0.04	0.07	0.06	0.07		0.14	0.14		0.11	0.11	

Intersection Summary

Cycle Length: 75  
 Actuated Cycle Length: 61.6  
 Natural Cycle: 70  
 Control Type: Actuated-Uncoordinated  
 Maximum v/c Ratio: 0.14

Lanes, Volumes, Timings  
1: Place d'Orleans & Centrum

AM Peak Hour  
2028 Future Background

Intersection Signal Delay: 7.9  
 Intersection Capacity Utilization 59.9%  
 Analysis Period (min) 15  
 Intersection LOS: A  
 ICU Level of Service B

Splits and Phases: 1: Place d'Orleans & Centrum



Intersection												
Int Delay, s/veh	2.4											
Movement	EBL	EBT	EBR	WBL	WBT	WBR	NBL	NBT	NBR	SBL	SBT	SBR
Lane Configurations	↔			↔			↔			↔		
Traffic Vol, veh/h	37	81	10	2	126	6	0	0	1	7	0	37
Future Vol, veh/h	37	81	10	2	126	6	0	0	1	7	0	37
Conflicting Peds, #/hr	8	0	9	9	0	8	0	0	3	3	0	0
Sign Control	Free	Free	Free	Free	Free	Free	Stop	Stop	Stop	Stop	Stop	Stop
RT Channelized	-	-	None	-	-	None	-	-	None	-	-	None
Storage Length	-	-	-	-	-	-	-	-	-	-	-	-
Veh in Median Storage, #	-	0	-	-	0	-	-	0	-	-	0	-
Grade, %	-	0	-	-	0	-	-	0	-	-	0	-
Peak Hour Factor	100	100	100	100	100	100	100	100	100	100	100	100
Heavy Vehicles, %	2	5	2	2	3	2	2	2	100	2	2	2
Mvmt Flow	37	81	10	2	126	6	0	0	1	7	0	37
Major/Minor	Major1			Major2			Minor1			Minor2		
Conflicting Flow All	140	0	0	100	0	0	321	313	98	305	315	137
Stage 1	-	-	-	-	-	-	169	169	-	141	141	-
Stage 2	-	-	-	-	-	-	152	144	-	164	174	-
Critical Hdwy	4.12	-	-	4.12	-	-	7.12	6.52	7.2	7.12	6.52	6.22
Critical Hdwy Stg 1	-	-	-	-	-	-	6.12	5.52	-	6.12	5.52	-
Critical Hdwy Stg 2	-	-	-	-	-	-	6.12	5.52	-	6.12	5.52	-
Follow-up Hdwy	2.218	-	-	2.218	-	-	3.518	4.018	4.2	3.518	4.018	3.318
Pot Cap-1 Maneuver	1443	-	-	1493	-	-	632	602	746	647	601	911
Stage 1	-	-	-	-	-	-	833	759	-	862	780	-
Stage 2	-	-	-	-	-	-	850	778	-	838	755	-
Platoon blocked, %	-	-	-	-	-	-	-	-	-	-	-	-
Mov Cap-1 Maneuver	1434	-	-	1483	-	-	589	577	739	627	576	905
Mov Cap-2 Maneuver	-	-	-	-	-	-	589	577	-	627	576	-
Stage 1	-	-	-	-	-	-	805	733	-	834	775	-
Stage 2	-	-	-	-	-	-	814	773	-	812	729	-
Approach	EB			WB			NB			SB		
HCM Control Delay, s	2.2			0.1			9.9			9.5		
HCM LOS	A			A			A			A		
Minor Lane/Major Mvmt	NBLn1	EBL	EBT	EBR	WBL	WBT	WBR	SBLn1				
Capacity (veh/h)	739	1434	-	-	1483	-	-	845				
HCM Lane V/C Ratio	0.001	0.026	-	-	0.001	-	-	0.052				
HCM Control Delay (s)	9.9	7.6	0	-	7.4	0	-	9.5				
HCM Lane LOS	A	A	A	-	A	A	-	A				
HCM 95th %tile Q(veh)	0	0.1	-	-	0	-	-	0.2				

Intersection						
Intersection Delay, s/veh	7.7					
Intersection LOS	A					
Movement	EBT	EBR	WBL	WBT	NBL	NBR
Lane Configurations	↔			↔	↔	↔
Traffic Vol, veh/h	20	47	39	18	58	36
Future Vol, veh/h	20	47	39	18	58	36
Peak Hour Factor	1.00	1.00	1.00	1.00	1.00	1.00
Heavy Vehicles, %	5	17	2	6	7	2
Mvmt Flow	20	47	39	18	58	36
Number of Lanes	1	0	0	1	1	1
Approach	EB		WB		NB	
Opposing Approach	WB		EB			
Opposing Lanes	1		1		0	
Conflicting Approach Left			NB		EB	
Conflicting Lanes Left	0		2		1	
Conflicting Approach Right	NB				WB	
Conflicting Lanes Right	2		0		1	
HCM Control Delay	7.2		7.7		8	
HCM LOS	A		A		A	
Lane	NBLn1	NBLn2	EBLn1	WBLn1		
Vol Left, %	100%	0%	0%	68%		
Vol Thru, %	0%	0%	30%	32%		
Vol Right, %	0%	100%	70%	0%		
Sign Control	Stop	Stop	Stop	Stop		
Traffic Vol by Lane	58	36	67	57		
LT Vol	58	0	0	39		
Through Vol	0	0	20	18		
RT Vol	0	36	47	0		
Lane Flow Rate	58	36	67	57		
Geometry Grp	7	7	2	2		
Degree of Util (X)	0.086	0.04	0.07	0.068		
Departure Headway (Hd)	5.336	4.049	3.768	4.284		
Convergence, Y/N	Yes	Yes	Yes	Yes		
Cap	669	879	933	824		
Service Time	3.088	1.8	1.862	2.372		
HCM Lane V/C Ratio	0.087	0.041	0.072	0.069		
HCM Control Delay	8.6	7	7.2	7.7		
HCM Lane LOS	A	A	A	A		
HCM 95th-tile Q	0.3	0.1	0.2	0.2		

HCM 2010 TWSC  
4: Centrum & Brisebois E

AM Peak Hour  
2028 Future Background

Intersection						
Int Delay, s/veh	2					
Movement	EBL	EBT	WBT	WBR	SBL	SBR
Lane Configurations		↕	↕		↕	↕
Traffic Vol, veh/h	11	19	26	1	0	5
Future Vol, veh/h	11	19	26	1	0	5
Conflicting Peds, #/hr	0	0	0	0	0	0
Sign Control	Free	Free	Free	Free	Stop	Stop
RT Channelized	-	None	-	None	-	None
Storage Length	-	-	-	-	0	-
Veh in Median Storage, #	-	0	0	-	0	-
Grade, %	-	0	0	-	0	-
Peak Hour Factor	100	100	100	100	100	100
Heavy Vehicles, %	9	2	2	2	2	20
Mvmt Flow	11	19	26	1	0	5
Major/Minor	Major1	Major2	Minor2			
Conflicting Flow All	27	0	0	68	27	
Stage 1	-	-	-	27	-	
Stage 2	-	-	-	41	-	
Critical Hdwy	4.19	-	-	6.42	6.4	
Critical Hdwy Stg 1	-	-	-	5.42	-	
Critical Hdwy Stg 2	-	-	-	5.42	-	
Follow-up Hdwy	2.281	-	-	3.518	3.48	
Pot Cap-1 Maneuver	1543	-	-	937	999	
Stage 1	-	-	-	996	-	
Stage 2	-	-	-	981	-	
Platoon blocked, %	-	-	-	-	-	
Mov Cap-1 Maneuver	1543	-	-	930	999	
Mov Cap-2 Maneuver	-	-	-	930	-	
Stage 1	-	-	-	989	-	
Stage 2	-	-	-	981	-	
Approach	EB	WB	SB			
HCM Control Delay, s	2.7	0	8.6			
HCM LOS			A			
Minor Lane/Major Mvmt	EBL	EBT	WBT	WBR	SBLn1	
Capacity (veh/h)	1543	-	-	-	999	
HCM Lane V/C Ratio	0.007	-	-	-	0.005	
HCM Control Delay (s)	7.3	0	-	-	8.6	
HCM Lane LOS	A	A	-	-	A	
HCM 95th %tile Q(veh)	0	-	-	-	0	

Lanes, Volumes, Timings  
5: Prestone & St Joseph

AM Peak Hour  
2028 Future Background

Lane Group	EBL	EBT	EBR	WBL	WBT	WBR	NBL	NBT	NBR	SBL	SBT	SBR
Lane Configurations	↕	↕	↕	↕	↕	↕	↕	↕	↕	↕	↕	↕
Traffic Volume (vph)	7	177	40	2	771	106	81	46	5	46	26	12
Future Volume (vph)	7	177	40	2	771	106	81	46	5	46	26	12
Satd. Flow (prot)	1658	3316	1375	1658	3316	1441	1626	1687	0	1566	1314	0
Fit Permitted	0.272			0.640			0.732			0.724		
Satd. Flow (perm)	475	3316	1375	1117	3316	1423	1252	1687	0	1191	1314	0
Satd. Flow (RTOR)			41			106		5			12	
Lane Group Flow (vph)	7	177	40	2	771	106	81	51	0	46	38	0
Turn Type	Perm	NA	Perm	Perm	NA	Perm	Perm	NA		Perm	NA	
Protected Phases		2			6			8				4
Permitted Phases	2		2	6		6	8				4	
Detector Phase	2	2	2	6	6	6	8	8			4	4
Switch Phase												
Minimum Initial (s)	10.0	10.0	10.0	10.0	10.0	10.0	10.0	10.0		10.0	10.0	
Minimum Split (s)	23.7	23.7	23.7	23.7	23.7	23.7	29.0	29.0		29.0	29.0	
Total Split (s)	51.0	51.0	51.0	51.0	51.0	51.0	29.0	29.0		29.0	29.0	
Total Split (%)	63.8%	63.8%	63.8%	63.8%	63.8%	63.8%	36.3%	36.3%		36.3%	36.3%	
Yellow Time (s)	3.3	3.3	3.3	3.3	3.3	3.3	3.3	3.3		3.3	3.3	
All-Red Time (s)	2.4	2.4	2.4	2.4	2.4	2.4	2.7	2.7		2.7	2.7	
Lost Time Adjust (s)	0.0	0.0	0.0	0.0	0.0	0.0	0.0	0.0		0.0	0.0	
Total Lost Time (s)	5.7	5.7	5.7	5.7	5.7	5.7	6.0	6.0		6.0	6.0	
Lead/Lag												
Lead-Lag Optimize?												
Recall Mode	None	None	None	None	None	None	Max	Max		Max	Max	
Act Effct Green (s)	18.1	18.1	18.1	18.1	18.1	18.1	23.1	23.1		23.1	23.1	
Actuated g/C Ratio	0.34	0.34	0.34	0.34	0.34	0.34	0.44	0.44		0.44	0.44	
v/c Ratio	0.04	0.16	0.08	0.01	0.68	0.19	0.15	0.07		0.09	0.07	
Control Delay	11.6	12.0	4.6	10.5	18.2	3.9	11.5	9.9		11.0	8.6	
Queue Delay	0.0	0.0	0.0	0.0	0.0	0.0	0.0	0.0		0.0	0.0	
Total Delay	11.6	12.0	4.6	10.5	18.2	3.9	11.5	9.9		11.0	8.6	
LOS	B	B	A	B	B	A	B	A		B	A	
Approach Delay		10.7			16.4			10.8			9.9	
Approach LOS		B			B			B			A	
Queue Length 50th (m)	0.4	6.0	0.0	0.1	32.1	0.0	4.3	2.3		2.4	1.3	
Queue Length 95th (m)	2.4	11.0	4.3	1.1	46.5	7.1	13.1	8.5		8.6	6.4	
Internal Link Dist (m)		163.5			149.6			92.4			92.1	
Turn Bay Length (m)	50.0		105.0	62.5		120.0	47.5					
Base Capacity (vph)	408	2850	1187	960	2850	1238	546	739		519	580	
Starvation Cap Reductn	0	0	0	0	0	0	0	0		0	0	
Spillback Cap Reductn	0	0	0	0	0	0	0	0		0	0	
Storage Cap Reductn	0	0	0	0	0	0	0	0		0	0	
Reduced v/c Ratio	0.02	0.06	0.03	0.00	0.27	0.09	0.15	0.07		0.09	0.07	
Intersection Summary												
Cycle Length: 80												
Actuated Cycle Length: 53												
Natural Cycle: 55												
Control Type: Actuated-Uncoordinated												
Maximum v/c Ratio: 0.68												



Lanes, Volumes, Timings  
5: Prestone & St Joseph

AM Peak Hour  
2028 Future Background

Intersection Signal Delay: 14.5 Intersection LOS: B  
Intersection Capacity Utilization 51.4% ICU Level of Service A  
Analysis Period (min) 15

Splits and Phases: 5: Prestone & St Joseph

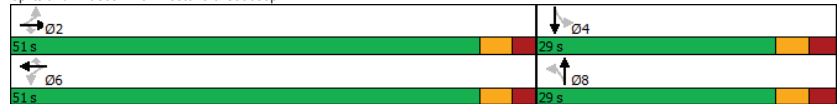

Lanes, Volumes, Timings  
1: Place d'Orleans & Centrum

PM Peak Hour  
2028 Future Background

Lane Group	EBL	EBT	EBR	WBL	WBT	WBR	NBL	NBT	NBR	SBL	SBT	SBR
Lane Configurations	↔	↕	↗	↖	↗	↖	↕	↕	↖	↗	↖	↗
Traffic Volume (vph)	94	57	220	48	46	14	102	153	73	126	144	42
Future Volume (vph)	94	57	220	48	46	14	102	153	73	126	144	42
Satd. Flow (prot)	1658	1745	1483	1658	1674	0	0	3097	0	0	3107	0
Fit Permitted	0.718			0.720				0.759			0.711	
Satd. Flow (perm)	1236	1745	1448	1242	1674	0	0	2383	0	0	2250	0
Satd. Flow (RTOR)			220		14			69			33	
Lane Group Flow (vph)	94	57	220	48	60	0	0	328	0	0	312	0
Turn Type	Perm	NA	Perm	Perm	NA		Perm	NA		Perm	NA	
Protected Phases		4			8			2			6	
Permitted Phases	4		4	8			2			6		
Detector Phase	4	4	4	8	8		2	2		6	6	
Switch Phase												
Minimum Initial (s)	10.0	10.0	10.0	10.0	10.0		10.0	10.0		10.0	10.0	
Minimum Split (s)	31.0	31.0	31.0	31.0	31.0		36.0	36.0		36.0	36.0	
Total Split (s)	32.0	32.0	32.0	32.0	32.0		53.0	53.0		53.0	53.0	
Total Split (%)	37.6%	37.6%	37.6%	37.6%	37.6%		62.4%	62.4%		62.4%	62.4%	
Yellow Time (s)	3.3	3.3	3.3	3.3	3.3		3.3	3.3		3.3	3.3	
All-Red Time (s)	2.7	2.7	2.7	2.7	2.7		2.7	2.7		2.7	2.7	
Lost Time Adjust (s)	0.0	0.0	0.0	0.0	0.0		0.0	0.0		0.0	0.0	
Total Lost Time (s)	6.0	6.0	6.0	6.0	6.0		6.0	6.0		6.0	6.0	
Lead/Lag												
Lead-Lag Optimize?												
Recall Mode	None	None	None	None	None		C-Max	C-Max		C-Max	C-Max	
Act Effct Green (s)	14.1	14.1	14.1	14.1	14.1		58.9	58.9		58.9	58.9	
Actuated g/C Ratio	0.17	0.17	0.17	0.17	0.17		0.69	0.69		0.69	0.69	
v/c Ratio	0.46	0.20	0.52	0.23	0.21		0.20	0.20		0.20	0.20	
Control Delay	37.6	29.8	8.6	31.1	24.3		4.8	4.8		5.4	5.4	
Queue Delay	0.0	0.0	0.0	0.0	0.0		0.0	0.0		0.0	0.0	
Total Delay	37.6	29.8	8.6	31.1	24.3		4.8	4.8		5.4	5.4	
LOS	D	C	A	C	C		A	A		A	A	
Approach Delay		19.2			27.3		4.8	4.8		5.4	5.4	
Approach LOS		B			C		A	A		A	A	
Queue Length 50th (m)	14.5	8.4	0.0	7.1	6.7		5.7	5.7		6.2	6.2	
Queue Length 95th (m)	23.7	15.2	15.1	13.8	14.1		16.6	16.6		17.7	17.7	
Internal Link Dist (m)		55.7			119.8		103.0	103.0		90.8	90.8	
Turn Bay Length (m)	52.0		20.0									
Base Capacity (vph)	378	533	595	379	521		1671	1671		1568	1568	
Starvation Cap Reductn	0	0	0	0	0		0	0		0	0	
Spillback Cap Reductn	0	0	0	0	0		0	0		0	0	
Storage Cap Reductn	0	0	0	0	0		0	0		0	0	
Reduced v/c Ratio	0.25	0.11	0.37	0.13	0.12		0.20	0.20		0.20	0.20	

Intersection Summary  
Cycle Length: 85  
Actuated Cycle Length: 85  
Offset: 0 (0%), Referenced to phase 2:NBTL and 6:SBTL, Start of Green  
Natural Cycle: 70  
Control Type: Actuated-Coordinated

Lanes, Volumes, Timings  
1: Place d'Orleans & Centrum

PM Peak Hour  
2028 Future Background

Maximum v/c Ratio: 0.52	Intersection LOS: B
Intersection Signal Delay: 11.9	ICU Level of Service D
Intersection Capacity Utilization 80.0%	
Analysis Period (min) 15	

Splits and Phases: 1: Place d'Orleans & Centrum

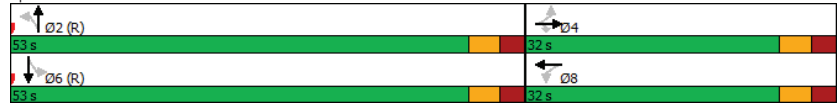

HCM 2010 TWSC  
2: Centrum & Brisebois W

PM Peak Hour  
2028 Future Background

Intersection												
Int Delay, s/veh		2.8										
Movement	EBL	EBT	EBR	WBL	WBT	WBR	NBL	NBT	NBR	SBL	SBT	SBR
Lane Configurations	↔			↔			↕			↕		
Traffic Vol, veh/h	49	179	8	1	118	9	7	0	8	12	0	58
Future Vol, veh/h	49	179	8	1	118	9	7	0	8	12	0	58
Conflicting Peds, #/hr	23	0	19	19	0	23	3	0	6	6	0	3
Sign Control	Free	Free	Free	Free	Free	Free	Stop	Stop	Stop	Stop	Stop	Stop
RT Channelized	-	-	None	-	-	None	-	-	None	-	-	None
Storage Length	-	-	-	-	-	-	-	-	-	-	-	-
Veh in Median Storage, #	-	0	-	-	0	-	-	0	-	-	0	-
Grade, %	-	0	-	-	0	-	-	0	-	-	0	-
Peak Hour Factor	100	100	100	100	100	100	100	100	100	100	100	100
Heavy Vehicles, %	2	3	2	2	5	2	2	2	2	2	2	2
Mvmt Flow	49	179	8	1	118	9	7	0	8	12	0	58
Major/Minor	Major1			Major2			Minor1			Minor2		
Conflicting Flow All	150	0	0	206	0	0	457	452	208	439	452	149
Stage 1	-	-	-	-	-	-	300	300	-	148	148	-
Stage 2	-	-	-	-	-	-	157	152	-	291	304	-
Critical Hdwy	4.12	-	-	4.12	-	-	7.12	6.52	6.22	7.12	6.52	6.22
Critical Hdwy Stg 1	-	-	-	-	-	-	6.12	5.52	-	6.12	5.52	-
Critical Hdwy Stg 2	-	-	-	-	-	-	6.12	5.52	-	6.12	5.52	-
Follow-up Hdwy	2,218	-	-	2,218	-	-	3,518	4,018	3,318	3,518	4,018	3,318
Pot Cap-1 Maneuver	1431	-	-	1365	-	-	514	503	832	528	503	898
Stage 1	-	-	-	-	-	-	709	666	-	855	775	-
Stage 2	-	-	-	-	-	-	845	772	-	717	663	-
Platoon blocked, %	-	-	-	-	-	-	-	-	-	-	-	-
Mov Cap-1 Maneuver	1405	-	-	1345	-	-	457	467	816	495	467	880
Mov Cap-2 Maneuver	-	-	-	-	-	-	457	467	-	495	467	-
Stage 1	-	-	-	-	-	-	671	631	-	807	760	-
Stage 2	-	-	-	-	-	-	787	757	-	679	628	-
Approach	EB			WB			NB			SB		
HCM Control Delay, s	1.6			0.1			11.2			10.1		
HCM LOS							B			B		
Minor Lane/Major Mvmt	NBLn1	EBL	EBT	EBR	WBL	WBT	WBR	SBLn1				
Capacity (veh/h)	597	1405	-	-	1345	-	-	776				
HCM Lane V/C Ratio	0.025	0.035	-	-	0.001	-	-	0.09				
HCM Control Delay (s)	11.2	7.7	0	-	7.7	0	-	10.1				
HCM Lane LOS	B	A	A	-	A	A	-	B				
HCM 95th %tile Q(veh)	0.1	0.1	-	-	0	-	-	0.3				

HCM 2010 AWSC  
3: Prestone & Centrum

PM Peak Hour  
2028 Future Background

Intersection						
Intersection Delay, s/veh	8					
Intersection LOS	A					
Movement						
	EBT	EBR	WBL	WBT	NBL	NBR
Lane Configurations	↔			↔	↔	↔
Traffic Vol, veh/h	39	113	53	18	78	37
Future Vol, veh/h	39	113	53	18	78	37
Peak Hour Factor	1.00	1.00	1.00	1.00	1.00	1.00
Heavy Vehicles, %	2	6	2	2	11	2
Mvmt Flow	39	113	53	18	78	37
Number of Lanes	1	0	0	1	1	1
Approach						
	EB	WB		NB		
Opposing Approach	WB	EB				
Opposing Lanes	1	1		0		
Conflicting Approach Left		NB		EB		
Conflicting Lanes Left	0	2		1		
Conflicting Approach Right	NB			WB		
Conflicting Lanes Right	2	0		1		
HCM Control Delay	7.6	8		8.6		
HCM LOS	A	A		A		
Lane						
	NBLn1	NBLn2	EBLn1	WBLn1		
Vol Left, %	100%	0%	0%	75%		
Vol Thru, %	0%	0%	26%	25%		
Vol Right, %	0%	100%	74%	0%		
Sign Control	Stop	Stop	Stop	Stop		
Traffic Vol by Lane	78	37	152	71		
LT Vol	78	0	0	53		
Through Vol	0	0	39	18		
RT Vol	0	37	113	0		
Lane Flow Rate	78	37	152	71		
Geometry Grp	7	7	2	2		
Degree of Util (X)	0.123	0.044	0.164	0.089		
Departure Headway (Hd)	5.676	4.318	3.875	4.536		
Convergence, Y/N	Yes	Yes	Yes	Yes		
Cap	636	834	930	793		
Service Time	3.376	2.018	1.882	2.547		
HCM Lane V/C Ratio	0.123	0.044	0.163	0.09		
HCM Control Delay	9.2	7.2	7.6	8		
HCM Lane LOS	A	A	A	A		
HCM 95th-tile Q	0.4	0.1	0.6	0.3		

HCM 2010 TWSC  
4: Centrum & Brisebois E

PM Peak Hour  
2028 Future Background

Intersection						
Int Delay, s/veh	1.7					
Movement						
	EBL	EBT	WBT	WBR	SBL	SBR
Lane Configurations		↔	↔		↔	↔
Traffic Vol, veh/h	8	49	39	0	0	16
Future Vol, veh/h	8	49	39	0	0	16
Conflicting Peds, #/hr	0	0	0	0	0	0
Sign Control	Free	Free	Free	Free	Stop	Stop
RT Channelized	-	None	-	None	-	None
Storage Length	-	-	-	-	0	-
Veh in Median Storage, #	-	0	0	-	0	-
Grade, %	-	0	0	-	0	-
Peak Hour Factor	100	100	100	100	100	100
Heavy Vehicles, %	2	2	2	2	2	2
Mvmt Flow	8	49	39	0	0	16
Major/Minor						
	Major1	Major2		Minor2		
Conflicting Flow All	39	0	-	0	104	39
Stage 1	-	-	-	-	39	-
Stage 2	-	-	-	-	65	-
Critical Hdwy	4.12	-	-	-	6.42	6.22
Critical Hdwy Stg 1	-	-	-	-	5.42	-
Critical Hdwy Stg 2	-	-	-	-	5.42	-
Follow-up Hdwy	2.218	-	-	-	3.518	3.318
Pot Cap-1 Maneuver	1571	-	-	-	894	1033
Stage 1	-	-	-	-	983	-
Stage 2	-	-	-	-	958	-
Platoon blocked, %	-	-	-	-	-	-
Mov Cap-1 Maneuver	1571	-	-	-	890	1033
Mov Cap-2 Maneuver	-	-	-	-	890	-
Stage 1	-	-	-	-	978	-
Stage 2	-	-	-	-	958	-
Approach						
	EB	WB		SB		
HCM Control Delay, s	1	0		8.5		
HCM LOS				A		
Minor Lane/Major Mvmt						
	EBL	EBT	WBT	WBR	SBLn1	
Capacity (veh/h)	1571	-	-	-	1033	
HCM Lane V/C Ratio	0.005	-	-	-	0.015	
HCM Control Delay (s)	7.3	0	-	-	8.5	
HCM Lane LOS	A	A	-	-	A	
HCM 95th %tile Q(veh)	0	-	-	-	0	

Lanes, Volumes, Timings  
5: Prestone & St Joseph

PM Peak Hour  
2028 Future Background

Lane Group	EBL	EBT	EBR	WBL	WBT	WBR	NBL	NBT	NBR	SBL	SBT	SBR
Lane Configurations	↔	↕	↔	↔	↕	↔	↔	↕	↔	↔	↕	↔
Traffic Volume (vph)	26	861	116	10	476	112	57	28	9	135	75	26
Future Volume (vph)	26	861	116	10	476	112	57	28	9	135	75	26
Satd. Flow (prot)	1658	3316	1483	1658	3316	1483	1658	1572	0	1658	1567	0
Fit Permitted	0.480			0.309			0.692			0.733		
Satd. Flow (perm)	837	3316	1444	538	3316	1464	1201	1572	0	1278	1567	0
Satd. Flow (RTOR)			116				112		9		22	
Lane Group Flow (vph)	26	861	116	10	476	112	57	37	0	135	101	0
Turn Type	Perm	NA	Perm	Perm	NA	Perm	Perm	NA	NA	Perm	NA	
Protected Phases		2			6		8			4		
Permitted Phases	2		2	6		6	8			4		
Detector Phase	2	2	2	6	6	6	8	8		4	4	
Switch Phase												
Minimum Initial (s)	10.0	10.0	10.0	10.0	10.0	10.0	10.0	10.0		10.0	10.0	
Minimum Split (s)	23.7	23.7	23.7	23.7	23.7	23.7	29.0	29.0		29.0	29.0	
Total Split (s)	51.0	51.0	51.0	51.0	51.0	51.0	29.0	29.0		29.0	29.0	
Total Split (%)	63.8%	63.8%	63.8%	63.8%	63.8%	63.8%	36.3%	36.3%		36.3%	36.3%	
Yellow Time (s)	3.3	3.3	3.3	3.3	3.3	3.3	3.3	3.3		3.3	3.3	
All-Red Time (s)	2.4	2.4	2.4	2.4	2.4	2.4	2.7	2.7		2.7	2.7	
Lost Time Adjust (s)	0.0	0.0	0.0	0.0	0.0	0.0	0.0	0.0		0.0	0.0	
Total Lost Time (s)	5.7	5.7	5.7	5.7	5.7	5.7	6.0	6.0		6.0	6.0	
Lead/Lag												
Lead-Lag Optimize?												
Recall Mode	Max	Max	Max	Max	Max	Max	None	None		None	None	
Act Effct Green (s)	48.3	48.3	48.3	48.3	48.3	48.3	14.1	14.1		14.1	14.1	
Actuated g/C Ratio	0.65	0.65	0.65	0.65	0.65	0.65	0.19	0.19		0.19	0.19	
v/c Ratio	0.05	0.40	0.12	0.03	0.22	0.11	0.25	0.12		0.56	0.32	
Control Delay	6.6	7.5	1.9	6.7	6.3	1.9	26.3	19.2		35.0	21.6	
Queue Delay	0.0	0.0	0.0	0.0	0.0	0.0	0.0	0.0		0.0	0.0	
Total Delay	6.6	7.5	1.9	6.7	6.3	1.9	26.3	19.2		35.0	21.6	
LOS	A	A	A	A	A	A	C	B		D	C	
Approach Delay		6.8			5.5		23.5			29.3		
Approach LOS		A			A		C			C		
Queue Length 50th (m)	1.0	23.4	0.0	0.4	11.2	0.0	6.5	3.1		16.3	9.0	
Queue Length 95th (m)	4.9	50.2	6.2	2.7	25.5	6.1	15.2	9.7		31.4	20.5	
Internal Link Dist (m)		163.5			149.6		92.4			92.1		
Turn Bay Length (m)	50.0		105.0	62.5		120.0	47.5					
Base Capacity (vph)	545	2159	980	350	2159	992	374	496		398	504	
Starvation Cap Reductn	0	0	0	0	0	0	0	0		0	0	
Spillback Cap Reductn	0	0	0	0	0	0	0	0		0	0	
Storage Cap Reductn	0	0	0	0	0	0	0	0		0	0	
Reduced v/c Ratio	0.05	0.40	0.12	0.03	0.22	0.11	0.15	0.07		0.34	0.20	

Intersection Summary	
Cycle Length:	80
Actuated Cycle Length:	74.1
Natural Cycle:	55
Control Type:	Actuated-Uncoordinated
Maximum v/c Ratio:	0.56

Lanes, Volumes, Timings  
5: Prestone & St Joseph

PM Peak Hour  
2028 Future Background

Intersection Signal Delay: 10.0	Intersection LOS: A
Intersection Capacity Utilization 50.3%	ICU Level of Service A
Analysis Period (min) 15	

Splits and Phases: 5: Prestone & St Joseph



# Appendix I

Synchro Intersection Worksheets – 2033 Future Background Conditions

Lanes, Volumes, Timings  
1: Place d'Orleans & Centrum

AM Peak Hour  
2033 Future Background

Lane Group	EBL	EBT	EBR	WBL	WBT	WBR	NBL	NBT	NBR	SBL	SBT	SBR
Lane Configurations	↔	↕	↔	↔	↕	↔	↔	↕	↔	↔	↕	↔
Traffic Volume (vph)	25	31	40	30	33	18	67	176	56	119	42	19
Future Volume (vph)	25	31	40	30	33	18	67	176	56	119	42	19
Satd. Flow (prot)	1566	1745	1401	1658	1631	0	0	3151	0	0	3027	0
Fit Permitted	0.724			0.737				0.856			0.679	
Satd. Flow (perm)	1185	1745	1375	1278	1631	0	0	2727	0	0	2124	0
Satd. Flow (RTOR)			44		18			53			19	
Lane Group Flow (vph)	25	31	40	30	51	0	0	299	0	0	180	0
Turn Type	Perm	NA	Perm	Perm	NA		Perm	NA		Perm	NA	
Protected Phases	4			8			8	2			6	
Permitted Phases	4		4	8			2			6		
Detector Phase	4	4	4	8	8		2	2		6	6	
Switch Phase												
Minimum Initial (s)	10.0	10.0	10.0	10.0	10.0		10.0	10.0		10.0	10.0	
Minimum Split (s)	31.0	31.0	31.0	31.0	31.0		36.0	36.0		36.0	36.0	
Total Split (s)	32.0	32.0	32.0	32.0	32.0		43.0	43.0		43.0	43.0	
Total Split (%)	42.7%	42.7%	42.7%	42.7%	42.7%		57.3%	57.3%		57.3%	57.3%	
Yellow Time (s)	3.3	3.3	3.3	3.3	3.3		3.3	3.3		3.3	3.3	
All-Red Time (s)	2.7	2.7	2.7	2.7	2.7		2.7	2.7		2.7	2.7	
Lost Time Adjust (s)	0.0	0.0	0.0	0.0	0.0		0.0	0.0		0.0	0.0	
Total Lost Time (s)	6.0	6.0	6.0	6.0	6.0		6.0	6.0		6.0	6.0	
Lead/Lag												
Lead-Lag Optimize?												
Recall Mode	None	None	None	None	None		Max	Max		Max	Max	
Act Effct Green (s)	12.6	12.6	12.6	12.6	12.6		46.3	46.3		46.3	46.3	
Actuated g/C Ratio	0.20	0.20	0.20	0.20	0.20		0.75	0.75		0.75	0.75	
v/c Ratio	0.10	0.09	0.13	0.11	0.15		0.15	0.15		0.15	0.11	
Control Delay	20.0	19.5	7.0	20.1	14.9		4.9	5.5		4.9	5.5	
Queue Delay	0.0	0.0	0.0	0.0	0.0		0.0	0.0		0.0	0.0	
Total Delay	20.0	19.5	7.0	20.1	14.9		4.9	5.5		4.9	5.5	
LOS	B	B	A	C	B		A	A		A	A	
Approach Delay	14.4				16.8		4.9	5.5		4.9	5.5	
Approach LOS	B				B		A	A		A	A	
Queue Length 50th (m)	2.3	2.9	0.0	2.8	3.1		4.8	3.1		4.8	3.1	
Queue Length 95th (m)	7.2	8.2	5.5	8.2	9.9		15.8	11.2		15.8	11.2	
Internal Link Dist (m)		55.7			119.8		103.0	90.8		103.0	90.8	
Turn Bay Length (m)	52.0		20.0									
Base Capacity (vph)	504	743	610	544	704		2060	1599		2060	1599	
Starvation Cap Reductn	0	0	0	0	0		0	0		0	0	
Spillback Cap Reductn	0	0	0	0	0		0	0		0	0	
Storage Cap Reductn	0	0	0	0	0		0	0		0	0	
Reduced v/c Ratio	0.05	0.04	0.07	0.06	0.07		0.15	0.11		0.15	0.11	

Intersection Summary

Cycle Length: 75  
Actuated Cycle Length: 61.6  
Natural Cycle: 70  
Control Type: Actuated-Uncoordinated  
Maximum v/c Ratio: 0.15

Lanes, Volumes, Timings  
1: Place d'Orleans & Centrum

AM Peak Hour  
2033 Future Background

Intersection Signal Delay: 7.9  
Intersection Capacity Utilization 60.4%  
Analysis Period (min) 15

Intersection LOS: A  
ICU Level of Service B

Splits and Phases: 1: Place d'Orleans & Centrum



Intersection												
Int Delay, s/veh	2.3											
Movement	EBL	EBT	EBR	WBL	WBT	WBR	NBL	NBT	NBR	SBL	SBT	SBR
Lane Configurations	↕			↕			↕			↕		
Traffic Vol, veh/h	37	82	10	2	127	6	0	0	1	7	0	37
Future Vol, veh/h	37	82	10	2	127	6	0	0	1	7	0	37
Conflicting Peds, #/hr	8	0	9	9	0	8	0	0	3	3	0	0
Sign Control	Free	Free	Free	Free	Free	Free	Stop	Stop	Stop	Stop	Stop	Stop
RT Channelized	-	-	None	-	-	None	-	-	None	-	-	None
Storage Length	-	-	-	-	-	-	-	-	-	-	-	-
Veh in Median Storage, #	-	0	-	-	0	-	-	0	-	-	0	-
Grade, %	-	0	-	-	0	-	-	0	-	-	0	-
Peak Hour Factor	100	100	100	100	100	100	100	100	100	100	100	100
Heavy Vehicles, %	2	5	2	2	3	2	2	2	100	2	2	2
Mvmt Flow	37	82	10	2	127	6	0	0	1	7	0	37
Major/Minor	Major1	Major2			Minor1			Minor2				
Conflicting Flow All	141	0	0	101	0	0	323	315	99	307	317	138
Stage 1	-	-	-	-	-	-	170	170	-	142	142	-
Stage 2	-	-	-	-	-	-	153	145	-	165	175	-
Critical Hdwy	4.12	-	-	4.12	-	-	7.12	6.52	7.2	7.12	6.52	6.22
Critical Hdwy Stg 1	-	-	-	-	-	-	6.12	5.52	-	6.12	5.52	-
Critical Hdwy Stg 2	-	-	-	-	-	-	6.12	5.52	-	6.12	5.52	-
Follow-up Hdwy	2.218	-	-	2.218	-	-	3.518	4.018	4.2	3.518	4.018	3.318
Pot Cap-1 Maneuver	1442	-	-	1491	-	-	630	601	745	645	599	910
Stage 1	-	-	-	-	-	-	832	758	-	861	779	-
Stage 2	-	-	-	-	-	-	849	777	-	837	754	-
Platoon blocked, %	-	-	-	-	-	-	-	-	-	-	-	-
Mov Cap-1 Maneuver	1433	-	-	1481	-	-	587	576	738	625	574	904
Mov Cap-2 Maneuver	-	-	-	-	-	-	587	576	-	625	574	-
Stage 1	-	-	-	-	-	-	804	732	-	833	774	-
Stage 2	-	-	-	-	-	-	813	772	-	811	728	-
Approach	EB	WB			NB			SB				
HCM Control Delay, s	2.2	0.1			9.9			9.5				
HCM LOS	A			A			A					
Minor Lane/Major Mvmt	NBLn1	EBL	EBT	EBR	WBL	WBT	WBR	SBLn1				
Capacity (veh/h)	738	1433	-	-	1481	-	-	844				
HCM Lane V/C Ratio	0.001	0.026	-	-	0.001	-	-	0.052				
HCM Control Delay (s)	9.9	7.6	0	-	7.4	0	-	9.5				
HCM Lane LOS	A	A	A	-	A	A	-	A				
HCM 95th %tile Q(veh)	0	0.1	-	-	0	-	-	0.2				

Intersection						
Intersection Delay, s/veh	7.7					
Intersection LOS	A					
Movement	EBT	EBR	WBL	WBT	NBL	NBR
Lane Configurations	↕			↕	↕	↕
Traffic Vol, veh/h	21	47	39	18	58	36
Future Vol, veh/h	21	47	39	18	58	36
Peak Hour Factor	1.00	1.00	1.00	1.00	1.00	1.00
Heavy Vehicles, %	5	17	2	6	7	2
Mvmt Flow	21	47	39	18	58	36
Number of Lanes	1	0	0	1	1	1
Approach	EB	WB		NB		
Opposing Approach	WB	EB				
Opposing Lanes	1	1		0		
Conflicting Approach Left		NB		EB		
Conflicting Lanes Left	0	2		1		
Conflicting Approach Right	NB			WB		
Conflicting Lanes Right	2	0		1		
HCM Control Delay	7.2	7.7		8		
HCM LOS	A	A		A		
Lane	NBLn1	NBLn2	EBLn1	WBLn1		
Vol Left, %	100%	0%	0%	68%		
Vol Thru, %	0%	0%	31%	32%		
Vol Right, %	0%	100%	69%	0%		
Sign Control	Stop	Stop	Stop	Stop		
Traffic Vol by Lane	58	36	68	57		
LT Vol	58	0	0	39		
Through Vol	0	0	21	18		
RT Vol	0	36	47	0		
Lane Flow Rate	58	36	68	57		
Geometry Grp	7	7	2	2		
Degree of Util (X)	0.086	0.04	0.071	0.068		
Departure Headway (Hd)	5.336	4.049	3.774	4.284		
Convergence, Y/N	Yes	Yes	Yes	Yes		
Cap	669	878	932	824		
Service Time	3.09	1.802	1.869	2.373		
HCM Lane V/C Ratio	0.087	0.041	0.073	0.069		
HCM Control Delay	8.6	7	7.2	7.7		
HCM Lane LOS	A	A	A	A		
HCM 95th %tile Q	0.3	0.1	0.2	0.2		

HCM 2010 TWSC  
4: Centrum & Brisebois E

AM Peak Hour  
2033 Future Background

Intersection						
Int Delay, s/veh	2					
Movement	EBL	EBT	WBT	WBR	SBL	SBR
Lane Configurations		↕	↕		↕	↕
Traffic Vol, veh/h	11	19	27	1	0	5
Future Vol, veh/h	11	19	27	1	0	5
Conflicting Peds, #/hr	0	0	0	0	0	0
Sign Control	Free	Free	Free	Free	Stop	Stop
RT Channelized	-	None	-	None	-	None
Storage Length	-	-	-	-	0	-
Veh in Median Storage, #	-	0	0	-	0	-
Grade, %	-	0	0	-	0	-
Peak Hour Factor	100	100	100	100	100	100
Heavy Vehicles, %	9	2	2	2	2	20
Mvmt Flow	11	19	27	1	0	5
Major/Minor	Major1	Major2	Minor2			
Conflicting Flow All	28	0	0	69	28	
Stage 1	-	-	-	28	-	
Stage 2	-	-	-	41	-	
Critical Hdwy	4.19	-	-	6.42	6.4	
Critical Hdwy Stg 1	-	-	-	5.42	-	
Critical Hdwy Stg 2	-	-	-	5.42	-	
Follow-up Hdwy	2.281	-	-	3.518	3.48	
Pot Cap-1 Maneuver	1541	-	-	936	998	
Stage 1	-	-	-	995	-	
Stage 2	-	-	-	981	-	
Platoon blocked, %	-	-	-	-	-	
Mov Cap-1 Maneuver	1541	-	-	929	998	
Mov Cap-2 Maneuver	-	-	-	929	-	
Stage 1	-	-	-	988	-	
Stage 2	-	-	-	981	-	
Approach	EB	WB	SB			
HCM Control Delay, s	2.7	0	8.6			
HCM LOS			A			
Minor Lane/Major Mvmt	EBL	EBT	WBT	WBR	SBLn1	
Capacity (veh/h)	1541	-	-	-	998	
HCM Lane V/C Ratio	0.007	-	-	-	0.005	
HCM Control Delay (s)	7.4	0	-	-	8.6	
HCM Lane LOS	A	A	-	-	A	
HCM 95th %tile Q(veh)	0	-	-	-	0	

Lanes, Volumes, Timings  
5: Prestone & St Joseph

AM Peak Hour  
2033 Future Background



Lane Group	EBL	EBT	EBR	WBL	WBT	WBR	NBL	NBT	NBR	SBL	SBT	SBR
Lane Configurations	↕	↕↕	↕	↕	↕↕	↕	↕	↕	↕	↕	↕	↕
Traffic Volume (vph)	7	179	40	2	848	106	81	46	5	46	26	12
Future Volume (vph)	7	179	40	2	848	106	81	46	5	46	26	12
Satd. Flow (prot)	1658	3316	1375	1658	3316	1441	1626	1687	0	1566	1314	0
Fit Permitted	0.235			0.639			0.732			0.724		
Satd. Flow (perm)	410	3316	1375	1115	3316	1423	1252	1687	0	1191	1314	0
Satd. Flow (RTOR)			41			106		5			12	
Lane Group Flow (vph)	7	179	40	2	848	106	81	51	0	46	38	0
Turn Type	Perm	NA	Perm	Perm	NA	Perm	Perm	NA		Perm	NA	
Protected Phases		2			6			8			4	
Permitted Phases	2		2	6		6	8				4	
Detector Phase	2	2	2	6	6	6	8	8			4	4
Switch Phase												
Minimum Initial (s)	10.0	10.0	10.0	10.0	10.0	10.0	10.0	10.0		10.0	10.0	
Minimum Split (s)	23.7	23.7	23.7	23.7	23.7	23.7	29.0	29.0		29.0	29.0	
Total Split (s)	51.0	51.0	51.0	51.0	51.0	51.0	29.0	29.0		29.0	29.0	
Total Split (%)	63.8%	63.8%	63.8%	63.8%	63.8%	63.8%	36.3%	36.3%		36.3%	36.3%	
Yellow Time (s)	3.3	3.3	3.3	3.3	3.3	3.3	3.3	3.3		3.3	3.3	
All-Red Time (s)	2.4	2.4	2.4	2.4	2.4	2.4	2.7	2.7		2.7	2.7	
Lost Time Adjust (s)	0.0	0.0	0.0	0.0	0.0	0.0	0.0	0.0		0.0	0.0	
Total Lost Time (s)	5.7	5.7	5.7	5.7	5.7	5.7	6.0	6.0		6.0	6.0	
Lead/Lag												
Lead-Lag Optimize?												
Recall Mode	None	None	None	None	None	None	Max	Max		Max	Max	
Act Effct Green (s)	19.8	19.8	19.8	19.8	19.8	19.8	23.2	23.2		23.2	23.2	
Actuated g/C Ratio	0.36	0.36	0.36	0.36	0.36	0.36	0.42	0.42		0.42	0.42	
v/c Ratio	0.05	0.15	0.08	0.00	0.71	0.18	0.15	0.07		0.09	0.07	
Control Delay	11.4	11.6	4.3	10.5	18.3	3.6	12.4	10.7		11.9	9.3	
Queue Delay	0.0	0.0	0.0	0.0	0.0	0.0	0.0	0.0		0.0	0.0	
Total Delay	11.4	11.6	4.3	10.5	18.3	3.6	12.4	10.7		11.9	9.3	
LOS	B	B	A	B	B	A	B	B		B	A	
Approach Delay	10.3			16.7			11.8			10.7		
Approach LOS	B			B			B			B		
Queue Length 50th (m)	0.4	6.0	0.0	0.1	36.4	0.0	4.8	2.6		2.6	1.5	
Queue Length 95th (m)	2.4	11.0	4.3	1.1	52.0	7.0	14.0	9.1		9.0	6.8	
Internal Link Dist (m)	163.5			149.6			92.4			92.1		
Turn Bay Length (m)	50.0		105.0		62.5		120.0		47.5			
Base Capacity (vph)	341	2762	1152	928	2762	1202	529	716		503	562	
Starvation Cap Reductn	0	0	0	0	0	0	0	0		0	0	
Spillback Cap Reductn	0	0	0	0	0	0	0	0		0	0	
Storage Cap Reductn	0	0	0	0	0	0	0	0		0	0	
Reduced v/c Ratio	0.02	0.06	0.03	0.00	0.31	0.09	0.15	0.07		0.09	0.07	
Intersection Summary												
Cycle Length: 80												
Actuated Cycle Length: 54.8												
Natural Cycle: 55												
Control Type: Actuated-Uncoordinated												
Maximum v/c Ratio: 0.71												



Lanes, Volumes, Timings  
5: Prestone & St Joseph

AM Peak Hour  
2033 Future Background

Intersection Signal Delay: 14.8 Intersection LOS: B  
Intersection Capacity Utilization 53.7% ICU Level of Service A  
Analysis Period (min) 15

Splits and Phases: 5: Prestone & St Joseph

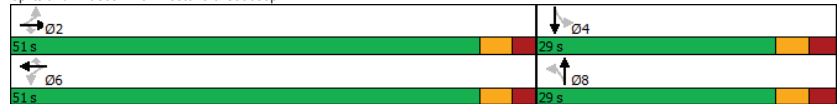

Lanes, Volumes, Timings  
1: Place d'Orleans & Centrum

PM Peak Hour  
2033 Future Background

Lane Group	EBL	EBT	EBR	WBL	WBT	WBR	NBL	NBT	NBR	SBL	SBT	SBR
Lane Configurations	↔	↕	↗	↖	↗	↖	↕	↕	↖	↗	↕	↕
Traffic Volume (vph)	94	57	220	48	46	14	102	153	73	126	158	42
Future Volume (vph)	94	57	220	48	46	14	102	153	73	126	158	42
Satd. Flow (prot)	1658	1745	1483	1658	1674	0	0	3097	0	0	3112	0
Fit Permitted	0.718			0.720				0.755			0.716	
Satd. Flow (perm)	1236	1745	1448	1242	1674	0	0	2371	0	0	2268	0
Satd. Flow (RTOR)			220		14			69			31	
Lane Group Flow (vph)	94	57	220	48	60	0	0	328	0	0	326	0
Turn Type	Perm	NA	Perm	Perm	NA		Perm	NA		Perm	NA	
Protected Phases		4			8			2			6	
Permitted Phases	4		4	8			2			6		
Detector Phase	4	4	4	8	8		2	2		6	6	
Switch Phase												
Minimum Initial (s)	10.0	10.0	10.0	10.0	10.0		10.0	10.0		10.0	10.0	
Minimum Split (s)	31.0	31.0	31.0	31.0	31.0		36.0	36.0		36.0	36.0	
Total Split (s)	32.0	32.0	32.0	32.0	32.0		53.0	53.0		53.0	53.0	
Total Split (%)	37.6%	37.6%	37.6%	37.6%	37.6%		62.4%	62.4%		62.4%	62.4%	
Yellow Time (s)	3.3	3.3	3.3	3.3	3.3		3.3	3.3		3.3	3.3	
All-Red Time (s)	2.7	2.7	2.7	2.7	2.7		2.7	2.7		2.7	2.7	
Lost Time Adjust (s)	0.0	0.0	0.0	0.0	0.0		0.0	0.0		0.0	0.0	
Total Lost Time (s)	6.0	6.0	6.0	6.0	6.0		6.0	6.0		6.0	6.0	
Lead/Lag												
Lead-Lag Optimize?												
Recall Mode	None	None	None	None	None		C-Max	C-Max		C-Max	C-Max	
Act Effct Green (s)	14.1	14.1	14.1	14.1	14.1		58.9	58.9		58.9	58.9	
Actuated g/C Ratio	0.17	0.17	0.17	0.17	0.17		0.69	0.69		0.69	0.69	
v/c Ratio	0.46	0.20	0.52	0.23	0.21		0.20	0.21		0.21	0.21	
Control Delay	37.6	29.8	8.6	31.1	24.3		4.8	5.5		4.8	5.5	
Queue Delay	0.0	0.0	0.0	0.0	0.0		0.0	0.0		0.0	0.0	
Total Delay	37.6	29.8	8.6	31.1	24.3		4.8	5.5		4.8	5.5	
LOS	D	C	A	C	C		A	A		A	A	
Approach Delay		19.2			27.3		4.8	5.5		4.8	5.5	
Approach LOS		B			C		A	A		A	A	
Queue Length 50th (m)	14.5	8.4	0.0	7.1	6.7		5.7	6.6		5.7	6.6	
Queue Length 95th (m)	23.7	15.2	15.1	13.8	14.1		16.6	18.6		16.6	18.6	
Internal Link Dist (m)		55.7			119.8		103.0	90.8		103.0	90.8	
Turn Bay Length (m)	52.0		20.0									
Base Capacity (vph)	378	533	595	379	521		1663	1580		1663	1580	
Starvation Cap Reductn	0	0	0	0	0		0	0		0	0	
Spillback Cap Reductn	0	0	0	0	0		0	0		0	0	
Storage Cap Reductn	0	0	0	0	0		0	0		0	0	
Reduced v/c Ratio	0.25	0.11	0.37	0.13	0.12		0.20	0.21		0.20	0.21	

Intersection Summary  
Cycle Length: 85  
Actuated Cycle Length: 85  
Offset: 0 (0%), Referenced to phase 2:NBTL and 6:SBTL, Start of Green  
Natural Cycle: 70  
Control Type: Actuated-Coordinated

Lanes, Volumes, Timings  
1: Place d'Orleans & Centrum

PM Peak Hour  
2033 Future Background

Maximum v/c Ratio: 0.52	Intersection LOS: B
Intersection Signal Delay: 11.8	ICU Level of Service D
Intersection Capacity Utilization 80.0%	
Analysis Period (min) 15	

Splits and Phases: 1: Place d'Orleans & Centrum

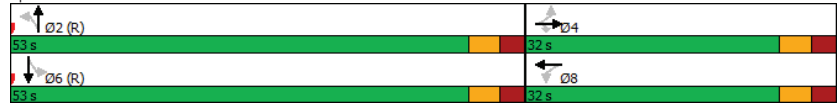

HCM 2010 TWSC  
2: Centrum & Brisebois W

PM Peak Hour  
2033 Future Background

Intersection												
Int Delay, s/veh 2.8												
Movement	EBL	EBT	EBR	WBL	WBT	WBR	NBL	NBT	NBR	SBL	SBT	SBR
Lane Configurations	↔			↔			↕			↕		
Traffic Vol, veh/h	49	181	8	1	120	9	7	0	8	12	0	58
Future Vol, veh/h	49	181	8	1	120	9	7	0	8	12	0	58
Conflicting Peds, #/hr	23	0	19	19	0	23	3	0	6	6	0	3
Sign Control	Free	Free	Free	Free	Free	Free	Stop	Stop	Stop	Stop	Stop	Stop
RT Channelized	-	-	None	-	-	None	-	-	None	-	-	None
Storage Length	-	-	-	-	-	-	-	-	-	-	-	-
Veh in Median Storage, #	-	0	-	-	0	-	-	0	-	-	0	-
Grade, %	-	0	-	-	0	-	-	0	-	-	0	-
Peak Hour Factor	100	100	100	100	100	100	100	100	100	100	100	100
Heavy Vehicles, %	2	3	2	2	5	2	2	2	2	2	2	2
Mvmt Flow	49	181	8	1	120	9	7	0	8	12	0	58

Major/Minor	Major1			Major2			Minor1			Minor2		
Conflicting Flow All	152	0	0	208	0	0	461	456	210	443	456	151
Stage 1	-	-	-	-	-	-	302	302	-	150	150	-
Stage 2	-	-	-	-	-	-	159	154	-	293	306	-
Critical Hdwy	4.12	-	-	4.12	-	-	7.12	6.52	6.22	7.12	6.52	6.22
Critical Hdwy Stg 1	-	-	-	-	-	-	6.12	5.52	-	6.12	5.52	-
Critical Hdwy Stg 2	-	-	-	-	-	-	6.12	5.52	-	6.12	5.52	-
Follow-up Hdwy	2,218	-	-	2,218	-	-	3,518	4,018	3,318	3,518	4,018	3,318
Pot Cap-1 Maneuver	1429	-	-	1363	-	-	511	501	830	525	501	895
Stage 1	-	-	-	-	-	-	707	664	-	853	773	-
Stage 2	-	-	-	-	-	-	843	770	-	715	662	-
Platoon blocked, %	-	-	-	-	-	-	-	-	-	-	-	-
Mov Cap-1 Maneuver	1403	-	-	1343	-	-	455	465	814	492	465	877
Mov Cap-2 Maneuver	-	-	-	-	-	-	455	465	-	492	465	-
Stage 1	-	-	-	-	-	-	670	629	-	805	758	-
Stage 2	-	-	-	-	-	-	785	755	-	677	627	-

Approach	EB	WB	NB	SB
HCM Control Delay, s	1.6	0.1	11.2	10.1
HCM LOS			B	B

Minor Lane/Major Mvmt	NBLn1	EBL	EBT	EBR	WBL	WBT	WBR	SBLn1
Capacity (veh/h)	595	1403	-	-	1343	-	-	773
HCM Lane V/C Ratio	0.025	0.035	-	-	0.001	-	-	0.091
HCM Control Delay (s)	11.2	7.7	0	-	7.7	0	-	10.1
HCM Lane LOS	B	A	A	-	A	A	-	B
HCM 95th %tile Q(veh)	0.1	0.1	-	-	0	-	-	0.3

HCM 2010 AWSC  
3: Prestone & Centrum

PM Peak Hour  
2033 Future Background

Intersection						
Intersection Delay, s/veh	8.1					
Intersection LOS	A					
Movement						
	EBT	EBR	WBL	WBT	NBL	NBR
Lane Configurations	↔			↔	↔	↔
Traffic Vol, veh/h	40	113	53	18	78	37
Future Vol, veh/h	40	113	53	18	78	37
Peak Hour Factor	1.00	1.00	1.00	1.00	1.00	1.00
Heavy Vehicles, %	2	6	2	2	11	2
Mvmt Flow	40	113	53	18	78	37
Number of Lanes	1	0	0	1	1	1
Approach						
	EB	WB		NB		
Opposing Approach	WB	EB				
Opposing Lanes	1	1		0		
Conflicting Approach Left		NB		EB		
Conflicting Lanes Left	0	2		1		
Conflicting Approach Right	NB			WB		
Conflicting Lanes Right	2	0		1		
HCM Control Delay	7.7	8		8.6		
HCM LOS	A	A		A		
Lane						
	NBLn1	NBLn2	EBLn1	WBLn1		
Vol Left, %	100%	0%	0%	75%		
Vol Thru, %	0%	0%	26%	25%		
Vol Right, %	0%	100%	74%	0%		
Sign Control	Stop	Stop	Stop	Stop		
Traffic Vol by Lane	78	37	153	71		
LT Vol	78	0	0	53		
Through Vol	0	0	40	18		
RT Vol	0	37	113	0		
Lane Flow Rate	78	37	153	71		
Geometry Grp	7	7	2	2		
Degree of Util (X)	0.123	0.044	0.165	0.089		
Departure Headway (Hd)	5.678	4.32	3.877	4.537		
Convergence, Y/N	Yes	Yes	Yes	Yes		
Cap	635	834	929	792		
Service Time	3.378	2.02	1.885	2.548		
HCM Lane V/C Ratio	0.123	0.044	0.165	0.09		
HCM Control Delay	9.2	7.2	7.7	8		
HCM Lane LOS	A	A	A	A		
HCM 95th-tile Q	0.4	0.1	0.6	0.3		

HCM 2010 TWSC  
4: Centrum & Brisebois E

PM Peak Hour  
2033 Future Background

Intersection						
Int Delay, s/veh	1.7					
Movement						
	EBL	EBT	WBT	WBR	SBL	SBR
Lane Configurations		↔	↔		↔	↔
Traffic Vol, veh/h	8	49	40	0	0	16
Future Vol, veh/h	8	49	40	0	0	16
Conflicting Peds, #/hr	0	0	0	0	0	0
Sign Control	Free	Free	Free	Free	Stop	Stop
RT Channelized	-	None	-	None	-	None
Storage Length	-	-	-	-	0	-
Veh in Median Storage, #	-	0	0	-	0	-
Grade, %	-	0	0	-	0	-
Peak Hour Factor	100	100	100	100	100	100
Heavy Vehicles, %	2	2	2	2	2	2
Mvmt Flow	8	49	40	0	0	16
Major/Minor						
	Major1	Major2		Minor2		
Conflicting Flow All	40	0	-	0	105	40
Stage 1	-	-	-	-	40	-
Stage 2	-	-	-	-	65	-
Critical Hdwy	4.12	-	-	-	6.42	6.22
Critical Hdwy Stg 1	-	-	-	-	5.42	-
Critical Hdwy Stg 2	-	-	-	-	5.42	-
Follow-up Hdwy	2.218	-	-	-	3.518	3.318
Pot Cap-1 Maneuver	1570	-	-	-	893	1031
Stage 1	-	-	-	-	982	-
Stage 2	-	-	-	-	958	-
Platoon blocked, %	-	-	-	-	-	-
Mov Cap-1 Maneuver	1570	-	-	-	889	1031
Mov Cap-2 Maneuver	-	-	-	-	889	-
Stage 1	-	-	-	-	977	-
Stage 2	-	-	-	-	958	-
Approach						
	EB	WB		SB		
HCM Control Delay, s	1	0		8.5		
HCM LOS				A		
Minor Lane/Major Mvmt						
	EBL	EBT	WBT	WBR SBLn1		
Capacity (veh/h)	1570	-	-	1031		
HCM Lane V/C Ratio	0.005	-	-	0.016		
HCM Control Delay (s)	7.3	0	-	8.5		
HCM Lane LOS	A	A	-	A		
HCM 95th %tile Q(veh)	0	-	-	0		

Lanes, Volumes, Timings  
5: Prestone & St Joseph

PM Peak Hour  
2033 Future Background

Lane Group	EBL	EBT	EBR	WBL	WBT	WBR	NBL	NBT	NBR	SBL	SBT	SBR
Lane Configurations	↔	↕	↔	↔	↕	↔	↔	↕	↔	↔	↕	↔
Traffic Volume (vph)	26	947	116	10	481	112	57	28	9	135	75	26
Future Volume (vph)	26	947	116	10	481	112	57	28	9	135	75	26
Satd. Flow (prot)	1658	3316	1483	1658	3316	1483	1658	1572	0	1658	1567	0
Fit Permitted	0.477			0.276			0.692			0.733		
Satd. Flow (perm)	832	3316	1444	481	3316	1464	1201	1572	0	1278	1567	0
Satd. Flow (RTOR)			116				112		9			22
Lane Group Flow (vph)	26	947	116	10	481	112	57	37	0	135	101	0
Turn Type	Perm	NA	Perm	Perm	NA	Perm	Perm	NA	NA	Perm	NA	
Protected Phases		2			6		8			4		
Permitted Phases	2		2	6		6	8			4		
Detector Phase	2	2	2	6	6	6	8	8		4	4	
Switch Phase												
Minimum Initial (s)	10.0	10.0	10.0	10.0	10.0	10.0	10.0	10.0		10.0	10.0	
Minimum Split (s)	23.7	23.7	23.7	23.7	23.7	23.7	29.0	29.0		29.0	29.0	
Total Split (s)	51.0	51.0	51.0	51.0	51.0	51.0	29.0	29.0		29.0	29.0	
Total Split (%)	63.8%	63.8%	63.8%	63.8%	63.8%	63.8%	36.3%	36.3%		36.3%	36.3%	
Yellow Time (s)	3.3	3.3	3.3	3.3	3.3	3.3	3.3	3.3		3.3	3.3	
All-Red Time (s)	2.4	2.4	2.4	2.4	2.4	2.4	2.7	2.7		2.7	2.7	
Lost Time Adjust (s)	0.0	0.0	0.0	0.0	0.0	0.0	0.0	0.0		0.0	0.0	
Total Lost Time (s)	5.7	5.7	5.7	5.7	5.7	5.7	6.0	6.0		6.0	6.0	
Lead/Lag												
Lead-Lag Optimize?												
Recall Mode	Max	Max	Max	Max	Max	Max	None	None		None	None	
Act Effct Green (s)	48.3	48.3	48.3	48.3	48.3	48.3	14.1	14.1		14.1	14.1	
Actuated g/C Ratio	0.65	0.65	0.65	0.65	0.65	0.65	0.19	0.19		0.19	0.19	
v/c Ratio	0.05	0.44	0.12	0.03	0.22	0.11	0.25	0.12		0.56	0.32	
Control Delay	6.6	7.8	1.9	6.8	6.3	1.9	26.3	19.2		35.0	21.6	
Queue Delay	0.0	0.0	0.0	0.0	0.0	0.0	0.0	0.0		0.0	0.0	
Total Delay	6.6	7.8	1.9	6.8	6.3	1.9	26.3	19.2		35.0	21.6	
LOS	A	A	A	A	A	A	C	B		D	C	
Approach Delay		7.2			5.5		23.5			29.3		
Approach LOS		A			A		C			C		
Queue Length 50th (m)	1.0	26.7	0.0	0.4	11.4	0.0	6.5	3.1		16.3	9.0	
Queue Length 95th (m)	4.9	56.7	6.2	2.7	25.8	6.1	15.2	9.7		31.4	20.5	
Internal Link Dist (m)		163.5			149.6		92.4			92.1		
Turn Bay Length (m)	50.0		105.0	62.5		120.0	47.5					
Base Capacity (vph)	541	2159	980	313	2159	992	374	496		398	504	
Starvation Cap Reductn	0	0	0	0	0	0	0	0		0	0	
Spillback Cap Reductn	0	0	0	0	0	0	0	0		0	0	
Storage Cap Reductn	0	0	0	0	0	0	0	0		0	0	
Reduced v/c Ratio	0.05	0.44	0.12	0.03	0.22	0.11	0.15	0.07		0.34	0.20	

Intersection Summary

Cycle Length: 80  
Actuated Cycle Length: 74.1  
Natural Cycle: 55  
Control Type: Actuated-Uncoordinated  
Maximum v/c Ratio: 0.56

Lanes, Volumes, Timings  
5: Prestone & St Joseph

PM Peak Hour  
2033 Future Background

Intersection Signal Delay: 10.0  
Intersection Capacity Utilization 52.8%  
Analysis Period (min) 15  
Intersection LOS: B  
ICU Level of Service A

Splits and Phases: 5: Prestone & St Joseph



# Appendix J

Synchro Intersection Worksheets – 2028 Future Total Conditions

Lanes, Volumes, Timings  
1: Place d'Orleans & Centrum

AM Peak Hour  
2028 Future Total

Lane Group	EBL	EBT	EBR	WBL	WBT	WBR	NBL	NBT	NBR	SBL	SBT	SBR
Lane Configurations	↔	↔	↔	↔	↔	↔	↔	↔	↔	↔	↔	↔
Traffic Volume (vph)	25	30	40	57	32	58	67	158	76	147	42	19
Future Volume (vph)	25	30	40	57	32	58	67	158	76	147	42	19
Satd. Flow (prot)	1566	1745	1401	1658	1551	0	0	3122	0	0	3033	0
Fit Permitted	0.699			0.738				0.850			0.652	
Satd. Flow (perm)	1145	1745	1375	1280	1551	0	0	2683	0	0	2047	0
Satd. Flow (RTOR)			44		58			76			19	
Lane Group Flow (vph)	25	30	40	57	90	0	0	301	0	0	208	0
Turn Type	Perm	NA	Perm	Perm	NA		Perm	NA		Perm	NA	
Protected Phases	4			8			8	2			6	
Permitted Phases	4		4	8			2			6		
Detector Phase	4	4	4	8	8		2	2		6	6	
Switch Phase												
Minimum Initial (s)	10.0	10.0	10.0	10.0	10.0		10.0	10.0		10.0	10.0	
Minimum Split (s)	31.0	31.0	31.0	31.0	31.0		36.0	36.0		36.0	36.0	
Total Split (s)	32.0	32.0	32.0	32.0	32.0		43.0	43.0		43.0	43.0	
Total Split (%)	42.7%	42.7%	42.7%	42.7%	42.7%		57.3%	57.3%		57.3%	57.3%	
Yellow Time (s)	3.3	3.3	3.3	3.3	3.3		3.3	3.3		3.3	3.3	
All-Red Time (s)	2.7	2.7	2.7	2.7	2.7		2.7	2.7		2.7	2.7	
Lost Time Adjust (s)	0.0	0.0	0.0	0.0	0.0		0.0	0.0		0.0	0.0	
Total Lost Time (s)	6.0	6.0	6.0	6.0	6.0		6.0	6.0		6.0	6.0	
Lead/Lag												
Lead-Lag Optimize?												
Recall Mode	None	None	None	None	None		Max	Max		Max	Max	
Act Effct Green (s)	12.6	12.6	12.6	12.6	12.6		42.2	42.2		42.2	42.2	
Actuated g/C Ratio	0.20	0.20	0.20	0.20	0.20		0.68	0.68		0.68	0.68	
v/c Ratio	0.11	0.08	0.13	0.22	0.25		0.16	0.16		0.15	0.15	
Control Delay	20.2	19.6	7.0	22.1	11.2		5.0	5.0		6.1	6.1	
Queue Delay	0.0	0.0	0.0	0.0	0.0		0.0	0.0		0.0	0.0	
Total Delay	20.2	19.6	7.0	22.1	11.2		5.0	5.0		6.1	6.1	
LOS	C	B	A	C	B		A	A		A	A	
Approach Delay		14.4			15.4		5.0	5.0		6.1	6.1	
Approach LOS		B			B		A	A		A	A	
Queue Length 50th (m)	2.3	2.8	0.0	5.4	3.0		4.3	4.3		3.7	3.7	
Queue Length 95th (m)	7.2	8.0	5.5	13.1	11.9		15.0	15.0		12.8	12.8	
Internal Link Dist (m)		55.7			119.8		103.0	103.0		90.8	90.8	
Turn Bay Length (m)	52.0		20.0									
Base Capacity (vph)	482	734	604	539	686		1845	1845		1395	1395	
Starvation Cap Reductn	0	0	0	0	0		0	0		0	0	
Spillback Cap Reductn	0	0	0	0	0		0	0		0	0	
Storage Cap Reductn	0	0	0	0	0		0	0		0	0	
Reduced v/c Ratio	0.05	0.04	0.07	0.11	0.13		0.16	0.16		0.15	0.15	

Intersection Summary

Cycle Length: 75  
Actuated Cycle Length: 62.2  
Natural Cycle: 70  
Control Type: Actuated-Uncoordinated  
Maximum v/c Ratio: 0.25

Lanes, Volumes, Timings  
1: Place d'Orleans & Centrum

AM Peak Hour  
2028 Future Total

Intersection Signal Delay: 8.5  
Intersection Capacity Utilization 61.8%  
Analysis Period (min) 15  
Intersection LOS: A  
ICU Level of Service B

Splits and Phases: 1: Place d'Orleans & Centrum



HCM 2010 TWSC  
2: Centrum & Brisebois W

AM Peak Hour  
2028 Future Total

Intersection												
Int Delay, s/veh	4.2											
Movement	EBL	EBT	EBR	WBL	WBT	WBR	NBL	NBT	NBR	SBL	SBT	SBR
Lane Configurations	↔			↔			↔			↔		
Traffic Vol, veh/h	83	81	10	2	126	7	0	0	1	8	0	102
Future Vol, veh/h	83	81	10	2	126	7	0	0	1	8	0	102
Conflicting Peds, #/hr	8	0	9	9	0	8	0	0	3	3	0	0
Sign Control	Free	Free	Free	Free	Free	Free	Stop	Stop	Stop	Stop	Stop	Stop
RT Channelized	-	-	None	-	-	None	-	-	None	-	-	None
Storage Length	-	-	-	-	-	-	-	-	-	-	-	-
Veh in Median Storage, #	-	0	-	-	0	-	-	0	-	-	0	-
Grade, %	-	0	-	-	0	-	-	0	-	-	0	-
Peak Hour Factor	100	100	100	100	100	100	100	100	100	100	100	100
Heavy Vehicles, %	2	5	2	2	3	2	2	2	100	2	2	2
Mvmt Flow	83	81	10	2	126	7	0	0	1	8	0	102
Major/Minor	Major1	Major2		Minor1		Minor2						
Conflicting Flow All	141	0	0	100	0	446	406	98	398	408	138	
Stage 1	-	-	-	-	-	261	261	-	142	142	-	
Stage 2	-	-	-	-	-	185	145	-	256	266	-	
Critical Hdwy	4.12	-	-	4.12	-	7.12	6.52	7.2	7.12	6.52	6.22	
Critical Hdwy Stg 1	-	-	-	-	-	6.12	5.52	-	6.12	5.52	-	
Critical Hdwy Stg 2	-	-	-	-	-	6.12	5.52	-	6.12	5.52	-	
Follow-up Hdwy	2.218	-	-	2.218	-	3.518	4.018	4.2	3.518	4.018	3.318	
Pot Cap-1 Maneuver	1442	-	-	1493	-	523	534	746	562	533	910	
Stage 1	-	-	-	-	-	744	692	-	861	779	-	
Stage 2	-	-	-	-	-	817	777	-	749	689	-	
Platoon blocked, %	-	-	-	-	-	-	-	-	-	-	-	
Mov Cap-1 Maneuver	1433	-	-	1483	-	439	494	739	530	494	904	
Mov Cap-2 Maneuver	-	-	-	-	-	439	494	-	530	494	-	
Stage 1	-	-	-	-	-	693	645	-	803	774	-	
Stage 2	-	-	-	-	-	724	772	-	701	642	-	
Approach	EB	WB		NB		SB						
HCM Control Delay, s	3.7	0.1		9.9		9.8						
HCM LOS	A		A		A		A					
Minor Lane/Major Mvmt	NBLn1	EBL	EBT	EBR	WBL	WBT	WBR	SBLn1				
Capacity (veh/h)	739	1433	-	-	1483	-	-	860				
HCM Lane V/C Ratio	0.001	0.058	-	-	0.001	-	-	0.128				
HCM Control Delay (s)	9.9	7.7	0	-	7.4	0	-	9.8				
HCM Lane LOS	A	A	A	-	A	A	-	A				
HCM 95th %tile Q(veh)	0	0.2	-	-	0	-	-	0.4				

HCM 2010 AWSC  
3: Prestone & Centrum

AM Peak Hour  
2028 Future Total

Intersection						
Intersection Delay, s/veh	8					
Intersection LOS	A					
Movement	EBT	EBR	WBL	WBT	NBL	NBR
Lane Configurations	↔			↔	↔	↔
Traffic Vol, veh/h	20	48	101	18	59	81
Future Vol, veh/h	20	48	101	18	59	81
Peak Hour Factor	1.00	1.00	1.00	1.00	1.00	1.00
Heavy Vehicles, %	5	17	2	6	7	2
Mvmt Flow	20	48	101	18	59	81
Number of Lanes	1	0	0	1	1	1
Approach	EB	WB	NB			
Opposing Approach	WB	EB				
Opposing Lanes	1	1	0			
Conflicting Approach Left		NB	EB			
Conflicting Lanes Left	0	2	1			
Conflicting Approach Right	NB		WB			
Conflicting Lanes Right	2	0	1			
HCM Control Delay	7.4	8.3	8			
HCM LOS	A	A	A			
Lane	NBLn1	NBLn2	EBLn1	WBLn1		
Vol Left, %	100%	0%	0%	85%		
Vol Thru, %	0%	0%	29%	15%		
Vol Right, %	0%	100%	71%	0%		
Sign Control	Stop	Stop	Stop	Stop		
Traffic Vol by Lane	59	81	68	119		
LT Vol	59	0	0	101		
Through Vol	0	0	20	18		
RT Vol	0	81	48	0		
Lane Flow Rate	59	81	68	119		
Geometry Grp	7	7	2	2		
Degree of Util (X)	0.091	0.096	0.076	0.149		
Departure Headway (Hd)	5.555	4.265	4.031	4.509		
Convergence, Y/N	Yes	Yes	Yes	Yes		
Cap	649	846	891	798		
Service Time	3.255	1.965	2.043	2.521		
HCM Lane V/C Ratio	0.091	0.096	0.076	0.149		
HCM Control Delay	8.8	7.4	7.4	8.3		
HCM Lane LOS	A	A	A	A		
HCM 95th %tile Q	0.3	0.3	0.2	0.5		

HCM 2010 TWSC  
4: Centrum & Brisebois E

AM Peak Hour  
2028 Future Total

Intersection						
Int Delay, s/veh	6					
Movement	EBL	EBT	WBT	WBR	SBL	SBR
Lane Configurations		↕	↕		↕	↕
Traffic Vol, veh/h	56	19	26	1	0	67
Future Vol, veh/h	56	19	26	1	0	67
Conflicting Peds, #/hr	0	0	0	0	0	0
Sign Control	Free	Free	Free	Free	Stop	Stop
RT Channelized	-	None	-	None	-	None
Storage Length	-	-	-	-	0	-
Veh in Median Storage, #	-	0	0	-	0	-
Grade, %	-	0	0	-	0	-
Peak Hour Factor	100	100	100	100	100	100
Heavy Vehicles, %	9	2	2	2	2	20
Mvmt Flow	56	19	26	1	0	67
Major/Minor	Major1	Major2	Minor2			
Conflicting Flow All	27	0	0	158	27	
Stage 1	-	-	-	27	-	
Stage 2	-	-	-	131	-	
Critical Hdwy	4.19	-	-	6.42	6.4	
Critical Hdwy Stg 1	-	-	-	5.42	-	
Critical Hdwy Stg 2	-	-	-	5.42	-	
Follow-up Hdwy	2.281	-	-	3.518	3.48	
Pot Cap-1 Maneuver	1543	-	-	833	999	
Stage 1	-	-	-	996	-	
Stage 2	-	-	-	895	-	
Platoon blocked, %	-	-	-	-	-	
Mov Cap-1 Maneuver	1543	-	-	802	999	
Mov Cap-2 Maneuver	-	-	-	802	-	
Stage 1	-	-	-	959	-	
Stage 2	-	-	-	895	-	
Approach	EB	WB	SB			
HCM Control Delay, s	5.5	0	8.9			
HCM LOS	A					
Minor Lane/Major Mvmt	EBL	EBT	WBT	WBR	SBLn1	
Capacity (veh/h)	1543	-	-	-	999	
HCM Lane V/C Ratio	0.036	-	-	-	0.067	
HCM Control Delay (s)	7.4	0	-	-	8.9	
HCM Lane LOS	A	A	-	-	A	
HCM 95th %tile Q(veh)	0.1	-	-	-	0.2	

Lanes, Volumes, Timings  
5: Prestone & St Joseph

AM Peak Hour  
2028 Future Total

Lane Group	EBL	EBT	EBR	WBL	WBT	WBR	NBL	NBT	NBR	SBL	SBT	SBR
Lane Configurations	↕	↕	↕	↕	↕	↕	↕	↕	↕	↕	↕	↕
Traffic Volume (vph)	8	176	40	2	768	133	81	63	5	81	51	15
Future Volume (vph)	8	176	40	2	768	133	81	63	5	81	51	15
Satd. Flow (prot)	1658	3316	1375	1658	3316	1441	1626	1693	0	1566	1307	0
Fit Permitted	0.273			0.641			0.714			0.713		
Satd. Flow (perm)	476	3316	1375	1119	3316	1423	1221	1693	0	1173	1307	0
Satd. Flow (RTOR)			41			133		5			15	
Lane Group Flow (vph)	8	176	40	2	768	133	81	68	0	81	66	0
Turn Type	Perm	NA	Perm	Perm	NA	Perm	Perm	NA		Perm	NA	
Protected Phases		2			6			8				4
Permitted Phases	2		2	6		6	8				4	
Detector Phase	2	2	2	6	6	6	8	8			4	4
Switch Phase												
Minimum Initial (s)	10.0	10.0	10.0	10.0	10.0	10.0	10.0	10.0		10.0	10.0	
Minimum Split (s)	23.7	23.7	23.7	23.7	23.7	23.7	29.0	29.0		29.0	29.0	
Total Split (s)	51.0	51.0	51.0	51.0	51.0	51.0	29.0	29.0		29.0	29.0	
Total Split (%)	63.8%	63.8%	63.8%	63.8%	63.8%	63.8%	36.3%	36.3%		36.3%	36.3%	
Yellow Time (s)	3.3	3.3	3.3	3.3	3.3	3.3	3.3	3.3		3.3	3.3	
All-Red Time (s)	2.4	2.4	2.4	2.4	2.4	2.4	2.7	2.7		2.7	2.7	
Lost Time Adjust (s)	0.0	0.0	0.0	0.0	0.0	0.0	0.0	0.0		0.0	0.0	
Total Lost Time (s)	5.7	5.7	5.7	5.7	5.7	5.7	6.0	6.0		6.0	6.0	
Lead/Lag												
Lead-Lag Optimize?												
Recall Mode	None	None	None	None	None	None	Max	Max		Max	Max	
Act Effct Green (s)	18.1	18.1	18.1	18.1	18.1	18.1	23.1	23.1		23.1	23.1	
Actuated g/C Ratio	0.34	0.34	0.34	0.34	0.34	0.34	0.44	0.44		0.44	0.44	
v/c Ratio	0.05	0.16	0.08	0.01	0.68	0.23	0.15	0.09		0.16	0.11	
Control Delay	11.8	12.0	4.6	10.5	18.1	3.8	11.5	10.1		11.6	9.3	
Queue Delay	0.0	0.0	0.0	0.0	0.0	0.0	0.0	0.0		0.0	0.0	
Total Delay	11.8	12.0	4.6	10.5	18.1	3.8	11.5	10.1		11.6	9.3	
LOS	B	B	A	B	B	A	B	B		B	A	
Approach Delay	10.7			16.0			10.9			10.6		
Approach LOS	B			B			B			B		
Queue Length 50th (m)	0.5	5.9	0.0	0.1	31.8	0.0	4.3	3.2		4.3	2.6	
Queue Length 95th (m)	2.7	10.9	4.3	1.1	46.4	8.0	13.2	10.7		13.3	9.9	
Internal Link Dist (m)	163.5			149.6			92.4			92.1		
Turn Bay Length (m)	50.0		105.0		62.5		120.0		47.5			
Base Capacity (vph)	409	2852	1188	962	2852	1242	533	742		512	579	
Starvation Cap Reductn	0	0	0	0	0	0	0	0		0	0	
Spillback Cap Reductn	0	0	0	0	0	0	0	0		0	0	
Storage Cap Reductn	0	0	0	0	0	0	0	0		0	0	
Reduced v/c Ratio	0.02	0.06	0.03	0.00	0.27	0.11	0.15	0.09		0.16	0.11	

Intersection Summary												
Cycle Length: 80												
Actuated Cycle Length: 53												
Natural Cycle: 55												
Control Type: Actuated-Uncoordinated												
Maximum v/c Ratio: 0.68												



Lanes, Volumes, Timings  
5: Prestone & St Joseph

AM Peak Hour  
2028 Future Total

Intersection Signal Delay: 14.1	Intersection LOS: B
Intersection Capacity Utilization 51.3%	ICU Level of Service A
Analysis Period (min) 15	

Splits and Phases: 5: Prestone & St Joseph

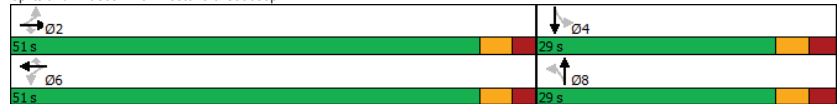

HCM 2010 TWSC  
6: Access #1 & Brisebois

AM Peak Hour  
2028 Future Total

Intersection						
Int Delay, s/veh	3.8					
Movement	EBT	EBR	WBL	WBT	NBL	NBR
Lane Configurations	↑			↑	↓	↓
Traffic Vol, veh/h	52	0	0	30	48	12
Future Vol, veh/h	52	0	0	30	48	12
Conflicting Peds, #/hr	0	0	0	0	0	0
Sign Control	Free	Free	Free	Free	Stop	Stop
RT Channelized	-	None	-	None	-	None
Storage Length	-	-	-	-	0	-
Veh in Median Storage, #	0	-	-	0	0	-
Grade, %	0	-	-	0	0	-
Peak Hour Factor	100	100	100	100	100	100
Heavy Vehicles, %	2	2	2	2	2	2
Mvmt Flow	52	0	0	30	48	12
Major/Minor	Major1	Major2	Minor1			
Conflicting Flow All	0	-	-	82	52	
Stage 1	-	-	-	52	-	
Stage 2	-	-	-	30	-	
Critical Hdwy	-	-	-	6.42	6.22	
Critical Hdwy Stg 1	-	-	-	5.42	-	
Critical Hdwy Stg 2	-	-	-	5.42	-	
Follow-up Hdwy	-	-	-	3.518	3.318	
Pot Cap-1 Maneuver	-	0	0	920	1016	
Stage 1	-	0	0	970	-	
Stage 2	-	0	0	993	-	
Platoon blocked, %	-	-	-	-	-	
Mov Cap-1 Maneuver	-	-	-	920	1016	
Mov Cap-2 Maneuver	-	-	-	920	-	
Stage 1	-	-	-	970	-	
Stage 2	-	-	-	993	-	
Approach	EB	WB	NB			
HCM Control Delay, s	0	0	9.1			
HCM LOS			A			
Minor Lane/Major Mvmt	NBLn1	EBT	WBT			
Capacity (veh/h)	938	-	-			
HCM Lane V/C Ratio	0.064	-	-			
HCM Control Delay (s)	9.1	-	-			
HCM Lane LOS	A	-	-			
HCM 95th %tile Q(veh)	0.2	-	-			

Lanes, Volumes, Timings  
7: Access #2 & Brisebois

AM Peak Hour  
2028 Future Total

Lane Group	EBT	EBR	WBL	WBT	NBL	NBR
Lane Configurations	↔		↔		↔	
Traffic Volume (vph)	54	11	0	30	0	0
Future Volume (vph)	54	11	0	30	0	0
Satd. Flow (prot)	1705	0	0	1745	0	0
Fit Permitted						
Satd. Flow (perm)	1705	0	0	1745	0	0
Lane Group Flow (vph)	65	0	0	30	0	0
Sign Control	Free		Free		Free	
<b>Intersection Summary</b>						
Control Type: Unsignalized						
Intersection Capacity Utilization 7.0%						
ICU Level of Service A						
Analysis Period (min) 15						

HCM 2010 TWSC  
8: Access #3 & Brisebois

AM Peak Hour  
2028 Future Total

<b>Intersection</b>						
Int Delay, s/veh	5.3					
Movement	EBT	EBR	WBL	WBT	NBL	NBR
Lane Configurations	↔		↔		↔	
Traffic Vol, veh/h	17	37	45	12	18	50
Future Vol, veh/h	17	37	45	12	18	50
Conflicting Peds, #/hr	0	0	0	0	0	0
Sign Control	Free	Free	Free	Free	Stop	Stop
RT Channelized	-	None	-	None	-	None
Storage Length	-	-	-	-	0	-
Veh in Median Storage, #	0	-	-	0	0	-
Grade, %	0	-	-	0	0	-
Peak Hour Factor	100	100	100	100	100	100
Heavy Vehicles, %	2	2	2	2	2	2
Mvmt Flow	17	37	45	12	18	50

Major/Minor	Major1	Major2	Minor1
Conflicting Flow All	0	0	138
Stage 1	-	-	36
Stage 2	-	-	102
Critical Hdwy	-	4.12	6.42
Critical Hdwy Stg 1	-	-	5.42
Critical Hdwy Stg 2	-	-	5.42
Follow-up Hdwy	-	2.218	3.318
Pot Cap-1 Maneuver	-	1551	855
Stage 1	-	-	986
Stage 2	-	-	922
Platoon blocked, %	-	-	-
Mov Cap-1 Maneuver	-	1551	830
Mov Cap-2 Maneuver	-	-	830
Stage 1	-	-	986
Stage 2	-	-	895

Approach	EB	WB	NB
HCM Control Delay, s	0	5.8	9
HCM LOS			A

Minor Lane/Major Mvmt	NBLn1	EBT	EBR	WBL	WBT
Capacity (veh/h)	973	-	-	1551	-
HCM Lane V/C Ratio	0.07	-	-	0.029	-
HCM Control Delay (s)	9	-	-	7.4	0
HCM Lane LOS	A	-	-	A	A
HCM 95th %tile Q(veh)	0.2	-	-	0.1	-

Lanes, Volumes, Timings  
1: Place d'Orleans & Centrum

PM Peak Hour  
2028 Future Total

Lane Group	EBL	EBT	EBR	WBL	WBT	WBR	NBL	NBT	NBR	SBL	SBT	SBR
Lane Configurations	↔	↕	↔	↔	↕	↔		↕	↔	↔	↕	↔
Traffic Volume (vph)	94	57	220	75	46	54	102	151	103	168	143	42
Future Volume (vph)	94	57	220	75	46	54	102	151	103	168	143	42
Satd. Flow (prot)	1658	1745	1483	1658	1581	0	0	3066	0	0	3105	0
Fit Permitted	0.692			0.720				0.756			0.667	
Satd. Flow (perm)	1193	1745	1448	1242	1581	0	0	2349	0	0	2116	0
Satd. Flow (RTOR)			220		54			103			28	
Lane Group Flow (vph)	94	57	220	75	100	0	0	356	0	0	353	0
Turn Type	Perm	NA	Perm	Perm	NA		Perm	NA		Perm	NA	
Protected Phases		4		8			8	2			6	
Permitted Phases	4		4	8			2			6		
Detector Phase	4	4	4	8	8		2	2		6	6	
Switch Phase												
Minimum Initial (s)	10.0	10.0	10.0	10.0	10.0		10.0	10.0		10.0	10.0	
Minimum Split (s)	31.0	31.0	31.0	31.0	31.0		36.0	36.0		36.0	36.0	
Total Split (s)	32.0	32.0	32.0	32.0	32.0		53.0	53.0		53.0	53.0	
Total Split (%)	37.6%	37.6%	37.6%	37.6%	37.6%		62.4%	62.4%		62.4%	62.4%	
Yellow Time (s)	3.3	3.3	3.3	3.3	3.3		3.3	3.3		3.3	3.3	
All-Red Time (s)	2.7	2.7	2.7	2.7	2.7		2.7	2.7		2.7	2.7	
Lost Time Adjust (s)	0.0	0.0	0.0	0.0	0.0		0.0	0.0		0.0	0.0	
Total Lost Time (s)	6.0	6.0	6.0	6.0	6.0		6.0	6.0		6.0	6.0	
Lead/Lag												
Lead-Lag Optimize?												
Recall Mode	None	None	None	None	None		C-Max	C-Max		C-Max	C-Max	
Act Effct Green (s)	14.3	14.3	14.3	14.3	14.3		58.7	58.7		58.7	58.7	
Actuated g/C Ratio	0.17	0.17	0.17	0.17	0.17		0.69	0.69		0.69	0.69	
v/c Ratio	0.47	0.20	0.52	0.36	0.32		0.22	0.22		0.24	0.24	
Control Delay	38.1	29.6	8.5	34.2	17.4		4.4	4.4		5.9	5.9	
Queue Delay	0.0	0.0	0.0	0.0	0.0		0.0	0.0		0.0	0.0	
Total Delay	38.1	29.6	8.5	34.2	17.4		4.4	4.4		5.9	5.9	
LOS	D	C	A	C	B		A	A		A	A	
Approach Delay		19.3			24.6		4.4	4.4		5.9	5.9	
Approach LOS		B			C		A	A		A	A	
Queue Length 50th (m)	14.4	8.3	0.0	11.3	6.7		5.6	5.6		7.7	7.7	
Queue Length 95th (m)	23.9	15.2	15.1	19.6	16.4		16.6	16.6		21.0	21.0	
Internal Link Dist (m)		55.7			119.8		103.0	103.0		90.8	90.8	
Turn Bay Length (m)	52.0		20.0									
Base Capacity (vph)	364	533	595	379	521		1655	1655		1470	1470	
Starvation Cap Reductn	0	0	0	0	0		0	0		0	0	
Spillback Cap Reductn	0	0	0	0	0		0	0		0	0	
Storage Cap Reductn	0	0	0	0	0		0	0		0	0	
Reduced v/c Ratio	0.26	0.11	0.37	0.20	0.19		0.22	0.22		0.24	0.24	

Intersection Summary

Cycle Length: 85
Actuated Cycle Length: 85
Offset: 0 (0%), Referenced to phase 2:NBTL and 6:SBTL, Start of Green
Natural Cycle: 70
Control Type: Actuated-Coordinated

Lanes, Volumes, Timings  
1: Place d'Orleans & Centrum

PM Peak Hour  
2028 Future Total

Maximum v/c Ratio: 0.52	Intersection LOS: B
Intersection Signal Delay: 12.0	ICU Level of Service D
Intersection Capacity Utilization 80.0%	
Analysis Period (min) 15	

Splits and Phases: 1: Place d'Orleans & Centrum



HCM 2010 TWSC  
2: Centrum & Brisebois W

PM Peak Hour  
2028 Future Total

Intersection												
Int Delay, s/veh	4.5											
Movement	EBL	EBT	EBR	WBL	WBT	WBR	NBL	NBT	NBR	SBL	SBT	SBR
Lane Configurations	↔			↔			↔			↔		
Traffic Vol, veh/h	119	179	8	1	118	17	7	0	8	20	0	123
Future Vol, veh/h	119	179	8	1	118	17	7	0	8	20	0	123
Conflicting Peds, #/hr	23	0	19	19	0	23	3	0	6	6	0	3
Sign Control	Free	Free	Free	Free	Free	Free	Stop	Stop	Stop	Stop	Stop	Stop
RT Channelized	-	-	None	-	-	None	-	-	None	-	-	None
Storage Length	-	-	-	-	-	-	-	-	-	-	-	-
Veh in Median Storage, #	-	0	-	-	0	-	-	0	-	-	0	-
Grade, %	-	0	-	-	0	-	-	0	-	-	0	-
Peak Hour Factor	100	100	100	100	100	100	100	100	100	100	100	100
Heavy Vehicles, %	2	3	2	2	5	2	2	2	2	2	2	2
Mvmt Flow	119	179	8	1	118	17	7	0	8	20	0	123
Major/Minor	Major1	Major2		Minor1	Minor2							
Conflicting Flow All	158	0	0	206	0	633	600	208	583	596	153	
Stage 1	-	-	-	-	-	440	440	-	152	152	-	
Stage 2	-	-	-	-	-	193	160	-	431	444	-	
Critical Hdwy	4.12	-	-	4.12	-	7.12	6.52	6.22	7.12	6.52	6.22	
Critical Hdwy Stg 1	-	-	-	-	-	6.12	5.52	-	6.12	5.52	-	
Critical Hdwy Stg 2	-	-	-	-	-	6.12	5.52	-	6.12	5.52	-	
Follow-up Hdwy	2.218	-	-	2.218	-	3.518	4.018	3.318	3.518	4.018	3.318	
Pot Cap-1 Maneuver	1422	-	-	1365	-	392	415	832	424	417	893	
Stage 1	-	-	-	-	-	596	578	-	850	772	-	
Stage 2	-	-	-	-	-	809	766	-	603	575	-	
Platoon blocked, %	-	-	-	-	-	-	-	-	-	-	-	
Mov Cap-1 Maneuver	1397	-	-	1345	-	307	363	816	380	365	875	
Mov Cap-2 Maneuver	-	-	-	-	-	307	363	-	380	365	-	
Stage 1	-	-	-	-	-	532	515	-	756	757	-	
Stage 2	-	-	-	-	-	693	751	-	538	512	-	
Approach	EB	WB		NB		SB						
HCM Control Delay, s	3	0.1		13.1		11						
HCM LOS	A			B		B						
Minor Lane/Major Mvmt	NBLn1	EBL	EBT	EBR	WBL	WBT	WBR	SBLn1				
Capacity (veh/h)	460	1397	-	-	1345	-	-	740				
HCM Lane V/C Ratio	0.033	0.085	-	-	0.001	-	-	0.193				
HCM Control Delay (s)	13.1	7.8	0	-	7.7	0	-	11				
HCM Lane LOS	B	A	A	-	A	A	-	B				
HCM 95th %tile Q(veh)	0.1	0.3	-	-	0	-	-	0.7				

HCM 2010 AWSC  
3: Prestone & Centrum

PM Peak Hour  
2028 Future Total

Intersection						
Intersection Delay, s/veh	8.5					
Intersection LOS	A					
Movement	EBT	EBR	WBL	WBT	NBL	NBR
Lane Configurations	↔		↔		↔	
Traffic Vol, veh/h	39	121	116	18	86	103
Future Vol, veh/h	39	121	116	18	86	103
Peak Hour Factor	1.00	1.00	1.00	1.00	1.00	1.00
Heavy Vehicles, %	2	6	2	2	11	2
Mvmt Flow	39	121	116	18	86	103
Number of Lanes	1	0	0	1	1	1
Approach	EB	WB		NB		
Opposing Approach	WB	EB				
Opposing Lanes	1	1		0		
Conflicting Approach Left		NB		EB		
Conflicting Lanes Left	0	2		1		
Conflicting Approach Right	NB			WB		
Conflicting Lanes Right	2	0		1		
HCM Control Delay	8.1	8.8		8.6		
HCM LOS	A	A		A		
Lane	NBLn1	NBLn2	EBLn1	WBLn1		
Vol Left, %	100%	0%	0%	87%		
Vol Thru, %	0%	0%	24%	13%		
Vol Right, %	0%	100%	76%	0%		
Sign Control	Stop	Stop	Stop	Stop		
Traffic Vol by Lane	86	103	160	134		
LT Vol	86	0	0	116		
Through Vol	0	0	39	18		
RT Vol	0	103	121	0		
Lane Flow Rate	86	103	160	134		
Geometry Grp	7	7	2	2		
Degree of Util (X)	0.14	0.128	0.183	0.177		
Departure Headway (Hd)	5.842	4.482	4.111	4.745		
Convergence, Y/N	Yes	Yes	Yes	Yes		
Cap	614	799	874	757		
Service Time	3.575	2.215	2.132	2.768		
HCM Lane V/C Ratio	0.14	0.129	0.183	0.177		
HCM Control Delay	9.5	7.9	8.1	8.8		
HCM Lane LOS	A	A	A	A		
HCM 95th-tile Q	0.5	0.4	0.7	0.6		

HCM 2010 TWSC  
4: Centrum & Brisebois E

PM Peak Hour  
2028 Future Total

Intersection						
Int Delay, s/veh	5.2					
Movement	EBL	EBT	WBT	WBR	SBL	SBR
Lane Configurations		↖	↗		↙	↘
Traffic Vol, veh/h	74	49	39	0	0	79
Future Vol, veh/h	74	49	39	0	0	79
Conflicting Peds, #/hr	0	0	0	0	0	0
Sign Control	Free	Free	Free	Free	Stop	Stop
RT Channelized	-	None	-	None	-	None
Storage Length	-	-	-	-	0	-
Veh in Median Storage, #	-	0	0	-	0	-
Grade, %	-	0	0	-	0	-
Peak Hour Factor	100	100	100	100	100	100
Heavy Vehicles, %	2	2	2	2	2	2
Mvmt Flow	74	49	39	0	0	79
Major/Minor	Major1	Major2	Minor2			
Conflicting Flow All	39	0	0	236	39	
Stage 1	-	-	-	39	-	
Stage 2	-	-	-	197	-	
Critical Hdwy	4.12	-	-	6.42	6.22	
Critical Hdwy Stg 1	-	-	-	5.42	-	
Critical Hdwy Stg 2	-	-	-	5.42	-	
Follow-up Hdwy	2,218	-	-	3,518	3,318	
Pot Cap-1 Maneuver	1571	-	-	752	1033	
Stage 1	-	-	-	983	-	
Stage 2	-	-	-	836	-	
Platoon blocked, %	-	-	-	-	-	
Mov Cap-1 Maneuver	1571	-	-	716	1033	
Mov Cap-2 Maneuver	-	-	-	716	-	
Stage 1	-	-	-	936	-	
Stage 2	-	-	-	836	-	
Approach	EB	WB	SB			
HCM Control Delay, s	4.5	0	8.8			
HCM LOS				A		
Minor Lane/Major Mvmt	EBL	EBT	WBT	WBR	SBLn1	
Capacity (veh/h)	1571	-	-	-	1033	
HCM Lane V/C Ratio	0.047	-	-	-	0.076	
HCM Control Delay (s)	7.4	0	-	-	8.8	
HCM Lane LOS	A	A	-	-	A	
HCM 95th %tile Q(veh)	0.1	-	-	-	0.2	

Lanes, Volumes, Timings  
5: Prestone & St Joseph

PM Peak Hour  
2028 Future Total

Lane Group	EBL	EBT	EBR	WBL	WBT	WBR	NBL	NBT	NBR	SBL	SBT	SBR
Lane Configurations	↖	↖↗	↖	↖	↖↗	↖	↖	↖↗	↖	↖	↖↗	↖
Traffic Volume (vph)	34	853	116	10	471	153	57	54	9	177	99	31
Future Volume (vph)	34	853	116	10	471	153	57	54	9	177	99	31
Satd. Flow (prot)	1658	3316	1483	1658	3316	1483	1658	1585	0	1658	1570	0
Fit Permitted	0.482			0.308			0.674			0.716		
Satd. Flow (perm)	841	3316	1444	537	3316	1464	1170	1585	0	1248	1570	0
Satd. Flow (RTOR)			116			153		9			20	
Lane Group Flow (vph)	34	853	116	10	471	153	57	63	0	177	130	0
Turn Type	Perm	NA	Perm	Perm	NA	Perm	Perm	NA		Perm	NA	
Protected Phases		2			6		8		8		4	
Permitted Phases	2		2	6		6	8			4		
Detector Phase	2	2	2	6	6	6	8	8		4	4	
Switch Phase												
Minimum Initial (s)	10.0	10.0	10.0	10.0	10.0	10.0	10.0	10.0		10.0	10.0	
Minimum Split (s)	23.7	23.7	23.7	23.7	23.7	23.7	29.0	29.0		29.0	29.0	
Total Split (s)	51.0	51.0	51.0	51.0	51.0	51.0	29.0	29.0		29.0	29.0	
Total Split (%)	63.8%	63.8%	63.8%	63.8%	63.8%	63.8%	36.3%	36.3%		36.3%	36.3%	
Yellow Time (s)	3.3	3.3	3.3	3.3	3.3	3.3	3.3	3.3		3.3	3.3	
All-Red Time (s)	2.4	2.4	2.4	2.4	2.4	2.4	2.7	2.7		2.7	2.7	
Lost Time Adjust (s)	0.0	0.0	0.0	0.0	0.0	0.0	0.0	0.0		0.0	0.0	
Total Lost Time (s)	5.7	5.7	5.7	5.7	5.7	5.7	6.0	6.0		6.0	6.0	
Lead/Lag												
Lead-Lag Optimize?												
Recall Mode	Max	Max	Max	Max	Max	Max	None	None		None	None	
Act Effct Green (s)	47.9	47.9	47.9	47.9	47.9	47.9	15.8	15.8		15.8	15.8	
Actuated g/C Ratio	0.64	0.64	0.64	0.64	0.64	0.64	0.21	0.21		0.21	0.21	
v/c Ratio	0.06	0.41	0.12	0.03	0.22	0.16	0.23	0.19		0.68	0.38	
Control Delay	7.2	8.2	2.0	7.2	6.9	1.8	25.3	21.2		40.0	23.4	
Queue Delay	0.0	0.0	0.0	0.0	0.0	0.0	0.0	0.0		0.0	0.0	
Total Delay	7.2	8.2	2.0	7.2	6.9	1.8	25.3	21.2		40.0	23.4	
LOS	A	A	A	A	A	A	C	C		D	C	
Approach Delay		7.5			5.7		23.2				33.0	
Approach LOS		A			A		C				C	
Queue Length 50th (m)	1.6	26.8	0.0	0.5	12.7	0.0	6.5	6.0		22.2	12.7	
Queue Length 95th (m)	6.0	49.5	6.2	2.7	25.2	7.0	15.2	14.9		41.1	26.2	
Internal Link Dist (m)		163.5			149.6		92.4				92.1	
Turn Bay Length (m)	50.0		105.0	62.5		120.0	47.5					
Base Capacity (vph)	533	2104	958	340	2104	985	358	491		382	494	
Starvation Cap Reductn	0	0	0	0	0	0	0	0		0	0	
Spillback Cap Reductn	0	0	0	0	0	0	0	0		0	0	
Storage Cap Reductn	0	0	0	0	0	0	0	0		0	0	
Reduced v/c Ratio	0.06	0.41	0.12	0.03	0.22	0.16	0.16	0.13		0.46	0.26	

Intersection Summary												
Cycle Length: 80												
Actuated Cycle Length: 75.4												
Natural Cycle: 55												
Control Type: Actuated-Uncoordinated												
Maximum v/c Ratio: 0.68												

Lanes, Volumes, Timings  
5: Prestone & St Joseph

PM Peak Hour  
2028 Future Total

Intersection Signal Delay: 11.6 Intersection LOS: B  
Intersection Capacity Utilization 63.6% ICU Level of Service B  
Analysis Period (min) 15

Splits and Phases: 5: Prestone & St Joseph

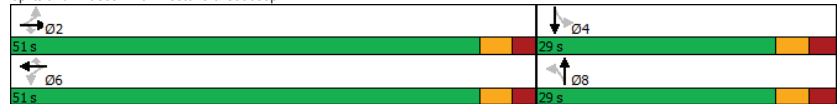

HCM 2010 TWSC  
6: Access #1 & Brisebois

PM Peak Hour  
2028 Future Total

Intersection						
Int Delay, s/veh	3.4					
Movement	EBT	EBR	WBL	WBT	NBL	NBR
Lane Configurations	↑			↑	↑	↑
Traffic Vol, veh/h	94	0	0	26	55	12
Future Vol, veh/h	94	0	0	26	55	12
Conflicting Peds, #/hr	0	0	0	0	0	0
Sign Control	Free	Free	Free	Free	Stop	Stop
RT Channelized	-	None	-	None	-	None
Storage Length	-	-	-	-	0	-
Veh in Median Storage, #	0	-	-	0	0	-
Grade, %	0	-	-	0	0	-
Peak Hour Factor	100	100	100	100	100	100
Heavy Vehicles, %	2	2	2	2	2	2
Mvmt Flow	94	0	0	26	55	12
Major/Minor	Major1	Major2	Minor1			
Conflicting Flow All	0	-	-	120	94	
Stage 1	-	-	-	94	-	
Stage 2	-	-	-	26	-	
Critical Hdwy	-	-	-	6.42	6.22	
Critical Hdwy Stg 1	-	-	-	5.42	-	
Critical Hdwy Stg 2	-	-	-	5.42	-	
Follow-up Hdwy	-	-	-	3.518	3.318	
Pot Cap-1 Maneuver	-	0	0	876	963	
Stage 1	-	0	0	930	-	
Stage 2	-	0	0	997	-	
Platoon blocked, %	-	-	-	-	-	
Mov Cap-1 Maneuver	-	-	-	876	963	
Mov Cap-2 Maneuver	-	-	-	876	-	
Stage 1	-	-	-	930	-	
Stage 2	-	-	-	997	-	
Approach	EB	WB	NB			
HCM Control Delay, s	0	0	9.4			
HCM LOS			A			
Minor Lane/Major Mvmt	NBLn1	EBT	WBT			
Capacity (veh/h)	890	-	-			
HCM Lane V/C Ratio	0.075	-	-			
HCM Control Delay (s)	9.4	-	-			
HCM Lane LOS	A	-	-			
HCM 95th %tile Q(veh)	0.2	-	-			

Lanes, Volumes, Timings  
7: Access #2 & Brisebois

PM Peak Hour  
2028 Future Total

Lane Group	EBT	EBR	WBL	WBT	NBL	NBR
Lane Configurations	↗			↖		
Traffic Volume (vph)	82	24	0	26	0	0
Future Volume (vph)	82	24	0	26	0	0
Satd. Flow (prot)	1691	0	0	1745	0	0
Fit Permitted						
Satd. Flow (perm)	1691	0	0	1745	0	0
Lane Group Flow (vph)	106	0	0	26	0	0
Sign Control	Free			Free	Free	
<b>Intersection Summary</b>						
Control Type: Unsignalized						
Intersection Capacity Utilization 9.4%						
ICU Level of Service A						
Analysis Period (min) 15						

HCM 2010 TWSC  
8: Access #3 & Brisebois

PM Peak Hour  
2028 Future Total

<b>Intersection</b>						
Int Delay, s/veh	5					
Movement	EBT	EBR	WBL	WBT	NBL	NBR
Lane Configurations	↗			↖	↗	↖
Traffic Vol, veh/h	28	54	66	8	18	51
Future Vol, veh/h	28	54	66	8	18	51
Conflicting Peds, #/hr	0	0	0	0	0	0
Sign Control	Free	Free	Free	Free	Stop	Stop
RT Channelized	-	None	-	None	-	None
Storage Length	-	-	-	-	0	-
Veh in Median Storage, #	0	-	-	0	0	-
Grade, %	0	-	-	0	0	-
Peak Hour Factor	100	100	100	100	100	100
Heavy Vehicles, %	2	2	2	2	2	2
Mvmt Flow	28	54	66	8	18	51

Major/Minor	Major1	Major2	Minor1
Conflicting Flow All	0	0	82
Stage 1	-	-	55
Stage 2	-	-	140
Critical Hdwy	-	4.12	6.42
Critical Hdwy Stg 1	-	-	5.42
Critical Hdwy Stg 2	-	-	5.42
Follow-up Hdwy	-	2.218	3.518
Pot Cap-1 Maneuver	-	1515	794
Stage 1	-	-	968
Stage 2	-	-	887
Platoon blocked, %	-	-	-
Mov Cap-1 Maneuver	-	1515	759
Mov Cap-2 Maneuver	-	-	759
Stage 1	-	-	968
Stage 2	-	-	848

Approach	EB	WB	NB
HCM Control Delay, s	0	6.7	9.2
HCM LOS			A

Minor Lane/Major Mvmt	NBLn1	EBT	EBR	WBL	WBT
Capacity (veh/h)	931	-	-	1515	-
HCM Lane V/C Ratio	0.074	-	-	0.044	-
HCM Control Delay (s)	9.2	-	-	7.5	0
HCM Lane LOS	A	-	-	A	A
HCM 95th %tile Q(veh)	0.2	-	-	0.1	-

# Appendix K

Synchro Intersection Worksheets – 2033 Future Total Conditions



Lanes, Volumes, Timings  
1: Place d'Orleans & Centrum

AM Peak Hour  
2033 Future Total

Lane Group	EBL	EBT	EBR	WBL	WBT	WBR	NBL	NBT	NBR	SBL	SBT	SBR
Lane Configurations	↔	↗	↘	↔	↗	↘	↔	↗	↘	↔	↗	↘
Traffic Volume (vph)	25	31	40	57	33	58	67	175	76	147	42	19
Future Volume (vph)	25	31	40	57	33	58	67	175	76	147	42	19
Satd. Flow (prot)	1566	1745	1401	1658	1553	0	0	3131	0	0	3033	0
Fit Permitted	0.698			0.737				0.854			0.647	
Satd. Flow (perm)	1143	1745	1375	1278	1553	0	0	2700	0	0	2031	0
Satd. Flow (RTOR)			44		58			76			19	
Lane Group Flow (vph)	25	31	40	57	91	0	0	318	0	0	208	0
Turn Type	Perm	NA	Perm	Perm	NA		Perm	NA		Perm	NA	
Protected Phases	4			8			8	2			6	
Permitted Phases	4		4	8			2			6		
Detector Phase	4	4	4	8	8		2	2		6	6	
Switch Phase												
Minimum Initial (s)	10.0	10.0	10.0	10.0	10.0		10.0	10.0		10.0	10.0	
Minimum Split (s)	31.0	31.0	31.0	31.0	31.0		36.0	36.0		36.0	36.0	
Total Split (s)	32.0	32.0	32.0	32.0	32.0		43.0	43.0		43.0	43.0	
Total Split (%)	42.7%	42.7%	42.7%	42.7%	42.7%		57.3%	57.3%		57.3%	57.3%	
Yellow Time (s)	3.3	3.3	3.3	3.3	3.3		3.3	3.3		3.3	3.3	
All-Red Time (s)	2.7	2.7	2.7	2.7	2.7		2.7	2.7		2.7	2.7	
Lost Time Adjust (s)	0.0	0.0	0.0	0.0	0.0		0.0	0.0		0.0	0.0	
Total Lost Time (s)	6.0	6.0	6.0	6.0	6.0		6.0	6.0		6.0	6.0	
Lead/Lag												
Lead-Lag Optimize?												
Recall Mode	None	None	None	None	None		Max	Max		Max	Max	
Act Effct Green (s)	12.6	12.6	12.6	12.6	12.6		42.2	42.2		42.2	42.2	
Actuated g/C Ratio	0.20	0.20	0.20	0.20	0.20		0.68	0.68		0.68	0.68	
v/c Ratio	0.11	0.09	0.13	0.22	0.25		0.17	0.17		0.15	0.15	
Control Delay	20.2	19.6	7.0	22.1	11.3		5.1	5.1		6.1	6.1	
Queue Delay	0.0	0.0	0.0	0.0	0.0		0.0	0.0		0.0	0.0	
Total Delay	20.2	19.6	7.0	22.1	11.3		5.1	5.1		6.1	6.1	
LOS	C	B	A	C	B		A	A		A	A	
Approach Delay		14.5			15.4		5.1	5.1		6.1	6.1	
Approach LOS		B			B		A	A		A	A	
Queue Length 50th (m)	2.3	2.9	0.0	5.4	3.1		4.7	4.7		3.7	3.7	
Queue Length 95th (m)	7.2	8.2	5.5	13.1	12.0		15.9	15.9		12.9	12.9	
Internal Link Dist (m)		55.7			119.8		103.0	103.0		90.8	90.8	
Turn Bay Length (m)	52.0		20.0									
Base Capacity (vph)	481	735	605	538	688		1856	1856		1384	1384	
Starvation Cap Reductn	0	0	0	0	0		0	0		0	0	
Spillback Cap Reductn	0	0	0	0	0		0	0		0	0	
Storage Cap Reductn	0	0	0	0	0		0	0		0	0	
Reduced v/c Ratio	0.05	0.04	0.07	0.11	0.13		0.17	0.17		0.15	0.15	

Intersection Summary

Cycle Length: 75  
Actuated Cycle Length: 62.2  
Natural Cycle: 70  
Control Type: Actuated-Uncoordinated  
Maximum v/c Ratio: 0.25

Lanes, Volumes, Timings  
1: Place d'Orleans & Centrum

AM Peak Hour  
2033 Future Total

Intersection Signal Delay: 8.5  
Intersection Capacity Utilization 62.3%  
Analysis Period (min) 15  
Intersection LOS: A  
ICU Level of Service B

Splits and Phases: 1: Place d'Orleans & Centrum

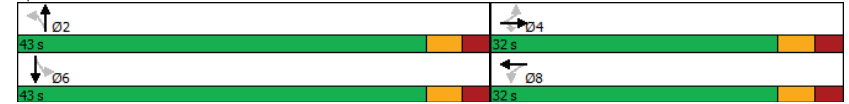

HCM 2010 TWSC  
2: Centrum & Brisebois W

AM Peak Hour  
2033 Future Total

Intersection												
Int Delay, s/veh	4.1											
Movement	EBL	EBT	EBR	WBL	WBT	WBR	NBL	NBT	NBR	SBL	SBT	SBR
Lane Configurations	↕			↕			↕			↕		
Traffic Vol, veh/h	83	82	10	2	127	7	0	0	1	8	0	102
Future Vol, veh/h	83	82	10	2	127	7	0	0	1	8	0	102
Conflicting Peds, #/hr	8	0	9	9	0	8	0	0	3	3	0	0
Sign Control	Free	Free	Free	Free	Free	Free	Stop	Stop	Stop	Stop	Stop	Stop
RT Channelized	-	-	None	-	-	None	-	-	None	-	-	None
Storage Length	-	-	-	-	-	-	-	-	-	-	-	-
Veh in Median Storage, #	-	0	-	-	0	-	-	0	-	-	0	-
Grade, %	-	0	-	-	0	-	-	0	-	-	0	-
Peak Hour Factor	100	100	100	100	100	100	100	100	100	100	100	100
Heavy Vehicles, %	2	5	2	2	3	2	2	2	100	2	2	2
Mvmt Flow	83	82	10	2	127	7	0	0	1	8	0	102
Major/Minor	Major1			Major2			Minor1			Minor2		
Conflicting Flow All	142	0	0	101	0	0	448	408	99	400	410	139
Stage 1	-	-	-	-	-	-	262	262	-	143	143	-
Stage 2	-	-	-	-	-	-	186	146	-	257	267	-
Critical Hdwy	4.12	-	-	4.12	-	-	7.12	6.52	7.2	7.12	6.52	6.22
Critical Hdwy Stg 1	-	-	-	-	-	-	6.12	5.52	-	6.12	5.52	-
Critical Hdwy Stg 2	-	-	-	-	-	-	6.12	5.52	-	6.12	5.52	-
Follow-up Hdwy	2.218	-	-	2.218	-	-	3.518	4.018	4.2	3.518	4.018	3.318
Pot Cap-1 Maneuver	1441	-	-	1491	-	-	521	533	745	560	531	909
Stage 1	-	-	-	-	-	-	743	691	-	860	779	-
Stage 2	-	-	-	-	-	-	816	776	-	748	688	-
Platoon blocked, %	-	-	-	-	-	-	-	-	-	-	-	-
Mov Cap-1 Maneuver	1432	-	-	1481	-	-	437	494	738	528	492	903
Mov Cap-2 Maneuver	-	-	-	-	-	-	437	494	-	528	492	-
Stage 1	-	-	-	-	-	-	692	644	-	802	774	-
Stage 2	-	-	-	-	-	-	723	771	-	700	641	-
Approach	EB			WB			NB			SB		
HCM Control Delay, s	3.6			0.1			9.9			9.8		
HCM LOS	A			A			A			A		
Minor Lane/Major Mvmt	NBLn1	EBL	EBT	EBR	WBL	WBT	WBR	SBLn1				
Capacity (veh/h)	738	1432	-	-	1481	-	-	859				
HCM Lane V/C Ratio	0.001	0.058	-	-	0.001	-	-	0.128				
HCM Control Delay (s)	9.9	7.7	0	-	7.4	0	-	9.8				
HCM Lane LOS	A	A	A	-	A	A	-	A				
HCM 95th %tile Q(veh)	0	0.2	-	-	0	-	-	0.4				

HCM 2010 AWSC  
3: Prestone & Centrum

AM Peak Hour  
2033 Future Total

Intersection						
Intersection Delay, s/veh	8					
Intersection LOS	A					
Movement	EBT	EBR	WBL	WBT	NBL	NBR
Lane Configurations	↕			↕	↕	↕
Traffic Vol, veh/h	21	48	101	18	59	81
Future Vol, veh/h	21	48	101	18	59	81
Peak Hour Factor	1.00	1.00	1.00	1.00	1.00	1.00
Heavy Vehicles, %	5	17	2	6	7	2
Mvmt Flow	21	48	101	18	59	81
Number of Lanes	1	0	0	1	1	1
Approach	EB		WB		NB	
Opposing Approach	WB		EB			
Opposing Lanes	1		1		0	
Conflicting Approach Left			NB		EB	
Conflicting Lanes Left	0		2		1	
Conflicting Approach Right	NB				WB	
Conflicting Lanes Right	2		0		1	
HCM Control Delay	7.4		8.3		8	
HCM LOS	A		A		A	
Lane	NBLn1	NBLn2	EBLn1	WBLn1		
Vol Left, %	100%	0%	0%	85%		
Vol Thru, %	0%	0%	30%	15%		
Vol Right, %	0%	100%	70%	0%		
Sign Control	Stop	Stop	Stop	Stop		
Traffic Vol by Lane	59	81	69	119		
LT Vol	59	0	0	101		
Through Vol	0	0	21	18		
RT Vol	0	81	48	0		
Lane Flow Rate	59	81	69	119		
Geometry Grp	7	7	2	2		
Degree of Util (X)	0.091	0.096	0.077	0.149		
Departure Headway (Hd)	5.545	4.256	4.039	4.513		
Convergence, Y/N	Yes	Yes	Yes	Yes		
Cap	649	845	890	797		
Service Time	3.257	1.967	2.049	2.522		
HCM Lane V/C Ratio	0.091	0.096	0.078	0.149		
HCM Control Delay	8.8	7.4	7.4	8.3		
HCM Lane LOS	A	A	A	A		
HCM 95th %tile Q	0.3	0.3	0.2	0.5		

HCM 2010 TWSC  
4: Centrum & Brisebois E

AM Peak Hour  
2033 Future Total

Intersection						
Int Delay, s/veh	5.9					
Movement	EBL	EBT	WBT	WBR	SBL	SBR
Lane Configurations		↕	↕		↕	↕
Traffic Vol, veh/h	56	19	27	1	0	67
Future Vol, veh/h	56	19	27	1	0	67
Conflicting Peds, #/hr	0	0	0	0	0	0
Sign Control	Free	Free	Free	Free	Stop	Stop
RT Channelized	-	None	-	None	-	None
Storage Length	-	-	-	-	0	-
Veh in Median Storage, #	-	0	0	-	0	-
Grade, %	-	0	0	-	0	-
Peak Hour Factor	100	100	100	100	100	100
Heavy Vehicles, %	9	2	2	2	2	20
Mvmt Flow	56	19	27	1	0	67
Major/Minor	Major1	Major2	Minor2			
Conflicting Flow All	28	0	0	159	28	
Stage 1	-	-	-	28	-	
Stage 2	-	-	-	131	-	
Critical Hdwy	4.19	-	-	6.42	6.4	
Critical Hdwy Stg 1	-	-	-	5.42	-	
Critical Hdwy Stg 2	-	-	-	5.42	-	
Follow-up Hdwy	2.281	-	-	3.518	3.48	
Pot Cap-1 Maneuver	1541	-	-	832	998	
Stage 1	-	-	-	995	-	
Stage 2	-	-	-	895	-	
Platoon blocked, %	-	-	-	-	-	
Mov Cap-1 Maneuver	1541	-	-	801	998	
Mov Cap-2 Maneuver	-	-	-	801	-	
Stage 1	-	-	-	958	-	
Stage 2	-	-	-	895	-	
Approach	EB	WB	SB			
HCM Control Delay, s	5.5	0	8.9			
HCM LOS	A					
Minor Lane/Major Mvmt	EBL	EBT	WBT	WBR	SBLn1	
Capacity (veh/h)	1541	-	-	-	998	
HCM Lane V/C Ratio	0.036	-	-	-	0.067	
HCM Control Delay (s)	7.4	0	-	-	8.9	
HCM Lane LOS	A	A	-	-	A	
HCM 95th %tile Q(veh)	0.1	-	-	-	0.2	

Lanes, Volumes, Timings  
5: Prestone & St Joseph

AM Peak Hour  
2033 Future Total



Lane Group	EBL	EBT	EBR	WBL	WBT	WBR	NBL	NBT	NBR	SBL	SBT	SBR
Lane Configurations	↕	↕↕	↕	↕	↕↕	↕	↕	↕	↕	↕	↕	↕
Traffic Volume (vph)	8	178	40	2	845	133	81	63	5	81	51	15
Future Volume (vph)	8	178	40	2	845	133	81	63	5	81	51	15
Satd. Flow (prot)	1658	3316	1375	1658	3316	1441	1626	1693	0	1566	1307	0
Fit Permitted	0.237			0.640			0.714			0.713		
Satd. Flow (perm)	414	3316	1375	1117	3316	1423	1221	1693	0	1173	1307	0
Satd. Flow (RTOR)			41			133		5			15	
Lane Group Flow (vph)	8	178	40	2	845	133	81	68	0	81	66	0
Turn Type	Perm	NA	Perm	Perm	NA	Perm	Perm	NA		Perm	NA	
Protected Phases		2			6			8				4
Permitted Phases	2		2	6		6	8				4	
Detector Phase	2	2	2	6	6	6	8	8			4	4
Switch Phase												
Minimum Initial (s)	10.0	10.0	10.0	10.0	10.0	10.0	10.0	10.0		10.0	10.0	
Minimum Split (s)	23.7	23.7	23.7	23.7	23.7	23.7	29.0	29.0		29.0	29.0	
Total Split (s)	51.0	51.0	51.0	51.0	51.0	51.0	29.0	29.0		29.0	29.0	
Total Split (%)	63.8%	63.8%	63.8%	63.8%	63.8%	63.8%	36.3%	36.3%		36.3%	36.3%	
Yellow Time (s)	3.3	3.3	3.3	3.3	3.3	3.3	3.3	3.3		3.3	3.3	
All-Red Time (s)	2.4	2.4	2.4	2.4	2.4	2.4	2.7	2.7		2.7	2.7	
Lost Time Adjust (s)	0.0	0.0	0.0	0.0	0.0	0.0	0.0	0.0		0.0	0.0	
Total Lost Time (s)	5.7	5.7	5.7	5.7	5.7	5.7	6.0	6.0		6.0	6.0	
Lead/Lag												
Lead-Lag Optimize?												
Recall Mode	None	None	None	None	None	None	Max	Max		Max	Max	
Act Effct Green (s)	19.8	19.8	19.8	19.8	19.8	19.8	23.1	23.1		23.1	23.1	
Actuated g/C Ratio	0.36	0.36	0.36	0.36	0.36	0.36	0.42	0.42		0.42	0.42	
v/c Ratio	0.05	0.15	0.08	0.00	0.70	0.22	0.16	0.09		0.16	0.12	
Control Delay	11.6	11.6	4.3	10.5	18.3	3.5	12.4	11.0		12.6	10.0	
Queue Delay	0.0	0.0	0.0	0.0	0.0	0.0	0.0	0.0		0.0	0.0	
Total Delay	11.6	11.6	4.3	10.5	18.3	3.5	12.4	11.0		12.6	10.0	
LOS	B	B	A	B	B	A	B	B		B	B	
Approach Delay	10.3			16.3			11.8			11.4		
Approach LOS	B			B			B			B		
Queue Length 50th (m)	0.5	6.0	0.0	0.1	36.2	0.0	4.8	3.6		4.8	2.9	
Queue Length 95th (m)	2.7	10.9	4.3	1.1	51.7	7.7	14.0	11.3		14.1	10.4	
Internal Link Dist (m)	163.5			149.6			92.4			92.1		
Turn Bay Length (m)	50.0		105.0		62.5		120.0		47.5			
Base Capacity (vph)	345	2763	1152	930	2763	1208	516	719		496	561	
Starvation Cap Reductn	0	0	0	0	0	0	0	0		0	0	
Spillback Cap Reductn	0	0	0	0	0	0	0	0		0	0	
Storage Cap Reductn	0	0	0	0	0	0	0	0		0	0	
Reduced v/c Ratio	0.02	0.06	0.03	0.00	0.31	0.11	0.16	0.09		0.16	0.12	
Intersection Summary												
Cycle Length: 80												
Actuated Cycle Length: 54.7												
Natural Cycle: 55												
Control Type: Actuated-Uncoordinated												
Maximum v/c Ratio: 0.70												

Lanes, Volumes, Timings  
5: Prestone & St Joseph

AM Peak Hour  
2033 Future Total

Intersection Signal Delay: 14.5 Intersection LOS: B  
Intersection Capacity Utilization 53.6% ICU Level of Service A  
Analysis Period (min) 15

Splits and Phases: 5: Prestone & St Joseph



HCM 2010 TWSC  
6: Access #1 & Brisebois

AM Peak Hour  
2033 Future Total

Intersection						
Int Delay, s/veh	3.8					
Movement	EBT	EBR	WBL	WBT	NBL	NBR
Lane Configurations	↑			↑	↓	↓
Traffic Vol, veh/h	52	0	0	30	48	12
Future Vol, veh/h	52	0	0	30	48	12
Conflicting Peds, #/hr	0	0	0	0	0	0
Sign Control	Free	Free	Free	Free	Stop	Stop
RT Channelized	-	None	-	None	-	None
Storage Length	-	-	-	-	0	-
Veh in Median Storage, #	0	-	-	0	0	-
Grade, %	0	-	-	0	0	-
Peak Hour Factor	100	100	100	100	100	100
Heavy Vehicles, %	2	2	2	2	2	2
Mvmt Flow	52	0	0	30	48	12
Major/Minor	Major1	Major2	Minor1			
Conflicting Flow All	0	-	-	82	52	
Stage 1	-	-	-	52	-	
Stage 2	-	-	-	30	-	
Critical Hdwy	-	-	-	6.42	6.22	
Critical Hdwy Stg 1	-	-	-	5.42	-	
Critical Hdwy Stg 2	-	-	-	5.42	-	
Follow-up Hdwy	-	-	-	3.518	3.318	
Pot Cap-1 Maneuver	-	0	0	920	1016	
Stage 1	-	0	0	970	-	
Stage 2	-	0	0	993	-	
Platoon blocked, %	-	-	-	-	-	
Mov Cap-1 Maneuver	-	-	-	920	1016	
Mov Cap-2 Maneuver	-	-	-	920	-	
Stage 1	-	-	-	970	-	
Stage 2	-	-	-	993	-	
Approach	EB	WB	NB			
HCM Control Delay, s	0	0	9.1			
HCM LOS			A			
Minor Lane/Major Mvmt	NBLn1	EBT	WBT			
Capacity (veh/h)	938	-	-			
HCM Lane V/C Ratio	0.064	-	-			
HCM Control Delay (s)	9.1	-	-			
HCM Lane LOS	A	-	-			
HCM 95th %tile Q(veh)	0.2	-	-			

Lanes, Volumes, Timings  
7: Access #2 & Brisebois

AM Peak Hour  
2033 Future Total

Lane Group	EBT	EBR	WBL	WBT	NBL	NBR
Lane Configurations	↖			↗		
Traffic Volume (vph)	54	11	0	30	0	0
Future Volume (vph)	54	11	0	30	0	0
Satd. Flow (prot)	1705	0	0	1745	0	0
Fit Permitted						
Satd. Flow (perm)	1705	0	0	1745	0	0
Lane Group Flow (vph)	65	0	0	30	0	0
Sign Control	Free			Free	Stop	
<b>Intersection Summary</b>						
Control Type: Unsignalized						
Intersection Capacity Utilization 7.0%						
ICU Level of Service A						
Analysis Period (min) 15						

HCM 2010 TWSC  
8: Access #3 & Brisebois

AM Peak Hour  
2033 Future Total

<b>Intersection</b>						
Int Delay, s/veh	5.3					
Movement	EBT	EBR	WBL	WBT	NBL	NBR
Lane Configurations	↖			↗	↖	↗
Traffic Vol, veh/h	17	37	45	12	18	50
Future Vol, veh/h	17	37	45	12	18	50
Conflicting Peds, #/hr	0	0	0	0	0	0
Sign Control	Free	Free	Free	Free	Stop	Stop
RT Channelized	-	None	-	None	-	None
Storage Length	-	-	-	-	0	-
Veh in Median Storage, #	0	-	-	0	0	-
Grade, %	0	-	-	0	0	-
Peak Hour Factor	100	100	100	100	100	100
Heavy Vehicles, %	2	2	2	2	2	2
Mvmt Flow	17	37	45	12	18	50

Major/Minor	Major1	Major2	Minor1
Conflicting Flow All	0	0	138
Stage 1	-	-	36
Stage 2	-	-	102
Critical Hdwy	-	4.12	6.42
Critical Hdwy Stg 1	-	-	5.42
Critical Hdwy Stg 2	-	-	5.42
Follow-up Hdwy	-	2.218	3.318
Pot Cap-1 Maneuver	-	1551	855
Stage 1	-	-	986
Stage 2	-	-	922
Platoon blocked, %	-	-	-
Mov Cap-1 Maneuver	-	1551	830
Mov Cap-2 Maneuver	-	-	830
Stage 1	-	-	986
Stage 2	-	-	895

Approach	EB	WB	NB
HCM Control Delay, s	0	5.8	9
HCM LOS			A

Minor Lane/Major Mvmt	NBLn1	EBT	EBR	WBL	WBT
Capacity (veh/h)	973	-	-	1551	-
HCM Lane V/C Ratio	0.07	-	-	0.029	-
HCM Control Delay (s)	9	-	-	7.4	0
HCM Lane LOS	A	-	-	A	A
HCM 95th %tile Q(veh)	0.2	-	-	0.1	-

Lanes, Volumes, Timings  
1: Place d'Orleans & Centrum

PM Peak Hour  
2033 Future Total

Lane Group	EBL	EBT	EBR	WBL	WBT	WBR	NBL	NBT	NBR	SBL	SBT	SBR
Lane Configurations	↔	↕	↔	↔	↕	↔		↕	↔	↔	↕	↔
Traffic Volume (vph)	94	57	220	75	46	54	102	151	103	168	157	42
Future Volume (vph)	94	57	220	75	46	54	102	151	103	168	157	42
Satd. Flow (prot)	1658	1745	1483	1658	1581	0	0	3066	0	0	3111	0
Fit Permitted	0.692			0.720				0.752			0.672	
Satd. Flow (perm)	1193	1745	1448	1242	1581	0	0	2336	0	0	2134	0
Satd. Flow (RTOR)			220		54			103			26	
Lane Group Flow (vph)	94	57	220	75	100	0	0	356	0	0	367	0
Turn Type	Perm	NA	Perm	Perm	NA		Perm	NA		Perm	NA	
Protected Phases		4			8			2			6	
Permitted Phases	4		4	8			2			6		
Detector Phase	4	4	4	8	8		2	2		6	6	
Switch Phase												
Minimum Initial (s)	10.0	10.0	10.0	10.0	10.0		10.0	10.0		10.0	10.0	
Minimum Split (s)	31.0	31.0	31.0	31.0	31.0		36.0	36.0		36.0	36.0	
Total Split (s)	32.0	32.0	32.0	32.0	32.0		53.0	53.0		53.0	53.0	
Total Split (%)	37.6%	37.6%	37.6%	37.6%	37.6%		62.4%	62.4%		62.4%	62.4%	
Yellow Time (s)	3.3	3.3	3.3	3.3	3.3		3.3	3.3		3.3	3.3	
All-Red Time (s)	2.7	2.7	2.7	2.7	2.7		2.7	2.7		2.7	2.7	
Lost Time Adjust (s)	0.0	0.0	0.0	0.0	0.0		0.0	0.0		0.0	0.0	
Total Lost Time (s)	6.0	6.0	6.0	6.0	6.0		6.0	6.0		6.0	6.0	
Lead/Lag												
Lead-Lag Optimize?												
Recall Mode	None	None	None	None	None		C-Max	C-Max		C-Max	C-Max	
Act Effct Green (s)	14.3	14.3	14.3	14.3	14.3		58.7	58.7		58.7	58.7	
Actuated g/C Ratio	0.17	0.17	0.17	0.17	0.17		0.69	0.69		0.69	0.69	
v/c Ratio	0.47	0.20	0.52	0.36	0.32		0.22	0.22		0.25	0.25	
Control Delay	38.1	29.6	8.5	34.2	17.4		4.4	4.4		5.9	5.9	
Queue Delay	0.0	0.0	0.0	0.0	0.0		0.0	0.0		0.0	0.0	
Total Delay	38.1	29.6	8.5	34.2	17.4		4.4	4.4		5.9	5.9	
LOS	D	C	A	C	B		A	A		A	A	
Approach Delay		19.3			24.6		4.4	4.4		5.9	5.9	
Approach LOS		B			C		A	A		A	A	
Queue Length 50th (m)	14.4	8.3	0.0	11.3	6.7		5.6	5.6		8.1	8.1	
Queue Length 95th (m)	23.9	15.2	15.1	19.6	16.4		16.6	16.6		21.9	21.9	
Internal Link Dist (m)		55.7			119.8		103.0	103.0		90.8	90.8	
Turn Bay Length (m)	52.0		20.0									
Base Capacity (vph)	364	533	595	379	521		1646	1646		1482	1482	
Starvation Cap Reductn	0	0	0	0	0		0	0		0	0	
Spillback Cap Reductn	0	0	0	0	0		0	0		0	0	
Storage Cap Reductn	0	0	0	0	0		0	0		0	0	
Reduced v/c Ratio	0.26	0.11	0.37	0.20	0.19		0.22	0.22		0.25	0.25	

Intersection Summary												
Cycle Length: 85												
Actuated Cycle Length: 85												
Offset: 0 (0%), Referenced to phase 2:NBT and 6:SBL, Start of Green												
Natural Cycle: 70												
Control Type: Actuated-Coordinated												

Lanes, Volumes, Timings  
1: Place d'Orleans & Centrum

PM Peak Hour  
2033 Future Total

Maximum v/c Ratio: 0.52	Intersection LOS: B
Intersection Signal Delay: 12.0	ICU Level of Service D
Intersection Capacity Utilization 80.0%	
Analysis Period (min) 15	

Splits and Phases: 1: Place d'Orleans & Centrum

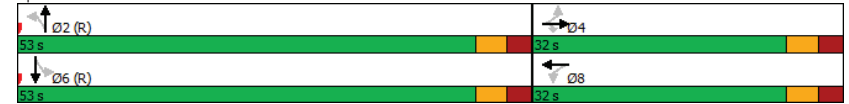

HCM 2010 TWSC  
2: Centrum & Brisebois W

PM Peak Hour  
2033 Future Total

Intersection												
Int Delay, s/veh	4.5											
Movement	EBL	EBT	EBR	WBL	WBT	WBR	NBL	NBT	NBR	SBL	SBT	SBR
Lane Configurations	↔			↔			↔			↔		
Traffic Vol, veh/h	119	181	8	1	120	17	7	0	8	20	0	123
Future Vol, veh/h	119	181	8	1	120	17	7	0	8	20	0	123
Conflicting Peds, #/hr	23	0	19	19	0	23	3	0	6	6	0	3
Sign Control	Free	Free	Free	Free	Free	Free	Stop	Stop	Stop	Stop	Stop	Stop
RT Channelized	-	-	None	-	-	None	-	-	None	-	-	None
Storage Length	-	-	-	-	-	-	-	-	-	-	-	-
Veh in Median Storage, #	-	0	-	-	0	-	-	0	-	-	0	-
Grade, %	-	0	-	-	0	-	-	0	-	-	0	-
Peak Hour Factor	100	100	100	100	100	100	100	100	100	100	100	100
Heavy Vehicles, %	2	3	2	2	5	2	2	2	2	2	2	2
Mvmt Flow	119	181	8	1	120	17	7	0	8	20	0	123
Major/Minor	Major1			Major2			Minor1			Minor2		
Conflicting Flow All	160	0	0	208	0	0	637	604	210	587	600	155
Stage 1	-	-	-	-	-	-	442	442	-	154	154	-
Stage 2	-	-	-	-	-	-	195	162	-	433	446	-
Critical Hdwy	4.12	-	-	4.12	-	-	7.12	6.52	6.22	7.12	6.52	6.22
Critical Hdwy Stg 1	-	-	-	-	-	-	6.12	5.52	-	6.12	5.52	-
Critical Hdwy Stg 2	-	-	-	-	-	-	6.12	5.52	-	6.12	5.52	-
Follow-up Hdwy	2.218	-	-	2.218	-	-	3.518	4.018	3.318	3.518	4.018	3.318
Pot Cap-1 Maneuver	1419	-	-	1363	-	-	390	412	830	421	415	891
Stage 1	-	-	-	-	-	-	594	576	-	848	770	-
Stage 2	-	-	-	-	-	-	807	764	-	601	574	-
Platoon blocked, %	-	-	-	-	-	-	-	-	-	-	-	-
Mov Cap-1 Maneuver	1394	-	-	1343	-	-	305	361	814	378	363	873
Mov Cap-2 Maneuver	-	-	-	-	-	-	305	361	-	378	363	-
Stage 1	-	-	-	-	-	-	530	513	-	754	755	-
Stage 2	-	-	-	-	-	-	691	749	-	536	511	-
Approach	EB			WB			NB			SB		
HCM Control Delay, s	3			0.1			13.1			11		
HCM LOS	A			A			B			B		
Minor Lane/Major Mvmt	NBLn1	EBL	EBT	EBR	WBL	WBT	WBR	SBLn1				
Capacity (veh/h)	458	1394	-	-	1343	-	-	738				
HCM Lane V/C Ratio	0.033	0.085	-	-	0.001	-	-	0.194				
HCM Control Delay (s)	13.1	7.8	0	-	7.7	0	-	11				
HCM Lane LOS	B	A	A	-	A	A	-	B				
HCM 95th %tile Q(veh)	0.1	0.3	-	-	0	-	-	0.7				

HCM 2010 AWSC  
3: Prestone & Centrum

PM Peak Hour  
2033 Future Total

Intersection						
Intersection Delay, s/veh	8.5					
Intersection LOS	A					
Movement	EBT	EBR	WBL	WBT	NBL	NBR
Lane Configurations	↔		↔		↔	
Traffic Vol, veh/h	40	121	116	18	86	103
Future Vol, veh/h	40	121	116	18	86	103
Peak Hour Factor	1.00	1.00	1.00	1.00	1.00	1.00
Heavy Vehicles, %	2	6	2	2	11	2
Mvmt Flow	40	121	116	18	86	103
Number of Lanes	1	0	0	1	1	1
Approach	EB		WB		NB	
Opposing Approach	WB		EB			
Opposing Lanes	1		1		0	
Conflicting Approach Left			NB		EB	
Conflicting Lanes Left	0		2		1	
Conflicting Approach Right	NB				WB	
Conflicting Lanes Right	2		0		1	
HCM Control Delay	8.1		8.8		8.6	
HCM LOS	A		A		A	
Lane	NBLn1	NBLn2	EBLn1	WBLn1		
Vol Left, %	100%	0%	0%	87%		
Vol Thru, %	0%	0%	25%	13%		
Vol Right, %	0%	100%	75%	0%		
Sign Control	Stop	Stop	Stop	Stop		
Traffic Vol by Lane	86	103	161	134		
LT Vol	86	0	0	116		
Through Vol	0	0	40	18		
RT Vol	0	103	121	0		
Lane Flow Rate	86	103	161	134		
Geometry Grp	7	7	2	2		
Degree of Util (X)	0.14	0.128	0.184	0.177		
Departure Headway (Hd)	5.846	4.485	4.114	4.747		
Convergence, Y/N	Yes	Yes	Yes	Yes		
Cap	614	798	873	757		
Service Time	3.577	2.216	2.135	2.769		
HCM Lane V/C Ratio	0.14	0.129	0.184	0.177		
HCM Control Delay	9.5	7.9	8.1	8.8		
HCM Lane LOS	A	A	A	A		
HCM 95th %tile Q	0.5	0.4	0.7	0.6		

HCM 2010 TWSC  
4: Centrum & Brisebois E

PM Peak Hour  
2033 Future Total

Intersection						
Int Delay, s/veh	5.2					
Movement	EBL	EBT	WBT	WBR	SBL	SBR
Lane Configurations		↖	↖		↗	↗
Traffic Vol, veh/h	74	49	40	0	0	79
Future Vol, veh/h	74	49	40	0	0	79
Conflicting Peds, #/hr	0	0	0	0	0	0
Sign Control	Free	Free	Free	Free	Stop	Stop
RT Channelized	-	None	-	None	-	None
Storage Length	-	-	-	-	0	-
Veh in Median Storage, #	-	0	0	-	0	-
Grade, %	-	0	0	-	0	-
Peak Hour Factor	100	100	100	100	100	100
Heavy Vehicles, %	2	2	2	2	2	2
Mvmt Flow	74	49	40	0	0	79
Major/Minor	Major1	Major2	Minor2			
Conflicting Flow All	40	0	-	0	237	40
Stage 1	-	-	-	-	40	-
Stage 2	-	-	-	-	197	-
Critical Hdwy	4.12	-	-	-	6.42	6.22
Critical Hdwy Stg 1	-	-	-	-	5.42	-
Critical Hdwy Stg 2	-	-	-	-	5.42	-
Follow-up Hdwy	2,218	-	-	-	3,518	3,318
Pot Cap-1 Maneuver	1570	-	-	-	751	1031
Stage 1	-	-	-	-	982	-
Stage 2	-	-	-	-	836	-
Platoon blocked, %	-	-	-	-	-	-
Mov Cap-1 Maneuver	1570	-	-	-	715	1031
Mov Cap-2 Maneuver	-	-	-	-	715	-
Stage 1	-	-	-	-	935	-
Stage 2	-	-	-	-	836	-
Approach	EB	WB	SB			
HCM Control Delay, s	4.5	0	8.8			
HCM LOS			A			
Minor Lane/Major Mvmt	EBL	EBT	WBT	WBR	SBLn1	
Capacity (veh/h)	1570	-	-	-	1031	
HCM Lane V/C Ratio	0.047	-	-	-	0.077	
HCM Control Delay (s)	7.4	0	-	-	8.8	
HCM Lane LOS	A	A	-	-	A	
HCM 95th %tile Q(veh)	0.1	-	-	-	0.2	

Lanes, Volumes, Timings  
5: Prestone & St Joseph

PM Peak Hour  
2033 Future Total

Lane Group	EBL	EBT	EBR	WBL	WBT	WBR	NBL	NBT	NBR	SBL	SBT	SBR
Lane Configurations	↖	↖↗	↖	↖	↖↗	↖	↖	↖	↖	↖	↖	↖
Traffic Volume (vph)	34	939	116	10	476	153	57	54	9	177	99	31
Future Volume (vph)	34	939	116	10	476	153	57	54	9	177	99	31
Satd. Flow (prot)	1658	3316	1483	1658	3316	1483	1658	1585	0	1658	1570	0
Fit Permitted	0.480			0.275			0.674			0.716		
Satd. Flow (perm)	837	3316	1444	479	3316	1464	1170	1585	0	1248	1570	0
Satd. Flow (RTOR)			116			153		9			20	
Lane Group Flow (vph)	34	939	116	10	476	153	57	63	0	177	130	0
Turn Type	Perm	NA	Perm	Perm	NA	Perm	Perm	NA		Perm	NA	
Protected Phases		2			6		8		8		4	
Permitted Phases	2		2	6		6	8		8		4	
Detector Phase	2	2	2	6	6	6	8	8		4	4	
Switch Phase												
Minimum Initial (s)	10.0	10.0	10.0	10.0	10.0	10.0	10.0	10.0		10.0	10.0	
Minimum Split (s)	23.7	23.7	23.7	23.7	23.7	23.7	29.0	29.0		29.0	29.0	
Total Split (s)	51.0	51.0	51.0	51.0	51.0	51.0	29.0	29.0		29.0	29.0	
Total Split (%)	63.8%	63.8%	63.8%	63.8%	63.8%	63.8%	36.3%	36.3%		36.3%	36.3%	
Yellow Time (s)	3.3	3.3	3.3	3.3	3.3	3.3	3.3	3.3		3.3	3.3	
All-Red Time (s)	2.4	2.4	2.4	2.4	2.4	2.4	2.7	2.7		2.7	2.7	
Lost Time Adjust (s)	0.0	0.0	0.0	0.0	0.0	0.0	0.0	0.0		0.0	0.0	
Total Lost Time (s)	5.7	5.7	5.7	5.7	5.7	5.7	6.0	6.0		6.0	6.0	
Lead/Lag												
Lead-Lag Optimize?												
Recall Mode	Max	Max	Max	Max	Max	Max	None	None		None	None	
Act Effct Green (s)	47.9	47.9	47.9	47.9	47.9	47.9	15.8	15.8		15.8	15.8	
Actuated g/C Ratio	0.64	0.64	0.64	0.64	0.64	0.64	0.21	0.21		0.21	0.21	
v/c Ratio	0.06	0.45	0.12	0.03	0.23	0.16	0.23	0.19		0.68	0.38	
Control Delay	7.2	8.6	2.0	7.3	6.9	1.8	25.3	21.2		40.0	23.4	
Queue Delay	0.0	0.0	0.0	0.0	0.0	0.0	0.0	0.0		0.0	0.0	
Total Delay	7.2	8.6	2.0	7.3	6.9	1.8	25.3	21.2		40.0	23.4	
LOS	A	A	A	A	A	A	C	C		D	C	
Approach Delay		7.9			5.7		23.2				33.0	
Approach LOS		A			A		C				C	
Queue Length 50th (m)	1.6	30.6	0.0	0.5	13.0	0.0	6.5	6.0		22.2	12.7	
Queue Length 95th (m)	6.0	56.1	6.2	2.7	25.5	7.0	15.2	14.9		41.1	26.2	
Internal Link Dist (m)		163.5			149.6		92.4				92.1	
Turn Bay Length (m)	50.0		105.0	62.5		120.0	47.5					
Base Capacity (vph)	531	2104	958	304	2104	985	358	491		382	494	
Starvation Cap Reductn	0	0	0	0	0	0	0	0		0	0	
Spillback Cap Reductn	0	0	0	0	0	0	0	0		0	0	
Storage Cap Reductn	0	0	0	0	0	0	0	0		0	0	
Reduced v/c Ratio	0.06	0.45	0.12	0.03	0.23	0.16	0.16	0.13		0.46	0.26	
Intersection Summary												
Cycle Length: 80												
Actuated Cycle Length: 75.4												
Natural Cycle: 55												
Control Type: Actuated-Uncoordinated												
Maximum v/c Ratio: 0.68												



Lanes, Volumes, Timings  
5: Prestone & St Joseph

PM Peak Hour  
2033 Future Total

Intersection Signal Delay: 11.6 Intersection LOS: B  
Intersection Capacity Utilization 63.6% ICU Level of Service B  
Analysis Period (min) 15

Splits and Phases: 5: Prestone & St Joseph

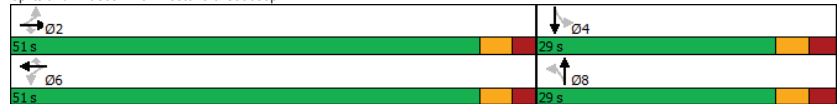

HCM 2010 TWSC  
6: Access #1 & Brisebois

PM Peak Hour  
2033 Future Total

Intersection						
Int Delay, s/veh	3.4					
Movement	EBT	EBR	WBL	WBT	NBL	NBR
Lane Configurations	↑				↑	↑
Traffic Vol, veh/h	94	0	0	26	55	12
Future Vol, veh/h	94	0	0	26	55	12
Conflicting Peds, #/hr	0	0	0	0	0	0
Sign Control	Free	Free	Free	Free	Stop	Stop
RT Channelized	-	None	-	None	-	None
Storage Length	-	-	-	-	0	-
Veh in Median Storage, #	0	-	-	0	0	-
Grade, %	0	-	-	0	0	-
Peak Hour Factor	100	100	100	100	100	100
Heavy Vehicles, %	2	2	2	2	2	2
Mvmt Flow	94	0	0	26	55	12
Major/Minor	Major1	Major2	Minor1			
Conflicting Flow All	0	-	-	120	94	
Stage 1	-	-	-	94	-	
Stage 2	-	-	-	26	-	
Critical Hdwy	-	-	-	6.42	6.22	
Critical Hdwy Stg 1	-	-	-	5.42	-	
Critical Hdwy Stg 2	-	-	-	5.42	-	
Follow-up Hdwy	-	-	-	3.518	3.318	
Pot Cap-1 Maneuver	-	0	0	876	963	
Stage 1	-	0	0	930	-	
Stage 2	-	0	0	997	-	
Platoon blocked, %	-	-	-	-	-	
Mov Cap-1 Maneuver	-	-	-	876	963	
Mov Cap-2 Maneuver	-	-	-	876	-	
Stage 1	-	-	-	930	-	
Stage 2	-	-	-	997	-	
Approach	EB	WB	NB			
HCM Control Delay, s	0	0	9.4			
HCM LOS			A			
Minor Lane/Major Mvmt	NBLn1	EBT	WBT			
Capacity (veh/h)	890	-	-			
HCM Lane V/C Ratio	0.075	-	-			
HCM Control Delay (s)	9.4	-	-			
HCM Lane LOS	A	-	-			
HCM 95th %tile Q(veh)	0.2	-	-			

Lanes, Volumes, Timings  
7: Access #2 & Brisebois

PM Peak Hour  
2033 Future Total

Lane Group	EBT	EBR	WBL	WBT	NBL	NBR
Lane Configurations	↗			↖		
Traffic Volume (vph)	82	24	0	26	0	0
Future Volume (vph)	82	24	0	26	0	0
Satd. Flow (prot)	1691	0	0	1745	0	0
Fit Permitted						
Satd. Flow (perm)	1691	0	0	1745	0	0
Lane Group Flow (vph)	106	0	0	26	0	0
Sign Control	Free			Free	Free	
<b>Intersection Summary</b>						
Control Type: Unsignalized						
Intersection Capacity Utilization 9.4%	ICU Level of Service A					
Analysis Period (min) 15						

HCM 2010 TWSC  
8: Access #3 & Brisebois

PM Peak Hour  
2033 Future Total

<b>Intersection</b>						
Int Delay, s/veh	5					
Movement	EBT	EBR	WBL	WBT	NBL	NBR
Lane Configurations	↗			↖	↗	↖
Traffic Vol, veh/h	28	54	66	8	18	51
Future Vol, veh/h	28	54	66	8	18	51
Conflicting Peds, #/hr	0	0	0	0	0	0
Sign Control	Free	Free	Free	Free	Stop	Stop
RT Channelized	-	None	-	None	-	None
Storage Length	-	-	-	-	0	-
Veh in Median Storage, #	0	-	-	0	0	-
Grade, %	0	-	-	0	0	-
Peak Hour Factor	100	100	100	100	100	100
Heavy Vehicles, %	2	2	2	2	2	2
Mvmt Flow	28	54	66	8	18	51

Major/Minor	Major1	Major2	Minor1
Conflicting Flow All	0	0	82
Stage 1	-	-	55
Stage 2	-	-	140
Critical Hdwy	-	4.12	6.42
Critical Hdwy Stg 1	-	-	5.42
Critical Hdwy Stg 2	-	-	5.42
Follow-up Hdwy	-	2.218	3.518
Pot Cap-1 Maneuver	-	1515	794
Stage 1	-	-	968
Stage 2	-	-	887
Platoon blocked, %	-	-	-
Mov Cap-1 Maneuver	-	1515	759
Mov Cap-2 Maneuver	-	-	759
Stage 1	-	-	968
Stage 2	-	-	848

Approach	EB	WB	NB
HCM Control Delay, s	0	6.7	9.2
HCM LOS			A

Minor Lane/Major Mvmt	NBLn1	EBT	EBR	WBL	WBT
Capacity (veh/h)	931	-	-	1515	-
HCM Lane V/C Ratio	0.074	-	-	0.044	-
HCM Control Delay (s)	9.2	-	-	7.5	0
HCM Lane LOS	A	-	-	A	A
HCM 95th %tile Q(veh)	0.2	-	-	0.1	-

# Appendix L

TDM Checklist

**TDM Measures Checklist:**  
*Non-Residential Developments (office, institutional, retail or industrial)*

Legend	
<b>BASIC</b>	The measure is generally feasible and effective, and in most cases would benefit the development and its users
<b>BETTER</b>	The measure could maximize support for users of sustainable modes, and optimize development performance
<b>★</b>	The measure is one of the most dependably effective tools to encourage the use of sustainable modes

TDM measures: <i>Non-residential developments</i>		Check if proposed & add descriptions
<b>1. TDM PROGRAM MANAGEMENT</b>		
<b>1.1 Program coordinator</b>		
<b>BASIC</b> ★	1.1.1 Designate an internal coordinator, or contract with an external coordinator	<input checked="" type="checkbox"/>
<b>1.2 Travel surveys</b>		
<b>BETTER</b>	1.2.1 Conduct periodic surveys to identify travel-related behaviours, attitudes, challenges and solutions, and to track progress	<input type="checkbox"/>
<b>2. WALKING AND CYCLING</b>		
<b>2.1 Information on walking/cycling routes &amp; destinations</b>		
<b>BASIC</b>	2.1.1 Display local area maps with walking/cycling access routes and key destinations at major entrances	<input checked="" type="checkbox"/>
<b>2.2 Bicycle skills training</b>		
<i>Commuter travel</i>		
<b>BETTER</b> ★	2.2.1 Offer on-site cycling courses for commuters, or subsidize off-site courses	<input type="checkbox"/>
<b>2.3 Valet bike parking</b>		
<i>Visitor travel</i>		
<b>BETTER</b>	2.3.1 Offer secure valet bike parking during public events when demand exceeds fixed supply (e.g. for festivals, concerts, games)	<input type="checkbox"/>

TDM measures: <i>Non-residential developments</i>		Check if proposed & add descriptions
<b>3. TRANSIT</b>		
<b>3.1 Transit information</b>		
<b>BASIC</b>	3.1.1 Display relevant transit schedules and route maps at entrances	<input checked="" type="checkbox"/>
<b>BASIC</b>	3.1.2 Provide online links to OC Transpo and STO information	<input checked="" type="checkbox"/>
<b>BETTER</b>	3.1.3 Provide real-time arrival information display at entrances	<input type="checkbox"/>
<b>3.2 Transit fare incentives</b>		
<i>Commuter travel</i>		
<b>BETTER</b>	3.2.1 Offer preloaded PRESTO cards to encourage commuters to use transit	<input type="checkbox"/>
<b>BETTER</b> ★	3.2.2 Subsidize or reimburse monthly transit pass purchases by employees	<input type="checkbox"/>
<i>Visitor travel</i>		
<b>BETTER</b>	3.2.3 Arrange inclusion of same-day transit fare in price of tickets (e.g. for festivals, concerts, games)	<input type="checkbox"/>
<b>3.3 Enhanced public transit service</b>		
<i>Commuter travel</i>		
<b>BETTER</b>	3.3.1 Contract with OC Transpo to provide enhanced transit services (e.g. for shift changes, weekends)	<input type="checkbox"/>
<i>Visitor travel</i>		
<b>BETTER</b>	3.3.2 Contract with OC Transpo to provide enhanced transit services (e.g. for festivals, concerts, games)	<input type="checkbox"/>
<b>3.4 Private transit service</b>		
<i>Commuter travel</i>		
<b>BETTER</b>	3.4.1 Provide shuttle service when OC Transpo cannot offer sufficient quality or capacity to serve demand (e.g. for shift changes, weekends)	<input type="checkbox"/>
<i>Visitor travel</i>		
<b>BETTER</b>	3.4.2 Provide shuttle service when OC Transpo cannot offer sufficient quality or capacity to serve demand (e.g. for festivals, concerts, games)	<input type="checkbox"/>

TDM measures: <i>Non-residential developments</i>		Check if proposed & add descriptions
<b>4. RIDESHARING</b>		
<b>4.1 Ridematching service</b>		
<i>Commuter travel</i>		
BASIC ★	4.1.1 Provide a dedicated ridematching portal at OttawaRideMatch.com	<input checked="" type="checkbox"/>
<b>4.2 Carpool parking price incentives</b>		
<i>Commuter travel</i>		
BETTER	4.2.1 Provide discounts on parking costs for registered carpools	<input type="checkbox"/>
<b>4.3 Vanpool service</b>		
<i>Commuter travel</i>		
BETTER	4.3.1 Provide a vanpooling service for long-distance commuters	<input type="checkbox"/>
<b>5. CARSHARING &amp; BIKESHARING</b>		
<b>5.1 Bikeshare stations &amp; memberships</b>		
BETTER	5.1.1 Contract with provider to install on-site bikeshare station for use by commuters and visitors	<input type="checkbox"/>
<i>Commuter travel</i>		
BETTER	5.1.2 Provide employees with bikeshare memberships for local business travel	<input type="checkbox"/>
<b>5.2 Carshare vehicles &amp; memberships</b>		
<i>Commuter travel</i>		
BETTER	5.2.1 Contract with provider to install on-site carshare vehicles and promote their use by tenants	<input type="checkbox"/>
BETTER	5.2.2 Provide employees with carshare memberships for local business travel	<input type="checkbox"/>
<b>6. PARKING</b>		
<b>6.1 Priced parking</b>		
<i>Commuter travel</i>		
BASIC ★	6.1.1 Charge for long-term parking (daily, weekly, monthly)	<input type="checkbox"/>
BASIC	6.1.2 Unbundle parking cost from lease rates at multi-tenant sites	<input checked="" type="checkbox"/>
<i>Visitor travel</i>		
BETTER	6.1.3 Charge for short-term parking (hourly)	<input type="checkbox"/>

TDM measures: <i>Non-residential developments</i>		Check if proposed & add descriptions
<b>7. TDM MARKETING &amp; COMMUNICATIONS</b>		
<b>7.1 Multimodal travel information</b>		
<i>Commuter travel</i>		
BASIC ★	7.1.1 Provide a multimodal travel option information package to new/relocating employees and students	<input checked="" type="checkbox"/>
<i>Visitor travel</i>		
BETTER ★	7.1.2 Include multimodal travel option information in invitations or advertising that attract visitors or customers (e.g. for festivals, concerts, games)	<input type="checkbox"/>
<b>7.2 Personalized trip planning</b>		
<i>Commuter travel</i>		
BETTER ★	7.2.1 Offer personalized trip planning to new/relocating employees	<input checked="" type="checkbox"/>
<b>7.3 Promotions</b>		
<i>Commuter travel</i>		
BETTER	7.3.1 Deliver promotions and incentives to maintain awareness, build understanding, and encourage trial of sustainable modes	<input type="checkbox"/>
<b>8. OTHER INCENTIVES &amp; AMENITIES</b>		
<b>8.1 Emergency ride home</b>		
<i>Commuter travel</i>		
BETTER ★	8.1.1 Provide emergency ride home service to non-driving commuters	<input type="checkbox"/>
<b>8.2 Alternative work arrangements</b>		
<i>Commuter travel</i>		
BASIC ★	8.2.1 Encourage flexible work hours	<input type="checkbox"/>
BETTER	8.2.2 Encourage compressed workweeks	<input checked="" type="checkbox"/>
BETTER ★	8.2.3 Encourage telework	<input type="checkbox"/>
<b>8.3 Local business travel options</b>		
<i>Commuter travel</i>		
BASIC ★	8.3.1 Provide local business travel options that minimize the need for employees to bring a personal car to work	<input type="checkbox"/>
<b>8.4 Commuter incentives</b>		
<i>Commuter travel</i>		
BETTER	8.4.1 Offer employees a taxable, mode-neutral commuting allowance	<input type="checkbox"/>
<b>8.5 On-site amenities</b>		
<i>Commuter travel</i>		
BETTER	8.5.1 Provide on-site amenities/services to minimize mid-day or mid-commute errands	<input type="checkbox"/>

**TDM Measures Checklist:**  
*Residential Developments (multi-family, condominium or subdivision)*

Legend	
<b>BASIC</b>	The measure is generally feasible and effective, and in most cases would benefit the development and its users
<b>BETTER</b>	The measure could maximize support for users of sustainable modes, and optimize development performance
<b>★</b>	The measure is one of the most dependably effective tools to encourage the use of sustainable modes

TDM measures: Residential developments		Check if proposed & add descriptions
<b>1. TDM PROGRAM MANAGEMENT</b>		
<b>1.1 Program coordinator</b>		
<b>BASIC</b> ★	1.1.1 Designate an internal coordinator, or contract with an external coordinator	<input checked="" type="checkbox"/>
<b>1.2 Travel surveys</b>		
<b>BETTER</b>	1.2.1 Conduct periodic surveys to identify travel-related behaviours, attitudes, challenges and solutions, and to track progress	<input type="checkbox"/>
<b>2. WALKING AND CYCLING</b>		
<b>2.1 Information on walking/cycling routes &amp; destinations</b>		
<b>BASIC</b>	2.1.1 Display local area maps with walking/cycling access routes and key destinations at major entrances ( <i>multi-family, condominium</i> )	<input checked="" type="checkbox"/>
<b>2.2 Bicycle skills training</b>		
<b>BETTER</b>	2.2.1 Offer on-site cycling courses for residents, or subsidize off-site courses	<input type="checkbox"/>

TDM measures: Residential developments		Check if proposed & add descriptions
<b>3. TRANSIT</b>		
<b>3.1 Transit information</b>		
<b>BASIC</b>	3.1.1 Display relevant transit schedules and route maps at entrances ( <i>multi-family, condominium</i> )	<input checked="" type="checkbox"/>
<b>BETTER</b>	3.1.2 Provide real-time arrival information display at entrances ( <i>multi-family, condominium</i> )	<input type="checkbox"/>
<b>3.2 Transit fare incentives</b>		
<b>BASIC</b> ★	3.2.1 Offer PRESTO cards preloaded with one monthly transit pass on residence purchase/move-in, to encourage residents to use transit	<input type="checkbox"/>
<b>BETTER</b>	3.2.2 Offer at least one year of free monthly transit passes on residence purchase/move-in	<input type="checkbox"/>
<b>3.3 Enhanced public transit service</b>		
<b>BETTER</b> ★	3.3.1 Contract with OC Transpo to provide early transit services until regular services are warranted by occupancy levels ( <i>subdivision</i> )	<input type="checkbox"/>
<b>3.4 Private transit service</b>		
<b>BETTER</b>	3.4.1 Provide shuttle service for seniors homes or lifestyle communities (e.g. scheduled mall or supermarket runs)	<input type="checkbox"/>
<b>4. CARSHARING &amp; BIKESHARING</b>		
<b>4.1 Bikeshare stations &amp; memberships</b>		
<b>BETTER</b>	4.1.1 Contract with provider to install on-site bikeshare station ( <i>multi-family</i> )	<input type="checkbox"/>
<b>BETTER</b>	4.1.2 Provide residents with bikeshare memberships, either free or subsidized ( <i>multi-family</i> )	<input type="checkbox"/>
<b>4.2 Carshare vehicles &amp; memberships</b>		
<b>BETTER</b>	4.2.1 Contract with provider to install on-site carshare vehicles and promote their use by residents	<input type="checkbox"/>
<b>BETTER</b>	4.2.2 Provide residents with carshare memberships, either free or subsidized	<input type="checkbox"/>
<b>5. PARKING</b>		
<b>5.1 Priced parking</b>		
<b>BASIC</b> ★	5.1.1 Unbundle parking cost from purchase price ( <i>condominium</i> )	<input checked="" type="checkbox"/>
<b>BASIC</b> ★	5.1.2 Unbundle parking cost from monthly rent ( <i>multi-family</i> )	<input checked="" type="checkbox"/>

TDM measures: Residential developments		Check if proposed & add descriptions
<b>6. TDM MARKETING &amp; COMMUNICATIONS</b>		
<b>6.1 Multimodal travel information</b>		
BASIC ★	6.1.1 Provide a multimodal travel option information package to new residents	<input checked="" type="checkbox"/>
<b>6.2 Personalized trip planning</b>		
BETTER ★	6.2.1 Offer personalized trip planning to new residents	<input type="checkbox"/>

**TDM-Supportive Development Design and Infrastructure Checklist:**  
*Non-Residential Developments (office, institutional, retail or industrial)*

Legend	
<b>REQUIRED</b>	The Official Plan or Zoning By-law provides related guidance that must be followed
<b>BASIC</b>	The measure is generally feasible and effective, and in most cases would benefit the development and its users
<b>BETTER</b>	The measure could maximize support for users of sustainable modes, and optimize development performance

TDM-supportive design & infrastructure measures: Non-residential developments		Check if completed & add descriptions, explanations or plan/drawing references
<b>1. WALKING &amp; CYCLING: ROUTES</b>		
<b>1.1 Building location &amp; access points</b>		
BASIC	1.1.1 Locate building close to the street, and do not locate parking areas between the street and building entrances	<input checked="" type="checkbox"/>
BASIC	1.1.2 Locate building entrances in order to minimize walking distances to sidewalks and transit stops/stations	<input checked="" type="checkbox"/>
BASIC	1.1.3 Locate building doors and windows to ensure visibility of pedestrians from the building, for their security and comfort	<input checked="" type="checkbox"/>
<b>1.2 Facilities for walking &amp; cycling</b>		
REQUIRED	1.2.1 Provide convenient, direct access to stations or major stops along rapid transit routes within 600 metres; minimize walking distances from buildings to rapid transit; provide pedestrian-friendly, weather-protected (where possible) environment between rapid transit accesses and building entrances; ensure quality linkages from sidewalks through building entrances to integrated stops/stations (see Official Plan policy 4.3.3)	<input checked="" type="checkbox"/>
REQUIRED	1.2.2 Provide safe, direct and attractive pedestrian access from public sidewalks to building entrances through such measures as: reducing distances between public sidewalks and major building entrances; providing walkways from public streets to major building entrances; within a site, providing walkways along the front of adjoining buildings, between adjacent buildings, and connecting areas where people may congregate, such as courtyards and transit stops; and providing weather protection through canopies, colonnades, and other design elements wherever possible (see Official Plan policy 4.3.12)	<input checked="" type="checkbox"/>

TDM-supportive design & infrastructure measures: <i>Non-residential developments</i>		Check if completed & add descriptions, explanations or plan/drawing references
REQUIRED	1.2.3 Provide sidewalks of smooth, well-drained walking surfaces of contrasting materials or treatments to differentiate pedestrian areas from vehicle areas, and provide marked pedestrian crosswalks at intersection sidewalks (see <i>Official Plan policy 4.3.10</i> )	<input checked="" type="checkbox"/>
REQUIRED	1.2.4 Make sidewalks and open space areas easily accessible through features such as gradual grade transition, depressed curbs at street corners and convenient access to extra-wide parking spaces and ramps (see <i>Official Plan policy 4.3.10</i> )	<input checked="" type="checkbox"/>
REQUIRED	1.2.5 Include adequately spaced inter-block/street cycling and pedestrian connections to facilitate travel by active transportation. Provide links to the existing or planned network of public sidewalks, multi-use pathways and on-road cycle routes. Where public sidewalks and multi-use pathways intersect with roads, consider providing traffic control devices to give priority to cyclists and pedestrians (see <i>Official Plan policy 4.3.11</i> )	<input checked="" type="checkbox"/>
BASIC	1.2.6 Provide safe, direct and attractive walking routes from building entrances to nearby transit stops	<input type="checkbox"/>
BASIC	1.2.7 Ensure that walking routes to transit stops are secure, visible, lighted, shaded and wind-protected wherever possible	<input type="checkbox"/>
BASIC	1.2.8 Design roads used for access or circulation by cyclists using a target operating speed of no more than 30 km/h, or provide a separated cycling facility	<input type="checkbox"/>
<b>1.3 Amenities for walking &amp; cycling</b>		
BASIC	1.3.1 Provide lighting, landscaping and benches along walking and cycling routes between building entrances and streets, sidewalks and trails	<input type="checkbox"/>
BASIC	1.3.2 Provide wayfinding signage for site access (where required, e.g. when multiple buildings or entrances exist) and egress (where warranted, such as when directions to reach transit stops/stations, trails or other common destinations are not obvious)	<input type="checkbox"/>

TDM-supportive design & infrastructure measures: <i>Non-residential developments</i>		Check if completed & add descriptions, explanations or plan/drawing references
<b>2. WALKING &amp; CYCLING: END-OF-TRIP FACILITIES</b>		
<b>2.1 Bicycle parking</b>		
REQUIRED	2.1.1 Provide bicycle parking in highly visible and lighted areas, sheltered from the weather wherever possible (see <i>Official Plan policy 4.3.6</i> )	<input checked="" type="checkbox"/>
REQUIRED	2.1.2 Provide the number of bicycle parking spaces specified for various land uses in different parts of Ottawa; provide convenient access to main entrances or well-used areas (see <i>Zoning By-law Section 111</i> )	<input checked="" type="checkbox"/>
REQUIRED	2.1.3 Ensure that bicycle parking spaces and access aisles meet minimum dimensions; that no more than 50% of spaces are vertical spaces; and that parking racks are securely anchored (see <i>Zoning By-law Section 111</i> )	<input checked="" type="checkbox"/>
BASIC	2.1.4 Provide bicycle parking spaces equivalent to the expected number of commuter cyclists (assuming the cycling mode share target is met), plus the expected peak number of customer/visitor cyclists	<input type="checkbox"/>
BETTER	2.1.5 Provide bicycle parking spaces equivalent to the expected number of commuter and customer/visitor cyclists, plus an additional buffer (e.g. 25 percent extra) to encourage other cyclists and ensure adequate capacity in peak cycling season	<input type="checkbox"/>
<b>2.2 Secure bicycle parking</b>		
REQUIRED	2.2.1 Where more than 50 bicycle parking spaces are provided for a single office building, locate at least 25% of spaces within a building/structure, a secure area (e.g. supervised parking lot or enclosure) or bicycle lockers (see <i>Zoning By-law Section 111</i> )	<input checked="" type="checkbox"/>
BETTER	2.2.2 Provide secure bicycle parking spaces equivalent to the expected number of commuter cyclists (assuming the cycling mode share target is met)	<input type="checkbox"/>
<b>2.3 Shower &amp; change facilities</b>		
BASIC	2.3.1 Provide shower and change facilities for the use of active commuters	<input type="checkbox"/>
BETTER	2.3.2 In addition to shower and change facilities, provide dedicated lockers, grooming stations, drying racks and laundry facilities for the use of active commuters	<input type="checkbox"/>
<b>2.4 Bicycle repair station</b>		
BETTER	2.4.1 Provide a permanent bike repair station, with commonly used tools and an air pump, adjacent to the main bicycle parking area (or secure bicycle parking area, if provided)	<input type="checkbox"/>



TDM-supportive design & infrastructure measures: <i>Non-residential developments</i>		Check if completed & add descriptions, explanations or plan/drawing references
<b>3. TRANSIT</b>		
<b>3.1 Customer amenities</b>		
BASIC	3.1.1 Provide shelters, lighting and benches at any on-site transit stops	<input type="checkbox"/>
BASIC	3.1.2 Where the site abuts an off-site transit stop and insufficient space exists for a transit shelter in the public right-of-way, protect land for a shelter and/or install a shelter	<input type="checkbox"/>
BETTER	3.1.3 Provide a secure and comfortable interior waiting area by integrating any on-site transit stops into the building	<input type="checkbox"/>
<b>4. RIDESHARING</b>		
<b>4.1 Pick-up &amp; drop-off facilities</b>		
BASIC	4.1.1 Provide a designated area for carpool drivers (plus taxis and ride-hailing services) to drop off or pick up passengers without using fire lanes or other no-stopping zones	<input checked="" type="checkbox"/>
<b>4.2 Carpool parking</b>		
BASIC	4.2.1 Provide signed parking spaces for carpools in a priority location close to a major building entrance, sufficient in number to accommodate the mode share target for carpools	<input type="checkbox"/>
BETTER	4.2.2 At large developments, provide spaces for carpools in a separate, access-controlled parking area to simplify enforcement	<input type="checkbox"/>
<b>5. CARSHARING &amp; BIKESHARING</b>		
<b>5.1 Carshare parking spaces</b>		
BETTER	5.1.1 Provide carshare parking spaces in permitted non-residential zones, occupying either required or provided parking spaces ( <i>see Zoning By-law Section 94</i> )	<input type="checkbox"/>
<b>5.2 Bikeshare station location</b>		
BETTER	5.2.1 Provide a designated bikeshare station area near a major building entrance, preferably lighted and sheltered with a direct walkway connection	<input type="checkbox"/>

TDM-supportive design & infrastructure measures: <i>Non-residential developments</i>		Check if completed & add descriptions, explanations or plan/drawing references
<b>6. PARKING</b>		
<b>6.1 Number of parking spaces</b>		
REQUIRED	6.1.1 Do not provide more parking than permitted by zoning, nor less than required by zoning, unless a variance is being applied for	<input checked="" type="checkbox"/>
BASIC	6.1.2 Provide parking for long-term and short-term users that is consistent with mode share targets, considering the potential for visitors to use off-site public parking	<input type="checkbox"/>
BASIC	6.1.3 Where a site features more than one use, provide shared parking and reduce the cumulative number of parking spaces accordingly ( <i>see Zoning By-law Section 104</i> )	<input type="checkbox"/>
BETTER	6.1.4 Reduce the minimum number of parking spaces required by zoning by one space for each 13 square metres of gross floor area provided as shower rooms, change rooms, locker rooms and other facilities for cyclists in conjunction with bicycle parking ( <i>see Zoning By-law Section 111</i> )	<input type="checkbox"/>
<b>6.2 Separate long-term &amp; short-term parking areas</b>		
BETTER	6.2.1 Separate short-term and long-term parking areas using signage or physical barriers, to permit access controls and simplify enforcement (i.e. to discourage employees from parking in visitor spaces, and vice versa)	<input type="checkbox"/>
<b>7. OTHER</b>		
<b>7.1 On-site amenities to minimize off-site trips</b>		
BETTER	7.1.1 Provide on-site amenities to minimize mid-day or mid-commute errands	<input type="checkbox"/>

**TDM-Supportive Development Design and Infrastructure Checklist:**  
*Residential Developments (multi-family or condominium)*

Legend	
REQUIRED	The Official Plan or Zoning By-law provides related guidance that must be followed
BASIC	The measure is generally feasible and effective, and in most cases would benefit the development and its users
BETTER	The measure could maximize support for users of sustainable modes, and optimize development performance

TDM-supportive design & infrastructure measures: <i>Residential developments</i>		Check if completed & add descriptions, explanations or plan/drawing references
<b>1. WALKING &amp; CYCLING: ROUTES</b>		
<b>1.1 Building location &amp; access points</b>		
BASIC	1.1.1 Locate building close to the street, and do not locate parking areas between the street and building entrances	<input checked="" type="checkbox"/>
BASIC	1.1.2 Locate building entrances in order to minimize walking distances to sidewalks and transit stops/stations	<input checked="" type="checkbox"/>
BASIC	1.1.3 Locate building doors and windows to ensure visibility of pedestrians from the building, for their security and comfort	<input checked="" type="checkbox"/>
<b>1.2 Facilities for walking &amp; cycling</b>		
REQUIRED	1.2.1 Provide convenient, direct access to stations or major stops along rapid transit routes within 600 metres; minimize walking distances from buildings to rapid transit; provide pedestrian-friendly, weather-protected (where possible) environment between rapid transit accesses and building entrances; ensure quality linkages from sidewalks through building entrances to integrated stops/stations (see <i>Official Plan policy 4.3.3</i> )	<input checked="" type="checkbox"/>
REQUIRED	1.2.2 Provide safe, direct and attractive pedestrian access from public sidewalks to building entrances through such measures as: reducing distances between public sidewalks and major building entrances; providing walkways from public streets to major building entrances; within a site, providing walkways along the front of adjoining buildings, between adjacent buildings, and connecting areas where people may congregate, such as courtyards and transit stops; and providing weather protection through canopies, colonnades, and other design elements wherever possible (see <i>Official Plan policy 4.3.12</i> )	<input checked="" type="checkbox"/>

TDM-supportive design & infrastructure measures: <i>Residential developments</i>		Check if completed & add descriptions, explanations or plan/drawing references
REQUIRED	1.2.3 Provide sidewalks of smooth, well-drained walking surfaces of contrasting materials or treatments to differentiate pedestrian areas from vehicle areas, and provide marked pedestrian crosswalks at intersection sidewalks (see <i>Official Plan policy 4.3.10</i> )	<input checked="" type="checkbox"/>
REQUIRED	1.2.4 Make sidewalks and open space areas easily accessible through features such as gradual grade transition, depressed curbs at street corners and convenient access to extra-wide parking spaces and ramps (see <i>Official Plan policy 4.3.10</i> )	<input checked="" type="checkbox"/>
REQUIRED	1.2.5 Include adequately spaced inter-block/street cycling and pedestrian connections to facilitate travel by active transportation. Provide links to the existing or planned network of public sidewalks, multi-use pathways and on-road cycle routes. Where public sidewalks and multi-use pathways intersect with roads, consider providing traffic control devices to give priority to cyclists and pedestrians (see <i>Official Plan policy 4.3.11</i> )	<input checked="" type="checkbox"/>
BASIC	1.2.6 Provide safe, direct and attractive walking routes from building entrances to nearby transit stops	<input type="checkbox"/>
BASIC	1.2.7 Ensure that walking routes to transit stops are secure, visible, lighted, shaded and wind-protected wherever possible	<input type="checkbox"/>
BASIC	1.2.8 Design roads used for access or circulation by cyclists using a target operating speed of no more than 30 km/h, or provide a separated cycling facility	<input type="checkbox"/>
<b>1.3 Amenities for walking &amp; cycling</b>		
BASIC	1.3.1 Provide lighting, landscaping and benches along walking and cycling routes between building entrances and streets, sidewalks and trails	<input type="checkbox"/>
BASIC	1.3.2 Provide wayfinding signage for site access (where required, e.g. when multiple buildings or entrances exist) and egress (where warranted, such as when directions to reach transit stops/stations, trails or other common destinations are not obvious)	<input type="checkbox"/>

TDM-supportive design & infrastructure measures: <i>Residential developments</i>		Check if completed & add descriptions, explanations or plan/drawing references
<b>2. WALKING &amp; CYCLING: END-OF-TRIP FACILITIES</b>		
<b>2.1 Bicycle parking</b>		
REQUIRED	2.1.1 Provide bicycle parking in highly visible and lighted areas, sheltered from the weather wherever possible (see <i>Official Plan policy 4.3.6</i> )	<input checked="" type="checkbox"/>
REQUIRED	2.1.2 Provide the number of bicycle parking spaces specified for various land uses in different parts of Ottawa; provide convenient access to main entrances or well-used areas (see <i>Zoning By-law Section 111</i> )	<input checked="" type="checkbox"/>
REQUIRED	2.1.3 Ensure that bicycle parking spaces and access aisles meet minimum dimensions; that no more than 50% of spaces are vertical spaces; and that parking racks are securely anchored (see <i>Zoning By-law Section 111</i> )	<input checked="" type="checkbox"/>
BASIC	2.1.4 Provide bicycle parking spaces equivalent to the expected number of resident-owned bicycles, plus the expected peak number of visitor cyclists	<input type="checkbox"/>
<b>2.2 Secure bicycle parking</b>		
REQUIRED	2.2.1 Where more than 50 bicycle parking spaces are provided for a single residential building, locate at least 25% of spaces within a building/structure, a secure area (e.g. supervised parking lot or enclosure) or bicycle lockers (see <i>Zoning By-law Section 111</i> )	<input checked="" type="checkbox"/>
BETTER	2.2.2 Provide secure bicycle parking spaces equivalent to at least the number of units at condominiums or multi-family residential developments	<input type="checkbox"/>
<b>2.3 Bicycle repair station</b>		
BETTER	2.3.1 Provide a permanent bike repair station, with commonly used tools and an air pump, adjacent to the main bicycle parking area (or secure bicycle parking area, if provided)	<input checked="" type="checkbox"/>
<b>3. TRANSIT</b>		
<b>3.1 Customer amenities</b>		
BASIC	3.1.1 Provide shelters, lighting and benches at any on-site transit stops	<input type="checkbox"/>
BASIC	3.1.2 Where the site abuts an off-site transit stop and insufficient space exists for a transit shelter in the public right-of-way, protect land for a shelter and/or install a shelter	<input type="checkbox"/>
BETTER	3.1.3 Provide a secure and comfortable interior waiting area by integrating any on-site transit stops into the building	<input type="checkbox"/>

TDM-supportive design & infrastructure measures: <i>Residential developments</i>		Check if completed & add descriptions, explanations or plan/drawing references
<b>4. RIDESHARING</b>		
<b>4.1 Pick-up &amp; drop-off facilities</b>		
BASIC	4.1.1 Provide a designated area for carpool drivers (plus taxis and ride-hailing services) to drop off or pick up passengers without using fire lanes or other no-stopping zones	<input checked="" type="checkbox"/>
<b>5. CARSHARING &amp; BIKESHARING</b>		
<b>5.1 Carshare parking spaces</b>		
BETTER	5.1.1 Provide up to three carshare parking spaces in an R3, R4 or R5 Zone for specified residential uses (see <i>Zoning By-law Section 94</i> )	<input type="checkbox"/>
<b>5.2 Bikeshare station location</b>		
BETTER	5.2.1 Provide a designated bikeshare station area near a major building entrance, preferably lighted and sheltered with a direct walkway connection	<input type="checkbox"/>
<b>6. PARKING</b>		
<b>6.1 Number of parking spaces</b>		
REQUIRED	6.1.1 Do not provide more parking than permitted by zoning, nor less than required by zoning, unless a variance is being applied for	<input checked="" type="checkbox"/>
BASIC	6.1.2 Provide parking for long-term and short-term users that is consistent with mode share targets, considering the potential for visitors to use off-site public parking	<input type="checkbox"/>
BASIC	6.1.3 Where a site features more than one use, provide shared parking and reduce the cumulative number of parking spaces accordingly (see <i>Zoning By-law Section 104</i> )	<input type="checkbox"/>
BETTER	6.1.4 Reduce the minimum number of parking spaces required by zoning by one space for each 13 square metres of gross floor area provided as shower rooms, change rooms, locker rooms and other facilities for cyclists in conjunction with bicycle parking (see <i>Zoning By-law Section 111</i> )	<input type="checkbox"/>
<b>6.2 Separate long-term &amp; short-term parking areas</b>		
BETTER	6.2.1 Provide separate areas for short-term and long-term parking (using signage or physical barriers) to permit access controls and simplify enforcement (i.e. to discourage residents from parking in visitor spaces, and vice versa)	<input type="checkbox"/>

# Appendix M

Turning Templates

# BRISEBOIS CRESCENT

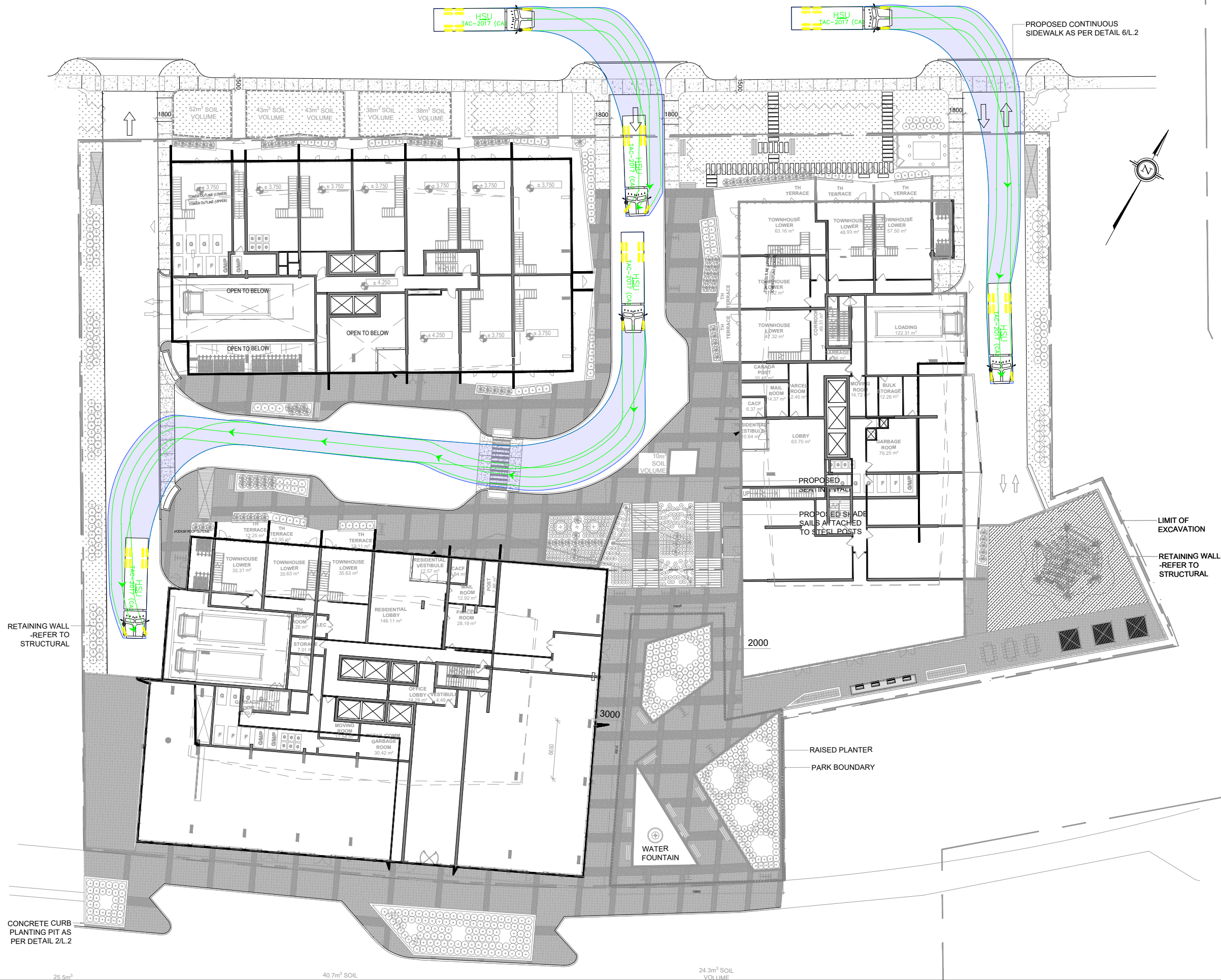

Notes:

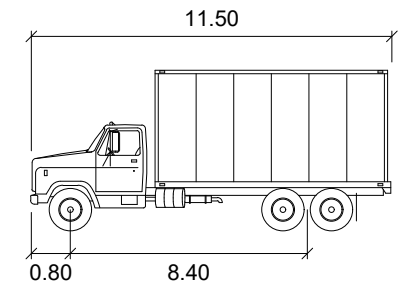

**HSU**

	units
Width	: 2.60
Track	: 2.60
Lock to Lock Time	: 6.0
Steering Angle	: 40.0

02	Updated Site Plan	AN	2024-02-28
REV:	DESCRIPTION:	BY:	DATE:
STATUS:			

**CGH Transportation**  
 6 Plaza Court  
 Ottawa, ON  
 K2H 7W1  
 (343) 999-9117

CLIENT: Bayview Group

ARCHITECT:

SITE: 265 Centrum Boulevard

TITLE: Turning Movement Analysis  
 HSU Inbound Movements

SCALE AT A3:	DATE:	DRAWN:	CHECKED:
NTS	2024-02-28	AN	AH
PROJECT NO:	DRAWING NO:	REVISION:	
2023-013	001	02	

# BRISEBOIS CRESCENT

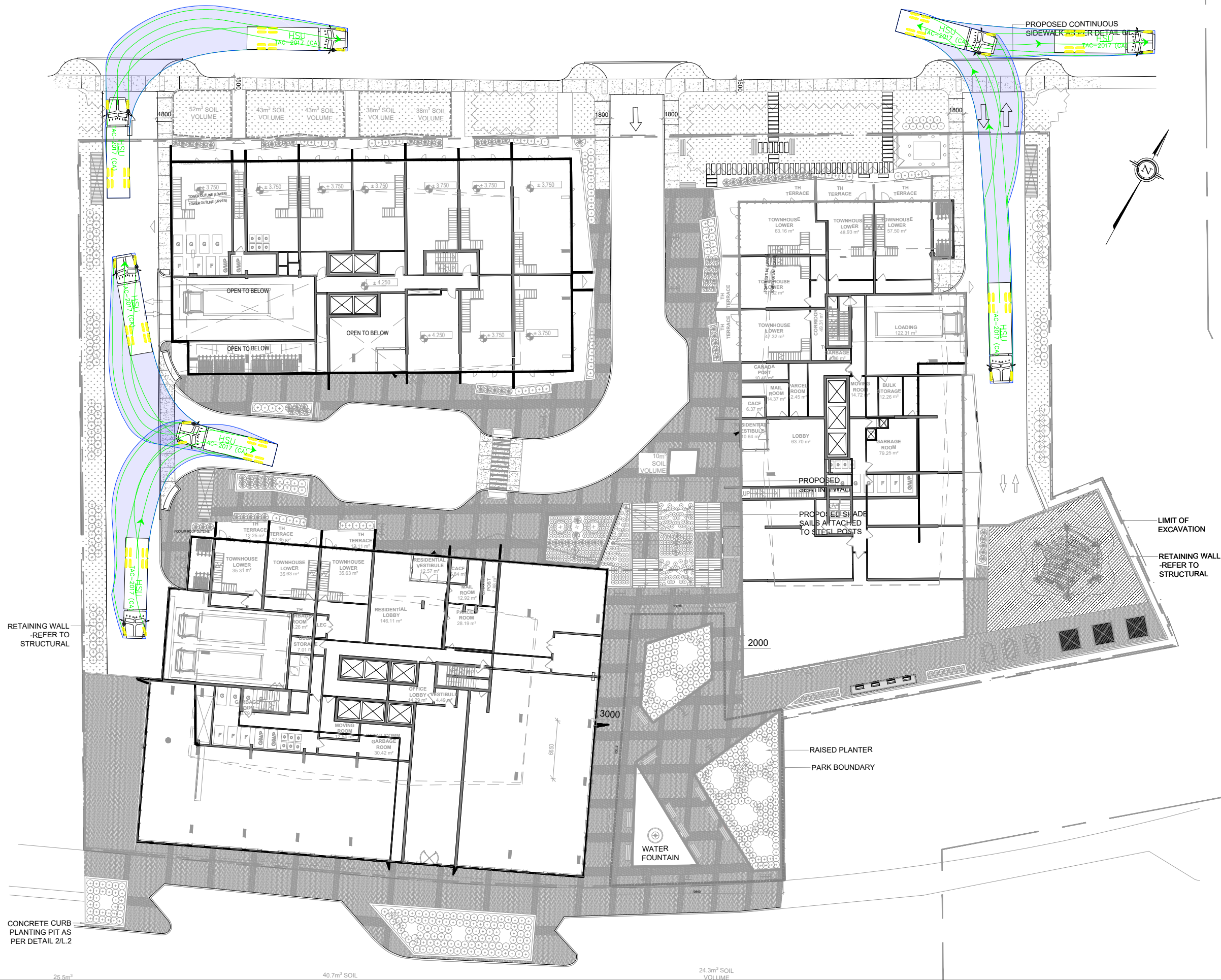

Notes:

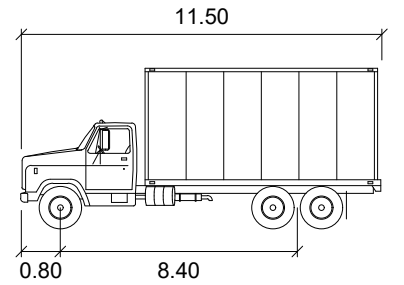

HSU

	units
Width	: 2.60
Track	: 2.60
Lock to Lock Time	: 6.0
Steering Angle	: 40.0

02	Updated Site Plan	AN	2024-02-28
REV:	DESCRIPTION:	BY:	DATE:
STATUS:			

**CGH Transportation**  
 6 Plaza Court  
 Ottawa, ON  
 K2H 7W1  
 (343) 999-9117

CLIENT: Bayview Group

ARCHITECT:

SITE: 265 Centrum Boulevard

TITLE: Turning Movement Analysis  
 HSU Outbound Movements

SCALE AT A3:	DATE:	DRAWN:	CHECKED:
NTS	2024-02-28	AN	AH
PROJECT NO:	DRAWING NO:	REVISION:	
2023-013	002	02	

# BRISEBOIS CRESCENT



Notes:

**MSU**

	units
Width	: 2.60
Track	: 2.60
Lock to Lock Time	: 6.0
Steering Angle	: 40.2

02	Updated Site Plan	AN	2024-02-28
REV:	DESCRIPTION:	BY:	DATE:
STATUS:			

**CGH Transportation**  
 6 Plaza Court  
 Ottawa, ON  
 K2H 7W1  
 (343) 999-9117

CLIENT: Bayview Group

ARCHITECT:

SITE: 265 Centrum Boulevard

TITLE: Turning Movement Analysis  
 MSU Inbound Movements

SCALE AT A3:	DATE:	DRAWN:	CHECKED:
NTS	2024-02-28	AN	AH
PROJECT NO:	DRAWING NO:	REVISION:	
2023-013	003	02	

# BRISEBOIS CRESCENT



Notes:

**MSU**

	units	meters
Width	:	2.60
Track	:	2.60
Lock to Lock Time	:	6.0
Steering Angle	:	40.2

02	Updated Site Plan	AN	2024-02-28
REV:	DESCRIPTION:	BY:	DATE:
STATUS:			

**CGH Transportation**  
 6 Plaza Court  
 Ottawa, ON  
 K2H 7W1  
 (343) 999-9117

CLIENT: Bayview Group

ARCHITECT:

SITE: 265 Centrum Boulevard

TITLE: Turning Movement Analysis  
 MSU Loading Movements

SCALE AT A3:	DATE:	DRAWN:	CHECKED:
NTS	2024-02-28	AN	AH
PROJECT NO:	DRAWING NO:	REVISION:	
2023-013	004	02	



# BRISEBOIS CRESCENT

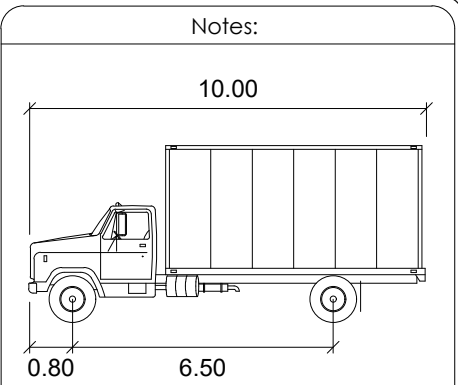

**MSU**

	units
Width	: 2.60
Track	: 2.60
Lock to Lock Time	: 6.0
Steering Angle	: 40.2

02	Updated Site Plan	AN	2024-02-28
REV:	DESCRIPTION:	BY:	DATE:
STATUS:			



**CGH Transportation**  
6 Plaza Court  
Ottawa, ON  
K2H 7W1  
(343) 999-9117

CLIENT:	Bayview Group
ARCHITECT:	

SITE:			
265 Centrum Boulevard			
TITLE: Turning Movement Analysis MSU Outbound Movements			
SCALE AT A3:	DATE:	DRAWN:	CHECKED:
NTS	2024-02-28	AN	AH
PROJECT NO:	DRAWING NO:	REVISION:	
2023-013	005	02	

# BRISEBOIS CRESCENT



Notes:

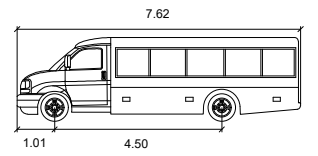

**AllStar Chevrolet 4500 (2016) Type 4**  
 meters  
 Width : 2.44  
 Track : 1.96  
 Lock to Lock Time : 6.0  
 Steering Angle : 34.2

02	Updated Site Plan	AN	2024-02-28
REV:	DESCRIPTION:	BY:	DATE:
STATUS:			

**CGH Transportation**  
 6 Plaza Court  
 Ottawa, ON  
 K2H 7W1  
 (343) 999-9117

CLIENT: Bayview Group

ARCHITECT:

SITE: 265 Centrum Boulevard

TITLE: Turning Movement Analysis  
 ParaTransp Inbound Movement

SCALE AT A3:	DATE:	DRAWN:	CHECKED:
NTS	2024-02-28	AN	AH
PROJECT NO:	DRAWING NO:	REVISION:	
2023-013	006	02	

# BRISEBOIS CRESCENT



Notes:

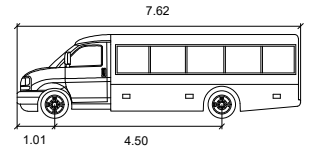

**AllStar Chevrolet 4500 (2016) Type 4**  
 meters  
 Width : 2.44  
 Track : 1.96  
 Lock to Lock Time : 6.0  
 Steering Angle : 34.2

02	Updated Site Plan	AN	2024-02-28
REV:	DESCRIPTION:	BY:	DATE:
STATUS:			

**CGH Transportation**  
 6 Plaza Court  
 Ottawa, ON  
 K2H 7W1  
 (343) 999-9117

CLIENT: Bayview Group

ARCHITECT:

SITE: 265 Centrum Boulevard

TITLE: Turning Movement Analysis  
 ParaTransp Outbound Movement

SCALE AT A3: NTS	DATE: 2024-02-28	DRAWN: AN	CHECKED: AH
PROJECT NO: 2023-013	DRAWING NO: 007	REVISION: 02	

# Appendix N

MMLOS Analysis



# Multi-Modal Level of Service - Segments Form

Consultant	CGH Transportation Inc.
Scenario	Existing/Future
Comments	

Project	265 Centrum Boulevard
Date	2/27/2024

SEGMENTS			Brisebois Crescent (Ex)	Centrum Boulevard	Brisebois Crescent (Fu)
			1	2	3
Pedestrian	Sidewalk Width	-	≥ 2 m	≥ 2 m	≥ 2 m
	Boulevard Width		< 0.5	< 0.5	< 0.5
	Avg Daily Curb Lane Traffic Volume		≤ 3000	≤ 3000	≤ 3000
	Operating Speed		> 50 to 60 km/h	> 30 to 50 km/h	> 50 to 60 km/h
	On-Street Parking		yes	yes	yes
	<b>Exposure to Traffic PLoS</b>		<b>C</b>	<b>B</b>	<b>C</b>
	Effective Sidewalk Width				
	Pedestrian Volume				
	<b>Crowding PLoS</b>	-	-	-	
	<b>Level of Service</b>	-	-	-	
Bicycle	Type of Cycling Facility	D	Mixed Traffic	Mixed Traffic	Mixed Traffic
	Number of Travel Lanes		≤ 2 (no centreline)	≤ 2 (no centreline)	≤ 2 (no centreline)
	Operating Speed		≥ 50 to 60 km/h	>40 to <50 km/h	≥ 50 to 60 km/h
	<b># of Lanes &amp; Operating Speed LoS</b>		<b>D</b>	<b>B</b>	<b>D</b>
	Bike Lane (+ Parking Lane) Width				
	<b>Bike Lane Width LoS</b>		-	-	-
	Bike Lane Blockages				
	<b>Blockage LoS</b>		-	-	-
	Median Refuge Width (no median = < 1.8 m)		< 1.8 m refuge	< 1.8 m refuge	< 1.8 m refuge
	No. of Lanes at Unsignalized Crossing		≤ 3 lanes	≤ 3 lanes	≤ 3 lanes
Sidestreet Operating Speed	>50 to 60 km/h	>40 to 50 km/h	>50 to 60 km/h		
	<b>Unsignalized Crossing - Lowest LoS</b>	<b>C</b>	<b>A</b>	<b>B</b>	
	<b>Level of Service</b>	<b>D</b>	<b>B</b>	<b>D</b>	
Transit	Facility Type	-			
	Friction or Ratio Transit:Posted Speed				
	<b>Level of Service</b>		-	-	-
Truck	Truck Lane Width	-			
	Travel Lanes per Direction				
	<b>Level of Service</b>		-	-	-