

Engineering

- Land/Site Development
- Municipal Infrastructure
- Environmental/Water Resources
- Traffic/Transportation
- Recreational

Planning

- Land/Site Development
- Planning Application Management
- Municipal Planning
- Urban Design
- Expert Witness (LPAT)
- Wireless Industry

Landscape Architecture

- Streetscapes & Public Amenities
- Open Space, Parks & Recreation
- Community & Residential
- Commercial & Institutional
- Environmental Restoration

1900 and 2000 City Park Drive Transportation Impact Assessment



**Proposed Mixed-Use Development
1900 and 2000 City Park Drive
Transportation Impact Assessment**

Prepared By:

NOVATECH
Suite 200, 240 Michael Cowpland Drive
Ottawa, Ontario
K2M 1P6

May 2023

Novatech File: 123006
Ref: R-2023-017

May 3, 2023

City of Ottawa
Planning and Growth Management Department
110 Laurier Ave. W., 4th Floor,
Ottawa, Ontario K1P 1J1

Attention: Mr. Patrick McMahon
Project Manager, Transportation Review

Dear Mr. McMahon:

Reference: 1900 and 2000 City Park Drive
Transportation Impact Assessment
Novatech File No. 123006

We are pleased to submit the following Transportation Impact Assessment Report, in support of Official Plan Amendment and Zoning By-law Amendment applications at 1900 and 2000 City Park Drive, for your review and signoff. The structure and format of this report is in accordance with the City of Ottawa Transportation Impact Assessment Guidelines (June 2017).

If you have any questions or comments regarding this report, please feel free to contact Brad Byvelds, or the undersigned.

Yours truly,

NOVATECH



Trevor Van Wiechen, M.Eng.
E.I.T. | Transportation



TIA Plan Reports

On 14 June 2017, the Council of the City of Ottawa adopted new Transportation Impact Assessment (TIA) Guidelines. In adopting the guidelines, Council established a requirement for those preparing and delivering transportation impact assessments and reports to sign a letter of certification.

Individuals submitting TIA reports will be responsible for all aspects of development-related transportation assessment and reporting, and undertaking such work, in accordance and compliance with the City of Ottawa's Official Plan, the Transportation Master Plan and the Transportation Impact Assessment (2017) Guidelines.

By submitting the attached TIA report (and any associated documents) and signing this document, the individual acknowledges that s/he meets the four criteria listed below.

CERTIFICATION

1. I have reviewed and have a sound understanding of the objectives, needs and requirements of the City of Ottawa's Official Plan, Transportation Master Plan and the Transportation Impact Assessment (2017) Guidelines;
2. I have a sound knowledge of industry standard practice with respect to the preparation of transportation impact assessment reports, including multi modal level of service review;
3. I have substantial experience (more than 5 years) in undertaking and delivering transportation impact studies (analysis, reporting and geometric design) with strong background knowledge in transportation planning, engineering or traffic operations; and
4. I am either a licensed¹ or registered² professional in good standing, whose field of expertise [check appropriate field(s)] is either transportation engineering or transportation planning .

1,2 License of registration body that oversees the profession is required to have a code of conduct and ethics guidelines that will ensure appropriate conduct and representation for transportation planning and/or transportation engineering works.

City Of Ottawa
Infrastructure Services and Community
Sustainability
Planning and Growth Management
110 Laurier Avenue West, 4th fl.
Ottawa, ON K1P 1J1
Tel. : 613-580-2424
Fax: 613-560-6006

Ville d'Ottawa
Services d'infrastructure et Viabilité des
collectivités
Urbanisme et Gestion de la croissance
110, avenue Laurier Ouest
Ottawa (Ontario) K1P 1J1
Tél. : 613-580-2424
Télécopieur: 613-560-6006

Dated at Ottawa this 3 day of May, 2023 .
(City)

Name: Brad Byvelds
(Please Print)

Professional Title: P. Eng. - Project Manager

B. Byvelds

Signature of Individual certifier that s/he meets the above four criteria

Office Contact Information (Please Print)	
Address:	240 Michael Cowpland Drive
City / Postal Code:	Ottawa, ON K2M 1P6
Telephone / Extension:	613-254-9643 ext. 286
E-Mail Address:	b.byvelds@novaetch-eng.com

TABLE OF CONTENTS

1.0 SCREENING.....I

1.1 INTRODUCTION 1

1.2 PROPOSED DEVELOPMENT 2

1.3 SCREENING FORM 2

2.0 SCOPING.....2

2.1 EXISTING CONDITIONS 2

2.1.1 Roadways.....2

2.1.2 Intersections3

2.1.3 Driveways7

2.1.4 Pedestrian and Cycling Facilities7

2.1.5 Transit8

2.1.6 Area Traffic Management10

2.1.7 Existing Traffic Volumes11

2.1.8 Collision Records.....13

2.2 PLANNED CONDITIONS 18

2.2.1 Planned Transit and Roadway Projects18

2.2.2 Other Area Developments20

2.3 STUDY AREA AND TIME PERIODS 20

2.4 EXEMPTIONS REVIEW..... 20

3.0 FORECASTING21

3.1 DEVELOPMENT-GENERATED TRAVEL DEMAND..... 21

3.1.1 Trip Generation.....21

3.1.2 Trip Distribution.....24

3.1.3 Trip Assignment.....25

3.2 BACKGROUND TRAFFIC 25

3.2.1 Other Area Development25

3.2.2 General Background Growth Rate26

3.3 FUTURE TRAFFIC CONDITIONS 26

3.4 DEMAND RATIONALIZATION..... 26

3.4.1 Existing Intersection Operations30

3.4.2 2037 Background Traffic Conditions30

4.0 ANALYSIS.....32

4.1 DEVELOPMENT DESIGN 32

4.2 PARKING 33

4.3 BOUNDARY STREETS 33

4.4 ACCESS INTERSECTIONS 33

4.5 TRANSPORTATION DEMAND MANAGEMENT 33

4.5.1 Context for TDM33

4.5.2 Need and Opportunity.....33

4.5.3 TDM Program33

4.6 NEIGHBOURHOOD TRAFFIC MANAGEMENT 33

4.7 TRANSIT 34

4.8 NETWORK CONCEPT 36

4.9 INTERSECTION DESIGN..... 37

4.9.1 Intersection MMLoS Review.....37

4.9.2 2037 Total Intersection Operations39

5.0 CONCLUSIONS AND RECOMMENDATIONS41

Figures

Figure 1: Site Location 1
 Figure 2: OC Transpo Bus Stop Locations 10
 Figure 3: Existing Traffic Volumes..... 12
 Figure 4: Net Site-Generated Volumes 27
 Figure 5: 2037 Background Traffic 28
 Figure 6: 2037 Total Traffic 29

Tables

Table 1: OC Transpo Transit Stops..... 8
 Table 2: OC Transpo Route Information 9
 Table 3: Reported Collisions 13
 Table 4: TIA Exemptions..... 21
 Table 5: Person Trips Generated by Proposed Development..... 22
 Table 6: TRANS and TOD Mode Share Comparison (Employment) 22
 Table 7: Peak Hour Person Trips by Mode..... 22
 Table 8: Person Trip Generation 22
 Table 9: TRANS and TOD Mode Share Comparison (Residential)..... 23
 Table 10: Peak Period Person Trips by Mode 23
 Table 11: Peak Hour Person Trips by Mode..... 23
 Table 12: Net Person Trip Generation..... 24
 Table 13: Existing Traffic Operations 30
 Table 14: 2037 Background Traffic Operations 31
 Table 15: 2037 Background Queues..... 31
 Table 16: Crossing Volumes at Stop #4447 35
 Table 17: Network Lane Capacity Analysis – 2037 Background Traffic..... 36
 Table 18: Network Lane Capacity Analysis – 2037 Total Traffic..... 37
 Table 19: Intersection MMLoS Summary..... 37
 Table 20: 2037 Total Traffic Operations 40
 Table 21: 2037 Total Queues..... 40
 Table 22: Ogilvie Road/City Park Drive Fully Protected Phasing Comparison..... 41

Appendices

Appendix A: Proposed Concept Plan
 Appendix B: TIA Screening Form
 Appendix C: OC Transpo Route Maps
 Appendix D: Traffic Count Data
 Appendix E: Collision Records
 Appendix F: Blair TOD Plan
 Appendix G: Relevant EA Report Excerpts
 Appendix H: Other Area Developments
 Appendix I: Strategic Long-Range Model Snapshots
 Appendix J: Signal Timing Plans
 Appendix K: Detailed Analysis Reports
 Appendix L: MMLoS Review

EXECUTIVE SUMMARY

This Transportation Impact Assessment (TIA) has been prepared in support of Official Plan Amendment and Zoning By-law Amendment applications for the property located at 1900 and 2000 City Park Drive. The subject site is currently partially vacant with an office building on the western portion. The subject site is surrounded by the following:

- City Park Drive and residential lands to the north,
- Highway 174 to the south,
- Residential and commercial land uses to the east, and
- City Centre Park to the west.

The City of Ottawa's Official Plan identifies the subject site is within the Outer Urban Transect and has 'Hub' and 'Evolving Neighbourhood' designations on Schedule B3. 2000 City Park Drive is currently zoned 'Transit Oriented Development' (TD2) while 1900 City Park Drive is currently zoned Mixed-Use Centre (MC).

For the purposes of this TIA, the proposed development is anticipated to include approximately 2,250 residential units within eight buildings. This is considered the maximum density for the subject site. The final development statistics and access locations for each building will be confirmed as part of future Site Plan Control applications for the development phases. The subject site is anticipated to be developed in phases with full build-out occurring in 2037.

The conclusions and recommendations of this TIA can be summarized as follows:

Forecasting

- The proposed development is anticipated to generate a net additional 753 person trips during the AM peak hour (including 135 vehicle trips), and an additional 742 person trips during the PM peak hour (including 143 vehicle trips).

Development Design

- The proposed development will include vehicular access to City Park Drive. Pedestrian connections are anticipated to be provided to the MUP's east and south of the site, as well as to the sidewalks along City Park Drive.

Transportation Demand Management (TDM)

- A review of the City's TDM Measures Checklist has been conducted by the proponent, who will consider the following TDM measures on a phase by phase basis within this development:
 - Display local area maps with walking/cycling access routes and key destinations at major entrances;
 - Display relevant transit schedules and route maps at entrances;
 - Unbundle parking from purchase cost (condo) or monthly rent (apartment); and
 - Provide multi-modal travel information package to new residents.

Neighbourhood Traffic Management

- Traffic generated by the proposed development is anticipated to increase traffic along City Park Drive at Ogilvie Road/Bathgate Drive by 29-32 vehicles, or one vehicle every two

minutes during peak hours. Traffic at City Park Drive at Ogilvie Road/1941 Ogilvie Road is anticipated to increase by 105-112 vehicles, or two vehicle a minute during peak hours.

- Since City Park Drive is expected to have lower volumes close to the subject site, no neighbourhood traffic management measures have been recommended as part of this proposed development.

Transit

- The proposed development is anticipated to generate an additional 496 transit trips during the AM peak hour and an additional 476 transit trips during the PM peak hour. The additional transit trips generated by the proposed development are anticipated to have a marginal impact on the current transit operations surrounding the site.
- A total of 38-62 people are anticipated to cross the street to Stop #4447 during the peak hours. As the existing transit stop is considered a desire line for pedestrians from the proposed development, consideration should be given to providing a pedestrian crossover along City Park Drive as the development advances. The timing for implementation of a future pedestrian crossover will be reviewed on a phase-by-phase basis through future Site Plan Control applications.

Network Concept

- The additional traffic generated by the subject site is not anticipated to have a significant impact on the overall operations of Blair Road or Ogilvie Road. Peak directional traffic along all roadways are anticipated to meet the target LOS E under the 2037 total traffic conditions.

Intersection MMLOS

- None of the study area intersections meet the target PLOS. There is limited opportunity to improve the PLOS at all intersections without reducing the number of lanes crossed;
- None of the study area intersections meet the target BLOS except for Ogilvie Road/Cadboro Road. There is limited opportunity to improve the BLOS at all intersections without providing two-stage left turning cycling facilities;
- All of the study area intersections meet the target TLOS except for Ogilvie Road/City Park Drive/Bathgate Drive, Ogilvie Road/City Park Drive, Ogilvie Road/Blair Road, and HWY 174 Westbound off-ramp/Blair Road;
- None of the study area intersections meet the target TkLOS except for HWY 174 Westbound off-ramp/Blair Road and HWY 174 Eastbound off-ramp/Blair Road; and
- All intersections meet the target AutoLOS except for Ogilvie Road/Blair Road.

Background Traffic Analysis

- The westbound left turning movement and northbound through movements at the Ogilvie Road/Blair Road intersection do not meet the target LOS E during the AM peak hour and the northbound right, westbound left, eastbound right and eastbound through movements do not meet the target LOS E in the PM peak hour. All other intersections within the study area are expected to meet the City's target.

- During the AM peak hour at the Ogilvie Road/Blair Road intersection, the average and maximum queue lengths of the westbound left movement exceed the current storage capacity. Additionally, the maximum queue lengths of the northbound left, the northbound through, and the southbound left turn movements exceed the existing storage capacity.
- During the PM peak hour at the Ogilvie Road/Blair Road intersection, the average and maximum queue lengths of the northbound right, the southbound through/right, and the westbound left movements and the maximum queue length for the southbound left turn movement exceed the existing storage length.

Total Traffic Analysis

- Traffic generated by the proposed development is anticipated to have marginal operational effects within the study area. The discussion of over-capacity movements and queue lengths are generally consistent with the background traffic analysis.
- Monitoring of collisions associated with the westbound left turn movement should be completed by the City as this development proceeds. Should the westbound left turn collision pattern continue, consideration by the City could be given for implementing a fully protected left turn phase. While queueing does increase under fully protected phasing the 95th percentile queues in the left turning lanes could be supported by existing storage lengths at the intersection.

Based on the foregoing, the proposed development can be recommended from a transportation perspective.

1.0 SCREENING

1.1 Introduction

This Transportation Impact Assessment (TIA) has been prepared in support of Official Plan Amendment and Zoning By-law Amendment applications for the property located at 1900 and 2000 City Park Drive. The subject site is currently partially vacant with an office building on the western portion. The subject site is surrounded by the following:

- City Park Drive and residential lands to the north,
- Highway 174 to the south,
- Residential and commercial land uses to the east, and
- City Centre Park to the west.

An aerial photo of the subject site is provided in **Figure 1** below.

Figure 1: Site Location

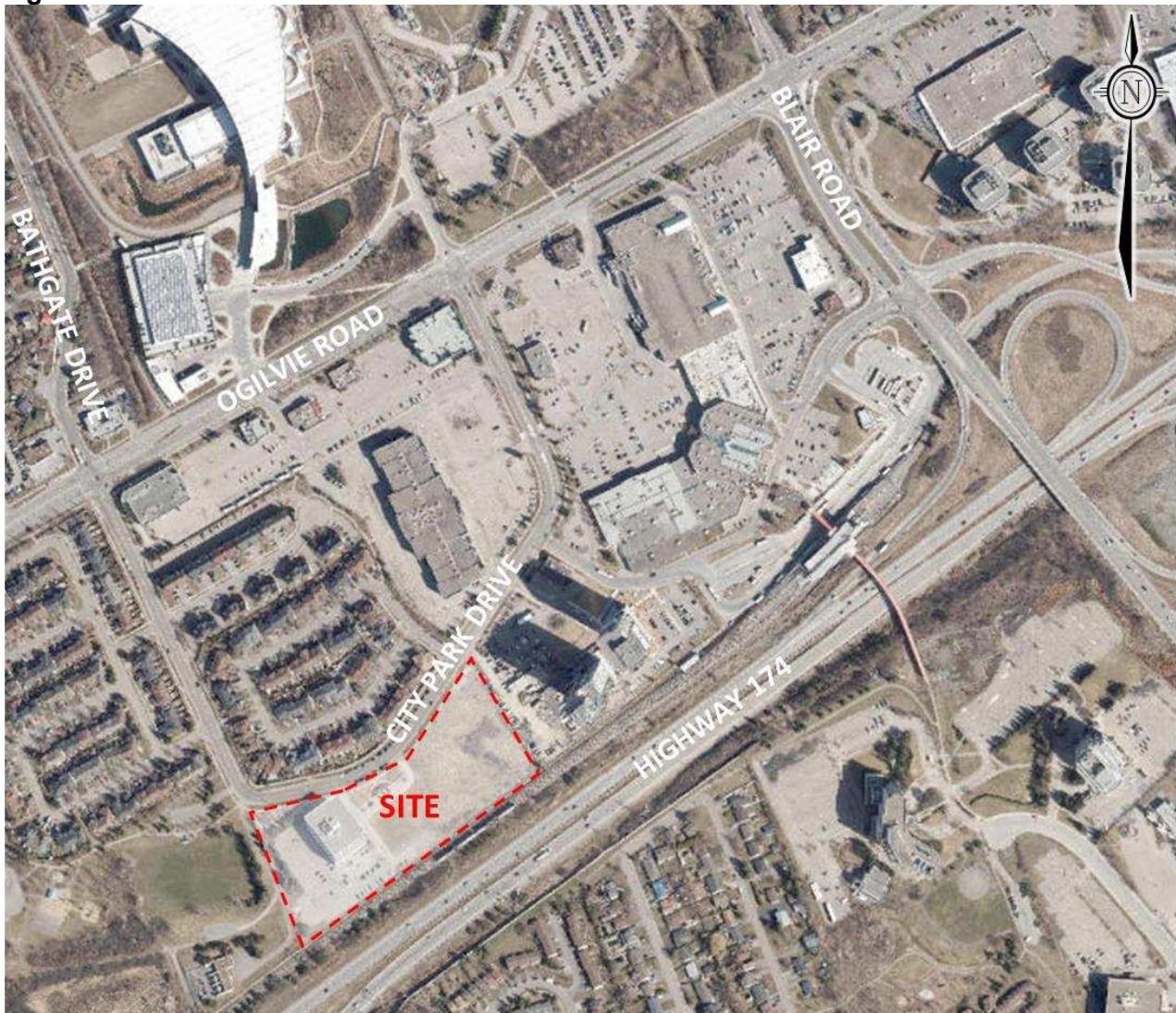

1.2 Proposed Development

The City of Ottawa's Official Plan identifies the subject site is within the Outer Urban Transect and has 'Hub' and 'Evolving Neighbourhood' designations on Schedule B3. 2000 City Park Drive is currently zoned 'Transit Oriented Development' (TD2) while 1900 City Park Drive is currently zoned Mixed-Use Centre (MC).

For the purposes of this TIA, the proposed development is anticipated to include approximately 2,250 residential units within eight buildings. This is considered the maximum density for the subject site. The final development statistics and access locations for each building will be confirmed as part of future Site Plan Control applications for the development phases. A preliminary concept plan for the subject site is provided in **Appendix A**. The subject site is anticipated to be developed in phases with full build-out occurring in 2037.

1.3 Screening Form

The City's 2017 TIA Guidelines identify three triggers for completing a TIA report, including trip generation, location, and safety. The criteria for each trigger are outlined in the City's TIA Screening Form, which is included in **Appendix B**. The trigger results are as follows:

- Trip Generation Trigger – The development is expected to generate more than 60 person trips/peak hour; further assessment **is required** based on this trigger.
- Location Triggers – The development is located within 600m of a transit station and is located in the Blair TOD Zone; further assessment **is required** based on this trigger.
- Safety Triggers – The development proposes no new accesses and does not flag any safety triggers; further assessment **is not required** based on this trigger.

2.0 SCOPING

2.1 Existing Conditions

2.1.1 Roadways

All roadways within the study area fall under the jurisdiction of the City of Ottawa.

City Park Drive is a collector road that loops to the south of Ogilvie Road. Within the study area, City Park Drive has a two-lane undivided urban cross-section, concrete sidewalks on both sides of the road, and an unposted regulatory speed limit of 50km/hr. The City's Official Plan does not identify a right-of-way protection along City Park Drive.

Ogilvie Road is an arterial road that runs in an east-west direction between Montreal Road and St. Laurent Boulevard. North of Montreal Road, Ogilvie Road continues as a major collector roadway to Quincy Avenue. Within the study area, Ogilvie Road has a four-lane divided urban cross-section, concrete sidewalks and bike lanes on both sides of the road and a posted speed limit of 60km/h.

Bathgate Drive is a collector road that runs in a north-south direction between Montreal Road and Ogilvie Road. Within the study area, Bathgate Road has a two-lane undivided urban cross-section, concrete sidewalks on both sides of the road and a posted speed limit of 40km/h.

Blair Road is an arterial road that runs in a north-south direction between Montreal Road and Innes Road. North of Montreal Road, Blair Road continues as a major collector roadway. To the north of Ogilvie Road, Blair Road has a two-lane undivided urban cross-section, a concrete sidewalk on the east side, and a posted speed limit of 50km/h. To the south of Ogilvie Road, Blair Road has a four-lane divided urban cross-section, concrete sidewalks on both sides of the road, and a posted speed limit of 70km/h.

Matheson Road is a collector road that runs in a north-south direction between Bathgate Drive and Ogilvie Road. North of Ogilvie Road, Matheson Road has a two-lane undivided urban cross-section, concrete sidewalks on both sides of the road and a posted speed limit of 40km/h.

Palmerston Drive is a local road that runs in a north-south direction between Ogilvie Road and Halmont Drive. Within the study area, Palmerston Drive has a two-lane undivided urban cross-section, concrete sidewalk on the east side of the road and a posted speed limit of 40km/h.

Highway 174 is a city freeway that runs in an east-west direction. Highway 174 has a divided four-lane cross-section and a posted speed limit of 100km/hr.

2.1.2 Intersections

Ogilvie Rd/Matheson Rd/Palmerston Dr

- Signalized four-legged intersection
- Northbound Approach (Palmerston Drive): one left turn lane and one shared through/right turn lane
- Southbound Approach (Matheson Road): one shared through/left turn lane and one channelized right turn lane
- Eastbound/Westbound Approach (Ogilvie Road): one left turn lane, one through lane, and one shared through/right turn lane
- Standard crosswalks are provided on each approach
- Bike lanes are provided on the eastbound and westbound approaches
- Bus bay's are provided in the southeast and northwest corners of the intersection



Ogilvie Rd/Cadboro Rd

- Signalized three-legged intersection
- Southbound Approach (Cadboro Road): one right turn lane
- Eastbound Approach (Ogilvie Road): two through lanes
- Westbound Approach (Ogilvie Road): one through lane and one shared through/right turn lane
- Standard crosswalks are provided on each approach
- Bike lanes are provided on the eastbound and westbound approaches
- A bus bay is provided on each of the northwest and southeast corners of the intersection
- A roughly 4.5m wide centre island pedestrian refuge is available for pedestrians crossing from north-south
- The southbound left turn movement is prohibited by the centre median island



Ogilvie Rd/Bathgate Dr/City Park Dr

- Signalized four-legged intersection
- Northbound/Southbound Approach (Bathgate Drive/City Park Drive): one left turn lane and one shared through/right turn lane
- Eastbound/Westbound Approach (Ogilvie Road): one left turn lane, two through lanes, and one right turn lane
- Standard crosswalks are provided on each approach
- Pocket bike lanes are provided on the eastbound and westbound approaches
- A bus bay is provided in the northwest corner of the intersection
- U-turns are prohibited on the westbound Ogilvie Road approach



Ogilvie Rd/1929 Ogilvie Rd/1900 Ogilvie Rd

- Signalized four-legged intersection
- Northbound Approach (1900 Ogilvie Road): one left turn lane and one shared through/right turn lane
- Southbound Approach (1929 Ogilvie Road): one shared through/left turn lane and one right turn lane
- Eastbound Approach (Ogilvie Road): one left turn lane, one through lane, and one shared through/right turn lane
- Westbound Approach (Ogilvie Road): one left turn lane, two through lanes, and one right turn lane
- Standard crosswalks are provided on each approach
- A bike lane/pocket bike lane is provided on the eastbound and westbound approach

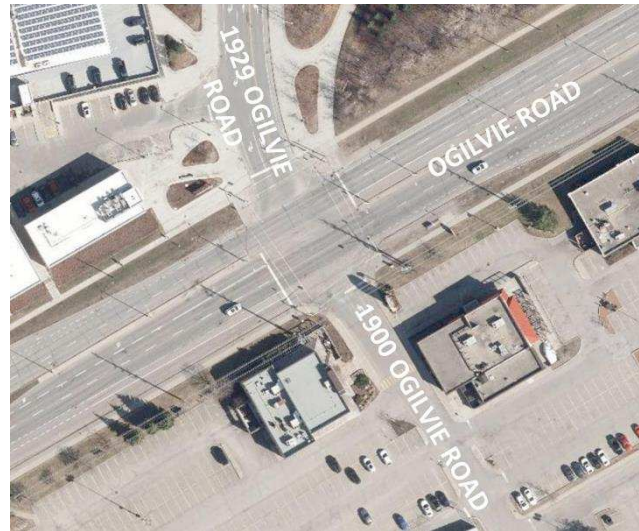

Ogilvie Rd/City Park Dr/1941 Ogilvie Rd

- Signalized four-legged intersection
- Northbound Approach (City Park Drive): one shared through/left turn lane, and one right turn lane
- Southbound Approach (1941 Ogilvie Road): one left turn lane and one shared through/channelized right turn lane
- Westbound Approach (Ogilvie Road): one left turn lane, two through lanes, and one channelized right turn lane
- Eastbound Approach (Ogilvie Road): one left turn lane, two through lanes, and one right turn lane
- Painted zebra crosswalks are provided on all approaches
- Pocket bike lanes are provided on the eastbound and westbound approach
- A bus bay is provided in the northwest corner of the intersection



Ogilvie Road/1980 Ogilvie Road

- Intersection pedestrian signal crossing Ogilvie Road
- Northbound Approach (1980 Ogilvie Road): one right turn lane
- Eastbound Approach (Ogilvie Road): two through lanes and one right turn lane
- Westbound Approach (Ogilvie Road): two through lanes
- A bike lane/pocket bike lane is provided on the eastbound and westbound approaches
- A roughly 2.0m wide centre island pedestrian refuge is available for pedestrians crossing from north-south
- The northbound left turn movement is prohibited by the centre median island



Ogilvie Rd/Blair Rd

- Signalized four-legged intersection
- Northbound Approach (Blair Road): two left turn lanes, one through lane, and one channelized right turn lane
- Southbound Approach (Blair Road): one left turn lane, one through lane, and one shared through/right turn lane
- Eastbound Approach (Ogilvie Road): one left turn lane, two through lanes, and one channelized right turn lane
- Westbound Approach (Ogilvie Road): two left turn lanes, one through lane, and one shared through/right turn lane
- Standard crosswalks are provided on all approaches.
- A bike lane/pocket bike lane is provided on the eastbound and southbound approach



Blair Rd/Highway 174 WB off-ramp/
1980 Ogilvie Rd

- Signalized four-legged intersection
- Northbound Approach (Blair Road): two left turn lanes and two through lanes
- Southbound Approach (Blair Road): three through lanes and one channelized right turn lane
- Westbound Approach (Hwy 174 WB off-ramp): one left turn lane, one through lane, and channelized right turn lane
- Eastbound Approach (1980 Ogilvie Road): one left turn lane and one right turn lane
- Standard crosswalks are provided on the southbound, westbound, and eastbound approaches.



Blair Road/Highway 174 EB off-ramp

- Signalized three-legged intersection
- Northbound Approach (Blair Road): two through lanes and one right turn lane
- Southbound Approach (Blair Road): one through lane and one shared through/left turn lane
- Westbound Approach (Hwy 174 EB off-ramp): one left turn lane, one bus lane, and one by-pass right turn lane
- Standard crosswalks are provided on all approaches.

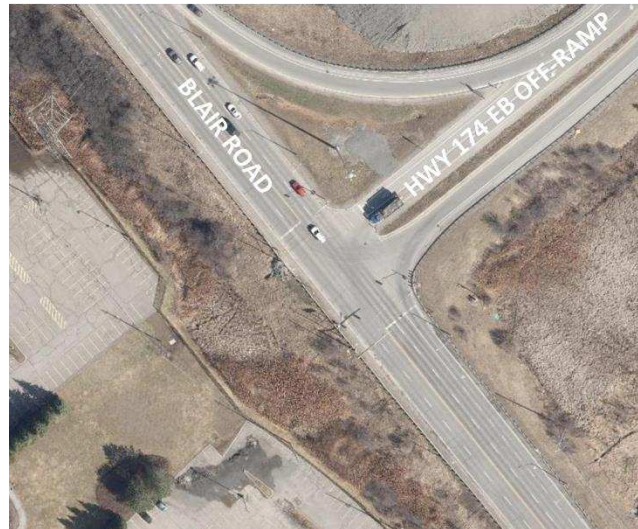

2.1.3 Driveways

A review of adjacent driveways along the boundary roads are provided as follows:

City Park Drive, South Side:

- One Driveway to City Centre Park
- One driveway to 1820 City Park Drive
- Two driveways to Frontier developments at 2280 City Park Drive
- One driveway to shopping mall at 1980 Ogilvie Road
- One driveway to gas station at 1970 Ogilvie Road

City Park Drive, North Side:

- Four driveways to commercial development at 1900 City Park Drive
- One driveway to residential parking for 4461 Harper Avenue
- One driveway to residential parking for 4430 Harper Avenue

2.1.4 Pedestrian and Cycling Facilities

Sidewalks within the study area are summarized as follows:

- Both sides of Ogilvie Road, City Park Drive, Matheson Road, Bathgate Drive, and Blair Road between Ogilvie Road and Highway 174 Westbound off-ramp; and
- The east side of Palmerston Drive and Blair Road north of Ogilvie Road.

In the City of Ottawa’s primary cycling network, Ogilvie Road and Blair Road are classified as Spine Routes. City Park Drive is classified as a local route to the west of the proposed development and is classified as a pathway link to the east of the proposed development. Bike lanes are provided on both sides of Ogilvie Road. Off-road pathways are provided through City Centre Park, connecting City Park Drive to Halmont Drive/Palmerston Drive.

2.1.5 Transit

The closest OC Transpo bus stops that serve various routes in the vicinity of the subject site are described in **Table 1** and are shown in **Figure 2**. A summary of OC Transpo routes which serve the study area is included in **Table 2**. Detailed route information and an excerpt from the OC Transpo System Map are included in **Appendix C**.

Table 1: OC Transpo Transit Stops

Stop	Location	Routes Served
#1778	South corner of City Park Drive/Blair Station access road	15, 25, 39
#1841	North side of City Park Drive mid-block between Frontier Path Private and Ambassador Avenue	15, 25, 39
#4447	North side of City Park Drive near 1900 City Park Drive	15, 25, 39
#4448	Northeast of City Park Drive/Jobin Crescent	15, 25, 39
#4449	South side of City Park Drive near 1900 City Park Drive	15, 25, 39
#4450	West side of City Park Drive mid-block between Wilbury Road and Jobin Crescent	15, 25, 39
#4451	Southwest corner of Ogilvie Road/City Park Drive/Bathgate Drive	15, 25, 39
#1927	Southwest corner of Ogilvie Road/City Park Drive	12, 23, 24, 28, 35, 39, 619, 624, 630, 631
#4446	East side of City Park Drive and 130m south of Blair Road	12, 23, 24, 26, 28, 35, 39, 619, 624, 630, 631
#1980	Northwest corner of Ogilvie Road/City Park Drive/Bathgate Drive	24, 39, 624, 633
#8513	Southeast corner of Ogilvie Road/City Park Drive/Bathgate Drive	24, 39, 624, 633
#3027	Blair Station	1, 12, 15, 21, 23, 24, 25, 26, 28, 30, 31, 32, 33, 34, 35, 38, 39, 42, 221, 222, 228, 231, 232, 234, 236, 237, 619, 624, 628, 630, 631

Table 2: OC Transpo Route Information

Route	From ↔ To	Frequency
1	Tunney's Pasture ↔ Blair	5-minute headways, 7-days per week
12 ¹	Blair ↔ St-Laurent	15-minute headways, 7-days per week all day service
15 ¹	Blair ↔ Parliament	5-minute headways, 7-days per week all day service
21	Canotek ↔ Blair	Monday-Friday, Routes offered in peak direction of travel
23	Rothwell Heights ↔ Blair	30-minute headways, Monday-Friday limited service
24	Beacon Hill ↔ St-Laurent	30-minute headways, 7-days per week all day service
25	La Cité ↔ Millennium	10-minute headways, 7-days per week all day service
26	Pineview ↔ Blair	30-minute headways, 7-days per week all day service
28	Blackburn Hamlet ↔ Blair	30-minute headways, 7-days per week all day service, no service on Sunday evenings
30	Blair ↔ Millennium	30-minute headways, 7-days per week all day service
31	Place d'Orléans ↔ Blair	Monday to Friday, select time periods only
32	Blair ↔ Chapel Hill	30-minute headways, 7-days per week, select time periods only
33	Blair ↔ Portobello	30-minute headways, Monday to Friday, all day service and select trips in the evening
35	Blair ↔ Esprit	30-minute headways, 7-days per week, all day service
38	Blair ↔ Jeanna d'Arc/Trim	30-minute headways, 7-days per week, all day service
39	Blair & N Rideau ↔ Millennium	15-minute headways, 7-days per week, all day service and limited overnight service
42	Blair ↔ Hurdman	30-minute headways, 7-days per week, no evening service on weekends and no late evening service on weekdays
221	Blair ↔ Cumberland	30-minute headways, Monday to Friday, Routes offered in peak direction of travel during peak periods
222	Blair ↔ Vars	30-minute headways, Monday to Friday, Routes offered in peak direction of travel during peak periods
228	Blair ↔ Navan-Sarsfield	30-minute headways, Monday to Friday, Routes offered in peak direction of travel during peak periods
231	Blair ↔ Meadowglen	60-minute headways, Monday to Friday, Routes offered in peak direction of travel during peak periods
232	Blair ↔ Queenswood Heights	30-minute headways, Monday to Friday, Routes offered in peak direction of travel during peak periods
234	Blair ↔ Tenth Line	30-minute headways, Monday to Friday, Routes offered in peak direction of travel during peak periods
236	Blair ↔ Esprit	30-minute headways, Monday to Friday, Routes offered in peak direction of travel during peak periods
237	Blair ↔ Jeanna d'Arc	60-minute headways, Monday to Friday, Routes offered in peak direction of travel during peak periods
619	Louis Riel ↔ Blair	One school bus route per day each direction Monday-Friday
624	Gloucester H.S. ↔ Rideau	One school bus route per day each direction Monday-Friday
628	Louis Riel	Four school bus routes in the morning, Monday-Friday
630	Blair/Colonel By/Gloucester H.S. ↔ Millennium	One school bus route per day each direction Monday-Friday

Route	From ↔ To	Frequency
631	Colonel By/Gloucester H.S. ↔ Chapel Hill	One school bus route per day each direction Monday-Friday
633	Lester B Pearson ↔ St-Laurent	One school bus route per day each direction Monday-Friday

1. As of April 23, 2023, Routes 12 and 15 have returned to their pre-construction schedule and routing.

Figure 2: OC Transpo Bus Stop Locations

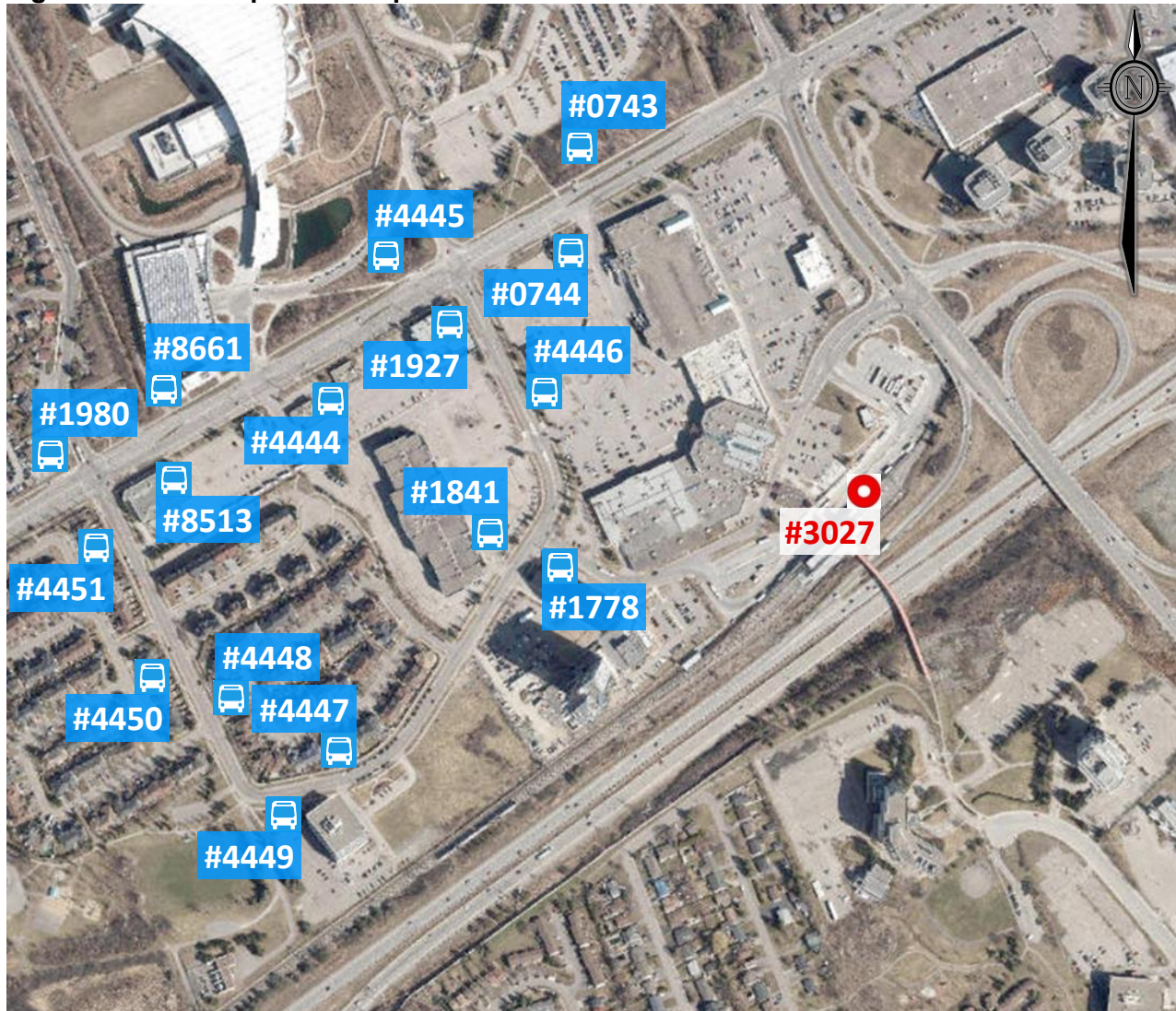

2.1.6 Area Traffic Management

There are no Area Traffic Management (ATM) studies within the study area that have been completed or are currently in progress.

The following traffic calming measures are currently in place within the study area:

- Matheson Road: 40KMHR MAX pavement markings, midblock and intersection narrowings, and flex posts
- Bathgate Drive: midblock and intersection narrowings and flex posts

- Palmerston Drive: 40KMHR MAX pavement markings
- Intersection Pedestrian Signals (IPS) at the Ogilvie Road/Cadboro Road intersection and a Mid-Block Pedestrian Signal (MPS) at Ogilvie Road mid-block between Blair Road and City Park Drive East.

2.1.7 Existing Traffic Volumes

Weekday traffic counts were used to determine the existing pedestrian, cyclist, and vehicular traffic volumes at the study area intersections. These counts were completed on the dates listed below:

- | | |
|--|-------------------|
| • Blair Road/Highway 174 EB off-ramp | March 22, 2023 |
| • Blair Road/Highway 174 WB off-ramp | March 22, 2023 |
| • Blair Road/Ogilvie Road | April 24, 2019 |
| • Blair Road/185m East of Bathgate Drive | January 16, 2019 |
| • Ogilvie Road/Bathgate Drive/City Park Drive | February 10, 2020 |
| • Ogilvie Road/Cadboro Road | January 9, 2019 |
| • Ogilvie Road/City Park Drive/1941 Ogilvie Road | January 9, 2019 |
| • Ogilvie Road/Matheson Road/Palmerston Drive | May 9, 2017 |

Observed weekday AM and PM peak hour traffic volumes at the study area intersections are shown in **Figure 3**. Peak hour summary sheets of the above traffic counts are included in **Appendix D**.

Figure 3: Existing Traffic Volumes

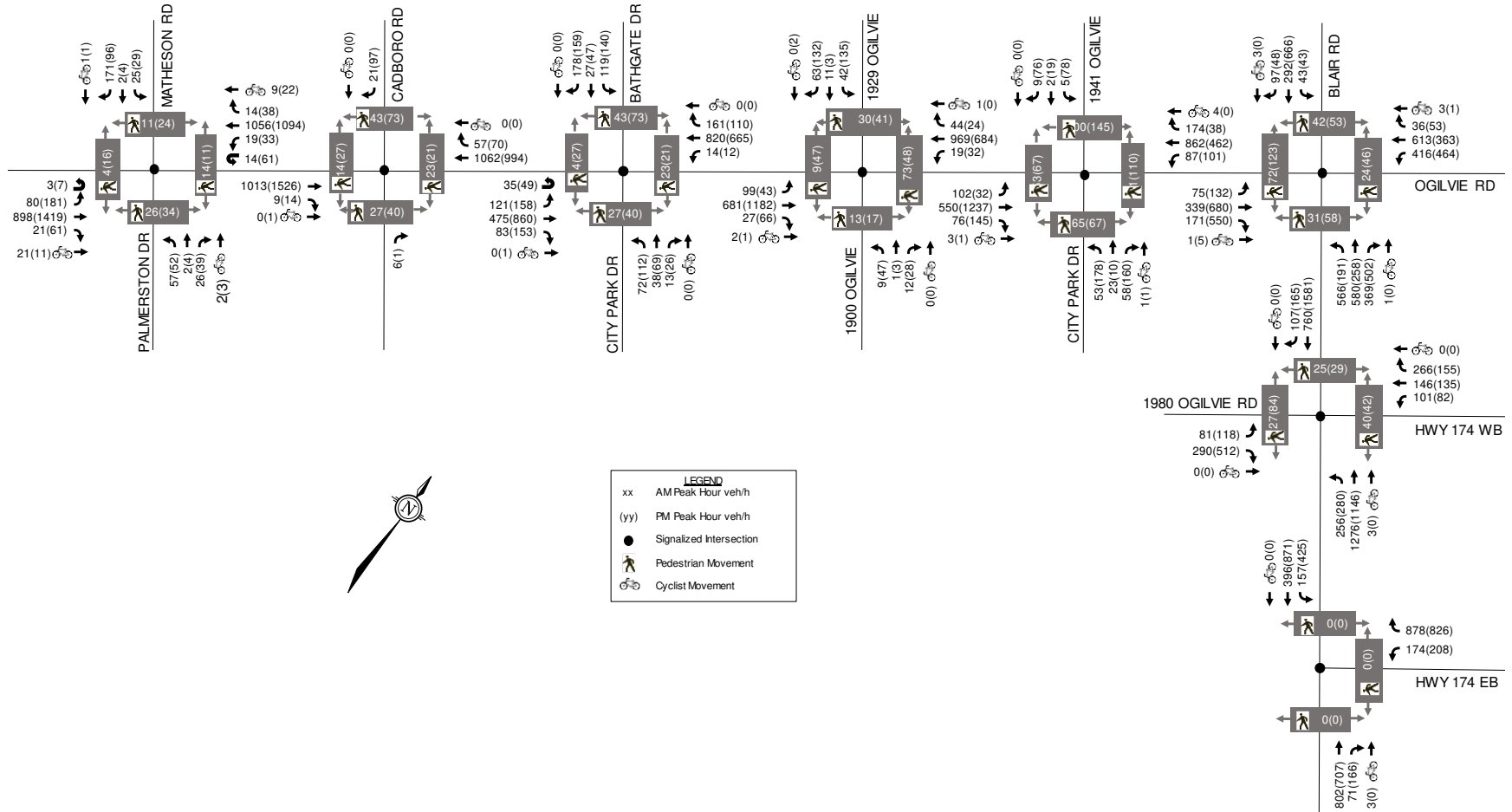

2.1.8 Collision Records

Historical collision data from the last five years were obtained from the City’s Public Works and Service Department for the study area intersections. Copies of the collision summary reports are included in **Appendix E**.

The collision data have been evaluated to identify collision patterns, which are defined in the 2017 TIA Guidelines as more than six collisions in five years for any one movement. **Table 3** summarizes the number of collisions at each intersection from January 1, 2016 to December 31, 2020. During the five-year period there were no reported fatal collisions in the analyzed area.

Table 3: Reported Collisions

Intersection/ Street Segment	Collision Types						Total
	Approaching	Angle	Rear End	Sideswipe	Turning Movement	SMV ⁽¹⁾ / Other	
Ambassador Avenue/City Park Drive	-	1	1	-	-	-	2
Blair Road/Ogilvie Road	-	1	65	12	1	5	84
Blair Road/Highway 174 Westbound On-Ramp	-	-	1	-	-	1	2
Blair Road/Highway 174 Eastbound Off-Ramp	-	-	2	-	-	-	2
Blair Road/Highway 174 Westbound Off-Ramp/1980 Ogilvie Road	-	10	37	5	10	4	66
Blair Road/Highway 174 Eastbound Off-ramp	2	3	21	5	17	6	54
Blair Road between Ogilvie Road and Highway 174 Westbound Off-Ramp/1980 Ogilvie Road	-	-	5	3	-	-	8
Blair Road between Highway 174 Westbound Off-Ramp/1980 Ogilvie Road and Highway 174 Westbound On-Ramps	-	-	1	1	-	-	2
Blair Road between Highway 174 Westbound On-Ramps and Highway 174 Eastbound Off-Ramp	-	-	2	-	-	-	2
Blair Road between Highway 174 Eastbound Off-Ramp and Highway 174 Eastbound On/Off-Ramp intersection	-	-	1	-	-	1	2
Cadboro Road/Ogilvie Road	-	-	7	-	-	2	9
City Park Drive/Wilbury Rd/Harper Ave	-	-	-	-	-	1	1
City Park Drive between Ambassador Avenue and Ogilvie Road	-	1	-	1	3	1	6
City Park between Ogilvie Road and Wilbury Road	-	-	-	-	1	1	2
Ogilvie Road/1900 Ogilvie Road/1929 Ogilvie Road	-	-	1	-	-	-	1
Ogilvie Road at pedestrian signal 240m west of Blair Road	-	-	6	-	-	-	6

Intersection/ Street Segment	Collision Types						Total
	Approaching	Angle	Rear End	Sideswipe	Turning Movement	SMV ⁽¹⁾ /Other	
Ogilvie Road/Bathgate Drive/City Park Drive	1	6	10	5	9	6	37
Ogilvie Road/City Park Drive East/1941 Ogilvie Road	-	1	9	-	12	2	24
Ogilvie Road/Matheson Road/Palmerston Drive	-	3	8	-	4	4	19
Ogilvie Road between City Park Drive West/Bathgate Drive and Cadboro Road	-	1	3	-	-	2	6
Ogilvie Road between City Park Drive West/Bathgate Drive and 1929 Ogilvie Road/1900 Ogilvie Road	-	-	4	2	-	-	6
Ogilvie Road between 1929 Ogilvie Road/1900 Ogilvie Road and City Park Drive East	-	-	1	1	-	-	2
Ogilvie Road between Blair Road and City Park Drive East	-	1	2	2	-	2	7
Ogilvie Road between Cadboro Road and Matheson Road	-	1	3	1	-	2	7

1. SMV = Single Motor Vehicle

Blair Road/Ogilvie Road

A total of 84 collisions were reported at this intersection over the last five years, of which there were one angle collision, 65 rear end collisions, 12 sideswipe collisions, one turning movement collisions, and five single-vehicle/other collisions. Nine of the collisions involved an injury and none involved a fatality. None of the collisions involved cyclists or pedestrians.

Of the 84 collisions at this location, nine of them occurred during rain conditions, six of them occurred during snow conditions, and one occurred during freezing rain conditions, for all other collisions weather was not a factor. Additionally, of the 84 collisions, 58 of them occurred during daylight hours.

Of the 65 rear end collisions, 26 involved northbound vehicles, 16 involved southbound vehicles, 22 involved eastbound vehicles, and 20 involved westbound vehicles. The rear end collision patterns at this intersection are anticipated to be attributable to high traffic volumes and congestion during peak periods.

Of the 12 side swipe collisions, two involved northbound vehicles, two involved southbound vehicles, three involved eastbound vehicles, and five involved westbound vehicles.

Calculations of the intersection collision rate per Million Entering Vehicles (MEV) for all collision types across the five-year study period showed an intersection collision rate of 1.08/MEV. Based on this analysis, Blair Road/Ogilvie Road does not experience an abnormally high rate of collisions.

Blair Road/Highway 174 Westbound Off-Ramp/1980 Ogilvie Road

A total of 66 collisions were reported at this intersection over the last five years, of which there were ten angle collisions, 37 rear end collisions, five sideswipe collisions, ten turning movement collisions, and four single-vehicle/other collisions. Thirteen of the collisions involved an injury and

none involved a fatality. None of the collisions involved cyclists and two of the collisions involved a pedestrian.

Of the 66 collisions at this location, 13 of them occurred during rain conditions, four of them occurred during snow conditions, and one occurred during freezing rain conditions, for all other collisions weather was not a factor. Additionally, of the 66 collisions, 47 of them occurred during daylight hours.

Of the ten angle collisions, five involved northbound and westbound vehicles, four involved southbound and westbound vehicles, and one involved a southbound and eastbound vehicle.

Of the 37 rear end collisions, two involved northbound vehicles, 16 involved southbound vehicles, one involved eastbound vehicles, and 18 involved westbound vehicles.

Southbound rear end collisions at this location could be attributed to high southbound traffic volumes. Westbound rear end collisions at this location could be attributed to a combination of the horizontal curvature of the road impacting sight lines, high traffic volumes, and the slight downward grade impacting stopping distance.

Of the ten turning movement collisions, northbound left turning vehicles, five involved eastbound left turning vehicles, and one involved a westbound left turning vehicle.

Calculations of the intersection collision rate per MEV for all collision types across the five-year study period showed an intersection collision rate of 0.77/MEV. Based on this analysis, Blair Road/Highway 174 Westbound Off-Ramp/1980 Ogilvie Road does not experience an abnormally high rate of collisions.

Blair Road/Highway 174 Eastbound Off-ramp

A total of 54 collisions were reported at this intersection over the last five years, of which there were two approaching collisions, three angle collisions, 21 rear end collisions, five sideswipe collisions, 17 turning movement collisions, five single vehicle collisions, and one other type collision. Thirteen of the collisions involved an injury and none involved a fatality. None of the collisions involved cyclists or pedestrians.

Of the 54 collisions at this location, 13 of them occurred during rain conditions and three of occurred during snow conditions, for all other collisions weather was not a factor. Additionally, of the 54 collisions, 34 of them occurred during daylight hours.

Of the 21 rear end collisions, five involved northbound vehicles, ten involved southbound vehicles, four involved eastbound vehicles, and two involved westbound vehicles.

Southbound rear end collisions at this location could be attributed to a slight downward grade impacting stopping distance and sight lines.

Of the 17 turning movement collisions, 16 involved southbound left turning vehicles and one involved a northbound vehicle performing a U-turn. Southbound turning movement collisions at this location could be attributed to the permitted left turn movement crossing multiple lanes of oncoming traffic with high volumes of southbound left turning vehicles and oncoming traffic.

Calculations of the intersection collision rate per MEV for all collision types across the five-year study period showed an intersection collision rate of 0.84/MEV. Based on this analysis, Blair Road/Highway 174 Eastbound Off-Ramp does not experience an abnormally high rate of collisions.

Cadboro Road/Ogilvie Road

A total of nine collisions were reported at this intersection over the last five years, of which there were seven rear end collisions and two single-vehicle/other collisions. Two of the collisions involved an injury and none involved a fatality. None of the collisions involved cyclists and one collision involved a pedestrian.

Of the nine collisions at this location, one of them occurred during rain conditions and one of them occurred during snow conditions, for all other collisions weather was not a factor. Additionally, of the nine collisions, seven of them occurred during daylight hours.

Of the seven rear end collisions, three involved westbound vehicles and four involved eastbound vehicles.

As there are less than six collisions of any specific collision type, there are no identifiable collision patterns at this intersection. Calculations of the intersection collision rate per MEV for all collision types across the five-year study period showed an intersection collision rate of 0.16/MEV. Based on this analysis, Cadboro Road/Ogilvie Road experiences a relatively low rate of collisions.

Ogilvie Road at pedestrian signal 240m west of Blair Road

A total of six collisions were reported at this intersection over the last five years, all six of which were rear end collisions. Two of the collisions involved an injury and none involved a fatality. None of the collisions involved cyclists and one collision involved a pedestrian.

Of the six collisions at this location, one of them occurred during snow conditions, for all other collisions weather was not a factor. Additionally, all six collisions occurred during daylight hours.

Of the six rear end collisions, one involved southbound vehicles, three involved westbound vehicles and two involved eastbound vehicles.

As there are less than six collisions of any specific collision type, there are no identifiable collision patterns at this intersection. Calculations of the intersection collision rate per MEV for all collision types across the five-year study period showed an intersection collision rate of 0.14/MEV. Based on this analysis, Ogilvie Road at pedestrian signal 240m west of Blair Road experiences a relatively low rate of collisions.

Ogilvie Road/Bathgate Drive/City Park Drive

A total of 37 collisions were reported at this intersection over the last five years, of which there were one approaching collision, six angle collisions, 10 rear end collisions, five sideswipe collisions, nine turning movement collisions, and six single-vehicle/other collisions. Twelve of the collisions involved an injury and none involved a fatality. None of the collisions involved cyclists and two of the collisions involved a pedestrian.

Of the 37 collisions at this location, two of them occurred during rain conditions, three of them occurred during snow conditions, and one occurred during freezing rain conditions, for all other collisions weather was not a factor. Additionally, of the 37 collisions, 29 of them occurred during daylight hours.

Of the six angle collisions, two involved northbound and eastbound vehicles, two involved southbound and westbound vehicles, one involved a northbound and westbound vehicle, and one involved a southbound and eastbound vehicle.

Of the ten rear end collisions, one involved northbound vehicles, one involved southbound vehicles, four involved eastbound vehicles, and four involved westbound vehicles.

Of the nine turning movement collisions, seven involved eastbound left turning vehicles, one involved a westbound left turning vehicle, and one involved a southbound left turning vehicle. The eastbound and westbound left turn movements at this intersection currently operate with a protected and permitted left turn phase. It is recommended that the City monitor the collision history for the eastbound left turn movement. Should the collision pattern continue, consideration could be given to implementing fully protected left turn phasing.

Of the six single motor vehicle or other collisions, one involved a northbound vehicle, one involved a southbound vehicle, one involved an eastbound vehicle, and three involved westbound vehicles.

Calculations of the intersection collision rate per MEV for all collision types across the five-year study period showed an intersection collision rate of 0.68/MEV. Based on this analysis, Ogilvie Road/Bathgate Drive/City Park Drive does not experience an abnormally high rate of collisions.

Ogilvie Road/City Park Drive/1941 Ogilvie Road

A total of 24 collisions were reported at this intersection over the last five years, of which there were one angle collision, nine rear end collisions, 12 turning movement collisions, and two single-vehicle/other collisions. Eight of the collisions involved an injury and none involved a fatality. None of the collisions involved cyclists and one collision involved a pedestrian.

Of the 24 collisions at this location, four of them occurred during rain conditions, one occurred during snow conditions, and one of them occurred during fog/mist/smoke/dust conditions, for all other collisions weather was not a factor. Additionally, of the 24 collisions, 19 of them occurred during daylight hours.

Of the nine rear end collisions, one involved northbound vehicles, three involved westbound vehicles and five involved eastbound vehicles.

Of the twelve turning movement collisions, nine involved westbound left turning vehicles, one involved a northbound left turning vehicle, one involved a southbound vehicle performing a U-turn, and one involved an eastbound vehicle performing a U-turn. The eastbound left turn movement at this intersection currently operates with a protected and permitted left turn phasing while the westbound left turn movement operates with a permitted left turn phase. It is recommended that the City monitor the collision history for the westbound left turn movement. Should the collision pattern continue, consideration could be given to implementing a protected and permitted left turn phasing, consistent with the eastbound left turn movement.

Due to the high volume of oncoming eastbound through and westbound left turning vehicles there are perhaps insufficient gaps for westbound vehicles to make safe turning movements at the Ogilvie Road/City Park Drive/1941 Ogilvie Road intersection.

Calculations of the intersection collision rate per MEV for all collision types across the five-year study period showed an intersection collision rate of 0.47/MEV. Based on this analysis, Ogilvie Road/City Park Drive/1941 Ogilvie Road does not experience an abnormally high rate of collisions.

Ogilvie Road/Matheson Road/Palmerston Drive

A total of 19 collisions were reported at this intersection over the last five years, of which there were three angle collisions, eight rear end collisions, four turning movement collisions, and four single-vehicle/other collisions. Two of the collisions involved an injury and none involved a fatality. None of the collisions involved cyclists or pedestrians.

Of the 19 collisions at this location, two of them occurred during rain conditions and three occurred during snow conditions, for all other collisions weather was not a factor. Additionally, of the 19 collisions, 14 of them occurred during daylight hours.

Of the eight rear end collisions, one involved southbound vehicles, six involved westbound vehicles and one involved eastbound vehicles. Rear end collisions at the Ogilvie Road/Matheson Road/Palmerston Drive intersection could be attributed to high westbound and eastbound traffic volumes.

Calculations of the intersection collision rate per MEV for all collision types across the five-year study period showed an intersection collision rate of 0.35/MEV. Based on this analysis, Ogilvie Road/Matheson Road/Palmerston Drive experiences a relatively low rate of collisions.

Other Intersections and Roadway Segments

As all other intersections and roadway segments have less than six collisions of any specific collision type, a further review of collisions is not required.

2.2 Planned Conditions

2.2.1 Planned Transit and Roadway Projects

The City of Ottawa's 2013 Transportation Master Plan (TMP) identifies the following projects within the study area:

- Blair Road - The 2031 Affordable Transit Network identifies transit signal priority and queue jump lanes between Innes Road and Blair station and exclusive bus lanes and transit signal priority between Blair Station and Montreal Road. Bus lanes are to be provided through a combination of road widening (north of Ogilvie Road) and conversion of existing traffic lanes (south of Ogilvie Road).
- Eastern LRT - The 2031 Affordable Transit Network identifies extension of LRT service following Highway 174 between Blair Station and Place d'Orléans Station. The 2031 Transit Network Concept identifies extension of LRT service following Highway 174 between Place d'Orleans Station and Trim Station. At the time of this writing the extension is scheduled for handover to the City in 2025.
- Ogilvie Road - The 2031 Transit Network Concept identifies transit signal priority between Montreal Road and St. Laurent Boulevard.
- Ottawa Road 174 - The 2031 Road Network Concept identifies widening of the road from four to six lanes between Highway 417 and Trim Road.

The City's 2013 Ottawa Cycling Plan (OCP) identifies the addition of Multi-Use Pathway on City Park Drive as well as the access to Blair Station as part of Phase 2 and bike lanes on Blair Road between Ogilvie Road and Meadowbrook Road as part of Phase 3.

The subject site is located within the Blair Transit Oriented Development (TOD) area. Consistent with the OCP, the Blair TOD Plan recommends improved cycling facilities along City Park Drive and the access to Blair Station. In addition to improved cycling facilities, the Blair TOD Plan recommends new sidewalks within the surrounding community. The proposed pedestrian and bicycle network from the Blair TOD Plan are included in **Appendix F**.

A new east-west Multi-Use pathway (MUP) will be constructed by the City of Ottawa along the rail corridor to the south. A new north-south MUP will also be constructed by the City within a 6m wide parcel along the eastern property line, connecting City Park Drive and the east-west MUP along the rail corridor. The new MUP network will form part of the City's Cross-town bikeway network. The timing for implementation of both pathways is currently unknown.

The Blair Road Transit Priority Environmental Assessment Study (April 2021) shows numerous changes to the Blair Road corridor. Notable changes to the Blair Road/Highway 174 Westbound off-ramp/1980 Ogilvie Road intersection include:

- Protected intersection design;
- Addition of a second westbound through lane;
- Removal of the westbound right turn channel;
- Addition of a new transit only eastbound right turn lane between the left turn lane and right turn lane; and
- Removal of the southbound channelized right turn lane and conversion of the curbside through lane to a through/right turn lane.

Notable changes to the Blair Road/Highway 174 Eastbound off-ramp include:

- Protected intersection design;
- Addition of a second westbound left turn lane;
- Modifications to the westbound right turn channel;
- Conversion of one northbound through lane to a transit only lane; and
- Addition of a southbound left turn lane.

A multi-use pathway will be provided on the west side of Blair Road with dedicated cycling and pedestrian facilities provided on the east side of Blair Road throughout the study area.

The Montreal-Blair Road Transit Priority Corridor Environmental Assessment Study (February 2022) shows numerous changes at the Blair Road/Ogilvie Road intersection, including:

- Protected intersection design;
- Addition of a second northbound through lane; and
- Addition of a new southbound right turn auxiliary lane.

Relevant excerpts from the Blair Road Transit Priority Environmental Assessment and the Montreal-Blair Road Transit Priority Corridor Environmental Assessment are included in **Appendix G**.

2.2.2 Other Area Developments

Other developments in the area include:

- Shoppers City East Redevelopment (1405 Blair Towers) – Proposed mixed-use development including retail, coffee shop, warehouse membership club store, and an 18-position gas-bar land uses to be developed in two phases. A TIS dated May 2016 was prepared in support of Phase 2. Full buildout was expected in 2017 and it is currently fully occupied.
- 2280 City Park Drive Residential Development – Proposed mixed-use development including residential, retail, and commercial land uses to be developed in five phases. A TIA dated August 2018 was prepared in support of Phase 2 and a TIA dated January 2019 was prepared in support of Phases 3-5. Build-out of all five phases is anticipated to occur in 2030.
- 1980 Ogilvie Road – Proposed mixed-use development including residential, office, and ground floor retail land uses to be developed in 4 stages. A TIA dated September 2019 was prepared in support of Stage 1. Stage 1 was anticipated to be built out in 2020.

Excerpts from relevant transportation studies have been attached in **Appendix H**.

2.3 Study Area and Time Periods

The study area for this report includes the boundary roadway City Park Drive as well as the following intersections:

- Ogilvie Road/Matheson Road/Palmerston Drive
- Ogilvie Road/Cadboro Road
- Ogilvie Road/City Park Drive/Bathgate Drive
- Ogilvie Road/1900 Ogilvie Road
- Ogilvie Road/City Park Drive
- Ogilvie Road/1980 Ogilvie Road (Intersection Pedestrian Signal)
- Ogilvie Road/Blair Road
- 174 Westbound off-ramp/Blair Road
- 174 Eastbound off-ramp/Blair Road

The selected time periods for the analysis are the weekday AM and PM peak hours, as they represent the ‘worst case’ combination of site generated traffic and adjacent street traffic. Analysis will be completed for the ultimate build-out year of 2037. Due to the extended buildout period, a five-year horizon will not be completed. A further review of traffic operations will be provided as each phase proceeds to the Site Plan Control application stage.

2.4 Exemptions Review

This module reviews possible exemptions from the final Transportation Impact Assessment, as outlined in the *2017 TIA Guidelines*. The applicable exemptions for this site are shown in **Table 4**.

Table 4: TIA Exemptions

Module	Element	Exemption Criteria	Status
Design Review Component			
4.1 Development Design	4.1.2 Circulation and Access	<ul style="list-style-type: none"> Only required for site plans 	Exempt
	4.1.3 New Street Networks	<ul style="list-style-type: none"> Only required for plans of subdivision 	Exempt
4.2 Parking	4.2.1 Parking Supply	<ul style="list-style-type: none"> Only required for site plans 	Exempt
	4.2.2 Spillover Parking	<ul style="list-style-type: none"> Only required for site plans where parking supply is 15% below unconstrained demand 	Exempt
Network Impact Component			
4.5 Transportation Demand Management	<i>All elements</i>	<ul style="list-style-type: none"> Not required for non-residential site plans expected to have fewer than 60 employees and/or students on location at any given time 	Not Exempt
4.6 Neighbourhood Traffic Management	4.6.1 Adjacent Neighbourhoods	<ul style="list-style-type: none"> Only required when the development relies on local or collector streets for access and total volumes exceed ATM capacity thresholds 	Not Exempt
4.8 Network Concept	<i>All elements</i>	<ul style="list-style-type: none"> Only required when proposed development generates more than 200 person-trips during the peak hour in excess of the equivalent volume permitted by the established zoning 	Not Exempt

As this TIA has been prepared in support of Zoning By-law Amendment and Official Plan Amendment applications, the Design Review components (Modules 4.1 to 4.4) are exempt from the analysis. A detailed review of Modules 4.1 to 4.4 will be conducted as part of the future Site Plan Control application.

3.0 FORECASTING

3.1 Development-Generated Travel Demand

3.1.1 Trip Generation

As a building containing office space currently exists at 1900 City Park Drive the net increase of person trips was studied. For the purposes of this analysis, the existing development consists of 93,000ft² of office space. The proposed development is anticipated to include a maximum of 2,250 residential units within eight buildings.

Existing Development

As the *TRANS Trip Generation Manual Summary Report*, prepared in October 2020 by WSP does not include trip rates for office land uses the *ITE Trip Generation Manual 11th Edition* was used. To convert ITE vehicle trip rates to person trip rates a 1.28 factor was applied to all trips generated by the development. Person trips generated by the development using ITE trip rates can be found in the following table.

Table 5: Person Trips Generated by Existing Development

Land Use	ITE Code	GFA	AM Peak Hour (pph) ⁽¹⁾			PM Peak Hour (pph)		
			IN	OUT	TOT	IN	OUT	TOT
Office	710	93,000 ft ²	177	24	201	34	166	200

1. PPH=Person Trips per Hour

The 2020 TRANS Trip Generation Manual provides modal shares for employment generators within the Beacon Hill Area. However, developments within 600m of rapid transit stations can be considered as Transit Oriented Developments (TOD). In TOD zones, the transit share is assumed to increase significantly compared to any TRANS O-D District. A summary of the TRANS employment generator mode shares, TOD mode shares, and assumed existing mode shares is provided in **Table 6**.

Table 6: TRANS and TOD Mode Share Comparison (Employment)

	Auto Driver	Auto Passenger	Transit	Cycling	Walking
TRANS	75%	5%	15%	0%	5%
TOD	15%	5%	65%	5%	10%
Proposed	40%	5%	40%	5%	10%

Using the trips generated in **Table 5** and the proposed mode share from **Table 6** trips generated during the peak hour were broken down by modal share in **Table 7**.

Table 7: Existing Peak Hour Person Trips by Mode

Travel Mode	Mode Share	AM Peak (pph) ⁽¹⁾			PM Peak (pph) ⁽¹⁾		
		IN	OUT	TOT	IN	OUT	TOT
TOTAL		177	24	201	34	166	200
Auto Driver	40%	71	10	81	13	67	80
Auto Passenger	5%	9	1	10	2	8	10
Transit	40%	70	10	80	13	67	80
Cyclist	5%	9	1	10	2	8	10
Pedestrian	10%	18	2	20	4	16	20

1. pph: person trips per period

Proposed Development

Trips generated by the proposed development have been estimated using the *2020 TRANS Trip Generation Manual*. The trip generation rates are taken from Table 3 and correspond to High-Rise Residential. The directional split between inbound and outbound trips are based on the blended splits presented in Table 9 of the report.

The estimated trip generation are summarized in **Table 8**.

Table 8: Person Trips Generated by Proposed Development

Land Use	TRANS Rate	Units	AM Peak (ppp) ⁽¹⁾			PM Peak (ppp) ⁽¹⁾		
			IN	OUT	TOT	IN	OUT	TOT
High-Rise Residential, Beacon Hill Area	AM: 0.80 PM: 0.90	2,250	558	1242	1800	1175	851	2025

1. ppp: person trips per period

The 2020 TRANS Trip Generation Manual provides modal shares for residential developments within the Beacon Hill Area. However, developments within 600m of rapid transit stations can be considered as Transit Oriented Developments (TOD). In TOD zones, the transit share is assumed to increase significantly compared to any TRANS O-D District. A summary of the TRANS residential

mode shares (average of AM and PM peak, rounded to nearest 5%), TOD mode shares, and assumed residential mode shares is provided in **Table 9**.

Table 9: TRANS and TOD Mode Share Comparison (Residential)

	Auto Driver	Auto Passenger	Transit	Cycling	Walking
TRANS	50%	15%	30%	0%	5%
TOD	15%	5%	65%	5%	10%
Proposed	25%	10%	50%	5%	10%

Using the trips generated in **Table 8** and the proposed mode share from **Table 9** trips generated during the peak period were broken down by modal share in **Table 10**. After breaking down the trips by modal shares in **Table 9** adjustment factors were applied to convert the peak period trips to peak hour trips in **Table 10**.

Table 10: Proposed Peak Period Person Trips by Mode

Travel Mode	Mode Share	AM Peak (ppp) ⁽¹⁾			PM Peak (ppp) ⁽¹⁾		
		IN	OUT	TOT	IN	OUT	TOT
TOTAL		558	1242	1800	1174	851	2025
Auto Driver	25%	140	311	450	293	213	506
Auto Passenger	10%	56	124	180	118	85	203
Transit	50%	279	621	900	587	425	1012
Cyclist	5%	28	62	90	59	43	102
Pedestrian	10%	56	124	180	117	85	202

2. ppp: person trips per period

Table 4 of the *2020 TRANS Trip Generation Manual* includes adjustment factors to convert the estimated number of trips generated for each mode from peak period to peak hour. A breakdown of the peak hour trips by mode is shown in **Table 11**.

Table 11: Proposed Peak Hour Person Trips by Mode

Travel Mode	Adjustment Factor		AM Peak (pph) ⁽¹⁾			PM Peak (pph) ⁽¹⁾		
	AM	PM	IN	OUT	TOT	IN	OUT	TOT
TOTAL			296	658	954	546	395	942
Auto Driver	0.48	0.44	67	149	216	129	94	223
Auto Passenger	0.48	0.44	27	59	86	52	37	89
Transit	0.55	0.47	154	342	496	276	200	476
Cyclist	0.58	0.48	16	36	52	28	20	49
Pedestrian	0.58	0.52	32	72	104	61	44	105

1. pph: person trips per hour

From the previous table, the proposed development is projected to generate 954 (296 in and 658 out) person trips during the AM peak hour and 942 (546 in and 395 out) person trips during the PM peak hour.

Net Trip Generation

A full breakdown of the net person trips generated by modal share is shown in **Table 12**.

Table 12: Net Person Trip Generation

Travel Mode	AM Peak Hour			PM Peak Hour		
	In	Out	Total	In	Out	Total
<i>Existing Development</i>						
Auto Driver	71	10	81	13	67	80
Auto Passenger	9	1	10	2	8	10
Transit	70	10	80	13	67	80
Cyclist	9	1	10	2	8	10
Pedestrian	18	2	20	4	16	20
Total	177	24	201	34	166	200
<i>Proposed Development</i>						
Auto Driver	67	149	216	129	94	223
Auto Passenger	27	59	86	52	37	89
Transit	154	342	496	276	200	476
Cyclist	16	36	52	28	20	49
Pedestrian	32	72	104	61	44	105
Total	296	658	954	546	395	942
<i>Net Trips</i>						
Auto Driver	-4	139	135	116	27	143
Auto Passenger	18	58	76	50	29	79
Transit	84	332	416	263	133	396
Cyclist	7	35	42	26	12	39
Pedestrian	14	70	84	57	28	85
Total	119	634	753	512	229	742

From the previous table, the net trips generated from the subject site is projected to be 753 (119 in and 634 out) person trips during the AM peak hour and 742 (512 in and 229 out) person trips during the PM peak hour.

3.1.2 Trip Distribution

Existing Development

The assumed distribution of trips generated by the existing office has been derived from existing commuter traffic patterns within the study area as well as a review of existing traffic movements entering the study area during the AM peak hour and exiting the study area during the PM peak hour. The anticipated trip distribution is:

- 25% to/from the west via Ogilvie Road
- 20% to/from the west via Highway 174
- 20% to/from the south via Blair Road
- 10% to/from the east via Ogilvie Road
- 10% to/from the east via Highway 174
- 10% to/from the north via Blair Road
- 5% to/from the north via Bathgate Drive

Proposed Development

The assumed distribution of trips generated by the proposed development has been derived from existing commuter traffic patterns within the study area as well as a review of existing traffic movements exiting the study area during the AM peak hour and entering the study area during the PM peak hour. The anticipated trip distribution is:

- 30% to/from the west via Highway 174
- 25% to/from the west via Ogilvie Road
- 15% to/from the north via Blair Road
- 10% to/from the south via Blair Road
- 10% to/from the east via Ogilvie Road
- 10% to/from the east via Highway 174

3.1.3 Trip Assignment

All traffic generated by this development is expected to access Ogilvie Road at either of two City Park Drive intersections. Traffic travelling to/from the west along Ogilvie Road is expected to access Ogilvie Road at the Ogilvie Road/Bathgate Drive/City Park Drive west intersection. Traffic travelling to/from the east along Ogilvie Road, along Blair Road, or on Highway 174 are expected to access Ogilvie Road at the Ogilvie Road/1941 Ogilvie Road/City Park Drive east intersection.

Although there is potential for cut through traffic utilizing the private roadway associated with 1980 Ogilvie Road near Blair Station to travel to and from Blair Road, traffic has not been assigned to this private roadway. Due to the presence of traffic calming measures within the 1980 Ogilvie Road site as well as high volumes of pedestrians and cyclists in the vicinity of Blair Station, trips generated by the subject site have been assigned to the adjacent public roadways during peak hours.

3.2 Background Traffic

3.2.1 Other Area Development

A review of other area development traffic has been conducted, per the developments listed in Section 2.2.2. Traffic generated by these developments have been considered in this analysis and added to the future background traffic volumes, as the development was completed after the most recent available traffic data. Relevant excerpts of the traffic study associated with the development below are included in **Appendix H**.

Shoppers City East Redevelopment (1405 Blair Towers)

The proposed mixed-use development is expected to generate 771 and 1072 vehicle trips during the AM and PM peak hours, respectively. Construction was completed in 2020.

2280 City Park Drive Residential Development

Phase 2 of the proposed residential development is expected to generate 41 and 43 vehicle trips during the AM and PM peak hours, respectively. Phases 3, 4, and 5 of the proposed residential development is expected to generate an additional 54 and 64 vehicle trips during the AM and PM peak hours, respectively. Construction of phase 2 was recently completed. Full build-out of the site is expected to be complete by 2030.

1980 Ogilvie Road

The proposed residential development is expected to generate 54 and 76 vehicle trips during the AM and PM peak hours, respectively. Full build-out of the site was expected by 2020 but the construction has not commenced.

3.2.2 General Background Growth Rate

A review has been conducted of snapshots of the City's *Strategic Long-Range Model*, which are included in **Appendix I**. Comparing snapshots of the 2011 and 2031 AM peak hour traffic volumes, showed growth rates between 0.1%-0.5% along Ogilvie Road, 0.2%-2% along Blair Road, and 0.7%-1.2% at the Highway 174 off-ramps. A background growth rate of 1% is assumed for Ogilvie Road, Blair Road, and Highway 174. This is consistent with other approved transportation studies in the study area that were completed in recent years.

3.3 Future Traffic Conditions

The figures listed below present the following future traffic conditions:

- Proposed site-generated traffic volumes in 2037 are shown in **Figure 4**;
- Background traffic volumes in 2037 are shown in **Figure 5**;
- Total traffic volumes in 2037 are shown in **Figure 6**;

3.4 Demand Rationalization

A review of the existing and background intersection operations has been conducted to determine if and when traffic volumes exceed capacity within the study area. The intersection parameters used in the analysis are consistent with the *2017 TIA Guidelines* (Saturated Flow Rate: 1,800 vphpl, Peak Hour Factor: 0.9 in existing conditions and 1.0 in future conditions).

Per Exhibit 22 of the *Multi-Modal Level of Service (MMLOS) Guidelines* (produced by IBI Group in October 2015), the target vehicular level of service (Auto LOS) for an arterial or collector road within 600m of a rapid transit station is an Auto LOS E, which equates to a vehicle-to-capacity (v/c) ratio of 1.0 or better at signalized intersections. This target applies to the following study area intersections: Ogilvie Road/1900 Ogilvie Road/1929 Ogilvie Road, Ogilvie Road/City Park Drive East/1941 Ogilvie Road, Blair Road/Ogilvie Road, Blair Road/1980 Ogilvie Road/HWY 174 WB Off-Ramp, and Blair Road/HWY 174 EB.

All other study area intersections are located in a 'General Urban Area' and have a target Auto LOS D, which equates to a vehicle-to-capacity (v/c) ratio of 0.9 or better at signalized intersections.

Signal timing plans were obtained from the City, and are included in **Appendix J**.

Figure 4: Net Site-Generated Volumes

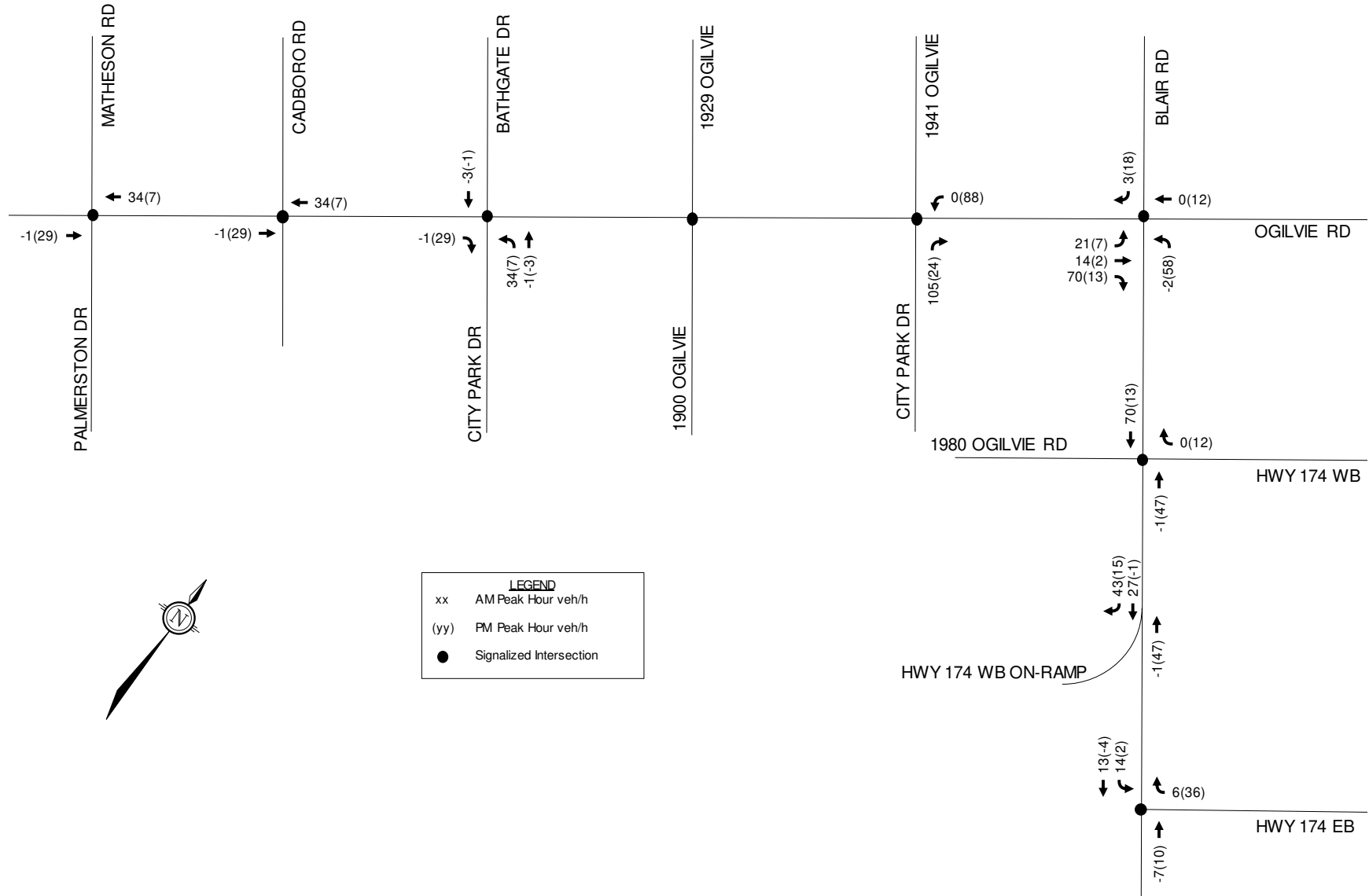

Figure 5: 2037 Background Traffic

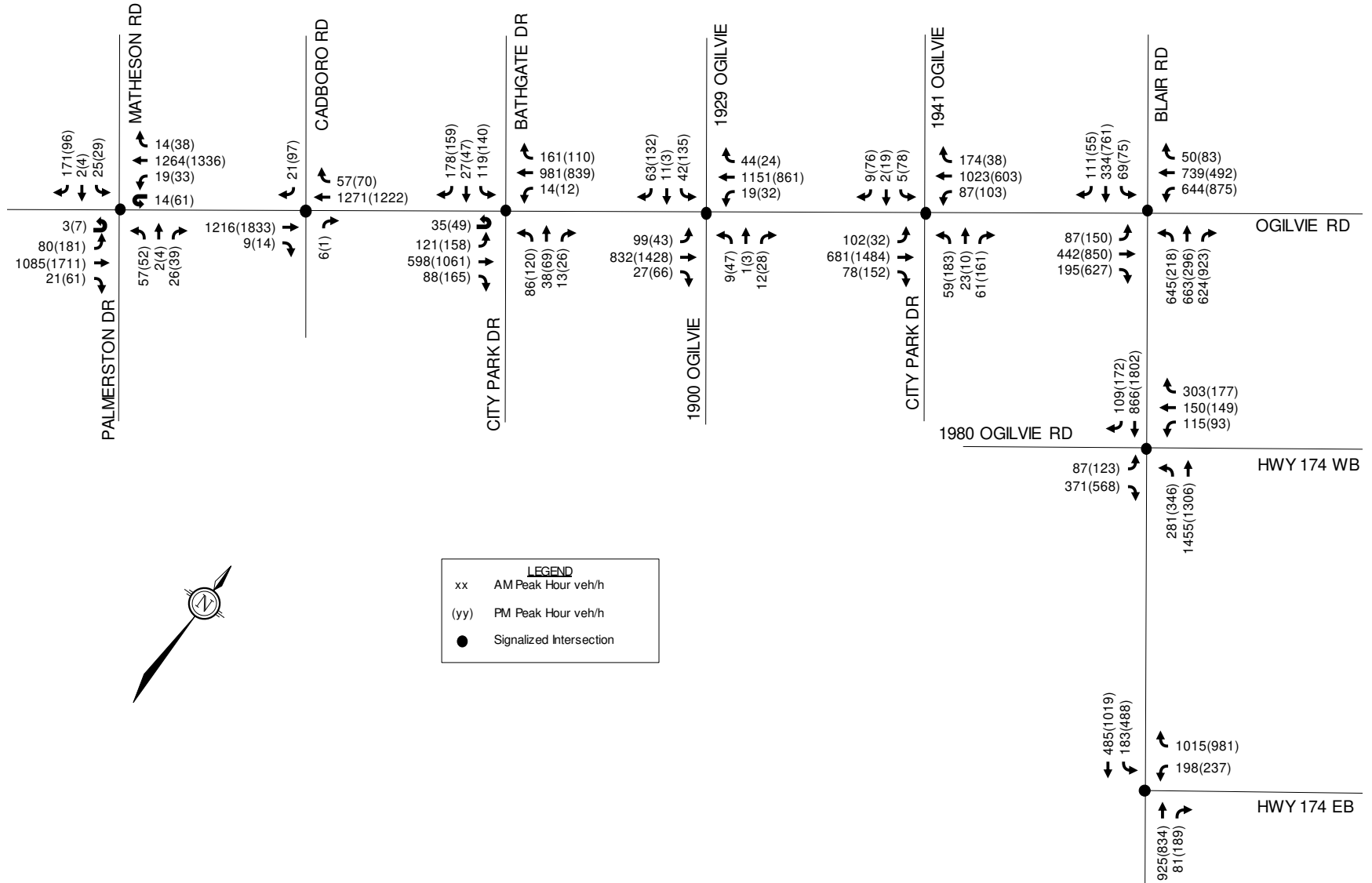
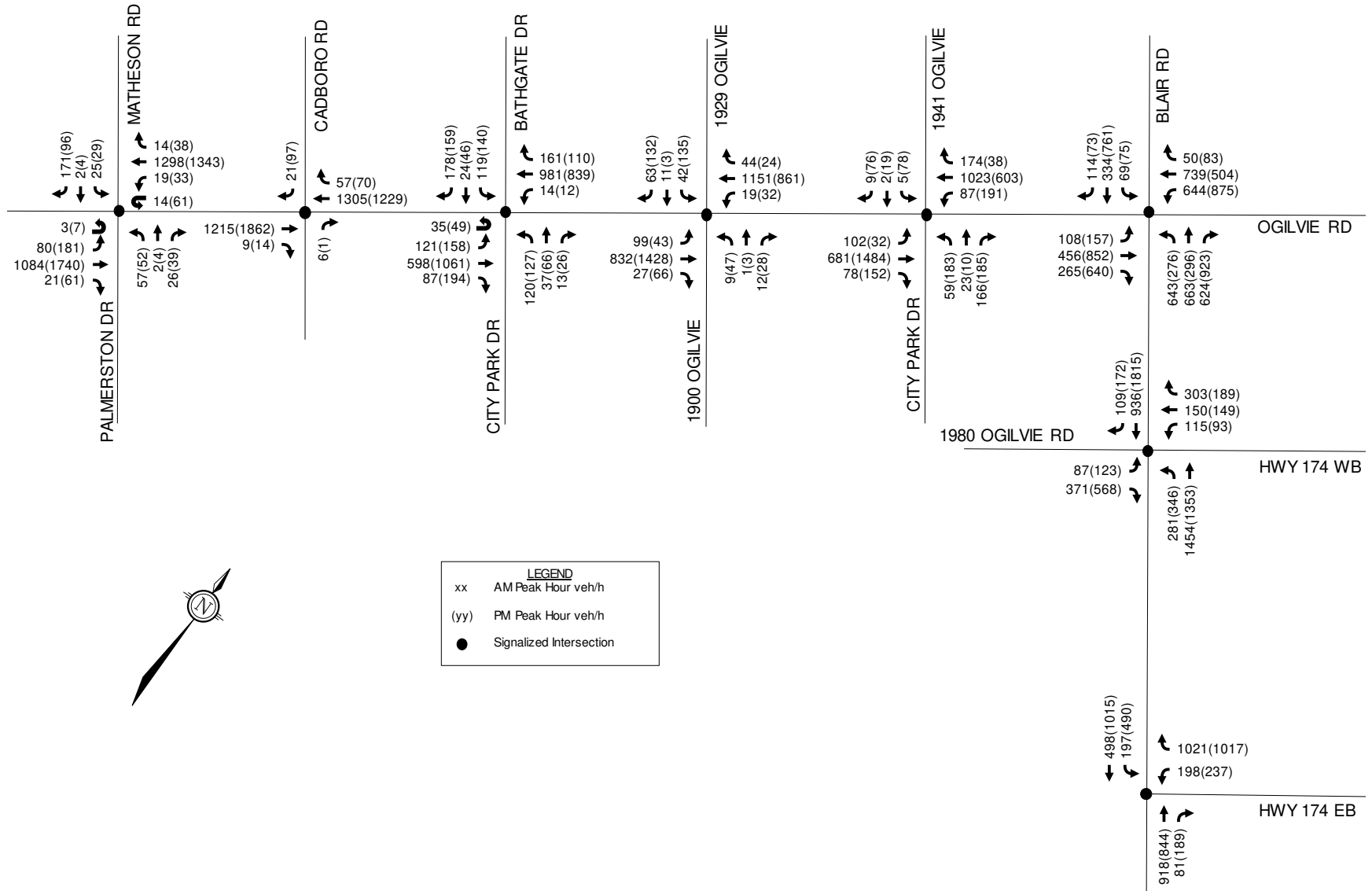

Figure 6: 2037 Total Traffic



3.4.1 Existing Intersection Operations

Intersection capacity analysis has been conducted for the existing traffic conditions. The results of the analysis are summarized in **Table 13** for the weekday AM and PM peak hours. Detailed reports are included in **Appendix K**.

Table 13: Existing Traffic Operations

Intersection	AM Peak			PM Peak		
	V/C	LOS	Mvmt	V/C	LOS	Mvmt
Ogilvie Road/Matheson Road/Palmerston Drive	0.56	A	WBT/R	0.75	C	EBT/R
Ogilvie Road/Cadboro Road	0.47	A	WBT/R	0.70	B	EBT/R
Ogilvie Road/City Park Drive/Bathgate Drive	0.65	B	SBL	0.72	C	NBL
Ogilvie Road/1900 Ogilvie Road	0.48	A	WBT/R	0.60	A	EBT
Ogilvie Road/City Park Drive	0.42	A	WBT	0.83	D	EBT
Ogilvie Road/Blair Road	0.97	E	NBT	1.04	F	EBR
HWY 174 Westbound off-ramp/Blair Road	0.70	B	WBR NBT	0.89	D	EBR
HWY 174 Eastbound off-ramp/Blair Road	0.66	B	WBR	0.92	E	SBT/L

Under existing traffic conditions, there is one failing movement at the Ogilvie Road/Blair Road intersection during the PM peak hour. All other intersections meet the target Auto LOS of E within 600m of Blair Station and the target Auto LOS of D elsewhere.

During the PM peak hour, the eastbound right turn lane on Ogilvie Road at Blair Road operates with a LOS F and a v/c ratio of 1.04. To achieve the target LOS E at this intersection, a reduction of 22 eastbound right turning vehicles is required. The reduction in eastbound right turning vehicles can be achieved by increased use of non-auto modes of transportation, alternative travel times (peak period spreading), and alternative routes of travel. A further description of each option is provided in the subsequent sections.

3.4.2 2037 Background Traffic Conditions

Intersection capacity analysis has been conducted for the 2037 background traffic conditions and are summarized in **Tables 14** and **15**. Detailed reports are included in **Appendix K**.

Table 14: 2037 Background Traffic Operations

Intersection	AM Peak			PM Peak		
	Delay or V/C	LOS	Mvmt	Delay or V/C	LOS	Mvmt
Ogilvie Road/Matheson Road/Palmerston Drive	0.60	A	WBT/R	0.80	C	EBT/R
Ogilvie Road/Cadboro Road	0.50	A	WBT/R	0.73	C	EBT/R
Ogilvie Road/City Park Drive/Bathgate Drive	0.60	A	WBT SBL	0.66	B	NBL
Ogilvie Road/1900 Ogilvie Road	0.51	A	WBT/R	0.65	B	EBT
Ogilvie Road/City Park Drive	0.44	A	WBT	0.85	D	EBT
Ogilvie Road/Blair Road	1.30	F	WBL	1.27	F	NBR
				1.25	F	WBL
	1.02	F	NBT	1.17	F	EBR
				1.03	F	EBT
HWY 174 Westbound off-ramp/Blair Road	0.72	C	NBT	0.89	D	EBR
HWY 174 Eastbound off-ramp/Blair Road	0.69	B	WBR	0.98	E	SBT/L

Table 15: 2037 Background Queues

Intersection	Mvmt	Storage/ Spacing ⁽¹⁾	AM Peak			PM Peak		
			v/c [LOS]	50 th % Queue (m)	95 th % Queue (m)	v/c [LOS]	50 th % Queue (m)	95 th % Queue (m)
Ogilvie Road/Blair Road	NBL	120m	0.95 [E]	91	#127	0.70 [B]	30	44
	NBT	220m	1.02 [F]	~194	#267	0.62 [B]	73	107
	NBR	200m	0.76 [C]	51	103	1.27 [F]	~227	#310
	SBL	30m	0.70 [B]	19	#42	0.56 [A]	20	36
	SBT/R	100m	0.62 [B]	55	74	0.97 [E]	~119	#164
	EBL	70m	0.58 [A]	24	40	0.77 [C]	40	#68
	EBT	230m	0.57 [A]	57	75	1.03 [F]	~132	#173
	EBR	230m	0.39 [A]	0	19	1.17 [F]	~157	#230
	WBL	110m	1.30 [F]	~118	#155	1.25 [F]	~155	#195
WBT/R	225m	0.81 [D]	106	#149	0.51 [A]	66	85	

1. Indicates the storage length for auxiliary lanes or the spacing to the nearest upstream intersection for through lanes

#: volume for the 95th percentile cycle exceeds capacity

~: approach is above capacity

The westbound left turning movement and northbound through movements at the Ogilvie Road/Blair Road intersection do not meet the target LOS E during the AM peak hour and the northbound right, westbound left, eastbound right and eastbound through movements do not meet the target LOS E in the PM peak hour. All other intersections within the study area are expected to meet the City’s target. A summary of the critical queueing at the study area intersections is provided below.

During the AM peak hour at the Ogilvie Road/Blair Road intersection, the average and maximum queue lengths of the westbound left movement exceed the current storage capacity. Additionally, the maximum queue lengths of the northbound left, the northbound through, and the southbound left turn movements exceed the existing storage capacity.

During the PM peak hour at the Ogilvie Road/Blair Road intersection, the average and maximum queue lengths of the northbound right, the southbound through/right, and the westbound left

movements and the maximum queue length for the southbound left turn movement exceed the existing storage length.

The approximate required reduction in volumes to meet the target Auto LOS for each over-capacity movement is included below.

AM Peak Hour

- Ogilvie Road/Blair Road
 - Westbound left turn (v/c: 1.30): reduction of 148 vehicles required;
 - Northbound through (v/c: 1.02): reduction of 9 vehicles required.

PM Peak Hour

- Ogilvie Road/Blair Road
 - Northbound right turn (v/c: 1.27): reduction of 192 vehicles required;
 - Westbound left turn (v/c: 1.25): reduction of 170 vehicles required;
 - Eastbound right turn (v/c: 1.17): reduction of 88 vehicles required;
 - Eastbound through (v/c: 1.03): reduction of 22 vehicles required.

Traffic throughout the study area could be displaced or alleviated through a combination of increased use of non-auto modes of transportation, alternate time to travel for drivers using the study area roadways to make use of off-peak capacity, and alternate routes for travel. A further description of each option is provided below.

Increased Use of Non-Auto Modes

As stated in Section 2.2.1 exclusive bus lanes and transit signal priority along Blair Road and the Eastern LRT extension to Trim Road are anticipated to be constructed prior to the 2037 build-out year. The transit network concept also includes transit signal priority and queue jump lanes along Ogilvie Road. These transit projects are anticipated to increase the transit modal share and decrease the auto modal share, thereby reducing traffic volumes within the study area.

Additionally, the new east-west MUP will be constructed by the City of Ottawa along the rail corridor to the south and will form part of the City's Cross-town bikeway network. This project is expected to increase the active modal shares and decrease the auto modal share, thereby reducing traffic volumes within the study area.

Alternate Travel Times

As congestion increases within the study area, some motorists may alter their travel to occur outside of the peak hours. This shift in travel times may result in a reduction of peak hour traffic volumes.

Alternate Routes of Travel

As congestion increases within the study area, some motorists may choose alternate routes of travel outside the study area. Other alternative east-west routes outside of the study area include Highway 174, Montreal Road, and Aviation Parkway.

4.0 ANALYSIS

4.1 Development Design

The proposed development will include vehicular access to City Park Drive. Pedestrian connections are anticipated to be provided to the MUP's east and south of the site, as well as to the sidewalks along City Park Drive.

4.2 Parking

A detailed review of Module 4.2 will be conducted as part of the future Site Plan Control application.

4.3 Boundary Streets

A detailed review of Module 4.3 will be conducted as part of the future Site Plan Control application.

4.4 Access Intersections

A detailed review of Module 4.4 will be conducted as part of the future Site Plan Control application.

4.5 Transportation Demand Management

4.5.1 Context for TDM

The proposed development is anticipated to include a maximum of 2,250 residential units within eight buildings. The unit type breakdown for each phase will be provided as part of the future Site Plan Control applications.

4.5.2 Need and Opportunity

As first discussed in Section 3.1.1, the mode share targets for the proposed development are a blended rate based on the observed mode shares for the Beacon Hill region, as outlined in the *TRANS Trip Generation Manual* and mode shares typically seen within a Transit Oriented Development zone.

Failure to meet the proposed mode share is not anticipated, due to the proximity of the subject site to large commercial developments and employment generators as well as planned active transportation projects and rapid transit projects in the area. To improve the use of non-auto modes for the proposed development, Transportation Demand Management (TDM) measures will be considered on a phase by phase basis as part of future Site Plan Control applications.

4.5.3 TDM Program

A review of the City's *TDM Measures Checklist* has been conducted to outline TDM measures that will be considered as part of future Site Plan Control applications. TDM measures include:

- Display local area maps with walking/cycling access routes and key destinations at major entrances;
- Display relevant transit schedules and route maps at entrances;
- Unbundle parking from purchase cost (condo) or monthly rent (apartment);
- Provide multi-modal travel information package to new residents.

4.6 Neighbourhood Traffic Management

The *2017 TIA Guidelines* identify two-way peak hour traffic volume thresholds for considering when a Neighbourhood Traffic Management (NTM) plan should be developed. The NTM two-way volume thresholds are as follows:

- Local Roadways: 120 vehicles during the peak hour, or 1,000 vehicles per day;
- Collector Roadways: 300 vehicles during the peak hour, or 2,500 vehicles per day;
- Major Collector Roadways: 600 vehicles during the peak hour, or 5,000 vehicles per day.

The proposed development will rely on the collector road City Park Drive for direct access. Based on the 2023 existing traffic conditions presented in **Figure 3**, two-way traffic volumes on the City Park Drive leg of the Ogilvie Road/Bathgate Drive/City Park Drive intersection is 247 in the AM peak hour and 419 in the PM peak hour and on the City Park Drive leg of the Ogilvie Road/1941 Ogilvie Road/City Park Drive intersection the traffic volumes are 299 in the AM peak hour and 613 in the PM peak hour. Traffic generated by the proposed development is anticipated to increase traffic along City Park Drive at Ogilvie Road/Bathgate Drive by 29-32 vehicles, or one vehicle every two minutes during peak hours. Traffic along City Park Drive at Ogilvie Road/1941 Ogilvie Road is anticipated to increase by 105-112 vehicles, or two vehicle a minute during peak hours.

Traffic volumes currently show that City Park Drive currently operates as a Major Collector Roadway according to the *NTM thresholds*. These high volumes can largely be attributed to the commercial developments along City Park Drive closer to Ogilvie Road. Since City Park Drive is expected to have lower volumes close to the subject site, no neighbourhood traffic management measures have been recommended as part of this proposed development.

4.7 Transit

Based on the trip generation estimates presented in Section 3.1.1, the proposed development is anticipated to generate the following number of transit trips:

- AM Peak Hour: 496 transit trips, including 342 boarding and 154 alighting;
- PM Peak Hour: 476 transit trips, including 200 boarding and 276 alighting.

The distribution of transit trips to/from the development has been estimated based on origin-destination data from the *TRANS O-D Survey Report*. The destinations of trips from the Beacon Hill district to all TRANS O-D districts during the AM peak period were used to develop the following transit distribution:

- 15% to/from the north via Routes 12, 23, and 24;
- 10% to/from the south via Routes 26, 28, 42, 222, and 228;
- 20% to/from the east via Routes 21, 25, 30, 31, 32, 33, 35, 38, 39, 221, 231, 232, 234, 236, and 237;
- 55% to/from the west via Route 1 and 15

Trips to/from the north are anticipated to be served by a combination of routes 12, 23, and 24. Trip distribution between these routes are anticipated to be roughly equal due to all routes serving slightly different areas and have similar headway times between busses. During the AM peak hour roughly 4-9 people would board each bus and roughly 2-4 people would alight from each bus and during the PM peak hour roughly 3-5 people would board each bus and roughly 3-7 people would alight from each bus. The net additional people added to each bus is not anticipated to impact the capacity of any bus heading to/from the north.

Trips to/from the south are anticipated to be served by a combination of routes 26, 28, 42, 222, and 228. Trip distribution between these routes are anticipated to be roughly equal due to all routes serving slightly different areas and all routes having headway times between busses of roughly 30

minutes. During the AM peak hour roughly 3-4 people would board each bus and roughly 1-2 people would alight from each bus and during the PM hour peak hour roughly 2 people would board each bus and roughly 3 people would alight from each bus. The net additional people added to each bus is not anticipated to impact the capacity of any bus heading to/from the south.

Trips to/from the east are anticipated to be served by a combination of routes 21, 25, 30, 31, 32, 33, 35, 38, 39, 221, 231, 232, 234, 236, and 237. Trip distribution between these routes is anticipated to be roughly equal due to all routes serving slightly different areas and all routes have similar headway times between busses. During the AM peak hour roughly 1-5 people would board each bus and roughly 1-2 people would alight from each bus and during the PM hour peak hour roughly 1-3 people would board each bus and roughly 1-4 people would alight from each bus. The net additional people added to each bus is not anticipated to impact the capacity of any bus heading to/from the east.

Trips to/from the west are anticipated to be served by a combination of routes 1 and 15. While both routes have a 5-minute headway in service it is estimated that Route 1 is preferable to Route 15 when the final destination is similar due to estimated travel time. Therefore, it is assumed that 70% of trips travelling west will use Route 1.

On Route 1 during the AM peak hour roughly 11 people would board each train and roughly 5 people would alight from each train and during the PM peak hour roughly 6 people would board each train and roughly 9 people would alight from each train. The net additional people added to each train is not anticipated to impact the capacity of any train heading to/from the west.

On Route 15 during the AM peak hour roughly 5 people would board each bus and roughly 2 people would alight from each bus and during the PM peak hour roughly 3 people would board each bus and roughly 4 people would alight from each bus. The net additional people added to each bus is not anticipated to impact the capacity of any bus heading to/from the west.

Based on the foregoing, the proposed development at ultimate buildout is not anticipated to have a significant impact on the existing operations of OC Transpo route.

As Bus Stop #4447 is located over 200m from the nearest pedestrian crossing along City Park Drive and expected to handle a significant amount of transit users from the subject site, volumes were studied to determine if a pedestrian crossover is warranted. Based on the previous analysis the number of pedestrian crossing the road at this location was estimated and shown in the following table.

Table 16: Crossing Volumes at Stop #4447

Route	AM Peak		PM Peak	
	Boarding	Alighting	Boarding	Alighting
15	60	-	36	-
25	-	1	-	1
39	-	1	-	1
TOTAL	60	2	36	2

Based on the above table a total of 38-62 people are anticipated to cross the street to Stop #4447 during the peak hours. As the existing transit stop is considered a desire line for pedestrians from the proposed development, consideration should be given to providing a pedestrian crossover along

City Park Drive as the development advances. The timing for implementation of a future pedestrian crossover will be reviewed on a phase-by-phase basis through future Site Plan Control applications.

4.8 Network Concept

A review of the future lane capacities at the boundaries of the study area has been conducted to determine if additional capacity is required. The directional capacities for each roadway have been estimated based on typical roadway characteristics and lane capacities used in the City's TRANS Long-Range Transportation Model. For the purposes of this analysis, the lane capacity of Ogilvie Road and Blair Road at both ends of the study area is considered to be 1,000 vphpl.

A summary of the lane capacity analysis for the 2037 background traffic conditions is included in **Table 17**.

Table 17: Network Lane Capacity Analysis – 2037 Background Traffic

Roadway	Directional Capacity (vph)	Traffic Volume AM (PM)	v/c Ratio AM (PM)	Auto LOS AM (PM)	Deficiency to Auto LOS 'F' ¹ AM (PM)
Blair Rd, north of Ogilvie Rd					
Northbound	1,000	800 (529)	0.80 (0.53)	C (A)	-
Southbound	1,000	514 (891)	0.51 (0.89)	A (D)	-
Blair Rd, south of Highway 174					
Northbound	2,000	1,006 (1,023)	0.50 (0.51)	A (A)	-
Southbound	2,000	683 (1,256)	0.34 (0.63)	A (B)	-
Ogilvie Rd, east of Blair Rd					
Eastbound	2,000	1,135 (1,848)	0.57 (0.92)	A (E)	-
Westbound	2,000	1,433 (1,450)	0.72 (0.73)	C (C)	-
Ogilvie Rd, west of Palmerston Dr					
Eastbound	2,000	1,189 (1,960)	0.59 (0.98)	A (E)	-
Westbound	2,000	1,495 (1,491)	0.75 (0.75)	C (C)	-

1: Target LOS F within 600m of Rapid Transit Station

Peak directional traffic along all roadways are anticipated to meet the target LOS E under the 2037 background traffic conditions.

A summary of the lane capacity analysis for the 2037 total traffic conditions is included in **Table 18**.

Table 18: Network Lane Capacity Analysis – 2037 Total Traffic

Roadway	Directional Capacity (vph)	Traffic Volume AM (PM)	v/c Ratio		Auto LOS		Deficiency to Auto LOS 'F' ¹ AM (PM)
			AM (PM)	AM (PM)	AM (PM)	AM (PM)	
Blair Rd, north of Ogilvie Rd	Northbound	1,000	821 (536)	0.82 (0.54)	D (A)		-
	Southbound	1,000	517 (909)	0.52 (0.91)	A (E)		-
Blair Rd, south of Highway 174	Northbound	2,000	999 (1,033)	0.50 (0.52)	A (A)		-
	Southbound	2,000	696 (1,252)	0.35 (0.63)	A (B)		-
Ogilvie Rd, east of Blair Rd	Eastbound	2,000	1,149 (1,850)	0.57 (0.93)	A (E)		-
	Westbound	2,000	1,443 (1,462)	0.72 (0.73)	C (C)		-
Ogilvie Rd, west of Palmerston Dr	Eastbound	2,000	1,188 (1,989)	0.59 (0.99)	A (E)		-
	Westbound	2,000	1,529 (1,498)	0.76 (0.75)	C (C)		-

1: Target LOS F within 600m of Rapid Transit Station

The additional traffic generated by the subject site is not anticipated to have a significant impact on the overall operations of Blair Road or Ogilvie Road. Peak directional traffic along all roadways are anticipated to meet the target LOS E under the 2037 total traffic conditions. Detailed intersection analysis is presented in Section 4.9.2 and includes more in-depth discussion of the anticipated impacts of the proposed development within the study area.

4.9 Intersection Design

4.9.1 Intersection MMLOS Review

This section provides a review of the signalized study area intersections using complete streets principles. The signalized intersections within the study area has been evaluated for PLOS, BLOS, TLOS, TkLOS, and AutoLOS based on existing conditions. The MMLOS targets considered in this review are associated with those outlined in Exhibit 22 of the *MMLOS Guidelines* for the 'General Urban Area' and when applicable 'Within 600m of a rapid transit station' Policy Area.

The full intersection MMLOS analysis is included in **Appendix L**. A summary of the results is shown in **Table 19**.

Table 19: Intersection MMLOS Summary

Intersection	PLOS		BLOS		TLOS		TkLOS		AutoLOS	
	Actual	Target	Actual	Target	Actual	Target	Actual	Target	Actual	Target
Ogilvie Road/Matheson Road/Palmerston Drive	F	C	F	C	C	D	E	D	C	D
Ogilvie Road/Cadboro Road	F	C	A	C	B	D	E	D	B	D
Ogilvie Road/City Park Drive/Bathgate Drive	F	C	F	C	F	D	E	D	C	D
Ogilvie Road/1900 Ogilvie Road	F	A	F	C	B	D	E	D	A	E
Ogilvie Road/City Park Drive	F	A	F	C	F	D	E	D	D	E
Ogilvie Road/Blair Road	F	A	F	C	F	C	E	D	F	E
HWY 174 Westbound off-ramp/Blair Road	F	A	F	C	F	C	B	D	D	E
HWY 174 Eastbound off-ramp/Blair Road	F	A	A	C	D	-	C	D	E	E

The results of the intersection MMLOS analysis can be summarized as follows:

- None of the study area intersections meet the target PLOS;
- None of the study area intersections meet the target BLOS except for Ogilvie Road/Cadboro Road;
- All of the study area intersections meet the target TLOS except for Ogilvie Road/City Park Drive/Bathgate Drive, Ogilvie Road/City Park Drive, Ogilvie Road/Blair Road, and HWY 174 Westbound off-ramp/Blair Road;
- None of the study area intersections meet the target TkLOS except for HWY 174 Westbound off-ramp/Blair Road and HWY 174 Eastbound off-ramp/Blair Road; and
- All intersections meet the target AutoLOS except for Ogilvie Road/Blair Road.

Ogilvie Road/Matheson Road/Palmerston Drive

The intersection does not meet the target PLOS C, BLOS C, or TkLOS.

There is limited opportunity to improve the PLOS and BLOS at this intersection without reducing the number of lanes crossed and providing two-stage left turning cycling facilities on all approaches. The northbound and eastbound right turn movement do not meet the target TkLOS. As the south leg of the intersection does not form part of the City's truck routes, the eastbound and northbound right turn movements are considered acceptable.

Ogilvie Road/Cadboro Road

The intersection does not meet the target PLOS C or TkLOS C.

There is limited opportunity to improve the PLOS at this intersection without reducing the number of lanes crossed. The westbound right turn movement does not meet the target TkLOS. As the north leg of the intersection does not form part of the City's truck routes, the westbound right turn movement is considered acceptable.

Ogilvie Road/City Park Drive/Bathgate Drive

The intersection does not meet the target PLOS C, BLOS C, TLOS, or TkLOS.

There is limited opportunity to improve the PLOS and BLOS at this intersection without reducing the number of lanes crossed and providing two-stage left turning cycling facilities on all approaches. The north and south approaches do not meet the target TLOS. As the major street is in the east-west direction any additional capacity will come at the expense of the transit routes along the main corridor and is therefore assumed to be acceptable. The eastbound and westbound right turn movements do not meet the target TkLOS. As the north and south legs of the intersection do not form part of the City's truck routes, the eastbound and westbound right turn movements are considered acceptable.

Ogilvie Road/1900 Ogilvie Road

The intersection does not meet the target PLOS C, BLOS C, or TkLOS.

There is limited opportunity to improve the PLOS and BLOS at this intersection without reducing the number of lanes crossed and providing two-stage left turning cycling facilities on all approaches. The eastbound and westbound right turn movements do not meet the target TkLOS. As the north and south legs of the intersection do not form part of the City's truck routes, the eastbound and westbound right turn movements are considered acceptable.

Ogilvie Road/City Park Drive

The intersection does not meet the target PLOS C, BLOS C, TLOS, or TkLOS.

There is limited opportunity to improve the PLOS and BLOS at this intersection without reducing the number of lanes crossed and providing two-stage left turning cycling facilities on all approaches. The south approach does not meet the target TLOS. As the major street is in the east-west direction any additional capacity will come at the expense of the transit routes along the main corridor and is therefore assumed to be acceptable. The westbound right turn movement does not meet the target TkLOS. As the north leg of the intersection does not form part of the City's truck routes, the westbound right turn movement is considered acceptable.

Ogilvie Road/Blair Road

The intersection does not meet the target PLOS C, BLOS C, TLOS, TkLOS, or AutoLOS.

No mitigation measures are proposed as part of the proposed development, as the City's planned Blair-Blair Transit Priority Corridor is anticipated to provide improvements for all modes at the Ogilvie Road/Blair Road intersection. As described in Section 2.2.1, the proposed alterations include a protected intersection design with painted zebra pavement markings at crosswalks, dedicated cycling facilities, and additional travel lanes.

HWY 174 Westbound off-ramp/Blair Road

The intersection does not meet the target PLOS C, BLOS C or TLOS.

No mitigation measures are proposed as part of the proposed development, as the City's planned Blair Transit Priority Project (Innes Road to Blair LRT Station) is anticipated to provide improved pedestrian, bike, and transit facilities along the Blair Road corridor. As described in Section 2.2.1, among the proposed alterations at this intersection are protected northeast and northwest corners, a sidewalk, and cycle track along the east side of Blair Road, a multi-use path on the west side of Blair Road, painted zebra pavement markings at crosswalks, and dedicated transit turning lanes on the 1980 Ogilvie Road approach.

HWY 174 Eastbound off-ramp/Blair Road

The intersection does not meet the target PLOS C.

No mitigation measures are proposed as part of the proposed development, as the City's planned Blair Transit Priority Project (Innes Road to Blair LRT Station) is anticipated to provide improved pedestrian, bike, and transit facilities along the Blair Road corridor. Among the proposed alterations at this intersection are a protected southeast corner, a sidewalk, and cycle track along the east side of Blair Road, a multi-use path on the west side of Blair Road, and painted zebra pavement markings at crosswalks.

4.9.2 2037 Total Intersection Operations

Intersection capacity analysis has been conducted for the 2037 total traffic conditions. The results of the analysis are summarized in **Tables 20** and **21** for the weekday AM and PM peak hours. Detailed reports are included in **Appendix K**.

Table 20: 2037 Total Traffic Operations

Intersection	AM Peak			PM Peak		
	Delay or V/C	LOS	Mvmt	Delay or V/C	LOS	Mvmt
Ogilvie Road/Matheson Road/Palmerston Drive	0.62	A	WBT/R	0.81	D	EBT/R
Ogilvie Road/Cadboro Road	0.51	A	WBT/R	0.74	C	EBT/R
Ogilvie Road/City Park Drive/Bathgate Drive	0.65	B	NBL	0.68	B	NBL
Ogilvie Road/1900 Ogilvie Road	0.51	A	WBT/R	0.65	B	EBT
Ogilvie Road/City Park Drive	0.47	A	WBT	0.92	E	EBT
Ogilvie Road/Blair Road	1.30	F	WBL	1.27	F	NBR
				1.25	F	WBL
	1.02	F	NBT	1.19	F	EBR
				1.03	F	EBT
			1.02	F	SBT/R	
HWY 174 Westbound off-ramp/Blair Road	0.72	C	NBT	0.89	D	EBR
HWY 174 Eastbound off-ramp/Blair Road	0.69	B	WBR	0.98	E	SBT/L

Table 21: 2037 Total Queues

Intersection	Mvmt	Storage/ Spacing ⁽¹⁾	AM Peak			PM Peak		
			v/c [LOS]	50 th % Queue (m)	95 th % Queue (m)	v/c [LOS]	50 th % Queue (m)	95 th % Queue (m)
Ogilvie Road/Blair Road	NBL	120m	0.95 [E]	91	#126	0.84 [D]	39	#61
	NBT	220m	1.02 [F]	~194	#267	0.62 [B]	73	107
	NBR	200m	0.76 [C]	51	103	1.27 [F]	~227	#310
	SBL	30m	0.70 [B]	19	#42	0.56 [A]	20	36
	SBT/R	100m	0.62 [B]	56	74	1.02 [F]	~129	#170
	EBL	70m	0.63 [B]	29	47	0.79 [C]	42	#73
	EBT	230m	0.59 [A]	60	78	1.03 [F]	~133	#173
	EBR	230m	0.48 [A]	0	23	1.19 [F]	~165	#238
	WBL	110m	1.30 [F]	~118	#155	1.25 [F]	~155	#195
WBT/R	225m	0.84 [D]	108	#157	0.52 [A]	68	87	

1. Indicates the storage length for auxiliary lanes or the spacing to the nearest upstream intersection for through lanes

#: volume for the 95th percentile cycle exceeds capacity

~: approach is above capacity

Comparing the previous tables and the 2037 background conditions, traffic generated by the proposed development is anticipated to have marginal operational effects within the study area. The southbound through/right turn lane is now over capacity with a V/C of 1.02 and previously had a V/C ratio of 0.97 during background traffic conditions and the 50th and 95th percentiles queues have increased by roughly one vehicle. The discussion of over-capacity movements and queue lengths are generally consistent with those described in Section 3.4.2.

Traffic generated by the development is expected to increase the volume of westbound left turning vehicles at Ogilvie Road/City Park Drive (east) by 85% in the PM peak hour while no additional westbound left traffic is projected in the AM peak hour. Currently the westbound left turn lane experiences a collision rate per MEV of 3.27 when comparing the ten collisions that occurred in the left turn lane (nine turning movement collisions and one rear end collision) and the existing traffic

volumes. While a collision rate of 3.27 per MEV could be considered high, collision rates tend to over-emphasize intersections or movements with lower volumes.

The westbound left turn movement at this intersection currently operates with a permitted phasing in the AM peak hour and permitted and protected left turn phasing in the PM peak hour. Monitoring of collisions associated with the westbound left turn movement should be completed by the City as this development proceeds. Should the westbound left turn collision pattern continue, consideration by the City could be given for implementing a fully protected left turn phase. Analysis was completed to compare the impacts of including a fully protected left turn phase to the east and west bound legs with 2037 total traffic conditions. The results of the analysis are summarized in **Table 22** for the weekday AM and PM peak hours. Detailed reports are included in **Appendix K**.

Table 22: Ogilvie Road/City Park Drive Fully Protected Phasing Comparison

Intersection	AM Peak			PM Peak		
	Delay or V/C	LOS	Mvmt	Delay or V/C	LOS	Mvmt
Ogilvie Road/City Park Drive	0.60	A	EBL	1.00	E	EBT

The existing storage length of the westbound left turn lane is 100m and the eastbound left turn lane is 40m. The protected phasing is anticipated to increase the 95th percentile westbound left turn queues from 18m to 31m in the AM peak hour and from 56m to 82m during the PM peak hour. Eastbound left turn queues are also anticipated to increase from 8m to 37m during the AM peak hour and from 3m to 9m during the PM peak hour. While queueing does increase under fully protected phasing the 95th percentile queues in the left turning lanes could be supported by existing storage lengths at the intersection.

5.0 CONCLUSIONS AND RECOMMENDATIONS

Based on the foregoing, the conclusions and recommendations of this TIA can be summarized as follows:

Forecasting

- The proposed development is anticipated to generate a net additional 753 person trips during the AM peak hour (including 135 vehicle trips), and an additional 742 person trips during the PM peak hour (including 143 vehicle trips).

Development Design

- The proposed development will include vehicular access to City Park Drive. Pedestrian connections are anticipated to be provided to the MUP's east and south of the site, as well as to the sidewalks along City Park Drive.

Transportation Demand Management (TDM)

- A review of the City's TDM Measures Checklist has been conducted by the proponent, who will consider the following TDM measures on a phase by phase basis within this development:
 - Display local area maps with walking/cycling access routes and key destinations at major entrances;
 - Display relevant transit schedules and route maps at entrances;
 - Unbundle parking from purchase cost (condo) or monthly rent (apartment); and

- Provide multi-modal travel information package to new residents.

Neighbourhood Traffic Management

- Traffic generated by the proposed development is anticipated to increase traffic along City Park Drive at Ogilvie Road/Bathgate Drive by 29-32 vehicles, or one vehicle every two minutes during peak hours. Traffic at City Park Drive at Ogilvie Road/1941 Ogilvie Road is anticipated to increase by 105-112 vehicles, or two vehicle a minute during peak hours.
- Since City Park Drive is expected to have lower volumes close to the subject site, no neighbourhood traffic management measures have been recommended as part of this proposed development.

Transit

- The proposed development is anticipated to generate an additional 496 transit trips during the AM peak hour and an additional 476 transit trips during the PM peak hour. The additional transit trips generated by the proposed development are anticipated to have a marginal impact on the current transit operations surrounding the site.
- A total of 38-62 people are anticipated to cross the street to Stop #4447 during the peak hours. As the existing transit stop is considered a desire line for pedestrians from the proposed development, consideration should be given to providing a pedestrian crossover along City Park Drive as the development advances. The timing for implementation of a future pedestrian crossover will be reviewed on a phase-by-phase basis through future Site Plan Control applications.

Network Concept

- The additional traffic generated by the subject site is not anticipated to have a significant impact on the overall operations of Blair Road or Ogilvie Road. Peak directional traffic along all roadways are anticipated to meet the target LOS E under the 2037 total traffic conditions.

Intersection MMLOS

- None of the study area intersections meet the target PLOS. There is limited opportunity to improve the PLOS at all intersections without reducing the number of lanes crossed;
- None of the study area intersections meet the target BLOS except for Ogilvie Road/Cadboro Road. There is limited opportunity to improve the BLOS at all intersections without providing two-stage left turning cycling facilities;
- All of the study area intersections meet the target TLOS except for Ogilvie Road/City Park Drive/Bathgate Drive, Ogilvie Road/City Park Drive, Ogilvie Road/Blair Road, and HWY 174 Westbound off-ramp/Blair Road;
- None of the study area intersections meet the target TkLOS except for HWY 174 Westbound off-ramp/Blair Road and HWY 174 Eastbound off-ramp/Blair Road; and
- All intersections meet the target AutoLOS except for Ogilvie Road/Blair Road.

Background Traffic Analysis

- The westbound left turning movement and northbound through movements at the Ogilvie Road/Blair Road intersection do not meet the target LOS E during the AM peak hour and

the northbound right, westbound left, eastbound right and eastbound through movements do not meet the target LOS E in the PM peak hour. All other intersections within the study area are expected to meet the City’s target.

- During the AM peak hour at the Ogilvie Road/Blair Road intersection, the average and maximum queue lengths of the westbound left movement exceed the current storage capacity. Additionally, the maximum queue lengths of the northbound left, the northbound through, and the southbound left turn movements exceed the existing storage capacity.
- During the PM peak hour at the Ogilvie Road/Blair Road intersection, the average and maximum queue lengths of the northbound right, the southbound through/right, and the westbound left movements and the maximum queue length for the southbound left turn movement exceed the existing storage length.

Total Traffic Analysis

- Traffic generated by the proposed development is anticipated to have marginal operational effects within the study area. The discussion of over-capacity movements and queue lengths are generally consistent with the background traffic analysis.
- Monitoring of collisions associated with the westbound left turn movement should be completed by the City as this development proceeds. Should the westbound left turn collision pattern continue, consideration by the City could be given for implementing a fully protected left turn phase. While queueing does increase under fully protected phasing the 95th percentile queues in the left turning lanes could be supported by existing storage lengths at the intersection.

Based on the foregoing, the proposed development can be recommended from a transportation perspective.

NOVATECH

Prepared by:



Trevor Van Wiechen, M.Eng.
E.I.T. | Transportation

Reviewed by:



Brad Byvelds, P.Eng.
Project Manager | Transportation

APPENDIX A

Proposed Site Plan



CLIENT Client
COLLONADE BRIDGEPORT

OUVRAGE Project
1900 & 2000 CITY PARK DRIVE

TITRE DU DESSIN Drawing Title:
ROOF PLAN

EMPLACEMENT Location
Gloucester - ON.

NO. PROJET Project No.
13048

DESSINE PAR Drawn by
VÉRIFIÉ PAR Checked by

NEUF 
ARCHITECT(E)S

NEUFarchitectes.com

DATE (aa.mm.jj)
23.04.11

RÉVISION Revision

ÉCHELLE Scale

NO. DESSIN Dwg Number

APPENDIX B

TIA Screening Form

City of Ottawa 2017 TIA Guidelines Screening Form

1. Description of Proposed Development

Municipal Address	1900/2000 City Park Drive
Description of Location	Mid-block between Ambassador Ave and Jobin Crescent
Land Use Classification	Multi-tower mixed-use
Development Size (units)	
Development Size (m ²)	
Number of Accesses and Locations	Two access on south side of City Park Drive
Phase of Development	
Buildout Year	

If available, please attach a sketch of the development or site plan to this form.

2. Trip Generation Trigger

Considering the Development's Land Use type and Size (as filled out in the previous section), please refer to the Trip Generation Trigger checks below.

Land Use Type	Minimum Development Size
Single-family homes	40 units
Townhomes or apartments	90 units
Office	3,500 m ²
Industrial	5,000 m ²
Fast-food restaurant or coffee shop	100 m ²
Destination retail	1,000 m ²
Gas station or convenience market	75 m ²

** If the development has a land use type other than what is presented in the table above, estimates of person-trip generation may be made based on average trip generation characteristics represented in the current edition of the Institute of Transportation Engineers (ITE) Trip Generation Manual.*

If the proposed development size is greater than the sizes identified above, the Trip Generation Trigger is satisfied.

3. Location Triggers

	Yes	No
Does the development propose a new driveway to a boundary street that is designated as part of the City's Transit Priority, Rapid Transit or Spine Bicycle Networks?		X
Is the development in a Design Priority Area (DPA) or Transit-oriented Development (TOD) zone?*	✓	

**DPA and TOD are identified in the City of Ottawa Official Plan (DPA in Section 2.5.1 and Schedules A and B; TOD in Annex 6). See Chapter 4 for a list of City of Ottawa Planning and Engineering documents that support the completion of TIA).*

If any of the above questions were answered with 'Yes,' the Location Trigger is satisfied.

4. Safety Triggers

	Yes	No
Are posted speed limits on a boundary street are 80 km/hr or greater?		X
Are there any horizontal/vertical curvatures on a boundary street limits sight lines at a proposed driveway?		X
Is the proposed driveway within the area of influence of an adjacent traffic signal or roundabout (i.e. within 300 m of intersection in rural conditions, or within 150 m of intersection in urban/ suburban conditions)?		X
Is the proposed driveway within auxiliary lanes of an intersection?		X
Does the proposed driveway make use of an existing median break that serves an existing site?		X
Is there is a documented history of traffic operations or safety concerns on the boundary streets within 500 m of the development?		X
Does the development include a drive-thru facility?		X

If any of the above questions were answered with 'Yes,' the Safety Trigger is satisfied.

5. Summary

	Yes	No
Does the development satisfy the Trip Generation Trigger?	✓	
Does the development satisfy the Location Trigger?	✓	
Does the development satisfy the Safety Trigger?		X



Transportation Impact Assessment Screening Form

If none of the triggers are satisfied, the TIA Study is complete. If one or more of the triggers is satisfied, the TIA Study must continue into the next stage (Screening and Scoping).

APPENDIX C

OC Transpo Route Maps

 EAST
EST

○ Blair



○ Cyrville

○ St-Laurent

○ Tremblay

■ VIA

○ Hurdman  SOUTH
SUD → 

○ Lees

24 min.

○ uOttawa

○ Rideau

○ Parliament
Parlement

○ Lyon

○ Pimisi

○ Bayview **2**

○ Tunney's Pasture

 WEST
OUEST



12

PARLIAMENT PARLEMENT BLAIR

Fréquent

7 days a week / 7 jours par semaine

All day service

Service toute la journée

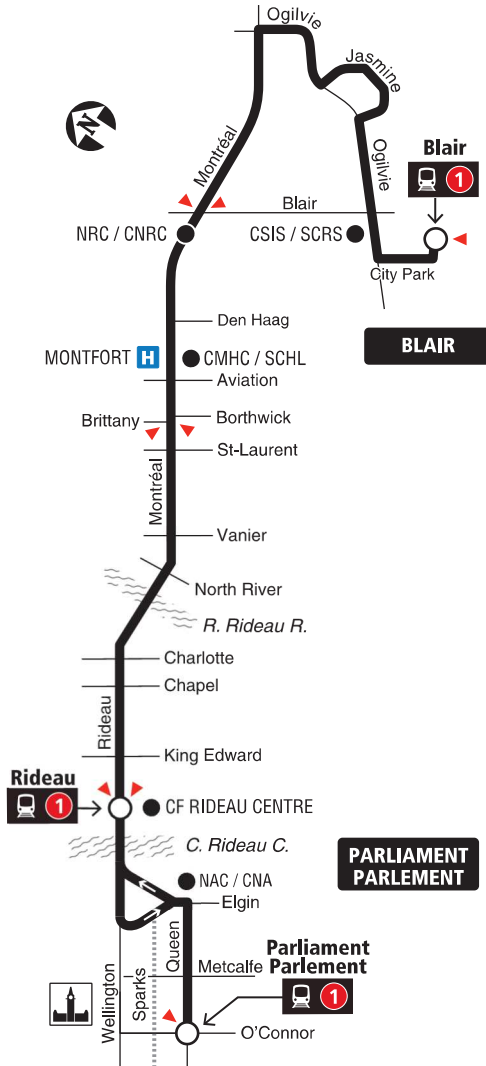

04.2023

- Station
- ▲ Timepoint / Heures de passage

04.2023

 **Schedule / Horaire 613-560-1000**
Text / Texto* 560560
plus your four digit bus stop number / plus votre numéro d'arrêt à quatre chiffres
*Standard message rates may apply / Les tarifs réguliers de messagerie texte peuvent s'appliquer

Customer Service
 Service à la clientèle **613-560-5000**

Lost and Found / Objets perdus **613-563-4011**

Security / Sécurité **613-741-2478**

Effective April 23, 2023
En vigueur 23 avril 2023

 **INFO 613-560-5000**
octranspo.com

15

GATINEAU BLAIR

Local

Monday to Friday / Lundi au vendredi
Peak Periods
Périodes de pointe

BLAIR

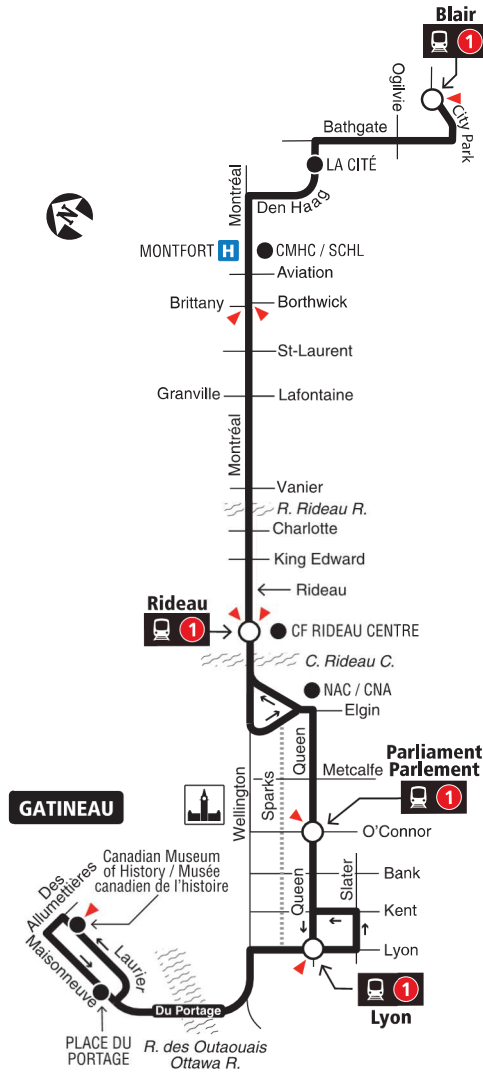

GATINEAU

- Station
- ▲ Timepoint / Heures de passage

04.2023

04.2023



Schedule / Horaire 613-560-1000

Text / Texto* 560560

plus your four digit bus stop number / plus votre numéro d'arrêt à quatre chiffres

*Standard message rates may apply / Les tarifs réguliers de messagerie texte peuvent s'appliquer

Customer Service

Service à la clientèle **613-560-5000**

Lost and Found / Objets perdus..... **613-563-4011**

Security / Sécurité..... **613-741-2478**

Effective April 23, 2023

En vigueur 23 avril 2023



INFO 613-560-5000
octranspo.com



21

CANOTEK BLAIR

Local

Monday to Friday / Lundi au vendredi

Peak periods only

Périodes de pointe seulement

CANOTEK

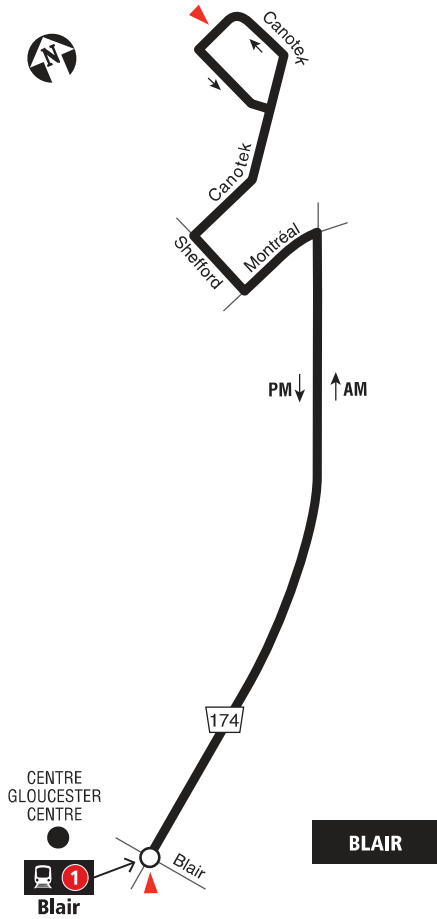

- Station
- ▲ Timepoint / Heures de passage

2019.06

 **Schedule / Horaire.....613-560-1000**
Text / Texto560560
plus your four digit bus stop number / plus votre numéro d'arrêt à quatre chiffres

Customer Service
 Service à la clientèle **613-741-4390**
 Lost and Found / Objets perdus..... **613-563-4011**
 Security / Sécurité **613-741-2478**

Effective June 25, 2017
En vigueur 25 juin 2017



23

ROTHWELL HEIGHTS

BLAIR

Local

Monday to Friday / Lundi au vendredi
Limited Service. No weekend service
Service limité. Aucun service la fin de semaine

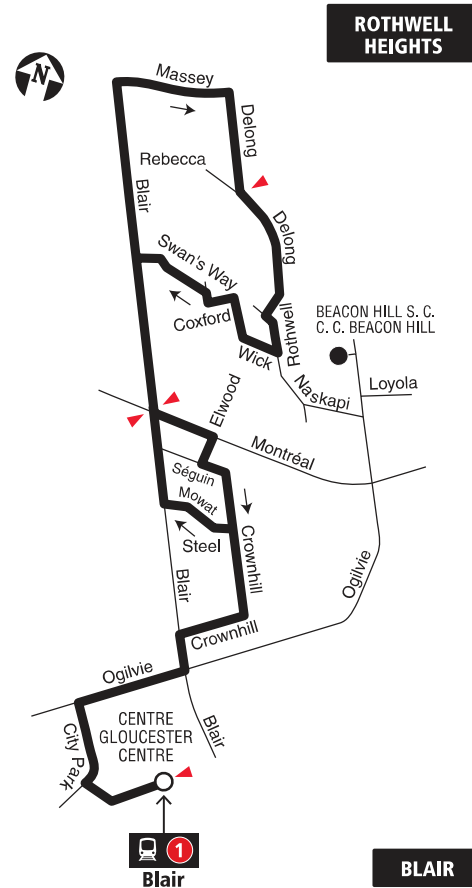

- Station
- ▲ Timepoint / Heures de passage

2019.06

Schedule / Horaire613-560-1000
Text / Texto560560

plus your four digit bus stop number / plus votre numéro d'arrêt à quatre chiffres

Customer Service
Service à la clientèle **613-741-4390**
Lost and Found / Objets perdus..... **613-563-4011**
Security / Sécurité **613-741-2478**

Effective April 23, 2018
En vigueur 23 avril 2018



24

BEACON HILL ST-LAURENT

Local

7 days a week / 7 jours par semaine

All day service
Service toute la journée

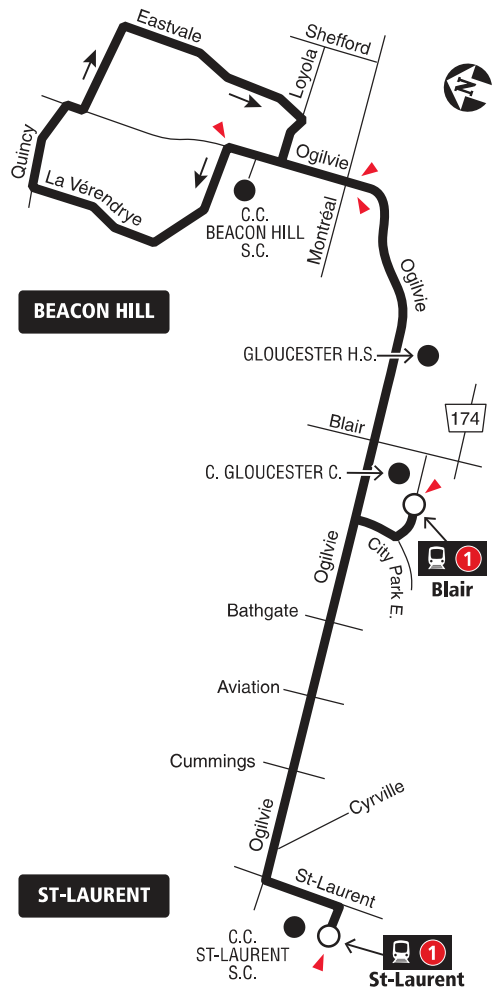

- Station
- ▲ Timepoint / Heures de passage

2019.07

Future route after O-Train Line 1 is open
Trajet du circuit après l'ouverture de la Ligne 1 de l'O-Train

Lost and Found / Objets perdus..... 613-563-4011
 Security / Sécurité 613-741-2478

OC Transpo INFO 613-741-4390
 octranspo.com



25

MILLENNIUM

LA CITÉ BLAIR

Fréquent

7 days a week / 7 jours par semaine

All day service

Service toute la journée

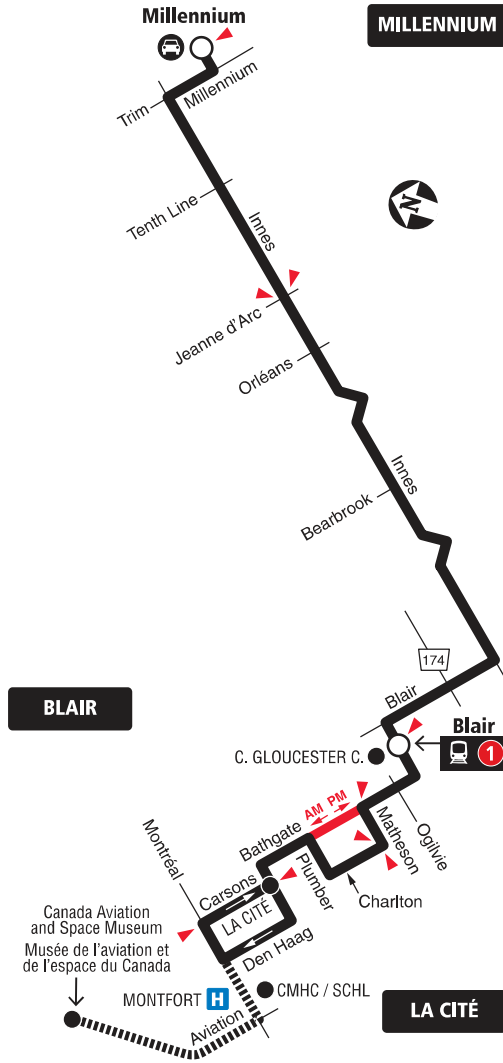

- Station
- Selected time periods / Périodes de temps sélectionnées
- Park & Ride / Parc-o-bus
- Timepoint / Heures de passage

2020.07

Schedule / Horaire.....613-560-1000
Text / Texto560560
plus your four digit bus stop number / plus votre numéro d'arrêt à quatre chiffres

Customer Service
 Service à la clientèle **613-741-4390**

Lost and Found / Objets perdus..... **613-563-4011**
 Security / Sécurité..... **613-741-2478**

Effective August 8, 2020
En vigueur 8 août 2020

INFO 613-741-4390
octranspo.com



26

BLAIR PINEVIEW

Local

7 days a week / 7 jours par semaine



All day service

Service toute la journée

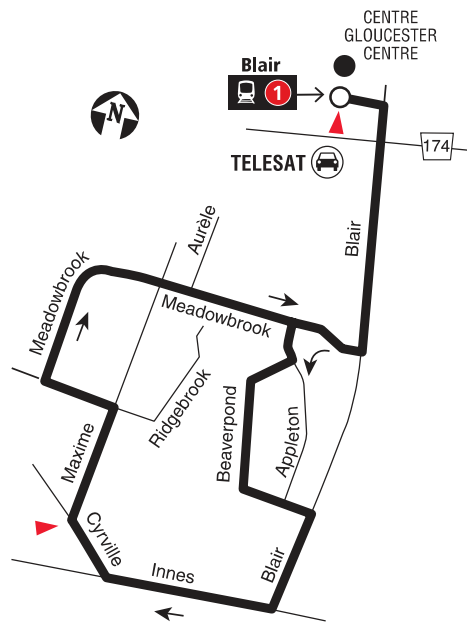
BLAIR



PINEVIEW

-  Station
-  Park & Ride / Parc-o-bs
-  Timepoint / Heures de passage

2019.06



Schedule / Horaire..... 613-560-1000

Text / Texto560560

plus your four digit bus stop number / plus votre numéro d'arrêt à quatre chiffres

Customer Service

Service à la clientèle 613-741-4390

Lost and Found / Objets perdus..... 613-563-4011

Security / Sécurité 613-741-2478

Effective June 25, 2017

En vigueur 25 juin 2017



INFO 613-741-4390
octranspo.com



28

BLACKBURN HAMLET BLAIR

Local

7 days a week / 7 jours par semaine
No Sunday evening service
Aucun service le dimanche en soirée

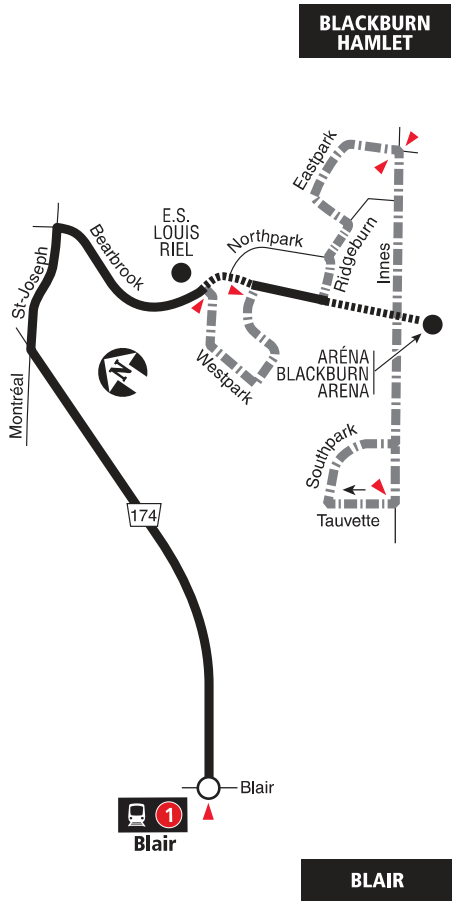

- Station
- No Saturday, Sunday or weekday evening service
Pas de service le samedi, le dimanche et les soirs durant la semaine
- Saturday, Sunday and weekday evening only
Samedi, dimanche et les soirs durant la semaine seulement
- Timepoint / Heures de passage

2019.06

Schedule / Horaire.....613-560-1000
Text / Texto560560
plus your four digit bus stop number / plus votre numéro d'arrêt à quatre chiffres

Customer Service
 Service à la clientèle **613-741-4390**

Lost and Found / Objets perdus..... **613-563-4011**
 Security / Sécurité..... **613-741-2478**

Effective June 25, 2017
En vigueur 25 juin 2017

INFO 613-741-4390
 octranspo.com

30

MILLENNIUM BLAIR

Local

7 days a week / 7 jours par semaine
All day service / Service toute la journée

BLAIR

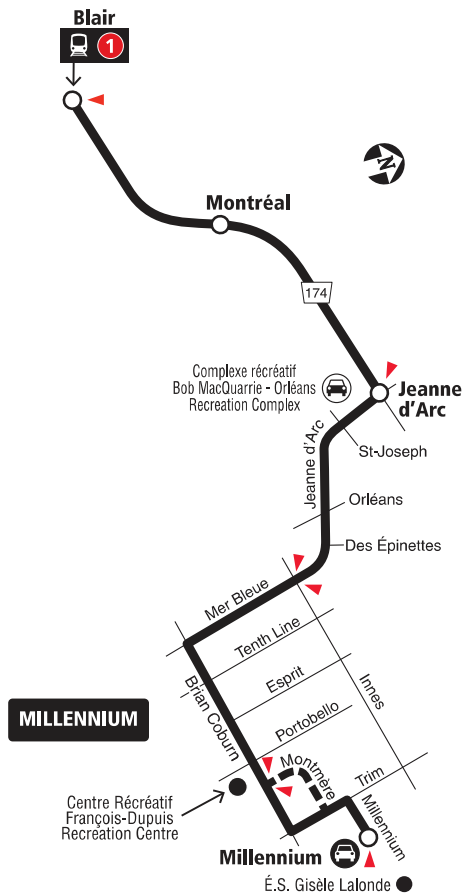

MILLENNIUM

- Station
- Peak periods / Périodes de pointe
- 🚗🚌 Park & Ride / Parc-o-bus
- ▲ Timepoint / Heures de passage

2019.07



Future route after O-Train Line 1 is open
Trajet du circuit après l'ouverture
de la Ligne 1 de l'O-Train

Lost and Found / Objets perdus..... 613-563-4011

Security / Sécurité..... 613-741-2478



INFO 613-741-4390
octranspo.com



31

PLACE D'ORLÉANS BLAIR

Local

Monday to Friday / Lundi au vendredi
Selected time periods only
Périodes sélectionnées seulement

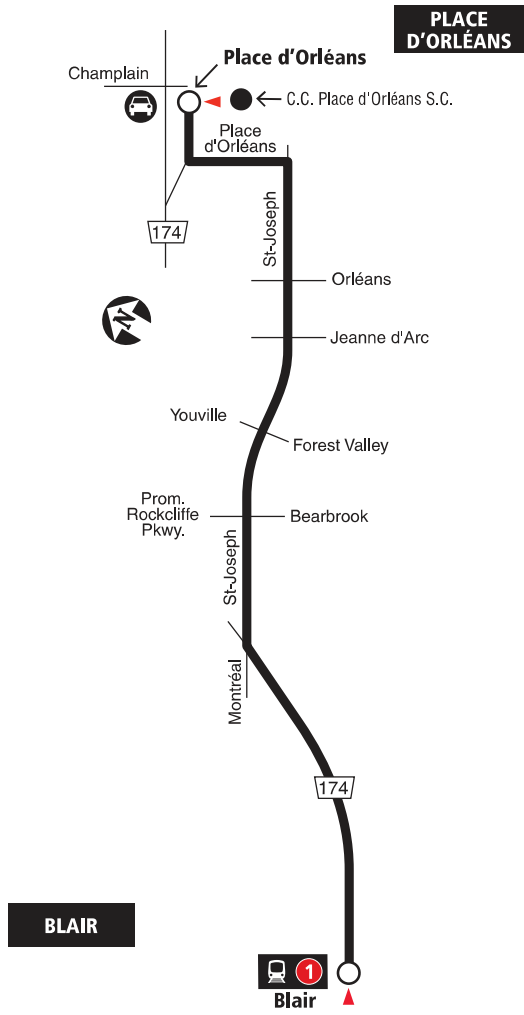

- Station
- Park & Ride / Parc-o-bus
- Timepoint / Postes d'attente

2019.06

Schedule / Horaire.....613-560-1000
Text / Texto560560
plus your four digit bus stop number / plus votre numéro d'arrêt à quatre chiffres

Customer Service
 Service à la clientèle **613-741-4390**

Lost and Found / Objets perdus..... **613-563-4011**

Security / Sécurité..... **613-741-2478**

Effective June 25, 2017
En vigueur 25 juin 2017

INFO 613-741-4390
 octranspo.com



32

SUNVIEW CHAPEL HILL BLAIR

Local

7 days a week / 7 jours par semaine

Selected time periods only

Périodes sélectionnées seulement

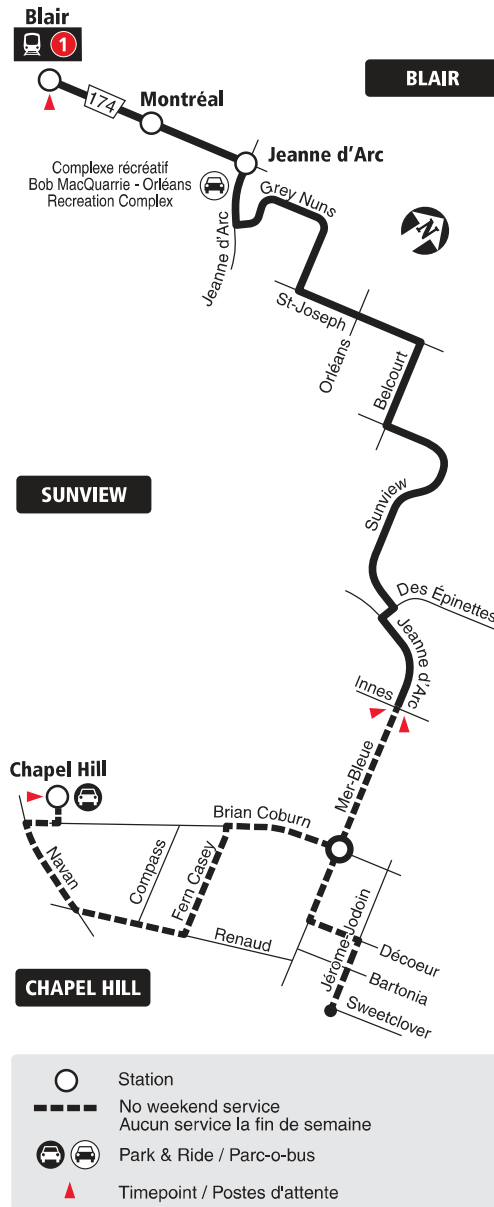

2021.09



Schedule / Horaire 613-560-1000

Text / Texto* 560560

plus your four digit bus stop number / plus votre numéro d'arrêt à quatre chiffres

*Standard message rates may apply / Les tarifs réguliers de messagerie texte peuvent s'appliquer

Customer Service

Service à la clientèle **613-560-5000**

Lost and Found / Objets perdus **613-563-4011**

Security / Sécurité **613-741-2478**

Effective September 5, 2021

En vigueur 5 septembre 2021



INFO 613-560-5000
octranspo.com



33

PORTOBELLO BLAIR PLACE D'ORLÉANS

Local

Monday to Friday / Lundi au vendredi

All day – Selected trips in the evening
Toute la journée – Service limité en soirée



○ Station 2021.06

▬ Weekday Peak trips only / Trajets de semaine en périodes de pointe seulement

🚗🚌 Park & Ride / Parc-o-bus

▲ Timepoint / Heures de passage

2021.06

Schedule / Horaire 613-560-1000
Text / Texto* 560560
plus your four digit bus stop number / plus votre numéro d'arrêt à quatre chiffres
*Standard message rates may apply / Les tarifs réguliers de messagerie texte peuvent s'appliquer

Customer Service
Service à la clientèle **613-560-5000**

Lost and Found / Objets perdus **613-563-4011**

Security / Sécurité **613-741-2478**

Effective June 20, 2021
En vigueur 20 juin 2021



35

ESPRIT BLAIR

Local

7 days a week / 7 jours par semaine
All day service
Service toute la journée

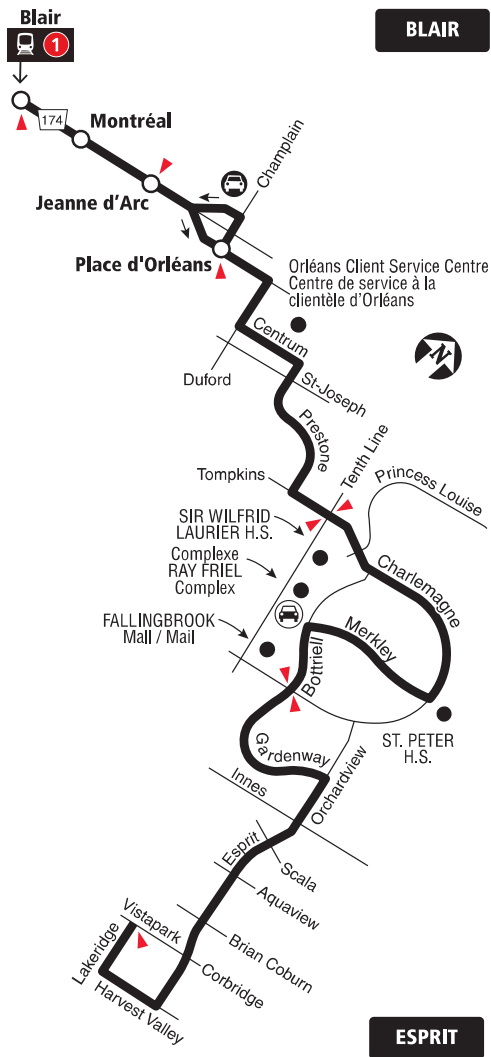

○ Station
 Park & Ride / Parc-o-bus
 ▲ Timepoint / Heures de passage

09.2021

2021.09

Schedule / Horaire.....613-560-1000
Text / Texto560560
plus your four digit bus stop number / plus votre numéro d'arrêt à quatre chiffres

Customer Service
 Service à la clientèle **613-560-5000**
 Lost and Found / Objets perdus..... **613-563-4011**
 Security / Sécurité..... **613-741-2478**

Effective September 5, 2021
En vigueur 5 septembre 2021



38

JEANNE D'ARC BLAIR

Local

7 days a week / 7 jours par semaine

All day service / Service toute la journée

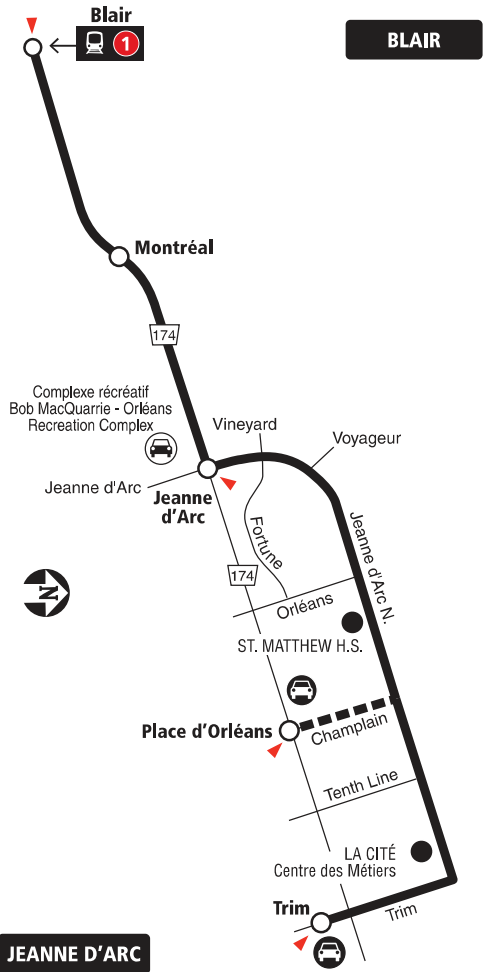

- Station
- No service westbound AM and eastbound PM /
Aucun service vers l'ouest AM et vers l'est PM
- Park & Ride / Parc-o-bus
- Timepoint / Heures de passage

2019.07

Future route after O-Train Line 1 is open
Trajet du circuit après l'ouverture
de la Ligne 1 de l'O-Train

Lost and Found / Objets perdus..... 613-563-4011
 Security / Sécurité..... 613-741-2478

INFO 613-741-4390
octranspo.com

39

Rapide

MILLENNIUM

BLAIR LA CITÉ

7 days a week / 7 jours par semaine

All day service and limited overnight
Service toute la journée et limité la nuit

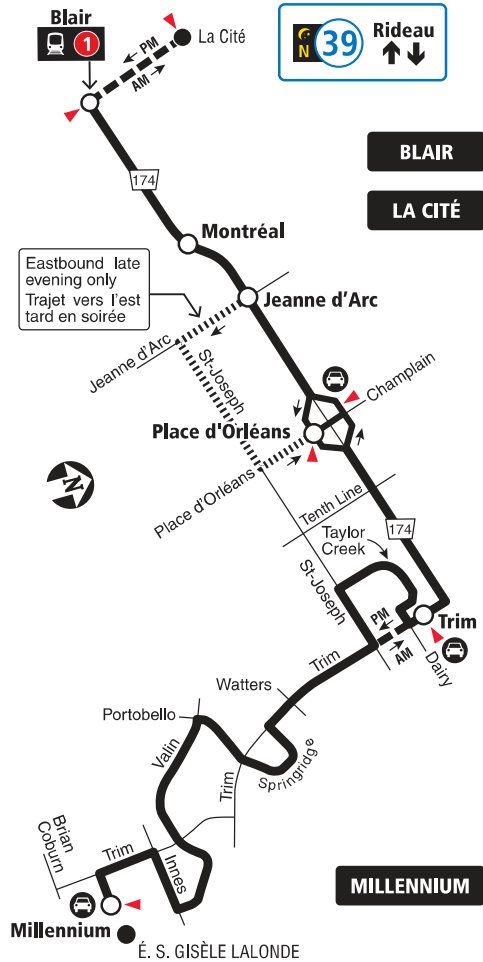

When O-Train Line 1 is not running overnight, Route 39 will be extended downtown to Rideau Station. / Lorsque la ligne 1 de l'O-Train ne circule pas la nuit, le circuit 39 sera prolongée au centre-ville jusqu'à la station Rideau.

2019.07





Future route after O-Train Line 1 is open
Trajet du circuit après l'ouverture de la Ligne 1 de l'O-Train

Lost and Found / Objets perdus..... 613-563-4011
Security / Sécurité..... 613-741-2478

INFO 613-741-4390
octranspo.com

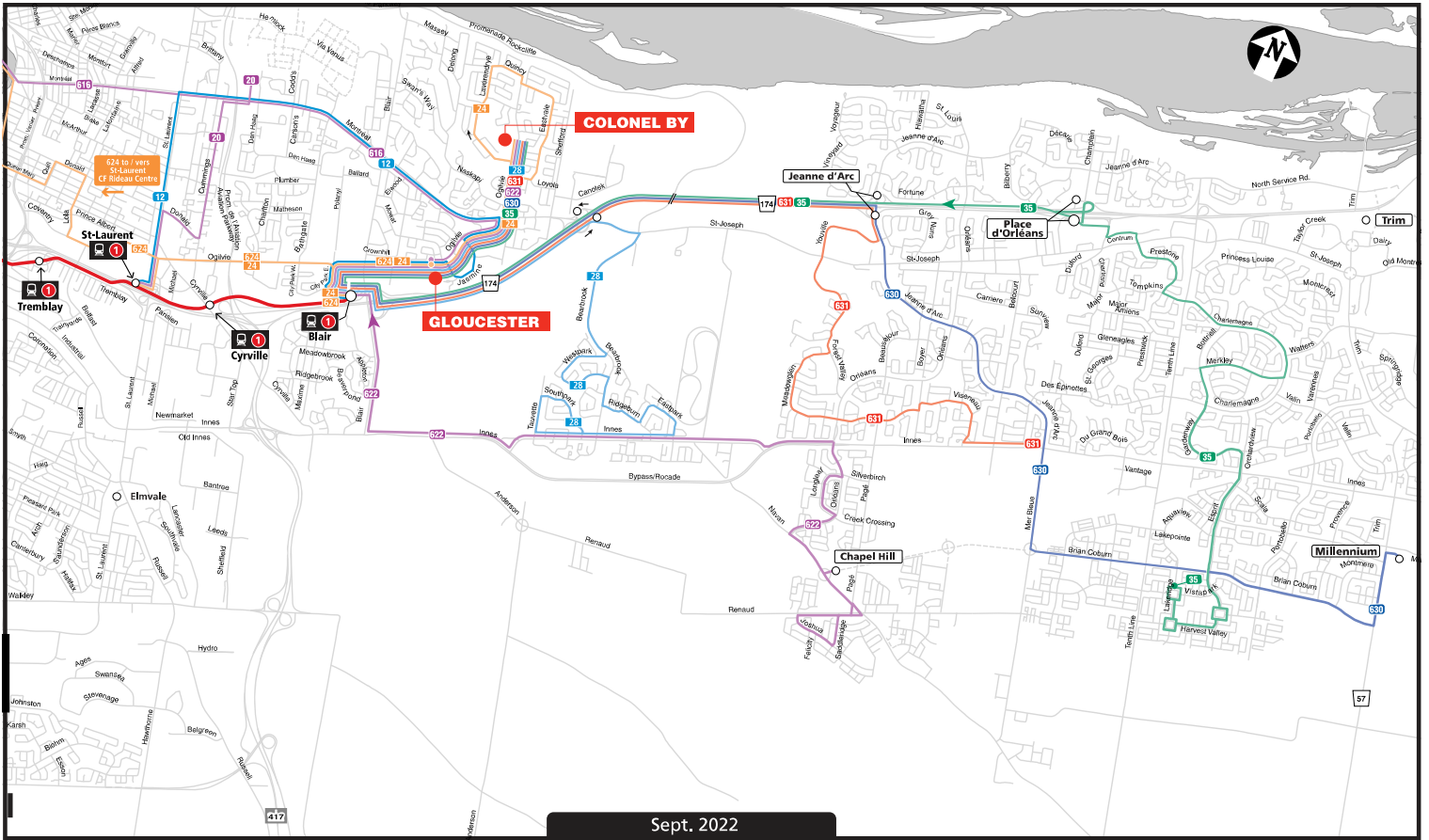



42

BLAIR HURDMAN

Local

7 days a week / 7 jours par semaine
No late eve. service Mon. to Fri. No eve. service weekends / Aucun service en fin de soirée du lun. au ven. Aucun service le soir les fins de semaine.

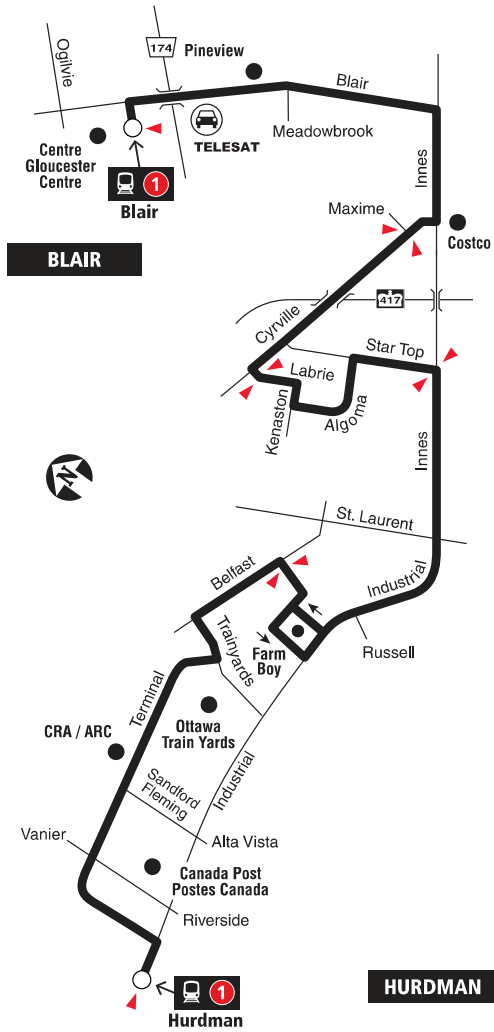

- Station
- Park & Ride / Parc-o-bus
- Timepoint / Postes d'attente

2019.06

Schedule / Horaire.....613-560-1000
Text / Texto560560
plus your four digit bus stop number / plus votre numéro d'arrêt à quatre chiffres

Customer Service
 Service à la clientèle **613-741-4390**
 Lost and Found / Objets perdus..... **613-563-4011**
 Security / Sécurité **613-741-2478**

Effective June 25, 2017
En vigueur 25 juin 2017



221

CUMBERLAND

BLAIR

Connexion

Monday to Friday / Lundi au vendredi

Peak periods only

Périodes de pointe seulement

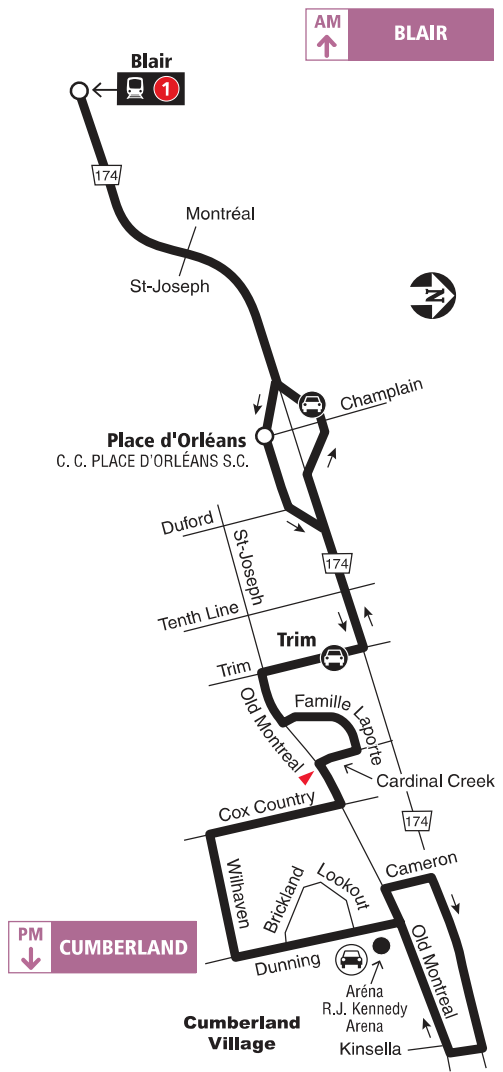

AM
↑
BLAIR

PM
↓
CUMBERLAND

- Station
- Park & Ride / Parc-o-bus
- Timepoint / Heures de passage

2019.07

Future route after O-Train Line 1 is open
Trajet du circuit après l'ouverture de la Ligne 1 de l'O-Train

Lost and Found / Objets perdus..... 613-563-4011
 Security / Sécurité..... 613-741-2478

INFO 613-741-4390
 octranspo.com



222

VARS BLAIR

Connexion

Monday to Friday / Lundi au vendredi

Peak periods only
Périodes de pointe seulement

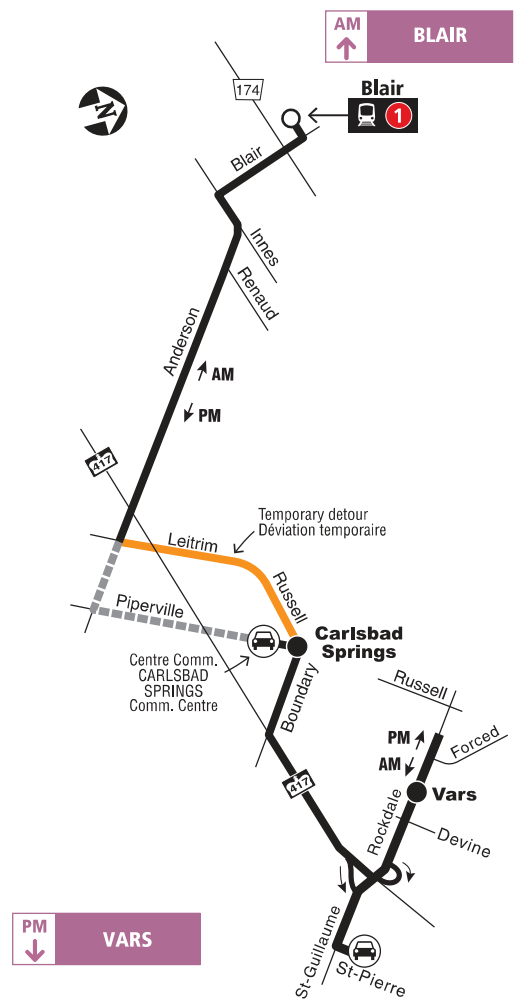

2021.05

Schedule / Horaire..... 613-560-1000
Text / Texto 560560
plus your four digit bus stop number / plus votre numéro d'arrêt à quatre chiffres

Customer Service
 Service à la clientèle 613-741-4390

Lost and Found / Objets perdus..... 613-563-4011

Security / Sécurité..... 613-741-2478

**Effective May 2021
 En vigueur mai 2021**

INFO 613-741-4390
 octranspo.com



228

NAVAN SARSFIELD BLAIR

Connexion

Monday to Friday / Lundi au vendredi

Peak periods only

Périodes de pointe seulement

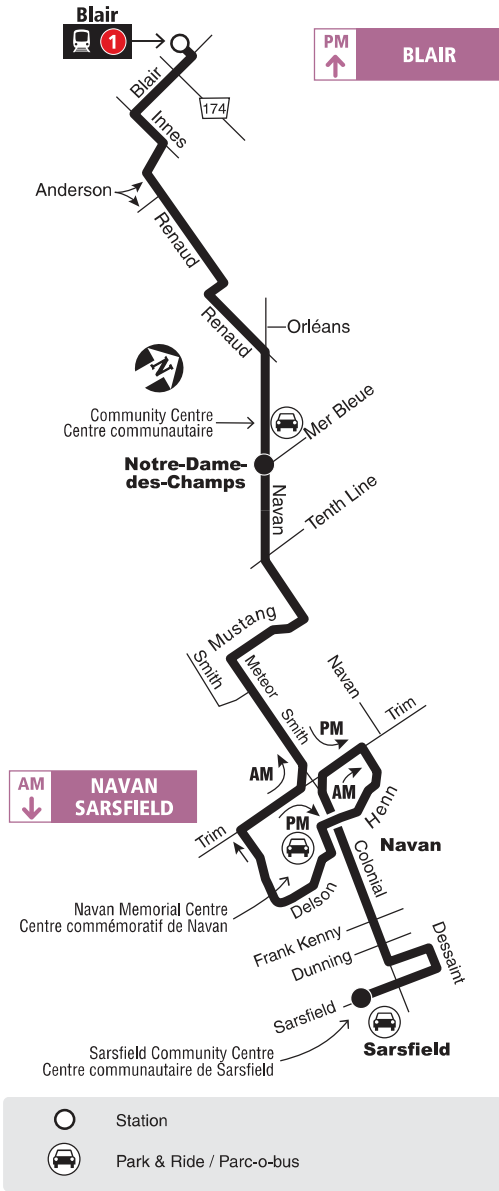

2019.10





Future route after O-Train Line 1 is open
Trajet du circuit après l'ouverture de la Ligne 1 de l'O-Train

Lost and Found / Objets perdus 613-563-4011
 Security / Sécurité 613-741-2478

INFO 613-741-4390
 octranspo.com



231

MEADOWGLEN BLAIR

Connexion

Monday to Friday / Lundi au vendredi



Peak periods only

Périodes de pointe seulement

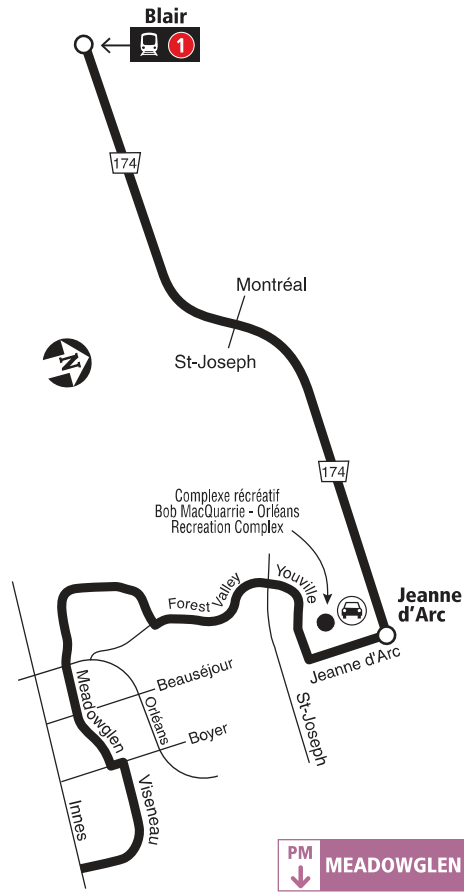
AM
↑
BLAIR



PM
↓
MEADOWGLEN

-  Station
-  Park & Ride / Parc-o-bus

2019.07



Future route after O-Train Line 1 is open
Trajet du circuit après l'ouverture
de la Ligne 1 de l'O-Train

Lost and Found / Objets perdus..... 613-563-4011

Security / Sécurité..... 613-741-2478



INFO 613-741-4390
octranspo.com



232

QUEENSWOOD HEIGHTS

BLAIR

Connexion

Monday to Friday / Lundi au vendredi

Peak periods only

Périodes de pointe seulement



2019.07



Future route after O-Train Line 1 is open
Trajet du circuit après l'ouverture de la Ligne 1 de l'O-Train

Lost and Found / Objets perdus..... 613-563-4011

Security / Sécurité..... 613-741-2478



INFO 613-741-4390
octranspo.com



234

TENTH LINE

BLAIR

Connexion

Monday to Friday / Lundi au vendredi

Peak periods only

Périodes de pointe seulement

AM
↑
BLAIR

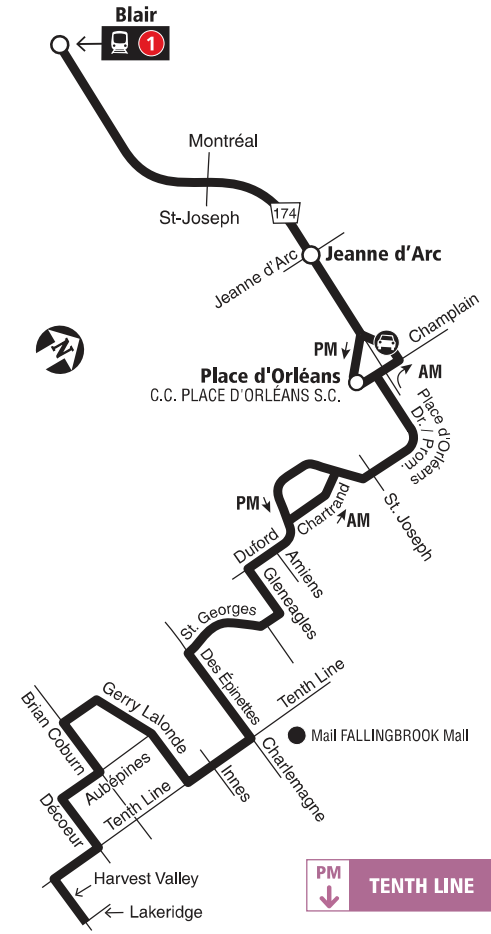

PM
↓
TENTH LINE

- Station
- Park & Ride / Parc-o-bus

2019.09

Future route after O-Train Line 1 is open
Trajet du circuit après l'ouverture de la Ligne 1 de l'O-Train

Lost and Found / Objets perdus..... **613-563-4011**
 Security / Sécurité..... **613-741-2478**

INFO 613-741-4390
octranspo.com



236

**ESPRIT
BLAIR**

Connexion

Monday to Friday / Lundi au vendredi

Peak periods only
Périodes de pointe seulement

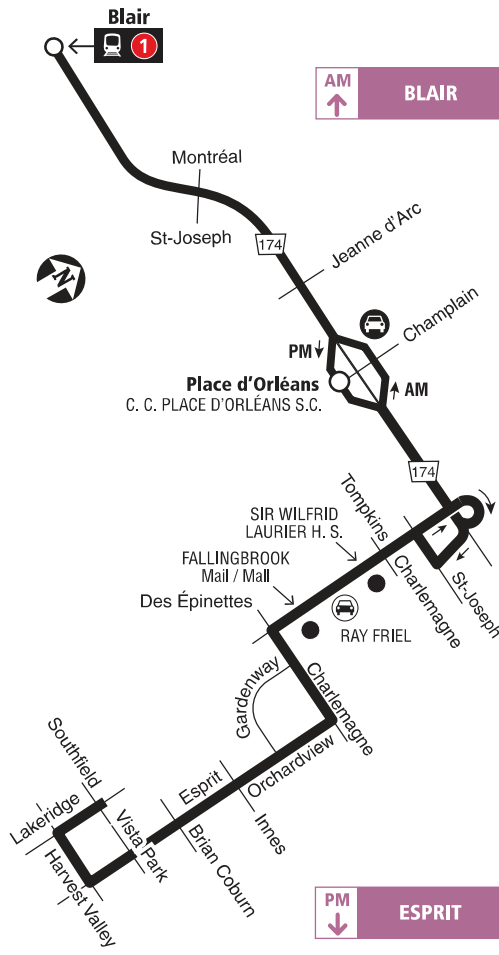

○ Station

Park & Ride / Parc-o-bus

2019.07

1

Future route after O-Train Line 1 is open
Trajet du circuit après l'ouverture de la Ligne 1 de l'O-Train

Lost and Found / Objets perdus..... **613-563-4011**
Security / Sécurité **613-741-2478**

INFO 613-741-4390
octranspo.com



237

JEANNE D'ARC BLAIR

Connexion

Monday to Friday / Lundi au vendredi

Peak periods only

Périodes de pointe seulement

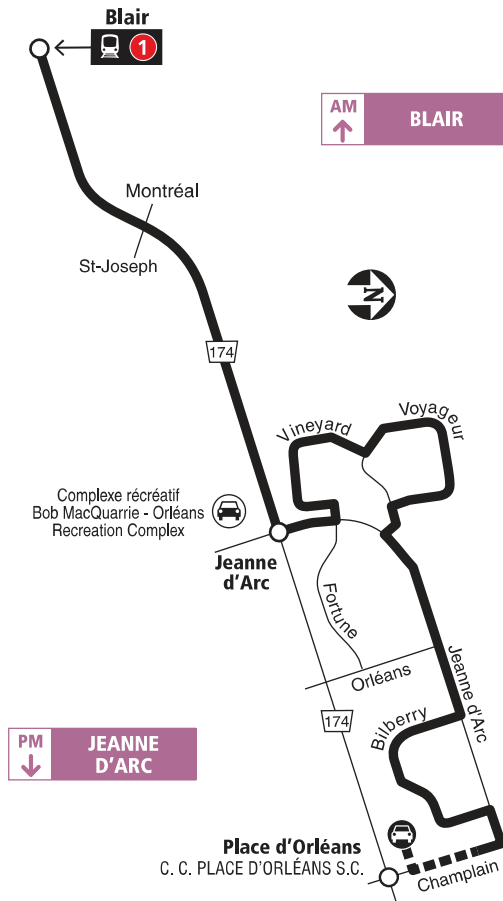

- Station
- PM Only / PM seulement
- Park & Ride / Parc-o-bus

2019.07

Future route after O-Train Line 1 is open
Trajet du circuit après l'ouverture de la Ligne 1 de l'O-Train

Lost and Found / Objets perdus..... 613-563-4011
 Security / Sécurité..... 613-741-2478

INFO 613-741-4390
 octranspo.com

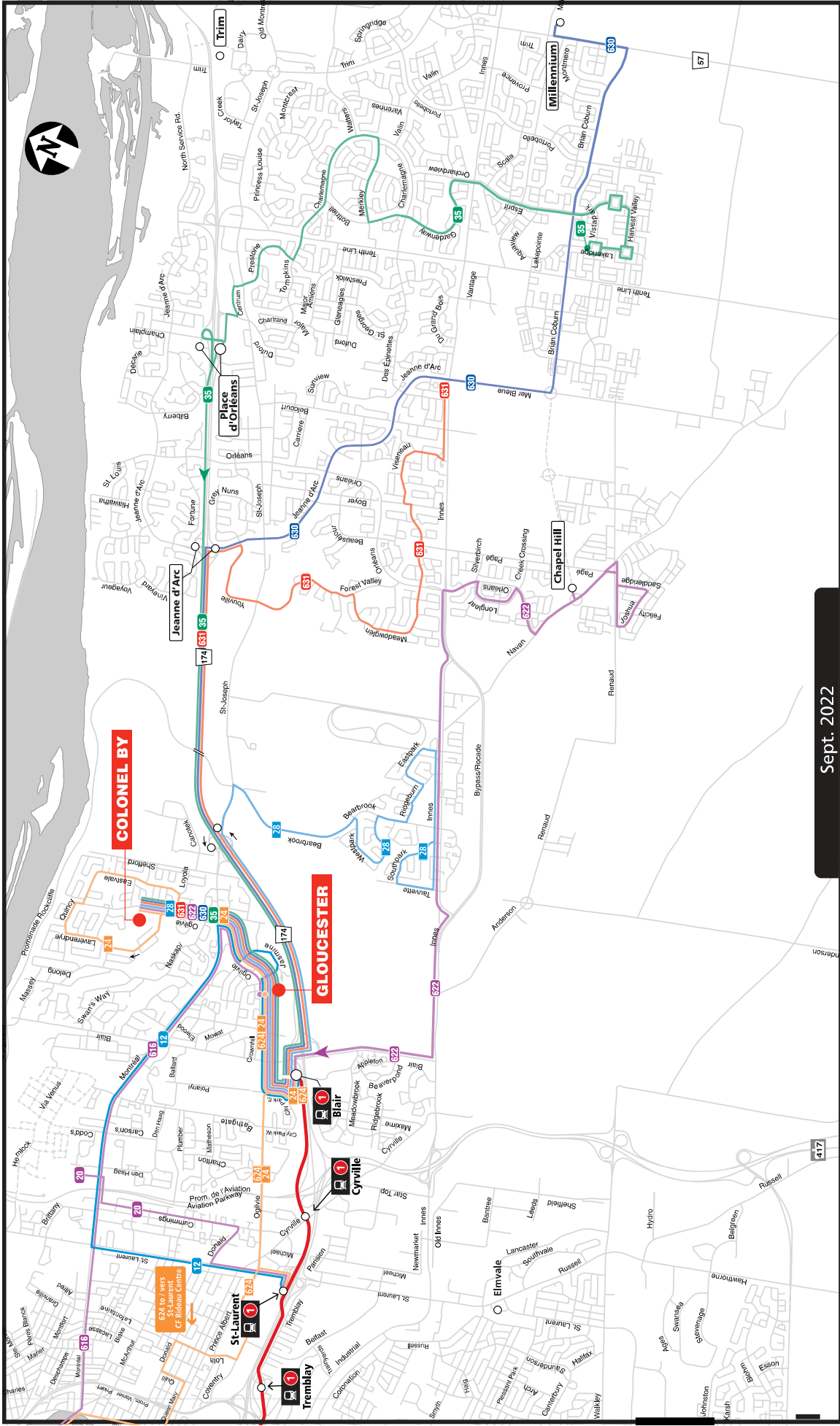

Sept. 2022

APPENDIX D

Traffic Count Data



Transportation Services - Traffic Services

Turning Movement Count - Peak Hour Diagram

OGILVIE RD @ MATHESON RD/PALMERSTON DR

Survey Date: Tuesday, May 09, 2017

Start Time: 07:00

WO No: 37015

Device: Miovision

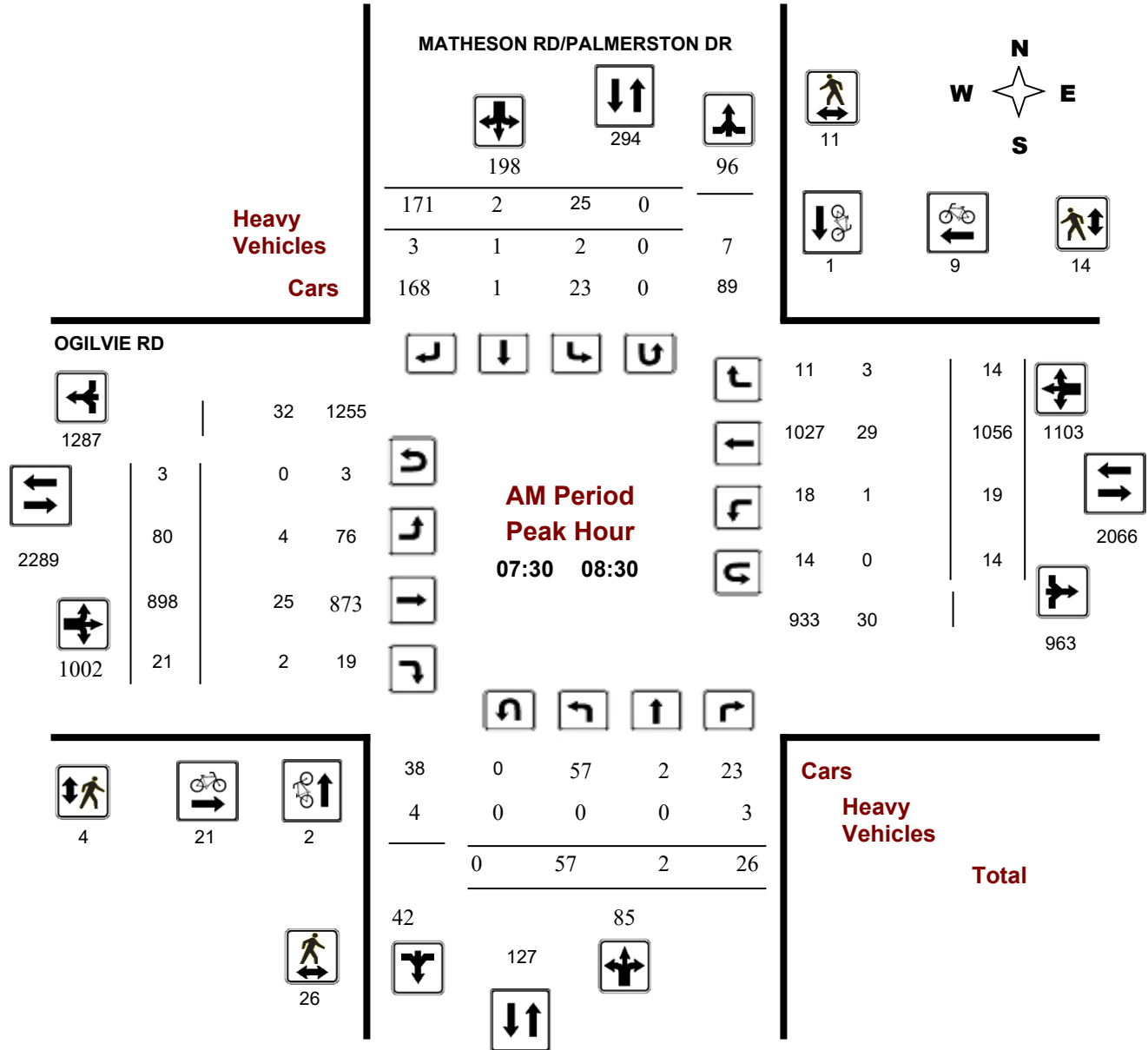

Turning Movement Count - Peak Hour Diagram

OGILVIE RD @ MATHESON RD/PALMERSTON DR

Survey Date: Tuesday, May 09, 2017

Start Time: 07:00

WO No: 37015

Device: Miovision

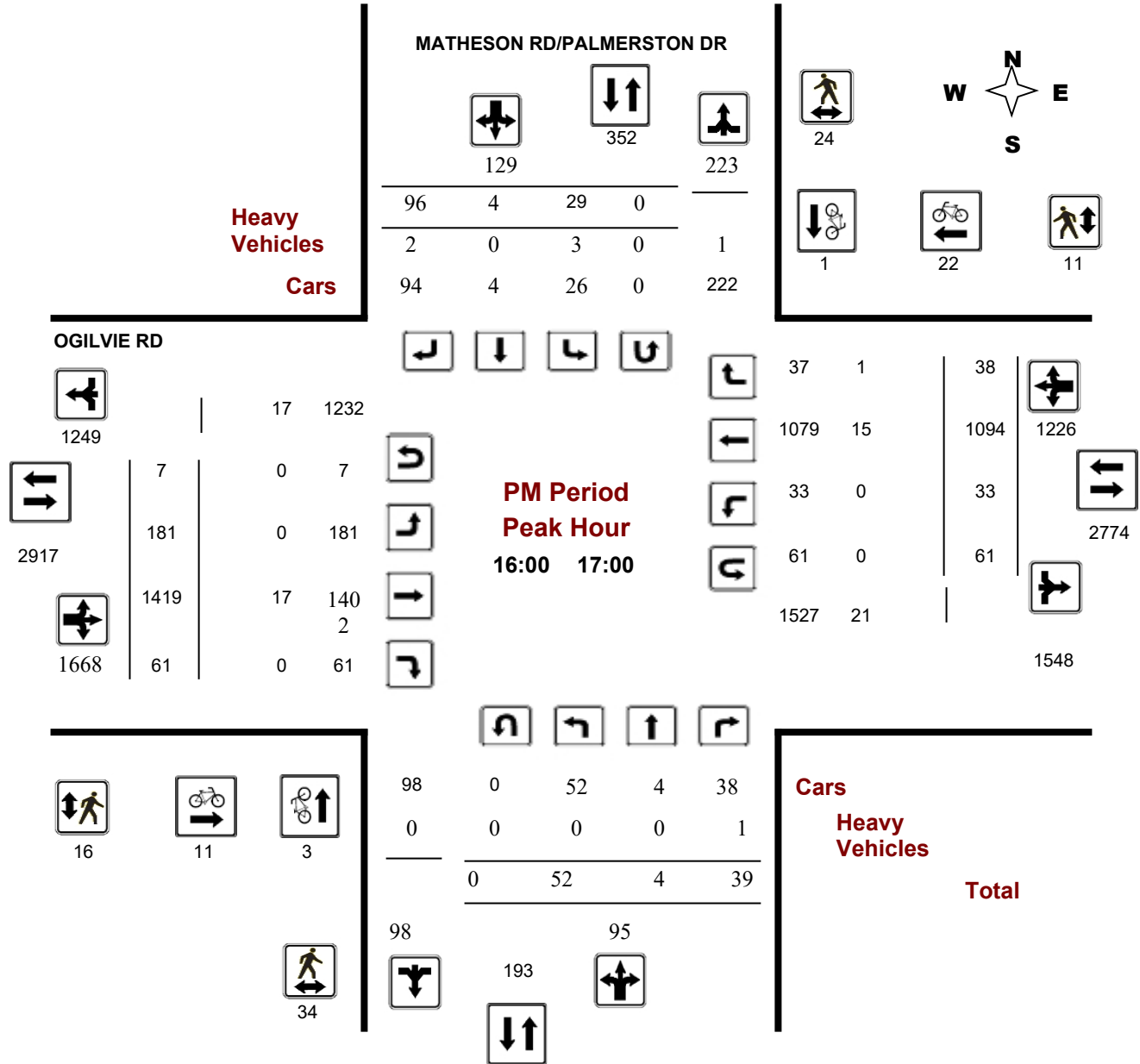

Turning Movement Count - Peak Hour Diagram

BLAIR RD @ REGIONAL RD 174 S/OR174 IC112 RAMP15

Survey Date: Tuesday, April 11, 2017

Start Time: 07:00

WO No: 36893

Device: Miovision

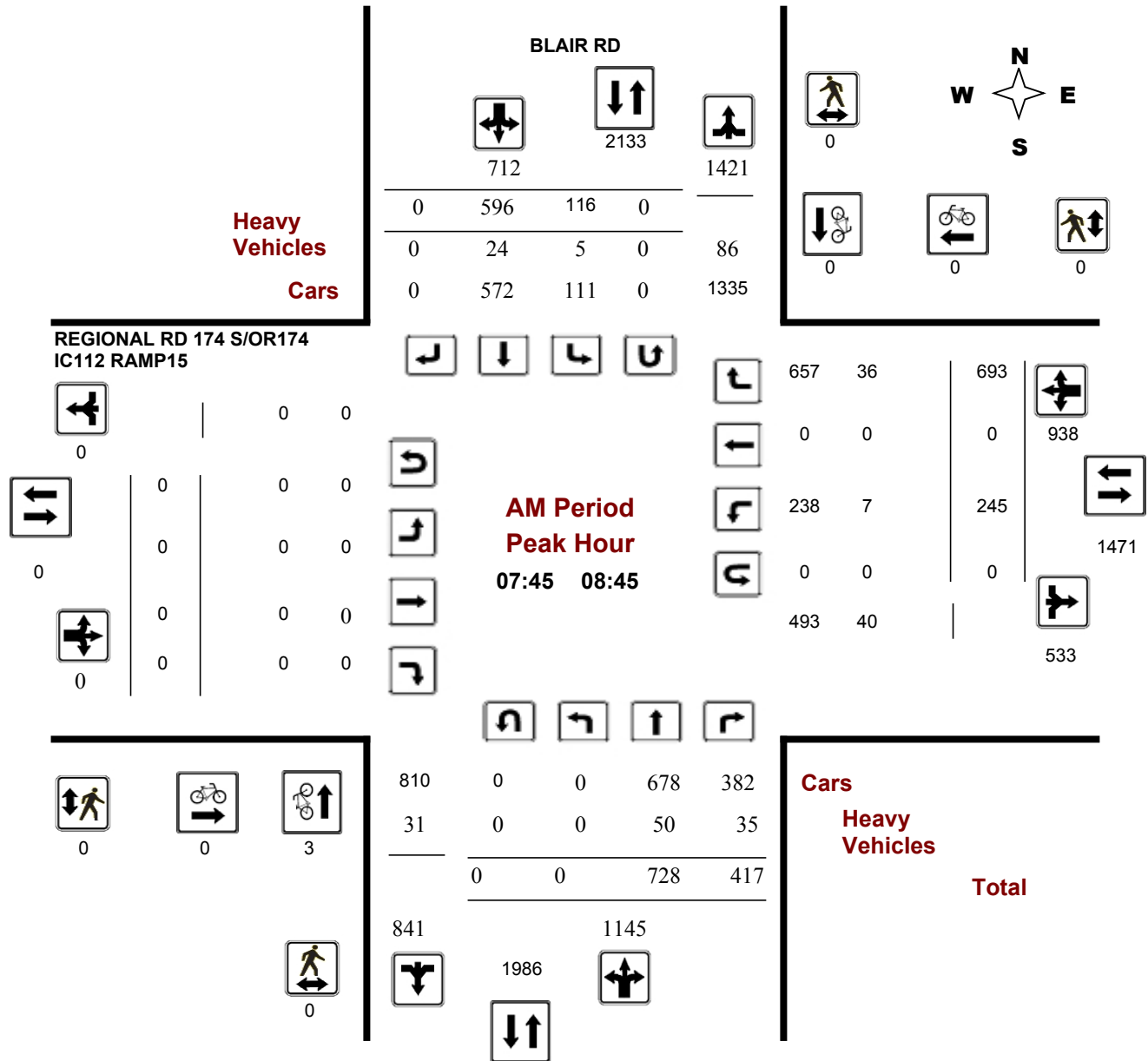

Comments

Turning Movement Count - Peak Hour Diagram

BLAIR RD @ REGIONAL RD 174 S/OR174 IC112 RAMP15

Survey Date: Tuesday, April 11, 2017

Start Time: 07:00

WO No: 36893

Device: Miovision

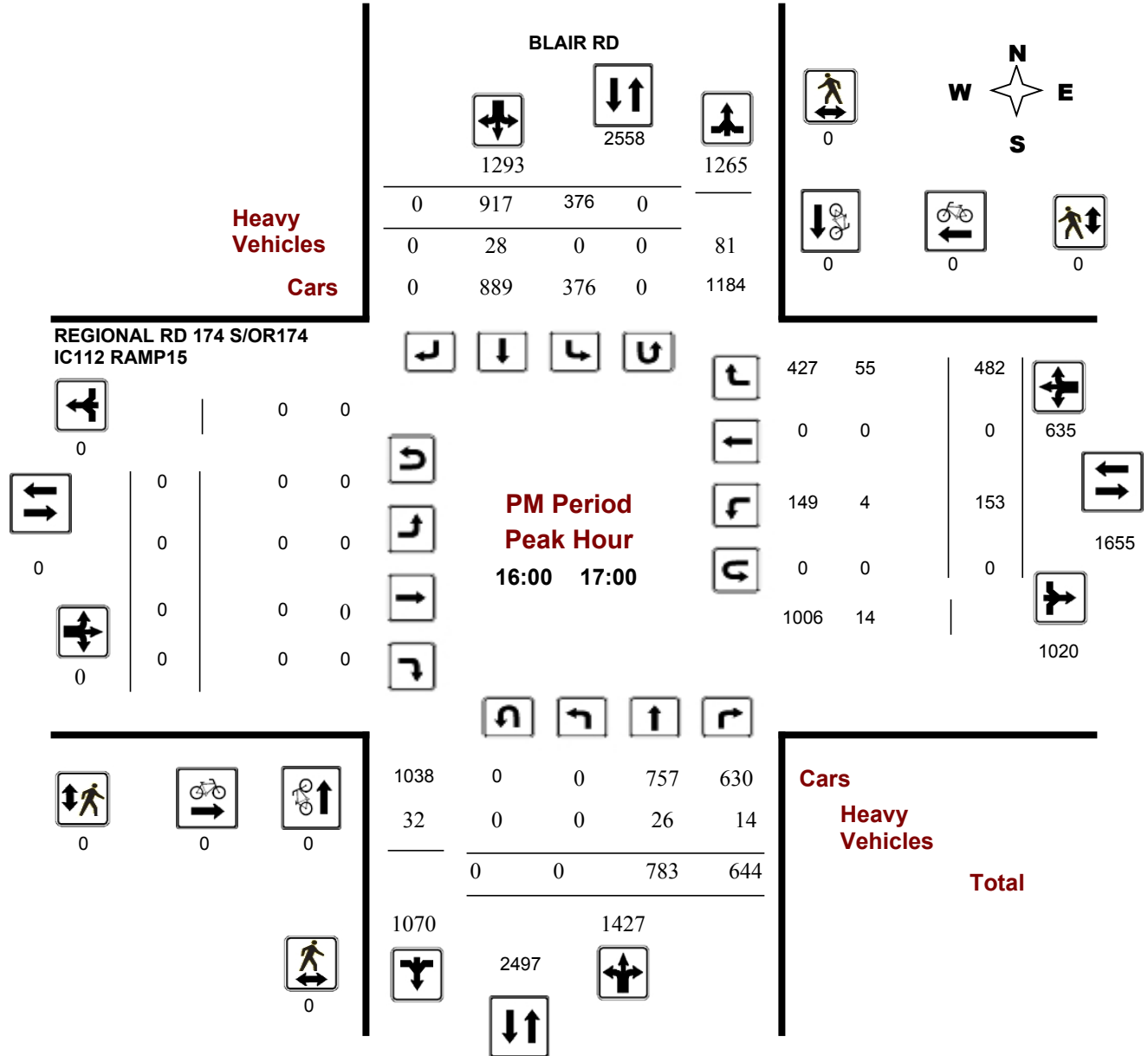



Turning Movement Count Summary, AM and PM Peak Hour Flow Diagrams All Vehicles Except Bicycles



Blair Road & Ottawa Road 174 E/B Off Ramps

Gloucester, ON

All Vehicles
(Except Bicycles & Electric Scooters)

Wednesday, March 22, 2023

0700-1000, 1130-1330 & 1500-1800

8 Hour Survey

City of Ottawa Ward ► 11

Ottawa Rd. 174 E/B Off

Total vehicle volume,
all approaches.
(A + C + D)

RIGHT TURN RAMP.
Includes 10 vehicles turning
from traffic signal.

19259

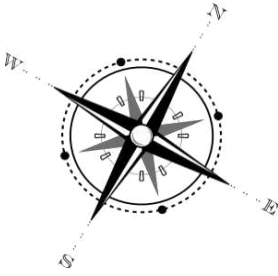

All Pedestrian Crossings

0	0
0	0
No Pedestrian Crossings Observed	
0	0
Total	
0	0

AM Peak Hour Flow Diagram

PM Peak Hour Flow Diagram

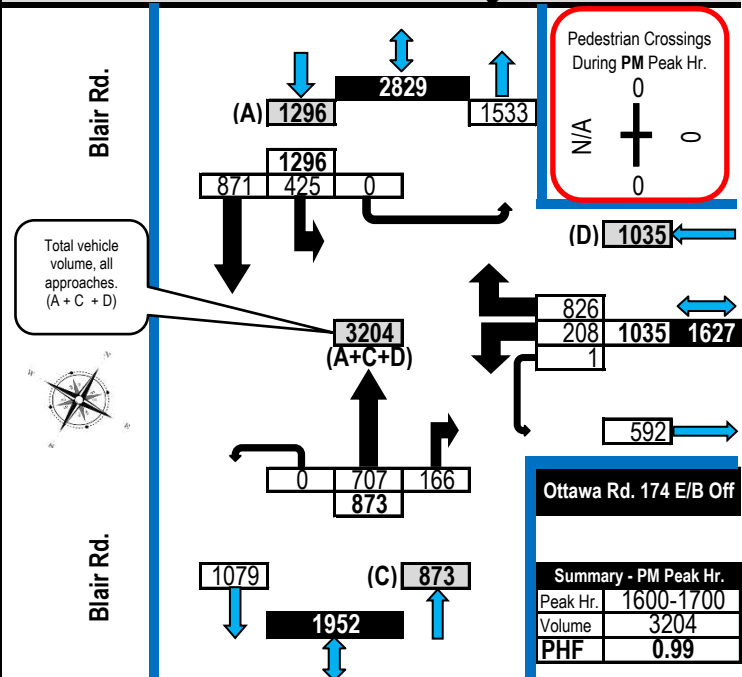
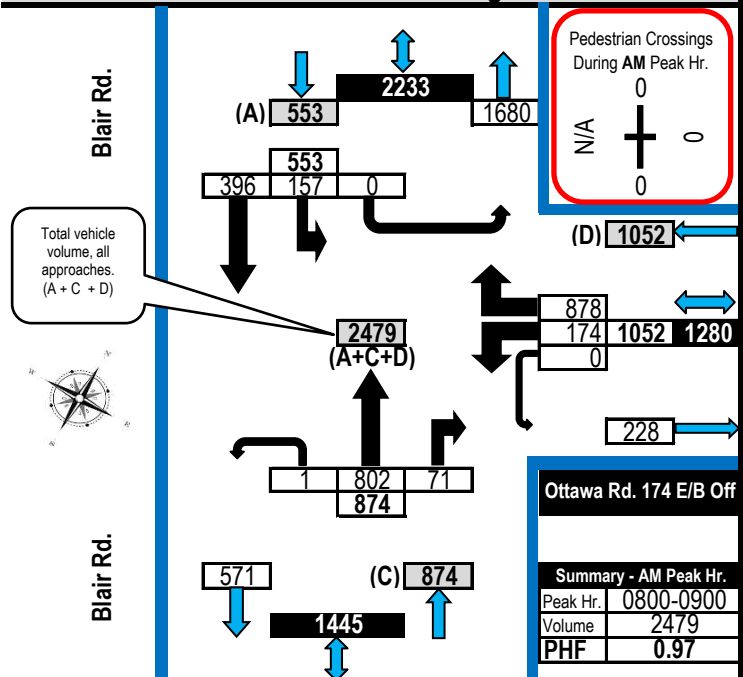

Summary - AM Peak Hr.

Peak Hr.	0800-0900
Volume	2479
PHF	0.97

Summary - PM Peak Hr.

Peak Hr.	1600-1700
Volume	3204
PHF	0.99

Turning Movement Count - Peak Hour Diagram

BLAIR RD @ OGILVIE RD

Survey Date: Wednesday, April 24, 2019

Start Time: 07:00

WO No: 38576

Device: Miovision

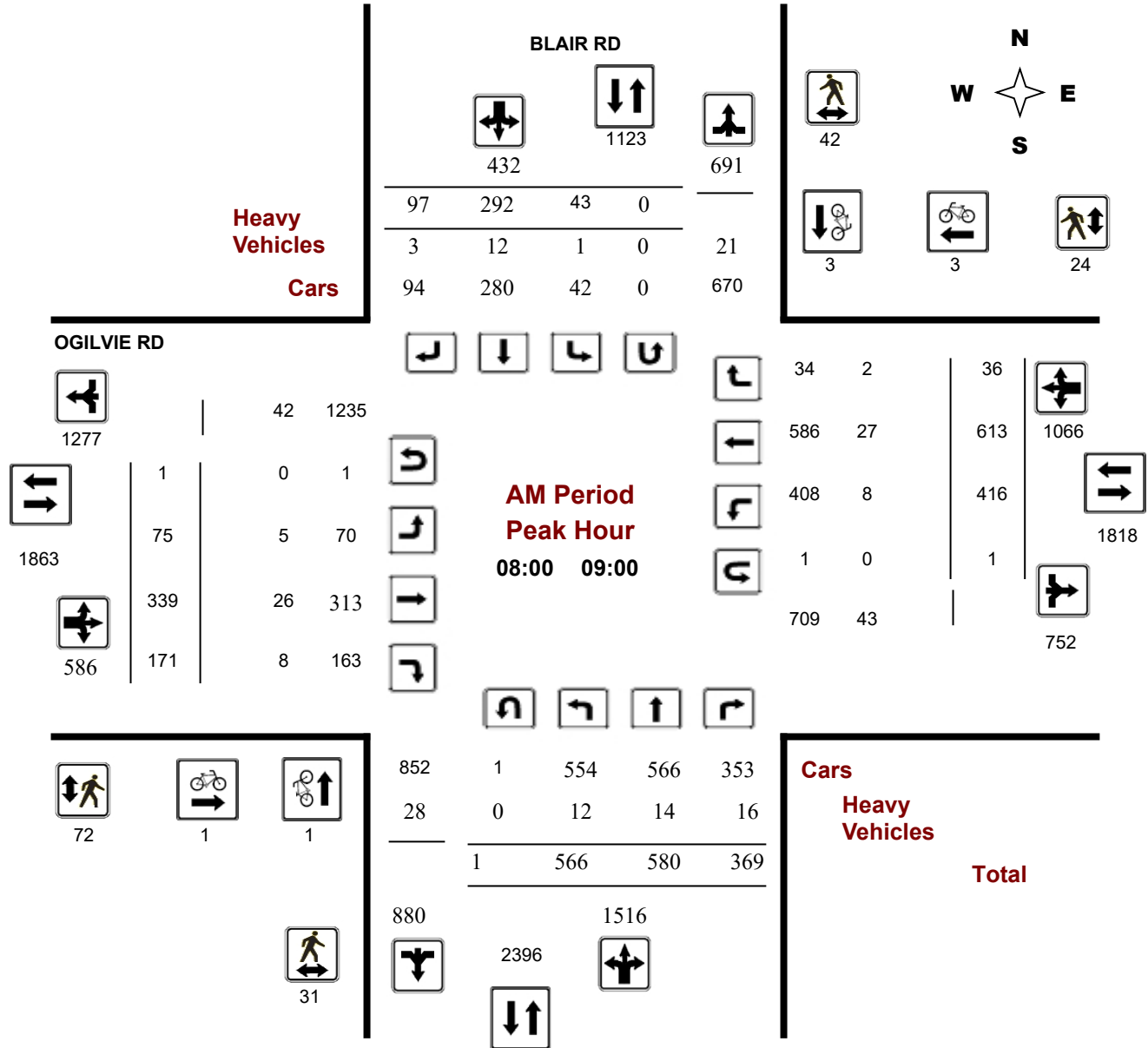

Turning Movement Count - Peak Hour Diagram

BLAIR RD @ OGILVIE RD

Survey Date: Wednesday, April 24, 2019

Start Time: 07:00

WO No: 38576

Device: Miovision

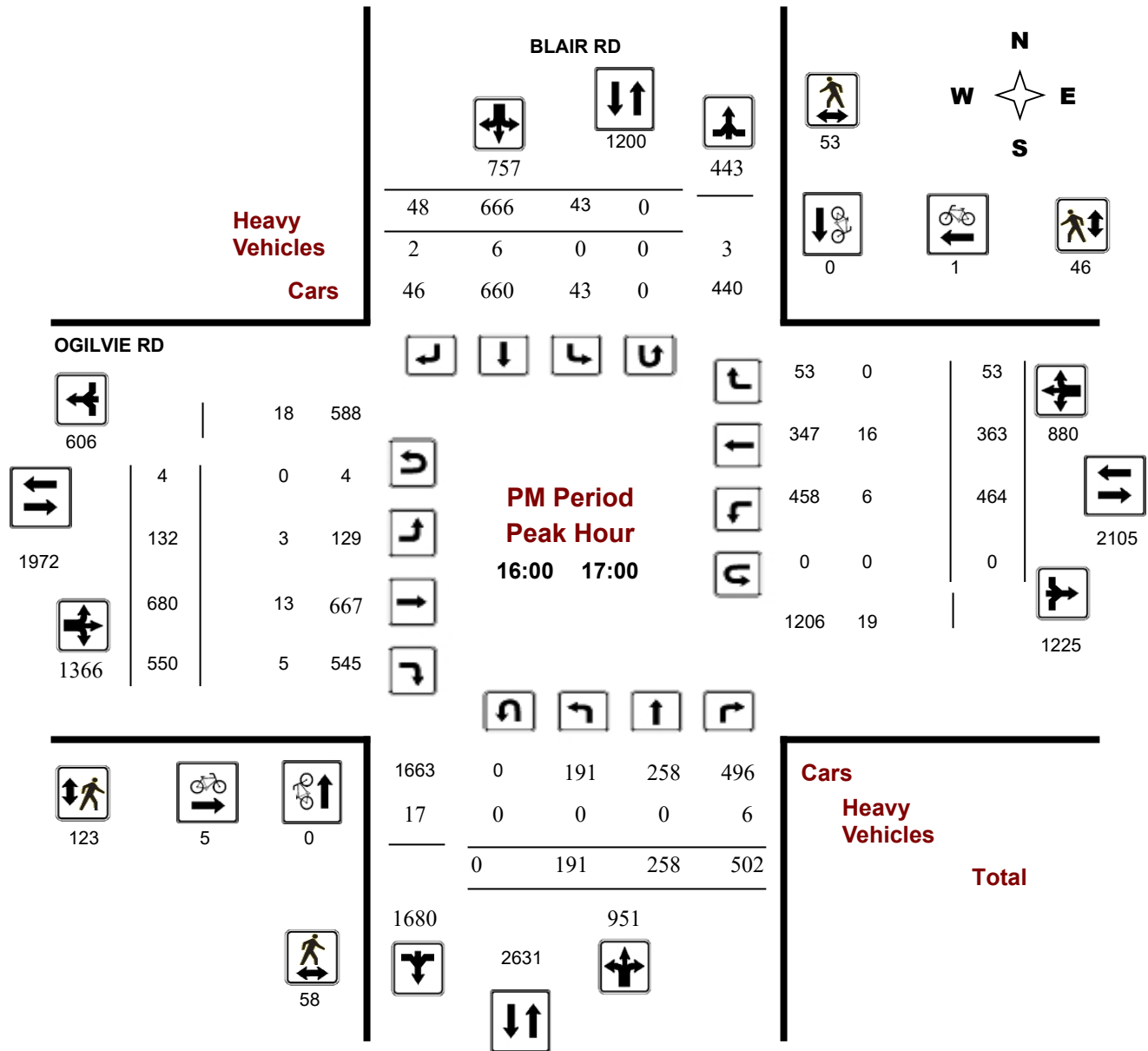

Comments

Turning Movement Count - Peak Hour Diagram

BLAIR RD @ REGIONAL RD 174 N/OR174 IC112 RAMP61

Survey Date: Wednesday, January 09, 2019

Start Time: 07:00

WO No: 38232

Device: Miovision

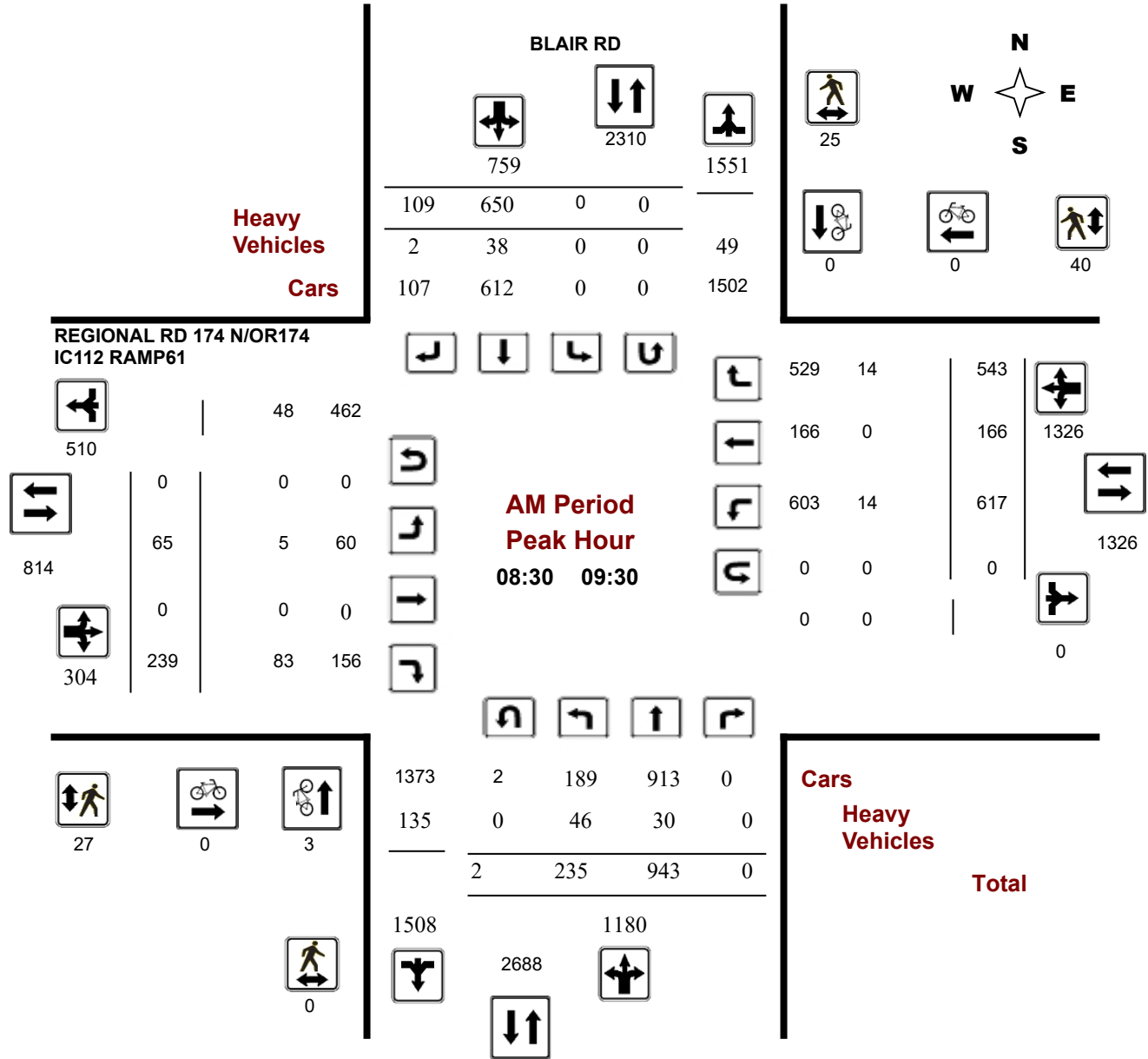

Comments

Turning Movement Count - Peak Hour Diagram

BLAIR RD @ REGIONAL RD 174 N/OR174 IC112 RAMP61

Survey Date: Wednesday, January 09, 2019

Start Time: 07:00

WO No: 38232

Device: Miovision

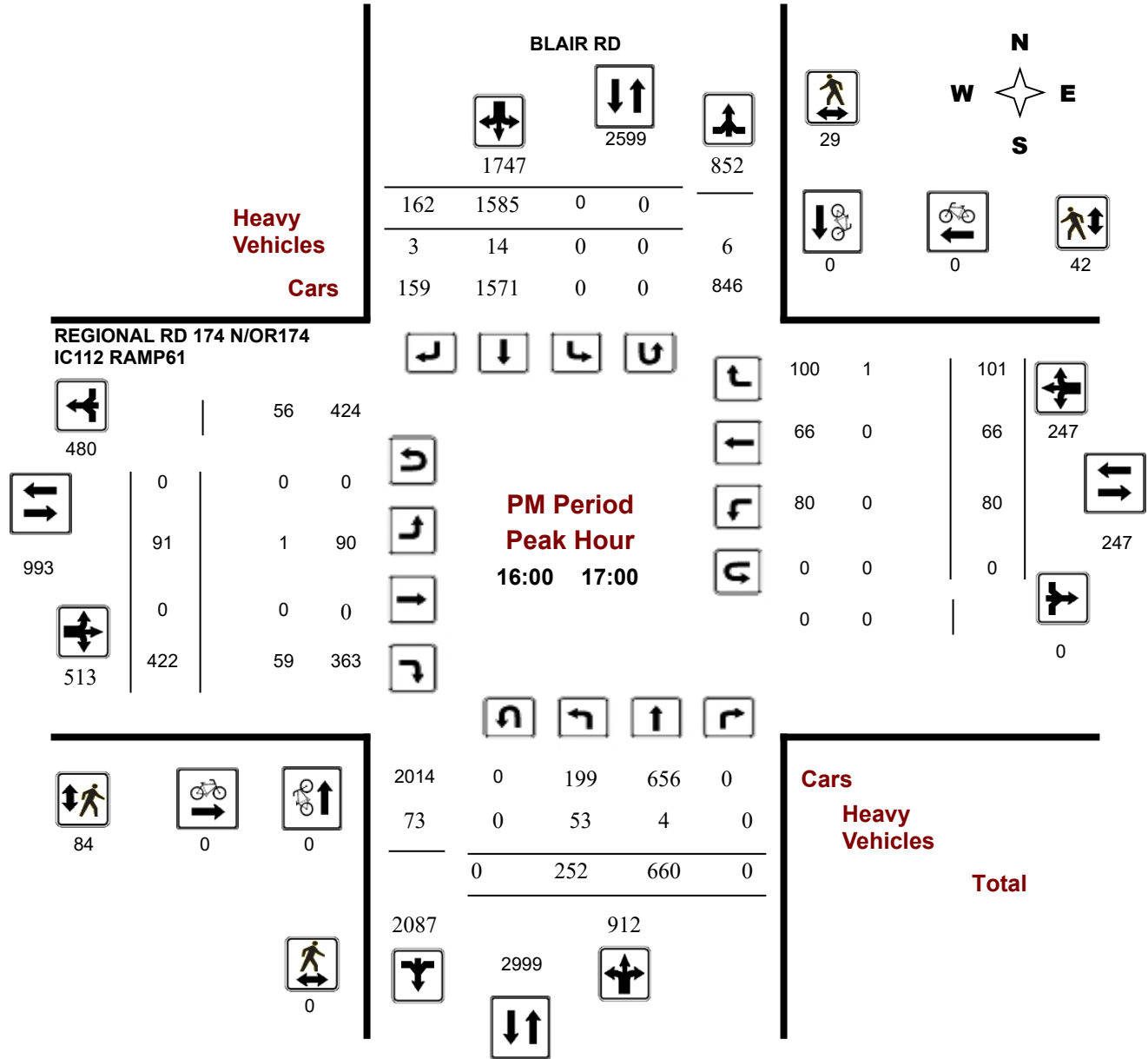

Comments



Turning Movement Count Summary, AM and PM Peak Hour Flow Diagrams



All Vehicles Except Bicycles

Blair Road & Ottawa Road 174 W/B Off Ramp Gloucester, ON

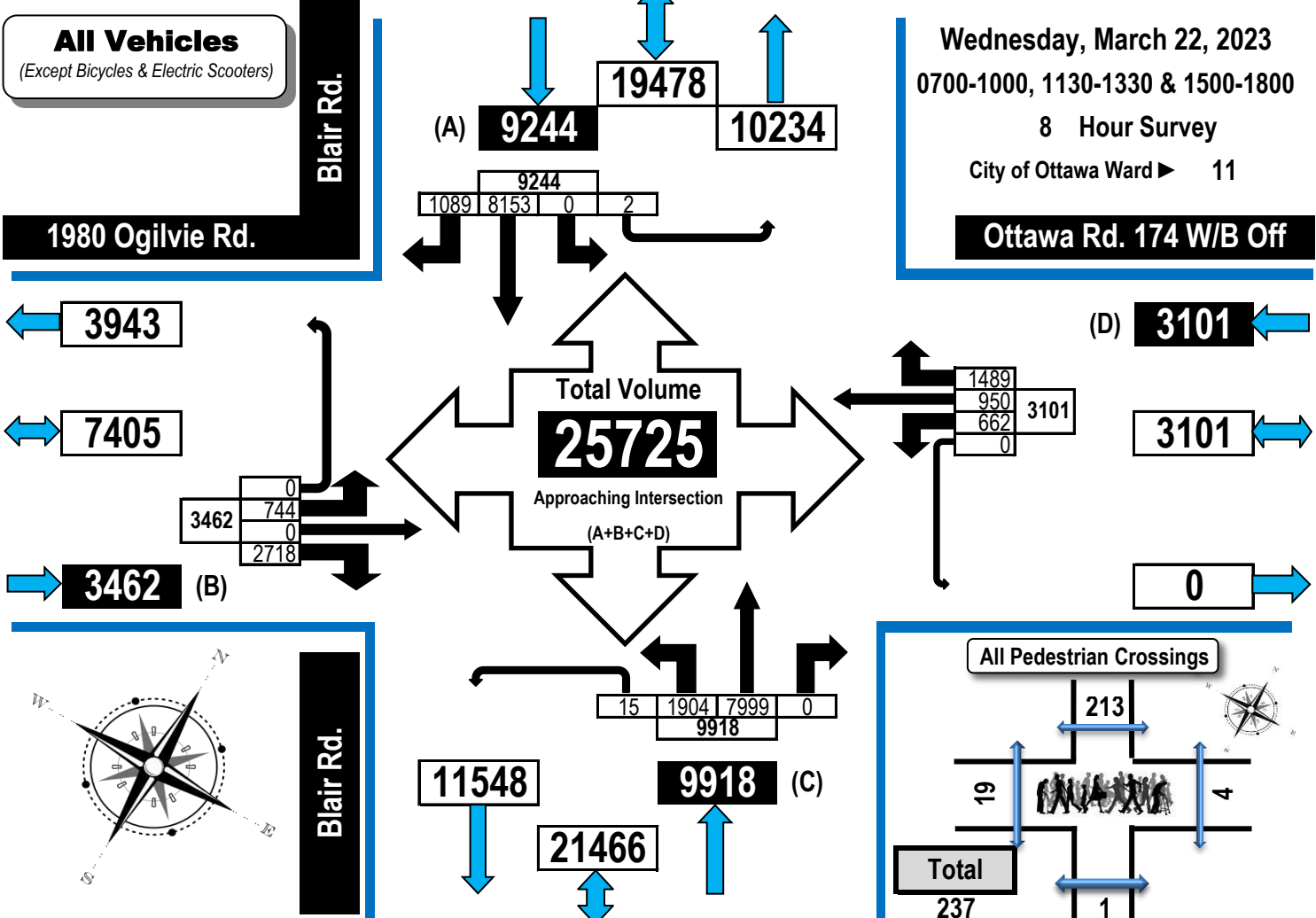

AM Peak Hour Flow Diagram PM Peak Hour Flow Diagram

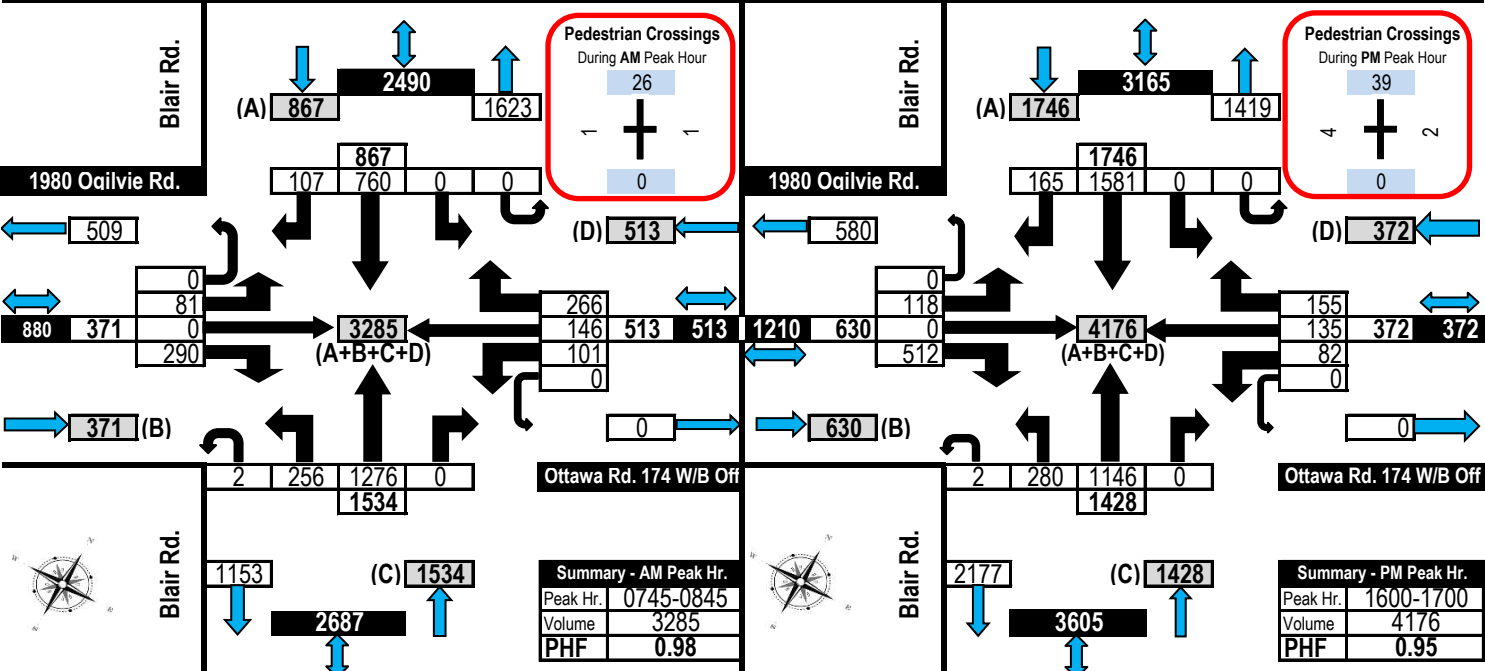

Turning Movement Count - Peak Hour Diagram

OGILVIE RD @ 185 E OF BATHGATE DR/185 E OF CIT

Survey Date: Wednesday, January 16, 2019

Start Time: 07:00

WO No: 38348

Device: Miovision

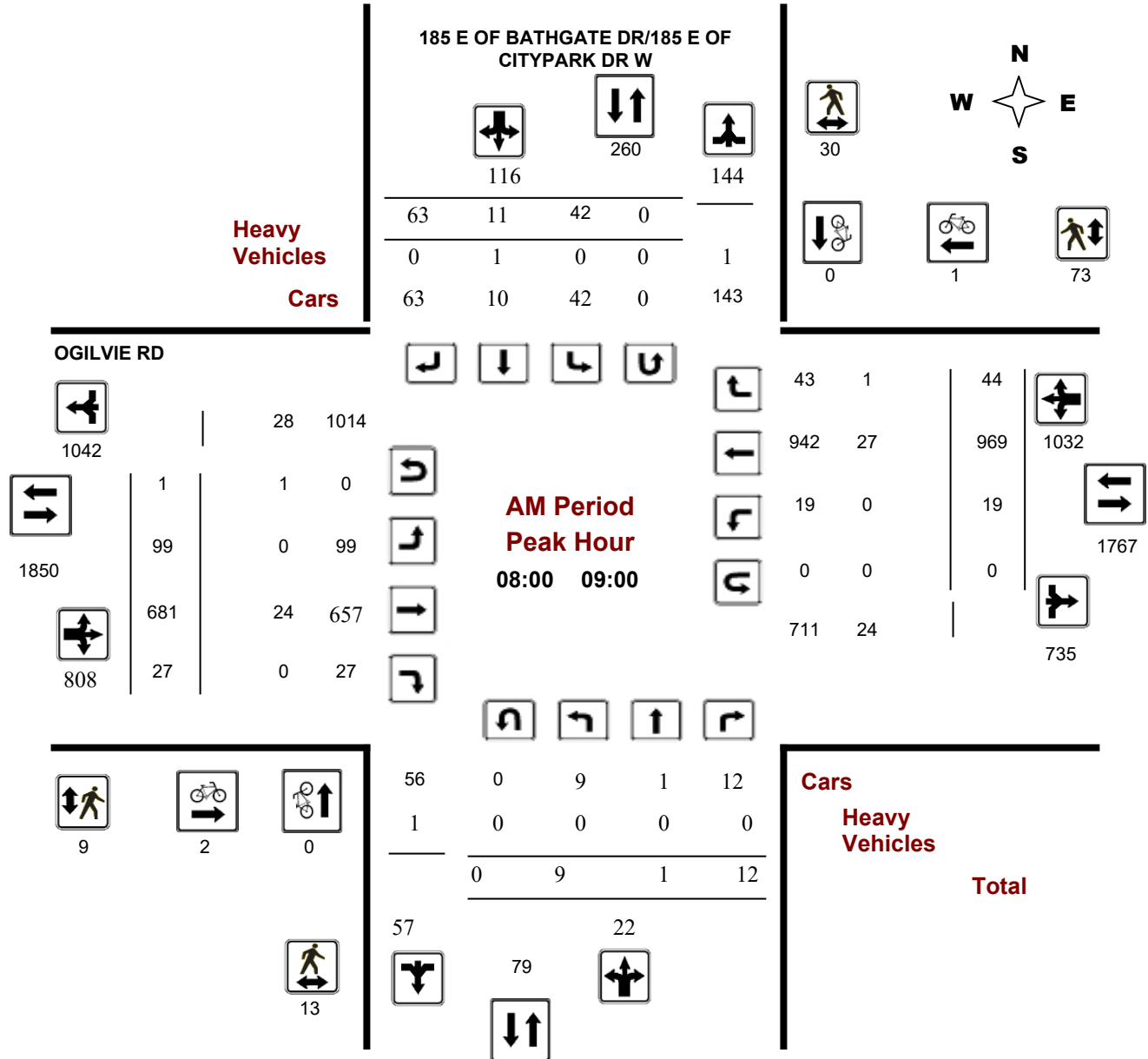

Turning Movement Count - Peak Hour Diagram

OGILVIE RD @ 185 E OF BATHGATE DR/185 E OF CIT

Survey Date: Wednesday, January 16, 2019

Start Time: 07:00

WO No: 38348

Device: Miovision

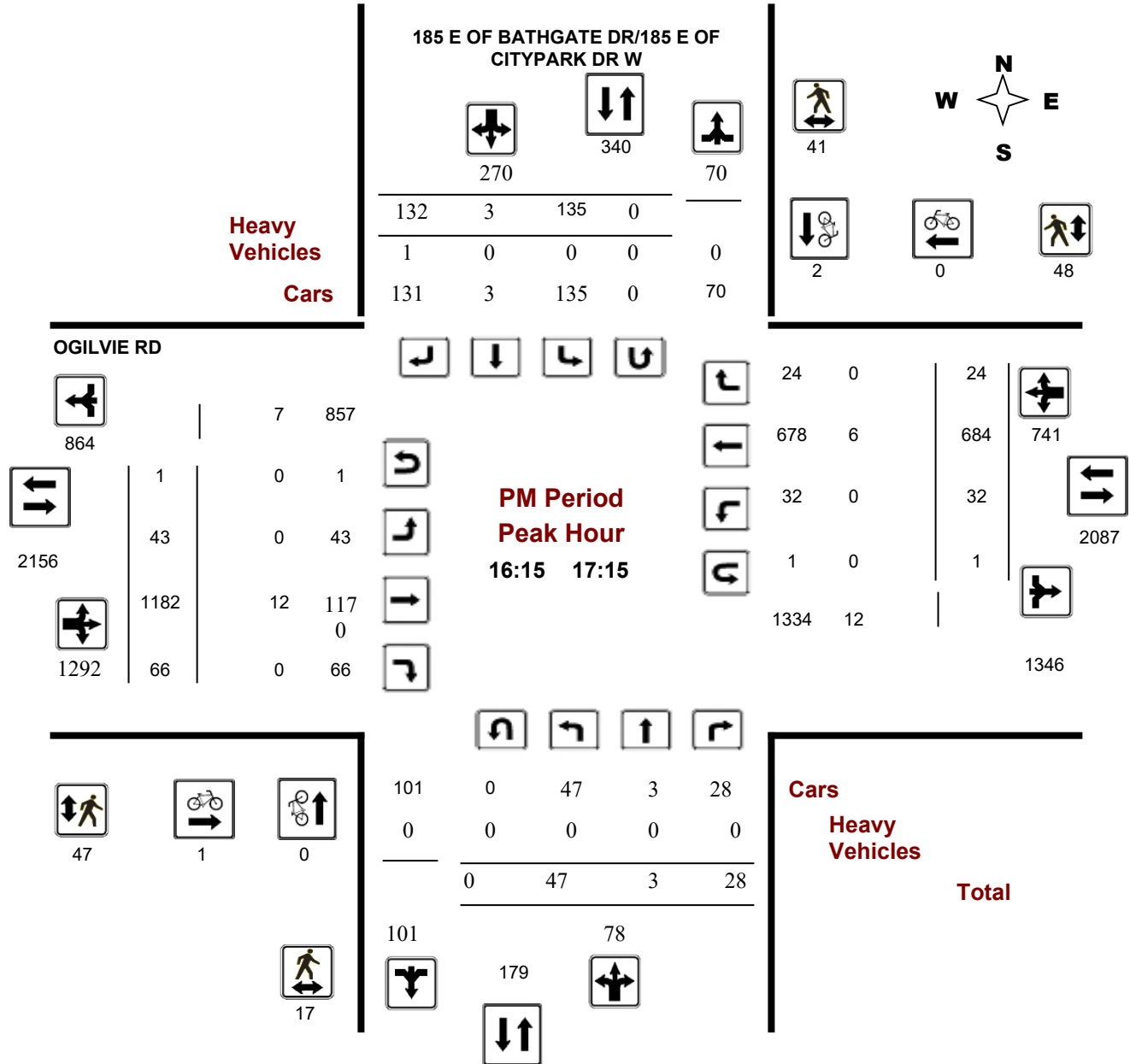

Comments



Transportation Services - Traffic Services

Turning Movement Count - Peak Hour Diagram

OGILVIE RD @ BATHGATE DR/CITYPARK DR W

Survey Date: Monday, February 10, 2020

Start Time: 07:00

WO No: 39454

Device: Miovision

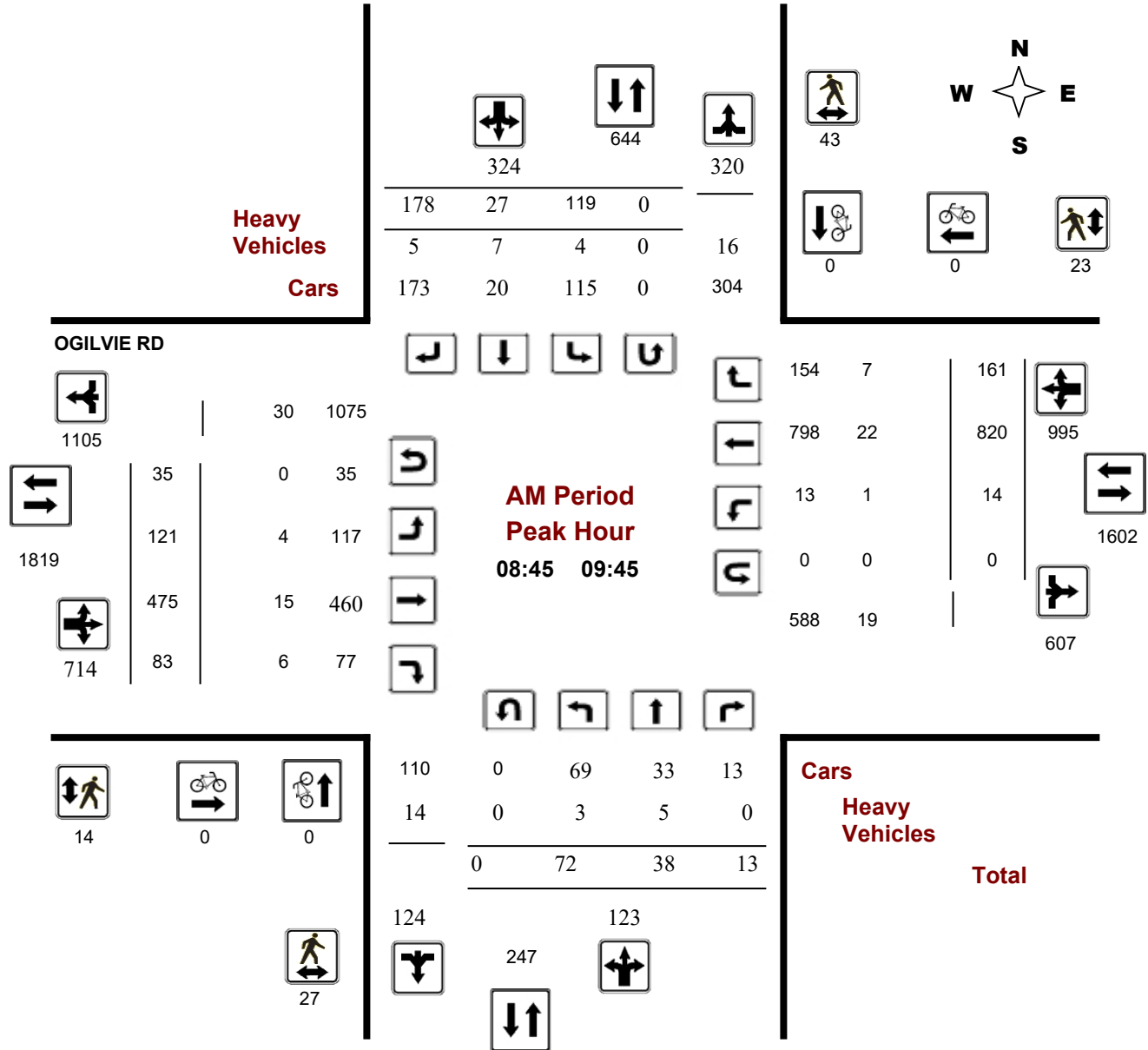

Comments



Transportation Services - Traffic Services

Turning Movement Count - Peak Hour Diagram

OGILVIE RD @ BATHGATE DR/CITYPARK DR W

Survey Date: Monday, February 10, 2020

Start Time: 07:00

WO No: 39454

Device: Miovision

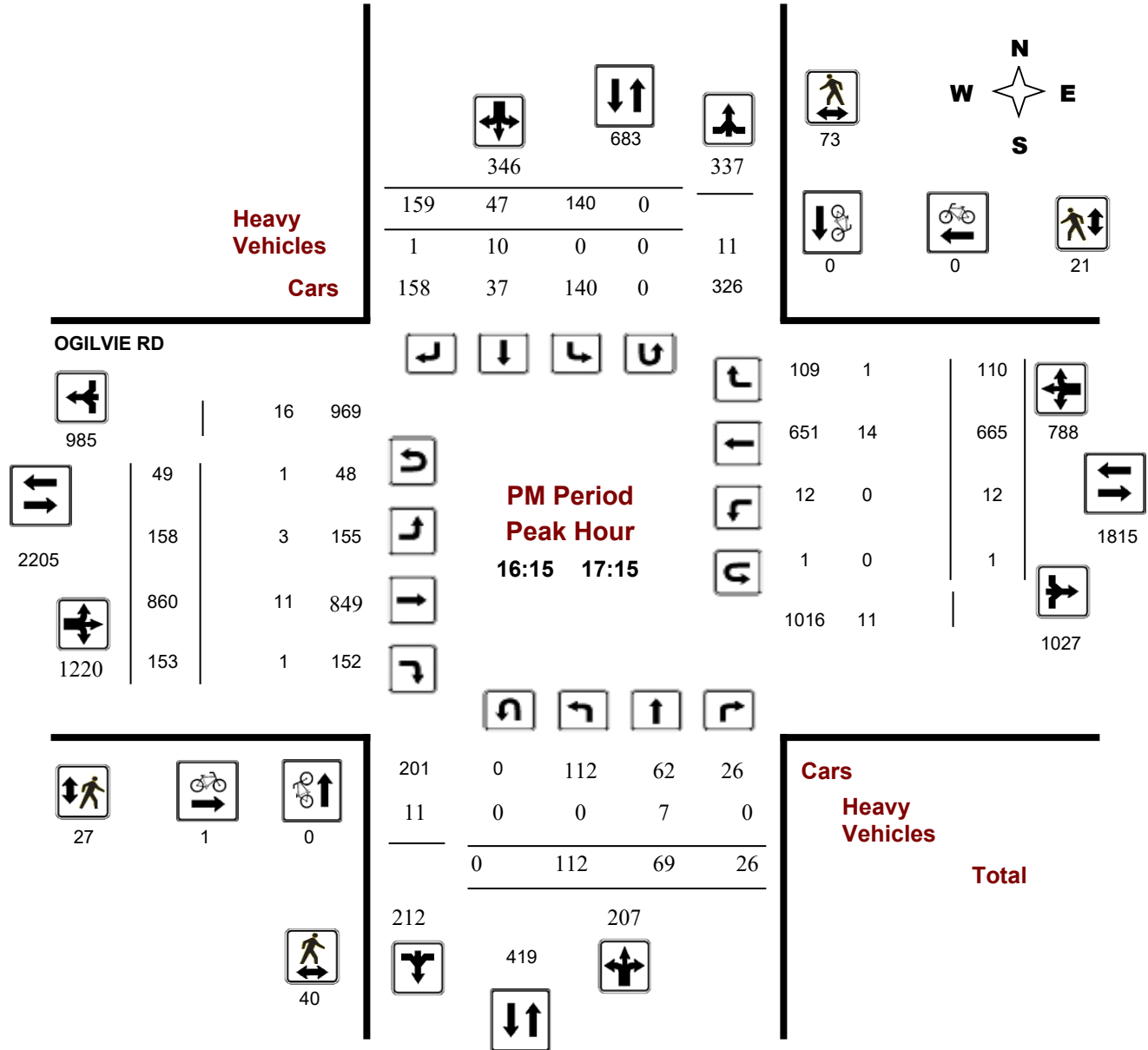

Turning Movement Count - Peak Hour Diagram

OGILVIE RD @ CITY PARK DR E/CSIS HQ ACCESS

Survey Date: Wednesday, January 09, 2019

Start Time: 07:00

WO No: 38237

Device: Miovision

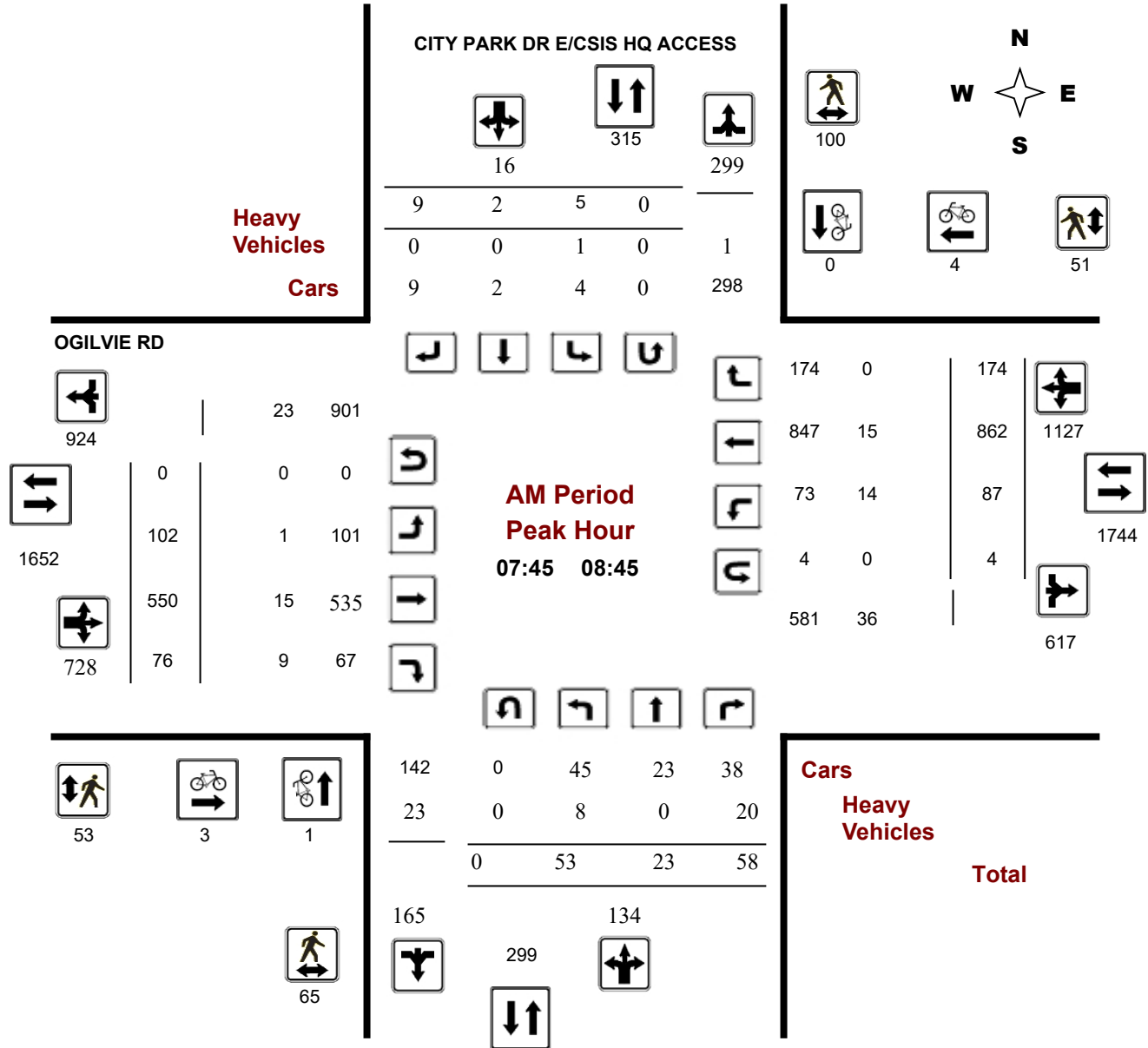

Turning Movement Count - Peak Hour Diagram

OGILVIE RD @ CITY PARK DR E/CSIS HQ ACCESS

Survey Date: Wednesday, January 09, 2019

Start Time: 07:00

WO No: 38237

Device: Miovision

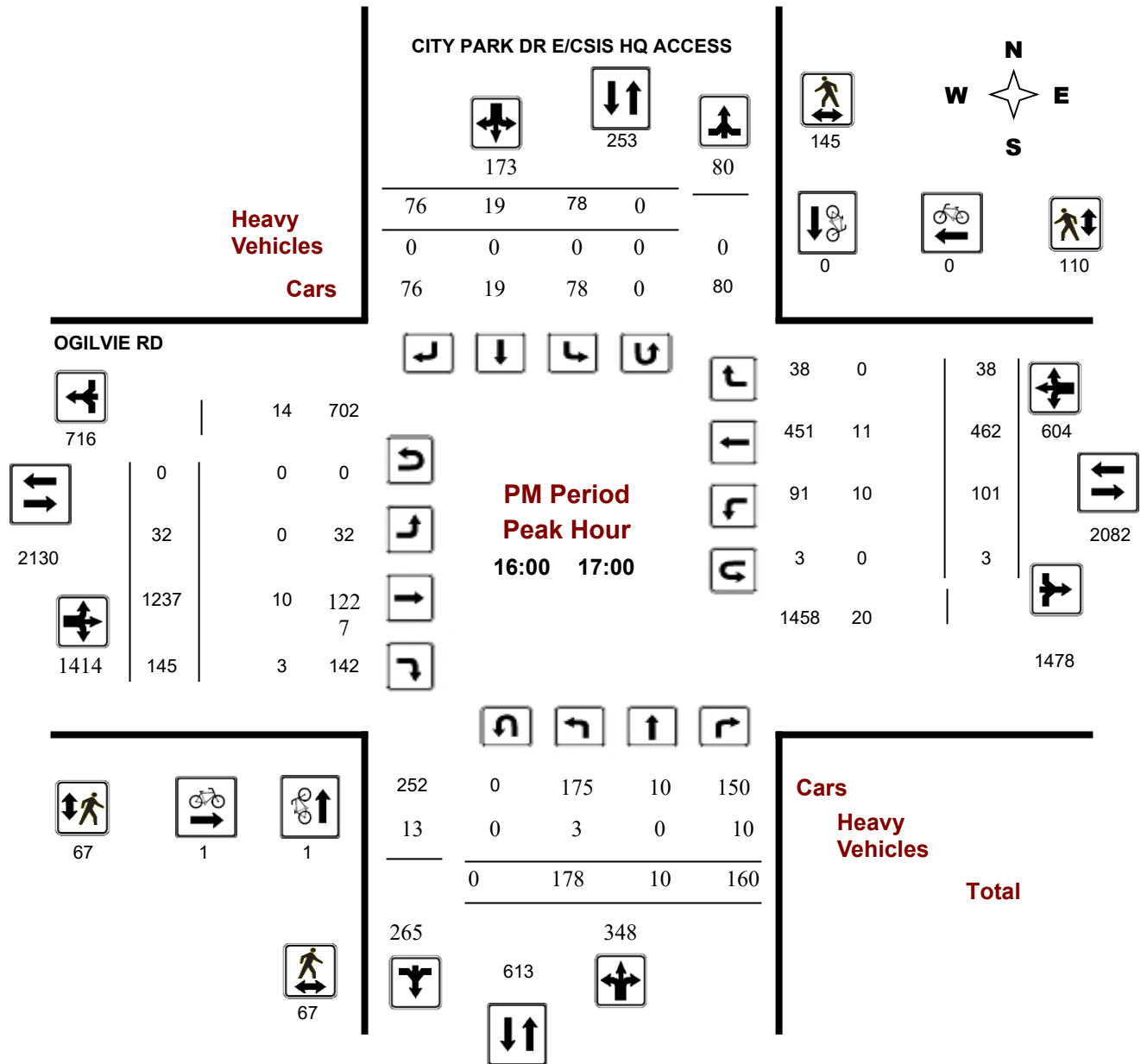

Comments

APPENDIX E

Collision Records



Transportation Services - Traffic Services

Collision Details Report - Public Version

From: January 1, 2016 To: December 31, 2020

Location: AMBASSADOR AVE @ CITY PARK DR

Traffic Control: Stop sign

Total Collisions: 2

Date/Day/Time	Environment	Impact Type	Classification	Surface Cond'n	Veh. Dir	Vehicle Manoeuvre	Vehicle type	First Event	No. Ped
2017-Nov-02, Thu,18:56	Rain	Angle	P.D. only	Wet	North	Turning left	Automobile, station wagon	Other motor vehicle	0
					West	Turning left	Automobile, station wagon	Other motor vehicle	
2018-Oct-31, Wed,17:11	Rain	Rear end	Non-fatal injury	Wet	South	Going ahead	Automobile, station wagon	Other motor vehicle	0
					South	Stopped	Automobile, station wagon	Other motor vehicle	

Location: BLAIR RD @ OGILVIE RD

Traffic Control: Traffic signal

Total Collisions: 84

Date/Day/Time	Environment	Impact Type	Classification	Surface Cond'n	Veh. Dir	Vehicle Manoeuvre	Vehicle type	First Event	No. Ped
2016-Jan-12, Tue,18:26	Clear	Rear end	P.D. only	Wet	East	Slowing or stopping	Automobile, station wagon	Other motor vehicle	0
					East	Stopped	Pick-up truck	Other motor vehicle	
2016-Feb-07, Sun,13:34	Clear	Rear end	P.D. only	Dry	North	Going ahead	Automobile, station wagon	Other motor vehicle	0
					North	Stopped	Passenger van	Other motor vehicle	
2016-Feb-12, Fri,17:15	Snow	Rear end	P.D. only	Loose snow	South	Unknown	Unknown	Other motor vehicle	0
					South	Stopped	Pick-up truck	Other motor vehicle	
2016-May-03, Tue,08:59	Clear	Rear end	P.D. only	Dry	South	Going ahead	Automobile, station wagon	Other motor vehicle	0
					South	Slowing or stopping	Automobile, station wagon	Other motor vehicle	
2016-May-12, Thu,16:34	Clear	Sideswipe	P.D. only	Dry	East	Turning left	Automobile, station wagon	Other motor vehicle	0
					East	Turning left	Automobile, station wagon	Other motor vehicle	
2016-Jun-09, Thu,06:35	Clear	SMV other	Non-fatal injury	Dry	South	Turning left	Motorcycle	Skidding/sliding	0
2016-Jul-22, Fri,14:29	Clear	Rear end	P.D. only	Dry	North	Going ahead	Automobile, station wagon	Other motor vehicle	0
					North	Stopped	Pick-up truck	Other motor vehicle	
2016-Aug-02, Tue,21:37	Clear	Rear end	P.D. only	Dry	South	Going ahead	Automobile, station wagon	Other motor vehicle	0
					South	Stopped	Pick-up truck	Other motor vehicle	



Transportation Services - Traffic Services

Collision Details Report - Public Version

From: January 1, 2016 To: December 31, 2020

Location: BLAIR RD @ OGILVIE RD

Traffic Control: Traffic signal

Total Collisions: 84

Date/Day/Time	Environment	Impact Type	Classification	Surface Cond'n	Veh. Dir	Vehicle Manoeuvre	Vehicle type	First Event	No. Ped
2016-Aug-12, Fri,16:16	Clear	Rear end	P.D. only	Wet	North	Going ahead	Automobile, station wagon	Other motor vehicle	0
					North	Stopped	Pick-up truck	Other motor vehicle	
					North	Stopped	Automobile, station wagon	Other motor vehicle	
2016-Sep-10, Sat,17:02	Clear	Rear end	P.D. only	Dry	South	Turning right	Automobile, station wagon	Other motor vehicle	0
					South	Turning right	Automobile, station wagon	Other motor vehicle	
2016-Sep-19, Mon,07:32	Clear	Rear end	P.D. only	Dry	North	Going ahead	Unknown	Other motor vehicle	0
					North	Stopped	Automobile, station wagon	Other motor vehicle	
2016-Dec-14, Wed,14:25	Clear	Rear end	P.D. only	Slush	South	Turning right	Automobile, station wagon	Other motor vehicle	0
					South	Turning right	Automobile, station wagon	Other motor vehicle	
2017-Jan-06, Fri,15:05	Clear	Sideswipe	P.D. only	Loose snow	South	Overtaking	Delivery van	Other motor vehicle	0
					South	Going ahead	Pick-up truck	Other motor vehicle	
2017-Jan-19, Thu,17:36	Clear	Rear end	P.D. only	Wet	West	Turning left	Automobile, station wagon	Other motor vehicle	0
					West	Turning left	Automobile, station wagon	Other motor vehicle	
2017-Feb-02, Thu,17:08	Clear	Rear end	P.D. only	Dry	East	Going ahead	Pick-up truck	Other motor vehicle	0
					East	Stopped	Automobile, station wagon	Other motor vehicle	
2017-Apr-04, Tue,11:34	Rain	Sideswipe	P.D. only	Wet	West	Overtaking	Automobile, station wagon	Other motor vehicle	0
					West	Turning left	Pick-up truck	Other motor vehicle	
2017-May-23, Tue,09:02	Clear	Rear end	Non-fatal injury	Dry	East	Going ahead	Automobile, station wagon	Other motor vehicle	0
					East	Stopped	Automobile, station wagon	Other motor vehicle	
					East	Stopped	Automobile, station wagon	Other motor vehicle	
					East	Stopped	Municipal transit bus	Other motor vehicle	
2017-Aug-17, Thu,21:39	Rain	Rear end	P.D. only	Wet	East	Going ahead	Automobile, station wagon	Other motor vehicle	0
					East	Stopped	Automobile, station wagon	Other motor vehicle	



Transportation Services - Traffic Services

Collision Details Report - Public Version

From: January 1, 2016 To: December 31, 2020

Location: BLAIR RD @ OGILVIE RD

Traffic Control: Traffic signal

Total Collisions: 84

Date/Day/Time	Environment	Impact Type	Classification	Surface Cond'n	Veh. Dir	Vehicle Manoeuver	Vehicle type	First Event	No. Ped
2017-Sep-04, Mon,15:05	Clear	Rear end	P.D. only	Dry	East	Going ahead	Automobile, station wagon	Other motor vehicle	0
					East	Going ahead	Automobile, station wagon	Other motor vehicle	
2017-Sep-06, Wed,11:09	Clear	Rear end	P.D. only	Dry	South	Going ahead	Automobile, station wagon	Other motor vehicle	0
					South	Stopped	Automobile, station wagon	Other motor vehicle	
2017-Sep-17, Sun,11:30	Clear	Rear end	P.D. only	Dry	South	Going ahead	Automobile, station wagon	Other motor vehicle	0
					South	Stopped	Automobile, station wagon	Other motor vehicle	
2017-Oct-04, Wed,13:16	Clear	Other	P.D. only	Dry	West	Reversing	Automobile, station wagon	Other motor vehicle	0
					East	Turning left	Automobile, station wagon	Other motor vehicle	
2017-Oct-27, Fri,11:57	Clear	Rear end	P.D. only	Dry	North	Going ahead	Automobile, station wagon	Other motor vehicle	0
					North	Stopped	Automobile, station wagon	Other motor vehicle	
2017-Oct-30, Mon,09:29	Rain	Rear end	P.D. only	Wet	North	Going ahead	Pick-up truck	Other motor vehicle	0
					North	Stopped	Tow truck	Other motor vehicle	
2017-Nov-21, Tue,15:59	Clear	Sideswipe	P.D. only	Dry	West	Turning left	Passenger van	Other motor vehicle	0
					West	Turning left	Automobile, station wagon	Other motor vehicle	
2017-Nov-29, Wed,08:56	Clear	Rear end	P.D. only	Wet	West	Turning right	Automobile, station wagon	Other motor vehicle	0
					West	Turning right	Automobile, station wagon	Other motor vehicle	
					West	Turning right	Automobile, station wagon	Other motor vehicle	
2017-Dec-05, Tue,20:15	Rain	Rear end	P.D. only	Wet	South	Going ahead	Automobile, station wagon	Other motor vehicle	0
					South	Stopped	Automobile, station wagon	Other motor vehicle	
2017-Dec-14, Thu,02:40	Clear	Sideswipe	P.D. only	Dry	South	Unknown	Unknown	Other motor vehicle	0
					South	Stopped	Automobile, station wagon	Other motor vehicle	
2017-Dec-23, Sat,14:16	Snow	Rear end	P.D. only	Loose snow	North	Slowing or stopping	Automobile, station wagon	Other motor vehicle	0
					North	Stopped	Automobile, station wagon	Other motor vehicle	



Transportation Services - Traffic Services

Collision Details Report - Public Version

From: January 1, 2016 To: December 31, 2020

Location: BLAIR RD @ OGILVIE RD

Traffic Control: Traffic signal

Total Collisions: 84

Date/Day/Time	Environment	Impact Type	Classification	Surface Cond'n	Veh. Dir	Vehicle Manoeuvre	Vehicle type	First Event	No. Ped
2017-Dec-31, Sun,12:59	Clear	Rear end	P.D. only	Dry	West	Slowing or stopping	Automobile, station wagon	Other motor vehicle	0
					West	Stopped	Automobile, station wagon	Other motor vehicle	
2018-Jan-14, Sun,17:28	Clear	Rear end	P.D. only	Dry	West	Slowing or stopping	Automobile, station wagon	Other motor vehicle	0
					West	Stopped	Automobile, station wagon	Other motor vehicle	
2018-Jan-16, Tue,09:04	Snow	Rear end	P.D. only	Ice	South	Slowing or stopping	Automobile, station wagon	Other motor vehicle	0
					South	Stopped	Automobile, station wagon	Other motor vehicle	
2018-Feb-26, Mon,07:41	Clear	Rear end	P.D. only	Dry	North	Going ahead	Automobile, station wagon	Other motor vehicle	0
					North	Turning left	Automobile, station wagon	Other motor vehicle	
2018-Mar-01, Thu,12:34	Clear	Rear end	P.D. only	Dry	West	Going ahead	Automobile, station wagon	Other motor vehicle	0
					West	Stopped	Automobile, station wagon	Other motor vehicle	
2018-Mar-08, Thu,18:34	Snow	Rear end	P.D. only	Wet	West	Changing lanes	Automobile, station wagon	Other motor vehicle	0
					West	Stopped	Automobile, station wagon	Other motor vehicle	
2018-Mar-27, Tue,20:10	Rain	Rear end	P.D. only	Wet	West	Unknown	Passenger van	Other motor vehicle	0
					West	Stopped	Automobile, station wagon	Other motor vehicle	
2018-Apr-12, Thu,16:58	Rain	Rear end	P.D. only	Wet	North	Turning right	Automobile, station wagon	Other motor vehicle	0
					North	Turning right	Automobile, station wagon	Other motor vehicle	
2018-May-15, Tue,20:45	Clear	Rear end	Non-fatal injury	Dry	South	Going ahead	Automobile, station wagon	Other motor vehicle	0
					South	Stopped	Automobile, station wagon	Other motor vehicle	
2018-May-18, Fri,15:12	Clear	Sideswipe	P.D. only	Dry	East	Overtaking	School bus	Other motor vehicle	0
					East	Going ahead	Automobile, station wagon	Other motor vehicle	
2018-May-25, Fri,11:30	Clear	Rear end	P.D. only	Dry	East	Turning right	Automobile, station wagon	Other motor vehicle	0
					East	Turning right	Automobile, station wagon	Other motor vehicle	
2018-May-30, Wed,16:23	Clear	Rear end	Non-fatal injury	Dry	West	Going ahead	Automobile, station wagon	Other motor vehicle	0
					West	Stopped	Automobile, station wagon	Other motor vehicle	



Transportation Services - Traffic Services

Collision Details Report - Public Version

From: January 1, 2016 To: December 31, 2020

Location: BLAIR RD @ OGILVIE RD

Traffic Control: Traffic signal

Total Collisions: 84

Date/Day/Time	Environment	Impact Type	Classification	Surface Cond'n	Veh. Dir	Vehicle Manoeuvre	Vehicle type	First Event	No. Ped
2018-Jun-06, Wed,12:06	Rain	Rear end	P.D. only	Wet	North	Slowing or stopping	Passenger van	Other motor vehicle	0
					North	Stopped	Pick-up truck	Other motor vehicle	
2018-Jun-09, Sat,20:44	Clear	Rear end	P.D. only	Dry	East	Going ahead	Passenger van	Other motor vehicle	0
					East	Slowing or stopping	Automobile, station wagon	Other motor vehicle	
2018-Jun-12, Tue,19:08	Clear	Rear end	P.D. only	Dry	West	Going ahead	Passenger van	Other motor vehicle	0
					West	Stopped	Automobile, station wagon	Other motor vehicle	
2018-Jul-30, Mon,14:30	Clear	Rear end	P.D. only	Dry	South	Going ahead	Automobile, station wagon	Other motor vehicle	0
					South	Going ahead	Ambulance	Other motor vehicle	
2018-Aug-17, Fri,07:29	Clear	Rear end	P.D. only	Dry	North	Going ahead	Automobile, station wagon	Other motor vehicle	0
					North	Slowing or stopping	Automobile, station wagon	Other motor vehicle	
					North	Stopped	Automobile, station wagon	Other motor vehicle	
2018-Sep-14, Fri,19:04	Clear	Other	P.D. only	Dry	North	Reversing	Automobile, station wagon	Other motor vehicle	0
					South	Going ahead	Automobile, station wagon	Other motor vehicle	
2018-Sep-23, Sun,12:41	Clear	Turning movement	P.D. only	Dry	West	Turning left	Automobile, station wagon	Other motor vehicle	0
					West	Turning left	Automobile, station wagon	Other motor vehicle	
2018-Nov-14, Wed,13:13	Clear	Sideswipe	P.D. only	Dry	North	Changing lanes	Automobile, station wagon	Other motor vehicle	0
					North	Turning right	Automobile, station wagon	Other motor vehicle	
2018-Dec-12, Wed,08:13	Clear	Rear end	P.D. only	Wet	North	Slowing or stopping	Unknown	Other motor vehicle	0
					North	Stopped	Automobile, station wagon	Other motor vehicle	
					North	Stopped	Automobile, station wagon	Other motor vehicle	
					North	Stopped	Automobile, station wagon	Other motor vehicle	
2018-Dec-12, Wed,18:26	Clear	Rear end	P.D. only	Loose snow	North	Going ahead	Automobile, station wagon	Other motor vehicle	0
					North	Unknown	Unknown	Other motor vehicle	



Transportation Services - Traffic Services

Collision Details Report - Public Version

From: January 1, 2016 To: December 31, 2020

Location: BLAIR RD @ OGILVIE RD

Traffic Control: Traffic signal

Total Collisions: 84

Date/Day/Time	Environment	Impact Type	Classification	Surface Cond'n	Veh. Dir	Vehicle Manoeuvre	Vehicle type	First Event	No. Ped
2018-Dec-30, Sun,17:20	Clear	Rear end	P.D. only	Ice	East	Going ahead	Automobile, station wagon	Other motor vehicle	0
					East	Slowing or stopping	Automobile, station wagon	Other motor vehicle	
2019-Apr-09, Tue,15:21	Freezing Rain	Rear end	Non-fatal injury	Slush	West	Stopped	Automobile, station wagon	Other motor vehicle	0
					West	Going ahead	Automobile, station wagon	Other motor vehicle	
2019-Jun-18, Tue,12:18	Clear	Rear end	P.D. only	Dry	East	Slowing or stopping	Automobile, station wagon	Other motor vehicle	0
					East	Slowing or stopping	Automobile, station wagon	Other motor vehicle	
2019-Sep-30, Mon,15:52	Clear	Other	P.D. only	Dry	East	Turning right	Passenger van	Ran off road	0
					East	Turning right	Automobile, station wagon	Other motor vehicle	
2019-Nov-01, Fri,10:25	Clear	Angle	Non-fatal injury	Dry	East	Going ahead	Automobile, station wagon	Other motor vehicle	0
					South	Going ahead	Automobile, station wagon	Other motor vehicle	
2019-Dec-11, Wed,17:52	Clear	Rear end	P.D. only	Loose snow	South	Going ahead	Automobile, station wagon	Other motor vehicle	0
					South	Stopped	Automobile, station wagon	Other motor vehicle	
2019-Dec-12, Thu,15:23	Clear	Sideswipe	P.D. only	Dry	East	Changing lanes	Automobile, station wagon	Other motor vehicle	0
					East	Stopped	Automobile, station wagon	Other motor vehicle	
					East	Stopped	Passenger van	Other motor vehicle	
2020-Jan-15, Wed,17:45	Clear	Sideswipe	P.D. only	Wet	North	Changing lanes	Pick-up truck	Other motor vehicle	0
					North	Going ahead	Automobile, station wagon	Other motor vehicle	
2020-Jan-30, Thu,11:50	Clear	Rear end	P.D. only	Dry	East	Turning right	Automobile, station wagon	Other motor vehicle	0
					East	Turning right	Pick-up truck	Other motor vehicle	
2020-Feb-12, Wed,14:15	Clear	Rear end	P.D. only	Dry	East	Turning right	Automobile, station wagon	Other motor vehicle	0
					East	Turning right	Automobile, station wagon	Other motor vehicle	
2020-Feb-23, Sun,00:15	Clear	Sideswipe	P.D. only	Dry	West	Turning left	Automobile, station wagon	Other motor vehicle	0
					West	Turning left	Pick-up truck	Other motor vehicle	



Transportation Services - Traffic Services

Collision Details Report - Public Version

From: January 1, 2016 To: December 31, 2020

Location: BLAIR RD @ OGILVIE RD

Traffic Control: Traffic signal

Total Collisions: 84

Date/Day/Time	Environment	Impact Type	Classification	Surface Cond'n	Veh. Dir	Vehicle Manoeuvre	Vehicle type	First Event	No. Ped
2020-Feb-28, Fri,08:58	Clear	Rear end	P.D. only	Ice	East	Going ahead	Passenger van	Other motor vehicle	0
					East	Going ahead	Tow truck	Other motor vehicle	
2020-Mar-05, Thu,10:18	Clear	Rear end	P.D. only	Dry	West	Changing lanes	Pick-up truck	Other motor vehicle	0
					West	Going ahead	Automobile, station wagon	Other motor vehicle	
2020-Mar-12, Thu,19:05	Clear	Rear end	P.D. only	Dry	North	Turning right	Unknown	Other motor vehicle	0
					North	Turning right	Automobile, station wagon	Other motor vehicle	
2020-Mar-16, Mon,16:24	Clear	Rear end	P.D. only	Dry	North	Turning left	Automobile, station wagon	Other motor vehicle	0
					North	Turning left	Automobile, station wagon	Other motor vehicle	
2020-May-26, Tue,15:15	Clear	Rear end	P.D. only	Dry	North	Turning right	Pick-up truck	Other motor vehicle	0
					North	Turning right	Automobile, station wagon	Other motor vehicle	
2020-Jun-26, Fri,06:15	Clear	Rear end	P.D. only	Dry	East	Slowing or stopping	Municipal transit bus	Other motor vehicle	0
					East	Stopped	Automobile, station wagon	Other motor vehicle	
2020-Sep-13, Sun,20:10	Clear	Rear end	P.D. only	Dry	East	Turning right	Automobile, station wagon	Other motor vehicle	0
					East	Turning right	Pick-up truck	Other motor vehicle	
2020-Sep-25, Fri,17:00	Clear	Rear end	P.D. only	Dry	West	Slowing or stopping	Automobile, station wagon	Other motor vehicle	0
					West	Stopped	Pick-up truck	Other motor vehicle	
2020-Oct-07, Wed,14:10	Clear	Rear end	P.D. only	Dry	East	Slowing or stopping	Automobile, station wagon	Other motor vehicle	0
					East	Stopped	Automobile, station wagon	Other motor vehicle	
2020-Oct-29, Thu,11:04	Clear	Rear end	P.D. only	Dry	East	Unknown	Unknown	Other motor vehicle	0
					East	Stopped	Automobile, station wagon	Other motor vehicle	
2020-Nov-02, Mon,09:45	Clear	Rear end	P.D. only	Dry	East	Turning right	Automobile, station wagon	Other motor vehicle	0
					East	Turning right	Pick-up truck	Other motor vehicle	
2020-Nov-03, Tue,14:43	Clear	Rear end	P.D. only	Dry	West	Turning left	Pick-up truck	Other motor vehicle	0
					West	Turning left	Pick-up truck	Other motor vehicle	



Transportation Services - Traffic Services

Collision Details Report - Public Version

From: January 1, 2016 To: December 31, 2020

Location: BLAIR RD @ OGILVIE RD

Traffic Control: Traffic signal

Total Collisions: 84

Date/Day/Time	Environment	Impact Type	Classification	Surface Cond'n	Veh. Dir	Vehicle Manoeuvre	Vehicle type	First Event	No. Ped
2020-Nov-08, Sun,16:40	Clear	Rear end	P.D. only	Dry	North	Turning right	Pick-up truck	Other motor vehicle	0
					North	Turning right	Pick-up truck	Other motor vehicle	
2020-Nov-17, Tue,13:24	Rain	Rear end	Non-fatal injury	Wet	North	Slowing or stopping	Automobile, station wagon	Other motor vehicle	0
					North	Stopped	Automobile, station wagon	Other motor vehicle	
2020-Nov-22, Sun,21:00	Snow	Rear end	P.D. only	Ice	North	Turning right	Unknown	Other motor vehicle	0
					North	Turning right	Automobile, station wagon	Other motor vehicle	
2020-Nov-25, Wed,07:25	Snow	Rear end	P.D. only	Ice	North	Going ahead	Pick-up truck	Other motor vehicle	0
					North	Stopped	Automobile, station wagon	Other motor vehicle	
2020-Nov-26, Thu,16:25	Rain	Rear end	P.D. only	Wet	North	Turning right	Delivery van	Other motor vehicle	0
					North	Turning right	Automobile, station wagon	Other motor vehicle	
2020-Nov-30, Mon,12:30	Clear	Rear end	P.D. only	Dry	South	Unknown	Unknown	Other motor vehicle	0
					South	Stopped	Pick-up truck	Other motor vehicle	
2020-Dec-09, Wed,17:45	Clear	Sideswipe	P.D. only	Dry	West	Changing lanes	Pick-up truck	Other motor vehicle	0
					West	Going ahead	Pick-up truck	Other motor vehicle	
2020-Dec-18, Fri,15:50	Clear	Sideswipe	Non-fatal injury	Dry	West	Changing lanes	Automobile, station wagon	Other motor vehicle	0
					West	Going ahead	Automobile, station wagon	Other motor vehicle	
2020-Dec-20, Sun,05:24	Clear	SMV other	P.D. only	Dry	North	Going ahead	Automobile, station wagon	Pole (sign, parking meter)	0
2020-Dec-29, Tue,10:36	Clear	Rear end	Non-fatal injury	Dry	North	Turning right	Automobile, station wagon	Other motor vehicle	0
					North	Turning right	Automobile, station wagon	Other motor vehicle	

Location: BLAIR RD @ OR174 IC112 RAMP26

Traffic Control: No control

Total Collisions: 2

Date/Day/Time	Environment	Impact Type	Classification	Surface Cond'n	Veh. Dir	Vehicle Manoeuvre	Vehicle type	First Event	No. Ped
2016-Nov-26, Sat,11:07	Clear	SMV other	P.D. only	Dry	West	Going ahead	Automobile, station wagon	Steel guide rail	0



Transportation Services - Traffic Services

Collision Details Report - Public Version

From: January 1, 2016 To: December 31, 2020

Location: BLAIR RD @ OR174 IC112 RAMP26

Traffic Control: No control

Total Collisions: 2

Date/Day/Time	Environment	Impact Type	Classification	Surface Cond'n	Veh. Dir	Vehicle Manoeuvre	Vehicle type	First Event	No. Ped
2017-Aug-03, Thu,08:15	Clear	Rear end	P.D. only	Dry	West	Going ahead	Pick-up truck	Other motor vehicle	0
					West	Stopped	Automobile, station wagon	Other motor vehicle	
					West	Stopped	Automobile, station wagon	Other motor vehicle	

Location: BLAIR RD @ OR174 IC112 RAMP52

Traffic Control: No control

Total Collisions: 2

Date/Day/Time	Environment	Impact Type	Classification	Surface Cond'n	Veh. Dir	Vehicle Manoeuvre	Vehicle type	First Event	No. Ped
2016-Dec-08, Thu,17:12	Snow	Rear end	Non-fatal injury	Loose snow	North	Slowing or stopping	Automobile, station wagon	Other motor vehicle	0
					North	Turning right	Automobile, station wagon	Other motor vehicle	
2019-Jun-07, Fri,12:00	Clear	Rear end	P.D. only	Dry	North	Merging	Passenger van	Other motor vehicle	0
					North	Merging	Passenger van	Other motor vehicle	

Location: BLAIR RD @ REGIONAL RD 174 N/OR174 IC112 RAMP61

Traffic Control: Traffic signal

Total Collisions: 66

Date/Day/Time	Environment	Impact Type	Classification	Surface Cond'n	Veh. Dir	Vehicle Manoeuvre	Vehicle type	First Event	No. Ped
2016-Feb-09, Tue,15:48	Clear	Turning movement	Non-fatal injury	Dry	East	Turning left	Pick-up truck	Other motor vehicle	0
					West	Going ahead	Automobile, station wagon	Other motor vehicle	
2016-Apr-01, Fri,16:00	Clear	Rear end	Non-fatal injury	Dry	West	Turning right	Automobile, station wagon	Other motor vehicle	0
					West	Turning right	Automobile, station wagon	Other motor vehicle	
2016-May-17, Tue,10:47	Clear	Rear end	P.D. only	Dry	East	Turning right	Pick-up truck	Other motor vehicle	0
					East	Turning right	Pick-up truck	Other motor vehicle	
2016-Jun-29, Wed,08:52	Clear	Angle	Non-fatal injury	Dry	West	Going ahead	Passenger van	Other motor vehicle	0
					North	Going ahead	Automobile, station wagon	Other motor vehicle	
2016-Sep-10, Sat,23:18	Rain	Turning movement	P.D. only	Wet	South	Going ahead	Passenger van	Other motor vehicle	0
					North	Turning left	Automobile, station wagon	Other motor vehicle	



Transportation Services - Traffic Services

Collision Details Report - Public Version

From: January 1, 2016 **To:** December 31, 2020

Location: BLAIR RD @ REGIONAL RD 174 N/OR174 IC112 RAMP61

Traffic Control: Traffic signal

Total Collisions: 66

Date/Day/Time	Environment	Impact Type	Classification	Surface Cond'n	Veh. Dir	Vehicle Manoeuvre	Vehicle type	First Event	No. Ped
2016-Sep-19, Mon,19:42	Clear	Sideswipe	P.D. only	Dry	East	Turning right	Automobile, station wagon	Other motor vehicle	0
					East	Turning right	Pick-up truck	Other motor vehicle	
2016-Sep-23, Fri,07:30	Rain	Rear end	P.D. only	Wet	West	Turning right	Automobile, station wagon	Other motor vehicle	0
					West	Turning right	Automobile, station wagon	Other motor vehicle	
2016-Oct-22, Sat,00:33	Rain	Rear end	Non-fatal injury	Wet	South	Slowing or stopping	Automobile, station wagon	Other motor vehicle	0
					South	Stopped	Automobile, station wagon	Other motor vehicle	
2016-Nov-14, Mon,14:08	Clear	Rear end	P.D. only	Dry	West	Changing lanes	Pick-up truck	Other motor vehicle	0
					West	Stopped	Pick-up truck	Other motor vehicle	
2016-Nov-21, Mon,09:10	Snow	Rear end	P.D. only	Slush	West	Slowing or stopping	Pick-up truck	Other motor vehicle	0
					West	Slowing or stopping	Automobile, station wagon	Other motor vehicle	
2017-Jan-06, Fri,14:40	Clear	Turning movement	P.D. only	Wet	East	Turning left	Passenger van	Other motor vehicle	0
					West	Going ahead	Automobile, station wagon	Other motor vehicle	
2017-Jan-19, Thu,14:56	Clear	Rear end	P.D. only	Dry	South	Going ahead	Automobile, station wagon	Other motor vehicle	0
					South	Stopped	Pick-up truck	Other motor vehicle	
2017-Jan-21, Sat,18:24	Clear	Rear end	P.D. only	Wet	South	Slowing or stopping	Automobile, station wagon	Other motor vehicle	0
					South	Slowing or stopping	Automobile, station wagon	Other motor vehicle	
					South	Slowing or stopping	Automobile, station wagon	Other motor vehicle	
2017-Feb-04, Sat,18:10	Clear	Sideswipe	P.D. only	Dry	South	Changing lanes	Automobile, station wagon	Other motor vehicle	0
					South	Going ahead	Automobile, station wagon	Other motor vehicle	
2017-Mar-18, Sat,10:00	Clear	Rear end	Non-fatal injury	Dry	South	Turning right	Pick-up truck	Other motor vehicle	0
					South	Turning right	Automobile, station wagon	Other motor vehicle	
2017-Mar-18, Sat,21:47	Clear	Turning movement	P.D. only	Dry	West	Turning left	Automobile, station wagon	Other motor vehicle	0
					East	Turning right	Automobile, station wagon	Other motor vehicle	



Transportation Services - Traffic Services

Collision Details Report - Public Version

From: January 1, 2016 **To:** December 31, 2020

Location: BLAIR RD @ REGIONAL RD 174 N/OR174 IC112 RAMP61

Traffic Control: Traffic signal

Total Collisions: 66

Date/Day/Time	Environment	Impact Type	Classification	Surface Cond'n	Veh. Dir	Vehicle Manoeuvre	Vehicle type	First Event	No. Ped
2017-Apr-03, Mon,07:46	Clear	Rear end	P.D. only	Dry	West	Unknown	Unknown	Other motor vehicle	0
					West	Stopped	Automobile, station wagon	Other motor vehicle	
2017-Apr-15, Sat,17:08	Rain	Turning movement	P.D. only	Wet	South	Going ahead	Pick-up truck	Other motor vehicle	0
					North	Turning left	Municipal transit bus	Other motor vehicle	
2017-May-04, Thu,21:21	Rain	Turning movement	P.D. only	Wet	East	Turning left	Unknown	Other motor vehicle	0
					West	Going ahead	Pick-up truck	Other motor vehicle	
2017-May-14, Sun,11:00	Rain	Rear end	Non-fatal injury	Wet	South	Going ahead	Unknown	Other motor vehicle	0
					South	Stopped	Automobile, station wagon	Other motor vehicle	
2017-May-18, Thu,07:40	Clear	Rear end	P.D. only	Dry	West	Turning right	Automobile, station wagon	Other motor vehicle	0
					West	Turning right	Pick-up truck	Other motor vehicle	
2017-May-24, Wed,10:30	Clear	Turning movement	Non-fatal injury	Dry	South	Going ahead	Pick-up truck	Other motor vehicle	0
					North	Turning left	Passenger van	Other motor vehicle	
2017-May-24, Wed,21:22	Clear	Angle	P.D. only	Dry	North	Going ahead	Automobile, station wagon	Other motor vehicle	0
					West	Going ahead	Automobile, station wagon	Other motor vehicle	
2017-Jun-07, Wed,20:01	Clear	Sideswipe	P.D. only	Dry	North	Changing lanes	Automobile, station wagon	Other motor vehicle	0
					North	Going ahead	Automobile, station wagon	Other motor vehicle	
2017-Jun-14, Wed,13:58	Clear	Rear end	P.D. only	Dry	West	Turning right	Automobile, station wagon	Other motor vehicle	0
					West	Turning right	Automobile, station wagon	Other motor vehicle	
2017-Jul-18, Tue,08:08	Clear	Rear end	P.D. only	Dry	West	Going ahead	Automobile, station wagon	Other motor vehicle	0
					West	Stopped	Automobile, station wagon	Other motor vehicle	
2017-Aug-04, Fri,15:48	Clear	Rear end	P.D. only	Dry	North	Changing lanes	Automobile, station wagon	Other motor vehicle	0
					North	Slowing or stopping	Pick-up truck	Other motor vehicle	
					North	Stopped	Automobile, station wagon	Other motor vehicle	



Transportation Services - Traffic Services

Collision Details Report - Public Version

From: January 1, 2016 To: December 31, 2020

Location: BLAIR RD @ REGIONAL RD 174 N/OR174 IC112 RAMP61

Traffic Control: Traffic signal

Total Collisions: 66

Date/Day/Time	Environment	Impact Type	Classification	Surface Cond'n	Veh. Dir	Vehicle Manoeuvre	Vehicle type	First Event	No. Ped
2017-Aug-11, Fri,00:40	Clear	Turning movement	P.D. only	Dry	East	Turning left	Automobile, station wagon	Other motor vehicle	0
					West	Going ahead	Automobile, station wagon	Other motor vehicle	
2017-Oct-04, Wed,12:26	Clear	Rear end	P.D. only	Dry	South	Going ahead	Passenger van	Other motor vehicle	0
					South	Stopped	Automobile, station wagon	Other motor vehicle	
2017-Oct-16, Mon,08:26	Clear	Rear end	P.D. only	Dry	West	Turning right	Automobile, station wagon	Other motor vehicle	0
					West	Turning right	Automobile, station wagon	Other motor vehicle	
2017-Nov-07, Tue,07:45	Clear	Rear end	P.D. only	Dry	West	Slowing or stopping	Automobile, station wagon	Other motor vehicle	0
					West	Slowing or stopping	Passenger van	Other motor vehicle	
2018-Mar-06, Tue,10:13	Clear	Angle	P.D. only	Dry	South	Going ahead	Automobile, station wagon	Other motor vehicle	0
					West	Going ahead	Automobile, station wagon	Other motor vehicle	
2018-Mar-22, Thu,10:57	Clear	Angle	P.D. only	Dry	West	Turning right	Bus (other)	Other motor vehicle	0
					North	Going ahead	Automobile, station wagon	Other motor vehicle	
2018-Mar-28, Wed,11:24	Clear	Angle	P.D. only	Dry	South	Going ahead	Automobile, station wagon	Other motor vehicle	0
					West	Going ahead	Automobile, station wagon	Other motor vehicle	
2018-Apr-16, Mon,16:09	Freezing Rain	Turning movement	P.D. only	Ice	South	Going ahead	Automobile, station wagon	Other motor vehicle	0
					North	Turning left	Automobile, station wagon	Other motor vehicle	
2018-May-29, Tue,18:34	Clear	Rear end	P.D. only	Dry	South	Going ahead	Automobile, station wagon	Other motor vehicle	0
					South	Stopped	Automobile, station wagon	Other motor vehicle	
2018-Jul-14, Sat,21:44	Clear	Angle	P.D. only	Dry	South	Going ahead	Automobile, station wagon	Other motor vehicle	0
					West	Going ahead	Automobile, station wagon	Other motor vehicle	
2018-Aug-14, Tue,19:12	Clear	Sideswipe	P.D. only	Dry	South	Overtaking	Automobile, station wagon	Other motor vehicle	0
					South	Merging	Automobile, station wagon	Other motor vehicle	
2018-Sep-05, Wed,11:48	Clear	Rear end	P.D. only	Dry	North	Slowing or stopping	Automobile, station wagon	Other motor vehicle	0
					North	Stopped	Automobile, station wagon	Other motor vehicle	



Transportation Services - Traffic Services

Collision Details Report - Public Version

From: January 1, 2016 To: December 31, 2020

Location: BLAIR RD @ REGIONAL RD 174 N/OR174 IC112 RAMP61

Traffic Control: Traffic signal

Total Collisions: 66

Date/Day/Time	Environment	Impact Type	Classification	Surface Cond'n	Veh. Dir	Vehicle Manoeuver	Vehicle type	First Event	No. Ped
2018-Sep-21, Fri,07:00	Rain	Rear end	P.D. only	Wet	West	Going ahead	Automobile, station wagon	Other motor vehicle	0
					West	Going ahead	Passenger van	Other motor vehicle	
2018-Oct-25, Thu,07:13	Clear	Rear end	P.D. only	Dry	West	Going ahead	Automobile, station wagon	Other motor vehicle	0
					West	Stopped	Automobile, station wagon	Other motor vehicle	
2018-Nov-01, Thu,21:38	Rain	SMV other	Non-fatal injury	Wet	East	Turning left	Automobile, station wagon	Pedestrian	1
2018-Nov-20, Tue,08:52	Snow	Rear end	P.D. only	Loose snow	South	Slowing or stopping	Automobile, station wagon	Other motor vehicle	0
					South	Stopped	School bus	Other motor vehicle	
2019-Jan-18, Fri,06:25	Snow	Rear end	Non-fatal injury	Wet	West	Going ahead	Automobile, station wagon	Other motor vehicle	0
					West	Slowing or stopping	Automobile, station wagon	Other motor vehicle	
2019-Jan-24, Thu,17:00	Clear	Rear end	P.D. only	Packed snow	South	Slowing or stopping	Automobile, station wagon	Other motor vehicle	0
					South	Stopped	Automobile, station wagon	Other motor vehicle	
2019-Jan-29, Tue,09:08	Snow	Rear end	P.D. only	Loose snow	South	Slowing or stopping	Automobile, station wagon	Other motor vehicle	0
					South	Slowing or stopping	Automobile, station wagon	Other motor vehicle	
					South	Slowing or stopping	Automobile, station wagon	Snowbank/drift	
2019-Mar-21, Thu,07:00	Clear	Rear end	P.D. only	Dry	West	Turning right	Automobile, station wagon	Other motor vehicle	0
					West	Turning right	Automobile, station wagon	Other motor vehicle	
2019-May-04, Sat,13:25	Clear	Sideswipe	P.D. only	Dry	South	Changing lanes	Automobile, station wagon	Other motor vehicle	0
					South	Going ahead	Automobile, station wagon	Other motor vehicle	
2019-May-08, Wed,09:30	Clear	Rear end	P.D. only	Dry	West	Turning right	Automobile, station wagon	Other motor vehicle	0
					West	Turning right	Automobile, station wagon	Other motor vehicle	
2019-Jul-11, Thu,18:00	Clear	Angle	P.D. only	Dry	North	Turning left	Automobile, station wagon	Other motor vehicle	0
					West	Going ahead	Automobile, station wagon	Other motor vehicle	



Transportation Services - Traffic Services

Collision Details Report - Public Version

From: January 1, 2016 To: December 31, 2020

Location: BLAIR RD @ REGIONAL RD 174 N/OR174 IC112 RAMP61

Traffic Control: Traffic signal

Total Collisions: 66

Date/Day/Time	Environment	Impact Type	Classification	Surface Cond'n	Veh. Dir	Vehicle Manoeuver	Vehicle type	First Event	No. Ped
2019-Aug-06, Tue,09:14	Clear	Rear end	P.D. only	Dry	West	Turning right	Automobile, station wagon	Other motor vehicle	0
					West	Turning right	Automobile, station wagon	Other motor vehicle	
2019-Aug-06, Tue,14:51	Rain	Rear end	P.D. only	Wet	South	Slowing or stopping	Automobile, station wagon	Other motor vehicle	0
					South	Slowing or stopping	Automobile, station wagon	Other motor vehicle	
2019-Aug-16, Fri,07:53	Clear	Rear end	P.D. only	Dry	South	Going ahead	Automobile, station wagon	Other motor vehicle	0
					South	Stopped	Delivery van	Other motor vehicle	
2019-Aug-25, Sun,12:50	Clear	Rear end	P.D. only	Dry	South	Turning right	Automobile, station wagon	Other motor vehicle	0
					South	Turning right	Automobile, station wagon	Other motor vehicle	
2019-Nov-27, Wed,17:38	Rain	Turning movement	Non-fatal injury	Wet	East	Turning left	Automobile, station wagon	Other motor vehicle	0
					West	Going ahead	Automobile, station wagon	Other motor vehicle	
2019-Dec-03, Tue,10:12	Clear	Angle	Non-fatal injury	Dry	North	Going ahead	Automobile, station wagon	Other motor vehicle	0
					West	Going ahead	Passenger van	Other motor vehicle	
2020-Jan-20, Mon,17:57	Clear	Rear end	P.D. only	Ice	South	Changing lanes	Automobile, station wagon	Other motor vehicle	0
					South	Changing lanes	Pick-up truck	Other motor vehicle	
2020-Jan-21, Tue,13:20	Clear	Rear end	P.D. only	Wet	South	Slowing or stopping	Delivery van	Other motor vehicle	0
					South	Stopped	Automobile, station wagon	Other motor vehicle	
2020-Feb-05, Wed,15:05	Clear	Rear end	P.D. only	Dry	South	Turning right	Automobile, station wagon	Other motor vehicle	0
					South	Turning right	Pick-up truck	Other motor vehicle	
2020-Feb-12, Wed,09:30	Clear	Rear end	Non-fatal injury	Dry	West	Turning right	Pick-up truck	Other motor vehicle	0
					West	Turning right	Pick-up truck	Other motor vehicle	
2020-Jun-20, Sat,19:48	Clear	Angle	P.D. only	Dry	South	Going ahead	Automobile, station wagon	Other motor vehicle	0
					East	Going ahead	Truck-other	Other motor vehicle	
2020-Jul-08, Wed,19:44	Clear	Other	P.D. only	Dry	East	Reversing	Pick-up truck	Other motor vehicle	0
					West	Stopped	Automobile, station wagon	Other motor vehicle	

Transportation Services - Traffic Services

Collision Details Report - Public Version

From: January 1, 2016 To: December 31, 2020

Location: BLAIR RD @ REGIONAL RD 174 N/OR174 IC112 RAMP61

Traffic Control: Traffic signal

Total Collisions: 66

Date/Day/Time	Environment	Impact Type	Classification	Surface Cond'n	Veh. Dir	Vehicle Manoeuvre	Vehicle type	First Event	No. Ped
2020-Sep-30, Wed,10:56	Rain	Rear end	P.D. only	Wet	West	Turning right	Automobile, station wagon	Other motor vehicle	0
					West	Turning right	Automobile, station wagon	Other motor vehicle	
2020-Nov-30, Mon,17:01	Rain	SMV other	Non-fatal injury	Wet	East	Turning left	Pick-up truck	Pedestrian	1
2020-Dec-12, Sat,16:00	Rain	Angle	P.D. only	Wet	South	Going ahead	Automobile, station wagon	Other motor vehicle	0
					West	Going ahead	Pick-up truck	Other motor vehicle	
2020-Dec-18, Fri,15:55	Clear	SMV other	P.D. only	Dry	West	Going ahead	Pick-up truck	Concrete guide rail	0

Location: BLAIR RD @ REGIONAL RD 174 S/OR174 IC112 RAMP15

Traffic Control: Traffic signal

Total Collisions: 54

Date/Day/Time	Environment	Impact Type	Classification	Surface Cond'n	Veh. Dir	Vehicle Manoeuvre	Vehicle type	First Event	No. Ped
2016-Jan-15, Fri,18:30	Clear	Turning movement	P.D. only	Wet	South	Turning left	Pick-up truck	Other motor vehicle	0
					North	Going ahead	Automobile, station wagon	Other motor vehicle	
2016-Jan-17, Sun,11:32	Clear	Turning movement	Non-fatal injury	Wet	South	Turning left	Pick-up truck	Other motor vehicle	0
					North	Going ahead	Automobile, station wagon	Other motor vehicle	
2016-Feb-06, Sat,13:10	Clear	Sideswipe	P.D. only	Dry	West	Overtaking	Automobile, station wagon	Other motor vehicle	0
					West	Stopped	Passenger van	Other motor vehicle	
2016-Feb-21, Sun,10:17	Clear	Turning movement	Non-fatal injury	Wet	North	Making "U" turn	Automobile, station wagon	Other motor vehicle	0
					South	Going ahead	Pick-up truck	Other motor vehicle	
2016-Feb-27, Sat,21:55	Clear	Turning movement	P.D. only	Wet	South	Turning left	Pick-up truck	Other motor vehicle	0
					North	Going ahead	Pick-up truck	Other motor vehicle	
2016-Aug-03, Wed,23:01	Clear	Turning movement	Non-fatal injury	Dry	South	Turning left	Automobile, station wagon	Other motor vehicle	0
					North	Going ahead	Motorcycle	Other motor vehicle	
					South	Turning left	Automobile, station wagon	Other motor vehicle	



Transportation Services - Traffic Services

Collision Details Report - Public Version

From: January 1, 2016 **To:** December 31, 2020

Location: BLAIR RD @ REGIONAL RD 174 S/OR174 IC112 RAMP15

Traffic Control: Traffic signal

Total Collisions: 54

Date/Day/Time	Environment	Impact Type	Classification	Surface Cond'n	Veh. Dir	Vehicle Manoeuvre	Vehicle type	First Event	No. Ped
2016-Sep-07, Wed,21:59	Rain	Rear end	P.D. only	Wet	South	Turning left	Automobile, station wagon	Other motor vehicle	0
					South	Turning left	Automobile, station wagon	Other motor vehicle	
2016-Nov-02, Wed,15:30	Clear	Rear end	P.D. only	Dry	East	Slowing or stopping	Automobile, station wagon	Other motor vehicle	0
					East	Slowing or stopping	Automobile, station wagon	Other motor vehicle	
2016-Nov-26, Sat,15:25	Clear	Turning movement	P.D. only	Dry	South	Turning left	Pick-up truck	Other motor vehicle	0
					North	Going ahead	Automobile, station wagon	Other motor vehicle	
2016-Nov-30, Wed,19:50	Rain	Turning movement	Non-fatal injury	Wet	South	Turning left	Pick-up truck	Other motor vehicle	0
					North	Going ahead	Passenger van	Skidding/sliding	
					South	Stopped	Pick-up truck	Other motor vehicle	
2017-Jan-09, Mon,13:30	Clear	Angle	P.D. only	Dry	East	Turning left	Automobile, station wagon	Other motor vehicle	0
					North	Going ahead	Automobile, station wagon	Other motor vehicle	
2017-Jan-10, Tue,08:30	Snow	SMV other	P.D. only	Slush	East	Going ahead	Automobile, station wagon	Cable guide rail	0
2017-Feb-11, Sat,11:51	Clear	Other	P.D. only	Wet	East	Going ahead	Automobile, station wagon	Debris falling off vehicle	0
					East	Going ahead	Automobile, station wagon	Other	
2017-Feb-12, Sun,02:45	Snow	Rear end	P.D. only	Loose snow	East	Going ahead	Automobile, station wagon	Other motor vehicle	0
					East	Stopped	Automobile, station wagon	Other motor vehicle	
2017-Mar-02, Thu,16:09	Clear	Rear end	P.D. only	Dry	North	Slowing or stopping	Automobile, station wagon	Other motor vehicle	0
					North	Stopped	Automobile, station wagon	Other motor vehicle	
2017-Mar-08, Wed,15:18	Clear	Rear end	P.D. only	Dry	South	Slowing or stopping	Pick-up truck	Other motor vehicle	0
					South	Turning left	Pick-up truck	Other motor vehicle	
2017-Jun-07, Wed,09:00	Clear	Turning movement	P.D. only	Dry	North	Going ahead	Automobile, station wagon	Other motor vehicle	0
					South	Turning left	Automobile, station wagon	Other motor vehicle	
2017-Jun-29, Thu,12:08	Rain	Rear end	P.D. only	Wet	South	Slowing or stopping	Automobile, station wagon	Other motor vehicle	0
					South	Turning left	Automobile, station wagon	Other motor vehicle	



Transportation Services - Traffic Services

Collision Details Report - Public Version

From: January 1, 2016 To: December 31, 2020

Location: BLAIR RD @ REGIONAL RD 174 S/OR174 IC112 RAMP15

Traffic Control: Traffic signal

Total Collisions: 54

Date/Day/Time	Environment	Impact Type	Classification	Surface Cond'n	Veh. Dir	Vehicle Manoeuver	Vehicle type	First Event	No. Ped
2017-Aug-10, Thu,09:01	Clear	Sideswipe	P.D. only	Dry	East	Changing lanes	Automobile, station wagon	Other motor vehicle	0
					East	Going ahead	Automobile, station wagon	Other motor vehicle	
2017-Aug-18, Fri,17:56	Rain	Rear end	P.D. only	Wet	North	Going ahead	Automobile, station wagon	Other motor vehicle	0
					North	Stopped	Automobile, station wagon	Other motor vehicle	
2017-Sep-12, Tue,17:08	Clear	Sideswipe	P.D. only	Dry	East	Merging	Automobile, station wagon	Other motor vehicle	0
					East	Going ahead	Automobile, station wagon	Other motor vehicle	
2017-Sep-29, Fri,22:20	Rain	Rear end	P.D. only	Wet	South	Slowing or stopping	Automobile, station wagon	Other motor vehicle	0
					South	Stopped	Automobile, station wagon	Other motor vehicle	
2017-Oct-12, Thu,07:35	Clear	Rear end	P.D. only	Dry	East	Turning right	Automobile, station wagon	Other motor vehicle	0
					East	Going ahead	Pick-up truck	Other motor vehicle	
2017-Nov-01, Wed,17:09	Rain	Turning movement	P.D. only	Wet	South	Turning left	Automobile, station wagon	Other motor vehicle	0
					North	Going ahead	Automobile, station wagon	Other motor vehicle	
2017-Nov-02, Thu,13:43	Rain	Rear end	P.D. only	Wet	South	Turning left	Automobile, station wagon	Other motor vehicle	0
					South	Turning left	Automobile, station wagon	Other motor vehicle	
					South	Turning left	Automobile, station wagon	Other motor vehicle	
2017-Dec-05, Tue,11:37	Rain	Rear end	P.D. only	Wet	South	Slowing or stopping	Automobile, station wagon	Other motor vehicle	0
					South	Stopped	Automobile, station wagon	Other motor vehicle	
2017-Dec-11, Mon,12:23	Clear	Rear end	P.D. only	Dry	South	Slowing or stopping	Truck - dump	Other motor vehicle	0
					South	Slowing or stopping	Automobile, station wagon	Other motor vehicle	
2017-Dec-23, Sat,11:59	Snow	Turning movement	Non-fatal injury	Loose snow	South	Turning left	Automobile, station wagon	Other motor vehicle	0
					North	Going ahead	Automobile, station wagon	Other motor vehicle	
2017-Dec-27, Wed,13:15	Clear	Rear end	P.D. only	Dry	East	Slowing or stopping	Automobile, station wagon	Other motor vehicle	0
					East	Slowing or stopping	Automobile, station wagon	Other motor vehicle	
2017-Dec-28, Thu,07:00	Clear	SMV other	P.D. only	Ice	East	Merging	Automobile, station wagon	Snowbank/drift	0



Transportation Services - Traffic Services

Collision Details Report - Public Version

From: January 1, 2016 To: December 31, 2020

Location: BLAIR RD @ REGIONAL RD 174 S/OR174 IC112 RAMP15

Traffic Control: Traffic signal

Total Collisions: 54

Date/Day/Time	Environment	Impact Type	Classification	Surface Cond'n	Veh. Dir	Vehicle Manoeuver	Vehicle type	First Event	No. Ped
2017-Dec-28, Thu,17:45	Clear	Rear end	P.D. only	Dry	North	Slowing or stopping	Automobile, station wagon	Other motor vehicle	0
					North	Going ahead	Automobile, station wagon	Other motor vehicle	
2017-Dec-29, Fri,16:16	Clear	Turning movement	P.D. only	Wet	North	Going ahead	Automobile, station wagon	Other motor vehicle	0
					South	Turning left	Automobile, station wagon	Other motor vehicle	
2017-Dec-29, Fri,18:14	Clear	Approaching	Non-fatal injury	Other	North	Going ahead	Automobile, station wagon	Other motor vehicle	0
					South	Stopped	Pick-up truck	Other motor vehicle	
					South	Stopped	Automobile, station wagon	Other motor vehicle	
2018-Jan-23, Tue,17:14	Rain	Turning movement	Non-fatal injury	Wet	South	Turning left	Automobile, station wagon	Other motor vehicle	0
					North	Going ahead	Automobile, station wagon	Other motor vehicle	
					North	Turning right	Municipal transit bus	Other motor vehicle	
2018-Feb-02, Fri,16:53	Clear	Approaching	P.D. only	Dry	North	Going ahead	Automobile, station wagon	Other motor vehicle	0
					South	Stopped	Automobile, station wagon	Other motor vehicle	
2018-Jun-13, Wed,14:40	Rain	SMV other	P.D. only	Wet	East	Turning right	Automobile, station wagon	Skidding/sliding	0
2018-Jul-06, Fri,11:28	Clear	Angle	Non-fatal injury	Dry	North	Going ahead	Automobile, station wagon	Other motor vehicle	0
					West	Turning left	Automobile, station wagon	Other motor vehicle	
2018-Jul-24, Tue,09:42	Clear	SMV other	P.D. only	Wet	South	Going ahead	Pick-up truck	Pole (utility, power)	0
2018-Dec-12, Wed,08:34	Clear	Sideswipe	P.D. only	Wet	West	Changing lanes	Automobile, station wagon	Other motor vehicle	0
					West	Turning left	Automobile, station wagon	Other motor vehicle	
2019-Feb-22, Fri,17:35	Clear	Rear end	Non-fatal injury	Dry	North	Slowing or stopping	Automobile, station wagon	Other motor vehicle	0
					North	Going ahead	Automobile, station wagon	Other motor vehicle	
2019-Jun-01, Sat,21:55	Clear	Turning movement	P.D. only	Dry	North	Turning right	Automobile, station wagon	Other motor vehicle	0
					South	Turning left	Automobile, station wagon	Other motor vehicle	
2019-Aug-08, Thu,16:33	Rain	Turning movement	Non-fatal injury	Wet	North	Going ahead	Automobile, station wagon	Other motor vehicle	0
					South	Turning left	Automobile, station wagon	Other motor vehicle	



Transportation Services - Traffic Services

Collision Details Report - Public Version

From: January 1, 2016 **To:** December 31, 2020

Location: BLAIR RD @ REGIONAL RD 174 S/OR174 IC112 RAMP15

Traffic Control: Traffic signal

Total Collisions: 54

Date/Day/Time	Environment	Impact Type	Classification	Surface Cond'n	Veh. Dir	Vehicle Manoeuvre	Vehicle type	First Event	No. Ped
2019-Aug-12, Mon,17:29	Rain	Rear end	P.D. only	Wet	North	Turning right	Automobile, station wagon	Other motor vehicle	0
					North	Turning right	Automobile, station wagon	Other motor vehicle	
2019-Aug-28, Wed,07:50	Rain	Rear end	P.D. only	Wet	South	Going ahead	Automobile, station wagon	Other motor vehicle	0
					South	Turning left	Automobile, station wagon	Other motor vehicle	
2019-Sep-17, Tue,15:28	Clear	Turning movement	Non-fatal injury	Dry	South	Turning left	Automobile, station wagon	Other motor vehicle	0
					North	Going ahead	Automobile, station wagon	Other motor vehicle	
2019-Sep-26, Thu,18:08	Clear	Angle	Non-fatal injury	Wet	West	Turning left	Automobile, station wagon	Other motor vehicle	0
					North	Going ahead	Automobile, station wagon	Other motor vehicle	
2019-Oct-14, Mon,22:55	Clear	Rear end	P.D. only	Dry	South	Turning left	Automobile, station wagon	Other motor vehicle	0
					South	Turning left	Automobile, station wagon	Other motor vehicle	
2019-Nov-04, Mon,10:26	Clear	Rear end	P.D. only	Wet	West	Turning right	Automobile, station wagon	Other motor vehicle	0
					West	Turning right	Automobile, station wagon	Other motor vehicle	
2019-Dec-21, Sat,03:33	Clear	SMV other	P.D. only	Ice	South	Turning left	Automobile, station wagon	Steel guide rail	0
2020-Feb-10, Mon,20:30	Clear	Rear end	P.D. only	Wet	South	Going ahead	Pick-up truck	Other motor vehicle	0
					South	Stopped	Automobile, station wagon	Other motor vehicle	
2020-Aug-25, Tue,21:13	Clear	Turning movement	Non-fatal injury	Dry	South	Turning left	Automobile, station wagon	Other motor vehicle	0
					North	Going ahead	Automobile, station wagon	Other motor vehicle	
2020-Sep-13, Sun,16:00	Clear	Sideswipe	P.D. only	Dry	South	Changing lanes	Pick-up truck	Other motor vehicle	0
					South	Going ahead	Pick-up truck	Other motor vehicle	
2020-Oct-30, Fri,18:30	Clear	Rear end	P.D. only	Dry	West	Going ahead	Passenger van	Other motor vehicle	0
					West	Stopped	Automobile, station wagon	Other motor vehicle	
2020-Dec-22, Tue,09:50	Clear	Turning movement	P.D. only	Dry	South	Turning left	Automobile, station wagon	Other motor vehicle	0
					South	Turning left	Pick-up truck	Other motor vehicle	



Transportation Services - Traffic Services

Collision Details Report - Public Version

From: January 1, 2016 To: December 31, 2020

Location: BLAIR RD btwn OGILVIE RD & OR174 IC112 RAMP36

Traffic Control: No control

Total Collisions: 8

Date/Day/Time	Environment	Impact Type	Classification	Surface Cond'n	Veh. Dir	Vehicle Manoeuvre	Vehicle type	First Event	No. Ped
2016-Oct-27, Thu,21:54	Snow	Rear end	P.D. only	Slush	South	Going ahead	Automobile, station wagon	Other motor vehicle	0
					South	Stopped	Automobile, station wagon	Other motor vehicle	
2016-Nov-14, Mon,18:02	Clear	Sideswipe	P.D. only	Dry	South	Changing lanes	Automobile, station wagon	Other motor vehicle	0
					South	Going ahead	Automobile, station wagon	Other motor vehicle	
2017-Aug-10, Thu,20:00	Clear	Rear end	Non-fatal injury	Dry	South	Slowing or stopping	Automobile, station wagon	Other motor vehicle	0
					South	Slowing or stopping	Automobile, station wagon	Other motor vehicle	
2019-Apr-26, Fri,14:25	Rain	Sideswipe	P.D. only	Wet	North	Changing lanes	Automobile, station wagon	Other motor vehicle	0
					North	Going ahead	Automobile, station wagon	Other motor vehicle	
2019-May-16, Thu,15:57	Clear	Rear end	P.D. only	Dry	South	Slowing or stopping	Automobile, station wagon	Other motor vehicle	0
					South	Stopped	Automobile, station wagon	Other motor vehicle	
					South	Stopped	Unknown	Other motor vehicle	
2019-Aug-17, Sat,15:28	Clear	Sideswipe	P.D. only	Dry	South	Going ahead	Automobile, station wagon	Other motor vehicle	0
					South	Going ahead	Automobile, station wagon	Other motor vehicle	
2019-Dec-12, Thu,14:50	Clear	Rear end	P.D. only	Dry	South	Slowing or stopping	Automobile, station wagon	Other motor vehicle	0
					South	Stopped	Automobile, station wagon	Other motor vehicle	
					South	Stopped	Automobile, station wagon	Other motor vehicle	
					South	Stopped	Automobile, station wagon	Other motor vehicle	
2020-Jun-22, Mon,08:26	Clear	Rear end	P.D. only	Dry	North	Going ahead	Automobile, station wagon	Other motor vehicle	0
					North	Stopped	Automobile, station wagon	Other motor vehicle	

Location: BLAIR RD btwn OR174 IC112 RAMP26 & OR174 IC112 RAMP36

Traffic Control: No control

Total Collisions: 2

Date/Day/Time	Environment	Impact Type	Classification	Surface Cond'n	Veh. Dir	Vehicle Manoeuvre	Vehicle type	First Event	No. Ped
2016-Oct-31, Mon,14:50	Clear	Sideswipe	P.D. only	Dry	South	Changing lanes	Pick-up truck	Other motor vehicle	0
					South	Going ahead	Automobile, station wagon	Other motor vehicle	



Transportation Services - Traffic Services

Collision Details Report - Public Version

From: January 1, 2016 To: December 31, 2020

Location: BLAIR RD btwn OR174 IC112 RAMP26 & OR174 IC112 RAMP36

Traffic Control: No control

Total Collisions: 2

Date/Day/Time	Environment	Impact Type	Classification	Surface Cond'n	Veh. Dir	Vehicle Manoeuvre	Vehicle type	First Event	No. Ped
2019-Jun-06, Thu,16:43	Clear	Rear end	P.D. only	Dry	South	Going ahead	Automobile, station wagon	Other motor vehicle	0
					South	Going ahead	Automobile, station wagon	Other motor vehicle	
					South	Slowing or stopping	Automobile, station wagon	Other motor vehicle	

Location: BLAIR RD btwn OR174 IC112 RAMP26 & OR174 IC112 RAMP52

Traffic Control: No control

Total Collisions: 2

Date/Day/Time	Environment	Impact Type	Classification	Surface Cond'n	Veh. Dir	Vehicle Manoeuvre	Vehicle type	First Event	No. Ped
2016-Oct-21, Fri,18:27	Rain	Rear end	Non-fatal injury	Wet	North	Changing lanes	Automobile, station wagon	Cyclist	0
					North	Going ahead	Bicycle	Other motor vehicle	
2018-Sep-18, Tue,15:00	Clear	Rear end	P.D. only	Dry	North	Going ahead	Automobile, station wagon	Other motor vehicle	0
					North	Slowing or stopping	School bus	Other motor vehicle	

Location: BLAIR RD btwn OR174 IC112 RAMP52 & OR174 IC112 RAMP53

Traffic Control: No control

Total Collisions: 2

Date/Day/Time	Environment	Impact Type	Classification	Surface Cond'n	Veh. Dir	Vehicle Manoeuvre	Vehicle type	First Event	No. Ped
2018-Jun-27, Wed,23:33	Rain	SMV other	P.D. only	Wet	East	Turning left	Automobile, station wagon	Skidding/sliding	0
2019-Oct-10, Thu,16:10	Clear	Rear end	Non-fatal injury	Dry	South	Going ahead	Automobile, station wagon	Other motor vehicle	0
					South	Stopped	Automobile, station wagon	Other motor vehicle	
					South	Stopped	Pick-up truck	Other motor vehicle	

Location: CADBORO RD @ OGILVIE RD

Traffic Control: Traffic signal

Total Collisions: 9

Date/Day/Time	Environment	Impact Type	Classification	Surface Cond'n	Veh. Dir	Vehicle Manoeuvre	Vehicle type	First Event	No. Ped
2016-Feb-24, Wed,14:50	Snow	Rear end	P.D. only	Ice	East	Changing lanes	Automobile, station wagon	Other motor vehicle	0
					East	Stopped	Automobile, station wagon	Other motor vehicle	



Transportation Services - Traffic Services

Collision Details Report - Public Version

From: January 1, 2016 To: December 31, 2020

Location: CADBORO RD @ OGILVIE RD

Traffic Control: Traffic signal

Total Collisions: 9

Date/Day/Time	Environment	Impact Type	Classification	Surface Cond'n	Veh. Dir	Vehicle Manoeuver	Vehicle type	First Event	No. Ped
2016-Jul-13, Wed,16:56	Clear	Rear end	P.D. only	Dry	East	Slowing or stopping	Automobile, station wagon	Other motor vehicle	0
					East	Going ahead	Automobile, station wagon	Other motor vehicle	
2018-Feb-21, Wed,15:55	Clear	Rear end	P.D. only	Dry	East	Changing lanes	Automobile, station wagon	Other motor vehicle	0
					East	Stopped	Automobile, station wagon	Other motor vehicle	
2018-Oct-02, Tue,08:02	Rain	Rear end	P.D. only	Wet	West	Changing lanes	Automobile, station wagon	Other motor vehicle	0
					West	Slowing or stopping	Automobile, station wagon	Other motor vehicle	
					West	Stopped	Automobile, station wagon	Other motor vehicle	
					West	Stopped	Automobile, station wagon	Other motor vehicle	
2019-Feb-05, Tue,16:43	Clear	Rear end	P.D. only	Wet	West	Slowing or stopping	Automobile, station wagon	Other motor vehicle	0
					West	Stopped	Automobile, station wagon	Other motor vehicle	
2019-May-25, Sat,16:00	Clear	Rear end	P.D. only	Dry	West	Going ahead	Automobile, station wagon	Other motor vehicle	0
					West	Slowing or stopping	Automobile, station wagon	Other motor vehicle	
2019-Oct-29, Tue,16:14	Clear	Rear end	Non-fatal injury	Dry	East	Going ahead	Delivery van	Other motor vehicle	0
					East	Stopped	Pick-up truck	Other motor vehicle	
					East	Stopped	Automobile, station wagon	Other motor vehicle	
2020-Jan-29, Wed,11:32	Clear	SMV other	P.D. only	Dry	South	Turning left	Automobile, station wagon	Curb	0
2020-Nov-05, Thu,18:05	Clear	SMV other	Non-fatal injury	Dry	South	Turning right	Pick-up truck	Pedestrian	1

Location: CITY PARK DR @ WILBURY RD/HARPER AVE W

Traffic Control: Stop sign

Total Collisions: 1

Date/Day/Time	Environment	Impact Type	Classification	Surface Cond'n	Veh. Dir	Vehicle Manoeuver	Vehicle type	First Event	No. Ped
2017-Jan-17, Tue,00:00	Clear	SMV unattended vehicle	P.D. only	Dry	South	Unknown	Unknown	Unattended vehicle	0

Transportation Services - Traffic Services

Collision Details Report - Public Version

From: January 1, 2016 To: December 31, 2020

Location: CITY PARK DR btwn AMBASSADOR AVE & OGILVIE RD

Traffic Control: No control

Total Collisions: 6

Date/Day/Time	Environment	Impact Type	Classification	Surface Cond'n	Veh. Dir	Vehicle Manoeuver	Vehicle type	First Event	No. Ped
2018-Jan-11, Thu,12:23	Clear	Turning movement	P.D. only	Wet	South	Making "U" turn	Unknown	Other motor vehicle	0
					South	Going ahead	Passenger van	Other motor vehicle	
2018-Feb-13, Tue,16:18	Clear	Angle	Non-fatal injury	Ice	East	Going ahead	Automobile, station wagon	Other motor vehicle	0
					North	Going ahead	Automobile, station wagon	Other motor vehicle	
2018-Oct-01, Mon,14:43	Clear	SMV other	Non-fatal injury	Dry	West	Turning right	Automobile, station wagon	Pedestrian	1
2018-Nov-19, Mon,11:39	Clear	Sideswipe	P.D. only	Wet	South	Pulling away from shoulder or curb	Automobile, station wagon	Other motor vehicle	0
					South	Going ahead	Automobile, station wagon	Other motor vehicle	
2019-Nov-20, Wed,17:04	Clear	Turning movement	P.D. only	Dry	South	Making "U" turn	Passenger van	Other motor vehicle	0
					South	Going ahead	Passenger van	Other motor vehicle	
2019-Dec-20, Fri,15:30	Clear	Turning movement	P.D. only	Dry	South	Turning left	Automobile, station wagon	Other motor vehicle	0
					North	Going ahead	Automobile, station wagon	Other motor vehicle	

Location: CITY PARK DR btwn OGILVIE RD & WILBURY RD

Traffic Control: No control

Total Collisions: 2

Date/Day/Time	Environment	Impact Type	Classification	Surface Cond'n	Veh. Dir	Vehicle Manoeuver	Vehicle type	First Event	No. Ped
2016-Dec-16, Fri,09:32	Clear	Turning movement	P.D. only	Wet	South	Turning left	Automobile, station wagon	Other motor vehicle	0
					North	Going ahead	Automobile, station wagon	Other motor vehicle	
2020-Jan-16, Thu,00:01	Clear	SMV unattended vehicle	P.D. only	Dry	North	Unknown	Unknown	Unattended vehicle	0

Location: OGILVIE RD @ 185 E OF BATHGATE DR/185 E OF CIT

Traffic Control: Traffic signal

Total Collisions: 1

Date/Day/Time	Environment	Impact Type	Classification	Surface Cond'n	Veh. Dir	Vehicle Manoeuver	Vehicle type	First Event	No. Ped
2019-Aug-23, Fri,20:30	Clear	Rear end	P.D. only	Dry	East	Slowing or stopping	Automobile, station wagon	Other motor vehicle	0
					East	Stopped	Automobile, station wagon	Other motor vehicle	



Transportation Services - Traffic Services

Collision Details Report - Public Version

From: January 1, 2016 **To:** December 31, 2020

Location: OGILVIE RD @ 240 W OF BLAIR RD

Traffic Control: Traffic signal

Total Collisions: 6

Date/Day/Time	Environment	Impact Type	Classification	Surface Cond'n	Veh. Dir	Vehicle Manoeuvre	Vehicle type	First Event	No. Ped
2016-Jan-12, Tue,14:33	Snow	Rear end	P.D. only	Loose snow	East	Slowing or stopping	Automobile, station wagon	Other motor vehicle	0
					East	Stopped	Automobile, station wagon	Other motor vehicle	
2016-Oct-17, Mon,15:40	Clear	Rear end	Non-fatal injury	Dry	South	Turning right	Automobile, station wagon	Other motor vehicle	0
					South	Turning right	Automobile, station wagon	Other motor vehicle	
2018-Mar-19, Mon,16:24	Clear	Rear end	P.D. only	Dry	West	Unknown	Unknown	Other motor vehicle	0
					West	Stopped	Automobile, station wagon	Other motor vehicle	
2019-Apr-06, Sat,17:31	Clear	Rear end	P.D. only	Dry	West	Going ahead	Automobile, station wagon	Other motor vehicle	0
					West	Slowing or stopping	Automobile, station wagon	Other motor vehicle	
2019-Aug-21, Wed,16:51	Clear	Rear end	Non-fatal injury	Dry	East	Going ahead	Automobile, station wagon	Other motor vehicle	0
					East	Slowing or stopping	Automobile, station wagon	Other motor vehicle	
2019-Oct-11, Fri,09:50	Clear	Rear end	P.D. only	Dry	West	Going ahead	Passenger van	Other motor vehicle	0
					West	Slowing or stopping	Automobile, station wagon	Other motor vehicle	

Location: OGILVIE RD @ BATHGATE DR/CITYPARK DR W

Traffic Control: Traffic signal

Total Collisions: 37

Date/Day/Time	Environment	Impact Type	Classification	Surface Cond'n	Veh. Dir	Vehicle Manoeuvre	Vehicle type	First Event	No. Ped
2016-Jan-05, Tue,08:40	Clear	Sideswipe	P.D. only	Dry	West	Going ahead	Automobile, station wagon	Other motor vehicle	0
					West	Turning left	Municipal transit bus	Other motor vehicle	
2016-Jan-05, Tue,08:46	Clear	Turning movement	P.D. only	Dry	East	Turning left	Pick-up truck	Other motor vehicle	0
					East	Going ahead	Automobile, station wagon	Other motor vehicle	
2016-Jan-09, Sat,18:15	Clear	Other	P.D. only	Wet	East	Making "U" turn	Automobile, station wagon	Other motor vehicle	0
					South	Turning right	Pick-up truck	Other motor vehicle	
2016-Mar-12, Sat,13:43	Clear	Turning movement	P.D. only	Dry	East	Making "U" turn	Pick-up truck	Other motor vehicle	0
					West	Changing lanes	Automobile, station wagon	Other motor vehicle	



Transportation Services - Traffic Services

Collision Details Report - Public Version

From: January 1, 2016 To: December 31, 2020

Location: OGILVIE RD @ BATHGATE DR/CITYPARK DR W

Traffic Control: Traffic signal

Total Collisions: 37

Date/Day/Time	Environment	Impact Type	Classification	Surface Cond'n	Veh. Dir	Vehicle Manoeuver	Vehicle type	First Event	No. Ped
2016-Jun-01, Wed,10:10	Clear	Turning movement	Non-fatal injury	Dry	East	Turning left	Automobile, station wagon	Other motor vehicle	0
					West	Going ahead	Automobile, station wagon	Other motor vehicle	
2016-Jun-11, Sat,15:14	Clear	Rear end	P.D. only	Dry	South	Slowing or stopping	Automobile, station wagon	Other motor vehicle	0
					South	Stopped	Automobile, station wagon	Other motor vehicle	
2016-Aug-13, Sat,10:27	Rain	Angle	Non-fatal injury	Wet	West	Going ahead	Automobile, station wagon	Other motor vehicle	0
					North	Going ahead	Pick-up truck	Other motor vehicle	
					South	Turning left	Automobile, station wagon	Other motor vehicle	
2016-Nov-06, Sun,15:45	Clear	SMV other	Non-fatal injury	Dry	West	Going ahead	Passenger van	Pedestrian	1
2017-Jan-09, Mon,18:30	Clear	Sideswipe	P.D. only	Slush	North	Changing lanes	Automobile, station wagon	Other motor vehicle	0
					North	Going ahead	Automobile, station wagon	Other motor vehicle	
2017-Jan-20, Fri,14:48	Freezing Rain	Rear end	Non-fatal injury	Wet	East	Slowing or stopping	Automobile, station wagon	Other motor vehicle	0
					East	Slowing or stopping	Pick-up truck	Other motor vehicle	
2017-Feb-18, Sat,12:10	Clear	Angle	Non-fatal injury	Wet	West	Going ahead	Automobile, station wagon	Other motor vehicle	0
					South	Going ahead	Automobile, station wagon	Other motor vehicle	
2017-Mar-04, Sat,00:30	Snow	SMV other	P.D. only	Ice	West	Turning left	Automobile, station wagon	Skidding/sliding	0
2017-Mar-12, Sun,14:00	Clear	Rear end	P.D. only	Dry	West	Going ahead	Pick-up truck	Other motor vehicle	0
					West	Slowing or stopping	Automobile, station wagon	Other motor vehicle	
2017-Apr-09, Sun,22:06	Clear	Turning movement	P.D. only	Dry	West	Going ahead	Unknown	Other motor vehicle	0
					East	Turning left	Automobile, station wagon	Other motor vehicle	
2017-Jun-20, Tue,08:06	Rain	Sideswipe	P.D. only	Wet	East	Slowing or stopping	Automobile, station wagon	Other motor vehicle	0
					East	Going ahead	Automobile, station wagon	Other motor vehicle	
2017-Jul-21, Fri,16:02	Clear	Angle	P.D. only	Dry	East	Going ahead	Automobile, station wagon	Other motor vehicle	0
					North	Going ahead	Municipal transit bus	Other motor vehicle	



Transportation Services - Traffic Services

Collision Details Report - Public Version

From: January 1, 2016 To: December 31, 2020

Location: OGILVIE RD @ BATHGATE DR/CITYPARK DR W

Traffic Control: Traffic signal

Total Collisions: 37

Date/Day/Time	Environment	Impact Type	Classification	Surface Cond'n	Veh. Dir	Vehicle Manoeuvre	Vehicle type	First Event	No. Ped
2017-Oct-11, Wed,15:00	Clear	Rear end	P.D. only	Dry	West	Going ahead	Automobile, station wagon	Other motor vehicle	0
					West	Stopped	Automobile, station wagon	Other motor vehicle	
2017-Nov-27, Mon,12:14	Clear	Angle	P.D. only	Ice	South	Turning right	Automobile, station wagon	Other motor vehicle	0
					East	Turning left	Automobile, station wagon	Other motor vehicle	
2017-Dec-29, Fri,10:41	Clear	Rear end	Non-fatal injury	Dry	East	Slowing or stopping	Automobile, station wagon	Other motor vehicle	0
					East	Slowing or stopping	Automobile, station wagon	Other motor vehicle	
2018-Jan-22, Mon,16:19	Snow	Turning movement	P.D. only	Loose snow	South	Turning left	Automobile, station wagon	Other motor vehicle	0
					North	Going ahead	Automobile, station wagon	Other motor vehicle	
2018-Mar-30, Fri,11:31	Clear	Angle	P.D. only	Dry	West	Slowing or stopping	Automobile, station wagon	Other motor vehicle	0
					South	Going ahead	Automobile, station wagon	Other motor vehicle	
2018-May-11, Fri,16:18	Clear	Turning movement	P.D. only	Dry	East	Making "U" turn	Automobile, station wagon	Other motor vehicle	0
					West	Going ahead	Automobile, station wagon	Other motor vehicle	
2018-Jun-02, Sat,14:57	Clear	Angle	P.D. only	Dry	East	Going ahead	Automobile, station wagon	Other motor vehicle	0
					North	Turning left	Pick-up truck	Other motor vehicle	
2018-Jul-12, Thu,13:05	Clear	SMV other	P.D. only	Dry	South	Turning left	Automobile, station wagon	Other	0
2018-Jul-14, Sat,15:25	Clear	Turning movement	Non-fatal injury	Dry	East	Turning left	Automobile, station wagon	Other motor vehicle	0
					West	Going ahead	Automobile, station wagon	Other motor vehicle	
2018-Aug-02, Thu,12:13	Clear	Rear end	Non-fatal injury	Dry	West	Going ahead	Passenger van	Other motor vehicle	0
					West	Stopped	Automobile, station wagon	Other motor vehicle	
2018-Aug-16, Thu,18:06	Clear	Sideswipe	P.D. only	Dry	East	Changing lanes	Automobile, station wagon	Other motor vehicle	0
					East	Going ahead	Automobile, station wagon	Other motor vehicle	
2018-Aug-30, Thu,17:20	Clear	Rear end	P.D. only	Dry	East	Going ahead	Automobile, station wagon	Other motor vehicle	0
					East	Stopped	Unknown	Other motor vehicle	



Transportation Services - Traffic Services

Collision Details Report - Public Version

From: January 1, 2016 To: December 31, 2020

Location: OGILVIE RD @ BATHGATE DR/CITYPARK DR W

Traffic Control: Traffic signal

Total Collisions: 37

Date/Day/Time	Environment	Impact Type	Classification	Surface Cond'n	Veh. Dir	Vehicle Manoeuvre	Vehicle type	First Event	No. Ped
2018-Oct-12, Fri,20:28	Clear	Turning movement	Non-fatal injury	Dry	East	Turning left	Automobile, station wagon	Other motor vehicle	0
					West	Going ahead	Automobile, station wagon	Other motor vehicle	
2019-Jan-03, Thu,07:37	Snow	SMV other	P.D. only	Slush	West	Going ahead	Automobile, station wagon	Ran off road	0
2019-Jan-21, Mon,15:30	Clear	Approaching	P.D. only	Ice	West	Going ahead	Automobile, station wagon	Skidding/sliding	0
					East	Going ahead	Automobile, station wagon	Other motor vehicle	
2019-Feb-15, Fri,18:18	Clear	Sideswipe	P.D. only	Dry	West	Overtaking	Pick-up truck	Other motor vehicle	0
					West	Stopped	Automobile, station wagon	Other motor vehicle	
2019-Jul-17, Wed,20:00	Clear	SMV other	Non-fatal injury	Dry	North	Turning left	Automobile, station wagon	Pedestrian	2
2019-Sep-05, Thu,15:45	Clear	Turning movement	Non-fatal injury	Dry	West	Turning left	Automobile, station wagon	Other motor vehicle	0
					East	Going ahead	Automobile, station wagon	Other motor vehicle	
2019-Dec-10, Tue,13:35	Clear	Rear end	P.D. only	Dry	East	Slowing or stopping	Automobile, station wagon	Other motor vehicle	0
					East	Stopped	Automobile, station wagon	Other motor vehicle	
2019-Dec-15, Sun,16:45	Clear	Rear end	P.D. only	Ice	North	Unknown	Unknown	Other motor vehicle	0
					North	Stopped	Automobile, station wagon	Other motor vehicle	
2020-Feb-12, Wed,09:04	Clear	Rear end	Non-fatal injury	Dry	West	Going ahead	Automobile, station wagon	Other motor vehicle	0
					West	Stopped	Automobile, station wagon	Other motor vehicle	

Location: OGILVIE RD @ CITY PARK DR E/CSIS HQ ACCESS

Traffic Control: Traffic signal

Total Collisions: 24

Date/Day/Time	Environment	Impact Type	Classification	Surface Cond'n	Veh. Dir	Vehicle Manoeuvre	Vehicle type	First Event	No. Ped
2016-Jan-29, Fri,12:48	Snow	Rear end	P.D. only	Wet	West	Turning left	Automobile, station wagon	Other motor vehicle	0
					West	Turning left	Automobile, station wagon	Other motor vehicle	
2016-Jun-02, Thu,18:47	Clear	Turning movement	Non-fatal injury	Dry	East	Making "U" turn	Automobile, station wagon	Other motor vehicle	0
					West	Going ahead	Automobile, station wagon	Other motor vehicle	



Transportation Services - Traffic Services

Collision Details Report - Public Version

From: January 1, 2016 To: December 31, 2020

Location: OGILVIE RD @ CITY PARK DR E/CSIS HQ ACCESS

Traffic Control: Traffic signal

Total Collisions: 24

Date/Day/Time	Environment	Impact Type	Classification	Surface Cond'n	Veh. Dir	Vehicle Manoeuvre	Vehicle type	First Event	No. Ped
2016-Jun-03, Fri,14:10	Clear	Rear end	Non-fatal injury	Dry	East	Going ahead	Automobile, station wagon	Other motor vehicle	0
					East	Stopped	Automobile, station wagon	Other motor vehicle	
2016-Jun-21, Tue,05:38	Clear	Angle	P.D. only	Dry	East	Going ahead	Automobile, station wagon	Other motor vehicle	0
					North	Turning left	Pick-up truck	Other motor vehicle	
2016-Sep-06, Tue,19:27	Clear	Turning movement	P.D. only	Dry	West	Making "U" turn	Pick-up truck	Other motor vehicle	0
					East	Going ahead	Pick-up truck	Other motor vehicle	
2016-Sep-08, Thu,13:51	Rain	Turning movement	Non-fatal injury	Wet	West	Turning left	Automobile, station wagon	Other motor vehicle	0
					East	Going ahead	Automobile, station wagon	Other motor vehicle	
2016-Oct-20, Thu,08:38	Fog, mist, smoke, dust	Turning movement	Non-fatal injury	Dry	West	Turning left	Pick-up truck	Other motor vehicle	0
					East	Going ahead	Pick-up truck	Other motor vehicle	
2016-Dec-30, Fri,13:03	Clear	Rear end	P.D. only	Dry	East	Changing lanes	Automobile, station wagon	Other motor vehicle	0
					East	Stopped	Automobile, station wagon	Other motor vehicle	
2017-Feb-17, Fri,18:51	Clear	Turning movement	P.D. only	Dry	West	Turning left	Pick-up truck	Other motor vehicle	0
					East	Going ahead	Automobile, station wagon	Other motor vehicle	
2017-May-18, Thu,19:13	Clear	Rear end	P.D. only	Dry	North	Going ahead	Automobile, station wagon	Other motor vehicle	0
					North	Stopped	Automobile, station wagon	Other motor vehicle	
2017-May-23, Tue,12:53	Clear	Rear end	Non-fatal injury	Dry	East	Going ahead	Pick-up truck	Other motor vehicle	0
					East	Stopped	Automobile, station wagon	Other motor vehicle	
					East	Stopped	Automobile, station wagon	Other motor vehicle	
					East	Stopped	Automobile, station wagon	Other motor vehicle	
2017-Sep-03, Sun,17:40	Rain	SMV other	Non-fatal injury	Wet	East	Turning right	Automobile, station wagon	Curb	0
2017-Oct-13, Fri,11:42	Clear	Turning movement	P.D. only	Dry	South	Going ahead	Pick-up truck	Other motor vehicle	0
					South	Making "U" turn	Automobile, station wagon	Other motor vehicle	



Transportation Services - Traffic Services

Collision Details Report - Public Version

From: January 1, 2016 To: December 31, 2020

Location: OGILVIE RD @ CITY PARK DR E/CSIS HQ ACCESS

Traffic Control: Traffic signal

Total Collisions: 24

Date/Day/Time	Environment	Impact Type	Classification	Surface Cond'n	Veh. Dir	Vehicle Manoeuvre	Vehicle type	First Event	No. Ped
2018-Jun-13, Wed,10:00	Rain	Turning movement	P.D. only	Wet	West	Turning left	Automobile, station wagon	Other motor vehicle	0
					East	Going ahead	Automobile, station wagon	Other motor vehicle	
2018-Jun-27, Wed,14:35	Clear	Turning movement	P.D. only	Dry	West	Turning left	Automobile, station wagon	Other motor vehicle	0
					East	Going ahead	Pick-up truck	Other motor vehicle	
2019-Jun-13, Thu,16:40	Clear	Rear end	P.D. only	Dry	East	Going ahead	Automobile, station wagon	Other motor vehicle	0
					East	Stopped	Automobile, station wagon	Other motor vehicle	
2019-Sep-05, Thu,15:15	Clear	Rear end	P.D. only	Dry	West	Going ahead	Automobile, station wagon	Other motor vehicle	0
					West	Stopped	Automobile, station wagon	Other motor vehicle	
2019-Sep-06, Fri,15:55	Rain	Rear end	P.D. only	Wet	West	Going ahead	Automobile, station wagon	Other motor vehicle	0
					West	Stopped	Automobile, station wagon	Other motor vehicle	
2019-Sep-21, Sat,11:25	Clear	Turning movement	P.D. only	Dry	West	Making "U" turn	Passenger van	Other motor vehicle	0
					East	Going ahead	Automobile, station wagon	Other motor vehicle	
2019-Sep-26, Thu,14:56	Clear	SMV other	Non-fatal injury	Dry	West	Going ahead	Automobile, station wagon	Pedestrian	1
2019-Nov-08, Fri,12:15	Clear	Rear end	P.D. only	Dry	East	Going ahead	Automobile, station wagon	Other motor vehicle	0
					East	Stopped	Automobile, station wagon	Other motor vehicle	
2020-Jan-31, Fri,06:50	Clear	Turning movement	Non-fatal injury	Dry	West	Turning left	Automobile, station wagon	Other motor vehicle	0
					East	Going ahead	Automobile, station wagon	Other motor vehicle	
2020-Nov-12, Thu,16:11	Clear	Turning movement	P.D. only	Dry	West	Turning left	Automobile, station wagon	Other motor vehicle	0
					East	Going ahead	Automobile, station wagon	Other motor vehicle	
2020-Dec-21, Mon,17:15	Clear	Turning movement	P.D. only	Wet	North	Turning left	Automobile, station wagon	Other motor vehicle	0
					South	Going ahead	Automobile, station wagon	Other motor vehicle	



Transportation Services - Traffic Services

Collision Details Report - Public Version

From: January 1, 2016 To: December 31, 2020

Location: OGILVIE RD @ MATHESON RD/PALMERSTON DR

Traffic Control: Traffic signal

Total Collisions: 19

Date/Day/Time	Environment	Impact Type	Classification	Surface Cond'n	Veh. Dir	Vehicle Manoeuvre	Vehicle type	First Event	No. Ped
2016-Feb-18, Thu,10:34	Clear	Turning movement	P.D. only	Wet	South	Turning left	Automobile, station wagon	Other motor vehicle	0
					North	Turning right	Passenger van	Other motor vehicle	
2016-Aug-29, Mon,08:55	Clear	Angle	P.D. only	Dry	West	Going ahead	Automobile, station wagon	Other motor vehicle	0
					South	Stopped	Automobile, station wagon	Other motor vehicle	
2017-Feb-22, Wed,12:24	Rain	Rear end	Non-fatal injury	Wet	South	Turning right	Passenger van	Other motor vehicle	0
					South	Turning right	Passenger van	Other motor vehicle	
2017-Jul-21, Fri,17:40	Clear	Rear end	P.D. only	Dry	West	Going ahead	Automobile, station wagon	Other motor vehicle	0
					West	Stopped	Automobile, station wagon	Other motor vehicle	
2017-Oct-05, Thu,16:02	Clear	Rear end	P.D. only	Dry	West	Going ahead	Automobile, station wagon	Other motor vehicle	0
					West	Stopped	Automobile, station wagon	Other motor vehicle	
2018-Feb-03, Sat,17:53	Snow	Rear end	P.D. only	Wet	East	Making "U" turn	Automobile, station wagon	Other motor vehicle	0
					East	Going ahead	Automobile, station wagon	Other motor vehicle	
2018-Feb-16, Fri,13:21	Clear	Rear end	P.D. only	Wet	West	Slowing or stopping	Automobile, station wagon	Other motor vehicle	0
					West	Going ahead	Automobile, station wagon	Other motor vehicle	
2018-Jul-09, Mon,09:04	Clear	Angle	P.D. only	Dry	West	Pulling onto shoulder or toward curb	Municipal transit bus	Other motor vehicle	0
					South	Turning right	Pick-up truck	Other motor vehicle	
2018-Nov-29, Thu,20:14	Clear	Turning movement	P.D. only	Dry	East	Making "U" turn	Automobile, station wagon	Other motor vehicle	0
					West	Going ahead	Automobile, station wagon	Other motor vehicle	
2018-Dec-06, Thu,09:21	Clear	Rear end	P.D. only	Wet	West	Going ahead	Pick-up truck	Other motor vehicle	0
					West	Stopped	Automobile, station wagon	Other motor vehicle	
2019-Jan-01, Tue,04:42	Snow	SMV other	P.D. only	Slush	West	Reversing	Snow plow	Pole (utility, power)	0
2019-Mar-10, Sun,13:13	Snow	SMV other	P.D. only	Packed snow	East	Going ahead	Automobile, station wagon	Skidding/sliding	0

Transportation Services - Traffic Services

Collision Details Report - Public Version

From: January 1, 2016 To: December 31, 2020

Location: OGILVIE RD @ MATHESON RD/PALMERSTON DR

Traffic Control: Traffic signal

Total Collisions: 19

Date/Day/Time	Environment	Impact Type	Classification	Surface Cond'n	Veh. Dir	Vehicle Manoeuvre	Vehicle type	First Event	No. Ped
2019-Apr-24, Wed,15:53	Clear	Turning movement	Non-fatal injury	Dry	West	Making "U" turn	Automobile, station wagon	Other motor vehicle	0
					East	Going ahead	Automobile, station wagon	Other motor vehicle	
2019-May-12, Sun,16:45	Clear	Rear end	P.D. only	Dry	West	Going ahead	Automobile, station wagon	Other motor vehicle	0
					West	Stopped	Automobile, station wagon	Other motor vehicle	
2019-Sep-15, Sun,19:45	Clear	Turning movement	P.D. only	Dry	West	Going ahead	Automobile, station wagon	Other motor vehicle	0
					East	Turning left	Automobile, station wagon	Other motor vehicle	
2019-Dec-20, Fri,08:54	Clear	Angle	P.D. only	Dry	East	Going ahead	Automobile, station wagon	Other motor vehicle	0
					North	Turning left	Automobile, station wagon	Other motor vehicle	
2020-Sep-09, Wed,17:00	Rain	Other	P.D. only	Wet	North	Reversing	Passenger van	Other motor vehicle	0
					South	Stopped	Automobile, station wagon	Other motor vehicle	
2020-Sep-10, Thu,20:54	Clear	SMV other	P.D. only	Dry	East	Turning right	Automobile, station wagon	Pole (utility, power)	0
2020-Sep-21, Mon,14:24	Clear	Rear end	P.D. only	Dry	West	Slowing or stopping	Automobile, station wagon	Other motor vehicle	0
					West	Stopped	Automobile, station wagon	Other motor vehicle	

Location: OGILVIE RD btwn 240 W OF BLAIR RD & CITY PARK DR

Traffic Control: No control

Total Collisions: 5

Date/Day/Time	Environment	Impact Type	Classification	Surface Cond'n	Veh. Dir	Vehicle Manoeuvre	Vehicle type	First Event	No. Ped
2017-May-18, Thu,16:42	Clear	Sideswipe	P.D. only	Dry	East	Changing lanes	Automobile, station wagon	Other motor vehicle	0
					East	Going ahead	Automobile, station wagon	Other motor vehicle	
2017-Dec-01, Fri,19:44	Clear	Rear end	P.D. only	Dry	East	Going ahead	Pick-up truck	Other motor vehicle	0
					East	Stopped	Pick-up truck	Other motor vehicle	
2017-Dec-08, Fri,10:43	Clear	SMV other	P.D. only	Dry	South	Reversing	Pick-up truck	Pole (utility, power)	0



Transportation Services - Traffic Services

Collision Details Report - Public Version

From: January 1, 2016 To: December 31, 2020

Location: OGILVIE RD btwn 240 W OF BLAIR RD & CITY PARK DR

Traffic Control: No control

Total Collisions: 5

Date/Day/Time	Environment	Impact Type	Classification	Surface Cond'n	Veh. Dir	Vehicle Manoeuver	Vehicle type	First Event	No. Ped
2018-Aug-17, Fri,07:16	Clear	Sideswipe	Non-fatal injury	Dry	West	Changing lanes	Automobile, station wagon	Other motor vehicle	1
					West	Going ahead	Automobile, station wagon	Other motor vehicle	
					East	Stopped	Automobile, station wagon	Other motor vehicle	
2020-May-10, Sun,22:17	Clear	SMV other	P.D. only	Dry	West	Going ahead	Pick-up truck	Pole (utility, power)	0

Location: OGILVIE RD btwn BATHGATE DR & CADBORO RD

Traffic Control: No control

Total Collisions: 6

Date/Day/Time	Environment	Impact Type	Classification	Surface Cond'n	Veh. Dir	Vehicle Manoeuver	Vehicle type	First Event	No. Ped
2016-Feb-21, Sun,00:00	Clear	SMV unattended vehicle	P.D. only	Wet	Unknown	Unknown	Unknown	Unattended vehicle	0
2016-May-06, Fri,17:28	Clear	Rear end	P.D. only	Dry	East	Slowing or stopping	Pick-up truck	Other motor vehicle	0
					East	Stopped	Passenger van	Other motor vehicle	
2017-Nov-16, Thu,16:45	Rain	Rear end	Non-fatal injury	Wet	East	Going ahead	Automobile, station wagon	Other motor vehicle	0
					East	Stopped	Automobile, station wagon	Other motor vehicle	
2018-Apr-24, Tue,23:41	Clear	SMV other	P.D. only	Dry	West	Going ahead	Automobile, station wagon	Building or wall	0
2019-Dec-21, Sat,13:37	Clear	Angle	P.D. only	Dry	South	Turning right	Automobile, station wagon	Other motor vehicle	0
					West	Going ahead	Automobile, station wagon	Other motor vehicle	
2020-Aug-09, Sun,23:17	Clear	Rear end	P.D. only	Dry	West	Changing lanes	Pick-up truck	Other motor vehicle	0
					West	Going ahead	Automobile, station wagon	Other motor vehicle	

Location: OGILVIE RD btwn BATHGATE DR & CITY PARK DR (1)

Traffic Control: No control

Total Collisions: 6

Date/Day/Time	Environment	Impact Type	Classification	Surface Cond'n	Veh. Dir	Vehicle Manoeuver	Vehicle type	First Event	No. Ped
2016-Jul-04, Mon,16:27	Clear	Rear end	Non-fatal injury	Dry	East	Going ahead	Pick-up truck	Other motor vehicle	0
					East	Slowing or stopping	Pick-up truck	Other motor vehicle	

Transportation Services - Traffic Services

Collision Details Report - Public Version

From: January 1, 2016 **To:** December 31, 2020

Location: OGILVIE RD btwn BATHGATE DR & CITY PARK DR (1)

Traffic Control: No control

Total Collisions: 6

Date/Day/Time	Environment	Impact Type	Classification	Surface Cond'n	Veh. Dir	Vehicle Manoeuvre	Vehicle type	First Event	No. Ped
2016-Aug-13, Sat,17:08	Snow	Rear end	Non-fatal injury	Wet	West	Going ahead	Automobile, station wagon	Other motor vehicle	0
					West	Slowing or stopping	Pick-up truck	Other motor vehicle	
2017-Feb-15, Wed,09:37	Snow	Rear end	Non-fatal injury	Packed snow	East	Going ahead	Automobile, station wagon	Other motor vehicle	0
					East	Stopped	Municipal transit bus	Other motor vehicle	
2019-May-15, Wed,17:54	Clear	Sideswipe	P.D. only	Dry	East	Changing lanes	Automobile, station wagon	Other motor vehicle	0
					East	Stopped	Automobile, station wagon	Other motor vehicle	
2019-Oct-17, Thu,18:58	Rain	Sideswipe	P.D. only	Wet	West	Changing lanes	Automobile, station wagon	Other motor vehicle	0
					West	Going ahead	Pick-up truck	Other motor vehicle	
2020-Jan-17, Fri,18:03	Clear	Rear end	Non-fatal injury	Dry	East	Going ahead	Automobile, station wagon	Other motor vehicle	0
					East	Stopped	Automobile, station wagon	Other motor vehicle	

Location: OGILVIE RD btwn BATHGATE DR & CITY PARK DR (2)

Traffic Control: No control

Total Collisions: 2

Date/Day/Time	Environment	Impact Type	Classification	Surface Cond'n	Veh. Dir	Vehicle Manoeuvre	Vehicle type	First Event	No. Ped
2016-Nov-01, Tue,11:14	Clear	Rear end	P.D. only	Dry	West	Going ahead	Automobile, station wagon	Other motor vehicle	0
					West	Slowing or stopping	Passenger van	Other motor vehicle	
					West	Slowing or stopping	Automobile, station wagon	Other motor vehicle	
2018-Oct-31, Wed,17:50	Rain	Sideswipe	P.D. only	Wet	East	Changing lanes	Pick-up truck	Other motor vehicle	0
					East	Going ahead	Automobile, station wagon	Other motor vehicle	

Location: OGILVIE RD btwn BLAIR RD (1) & CITY PARK DR

Traffic Control: No control

Total Collisions: 2

Date/Day/Time	Environment	Impact Type	Classification	Surface Cond'n	Veh. Dir	Vehicle Manoeuvre	Vehicle type	First Event	No. Ped
2016-Sep-30, Fri,13:01	Clear	Angle	P.D. only	Dry	East	Changing lanes	Automobile, station wagon	Other motor vehicle	0
					North	Turning right	Pick-up truck	Other motor vehicle	



Transportation Services - Traffic Services

Collision Details Report - Public Version

From: January 1, 2016 To: December 31, 2020

Location: OGILVIE RD btwn BLAIR RD (1) & CITY PARK DR

Traffic Control: No control

Total Collisions: 2

Date/Day/Time	Environment	Impact Type	Classification	Surface Cond'n	Veh. Dir	Vehicle Manoeuver	Vehicle type	First Event	No. Ped
2020-Dec-12, Sat,15:17	Freezing Rain	Rear end	Non-fatal injury	Ice	East	Going ahead	Automobile, station wagon	Other motor vehicle	0
					East	Slowing or stopping	Pick-up truck	Other motor vehicle	

Location: OGILVIE RD btwn CADBORO RD & MATHESON RD

Traffic Control: No control

Total Collisions: 7

Date/Day/Time	Environment	Impact Type	Classification	Surface Cond'n	Veh. Dir	Vehicle Manoeuver	Vehicle type	First Event	No. Ped
2016-Apr-08, Fri,17:28	Clear	Sideswipe	P.D. only	Wet	East	Changing lanes	Unknown	Other motor vehicle	0
					East	Going ahead	Passenger van	Other motor vehicle	
2018-Jan-02, Tue,21:40	Snow	Angle	Non-fatal injury	Slush	South	Turning right	Automobile, station wagon	Other motor vehicle	0
					West	Going ahead	Automobile, station wagon	Other motor vehicle	
2018-May-28, Mon,20:56	Clear	SMV other	Non-fatal injury	Dry	East	Going ahead	Automobile, station wagon	Ran off road	0
2018-Jul-30, Mon,13:13	Clear	SMV other	P.D. only	Dry	South	Turning right	Automobile, station wagon	Pole (utility, power)	0
2019-Apr-04, Thu,08:15	Clear	Rear end	P.D. only	Dry	East	Going ahead	Automobile, station wagon	Other motor vehicle	0
					East	Slowing or stopping	Automobile, station wagon	Other motor vehicle	
2020-Jan-11, Sat,21:20	Clear	Rear end	P.D. only	Wet	East	Going ahead	Automobile, station wagon	Other motor vehicle	0
					East	Going ahead	Pick-up truck	Other motor vehicle	
2020-Jan-29, Wed,15:17	Clear	Rear end	P.D. only	Loose snow	West	Going ahead	Pick-up truck	Other motor vehicle	0
					West	Stopped	Passenger van	Other motor vehicle	

APPENDIX F

Blair TOD Plan

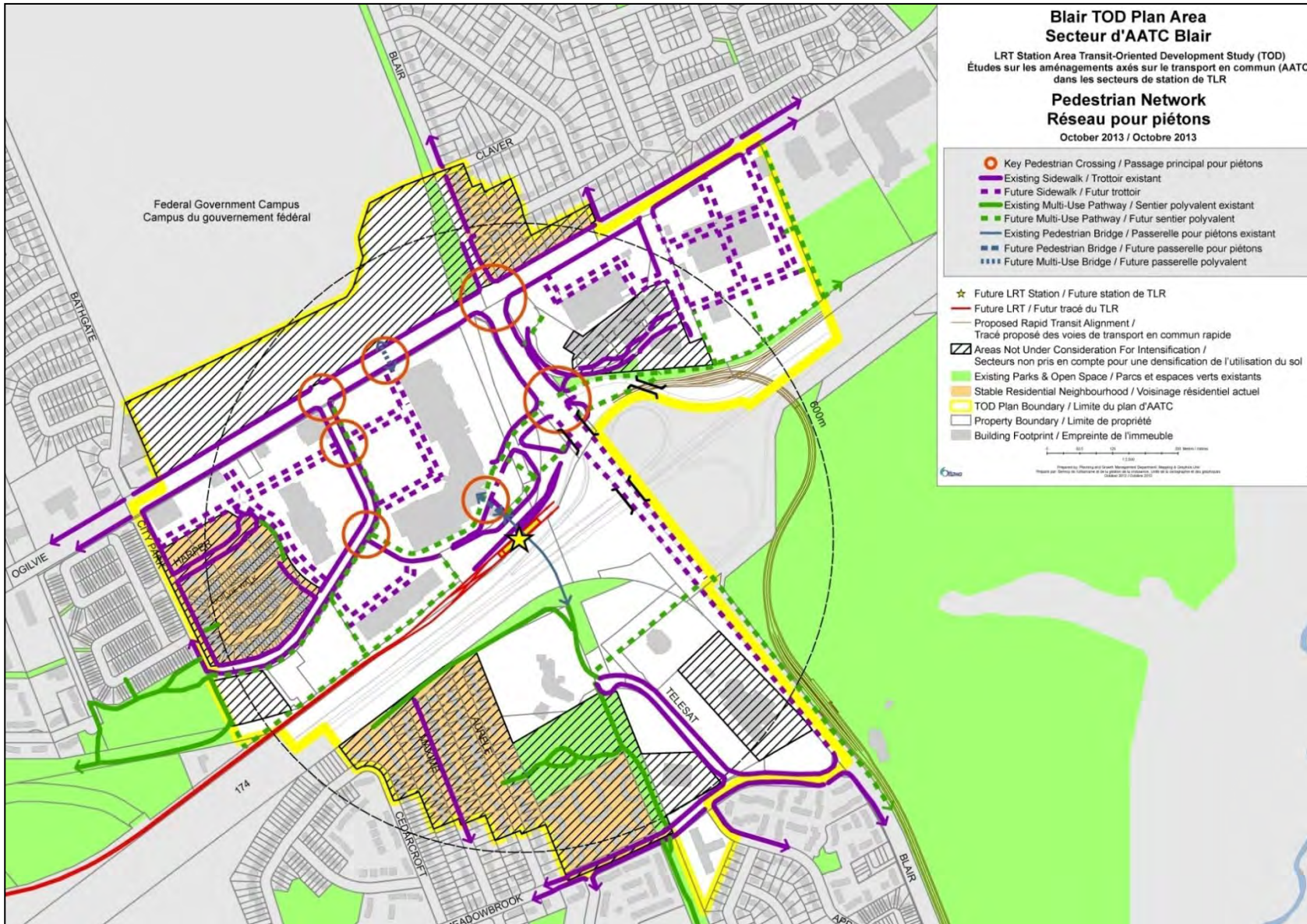

Figure 72: Blair Pedestrian Network

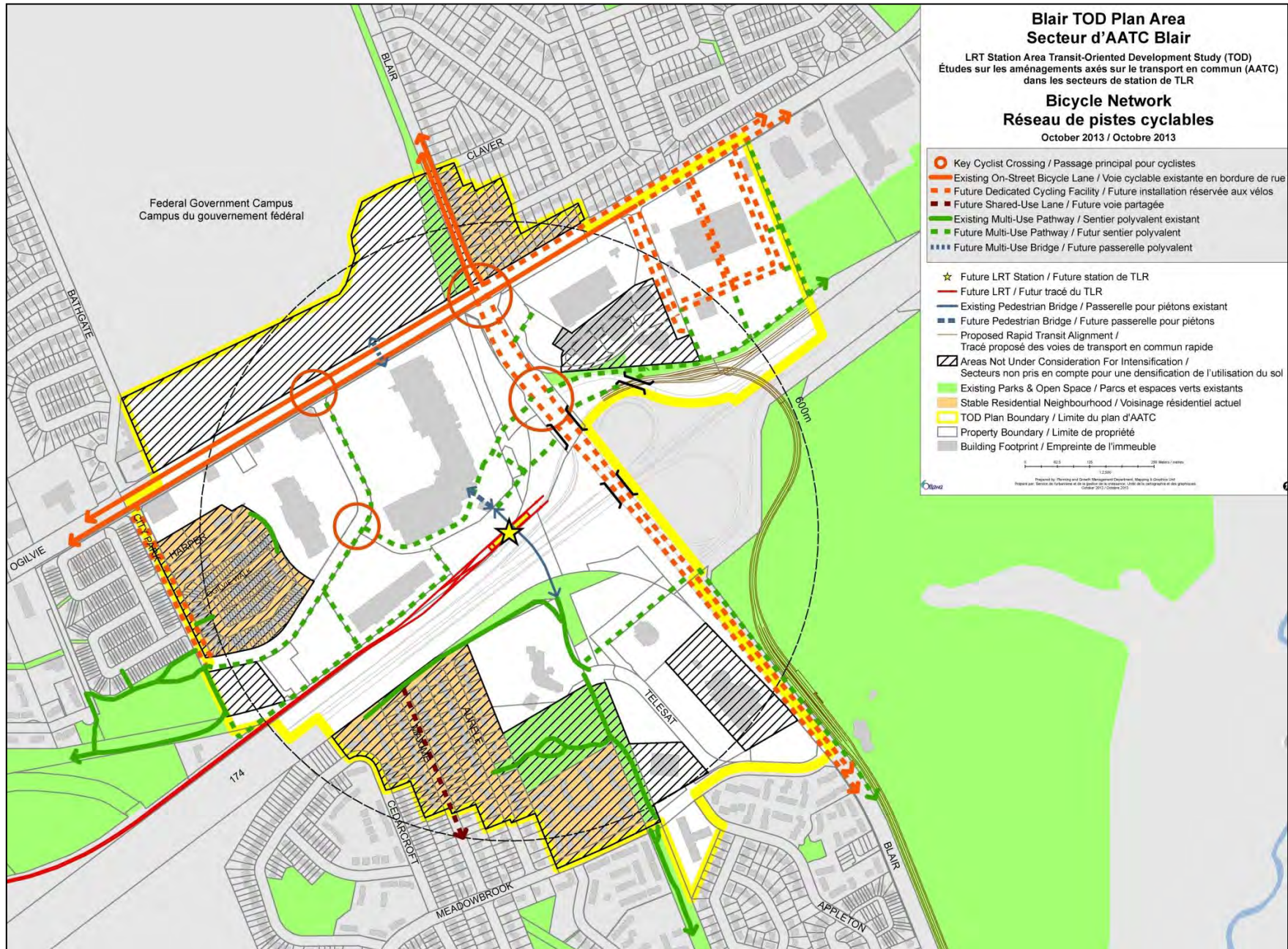
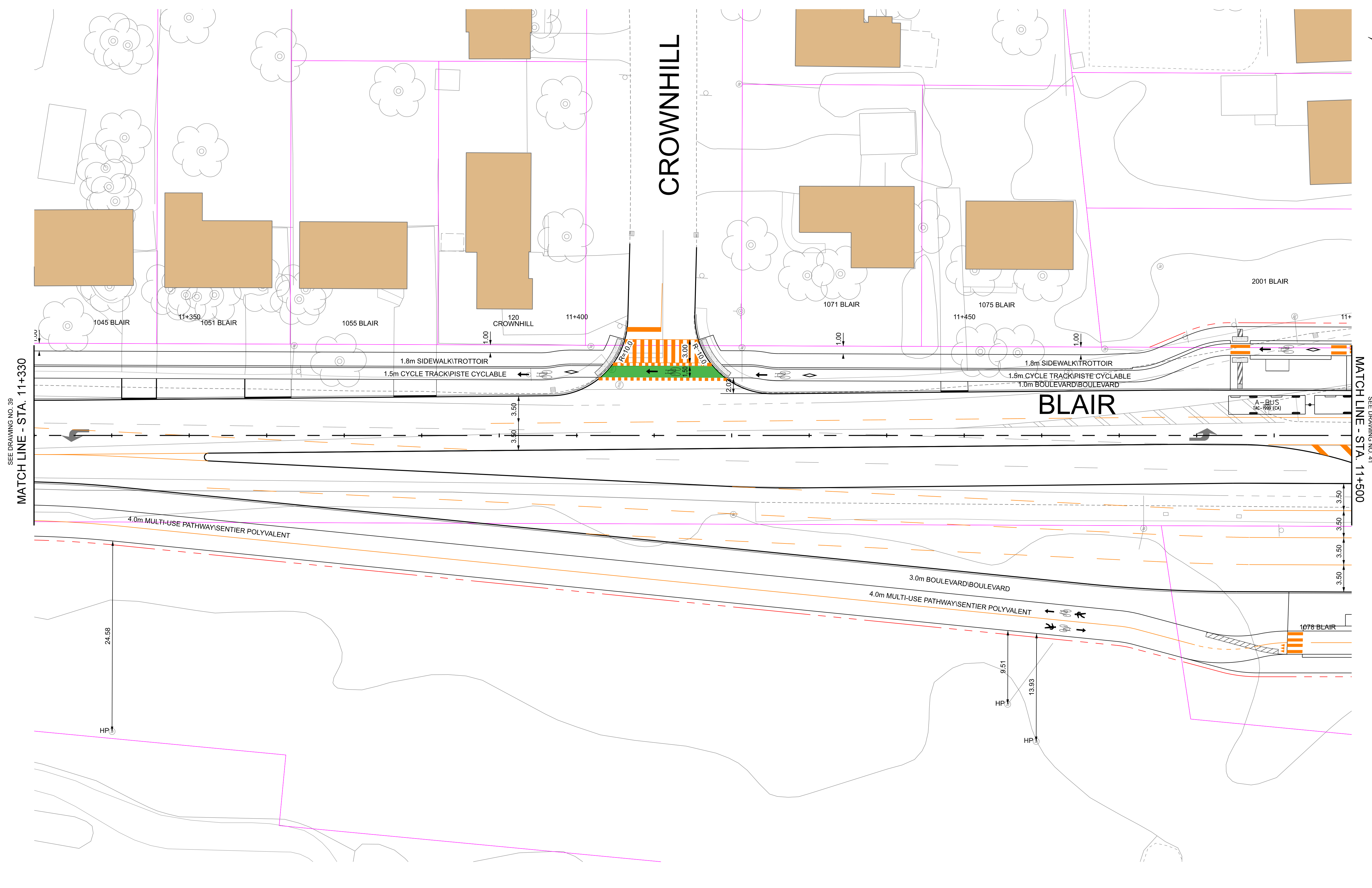

Figure 73: Blair Bicycle Network

APPENDIX G

Relevant EA Report Excerpts



SEE DRAWING NO. 39
MATCH LINE - STA. 11+330

MATCH LINE - STA. 11+500
SEE DRAWING NO. 41

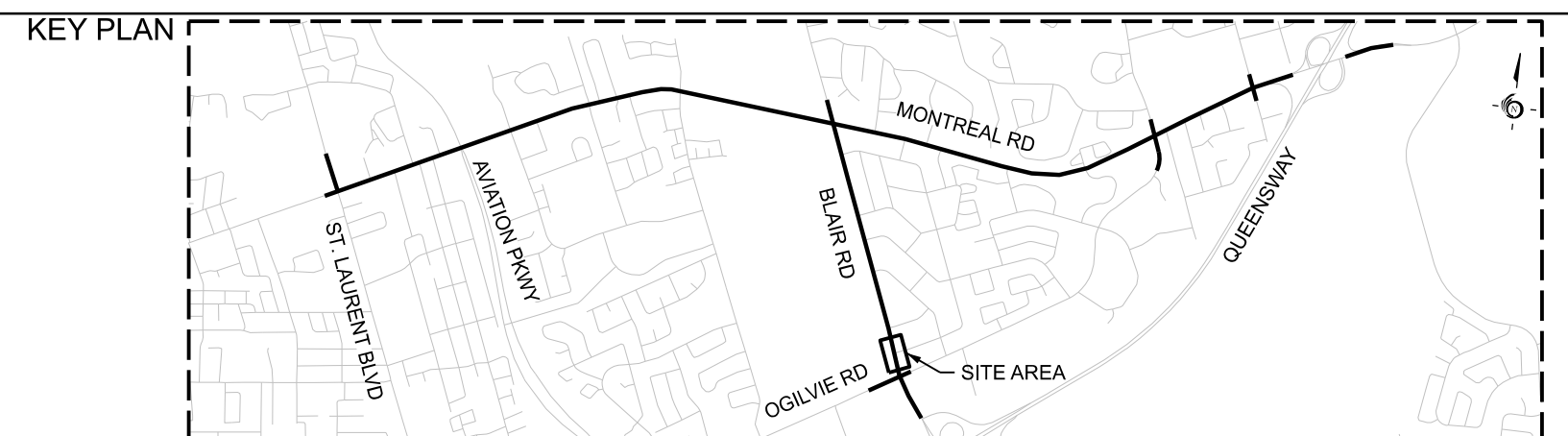

LEGEND	
	EXISTING PROPERTY LINE
	EXISTING ROW PROTECTION
	PROPOSED PROPERTY LINE
	EXISTING CONDITIONS
	PROPOSED FUNCTIONAL DESIGN
	PROPOSED FUNCTIONAL DESIGN PAVEMENT MARKINGS

PARSONS

Date: 23 August 2021
 Project Manager: _____
 Scale: _____
 CAD File Name: 477003-2000-EA-40.DGN

Designed By: _____
 Discipline Engineer: _____
 Drawn By: _____
 Checked By: _____
 Plot Date: _____

Ottawa

MONTREAL - BLAIR TRANSIT PRIORITY CORRIDOR
 STA. 11+330 to STA 11+500

Drawings No.: _____
 Revision: 00
 Sheet No.: 40

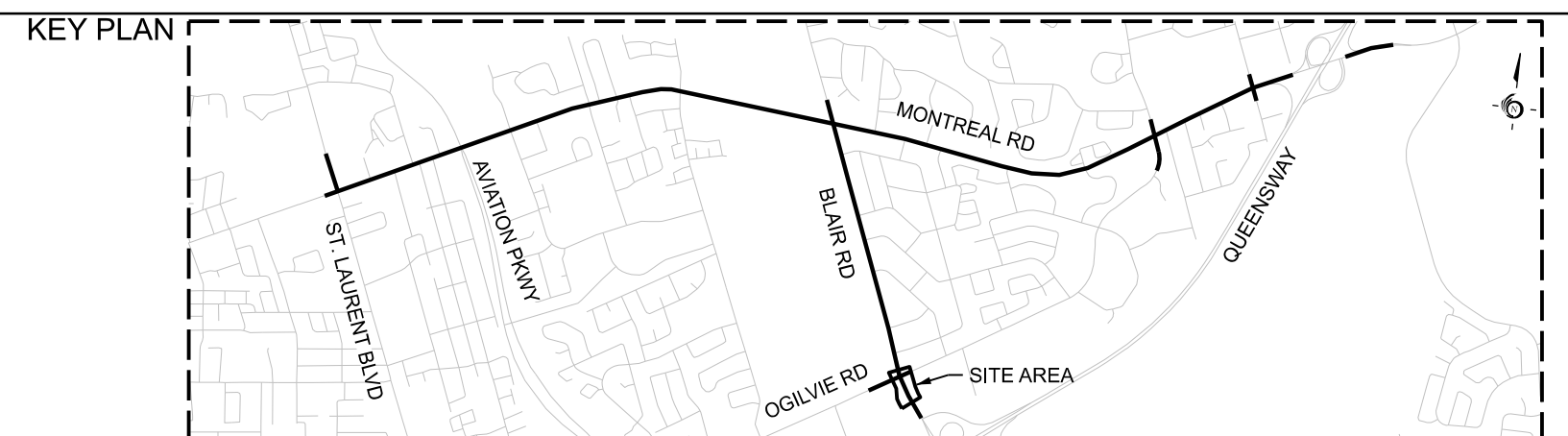
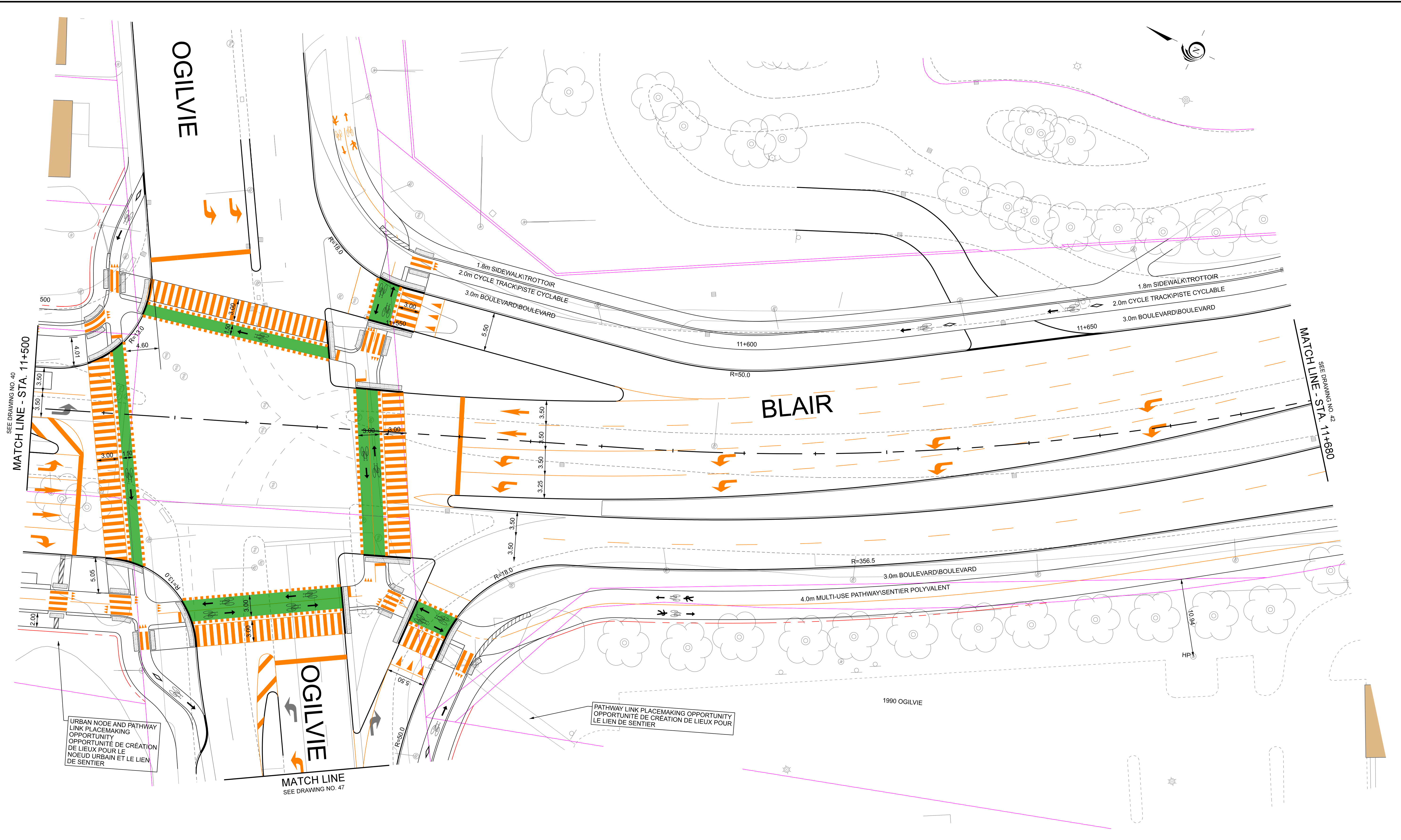

LEGEND	
	EXISTING PROPERTY LINE
	EXISTING ROW PROTECTION
	PROPOSED PROPERTY LINE
	EXISTING CONDITIONS
	PROPOSED FUNCTIONAL DESIGN
	PROPOSED FUNCTIONAL DESIGN PAVEMENT MARKINGS

PARSONS

Date: 22 October 2021
 Project Manager: []
 Scale: []
 CAD File Name: 477003-2000-EA-41.DGN

Designed By: []
 Discipline Engineer: []
 Drawn By: []
 Checked By: []
 Plot Date: []

Ottawa

MONTREAL - BLAIR TRANSIT PRIORITY CORRIDOR
 STA. 11+500 TO STA 11+680

Drawings No.: []
 Revision: 00
 Sheet No.: 41

SEE DRAWING NO. 41
MATCH LINE - STA. 11+680

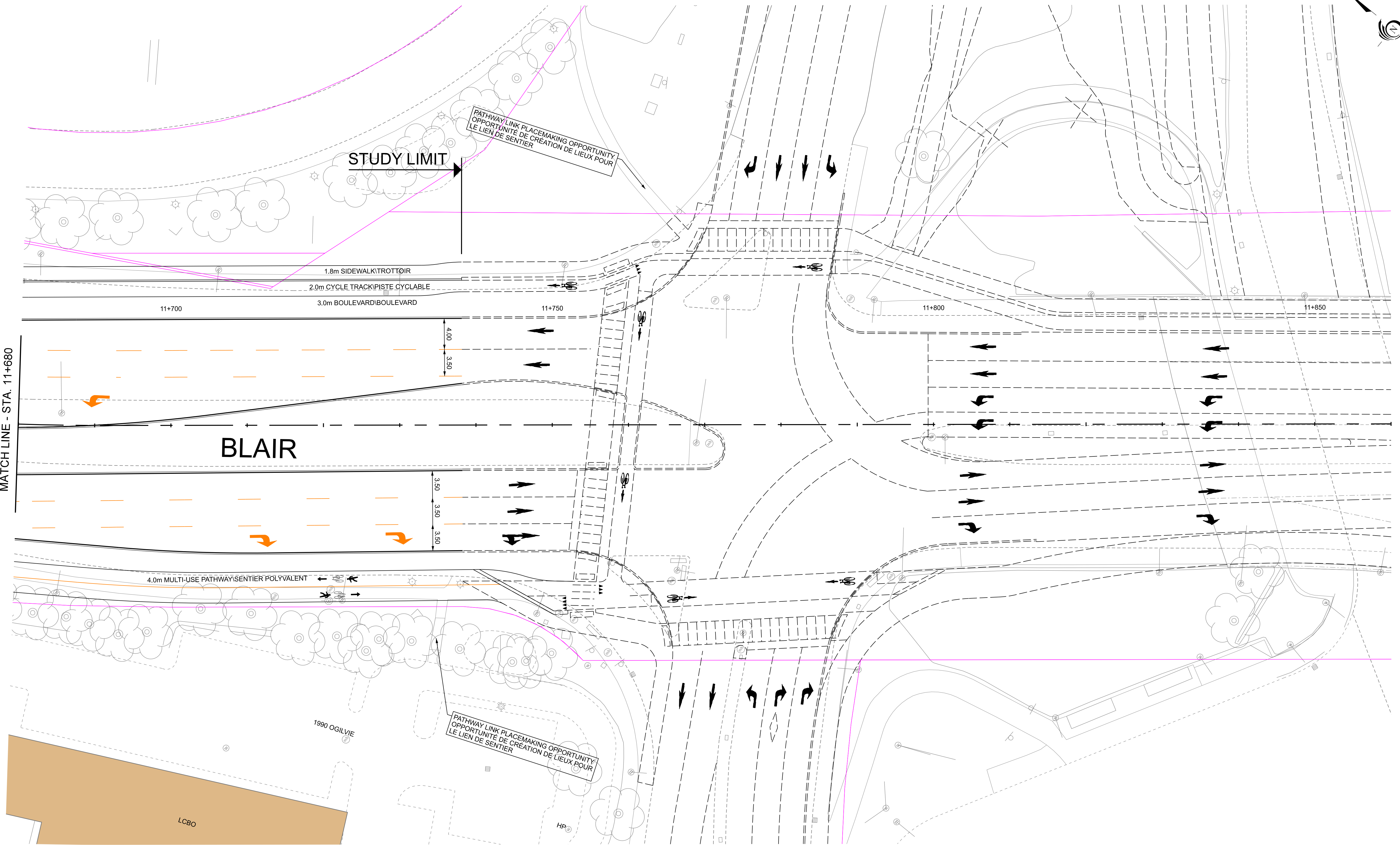

KEY PLAN

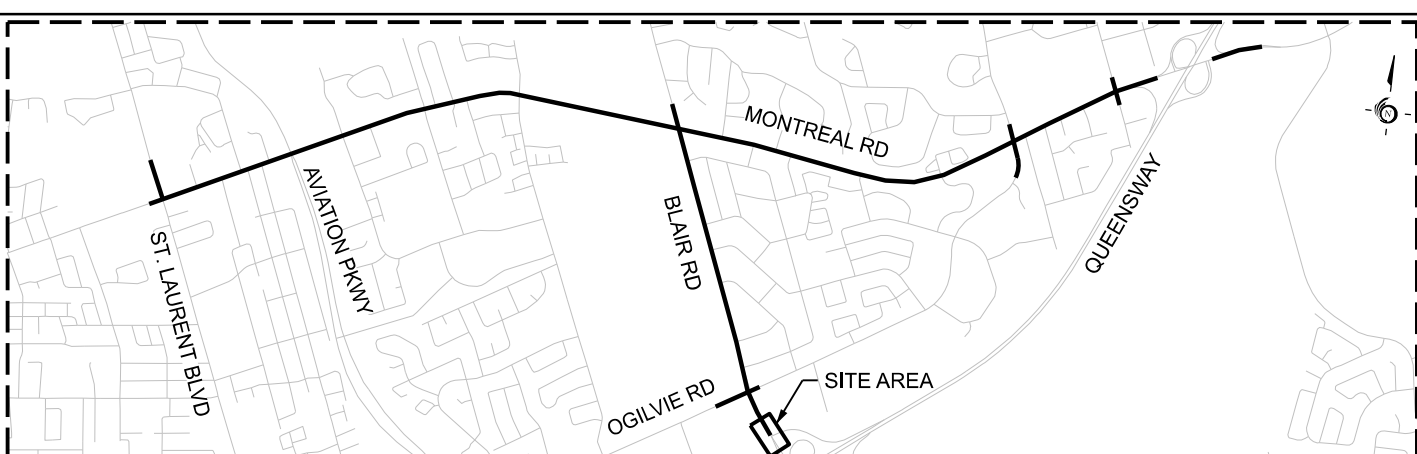

LEGEND

- EXISTING PROPERTY LINE
- EXISTING ROW PROTECTION
- PROPOSED PROPERTY LINE
- EXISTING CONDITIONS
- PROPOSED FUNCTIONAL DESIGN
- PROPOSED FUNCTIONAL DESIGN PAVEMENT MARKINGS
- BLAIR ROAD TRANSIT PRIORITY EA DESIGN



Date: 22 October 2021	Designed By:	Drawn By:
Project Manager:	Discipline Engineer:	Checked By:
Scale:		
CAD File Name: 477003-2000-EA-42.DGN	Plot Date:	Drawings No.:



MONTREAL - BLAIR TRANSIT PRIORITY CORRIDOR
STA. 11+680 to STA 11+860

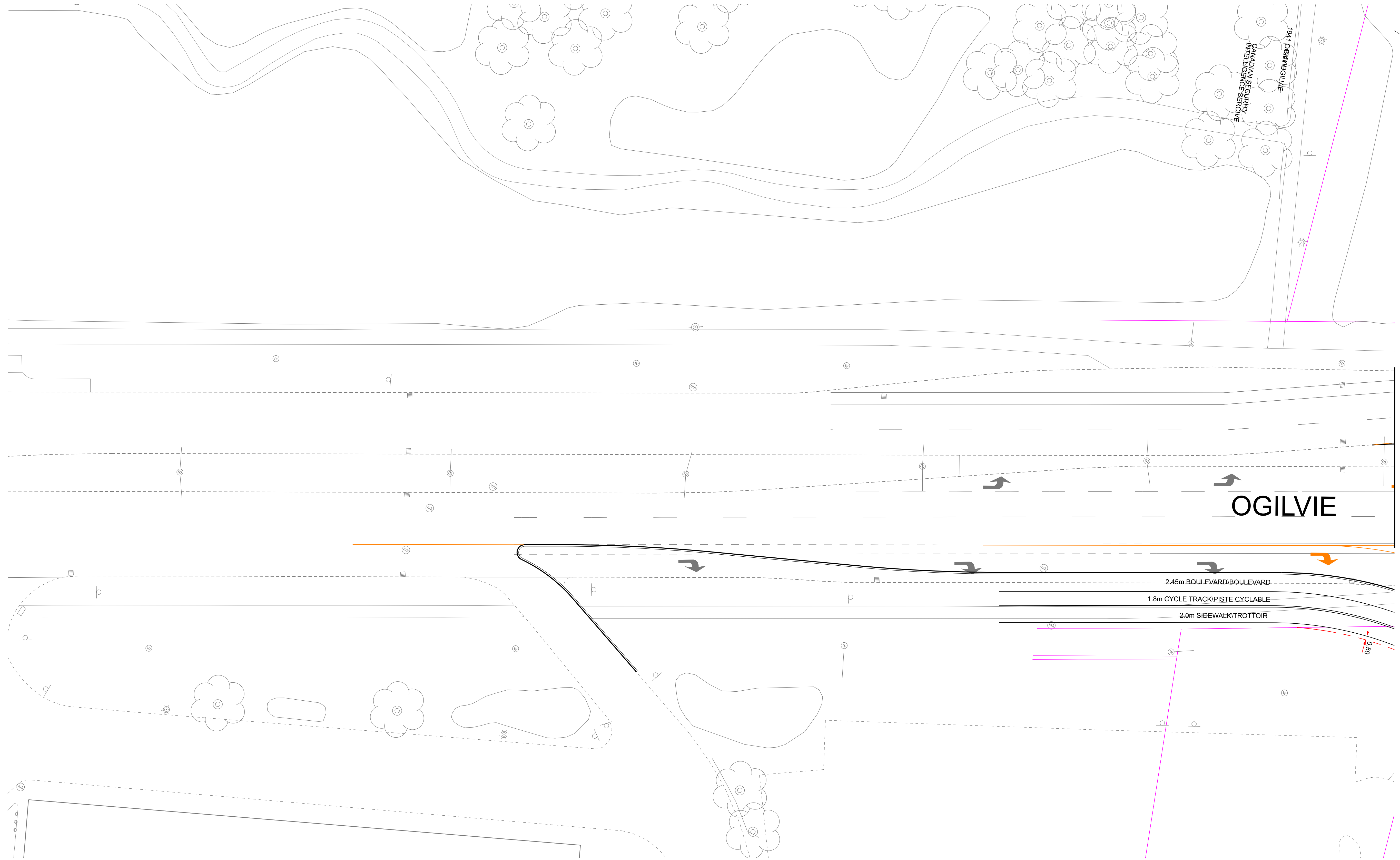

MATCH LINE
SEE DRAWING NO. 41

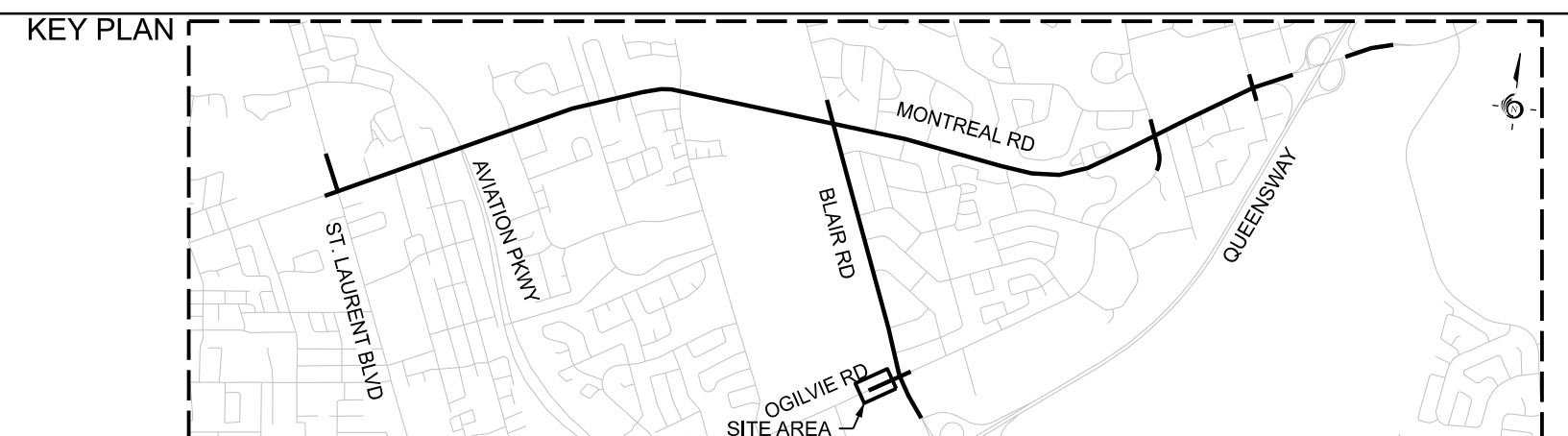

LEGEND

	EXISTING PROPERTY LINE		EXISTING CONDITIONS
	EXISTING ROW PROTECTION		PROPOSED FUNCTIONAL DESIGN
	PROPOSED PROPERTY LINE		PROPOSED FUNCTIONAL DESIGN PAVEMENT MARKINGS

PARSONS

Date: 23 August 2021	Designed By:	Drawn By:
Project Manager:	Discipline Engineer:	Checked By:
Scale:		
CAD File Name: 477003-2000-EA-47.DGN	Plot Date:	Drawings No.:

Ottawa

**MONTREAL - BLAIR TRANSIT PRIORITY CORRIDOR
OGILVIE ROAD**

Revision: 00	Sheet No.: 47
--------------	---------------

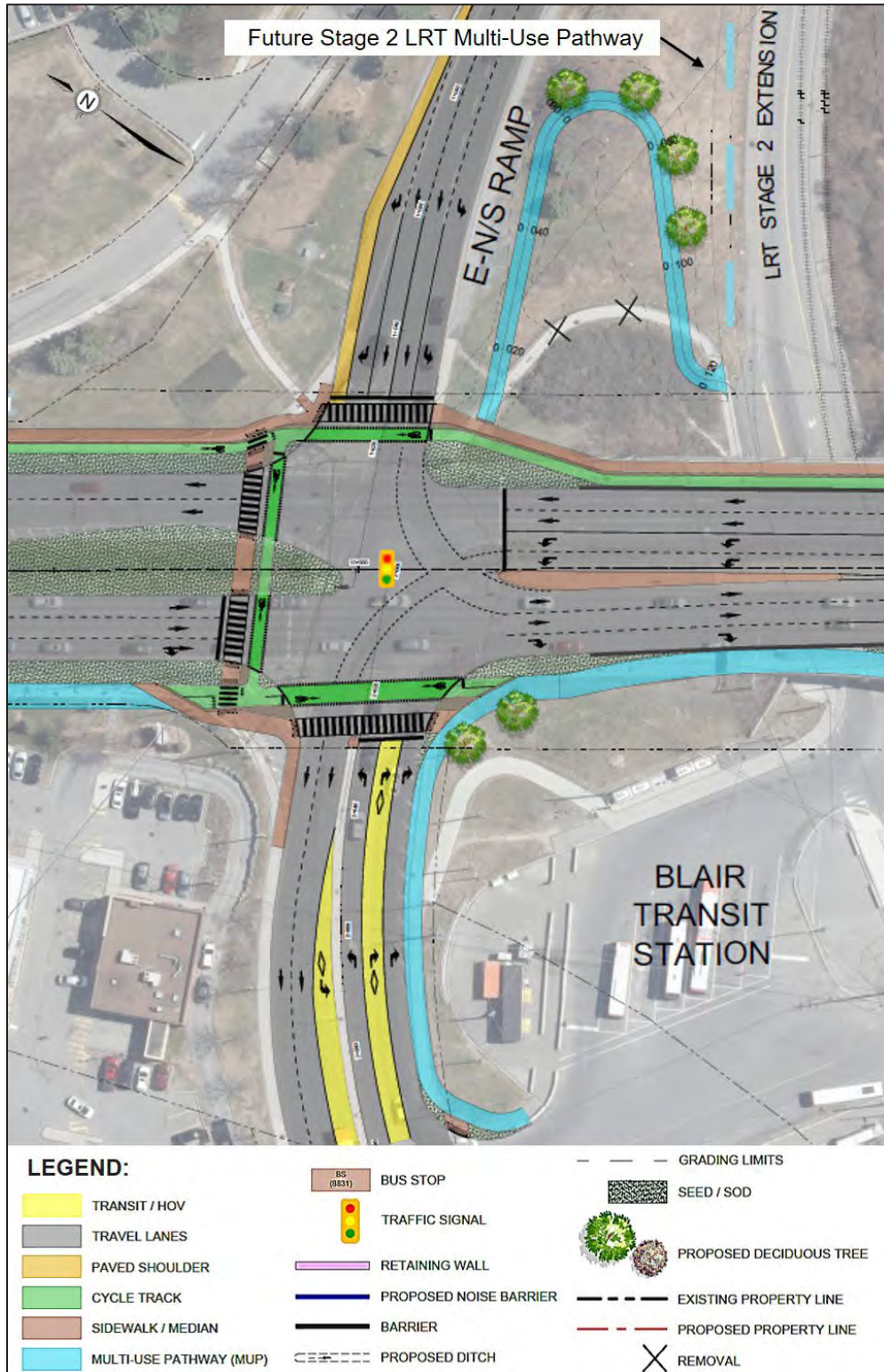

Figure 9-5: Protected Intersection and Highlights at Blair Station

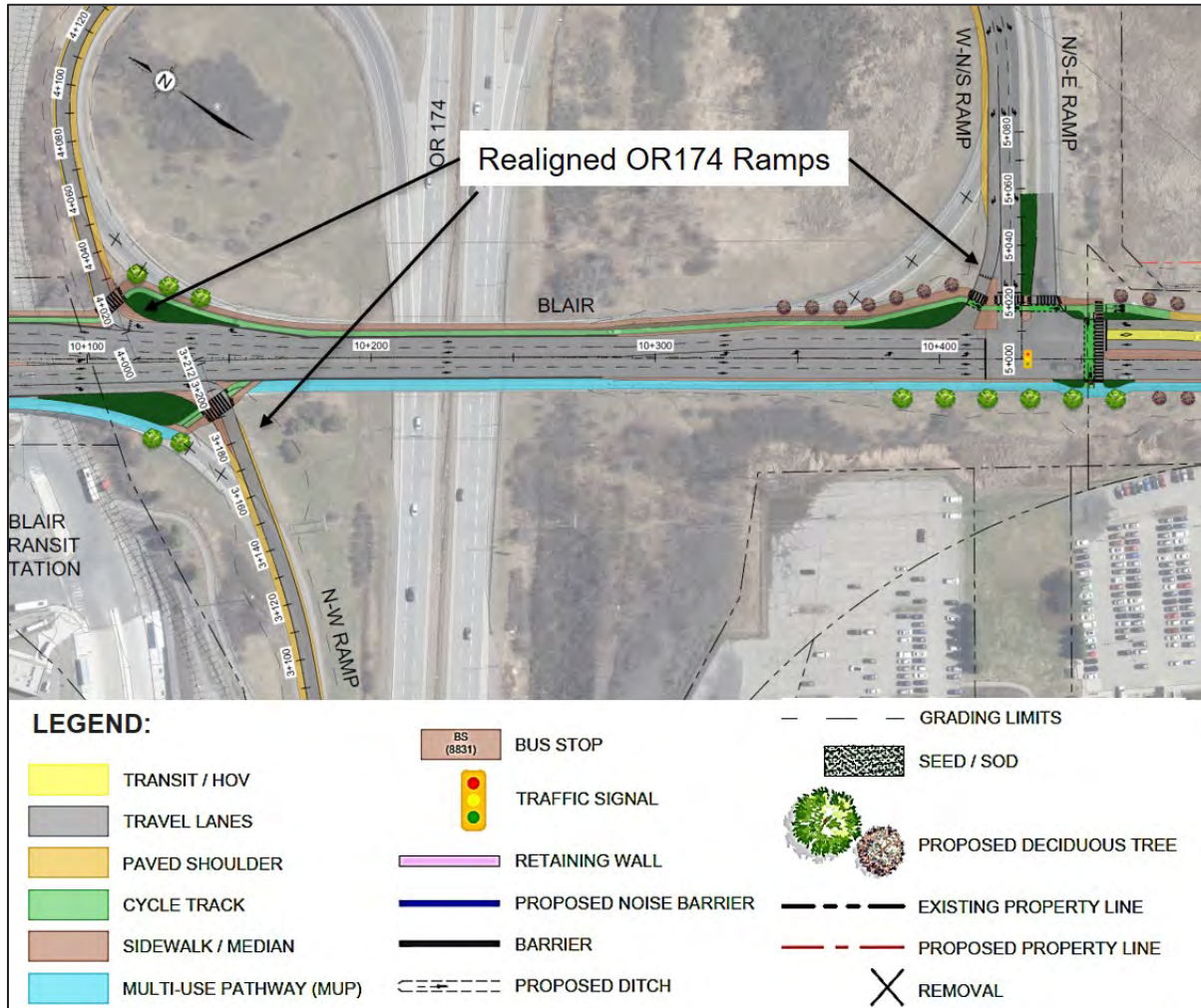

Figure 9-2: Realigned OR174 Interchange Ramps

South of OR174, Blair Road currently transitions from four to two lanes just south of Meadowbrook Road. For the existing four lane section between OR174 and Meadowbrook Road, only minor widening is required and a conversion of the two outer general traffic lanes to transit and HOV lanes is proposed. The northbound transit/HOV lane terminates at the intersection south of OR174 to allow buses destined to Blair Station to weave across to the left lane. Further south between Meadowbrook Road and Innes Road, Blair Road is currently a two-lane road and widening to four lanes is recommended to accommodate dedicated transit and HOV lanes.

Of the cross-section alternatives considered for Blair Road from south of OR174 to Innes Road, Option 1 is recommended. The NCC Greenbelt is on the east side of Blair Road and this project proposes to maintain the existing east rural grading and ditching to preserve the rural character of the Greenbelt. On the west side of Blair Road, a 3.0 m MUP will extend from the OR174 bridge overpass to Innes Road and will provide direct access to the adjacent Pineview Community. A MUP on the west side is preferred as it accommodates bi-directional cycling and reduces the need for northbound cyclists to cross Blair Road. Design refinements to the Recommended Design that arose through

APPENDIX H

Other Area Developments

January
2019

2280 City Park Drive Residential Development

Plan of Subdivision - TIA Strategy Report



Prepared for:

RIO  **CAN**

Prepared by:

PARSONS

Figure 9 : New Site-Generated Peak Hour Traffic Assignment

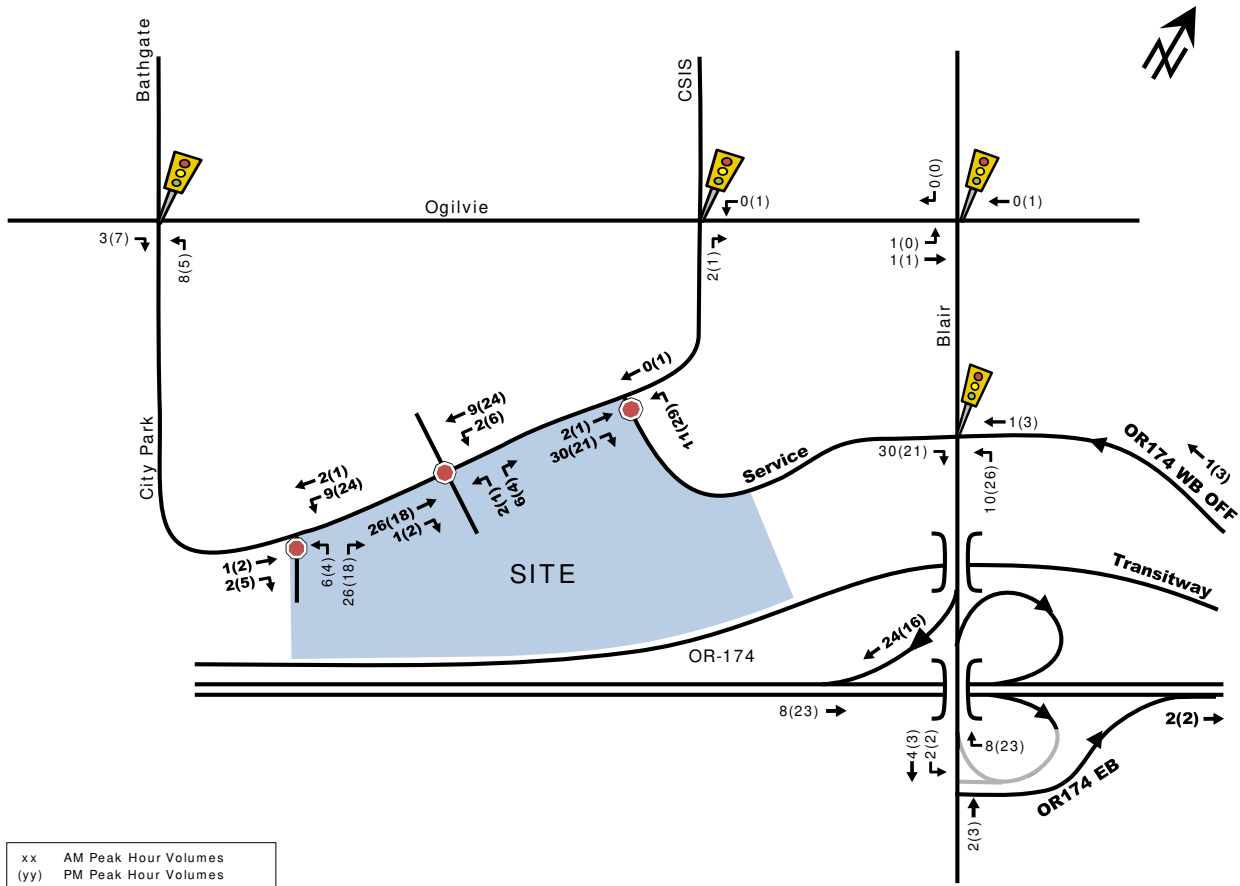

10. BACKGROUND TRAFFIC NETWORK

10.1. TRANSPORTATION NETWORK CHANGES

Several notable transportation network changes are proposed within the study area as per the 2013 TMP - 2031 Affordable Network, they are listed as follows:

Blair Road network changes

- Widen from two to four lanes between Meadowbrook Road and Innes Road;
- Exclusive bus lanes and transit signal priority between Blair Station and Montreal Road. Bus lanes to be provided through a combination of road widening (north of Ogilvie Road) and conversion of existing traffic lanes (south of Ogilvie Road);
- Transit signal priority and queue jump lanes between Innes Road and Blair Station; and
- Affordable: Eastern extension of LRT service following Ottawa Road 174 between Blair Station and Place d'Orléans Station.

Ogilvie Road network changes

- Transit signal priority between Blair Road and St. Laurent Boulevard.

1980 Ogilvie Road Transportation Impact Assessment

Step 1 Screening Report

Step 2 Scoping Report

Step 3 Forecasting Report

Step 4 Strategy Report

Prepared for:

First Capital Asset Management ULC
RDC 113, 7600 Boulevard Viau
Montreal, Quebec, H1S 2P3

Prepared by:



13 Markham Avenue
Nepean, ON K2G 3Z1

September 2019

PN: 2018-30

Table 13: OD Survey Existing Mode Share – Beacon Hill

To/From	% of Trips
North	5%
South	30%
East	20%
West	45%
Total	100%

5.3 Trip Assignment

Using the distribution outlined above, turning movement splits, and access to major transportation infrastructure, the trips generated by the site have been assigned to the Study Area road network. Figure 9 illustrates the new site generated volumes.

Figure 9: New Site Generation Auto Volumes

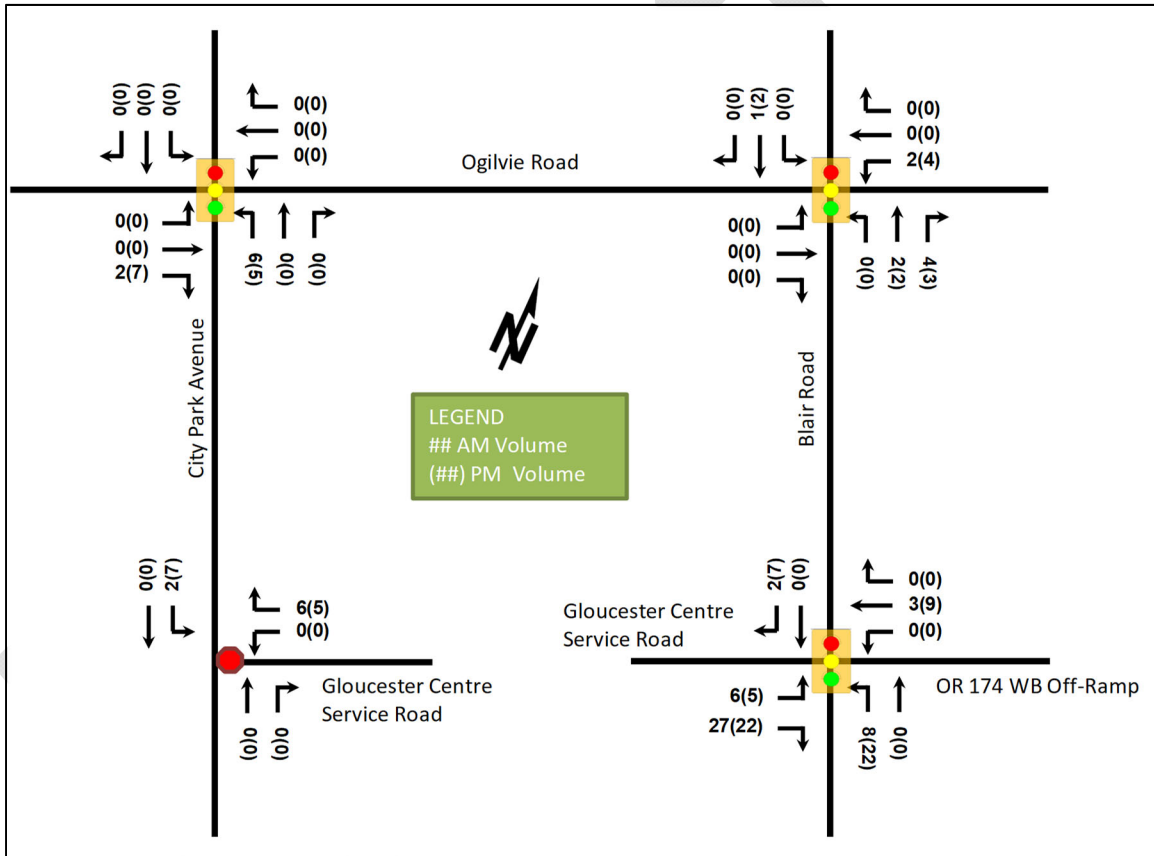

6 Background Network Travel Demands

6.1 Transportation Network Plans

The transportation network plans were discussed in Section 2.3.1. The opening of the Blair LRT station, transit priority along Blair Road, and isolated transit measures to Innes Road have been accounted for within the modal share assumptions and will be reinforced by the opening of Phase 2. No road improvements are noted for the area.

The additional connectivity provided by the multi-use pathway along City Park Drive and the LRT line will improve the active mode network but is not anticipated to significantly impact the modal shares used in the future trip generation.



© Ecogis, Earth 2015

Shoppers City East Redevelopment - Phase II

Transportation Impact Study

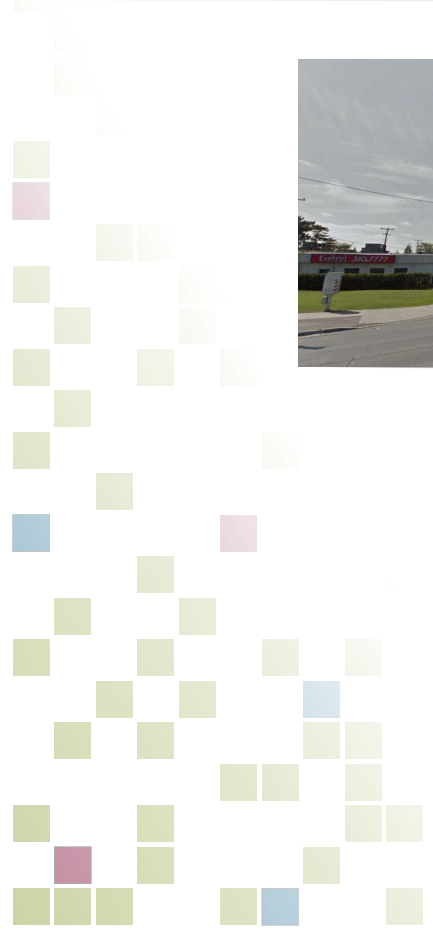

Prepared for:

Prepared by:



TRINITY

PARSONS

Figure 6: Projected 2017 Baseline Traffic Volumes

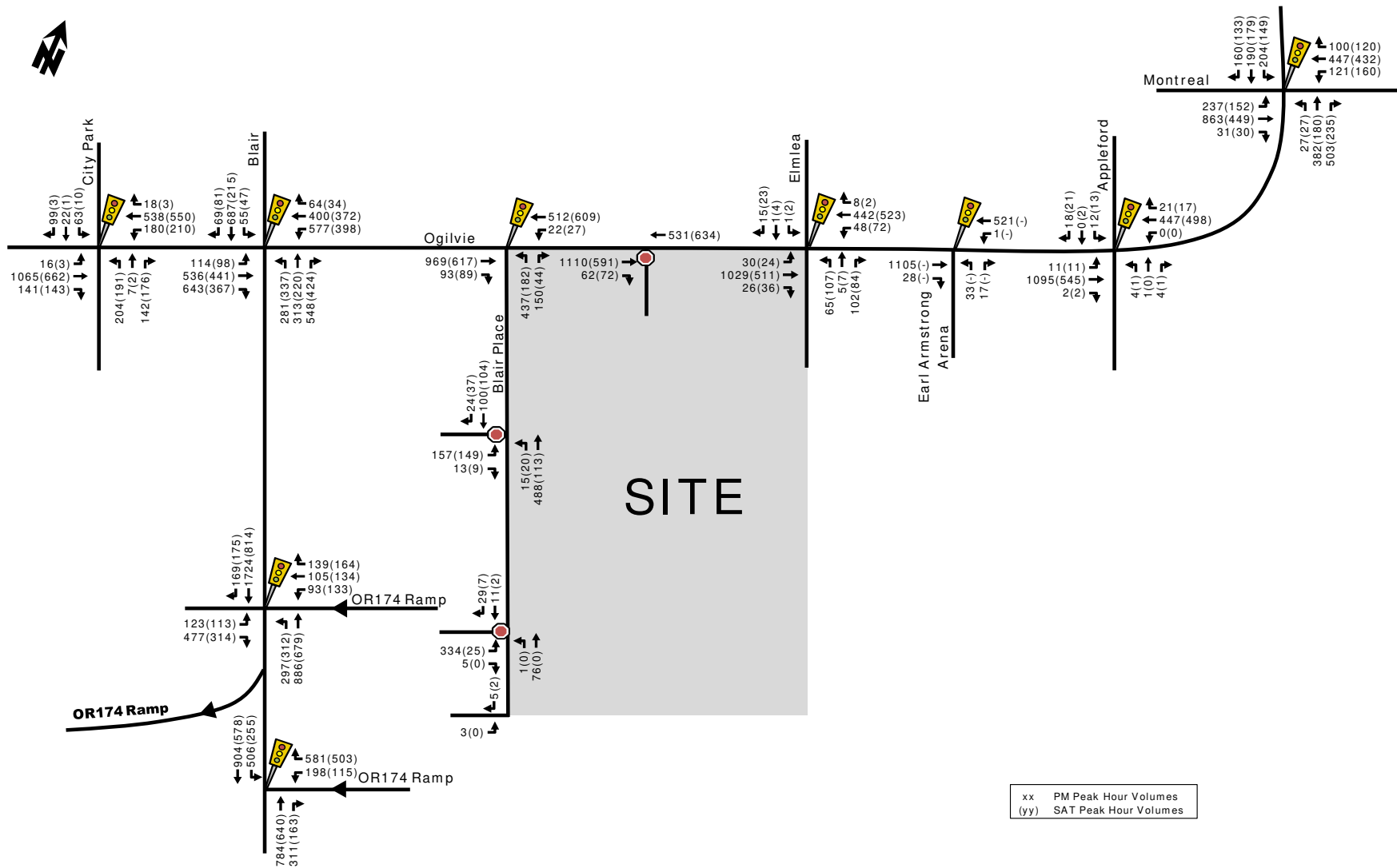
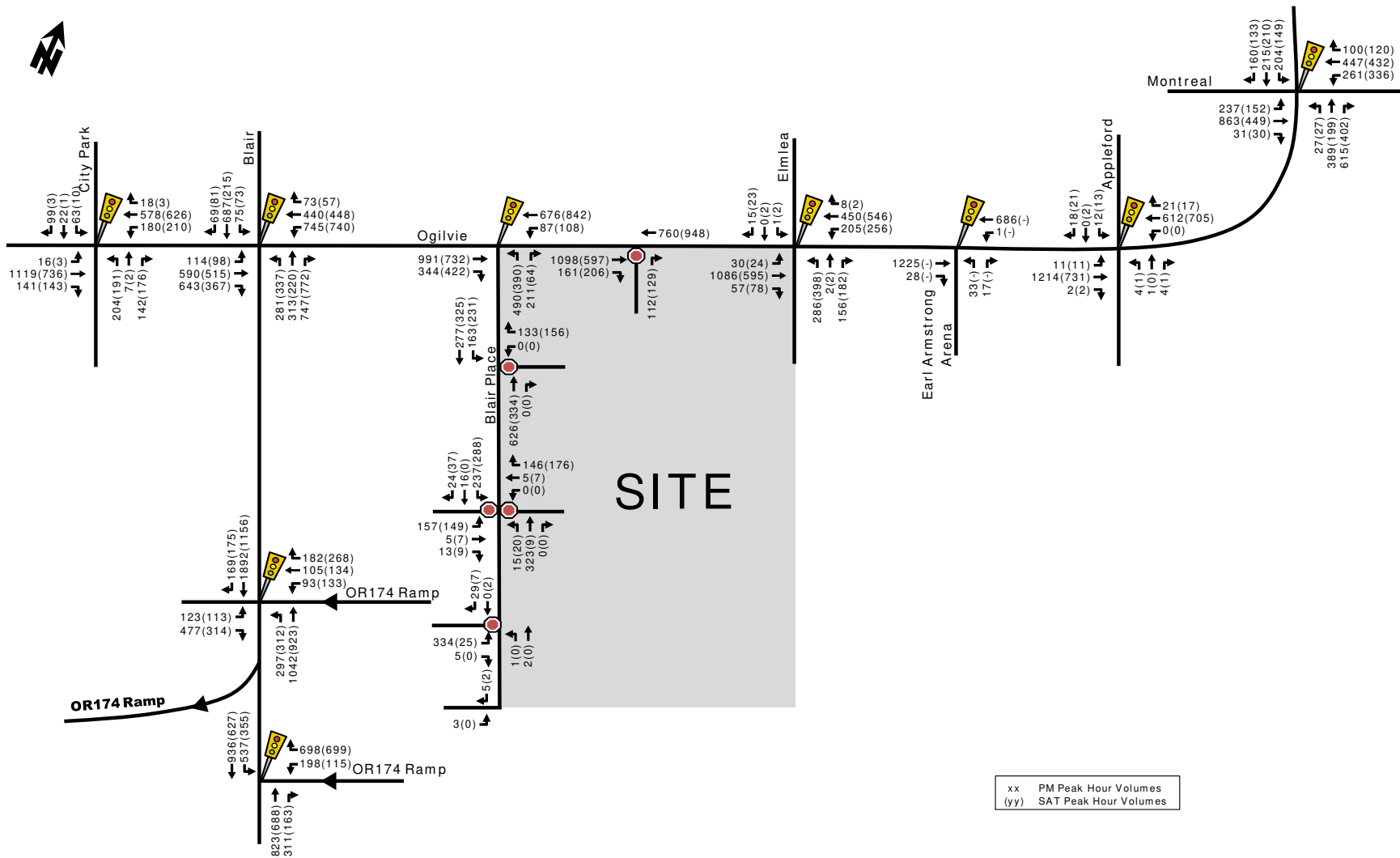

Figure 10: Total Projected 2017 Peak Hour Traffic Volumes



APPENDIX I

Strategic Long Range Model Snapshots

TRANS Regional Model

Version 2.15 - Assigned June 16, 2020

AM Peak Hour Total Traffic Volume

Ogilvie Road/Blair Road Area

2011 Model - Basecase

N/A

User Initials: TIMW

Plot Prepared: Jan 17, 2023

EMME Scenario: 21713



Legend

AM Peak Hour Total Traffic Volume

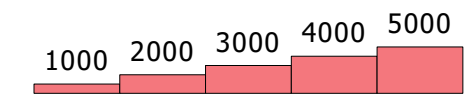

Distance (m)

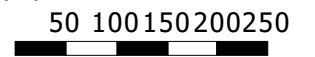

The TRANS model is continuously refined & maintained, and all information is provided in good faith. However, model outputs are provided "as is", and no warranty or guarantee is provided as to the accuracy, reliability or reasonableness of the results. In using this data, you agree to accept any and all risks arising from any incorrect, incomplete, or misleading information.

Recipients are required to use caution and professional judgement in using and interpreting model outputs. In particular, caution should be used when focusing on a geographically limited area (such as a single road or intersection), as the model is primarily designed to simulate regional-scale phenomena and has been calibrated at a regional level.

As general good practice, it is recommended that the user confirm the network coding within the area of interest, and compare base year forecasts against traffic count data to assess the extent to which the model may be over- or under-estimating the travel demand.

TRANS Regional Model

Version 2.15 - Assigned June 16, 2020

AM Peak Hour Total Traffic Volume

Ogilvie Road/Blair Road Area

2031 Model - Basecase

N/A

User Initials: TIMW
Plot Prepared: Jan 17, 2023
EMME Scenario: 21715



Legend

AM Peak Hour Total Traffic Volume

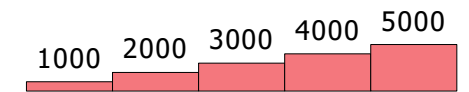

Distance (m)

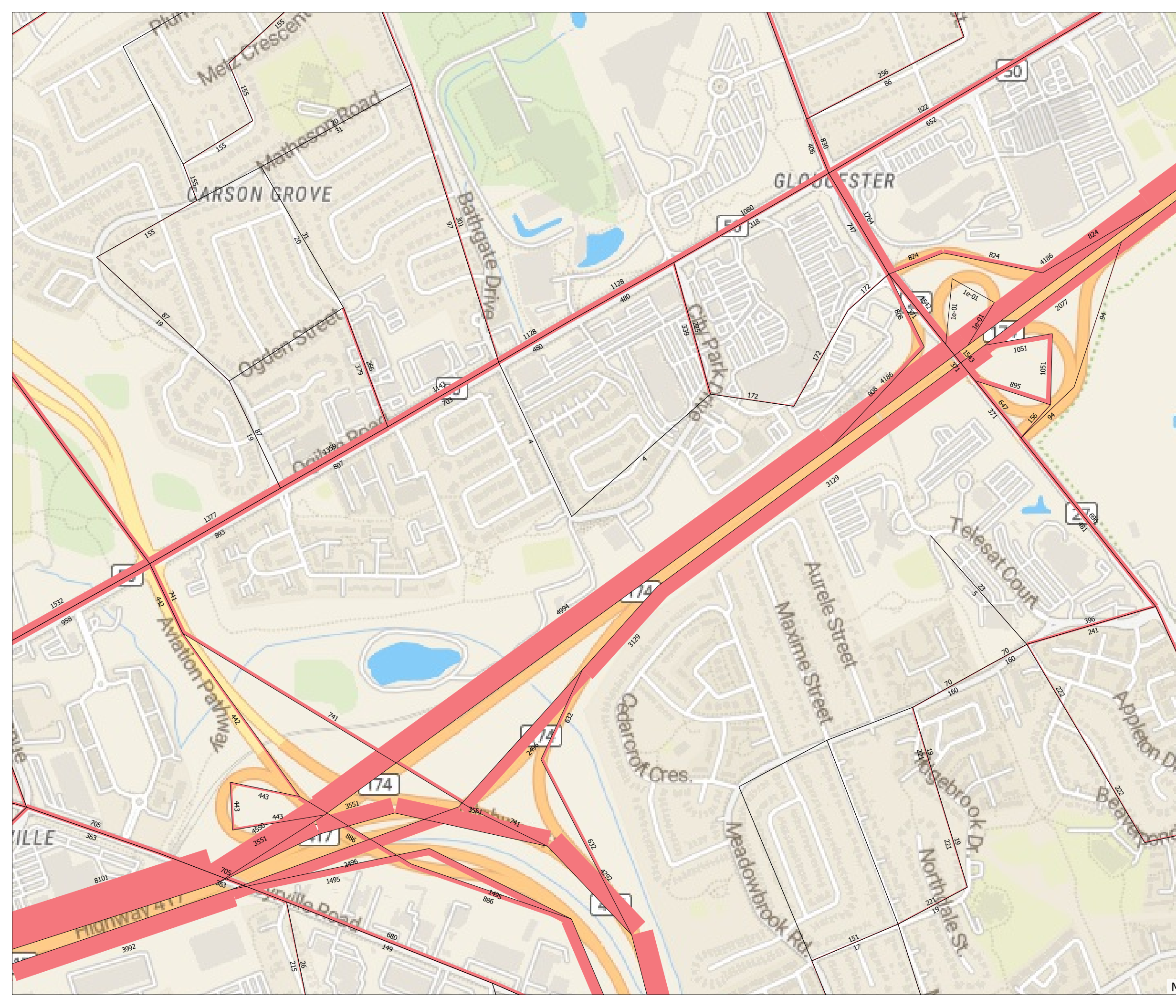
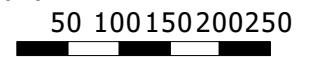

The TRANS model is continuously refined & maintained, and all information is provided in good faith. However, model outputs are provided "as is", and no warranty or guarantee is provided as to the accuracy, reliability or reasonableness of the results. In using this data, you agree to accept any and all risks arising from any incorrect, incomplete, or misleading information.

Recipients are required to use caution and professional judgement in using and interpreting model outputs. In particular, caution should be used when focusing on a geographically limited area (such as a single road or intersection), as the model is primarily designed to simulate regional-scale phenomena and has been calibrated at a regional level.

As a general good practice, it is recommended that the user confirm the network coding within the area of interest, and compare base year forecasts against traffic count data to assess the extent to which the model may be over- or under-estimating the travel demand.

APPENDIX J

Signal Timing Plans

Traffic Signal Timing

City of Ottawa, Public Works Department

Traffic Signal Operations Unit

Intersection:	<i>Main:</i> Ogilvie	<i>Side:</i> Bathgate / City Park (W)
Controller:	ATC 3	TSD: 5219
Author:	Othman Benamrane	Date: 18-Jan-2023

Existing Timing Plans†

	Plan							Ped Minimum Time		
	Morning	Off Peak	PM Peak	Night	Weekend	AM Peak	Evening	Walk	DW	A+R
Cycle	90	90	100	80	90	100	90			
Offset	27	5	19	X	5	29	5			
EB Thru	32	32	37	37	32	42	32	9	15	3.7+2.3
WB Thru	32	32	37	37	32	42	32	9	15	3.7+2.3
NB Thru	43	43	43	43	43	43	43	7	28	3.0+4.4
SB Thru	43	43	43	43	43	43	43	7	28	3.0+4.4
EB Left	15	15	20	-	15	15	15	-	-	3.7+1.0
WB Left	15	15	20	-	15	15	15	-	-	3.7+1.0

Phasing Sequence‡

Plan: 1, 2, 3, 5, 11, 12

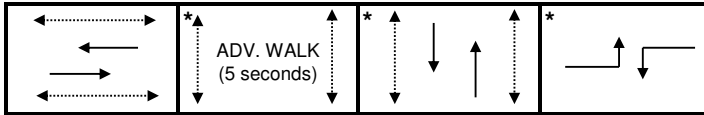

Plan: 4

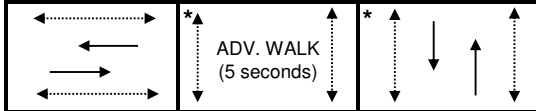

Schedule

Weekday		Saturday		Sunday	
Time	Plan	Time	Plan	Time	Plan
0:15	4	0:15	4	0:15	4
6:30	1	8:30	5	8:30	2
7:30	11	19:00	2	22:30	4
9:00	1	22:30	4		
9:30	2				
15:00	3				
18:30	2				
22:30	4				

Notes

- †: Time for each direction includes amber and all red intervals
- ‡: Start of first phase should be used as reference point for offset
- Asterisk (*) Indicates actuated phase
- (fp): Fully Protected Left Turn
- ◄.....► Pedestrian signal

Cost is \$61.16 (\$54.12 + HST)

Traffic Signal Timing

City of Ottawa, Public Works Department

Traffic Signal Operations Unit

Intersection:	<i>Main:</i> Ogilvie	<i>Side:</i> Blair
Controller:	ATC3	TSD: 5300
Author:	Othman Benamrane	Date: 18-Jan-2023

Existing Timing Plans†

	Plan					Ped Minimum Time		
	Off Peak 2	PM Peak 3	Night 4	Weekend 5	AM Peak 11	Walk	DW	A+R
Cycle	130	140	110	130	140			
Offset	X	0	X	120	X			
EB Thru	39	41	40	39	39	7	25	3.3+3.3
WB Thru	55	53	40	63	39	7	25	3.3+3.3
NB Left (fp)	19	21	16	17	36	-	-	4.2+2.3
SB Left (fp)	19	21	16	17	15	-	-	4.2+2.3
NB Thru	35	41	38	35	58	7	22	4.2+2.3
SB Thru	35	41	38	35	37	7	22	4.2+2.3
EB Left (fp)	21	25	16	15	28	-	-	3.7+3.1
WB Left (fp)	37	37	16	39	28	-	-	3.7+3.1

Phasing Sequence‡

Plan: 11

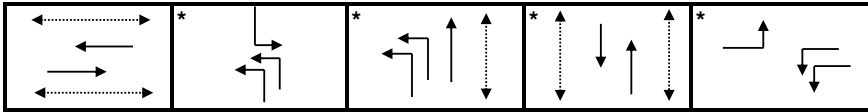

Plan: 2,3,5

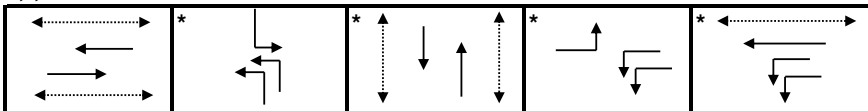

Plan: 4

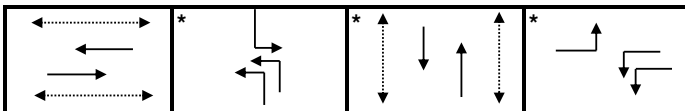

Schedule

Weekday

Time	Plan
0:15	4
6:30	11
9:30	2
15:00	3
18:30	2
22:30	4

Saturday

Time	Plan
0:15	4
7:00	5
22:00	4

Sunday

Time	Plan
0:15	4
7:00	5
21:00	4

Notes

- †: Time for each direction includes amber and all red intervals
- ‡: Start of first phase should be used as reference point for offset
- Asterisk (*) Indicates actuated phase
- (fp): Fully Protected Left Turn
- ◄.....► Pedestrian signal

Cost is \$61.16 (\$54.12 + HST)

Traffic Signal Timing

City of Ottawa, Public Works Department

Traffic Signal Operations Unit

Intersection:	<i>Main:</i> Blair	<i>Side:</i>	174 EB Off Ramp
Controller:	ATC3	TSD:	5452
Author:	Othman Benamrane	Date:	18-Jan-2023

Existing Timing Plans[†]

	Plan					Ped Minimum Time		
	AM Peak	Off Peak	PM Peak	Night	Weekend	Walk	DW	A+R
	1	2	3	4	5			
Cycle	90	90	110	75	90			
Offset	X	X	32	X	X			
NB Thru	55	50	52	50	50	7	17	4.2+2.3
SB Thru	55	50	80	50	50	-	-	4.2+2.3
WB Thru/Left	35	25	30	25	25	7	12	3.3+3.0
NB Right	35	25	30	25	25	-	-	3.3+3.0
SB Left	-	15	28	-	15	-	-	4.2+1.8

Phasing Sequence[‡]

Plan: 1,4

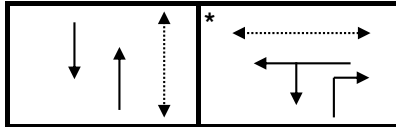

Plan: 2,3,5

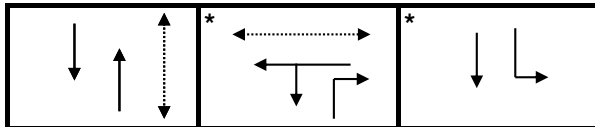

Schedule

Weekday		Saturday		Sunday	
Time	Plan	Time	Plan	Time	Plan
0:15	4	0:15	4	0:15	4
6:30	1	7:00	5	7:00	5
9:30	2	22:00	4	21:00	4
15:00	3				
18:30	2				
22:30	4				

Notes

- †: Time for each direction includes amber and all red intervals
- ‡: Start of first phase should be used as reference point for offset
- Asterisk (*) Indicates actuated phase
- (fp): Fully Protected Left Turn
- ◀.....▶ Pedestrian signal

Traffic Signal Timing

City of Ottawa, Public Works Department

Traffic Signal Operations Unit

Intersection:	<u>Main:</u> Blair	Side:	174 WB Off Ramp
Controller:	<u>ATC3</u>	TSD:	<u>5867</u>
Author:	<u>Othman Benamrane</u>	Date:	<u>18-Jan-2023</u>

Existing Timing Plans[†]

	Plan					Ped Minimum Time		
	AM Peak 1	Off Peak 2	PM Peak 3	Night 4	Weekend 5	Walk	DW	A+R
Cycle	100	95	130	85	95			
Offset	X	X	50	X	X			
NB Thru	32	34	94	34	32	7	17	4.2+1.9
SB Thru	32	34	63	34	32	7	17	4.2+1.9
EB Thru	41	36	36	36	36	-	-	3.3+3.5
WB Thru	41	36	36	36	36	7	23	3.3+3.5
NB Left (fp)	27	25	31	15	27	-	-	4.2+2.2
EB Right	27	25	31	15	27	-	-	4.2+2.2

Phasing Sequence[‡]

Plan: All

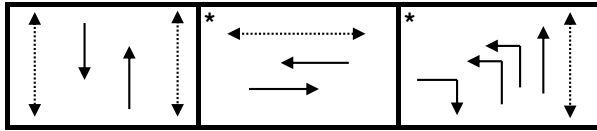

- Notes:** 1) For plan 4, if the EW pedestrian phase is not actuated, the WB phase will force off after 10s
 2) For all other plans, if EW pedestrian phase is not actuated, the WB phase will force off after 20s

Schedule

Weekday		Saturday		Sunday	
Time	Plan	Time	Plan	Time	Plan
0:15	4	0:15	4	0:15	4
6:30	1	7:00	5	7:00	5
9:30	2	22:00	4	21:00	4
15:00	3				
18:30	2				
22:30	4				

Notes

- †: Time for each direction includes amber and all red intervals
 ‡: Start of first phase should be used as reference point for offset
 Asterisk (*) Indicates actuated phase
 (fp): Fully Protected Left Turn
 ◀.....▶ Pedestrian signal

Cost is \$61.16 (\$54.12 + HST)

Traffic Signal Timing

City of Ottawa, Public Works Department

Traffic Signal Operations Unit

Intersection:	<i>Main:</i> Ogilvie	<i>Side:</i> City Park (East)
Controller:	MS 3200	TSD: 5883
Author:	Othman Benamrane	Date: 18-Jan-2023

Existing Timing Plans†

	Plan							Ped Minimum Time		
	Morning 1	Off Peak 2	PM Peak 3	Night 4	Weekend 5	AM Peak 11	Evening 12	Walk	DW	A+R
Cycle	90	90	100	75	90	100	90			
Offset	88	12	30	X	12	13	12			
EB Thru	51	36	46	36	36	61	36	7	22	3.7+2.4
WB Thru	51	51	61	36	51	61	51	7	22	3.7+2.4
NB Thru	39	39	39	39	39	39	39	7	25	3.3+3.2
SB Thru	39	39	39	39	39	39	39	7	25	3.3+3.2
WB Left	-	15	15	-	15	-	15	-	-	3.0+1.0

Phasing Sequence‡

Plan: 2, 3, 5, 12

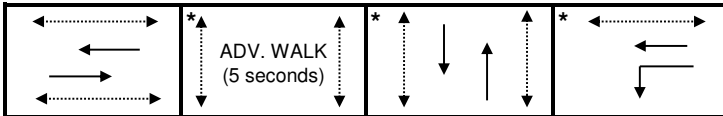

Plan: 1, 4, 11

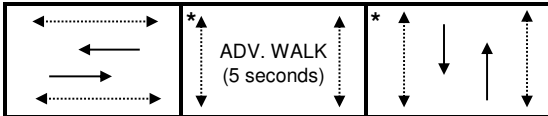

Schedule

Weekday

Time	Plan
0:15	4
6:30	1
7:30	11
9:00	1
9:30	2
15:00	3
18:30	12
22:30	4

Saturday

Time	Plan
0:15	4
8:30	5
19:00	2
22:30	4

Sunday

Time	Plan
0:15	4
8:30	2
22:30	4

Notes

- †: Time for each direction includes amber and all red intervals
- ‡: Start of first phase should be used as reference point for offset
- Asterisk (*) Indicates actuated phase
- (fp): Fully Protected Left Turn
- ◄.....► Pedestrian signal

Cost is \$61.16 (\$54.12 + HST)

Traffic Signal Timing

City of Ottawa, Public Works Department

Traffic Signal Operations Unit

Intersection:	<i>Main:</i> Ogilvie	<i>Side:</i> Matheson / Palmerston
Controller:	MS 3200	TSD: 6140
Author:	Othman Benamrane	Date: 18-Jan-2023

Existing Timing Plans†

	Plan							Ped Minimum Time		
	Morning 1	Off Peak 2	PM Peak 3	Night 4	Weekend 5	AM Peak 11	Evening 12	Walk	DW	A+R
Cycle	90	90	120	80	90	100	90			
Offset	48	50	50	X	50	54	50			
EB Thru	40	40	65	40	40	47	50	15	13	3.7+1.9
WB Thru	40	40	65	40	40	47	50	15	13	3.7+1.9
NB Thru	40	40	40	40	40	40	40	7	26	3.0+4.2
SB Thru	40	40	40	40	40	40	40	7	26	3.0+4.2
EB Left	10	10	15	-	10	13	-	-	-	3.7+1.0
WB Left	10	10	15	-	10	13	-	-	-	3.7+1.0

Phasing Sequence‡

Plan: 1, 2, 3, 5, 11

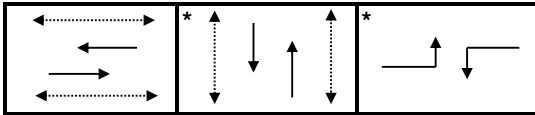

Plan: 4, 12

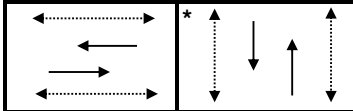

Schedule

Weekday		Saturday		Sunday	
Time	Plan	Time	Plan	Time	Plan
0:15	4	0:15	4	0:15	4
6:30	1	8:30	5	8:30	2
7:30	11	19:00	2	22:30	4
9:00	1	22:30	4		
9:30	2				
15:00	3				
18:30	12				
22:30	4				

Notes

- †: Time for each direction includes amber and all red intervals
- ‡: Start of first phase should be used as reference point for offset
- Asterisk (*) Indicates actuated phase
- (fp): Fully Protected Left Turn
- ◄.....► Pedestrian signal

Cost is \$61.16 (\$54.12 + HST)

Traffic Signal Timing

City of Ottawa, Public Works Department

Traffic Signal Operations Unit

Intersection:	<i>Main:</i> Ogilvie	<i>Side:</i> Silver City
Controller:	MS 3200	TSD: 6427
Author:	Othman Benamrane	Date: 18-Jan-2023

Existing Timing Plans[†]

	Plan					Ped Minimum Time				
	Morning 1	Off Peak 2	PM Peak 3	Night 4	Weekend 5	AM Peak 11	Evening 12	Walk	DW	A+R
Cycle	90	90	100	75	90	100	90			
Offset	12	88	8	X	88	12	88			
EB Thru	53	53	63	38	53	63	53	11	13	3.7+2.2
WB Thru	53	53	63	38	53	63	53	11	13	3.7+2.2
NB Thru	37	37	37	37	37	37	37	7	23	3.3+3.4
SB Thru	37	37	37	37	37	37	37	7	23	3.3+3.4

Phasing Sequence[‡]

Plan: All

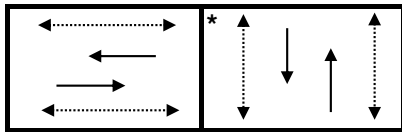

Notes: 1) If the NS pedestrian phase is not actuated, the NS phases will force off after 25s

Schedule

Weekday		Saturday		Sunday	
Time	Plan	Time	Plan	Time	Plan
0:15	4	0:15	4	0:15	4
6:30	1	8:30	5	8:30	2
7:30	11	19:00	2	22:30	4
9:00	1	22:30	4		
9:30	2				
15:00	3				
18:30	12				
22:30	4				

Notes

†: Time for each direction includes amber and all red intervals
 ‡: Start of first phase should be used as reference point for offset
 Asterisk (*) Indicates actuated phase
 (fp): Fully Protected Left Turn
 ◄.....► Pedestrian signal

Cost is \$61.16 (\$54.12 + HST)

APPENDIX K

Detailed Analysis Reports

1900/2000 City Park Drive
3: Blair Road & Ogilvie Road

Existing AM



Lane Group	EBL	EBT	EBR	WBL	WBT	WBR	NBL	NBT	NBR	SBL	SBT	SBR
Lane Configurations												
Traffic Volume (vph)	75	339	171	416	613	36	566	580	369	43	292	97
Future Volume (vph)	75	339	171	416	613	36	566	580	369	43	292	97
Ideal Flow (vphpl)	1800	1800	1800	1800	1800	1800	1800	1800	1800	1800	1800	1800
Storage Length (m)	70.0		0.0	110.0		0.0	120.0		0.0	30.0		0.0
Storage Lanes	1		1	2		0	2		1	1		0
Taper Length (m)	40.0			60.0			60.0			45.0		
Lane Util. Factor	1.00	0.95	1.00	0.97	0.95	0.95	0.97	1.00	1.00	1.00	0.95	0.95
Ped Bike Factor					1.00						0.99	
Frt			0.850		0.992				0.850		0.962	
Flt Protected	0.950			0.950			0.950			0.950		
Satd. Flow (prot)	1679	3357	1502	3257	3316	0	3257	1767	1502	1679	3187	0
Flt Permitted	0.950			0.950			0.950			0.950		
Satd. Flow (perm)	1679	3357	1502	3257	3316	0	3257	1767	1502	1679	3187	0
Right Turn on Red			Yes			Yes			Yes			Yes
Satd. Flow (RTOR)			190		4				285		30	
Link Speed (k/h)		60			60			60			60	
Link Distance (m)		372.0			396.5			239.9			411.0	
Travel Time (s)		22.3			23.8			14.4			24.7	
Confl. Peds. (#/hr)							25					27
Confl. Bikes (#/hr)							3					3
Peak Hour Factor	0.90	0.90	0.90	0.90	0.90	0.90	0.90	0.90	0.90	0.90	0.90	0.90
Heavy Vehicles (%)	3%	3%	3%	3%	3%	3%	3%	3%	3%	3%	3%	3%
Adj. Flow (vph)	83	377	190	462	681	40	629	644	410	48	324	108
Shared Lane Traffic (%)												
Lane Group Flow (vph)	83	377	190	462	721	0	629	644	410	48	432	0
Enter Blocked Intersection	No	No	No	No	No	No	No	No	No	No	No	No
Lane Alignment	Left	Left	Right	Left	Left	Right	Left	Left	Right	Left	Left	Right
Median Width(m)		7.4			7.4			7.4			7.4	
Link Offset(m)		0.0			0.0			0.0			0.0	
Crosswalk Width(m)		4.9			4.9			4.9			4.9	
Two way Left Turn Lane												
Headway Factor	1.06	1.06	1.06	1.06	1.06	1.06	1.06	1.06	1.06	1.06	1.06	1.06
Turning Speed (k/h)	24		14	24		14	24		14	24		14
Number of Detectors	1	2	1	1	2		1	2	1	1	2	
Detector Template	Left	Thru	Right	Left	Thru		Left	Thru	Right	Left	Thru	
Leading Detector (m)	6.1	30.5	6.1	6.1	30.5		6.1	30.5	6.1	6.1	30.5	
Trailing Detector (m)	0.0	0.0	0.0	0.0	0.0		0.0	0.0	0.0	0.0	0.0	
Detector 1 Position(m)	0.0	0.0	0.0	0.0	0.0		0.0	0.0	0.0	0.0	0.0	
Detector 1 Size(m)	6.1	1.8	6.1	6.1	1.8		6.1	1.8	6.1	6.1	1.8	
Detector 1 Type	Cl+Ex	Cl+Ex	Cl+Ex	Cl+Ex	Cl+Ex		Cl+Ex	Cl+Ex	Cl+Ex	Cl+Ex	Cl+Ex	
Detector 1 Channel												
Detector 1 Extend (s)	0.0	0.0	0.0	0.0	0.0		0.0	0.0	0.0	0.0	0.0	
Detector 1 Queue (s)	0.0	0.0	0.0	0.0	0.0		0.0	0.0	0.0	0.0	0.0	
Detector 1 Delay (s)	0.0	0.0	0.0	0.0	0.0		0.0	0.0	0.0	0.0	0.0	
Detector 2 Position(m)		28.7			28.7			28.7			28.7	
Detector 2 Size(m)		1.8			1.8			1.8			1.8	
Detector 2 Type		Cl+Ex			Cl+Ex			Cl+Ex			Cl+Ex	
Detector 2 Channel												

1900/2000 City Park Drive
3: Blair Road & Ogilvie Road

Existing AM



Lane Group	EBL	EBT	EBR	WBL	WBT	WBR	NBL	NBT	NBR	SBL	SBT	SBR
Detector 2 Extend (s)		0.0			0.0			0.0			0.0	
Turn Type	Prot	NA	Perm	Prot	NA		Prot	NA	Perm	Prot	NA	
Protected Phases	5	2		1	6		3	8		7	4	
Permitted Phases			2						8			
Detector Phase	5	2	2	1	6		3	8	8	7	4	
Switch Phase												
Minimum Initial (s)	5.0	10.0	10.0	5.0	10.0		5.0	10.0	10.0	5.0	10.0	
Minimum Split (s)	11.8	38.6	38.6	11.8	38.6		11.5	35.5	35.5	11.5	35.5	
Total Split (s)	28.0	39.0	39.0	28.0	39.0		36.0	58.0	58.0	15.0	37.0	
Total Split (%)	20.0%	27.9%	27.9%	20.0%	27.9%		25.7%	41.4%	41.4%	10.7%	26.4%	
Maximum Green (s)	21.2	32.4	32.4	21.2	32.4		29.5	51.5	51.5	8.5	30.5	
Yellow Time (s)	3.7	3.3	3.3	3.7	3.3		4.2	4.2	4.2	4.2	4.2	
All-Red Time (s)	3.1	3.3	3.3	3.1	3.3		2.3	2.3	2.3	2.3	2.3	
Lost Time Adjust (s)	0.0	0.0	0.0	0.0	0.0		0.0	0.0	0.0	0.0	0.0	
Total Lost Time (s)	6.8	6.6	6.6	6.8	6.6		6.5	6.5	6.5	6.5	6.5	
Lead/Lag	Lead	Lag	Lag	Lead	Lag		Lead	Lag	Lag	Lead	Lag	
Lead-Lag Optimize?	Yes	Yes	Yes	Yes	Yes		Yes	Yes	Yes	Yes	Yes	
Vehicle Extension (s)	3.0	3.0	3.0	3.0	3.0		3.0	3.0	3.0	3.0	3.0	
Recall Mode	None	Max	Max	None	Max		None	None	None	None	None	
Walk Time (s)		7.0	7.0		7.0			7.0	7.0		7.0	
Flash Dont Walk (s)		25.0	25.0		25.0			22.0	22.0		22.0	
Pedestrian Calls (#/hr)		20	20		20			25	25		25	
Act Effct Green (s)	12.1	32.5	32.5	20.9	41.3		28.4	51.5	51.5	7.8	28.2	
Actuated g/C Ratio	0.09	0.24	0.24	0.15	0.30		0.21	0.38	0.38	0.06	0.21	
v/c Ratio	0.56	0.47	0.38	0.93	0.72		0.93	0.97	0.55	0.51	0.63	
Control Delay	74.3	47.7	8.1	83.0	48.3		74.1	69.8	13.2	82.3	50.5	
Queue Delay	0.0	0.0	0.0	0.0	0.0		0.0	0.0	0.0	0.0	0.0	
Total Delay	74.3	47.7	8.1	83.0	48.3		74.1	69.8	13.2	82.3	50.5	
LOS	E	D	A	F	D		E	E	B	F	D	
Approach Delay		39.5			61.8			57.6			53.7	
Approach LOS		D			E			E			D	

Intersection Summary





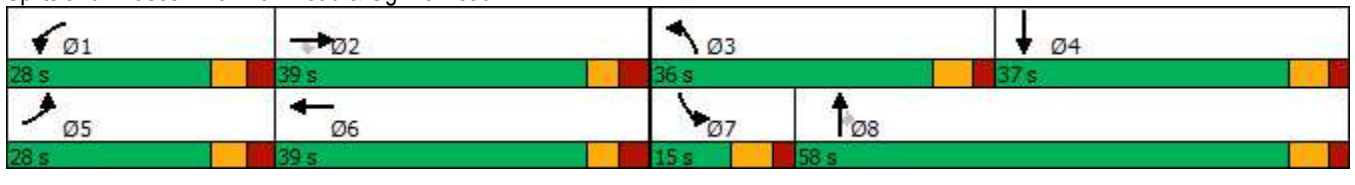

















Area Type:	Other
Cycle Length:	140
Actuated Cycle Length:	136.5
Natural Cycle:	130
Control Type:	Semi Act-Uncoord
Maximum v/c Ratio:	0.97
Intersection Signal Delay:	55.4
Intersection LOS:	E
Intersection Capacity Utilization:	89.5%
ICU Level of Service:	E
Analysis Period (min):	15

Splits and Phases: 3: Blair Road & Ogilvie Road



1900/2000 City Park Drive
 6: Blair Road & 1980 Ogilvie Road/Hwy 174 WB off

Existing AM

												
Lane Group	EBL	EBT	EBR	WBL	WBT	WBR	NBL	NBT	NBR	SBL	SBT	SBR
Lane Configurations												
Traffic Volume (vph)	81	0	290	101	146	266	256	1276	0	0	760	107
Future Volume (vph)	81	0	290	101	146	266	256	1276	0	0	760	107
Ideal Flow (vphpl)	1800	1800	1800	1800	1800	1800	1800	1800	1800	1800	1800	1800
Storage Length (m)	0.0		70.0	0.0		70.0	60.0		0.0	0.0		50.0
Storage Lanes	1		1	1		1	2		0	0		1
Taper Length (m)	7.6			7.6			100.0			7.6		
Lane Util. Factor	1.00	1.00	1.00	1.00	1.00	1.00	0.97	0.95	1.00	1.00	0.91	1.00
Frt			0.850			0.850						0.850
Flt Protected	0.950			0.950			0.950					
Satd. Flow (prot)	1340	0	1199	1695	1784	1517	3164	3262	0	0	4732	1473
Flt Permitted	0.654			0.950			0.950					
Satd. Flow (perm)	923	0	1199	1695	1784	1517	3164	3262	0	0	4732	1473
Right Turn on Red			Yes			Yes			Yes			Yes
Satd. Flow (RTOR)			34			104						119
Link Speed (k/h)		60			60			60				60
Link Distance (m)		518.9			416.4			90.2				239.9
Travel Time (s)		31.1			25.0			5.4				14.4
Peak Hour Factor	0.90	0.90	0.90	0.90	0.90	0.90	0.90	0.90	0.90	0.90	0.90	0.90
Heavy Vehicles (%)	29%	29%	29%	2%	2%	2%	6%	6%	6%	5%	5%	5%
Adj. Flow (vph)	90	0	322	112	162	296	284	1418	0	0	844	119
Shared Lane Traffic (%)												
Lane Group Flow (vph)	90	0	322	112	162	296	284	1418	0	0	844	119
Enter Blocked Intersection	No	No	No	No	No	No	No	No	No	No	No	No
Lane Alignment	Left	Left	Right	Left	Left	Right	Left	Left	Right	Left	Left	Right
Median Width(m)		3.7			3.7			7.4				7.4
Link Offset(m)		0.0			0.0			0.0				0.0
Crosswalk Width(m)		4.9			4.9			4.9				4.9
Two way Left Turn Lane												
Headway Factor	1.06	1.06	1.06	1.06	1.06	1.06	1.06	1.06	1.06	1.06	1.06	1.06
Turning Speed (k/h)	24		14	24		14	24		14	24		14
Number of Detectors	1		1	1	2	1	1	2				2
Detector Template	Left		Right	Left	Thru	Right	Left	Thru				Thru
Leading Detector (m)	6.1		6.1	6.1	30.5	6.1	6.1	30.5				30.5
Trailing Detector (m)	0.0		0.0	0.0	0.0	0.0	0.0	0.0				0.0
Detector 1 Position(m)	0.0		0.0	0.0	0.0	0.0	0.0	0.0				0.0
Detector 1 Size(m)	6.1		6.1	6.1	1.8	6.1	6.1	1.8				1.8
Detector 1 Type	Cl+Ex		Cl+Ex	Cl+Ex	Cl+Ex	Cl+Ex	Cl+Ex	Cl+Ex				Cl+Ex
Detector 1 Channel												
Detector 1 Extend (s)	0.0		0.0	0.0	0.0	0.0	0.0	0.0				0.0
Detector 1 Queue (s)	0.0		0.0	0.0	0.0	0.0	0.0	0.0				0.0
Detector 1 Delay (s)	0.0		0.0	0.0	0.0	0.0	0.0	0.0				0.0
Detector 2 Position(m)					28.7			28.7				28.7
Detector 2 Size(m)					1.8			1.8				1.8
Detector 2 Type					Cl+Ex			Cl+Ex				Cl+Ex
Detector 2 Channel												
Detector 2 Extend (s)					0.0			0.0				0.0
Turn Type	Perm		pm+ov	Perm	NA	Perm	Prot	NA				NA
Protected Phases			5		8		5	2				6

1900/2000 City Park Drive
 9: City Park Drive/1941 Ogilvie & Ogilvie Road

Existing AM



Lane Group	EBL	EBT	EBR	WBL	WBT	WBR	NBL	NBT	NBR	SBL	SBT	SBR
Lane Configurations												
Traffic Volume (vph)	102	550	76	87	862	174	53	23	58	5	2	9
Future Volume (vph)	102	550	76	87	862	174	53	23	58	5	2	9
Ideal Flow (vphpl)	1800	1800	1800	1800	1800	1800	1800	1800	1800	1800	1800	1800
Storage Length (m)	40.0		100.0	100.0		50.0	0.0		60.0	20.0		10.0
Storage Lanes	1		1	1		1	0		1	1		1
Taper Length (m)	30.0			25.0			7.6			15.0		
Lane Util. Factor	1.00	0.95	1.00	1.00	0.95	1.00	1.00	1.00	1.00	1.00	1.00	1.00
Ped Bike Factor	0.96		0.87	0.96		0.81		0.96	0.93	0.95		
Frt			0.850			0.850			0.850			0.850
Flt Protected	0.950			0.950				0.966		0.950		
Satd. Flow (prot)	1695	3390	1517	1679	3357	1502	0	1628	1432	1695	1784	1517
Flt Permitted	0.265			0.411				0.792		0.702		
Satd. Flow (perm)	456	3390	1320	694	3357	1211	0	1280	1334	1190	1784	1517
Right Turn on Red			Yes			Yes			Yes			Yes
Satd. Flow (RTOR)			84			193			64			56
Link Speed (k/h)		60			60			60				60
Link Distance (m)		224.7			372.0			239.4				142.3
Travel Time (s)		13.5			22.3			14.4				8.5
Confl. Peds. (#/hr)	100		65	65		100	53		51	51		
Confl. Bikes (#/hr)						9			2			
Peak Hour Factor	0.90	0.90	0.90	0.90	0.90	0.90	0.90	0.90	0.90	0.90	0.90	0.90
Heavy Vehicles (%)	2%	2%	2%	3%	3%	3%	8%	8%	8%	2%	2%	2%
Adj. Flow (vph)	113	611	84	97	958	193	59	26	64	6	2	10
Shared Lane Traffic (%)												
Lane Group Flow (vph)	113	611	84	97	958	193	0	85	64	6	2	10
Enter Blocked Intersection	No	No	No	No	No	No	No	No	No	No	No	No
Lane Alignment	Left	Left	Right	Left	Left	Right	Left	Left	Right	Left	Left	Right
Median Width(m)		3.7			3.7			3.7				3.7
Link Offset(m)		0.0			0.0			0.0				0.0
Crosswalk Width(m)		4.9			4.9			4.9				4.9
Two way Left Turn Lane												
Headway Factor	1.06	1.06	1.06	1.06	1.06	1.06	1.06	1.06	1.06	1.06	1.06	1.06
Turning Speed (k/h)	24		14	24		14	24		14	24		14
Number of Detectors	1	2	1	1	2	1	1	2	1	1	2	1
Detector Template	Left	Thru	Right	Left	Thru	Right	Left	Thru	Right	Left	Thru	Right
Leading Detector (m)	6.1	30.5	6.1	6.1	30.5	6.1	6.1	30.5	6.1	6.1	30.5	6.1
Trailing Detector (m)	0.0	0.0	0.0	0.0	0.0	0.0	0.0	0.0	0.0	0.0	0.0	0.0
Detector 1 Position(m)	0.0	0.0	0.0	0.0	0.0	0.0	0.0	0.0	0.0	0.0	0.0	0.0
Detector 1 Size(m)	6.1	1.8	6.1	6.1	1.8	6.1	6.1	1.8	6.1	6.1	1.8	6.1
Detector 1 Type	Cl+Ex	Cl+Ex	Cl+Ex	Cl+Ex	Cl+Ex	Cl+Ex	Cl+Ex	Cl+Ex	Cl+Ex	Cl+Ex	Cl+Ex	Cl+Ex
Detector 1 Channel												
Detector 1 Extend (s)	0.0	0.0	0.0	0.0	0.0	0.0	0.0	0.0	0.0	0.0	0.0	0.0
Detector 1 Queue (s)	0.0	0.0	0.0	0.0	0.0	0.0	0.0	0.0	0.0	0.0	0.0	0.0
Detector 1 Delay (s)	0.0	0.0	0.0	0.0	0.0	0.0	0.0	0.0	0.0	0.0	0.0	0.0
Detector 2 Position(m)		28.7			28.7			28.7				28.7
Detector 2 Size(m)		1.8			1.8			1.8				1.8
Detector 2 Type		Cl+Ex			Cl+Ex			Cl+Ex				Cl+Ex
Detector 2 Channel												

Lane Group	Ø3	Ø7
Lane Configurations		
Traffic Volume (vph)		
Future Volume (vph)		
Ideal Flow (vphpl)		
Storage Length (m)		
Storage Lanes		
Taper Length (m)		
Lane Util. Factor		
Ped Bike Factor		
Frt		
Flt Protected		
Satd. Flow (prot)		
Flt Permitted		
Satd. Flow (perm)		
Right Turn on Red		
Satd. Flow (RTOR)		
Link Speed (k/h)		
Link Distance (m)		
Travel Time (s)		
Confl. Peds. (#/hr)		
Confl. Bikes (#/hr)		
Peak Hour Factor		
Heavy Vehicles (%)		
Adj. Flow (vph)		
Shared Lane Traffic (%)		
Lane Group Flow (vph)		
Enter Blocked Intersection		
Lane Alignment		
Median Width(m)		
Link Offset(m)		
Crosswalk Width(m)		
Two way Left Turn Lane		
Headway Factor		
Turning Speed (k/h)		
Number of Detectors		
Detector Template		
Leading Detector (m)		
Trailing Detector (m)		
Detector 1 Position(m)		
Detector 1 Size(m)		
Detector 1 Type		
Detector 1 Channel		
Detector 1 Extend (s)		
Detector 1 Queue (s)		
Detector 1 Delay (s)		
Detector 2 Position(m)		
Detector 2 Size(m)		
Detector 2 Type		
Detector 2 Channel		

1900/2000 City Park Drive

9: City Park Drive/1941 Ogilvie & Ogilvie Road

Existing AM



Lane Group	EBL	EBT	EBR	WBL	WBT	WBR	NBL	NBT	NBR	SBL	SBT	SBR
Detector 2 Extend (s)		0.0			0.0			0.0			0.0	
Turn Type	Perm	NA	Perm	Perm	NA	Perm	Perm	NA	Perm	Perm	NA	Perm
Protected Phases		2			6			8			4	
Permitted Phases	2		2	6		6	8		8	4		4
Detector Phase	2	2	2	6	6	6	8	8	8	4	4	4
Switch Phase												
Minimum Initial (s)	10.0	10.0	10.0	10.0	10.0	10.0	10.0	10.0	10.0	10.0	10.0	10.0
Minimum Split (s)	35.1	35.1	35.1	35.1	35.1	35.1	33.5	33.5	33.5	33.5	33.5	33.5
Total Split (s)	61.0	61.0	61.0	61.0	61.0	61.0	34.0	34.0	34.0	34.0	34.0	34.0
Total Split (%)	61.0%	61.0%	61.0%	61.0%	61.0%	61.0%	34.0%	34.0%	34.0%	34.0%	34.0%	34.0%
Maximum Green (s)	54.9	54.9	54.9	54.9	54.9	54.9	27.5	27.5	27.5	27.5	27.5	27.5
Yellow Time (s)	3.7	3.7	3.7	3.7	3.7	3.7	3.3	3.3	3.3	3.3	3.3	3.3
All-Red Time (s)	2.4	2.4	2.4	2.4	2.4	2.4	3.2	3.2	3.2	3.2	3.2	3.2
Lost Time Adjust (s)	0.0	0.0	0.0	0.0	0.0	0.0		0.0	0.0	0.0	0.0	0.0
Total Lost Time (s)	6.1	6.1	6.1	6.1	6.1	6.1		6.5	6.5	6.5	6.5	6.5
Lead/Lag							Lag	Lag	Lag	Lag	Lag	Lag
Lead-Lag Optimize?							Yes	Yes	Yes	Yes	Yes	Yes
Vehicle Extension (s)	3.0	3.0	3.0	3.0	3.0	3.0	3.0	3.0	3.0	3.0	3.0	3.0
Recall Mode	C-Max	C-Max	C-Max	C-Max	C-Max	C-Max	None	None	None	None	None	None
Walk Time (s)	7.0	7.0	7.0	7.0	7.0	7.0	2.0	2.0	2.0	2.0	2.0	2.0
Flash Dont Walk (s)	22.0	22.0	22.0	22.0	22.0	22.0	25.0	25.0	25.0	25.0	25.0	25.0
Pedestrian Calls (#/hr)	35	35	35	35	35	35	35	35	35	35	35	35
Act Effct Green (s)	68.7	68.7	68.7	68.7	68.7	68.7		20.2	20.2	20.2	20.2	20.2
Actuated g/C Ratio	0.69	0.69	0.69	0.69	0.69	0.69		0.20	0.20	0.20	0.20	0.20
v/c Ratio	0.36	0.26	0.09	0.20	0.42	0.22		0.33	0.20	0.03	0.01	0.03
Control Delay	7.8	2.7	0.3	11.6	11.0	2.3		35.0	8.9	27.2	27.0	0.1
Queue Delay	0.0	0.0	0.0	0.0	0.0	0.0		0.0	0.0	0.0	0.0	0.0
Total Delay	7.8	2.7	0.3	11.6	11.0	2.3		35.0	8.9	27.2	27.0	0.1
LOS	A	A	A	B	B	A		C	A	C	C	A
Approach Delay		3.2			9.7			23.8			12.1	
Approach LOS		A			A			C			B	

Intersection Summary

Area Type: Other
 Cycle Length: 100
 Actuated Cycle Length: 100
 Offset: 13 (13%), Referenced to phase 2:EBTL and 6:WBTL, Start of Green
 Natural Cycle: 80
 Control Type: Actuated-Coordinated
 Maximum v/c Ratio: 0.42
 Intersection Signal Delay: 8.3
 Intersection Capacity Utilization 69.5%
 Analysis Period (min) 15
 Intersection LOS: A
 ICU Level of Service C

Splits and Phases: 9: City Park Drive/1941 Ogilvie & Ogilvie Road

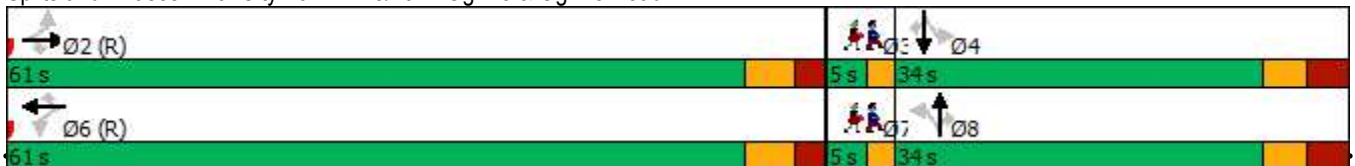

Lane Group	Ø3	Ø7
Detector 2 Extend (s)		
Turn Type		
Protected Phases	3	7
Permitted Phases		
Detector Phase		
Switch Phase		
Minimum Initial (s)	1.0	1.0
Minimum Split (s)	5.0	5.0
Total Split (s)	5.0	5.0
Total Split (%)	5%	5%
Maximum Green (s)	3.0	3.0
Yellow Time (s)	2.0	2.0
All-Red Time (s)	0.0	0.0
Lost Time Adjust (s)		
Total Lost Time (s)		
Lead/Lag	Lead	Lead
Lead-Lag Optimize?	Yes	Yes
Vehicle Extension (s)	3.0	3.0
Recall Mode	None	None
Walk Time (s)	0.0	0.0
Flash Dont Walk (s)	0.0	0.0
Pedestrian Calls (#/hr)	35	35
Act Effct Green (s)		
Actuated g/C Ratio		
v/c Ratio		
Control Delay		
Queue Delay		
Total Delay		
LOS		
Approach Delay		
Approach LOS		
Intersection Summary		

1900/2000 City Park Drive

12: 1900 Ogilvie Road/1929 Ogilvie Road & Ogilvie Road

Existing AM

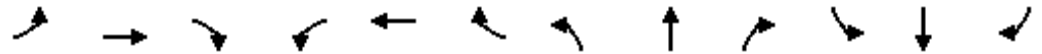

Lane Group	EBL	EBT	EBR	WBL	WBT	WBR	NBL	NBT	NBR	SBL	SBT	SBR
Lane Configurations												
Traffic Volume (vph)	99	681	27	19	969	44	9	1	12	42	11	63
Future Volume (vph)	99	681	27	19	969	44	9	1	12	42	11	63
Ideal Flow (vphpl)	1800	1800	1800	1800	1800	1800	1800	1800	1800	1800	1800	1800
Storage Length (m)	60.0		80.0	90.0		0.0	0.0		0.0	0.0		0.0
Storage Lanes	1		1	1		0	1		0	0		1
Taper Length (m)	30.0			20.0			7.6			7.6		
Lane Util. Factor	1.00	0.95	1.00	1.00	0.95	0.95	1.00	1.00	1.00	1.00	1.00	1.00
Ped Bike Factor	0.99		0.95	0.99	1.00		0.96	0.95			0.96	0.94
Fr _t			0.850		0.993			0.861				0.850
Fl _t Protected	0.950			0.950			0.950				0.962	
Satd. Flow (prot)	1695	3390	1517	1679	3319	0	1695	1452	0	0	1717	1517
Fl _t Permitted	0.215			0.346			0.719				0.767	
Satd. Flow (perm)	379	3390	1434	605	3319	0	1227	1452	0	0	1317	1429
Right Turn on Red			Yes			Yes			Yes			Yes
Satd. Flow (RTOR)			40		8			13				70
Link Speed (k/h)		60			60			60				60
Link Distance (m)		190.5			224.7			86.0				56.6
Travel Time (s)		11.4			13.5			5.2				3.4
Confl. Peds. (#/hr)	41		17	17		41	47		48	48		47
Peak Hour Factor	0.90	0.90	0.90	0.90	0.90	0.90	0.90	0.90	0.90	0.90	0.90	0.90
Heavy Vehicles (%)	2%	2%	2%	3%	3%	3%	2%	2%	2%	2%	2%	2%
Adj. Flow (vph)	110	757	30	21	1077	49	10	1	13	47	12	70
Shared Lane Traffic (%)												
Lane Group Flow (vph)	110	757	30	21	1126	0	10	14	0	0	59	70
Enter Blocked Intersection	No	No	No	No	No	No	No	No	No	No	No	No
Lane Alignment	Left	Left	Right	Left	Left	Right	Left	Left	Right	Left	Left	Right
Median Width(m)		3.7			3.7			3.7				3.7
Link Offset(m)		0.0			0.0			0.0				0.0
Crosswalk Width(m)		4.9			4.9			4.9				4.9
Two way Left Turn Lane												
Headway Factor	1.06	1.06	1.06	1.06	1.06	1.06	1.06	1.06	1.06	1.06	1.06	1.06
Turning Speed (k/h)	24		14	24		14	24		14	24		14
Number of Detectors	1	2	1	1	2		1	2		1	2	1
Detector Template	Left	Thru	Right	Left	Thru		Left	Thru		Left	Thru	Right
Leading Detector (m)	6.1	30.5	6.1	6.1	30.5		6.1	30.5		6.1	30.5	6.1
Trailing Detector (m)	0.0	0.0	0.0	0.0	0.0		0.0	0.0		0.0	0.0	0.0
Detector 1 Position(m)	0.0	0.0	0.0	0.0	0.0		0.0	0.0		0.0	0.0	0.0
Detector 1 Size(m)	6.1	1.8	6.1	6.1	1.8		6.1	1.8		6.1	1.8	6.1
Detector 1 Type	Cl+Ex	Cl+Ex	Cl+Ex	Cl+Ex	Cl+Ex		Cl+Ex	Cl+Ex		Cl+Ex	Cl+Ex	Cl+Ex
Detector 1 Channel												
Detector 1 Extend (s)	0.0	0.0	0.0	0.0	0.0		0.0	0.0		0.0	0.0	0.0
Detector 1 Queue (s)	0.0	0.0	0.0	0.0	0.0		0.0	0.0		0.0	0.0	0.0
Detector 1 Delay (s)	0.0	0.0	0.0	0.0	0.0		0.0	0.0		0.0	0.0	0.0
Detector 2 Position(m)		28.7			28.7			28.7				28.7
Detector 2 Size(m)		1.8			1.8			1.8				1.8
Detector 2 Type		Cl+Ex			Cl+Ex			Cl+Ex				Cl+Ex
Detector 2 Channel												
Detector 2 Extend (s)		0.0			0.0			0.0				0.0

1900/2000 City Park Drive

12: 1900 Ogilvie Road/1929 Ogilvie Road & Ogilvie Road

Existing AM



Lane Group	EBL	EBT	EBR	WBL	WBT	WBR	NBL	NBT	NBR	SBL	SBT	SBR
Turn Type	Perm	NA	Perm	Perm	NA		Perm	NA		Perm	NA	Perm
Protected Phases		2			6			8			4	
Permitted Phases	2		2	6			8			4		4
Detector Phase	2	2	2	6	6		8	8		4	4	4
Switch Phase												
Minimum Initial (s)	10.0	10.0	10.0	10.0	10.0		10.0	10.0		10.0	10.0	10.0
Minimum Split (s)	29.9	29.9	29.9	29.9	29.9		36.7	36.7		36.7	36.7	36.7
Total Split (s)	63.0	63.0	63.0	63.0	63.0		37.0	37.0		37.0	37.0	37.0
Total Split (%)	63.0%	63.0%	63.0%	63.0%	63.0%		37.0%	37.0%		37.0%	37.0%	37.0%
Maximum Green (s)	57.1	57.1	57.1	57.1	57.1		30.3	30.3		30.3	30.3	30.3
Yellow Time (s)	3.7	3.7	3.7	3.7	3.7		3.3	3.3		3.3	3.3	3.3
All-Red Time (s)	2.2	2.2	2.2	2.2	2.2		3.4	3.4		3.4	3.4	3.4
Lost Time Adjust (s)	0.0	0.0	0.0	0.0	0.0		0.0	0.0		0.0	0.0	0.0
Total Lost Time (s)	5.9	5.9	5.9	5.9	5.9		6.7	6.7		6.7	6.7	6.7
Lead/Lag												
Lead-Lag Optimize?												
Vehicle Extension (s)	3.0	3.0	3.0	3.0	3.0		3.0	3.0		3.0	3.0	3.0
Recall Mode	C-Max	C-Max	C-Max	C-Max	C-Max		None	None		None	None	None
Walk Time (s)	11.0	11.0	11.0	11.0	11.0		7.0	7.0		7.0	7.0	7.0
Flash Dont Walk (s)	13.0	13.0	13.0	13.0	13.0		23.0	23.0		23.0	23.0	23.0
Pedestrian Calls (#/hr)	10	10	10	10	10		30	30		30	30	30
Act Effct Green (s)	69.9	69.9	69.9	69.9	69.9		22.0	22.0		22.0	22.0	22.0
Actuated g/C Ratio	0.70	0.70	0.70	0.70	0.70		0.22	0.22		0.22	0.22	0.22
v/c Ratio	0.42	0.32	0.03	0.05	0.48		0.04	0.04		0.20	0.19	0.19
Control Delay	16.8	8.6	2.2	5.7	5.4		25.2	13.2		29.8	7.7	7.7
Queue Delay	0.0	0.0	0.0	0.0	0.0		0.0	0.0		0.0	0.0	0.0
Total Delay	16.8	8.6	2.2	5.7	5.4		25.2	13.2		29.8	7.7	7.7
LOS	B	A	A	A	A		C	B		C	A	A
Approach Delay		9.4			5.4			18.2			17.8	
Approach LOS		A			A			B			B	

Intersection Summary

Area Type:	Other
Cycle Length:	100
Actuated Cycle Length:	100
Offset:	12 (12%), Referenced to phase 2:EBTL and 6:WBTL, Start of Green
Natural Cycle:	80
Control Type:	Actuated-Coordinated
Maximum v/c Ratio:	0.48
Intersection Signal Delay:	7.9
Intersection LOS:	A
Intersection Capacity Utilization:	89.1%
ICU Level of Service:	E
Analysis Period (min):	15

Splits and Phases: 12: 1900 Ogilvie Road/1929 Ogilvie Road & Ogilvie Road

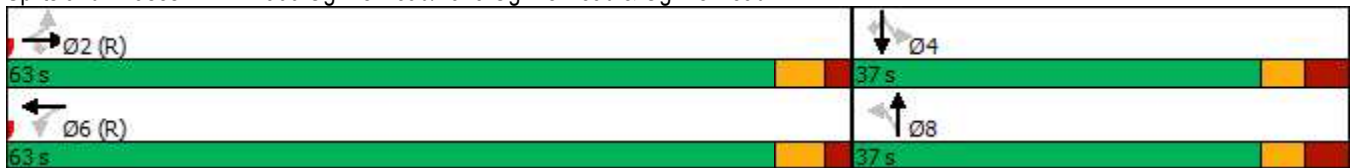

1900/2000 City Park Drive
 15: City Park Drive/Bathgate Drive & Ogilvie Road

Existing AM



Lane Group	EBL	EBT	EBR	WBL	WBT	WBR	NBL	NBT	NBR	SBL	SBT	SBR
Lane Configurations												
Traffic Volume (vph)	156	475	83	14	820	161	72	38	13	119	27	178
Future Volume (vph)	156	475	83	14	820	161	72	38	13	119	27	178
Ideal Flow (vphpl)	1800	1800	1800	1800	1800	1800	1800	1800	1800	1800	1800	1800
Storage Length (m)	70.0		40.0	45.0		70.0	30.0		0.0	20.0		0.0
Storage Lanes	1		1	1		1	1		0	1		0
Taper Length (m)	30.0			30.0			25.0			25.0		
Lane Util. Factor	1.00	0.95	1.00	1.00	0.95	1.00	1.00	1.00	1.00	1.00	1.00	1.00
Ped Bike Factor	0.98		0.92	0.98		0.89	0.99	0.99		0.98	0.98	
Frt			0.850			0.850		0.962			0.870	
Flt Protected	0.950			0.950			0.950			0.950		
Satd. Flow (prot)	1679	3357	1502	1679	3357	1502	1631	1637	0	1647	1474	0
Flt Permitted	0.201			0.456			0.599			0.603		
Satd. Flow (perm)	349	3357	1389	787	3357	1340	1018	1637	0	1023	1474	0
Right Turn on Red			Yes			Yes			Yes			Yes
Satd. Flow (RTOR)			121			179		14			198	
Link Speed (k/h)		60			60			60			60	
Link Distance (m)		256.0			190.5			345.6			177.6	
Travel Time (s)		15.4			11.4			20.7			10.7	
Confl. Peds. (#/hr)	43		27	27		43	14		23	23		14
Peak Hour Factor	0.90	0.90	0.90	0.90	0.90	0.90	0.90	0.90	0.90	0.90	0.90	0.90
Heavy Vehicles (%)	3%	3%	3%	3%	3%	3%	6%	6%	6%	5%	5%	5%
Adj. Flow (vph)	173	528	92	16	911	179	80	42	14	132	30	198
Shared Lane Traffic (%)												
Lane Group Flow (vph)	173	528	92	16	911	179	80	56	0	132	228	0
Enter Blocked Intersection	No	No	No	No	No	No	No	No	No	No	No	No
Lane Alignment	Left	Left	Right	Left	Left	Right	Left	Left	Right	Left	Left	Right
Median Width(m)		3.7			3.7			3.7			3.7	
Link Offset(m)		0.0			0.0			0.0			0.0	
Crosswalk Width(m)		4.9			4.9			4.9			4.9	
Two way Left Turn Lane												
Headway Factor	1.06	1.06	1.06	1.06	1.06	1.06	1.06	1.06	1.06	1.06	1.06	1.06
Turning Speed (k/h)	24		14	24		14	24		14	24		14
Number of Detectors	1	2	1	1	2	1	1	2		1	2	
Detector Template	Left	Thru	Right	Left	Thru	Right	Left	Thru		Left	Thru	
Leading Detector (m)	6.1	30.5	6.1	6.1	30.5	6.1	6.1	30.5		6.1	30.5	
Trailing Detector (m)	0.0	0.0	0.0	0.0	0.0	0.0	0.0	0.0		0.0	0.0	
Detector 1 Position(m)	0.0	0.0	0.0	0.0	0.0	0.0	0.0	0.0		0.0	0.0	
Detector 1 Size(m)	6.1	1.8	6.1	6.1	1.8	6.1	6.1	1.8		6.1	1.8	
Detector 1 Type	Cl+Ex	Cl+Ex	Cl+Ex	Cl+Ex	Cl+Ex	Cl+Ex	Cl+Ex	Cl+Ex		Cl+Ex	Cl+Ex	
Detector 1 Channel												
Detector 1 Extend (s)	0.0	0.0	0.0	0.0	0.0	0.0	0.0	0.0		0.0	0.0	
Detector 1 Queue (s)	0.0	0.0	0.0	0.0	0.0	0.0	0.0	0.0		0.0	0.0	
Detector 1 Delay (s)	0.0	0.0	0.0	0.0	0.0	0.0	0.0	0.0		0.0	0.0	
Detector 2 Position(m)		28.7			28.7			28.7			28.7	
Detector 2 Size(m)		1.8			1.8			1.8			1.8	
Detector 2 Type		Cl+Ex			Cl+Ex			Cl+Ex			Cl+Ex	
Detector 2 Channel												
Detector 2 Extend (s)		0.0			0.0			0.0			0.0	

Lane Group	Ø3	Ø7
Lane Configurations		
Traffic Volume (vph)		
Future Volume (vph)		
Ideal Flow (vphpl)		
Storage Length (m)		
Storage Lanes		
Taper Length (m)		
Lane Util. Factor		
Ped Bike Factor		
Frt		
Flt Protected		
Satd. Flow (prot)		
Flt Permitted		
Satd. Flow (perm)		
Right Turn on Red		
Satd. Flow (RTOR)		
Link Speed (k/h)		
Link Distance (m)		
Travel Time (s)		
Confl. Peds. (#/hr)		
Peak Hour Factor		
Heavy Vehicles (%)		
Adj. Flow (vph)		
Shared Lane Traffic (%)		
Lane Group Flow (vph)		
Enter Blocked Intersection		
Lane Alignment		
Median Width(m)		
Link Offset(m)		
Crosswalk Width(m)		
Two way Left Turn Lane		
Headway Factor		
Turning Speed (k/h)		
Number of Detectors		
Detector Template		
Leading Detector (m)		
Trailing Detector (m)		
Detector 1 Position(m)		
Detector 1 Size(m)		
Detector 1 Type		
Detector 1 Channel		
Detector 1 Extend (s)		
Detector 1 Queue (s)		
Detector 1 Delay (s)		
Detector 2 Position(m)		
Detector 2 Size(m)		
Detector 2 Type		
Detector 2 Channel		
Detector 2 Extend (s)		

1900/2000 City Park Drive
 15: City Park Drive/Bathgate Drive & Ogilvie Road

Existing AM



Lane Group	EBL	EBT	EBR	WBL	WBT	WBR	NBL	NBT	NBR	SBL	SBT	SBR
Turn Type	pm+pt	NA	Perm	pm+pt	NA	Perm	Perm	NA		Perm	NA	
Protected Phases	5	2		1	6			8				4
Permitted Phases	2		2	6		6	8			4		
Detector Phase	5	2	2	1	6	6	8	8		4		4
Switch Phase												
Minimum Initial (s)	5.0	10.0	10.0	5.0	10.0	10.0	10.0	10.0		10.0	10.0	
Minimum Split (s)	9.7	30.0	30.0	9.7	30.0	30.0	37.4	37.4		37.4	37.4	
Total Split (s)	15.0	42.0	42.0	15.0	42.0	42.0	38.0	38.0		38.0	38.0	
Total Split (%)	15.0%	42.0%	42.0%	15.0%	42.0%	42.0%	38.0%	38.0%		38.0%	38.0%	
Maximum Green (s)	10.3	36.0	36.0	10.3	36.0	36.0	30.6	30.6		30.6	30.6	
Yellow Time (s)	3.7	3.7	3.7	3.7	3.7	3.7	3.0	3.0		3.0	3.0	
All-Red Time (s)	1.0	2.3	2.3	1.0	2.3	2.3	4.4	4.4		4.4	4.4	
Lost Time Adjust (s)	0.0	0.0	0.0	0.0	0.0	0.0	0.0	0.0		0.0	0.0	
Total Lost Time (s)	4.7	6.0	6.0	4.7	6.0	6.0	7.4	7.4		7.4	7.4	
Lead/Lag	Lead	Lag	Lag	Lead	Lag	Lag	Lag	Lag		Lag	Lag	
Lead-Lag Optimize?	Yes	Yes	Yes	Yes	Yes	Yes	Yes	Yes		Yes	Yes	
Vehicle Extension (s)	3.0	3.0	3.0	3.0	3.0	3.0	3.0	3.0		3.0	3.0	
Recall Mode	None	C-Max	C-Max	None	C-Max	C-Max	None	None		None	None	
Walk Time (s)		9.0	9.0		9.0	9.0	2.0	2.0		2.0	2.0	
Flash Dont Walk (s)		15.0	15.0		15.0	15.0	28.0	28.0		28.0	28.0	
Pedestrian Calls (#/hr)		15	15		15	15	15	15		15	15	
Act Effct Green (s)	62.9	57.2	57.2	55.1	47.9	47.9	19.9	19.9		19.9	19.9	
Actuated g/C Ratio	0.63	0.57	0.57	0.55	0.48	0.48	0.20	0.20		0.20	0.20	
v/c Ratio	0.51	0.28	0.11	0.03	0.57	0.24	0.40	0.17		0.65	0.51	
Control Delay	26.2	22.6	10.5	6.3	12.0	1.3	37.7	24.1		49.9	10.3	
Queue Delay	0.0	0.0	0.0	0.0	0.0	0.0	0.0	0.0		0.0	0.0	
Total Delay	26.2	22.6	10.5	6.3	12.0	1.3	37.7	24.1		49.9	10.3	
LOS	C	C	B	A	B	A	D	C		D	B	
Approach Delay		22.0			10.2			32.1			24.8	
Approach LOS		C			B			C			C	

Intersection Summary

Area Type: Other
 Cycle Length: 100
 Actuated Cycle Length: 100
 Offset: 29 (29%), Referenced to phase 2:EBTL and 6:WBTL, Start of Green
 Natural Cycle: 85
 Control Type: Actuated-Coordinated
 Maximum v/c Ratio: 0.65
 Intersection Signal Delay: 17.5
 Intersection LOS: B
 Intersection Capacity Utilization 80.9%
 ICU Level of Service D
 Analysis Period (min) 15

Splits and Phases: 15: City Park Drive/Bathgate Drive & Ogilvie Road



Lane Group	Ø3	Ø7
Turn Type		
Protected Phases	3	7
Permitted Phases		
Detector Phase		
Switch Phase		
Minimum Initial (s)	1.0	1.0
Minimum Split (s)	5.0	5.0
Total Split (s)	5.0	5.0
Total Split (%)	5%	5%
Maximum Green (s)	3.0	3.0
Yellow Time (s)	2.0	2.0
All-Red Time (s)	0.0	0.0
Lost Time Adjust (s)		
Total Lost Time (s)		
Lead/Lag	Lead	Lead
Lead-Lag Optimize?	Yes	Yes
Vehicle Extension (s)	3.0	3.0
Recall Mode	Ped	Ped
Walk Time (s)	0.0	0.0
Flash Dont Walk (s)	0.0	0.0
Pedestrian Calls (#/hr)	15	15
Act Effct Green (s)		
Actuated g/C Ratio		
v/c Ratio		
Control Delay		
Queue Delay		
Total Delay		
LOS		
Approach Delay		
Approach LOS		
Intersection Summary		

1900/2000 City Park Drive
 18: Palmerston Drive/Matheson Road & Ogilvie Road

Existing AM



Lane Group	EBL	EBT	EBR	WBL	WBT	WBR	NBL	NBT	NBR	SBL	SBT	SBR
Lane Configurations												
Traffic Volume (vph)	83	898	21	33	1056	14	57	2	26	25	2	171
Future Volume (vph)	83	898	21	33	1056	14	57	2	26	25	2	171
Ideal Flow (vphpl)	1800	1800	1800	1800	1800	1800	1800	1800	1800	1800	1800	1800
Storage Length (m)	70.0		0.0	70.0		0.0	15.0		0.0	0.0		35.0
Storage Lanes	1		0	1		0	1		0	0		1
Taper Length (m)	30.0			30.0			7.6			7.6		
Lane Util. Factor	1.00	0.95	0.95	1.00	0.95	0.95	1.00	1.00	1.00	1.00	1.00	1.00
Ped Bike Factor	1.00	1.00		0.99	1.00		1.00	0.98			0.99	0.99
Frt		0.997			0.998			0.860				0.850
Flt Protected	0.950			0.950			0.950				0.955	
Satd. Flow (prot)	1695	3374	0	1695	3381	0	1662	1469	0	0	1704	1517
Flt Permitted	0.176			0.243			0.738				0.718	
Satd. Flow (perm)	313	3374	0	430	3381	0	1287	1469	0	0	1267	1497
Right Turn on Red			Yes			Yes			Yes			Yes
Satd. Flow (RTOR)		3			2			29				190
Link Speed (k/h)		60			60			60				60
Link Distance (m)		314.1			266.1			176.2				174.1
Travel Time (s)		18.8			16.0			10.6				10.4
Confl. Peds. (#/hr)	11		26	26		11	4		14	14		
Confl. Bikes (#/hr)			21			9			2			1
Peak Hour Factor	0.90	0.90	0.90	0.90	0.90	0.90	0.90	0.90	0.90	0.90	0.90	0.90
Heavy Vehicles (%)	2%	2%	2%	2%	2%	2%	4%	4%	4%	2%	2%	2%
Adj. Flow (vph)	92	998	23	37	1173	16	63	2	29	28	2	190
Shared Lane Traffic (%)												
Lane Group Flow (vph)	92	1021	0	37	1189	0	63	31	0	0	30	190
Enter Blocked Intersection	No	No	No	No	No	No	No	No	No	No	No	No
Lane Alignment	Left	Left	Right	Left	Left	Right	Left	Left	Right	Left	Left	Right
Median Width(m)		3.7			3.7			3.7				3.7
Link Offset(m)		0.0			0.0			0.0				0.0
Crosswalk Width(m)		4.9			4.9			4.9				4.9
Two way Left Turn Lane												
Headway Factor	1.06	1.06	1.06	1.06	1.06	1.06	1.06	1.06	1.06	1.06	1.06	1.06
Turning Speed (k/h)	24		14	24		14	24		14	24		14
Number of Detectors	1	2		1	2		1	2		1	2	1
Detector Template	Left	Thru		Left	Thru		Left	Thru		Left	Thru	Right
Leading Detector (m)	6.1	30.5		6.1	30.5		6.1	30.5		6.1	30.5	6.1
Trailing Detector (m)	0.0	0.0		0.0	0.0		0.0	0.0		0.0	0.0	0.0
Detector 1 Position(m)	0.0	0.0		0.0	0.0		0.0	0.0		0.0	0.0	0.0
Detector 1 Size(m)	6.1	1.8		6.1	1.8		6.1	1.8		6.1	1.8	6.1
Detector 1 Type	Cl+Ex	Cl+Ex		Cl+Ex	Cl+Ex		Cl+Ex	Cl+Ex		Cl+Ex	Cl+Ex	Cl+Ex
Detector 1 Channel												
Detector 1 Extend (s)	0.0	0.0		0.0	0.0		0.0	0.0		0.0	0.0	0.0
Detector 1 Queue (s)	0.0	0.0		0.0	0.0		0.0	0.0		0.0	0.0	0.0
Detector 1 Delay (s)	0.0	0.0		0.0	0.0		0.0	0.0		0.0	0.0	0.0
Detector 2 Position(m)		28.7			28.7			28.7				28.7
Detector 2 Size(m)		1.8			1.8			1.8				1.8
Detector 2 Type		Cl+Ex			Cl+Ex			Cl+Ex				Cl+Ex
Detector 2 Channel												

1900/2000 City Park Drive
 22: Blair Road & Hwy 174 EB off

Existing AM



Lane Group	WBL	WBR	NBT	NBR	SBL	SBT
Lane Configurations						
Traffic Volume (vph)	174	878	802	71	157	396
Future Volume (vph)	174	878	802	71	157	396
Ideal Flow (vphpl)	1800	1800	1800	1800	1800	1800
Storage Length (m)	0.0	0.0		70.0	0.0	
Storage Lanes	1	1		1	0	
Taper Length (m)	7.6				7.6	
Lane Util. Factor	1.00	1.00	0.95	1.00	0.95	0.95
Fr _t		0.850		0.850		
Fl _t Protected	0.950					0.986
Satd. Flow (prot)	1647	1473	3325	1488	0	3217
Fl _t Permitted	0.950					0.581
Satd. Flow (perm)	1647	1473	3325	1488	0	1895
Right Turn on Red		Yes		Yes		
Satd. Flow (RTOR)		483				
Link Speed (k/h)	60		60			60
Link Distance (m)	216.4		230.9			341.9
Travel Time (s)	13.0		13.9			20.5
Peak Hour Factor	0.90	0.90	0.90	0.90	0.90	0.90
Heavy Vehicles (%)	5%	5%	4%	4%	6%	6%
Adj. Flow (vph)	193	976	891	79	174	440
Shared Lane Traffic (%)						
Lane Group Flow (vph)	193	976	891	79	0	614
Enter Blocked Intersection	No	No	No	No	No	No
Lane Alignment	Left	Right	Left	Right	Left	Left
Median Width(m)	3.7		0.0			0.0
Link Offset(m)	0.0		0.0			0.0
Crosswalk Width(m)	4.9		4.9			4.9
Two way Left Turn Lane						
Headway Factor	1.06	1.06	1.06	1.06	1.06	1.06
Turning Speed (k/h)	24	14		14	24	
Number of Detectors	1	1	2	1	1	2
Detector Template	Left	Right	Thru	Right	Left	Thru
Leading Detector (m)	6.1	6.1	30.5	6.1	6.1	30.5
Trailing Detector (m)	0.0	0.0	0.0	0.0	0.0	0.0
Detector 1 Position(m)	0.0	0.0	0.0	0.0	0.0	0.0
Detector 1 Size(m)	6.1	6.1	1.8	6.1	6.1	1.8
Detector 1 Type	Cl+Ex	Cl+Ex	Cl+Ex	Cl+Ex	Cl+Ex	Cl+Ex
Detector 1 Channel						
Detector 1 Extend (s)	0.0	0.0	0.0	0.0	0.0	0.0
Detector 1 Queue (s)	0.0	0.0	0.0	0.0	0.0	0.0
Detector 1 Delay (s)	0.0	0.0	0.0	0.0	0.0	0.0
Detector 2 Position(m)			28.7			28.7
Detector 2 Size(m)			1.8			1.8
Detector 2 Type			Cl+Ex			Cl+Ex
Detector 2 Channel						
Detector 2 Extend (s)			0.0			0.0
Turn Type	Prot	Free	NA	pm+ov	Perm	NA
Protected Phases	8		2	8		6

1900/2000 City Park Drive
 22: Blair Road & Hwy 174 EB off

Existing AM



Lane Group	WBL	WBR	NBT	NBR	SBL	SBT
Permitted Phases		Free		2	6	
Detector Phase	8		2	8	6	6
Switch Phase						
Minimum Initial (s)	5.0		10.0	5.0	10.0	10.0
Minimum Split (s)	25.3		30.5	25.3	16.5	16.5
Total Split (s)	35.0		55.0	35.0	55.0	55.0
Total Split (%)	38.9%		61.1%	38.9%	61.1%	61.1%
Maximum Green (s)	28.7		48.5	28.7	48.5	48.5
Yellow Time (s)	3.3		4.2	3.3	4.2	4.2
All-Red Time (s)	3.0		2.3	3.0	2.3	2.3
Lost Time Adjust (s)	0.0		0.0	0.0		0.0
Total Lost Time (s)	6.3		6.5	6.3		6.5
Lead/Lag						
Lead-Lag Optimize?						
Vehicle Extension (s)	3.0		3.0	3.0	3.0	3.0
Recall Mode	None		Max	None	Max	Max
Walk Time (s)	7.0		7.0	7.0		
Flash Dont Walk (s)	12.0		17.0	12.0		
Pedestrian Calls (#/hr)	0		0	0		
Act Effct Green (s)	14.0	75.4	48.6	75.4		48.6
Actuated g/C Ratio	0.19	1.00	0.64	1.00		0.64
v/c Ratio	0.63	0.66	0.42	0.05		0.50
Control Delay	38.0	2.4	7.8	0.1		9.5
Queue Delay	0.0	0.0	0.0	0.0		0.0
Total Delay	38.0	2.4	7.8	0.1		9.5
LOS	D	A	A	A		A
Approach Delay	8.3		7.1			9.5
Approach LOS	A		A			A

Intersection Summary

Area Type: Other
 Cycle Length: 90
 Actuated Cycle Length: 75.4
 Natural Cycle: 60
 Control Type: Semi Act-Uncoord
 Maximum v/c Ratio: 0.66
 Intersection Signal Delay: 8.1
 Intersection LOS: A
 Intersection Capacity Utilization 66.0%
 ICU Level of Service C
 Analysis Period (min) 15

Splits and Phases: 22: Blair Road & Hwy 174 EB off

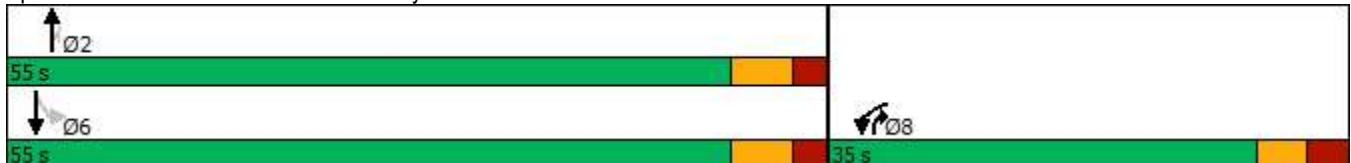

1900/2000 City Park Drive
 26: Residential/Cadboro Road & Ogilvie Road

Existing AM



Lane Group	EBL	EBT	EBR	WBL	WBT	WBR	NBL	NBT	NBR	SBL	SBT	SBR
Lane Configurations		↑↓			↑↓				↑			↑
Traffic Volume (vph)	0	1013	9	0	1062	57	0	0	6	0	0	21
Future Volume (vph)	0	1013	9	0	1062	57	0	0	6	0	0	21
Ideal Flow (vphpl)	1800	1800	1800	1800	1800	1800	1800	1800	1800	1800	1800	1800
Lane Util. Factor	1.00	0.95	0.95	1.00	0.95	0.95	1.00	1.00	1.00	1.00	1.00	1.00
Fr _t		0.999			0.992				0.865			0.865
Fl _t Protected												
Satd. Flow (prot)	0	3387	0	0	3363	0	0	0	1543	0	0	1543
Fl _t Permitted												
Satd. Flow (perm)	0	3387	0	0	3363	0	0	0	1543	0	0	1543
Right Turn on Red			Yes			Yes			Yes			Yes
Satd. Flow (RTOR)		1			8				67			59
Link Speed (k/h)		60			60			60				60
Link Distance (m)		266.1			256.0			114.0				107.3
Travel Time (s)		16.0			15.4			6.8				6.4
Peak Hour Factor	0.90	0.90	0.90	0.90	0.90	0.90	0.90	0.90	0.90	0.90	0.90	0.90
Adj. Flow (vph)	0	1126	10	0	1180	63	0	0	7	0	0	23
Shared Lane Traffic (%)												
Lane Group Flow (vph)	0	1136	0	0	1243	0	0	0	7	0	0	23
Enter Blocked Intersection	No	No	No	No	No	No	No	No	No	No	No	No
Lane Alignment	Left	Left	Right	Left	Left	Right	Left	Left	Right	Left	Left	Right
Median Width(m)		3.7			3.7			0.0				0.0
Link Offset(m)		0.0			0.0			0.0				0.0
Crosswalk Width(m)		1.6			1.6			1.6				1.6
Two way Left Turn Lane												
Headway Factor	1.06	1.06	1.06	1.06	1.06	1.06	1.06	1.06	1.06	1.06	1.06	1.06
Turning Speed (k/h)	97		97	97		97	97		97	97		97
Number of Detectors		2			2				1			1
Detector Template		Thru			Thru				Right			Right
Leading Detector (m)		10.0			10.0				2.0			2.0
Trailing Detector (m)		0.0			0.0				0.0			0.0
Detector 1 Position(m)		0.0			0.0				0.0			0.0
Detector 1 Size(m)		0.6			0.6				2.0			2.0
Detector 1 Type		Cl+Ex			Cl+Ex				Cl+Ex			Cl+Ex
Detector 1 Channel												
Detector 1 Extend (s)		0.0			0.0				0.0			0.0
Detector 1 Queue (s)		0.0			0.0				0.0			0.0
Detector 1 Delay (s)		0.0			0.0				0.0			0.0
Detector 2 Position(m)		9.4			9.4							
Detector 2 Size(m)		0.6			0.6							
Detector 2 Type		Cl+Ex			Cl+Ex							
Detector 2 Channel												
Detector 2 Extend (s)		0.0			0.0							
Turn Type		NA			NA				Perm			Perm
Protected Phases		2			6							
Permitted Phases									8			4
Detector Phase		2			6				8			4
Switch Phase												
Minimum Initial (s)		10.0			10.0				5.0			5.0

1900/2000 City Park Drive
 26: Residential/Cadboro Road & Ogilvie Road

Existing AM



Lane Group	EBL	EBT	EBR	WBL	WBT	WBR	NBL	NBT	NBR	SBL	SBT	SBR
Minimum Split (s)		35.0			35.0				40.0			40.0
Total Split (s)		60.0			60.0				40.0			40.0
Total Split (%)		60.0%			60.0%				40.0%			40.0%
Maximum Green (s)		54.0			54.0				36.0			36.0
Yellow Time (s)		3.7			3.7				3.0			3.0
All-Red Time (s)		2.3			2.3				1.0			1.0
Lost Time Adjust (s)		0.0			0.0				0.0			0.0
Total Lost Time (s)		6.0			6.0				4.0			4.0
Lead/Lag												
Lead-Lag Optimize?												
Vehicle Extension (s)		3.0			3.0				3.0			3.0
Recall Mode		C-Max			C-Max				None			None
Walk Time (s)		15.0			15.0				24.0			24.0
Flash Dont Walk (s)		14.0			14.0				12.0			12.0
Pedestrian Calls (#/hr)		20			20				15			15
Act Effct Green (s)		78.5			78.5				17.7			17.7
Actuated g/C Ratio		0.78			0.78				0.18			0.18
v/c Ratio		0.43			0.47				0.02			0.07
Control Delay		6.3			4.2				0.2			0.6
Queue Delay		0.0			0.0				0.0			0.0
Total Delay		6.3			4.2				0.2			0.6
LOS		A			A				A			A
Approach Delay		6.3			4.2			0.2			0.6	
Approach LOS		A			A			A			A	

Intersection Summary

Area Type:	Other
Cycle Length:	100
Actuated Cycle Length:	100
Offset:	42 (42%), Referenced to phase 2:EBT and 6:WBT, Start of Green
Natural Cycle:	75
Control Type:	Actuated-Coordinated
Maximum v/c Ratio:	0.47
Intersection Signal Delay:	5.2
Intersection LOS:	A
Intersection Capacity Utilization	45.4%
ICU Level of Service	A
Analysis Period (min)	15

Splits and Phases: 26: Residential/Cadboro Road & Ogilvie Road



1900/2000 City Park Drive
3: Blair Road & Ogilvie Road

Existing PM



Lane Group	EBL	EBT	EBR	WBL	WBT	WBR	NBL	NBT	NBR	SBL	SBT	SBR
Lane Configurations												
Traffic Volume (vph)	132	680	550	464	363	53	191	258	502	43	666	48
Future Volume (vph)	132	680	550	464	363	53	191	258	502	43	666	48
Ideal Flow (vphpl)	1800	1800	1800	1800	1800	1800	1800	1800	1800	1800	1800	1800
Storage Length (m)	70.0		0.0	110.0		0.0	120.0		0.0	30.0		0.0
Storage Lanes	1		1	2		0	2		1	1		0
Taper Length (m)	40.0			60.0			60.0			45.0		
Lane Util. Factor	1.00	0.95	1.00	0.97	0.95	0.95	0.97	1.00	1.00	1.00	0.95	0.95
Ped Bike Factor					0.99						0.99	
Frt			0.850		0.981				0.850		0.990	
Flt Protected	0.950			0.950			0.950			0.950		
Satd. Flow (prot)	1679	3357	1502	3257	3259	0	3257	1767	1502	1679	3295	0
Flt Permitted	0.950			0.950			0.950			0.950		
Satd. Flow (perm)	1679	3357	1502	3257	3259	0	3257	1767	1502	1679	3295	0
Right Turn on Red			Yes			Yes			Yes			Yes
Satd. Flow (RTOR)			236		12				481			5
Link Speed (k/h)		60			60			60			60	
Link Distance (m)		372.0			396.5			239.9			411.0	
Travel Time (s)		22.3			23.8			14.4			24.7	
Confl. Peds. (#/hr)						29						84
Peak Hour Factor	0.90	0.90	0.90	0.90	0.90	0.90	0.90	0.90	0.90	0.90	0.90	0.90
Heavy Vehicles (%)	3%	3%	3%	3%	3%	3%	3%	3%	3%	3%	3%	3%
Adj. Flow (vph)	147	756	611	516	403	59	212	287	558	48	740	53
Shared Lane Traffic (%)												
Lane Group Flow (vph)	147	756	611	516	462	0	212	287	558	48	793	0
Enter Blocked Intersection	No	No	No	No	No	No	No	No	No	No	No	No
Lane Alignment	Left	Left	Right	Left	Left	Right	Left	Left	Right	Left	Left	Right
Median Width(m)		7.4			7.4			7.4			7.4	
Link Offset(m)		0.0			0.0			0.0			0.0	
Crosswalk Width(m)		4.9			4.9			4.9			4.9	
Two way Left Turn Lane												
Headway Factor	1.06	1.06	1.06	1.06	1.06	1.06	1.06	1.06	1.06	1.06	1.06	1.06
Turning Speed (k/h)	24		14	24		14	24		14	24		14
Number of Detectors	1	2	1	1	2		1	2	1	1	2	
Detector Template	Left	Thru	Right	Left	Thru		Left	Thru	Right	Left	Thru	
Leading Detector (m)	6.1	30.5	6.1	6.1	30.5		6.1	30.5	6.1	6.1	30.5	
Trailing Detector (m)	0.0	0.0	0.0	0.0	0.0		0.0	0.0	0.0	0.0	0.0	
Detector 1 Position(m)	0.0	0.0	0.0	0.0	0.0		0.0	0.0	0.0	0.0	0.0	
Detector 1 Size(m)	6.1	1.8	6.1	6.1	1.8		6.1	1.8	6.1	6.1	1.8	
Detector 1 Type	Cl+Ex	Cl+Ex	Cl+Ex	Cl+Ex	Cl+Ex		Cl+Ex	Cl+Ex	Cl+Ex	Cl+Ex	Cl+Ex	
Detector 1 Channel												
Detector 1 Extend (s)	0.0	0.0	0.0	0.0	0.0		0.0	0.0	0.0	0.0	0.0	
Detector 1 Queue (s)	0.0	0.0	0.0	0.0	0.0		0.0	0.0	0.0	0.0	0.0	
Detector 1 Delay (s)	0.0	0.0	0.0	0.0	0.0		0.0	0.0	0.0	0.0	0.0	
Detector 2 Position(m)		28.7			28.7			28.7			28.7	
Detector 2 Size(m)		1.8			1.8			1.8			1.8	
Detector 2 Type		Cl+Ex			Cl+Ex			Cl+Ex			Cl+Ex	
Detector 2 Channel												
Detector 2 Extend (s)		0.0			0.0			0.0			0.0	

1900/2000 City Park Drive
3: Blair Road & Ogilvie Road

Existing PM



Lane Group	EBL	EBT	EBR	WBL	WBT	WBR	NBL	NBT	NBR	SBL	SBT	SBR
Turn Type	Prot	NA	Perm	Prot	NA		Prot	NA	Perm	Prot	NA	
Protected Phases	5	2		1	6		3	8		7	4	
Permitted Phases			2						8			
Detector Phase	5	2	2	1	6		3	8	8	7	4	
Switch Phase												
Minimum Initial (s)	5.0	10.0	10.0	5.0	10.0		5.0	10.0	10.0	5.0	10.0	
Minimum Split (s)	11.8	38.6	38.6	11.8	38.6		11.5	35.5	35.5	11.5	35.5	
Total Split (s)	25.0	41.0	41.0	37.0	53.0		21.0	41.0	41.0	21.0	41.0	
Total Split (%)	17.9%	29.3%	29.3%	26.4%	37.9%		15.0%	29.3%	29.3%	15.0%	29.3%	
Maximum Green (s)	18.2	34.4	34.4	30.2	46.4		14.5	34.5	34.5	14.5	34.5	
Yellow Time (s)	3.7	3.3	3.3	3.7	3.3		4.2	4.2	4.2	4.2	4.2	
All-Red Time (s)	3.1	3.3	3.3	3.1	3.3		2.3	2.3	2.3	2.3	2.3	
Lost Time Adjust (s)	0.0	0.0	0.0	0.0	0.0		0.0	0.0	0.0	0.0	0.0	
Total Lost Time (s)	6.8	6.6	6.6	6.8	6.6		6.5	6.5	6.5	6.5	6.5	
Lead/Lag	Lead	Lag	Lag	Lead	Lag		Lead	Lag	Lag	Lead	Lag	
Lead-Lag Optimize?	Yes	Yes	Yes	Yes	Yes		Yes	Yes	Yes	Yes	Yes	
Vehicle Extension (s)	3.0	3.0	3.0	3.0	3.0		3.0	3.0	3.0	3.0	3.0	
Recall Mode	None	C-Max	C-Max	None	C-Max		None	None	None	None	None	
Walk Time (s)		7.0	7.0		7.0			7.0	7.0		7.0	
Flash Dont Walk (s)		25.0	25.0		25.0			22.0	22.0		22.0	
Pedestrian Calls (#/hr)		30	30		30			35	35		35	
Act Effct Green (s)	16.0	38.6	38.6	26.6	49.2		13.3	41.5	41.5	9.4	35.1	
Actuated g/C Ratio	0.11	0.28	0.28	0.19	0.35		0.10	0.30	0.30	0.07	0.25	
v/c Ratio	0.77	0.82	1.04	0.83	0.40		0.69	0.55	0.71	0.43	0.96	
Control Delay	84.7	56.3	79.7	66.9	35.3		73.0	47.6	13.0	73.6	73.6	
Queue Delay	0.0	0.0	0.0	0.0	0.0		0.0	0.0	0.0	0.0	0.0	
Total Delay	84.7	56.3	79.7	66.9	35.3		73.0	47.6	13.0	73.6	73.6	
LOS	F	E	E	E	D		E	D	B	E	E	
Approach Delay		68.5			51.9			34.4			73.6	
Approach LOS		E			D			C			E	

Intersection Summary

Area Type: Other
 Cycle Length: 140
 Actuated Cycle Length: 140
 Offset: 0 (0%), Referenced to phase 2:EBT and 6:WBT, Start of Green
 Natural Cycle: 120
 Control Type: Actuated-Coordinated
 Maximum v/c Ratio: 1.04
 Intersection Signal Delay: 57.6
 Intersection LOS: E
 Intersection Capacity Utilization 90.5%
 ICU Level of Service E
 Analysis Period (min) 15

Splits and Phases: 3: Blair Road & Ogilvie Road



1900/2000 City Park Drive

6: Blair Road & 1980 Ogilvie Road/Hwy 174 WB off

Existing PM

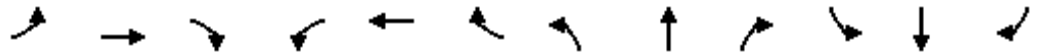

Lane Group	EBL	EBT	EBR	WBL	WBT	WBR	NBL	NBT	NBR	SBL	SBT	SBR
Lane Configurations												
Traffic Volume (vph)	118	0	512	82	135	155	280	1146	0	0	1581	165
Future Volume (vph)	118	0	512	82	135	155	280	1146	0	0	1581	165
Ideal Flow (vphpl)	1800	1800	1800	1800	1800	1800	1800	1800	1800	1800	1800	1800
Storage Length (m)	0.0		70.0	0.0		70.0	60.0		0.0	0.0		50.0
Storage Lanes	1		1	1		1	2		0	0		1
Taper Length (m)	7.6			7.6			100.0			7.6		
Lane Util. Factor	1.00	1.00	1.00	1.00	1.00	1.00	0.97	0.95	1.00	1.00	0.91	1.00
Frt			0.850			0.850						0.850
Flt Protected	0.950			0.950			0.950					
Satd. Flow (prot)	1544	0	1381	1695	1784	1517	3164	3262	0	0	4871	1517
Flt Permitted	0.582			0.950			0.950					
Satd. Flow (perm)	946	0	1381	1695	1784	1517	3164	3262	0	0	4871	1517
Right Turn on Red			Yes			Yes			Yes			Yes
Satd. Flow (RTOR)			26			89						106
Link Speed (k/h)		60			60			60				60
Link Distance (m)		518.9			416.4			90.2				239.9
Travel Time (s)		31.1			25.0			5.4				14.4
Peak Hour Factor	0.90	0.90	0.90	0.90	0.90	0.90	0.90	0.90	0.90	0.90	0.90	0.90
Heavy Vehicles (%)	12%	12%	12%	2%	2%	2%	6%	6%	6%	2%	2%	2%
Adj. Flow (vph)	131	0	569	91	150	172	311	1273	0	0	1757	183
Shared Lane Traffic (%)												
Lane Group Flow (vph)	131	0	569	91	150	172	311	1273	0	0	1757	183
Enter Blocked Intersection	No	No	No	No	No	No	No	No	No	No	No	No
Lane Alignment	Left	Left	Right	Left	Left	Right	Left	Left	Right	Left	Left	Right
Median Width(m)		3.7			3.7			7.4				7.4
Link Offset(m)		0.0			0.0			0.0				0.0
Crosswalk Width(m)		4.9			4.9			4.9				4.9
Two way Left Turn Lane												
Headway Factor	1.06	1.06	1.06	1.06	1.06	1.06	1.06	1.06	1.06	1.06	1.06	1.06
Turning Speed (k/h)	24		14	24		14	24		14	24		14
Number of Detectors	1		1	1	2	1	1	2				2
Detector Template	Left		Right	Left	Thru	Right	Left	Thru				Thru
Leading Detector (m)	6.1		6.1	6.1	30.5	6.1	6.1	30.5				30.5
Trailing Detector (m)	0.0		0.0	0.0	0.0	0.0	0.0	0.0				0.0
Detector 1 Position(m)	0.0		0.0	0.0	0.0	0.0	0.0	0.0				0.0
Detector 1 Size(m)	6.1		6.1	6.1	1.8	6.1	6.1	1.8				1.8
Detector 1 Type	Cl+Ex		Cl+Ex	Cl+Ex	Cl+Ex	Cl+Ex	Cl+Ex	Cl+Ex				Cl+Ex
Detector 1 Channel												
Detector 1 Extend (s)	0.0		0.0	0.0	0.0	0.0	0.0	0.0				0.0
Detector 1 Queue (s)	0.0		0.0	0.0	0.0	0.0	0.0	0.0				0.0
Detector 1 Delay (s)	0.0		0.0	0.0	0.0	0.0	0.0	0.0				0.0
Detector 2 Position(m)					28.7			28.7				28.7
Detector 2 Size(m)					1.8			1.8				1.8
Detector 2 Type					Cl+Ex			Cl+Ex				Cl+Ex
Detector 2 Channel												
Detector 2 Extend (s)					0.0			0.0				0.0
Turn Type	Perm		pm+ov	Perm	NA	Perm	Prot	NA				NA
Protected Phases			5		8		5	2				6

1900/2000 City Park Drive
 9: City Park Drive/1941 Ogilvie & Ogilvie Road

Existing PM



Lane Group	EBL	EBT	EBR	WBL	WBT	WBR	NBL	NBT	NBR	SBL	SBT	SBR
Lane Configurations												
Traffic Volume (vph)	32	1237	145	101	462	38	178	10	160	78	19	76
Future Volume (vph)	32	1237	145	101	462	38	178	10	160	78	19	76
Ideal Flow (vphpl)	1800	1800	1800	1800	1800	1800	1800	1800	1800	1800	1800	1800
Storage Length (m)	40.0		100.0	100.0		50.0	0.0		60.0	20.0		10.0
Storage Lanes	1		1	1		1	0		1	1		1
Taper Length (m)	30.0			25.0			7.6			15.0		
Lane Util. Factor	1.00	0.95	1.00	1.00	0.95	1.00	1.00	1.00	1.00	1.00	1.00	1.00
Ped Bike Factor	0.88		0.87			0.73		0.93	0.87	0.91		0.92
Fr _t			0.850			0.850			0.850			0.850
Fl _t Protected	0.950			0.950				0.955		0.950		
Satd. Flow (prot)	1695	3390	1517	1679	3357	1502	0	1609	1432	1695	1784	1517
Fl _t Permitted	0.463			0.077				0.722		0.530		
Satd. Flow (perm)	725	3390	1315	136	3357	1104	0	1133	1244	864	1784	1388
Right Turn on Red			Yes			Yes			Yes			Yes
Satd. Flow (RTOR)			161			60			178			99
Link Speed (k/h)		60			60			60				60
Link Distance (m)		224.7			372.0			239.4				142.3
Travel Time (s)		13.5			22.3			14.4				8.5
Confl. Peds. (#/hr)	145		67	67		145	67		110	110		67
Peak Hour Factor	0.90	0.90	0.90	0.90	0.90	0.90	0.90	0.90	0.90	0.90	0.90	0.90
Heavy Vehicles (%)	2%	2%	2%	3%	3%	3%	8%	8%	8%	2%	2%	2%
Adj. Flow (vph)	36	1374	161	112	513	42	198	11	178	87	21	84
Shared Lane Traffic (%)												
Lane Group Flow (vph)	36	1374	161	112	513	42	0	209	178	87	21	84
Enter Blocked Intersection	No	No	No	No	No	No	No	No	No	No	No	No
Lane Alignment	Left	Left	Right	Left	Left	Right	Left	Left	Right	Left	Left	Right
Median Width(m)		3.7			3.7			3.7				3.7
Link Offset(m)		0.0			0.0			0.0				0.0
Crosswalk Width(m)		4.9			4.9			4.9				4.9
Two way Left Turn Lane												
Headway Factor	1.06	1.06	1.06	1.06	1.06	1.06	1.06	1.06	1.06	1.06	1.06	1.06
Turning Speed (k/h)	24		14	24		14	24		14	24		14
Number of Detectors	1	2	1	1	2	1	1	2	1	1	2	1
Detector Template	Left	Thru	Right	Left	Thru	Right	Left	Thru	Right	Left	Thru	Right
Leading Detector (m)	6.1	30.5	6.1	6.1	30.5	6.1	6.1	30.5	6.1	6.1	30.5	6.1
Trailing Detector (m)	0.0	0.0	0.0	0.0	0.0	0.0	0.0	0.0	0.0	0.0	0.0	0.0
Detector 1 Position(m)	0.0	0.0	0.0	0.0	0.0	0.0	0.0	0.0	0.0	0.0	0.0	0.0
Detector 1 Size(m)	6.1	1.8	6.1	6.1	1.8	6.1	6.1	1.8	6.1	6.1	1.8	6.1
Detector 1 Type	Cl+Ex	Cl+Ex	Cl+Ex	Cl+Ex	Cl+Ex	Cl+Ex	Cl+Ex	Cl+Ex	Cl+Ex	Cl+Ex	Cl+Ex	Cl+Ex
Detector 1 Channel												
Detector 1 Extend (s)	0.0	0.0	0.0	0.0	0.0	0.0	0.0	0.0	0.0	0.0	0.0	0.0
Detector 1 Queue (s)	0.0	0.0	0.0	0.0	0.0	0.0	0.0	0.0	0.0	0.0	0.0	0.0
Detector 1 Delay (s)	0.0	0.0	0.0	0.0	0.0	0.0	0.0	0.0	0.0	0.0	0.0	0.0
Detector 2 Position(m)		28.7			28.7			28.7				28.7
Detector 2 Size(m)		1.8			1.8			1.8				1.8
Detector 2 Type		Cl+Ex			Cl+Ex			Cl+Ex				Cl+Ex
Detector 2 Channel												
Detector 2 Extend (s)		0.0			0.0			0.0				0.0

Lane Group	Ø3	Ø7
Lane Configurations		
Traffic Volume (vph)		
Future Volume (vph)		
Ideal Flow (vphpl)		
Storage Length (m)		
Storage Lanes		
Taper Length (m)		
Lane Util. Factor		
Ped Bike Factor		
Frt		
Flt Protected		
Satd. Flow (prot)		
Flt Permitted		
Satd. Flow (perm)		
Right Turn on Red		
Satd. Flow (RTOR)		
Link Speed (k/h)		
Link Distance (m)		
Travel Time (s)		
Confl. Peds. (#/hr)		
Peak Hour Factor		
Heavy Vehicles (%)		
Adj. Flow (vph)		
Shared Lane Traffic (%)		
Lane Group Flow (vph)		
Enter Blocked Intersection		
Lane Alignment		
Median Width(m)		
Link Offset(m)		
Crosswalk Width(m)		
Two way Left Turn Lane		
Headway Factor		
Turning Speed (k/h)		
Number of Detectors		
Detector Template		
Leading Detector (m)		
Trailing Detector (m)		
Detector 1 Position(m)		
Detector 1 Size(m)		
Detector 1 Type		
Detector 1 Channel		
Detector 1 Extend (s)		
Detector 1 Queue (s)		
Detector 1 Delay (s)		
Detector 2 Position(m)		
Detector 2 Size(m)		
Detector 2 Type		
Detector 2 Channel		
Detector 2 Extend (s)		

1900/2000 City Park Drive
 9: City Park Drive/1941 Ogilvie & Ogilvie Road

Existing PM



Lane Group	EBL	EBT	EBR	WBL	WBT	WBR	NBL	NBT	NBR	SBL	SBT	SBR
Turn Type	Perm	NA	Perm	pm+pt	NA	Perm	Perm	NA	Perm	Perm	NA	Perm
Protected Phases		2		1	6			8			4	
Permitted Phases	2		2	6		6	8		8	4		4
Detector Phase	2	2	2	1	6	6	8	8	8	4	4	4
Switch Phase												
Minimum Initial (s)	10.0	10.0	10.0	5.0	10.0	10.0	10.0	10.0	10.0	10.0	10.0	10.0
Minimum Split (s)	35.1	35.1	35.1	9.0	35.1	35.1	33.5	33.5	33.5	33.5	33.5	33.5
Total Split (s)	46.0	46.0	46.0	15.0	61.0	61.0	34.0	34.0	34.0	34.0	34.0	34.0
Total Split (%)	46.0%	46.0%	46.0%	15.0%	61.0%	61.0%	34.0%	34.0%	34.0%	34.0%	34.0%	34.0%
Maximum Green (s)	39.9	39.9	39.9	11.0	54.9	54.9	27.5	27.5	27.5	27.5	27.5	27.5
Yellow Time (s)	3.7	3.7	3.7	3.0	3.7	3.7	3.3	3.3	3.3	3.3	3.3	3.3
All-Red Time (s)	2.4	2.4	2.4	1.0	2.4	2.4	3.2	3.2	3.2	3.2	3.2	3.2
Lost Time Adjust (s)	0.0	0.0	0.0	0.0	0.0	0.0		0.0	0.0	0.0	0.0	0.0
Total Lost Time (s)	6.1	6.1	6.1	4.0	6.1	6.1		6.5	6.5	6.5	6.5	6.5
Lead/Lag	Lag	Lag	Lag	Lead			Lag	Lag	Lag	Lag	Lag	Lag
Lead-Lag Optimize?	Yes	Yes	Yes	Yes			Yes	Yes	Yes	Yes	Yes	Yes
Vehicle Extension (s)	3.0	3.0	3.0	3.0	3.0	3.0	3.0	3.0	3.0	3.0	3.0	3.0
Recall Mode	C-Max	C-Max	C-Max	None	C-Max	C-Max	None	None	None	None	None	None
Walk Time (s)	7.0	7.0	7.0		7.0	7.0	2.0	2.0	2.0	2.0	2.0	2.0
Flash Dont Walk (s)	22.0	22.0	22.0		22.0	22.0	25.0	25.0	25.0	25.0	25.0	25.0
Pedestrian Calls (#/hr)	35	35	35		35	35	35	35	35	35	35	35
Act Effct Green (s)	48.8	48.8	48.8	63.3	61.2	61.2		23.2	23.2	23.2	23.2	23.2
Actuated g/C Ratio	0.49	0.49	0.49	0.63	0.61	0.61		0.23	0.23	0.23	0.23	0.23
v/c Ratio	0.10	0.83	0.22	0.52	0.25	0.06		0.80	0.42	0.43	0.05	0.21
Control Delay	9.7	21.3	1.1	21.7	10.4	1.8		57.5	7.7	38.4	27.5	5.7
Queue Delay	0.0	0.0	0.0	0.0	0.0	0.0		0.0	0.0	0.0	0.0	0.0
Total Delay	9.7	21.3	1.1	21.7	10.4	1.8		57.5	7.7	38.4	27.5	5.7
LOS	A	C	A	C	B	A		E	A	D	C	A
Approach Delay		19.0			11.8			34.6			22.9	
Approach LOS		B			B			C			C	

Intersection Summary

Area Type: Other
 Cycle Length: 100
 Actuated Cycle Length: 100
 Offset: 30 (30%), Referenced to phase 2:EBTL and 6:WBTL, Start of Green
 Natural Cycle: 85
 Control Type: Actuated-Coordinated
 Maximum v/c Ratio: 0.83
 Intersection Signal Delay: 19.7
 Intersection LOS: B
 Intersection Capacity Utilization 95.3%
 ICU Level of Service F
 Analysis Period (min) 15

Splits and Phases: 9: City Park Drive/1941 Ogilvie & Ogilvie Road



Lane Group	Ø3	Ø7
Turn Type		
Protected Phases	3	7
Permitted Phases		
Detector Phase		
Switch Phase		
Minimum Initial (s)	1.0	1.0
Minimum Split (s)	5.0	5.0
Total Split (s)	5.0	5.0
Total Split (%)	5%	5%
Maximum Green (s)	3.0	3.0
Yellow Time (s)	2.0	2.0
All-Red Time (s)	0.0	0.0
Lost Time Adjust (s)		
Total Lost Time (s)		
Lead/Lag	Lead	Lead
Lead-Lag Optimize?	Yes	Yes
Vehicle Extension (s)	3.0	3.0
Recall Mode	None	None
Walk Time (s)	0.0	0.0
Flash Dont Walk (s)	0.0	0.0
Pedestrian Calls (#/hr)	35	35
Act Effct Green (s)		
Actuated g/C Ratio		
v/c Ratio		
Control Delay		
Queue Delay		
Total Delay		
LOS		
Approach Delay		
Approach LOS		
Intersection Summary		

1900/2000 City Park Drive

12: 1900 Ogilvie Road/1929 Ogilvie Road & Ogilvie Road

Existing PM

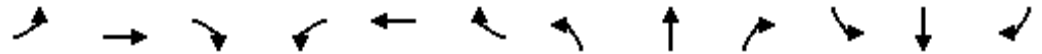

Lane Group	EBL	EBT	EBR	WBL	WBT	WBR	NBL	NBT	NBR	SBL	SBT	SBR
Lane Configurations												
Traffic Volume (vph)	43	1182	66	32	684	24	47	3	28	135	3	132
Future Volume (vph)	43	1182	66	32	684	24	47	3	28	135	3	132
Ideal Flow (vphpl)	1800	1800	1800	1800	1800	1800	1800	1800	1800	1800	1800	1800
Storage Length (m)	60.0		80.0	90.0		0.0	0.0		0.0	0.0		0.0
Storage Lanes	1		1	1		0	1		0	0		1
Taper Length (m)	30.0			20.0			7.6			7.6		
Lane Util. Factor	1.00	0.95	1.00	1.00	0.95	0.95	1.00	1.00	1.00	1.00	1.00	1.00
Frt			0.850		0.995			0.863				0.850
Flt Protected	0.950			0.950			0.950				0.953	
Satd. Flow (prot)	1695	3390	1517	1679	3342	0	1695	1540	0	0	1700	1517
Flt Permitted	0.328			0.157			0.646				0.705	
Satd. Flow (perm)	585	3390	1517	277	3342	0	1153	1540	0	0	1258	1517
Right Turn on Red			Yes			Yes			Yes			Yes
Satd. Flow (RTOR)			73		6			31				147
Link Speed (k/h)		60			60			60				60
Link Distance (m)		190.5			224.7			86.0				56.6
Travel Time (s)		11.4			13.5			5.2				3.4
Peak Hour Factor	0.90	0.90	0.90	0.90	0.90	0.90	0.90	0.90	0.90	0.90	0.90	0.90
Heavy Vehicles (%)	2%	2%	2%	3%	3%	2%	2%	2%	2%	2%	2%	2%
Adj. Flow (vph)	48	1313	73	36	760	27	52	3	31	150	3	147
Shared Lane Traffic (%)												
Lane Group Flow (vph)	48	1313	73	36	787	0	52	34	0	0	153	147
Enter Blocked Intersection	No	No	No	No	No	No	No	No	No	No	No	No
Lane Alignment	Left	Left	Right	Left	Left	Right	Left	Left	Right	Left	Left	Right
Median Width(m)		3.7			3.7			3.7				3.7
Link Offset(m)		0.0			0.0			0.0				0.0
Crosswalk Width(m)		4.9			4.9			4.9				4.9
Two way Left Turn Lane												
Headway Factor	1.06	1.06	1.06	1.06	1.06	1.06	1.06	1.06	1.06	1.06	1.06	1.06
Turning Speed (k/h)	24		14	24		14	24		14	24		14
Number of Detectors	1	2	1	1	2		1	2		1	2	1
Detector Template	Left	Thru	Right	Left	Thru		Left	Thru		Left	Thru	Right
Leading Detector (m)	6.1	30.5	6.1	6.1	30.5		6.1	30.5		6.1	30.5	6.1
Trailing Detector (m)	0.0	0.0	0.0	0.0	0.0		0.0	0.0		0.0	0.0	0.0
Detector 1 Position(m)	0.0	0.0	0.0	0.0	0.0		0.0	0.0		0.0	0.0	0.0
Detector 1 Size(m)	6.1	1.8	6.1	6.1	1.8		6.1	1.8		6.1	1.8	6.1
Detector 1 Type	Cl+Ex	Cl+Ex	Cl+Ex	Cl+Ex	Cl+Ex		Cl+Ex	Cl+Ex		Cl+Ex	Cl+Ex	Cl+Ex
Detector 1 Channel												
Detector 1 Extend (s)	0.0	0.0	0.0	0.0	0.0		0.0	0.0		0.0	0.0	0.0
Detector 1 Queue (s)	0.0	0.0	0.0	0.0	0.0		0.0	0.0		0.0	0.0	0.0
Detector 1 Delay (s)	0.0	0.0	0.0	0.0	0.0		0.0	0.0		0.0	0.0	0.0
Detector 2 Position(m)		28.7			28.7			28.7				28.7
Detector 2 Size(m)		1.8			1.8			1.8				1.8
Detector 2 Type		Cl+Ex			Cl+Ex			Cl+Ex				Cl+Ex
Detector 2 Channel												
Detector 2 Extend (s)		0.0			0.0			0.0				0.0
Turn Type	Perm	NA	Perm	Perm	NA		Perm	NA		Perm	NA	Perm
Protected Phases		2			6			8				4

1900/2000 City Park Drive

12: 1900 Ogilvie Road/1929 Ogilvie Road & Ogilvie Road

Existing PM



Lane Group	EBL	EBT	EBR	WBL	WBT	WBR	NBL	NBT	NBR	SBL	SBT	SBR
Permitted Phases	2		2	6			8			4		4
Detector Phase	2	2	2	6	6		8	8		4	4	4
Switch Phase												
Minimum Initial (s)	10.0	10.0	10.0	10.0	10.0		10.0	10.0		10.0	10.0	10.0
Minimum Split (s)	29.9	29.9	29.9	29.9	29.9		36.7	36.7		36.7	36.7	36.7
Total Split (s)	63.0	63.0	63.0	63.0	63.0		37.0	37.0		37.0	37.0	37.0
Total Split (%)	63.0%	63.0%	63.0%	63.0%	63.0%		37.0%	37.0%		37.0%	37.0%	37.0%
Maximum Green (s)	57.1	57.1	57.1	57.1	57.1		30.3	30.3		30.3	30.3	30.3
Yellow Time (s)	3.7	3.7	3.7	3.7	3.7		3.3	3.3		3.3	3.3	3.3
All-Red Time (s)	2.2	2.2	2.2	2.2	2.2		3.4	3.4		3.4	3.4	3.4
Lost Time Adjust (s)	0.0	0.0	0.0	0.0	0.0		0.0	0.0		0.0	0.0	0.0
Total Lost Time (s)	5.9	5.9	5.9	5.9	5.9		6.7	6.7		6.7	6.7	6.7
Lead/Lag												
Lead-Lag Optimize?												
Vehicle Extension (s)	3.0	3.0	3.0	3.0	3.0		3.0	3.0		3.0	3.0	3.0
Recall Mode	C-Max	C-Max	C-Max	C-Max	C-Max		None	None		None	None	None
Walk Time (s)	11.0	11.0	11.0	11.0	11.0		7.0	7.0		7.0	7.0	7.0
Flash Dont Walk (s)	13.0	13.0	13.0	13.0	13.0		23.0	23.0		23.0	23.0	23.0
Pedestrian Calls (#/hr)	20	20	20	20	20		30	30		30	30	30
Act Effct Green (s)	64.5	64.5	64.5	64.5	64.5		22.9	22.9		22.9	22.9	22.9
Actuated g/C Ratio	0.64	0.64	0.64	0.64	0.64		0.23	0.23		0.23	0.23	0.23
v/c Ratio	0.13	0.60	0.07	0.20	0.36		0.20	0.09		0.53	0.32	0.32
Control Delay	6.3	8.5	0.9	9.5	6.6		29.3	10.5		38.8	6.4	6.4
Queue Delay	0.0	0.1	0.0	0.0	0.0		0.0	0.0		0.0	0.0	0.0
Total Delay	6.3	8.6	0.9	9.5	6.6		29.3	10.5		38.8	6.4	6.4
LOS	A	A	A	A	A		C	B		D	A	A
Approach Delay		8.1			6.7			21.9			23.0	
Approach LOS		A			A			C			C	

Intersection Summary

Area Type:	Other
Cycle Length:	100
Actuated Cycle Length:	100
Offset:	8 (8%), Referenced to phase 2:EBTL and 6:WBTL, Start of Green
Natural Cycle:	75
Control Type:	Actuated-Coordinated
Maximum v/c Ratio:	0.60
Intersection Signal Delay:	9.8
Intersection LOS:	A
Intersection Capacity Utilization:	62.9%
ICU Level of Service:	B
Analysis Period (min):	15

Splits and Phases: 12: 1900 Ogilvie Road/1929 Ogilvie Road & Ogilvie Road

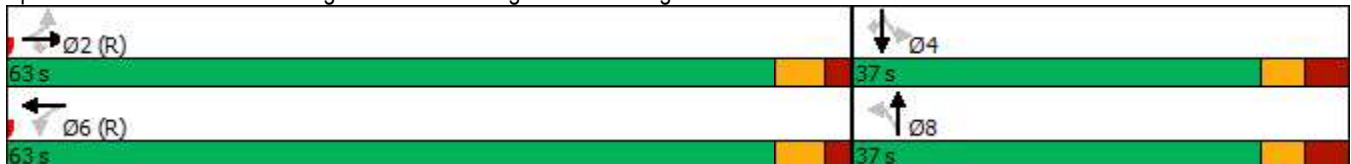

1900/2000 City Park Drive
 15: City Park Drive/Bathgate Drive & Ogilvie Road

Existing PM



Lane Group	EBL	EBT	EBR	WBL	WBT	WBR	NBL	NBT	NBR	SBL	SBT	SBR
Lane Configurations												
Traffic Volume (vph)	207	860	153	12	665	110	112	69	26	140	47	159
Future Volume (vph)	207	860	153	12	665	110	112	69	26	140	47	159
Ideal Flow (vphpl)	1800	1800	1800	1800	1800	1800	1800	1800	1800	1800	1800	1800
Storage Length (m)	70.0		40.0	45.0		70.0	30.0		0.0	20.0		0.0
Storage Lanes	1		1	1		1	1		0	1		0
Taper Length (m)	30.0			30.0			25.0			25.0		
Lane Util. Factor	1.00	0.95	1.00	1.00	0.95	1.00	1.00	1.00	1.00	1.00	1.00	1.00
Ped Bike Factor	0.96		0.90	0.99		0.83	0.98	0.99		0.98	0.97	
Fr _t			0.850			0.850		0.959			0.884	
Fl _t Protected	0.950			0.950			0.950			0.950		
Satd. Flow (prot)	1679	3357	1502	1679	3357	1502	1631	1632	0	1647	1487	0
Fl _t Permitted	0.265			0.291			0.494			0.689		
Satd. Flow (perm)	450	3357	1349	508	3357	1248	832	1632	0	1173	1487	0
Right Turn on Red			Yes			Yes			Yes			Yes
Satd. Flow (RTOR)			121			122		20			177	
Link Speed (k/h)		60			60			60			60	
Link Distance (m)		256.0			190.5			345.6			177.6	
Travel Time (s)		15.4			11.4			20.7			10.7	
Confl. Peds. (#/hr)	73		40	40		73	27		21	21		27
Peak Hour Factor	0.90	0.90	0.90	0.90	0.90	0.90	0.90	0.90	0.90	0.90	0.90	0.90
Heavy Vehicles (%)	3%	3%	3%	3%	3%	3%	6%	6%	6%	5%	5%	5%
Adj. Flow (vph)	230	956	170	13	739	122	124	77	29	156	52	177
Shared Lane Traffic (%)												
Lane Group Flow (vph)	230	956	170	13	739	122	124	106	0	156	229	0
Enter Blocked Intersection	No	No	No	No	No	No	No	No	No	No	No	No
Lane Alignment	Left	Left	Right	Left	Left	Right	Left	Left	Right	Left	Left	Right
Median Width(m)		3.7			3.7			3.7			3.7	
Link Offset(m)		0.0			0.0			0.0			0.0	
Crosswalk Width(m)		4.9			4.9			4.9			4.9	
Two way Left Turn Lane												
Headway Factor	1.06	1.06	1.06	1.06	1.06	1.06	1.06	1.06	1.06	1.06	1.06	1.06
Turning Speed (k/h)	24		14	24		14	24		14	24		14
Number of Detectors	1	2	1	1	2	1	1	2		1	2	
Detector Template	Left	Thru	Right	Left	Thru	Right	Left	Thru		Left	Thru	
Leading Detector (m)	6.1	30.5	6.1	6.1	30.5	6.1	6.1	30.5		6.1	30.5	
Trailing Detector (m)	0.0	0.0	0.0	0.0	0.0	0.0	0.0	0.0		0.0	0.0	
Detector 1 Position(m)	0.0	0.0	0.0	0.0	0.0	0.0	0.0	0.0		0.0	0.0	
Detector 1 Size(m)	6.1	1.8	6.1	6.1	1.8	6.1	6.1	1.8		6.1	1.8	
Detector 1 Type	Cl+Ex	Cl+Ex	Cl+Ex	Cl+Ex	Cl+Ex	Cl+Ex	Cl+Ex	Cl+Ex		Cl+Ex	Cl+Ex	
Detector 1 Channel												
Detector 1 Extend (s)	0.0	0.0	0.0	0.0	0.0	0.0	0.0	0.0		0.0	0.0	
Detector 1 Queue (s)	0.0	0.0	0.0	0.0	0.0	0.0	0.0	0.0		0.0	0.0	
Detector 1 Delay (s)	0.0	0.0	0.0	0.0	0.0	0.0	0.0	0.0		0.0	0.0	
Detector 2 Position(m)		28.7			28.7			28.7			28.7	
Detector 2 Size(m)		1.8			1.8			1.8			1.8	
Detector 2 Type		Cl+Ex			Cl+Ex			Cl+Ex			Cl+Ex	
Detector 2 Channel												
Detector 2 Extend (s)		0.0			0.0			0.0			0.0	

Lane Group	Ø3	Ø7
Lane Configurations		
Traffic Volume (vph)		
Future Volume (vph)		
Ideal Flow (vphpl)		
Storage Length (m)		
Storage Lanes		
Taper Length (m)		
Lane Util. Factor		
Ped Bike Factor		
Frt		
Flt Protected		
Satd. Flow (prot)		
Flt Permitted		
Satd. Flow (perm)		
Right Turn on Red		
Satd. Flow (RTOR)		
Link Speed (k/h)		
Link Distance (m)		
Travel Time (s)		
Confl. Peds. (#/hr)		
Peak Hour Factor		
Heavy Vehicles (%)		
Adj. Flow (vph)		
Shared Lane Traffic (%)		
Lane Group Flow (vph)		
Enter Blocked Intersection		
Lane Alignment		
Median Width(m)		
Link Offset(m)		
Crosswalk Width(m)		
Two way Left Turn Lane		
Headway Factor		
Turning Speed (k/h)		
Number of Detectors		
Detector Template		
Leading Detector (m)		
Trailing Detector (m)		
Detector 1 Position(m)		
Detector 1 Size(m)		
Detector 1 Type		
Detector 1 Channel		
Detector 1 Extend (s)		
Detector 1 Queue (s)		
Detector 1 Delay (s)		
Detector 2 Position(m)		
Detector 2 Size(m)		
Detector 2 Type		
Detector 2 Channel		
Detector 2 Extend (s)		

1900/2000 City Park Drive
 15: City Park Drive/Bathgate Drive & Ogilvie Road

Existing PM



Lane Group	EBL	EBT	EBR	WBL	WBT	WBR	NBL	NBT	NBR	SBL	SBT	SBR
Turn Type	pm+pt	NA	Perm	pm+pt	NA	Perm	Perm	NA		Perm	NA	
Protected Phases	5	2		1	6			8				4
Permitted Phases	2		2	6		6	8			4		
Detector Phase	5	2	2	1	6	6	8	8		4		4
Switch Phase												
Minimum Initial (s)	5.0	10.0	10.0	5.0	10.0	10.0	10.0	10.0		10.0	10.0	
Minimum Split (s)	9.7	30.0	30.0	9.7	30.0	30.0	37.4	37.4		37.4	37.4	
Total Split (s)	20.0	37.0	37.0	20.0	37.0	37.0	38.0	38.0		38.0	38.0	
Total Split (%)	20.0%	37.0%	37.0%	20.0%	37.0%	37.0%	38.0%	38.0%		38.0%	38.0%	
Maximum Green (s)	15.3	31.0	31.0	15.3	31.0	31.0	30.6	30.6		30.6	30.6	
Yellow Time (s)	3.7	3.7	3.7	3.7	3.7	3.7	3.0	3.0		3.0	3.0	
All-Red Time (s)	1.0	2.3	2.3	1.0	2.3	2.3	4.4	4.4		4.4	4.4	
Lost Time Adjust (s)	0.0	0.0	0.0	0.0	0.0	0.0	0.0	0.0		0.0	0.0	
Total Lost Time (s)	4.7	6.0	6.0	4.7	6.0	6.0	7.4	7.4		7.4	7.4	
Lead/Lag	Lead	Lag	Lag	Lead	Lag	Lag	Lag	Lag		Lag	Lag	
Lead-Lag Optimize?	Yes	Yes	Yes	Yes	Yes	Yes	Yes	Yes		Yes	Yes	
Vehicle Extension (s)	3.0	3.0	3.0	3.0	3.0	3.0	3.0	3.0		3.0	3.0	
Recall Mode	None	C-Max	C-Max	None	C-Max	C-Max	None	None		None	None	
Walk Time (s)		9.0	9.0		9.0	9.0	2.0	2.0		2.0	2.0	
Flash Dont Walk (s)		15.0	15.0		15.0	15.0	28.0	28.0		28.0	28.0	
Pedestrian Calls (#/hr)		30	30		30	30	20	20		20	20	
Act Effct Green (s)	62.0	58.5	58.5	51.5	44.3	44.3	20.9	20.9		20.9	20.9	
Actuated g/C Ratio	0.62	0.58	0.58	0.52	0.44	0.44	0.21	0.21		0.21	0.21	
v/c Ratio	0.54	0.49	0.20	0.04	0.50	0.20	0.72	0.30		0.64	0.51	
Control Delay	19.9	14.1	7.1	7.6	15.0	1.5	57.4	26.5		46.4	12.2	
Queue Delay	0.0	0.0	0.0	0.0	0.0	0.0	0.0	0.0		0.0	0.0	
Total Delay	19.9	14.1	7.1	7.6	15.0	1.5	57.4	26.5		46.4	12.2	
LOS	B	B	A	A	B	A	E	C		D	B	
Approach Delay		14.2			13.0			43.1			26.1	
Approach LOS		B			B			D			C	

Intersection Summary

Area Type: Other
 Cycle Length: 100
 Actuated Cycle Length: 100
 Offset: 19 (19%), Referenced to phase 2:EBTL and 6:WBTL, Start of Green
 Natural Cycle: 85
 Control Type: Actuated-Coordinated
 Maximum v/c Ratio: 0.72
 Intersection Signal Delay: 17.8
 Intersection LOS: B
 Intersection Capacity Utilization 82.6%
 ICU Level of Service E
 Analysis Period (min) 15

Splits and Phases: 15: City Park Drive/Bathgate Drive & Ogilvie Road



Lane Group	Ø3	Ø7
Turn Type		
Protected Phases	3	7
Permitted Phases		
Detector Phase		
Switch Phase		
Minimum Initial (s)	1.0	1.0
Minimum Split (s)	5.0	5.0
Total Split (s)	5.0	5.0
Total Split (%)	5%	5%
Maximum Green (s)	3.0	3.0
Yellow Time (s)	2.0	2.0
All-Red Time (s)	0.0	0.0
Lost Time Adjust (s)		
Total Lost Time (s)		
Lead/Lag	Lead	Lead
Lead-Lag Optimize?	Yes	Yes
Vehicle Extension (s)	3.0	3.0
Recall Mode	Ped	Ped
Walk Time (s)	0.0	0.0
Flash Dont Walk (s)	0.0	0.0
Pedestrian Calls (#/hr)	20	20
Act Effct Green (s)		
Actuated g/C Ratio		
v/c Ratio		
Control Delay		
Queue Delay		
Total Delay		
LOS		
Approach Delay		
Approach LOS		
Intersection Summary		

1900/2000 City Park Drive
 18: Palmerston Drive/Matheson Road & Ogilvie Road

Existing PM

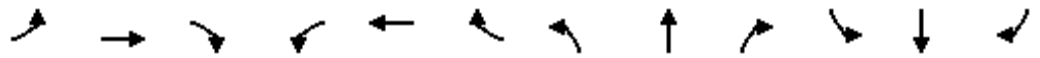

Lane Group	EBL	EBT	EBR	WBL	WBT	WBR	NBL	NBT	NBR	SBL	SBT	SBR
Lane Configurations												
Traffic Volume (vph)	188	1419	61	94	1094	38	52	4	39	29	4	96
Future Volume (vph)	188	1419	61	94	1094	38	52	4	39	29	4	96
Ideal Flow (vphpl)	1800	1800	1800	1800	1800	1800	1800	1800	1800	1800	1800	1800
Storage Length (m)	70.0		0.0	70.0		0.0	15.0		0.0	0.0		35.0
Storage Lanes	1		0	1		0	1		0	0		1
Taper Length (m)	30.0			30.0			7.6			7.6		
Lane Util. Factor	1.00	0.95	0.95	1.00	0.95	0.95	1.00	1.00	1.00	1.00	1.00	1.00
Ped Bike Factor		1.00			1.00		0.98	0.98			0.99	0.99
Frt		0.994			0.995			0.863				0.850
Flt Protected	0.950			0.950			0.950				0.957	
Satd. Flow (prot)	1695	3356	0	1695	3364	0	1662	1474	0	0	1708	1517
Flt Permitted	0.158			0.091			0.734				0.716	
Satd. Flow (perm)	282	3356	0	162	3364	0	1263	1474	0	0	1265	1497
Right Turn on Red			Yes			Yes			Yes			Yes
Satd. Flow (RTOR)		5			4			43				107
Link Speed (k/h)		60			60			60				60
Link Distance (m)		314.1			266.1			176.2				174.1
Travel Time (s)		18.8			16.0			10.6				10.4
Confl. Peds. (#/hr)	24		34	34		24	16		11	11		
Confl. Bikes (#/hr)			11			22			3			1
Peak Hour Factor	0.90	0.90	0.90	0.90	0.90	0.90	0.90	0.90	0.90	0.90	0.90	0.90
Heavy Vehicles (%)	2%	2%	2%	2%	2%	2%	4%	4%	4%	2%	2%	2%
Adj. Flow (vph)	209	1577	68	104	1216	42	58	4	43	32	4	107
Shared Lane Traffic (%)												
Lane Group Flow (vph)	209	1645	0	104	1258	0	58	47	0	0	36	107
Enter Blocked Intersection	No	No	No	No	No	No	No	No	No	No	No	No
Lane Alignment	Left	Left	Right	Left	Left	Right	Left	Left	Right	Left	Left	Right
Median Width(m)		3.7			3.7			3.7				3.7
Link Offset(m)		0.0			0.0			0.0				0.0
Crosswalk Width(m)		4.9			4.9			4.9				4.9
Two way Left Turn Lane												
Headway Factor	1.06	1.06	1.06	1.06	1.06	1.06	1.06	1.06	1.06	1.06	1.06	1.06
Turning Speed (k/h)	24		14	24		14	24		14	24		14
Number of Detectors	1	2		1	2		1	2		1	2	1
Detector Template	Left	Thru		Left	Thru		Left	Thru		Left	Thru	Right
Leading Detector (m)	6.1	30.5		6.1	30.5		6.1	30.5		6.1	30.5	6.1
Trailing Detector (m)	0.0	0.0		0.0	0.0		0.0	0.0		0.0	0.0	0.0
Detector 1 Position(m)	0.0	0.0		0.0	0.0		0.0	0.0		0.0	0.0	0.0
Detector 1 Size(m)	6.1	1.8		6.1	1.8		6.1	1.8		6.1	1.8	6.1
Detector 1 Type	Cl+Ex	Cl+Ex		Cl+Ex	Cl+Ex		Cl+Ex	Cl+Ex		Cl+Ex	Cl+Ex	Cl+Ex
Detector 1 Channel												
Detector 1 Extend (s)	0.0	0.0		0.0	0.0		0.0	0.0		0.0	0.0	0.0
Detector 1 Queue (s)	0.0	0.0		0.0	0.0		0.0	0.0		0.0	0.0	0.0
Detector 1 Delay (s)	0.0	0.0		0.0	0.0		0.0	0.0		0.0	0.0	0.0
Detector 2 Position(m)		28.7			28.7			28.7				28.7
Detector 2 Size(m)		1.8			1.8			1.8				1.8
Detector 2 Type		Cl+Ex			Cl+Ex			Cl+Ex				Cl+Ex
Detector 2 Channel												

1900/2000 City Park Drive
 22: Blair Road & Hwy 174 EB off

Existing PM



Lane Group	WBL	WBR	NBT	NBR	SBL	SBT
Lane Configurations						
Traffic Volume (vph)	208	826	707	166	425	871
Future Volume (vph)	208	826	707	166	425	871
Ideal Flow (vphpl)	1800	1800	1800	1800	1800	1800
Storage Length (m)	0.0	0.0		70.0	0.0	
Storage Lanes	1	1		1	0	
Taper Length (m)	7.6				7.6	
Lane Util. Factor	1.00	1.00	0.95	1.00	0.95	0.95
Fr _t		0.850		0.850		
Fl _t Protected	0.950					0.984
Satd. Flow (prot)	1647	1473	3325	1488	0	3210
Fl _t Permitted	0.950					0.531
Satd. Flow (perm)	1647	1473	3325	1488	0	1732
Right Turn on Red		Yes		Yes		
Satd. Flow (RTOR)		590		184		
Link Speed (k/h)	60		60			60
Link Distance (m)	216.4		230.9			341.9
Travel Time (s)	13.0		13.9			20.5
Peak Hour Factor	0.90	0.90	0.90	0.90	0.90	0.90
Heavy Vehicles (%)	5%	5%	4%	4%	6%	6%
Adj. Flow (vph)	231	918	786	184	472	968
Shared Lane Traffic (%)						
Lane Group Flow (vph)	231	918	786	184	0	1440
Enter Blocked Intersection	No	No	No	No	No	No
Lane Alignment	Left	Right	Left	Right	Left	Left
Median Width(m)	3.7		0.0			0.0
Link Offset(m)	0.0		0.0			0.0
Crosswalk Width(m)	4.9		4.9			4.9
Two way Left Turn Lane						
Headway Factor	1.06	1.06	1.06	1.06	1.06	1.06
Turning Speed (k/h)	24	14		14	24	
Number of Detectors	1	1	2	1	1	2
Detector Template	Left	Right	Thru	Right	Left	Thru
Leading Detector (m)	6.1	6.1	30.5	6.1	6.1	30.5
Trailing Detector (m)	0.0	0.0	0.0	0.0	0.0	0.0
Detector 1 Position(m)	0.0	0.0	0.0	0.0	0.0	0.0
Detector 1 Size(m)	6.1	6.1	1.8	6.1	6.1	1.8
Detector 1 Type	Cl+Ex	Cl+Ex	Cl+Ex	Cl+Ex	Cl+Ex	Cl+Ex
Detector 1 Channel						
Detector 1 Extend (s)	0.0	0.0	0.0	0.0	0.0	0.0
Detector 1 Queue (s)	0.0	0.0	0.0	0.0	0.0	0.0
Detector 1 Delay (s)	0.0	0.0	0.0	0.0	0.0	0.0
Detector 2 Position(m)			28.7			28.7
Detector 2 Size(m)			1.8			1.8
Detector 2 Type			Cl+Ex			Cl+Ex
Detector 2 Channel						
Detector 2 Extend (s)			0.0			0.0
Turn Type	Prot	Free	NA	pm+ov	pm+pt	NA
Protected Phases	8		2	8	1	6

1900/2000 City Park Drive
 22: Blair Road & Hwy 174 EB off

Existing PM



Lane Group	WBL	WBR	NBT	NBR	SBL	SBT
Permitted Phases	Free		2		6	
Detector Phase	8		2	8	1	6
Switch Phase						
Minimum Initial (s)	5.0		10.0	5.0	5.0	1.0
Minimum Split (s)	25.3		30.5	25.3	11.0	30.5
Total Split (s)	30.0		52.0	30.0	28.0	80.0
Total Split (%)	27.3%		47.3%	27.3%	25.5%	72.7%
Maximum Green (s)	23.7		45.5	23.7	22.0	73.5
Yellow Time (s)	3.3		4.2	3.3	4.2	4.2
All-Red Time (s)	3.0		2.3	3.0	1.8	2.3
Lost Time Adjust (s)	0.0		0.0	0.0		0.0
Total Lost Time (s)	6.3		6.5	6.3		6.5
Lead/Lag			Lag		Lead	
Lead-Lag Optimize?			Yes		Yes	
Vehicle Extension (s)	3.0		3.0	3.0	3.0	3.0
Recall Mode	None		C-Max	None	Max	C-Max
Walk Time (s)	7.0		7.0	7.0		7.0
Flash Dont Walk (s)	12.0		17.0	12.0		17.0
Pedestrian Calls (#/hr)	0		0	0		0
Act Effct Green (s)	19.7	110.0	45.5	71.7		77.5
Actuated g/C Ratio	0.18	1.00	0.41	0.65		0.70
v/c Ratio	0.78	0.62	0.57	0.18		0.92
Control Delay	61.2	2.0	26.8	1.2		22.8
Queue Delay	0.0	0.0	0.0	0.0		0.0
Total Delay	61.2	2.0	26.8	1.2		22.8
LOS	E	A	C	A		C
Approach Delay	13.9		22.0			22.8
Approach LOS	B		C			C

Intersection Summary

Area Type: Other
 Cycle Length: 110
 Actuated Cycle Length: 110
 Offset: 32 (29%), Referenced to phase 2:NBT and 6:SBTL, Start of Green
 Natural Cycle: 130
 Control Type: Actuated-Coordinated
 Maximum v/c Ratio: 0.92
 Intersection Signal Delay: 19.7
 Intersection LOS: B
 Intersection Capacity Utilization 87.3%
 ICU Level of Service E
 Analysis Period (min) 15

Splits and Phases: 22: Blair Road & Hwy 174 EB off



1900/2000 City Park Drive
 26: Residential/Cadboro Road & Ogilvie Road

Existing PM



Lane Group	EBL	EBT	EBR	WBL	WBT	WBR	NBL	NBT	NBR	SBL	SBT	SBR
Lane Configurations		↑↓			↑↓				↑			↑
Traffic Volume (vph)	0	1526	14	0	994	70	0	0	1	0	0	97
Future Volume (vph)	0	1526	14	0	994	70	0	0	1	0	0	97
Ideal Flow (vphpl)	1800	1800	1800	1800	1800	1800	1800	1800	1800	1800	1800	1800
Lane Util. Factor	1.00	0.95	0.95	1.00	0.95	0.95	1.00	1.00	1.00	1.00	1.00	1.00
Fr _t		0.999			0.990				0.865			0.865
Fl _t Protected												
Satd. Flow (prot)	0	3387	0	0	3356	0	0	0	1543	0	0	1543
Fl _t Permitted												
Satd. Flow (perm)	0	3387	0	0	3356	0	0	0	1543	0	0	1543
Right Turn on Red			Yes			Yes			Yes			Yes
Satd. Flow (RTOR)		1			11				33			71
Link Speed (k/h)		60			60			60				60
Link Distance (m)		266.1			256.0			114.0				107.3
Travel Time (s)		16.0			15.4			6.8				6.4
Peak Hour Factor	0.90	0.90	0.90	0.90	0.90	0.90	0.90	0.90	0.90	0.90	0.90	0.90
Adj. Flow (vph)	0	1696	16	0	1104	78	0	0	1	0	0	108
Shared Lane Traffic (%)												
Lane Group Flow (vph)	0	1712	0	0	1182	0	0	0	1	0	0	108
Enter Blocked Intersection	No	No	No	No	No	No	No	No	No	No	No	No
Lane Alignment	Left	Left	Right	Left	Left	Right	Left	Left	Right	Left	Left	Right
Median Width(m)		3.7			3.7			0.0				0.0
Link Offset(m)		0.0			0.0			0.0				0.0
Crosswalk Width(m)		1.6			1.6			1.6				1.6
Two way Left Turn Lane												
Headway Factor	1.06	1.06	1.06	1.06	1.06	1.06	1.06	1.06	1.06	1.06	1.06	1.06
Turning Speed (k/h)	24		14	24		14	24		14	24		14
Number of Detectors		2			2				1			1
Detector Template		Thru			Thru				Right			Right
Leading Detector (m)		10.0			10.0				2.0			2.0
Trailing Detector (m)		0.0			0.0				0.0			0.0
Detector 1 Position(m)		0.0			0.0				0.0			0.0
Detector 1 Size(m)		0.6			0.6				2.0			2.0
Detector 1 Type		Cl+Ex			Cl+Ex				Cl+Ex			Cl+Ex
Detector 1 Channel												
Detector 1 Extend (s)		0.0			0.0				0.0			0.0
Detector 1 Queue (s)		0.0			0.0				0.0			0.0
Detector 1 Delay (s)		0.0			0.0				0.0			0.0
Detector 2 Position(m)		9.4			9.4							
Detector 2 Size(m)		0.6			0.6							
Detector 2 Type		Cl+Ex			Cl+Ex							
Detector 2 Channel												
Detector 2 Extend (s)		0.0			0.0							
Turn Type		NA			NA				Perm			Perm
Protected Phases		2			6							
Permitted Phases									8			4
Detector Phase		2			6				8			4
Switch Phase												
Minimum Initial (s)		10.0			10.0				5.0			5.0

1900/2000 City Park Drive
 26: Residential/Cadboro Road & Ogilvie Road

Existing PM



Lane Group	EBL	EBT	EBR	WBL	WBT	WBR	NBL	NBT	NBR	SBL	SBT	SBR
Minimum Split (s)		35.0			35.0				40.0			40.0
Total Split (s)		60.0			60.0				40.0			40.0
Total Split (%)		60.0%			60.0%				40.0%			40.0%
Maximum Green (s)		54.0			54.0				36.0			36.0
Yellow Time (s)		3.7			3.7				3.0			3.0
All-Red Time (s)		2.3			2.3				1.0			1.0
Lost Time Adjust (s)		0.0			0.0				0.0			0.0
Total Lost Time (s)		6.0			6.0				4.0			4.0
Lead/Lag												
Lead-Lag Optimize?												
Vehicle Extension (s)		3.0			3.0				3.0			3.0
Recall Mode		C-Max			C-Max				None			None
Walk Time (s)		15.0			15.0				24.0			24.0
Flash Dont Walk (s)		14.0			14.0				12.0			12.0
Pedestrian Calls (#/hr)		30			30				20			20
Act Effct Green (s)		71.8			71.8				18.2			18.2
Actuated g/C Ratio		0.72			0.72				0.18			0.18
v/c Ratio		0.70			0.49				0.00			0.32
Control Delay		14.5			8.1				0.0			13.4
Queue Delay		0.0			0.0				0.0			0.0
Total Delay		14.5			8.1				0.0			13.4
LOS		B			A				A			B
Approach Delay		14.5			8.1						13.4	
Approach LOS		B			A						B	

Intersection Summary

Area Type:	Other
Cycle Length:	100
Actuated Cycle Length:	100
Offset:	4 (4%), Referenced to phase 2:EBT and 6:WBT, Start of Green
Natural Cycle:	90
Control Type:	Actuated-Coordinated
Maximum v/c Ratio:	0.70
Intersection Signal Delay:	11.9
Intersection LOS:	B
Intersection Capacity Utilization:	57.5%
ICU Level of Service:	B
Analysis Period (min):	15

Splits and Phases: 26: Residential/Cadboro Road & Ogilvie Road

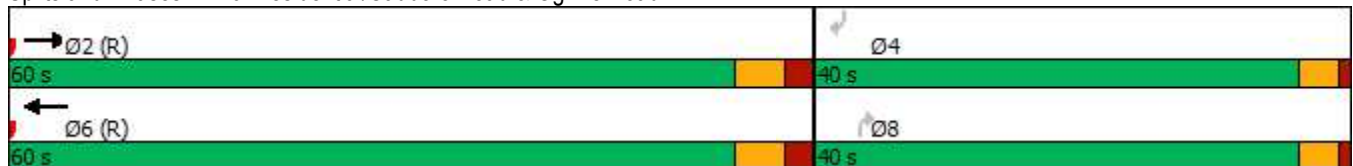

1900/2000 City Park Drive
3: Blair Road & Ogilvie Road

BG 2037 AM



Lane Group	EBL	EBT	EBR	WBL	WBT	WBR	NBL	NBT	NBR	SBL	SBT	SBR
Lane Configurations												
Traffic Volume (vph)	87	442	195	644	739	50	645	663	624	69	334	111
Future Volume (vph)	87	442	195	644	739	50	645	663	624	69	334	111
Ideal Flow (vphpl)	1800	1800	1800	1800	1800	1800	1800	1800	1800	1800	1800	1800
Storage Length (m)	70.0		0.0	110.0		0.0	120.0		0.0	30.0		0.0
Storage Lanes	1		1	2		0	2		1	1		0
Taper Length (m)	40.0			60.0			60.0			45.0		
Lane Util. Factor	1.00	0.95	1.00	0.97	0.95	0.95	0.97	1.00	1.00	1.00	0.95	0.95
Ped Bike Factor					1.00						0.99	
Frt			0.850		0.990				0.850		0.963	
Flt Protected	0.950			0.950			0.950			0.950		
Satd. Flow (prot)	1679	3357	1502	3257	3307	0	3257	1767	1502	1679	3190	0
Flt Permitted	0.950			0.950			0.950			0.950		
Satd. Flow (perm)	1679	3357	1502	3257	3307	0	3257	1767	1502	1679	3190	0
Right Turn on Red			Yes			Yes			Yes			Yes
Satd. Flow (RTOR)			195		5				421			30
Link Speed (k/h)		60			60			60			60	
Link Distance (m)		372.0			396.5			239.9			411.0	
Travel Time (s)		22.3			23.8			14.4			24.7	
Confl. Peds. (#/hr)							25					27
Confl. Bikes (#/hr)							3					3
Peak Hour Factor	1.00	1.00	1.00	1.00	1.00	1.00	1.00	1.00	1.00	1.00	1.00	1.00
Heavy Vehicles (%)	3%	3%	3%	3%	3%	3%	3%	3%	3%	3%	3%	3%
Adj. Flow (vph)	87	442	195	644	739	50	645	663	624	69	334	111
Shared Lane Traffic (%)												
Lane Group Flow (vph)	87	442	195	644	789	0	645	663	624	69	445	0
Enter Blocked Intersection	No	No	No	No	No	No	No	No	No	No	No	No
Lane Alignment	Left	Left	Right	Left	Left	Right	Left	Left	Right	Left	Left	Right
Median Width(m)		7.4			7.4			7.4			7.4	
Link Offset(m)		0.0			0.0			0.0			0.0	
Crosswalk Width(m)		4.9			4.9			4.9			4.9	
Two way Left Turn Lane												
Headway Factor	1.06	1.06	1.06	1.06	1.06	1.06	1.06	1.06	1.06	1.06	1.06	1.06
Turning Speed (k/h)	24		14	24		14	24		14	24		14
Number of Detectors	1	2	1	1	2		1	2	1	1	2	
Detector Template	Left	Thru	Right	Left	Thru		Left	Thru	Right	Left	Thru	
Leading Detector (m)	6.1	30.5	6.1	6.1	30.5		6.1	30.5	6.1	6.1	30.5	
Trailing Detector (m)	0.0	0.0	0.0	0.0	0.0		0.0	0.0	0.0	0.0	0.0	
Detector 1 Position(m)	0.0	0.0	0.0	0.0	0.0		0.0	0.0	0.0	0.0	0.0	
Detector 1 Size(m)	6.1	1.8	6.1	6.1	1.8		6.1	1.8	6.1	6.1	1.8	
Detector 1 Type	Cl+Ex	Cl+Ex	Cl+Ex	Cl+Ex	Cl+Ex		Cl+Ex	Cl+Ex	Cl+Ex	Cl+Ex	Cl+Ex	
Detector 1 Channel												
Detector 1 Extend (s)	0.0	0.0	0.0	0.0	0.0		0.0	0.0	0.0	0.0	0.0	
Detector 1 Queue (s)	0.0	0.0	0.0	0.0	0.0		0.0	0.0	0.0	0.0	0.0	
Detector 1 Delay (s)	0.0	0.0	0.0	0.0	0.0		0.0	0.0	0.0	0.0	0.0	
Detector 2 Position(m)		28.7			28.7			28.7			28.7	
Detector 2 Size(m)		1.8			1.8			1.8			1.8	
Detector 2 Type		Cl+Ex			Cl+Ex			Cl+Ex			Cl+Ex	
Detector 2 Channel												

1900/2000 City Park Drive
3: Blair Road & Ogilvie Road

BG 2037 AM



Lane Group	EBL	EBT	EBR	WBL	WBT	WBR	NBL	NBT	NBR	SBL	SBT	SBR
Detector 2 Extend (s)		0.0			0.0			0.0			0.0	
Turn Type	Prot	NA	Perm	Prot	NA		Prot	NA	Perm	Prot	NA	
Protected Phases	5	2		1	6		3	8		7	4	
Permitted Phases			2						8			
Detector Phase	5	2	2	1	6		3	8	8	7	4	
Switch Phase												
Minimum Initial (s)	5.0	10.0	10.0	5.0	10.0		5.0	10.0	10.0	5.0	10.0	
Minimum Split (s)	11.8	38.6	38.6	11.8	38.6		11.5	35.5	35.5	11.5	35.5	
Total Split (s)	28.0	39.0	39.0	28.0	39.0		36.0	58.0	58.0	15.0	37.0	
Total Split (%)	20.0%	27.9%	27.9%	20.0%	27.9%		25.7%	41.4%	41.4%	10.7%	26.4%	
Maximum Green (s)	21.2	32.4	32.4	21.2	32.4		29.5	51.5	51.5	8.5	30.5	
Yellow Time (s)	3.7	3.3	3.3	3.7	3.3		4.2	4.2	4.2	4.2	4.2	
All-Red Time (s)	3.1	3.3	3.3	3.1	3.3		2.3	2.3	2.3	2.3	2.3	
Lost Time Adjust (s)	0.0	0.0	0.0	0.0	0.0		0.0	0.0	0.0	0.0	0.0	
Total Lost Time (s)	6.8	6.6	6.6	6.8	6.6		6.5	6.5	6.5	6.5	6.5	
Lead/Lag	Lead	Lag	Lag	Lead	Lag		Lead	Lag	Lag	Lead	Lag	
Lead-Lag Optimize?	Yes	Yes	Yes	Yes	Yes		Yes	Yes	Yes	Yes	Yes	
Vehicle Extension (s)	3.0	3.0	3.0	3.0	3.0		3.0	3.0	3.0	3.0	3.0	
Recall Mode	None	Max	Max	None	Max		None	None	None	None	None	
Walk Time (s)		7.0	7.0		7.0			7.0	7.0		7.0	
Flash Dont Walk (s)		25.0	25.0		25.0			22.0	22.0		22.0	
Pedestrian Calls (#/hr)		20	20		20			25	25		25	
Act Effct Green (s)	12.6	32.4	32.4	21.2	41.0		29.2	51.5	51.5	8.2	30.6	
Actuated g/C Ratio	0.09	0.23	0.23	0.15	0.29		0.21	0.37	0.37	0.06	0.22	
v/c Ratio	0.58	0.57	0.39	1.30	0.81		0.95	1.02	0.76	0.70	0.62	
Control Delay	75.4	50.9	8.1	196.3	53.5		78.5	83.3	18.8	99.2	50.2	
Queue Delay	0.0	0.0	0.0	0.0	0.0		0.0	0.0	0.0	0.0	0.0	
Total Delay	75.4	50.9	8.1	196.3	53.5		78.5	83.3	18.8	99.2	50.2	
LOS	E	D	A	F	D		E	F	B	F	D	
Approach Delay		42.3			117.7			60.9			56.8	
Approach LOS		D			F			E			E	

Intersection Summary

Area Type:	Other
Cycle Length:	140
Actuated Cycle Length:	139.7
Natural Cycle:	150
Control Type:	Semi Act-Uncoord
Maximum v/c Ratio:	1.30
Intersection Signal Delay:	75.2
Intersection LOS:	E
Intersection Capacity Utilization	95.3%
ICU Level of Service	F
Analysis Period (min)	15

Splits and Phases: 3: Blair Road & Ogilvie Road

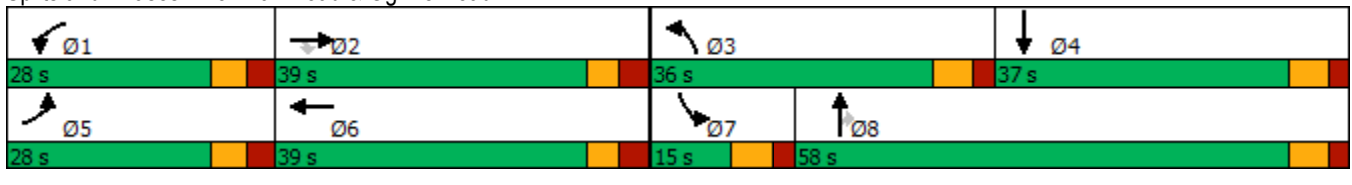

1900/2000 City Park Drive
 6: Blair Road & 1980 Ogilvie Road/Hwy 174 WB off

BG 2037 AM

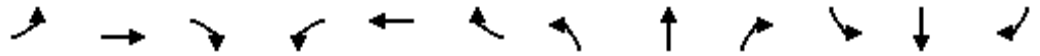

Lane Group	EBL	EBT	EBR	WBL	WBT	WBR	NBL	NBT	NBR	SBL	SBT	SBR
Lane Configurations	↖		↗	↖	↗	↗	↖↗	↖↗			↖↗↗	↖↗
Traffic Volume (vph)	87	0	371	115	150	303	281	1455	0	0	866	109
Future Volume (vph)	87	0	371	115	150	303	281	1455	0	0	866	109
Ideal Flow (vphpl)	1800	1800	1800	1800	1800	1800	1800	1800	1800	1800	1800	1800
Storage Length (m)	0.0		70.0	0.0		70.0	60.0		0.0	0.0		50.0
Storage Lanes	1		1	1		1	2		0	0		1
Taper Length (m)	7.6			7.6			100.0			7.6		
Lane Util. Factor	1.00	1.00	1.00	1.00	1.00	1.00	0.97	0.95	1.00	1.00	0.91	1.00
Frt			0.850			0.850						0.850
Flt Protected	0.950			0.950			0.950					
Satd. Flow (prot)	1340	0	1199	1695	1784	1517	3164	3262	0	0	4732	1473
Flt Permitted	0.662			0.950			0.950					
Satd. Flow (perm)	934	0	1199	1695	1784	1517	3164	3262	0	0	4732	1473
Right Turn on Red			Yes			Yes			Yes			Yes
Satd. Flow (RTOR)			34			104						111
Link Speed (k/h)		60			60			60				60
Link Distance (m)		518.9			416.4			90.2				239.9
Travel Time (s)		31.1			25.0			5.4				14.4
Peak Hour Factor	1.00	1.00	1.00	1.00	1.00	1.00	1.00	1.00	1.00	1.00	1.00	1.00
Heavy Vehicles (%)	29%	29%	29%	2%	2%	2%	6%	6%	6%	5%	5%	5%
Adj. Flow (vph)	87	0	371	115	150	303	281	1455	0	0	866	109
Shared Lane Traffic (%)												
Lane Group Flow (vph)	87	0	371	115	150	303	281	1455	0	0	866	109
Enter Blocked Intersection	No	No	No	No	No	No	No	No	No	No	No	No
Lane Alignment	Left	Left	Right	Left	Left	Right	Left	Left	Right	Left	Left	Right
Median Width(m)		3.7			3.7			7.4				7.4
Link Offset(m)		0.0			0.0			0.0				0.0
Crosswalk Width(m)		4.9			4.9			4.9				4.9
Two way Left Turn Lane												
Headway Factor	1.06	1.06	1.06	1.06	1.06	1.06	1.06	1.06	1.06	1.06	1.06	1.06
Turning Speed (k/h)	24		14	24		14	24		14	24		14
Number of Detectors	1		1	1	2	1	1	2				2
Detector Template	Left		Right	Left	Thru	Right	Left	Thru				Thru
Leading Detector (m)	6.1		6.1	6.1	30.5	6.1	6.1	30.5				30.5
Trailing Detector (m)	0.0		0.0	0.0	0.0	0.0	0.0	0.0				0.0
Detector 1 Position(m)	0.0		0.0	0.0	0.0	0.0	0.0	0.0				0.0
Detector 1 Size(m)	6.1		6.1	6.1	1.8	6.1	6.1	1.8				1.8
Detector 1 Type	Cl+Ex		Cl+Ex	Cl+Ex	Cl+Ex	Cl+Ex	Cl+Ex	Cl+Ex				Cl+Ex
Detector 1 Channel												
Detector 1 Extend (s)	0.0		0.0	0.0	0.0	0.0	0.0	0.0				0.0
Detector 1 Queue (s)	0.0		0.0	0.0	0.0	0.0	0.0	0.0				0.0
Detector 1 Delay (s)	0.0		0.0	0.0	0.0	0.0	0.0	0.0				0.0
Detector 2 Position(m)					28.7			28.7				28.7
Detector 2 Size(m)					1.8			1.8				1.8
Detector 2 Type					Cl+Ex			Cl+Ex				Cl+Ex
Detector 2 Channel												
Detector 2 Extend (s)					0.0			0.0				0.0
Turn Type	Perm		pm+ov	Perm	NA	Perm	Prot	NA				NA
Protected Phases			5		8		5	2				6

1900/2000 City Park Drive
 6: Blair Road & 1980 Ogilvie Road/Hwy 174 WB off

BG 2037 AM



Lane Group	EBL	EBT	EBR	WBL	WBT	WBR	NBL	NBT	NBR	SBL	SBT	SBR
Permitted Phases	4		4	8		8						6
Detector Phase	4		5	8	8	8	5	2			6	6
Switch Phase												
Minimum Initial (s)	10.0		5.0	10.0	10.0	10.0	5.0	10.0			10.0	10.0
Minimum Split (s)	16.8		11.4	36.8	36.8	36.8	11.4	30.1			30.1	30.1
Total Split (s)	41.0		27.0	41.0	41.0	41.0	27.0	59.0			32.0	32.0
Total Split (%)	41.0%		27.0%	41.0%	41.0%	41.0%	27.0%	59.0%			32.0%	32.0%
Maximum Green (s)	34.2		20.6	34.2	34.2	34.2	20.6	52.9			25.9	25.9
Yellow Time (s)	3.3		4.2	3.3	3.3	3.3	4.2	4.2			4.2	4.2
All-Red Time (s)	3.5		2.2	3.5	3.5	3.5	2.2	1.9			1.9	1.9
Lost Time Adjust (s)	0.0		0.0	0.0	0.0	0.0	0.0	0.0			0.0	0.0
Total Lost Time (s)	6.8		6.4	6.8	6.8	6.8	6.4	6.1			6.1	6.1
Lead/Lag			Lead				Lead				Lag	Lag
Lead-Lag Optimize?			Yes				Yes				Yes	Yes
Vehicle Extension (s)	3.0		3.0	3.0	3.0	3.0	3.0	3.0			3.0	3.0
Recall Mode	None		None	None	None	None	None	Max			Max	Max
Walk Time (s)				7.0	7.0	7.0		7.0			7.0	7.0
Flash Dont Walk (s)				23.0	23.0	23.0		17.0			17.0	17.0
Pedestrian Calls (#/hr)				20	20	20		20			20	20
Act Effct Green (s)	19.5		39.6	19.5	19.5	19.5	13.2	53.4			33.8	33.8
Actuated g/C Ratio	0.23		0.46	0.23	0.23	0.23	0.15	0.62			0.39	0.39
v/c Ratio	0.41		0.65	0.30	0.37	0.71	0.58	0.72			0.47	0.17
Control Delay	33.2		20.7	28.3	29.6	28.9	39.5	15.5			22.7	5.8
Queue Delay	0.0		0.0	0.0	0.0	0.0	0.0	0.0			0.0	0.0
Total Delay	33.2		20.7	28.3	29.6	28.9	39.5	15.5			22.7	5.8
LOS	C		C	C	C	C	D	B			C	A
Approach Delay		23.1			29.0			19.4			20.8	
Approach LOS		C			C			B			C	

Intersection Summary

Area Type: Other
 Cycle Length: 100
 Actuated Cycle Length: 86
 Natural Cycle: 80
 Control Type: Semi Act-Uncoord
 Maximum v/c Ratio: 0.72
 Intersection Signal Delay: 21.7
 Intersection LOS: C
 Intersection Capacity Utilization 81.4%
 ICU Level of Service D
 Analysis Period (min) 15

Splits and Phases: 6: Blair Road & 1980 Ogilvie Road/Hwy 174 WB off

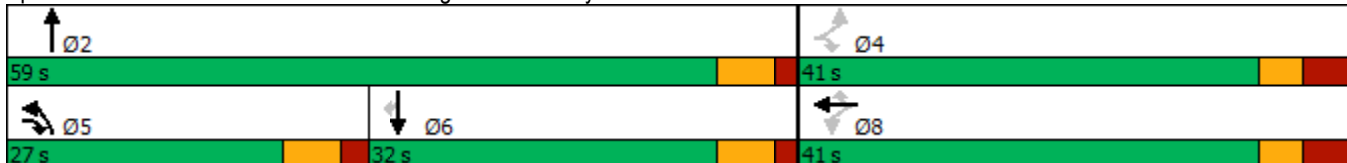

1900/2000 City Park Drive
 9: City Park Drive/1941 Ogilvie & Ogilvie Road

BG 2037 AM



Lane Group	EBL	EBT	EBR	WBL	WBT	WBR	NBL	NBT	NBR	SBL	SBT	SBR
Lane Configurations												
Traffic Volume (vph)	102	681	78	87	1023	174	59	23	61	5	2	9
Future Volume (vph)	102	681	78	87	1023	174	59	23	61	5	2	9
Ideal Flow (vphpl)	1800	1800	1800	1800	1800	1800	1800	1800	1800	1800	1800	1800
Storage Length (m)	40.0		100.0	100.0		50.0	0.0		60.0	20.0		10.0
Storage Lanes	1		1	1		1	0		1	1		1
Taper Length (m)	30.0			25.0			7.6			15.0		
Lane Util. Factor	1.00	0.95	1.00	1.00	0.95	1.00	1.00	1.00	1.00	1.00	1.00	1.00
Ped Bike Factor	0.97		0.87	0.96		0.81		0.96	0.93	0.95		
Frt			0.850			0.850			0.850			0.850
Flt Protected	0.950			0.950				0.965		0.950		
Satd. Flow (prot)	1695	3390	1517	1679	3357	1502	0	1626	1432	1695	1784	1517
Flt Permitted	0.243			0.378				0.786		0.704		
Satd. Flow (perm)	420	3390	1320	641	3357	1211	0	1269	1334	1193	1784	1517
Right Turn on Red			Yes			Yes			Yes			Yes
Satd. Flow (RTOR)			78			174			61			56
Link Speed (k/h)		60			60			60				60
Link Distance (m)		224.7			372.0			239.4				142.3
Travel Time (s)		13.5			22.3			14.4				8.5
Confl. Peds. (#/hr)	100		65	65		100	53		51	51		
Confl. Bikes (#/hr)						9			2			
Peak Hour Factor	1.00	1.00	1.00	1.00	1.00	1.00	1.00	1.00	1.00	1.00	1.00	1.00
Heavy Vehicles (%)	2%	2%	2%	3%	3%	3%	8%	8%	8%	2%	2%	2%
Adj. Flow (vph)	102	681	78	87	1023	174	59	23	61	5	2	9
Shared Lane Traffic (%)												
Lane Group Flow (vph)	102	681	78	87	1023	174	0	82	61	5	2	9
Enter Blocked Intersection	No	No	No	No	No	No	No	No	No	No	No	No
Lane Alignment	Left	Left	Right	Left	Left	Right	Left	Left	Right	Left	Left	Right
Median Width(m)		3.7			3.7			3.7				3.7
Link Offset(m)		0.0			0.0			0.0				0.0
Crosswalk Width(m)		4.9			4.9			4.9				4.9
Two way Left Turn Lane												
Headway Factor	1.06	1.06	1.06	1.06	1.06	1.06	1.06	1.06	1.06	1.06	1.06	1.06
Turning Speed (k/h)	24		14	24		14	24		14	24		14
Number of Detectors	1	2	1	1	2	1	1	2	1	1	2	1
Detector Template	Left	Thru	Right	Left	Thru	Right	Left	Thru	Right	Left	Thru	Right
Leading Detector (m)	6.1	30.5	6.1	6.1	30.5	6.1	6.1	30.5	6.1	6.1	30.5	6.1
Trailing Detector (m)	0.0	0.0	0.0	0.0	0.0	0.0	0.0	0.0	0.0	0.0	0.0	0.0
Detector 1 Position(m)	0.0	0.0	0.0	0.0	0.0	0.0	0.0	0.0	0.0	0.0	0.0	0.0
Detector 1 Size(m)	6.1	1.8	6.1	6.1	1.8	6.1	6.1	1.8	6.1	6.1	1.8	6.1
Detector 1 Type	Cl+Ex	Cl+Ex	Cl+Ex	Cl+Ex	Cl+Ex	Cl+Ex	Cl+Ex	Cl+Ex	Cl+Ex	Cl+Ex	Cl+Ex	Cl+Ex
Detector 1 Channel												
Detector 1 Extend (s)	0.0	0.0	0.0	0.0	0.0	0.0	0.0	0.0	0.0	0.0	0.0	0.0
Detector 1 Queue (s)	0.0	0.0	0.0	0.0	0.0	0.0	0.0	0.0	0.0	0.0	0.0	0.0
Detector 1 Delay (s)	0.0	0.0	0.0	0.0	0.0	0.0	0.0	0.0	0.0	0.0	0.0	0.0
Detector 2 Position(m)		28.7			28.7			28.7				28.7
Detector 2 Size(m)		1.8			1.8			1.8				1.8
Detector 2 Type		Cl+Ex			Cl+Ex			Cl+Ex				Cl+Ex
Detector 2 Channel												

Lane Group	Ø3	Ø7
Lane Configurations		
Traffic Volume (vph)		
Future Volume (vph)		
Ideal Flow (vphpl)		
Storage Length (m)		
Storage Lanes		
Taper Length (m)		
Lane Util. Factor		
Ped Bike Factor		
Frt		
Flt Protected		
Satd. Flow (prot)		
Flt Permitted		
Satd. Flow (perm)		
Right Turn on Red		
Satd. Flow (RTOR)		
Link Speed (k/h)		
Link Distance (m)		
Travel Time (s)		
Confl. Peds. (#/hr)		
Confl. Bikes (#/hr)		
Peak Hour Factor		
Heavy Vehicles (%)		
Adj. Flow (vph)		
Shared Lane Traffic (%)		
Lane Group Flow (vph)		
Enter Blocked Intersection		
Lane Alignment		
Median Width(m)		
Link Offset(m)		
Crosswalk Width(m)		
Two way Left Turn Lane		
Headway Factor		
Turning Speed (k/h)		
Number of Detectors		
Detector Template		
Leading Detector (m)		
Trailing Detector (m)		
Detector 1 Position(m)		
Detector 1 Size(m)		
Detector 1 Type		
Detector 1 Channel		
Detector 1 Extend (s)		
Detector 1 Queue (s)		
Detector 1 Delay (s)		
Detector 2 Position(m)		
Detector 2 Size(m)		
Detector 2 Type		
Detector 2 Channel		

1900/2000 City Park Drive
 9: City Park Drive/1941 Ogilvie & Ogilvie Road

BG 2037 AM



Lane Group	EBL	EBT	EBR	WBL	WBT	WBR	NBL	NBT	NBR	SBL	SBT	SBR
Detector 2 Extend (s)		0.0			0.0			0.0			0.0	
Turn Type	Perm	NA	Perm	Perm	NA	Perm	Perm	NA	Perm	Perm	NA	Perm
Protected Phases		2			6			8			4	
Permitted Phases	2		2	6		6	8		8	4		4
Detector Phase	2	2	2	6	6	6	8	8	8	4	4	4
Switch Phase												
Minimum Initial (s)	10.0	10.0	10.0	10.0	10.0	10.0	10.0	10.0	10.0	10.0	10.0	10.0
Minimum Split (s)	35.1	35.1	35.1	35.1	35.1	35.1	33.5	33.5	33.5	33.5	33.5	33.5
Total Split (s)	61.0	61.0	61.0	61.0	61.0	61.0	34.0	34.0	34.0	34.0	34.0	34.0
Total Split (%)	61.0%	61.0%	61.0%	61.0%	61.0%	61.0%	34.0%	34.0%	34.0%	34.0%	34.0%	34.0%
Maximum Green (s)	54.9	54.9	54.9	54.9	54.9	54.9	27.5	27.5	27.5	27.5	27.5	27.5
Yellow Time (s)	3.7	3.7	3.7	3.7	3.7	3.7	3.3	3.3	3.3	3.3	3.3	3.3
All-Red Time (s)	2.4	2.4	2.4	2.4	2.4	2.4	3.2	3.2	3.2	3.2	3.2	3.2
Lost Time Adjust (s)	0.0	0.0	0.0	0.0	0.0	0.0		0.0	0.0	0.0	0.0	0.0
Total Lost Time (s)	6.1	6.1	6.1	6.1	6.1	6.1		6.5	6.5	6.5	6.5	6.5
Lead/Lag							Lag	Lag	Lag	Lag	Lag	Lag
Lead-Lag Optimize?							Yes	Yes	Yes	Yes	Yes	Yes
Vehicle Extension (s)	3.0	3.0	3.0	3.0	3.0	3.0	3.0	3.0	3.0	3.0	3.0	3.0
Recall Mode	C-Max	C-Max	C-Max	C-Max	C-Max	C-Max	None	None	None	None	None	None
Walk Time (s)	7.0	7.0	7.0	7.0	7.0	7.0	2.0	2.0	2.0	2.0	2.0	2.0
Flash Dont Walk (s)	22.0	22.0	22.0	22.0	22.0	22.0	25.0	25.0	25.0	25.0	25.0	25.0
Pedestrian Calls (#/hr)	35	35	35	35	35	35	35	35	35	35	35	35
Act Effct Green (s)	68.7	68.7	68.7	68.7	68.7	68.7		20.2	20.2	20.2	20.2	20.2
Actuated g/C Ratio	0.69	0.69	0.69	0.69	0.69	0.69		0.20	0.20	0.20	0.20	0.20
v/c Ratio	0.35	0.29	0.08	0.20	0.44	0.20		0.32	0.19	0.02	0.01	0.03
Control Delay	8.1	2.9	0.3	11.7	11.4	2.3		34.8	9.1	27.2	27.0	0.1
Queue Delay	0.0	0.0	0.0	0.0	0.0	0.0		0.0	0.0	0.0	0.0	0.0
Total Delay	8.1	2.9	0.3	11.7	11.4	2.3		34.8	9.1	27.2	27.0	0.1
LOS	A	A	A	B	B	A		C	A	C	C	A
Approach Delay		3.3			10.2			23.8			11.9	
Approach LOS		A			B			C			B	

Intersection Summary

Area Type: Other
 Cycle Length: 100
 Actuated Cycle Length: 100
 Offset: 13 (13%), Referenced to phase 2:EBTL and 6:WBTL, Start of Green
 Natural Cycle: 80
 Control Type: Actuated-Coordinated
 Maximum v/c Ratio: 0.44
 Intersection Signal Delay: 8.5
 Intersection LOS: A
 Intersection Capacity Utilization 74.2%
 ICU Level of Service D
 Analysis Period (min) 15

Splits and Phases: 9: City Park Drive/1941 Ogilvie & Ogilvie Road

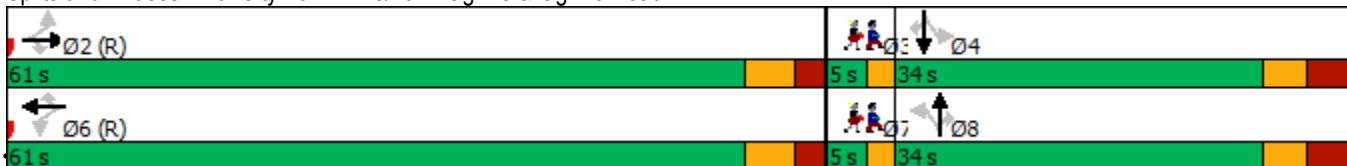

Lane Group	Ø3	Ø7
Detector 2 Extend (s)		
Turn Type		
Protected Phases	3	7
Permitted Phases		
Detector Phase		
Switch Phase		
Minimum Initial (s)	1.0	1.0
Minimum Split (s)	5.0	5.0
Total Split (s)	5.0	5.0
Total Split (%)	5%	5%
Maximum Green (s)	3.0	3.0
Yellow Time (s)	2.0	2.0
All-Red Time (s)	0.0	0.0
Lost Time Adjust (s)		
Total Lost Time (s)		
Lead/Lag	Lead	Lead
Lead-Lag Optimize?	Yes	Yes
Vehicle Extension (s)	3.0	3.0
Recall Mode	None	None
Walk Time (s)	0.0	0.0
Flash Dont Walk (s)	0.0	0.0
Pedestrian Calls (#/hr)	35	35
Act Effct Green (s)		
Actuated g/C Ratio		
v/c Ratio		
Control Delay		
Queue Delay		
Total Delay		
LOS		
Approach Delay		
Approach LOS		
Intersection Summary		

1900/2000 City Park Drive

12: 1900 Ogilvie Road/1929 Ogilvie Road & Ogilvie Road

BG 2037 AM



Lane Group	EBL	EBT	EBR	WBL	WBT	WBR	NBL	NBT	NBR	SBL	SBT	SBR
Lane Configurations												
Traffic Volume (vph)	99	832	27	19	1151	44	9	1	12	42	11	63
Future Volume (vph)	99	832	27	19	1151	44	9	1	12	42	11	63
Ideal Flow (vphpl)	1800	1800	1800	1800	1800	1800	1800	1800	1800	1800	1800	1800
Storage Length (m)	60.0		80.0	90.0		0.0	0.0		0.0	0.0		0.0
Storage Lanes	1		1	1		0	1		0	0		1
Taper Length (m)	30.0			20.0			7.6			7.6		
Lane Util. Factor	1.00	0.95	1.00	1.00	0.95	0.95	1.00	1.00	1.00	1.00	1.00	1.00
Ped Bike Factor	0.99		0.95	0.99	1.00		0.96	0.95			0.96	0.94
Fr _t			0.850		0.994			0.862				0.850
Fl _t Protected	0.950			0.950			0.950				0.962	
Satd. Flow (prot)	1695	3390	1517	1679	3324	0	1695	1454	0	0	1717	1517
Fl _t Permitted	0.195			0.316			0.722				0.774	
Satd. Flow (perm)	344	3390	1434	553	3324	0	1232	1454	0	0	1329	1429
Right Turn on Red			Yes			Yes			Yes			Yes
Satd. Flow (RTOR)			40		6			12				61
Link Speed (k/h)		60			60			60				60
Link Distance (m)		190.5			224.7			86.0				56.6
Travel Time (s)		11.4			13.5			5.2				3.4
Confl. Peds. (#/hr)	41		17	17		41	47		48	48		47
Peak Hour Factor	1.00	1.00	1.00	1.00	1.00	1.00	1.00	1.00	1.00	1.00	1.00	1.00
Heavy Vehicles (%)	2%	2%	2%	3%	3%	3%	2%	2%	2%	2%	2%	2%
Adj. Flow (vph)	99	832	27	19	1151	44	9	1	12	42	11	63
Shared Lane Traffic (%)												
Lane Group Flow (vph)	99	832	27	19	1195	0	9	13	0	0	53	63
Enter Blocked Intersection	No	No	No	No	No	No	No	No	No	No	No	No
Lane Alignment	Left	Left	Right	Left	Left	Right	Left	Left	Right	Left	Left	Right
Median Width(m)		3.7			3.7			3.7				3.7
Link Offset(m)		0.0			0.0			0.0				0.0
Crosswalk Width(m)		4.9			4.9			4.9				4.9
Two way Left Turn Lane												
Headway Factor	1.06	1.06	1.06	1.06	1.06	1.06	1.06	1.06	1.06	1.06	1.06	1.06
Turning Speed (k/h)	24		14	24		14	24		14	24		14
Number of Detectors	1	2	1	1	2		1	2		1	2	1
Detector Template	Left	Thru	Right	Left	Thru		Left	Thru		Left	Thru	Right
Leading Detector (m)	6.1	30.5	6.1	6.1	30.5		6.1	30.5		6.1	30.5	6.1
Trailing Detector (m)	0.0	0.0	0.0	0.0	0.0		0.0	0.0		0.0	0.0	0.0
Detector 1 Position(m)	0.0	0.0	0.0	0.0	0.0		0.0	0.0		0.0	0.0	0.0
Detector 1 Size(m)	6.1	1.8	6.1	6.1	1.8		6.1	1.8		6.1	1.8	6.1
Detector 1 Type	Cl+Ex	Cl+Ex	Cl+Ex	Cl+Ex	Cl+Ex		Cl+Ex	Cl+Ex		Cl+Ex	Cl+Ex	Cl+Ex
Detector 1 Channel												
Detector 1 Extend (s)	0.0	0.0	0.0	0.0	0.0		0.0	0.0		0.0	0.0	0.0
Detector 1 Queue (s)	0.0	0.0	0.0	0.0	0.0		0.0	0.0		0.0	0.0	0.0
Detector 1 Delay (s)	0.0	0.0	0.0	0.0	0.0		0.0	0.0		0.0	0.0	0.0
Detector 2 Position(m)		28.7			28.7			28.7				28.7
Detector 2 Size(m)		1.8			1.8			1.8				1.8
Detector 2 Type		Cl+Ex			Cl+Ex			Cl+Ex				Cl+Ex
Detector 2 Channel												
Detector 2 Extend (s)		0.0			0.0			0.0				0.0

1900/2000 City Park Drive

12: 1900 Ogilvie Road/1929 Ogilvie Road & Ogilvie Road

BG 2037 AM



Lane Group	EBL	EBT	EBR	WBL	WBT	WBR	NBL	NBT	NBR	SBL	SBT	SBR
Turn Type	Perm	NA	Perm	Perm	NA		Perm	NA		Perm	NA	Perm
Protected Phases		2			6			8			4	
Permitted Phases	2		2	6			8			4		4
Detector Phase	2	2	2	6	6		8	8		4	4	4
Switch Phase												
Minimum Initial (s)	10.0	10.0	10.0	10.0	10.0		10.0	10.0		10.0	10.0	10.0
Minimum Split (s)	29.9	29.9	29.9	29.9	29.9		36.7	36.7		36.7	36.7	36.7
Total Split (s)	63.0	63.0	63.0	63.0	63.0		37.0	37.0		37.0	37.0	37.0
Total Split (%)	63.0%	63.0%	63.0%	63.0%	63.0%		37.0%	37.0%		37.0%	37.0%	37.0%
Maximum Green (s)	57.1	57.1	57.1	57.1	57.1		30.3	30.3		30.3	30.3	30.3
Yellow Time (s)	3.7	3.7	3.7	3.7	3.7		3.3	3.3		3.3	3.3	3.3
All-Red Time (s)	2.2	2.2	2.2	2.2	2.2		3.4	3.4		3.4	3.4	3.4
Lost Time Adjust (s)	0.0	0.0	0.0	0.0	0.0		0.0	0.0		0.0	0.0	0.0
Total Lost Time (s)	5.9	5.9	5.9	5.9	5.9		6.7	6.7		6.7	6.7	6.7
Lead/Lag												
Lead-Lag Optimize?												
Vehicle Extension (s)	3.0	3.0	3.0	3.0	3.0		3.0	3.0		3.0	3.0	3.0
Recall Mode	C-Max	C-Max	C-Max	C-Max	C-Max		None	None		None	None	None
Walk Time (s)	11.0	11.0	11.0	11.0	11.0		7.0	7.0		7.0	7.0	7.0
Flash Dont Walk (s)	13.0	13.0	13.0	13.0	13.0		23.0	23.0		23.0	23.0	23.0
Pedestrian Calls (#/hr)	10	10	10	10	10		30	30		30	30	30
Act Effct Green (s)	69.9	69.9	69.9	69.9	69.9		22.0	22.0		22.0	22.0	22.0
Actuated g/C Ratio	0.70	0.70	0.70	0.70	0.70		0.22	0.22		0.22	0.22	0.22
v/c Ratio	0.41	0.35	0.03	0.05	0.51		0.03	0.04		0.18	0.17	0.17
Control Delay	17.1	8.5	1.6	5.7	5.5		25.2	13.3		29.3	8.5	8.5
Queue Delay	0.0	0.0	0.0	0.0	0.0		0.0	0.0		0.0	0.0	0.0
Total Delay	17.1	8.5	1.6	5.7	5.5		25.2	13.3		29.3	8.5	8.5
LOS	B	A	A	A	A		C	B		C	A	A
Approach Delay		9.2			5.5			18.2			18.0	
Approach LOS		A			A			B			B	

Intersection Summary

Area Type:	Other
Cycle Length:	100
Actuated Cycle Length:	100
Offset:	12 (12%), Referenced to phase 2:EBTL and 6:WBTL, Start of Green
Natural Cycle:	80
Control Type:	Actuated-Coordinated
Maximum v/c Ratio:	0.51
Intersection Signal Delay:	7.8
Intersection LOS:	A
Intersection Capacity Utilization:	94.4%
ICU Level of Service:	F
Analysis Period (min):	15

Splits and Phases: 12: 1900 Ogilvie Road/1929 Ogilvie Road & Ogilvie Road

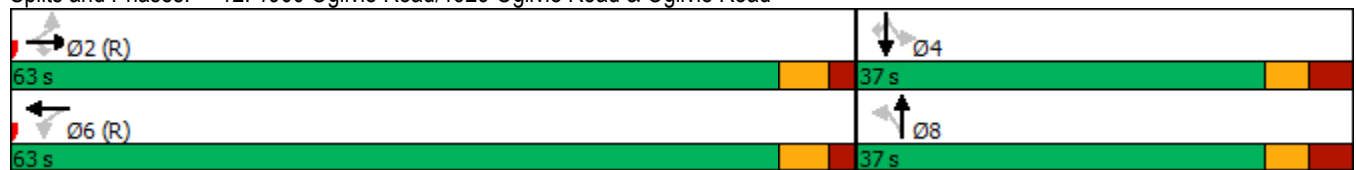

1900/2000 City Park Drive
 15: City Park Drive/Bathgate Drive & Ogilvie Road

BG 2037 AM



Lane Group	EBL	EBT	EBR	WBL	WBT	WBR	NBL	NBT	NBR	SBL	SBT	SBR
Lane Configurations												
Traffic Volume (vph)	156	598	88	14	981	161	86	38	13	119	27	178
Future Volume (vph)	156	598	88	14	981	161	86	38	13	119	27	178
Ideal Flow (vphpl)	1800	1800	1800	1800	1800	1800	1800	1800	1800	1800	1800	1800
Storage Length (m)	70.0		40.0	45.0		70.0	30.0		0.0	20.0		0.0
Storage Lanes	1		1	1		1	1		0	1		0
Taper Length (m)	30.0			30.0			25.0			25.0		
Lane Util. Factor	1.00	0.95	1.00	1.00	0.95	1.00	1.00	1.00	1.00	1.00	1.00	1.00
Ped Bike Factor	0.99		0.92	0.98		0.89	0.99	0.99		0.98	0.98	
Fr _t			0.850			0.850		0.962			0.870	
Fl _t Protected	0.950			0.950			0.950			0.950		
Satd. Flow (prot)	1679	3357	1502	1679	3357	1502	1631	1637	0	1647	1474	0
Fl _t Permitted	0.179			0.426			0.629			0.603		
Satd. Flow (perm)	312	3357	1389	737	3357	1340	1069	1637	0	1023	1474	0
Right Turn on Red			Yes			Yes			Yes			Yes
Satd. Flow (RTOR)			121			161		13			178	
Link Speed (k/h)		60			60			60			60	
Link Distance (m)		257.6			190.5			345.6			177.6	
Travel Time (s)		15.5			11.4			20.7			10.7	
Confl. Peds. (#/hr)	43		27	27		43	14		23	23		14
Peak Hour Factor	1.00	1.00	1.00	1.00	1.00	1.00	1.00	1.00	1.00	1.00	1.00	1.00
Heavy Vehicles (%)	3%	3%	3%	3%	3%	3%	6%	6%	6%	5%	5%	5%
Adj. Flow (vph)	156	598	88	14	981	161	86	38	13	119	27	178
Shared Lane Traffic (%)												
Lane Group Flow (vph)	156	598	88	14	981	161	86	51	0	119	205	0
Enter Blocked Intersection	No	No	No	No	No	No	No	No	No	No	No	No
Lane Alignment	Left	Left	Right	Left	Left	Right	Left	Left	Right	Left	Left	Right
Median Width(m)		3.7			3.7			3.7			3.7	
Link Offset(m)		0.0			0.0			0.0			0.0	
Crosswalk Width(m)		4.9			4.9			4.9			4.9	
Two way Left Turn Lane												
Headway Factor	1.06	1.06	1.06	1.06	1.06	1.06	1.06	1.06	1.06	1.06	1.06	1.06
Turning Speed (k/h)	24		14	24		14	24		14	24		14
Number of Detectors	1	2	1	1	2	1	1	2		1	2	
Detector Template	Left	Thru	Right	Left	Thru	Right	Left	Thru		Left	Thru	
Leading Detector (m)	6.1	30.5	6.1	6.1	30.5	6.1	6.1	30.5		6.1	30.5	
Trailing Detector (m)	0.0	0.0	0.0	0.0	0.0	0.0	0.0	0.0		0.0	0.0	
Detector 1 Position(m)	0.0	0.0	0.0	0.0	0.0	0.0	0.0	0.0		0.0	0.0	
Detector 1 Size(m)	6.1	1.8	6.1	6.1	1.8	6.1	6.1	1.8		6.1	1.8	
Detector 1 Type	Cl+Ex	Cl+Ex	Cl+Ex	Cl+Ex	Cl+Ex	Cl+Ex	Cl+Ex	Cl+Ex		Cl+Ex	Cl+Ex	
Detector 1 Channel												
Detector 1 Extend (s)	0.0	0.0	0.0	0.0	0.0	0.0	0.0	0.0		0.0	0.0	
Detector 1 Queue (s)	0.0	0.0	0.0	0.0	0.0	0.0	0.0	0.0		0.0	0.0	
Detector 1 Delay (s)	0.0	0.0	0.0	0.0	0.0	0.0	0.0	0.0		0.0	0.0	
Detector 2 Position(m)		28.7			28.7			28.7			28.7	
Detector 2 Size(m)		1.8			1.8			1.8			1.8	
Detector 2 Type		Cl+Ex			Cl+Ex			Cl+Ex			Cl+Ex	
Detector 2 Channel												
Detector 2 Extend (s)		0.0			0.0			0.0			0.0	

Lane Group	Ø3	Ø7
Lane Configurations		
Traffic Volume (vph)		
Future Volume (vph)		
Ideal Flow (vphpl)		
Storage Length (m)		
Storage Lanes		
Taper Length (m)		
Lane Util. Factor		
Ped Bike Factor		
Frt		
Flt Protected		
Satd. Flow (prot)		
Flt Permitted		
Satd. Flow (perm)		
Right Turn on Red		
Satd. Flow (RTOR)		
Link Speed (k/h)		
Link Distance (m)		
Travel Time (s)		
Confl. Peds. (#/hr)		
Peak Hour Factor		
Heavy Vehicles (%)		
Adj. Flow (vph)		
Shared Lane Traffic (%)		
Lane Group Flow (vph)		
Enter Blocked Intersection		
Lane Alignment		
Median Width(m)		
Link Offset(m)		
Crosswalk Width(m)		
Two way Left Turn Lane		
Headway Factor		
Turning Speed (k/h)		
Number of Detectors		
Detector Template		
Leading Detector (m)		
Trailing Detector (m)		
Detector 1 Position(m)		
Detector 1 Size(m)		
Detector 1 Type		
Detector 1 Channel		
Detector 1 Extend (s)		
Detector 1 Queue (s)		
Detector 1 Delay (s)		
Detector 2 Position(m)		
Detector 2 Size(m)		
Detector 2 Type		
Detector 2 Channel		
Detector 2 Extend (s)		

1900/2000 City Park Drive
 15: City Park Drive/Bathgate Drive & Ogilvie Road

BG 2037 AM



Lane Group	EBL	EBT	EBR	WBL	WBT	WBR	NBL	NBT	NBR	SBL	SBT	SBR
Turn Type	pm+pt	NA	Perm	pm+pt	NA	Perm	Perm	NA		Perm	NA	
Protected Phases	5	2		1	6			8				4
Permitted Phases	2		2	6		6	8			4		
Detector Phase	5	2	2	1	6	6	8	8		4		4
Switch Phase												
Minimum Initial (s)	5.0	10.0	10.0	5.0	10.0	10.0	10.0	10.0		10.0		10.0
Minimum Split (s)	9.7	30.0	30.0	9.7	30.0	30.0	37.4	37.4		37.4		37.4
Total Split (s)	15.0	42.0	42.0	15.0	42.0	42.0	38.0	38.0		38.0		38.0
Total Split (%)	15.0%	42.0%	42.0%	15.0%	42.0%	42.0%	38.0%	38.0%		38.0%		38.0%
Maximum Green (s)	10.3	36.0	36.0	10.3	36.0	36.0	30.6	30.6		30.6		30.6
Yellow Time (s)	3.7	3.7	3.7	3.7	3.7	3.7	3.0	3.0		3.0		3.0
All-Red Time (s)	1.0	2.3	2.3	1.0	2.3	2.3	4.4	4.4		4.4		4.4
Lost Time Adjust (s)	0.0	0.0	0.0	0.0	0.0	0.0	0.0	0.0		0.0		0.0
Total Lost Time (s)	4.7	6.0	6.0	4.7	6.0	6.0	7.4	7.4		7.4		7.4
Lead/Lag	Lead	Lag	Lag	Lead	Lag	Lag	Lag	Lag		Lag		Lag
Lead-Lag Optimize?	Yes	Yes	Yes	Yes	Yes	Yes	Yes	Yes		Yes		Yes
Vehicle Extension (s)	3.0	3.0	3.0	3.0	3.0	3.0	3.0	3.0		3.0		3.0
Recall Mode	None	C-Max	C-Max	None	C-Max	C-Max	None	None		None		None
Walk Time (s)		9.0	9.0		9.0	9.0	2.0	2.0		2.0		2.0
Flash Dont Walk (s)		15.0	15.0		15.0	15.0	28.0	28.0		28.0		28.0
Pedestrian Calls (#/hr)		15	15		15	15	15	15		15		15
Act Effct Green (s)	63.3	59.9	59.9	55.7	48.5	48.5	19.5	19.5		19.5		19.5
Actuated g/C Ratio	0.63	0.60	0.60	0.56	0.48	0.48	0.20	0.20		0.20		0.20
v/c Ratio	0.49	0.30	0.10	0.03	0.60	0.22	0.42	0.16		0.60		0.48
Control Delay	25.7	21.4	10.1	6.1	12.4	1.2	38.5	24.0		47.2		10.2
Queue Delay	0.0	0.0	0.0	0.0	0.0	0.0	0.0	0.0		0.0		0.0
Total Delay	25.7	21.4	10.1	6.1	12.4	1.2	38.5	24.0		47.2		10.2
LOS	C	C	B	A	B	A	D	C		D		B
Approach Delay		21.0			10.8			33.1				23.8
Approach LOS		C			B			C				C

Intersection Summary

Area Type:	Other
Cycle Length:	100
Actuated Cycle Length:	100
Offset:	29 (29%), Referenced to phase 2:EBTL and 6:WBTL, Start of Green
Natural Cycle:	85
Control Type:	Actuated-Coordinated
Maximum v/c Ratio:	0.60
Intersection Signal Delay:	17.2
Intersection LOS:	B
Intersection Capacity Utilization	85.6%
ICU Level of Service	E
Analysis Period (min)	15

Splits and Phases: 15: City Park Drive/Bathgate Drive & Ogilvie Road

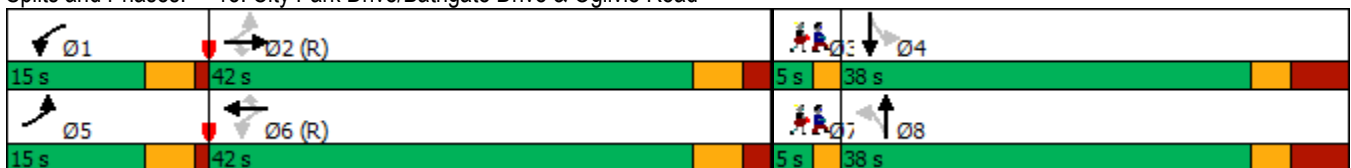

Lane Group	Ø3	Ø7
Turn Type		
Protected Phases	3	7
Permitted Phases		
Detector Phase		
Switch Phase		
Minimum Initial (s)	1.0	1.0
Minimum Split (s)	5.0	5.0
Total Split (s)	5.0	5.0
Total Split (%)	5%	5%
Maximum Green (s)	3.0	3.0
Yellow Time (s)	2.0	2.0
All-Red Time (s)	0.0	0.0
Lost Time Adjust (s)		
Total Lost Time (s)		
Lead/Lag	Lead	Lead
Lead-Lag Optimize?	Yes	Yes
Vehicle Extension (s)	3.0	3.0
Recall Mode	Ped	Ped
Walk Time (s)	0.0	0.0
Flash Dont Walk (s)	0.0	0.0
Pedestrian Calls (#/hr)	15	15
Act Effct Green (s)		
Actuated g/C Ratio		
v/c Ratio		
Control Delay		
Queue Delay		
Total Delay		
LOS		
Approach Delay		
Approach LOS		
Intersection Summary		

1900/2000 City Park Drive
 18: Residential/Cadboro Road & Ogilvie Road

BG 2037 AM



Lane Group	EBL	EBT	EBR	WBL	WBT	WBR	NBL	NBT	NBR	SBL	SBT	SBR
Lane Configurations		↑↓			↑↓				↑			↑
Traffic Volume (vph)	0	1216	9	0	1271	57	0	0	6	0	0	21
Future Volume (vph)	0	1216	9	0	1271	57	0	0	6	0	0	21
Ideal Flow (vphpl)	1800	1800	1800	1800	1800	1800	1800	1800	1800	1800	1800	1800
Lane Util. Factor	1.00	0.95	0.95	1.00	0.95	0.95	1.00	1.00	1.00	1.00	1.00	1.00
Fr _t		0.999			0.994				0.865			0.865
Fl _t Protected												
Satd. Flow (prot)	0	3387	0	0	3370	0	0	0	1543	0	0	1543
Fl _t Permitted												
Satd. Flow (perm)	0	3387	0	0	3370	0	0	0	1543	0	0	1543
Right Turn on Red			Yes			Yes			Yes			Yes
Satd. Flow (RTOR)		1			7				53			46
Link Speed (k/h)		60			60			60				60
Link Distance (m)		264.5			257.6			90.1				116.1
Travel Time (s)		15.9			15.5			5.4				7.0
Peak Hour Factor	1.00	1.00	1.00	1.00	1.00	1.00	1.00	1.00	1.00	1.00	1.00	1.00
Adj. Flow (vph)	0	1216	9	0	1271	57	0	0	6	0	0	21
Shared Lane Traffic (%)												
Lane Group Flow (vph)	0	1225	0	0	1328	0	0	0	6	0	0	21
Enter Blocked Intersection	No	No	No	No	No	No	No	No	No	No	No	No
Lane Alignment	Left	Left	Right	Left	Left	Right	Left	Left	Right	Left	Left	Right
Median Width(m)		3.7			3.7			0.0				0.0
Link Offset(m)		0.0			0.0			0.0				0.0
Crosswalk Width(m)		1.6			1.6			1.6				1.6
Two way Left Turn Lane												
Headway Factor	1.06	1.06	1.06	1.06	1.06	1.06	1.06	1.06	1.06	1.06	1.06	1.06
Turning Speed (k/h)	24		14	24		14	24		14	24		14
Number of Detectors		2			2				1			1
Detector Template		Thru			Thru				Right			Right
Leading Detector (m)		10.0			10.0				2.0			2.0
Trailing Detector (m)		0.0			0.0				0.0			0.0
Detector 1 Position(m)		0.0			0.0				0.0			0.0
Detector 1 Size(m)		0.6			0.6				2.0			2.0
Detector 1 Type		Cl+Ex			Cl+Ex				Cl+Ex			Cl+Ex
Detector 1 Channel												
Detector 1 Extend (s)		0.0			0.0				0.0			0.0
Detector 1 Queue (s)		0.0			0.0				0.0			0.0
Detector 1 Delay (s)		0.0			0.0				0.0			0.0
Detector 2 Position(m)		9.4			9.4							
Detector 2 Size(m)		0.6			0.6							
Detector 2 Type		Cl+Ex			Cl+Ex							
Detector 2 Channel												
Detector 2 Extend (s)		0.0			0.0							
Turn Type		NA			NA				Perm			Perm
Protected Phases		2			6							
Permitted Phases									8			4
Detector Phase		2			6				8			4
Switch Phase												
Minimum Initial (s)		10.0			10.0				5.0			5.0

1900/2000 City Park Drive
 18: Residential/Cadboro Road & Ogilvie Road

BG 2037 AM



Lane Group	EBL	EBT	EBR	WBL	WBT	WBR	NBL	NBT	NBR	SBL	SBT	SBR
Minimum Split (s)		35.0			35.0				40.0			40.0
Total Split (s)		60.0			60.0				40.0			40.0
Total Split (%)		60.0%			60.0%				40.0%			40.0%
Maximum Green (s)		54.0			54.0				36.0			36.0
Yellow Time (s)		3.7			3.7				3.0			3.0
All-Red Time (s)		2.3			2.3				1.0			1.0
Lost Time Adjust (s)		0.0			0.0				0.0			0.0
Total Lost Time (s)		6.0			6.0				4.0			4.0
Lead/Lag												
Lead-Lag Optimize?												
Vehicle Extension (s)		3.0			3.0				3.0			3.0
Recall Mode		C-Max			C-Max				None			None
Walk Time (s)		15.0			15.0				24.0			24.0
Flash Dont Walk (s)		14.0			14.0				12.0			12.0
Pedestrian Calls (#/hr)		20			20				15			15
Act Effct Green (s)		78.5			78.5				17.7			17.7
Actuated g/C Ratio		0.78			0.78				0.18			0.18
v/c Ratio		0.46			0.50				0.02			0.07
Control Delay		7.0			4.4				0.2			2.1
Queue Delay		0.0			0.0				0.0			0.0
Total Delay		7.0			4.4				0.2			2.1
LOS		A			A				A			A
Approach Delay		7.0			4.4			0.2			2.1	
Approach LOS		A			A			A			A	

Intersection Summary

Area Type:	Other
Cycle Length:	100
Actuated Cycle Length:	100
Offset:	42 (42%), Referenced to phase 2:EBT and 6:WBT, Start of Green
Natural Cycle:	80
Control Type:	Actuated-Coordinated
Maximum v/c Ratio:	0.50
Intersection Signal Delay:	5.6
Intersection LOS:	A
Intersection Capacity Utilization:	51.5%
ICU Level of Service:	A
Analysis Period (min):	15

Splits and Phases: 18: Residential/Cadboro Road & Ogilvie Road

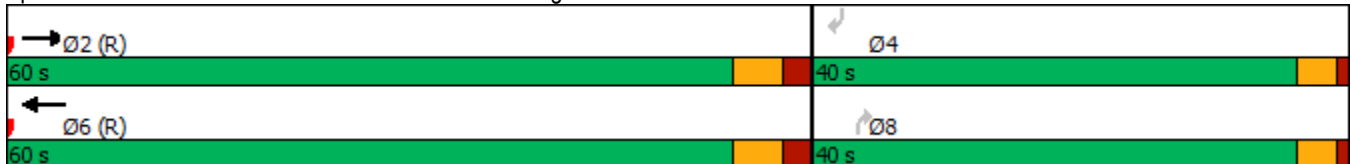

1900/2000 City Park Drive
 22: Blair Road & Hwy 174 EB off

BG 2037 AM



Lane Group	WBL	WBR	NBT	NBR	SBL	SBT
Lane Configurations						
Traffic Volume (vph)	198	1015	925	81	183	485
Future Volume (vph)	198	1015	925	81	183	485
Ideal Flow (vphpl)	1800	1800	1800	1800	1800	1800
Storage Length (m)	0.0	0.0		70.0	0.0	
Storage Lanes	1	1		1	0	
Taper Length (m)	7.6				7.6	
Lane Util. Factor	1.00	1.00	0.95	1.00	0.95	0.95
Fr _t		0.850		0.850		
Fl _t Protected	0.950					0.986
Satd. Flow (prot)	1647	1473	3325	1488	0	3217
Fl _t Permitted	0.950					0.576
Satd. Flow (perm)	1647	1473	3325	1488	0	1879
Right Turn on Red		Yes		Yes		
Satd. Flow (RTOR)		476				
Link Speed (k/h)	60		60			60
Link Distance (m)	216.4		230.9			341.9
Travel Time (s)	13.0		13.9			20.5
Peak Hour Factor	1.00	1.00	1.00	1.00	1.00	1.00
Heavy Vehicles (%)	5%	5%	4%	4%	6%	6%
Adj. Flow (vph)	198	1015	925	81	183	485
Shared Lane Traffic (%)						
Lane Group Flow (vph)	198	1015	925	81	0	668
Enter Blocked Intersection	No	No	No	No	No	No
Lane Alignment	Left	Right	Left	Right	Left	Left
Median Width(m)	3.7		0.0			0.0
Link Offset(m)	0.0		0.0			0.0
Crosswalk Width(m)	4.9		4.9			4.9
Two way Left Turn Lane						
Headway Factor	1.06	1.06	1.06	1.06	1.06	1.06
Turning Speed (k/h)	24	14		14	24	
Number of Detectors	1	1	2	1	1	2
Detector Template	Left	Right	Thru	Right	Left	Thru
Leading Detector (m)	6.1	6.1	30.5	6.1	6.1	30.5
Trailing Detector (m)	0.0	0.0	0.0	0.0	0.0	0.0
Detector 1 Position(m)	0.0	0.0	0.0	0.0	0.0	0.0
Detector 1 Size(m)	6.1	6.1	1.8	6.1	6.1	1.8
Detector 1 Type	Cl+Ex	Cl+Ex	Cl+Ex	Cl+Ex	Cl+Ex	Cl+Ex
Detector 1 Channel						
Detector 1 Extend (s)	0.0	0.0	0.0	0.0	0.0	0.0
Detector 1 Queue (s)	0.0	0.0	0.0	0.0	0.0	0.0
Detector 1 Delay (s)	0.0	0.0	0.0	0.0	0.0	0.0
Detector 2 Position(m)			28.7			28.7
Detector 2 Size(m)			1.8			1.8
Detector 2 Type			Cl+Ex			Cl+Ex
Detector 2 Channel						
Detector 2 Extend (s)			0.0			0.0
Turn Type	Prot	Free	NA	pm+ov	Perm	NA
Protected Phases	8		2	8		6

1900/2000 City Park Drive
 22: Blair Road & Hwy 174 EB off

BG 2037 AM



Lane Group	WBL	WBR	NBT	NBR	SBL	SBT
Permitted Phases		Free		2	6	
Detector Phase	8		2	8	6	6
Switch Phase						
Minimum Initial (s)	5.0		10.0	5.0	10.0	10.0
Minimum Split (s)	25.3		30.5	25.3	16.5	16.5
Total Split (s)	35.0		55.0	35.0	55.0	55.0
Total Split (%)	38.9%		61.1%	38.9%	61.1%	61.1%
Maximum Green (s)	28.7		48.5	28.7	48.5	48.5
Yellow Time (s)	3.3		4.2	3.3	4.2	4.2
All-Red Time (s)	3.0		2.3	3.0	2.3	2.3
Lost Time Adjust (s)	0.0		0.0	0.0		0.0
Total Lost Time (s)	6.3		6.5	6.3		6.5
Lead/Lag						
Lead-Lag Optimize?						
Vehicle Extension (s)	3.0		3.0	3.0	3.0	3.0
Recall Mode	None		Max	None	Max	Max
Walk Time (s)	7.0		7.0	7.0		
Flash Dont Walk (s)	12.0		17.0	12.0		
Pedestrian Calls (#/hr)	0		0	0		
Act Effct Green (s)	14.2	75.7	48.6	75.7		48.6
Actuated g/C Ratio	0.19	1.00	0.64	1.00		0.64
v/c Ratio	0.64	0.69	0.43	0.05		0.55
Control Delay	38.1	2.7	8.0	0.1		10.5
Queue Delay	0.0	0.0	0.0	0.0		0.0
Total Delay	38.1	2.7	8.0	0.1		10.5
LOS	D	A	A	A		B
Approach Delay	8.4		7.4			10.5
Approach LOS	A		A			B

Intersection Summary

Area Type: Other
 Cycle Length: 90
 Actuated Cycle Length: 75.7
 Natural Cycle: 60
 Control Type: Semi Act-Uncoord
 Maximum v/c Ratio: 0.69
 Intersection Signal Delay: 8.6
 Intersection Capacity Utilization 74.4%
 Analysis Period (min) 15
 Intersection LOS: A
 ICU Level of Service D

Splits and Phases: 22: Blair Road & Hwy 174 EB off

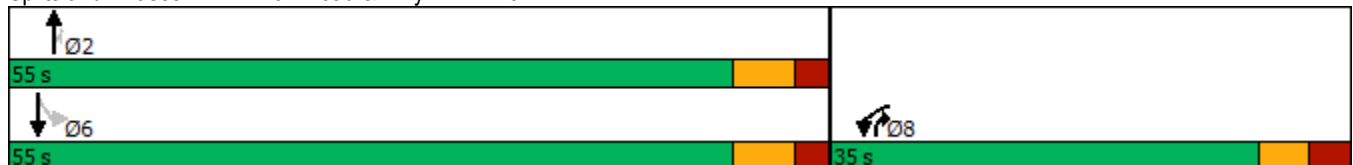

1900/2000 City Park Drive

1630: Palmerston Drive/Matheson Road & Ogilvie Road

BG 2037 AM



Lane Group	EBL	EBT	EBR	WBL	WBT	WBR	NBL	NBT	NBR	SBL	SBT	SBR
Lane Configurations												
Traffic Volume (vph)	83	1085	21	33	1264	14	57	2	26	25	2	171
Future Volume (vph)	83	1085	21	33	1264	14	57	2	26	25	2	171
Ideal Flow (vphpl)	1800	1800	1800	1800	1800	1800	1800	1800	1800	1800	1800	1800
Storage Length (m)	70.0		0.0	70.0		0.0	15.0		0.0	0.0		35.0
Storage Lanes	1		0	1		0	1		0	0		1
Taper Length (m)	30.0			30.0			7.6			7.6		
Lane Util. Factor	1.00	0.95	0.95	1.00	0.95	0.95	1.00	1.00	1.00	1.00	1.00	1.00
Ped Bike Factor		1.00		0.99	1.00		1.00	0.98			0.99	0.99
Frt		0.997			0.998			0.861				0.850
Flt Protected	0.950			0.950			0.950				0.956	
Satd. Flow (prot)	1695	3375	0	1695	3382	0	1662	1471	0	0	1706	1517
Flt Permitted	0.153			0.216			0.740				0.727	
Satd. Flow (perm)	273	3375	0	383	3382	0	1290	1471	0	0	1282	1497
Right Turn on Red			Yes			Yes			Yes			Yes
Satd. Flow (RTOR)		2			1			26				171
Link Speed (k/h)		60			60			60				60
Link Distance (m)		314.1			264.5			176.2				174.1
Travel Time (s)		18.8			15.9			10.6				10.4
Confl. Peds. (#/hr)	11		26	26		11	4		14	14		
Confl. Bikes (#/hr)			21			9			2			1
Peak Hour Factor	1.00	1.00	1.00	1.00	1.00	1.00	1.00	1.00	1.00	1.00	1.00	1.00
Heavy Vehicles (%)	2%	2%	2%	2%	2%	2%	4%	4%	4%	2%	2%	2%
Adj. Flow (vph)	83	1085	21	33	1264	14	57	2	26	25	2	171
Shared Lane Traffic (%)												
Lane Group Flow (vph)	83	1106	0	33	1278	0	57	28	0	0	27	171
Enter Blocked Intersection	No	No	No	No	No	No	No	No	No	No	No	No
Lane Alignment	Left	Left	Right	Left	Left	Right	Left	Left	Right	Left	Left	Right
Median Width(m)		3.7			3.7			3.7				3.7
Link Offset(m)		0.0			0.0			0.0				0.0
Crosswalk Width(m)		4.9			4.9			4.9				4.9
Two way Left Turn Lane												
Headway Factor	1.06	1.06	1.06	1.06	1.06	1.06	1.06	1.06	1.06	1.06	1.06	1.06
Turning Speed (k/h)	24		14	24		14	24		14	24		14
Number of Detectors	1	2		1	2		1	2		1	2	1
Detector Template	Left	Thru		Left	Thru		Left	Thru		Left	Thru	Right
Leading Detector (m)	6.1	30.5		6.1	30.5		6.1	30.5		6.1	30.5	6.1
Trailing Detector (m)	0.0	0.0		0.0	0.0		0.0	0.0		0.0	0.0	0.0
Detector 1 Position(m)	0.0	0.0		0.0	0.0		0.0	0.0		0.0	0.0	0.0
Detector 1 Size(m)	6.1	1.8		6.1	1.8		6.1	1.8		6.1	1.8	6.1
Detector 1 Type	Cl+Ex	Cl+Ex		Cl+Ex	Cl+Ex		Cl+Ex	Cl+Ex		Cl+Ex	Cl+Ex	Cl+Ex
Detector 1 Channel												
Detector 1 Extend (s)	0.0	0.0		0.0	0.0		0.0	0.0		0.0	0.0	0.0
Detector 1 Queue (s)	0.0	0.0		0.0	0.0		0.0	0.0		0.0	0.0	0.0
Detector 1 Delay (s)	0.0	0.0		0.0	0.0		0.0	0.0		0.0	0.0	0.0
Detector 2 Position(m)		28.7			28.7			28.7				28.7
Detector 2 Size(m)		1.8			1.8			1.8				1.8
Detector 2 Type		Cl+Ex			Cl+Ex			Cl+Ex				Cl+Ex
Detector 2 Channel												

1900/2000 City Park Drive

1630: Palmerston Drive/Matheson Road & Ogilvie Road

BG 2037 AM



Lane Group	EBL	EBT	EBR	WBL	WBT	WBR	NBL	NBT	NBR	SBL	SBT	SBR
Detector 2 Extend (s)		0.0			0.0			0.0			0.0	
Turn Type	pm+pt	NA		pm+pt	NA		Perm	NA		Perm	NA	Perm
Protected Phases	5	2		1	6			8			4	
Permitted Phases	2			6			8			4		4
Detector Phase	5	2		1	6		8	8		4	4	4
Switch Phase												
Minimum Initial (s)	5.0	10.0		5.0	10.0		10.0	10.0		10.0	10.0	10.0
Minimum Split (s)	9.7	33.6		9.7	33.6		40.2	40.2		40.2	40.2	40.2
Total Split (s)	13.0	47.0		13.0	47.0		40.0	40.0		40.0	40.0	40.0
Total Split (%)	13.0%	47.0%		13.0%	47.0%		40.0%	40.0%		40.0%	40.0%	40.0%
Maximum Green (s)	8.3	41.4		8.3	41.4		32.8	32.8		32.8	32.8	32.8
Yellow Time (s)	3.7	3.7		3.7	3.7		3.0	3.0		3.0	3.0	3.0
All-Red Time (s)	1.0	1.9		1.0	1.9		4.2	4.2		4.2	4.2	4.2
Lost Time Adjust (s)	0.0	0.0		0.0	0.0		0.0	0.0		0.0	0.0	0.0
Total Lost Time (s)	4.7	5.6		4.7	5.6		7.2	7.2		7.2	7.2	7.2
Lead/Lag	Lead	Lag		Lead	Lag							
Lead-Lag Optimize?	Yes	Yes		Yes	Yes							
Vehicle Extension (s)	3.0	3.0		3.0	3.0		3.0	3.0		3.0	3.0	3.0
Recall Mode	None	C-Max		None	C-Max		None	None		None	None	None
Walk Time (s)		15.0			15.0		7.0	7.0		7.0	7.0	7.0
Flash Dont Walk (s)		13.0			13.0		26.0	26.0		26.0	26.0	26.0
Pedestrian Calls (#/hr)		10			10		10	10		10	10	10
Act Effct Green (s)	70.9	65.6		68.9	62.9		14.9	14.9			14.9	14.9
Actuated g/C Ratio	0.71	0.66		0.69	0.63		0.15	0.15			0.15	0.15
v/c Ratio	0.29	0.50		0.10	0.60		0.30	0.12			0.14	0.46
Control Delay	8.3	12.7		4.6	7.9		38.9	13.0			34.7	9.0
Queue Delay	0.0	0.0		0.0	0.0		0.0	0.0			0.0	0.0
Total Delay	8.3	12.7		4.6	7.9		38.9	13.0			34.7	9.0
LOS	A	B		A	A		D	B			C	A
Approach Delay		12.4			7.8			30.4			12.5	
Approach LOS		B			A			C			B	

Intersection Summary

Area Type:	Other
Cycle Length:	100
Actuated Cycle Length:	100
Offset:	54 (54%), Referenced to phase 2:EBTL and 6:WBTL, Start of Green
Natural Cycle:	85
Control Type:	Actuated-Coordinated
Maximum v/c Ratio:	0.60
Intersection Signal Delay:	10.8
Intersection LOS:	B
Intersection Capacity Utilization:	80.7%
ICU Level of Service:	D
Analysis Period (min):	15

Splits and Phases: 1630: Palmerston Drive/Matheson Road & Ogilvie Road

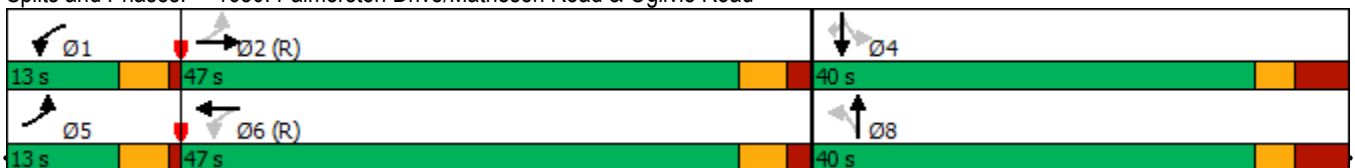

1900/2000 City Park Drive
3: Blair Road & Ogilvie Road

BG 2037 PM



Lane Group	EBL	EBT	EBR	WBL	WBT	WBR	NBL	NBT	NBR	SBL	SBT	SBR
Lane Configurations												
Traffic Volume (vph)	150	850	627	875	492	83	218	296	923	75	761	55
Future Volume (vph)	150	850	627	875	492	83	218	296	923	75	761	55
Ideal Flow (vphpl)	1800	1800	1800	1800	1800	1800	1800	1800	1800	1800	1800	1800
Storage Length (m)	70.0		0.0	110.0		0.0	120.0		0.0	30.0		0.0
Storage Lanes	1		1	2		0	2		1	1		0
Taper Length (m)	40.0			60.0			60.0			45.0		
Lane Util. Factor	1.00	0.95	1.00	0.97	0.95	0.95	0.97	1.00	1.00	1.00	0.95	0.95
Ped Bike Factor					0.99						0.99	
Frt			0.850		0.978				0.850		0.990	
Flt Protected	0.950			0.950			0.950			0.950		
Satd. Flow (prot)	1679	3357	1502	3257	3244	0	3257	1767	1502	1679	3294	0
Flt Permitted	0.950			0.950			0.950			0.950		
Satd. Flow (perm)	1679	3357	1502	3257	3244	0	3257	1767	1502	1679	3294	0
Right Turn on Red			Yes			Yes			Yes			Yes
Satd. Flow (RTOR)			223		15				443			5
Link Speed (k/h)		60			60			60			60	
Link Distance (m)		372.0			396.5			239.9			411.0	
Travel Time (s)		22.3			23.8			14.4			24.7	
Confl. Peds. (#/hr)						29						84
Peak Hour Factor	1.00	1.00	1.00	1.00	1.00	1.00	1.00	1.00	1.00	1.00	1.00	1.00
Heavy Vehicles (%)	3%	3%	3%	3%	3%	3%	3%	3%	3%	3%	3%	3%
Adj. Flow (vph)	150	850	627	875	492	83	218	296	923	75	761	55
Shared Lane Traffic (%)												
Lane Group Flow (vph)	150	850	627	875	575	0	218	296	923	75	816	0
Enter Blocked Intersection	No	No	No	No	No	No	No	No	No	No	No	No
Lane Alignment	Left	Left	Right	Left	Left	Right	Left	Left	Right	Left	Left	Right
Median Width(m)		7.4			7.4			7.4			7.4	
Link Offset(m)		0.0			0.0			0.0			0.0	
Crosswalk Width(m)		4.9			4.9			4.9			4.9	
Two way Left Turn Lane												
Headway Factor	1.06	1.06	1.06	1.06	1.06	1.06	1.06	1.06	1.06	1.06	1.06	1.06
Turning Speed (k/h)	24		14	24		14	24		14	24		14
Number of Detectors	1	2	1	1	2		1	2	1	1		2
Detector Template	Left	Thru	Right	Left	Thru		Left	Thru	Right	Left	Thru	
Leading Detector (m)	6.1	30.5	6.1	6.1	30.5		6.1	30.5	6.1	6.1		30.5
Trailing Detector (m)	0.0	0.0	0.0	0.0	0.0		0.0	0.0	0.0	0.0		0.0
Detector 1 Position(m)	0.0	0.0	0.0	0.0	0.0		0.0	0.0	0.0	0.0		0.0
Detector 1 Size(m)	6.1	1.8	6.1	6.1	1.8		6.1	1.8	6.1	6.1		1.8
Detector 1 Type	Cl+Ex	Cl+Ex	Cl+Ex	Cl+Ex	Cl+Ex		Cl+Ex	Cl+Ex	Cl+Ex	Cl+Ex		Cl+Ex
Detector 1 Channel												
Detector 1 Extend (s)	0.0	0.0	0.0	0.0	0.0		0.0	0.0	0.0	0.0		0.0
Detector 1 Queue (s)	0.0	0.0	0.0	0.0	0.0		0.0	0.0	0.0	0.0		0.0
Detector 1 Delay (s)	0.0	0.0	0.0	0.0	0.0		0.0	0.0	0.0	0.0		0.0
Detector 2 Position(m)		28.7			28.7			28.7				28.7
Detector 2 Size(m)		1.8			1.8			1.8				1.8
Detector 2 Type		Cl+Ex			Cl+Ex			Cl+Ex				Cl+Ex
Detector 2 Channel												
Detector 2 Extend (s)		0.0			0.0			0.0				0.0

1900/2000 City Park Drive
 3: Blair Road & Ogilvie Road

BG 2037 PM



Lane Group	EBL	EBT	EBR	WBL	WBT	WBR	NBL	NBT	NBR	SBL	SBT	SBR
Turn Type	Prot	NA	Perm	Prot	NA		Prot	NA	Perm	Prot	NA	
Protected Phases	5	2		1	6		3	8		7	4	
Permitted Phases			2						8			
Detector Phase	5	2	2	1	6		3	8	8	7	4	
Switch Phase												
Minimum Initial (s)	5.0	10.0	10.0	5.0	10.0		5.0	10.0	10.0	5.0	10.0	
Minimum Split (s)	11.8	38.6	38.6	11.8	38.6		11.5	35.5	35.5	11.5	35.5	
Total Split (s)	25.0	41.0	41.0	37.0	53.0		21.0	41.0	41.0	21.0	41.0	
Total Split (%)	17.9%	29.3%	29.3%	26.4%	37.9%		15.0%	29.3%	29.3%	15.0%	29.3%	
Maximum Green (s)	18.2	34.4	34.4	30.2	46.4		14.5	34.5	34.5	14.5	34.5	
Yellow Time (s)	3.7	3.3	3.3	3.7	3.3		4.2	4.2	4.2	4.2	4.2	
All-Red Time (s)	3.1	3.3	3.3	3.1	3.3		2.3	2.3	2.3	2.3	2.3	
Lost Time Adjust (s)	0.0	0.0	0.0	0.0	0.0		0.0	0.0	0.0	0.0	0.0	
Total Lost Time (s)	6.8	6.6	6.6	6.8	6.6		6.5	6.5	6.5	6.5	6.5	
Lead/Lag	Lead	Lag	Lag	Lead	Lag		Lead	Lag	Lag	Lead	Lag	
Lead-Lag Optimize?	Yes	Yes	Yes	Yes	Yes		Yes	Yes	Yes	Yes	Yes	
Vehicle Extension (s)	3.0	3.0	3.0	3.0	3.0		3.0	3.0	3.0	3.0	3.0	
Recall Mode	None	C-Max	C-Max	None	C-Max		None	None	None	None	None	
Walk Time (s)		7.0	7.0		7.0			7.0	7.0		7.0	
Flash Dont Walk (s)		25.0	25.0		25.0			22.0	22.0		22.0	
Pedestrian Calls (#/hr)		30	30		30			35	35		35	
Act Effct Green (s)	16.2	34.4	34.4	30.2	48.4		13.4	37.7	37.7	11.3	35.6	
Actuated g/C Ratio	0.12	0.25	0.25	0.22	0.35		0.10	0.27	0.27	0.08	0.25	
v/c Ratio	0.77	1.03	1.17	1.25	0.51		0.70	0.62	1.27	0.56	0.97	
Control Delay	85.3	90.8	124.0	167.4	37.7		73.6	52.3	153.8	77.1	76.0	
Queue Delay	0.0	0.0	0.0	0.0	0.0		0.0	0.0	0.0	0.0	0.0	
Total Delay	85.3	90.8	124.0	167.4	37.7		73.6	52.3	153.8	77.1	76.0	
LOS	F	F	F	F	D		E	D	F	E	E	
Approach Delay		103.1			116.0			120.7			76.1	
Approach LOS		F			F			F			E	

Intersection Summary

Area Type: Other
 Cycle Length: 140
 Actuated Cycle Length: 140
 Offset: 0 (0%), Referenced to phase 2:EBT and 6:WBT, Start of Green
 Natural Cycle: 150
 Control Type: Actuated-Coordinated
 Maximum v/c Ratio: 1.27
 Intersection Signal Delay: 106.8 Intersection LOS: F
 Intersection Capacity Utilization 108.3% ICU Level of Service G
 Analysis Period (min) 15

Splits and Phases: 3: Blair Road & Ogilvie Road

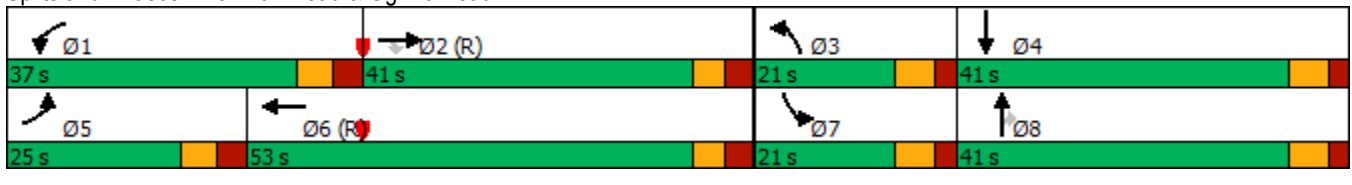

1900/2000 City Park Drive
 6: Blair Road & 1980 Ogilvie Road/Hwy 174 WB off

BG 2037 PM

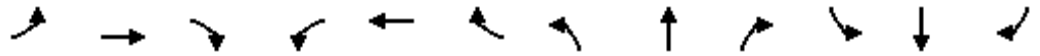

Lane Group	EBL	EBT	EBR	WBL	WBT	WBR	NBL	NBT	NBR	SBL	SBT	SBR
Lane Configurations												
Traffic Volume (vph)	123	0	568	93	149	177	346	1306	0	0	1802	172
Future Volume (vph)	123	0	568	93	149	177	346	1306	0	0	1802	172
Ideal Flow (vphpl)	1800	1800	1800	1800	1800	1800	1800	1800	1800	1800	1800	1800
Storage Length (m)	0.0		70.0	0.0		70.0	60.0		0.0	0.0		50.0
Storage Lanes	1		1	1		1	2		0	0		1
Taper Length (m)	7.6			7.6			100.0			7.6		
Lane Util. Factor	1.00	1.00	1.00	1.00	1.00	1.00	0.97	0.95	1.00	1.00	0.91	1.00
Frt			0.850			0.850						0.850
Flt Protected	0.950			0.950			0.950					
Satd. Flow (prot)	1544	0	1381	1695	1784	1517	3164	3262	0	0	4871	1517
Flt Permitted	0.582			0.950			0.950					
Satd. Flow (perm)	946	0	1381	1695	1784	1517	3164	3262	0	0	4871	1517
Right Turn on Red			Yes			Yes			Yes			Yes
Satd. Flow (RTOR)			26			84						97
Link Speed (k/h)		60			60			60				60
Link Distance (m)		518.9			416.4			90.2				239.9
Travel Time (s)		31.1			25.0			5.4				14.4
Peak Hour Factor	1.00	1.00	1.00	1.00	1.00	1.00	1.00	1.00	1.00	1.00	1.00	1.00
Heavy Vehicles (%)	12%	12%	12%	2%	2%	2%	6%	6%	6%	2%	2%	2%
Adj. Flow (vph)	123	0	568	93	149	177	346	1306	0	0	1802	172
Shared Lane Traffic (%)												
Lane Group Flow (vph)	123	0	568	93	149	177	346	1306	0	0	1802	172
Enter Blocked Intersection	No	No	No	No	No	No	No	No	No	No	No	No
Lane Alignment	Left	Left	Right	Left	Left	Right	Left	Left	Right	Left	Left	Right
Median Width(m)		3.7			3.7			7.4				7.4
Link Offset(m)		0.0			0.0			0.0				0.0
Crosswalk Width(m)		4.9			4.9			4.9				4.9
Two way Left Turn Lane												
Headway Factor	1.06	1.06	1.06	1.06	1.06	1.06	1.06	1.06	1.06	1.06	1.06	1.06
Turning Speed (k/h)	24		14	24		14	24		14	24		14
Number of Detectors	1		1	1	2	1	1	2				2
Detector Template	Left		Right	Left	Thru	Right	Left	Thru				Thru
Leading Detector (m)	6.1		6.1	6.1	30.5	6.1	6.1	30.5				30.5
Trailing Detector (m)	0.0		0.0	0.0	0.0	0.0	0.0	0.0				0.0
Detector 1 Position(m)	0.0		0.0	0.0	0.0	0.0	0.0	0.0				0.0
Detector 1 Size(m)	6.1		6.1	6.1	1.8	6.1	6.1	1.8				1.8
Detector 1 Type	Cl+Ex		Cl+Ex	Cl+Ex	Cl+Ex	Cl+Ex	Cl+Ex	Cl+Ex				Cl+Ex
Detector 1 Channel												
Detector 1 Extend (s)	0.0		0.0	0.0	0.0	0.0	0.0	0.0				0.0
Detector 1 Queue (s)	0.0		0.0	0.0	0.0	0.0	0.0	0.0				0.0
Detector 1 Delay (s)	0.0		0.0	0.0	0.0	0.0	0.0	0.0				0.0
Detector 2 Position(m)					28.7			28.7				28.7
Detector 2 Size(m)					1.8			1.8				1.8
Detector 2 Type					Cl+Ex			Cl+Ex				Cl+Ex
Detector 2 Channel												
Detector 2 Extend (s)					0.0			0.0				0.0
Turn Type	Perm		pm+ov	Perm	NA	Perm	Prot	NA				NA
Protected Phases			5		8		5	2				6

1900/2000 City Park Drive
 9: City Park Drive/1941 Ogilvie & Ogilvie Road

BG 2037 PM



Lane Group	EBL	EBT	EBR	WBL	WBT	WBR	NBL	NBT	NBR	SBL	SBT	SBR
Lane Configurations												
Traffic Volume (vph)	32	1484	152	103	603	38	183	10	161	78	19	76
Future Volume (vph)	32	1484	152	103	603	38	183	10	161	78	19	76
Ideal Flow (vphpl)	1800	1800	1800	1800	1800	1800	1800	1800	1800	1800	1800	1800
Storage Length (m)	40.0		100.0	100.0		50.0	0.0		60.0	20.0		10.0
Storage Lanes	1		1	1		1	0		1	1		1
Taper Length (m)	30.0			25.0			7.6			15.0		
Lane Util. Factor	1.00	0.95	1.00	1.00	0.95	1.00	1.00	1.00	1.00	1.00	1.00	1.00
Ped Bike Factor	0.89		0.87			0.73		0.93	0.87	0.91		0.92
Fr _t			0.850			0.850			0.850			0.850
Fl _t Protected	0.950			0.950				0.955		0.950		
Satd. Flow (prot)	1695	3390	1517	1679	3357	1502	0	1609	1432	1695	1784	1517
Fl _t Permitted	0.424			0.074				0.723		0.558		
Satd. Flow (perm)	675	3390	1315	131	3357	1104	0	1135	1244	906	1784	1388
Right Turn on Red			Yes			Yes			Yes			Yes
Satd. Flow (RTOR)			152			60			161			99
Link Speed (k/h)		60			60			60				60
Link Distance (m)		224.7			372.0			239.4				142.3
Travel Time (s)		13.5			22.3			14.4				8.5
Confl. Peds. (#/hr)	145		67	67		145	67		110	110		67
Peak Hour Factor	1.00	1.00	1.00	1.00	1.00	1.00	1.00	1.00	1.00	1.00	1.00	1.00
Heavy Vehicles (%)	2%	2%	2%	3%	3%	3%	8%	8%	8%	2%	2%	2%
Adj. Flow (vph)	32	1484	152	103	603	38	183	10	161	78	19	76
Shared Lane Traffic (%)												
Lane Group Flow (vph)	32	1484	152	103	603	38	0	193	161	78	19	76
Enter Blocked Intersection	No	No	No	No	No	No	No	No	No	No	No	No
Lane Alignment	Left	Left	Right	Left	Left	Right	Left	Left	Right	Left	Left	Right
Median Width(m)		3.7			3.7			3.7				3.7
Link Offset(m)		0.0			0.0			0.0				0.0
Crosswalk Width(m)		4.9			4.9			4.9				4.9
Two way Left Turn Lane												
Headway Factor	1.06	1.06	1.06	1.06	1.06	1.06	1.06	1.06	1.06	1.06	1.06	1.06
Turning Speed (k/h)	24		14	24		14	24		14	24		14
Number of Detectors	1	2	1	1	2	1	1	2	1	1	2	1
Detector Template	Left	Thru	Right	Left	Thru	Right	Left	Thru	Right	Left	Thru	Right
Leading Detector (m)	6.1	30.5	6.1	6.1	30.5	6.1	6.1	30.5	6.1	6.1	30.5	6.1
Trailing Detector (m)	0.0	0.0	0.0	0.0	0.0	0.0	0.0	0.0	0.0	0.0	0.0	0.0
Detector 1 Position(m)	0.0	0.0	0.0	0.0	0.0	0.0	0.0	0.0	0.0	0.0	0.0	0.0
Detector 1 Size(m)	6.1	1.8	6.1	6.1	1.8	6.1	6.1	1.8	6.1	6.1	1.8	6.1
Detector 1 Type	Cl+Ex	Cl+Ex	Cl+Ex	Cl+Ex	Cl+Ex	Cl+Ex	Cl+Ex	Cl+Ex	Cl+Ex	Cl+Ex	Cl+Ex	Cl+Ex
Detector 1 Channel												
Detector 1 Extend (s)	0.0	0.0	0.0	0.0	0.0	0.0	0.0	0.0	0.0	0.0	0.0	0.0
Detector 1 Queue (s)	0.0	0.0	0.0	0.0	0.0	0.0	0.0	0.0	0.0	0.0	0.0	0.0
Detector 1 Delay (s)	0.0	0.0	0.0	0.0	0.0	0.0	0.0	0.0	0.0	0.0	0.0	0.0
Detector 2 Position(m)		28.7			28.7			28.7				28.7
Detector 2 Size(m)		1.8			1.8			1.8				1.8
Detector 2 Type		Cl+Ex			Cl+Ex			Cl+Ex				Cl+Ex
Detector 2 Channel												
Detector 2 Extend (s)		0.0			0.0			0.0				0.0

Lane Group	Ø3	Ø7
Lane Configurations		
Traffic Volume (vph)		
Future Volume (vph)		
Ideal Flow (vphpl)		
Storage Length (m)		
Storage Lanes		
Taper Length (m)		
Lane Util. Factor		
Ped Bike Factor		
Frt		
Flt Protected		
Satd. Flow (prot)		
Flt Permitted		
Satd. Flow (perm)		
Right Turn on Red		
Satd. Flow (RTOR)		
Link Speed (k/h)		
Link Distance (m)		
Travel Time (s)		
Confl. Peds. (#/hr)		
Peak Hour Factor		
Heavy Vehicles (%)		
Adj. Flow (vph)		
Shared Lane Traffic (%)		
Lane Group Flow (vph)		
Enter Blocked Intersection		
Lane Alignment		
Median Width(m)		
Link Offset(m)		
Crosswalk Width(m)		
Two way Left Turn Lane		
Headway Factor		
Turning Speed (k/h)		
Number of Detectors		
Detector Template		
Leading Detector (m)		
Trailing Detector (m)		
Detector 1 Position(m)		
Detector 1 Size(m)		
Detector 1 Type		
Detector 1 Channel		
Detector 1 Extend (s)		
Detector 1 Queue (s)		
Detector 1 Delay (s)		
Detector 2 Position(m)		
Detector 2 Size(m)		
Detector 2 Type		
Detector 2 Channel		
Detector 2 Extend (s)		

1900/2000 City Park Drive
 9: City Park Drive/1941 Ogilvie & Ogilvie Road

BG 2037 PM



Lane Group	EBL	EBT	EBR	WBL	WBT	WBR	NBL	NBT	NBR	SBL	SBT	SBR
Turn Type	Perm	NA	Perm	pm+pt	NA	Perm	Perm	NA	Perm	Perm	NA	Perm
Protected Phases		2		1	6			8			4	
Permitted Phases	2		2	6		6	8		8	4		4
Detector Phase	2	2	2	1	6	6	8	8	8	4	4	4
Switch Phase												
Minimum Initial (s)	10.0	10.0	10.0	5.0	10.0	10.0	10.0	10.0	10.0	10.0	10.0	10.0
Minimum Split (s)	35.1	35.1	35.1	9.0	35.1	35.1	33.5	33.5	33.5	33.5	33.5	33.5
Total Split (s)	46.0	46.0	46.0	15.0	61.0	61.0	34.0	34.0	34.0	34.0	34.0	34.0
Total Split (%)	46.0%	46.0%	46.0%	15.0%	61.0%	61.0%	34.0%	34.0%	34.0%	34.0%	34.0%	34.0%
Maximum Green (s)	39.9	39.9	39.9	11.0	54.9	54.9	27.5	27.5	27.5	27.5	27.5	27.5
Yellow Time (s)	3.7	3.7	3.7	3.0	3.7	3.7	3.3	3.3	3.3	3.3	3.3	3.3
All-Red Time (s)	2.4	2.4	2.4	1.0	2.4	2.4	3.2	3.2	3.2	3.2	3.2	3.2
Lost Time Adjust (s)	0.0	0.0	0.0	0.0	0.0	0.0		0.0	0.0	0.0	0.0	0.0
Total Lost Time (s)	6.1	6.1	6.1	4.0	6.1	6.1		6.5	6.5	6.5	6.5	6.5
Lead/Lag	Lag	Lag	Lag	Lead			Lag	Lag	Lag	Lag	Lag	Lag
Lead-Lag Optimize?	Yes	Yes	Yes	Yes			Yes	Yes	Yes	Yes	Yes	Yes
Vehicle Extension (s)	3.0	3.0	3.0	3.0	3.0	3.0	3.0	3.0	3.0	3.0	3.0	3.0
Recall Mode	C-Max	C-Max	C-Max	None	C-Max	C-Max	None	None	None	None	None	None
Walk Time (s)	7.0	7.0	7.0		7.0	7.0	2.0	2.0	2.0	2.0	2.0	2.0
Flash Dont Walk (s)	22.0	22.0	22.0		22.0	22.0	25.0	25.0	25.0	25.0	25.0	25.0
Pedestrian Calls (#/hr)	35	35	35		35	35	35	35	35	35	35	35
Act Effct Green (s)	51.6	51.6	51.6	63.9	61.8	61.8		22.6	22.6	22.6	22.6	22.6
Actuated g/C Ratio	0.52	0.52	0.52	0.64	0.62	0.62		0.23	0.23	0.23	0.23	0.23
v/c Ratio	0.09	0.85	0.20	0.49	0.29	0.05		0.75	0.40	0.38	0.05	0.19
Control Delay	9.1	20.7	1.0	20.3	10.6	1.4		53.9	7.8	36.6	27.6	4.5
Queue Delay	0.0	0.0	0.0	0.0	0.0	0.0		0.0	0.0	0.0	0.0	0.0
Total Delay	9.1	20.7	1.0	20.3	10.6	1.4		53.9	7.8	36.6	27.6	4.5
LOS	A	C	A	C	B	A		D	A	D	C	A
Approach Delay		18.7			11.5			32.9			21.5	
Approach LOS		B			B			C			C	

Intersection Summary

Area Type: Other
 Cycle Length: 100
 Actuated Cycle Length: 100
 Offset: 30 (30%), Referenced to phase 2:EBTL and 6:WBTL, Start of Green
 Natural Cycle: 95
 Control Type: Actuated-Coordinated
 Maximum v/c Ratio: 0.85
 Intersection Signal Delay: 18.8
 Intersection LOS: B
 Intersection Capacity Utilization 102.6%
 ICU Level of Service G
 Analysis Period (min) 15

Splits and Phases: 9: City Park Drive/1941 Ogilvie & Ogilvie Road

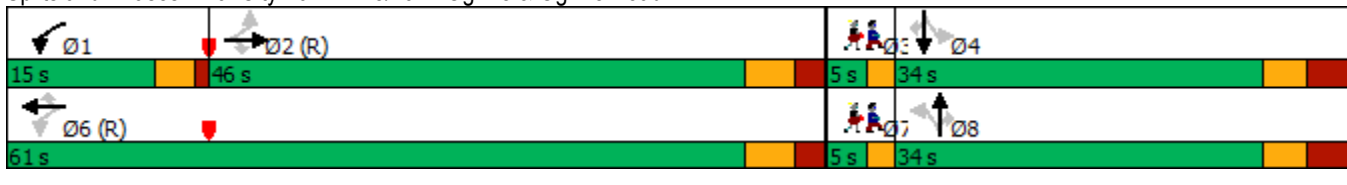

Lane Group	Ø3	Ø7
Turn Type		
Protected Phases	3	7
Permitted Phases		
Detector Phase		
Switch Phase		
Minimum Initial (s)	1.0	1.0
Minimum Split (s)	5.0	5.0
Total Split (s)	5.0	5.0
Total Split (%)	5%	5%
Maximum Green (s)	3.0	3.0
Yellow Time (s)	2.0	2.0
All-Red Time (s)	0.0	0.0
Lost Time Adjust (s)		
Total Lost Time (s)		
Lead/Lag	Lead	Lead
Lead-Lag Optimize?	Yes	Yes
Vehicle Extension (s)	3.0	3.0
Recall Mode	None	None
Walk Time (s)	0.0	0.0
Flash Dont Walk (s)	0.0	0.0
Pedestrian Calls (#/hr)	35	35
Act Effct Green (s)		
Actuated g/C Ratio		
v/c Ratio		
Control Delay		
Queue Delay		
Total Delay		
LOS		
Approach Delay		
Approach LOS		
Intersection Summary		

1900/2000 City Park Drive

12: 1900 Ogilvie Road/1929 Ogilvie Road & Ogilvie Road

BG 2037 PM

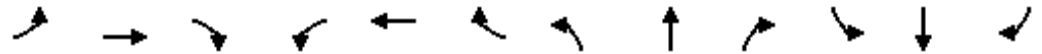

Lane Group	EBL	EBT	EBR	WBL	WBT	WBR	NBL	NBT	NBR	SBL	SBT	SBR
Lane Configurations												
Traffic Volume (vph)	43	1428	66	32	861	24	47	3	28	135	3	132
Future Volume (vph)	43	1428	66	32	861	24	47	3	28	135	3	132
Ideal Flow (vphpl)	1800	1800	1800	1800	1800	1800	1800	1800	1800	1800	1800	1800
Storage Length (m)	60.0		80.0	90.0		0.0	0.0		0.0	0.0		0.0
Storage Lanes	1		1	1		0	1		0	0		1
Taper Length (m)	30.0			20.0			7.6			7.6		
Lane Util. Factor	1.00	0.95	1.00	1.00	0.95	0.95	1.00	1.00	1.00	1.00	1.00	1.00
Frt			0.850		0.996			0.865				0.850
Flt Protected	0.950			0.950			0.950				0.953	
Satd. Flow (prot)	1695	3390	1517	1679	3345	0	1695	1543	0	0	1700	1517
Flt Permitted	0.289			0.131			0.669				0.708	
Satd. Flow (perm)	516	3390	1517	231	3345	0	1194	1543	0	0	1263	1517
Right Turn on Red			Yes			Yes			Yes			Yes
Satd. Flow (RTOR)			66		5			28				132
Link Speed (k/h)		60			60			60				60
Link Distance (m)		190.5			224.7			86.0				56.6
Travel Time (s)		11.4			13.5			5.2				3.4
Peak Hour Factor	1.00	1.00	1.00	1.00	1.00	1.00	1.00	1.00	1.00	1.00	1.00	1.00
Heavy Vehicles (%)	2%	2%	2%	3%	3%	2%	2%	2%	2%	2%	2%	2%
Adj. Flow (vph)	43	1428	66	32	861	24	47	3	28	135	3	132
Shared Lane Traffic (%)												
Lane Group Flow (vph)	43	1428	66	32	885	0	47	31	0	0	138	132
Enter Blocked Intersection	No	No	No	No	No	No	No	No	No	No	No	No
Lane Alignment	Left	Left	Right	Left	Left	Right	Left	Left	Right	Left	Left	Right
Median Width(m)		3.7			3.7			3.7				3.7
Link Offset(m)		0.0			0.0			0.0				0.0
Crosswalk Width(m)		4.9			4.9			4.9				4.9
Two way Left Turn Lane												
Headway Factor	1.06	1.06	1.06	1.06	1.06	1.06	1.06	1.06	1.06	1.06	1.06	1.06
Turning Speed (k/h)	24		14	24		14	24		14	24		14
Number of Detectors	1	2	1	1	2		1	2		1	2	1
Detector Template	Left	Thru	Right	Left	Thru		Left	Thru		Left	Thru	Right
Leading Detector (m)	6.1	30.5	6.1	6.1	30.5		6.1	30.5		6.1	30.5	6.1
Trailing Detector (m)	0.0	0.0	0.0	0.0	0.0		0.0	0.0		0.0	0.0	0.0
Detector 1 Position(m)	0.0	0.0	0.0	0.0	0.0		0.0	0.0		0.0	0.0	0.0
Detector 1 Size(m)	6.1	1.8	6.1	6.1	1.8		6.1	1.8		6.1	1.8	6.1
Detector 1 Type	Cl+Ex	Cl+Ex	Cl+Ex	Cl+Ex	Cl+Ex		Cl+Ex	Cl+Ex		Cl+Ex	Cl+Ex	Cl+Ex
Detector 1 Channel												
Detector 1 Extend (s)	0.0	0.0	0.0	0.0	0.0		0.0	0.0		0.0	0.0	0.0
Detector 1 Queue (s)	0.0	0.0	0.0	0.0	0.0		0.0	0.0		0.0	0.0	0.0
Detector 1 Delay (s)	0.0	0.0	0.0	0.0	0.0		0.0	0.0		0.0	0.0	0.0
Detector 2 Position(m)		28.7			28.7			28.7				28.7
Detector 2 Size(m)		1.8			1.8			1.8				1.8
Detector 2 Type		Cl+Ex			Cl+Ex			Cl+Ex				Cl+Ex
Detector 2 Channel												
Detector 2 Extend (s)		0.0			0.0			0.0				0.0
Turn Type	Perm	NA	Perm	Perm	NA		Perm	NA		Perm	NA	Perm
Protected Phases		2			6			8				4

1900/2000 City Park Drive

12: 1900 Ogilvie Road/1929 Ogilvie Road & Ogilvie Road

BG 2037 PM

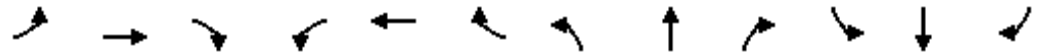

Lane Group	EBL	EBT	EBR	WBL	WBT	WBR	NBL	NBT	NBR	SBL	SBT	SBR
Permitted Phases	2		2	6			8			4		4
Detector Phase	2	2	2	6	6		8	8		4	4	4
Switch Phase												
Minimum Initial (s)	10.0	10.0	10.0	10.0	10.0		10.0	10.0		10.0	10.0	10.0
Minimum Split (s)	29.9	29.9	29.9	29.9	29.9		36.7	36.7		36.7	36.7	36.7
Total Split (s)	63.0	63.0	63.0	63.0	63.0		37.0	37.0		37.0	37.0	37.0
Total Split (%)	63.0%	63.0%	63.0%	63.0%	63.0%		37.0%	37.0%		37.0%	37.0%	37.0%
Maximum Green (s)	57.1	57.1	57.1	57.1	57.1		30.3	30.3		30.3	30.3	30.3
Yellow Time (s)	3.7	3.7	3.7	3.7	3.7		3.3	3.3		3.3	3.3	3.3
All-Red Time (s)	2.2	2.2	2.2	2.2	2.2		3.4	3.4		3.4	3.4	3.4
Lost Time Adjust (s)	0.0	0.0	0.0	0.0	0.0		0.0	0.0		0.0	0.0	0.0
Total Lost Time (s)	5.9	5.9	5.9	5.9	5.9		6.7	6.7		6.7	6.7	6.7
Lead/Lag												
Lead-Lag Optimize?												
Vehicle Extension (s)	3.0	3.0	3.0	3.0	3.0		3.0	3.0		3.0	3.0	3.0
Recall Mode	C-Max	C-Max	C-Max	C-Max	C-Max		None	None		None	None	None
Walk Time (s)	11.0	11.0	11.0	11.0	11.0		7.0	7.0		7.0	7.0	7.0
Flash Dont Walk (s)	13.0	13.0	13.0	13.0	13.0		23.0	23.0		23.0	23.0	23.0
Pedestrian Calls (#/hr)	20	20	20	20	20		30	30		30	30	30
Act Effct Green (s)	64.7	64.7	64.7	64.7	64.7		22.7	22.7		22.7	22.7	22.7
Actuated g/C Ratio	0.65	0.65	0.65	0.65	0.65		0.23	0.23		0.23	0.23	0.23
v/c Ratio	0.13	0.65	0.07	0.21	0.41		0.17	0.08		0.48	0.30	0.30
Control Delay	5.9	8.4	0.7	10.5	6.8		28.9	11.0		37.2	6.6	6.6
Queue Delay	0.0	0.1	0.0	0.0	0.0		0.0	0.0		0.0	0.0	0.0
Total Delay	5.9	8.5	0.7	10.5	6.8		28.9	11.0		37.2	6.6	6.6
LOS	A	A	A	B	A		C	B		D	A	A
Approach Delay		8.1			7.0			21.8			22.2	
Approach LOS		A			A			C			C	

Intersection Summary

Area Type:	Other
Cycle Length:	100
Actuated Cycle Length:	100
Offset:	8 (8%), Referenced to phase 2:EBTL and 6:WBTL, Start of Green
Natural Cycle:	80
Control Type:	Actuated-Coordinated
Maximum v/c Ratio:	0.65
Intersection Signal Delay:	9.5
Intersection LOS:	A
Intersection Capacity Utilization:	66.9%
ICU Level of Service:	C
Analysis Period (min):	15

Splits and Phases: 12: 1900 Ogilvie Road/1929 Ogilvie Road & Ogilvie Road

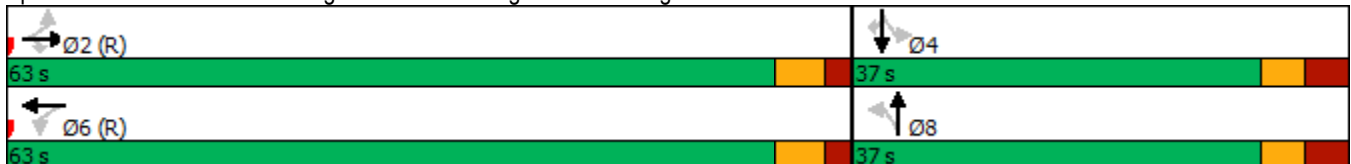

1900/2000 City Park Drive
 15: City Park Drive/Bathgate Drive & Ogilvie Road

BG 2037 PM



Lane Group	EBL	EBT	EBR	WBL	WBT	WBR	NBL	NBT	NBR	SBL	SBT	SBR
Lane Configurations												
Traffic Volume (vph)	207	1061	165	12	839	110	120	69	26	140	47	159
Future Volume (vph)	207	1061	165	12	839	110	120	69	26	140	47	159
Ideal Flow (vphpl)	1800	1800	1800	1800	1800	1800	1800	1800	1800	1800	1800	1800
Storage Length (m)	70.0		40.0	45.0		70.0	30.0		0.0	20.0		0.0
Storage Lanes	1		1	1		1	1		0	1		0
Taper Length (m)	30.0			30.0			25.0			25.0		
Lane Util. Factor	1.00	0.95	1.00	1.00	0.95	1.00	1.00	1.00	1.00	1.00	1.00	1.00
Ped Bike Factor	0.97		0.90			0.83	0.98	0.99		0.98	0.97	
Fr _t			0.850			0.850		0.959			0.884	
Fl _t Protected	0.950			0.950			0.950			0.950		
Satd. Flow (prot)	1679	3357	1502	1679	3357	1502	1631	1632	0	1647	1487	0
Fl _t Permitted	0.226			0.245			0.539			0.695		
Satd. Flow (perm)	387	3357	1349	433	3357	1248	907	1632	0	1182	1487	0
Right Turn on Red			Yes			Yes			Yes			Yes
Satd. Flow (RTOR)			121			121		20			159	
Link Speed (k/h)		60			60			60			60	
Link Distance (m)		257.6			190.5			345.6			177.6	
Travel Time (s)		15.5			11.4			20.7			10.7	
Confl. Peds. (#/hr)	73		40	40		73	27		21	21		27
Peak Hour Factor	1.00	1.00	1.00	1.00	1.00	1.00	1.00	1.00	1.00	1.00	1.00	1.00
Heavy Vehicles (%)	3%	3%	3%	3%	3%	3%	6%	6%	6%	5%	5%	5%
Adj. Flow (vph)	207	1061	165	12	839	110	120	69	26	140	47	159
Shared Lane Traffic (%)												
Lane Group Flow (vph)	207	1061	165	12	839	110	120	95	0	140	206	0
Enter Blocked Intersection	No	No	No	No	No	No	No	No	No	No	No	No
Lane Alignment	Left	Left	Right	Left	Left	Right	Left	Left	Right	Left	Left	Right
Median Width(m)		3.7			3.7			3.7			3.7	
Link Offset(m)		0.0			0.0			0.0			0.0	
Crosswalk Width(m)		4.9			4.9			4.9			4.9	
Two way Left Turn Lane												
Headway Factor	1.06	1.06	1.06	1.06	1.06	1.06	1.06	1.06	1.06	1.06	1.06	1.06
Turning Speed (k/h)	24		14	24		14	24		14	24		14
Number of Detectors	1	2	1	1	2	1	1	2		1	2	
Detector Template	Left	Thru	Right	Left	Thru	Right	Left	Thru		Left	Thru	
Leading Detector (m)	6.1	30.5	6.1	6.1	30.5	6.1	6.1	30.5		6.1	30.5	
Trailing Detector (m)	0.0	0.0	0.0	0.0	0.0	0.0	0.0	0.0		0.0	0.0	
Detector 1 Position(m)	0.0	0.0	0.0	0.0	0.0	0.0	0.0	0.0		0.0	0.0	
Detector 1 Size(m)	6.1	1.8	6.1	6.1	1.8	6.1	6.1	1.8		6.1	1.8	
Detector 1 Type	Cl+Ex	Cl+Ex	Cl+Ex	Cl+Ex	Cl+Ex	Cl+Ex	Cl+Ex	Cl+Ex		Cl+Ex	Cl+Ex	
Detector 1 Channel												
Detector 1 Extend (s)	0.0	0.0	0.0	0.0	0.0	0.0	0.0	0.0		0.0	0.0	
Detector 1 Queue (s)	0.0	0.0	0.0	0.0	0.0	0.0	0.0	0.0		0.0	0.0	
Detector 1 Delay (s)	0.0	0.0	0.0	0.0	0.0	0.0	0.0	0.0		0.0	0.0	
Detector 2 Position(m)		28.7			28.7			28.7			28.7	
Detector 2 Size(m)		1.8			1.8			1.8			1.8	
Detector 2 Type		Cl+Ex			Cl+Ex			Cl+Ex			Cl+Ex	
Detector 2 Channel												
Detector 2 Extend (s)		0.0			0.0			0.0			0.0	

Lane Group	Ø3	Ø7
Lane Configurations		
Traffic Volume (vph)		
Future Volume (vph)		
Ideal Flow (vphpl)		
Storage Length (m)		
Storage Lanes		
Taper Length (m)		
Lane Util. Factor		
Ped Bike Factor		
Frt		
Flt Protected		
Satd. Flow (prot)		
Flt Permitted		
Satd. Flow (perm)		
Right Turn on Red		
Satd. Flow (RTOR)		
Link Speed (k/h)		
Link Distance (m)		
Travel Time (s)		
Confl. Peds. (#/hr)		
Peak Hour Factor		
Heavy Vehicles (%)		
Adj. Flow (vph)		
Shared Lane Traffic (%)		
Lane Group Flow (vph)		
Enter Blocked Intersection		
Lane Alignment		
Median Width(m)		
Link Offset(m)		
Crosswalk Width(m)		
Two way Left Turn Lane		
Headway Factor		
Turning Speed (k/h)		
Number of Detectors		
Detector Template		
Leading Detector (m)		
Trailing Detector (m)		
Detector 1 Position(m)		
Detector 1 Size(m)		
Detector 1 Type		
Detector 1 Channel		
Detector 1 Extend (s)		
Detector 1 Queue (s)		
Detector 1 Delay (s)		
Detector 2 Position(m)		
Detector 2 Size(m)		
Detector 2 Type		
Detector 2 Channel		
Detector 2 Extend (s)		

1900/2000 City Park Drive
 15: City Park Drive/Bathgate Drive & Ogilvie Road

BG 2037 PM



Lane Group	EBL	EBT	EBR	WBL	WBT	WBR	NBL	NBT	NBR	SBL	SBT	SBR
Turn Type	pm+pt	NA	Perm	pm+pt	NA	Perm	Perm	NA		Perm	NA	
Protected Phases	5	2		1	6			8				4
Permitted Phases	2		2	6		6	8			4		
Detector Phase	5	2	2	1	6	6	8	8		4		4
Switch Phase												
Minimum Initial (s)	5.0	10.0	10.0	5.0	10.0	10.0	10.0	10.0		10.0		10.0
Minimum Split (s)	9.7	30.0	30.0	9.7	30.0	30.0	37.4	37.4		37.4		37.4
Total Split (s)	20.0	37.0	37.0	20.0	37.0	37.0	38.0	38.0		38.0		38.0
Total Split (%)	20.0%	37.0%	37.0%	20.0%	37.0%	37.0%	38.0%	38.0%		38.0%		38.0%
Maximum Green (s)	15.3	31.0	31.0	15.3	31.0	31.0	30.6	30.6		30.6		30.6
Yellow Time (s)	3.7	3.7	3.7	3.7	3.7	3.7	3.0	3.0		3.0		3.0
All-Red Time (s)	1.0	2.3	2.3	1.0	2.3	2.3	4.4	4.4		4.4		4.4
Lost Time Adjust (s)	0.0	0.0	0.0	0.0	0.0	0.0	0.0	0.0		0.0		0.0
Total Lost Time (s)	4.7	6.0	6.0	4.7	6.0	6.0	7.4	7.4		7.4		7.4
Lead/Lag	Lead	Lag	Lag	Lead	Lag	Lag	Lag	Lag		Lag		Lag
Lead-Lag Optimize?	Yes	Yes	Yes	Yes	Yes	Yes	Yes	Yes		Yes		Yes
Vehicle Extension (s)	3.0	3.0	3.0	3.0	3.0	3.0	3.0	3.0		3.0		3.0
Recall Mode	None	C-Max	C-Max	None	C-Max	C-Max	None	None		None		None
Walk Time (s)		9.0	9.0		9.0	9.0	2.0	2.0		2.0		2.0
Flash Dont Walk (s)		15.0	15.0		15.0	15.0	28.0	28.0		28.0		28.0
Pedestrian Calls (#/hr)		30	30		30	30	20	20		20		20
Act Effct Green (s)	62.6	59.1	59.1	52.6	45.4	45.4	20.3	20.3		20.3		20.3
Actuated g/C Ratio	0.63	0.59	0.59	0.53	0.45	0.45	0.20	0.20		0.20		0.20
v/c Ratio	0.54	0.54	0.20	0.04	0.55	0.17	0.66	0.27		0.59		0.48
Control Delay	20.9	14.6	7.0	8.7	16.5	2.0	51.3	25.5		44.1		12.1
Queue Delay	0.0	0.0	0.0	0.0	0.0	0.0	0.0	0.0		0.0		0.0
Total Delay	20.9	14.6	7.0	8.7	16.5	2.0	51.3	25.5		44.1		12.1
LOS	C	B	A	A	B	A	D	C		D		B
Approach Delay		14.6			14.7			39.9				25.0
Approach LOS		B			B			D				C

Intersection Summary

Area Type:	Other
Cycle Length:	100
Actuated Cycle Length:	100
Offset:	19 (19%), Referenced to phase 2:EBTL and 6:WBTL, Start of Green
Natural Cycle:	85
Control Type:	Actuated-Coordinated
Maximum v/c Ratio:	0.66
Intersection Signal Delay:	17.7
Intersection LOS:	B
Intersection Capacity Utilization	87.0%
ICU Level of Service	E
Analysis Period (min)	15

Splits and Phases: 15: City Park Drive/Bathgate Drive & Ogilvie Road

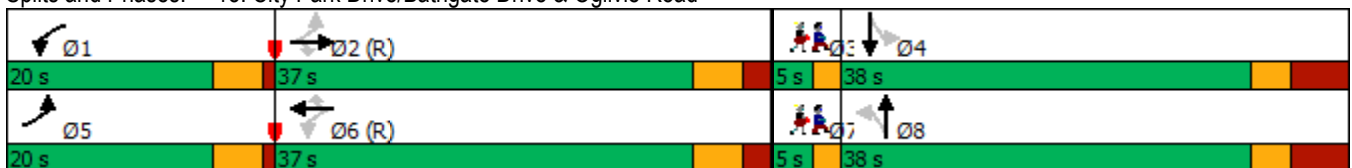

Lane Group	Ø3	Ø7
Turn Type		
Protected Phases	3	7
Permitted Phases		
Detector Phase		
Switch Phase		
Minimum Initial (s)	1.0	1.0
Minimum Split (s)	5.0	5.0
Total Split (s)	5.0	5.0
Total Split (%)	5%	5%
Maximum Green (s)	3.0	3.0
Yellow Time (s)	2.0	2.0
All-Red Time (s)	0.0	0.0
Lost Time Adjust (s)		
Total Lost Time (s)		
Lead/Lag	Lead	Lead
Lead-Lag Optimize?	Yes	Yes
Vehicle Extension (s)	3.0	3.0
Recall Mode	Ped	Ped
Walk Time (s)	0.0	0.0
Flash Dont Walk (s)	0.0	0.0
Pedestrian Calls (#/hr)	20	20
Act Effct Green (s)		
Actuated g/C Ratio		
v/c Ratio		
Control Delay		
Queue Delay		
Total Delay		
LOS		
Approach Delay		
Approach LOS		
Intersection Summary		

1900/2000 City Park Drive
 18: Residential/Cadboro Road & Ogilvie Road

BG 2037 PM



Lane Group	EBL	EBT	EBR	WBL	WBT	WBR	NBL	NBT	NBR	SBL	SBT	SBR
Lane Configurations		↑↑			↑↑				↑			↑
Traffic Volume (vph)	0	1833	14	0	1222	70	0	0	1	0	0	97
Future Volume (vph)	0	1833	14	0	1222	70	0	0	1	0	0	97
Ideal Flow (vphpl)	1800	1800	1800	1800	1800	1800	1800	1800	1800	1800	1800	1800
Lane Util. Factor	1.00	0.95	0.95	1.00	0.95	0.95	1.00	1.00	1.00	1.00	1.00	1.00
Fr _t		0.999			0.992				0.865			0.865
Fl _t Protected												
Satd. Flow (prot)	0	3387	0	0	3363	0	0	0	1543	0	0	1543
Fl _t Permitted												
Satd. Flow (perm)	0	3387	0	0	3363	0	0	0	1543	0	0	1543
Right Turn on Red			Yes			Yes			Yes			Yes
Satd. Flow (RTOR)		1			9				33			53
Link Speed (k/h)		60			60			60				60
Link Distance (m)		264.5			257.6			90.1				116.1
Travel Time (s)		15.9			15.5			5.4				7.0
Peak Hour Factor	1.00	1.00	1.00	1.00	1.00	1.00	1.00	1.00	1.00	1.00	1.00	1.00
Adj. Flow (vph)	0	1833	14	0	1222	70	0	0	1	0	0	97
Shared Lane Traffic (%)												
Lane Group Flow (vph)	0	1847	0	0	1292	0	0	0	1	0	0	97
Enter Blocked Intersection	No	No	No	No	No	No	No	No	No	No	No	No
Lane Alignment	Left	Left	Right	Left	Left	Right	Left	Left	Right	Left	Left	Right
Median Width(m)		3.7			3.7			0.0				0.0
Link Offset(m)		0.0			0.0			0.0				0.0
Crosswalk Width(m)		1.6			1.6			1.6				1.6
Two way Left Turn Lane												
Headway Factor	1.06	1.06	1.06	1.06	1.06	1.06	1.06	1.06	1.06	1.06	1.06	1.06
Turning Speed (k/h)	97		97	97		97	97		97	97		97
Number of Detectors		2			2				1			1
Detector Template		Thru			Thru				Right			Right
Leading Detector (m)		10.0			10.0				2.0			2.0
Trailing Detector (m)		0.0			0.0				0.0			0.0
Detector 1 Position(m)		0.0			0.0				0.0			0.0
Detector 1 Size(m)		0.6			0.6				2.0			2.0
Detector 1 Type		Cl+Ex			Cl+Ex				Cl+Ex			Cl+Ex
Detector 1 Channel												
Detector 1 Extend (s)		0.0			0.0				0.0			0.0
Detector 1 Queue (s)		0.0			0.0				0.0			0.0
Detector 1 Delay (s)		0.0			0.0				0.0			0.0
Detector 2 Position(m)		9.4			9.4							
Detector 2 Size(m)		0.6			0.6							
Detector 2 Type		Cl+Ex			Cl+Ex							
Detector 2 Channel												
Detector 2 Extend (s)		0.0			0.0							
Turn Type		NA			NA				Perm			Perm
Protected Phases		2			6							
Permitted Phases									8			4
Detector Phase		2			6				8			4
Switch Phase												
Minimum Initial (s)		10.0			10.0				5.0			5.0

1900/2000 City Park Drive
 18: Residential/Cadboro Road & Ogilvie Road

BG 2037 PM



Lane Group	EBL	EBT	EBR	WBL	WBT	WBR	NBL	NBT	NBR	SBL	SBT	SBR
Minimum Split (s)		35.0			35.0				40.0			40.0
Total Split (s)		60.0			60.0				40.0			40.0
Total Split (%)		60.0%			60.0%				40.0%			40.0%
Maximum Green (s)		54.0			54.0				36.0			36.0
Yellow Time (s)		3.7			3.7				3.0			3.0
All-Red Time (s)		2.3			2.3				1.0			1.0
Lost Time Adjust (s)		0.0			0.0				0.0			0.0
Total Lost Time (s)		6.0			6.0				4.0			4.0
Lead/Lag												
Lead-Lag Optimize?												
Vehicle Extension (s)		3.0			3.0				3.0			3.0
Recall Mode		C-Max			C-Max				None			None
Walk Time (s)		15.0			15.0				24.0			24.0
Flash Dont Walk (s)		14.0			14.0				12.0			12.0
Pedestrian Calls (#/hr)		30			30				20			20
Act Effct Green (s)		74.7			74.7				18.4			18.4
Actuated g/C Ratio		0.75			0.75				0.18			0.18
v/c Ratio		0.73			0.51				0.00			0.30
Control Delay		15.5			9.2				0.0			16.3
Queue Delay		0.0			0.0				0.0			0.0
Total Delay		15.5			9.2				0.0			16.3
LOS		B			A				A			B
Approach Delay		15.5			9.2						16.3	
Approach LOS		B			A						B	

Intersection Summary

Area Type:	Other
Cycle Length:	100
Actuated Cycle Length:	100
Offset:	4 (4%), Referenced to phase 2:EBT and 6:WBT, Start of Green
Natural Cycle:	90
Control Type:	Actuated-Coordinated
Maximum v/c Ratio:	0.73
Intersection Signal Delay:	13.0
Intersection LOS:	B
Intersection Capacity Utilization:	66.5%
ICU Level of Service:	C
Analysis Period (min):	15

Splits and Phases: 18: Residential/Cadboro Road & Ogilvie Road

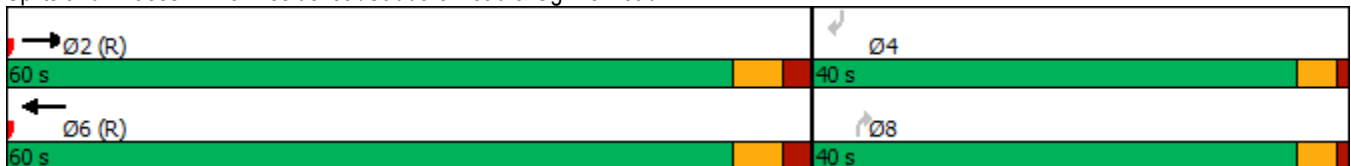

1900/2000 City Park Drive
22: Blair Road & Hwy 174 EB off

BG 2037 PM



Lane Group	WBL	WBR	NBT	NBR	SBL	SBT
Lane Configurations						
Traffic Volume (vph)	237	981	834	189	488	1019
Future Volume (vph)	237	981	834	189	488	1019
Ideal Flow (vphpl)	1800	1800	1800	1800	1800	1800
Storage Length (m)	0.0	0.0		70.0	0.0	
Storage Lanes	1	1		1	0	
Taper Length (m)	7.6				7.6	
Lane Util. Factor	1.00	1.00	0.95	1.00	0.95	0.95
Frt		0.850		0.850		
Flt Protected	0.950					0.984
Satd. Flow (prot)	1647	1473	3325	1488	0	3210
Flt Permitted	0.950					0.521
Satd. Flow (perm)	1647	1473	3325	1488	0	1700
Right Turn on Red		Yes		Yes		
Satd. Flow (RTOR)		584		189		
Link Speed (k/h)	60		60			60
Link Distance (m)	216.4		230.9			341.9
Travel Time (s)	13.0		13.9			20.5
Peak Hour Factor	1.00	1.00	1.00	1.00	1.00	1.00
Heavy Vehicles (%)	5%	5%	4%	4%	6%	6%
Adj. Flow (vph)	237	981	834	189	488	1019
Shared Lane Traffic (%)						
Lane Group Flow (vph)	237	981	834	189	0	1507
Enter Blocked Intersection	No	No	No	No	No	No
Lane Alignment	Left	Right	Left	Right	Left	Left
Median Width(m)	3.7		0.0			0.0
Link Offset(m)	0.0		0.0			0.0
Crosswalk Width(m)	4.9		4.9			4.9
Two way Left Turn Lane						
Headway Factor	1.06	1.06	1.06	1.06	1.06	1.06
Turning Speed (k/h)	24	14		14	24	
Number of Detectors	1	1	2	1	1	2
Detector Template	Left	Right	Thru	Right	Left	Thru
Leading Detector (m)	6.1	6.1	30.5	6.1	6.1	30.5
Trailing Detector (m)	0.0	0.0	0.0	0.0	0.0	0.0
Detector 1 Position(m)	0.0	0.0	0.0	0.0	0.0	0.0
Detector 1 Size(m)	6.1	6.1	1.8	6.1	6.1	1.8
Detector 1 Type	Cl+Ex	Cl+Ex	Cl+Ex	Cl+Ex	Cl+Ex	Cl+Ex
Detector 1 Channel						
Detector 1 Extend (s)	0.0	0.0	0.0	0.0	0.0	0.0
Detector 1 Queue (s)	0.0	0.0	0.0	0.0	0.0	0.0
Detector 1 Delay (s)	0.0	0.0	0.0	0.0	0.0	0.0
Detector 2 Position(m)			28.7			28.7
Detector 2 Size(m)			1.8			1.8
Detector 2 Type			Cl+Ex			Cl+Ex
Detector 2 Channel						
Detector 2 Extend (s)			0.0			0.0
Turn Type	Prot	Free	NA	pm+ov	pm+pt	NA
Protected Phases	8		2	8	1	6

1900/2000 City Park Drive
 22: Blair Road & Hwy 174 EB off

BG 2037 PM



Lane Group	WBL	WBR	NBT	NBR	SBL	SBT
Permitted Phases	Free		2		6	
Detector Phase	8		2	8	1	6
Switch Phase						
Minimum Initial (s)	5.0		10.0	5.0	5.0	1.0
Minimum Split (s)	25.3		30.5	25.3	11.0	30.5
Total Split (s)	30.0		52.0	30.0	28.0	80.0
Total Split (%)	27.3%		47.3%	27.3%	25.5%	72.7%
Maximum Green (s)	23.7		45.5	23.7	22.0	73.5
Yellow Time (s)	3.3		4.2	3.3	4.2	4.2
All-Red Time (s)	3.0		2.3	3.0	1.8	2.3
Lost Time Adjust (s)	0.0		0.0	0.0		0.0
Total Lost Time (s)	6.3		6.5	6.3		6.5
Lead/Lag			Lag		Lead	
Lead-Lag Optimize?			Yes		Yes	
Vehicle Extension (s)	3.0		3.0	3.0	3.0	3.0
Recall Mode	None		C-Max	None	Max	C-Max
Walk Time (s)	7.0		7.0	7.0		7.0
Flash Dont Walk (s)	12.0		17.0	12.0		17.0
Pedestrian Calls (#/hr)	0		0	0		0
Act Effct Green (s)	20.0	110.0	45.5	72.0		77.2
Actuated g/C Ratio	0.18	1.00	0.41	0.65		0.70
v/c Ratio	0.80	0.67	0.61	0.18		0.98
Control Delay	61.9	2.4	27.6	1.2		32.2
Queue Delay	0.0	0.0	0.0	0.0		0.0
Total Delay	61.9	2.4	27.6	1.2		32.2
LOS	E	A	C	A		C
Approach Delay	14.0		22.7			32.2
Approach LOS	B		C			C

Intersection Summary

Area Type: Other
 Cycle Length: 110
 Actuated Cycle Length: 110
 Offset: 32 (29%), Referenced to phase 2:NBT and 6:SBTL, Start of Green
 Natural Cycle: 150
 Control Type: Actuated-Coordinated
 Maximum v/c Ratio: 0.98
 Intersection Signal Delay: 23.7
 Intersection LOS: C
 Intersection Capacity Utilization 99.0%
 ICU Level of Service F
 Analysis Period (min) 15

Splits and Phases: 22: Blair Road & Hwy 174 EB off



1900/2000 City Park Drive

1630: Palmerston Drive/Matheson Road & Ogilvie Road

BG 2037 PM



Lane Group	EBL	EBT	EBR	WBL	WBT	WBR	NBL	NBT	NBR	SBL	SBT	SBR
Lane Configurations												
Traffic Volume (vph)	188	1711	61	94	1336	38	52	4	39	29	4	96
Future Volume (vph)	188	1711	61	94	1336	38	52	4	39	29	4	96
Ideal Flow (vphpl)	1800	1800	1800	1800	1800	1800	1800	1800	1800	1800	1800	1800
Storage Length (m)	70.0		0.0	70.0		0.0	15.0		0.0	0.0		35.0
Storage Lanes	1		0	1		0	1		0	0		1
Taper Length (m)	30.0			30.0			7.6			7.6		
Lane Util. Factor	1.00	0.95	0.95	1.00	0.95	0.95	1.00	1.00	1.00	1.00	1.00	1.00
Ped Bike Factor		1.00			1.00		0.98	0.98			0.99	0.99
Frt		0.995			0.996			0.864				0.850
Flt Protected	0.950			0.950			0.950				0.958	
Satd. Flow (prot)	1695	3362	0	1695	3369	0	1662	1476	0	0	1709	1517
Flt Permitted	0.129			0.072			0.736				0.721	
Satd. Flow (perm)	230	3362	0	128	3369	0	1267	1476	0	0	1274	1497
Right Turn on Red			Yes			Yes			Yes			Yes
Satd. Flow (RTOR)		4			3			39				96
Link Speed (k/h)		60			60			60				60
Link Distance (m)		314.1			264.5			176.2				174.1
Travel Time (s)		18.8			15.9			10.6				10.4
Confl. Peds. (#/hr)	24		34	34		24	16		11	11		
Confl. Bikes (#/hr)			11			22			3			1
Peak Hour Factor	1.00	1.00	1.00	1.00	1.00	1.00	1.00	1.00	1.00	1.00	1.00	1.00
Heavy Vehicles (%)	2%	2%	2%	2%	2%	2%	4%	4%	4%	2%	2%	2%
Adj. Flow (vph)	188	1711	61	94	1336	38	52	4	39	29	4	96
Shared Lane Traffic (%)												
Lane Group Flow (vph)	188	1772	0	94	1374	0	52	43	0	0	33	96
Enter Blocked Intersection	No	No	No	No	No	No	No	No	No	No	No	No
Lane Alignment	Left	Left	Right	Left	Left	Right	Left	Left	Right	Left	Left	Right
Median Width(m)		3.7			3.7			3.7				3.7
Link Offset(m)		0.0			0.0			0.0				0.0
Crosswalk Width(m)		4.9			4.9			4.9				4.9
Two way Left Turn Lane												
Headway Factor	1.06	1.06	1.06	1.06	1.06	1.06	1.06	1.06	1.06	1.06	1.06	1.06
Turning Speed (k/h)	24		14	24		14	24		14	24		14
Number of Detectors	1	2		1	2		1	2		1	2	1
Detector Template	Left	Thru		Left	Thru		Left	Thru		Left	Thru	Right
Leading Detector (m)	6.1	30.5		6.1	30.5		6.1	30.5		6.1	30.5	6.1
Trailing Detector (m)	0.0	0.0		0.0	0.0		0.0	0.0		0.0	0.0	0.0
Detector 1 Position(m)	0.0	0.0		0.0	0.0		0.0	0.0		0.0	0.0	0.0
Detector 1 Size(m)	6.1	1.8		6.1	1.8		6.1	1.8		6.1	1.8	6.1
Detector 1 Type	Cl+Ex	Cl+Ex		Cl+Ex	Cl+Ex		Cl+Ex	Cl+Ex		Cl+Ex	Cl+Ex	Cl+Ex
Detector 1 Channel												
Detector 1 Extend (s)	0.0	0.0		0.0	0.0		0.0	0.0		0.0	0.0	0.0
Detector 1 Queue (s)	0.0	0.0		0.0	0.0		0.0	0.0		0.0	0.0	0.0
Detector 1 Delay (s)	0.0	0.0		0.0	0.0		0.0	0.0		0.0	0.0	0.0
Detector 2 Position(m)		28.7			28.7			28.7				28.7
Detector 2 Size(m)		1.8			1.8			1.8				1.8
Detector 2 Type		Cl+Ex			Cl+Ex			Cl+Ex				Cl+Ex
Detector 2 Channel												

1900/2000 City Park Drive

1630: Palmerston Drive/Matheson Road & Ogilvie Road

BG 2037 PM



Lane Group	EBL	EBT	EBR	WBL	WBT	WBR	NBL	NBT	NBR	SBL	SBT	SBR
Detector 2 Extend (s)		0.0			0.0			0.0			0.0	
Turn Type	pm+pt	NA		pm+pt	NA		Perm	NA		Perm	NA	Perm
Protected Phases	5	2		1	6			8			4	
Permitted Phases	2			6			8			4		4
Detector Phase	5	2		1	6		8	8		4	4	4
Switch Phase												
Minimum Initial (s)	5.0	10.0		5.0	10.0		10.0	10.0		10.0	10.0	10.0
Minimum Split (s)	9.7	33.6		9.7	33.6		40.2	40.2		40.2	40.2	40.2
Total Split (s)	15.0	65.0		15.0	65.0		40.0	40.0		40.0	40.0	40.0
Total Split (%)	12.5%	54.2%		12.5%	54.2%		33.3%	33.3%		33.3%	33.3%	33.3%
Maximum Green (s)	10.3	59.4		10.3	59.4		32.8	32.8		32.8	32.8	32.8
Yellow Time (s)	3.7	3.7		3.7	3.7		3.0	3.0		3.0	3.0	3.0
All-Red Time (s)	1.0	1.9		1.0	1.9		4.2	4.2		4.2	4.2	4.2
Lost Time Adjust (s)	0.0	0.0		0.0	0.0		0.0	0.0			0.0	0.0
Total Lost Time (s)	4.7	5.6		4.7	5.6		7.2	7.2			7.2	7.2
Lead/Lag	Lead	Lag		Lead	Lag							
Lead-Lag Optimize?	Yes	Yes		Yes	Yes							
Vehicle Extension (s)	3.0	3.0		3.0	3.0		3.0	3.0		3.0	3.0	3.0
Recall Mode	None	C-Max		None	C-Max		None	None		None	None	None
Walk Time (s)		15.0			15.0		7.0	7.0		7.0	7.0	7.0
Flash Dont Walk (s)		13.0			13.0		26.0	26.0		26.0	26.0	26.0
Pedestrian Calls (#/hr)		25			25		10	10		10	10	10
Act Effct Green (s)	91.5	79.5		85.0	76.2		15.1	15.1			15.1	15.1
Actuated g/C Ratio	0.76	0.66		0.71	0.64		0.13	0.13			0.13	0.13
v/c Ratio	0.60	0.80		0.48	0.64		0.33	0.20			0.21	0.35
Control Delay	16.9	19.9		19.8	17.0		50.3	15.6			46.4	11.2
Queue Delay	0.0	0.0		0.0	0.0		0.0	0.0			0.0	0.0
Total Delay	16.9	19.9		19.8	17.0		50.3	15.6			46.4	11.2
LOS	B	B		B	B		D	B			D	B
Approach Delay		19.6			17.2			34.6			20.2	
Approach LOS		B			B			C			C	

Intersection Summary

Area Type: Other

Cycle Length: 120

Actuated Cycle Length: 120

Offset: 50 (42%), Referenced to phase 2:EBTL and 6:WBTL, Start of Green

Natural Cycle: 115

Control Type: Actuated-Coordinated

Maximum v/c Ratio: 0.80

Intersection Signal Delay: 19.1

Intersection LOS: B

Intersection Capacity Utilization 87.3%

ICU Level of Service E

Analysis Period (min) 15

Splits and Phases: 1630: Palmerston Drive/Matheson Road & Ogilvie Road

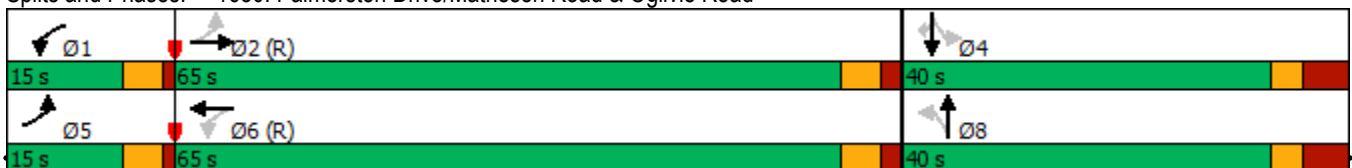

1900/2000 City Park Drive
3: Blair Road & Ogilvie Road

BG 2037 AM DR



Lane Group	EBL	EBT	EBR	WBL	WBT	WBR	NBL	NBT	NBR	SBL	SBT	SBR
Lane Configurations												
Traffic Volume (vph)	87	442	195	496	739	50	645	654	624	69	334	111
Future Volume (vph)	87	442	195	496	739	50	645	654	624	69	334	111
Ideal Flow (vphpl)	1800	1800	1800	1800	1800	1800	1800	1800	1800	1800	1800	1800
Storage Length (m)	70.0		0.0	110.0		0.0	120.0		0.0	30.0		0.0
Storage Lanes	1		1	2		0	2		1	1		0
Taper Length (m)	40.0			60.0			60.0			45.0		
Lane Util. Factor	1.00	0.95	1.00	0.97	0.95	0.95	0.97	1.00	1.00	1.00	0.95	0.95
Ped Bike Factor					1.00						0.99	
Frt			0.850		0.990				0.850		0.963	
Flt Protected	0.950			0.950			0.950			0.950		
Satd. Flow (prot)	1679	3357	1502	3257	3307	0	3257	1767	1502	1679	3190	0
Flt Permitted	0.950			0.950			0.950			0.950		
Satd. Flow (perm)	1679	3357	1502	3257	3307	0	3257	1767	1502	1679	3190	0
Right Turn on Red			Yes			Yes			Yes			Yes
Satd. Flow (RTOR)			195		5				427		30	
Link Speed (k/h)		60			60			60			60	
Link Distance (m)		372.0			396.5			239.9			411.0	
Travel Time (s)		22.3			23.8			14.4			24.7	
Confl. Peds. (#/hr)						25						27
Confl. Bikes (#/hr)						3						3
Peak Hour Factor	1.00	1.00	1.00	1.00	1.00	1.00	1.00	1.00	1.00	1.00	1.00	1.00
Heavy Vehicles (%)	3%	3%	3%	3%	3%	3%	3%	3%	3%	3%	3%	3%
Adj. Flow (vph)	87	442	195	496	739	50	645	654	624	69	334	111
Shared Lane Traffic (%)												
Lane Group Flow (vph)	87	442	195	496	789	0	645	654	624	69	445	0
Enter Blocked Intersection	No	No	No	No	No	No	No	No	No	No	No	No
Lane Alignment	Left	Left	Right	Left	Left	Right	Left	Left	Right	Left	Left	Right
Median Width(m)		7.4			7.4			7.4			7.4	
Link Offset(m)		0.0			0.0			0.0			0.0	
Crosswalk Width(m)		4.9			4.9			4.9			4.9	
Two way Left Turn Lane												
Headway Factor	1.06	1.06	1.06	1.06	1.06	1.06	1.06	1.06	1.06	1.06	1.06	1.06
Turning Speed (k/h)	24		14	24		14	24		14	24		14
Number of Detectors	1	2	1	1	2		1	2	1	1	2	
Detector Template	Left	Thru	Right	Left	Thru		Left	Thru	Right	Left	Thru	
Leading Detector (m)	6.1	30.5	6.1	6.1	30.5		6.1	30.5	6.1	6.1	30.5	
Trailing Detector (m)	0.0	0.0	0.0	0.0	0.0		0.0	0.0	0.0	0.0	0.0	
Detector 1 Position(m)	0.0	0.0	0.0	0.0	0.0		0.0	0.0	0.0	0.0	0.0	
Detector 1 Size(m)	6.1	1.8	6.1	6.1	1.8		6.1	1.8	6.1	6.1	1.8	
Detector 1 Type	Cl+Ex	Cl+Ex	Cl+Ex	Cl+Ex	Cl+Ex		Cl+Ex	Cl+Ex	Cl+Ex	Cl+Ex	Cl+Ex	
Detector 1 Channel												
Detector 1 Extend (s)	0.0	0.0	0.0	0.0	0.0		0.0	0.0	0.0	0.0	0.0	
Detector 1 Queue (s)	0.0	0.0	0.0	0.0	0.0		0.0	0.0	0.0	0.0	0.0	
Detector 1 Delay (s)	0.0	0.0	0.0	0.0	0.0		0.0	0.0	0.0	0.0	0.0	
Detector 2 Position(m)		28.7			28.7			28.7			28.7	
Detector 2 Size(m)		1.8			1.8			1.8			1.8	
Detector 2 Type		Cl+Ex			Cl+Ex			Cl+Ex			Cl+Ex	
Detector 2 Channel												

1900/2000 City Park Drive
3: Blair Road & Ogilvie Road

BG 2037 AM DR



Lane Group	EBL	EBT	EBR	WBL	WBT	WBR	NBL	NBT	NBR	SBL	SBT	SBR
Detector 2 Extend (s)		0.0			0.0			0.0			0.0	
Turn Type	Prot	NA	Perm	Prot	NA		Prot	NA	Perm	Prot	NA	
Protected Phases	5	2		1	6		3	8		7	4	
Permitted Phases			2						8			
Detector Phase	5	2	2	1	6		3	8	8	7	4	
Switch Phase												
Minimum Initial (s)	5.0	10.0	10.0	5.0	10.0		5.0	10.0	10.0	5.0	10.0	
Minimum Split (s)	11.8	38.6	38.6	11.8	38.6		11.5	35.5	35.5	11.5	35.5	
Total Split (s)	28.0	39.0	39.0	28.0	39.0		36.0	58.0	58.0	15.0	37.0	
Total Split (%)	20.0%	27.9%	27.9%	20.0%	27.9%		25.7%	41.4%	41.4%	10.7%	26.4%	
Maximum Green (s)	21.2	32.4	32.4	21.2	32.4		29.5	51.5	51.5	8.5	30.5	
Yellow Time (s)	3.7	3.3	3.3	3.7	3.3		4.2	4.2	4.2	4.2	4.2	
All-Red Time (s)	3.1	3.3	3.3	3.1	3.3		2.3	2.3	2.3	2.3	2.3	
Lost Time Adjust (s)	0.0	0.0	0.0	0.0	0.0		0.0	0.0	0.0	0.0	0.0	
Total Lost Time (s)	6.8	6.6	6.6	6.8	6.6		6.5	6.5	6.5	6.5	6.5	
Lead/Lag	Lead	Lag	Lag	Lead	Lag		Lead	Lag	Lag	Lead	Lag	
Lead-Lag Optimize?	Yes	Yes	Yes	Yes	Yes		Yes	Yes	Yes	Yes	Yes	
Vehicle Extension (s)	3.0	3.0	3.0	3.0	3.0		3.0	3.0	3.0	3.0	3.0	
Recall Mode	None	Max	Max	None	Max		None	None	None	None	None	
Walk Time (s)		7.0	7.0		7.0			7.0	7.0		7.0	
Flash Dont Walk (s)		25.0	25.0		25.0			22.0	22.0		22.0	
Pedestrian Calls (#/hr)		20	20		20			25	25		25	
Act Effct Green (s)	12.6	32.4	32.4	21.2	41.0		29.2	51.5	51.5	8.2	30.6	
Actuated g/C Ratio	0.09	0.23	0.23	0.15	0.29		0.21	0.37	0.37	0.06	0.22	
v/c Ratio	0.58	0.57	0.39	1.00	0.81		0.95	1.00	0.76	0.70	0.62	
Control Delay	75.4	50.9	8.1	100.0	53.5		78.5	80.2	18.2	99.2	50.2	
Queue Delay	0.0	0.0	0.0	0.0	0.0		0.0	0.0	0.0	0.0	0.0	
Total Delay	75.4	50.9	8.1	100.0	53.5		78.5	80.2	18.2	99.2	50.2	
LOS	E	D	A	F	D		E	F	B	F	D	
Approach Delay		42.3			71.4			59.5			56.8	
Approach LOS		D			E			E			E	

Intersection Summary

Area Type:	Other
Cycle Length:	140
Actuated Cycle Length:	139.7
Natural Cycle:	140
Control Type:	Semi Act-Uncoord
Maximum v/c Ratio:	1.00
Intersection Signal Delay:	59.8
Intersection LOS:	E
Intersection Capacity Utilization:	94.3%
ICU Level of Service:	F
Analysis Period (min):	15

Splits and Phases: 3: Blair Road & Ogilvie Road

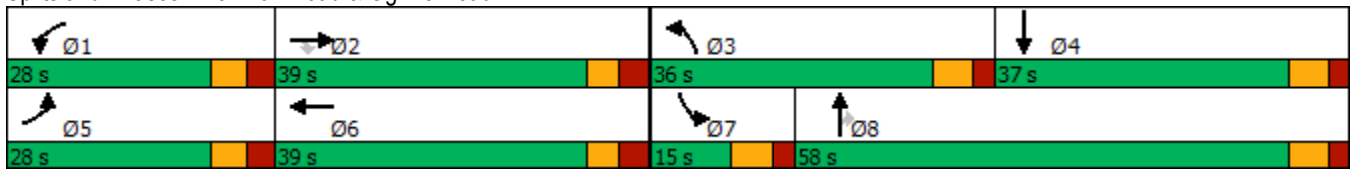

1900/2000 City Park Drive

6: Blair Road & 1980 Ogilvie Road/Hwy 174 WB off

BG 2037 AM DR



Lane Group	EBL	EBT	EBR	WBL	WBT	WBR	NBL	NBT	NBR	SBL	SBT	SBR
Lane Configurations	↘		↗	↘	↗	↗	↗↘	↗↘			↗↘↘	↗
Traffic Volume (vph)	87	0	371	115	150	303	281	1455	0	0	866	109
Future Volume (vph)	87	0	371	115	150	303	281	1455	0	0	866	109
Ideal Flow (vphpl)	1800	1800	1800	1800	1800	1800	1800	1800	1800	1800	1800	1800
Storage Length (m)	0.0		70.0	0.0		70.0	60.0		0.0	0.0		50.0
Storage Lanes	1		1	1		1	2		0	0		1
Taper Length (m)	7.6			7.6			100.0			7.6		
Lane Util. Factor	1.00	1.00	1.00	1.00	1.00	1.00	0.97	0.95	1.00	1.00	0.91	1.00
Frt			0.850			0.850						0.850
Flt Protected	0.950			0.950			0.950					
Satd. Flow (prot)	1340	0	1199	1695	1784	1517	3164	3262	0	0	4732	1473
Flt Permitted	0.662			0.950			0.950					
Satd. Flow (perm)	934	0	1199	1695	1784	1517	3164	3262	0	0	4732	1473
Right Turn on Red			Yes			Yes			Yes			Yes
Satd. Flow (RTOR)			34			104						111
Link Speed (k/h)		60			60			60				60
Link Distance (m)		518.9			416.4			90.2				239.9
Travel Time (s)		31.1			25.0			5.4				14.4
Peak Hour Factor	1.00	1.00	1.00	1.00	1.00	1.00	1.00	1.00	1.00	1.00	1.00	1.00
Heavy Vehicles (%)	29%	29%	29%	2%	2%	2%	6%	6%	6%	5%	5%	5%
Adj. Flow (vph)	87	0	371	115	150	303	281	1455	0	0	866	109
Shared Lane Traffic (%)												
Lane Group Flow (vph)	87	0	371	115	150	303	281	1455	0	0	866	109
Enter Blocked Intersection	No	No	No	No	No	No	No	No	No	No	No	No
Lane Alignment	Left	Left	Right	Left	Left	Right	Left	Left	Right	Left	Left	Right
Median Width(m)		3.7			3.7			7.4				7.4
Link Offset(m)		0.0			0.0			0.0				0.0
Crosswalk Width(m)		4.9			4.9			4.9				4.9
Two way Left Turn Lane												
Headway Factor	1.06	1.06	1.06	1.06	1.06	1.06	1.06	1.06	1.06	1.06	1.06	1.06
Turning Speed (k/h)	24		14	24		14	24		14	24		14
Number of Detectors	1		1	1	2	1	1	2				2
Detector Template	Left		Right	Left	Thru	Right	Left	Thru				Thru
Leading Detector (m)	6.1		6.1	6.1	30.5	6.1	6.1	30.5				30.5
Trailing Detector (m)	0.0		0.0	0.0	0.0	0.0	0.0	0.0				0.0
Detector 1 Position(m)	0.0		0.0	0.0	0.0	0.0	0.0	0.0				0.0
Detector 1 Size(m)	6.1		6.1	6.1	1.8	6.1	6.1	1.8				1.8
Detector 1 Type	Cl+Ex		Cl+Ex	Cl+Ex	Cl+Ex	Cl+Ex	Cl+Ex	Cl+Ex				Cl+Ex
Detector 1 Channel												
Detector 1 Extend (s)	0.0		0.0	0.0	0.0	0.0	0.0	0.0				0.0
Detector 1 Queue (s)	0.0		0.0	0.0	0.0	0.0	0.0	0.0				0.0
Detector 1 Delay (s)	0.0		0.0	0.0	0.0	0.0	0.0	0.0				0.0
Detector 2 Position(m)					28.7			28.7				28.7
Detector 2 Size(m)					1.8			1.8				1.8
Detector 2 Type					Cl+Ex			Cl+Ex				Cl+Ex
Detector 2 Channel												
Detector 2 Extend (s)					0.0			0.0				0.0
Turn Type	Perm		pm+ov	Perm	NA	Perm	Prot	NA				NA
Protected Phases			5		8		5	2				6

1900/2000 City Park Drive
 6: Blair Road & 1980 Ogilvie Road/Hwy 174 WB off

BG 2037 AM DR



Lane Group	EBL	EBT	EBR	WBL	WBT	WBR	NBL	NBT	NBR	SBL	SBT	SBR
Permitted Phases	4		4	8		8						6
Detector Phase	4		5	8	8	8	5	2			6	6
Switch Phase												
Minimum Initial (s)	10.0		5.0	10.0	10.0	10.0	5.0	10.0			10.0	10.0
Minimum Split (s)	16.8		11.4	36.8	36.8	36.8	11.4	30.1			30.1	30.1
Total Split (s)	41.0		27.0	41.0	41.0	41.0	27.0	59.0			32.0	32.0
Total Split (%)	41.0%		27.0%	41.0%	41.0%	41.0%	27.0%	59.0%			32.0%	32.0%
Maximum Green (s)	34.2		20.6	34.2	34.2	34.2	20.6	52.9			25.9	25.9
Yellow Time (s)	3.3		4.2	3.3	3.3	3.3	4.2	4.2			4.2	4.2
All-Red Time (s)	3.5		2.2	3.5	3.5	3.5	2.2	1.9			1.9	1.9
Lost Time Adjust (s)	0.0		0.0	0.0	0.0	0.0	0.0	0.0			0.0	0.0
Total Lost Time (s)	6.8		6.4	6.8	6.8	6.8	6.4	6.1			6.1	6.1
Lead/Lag			Lead				Lead				Lag	Lag
Lead-Lag Optimize?			Yes				Yes				Yes	Yes
Vehicle Extension (s)	3.0		3.0	3.0	3.0	3.0	3.0	3.0			3.0	3.0
Recall Mode	None		None	None	None	None	None	Max			Max	Max
Walk Time (s)				7.0	7.0	7.0		7.0			7.0	7.0
Flash Dont Walk (s)				23.0	23.0	23.0		17.0			17.0	17.0
Pedestrian Calls (#/hr)				20	20	20		20			20	20
Act Effct Green (s)	19.5		39.6	19.5	19.5	19.5	13.2	53.4			33.8	33.8
Actuated g/C Ratio	0.23		0.46	0.23	0.23	0.23	0.15	0.62			0.39	0.39
v/c Ratio	0.41		0.65	0.30	0.37	0.71	0.58	0.72			0.47	0.17
Control Delay	33.2		20.7	28.3	29.6	28.9	39.5	15.5			22.7	5.8
Queue Delay	0.0		0.0	0.0	0.0	0.0	0.0	0.0			0.0	0.0
Total Delay	33.2		20.7	28.3	29.6	28.9	39.5	15.5			22.7	5.8
LOS	C		C	C	C	C	D	B			C	A
Approach Delay		23.1			29.0			19.4			20.8	
Approach LOS		C			C			B			C	

Intersection Summary

Area Type: Other
 Cycle Length: 100
 Actuated Cycle Length: 86
 Natural Cycle: 80
 Control Type: Semi Act-Uncoord
 Maximum v/c Ratio: 0.72
 Intersection Signal Delay: 21.7
 Intersection LOS: C
 Intersection Capacity Utilization 81.4%
 ICU Level of Service D
 Analysis Period (min) 15

Splits and Phases: 6: Blair Road & 1980 Ogilvie Road/Hwy 174 WB off

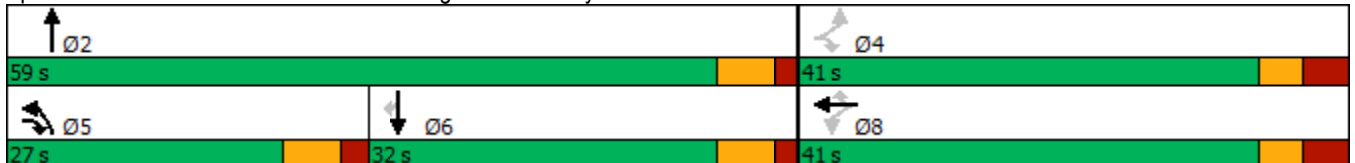

1900/2000 City Park Drive
 9: City Park Drive/1941 Ogilvie & Ogilvie Road

BG 2037 AM DR



Lane Group	EBL	EBT	EBR	WBL	WBT	WBR	NBL	NBT	NBR	SBL	SBT	SBR
Lane Configurations												
Traffic Volume (vph)	102	681	78	87	1023	174	59	23	61	5	2	9
Future Volume (vph)	102	681	78	87	1023	174	59	23	61	5	2	9
Ideal Flow (vphpl)	1800	1800	1800	1800	1800	1800	1800	1800	1800	1800	1800	1800
Storage Length (m)	40.0		100.0	100.0		50.0	0.0		60.0	20.0		10.0
Storage Lanes	1		1	1		1	0		1	1		1
Taper Length (m)	30.0			25.0			7.6			15.0		
Lane Util. Factor	1.00	0.95	1.00	1.00	0.95	1.00	1.00	1.00	1.00	1.00	1.00	1.00
Ped Bike Factor	0.97		0.87	0.96		0.81		0.96	0.93	0.95		
Frt			0.850			0.850			0.850			0.850
Flt Protected	0.950			0.950				0.965		0.950		
Satd. Flow (prot)	1695	3390	1517	1679	3357	1502	0	1626	1432	1695	1784	1517
Flt Permitted	0.243			0.378				0.786		0.704		
Satd. Flow (perm)	420	3390	1320	641	3357	1211	0	1269	1334	1193	1784	1517
Right Turn on Red			Yes			Yes			Yes			Yes
Satd. Flow (RTOR)			78			174			61			56
Link Speed (k/h)		60			60			60				60
Link Distance (m)		224.7			372.0			239.4				142.3
Travel Time (s)		13.5			22.3			14.4				8.5
Confl. Peds. (#/hr)	100		65	65		100	53		51	51		
Confl. Bikes (#/hr)						9			2			
Peak Hour Factor	1.00	1.00	1.00	1.00	1.00	1.00	1.00	1.00	1.00	1.00	1.00	1.00
Heavy Vehicles (%)	2%	2%	2%	3%	3%	3%	8%	8%	8%	2%	2%	2%
Adj. Flow (vph)	102	681	78	87	1023	174	59	23	61	5	2	9
Shared Lane Traffic (%)												
Lane Group Flow (vph)	102	681	78	87	1023	174	0	82	61	5	2	9
Enter Blocked Intersection	No	No	No	No	No	No	No	No	No	No	No	No
Lane Alignment	Left	Left	Right	Left	Left	Right	Left	Left	Right	Left	Left	Right
Median Width(m)		3.7			3.7			3.7				3.7
Link Offset(m)		0.0			0.0			0.0				0.0
Crosswalk Width(m)		4.9			4.9			4.9				4.9
Two way Left Turn Lane												
Headway Factor	1.06	1.06	1.06	1.06	1.06	1.06	1.06	1.06	1.06	1.06	1.06	1.06
Turning Speed (k/h)	24		14	24		14	24		14	24		14
Number of Detectors	1	2	1	1	2	1	1	2	1	1	2	1
Detector Template	Left	Thru	Right	Left	Thru	Right	Left	Thru	Right	Left	Thru	Right
Leading Detector (m)	6.1	30.5	6.1	6.1	30.5	6.1	6.1	30.5	6.1	6.1	30.5	6.1
Trailing Detector (m)	0.0	0.0	0.0	0.0	0.0	0.0	0.0	0.0	0.0	0.0	0.0	0.0
Detector 1 Position(m)	0.0	0.0	0.0	0.0	0.0	0.0	0.0	0.0	0.0	0.0	0.0	0.0
Detector 1 Size(m)	6.1	1.8	6.1	6.1	1.8	6.1	6.1	1.8	6.1	6.1	1.8	6.1
Detector 1 Type	Cl+Ex	Cl+Ex	Cl+Ex	Cl+Ex	Cl+Ex	Cl+Ex	Cl+Ex	Cl+Ex	Cl+Ex	Cl+Ex	Cl+Ex	Cl+Ex
Detector 1 Channel												
Detector 1 Extend (s)	0.0	0.0	0.0	0.0	0.0	0.0	0.0	0.0	0.0	0.0	0.0	0.0
Detector 1 Queue (s)	0.0	0.0	0.0	0.0	0.0	0.0	0.0	0.0	0.0	0.0	0.0	0.0
Detector 1 Delay (s)	0.0	0.0	0.0	0.0	0.0	0.0	0.0	0.0	0.0	0.0	0.0	0.0
Detector 2 Position(m)		28.7			28.7			28.7				28.7
Detector 2 Size(m)		1.8			1.8			1.8				1.8
Detector 2 Type		Cl+Ex			Cl+Ex			Cl+Ex				Cl+Ex
Detector 2 Channel												

Lane Group	Ø3	Ø7
Lane Configurations		
Traffic Volume (vph)		
Future Volume (vph)		
Ideal Flow (vphpl)		
Storage Length (m)		
Storage Lanes		
Taper Length (m)		
Lane Util. Factor		
Ped Bike Factor		
Frt		
Flt Protected		
Satd. Flow (prot)		
Flt Permitted		
Satd. Flow (perm)		
Right Turn on Red		
Satd. Flow (RTOR)		
Link Speed (k/h)		
Link Distance (m)		
Travel Time (s)		
Confl. Peds. (#/hr)		
Confl. Bikes (#/hr)		
Peak Hour Factor		
Heavy Vehicles (%)		
Adj. Flow (vph)		
Shared Lane Traffic (%)		
Lane Group Flow (vph)		
Enter Blocked Intersection		
Lane Alignment		
Median Width(m)		
Link Offset(m)		
Crosswalk Width(m)		
Two way Left Turn Lane		
Headway Factor		
Turning Speed (k/h)		
Number of Detectors		
Detector Template		
Leading Detector (m)		
Trailing Detector (m)		
Detector 1 Position(m)		
Detector 1 Size(m)		
Detector 1 Type		
Detector 1 Channel		
Detector 1 Extend (s)		
Detector 1 Queue (s)		
Detector 1 Delay (s)		
Detector 2 Position(m)		
Detector 2 Size(m)		
Detector 2 Type		
Detector 2 Channel		

1900/2000 City Park Drive
 9: City Park Drive/1941 Ogilvie & Ogilvie Road

BG 2037 AM DR



Lane Group	EBL	EBT	EBR	WBL	WBT	WBR	NBL	NBT	NBR	SBL	SBT	SBR
Detector 2 Extend (s)		0.0			0.0			0.0			0.0	
Turn Type	Perm	NA	Perm	Perm	NA	Perm	Perm	NA	Perm	Perm	NA	Perm
Protected Phases		2			6			8			4	
Permitted Phases	2		2	6		6	8		8	4		4
Detector Phase	2	2	2	6	6	6	8	8	8	4	4	4
Switch Phase												
Minimum Initial (s)	10.0	10.0	10.0	10.0	10.0	10.0	10.0	10.0	10.0	10.0	10.0	10.0
Minimum Split (s)	35.1	35.1	35.1	35.1	35.1	35.1	33.5	33.5	33.5	33.5	33.5	33.5
Total Split (s)	61.0	61.0	61.0	61.0	61.0	61.0	34.0	34.0	34.0	34.0	34.0	34.0
Total Split (%)	61.0%	61.0%	61.0%	61.0%	61.0%	61.0%	34.0%	34.0%	34.0%	34.0%	34.0%	34.0%
Maximum Green (s)	54.9	54.9	54.9	54.9	54.9	54.9	27.5	27.5	27.5	27.5	27.5	27.5
Yellow Time (s)	3.7	3.7	3.7	3.7	3.7	3.7	3.3	3.3	3.3	3.3	3.3	3.3
All-Red Time (s)	2.4	2.4	2.4	2.4	2.4	2.4	3.2	3.2	3.2	3.2	3.2	3.2
Lost Time Adjust (s)	0.0	0.0	0.0	0.0	0.0	0.0		0.0	0.0	0.0	0.0	0.0
Total Lost Time (s)	6.1	6.1	6.1	6.1	6.1	6.1		6.5	6.5	6.5	6.5	6.5
Lead/Lag							Lag	Lag	Lag	Lag	Lag	Lag
Lead-Lag Optimize?							Yes	Yes	Yes	Yes	Yes	Yes
Vehicle Extension (s)	3.0	3.0	3.0	3.0	3.0	3.0	3.0	3.0	3.0	3.0	3.0	3.0
Recall Mode	C-Max	C-Max	C-Max	C-Max	C-Max	C-Max	None	None	None	None	None	None
Walk Time (s)	7.0	7.0	7.0	7.0	7.0	7.0	2.0	2.0	2.0	2.0	2.0	2.0
Flash Dont Walk (s)	22.0	22.0	22.0	22.0	22.0	22.0	25.0	25.0	25.0	25.0	25.0	25.0
Pedestrian Calls (#/hr)	35	35	35	35	35	35	35	35	35	35	35	35
Act Effct Green (s)	68.7	68.7	68.7	68.7	68.7	68.7		20.2	20.2	20.2	20.2	20.2
Actuated g/C Ratio	0.69	0.69	0.69	0.69	0.69	0.69		0.20	0.20	0.20	0.20	0.20
v/c Ratio	0.35	0.29	0.08	0.20	0.44	0.20		0.32	0.19	0.02	0.01	0.03
Control Delay	8.1	2.9	0.3	11.7	11.4	2.3		34.8	9.1	27.2	27.0	0.1
Queue Delay	0.0	0.0	0.0	0.0	0.0	0.0		0.0	0.0	0.0	0.0	0.0
Total Delay	8.1	2.9	0.3	11.7	11.4	2.3		34.8	9.1	27.2	27.0	0.1
LOS	A	A	A	B	B	A		C	A	C	C	A
Approach Delay		3.3			10.2			23.8			11.9	
Approach LOS		A			B			C			B	

Intersection Summary

Area Type: Other
 Cycle Length: 100
 Actuated Cycle Length: 100
 Offset: 13 (13%), Referenced to phase 2:EBTL and 6:WBTL, Start of Green
 Natural Cycle: 80
 Control Type: Actuated-Coordinated
 Maximum v/c Ratio: 0.44
 Intersection Signal Delay: 8.5
 Intersection LOS: A
 Intersection Capacity Utilization 74.2%
 ICU Level of Service D
 Analysis Period (min) 15

Splits and Phases: 9: City Park Drive/1941 Ogilvie & Ogilvie Road

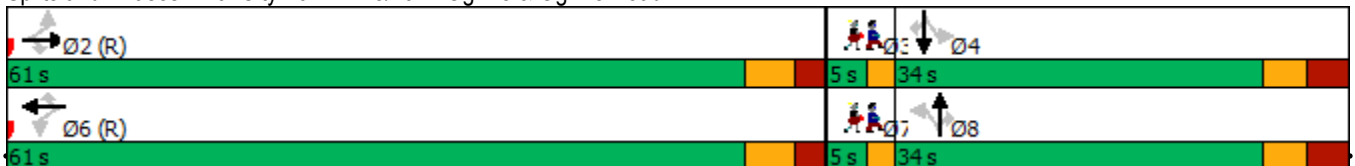

Lane Group	Ø3	Ø7
Detector 2 Extend (s)		
Turn Type		
Protected Phases	3	7
Permitted Phases		
Detector Phase		
Switch Phase		
Minimum Initial (s)	1.0	1.0
Minimum Split (s)	5.0	5.0
Total Split (s)	5.0	5.0
Total Split (%)	5%	5%
Maximum Green (s)	3.0	3.0
Yellow Time (s)	2.0	2.0
All-Red Time (s)	0.0	0.0
Lost Time Adjust (s)		
Total Lost Time (s)		
Lead/Lag	Lead	Lead
Lead-Lag Optimize?	Yes	Yes
Vehicle Extension (s)	3.0	3.0
Recall Mode	None	None
Walk Time (s)	0.0	0.0
Flash Dont Walk (s)	0.0	0.0
Pedestrian Calls (#/hr)	35	35
Act Effct Green (s)		
Actuated g/C Ratio		
v/c Ratio		
Control Delay		
Queue Delay		
Total Delay		
LOS		
Approach Delay		
Approach LOS		
Intersection Summary		

1900/2000 City Park Drive

12: 1900 Ogilvie Road/1929 Ogilvie Road & Ogilvie Road

BG 2037 AM DR



Lane Group	EBL	EBT	EBR	WBL	WBT	WBR	NBL	NBT	NBR	SBL	SBT	SBR
Lane Configurations												
Traffic Volume (vph)	99	832	27	19	1151	44	9	1	12	42	11	63
Future Volume (vph)	99	832	27	19	1151	44	9	1	12	42	11	63
Ideal Flow (vphpl)	1800	1800	1800	1800	1800	1800	1800	1800	1800	1800	1800	1800
Storage Length (m)	60.0		80.0	90.0		0.0	0.0		0.0	0.0		0.0
Storage Lanes	1		1	1		0	1		0	0		1
Taper Length (m)	30.0			20.0			7.6			7.6		
Lane Util. Factor	1.00	0.95	1.00	1.00	0.95	0.95	1.00	1.00	1.00	1.00	1.00	1.00
Ped Bike Factor	0.99		0.95	0.99	1.00		0.96	0.95			0.96	0.94
Fr _t			0.850		0.994			0.862				0.850
Fl _t Protected	0.950			0.950			0.950				0.962	
Satd. Flow (prot)	1695	3390	1517	1679	3324	0	1695	1454	0	0	1717	1517
Fl _t Permitted	0.195			0.316			0.722				0.774	
Satd. Flow (perm)	344	3390	1434	553	3324	0	1232	1454	0	0	1329	1429
Right Turn on Red			Yes			Yes			Yes			Yes
Satd. Flow (RTOR)			40		6			12				61
Link Speed (k/h)		60			60			60				60
Link Distance (m)		190.5			224.7			86.0				56.6
Travel Time (s)		11.4			13.5			5.2				3.4
Confl. Peds. (#/hr)	41		17	17		41	47		48	48		47
Peak Hour Factor	1.00	1.00	1.00	1.00	1.00	1.00	1.00	1.00	1.00	1.00	1.00	1.00
Heavy Vehicles (%)	2%	2%	2%	3%	3%	3%	2%	2%	2%	2%	2%	2%
Adj. Flow (vph)	99	832	27	19	1151	44	9	1	12	42	11	63
Shared Lane Traffic (%)												
Lane Group Flow (vph)	99	832	27	19	1195	0	9	13	0	0	53	63
Enter Blocked Intersection	No	No	No	No	No	No	No	No	No	No	No	No
Lane Alignment	Left	Left	Right	Left	Left	Right	Left	Left	Right	Left	Left	Right
Median Width(m)		3.7			3.7			3.7				3.7
Link Offset(m)		0.0			0.0			0.0				0.0
Crosswalk Width(m)		4.9			4.9			4.9				4.9
Two way Left Turn Lane												
Headway Factor	1.06	1.06	1.06	1.06	1.06	1.06	1.06	1.06	1.06	1.06	1.06	1.06
Turning Speed (k/h)	24		14	24		14	24		14	24		14
Number of Detectors	1	2	1	1	2		1	2		1	2	1
Detector Template	Left	Thru	Right	Left	Thru		Left	Thru		Left	Thru	Right
Leading Detector (m)	6.1	30.5	6.1	6.1	30.5		6.1	30.5		6.1	30.5	6.1
Trailing Detector (m)	0.0	0.0	0.0	0.0	0.0		0.0	0.0		0.0	0.0	0.0
Detector 1 Position(m)	0.0	0.0	0.0	0.0	0.0		0.0	0.0		0.0	0.0	0.0
Detector 1 Size(m)	6.1	1.8	6.1	6.1	1.8		6.1	1.8		6.1	1.8	6.1
Detector 1 Type	Cl+Ex	Cl+Ex	Cl+Ex	Cl+Ex	Cl+Ex		Cl+Ex	Cl+Ex		Cl+Ex	Cl+Ex	Cl+Ex
Detector 1 Channel												
Detector 1 Extend (s)	0.0	0.0	0.0	0.0	0.0		0.0	0.0		0.0	0.0	0.0
Detector 1 Queue (s)	0.0	0.0	0.0	0.0	0.0		0.0	0.0		0.0	0.0	0.0
Detector 1 Delay (s)	0.0	0.0	0.0	0.0	0.0		0.0	0.0		0.0	0.0	0.0
Detector 2 Position(m)		28.7			28.7			28.7				28.7
Detector 2 Size(m)		1.8			1.8			1.8				1.8
Detector 2 Type		Cl+Ex			Cl+Ex			Cl+Ex				Cl+Ex
Detector 2 Channel												
Detector 2 Extend (s)		0.0			0.0			0.0				0.0

1900/2000 City Park Drive

12: 1900 Ogilvie Road/1929 Ogilvie Road & Ogilvie Road

BG 2037 AM DR



Lane Group	EBL	EBT	EBR	WBL	WBT	WBR	NBL	NBT	NBR	SBL	SBT	SBR
Turn Type	Perm	NA	Perm	Perm	NA		Perm	NA		Perm	NA	Perm
Protected Phases		2			6			8			4	
Permitted Phases	2		2	6			8			4		4
Detector Phase	2	2	2	6	6		8	8		4	4	4
Switch Phase												
Minimum Initial (s)	10.0	10.0	10.0	10.0	10.0		10.0	10.0		10.0	10.0	10.0
Minimum Split (s)	29.9	29.9	29.9	29.9	29.9		36.7	36.7		36.7	36.7	36.7
Total Split (s)	63.0	63.0	63.0	63.0	63.0		37.0	37.0		37.0	37.0	37.0
Total Split (%)	63.0%	63.0%	63.0%	63.0%	63.0%		37.0%	37.0%		37.0%	37.0%	37.0%
Maximum Green (s)	57.1	57.1	57.1	57.1	57.1		30.3	30.3		30.3	30.3	30.3
Yellow Time (s)	3.7	3.7	3.7	3.7	3.7		3.3	3.3		3.3	3.3	3.3
All-Red Time (s)	2.2	2.2	2.2	2.2	2.2		3.4	3.4		3.4	3.4	3.4
Lost Time Adjust (s)	0.0	0.0	0.0	0.0	0.0		0.0	0.0		0.0	0.0	0.0
Total Lost Time (s)	5.9	5.9	5.9	5.9	5.9		6.7	6.7		6.7	6.7	6.7
Lead/Lag												
Lead-Lag Optimize?												
Vehicle Extension (s)	3.0	3.0	3.0	3.0	3.0		3.0	3.0		3.0	3.0	3.0
Recall Mode	C-Max	C-Max	C-Max	C-Max	C-Max		None	None		None	None	None
Walk Time (s)	11.0	11.0	11.0	11.0	11.0		7.0	7.0		7.0	7.0	7.0
Flash Dont Walk (s)	13.0	13.0	13.0	13.0	13.0		23.0	23.0		23.0	23.0	23.0
Pedestrian Calls (#/hr)	10	10	10	10	10		30	30		30	30	30
Act Effct Green (s)	69.9	69.9	69.9	69.9	69.9		22.0	22.0		22.0	22.0	22.0
Actuated g/C Ratio	0.70	0.70	0.70	0.70	0.70		0.22	0.22		0.22	0.22	0.22
v/c Ratio	0.41	0.35	0.03	0.05	0.51		0.03	0.04		0.18	0.17	0.17
Control Delay	17.1	8.5	1.6	5.7	5.5		25.2	13.3		29.3	8.5	8.5
Queue Delay	0.0	0.0	0.0	0.0	0.0		0.0	0.0		0.0	0.0	0.0
Total Delay	17.1	8.5	1.6	5.7	5.5		25.2	13.3		29.3	8.5	8.5
LOS	B	A	A	A	A		C	B		C	A	A
Approach Delay		9.2			5.5			18.2			18.0	
Approach LOS		A			A			B			B	

Intersection Summary

Area Type:	Other
Cycle Length:	100
Actuated Cycle Length:	100
Offset:	12 (12%), Referenced to phase 2:EBTL and 6:WBTL, Start of Green
Natural Cycle:	80
Control Type:	Actuated-Coordinated
Maximum v/c Ratio:	0.51
Intersection Signal Delay:	7.8
Intersection LOS:	A
Intersection Capacity Utilization:	94.4%
ICU Level of Service:	F
Analysis Period (min):	15

Splits and Phases: 12: 1900 Ogilvie Road/1929 Ogilvie Road & Ogilvie Road

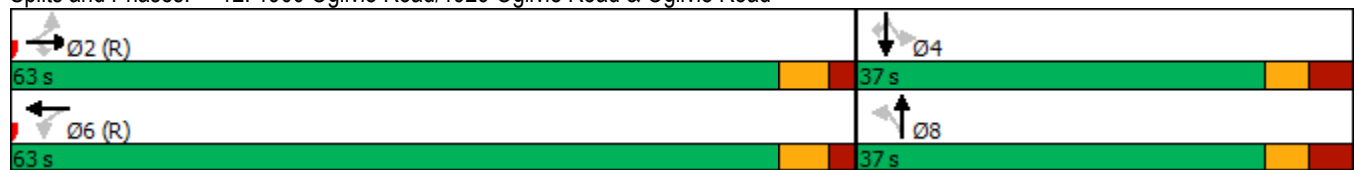

1900/2000 City Park Drive
 15: City Park Drive/Bathgate Drive & Ogilvie Road

BG 2037 AM DR



Lane Group	EBL	EBT	EBR	WBL	WBT	WBR	NBL	NBT	NBR	SBL	SBT	SBR
Lane Configurations												
Traffic Volume (vph)	156	598	88	14	981	161	86	38	13	119	27	178
Future Volume (vph)	156	598	88	14	981	161	86	38	13	119	27	178
Ideal Flow (vphpl)	1800	1800	1800	1800	1800	1800	1800	1800	1800	1800	1800	1800
Storage Length (m)	70.0		40.0	45.0		70.0	30.0		0.0	20.0		0.0
Storage Lanes	1		1	1		1	1		0	1		0
Taper Length (m)	30.0			30.0			25.0			25.0		
Lane Util. Factor	1.00	0.95	1.00	1.00	0.95	1.00	1.00	1.00	1.00	1.00	1.00	1.00
Ped Bike Factor	0.99		0.92	0.98		0.89	0.99	0.99		0.98	0.98	
Frt			0.850			0.850		0.962			0.870	
Flt Protected	0.950			0.950			0.950			0.950		
Satd. Flow (prot)	1679	3357	1502	1679	3357	1502	1631	1637	0	1647	1474	0
Flt Permitted	0.179			0.426			0.629			0.603		
Satd. Flow (perm)	312	3357	1389	737	3357	1340	1069	1637	0	1023	1474	0
Right Turn on Red			Yes			Yes			Yes			Yes
Satd. Flow (RTOR)			121			161		13			178	
Link Speed (k/h)		60			60			60			60	
Link Distance (m)		257.6			190.5			345.6			177.6	
Travel Time (s)		15.5			11.4			20.7			10.7	
Confl. Peds. (#/hr)	43		27	27		43	14		23	23		14
Peak Hour Factor	1.00	1.00	1.00	1.00	1.00	1.00	1.00	1.00	1.00	1.00	1.00	1.00
Heavy Vehicles (%)	3%	3%	3%	3%	3%	3%	6%	6%	6%	5%	5%	5%
Adj. Flow (vph)	156	598	88	14	981	161	86	38	13	119	27	178
Shared Lane Traffic (%)												
Lane Group Flow (vph)	156	598	88	14	981	161	86	51	0	119	205	0
Enter Blocked Intersection	No	No	No	No	No	No	No	No	No	No	No	No
Lane Alignment	Left	Left	Right	Left	Left	Right	Left	Left	Right	Left	Left	Right
Median Width(m)		3.7			3.7			3.7			3.7	
Link Offset(m)		0.0			0.0			0.0			0.0	
Crosswalk Width(m)		4.9			4.9			4.9			4.9	
Two way Left Turn Lane												
Headway Factor	1.06	1.06	1.06	1.06	1.06	1.06	1.06	1.06	1.06	1.06	1.06	1.06
Turning Speed (k/h)	24		14	24		14	24		14	24		14
Number of Detectors	1	2	1	1	2	1	1	2		1	2	
Detector Template	Left	Thru	Right	Left	Thru	Right	Left	Thru		Left	Thru	
Leading Detector (m)	6.1	30.5	6.1	6.1	30.5	6.1	6.1	30.5		6.1	30.5	
Trailing Detector (m)	0.0	0.0	0.0	0.0	0.0	0.0	0.0	0.0		0.0	0.0	
Detector 1 Position(m)	0.0	0.0	0.0	0.0	0.0	0.0	0.0	0.0		0.0	0.0	
Detector 1 Size(m)	6.1	1.8	6.1	6.1	1.8	6.1	6.1	1.8		6.1	1.8	
Detector 1 Type	Cl+Ex	Cl+Ex	Cl+Ex	Cl+Ex	Cl+Ex	Cl+Ex	Cl+Ex	Cl+Ex		Cl+Ex	Cl+Ex	
Detector 1 Channel												
Detector 1 Extend (s)	0.0	0.0	0.0	0.0	0.0	0.0	0.0	0.0		0.0	0.0	
Detector 1 Queue (s)	0.0	0.0	0.0	0.0	0.0	0.0	0.0	0.0		0.0	0.0	
Detector 1 Delay (s)	0.0	0.0	0.0	0.0	0.0	0.0	0.0	0.0		0.0	0.0	
Detector 2 Position(m)		28.7			28.7			28.7			28.7	
Detector 2 Size(m)		1.8			1.8			1.8			1.8	
Detector 2 Type		Cl+Ex			Cl+Ex			Cl+Ex			Cl+Ex	
Detector 2 Channel												
Detector 2 Extend (s)		0.0			0.0			0.0			0.0	

Lane Group	Ø3	Ø7
Lane Configurations		
Traffic Volume (vph)		
Future Volume (vph)		
Ideal Flow (vphpl)		
Storage Length (m)		
Storage Lanes		
Taper Length (m)		
Lane Util. Factor		
Ped Bike Factor		
Frt		
Flt Protected		
Satd. Flow (prot)		
Flt Permitted		
Satd. Flow (perm)		
Right Turn on Red		
Satd. Flow (RTOR)		
Link Speed (k/h)		
Link Distance (m)		
Travel Time (s)		
Confl. Peds. (#/hr)		
Peak Hour Factor		
Heavy Vehicles (%)		
Adj. Flow (vph)		
Shared Lane Traffic (%)		
Lane Group Flow (vph)		
Enter Blocked Intersection		
Lane Alignment		
Median Width(m)		
Link Offset(m)		
Crosswalk Width(m)		
Two way Left Turn Lane		
Headway Factor		
Turning Speed (k/h)		
Number of Detectors		
Detector Template		
Leading Detector (m)		
Trailing Detector (m)		
Detector 1 Position(m)		
Detector 1 Size(m)		
Detector 1 Type		
Detector 1 Channel		
Detector 1 Extend (s)		
Detector 1 Queue (s)		
Detector 1 Delay (s)		
Detector 2 Position(m)		
Detector 2 Size(m)		
Detector 2 Type		
Detector 2 Channel		
Detector 2 Extend (s)		

1900/2000 City Park Drive
 15: City Park Drive/Bathgate Drive & Ogilvie Road

BG 2037 AM DR



Lane Group	EBL	EBT	EBR	WBL	WBT	WBR	NBL	NBT	NBR	SBL	SBT	SBR
Turn Type	pm+pt	NA	Perm	pm+pt	NA	Perm	Perm	NA		Perm	NA	
Protected Phases	5	2		1	6			8			4	
Permitted Phases	2		2	6		6	8			4		
Detector Phase	5	2	2	1	6	6	8	8		4	4	
Switch Phase												
Minimum Initial (s)	5.0	10.0	10.0	5.0	10.0	10.0	10.0	10.0		10.0	10.0	
Minimum Split (s)	9.7	30.0	30.0	9.7	30.0	30.0	37.4	37.4		37.4	37.4	
Total Split (s)	15.0	42.0	42.0	15.0	42.0	42.0	38.0	38.0		38.0	38.0	
Total Split (%)	15.0%	42.0%	42.0%	15.0%	42.0%	42.0%	38.0%	38.0%		38.0%	38.0%	
Maximum Green (s)	10.3	36.0	36.0	10.3	36.0	36.0	30.6	30.6		30.6	30.6	
Yellow Time (s)	3.7	3.7	3.7	3.7	3.7	3.7	3.0	3.0		3.0	3.0	
All-Red Time (s)	1.0	2.3	2.3	1.0	2.3	2.3	4.4	4.4		4.4	4.4	
Lost Time Adjust (s)	0.0	0.0	0.0	0.0	0.0	0.0	0.0	0.0		0.0	0.0	
Total Lost Time (s)	4.7	6.0	6.0	4.7	6.0	6.0	7.4	7.4		7.4	7.4	
Lead/Lag	Lead	Lag	Lag	Lead	Lag	Lag	Lag	Lag		Lag	Lag	
Lead-Lag Optimize?	Yes	Yes	Yes	Yes	Yes	Yes	Yes	Yes		Yes	Yes	
Vehicle Extension (s)	3.0	3.0	3.0	3.0	3.0	3.0	3.0	3.0		3.0	3.0	
Recall Mode	None	C-Max	C-Max	None	C-Max	C-Max	None	None		None	None	
Walk Time (s)		9.0	9.0		9.0	9.0	2.0	2.0		2.0	2.0	
Flash Dont Walk (s)		15.0	15.0		15.0	15.0	28.0	28.0		28.0	28.0	
Pedestrian Calls (#/hr)		15	15		15	15	15	15		15	15	
Act Effct Green (s)	63.3	59.9	59.9	55.7	48.5	48.5	19.5	19.5		19.5	19.5	
Actuated g/C Ratio	0.63	0.60	0.60	0.56	0.48	0.48	0.20	0.20		0.20	0.20	
v/c Ratio	0.49	0.30	0.10	0.03	0.60	0.22	0.42	0.16		0.60	0.48	
Control Delay	25.7	21.4	10.1	6.1	12.4	1.2	38.5	24.0		47.2	10.2	
Queue Delay	0.0	0.0	0.0	0.0	0.0	0.0	0.0	0.0		0.0	0.0	
Total Delay	25.7	21.4	10.1	6.1	12.4	1.2	38.5	24.0		47.2	10.2	
LOS	C	C	B	A	B	A	D	C		D	B	
Approach Delay		21.0			10.8			33.1			23.8	
Approach LOS		C			B			C			C	

Intersection Summary

Area Type: Other
 Cycle Length: 100
 Actuated Cycle Length: 100
 Offset: 29 (29%), Referenced to phase 2:EBTL and 6:WBTL, Start of Green
 Natural Cycle: 85
 Control Type: Actuated-Coordinated
 Maximum v/c Ratio: 0.60
 Intersection Signal Delay: 17.2
 Intersection LOS: B
 Intersection Capacity Utilization 85.6%
 ICU Level of Service E
 Analysis Period (min) 15

Splits and Phases: 15: City Park Drive/Bathgate Drive & Ogilvie Road

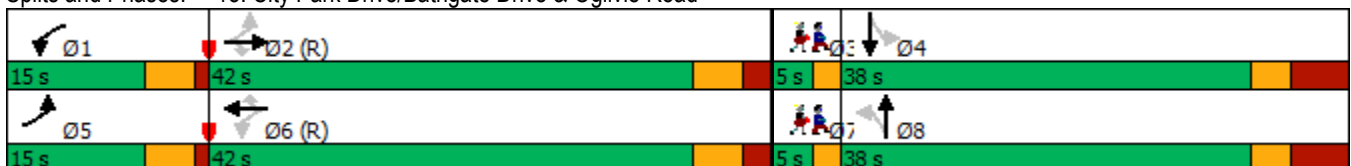

Lane Group	Ø3	Ø7
Turn Type		
Protected Phases	3	7
Permitted Phases		
Detector Phase		
Switch Phase		
Minimum Initial (s)	1.0	1.0
Minimum Split (s)	5.0	5.0
Total Split (s)	5.0	5.0
Total Split (%)	5%	5%
Maximum Green (s)	3.0	3.0
Yellow Time (s)	2.0	2.0
All-Red Time (s)	0.0	0.0
Lost Time Adjust (s)		
Total Lost Time (s)		
Lead/Lag	Lead	Lead
Lead-Lag Optimize?	Yes	Yes
Vehicle Extension (s)	3.0	3.0
Recall Mode	Ped	Ped
Walk Time (s)	0.0	0.0
Flash Dont Walk (s)	0.0	0.0
Pedestrian Calls (#/hr)	15	15
Act Effct Green (s)		
Actuated g/C Ratio		
v/c Ratio		
Control Delay		
Queue Delay		
Total Delay		
LOS		
Approach Delay		
Approach LOS		
Intersection Summary		

1900/2000 City Park Drive
 18: Residential/Cadboro Road & Ogilvie Road

BG 2037 AM DR



Lane Group	EBL	EBT	EBR	WBL	WBT	WBR	NBL	NBT	NBR	SBL	SBT	SBR
Lane Configurations		↑↓			↑↓				↑			↑
Traffic Volume (vph)	0	1216	9	0	1271	57	0	0	6	0	0	21
Future Volume (vph)	0	1216	9	0	1271	57	0	0	6	0	0	21
Ideal Flow (vphpl)	1800	1800	1800	1800	1800	1800	1800	1800	1800	1800	1800	1800
Lane Util. Factor	1.00	0.95	0.95	1.00	0.95	0.95	1.00	1.00	1.00	1.00	1.00	1.00
Fr _t		0.999			0.994				0.865			0.865
Fl _t Protected												
Satd. Flow (prot)	0	3387	0	0	3370	0	0	0	1543	0	0	1543
Fl _t Permitted												
Satd. Flow (perm)	0	3387	0	0	3370	0	0	0	1543	0	0	1543
Right Turn on Red			Yes			Yes			Yes			Yes
Satd. Flow (RTOR)		1			7				53			46
Link Speed (k/h)		60			60			60				60
Link Distance (m)		264.5			257.6			90.1				116.1
Travel Time (s)		15.9			15.5			5.4				7.0
Peak Hour Factor	1.00	1.00	1.00	1.00	1.00	1.00	1.00	1.00	1.00	1.00	1.00	1.00
Adj. Flow (vph)	0	1216	9	0	1271	57	0	0	6	0	0	21
Shared Lane Traffic (%)												
Lane Group Flow (vph)	0	1225	0	0	1328	0	0	0	6	0	0	21
Enter Blocked Intersection	No	No	No	No	No	No	No	No	No	No	No	No
Lane Alignment	Left	Left	Right	Left	Left	Right	Left	Left	Right	Left	Left	Right
Median Width(m)		3.7			3.7			0.0				0.0
Link Offset(m)		0.0			0.0			0.0				0.0
Crosswalk Width(m)		1.6			1.6			1.6				1.6
Two way Left Turn Lane												
Headway Factor	1.06	1.06	1.06	1.06	1.06	1.06	1.06	1.06	1.06	1.06	1.06	1.06
Turning Speed (k/h)	24		14	24		14	24		14	24		14
Number of Detectors		2			2				1			1
Detector Template		Thru			Thru				Right			Right
Leading Detector (m)		10.0			10.0				2.0			2.0
Trailing Detector (m)		0.0			0.0				0.0			0.0
Detector 1 Position(m)		0.0			0.0				0.0			0.0
Detector 1 Size(m)		0.6			0.6				2.0			2.0
Detector 1 Type		Cl+Ex			Cl+Ex				Cl+Ex			Cl+Ex
Detector 1 Channel												
Detector 1 Extend (s)		0.0			0.0				0.0			0.0
Detector 1 Queue (s)		0.0			0.0				0.0			0.0
Detector 1 Delay (s)		0.0			0.0				0.0			0.0
Detector 2 Position(m)		9.4			9.4							
Detector 2 Size(m)		0.6			0.6							
Detector 2 Type		Cl+Ex			Cl+Ex							
Detector 2 Channel												
Detector 2 Extend (s)		0.0			0.0							
Turn Type		NA			NA				Perm			Perm
Protected Phases		2			6							
Permitted Phases									8			4
Detector Phase		2			6				8			4
Switch Phase												
Minimum Initial (s)		10.0			10.0				5.0			5.0

1900/2000 City Park Drive
 18: Residential/Cadboro Road & Ogilvie Road

BG 2037 AM DR



Lane Group	EBL	EBT	EBR	WBL	WBT	WBR	NBL	NBT	NBR	SBL	SBT	SBR
Minimum Split (s)		35.0			35.0				40.0			40.0
Total Split (s)		60.0			60.0				40.0			40.0
Total Split (%)		60.0%			60.0%				40.0%			40.0%
Maximum Green (s)		54.0			54.0				36.0			36.0
Yellow Time (s)		3.7			3.7				3.0			3.0
All-Red Time (s)		2.3			2.3				1.0			1.0
Lost Time Adjust (s)		0.0			0.0				0.0			0.0
Total Lost Time (s)		6.0			6.0				4.0			4.0
Lead/Lag												
Lead-Lag Optimize?												
Vehicle Extension (s)		3.0			3.0				3.0			3.0
Recall Mode		C-Max			C-Max				None			None
Walk Time (s)		15.0			15.0				24.0			24.0
Flash Dont Walk (s)		14.0			14.0				12.0			12.0
Pedestrian Calls (#/hr)		20			20				15			15
Act Effct Green (s)		78.5			78.5				17.7			17.7
Actuated g/C Ratio		0.78			0.78				0.18			0.18
v/c Ratio		0.46			0.50				0.02			0.07
Control Delay		7.0			4.4				0.2			2.1
Queue Delay		0.0			0.0				0.0			0.0
Total Delay		7.0			4.4				0.2			2.1
LOS		A			A				A			A
Approach Delay		7.0			4.4			0.2			2.1	
Approach LOS		A			A			A			A	

Intersection Summary

Area Type:	Other
Cycle Length:	100
Actuated Cycle Length:	100
Offset:	42 (42%), Referenced to phase 2:EBT and 6:WBT, Start of Green
Natural Cycle:	80
Control Type:	Actuated-Coordinated
Maximum v/c Ratio:	0.50
Intersection Signal Delay:	5.6
Intersection LOS:	A
Intersection Capacity Utilization:	51.5%
ICU Level of Service:	A
Analysis Period (min):	15

Splits and Phases: 18: Residential/Cadboro Road & Ogilvie Road

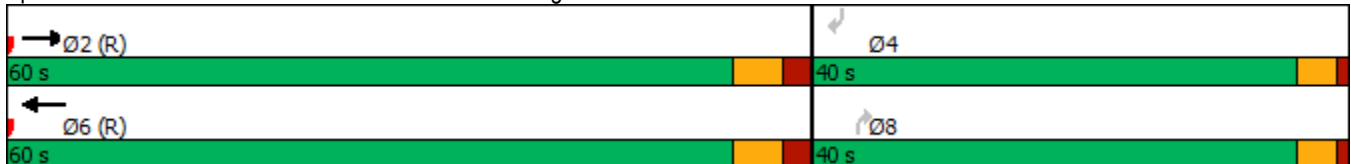

1900/2000 City Park Drive
 22: Blair Road & Hwy 174 EB off

BG 2037 AM DR



Lane Group	WBL	WBR	NBT	NBR	SBL	SBT
Lane Configurations						
Traffic Volume (vph)	198	1015	925	81	183	485
Future Volume (vph)	198	1015	925	81	183	485
Ideal Flow (vphpl)	1800	1800	1800	1800	1800	1800
Storage Length (m)	0.0	0.0		70.0	0.0	
Storage Lanes	1	1		1	0	
Taper Length (m)	7.6				7.6	
Lane Util. Factor	1.00	1.00	0.95	1.00	0.95	0.95
Frt		0.850		0.850		
Flt Protected	0.950					0.986
Satd. Flow (prot)	1647	1473	3325	1488	0	3217
Flt Permitted	0.950					0.576
Satd. Flow (perm)	1647	1473	3325	1488	0	1879
Right Turn on Red		Yes		Yes		
Satd. Flow (RTOR)		476				
Link Speed (k/h)	60		60			60
Link Distance (m)	216.4		230.9			341.9
Travel Time (s)	13.0		13.9			20.5
Peak Hour Factor	1.00	1.00	1.00	1.00	1.00	1.00
Heavy Vehicles (%)	5%	5%	4%	4%	6%	6%
Adj. Flow (vph)	198	1015	925	81	183	485
Shared Lane Traffic (%)						
Lane Group Flow (vph)	198	1015	925	81	0	668
Enter Blocked Intersection	No	No	No	No	No	No
Lane Alignment	Left	Right	Left	Right	Left	Left
Median Width(m)	3.7		0.0			0.0
Link Offset(m)	0.0		0.0			0.0
Crosswalk Width(m)	4.9		4.9			4.9
Two way Left Turn Lane						
Headway Factor	1.06	1.06	1.06	1.06	1.06	1.06
Turning Speed (k/h)	24	14		14	24	
Number of Detectors	1	1	2	1	1	2
Detector Template	Left	Right	Thru	Right	Left	Thru
Leading Detector (m)	6.1	6.1	30.5	6.1	6.1	30.5
Trailing Detector (m)	0.0	0.0	0.0	0.0	0.0	0.0
Detector 1 Position(m)	0.0	0.0	0.0	0.0	0.0	0.0
Detector 1 Size(m)	6.1	6.1	1.8	6.1	6.1	1.8
Detector 1 Type	Cl+Ex	Cl+Ex	Cl+Ex	Cl+Ex	Cl+Ex	Cl+Ex
Detector 1 Channel						
Detector 1 Extend (s)	0.0	0.0	0.0	0.0	0.0	0.0
Detector 1 Queue (s)	0.0	0.0	0.0	0.0	0.0	0.0
Detector 1 Delay (s)	0.0	0.0	0.0	0.0	0.0	0.0
Detector 2 Position(m)			28.7			28.7
Detector 2 Size(m)			1.8			1.8
Detector 2 Type			Cl+Ex			Cl+Ex
Detector 2 Channel						
Detector 2 Extend (s)			0.0			0.0
Turn Type	Prot	Free	NA	pm+ov	Perm	NA
Protected Phases	8		2	8		6

1900/2000 City Park Drive
 22: Blair Road & Hwy 174 EB off

BG 2037 AM DR



Lane Group	WBL	WBR	NBT	NBR	SBL	SBT
Permitted Phases		Free		2	6	
Detector Phase	8		2	8	6	6
Switch Phase						
Minimum Initial (s)	5.0		10.0	5.0	10.0	10.0
Minimum Split (s)	25.3		30.5	25.3	16.5	16.5
Total Split (s)	35.0		55.0	35.0	55.0	55.0
Total Split (%)	38.9%		61.1%	38.9%	61.1%	61.1%
Maximum Green (s)	28.7		48.5	28.7	48.5	48.5
Yellow Time (s)	3.3		4.2	3.3	4.2	4.2
All-Red Time (s)	3.0		2.3	3.0	2.3	2.3
Lost Time Adjust (s)	0.0		0.0	0.0		0.0
Total Lost Time (s)	6.3		6.5	6.3		6.5
Lead/Lag						
Lead-Lag Optimize?						
Vehicle Extension (s)	3.0		3.0	3.0	3.0	3.0
Recall Mode	None		Max	None	Max	Max
Walk Time (s)	7.0		7.0	7.0		
Flash Dont Walk (s)	12.0		17.0	12.0		
Pedestrian Calls (#/hr)	0		0	0		
Act Effct Green (s)	14.2	75.7	48.6	75.7		48.6
Actuated g/C Ratio	0.19	1.00	0.64	1.00		0.64
v/c Ratio	0.64	0.69	0.43	0.05		0.55
Control Delay	38.1	2.7	8.0	0.1		10.5
Queue Delay	0.0	0.0	0.0	0.0		0.0
Total Delay	38.1	2.7	8.0	0.1		10.5
LOS	D	A	A	A		B
Approach Delay	8.4		7.4			10.5
Approach LOS	A		A			B

Intersection Summary

Area Type: Other
 Cycle Length: 90
 Actuated Cycle Length: 75.7
 Natural Cycle: 60
 Control Type: Semi Act-Uncoord
 Maximum v/c Ratio: 0.69
 Intersection Signal Delay: 8.6
 Intersection LOS: A
 Intersection Capacity Utilization 74.4%
 ICU Level of Service D
 Analysis Period (min) 15

Splits and Phases: 22: Blair Road & Hwy 174 EB off

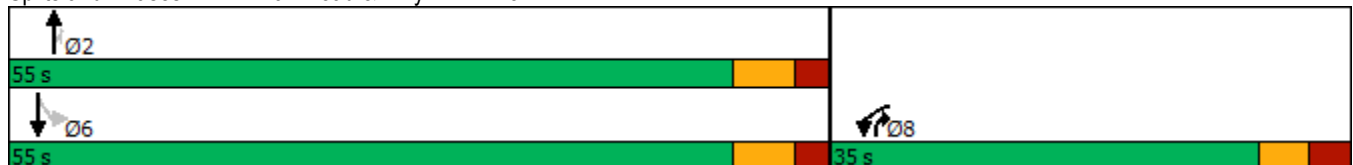

1900/2000 City Park Drive
 1630: Palmerston Drive/Matheson Road & Ogilvie Road

BG 2037 AM DR



Lane Group	EBL	EBT	EBR	WBL	WBT	WBR	NBL	NBT	NBR	SBL	SBT	SBR
Lane Configurations												
Traffic Volume (vph)	83	1085	21	33	1264	14	57	2	26	25	2	171
Future Volume (vph)	83	1085	21	33	1264	14	57	2	26	25	2	171
Ideal Flow (vphpl)	1800	1800	1800	1800	1800	1800	1800	1800	1800	1800	1800	1800
Storage Length (m)	70.0		0.0	70.0		0.0	15.0		0.0	0.0		35.0
Storage Lanes	1		0	1		0	1		0	0		1
Taper Length (m)	30.0			30.0			7.6			7.6		
Lane Util. Factor	1.00	0.95	0.95	1.00	0.95	0.95	1.00	1.00	1.00	1.00	1.00	1.00
Ped Bike Factor		1.00		0.99	1.00		1.00	0.98			0.99	0.99
Frt		0.997			0.998			0.861				0.850
Flt Protected	0.950			0.950			0.950				0.956	
Satd. Flow (prot)	1695	3375	0	1695	3382	0	1662	1471	0	0	1706	1517
Flt Permitted	0.153			0.216			0.740				0.727	
Satd. Flow (perm)	273	3375	0	383	3382	0	1290	1471	0	0	1282	1497
Right Turn on Red			Yes			Yes			Yes			Yes
Satd. Flow (RTOR)		2			1			26				171
Link Speed (k/h)		60			60			60				60
Link Distance (m)		314.1			264.5			176.2				174.1
Travel Time (s)		18.8			15.9			10.6				10.4
Confl. Peds. (#/hr)	11		26	26		11	4		14	14		
Confl. Bikes (#/hr)			21			9			2			1
Peak Hour Factor	1.00	1.00	1.00	1.00	1.00	1.00	1.00	1.00	1.00	1.00	1.00	1.00
Heavy Vehicles (%)	2%	2%	2%	2%	2%	2%	4%	4%	4%	2%	2%	2%
Adj. Flow (vph)	83	1085	21	33	1264	14	57	2	26	25	2	171
Shared Lane Traffic (%)												
Lane Group Flow (vph)	83	1106	0	33	1278	0	57	28	0	0	27	171
Enter Blocked Intersection	No	No	No	No	No	No	No	No	No	No	No	No
Lane Alignment	Left	Left	Right	Left	Left	Right	Left	Left	Right	Left	Left	Right
Median Width(m)		3.7			3.7			3.7				3.7
Link Offset(m)		0.0			0.0			0.0				0.0
Crosswalk Width(m)		4.9			4.9			4.9				4.9
Two way Left Turn Lane												
Headway Factor	1.06	1.06	1.06	1.06	1.06	1.06	1.06	1.06	1.06	1.06	1.06	1.06
Turning Speed (k/h)	24		14	24		14	24		14	24		14
Number of Detectors	1	2		1	2		1	2		1	2	1
Detector Template	Left	Thru		Left	Thru		Left	Thru		Left	Thru	Right
Leading Detector (m)	6.1	30.5		6.1	30.5		6.1	30.5		6.1	30.5	6.1
Trailing Detector (m)	0.0	0.0		0.0	0.0		0.0	0.0		0.0	0.0	0.0
Detector 1 Position(m)	0.0	0.0		0.0	0.0		0.0	0.0		0.0	0.0	0.0
Detector 1 Size(m)	6.1	1.8		6.1	1.8		6.1	1.8		6.1	1.8	6.1
Detector 1 Type	Cl+Ex	Cl+Ex		Cl+Ex	Cl+Ex		Cl+Ex	Cl+Ex		Cl+Ex	Cl+Ex	Cl+Ex
Detector 1 Channel												
Detector 1 Extend (s)	0.0	0.0		0.0	0.0		0.0	0.0		0.0	0.0	0.0
Detector 1 Queue (s)	0.0	0.0		0.0	0.0		0.0	0.0		0.0	0.0	0.0
Detector 1 Delay (s)	0.0	0.0		0.0	0.0		0.0	0.0		0.0	0.0	0.0
Detector 2 Position(m)		28.7			28.7			28.7				28.7
Detector 2 Size(m)		1.8			1.8			1.8				1.8
Detector 2 Type		Cl+Ex			Cl+Ex			Cl+Ex				Cl+Ex
Detector 2 Channel												

1900/2000 City Park Drive

1630: Palmerston Drive/Matheson Road & Ogilvie Road

BG 2037 AM DR



Lane Group	EBL	EBT	EBR	WBL	WBT	WBR	NBL	NBT	NBR	SBL	SBT	SBR
Detector 2 Extend (s)		0.0			0.0			0.0			0.0	
Turn Type	pm+pt	NA		pm+pt	NA		Perm	NA		Perm	NA	Perm
Protected Phases	5	2		1	6			8			4	
Permitted Phases	2			6			8			4		4
Detector Phase	5	2		1	6		8	8		4	4	4
Switch Phase												
Minimum Initial (s)	5.0	10.0		5.0	10.0		10.0	10.0		10.0	10.0	10.0
Minimum Split (s)	9.7	33.6		9.7	33.6		40.2	40.2		40.2	40.2	40.2
Total Split (s)	13.0	47.0		13.0	47.0		40.0	40.0		40.0	40.0	40.0
Total Split (%)	13.0%	47.0%		13.0%	47.0%		40.0%	40.0%		40.0%	40.0%	40.0%
Maximum Green (s)	8.3	41.4		8.3	41.4		32.8	32.8		32.8	32.8	32.8
Yellow Time (s)	3.7	3.7		3.7	3.7		3.0	3.0		3.0	3.0	3.0
All-Red Time (s)	1.0	1.9		1.0	1.9		4.2	4.2		4.2	4.2	4.2
Lost Time Adjust (s)	0.0	0.0		0.0	0.0		0.0	0.0		0.0	0.0	0.0
Total Lost Time (s)	4.7	5.6		4.7	5.6		7.2	7.2		7.2	7.2	7.2
Lead/Lag	Lead	Lag		Lead	Lag							
Lead-Lag Optimize?	Yes	Yes		Yes	Yes							
Vehicle Extension (s)	3.0	3.0		3.0	3.0		3.0	3.0		3.0	3.0	3.0
Recall Mode	None	C-Max		None	C-Max		None	None		None	None	None
Walk Time (s)		15.0			15.0		7.0	7.0		7.0	7.0	7.0
Flash Dont Walk (s)		13.0			13.0		26.0	26.0		26.0	26.0	26.0
Pedestrian Calls (#/hr)		10			10		10	10		10	10	10
Act Effct Green (s)	70.9	65.6		68.9	62.9		14.9	14.9			14.9	14.9
Actuated g/C Ratio	0.71	0.66		0.69	0.63		0.15	0.15			0.15	0.15
v/c Ratio	0.29	0.50		0.10	0.60		0.30	0.12			0.14	0.46
Control Delay	8.3	12.7		4.6	7.9		38.9	13.0			34.7	9.0
Queue Delay	0.0	0.0		0.0	0.0		0.0	0.0			0.0	0.0
Total Delay	8.3	12.7		4.6	7.9		38.9	13.0			34.7	9.0
LOS	A	B		A	A		D	B			C	A
Approach Delay		12.4			7.8			30.4			12.5	
Approach LOS		B			A			C			B	

Intersection Summary

Area Type:	Other
Cycle Length:	100
Actuated Cycle Length:	100
Offset:	54 (54%), Referenced to phase 2:EBTL and 6:WBTL, Start of Green
Natural Cycle:	85
Control Type:	Actuated-Coordinated
Maximum v/c Ratio:	0.60
Intersection Signal Delay:	10.8
Intersection LOS:	B
Intersection Capacity Utilization:	80.7%
ICU Level of Service:	D
Analysis Period (min):	15

Splits and Phases: 1630: Palmerston Drive/Matheson Road & Ogilvie Road

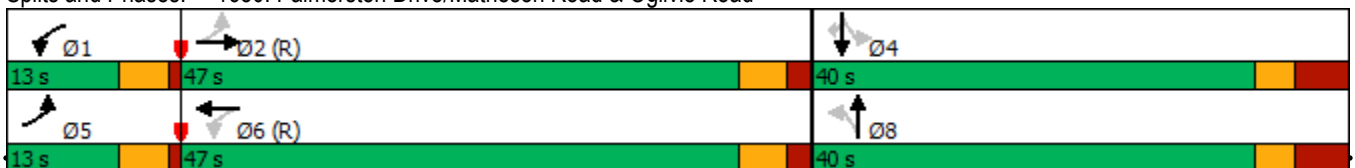

3: Blair Road & Ogilvie Road

BG 2037 PM DR



Lane Group	EBL	EBT	EBR	WBL	WBT	WBR	NBL	NBT	NBR	SBL	SBT	SBR
Lane Configurations												
Traffic Volume (vph)	150	828	539	705	492	83	218	296	731	75	761	55
Future Volume (vph)	150	828	539	705	492	83	218	296	731	75	761	55
Ideal Flow (vphpl)	1800	1800	1800	1800	1800	1800	1800	1800	1800	1800	1800	1800
Storage Length (m)	70.0		0.0	110.0		0.0	120.0		0.0	30.0		0.0
Storage Lanes	1		1	2		0	2		1	1		0
Taper Length (m)	40.0			60.0			60.0			45.0		
Lane Util. Factor	1.00	0.95	1.00	0.97	0.95	0.95	0.97	1.00	1.00	1.00	0.95	0.95
Ped Bike Factor					0.99						0.99	
Frt			0.850		0.978				0.850		0.990	
Flt Protected	0.950			0.950			0.950			0.950		
Satd. Flow (prot)	1679	3357	1502	3257	3244	0	3257	1767	1502	1679	3294	0
Flt Permitted	0.950			0.950			0.950			0.950		
Satd. Flow (perm)	1679	3357	1502	3257	3244	0	3257	1767	1502	1679	3294	0
Right Turn on Red			Yes			Yes			Yes			Yes
Satd. Flow (RTOR)			225		15				444		5	
Link Speed (k/h)		60			60			60			60	
Link Distance (m)		372.0			396.5			239.9			411.0	
Travel Time (s)		22.3			23.8			14.4			24.7	
Confl. Peds. (#/hr)						29						84
Peak Hour Factor	1.00	1.00	1.00	1.00	1.00	1.00	1.00	1.00	1.00	1.00	1.00	1.00
Heavy Vehicles (%)	3%	3%	3%	3%	3%	3%	3%	3%	3%	3%	3%	3%
Adj. Flow (vph)	150	828	539	705	492	83	218	296	731	75	761	55
Shared Lane Traffic (%)												
Lane Group Flow (vph)	150	828	539	705	575	0	218	296	731	75	816	0
Enter Blocked Intersection	No	No	No	No	No	No	No	No	No	No	No	No
Lane Alignment	Left	Left	Right	Left	Left	Right	Left	Left	Right	Left	Left	Right
Median Width(m)		7.4			7.4			7.4			7.4	
Link Offset(m)		0.0			0.0			0.0			0.0	
Crosswalk Width(m)		4.9			4.9			4.9			4.9	
Two way Left Turn Lane												
Headway Factor	1.06	1.06	1.06	1.06	1.06	1.06	1.06	1.06	1.06	1.06	1.06	1.06
Turning Speed (k/h)	24		14	24		14	24		14	24		14
Number of Detectors	1	2	1	1	2		1	2	1	1	2	
Detector Template	Left	Thru	Right	Left	Thru		Left	Thru	Right	Left	Thru	
Leading Detector (m)	6.1	30.5	6.1	6.1	30.5		6.1	30.5	6.1	6.1	30.5	
Trailing Detector (m)	0.0	0.0	0.0	0.0	0.0		0.0	0.0	0.0	0.0	0.0	
Detector 1 Position(m)	0.0	0.0	0.0	0.0	0.0		0.0	0.0	0.0	0.0	0.0	
Detector 1 Size(m)	6.1	1.8	6.1	6.1	1.8		6.1	1.8	6.1	6.1	1.8	
Detector 1 Type	Cl+Ex	Cl+Ex	Cl+Ex	Cl+Ex	Cl+Ex		Cl+Ex	Cl+Ex	Cl+Ex	Cl+Ex	Cl+Ex	
Detector 1 Channel												
Detector 1 Extend (s)	0.0	0.0	0.0	0.0	0.0		0.0	0.0	0.0	0.0	0.0	
Detector 1 Queue (s)	0.0	0.0	0.0	0.0	0.0		0.0	0.0	0.0	0.0	0.0	
Detector 1 Delay (s)	0.0	0.0	0.0	0.0	0.0		0.0	0.0	0.0	0.0	0.0	
Detector 2 Position(m)		28.7			28.7			28.7			28.7	
Detector 2 Size(m)		1.8			1.8			1.8			1.8	
Detector 2 Type		Cl+Ex			Cl+Ex			Cl+Ex			Cl+Ex	
Detector 2 Channel												
Detector 2 Extend (s)		0.0			0.0			0.0			0.0	

3: Blair Road & Ogilvie Road

BG 2037 PM DR



Lane Group	EBL	EBT	EBR	WBL	WBT	WBR	NBL	NBT	NBR	SBL	SBT	SBR
Turn Type	Prot	NA	Perm	Prot	NA		Prot	NA	Perm	Prot	NA	
Protected Phases	5	2		1	6		3	8		7	4	
Permitted Phases			2						8			
Detector Phase	5	2	2	1	6		3	8	8	7	4	
Switch Phase												
Minimum Initial (s)	5.0	10.0	10.0	5.0	10.0		5.0	10.0	10.0	5.0	10.0	
Minimum Split (s)	11.8	38.6	38.6	11.8	38.6		11.5	35.5	35.5	11.5	35.5	
Total Split (s)	25.0	41.0	41.0	37.0	53.0		21.0	41.0	41.0	21.0	41.0	
Total Split (%)	17.9%	29.3%	29.3%	26.4%	37.9%		15.0%	29.3%	29.3%	15.0%	29.3%	
Maximum Green (s)	18.2	34.4	34.4	30.2	46.4		14.5	34.5	34.5	14.5	34.5	
Yellow Time (s)	3.7	3.3	3.3	3.7	3.3		4.2	4.2	4.2	4.2	4.2	
All-Red Time (s)	3.1	3.3	3.3	3.1	3.3		2.3	2.3	2.3	2.3	2.3	
Lost Time Adjust (s)	0.0	0.0	0.0	0.0	0.0		0.0	0.0	0.0	0.0	0.0	
Total Lost Time (s)	6.8	6.6	6.6	6.8	6.6		6.5	6.5	6.5	6.5	6.5	
Lead/Lag	Lead	Lag	Lag	Lead	Lag		Lead	Lag	Lag	Lead	Lag	
Lead-Lag Optimize?	Yes	Yes	Yes	Yes	Yes		Yes	Yes	Yes	Yes	Yes	
Vehicle Extension (s)	3.0	3.0	3.0	3.0	3.0		3.0	3.0	3.0	3.0	3.0	
Recall Mode	None	C-Max	C-Max	None	C-Max		None	None	None	None	None	
Walk Time (s)		7.0	7.0		7.0			7.0	7.0		7.0	
Flash Dont Walk (s)		25.0	25.0		25.0			22.0	22.0		22.0	
Pedestrian Calls (#/hr)		30	30		30			35	35		35	
Act Effct Green (s)	16.2	34.4	34.4	30.2	48.4		13.4	37.7	37.7	11.3	35.6	
Actuated g/C Ratio	0.12	0.25	0.25	0.22	0.35		0.10	0.27	0.27	0.08	0.25	
v/c Ratio	0.77	1.00	1.00	1.00	0.51		0.70	0.62	1.00	0.56	0.97	
Control Delay	85.3	84.7	69.8	89.2	37.7		73.6	52.3	54.4	77.1	76.0	
Queue Delay	0.0	0.0	0.0	0.0	0.0		0.0	0.0	0.0	0.0	0.0	
Total Delay	85.3	84.7	69.8	89.2	37.7		73.6	52.3	54.4	77.1	76.0	
LOS	F	F	E	F	D		E	D	D	E	E	
Approach Delay		79.5			66.1			57.2			76.1	
Approach LOS		E			E			E			E	

Intersection Summary

Area Type:	Other
Cycle Length:	140
Actuated Cycle Length:	140
Offset:	0 (0%), Referenced to phase 2:EBT and 6:WBT, Start of Green
Natural Cycle:	140
Control Type:	Actuated-Coordinated
Maximum v/c Ratio:	1.00
Intersection Signal Delay:	69.8
Intersection LOS:	E
Intersection Capacity Utilization:	98.4%
ICU Level of Service:	F
Analysis Period (min):	15

Splits and Phases: 3: Blair Road & Ogilvie Road

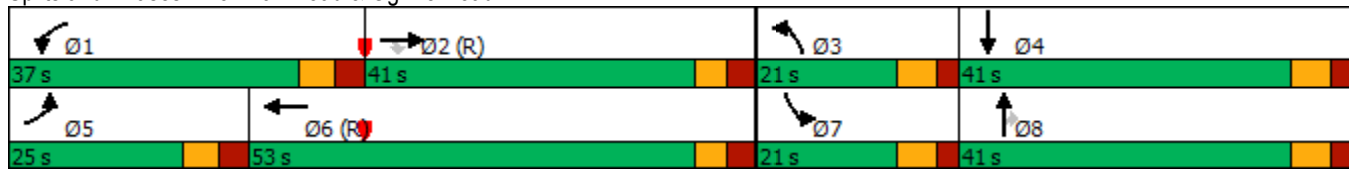

6: Blair Road & 1980 Ogilvie Road/Hwy 174 WB off

BG 2037 PM DR



Lane Group	EBL	EBT	EBR	WBL	WBT	WBR	NBL	NBT	NBR	SBL	SBT	SBR
Lane Configurations												
Traffic Volume (vph)	123	0	568	93	149	177	346	1306	0	0	1802	172
Future Volume (vph)	123	0	568	93	149	177	346	1306	0	0	1802	172
Ideal Flow (vphpl)	1800	1800	1800	1800	1800	1800	1800	1800	1800	1800	1800	1800
Storage Length (m)	0.0		70.0	0.0		70.0	60.0		0.0	0.0		50.0
Storage Lanes	1		1	1		1	2		0	0		1
Taper Length (m)	7.6			7.6			100.0			7.6		
Lane Util. Factor	1.00	1.00	1.00	1.00	1.00	1.00	0.97	0.95	1.00	1.00	0.91	1.00
Frt			0.850			0.850						0.850
Flt Protected	0.950			0.950			0.950					
Satd. Flow (prot)	1544	0	1381	1695	1784	1517	3164	3262	0	0	4871	1517
Flt Permitted	0.582			0.950			0.950					
Satd. Flow (perm)	946	0	1381	1695	1784	1517	3164	3262	0	0	4871	1517
Right Turn on Red			Yes			Yes			Yes			Yes
Satd. Flow (RTOR)			26			84						97
Link Speed (k/h)		60			60			60				60
Link Distance (m)		518.9			416.4			90.2				239.9
Travel Time (s)		31.1			25.0			5.4				14.4
Peak Hour Factor	1.00	1.00	1.00	1.00	1.00	1.00	1.00	1.00	1.00	1.00	1.00	1.00
Heavy Vehicles (%)	12%	12%	12%	2%	2%	2%	6%	6%	6%	2%	2%	2%
Adj. Flow (vph)	123	0	568	93	149	177	346	1306	0	0	1802	172
Shared Lane Traffic (%)												
Lane Group Flow (vph)	123	0	568	93	149	177	346	1306	0	0	1802	172
Enter Blocked Intersection	No	No	No	No	No	No	No	No	No	No	No	No
Lane Alignment	Left	Left	Right	Left	Left	Right	Left	Left	Right	Left	Left	Right
Median Width(m)		3.7			3.7			7.4				7.4
Link Offset(m)		0.0			0.0			0.0				0.0
Crosswalk Width(m)		4.9			4.9			4.9				4.9
Two way Left Turn Lane												
Headway Factor	1.06	1.06	1.06	1.06	1.06	1.06	1.06	1.06	1.06	1.06	1.06	1.06
Turning Speed (k/h)	24		14	24		14	24		14	24		14
Number of Detectors	1		1	1	2	1	1	2				2
Detector Template	Left		Right	Left	Thru	Right	Left	Thru				Thru
Leading Detector (m)	6.1		6.1	6.1	30.5	6.1	6.1	30.5				30.5
Trailing Detector (m)	0.0		0.0	0.0	0.0	0.0	0.0	0.0				0.0
Detector 1 Position(m)	0.0		0.0	0.0	0.0	0.0	0.0	0.0				0.0
Detector 1 Size(m)	6.1		6.1	6.1	1.8	6.1	6.1	1.8				1.8
Detector 1 Type	Cl+Ex		Cl+Ex	Cl+Ex	Cl+Ex	Cl+Ex	Cl+Ex	Cl+Ex				Cl+Ex
Detector 1 Channel												
Detector 1 Extend (s)	0.0		0.0	0.0	0.0	0.0	0.0	0.0				0.0
Detector 1 Queue (s)	0.0		0.0	0.0	0.0	0.0	0.0	0.0				0.0
Detector 1 Delay (s)	0.0		0.0	0.0	0.0	0.0	0.0	0.0				0.0
Detector 2 Position(m)					28.7			28.7				28.7
Detector 2 Size(m)					1.8			1.8				1.8
Detector 2 Type					Cl+Ex			Cl+Ex				Cl+Ex
Detector 2 Channel												
Detector 2 Extend (s)					0.0			0.0				0.0
Turn Type	Perm		pm+ov	Perm	NA	Perm	Prot	NA				NA
Protected Phases			5		8		5	2				6

6: Blair Road & 1980 Ogilvie Road/Hwy 174 WB off

BG 2037 PM DR



Lane Group	EBL	EBT	EBR	WBL	WBT	WBR	NBL	NBT	NBR	SBL	SBT	SBR
Permitted Phases	4		4	8		8						6
Detector Phase	4		5	8	8	8	5	2			6	6
Switch Phase												
Minimum Initial (s)	10.0		5.0	10.0	10.0	10.0	5.0	10.0			10.0	10.0
Minimum Split (s)	16.8		11.4	36.8	36.8	36.8	11.4	30.1			30.1	30.1
Total Split (s)	36.0		31.0	36.0	36.0	36.0	31.0	94.0			63.0	63.0
Total Split (%)	27.7%		23.8%	27.7%	27.7%	27.7%	23.8%	72.3%			48.5%	48.5%
Maximum Green (s)	29.2		24.6	29.2	29.2	29.2	24.6	87.9			56.9	56.9
Yellow Time (s)	3.3		4.2	3.3	3.3	3.3	4.2	4.2			4.2	4.2
All-Red Time (s)	3.5		2.2	3.5	3.5	3.5	2.2	1.9			1.9	1.9
Lost Time Adjust (s)	0.0		0.0	0.0	0.0	0.0	0.0	0.0			0.0	0.0
Total Lost Time (s)	6.8		6.4	6.8	6.8	6.8	6.4	6.1			6.1	6.1
Lead/Lag			Lead				Lead				Lag	Lag
Lead-Lag Optimize?			Yes				Yes				Yes	Yes
Vehicle Extension (s)	3.0		3.0	3.0	3.0	3.0	3.0	3.0			3.0	3.0
Recall Mode	None		None	None	None	None	None	C-Max			C-Max	C-Max
Walk Time (s)				7.0	7.0	7.0		7.0			7.0	7.0
Flash Dont Walk (s)				23.0	23.0	23.0		17.0			17.0	17.0
Pedestrian Calls (#/hr)				20	20	20		30			30	30
Act Effct Green (s)	23.3		58.6	23.3	23.3	23.3	28.5	93.8			58.9	58.9
Actuated g/C Ratio	0.18		0.45	0.18	0.18	0.18	0.22	0.72			0.45	0.45
v/c Ratio	0.73		0.89	0.31	0.47	0.52	0.50	0.56			0.82	0.23
Control Delay	72.8		48.9	46.8	51.0	28.9	48.4	10.5			35.2	10.8
Queue Delay	0.0		0.0	0.0	0.0	0.0	0.0	0.0			0.0	0.0
Total Delay	72.8		48.9	46.8	51.0	28.9	48.4	10.5			35.2	10.8
LOS	E		D	D	D	C	D	B			D	B
Approach Delay		53.1			40.8			18.4			33.1	
Approach LOS		D			D			B			C	

Intersection Summary

Area Type: Other
 Cycle Length: 130
 Actuated Cycle Length: 130
 Offset: 50 (38%), Referenced to phase 2:NBT and 6:SBT, Start of Green
 Natural Cycle: 90
 Control Type: Actuated-Coordinated
 Maximum v/c Ratio: 0.89
 Intersection Signal Delay: 31.6
 Intersection LOS: C
 Intersection Capacity Utilization 98.3%
 ICU Level of Service F
 Analysis Period (min) 15

Splits and Phases: 6: Blair Road & 1980 Ogilvie Road/Hwy 174 WB off

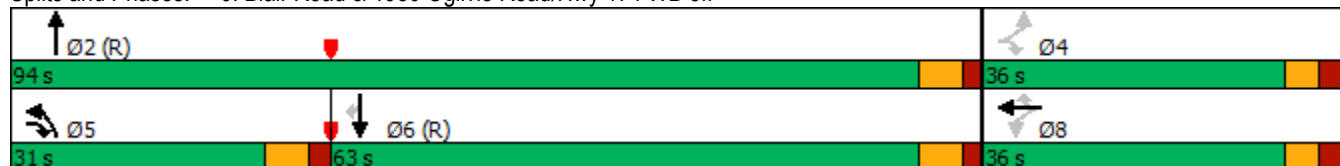

9: City Park Drive/1941 Ogilvie & Ogilvie Road

BG 2037 PM DR



Lane Group	EBL	EBT	EBR	WBL	WBT	WBR	NBL	NBT	NBR	SBL	SBT	SBR
Lane Configurations												
Traffic Volume (vph)	32	1484	152	103	603	38	183	10	161	78	19	76
Future Volume (vph)	32	1484	152	103	603	38	183	10	161	78	19	76
Ideal Flow (vphpl)	1800	1800	1800	1800	1800	1800	1800	1800	1800	1800	1800	1800
Storage Length (m)	40.0		100.0	100.0		50.0	0.0		60.0	20.0		10.0
Storage Lanes	1		1	1		1	0		1	1		1
Taper Length (m)	30.0			25.0			7.6			15.0		
Lane Util. Factor	1.00	0.95	1.00	1.00	0.95	1.00	1.00	1.00	1.00	1.00	1.00	1.00
Ped Bike Factor	0.89		0.87			0.73		0.93	0.87	0.91		0.92
Fr _t			0.850			0.850			0.850			0.850
Fl _t Protected	0.950			0.950				0.955		0.950		
Satd. Flow (prot)	1695	3390	1517	1679	3357	1502	0	1609	1432	1695	1784	1517
Fl _t Permitted	0.424			0.074				0.723		0.558		
Satd. Flow (perm)	675	3390	1315	131	3357	1104	0	1135	1244	906	1784	1388
Right Turn on Red			Yes			Yes			Yes			Yes
Satd. Flow (RTOR)			152			60			161			99
Link Speed (k/h)		60			60			60				60
Link Distance (m)		224.7			372.0			239.4				142.3
Travel Time (s)		13.5			22.3			14.4				8.5
Confl. Peds. (#/hr)	145		67	67		145	67		110	110		67
Peak Hour Factor	1.00	1.00	1.00	1.00	1.00	1.00	1.00	1.00	1.00	1.00	1.00	1.00
Heavy Vehicles (%)	2%	2%	2%	3%	3%	3%	8%	8%	8%	2%	2%	2%
Adj. Flow (vph)	32	1484	152	103	603	38	183	10	161	78	19	76
Shared Lane Traffic (%)												
Lane Group Flow (vph)	32	1484	152	103	603	38	0	193	161	78	19	76
Enter Blocked Intersection	No	No	No	No	No	No	No	No	No	No	No	No
Lane Alignment	Left	Left	Right	Left	Left	Right	Left	Left	Right	Left	Left	Right
Median Width(m)		3.7			3.7			3.7				3.7
Link Offset(m)		0.0			0.0			0.0				0.0
Crosswalk Width(m)		4.9			4.9			4.9				4.9
Two way Left Turn Lane												
Headway Factor	1.06	1.06	1.06	1.06	1.06	1.06	1.06	1.06	1.06	1.06	1.06	1.06
Turning Speed (k/h)	24		14	24		14	24		14	24		14
Number of Detectors	1	2	1	1	2	1	1	2	1	1	2	1
Detector Template	Left	Thru	Right	Left	Thru	Right	Left	Thru	Right	Left	Thru	Right
Leading Detector (m)	6.1	30.5	6.1	6.1	30.5	6.1	6.1	30.5	6.1	6.1	30.5	6.1
Trailing Detector (m)	0.0	0.0	0.0	0.0	0.0	0.0	0.0	0.0	0.0	0.0	0.0	0.0
Detector 1 Position(m)	0.0	0.0	0.0	0.0	0.0	0.0	0.0	0.0	0.0	0.0	0.0	0.0
Detector 1 Size(m)	6.1	1.8	6.1	6.1	1.8	6.1	6.1	1.8	6.1	6.1	1.8	6.1
Detector 1 Type	Cl+Ex	Cl+Ex	Cl+Ex	Cl+Ex	Cl+Ex	Cl+Ex	Cl+Ex	Cl+Ex	Cl+Ex	Cl+Ex	Cl+Ex	Cl+Ex
Detector 1 Channel												
Detector 1 Extend (s)	0.0	0.0	0.0	0.0	0.0	0.0	0.0	0.0	0.0	0.0	0.0	0.0
Detector 1 Queue (s)	0.0	0.0	0.0	0.0	0.0	0.0	0.0	0.0	0.0	0.0	0.0	0.0
Detector 1 Delay (s)	0.0	0.0	0.0	0.0	0.0	0.0	0.0	0.0	0.0	0.0	0.0	0.0
Detector 2 Position(m)		28.7			28.7			28.7				28.7
Detector 2 Size(m)		1.8			1.8			1.8				1.8
Detector 2 Type		Cl+Ex			Cl+Ex			Cl+Ex				Cl+Ex
Detector 2 Channel												
Detector 2 Extend (s)		0.0			0.0			0.0				0.0

Lane Group	Ø3	Ø7
Lane Configurations		
Traffic Volume (vph)		
Future Volume (vph)		
Ideal Flow (vphpl)		
Storage Length (m)		
Storage Lanes		
Taper Length (m)		
Lane Util. Factor		
Ped Bike Factor		
Frt		
Flt Protected		
Satd. Flow (prot)		
Flt Permitted		
Satd. Flow (perm)		
Right Turn on Red		
Satd. Flow (RTOR)		
Link Speed (k/h)		
Link Distance (m)		
Travel Time (s)		
Confl. Peds. (#/hr)		
Peak Hour Factor		
Heavy Vehicles (%)		
Adj. Flow (vph)		
Shared Lane Traffic (%)		
Lane Group Flow (vph)		
Enter Blocked Intersection		
Lane Alignment		
Median Width(m)		
Link Offset(m)		
Crosswalk Width(m)		
Two way Left Turn Lane		
Headway Factor		
Turning Speed (k/h)		
Number of Detectors		
Detector Template		
Leading Detector (m)		
Trailing Detector (m)		
Detector 1 Position(m)		
Detector 1 Size(m)		
Detector 1 Type		
Detector 1 Channel		
Detector 1 Extend (s)		
Detector 1 Queue (s)		
Detector 1 Delay (s)		
Detector 2 Position(m)		
Detector 2 Size(m)		
Detector 2 Type		
Detector 2 Channel		
Detector 2 Extend (s)		

Lane Group	Ø3	Ø7
Turn Type		
Protected Phases	3	7
Permitted Phases		
Detector Phase		
Switch Phase		
Minimum Initial (s)	1.0	1.0
Minimum Split (s)	5.0	5.0
Total Split (s)	5.0	5.0
Total Split (%)	5%	5%
Maximum Green (s)	3.0	3.0
Yellow Time (s)	2.0	2.0
All-Red Time (s)	0.0	0.0
Lost Time Adjust (s)		
Total Lost Time (s)		
Lead/Lag	Lead	Lead
Lead-Lag Optimize?	Yes	Yes
Vehicle Extension (s)	3.0	3.0
Recall Mode	None	None
Walk Time (s)	0.0	0.0
Flash Dont Walk (s)	0.0	0.0
Pedestrian Calls (#/hr)	35	35
Act Effct Green (s)		
Actuated g/C Ratio		
v/c Ratio		
Control Delay		
Queue Delay		
Total Delay		
LOS		
Approach Delay		
Approach LOS		
Intersection Summary		

12: 1900 Ogilvie Road/1929 Ogilvie Road & Ogilvie Road

BG 2037 PM DR



Lane Group	EBL	EBT	EBR	WBL	WBT	WBR	NBL	NBT	NBR	SBL	SBT	SBR
Lane Configurations												
Traffic Volume (vph)	43	1428	66	32	861	24	47	3	28	135	3	132
Future Volume (vph)	43	1428	66	32	861	24	47	3	28	135	3	132
Ideal Flow (vphpl)	1800	1800	1800	1800	1800	1800	1800	1800	1800	1800	1800	1800
Storage Length (m)	60.0		80.0	90.0		0.0	0.0		0.0	0.0		0.0
Storage Lanes	1		1	1		0	1		0	0		1
Taper Length (m)	30.0			20.0			7.6			7.6		
Lane Util. Factor	1.00	0.95	1.00	1.00	0.95	0.95	1.00	1.00	1.00	1.00	1.00	1.00
Frt			0.850		0.996			0.865				0.850
Flt Protected	0.950			0.950			0.950				0.953	
Satd. Flow (prot)	1695	3390	1517	1679	3345	0	1695	1543	0	0	1700	1517
Flt Permitted	0.289			0.131			0.669				0.708	
Satd. Flow (perm)	516	3390	1517	231	3345	0	1194	1543	0	0	1263	1517
Right Turn on Red			Yes			Yes			Yes			Yes
Satd. Flow (RTOR)			66		5			28				132
Link Speed (k/h)		60			60			60				60
Link Distance (m)		190.5			224.7			86.0				56.6
Travel Time (s)		11.4			13.5			5.2				3.4
Peak Hour Factor	1.00	1.00	1.00	1.00	1.00	1.00	1.00	1.00	1.00	1.00	1.00	1.00
Heavy Vehicles (%)	2%	2%	2%	3%	3%	2%	2%	2%	2%	2%	2%	2%
Adj. Flow (vph)	43	1428	66	32	861	24	47	3	28	135	3	132
Shared Lane Traffic (%)												
Lane Group Flow (vph)	43	1428	66	32	885	0	47	31	0	0	138	132
Enter Blocked Intersection	No	No	No	No	No	No	No	No	No	No	No	No
Lane Alignment	Left	Left	Right	Left	Left	Right	Left	Left	Right	Left	Left	Right
Median Width(m)		3.7			3.7			3.7				3.7
Link Offset(m)		0.0			0.0			0.0				0.0
Crosswalk Width(m)		4.9			4.9			4.9				4.9
Two way Left Turn Lane												
Headway Factor	1.06	1.06	1.06	1.06	1.06	1.06	1.06	1.06	1.06	1.06	1.06	1.06
Turning Speed (k/h)	24		14	24		14	24		14	24		14
Number of Detectors	1	2	1	1	2		1	2		1	2	1
Detector Template	Left	Thru	Right	Left	Thru		Left	Thru		Left	Thru	Right
Leading Detector (m)	6.1	30.5	6.1	6.1	30.5		6.1	30.5		6.1	30.5	6.1
Trailing Detector (m)	0.0	0.0	0.0	0.0	0.0		0.0	0.0		0.0	0.0	0.0
Detector 1 Position(m)	0.0	0.0	0.0	0.0	0.0		0.0	0.0		0.0	0.0	0.0
Detector 1 Size(m)	6.1	1.8	6.1	6.1	1.8		6.1	1.8		6.1	1.8	6.1
Detector 1 Type	Cl+Ex	Cl+Ex	Cl+Ex	Cl+Ex	Cl+Ex		Cl+Ex	Cl+Ex		Cl+Ex	Cl+Ex	Cl+Ex
Detector 1 Channel												
Detector 1 Extend (s)	0.0	0.0	0.0	0.0	0.0		0.0	0.0		0.0	0.0	0.0
Detector 1 Queue (s)	0.0	0.0	0.0	0.0	0.0		0.0	0.0		0.0	0.0	0.0
Detector 1 Delay (s)	0.0	0.0	0.0	0.0	0.0		0.0	0.0		0.0	0.0	0.0
Detector 2 Position(m)		28.7			28.7			28.7				28.7
Detector 2 Size(m)		1.8			1.8			1.8				1.8
Detector 2 Type		Cl+Ex			Cl+Ex			Cl+Ex				Cl+Ex
Detector 2 Channel												
Detector 2 Extend (s)		0.0			0.0			0.0				0.0
Turn Type	Perm	NA	Perm	Perm	NA		Perm	NA		Perm	NA	Perm
Protected Phases		2			6			8				4

12: 1900 Ogilvie Road/1929 Ogilvie Road & Ogilvie Road

BG 2037 PM DR



Lane Group	EBL	EBT	EBR	WBL	WBT	WBR	NBL	NBT	NBR	SBL	SBT	SBR
Permitted Phases	2		2	6			8			4		4
Detector Phase	2	2	2	6	6		8	8		4	4	4
Switch Phase												
Minimum Initial (s)	10.0	10.0	10.0	10.0	10.0		10.0	10.0		10.0	10.0	10.0
Minimum Split (s)	29.9	29.9	29.9	29.9	29.9		36.7	36.7		36.7	36.7	36.7
Total Split (s)	63.0	63.0	63.0	63.0	63.0		37.0	37.0		37.0	37.0	37.0
Total Split (%)	63.0%	63.0%	63.0%	63.0%	63.0%		37.0%	37.0%		37.0%	37.0%	37.0%
Maximum Green (s)	57.1	57.1	57.1	57.1	57.1		30.3	30.3		30.3	30.3	30.3
Yellow Time (s)	3.7	3.7	3.7	3.7	3.7		3.3	3.3		3.3	3.3	3.3
All-Red Time (s)	2.2	2.2	2.2	2.2	2.2		3.4	3.4		3.4	3.4	3.4
Lost Time Adjust (s)	0.0	0.0	0.0	0.0	0.0		0.0	0.0		0.0	0.0	0.0
Total Lost Time (s)	5.9	5.9	5.9	5.9	5.9		6.7	6.7		6.7	6.7	6.7
Lead/Lag												
Lead-Lag Optimize?												
Vehicle Extension (s)	3.0	3.0	3.0	3.0	3.0		3.0	3.0		3.0	3.0	3.0
Recall Mode	C-Max	C-Max	C-Max	C-Max	C-Max		None	None		None	None	None
Walk Time (s)	11.0	11.0	11.0	11.0	11.0		7.0	7.0		7.0	7.0	7.0
Flash Dont Walk (s)	13.0	13.0	13.0	13.0	13.0		23.0	23.0		23.0	23.0	23.0
Pedestrian Calls (#/hr)	20	20	20	20	20		30	30		30	30	30
Act Effct Green (s)	64.7	64.7	64.7	64.7	64.7		22.7	22.7		22.7	22.7	22.7
Actuated g/C Ratio	0.65	0.65	0.65	0.65	0.65		0.23	0.23		0.23	0.23	0.23
v/c Ratio	0.13	0.65	0.07	0.21	0.41		0.17	0.08		0.48	0.30	0.30
Control Delay	5.9	8.4	0.7	10.5	6.8		28.9	11.0		37.2	6.6	6.6
Queue Delay	0.0	0.1	0.0	0.0	0.0		0.0	0.0		0.0	0.0	0.0
Total Delay	5.9	8.5	0.7	10.5	6.8		28.9	11.0		37.2	6.6	6.6
LOS	A	A	A	B	A		C	B		D	A	A
Approach Delay		8.1			7.0			21.8			22.2	
Approach LOS		A			A			C			C	

Intersection Summary

Area Type:	Other
Cycle Length:	100
Actuated Cycle Length:	100
Offset:	8 (8%), Referenced to phase 2:EBTL and 6:WBTL, Start of Green
Natural Cycle:	80
Control Type:	Actuated-Coordinated
Maximum v/c Ratio:	0.65
Intersection Signal Delay:	9.5
Intersection LOS:	A
Intersection Capacity Utilization:	66.9%
ICU Level of Service:	C
Analysis Period (min):	15

Splits and Phases: 12: 1900 Ogilvie Road/1929 Ogilvie Road & Ogilvie Road

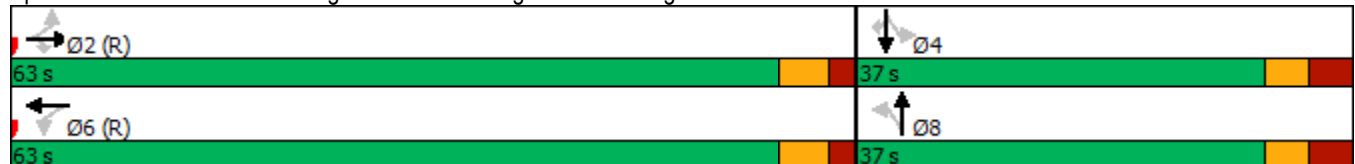

15: City Park Drive/Bathgate Drive & Ogilvie Road

BG 2037 PM DR



Lane Group	EBL	EBT	EBR	WBL	WBT	WBR	NBL	NBT	NBR	SBL	SBT	SBR
Lane Configurations												
Traffic Volume (vph)	207	1061	165	12	839	110	120	69	26	140	47	159
Future Volume (vph)	207	1061	165	12	839	110	120	69	26	140	47	159
Ideal Flow (vphpl)	1800	1800	1800	1800	1800	1800	1800	1800	1800	1800	1800	1800
Storage Length (m)	70.0		40.0	45.0		70.0	30.0		0.0	20.0		0.0
Storage Lanes	1		1	1		1	1		0	1		0
Taper Length (m)	30.0			30.0			25.0			25.0		
Lane Util. Factor	1.00	0.95	1.00	1.00	0.95	1.00	1.00	1.00	1.00	1.00	1.00	1.00
Ped Bike Factor	0.97		0.90			0.83	0.98	0.99		0.98	0.97	
Fr _t			0.850			0.850		0.959			0.884	
Fl _t Protected	0.950			0.950			0.950			0.950		
Satd. Flow (prot)	1679	3357	1502	1679	3357	1502	1631	1632	0	1647	1487	0
Fl _t Permitted	0.226			0.245			0.539			0.695		
Satd. Flow (perm)	387	3357	1349	433	3357	1248	907	1632	0	1182	1487	0
Right Turn on Red			Yes			Yes			Yes			Yes
Satd. Flow (RTOR)			121			121		20			159	
Link Speed (k/h)		60			60			60			60	
Link Distance (m)		257.6			190.5			345.6			177.6	
Travel Time (s)		15.5			11.4			20.7			10.7	
Confl. Peds. (#/hr)	73		40	40		73	27		21	21		27
Peak Hour Factor	1.00	1.00	1.00	1.00	1.00	1.00	1.00	1.00	1.00	1.00	1.00	1.00
Heavy Vehicles (%)	3%	3%	3%	3%	3%	3%	6%	6%	6%	5%	5%	5%
Adj. Flow (vph)	207	1061	165	12	839	110	120	69	26	140	47	159
Shared Lane Traffic (%)												
Lane Group Flow (vph)	207	1061	165	12	839	110	120	95	0	140	206	0
Enter Blocked Intersection	No	No	No	No	No	No	No	No	No	No	No	No
Lane Alignment	Left	Left	Right	Left	Left	Right	Left	Left	Right	Left	Left	Right
Median Width(m)		3.7			3.7			3.7			3.7	
Link Offset(m)		0.0			0.0			0.0			0.0	
Crosswalk Width(m)		4.9			4.9			4.9			4.9	
Two way Left Turn Lane												
Headway Factor	1.06	1.06	1.06	1.06	1.06	1.06	1.06	1.06	1.06	1.06	1.06	1.06
Turning Speed (k/h)	24		14	24		14	24		14	24		14
Number of Detectors	1	2	1	1	2	1	1	2		1	2	
Detector Template	Left	Thru	Right	Left	Thru	Right	Left	Thru		Left	Thru	
Leading Detector (m)	6.1	30.5	6.1	6.1	30.5	6.1	6.1	30.5		6.1	30.5	
Trailing Detector (m)	0.0	0.0	0.0	0.0	0.0	0.0	0.0	0.0		0.0	0.0	
Detector 1 Position(m)	0.0	0.0	0.0	0.0	0.0	0.0	0.0	0.0		0.0	0.0	
Detector 1 Size(m)	6.1	1.8	6.1	6.1	1.8	6.1	6.1	1.8		6.1	1.8	
Detector 1 Type	Cl+Ex	Cl+Ex	Cl+Ex	Cl+Ex	Cl+Ex	Cl+Ex	Cl+Ex	Cl+Ex		Cl+Ex	Cl+Ex	
Detector 1 Channel												
Detector 1 Extend (s)	0.0	0.0	0.0	0.0	0.0	0.0	0.0	0.0		0.0	0.0	
Detector 1 Queue (s)	0.0	0.0	0.0	0.0	0.0	0.0	0.0	0.0		0.0	0.0	
Detector 1 Delay (s)	0.0	0.0	0.0	0.0	0.0	0.0	0.0	0.0		0.0	0.0	
Detector 2 Position(m)		28.7			28.7			28.7			28.7	
Detector 2 Size(m)		1.8			1.8			1.8			1.8	
Detector 2 Type		Cl+Ex			Cl+Ex			Cl+Ex			Cl+Ex	
Detector 2 Channel												
Detector 2 Extend (s)		0.0			0.0			0.0			0.0	

Lane Group	Ø3	Ø7
Lane Configurations		
Traffic Volume (vph)		
Future Volume (vph)		
Ideal Flow (vphpl)		
Storage Length (m)		
Storage Lanes		
Taper Length (m)		
Lane Util. Factor		
Ped Bike Factor		
Frt		
Flt Protected		
Satd. Flow (prot)		
Flt Permitted		
Satd. Flow (perm)		
Right Turn on Red		
Satd. Flow (RTOR)		
Link Speed (k/h)		
Link Distance (m)		
Travel Time (s)		
Confl. Peds. (#/hr)		
Peak Hour Factor		
Heavy Vehicles (%)		
Adj. Flow (vph)		
Shared Lane Traffic (%)		
Lane Group Flow (vph)		
Enter Blocked Intersection		
Lane Alignment		
Median Width(m)		
Link Offset(m)		
Crosswalk Width(m)		
Two way Left Turn Lane		
Headway Factor		
Turning Speed (k/h)		
Number of Detectors		
Detector Template		
Leading Detector (m)		
Trailing Detector (m)		
Detector 1 Position(m)		
Detector 1 Size(m)		
Detector 1 Type		
Detector 1 Channel		
Detector 1 Extend (s)		
Detector 1 Queue (s)		
Detector 1 Delay (s)		
Detector 2 Position(m)		
Detector 2 Size(m)		
Detector 2 Type		
Detector 2 Channel		
Detector 2 Extend (s)		

15: City Park Drive/Bathgate Drive & Ogilvie Road

BG 2037 PM DR



Lane Group	EBL	EBT	EBR	WBL	WBT	WBR	NBL	NBT	NBR	SBL	SBT	SBR
Turn Type	pm+pt	NA	Perm	pm+pt	NA	Perm	Perm	NA		Perm	NA	
Protected Phases	5	2		1	6			8				4
Permitted Phases	2		2	6		6	8			4		
Detector Phase	5	2	2	1	6	6	8	8		4		4
Switch Phase												
Minimum Initial (s)	5.0	10.0	10.0	5.0	10.0	10.0	10.0	10.0		10.0		10.0
Minimum Split (s)	9.7	30.0	30.0	9.7	30.0	30.0	37.4	37.4		37.4		37.4
Total Split (s)	20.0	37.0	37.0	20.0	37.0	37.0	38.0	38.0		38.0		38.0
Total Split (%)	20.0%	37.0%	37.0%	20.0%	37.0%	37.0%	38.0%	38.0%		38.0%		38.0%
Maximum Green (s)	15.3	31.0	31.0	15.3	31.0	31.0	30.6	30.6		30.6		30.6
Yellow Time (s)	3.7	3.7	3.7	3.7	3.7	3.7	3.0	3.0		3.0		3.0
All-Red Time (s)	1.0	2.3	2.3	1.0	2.3	2.3	4.4	4.4		4.4		4.4
Lost Time Adjust (s)	0.0	0.0	0.0	0.0	0.0	0.0	0.0	0.0		0.0		0.0
Total Lost Time (s)	4.7	6.0	6.0	4.7	6.0	6.0	7.4	7.4		7.4		7.4
Lead/Lag	Lead	Lag	Lag	Lead	Lag	Lag	Lag	Lag		Lag		Lag
Lead-Lag Optimize?	Yes	Yes	Yes	Yes	Yes	Yes	Yes	Yes		Yes		Yes
Vehicle Extension (s)	3.0	3.0	3.0	3.0	3.0	3.0	3.0	3.0		3.0		3.0
Recall Mode	None	C-Max	C-Max	None	C-Max	C-Max	None	None		None		None
Walk Time (s)		9.0	9.0		9.0	9.0	2.0	2.0		2.0		2.0
Flash Dont Walk (s)		15.0	15.0		15.0	15.0	28.0	28.0		28.0		28.0
Pedestrian Calls (#/hr)		30	30		30	30	20	20		20		20
Act Effct Green (s)	62.6	59.1	59.1	52.6	45.4	45.4	20.3	20.3		20.3		20.3
Actuated g/C Ratio	0.63	0.59	0.59	0.53	0.45	0.45	0.20	0.20		0.20		0.20
v/c Ratio	0.54	0.54	0.20	0.04	0.55	0.17	0.66	0.27		0.59		0.48
Control Delay	20.9	14.6	7.0	8.7	16.5	2.0	51.3	25.5		44.1		12.1
Queue Delay	0.0	0.0	0.0	0.0	0.0	0.0	0.0	0.0		0.0		0.0
Total Delay	20.9	14.6	7.0	8.7	16.5	2.0	51.3	25.5		44.1		12.1
LOS	C	B	A	A	B	A	D	C		D		B
Approach Delay		14.6			14.7			39.9				25.0
Approach LOS		B			B			D				C

Intersection Summary

Area Type:	Other
Cycle Length:	100
Actuated Cycle Length:	100
Offset:	19 (19%), Referenced to phase 2:EBTL and 6:WBTL, Start of Green
Natural Cycle:	85
Control Type:	Actuated-Coordinated
Maximum v/c Ratio:	0.66
Intersection Signal Delay:	17.7
Intersection LOS:	B
Intersection Capacity Utilization	87.0%
ICU Level of Service	E
Analysis Period (min)	15

Splits and Phases: 15: City Park Drive/Bathgate Drive & Ogilvie Road



Lane Group	Ø3	Ø7
Turn Type		
Protected Phases	3	7
Permitted Phases		
Detector Phase		
Switch Phase		
Minimum Initial (s)	1.0	1.0
Minimum Split (s)	5.0	5.0
Total Split (s)	5.0	5.0
Total Split (%)	5%	5%
Maximum Green (s)	3.0	3.0
Yellow Time (s)	2.0	2.0
All-Red Time (s)	0.0	0.0
Lost Time Adjust (s)		
Total Lost Time (s)		
Lead/Lag	Lead	Lead
Lead-Lag Optimize?	Yes	Yes
Vehicle Extension (s)	3.0	3.0
Recall Mode	Ped	Ped
Walk Time (s)	0.0	0.0
Flash Dont Walk (s)	0.0	0.0
Pedestrian Calls (#/hr)	20	20
Act Effct Green (s)		
Actuated g/C Ratio		
v/c Ratio		
Control Delay		
Queue Delay		
Total Delay		
LOS		
Approach Delay		
Approach LOS		
Intersection Summary		

18: Residential/Cadboro Road & Ogilvie Road

BG 2037 PM DR



Lane Group	EBL	EBT	EBR	WBL	WBT	WBR	NBL	NBT	NBR	SBL	SBT	SBR
Lane Configurations		↑↑			↑↑				↑			↑
Traffic Volume (vph)	0	1833	14	0	1222	70	0	0	1	0	0	97
Future Volume (vph)	0	1833	14	0	1222	70	0	0	1	0	0	97
Ideal Flow (vphpl)	1800	1800	1800	1800	1800	1800	1800	1800	1800	1800	1800	1800
Lane Util. Factor	1.00	0.95	0.95	1.00	0.95	0.95	1.00	1.00	1.00	1.00	1.00	1.00
Fr _t		0.999			0.992				0.865			0.865
Fl _t Protected												
Satd. Flow (prot)	0	3387	0	0	3363	0	0	0	1543	0	0	1543
Fl _t Permitted												
Satd. Flow (perm)	0	3387	0	0	3363	0	0	0	1543	0	0	1543
Right Turn on Red			Yes			Yes			Yes			Yes
Satd. Flow (RTOR)		1			9				33			53
Link Speed (k/h)		60			60			60				60
Link Distance (m)		264.5			257.6			90.1				116.1
Travel Time (s)		15.9			15.5			5.4				7.0
Peak Hour Factor	1.00	1.00	1.00	1.00	1.00	1.00	1.00	1.00	1.00	1.00	1.00	1.00
Adj. Flow (vph)	0	1833	14	0	1222	70	0	0	1	0	0	97
Shared Lane Traffic (%)												
Lane Group Flow (vph)	0	1847	0	0	1292	0	0	0	1	0	0	97
Enter Blocked Intersection	No	No	No	No	No	No	No	No	No	No	No	No
Lane Alignment	Left	Left	Right	Left	Left	Right	Left	Left	Right	Left	Left	Right
Median Width(m)		3.7			3.7			0.0				0.0
Link Offset(m)		0.0			0.0			0.0				0.0
Crosswalk Width(m)		1.6			1.6			1.6				1.6
Two way Left Turn Lane												
Headway Factor	1.06	1.06	1.06	1.06	1.06	1.06	1.06	1.06	1.06	1.06	1.06	1.06
Turning Speed (k/h)	97		97	97		97	97		97	97		97
Number of Detectors		2			2				1			1
Detector Template		Thru			Thru				Right			Right
Leading Detector (m)		10.0			10.0				2.0			2.0
Trailing Detector (m)		0.0			0.0				0.0			0.0
Detector 1 Position(m)		0.0			0.0				0.0			0.0
Detector 1 Size(m)		0.6			0.6				2.0			2.0
Detector 1 Type		Cl+Ex			Cl+Ex				Cl+Ex			Cl+Ex
Detector 1 Channel												
Detector 1 Extend (s)		0.0			0.0				0.0			0.0
Detector 1 Queue (s)		0.0			0.0				0.0			0.0
Detector 1 Delay (s)		0.0			0.0				0.0			0.0
Detector 2 Position(m)		9.4			9.4							
Detector 2 Size(m)		0.6			0.6							
Detector 2 Type		Cl+Ex			Cl+Ex							
Detector 2 Channel												
Detector 2 Extend (s)		0.0			0.0							
Turn Type		NA			NA				Perm			Perm
Protected Phases		2			6							
Permitted Phases									8			4
Detector Phase		2			6				8			4
Switch Phase												
Minimum Initial (s)		10.0			10.0				5.0			5.0

18: Residential/Cadboro Road & Ogilvie Road

BG 2037 PM DR



Lane Group	EBL	EBT	EBR	WBL	WBT	WBR	NBL	NBT	NBR	SBL	SBT	SBR
Minimum Split (s)		35.0			35.0				40.0			40.0
Total Split (s)		60.0			60.0				40.0			40.0
Total Split (%)		60.0%			60.0%				40.0%			40.0%
Maximum Green (s)		54.0			54.0				36.0			36.0
Yellow Time (s)		3.7			3.7				3.0			3.0
All-Red Time (s)		2.3			2.3				1.0			1.0
Lost Time Adjust (s)		0.0			0.0				0.0			0.0
Total Lost Time (s)		6.0			6.0				4.0			4.0
Lead/Lag												
Lead-Lag Optimize?												
Vehicle Extension (s)		3.0			3.0				3.0			3.0
Recall Mode		C-Max			C-Max				None			None
Walk Time (s)		15.0			15.0				24.0			24.0
Flash Dont Walk (s)		14.0			14.0				12.0			12.0
Pedestrian Calls (#/hr)		30			30				20			20
Act Effct Green (s)		74.7			74.7				18.4			18.4
Actuated g/C Ratio		0.75			0.75				0.18			0.18
v/c Ratio		0.73			0.51				0.00			0.30
Control Delay		15.5			9.2				0.0			16.3
Queue Delay		0.0			0.0				0.0			0.0
Total Delay		15.5			9.2				0.0			16.3
LOS		B			A				A			B
Approach Delay		15.5			9.2							16.3
Approach LOS		B			A							B

Intersection Summary

Area Type:	Other
Cycle Length:	100
Actuated Cycle Length:	100
Offset:	4 (4%), Referenced to phase 2:EBT and 6:WBT, Start of Green
Natural Cycle:	90
Control Type:	Actuated-Coordinated
Maximum v/c Ratio:	0.73
Intersection Signal Delay:	13.0
Intersection LOS:	B
Intersection Capacity Utilization	66.5%
ICU Level of Service	C
Analysis Period (min)	15

Splits and Phases: 18: Residential/Cadboro Road & Ogilvie Road

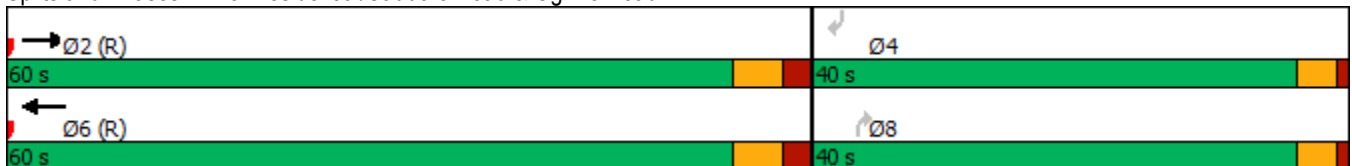



Lane Group	WBL	WBR	NBT	NBR	SBL	SBT
Lane Configurations						
Traffic Volume (vph)	237	981	834	189	488	1019
Future Volume (vph)	237	981	834	189	488	1019
Ideal Flow (vphpl)	1800	1800	1800	1800	1800	1800
Storage Length (m)	0.0	0.0		70.0	0.0	
Storage Lanes	1	1		1	0	
Taper Length (m)	7.6				7.6	
Lane Util. Factor	1.00	1.00	0.95	1.00	0.95	0.95
Fr _t		0.850		0.850		
Fl _t Protected	0.950					0.984
Satd. Flow (prot)	1647	1473	3325	1488	0	3210
Fl _t Permitted	0.950					0.521
Satd. Flow (perm)	1647	1473	3325	1488	0	1700
Right Turn on Red		Yes		Yes		
Satd. Flow (RTOR)		584		189		
Link Speed (k/h)	60		60			60
Link Distance (m)	216.4		230.9			341.9
Travel Time (s)	13.0		13.9			20.5
Peak Hour Factor	1.00	1.00	1.00	1.00	1.00	1.00
Heavy Vehicles (%)	5%	5%	4%	4%	6%	6%
Adj. Flow (vph)	237	981	834	189	488	1019
Shared Lane Traffic (%)						
Lane Group Flow (vph)	237	981	834	189	0	1507
Enter Blocked Intersection	No	No	No	No	No	No
Lane Alignment	Left	Right	Left	Right	Left	Left
Median Width(m)	3.7		0.0			0.0
Link Offset(m)	0.0		0.0			0.0
Crosswalk Width(m)	4.9		4.9			4.9
Two way Left Turn Lane						
Headway Factor	1.06	1.06	1.06	1.06	1.06	1.06
Turning Speed (k/h)	24	14		14	24	
Number of Detectors	1	1	2	1	1	2
Detector Template	Left	Right	Thru	Right	Left	Thru
Leading Detector (m)	6.1	6.1	30.5	6.1	6.1	30.5
Trailing Detector (m)	0.0	0.0	0.0	0.0	0.0	0.0
Detector 1 Position(m)	0.0	0.0	0.0	0.0	0.0	0.0
Detector 1 Size(m)	6.1	6.1	1.8	6.1	6.1	1.8
Detector 1 Type	Cl+Ex	Cl+Ex	Cl+Ex	Cl+Ex	Cl+Ex	Cl+Ex
Detector 1 Channel						
Detector 1 Extend (s)	0.0	0.0	0.0	0.0	0.0	0.0
Detector 1 Queue (s)	0.0	0.0	0.0	0.0	0.0	0.0
Detector 1 Delay (s)	0.0	0.0	0.0	0.0	0.0	0.0
Detector 2 Position(m)			28.7			28.7
Detector 2 Size(m)			1.8			1.8
Detector 2 Type			Cl+Ex			Cl+Ex
Detector 2 Channel						
Detector 2 Extend (s)			0.0			0.0
Turn Type	Prot	Free	NA	pm+ov	pm+pt	NA
Protected Phases	8		2	8	1	6



Lane Group	WBL	WBR	NBT	NBR	SBL	SBT
Permitted Phases	Free		2		6	
Detector Phase	8		2	8	1	6
Switch Phase						
Minimum Initial (s)	5.0		10.0	5.0	5.0	1.0
Minimum Split (s)	25.3		30.5	25.3	11.0	30.5
Total Split (s)	30.0		52.0	30.0	28.0	80.0
Total Split (%)	27.3%		47.3%	27.3%	25.5%	72.7%
Maximum Green (s)	23.7		45.5	23.7	22.0	73.5
Yellow Time (s)	3.3		4.2	3.3	4.2	4.2
All-Red Time (s)	3.0		2.3	3.0	1.8	2.3
Lost Time Adjust (s)	0.0		0.0	0.0		0.0
Total Lost Time (s)	6.3		6.5	6.3		6.5
Lead/Lag			Lag			Lead
Lead-Lag Optimize?			Yes			Yes
Vehicle Extension (s)	3.0		3.0	3.0	3.0	3.0
Recall Mode	None		C-Max	None	Max	C-Max
Walk Time (s)	7.0		7.0	7.0		7.0
Flash Dont Walk (s)	12.0		17.0	12.0		17.0
Pedestrian Calls (#/hr)	0		0	0		0
Act Effct Green (s)	20.0	110.0	45.5	72.0		77.2
Actuated g/C Ratio	0.18	1.00	0.41	0.65		0.70
v/c Ratio	0.80	0.67	0.61	0.18		0.98
Control Delay	61.9	2.4	27.6	1.2		32.2
Queue Delay	0.0	0.0	0.0	0.0		0.0
Total Delay	61.9	2.4	27.6	1.2		32.2
LOS	E	A	C	A		C
Approach Delay	14.0		22.7			32.2
Approach LOS	B		C			C

Intersection Summary

Area Type: Other
 Cycle Length: 110
 Actuated Cycle Length: 110
 Offset: 32 (29%), Referenced to phase 2:NBT and 6:SBTL, Start of Green
 Natural Cycle: 150
 Control Type: Actuated-Coordinated
 Maximum v/c Ratio: 0.98
 Intersection Signal Delay: 23.7
 Intersection LOS: C
 Intersection Capacity Utilization 99.0%
 ICU Level of Service F
 Analysis Period (min) 15

Splits and Phases: 22: Blair Road & Hwy 174 EB off



1630: Palmerston Drive/Matheson Road & Ogilvie Road

BG 2037 PM DR



Lane Group	EBL	EBT	EBR	WBL	WBT	WBR	NBL	NBT	NBR	SBL	SBT	SBR
Lane Configurations												
Traffic Volume (vph)	188	1711	61	94	1336	38	52	4	39	29	4	96
Future Volume (vph)	188	1711	61	94	1336	38	52	4	39	29	4	96
Ideal Flow (vphpl)	1800	1800	1800	1800	1800	1800	1800	1800	1800	1800	1800	1800
Storage Length (m)	70.0		0.0	70.0		0.0	15.0		0.0	0.0		35.0
Storage Lanes	1		0	1		0	1		0	0		1
Taper Length (m)	30.0			30.0			7.6			7.6		
Lane Util. Factor	1.00	0.95	0.95	1.00	0.95	0.95	1.00	1.00	1.00	1.00	1.00	1.00
Ped Bike Factor		1.00			1.00		0.98	0.98			0.99	0.99
Frt		0.995			0.996			0.864				0.850
Flt Protected	0.950			0.950			0.950				0.958	
Satd. Flow (prot)	1695	3362	0	1695	3369	0	1662	1476	0	0	1709	1517
Flt Permitted	0.129			0.072			0.736				0.721	
Satd. Flow (perm)	230	3362	0	128	3369	0	1267	1476	0	0	1274	1497
Right Turn on Red			Yes			Yes			Yes			Yes
Satd. Flow (RTOR)		4			3			39				96
Link Speed (k/h)		60			60			60				60
Link Distance (m)		314.1			264.5			176.2				174.1
Travel Time (s)		18.8			15.9			10.6				10.4
Confl. Peds. (#/hr)	24		34	34		24	16		11	11		
Confl. Bikes (#/hr)			11			22			3			1
Peak Hour Factor	1.00	1.00	1.00	1.00	1.00	1.00	1.00	1.00	1.00	1.00	1.00	1.00
Heavy Vehicles (%)	2%	2%	2%	2%	2%	2%	4%	4%	4%	2%	2%	2%
Adj. Flow (vph)	188	1711	61	94	1336	38	52	4	39	29	4	96
Shared Lane Traffic (%)												
Lane Group Flow (vph)	188	1772	0	94	1374	0	52	43	0	0	33	96
Enter Blocked Intersection	No	No	No	No	No	No	No	No	No	No	No	No
Lane Alignment	Left	Left	Right	Left	Left	Right	Left	Left	Right	Left	Left	Right
Median Width(m)		3.7			3.7			3.7				3.7
Link Offset(m)		0.0			0.0			0.0				0.0
Crosswalk Width(m)		4.9			4.9			4.9				4.9
Two way Left Turn Lane												
Headway Factor	1.06	1.06	1.06	1.06	1.06	1.06	1.06	1.06	1.06	1.06	1.06	1.06
Turning Speed (k/h)	24		14	24		14	24		14	24		14
Number of Detectors	1	2		1	2		1	2		1	2	1
Detector Template	Left	Thru		Left	Thru		Left	Thru		Left	Thru	Right
Leading Detector (m)	6.1	30.5		6.1	30.5		6.1	30.5		6.1	30.5	6.1
Trailing Detector (m)	0.0	0.0		0.0	0.0		0.0	0.0		0.0	0.0	0.0
Detector 1 Position(m)	0.0	0.0		0.0	0.0		0.0	0.0		0.0	0.0	0.0
Detector 1 Size(m)	6.1	1.8		6.1	1.8		6.1	1.8		6.1	1.8	6.1
Detector 1 Type	Cl+Ex	Cl+Ex		Cl+Ex	Cl+Ex		Cl+Ex	Cl+Ex		Cl+Ex	Cl+Ex	Cl+Ex
Detector 1 Channel												
Detector 1 Extend (s)	0.0	0.0		0.0	0.0		0.0	0.0		0.0	0.0	0.0
Detector 1 Queue (s)	0.0	0.0		0.0	0.0		0.0	0.0		0.0	0.0	0.0
Detector 1 Delay (s)	0.0	0.0		0.0	0.0		0.0	0.0		0.0	0.0	0.0
Detector 2 Position(m)		28.7			28.7			28.7				28.7
Detector 2 Size(m)		1.8			1.8			1.8				1.8
Detector 2 Type		Cl+Ex			Cl+Ex			Cl+Ex				Cl+Ex
Detector 2 Channel												

1900/2000 City Park Drive
3: Blair Road & Ogilvie Road

Tot 2037 AM



Lane Group	EBL	EBT	EBR	WBL	WBT	WBR	NBL	NBT	NBR	SBL	SBT	SBR
Lane Configurations	↘	↑↑	↗	↘↗	↑↑		↘↗	↑	↗	↘	↑↑	
Traffic Volume (vph)	108	456	265	644	739	50	643	663	624	69	334	114
Future Volume (vph)	108	456	265	644	739	50	643	663	624	69	334	114
Ideal Flow (vphpl)	1800	1800	1800	1800	1800	1800	1800	1800	1800	1800	1800	1800
Storage Length (m)	70.0		0.0	110.0		0.0	120.0		0.0	30.0		0.0
Storage Lanes	1		1	2		0	2		1	1		0
Taper Length (m)	40.0			60.0			60.0			45.0		
Lane Util. Factor	1.00	0.95	1.00	0.97	0.95	0.95	0.97	1.00	1.00	1.00	0.95	0.95
Ped Bike Factor					1.00						0.99	
Frt			0.850		0.990				0.850		0.962	
Flt Protected	0.950			0.950			0.950			0.950		
Satd. Flow (prot)	1679	3357	1502	3257	3307	0	3257	1767	1502	1679	3186	0
Flt Permitted	0.950			0.950			0.950			0.950		
Satd. Flow (perm)	1679	3357	1502	3257	3307	0	3257	1767	1502	1679	3186	0
Right Turn on Red			Yes			Yes			Yes			Yes
Satd. Flow (RTOR)			265		5				421		31	
Link Speed (k/h)		60			60			60			60	
Link Distance (m)		372.0			396.5			239.9			411.0	
Travel Time (s)		22.3			23.8			14.4			24.7	
Confl. Peds. (#/hr)						25						27
Confl. Bikes (#/hr)						3						3
Peak Hour Factor	1.00	1.00	1.00	1.00	1.00	1.00	1.00	1.00	1.00	1.00	1.00	1.00
Heavy Vehicles (%)	3%	3%	3%	3%	3%	3%	3%	3%	3%	3%	3%	3%
Adj. Flow (vph)	108	456	265	644	739	50	643	663	624	69	334	114
Shared Lane Traffic (%)												
Lane Group Flow (vph)	108	456	265	644	789	0	643	663	624	69	448	0
Enter Blocked Intersection	No	No	No	No	No	No	No	No	No	No	No	No
Lane Alignment	Left	Left	Right	Left	Left	Right	Left	Left	Right	Left	Left	Right
Median Width(m)		7.4			7.4			7.4			7.4	
Link Offset(m)		0.0			0.0			0.0			0.0	
Crosswalk Width(m)		4.9			4.9			4.9			4.9	
Two way Left Turn Lane												
Headway Factor	1.06	1.06	1.06	1.06	1.06	1.06	1.06	1.06	1.06	1.06	1.06	1.06
Turning Speed (k/h)	24		14	24		14	24		14	24		14
Number of Detectors	1	2	1	1	2		1	2	1	1	2	
Detector Template	Left	Thru	Right	Left	Thru		Left	Thru	Right	Left	Thru	
Leading Detector (m)	6.1	30.5	6.1	6.1	30.5		6.1	30.5	6.1	6.1	30.5	
Trailing Detector (m)	0.0	0.0	0.0	0.0	0.0		0.0	0.0	0.0	0.0	0.0	
Detector 1 Position(m)	0.0	0.0	0.0	0.0	0.0		0.0	0.0	0.0	0.0	0.0	
Detector 1 Size(m)	6.1	1.8	6.1	6.1	1.8		6.1	1.8	6.1	6.1	1.8	
Detector 1 Type	Cl+Ex	Cl+Ex	Cl+Ex	Cl+Ex	Cl+Ex		Cl+Ex	Cl+Ex	Cl+Ex	Cl+Ex	Cl+Ex	
Detector 1 Channel												
Detector 1 Extend (s)	0.0	0.0	0.0	0.0	0.0		0.0	0.0	0.0	0.0	0.0	
Detector 1 Queue (s)	0.0	0.0	0.0	0.0	0.0		0.0	0.0	0.0	0.0	0.0	
Detector 1 Delay (s)	0.0	0.0	0.0	0.0	0.0		0.0	0.0	0.0	0.0	0.0	
Detector 2 Position(m)		28.7			28.7			28.7			28.7	
Detector 2 Size(m)		1.8			1.8			1.8			1.8	
Detector 2 Type		Cl+Ex			Cl+Ex			Cl+Ex			Cl+Ex	
Detector 2 Channel												

1900/2000 City Park Drive
 3: Blair Road & Ogilvie Road

Tot 2037 AM



Lane Group	EBL	EBT	EBR	WBL	WBT	WBR	NBL	NBT	NBR	SBL	SBT	SBR
Detector 2 Extend (s)		0.0			0.0			0.0			0.0	
Turn Type	Prot	NA	Perm	Prot	NA		Prot	NA	Perm	Prot	NA	
Protected Phases	5	2		1	6		3	8		7	4	
Permitted Phases			2						8			
Detector Phase	5	2	2	1	6		3	8	8	7	4	
Switch Phase												
Minimum Initial (s)	5.0	10.0	10.0	5.0	10.0		5.0	10.0	10.0	5.0	10.0	
Minimum Split (s)	11.8	38.6	38.6	11.8	38.6		11.5	35.5	35.5	11.5	35.5	
Total Split (s)	28.0	39.0	39.0	28.0	39.0		36.0	58.0	58.0	15.0	37.0	
Total Split (%)	20.0%	27.9%	27.9%	20.0%	27.9%		25.7%	41.4%	41.4%	10.7%	26.4%	
Maximum Green (s)	21.2	32.4	32.4	21.2	32.4		29.5	51.5	51.5	8.5	30.5	
Yellow Time (s)	3.7	3.3	3.3	3.7	3.3		4.2	4.2	4.2	4.2	4.2	
All-Red Time (s)	3.1	3.3	3.3	3.1	3.3		2.3	2.3	2.3	2.3	2.3	
Lost Time Adjust (s)	0.0	0.0	0.0	0.0	0.0		0.0	0.0	0.0	0.0	0.0	
Total Lost Time (s)	6.8	6.6	6.6	6.8	6.6		6.5	6.5	6.5	6.5	6.5	
Lead/Lag	Lead	Lag	Lag	Lead	Lag		Lead	Lag	Lag	Lead	Lag	
Lead-Lag Optimize?	Yes	Yes	Yes	Yes	Yes		Yes	Yes	Yes	Yes	Yes	
Vehicle Extension (s)	3.0	3.0	3.0	3.0	3.0		3.0	3.0	3.0	3.0	3.0	
Recall Mode	None	Max	Max	None	Max		None	None	None	None	None	
Walk Time (s)		7.0	7.0		7.0			7.0	7.0		7.0	
Flash Dont Walk (s)		25.0	25.0		25.0			22.0	22.0		22.0	
Pedestrian Calls (#/hr)		20	20		20			25	25		25	
Act Effct Green (s)	14.3	32.4	32.4	21.2	39.3		29.1	51.5	51.5	8.2	30.6	
Actuated g/C Ratio	0.10	0.23	0.23	0.15	0.28		0.21	0.37	0.37	0.06	0.22	
v/c Ratio	0.63	0.59	0.48	1.30	0.84		0.95	1.02	0.76	0.70	0.62	
Control Delay	75.9	51.3	8.0	196.3	57.0		78.3	83.3	18.8	99.2	50.2	
Queue Delay	0.0	0.0	0.0	0.0	0.0		0.0	0.0	0.0	0.0	0.0	
Total Delay	75.9	51.3	8.0	196.3	57.0		78.3	83.3	18.8	99.2	50.2	
LOS	E	D	A	F	E		E	F	B	F	D	
Approach Delay		40.7			119.6			60.8			56.7	
Approach LOS		D			F			E			E	

Intersection Summary

Area Type:	Other
Cycle Length:	140
Actuated Cycle Length:	139.7
Natural Cycle:	150
Control Type:	Semi Act-Uncoord
Maximum v/c Ratio:	1.30
Intersection Signal Delay:	74.7
Intersection LOS:	E
Intersection Capacity Utilization	96.0%
ICU Level of Service	F
Analysis Period (min)	15

Splits and Phases: 3: Blair Road & Ogilvie Road

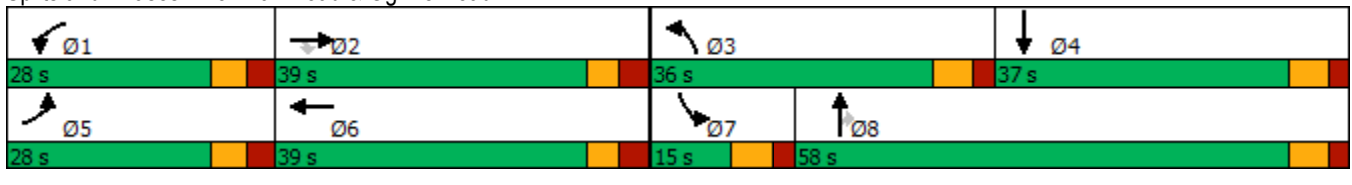

1900/2000 City Park Drive

6: Blair Road & 1980 Ogilvie Road/Hwy 174 WB off

Tot 2037 AM

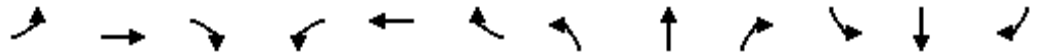

Lane Group	EBL	EBT	EBR	WBL	WBT	WBR	NBL	NBT	NBR	SBL	SBT	SBR
Lane Configurations	↘		↗	↘	↗	↗	↗↘	↗↘			↗↘↘	↗
Traffic Volume (vph)	87	0	371	115	150	303	281	1454	0	0	936	109
Future Volume (vph)	87	0	371	115	150	303	281	1454	0	0	936	109
Ideal Flow (vphpl)	1800	1800	1800	1800	1800	1800	1800	1800	1800	1800	1800	1800
Storage Length (m)	0.0		70.0	0.0		70.0	60.0		0.0	0.0		50.0
Storage Lanes	1		1	1		1	2		0	0		1
Taper Length (m)	7.6			7.6			100.0			7.6		
Lane Util. Factor	1.00	1.00	1.00	1.00	1.00	1.00	0.97	0.95	1.00	1.00	0.91	1.00
Frt			0.850			0.850						0.850
Flt Protected	0.950			0.950			0.950					
Satd. Flow (prot)	1340	0	1199	1695	1784	1517	3164	3262	0	0	4732	1473
Flt Permitted	0.662			0.950			0.950					
Satd. Flow (perm)	934	0	1199	1695	1784	1517	3164	3262	0	0	4732	1473
Right Turn on Red			Yes			Yes			Yes			Yes
Satd. Flow (RTOR)			34			104						111
Link Speed (k/h)		60			60			60				60
Link Distance (m)		518.9			416.4			90.2				239.9
Travel Time (s)		31.1			25.0			5.4				14.4
Peak Hour Factor	1.00	1.00	1.00	1.00	1.00	1.00	1.00	1.00	1.00	1.00	1.00	1.00
Heavy Vehicles (%)	29%	29%	29%	2%	2%	2%	6%	6%	6%	5%	5%	5%
Adj. Flow (vph)	87	0	371	115	150	303	281	1454	0	0	936	109
Shared Lane Traffic (%)												
Lane Group Flow (vph)	87	0	371	115	150	303	281	1454	0	0	936	109
Enter Blocked Intersection	No	No	No	No	No	No	No	No	No	No	No	No
Lane Alignment	Left	Left	Right	Left	Left	Right	Left	Left	Right	Left	Left	Right
Median Width(m)		3.7			3.7			7.4				7.4
Link Offset(m)		0.0			0.0			0.0				0.0
Crosswalk Width(m)		4.9			4.9			4.9				4.9
Two way Left Turn Lane												
Headway Factor	1.06	1.06	1.06	1.06	1.06	1.06	1.06	1.06	1.06	1.06	1.06	1.06
Turning Speed (k/h)	24		14	24		14	24		14	24		14
Number of Detectors	1		1	1	2	1	1	2			2	1
Detector Template	Left		Right	Left	Thru	Right	Left	Thru			Thru	Right
Leading Detector (m)	6.1		6.1	6.1	30.5	6.1	6.1	30.5			30.5	6.1
Trailing Detector (m)	0.0		0.0	0.0	0.0	0.0	0.0	0.0			0.0	0.0
Detector 1 Position(m)	0.0		0.0	0.0	0.0	0.0	0.0	0.0			0.0	0.0
Detector 1 Size(m)	6.1		6.1	6.1	1.8	6.1	6.1	1.8			1.8	6.1
Detector 1 Type	Cl+Ex		Cl+Ex	Cl+Ex	Cl+Ex	Cl+Ex	Cl+Ex	Cl+Ex			Cl+Ex	Cl+Ex
Detector 1 Channel												
Detector 1 Extend (s)	0.0		0.0	0.0	0.0	0.0	0.0	0.0			0.0	0.0
Detector 1 Queue (s)	0.0		0.0	0.0	0.0	0.0	0.0	0.0			0.0	0.0
Detector 1 Delay (s)	0.0		0.0	0.0	0.0	0.0	0.0	0.0			0.0	0.0
Detector 2 Position(m)					28.7			28.7			28.7	
Detector 2 Size(m)					1.8			1.8			1.8	
Detector 2 Type					Cl+Ex			Cl+Ex			Cl+Ex	
Detector 2 Channel												
Detector 2 Extend (s)					0.0			0.0			0.0	
Turn Type	Perm		pm+ov	Perm	NA	Perm	Prot	NA			NA	Perm
Protected Phases			5		8		5	2			6	

1900/2000 City Park Drive

6: Blair Road & 1980 Ogilvie Road/Hwy 174 WB off

Tot 2037 AM



Lane Group	EBL	EBT	EBR	WBL	WBT	WBR	NBL	NBT	NBR	SBL	SBT	SBR
Permitted Phases	4		4	8		8						6
Detector Phase	4		5	8	8	8	5	2			6	6
Switch Phase												
Minimum Initial (s)	10.0		5.0	10.0	10.0	10.0	5.0	10.0			10.0	10.0
Minimum Split (s)	16.8		11.4	36.8	36.8	36.8	11.4	30.1			30.1	30.1
Total Split (s)	41.0		27.0	41.0	41.0	41.0	27.0	59.0			32.0	32.0
Total Split (%)	41.0%		27.0%	41.0%	41.0%	41.0%	27.0%	59.0%			32.0%	32.0%
Maximum Green (s)	34.2		20.6	34.2	34.2	34.2	20.6	52.9			25.9	25.9
Yellow Time (s)	3.3		4.2	3.3	3.3	3.3	4.2	4.2			4.2	4.2
All-Red Time (s)	3.5		2.2	3.5	3.5	3.5	2.2	1.9			1.9	1.9
Lost Time Adjust (s)	0.0		0.0	0.0	0.0	0.0	0.0	0.0			0.0	0.0
Total Lost Time (s)	6.8		6.4	6.8	6.8	6.8	6.4	6.1			6.1	6.1
Lead/Lag			Lead				Lead				Lag	Lag
Lead-Lag Optimize?			Yes				Yes				Yes	Yes
Vehicle Extension (s)	3.0		3.0	3.0	3.0	3.0	3.0	3.0			3.0	3.0
Recall Mode	None		None	None	None	None	None	Max			Max	Max
Walk Time (s)				7.0	7.0	7.0		7.0			7.0	7.0
Flash Dont Walk (s)				23.0	23.0	23.0		17.0			17.0	17.0
Pedestrian Calls (#/hr)				20	20	20		20			20	20
Act Effct Green (s)	19.5		39.6	19.5	19.5	19.5	13.2	53.4			33.8	33.8
Actuated g/C Ratio	0.23		0.46	0.23	0.23	0.23	0.15	0.62			0.39	0.39
v/c Ratio	0.41		0.65	0.30	0.37	0.71	0.58	0.72			0.50	0.17
Control Delay	33.2		20.7	28.3	29.6	28.9	39.5	15.5			23.3	5.8
Queue Delay	0.0		0.0	0.0	0.0	0.0	0.0	0.0			0.0	0.0
Total Delay	33.2		20.7	28.3	29.6	28.9	39.5	15.5			23.3	5.8
LOS	C		C	C	C	C	D	B			C	A
Approach Delay		23.1			29.0			19.4			21.4	
Approach LOS		C			C			B			C	

Intersection Summary

Area Type: Other

Cycle Length: 100

Actuated Cycle Length: 86

Natural Cycle: 80

Control Type: Semi Act-Uncoord

Maximum v/c Ratio: 0.72

Intersection Signal Delay: 21.8

Intersection LOS: C

Intersection Capacity Utilization 81.4%

ICU Level of Service D

Analysis Period (min) 15

Splits and Phases: 6: Blair Road & 1980 Ogilvie Road/Hwy 174 WB off

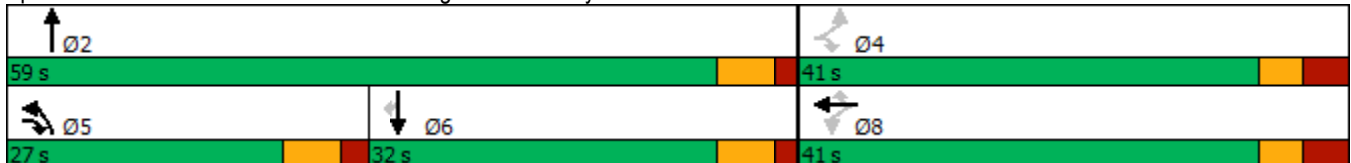

1900/2000 City Park Drive
7: 1980 Ogilvie Road

Tot 2037 AM



Lane Group	WBL	WBR	NBT	NBR	SBL	SBT
Lane Configurations						
Traffic Volume (vph)	0	0	0	0	0	0
Future Volume (vph)	0	0	0	0	0	0
Ideal Flow (vphpl)	1800	1800	1800	1800	1800	1800
Lane Util. Factor	1.00	1.00	1.00	1.00	1.00	1.00
Frnt						
Flt Protected						
Satd. Flow (prot)	1784	0	1784	0	0	1784
Flt Permitted						
Satd. Flow (perm)	1784	0	1784	0	0	1784
Link Speed (k/h)	60		60			60
Link Distance (m)	518.9		235.1			57.3
Travel Time (s)	31.1		14.1			3.4
Peak Hour Factor	0.90	0.90	0.90	0.90	0.90	0.90
Adj. Flow (vph)	0	0	0	0	0	0
Shared Lane Traffic (%)						
Lane Group Flow (vph)	0	0	0	0	0	0
Enter Blocked Intersection	No	No	No	No	No	No
Lane Alignment	Left	Right	Left	Right	Left	Left
Median Width(m)	3.7		0.0			0.0
Link Offset(m)	0.0		0.0			0.0
Crosswalk Width(m)	4.9		4.9			4.9
Two way Left Turn Lane						
Headway Factor	1.06	1.06	1.06	1.06	1.06	1.06
Turning Speed (k/h)	24	14		14	24	
Sign Control	Stop		Free			Free
Intersection Summary						
Area Type:	Other					
Control Type:	Unsignalized					
Intersection Capacity Utilization	0.0%		ICU Level of Service A			
Analysis Period (min)	15					

1900/2000 City Park Drive
 9: City Park Drive/1941 Ogilvie & Ogilvie Road

Tot 2037 AM



Lane Group	EBL	EBT	EBR	WBL	WBT	WBR	NBL	NBT	NBR	SBL	SBT	SBR
Lane Configurations												
Traffic Volume (vph)	102	681	78	87	1023	174	59	23	166	5	2	9
Future Volume (vph)	102	681	78	87	1023	174	59	23	166	5	2	9
Ideal Flow (vphpl)	1800	1800	1800	1800	1800	1800	1800	1800	1800	1800	1800	1800
Storage Length (m)	40.0		100.0	100.0		50.0	0.0		60.0	20.0		10.0
Storage Lanes	1		1	1		1	0		1	1		1
Taper Length (m)	30.0			25.0			7.6			15.0		
Lane Util. Factor	1.00	0.95	1.00	1.00	0.95	1.00	1.00	1.00	1.00	1.00	1.00	1.00
Ped Bike Factor	0.97		0.87	0.96		0.81		0.96	0.93	0.95		
Frt			0.850			0.850			0.850			0.850
Flt Protected	0.950			0.950				0.965		0.950		
Satd. Flow (prot)	1695	3390	1517	1679	3357	1502	0	1626	1432	1695	1784	1517
Flt Permitted	0.238			0.374				0.786		0.704		
Satd. Flow (perm)	411	3390	1320	635	3357	1211	0	1269	1334	1193	1784	1517
Right Turn on Red			Yes			Yes			Yes			Yes
Satd. Flow (RTOR)			78			174			166			56
Link Speed (k/h)		60			60			60				60
Link Distance (m)		224.7			372.0			239.4				142.3
Travel Time (s)		13.5			22.3			14.4				8.5
Confl. Peds. (#/hr)	100		65	65		100	53		51	51		
Confl. Bikes (#/hr)						9			2			
Peak Hour Factor	1.00	1.00	1.00	1.00	1.00	1.00	1.00	1.00	1.00	1.00	1.00	1.00
Heavy Vehicles (%)	2%	2%	2%	3%	3%	3%	8%	8%	8%	2%	2%	2%
Adj. Flow (vph)	102	681	78	87	1023	174	59	23	166	5	2	9
Shared Lane Traffic (%)												
Lane Group Flow (vph)	102	681	78	87	1023	174	0	82	166	5	2	9
Enter Blocked Intersection	No	No	No	No	No	No	No	No	No	No	No	No
Lane Alignment	Left	Left	Right	Left	Left	Right	Left	Left	Right	Left	Left	Right
Median Width(m)		3.7			3.7			3.7				3.7
Link Offset(m)		0.0			0.0			0.0				0.0
Crosswalk Width(m)		4.9			4.9			4.9				4.9
Two way Left Turn Lane												
Headway Factor	1.06	1.06	1.06	1.06	1.06	1.06	1.06	1.06	1.06	1.06	1.06	1.06
Turning Speed (k/h)	24		14	24		14	24		14	24		14
Number of Detectors	1	2	1	1	2	1	1	2	1	1	2	1
Detector Template	Left	Thru	Right	Left	Thru	Right	Left	Thru	Right	Left	Thru	Right
Leading Detector (m)	6.1	30.5	6.1	6.1	30.5	6.1	6.1	30.5	6.1	6.1	30.5	6.1
Trailing Detector (m)	0.0	0.0	0.0	0.0	0.0	0.0	0.0	0.0	0.0	0.0	0.0	0.0
Detector 1 Position(m)	0.0	0.0	0.0	0.0	0.0	0.0	0.0	0.0	0.0	0.0	0.0	0.0
Detector 1 Size(m)	6.1	1.8	6.1	6.1	1.8	6.1	6.1	1.8	6.1	6.1	1.8	6.1
Detector 1 Type	Cl+Ex	Cl+Ex	Cl+Ex	Cl+Ex	Cl+Ex	Cl+Ex	Cl+Ex	Cl+Ex	Cl+Ex	Cl+Ex	Cl+Ex	Cl+Ex
Detector 1 Channel												
Detector 1 Extend (s)	0.0	0.0	0.0	0.0	0.0	0.0	0.0	0.0	0.0	0.0	0.0	0.0
Detector 1 Queue (s)	0.0	0.0	0.0	0.0	0.0	0.0	0.0	0.0	0.0	0.0	0.0	0.0
Detector 1 Delay (s)	0.0	0.0	0.0	0.0	0.0	0.0	0.0	0.0	0.0	0.0	0.0	0.0
Detector 2 Position(m)		28.7			28.7			28.7				28.7
Detector 2 Size(m)		1.8			1.8			1.8				1.8
Detector 2 Type		Cl+Ex			Cl+Ex			Cl+Ex				Cl+Ex
Detector 2 Channel												

Lane Group	Ø3	Ø7
Lane Configurations		
Traffic Volume (vph)		
Future Volume (vph)		
Ideal Flow (vphpl)		
Storage Length (m)		
Storage Lanes		
Taper Length (m)		
Lane Util. Factor		
Ped Bike Factor		
Frt		
Flt Protected		
Satd. Flow (prot)		
Flt Permitted		
Satd. Flow (perm)		
Right Turn on Red		
Satd. Flow (RTOR)		
Link Speed (k/h)		
Link Distance (m)		
Travel Time (s)		
Confl. Peds. (#/hr)		
Confl. Bikes (#/hr)		
Peak Hour Factor		
Heavy Vehicles (%)		
Adj. Flow (vph)		
Shared Lane Traffic (%)		
Lane Group Flow (vph)		
Enter Blocked Intersection		
Lane Alignment		
Median Width(m)		
Link Offset(m)		
Crosswalk Width(m)		
Two way Left Turn Lane		
Headway Factor		
Turning Speed (k/h)		
Number of Detectors		
Detector Template		
Leading Detector (m)		
Trailing Detector (m)		
Detector 1 Position(m)		
Detector 1 Size(m)		
Detector 1 Type		
Detector 1 Channel		
Detector 1 Extend (s)		
Detector 1 Queue (s)		
Detector 1 Delay (s)		
Detector 2 Position(m)		
Detector 2 Size(m)		
Detector 2 Type		
Detector 2 Channel		

1900/2000 City Park Drive

9: City Park Drive/1941 Ogilvie & Ogilvie Road

Tot 2037 AM



Lane Group	EBL	EBT	EBR	WBL	WBT	WBR	NBL	NBT	NBR	SBL	SBT	SBR
Detector 2 Extend (s)		0.0			0.0			0.0			0.0	
Turn Type	Perm	NA	Perm	Perm	NA	Perm	Perm	NA	Perm	Perm	NA	Perm
Protected Phases		2			6			8			4	
Permitted Phases	2		2	6		6	8		8	4		4
Detector Phase	2	2	2	6	6	6	8	8	8	4	4	4
Switch Phase												
Minimum Initial (s)	10.0	10.0	10.0	10.0	10.0	10.0	10.0	10.0	10.0	10.0	10.0	10.0
Minimum Split (s)	35.1	35.1	35.1	35.1	35.1	35.1	33.5	33.5	33.5	33.5	33.5	33.5
Total Split (s)	61.0	61.0	61.0	61.0	61.0	61.0	34.0	34.0	34.0	34.0	34.0	34.0
Total Split (%)	61.0%	61.0%	61.0%	61.0%	61.0%	61.0%	34.0%	34.0%	34.0%	34.0%	34.0%	34.0%
Maximum Green (s)	54.9	54.9	54.9	54.9	54.9	54.9	27.5	27.5	27.5	27.5	27.5	27.5
Yellow Time (s)	3.7	3.7	3.7	3.7	3.7	3.7	3.3	3.3	3.3	3.3	3.3	3.3
All-Red Time (s)	2.4	2.4	2.4	2.4	2.4	2.4	3.2	3.2	3.2	3.2	3.2	3.2
Lost Time Adjust (s)	0.0	0.0	0.0	0.0	0.0	0.0		0.0	0.0	0.0	0.0	0.0
Total Lost Time (s)	6.1	6.1	6.1	6.1	6.1	6.1		6.5	6.5	6.5	6.5	6.5
Lead/Lag							Lag	Lag	Lag	Lag	Lag	Lag
Lead-Lag Optimize?							Yes	Yes	Yes	Yes	Yes	Yes
Vehicle Extension (s)	3.0	3.0	3.0	3.0	3.0	3.0	3.0	3.0	3.0	3.0	3.0	3.0
Recall Mode	C-Max	C-Max	C-Max	C-Max	C-Max	C-Max	None	None	None	None	None	None
Walk Time (s)	7.0	7.0	7.0	7.0	7.0	7.0	2.0	2.0	2.0	2.0	2.0	2.0
Flash Dont Walk (s)	22.0	22.0	22.0	22.0	22.0	22.0	25.0	25.0	25.0	25.0	25.0	25.0
Pedestrian Calls (#/hr)	35	35	35	35	35	35	35	35	35	35	35	35
Act Effct Green (s)	64.2	64.2	64.2	64.2	64.2	64.2		20.2	20.2	20.2	20.2	20.2
Actuated g/C Ratio	0.64	0.64	0.64	0.64	0.64	0.64		0.20	0.20	0.20	0.20	0.20
v/c Ratio	0.39	0.31	0.09	0.21	0.47	0.21		0.32	0.41	0.02	0.01	0.03
Control Delay	9.4	3.5	0.3	12.0	12.0	2.3		34.8	8.0	27.2	27.0	0.1
Queue Delay	0.0	0.0	0.0	0.0	0.0	0.0		0.0	0.0	0.0	0.0	0.0
Total Delay	9.4	3.5	0.3	12.0	12.0	2.3		34.8	8.0	27.2	27.0	0.1
LOS	A	A	A	B	B	A		C	A	C	C	A
Approach Delay		3.9			10.7			16.8			11.9	
Approach LOS		A			B			B			B	

Intersection Summary

Area Type: Other
 Cycle Length: 100
 Actuated Cycle Length: 100
 Offset: 13 (13%), Referenced to phase 2:EBTL and 6:WBTL, Start of Green
 Natural Cycle: 80
 Control Type: Actuated-Coordinated
 Maximum v/c Ratio: 0.47
 Intersection Signal Delay: 8.9
 Intersection Capacity Utilization 74.2%
 Analysis Period (min) 15
 Intersection LOS: A
 ICU Level of Service D

Splits and Phases: 9: City Park Drive/1941 Ogilvie & Ogilvie Road

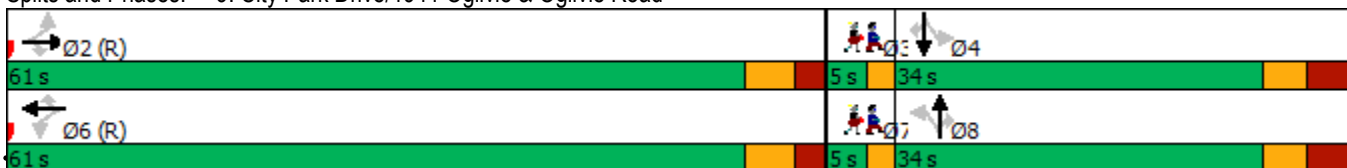

Lane Group	Ø3	Ø7
Detector 2 Extend (s)		
Turn Type		
Protected Phases	3	7
Permitted Phases		
Detector Phase		
Switch Phase		
Minimum Initial (s)	1.0	1.0
Minimum Split (s)	5.0	5.0
Total Split (s)	5.0	5.0
Total Split (%)	5%	5%
Maximum Green (s)	3.0	3.0
Yellow Time (s)	2.0	2.0
All-Red Time (s)	0.0	0.0
Lost Time Adjust (s)		
Total Lost Time (s)		
Lead/Lag	Lead	Lead
Lead-Lag Optimize?	Yes	Yes
Vehicle Extension (s)	3.0	3.0
Recall Mode	None	None
Walk Time (s)	0.0	0.0
Flash Dont Walk (s)	0.0	0.0
Pedestrian Calls (#/hr)	35	35
Act Effct Green (s)		
Actuated g/C Ratio		
v/c Ratio		
Control Delay		
Queue Delay		
Total Delay		
LOS		
Approach Delay		
Approach LOS		
Intersection Summary		

1900/2000 City Park Drive

12: 1900 Ogilvie Road/1929 Ogilvie Road & Ogilvie Road

Tot 2037 AM



Lane Group	EBL	EBT	EBR	WBL	WBT	WBR	NBL	NBT	NBR	SBL	SBT	SBR
Lane Configurations												
Traffic Volume (vph)	99	832	27	19	1151	44	9	1	12	42	11	63
Future Volume (vph)	99	832	27	19	1151	44	9	1	12	42	11	63
Ideal Flow (vphpl)	1800	1800	1800	1800	1800	1800	1800	1800	1800	1800	1800	1800
Storage Length (m)	60.0		80.0	90.0		0.0	0.0		0.0	0.0		0.0
Storage Lanes	1		1	1		0	1		0	0		1
Taper Length (m)	30.0			20.0			7.6			7.6		
Lane Util. Factor	1.00	0.95	1.00	1.00	0.95	0.95	1.00	1.00	1.00	1.00	1.00	1.00
Ped Bike Factor	0.99		0.95	0.99	1.00		0.96	0.95			0.96	0.94
Fr _t			0.850		0.994			0.862				0.850
Fl _t Protected	0.950			0.950			0.950				0.962	
Satd. Flow (prot)	1695	3390	1517	1679	3324	0	1695	1454	0	0	1717	1517
Fl _t Permitted	0.195			0.316			0.722				0.774	
Satd. Flow (perm)	344	3390	1434	553	3324	0	1232	1454	0	0	1329	1429
Right Turn on Red			Yes			Yes			Yes			Yes
Satd. Flow (RTOR)			40		6			12				61
Link Speed (k/h)		60			60			60				60
Link Distance (m)		190.5			224.7			86.0				56.6
Travel Time (s)		11.4			13.5			5.2				3.4
Confl. Peds. (#/hr)	41		17	17		41	47		48	48		47
Peak Hour Factor	1.00	1.00	1.00	1.00	1.00	1.00	1.00	1.00	1.00	1.00	1.00	1.00
Heavy Vehicles (%)	2%	2%	2%	3%	3%	3%	2%	2%	2%	2%	2%	2%
Adj. Flow (vph)	99	832	27	19	1151	44	9	1	12	42	11	63
Shared Lane Traffic (%)												
Lane Group Flow (vph)	99	832	27	19	1195	0	9	13	0	0	53	63
Enter Blocked Intersection	No	No	No	No	No	No	No	No	No	No	No	No
Lane Alignment	Left	Left	Right	Left	Left	Right	Left	Left	Right	Left	Left	Right
Median Width(m)		3.7			3.7			3.7				3.7
Link Offset(m)		0.0			0.0			0.0				0.0
Crosswalk Width(m)		4.9			4.9			4.9				4.9
Two way Left Turn Lane												
Headway Factor	1.06	1.06	1.06	1.06	1.06	1.06	1.06	1.06	1.06	1.06	1.06	1.06
Turning Speed (k/h)	24		14	24		14	24		14	24		14
Number of Detectors	1	2	1	1	2		1	2		1	2	1
Detector Template	Left	Thru	Right	Left	Thru		Left	Thru		Left	Thru	Right
Leading Detector (m)	6.1	30.5	6.1	6.1	30.5		6.1	30.5		6.1	30.5	6.1
Trailing Detector (m)	0.0	0.0	0.0	0.0	0.0		0.0	0.0		0.0	0.0	0.0
Detector 1 Position(m)	0.0	0.0	0.0	0.0	0.0		0.0	0.0		0.0	0.0	0.0
Detector 1 Size(m)	6.1	1.8	6.1	6.1	1.8		6.1	1.8		6.1	1.8	6.1
Detector 1 Type	Cl+Ex	Cl+Ex	Cl+Ex	Cl+Ex	Cl+Ex		Cl+Ex	Cl+Ex		Cl+Ex	Cl+Ex	Cl+Ex
Detector 1 Channel												
Detector 1 Extend (s)	0.0	0.0	0.0	0.0	0.0		0.0	0.0		0.0	0.0	0.0
Detector 1 Queue (s)	0.0	0.0	0.0	0.0	0.0		0.0	0.0		0.0	0.0	0.0
Detector 1 Delay (s)	0.0	0.0	0.0	0.0	0.0		0.0	0.0		0.0	0.0	0.0
Detector 2 Position(m)		28.7			28.7			28.7				28.7
Detector 2 Size(m)		1.8			1.8			1.8				1.8
Detector 2 Type		Cl+Ex			Cl+Ex			Cl+Ex				Cl+Ex
Detector 2 Channel												
Detector 2 Extend (s)		0.0			0.0			0.0				0.0

1900/2000 City Park Drive

12: 1900 Ogilvie Road/1929 Ogilvie Road & Ogilvie Road

Tot 2037 AM



Lane Group	EBL	EBT	EBR	WBL	WBT	WBR	NBL	NBT	NBR	SBL	SBT	SBR
Turn Type	Perm	NA	Perm	Perm	NA		Perm	NA		Perm	NA	Perm
Protected Phases		2			6			8			4	
Permitted Phases	2		2	6			8			4		4
Detector Phase	2	2	2	6	6		8	8		4	4	4
Switch Phase												
Minimum Initial (s)	10.0	10.0	10.0	10.0	10.0		10.0	10.0		10.0	10.0	10.0
Minimum Split (s)	29.9	29.9	29.9	29.9	29.9		36.7	36.7		36.7	36.7	36.7
Total Split (s)	63.0	63.0	63.0	63.0	63.0		37.0	37.0		37.0	37.0	37.0
Total Split (%)	63.0%	63.0%	63.0%	63.0%	63.0%		37.0%	37.0%		37.0%	37.0%	37.0%
Maximum Green (s)	57.1	57.1	57.1	57.1	57.1		30.3	30.3		30.3	30.3	30.3
Yellow Time (s)	3.7	3.7	3.7	3.7	3.7		3.3	3.3		3.3	3.3	3.3
All-Red Time (s)	2.2	2.2	2.2	2.2	2.2		3.4	3.4		3.4	3.4	3.4
Lost Time Adjust (s)	0.0	0.0	0.0	0.0	0.0		0.0	0.0			0.0	0.0
Total Lost Time (s)	5.9	5.9	5.9	5.9	5.9		6.7	6.7			6.7	6.7
Lead/Lag												
Lead-Lag Optimize?												
Vehicle Extension (s)	3.0	3.0	3.0	3.0	3.0		3.0	3.0		3.0	3.0	3.0
Recall Mode	C-Max	C-Max	C-Max	C-Max	C-Max		None	None		None	None	None
Walk Time (s)	11.0	11.0	11.0	11.0	11.0		7.0	7.0		7.0	7.0	7.0
Flash Dont Walk (s)	13.0	13.0	13.0	13.0	13.0		23.0	23.0		23.0	23.0	23.0
Pedestrian Calls (#/hr)	10	10	10	10	10		30	30		30	30	30
Act Effct Green (s)	69.9	69.9	69.9	69.9	69.9		22.0	22.0			22.0	22.0
Actuated g/C Ratio	0.70	0.70	0.70	0.70	0.70		0.22	0.22			0.22	0.22
v/c Ratio	0.41	0.35	0.03	0.05	0.51		0.03	0.04			0.18	0.17
Control Delay	17.0	8.4	1.7	5.7	5.5		25.2	13.3			29.3	8.5
Queue Delay	0.0	0.0	0.0	0.0	0.0		0.0	0.0			0.0	0.0
Total Delay	17.0	8.4	1.7	5.7	5.5		25.2	13.3			29.3	8.5
LOS	B	A	A	A	A		C	B			C	A
Approach Delay		9.1			5.5			18.2			18.0	
Approach LOS		A			A			B			B	

Intersection Summary

Area Type: Other
 Cycle Length: 100
 Actuated Cycle Length: 100
 Offset: 12 (12%), Referenced to phase 2:EBTL and 6:WBTL, Start of Green
 Natural Cycle: 80
 Control Type: Actuated-Coordinated
 Maximum v/c Ratio: 0.51
 Intersection Signal Delay: 7.7
 Intersection LOS: A
 Intersection Capacity Utilization 94.4%
 ICU Level of Service F
 Analysis Period (min) 15

Splits and Phases: 12: 1900 Ogilvie Road/1929 Ogilvie Road & Ogilvie Road

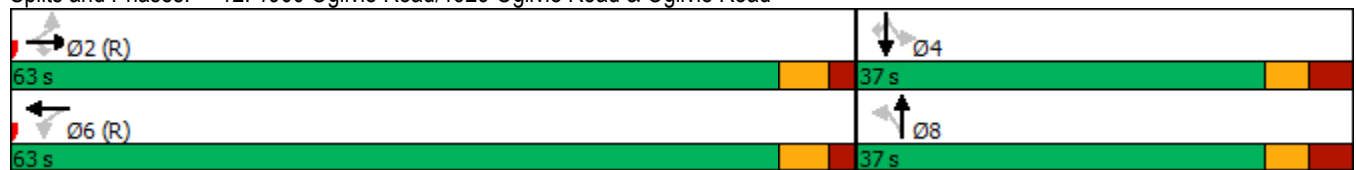

1900/2000 City Park Drive
 15: City Park Drive/Bathgate Drive & Ogilvie Road

Tot 2037 AM



Lane Group	EBL	EBT	EBR	WBL	WBT	WBR	NBL	NBT	NBR	SBL	SBT	SBR
Lane Configurations												
Traffic Volume (vph)	156	598	87	14	981	161	120	37	13	119	24	178
Future Volume (vph)	156	598	87	14	981	161	120	37	13	119	24	178
Ideal Flow (vphpl)	1800	1800	1800	1800	1800	1800	1800	1800	1800	1800	1800	1800
Storage Length (m)	70.0		40.0	45.0		70.0	30.0		0.0	20.0		0.0
Storage Lanes	1		1	1		1	1		0	1		0
Taper Length (m)	30.0			30.0			25.0			25.0		
Lane Util. Factor	1.00	0.95	1.00	1.00	0.95	1.00	1.00	1.00	1.00	1.00	1.00	1.00
Ped Bike Factor	0.99		0.92	0.98		0.89	0.99	0.99		0.98	0.98	
Fr _t			0.850			0.850		0.961			0.868	
Fl _t Protected	0.950			0.950			0.950			0.950		
Satd. Flow (prot)	1679	3357	1502	1679	3357	1502	1631	1635	0	1647	1470	0
Fl _t Permitted	0.182			0.426			0.546			0.724		
Satd. Flow (perm)	317	3357	1389	737	3357	1340	928	1635	0	1228	1470	0
Right Turn on Red			Yes			Yes			Yes			Yes
Satd. Flow (RTOR)			121			161		13			178	
Link Speed (k/h)		60			60			60			60	
Link Distance (m)		257.6			190.5			345.6			177.6	
Travel Time (s)		15.5			11.4			20.7			10.7	
Confl. Peds. (#/hr)	43		27	27		43	14		23	23		14
Peak Hour Factor	1.00	1.00	1.00	1.00	1.00	1.00	1.00	1.00	1.00	1.00	1.00	1.00
Heavy Vehicles (%)	3%	3%	3%	3%	3%	3%	6%	6%	6%	5%	5%	5%
Adj. Flow (vph)	156	598	87	14	981	161	120	37	13	119	24	178
Shared Lane Traffic (%)												
Lane Group Flow (vph)	156	598	87	14	981	161	120	50	0	119	202	0
Enter Blocked Intersection	No	No	No	No	No	No	No	No	No	No	No	No
Lane Alignment	Left	Left	Right	Left	Left	Right	Left	Left	Right	Left	Left	Right
Median Width(m)		3.7			3.7			3.7			3.7	
Link Offset(m)		0.0			0.0			0.0			0.0	
Crosswalk Width(m)		4.9			4.9			4.9			4.9	
Two way Left Turn Lane												
Headway Factor	1.06	1.06	1.06	1.06	1.06	1.06	1.06	1.06	1.06	1.06	1.06	1.06
Turning Speed (k/h)	24		14	24		14	24		14	24		14
Number of Detectors	1	2	1	1	2	1	1	2		1	2	
Detector Template	Left	Thru	Right	Left	Thru	Right	Left	Thru		Left	Thru	
Leading Detector (m)	6.1	30.5	6.1	6.1	30.5	6.1	6.1	30.5		6.1	30.5	
Trailing Detector (m)	0.0	0.0	0.0	0.0	0.0	0.0	0.0	0.0		0.0	0.0	
Detector 1 Position(m)	0.0	0.0	0.0	0.0	0.0	0.0	0.0	0.0		0.0	0.0	
Detector 1 Size(m)	6.1	1.8	6.1	6.1	1.8	6.1	6.1	1.8		6.1	1.8	
Detector 1 Type	Cl+Ex	Cl+Ex	Cl+Ex	Cl+Ex	Cl+Ex	Cl+Ex	Cl+Ex	Cl+Ex		Cl+Ex	Cl+Ex	
Detector 1 Channel												
Detector 1 Extend (s)	0.0	0.0	0.0	0.0	0.0	0.0	0.0	0.0		0.0	0.0	
Detector 1 Queue (s)	0.0	0.0	0.0	0.0	0.0	0.0	0.0	0.0		0.0	0.0	
Detector 1 Delay (s)	0.0	0.0	0.0	0.0	0.0	0.0	0.0	0.0		0.0	0.0	
Detector 2 Position(m)		28.7			28.7			28.7			28.7	
Detector 2 Size(m)		1.8			1.8			1.8			1.8	
Detector 2 Type		Cl+Ex			Cl+Ex			Cl+Ex			Cl+Ex	
Detector 2 Channel												
Detector 2 Extend (s)		0.0			0.0			0.0			0.0	

Lane Group	Ø3	Ø7
Lane Configurations		
Traffic Volume (vph)		
Future Volume (vph)		
Ideal Flow (vphpl)		
Storage Length (m)		
Storage Lanes		
Taper Length (m)		
Lane Util. Factor		
Ped Bike Factor		
Frt		
Flt Protected		
Satd. Flow (prot)		
Flt Permitted		
Satd. Flow (perm)		
Right Turn on Red		
Satd. Flow (RTOR)		
Link Speed (k/h)		
Link Distance (m)		
Travel Time (s)		
Confl. Peds. (#/hr)		
Peak Hour Factor		
Heavy Vehicles (%)		
Adj. Flow (vph)		
Shared Lane Traffic (%)		
Lane Group Flow (vph)		
Enter Blocked Intersection		
Lane Alignment		
Median Width(m)		
Link Offset(m)		
Crosswalk Width(m)		
Two way Left Turn Lane		
Headway Factor		
Turning Speed (k/h)		
Number of Detectors		
Detector Template		
Leading Detector (m)		
Trailing Detector (m)		
Detector 1 Position(m)		
Detector 1 Size(m)		
Detector 1 Type		
Detector 1 Channel		
Detector 1 Extend (s)		
Detector 1 Queue (s)		
Detector 1 Delay (s)		
Detector 2 Position(m)		
Detector 2 Size(m)		
Detector 2 Type		
Detector 2 Channel		
Detector 2 Extend (s)		

1900/2000 City Park Drive
 15: City Park Drive/Bathgate Drive & Ogilvie Road

Tot 2037 AM



Lane Group	EBL	EBT	EBR	WBL	WBT	WBR	NBL	NBT	NBR	SBL	SBT	SBR
Turn Type	pm+pt	NA	Perm	pm+pt	NA	Perm	Perm	NA		Perm	NA	
Protected Phases	5	2		1	6			8			4	
Permitted Phases	2		2	6		6	8			4		
Detector Phase	5	2	2	1	6	6	8	8		4	4	
Switch Phase												
Minimum Initial (s)	5.0	10.0	10.0	5.0	10.0	10.0	10.0	10.0		10.0	10.0	
Minimum Split (s)	9.7	30.0	30.0	9.7	30.0	30.0	37.4	37.4		37.4	37.4	
Total Split (s)	15.0	42.0	42.0	15.0	42.0	42.0	38.0	38.0		38.0	38.0	
Total Split (%)	15.0%	42.0%	42.0%	15.0%	42.0%	42.0%	38.0%	38.0%		38.0%	38.0%	
Maximum Green (s)	10.3	36.0	36.0	10.3	36.0	36.0	30.6	30.6		30.6	30.6	
Yellow Time (s)	3.7	3.7	3.7	3.7	3.7	3.7	3.0	3.0		3.0	3.0	
All-Red Time (s)	1.0	2.3	2.3	1.0	2.3	2.3	4.4	4.4		4.4	4.4	
Lost Time Adjust (s)	0.0	0.0	0.0	0.0	0.0	0.0	0.0	0.0		0.0	0.0	
Total Lost Time (s)	4.7	6.0	6.0	4.7	6.0	6.0	7.4	7.4		7.4	7.4	
Lead/Lag	Lead	Lag	Lag	Lead	Lag	Lag	Lag	Lag		Lag	Lag	
Lead-Lag Optimize?	Yes	Yes	Yes	Yes	Yes	Yes	Yes	Yes		Yes	Yes	
Vehicle Extension (s)	3.0	3.0	3.0	3.0	3.0	3.0	3.0	3.0		3.0	3.0	
Recall Mode	None	C-Max	C-Max	None	C-Max	C-Max	None	None		None	None	
Walk Time (s)		9.0	9.0		9.0	9.0	2.0	2.0		2.0	2.0	
Flash Dont Walk (s)		15.0	15.0		15.0	15.0	28.0	28.0		28.0	28.0	
Pedestrian Calls (#/hr)		15	15		15	15	15	15		15	15	
Act Effct Green (s)	62.7	59.2	59.2	55.0	47.8	47.8	20.1	20.1		20.1	20.1	
Actuated g/C Ratio	0.63	0.59	0.59	0.55	0.48	0.48	0.20	0.20		0.20	0.20	
v/c Ratio	0.49	0.30	0.10	0.03	0.61	0.22	0.65	0.15		0.48	0.46	
Control Delay	25.9	21.7	10.0	6.1	12.5	1.3	50.4	23.5		39.6	9.7	
Queue Delay	0.0	0.0	0.0	0.0	0.0	0.0	0.0	0.0		0.0	0.0	
Total Delay	25.9	21.7	10.0	6.1	12.5	1.3	50.4	23.5		39.6	9.7	
LOS	C	C	A	A	B	A	D	C		D	A	
Approach Delay		21.3			10.8			42.5			20.8	
Approach LOS		C			B			D			C	

Intersection Summary

Area Type:	Other
Cycle Length:	100
Actuated Cycle Length:	100
Offset:	29 (29%), Referenced to phase 2:EBTL and 6:WBTL, Start of Green
Natural Cycle:	85
Control Type:	Actuated-Coordinated
Maximum v/c Ratio:	0.65
Intersection Signal Delay:	17.8
Intersection LOS:	B
Intersection Capacity Utilization	85.5%
ICU Level of Service	E
Analysis Period (min)	15

Splits and Phases: 15: City Park Drive/Bathgate Drive & Ogilvie Road

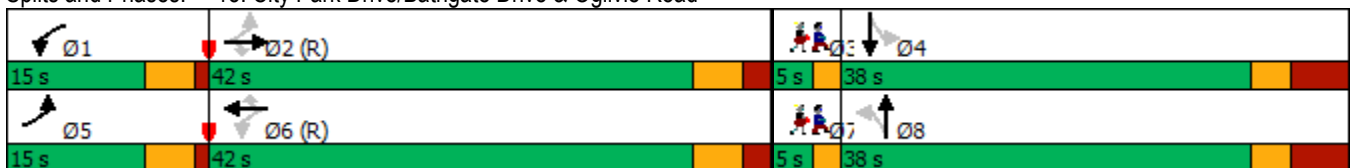

Lane Group	Ø3	Ø7
Turn Type		
Protected Phases	3	7
Permitted Phases		
Detector Phase		
Switch Phase		
Minimum Initial (s)	1.0	1.0
Minimum Split (s)	5.0	5.0
Total Split (s)	5.0	5.0
Total Split (%)	5%	5%
Maximum Green (s)	3.0	3.0
Yellow Time (s)	2.0	2.0
All-Red Time (s)	0.0	0.0
Lost Time Adjust (s)		
Total Lost Time (s)		
Lead/Lag	Lead	Lead
Lead-Lag Optimize?	Yes	Yes
Vehicle Extension (s)	3.0	3.0
Recall Mode	Ped	Ped
Walk Time (s)	0.0	0.0
Flash Dont Walk (s)	0.0	0.0
Pedestrian Calls (#/hr)	15	15
Act Effct Green (s)		
Actuated g/C Ratio		
v/c Ratio		
Control Delay		
Queue Delay		
Total Delay		
LOS		
Approach Delay		
Approach LOS		
Intersection Summary		

1900/2000 City Park Drive
 18: Residential/Cadboro Road & Ogilvie Road

Tot 2037 AM



Lane Group	EBL	EBT	EBR	WBL	WBT	WBR	NBL	NBT	NBR	SBL	SBT	SBR
Lane Configurations		↑↓			↑↓				↑			↑
Traffic Volume (vph)	0	1215	9	0	1305	57	0	0	6	0	0	21
Future Volume (vph)	0	1215	9	0	1305	57	0	0	6	0	0	21
Ideal Flow (vphpl)	1800	1800	1800	1800	1800	1800	1800	1800	1800	1800	1800	1800
Lane Util. Factor	1.00	0.95	0.95	1.00	0.95	0.95	1.00	1.00	1.00	1.00	1.00	1.00
Fr _t		0.999			0.994				0.865			0.865
Fl _t Protected												
Satd. Flow (prot)	0	3387	0	0	3370	0	0	0	1543	0	0	1543
Fl _t Permitted												
Satd. Flow (perm)	0	3387	0	0	3370	0	0	0	1543	0	0	1543
Right Turn on Red			Yes			Yes			Yes			Yes
Satd. Flow (RTOR)		1			7				53			42
Link Speed (k/h)		60			60			60				60
Link Distance (m)		264.5			257.6			90.1				116.1
Travel Time (s)		15.9			15.5			5.4				7.0
Peak Hour Factor	1.00	1.00	1.00	1.00	1.00	1.00	1.00	1.00	1.00	1.00	1.00	1.00
Adj. Flow (vph)	0	1215	9	0	1305	57	0	0	6	0	0	21
Shared Lane Traffic (%)												
Lane Group Flow (vph)	0	1224	0	0	1362	0	0	0	6	0	0	21
Enter Blocked Intersection	No	No	No	No	No	No	No	No	No	No	No	No
Lane Alignment	Left	Left	Right	Left	Left	Right	Left	Left	Right	Left	Left	Right
Median Width(m)		3.7			3.7			0.0				0.0
Link Offset(m)		0.0			0.0			0.0				0.0
Crosswalk Width(m)		1.6			1.6			1.6				1.6
Two way Left Turn Lane												
Headway Factor	1.06	1.06	1.06	1.06	1.06	1.06	1.06	1.06	1.06	1.06	1.06	1.06
Turning Speed (k/h)	24		14	24		14	24		14	24		14
Number of Detectors		2			2				1			1
Detector Template		Thru			Thru				Right			Right
Leading Detector (m)		10.0			10.0				2.0			2.0
Trailing Detector (m)		0.0			0.0				0.0			0.0
Detector 1 Position(m)		0.0			0.0				0.0			0.0
Detector 1 Size(m)		0.6			0.6				2.0			2.0
Detector 1 Type		Cl+Ex			Cl+Ex				Cl+Ex			Cl+Ex
Detector 1 Channel												
Detector 1 Extend (s)		0.0			0.0				0.0			0.0
Detector 1 Queue (s)		0.0			0.0				0.0			0.0
Detector 1 Delay (s)		0.0			0.0				0.0			0.0
Detector 2 Position(m)		9.4			9.4							
Detector 2 Size(m)		0.6			0.6							
Detector 2 Type		Cl+Ex			Cl+Ex							
Detector 2 Channel												
Detector 2 Extend (s)		0.0			0.0							
Turn Type		NA			NA				Perm			Perm
Protected Phases		2			6							
Permitted Phases									8			4
Detector Phase		2			6				8			4
Switch Phase												
Minimum Initial (s)		10.0			10.0				5.0			5.0

1900/2000 City Park Drive
 18: Residential/Cadboro Road & Ogilvie Road

Tot 2037 AM



Lane Group	EBL	EBT	EBR	WBL	WBT	WBR	NBL	NBT	NBR	SBL	SBT	SBR
Minimum Split (s)		35.0			35.0				40.0			40.0
Total Split (s)		60.0			60.0				40.0			40.0
Total Split (%)		60.0%			60.0%				40.0%			40.0%
Maximum Green (s)		54.0			54.0				36.0			36.0
Yellow Time (s)		3.7			3.7				3.0			3.0
All-Red Time (s)		2.3			2.3				1.0			1.0
Lost Time Adjust (s)		0.0			0.0				0.0			0.0
Total Lost Time (s)		6.0			6.0				4.0			4.0
Lead/Lag												
Lead-Lag Optimize?												
Vehicle Extension (s)		3.0			3.0				3.0			3.0
Recall Mode		C-Max			C-Max				None			None
Walk Time (s)		15.0			15.0				24.0			24.0
Flash Dont Walk (s)		14.0			14.0				12.0			12.0
Pedestrian Calls (#/hr)		20			20				15			15
Act Effct Green (s)		78.5			78.5				17.7			17.7
Actuated g/C Ratio		0.78			0.78				0.18			0.18
v/c Ratio		0.46			0.51				0.02			0.07
Control Delay		7.0			5.4				0.2			2.9
Queue Delay		0.0			0.0				0.0			0.0
Total Delay		7.0			5.4				0.2			2.9
LOS		A			A				A			A
Approach Delay		7.0			5.4			0.2			2.9	
Approach LOS		A			A			A			A	

Intersection Summary

Area Type:	Other
Cycle Length:	100
Actuated Cycle Length:	100
Offset:	42 (42%), Referenced to phase 2:EBT and 6:WBT, Start of Green
Natural Cycle:	80
Control Type:	Actuated-Coordinated
Maximum v/c Ratio:	0.51
Intersection Signal Delay:	6.1
Intersection LOS:	A
Intersection Capacity Utilization:	52.5%
ICU Level of Service:	A
Analysis Period (min):	15

Splits and Phases: 18: Residential/Cadboro Road & Ogilvie Road

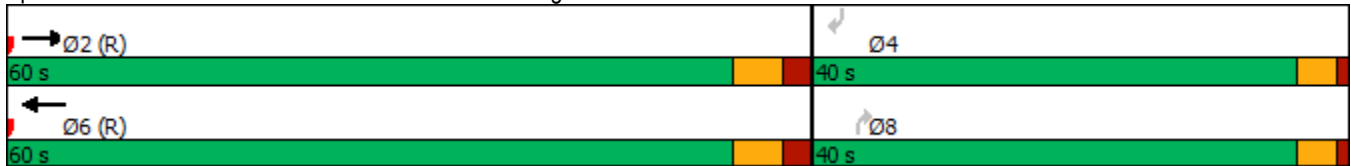

1900/2000 City Park Drive
 22: Blair Road & Hwy 174 EB off

Tot 2037 AM



Lane Group	WBL	WBR	NBT	NBR	SBL	SBT
Lane Configurations						
Traffic Volume (vph)	198	1021	918	81	197	498
Future Volume (vph)	198	1021	918	81	197	498
Ideal Flow (vphpl)	1800	1800	1800	1800	1800	1800
Storage Length (m)	0.0	0.0		70.0	0.0	
Storage Lanes	1	1		1	0	
Taper Length (m)	7.6				7.6	
Lane Util. Factor	1.00	1.00	0.95	1.00	0.95	0.95
Fr _t		0.850		0.850		
Fl _t Protected	0.950					0.986
Satd. Flow (prot)	1647	1473	3325	1488	0	3217
Fl _t Permitted	0.950					0.574
Satd. Flow (perm)	1647	1473	3325	1488	0	1873
Right Turn on Red		Yes		Yes		
Satd. Flow (RTOR)		478				
Link Speed (k/h)	60		60			60
Link Distance (m)	216.4		230.9			341.9
Travel Time (s)	13.0		13.9			20.5
Peak Hour Factor	1.00	1.00	1.00	1.00	1.00	1.00
Heavy Vehicles (%)	5%	5%	4%	4%	6%	6%
Adj. Flow (vph)	198	1021	918	81	197	498
Shared Lane Traffic (%)						
Lane Group Flow (vph)	198	1021	918	81	0	695
Enter Blocked Intersection	No	No	No	No	No	No
Lane Alignment	Left	Right	Left	Right	Left	Left
Median Width(m)	3.7		0.0			0.0
Link Offset(m)	0.0		0.0			0.0
Crosswalk Width(m)	4.9		4.9			4.9
Two way Left Turn Lane						
Headway Factor	1.06	1.06	1.06	1.06	1.06	1.06
Turning Speed (k/h)	24	14		14	24	
Number of Detectors	1	1	2	1	1	2
Detector Template	Left	Right	Thru	Right	Left	Thru
Leading Detector (m)	6.1	6.1	30.5	6.1	6.1	30.5
Trailing Detector (m)	0.0	0.0	0.0	0.0	0.0	0.0
Detector 1 Position(m)	0.0	0.0	0.0	0.0	0.0	0.0
Detector 1 Size(m)	6.1	6.1	1.8	6.1	6.1	1.8
Detector 1 Type	Cl+Ex	Cl+Ex	Cl+Ex	Cl+Ex	Cl+Ex	Cl+Ex
Detector 1 Channel						
Detector 1 Extend (s)	0.0	0.0	0.0	0.0	0.0	0.0
Detector 1 Queue (s)	0.0	0.0	0.0	0.0	0.0	0.0
Detector 1 Delay (s)	0.0	0.0	0.0	0.0	0.0	0.0
Detector 2 Position(m)			28.7			28.7
Detector 2 Size(m)			1.8			1.8
Detector 2 Type			Cl+Ex			Cl+Ex
Detector 2 Channel						
Detector 2 Extend (s)			0.0			0.0
Turn Type	Prot	Free	NA	pm+ov	Perm	NA
Protected Phases	8		2	8		6

1900/2000 City Park Drive
 22: Blair Road & Hwy 174 EB off

Tot 2037 AM



Lane Group	WBL	WBR	NBT	NBR	SBL	SBT
Permitted Phases		Free		2	6	
Detector Phase	8		2	8	6	6
Switch Phase						
Minimum Initial (s)	5.0		10.0	5.0	10.0	10.0
Minimum Split (s)	25.3		30.5	25.3	16.5	16.5
Total Split (s)	35.0		55.0	35.0	55.0	55.0
Total Split (%)	38.9%		61.1%	38.9%	61.1%	61.1%
Maximum Green (s)	28.7		48.5	28.7	48.5	48.5
Yellow Time (s)	3.3		4.2	3.3	4.2	4.2
All-Red Time (s)	3.0		2.3	3.0	2.3	2.3
Lost Time Adjust (s)	0.0		0.0	0.0		0.0
Total Lost Time (s)	6.3		6.5	6.3		6.5
Lead/Lag						
Lead-Lag Optimize?						
Vehicle Extension (s)	3.0		3.0	3.0	3.0	3.0
Recall Mode	None		Max	None	Max	Max
Walk Time (s)	7.0		7.0	7.0		
Flash Dont Walk (s)	12.0		17.0	12.0		
Pedestrian Calls (#/hr)	0		0	0		
Act Effct Green (s)	14.2	75.7	48.6	75.7		48.6
Actuated g/C Ratio	0.19	1.00	0.64	1.00		0.64
v/c Ratio	0.64	0.69	0.43	0.05		0.58
Control Delay	38.1	2.7	8.0	0.1		10.9
Queue Delay	0.0	0.0	0.0	0.0		0.0
Total Delay	38.1	2.7	8.0	0.1		10.9
LOS	D	A	A	A		B
Approach Delay	8.5		7.4			10.9
Approach LOS	A		A			B

Intersection Summary

Area Type: Other
 Cycle Length: 90
 Actuated Cycle Length: 75.7
 Natural Cycle: 60
 Control Type: Semi Act-Uncoord
 Maximum v/c Ratio: 0.69
 Intersection Signal Delay: 8.7
 Intersection Capacity Utilization 75.0%
 Analysis Period (min) 15
 Intersection LOS: A
 ICU Level of Service D

Splits and Phases: 22: Blair Road & Hwy 174 EB off

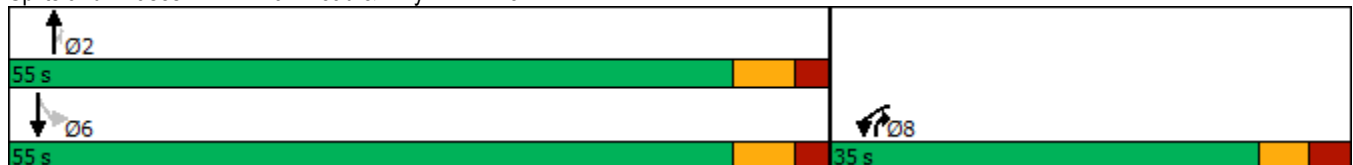

1900/2000 City Park Drive
25: Blair Road

Tot 2037 AM



Lane Group	EBL	EBR	NBL	NBT	SBT	SBR
Lane Configurations				↑↑	↑↑	↗
Traffic Volume (vph)	0	0	0	0	0	0
Future Volume (vph)	0	0	0	0	0	0
Ideal Flow (vphpl)	1800	1800	1800	1800	1800	1800
Lane Util. Factor	1.00	1.00	1.00	0.95	0.95	1.00
Fr						
Flt Protected						
Satd. Flow (prot)	0	0	0	3390	3390	1784
Flt Permitted						
Satd. Flow (perm)	0	0	0	3390	3390	1784
Link Speed (k/h)	60			60	60	
Link Distance (m)	105.8			341.9	90.2	
Travel Time (s)	6.3			20.5	5.4	
Peak Hour Factor	0.90	0.90	0.90	0.90	0.90	0.90
Adj. Flow (vph)	0	0	0	0	0	0
Shared Lane Traffic (%)						
Lane Group Flow (vph)	0	0	0	0	0	0
Enter Blocked Intersection	No	No	No	No	No	No
Lane Alignment	Left	Right	Left	Left	Left	Right
Median Width(m)	0.0			7.4	7.4	
Link Offset(m)	0.0			0.0	0.0	
Crosswalk Width(m)	1.6			1.6	1.6	
Two way Left Turn Lane						
Headway Factor	1.06	1.06	1.06	1.06	1.06	1.06
Turning Speed (k/h)	24	14	24			14
Sign Control	Yield			Free	Free	

Intersection Summary

Area Type:	Other
Control Type:	Unsignalized
Intersection Capacity Utilization	0.0%
Analysis Period (min)	15
	ICU Level of Service A

1900/2000 City Park Drive

1630: Palmerston Drive/Matheson Road & Ogilvie Road

Tot 2037 AM

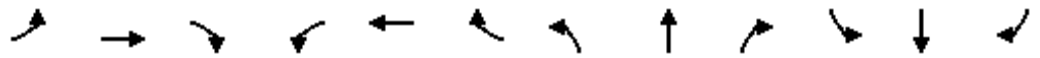

Lane Group	EBL	EBT	EBR	WBL	WBT	WBR	NBL	NBT	NBR	SBL	SBT	SBR
Lane Configurations												
Traffic Volume (vph)	83	1084	21	33	1298	14	57	2	26	25	2	171
Future Volume (vph)	83	1084	21	33	1298	14	57	2	26	25	2	171
Ideal Flow (vphpl)	1800	1800	1800	1800	1800	1800	1800	1800	1800	1800	1800	1800
Storage Length (m)	70.0		0.0	70.0		0.0	15.0		0.0	0.0		35.0
Storage Lanes	1		0	1		0	1		0	0		1
Taper Length (m)	30.0			30.0			7.6			7.6		
Lane Util. Factor	1.00	0.95	0.95	1.00	0.95	0.95	1.00	1.00	1.00	1.00	1.00	1.00
Ped Bike Factor		1.00		0.99	1.00		1.00	0.98			0.99	0.99
Frt		0.997			0.998			0.861				0.850
Flt Protected	0.950			0.950			0.950				0.956	
Satd. Flow (prot)	1695	3375	0	1695	3382	0	1662	1471	0	0	1706	1517
Flt Permitted	0.145			0.216			0.740				0.727	
Satd. Flow (perm)	259	3375	0	383	3382	0	1290	1471	0	0	1282	1497
Right Turn on Red			Yes			Yes			Yes			Yes
Satd. Flow (RTOR)		2			1			26				171
Link Speed (k/h)		60			60			60				60
Link Distance (m)		314.1			264.5			176.2				174.1
Travel Time (s)		18.8			15.9			10.6				10.4
Confl. Peds. (#/hr)	11		26	26		11	4		14	14		
Confl. Bikes (#/hr)			21			9			2			1
Peak Hour Factor	1.00	1.00	1.00	1.00	1.00	1.00	1.00	1.00	1.00	1.00	1.00	1.00
Heavy Vehicles (%)	2%	2%	2%	2%	2%	2%	4%	4%	4%	2%	2%	2%
Adj. Flow (vph)	83	1084	21	33	1298	14	57	2	26	25	2	171
Shared Lane Traffic (%)												
Lane Group Flow (vph)	83	1105	0	33	1312	0	57	28	0	0	27	171
Enter Blocked Intersection	No	No	No	No	No	No	No	No	No	No	No	No
Lane Alignment	Left	Left	Right	Left	Left	Right	Left	Left	Right	Left	Left	Right
Median Width(m)		3.7			3.7			3.7				3.7
Link Offset(m)		0.0			0.0			0.0				0.0
Crosswalk Width(m)		4.9			4.9			4.9				4.9
Two way Left Turn Lane												
Headway Factor	1.06	1.06	1.06	1.06	1.06	1.06	1.06	1.06	1.06	1.06	1.06	1.06
Turning Speed (k/h)	24		14	24		14	24		14	24		14
Number of Detectors	1	2		1	2		1	2		1	2	1
Detector Template	Left	Thru		Left	Thru		Left	Thru		Left	Thru	Right
Leading Detector (m)	6.1	30.5		6.1	30.5		6.1	30.5		6.1	30.5	6.1
Trailing Detector (m)	0.0	0.0		0.0	0.0		0.0	0.0		0.0	0.0	0.0
Detector 1 Position(m)	0.0	0.0		0.0	0.0		0.0	0.0		0.0	0.0	0.0
Detector 1 Size(m)	6.1	1.8		6.1	1.8		6.1	1.8		6.1	1.8	6.1
Detector 1 Type	Cl+Ex	Cl+Ex		Cl+Ex	Cl+Ex		Cl+Ex	Cl+Ex		Cl+Ex	Cl+Ex	Cl+Ex
Detector 1 Channel												
Detector 1 Extend (s)	0.0	0.0		0.0	0.0		0.0	0.0		0.0	0.0	0.0
Detector 1 Queue (s)	0.0	0.0		0.0	0.0		0.0	0.0		0.0	0.0	0.0
Detector 1 Delay (s)	0.0	0.0		0.0	0.0		0.0	0.0		0.0	0.0	0.0
Detector 2 Position(m)		28.7			28.7			28.7				28.7
Detector 2 Size(m)		1.8			1.8			1.8				1.8
Detector 2 Type		Cl+Ex			Cl+Ex			Cl+Ex				Cl+Ex
Detector 2 Channel												

1900/2000 City Park Drive

1630: Palmerston Drive/Matheson Road & Ogilvie Road

Tot 2037 AM



Lane Group	EBL	EBT	EBR	WBL	WBT	WBR	NBL	NBT	NBR	SBL	SBT	SBR
Detector 2 Extend (s)		0.0			0.0			0.0			0.0	
Turn Type	pm+pt	NA		pm+pt	NA		Perm	NA		Perm	NA	Perm
Protected Phases	5	2		1	6			8			4	
Permitted Phases	2			6			8			4		4
Detector Phase	5	2		1	6		8	8		4	4	4
Switch Phase												
Minimum Initial (s)	5.0	10.0		5.0	10.0		10.0	10.0		10.0	10.0	10.0
Minimum Split (s)	9.7	33.6		9.7	33.6		40.2	40.2		40.2	40.2	40.2
Total Split (s)	13.0	47.0		13.0	47.0		40.0	40.0		40.0	40.0	40.0
Total Split (%)	13.0%	47.0%		13.0%	47.0%		40.0%	40.0%		40.0%	40.0%	40.0%
Maximum Green (s)	8.3	41.4		8.3	41.4		32.8	32.8		32.8	32.8	32.8
Yellow Time (s)	3.7	3.7		3.7	3.7		3.0	3.0		3.0	3.0	3.0
All-Red Time (s)	1.0	1.9		1.0	1.9		4.2	4.2		4.2	4.2	4.2
Lost Time Adjust (s)	0.0	0.0		0.0	0.0		0.0	0.0		0.0	0.0	0.0
Total Lost Time (s)	4.7	5.6		4.7	5.6		7.2	7.2		7.2	7.2	7.2
Lead/Lag	Lead	Lag		Lead	Lag							
Lead-Lag Optimize?	Yes	Yes		Yes	Yes							
Vehicle Extension (s)	3.0	3.0		3.0	3.0		3.0	3.0		3.0	3.0	3.0
Recall Mode	None	C-Max		None	C-Max		None	None		None	None	None
Walk Time (s)		15.0			15.0		7.0	7.0		7.0	7.0	7.0
Flash Dont Walk (s)		13.0			13.0		26.0	26.0		26.0	26.0	26.0
Pedestrian Calls (#/hr)		10			10		10	10		10	10	10
Act Effct Green (s)	70.9	65.6		68.9	62.9		14.9	14.9			14.9	14.9
Actuated g/C Ratio	0.71	0.66		0.69	0.63		0.15	0.15			0.15	0.15
v/c Ratio	0.30	0.50		0.10	0.62		0.30	0.12			0.14	0.46
Control Delay	8.6	12.7		5.1	8.8		38.9	13.0			34.7	9.0
Queue Delay	0.0	0.0		0.0	0.0		0.0	0.0			0.0	0.0
Total Delay	8.6	12.7		5.1	8.8		38.9	13.0			34.7	9.0
LOS	A	B		A	A		D	B			C	A
Approach Delay		12.4			8.7			30.4			12.5	
Approach LOS		B			A			C			B	

Intersection Summary

Area Type:	Other
Cycle Length:	100
Actuated Cycle Length:	100
Offset:	54 (54%), Referenced to phase 2:EBTL and 6:WBTL, Start of Green
Natural Cycle:	85
Control Type:	Actuated-Coordinated
Maximum v/c Ratio:	0.62
Intersection Signal Delay:	11.2
Intersection LOS:	B
Intersection Capacity Utilization:	81.7%
ICU Level of Service:	D
Analysis Period (min):	15

Splits and Phases: 1630: Palmerston Drive/Matheson Road & Ogilvie Road

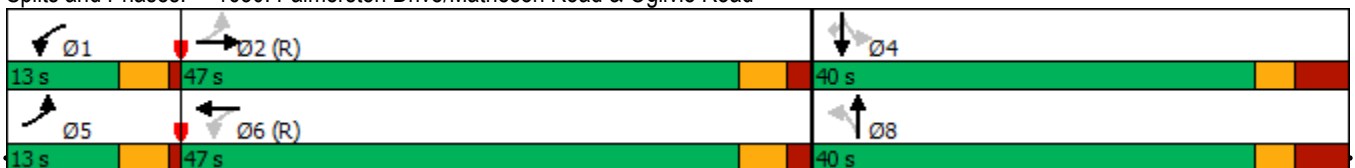

1900/2000 City Park Drive
 3: Blair Road & Ogilvie Road

Tot 2037 PM



Lane Group	EBL	EBT	EBR	WBL	WBT	WBR	NBL	NBT	NBR	SBL	SBT	SBR
Lane Configurations												
Traffic Volume (vph)	157	852	640	875	504	83	276	296	923	75	761	73
Future Volume (vph)	157	852	640	875	504	83	276	296	923	75	761	73
Ideal Flow (vphpl)	1800	1800	1800	1800	1800	1800	1800	1800	1800	1800	1800	1800
Storage Length (m)	70.0		0.0	110.0		0.0	120.0		0.0	30.0		0.0
Storage Lanes	1		1	2		0	2		1	1		0
Taper Length (m)	40.0			60.0			60.0			45.0		
Lane Util. Factor	1.00	0.95	1.00	0.97	0.95	0.95	0.97	1.00	1.00	1.00	0.95	0.95
Ped Bike Factor					0.99						0.99	
Frt			0.850		0.979				0.850		0.987	
Flt Protected	0.950			0.950			0.950			0.950		
Satd. Flow (prot)	1679	3357	1502	3257	3249	0	3257	1767	1502	1679	3276	0
Flt Permitted	0.950			0.950			0.950			0.950		
Satd. Flow (perm)	1679	3357	1502	3257	3249	0	3257	1767	1502	1679	3276	0
Right Turn on Red			Yes			Yes			Yes			Yes
Satd. Flow (RTOR)			223		14				443		7	
Link Speed (k/h)		60			60			60			60	
Link Distance (m)		372.0			396.5			239.9			411.0	
Travel Time (s)		22.3			23.8			14.4			24.7	
Confl. Peds. (#/hr)						29						84
Peak Hour Factor	1.00	1.00	1.00	1.00	1.00	1.00	1.00	1.00	1.00	1.00	1.00	1.00
Heavy Vehicles (%)	3%	3%	3%	3%	3%	3%	3%	3%	3%	3%	3%	3%
Adj. Flow (vph)	157	852	640	875	504	83	276	296	923	75	761	73
Shared Lane Traffic (%)												
Lane Group Flow (vph)	157	852	640	875	587	0	276	296	923	75	834	0
Enter Blocked Intersection	No	No	No	No	No	No	No	No	No	No	No	No
Lane Alignment	Left	Left	Right	Left	Left	Right	Left	Left	Right	Left	Left	Right
Median Width(m)		7.4			7.4			7.4			7.4	
Link Offset(m)		0.0			0.0			0.0			0.0	
Crosswalk Width(m)		4.9			4.9			4.9			4.9	
Two way Left Turn Lane												
Headway Factor	1.06	1.06	1.06	1.06	1.06	1.06	1.06	1.06	1.06	1.06	1.06	1.06
Turning Speed (k/h)	24		14	24		14	24		14	24		14
Number of Detectors	1	2	1	1	2		1	2	1	1	2	
Detector Template	Left	Thru	Right	Left	Thru		Left	Thru	Right	Left	Thru	
Leading Detector (m)	6.1	30.5	6.1	6.1	30.5		6.1	30.5	6.1	6.1	30.5	
Trailing Detector (m)	0.0	0.0	0.0	0.0	0.0		0.0	0.0	0.0	0.0	0.0	
Detector 1 Position(m)	0.0	0.0	0.0	0.0	0.0		0.0	0.0	0.0	0.0	0.0	
Detector 1 Size(m)	6.1	1.8	6.1	6.1	1.8		6.1	1.8	6.1	6.1	1.8	
Detector 1 Type	Cl+Ex	Cl+Ex	Cl+Ex	Cl+Ex	Cl+Ex		Cl+Ex	Cl+Ex	Cl+Ex	Cl+Ex	Cl+Ex	
Detector 1 Channel												
Detector 1 Extend (s)	0.0	0.0	0.0	0.0	0.0		0.0	0.0	0.0	0.0	0.0	
Detector 1 Queue (s)	0.0	0.0	0.0	0.0	0.0		0.0	0.0	0.0	0.0	0.0	
Detector 1 Delay (s)	0.0	0.0	0.0	0.0	0.0		0.0	0.0	0.0	0.0	0.0	
Detector 2 Position(m)		28.7			28.7			28.7			28.7	
Detector 2 Size(m)		1.8			1.8			1.8			1.8	
Detector 2 Type		Cl+Ex			Cl+Ex			Cl+Ex			Cl+Ex	
Detector 2 Channel												
Detector 2 Extend (s)		0.0			0.0			0.0			0.0	

1900/2000 City Park Drive
 3: Blair Road & Ogilvie Road

Tot 2037 PM



Lane Group	EBL	EBT	EBR	WBL	WBT	WBR	NBL	NBT	NBR	SBL	SBT	SBR
Turn Type	Prot	NA	Perm	Prot	NA		Prot	NA	Perm	Prot	NA	
Protected Phases	5	2		1	6		3	8		7	4	
Permitted Phases			2						8			
Detector Phase	5	2	2	1	6		3	8	8	7	4	
Switch Phase												
Minimum Initial (s)	5.0	10.0	10.0	5.0	10.0		5.0	10.0	10.0	5.0	10.0	
Minimum Split (s)	11.8	38.6	38.6	11.8	38.6		11.5	35.5	35.5	11.5	35.5	
Total Split (s)	25.0	41.0	41.0	37.0	53.0		21.0	41.0	41.0	21.0	41.0	
Total Split (%)	17.9%	29.3%	29.3%	26.4%	37.9%		15.0%	29.3%	29.3%	15.0%	29.3%	
Maximum Green (s)	18.2	34.4	34.4	30.2	46.4		14.5	34.5	34.5	14.5	34.5	
Yellow Time (s)	3.7	3.3	3.3	3.7	3.3		4.2	4.2	4.2	4.2	4.2	
All-Red Time (s)	3.1	3.3	3.3	3.1	3.3		2.3	2.3	2.3	2.3	2.3	
Lost Time Adjust (s)	0.0	0.0	0.0	0.0	0.0		0.0	0.0	0.0	0.0	0.0	
Total Lost Time (s)	6.8	6.6	6.6	6.8	6.6		6.5	6.5	6.5	6.5	6.5	
Lead/Lag	Lead	Lag	Lag	Lead	Lag		Lead	Lag	Lag	Lead	Lag	
Lead-Lag Optimize?	Yes	Yes	Yes	Yes	Yes		Yes	Yes	Yes	Yes	Yes	
Vehicle Extension (s)	3.0	3.0	3.0	3.0	3.0		3.0	3.0	3.0	3.0	3.0	
Recall Mode	None	C-Max	C-Max	None	C-Max		None	None	None	None	None	
Walk Time (s)		7.0	7.0		7.0			7.0	7.0		7.0	
Flash Dont Walk (s)		25.0	25.0		25.0			22.0	22.0		22.0	
Pedestrian Calls (#/hr)		30	30		30			35	35		35	
Act Effct Green (s)	16.5	34.4	34.4	30.2	48.1		14.2	37.7	37.7	11.3	34.8	
Actuated g/C Ratio	0.12	0.25	0.25	0.22	0.34		0.10	0.27	0.27	0.08	0.25	
v/c Ratio	0.79	1.03	1.19	1.25	0.52		0.84	0.62	1.27	0.56	1.02	
Control Delay	86.8	91.4	133.4	167.4	38.2		83.2	52.3	153.8	77.1	87.1	
Queue Delay	0.0	0.0	0.0	0.0	0.0		0.0	0.0	0.0	0.0	0.0	
Total Delay	86.8	91.4	133.4	167.4	38.2		83.2	52.3	153.8	77.1	87.1	
LOS	F	F	F	F	D		F	D	F	E	F	
Approach Delay		107.3			115.6			120.7			86.3	
Approach LOS		F			F			F			F	

Intersection Summary

Area Type: Other
 Cycle Length: 140
 Actuated Cycle Length: 140
 Offset: 0 (0%), Referenced to phase 2:EBT and 6:WBT, Start of Green
 Natural Cycle: 140
 Control Type: Actuated-Coordinated
 Maximum v/c Ratio: 1.27
 Intersection Signal Delay: 109.6 Intersection LOS: F
 Intersection Capacity Utilization 109.9% ICU Level of Service H
 Analysis Period (min) 15

Splits and Phases: 3: Blair Road & Ogilvie Road

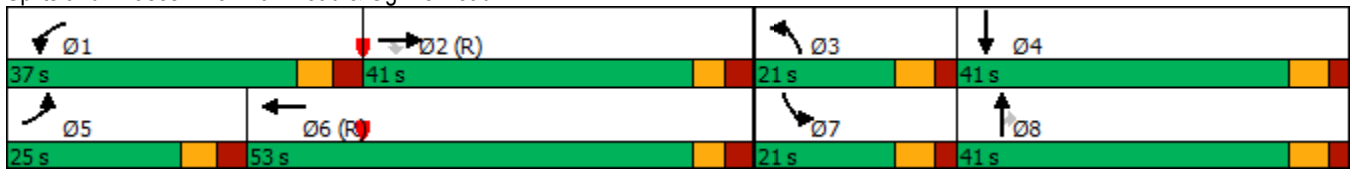

1900/2000 City Park Drive

6: Blair Road & 1980 Ogilvie Road/Hwy 174 WB off

Tot 2037 PM

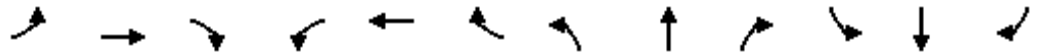

Lane Group	EBL	EBT	EBR	WBL	WBT	WBR	NBL	NBT	NBR	SBL	SBT	SBR
Lane Configurations												
Traffic Volume (vph)	123	0	568	93	149	189	346	1353	0	0	1815	172
Future Volume (vph)	123	0	568	93	149	189	346	1353	0	0	1815	172
Ideal Flow (vphpl)	1800	1800	1800	1800	1800	1800	1800	1800	1800	1800	1800	1800
Storage Length (m)	0.0		70.0	0.0		70.0	60.0		0.0	0.0		50.0
Storage Lanes	1		1	1		1	2		0	0		1
Taper Length (m)	7.6			7.6			100.0			7.6		
Lane Util. Factor	1.00	1.00	1.00	1.00	1.00	1.00	0.97	0.95	1.00	1.00	0.91	1.00
Frt			0.850			0.850						0.850
Flt Protected	0.950			0.950			0.950					
Satd. Flow (prot)	1544	0	1381	1695	1784	1517	3164	3262	0	0	4871	1517
Flt Permitted	0.582			0.950			0.950					
Satd. Flow (perm)	946	0	1381	1695	1784	1517	3164	3262	0	0	4871	1517
Right Turn on Red			Yes			Yes			Yes			Yes
Satd. Flow (RTOR)			26			80						97
Link Speed (k/h)		60			60			60				60
Link Distance (m)		518.9			416.4			90.2				239.9
Travel Time (s)		31.1			25.0			5.4				14.4
Peak Hour Factor	1.00	1.00	1.00	1.00	1.00	1.00	1.00	1.00	1.00	1.00	1.00	1.00
Heavy Vehicles (%)	12%	12%	12%	2%	2%	2%	6%	6%	6%	2%	2%	2%
Adj. Flow (vph)	123	0	568	93	149	189	346	1353	0	0	1815	172
Shared Lane Traffic (%)												
Lane Group Flow (vph)	123	0	568	93	149	189	346	1353	0	0	1815	172
Enter Blocked Intersection	No	No	No	No	No	No	No	No	No	No	No	No
Lane Alignment	Left	Left	Right	Left	Left	Right	Left	Left	Right	Left	Left	Right
Median Width(m)		3.7			3.7			7.4				7.4
Link Offset(m)		0.0			0.0			0.0				0.0
Crosswalk Width(m)		4.9			4.9			4.9				4.9
Two way Left Turn Lane												
Headway Factor	1.06	1.06	1.06	1.06	1.06	1.06	1.06	1.06	1.06	1.06	1.06	1.06
Turning Speed (k/h)	24		14	24		14	24		14	24		14
Number of Detectors	1		1	1	2	1	1	2			2	1
Detector Template	Left		Right	Left	Thru	Right	Left	Thru			Thru	Right
Leading Detector (m)	6.1		6.1	6.1	30.5	6.1	6.1	30.5			30.5	6.1
Trailing Detector (m)	0.0		0.0	0.0	0.0	0.0	0.0	0.0			0.0	0.0
Detector 1 Position(m)	0.0		0.0	0.0	0.0	0.0	0.0	0.0			0.0	0.0
Detector 1 Size(m)	6.1		6.1	6.1	1.8	6.1	6.1	1.8			1.8	6.1
Detector 1 Type	Cl+Ex		Cl+Ex	Cl+Ex	Cl+Ex	Cl+Ex	Cl+Ex	Cl+Ex			Cl+Ex	Cl+Ex
Detector 1 Channel												
Detector 1 Extend (s)	0.0		0.0	0.0	0.0	0.0	0.0	0.0			0.0	0.0
Detector 1 Queue (s)	0.0		0.0	0.0	0.0	0.0	0.0	0.0			0.0	0.0
Detector 1 Delay (s)	0.0		0.0	0.0	0.0	0.0	0.0	0.0			0.0	0.0
Detector 2 Position(m)					28.7			28.7			28.7	
Detector 2 Size(m)					1.8			1.8			1.8	
Detector 2 Type					Cl+Ex			Cl+Ex			Cl+Ex	
Detector 2 Channel												
Detector 2 Extend (s)					0.0			0.0			0.0	
Turn Type	Perm		pm+ov	Perm	NA	Perm	Prot	NA			NA	Perm
Protected Phases			5		8		5	2			6	

1900/2000 City Park Drive
 6: Blair Road & 1980 Ogilvie Road/Hwy 174 WB off

Tot 2037 PM



Lane Group	EBL	EBT	EBR	WBL	WBT	WBR	NBL	NBT	NBR	SBL	SBT	SBR
Permitted Phases	4		4	8		8						6
Detector Phase	4		5	8	8	8	5	2			6	6
Switch Phase												
Minimum Initial (s)	10.0		5.0	10.0	10.0	10.0	5.0	10.0			10.0	10.0
Minimum Split (s)	16.8		11.4	36.8	36.8	36.8	11.4	30.1			30.1	30.1
Total Split (s)	36.0		31.0	36.0	36.0	36.0	31.0	94.0			63.0	63.0
Total Split (%)	27.7%		23.8%	27.7%	27.7%	27.7%	23.8%	72.3%			48.5%	48.5%
Maximum Green (s)	29.2		24.6	29.2	29.2	29.2	24.6	87.9			56.9	56.9
Yellow Time (s)	3.3		4.2	3.3	3.3	3.3	4.2	4.2			4.2	4.2
All-Red Time (s)	3.5		2.2	3.5	3.5	3.5	2.2	1.9			1.9	1.9
Lost Time Adjust (s)	0.0		0.0	0.0	0.0	0.0	0.0	0.0			0.0	0.0
Total Lost Time (s)	6.8		6.4	6.8	6.8	6.8	6.4	6.1			6.1	6.1
Lead/Lag			Lead				Lead				Lag	Lag
Lead-Lag Optimize?			Yes				Yes				Yes	Yes
Vehicle Extension (s)	3.0		3.0	3.0	3.0	3.0	3.0	3.0			3.0	3.0
Recall Mode	None		None	None	None	None	None	C-Max			C-Max	C-Max
Walk Time (s)				7.0	7.0	7.0		7.0			7.0	7.0
Flash Dont Walk (s)				23.0	23.0	23.0		17.0			17.0	17.0
Pedestrian Calls (#/hr)				20	20	20		30			30	30
Act Effct Green (s)	23.3		58.6	23.3	23.3	23.3	28.5	93.8			58.9	58.9
Actuated g/C Ratio	0.18		0.45	0.18	0.18	0.18	0.22	0.72			0.45	0.45
v/c Ratio	0.73		0.89	0.31	0.47	0.56	0.50	0.58			0.82	0.23
Control Delay	72.8		48.9	46.8	51.0	32.7	48.4	10.8			35.5	10.8
Queue Delay	0.0		0.0	0.0	0.0	0.0	0.0	0.0			0.0	0.0
Total Delay	72.8		48.9	46.8	51.0	32.7	48.4	10.8			35.5	10.8
LOS	E		D	D	D	C	D	B			D	B
Approach Delay		53.1			42.1			18.5			33.3	
Approach LOS		D			D			B			C	

Intersection Summary

Area Type: Other
 Cycle Length: 130
 Actuated Cycle Length: 130
 Offset: 50 (38%), Referenced to phase 2:NBT and 6:SBT, Start of Green
 Natural Cycle: 90
 Control Type: Actuated-Coordinated
 Maximum v/c Ratio: 0.89
 Intersection Signal Delay: 31.7
 Intersection LOS: C
 Intersection Capacity Utilization 98.6%
 ICU Level of Service F
 Analysis Period (min) 15

Splits and Phases: 6: Blair Road & 1980 Ogilvie Road/Hwy 174 WB off

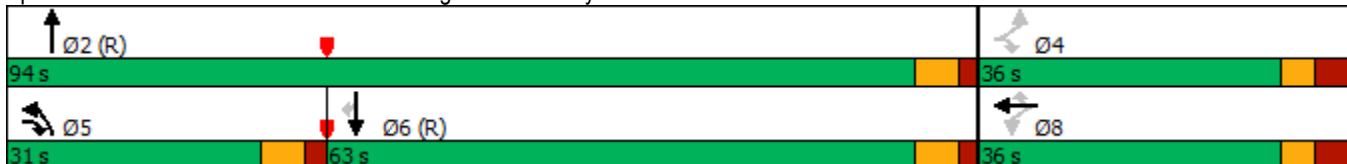

1900/2000 City Park Drive
7: 1980 Ogilvie Road

Tot 2037 PM



Lane Group	WBL	WBR	NBT	NBR	SBL	SBT
Lane Configurations						
Traffic Volume (vph)	0	0	0	0	0	0
Future Volume (vph)	0	0	0	0	0	0
Ideal Flow (vphpl)	1800	1800	1800	1800	1800	1800
Lane Util. Factor	1.00	1.00	1.00	1.00	1.00	1.00
Frnt						
Flt Protected						
Satd. Flow (prot)	1784	0	1784	0	0	1784
Flt Permitted						
Satd. Flow (perm)	1784	0	1784	0	0	1784
Link Speed (k/h)	60		60			60
Link Distance (m)	518.9		235.1			57.3
Travel Time (s)	31.1		14.1			3.4
Peak Hour Factor	1.00	1.00	1.00	1.00	1.00	1.00
Adj. Flow (vph)	0	0	0	0	0	0
Shared Lane Traffic (%)						
Lane Group Flow (vph)	0	0	0	0	0	0
Enter Blocked Intersection	No	No	No	No	No	No
Lane Alignment	Left	Right	Left	Right	Left	Left
Median Width(m)	3.7		0.0			0.0
Link Offset(m)	0.0		0.0			0.0
Crosswalk Width(m)	4.9		4.9			4.9
Two way Left Turn Lane						
Headway Factor	1.06	1.06	1.06	1.06	1.06	1.06
Turning Speed (k/h)	24	14		14	24	
Sign Control	Stop		Free			Free

Intersection Summary

Area Type:	Other
Control Type:	Unsignalized
Intersection Capacity Utilization	0.0%
Analysis Period (min)	15
	ICU Level of Service A

1900/2000 City Park Drive
 9: City Park Drive/1941 Ogilvie & Ogilvie Road

Tot 2037 PM



Lane Group	EBL	EBT	EBR	WBL	WBT	WBR	NBL	NBT	NBR	SBL	SBT	SBR
Lane Configurations												
Traffic Volume (vph)	32	1484	152	191	603	38	183	10	185	78	19	76
Future Volume (vph)	32	1484	152	191	603	38	183	10	185	78	19	76
Ideal Flow (vphpl)	1800	1800	1800	1800	1800	1800	1800	1800	1800	1800	1800	1800
Storage Length (m)	40.0		100.0	100.0		50.0	0.0		60.0	20.0		10.0
Storage Lanes	1		1	1		1	0		1	1		1
Taper Length (m)	30.0			25.0			7.6			15.0		
Lane Util. Factor	1.00	0.95	1.00	1.00	0.95	1.00	1.00	1.00	1.00	1.00	1.00	1.00
Ped Bike Factor	0.89		0.87			0.73		0.93	0.87	0.91		0.92
Fr _t			0.850			0.850			0.850			0.850
Fl _t Protected	0.950			0.950				0.955		0.950		
Satd. Flow (prot)	1695	3390	1517	1679	3357	1502	0	1609	1432	1695	1784	1517
Fl _t Permitted	0.424			0.079				0.723		0.558		
Satd. Flow (perm)	675	3390	1315	140	3357	1104	0	1135	1244	906	1784	1388
Right Turn on Red			Yes			Yes			Yes			Yes
Satd. Flow (RTOR)			152			60			185			99
Link Speed (k/h)		60			60			60				60
Link Distance (m)		224.7			372.0			239.4				142.3
Travel Time (s)		13.5			22.3			14.4				8.5
Confl. Peds. (#/hr)	145		67	67		145	67		110	110		67
Peak Hour Factor	1.00	1.00	1.00	1.00	1.00	1.00	1.00	1.00	1.00	1.00	1.00	1.00
Heavy Vehicles (%)	2%	2%	2%	3%	3%	3%	8%	8%	8%	2%	2%	2%
Adj. Flow (vph)	32	1484	152	191	603	38	183	10	185	78	19	76
Shared Lane Traffic (%)												
Lane Group Flow (vph)	32	1484	152	191	603	38	0	193	185	78	19	76
Enter Blocked Intersection	No	No	No	No	No	No	No	No	No	No	No	No
Lane Alignment	Left	Left	Right	Left	Left	Right	Left	Left	Right	Left	Left	Right
Median Width(m)		3.7			3.7			3.7				3.7
Link Offset(m)		0.0			0.0			0.0				0.0
Crosswalk Width(m)		4.9			4.9			4.9				4.9
Two way Left Turn Lane												
Headway Factor	1.06	1.06	1.06	1.06	1.06	1.06	1.06	1.06	1.06	1.06	1.06	1.06
Turning Speed (k/h)	24		14	24		14	24		14	24		14
Number of Detectors	1	2	1	1	2	1	1	2	1	1	2	1
Detector Template	Left	Thru	Right	Left	Thru	Right	Left	Thru	Right	Left	Thru	Right
Leading Detector (m)	6.1	30.5	6.1	6.1	30.5	6.1	6.1	30.5	6.1	6.1	30.5	6.1
Trailing Detector (m)	0.0	0.0	0.0	0.0	0.0	0.0	0.0	0.0	0.0	0.0	0.0	0.0
Detector 1 Position(m)	0.0	0.0	0.0	0.0	0.0	0.0	0.0	0.0	0.0	0.0	0.0	0.0
Detector 1 Size(m)	6.1	1.8	6.1	6.1	1.8	6.1	6.1	1.8	6.1	6.1	1.8	6.1
Detector 1 Type	Cl+Ex	Cl+Ex	Cl+Ex	Cl+Ex	Cl+Ex	Cl+Ex	Cl+Ex	Cl+Ex	Cl+Ex	Cl+Ex	Cl+Ex	Cl+Ex
Detector 1 Channel												
Detector 1 Extend (s)	0.0	0.0	0.0	0.0	0.0	0.0	0.0	0.0	0.0	0.0	0.0	0.0
Detector 1 Queue (s)	0.0	0.0	0.0	0.0	0.0	0.0	0.0	0.0	0.0	0.0	0.0	0.0
Detector 1 Delay (s)	0.0	0.0	0.0	0.0	0.0	0.0	0.0	0.0	0.0	0.0	0.0	0.0
Detector 2 Position(m)		28.7			28.7			28.7				28.7
Detector 2 Size(m)		1.8			1.8			1.8				1.8
Detector 2 Type		Cl+Ex			Cl+Ex			Cl+Ex				Cl+Ex
Detector 2 Channel												
Detector 2 Extend (s)		0.0			0.0			0.0				0.0

Lane Group	Ø3	Ø7
Lane Configurations		
Traffic Volume (vph)		
Future Volume (vph)		
Ideal Flow (vphpl)		
Storage Length (m)		
Storage Lanes		
Taper Length (m)		
Lane Util. Factor		
Ped Bike Factor		
Frt		
Flt Protected		
Satd. Flow (prot)		
Flt Permitted		
Satd. Flow (perm)		
Right Turn on Red		
Satd. Flow (RTOR)		
Link Speed (k/h)		
Link Distance (m)		
Travel Time (s)		
Confl. Peds. (#/hr)		
Peak Hour Factor		
Heavy Vehicles (%)		
Adj. Flow (vph)		
Shared Lane Traffic (%)		
Lane Group Flow (vph)		
Enter Blocked Intersection		
Lane Alignment		
Median Width(m)		
Link Offset(m)		
Crosswalk Width(m)		
Two way Left Turn Lane		
Headway Factor		
Turning Speed (k/h)		
Number of Detectors		
Detector Template		
Leading Detector (m)		
Trailing Detector (m)		
Detector 1 Position(m)		
Detector 1 Size(m)		
Detector 1 Type		
Detector 1 Channel		
Detector 1 Extend (s)		
Detector 1 Queue (s)		
Detector 1 Delay (s)		
Detector 2 Position(m)		
Detector 2 Size(m)		
Detector 2 Type		
Detector 2 Channel		
Detector 2 Extend (s)		

1900/2000 City Park Drive
 9: City Park Drive/1941 Ogilvie & Ogilvie Road

Tot 2037 PM



Lane Group	EBL	EBT	EBR	WBL	WBT	WBR	NBL	NBT	NBR	SBL	SBT	SBR
Turn Type	Perm	NA	Perm	pm+pt	NA	Perm	Perm	NA	Perm	Perm	NA	Perm
Protected Phases		2		1	6			8			4	
Permitted Phases	2		2	6		6	8		8	4		4
Detector Phase	2	2	2	1	6	6	8	8	8	4	4	4
Switch Phase												
Minimum Initial (s)	10.0	10.0	10.0	5.0	10.0	10.0	10.0	10.0	10.0	10.0	10.0	10.0
Minimum Split (s)	35.1	35.1	35.1	9.0	35.1	35.1	33.5	33.5	33.5	33.5	33.5	33.5
Total Split (s)	46.0	46.0	46.0	15.0	61.0	61.0	34.0	34.0	34.0	34.0	34.0	34.0
Total Split (%)	46.0%	46.0%	46.0%	15.0%	61.0%	61.0%	34.0%	34.0%	34.0%	34.0%	34.0%	34.0%
Maximum Green (s)	39.9	39.9	39.9	11.0	54.9	54.9	27.5	27.5	27.5	27.5	27.5	27.5
Yellow Time (s)	3.7	3.7	3.7	3.0	3.7	3.7	3.3	3.3	3.3	3.3	3.3	3.3
All-Red Time (s)	2.4	2.4	2.4	1.0	2.4	2.4	3.2	3.2	3.2	3.2	3.2	3.2
Lost Time Adjust (s)	0.0	0.0	0.0	0.0	0.0	0.0		0.0	0.0	0.0	0.0	0.0
Total Lost Time (s)	6.1	6.1	6.1	4.0	6.1	6.1		6.5	6.5	6.5	6.5	6.5
Lead/Lag	Lag	Lag	Lag	Lead			Lag	Lag	Lag	Lag	Lag	Lag
Lead-Lag Optimize?	Yes	Yes	Yes	Yes			Yes	Yes	Yes	Yes	Yes	Yes
Vehicle Extension (s)	3.0	3.0	3.0	3.0	3.0	3.0	3.0	3.0	3.0	3.0	3.0	3.0
Recall Mode	C-Max	C-Max	C-Max	None	C-Max	C-Max	None	None	None	None	None	None
Walk Time (s)	7.0	7.0	7.0		7.0	7.0	2.0	2.0	2.0	2.0	2.0	2.0
Flash Dont Walk (s)	22.0	22.0	22.0		22.0	22.0	25.0	25.0	25.0	25.0	25.0	25.0
Pedestrian Calls (#/hr)	35	35	35		35	35	35	35	35	35	35	35
Act Effct Green (s)	47.8	47.8	47.8	63.9	61.8	61.8		22.6	22.6	22.6	22.6	22.6
Actuated g/C Ratio	0.48	0.48	0.48	0.64	0.62	0.62		0.23	0.23	0.23	0.23	0.23
v/c Ratio	0.10	0.92	0.21	0.78	0.29	0.05		0.75	0.44	0.38	0.05	0.19
Control Delay	9.7	27.5	1.2	42.5	10.6	1.4		53.9	7.9	36.6	27.6	4.5
Queue Delay	0.0	0.0	0.0	0.0	0.0	0.0		0.0	0.0	0.0	0.0	0.0
Total Delay	9.7	27.5	1.2	42.5	10.6	1.4		53.9	7.9	36.6	27.6	4.5
LOS	A	C	A	D	B	A		D	A	D	C	A
Approach Delay		24.8			17.5			31.4			21.5	
Approach LOS		C			B			C			C	

Intersection Summary

Area Type: Other
 Cycle Length: 100
 Actuated Cycle Length: 100
 Offset: 30 (30%), Referenced to phase 2:EBTL and 6:WBTL, Start of Green
 Natural Cycle: 95
 Control Type: Actuated-Coordinated
 Maximum v/c Ratio: 0.92
 Intersection Signal Delay: 23.4
 Intersection LOS: C
 Intersection Capacity Utilization 102.6%
 ICU Level of Service G
 Analysis Period (min) 15

Splits and Phases: 9: City Park Drive/1941 Ogilvie & Ogilvie Road

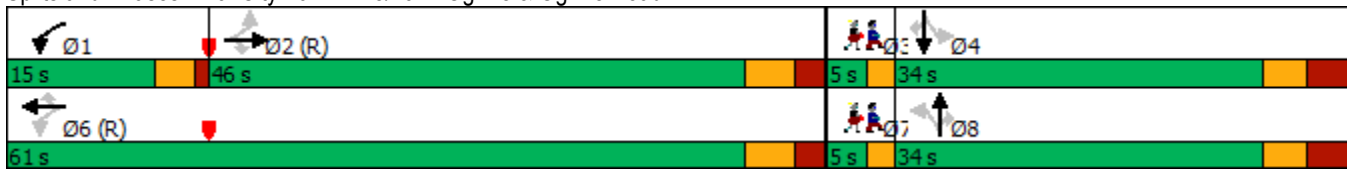

Lane Group	Ø3	Ø7
Turn Type		
Protected Phases	3	7
Permitted Phases		
Detector Phase		
Switch Phase		
Minimum Initial (s)	1.0	1.0
Minimum Split (s)	5.0	5.0
Total Split (s)	5.0	5.0
Total Split (%)	5%	5%
Maximum Green (s)	3.0	3.0
Yellow Time (s)	2.0	2.0
All-Red Time (s)	0.0	0.0
Lost Time Adjust (s)		
Total Lost Time (s)		
Lead/Lag	Lead	Lead
Lead-Lag Optimize?	Yes	Yes
Vehicle Extension (s)	3.0	3.0
Recall Mode	None	None
Walk Time (s)	0.0	0.0
Flash Dont Walk (s)	0.0	0.0
Pedestrian Calls (#/hr)	35	35
Act Effct Green (s)		
Actuated g/C Ratio		
v/c Ratio		
Control Delay		
Queue Delay		
Total Delay		
LOS		
Approach Delay		
Approach LOS		
Intersection Summary		

1900/2000 City Park Drive

12: 1900 Ogilvie Road/1929 Ogilvie Road & Ogilvie Road

Tot 2037 PM



Lane Group	EBL	EBT	EBR	WBL	WBT	WBR	NBL	NBT	NBR	SBL	SBT	SBR
Lane Configurations												
Traffic Volume (vph)	43	1428	66	32	861	24	47	3	28	135	3	132
Future Volume (vph)	43	1428	66	32	861	24	47	3	28	135	3	132
Ideal Flow (vphpl)	1800	1800	1800	1800	1800	1800	1800	1800	1800	1800	1800	1800
Storage Length (m)	60.0		80.0	90.0		0.0	0.0		0.0	0.0		0.0
Storage Lanes	1		1	1		0	1		0	0		1
Taper Length (m)	30.0			20.0			7.6			7.6		
Lane Util. Factor	1.00	0.95	1.00	1.00	0.95	0.95	1.00	1.00	1.00	1.00	1.00	1.00
Frt			0.850		0.996			0.865				0.850
Flt Protected	0.950			0.950			0.950				0.953	
Satd. Flow (prot)	1695	3390	1517	1679	3345	0	1695	1543	0	0	1700	1517
Flt Permitted	0.289			0.131			0.669				0.708	
Satd. Flow (perm)	516	3390	1517	231	3345	0	1194	1543	0	0	1263	1517
Right Turn on Red			Yes			Yes			Yes			Yes
Satd. Flow (RTOR)			66		5			28				132
Link Speed (k/h)		60			60			60				60
Link Distance (m)		190.5			224.7			86.0				56.6
Travel Time (s)		11.4			13.5			5.2				3.4
Peak Hour Factor	1.00	1.00	1.00	1.00	1.00	1.00	1.00	1.00	1.00	1.00	1.00	1.00
Heavy Vehicles (%)	2%	2%	2%	3%	3%	2%	2%	2%	2%	2%	2%	2%
Adj. Flow (vph)	43	1428	66	32	861	24	47	3	28	135	3	132
Shared Lane Traffic (%)												
Lane Group Flow (vph)	43	1428	66	32	885	0	47	31	0	0	138	132
Enter Blocked Intersection	No	No	No	No	No	No	No	No	No	No	No	No
Lane Alignment	Left	Left	Right	Left	Left	Right	Left	Left	Right	Left	Left	Right
Median Width(m)		3.7			3.7			3.7				3.7
Link Offset(m)		0.0			0.0			0.0				0.0
Crosswalk Width(m)		4.9			4.9			4.9				4.9
Two way Left Turn Lane												
Headway Factor	1.06	1.06	1.06	1.06	1.06	1.06	1.06	1.06	1.06	1.06	1.06	1.06
Turning Speed (k/h)	24		14	24		14	24		14	24		14
Number of Detectors	1	2	1	1	2		1	2		1	2	1
Detector Template	Left	Thru	Right	Left	Thru		Left	Thru		Left	Thru	Right
Leading Detector (m)	6.1	30.5	6.1	6.1	30.5		6.1	30.5		6.1	30.5	6.1
Trailing Detector (m)	0.0	0.0	0.0	0.0	0.0		0.0	0.0		0.0	0.0	0.0
Detector 1 Position(m)	0.0	0.0	0.0	0.0	0.0		0.0	0.0		0.0	0.0	0.0
Detector 1 Size(m)	6.1	1.8	6.1	6.1	1.8		6.1	1.8		6.1	1.8	6.1
Detector 1 Type	Cl+Ex	Cl+Ex	Cl+Ex	Cl+Ex	Cl+Ex		Cl+Ex	Cl+Ex		Cl+Ex	Cl+Ex	Cl+Ex
Detector 1 Channel												
Detector 1 Extend (s)	0.0	0.0	0.0	0.0	0.0		0.0	0.0		0.0	0.0	0.0
Detector 1 Queue (s)	0.0	0.0	0.0	0.0	0.0		0.0	0.0		0.0	0.0	0.0
Detector 1 Delay (s)	0.0	0.0	0.0	0.0	0.0		0.0	0.0		0.0	0.0	0.0
Detector 2 Position(m)		28.7			28.7			28.7				28.7
Detector 2 Size(m)		1.8			1.8			1.8				1.8
Detector 2 Type		Cl+Ex			Cl+Ex			Cl+Ex				Cl+Ex
Detector 2 Channel												
Detector 2 Extend (s)		0.0			0.0			0.0				0.0
Turn Type	Perm	NA	Perm	Perm	NA		Perm	NA		Perm	NA	Perm
Protected Phases		2			6			8				4

1900/2000 City Park Drive

12: 1900 Ogilvie Road/1929 Ogilvie Road & Ogilvie Road

Tot 2037 PM



Lane Group	EBL	EBT	EBR	WBL	WBT	WBR	NBL	NBT	NBR	SBL	SBT	SBR
Permitted Phases	2		2	6			8			4		4
Detector Phase	2	2	2	6	6		8	8		4	4	4
Switch Phase												
Minimum Initial (s)	10.0	10.0	10.0	10.0	10.0		10.0	10.0		10.0	10.0	10.0
Minimum Split (s)	29.9	29.9	29.9	29.9	29.9		36.7	36.7		36.7	36.7	36.7
Total Split (s)	63.0	63.0	63.0	63.0	63.0		37.0	37.0		37.0	37.0	37.0
Total Split (%)	63.0%	63.0%	63.0%	63.0%	63.0%		37.0%	37.0%		37.0%	37.0%	37.0%
Maximum Green (s)	57.1	57.1	57.1	57.1	57.1		30.3	30.3		30.3	30.3	30.3
Yellow Time (s)	3.7	3.7	3.7	3.7	3.7		3.3	3.3		3.3	3.3	3.3
All-Red Time (s)	2.2	2.2	2.2	2.2	2.2		3.4	3.4		3.4	3.4	3.4
Lost Time Adjust (s)	0.0	0.0	0.0	0.0	0.0		0.0	0.0		0.0	0.0	0.0
Total Lost Time (s)	5.9	5.9	5.9	5.9	5.9		6.7	6.7		6.7	6.7	6.7
Lead/Lag												
Lead-Lag Optimize?												
Vehicle Extension (s)	3.0	3.0	3.0	3.0	3.0		3.0	3.0		3.0	3.0	3.0
Recall Mode	C-Max	C-Max	C-Max	C-Max	C-Max		None	None		None	None	None
Walk Time (s)	11.0	11.0	11.0	11.0	11.0		7.0	7.0		7.0	7.0	7.0
Flash Dont Walk (s)	13.0	13.0	13.0	13.0	13.0		23.0	23.0		23.0	23.0	23.0
Pedestrian Calls (#/hr)	20	20	20	20	20		30	30		30	30	30
Act Effct Green (s)	64.7	64.7	64.7	64.7	64.7		22.7	22.7		22.7	22.7	22.7
Actuated g/C Ratio	0.65	0.65	0.65	0.65	0.65		0.23	0.23		0.23	0.23	0.23
v/c Ratio	0.13	0.65	0.07	0.21	0.41		0.17	0.08		0.48	0.30	0.30
Control Delay	5.8	8.4	0.7	10.5	6.8		28.9	11.0		37.2	6.6	6.6
Queue Delay	0.0	0.1	0.0	0.0	0.0		0.0	0.0		0.0	0.0	0.0
Total Delay	5.8	8.5	0.7	10.5	6.8		28.9	11.0		37.2	6.6	6.6
LOS	A	A	A	B	A		C	B		D	A	A
Approach Delay		8.1			7.0			21.8			22.2	
Approach LOS		A			A			C			C	

Intersection Summary

Area Type:	Other
Cycle Length:	100
Actuated Cycle Length:	100
Offset:	8 (8%), Referenced to phase 2:EBTL and 6:WBTL, Start of Green
Natural Cycle:	80
Control Type:	Actuated-Coordinated
Maximum v/c Ratio:	0.65
Intersection Signal Delay:	9.4
Intersection LOS:	A
Intersection Capacity Utilization:	66.9%
ICU Level of Service:	C
Analysis Period (min):	15

Splits and Phases: 12: 1900 Ogilvie Road/1929 Ogilvie Road & Ogilvie Road

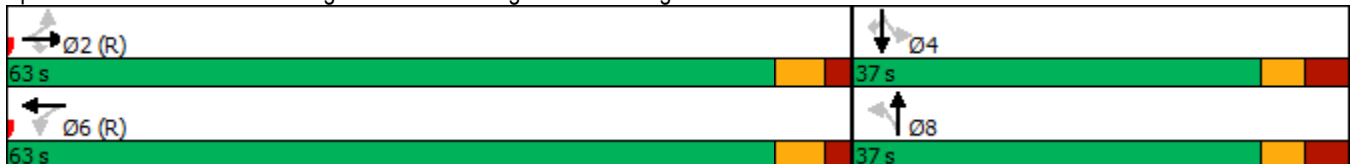

1900/2000 City Park Drive
 15: City Park Drive/Bathgate Drive & Ogilvie Road

Tot 2037 PM



Lane Group	EBL	EBT	EBR	WBL	WBT	WBR	NBL	NBT	NBR	SBL	SBT	SBR
Lane Configurations												
Traffic Volume (vph)	207	1061	194	12	839	110	127	66	26	140	46	159
Future Volume (vph)	207	1061	194	12	839	110	127	66	26	140	46	159
Ideal Flow (vphpl)	1800	1800	1800	1800	1800	1800	1800	1800	1800	1800	1800	1800
Storage Length (m)	70.0		40.0	45.0		70.0	30.0		0.0	20.0		0.0
Storage Lanes	1		1	1		1	1		0	1		0
Taper Length (m)	30.0			30.0			25.0			25.0		
Lane Util. Factor	1.00	0.95	1.00	1.00	0.95	1.00	1.00	1.00	1.00	1.00	1.00	1.00
Ped Bike Factor	0.97		0.90			0.83	0.98	0.99		0.98	0.97	
Fr _t			0.850			0.850		0.958			0.884	
Fl _t Protected	0.950			0.950			0.950			0.950		
Satd. Flow (prot)	1679	3357	1502	1679	3357	1502	1631	1630	0	1647	1487	0
Fl _t Permitted	0.225			0.244			0.543			0.697		
Satd. Flow (perm)	385	3357	1349	431	3357	1248	914	1630	0	1186	1487	0
Right Turn on Red			Yes			Yes			Yes			Yes
Satd. Flow (RTOR)			121			121		20			159	
Link Speed (k/h)		60			60			60			60	
Link Distance (m)		257.6			190.5			345.6			177.6	
Travel Time (s)		15.5			11.4			20.7			10.7	
Confl. Peds. (#/hr)	73		40	40		73	27		21	21		27
Peak Hour Factor	1.00	1.00	1.00	1.00	1.00	1.00	1.00	1.00	1.00	1.00	1.00	1.00
Heavy Vehicles (%)	3%	3%	3%	3%	3%	3%	6%	6%	6%	5%	5%	5%
Adj. Flow (vph)	207	1061	194	12	839	110	127	66	26	140	46	159
Shared Lane Traffic (%)												
Lane Group Flow (vph)	207	1061	194	12	839	110	127	92	0	140	205	0
Enter Blocked Intersection	No	No	No	No	No	No	No	No	No	No	No	No
Lane Alignment	Left	Left	Right	Left	Left	Right	Left	Left	Right	Left	Left	Right
Median Width(m)		3.7			3.7			3.7			3.7	
Link Offset(m)		0.0			0.0			0.0			0.0	
Crosswalk Width(m)		4.9			4.9			4.9			4.9	
Two way Left Turn Lane												
Headway Factor	1.06	1.06	1.06	1.06	1.06	1.06	1.06	1.06	1.06	1.06	1.06	1.06
Turning Speed (k/h)	24		14	24		14	24		14	24		14
Number of Detectors	1	2	1	1	2	1	1	2		1	2	
Detector Template	Left	Thru	Right	Left	Thru	Right	Left	Thru		Left	Thru	
Leading Detector (m)	6.1	30.5	6.1	6.1	30.5	6.1	6.1	30.5		6.1	30.5	
Trailing Detector (m)	0.0	0.0	0.0	0.0	0.0	0.0	0.0	0.0		0.0	0.0	
Detector 1 Position(m)	0.0	0.0	0.0	0.0	0.0	0.0	0.0	0.0		0.0	0.0	
Detector 1 Size(m)	6.1	1.8	6.1	6.1	1.8	6.1	6.1	1.8		6.1	1.8	
Detector 1 Type	Cl+Ex	Cl+Ex	Cl+Ex	Cl+Ex	Cl+Ex	Cl+Ex	Cl+Ex	Cl+Ex		Cl+Ex	Cl+Ex	
Detector 1 Channel												
Detector 1 Extend (s)	0.0	0.0	0.0	0.0	0.0	0.0	0.0	0.0		0.0	0.0	
Detector 1 Queue (s)	0.0	0.0	0.0	0.0	0.0	0.0	0.0	0.0		0.0	0.0	
Detector 1 Delay (s)	0.0	0.0	0.0	0.0	0.0	0.0	0.0	0.0		0.0	0.0	
Detector 2 Position(m)		28.7			28.7			28.7			28.7	
Detector 2 Size(m)		1.8			1.8			1.8			1.8	
Detector 2 Type		Cl+Ex			Cl+Ex			Cl+Ex			Cl+Ex	
Detector 2 Channel												
Detector 2 Extend (s)		0.0			0.0			0.0			0.0	

Lane Group	Ø3	Ø7
Lane Configurations		
Traffic Volume (vph)		
Future Volume (vph)		
Ideal Flow (vphpl)		
Storage Length (m)		
Storage Lanes		
Taper Length (m)		
Lane Util. Factor		
Ped Bike Factor		
Frt		
Flt Protected		
Satd. Flow (prot)		
Flt Permitted		
Satd. Flow (perm)		
Right Turn on Red		
Satd. Flow (RTOR)		
Link Speed (k/h)		
Link Distance (m)		
Travel Time (s)		
Confl. Peds. (#/hr)		
Peak Hour Factor		
Heavy Vehicles (%)		
Adj. Flow (vph)		
Shared Lane Traffic (%)		
Lane Group Flow (vph)		
Enter Blocked Intersection		
Lane Alignment		
Median Width(m)		
Link Offset(m)		
Crosswalk Width(m)		
Two way Left Turn Lane		
Headway Factor		
Turning Speed (k/h)		
Number of Detectors		
Detector Template		
Leading Detector (m)		
Trailing Detector (m)		
Detector 1 Position(m)		
Detector 1 Size(m)		
Detector 1 Type		
Detector 1 Channel		
Detector 1 Extend (s)		
Detector 1 Queue (s)		
Detector 1 Delay (s)		
Detector 2 Position(m)		
Detector 2 Size(m)		
Detector 2 Type		
Detector 2 Channel		
Detector 2 Extend (s)		

1900/2000 City Park Drive
 15: City Park Drive/Bathgate Drive & Ogilvie Road

Tot 2037 PM



Lane Group	EBL	EBT	EBR	WBL	WBT	WBR	NBL	NBT	NBR	SBL	SBT	SBR
Turn Type	pm+pt	NA	Perm	pm+pt	NA	Perm	Perm	NA		Perm	NA	
Protected Phases	5	2		1	6			8				4
Permitted Phases	2		2	6		6	8			4		
Detector Phase	5	2	2	1	6	6	8	8		4		4
Switch Phase												
Minimum Initial (s)	5.0	10.0	10.0	5.0	10.0	10.0	10.0	10.0		10.0	10.0	
Minimum Split (s)	9.7	30.0	30.0	9.7	30.0	30.0	37.4	37.4		37.4	37.4	
Total Split (s)	20.0	37.0	37.0	20.0	37.0	37.0	38.0	38.0		38.0	38.0	
Total Split (%)	20.0%	37.0%	37.0%	20.0%	37.0%	37.0%	38.0%	38.0%		38.0%	38.0%	
Maximum Green (s)	15.3	31.0	31.0	15.3	31.0	31.0	30.6	30.6		30.6	30.6	
Yellow Time (s)	3.7	3.7	3.7	3.7	3.7	3.7	3.0	3.0		3.0	3.0	
All-Red Time (s)	1.0	2.3	2.3	1.0	2.3	2.3	4.4	4.4		4.4	4.4	
Lost Time Adjust (s)	0.0	0.0	0.0	0.0	0.0	0.0	0.0	0.0		0.0	0.0	
Total Lost Time (s)	4.7	6.0	6.0	4.7	6.0	6.0	7.4	7.4		7.4	7.4	
Lead/Lag	Lead	Lag	Lag	Lead	Lag	Lag	Lag	Lag		Lag	Lag	
Lead-Lag Optimize?	Yes	Yes	Yes	Yes	Yes	Yes	Yes	Yes		Yes	Yes	
Vehicle Extension (s)	3.0	3.0	3.0	3.0	3.0	3.0	3.0	3.0		3.0	3.0	
Recall Mode	None	C-Max	C-Max	None	C-Max	C-Max	None	None		None	None	
Walk Time (s)		9.0	9.0		9.0	9.0	2.0	2.0		2.0	2.0	
Flash Dont Walk (s)		15.0	15.0		15.0	15.0	28.0	28.0		28.0	28.0	
Pedestrian Calls (#/hr)		30	30		30	30	20	20		20	20	
Act Effct Green (s)	62.4	58.8	58.8	52.4	45.2	45.2	20.5	20.5		20.5	20.5	
Actuated g/C Ratio	0.62	0.59	0.59	0.52	0.45	0.45	0.20	0.20		0.20	0.20	
v/c Ratio	0.54	0.54	0.23	0.04	0.55	0.17	0.68	0.26		0.58	0.48	
Control Delay	21.0	14.6	7.8	8.8	16.6	2.0	52.8	25.1		43.4	11.9	
Queue Delay	0.0	0.0	0.0	0.0	0.0	0.0	0.0	0.0		0.0	0.0	
Total Delay	21.0	14.6	7.8	8.8	16.6	2.0	52.8	25.1		43.4	11.9	
LOS	C	B	A	A	B	A	D	C		D	B	
Approach Delay		14.6			14.8			41.2			24.7	
Approach LOS		B			B			D			C	

Intersection Summary

Area Type:	Other
Cycle Length:	100
Actuated Cycle Length:	100
Offset:	19 (19%), Referenced to phase 2:EBTL and 6:WBTL, Start of Green
Natural Cycle:	85
Control Type:	Actuated-Coordinated
Maximum v/c Ratio:	0.68
Intersection Signal Delay:	17.8
Intersection LOS:	B
Intersection Capacity Utilization	87.0%
ICU Level of Service	E
Analysis Period (min)	15

Splits and Phases: 15: City Park Drive/Bathgate Drive & Ogilvie Road

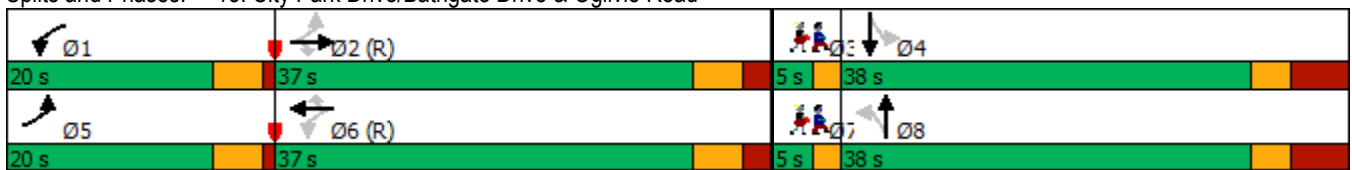

Lane Group	Ø3	Ø7
Turn Type		
Protected Phases	3	7
Permitted Phases		
Detector Phase		
Switch Phase		
Minimum Initial (s)	1.0	1.0
Minimum Split (s)	5.0	5.0
Total Split (s)	5.0	5.0
Total Split (%)	5%	5%
Maximum Green (s)	3.0	3.0
Yellow Time (s)	2.0	2.0
All-Red Time (s)	0.0	0.0
Lost Time Adjust (s)		
Total Lost Time (s)		
Lead/Lag	Lead	Lead
Lead-Lag Optimize?	Yes	Yes
Vehicle Extension (s)	3.0	3.0
Recall Mode	Ped	Ped
Walk Time (s)	0.0	0.0
Flash Dont Walk (s)	0.0	0.0
Pedestrian Calls (#/hr)	20	20
Act Effct Green (s)		
Actuated g/C Ratio		
v/c Ratio		
Control Delay		
Queue Delay		
Total Delay		
LOS		
Approach Delay		
Approach LOS		
Intersection Summary		

1900/2000 City Park Drive
 18: Residential/Cadboro Road & Ogilvie Road

Tot 2037 PM



Lane Group	EBL	EBT	EBR	WBL	WBT	WBR	NBL	NBT	NBR	SBL	SBT	SBR
Lane Configurations		↑↑			↑↑				↑			↑
Traffic Volume (vph)	0	1862	14	0	1229	70	0	0	1	0	0	97
Future Volume (vph)	0	1862	14	0	1229	70	0	0	1	0	0	97
Ideal Flow (vphpl)	1800	1800	1800	1800	1800	1800	1800	1800	1800	1800	1800	1800
Lane Util. Factor	1.00	0.95	0.95	1.00	0.95	0.95	1.00	1.00	1.00	1.00	1.00	1.00
Fr _t		0.999			0.992				0.865			0.865
Fl _t Protected												
Satd. Flow (prot)	0	3387	0	0	3363	0	0	0	1543	0	0	1543
Fl _t Permitted												
Satd. Flow (perm)	0	3387	0	0	3363	0	0	0	1543	0	0	1543
Right Turn on Red			Yes			Yes			Yes			Yes
Satd. Flow (RTOR)		1			9				33			52
Link Speed (k/h)		60			60			60				60
Link Distance (m)		264.5			257.6			90.1				116.1
Travel Time (s)		15.9			15.5			5.4				7.0
Peak Hour Factor	1.00	1.00	1.00	1.00	1.00	1.00	1.00	1.00	1.00	1.00	1.00	1.00
Adj. Flow (vph)	0	1862	14	0	1229	70	0	0	1	0	0	97
Shared Lane Traffic (%)												
Lane Group Flow (vph)	0	1876	0	0	1299	0	0	0	1	0	0	97
Enter Blocked Intersection	No	No	No	No	No	No	No	No	No	No	No	No
Lane Alignment	Left	Left	Right	Left	Left	Right	Left	Left	Right	Left	Left	Right
Median Width(m)		3.7			3.7			0.0				0.0
Link Offset(m)		0.0			0.0			0.0				0.0
Crosswalk Width(m)		1.6			1.6			1.6				1.6
Two way Left Turn Lane												
Headway Factor	1.06	1.06	1.06	1.06	1.06	1.06	1.06	1.06	1.06	1.06	1.06	1.06
Turning Speed (k/h)	97		97	97		97	97		97	97		97
Number of Detectors		2			2				1			1
Detector Template		Thru			Thru				Right			Right
Leading Detector (m)		10.0			10.0				2.0			2.0
Trailing Detector (m)		0.0			0.0				0.0			0.0
Detector 1 Position(m)		0.0			0.0				0.0			0.0
Detector 1 Size(m)		0.6			0.6				2.0			2.0
Detector 1 Type		Cl+Ex			Cl+Ex				Cl+Ex			Cl+Ex
Detector 1 Channel												
Detector 1 Extend (s)		0.0			0.0				0.0			0.0
Detector 1 Queue (s)		0.0			0.0				0.0			0.0
Detector 1 Delay (s)		0.0			0.0				0.0			0.0
Detector 2 Position(m)		9.4			9.4							
Detector 2 Size(m)		0.6			0.6							
Detector 2 Type		Cl+Ex			Cl+Ex							
Detector 2 Channel												
Detector 2 Extend (s)		0.0			0.0							
Turn Type		NA			NA				Perm			Perm
Protected Phases		2			6							
Permitted Phases									8			4
Detector Phase		2			6				8			4
Switch Phase												
Minimum Initial (s)		10.0			10.0				5.0			5.0

1900/2000 City Park Drive
 18: Residential/Cadboro Road & Ogilvie Road

Tot 2037 PM



Lane Group	EBL	EBT	EBR	WBL	WBT	WBR	NBL	NBT	NBR	SBL	SBT	SBR
Minimum Split (s)		35.0			35.0				40.0			40.0
Total Split (s)		60.0			60.0				40.0			40.0
Total Split (%)		60.0%			60.0%				40.0%			40.0%
Maximum Green (s)		54.0			54.0				36.0			36.0
Yellow Time (s)		3.7			3.7				3.0			3.0
All-Red Time (s)		2.3			2.3				1.0			1.0
Lost Time Adjust (s)		0.0			0.0				0.0			0.0
Total Lost Time (s)		6.0			6.0				4.0			4.0
Lead/Lag												
Lead-Lag Optimize?												
Vehicle Extension (s)		3.0			3.0				3.0			3.0
Recall Mode		C-Max			C-Max				None			None
Walk Time (s)		15.0			15.0				24.0			24.0
Flash Dont Walk (s)		14.0			14.0				12.0			12.0
Pedestrian Calls (#/hr)		30			30				20			20
Act Effct Green (s)		74.6			74.6				18.5			18.5
Actuated g/C Ratio		0.75			0.75				0.18			0.18
v/c Ratio		0.74			0.52				0.00			0.30
Control Delay		15.8			9.3				0.0			16.5
Queue Delay		0.0			0.0				0.0			0.0
Total Delay		15.8			9.3				0.0			16.5
LOS		B			A				A			B
Approach Delay		15.8			9.3						16.5	
Approach LOS		B			A						B	

Intersection Summary

Area Type:	Other
Cycle Length:	100
Actuated Cycle Length:	100
Offset:	4 (4%), Referenced to phase 2:EBT and 6:WBT, Start of Green
Natural Cycle:	100
Control Type:	Actuated-Coordinated
Maximum v/c Ratio:	0.74
Intersection Signal Delay:	13.2
Intersection LOS:	B
Intersection Capacity Utilization:	67.3%
ICU Level of Service:	C
Analysis Period (min):	15

Splits and Phases: 18: Residential/Cadboro Road & Ogilvie Road

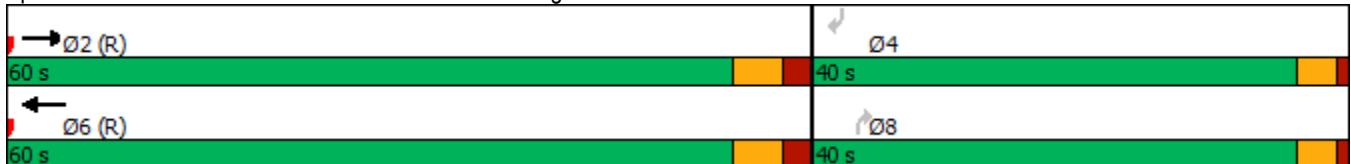

1900/2000 City Park Drive
 22: Blair Road & Hwy 174 EB off

Tot 2037 PM



Lane Group	WBL	WBR	NBT	NBR	SBL	SBT
Lane Configurations						
Traffic Volume (vph)	237	1017	844	189	490	1015
Future Volume (vph)	237	1017	844	189	490	1015
Ideal Flow (vphpl)	1800	1800	1800	1800	1800	1800
Storage Length (m)	0.0	0.0		70.0	0.0	
Storage Lanes	1	1		1	0	
Taper Length (m)	7.6				7.6	
Lane Util. Factor	1.00	1.00	0.95	1.00	0.95	0.95
Fr _t		0.850		0.850		
Fl _t Protected	0.950					0.984
Satd. Flow (prot)	1647	1473	3325	1488	0	3210
Fl _t Permitted	0.950					0.519
Satd. Flow (perm)	1647	1473	3325	1488	0	1693
Right Turn on Red		Yes		Yes		
Satd. Flow (RTOR)		582		189		
Link Speed (k/h)	60		60			60
Link Distance (m)	216.4		230.9			341.9
Travel Time (s)	13.0		13.9			20.5
Peak Hour Factor	1.00	1.00	1.00	1.00	1.00	1.00
Heavy Vehicles (%)	5%	5%	4%	4%	6%	6%
Adj. Flow (vph)	237	1017	844	189	490	1015
Shared Lane Traffic (%)						
Lane Group Flow (vph)	237	1017	844	189	0	1505
Enter Blocked Intersection	No	No	No	No	No	No
Lane Alignment	Left	Right	Left	Right	Left	Left
Median Width(m)	3.7		0.0			0.0
Link Offset(m)	0.0		0.0			0.0
Crosswalk Width(m)	4.9		4.9			4.9
Two way Left Turn Lane						
Headway Factor	1.06	1.06	1.06	1.06	1.06	1.06
Turning Speed (k/h)	24	14		14	24	
Number of Detectors	1	1	2	1	1	2
Detector Template	Left	Right	Thru	Right	Left	Thru
Leading Detector (m)	6.1	6.1	30.5	6.1	6.1	30.5
Trailing Detector (m)	0.0	0.0	0.0	0.0	0.0	0.0
Detector 1 Position(m)	0.0	0.0	0.0	0.0	0.0	0.0
Detector 1 Size(m)	6.1	6.1	1.8	6.1	6.1	1.8
Detector 1 Type	Cl+Ex	Cl+Ex	Cl+Ex	Cl+Ex	Cl+Ex	Cl+Ex
Detector 1 Channel						
Detector 1 Extend (s)	0.0	0.0	0.0	0.0	0.0	0.0
Detector 1 Queue (s)	0.0	0.0	0.0	0.0	0.0	0.0
Detector 1 Delay (s)	0.0	0.0	0.0	0.0	0.0	0.0
Detector 2 Position(m)			28.7			28.7
Detector 2 Size(m)			1.8			1.8
Detector 2 Type			Cl+Ex			Cl+Ex
Detector 2 Channel						
Detector 2 Extend (s)			0.0			0.0
Turn Type	Prot	Free	NA	pm+ov	pm+pt	NA
Protected Phases	8		2	8	1	6

1900/2000 City Park Drive
 22: Blair Road & Hwy 174 EB off

Tot 2037 PM



Lane Group	WBL	WBR	NBT	NBR	SBL	SBT
Permitted Phases	Free		2		6	
Detector Phase	8		2	8	1	6
Switch Phase						
Minimum Initial (s)	5.0		10.0	5.0	5.0	1.0
Minimum Split (s)	25.3		30.5	25.3	11.0	30.5
Total Split (s)	30.0		52.0	30.0	28.0	80.0
Total Split (%)	27.3%		47.3%	27.3%	25.5%	72.7%
Maximum Green (s)	23.7		45.5	23.7	22.0	73.5
Yellow Time (s)	3.3		4.2	3.3	4.2	4.2
All-Red Time (s)	3.0		2.3	3.0	1.8	2.3
Lost Time Adjust (s)	0.0		0.0	0.0		0.0
Total Lost Time (s)	6.3		6.5	6.3		6.5
Lead/Lag			Lag		Lead	
Lead-Lag Optimize?			Yes		Yes	
Vehicle Extension (s)	3.0		3.0	3.0	3.0	3.0
Recall Mode	None		C-Max	None	Max	C-Max
Walk Time (s)	7.0		7.0	7.0		7.0
Flash Dont Walk (s)	12.0		17.0	12.0		17.0
Pedestrian Calls (#/hr)	0		0	0		0
Act Effct Green (s)	20.0	110.0	45.5	72.0		77.2
Actuated g/C Ratio	0.18	1.00	0.41	0.65		0.70
v/c Ratio	0.80	0.69	0.61	0.18		0.98
Control Delay	61.9	2.7	27.7	1.2		32.4
Queue Delay	0.0	0.0	0.0	0.0		0.0
Total Delay	61.9	2.7	27.7	1.2		32.4
LOS	E	A	C	A		C
Approach Delay	13.9		22.9			32.4
Approach LOS	B		C			C

Intersection Summary

Area Type: Other
 Cycle Length: 110
 Actuated Cycle Length: 110
 Offset: 32 (29%), Referenced to phase 2:NBT and 6:SBTL, Start of Green
 Natural Cycle: 150
 Control Type: Actuated-Coordinated
 Maximum v/c Ratio: 0.98
 Intersection Signal Delay: 23.7
 Intersection LOS: C
 Intersection Capacity Utilization 99.2%
 ICU Level of Service F
 Analysis Period (min) 15

Splits and Phases: 22: Blair Road & Hwy 174 EB off

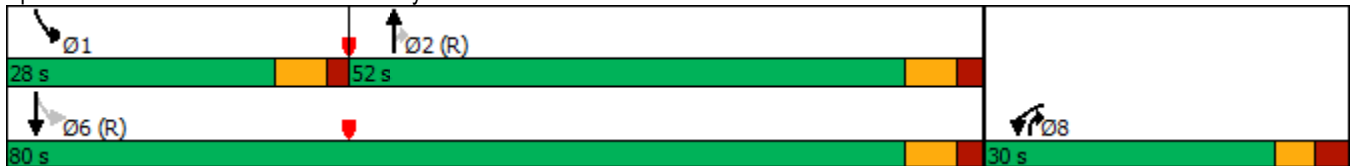

1900/2000 City Park Drive
25: Blair Road

Tot 2037 PM



Lane Group	EBL	EBR	NBL	NBT	SBT	SBR
Lane Configurations				↑↑	↑↑	↗
Traffic Volume (vph)	0	0	0	0	0	0
Future Volume (vph)	0	0	0	0	0	0
Ideal Flow (vphpl)	1800	1800	1800	1800	1800	1800
Lane Util. Factor	1.00	1.00	1.00	0.95	0.95	1.00
Fr						
Flt Protected						
Satd. Flow (prot)	0	0	0	3390	3390	1784
Flt Permitted						
Satd. Flow (perm)	0	0	0	3390	3390	1784
Link Speed (k/h)	60			60	60	
Link Distance (m)	105.8			341.9	90.2	
Travel Time (s)	6.3			20.5	5.4	
Peak Hour Factor	1.00	1.00	1.00	1.00	1.00	1.00
Adj. Flow (vph)	0	0	0	0	0	0
Shared Lane Traffic (%)						
Lane Group Flow (vph)	0	0	0	0	0	0
Enter Blocked Intersection	No	No	No	No	No	No
Lane Alignment	Left	Right	Left	Left	Left	Right
Median Width(m)	0.0			7.4	7.4	
Link Offset(m)	0.0			0.0	0.0	
Crosswalk Width(m)	1.6			1.6	1.6	
Two way Left Turn Lane						
Headway Factor	1.06	1.06	1.06	1.06	1.06	1.06
Turning Speed (k/h)	24	14	24			14
Sign Control	Yield			Free	Free	

Intersection Summary

Area Type:	Other
Control Type:	Unsignalized
Intersection Capacity Utilization	0.0% ICU Level of Service A
Analysis Period (min)	15

1900/2000 City Park Drive

1630: Palmerston Drive/Matheson Road & Ogilvie Road

Tot 2037 PM



Lane Group	EBL	EBT	EBR	WBL	WBT	WBR	NBL	NBT	NBR	SBL	SBT	SBR
Lane Configurations												
Traffic Volume (vph)	188	1740	61	94	1343	38	52	4	39	29	4	96
Future Volume (vph)	188	1740	61	94	1343	38	52	4	39	29	4	96
Ideal Flow (vphpl)	1800	1800	1800	1800	1800	1800	1800	1800	1800	1800	1800	1800
Storage Length (m)	70.0		0.0	70.0		0.0	15.0		0.0	0.0		35.0
Storage Lanes	1		0	1		0	1		0	0		1
Taper Length (m)	30.0			30.0			7.6			7.6		
Lane Util. Factor	1.00	0.95	0.95	1.00	0.95	0.95	1.00	1.00	1.00	1.00	1.00	1.00
Ped Bike Factor		1.00			1.00		0.98	0.98			0.99	0.99
Frt		0.995			0.996			0.864				0.850
Flt Protected	0.950			0.950			0.950				0.958	
Satd. Flow (prot)	1695	3362	0	1695	3369	0	1662	1476	0	0	1709	1517
Flt Permitted	0.127			0.067			0.736				0.721	
Satd. Flow (perm)	227	3362	0	120	3369	0	1267	1476	0	0	1274	1497
Right Turn on Red			Yes			Yes			Yes			Yes
Satd. Flow (RTOR)		4			3			39				96
Link Speed (k/h)		60			60			60				60
Link Distance (m)		314.1			264.5			176.2				174.1
Travel Time (s)		18.8			15.9			10.6				10.4
Confl. Peds. (#/hr)	24		34	34		24	16		11	11		
Confl. Bikes (#/hr)			11			22			3			1
Peak Hour Factor	1.00	1.00	1.00	1.00	1.00	1.00	1.00	1.00	1.00	1.00	1.00	1.00
Heavy Vehicles (%)	2%	2%	2%	2%	2%	2%	4%	4%	4%	2%	2%	2%
Adj. Flow (vph)	188	1740	61	94	1343	38	52	4	39	29	4	96
Shared Lane Traffic (%)												
Lane Group Flow (vph)	188	1801	0	94	1381	0	52	43	0	0	33	96
Enter Blocked Intersection	No	No	No	No	No	No	No	No	No	No	No	No
Lane Alignment	Left	Left	Right	Left	Left	Right	Left	Left	Right	Left	Left	Right
Median Width(m)		3.7			3.7			3.7				3.7
Link Offset(m)		0.0			0.0			0.0				0.0
Crosswalk Width(m)		4.9			4.9			4.9				4.9
Two way Left Turn Lane												
Headway Factor	1.06	1.06	1.06	1.06	1.06	1.06	1.06	1.06	1.06	1.06	1.06	1.06
Turning Speed (k/h)	24		14	24		14	24		14	24		14
Number of Detectors	1	2		1	2		1	2		1	2	1
Detector Template	Left	Thru		Left	Thru		Left	Thru		Left	Thru	Right
Leading Detector (m)	6.1	30.5		6.1	30.5		6.1	30.5		6.1	30.5	6.1
Trailing Detector (m)	0.0	0.0		0.0	0.0		0.0	0.0		0.0	0.0	0.0
Detector 1 Position(m)	0.0	0.0		0.0	0.0		0.0	0.0		0.0	0.0	0.0
Detector 1 Size(m)	6.1	1.8		6.1	1.8		6.1	1.8		6.1	1.8	6.1
Detector 1 Type	Cl+Ex	Cl+Ex		Cl+Ex	Cl+Ex		Cl+Ex	Cl+Ex		Cl+Ex	Cl+Ex	Cl+Ex
Detector 1 Channel												
Detector 1 Extend (s)	0.0	0.0		0.0	0.0		0.0	0.0		0.0	0.0	0.0
Detector 1 Queue (s)	0.0	0.0		0.0	0.0		0.0	0.0		0.0	0.0	0.0
Detector 1 Delay (s)	0.0	0.0		0.0	0.0		0.0	0.0		0.0	0.0	0.0
Detector 2 Position(m)		28.7			28.7			28.7				28.7
Detector 2 Size(m)		1.8			1.8			1.8				1.8
Detector 2 Type		Cl+Ex			Cl+Ex			Cl+Ex				Cl+Ex
Detector 2 Channel												

1900/2000 City Park Drive

1630: Palmerston Drive/Matheson Road & Ogilvie Road

Tot 2037 PM



Lane Group	EBL	EBT	EBR	WBL	WBT	WBR	NBL	NBT	NBR	SBL	SBT	SBR
Detector 2 Extend (s)		0.0			0.0			0.0			0.0	
Turn Type	pm+pt	NA		pm+pt	NA		Perm	NA		Perm	NA	Perm
Protected Phases	5	2		1	6			8			4	
Permitted Phases	2			6			8			4		4
Detector Phase	5	2		1	6		8	8		4	4	4
Switch Phase												
Minimum Initial (s)	5.0	10.0		5.0	10.0		10.0	10.0		10.0	10.0	10.0
Minimum Split (s)	9.7	33.6		9.7	33.6		40.2	40.2		40.2	40.2	40.2
Total Split (s)	15.0	65.0		15.0	65.0		40.0	40.0		40.0	40.0	40.0
Total Split (%)	12.5%	54.2%		12.5%	54.2%		33.3%	33.3%		33.3%	33.3%	33.3%
Maximum Green (s)	10.3	59.4		10.3	59.4		32.8	32.8		32.8	32.8	32.8
Yellow Time (s)	3.7	3.7		3.7	3.7		3.0	3.0		3.0	3.0	3.0
All-Red Time (s)	1.0	1.9		1.0	1.9		4.2	4.2		4.2	4.2	4.2
Lost Time Adjust (s)	0.0	0.0		0.0	0.0		0.0	0.0		0.0	0.0	0.0
Total Lost Time (s)	4.7	5.6		4.7	5.6		7.2	7.2		7.2	7.2	7.2
Lead/Lag	Lead	Lag		Lead	Lag							
Lead-Lag Optimize?	Yes	Yes		Yes	Yes							
Vehicle Extension (s)	3.0	3.0		3.0	3.0		3.0	3.0		3.0	3.0	3.0
Recall Mode	None	C-Max		None	C-Max		None	None		None	None	None
Walk Time (s)		15.0			15.0		7.0	7.0		7.0	7.0	7.0
Flash Dont Walk (s)		13.0			13.0		26.0	26.0		26.0	26.0	26.0
Pedestrian Calls (#/hr)		25			25		10	10		10	10	10
Act Effct Green (s)	91.5	79.5		84.8	76.0		15.1	15.1			15.1	15.1
Actuated g/C Ratio	0.76	0.66		0.71	0.63		0.13	0.13			0.13	0.13
v/c Ratio	0.60	0.81		0.50	0.65		0.33	0.20			0.21	0.35
Control Delay	17.0	20.4		22.1	17.3		50.3	15.6			46.4	11.2
Queue Delay	0.0	0.0		0.0	0.0		0.0	0.0			0.0	0.0
Total Delay	17.0	20.4		22.1	17.3		50.3	15.6			46.4	11.2
LOS	B	C		C	B		D	B			D	B
Approach Delay		20.1			17.6			34.6			20.2	
Approach LOS		C			B			C			C	

Intersection Summary

Area Type:	Other
Cycle Length:	120
Actuated Cycle Length:	120
Offset:	50 (42%), Referenced to phase 2:EBTL and 6:WBTL, Start of Green
Natural Cycle:	115
Control Type:	Actuated-Coordinated
Maximum v/c Ratio:	0.81
Intersection Signal Delay:	19.4
Intersection LOS:	B
Intersection Capacity Utilization:	88.2%
ICU Level of Service:	E
Analysis Period (min):	15

Splits and Phases: 1630: Palmerston Drive/Matheson Road & Ogilvie Road

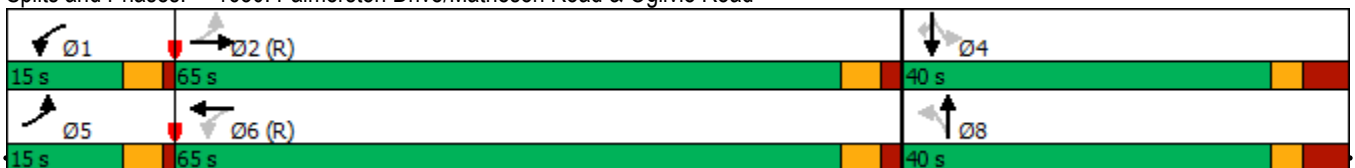

1900/2000 City Park Drive
 9: City Park Drive/1941 Ogilvie & Ogilvie Road

Tot 2037 AM Fully Protected



Lane Group	EBL	EBT	EBR	WBL	WBT	WBR	NBL	NBT	NBR	SBL	SBT	SBR
Lane Configurations												
Traffic Volume (vph)	102	681	78	87	1023	174	59	23	166	5	2	9
Future Volume (vph)	102	681	78	87	1023	174	59	23	166	5	2	9
Ideal Flow (vphpl)	1800	1800	1800	1800	1800	1800	1800	1800	1800	1800	1800	1800
Storage Length (m)	40.0		100.0	100.0		50.0	0.0		60.0	20.0		10.0
Storage Lanes	1		1	1		1	0		1	1		1
Taper Length (m)	30.0			25.0			7.6			15.0		
Lane Util. Factor	1.00	0.95	1.00	1.00	0.95	1.00	1.00	1.00	1.00	1.00	1.00	1.00
Ped Bike Factor	0.96		0.87	0.96		0.80		0.96	0.93	0.95		
Frt			0.850			0.850			0.850			0.850
Flt Protected	0.950			0.950				0.965		0.950		
Satd. Flow (prot)	1695	3390	1517	1679	3357	1502	0	1626	1432	1695	1784	1517
Flt Permitted	0.950			0.950				0.786		0.704		
Satd. Flow (perm)	1625	3390	1320	1606	3357	1208	0	1269	1334	1193	1784	1517
Right Turn on Red			Yes			Yes			Yes			Yes
Satd. Flow (RTOR)			109			146			166			105
Link Speed (k/h)		60			60			60				60
Link Distance (m)		224.7			372.0			239.4				142.3
Travel Time (s)		13.5			22.3			14.4				8.5
Confl. Peds. (#/hr)	100		65	65		100	53		51	51		
Confl. Bikes (#/hr)						9			2			
Peak Hour Factor	1.00	1.00	1.00	1.00	1.00	1.00	1.00	1.00	1.00	1.00	1.00	1.00
Heavy Vehicles (%)	2%	2%	2%	3%	3%	3%	8%	8%	8%	2%	2%	2%
Adj. Flow (vph)	102	681	78	87	1023	174	59	23	166	5	2	9
Shared Lane Traffic (%)												
Lane Group Flow (vph)	102	681	78	87	1023	174	0	82	166	5	2	9
Enter Blocked Intersection	No	No	No	No	No	No	No	No	No	No	No	No
Lane Alignment	Left	Left	Right	Left	Left	Right	Left	Left	Right	Left	Left	Right
Median Width(m)		3.7			3.7			3.7				3.7
Link Offset(m)		0.0			0.0			0.0				0.0
Crosswalk Width(m)		4.9			4.9			4.9				4.9
Two way Left Turn Lane												
Headway Factor	1.06	1.06	1.06	1.06	1.06	1.06	1.06	1.06	1.06	1.06	1.06	1.06
Turning Speed (k/h)	24		14	24		14	24		14	24		14
Number of Detectors	1	2	1	1	2	1	1	2	1	1	2	1
Detector Template	Left	Thru	Right	Left	Thru	Right	Left	Thru	Right	Left	Thru	Right
Leading Detector (m)	6.1	30.5	6.1	6.1	30.5	6.1	6.1	30.5	6.1	6.1	30.5	6.1
Trailing Detector (m)	0.0	0.0	0.0	0.0	0.0	0.0	0.0	0.0	0.0	0.0	0.0	0.0
Detector 1 Position(m)	0.0	0.0	0.0	0.0	0.0	0.0	0.0	0.0	0.0	0.0	0.0	0.0
Detector 1 Size(m)	6.1	1.8	6.1	6.1	1.8	6.1	6.1	1.8	6.1	6.1	1.8	6.1
Detector 1 Type	Cl+Ex	Cl+Ex	Cl+Ex	Cl+Ex	Cl+Ex	Cl+Ex	Cl+Ex	Cl+Ex	Cl+Ex	Cl+Ex	Cl+Ex	Cl+Ex
Detector 1 Channel												
Detector 1 Extend (s)	0.0	0.0	0.0	0.0	0.0	0.0	0.0	0.0	0.0	0.0	0.0	0.0
Detector 1 Queue (s)	0.0	0.0	0.0	0.0	0.0	0.0	0.0	0.0	0.0	0.0	0.0	0.0
Detector 1 Delay (s)	0.0	0.0	0.0	0.0	0.0	0.0	0.0	0.0	0.0	0.0	0.0	0.0
Detector 2 Position(m)		28.7			28.7			28.7				28.7
Detector 2 Size(m)		1.8			1.8			1.8				1.8
Detector 2 Type		Cl+Ex			Cl+Ex			Cl+Ex				Cl+Ex
Detector 2 Channel												

Lane Group	Ø3	Ø7
Lane Configurations		
Traffic Volume (vph)		
Future Volume (vph)		
Ideal Flow (vphpl)		
Storage Length (m)		
Storage Lanes		
Taper Length (m)		
Lane Util. Factor		
Ped Bike Factor		
Frt		
Flt Protected		
Satd. Flow (prot)		
Flt Permitted		
Satd. Flow (perm)		
Right Turn on Red		
Satd. Flow (RTOR)		
Link Speed (k/h)		
Link Distance (m)		
Travel Time (s)		
Confl. Peds. (#/hr)		
Confl. Bikes (#/hr)		
Peak Hour Factor		
Heavy Vehicles (%)		
Adj. Flow (vph)		
Shared Lane Traffic (%)		
Lane Group Flow (vph)		
Enter Blocked Intersection		
Lane Alignment		
Median Width(m)		
Link Offset(m)		
Crosswalk Width(m)		
Two way Left Turn Lane		
Headway Factor		
Turning Speed (k/h)		
Number of Detectors		
Detector Template		
Leading Detector (m)		
Trailing Detector (m)		
Detector 1 Position(m)		
Detector 1 Size(m)		
Detector 1 Type		
Detector 1 Channel		
Detector 1 Extend (s)		
Detector 1 Queue (s)		
Detector 1 Delay (s)		
Detector 2 Position(m)		
Detector 2 Size(m)		
Detector 2 Type		
Detector 2 Channel		

Lane Group	Ø3	Ø7
Detector 2 Extend (s)		
Turn Type		
Protected Phases	3	7
Permitted Phases		
Detector Phase		
Switch Phase		
Minimum Initial (s)	1.0	1.0
Minimum Split (s)	5.0	5.0
Total Split (s)	5.0	5.0
Total Split (%)	5%	5%
Maximum Green (s)	3.0	3.0
Yellow Time (s)	2.0	2.0
All-Red Time (s)	0.0	0.0
Lost Time Adjust (s)		
Total Lost Time (s)		
Lead/Lag	Lead	Lead
Lead-Lag Optimize?	Yes	Yes
Vehicle Extension (s)	3.0	3.0
Recall Mode	None	None
Walk Time (s)	0.0	0.0
Flash Dont Walk (s)	0.0	0.0
Pedestrian Calls (#/hr)	35	35
Act Effct Green (s)		
Actuated g/C Ratio		
v/c Ratio		
Control Delay		
Queue Delay		
Total Delay		
LOS		
Approach Delay		
Approach LOS		
Intersection Summary		

1900/2000 City Park Drive
 9: City Park Drive/1941 Ogilvie & Ogilvie Road

Tot 2037 PM Fully Protected



Lane Group	EBL	EBT	EBR	WBL	WBT	WBR	NBL	NBT	NBR	SBL	SBT	SBR
Lane Configurations												
Traffic Volume (vph)	32	1484	152	191	603	38	183	10	185	78	19	76
Future Volume (vph)	32	1484	152	191	603	38	183	10	185	78	19	76
Ideal Flow (vphpl)	1800	1800	1800	1800	1800	1800	1800	1800	1800	1800	1800	1800
Storage Length (m)	40.0		100.0	100.0		50.0	0.0		60.0	20.0		10.0
Storage Lanes	1		1	1		1	0		1	1		1
Taper Length (m)	30.0			25.0			7.6			15.0		
Lane Util. Factor	1.00	0.95	1.00	1.00	0.95	1.00	1.00	1.00	1.00	1.00	1.00	1.00
Ped Bike Factor	0.89		0.87	0.99		0.73		0.93	0.87	0.91		0.92
Fr _t			0.850			0.850			0.850			0.850
Fl _t Protected	0.950			0.950				0.955		0.950		
Satd. Flow (prot)	1695	3390	1517	1679	3357	1502	0	1609	1432	1695	1784	1517
Fl _t Permitted	0.950			0.950				0.723		0.557		
Satd. Flow (perm)	1512	3390	1315	1654	3357	1104	0	1135	1244	905	1784	1388
Right Turn on Red			Yes			Yes			Yes			Yes
Satd. Flow (RTOR)			152			104			185			143
Link Speed (k/h)		60			60			60				60
Link Distance (m)		224.7			372.0			239.4				142.3
Travel Time (s)		13.5			22.3			14.4				8.5
Confl. Peds. (#/hr)	145		67	67		145	67		110	110		67
Peak Hour Factor	1.00	1.00	1.00	1.00	1.00	1.00	1.00	1.00	1.00	1.00	1.00	1.00
Heavy Vehicles (%)	2%	2%	2%	3%	3%	3%	8%	8%	8%	2%	2%	2%
Adj. Flow (vph)	32	1484	152	191	603	38	183	10	185	78	19	76
Shared Lane Traffic (%)												
Lane Group Flow (vph)	32	1484	152	191	603	38	0	193	185	78	19	76
Enter Blocked Intersection	No	No	No	No	No	No	No	No	No	No	No	No
Lane Alignment	Left	Left	Right	Left	Left	Right	Left	Left	Right	Left	Left	Right
Median Width(m)		3.7			3.7			3.7				3.7
Link Offset(m)		0.0			0.0			0.0				0.0
Crosswalk Width(m)		4.9			4.9			4.9				4.9
Two way Left Turn Lane												
Headway Factor	1.06	1.06	1.06	1.06	1.06	1.06	1.06	1.06	1.06	1.06	1.06	1.06
Turning Speed (k/h)	24		14	24		14	24		14	24		14
Number of Detectors	1	2	1	1	2	1	1	2	1	1	2	1
Detector Template	Left	Thru	Right	Left	Thru	Right	Left	Thru	Right	Left	Thru	Right
Leading Detector (m)	6.1	30.5	6.1	6.1	30.5	6.1	6.1	30.5	6.1	6.1	30.5	6.1
Trailing Detector (m)	0.0	0.0	0.0	0.0	0.0	0.0	0.0	0.0	0.0	0.0	0.0	0.0
Detector 1 Position(m)	0.0	0.0	0.0	0.0	0.0	0.0	0.0	0.0	0.0	0.0	0.0	0.0
Detector 1 Size(m)	6.1	1.8	6.1	6.1	1.8	6.1	6.1	1.8	6.1	6.1	1.8	6.1
Detector 1 Type	Cl+Ex	Cl+Ex	Cl+Ex	Cl+Ex	Cl+Ex	Cl+Ex	Cl+Ex	Cl+Ex	Cl+Ex	Cl+Ex	Cl+Ex	Cl+Ex
Detector 1 Channel												
Detector 1 Extend (s)	0.0	0.0	0.0	0.0	0.0	0.0	0.0	0.0	0.0	0.0	0.0	0.0
Detector 1 Queue (s)	0.0	0.0	0.0	0.0	0.0	0.0	0.0	0.0	0.0	0.0	0.0	0.0
Detector 1 Delay (s)	0.0	0.0	0.0	0.0	0.0	0.0	0.0	0.0	0.0	0.0	0.0	0.0
Detector 2 Position(m)		28.7			28.7			28.7				28.7
Detector 2 Size(m)		1.8			1.8			1.8				1.8
Detector 2 Type		Cl+Ex			Cl+Ex			Cl+Ex				Cl+Ex
Detector 2 Channel												
Detector 2 Extend (s)		0.0			0.0			0.0				0.0

Lane Group	Ø3	Ø7
Lane Configurations		
Traffic Volume (vph)		
Future Volume (vph)		
Ideal Flow (vphpl)		
Storage Length (m)		
Storage Lanes		
Taper Length (m)		
Lane Util. Factor		
Ped Bike Factor		
Frt		
Flt Protected		
Satd. Flow (prot)		
Flt Permitted		
Satd. Flow (perm)		
Right Turn on Red		
Satd. Flow (RTOR)		
Link Speed (k/h)		
Link Distance (m)		
Travel Time (s)		
Confl. Peds. (#/hr)		
Peak Hour Factor		
Heavy Vehicles (%)		
Adj. Flow (vph)		
Shared Lane Traffic (%)		
Lane Group Flow (vph)		
Enter Blocked Intersection		
Lane Alignment		
Median Width(m)		
Link Offset(m)		
Crosswalk Width(m)		
Two way Left Turn Lane		
Headway Factor		
Turning Speed (k/h)		
Number of Detectors		
Detector Template		
Leading Detector (m)		
Trailing Detector (m)		
Detector 1 Position(m)		
Detector 1 Size(m)		
Detector 1 Type		
Detector 1 Channel		
Detector 1 Extend (s)		
Detector 1 Queue (s)		
Detector 1 Delay (s)		
Detector 2 Position(m)		
Detector 2 Size(m)		
Detector 2 Type		
Detector 2 Channel		
Detector 2 Extend (s)		

1900/2000 City Park Drive
 9: City Park Drive/1941 Ogilvie & Ogilvie Road

Tot 2037 PM Fully Protected



Lane Group	EBL	EBT	EBR	WBL	WBT	WBR	NBL	NBT	NBR	SBL	SBT	SBR
Turn Type	Prot	NA	Perm	Prot	NA	Perm	Perm	NA	Perm	Perm	NA	Perm
Protected Phases	5	2		1	6			8			4	
Permitted Phases			2			6	8		8	4		4
Detector Phase	5	2	2	1	6	6	8	8	8	4	4	4
Switch Phase												
Minimum Initial (s)	5.0	10.0	10.0	5.0	10.0	10.0	10.0	10.0	10.0	10.0	10.0	10.0
Minimum Split (s)	9.5	35.1	35.1	9.0	35.1	35.1	33.5	33.5	33.5	33.5	33.5	33.5
Total Split (s)	10.3	46.5	46.5	15.0	51.2	51.2	33.5	33.5	33.5	33.5	33.5	33.5
Total Split (%)	10.3%	46.5%	46.5%	15.0%	51.2%	51.2%	33.5%	33.5%	33.5%	33.5%	33.5%	33.5%
Maximum Green (s)	6.3	40.4	40.4	11.0	45.1	45.1	27.0	27.0	27.0	27.0	27.0	27.0
Yellow Time (s)	3.0	3.7	3.7	3.0	3.7	3.7	3.3	3.3	3.3	3.3	3.3	3.3
All-Red Time (s)	1.0	2.4	2.4	1.0	2.4	2.4	3.2	3.2	3.2	3.2	3.2	3.2
Lost Time Adjust (s)	0.0	0.0	0.0	0.0	0.0	0.0		0.0	0.0	0.0	0.0	0.0
Total Lost Time (s)	4.0	6.1	6.1	4.0	6.1	6.1		6.5	6.5	6.5	6.5	6.5
Lead/Lag	Lead	Lag	Lag	Lead	Lag	Lag	Lag	Lag	Lag	Lag	Lag	Lag
Lead-Lag Optimize?	Yes	Yes	Yes	Yes	Yes	Yes	Yes	Yes	Yes	Yes	Yes	Yes
Vehicle Extension (s)	3.0	3.0	3.0	3.0	3.0	3.0	3.0	3.0	3.0	3.0	3.0	3.0
Recall Mode	None	C-Max	C-Max	None	C-Max	C-Max	None	None	None	None	None	None
Walk Time (s)		7.0	7.0		7.0	7.0	2.0	2.0	2.0	2.0	2.0	2.0
Flash Dont Walk (s)		22.0	22.0		22.0	22.0	25.0	25.0	25.0	25.0	25.0	25.0
Pedestrian Calls (#/hr)		35	35		35	35	35	35	35	35	35	35
Act Effct Green (s)	6.1	43.9	43.9	14.1	55.8	55.8		22.5	22.5	22.5	22.5	22.5
Actuated g/C Ratio	0.06	0.44	0.44	0.14	0.56	0.56		0.22	0.22	0.22	0.22	0.22
v/c Ratio	0.31	1.00	0.23	0.81	0.32	0.06		0.76	0.44	0.38	0.05	0.18
Control Delay	47.8	50.1	9.3	70.3	15.1	0.2		54.4	7.9	36.8	27.7	0.9
Queue Delay	0.0	0.0	0.0	0.0	0.0	0.0		0.0	0.0	0.0	0.0	0.0
Total Delay	47.8	50.1	9.3	70.3	15.1	0.2		54.4	7.9	36.8	27.7	0.9
LOS	D	D	A	E	B	A		D	A	D	C	A
Approach Delay		46.3			27.1			31.7			20.1	
Approach LOS		D			C			C			C	

Intersection Summary

Area Type: Other
 Cycle Length: 100
 Actuated Cycle Length: 100
 Offset: 0 (0%), Referenced to phase 2:EBT and 6:WBT, Start of Green
 Natural Cycle: 105
 Control Type: Actuated-Coordinated
 Maximum v/c Ratio: 1.00
 Intersection Signal Delay: 37.8
 Intersection LOS: D
 Intersection Capacity Utilization 102.6%
 ICU Level of Service G
 Analysis Period (min) 15

Splits and Phases: 9: City Park Drive/1941 Ogilvie & Ogilvie Road

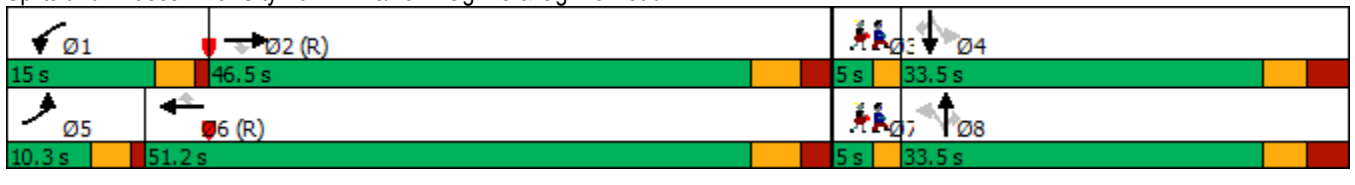

Lane Group	Ø3	Ø7
Turn Type		
Protected Phases	3	7
Permitted Phases		
Detector Phase		
Switch Phase		
Minimum Initial (s)	1.0	1.0
Minimum Split (s)	5.0	5.0
Total Split (s)	5.0	5.0
Total Split (%)	5%	5%
Maximum Green (s)	3.0	3.0
Yellow Time (s)	2.0	2.0
All-Red Time (s)	0.0	0.0
Lost Time Adjust (s)		
Total Lost Time (s)		
Lead/Lag	Lead	Lead
Lead-Lag Optimize?	Yes	Yes
Vehicle Extension (s)	3.0	3.0
Recall Mode	None	None
Walk Time (s)	0.0	0.0
Flash Dont Walk (s)	0.0	0.0
Pedestrian Calls (#/hr)	35	35
Act Effct Green (s)		
Actuated g/C Ratio		
v/c Ratio		
Control Delay		
Queue Delay		
Total Delay		
LOS		
Approach Delay		
Approach LOS		
Intersection Summary		

APPENDIX L

MMLOS Review

Intersection MMLOS Analysis

The following is a review of the MMLOS of the signalized intersections within the study area, using complete streets principles. Ogilvie Road/Blair Road, Ogilvie Road/1900 Ogilvie Road, Ogilvie Road/City Park Drive, Ogilvie Road/Blair Road, HWY 174 Westbound off-ramp/Blair Road, and HWY 174 Eastbound off-ramp/Blair Road have been evaluated using the MMLOS targets for intersections within 600m of a rapid transit station. Ogilvie Road/Matheson Road/Palmerston Drive and Ogilvie Road/City Park Drive/Bathgate Drive have been evaluated using the worst case MMLOS targets for intersections within a Mixed-Use Centre or Employment Area.

Exhibit 5 of the Addendum to the MMLOS Guidelines has been used to evaluate the existing PLOS at the intersections listed above. Exhibit 22 of the MMLOS Guidelines suggests a target PLOS A for all roadways within 600m of a rapid transit station and a target PLOS C within a Mixed-Use Centre or Employment Area. The results of the intersection PLOS analysis are summarized in **Table 5**.

Exhibit 12 of the MMLOS Guidelines has been used to evaluate the existing BLOS at the intersection listed above. As per Exhibit 22 of the MMLOS Guidelines suggest a target BLOS C for arterial spine routes within 600m of rapid transit, in a Mixed-Use Centre, or in the Employment Area. It also suggests a target BLOS B for local routes along collector roads. The results of the intersection BLOS analysis are summarized in **Table 6**.

Exhibit 16 of the MMLOS Guidelines has been used to evaluate the existing TLOS at the intersection listed above. Exhibit 22 of the MMLOS Guidelines identifies a target TLOS D for all roads with isolated transit priority measures within 600m of rapid transit, in a Mixed Use Centre, or in the Employment Area. The TLOS has been evaluated for every approach that is currently used by transit. The results of the intersection TLOS analysis are summarized in **Table 7**.

Exhibit 21 of the MMLOS Guidelines has been used to evaluate the existing TkLOS at the intersection listed above. Exhibit 22 of the MMLOS Guidelines identifies a target TkLOS B for truck arterial truck routes in the Employment Area and a TkLOS D for arterial truck routes in within 600m of rapid transit or in a Mixed Use Centre. The results of the intersection TkLOS analysis are summarized in **Table 8**.

Table 1: PLOS Intersection Analysis – Ogilvie Road/Matheson Road/Palmerston Road

Criteria	North Approach		South Approach		East Approach		West Approach	
Campeau Road/Matheson Road/Palmerston Drive								
PETSI SCORE								
<i>CROSSING DISTANCE CONDITIONS</i>								
Median > 2.4m in Width	No	72	No	72	No	6	No	23
Lanes Crossed (3.5m Lane Width)	5		5		9		8	
<i>SIGNAL PHASING AND TIMING</i>								
Left Turn Conflict	Perm + Prot	-8	Perm + Prot	-8	Permissive	-8	Permissive	-8
Right Turn Conflict	Permissive or Yield	-5	Permissive or Yield	-5	Permissive or Yield	-5	Permissive or Yield	-5
Right Turn on Red	N/A	0	RTOR Allowed	-3	RTOR Allowed	-3	RTOR Allowed	-3
Leading Pedestrian Interval	No	-2	No	-2	No	-2	No	-2
<i>CORNER RADIUS</i>								
Parallel Radius	> 15m to 25m	-8	> 10m to 15m	-6	> 10m to 15m	-6	> 15m to 25m	-8
Parallel Right Turn Channel	No Right Turn Channel	-4	No Right Turn Channel	-4	No Right Turn Channel	-4	Conventional without Receiving	0
Perpendicular Radius	> 15m to 25m	-8	N/A	0	N/A	0	N/A	0
Perpendicular Right Turn Channel	Conventional without Receiving	0	N/A	0	N/A	0	N/A	0
<i>CROSSING TREATMENT</i>								
Treatment	Standard	-7	Standard	-7	Standard	-7	Standard	-7
PETSI SCORE		30		37		-29		-10
LOS		E		E		F		F
DELAY SCORE								
Cycle Length		120		120		120		120
Pedestrian Walk Time		28.4		28.4		6.8		6.8
DELAY SCORE		35		35		53.4		53.4
LOS		D		D		E		E
OVERALL		E		E		F		F

Table 2: PLOS Intersection Analysis – Ogilvie Road/Cadboro Road

Criteria	North Approach		East Approach		West Approach	
Ogilvie Road/Cadboro Road						
PETSI SCORE						
<i>CROSSING DISTANCE CONDITIONS</i>						
Median > 2.4m in Width	No	72	Yes	30	Yes	30
Lanes Crossed (3.5m Lane Width)	5		8		8	
<i>SIGNAL PHASING AND TIMING</i>						
Left Turn Conflict	No Left Turn/Prohibited	0	No Left Turn/Prohibited	0	No Left Turn/Prohibited	0
Right Turn Conflict	Permissive or Yield	-5	Permissive or Yield	-5	No Right Turn/Prohibited	0
Right Turn on Red	RTOR Allowed	-3	RTOR Allowed	-3	RTOR Allowed	-3
Leading Pedestrian Interval	No	-2	No	-2	No	-2
<i>CORNER RADIUS</i>						
Parallel Radius	> 15m to 25m	-8	> 10m to 15m	-6	> 3m to 5m	-4
Parallel Right Turn Channel	No Right Turn Channel	-4	No Right Turn Channel	-4	No Right Turn Channel	-4
Perpendicular Radius	N/A	0	N/A	0	N/A	0
Perpendicular Right Turn Channel	N/A	0	N/A	0	N/A	0
<i>CROSSING TREATMENT</i>						
Treatment	Standard	-7	Standard	-7	Standard	-7
PETSI SCORE		43		3		10
LOS		E		F		F
DELAY SCORE						
Cycle Length		100		100		100
Pedestrian Walk Time		40		24		24
DELAY SCORE		18		28.9		28.9
LOS		B		C		C
OVERALL		E		F		F

Table 3: PLOS Intersection Analysis – Ogilvie Road/City Park Drive/Bathgate Drive

Criteria	North Approach		South Approach		East Approach		West Approach	
Ogilvie Road/City Park Drive/Bathgate Drive								
PETSI SCORE								
<i>CROSSING DISTANCE CONDITIONS</i>								
Median > 2.4m in Width	No	55	No	55	No	23	No	6
Lanes Crossed (3.5m Lane Width)	6		6		8		9	
<i>SIGNAL PHASING AND TIMING</i>								
Left Turn Conflict	Perm + Prot	-8	Perm + Prot	-8	Permissive	-8	Permissive	-8
Right Turn Conflict	Permissive or Yield	-5	Permissive or Yield	-5	Permissive or Yield	-5	Permissive or Yield	-5
Right Turn on Red	RTOR Allowed	-3	RTOR Allowed	-3	RTOR Allowed	-3	RTOR Allowed	-3
Leading Pedestrian Interval	No	-2	No	-2	Yes	0	Yes	0
<i>CORNER RADIUS</i>								
Parallel Radius	> 15m to 25m	-8	> 10m to 15m	-6	> 10m to 15m	-6	> 10m to 15m	-6
Parallel Right Turn Channel	No Right Turn Channel	-4	No Right Turn Channel	-4	No Right Turn Channel	-4	No Right Turn Channel	-4
Perpendicular Radius	N/A	0	N/A	0	N/A	0	N/A	0
Perpendicular Right Turn Channel	N/A	0	N/A	0	N/A	0	N/A	0
<i>CROSSING TREATMENT</i>								
Treatment	Standard	-7	Standard	-7	Standard	-7	Standard	-7
PETSI SCORE		18		20		-10		-27
LOS		F		F		F		F
DELAY SCORE								
Cycle Length		100		100		100		100
Pedestrian Walk Time		16		16		7.6		7.6
DELAY SCORE		35.3		35.3		42.7		42.7
LOS		D		D		E		E
OVERALL		F		F		F		F

Table 4: PLOS Intersection Analysis – Ogilvie Road/1900 Ogilvie Road

Criteria	North Approach		South Approach		East Approach		West Approach	
Ogilvie Road/1900 Ogilvie Road								
PETSI SCORE								
<i>CROSSING DISTANCE CONDITIONS</i>								
Median > 2.4m in Width	No	88	No	72	No	39	No	23
Lanes Crossed (3.5m Lane Width)	4		5		7		8	
<i>SIGNAL PHASING AND TIMING</i>								
Left Turn Conflict	Permissive	-8	Permissive	-8	Permissive	-8	Permissive	-8
Right Turn Conflict	Permissive or Yield	-5	Permissive or Yield	-5	Permissive or Yield	-5	Permissive or Yield	-5
Right Turn on Red	RTOR Allowed	-3	RTOR Allowed	-3	RTOR Allowed	-3	RTOR Allowed	-3
Leading Pedestrian Interval	No	-2	No	-2	No	-2	No	-2
<i>CORNER RADIUS</i>								
Parallel Radius	> 10m to 15m	-6	> 10m to 15m	-6	> 10m to 15m	-6	> 10m to 15m	-6
Parallel Right Turn Channel	No Right Turn Channel	-4	No Right Turn Channel	-4	No Right Turn Channel	-4	No Right Turn Channel	-4
Perpendicular Radius	N/A	0	N/A	0	N/A	0	N/A	0
Perpendicular Right Turn Channel	N/A	0	N/A	0	N/A	0	N/A	0
<i>CROSSING TREATMENT</i>								
Treatment	Standard	-7	Standard	-7	Standard	-7	Standard	-7
	PETSI SCORE	53		37		4		-12
	LOS	D		E		F		F
DELAY SCORE								
Cycle Length		100		100		100		100
Pedestrian Walk Time		44.1		44.1		7.3		7.3
	DELAY SCORE	15.6		15.6		43		43
	LOS	B		B		E		E
	OVERALL	D		E		F		F

Table 5: PLOS Intersection Analysis – Ogilvie Road/City Park Drive East

Criteria	North Approach		South Approach		East Approach		West Approach	
Ogilvie Road/City Park Drive East								
PETSI SCORE								
<i>CROSSING DISTANCE CONDITIONS</i>								
Median > 2.4m in Width	No	105	No	23	No	23	No	6
Lanes Crossed (3.5m Lane Width)	3		8		8		9	
<i>SIGNAL PHASING AND TIMING</i>								
Left Turn Conflict	Permissive	-8	Permissive	-8	Permissive	-8	Permissive	-8
Right Turn Conflict	Permissive or Yield	-5	Permissive or Yield	-5	Permissive or Yield	-5	Permissive or Yield	-5
Right Turn on Red	N/A	0	RTOR Allowed	-3	N/A	0	RTOR Allowed	-3
Leading Pedestrian Interval	No	-2	No	-2	Yes	0	Yes	0
<i>CORNER RADIUS</i>								
Parallel Radius	> 15m to 25m	-8	> 10m to 15m	-6	> 15m to 25m	-8	> 15m to 25m	-8
Parallel Right Turn Channel	Conventional without Receiving	0	No Right Turn Channel	-4	No Right Turn Channel	-4	Conventional with Receiving	-3
Perpendicular Radius	> 15m to 25m	-8	N/A	0	> 15m to 25m	-8	N/A	0
Perpendicular Right Turn Channel	Conventional without Receiving	0	N/A	0	Conventional without Receiving	0	N/A	0
<i>CROSSING TREATMENT</i>								
Treatment	Zebra Stripe	-4	Zebra Stripe	-4	Zebra Stripe	-4	Zebra Stripe	-4
PETSI SCORE		70		-9		-14		-25
LOS		C		F		F		F
DELAY SCORE								
Cycle Length		100		100		100		100
Pedestrian Walk Time		17.9		32.9		2.5		2.5
DELAY SCORE		33.7		22.5		47.5		47.5
LOS		D		C		E		E
OVERALL		D		F		F		F

Table 6: PLOS Intersection Analysis – Ogilvie Road/Blair Road

Criteria	North Approach		South Approach		East Approach		West Approach	
Ogilvie Road/Blair Road								
PETSI SCORE								
<i>CROSSING DISTANCE CONDITIONS</i>								
Median > 2.4m in Width	No	6	No	39	No	23	No	39
Lanes Crossed (3.5m Lane Width)	9		7		8		7	
<i>SIGNAL PHASING AND TIMING</i>								
Left Turn Conflict	Protected	0	Protected	0	Protected	0	Protected	0
Right Turn Conflict	Permissive or Yield	-5	Permissive or Yield	-5	Permissive or Yield	-5	Permissive or Yield	-5
Right Turn on Red	RTOR Allowed	-3	N/A	0	RTOR Allowed	-3	N/A	0
Leading Pedestrian Interval	No	-2	No	-2	No	-2	No	-2
<i>CORNER RADIUS</i>								
Parallel Radius	> 10m to 15m	-6	> 25m	-9	> 25m	-9	> 10m to 15m	-6
Parallel Right Turn Channel	No Right Turn Channel	-4	Conventional with Receiving	-3	Conventional without Receiving	0	No Right Turn Channel	-4
Perpendicular Radius	N/A	0	> 25m	-9	N/A	0	> 25m	-9
Perpendicular Right Turn Channel	N/A	0	Conventional without Receiving	0	N/A	0	Conventional with Receiving	-3
<i>CROSSING TREATMENT</i>								
Treatment	Standard	-7	Standard	-7	Standard	-7	Standard	-7
PETSI SCORE		-21		4		-3		0
LOS		F		F		F		F
DELAY SCORE								
Cycle Length		140		140		140		140
Pedestrian Walk Time		7.4		7.4		12.5		8.5
DELAY SCORE		62.8		62.8		58.1		61.8
LOS		F		F		E		F
OVERALL		F		F		F		F

Table 7: PLOS Intersection Analysis – Blair Road/HWY 174 WB off-ramp

Criteria	North Approach		East Approach		West Approach	
Blair Road/HWY 174 WB						
PETSI SCORE						
<i>CROSSING DISTANCE CONDITIONS</i>						
Median > 2.4m in Width	Yes	0	No	105	No	39
Lanes Crossed (3.5m Lane Width)	10 +		3		7	
<i>SIGNAL PHASING AND TIMING</i>						
Left Turn Conflict	Permissive	-8	No Left Turn/Prohibited	0	Protected	0
Right Turn Conflict	Permissive or Yield	-5	No Right Turn/Prohibited	0	Permissive or Yield	-5
Right Turn on Red	RTOR Allowed	-3	RTOR Allowed	-3	RTOR Allowed	-3
Leading Pedestrian Interval	No	-2	No	-2	No	-2
<i>CORNER RADIUS</i>						
Parallel Radius	> 25m	-9	No Right Turn	0	> 25m	-9
Parallel Right Turn Channel	Conventional with Receiving	-3	No Right Turn	0	Conventional without Receiving	0
Perpendicular Radius	> 25m	-9	> 25m	-9	N/A	0
Perpendicular Right Turn Channel	Conventional without Receiving	0	Conventional with Receiving	-3	N/A	0
<i>CROSSING TREATMENT</i>						
Treatment	Standard	-7	Standard	-7	Standard	-7
	PETSI SCORE	-46		81		13
	LOS	F		B		F
DELAY SCORE						
Cycle Length		130		130		130
Pedestrian Walk Time		6.2		35.9		8.9
	DELAY SCORE	58.9		34.1		56.4
	LOS	E		D		E
	OVERALL	F		D		F

Table 8: PLOS Intersection Analysis – Blair Road/HWY 174 EB

Criteria	North Approach		South Approach		East Approach	
Blair Road/HWY 174 EB						
PETSI SCORE						
<i>CROSSING DISTANCE CONDITIONS</i>						
Median > 2.4m in Width	No	72	No	55	No	23
Lanes Crossed (3.5m Lane Width)	5		6		8	
<i>SIGNAL PHASING AND TIMING</i>						
Left Turn Conflict	No Left Turn/Prohibited	0	Permissive	-8	Permissive	-8
Right Turn Conflict	No Right Turn/Prohibited	0	No Right Turn/Prohibited	0	Permissive or Yield	-5
Right Turn on Red	N/A	0	RTOR Allowed	-3	N/A	0
Leading Pedestrian Interval	No	-2	No	-2	No	-2
<i>CORNER RADIUS</i>						
Parallel Radius	No Right Turn	0	No Right Turn	0	> 15m to 25m	-8
Parallel Right Turn Channel	No Right Turn	0	No Right Turn	0	No Right Turn Channel	-4
Perpendicular Radius	N/A	0	N/A	0	N/A	0
Perpendicular Right Turn Channel	N/A	0	N/A	0	N/A	0
<i>CROSSING TREATMENT</i>						
Treatment	Standard	-7	Standard	-7	Standard	-7
PETSI SCORE		63		35		-11
LOS		C		E		F
DELAY SCORE						
Cycle Length		90		90		90
Pedestrian Walk Time		16.7		31.5		31.5
DELAY SCORE		29.8		19		19
LOS		C		B		B
OVERALL		C		E		F

Table 9: BLOS Intersection Analysis

Approach	Facility Type	Criteria	Travel Lanes and/or Speed	BLOS
Ogilvie Road/Matheson Road/Palmerston Drive				
North Approach	Mixed Traffic	Right Turn Lane Characteristics	Right-turn lane longer than 50m	F
		Left Turn Accommodation	No lane crossed $\leq 50\text{km/h}$	B
South Approach	Mixed Traffic	Right Turn Lane Characteristics	Shared through/right turn lane	A
		Left Turn Accommodation	One lane crossed $\leq 50\text{km/h}$	D
East Approach	Bike Lane	Right Turn Lane Characteristics	No impact on LTS	A
		Left Turn Accommodation	Two lanes crossed $\geq 60\text{km/h}$	F
West Approach	Bike Lane	Right Turn Lane Characteristics	No impact on LTS	A
		Left Turn Accommodation	Two lanes crossed $\geq 60\text{km/h}$	F
Ogilvie Road/Cadboro Road				
North Approach	Mixed Traffic	Right Turn Lane Characteristics	Shared through/right turn lane	A
East Approach	Bike Lane	Right Turn Lane Characteristics	No impact on LTS	A
West Approach	Bike Lane	Right Turn Lane Characteristics	No impact on LTS	A
Ogilvie Road/Bathgate Drive/City Park Drive				
North Approach	Mixed Traffic	Right Turn Lane Characteristics	Shared through/right turn lane	A
		Left Turn Accommodation	One lane crossed $\leq 50\text{km/h}$	D
South Approach	Mixed Traffic	Right Turn Lane Characteristics	Shared through/right turn lane	A
		Left Turn Accommodation	One lane crossed $\geq 60\text{km/h}$	F
East Approach	Bike Lane	Right Turn Lane Characteristics	No impact on LTS	A
		Left Turn Accommodation	Two lanes crossed $\geq 60\text{km/h}$	F
West Approach	Bike Lane	Right Turn Lane Characteristics	No impact on LTS	A
		Left Turn Accommodation	Two lanes crossed $\geq 60\text{km/h}$	F
Ogilvie Road/1929 Ogilvie Road/1900 Ogilvie Road				
North Approach	Mixed Traffic	Right Turn Lane Characteristics	Right-turn lane longer than 50m	F
		Left Turn Accommodation	One lane crossed $\leq 50\text{km/h}$	B
South Approach	Mixed Traffic	Right Turn Lane Characteristics	Shared through/right turn lane	A
		Left Turn Accommodation	One lane crossed $\leq 50\text{km/h}$	B
East Approach	Bike Lane	Right Turn Lane Characteristics	No impact on LTS	A
		Left Turn Accommodation	Two lanes crossed $\geq 60\text{km/h}$	D

Approach	Facility Type	Criteria	Travel Lanes and/or Speed	BLOS
West Approach	Pocket Bike Lane	Right Turn Lane Characteristics	Right-turn lane longer than 50m	D
		Left Turn Accommodation	One lane crossed \geq 60km/h	F
Ogilvie Road/City Park Drive/1941 Ogilvie Road				
North Approach	Mixed Traffic	Right Turn Lane Characteristics	Right-turn lane 25-50m long turning speed > 25km/h	E
		Left Turn Accommodation	No lane crossed \leq 50km/h	B
South Approach	Mixed Traffic	Right Turn Lane Characteristics	No impact on LTS	A
		Left Turn Accommodation	One lane crossed \geq 60km/h	F
East Approach	Pocket Bike Lane	Right Turn Lane Characteristics	Right-turn lane longer than 50m	D
		Left Turn Accommodation	Two lanes crossed \geq 60km/h	F
West Approach	Pocket Bike Lane	Right Turn Lane Characteristics	Right-turn lane longer than 50m	D
		Left Turn Accommodation	One lane crossed \geq 60km/h	F
Ogilvie Road/Blair Road				
North Approach	Bike Lane	Right Turn Lane Characteristics	No impact on LTS	A
		Left Turn Accommodation	One lane crossed \geq 60km/h	F
South Approach	Mixed Traffic	Right Turn Lane Characteristics	Right-turn lane longer than 50m	F
		Left Turn Accommodation	One lane crossed \geq 60km/h	F
East Approach	Mixed Traffic	Right Turn Lane Characteristics	No impact on LTS	A
		Left Turn Accommodation	Dual left turn lanes	F
West Approach	Pocket Bike Lane	Right Turn Lane Characteristics	Right-turn lane longer than 50m	F
		Left Turn Accommodation	Two lanes crossed \geq 60km/h	F
Blair Road/Highway 174 WB off-ramp/1980 Ogilvie Road				
North Approach	Mixed Traffic	Right Turn Lane Characteristics	Right-turn lane longer than 50m	F
South Approach	Mixed Traffic	Left Turn Accommodation	Dual left turn lanes	F
West Approach	Mixed Traffic	Right Turn Lane Characteristics	Right-turn lane longer than 50m	F
		Left Turn Accommodation	One lane crossed \geq 60km/h	F
Blair Road/Highway 174 EB				
North Approach	Mixed Traffic	Left Turn Accommodation	No left turn	A
South Approach	Mixed Traffic	Right Turn Lane Characteristics	No right turn	A

Table 10: TLOS Intersection Analysis

Approach	Delay ⁽¹⁾		TLOS
	AM Peak	PM Peak	
Ogilvie Road/Matheson Road/Palmerston Drive			
East Approach	9 sec	14 sec	C
West Approach	12 sec	15 sec	C
Ogilvie Road/Cadboro Road			
East Approach	1 sec	2 sec	B
West Approach	4 sec	5 sec	B
Ogilvie Road/Bathgate Drive/City Park Drive			
North Approach	35 sec	30 sec	E
South Approach	39 sec	56 sec	F
East Approach	13 sec	13 sec	C
West Approach	11 sec	15 sec	C
Ogilvie Road/1929 Ogilvie Road/1900 Ogilvie Road			
East Approach	3 sec	4 sec	B
West Approach	2 sec	6 sec	B
Ogilvie Road/City Park Drive/1941 Ogilvie Road			
South Approach	52 sec	37 sec	F
East Approach	6 sec	12 sec	C
West Approach	2 sec	21 sec	D
Ogilvie Road/Blair Road			
North Approach	54 sec	72 sec	F
South Approach	58 sec	34 sec	F
East Approach	62 sec	51 sec	F
West Approach	40 sec	72 sec	F
Blair Road/Highway 174 WB off-ramp/1980 Ogilvie Road			
North Approach	25 sec	28 sec	D
South Approach	24 sec	16 sec	C
West Approach	16 sec	48 sec	F
Blair Road/Highway 174 EB			
North Approach	14 sec	18 sec	C
South Approach	10 sec	28 sec	D

1. Delay based on outputs from Synchro analysis of existing conditions

Table 11: TkLOS Intersection Analysis

Approach	Effective Corner Radius	Number of Receiving Lanes Departing Intersection	TkLOS
Ogilvie Road/Matheson Road/Palmerston Drive			
North Approach	> 15m	2	A
South Approach	< 10m	2	D
East Approach	10m to 15m	2	B
West Approach	10m to 15m	1	E
Ogilvie Road/Cadboro Road			
North Approach	10m to 15m	2	B
East Approach	10m to 15m	1	E
West Approach	N/A	N/A	N/A
Ogilvie Road/Bathgate Drive/City Park Drive			
North Approach	10m to 15m	2	B

Approach	Effective Corner Radius	Number of Receiving Lanes Departing Intersection	TkLOS
South Approach	10m to 15m	2	B
East Approach	10m to 15m	1	E
West Approach	10m to 15m	1	E
Ogilvie Road/1929 Ogilvie Road/1900 Ogilvie Road			
North Approach	10m to 15m	2	B
South Approach	10m to 15m	2	B
East Approach	10m to 15m	1	E
West Approach	10m to 15m	1	E
Ogilvie Road/City Park Drive/1941 Ogilvie Road			
North Approach	> 15m	2	A
South Approach	10m to 15m	2	B
East Approach	> 15m	1	C
West Approach	10m to 15m	1	E
Ogilvie Road/Blair Road			
North Approach	10m to 15m	2	B
South Approach	> 15m	2	A
East Approach	10m to 15m	1	E
West Approach	> 15m	3	A
Blair Road/Highway 174 WB off-ramp/1980 Ogilvie Road			
North Approach	> 15m	2	A
South Approach	N/A	N/A	N/A
East Approach	> 15m	2	A
West Approach	10m to 15m	2	B
Blair Road/Highway 174 EB			
North Approach	N/A	2	N/A
South Approach	> 15m	1	C
East Approach	> 15m	2	A