



8600 Jeanne D'Arc Blvd North Petrie's Landing III

TIA Strategy Report

DRAFT

September 2023



TIA Plan Reports

On 14 June 2017, the Council of the City of Ottawa adopted new Transportation Impact Assessment (TIA) Guidelines. In adopting the guidelines, Council established a requirement for those preparing and delivering transportation impact assessments and reports to sign a letter of certification.

Individuals submitting TIA reports will be responsible for all aspects of development-related transportation assessment and reporting, and undertaking such work, in accordance and compliance with the City of Ottawa's Official Plan, the Transportation Master Plan and the Transportation Impact Assessment (2017) Guidelines.

By submitting the attached TIA report (and any associated documents) and signing this document, the individual acknowledges that s/he meets the four criteria listed below.

CERTIFICATION

1. I have reviewed and have a sound understanding of the objectives, needs and requirements of the City of Ottawa's Official Plan, Transportation Master Plan and the Transportation Impact Assessment (2017) Guidelines;
2. I have a sound knowledge of industry standard practice with respect to the preparation of transportation impact assessment reports, including multi modal level of service review;
3. I have substantial experience (more than 5 years) in undertaking and delivering transportation impact studies (analysis, reporting and geometric design) with strong background knowledge in transportation planning, engineering or traffic operations; and
4. I am either a licensed¹ or registered² professional in good standing, whose field of expertise [check appropriate field(s)] is either transportation engineering or transportation planning .

1,2 License of registration body that oversees the profession is required to have a code of conduct and ethics guidelines that will ensure appropriate conduct and representation for transportation planning and/or transportation engineering works.

City Of Ottawa
Infrastructure Services and Community
Sustainability
Planning and Growth Management
110 Laurier Avenue West, 4th fl.
Ottawa, ON K1P 1J1
Tel. : 613-580-2424
Fax: 613-560-6006

Ville d'Ottawa
Services d'infrastructure et Viabilité des
collectivités
Urbanisme et Gestion de la croissance
110, avenue Laurier Ouest
Ottawa (Ontario) K1P 1J1
Tél. : 613-580-2424
Télécopieur: 613-560-6006

Dated at Ottawa this 19 day of September, 2023
(City)

Name: Austin Shih, M.A.Sc., P.Eng
(Please Print)

Professional Title: Senior Transportation Engineer



Signature of Individual certifier that s/he meets the above four criteria

Office Contact Information (Please Print)
Address: 1223 Michael Street North, Suite 100
City / Postal Code: Ottawa, Ontario, K1J 7T2
Telephone / Extension: 613-691-1569
E-Mail Address: austin.shih@parsons.com



8600 Jeanne D'Arc Blvd North – Petrie's Landing III

TIA Strategy Report

prepared for:
BrigI
98 Rue Lois
Gatineau, QC J8Y 3R7

prepared by:
 **PARSONS**
1223 Michael Street North
Suite 100
Ottawa, ON K1J 7T2

September 19, 2023

478566-01000

Document Control Page

CLIENT:	Brigil
PROJECT NAME:	8600 Jeanne D'Arc Boulevard N. – Petrie's Landing III
REPORT TITLE:	TIA Step 4 Strategy Report
PARSONS PROJECT NO:	478566 – 01000
VERSION:	DRAFT
DIGITAL MASTER:	https://parsons365can.sharepoint.com/sites/OttawaHub/Projects/Projects/478566 - Petrie III - 8600 Jeanne D Arc (BRIGIL)/4. 01000 - WBS NAME/Documents/STEP4 Strategy/Strategy Report - Petries Landing III Draft Final.docx
ORIGINATOR	Juan Lavin, P. Eng.
REVIEWER:	Austin Shih, M.A.Sc., P.Eng.
AUTHORIZATION:	
CIRCULATION LIST:	Mike Giampa, P.Eng.
HISTORY:	<ol style="list-style-type: none"> 1. TIA Step 1 Screening Form – June 3, 2023 2. TIA Step 2 Scoping Report – June 8, 2023 3. TIA Step 3 & 4 Strategy – September 19, 2023

TABLE OF CONTENTS

DOCUMENT CONTROL PAGE.....	ii
1. SCREENING FORM.....	1
2. SCOPING REPORT.....	1
2.1. EXISTING AND PLANNED CONDITIONS.....	1
2.1.1. PROPOSED DEVELOPMENT.....	1
2.1.2. EXISTING CONDITIONS.....	3
2.1.3. PLANNED CONDITIONS.....	11
2.2. STUDY AREA AND TIME PERIODS.....	17
2.3. EXEMPTION REVIEW.....	17
3. FORECASTING REPORT.....	18
3.1. DEVELOPMENT-GENERATED TRAVEL DEMAND.....	18
3.1.1. TRIP GENERATION AND MODE SHARES.....	18
3.1.2. TRIP DISTRIBUTION.....	24
3.1.3. TRIP ASSIGNMENT.....	24
3.2. BACKGROUND NETWORK TRAVEL DEMANDS.....	25
3.2.1. TRANSPORTATION NETWORK PLANS.....	25
3.2.2. BACKGROUND GROWTH.....	26
3.2.3. OTHER DEVELOPMENTS.....	26
3.3. DEMAND RATIONALIZATION.....	27
4. STRATEGY REPORT.....	28
4.1.1. DESIGN FOR SUSTAINABLE MODES.....	28
4.1.2. CIRCULATION AND ACCESS.....	29
4.1.3. NEW STREETS NETWORK.....	29
4.2. PARKING.....	30
4.3. BOUNDARY STREET DESIGN.....	30
4.3.1. EXISTING & FUTURE CONDITIONS.....	30
4.4. ACCESS INTERSECTION LOCATION.....	31
4.5. TRANSPORTATION DEMAND MANAGEMENT.....	32
4.5.1. CONTEXT FOR TDM.....	32
4.5.2. NEED AND OPPORTUNITY.....	32
4.5.3. TDM PROGRAM.....	32
4.6. NEIGHBORHOOD TRAFFIC MANAGEMENT.....	33
4.6.1. ADJACENT NEIGHBORHOODS.....	33
4.7. TRANSIT.....	33
4.7.1. ROUTE CAPACITY.....	33
4.7.2. TRANSIT PRIORITY.....	34
4.8. REVIEW OF NETWORK CONCEPT.....	34
4.9. INTERSECTION DESIGN.....	35
4.9.1. INTERSECTION CONTROL.....	35
4.9.2. INTERSECTION DESIGN.....	35
4.9.3. INTERSECTION PERFORMANCE.....	36
4.9.4. QUEUEING ANALYSIS.....	40
5. FINDINGS AND RECOMMENDATIONS.....	41

LIST OF FIGURES

FIGURE 1: LOCAL CONTEXT	1
FIGURE 2: PROPOSED SITE PLAN	2
FIGURE 3: EXISTING DRIVEWAYS ADJACENT TO DEVELOPMENT	6
FIGURE 4: EXISTING SIDEWALKS AND MUPS NEAR THE SITE	7
FIGURE 5: EXISTING CYCLING NETWORK	7
FIGURE 6: AREA TRANSIT NETWORK	8
FIGURE 7: NEARBY TRANSIT STOPS	8
FIGURE 8: EXISTING PEAK HOUR TRAFFIC VOLUMES	9
FIGURE 9: EXISTING PEAK HOUR PEDESTRIAN/CYCLING VOLUMES	10
FIGURE 10: TENTH LINE ROAD LOOKING NORTH TOWARDS TENTH LINE/ST. JOSEPH INTERSECTION	11
FIGURE 11: EXISTING AND FUTURE ‘ULTIMATE CYCLING NETWORK’	12
FIGURE 12: H174 WIDENING POTENTIAL CROSS-SECTION EAST OF THE SITE	12
FIGURE 13: STAGE 2 LRT SYSTEM MAP	13
FIGURE 14: STAGE 2 LRT STATION CONNECTIVITY ENHANCEMENT STUDY	14
FIGURE 15: ORLÉANS CORRIDOR SECONDARY PLAN – SCHEDULE C MOBILITY IMPROVEMENTS	15
FIGURE 16: OTHER AREA DEVELOPMENTS	15
FIGURE 17: CARDINAL CREEK VILLAGE	16
FIGURE 18: STUDY AREA BOUNDARIES AND INTERSECTIONS	17
FIGURE 19: SITE GENERATED TRAFFIC PERCENT DISTRIBUTION	24
FIGURE 20: ‘NEW’ SITE-GENERATED TRAFFIC S1 (NON-TOD) - NO DIRECT CONNECTION TO LRT	25
FIGURE 21: ‘NEW’ SITE-GENERATED TRAFFIC S2 (TOD) - DIRECT CONNECTION TO LRT	25
FIGURE 22: OTHER AREA DEVELOPMENT BACKGROUND VOLUMES	27
FIGURE 23: WALKING SCENARIOS TO TRIM LRT STATION	28
FIGURE 24: PROPOSED NEW STREETS SERVICING THE SITE	30
FIGURE 25: ORLÉANS CORRIDOR SECONDARY PLAN MAXIMUM BUILDING HEIGHTS	34
FIGURE 26: FUTURE BACKGROUND STUDY AREA INTERSECTION VOLUMES	37
FIGURE 27: FULL-BUILDOUT TOTAL PROJECTED PEAK HOUR TRAFFIC VOLUMES S1 (NON-TOD)	38
FIGURE 28: FULL-BUILDOUT TOTAL PROJECTED PEAK HOUR TRAFFIC VOLUMES S2 (TOD)	39

LIST OF TABLES

TABLE 1: PROPOSED SITE STATISTICS	2
TABLE 2: EXEMPTIONS REVIEW SUMMARY	18
TABLE 3: 2020 TRANS RESIDENTIAL TRIP GENERATION RATES & ITE COMMERCIAL/OFFICE RATES	18
TABLE 4: PROJECTED PEAK PERIOD PERSON TRIP GENERATION – TRANS MODEL 2020 & ITE	19
TABLE 5: RESIDENTIAL PEAK PERIOD TRIPS USING TRANS 2020 MODE SHARES	19
TABLE 6: PEAK PERIOD TO PEAK HOUR CONVERSION FACTOR (2020 TRANS MANUAL - RESIDENTIAL)	19
TABLE 7: RESIDENTIAL PEAK HOUR TRIPS GENERATED USING TRANS 2020 MODE SHARES	19
TABLE 8: TRANS AND PROPOSED MODE SHARES FOR EACH LAND USE & SCENARIO	20
TABLE 9: RESIDENTIAL PEAK HOUR TRIPS GENERATED - S1 MODE SHARES (NON-TOD)	21
TABLE 10: SHOPPING CENTER PEAK HOUR TRIPS GENERATED - S1 MODE SHARES (NON-TOD)	21
TABLE 11: GENERAL OFFICE PEAK HOUR TRIPS GENERATED - S1 MODE SHARES (NON-TOD)	22
TABLE 12: TOTAL COMBINED TRIPS GENERATED - S1 MODE SHARES (NON-TOD)	22
TABLE 13: RESIDENTIAL PEAK HOUR TRIPS GENERATED – S2 MODE SHARES (TOD)	22
TABLE 14: SHOPPING CENTER PEAK HOUR TRIPS GENERATED – S2 MODE SHARES (TOD)	23
TABLE 15: GENERAL OFFICE PEAK HOUR TRIPS GENERATED – S2 MODE SHARES (TOD)	23
TABLE 16: TOTAL COMBINED TRIPS GENERATED – S2 MODE SHARES (TOD)	23
TABLE 17: TRIM/H174 HISTORICAL BACKGROUND GROWTH (2008-2023)	26

TABLE 18: MMLOS – BOUNDARY STREET SEGMENTS EXISTING AND FUTURE CONDITIONS	31
TABLE 19: MMLOS – EXISTING AND FUTURE INTERSECTION CONDITIONS	35
TABLE 20: EXISTING INTERSECTION PERFORMANCE.....	36
TABLE 21: FUTURE BACKGROUND INTERSECTION PERFORMANCE	37
TABLE 22: FULL-BUILDOUT INTERSECTION PERFORMANCE – S1 (NON-TOD).....	38
TABLE 23: FULL-BUILDOUT INTERSECTION PERFORMANCE – S2 (TOD).....	39
TABLE 24: QUEUEING ANALYSIS FOR SCENARIO 1 AT SENSITIVE LOCATIONS	40
TABLE 25: QUEUEING ANALYSIS SENSITIVITY FOR TRIM/H174 EBL.....	40

LIST OF APPENDICES

APPENDIX A – SCREENING FORM
APPENDIX B – TRAFFIC COUNT DATA
APPENDIX C – COLLISION DATA
APPENDIX D – ORLEANS CORRIDOR SECONDARY PLAN - FIGURES
APPENDIX E – INTERNAL TRIP GENERATION REDUCTION CALCULATIONS
APPENDIX F – PROJECTED BACKGROUND GROWTH
APPENDIX G – PROPOSED CROSS-SECTIONS FOR PUBLIC AND PRIVATE ROAD
APPENDIX H – MMLOS ANALYSIS: ROAD SEGMENTS
APPENDIX I – DRAFT TDM CHECKLIST
APPENDIX J – WARRANT ANALYSIS
APPENDIX K – AUXILIARY LEFT-TURN LANE WARRANT
APPENDIX L – MMLOS ANALYSIS: INTERSECTIONS
APPENDIX M – SYNCHRO ANALYSIS: EXISTING CONDITIONS
APPENDIX N – SYNCHRO ANALYSIS: BACKGROUND CONDITIONS
APPENDIX O – SYNCHRO ANALYSIS: S1 NON-TOD CONDITIONS
APPENDIX P – SYNCHRO ANALYSIS: S2 TOD CONDITIONS
APPENDIX Q – SIMTRAFFIC QUEUEING ANALYSIS

TIA Strategy Report

Parsons has been retained by Brigil to prepare a Transportation Impact Assessment (TIA) in support of a Zoning By-Law Amendment (ZBLA) and an Official Plan Amendment (OPA) for a residential development located at 8600 Jeanne D'Arc Boulevard N., also known as Petrie's Landing III in Orléans district. This document follows the new TIA process, as outlined in the City Transportation Impact Assessment (TIA) Guidelines (2017). The following report represents Step 4 – Strategy Report.

1. Screening Form

The screening form confirmed the need for a TIA Report based on the trip generation trigger, given that the proposed development consists of twelve mixed-use buildings with approximately 3,200 residential apartment units, 110,000 ft² of office space and 165,000 ft² of commercial space; and the location trigger, given that the development is located within a transit-oriented development (within 600m radius of Trim LRT Station) and spine cycling route. The safety trigger was not met. The Screening Form has been provided in **Appendix A**.

2. Scoping Report

2.1. Existing and Planned Conditions

2.1.1. PROPOSED DEVELOPMENT

The subject site is located at the municipal addresses of 8600 Jeanne D'Arc Boulevard N, bounded by Jeanne D'Arc Boulevard to the north, Centre des Métiers Minto to the east, Ottawa Regional Road 174 (H174) to the south, and Taylor Creek to the west. The lot is currently vacant.

The proposed study area includes the intersections of Trim/H174, Trim/Jeanne D'Arc, Tweddle/Jeanne D'Arc, Tenth Line/Jeanne D'Arc, Tenth Line/St. Joseph, Old Tenth Line/St. Joseph, and roadway segments adjacent to the site or between intersections as shown in **Figure 1**. The latest envisioned development has been provided in **Figure 2** with a summary of site statistics in **Table 1**.

Figure 1: Local Context



The development will be built out in multiple phases extending past 2030 horizon. Currently, there are four phases, A to D, proposed but are subject to change based on market demands. Once complete, the full buildout of the site will make use of three accesses into the site, including two public roads and a private road, all to and from Jeanne D'Arc Boulevard.

Table 1: Proposed Site Statistics

Phase of Development (A to D) and Building Number	Number of Storeys	Number of Units	Proposed Office Space (ft ²)	Proposed Commercial Space (ft ²)
A1	4	18	110,000 ft ² with exact distribution to be determined.	165,000 ft ² with exact distribution to be determined.
A2	6	88		
A3	6	141		
A4	6	145		
B1	9	302		
B2	9	288		
B3	30-40	439		
C1	9	110		
C2	30-40	408		
D1	30-40	830		
D2	30-40	408		
Combined Totals		3,177		

Figure 2: Proposed Site Plan

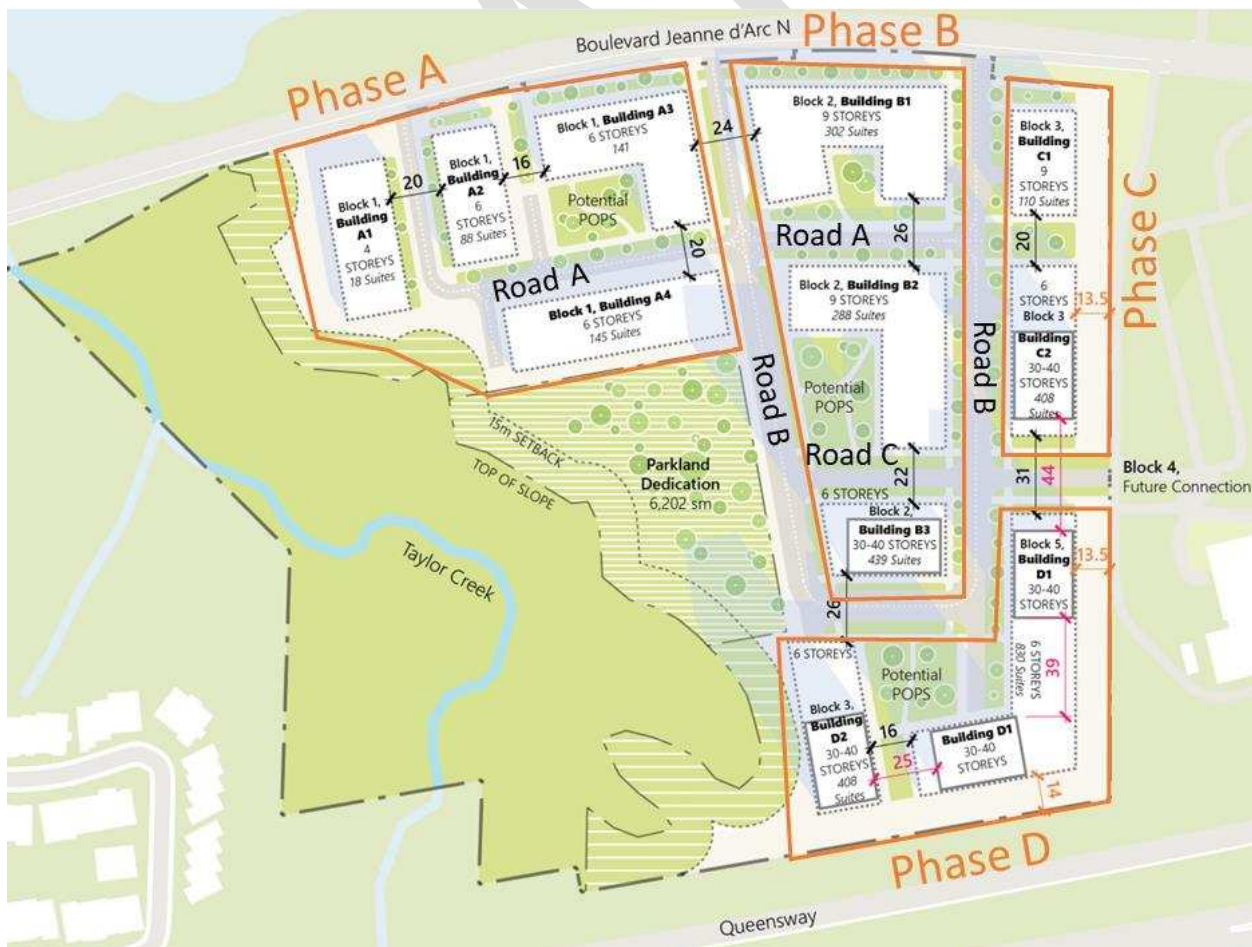

The property is currently zoned as DR which stands for development reserve for future urban developments. Under zoning, this site has a specific policy clause which states “urban employment area”, requiring the site to provide at least 10,000 m² (107,640 ft²) of office space prior to permitting any residential uses. Once that policy is fulfilled, then mixed-use buildings including residential can be built, with a maximum height of 10-storeys which triggers the re-zoning application (ZBLA) and Official Plan Amendment (OPA) to allow a higher maximum building height proposed up to 40-storeys.

It is noteworthy that the recently approved New Official Plan recommends intensification near rapid transit stations such as Trim LRT station expected to be completed by early 2025¹. Within the higher density principles, high-rise buildings have been categorized as 10 to 40-storeys high. The Orléans Corridor Secondary Plan that is currently ongoing also recommends parts of this development be granted permission to build up to 40-storeys and the other half limited to 9-storeys. More details regarding the secondary plan are provided in **Section 2.1.3**.

2.1.2. EXISTING CONDITIONS

Area Road Network

Ottawa Regional Road 174 (H174) is an east-west City-owned freeway, which extends from H417 in the west to past City of Ottawa limits, near Canan Road. Within the study area, H174 has a four-lane cross section and auxiliary turn lanes are provided at its intersection with the recently realigned Trim Road. The posted speed limit within the study area is 90 km/h.

Trim Road is classified as an arterial roadway which extends from Jeanne D’Arc Boulevard (formerly known as North Service Road) to beyond the town of Navan. Trim Road was recently realigned, being shifted approximately 250 meters east of its former location, displaced by the new location of future Trim LRT Station. Within the study area, Trim Road has a two-lane cross section north of H174 and a three-lane cross section south of H174 (two northbound, one southbound). The former Trim Road alignments towards H174 have been closed off and function as cul-de-sac driveways. The posted speed limit is 50 km/h.

Jeanne D’Arc Boulevard is a major collector roadway west of the realigned Trim Road. East of Trim Road, Jeanne D’Arc Boulevard continues as Inlet Private as a local road. Within the study area, Jeanne D’Arc Boulevard has a two-lane cross section. The posted speed limit is 60 km/h.

Tenth Line Road is a north-south arterial roadway that extends from Jeanne D’Arc Boulevard in the north to Smith Road in the south. Within the study area, Tenth Line Road has a four-lane cross-section, the posted speed limit is 60 km/h.

Inlet Private is the continuation of Jeanne D’Arc Boulevard east of the realigned Trim Road and extends for about 200m to the east to Brigil Petrie’s Landing I Towers. Inlet Private is a local roadway with an unposted speed limit assumed to be 50km/h.

Tweddle Road is the northern continuation of former Trim Road, extending north of H174 to Petrie Island Beach. South of Jeanne D’Arc Boulevard, Tweddle Road operates as a cul-de-sac. Tweddle Road is a local road with a posted speed limit of 40km/h.

Old Tenth Line Road is a north-south City-owned off-ramp that extends from H174 in the north (for eastbound off-vehicles) and extends to Tenth Line Road. South of St. Joseph, Old Tenth Line Road is an arterial road. Within the study area, Old Tenth Line Road has a three-lane cross-section, with two southbound lanes and one northbound lane. The posted speed limit is 60 km/h.

¹ <https://ottawa.ctvnews.ca/stage-2-of-ottawa-lrt-faces-further-delay-1.6333917#:~:text=It's%20now%20scheduled%20to%20open%20in%20late%202026.>

Existing Study Area Intersections

The Trim/H174 was recently relocated approximately 250 meters east of the former location. The design shown and described below shows the ultimate buildout design, however it is acknowledged that the existing intersection is mostly the same with the exception that it has a double northbound left instead of triple left and the westbound approach has a double through lane and two receiving lanes as opposed to three.

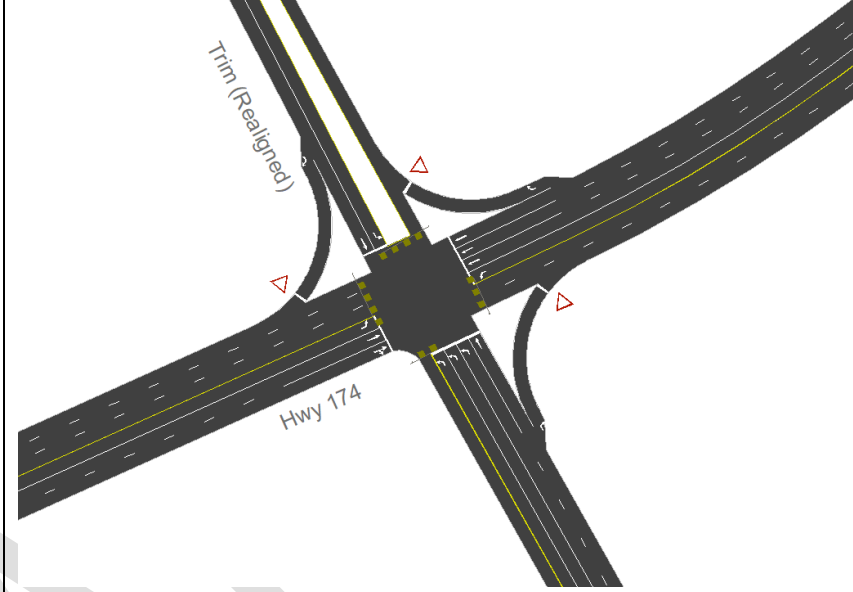
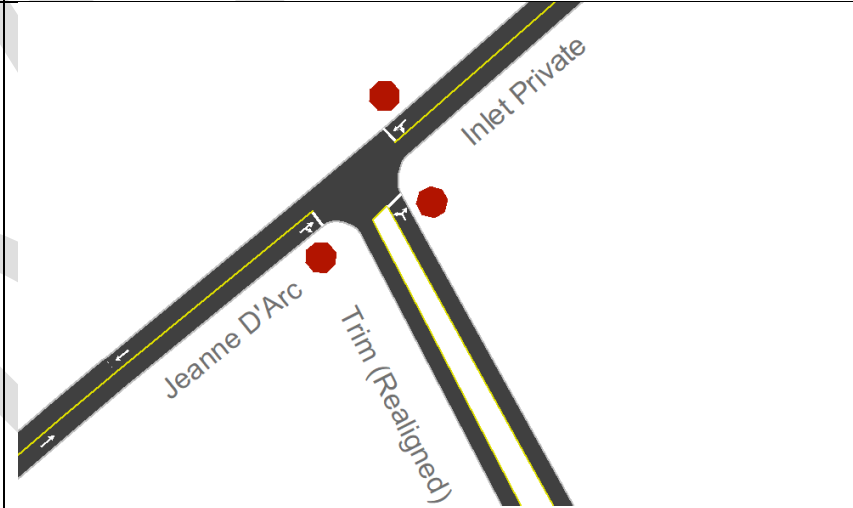
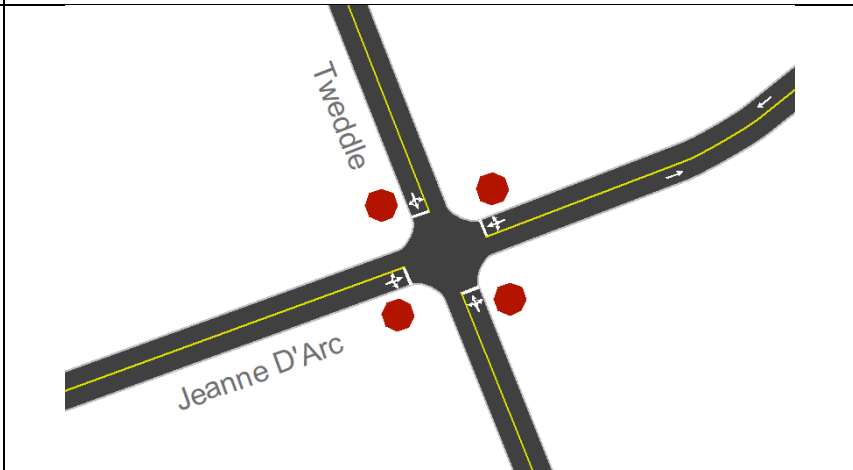
<p>Trim/H174 (realigned - ultimate)</p> <p>The Trim/ H174 intersection is a signalized four-legged intersection. The eastbound approach consists of a single left-turn lane and two through lanes. The westbound approach consists of a single left-turn lane, a triple through lane and a channelized right-turn lane. The northbound approach consists of a triple left-turn lane, a single through lane and a channelized right-turn lane. The southbound approach consists of a single left-turn lane, a single through lane and a channelized right-turn lane. A bi-directional cross-ride is proposed on the east leg of the intersection.</p>	
<p>Trim/Jeanne D’Arc (realigned)</p> <p>The Trim/Jeanne D’Arc intersection is a three-legged intersection with all-way STOP control. All approaches consist of a single full-movement lane. The south approach proposes a bi-directional cross-ride facility which connects the proposed MUP on the east side of Trim Road to the MUP on the south side of Jeanne D’Arc Boulevard.</p>	
<p>Tweddle/Jeanne D’Arc</p> <p>The Tweddle/Jeanne D’Arc intersection is a four-legged intersection with all-way STOP control. All approaches consist of a single full-movement lane. Bi-directional cross-ride facilities are proposed on the east approach and north approach, connecting the MUP on the south side of Jeanne D’Arc east of Tweddle to the MUP on the north side of Jeanne D’Arc Boulevard west of Tweddle Road.</p>	

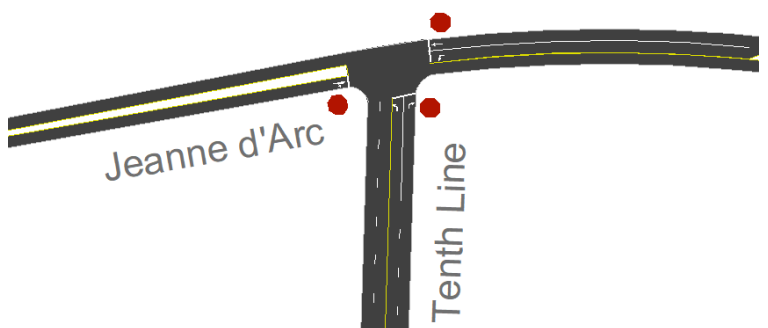
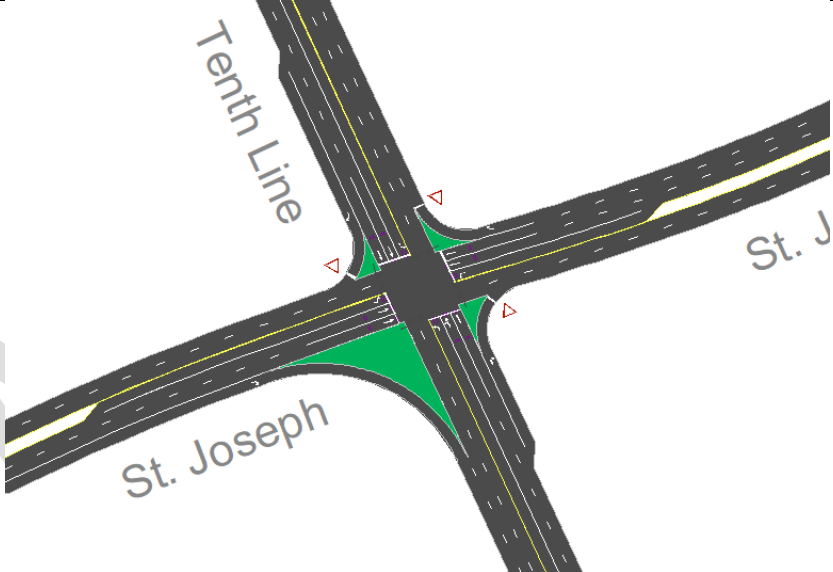
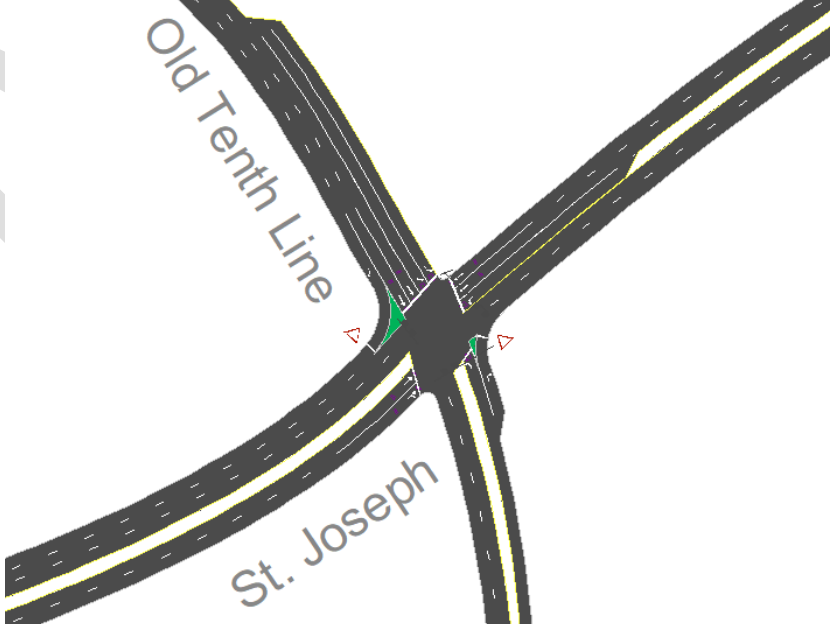
<p>Tenth Line/Jeanne D’Arc</p> <p>The Tenth Line/Jeanne D’Arc intersection is an unsignalized three-legged all-way stop intersection. The eastbound approach consists of a single through-right turn lane. The westbound approach consists of a left-turn lane and a through lane. The northbound approach consists of a left-turn lane and a right-turn lane. All movements are permitted at this location.</p>	
<p>Tenth Line/St. Joseph</p> <p>The Tenth Line/St. Joseph intersection is a signalized four-legged intersection. All approaches except for the south approach consist of a channelized right-turn lane, a left-turn lane and two through lanes. The south approach consists of a channelized right-turn lane, a left-turn lane and a through-left shared lane, and a single through lane. All movements are permitted at this location.</p>	
<p>Old Tenth Line/St. Joseph</p> <p>The Old Tenth Line/St. Joseph intersection is a signalized four-legged intersection. The north approach is a one-way only off-ramp from H174 and consists of a channelized right-turn lane, a double left-turn lane and two through lanes. The west approach consists of a shared through-right lane and a through lane. The south approach consists of a single left-turn lane and a channelized right-turn lane. The east approach consists of a single left-turn lane and two through lanes. Trucks are not allowed to continue southbound, and pedestrians cannot cross on the east leg. Vehicles are not allowed to turn or continue northbound.</p>	

Existing Driveways to Adjacent Developments

The existing driveways on adjacent roads to the development and within influence as shown in **Figure 3** include:

- Prestige Circle is a private road that provides access to Brigil's Petrie's Landing II which consists of approximately 460 residential units. This access is approximately 420m west from the site's boundary line.
- Parkrose Private provides access to a small community of approximately 110 row houses. This access is approximately 180m west from the site's boundary line.
- Centre des Métiers Minto College is a technical school with approximately 90 parking spaces. This access is approximately 20m east from the site's boundary line.
- 8865 Jeanne D'Arc Boulevard has 8 parking spaces to service Brigil's sale center. This access is approximately 360m east from the site's boundary line.

Figure 3: Existing Driveways Adjacent to Development



Existing Area Traffic Management Measures

Below are the existing area traffic management measures within the study area:

- Red light cameras at Tenth Line/St. Joseph and at Old Tenth Line/St. Joseph
- Two "Prepare to Stop when Flashing" signals on H174, each approximately 600m to the west of Old Trim Road and 600m to the east of Trim Road; and,
- One High Deer Collision Corridor signal on H174 westbound approximately 300m to the west of Old Trim Road.

Pedestrian/Cycling Network

There is sidewalk on the south side of Jeanne D'Arc Boulevard and Inlet Private. The north side of Jeanne D'Arc Boulevard has a paved, separated multi-use pathway (MUP) which extends from Tweddle Road westward to Tenth Line Road, but no facilities on the north side of Jeanne D'Arc Boulevard east of Tweddle Road. Sidewalk facilities are provided on the west side of former Trim Road (now called Tweddle Road) on the north side of H174. South of H174, the east and west sides of former Trim Road have paved multi-use pathways (MUPs).

Since the realignment of Trim/H174 intersection new facilities have been incorporated on the realigned Trim Road, including a MUP on the east side from Jeanne D'Arc Boulevard to the most southernly point of Trim Road within the study area. A new MUP on the south side of Jeanne D'Arc Boulevard is currently under construction. Tenth Line Road, Old Tenth Line Road and St. Joseph Boulevard all have sidewalks on both sides of the road. Sidewalks and Multi-Use Pathways (MUPs) have been illustrated in **Figure 4**.

Figure 4: Existing Sidewalks and MUPs Near the Site

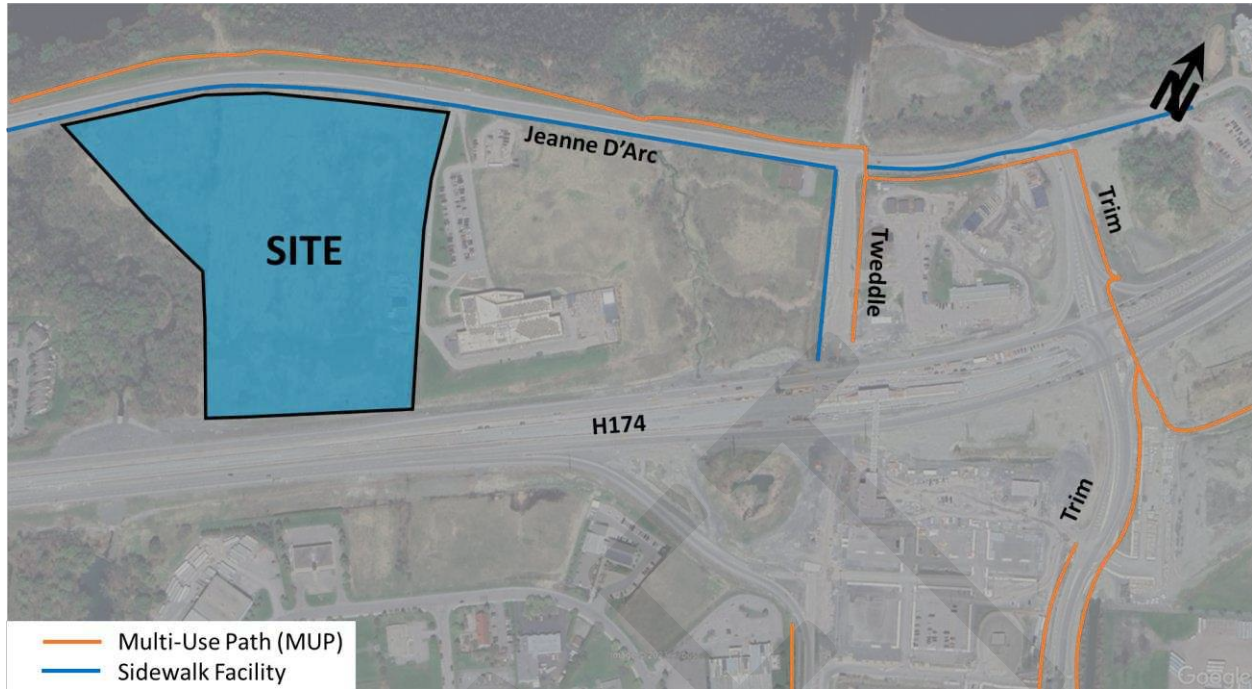

The existing cycling map shown in **Figure 5** illustrates cycle tracks on Trim Road south of the Trim Park and Ride to Brian Coburn, Jeanne D'Arc Boulevard west of Tweddle has paved shoulders and a Multi-Use Pathway (MUP) on the north side of the road. The new realigned Trim Road has cycling paths on both sides of the road south of H174 and on the east side of the road north of H174. St. Joseph Boulevard has cycle tracks east of Old Tenth Line Road, originating just east of the eastbound on ramp to beyond Trim Road.

Figure 5: Existing Cycling Network

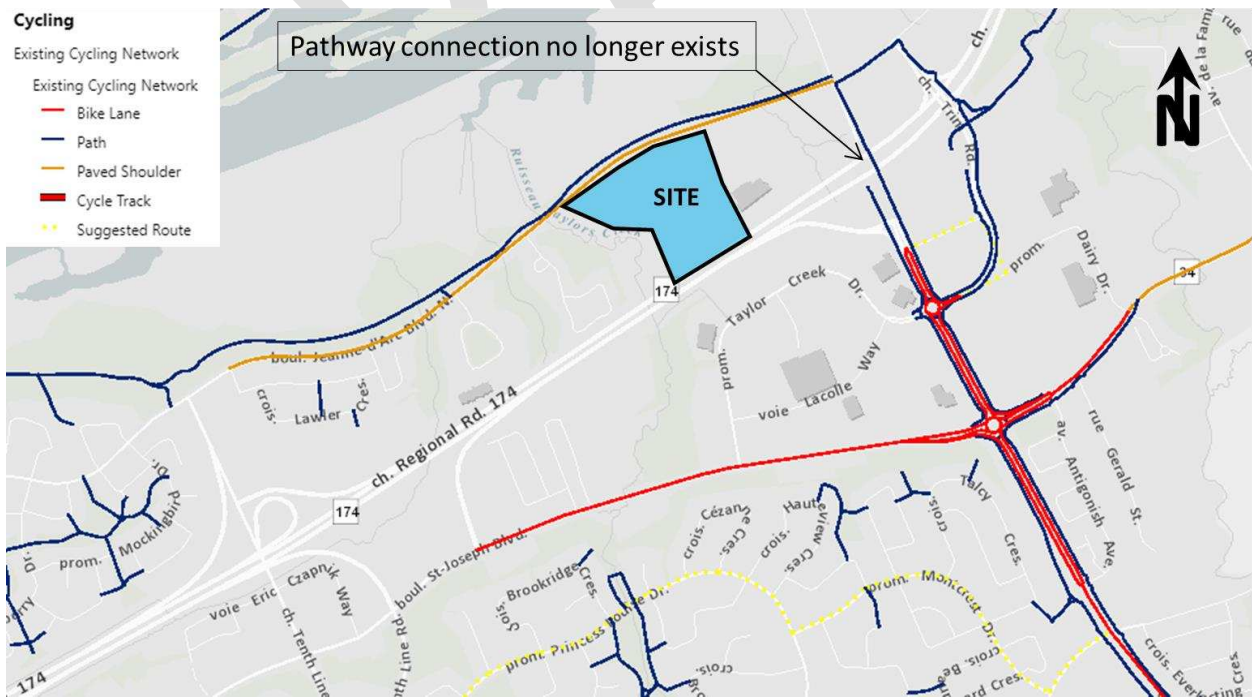

Note: Path connection through H174 extending from former Trim Road alignment to Tweddle Road no longer exists and does not reflect ongoing Stage 2 reconfigurations.

Within the TMP, Jeanne D’Arc Boulevard and Tweddle are classified a spine route and have a major pathway, the realigned Trim Road is classified a major pathway, Tenth Line Road and St. Joseph Boulevard are classified spine bike routes. West and south of the Tenth Line/St. Joseph intersection, both are classified cross-town bikeways.

Transit Network

The transit network for the study area is illustrated in **Figure 6** with nearby transit stops shows in **Figure 7**. The following OC Transpo routes currently operating within 600m walking distance to the site include:

- Route #38 (Blair <-> Jeanne D’Arc/Trim):** identified by OC Transpo as a “Local Route”, this route operates on customized routing and schedules, to serve local destinations with connection to the Confederation LRT Line. Route #38 operates at an average rate of every 30 minutes during weekdays. Bus stops for this route are available on both sides of Jeanne D’Arc Boulevard, adjacent to the site (stops #0755 and #0754).

Figure 6: Area Transit Network



Figure 7: Nearby Transit Stops

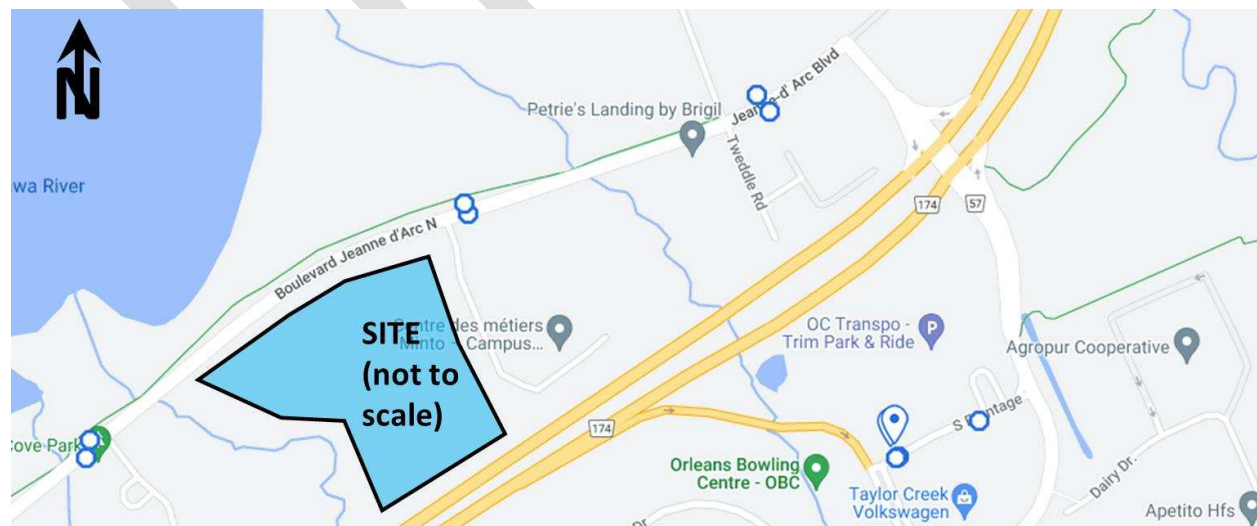

Peak Hour Travel Demands

The existing peak hour traffic vehicle and active travel volumes within the study area, as illustrated in **Figure 8** and **Figure 9** respectively, were obtained from the City of Ottawa and counts performed by Parsons. The peak hour traffic volume count data has been provided in **Appendix B**. It is noteworthy that various volumes at study area intersections were adjusted to reflect existing conditions, such as:

- Tweddle Road and Trim Road intersections with Jeanne D'Arc Boulevard had their traffic volumes redistributed based on the new existing road geometry assuming the same number of trips and overall origin-destination route.
- Trips from now built and occupied Petrie's Landing I, Towers 2 and 3 were layered on to existing volumes.
- Trips from now built and occupied Petrie's Landing II, Blocks 6 and 7 were layered on to existing volumes.

Figure 8: Existing Peak Hour Traffic Volumes

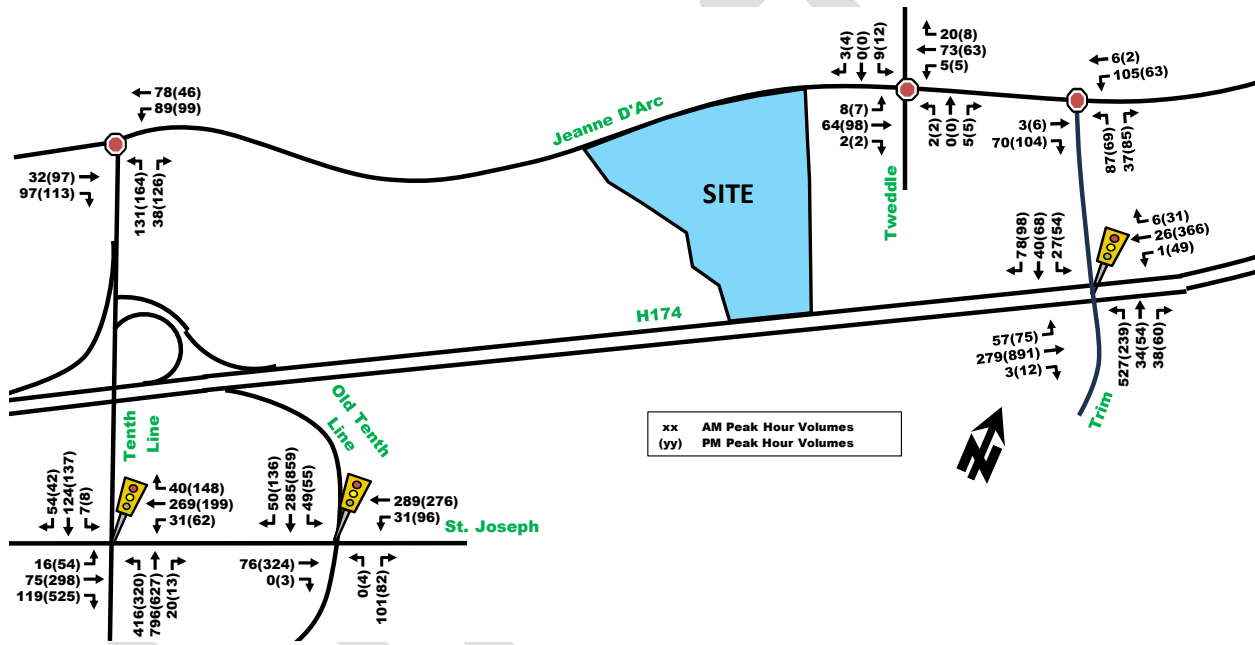
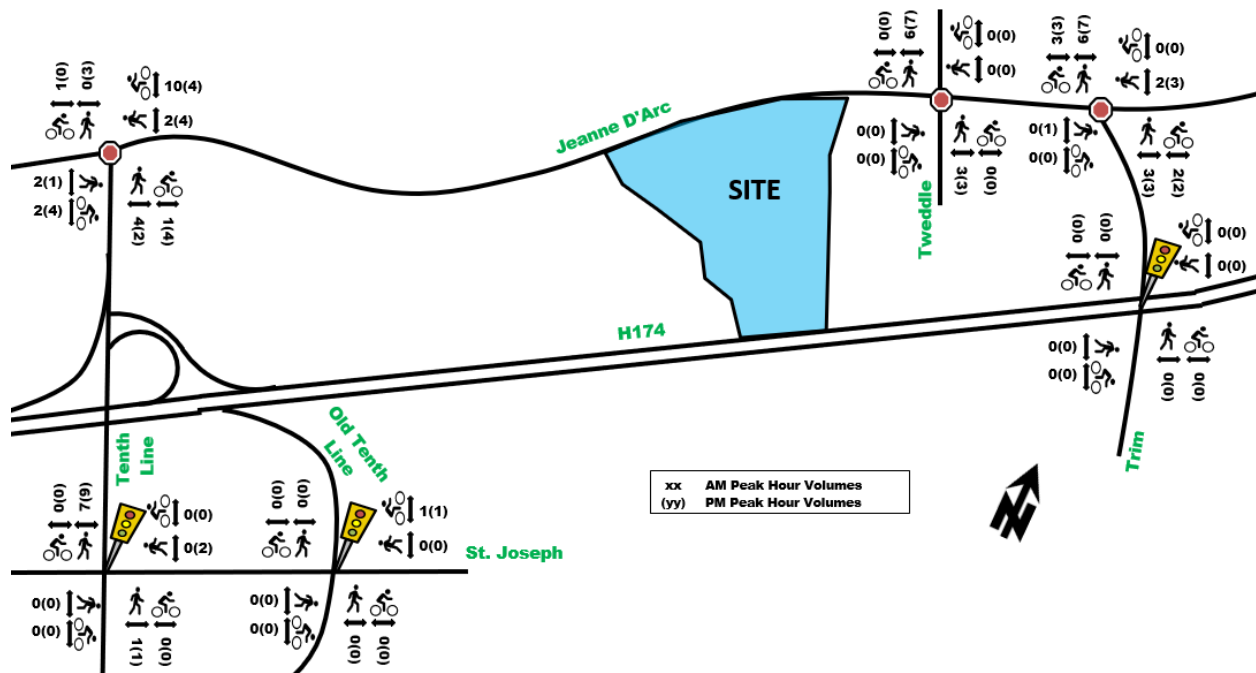

Figure 9: Existing Peak Hour Pedestrian/Cycling Volumes



Existing Road Safety Conditions

A five-year collision history data (2017-2021, inclusive) was obtained from the City of Ottawa open data source for all intersections and road segments within the study area. Note that the collisions recorded for Trim/H174 and Tweddle/Jeanne D'Arc (former Trim/Jeanne D'Arc) reflect the old road geometry as the shift in intersection location occurred in late 2021. No collisions were found at either of the two new intersections (realigned Trim/H174 and realigned Trim/Jeanne D'Arc). Upon analyzing the collision data, the total number of collisions observed within the study area was determined to be 184 collisions within the past five-years, with 84% causing property damage only and 16% causing non-fatal injuries. There were no fatal injuries recorded. Within the study area, the quantity of collisions, collisions per million entering vehicles (MEV) and/or distance of mid-block at each location has occurred at a rate of:

- Former Trim/H174: 56, MEV 0.90
- Former Trim/Jeanne D'Arc: 2, MEV 0.36
- Tenth Line/Jeanne D'Arc: 5, MEV 0.35
- Tenth Line Ramps H174: 9
- Tenth Line/St. Joseph: 70, MEV 1.36
- Old Tenth Line/St. Joseph: 30, MEV 0.99
- Mid-block Jeanne D'Arc: 2 (2.1km)
- Mid-block Tenth Line: 9 (750m)
- Mid-block St. Joseph: 1 (250m)
- Collisions with Pedestrians: 0
- Collisions with Cyclists: 1 (<1%)

Overall, there were very few collisions with active transportation users, likely because very few people bike or walk to work within this study area. The former Trim Road intersections have significantly changed and are pending newer data to identify new trends and deficiencies based on their new geometries.

The intersection of Tenth Line/St. Joseph exhibited a higher-than-average quantity of collisions, with rear end type collision accounting for more than 50% of collision types. The heavy northbound movement may have sight line issues caused by grades from the road dropping from the plateau escarpment down to the valley below as shown in **Figure 10**.

Figure 10: Tenth Line Road Looking North Towards Tenth Line/St. Joseph Intersection



The heavy northbound movement and reduced total reaction time available due to grades impeding vision of downstream vehicles which may suddenly stop due to a red light could cause this increased risk of collision at this location. Most collisions, 84% result in property damage only. The City of Ottawa could consider adding an advanced “prepare to stop” flashing beacon upstream of the intersection to warn drivers of upcoming red lights and likely stopped vehicles.

Detailed collision analysis has been provided in **Appendix C**.

2.1.3. PLANNED CONDITIONS

Planned Study Area Transportation Network Changes

Cycling Network (2013 Transportation Master Plan)

Within the Ottawa 2013 Ultimate Cycling Plan, Tweddle Road is classified as a ‘local route’. A major pathway is proposed on the south side of Jeanne D’Arc Boulevard east of Tweddle Road, extending beyond the Trim/Jeanne D’Arc intersection and continuing between Brigil Petrie’s Landing I development and H174 towards the Cardinal Creek pathways. A connection between the pathway on the south side of Jeanne D’Arc Boulevard to the Trim LRT Station is proposed on the east side of Trim Road from Jeanne D’Arc Boulevard to the park and ride signalized intersection, where it continues on the west side of Trim Road to the former cycle facilities. The segment of Tenth Line Road from Jeanne D’Arc Boulevard to St. Joseph Boulevard is classified as a future spine route, and the segment from Tenth Line Road to the existing cycle tracks on St. Joseph Boulevard are proposed as spine route also. **Figure 11** depicts the existing and future network. Note that the latest information on GeoOttawa does not reflect the realignment of Trim Road. Cycle facilities are proposed on the realigned Trim Road. It is assumed the realigned Trim Road will maintain the same cycling classification and facilities as the former Trim Road proposes.

In addition to the Ultimate Cycling Plan, the Orléans Corridor Secondary Plan (more detail later in this section) proposes physically separated cycling facilities along the entire frontage of the site on the south side of Jeanne D’Arc Boulevard, extending from Taylor Creek to Tweddle Road, connecting to a recently built MUP.

Figure 11: Existing and Future 'Ultimate Cycling Network'

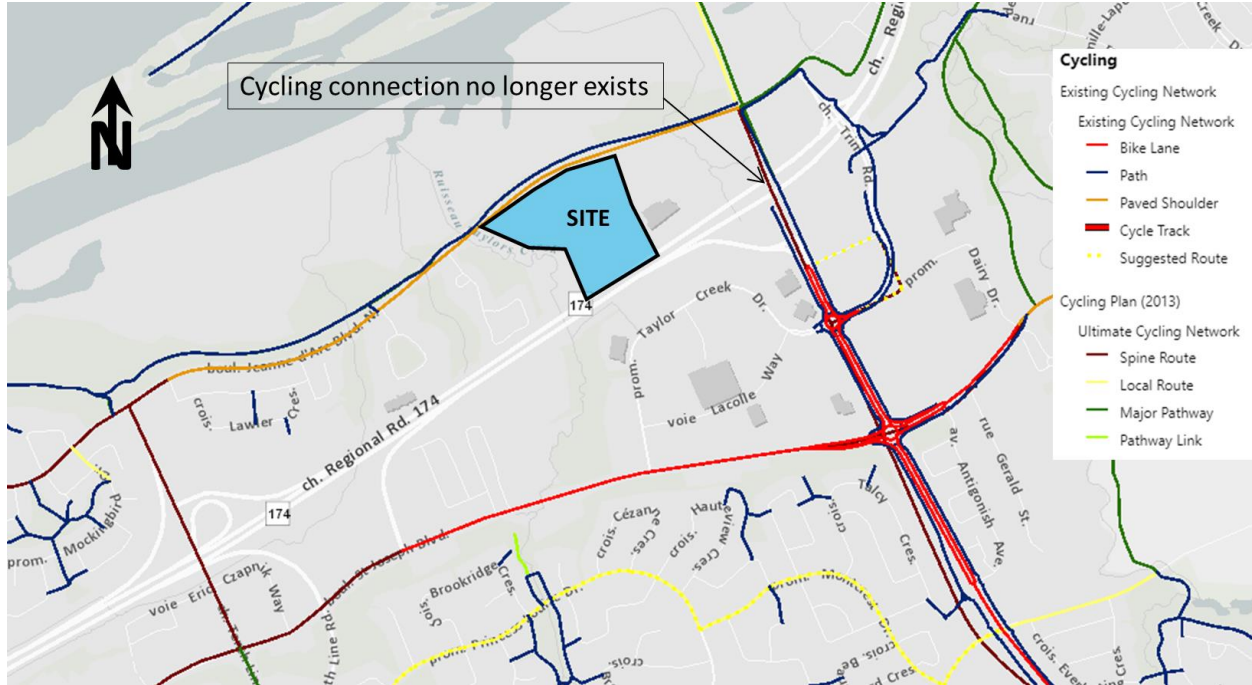

Source: Geoottawa.ca; note: cycling facilities from former Trim Road to Tweddle via H174 no longer exist due to Stage 2 LRT.

H174 Widening (pre-2014)

An Environmental Assessment for the potential widening of H174 was conducted by the Townships of Prescott-Russell/City of Ottawa. The widening of H174 to six-lanes from H417 to Trim Road and to four-lanes from Trim Road to the City boundary is identified as a road project in the 2013 City of Ottawa Transportation Master Plan. However, the widening of H174 is not identified as part of the Affordable Network Plan within the TMP. Therefore, the road widening of H174 east of Trim Road is unlikely within the foreseeable future. A potential cross-section is illustrated in **Figure 12**.

Figure 12: H174 Widening Potential Cross-Section East of the Site

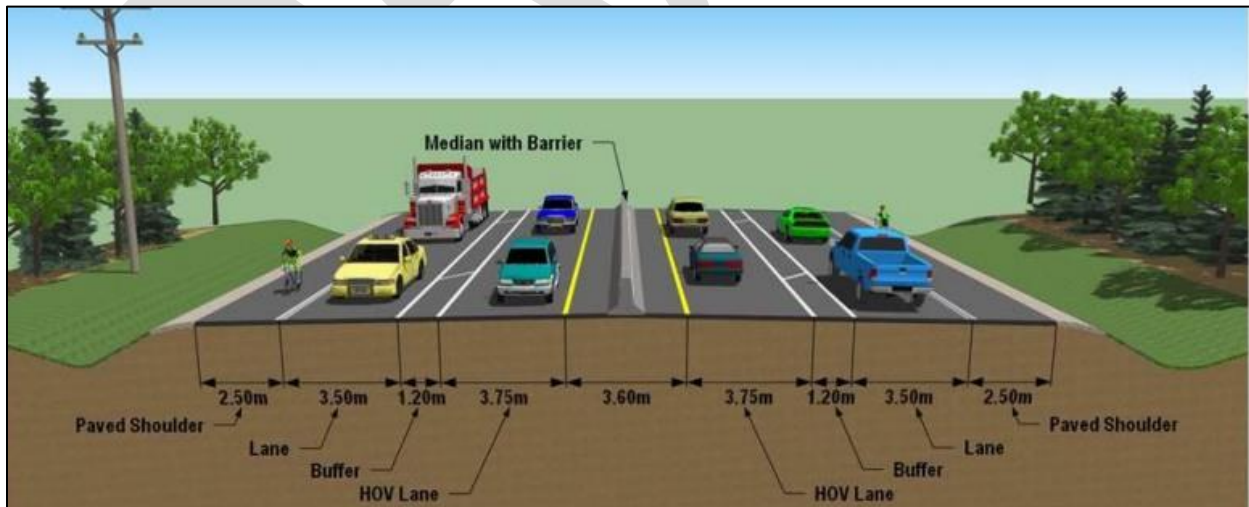

Source: <http://ottwatch.ca/meetings/file/366361>

Stage 2 LRT (Construction Began 2019)

Stage 2 of the City of Ottawa LRT system is currently under construction. Stage 2, as shown in **Figure 13**, is a package of three extensions – south, east and west – totaling 44 km of new rail and 24 new LRT stations. The

subject site will be located within 450 to 800m of rapid transit Trim Station in a direct line radius, however at least 1.3km walking distance based on existing pedestrian infrastructure.

The current construction schedule forecasts the Confederation Line East extension will be completed by early 2025².

Figure 13: Stage 2 LRT System Map

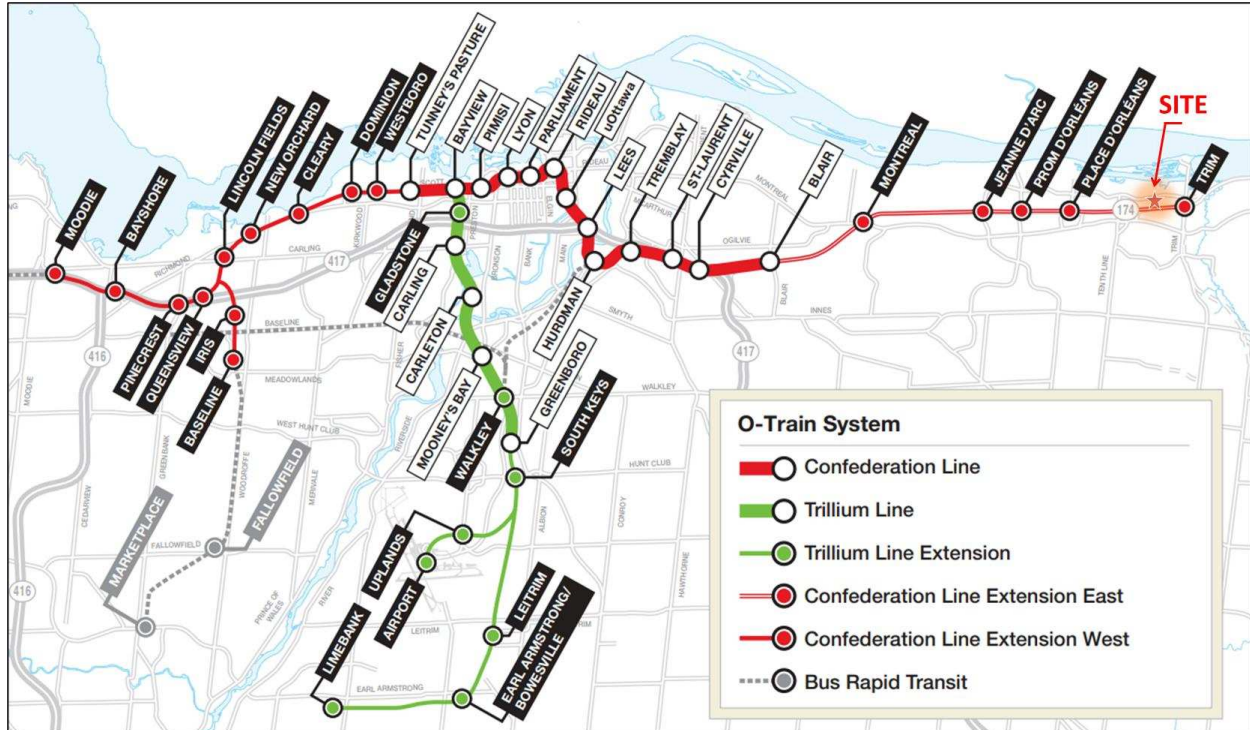

Construction of the new Trim LRT Station is well underway. As part of the construction, the former Trim/H174 at-grade intersection was relocated approximately 250 meters east to allow for the new LRT station to be located at the former location of the intersection. **Section 4.1** will provide further detail on active transportation facilities proposed at the new intersection once fully built-out. At the moment, the new relocated Trim/H174 intersection has been built to interim conditions while the construction of the future Trim LRT Station is ongoing.

The Trim Road Park and Ride Facility will be modified to include a new bus loop, bus lay-bys, and bus station platforms. It is noteworthy that the subject site is located within 600m from the future Trim Road LRT Station and is therefore considered to be within the Trim Station TOD area. **Section 4.1** will discuss potential mitigations to reduce the existing long walking route to get to the future LRT station.

Figure 14 illustrates the planned LRT station location and recently constructed interchange at Trim/H174. This new intersection location accommodates the LRT rail tracks. Trim Road was truncated both north and south of H174 to accommodate the new station. Trim Road to the south of H174 has been realigned to the Trim Road roundabout connection with Taylor Creek Drive. **Figure 14** is only a preliminary design and subject to change as the detailed design of the realignment is still ongoing. The precise location and types of facilities proposed by the new realigned Trim/H174 and new Trim/Jeanne D'Arc have yet to be finalized within the final detailed design plan. **Section 4.1** will provide additional details.

² <https://ottawa.ctvnews.ca/stage-2-of-ottawa-lrt-faces-further-delay-1.6333917#:~:text=The%20Confederation%20Line%20west%20extension,to%20open%20in%20late%202026.>

Figure 14: Stage 2 LRT Station Connectivity Enhancement Study

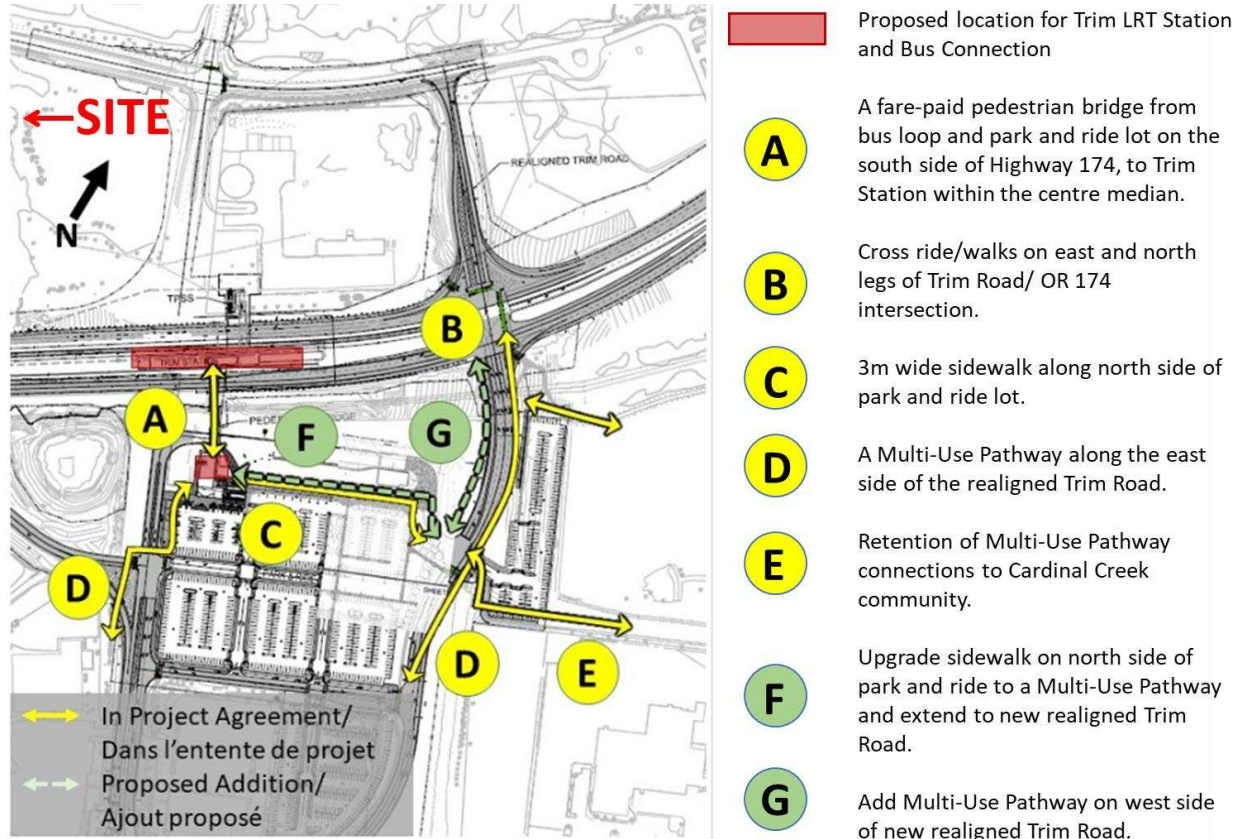

Source: <https://ottawa.ca/en/city-hall/public-engagement/projects/stage-2-lrt-station-connectivity-enhancement-study>

Orléans Corridor Secondary Plan (June 8th, 2022)

The City of Ottawa has undertaken a secondary plan for Orléans which has the intention of providing more specific direction and guidance beyond the recently approved New Official Plan for Ottawa. The secondary plan has a high level of focus on LRT transit connectivity and specific corridors.

Policy 28 within the Orléans Corridor Secondary Plan states:

“A multi-use pathway (MUP) will be constructed to link Tweddle Road, connecting the future active transportation bridge to the future street network in the master planned development site at 8600 Jeanne d’Arc Boulevard. The pathway will cross the watercourse west of Tweddle Road, utilize the Highway 174 right-of-way, and may traverse the Collège La Cité campus, linking the station with both the campus, and the future street network of the master planned development. The MUP will be designed, funded, and constructed by the proponent of the master planned development at 8600 Jeanne d’Arc Boulevard, as a condition of development approval and completed prior to occupancy of the first phase”³

In conjunction to the Orléans Corridor Secondary Plan, the City of Ottawa has recently undertaken a separate Environmental Assessment (EA) Study to determine the feasibility of adding a pedestrian bridge from the Trim LRT Station to the north side of H174, reducing the walking distance to the future development to a potential 450 to 850m walk from all locations within site.

The City of Ottawa’s New Transportation Master Plan (New TMP) that is currently being developed highlights a future bridge connection over H174 near to the Trim LRT Station within the “Active Transportation Major Structures” early figures released.

³ <https://pub-ottawa.escribemeetings.com/filestream.ashx?DocumentId=94222>

Figure 15 illustrates the potential future MUP connection from Trim LRT Station to the site of this development based on the Orléans Corridor Secondary Plan. The full figure has been provided in Appendix D, along with other key maps from the secondary plan and New TMP.

Figure 15: Orléans Corridor Secondary Plan – Schedule C Mobility Improvements

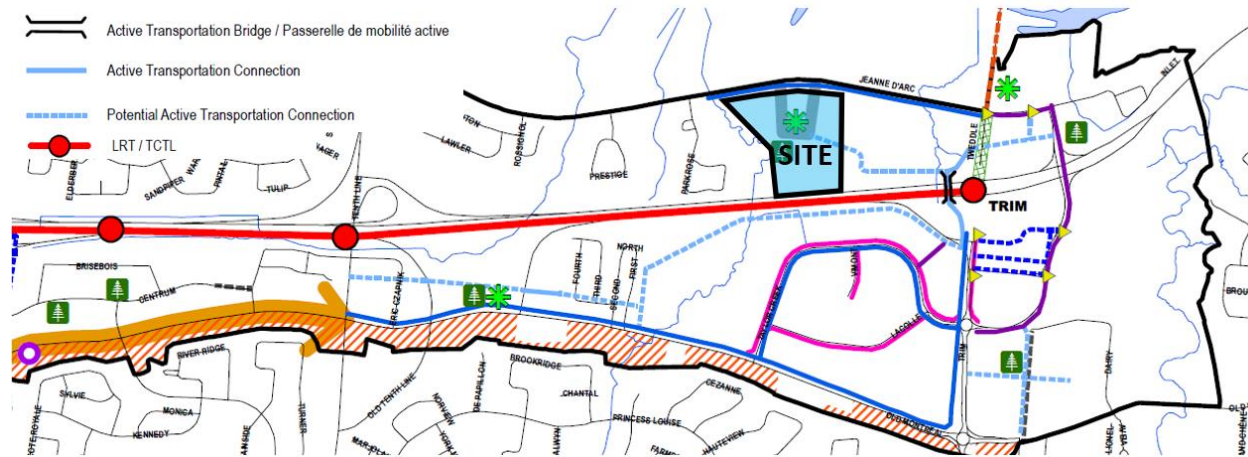

Other Area Developments

The following section outlines adjacent developments in the general area that were considered in the TIA. The criteria for inclusion of other area developments are either approved developments or developments that have an active planning application that are generally within a 1-km radius of the subject site. Figure 16 illustrates the location and relative size of relevant other area developments.

Figure 16: Other Area Developments



1-Petrie's Landing I

Brigil is proposing the construction of a residential development consisting of approximately 1,130 residential units total within 5 towers (including the increase of 44 units for tower 4 captured in the June 23rd, 2021, addendum by Parsons). At the time this report was written, towers 1, 2 and 3 are occupied and tower 4 is under construction; however, the most recent count reflects trip volumes from tower 1 only and will have the remainder tower volumes layered on separately. The proposed Petrie's Landing I is located off of Inlet Private and is located approximately 850m east of the subject site. The projected two-way vehicle trips to be layered on for this proposed residential development are approximately 300 to 270 veh/h during the AM and PM peak hours respectively according to a TIA prepared by Parsons (July 2019) plus addendum (June 2021).

2-Petrie's Landing II

Brigil is proposing the construction of a residential development consisting of approximately 460 residential units total within 8 block buildings. At the time this report was written, blocks 1 through 7 are occupied and block 8 is under construction. Block 8 has been decreased from 214 to 113 units as per the latest update done by Parsons on February 23, 2021. The most recent count reflects trip volumes from blocks 1 through 5 only and will have the remainder block volumes layered on separately. The proposed Petrie's Landing II is located south of Jeanne D'Arc Boulevard, approximately 700m west of the subject site. The projected two-way vehicle trips to be layered on for this proposed residential development are approximately 155 to 130 veh/h during the AM and PM peak hours, respectively according to a TIA prepared by Parsons (February 2021).

3-1009 Trim Road

9378-0633 Quebec Inc. has proposed the construction of a mixed-use development consisting of four 24 to 32-storey buildings with approximately 960 residential units and 56,000 ft² of commercial retail and office space. The TIA prepared by Parsons on December 10, 2021 forecasts approximately 150 to 155 new two-way vehicle trips from this site, which will be layered on to background volumes. The site is located approximately 550m east of the subject site.

4-Cardinal Creek

Tamarack Homes is currently constructing a 1,446-unit subdivision and a 430,000 ft² shopping centre, south of H174 and east of Cardinal Creek, as illustrated in **Figure 17**. The Transportation Impact Study (prepared by IBI Group, October 2013) projected approximately 1,460 veh/h and 2,619 veh/h by horizon year 2031 (full build-out) during the morning and afternoon peak hours, respectively. These volumes will be layered on to background conditions. The site is located approximately 2kms away once their new access to H174 is complete.

Figure 17: Cardinal Creek Village

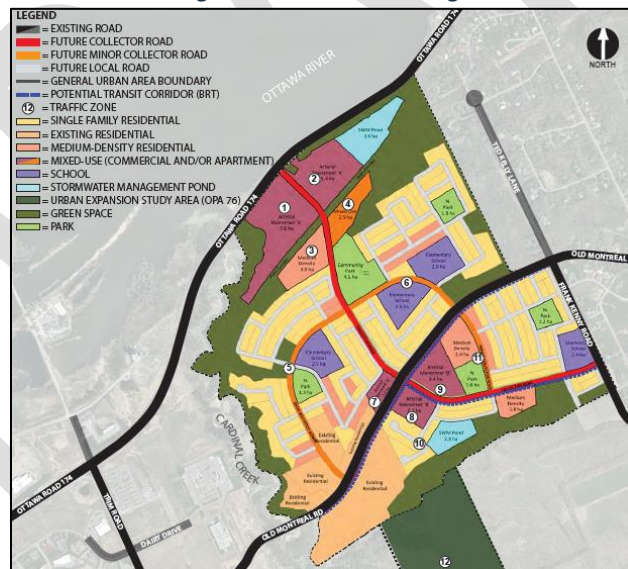

5-Phoenix Homes

Phoenix Homes is currently constructing a subdivision consisting of 432 terrace flats, 35 townhomes and 16 semi-detached homes along Old Montreal Road, within Cardinal Creek Village. The Transportation Impact Study (prepared by WSP Group, March 2018) projected approximately 251 veh/h and 295 veh/h by horizon year 2022 (full build-out) during the morning and afternoon peak hours, respectively. These volumes will be layered on to background conditions. The site is located approximately 3kms away.

6-Hillside Commons

Phoenix Homes is proposing a 9-storey apartment building consisting of 274 residential units, located at the northwest corner of Tenth Line/St. Joseph intersection. The Transportation Impact Study (prepared by Novatech, January 2023) projected approximately 60 veh/h by horizon year 2024 (full build-out) during the morning and afternoon peak hours. These volumes will be layered on to background conditions.

7-265 Centrum

Bayview Orléans Inc is proposing three high-rise mixed-use buildings, a 30, 35 and 40-storey apartment buildings consisting of 1,127 residential units, 8,970 ft² of commercial space and 31,571 ft² of office space, located near the Shenkman Center. The Transportation Impact Study (prepared by CGH, March 2023) projected approximately 545 to 555 veh/h by horizon year 2028 (full build-out) during the morning and afternoon peak hours. These volumes will be layered on to background conditions.

2.2. Study Area and Time Periods

Full buildout of the proposed residential development is envisioned well beyond 2030. For the purpose of this analysis, it will be assumed that the development will be complete by 2035, using the weekday morning and afternoon peak hour time periods.

Proposed study area intersections and boundary roads are outlined below and highlighted in **Figure 18**.

- Trim/H174 intersection;
- Trim/Jeanne D’Arc intersection;
- Tweddle/Jeanne D’Arc intersection;
- Tenth Line/Jeanne D’Arc;
- Tenth Line/St. Joseph intersection;
- Old Tenth Line/St. Joseph intersection; and,
- Along Jeanne D’Arc Blvd adjacent to the site.

Figure 18: Study Area Boundaries and Intersections



2.3. Exemption Review

Table 2 below summarizes the modules/elements of the TIA process which are recommended to be exempt in the subsequent steps of the TIA process, based on the City’s TIA guidelines and the subject site.

Table 2: Exemptions Review Summary

Module	Element	Exemption Consideration
4.1 Development Design	4.1.2 Circulation and Access	Only required for Site Plan Application (SPA)
4.2 Parking	All Elements	Only required for SPA. The parking is expected to meet By-Law requirements once a Site Plan Application (SPA) is submitted

3. Forecasting Report

3.1. Development-Generated Travel Demand

3.1.1. TRIP GENERATION AND MODE SHARES

The development will be a greenfield development, to be constructed on a barren parcel of land. The latest plan of subdivision proposes 3,177 units, however, for this trip generation analysis, 3,200 units will be used to show a higher unit potential. Trip generation rates for proposed residential units, envisioned within twelve buildings, were based on the City’s 2020 TRANS Trip Generation Manual. The trip generation rates for proposed commercial and office uses were based on the ITE’s Trip Generation Manual 11th Edition. These trip generation rates have been summarized in **Table 3**. Each phase will be analyzed individually through their Site Plan Application (SPA) submissions, however for this ZBLA and OPA submission, only the most critical ultimate buildout scenario will be analyzed.

Table 3: 2020 TRANS Residential Trip Generation Rates & ITE Commercial/Office Rates

Land Use	Data Source	Units or Size	Trip Rates	
			AM Peak	PM Peak
High Rise Apartments	TRANS 2020	3,200 units	$T = 0.80(du)$	$T = 0.90(du)$
Shopping Center (>150K ft ²)	ITE 820	165,000 ft ²	$T = 0.84(x)$	$T = 3.40(x)$
General Office	ITE 710	110,000 ft ²	$T = 0.86\ln(x) + 1.16$	$T = 0.83\ln(x) + 1.29$

Note: T = Average Vehicle Trip Ends; du = dwelling units; x = GFA in 1,000 ft²; average rate equation was used for commercial

ITE derives its trip generation rates based on empirical data from various sites observed. Shopping centers are normally large stand-alone isolated buildings in major arterial nodes with regional attractions (i.e. malls), which does not meet the developments site context with small dispersed commercial uses within the twelve buildings and accessed by an isolated arterial route.

Similarly, office land uses generally comprise of large office complexes, with office only uses such as the office buildings downtown or Tunney’s Pasture Complex as an example. Given that the office land uses will be scattered within site buildings and will normally be dispersed in smaller blocks throughout, a more local attraction or flexible space use for residents is appropriate. To better represent the more locally targeted commercial and office uses, a direct reduction in people trips of 40% and 10% respectively was deemed appropriate. Note that further discussion regarding pass-by trips and internally reduced have been provided in following “Further Assumptions” below and **Table 8**.

Using the TRANS Trip Generation rates, the total amount of person trips generated by the proposed 3,200 residential units was calculated. Similarly, using the ITE trip rates, commercial and office vehicle trip generation rates were converted to modified person trips by multiplying them by 1.28 to account for typical North American auto occupancy, transit use and non-motorized mode. This modified person trip was then multiplied by the respective land use size to obtain a person trip. The resultant people trip generation per land use are summarized in **Table 4**.

Table 4: Projected Peak Period Person Trip Generation – TRANS Model 2020 & ITE

Land Use	Land Use Size	AM Peak Period Person Trips	PM Peak Period Person Trips
Twelve Residential Buildings	3,200 units	2,560	2,880
Commercial Uses	165,000 ft ²	177	718
Commercial Uses 40% Reduction		106	431
Office Uses	110,000 ft ²	233	230
Office Uses 10% Reduction		209	207

The projected site peak period person trips for residential uses were then divided based on the mode shares for Orléans according to TRANS 2020 table 5, as summarized in **Table 5**.

Table 5: Residential Peak Period Trips using TRANS 2020 Mode Shares

Travel Mode	AM Peak Period		PM Peak Period	
	Mode Share	Person Trip	Mode Share	Person Trips
Auto Driver	54%	1,386	61%	1,743
Auto Passenger	7%	182	13%	363
Transit	29%	734	21%	604
Cycling	0%	0	0%	0
Walking	10%	258	6%	170
Total Person Trips	100%	2,560	100%	2,880

Standard traffic analysis is usually conducted using the morning and afternoon peak hour trips as they represent a worst-case scenario. The 2020 TRANS Manual uses peak periods which can exceed the peak hours. Table 4 within the 2020 TRANS Manual includes factors for converting peak periods into peak hour traffic volumes as seen in **Table 6**. Note that conversion factors for passenger trips are assumed to be the same as auto driver.

Table 6: Peak Period to Peak Hour Conversion Factor (2020 TRANS Manual - Residential)

Travel Mode	Peak Period to Peak Hour Conversion Factors	
	AM	PM
Auto Driver	0.48	0.44
Passenger	0.48	0.44
Transit	0.55	0.47
Bike	0.58	0.48
Walk	0.58	0.52

Using the peak period to peak hour conversion rates from **Table 6**, the derived peak period trips by mode shares for Orléans, and the inbound and outbound splits from table 9 within the TRANS 2020 Manual, then the residential peak hour trips generated by the site for TRANS 2020 Orléans mode share can be calculated, as seen summarized in **Table 7**.

Table 7: Residential Peak Hour Trips Generated Using TRANS 2020 Mode Shares

Travel Mode	Mode Share	AM Peak Hour (Trips/h)			Mode Share	PM Peak Hour (Trips/h)		
		In	Out	Total		In	Out	Total
Auto Driver	54%	194	432	626	61%	418	303	721
Auto Passenger	7%	25	57	82	13%	87	63	150
Transit	29%	118	262	379	21%	155	112	267
Cycling	0%	0	0	0	0%	0	0	0
Walking	10%	44	97	141	6%	48	35	83
Total Person Trips	100%	381	847	1,228	100%	708	513	1,221
Total 'New' Residential Auto Trips		194	432	626	-	418	303	721

Mode Share Assumptions:

The site is located within 450 to 800m radius to future Trim LRT Station. At the time this report was written, there were no solidified plans for a pedestrian/cyclist bridge from the north side of H174 to the future LRT Station. Existing infrastructure would force pedestrians north to Jeanne D'Arc Boulevard and east to the

realigned at grade Trim/H174 intersection, to then return west to the new LRT Station. The existing infrastructure would result in approximately 1.3km walk distance to access the future LRT Station.

As discussed in **Section 2.1.3. Planned Conditions**, both an EA study for a bridge connection to LRT plus a new MUP facility bordering the north side of H174 as per the Orléans Corridor Secondary Plan are proposed. For the purpose of this development, two scenarios will be analyzed:

- **Scenario 1 (S1):** mode shares similar to TRANS for Orléans, assuming no direct connectivity to the future Trim LRT Station, located approximately 1.3km walk using existing infrastructure. These mode shares reflect a non-transit-oriented development (non-TOD).
- **Scenario 2 (S2):** transit-oriented development (TOD), with future MUP and pedestrian bridge connecting the north side of H174 to LRT, resulting in approximately 450 to 850m walk to the future Trim LRT Station from anywhere within the site.

The proposed mode shares for each land use have been summarized in **Table 8**.

Table 8: TRANS and Proposed Mode Shares for Each Land Use & Scenario

Land Use	Travel Mode	TRANS Mode Share		Proposed Mode Share		Proposed Modal Share Rationale
		AM	PM	S1 ₁	S2 ₁	
Residential	Auto Driver	54%	61%	55%	35%	The TRANS mode shares are within anticipated S1 mode shares if no MUP and bridge connection to LRT is built. If the walking distance for residents is reduced to 450 to 850m to reach high quality transit (LRT), then an increase in transit mode share and a decrease in vehicle mode share is anticipated.
	Auto Pass.	7%	13%	10%	10%	
	Transit	29%	21%	25%	45%	
	Cycling	0%	0%	5%	5%	
	Walking	10%	6%	5%	5%	
Commercial	Auto Driver	77%	71%	40%	25%	This development is not located adjacent to a major commuter arterial road. It is unlikely that people will significantly divert their driving trips to this location. Currently, there are over 10,000 new residential units proposed within a 1km radius, with Petrie's Landing I, II and III, 1009 Tweddle, etc., which would attract walking trips. An LRT connection would further reduce vehicle trips and encourage more transit trips.
	Auto Pass.	14%	20%	10%	5%	
	Transit	3%	2%	15%	35%	
	Cycling	0%	1%	5%	5%	
	Walking	6%	5%	30%	30%	
Office	Auto Driver	71%	71%	65%	40%	The TRANS mode shares for employment area are generally within S1 anticipated mode shares. A slight increase in transit was allotted given local route #38. If a walking distance less than 800m from LRT to office uses was achieved, then a large shift from driving alone to transit is anticipated.
	Auto Pass.	6%	6%	6%	6%	
	Transit	13%	13%	19%	44%	
	Cycling	1%	1%	5%	5%	The site is located near MUPs and cycling trails. Some residents from nearby high density may walk to an office space at the site.
	Walking	8%	8%	5%	5%	
1. S1 = Scenario 1; S2 = Scenario 2; AM and PM mode shares are the same for S1 and S2 scenarios.						

Further Assumptions:

As described previously in this module, a 40% reduction in people trips for commercial uses and 10% reduction in people trips for office uses was deemed appropriate given their context as ancillary uses within local community of residential towers and its site context abutting an arterial road which does not provide significant connectivity to the surrounding neighbourhoods or functions as a major commuting route. Neither the commercial nor the office uses are meant to act as stand-alone regional attractors such as a large shopping center or a large office complex.

The commercial and office elements of the proposed development are intended primarily to serve locally within this development and nearby high-density developments such as Centre des Métiers Minto adjacent to the site, future proposed development at 1009 Tweddle Road, Petrie's Landing I and II, and adjacent Taylor Creek community.

Given the mixture of land uses proposed onsite, an internal reduction rate was applied based on mixed-use parameters described in Section 6.5 of the ITE Trip Generation Manual 3rd Edition, to account for multi-purpose trips such as a local resident shopping within the development prior to travelling to work. These trips may be reduced to eliminate potentially double counted trips, which has been incorporated in the trip generation tables that follow. The base calculation for determining the quantity of internal reductions has been provided in **Appendix E**.

Pass-by trips were also considered for commercial uses. Pass-by trips are intermediate trips along the original route between the primary origin and destination, such as a trip to retail within this site between an origin and destination trip that is not within this site. These are not considered 'new' trips, but existing trips already on the network. Appendix E of the ITE Trip Generation Manual 3rd edition was used to determine pass-by rates. Pass-by trips were calculated after the internal reduction factor was applied. Note that a slightly lower than recommended pass-by trip for commercial uses was used given that Jeanne D'Arc Boulevard adjacent to the site does not provide direct connectivity serving large communities and overall traffic volumes on Jeanne D'Arc Boulevard are low, providing a low pool of vehicles which may produce a pass-by trip.

Scenario 1 (Non-TOD): No Direct Pedestrian Connectivity to Trim LRT Station

In the event that a direct pedestrian and cyclist connectivity to the future Trim LRT Station such as a grade separated bridge crossing plus a MUP adjacent to the north side of H174 is not provided, then a higher driver mode share and lower transit mode share is anticipated due to the 1.3km required distance to LRT. The following **Table 9** for residential trips, **Table 10** for commercial trips and **Table 11** for office trips have been derived using people trips from **Table 4**, mode shares from **Table 8**, Scenario 1 (S1) and future assumptions as described above. Note that the average rate for shopping center was used over the fitter curve given that the size of the commercial uses proposed is at the lower end of all sites surveyed and was better represented by the average rate.

Table 9: Residential Peak Hour Trips Generated - S1 Mode Shares (Non-TOD)

Travel Mode	Mode Share AM & PM	AM Peak Hour (Trips/hr)			PM Peak Hour (Trips/hr)		
		In	Out	Total	In	Out	Total
Auto Driver	55%	221	488	708	389	280	669
<i>Pre-Internal Reduction Vehicles Reduced</i>		223	496	718	414	300	714
		-2	-8	-10	-25	-20	-45
Auto Passenger	10%	40	90	131	75	55	130
Transit	25%	101	225	326	188	136	325
Cycling	5%	20	45	65	38	27	65
Walking	5%	20	45	65	38	27	65
Total Person Trips	100%	405	901	1,306	753	546	1,299
Total 'New' Residential Auto Trips		221	488	708	389	280	669

Table 10: Shopping Center Peak Hour Trips Generated - S1 Mode Shares (Non-TOD)

Travel Mode	Mode Share AM & PM	AM Peak Hour (Trips/hr)			PM Peak Hour (Trips/hr)		
		In	Out	Total	In	Out	Total
Auto Driver	40%	17	10	27	68	65	133
<i>Pre-Internal Reduction Vehicles Reduced</i>		26	17	43	83	90	173
		-9	-7	-16	-15	-25	-40
Auto Passenger	10%	7	4	11	21	23	44
Transit	15%	10	6	16	30	34	64
Cycling	5%	3	2	5	10	11	21
Walking	30%	19	12	31	62	67	129
Total Person Trips	100%	56	34	90	191	200	391
Less Pass-by 0% AM (25% PM)		0	0	0	-17	-17	-34
Total 'New' Shopping Center Auto Trips		17	10	27	51	48	99

Table 11: General Office Peak Hour Trips Generated - S1 Mode Shares (Non-TOD)

Travel Mode	Mode Share AM & PM	AM Peak Hour (Trips/hr)			PM Peak Hour (Trips/hr)		
		In	Out	Total	In	Out	Total
Auto Driver	65%	110	12	122	9	103	112
<i>Pre-Internal Reduction</i>		119	17	136	23	112	135
<i>Vehicles Reduced</i>		-9	-5	-14	-14	-9	-23
Auto Passenger	6%	11	2	13	3	11	14
Transit	19%	35	5	40	6	32	38
Cycling	5%	9	1	10	2	9	10
Walking	5%	9	1	10	2	9	10
Total Person Trips	100%	174	21	195	22	164	184
Less Pass-by 0% AM (0% PM)		0	0	0	0	0	0
Total 'New' General Office Auto Trips		110	12	122	9	103	112

The combined trips generated at full buildout using Scenario 1 (non-TOD) mode shares, assuming no direct connectivity to LRT can be found on **Table 12**.

Table 12: Total Combined Trips Generated - S1 Mode Shares (Non-TOD)

Travel Mode	AM Peak Hour (Trips/hr)			PM Peak Hour (Trips/hr)		
	In	Out	Total	In	Out	Total
Auto Driver	348	510	857	466	448	914
<i>Pre-Internal Reduction</i>	368	530	897	520	502	1,022
<i>Vehicles Reduced</i>	-20	-20	-40	-54	-54	-108
Auto Passenger	58	96	155	99	89	188
Transit	146	236	382	224	202	427
Cycling	32	48	80	50	47	96
Walking	48	58	106	102	103	204
Total Person Trips	633	948	1,581	941	890	1,829
Less Pass-by AM (PM)	0	0	0	-17	-17	-34
Total 'New' Combined Auto Trips	348	510	857	449	431	880

Scenario 2: Direct Pedestrian Connectivity to Trim LRT Station is Provided

Scenario 2 proposes a MUP on the north side of H174 and a grade separated connectivity from the MUP to future Trim LRT Station as required by policy 28 within the Orléans Corridor Secondary Plan. This scenario would leverage its proximity to high quality rapid transit by providing fast connectivity within reasonable walking distance. The following **Table 13** for residential trips, **Table 14** for commercial trips and **Table 15** for office trips have been derived using people trips from **Table 4**, mode shares from **Table 8**, Scenario 2 (S2) and future assumptions as described above. Note that the average rate for shopping center was used over the fitter curve given that the size of the commercial uses proposed is at the lower end of all sites surveyed and was better represented by the average rate.

Table 13: Residential Peak Hour Trips Generated – S2 Mode Shares (TOD)

Travel Mode	Mode Share AM & PM	AM Peak Hour (Trips/hr)			PM Peak Hour (Trips/hr)		
		In	Out	Total	In	Out	Total
Auto Driver	35%	140	310	450	248	178	426
<i>Pre-Internal Reduction</i>		142	315	457	264	191	455
<i>Vehicles Reduced</i>		-2	-5	-7	-16	-13	-29
Auto Passenger	10%	40	90	131	75	55	130
Transit	45%	182	405	588	339	245	585
Cycling	5%	20	45	65	38	27	65
Walking	5%	20	45	65	38	27	65
Total Person Trips	100%	405	901	1,306	753	546	1,299
Total 'New' Residential Auto Trips		140	310	450	248	178	426

Table 14: Shopping Center Peak Hour Trips Generated – S2 Mode Shares (TOD)

Travel Mode	Mode Share	AM Peak Hour (Trips/hr)			PM Peak Hour (Trips/hr)		
		In	Out	Total	In	Out	Total
Auto Driver	25%	11	6	17	43	41	84
Pre-Internal Reduction		17	11	28	52	57	109
Vehicles Reduced		-6	-5	-11	-9	-16	-25
Auto Passenger	5%	4	2	6	10	12	22
Transit	35%	22	14	36	72	78	150
Cycling	5%	3	2	5	10	11	21
Walking	30%	19	12	31	62	67	129
Total Person Trips	100%	59	36	95	197	209	406
Less Pass-by 0% AM (25% PM)		0	0	0	-11	-11	-22
Total 'New' Shopping Center Auto Trips		11	6	17	32	30	62

Table 15: General Office Peak Hour Trips Generated – S2 Mode Shares (TOD)

Travel Mode	Mode Share	AM Peak Hour (Trips/hr)			PM Peak Hour (Trips/hr)		
		In	Out	Total	In	Out	Total
Auto Driver	40%	69	8	77	5	64	69
Pre-Internal Reduction		74	11	85	14	69	83
Vehicles Reduced		-5	-3	-8	-9	-5	-14
Auto Passenger	6%	11	2	13	3	11	14
Transit	44%	80	11	91	15	75	90
Cycling	5%	9	1	10	2	9	10
Walking	5%	9	1	10	2	9	10
Total Person Trips	100%	178	23	201	27	168	193
Less Pass-by 0% AM (0% PM)		0	0	0	0	0	0
Total 'New' General Office Auto Trips		69	8	77	5	64	69

The combined trips generated at full buildout using Scenario 2 (TOD) mode shares, assuming direct connectivity to LRT can be found on **Table 16**.

Table 16: Total Combined Trips Generated – S2 Mode Shares (TOD)

Travel Mode	AM Peak Hour (Trips/hr)			PM Peak Hour (Trips/hr)			
	In	Out	Total	In	Out	Total	
Auto Driver	220	324	544	296	283	579	
Pre-Internal Reduction	233	337	570	330	317	647	
Vehicles Reduced	-13	-13	-26	-34	-34	-68	
Auto Passenger	55	94	150	88	78	166	
Transit	277	423	701	406	378	785	
Pre-Internal Reduction	284	430	715	426	398	825	
Difference vehicles reduced with no LRT	-7	-7	-14	-20	-20	-40	
Cycling	32	48	80	50	47	96	
Walking	48	58	106	102	103	204	
Total Person Trips	633	948	1,581	941	890	1,829	
Less Pass-by AM (PM)		0	0	0	-11	-11	-22
Total 'New' Combined Auto Trips		220	324	544	285	272	557
1. The difference in trips internally reduced by vehicles without direct LRT connectivity (S1) were reduced from transit trips in this scenario, maintaining the same total person trips.							

As shown in **Table 16**, based on the assumption that a pedestrian and cyclist connectivity plus a bridge to Trim LRT Station is provided (Scenario 2), reducing walking distances to approximately 450 to 850m, then the proposed site is projected to generate approximately 545 to 555 new auto-trips per hour during the weekday commuter peak hours if the proposed twelve buildings with ground retail and office uses were built.

The increase in two-way transit trips is estimated to be approximately 700 to 785 persons per hour, and the increase in walk/cycling trips is approximately 185 to 300 persons per hour during the peak hours.

If a direct connection to the future Trim LRT Station is not achieved (Scenario 1), it is forecasted that a larger percentage of people will drive and fewer would take transit, with forecasted vehicular volumes of 855 to 880 during the peak hours, an increase in vehicles of approximately 315 to 325 more vehicles during the AM and PM peak hours respectively.

3.1.2. TRIP DISTRIBUTION

Based on the OD Mode Share Survey, existing traffic volume counts and the location of adjacent arterial roadways and neighborhoods, the distribution of site-generated traffic volumes has been illustrated in **Figure 19**.

Figure 19: Site Generated Traffic Percent Distribution



3.1.3. TRIP ASSIGNMENT

The 'new' site-generated vehicle trips provided in **Table 12**, were assigned to the study area network as shown in **Figure 20** in the event that no direct connectivity to the LRT network is provided (Scenario 1, non-TOD).

Figure 21 illustrates 'new' site-generated vehicle trips from Table 16 which reflect the addition of a direct connectivity from the development to the LRT Station (Scenario 2, TOD). Note that negative numbers reflect pass-by trips.

Figure 20: 'New' Site-Generated Traffic S1 (Non-TOD) - No Direct Connection to LRT

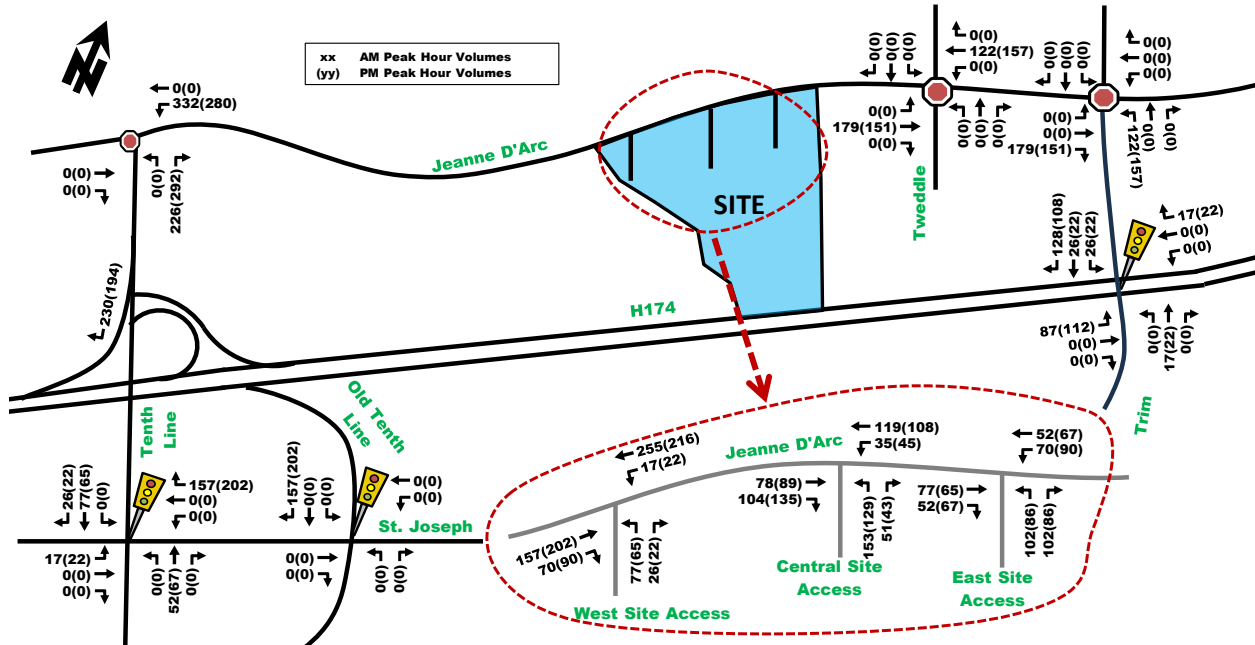
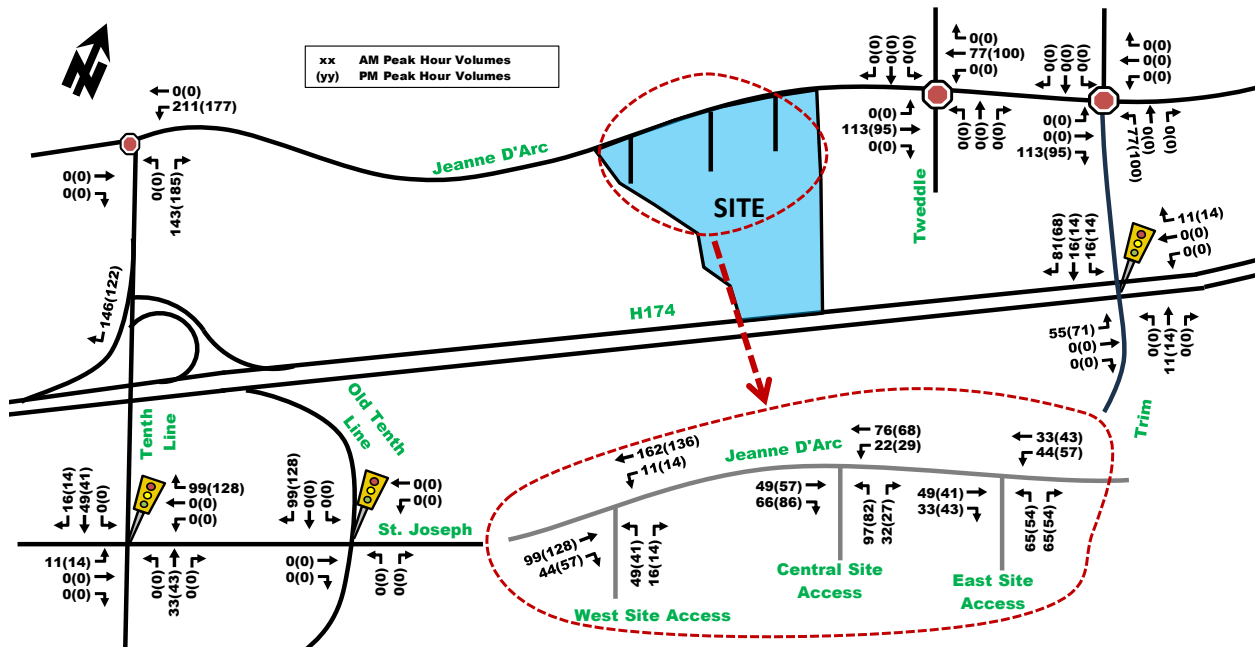

Figure 21: 'New' Site-Generated Traffic S2 (TOD) - Direct Connection to LRT



3.2. Background Network Travel Demands

3.2.1. TRANSPORTATION NETWORK PLANS

As mentioned in Section 2.1.3 Planned Conditions, the Stage 2 LRT expansion is currently underway, with estimated completion of Trim LRT Station by early 2025. located within 450m to 800m radius of the site.

For further detail, refer to **Section 2.1.3**.

3.2.2. BACKGROUND GROWTH

The emphasis in the New Official Plan and 2013 Transportation Master Plan (and is expected to remain a key objective in the ongoing TMP update) is to prioritize transit, encourage intensification around transit stations, encourage mixed-use developments and provide “complete streets” that better accommodate the active transportation needs of its residents and reduce the use of the private auto.

Once Stage 2 LRT extension is completed, approximately 77% of Ottawa residents will be within 5km of light rail⁴. More specifically, this development and nearby developments will be located even closer to LRT, with this development located within 450 to 800m radius from future Trim LRT Station. This large improvement in transit facilities will likely result in more transit related trips and fewer vehicle related trips within the study area.

The following background traffic growth (summarized in **Table 17**) was calculated based on historical traffic count data (years 2008, 2010, 2012, and 2017 and 2023) provided by the City of Ottawa at the Trim/H174 intersection near the site. Note that the year 2023 east approach turning southbound was averaged with other years as the eastbound right-turn volumes are no longer present at this intersection (off-ramp is still located at the former Trim/H174 intersection location). Detailed background traffic growth analysis is included as **Appendix F**.

Table 17: Trim/H174 Historical Background Growth (2008-2023)

Time Period	Percent Annual Change				
	North Leg	South Leg	East Leg	West Leg	Overall
8 hrs	1.05%	-2.49%	-1.48%	-2.91%	-2.21%
AM Peak	4.56%	-1.01%	-0.27%	-1.58%	-0.85%
PM Peak	3.41%	-3.53%	-1.48%	-3.67%	-2.58%

As shown in **Table 17**, the Trim/H174 intersection, has experienced negative growth over the years. A sensitivity test was done, and the 2023 counts were removed. Overall, there was still a close to 0% growth rate annually. The data overall suggests an increase in volumes at the north leg which can be explained by the new Brigil Towers from Petrie’s Landing I, and a decrease in all other movements. It is acknowledged that Jeanne D’Arc Boulevard will continue to experience growth due to substantial new developments, but these will be layered on individually.

Given the current trends observed in **Table 17**, future forecasted reduction in vehicle usage due to City wide transit and cycling initiatives, improvements to high quality LRT near the site and the lasting Covid-19 work from home/flexible work schedule, then a 0% annual growth rate (plus layering of other known developments) is adequate and may even represent a conservative assumption. Known other area developments will be manually added to study area intersections.

3.2.3. OTHER DEVELOPMENTS

The volumes from the other area development as mentioned in **Section 2.1.3** were layered onto the existing traffic volumes for the future analysis volumes. It is acknowledged that there are some areas remaining which may be developed at a future date, as shown in **Figure 25** and provided in **Appendix D**. **Figure 22** illustrates the site generated volumes for other area developments including the remainder of Petrie’s Landing I and II, remainder of Cardinal Creek, Phoenix Developments, 265 Centrum, and 3277 St. Joseph.

⁴ <https://ottawa.ca/en/planning-development-and-construction/major-projects/stage-2-light-rail-transit-project/overview#section-74f946f7-8138-491b-a748-f8e569072c88>

Figure 22: Other Area Development Background Volumes

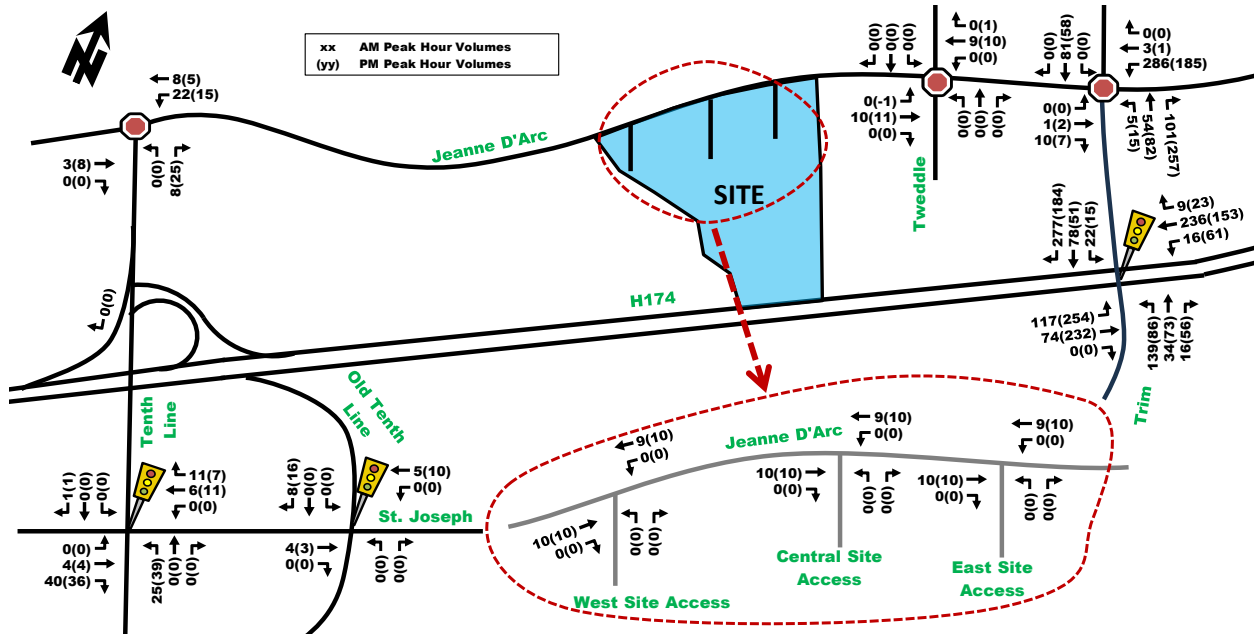

Negative value reflects pass by trips. Some developments are located within two shown intersections, resulting in the appearance of unbalanced volumes.

3.3. Demand Rationalization

Within the past few years, major changes have occurred within the City of Ottawa, affecting travel patterns and transportation demand.

The Covid-19 pandemic has had long-lasting effects on work culture, reducing many former traditional AM peak and PM peak hour work commute trips. Some trips have been eliminated altogether by people who have decided to continue to work from home. Others have adopted a more flexible work schedule, reducing pressures on the peak hour demands. Although some have begun to return to offices and places of work, it has become evident that a full return to in-person work is not likely.

In 2017, the City of Ottawa completed Stage 1 LRT which provided a large improvement to rapid transit; however, it did not provide a seamless connectivity to Orléans, requiring transit users to transfer at Blair Station and continue their commute on a bus. By early 2025, Stage 2 LRT expansion is anticipated, which would eliminate the need to transfer from LRT to a bus and highly improve the commute experience. Once Stage 2 LRT is complete, a much larger shift in vehicle users to transit users is forecasted for the Orléans district.

Particular to this development, two different mode shares were proposed. Scenario 1 yielded a higher vehicle trip generation due to an inconvenient 1.3km walk to rapid transit station. If an improved shorter distance connection to rapid transit is provided, then a reduction in vehicle trips is justifiable, as reflected in Scenario 2. Both scenarios will be compared in **Section 4.9**.

The background growth projections as discussed in **Section 3.2.2**, support the changes to work environment and city-wide transit initiatives. Once Stage 2 LRT is complete, an even further reduction in background volumes is anticipated, which could result in further reductions in background volumes. For this reason, a 0% background volume growth is not only justified, but it may even be considered conservative. Known other future development volumes will be layered on individually to account for their influence. Sufficient capacity is anticipated throughout the study area.

4. Strategy Report

4.1.1. DESIGN FOR SUSTAINABLE MODES

Location of Transit Facilities

For the purpose of this report, two scenarios have been analyzed as illustrated in **Figure 23**. Scenario 1 (non-TOD) assumes that the Trim LRT Station to be operational by early 2025 will only provide rider connectivity to the south side of H174. This scenario would then require people to walk to the sidewalk facilities on Jeanne D'Arc Boulevard and either take local low-frequency (approximately every 30 minutes) route 38 to Trim Station or walk east to the at-grade Trim/H174 intersection, cross H174 and then return west to the station. This scenario results in a minimum walk of approximately 1.3km if no MUP and bridge is built, or 1.2km if only the MUP is built, both resulting in subpar walking distances and non-inducive of transit-oriented development.

Scenario 2 (TOD) assumes that a multi-use pathway (MUP) along the south side of Centre des Métiers Minto and north side of H174, along with a bridge connection from the Trim LRT Station to the MUP is provided. The City of Ottawa is currently conducting an EA Study for the bridge connection to the north, while a right-of-way has been identified already within the Orléans Corridor Secondary Plan. It is understood that Scenario 2 is the likelier of the two scenarios given the size of the development and need for high quality transit connectivity. Furthermore, within the Orléans Corridor Secondary Plan, policy 28, states that this MUP and bridge connection are a requirement to development approval prior to occupancy for Phase 1. Scenario 2 could offer connectivity to LRT in as little as 450m walking distance from the site, and within 850m to all locations within the site.

Figure 23: Walking Scenarios to Trim LRT Station



The subject site has existing bus stops located near the northeast quadrant of the site, located near the driveway to Centre des Métiers Minto and also approximately 200m to the west of the site near the Parkrose Private access, servicing local route 38. The distance between these bus stops is approximately 580m. Based on the separation between bus stops and the likely high demand for transit for this development, a new bus stop is recommended fronting the site.

Pedestrian/Cycling Routes and Facilities

The latest site concept proposes internal walkways that permeate the site, providing connectivity from all buildings to sidewalk infrastructure within the site and connecting to the external site network. The Orléans Corridor Secondary Plan proposes physically separated cycling facilities on Jeanne D'Arc Boulevard from the western edge of the site to the recently built MUP on the east side of Tweddle Road. An additional MUP already exists on the north side of Jeanne D'Arc Boulevard.

As mentioned previously and shown in **Figure 23**, a new MUP between Centre des Métiers Minto and north side of H174 is proposed, which would significantly shorten the distance between this development and future Trim LRT Station, given that a new bridge connection to the north is provided.

Internal facilities are anticipated to meet or exceed city design standards and roads are envisioned to be built as complete streets, prioritizing active transportation. **Section 4.1.3.** provides more details on proposed road and active transportation infrastructure.

Bicycle Parking

Bicycle parking is anticipated to meet or exceed the minimum by-law. Further details will be available during Site Plan Application process.

4.1.2. CIRCULATION AND ACCESS

Exempt, refer to **Table 2**.

4.1.3. NEW STREETS NETWORK

The new roads proposed along with their designation for the development have been illustrated in **Figure 24** and described below.

Road A: A private road as shown in red will provide access to the western site access and bisect both sides of the public local road crescent. The private road will be treated like a private laneway with a focus on active transportation and providing limited vehicle access for trucks, deliveries and local resident access. The design of Road A is still being refined and will be confirmed at the Site Plan Control stage.

Road B: A public local road crescent with a 20m right-of-way (ROW) as shown in orange has been proposed, which would provide access to the central and eastern site accesses. The cross-section for the public road has been proposed in accordance with the recently released 2023 City of Ottawa 20m ROW local street cross-section. The 20m City of Ottawa ROW have been provided in **Appendix G** along with the draft Plan of Subdivision schematic. As per the City of Ottawa 20m ROW, it will include a single travel lane per direction with periodic bulb-outs for loading or parking for a combined asphalt width of 8.5m. The 20m ROW public road is anticipated to have 2.0m wide sidewalks on both sides of the road and 3.75m of boulevard for landscaping and utility infrastructure.

Road B is expected to be designed as 30 km/h residential streets, based on the corresponding City toolbox document, which includes both horizontal and vertical deflections measures such as bulb-outs and speed humps. Traffic calming measures will be confirmed during Site Plan Control stage.

Road C: A future connection to the Centre des Métiers Minto as shown in purple may be provided or may be reserved for active transportation users only, functioning as the portal between the development and the future MUP connection to the Trim LRT Station. This connection is conceptual at this time and will be confirmed during Site Plan Control stage.

Figure 24: Proposed New Streets Servicing the Site

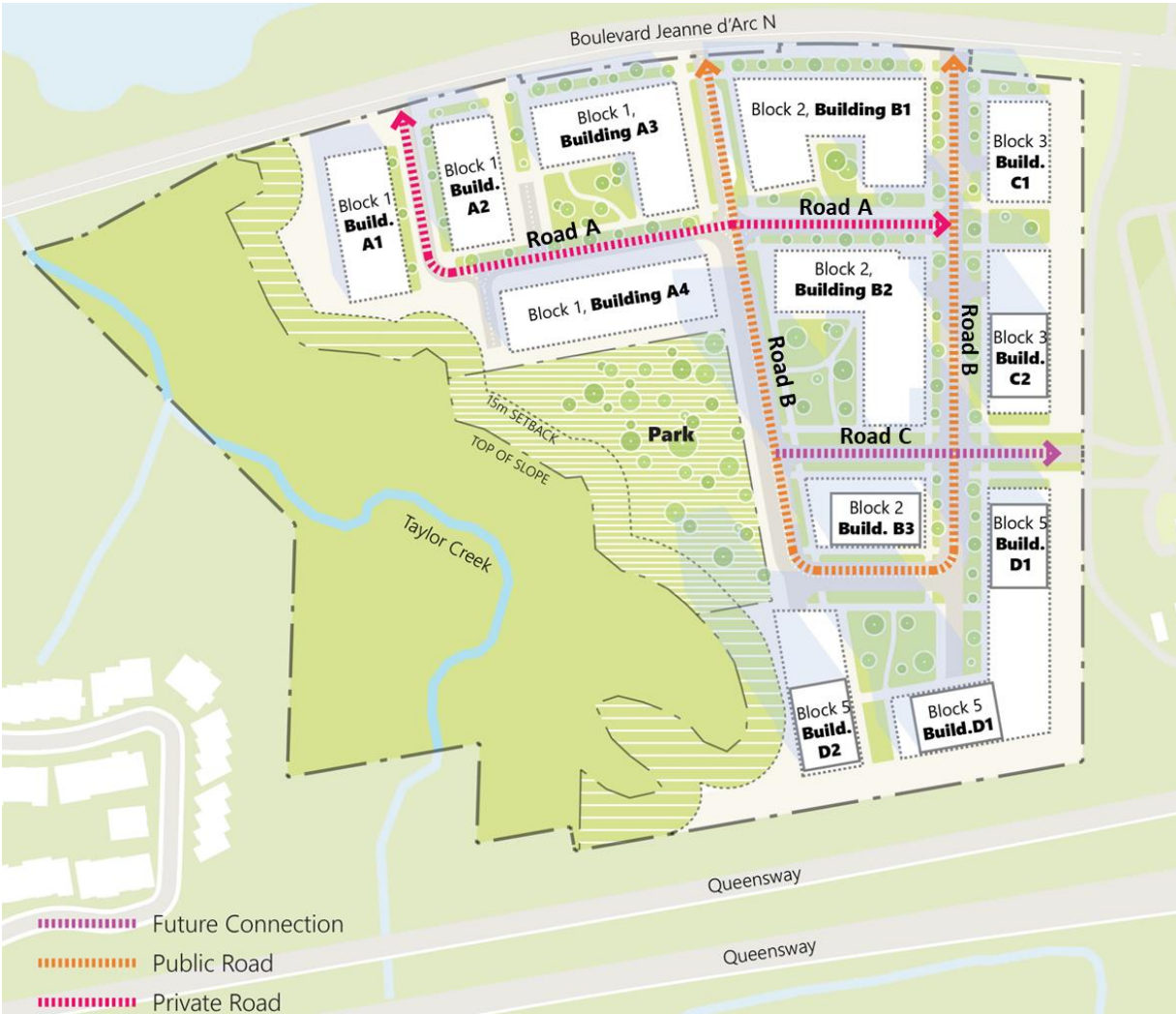

4.2. Parking

This section is exempt, refer to **Table 2**. To be confirmed during the Site Plan Control application for each future development Phase.

4.3. Boundary Street Design

4.3.1. EXISTING & FUTURE CONDITIONS

The boundary street to the proposed development is Jeanne D'Arc Boulevard.

- *Jeanne D'Arc Boulevard:*
 - 1 vehicle travel lane in each direction;
 - >2m MUP on north side of road with greater than 8m boulevard separation;
 - 2m sidewalk on south side of road without boulevard separation;
 - Less than 3,000 vehicles per day existing, assumed exceeds 3,000 in future;
 - Posted speed 60km/h (used 70km/h);
 - Classified as major collector roadway;

- Classified as future spine route. Existing curbside bike lanes and paved shoulder. Assumed physically separated bike lanes in future as per Orléans Corridor Secondary Plan; and,
- Not identified as a Truck Route.

The proposed site is located within 600m of a rapid transit and not within 300m of a school. Multi-modal Level of Service analysis for the subject road segments adjacent to the site is summarized in **Table 18** with detail analysis provided in **Appendix H**.

Table 18: MMLoS – Boundary Street Segments Existing and Future Conditions

Road Segment	Level of Service							
	Pedestrian		Bicycle		Transit		Truck	
	PLoS	Target	BLoS	Target	TLoS	Target	TkLoS	Target
Jeanne D’Arc North Side Existing	F	A	C	B	D	N/A	C	N/A
Jeanne D’Arc South Side Existing	D	A	C	B	D	N/A	C	N/A
Jeanne D’Arc South Side Future	F	A	A	B	D	N/A	C	N/A

Pedestrian

Neither existing nor future Jeanne D’Arc Boulevard road segment met the pedestrian PLoS targets due to the 60km/h posted speed limit. The MUP north of Jeanne D’Arc Boulevard was omitted from analysis given its distance from the roadway, however it would still not meet the ambitious PLoS target ‘A’ driven by its proximity to LRT Station. To achieve a PLoS ‘A’ in future conditions, the posted speed would need to be reduced to 30km/h and verified compliance using a speed test.

Bicycle

If the speed limit was reduced to 50km/h and verified compliance using a speed test, then both sides of the road would meet the BLoS targets in existing conditions. The BLoS target is met using future conditions.

Transit

Jeanne D’Arc Boulevard is not part of a transit priority corridor.

Truck

Jeanne D’Arc Boulevard is not part of a truck route.

4.4. Access Intersection Location

As per the new City of Ottawa TIA Guidelines revisions from June 14, 2023, this module has been compressed and former sections 4.4.2 Access Control and 4.4.3 Access Design have been moved to sections 4.9.1 and 4.9.2 respectively. This module will focus on the location of the future access intersections.

As previously discussed in **Section 4.1.3**, the development is proposing three new access to Jeanne D’Arc Boulevard. The easternmost driveway is proposed as a public road along with the center access, and the western access is proposed as a private road. From east to west, the accesses will have a separation of approximately 100m from east to center access and 120m from center to western access. The type of access control will be determined in **Section 4.9.1**.

Although the quantity of parking spaces is not yet known at this time, it can be assumed that the development will provide more than 300 parking spaces. According to the City of Ottawa Private Approach By-Law Section 25, if a site has more than 300 parking spaces, a minimum distance between the private approach and signalized intersection is 75m. In the unlikely event that an access needs to be signalized, the distance between each access is greater than 75m and would thus satisfy the Private Approach By-Law.

4.5. Transportation Demand Management

4.5.1. CONTEXT FOR TDM

It was assumed that trips generated by the proposed development will have a general balanced inbound and outbound distribution during peak hours. Residents are more likely to leave the site in the morning peak period to go to work and return from work in the afternoon peak period, while office uses are likelier to arrive in the morning peak period and depart in the afternoon. Commercial users will likely come and go throughout the day, with a heavier influence in the afternoon peak period.

Sections 3.1.1 and 3.1.2 describe how many trips are anticipated per travel mode and anticipates the likely locations that they will travel to and from based on the OD-Survey 2011 for Orléans. The site is located between 450 to 800m from future Trim LRT Station if scenario 2 is implemented, making it a great candidate for transit-oriented travel. Additionally, shared parking provisions for residential/commercial/office uses could reduce the overall need for quantity of parking provided, given that commercial parking likely occurs at different times than residential visitor parking and office patrons.

4.5.2. NEED AND OPPORTUNITY

With investments in rapid transit within walkable distance, the site has a good opportunity to levy this upcoming service and help reduce its environmental footprint and congestion throughout the city. A strong focus on TDM measures to encourage sustainable active mode shares is highly recommended.

4.5.3. TDM PROGRAM

The TDM infrastructure and measures checklist has been completed as a recommended draft list given that this is a zoning by-law application and not a detailed Site Plan Application (SPA). These checklists will be revisited during SPA submission for each phase of development. The draft measures have been provided in **Appendix I**.

Regarding the TDM Supportive Development Design and Infrastructure Checklist:

- All ten (10) Required measures related to walking and cycling (facilities and bicycle parking) and vehicle parking are anticipated to be satisfied.
- Thirteen (13) of fourteen (14) Basic measures related to walking and cycling, transit, ridesharing and parking are anticipated to be satisfied or are not applicable.
- Five (5) of the of the seven (7) candidate Better measures are also proposed or are non-applicable, including:
 - Providing bikeshare and rideshare facilities.
 - Separate long-term and short-term parking areas.

Regarding the TDM Measures Checklist, the developer has indicated there is a willingness to consider the following measures:

- Six (6) out of seven (7) “basic” measures related to walking, cycling, transit, parking and TDM marketing will likely be satisfied. Three (3) of those, which have been designated by an asterisk (*), are considered by the TDM Measures to be some of the most dependably effective tools to encourage sustainable travel modes. This includes:
 - Designate an internal coordinator or contract with external coordinator.
 - Display walking and cycling information at major entrances.
 - Display transit information at major entrances.
 - *Offer preloaded PRESTO card to residents with one monthly transit pass.
 - * Unbundle parking costs from monthly rent.
 - * Provide multi-modal travel information package to new residents.
- Six (6) out of eleven (11) “better” measures related to walking, cycling, transit, parking and TDM marketing will likely be satisfied. One (1) of those, which has been designated by an asterisk (*), is

considered by the TDM Measures to be some of the most dependably effective tools to encourage sustainable travel modes. This includes:

- Contract with provider to install on-site bikeshare and carshare.
- Offer on-site cycling courses for residents or subsidize off-site courses.
- *Offer personalized trip planning to new residents.
- Conduct periodic surveys to identify travel related behaviors.

4.6. Neighborhood Traffic Management

4.6.1. ADJACENT NEIGHBORHOODS

There are no adjacent neighbourhoods with local or collector roads which would provide commuter routes for this development. Jeanne D'Arc Boulevard is a major collector road with no direct frontage homes which will provide direct access to H174. This section is therefore exempt.

Although not an adjacent neighbourhood and rather an internal site road, the new public local road loop will be designed as a 30km/h residential street, including speed humps and bulb-outs as well as on-street parking as traffic calming methods (as discussed in **Section 4.1.3.**). The internal roads are short in distance and have various curvatures and features to dissuade speeding within the site. The internal roads do not provide connectivity to any other city road or developments, mitigating any risk of traffic infiltration or shortcutting through the site. As such, the local road classification for the new public street was considered appropriate.

4.7. Transit

4.7.1. ROUTE CAPACITY

Within **Section 3.1.2.**, the trips generated by the site for both Scenario 1 and Scenario 2 mode shares were derived. Scenario 1 (non-TOD), which assumes a more car-centric mode share forecasts approximately 380 to 425 two-way transit trips for the AM and PM peak respectively. The majority of these transit trips would be assumed to take local busses adjacent to the site on Jeanne D'Arc Boulevard given the unattractive approximate 1.3km walk to Trim LRT Station if no improvements to connectivity are provided.

OC Transpo currently operates local bus route #38 adjacent to the site, with headways of approximately 30 minutes per bus. Considering that buses within the OC Transpo fleet such as the New Flyer D60L with a total capacity of 110 passengers or Alexander Dennis Enviro 500 with approximately 100 passengers, then the 380 to 425 anticipated trips per hour from the site would not be able to be accommodated within the current bus schedule. If Scenario 1 comes to fruition, then OC Transpo and the site would have to closely monitor bus occupancy to determine how much more capacity is required fronting the site.

Scenario 2 (TOD) mode shares project approximately 700 to 785 two-way transit trips for the AM and PM peak hours respectively. Although this reflects a large increase in transit trips from the site, Scenario 2 does offer far more convenient connection to the Trim LRT Station, with all buildings having a walking distance to the station between 450 to 850m, considered a very reasonable walking distance for most abled people. In fact, the highest density buildings are proposed on the southeast quadrant of the site, closest to the LRT Station. The OC Transpo website suggests that the Confederation Line will have a capacity of 600 passengers per train with a headway of 12 trains per hour, resulting in a capacity of 7,200 passengers per hour per direction. It is important to note that of the forecasted trips, some will be headed towards Trim Station while others will be departing this station. Based on the projected capacity of the Confederation Line, there should be sufficient capacity to accommodate all transit trips within Scenario 2. Additional capacity is available on local route #38 and other buses operating out of Trim Station.

4.7.2. TRANSIT PRIORITY

Jeanne D'Arc Boulevard is not part of a transit priority corridor. The intersections from the site to Jeanne D'Arc Boulevard are anticipated to be stop controlled on the site access and free-flow on Jeanne D'Arc Boulevard, thus not significantly affecting bus travel times.

The Confederation LRT Line is grade separated from all intersections and will not be affected by vehicular traffic generated by the site.

4.8. Review of Network Concept

The proposed site is currently zoned as DR (developmental reserve) which allow buildings up to 3-storeys or 11m high. All buildings will exceed 3-storeys high, and given the densities proposed, the development will exceed 200 peak hour person trips more than the equivalent volume permitted by the established zoning.

Although there will be an increase in people trips by the new development, far exceeding the current established zoning, it does fit within the Orléans Corridor Secondary Plan and New Official Plan guidelines. Within the New Official Plan for the City of Ottawa, the site is located in a Protected Major Transit Station Area (PMTSA), and within the Orléans Corridor Secondary Plan, the eastern half of the site is located within a Station Core Zone, which have targets for providing high density near these major transit hubs.

In addition, within the Orléans Corridor Secondary Plan, the eastern half of the site has been denoted as a zone allowing 40-storey high buildings, and the western half with 9-storey buildings allowed, as seen in **Figure 25** (and provided in high definition in **Appendix D**). The latest site concept for this development as shown in **Figure 2** proposes buildings with maximum heights consistent with the secondary plan.

Figure 25: Orléans Corridor Secondary Plan Maximum Building Heights

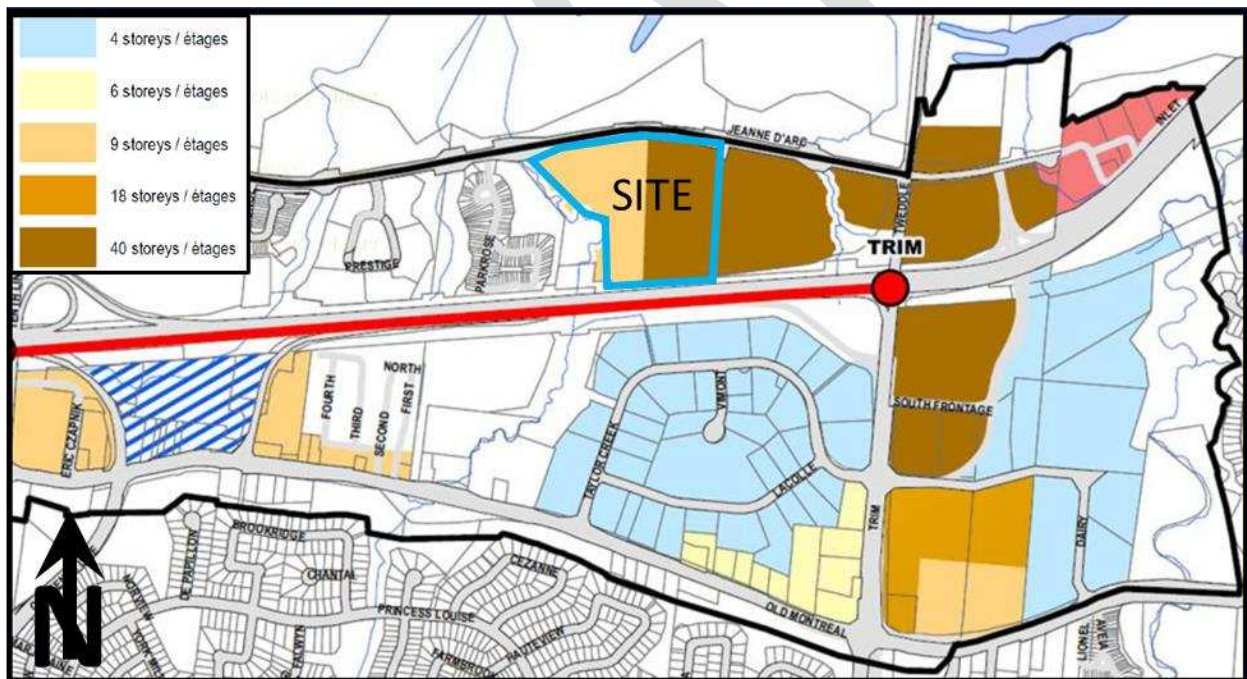

Given the site's context, if a MUP and bridge connection from the site to the future Trim LRT Station via the north side of H174 is built, achieving a walking distance of 450 to 850m to high quality rapid transit facilities, then the scale of this development is considered adequate and aligns with City of Ottawa's long term planning vision.

4.9. Intersection Design

4.9.1. INTERSECTION CONTROL

A traffic signal warrant for the more conservative Scenario 1 at the three site intersections was completed and the need for traffic signals at any of the site accesses was not warranted. A further analysis determined that even if all in and out vehicle traffic from the site was combined into a single access, the need for traffic signals would approach the warrant, but still not be fully warranted.

Similarly, an all-way-stop-control (AWSC) warrant was performed at all site access intersections. Due to the directional splits, the east site access intersection could qualify as an AWSC intersection if Scenario 1 was implemented. The central access is also very close to meeting the AWSC warrant at 97% of warrant met. Scenario 2 on the other hand did not meet any of the AWSC warrant. **Section 4.9.3.** will assume that all study area intersections will be kept as unsignalized intersections with stop control on the southern leg. If intersection operations are subpar, or the need for a controlled pedestrian crossing of Jeanne D'Arc Boulevard is deemed necessary to access westbound transit stop for example, then consideration for AWSC or signalized intersection will be further explored.

It's recommended that each individual Site Plan Application reassess the need for a revised intersection control. All warrant analysis has been provided in **Appendix J.**

4.9.2. INTERSECTION DESIGN

The internal roads have been designed to City's standards for local roads and a 30km/h residential street. Auxiliary left-turn lane warrants were reviewed using the Geometric Design Guide Part 3 Nomographs, with detailed analysis in **Appendix K.**

- For **Scenario 1** mode shares, the west site access does not require a westbound left-turn, however both central and east site access suggests a 15m storage lane be provided.
- For **Scenario 2** mode shares, none of the three accesses suggest the need for an auxiliary lane.

There may be consideration for a right-turn storage/deceleration lane, particularly at the central access which forecasts approximately 150 right-turns during the PM peak hour. However, the site context and low through volumes may negate the need for this storage lane. Further review for the need of right-turn lanes is recommended during Site Plan Application.

The upcoming analysis will assume no auxiliary right-turn or left-turn lanes will be provided, resulting in a more conservative analysis. The outcome of the intersection capacity results in this study (**Section 4.9.3**) will confirm the auxiliary lane requirements.

Potential implications related to future driveways to the subject site and site access to Jeanne D'Arc Boulevard (such as truck movements) will be reviewed during the Site Plan Control application for each individual phase of development.

Multi-Modal Level of Service

Only signalized intersections are considered for the intersection Level of Service measures in the MMLoS Guidelines. The MMLoS analysis is summarized in **Table 19**, with detailed analyses provided in **Appendix L.**

Table 19: MMLoS – Existing and Future Intersection Conditions

Intersection	Level of Service							
	Pedestrian		Bicycle		Transit		Truck	
	pLoS	Target	bLoS	Target	tLoS	Target	TkLoS	Target
Trim/H174	F	A	D	C	F	N/A	A	D
Tenth Line/St. Joseph	F	C	F	C	F	N/A	A	D
Old Tenth Line/St. Joseph	F	C	E	C	-	N/A	A	D

Pedestrian

- No signalized intersection within the study area met the desirable pedestrian target. All intersections had a pLoS of 'F' predominantly based on the number of lanes that would need to be crossed for pedestrians (note that the number of lanes was determined from dividing the crossing distance by 3.5m and not by actual visible lanes). No mitigation would lower the pLoS to a level close to the desired MMLOS target without significantly reducing the vehicle capacity.

Bicycle

- No intersection met the bicycle minimum desirable target of bLoS 'C'. All intersections had at least one approach using mixed cycling facilities. If cycling facilities were provided at all intersection legs, including reducing the length of right-turning vehicle space to pocket bike lane conflict zone and left-turn treatments provided, then the bLoS target would be met.

Transit

- No intersection had transit priority corridors or measures, and as such, no tLoS minimum desirable target has been set.

Truck

- The truck TkLoS minimum desirable target was met at all study area intersections.

4.9.3. INTERSECTION PERFORMANCE

Existing Conditions

The following **Table 20** provides a summary of the existing traffic operations at the study area intersection based on volumes from **Figure 8** and Synchro (V11) traffic analysis software. The subject intersections were assessed in terms of the volume-to-capacity (v/c) ratio and the corresponding Level of Service (LoS) for the critical movement(s). The Synchro model outputs of existing conditions are provided within **Appendix M**.

Table 20: Existing Intersection Performance

Intersection	Weekday AM Peak (PM Peak)					
	Critical Movement			Intersection		
	LoS	max. v/c or avg. delay (s)	Movement	Delay (s)	LoS	v/c
Signalized Intersections						
Trim/H174	C(A)	0.75(0.59)	NBL(EBL)	40.5(32.5)	B(A)	0.67(0.36)
Tenth Line/St. Joseph	B(C)	0.70(0.79)	NBT(EBR)	35.9(31.1)	B(B)	0.64(0.66)
Old Tenth Line/St. Joseph	A(C)	0.33(0.75)	SBT(SBT)	16.8(20.3)	A(B)	0.31(0.63)
Unsignalized Intersections						
Trim/Jeanne D'Arc	A(A)	8(8)	WB(WB)	8(8)	A(A)	-
Tweddle/Jeanne D'Arc	A(A)	8(8)	WB(WB)	8(8)	A(A)	-
Tenth Line/Jeanne D'Arc	B(B)	10(11)	NB(EB)	9(10)	A(B)	-
Note: Analysis of signalized intersections assumes a PHF of 0.90 and a saturation flow rate of 1800 veh/h/lane.						

As shown in **Table 20**, all the intersections within the subject area are currently operating 'as a whole' at good LoS 'B' or better during the AM and PM peak hours with 'critical movements' at study area intersections currently operating at a good LoS 'C' or better during both peak hours.

Background Conditions

As discussed in **Section 3.2**, a 0% annual growth factor plus layering of other area developments was used to develop the background traffic volumes. **Figure 26** shows the projected background volumes in the network considering approved and proposed developments within the area. The projected operational results are shown in **Table 21**. The detailed Synchro results can be found in **Appendix N**.

Figure 26: Future Background Study Area Intersection Volumes

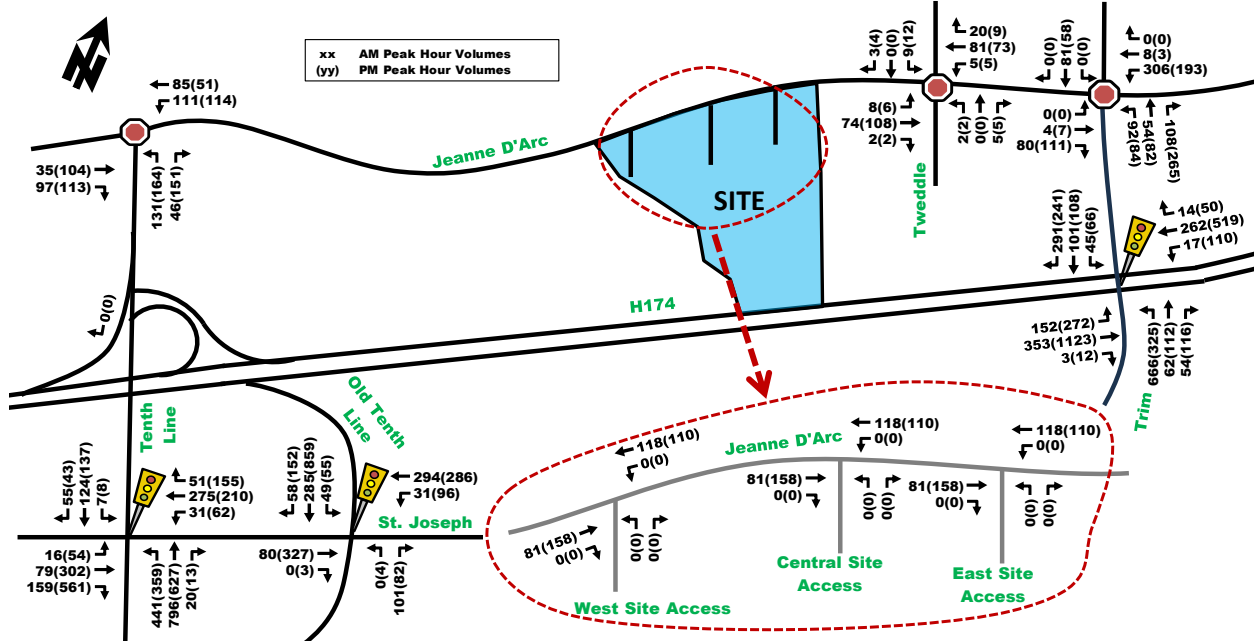

Table 21: Future Background Intersection Performance

Intersection	Weekday AM Peak (PM Peak)					
	Critical Movement			Intersection		
	LoS	max. v/c or avg. delay (s)	Movement	Delay (s)	LoS	v/c
Signalized Intersections						
Trim/H174	C(D)	0.77(0.83)	NBL(EBL)	39.8(40.2)	A(A)	0.58(0.53)
Tenth Line/St. Joseph	B(C)	0.63(0.78)	NBL(EBR)	34.0(30.3)	A(B)	0.51(0.62)
Old Tenth Line/St. Joseph	A(B)	0.30(0.68)	SBT(SBT)	16.5(19.0)	A(A)	0.28(0.57)
Unsignalized Intersections						
Trim/Jeanne D'Arc	B(B)	12(13)	WB(WB)	11(11)	B(B)	-
Tweddle/Jeanne D'Arc	A(A)	8(8)	EB(WB)	8(8)	A(A)	-
Tenth Line/Jeanne D'Arc	B(B)	10(10)	NB(WB)	9(10)	A(B)	-

Note: Analysis of signalized intersections assumes a PHF of 1.00 and a saturation flow rate of 1800 veh/h/lane.

As seen in **Table 21**, most intersections will operate similarly to existing or slightly worse given the increase in background vehicle volumes. All intersections continue to operate overall at good LoS 'B' or better and with critical movements of 'D' or better.

Future Conditions at Full-Buildout Scenario 1 – No Direct Connection to LRT (Non-TOD)

The future full-buildout volumes assuming Scenario 1 mode shares are illustrated in **Figure 27**, which assumes the layering of site generated traffic volumes on to the future network background volumes in the event that a direct link to the future Trim LRT Station is not provided. This scenario relies heavier on vehicular travel than Scenario 2. It is noteworthy that the Orléans Corridor Secondary Plan has a policy that requires Brigid to provide a direct link to Trim LRT Station prior to occupancy of any units at this proposed location. As discussed in **Section 4.1**, both a new MUP on north side of H174 and a bridge to the LRT Station is required to make walking trips from the site to the LRT feasible. Only providing a MUP still requires transit users to walk 1.2kms which exceeds a reasonable walking distance.

The projected traffic volumes are summarized in **Table 22**, with detailed Synchro results provided in **Appendix O**.

Figure 27: Full-Buildout Total Projected Peak Hour Traffic Volumes S1 (Non-TOD)

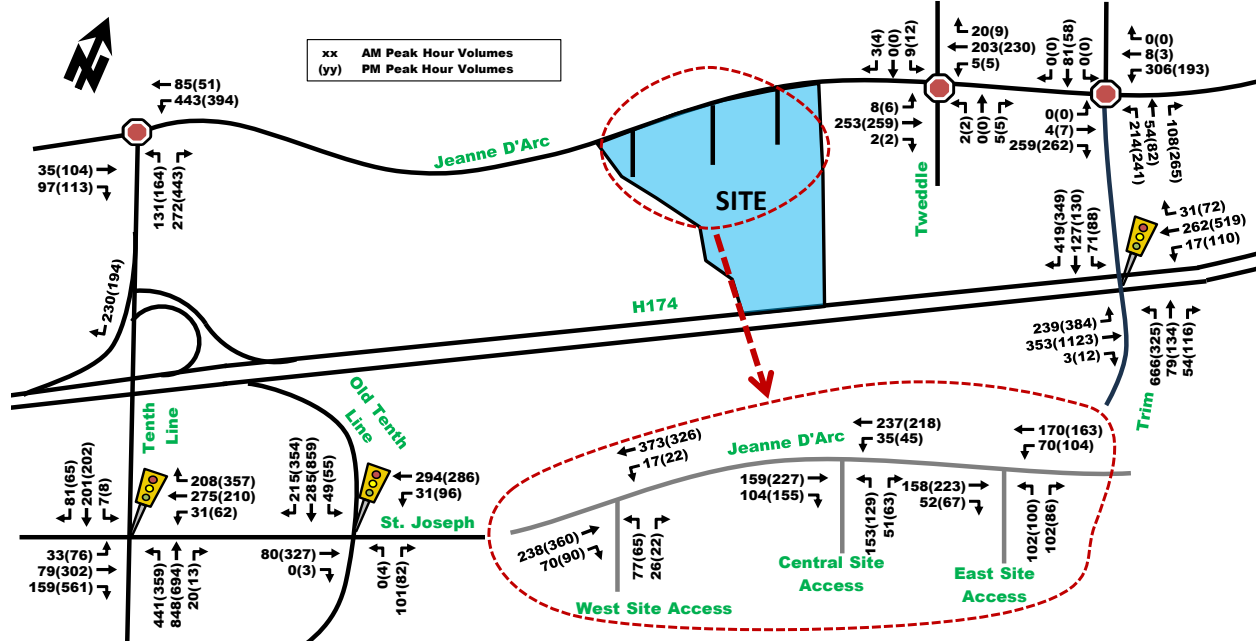

Table 22: Full-Buildout Intersection Performance – S1 (Non-TOD)

Intersection	Weekday AM Peak (PM Peak)					
	Critical Movement			Intersection		
	LoS	max. v/c or avg. delay (s)	Movement	Delay (s)	LoS	v/c
Signalized Intersections						
Trim/H174 ₁	D(E)	0.82(0.97)	EBL(EBL)	41.9(47.6)	B(B)	0.65(0.63)
Tenth Line/St. Joseph	B(C)	0.67(0.78)	NBT(EBR)	33.4(29.7)	B(B)	0.63(0.65)
Old Tenth Line/St. Joseph	A(B)	0.30(0.68)	SBT(SBT)	14.0(17.2)	A(A)	0.28(0.57)
Unsignalized Intersections						
Trim/Jeanne D'Arc	C(D)	17(31)	NB(NB)	14(22)	B(C)	-
Tweddle/Jeanne D'Arc	A(A)	9(9)	EB(WB)	9(9)	A(A)	-
Tenth Line/Jeanne D'Arc	D(D)	26(29)	NB(WB)	19(22)	C(C)	-
West Access/Jeanne D'Arc	C(C)	16(17)	NB(NB)	2(2)	A(A)	-
Central Access/Jeanne D'Arc	C(C)	17(19)	NB(NB)	5(5)	A(A)	-
East Access/Jeanne D'Arc	C(C)	16(19)	NB(NB)	6(6)	A(A)	-

Note: Analysis of signalized intersections assumes a PHF of 1.00 and a saturation flow rate of 1800 veh/h/lane. 1. Signal timing was optimized to improve intersection operations.

In the event that no direct connection between the site and the future Trim LRT Station is provided, forcing transit users to walk 1.3kms to the LRT station versus 450 to 850m to the station, then a higher reliance on personal vehicles is anticipated. This increase in vehicular volumes from the site plus other area developments creates a deterioration in intersection performance as shown in **Table 22**. Trim/H174 has the eastbound left-turn movement approaching capacity at 0.97 v/c. If conditions were to become more congested, there is ample capacity at Tenth Line/St. Joseph and Old Tenth Line/St. Joseph intersections, allowing for vehicles to adjust their route and shift some vehicles from the Trim Road access to the Tenth Line Road access.

The site accesses are anticipated to operate well. **Section 4.9.4** will examine the effects on queues at sensitive intersections such as Trim/Jeanne D'Arc.

Future Conditions at Full-Buildout Scenario 2 – Direct Connection to LRT (TOD)

The future full-buildout volumes assuming Scenario 2 mode shares are illustrated in **Figure 28**, which assumes the layering of site generated traffic volumes on to the future network background volumes in the event that a direct link to the future Trim LRT Station is provided, shortening the distance from the development to high quality LRT transit from 1.3kms to 450-850m walk. Scenario 2 reflects an outcome based on policies/initiatives by the City of Ottawa and Orléans Corridor Secondary Plan requiring Brigid to provide a direct link to Trim LRT Station prior to occupancy of any units at this proposed location.

The projected traffic volumes are summarized in **Table 23**, with detailed Synchro results provided in **Appendix P**.

Figure 28: Full-Buildout Total Projected Peak Hour Traffic Volumes S2 (TOD)

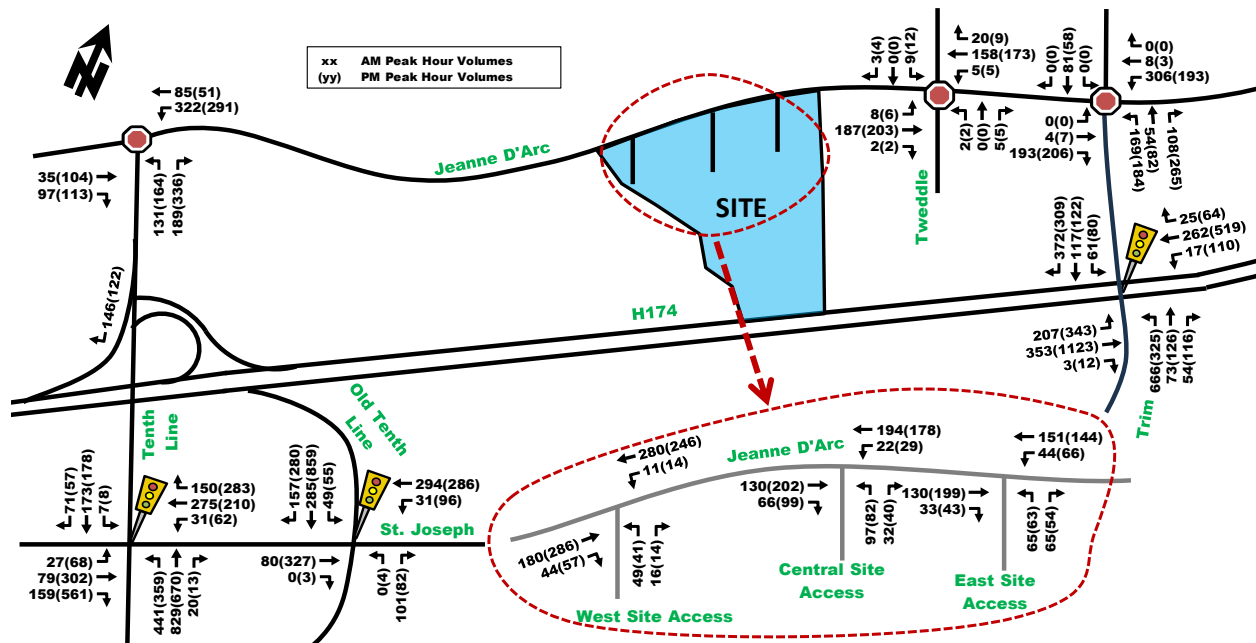

Table 23: Full-Buildout Intersection Performance – S2 (TOD)

Intersection	Weekday AM Peak (PM Peak)					
	Critical Movement			Intersection		
	LoS	max. v/c or avg. delay (s)	Movement	Delay (s)	LoS	v/c
Signalized Intersections						
Trim/H174 ₁	C(E)	0.80(0.96)	EBL(EBL)	41.6(47.0)	B(A)	0.64(0.59)
Tenth Line/St. Joseph	B(C)	0.66(0.78)	NBT(EBR)	33.6(29.9)	A(B)	0.60(0.64)
Old Tenth Line/St. Joseph	A(B)	0.30(0.68)	SBT(SBT)	14.8(17.8)	A(A)	0.28(0.57)
Unsignalized Intersections						
Trim/Jeanne D'Arc	B(C)	14(20)	WB(NB)	13(16)	B(C)	-
Tweddle/Jeanne D'Arc	A(A)	8(9)	EB(WB)	8(8)	A(A)	-
Tenth Line/Jeanne D'Arc	C(C)	15(16)	NB(WB)	12(14)	B(B)	-
West Access/Jeanne D'Arc	B(B)	12(13)	NB(NB)	2(1)	A(A)	-
Central Access/Jeanne D'Arc	B(B)	13(14)	NB(NB)	3(3)	A(A)	-
East Access/Jeanne D'Arc	B(B)	13(14)	NB(NB)	4(4)	A(A)	-

Note: Analysis of signalized intersections assumes a PHF of 1.00 and a saturation flow rate of 1800 veh/h/lane. 1. Signal timing was optimized to improve intersection operations.

As shown in **Table 23**, all intersections will operate at good LoS 'C' or better and with critical movements of acceptable 'C' or better with the exception of Trim/H174 which has the eastbound left-turn movement approaching capacity. The intersection performance for scenario 2 mode shares, assuming a higher transit-oriented development with a MUP and bridge connectivity to the future Trim LRT Station (within 450 to 850m walking distance), operates similarly to background conditions with the exception of the Trim/H174 eastbound left-turn movement only. As a whole, the Trim/H174 intersection operates similarly to background conditions.

Overall, in terms of intersection capacity, all intersections are anticipated to operate within city standards. The section below will analyze queueing implications, if any.

4.9.4. QUEUEING ANALYSIS

The following **Table 24** summarizes queueing results based on Synchro and SimTraffic software for various intersection locations were deemed sensitive or at risk of queue spillback on to downstream intersection. Scenario 1 was used for all analysis as it is more conservative than Scenario 2.

Table 24: Queueing Analysis for Scenario 1 at Sensitive Locations

Movement & Location	Storage Length + Taper	Queue AM (PM) (in meters)			
		Synchro ¹		SimTraffic	
		50 th Percentile	95 th Percentile	50 th Percentile	95 th Percentile
EBL Trim/H174	175 + 25 m	59 (116)	#101 (#177)	54 (169)	89 (215)
EB Trim/Jeanne D'Arc	160 m	-	-	25 (19)	50 (33)
NB Trim/Jeanne D'Arc	150 m	-	-	46 (63)	81 (105)
WBL Site Access (crit.)	-	-	-	5 (8)	15 (19)
NB Site Access (crit.)	-	-	-	15 (15)	26 (27)

1. Synchro queues were only used for signalized intersections.

As seen in **Table 24**, all queues are within their storage capacity except for Trim/H174 eastbound left-turn which is forecasted to spill on to H174 under current assumptions for Scenario 1 during the PM peak hour.

A further sensitivity was completed for the Trim/H174 eastbound left-turn during the PM peak hours only, as shown in **Table 25**. Detailed SimTraffic outputs have been provided in **Appendix Q**.

Table 25: Queueing Analysis Sensitivity for Trim/H174 EBL

EBL at Trim/H174 Scenario	Storage Length + Taper	Queue AM (PM) (in meters)			
		Synchro ¹		SimTraffic	
		50 th Percentile	95 th Percentile	50 th Percentile	95 th Percentile
Background (PM)	175 + 25 m	(66)	(#118)	(59)	(90)
Scenario 2 (PM)		(94)	(#153)	(141)	(214)
Scenario 1 Dual EBL (PM)		(49)	(63)	(70)	(108)

Scenario 1 adds approximately 112 left-turning vehicles and Scenario 2 adds approximately 71 left-turning vehicles to PM background volumes for the eastbound movement at Trim/H174. These added eastbound left-turning vehicles equate to approximately 29% and 21% of new left-turning vehicles respectively. Although not a significantly large proportion of new volumes added to this movement at this intersection, it does increase the left-turning volume to above 300 vehicles per hour, which begins to approach the point of maximum capacity for a single left-turn lane. As shown in **Table 25**, adding a second eastbound left-turn lane results in adequate capacity and queueing storage room.

However, the addition of a new eastbound left-turn lane is expected to trigger significant retrofits to the recently constructed intersection resulting in large cost implications. For these reasons, it is recommended that adding a second eastbound left-turn lane be considered a 'last resort'.

A 'do nothing' approach should be considered in the short-term. **Table 25** demonstrated that a minor increase in left-turning vehicles of just 71 more vehicles in the PM peak hour (approximately 1 more vehicle per minute)

resulted in more than doubling of the forecasted queues and the difference between ample storage capacity to queueing capacity exceeded.

Firstly, there is a measure of redundancy in the road network. If frequent queues and delays form at the eastbound left-turn at Trim/H174, commuters coming from the west may adapt their route and more likely use Tenth Line Rd as an alternative route, thus reducing stress at Trim/H174. The Tenth Line Rd route offers similar travel times based on Google Maps and has available capacity based on results shown in **Section 4.9.3**. A sensitivity test detouring all eastbound left-turners from Trim/H174 via Tenth Line Rd using the most critical Scenario 1 PM volumes confirmed that the Tenth Line corridor had sufficient capacity both in Synchro intersection performance and SimTraffic queueing analysis.

Secondly, as previously discussed in **Section 3.3 Demand Rationalization**, it could be argued that the Scenario 1 background growth and trip generation assumptions may be overly conservative, especially considering the investments by the City of Ottawa to the surrounding transit and active transportation networks, including the Stage 2 extension and the future Trim LRT Station. Flexible working schedules stemming from the Covid-19 pandemic may also result in sustained decreases in vehicle background volumes in the fullness of time. These trends will take time to mature as Stage 2 construction concludes. While significant development in surrounding community was forecasted in this TIA, the specific timing is ultimately uncertain and largely dependent on market forces, which may ebb and flow over time. For these reasons, re-evaluation of the Trim/H174 intersection should be completed as part of future Site Plan Control applications for individual phases to verify the results herein. If capacity and queuing projections continue to show significant stress approaching the buildout horizon in this TIA, the city may then consider the viability of the 'last resort' option: adding an additional eastbound left-turn lane.

Finally, the sensitivity of this intersection to minor fluctuations in vehicle traffic further validates the importance of the city's continued investment in a highly connected network of infrastructure conducive to transit-oriented developments. The construction of the proposed pedestrian bridge from the north side of H174 to the Trim LRT Station will further leverage the new LRT Station and further strengthen connectivity for all developments in the area, including adjacent developments. These efforts would give transit the utmost opportunity to thrive and reduce the need of further costly road network modifications.

5. Findings and Recommendations

Based on the results summarized herein the following findings and recommendations are provided:

Existing Conditions

- The site is currently a vacant field.
- Local bus route #38 operates adjacent to the site. Trim Station which is located generally within 600m radius from the site is currently under construction as part of the Confederation LRT Line Expansion, anticipated to be operational by year 2025. Currently, there is no planned direct access from the completed Trim LRT Station to the north side of H174. To access the future station from the proposed site under current conditions, transit users would have to walk to at-grade Trim/H174 intersection and backtrack to the station, resulting in approximately 1.3km walk.
- Tenth Line/St. Joseph exhibited a higher-than-average quantity of collisions, likely due to a sight line issue caused by grades and heavy volumes. The City of Ottawa could consider an advanced "prepare to stop" flashing beacon upstream to warn drivers of upcoming red lights and likely stopped vehicles. No other intersections or road segments revealed any reoccurring collision pattern of concern.
- All study area intersections currently operate at very good LoS 'B' or better, with critical movements operating at good LoS 'C' or better.

Proposed Development

- Brigid is proposing a mixed-use development consisting of 12 buildings ranging in height from 4 to 40-stories. A total of 3,177 residential units (used 3,200 units for trip generation for a more conservative max potential), approximately 110,000 ft² of office space and 165,000 ft² of commercial retail space is envisioned. The site will likely be built out in four phases, extending past the year 2030 horizon.
- The City of Ottawa's New Transportation Master Plan that is currently being developed highlights a future bridge connection over H174 near to the Trim LRT Station within the "Active Transportation Major Structures" early figures released. Within the Orléans Corridor Secondary Plan, a clause states that a multi-use pathway (MUP) along the north side of H174 from the development to a future new grade-separated crossing to the Trim LRT Station will be required for development approval prior to the occupancy of the first phase.
- Two mode share scenarios were developed to assess the implications if a direct pathway connection with a bridge to the Trim LRT Station is or is not achieved. Without this connection, it would not be realistic to assume transit-oriented development (TOD) mode shares.
 - Scenario 1 (non-TOD): mode shares similar to TRANS for Orléans, assuming existing conditions with no direct connectivity to the future Trim LRT Station resulting in approximately 1.3km walk to LRT Station. Note that if only the MUP on the north side of H174 was built without a bridge over H174 to the Trim LRT Station, it would still result in approximately 1.2km walk, considered non-transit-oriented or non-walking inductive to rapid transit.
 - Scenario 2 (TOD): transit-oriented development, with future MUP and pedestrian bridge connecting the north side of H174 to the future Trim LRT Station resulting in approximately 450 to 850m walk.
- Scenario 1 forecasts approximately 855 to 880 'new' two-way vehicle trips, 380 to 425 'new' two-way transit trips and 185 to 300 'new' two-way active trips.
- Scenario 2 forecasts approximately 545 to 555 'new' two-way vehicle trips, 700 to 785 'new' two-way transit trips and 185 to 300 'new' two-way active trips.
- The proposed development includes a new local public street (Road B) and a new local private street (Road A). The public street has been proposed designed according to the recent City of Ottawa 20m ROW local road cross section including 2m wide sidewalks on both sides. The private road is still being refined but is expected to function as a private laneway catered to active transportation users, with limited access to delivery trucks and residential access. A future connection to Centre des Métiers Minto (Road C) has been identified, but this connection is currently conceptual, and the road user type has yet to be identified.

The site roads are proposed as a 30km/h residential street, based on the corresponding City of Ottawa toolbox, which includes speed humps and periodic bulbouts with parking on one side. With three access intersections to Jeanne D'Arc Boulevard to spread site generated traffic, and no connection to any other road eliminating the risk of cut through or infiltrated traffic, the designation as local streets is appropriate.

- TDM measures are highly encouraged for the site, including but not limited to preloaded Presto cards for new tenants, TDM coordinator, unbundled car parking from monthly rent, shared commercial/residential visitor parking provisions, providing bike share and car share facilities, etc. TDM measures will be confirmed in each Site Plan Application.

Future Conditions

- Peak hour traffic volumes from nearby adjacent developments were incorporated into the future traffic volume projections. No additional background volume growth was applied.

- The MMLOS road segment analysis showed that none of the pedestrian target level of service were met due to lack of sidewalk facilities, lack of boulevard separation and posted speeds of 60km/h being too high. The bicycle BLoS targets were only met for future south side of Jeanne D'Arc Boulevard, adjacent to the development. The existing facilities could meet the target goal if Jeanne D'Arc Boulevard's operating speed was lowered to 50km/h, confirmed by a speed survey. There were no transit or truck targets for road segments.
- The MMLOS intersection (for signalized intersections only) analysis showed that only truck target goals were met. There were no transit targets set as no intersection was within a transit priority corridor.

Bicycle intersection targets were not met due to lack of cycling facilities, the introduction of pocket bike lanes being too long and exposing cyclists to right-turning vehicle conflict for too long (on St. Joseph) or operating speeds being too high.

The pedestrian targets were not met at any intersection due to the quantity of lanes required to cross.
- Scenario 1 has good overall intersection performance of LoS 'C' or better and acceptable critical movements of LoS 'E'. The eastbound left-turn at Trim/H174 is approaching capacity, however an alternate route into the site coming from the west is available via Tenth Line Road. Tenth Line Road off-ramp offers a similar travel time to the site and currently has ample capacity if commuters were to adopt this route.
- Scenario 2 will operate better than Scenario 1, with good overall LoS 'C' or better and acceptable critical movements of LoS 'E'.
- The eastbound left-turn at Trim/H147 intersection was shown to be sensitive in the PM peak hour to site generated vehicles added compared to background conditions. A relatively small increase in background volumes yielded the difference between ample storage capacity to overflow queueing at this location. There are many factors which could influence the base background volumes as described in **Section 3.3** and could result in lower volumes than forecasted within this report. If the base background volumes were slightly lower than forecasted in this report, then there would be no queueing implications. For this reason, the recommended approach for this intersection is 'do nothing' approach and re-evaluate every time a large new development in the study area is built is.
 - The sensitivity of this movement to minor fluctuations in vehicle traffic further validates the importance of the city's continued investment in a highly connected network of infrastructure conducive to transit-oriented developments. The construction of the proposed pedestrian bridge from the north side of H174 to the Trim LRT Station will further leverage the new LRT Station and further strengthen connectivity for all developments in the area.
 - There is redundancy in the road network. If frequent queues and delays form at Trim/H174, commuters coming from the west may adapt their route and more likely use Tenth Line Rd as an alternative route. Sensitivity testing showed there is sufficient capacity to accommodate all of site generated traffic via the Tenth Line Rd and Jeanne D'Arc Blvd corridor.
 - If none of the above works as a mitigation to queues, a double eastbound left-turn could be considered.
- Active transportation details will become available once a Site Plan Application is filed for each phase of development, however the site is anticipated to provide strong connectivity to the future Trim LRT Station and is anticipated to integrate well into the existing and future proposed cycling and pedestrian infrastructure.

Based on the preceding report, the proposed Brigil Development located at 8600 Jeanne D'Arc Boulevard is recommended from a transportation perspective.

Prepared By:



Juan Lavin, P. Eng.
Transportation Engineer

Reviewed By:



Austin Shih, M.A.Sc., P.Eng.
Senior Transportation Engineer

DRAFT

APPENDIX A

SCREENING FORM

City of Ottawa 2017 TIA Guidelines

Date

8-Jun-23

TIA Screening Form

Project

Petrie's Landing III

Project Number

478566 - 01000

Results of Screening	Yes/No
Development Satisfies the Trip Generation Trigger	Yes
Development Satisfies the Location Trigger	Yes
Development Satisfies the Safety Trigger	No

Module 1.1 - Description of Proposed Development	
Municipal Address	8600 Jeanne D'Arc Boulevard N
Description of location	Vacant land bound by Jeanne D'Arc, Hwy 174, Taylor Creek and Centre des Metiers Minto Desjardins de la Cite
Land Use	Mixed-use, proposing residential, retail, restaurant/bar and office space
Development Size	Proposed approximately 3,177 residential units, 110,000sqft office space, 165,000sqft ground floor commercial spaces
Number of Accesses and Locations	3 proposed, 2 public roads with ROW 20m, 1 private road with ROW
Development Phasing	Multi-phased
Buildout Year	2030+
Sketch Plan / Site Plan	See attached

Module 1.2 - Trip Generation Trigger		
Land Use Type	Townhomes or Apartments	
Development Size	3000	Units
Trip Generation Trigger Met?	Yes	

Module 1.3 - Location Triggers		
Development Proposes a new driveway to a boundary street that is designated as part of the City's Transit Priority, Rapid Transit, or Spine Bicycle Networks (See Sheet 3)	Yes	Jeanne D'Arc is a spine route
Development is in a Design Priority Area (DPA) or Transit-oriented Development (TOD) zone. (See Sheet 3)	Yes	Within 600m of Trim LRT Station
Location Trigger Met?	Yes	

Module 1.4 - Safety Triggers		
Posted Speed Limit on any boundary road	<80	km/h
Horizontal / Vertical Curvature on a boundary street limits sight lines at a proposed driveway	No	
A proposed driveway is within the area of influence of an adjacent traffic signal or roundabout (i.e. within 300 m of intersection in rural conditions, or within 150 m of intersection in urban/ suburban conditions) or within auxiliary lanes of an intersection;	No	
A proposed driveway makes use of an existing median break that serves an existing site	No	
There is a documented history of traffic operations or safety concerns on the boundary streets within 500 m of the development	No	
The development includes a drive-thru facility	No	
Safety Trigger Met?	No	

Concept Plan

1 | Design Principles & Planning Strategy

Petrie's Landing III has potential to create a mixed-use walkable development that introduces commercial and residential areas, open landscape areas, and create a variety of public spaces that foster a community atmosphere. The edges of the site have the opportunity to create frontages along Jeanne-D'Arc Boulevard and activate the streetscape. Within the site itself new blocks and buildings are organized with higher density on the south by the Queensway and transition to mid-rise buildings along Jeanne-D'Arc Boulevard. The massing strives to maximize frontage and create a hierarchy in the site. The towers are arranged to provide generous separations which ensure views and natural light for both the residents of the towers and to allow sun light and airflow to adequately pass through the towers to the public realm. The network of sidewalks and various open spaces and parks encourage pedestrian movement, which generates more commercial activity for new commercial spaces and frontages which connect and attract pedestrians to the new developments within the site.



- Tower Separation Dimensions
- Tower Separation Dimensions
- ⋯ Phasing Line

Public vs. Private Roads

2 | Site Circulation

The site introduces three entrances from Jeanne d'Arc Boulevard. A new public road that loops into the development that the majority of people entering the site will use. Two new private streets will connect the site to the adjacent property to the east in a future scenario. The streets will be designed to enhance the streetscape and contribute to maintaining safety within the development. Parking will be provided below grade and will be publicly accessible.



Site

5 | Massing - Height, Density & Transition

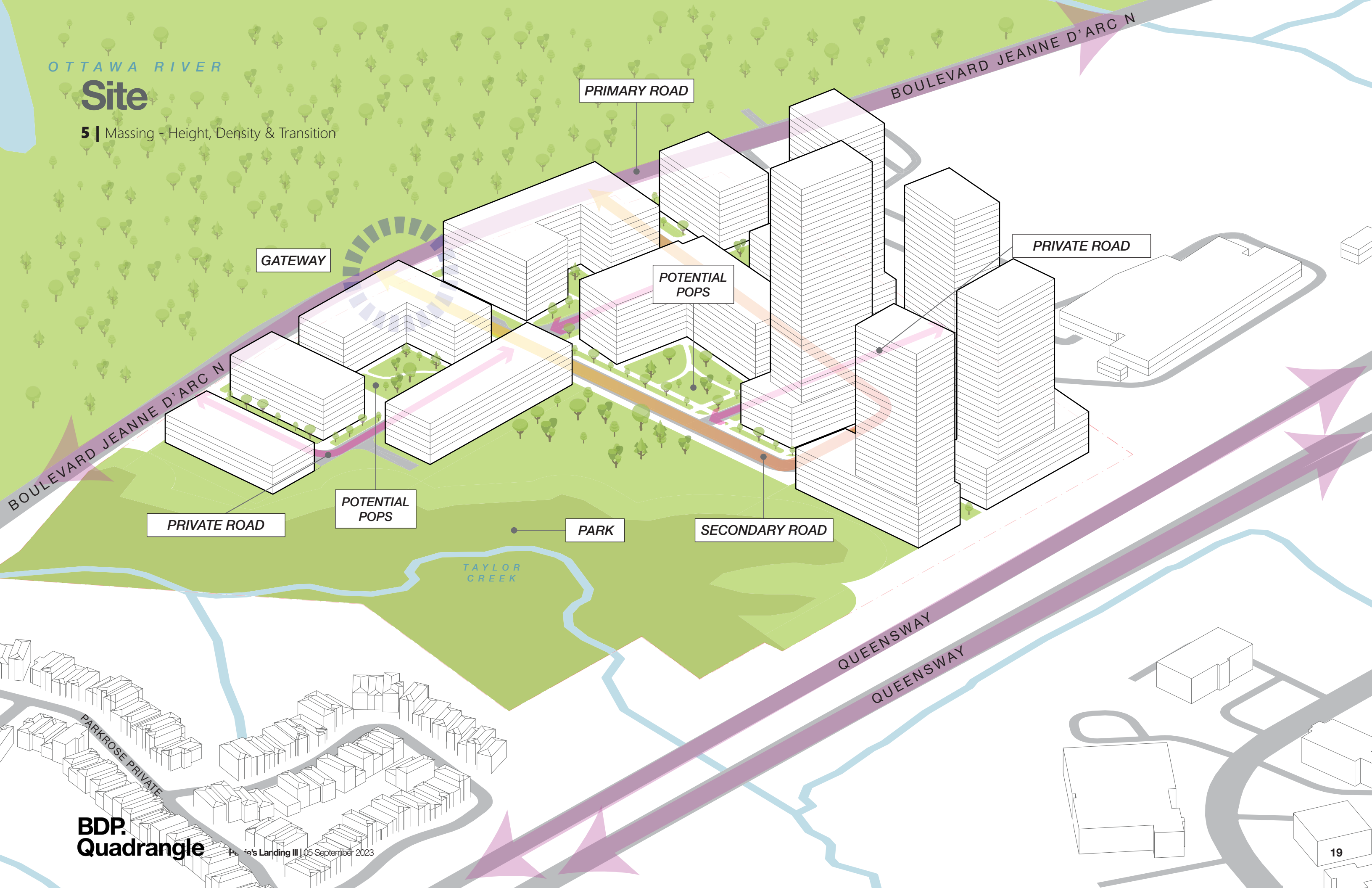

PRIMARY ROAD

BOULEVARD JEANNE D'ARC N

PRIVATE ROAD

GATEWAY

POTENTIAL POPS

BOULEVARD JEANNE D'ARC N

PRIVATE ROAD

POTENTIAL POPS

PARK

SECONDARY ROAD

TAYLOR CREEK

QUEENSWAY

QUEENSWAY

APPENDIX B

TRAFFIC COUNT DATA

Turning Movement Count - Peak Hour Diagram

OLD TENTH LINE RD/OR174 IC101 RAMP63 @ ST. JOS

Survey Date: Thursday, January 25, 2018

Start Time: 07:00

WO No: 37452

Device: Miovision

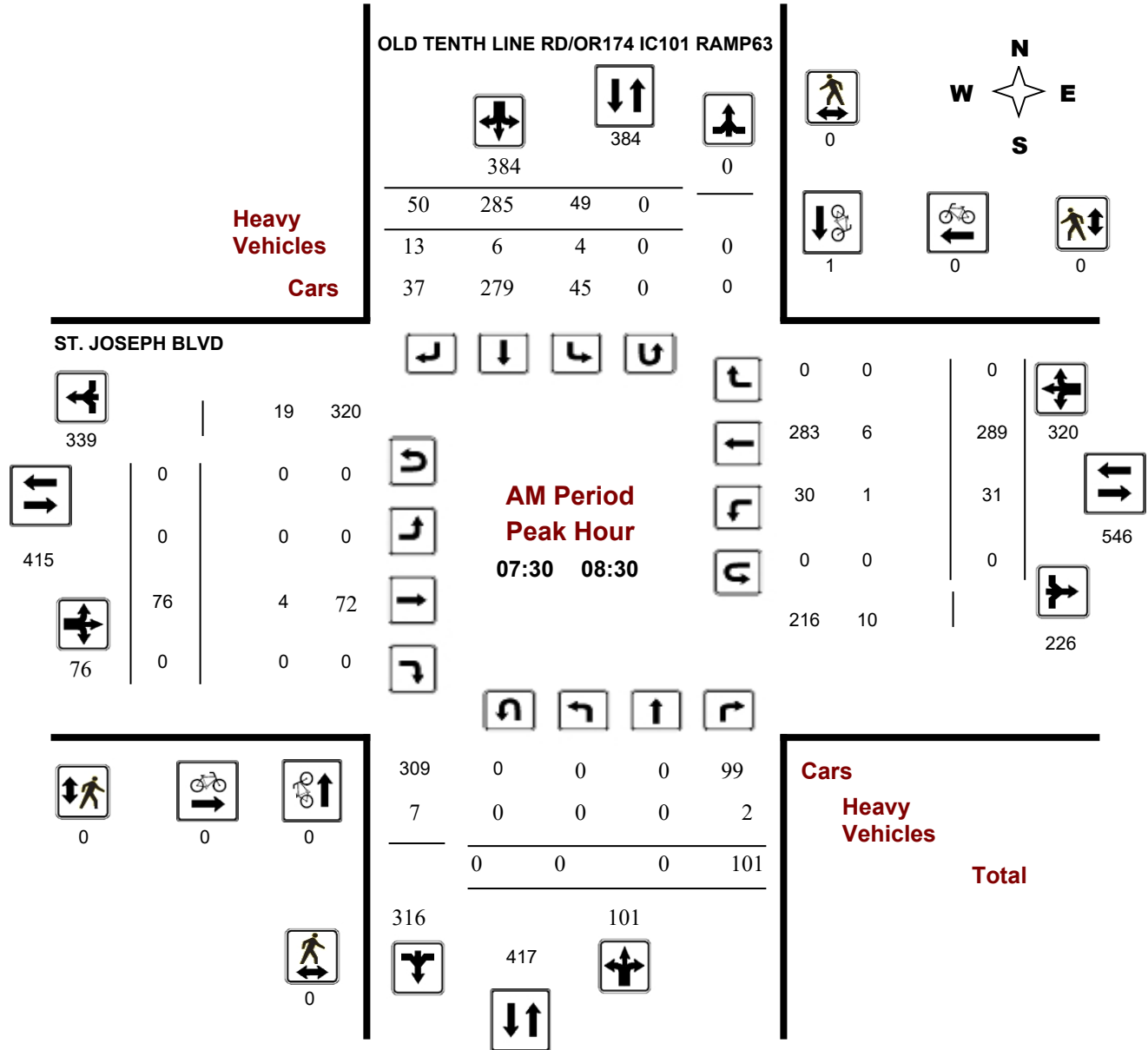

Turning Movement Count - Peak Hour Diagram

OLD TENTH LINE RD/OR174 IC101 RAMP63 @ ST. JOS

Survey Date: Thursday, January 25, 2018

Start Time: 07:00

WO No: 37452

Device: Miovision

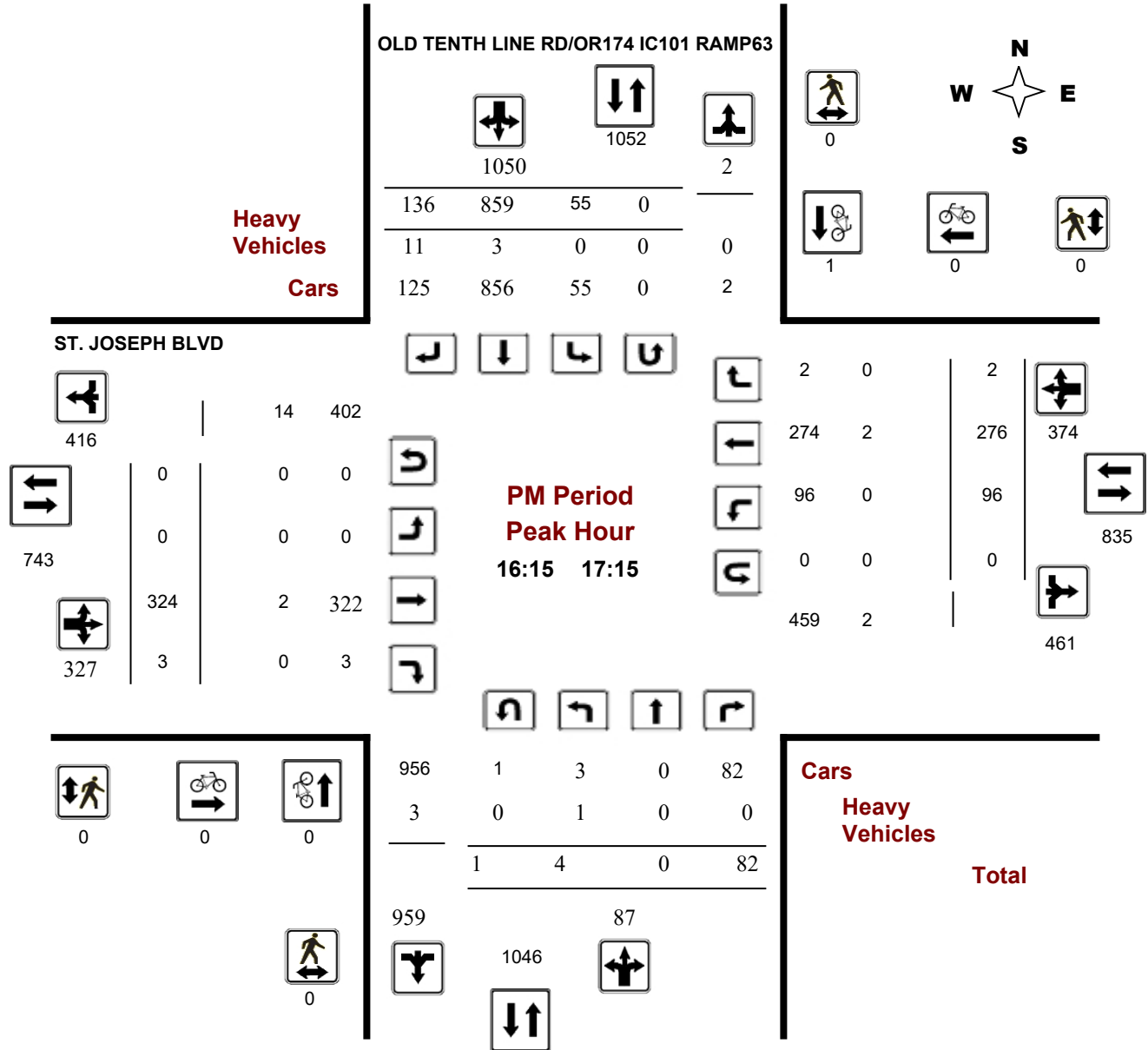

Comments



Transportation Services - Traffic Services

Turning Movement Count - Peak Hour Diagram

REGIONAL RD 174 @ TRIM RD

Survey Date: Tuesday, February 07, 2023

Start Time: 07:00

WO No: 40774

Device: Miovision

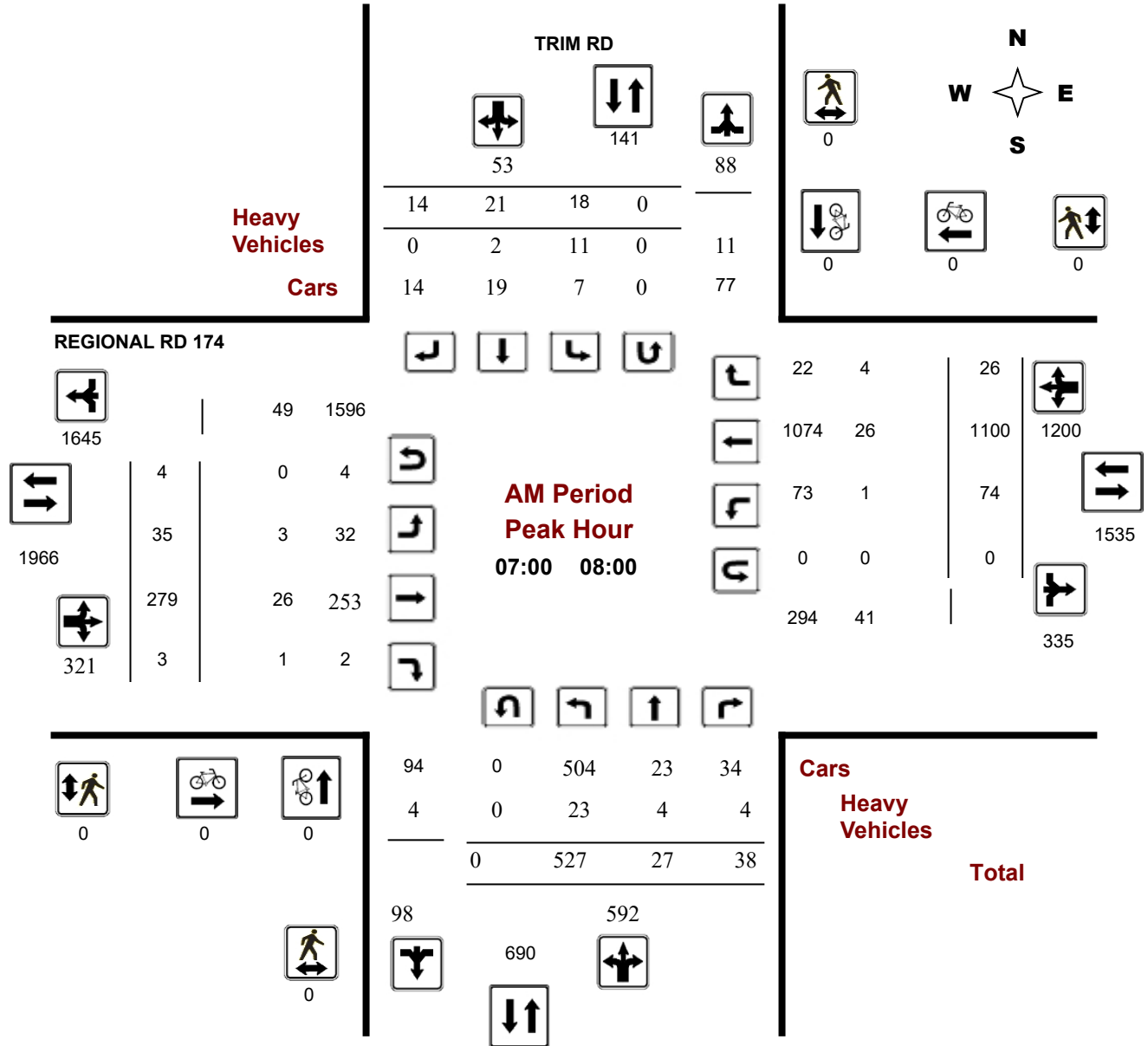



Transportation Services - Traffic Services

Turning Movement Count - Peak Hour Diagram

REGIONAL RD 174 @ TRIM RD

Survey Date: Tuesday, February 07, 2023

Start Time: 07:00

WO No: 40774

Device: Miovision

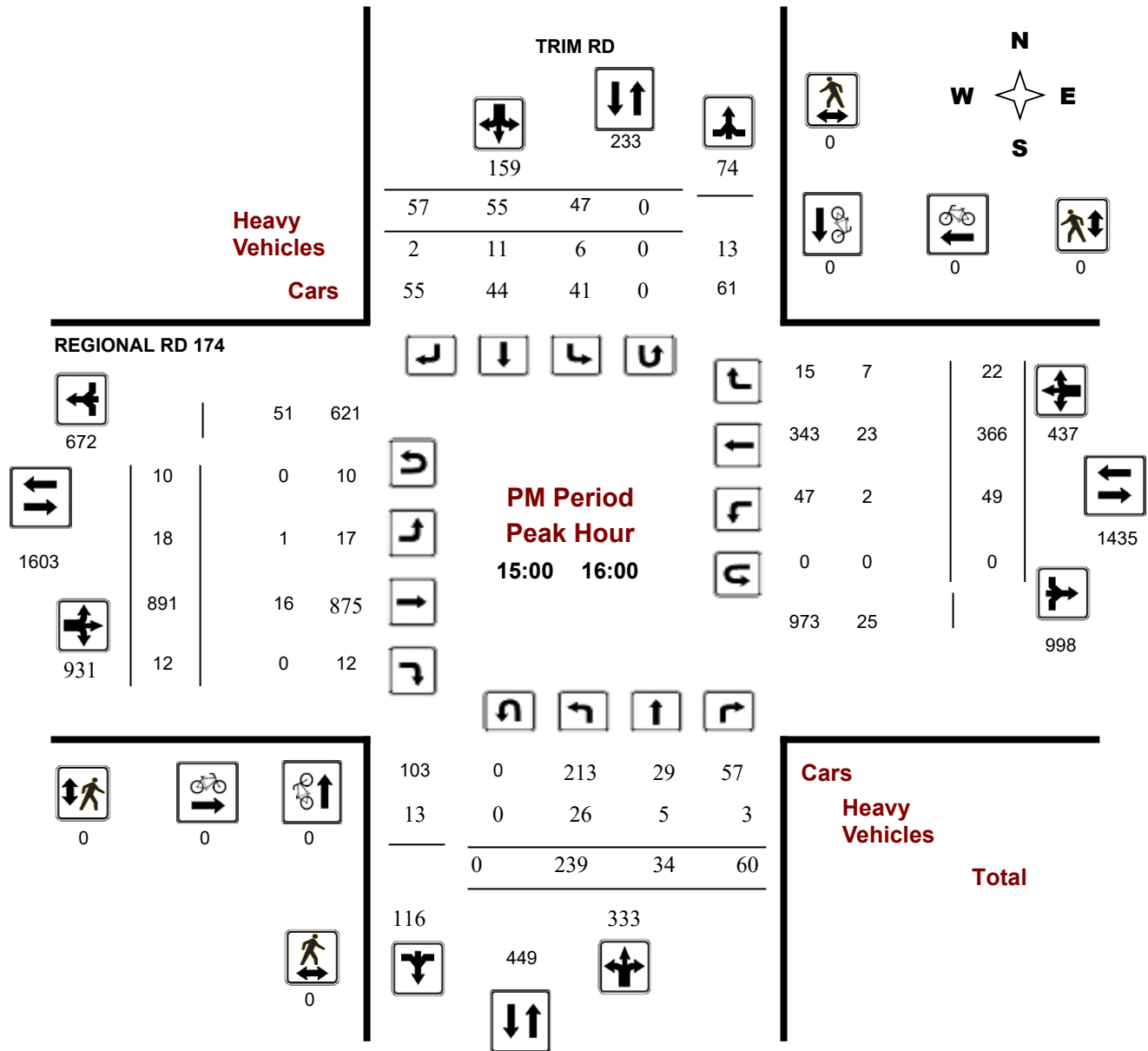



Transportation Services - Traffic Services

Turning Movement Count - Peak Hour Diagram

ST. JOSEPH BLVD @ TENTH LINE RD

Survey Date: Tuesday, March 20, 2018

Start Time: 07:00

WO No: 37613

Device: Miovision

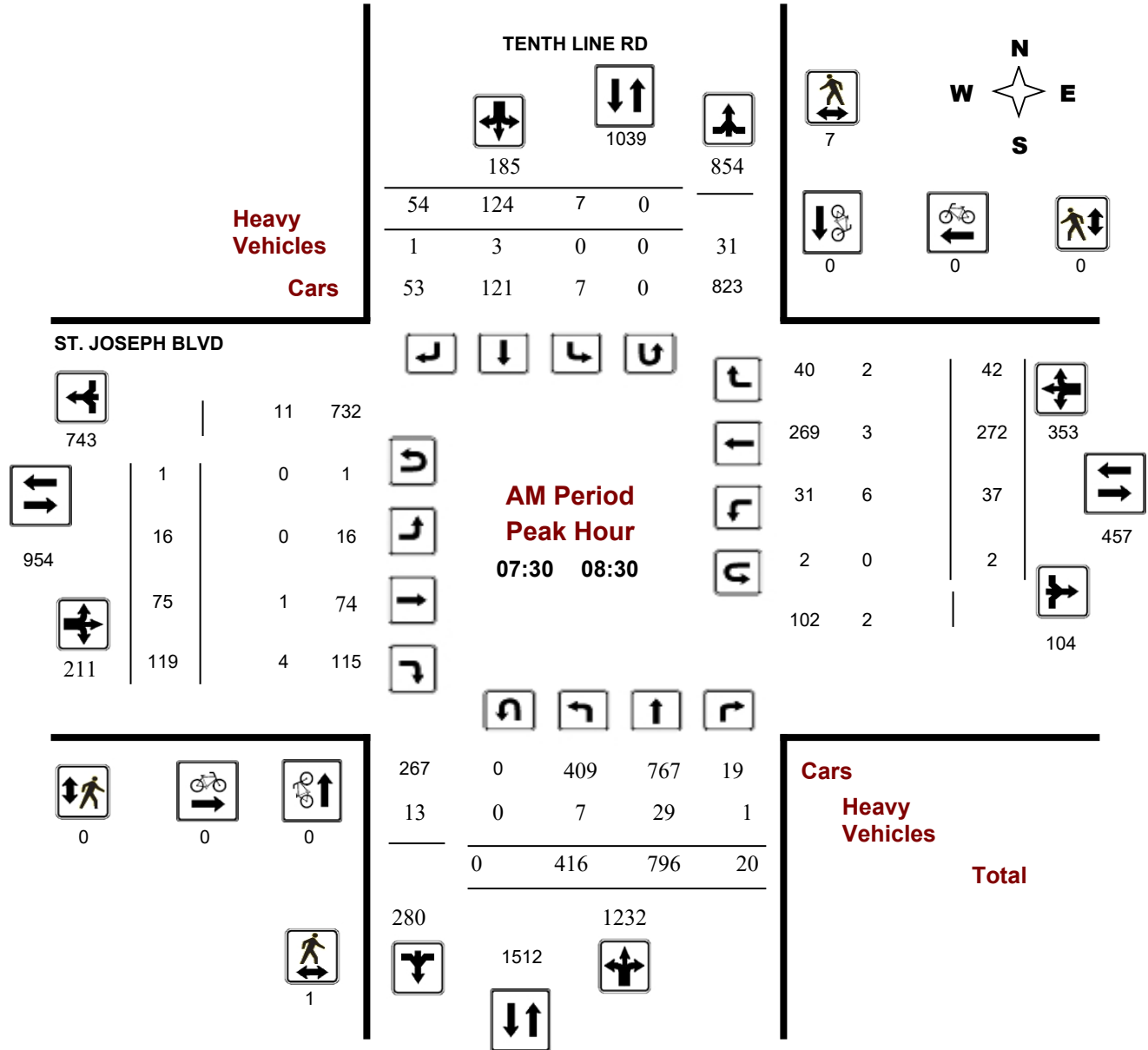

Turning Movement Count - Peak Hour Diagram

ST. JOSEPH BLVD @ TENTH LINE RD

Survey Date: Tuesday, March 20, 2018

Start Time: 07:00

WO No: 37613

Device: Miovision

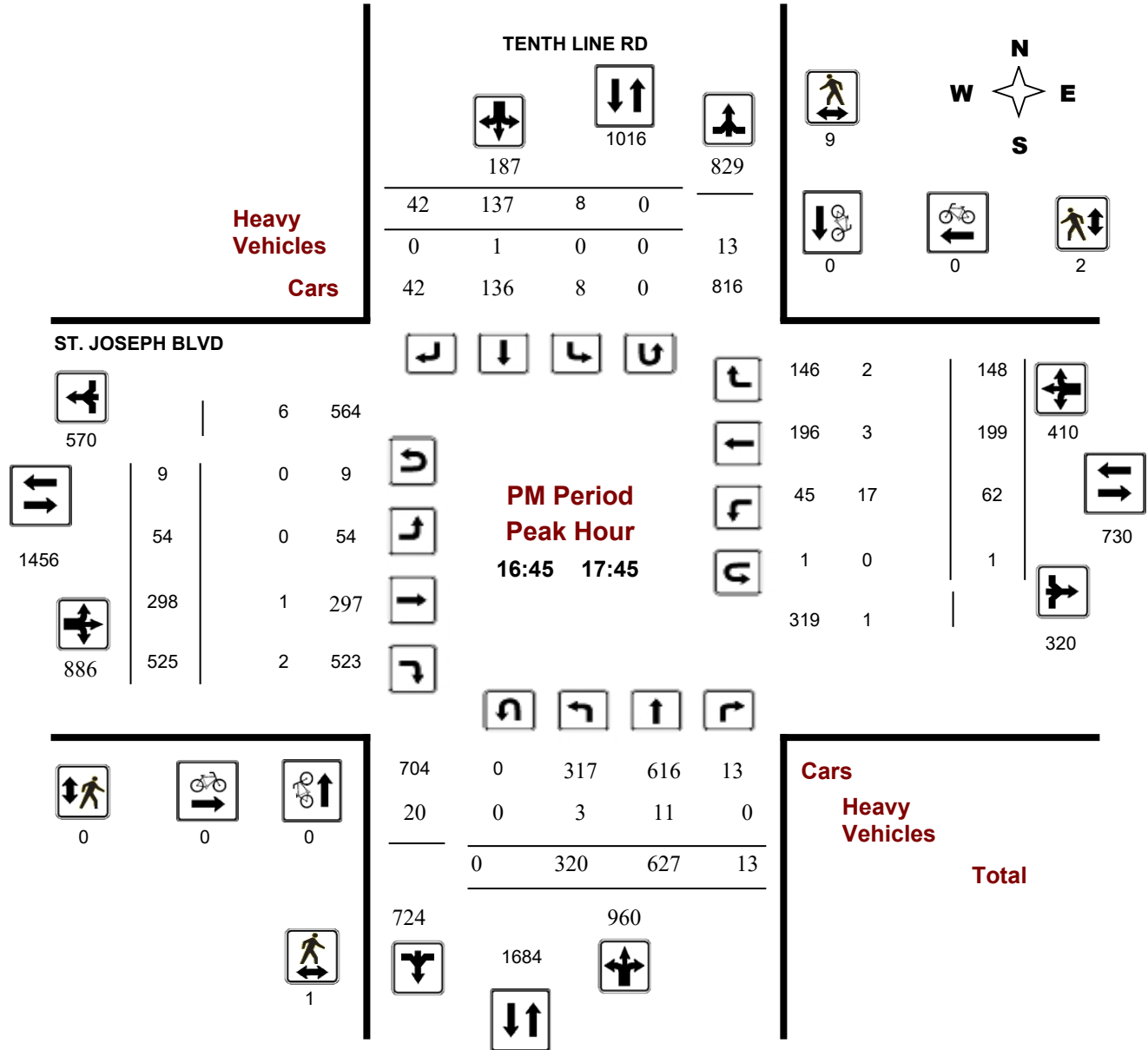

Comments



Turning Movement Count Summary, AM and PM Peak Hour Flow Diagrams

Automobiles, Taxis, Light Trucks, Vans, SUV's, Motorcycles, Heavy Trucks, Buses, and School Buses

Jeanne d'Arc Boulevard North & Trim Road Orléans, ON

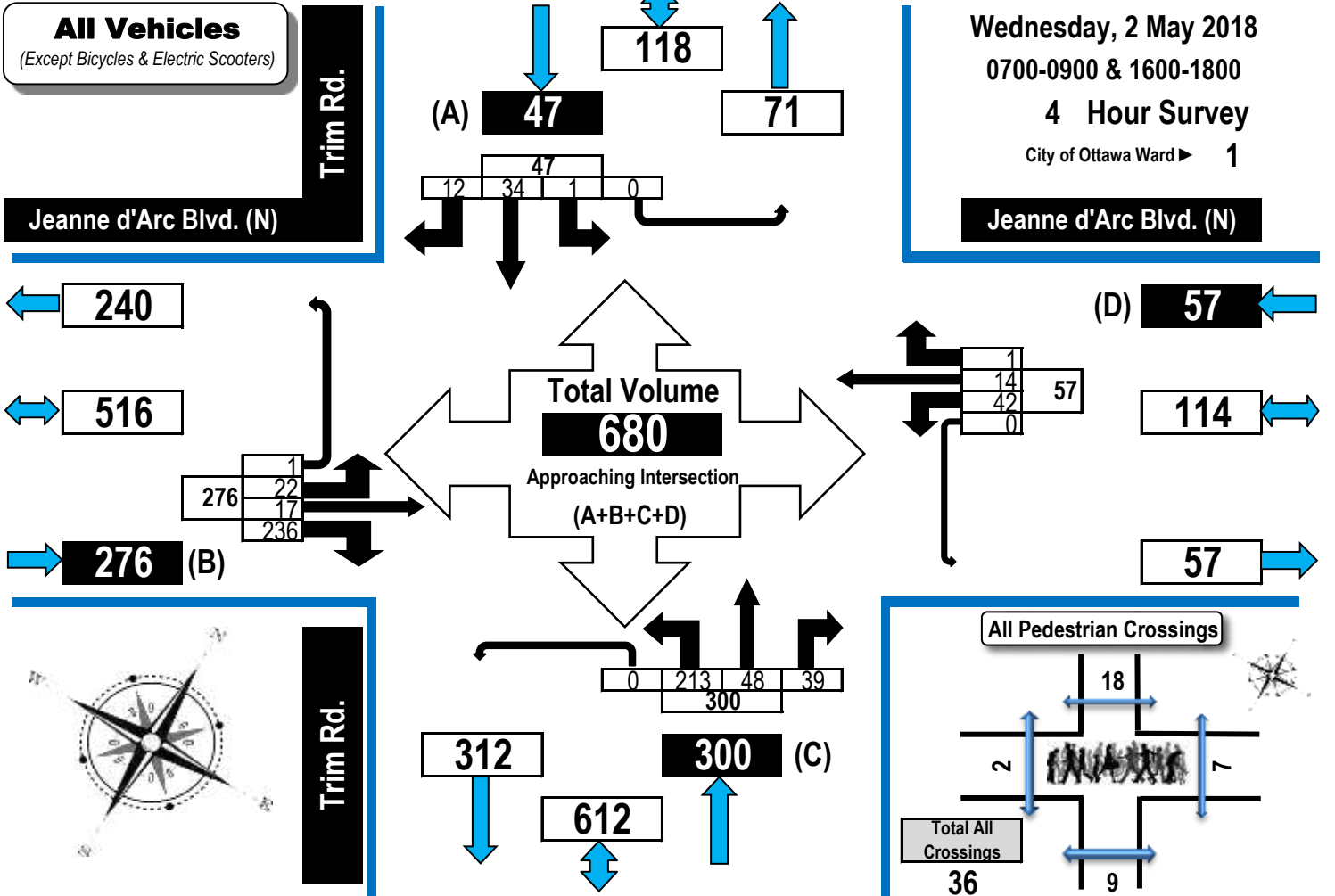

AM Peak Hour Flow Diagram PM Peak Hour Flow Diagram

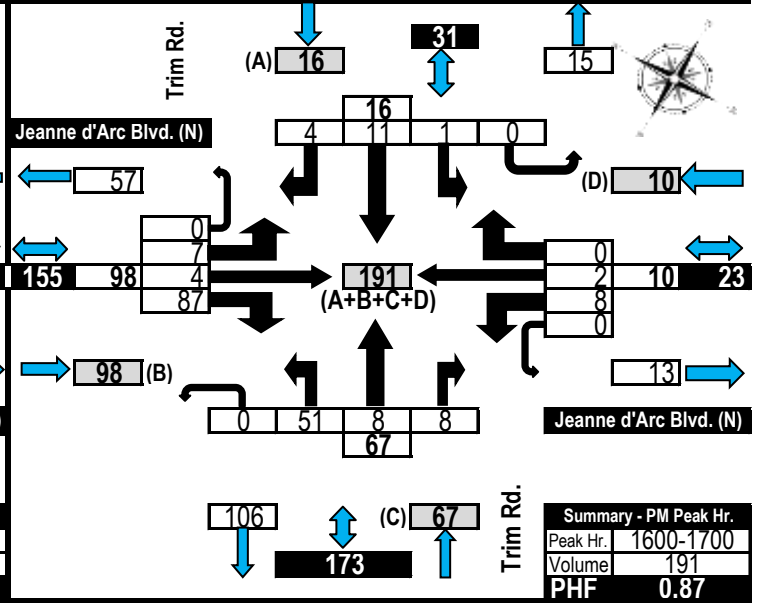
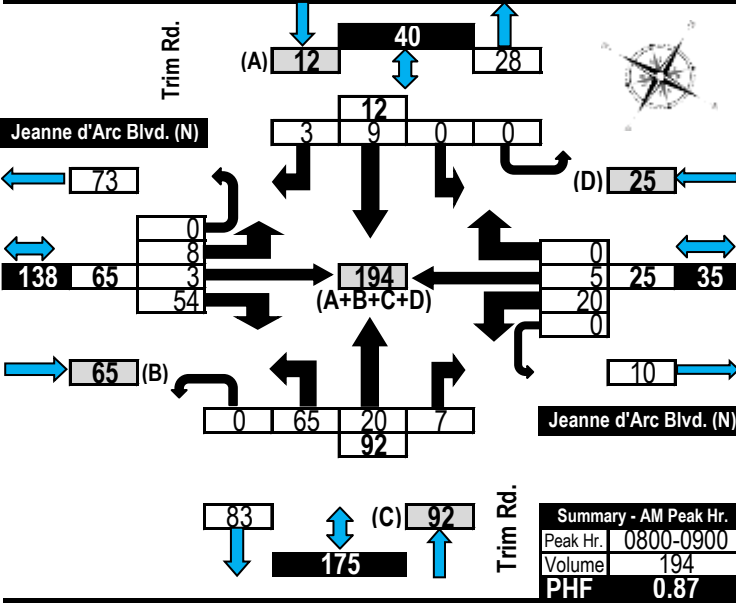

Intersection Peak Hour

Location: Tenth Line at Jeanne D'Arc , Ottawa
GPS Coordinates:
Date: 2017-09-14
Day of week: Thursday
Weather: Sunny
Analyst: Rani Nahas

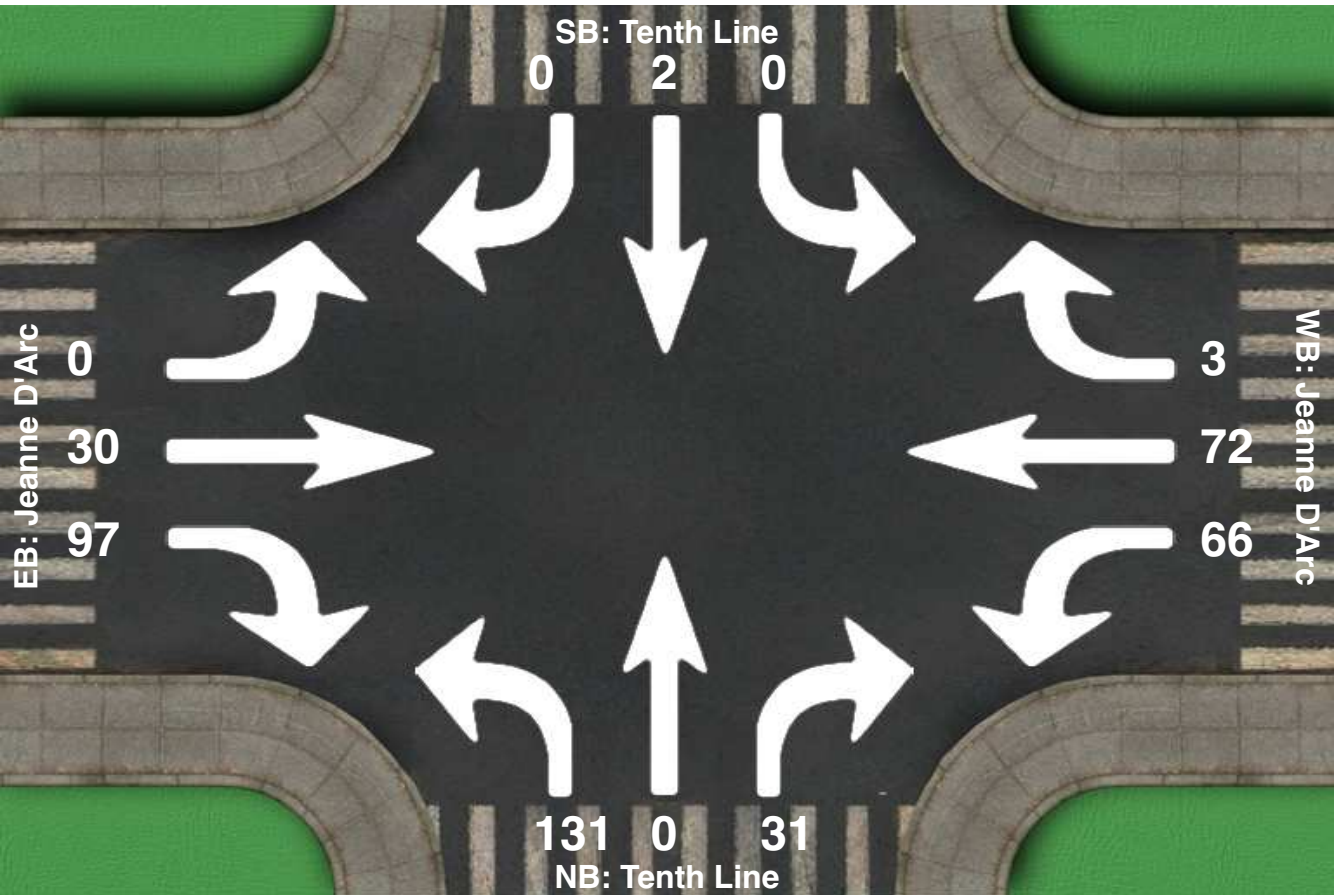

Intersection Peak Hour

07:15 - 08:15

	SouthBound			Westbound			Northbound			Eastbound			Total
	Left	Thru	Right	Left	Thru	Right	Left	Thru	Right	Left	Thru	Right	
Vehicle Total	0	2	0	66	72	3	131	0	31	0	30	97	432
Factor	0.00	0.08	0.00	0.61	0.60	0.25	0.68	0.00	0.52	0.00	0.36	0.73	0.84
Approach Factor	0.08			0.69			0.68			0.59			

Intersection Peak Hour

Location: Tenth Line at Jeanne D'Arc, Ottawa
GPS Coordinates:
Date: 2017-09-14
Day of week: Thursday
Weather: Sunny
Analyst: Rani Nahas

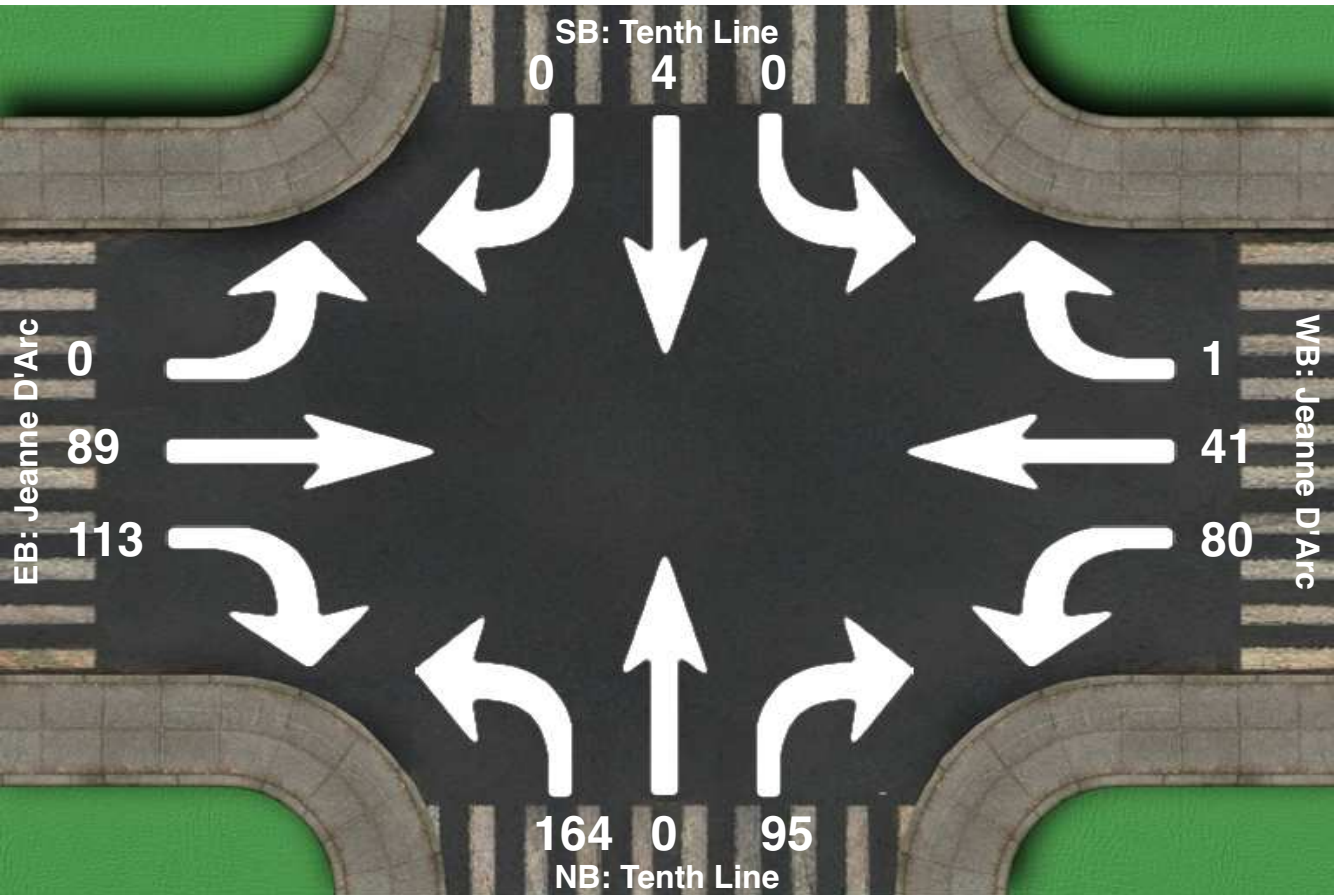

Intersection Peak Hour

16:30 - 17:30

	SouthBound			Westbound			Northbound			Eastbound			Total
	Left	Thru	Right	Left	Thru	Right	Left	Thru	Right	Left	Thru	Right	
Vehicle Total	0	4	0	80	41	1	164	0	95	0	89	113	587
Factor	0.00	0.33	0.00	0.51	0.49	0.08	0.65	0.00	0.61	0.00	0.53	0.55	0.79
Approach Factor	0.33			0.68			0.80			0.67			

APPENDIX C

COLLISION DATA

Total Area

Classification of Accident	Rear End	Turning Movement	Sideswipe	Angle	Approaching	SMV other	SMV unattended vehicle	Other	Total
P.D. only	82	11	23	16	2	20	0	0	154
Non-fatal injury	12	4	1	8	0	4	0	1	30
Non-reportable	0	0	0	0	0	0	0	0	0
Total	94	15	24	24	2	24	0	1	184
	#1 or 51%	#5 or 8%	#2 or 13%	#2 or 13%	#6 or 1%	#2 or 13%	#8 or 0%	#7 or 1%	

84%
16%
0%
100%

REGIONAL RD 174/TRIM RD

Years	Total # Collisions	24 Hr AADT Veh Volume	Days	Collisions/MEV
2017-2021	56	34,176	1825	0.90

Peds	Cyclists
0	0

Classification of Accident	Rear End	Turning Movement	Sideswipe	Angle	Approaching	SMV other	SMV unattended vehicle	Other	Total
P.D. only	30	3	11	0	0	6	0	0	50
Non-fatal injury	3	1	0	1	0	0	0	1	6
Non-reportable	0	0	0	0	0	0	0	0	0
Total	33	4	11	1	0	6	0	1	56
	59%	7%	20%	2%	0%	11%	0%	2%	

89%
11%
0%
100%

NORTH SERVICE RD/TRIM RD

Years	Total # Collisions	24 Hr AADT Veh Volume	Days	Collisions/MEV
2017-2021	2	3,080	1825	0.36

Peds	Cyclists
0	0

Classification of Accident	Rear End	Turning Movement	Sideswipe	Angle	Approaching	SMV other	SMV unattended vehicle	Other	Total
P.D. only	1	0	0	0	0	0	0	0	1
Non-fatal injury	0	0	0	0	0	1	0	0	1
Non-reportable	0	0	0	0	0	0	0	0	0
Total	1	0	0	0	0	1	0	0	2
	50%	0%	0%	0%	0%	50%	0%	0%	

50%
50%
0%
100%

JEANNE D'ARC BLVD/NORTH SERVICE RD/TENTH LIN

Years	Total # Collisions	24 Hr AADT Veh Volume	Days	Collisions/MEV
2017-2021	5	7,904	1825	0.35

Peds	Cyclists
0	1

Classification of Accident	Rear End	Turning Movement	Sideswipe	Angle	Approaching	SMV other	SMV unattended vehicle	Other	Total
P.D. only	2	0	0	0	0	0	0	0	2
Non-fatal injury	1	1	0	0	0	1	0	0	3
Non-reportable	0	0	0	0	0	0	0	0	0
Total	3	1	0	0	0	1	0	0	5
	60%	20%	0%	0%	0%	20%	0%	0%	

40%
60%
0%
100%

TENTH LINE RD/OR174 IC101 RAMP61

Years	Total # Collisions	24 Hr AADT Veh Volume	Days	Collisions/MEV
2017-2021	5	n/a	1825	n/a

Peds	Cyclists
0	0

Classification of Accident	Rear End	Turning Movement	Sideswipe	Angle	Approaching	SMV other	SMV unattended vehicle	Other	Total
P.D. only	2	1	0	2	0	0	0	0	5
Non-fatal injury	0	0	0	0	0	0	0	0	0
Non-reportable	0	0	0	0	0	0	0	0	0
Total	2	1	0	2	0	0	0	0	5
	40%	20%	0%	40%	0%	0%	0%	0%	

100%
0%
0%
100%

TENTH LINE RD/OR174 IC101 RAMP26

Years	Total # Collisions	24 Hr AADT Veh Volume	Days	Collisions/MEV
2017-2021	4	n/a	1825	n/a

Peds	Cyclists
0	0

Classification of Accident	Rear End	Turning Movement	Sideswipe	Angle	Approaching	SMV other	SMV unattended vehicle	Other	Total
P.D. only	3	0	0	0	0	1	0	0	4
Non-fatal injury	0	0	0	0	0	0	0	0	0
Non-reportable	0	0	0	0	0	0	0	0	0
Total	3	0	0	0	0	1	0	0	4
	75%	0%	0%	0%	0%	25%	0%	0%	

100%
0%
0%
100%

ST. JOSEPH BLVD/TENTH LINE RD

Years	Total # Collisions	24 Hr AADT Veh Volume	Days	Collisions/MEV
2017-2021	70	28,137	1825	1.36

Peds	Cyclists
0	0

Classification of Accident	Rear End	Turning Movement	Sideswipe	Angle	Approaching	SMV other	SMV unattended vehicle	Other	Total
P.D. only	35	2	10	8	1	3	0	0	59
Non-fatal injury	5	2	1	2	0	1	0	0	11
Non-reportable	0	0	0	0	0	0	0	0	0
Total	40	4	11	10	1	4	0	0	70
	57%	6%	16%	14%	1%	6%	0%	0%	

84%
16%
0%
100%

OLD TENTH LINE RD/OR174 IC101 RAMP63/ST. JOS

Years	Total # Collisions	24 Hr AADT Veh Volume	Days	Collisions/MEV
2017-2021	30	16,521	1825	0.99

Peds	Cyclists
0	0

Classification of Accident	Rear End	Turning Movement	Sideswipe	Angle	Approaching	SMV other	SMV unattended vehicle	Other	Total
P.D. only	6	4	1	5	0	9	0	0	25
Non-fatal injury	0	0	0	5	0	0	0	0	5
Non-reportable	0	0	0	0	0	0	0	0	0
Total	6	4	1	10	0	9	0	0	30
	20%	13%	3%	33%	0%	30%	0%	0%	

83%
17%
0%
100%

ROAD SEGMENTS

NORTH SERVICE RD, TENTH LINE to TRIM RD

Years	Total # Collisions	24 Hr AADT Veh Volume	Days	Collisions/MEV
2017-2021	2	n/a	1825	n/a

Peds	Cyclists
0	0

Classification of Accident	Rear End	Turning Movement	Sideswipe	Angle	Approaching	SMV other	SMV unattended vehicle	Other	Total
P.D. only	0	0	0	0	1	0	0	0	1
Non-fatal injury	0	0	0	0	0	1	0	0	1
Non-reportable	0	0	0	0	0	0	0	0	0
Total	0	0	0	0	1	1	0	0	2
	0%	0%	0%	0%	50%	50%	0%	0%	

50%
50%
0%
100%

TENTH LINE RD, OR174 IC101 RAMP36 to OR174 IC101 RAMP61

Years	Total # Collisions	24 Hr AADT Veh Volume	Days	Collisions/MEV
2017-2021	3	n/a	1825	n/a

Peds	Cyclists
0	0

Classification of Accident	Rear End	Turning Movement	Sideswipe	Angle	Approaching	SMV other	SMV unattended vehicle	Other	Total
P.D. only	0	1	0	1	0	0	0	0	2
Non-fatal injury	1	0	0	0	0	0	0	0	1
Non-reportable	0	0	0	0	0	0	0	0	0
Total	1	1	0	1	0	0	0	0	3
	33%	33%	0%	33%	0%	0%	0%	0%	

67%
33%
0%
100%

TENTH LINE RD, OR174 IC101 RAMP26 to ST. JOSEPH BLVD

Years	Total # Collisions	24 Hr AADT Veh Volume	Days	Collisions/MEV
2017-2021	6	n/a	1825	n/a

Peds	Cyclists
0	0

Classification of Accident	Rear End	Turning Movement	Sideswipe	Angle	Approaching	SMV other	SMV unattended vehicle	Other	Total
P.D. only	3	0	1	0	0	0	0	0	4
Non-fatal injury	2	0	0	0	0	0	0	0	2
Non-reportable	0	0	0	0	0	0	0	0	0
Total	5	0	1	0	0	0	0	0	6
	83%	0%	17%	0%	0%	0%	0%	0%	

67%
33%
0%
100%

ST. JOSEPH BLVD, OR174 IC101 RAMP63 to TENTH LINE RD

Years	Total # Collisions	24 Hr AADT Veh Volume	Days	Collisions/MEV
2017-2021	1	n/a	1825	n/a

Peds	Cyclists
0	0

Classification of Accident	Rear End	Turning Movement	Sideswipe	Angle	Approaching	SMV other	SMV unattended vehicle	Other	Total
P.D. only	0	0	0	0	0	1	0	0	1

100%

Non-fatal injury	0	0	0	0	0	0	0	0	0	0%
Non-reportable	0	0	0	0	0	0	0	0	0	0%
Total	0	0	0	0	0	1	0	0	1	100%

0%

0%

0%

0%

0%

100%

0%

0%

100%





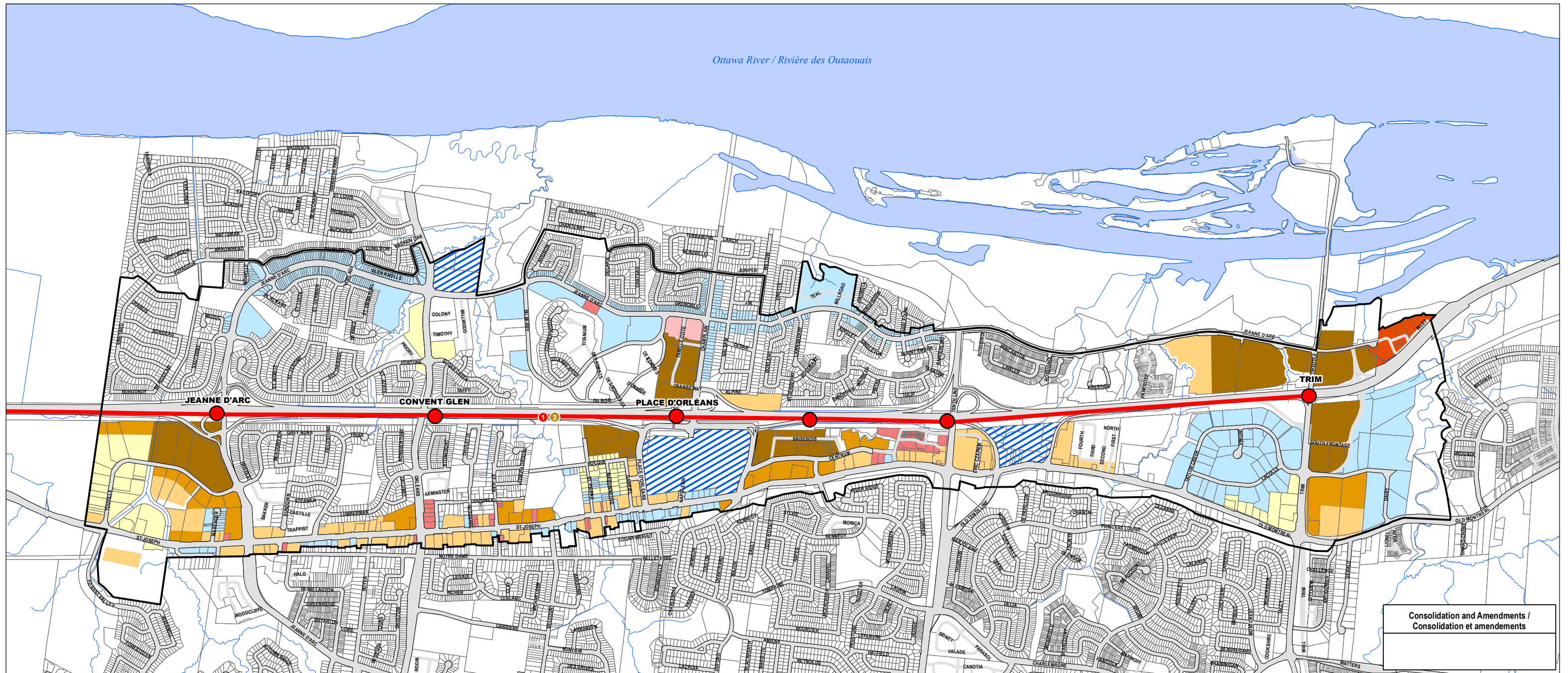



APPENDIX D

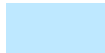

ORLEANS CORRIDOR SECONDARY PLAN – FIGURES

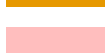

Consolidation and Amendments /
Consolidation et amendements

MAXIMUM BUILDING HEIGHTS / HAUTEURS MAXIMALES DES IMMEUBLES

- | | | | |
|--|---------------------|---|--|
|  | 4 storeys / étages |  | 32 storeys / étages - to reflect development approvals / pour refléter les approbations de développement |
|  | 6 storeys / étages |  | 40 storeys / étages |
|  | 9 storeys / étages |  | Conditional Height / Des hauteurs soumises à des conditions |
|  | 18 storeys / étages |  | Height through Demonstration Plan / Les hauteurs seront identifiées par un plan de démonstration |
|  | 25 storeys / étages | | |

-  Secondary Plan Boundary / Limite du plan secondaire
-  Light Rail Transit (LRT) / Transport en commun par train léger (TCTL)
-  O-Train Lines / Lignes de l'O-Train

**Orléans Corridor /
Le couloir d'Orléans**



**SECONDARY PLAN - Volume 2
Schedule B - Maximum Building Heights**

**PLAN SECONDAIRE - Volume 2
Annexe B - Hauteurs maximales des immeubles**



* Note:
 1/ All Parks shown on this plan are approximate and their size and configuration are subject to change.
 2/ The locations of POPS and "Potential Future Streets" shown on this plan are preliminary and their location is subject to change.
 3/ Escarpment area is approximate
 4/ Please refer to Stage 2 LRT designs for more accurate Stage 2 active transportation improvements information.

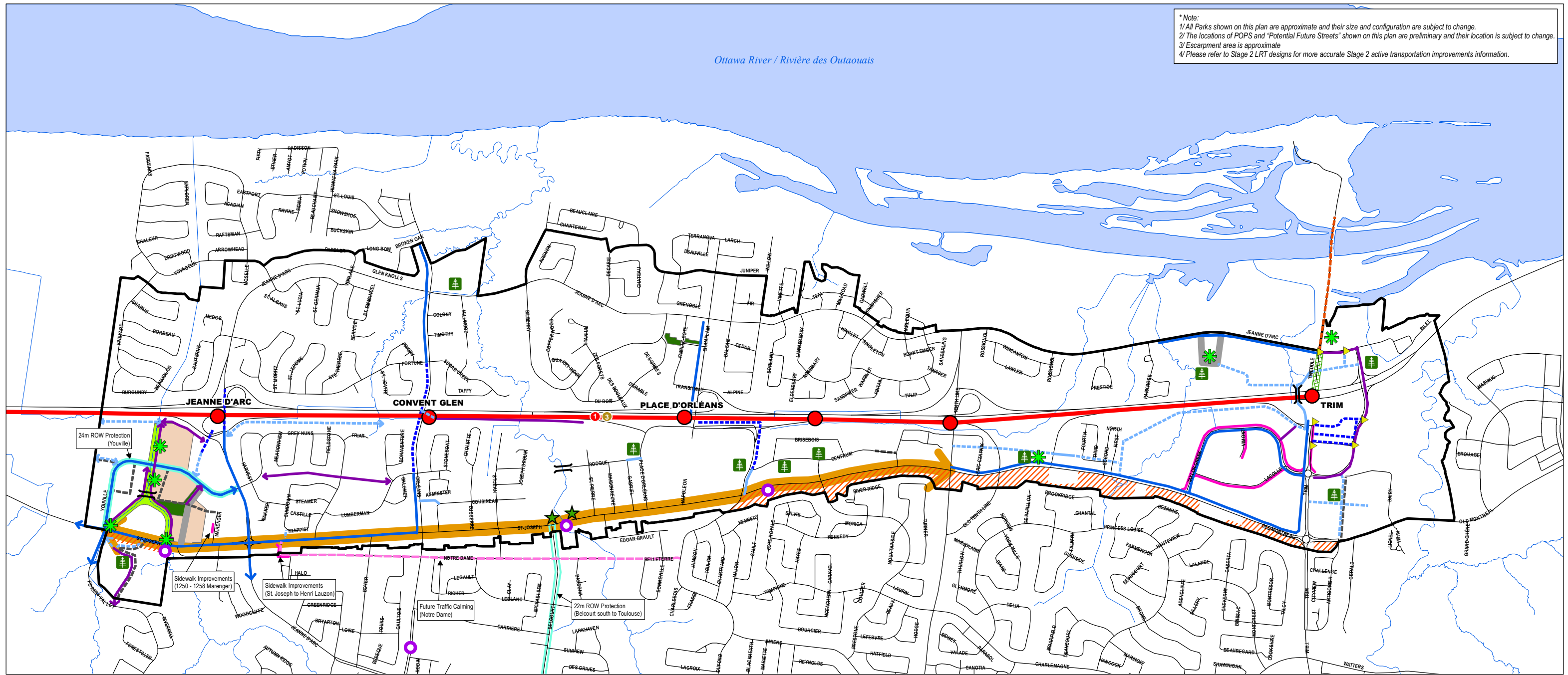

- Park / Parc
- Potential Park /
- Voyageur Creek Greenway Corridor
- Potential Privately-owned Public Space (POPS)
- Linear Park/Woonerf
- Lands Subject to Land Owner Agreements
- Escarpment Area (development prohibited)
- Potential Public Realm Improvement
- New Street
- Potential New Street (Public or Private)
- Road Improvements
- Future Traffic Calming
- 22m ROW Protection
- Sidewalk Improvements
- Pedestrian Crosswalk
- Active Transportation Bridge / Passerelle de mobilité active
- Active Transportation Connection
- Potential Active Transportation Connection
- Physically-separated Cycling Facility /
- Multi-Use Pathway (MUP) / Sentier polyvalent
- LRT Stage 2 Active Transportation Improvements
- St Joseph Boulevard Concept Plan (Annex B)
- Secondary Plan Boundary / Limite du plan secondaire
- LRT / TCTL
- O-Train Lines / Lignes de l'O-Train

**Orléans Corridor /
Le couloir d'Orléans**

SECONDARY PLAN - Volume 2
Schedule C - Public Realm and Mobility Improvements

PLAN SECONDAIRE - Volume 2
Annex C - Domaine public



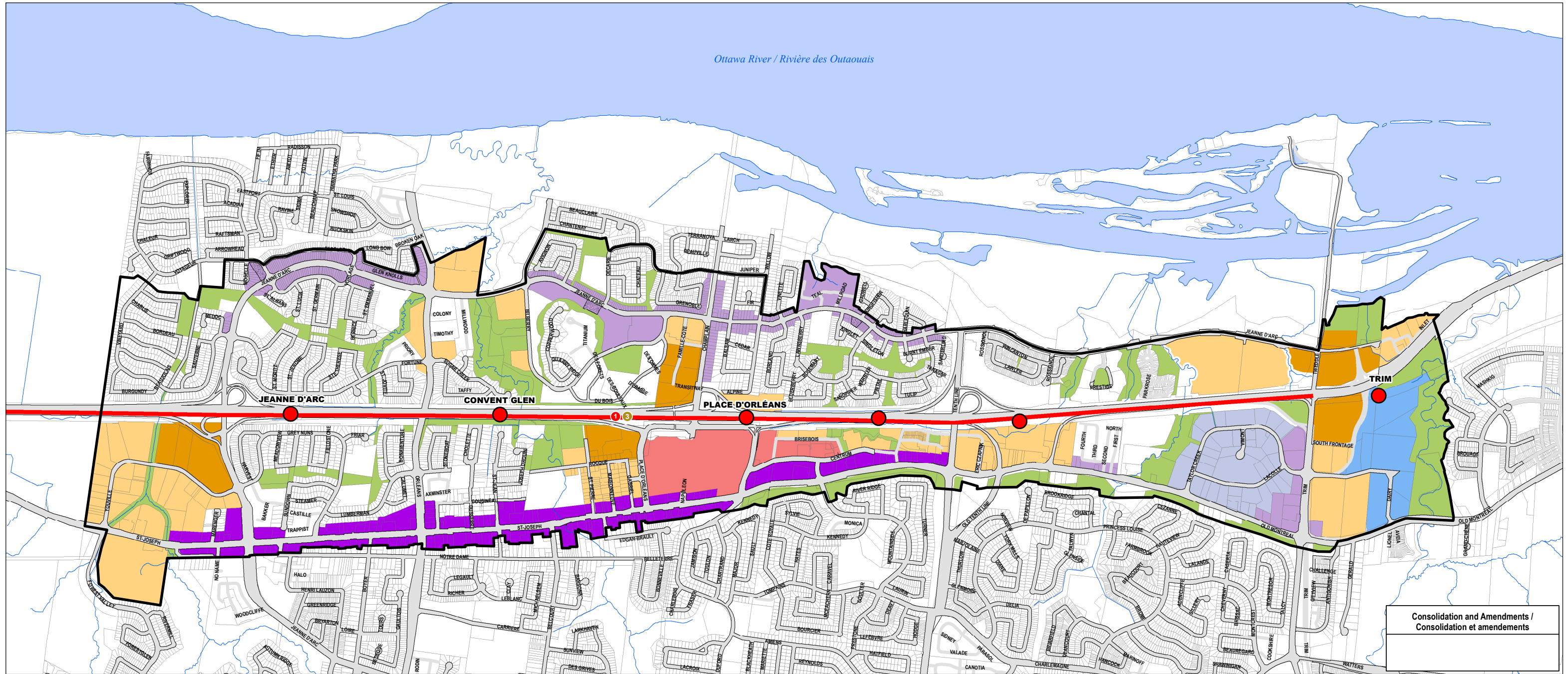

Consolidation and Amendments /
Consolidation et amendements

- Orleans Town Centre / Centre-ville d'Orléans
- Station Area - Core / Zone centrale de la station
- Station Area - Periphery / Zone périphérique de la station
- St Joseph Mainstreet / Rue principale Saint-Joseph
- O-Train Minor Corridor / Couloir – Rue principale mineure de l'O-Train

- Industrial and Logistics / Industrie et logistique
- Local Production and Entertainment / Production et loisirs de la localité
- Greenspace / Espaces verts
- Neighbourhood / Quartier

OVERLAY / AFFECTATION SUPPLÉMENTAIRE

- Local Commercial Anchor / Ancre commerciale local

- Secondary Plan Boundary / Limite du plan secondaire
- Light Rail Transit (LRT) / Transport en commun par train léger (TCTL)
- O-Train Lines / Lignes de l'O-Train

Orléans Corridor / Le couloir d'Orléans



SECONDARY PLAN - Volume 2
Schedule A - Designation Plan

PLAN SECONDAIRE - Volume 2
Annexe A - Plan de désignation



APPENDIX E

INTERNAL TRIP GENERATION REDUCTION CALCULATIONS

NCHRP 684 Internal Trip Capture Estimation Tool			
Project Name:	Petrie's Landing III	Organization:	Parsons
Project Location:	8600 Jeanne D'Arc	Performed By:	
Scenario Description:	Scenario 1 - Non TOD	Date:	6/26/2023
Analysis Year:		Checked By:	
Analysis Period:	AM Street Peak Hour	Date:	

Table 1-A: Base Vehicle-Trip Generation Estimates (Single-Use Site Estimate)						
Land Use	Development Data (For Information Only)			Estimated Vehicle-Trips ³		
	ITE LUCs ¹	Quantity	Units	Total	Entering	Exiting
Office				136	119	17
Retail				43	26	17
Restaurant				0		
Cinema/Entertainment				0		
Residential				711	223	488
Hotel				0		
All Other Land Uses ²				0		
				890	368	522

Table 2-A: Mode Split and Vehicle Occupancy Estimates						
Land Use	Entering Trips			Exiting Trips		
	Veh. Occ. ⁴	% Transit	% Non-Motorized	Veh. Occ. ⁴	% Transit	% Non-Motorized
Office						
Retail						
Restaurant						
Cinema/Entertainment						
Residential						
Hotel						
All Other Land Uses ²						

Table 3-A: Average Land Use Interchange Distances (Feet Walking Distance)						
Origin (From)	Destination (To)					
	Office	Retail	Restaurant	Cinema/Entertainment	Residential	Hotel
Office						
Retail						
Restaurant						
Cinema/Entertainment						
Residential						
Hotel						

Table 4-A: Internal Person-Trip Origin-Destination Matrix*						
Origin (From)	Destination (To)					
	Office	Retail	Restaurant	Cinema/Entertainment	Residential	Hotel
Office		5	0	0	0	0
Retail	5		0	0	2	0
Restaurant	0	0		0	0	0
Cinema/Entertainment	0	0	0		0	0
Residential	4	4	0	0		0
Hotel	0	0	0	0	0	

Table 5-A: Computations Summary			
	Total	Entering	Exiting
All Person-Trips	890	368	522
Internal Capture Percentage	4%	5%	4%
External Vehicle-Trips ⁵	850	348	502
External Transit-Trips ⁶	0	0	0
External Non-Motorized Trips ⁶	0	0	0

Table 6-A: Internal Trip Capture Percentages by Land Use		
Land Use	Entering Trips	Exiting Trips
Office	8%	29%
Retail	35%	41%
Restaurant	N/A	N/A
Cinema/Entertainment	N/A	N/A
Residential	1%	2%
Hotel	N/A	N/A

¹Land Use Codes (LUCs) from *Trip Generation Manual*, published by the Institute of Transportation Engineers.

²Total estimate for all other land uses at mixed-use development site is not subject to internal trip capture computations in this estimator.

³Enter trips assuming no transit or non-motorized trips (as assumed in *ITE Trip Generation Manual*).

⁴Enter vehicle occupancy assumed in Table 1-A vehicle trips. If vehicle occupancy changes for proposed mixed-use project, manual adjustments must be made to Tables 5-A, 9-A (O and D). Enter transit, non-motorized percentages that will result with proposed mixed-use project complete.

⁵Vehicle-trips computed using the mode split and vehicle occupancy values provided in Table 2-A.

⁶Person-Trips

*Indicates computation that has been rounded to the nearest whole number.

Estimation Tool Developed by the Texas A&M Transportation Institute - Version 2013.1

Project Name:	Petrie's Landing III
Analysis Period:	AM Street Peak Hour

Land Use	Table 7-A (D): Entering Trips			Table 7-A (O): Exiting Trips		
	Veh. Occ.	Vehicle-Trips	Person-Trips*	Veh. Occ.	Vehicle-Trips	Person-Trips*
Office	1.00	119	119	1.00	17	17
Retail	1.00	26	26	1.00	17	17
Restaurant	1.00	0	0	1.00	0	0
Cinema/Entertainment	1.00	0	0	1.00	0	0
Residential	1.00	223	223	1.00	488	488
Hotel	1.00	0	0	1.00	0	0

Origin (From)	Destination (To)					
	Office	Retail	Restaurant	Cinema/Entertainment	Residential	Hotel
Office		5	11	0	0	0
Retail	5		2	0	2	0
Restaurant	0	0		0	0	0
Cinema/Entertainment	0	0	0		0	0
Residential	10	5	98	0		0
Hotel	0	0	0	0	0	

Origin (From)	Destination (To)					
	Office	Retail	Restaurant	Cinema/Entertainment	Residential	Hotel
Office		8	0	0	0	0
Retail	5		0	0	4	0
Restaurant	17	2		0	11	0
Cinema/Entertainment	0	0	0		0	0
Residential	4	4	0	0		0
Hotel	4	1	0	0	0	

Destination Land Use	Person-Trip Estimates			External Trips by Mode*		
	Internal	External	Total	Vehicles ¹	Transit ²	Non-Motorized ²
Office	9	110	119	110	0	0
Retail	9	17	26	17	0	0
Restaurant	0	0	0	0	0	0
Cinema/Entertainment	0	0	0	0	0	0
Residential	2	221	223	221	0	0
Hotel	0	0	0	0	0	0
All Other Land Uses ³	0	0	0	0	0	0

Origin Land Use	Person-Trip Estimates			External Trips by Mode*		
	Internal	External	Total	Vehicles ¹	Transit ²	Non-Motorized ²
Office	5	12	17	12	0	0
Retail	7	10	17	10	0	0
Restaurant	0	0	0	0	0	0
Cinema/Entertainment	0	0	0	0	0	0
Residential	8	480	488	480	0	0
Hotel	0	0	0	0	0	0
All Other Land Uses ³	0	0	0	0	0	0

¹Vehicle-trips computed using the mode split and vehicle occupancy values provided in Table 2-A
²Person-Trips
³Total estimate for all other land uses at mixed-use development site is not subject to internal trip capture computations in this estimator
*Indicates computation that has been rounded to the nearest whole number.

NCHRP 684 Internal Trip Capture Estimation Tool			
Project Name:	Petrie's Landing III	Organization:	Parsons
Project Location:	8600 Jeanne D'Arc	Performed By:	
Scenario Description:	Scenario 1 - Non TOD	Date:	6/26/2023
Analysis Year:		Checked By:	
Analysis Period:	PM Street Peak Hour	Date:	

Table 1-P: Base Vehicle-Trip Generation Estimates (Single-Use Site Estimate)						
Land Use	Development Data (For Information Only)			Estimated Vehicle-Trips ³		
	ITE LUCs ¹	Quantity	Units	Total	Entering	Exiting
Office				135	23	112
Retail				173	83	90
Restaurant				0		
Cinema/Entertainment				0		
Residential				714	414	300
Hotel				0		
All Other Land Uses ²				0		
				1,022	520	502

Table 2-P: Mode Split and Vehicle Occupancy Estimates						
Land Use	Entering Trips			Exiting Trips		
	Veh. Occ. ⁴	% Transit	% Non-Motorized	Veh. Occ. ⁴	% Transit	% Non-Motorized
Office						
Retail						
Restaurant						
Cinema/Entertainment						
Residential						
Hotel						
All Other Land Uses ²						

Table 3-P: Average Land Use Interchange Distances (Feet Walking Distance)						
Origin (From)	Destination (To)					
	Office	Retail	Restaurant	Cinema/Entertainment	Residential	Hotel
Office		150			150	
Retail					150	
Restaurant						
Cinema/Entertainment						
Residential		150				
Hotel						

Table 4-P: Internal Person-Trip Origin-Destination Matrix*						
Origin (From)	Destination (To)					
	Office	Retail	Restaurant	Cinema/Entertainment	Residential	Hotel
Office		7	0	0	2	0
Retail	2		0	0	23	0
Restaurant	0	0		0	0	0
Cinema/Entertainment	0	0	0		0	0
Residential	12	8	0	0		0
Hotel	0	0	0	0	0	

Table 5-P: Computations Summary			
	Total	Entering	Exiting
All Person-Trips	1,022	520	502
Internal Capture Percentage	11%	10%	11%
External Vehicle-Trips ⁵	914	466	448
External Transit-Trips ⁶	0	0	0
External Non-Motorized Trips ⁶	0	0	0

Table 6-P: Internal Trip Capture Percentages by Land Use		
Land Use	Entering Trips	Exiting Trips
Office	61%	8%
Retail	18%	28%
Restaurant	N/A	N/A
Cinema/Entertainment	N/A	N/A
Residential	6%	7%
Hotel	N/A	N/A

¹Land Use Codes (LUCs) from *Trip Generation Manual*, published by the Institute of Transportation Engineers.

²Total estimate for all other land uses at mixed-use development site is not subject to internal trip capture computations in this estimator.

³Enter trips assuming no transit or non-motorized trips (as assumed in *ITE Trip Generation Manual*).

⁴Enter vehicle occupancy assumed in Table 1-P vehicle trips. If vehicle occupancy changes for proposed mixed-use project, manual adjustments must be made.

⁵Vehicle-trips computed using the mode split and vehicle occupancy values provided in Table 2-P.

⁶Person-Trips

*Indicates computation that has been rounded to the nearest whole number.

Estimation Tool Developed by the Texas A&M Transportation Institute - Version 2013.1

Project Name:	Petrie's Landing III
Analysis Period:	PM Street Peak Hour

Table 7-P: Conversion of Vehicle-Trip Ends to Person-Trip Ends						
Land Use	Table 7-P (D): Entering Trips			Table 7-P (O): Exiting Trips		
	Veh. Occ.	Vehicle-Trips	Person-Trips*	Veh. Occ.	Vehicle-Trips	Person-Trips*
Office	1.00	23	23	1.00	112	112
Retail	1.00	83	83	1.00	90	90
Restaurant	1.00	0	0	1.00	0	0
Cinema/Entertainment	1.00	0	0	1.00	0	0
Residential	1.00	414	414	1.00	300	300
Hotel	1.00	0	0	1.00	0	0

Table 8-P (O): Internal Person-Trip Origin-Destination Matrix (Computed at Origin)						
Origin (From)	Destination (To)					
	Office	Retail	Restaurant	Cinema/Entertainment	Residential	Hotel
Office		22	4	0	2	0
Retail	2		26	4	23	5
Restaurant	0	0		0	0	0
Cinema/Entertainment	0	0	0		0	0
Residential	12	126	63	0		9
Hotel	0	0	0	0	0	

Table 8-P (D): Internal Person-Trip Origin-Destination Matrix (Computed at Destination)						
Origin (From)	Destination (To)					
	Office	Retail	Restaurant	Cinema/Entertainment	Residential	Hotel
Office		7	0	0	17	0
Retail	7		0	0	190	0
Restaurant	7	42		0	66	0
Cinema/Entertainment	1	3	0		17	0
Residential	13	8	0	0		0
Hotel	0	2	0	0	0	

Table 9-P (D): Internal and External Trips Summary (Entering Trips)						
Destination Land Use	Person-Trip Estimates			External Trips by Mode*		
	Internal	External	Total	Vehicles ¹	Transit ²	Non-Motorized ²
Office	14	9	23	9	0	0
Retail	15	68	83	68	0	0
Restaurant	0	0	0	0	0	0
Cinema/Entertainment	0	0	0	0	0	0
Residential	25	389	414	389	0	0
Hotel	0	0	0	0	0	0
All Other Land Uses ³	0	0	0	0	0	0

Table 9-P (O): Internal and External Trips Summary (Exiting Trips)						
Origin Land Use	Person-Trip Estimates			External Trips by Mode*		
	Internal	External	Total	Vehicles ¹	Transit ²	Non-Motorized ²
Office	9	103	112	103	0	0
Retail	25	65	90	65	0	0
Restaurant	0	0	0	0	0	0
Cinema/Entertainment	0	0	0	0	0	0
Residential	20	280	300	280	0	0
Hotel	0	0	0	0	0	0
All Other Land Uses ³	0	0	0	0	0	0

¹Vehicle-trips computed using the mode split and vehicle occupancy values provided in Table 2-P
²Person-Trips
³Total estimate for all other land uses at mixed-use development site is not subject to internal trip capture computations in this estimator
*Indicates computation that has been rounded to the nearest whole number.

NCHRP 684 Internal Trip Capture Estimation Tool			
Project Name:	Petrie's Landing III	Organization:	Parsons
Project Location:	8600 Jeanne D'Arc	Performed By:	
Scenario Description:	Scenario 2 - TOD	Date:	6/26/2023
Analysis Year:		Checked By:	
Analysis Period:	AM Street Peak Hour	Date:	

Table 1-A: Base Vehicle-Trip Generation Estimates (Single-Use Site Estimate)						
Land Use	Development Data (For Information Only)			Estimated Vehicle-Trips ³		
	ITE LUCs ¹	Quantity	Units	Total	Entering	Exiting
Office				85	74	11
Retail				28	17	11
Restaurant				0		
Cinema/Entertainment				0		
Residential				457	142	315
Hotel				0		
All Other Land Uses ²				0		
				570	233	337

Table 2-A: Mode Split and Vehicle Occupancy Estimates						
Land Use	Entering Trips			Exiting Trips		
	Veh. Occ. ⁴	% Transit	% Non-Motorized	Veh. Occ. ⁴	% Transit	% Non-Motorized
Office						
Retail						
Restaurant						
Cinema/Entertainment						
Residential						
Hotel						
All Other Land Uses ²						

Table 3-A: Average Land Use Interchange Distances (Feet Walking Distance)						
Origin (From)	Destination (To)					
	Office	Retail	Restaurant	Cinema/Entertainment	Residential	Hotel
Office						
Retail						
Restaurant						
Cinema/Entertainment						
Residential						
Hotel						

Table 4-A: Internal Person-Trip Origin-Destination Matrix*						
Origin (From)	Destination (To)					
	Office	Retail	Restaurant	Cinema/Entertainment	Residential	Hotel
Office		3	0	0	0	0
Retail	3		0	0	2	0
Restaurant	0	0		0	0	0
Cinema/Entertainment	0	0	0		0	0
Residential	2	3	0	0		0
Hotel	0	0	0	0	0	

Table 5-A: Computations Summary			
	Total	Entering	Exiting
All Person-Trips	570	233	337
Internal Capture Percentage	5%	6%	4%
External Vehicle-Trips ⁵	544	220	324
External Transit-Trips ⁶	0	0	0
External Non-Motorized Trips ⁶	0	0	0

Table 6-A: Internal Trip Capture Percentages by Land Use		
Land Use	Entering Trips	Exiting Trips
Office	7%	27%
Retail	35%	45%
Restaurant	N/A	N/A
Cinema/Entertainment	N/A	N/A
Residential	1%	2%
Hotel	N/A	N/A

¹Land Use Codes (LUCs) from *Trip Generation Manual*, published by the Institute of Transportation Engineers.

²Total estimate for all other land uses at mixed-use development site is not subject to internal trip capture computations in this estimator.

³Enter trips assuming no transit or non-motorized trips (as assumed in *ITE Trip Generation Manual*).

⁴Enter vehicle occupancy assumed in Table 1-A vehicle trips. If vehicle occupancy changes for proposed mixed-use project, manual adjustments must be made to Tables 5-A, 9-A (O and D). Enter transit, non-motorized percentages that will result with proposed mixed-use project complete.

⁵Vehicle-trips computed using the mode split and vehicle occupancy values provided in Table 2-A.

⁶Person-Trips

*Indicates computation that has been rounded to the nearest whole number.

Estimation Tool Developed by the Texas A&M Transportation Institute - Version 2013.1

Project Name:	Petrie's Landing III
Analysis Period:	AM Street Peak Hour

Land Use	Table 7-A (D): Entering Trips			Table 7-A (O): Exiting Trips		
	Veh. Occ.	Vehicle-Trips	Person-Trips*	Veh. Occ.	Vehicle-Trips	Person-Trips*
Office	1.00	74	74	1.00	11	11
Retail	1.00	17	17	1.00	11	11
Restaurant	1.00	0	0	1.00	0	0
Cinema/Entertainment	1.00	0	0	1.00	0	0
Residential	1.00	142	142	1.00	315	315
Hotel	1.00	0	0	1.00	0	0

Origin (From)	Destination (To)					
	Office	Retail	Restaurant	Cinema/Entertainment	Residential	Hotel
Office		3	7	0	0	0
Retail	3		1	0	2	0
Restaurant	0	0		0	0	0
Cinema/Entertainment	0	0	0		0	0
Residential	6	3	63	0		0
Hotel	0	0	0	0	0	

Origin (From)	Destination (To)					
	Office	Retail	Restaurant	Cinema/Entertainment	Residential	Hotel
Office		5	0	0	0	0
Retail	3		0	0	3	0
Restaurant	10	1		0	7	0
Cinema/Entertainment	0	0	0		0	0
Residential	2	3	0	0		0
Hotel	2	1	0	0	0	

Destination Land Use	Person-Trip Estimates			External Trips by Mode*		
	Internal	External	Total	Vehicles ¹	Transit ²	Non-Motorized ²
Office	5	69	74	69	0	0
Retail	6	11	17	11	0	0
Restaurant	0	0	0	0	0	0
Cinema/Entertainment	0	0	0	0	0	0
Residential	2	140	142	140	0	0
Hotel	0	0	0	0	0	0
All Other Land Uses ³	0	0	0	0	0	0

Origin Land Use	Person-Trip Estimates			External Trips by Mode*		
	Internal	External	Total	Vehicles ¹	Transit ²	Non-Motorized ²
Office	3	8	11	8	0	0
Retail	5	6	11	6	0	0
Restaurant	0	0	0	0	0	0
Cinema/Entertainment	0	0	0	0	0	0
Residential	5	310	315	310	0	0
Hotel	0	0	0	0	0	0
All Other Land Uses ³	0	0	0	0	0	0

¹Vehicle-trips computed using the mode split and vehicle occupancy values provided in Table 2-A
²Person-Trips
³Total estimate for all other land uses at mixed-use development site is not subject to internal trip capture computations in this estimator
*Indicates computation that has been rounded to the nearest whole number.

NCHRP 684 Internal Trip Capture Estimation Tool			
Project Name:	Petrie's Landing III	Organization:	Parsons
Project Location:	8600 Jeanne D'Arc	Performed By:	
Scenario Description:	Scenario 2 - TOD	Date:	6/26/2023
Analysis Year:		Checked By:	
Analysis Period:	PM Street Peak Hour	Date:	

Table 1-P: Base Vehicle-Trip Generation Estimates (Single-Use Site Estimate)						
Land Use	Development Data (For Information Only)			Estimated Vehicle-Trips ³		
	ITE LUCs ¹	Quantity	Units	Total	Entering	Exiting
Office				83	14	69
Retail				109	52	57
Restaurant				0		
Cinema/Entertainment				0		
Residential				455	264	191
Hotel				0		
All Other Land Uses ²				0		
				647	330	317

Table 2-P: Mode Split and Vehicle Occupancy Estimates						
Land Use	Entering Trips			Exiting Trips		
	Veh. Occ. ⁴	% Transit	% Non-Motorized	Veh. Occ. ⁴	% Transit	% Non-Motorized
Office						
Retail						
Restaurant						
Cinema/Entertainment						
Residential						
Hotel						
All Other Land Uses ²						

Table 3-P: Average Land Use Interchange Distances (Feet Walking Distance)						
Origin (From)	Destination (To)					
	Office	Retail	Restaurant	Cinema/Entertainment	Residential	Hotel
Office		150			150	
Retail					150	
Restaurant						
Cinema/Entertainment						
Residential		150				
Hotel						

Table 4-P: Internal Person-Trip Origin-Destination Matrix*						
Origin (From)	Destination (To)					
	Office	Retail	Restaurant	Cinema/Entertainment	Residential	Hotel
Office		4	0	0	1	0
Retail	1		0	0	15	0
Restaurant	0	0		0	0	0
Cinema/Entertainment	0	0	0		0	0
Residential	8	5	0	0		0
Hotel	0	0	0	0	0	

Table 5-P: Computations Summary			
	Total	Entering	Exiting
All Person-Trips	647	330	317
Internal Capture Percentage	11%	10%	11%
External Vehicle-Trips ⁵	579	296	283
External Transit-Trips ⁶	0	0	0
External Non-Motorized Trips ⁶	0	0	0

Table 6-P: Internal Trip Capture Percentages by Land Use		
Land Use	Entering Trips	Exiting Trips
Office	64%	7%
Retail	17%	28%
Restaurant	N/A	N/A
Cinema/Entertainment	N/A	N/A
Residential	6%	7%
Hotel	N/A	N/A

¹Land Use Codes (LUCs) from *Trip Generation Manual*, published by the Institute of Transportation Engineers.

²Total estimate for all other land uses at mixed-use development site is not subject to internal trip capture computations in this estimator.

³Enter trips assuming no transit or non-motorized trips (as assumed in *ITE Trip Generation Manual*).

⁴Enter vehicle occupancy assumed in Table 1-P vehicle trips. If vehicle occupancy changes for proposed mixed-use project, manual adjustments must be made.

⁵Vehicle-trips computed using the mode split and vehicle occupancy values provided in Table 2-P.

⁶Person-Trips

*Indicates computation that has been rounded to the nearest whole number.

Estimation Tool Developed by the Texas A&M Transportation Institute - Version 2013.1

Project Name:	Petrie's Landing III
Analysis Period:	PM Street Peak Hour

Table 7-P: Conversion of Vehicle-Trip Ends to Person-Trip Ends						
Land Use	Table 7-P (D): Entering Trips			Table 7-P (O): Exiting Trips		
	Veh. Occ.	Vehicle-Trips	Person-Trips*	Veh. Occ.	Vehicle-Trips	Person-Trips*
Office	1.00	14	14	1.00	69	69
Retail	1.00	52	52	1.00	57	57
Restaurant	1.00	0	0	1.00	0	0
Cinema/Entertainment	1.00	0	0	1.00	0	0
Residential	1.00	264	264	1.00	191	191
Hotel	1.00	0	0	1.00	0	0

Table 8-P (O): Internal Person-Trip Origin-Destination Matrix (Computed at Origin)						
Origin (From)	Destination (To)					
	Office	Retail	Restaurant	Cinema/Entertainment	Residential	Hotel
Office		14	3	0	1	0
Retail	1		17	2	15	3
Restaurant	0	0		0	0	0
Cinema/Entertainment	0	0	0		0	0
Residential	8	80	40	0		6
Hotel	0	0	0	0	0	

Table 8-P (D): Internal Person-Trip Origin-Destination Matrix (Computed at Destination)						
Origin (From)	Destination (To)					
	Office	Retail	Restaurant	Cinema/Entertainment	Residential	Hotel
Office		4	0	0	11	0
Retail	4		0	0	121	0
Restaurant	4	26		0	42	0
Cinema/Entertainment	1	2	0		11	0
Residential	8	5	0	0		0
Hotel	0	1	0	0	0	

Table 9-P (D): Internal and External Trips Summary (Entering Trips)						
Destination Land Use	Person-Trip Estimates			External Trips by Mode*		
	Internal	External	Total	Vehicles ¹	Transit ²	Non-Motorized ²
Office	9	5	14	5	0	0
Retail	9	43	52	43	0	0
Restaurant	0	0	0	0	0	0
Cinema/Entertainment	0	0	0	0	0	0
Residential	16	248	264	248	0	0
Hotel	0	0	0	0	0	0
All Other Land Uses ³	0	0	0	0	0	0

Table 9-P (O): Internal and External Trips Summary (Exiting Trips)						
Origin Land Use	Person-Trip Estimates			External Trips by Mode*		
	Internal	External	Total	Vehicles ¹	Transit ²	Non-Motorized ²
Office	5	64	69	64	0	0
Retail	16	41	57	41	0	0
Restaurant	0	0	0	0	0	0
Cinema/Entertainment	0	0	0	0	0	0
Residential	13	178	191	178	0	0
Hotel	0	0	0	0	0	0
All Other Land Uses ³	0	0	0	0	0	0

¹Vehicle-trips computed using the mode split and vehicle occupancy values provided in Table 2-P
²Person-Trips
³Total estimate for all other land uses at mixed-use development site is not subject to internal trip capture computations in this estimator
*Indicates computation that has been rounded to the nearest whole number.

APPENDIX F

PROJECTED BACKGROUND GROWTH

Trim/OR 174
8 hrs

Year	Date	North Leg		South Leg		East Leg		West Leg		Total
		SB	NB	NB	SB	WB	EB	EB	WB	
2008	Friday 20 June	618	391	4770	5319	6281	6058	10034	9935	43406
2010	Friday 9 July	744	722	5389	4539	6433	6484	9542	10363	44216
2012	Friday 8 June	329	441	4696	4430	5833	5818	8875	9044	39466
2017	Wednesday 19 April	590	518	4739	5742	5522	5570	10003	9024	41708
2023	Tues, Feb 07	691	630	3020	3086	5174	4942	4635	7168	29346

used proportion of other 4 counts averaged x proportion 2023 vs average of all other years for SB South Leg

North Leg	Year	Counts				% Change			
		NB	SB	NB+SB	INT	NB	SB	NB+SB	INT
	2008	391	618	1009	43406				
	2010	722	744	1466	44216	84.7%	20.4%	45.3%	1.9%
	2012	441	329	770	39466	-38.9%	-55.8%	-47.5%	-10.7%
	2017	518	590	1108	41708	17.5%	79.3%	43.9%	5.7%
	2023	630	691	1321	29346	21.6%	17.1%	19.2%	-29.6%

Regression Estimate 2008 495 568 1063 44847
Regression Estimate 2023 609 634 1243 31800

Average Annual Change 1.39% 0.74% 1.05% -2.27%

West Leg	Year	Counts				% Change			
		EB	WB	EB+WB	INT	EB	WB	EB+WB	INT
	2008	10034	9935	19969	43406				
	2010	9542	10363	19905	44216	-4.9%	4.3%	-0.3%	1.9%
	2012	8875	9044	17919	39466	-7.0%	-12.7%	-10.0%	-10.7%
	2017	10003	9024	19027	41708	12.7%	-0.2%	6.2%	5.7%
	2023	4635	7168	11803	29346	-53.7%	-20.6%	-38.0%	-29.6%

Regression Estimate 2008 10442 10240 20682
Regression Estimate 2023 5881 7408 13288

Average Annual Change -3.76% -2.14% -2.91%

East Leg	Year	Counts				% Change			
		EB	WB	EB+WB	INT	EB	WB	EB+WB	INT
	2008	6058	6281	12339	43406				
	2010	6484	6433	12917	44216	7.0%	2.4%	4.7%	1.9%
	2012	5818	5833	11651	39466	-10.3%	-9.3%	-9.8%	-10.7%
	2017	5570	5522	11092	41708	-4.3%	-5.3%	-4.8%	5.7%
	2023	4942	5174	10116	29346	-11.3%	-6.3%	-8.8%	-29.6%

Regression Estimate 2008 6298 6340 12637
Regression Estimate 2023 4990 5112 10101

Average Annual Change -1.54% -1.42% -1.48%

South Leg	Year	Counts				% Change			
		NB	SB	NB+SB	INT	NB	SB	NB+SB	INT
	2008	4770	5319	10089	43406				
	2010	5389	4539	9928	44216	13.0%	-14.7%	-1.6%	1.9%
	2012	4696	4430	9126	39466	-12.9%	-2.4%	-8.1%	-10.7%
	2017	4739	5742	10481	41708	0.9%	29.6%	14.8%	5.7%
	2023	3020	3086	6106	29346	-36.3%	-46.3%	-41.7%	-29.6%

Regression Estimate 2008 5270 5196 10465
Regression Estimate 2023 3403 3765 7167

Average Annual Change -2.87% -2.13% -2.49%

Trim/OR 174
AM Peak

Year	Date	North Leg		South Leg		East Leg		West Leg		Total
		SB	NB	NB	SB	WB	EB	EB	WB	
2008	Friday 20 June	34	14	649	439	1326	294	674	1836	5266
2010	Friday 9 July	42	46	819	454	1309	387	720	2003	5780
2012	Friday 8 June	62	64	875	414	1292	313	578	2016	5614
2017	Wednesday 19 April	48	51	807	537	1324	428	727	1890	5812
2023	Tues, Feb 07	53	88	592	346	1200	335	321	1645	4580

used proportion of other 4 counts averaged x proportion 2023 vs average of all other years for SB South Leg

North Leg	Year	Counts				% Change			
		NB	SB	NB+SB	INT	NB	SB	NB+SB	INT
	2008	14	34	48	5266				
	2010	46	42	88	5780	228.6%	23.5%	83.3%	9.8%
	2012	64	62	126	5614	39.1%	47.6%	43.2%	-2.9%
	2017	51	48	99	5812	-20.3%	-22.6%	-21.4%	3.5%
	2023	88	53	141	4580	72.5%	10.4%	42.4%	-21.2%

Regression Estimate 2008 30 43 73 5710
 Regression Estimate 2023 86 56 142 4961
Average Annual Change 7.30% 1.77% 4.56% -0.93%

West Leg	Year	Counts				% Change			
		EB	WB	EB+WB	INT	EB	WB	EB+WB	INT
	2008	674	1836	2510	5266				
	2010	720	2003	2723	5780	6.8%	9.1%	8.5%	9.8%
	2012	578	2016	2594	5614	-19.7%	0.6%	-4.7%	-2.9%
	2017	727	1890	2617	5812	25.8%	-6.3%	0.9%	3.5%
	2023	321	1645	1966	4580	-55.8%	-13.0%	-24.9%	-21.2%

Regression Estimate 2008 728 1984 2712
 Regression Estimate 2023 418 1719 2137
Average Annual Change -3.62% -0.95% -1.58%

East Leg	Year	Counts				% Change			
		EB	WB	EB+WB	INT	EB	WB	EB+WB	INT
	2008	294	1326	1620	5266				
	2010	387	1309	1696	5780	31.6%	-1.3%	4.7%	9.8%
	2012	313	1292	1605	5614	-19.1%	-1.3%	-5.4%	-2.9%
	2017	428	1324	1752	5812	36.7%	2.5%	9.2%	3.5%
	2023	335	1200	1535	4580	-21.7%	-9.4%	-12.4%	-21.2%

Regression Estimate 2008 337 1331 1668
 Regression Estimate 2023 374 1228 1602
Average Annual Change 0.70% -0.54% -0.27%

South Leg	Year	Counts				% Change			
		NB	SB	NB+SB	INT	NB	SB	NB+SB	INT
	2008	649	439	1088	5266				
	2010	819	454	1273	5780	26.2%	3.4%	17.0%	9.8%
	2012	875	414	1289	5614	6.8%	-8.8%	1.3%	-2.9%
	2017	807	537	1344	5812	-7.8%	29.7%	4.3%	3.5%
	2023	592	346	938	4580	-26.6%	-35.6%	-30.2%	-21.2%

Regression Estimate 2008 797 461 1257
 Regression Estimate 2023 676 404 1080
Average Annual Change -1.09% -0.87% -1.01%

Trim/OR 174
PM Peak

Year	Date	North Leg		South Leg		East Leg		West Leg		Total
		SB	NB	NB	SB	WB	EB	EB	WB	
2008	Friday 20 June	64	60	494	1051	424	1354	2206	723	6376
2010	Friday 9 July	107	40	603	1007	664	1334	2131	1124	7010
2012	Friday 8 June	94	69	634	905	624	1353	2024	1049	6752
2017	Wednesday 19 April	56	61	587	801	657	1284	1839	993	6278
2023	Tues, Feb 07	159	74	333	540	437	998	931	672	4144

used proportion of other 4 counts averaged x proportion 2023 vs average of all other years for SB South Leg

North Leg	Year	Counts				% Change			
		NB	SB	NB+SB	INT	NB	SB	NB+SB	INT
	2008	60	64	124	6376				
	2010	40	107	147	7010	-33.3%	67.2%	18.5%	9.9%
	2012	69	94	163	6752	72.5%	-12.1%	10.9%	-3.7%
	2017	61	56	117	6278	-11.6%	-40.4%	-28.2%	-7.0%
	2023	74	159	233	4144	21.3%	183.9%	99.1%	-34.0%

Regression Estimate	2008	53	71	124	7085
Regression Estimate	2023	73	133	205	4653
Average Annual Change		2.12%	4.23%	3.41%	-2.76%

West Leg	Year	Counts				% Change			
		EB	WB	EB+WB	INT	EB	WB	EB+WB	INT
	2008	2206	723	2929	6376				
	2010	2131	1124	3255	7010	-3.4%	55.5%	11.1%	9.9%
	2012	2024	1049	3073	6752	-5.0%	-6.7%	-5.6%	-3.7%
	2017	1839	993	2832	6278	-9.1%	-5.3%	-7.8%	-7.0%
	2023	931	672	1603	4144	-49.4%	-32.3%	-43.4%	-34.0%

Regression Estimate	2008	2316	990	3306
Regression Estimate	2023	1092	795	1887
Average Annual Change		-4.89%	-1.46%	-3.67%

East Leg	Year	Counts				% Change			
		EB	WB	EB+WB	INT	EB	WB	EB+WB	INT
	2008	1354	424	1778	6376				
	2010	1334	664	1998	7010	-1.5%	56.6%	12.4%	9.9%
	2012	1353	624	1977	6752	1.4%	-6.0%	-1.1%	-3.7%
	2017	1284	657	1941	6278	-5.1%	5.3%	-1.8%	-7.0%
	2023	998	437	1435	4144	-22.3%	-33.5%	-26.1%	-34.0%

Regression Estimate	2008	1402	584	1985
Regression Estimate	2023	1059	528	1587
Average Annual Change		-1.85%	-0.67%	-1.48%

South Leg	Year	Counts				% Change			
		NB	SB	NB+SB	INT	NB	SB	NB+SB	INT
	2008	494	1051	1545	6376				
	2010	603	1007	1610	7010	22.1%	-4.2%	4.2%	9.9%
	2012	634	905	1539	6752	5.1%	-10.1%	-4.4%	-3.7%
	2017	587	801	1388	6278	-7.4%	-11.5%	-9.8%	-7.0%
	2023	333	540	873	4144	-43.3%	-32.6%	-37.1%	-34.0%

Regression Estimate	2008	608	1061	1669
Regression Estimate	2023	414	560	974
Average Annual Change		-2.53%	-4.17%	-3.53%

APPENDIX G

PROPOSED CROSS-SECTIONS FOR PUBLIC AND PRIVATE ROAD

SUBJECT TO THE CONDITIONS, IF ANY, SET FORTH IN OUR LETTER DATED:
 THIS DRAFT PLAN IS APPROVED BY THE CITY OF OTTAWA UNDER SECTION 8 OF THE PLANNING ACT, THIS _____ DAY OF _____, 20____.
 GERALDINE WILDMAN MCF. RFP, ACTING MANAGER, DEVELOPMENT REVIEW/STAFF PLANNING, REAL ESTATE AND ECONOMIC DEVELOPMENT DEPARTMENT, CITY OF OTTAWA

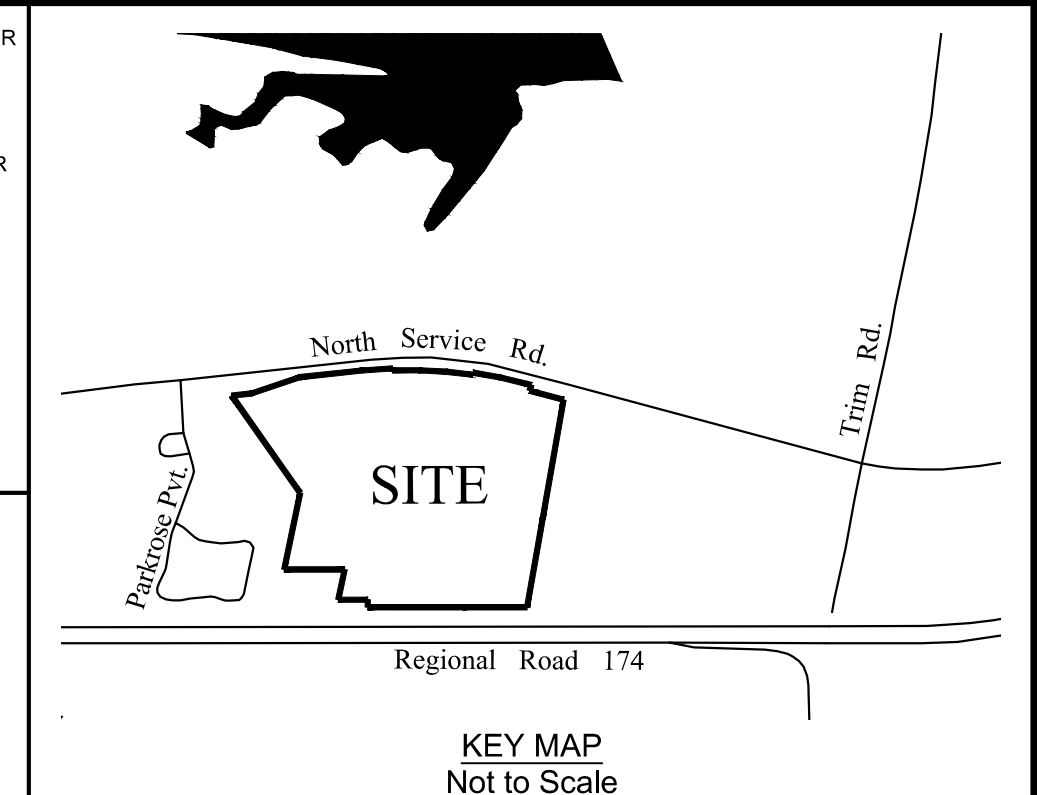

DRAFT PLAN OF SUBDIVISION OF
PART OF LOTS 31 AND 32
CONCESSION 1 (OLD SURVEY)
 Geographic Township of Cumberland
 CITY OF OTTAWA
 Prepared by Annis, O'Sullivan, Vollebek Ltd.

Scale 1 : 500
 METRIC
 DISTANCES SHOWN ON THIS PLAN ARE IN METRES AND CAN BE CONVERTED TO FEET BY DIVIDING BY 0.3048

SURVEYOR'S CERTIFICATE
 I CERTIFY THAT:
 The boundaries of the lands to be subdivided and their relationship to adjoining lands have been accurately and correctly shown.
 Date: _____ E. H. Horweyer
 ONTARIO LAND SURVEYOR

OWNER'S CERTIFICATE
 This is to certify that I am the owner / agent of the lands to be subdivided and that this plan was prepared in accordance with my instructions.
 Date: _____ Jean-Luc Rivard (Authorized Signing Officer)
 3223701 CANADA INC.
 I have authority to bind the corporation.

- Notes & Legend**
- Denotes
- MH-ST - Maintenance Hole (Storm Sewer)
 - MH - Maintenance Hole (Sanitary)
 - MH-U - Maintenance Hole (Unidentified)
 - FV - Fire Hydrant
 - WV - Water Valve
 - CB - Catch Basin
 - + AN - Anchor
 - LS - Light Standard
 - UP - Utility Pole
 - PAW - Post and Wire
 - CSP - Corrugated Steel Pipe
 - PPP - Plastic Pipe
 - TOS - Top of Slope
 - BOS - Bottom of Slope
 - + ELEV - Location of Elevations
 - C/L - Centreline
 - — — — — Property Line
 - △ S - Sign
 - - Diameter
 - Inv. - Invert
 - T/G - Top of Grate
 - + ELEV - Location of Existing Elevations

AREA SCHEDULE	
BLOCK	Square Metres
1	19376
2	13509
3	6150
4	851
5	15635
6	8861
7	30162
Street No. 1	996
Total	104531

- ADDITIONAL INFORMATION REQUIRED UNDER SECTION 51-17 OF THE PLANNING ACT**
- (a) see plan
 - (b) see plan
 - (c) see plan
 - (d) multifamily residential housing
 - (e) see plan
 - (f) see plan
 - (g) see plan
 - (h) City of Ottawa
 - (i) see scale report
 - (j) see plan
 - (k) sanitary, storm sewers, municipal water, bell, hydro, cable and gas to be available
 - (l) see plan



1. STANDARD CROSS-SECTIONS TO BE READ IN CONJUNCTION WITH THE GENERAL STANDARD CROSS-SECTION NOTES AND OTHER APPLICABLE CITY AND UTILITY PLANS AND DETAILS.
2. CONCRETE CURBS TO BE CONSTRUCTED AS PER CITY OF OTTAWA STANDARD DETAILS.
3. TYPICAL FRONT YARD SETBACK IS TO BE CLEAR AND UNENCUMBERED OF ANY SUBSURFACE BUILDING ENCROACHMENTS.
4. FIRE HYDRANTS TO BE LOCATED ON THE WATERMAIN SIDE OF THE STREET.
5. CATCH BASINS TO BE PER CITY OF OTTAWA DETAIL S2.
6. GAS MAIN SHALL HAVE A MINIMUM OF 0.6M CLEARANCE FROM STRUCTURES (E.G. CATCH BASINS AND HYDRANTS) AND 1.2 M FROM TREE ROOT BALL.
7. STREETLIGHTS CAN BE LOCATED ON EITHER SIDE OF THE RIGHT-OF-WAY.
8. GAS MAIN SHALL HAVE A MINIMUM OF 0.6 M CLEARANCE FROM STRUCTURES (E.G. CATCH BASINS AND HYDRANTS) AND 1.2 M FROM TREE ROOT BALL.
9. JOINT-USE UTILITY TRENCH (JUT) UNDER SIDEWALK AS PER DETAIL UDS0049 (REV 22) HELD BY OTTAWA HYDRO.
10. GRADE LEVEL BOX (GLB) AS DRAWN SHOWS GLB3660. EXACT LOCATION TO BE CONFIRMED. THIS CROSS SECTION TO BE USED IF CONCRETE ENCASED HYDRO DUCT OR ANOTHER SEPARATE UTILITY DUCT IS REQUIRED. IF CONCRETE ENCASED HYDRO DUCT IS UTILIZED, INSTALLATION AS PER DETAIL UDS0051.
11. WHEN CONCRETE DUCT BANKS ARE REQUIRED, ADDITIONAL CLEARANCE IS REQUIRED FOR THE INSTALLATION OF A 2.2M X 4.0M MAINTENANCE HOLE PER OTTAWA HYDRO DETAIL UCS0014. LOCATIONS TO BE DETERMINED DURING DESIGN PHASE.
12. TREE CLEARANCES TO HYDRO OTTAWA PLANT SHALL FOLLOW GCS0038.
13. CLEARANCES SHOWN ARE MINIMUMS.

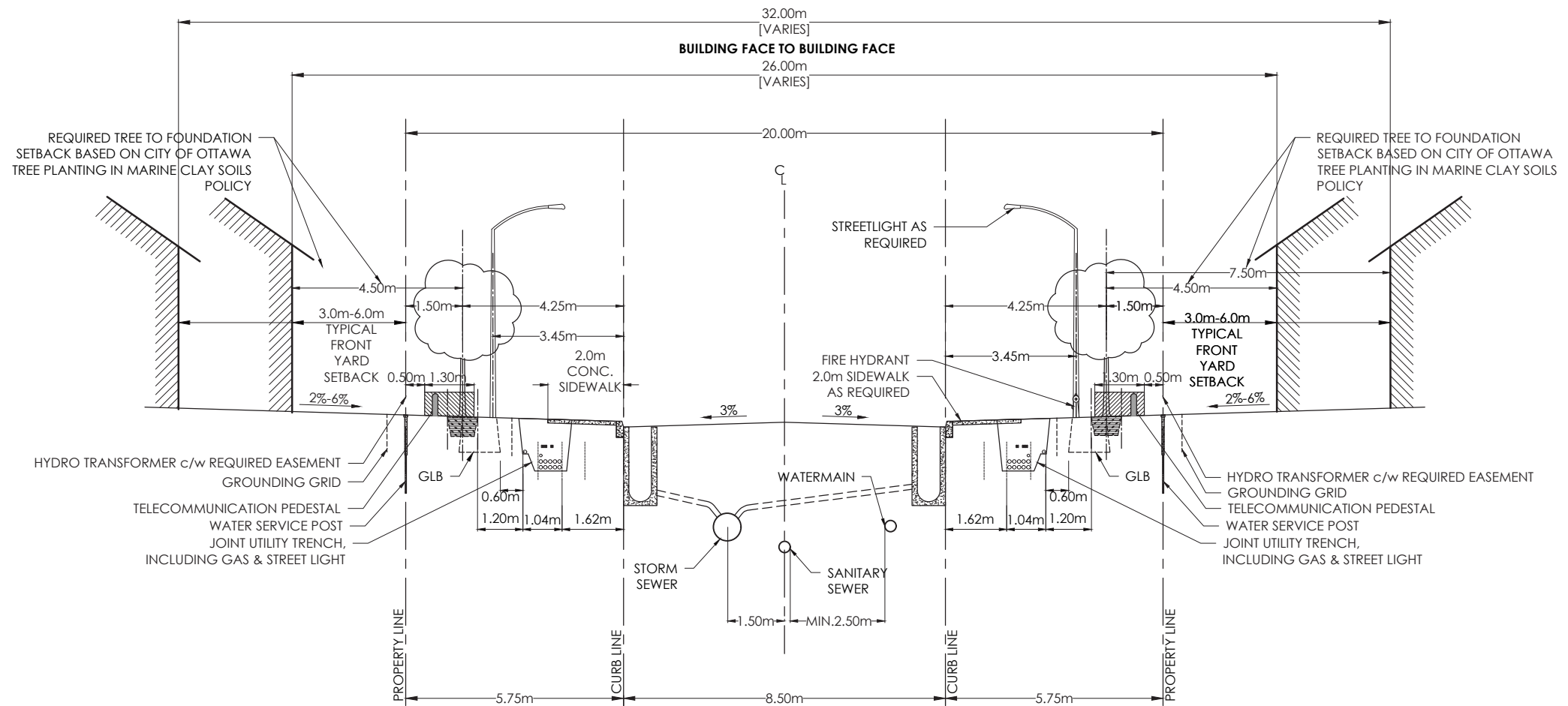

20.0m ROW CROSS SECTION

REV. DATE: AUG. 2022
DWG. No. ROW-20.0

Site Sections

5 | Massing - Height, Density & Transition

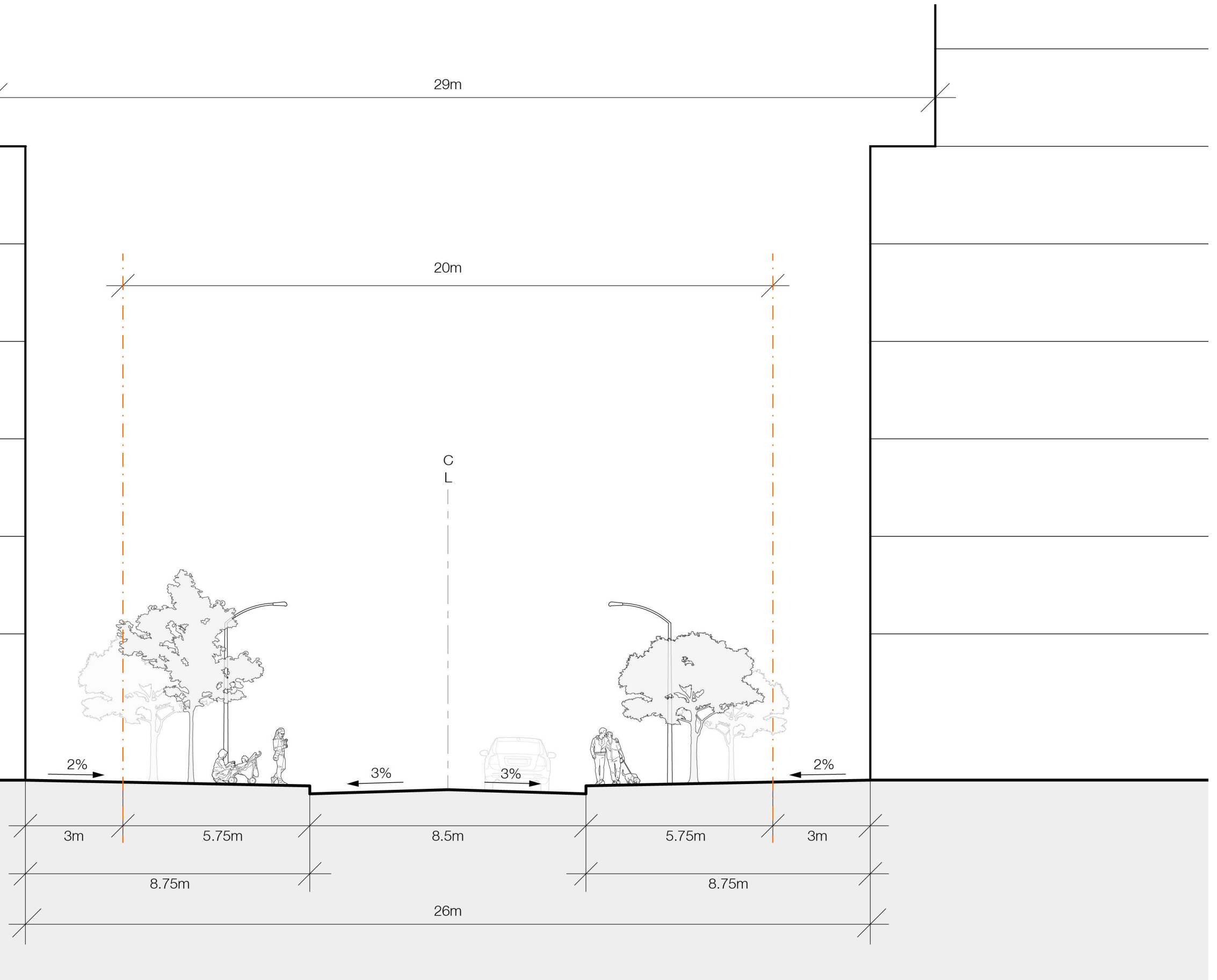
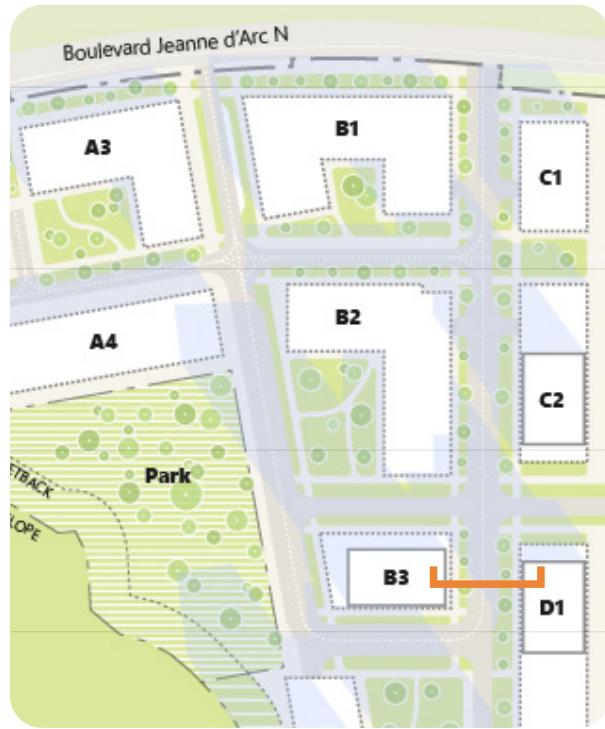

APPENDIX H

MMLOS ANALYSIS: ROAD SEGMENTS

APPENDIX I

DRAFT TDM CHECKLIST

TDM-Supportive Development Design and Infrastructure Checklist:
Residential Developments (multi-family or condominium)

Legend	
REQUIRED	The Official Plan or Zoning By-law provides related guidance that must be followed
BASIC	The measure is generally feasible and effective, and in most cases would benefit the development and its users
BETTER	The measure could maximize support for users of sustainable modes, and optimize development performance

TDM-supportive design & infrastructure measures: <i>Residential developments</i>		Check if completed & add descriptions, explanations or plan/drawing references
1. WALKING & CYCLING: ROUTES		
1.1 Building location & access points		
BASIC	1.1.1 Locate building close to the street, and do not locate parking areas between the street and building entrances	<input checked="" type="checkbox"/> parking underground
BASIC	1.1.2 Locate building entrances in order to minimize walking distances to sidewalks and transit stops/stations	<input checked="" type="checkbox"/>
BASIC	1.1.3 Locate building doors and windows to ensure visibility of pedestrians from the building, for their security and comfort	<input checked="" type="checkbox"/>
1.2 Facilities for walking & cycling		
REQUIRED	1.2.1 Provide convenient, direct access to stations or major stops along rapid transit routes within 600 metres; minimize walking distances from buildings to rapid transit; provide pedestrian-friendly, weather-protected (where possible) environment between rapid transit accesses and building entrances; ensure quality linkages from sidewalks through building entrances to integrated stops/stations (<i>see Official Plan policy 4.3.3</i>)	<input checked="" type="checkbox"/> anticipated MUP on north side of H174, connecting to a new bridge connection from Trim LRT Station to MUP on north side of H174.
REQUIRED	1.2.2 Provide safe, direct and attractive pedestrian access from public sidewalks to building entrances through such measures as: reducing distances between public sidewalks and major building entrances; providing walkways from public streets to major building entrances; within a site, providing walkways along the front of adjoining buildings, between adjacent buildings, and connecting areas where people may congregate, such as courtyards and transit stops; and providing weather protection through canopies, colonnades, and other design elements wherever possible (<i>see Official Plan policy 4.3.12</i>)	<input checked="" type="checkbox"/>

TDM-supportive design & infrastructure measures: <i>Residential developments</i>		Check if completed & add descriptions, explanations or plan/drawing references
REQUIRED	1.2.3 Provide sidewalks of smooth, well-drained walking surfaces of contrasting materials or treatments to differentiate pedestrian areas from vehicle areas, and provide marked pedestrian crosswalks at intersection sidewalks (see <i>Official Plan policy 4.3.10</i>)	<input checked="" type="checkbox"/>
REQUIRED	1.2.4 Make sidewalks and open space areas easily accessible through features such as gradual grade transition, depressed curbs at street corners and convenient access to extra-wide parking spaces and ramps (see <i>Official Plan policy 4.3.10</i>)	<input checked="" type="checkbox"/>
REQUIRED	1.2.5 Include adequately spaced inter-block/street cycling and pedestrian connections to facilitate travel by active transportation. Provide links to the existing or planned network of public sidewalks, multi-use pathways and on-road cycle routes. Where public sidewalks and multi-use pathways intersect with roads, consider providing traffic control devices to give priority to cyclists and pedestrians (see <i>Official Plan policy 4.3.11</i>)	<input checked="" type="checkbox"/>
BASIC	1.2.6 Provide safe, direct and attractive walking routes from building entrances to nearby transit stops	<input checked="" type="checkbox"/>
BASIC	1.2.7 Ensure that walking routes to transit stops are secure, visible, lighted, shaded and wind-protected wherever possible	<input checked="" type="checkbox"/>
BASIC	1.2.8 Design roads used for access or circulation by cyclists using a target operating speed of no more than 30 km/h, or provide a separated cycling facility	<input checked="" type="checkbox"/> 30km/h streets envisioned
1.3 Amenities for walking & cycling		
BASIC	1.3.1 Provide lighting, landscaping and benches along walking and cycling routes between building entrances and streets, sidewalks and trails	<input checked="" type="checkbox"/>
BASIC	1.3.2 Provide wayfinding signage for site access (where required, e.g. when multiple buildings or entrances exist) and egress (where warranted, such as when directions to reach transit stops/stations, trails or other common destinations are not obvious)	<input checked="" type="checkbox"/>

TDM-supportive design & infrastructure measures: <i>Residential developments</i>		Check if completed & add descriptions, explanations or plan/drawing references
2. WALKING & CYCLING: END-OF-TRIP FACILITIES		
2.1 Bicycle parking		
REQUIRED	2.1.1 Provide bicycle parking in highly visible and lighted areas, sheltered from the weather wherever possible (see <i>Official Plan policy 4.3.6</i>)	<input checked="" type="checkbox"/>
REQUIRED	2.1.2 Provide the number of bicycle parking spaces specified for various land uses in different parts of Ottawa; provide convenient access to main entrances or well-used areas (see <i>Zoning By-law Section 111</i>)	<input checked="" type="checkbox"/> Anticipated. To be confirmed in SPA
REQUIRED	2.1.3 Ensure that bicycle parking spaces and access aisles meet minimum dimensions; that no more than 50% of spaces are vertical spaces; and that parking racks are securely anchored (see <i>Zoning By-law Section 111</i>)	<input checked="" type="checkbox"/>
BASIC	2.1.4 Provide bicycle parking spaces equivalent to the expected number of resident-owned bicycles, plus the expected peak number of visitor cyclists	<input checked="" type="checkbox"/>
2.2 Secure bicycle parking		
REQUIRED	2.2.1 Where more than 50 bicycle parking spaces are provided for a single residential building, locate at least 25% of spaces within a building/structure, a secure area (e.g. supervised parking lot or enclosure) or bicycle lockers (see <i>Zoning By-law Section 111</i>)	<input checked="" type="checkbox"/>
BETTER	2.2.2 Provide secure bicycle parking spaces equivalent to at least the number of units at condominiums or multi-family residential developments	<input checked="" type="checkbox"/> to be determined in SPA
2.3 Bicycle repair station		
BETTER	2.3.1 Provide a permanent bike repair station, with commonly used tools and an air pump, adjacent to the main bicycle parking area (or secure bicycle parking area, if provided)	<input checked="" type="checkbox"/> to be considered during SPA
3. TRANSIT		
3.1 Customer amenities		
BASIC	3.1.1 Provide shelters, lighting and benches at any on-site transit stops	<input checked="" type="checkbox"/> to be considered during SPA
BASIC	3.1.2 Where the site abuts an off-site transit stop and insufficient space exists for a transit shelter in the public right-of-way, protect land for a shelter and/or install a shelter	<input type="checkbox"/>
BETTER	3.1.3 Provide a secure and comfortable interior waiting area by integrating any on-site transit stops into the building	<input type="checkbox"/>

TDM-supportive design & infrastructure measures: <i>Residential developments</i>		Check if completed & add descriptions, explanations or plan/drawing references
4. RIDESHARING		
4.1 Pick-up & drop-off facilities		
BASIC	4.1.1 Provide a designated area for carpool drivers (plus taxis and ride-hailing services) to drop off or pick up passengers without using fire lanes or other no-stopping zones	<input checked="" type="checkbox"/>
5. CARSHARING & BIKESHARING		
5.1 Carshare parking spaces		
BETTER	5.1.1 Provide up to three carshare parking spaces in an R3, R4 or R5 Zone for specified residential uses (see <i>Zoning By-law Section 94</i>)	<input checked="" type="checkbox"/>
5.2 Bikeshare station location		
BETTER	5.2.1 Provide a designated bikeshare station area near a major building entrance, preferably lighted and sheltered with a direct walkway connection	<input checked="" type="checkbox"/>
6. PARKING		
6.1 Number of parking spaces		
REQUIRED	6.1.1 Do not provide more parking than permitted by zoning, nor less than required by zoning, unless a variance is being applied for	<input checked="" type="checkbox"/> To be confirmed during SPA
BASIC	6.1.2 Provide parking for long-term and short-term users that is consistent with mode share targets, considering the potential for visitors to use off-site public parking	<input checked="" type="checkbox"/>
BASIC	6.1.3 Where a site features more than one use, provide shared parking and reduce the cumulative number of parking spaces accordingly (see <i>Zoning By-law Section 104</i>)	<input checked="" type="checkbox"/>
BETTER	6.1.4 Reduce the minimum number of parking spaces required by zoning by one space for each 13 square metres of gross floor area provided as shower rooms, change rooms, locker rooms and other facilities for cyclists in conjunction with bicycle parking (see <i>Zoning By-law Section 111</i>)	<input type="checkbox"/>
6.2 Separate long-term & short-term parking areas		
BETTER	6.2.1 Provide separate areas for short-term and long-term parking (using signage or physical barriers) to permit access controls and simplify enforcement (i.e. to discourage residents from parking in visitor spaces, and vice versa)	<input checked="" type="checkbox"/>

TDM Measures Checklist:
Residential Developments (multi-family, condominium or subdivision)

Legend	
BASIC	The measure is generally feasible and effective, and in most cases would benefit the development and its users
BETTER	The measure could maximize support for users of sustainable modes, and optimize development performance
★	The measure is one of the most dependably effective tools to encourage the use of sustainable modes

TDM measures: <i>Residential developments</i>		Check if proposed & add descriptions
1. TDM PROGRAM MANAGEMENT		
1.1 Program coordinator		
BASIC	★ 1.1.1 Designate an internal coordinator, or contract with an external coordinator	<input checked="" type="checkbox"/>
1.2 Travel surveys		
BETTER	1.2.1 Conduct periodic surveys to identify travel-related behaviours, attitudes, challenges and solutions, and to track progress	<input checked="" type="checkbox"/>
2. WALKING AND CYCLING		
2.1 Information on walking/cycling routes & destinations		
BASIC	2.1.1 Display local area maps with walking/cycling access routes and key destinations at major entrances (<i>multi-family, condominium</i>)	<input checked="" type="checkbox"/>
2.2 Bicycle skills training		
BETTER	2.2.1 Offer on-site cycling courses for residents, or subsidize off-site courses	<input checked="" type="checkbox"/>

TDM measures: <i>Residential developments</i>		Check if proposed & add descriptions
3. TRANSIT		
3.1 Transit information		
BASIC	3.1.1 Display relevant transit schedules and route maps at entrances (<i>multi-family, condominium</i>)	<input checked="" type="checkbox"/>
BETTER	3.1.2 Provide real-time arrival information display at entrances (<i>multi-family, condominium</i>)	<input type="checkbox"/>
3.2 Transit fare incentives		
BASIC ★	3.2.1 Offer PRESTO cards preloaded with one monthly transit pass on residence purchase/move-in, to encourage residents to use transit	<input checked="" type="checkbox"/>
BETTER	3.2.2 Offer at least one year of free monthly transit passes on residence purchase/move-in	<input type="checkbox"/>
3.3 Enhanced public transit service		
BETTER ★	3.3.1 Contract with OC Transpo to provide early transit services until regular services are warranted by occupancy levels (<i>subdivision</i>)	<input type="checkbox"/>
3.4 Private transit service		
BETTER	3.4.1 Provide shuttle service for seniors homes or lifestyle communities (e.g. scheduled mall or supermarket runs)	<input type="checkbox"/>
4. CARSHARING & BIKESHARING		
4.1 Bikeshare stations & memberships		
BETTER	4.1.1 Contract with provider to install on-site bikeshare station (<i>multi-family</i>)	<input checked="" type="checkbox"/>
BETTER	4.1.2 Provide residents with bikeshare memberships, either free or subsidized (<i>multi-family</i>)	<input checked="" type="checkbox"/>
4.2 Carshare vehicles & memberships		
BETTER	4.2.1 Contract with provider to install on-site carshare vehicles and promote their use by residents	<input checked="" type="checkbox"/>
BETTER	4.2.2 Provide residents with carshare memberships, either free or subsidized	<input type="checkbox"/>
5. PARKING		
5.1 Priced parking		
BASIC ★	5.1.1 Unbundle parking cost from purchase price (<i>condominium</i>)	<input type="checkbox"/>
BASIC ★	5.1.2 Unbundle parking cost from monthly rent (<i>multi-family</i>)	<input checked="" type="checkbox"/>

TDM measures: <i>Residential developments</i>		Check if proposed & add descriptions
6. TDM MARKETING & COMMUNICATIONS		
6.1 Multimodal travel information		
BASIC	★ 6.1.1 Provide a multimodal travel option information package to new residents	<input checked="" type="checkbox"/>
6.2 Personalized trip planning		
BETTER	★ 6.2.1 Offer personalized trip planning to new residents	<input checked="" type="checkbox"/>

TDM-Supportive Development Design and Infrastructure Checklist: Non-Residential Developments (office, institutional, retail or industrial)

Legend	
REQUIRED	The Official Plan or Zoning By-law provides related guidance that must be followed
BASIC	The measure is generally feasible and effective, and in most cases would benefit the development and its users
BETTER	The measure could maximize support for users of sustainable modes, and optimize development performance

TDM-supportive design & infrastructure measures: <i>Non-residential developments</i>		Check if completed & add descriptions, explanations or plan/drawing references
1. WALKING & CYCLING: ROUTES		
1.1 Building location & access points		
BASIC	1.1.1 Locate building close to the street, and do not locate parking areas between the street and building entrances	<input checked="" type="checkbox"/>
BASIC	1.1.2 Locate building entrances in order to minimize walking distances to sidewalks and transit stops/stations	<input checked="" type="checkbox"/>
BASIC	1.1.3 Locate building doors and windows to ensure visibility of pedestrians from the building, for their security and comfort	<input checked="" type="checkbox"/>
1.2 Facilities for walking & cycling		
REQUIRED	1.2.1 Provide convenient, direct access to stations or major stops along rapid transit routes within 600 metres; minimize walking distances from buildings to rapid transit; provide pedestrian-friendly, weather-protected (where possible) environment between rapid transit accesses and building entrances; ensure quality linkages from sidewalks through building entrances to integrated stops/stations (see <i>Official Plan policy 4.3.3</i>)	<input checked="" type="checkbox"/>
REQUIRED	1.2.2 Provide safe, direct and attractive pedestrian access from public sidewalks to building entrances through such measures as: reducing distances between public sidewalks and major building entrances; providing walkways from public streets to major building entrances; within a site, providing walkways along the front of adjoining buildings, between adjacent buildings, and connecting areas where people may congregate, such as courtyards and transit stops; and providing weather protection through canopies, colonnades, and other design elements wherever possible (see <i>Official Plan policy 4.3.12</i>)	<input checked="" type="checkbox"/>

TDM-supportive design & infrastructure measures: <i>Non-residential developments</i>		Check if completed & add descriptions, explanations or plan/drawing references
REQUIRED	1.2.3 Provide sidewalks of smooth, well-drained walking surfaces of contrasting materials or treatments to differentiate pedestrian areas from vehicle areas, and provide marked pedestrian crosswalks at intersection sidewalks (<i>see Official Plan policy 4.3.10</i>)	<input checked="" type="checkbox"/>
REQUIRED	1.2.4 Make sidewalks and open space areas easily accessible through features such as gradual grade transition, depressed curbs at street corners and convenient access to extra-wide parking spaces and ramps (<i>see Official Plan policy 4.3.10</i>)	<input checked="" type="checkbox"/>
REQUIRED	1.2.5 Include adequately spaced inter-block/street cycling and pedestrian connections to facilitate travel by active transportation. Provide links to the existing or planned network of public sidewalks, multi-use pathways and on-road cycle routes. Where public sidewalks and multi-use pathways intersect with roads, consider providing traffic control devices to give priority to cyclists and pedestrians (<i>see Official Plan policy 4.3.11</i>)	<input checked="" type="checkbox"/>
BASIC	1.2.6 Provide safe, direct and attractive walking routes from building entrances to nearby transit stops	<input checked="" type="checkbox"/>
BASIC	1.2.7 Ensure that walking routes to transit stops are secure, visible, lighted, shaded and wind-protected wherever possible	<input checked="" type="checkbox"/>
BASIC	1.2.8 Design roads used for access or circulation by cyclists using a target operating speed of no more than 30 km/h, or provide a separated cycling facility	<input checked="" type="checkbox"/>
1.3 Amenities for walking & cycling		
BASIC	1.3.1 Provide lighting, landscaping and benches along walking and cycling routes between building entrances and streets, sidewalks and trails	<input checked="" type="checkbox"/>
BASIC	1.3.2 Provide wayfinding signage for site access (where required, e.g. when multiple buildings or entrances exist) and egress (where warranted, such as when directions to reach transit stops/stations, trails or other common destinations are not obvious)	<input checked="" type="checkbox"/>

TDM-supportive design & infrastructure measures: <i>Non-residential developments</i>		Check if completed & add descriptions, explanations or plan/drawing references
2. WALKING & CYCLING: END-OF-TRIP FACILITIES		
2.1 Bicycle parking		
REQUIRED	2.1.1 Provide bicycle parking in highly visible and lighted areas, sheltered from the weather wherever possible (see <i>Official Plan policy 4.3.6</i>)	<input checked="" type="checkbox"/>
REQUIRED	2.1.2 Provide the number of bicycle parking spaces specified for various land uses in different parts of Ottawa; provide convenient access to main entrances or well-used areas (see <i>Zoning By-law Section 111</i>)	<input checked="" type="checkbox"/>
REQUIRED	2.1.3 Ensure that bicycle parking spaces and access aisles meet minimum dimensions; that no more than 50% of spaces are vertical spaces; and that parking racks are securely anchored (see <i>Zoning By-law Section 111</i>)	<input checked="" type="checkbox"/>
BASIC	2.1.4 Provide bicycle parking spaces equivalent to the expected number of commuter cyclists (assuming the cycling mode share target is met), plus the expected peak number of customer/visitor cyclists	<input checked="" type="checkbox"/>
BETTER	2.1.5 Provide bicycle parking spaces equivalent to the expected number of commuter and customer/visitor cyclists, plus an additional buffer (e.g. 25 percent extra) to encourage other cyclists and ensure adequate capacity in peak cycling season	<input checked="" type="checkbox"/>
2.2 Secure bicycle parking		
REQUIRED	2.2.1 Where more than 50 bicycle parking spaces are provided for a single office building, locate at least 25% of spaces within a building/structure, a secure area (e.g. supervised parking lot or enclosure) or bicycle lockers (see <i>Zoning By-law Section 111</i>)	<input checked="" type="checkbox"/>
BETTER	2.2.2 Provide secure bicycle parking spaces equivalent to the expected number of commuter cyclists (assuming the cycling mode share target is met)	<input checked="" type="checkbox"/>
2.3 Shower & change facilities		
BASIC	2.3.1 Provide shower and change facilities for the use of active commuters	<input type="checkbox"/>
BETTER	2.3.2 In addition to shower and change facilities, provide dedicated lockers, grooming stations, drying racks and laundry facilities for the use of active commuters	<input type="checkbox"/>
2.4 Bicycle repair station		
BETTER	2.4.1 Provide a permanent bike repair station, with commonly used tools and an air pump, adjacent to the main bicycle parking area (or secure bicycle parking area, if provided)	<input type="checkbox"/>

TDM-supportive design & infrastructure measures: <i>Non-residential developments</i>		Check if completed & add descriptions, explanations or plan/drawing references
3. TRANSIT		
3.1 Customer amenities		
BASIC	3.1.1 Provide shelters, lighting and benches at any on-site transit stops	<input type="checkbox"/>
BASIC	3.1.2 Where the site abuts an off-site transit stop and insufficient space exists for a transit shelter in the public right-of-way, protect land for a shelter and/or install a shelter	<input checked="" type="checkbox"/>
BETTER	3.1.3 Provide a secure and comfortable interior waiting area by integrating any on-site transit stops into the building	<input type="checkbox"/>
4. RIDESHARING		
4.1 Pick-up & drop-off facilities		
BASIC	4.1.1 Provide a designated area for carpool drivers (plus taxis and ride-hailing services) to drop off or pick up passengers without using fire lanes or other no-stopping zones	<input checked="" type="checkbox"/>
4.2 Carpool parking		
BASIC	4.2.1 Provide signed parking spaces for carpools in a priority location close to a major building entrance, sufficient in number to accommodate the mode share target for carpools	<input type="checkbox"/>
BETTER	4.2.2 At large developments, provide spaces for carpools in a separate, access-controlled parking area to simplify enforcement	<input type="checkbox"/>
5. CARSHARING & BIKESHARING		
5.1 Carshare parking spaces		
BETTER	5.1.1 Provide carshare parking spaces in permitted non-residential zones, occupying either required or provided parking spaces (<i>see Zoning By-law Section 94</i>)	<input type="checkbox"/>
5.2 Bikeshare station location		
BETTER	5.2.1 Provide a designated bikeshare station area near a major building entrance, preferably lighted and sheltered with a direct walkway connection	<input type="checkbox"/>

TDM-supportive design & infrastructure measures: <i>Non-residential developments</i>		Check if completed & add descriptions, explanations or plan/drawing references
6. PARKING		
6.1 Number of parking spaces		
REQUIRED	6.1.1 Do not provide more parking than permitted by zoning, nor less than required by zoning, unless a variance is being applied for	<input checked="" type="checkbox"/>
BASIC	6.1.2 Provide parking for long-term and short-term users that is consistent with mode share targets, considering the potential for visitors to use off-site public parking	<input checked="" type="checkbox"/>
BASIC	6.1.3 Where a site features more than one use, provide shared parking and reduce the cumulative number of parking spaces accordingly (<i>see Zoning By-law Section 104</i>)	<input checked="" type="checkbox"/>
BETTER	6.1.4 Reduce the minimum number of parking spaces required by zoning by one space for each 13 square metres of gross floor area provided as shower rooms, change rooms, locker rooms and other facilities for cyclists in conjunction with bicycle parking (<i>see Zoning By-law Section 111</i>)	<input type="checkbox"/>
6.2 Separate long-term & short-term parking areas		
BETTER	6.2.1 Separate short-term and long-term parking areas using signage or physical barriers, to permit access controls and simplify enforcement (i.e. to discourage employees from parking in visitor spaces, and vice versa)	<input checked="" type="checkbox"/>
7. OTHER		
7.1 On-site amenities to minimize off-site trips		
BETTER	7.1.1 Provide on-site amenities to minimize mid-day or mid-commute errands	<input type="checkbox"/>

TDM Measures Checklist:
Non-Residential Developments (office, institutional, retail or industrial)

Legend	
BASIC	The measure is generally feasible and effective, and in most cases would benefit the development and its users
BETTER	The measure could maximize support for users of sustainable modes, and optimize development performance
★	The measure is one of the most dependably effective tools to encourage the use of sustainable modes

TDM measures: <i>Non-residential developments</i>		Check if proposed & add descriptions
1. TDM PROGRAM MANAGEMENT		
1.1 Program coordinator		
BASIC ★	1.1.1 Designate an internal coordinator, or contract with an external coordinator	<input checked="" type="checkbox"/>
1.2 Travel surveys		
BETTER	1.2.1 Conduct periodic surveys to identify travel-related behaviours, attitudes, challenges and solutions, and to track progress	<input checked="" type="checkbox"/>
2. WALKING AND CYCLING		
2.1 Information on walking/cycling routes & destinations		
BASIC	2.1.1 Display local area maps with walking/cycling access routes and key destinations at major entrances	<input checked="" type="checkbox"/>
2.2 Bicycle skills training		
<i>Commuter travel</i>		
BETTER ★	2.2.1 Offer on-site cycling courses for commuters, or subsidize off-site courses	<input checked="" type="checkbox"/>
2.3 Valet bike parking		
<i>Visitor travel</i>		
BETTER	2.3.1 Offer secure valet bike parking during public events when demand exceeds fixed supply (e.g. for festivals, concerts, games)	<input type="checkbox"/>

TDM measures: <i>Non-residential developments</i>		Check if proposed & add descriptions
3. TRANSIT		
3.1 Transit information		
BASIC	3.1.1 Display relevant transit schedules and route maps at entrances	<input checked="" type="checkbox"/>
BASIC	3.1.2 Provide online links to OC Transpo and STO information	<input checked="" type="checkbox"/>
BETTER	3.1.3 Provide real-time arrival information display at entrances	<input type="checkbox"/>
3.2 Transit fare incentives		
<i>Commuter travel</i>		
BETTER	3.2.1 Offer preloaded PRESTO cards to encourage commuters to use transit	<input checked="" type="checkbox"/>
BETTER ★	3.2.2 Subsidize or reimburse monthly transit pass purchases by employees	<input type="checkbox"/>
<i>Visitor travel</i>		
BETTER	3.2.3 Arrange inclusion of same-day transit fare in price of tickets (e.g. for festivals, concerts, games)	<input type="checkbox"/>
3.3 Enhanced public transit service		
<i>Commuter travel</i>		
BETTER	3.3.1 Contract with OC Transpo to provide enhanced transit services (e.g. for shift changes, weekends)	<input type="checkbox"/>
<i>Visitor travel</i>		
BETTER	3.3.2 Contract with OC Transpo to provide enhanced transit services (e.g. for festivals, concerts, games)	<input type="checkbox"/>
3.4 Private transit service		
<i>Commuter travel</i>		
BETTER	3.4.1 Provide shuttle service when OC Transpo cannot offer sufficient quality or capacity to serve demand (e.g. for shift changes, weekends)	<input type="checkbox"/>
<i>Visitor travel</i>		
BETTER	3.4.2 Provide shuttle service when OC Transpo cannot offer sufficient quality or capacity to serve demand (e.g. for festivals, concerts, games)	<input type="checkbox"/>

TDM measures: <i>Non-residential developments</i>		Check if proposed & add descriptions
4. RIDESHARING		
4.1 Ridematching service		
<i>Commuter travel</i>		
BASIC	★ 4.1.1 Provide a dedicated ridematching portal at OttawaRideMatch.com	<input type="checkbox"/>
4.2 Carpool parking price incentives		
<i>Commuter travel</i>		
BETTER	4.2.1 Provide discounts on parking costs for registered carpools	<input type="checkbox"/>
4.3 Vanpool service		
<i>Commuter travel</i>		
BETTER	4.3.1 Provide a vanpooling service for long-distance commuters	<input type="checkbox"/>
5. CARSHARING & BIKESHARING		
5.1 Bikeshare stations & memberships		
BETTER	5.1.1 Contract with provider to install on-site bikeshare station for use by commuters and visitors	<input checked="" type="checkbox"/>
<i>Commuter travel</i>		
BETTER	5.1.2 Provide employees with bikeshare memberships for local business travel	<input checked="" type="checkbox"/>
5.2 Carshare vehicles & memberships		
<i>Commuter travel</i>		
BETTER	5.2.1 Contract with provider to install on-site carshare vehicles and promote their use by tenants	<input checked="" type="checkbox"/>
BETTER	5.2.2 Provide employees with carshare memberships for local business travel	<input type="checkbox"/>
6. PARKING		
6.1 Priced parking		
<i>Commuter travel</i>		
BASIC	★ 6.1.1 Charge for long-term parking (daily, weekly, monthly)	<input type="checkbox"/>
BASIC	6.1.2 Unbundle parking cost from lease rates at multi-tenant sites	<input checked="" type="checkbox"/>
<i>Visitor travel</i>		
BETTER	6.1.3 Charge for short-term parking (hourly)	<input type="checkbox"/>

TDM measures: <i>Non-residential developments</i>		Check if proposed & add descriptions
7. TDM MARKETING & COMMUNICATIONS		
7.1 Multimodal travel information		
<i>Commuter travel</i>		
BASIC ★	7.1.1 Provide a multimodal travel option information package to new/relocating employees and students	<input checked="" type="checkbox"/>
<i>Visitor travel</i>		
BETTER ★	7.1.2 Include multimodal travel option information in invitations or advertising that attract visitors or customers (e.g. for festivals, concerts, games)	<input type="checkbox"/>
7.2 Personalized trip planning		
<i>Commuter travel</i>		
BETTER ★	7.2.1 Offer personalized trip planning to new/relocating employees	<input checked="" type="checkbox"/>
7.3 Promotions		
<i>Commuter travel</i>		
BETTER	7.3.1 Deliver promotions and incentives to maintain awareness, build understanding, and encourage trial of sustainable modes	<input type="checkbox"/>
8. OTHER INCENTIVES & AMENITIES		
8.1 Emergency ride home		
<i>Commuter travel</i>		
BETTER ★	8.1.1 Provide emergency ride home service to non-driving commuters	<input type="checkbox"/>
8.2 Alternative work arrangements		
<i>Commuter travel</i>		
BASIC ★	8.2.1 Encourage flexible work hours	<input type="checkbox"/>
BETTER	8.2.2 Encourage compressed workweeks	<input type="checkbox"/>
BETTER ★	8.2.3 Encourage telework	<input type="checkbox"/>
8.3 Local business travel options		
<i>Commuter travel</i>		
BASIC ★	8.3.1 Provide local business travel options that minimize the need for employees to bring a personal car to work	<input type="checkbox"/>
8.4 Commuter incentives		
<i>Commuter travel</i>		
BETTER	8.4.1 Offer employees a taxable, mode-neutral commuting allowance	<input type="checkbox"/>
8.5 On-site amenities		
<i>Commuter travel</i>		
BETTER	8.5.1 Provide on-site amenities/services to minimize mid-day or mid-commute errands	<input type="checkbox"/>

APPENDIX J

WARRANT ANALYSIS

West Site/Jeanne D'Arc - (peak hour signal warrant)

Signal Warrant	Description	Minimum Requirement for Two Lane Roadways		Compliance		
		Restricted Flow - Operating Speed Less Than 70 km/h	Sectional %	Entire %	Warrant	
Intersection	1. Minimum Vehicular Volume	(1) A	Vehicle Volume, All Approaches for Each of the Heaviest 8 Hours of on Average Day, and	720	60%	48% No
		(4) B	Vehicle Volume, Along Minor Streets for Each of the Same 8 Hours	255	19%	
	2. Delay to Cross Traffic	(1) A	Vehicle Volume, Along Major Street for Each of the Heaviest 8 Hours of an Average Day, and	720	54%	
		(2) B	Combined Vehicle and Pedestrian Volume <u>Crossing</u> the Major Street for Each of the Same 8 Hours	75	48%	

Notes

- 1 Vehicle Volume Warrants (1A), (2A) and (5B) for Roadways Having Two or More Moving Lanes in one Direction Should Be 25% Higher Than Values Given Above
- 2 For Definition of Crossing Volume Refer to Note 4 on the Signal Warrant Analysis Form B2.03.08
- 3 The Lowest Sectional Percentage Governs the Entire Warrant
- 4 For "T" Intersections the Warrant Values for Minor Street Should be Increased by 50% (Warrant 1B only)

No

Yes

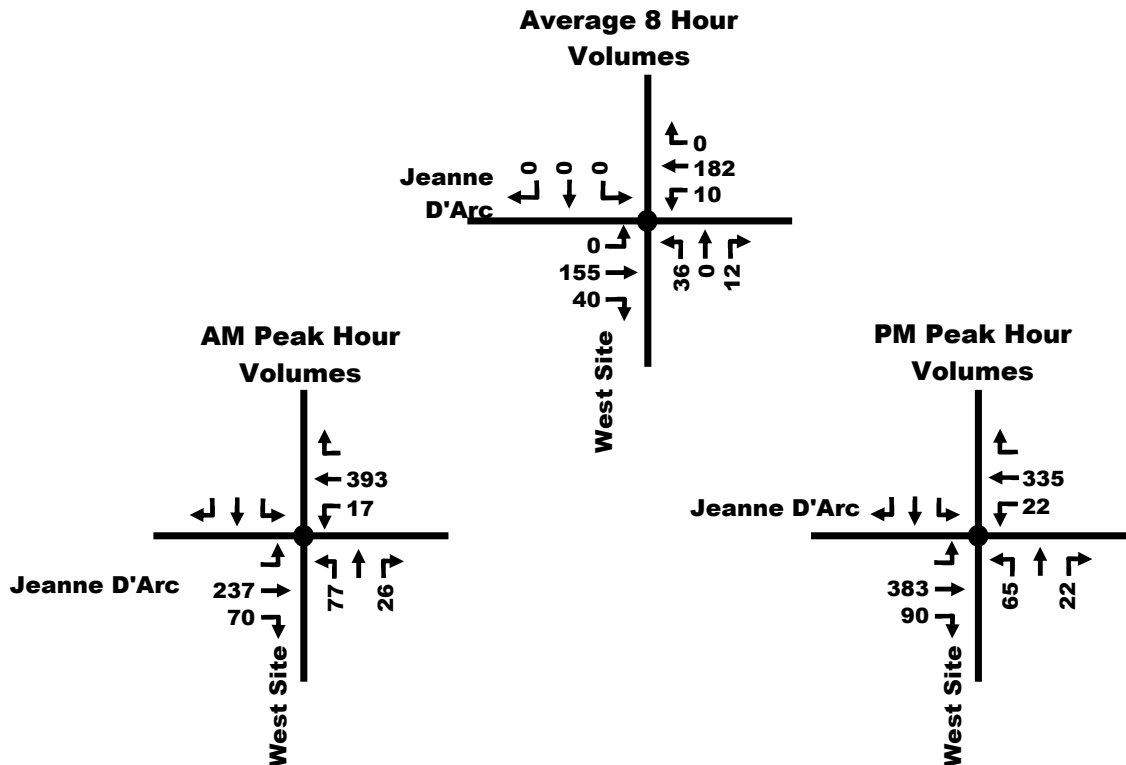

Central Site/Jeanne D'Arc - (peak hour signal warrant)

Signal Warrant	Description	Minimum Requirement for Two Lane Roadways	Compliance			
		Restricted Flow - Operating Speed Less Than 70 km/h	Sectional %	Entire %	Warrant	
Intersection	1. Minimum Vehicular Volume	(1) A Vehicle Volume, All Approaches for Each of the Heaviest 8 Hours of on Average Day, and	720	57%	39%	43% No
		(4) B Vehicle Volume, Along Minor Streets for Each of the Same 8 Hours	255	39%		
	2. Delay to Cross Traffic	(1) A Vehicle Volume, Along Major Street for Each of the Heaviest 8 Hours of an Average Day, and	720	43%	43%	
		(2) B Combined Vehicle and Pedestrian Volume <u>Crossing</u> the Major Street for Each of the Same 8 Hours	75	95%		

Notes

- 1 Vehicle Volume Warrants (1A), (2A) and (5B) for Roadways Having Two or More Moving Lanes in one Direction Should Be 25% Higher Than Values Given Above
- 2 For Definition of Crossing Volume Refer to Note 4 on the Signal Warrant Analysis Form B2.03.08
- 3 The Lowest Sectional Percentage Governs the Entire Warrant
- 4 For "T" Intersections the Warrant Values for Minor Street Should be Increased by 50% (Warrant 1B only)

No

Yes

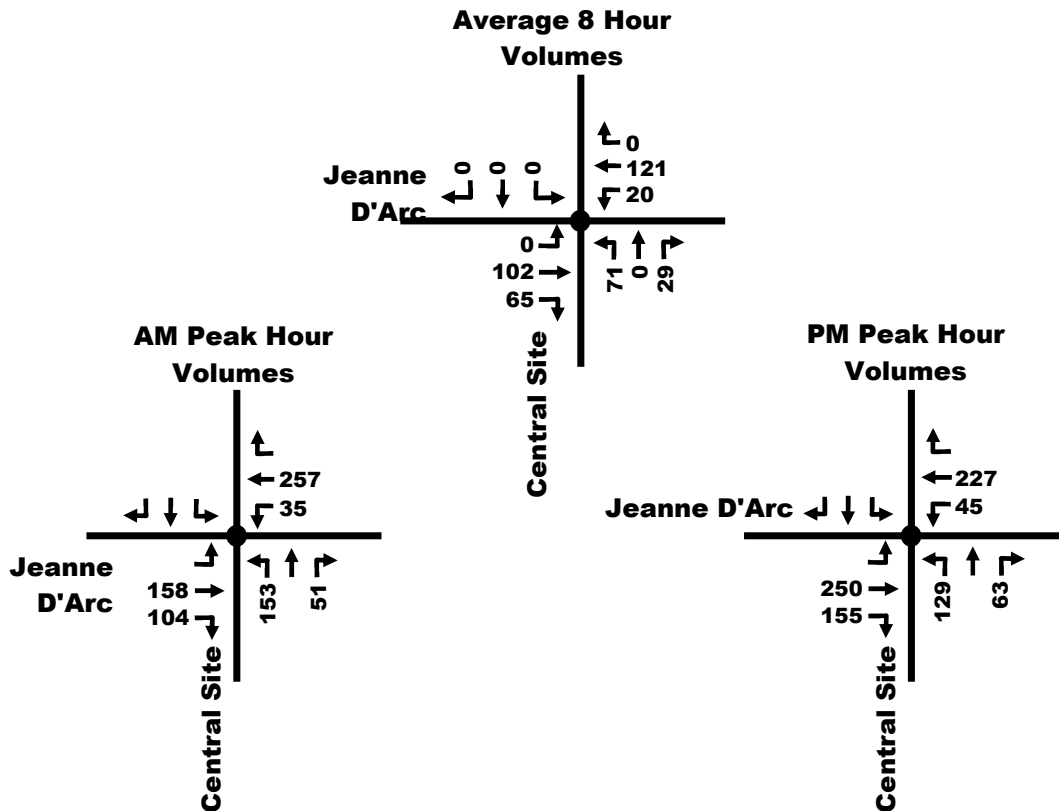

East Site/Jeanne D'Arc - (peak hour signal warrant)

Signal Warrant	Description	Minimum Requirement for Two Lane Roadways		Compliance		
		Restricted Flow - Operating Speed Less Than 70 km/h	Sectional %	Entire %	Warrant	
Intersection	1. Minimum Vehicular Volume	(1) A	Vehicle Volume, All Approaches for Each of the Heaviest 8 Hours of on Average Day, and	720	51%	38% No
		(4) B	Vehicle Volume, Along Minor Streets for Each of the Same 8 Hours	255	38%	
	2. Delay to Cross Traffic	(1) A	Vehicle Volume, Along Major Street for Each of the Heaviest 8 Hours of an Average Day, and	720	37%	
		(2) B	Combined Vehicle and Pedestrian Volume <u>Crossing</u> the Major Street for Each of the Same 8 Hours	75	68%	

Notes

- 1 Vehicle Volume Warrants (1A), (2A) and (5B) for Roadways Having Two or More Moving Lanes in one Direction Should Be 25% Higher Than Values Given Above
- 2 For Definition of Crossing Volume Refer to Note 4 on the Signal Warrant Analysis Form B2.03.08
- 3 The Lowest Sectional Percentage Governs the Entire Warrant
- 4 For "T" Intersections the Warrant Values for Minor Street Should be Increased by 50% (Warrant 1B only)

No

Yes

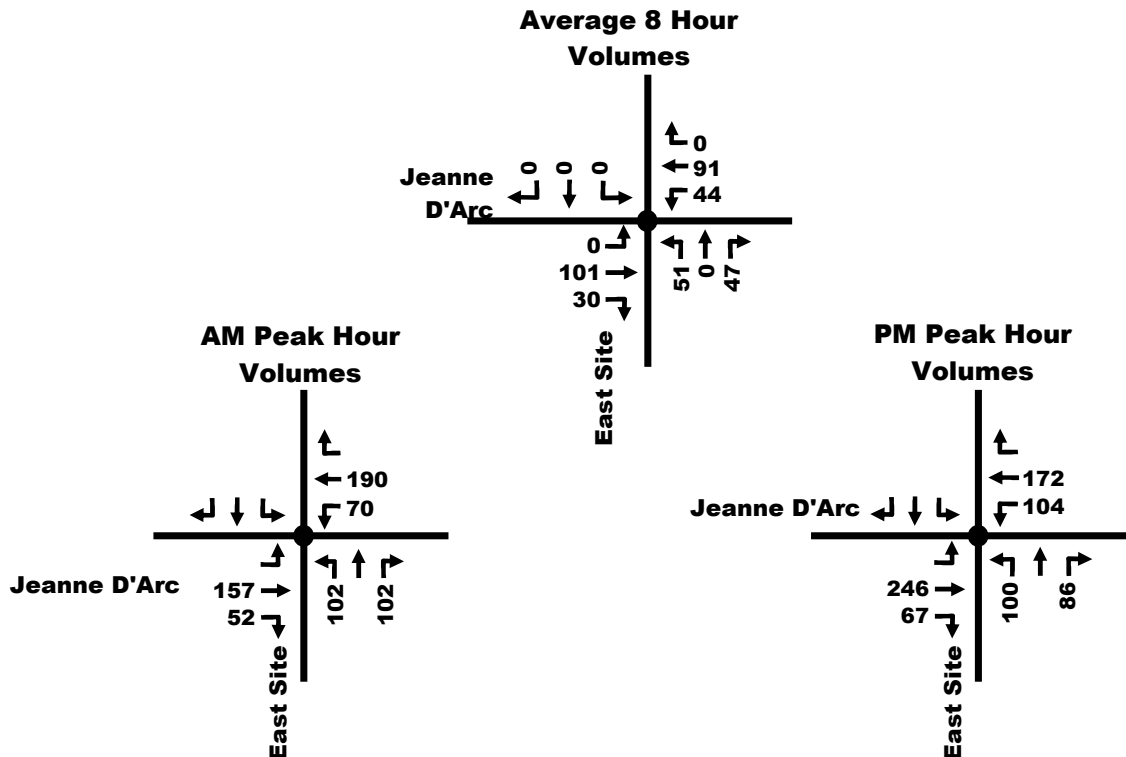

All Combined Site/Jeanne D'Arc - (peak hour signal warrant)

Signal Warrant	Description	Minimum Requirement for Two Lane Roadways	Compliance			
		Restricted Flow - Operating Speed Less Than 70 km/h	Sectional %	Entire %	Warrant	
Intersection	1. Minimum Vehicular Volume	(1) A Vehicle Volume, All Approaches for Each of the Heaviest 8 Hours of on Average Day, and	720	94%	94%	94% No
		(4) B Vehicle Volume, Along Minor Streets for Each of the Same 8 Hours	255	96%		
	2. Delay to Cross Traffic	(1) A Vehicle Volume, Along Major Street for Each of the Heaviest 8 Hours of an Average Day, and	720	60%	60%	
		(2) B Combined Vehicle and Pedestrian Volume <u>Crossing</u> the Major Street for Each of the Same 8 Hours	75	209%		

Notes

- 1 Vehicle Volume Warrants (1A), (2A) and (5B) for Roadways Having Two or More Moving Lanes in one Direction Should Be 25% Higher Than Values Given Above
- 2 For Definition of Crossing Volume Refer to Note 4 on the Signal Warrant Analysis Form B2.03.08
- 3 The Lowest Sectional Percentage Governs the Entire Warrant
- 4 For "T" Intersections the Warrant Values for Minor Street Should be Increased by 50% (Warrant 1B only)

No

Yes

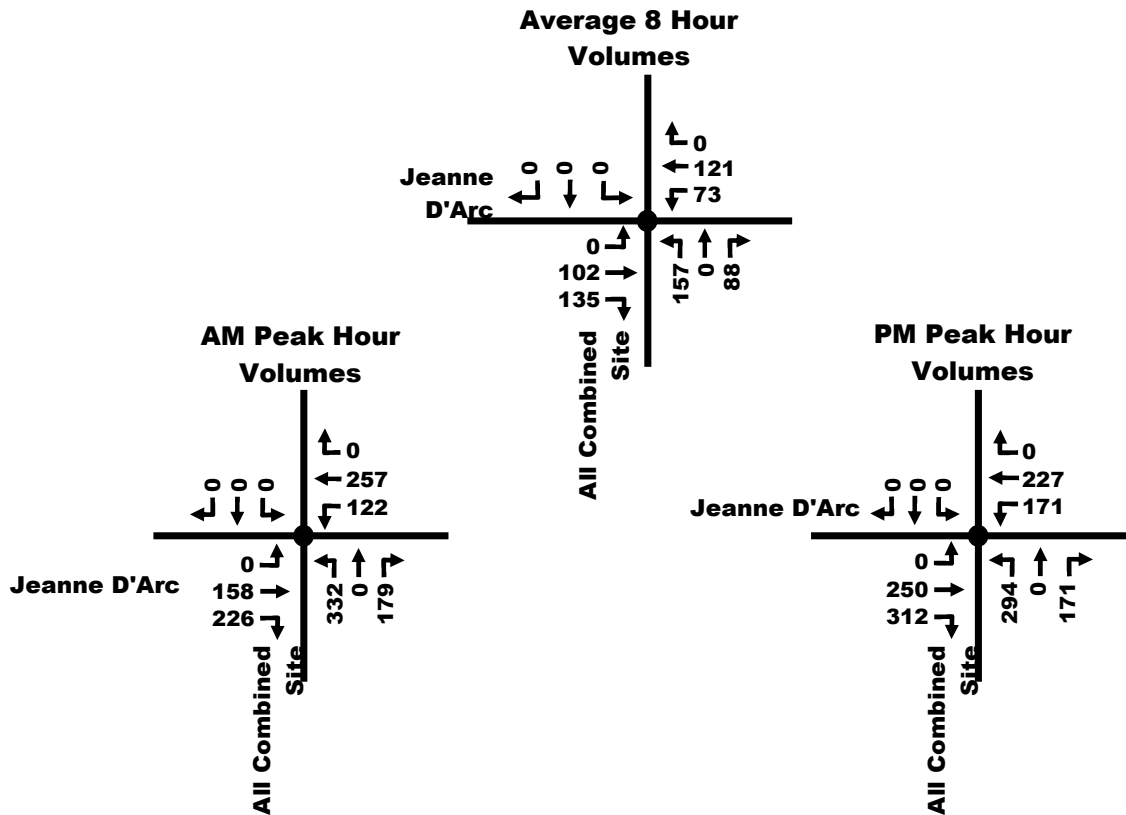

West Site/Jeanne D'Arc - Existing

AWSC Warrant		Description	Minimum Requirement for a 'T' intersection	Compliance		
				Sectional %	Entire %	Warrant
Intersection	1. Minimum Volume Criterion	A	Vehicle Volume, All Approaches for Each of the Heaviest 8 Hours of on Average Day, or	200	218%	No
		B	Vehicle Volume, All Approaches for the Heaviest Peak Hour, and	350	262%	
		C	Vehicle and pedestrian Volume, Along Minor Streets for Each of the Same 8 Hours, and	80	60%	
		D	The volume split between the major and minor streets	75/25	37%	
	2. Minimum Collision Criterion	A	Vehicle Volume, Along Major Street for Each of the Heaviest 8 Hours of an Average Day, and	9	0%	0%

Note: 0 preventable by AWSC collisions (i.e. right angle and turning movement collisions) were reported during a 3 year time period

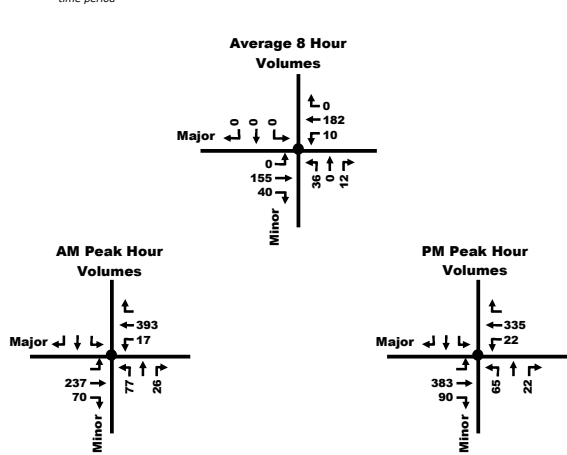

	Peak	Minor West Site				Major Jeanne D'Arc							
		NBL	NBT	NBR	SBL	SBT	SBR	EBL	EBT	EBR	WBL	WBT	WBR
Existing	8 hr												
	AM	77		26						237	70	17	393
	PM	65		22						383	90	22	335
Site Generated	AM												
	PM												
	Avg. 8 hr	36	0	12	0	0	0	0	155	40	10	182	0

Central Site/Jeanne D'Arc - Existing

AWSC Warrant		Description	Minimum Requirement for a 'T' intersection	Compliance		
				Sectional %	Entire %	Warrant
Intersection	1. Minimum Volume Criterion	A	Vehicle Volume, All Approaches for Each of the Heaviest 8 Hours of on Average Day, or	200	204%	No
		B	Vehicle Volume, All Approaches for the Heaviest Peak Hour, and	350	248%	
		C	Vehicle and pedestrian Volume, Along Minor Streets for Each of the Same 8 Hours, and	80	125%	
		D	The volume split between the major and minor streets	75/25	97%	
	2. Minimum Collision Criterion	A	Vehicle Volume, Along Major Street for Each of the Heaviest 8 Hours of an Average Day, and	9	0%	0%

Note: 0 preventable by AWSC collisions (i.e. right angle and turning movement collisions) were reported during a 3 year time period

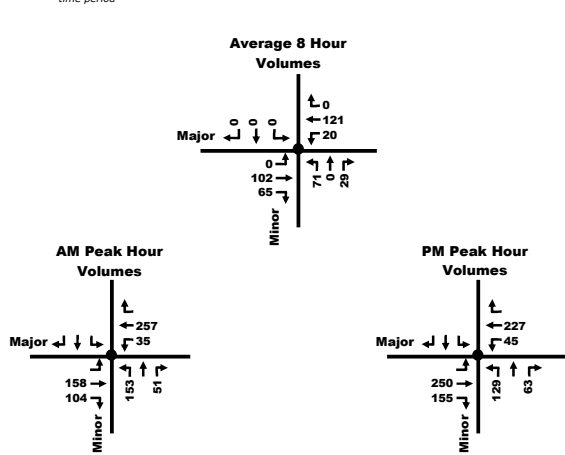

Existing	Peak	Minor Central Site				Major Jeanne D'Arc							
		NBL	NBT	NBR	SBL	SBT	SBR	EBL	EBT	EBR	WBL	WBT	WBR
Existing	8 hr AM	153		51						158	104	35	257
	PM	129		63						250	155	45	227
Site Generated	AM												
	PM												
	Avg. 8 hr	71	0	29	0	0	0	0	102	65	20	121	0

East Site/Jeanne D'Arc - Existing

AWSC Warrant	Description	Minimum Requirement for a 'T' intersection	Compliance			
			Sectional %	Entire %	Warrant	
Intersection 1. Minimum Volume Criterion	A	Vehicle Volume, All Approaches for Each of the Heaviest 8 Hours of on Average Day, or	200	182%	111%	Yes
	B	Vehicle Volume, All Approaches for the Heaviest Peak Hour, and	350	221%		
	C	Vehicle and pedestrian Volume, Along Minor Streets for Each of the Same 8 Hours, and	80	123%		
	D	The volume split between the major and minor streets	75/25	111%		
2. Minimum Collision Criterion	A	Vehicle Volume, Along Major Street for Each of the Heaviest 8 Hours of an Average Day, and	9	0%	0%	

Note: 0 preventable by AWSC collisions (i.e. right angle and turning movement collisions) were reported during a 3 year time period

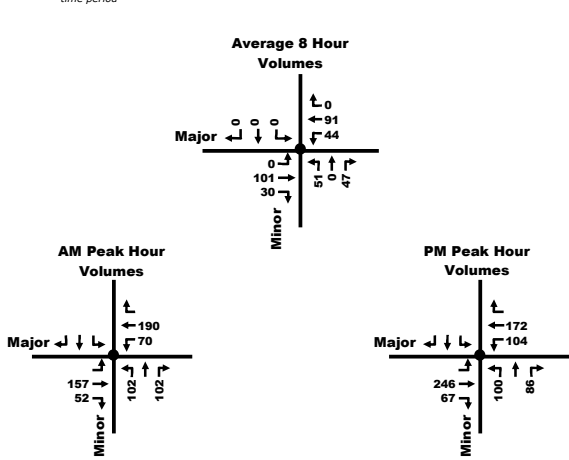

Peak	Minor East Site				Major Jeanne D'Arc							
	NBL	NBT	NBR	SBL	SBT	SBR	EBL	EBT	EBR	WBL	WBT	WBR
Existing												
8 hr												
AM	102		102					157	52	70	190	
PM	100		86					246	67	104	172	
Site Generated												
AM												
PM												
Avg. 8 hr	51	0	47	0	0	0	0	101	30	44	91	0

All combined/Jeanne D'Arc - Existing

AWSC Warrant		Description	Minimum Requirement for a 'T' intersection	Compliance			
				Sectional %	Entire %	Warrant	
Intersection	1. Minimum Volume Criterion	A	Vehicle Volume, All Approaches for Each of the Heaviest 8 Hours of on Average Day, or	200	338%	171%	Yes
		B	Vehicle Volume, All Approaches for the Heaviest Peak Hour, and	350	407%		
		C	Vehicle and pedestrian Volume, Along Minor Streets for Each of the Same 8 Hours, and	80	306%		
		D	The volume split between the major and minor streets	75/25	171%		
	2. Minimum Collision Criterion	A	Vehicle Volume, Along Major Street for Each of the Heaviest 8 Hours of an Average Day, and	9	0%	0%	

Note: 0 preventable by AWSC collisions (i.e. right angle and turning movement collisions) were reported during a 3 year time period

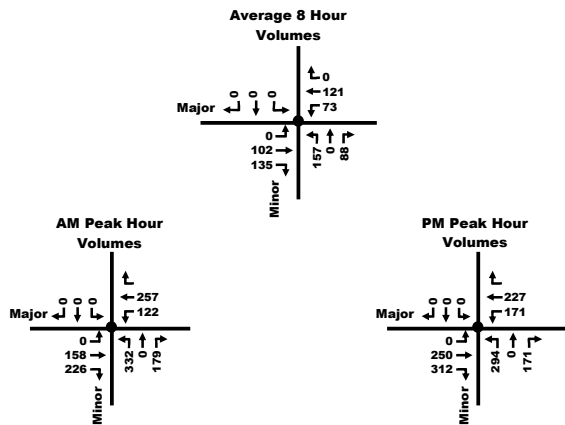

Peak	Minor						Major					
	NBL	NBT	All combined		SBT	SBR	EBL	EBT	Jeanne D'Arc		WBT	WBR
			NBR	SBL					EBR	WBL		
Existing												
8 hr												
AM	332	0	179	0	0	0	0	158	226	122	257	
PM	294	0	171	0	0	0	0	250	312	171	227	
Site Generated												
AM												
PM												
Avg. 8 hr	157	0	88	0	0	0	0	102	135	73	121	0

East Site (S2)/Jeanne D'Arc - Existing

AWSC Warrant		Description	Minimum Requirement for a 'T' intersection	Compliance			
				Sectional %	Entire %	Warrant	
Intersection	1. Minimum Volume Criterion	A	Vehicle Volume, All Approaches for Each of the Heaviest 8 Hours of on Average Day, or	200	139%	78%	No
		B	Vehicle Volume, All Approaches for the Heaviest Peak Hour, and	350	172%		
		C	Vehicle and pedestrian Volume, Along Minor Streets for Each of the Same 8 Hours, and	80	78%		
		D	The volume split between the major and minor streets	75/25	86%		
	2. Minimum Collision Criterion	A	Vehicle Volume, Along Major Street for Each of the Heaviest 8 Hours of an Average Day, and	9	0%	0%	

Note: 0 preventable by AWSC collisions (i.e. right angle and turning movement collisions) were reported during a 3 year time period

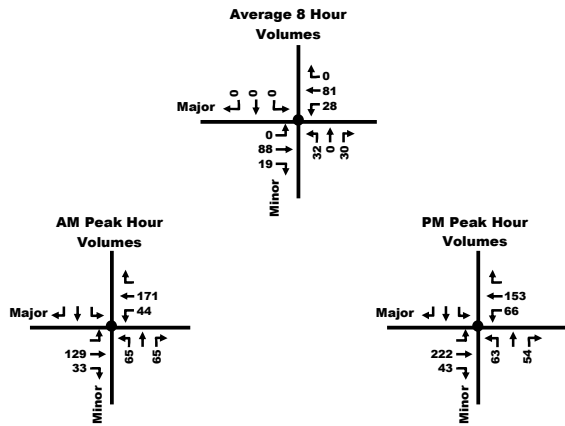

Peak	Minor East Site (S2)				Major Jeanne D'Arc							
	NBL	NBT	NBR	SBL	SBT	SBR	EBL	EBT	EBR	WBL	WBT	WBR
Existing												
8 hr												
AM	65		65						129	33	44	171
PM	63		54						222	43	66	153
Site Generated												
AM												
PM												
Avg. 8 hr	32	0	30	0	0	0	0	88	19	28	81	0

APPENDIX K

AUXILIARY LEFT-TURN LANE WARRANT

	Design Speed	Advancing Traffic Volume (V_A)		Opposing Traffic Volume (V_O)		Left Turn Traffic Volume (V_L)		% of Left Turning Traffic		Warrant Left Turn Lane
		AM	PM	AM	PM	AM	PM	AM	PM	
Existing										
West Access/Jeanne D'Arc	70	410	357	307	473	17	22	4%	6%	No

Peak	NBL	NBT	NBR	SBL	SBT	SBR	EBL	EBT	EBR	WBL	WBT	WBR
AM	77		26					237	70	17	393	
PM	65		22					383	90	22	335	

Warrant?

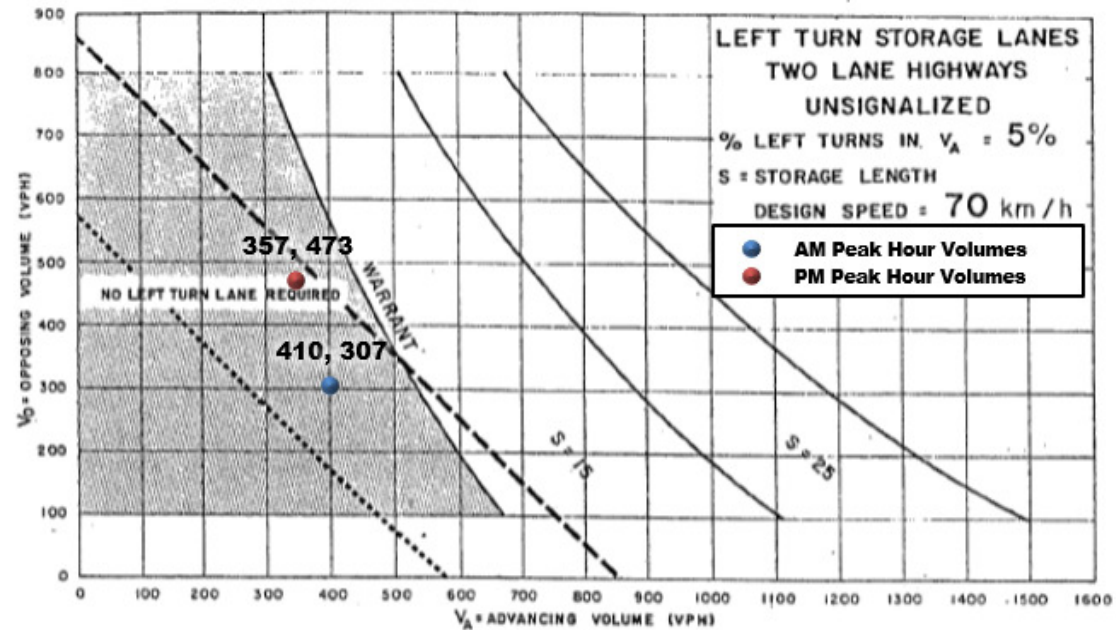

----- TRAFFIC SIGNALS MAY BE WARRANTED IN RURAL AREAS OR URBAN AREAS WITH RESTRICTED FLOW

..... TRAFFIC SIGNALS MAY BE WARRANTED IN "FREE FLOW" URBAN AREAS

	Design Speed	Advancing Traffic Volume (V_A)		Opposing Traffic Volume (V_O)		Left Turn Traffic Volume (V_L)		% of Left Turning Traffic		Warrant Left Turn Lane
		AM	PM	AM	PM	AM	PM	AM	PM	
Existing										
Central Access/Jeanne D'Arc	70	292	272	262	405	35	45	12%	17%	Yes

Peak	NBL	NBT	NBR	SBL	SBT	SBR	EBL	EBT	EBR	WBL	WBT	WBR
AM	153		51					158	104	35	257	
PM	129		63					250	155	45	227	

Warrant?

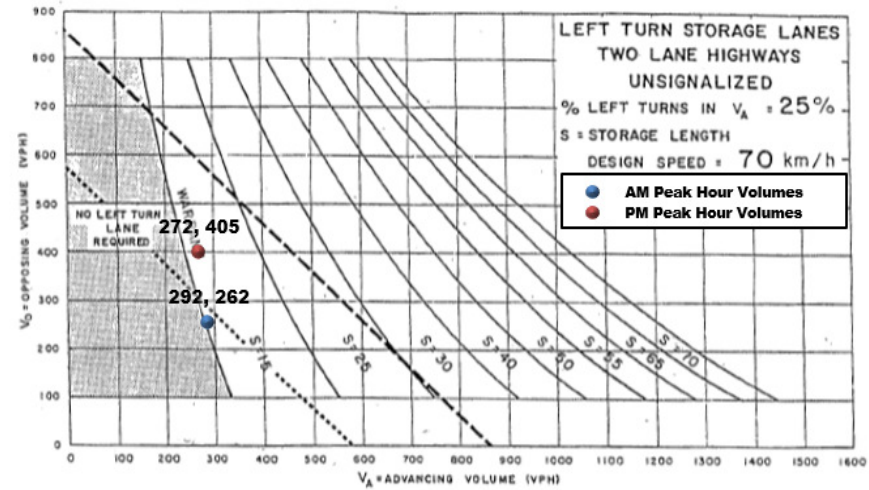
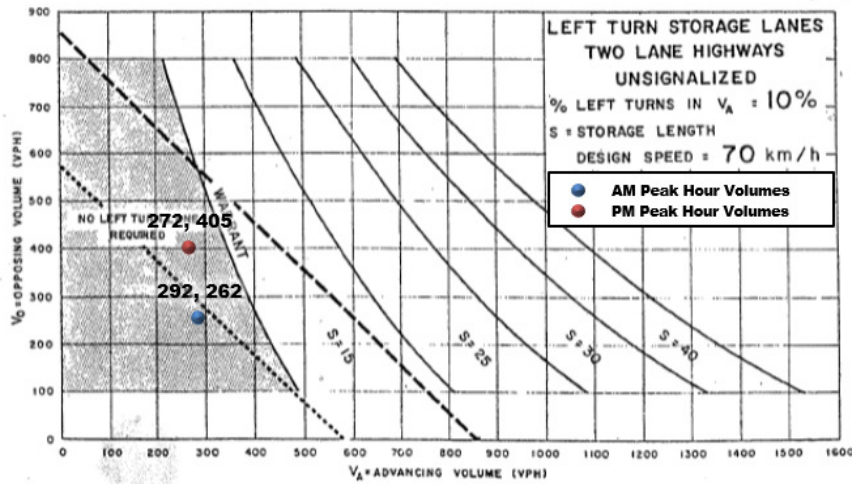

- TRAFFIC SIGNALS MAY BE WARRANTED IN RURAL AREAS OR URBAN AREAS WITH RESTRICTED FLOW
- TRAFFIC SIGNALS MAY BE WARRANTED IN "FREE FLOW" URBAN AREAS

	Design Speed	Advancing Traffic Volume (V_A)		Opposing Traffic Volume (V_O)		Left Turn Traffic Volume (V_L)		% of Left Turning Traffic		Warrant Left Turn Lane
		AM	PM	AM	PM	AM	PM	AM	PM	
Existing										
East Access/Jeanne D'Arc	70	260	276	209	313	70	104	27%	38%	Yes

Peak	NBL	NBT	NBR	SBL	SBT	SBR	EBL	EBT	EBR	WBL	WBT	WBR
										Warrant?		
AM		102							157	52	70	190
PM		100							246	67	104	172

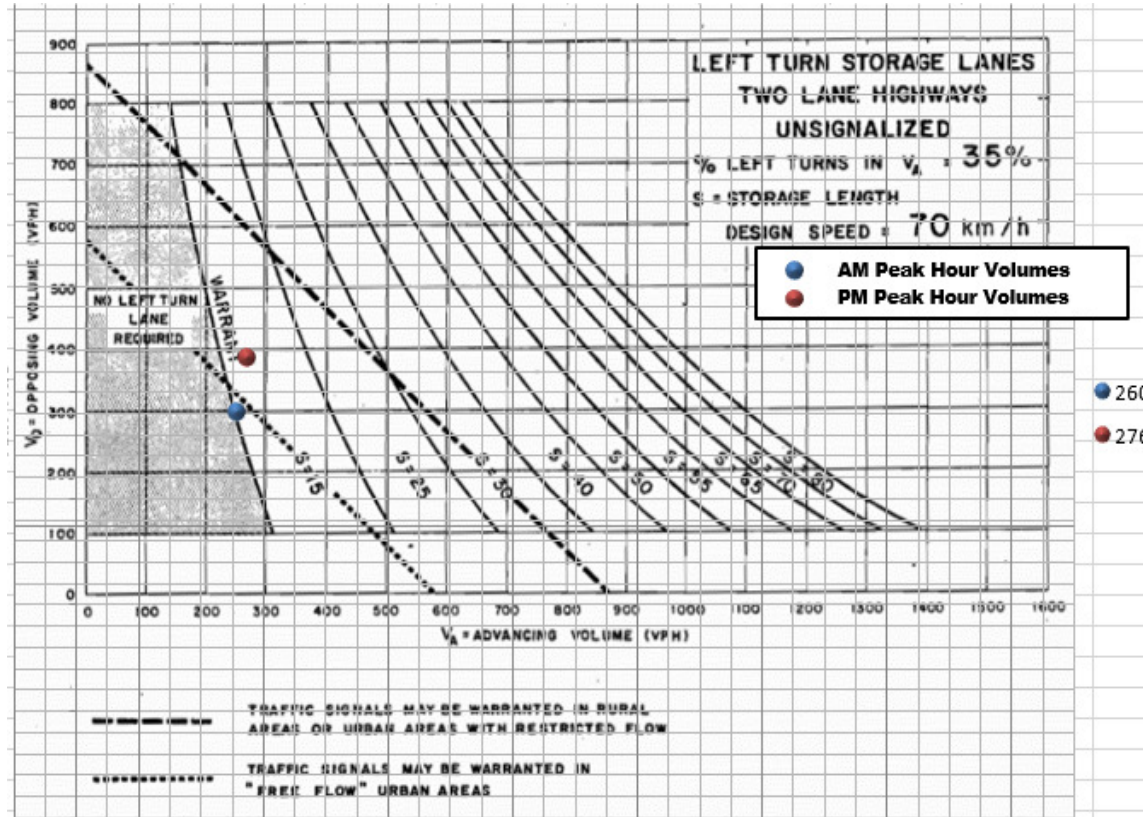

	Design Speed	Advancing Traffic Volume (V_A)		Opposing Traffic Volume (V_O)		Left Turn Traffic Volume (V_L)		% of Left Turning Traffic		Warrant Left Turn Lane
		AM	PM	AM	PM	AM	PM	AM	PM	
Existing										
Central Access (S2)/Jeanne D'Arc	70	236	216	195	324	22	29	9%	13%	No

Peak	NBL	NBT	NBR	SBL	SBT	SBR	EBL	EBT	EBR	WBL	WBT	WBR	Warrant?	
AM		97							129	66			22	214
PM		82							225	99			29	187

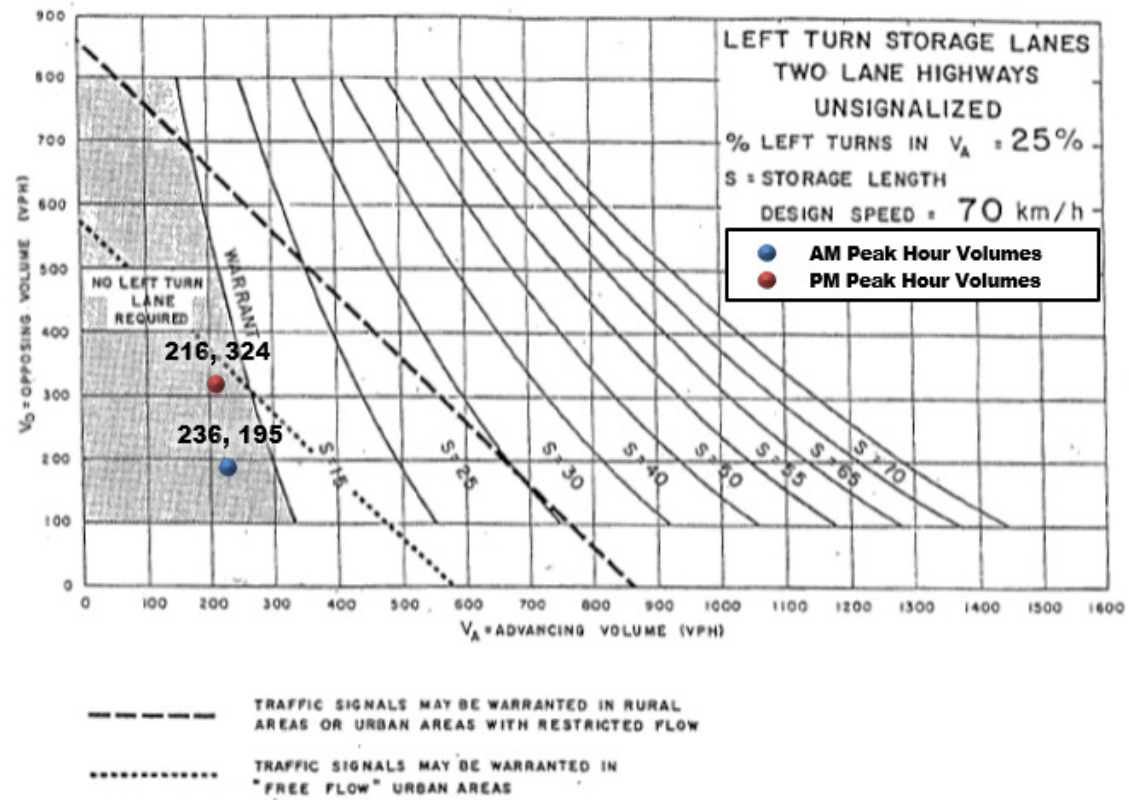

	Design Speed	Advancing Traffic Volume (V_A)		Opposing Traffic Volume (V_O)		Left Turn Traffic Volume (V_L)		% of Left Turning Traffic		Warrant Left Turn Lane
		AM	PM	AM	PM	AM	PM	AM	PM	
Existing										
East Access (S2)/Jeanne D'Arc	70	215	219	162	265	44	66	20%	30%	No

Peak	NBL	NBT	NBR	SBL	SBT	SBR	EBL	EBT	EBR	WBL	WBT	WBR
										Warrant?		
AM	65		65					129	33	44	171	
PM	63		54					222	43	66	153	

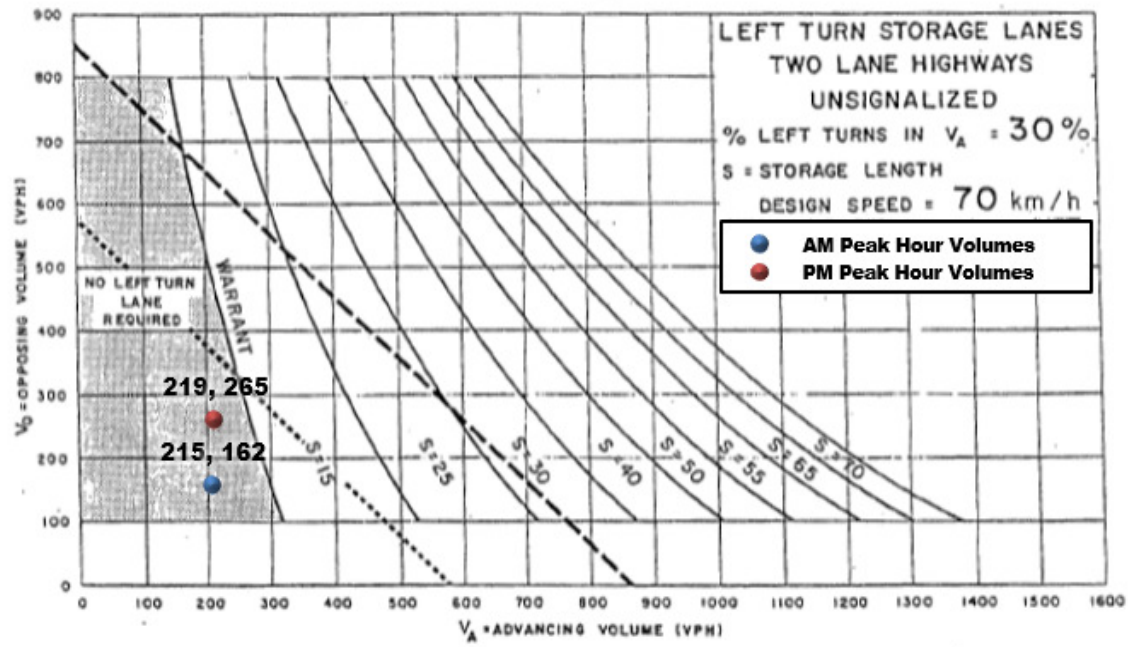

APPENDIX L

MMLOS ANALYSIS: INTERSECTIONS

Multi-Modal Level of Service - Intersections Form

Consultant
Scenario
Comments

Parsons
Petrie's Landing III

Project
Date

478566
4-Jul-23

Unlocked Rows for Replicating

INTERSECTIONS		Trim/H174				Tenth Line/St. Joseph				Old Tenth Line/St. Joseph			
Crossing Side		NORTH	SOUTH	EAST	WEST	NORTH	SOUTH	EAST	WEST	NORTH	SOUTH	EAST	WEST
Pedestrian	Lanes	8	8	10+		8	8	9	9	6	6		7
	Median	No Median - 2.4 m	No Median - 2.4 m	Median > 2.4 m		No Median - 2.4 m	No Median - 2.4 m	No Median - 2.4 m	No Median - 2.4 m	No Median - 2.4 m	No Median - 2.4 m		No Median - 2.4 m
	Conflicting Left Turns	Protected	Protected	Protected		Protected	Protected	Protected/ Permissive	Protected/ Permissive	Protected	Protected		No left turn / Prohib.
	Conflicting Right Turns	Permissive or yield control	Permissive or yield control	Permissive or yield control		Permissive or yield control	Permissive or yield control	Permissive or yield control	Permissive or yield control	Permissive or yield control	Permissive or yield control		Permissive or yield control
	Right Turns on Red (RTOR) ?	RTOR allowed	RTOR allowed	RTOR allowed		RTOR allowed	RTOR allowed	RTOR prohibited	RTOR allowed	RTOR allowed	RTOR allowed		RTOR allowed
	Ped Signal Leading Interval?	No	No	No		No	No	No	No	No	No		No
	Right Turn Channel	Conv'tl without Receiving Lane	Conv'tl without Receiving Lane	Conv'tl without Receiving Lane		Conv'tl without Receiving Lane	Conv'tl without Receiving Lane	Conventional with Receiving Lane	Conventional with Receiving Lane	Conventional with Receiving Lane	Conv'tl without Receiving Lane		No Channel
	Corner Radius	10-15m	10-15m	10-15m		>25m	>25m	>25m	>25m	>25m	>25m		3-5m
	Crosswalk Type	Std transverse markings	Textured/coloured pavement	Textured/coloured pavement		Std transverse markings	Std transverse markings	Std transverse markings	Std transverse markings	Std transverse markings	Std transverse markings		Std transverse markings
	PETSI Score	0	3	-20		-3	-3	-28	-31	26	29		14
	Ped. Exposure to Traffic LoS	F	F	#N/A	-	F	F	#N/A	#N/A	F	F	-	F
	Cycle Length												
Effective Walk Time													
Average Pedestrian Delay													
Pedestrian Delay LoS	-	-	-	-	-	-	-	-	-	-	-	-	
Level of Service	F	F	#N/A	-	F	F	#N/A	#N/A	F	F	-	F	
	#N/A				#N/A				F				
Approach From		NORTH	SOUTH	EAST	WEST	NORTH	SOUTH	EAST	WEST	NORTH	SOUTH	EAST	WEST
Bicycle	Bicycle Lane Arrangement on Approach	Mixed Traffic	Mixed Traffic	Curb Bike Lane, Cycletrack or MUP		Mixed Traffic	Mixed Traffic	Curb Bike Lane, Cycletrack or MUP	Mixed Traffic		Mixed Traffic	Mixed Traffic	Mixed Traffic
	Right Turn Lane Configuration	≤ 50 m	≤ 50 m	Not Applicable		> 50 m	> 50 m	Not Applicable	> 50 m		≤ 50 m	≤ 50 m	≤ 50 m
	Right Turning Speed	≤ 25 km/h	≤ 25 km/h	Not Applicable		>25 km/h	>25 km/h	Not Applicable	>25 km/h		≤ 25 km/h	≤ 25 km/h	≤ 25 km/h
	Cyclist relative to RT motorists	D	D	Not Applicable	-	F	F	Not Applicable	F	-	D	D	D
	Separated or Mixed Traffic	Mixed Traffic	Mixed Traffic	Separated	-	Mixed Traffic	Mixed Traffic	Separated	Mixed Traffic	-	Mixed Traffic	Mixed Traffic	Mixed Traffic
	Left Turn Approach	No lane crossed	No lane crossed	No lane crossed		≥ 2 lanes crossed	≥ 2 lanes crossed	≥ 2 lanes crossed	≥ 2 lanes crossed		No lane crossed	One lane crossed	No lane crossed
	Operating Speed	≥ 60 km/h	≥ 60 km/h	≥ 60 km/h		≥ 60 km/h	≥ 60 km/h	≥ 60 km/h	≥ 60 km/h		> 50 to < 60 km/h	> 50 to < 60 km/h	> 50 to < 60 km/h
	Left Turning Cyclist	C	C	C	-	F	F	F	F	-	C	E	C
Level of Service	D	D	C	-	F	F	F	F	-	D	E	D	
	D				F				E				
Transit	Average Signal Delay	> 40 sec	> 40 sec			> 40 sec	≤ 40 sec			≤ 20 sec			
	Level of Service	F	F	-	-	F	E	-	C	-	-	-	-
	F				F				-				
Truck	Effective Corner Radius	> 15 m	> 15 m	> 15 m	> 15 m	> 15 m	> 15 m	> 15 m	> 15 m	> 15 m	> 15 m		
	Number of Receiving Lanes on Departure from Intersection	≥ 2	≥ 2	≥ 2	≥ 2	≥ 2	≥ 2	≥ 2	≥ 2	≥ 2	≥ 2		
Level of Service	A	A	A	A	A	A	A	A	A	A	-	-	
	A				A				A				
Auto	Volume to Capacity Ratio												
	Level of Service												
	-				-				-				























APPENDIX M

SYCNHRO ANALYSIS: EXISTING CONDITIONS

Lanes, Volumes, Timings

1: Trim & H174

Existing AM

												
Lane Group	EBL	EBT	EBR	WBL	WBT	WBR	NBL	NBT	NBR	SBL	SBT	SBR
Lane Configurations												
Traffic Volume (vph)	57	279	3	1	26	6	527	34	38	27	40	78
Future Volume (vph)	57	279	3	1	26	6	527	34	38	27	40	78
Satd. Flow (prot)	1695	3387	0	1695	4871	1517	4780	1784	1517	1695	1784	1517
Flt Permitted	0.950			0.950			0.950			0.950		
Satd. Flow (perm)	1695	3387	0	1695	4871	1517	4780	1784	1517	1695	1784	1517
Satd. Flow (RTOR)		1				218			156			217
Lane Group Flow (vph)	63	313	0	1	29	7	586	38	42	30	44	87
Turn Type	Prot	NA		Prot	NA	Perm	Prot	NA	Perm	Prot	NA	Perm
Protected Phases	5	2		1	6		3	8		7	4	
Permitted Phases						6			8			4
Detector Phase	5	2		1	6	6	3	8	8	7	4	4
Switch Phase												
Minimum Initial (s)	1.0	5.0		1.0	5.0	5.0	1.0	5.0	5.0	1.0	5.0	5.0
Minimum Split (s)	8.5	41.2		8.5	41.2	41.2	8.2	42.4	42.4	7.9	12.4	12.4
Total Split (s)	15.0	50.0		20.0	55.0	55.0	42.0	43.0	43.0	17.0	18.0	18.0
Total Split (%)	11.5%	38.5%		15.4%	42.3%	42.3%	32.3%	33.1%	33.1%	13.1%	13.8%	13.8%
Yellow Time (s)	3.3	5.1		3.3	5.1	5.1	3.3	3.3	3.3	3.3	3.3	3.3
All-Red Time (s)	4.2	2.1		3.8	2.1	2.1	3.9	4.1	4.1	3.6	4.1	4.1
Lost Time Adjust (s)	0.0	0.0		0.0	0.0	0.0	0.0	0.0	0.0	0.0	0.0	0.0
Total Lost Time (s)	7.5	7.2		7.1	7.2	7.2	7.2	7.4	7.4	6.9	7.4	7.4
Lead/Lag	Lead	Lag		Lead	Lag	Lag	Lead	Lag	Lag	Lead	Lag	Lag
Lead-Lag Optimize?	Yes	Yes		Yes	Yes	Yes	Yes	Yes	Yes	Yes	Yes	Yes
Recall Mode	None	C-Min		None	C-Min	C-Min	None	None	None	None	None	None
Act Effct Green (s)	10.5	74.1		5.6	61.6	61.6	21.3	29.1	29.1	7.8	10.2	10.2
Actuated g/C Ratio	0.08	0.57		0.04	0.47	0.47	0.16	0.22	0.22	0.06	0.08	0.08
v/c Ratio	0.46	0.16		0.01	0.01	0.01	0.75	0.10	0.09	0.30	0.32	0.27
Control Delay	67.2	15.8		60.0	24.4	0.0	58.0	40.7	0.4	65.1	60.4	2.1
Queue Delay	0.0	0.0		0.0	0.0	0.0	0.0	0.0	0.0	0.0	0.0	0.0
Total Delay	67.2	15.8		60.0	24.4	0.0	58.0	40.7	0.4	65.1	60.4	2.1
LOS	E	B		E	C	A	E	D	A	E	E	A
Approach Delay		24.4			20.8			53.3			29.8	
Approach LOS		C			C			D			C	
Queue Length 50th (m)	15.7	17.4		0.3	1.4	0.0	51.3	8.3	0.0	7.5	11.0	0.0
Queue Length 95th (m)	29.7	39.2		2.3	4.3	0.0	61.9	16.1	0.0	17.2	21.2	0.0
Internal Link Dist (m)		313.0			478.0			348.7			179.7	
Turn Bay Length (m)	150.0			150.0		30.0	200.0		40.0	150.0		40.0
Base Capacity (vph)	139	1931		168	2355	846	1279	488	528	132	169	341
Starvation Cap Reductn	0	0		0	0	0	0	0	0	0	0	0
Spillback Cap Reductn	0	0		0	0	0	0	0	0	0	0	0
Storage Cap Reductn	0	0		0	0	0	0	0	0	0	0	0
Reduced v/c Ratio	0.45	0.16		0.01	0.01	0.01	0.46	0.08	0.08	0.23	0.26	0.26

Intersection Summary

Cycle Length: 130

Actuated Cycle Length: 130

Offset: 54.5 (42%), Referenced to phase 2:EBT and 6:WBT, Start of Green

Natural Cycle: 100

Control Type: Actuated-Coordinated

Lanes, Volumes, Timings

1: Trim & H174

Existing AM

Maximum v/c Ratio: 0.75

Intersection Signal Delay: 40.5

Intersection LOS: D

Intersection Capacity Utilization 39.4%

ICU Level of Service A

Analysis Period (min) 15

Splits and Phases: 1: Trim & H174

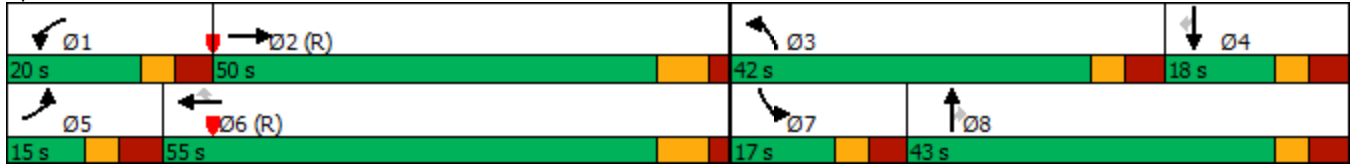

Lanes, Volumes, Timings
5: Tenth Line & St. Joseph

Existing AM



Lane Group	EBL	EBT	EBR	WBL	WBT	WBR	NBL	NBT	NBR	SBL	SBT	SBR
Lane Configurations	↘	↑↑	↗	↘	↑↑	↗	↘	↑↑	↗	↘	↑↑	↗
Traffic Volume (vph)	16	75	119	31	269	40	416	796	20	7	124	54
Future Volume (vph)	16	75	119	31	269	40	416	796	20	7	124	54
Satd. Flow (prot)	1695	3390	1517	1695	3390	1517	1543	3241	1517	1695	3390	1517
Flt Permitted	0.460			0.700			0.950	0.998		0.950		
Satd. Flow (perm)	815	3390	1496	1247	3390	1481	1543	3241	1517	1695	3390	1517
Satd. Flow (RTOR)			132			131			130			130
Lane Group Flow (vph)	18	83	132	34	299	44	416	930	22	8	138	60
Turn Type	pm+pt	NA	Perm	pm+pt	NA	Perm	Split	NA	Perm	Split	NA	Perm
Protected Phases	7	4		3	8		5	5		6	6	
Permitted Phases	4		4	8		8			5			6
Minimum Split (s)	11.0	29.1	29.1	11.0	29.1	29.1	32.3	32.3	32.3	32.3	32.3	32.3
Total Split (s)	14.0	28.1	28.1	14.0	28.1	28.1	59.3	59.3	59.3	28.3	28.3	28.3
Total Split (%)	10.8%	21.7%	21.7%	10.8%	21.7%	21.7%	45.7%	45.7%	45.7%	21.8%	21.8%	21.8%
Yellow Time (s)	3.7	3.7	3.7	3.7	3.7	3.7	3.7	3.7	3.7	3.7	3.7	3.7
All-Red Time (s)	2.3	2.4	2.4	2.3	2.4	2.4	2.6	2.6	2.6	2.6	2.6	2.6
Lost Time Adjust (s)	0.0	0.0	0.0	0.0	0.0	0.0	0.0	0.0	0.0	0.0	0.0	0.0
Total Lost Time (s)	6.0	6.1	6.1	6.0	6.1	6.1	6.3	6.3	6.3	6.3	6.3	6.3
Lead/Lag	Lead	Lag	Lag	Lead	Lag	Lag	Lead	Lead	Lead	Lag	Lag	Lag
Lead-Lag Optimize?	Yes	Yes	Yes	Yes	Yes	Yes	Yes	Yes	Yes	Yes	Yes	Yes
Act Effct Green (s)	30.1	22.0	22.0	30.1	22.0	22.0	53.0	53.0	53.0	22.0	22.0	22.0
Actuated g/C Ratio	0.23	0.17	0.17	0.23	0.17	0.17	0.41	0.41	0.41	0.17	0.17	0.17
v/c Ratio	0.07	0.14	0.36	0.11	0.52	0.12	0.66	0.70	0.03	0.03	0.24	0.16
Control Delay	35.2	46.7	10.6	35.7	52.7	0.7	37.2	35.3	0.1	45.4	47.9	1.0
Queue Delay	0.0	0.0	0.0	0.0	0.0	0.0	0.0	0.0	0.0	0.0	0.0	0.0
Total Delay	35.2	46.7	10.6	35.7	52.7	0.7	37.2	35.3	0.1	45.4	47.9	1.0
LOS	D	D	B	D	D	A	D	D	A	D	D	A
Approach Delay		25.4			45.1			35.3				34.1
Approach LOS		C			D			D				C
Queue Length 50th (m)	3.4	9.6	0.0	6.4	37.0	0.0	93.5	106.9	0.0	1.7	16.2	0.0
Queue Length 95th (m)	9.5	17.2	17.4	14.9	51.8	0.0	133.9	131.8	0.0	6.6	26.0	0.0
Internal Link Dist (m)		434.4			241.4			325.6				408.6
Turn Bay Length (m)	100.0		140.0	65.0			160.0		50.0	110.0		70.0
Base Capacity (vph)	243	575	363	317	575	359	630	1324	696	287	575	365
Starvation Cap Reductn	0	0	0	0	0	0	0	0	0	0	0	0
Spillback Cap Reductn	0	0	0	0	0	0	0	0	0	0	0	0
Storage Cap Reductn	0	0	0	0	0	0	0	0	0	0	0	0
Reduced v/c Ratio	0.07	0.14	0.36	0.11	0.52	0.12	0.66	0.70	0.03	0.03	0.24	0.16

Intersection Summary

Cycle Length: 129.7

Actuated Cycle Length: 129.7

Offset: 0 (0%), Referenced to phase 2: and 6:SBTL, Start of Green

Natural Cycle: 105

Control Type: Pretimed

Maximum v/c Ratio: 0.70

Intersection Signal Delay: 35.9

Intersection LOS: D

Intersection Capacity Utilization 62.9%

ICU Level of Service B

Analysis Period (min) 15

Lanes, Volumes, Timings
 5: Tenth Line & St. Joseph





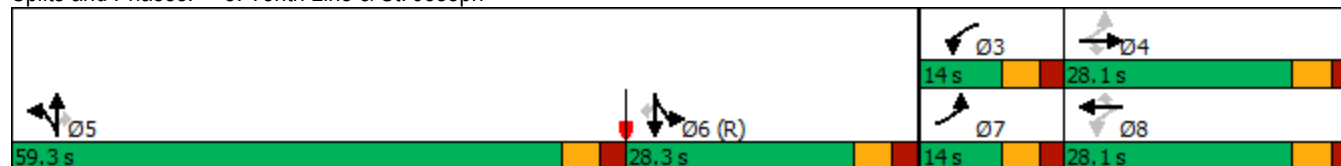















Existing AM

Splits and Phases: 5: Tenth Line & St. Joseph



Lanes, Volumes, Timings
6: Old Tenth Line & St. Joseph

Existing AM

												
Lane Group	EBL	EBT	EBR	WBL	WBT	WBR	NBL	NBT	NBR	SBL	SBT	SBR
Lane Configurations												
Traffic Volume (vph)	0	76	0	31	289	0	0	0	101	49	285	50
Future Volume (vph)	0	76	0	31	289	0	0	0	101	49	285	50
Satd. Flow (prot)	0	3390	0	1695	3390	0	1784	0	1517	3288	3390	1517
Flt Permitted				0.700						0.950		
Satd. Flow (perm)	0	3390	0	1249	3390	0	1784	0	1498	3288	3390	1517
Satd. Flow (RTOR)									878			241
Lane Group Flow (vph)	0	84	0	34	321	0	0	0	112	54	317	56
Turn Type		NA		Perm	NA		Prot		Free	Prot	NA	Free
Protected Phases		4			8		5			1	6	
Permitted Phases				8					Free			Free
Minimum Split (s)		25.6		25.6	25.6		11.3			12.0	30.0	
Total Split (s)		31.6		31.6	31.6		16.3			45.0	28.7	
Total Split (%)		41.3%		41.3%	41.3%		21.3%			58.7%	37.5%	
Yellow Time (s)		3.7		3.7	3.7		3.7			3.7	3.7	
All-Red Time (s)		2.9		2.9	2.9		2.6			3.3	3.3	
Lost Time Adjust (s)		0.0		0.0	0.0		0.0			0.0	0.0	
Total Lost Time (s)		6.6		6.6	6.6		6.3			7.0	7.0	
Lead/Lag							Lead					Lag
Lead-Lag Optimize?							Yes					Yes
Act Effct Green (s)		25.0		25.0	25.0				76.6	38.0	21.7	76.6
Actuated g/C Ratio		0.33		0.33	0.33				1.00	0.50	0.28	1.00
v/c Ratio		0.08		0.08	0.29				0.07	0.03	0.33	0.04
Control Delay		18.1		18.7	20.1				0.1	10.0	22.9	0.0
Queue Delay		0.0		0.0	0.0				0.0	0.0	0.0	0.0
Total Delay		18.1		18.7	20.1				0.1	10.0	22.9	0.0
LOS		B		B	C				A	A	C	A
Approach Delay		18.1			20.0		0.1				18.3	
Approach LOS		B			B		A				B	
Queue Length 50th (m)		4.3		3.4	17.9				0.0	1.9	19.0	0.0
Queue Length 95th (m)		8.9		9.3	27.7				0.0	4.5	29.3	0.0
Internal Link Dist (m)		241.4			372.8		239.6				226.3	
Turn Bay Length (m)				60.0					10.0	90.0		
Base Capacity (vph)		1106		407	1106				1498	1631	960	1517
Starvation Cap Reductn		0		0	0				0	0	0	0
Spillback Cap Reductn		0		0	0				0	0	0	0
Storage Cap Reductn		0		0	0				0	0	0	0
Reduced v/c Ratio		0.08		0.08	0.29				0.07	0.03	0.33	0.04

Intersection Summary

Cycle Length: 76.6
 Actuated Cycle Length: 76.6
 Offset: 0 (0%), Referenced to phase 2: and 6:SBT, Start of Green
 Natural Cycle: 70
 Control Type: Pretimed
 Maximum v/c Ratio: 0.33
 Intersection Signal Delay: 16.8
 Intersection Capacity Utilization 28.1%
 Analysis Period (min) 15
 Intersection LOS: B
 ICU Level of Service A

Lanes, Volumes, Timings
6: Old Tenth Line & St. Joseph

Existing AM

Splits and Phases: 6: Old Tenth Line & St. Joseph

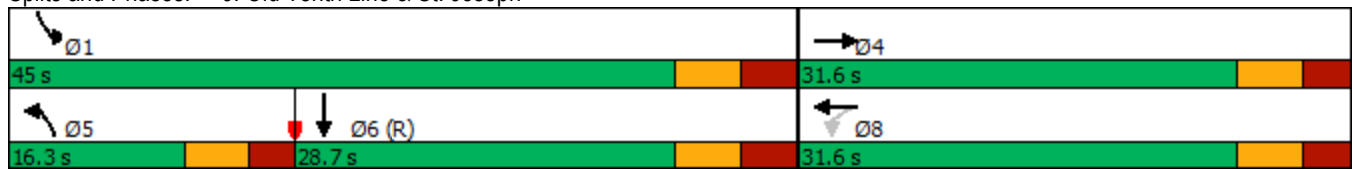

Intersection	
Intersection Delay, s/veh	8
Intersection LOS	A

Movement	EBT	EBR	WBL	WBT	NBL	NBR
Lane Configurations						
Traffic Vol, veh/h	3	70	105	6	87	37
Future Vol, veh/h	3	70	105	6	87	37
Peak Hour Factor	0.90	0.90	0.90	0.90	0.90	0.90
Heavy Vehicles, %	2	2	2	2	2	2
Mvmt Flow	3	78	117	7	97	41
Number of Lanes	1	0	0	1	1	0

Approach	EB	WB	NB
Opposing Approach	WB	EB	
Opposing Lanes	1	1	0
Conflicting Approach Left		NB	EB
Conflicting Lanes Left	0	1	1
Conflicting Approach Right	NB		WB
Conflicting Lanes Right	1	0	1
HCM Control Delay	7.2	8.4	8.2
HCM LOS	A	A	A

Lane	NBLn1	EBLn1	WBLn1
Vol Left, %	70%	0%	95%
Vol Thru, %	0%	4%	5%
Vol Right, %	30%	96%	0%
Sign Control	Stop	Stop	Stop
Traffic Vol by Lane	124	73	111
LT Vol	87	0	105
Through Vol	0	3	6
RT Vol	37	70	0
Lane Flow Rate	138	81	123
Geometry Grp	1	1	1
Degree of Util (X)	0.166	0.086	0.155
Departure Headway (Hd)	4.346	3.813	4.529
Convergence, Y/N	Yes	Yes	Yes
Cap	828	943	797
Service Time	2.357	1.824	2.529
HCM Lane V/C Ratio	0.167	0.086	0.154
HCM Control Delay	8.2	7.2	8.4
HCM Lane LOS	A	A	A
HCM 95th-tile Q	0.6	0.3	0.5

Intersection	
Intersection Delay, s/veh	7.5
Intersection LOS	A

Movement	EBL	EBT	EBR	WBL	WBT	WBR	NBL	NBT	NBR	SBL	SBT	SBR
Lane Configurations		↕			↕			↕			↕	
Traffic Vol, veh/h	8	64	2	5	73	20	2	0	5	9	0	3
Future Vol, veh/h	8	64	2	5	73	20	2	0	5	9	0	3
Peak Hour Factor	0.90	0.90	0.90	0.90	0.90	0.90	0.90	0.90	0.90	0.90	0.90	0.90
Heavy Vehicles, %	2	2	2	2	2	2	2	2	2	2	2	2
Mvmt Flow	9	71	2	6	81	22	2	0	6	10	0	3
Number of Lanes	0	1	0	0	1	0	0	1	0	0	1	0

Approach	EB	WB	NB	SB
Opposing Approach	WB	EB	SB	NB
Opposing Lanes	1	1	1	1
Conflicting Approach Left	SB	NB	EB	WB
Conflicting Lanes Left	1	1	1	1
Conflicting Approach Right	NB	SB	WB	EB
Conflicting Lanes Right	1	1	1	1
HCM Control Delay	7.5	7.5	7	7.4
HCM LOS	A	A	A	A

Lane	NBLn1	EBLn1	WBLn1	SBLn1
Vol Left, %	29%	11%	5%	75%
Vol Thru, %	0%	86%	74%	0%
Vol Right, %	71%	3%	20%	25%
Sign Control	Stop	Stop	Stop	Stop
Traffic Vol by Lane	7	74	98	12
LT Vol	2	8	5	9
Through Vol	0	64	73	0
RT Vol	5	2	20	3
Lane Flow Rate	8	82	109	13
Geometry Grp	1	1	1	1
Degree of Util (X)	0.008	0.093	0.119	0.016
Departure Headway (Hd)	3.901	4.058	3.92	4.269
Convergence, Y/N	Yes	Yes	Yes	Yes
Cap	904	882	914	828
Service Time	1.984	2.087	1.947	2.349
HCM Lane V/C Ratio	0.009	0.093	0.119	0.016
HCM Control Delay	7	7.5	7.5	7.4
HCM Lane LOS	A	A	A	A
HCM 95th-tile Q	0	0.3	0.4	0

Intersection	
Intersection Delay, s/veh	9.2
Intersection LOS	A

Movement	EBT	EBR	WBL	WBT	NBL	NBR
Lane Configurations	↻		↻	↻	↻	↻
Traffic Vol, veh/h	32	97	89	78	131	38
Future Vol, veh/h	32	97	89	78	131	38
Peak Hour Factor	0.90	0.90	0.90	0.90	0.90	0.90
Heavy Vehicles, %	2	2	2	2	2	2
Mvmt Flow	36	108	99	87	146	42
Number of Lanes	1	0	1	1	1	1

Approach	EB	WB	NB
Opposing Approach	WB	EB	
Opposing Lanes	2	1	0
Conflicting Approach Left		NB	EB
Conflicting Lanes Left	0	2	1
Conflicting Approach Right	NB		WB
Conflicting Lanes Right	2	0	2
HCM Control Delay	8.7	9.1	9.8
HCM LOS	A	A	A

Lane	NBLn1	NBLn2	EBLn1	WBLn1	WBLn2
Vol Left, %	100%	0%	0%	100%	0%
Vol Thru, %	0%	0%	25%	0%	100%
Vol Right, %	0%	100%	75%	0%	0%
Sign Control	Stop	Stop	Stop	Stop	Stop
Traffic Vol by Lane	131	38	129	89	78
LT Vol	131	0	0	89	0
Through Vol	0	0	32	0	78
RT Vol	0	38	97	0	0
Lane Flow Rate	146	42	143	99	87
Geometry Grp	7	7	4	7	7
Degree of Util (X)	0.236	0.054	0.185	0.156	0.125
Departure Headway (Hd)	5.841	4.634	4.639	5.692	5.189
Convergence, Y/N	Yes	Yes	Yes	Yes	Yes
Cap	614	771	773	630	691
Service Time	3.584	2.377	2.674	3.427	2.923
HCM Lane V/C Ratio	0.238	0.054	0.185	0.157	0.126
HCM Control Delay	10.4	7.6	8.7	9.5	8.7
HCM Lane LOS	B	A	A	A	A
HCM 95th-tile Q	0.9	0.2	0.7	0.5	0.4

Lanes, Volumes, Timings

1: Trim & H174

Existing PM

Lane Group	EBL	EBT	EBR	WBL	WBT	WBR	NBL	NBT	NBR	SBL	SBT	SBR
Lane Configurations												
Traffic Volume (vph)	75	891	12	49	366	31	239	54	60	54	68	98
Future Volume (vph)	75	891	12	49	366	31	239	54	60	54	68	98
Satd. Flow (prot)	1695	3383	0	1695	4871	1517	4780	1784	1517	1695	1784	1517
Flt Permitted	0.950			0.950			0.950			0.950		
Satd. Flow (perm)	1695	3383	0	1695	4871	1517	4780	1784	1517	1695	1784	1517
Satd. Flow (RTOR)		1				218			156			217
Lane Group Flow (vph)	83	1003	0	54	407	34	266	60	67	60	76	109
Turn Type	Prot	NA		Prot	NA	Perm	Prot	NA	Perm	Prot	NA	Perm
Protected Phases	5	2		1	6		3	8		7	4	
Permitted Phases						6			8			4
Detector Phase	5	2		1	6	6	3	8	8	7	4	4
Switch Phase												
Minimum Initial (s)	1.0	5.0		1.0	5.0	5.0	1.0	5.0	5.0	1.0	5.0	5.0
Minimum Split (s)	8.5	41.2		8.5	41.2	41.2	8.2	42.4	42.4	7.9	12.4	12.4
Total Split (s)	16.0	54.0		16.0	54.0	54.0	33.0	43.0	43.0	17.0	27.0	27.0
Total Split (%)	12.3%	41.5%		12.3%	41.5%	41.5%	25.4%	33.1%	33.1%	13.1%	20.8%	20.8%
Yellow Time (s)	3.3	5.1		3.3	5.1	5.1	3.3	3.3	3.3	3.3	3.3	3.3
All-Red Time (s)	4.2	2.1		3.8	2.1	2.1	3.9	4.1	4.1	3.6	4.1	4.1
Lost Time Adjust (s)	0.0	0.0		0.0	0.0	0.0	0.0	0.0	0.0	0.0	0.0	0.0
Total Lost Time (s)	7.5	7.2		7.1	7.2	7.2	7.2	7.4	7.4	6.9	7.4	7.4
Lead/Lag	Lead	Lag		Lead	Lag	Lag	Lead	Lag	Lag	Lead	Lag	Lag
Lead-Lag Optimize?	Yes	Yes		Yes	Yes	Yes	Yes	Yes	Yes	Yes	Yes	Yes
Recall Mode	None	C-Min		None	C-Min	C-Min	None	None	None	None	None	None
Act Effct Green (s)	10.9	68.6		8.7	63.5	63.5	12.6	20.0	20.0	9.2	13.7	13.7
Actuated g/C Ratio	0.08	0.53		0.07	0.49	0.49	0.10	0.15	0.15	0.07	0.11	0.11
v/c Ratio	0.59	0.56		0.48	0.17	0.04	0.58	0.22	0.18	0.50	0.40	0.31
Control Delay	74.1	25.3		71.9	20.6	0.1	61.0	49.0	1.1	72.3	58.0	2.2
Queue Delay	0.0	0.0		0.0	0.0	0.0	0.0	0.0	0.0	0.0	0.0	0.0
Total Delay	74.1	25.3		71.9	20.6	0.1	61.0	49.0	1.1	72.3	58.0	2.2
LOS	E	C		E	C	A	E	D	A	E	E	A
Approach Delay		29.0			24.8			48.9			36.7	
Approach LOS		C			C			D			D	
Queue Length 50th (m)	20.6	88.4		13.5	20.3	0.0	23.5	14.5	0.0	15.0	18.9	0.0
Queue Length 95th (m)	#46.1	149.2		27.3	35.0	0.0	32.1	22.9	0.0	29.4	29.5	0.0
Internal Link Dist (m)		313.0			478.0			348.7			179.7	
Turn Bay Length (m)	150.0			150.0		30.0	200.0		40.0	150.0		40.0
Base Capacity (vph)	143	1785		124	2380	852	948	488	528	135	295	432
Starvation Cap Reductn	0	0		0	0	0	0	0	0	0	0	0
Spillback Cap Reductn	0	0		0	0	0	0	0	0	0	0	0
Storage Cap Reductn	0	0		0	0	0	0	0	0	0	0	0
Reduced v/c Ratio	0.58	0.56		0.44	0.17	0.04	0.28	0.12	0.13	0.44	0.26	0.25

Intersection Summary

Cycle Length: 130

Actuated Cycle Length: 130

Offset: 54.5 (42%), Referenced to phase 2:EBT and 6:WBT, Start of Green

Natural Cycle: 100

Control Type: Actuated-Coordinated

Lanes, Volumes, Timings

1: Trim & H174

Existing PM

Maximum v/c Ratio: 0.59

Intersection Signal Delay: 32.5

Intersection LOS: C

Intersection Capacity Utilization 59.3%

ICU Level of Service B

Analysis Period (min) 15

95th percentile volume exceeds capacity, queue may be longer.

Queue shown is maximum after two cycles.

Splits and Phases: 1: Trim & H174

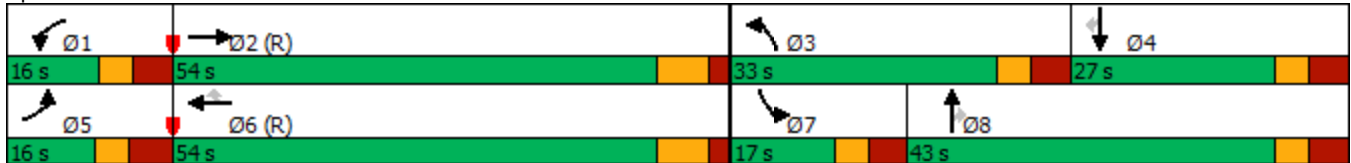

Lanes, Volumes, Timings
5: Tenth Line & St. Joseph

Existing PM



Lane Group	EBL	EBT	EBR	WBL	WBT	WBR	NBL	NBT	NBR	SBL	SBT	SBR
Lane Configurations												
Traffic Volume (vph)	54	298	525	62	199	148	320	627	13	8	137	42
Future Volume (vph)	54	298	525	62	199	148	320	627	13	8	137	42
Satd. Flow (prot)	1695	3390	1517	1695	3390	1517	1543	3241	1517	1695	3390	1517
Flt Permitted	0.576			0.415			0.950	0.998		0.950		
Satd. Flow (perm)	1017	3390	1496	740	3390	1476	1543	3241	1494	1693	3390	1517
Satd. Flow (RTOR)			583			164			130			130
Lane Group Flow (vph)	60	331	583	69	221	164	320	733	14	9	152	47
Turn Type	pm+pt	NA	Perm	pm+pt	NA	Perm	Split	NA	Perm	Split	NA	Perm
Protected Phases	7	4		3	8		5	5		6	6	
Permitted Phases	4		4	8		8			5			6
Minimum Split (s)	11.0	29.1	29.1	11.0	29.1	29.1	32.3	32.3	32.3	32.3	32.3	32.3
Total Split (s)	14.0	28.1	28.1	14.0	28.1	28.1	59.3	59.3	59.3	28.3	28.3	28.3
Total Split (%)	10.8%	21.7%	21.7%	10.8%	21.7%	21.7%	45.7%	45.7%	45.7%	21.8%	21.8%	21.8%
Yellow Time (s)	3.7	3.7	3.7	3.7	3.7	3.7	3.7	3.7	3.7	3.7	3.7	3.7
All-Red Time (s)	2.3	2.4	2.4	2.3	2.4	2.4	2.6	2.6	2.6	2.6	2.6	2.6
Lost Time Adjust (s)	0.0	0.0	0.0	0.0	0.0	0.0	0.0	0.0	0.0	0.0	0.0	0.0
Total Lost Time (s)	6.0	6.1	6.1	6.0	6.1	6.1	6.3	6.3	6.3	6.3	6.3	6.3
Lead/Lag	Lead	Lag	Lag	Lead	Lag	Lag	Lead	Lead	Lead	Lag	Lag	Lag
Lead-Lag Optimize?	Yes	Yes	Yes	Yes	Yes	Yes	Yes	Yes	Yes	Yes	Yes	Yes
Act Effct Green (s)	30.1	22.0	22.0	30.1	22.0	22.0	53.0	53.0	53.0	22.0	22.0	22.0
Actuated g/C Ratio	0.23	0.17	0.17	0.23	0.17	0.17	0.41	0.41	0.41	0.17	0.17	0.17
v/c Ratio	0.22	0.58	0.79	0.30	0.38	0.42	0.51	0.55	0.02	0.03	0.26	0.13
Control Delay	37.4	54.1	12.6	39.1	50.1	10.4	32.1	31.3	0.1	45.5	48.2	0.7
Queue Delay	0.0	0.0	0.0	0.0	0.0	0.0	0.0	0.0	0.0	0.0	0.0	0.0
Total Delay	37.4	54.1	12.6	39.1	50.1	10.4	32.1	31.3	0.1	45.5	48.2	0.7
LOS	D	D	B	D	D	B	C	C	A	D	D	A
Approach Delay		28.2			34.1			31.1				37.4
Approach LOS		C			C			C				D
Queue Length 50th (m)	11.5	41.4	0.0	13.3	26.7	0.0	66.1	77.7	0.0	1.9	18.0	0.0
Queue Length 95th (m)	22.6	57.1	39.3	25.4	39.2	19.2	97.1	97.6	0.0	7.0	28.3	0.0
Internal Link Dist (m)		434.4			241.4			325.6				408.6
Turn Bay Length (m)	100.0		140.0	65.0			160.0		50.0	110.0		70.0
Base Capacity (vph)	277	575	737	230	575	386	630	1324	687	287	575	365
Starvation Cap Reductn	0	0	0	0	0	0	0	0	0	0	0	0
Spillback Cap Reductn	0	0	0	0	0	0	0	0	0	0	0	0
Storage Cap Reductn	0	0	0	0	0	0	0	0	0	0	0	0
Reduced v/c Ratio	0.22	0.58	0.79	0.30	0.38	0.42	0.51	0.55	0.02	0.03	0.26	0.13

Intersection Summary

Cycle Length: 129.7

Actuated Cycle Length: 129.7

Offset: 0 (0%), Referenced to phase 6:SBTL, Start of Green

Natural Cycle: 105

Control Type: Pretimed

Maximum v/c Ratio: 0.79

Intersection Signal Delay: 31.1

Intersection LOS: C

Intersection Capacity Utilization 69.7%

ICU Level of Service C

Analysis Period (min) 15

Lanes, Volumes, Timings
 5: Tenth Line & St. Joseph





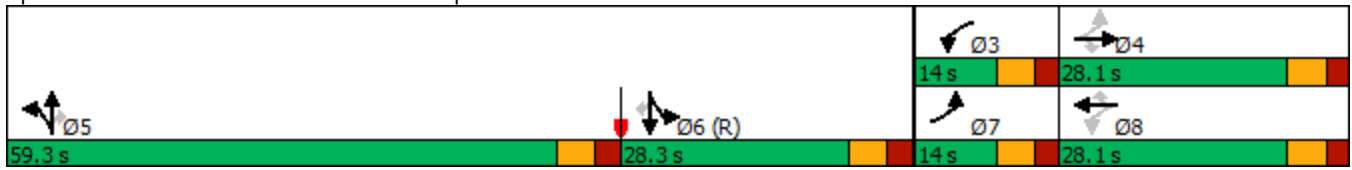















Existing PM

Splits and Phases: 5: Tenth Line & St. Joseph



Lanes, Volumes, Timings
6: Old Tenth Line & St. Joseph

Existing PM

												
Lane Group	EBL	EBT	EBR	WBL	WBT	WBR	NBL	NBT	NBR	SBL	SBT	SBR
Lane Configurations												
Traffic Volume (vph)	0	324	3	96	276	0	4	0	82	55	859	136
Future Volume (vph)	0	324	3	96	276	0	4	0	82	55	859	136
Satd. Flow (prot)	0	3387	0	1695	3390	0	1695	0	1517	3288	3390	1517
Flt Permitted				0.535			0.950			0.950		
Satd. Flow (perm)	0	3387	0	955	3390	0	1695	0	1498	3288	3390	1517
Satd. Flow (RTOR)		1							257			257
Lane Group Flow (vph)	0	363	0	107	307	0	4	0	91	61	954	151
Turn Type		NA		Perm	NA		Prot		Free	Prot	NA	Free
Protected Phases		4			8		5			1	6	
Permitted Phases				8					Free			Free
Minimum Split (s)		25.6		25.6	25.6		11.3			12.0	30.0	
Total Split (s)		26.6		26.6	26.6		11.3			45.0	33.7	
Total Split (%)		37.2%		37.2%	37.2%		15.8%			62.8%	47.1%	
Yellow Time (s)		3.7		3.7	3.7		3.7			3.7	3.7	
All-Red Time (s)		2.9		2.9	2.9		2.6			3.3	3.3	
Lost Time Adjust (s)		0.0		0.0	0.0		0.0			0.0	0.0	
Total Lost Time (s)		6.6		6.6	6.6		6.3			7.0	7.0	
Lead/Lag							Lead					Lag
Lead-Lag Optimize?							Yes					Yes
Act Effct Green (s)		20.0		20.0	20.0		5.0		71.6	38.0	26.7	71.6
Actuated g/C Ratio		0.28		0.28	0.28		0.07		1.00	0.53	0.37	1.00
v/c Ratio		0.38		0.40	0.32		0.03		0.06	0.03	0.75	0.10
Control Delay		22.2		26.5	21.6		31.8		0.1	8.2	24.2	0.1
Queue Delay		0.0		0.0	0.0		0.0		0.0	0.0	0.0	0.0
Total Delay		22.2		26.5	21.6		31.8		0.1	8.2	24.2	0.1
LOS		C		C	C		C		A	A	C	A
Approach Delay		22.2			22.9			1.4			20.3	
Approach LOS		C			C			A			C	
Queue Length 50th (m)		20.5		11.6	17.1		0.5		0.0	1.8	57.4	0.0
Queue Length 95th (m)		31.5		25.2	27.0		3.1		0.0	4.2	78.5	0.0
Internal Link Dist (m)		241.4			372.8			239.6			226.3	
Turn Bay Length (m)				60.0					10.0	90.0		
Base Capacity (vph)		946		266	946		118		1498	1745	1264	1517
Starvation Cap Reductn		0		0	0		0		0	0	0	0
Spillback Cap Reductn		0		0	0		0		0	0	0	0
Storage Cap Reductn		0		0	0		0		0	0	0	0
Reduced v/c Ratio		0.38		0.40	0.32		0.03		0.06	0.03	0.75	0.10

Intersection Summary

Cycle Length: 71.6	
Actuated Cycle Length: 71.6	
Offset: 0 (0%), Referenced to phase 6:SBT, Start of Green	
Natural Cycle: 70	
Control Type: Pretimed	
Maximum v/c Ratio: 0.75	
Intersection Signal Delay: 20.3	Intersection LOS: C
Intersection Capacity Utilization 57.1%	ICU Level of Service B
Analysis Period (min) 15	

Lanes, Volumes, Timings
6: Old Tenth Line & St. Joseph

Existing PM

Splits and Phases: 6: Old Tenth Line & St. Joseph



Intersection	
Intersection Delay, s/veh	7.9
Intersection LOS	A

Movement	EBT	EBR	WBL	WBT	NBL	NBR
Lane Configurations						
Traffic Vol, veh/h	6	104	63	2	69	85
Future Vol, veh/h	6	104	63	2	69	85
Peak Hour Factor	0.90	0.90	0.90	0.90	0.90	0.90
Heavy Vehicles, %	2	2	2	2	2	2
Mvmt Flow	7	116	70	2	77	94
Number of Lanes	1	0	0	1	1	0

Approach	EB	WB	NB
Opposing Approach	WB	EB	
Opposing Lanes	1	1	0
Conflicting Approach Left		NB	EB
Conflicting Lanes Left	0	1	1
Conflicting Approach Right	NB		WB
Conflicting Lanes Right	1	0	1
HCM Control Delay	7.4	8.1	8.1
HCM LOS	A	A	A

Lane	NBLn1	EBLn1	WBLn1
Vol Left, %	45%	0%	97%
Vol Thru, %	0%	5%	3%
Vol Right, %	55%	95%	0%
Sign Control	Stop	Stop	Stop
Traffic Vol by Lane	154	110	65
LT Vol	69	0	63
Through Vol	0	6	2
RT Vol	85	104	0
Lane Flow Rate	171	122	72
Geometry Grp	1	1	1
Degree of Util (X)	0.191	0.13	0.091
Departure Headway (Hd)	4.025	3.824	4.526
Convergence, Y/N	Yes	Yes	Yes
Cap	878	944	779
Service Time	2.115	1.824	2.624
HCM Lane V/C Ratio	0.195	0.129	0.092
HCM Control Delay	8.1	7.4	8.1
HCM Lane LOS	A	A	A
HCM 95th-tile Q	0.7	0.4	0.3

Intersection	
Intersection Delay, s/veh	7.6
Intersection LOS	A

Movement	EBL	EBT	EBR	WBL	WBT	WBR	NBL	NBT	NBR	SBL	SBT	SBR
Lane Configurations		↕			↕			↕			↕	
Traffic Vol, veh/h	7	98	2	5	63	8	2	0	5	12	0	4
Future Vol, veh/h	7	98	2	5	63	8	2	0	5	12	0	4
Peak Hour Factor	0.90	0.90	0.90	0.90	0.90	0.90	0.90	0.90	0.90	0.90	0.90	0.90
Heavy Vehicles, %	2	2	2	2	2	2	2	2	2	2	2	2
Mvmt Flow	8	109	2	6	70	9	2	0	6	13	0	4
Number of Lanes	0	1	0	0	1	0	0	1	0	0	1	0

Approach	EB	WB	NB	SB
Opposing Approach	WB	EB	SB	NB
Opposing Lanes	1	1	1	1
Conflicting Approach Left	SB	NB	EB	WB
Conflicting Lanes Left	1	1	1	1
Conflicting Approach Right	NB	SB	WB	EB
Conflicting Lanes Right	1	1	1	1
HCM Control Delay	7.7	7.5	7.1	7.5
HCM LOS	A	A	A	A

Lane	NBLn1	EBLn1	WBLn1	SBLn1
Vol Left, %	29%	7%	7%	75%
Vol Thru, %	0%	92%	83%	0%
Vol Right, %	71%	2%	11%	25%
Sign Control	Stop	Stop	Stop	Stop
Traffic Vol by Lane	7	107	76	16
LT Vol	2	7	5	12
Through Vol	0	98	63	0
RT Vol	5	2	8	4
Lane Flow Rate	8	119	84	18
Geometry Grp	1	1	1	1
Degree of Util (X)	0.008	0.134	0.094	0.021
Departure Headway (Hd)	3.925	4.044	4.018	4.29
Convergence, Y/N	Yes	Yes	Yes	Yes
Cap	896	886	889	822
Service Time	2.019	2.072	2.054	2.38
HCM Lane V/C Ratio	0.009	0.134	0.094	0.022
HCM Control Delay	7.1	7.7	7.5	7.5
HCM Lane LOS	A	A	A	A
HCM 95th-tile Q	0	0.5	0.3	0.1

Intersection	
Intersection Delay, s/veh	10.3
Intersection LOS	B

Movement	EBT	EBR	WBL	WBT	NBL	NBR
Lane Configurations	↻		↻	↻	↻	↻
Traffic Vol, veh/h	97	113	99	46	164	126
Future Vol, veh/h	97	113	99	46	164	126
Peak Hour Factor	0.90	0.90	0.90	0.90	0.90	0.90
Heavy Vehicles, %	2	2	2	2	2	2
Mvmt Flow	108	126	110	51	182	140
Number of Lanes	1	0	1	1	1	1

Approach	EB	WB	NB
Opposing Approach	WB	EB	
Opposing Lanes	2	1	0
Conflicting Approach Left		NB	EB
Conflicting Lanes Left	0	2	1
Conflicting Approach Right	NB		WB
Conflicting Lanes Right	2	0	2
HCM Control Delay	10.6	9.9	10.3
HCM LOS	B	A	B

Lane	NBLn1	NBLn2	EBLn1	WBLn1	WBLn2
Vol Left, %	100%	0%	0%	100%	0%
Vol Thru, %	0%	0%	46%	0%	100%
Vol Right, %	0%	100%	54%	0%	0%
Sign Control	Stop	Stop	Stop	Stop	Stop
Traffic Vol by Lane	164	126	210	99	46
LT Vol	164	0	0	99	0
Through Vol	0	0	97	0	46
RT Vol	0	126	113	0	0
Lane Flow Rate	182	140	233	110	51
Geometry Grp	7	7	4	7	7
Degree of Util (X)	0.306	0.188	0.328	0.187	0.08
Departure Headway (Hd)	6.042	4.833	5.058	6.133	5.628
Convergence, Y/N	Yes	Yes	Yes	Yes	Yes
Cap	590	735	705	581	631
Service Time	3.817	2.608	3.126	3.913	3.408
HCM Lane V/C Ratio	0.308	0.19	0.33	0.189	0.081
HCM Control Delay	11.5	8.7	10.6	10.3	8.9
HCM Lane LOS	B	A	B	B	A
HCM 95th-tile Q	1.3	0.7	1.4	0.7	0.3

APPENDIX N

SYCNHRO ANALYSIS: BACKGROUND CONDITIONS

Lanes, Volumes, Timings

1: Trim & H174

Background AM

Lane Group	EBL	EBT	EBR	WBL	WBT	WBR	NBL	NBT	NBR	SBL	SBT	SBR
Lane Configurations												
Traffic Volume (vph)	152	353	3	17	262	14	666	62	54	45	101	291
Future Volume (vph)	152	353	3	17	262	14	666	62	54	45	101	291
Satd. Flow (prot)	1695	3387	0	1695	4871	1517	4780	1784	1517	1695	1784	1517
Flt Permitted	0.950			0.950			0.950			0.950		
Satd. Flow (perm)	1695	3387	0	1695	4871	1517	4780	1784	1517	1695	1784	1517
Satd. Flow (RTOR)		1				218			156			291
Lane Group Flow (vph)	152	356	0	17	262	14	666	62	54	45	101	291
Turn Type	Prot	NA		Prot	NA	Perm	Prot	NA	Perm	Prot	NA	Perm
Protected Phases	5	2		1	6		3	8		7	4	
Permitted Phases						6			8			4
Detector Phase	5	2		1	6	6	3	8	8	7	4	4
Switch Phase												
Minimum Initial (s)	1.0	5.0		1.0	5.0	5.0	1.0	5.0	5.0	1.0	5.0	5.0
Minimum Split (s)	8.5	41.2		8.5	41.2	41.2	8.2	42.4	42.4	7.9	12.4	12.4
Total Split (s)	15.0	50.0		20.0	55.0	55.0	42.0	43.0	43.0	17.0	18.0	18.0
Total Split (%)	11.5%	38.5%		15.4%	42.3%	42.3%	32.3%	33.1%	33.1%	13.1%	13.8%	13.8%
Yellow Time (s)	3.3	5.1		3.3	5.1	5.1	3.3	3.3	3.3	3.3	3.3	3.3
All-Red Time (s)	4.2	2.1		3.8	2.1	2.1	3.9	4.1	4.1	3.6	4.1	4.1
Lost Time Adjust (s)	0.0	0.0		0.0	0.0	0.0	0.0	0.0	0.0	0.0	0.0	0.0
Total Lost Time (s)	7.5	7.2		7.1	7.2	7.2	7.2	7.4	7.4	6.9	7.4	7.4
Lead/Lag	Lead	Lag		Lead	Lag	Lag	Lead	Lag	Lag	Lead	Lag	Lag
Lead-Lag Optimize?	Yes	Yes		Yes	Yes	Yes	Yes	Yes	Yes	Yes	Yes	Yes
Recall Mode	None	C-Min		None	C-Min	C-Min	None	None	None	None	None	None
Act Effct Green (s)	23.6	65.4		6.9	40.4	40.4	23.6	30.6	30.6	8.8	13.1	13.1
Actuated g/C Ratio	0.18	0.50		0.05	0.31	0.31	0.18	0.24	0.24	0.07	0.10	0.10
v/c Ratio	0.50	0.21		0.19	0.17	0.02	0.77	0.15	0.11	0.39	0.56	0.70
Control Delay	56.1	21.2		63.2	33.2	0.1	56.7	40.2	0.5	67.1	67.2	15.5
Queue Delay	0.0	0.0		0.0	0.0	0.0	0.0	0.0	0.0	0.0	0.0	0.0
Total Delay	56.1	21.2		63.2	33.2	0.1	56.7	40.2	0.5	67.1	67.2	15.5
LOS	E	C		E	C	A	E	D	A	E	E	B
Approach Delay		31.6			33.4			51.5			32.8	
Approach LOS		C			C			D			C	
Queue Length 50th (m)	35.8	23.1		4.3	17.6	0.0	58.2	13.0	0.0	11.3	25.1	0.0
Queue Length 95th (m)	#72.7	47.2		12.0	25.7	0.0	68.4	23.5	0.0	23.2	41.8	26.5
Internal Link Dist (m)		686.1			478.0			348.7			179.7	
Turn Bay Length (m)	175.0			150.0		30.0	200.0		40.0	150.0		40.0
Base Capacity (vph)	307	1704		168	1791	695	1279	488	528	137	186	418
Starvation Cap Reductn	0	0		0	0	0	0	0	0	0	0	0
Spillback Cap Reductn	0	0		0	0	0	0	0	0	0	0	0
Storage Cap Reductn	0	0		0	0	0	0	0	0	0	0	0
Reduced v/c Ratio	0.50	0.21		0.10	0.15	0.02	0.52	0.13	0.10	0.33	0.54	0.70

Intersection Summary

Cycle Length: 130

Actuated Cycle Length: 130

Offset: 54.5 (42%), Referenced to phase 2:EBT and 6:WBT, Start of Green

Natural Cycle: 110

Control Type: Actuated-Coordinated

Lanes, Volumes, Timings

1: Trim & H174

Background AM

Maximum v/c Ratio: 0.77

Intersection Signal Delay: 39.8

Intersection LOS: D

Intersection Capacity Utilization 55.9%

ICU Level of Service B

Analysis Period (min) 15

95th percentile volume exceeds capacity, queue may be longer.

Queue shown is maximum after two cycles.

Splits and Phases: 1: Trim & H174

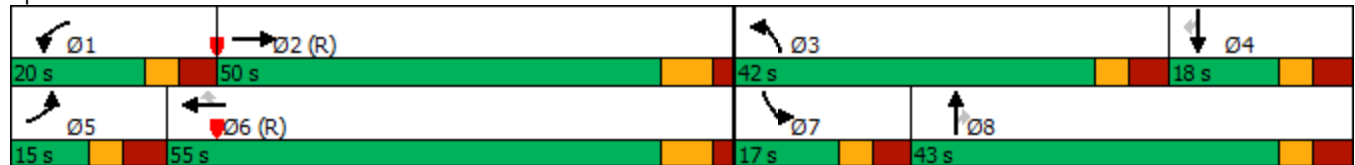

Lanes, Volumes, Timings
5: Tenth Line & St. Joseph

Background AM



Lane Group	EBL	EBT	EBR	WBL	WBT	WBR	NBL	NBT	NBR	SBL	SBT	SBR
Lane Configurations												
Traffic Volume (vph)	16	79	159	31	275	51	441	796	20	7	124	55
Future Volume (vph)	16	79	159	31	275	51	441	796	20	7	124	55
Satd. Flow (prot)	1695	3390	1517	1695	3390	1517	1543	3238	1517	1695	3390	1517
Flt Permitted	0.495			0.703			0.950	0.997		0.950		
Satd. Flow (perm)	877	3390	1496	1252	3390	1481	1543	3238	1517	1695	3390	1517
Satd. Flow (RTOR)			159			131			130			130
Lane Group Flow (vph)	16	79	159	31	275	51	397	840	20	7	124	55
Turn Type	pm+pt	NA	Perm	pm+pt	NA	Perm	Split	NA	Perm	Split	NA	Perm
Protected Phases	7	4		3	8		5	5		6	6	
Permitted Phases	4		4	8		8			5			6
Minimum Split (s)	11.0	29.1	29.1	11.0	29.1	29.1	32.3	32.3	32.3	32.3	32.3	32.3
Total Split (s)	14.0	28.1	28.1	14.0	28.1	28.1	59.3	59.3	59.3	28.3	28.3	28.3
Total Split (%)	10.8%	21.7%	21.7%	10.8%	21.7%	21.7%	45.7%	45.7%	45.7%	21.8%	21.8%	21.8%
Yellow Time (s)	3.7	3.7	3.7	3.7	3.7	3.7	3.7	3.7	3.7	3.7	3.7	3.7
All-Red Time (s)	2.3	2.4	2.4	2.3	2.4	2.4	2.6	2.6	2.6	2.6	2.6	2.6
Lost Time Adjust (s)	0.0	0.0	0.0	0.0	0.0	0.0	0.0	0.0	0.0	0.0	0.0	0.0
Total Lost Time (s)	6.0	6.1	6.1	6.0	6.1	6.1	6.3	6.3	6.3	6.3	6.3	6.3
Lead/Lag	Lead	Lag	Lag	Lead	Lag	Lag	Lead	Lead	Lead	Lag	Lag	Lag
Lead-Lag Optimize?	Yes	Yes	Yes	Yes	Yes	Yes	Yes	Yes	Yes	Yes	Yes	Yes
Act Effct Green (s)	30.1	22.0	22.0	30.1	22.0	22.0	53.0	53.0	53.0	22.0	22.0	22.0
Actuated g/C Ratio	0.23	0.17	0.17	0.23	0.17	0.17	0.41	0.41	0.41	0.17	0.17	0.17
v/c Ratio	0.06	0.14	0.41	0.10	0.48	0.14	0.63	0.63	0.03	0.02	0.22	0.15
Control Delay	35.0	46.6	10.4	35.5	51.8	0.8	36.0	33.3	0.1	45.4	47.6	0.9
Queue Delay	0.0	0.0	0.0	0.0	0.0	0.0	0.0	0.0	0.0	0.0	0.0	0.0
Total Delay	35.0	46.6	10.4	35.5	51.8	0.8	36.0	33.3	0.1	45.4	47.6	0.9
LOS	C	D	B	D	D	A	D	C	A	D	D	A
Approach Delay		23.2			43.1			33.6				33.7
Approach LOS		C			D			C				C
Queue Length 50th (m)	3.0	9.1	0.0	5.9	33.8	0.0	87.6	93.0	0.0	1.5	14.5	0.0
Queue Length 95th (m)	8.7	16.5	18.6	13.7	47.9	0.0	126.2	115.5	0.0	5.9	23.8	0.0
Internal Link Dist (m)		434.4			241.4			325.6				408.6
Turn Bay Length (m)	100.0		140.0	65.0			160.0		50.0	110.0		70.0
Base Capacity (vph)	253	575	385	317	575	359	630	1323	696	287	575	365
Starvation Cap Reductn	0	0	0	0	0	0	0	0	0	0	0	0
Spillback Cap Reductn	0	0	0	0	0	0	0	0	0	0	0	0
Storage Cap Reductn	0	0	0	0	0	0	0	0	0	0	0	0
Reduced v/c Ratio	0.06	0.14	0.41	0.10	0.48	0.14	0.63	0.63	0.03	0.02	0.22	0.15

Intersection Summary

Cycle Length: 129.7
 Actuated Cycle Length: 129.7
 Offset: 0 (0%), Referenced to phase 6:SBTL, Start of Green
 Natural Cycle: 105
 Control Type: Pretimed
 Maximum v/c Ratio: 0.63
 Intersection Signal Delay: 34.0
 Intersection Capacity Utilization 63.4%
 Analysis Period (min) 15
 Intersection LOS: C
 ICU Level of Service B

Lanes, Volumes, Timings
 5: Tenth Line & St. Joseph





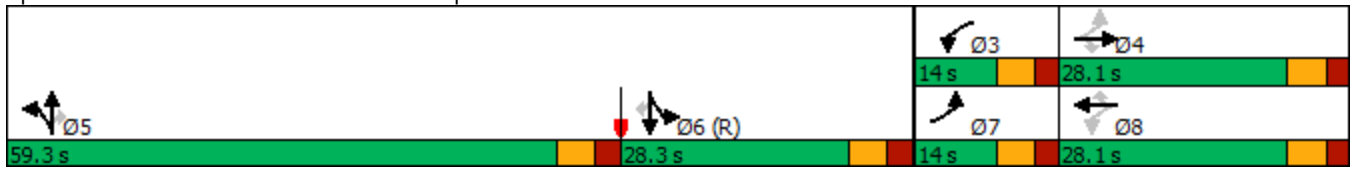















Background AM

Splits and Phases: 5: Tenth Line & St. Joseph



Lanes, Volumes, Timings
6: Old Tenth Line & St. Joseph

Background AM

												
Lane Group	EBL	EBT	EBR	WBL	WBT	WBR	NBL	NBT	NBR	SBL	SBT	SBR
Lane Configurations												
Traffic Volume (vph)	0	80	0	31	294	0	0	0	101	49	285	58
Future Volume (vph)	0	80	0	31	294	0	0	0	101	49	285	58
Satd. Flow (prot)	0	3390	0	1695	3390	0	1784	0	1517	3288	3390	1517
Flt Permitted				0.702						0.950		
Satd. Flow (perm)	0	3390	0	1253	3390	0	1784	0	1498	3288	3390	1517
Satd. Flow (RTOR)									890			241
Lane Group Flow (vph)	0	80	0	31	294	0	0	0	101	49	285	58
Turn Type		NA		Perm	NA		Prot		Free	Prot	NA	Free
Protected Phases		4			8		5			1	6	
Permitted Phases				8					Free			Free
Minimum Split (s)		25.6		25.6	25.6		11.3			12.0	30.0	
Total Split (s)		31.6		31.6	31.6		16.3			45.0	28.7	
Total Split (%)		41.3%		41.3%	41.3%		21.3%			58.7%	37.5%	
Yellow Time (s)		3.7		3.7	3.7		3.7			3.7	3.7	
All-Red Time (s)		2.9		2.9	2.9		2.6			3.3	3.3	
Lost Time Adjust (s)		0.0		0.0	0.0		0.0			0.0	0.0	
Total Lost Time (s)		6.6		6.6	6.6		6.3			7.0	7.0	
Lead/Lag							Lead					Lag
Lead-Lag Optimize?							Yes					Yes
Act Effct Green (s)		25.0		25.0	25.0				76.6	38.0	21.7	76.6
Actuated g/C Ratio		0.33		0.33	0.33				1.00	0.50	0.28	1.00
v/c Ratio		0.07		0.08	0.27				0.07	0.03	0.30	0.04
Control Delay		18.1		18.6	19.8				0.1	10.0	22.5	0.1
Queue Delay		0.0		0.0	0.0				0.0	0.0	0.0	0.0
Total Delay		18.1		18.6	19.8				0.1	10.0	22.5	0.1
LOS		B		B	B				A	A	C	A
Approach Delay		18.1			19.7		0.1				17.6	
Approach LOS		B			B		A				B	
Queue Length 50th (m)		4.1		3.1	16.3				0.0	1.7	16.9	0.0
Queue Length 95th (m)		8.6		8.8	25.4				0.0	4.2	26.6	0.0
Internal Link Dist (m)		241.4			372.8		239.6				226.3	
Turn Bay Length (m)				60.0					10.0	90.0		
Base Capacity (vph)		1106		408	1106				1498	1631	960	1517
Starvation Cap Reductn		0		0	0				0	0	0	0
Spillback Cap Reductn		0		0	0				0	0	0	0
Storage Cap Reductn		0		0	0				0	0	0	0
Reduced v/c Ratio		0.07		0.08	0.27				0.07	0.03	0.30	0.04

Intersection Summary

Cycle Length: 76.6	
Actuated Cycle Length: 76.6	
Offset: 0 (0%), Referenced to phase 6:SBT, Start of Green	
Natural Cycle: 70	
Control Type: Pretimed	
Maximum v/c Ratio: 0.30	
Intersection Signal Delay: 16.5	Intersection LOS: B
Intersection Capacity Utilization 28.2%	ICU Level of Service A
Analysis Period (min) 15	

Lanes, Volumes, Timings
6: Old Tenth Line & St. Joseph

Background AM

Splits and Phases: 6: Old Tenth Line & St. Joseph

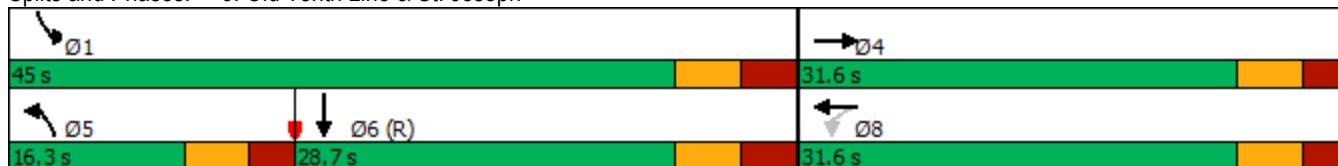

Intersection	
Intersection Delay, s/veh	10.8
Intersection LOS	B

Movement	EBL	EBT	EBR	WBL	WBT	WBR	NBL	NBT	NBR	SBL	SBT	SBR
Lane Configurations		↕			↕			↕			↕	
Traffic Vol, veh/h	0	4	80	306	8	0	92	54	108	0	81	0
Future Vol, veh/h	0	4	80	306	8	0	92	54	108	0	81	0
Peak Hour Factor	1.00	1.00	1.00	1.00	1.00	1.00	1.00	1.00	1.00	1.00	1.00	1.00
Heavy Vehicles, %	2	2	2	2	2	2	2	2	2	2	2	2
Mvmt Flow	0	4	80	306	8	0	92	54	108	0	81	0
Number of Lanes	0	1	0	0	1	0	0	1	0	0	1	0

Approach	EB	WB	NB	SB
Opposing Approach	WB	EB	SB	NB
Opposing Lanes	1	1	1	1
Conflicting Approach Left	SB	NB	EB	WB
Conflicting Lanes Left	1	1	1	1
Conflicting Approach Right	NB	SB	WB	EB
Conflicting Lanes Right	1	1	1	1
HCM Control Delay	8.3	12.1	10.5	9.1
HCM LOS	A	B	B	A

Lane	NBLn1	EBLn1	WBLn1	SBLn1
Vol Left, %	36%	0%	97%	0%
Vol Thru, %	21%	5%	3%	100%
Vol Right, %	43%	95%	0%	0%
Sign Control	Stop	Stop	Stop	Stop
Traffic Vol by Lane	254	84	314	81
LT Vol	92	0	306	0
Through Vol	54	4	8	81
RT Vol	108	80	0	0
Lane Flow Rate	254	84	314	81
Geometry Grp	1	1	1	1
Degree of Util (X)	0.342	0.108	0.44	0.118
Departure Headway (Hd)	4.851	4.608	5.047	5.264
Convergence, Y/N	Yes	Yes	Yes	Yes
Cap	734	767	706	673
Service Time	2.923	2.701	3.12	3.358
HCM Lane V/C Ratio	0.346	0.11	0.445	0.12
HCM Control Delay	10.5	8.3	12.1	9.1
HCM Lane LOS	B	A	B	A
HCM 95th-tile Q	1.5	0.4	2.3	0.4

Intersection	
Intersection Delay, s/veh	7.5
Intersection LOS	A

Movement	EBL	EBT	EBR	WBL	WBT	WBR	NBL	NBT	NBR	SBL	SBT	SBR
Lane Configurations		↕			↕			↕			↕	
Traffic Vol, veh/h	8	74	2	5	81	20	2	0	5	9	0	3
Future Vol, veh/h	8	74	2	5	81	20	2	0	5	9	0	3
Peak Hour Factor	1.00	1.00	1.00	1.00	1.00	1.00	1.00	1.00	1.00	1.00	1.00	1.00
Heavy Vehicles, %	2	2	2	2	2	2	2	2	2	2	2	2
Mvmt Flow	8	74	2	5	81	20	2	0	5	9	0	3
Number of Lanes	0	1	0	0	1	0	0	1	0	0	1	0

Approach	EB	WB	NB	SB
Opposing Approach	WB	EB	SB	NB
Opposing Lanes	1	1	1	1
Conflicting Approach Left	SB	NB	EB	WB
Conflicting Lanes Left	1	1	1	1
Conflicting Approach Right	NB	SB	WB	EB
Conflicting Lanes Right	1	1	1	1
HCM Control Delay	7.5	7.5	7	7.4
HCM LOS	A	A	A	A

Lane	NBLn1	EBLn1	WBLn1	SBLn1
Vol Left, %	29%	10%	5%	75%
Vol Thru, %	0%	88%	76%	0%
Vol Right, %	71%	2%	19%	25%
Sign Control	Stop	Stop	Stop	Stop
Traffic Vol by Lane	7	84	106	12
LT Vol	2	8	5	9
Through Vol	0	74	81	0
RT Vol	5	2	20	3
Lane Flow Rate	7	84	106	12
Geometry Grp	1	1	1	1
Degree of Util (X)	0.008	0.095	0.116	0.014
Departure Headway (Hd)	3.898	4.051	3.926	4.266
Convergence, Y/N	Yes	Yes	Yes	Yes
Cap	905	884	913	828
Service Time	1.98	2.08	1.953	2.348
HCM Lane V/C Ratio	0.008	0.095	0.116	0.014
HCM Control Delay	7	7.5	7.5	7.4
HCM Lane LOS	A	A	A	A
HCM 95th-tile Q	0	0.3	0.4	0

Intersection	
Intersection Delay, s/veh	9.2
Intersection LOS	A

Movement	EBT	EBR	WBL	WBT	NBL	NBR
Lane Configurations	↻		↻	↻	↻	↻
Traffic Vol, veh/h	35	97	111	85	131	46
Future Vol, veh/h	35	97	111	85	131	46
Peak Hour Factor	1.00	1.00	1.00	1.00	1.00	1.00
Heavy Vehicles, %	2	2	2	2	2	2
Mvmt Flow	35	97	111	85	131	46
Number of Lanes	1	0	1	1	1	1

Approach	EB	WB	NB
Opposing Approach	WB	EB	
Opposing Lanes	2	1	0
Conflicting Approach Left		NB	EB
Conflicting Lanes Left	0	2	1
Conflicting Approach Right	NB		WB
Conflicting Lanes Right	2	0	2
HCM Control Delay	8.6	9.2	9.6
HCM LOS	A	A	A

Lane	NBLn1	NBLn2	EBLn1	WBLn1	WBLn2
Vol Left, %	100%	0%	0%	100%	0%
Vol Thru, %	0%	0%	27%	0%	100%
Vol Right, %	0%	100%	73%	0%	0%
Sign Control	Stop	Stop	Stop	Stop	Stop
Traffic Vol by Lane	131	46	132	111	85
LT Vol	131	0	0	111	0
Through Vol	0	0	35	0	85
RT Vol	0	46	97	0	0
Lane Flow Rate	131	46	132	111	85
Geometry Grp	7	7	4	7	7
Degree of Util (X)	0.213	0.059	0.17	0.174	0.121
Departure Headway (Hd)	5.841	4.635	4.625	5.644	5.142
Convergence, Y/N	Yes	Yes	Yes	Yes	Yes
Cap	614	771	775	636	697
Service Time	3.581	2.374	2.659	3.378	2.875
HCM Lane V/C Ratio	0.213	0.06	0.17	0.175	0.122
HCM Control Delay	10.2	7.7	8.6	9.6	8.6
HCM Lane LOS	B	A	A	A	A
HCM 95th-tile Q	0.8	0.2	0.6	0.6	0.4

Lanes, Volumes, Timings

1: Trim & H174

Background PM

Lane Group	EBL	EBT	EBR	WBL	WBT	WBR	NBL	NBT	NBR	SBL	SBT	SBR
Lane Configurations												
Traffic Volume (vph)	272	1123	12	110	519	50	325	112	116	66	108	241
Future Volume (vph)	272	1123	12	110	519	50	325	112	116	66	108	241
Satd. Flow (prot)	1695	3383	0	1695	4871	1517	4780	1784	1517	1695	1784	1517
Flt Permitted	0.950			0.950			0.950			0.950		
Satd. Flow (perm)	1695	3383	0	1695	4871	1517	4780	1784	1517	1695	1784	1517
Satd. Flow (RTOR)		1				278			216			276
Lane Group Flow (vph)	272	1135	0	110	519	50	325	112	116	66	108	241
Turn Type	Prot	NA		Prot	NA	Perm	Prot	NA	Perm	Prot	NA	Perm
Protected Phases	5	2		1	6		3	8		7	4	
Permitted Phases						6			8			4
Detector Phase	5	2		1	6	6	3	8	8	7	4	4
Switch Phase												
Minimum Initial (s)	1.0	5.0		1.0	5.0	5.0	1.0	5.0	5.0	1.0	5.0	5.0
Minimum Split (s)	8.5	41.2		8.5	41.2	41.2	8.2	42.4	42.4	7.9	12.4	12.4
Total Split (s)	31.0	55.6		18.0	42.6	42.6	21.3	42.4	42.4	14.0	35.1	35.1
Total Split (%)	23.8%	42.8%		13.8%	32.8%	32.8%	16.4%	32.6%	32.6%	10.8%	27.0%	27.0%
Yellow Time (s)	3.3	5.1		3.3	5.1	5.1	3.3	3.3	3.3	3.3	3.3	3.3
All-Red Time (s)	4.2	2.1		3.8	2.1	2.1	3.9	4.1	4.1	3.6	4.1	4.1
Lost Time Adjust (s)	0.0	0.0		0.0	0.0	0.0	0.0	0.0	0.0	0.0	0.0	0.0
Total Lost Time (s)	7.5	7.2		7.1	7.2	7.2	7.2	7.4	7.4	6.9	7.4	7.4
Lead/Lag	Lead	Lag		Lead	Lag	Lag	Lead	Lag	Lag	Lead	Lag	Lag
Lead-Lag Optimize?	Yes	Yes		Yes	Yes	Yes	Yes	Yes	Yes	Yes	Yes	Yes
Recall Mode	None	C-Min		None	C-Min	C-Min	None	None	None	None	None	None
Act Effct Green (s)	25.2	60.0		12.8	47.2	47.2	13.2	23.5	23.5	7.9	15.1	15.1
Actuated g/C Ratio	0.19	0.46		0.10	0.36	0.36	0.10	0.18	0.18	0.06	0.12	0.12
v/c Ratio	0.83	0.73		0.66	0.29	0.07	0.67	0.35	0.26	0.65	0.52	0.57
Control Delay	71.0	33.3		75.4	31.9	0.2	63.5	48.9	1.4	87.3	61.4	8.4
Queue Delay	0.0	0.0		0.0	0.0	0.0	0.0	0.0	0.0	0.0	0.0	0.0
Total Delay	71.0	33.3		75.4	31.9	0.2	63.5	48.9	1.4	87.3	61.4	8.4
LOS	E	C		E	C	A	E	D	A	F	E	A
Approach Delay		40.6			36.6			47.5			34.7	
Approach LOS		D			D			D			C	
Queue Length 50th (m)	65.8	122.9		27.2	35.2	0.0	28.6	26.6	0.0	16.7	26.9	0.0
Queue Length 95th (m)	#117.5	#183.2		#58.5	50.8	0.0	39.1	38.6	0.0	#40.3	40.2	13.2
Internal Link Dist (m)		686.1			478.0			348.7			179.7	
Turn Bay Length (m)	175.0			150.0		30.0	200.0		40.0	150.0		40.0
Base Capacity (vph)	338	1563		170	1766	727	518	480	566	103	380	540
Starvation Cap Reductn	0	0		0	0	0	0	0	0	0	0	0
Spillback Cap Reductn	0	0		0	0	0	0	0	0	0	0	0
Storage Cap Reductn	0	0		0	0	0	0	0	0	0	0	0
Reduced v/c Ratio	0.80	0.73		0.65	0.29	0.07	0.63	0.23	0.20	0.64	0.28	0.45

Intersection Summary

Cycle Length: 130

Actuated Cycle Length: 130

Offset: 54.5 (42%), Referenced to phase 2:EBT and 6:WBT, Start of Green

Natural Cycle: 120

Control Type: Actuated-Coordinated

Lanes, Volumes, Timings

1: Trim & H174

Background PM

Maximum v/c Ratio: 0.83

Intersection Signal Delay: 40.2

Intersection LOS: D

Intersection Capacity Utilization 70.9%

ICU Level of Service C

Analysis Period (min) 15

95th percentile volume exceeds capacity, queue may be longer.

Queue shown is maximum after two cycles.

Splits and Phases: 1: Trim & H174



Lanes, Volumes, Timings
5: Tenth Line & St. Joseph

Background PM



Lane Group	EBL	EBT	EBR	WBL	WBT	WBR	NBL	NBT	NBR	SBL	SBT	SBR
Lane Configurations												
Traffic Volume (vph)	54	302	561	62	210	155	359	627	13	8	137	43
Future Volume (vph)	54	302	561	62	210	155	359	627	13	8	137	43
Satd. Flow (prot)	1695	3390	1517	1695	3390	1517	1543	3238	1517	1695	3390	1517
Flt Permitted	0.594			0.456			0.950	0.997		0.950		
Satd. Flow (perm)	1048	3390	1496	813	3390	1476	1543	3238	1494	1693	3390	1517
Satd. Flow (RTOR)			561			155			130			130
Lane Group Flow (vph)	54	302	561	62	210	155	320	666	13	8	137	43
Turn Type	pm+pt	NA	Perm	pm+pt	NA	Perm	Split	NA	Perm	Split	NA	Perm
Protected Phases	7	4		3	8		5	5		6	6	
Permitted Phases	4		4	8		8			5			6
Minimum Split (s)	11.0	29.1	29.1	11.0	29.1	29.1	32.3	32.3	32.3	32.3	32.3	32.3
Total Split (s)	14.0	28.1	28.1	14.0	28.1	28.1	59.3	59.3	59.3	28.3	28.3	28.3
Total Split (%)	10.8%	21.7%	21.7%	10.8%	21.7%	21.7%	45.7%	45.7%	45.7%	21.8%	21.8%	21.8%
Yellow Time (s)	3.7	3.7	3.7	3.7	3.7	3.7	3.7	3.7	3.7	3.7	3.7	3.7
All-Red Time (s)	2.3	2.4	2.4	2.3	2.4	2.4	2.6	2.6	2.6	2.6	2.6	2.6
Lost Time Adjust (s)	0.0	0.0	0.0	0.0	0.0	0.0	0.0	0.0	0.0	0.0	0.0	0.0
Total Lost Time (s)	6.0	6.1	6.1	6.0	6.1	6.1	6.3	6.3	6.3	6.3	6.3	6.3
Lead/Lag	Lead	Lag	Lag	Lead	Lag	Lag	Lead	Lead	Lead	Lag	Lag	Lag
Lead-Lag Optimize?	Yes	Yes	Yes	Yes	Yes	Yes	Yes	Yes	Yes	Yes	Yes	Yes
Act Effct Green (s)	30.1	22.0	22.0	30.1	22.0	22.0	53.0	53.0	53.0	22.0	22.0	22.0
Actuated g/C Ratio	0.23	0.17	0.17	0.23	0.17	0.17	0.41	0.41	0.41	0.17	0.17	0.17
v/c Ratio	0.19	0.53	0.78	0.26	0.37	0.41	0.51	0.50	0.02	0.03	0.24	0.12
Control Delay	37.0	52.8	12.4	38.2	49.8	10.4	32.1	30.2	0.1	45.4	47.9	0.7
Queue Delay	0.0	0.0	0.0	0.0	0.0	0.0	0.0	0.0	0.0	0.0	0.0	0.0
Total Delay	37.0	52.8	12.4	38.2	49.8	10.4	32.1	30.2	0.1	45.4	47.9	0.7
LOS	D	D	B	D	D	B	C	C	A	D	D	A
Approach Delay		27.2			33.8			30.4				37.0
Approach LOS		C			C			C				D
Queue Length 50th (m)	10.3	37.4	0.0	11.9	25.3	0.0	66.1	68.7	0.0	1.7	16.1	0.0
Queue Length 95th (m)	20.9	52.4	37.8	23.3	37.4	18.7	97.1	87.4	0.0	6.6	25.8	0.0
Internal Link Dist (m)		434.4			241.4			325.6				408.6
Turn Bay Length (m)	100.0		140.0	65.0			160.0		50.0	110.0		70.0
Base Capacity (vph)	283	575	719	243	575	379	630	1323	687	287	575	365
Starvation Cap Reductn	0	0	0	0	0	0	0	0	0	0	0	0
Spillback Cap Reductn	0	0	0	0	0	0	0	0	0	0	0	0
Storage Cap Reductn	0	0	0	0	0	0	0	0	0	0	0	0
Reduced v/c Ratio	0.19	0.53	0.78	0.26	0.37	0.41	0.51	0.50	0.02	0.03	0.24	0.12

Intersection Summary

Cycle Length: 129.7
 Actuated Cycle Length: 129.7
 Offset: 0 (0%), Referenced to phase 6:SBTL, Start of Green
 Natural Cycle: 105
 Control Type: Pretimed
 Maximum v/c Ratio: 0.78
 Intersection Signal Delay: 30.3
 Intersection Capacity Utilization 69.7%
 Analysis Period (min) 15
 Intersection LOS: C
 ICU Level of Service C

Lanes, Volumes, Timings
 5: Tenth Line & St. Joseph





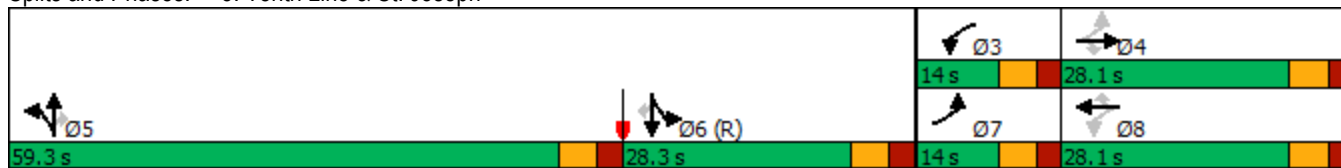







Background PM

Splits and Phases: 5: Tenth Line & St. Joseph



Lanes, Volumes, Timings
6: Old Tenth Line & St. Joseph

Background PM

												
Lane Group	EBL	EBT	EBR	WBL	WBT	WBR	NBL	NBT	NBR	SBL	SBT	SBR
Lane Configurations		↑↑		↖	↑↑		↖		↖	↖↖	↑↑	↖
Traffic Volume (vph)	0	327	3	96	286	0	4	0	82	55	859	152
Future Volume (vph)	0	327	3	96	286	0	4	0	82	55	859	152
Satd. Flow (prot)	0	3387	0	1695	3390	0	1695	0	1517	3288	3390	1517
Flt Permitted				0.553			0.950			0.950		
Satd. Flow (perm)	0	3387	0	987	3390	0	1695	0	1498	3288	3390	1517
Satd. Flow (RTOR)		1							257			257
Lane Group Flow (vph)	0	330	0	96	286	0	4	0	82	55	859	152
Turn Type		NA		Perm	NA		Prot		Free	Prot	NA	Free
Protected Phases		4			8		5			1	6	
Permitted Phases				8					Free			Free
Minimum Split (s)		25.6		25.6	25.6		11.3			12.0	30.0	
Total Split (s)		26.6		26.6	26.6		11.3			45.0	33.7	
Total Split (%)		37.2%		37.2%	37.2%		15.8%			62.8%	47.1%	
Yellow Time (s)		3.7		3.7	3.7		3.7			3.7	3.7	
All-Red Time (s)		2.9		2.9	2.9		2.6			3.3	3.3	
Lost Time Adjust (s)		0.0		0.0	0.0		0.0			0.0	0.0	
Total Lost Time (s)		6.6		6.6	6.6		6.3			7.0	7.0	
Lead/Lag							Lead					Lag
Lead-Lag Optimize?							Yes					Yes
Act Effct Green (s)		20.0		20.0	20.0		5.0		71.6	38.0	26.7	71.6
Actuated g/C Ratio		0.28		0.28	0.28		0.07		1.00	0.53	0.37	1.00
v/c Ratio		0.35		0.35	0.30		0.03		0.05	0.03	0.68	0.10
Control Delay		21.8		25.0	21.4		31.8		0.1	8.1	22.2	0.1
Queue Delay		0.0		0.0	0.0		0.0		0.0	0.0	0.0	0.0
Total Delay		21.8		25.0	21.4		31.8		0.1	8.1	22.2	0.1
LOS		C		C	C		C		A	A	C	A
Approach Delay		21.8			22.3			1.5				18.3
Approach LOS		C			C			A				B
Queue Length 50th (m)		18.4		10.3	15.8		0.5		0.0	1.7	49.7	0.0
Queue Length 95th (m)		28.8		22.5	25.2		3.1		0.0	4.0	68.6	0.0
Internal Link Dist (m)		241.4			372.8			239.6			226.3	
Turn Bay Length (m)				60.0					10.0	90.0		
Base Capacity (vph)		946		275	946		118		1498	1745	1264	1517
Starvation Cap Reductn		0		0	0		0		0	0	0	0
Spillback Cap Reductn		0		0	0		0		0	0	0	0
Storage Cap Reductn		0		0	0		0		0	0	0	0
Reduced v/c Ratio		0.35		0.35	0.30		0.03		0.05	0.03	0.68	0.10

Intersection Summary

Cycle Length: 71.6
 Actuated Cycle Length: 71.6
 Offset: 0 (0%), Referenced to phase 6:SBT, Start of Green
 Natural Cycle: 70
 Control Type: Pretimed
 Maximum v/c Ratio: 0.68
 Intersection Signal Delay: 19.0
 Intersection Capacity Utilization 57.2%
 Analysis Period (min) 15
 Intersection LOS: B
 ICU Level of Service B

Lanes, Volumes, Timings
 6: Old Tenth Line & St. Joseph

Background PM

Splits and Phases: 6: Old Tenth Line & St. Joseph

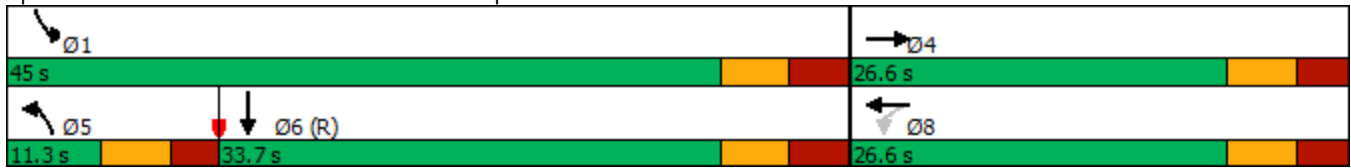

Intersection	
Intersection Delay, s/veh	11.4
Intersection LOS	B

Movement	EBL	EBT	EBR	WBL	WBT	WBR	NBL	NBT	NBR	SBL	SBT	SBR
Lane Configurations		↕			↕			↕			↕	
Traffic Vol, veh/h	0	7	111	193	3	0	84	82	265	0	58	0
Future Vol, veh/h	0	7	111	193	3	0	84	82	265	0	58	0
Peak Hour Factor	1.00	1.00	1.00	1.00	1.00	1.00	1.00	1.00	1.00	1.00	1.00	1.00
Heavy Vehicles, %	2	2	2	2	2	2	2	2	2	2	2	2
Mvmt Flow	0	7	111	193	3	0	84	82	265	0	58	0
Number of Lanes	0	1	0	0	1	0	0	1	0	0	1	0

Approach	EB	WB	NB	SB
Opposing Approach	WB	EB	SB	NB
Opposing Lanes	1	1	1	1
Conflicting Approach Left	SB	NB	EB	WB
Conflicting Lanes Left	1	1	1	1
Conflicting Approach Right	NB	SB	WB	EB
Conflicting Lanes Right	1	1	1	1
HCM Control Delay	8.8	10.8	12.7	8.9
HCM LOS	A	B	B	A

Lane	NBLn1	EBLn1	WBLn1	SBLn1
Vol Left, %	19%	0%	98%	0%
Vol Thru, %	19%	6%	2%	100%
Vol Right, %	61%	94%	0%	0%
Sign Control	Stop	Stop	Stop	Stop
Traffic Vol by Lane	431	118	196	58
LT Vol	84	0	193	0
Through Vol	82	7	3	58
RT Vol	265	111	0	0
Lane Flow Rate	431	118	196	58
Geometry Grp	1	1	1	1
Degree of Util (X)	0.537	0.16	0.3	0.086
Departure Headway (Hd)	4.482	4.887	5.507	5.363
Convergence, Y/N	Yes	Yes	Yes	Yes
Cap	797	737	657	670
Service Time	2.563	2.896	3.507	3.383
HCM Lane V/C Ratio	0.541	0.16	0.298	0.087
HCM Control Delay	12.7	8.8	10.8	8.9
HCM Lane LOS	B	A	B	A
HCM 95th-tile Q	3.2	0.6	1.3	0.3

Intersection	
Intersection Delay, s/veh	7.6
Intersection LOS	A

Movement	EBL	EBT	EBR	WBL	WBT	WBR	NBL	NBT	NBR	SBL	SBT	SBR
Lane Configurations		↕			↕			↕			↕	
Traffic Vol, veh/h	6	108	2	5	73	9	2	0	5	12	0	4
Future Vol, veh/h	6	108	2	5	73	9	2	0	5	12	0	4
Peak Hour Factor	1.00	1.00	1.00	1.00	1.00	1.00	1.00	1.00	1.00	1.00	1.00	1.00
Heavy Vehicles, %	2	2	2	2	2	2	2	2	2	2	2	2
Mvmt Flow	6	108	2	5	73	9	2	0	5	12	0	4
Number of Lanes	0	1	0	0	1	0	0	1	0	0	1	0

Approach	EB	WB	NB	SB
Opposing Approach	WB	EB	SB	NB
Opposing Lanes	1	1	1	1
Conflicting Approach Left	SB	NB	EB	WB
Conflicting Lanes Left	1	1	1	1
Conflicting Approach Right	NB	SB	WB	EB
Conflicting Lanes Right	1	1	1	1
HCM Control Delay	7.7	7.5	7	7.5
HCM LOS	A	A	A	A

Lane	NBLn1	EBLn1	WBLn1	SBLn1
Vol Left, %	29%	5%	6%	75%
Vol Thru, %	0%	93%	84%	0%
Vol Right, %	71%	2%	10%	25%
Sign Control	Stop	Stop	Stop	Stop
Traffic Vol by Lane	7	116	87	16
LT Vol	2	6	5	12
Through Vol	0	108	73	0
RT Vol	5	2	9	4
Lane Flow Rate	7	116	87	16
Geometry Grp	1	1	1	1
Degree of Util (X)	0.008	0.13	0.097	0.019
Departure Headway (Hd)	3.922	4.038	4.009	4.287
Convergence, Y/N	Yes	Yes	Yes	Yes
Cap	897	886	891	823
Service Time	2.015	2.069	2.046	2.378
HCM Lane V/C Ratio	0.008	0.131	0.098	0.019
HCM Control Delay	7	7.7	7.5	7.5
HCM Lane LOS	A	A	A	A
HCM 95th-tile Q	0	0.4	0.3	0.1

Intersection	
Intersection Delay, s/veh	10
Intersection LOS	A

Movement	EBT	EBR	WBL	WBT	NBL	NBR
Lane Configurations	↻		↻	↻	↻	↻
Traffic Vol, veh/h	104	113	114	51	164	151
Future Vol, veh/h	104	113	114	51	164	151
Peak Hour Factor	1.00	1.00	1.00	1.00	1.00	1.00
Heavy Vehicles, %	2	2	2	2	2	2
Mvmt Flow	104	113	114	51	164	151
Number of Lanes	1	0	1	1	1	1

Approach	EB	WB	NB
Opposing Approach	WB	EB	
Opposing Lanes	2	1	0
Conflicting Approach Left		NB	EB
Conflicting Lanes Left	0	2	1
Conflicting Approach Right	NB		WB
Conflicting Lanes Right	2	0	2
HCM Control Delay	10.3	9.8	10
HCM LOS	B	A	A

Lane	NBLn1	NBLn2	EBLn1	WBLn1	WBLn2
Vol Left, %	100%	0%	0%	100%	0%
Vol Thru, %	0%	0%	48%	0%	100%
Vol Right, %	0%	100%	52%	0%	0%
Sign Control	Stop	Stop	Stop	Stop	Stop
Traffic Vol by Lane	164	151	217	114	51
LT Vol	164	0	0	114	0
Through Vol	0	0	104	0	51
RT Vol	0	151	113	0	0
Lane Flow Rate	164	151	217	114	51
Geometry Grp	7	7	4	7	7
Degree of Util (X)	0.274	0.202	0.304	0.193	0.079
Departure Headway (Hd)	6.014	4.806	5.043	6.081	5.576
Convergence, Y/N	Yes	Yes	Yes	Yes	Yes
Cap	594	741	707	586	637
Service Time	3.783	2.574	3.108	3.857	3.352
HCM Lane V/C Ratio	0.276	0.204	0.307	0.195	0.08
HCM Control Delay	11.1	8.8	10.3	10.3	8.8
HCM Lane LOS	B	A	B	B	A
HCM 95th-tile Q	1.1	0.8	1.3	0.7	0.3

APPENDIX O

SYCNHRO ANALYSIS: S1 NON-TOD CONDITIONS

Lanes, Volumes, Timings

1: Trim & H174

Scenario 1 AM

Lane Group	EBL	EBT	EBR	WBL	WBT	WBR	NBL	NBT	NBR	SBL	SBT	SBR
Lane Configurations												
Traffic Volume (vph)	239	353	3	17	262	31	666	79	54	71	127	419
Future Volume (vph)	239	353	3	17	262	31	666	79	54	71	127	419
Satd. Flow (prot)	1695	3376	0	1695	4871	1517	4780	1784	1517	1695	1784	1517
Flt Permitted	0.950			0.950			0.950			0.950		
Satd. Flow (perm)	1673	3376	0	1300	4871	1458	4780	1784	1151	1357	1784	1517
Satd. Flow (RTOR)		1				278			216			417
Lane Group Flow (vph)	239	356	0	17	262	31	666	79	54	71	127	419
Turn Type	Prot	NA		Prot	NA	Perm	Prot	NA	Perm	Prot	NA	Perm
Protected Phases	5	2		1	6		3	8		7	4	
Permitted Phases						6			8			4
Detector Phase	5	2		1	6	6	3	8	8	7	4	4
Switch Phase												
Minimum Initial (s)	1.0	5.0		1.0	5.0	5.0	1.0	5.0	5.0	1.0	5.0	5.0
Minimum Split (s)	8.5	41.2		8.5	41.2	41.2	8.2	42.4	42.4	7.9	12.4	12.4
Total Split (s)	30.0	60.8		12.8	43.6	43.6	28.4	42.4	42.4	14.0	28.0	28.0
Total Split (%)	23.1%	46.8%		9.8%	33.5%	33.5%	21.8%	32.6%	32.6%	10.8%	21.5%	21.5%
Yellow Time (s)	3.3	5.1		3.3	5.1	5.1	3.3	3.3	3.3	3.3	3.3	3.3
All-Red Time (s)	4.2	2.1		3.8	2.1	2.1	3.9	4.1	4.1	3.6	4.1	4.1
Lost Time Adjust (s)	0.0	0.0		0.0	0.0	0.0	0.0	0.0	0.0	0.0	0.0	0.0
Total Lost Time (s)	7.5	7.2		7.1	7.2	7.2	7.2	7.4	7.4	6.9	7.4	7.4
Lead/Lag	Lead	Lag		Lead	Lag	Lag	Lead	Lag	Lag	Lead	Lag	Lag
Lead-Lag Optimize?	Yes	Yes		Yes	Yes	Yes	Yes	Yes	Yes	Yes	Yes	Yes
Recall Mode	None	C-Min		None	C-Min	C-Min	None	None	None	None	None	None
Act Effct Green (s)	22.4	60.5		6.3	36.1	36.1	22.6	32.2	32.2	10.4	19.6	19.6
Actuated g/C Ratio	0.17	0.47		0.05	0.28	0.28	0.17	0.25	0.25	0.08	0.15	0.15
v/c Ratio	0.82	0.23		0.21	0.19	0.05	0.80	0.18	0.12	0.53	0.47	0.72
Control Delay	73.9	23.5		65.7	38.4	0.2	59.5	38.2	0.6	71.6	55.7	12.3
Queue Delay	0.0	0.0		0.0	0.0	0.0	0.0	0.0	0.0	0.0	0.0	0.0
Total Delay	73.9	23.5		65.7	38.4	0.2	59.5	38.2	0.6	71.6	55.7	12.3
LOS	E	C		E	D	A	E	D	A	E	E	B
Approach Delay		43.7			36.1			53.4			28.1	
Approach LOS		D			D			D			C	
Queue Length 50th (m)	58.6	27.4		4.3	20.1	0.0	58.2	15.5	0.0	17.6	29.2	0.4
Queue Length 95th (m)	#100.8	43.7		12.3	27.2	0.0	72.1	28.5	0.0	#36.2	50.0	32.0
Internal Link Dist (m)		686.1			478.0			348.7			179.7	
Turn Bay Length (m)	175.0			150.0		30.0	200.0		40.0	150.0		40.0
Base Capacity (vph)	310	1624		82	1510	644	847	480	467	135	301	602
Starvation Cap Reductn	0	0		0	0	0	0	0	0	0	0	0
Spillback Cap Reductn	0	0		0	0	0	0	0	0	0	0	0
Storage Cap Reductn	0	0		0	0	0	0	0	0	0	0	0
Reduced v/c Ratio	0.77	0.22		0.21	0.17	0.05	0.79	0.16	0.12	0.53	0.42	0.70

Intersection Summary

Cycle Length: 130

Actuated Cycle Length: 130

Offset: 54.5 (42%), Referenced to phase 2:EBT and 6:WBT, Start of Green

Natural Cycle: 120

Control Type: Actuated-Coordinated

Lanes, Volumes, Timings

1: Trim & H174

Scenario 1 AM

Maximum v/c Ratio: 0.82

Intersection Signal Delay: 41.9

Intersection LOS: D

Intersection Capacity Utilization 99.8%

ICU Level of Service F

Analysis Period (min) 15

95th percentile volume exceeds capacity, queue may be longer.

Queue shown is maximum after two cycles.

Splits and Phases: 1: Trim & H174



Lanes, Volumes, Timings
5: Tenth Line & St. Joseph

Scenario 1 AM



Lane Group	EBL	EBT	EBR	WBL	WBT	WBR	NBL	NBT	NBR	SBL	SBT	SBR
Lane Configurations												
Traffic Volume (vph)	33	79	159	31	275	208	441	848	20	7	201	81
Future Volume (vph)	33	79	159	31	275	208	441	848	20	7	201	81
Satd. Flow (prot)	1695	3390	1517	1695	3390	1517	1543	3241	1517	1695	3390	1517
Flt Permitted	0.495			0.703			0.950	0.998		0.950		
Satd. Flow (perm)	874	3390	1476	1245	3390	1464	1534	3240	1483	1691	3390	1478
Satd. Flow (RTOR)			159			208			130			130
Lane Group Flow (vph)	33	79	159	31	275	208	397	892	20	7	201	81
Turn Type	pm+pt	NA	Perm	pm+pt	NA	Perm	Split	NA	Perm	Split	NA	Perm
Protected Phases	7	4		3	8		5	5		6	6	
Permitted Phases	4		4	8		8			5			6
Minimum Split (s)	11.0	29.1	29.1	11.0	29.1	29.1	32.3	32.3	32.3	32.3	32.3	32.3
Total Split (s)	14.0	28.1	28.1	14.0	28.1	28.1	59.3	59.3	59.3	28.3	28.3	28.3
Total Split (%)	10.8%	21.7%	21.7%	10.8%	21.7%	21.7%	45.7%	45.7%	45.7%	21.8%	21.8%	21.8%
Yellow Time (s)	3.7	3.7	3.7	3.7	3.7	3.7	3.7	3.7	3.7	3.7	3.7	3.7
All-Red Time (s)	2.3	2.4	2.4	2.3	2.4	2.4	2.6	2.6	2.6	2.6	2.6	2.6
Lost Time Adjust (s)	0.0	0.0	0.0	0.0	0.0	0.0	0.0	0.0	0.0	0.0	0.0	0.0
Total Lost Time (s)	6.0	6.1	6.1	6.0	6.1	6.1	6.3	6.3	6.3	6.3	6.3	6.3
Lead/Lag	Lead	Lag	Lag	Lead	Lag	Lag	Lead	Lead	Lead	Lag	Lag	Lag
Lead-Lag Optimize?	Yes	Yes	Yes	Yes	Yes	Yes	Yes	Yes	Yes	Yes	Yes	Yes
Act Effct Green (s)	30.1	22.0	22.0	30.1	22.0	22.0	53.0	53.0	53.0	22.0	22.0	22.0
Actuated g/C Ratio	0.23	0.17	0.17	0.23	0.17	0.17	0.41	0.41	0.41	0.17	0.17	0.17
v/c Ratio	0.13	0.14	0.42	0.10	0.48	0.49	0.63	0.67	0.03	0.02	0.35	0.23
Control Delay	36.1	46.6	10.4	35.5	51.8	10.4	36.0	34.4	0.1	45.4	49.5	2.8
Queue Delay	0.0	0.0	0.0	0.0	0.0	0.0	0.0	0.0	0.0	0.0	0.0	0.0
Total Delay	36.1	46.6	10.4	35.5	51.8	10.4	36.0	34.4	0.1	45.4	49.5	2.8
LOS	D	D	B	D	D	B	D	C	A	D	D	A
Approach Delay		24.1			34.1			34.4				36.3
Approach LOS		C			C			C				D
Queue Length 50th (m)	6.2	9.1	0.0	5.9	33.8	0.0	87.6	100.9	0.0	1.5	24.1	0.0
Queue Length 95th (m)	14.5	16.5	18.7	13.7	47.9	21.6	126.2	124.9	0.0	5.9	36.1	2.8
Internal Link Dist (m)		434.4			241.4			325.6				408.6
Turn Bay Length (m)	100.0		140.0	65.0			160.0		50.0	110.0		70.0
Base Capacity (vph)	253	575	382	316	575	421	630	1324	682	287	575	358
Starvation Cap Reductn	0	0	0	0	0	0	0	0	0	0	0	0
Spillback Cap Reductn	0	0	0	0	0	0	0	0	0	0	0	0
Storage Cap Reductn	0	0	0	0	0	0	0	0	0	0	0	0
Reduced v/c Ratio	0.13	0.14	0.42	0.10	0.48	0.49	0.63	0.67	0.03	0.02	0.35	0.23

Intersection Summary

Cycle Length: 129.7
 Actuated Cycle Length: 129.7
 Offset: 0 (0%), Referenced to phase 6:SBTL, Start of Green
 Natural Cycle: 105
 Control Type: Pretimed
 Maximum v/c Ratio: 0.67
 Intersection Signal Delay: 33.4
 Intersection LOS: C
 Intersection Capacity Utilization 91.1%
 ICU Level of Service F
 Analysis Period (min) 15

Lanes, Volumes, Timings
 5: Tenth Line & St. Joseph





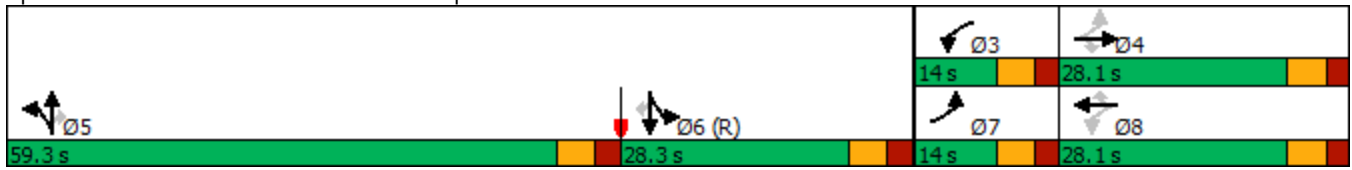















Scenario 1 AM

Splits and Phases: 5: Tenth Line & St. Joseph



Lanes, Volumes, Timings
6: Old Tenth Line & St. Joseph

Scenario 1 AM

												
Lane Group	EBL	EBT	EBR	WBL	WBT	WBR	NBL	NBT	NBR	SBL	SBT	SBR
Lane Configurations												
Traffic Volume (vph)	0	80	0	31	294	0	0	0	101	49	285	215
Future Volume (vph)	0	80	0	31	294	0	0	0	101	49	285	215
Satd. Flow (prot)	0	3390	0	1695	3390	0	1784	0	1517	3288	3390	1517
Flt Permitted				0.702						0.950		
Satd. Flow (perm)	0	3390	0	1246	3390	0	1784	0	1495	3288	3390	1517
Satd. Flow (RTOR)									877			241
Lane Group Flow (vph)	0	80	0	31	294	0	0	0	101	49	285	215
Turn Type		NA		Perm	NA		Prot		Free	Prot	NA	Free
Protected Phases		4			8		5			1	6	
Permitted Phases				8					Free			Free
Minimum Split (s)		25.6		25.6	25.6		11.3			12.0	30.0	
Total Split (s)		31.6		31.6	31.6		16.3			45.0	28.7	
Total Split (%)		41.3%		41.3%	41.3%		21.3%			58.7%	37.5%	
Yellow Time (s)		3.7		3.7	3.7		3.7			3.7	3.7	
All-Red Time (s)		2.9		2.9	2.9		2.6			3.3	3.3	
Lost Time Adjust (s)		0.0		0.0	0.0		0.0			0.0	0.0	
Total Lost Time (s)		6.6		6.6	6.6		6.3			7.0	7.0	
Lead/Lag							Lead					Lag
Lead-Lag Optimize?							Yes					Yes
Act Effct Green (s)		25.0		25.0	25.0				76.6	38.0	21.7	76.6
Actuated g/C Ratio		0.33		0.33	0.33				1.00	0.50	0.28	1.00
v/c Ratio		0.07		0.08	0.27				0.07	0.03	0.30	0.14
Control Delay		18.1		18.6	19.8				0.1	10.0	22.5	0.2
Queue Delay		0.0		0.0	0.0				0.0	0.0	0.0	0.0
Total Delay		18.1		18.6	19.8				0.1	10.0	22.5	0.2
LOS		B		B	B				A	A	C	A
Approach Delay		18.1			19.7		0.1				12.7	
Approach LOS		B			B		A				B	
Queue Length 50th (m)		4.1		3.1	16.3				0.0	1.7	16.9	0.0
Queue Length 95th (m)		8.6		8.8	25.4				0.0	4.2	26.6	0.0
Internal Link Dist (m)		241.4			372.8		239.6				226.3	
Turn Bay Length (m)				60.0					10.0	90.0		
Base Capacity (vph)		1106		406	1106				1495	1631	960	1517
Starvation Cap Reductn		0		0	0				0	0	0	0
Spillback Cap Reductn		0		0	0				0	0	0	0
Storage Cap Reductn		0		0	0				0	0	0	0
Reduced v/c Ratio		0.07		0.08	0.27				0.07	0.03	0.30	0.14

Intersection Summary

Cycle Length: 76.6
 Actuated Cycle Length: 76.6
 Offset: 0 (0%), Referenced to phase 6:SBT, Start of Green
 Natural Cycle: 70
 Control Type: Pretimed
 Maximum v/c Ratio: 0.30
 Intersection Signal Delay: 14.0
 Intersection Capacity Utilization 38.0%
 Analysis Period (min) 15

Intersection LOS: B
 ICU Level of Service A

Lanes, Volumes, Timings
6: Old Tenth Line & St. Joseph

Scenario 1 AM

Splits and Phases: 6: Old Tenth Line & St. Joseph

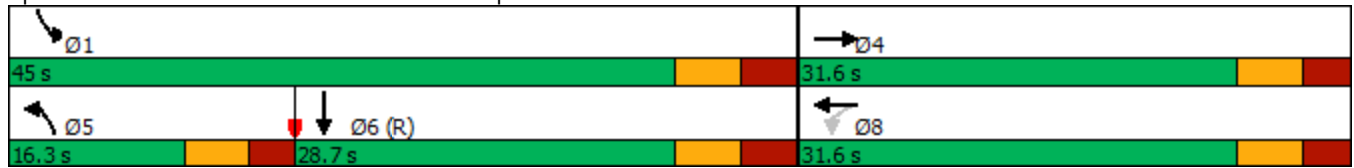

Intersection						
Int Delay, s/veh	2.2					
Movement	EBT	EBR	WBL	WBT	NBL	NBR
Lane Configurations						
Traffic Vol, veh/h	238	70	17	373	77	26
Future Vol, veh/h	238	70	17	373	77	26
Conflicting Peds, #/hr	0	15	15	0	5	5
Sign Control	Free	Free	Free	Free	Stop	Stop
RT Channelized	-	None	-	None	-	None
Storage Length	-	-	-	-	0	-
Veh in Median Storage, #	0	-	-	0	0	-
Grade, %	0	-	-	0	0	-
Peak Hour Factor	100	100	100	100	100	100
Heavy Vehicles, %	2	2	2	2	2	2
Mvmt Flow	238	70	17	373	77	26

Major/Minor	Major1	Major2	Minor1			
Conflicting Flow All	0	0	323	0	700	293
Stage 1	-	-	-	-	288	-
Stage 2	-	-	-	-	412	-
Critical Hdwy	-	-	4.12	-	6.42	6.22
Critical Hdwy Stg 1	-	-	-	-	5.42	-
Critical Hdwy Stg 2	-	-	-	-	5.42	-
Follow-up Hdwy	-	-	2.218	-	3.518	3.318
Pot Cap-1 Maneuver	-	-	1237	-	405	746
Stage 1	-	-	-	-	761	-
Stage 2	-	-	-	-	669	-
Platoon blocked, %	-	-	-	-	-	-
Mov Cap-1 Maneuver	-	-	1220	-	390	732
Mov Cap-2 Maneuver	-	-	-	-	390	-
Stage 1	-	-	-	-	750	-
Stage 2	-	-	-	-	654	-

Approach	EB	WB	NB
HCM Control Delay, s	0	0.3	15.6
HCM LOS			C

Minor Lane/Major Mvmt	NBLn1	EBT	EBR	WBL	WBT
Capacity (veh/h)	442	-	-	1220	-
HCM Lane V/C Ratio	0.233	-	-	0.014	-
HCM Control Delay (s)	15.6	-	-	8	0
HCM Lane LOS	C	-	-	A	A
HCM 95th %tile Q(veh)	0.9	-	-	0	-

Intersection						
Int Delay, s/veh	4.9					
Movement	EBT	EBR	WBL	WBT	NBL	NBR
Lane Configurations						
Traffic Vol, veh/h	159	104	35	237	153	51
Future Vol, veh/h	159	104	35	237	153	51
Conflicting Peds, #/hr	0	25	25	0	10	10
Sign Control	Free	Free	Free	Free	Stop	Stop
RT Channelized	-	None	-	None	-	None
Storage Length	-	-	-	-	0	-
Veh in Median Storage, #	0	-	-	0	0	-
Grade, %	0	-	-	0	0	-
Peak Hour Factor	100	100	100	100	100	100
Heavy Vehicles, %	2	2	2	2	2	2
Mvmt Flow	159	104	35	237	153	51

Major/Minor	Major1	Major2	Minor1			
Conflicting Flow All	0	0	288	0	553	246
Stage 1	-	-	-	-	236	-
Stage 2	-	-	-	-	317	-
Critical Hdwy	-	-	4.12	-	6.42	6.22
Critical Hdwy Stg 1	-	-	-	-	5.42	-
Critical Hdwy Stg 2	-	-	-	-	5.42	-
Follow-up Hdwy	-	-	2.218	-	3.518	3.318
Pot Cap-1 Maneuver	-	-	1274	-	494	793
Stage 1	-	-	-	-	803	-
Stage 2	-	-	-	-	738	-
Platoon blocked, %	-	-	-	-	-	-
Mov Cap-1 Maneuver	-	-	1245	-	463	768
Mov Cap-2 Maneuver	-	-	-	-	463	-
Stage 1	-	-	-	-	785	-
Stage 2	-	-	-	-	708	-

Approach	EB	WB	NB
HCM Control Delay, s	0	1	16.5
HCM LOS			C

Minor Lane/Major Mvmt	NBLn1	EBT	EBR	WBL	WBT
Capacity (veh/h)	514	-	-	1245	-
HCM Lane V/C Ratio	0.397	-	-	0.028	-
HCM Control Delay (s)	16.5	-	-	8	0
HCM Lane LOS	C	-	-	A	A
HCM 95th %tile Q(veh)	1.9	-	-	0.1	-

Intersection						
Int Delay, s/veh	5.8					
Movement	EBT	EBR	WBL	WBT	NBL	NBR
Lane Configurations	↔			↔		↔
Traffic Vol, veh/h	158	52	70	170	102	102
Future Vol, veh/h	158	52	70	170	102	102
Conflicting Peds, #/hr	0	60	60	0	10	10
Sign Control	Free	Free	Free	Free	Stop	Stop
RT Channelized	-	None	-	None	-	None
Storage Length	-	-	-	-	0	-
Veh in Median Storage, #	0	-	-	0	0	-
Grade, %	0	-	-	0	0	-
Peak Hour Factor	100	100	100	100	100	100
Heavy Vehicles, %	2	2	2	2	2	2
Mvmt Flow	158	52	70	170	102	102

Major/Minor	Major1	Major2	Minor1		
Conflicting Flow All	0	0	270	0	564
Stage 1	-	-	-	-	244
Stage 2	-	-	-	-	320
Critical Hdwy	-	-	4.12	-	6.42
Critical Hdwy Stg 1	-	-	-	-	5.42
Critical Hdwy Stg 2	-	-	-	-	5.42
Follow-up Hdwy	-	-	2.218	-	3.518
Pot Cap-1 Maneuver	-	-	1293	-	487
Stage 1	-	-	-	-	797
Stage 2	-	-	-	-	736
Platoon blocked, %	-	-	-	-	-
Mov Cap-1 Maneuver	-	-	1221	-	427
Mov Cap-2 Maneuver	-	-	-	-	427
Stage 1	-	-	-	-	753
Stage 2	-	-	-	-	683

Approach	EB	WB	NB
HCM Control Delay, s	0	2.4	15.7
HCM LOS			C

Minor Lane/Major Mvmt	NBLn1	EBT	EBR	WBL	WBT
Capacity (veh/h)	540	-	-	1221	-
HCM Lane V/C Ratio	0.378	-	-	0.057	-
HCM Control Delay (s)	15.7	-	-	8.1	0
HCM Lane LOS	C	-	-	A	A
HCM 95th %tile Q(veh)	1.7	-	-	0.2	-

Intersection	
Intersection Delay, s/veh	14.4
Intersection LOS	B

Movement	EBL	EBT	EBR	WBL	WBT	WBR	NBL	NBT	NBR	SBL	SBT	SBR
Lane Configurations		↕			↕			↕			↕	
Traffic Vol, veh/h	0	4	259	306	8	0	214	54	108	0	81	0
Future Vol, veh/h	0	4	259	306	8	0	214	54	108	0	81	0
Peak Hour Factor	1.00	1.00	1.00	1.00	1.00	1.00	1.00	1.00	1.00	1.00	1.00	1.00
Heavy Vehicles, %	2	2	2	2	2	2	2	2	2	2	2	2
Mvmt Flow	0	4	259	306	8	0	214	54	108	0	81	0
Number of Lanes	0	1	0	0	1	0	0	1	0	0	1	0

Approach	EB	WB	NB	SB
Opposing Approach	WB	EB	SB	NB
Opposing Lanes	1	1	1	1
Conflicting Approach Left	SB	NB	EB	WB
Conflicting Lanes Left	1	1	1	1
Conflicting Approach Right	NB	SB	WB	EB
Conflicting Lanes Right	1	1	1	1
HCM Control Delay	11.6	15.2	16.5	10.4
HCM LOS	B	C	C	B

Lane	NBLn1	EBLn1	WBLn1	SBLn1
Vol Left, %	57%	0%	97%	0%
Vol Thru, %	14%	2%	3%	100%
Vol Right, %	29%	98%	0%	0%
Sign Control	Stop	Stop	Stop	Stop
Traffic Vol by Lane	376	263	314	81
LT Vol	214	0	306	0
Through Vol	54	4	8	81
RT Vol	108	259	0	0
Lane Flow Rate	376	263	314	81
Geometry Grp	1	1	1	1
Degree of Util (X)	0.589	0.384	0.515	0.142
Departure Headway (Hd)	5.635	5.262	5.905	6.295
Convergence, Y/N	Yes	Yes	Yes	Yes
Cap	635	679	606	565
Service Time	3.701	3.342	3.981	4.393
HCM Lane V/C Ratio	0.592	0.387	0.518	0.143
HCM Control Delay	16.5	11.6	15.2	10.4
HCM Lane LOS	C	B	C	B
HCM 95th-tile Q	3.8	1.8	2.9	0.5

Intersection	
Intersection Delay, s/veh	8.8
Intersection LOS	A

Movement	EBL	EBT	EBR	WBL	WBT	WBR	NBL	NBT	NBR	SBL	SBT	SBR
Lane Configurations		↕			↕			↕			↕	
Traffic Vol, veh/h	8	253	2	5	203	20	2	0	5	9	0	3
Future Vol, veh/h	8	253	2	5	203	20	2	0	5	9	0	3
Peak Hour Factor	1.00	1.00	1.00	1.00	1.00	1.00	1.00	1.00	1.00	1.00	1.00	1.00
Heavy Vehicles, %	2	2	2	2	2	2	2	2	2	2	2	2
Mvmt Flow	8	253	2	5	203	20	2	0	5	9	0	3
Number of Lanes	0	1	0	0	1	0	0	1	0	0	1	0

Approach	EB	WB	NB	SB
Opposing Approach	WB	EB	SB	NB
Opposing Lanes	1	1	1	1
Conflicting Approach Left	SB	NB	EB	WB
Conflicting Lanes Left	1	1	1	1
Conflicting Approach Right	NB	SB	WB	EB
Conflicting Lanes Right	1	1	1	1
HCM Control Delay	9	8.7	7.7	8.1
HCM LOS	A	A	A	A

Lane	NBLn1	EBLn1	WBLn1	SBLn1
Vol Left, %	29%	3%	2%	75%
Vol Thru, %	0%	96%	89%	0%
Vol Right, %	71%	1%	9%	25%
Sign Control	Stop	Stop	Stop	Stop
Traffic Vol by Lane	7	263	228	12
LT Vol	2	8	5	9
Through Vol	0	253	203	0
RT Vol	5	2	20	3
Lane Flow Rate	7	263	228	12
Geometry Grp	1	1	1	1
Degree of Util (X)	0.009	0.302	0.261	0.017
Departure Headway (Hd)	4.627	4.139	4.116	4.994
Convergence, Y/N	Yes	Yes	Yes	Yes
Cap	778	860	862	721
Service Time	2.628	2.207	2.191	2.994
HCM Lane V/C Ratio	0.009	0.306	0.265	0.017
HCM Control Delay	7.7	9	8.7	8.1
HCM Lane LOS	A	A	A	A
HCM 95th-tile Q	0	1.3	1	0.1

Intersection	
Intersection Delay, s/veh	19
Intersection LOS	C

Movement	EBT	EBR	WBL	WBT	NBL	NBR
Lane Configurations	↻		↻	↻	↻	↻
Traffic Vol, veh/h	35	97	443	85	131	272
Future Vol, veh/h	35	97	443	85	131	272
Peak Hour Factor	1.00	1.00	1.00	1.00	1.00	1.00
Heavy Vehicles, %	2	2	2	2	2	2
Mvmt Flow	35	97	443	85	131	272
Number of Lanes	1	0	1	1	1	1

Approach	EB	WB	NB
Opposing Approach	WB	EB	
Opposing Lanes	2	1	0
Conflicting Approach Left		NB	EB
Conflicting Lanes Left	0	2	1
Conflicting Approach Right	NB		WB
Conflicting Lanes Right	2	0	2
HCM Control Delay	10.5	26	12.6
HCM LOS	B	D	B

Lane	NBLn1	NBLn2	EBLn1	WBLn1	WBLn2
Vol Left, %	100%	0%	0%	100%	0%
Vol Thru, %	0%	0%	27%	0%	100%
Vol Right, %	0%	100%	73%	0%	0%
Sign Control	Stop	Stop	Stop	Stop	Stop
Traffic Vol by Lane	131	272	132	443	85
LT Vol	131	0	0	443	0
Through Vol	0	0	35	0	85
RT Vol	0	272	97	0	0
Lane Flow Rate	131	272	132	443	85
Geometry Grp	7	7	4	7	7
Degree of Util (X)	0.253	0.434	0.215	0.79	0.14
Departure Headway (Hd)	6.959	5.744	5.87	6.419	5.913
Convergence, Y/N	Yes	Yes	Yes	Yes	Yes
Cap	516	626	611	563	607
Service Time	4.706	3.49	3.915	4.152	3.646
HCM Lane V/C Ratio	0.254	0.435	0.216	0.787	0.14
HCM Control Delay	12.1	12.9	10.5	29.2	9.6
HCM Lane LOS	B	B	B	D	A
HCM 95th-tile Q	1	2.2	0.8	7.5	0.5

Lanes, Volumes, Timings

1: Trim & H174

Scenario 1 PM

Lane Group	EBL	EBT	EBR	WBL	WBT	WBR	NBL	NBT	NBR	SBL	SBT	SBR
Lane Configurations												
Traffic Volume (vph)	384	1123	12	110	519	72	325	134	116	88	130	349
Future Volume (vph)	384	1123	12	110	519	72	325	134	116	88	130	349
Satd. Flow (prot)	1695	3369	0	1695	4871	1517	4780	1784	1517	1695	1784	1517
Flt Permitted	0.950			0.950			0.950			0.950		
Satd. Flow (perm)	1679	3369	0	1561	4871	1458	4780	1784	1155	1381	1784	1517
Satd. Flow (RTOR)		1				278			216			349
Lane Group Flow (vph)	384	1135	0	110	519	72	325	134	116	88	130	349
Turn Type	Prot	NA		Prot	NA	Perm	Prot	NA	Perm	Prot	NA	Perm
Protected Phases	5	2		1	6		3	8		7	4	
Permitted Phases						6			8			4
Detector Phase	5	2		1	6	6	3	8	8	7	4	4
Switch Phase												
Minimum Initial (s)	1.0	5.0		1.0	5.0	5.0	1.0	5.0	5.0	1.0	5.0	5.0
Minimum Split (s)	8.5	41.2		8.5	41.2	41.2	8.2	42.4	42.4	7.9	12.4	12.4
Total Split (s)	33.0	57.6		17.0	41.6	41.6	21.3	42.4	42.4	13.0	34.1	34.1
Total Split (%)	25.4%	44.3%		13.1%	32.0%	32.0%	16.4%	32.6%	32.6%	10.0%	26.2%	26.2%
Yellow Time (s)	3.3	5.1		3.3	5.1	5.1	3.3	3.3	3.3	3.3	3.3	3.3
All-Red Time (s)	4.2	2.1		3.8	2.1	2.1	3.9	4.1	4.1	3.6	4.1	4.1
Lost Time Adjust (s)	0.0	0.0		0.0	0.0	0.0	0.0	0.0	0.0	0.0	0.0	0.0
Total Lost Time (s)	7.5	7.2		7.1	7.2	7.2	7.2	7.4	7.4	6.9	7.4	7.4
Lead/Lag	Lead	Lag		Lead	Lag	Lag	Lead	Lag	Lag	Lead	Lag	Lag
Lead-Lag Optimize?	Yes	Yes		Yes	Yes	Yes	Yes	Yes	Yes	Yes	Yes	Yes
Recall Mode	None	C-Min		None	C-Min	C-Min	None	None	None	None	None	None
Act Effct Green (s)	30.3	53.1		9.9	32.3	32.3	13.2	29.9	29.9	8.5	24.9	24.9
Actuated g/C Ratio	0.23	0.41		0.08	0.25	0.25	0.10	0.23	0.23	0.07	0.19	0.19
v/c Ratio	0.97	0.82		0.85	0.43	0.13	0.67	0.33	0.27	0.80	0.38	0.61
Control Delay	89.5	41.4		106.3	41.9	0.5	63.5	42.0	1.5	104.6	48.5	9.4
Queue Delay	0.0	0.0		0.0	0.0	0.0	0.0	0.0	0.0	0.0	0.0	0.0
Total Delay	89.5	41.4		106.3	41.9	0.5	63.5	42.0	1.5	104.6	48.5	9.4
LOS	F	D		F	D	A	E	D	A	F	D	A
Approach Delay		53.6			47.8			46.0			33.1	
Approach LOS		D			D			D			C	
Queue Length 50th (m)	~115.9	139.9		28.4	40.2	0.0	28.6	27.2	0.0	~25.7	28.8	0.0
Queue Length 95th (m)	#177.1	169.6		#62.0	51.4	0.0	39.1	45.0	0.0	#59.7	47.8	26.4
Internal Link Dist (m)		686.1			478.0			348.7			179.7	
Turn Bay Length (m)	175.0			150.0		30.0	200.0		40.0	150.0		40.0
Base Capacity (vph)	395	1392		129	1288	590	518	480	468	110	378	596
Starvation Cap Reductn	0	0		0	0	0	0	0	0	0	0	0
Spillback Cap Reductn	0	0		0	0	0	0	0	0	0	0	0
Storage Cap Reductn	0	0		0	0	0	0	0	0	0	0	0
Reduced v/c Ratio	0.97	0.82		0.85	0.40	0.12	0.63	0.28	0.25	0.80	0.34	0.59

Intersection Summary

Cycle Length: 130

Actuated Cycle Length: 130

Offset: 54.5 (42%), Referenced to phase 2:EBT and 6:WBT, Start of Green

Natural Cycle: 130

Control Type: Actuated-Coordinated

Lanes, Volumes, Timings

1: Trim & H174

Scenario 1 PM

Maximum v/c Ratio: 0.97

Intersection Signal Delay: 47.6

Intersection LOS: D

Intersection Capacity Utilization 109.2%

ICU Level of Service H

Analysis Period (min) 15

~ Volume exceeds capacity, queue is theoretically infinite.

Queue shown is maximum after two cycles.

95th percentile volume exceeds capacity, queue may be longer.

Queue shown is maximum after two cycles.

Splits and Phases: 1: Trim & H174

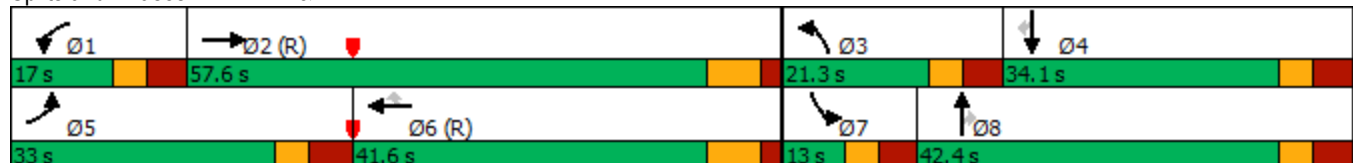

Lanes, Volumes, Timings
5: Tenth Line & St. Joseph

Scenario 1 PM



Lane Group	EBL	EBT	EBR	WBL	WBT	WBR	NBL	NBT	NBR	SBL	SBT	SBR
Lane Configurations												
Traffic Volume (vph)	76	302	561	62	210	357	359	694	13	8	202	65
Future Volume (vph)	76	302	561	62	210	357	359	694	13	8	202	65
Satd. Flow (prot)	1695	3390	1517	1695	3390	1517	1543	3241	1517	1695	3390	1517
Flt Permitted	0.594			0.456			0.950	0.998		0.950		
Satd. Flow (perm)	1040	3390	1476	810	3390	1451	1534	3240	1483	1690	3390	1478
Satd. Flow (RTOR)			561			357			130			130
Lane Group Flow (vph)	76	302	561	62	210	357	323	730	13	8	202	65
Turn Type	pm+pt	NA	Perm	pm+pt	NA	Perm	Split	NA	Perm	Split	NA	Perm
Protected Phases	7	4		3	8		5	5		6	6	
Permitted Phases	4		4	8		8			5			6
Minimum Split (s)	11.0	29.1	29.1	11.0	29.1	29.1	32.3	32.3	32.3	32.3	32.3	32.3
Total Split (s)	14.0	28.1	28.1	14.0	28.1	28.1	59.3	59.3	59.3	28.3	28.3	28.3
Total Split (%)	10.8%	21.7%	21.7%	10.8%	21.7%	21.7%	45.7%	45.7%	45.7%	21.8%	21.8%	21.8%
Yellow Time (s)	3.7	3.7	3.7	3.7	3.7	3.7	3.7	3.7	3.7	3.7	3.7	3.7
All-Red Time (s)	2.3	2.4	2.4	2.3	2.4	2.4	2.6	2.6	2.6	2.6	2.6	2.6
Lost Time Adjust (s)	0.0	0.0	0.0	0.0	0.0	0.0	0.0	0.0	0.0	0.0	0.0	0.0
Total Lost Time (s)	6.0	6.1	6.1	6.0	6.1	6.1	6.3	6.3	6.3	6.3	6.3	6.3
Lead/Lag	Lead	Lag	Lag	Lead	Lag	Lag	Lead	Lead	Lead	Lag	Lag	Lag
Lead-Lag Optimize?	Yes	Yes	Yes	Yes	Yes	Yes	Yes	Yes	Yes	Yes	Yes	Yes
Act Effct Green (s)	30.1	22.0	22.0	30.1	22.0	22.0	53.0	53.0	53.0	22.0	22.0	22.0
Actuated g/C Ratio	0.23	0.17	0.17	0.23	0.17	0.17	0.41	0.41	0.41	0.17	0.17	0.17
v/c Ratio	0.27	0.53	0.78	0.26	0.37	0.66	0.51	0.55	0.02	0.03	0.35	0.18
Control Delay	38.4	52.8	12.6	38.2	49.8	11.2	32.3	31.2	0.1	45.4	49.5	1.1
Queue Delay	0.0	0.0	0.0	0.0	0.0	0.0	0.0	0.0	0.0	0.0	0.0	0.0
Total Delay	38.4	52.8	12.6	38.2	49.8	11.2	32.3	31.2	0.1	45.4	49.5	1.1
LOS	D	D	B	D	D	B	C	C	A	D	D	A
Approach Delay		27.6			26.7			31.2				38.0
Approach LOS		C			C			C				D
Queue Length 50th (m)	14.7	37.4	0.0	11.9	25.3	0.0	67.0	77.2	0.0	1.7	24.2	0.0
Queue Length 95th (m)	27.6	52.4	38.3	23.3	37.4	28.9	98.1	97.1	0.0	6.6	36.2	0.0
Internal Link Dist (m)		434.4			241.4			325.6				408.6
Turn Bay Length (m)	100.0		140.0	65.0			160.0		50.0	110.0		70.0
Base Capacity (vph)	281	575	716	242	575	542	630	1324	682	287	575	358
Starvation Cap Reductn	0	0	0	0	0	0	0	0	0	0	0	0
Spillback Cap Reductn	0	0	0	0	0	0	0	0	0	0	0	0
Storage Cap Reductn	0	0	0	0	0	0	0	0	0	0	0	0
Reduced v/c Ratio	0.27	0.53	0.78	0.26	0.37	0.66	0.51	0.55	0.02	0.03	0.35	0.18

Intersection Summary

Cycle Length: 129.7

Actuated Cycle Length: 129.7

Offset: 0 (0%), Referenced to phase 6:SBTL, Start of Green

Natural Cycle: 105

Control Type: Pretimed

Maximum v/c Ratio: 0.78

Intersection Signal Delay: 29.7

Intersection LOS: C

Intersection Capacity Utilization 87.5%

ICU Level of Service E

Analysis Period (min) 15

Lanes, Volumes, Timings
 5: Tenth Line & St. Joseph





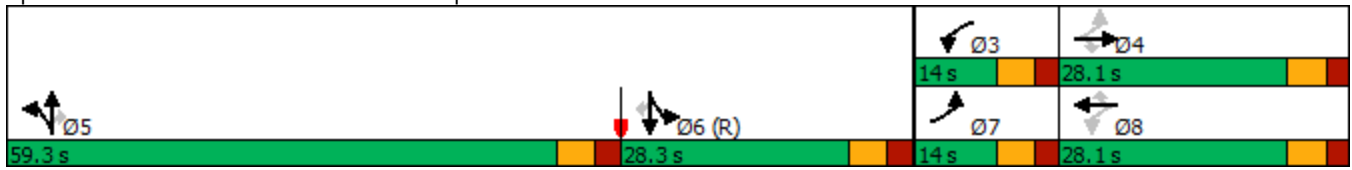















Scenario 1 PM

Splits and Phases: 5: Tenth Line & St. Joseph



Lanes, Volumes, Timings
6: Old Tenth Line & St. Joseph

Scenario 1 PM

												
Lane Group	EBL	EBT	EBR	WBL	WBT	WBR	NBL	NBT	NBR	SBL	SBT	SBR
Lane Configurations												
Traffic Volume (vph)	0	327	3	96	286	0	4	0	82	55	859	354
Future Volume (vph)	0	327	3	96	286	0	4	0	82	55	859	354
Satd. Flow (prot)	0	3386	0	1695	3390	0	1695	0	1517	3288	3390	1517
Flt Permitted				0.553			0.950			0.950		
Satd. Flow (perm)	0	3386	0	983	3390	0	1693	0	1495	3288	3390	1517
Satd. Flow (RTOR)		1							257			354
Lane Group Flow (vph)	0	330	0	96	286	0	4	0	82	55	859	354
Turn Type		NA		Perm	NA		Prot		Free	Prot	NA	Free
Protected Phases		4			8		5			1	6	
Permitted Phases				8					Free			Free
Minimum Split (s)		25.6		25.6	25.6		11.3			12.0	30.0	
Total Split (s)		26.6		26.6	26.6		11.3			45.0	33.7	
Total Split (%)		37.2%		37.2%	37.2%		15.8%			62.8%	47.1%	
Yellow Time (s)		3.7		3.7	3.7		3.7			3.7	3.7	
All-Red Time (s)		2.9		2.9	2.9		2.6			3.3	3.3	
Lost Time Adjust (s)		0.0		0.0	0.0		0.0			0.0	0.0	
Total Lost Time (s)		6.6		6.6	6.6		6.3			7.0	7.0	
Lead/Lag							Lead					Lag
Lead-Lag Optimize?							Yes					Yes
Act Effct Green (s)		20.0		20.0	20.0		5.0		71.6	38.0	26.7	71.6
Actuated g/C Ratio		0.28		0.28	0.28		0.07		1.00	0.53	0.37	1.00
v/c Ratio		0.35		0.35	0.30		0.03		0.05	0.03	0.68	0.23
Control Delay		21.8		25.1	21.4		31.8		0.1	8.1	22.2	0.4
Queue Delay		0.0		0.0	0.0		0.0		0.0	0.0	0.0	0.0
Total Delay		21.8		25.1	21.4		31.8		0.1	8.1	22.2	0.4
LOS		C		C	C		C		A	A	C	A
Approach Delay		21.8			22.3			1.5			15.5	
Approach LOS		C			C			A			B	
Queue Length 50th (m)		18.4		10.3	15.8		0.5		0.0	1.7	49.7	0.0
Queue Length 95th (m)		28.8		22.5	25.2		3.1		0.0	4.0	68.6	0.0
Internal Link Dist (m)		241.4			372.8			239.6			226.3	
Turn Bay Length (m)				60.0					10.0	90.0		
Base Capacity (vph)		946		274	946		118		1495	1745	1264	1517
Starvation Cap Reductn		0		0	0		0		0	0	0	0
Spillback Cap Reductn		0		0	0		0		0	0	0	0
Storage Cap Reductn		0		0	0		0		0	0	0	0
Reduced v/c Ratio		0.35		0.35	0.30		0.03		0.05	0.03	0.68	0.23

Intersection Summary

Cycle Length: 71.6	
Actuated Cycle Length: 71.6	
Offset: 0 (0%), Referenced to phase 6:SBT, Start of Green	
Natural Cycle: 70	
Control Type: Pretimed	
Maximum v/c Ratio: 0.68	
Intersection Signal Delay: 17.2	Intersection LOS: B
Intersection Capacity Utilization 63.3%	ICU Level of Service B
Analysis Period (min) 15	

Lanes, Volumes, Timings
 6: Old Tenth Line & St. Joseph

Scenario 1 PM

Splits and Phases: 6: Old Tenth Line & St. Joseph

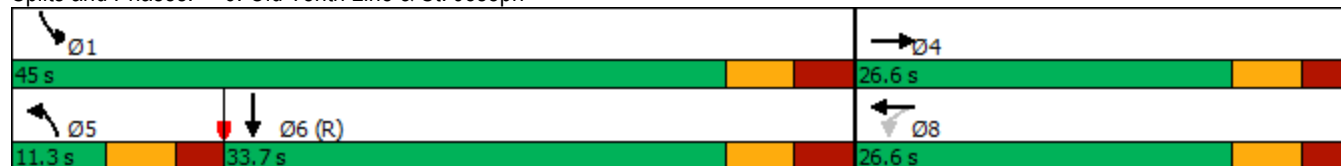

Intersection						
Int Delay, s/veh	1.9					
Movement	EBT	EBR	WBL	WBT	NBL	NBR
Lane Configurations						
Traffic Vol, veh/h	360	90	22	326	65	22
Future Vol, veh/h	360	90	22	326	65	22
Conflicting Peds, #/hr	0	15	15	0	5	5
Sign Control	Free	Free	Free	Free	Stop	Stop
RT Channelized	-	None	-	None	-	None
Storage Length	-	-	-	-	0	-
Veh in Median Storage, #	0	-	-	0	0	-
Grade, %	0	-	-	0	0	-
Peak Hour Factor	100	100	100	100	100	100
Heavy Vehicles, %	2	2	2	2	2	2
Mvmt Flow	360	90	22	326	65	22

Major/Minor	Major1	Major2	Minor1		
Conflicting Flow All	0	0	465	0	795
Stage 1	-	-	-	-	420
Stage 2	-	-	-	-	375
Critical Hdwy	-	-	4.12	-	6.42
Critical Hdwy Stg 1	-	-	-	-	5.42
Critical Hdwy Stg 2	-	-	-	-	5.42
Follow-up Hdwy	-	-	2.218	-	3.518
Pot Cap-1 Maneuver	-	-	1096	-	357
Stage 1	-	-	-	-	663
Stage 2	-	-	-	-	695
Platoon blocked, %	-	-	-	-	-
Mov Cap-1 Maneuver	-	-	1081	-	342
Mov Cap-2 Maneuver	-	-	-	-	342
Stage 1	-	-	-	-	654
Stage 2	-	-	-	-	674

Approach	EB	WB	NB
HCM Control Delay, s	0	0.5	17.1
HCM LOS			C

Minor Lane/Major Mvmt	NBLn1	EBT	EBR	WBL	WBT
Capacity (veh/h)	385	-	-	1081	-
HCM Lane V/C Ratio	0.226	-	-	0.02	-
HCM Control Delay (s)	17.1	-	-	8.4	0
HCM Lane LOS	C	-	-	A	A
HCM 95th %tile Q(veh)	0.9	-	-	0.1	-

Intersection						
Int Delay, s/veh	4.7					
Movement	EBT	EBR	WBL	WBT	NBL	NBR
Lane Configurations	T			T		T
Traffic Vol, veh/h	227	155	45	218	129	63
Future Vol, veh/h	227	155	45	218	129	63
Conflicting Peds, #/hr	0	35	35	0	10	10
Sign Control	Free	Free	Free	Free	Stop	Stop
RT Channelized	-	None	-	None	-	None
Storage Length	-	-	-	-	0	-
Veh in Median Storage, #	0	-	-	0	0	-
Grade, %	0	-	-	0	0	-
Peak Hour Factor	100	100	100	100	100	100
Heavy Vehicles, %	2	2	2	2	2	2
Mvmt Flow	227	155	45	218	129	63

Major/Minor	Major1	Major2	Minor1		
Conflicting Flow All	0	0	417	0	658
Stage 1	-	-	-	-	340
Stage 2	-	-	-	-	318
Critical Hdwy	-	-	4.12	-	6.42
Critical Hdwy Stg 1	-	-	-	-	5.42
Critical Hdwy Stg 2	-	-	-	-	5.42
Follow-up Hdwy	-	-	2.218	-	3.518
Pot Cap-1 Maneuver	-	-	1142	-	429
Stage 1	-	-	-	-	721
Stage 2	-	-	-	-	738
Platoon blocked, %	-	-	-	-	-
Mov Cap-1 Maneuver	-	-	1105	-	393
Mov Cap-2 Maneuver	-	-	-	-	393
Stage 1	-	-	-	-	698
Stage 2	-	-	-	-	697

Approach	EB	WB	NB
HCM Control Delay, s	0	1.4	18.6
HCM LOS			C

Minor Lane/Major Mvmt	NBLn1	EBT	EBR	WBL	WBT
Capacity (veh/h)	454	-	-	1105	-
HCM Lane V/C Ratio	0.423	-	-	0.041	-
HCM Control Delay (s)	18.6	-	-	8.4	0
HCM Lane LOS	C	-	-	A	A
HCM 95th %tile Q(veh)	2.1	-	-	0.1	-

Intersection						
Int Delay, s/veh	6					
Movement	EBT	EBR	WBL	WBT	NBL	NBR
Lane Configurations						
Traffic Vol, veh/h	223	67	104	163	100	86
Future Vol, veh/h	223	67	104	163	100	86
Conflicting Peds, #/hr	0	65	65	0	10	10
Sign Control	Free	Free	Free	Free	Stop	Stop
RT Channelized	-	None	-	None	-	None
Storage Length	-	-	-	-	0	-
Veh in Median Storage, #	0	-	-	0	0	-
Grade, %	0	-	-	0	0	-
Peak Hour Factor	100	100	100	100	100	100
Heavy Vehicles, %	2	2	2	2	2	2
Mvmt Flow	223	67	104	163	100	86

Major/Minor	Major1	Major2	Minor1		
Conflicting Flow All	0	0	355	0	703 332
Stage 1	-	-	-	-	322 -
Stage 2	-	-	-	-	381 -
Critical Hdwy	-	-	4.12	-	6.42 6.22
Critical Hdwy Stg 1	-	-	-	-	5.42 -
Critical Hdwy Stg 2	-	-	-	-	5.42 -
Follow-up Hdwy	-	-	2.218	-	3.518 3.318
Pot Cap-1 Maneuver	-	-	1204	-	404 710
Stage 1	-	-	-	-	735 -
Stage 2	-	-	-	-	691 -
Platoon blocked, %	-	-	-	-	-
Mov Cap-1 Maneuver	-	-	1132	-	338 661
Mov Cap-2 Maneuver	-	-	-	-	338 -
Stage 1	-	-	-	-	691 -
Stage 2	-	-	-	-	616 -

Approach	EB	WB	NB
HCM Control Delay, s	0	3.3	19.2
HCM LOS			C

Minor Lane/Major Mvmt	NBLn1	EBT	EBR	WBL	WBT
Capacity (veh/h)	437	-	-	1132	-
HCM Lane V/C Ratio	0.426	-	-	0.092	-
HCM Control Delay (s)	19.2	-	-	8.5	0
HCM Lane LOS	C	-	-	A	A
HCM 95th %tile Q(veh)	2.1	-	-	0.3	-

Intersection	
Intersection Delay, s/veh	22.1
Intersection LOS	C

Movement	EBL	EBT	EBR	WBL	WBT	WBR	NBL	NBT	NBR	SBL	SBT	SBR
Lane Configurations		↕			↕			↕			↕	
Traffic Vol, veh/h	0	7	262	193	3	0	241	82	265	0	58	0
Future Vol, veh/h	0	7	262	193	3	0	241	82	265	0	58	0
Peak Hour Factor	1.00	1.00	1.00	1.00	1.00	1.00	1.00	1.00	1.00	1.00	1.00	1.00
Heavy Vehicles, %	2	2	2	2	2	2	2	2	2	2	2	2
Mvmt Flow	0	7	262	193	3	0	241	82	265	0	58	0
Number of Lanes	0	1	0	0	1	0	0	1	0	0	1	0

Approach	EB	WB	NB	SB
Opposing Approach	WB	EB	SB	NB
Opposing Lanes	1	1	1	1
Conflicting Approach Left	SB	NB	EB	WB
Conflicting Lanes Left	1	1	1	1
Conflicting Approach Right	NB	SB	WB	EB
Conflicting Lanes Right	1	1	1	1
HCM Control Delay	12.5	12.9	30.8	10.2
HCM LOS	B	B	D	B

Lane	NBLn1	EBLn1	WBLn1	SBLn1
Vol Left, %	41%	0%	98%	0%
Vol Thru, %	14%	3%	2%	100%
Vol Right, %	45%	97%	0%	0%
Sign Control	Stop	Stop	Stop	Stop
Traffic Vol by Lane	588	269	196	58
LT Vol	241	0	193	0
Through Vol	82	7	3	58
RT Vol	265	262	0	0
Lane Flow Rate	588	269	196	58
Geometry Grp	1	1	1	1
Degree of Util (X)	0.851	0.413	0.349	0.104
Departure Headway (Hd)	5.209	5.528	6.405	6.438
Convergence, Y/N	Yes	Yes	Yes	Yes
Cap	694	646	557	560
Service Time	3.273	3.614	4.498	4.438
HCM Lane V/C Ratio	0.847	0.416	0.352	0.104
HCM Control Delay	30.8	12.5	12.9	10.2
HCM Lane LOS	D	B	B	B
HCM 95th-tile Q	9.7	2	1.6	0.3

Intersection	
Intersection Delay, s/veh	9
Intersection LOS	A

Movement	EBL	EBT	EBR	WBL	WBT	WBR	NBL	NBT	NBR	SBL	SBT	SBR
Lane Configurations		↕			↕			↕			↕	
Traffic Vol, veh/h	6	259	2	5	230	9	2	0	5	12	0	4
Future Vol, veh/h	6	259	2	5	230	9	2	0	5	12	0	4
Peak Hour Factor	1.00	1.00	1.00	1.00	1.00	1.00	1.00	1.00	1.00	1.00	1.00	1.00
Heavy Vehicles, %	2	2	2	2	2	2	2	2	2	2	2	2
Mvmt Flow	6	259	2	5	230	9	2	0	5	12	0	4
Number of Lanes	0	1	0	0	1	0	0	1	0	0	1	0

Approach	EB	WB	NB	SB
Opposing Approach	WB	EB	SB	NB
Opposing Lanes	1	1	1	1
Conflicting Approach Left	SB	NB	EB	WB
Conflicting Lanes Left	1	1	1	1
Conflicting Approach Right	NB	SB	WB	EB
Conflicting Lanes Right	1	1	1	1
HCM Control Delay	9.1	8.9	7.7	8.2
HCM LOS	A	A	A	A

Lane	NBLn1	EBLn1	WBLn1	SBLn1
Vol Left, %	29%	2%	2%	75%
Vol Thru, %	0%	97%	94%	0%
Vol Right, %	71%	1%	4%	25%
Sign Control	Stop	Stop	Stop	Stop
Traffic Vol by Lane	7	267	244	16
LT Vol	2	6	5	12
Through Vol	0	259	230	0
RT Vol	5	2	9	4
Lane Flow Rate	7	267	244	16
Geometry Grp	1	1	1	1
Degree of Util (X)	0.009	0.308	0.282	0.022
Departure Headway (Hd)	4.68	4.156	4.154	5.041
Convergence, Y/N	Yes	Yes	Yes	Yes
Cap	769	854	854	714
Service Time	2.681	2.233	2.237	3.041
HCM Lane V/C Ratio	0.009	0.313	0.286	0.022
HCM Control Delay	7.7	9.1	8.9	8.2
HCM Lane LOS	A	A	A	A
HCM 95th-tile Q	0	1.3	1.2	0.1

Intersection	
Intersection Delay, s/veh	22.2
Intersection LOS	C





























Movement	EBT	EBR	WBL	WBT	NBL	NBR
Lane Configurations	↻		↻	↻	↻	↻
Traffic Vol, veh/h	104	113	394	51	164	443
Future Vol, veh/h	104	113	394	51	164	443
Peak Hour Factor	1.00	1.00	1.00	1.00	1.00	1.00
Heavy Vehicles, %	2	2	2	2	2	2
Mvmt Flow	104	113	394	51	164	443
Number of Lanes	1	0	1	1	1	1

Approach	EB	WB	NB
Opposing Approach	WB	EB	
Opposing Lanes	2	1	0
Conflicting Approach Left		NB	EB
Conflicting Lanes Left	0	2	1
Conflicting Approach Right	NB		WB
Conflicting Lanes Right	2	0	2
HCM Control Delay	13.8	28.9	20.3
HCM LOS	B	D	C

Lane	NBLn1	NBLn2	EBLn1	WBLn1	WBLn2
Vol Left, %	100%	0%	0%	100%	0%
Vol Thru, %	0%	0%	48%	0%	100%
Vol Right, %	0%	100%	52%	0%	0%
Sign Control	Stop	Stop	Stop	Stop	Stop
Traffic Vol by Lane	164	443	217	394	51
LT Vol	164	0	0	394	0
Through Vol	0	0	104	0	51
RT Vol	0	443	113	0	0
Lane Flow Rate	164	443	217	394	51
Geometry Grp	7	7	4	7	7
Degree of Util (X)	0.325	0.727	0.392	0.783	0.094
Departure Headway (Hd)	7.127	5.908	6.508	7.156	6.647
Convergence, Y/N	Yes	Yes	Yes	Yes	Yes
Cap	502	607	549	504	537
Service Time	4.9	3.68	4.587	4.926	4.417
HCM Lane V/C Ratio	0.327	0.73	0.395	0.782	0.095
HCM Control Delay	13.3	22.9	13.8	31.3	10.1
HCM Lane LOS	B	C	B	D	B
HCM 95th-tile Q	1.4	6.1	1.9	7.1	0.3

Lanes, Volumes, Timings
1: Trim & H174

Dual EBL
09/14/2023

												
Lane Group	EBL	EBT	EBR	WBL	WBT	WBR	NBL	NBT	NBR	SBL	SBT	SBR
Lane Configurations	 	 			  		  					
Traffic Volume (vph)	384	1123	12	110	519	72	325	134	116	88	130	349
Future Volume (vph)	384	1123	12	110	519	72	325	134	116	88	130	349
Satd. Flow (prot)	3288	3369	0	1695	4871	1517	4780	1784	1517	1695	1784	1517
Flt Permitted	0.950			0.950			0.950			0.950		
Satd. Flow (perm)	3258	3369	0	1561	4871	1481	4780	1784	1155	1381	1784	1517
Satd. Flow (RTOR)		1				278			216			349
Lane Group Flow (vph)	384	1135	0	110	519	72	325	134	116	88	130	349
Turn Type	Prot	NA		Prot	NA	Perm	Prot	NA	Perm	Prot	NA	Perm
Protected Phases	5	2		1	6		3	8		7	4	
Permitted Phases						6			8			4
Detector Phase	5	2		1	6	6	3	8	8	7	4	4
Switch Phase												
Minimum Initial (s)	1.0	5.0		1.0	5.0	5.0	1.0	5.0	5.0	1.0	5.0	5.0
Minimum Split (s)	8.5	41.2		8.5	41.2	41.2	8.2	42.4	42.4	7.9	12.4	12.4
Total Split (s)	33.0	57.6		17.0	41.6	41.6	21.3	42.4	42.4	13.0	34.1	34.1
Total Split (%)	25.4%	44.3%		13.1%	32.0%	32.0%	16.4%	32.6%	32.6%	10.0%	26.2%	26.2%
Yellow Time (s)	3.3	5.1		3.3	5.1	5.1	3.3	3.3	3.3	3.3	3.3	3.3
All-Red Time (s)	4.2	2.1		3.8	2.1	2.1	3.9	4.1	4.1	3.6	4.1	4.1
Lost Time Adjust (s)	0.0	0.0		0.0	0.0	0.0	0.0	0.0	0.0	0.0	0.0	0.0
Total Lost Time (s)	7.5	7.2		7.1	7.2	7.2	7.2	7.4	7.4	6.9	7.4	7.4
Lead/Lag	Lead	Lag		Lead	Lag	Lag	Lead	Lag	Lag	Lead	Lag	Lag
Lead-Lag Optimize?	Yes	Yes		Yes	Yes	Yes	Yes	Yes	Yes	Yes	Yes	Yes
Recall Mode	None	C-Min		None	C-Min	C-Min	None	None	None	None	None	None
Act Effct Green (s)	20.4	53.1		9.9	42.3	42.3	13.2	29.9	29.9	8.5	24.9	24.9
Actuated g/C Ratio	0.16	0.41		0.08	0.33	0.33	0.10	0.23	0.23	0.07	0.19	0.19
v/c Ratio	0.75	0.82		0.85	0.33	0.11	0.67	0.33	0.27	0.80	0.38	0.61
Control Delay	61.5	41.4		106.3	35.5	0.3	63.5	42.0	1.5	104.6	48.5	9.4
Queue Delay	0.0	0.0		0.0	0.0	0.0	0.0	0.0	0.0	0.0	0.0	0.0
Total Delay	61.5	41.4		106.3	35.5	0.3	63.5	42.0	1.5	104.6	48.5	9.4
LOS	E	D		F	D	A	E	D	A	F	D	A
Approach Delay		46.5			43.0			46.0			33.1	
Approach LOS		D			D			D			C	
Queue Length 50th (m)	49.0	139.9		28.4	37.9	0.0	28.6	27.2	0.0	~25.7	28.8	0.0
Queue Length 95th (m)	63.1	169.6		#62.0	51.3	0.0	39.1	45.0	0.0	#59.7	47.8	26.4
Internal Link Dist (m)		686.1			478.0			348.7			179.7	
Turn Bay Length (m)	80.0			150.0		30.0	200.0		40.0	150.0		40.0
Base Capacity (vph)	644	1392		129	1584	669	518	480	468	110	378	596
Starvation Cap Reductn	0	0		0	0	0	0	0	0	0	0	0
Spillback Cap Reductn	0	0		0	0	0	0	0	0	0	0	0
Storage Cap Reductn	0	0		0	0	0	0	0	0	0	0	0
Reduced v/c Ratio	0.60	0.82		0.85	0.33	0.11	0.63	0.28	0.25	0.80	0.34	0.59

Intersection Summary
 Cycle Length: 130
 Actuated Cycle Length: 130
 Offset: 54.5 (42%), Referenced to phase 2:EBT and 6:WBT, Start of Green
 Natural Cycle: 120
 Control Type: Actuated-Coordinated

Lanes, Volumes, Timings

1: Trim & H174

Dual EBL
09/14/2023

Maximum v/c Ratio: 0.85

Intersection Signal Delay: 43.4

Intersection LOS: D

Intersection Capacity Utilization 98.3%

ICU Level of Service F

Analysis Period (min) 15

~ Volume exceeds capacity, queue is theoretically infinite.

Queue shown is maximum after two cycles.

95th percentile volume exceeds capacity, queue may be longer.

Queue shown is maximum after two cycles.

Splits and Phases: 1: Trim & H174

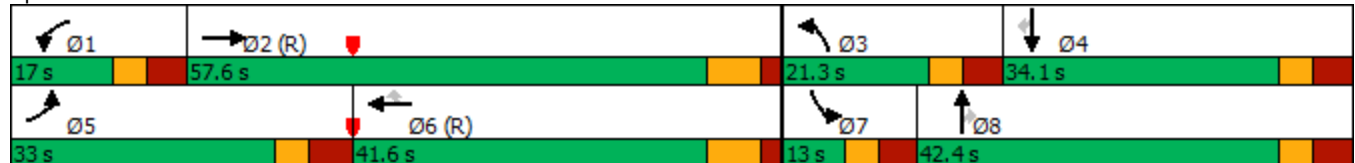

APPENDIX P

SYCNHRO ANALYSIS: S2 TOD CONDITIONS

Lanes, Volumes, Timings

1: Trim & H174

Scenario 2 AM

Lane Group	EBL	EBT	EBR	WBL	WBT	WBR	NBL	NBT	NBR	SBL	SBT	SBR
Lane Configurations												
Traffic Volume (vph)	207	353	3	17	262	25	666	73	54	61	117	372
Future Volume (vph)	207	353	3	17	262	25	666	73	54	61	117	372
Satd. Flow (prot)	1695	3376	0	1695	4871	1517	4780	1784	1517	1695	1784	1517
Flt Permitted	0.950			0.950			0.950			0.950		
Satd. Flow (perm)	1673	3376	0	1300	4871	1458	4780	1784	1151	1354	1784	1517
Satd. Flow (RTOR)		1				278			216			372
Lane Group Flow (vph)	207	356	0	17	262	25	666	73	54	61	117	372
Turn Type	Prot	NA		Prot	NA	Perm	Prot	NA	Perm	Prot	NA	Perm
Protected Phases	5	2		1	6		3	8		7	4	
Permitted Phases						6			8			4
Detector Phase	5	2		1	6	6	3	8	8	7	4	4
Switch Phase												
Minimum Initial (s)	1.0	5.0		1.0	5.0	5.0	1.0	5.0	5.0	1.0	5.0	5.0
Minimum Split (s)	8.5	41.2		8.5	41.2	41.2	8.2	42.4	42.4	7.9	12.4	12.4
Total Split (s)	30.0	60.8		12.8	43.6	43.6	28.4	42.4	42.4	14.0	28.0	28.0
Total Split (%)	23.1%	46.8%		9.8%	33.5%	33.5%	21.8%	32.6%	32.6%	10.8%	21.5%	21.5%
Yellow Time (s)	3.3	5.1		3.3	5.1	5.1	3.3	3.3	3.3	3.3	3.3	3.3
All-Red Time (s)	4.2	2.1		3.8	2.1	2.1	3.9	4.1	4.1	3.6	4.1	4.1
Lost Time Adjust (s)	0.0	0.0		0.0	0.0	0.0	0.0	0.0	0.0	0.0	0.0	0.0
Total Lost Time (s)	7.5	7.2		7.1	7.2	7.2	7.2	7.4	7.4	6.9	7.4	7.4
Lead/Lag	Lead	Lag		Lead	Lag	Lag	Lead	Lag	Lag	Lead	Lag	Lag
Lead-Lag Optimize?	Yes	Yes		Yes	Yes	Yes	Yes	Yes	Yes	Yes	Yes	Yes
Recall Mode	None	C-Min		None	C-Min	C-Min	None	None	None	None	None	None
Act Effct Green (s)	20.0	61.3		6.3	39.3	39.3	22.6	35.0	35.0	9.5	18.8	18.8
Actuated g/C Ratio	0.15	0.47		0.05	0.30	0.30	0.17	0.27	0.27	0.07	0.14	0.14
v/c Ratio	0.80	0.22		0.21	0.18	0.04	0.80	0.15	0.12	0.50	0.45	0.69
Control Delay	74.5	23.0		65.7	36.1	0.1	59.5	37.3	0.5	71.7	55.9	12.1
Queue Delay	0.0	0.0		0.0	0.0	0.0	0.0	0.0	0.0	0.0	0.0	0.0
Total Delay	74.5	23.0		65.7	36.1	0.1	59.5	37.3	0.5	71.7	55.9	12.1
LOS	E	C		E	D	A	E	D	A	E	E	B
Approach Delay		41.9			34.8			53.4			28.1	
Approach LOS		D			C			D			C	
Queue Length 50th (m)	51.2	26.8		4.3	19.1	0.0	58.2	14.3	0.0	15.2	27.1	0.0
Queue Length 95th (m)	#81.1	43.7		12.3	27.2	0.0	72.1	26.8	0.0	30.1	46.4	29.3
Internal Link Dist (m)		686.1			478.0			348.7			179.7	
Turn Bay Length (m)	175.0			150.0		30.0	200.0		40.0	150.0		40.0
Base Capacity (vph)	297	1639		82	1554	654	847	480	467	124	291	559
Starvation Cap Reductn	0	0		0	0	0	0	0	0	0	0	0
Spillback Cap Reductn	0	0		0	0	0	0	0	0	0	0	0
Storage Cap Reductn	0	0		0	0	0	0	0	0	0	0	0
Reduced v/c Ratio	0.70	0.22		0.21	0.17	0.04	0.79	0.15	0.12	0.49	0.40	0.67

Intersection Summary

Cycle Length: 130
 Actuated Cycle Length: 130
 Offset: 54.5 (42%), Referenced to phase 2:EBT and 6:WBT, Start of Green
 Natural Cycle: 110
 Control Type: Actuated-Coordinated

Lanes, Volumes, Timings

1: Trim & H174

Scenario 2 AM

Maximum v/c Ratio: 0.80

Intersection Signal Delay: 41.6

Intersection LOS: D

Intersection Capacity Utilization 88.0%

ICU Level of Service E

Analysis Period (min) 15

95th percentile volume exceeds capacity, queue may be longer.

Queue shown is maximum after two cycles.

Splits and Phases: 1: Trim & H174



Lanes, Volumes, Timings
5: Tenth Line & St. Joseph

Scenario 2 AM



Lane Group	EBL	EBT	EBR	WBL	WBT	WBR	NBL	NBT	NBR	SBL	SBT	SBR
Lane Configurations												
Traffic Volume (vph)	27	79	159	31	275	150	441	829	20	7	173	71
Future Volume (vph)	27	79	159	31	275	150	441	829	20	7	173	71
Satd. Flow (prot)	1695	3390	1517	1695	3390	1517	1543	3238	1517	1695	3390	1517
Flt Permitted	0.495			0.703			0.950	0.997		0.950		
Satd. Flow (perm)	874	3390	1476	1245	3390	1464	1533	3237	1483	1691	3390	1478
Satd. Flow (RTOR)			159			150			130			130
Lane Group Flow (vph)	27	79	159	31	275	150	397	873	20	7	173	71
Turn Type	pm+pt	NA	Perm	pm+pt	NA	Perm	Split	NA	Perm	Split	NA	Perm
Protected Phases	7	4		3	8		5	5		6	6	
Permitted Phases	4		4	8		8			5			6
Minimum Split (s)	11.0	29.1	29.1	11.0	29.1	29.1	32.3	32.3	32.3	32.3	32.3	32.3
Total Split (s)	14.0	28.1	28.1	14.0	28.1	28.1	59.3	59.3	59.3	28.3	28.3	28.3
Total Split (%)	10.8%	21.7%	21.7%	10.8%	21.7%	21.7%	45.7%	45.7%	45.7%	21.8%	21.8%	21.8%
Yellow Time (s)	3.7	3.7	3.7	3.7	3.7	3.7	3.7	3.7	3.7	3.7	3.7	3.7
All-Red Time (s)	2.3	2.4	2.4	2.3	2.4	2.4	2.6	2.6	2.6	2.6	2.6	2.6
Lost Time Adjust (s)	0.0	0.0	0.0	0.0	0.0	0.0	0.0	0.0	0.0	0.0	0.0	0.0
Total Lost Time (s)	6.0	6.1	6.1	6.0	6.1	6.1	6.3	6.3	6.3	6.3	6.3	6.3
Lead/Lag	Lead	Lag	Lag	Lead	Lag	Lag	Lead	Lead	Lead	Lag	Lag	Lag
Lead-Lag Optimize?	Yes	Yes	Yes	Yes	Yes	Yes	Yes	Yes	Yes	Yes	Yes	Yes
Act Effct Green (s)	30.1	22.0	22.0	30.1	22.0	22.0	53.0	53.0	53.0	22.0	22.0	22.0
Actuated g/C Ratio	0.23	0.17	0.17	0.23	0.17	0.17	0.41	0.41	0.41	0.17	0.17	0.17
v/c Ratio	0.11	0.14	0.42	0.10	0.48	0.40	0.63	0.66	0.03	0.02	0.30	0.20
Control Delay	35.7	46.6	10.4	35.5	51.8	10.6	36.0	34.0	0.1	45.4	48.8	1.2
Queue Delay	0.0	0.0	0.0	0.0	0.0	0.0	0.0	0.0	0.0	0.0	0.0	0.0
Total Delay	35.7	46.6	10.4	35.5	51.8	10.6	36.0	34.0	0.1	45.4	48.8	1.2
LOS	D	D	B	D	D	B	D	C	A	D	D	A
Approach Delay		23.8			37.2			34.1				35.2
Approach LOS		C			D			C				D
Queue Length 50th (m)	5.1	9.1	0.0	5.9	33.8	0.0	87.6	98.0	0.0	1.5	20.5	0.0
Queue Length 95th (m)	12.5	16.5	18.7	13.7	47.9	18.2	126.2	121.4	0.0	5.9	31.5	0.0
Internal Link Dist (m)		434.4			241.4			325.6				408.6
Turn Bay Length (m)	100.0		140.0	65.0			160.0		50.0	110.0		70.0
Base Capacity (vph)	253	575	382	316	575	372	630	1323	682	287	575	358
Starvation Cap Reductn	0	0	0	0	0	0	0	0	0	0	0	0
Spillback Cap Reductn	0	0	0	0	0	0	0	0	0	0	0	0
Storage Cap Reductn	0	0	0	0	0	0	0	0	0	0	0	0
Reduced v/c Ratio	0.11	0.14	0.42	0.10	0.48	0.40	0.63	0.66	0.03	0.02	0.30	0.20

Intersection Summary

Cycle Length: 129.7

Actuated Cycle Length: 129.7

Offset: 0 (0%), Referenced to phase 6:SBTL, Start of Green

Natural Cycle: 105

Control Type: Pretimed

Maximum v/c Ratio: 0.66

Intersection Signal Delay: 33.6

Intersection LOS: C

Intersection Capacity Utilization 86.1%

ICU Level of Service E

Analysis Period (min) 15

Lanes, Volumes, Timings
 5: Tenth Line & St. Joseph





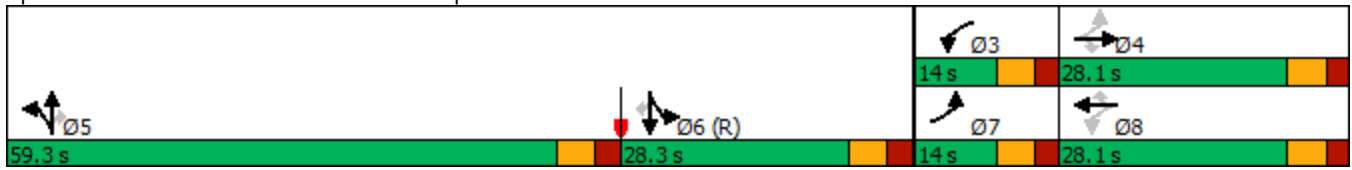















Scenario 2 AM

Splits and Phases: 5: Tenth Line & St. Joseph



Lanes, Volumes, Timings
6: Old Tenth Line & St. Joseph

Scenario 2 AM

												
Lane Group	EBL	EBT	EBR	WBL	WBT	WBR	NBL	NBT	NBR	SBL	SBT	SBR
Lane Configurations												
Traffic Volume (vph)	0	80	0	31	294	0	0	0	101	49	285	157
Future Volume (vph)	0	80	0	31	294	0	0	0	101	49	285	157
Satd. Flow (prot)	0	3390	0	1695	3390	0	1784	0	1517	3288	3390	1517
Flt Permitted				0.702						0.950		
Satd. Flow (perm)	0	3390	0	1246	3390	0	1784	0	1495	3288	3390	1517
Satd. Flow (RTOR)									877			241
Lane Group Flow (vph)	0	80	0	31	294	0	0	0	101	49	285	157
Turn Type		NA		Perm	NA		Prot		Free	Prot	NA	Free
Protected Phases		4			8		5			1	6	
Permitted Phases				8					Free			Free
Minimum Split (s)		25.6		25.6	25.6		11.3			12.0	30.0	
Total Split (s)		31.6		31.6	31.6		16.3			45.0	28.7	
Total Split (%)		41.3%		41.3%	41.3%		21.3%			58.7%	37.5%	
Yellow Time (s)		3.7		3.7	3.7		3.7			3.7	3.7	
All-Red Time (s)		2.9		2.9	2.9		2.6			3.3	3.3	
Lost Time Adjust (s)		0.0		0.0	0.0		0.0			0.0	0.0	
Total Lost Time (s)		6.6		6.6	6.6		6.3			7.0	7.0	
Lead/Lag							Lead					Lag
Lead-Lag Optimize?							Yes					Yes
Act Effct Green (s)		25.0		25.0	25.0				76.6	38.0	21.7	76.6
Actuated g/C Ratio		0.33		0.33	0.33				1.00	0.50	0.28	1.00
v/c Ratio		0.07		0.08	0.27				0.07	0.03	0.30	0.10
Control Delay		18.1		18.6	19.8				0.1	10.0	22.5	0.1
Queue Delay		0.0		0.0	0.0				0.0	0.0	0.0	0.0
Total Delay		18.1		18.6	19.8				0.1	10.0	22.5	0.1
LOS		B		B	B				A	A	C	A
Approach Delay		18.1			19.7		0.1				14.1	
Approach LOS		B			B		A				B	
Queue Length 50th (m)		4.1		3.1	16.3				0.0	1.7	16.9	0.0
Queue Length 95th (m)		8.6		8.8	25.4				0.0	4.2	26.6	0.0
Internal Link Dist (m)		241.4			372.8		239.6				226.3	
Turn Bay Length (m)				60.0					10.0	90.0		
Base Capacity (vph)		1106		406	1106				1495	1631	960	1517
Starvation Cap Reductn		0		0	0				0	0	0	0
Spillback Cap Reductn		0		0	0				0	0	0	0
Storage Cap Reductn		0		0	0				0	0	0	0
Reduced v/c Ratio		0.07		0.08	0.27				0.07	0.03	0.30	0.10

Intersection Summary

Cycle Length: 76.6
 Actuated Cycle Length: 76.6
 Offset: 0 (0%), Referenced to phase 6:SBT, Start of Green
 Natural Cycle: 70
 Control Type: Pretimed
 Maximum v/c Ratio: 0.30
 Intersection Signal Delay: 14.8 Intersection LOS: B
 Intersection Capacity Utilization 38.0% ICU Level of Service A
 Analysis Period (min) 15

Lanes, Volumes, Timings
 6: Old Tenth Line & St. Joseph

Scenario 2 AM

Splits and Phases: 6: Old Tenth Line & St. Joseph



Intersection						
Int Delay, s/veh	1.5					
Movement	EBT	EBR	WBL	WBT	NBL	NBR
Lane Configurations						
Traffic Vol, veh/h	180	44	11	280	49	16
Future Vol, veh/h	180	44	11	280	49	16
Conflicting Peds, #/hr	0	15	15	0	5	5
Sign Control	Free	Free	Free	Free	Stop	Stop
RT Channelized	-	None	-	None	-	None
Storage Length	-	-	-	-	0	-
Veh in Median Storage, #	0	-	-	0	0	-
Grade, %	0	-	-	0	0	-
Peak Hour Factor	100	100	100	100	100	100
Heavy Vehicles, %	2	2	2	2	2	2
Mvmt Flow	180	44	11	280	49	16

Major/Minor	Major1	Major2	Minor1		
Conflicting Flow All	0	0	239	0	524 222
Stage 1	-	-	-	-	217 -
Stage 2	-	-	-	-	307 -
Critical Hdwy	-	-	4.12	-	6.42 6.22
Critical Hdwy Stg 1	-	-	-	-	5.42 -
Critical Hdwy Stg 2	-	-	-	-	5.42 -
Follow-up Hdwy	-	-	2.218	-	3.518 3.318
Pot Cap-1 Maneuver	-	-	1328	-	514 818
Stage 1	-	-	-	-	819 -
Stage 2	-	-	-	-	746 -
Platoon blocked, %	-	-	-	-	-
Mov Cap-1 Maneuver	-	-	1310	-	499 803
Mov Cap-2 Maneuver	-	-	-	-	499 -
Stage 1	-	-	-	-	808 -
Stage 2	-	-	-	-	735 -

Approach	EB	WB	NB
HCM Control Delay, s	0	0.3	12.4
HCM LOS			B

Minor Lane/Major Mvmt	NBLn1	EBT	EBR	WBL	WBT
Capacity (veh/h)	550	-	-	1310	-
HCM Lane V/C Ratio	0.118	-	-	0.008	-
HCM Control Delay (s)	12.4	-	-	7.8	0
HCM Lane LOS	B	-	-	A	A
HCM 95th %tile Q(veh)	0.4	-	-	0	-

Intersection						
Int Delay, s/veh	3.3					
Movement	EBT	EBR	WBL	WBT	NBL	NBR
Lane Configurations						
Traffic Vol, veh/h	130	66	22	194	97	32
Future Vol, veh/h	130	66	22	194	97	32
Conflicting Peds, #/hr	0	25	25	0	10	10
Sign Control	Free	Free	Free	Free	Stop	Stop
RT Channelized	-	None	-	None	-	None
Storage Length	-	-	-	-	0	-
Veh in Median Storage, #	0	-	-	0	0	-
Grade, %	0	-	-	0	0	-
Peak Hour Factor	100	100	100	100	100	100
Heavy Vehicles, %	2	2	2	2	2	2
Mvmt Flow	130	66	22	194	97	32

Major/Minor	Major1	Major2	Minor1		
Conflicting Flow All	0	0	221	0	436 198
Stage 1	-	-	-	-	188 -
Stage 2	-	-	-	-	248 -
Critical Hdwy	-	-	4.12	-	6.42 6.22
Critical Hdwy Stg 1	-	-	-	-	5.42 -
Critical Hdwy Stg 2	-	-	-	-	5.42 -
Follow-up Hdwy	-	-	2.218	-	3.518 3.318
Pot Cap-1 Maneuver	-	-	1348	-	578 843
Stage 1	-	-	-	-	844 -
Stage 2	-	-	-	-	793 -
Platoon blocked, %	-	-	-	-	-
Mov Cap-1 Maneuver	-	-	1317	-	549 816
Mov Cap-2 Maneuver	-	-	-	-	549 -
Stage 1	-	-	-	-	825 -
Stage 2	-	-	-	-	771 -

Approach	EB	WB	NB
HCM Control Delay, s	0	0.8	12.7
HCM LOS			B

Minor Lane/Major Mvmt	NBLn1	EBT	EBR	WBL	WBT
Capacity (veh/h)	597	-	-	1317	-
HCM Lane V/C Ratio	0.216	-	-	0.017	-
HCM Control Delay (s)	12.7	-	-	7.8	0
HCM Lane LOS	B	-	-	A	A
HCM 95th %tile Q(veh)	0.8	-	-	0.1	-

Intersection						
Int Delay, s/veh	4					
Movement	EBT	EBR	WBL	WBT	NBL	NBR
Lane Configurations						
Traffic Vol, veh/h	130	33	44	151	65	65
Future Vol, veh/h	130	33	44	151	65	65
Conflicting Peds, #/hr	0	60	60	0	10	10
Sign Control	Free	Free	Free	Free	Stop	Stop
RT Channelized	-	None	-	None	-	None
Storage Length	-	-	-	-	0	-
Veh in Median Storage, #	0	-	-	0	0	-
Grade, %	0	-	-	0	0	-
Peak Hour Factor	100	100	100	100	100	100
Heavy Vehicles, %	2	2	2	2	2	2
Mvmt Flow	130	33	44	151	65	65

Major/Minor	Major1	Major2	Minor1		
Conflicting Flow All	0	0	223	0	456 217
Stage 1	-	-	-	-	207 -
Stage 2	-	-	-	-	249 -
Critical Hdwy	-	-	4.12	-	6.42 6.22
Critical Hdwy Stg 1	-	-	-	-	5.42 -
Critical Hdwy Stg 2	-	-	-	-	5.42 -
Follow-up Hdwy	-	-	2.218	-	3.518 3.318
Pot Cap-1 Maneuver	-	-	1346	-	562 823
Stage 1	-	-	-	-	828 -
Stage 2	-	-	-	-	792 -
Platoon blocked, %	-	-	-	-	-
Mov Cap-1 Maneuver	-	-	1271	-	506 770
Mov Cap-2 Maneuver	-	-	-	-	506 -
Stage 1	-	-	-	-	782 -
Stage 2	-	-	-	-	755 -

Approach	EB	WB	NB
HCM Control Delay, s	0	1.8	12.5
HCM LOS			B

Minor Lane/Major Mvmt	NBLn1	EBT	EBR	WBL	WBT
Capacity (veh/h)	611	-	-	1271	-
HCM Lane V/C Ratio	0.213	-	-	0.035	-
HCM Control Delay (s)	12.5	-	-	7.9	0
HCM Lane LOS	B	-	-	A	A
HCM 95th %tile Q(veh)	0.8	-	-	0.1	-

Intersection	
Intersection Delay, s/veh	12.6
Intersection LOS	B

Movement	EBL	EBT	EBR	WBL	WBT	WBR	NBL	NBT	NBR	SBL	SBT	SBR
Lane Configurations		↕			↕			↕			↕	
Traffic Vol, veh/h	0	4	193	306	8	0	169	54	108	0	81	0
Future Vol, veh/h	0	4	193	306	8	0	169	54	108	0	81	0
Peak Hour Factor	1.00	1.00	1.00	1.00	1.00	1.00	1.00	1.00	1.00	1.00	1.00	1.00
Heavy Vehicles, %	2	2	2	2	2	2	2	2	2	2	2	2
Mvmt Flow	0	4	193	306	8	0	169	54	108	0	81	0
Number of Lanes	0	1	0	0	1	0	0	1	0	0	1	0

Approach	EB	WB	NB	SB
Opposing Approach	WB	EB	SB	NB
Opposing Lanes	1	1	1	1
Conflicting Approach Left	SB	NB	EB	WB
Conflicting Lanes Left	1	1	1	1
Conflicting Approach Right	NB	SB	WB	EB
Conflicting Lanes Right	1	1	1	1
HCM Control Delay	10	13.9	13.6	9.9
HCM LOS	A	B	B	A

Lane	NBLn1	EBLn1	WBLn1	SBLn1
Vol Left, %	51%	0%	97%	0%
Vol Thru, %	16%	2%	3%	100%
Vol Right, %	33%	98%	0%	0%
Sign Control	Stop	Stop	Stop	Stop
Traffic Vol by Lane	331	197	314	81
LT Vol	169	0	306	0
Through Vol	54	4	8	81
RT Vol	108	193	0	0
Lane Flow Rate	331	197	314	81
Geometry Grp	1	1	1	1
Degree of Util (X)	0.494	0.276	0.488	0.133
Departure Headway (Hd)	5.371	5.04	5.594	5.916
Convergence, Y/N	Yes	Yes	Yes	Yes
Cap	669	709	644	603
Service Time	3.416	3.091	3.638	3.979
HCM Lane V/C Ratio	0.495	0.278	0.488	0.134
HCM Control Delay	13.6	10	13.9	9.9
HCM Lane LOS	B	A	B	A
HCM 95th-tile Q	2.7	1.1	2.7	0.5

Intersection	
Intersection Delay, s/veh	8.3
Intersection LOS	A

Movement	EBL	EBT	EBR	WBL	WBT	WBR	NBL	NBT	NBR	SBL	SBT	SBR
Lane Configurations		↕			↕			↕			↕	
Traffic Vol, veh/h	8	187	2	5	158	20	2	0	5	9	0	3
Future Vol, veh/h	8	187	2	5	158	20	2	0	5	9	0	3
Peak Hour Factor	1.00	1.00	1.00	1.00	1.00	1.00	1.00	1.00	1.00	1.00	1.00	1.00
Heavy Vehicles, %	2	2	2	2	2	2	2	2	2	2	2	2
Mvmt Flow	8	187	2	5	158	20	2	0	5	9	0	3
Number of Lanes	0	1	0	0	1	0	0	1	0	0	1	0

Approach	EB	WB	NB	SB
Opposing Approach	WB	EB	SB	NB
Opposing Lanes	1	1	1	1
Conflicting Approach Left	SB	NB	EB	WB
Conflicting Lanes Left	1	1	1	1
Conflicting Approach Right	NB	SB	WB	EB
Conflicting Lanes Right	1	1	1	1
HCM Control Delay	8.4	8.2	7.4	7.8
HCM LOS	A	A	A	A

Lane	NBLn1	EBLn1	WBLn1	SBLn1
Vol Left, %	29%	4%	3%	75%
Vol Thru, %	0%	95%	86%	0%
Vol Right, %	71%	1%	11%	25%
Sign Control	Stop	Stop	Stop	Stop
Traffic Vol by Lane	7	197	183	12
LT Vol	2	8	5	9
Through Vol	0	187	158	0
RT Vol	5	2	20	3
Lane Flow Rate	7	197	183	12
Geometry Grp	1	1	1	1
Degree of Util (X)	0.009	0.225	0.206	0.016
Departure Headway (Hd)	4.389	4.106	4.054	4.756
Convergence, Y/N	Yes	Yes	Yes	Yes
Cap	820	869	878	757
Service Time	2.39	2.159	2.112	2.757
HCM Lane V/C Ratio	0.009	0.227	0.208	0.016
HCM Control Delay	7.4	8.4	8.2	7.8
HCM Lane LOS	A	A	A	A
HCM 95th-tile Q	0	0.9	0.8	0

Intersection	
Intersection Delay, s/veh	12.4
Intersection LOS	B

Movement	EBT	EBR	WBL	WBT	NBL	NBR
Lane Configurations	↻		↻	↻	↻	↻
Traffic Vol, veh/h	35	97	322	85	131	189
Future Vol, veh/h	35	97	322	85	131	189
Peak Hour Factor	1.00	1.00	1.00	1.00	1.00	1.00
Heavy Vehicles, %	2	2	2	2	2	2
Mvmt Flow	35	97	322	85	131	189
Number of Lanes	1	0	1	1	1	1

Approach	EB	WB	NB
Opposing Approach	WB	EB	
Opposing Lanes	2	1	0
Conflicting Approach Left		NB	EB
Conflicting Lanes Left	0	2	1
Conflicting Approach Right	NB		WB
Conflicting Lanes Right	2	0	2
HCM Control Delay	9.7	14.6	10.6
HCM LOS	A	B	B

Lane	NBLn1	NBLn2	EBLn1	WBLn1	WBLn2
Vol Left, %	100%	0%	0%	100%	0%
Vol Thru, %	0%	0%	27%	0%	100%
Vol Right, %	0%	100%	73%	0%	0%
Sign Control	Stop	Stop	Stop	Stop	Stop
Traffic Vol by Lane	131	189	132	322	85
LT Vol	131	0	0	322	0
Through Vol	0	0	35	0	85
RT Vol	0	189	97	0	0
Lane Flow Rate	131	189	132	322	85
Geometry Grp	7	7	4	7	7
Degree of Util (X)	0.239	0.281	0.197	0.548	0.133
Departure Headway (Hd)	6.571	5.359	5.381	6.123	5.618
Convergence, Y/N	Yes	Yes	Yes	Yes	Yes
Cap	550	675	668	589	640
Service Time	4.271	3.059	3.407	3.844	3.339
HCM Lane V/C Ratio	0.238	0.28	0.198	0.547	0.133
HCM Control Delay	11.3	10.1	9.7	16	9.2
HCM Lane LOS	B	B	A	C	A
HCM 95th-tile Q	0.9	1.2	0.7	3.3	0.5

Lanes, Volumes, Timings

1: Trim & H174

Scenario 2 PM

Lane Group	EBL	EBT	EBR	WBL	WBT	WBR	NBL	NBT	NBR	SBL	SBT	SBR
Lane Configurations												
Traffic Volume (vph)	343	1123	12	110	519	64	325	126	116	80	122	309
Future Volume (vph)	343	1123	12	110	519	64	325	126	116	80	122	309
Satd. Flow (prot)	1695	3369	0	1695	4871	1517	4780	1784	1517	1695	1784	1517
Flt Permitted	0.950			0.950			0.950			0.950		
Satd. Flow (perm)	1679	3369	0	1561	4871	1458	4780	1784	1155	1378	1784	1517
Satd. Flow (RTOR)		1				278			216			309
Lane Group Flow (vph)	343	1135	0	110	519	64	325	126	116	80	122	309
Turn Type	Prot	NA		Prot	NA	Perm	Prot	NA	Perm	Prot	NA	Perm
Protected Phases	5	2		1	6		3	8		7	4	
Permitted Phases						6			8			4
Detector Phase	5	2		1	6	6	3	8	8	7	4	4
Switch Phase												
Minimum Initial (s)	1.0	5.0		1.0	5.0	5.0	1.0	5.0	5.0	1.0	5.0	5.0
Minimum Split (s)	8.5	41.2		8.5	41.2	41.2	8.2	42.4	42.4	7.9	12.4	12.4
Total Split (s)	33.0	57.6		17.0	41.6	41.6	21.3	42.4	42.4	13.0	34.1	34.1
Total Split (%)	25.4%	44.3%		13.1%	32.0%	32.0%	16.4%	32.6%	32.6%	10.0%	26.2%	26.2%
Yellow Time (s)	3.3	5.1		3.3	5.1	5.1	3.3	3.3	3.3	3.3	3.3	3.3
All-Red Time (s)	4.2	2.1		3.8	2.1	2.1	3.9	4.1	4.1	3.6	4.1	4.1
Lost Time Adjust (s)	0.0	0.0		0.0	0.0	0.0	0.0	0.0	0.0	0.0	0.0	0.0
Total Lost Time (s)	7.5	7.2		7.1	7.2	7.2	7.2	7.4	7.4	6.9	7.4	7.4
Lead/Lag	Lead	Lag		Lead	Lag	Lag	Lead	Lag	Lag	Lead	Lag	Lag
Lead-Lag Optimize?	Yes	Yes		Yes	Yes	Yes	Yes	Yes	Yes	Yes	Yes	Yes
Recall Mode	None	C-Min		None	C-Min	C-Min	None	None	None	None	None	None
Act Effct Green (s)	27.3	53.8		9.9	36.0	36.0	13.2	29.8	29.8	7.9	24.2	24.2
Actuated g/C Ratio	0.21	0.41		0.08	0.28	0.28	0.10	0.23	0.23	0.06	0.19	0.19
v/c Ratio	0.96	0.81		0.85	0.38	0.11	0.67	0.31	0.27	0.78	0.37	0.58
Control Delay	90.8	40.6		106.3	39.6	0.4	63.5	41.6	1.5	104.7	48.4	9.4
Queue Delay	0.0	0.0		0.0	0.0	0.0	0.0	0.0	0.0	0.0	0.0	0.0
Total Delay	90.8	40.6		106.3	39.6	0.4	63.5	41.6	1.5	104.7	48.4	9.4
LOS	F	D		F	D	A	E	D	A	F	D	A
Approach Delay		52.3			46.6			45.9			33.6	
Approach LOS		D			D			D			C	
Queue Length 50th (m)	~94.1	139.9		28.4	40.2	0.0	28.6	25.5	0.0	~21.0	26.9	0.0
Queue Length 95th (m)	#152.6	169.6		#62.0	51.4	0.0	39.1	42.6	0.0	#53.9	45.3	24.7
Internal Link Dist (m)		686.1			478.0			348.7			179.7	
Turn Bay Length (m)	175.0			150.0		30.0	200.0		40.0	150.0		40.0
Base Capacity (vph)	356	1410		129	1371	610	518	480	468	102	378	565
Starvation Cap Reductn	0	0		0	0	0	0	0	0	0	0	0
Spillback Cap Reductn	0	0		0	0	0	0	0	0	0	0	0
Storage Cap Reductn	0	0		0	0	0	0	0	0	0	0	0
Reduced v/c Ratio	0.96	0.80		0.85	0.38	0.10	0.63	0.26	0.25	0.78	0.32	0.55

Intersection Summary

Cycle Length: 130
 Actuated Cycle Length: 130
 Offset: 54.5 (42%), Referenced to phase 2:EBT and 6:WBT, Start of Green
 Natural Cycle: 130
 Control Type: Actuated-Coordinated

Lanes, Volumes, Timings

1: Trim & H174

Scenario 2 PM

Maximum v/c Ratio: 0.96

Intersection Signal Delay: 47.0

Intersection LOS: D

Intersection Capacity Utilization 106.4%

ICU Level of Service G

Analysis Period (min) 15

~ Volume exceeds capacity, queue is theoretically infinite.

Queue shown is maximum after two cycles.

95th percentile volume exceeds capacity, queue may be longer.

Queue shown is maximum after two cycles.

Splits and Phases: 1: Trim & H174

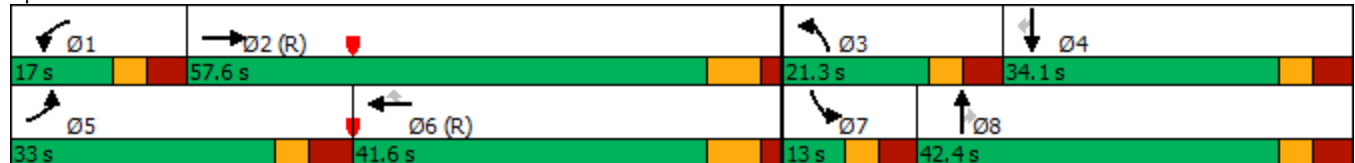

Lanes, Volumes, Timings
5: Tenth Line & St. Joseph

Scenario 2 PM



Lane Group	EBL	EBT	EBR	WBL	WBT	WBR	NBL	NBT	NBR	SBL	SBT	SBR
Lane Configurations	↘	↑↑	↗	↘	↑↑	↗	↘	↑↑	↗	↘	↑↑	↗
Traffic Volume (vph)	68	302	561	62	210	283	359	670	13	8	178	57
Future Volume (vph)	68	302	561	62	210	283	359	670	13	8	178	57
Satd. Flow (prot)	1695	3390	1517	1695	3390	1517	1543	3238	1517	1695	3390	1517
Flt Permitted	0.594			0.456			0.950	0.997		0.950		
Satd. Flow (perm)	1040	3390	1476	810	3390	1451	1534	3237	1483	1690	3390	1478
Satd. Flow (RTOR)			561			283			130			130
Lane Group Flow (vph)	68	302	561	62	210	283	323	706	13	8	178	57
Turn Type	pm+pt	NA	Perm	pm+pt	NA	Perm	Split	NA	Perm	Split	NA	Perm
Protected Phases	7	4		3	8		5	5		6	6	
Permitted Phases	4		4	8		8			5			6
Minimum Split (s)	11.0	29.1	29.1	11.0	29.1	29.1	32.3	32.3	32.3	32.3	32.3	32.3
Total Split (s)	14.0	28.1	28.1	14.0	28.1	28.1	59.3	59.3	59.3	28.3	28.3	28.3
Total Split (%)	10.8%	21.7%	21.7%	10.8%	21.7%	21.7%	45.7%	45.7%	45.7%	21.8%	21.8%	21.8%
Yellow Time (s)	3.7	3.7	3.7	3.7	3.7	3.7	3.7	3.7	3.7	3.7	3.7	3.7
All-Red Time (s)	2.3	2.4	2.4	2.3	2.4	2.4	2.6	2.6	2.6	2.6	2.6	2.6
Lost Time Adjust (s)	0.0	0.0	0.0	0.0	0.0	0.0	0.0	0.0	0.0	0.0	0.0	0.0
Total Lost Time (s)	6.0	6.1	6.1	6.0	6.1	6.1	6.3	6.3	6.3	6.3	6.3	6.3
Lead/Lag	Lead	Lag	Lag	Lead	Lag	Lag	Lead	Lead	Lead	Lag	Lag	Lag
Lead-Lag Optimize?	Yes	Yes	Yes	Yes	Yes	Yes	Yes	Yes	Yes	Yes	Yes	Yes
Act Effct Green (s)	30.1	22.0	22.0	30.1	22.0	22.0	53.0	53.0	53.0	22.0	22.0	22.0
Actuated g/C Ratio	0.23	0.17	0.17	0.23	0.17	0.17	0.41	0.41	0.41	0.17	0.17	0.17
v/c Ratio	0.24	0.53	0.78	0.26	0.37	0.59	0.51	0.53	0.02	0.03	0.31	0.16
Control Delay	37.8	52.8	12.6	38.2	49.8	10.7	32.3	30.8	0.1	45.4	48.9	0.9
Queue Delay	0.0	0.0	0.0	0.0	0.0	0.0	0.0	0.0	0.0	0.0	0.0	0.0
Total Delay	37.8	52.8	12.6	38.2	49.8	10.7	32.3	30.8	0.1	45.4	48.9	0.9
LOS	D	D	B	D	D	B	C	C	A	D	D	A
Approach Delay		27.5			28.6			30.9				37.5
Approach LOS		C			C			C				D
Queue Length 50th (m)	13.1	37.4	0.0	11.9	25.3	0.0	67.0	74.0	0.0	1.7	21.2	0.0
Queue Length 95th (m)	25.0	52.4	38.3	23.3	37.4	25.3	98.1	93.3	0.0	6.6	32.5	0.0
Internal Link Dist (m)		434.4			241.4			325.6				408.6
Turn Bay Length (m)	100.0		140.0	65.0			160.0		50.0	110.0		70.0
Base Capacity (vph)	281	575	716	242	575	481	630	1323	682	287	575	358
Starvation Cap Reductn	0	0	0	0	0	0	0	0	0	0	0	0
Spillback Cap Reductn	0	0	0	0	0	0	0	0	0	0	0	0
Storage Cap Reductn	0	0	0	0	0	0	0	0	0	0	0	0
Reduced v/c Ratio	0.24	0.53	0.78	0.26	0.37	0.59	0.51	0.53	0.02	0.03	0.31	0.16

Intersection Summary

Cycle Length: 129.7
 Actuated Cycle Length: 129.7
 Offset: 0 (0%), Referenced to phase 6:SBTL, Start of Green
 Natural Cycle: 105
 Control Type: Pretimed
 Maximum v/c Ratio: 0.78
 Intersection Signal Delay: 29.9
 Intersection Capacity Utilization 87.3%
 Analysis Period (min) 15
 Intersection LOS: C
 ICU Level of Service E

Lanes, Volumes, Timings
 5: Tenth Line & St. Joseph





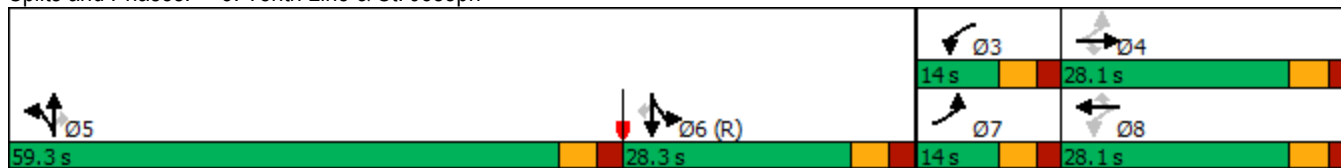















Scenario 2 PM

Splits and Phases: 5: Tenth Line & St. Joseph



Lanes, Volumes, Timings
6: Old Tenth Line & St. Joseph

Scenario 2 PM

												
Lane Group	EBL	EBT	EBR	WBL	WBT	WBR	NBL	NBT	NBR	SBL	SBT	SBR
Lane Configurations												
Traffic Volume (vph)	0	327	3	96	286	0	4	0	82	55	859	280
Future Volume (vph)	0	327	3	96	286	0	4	0	82	55	859	280
Satd. Flow (prot)	0	3386	0	1695	3390	0	1695	0	1517	3288	3390	1517
Flt Permitted				0.553			0.950			0.950		
Satd. Flow (perm)	0	3386	0	983	3390	0	1693	0	1495	3288	3390	1517
Satd. Flow (RTOR)		1							257			280
Lane Group Flow (vph)	0	330	0	96	286	0	4	0	82	55	859	280
Turn Type		NA		Perm	NA		Prot		Free	Prot	NA	Free
Protected Phases		4			8		5			1	6	
Permitted Phases				8					Free			Free
Minimum Split (s)		25.6		25.6	25.6		11.3			12.0	30.0	
Total Split (s)		26.6		26.6	26.6		11.3			45.0	33.7	
Total Split (%)		37.2%		37.2%	37.2%		15.8%			62.8%	47.1%	
Yellow Time (s)		3.7		3.7	3.7		3.7			3.7	3.7	
All-Red Time (s)		2.9		2.9	2.9		2.6			3.3	3.3	
Lost Time Adjust (s)		0.0		0.0	0.0		0.0			0.0	0.0	
Total Lost Time (s)		6.6		6.6	6.6		6.3			7.0	7.0	
Lead/Lag							Lead					Lag
Lead-Lag Optimize?							Yes					Yes
Act Effct Green (s)		20.0		20.0	20.0		5.0		71.6	38.0	26.7	71.6
Actuated g/C Ratio		0.28		0.28	0.28		0.07		1.00	0.53	0.37	1.00
v/c Ratio		0.35		0.35	0.30		0.03		0.05	0.03	0.68	0.18
Control Delay		21.8		25.1	21.4		31.8		0.1	8.1	22.2	0.3
Queue Delay		0.0		0.0	0.0		0.0		0.0	0.0	0.0	0.0
Total Delay		21.8		25.1	21.4		31.8		0.1	8.1	22.2	0.3
LOS		C		C	C		C		A	A	C	A
Approach Delay		21.8			22.3			1.5				16.4
Approach LOS		C			C			A				B
Queue Length 50th (m)		18.4		10.3	15.8		0.5		0.0	1.7	49.7	0.0
Queue Length 95th (m)		28.8		22.5	25.2		3.1		0.0	4.0	68.6	0.0
Internal Link Dist (m)		241.4			372.8			239.6			226.3	
Turn Bay Length (m)				60.0					10.0	90.0		
Base Capacity (vph)		946		274	946		118		1495	1745	1264	1517
Starvation Cap Reductn		0		0	0		0		0	0	0	0
Spillback Cap Reductn		0		0	0		0		0	0	0	0
Storage Cap Reductn		0		0	0		0		0	0	0	0
Reduced v/c Ratio		0.35		0.35	0.30		0.03		0.05	0.03	0.68	0.18

Intersection Summary

Cycle Length: 71.6
 Actuated Cycle Length: 71.6
 Offset: 0 (0%), Referenced to phase 6:SBT, Start of Green
 Natural Cycle: 70
 Control Type: Pretimed
 Maximum v/c Ratio: 0.68
 Intersection Signal Delay: 17.8
 Intersection Capacity Utilization 63.3%
 Analysis Period (min) 15
 Intersection LOS: B
 ICU Level of Service B

Lanes, Volumes, Timings
6: Old Tenth Line & St. Joseph

Scenario 2 PM

Splits and Phases: 6: Old Tenth Line & St. Joseph



Intersection						
Int Delay, s/veh	1.3					
Movement	EBT	EBR	WBL	WBT	NBL	NBR
Lane Configurations						
Traffic Vol, veh/h	286	57	14	246	41	14
Future Vol, veh/h	286	57	14	246	41	14
Conflicting Peds, #/hr	0	15	15	0	5	5
Sign Control	Free	Free	Free	Free	Stop	Stop
RT Channelized	-	None	-	None	-	None
Storage Length	-	-	-	-	0	-
Veh in Median Storage, #	0	-	-	0	0	-
Grade, %	0	-	-	0	0	-
Peak Hour Factor	100	100	100	100	100	100
Heavy Vehicles, %	2	2	2	2	2	2
Mvmt Flow	286	57	14	246	41	14

Major/Minor	Major1	Major2	Minor1	Minor2	Minor3
Conflicting Flow All	0	0	358	0	609
Stage 1	-	-	-	-	330
Stage 2	-	-	-	-	279
Critical Hdwy	-	-	4.12	-	6.42
Critical Hdwy Stg 1	-	-	-	-	5.42
Critical Hdwy Stg 2	-	-	-	-	5.42
Follow-up Hdwy	-	-	2.218	-	3.518
Pot Cap-1 Maneuver	-	-	1201	-	458
Stage 1	-	-	-	-	728
Stage 2	-	-	-	-	768
Platoon blocked, %	-	-	-	-	-
Mov Cap-1 Maneuver	-	-	1184	-	443
Mov Cap-2 Maneuver	-	-	-	-	443
Stage 1	-	-	-	-	718
Stage 2	-	-	-	-	753

Approach	EB	WB	NB
HCM Control Delay, s	0	0.4	13.3
HCM LOS			B

Minor Lane/Major Mvmt	NBLn1	EBT	EBR	WBL	WBT
Capacity (veh/h)	488	-	-	1184	-
HCM Lane V/C Ratio	0.113	-	-	0.012	-
HCM Control Delay (s)	13.3	-	-	8.1	0
HCM Lane LOS	B	-	-	A	A
HCM 95th %tile Q(veh)	0.4	-	-	0	-

Intersection						
Int Delay, s/veh	3					
Movement	EBT	EBR	WBL	WBT	NBL	NBR
Lane Configurations						
Traffic Vol, veh/h	202	99	29	178	82	40
Future Vol, veh/h	202	99	29	178	82	40
Conflicting Peds, #/hr	0	35	35	0	10	10
Sign Control	Free	Free	Free	Free	Stop	Stop
RT Channelized	-	None	-	None	-	None
Storage Length	-	-	-	-	0	-
Veh in Median Storage, #	0	-	-	0	0	-
Grade, %	0	-	-	0	0	-
Peak Hour Factor	100	100	100	100	100	100
Heavy Vehicles, %	2	2	2	2	2	2
Mvmt Flow	202	99	29	178	82	40

Major/Minor	Major1	Major2	Minor1		
Conflicting Flow All	0	0	336	0	533 297
Stage 1	-	-	-	-	287 -
Stage 2	-	-	-	-	246 -
Critical Hdwy	-	-	4.12	-	6.42 6.22
Critical Hdwy Stg 1	-	-	-	-	5.42 -
Critical Hdwy Stg 2	-	-	-	-	5.42 -
Follow-up Hdwy	-	-	2.218	-	3.518 3.318
Pot Cap-1 Maneuver	-	-	1223	-	507 742
Stage 1	-	-	-	-	762 -
Stage 2	-	-	-	-	795 -
Platoon blocked, %	-	-	-	-	-
Mov Cap-1 Maneuver	-	-	1183	-	473 711
Mov Cap-2 Maneuver	-	-	-	-	473 -
Stage 1	-	-	-	-	738 -
Stage 2	-	-	-	-	766 -

Approach	EB	WB	NB
HCM Control Delay, s	0	1.1	13.8
HCM LOS			B

Minor Lane/Major Mvmt	NBLn1	EBT	EBR	WBL	WBT
Capacity (veh/h)	531	-	-	1183	-
HCM Lane V/C Ratio	0.23	-	-	0.025	-
HCM Control Delay (s)	13.8	-	-	8.1	0
HCM Lane LOS	B	-	-	A	A
HCM 95th %tile Q(veh)	0.9	-	-	0.1	-

Intersection						
Int Delay, s/veh	3.8					
Movement	EBT	EBR	WBL	WBT	NBL	NBR
Lane Configurations						
Traffic Vol, veh/h	199	43	66	144	63	54
Future Vol, veh/h	199	43	66	144	63	54
Conflicting Peds, #/hr	0	65	65	0	10	10
Sign Control	Free	Free	Free	Free	Stop	Stop
RT Channelized	-	None	-	None	-	None
Storage Length	-	-	-	-	0	-
Veh in Median Storage, #	0	-	-	0	0	-
Grade, %	0	-	-	0	0	-
Peak Hour Factor	100	100	100	100	100	100
Heavy Vehicles, %	2	2	2	2	2	2
Mvmt Flow	199	43	66	144	63	54

Major/Minor	Major1	Major2	Minor1		
Conflicting Flow All	0	0	307	0	572
Stage 1	-	-	-	-	286
Stage 2	-	-	-	-	286
Critical Hdwy	-	-	4.12	-	6.42
Critical Hdwy Stg 1	-	-	-	-	5.42
Critical Hdwy Stg 2	-	-	-	-	5.42
Follow-up Hdwy	-	-	2.218	-	3.518
Pot Cap-1 Maneuver	-	-	1254	-	482
Stage 1	-	-	-	-	763
Stage 2	-	-	-	-	763
Platoon blocked, %	-	-	-	-	-
Mov Cap-1 Maneuver	-	-	1179	-	422
Mov Cap-2 Maneuver	-	-	-	-	422
Stage 1	-	-	-	-	717
Stage 2	-	-	-	-	710

Approach	EB	WB	NB
HCM Control Delay, s	0	2.6	14
HCM LOS			B

Minor Lane/Major Mvmt	NBLn1	EBT	EBR	WBL	WBT
Capacity (veh/h)	515	-	-	1179	-
HCM Lane V/C Ratio	0.227	-	-	0.056	-
HCM Control Delay (s)	14	-	-	8.2	0
HCM Lane LOS	B	-	-	A	A
HCM 95th %tile Q(veh)	0.9	-	-	0.2	-

Intersection	
Intersection Delay, s/veh	16.1
Intersection LOS	C

Movement	EBL	EBT	EBR	WBL	WBT	WBR	NBL	NBT	NBR	SBL	SBT	SBR
Lane Configurations		↕			↕			↕			↕	
Traffic Vol, veh/h	0	7	206	193	3	0	184	82	265	0	58	0
Future Vol, veh/h	0	7	206	193	3	0	184	82	265	0	58	0
Peak Hour Factor	1.00	1.00	1.00	1.00	1.00	1.00	1.00	1.00	1.00	1.00	1.00	1.00
Heavy Vehicles, %	2	2	2	2	2	2	2	2	2	2	2	2
Mvmt Flow	0	7	206	193	3	0	184	82	265	0	58	0
Number of Lanes	0	1	0	0	1	0	0	1	0	0	1	0

Approach	EB	WB	NB	SB
Opposing Approach	WB	EB	SB	NB
Opposing Lanes	1	1	1	1
Conflicting Approach Left	SB	NB	EB	WB
Conflicting Lanes Left	1	1	1	1
Conflicting Approach Right	NB	SB	WB	EB
Conflicting Lanes Right	1	1	1	1
HCM Control Delay	10.7	12.1	20.4	9.6
HCM LOS	B	B	C	A

Lane	NBLn1	EBLn1	WBLn1	SBLn1
Vol Left, %	35%	0%	98%	0%
Vol Thru, %	15%	3%	2%	100%
Vol Right, %	50%	97%	0%	0%
Sign Control	Stop	Stop	Stop	Stop
Traffic Vol by Lane	531	213	196	58
LT Vol	184	0	193	0
Through Vol	82	7	3	58
RT Vol	265	206	0	0
Lane Flow Rate	531	213	196	58
Geometry Grp	1	1	1	1
Degree of Util (X)	0.732	0.312	0.329	0.096
Departure Headway (Hd)	4.962	5.276	6.046	5.939
Convergence, Y/N	Yes	Yes	Yes	Yes
Cap	727	677	592	600
Service Time	3.003	3.333	4.103	4.007
HCM Lane V/C Ratio	0.73	0.315	0.331	0.097
HCM Control Delay	20.4	10.7	12.1	9.6
HCM Lane LOS	C	B	B	A
HCM 95th-tile Q	6.5	1.3	1.4	0.3

Intersection	
Intersection Delay, s/veh	8.4
Intersection LOS	A

Movement	EBL	EBT	EBR	WBL	WBT	WBR	NBL	NBT	NBR	SBL	SBT	SBR
Lane Configurations		↕			↕			↕			↕	
Traffic Vol, veh/h	6	203	2	5	173	9	2	0	5	12	0	4
Future Vol, veh/h	6	203	2	5	173	9	2	0	5	12	0	4
Peak Hour Factor	1.00	1.00	1.00	1.00	1.00	1.00	1.00	1.00	1.00	1.00	1.00	1.00
Heavy Vehicles, %	2	2	2	2	2	2	2	2	2	2	2	2
Mvmt Flow	6	203	2	5	173	9	2	0	5	12	0	4
Number of Lanes	0	1	0	0	1	0	0	1	0	0	1	0

Approach	EB	WB	NB	SB
Opposing Approach	WB	EB	SB	NB
Opposing Lanes	1	1	1	1
Conflicting Approach Left	SB	NB	EB	WB
Conflicting Lanes Left	1	1	1	1
Conflicting Approach Right	NB	SB	WB	EB
Conflicting Lanes Right	1	1	1	1
HCM Control Delay	8.5	8.3	7.5	7.9
HCM LOS	A	A	A	A

Lane	NBLn1	EBLn1	WBLn1	SBLn1
Vol Left, %	29%	3%	3%	75%
Vol Thru, %	0%	96%	93%	0%
Vol Right, %	71%	1%	5%	25%
Sign Control	Stop	Stop	Stop	Stop
Traffic Vol by Lane	7	211	187	16
LT Vol	2	6	5	12
Through Vol	0	203	173	0
RT Vol	5	2	9	4
Lane Flow Rate	7	211	187	16
Geometry Grp	1	1	1	1
Degree of Util (X)	0.009	0.241	0.213	0.021
Departure Headway (Hd)	4.437	4.113	4.108	4.797
Convergence, Y/N	Yes	Yes	Yes	Yes
Cap	811	865	866	751
Service Time	2.437	2.173	2.173	2.798
HCM Lane V/C Ratio	0.009	0.244	0.216	0.021
HCM Control Delay	7.5	8.5	8.3	7.9
HCM Lane LOS	A	A	A	A
HCM 95th-tile Q	0	0.9	0.8	0.1

Intersection	
Intersection Delay, s/veh	14.1
Intersection LOS	B

Movement	EBT	EBR	WBL	WBT	NBL	NBR
Lane Configurations	↻		↻	↻	↻	↻
Traffic Vol, veh/h	104	113	291	51	164	336
Future Vol, veh/h	104	113	291	51	164	336
Peak Hour Factor	1.00	1.00	1.00	1.00	1.00	1.00
Heavy Vehicles, %	2	2	2	2	2	2
Mvmt Flow	104	113	291	51	164	336
Number of Lanes	1	0	1	1	1	1

Approach	EB	WB	NB
Opposing Approach	WB	EB	
Opposing Lanes	2	1	0
Conflicting Approach Left		NB	EB
Conflicting Lanes Left	0	2	1
Conflicting Approach Right	NB		WB
Conflicting Lanes Right	2	0	2
HCM Control Delay	12.3	16.2	13.5
HCM LOS	B	C	B

Lane	NBLn1	NBLn2	EBLn1	WBLn1	WBLn2
Vol Left, %	100%	0%	0%	100%	0%
Vol Thru, %	0%	0%	48%	0%	100%
Vol Right, %	0%	100%	52%	0%	0%
Sign Control	Stop	Stop	Stop	Stop	Stop
Traffic Vol by Lane	164	336	217	291	51
LT Vol	164	0	0	291	0
Through Vol	0	0	104	0	51
RT Vol	0	336	113	0	0
Lane Flow Rate	164	336	217	291	51
Geometry Grp	7	7	4	7	7
Degree of Util (X)	0.306	0.514	0.358	0.546	0.089
Departure Headway (Hd)	6.721	5.507	5.94	6.76	6.252
Convergence, Y/N	Yes	Yes	Yes	Yes	Yes
Cap	535	655	605	533	573
Service Time	4.464	3.249	3.984	4.503	3.995
HCM Lane V/C Ratio	0.307	0.513	0.359	0.546	0.089
HCM Control Delay	12.4	14	12.3	17.4	9.6
HCM Lane LOS	B	B	B	C	A
HCM 95th-tile Q	1.3	3	1.6	3.3	0.3

APPENDIX Q

SIMTRAFFIC QUEUEING ANALYSIS

Intersection: 1: Trim & H174

Movement	EB	EB	EB	WB	WB	WB	WB	WB	NB	NB	NB	NB
Directions Served	L	T	TR	L	T	T	T	R	L	L	L	T
Maximum Queue (m)	98.7	49.7	52.8	17.2	45.9	43.8	29.6	6.6	59.3	92.6	102.6	34.1
Average Queue (m)	54.2	26.3	28.0	4.8	26.2	19.4	3.4	0.4	32.7	60.0	69.0	11.5
95th Queue (m)	89.1	43.7	46.8	13.3	40.6	36.2	15.3	4.2	64.7	83.4	93.8	26.0
Link Distance (m)		697.7	697.7		488.1	488.1	488.1				360.3	360.3
Upstream Blk Time (%)												
Queuing Penalty (veh)												
Storage Bay Dist (m)	175.0			150.0				30.0	200.0	200.0		
Storage Blk Time (%)							0					0
Queuing Penalty (veh)							0					0

Intersection: 1: Trim & H174

Movement	SB	SB	SB
Directions Served	L	T	R
Maximum Queue (m)	52.0	118.2	47.5
Average Queue (m)	16.9	38.2	18.6
95th Queue (m)	37.9	85.5	55.7
Link Distance (m)		179.2	
Upstream Blk Time (%)		0	
Queuing Penalty (veh)		0	
Storage Bay Dist (m)	150.0		40.0
Storage Blk Time (%)		6	3
Queuing Penalty (veh)		30	5

Intersection: 2: Trim & Jeanne D'Arc

Movement	EB	WB	NB	SB
Directions Served	LTR	LTR	LTR	LTR
Maximum Queue (m)	64.9	96.4	93.3	27.1
Average Queue (m)	24.9	35.6	46.4	10.7
95th Queue (m)	49.6	73.3	80.9	20.0
Link Distance (m)	185.0	134.8	179.2	79.2
Upstream Blk Time (%)		0		
Queuing Penalty (veh)		0		
Storage Bay Dist (m)				
Storage Blk Time (%)				
Queuing Penalty (veh)				

Intersection: 3: Tweddle & Jeanne D'Arc

Movement	EB	WB	NB	SB
Directions Served	LTR	LTR	LTR	LTR
Maximum Queue (m)	26.8	23.0	9.0	9.2
Average Queue (m)	14.5	11.6	1.6	3.2
95th Queue (m)	22.2	18.2	7.1	10.3
Link Distance (m)	457.6	185.0	165.8	181.0
Upstream Blk Time (%)				
Queuing Penalty (veh)				
Storage Bay Dist (m)				
Storage Blk Time (%)				
Queuing Penalty (veh)				

Intersection: 4: Tenth Line & Jeanne D'Arc

Movement	EB	WB	WB	NB	NB
Directions Served	TR	L	T	L	R
Maximum Queue (m)	23.9	54.1	18.6	19.4	25.4
Average Queue (m)	12.0	23.3	10.0	9.2	11.9
95th Queue (m)	19.6	40.4	16.4	15.6	20.6
Link Distance (m)	181.9				
Upstream Blk Time (%)					
Queuing Penalty (veh)					
Storage Bay Dist (m)		145.0			
Storage Blk Time (%)					
Queuing Penalty (veh)					

Intersection: 5: Tenth Line & St. Joseph

Movement	EB	EB	EB	WB	WB	WB	NB	NB	NB	NB	SB	SB
Directions Served	L	T	T	L	T	T	L	LT	T	R	L	T
Maximum Queue (m)	23.2	28.2	16.8	21.9	52.9	73.9	121.2	143.2	130.8	57.4	8.6	54.5
Average Queue (m)	7.0	11.9	4.6	6.0	27.1	32.1	73.3	98.2	87.2	8.5	1.3	32.1
95th Queue (m)	17.6	23.5	13.0	16.2	45.6	58.5	110.7	132.2	120.2	41.9	6.2	49.0
Link Distance (m)		446.7	446.7		230.4	230.4		337.3	337.3			
Upstream Blk Time (%)												
Queuing Penalty (veh)												
Storage Bay Dist (m)	100.0			65.0			160.0			50.0	110.0	
Storage Blk Time (%)						0		0	26	0		
Queuing Penalty (veh)						0		0	5	0		

Intersection: 5: Tenth Line & St. Joseph

Movement	SB
Directions Served	T
Maximum Queue (m)	45.0
Average Queue (m)	21.7
95th Queue (m)	43.2
Link Distance (m)	
Upstream Blk Time (%)	
Queuing Penalty (veh)	
Storage Bay Dist (m)	
Storage Blk Time (%)	
Queuing Penalty (veh)	

Intersection: 6: Old Tenth Line & St. Joseph

Movement	EB	EB	WB	WB	WB	NB	SB	SB	SB	SB	SB
Directions Served	T	TR	L	T	T	R	L	L	T	T	R
Maximum Queue (m)	16.4	20.3	15.9	33.9	39.9	6.2	6.0	16.9	44.9	36.4	1.6
Average Queue (m)	4.3	6.2	4.0	17.6	19.3	0.3	0.3	4.4	23.7	8.8	0.1
95th Queue (m)	11.6	16.9	11.6	30.0	35.0	3.3	2.8	12.8	39.6	23.3	1.6
Link Distance (m)	230.4	230.4		388.9	388.9				237.7	237.7	237.7
Upstream Blk Time (%)											
Queuing Penalty (veh)											
Storage Bay Dist (m)			60.0			10.0	90.0	90.0			
Storage Blk Time (%)						0					
Queuing Penalty (veh)						0					

Intersection: 7: Tenth Line & H174 WB on-off

Movement	SB	SB
Directions Served	T	R
Maximum Queue (m)	2.8	2.7
Average Queue (m)	0.1	0.2
95th Queue (m)	2.8	3.7
Link Distance (m)	295.6	
Upstream Blk Time (%)		
Queuing Penalty (veh)		
Storage Bay Dist (m)	50.0	
Storage Blk Time (%)		
Queuing Penalty (veh)		

Intersection: 8: West Access & Jeanne D'Arc

Movement	EB	WB	NB
Directions Served	TR	LT	LR
Maximum Queue (m)	10.6	17.3	25.8
Average Queue (m)	0.6	2.4	11.3
95th Queue (m)	5.5	10.7	19.5
Link Distance (m)		135.3	85.7
Upstream Blk Time (%)			
Queuing Penalty (veh)			
Storage Bay Dist (m)			
Storage Blk Time (%)			
Queuing Penalty (veh)			

Intersection: 9: Center Access & Jeanne D'Arc

Movement	EB	WB	NB
Directions Served	TR	LT	LR
Maximum Queue (m)	12.0	19.1	33.5
Average Queue (m)	0.8	3.5	15.0
95th Queue (m)	6.0	12.7	26.1
Link Distance (m)	135.3	119.9	103.8
Upstream Blk Time (%)			
Queuing Penalty (veh)			
Storage Bay Dist (m)			
Storage Blk Time (%)			
Queuing Penalty (veh)			

Intersection: 10: West Access & Jeanne D'Arc

Movement	EB	WB	NB
Directions Served	TR	LT	LR
Maximum Queue (m)	8.6	17.6	31.5
Average Queue (m)	0.5	5.4	15.4
95th Queue (m)	3.9	14.8	25.9
Link Distance (m)	119.9	457.6	99.3
Upstream Blk Time (%)			
Queuing Penalty (veh)			
Storage Bay Dist (m)			
Storage Blk Time (%)			
Queuing Penalty (veh)			

Intersection: 14: Jeanne D'Arc

Movement
Directions Served
Maximum Queue (m)
Average Queue (m)
95th Queue (m)
Link Distance (m)
Upstream Blk Time (%)
Queuing Penalty (veh)
Storage Bay Dist (m)
Storage Blk Time (%)
Queuing Penalty (veh)

Network Summary

Network wide Queuing Penalty: 41

Intersection: 1: Trim & H174

Movement	EB	EB	EB	WB	WB	WB	WB	WB	NB	NB	NB	NB
Directions Served	L	T	TR	L	T	T	T	R	L	L	L	T
Maximum Queue (m)	182.5	532.1	523.1	49.8	63.6	62.5	52.7	15.2	46.2	64.2	71.9	59.9
Average Queue (m)	169.1	306.3	296.6	24.6	42.9	40.2	23.6	1.7	9.6	37.9	46.4	24.2
95th Queue (m)	215.1	581.7	568.4	45.7	58.2	58.4	49.7	8.7	36.6	59.5	66.5	46.6
Link Distance (m)		697.7	697.7		488.1	488.1	488.1				360.3	360.3
Upstream Blk Time (%)		3	2									
Queuing Penalty (veh)		0	0									
Storage Bay Dist (m)	175.0			150.0				30.0	200.0	200.0		
Storage Blk Time (%)	65	2					2					2
Queuing Penalty (veh)	363	7					1					2

Intersection: 1: Trim & H174

Movement	NB	SB	SB	SB
Directions Served	R	L	T	R
Maximum Queue (m)	47.0	61.7	70.2	46.9
Average Queue (m)	3.4	28.3	26.7	7.3
95th Queue (m)	23.1	55.7	53.6	35.1
Link Distance (m)			179.2	
Upstream Blk Time (%)				
Queuing Penalty (veh)				
Storage Bay Dist (m)	40.0	150.0		40.0
Storage Blk Time (%)	0		3	0
Queuing Penalty (veh)	0		13	0

Intersection: 2: Trim & Jeanne D'Arc

Movement	EB	WB	NB	SB
Directions Served	LTR	LTR	LTR	LTR
Maximum Queue (m)	41.2	38.2	149.3	20.3
Average Queue (m)	18.5	17.1	62.9	8.6
95th Queue (m)	32.9	29.4	105.1	16.1
Link Distance (m)	185.0	134.8	179.2	79.2
Upstream Blk Time (%)				
Queuing Penalty (veh)				
Storage Bay Dist (m)				
Storage Blk Time (%)				
Queuing Penalty (veh)				

Intersection: 3: Tweddle & Jeanne D'Arc

Movement	EB	WB	NB	SB
Directions Served	LTR	LTR	LTR	LTR
Maximum Queue (m)	24.5	21.9	9.1	11.0
Average Queue (m)	14.7	11.3	1.7	3.7
95th Queue (m)	21.8	17.4	7.3	11.1
Link Distance (m)	457.6	185.0	165.8	181.0
Upstream Blk Time (%)				
Queuing Penalty (veh)				
Storage Bay Dist (m)				
Storage Blk Time (%)				
Queuing Penalty (veh)				

Intersection: 4: Tenth Line & Jeanne D'Arc

Movement	EB	WB	WB	NB	NB
Directions Served	TR	L	T	L	R
Maximum Queue (m)	37.4	50.5	18.8	22.4	57.8
Average Queue (m)	16.5	22.9	8.7	10.3	22.6
95th Queue (m)	28.2	39.0	15.5	18.2	43.3
Link Distance (m)	181.9				
Upstream Blk Time (%)					
Queuing Penalty (veh)					
Storage Bay Dist (m)		145.0			
Storage Blk Time (%)					
Queuing Penalty (veh)					

Queuing and Blocking Report

09/14/2023

Intersection: 5: Tenth Line & St. Joseph

Movement	EB	EB	EB	WB	WB	WB	NB	NB	NB	NB	SB	SB
Directions Served	L	T	T	L	T	T	L	LT	T	R	L	T
Maximum Queue (m)	38.6	53.4	52.5	28.4	42.7	67.8	97.8	116.9	102.4	57.1	13.2	54.4
Average Queue (m)	15.5	34.7	29.9	11.6	20.2	25.2	57.5	81.3	69.4	5.5	1.9	31.9
95th Queue (m)	31.2	51.0	49.0	23.9	37.2	52.6	91.9	106.6	94.0	33.2	8.3	49.0
Link Distance (m)		446.7	446.7		230.4	230.4		337.3	337.3			
Upstream Blk Time (%)												
Queuing Penalty (veh)												
Storage Bay Dist (m)	100.0			65.0			160.0			50.0	110.0	
Storage Blk Time (%)									18	0		
Queuing Penalty (veh)									2	0		

Intersection: 5: Tenth Line & St. Joseph

Movement	SB
Directions Served	T
Maximum Queue (m)	46.5
Average Queue (m)	19.0
95th Queue (m)	42.3
Link Distance (m)	
Upstream Blk Time (%)	
Queuing Penalty (veh)	
Storage Bay Dist (m)	
Storage Blk Time (%)	
Queuing Penalty (veh)	

Intersection: 6: Old Tenth Line & St. Joseph

Movement	EB	EB	WB	WB	WB	NB	SB	SB	SB	SB	SB
Directions Served	T	TR	L	T	T	R	L	L	T	T	R
Maximum Queue (m)	53.9	58.1	39.5	30.5	49.2	7.5	5.9	24.7	84.2	73.8	1.7
Average Queue (m)	25.0	30.3	16.0	13.8	22.9	0.4	0.5	4.9	49.4	38.8	0.1
95th Queue (m)	49.6	56.0	31.0	26.1	40.1	3.8	3.6	17.4	72.0	64.2	1.6
Link Distance (m)	230.4	230.4		388.9	388.9				237.7	237.7	237.7
Upstream Blk Time (%)											
Queuing Penalty (veh)											
Storage Bay Dist (m)			60.0			10.0	90.0	90.0			
Storage Blk Time (%)						0			0		
Queuing Penalty (veh)						0			0		

Intersection: 7: Tenth Line & H174 WB on-off

Movement

Directions Served
 Maximum Queue (m)
 Average Queue (m)
 95th Queue (m)
 Link Distance (m)
 Upstream Blk Time (%)
 Queuing Penalty (veh)
 Storage Bay Dist (m)
 Storage Blk Time (%)
 Queuing Penalty (veh)

Intersection: 8: West Access & Jeanne D'Arc

Movement	EB	WB	NB
Directions Served	TR	LT	LR
Maximum Queue (m)	11.5	20.3	25.2
Average Queue (m)	0.6	3.7	10.7
95th Queue (m)	6.0	13.2	19.2
Link Distance (m)		135.3	85.7
Upstream Blk Time (%)			
Queuing Penalty (veh)			
Storage Bay Dist (m)			
Storage Blk Time (%)			
Queuing Penalty (veh)			

Intersection: 9: Center Access & Jeanne D'Arc

Movement	EB	WB	NB
Directions Served	TR	LT	LR
Maximum Queue (m)	18.0	20.6	34.2
Average Queue (m)	2.1	5.9	15.2
95th Queue (m)	10.9	16.7	27.2
Link Distance (m)	135.3	119.9	103.8
Upstream Blk Time (%)			
Queuing Penalty (veh)			
Storage Bay Dist (m)			
Storage Blk Time (%)			
Queuing Penalty (veh)			

Intersection: 10: West Access & Jeanne D'Arc

Movement	EB	WB	NB
Directions Served	TR	LT	LR
Maximum Queue (m)	13.0	22.4	33.8
Average Queue (m)	0.8	8.3	15.0
95th Queue (m)	5.7	19.3	26.3
Link Distance (m)	119.9	457.6	99.3
Upstream Blk Time (%)			
Queuing Penalty (veh)			
Storage Bay Dist (m)			
Storage Blk Time (%)			
Queuing Penalty (veh)			

Intersection: 14: Jeanne D'Arc

Movement
Directions Served
Maximum Queue (m)
Average Queue (m)
95th Queue (m)
Link Distance (m)
Upstream Blk Time (%)
Queuing Penalty (veh)
Storage Bay Dist (m)
Storage Blk Time (%)
Queuing Penalty (veh)

Network Summary

Network wide Queuing Penalty: 390

Queuing and Blocking Report

09/14/2023

Intersection: 1: Trim & H174

Movement	EB	EB	EB	WB	WB	WB	WB	WB	NB	NB	NB	NB
Directions Served	L	T	TR	L	T	T	T	R	L	L	L	T
Maximum Queue (m)	87.6	47.6	49.8	17.1	48.7	45.3	27.4	5.5	67.7	93.4	101.7	30.0
Average Queue (m)	47.1	24.8	26.9	4.4	27.0	21.3	3.2	0.2	33.5	60.5	70.7	11.0
95th Queue (m)	77.5	42.3	45.1	12.6	42.9	39.0	14.7	2.9	67.3	86.1	97.1	24.6
Link Distance (m)		697.7	697.7		488.1	488.1	488.1				360.3	360.3
Upstream Blk Time (%)												
Queuing Penalty (veh)												
Storage Bay Dist (m)	175.0			150.0				30.0	200.0	200.0		
Storage Blk Time (%)								0				0
Queuing Penalty (veh)								0				0

Intersection: 1: Trim & H174

Movement	SB	SB	SB
Directions Served	L	T	R
Maximum Queue (m)	38.0	73.8	47.5
Average Queue (m)	15.3	26.2	11.3
95th Queue (m)	30.7	53.5	43.6
Link Distance (m)		179.2	
Upstream Blk Time (%)			
Queuing Penalty (veh)			
Storage Bay Dist (m)	150.0		40.0
Storage Blk Time (%)		3	1
Queuing Penalty (veh)		12	2

Intersection: 2: Trim & Jeanne D'Arc

Movement	EB	WB	NB	SB
Directions Served	LTR	LTR	LTR	LTR
Maximum Queue (m)	34.2	77.6	99.6	24.5
Average Queue (m)	16.9	28.7	40.0	10.8
95th Queue (m)	29.2	56.7	74.8	20.4
Link Distance (m)	185.0	134.8	179.2	79.2
Upstream Blk Time (%)				
Queuing Penalty (veh)				
Storage Bay Dist (m)				
Storage Blk Time (%)				
Queuing Penalty (veh)				

Intersection: 3: Tweddle & Jeanne D'Arc

Movement	EB	WB	NB	SB
Directions Served	LTR	LTR	LTR	LTR
Maximum Queue (m)	25.5	19.0	9.1	9.9
Average Queue (m)	13.3	10.5	1.7	3.3
95th Queue (m)	21.5	15.6	7.4	10.5
Link Distance (m)	457.6	185.0	165.8	181.0
Upstream Blk Time (%)				
Queuing Penalty (veh)				
Storage Bay Dist (m)				
Storage Blk Time (%)				
Queuing Penalty (veh)				

Intersection: 4: Tenth Line & Jeanne D'Arc

Movement	EB	WB	WB	NB	NB
Directions Served	TR	L	T	L	R
Maximum Queue (m)	20.1	33.4	20.1	22.5	24.2
Average Queue (m)	11.3	17.9	10.3	9.3	9.6
95th Queue (m)	17.8	27.5	16.4	16.5	18.0
Link Distance (m)	181.9				
Upstream Blk Time (%)					
Queuing Penalty (veh)					
Storage Bay Dist (m)		145.0			
Storage Blk Time (%)					
Queuing Penalty (veh)					

Intersection: 5: Tenth Line & St. Joseph

Movement	EB	EB	EB	WB	WB	WB	NB	NB	NB	NB	SB	SB
Directions Served	L	T	T	L	T	T	L	LT	T	R	L	T
Maximum Queue (m)	16.7	28.4	20.8	22.5	47.5	52.2	116.6	130.4	123.2	57.5	11.2	45.7
Average Queue (m)	6.5	11.6	5.0	6.5	25.2	28.2	69.8	94.8	83.5	6.0	1.4	26.9
95th Queue (m)	15.7	22.6	14.4	16.9	42.4	46.4	105.5	124.3	112.5	34.9	6.7	42.0
Link Distance (m)		446.7	446.7		230.4	230.4		337.3	337.3			
Upstream Blk Time (%)												
Queuing Penalty (veh)												
Storage Bay Dist (m)	100.0			65.0			160.0			50.0	110.0	
Storage Blk Time (%)									26	0		
Queuing Penalty (veh)									5	0		

Intersection: 5: Tenth Line & St. Joseph

Movement	SB	SB
Directions Served	T	R
Maximum Queue (m)	39.6	3.5
Average Queue (m)	15.1	0.1
95th Queue (m)	35.7	3.4
Link Distance (m)		
Upstream Blk Time (%)		
Queuing Penalty (veh)		
Storage Bay Dist (m)		70.0
Storage Blk Time (%)		
Queuing Penalty (veh)		

Intersection: 6: Old Tenth Line & St. Joseph

Movement	EB	EB	WB	WB	WB	NB	SB	SB	SB	SB
Directions Served	T	TR	L	T	T	R	L	L	T	T
Maximum Queue (m)	15.7	24.4	17.7	36.5	35.9	9.8	5.9	18.0	44.5	34.1
Average Queue (m)	4.4	6.1	4.0	17.2	17.3	0.5	0.4	4.6	23.6	9.7
95th Queue (m)	11.6	16.8	12.1	30.3	31.0	4.4	3.1	13.2	38.8	23.6
Link Distance (m)	230.4	230.4		388.9	388.9				237.7	237.7
Upstream Blk Time (%)										
Queuing Penalty (veh)										
Storage Bay Dist (m)			60.0			10.0	90.0	90.0		
Storage Blk Time (%)						0				
Queuing Penalty (veh)						0				

Intersection: 7: Tenth Line & H174 WB on-off

Movement	SB	SB
Directions Served	T	R
Maximum Queue (m)	2.8	2.3
Average Queue (m)	0.1	0.1
95th Queue (m)	2.8	2.2
Link Distance (m)	295.6	
Upstream Blk Time (%)		
Queuing Penalty (veh)		
Storage Bay Dist (m)	50.0	
Storage Blk Time (%)		
Queuing Penalty (veh)		

Intersection: 8: West Access & Jeanne D'Arc

Movement	EB	WB	NB
Directions Served	TR	LT	LR
Maximum Queue (m)	2.4	14.5	19.5
Average Queue (m)	0.1	1.1	8.9
95th Queue (m)	1.8	7.4	15.6
Link Distance (m)		135.3	85.7
Upstream Blk Time (%)			
Queuing Penalty (veh)			
Storage Bay Dist (m)			
Storage Blk Time (%)			
Queuing Penalty (veh)			

Intersection: 9: Center Access & Jeanne D'Arc

Movement	EB	WB	NB
Directions Served	TR	LT	LR
Maximum Queue (m)	7.1	13.8	25.4
Average Queue (m)	0.3	1.7	10.7
95th Queue (m)	3.5	8.3	19.3
Link Distance (m)	135.3	119.9	103.8
Upstream Blk Time (%)			
Queuing Penalty (veh)			
Storage Bay Dist (m)			
Storage Blk Time (%)			
Queuing Penalty (veh)			

Intersection: 10: West Access & Jeanne D'Arc

Movement	EB	WB	NB
Directions Served	TR	LT	LR
Maximum Queue (m)	6.9	17.0	21.5
Average Queue (m)	0.3	3.5	11.0
95th Queue (m)	2.9	12.3	18.0
Link Distance (m)	119.9	457.6	99.3
Upstream Blk Time (%)			
Queuing Penalty (veh)			
Storage Bay Dist (m)			
Storage Blk Time (%)			
Queuing Penalty (veh)			

Intersection: 14: Jeanne D'Arc

Movement
Directions Served
Maximum Queue (m)
Average Queue (m)
95th Queue (m)
Link Distance (m)
Upstream Blk Time (%)
Queuing Penalty (veh)
Storage Bay Dist (m)
Storage Blk Time (%)
Queuing Penalty (veh)

Network Summary

Network wide Queuing Penalty: 20

Intersection: 1: Trim & H174

Movement	EB	EB	EB	WB	WB	WB	WB	WB	NB	NB	NB	NB
Directions Served	L	T	TR	L	T	T	T	R	L	L	L	T
Maximum Queue (m)	170.6	263.6	259.9	58.5	62.7	63.6	55.9	12.8	45.8	64.7	72.0	52.4
Average Queue (m)	141.4	159.6	158.4	30.9	43.2	40.9	25.3	1.5	9.7	37.7	47.1	21.2
95th Queue (m)	213.9	309.0	298.3	55.3	59.0	58.6	52.2	7.4	36.8	60.8	66.4	41.3
Link Distance (m)		697.7	697.7		488.1	488.1	488.1				360.3	360.3
Upstream Blk Time (%)												
Queuing Penalty (veh)												
Storage Bay Dist (m)	175.0			150.0				30.0	200.0	200.0		
Storage Blk Time (%)	29	0						3				1
Queuing Penalty (veh)	163	2						2				1

Intersection: 1: Trim & H174

Movement	NB	SB	SB	SB
Directions Served	R	L	T	R
Maximum Queue (m)	28.2	52.3	66.6	46.1
Average Queue (m)	1.5	24.0	24.7	4.4
95th Queue (m)	15.2	45.7	49.1	26.8
Link Distance (m)			179.2	
Upstream Blk Time (%)				
Queuing Penalty (veh)				
Storage Bay Dist (m)	40.0	150.0		40.0
Storage Blk Time (%)	0		2	0
Queuing Penalty (veh)	0		9	0

Intersection: 2: Trim & Jeanne D'Arc

Movement	EB	WB	NB	SB
Directions Served	LTR	LTR	LTR	LTR
Maximum Queue (m)	35.3	33.1	116.0	19.1
Average Queue (m)	16.0	16.7	56.6	8.6
95th Queue (m)	27.4	27.8	89.6	15.2
Link Distance (m)	185.0	134.8	179.2	79.2
Upstream Blk Time (%)				
Queuing Penalty (veh)				
Storage Bay Dist (m)				
Storage Blk Time (%)				
Queuing Penalty (veh)				

Intersection: 3: Tweddle & Jeanne D'Arc

Movement	EB	WB	NB	SB
Directions Served	LTR	LTR	LTR	LTR
Maximum Queue (m)	22.1	21.0	9.1	10.0
Average Queue (m)	13.6	10.4	1.8	3.9
95th Queue (m)	20.3	15.3	7.7	11.3
Link Distance (m)	457.6	185.0	165.8	181.0
Upstream Blk Time (%)				
Queuing Penalty (veh)				
Storage Bay Dist (m)				
Storage Blk Time (%)				
Queuing Penalty (veh)				

Intersection: 4: Tenth Line & Jeanne D'Arc

Movement	EB	WB	WB	NB	NB
Directions Served	TR	L	T	L	R
Maximum Queue (m)	29.6	35.7	19.5	22.3	38.6
Average Queue (m)	15.2	17.8	8.2	10.0	15.5
95th Queue (m)	25.0	27.6	15.6	17.3	28.2
Link Distance (m)	181.9				
Upstream Blk Time (%)					
Queuing Penalty (veh)					
Storage Bay Dist (m)		145.0			
Storage Blk Time (%)					
Queuing Penalty (veh)					

Intersection: 5: Tenth Line & St. Joseph

Movement	EB	EB	EB	WB	WB	WB	NB	NB	NB	NB	SB	SB
Directions Served	L	T	T	L	T	T	L	LT	T	R	L	T
Maximum Queue (m)	37.1	59.8	58.4	32.4	38.9	43.6	95.4	113.8	105.9	51.5	11.4	49.2
Average Queue (m)	15.1	35.0	29.7	13.4	18.8	22.9	56.6	79.7	68.2	4.1	1.5	28.8
95th Queue (m)	31.1	52.4	50.7	26.1	33.7	38.8	91.2	107.0	95.8	28.4	6.9	45.5
Link Distance (m)		446.7	446.7		230.4	230.4		337.3	337.3			
Upstream Blk Time (%)												
Queuing Penalty (veh)												
Storage Bay Dist (m)	100.0			65.0			160.0			50.0	110.0	
Storage Blk Time (%)									17	0		
Queuing Penalty (veh)									2	0		

Intersection: 5: Tenth Line & St. Joseph

Movement	SB
Directions Served	T
Maximum Queue (m)	42.0
Average Queue (m)	15.5
95th Queue (m)	37.0
Link Distance (m)	
Upstream Blk Time (%)	
Queuing Penalty (veh)	
Storage Bay Dist (m)	
Storage Blk Time (%)	
Queuing Penalty (veh)	

Intersection: 6: Old Tenth Line & St. Joseph

Movement	EB	EB	WB	WB	WB	NB	SB	SB	SB	SB	SB
Directions Served	T	TR	L	T	T	R	L	L	T	T	R
Maximum Queue (m)	55.9	59.3	38.5	31.1	46.0	10.8	6.6	16.4	73.8	67.4	1.6
Average Queue (m)	24.3	30.0	15.1	14.7	21.7	0.6	0.2	4.8	49.5	39.2	0.1
95th Queue (m)	49.3	56.0	31.1	26.8	39.1	5.0	2.6	12.9	68.5	62.8	1.5
Link Distance (m)	230.4	230.4		388.9	388.9				237.7	237.7	237.7
Upstream Blk Time (%)											
Queuing Penalty (veh)											
Storage Bay Dist (m)			60.0			10.0	90.0	90.0			
Storage Blk Time (%)			0			0					
Queuing Penalty (veh)			0			0					

Intersection: 7: Tenth Line & H174 WB on-off

Movement
Directions Served
Maximum Queue (m)
Average Queue (m)
95th Queue (m)
Link Distance (m)
Upstream Blk Time (%)
Queuing Penalty (veh)
Storage Bay Dist (m)
Storage Blk Time (%)
Queuing Penalty (veh)

Intersection: 8: West Access & Jeanne D'Arc

Movement	EB	WB	NB
Directions Served	TR	LT	LR
Maximum Queue (m)	8.4	14.5	20.8
Average Queue (m)	0.4	1.6	8.6
95th Queue (m)	4.1	8.2	15.8
Link Distance (m)		135.3	85.7
Upstream Blk Time (%)			
Queuing Penalty (veh)			
Storage Bay Dist (m)			
Storage Blk Time (%)			
Queuing Penalty (veh)			

Intersection: 9: Center Access & Jeanne D'Arc

Movement	EB	WB	NB
Directions Served	TR	LT	LR
Maximum Queue (m)	14.4	14.5	23.2
Average Queue (m)	1.2	3.1	10.7
95th Queue (m)	7.6	10.9	19.5
Link Distance (m)	135.3	119.9	103.8
Upstream Blk Time (%)			
Queuing Penalty (veh)			
Storage Bay Dist (m)			
Storage Blk Time (%)			
Queuing Penalty (veh)			

Intersection: 10: West Access & Jeanne D'Arc

Movement	EB	WB	NB
Directions Served	TR	LT	LR
Maximum Queue (m)	9.3	20.4	24.4
Average Queue (m)	0.5	5.8	10.9
95th Queue (m)	3.8	16.8	18.5
Link Distance (m)	119.9	457.6	99.3
Upstream Blk Time (%)			
Queuing Penalty (veh)			
Storage Bay Dist (m)			
Storage Blk Time (%)			
Queuing Penalty (veh)			

Intersection: 14: Jeanne D'Arc

Movement
Directions Served
Maximum Queue (m)
Average Queue (m)
95th Queue (m)
Link Distance (m)
Upstream Blk Time (%)
Queuing Penalty (veh)
Storage Bay Dist (m)
Storage Blk Time (%)
Queuing Penalty (veh)

Network Summary

Network wide Queuing Penalty: 179

Intersection: 1: Trim & H174

Movement	EB	EB	EB	WB	WB	WB	WB	WB	NB	NB	NB	NB
Directions Served	L	T	TR	L	T	T	T	R	L	L	L	T
Maximum Queue (m)	98.7	153.6	152.8	48.4	59.9	59.1	50.7	14.3	44.1	61.7	73.6	55.6
Average Queue (m)	59.1	88.3	92.1	22.9	39.1	36.0	20.1	1.4	5.7	35.1	44.7	22.5
95th Queue (m)	89.7	132.7	134.7	42.1	56.0	55.4	46.7	7.6	27.9	58.8	64.1	44.9
Link Distance (m)		697.7	697.7		488.1	488.1	488.1				360.3	360.3
Upstream Blk Time (%)												
Queuing Penalty (veh)												
Storage Bay Dist (m)	175.0			150.0				30.0	200.0	200.0		
Storage Blk Time (%)		0					2					2
Queuing Penalty (veh)		0					1					2

Intersection: 1: Trim & H174

Movement	NB	SB	SB	SB
Directions Served	R	L	T	R
Maximum Queue (m)	42.4	47.2	58.9	42.4
Average Queue (m)	2.9	18.0	24.3	4.2
95th Queue (m)	21.5	37.8	47.9	26.2
Link Distance (m)			179.2	
Upstream Blk Time (%)				
Queuing Penalty (veh)				
Storage Bay Dist (m)	40.0	150.0		40.0
Storage Blk Time (%)	0		2	0
Queuing Penalty (veh)	0		7	0

Intersection: 2: Trim & Jeanne D'Arc

Movement	EB	WB	NB	SB
Directions Served	LTR	LTR	LTR	LTR
Maximum Queue (m)	23.2	32.3	111.1	17.7
Average Queue (m)	10.4	15.5	42.5	8.0
95th Queue (m)	17.7	26.0	78.9	14.7
Link Distance (m)	185.0	134.8	179.2	79.2
Upstream Blk Time (%)				
Queuing Penalty (veh)				
Storage Bay Dist (m)				
Storage Blk Time (%)				
Queuing Penalty (veh)				

Intersection: 3: Tweddle & Jeanne D'Arc

Movement	EB	WB	NB	SB
Directions Served	LTR	LTR	LTR	LTR
Maximum Queue (m)	20.7	11.9	8.1	9.3
Average Queue (m)	11.1	9.0	1.4	3.7
95th Queue (m)	17.9	12.0	6.7	11.0
Link Distance (m)	457.6	185.0	165.8	181.0
Upstream Blk Time (%)				
Queuing Penalty (veh)				
Storage Bay Dist (m)				
Storage Blk Time (%)				
Queuing Penalty (veh)				

Intersection: 4: Tenth Line & Jeanne D'Arc

Movement	EB	WB	WB	NB	NB
Directions Served	TR	L	T	L	R
Maximum Queue (m)	26.6	20.0	19.6	19.7	19.2
Average Queue (m)	13.5	10.7	8.6	9.6	8.5
95th Queue (m)	21.7	16.4	15.7	16.4	15.1
Link Distance (m)	181.9				
Upstream Blk Time (%)					
Queuing Penalty (veh)					
Storage Bay Dist (m)		145.0			
Storage Blk Time (%)					
Queuing Penalty (veh)					

Intersection: 5: Tenth Line & St. Joseph

Movement	EB	EB	EB	WB	WB	WB	NB	NB	NB	NB	SB	SB
Directions Served	L	T	T	L	T	T	L	LT	T	R	L	T
Maximum Queue (m)	31.7	55.0	53.8	31.8	43.4	44.9	93.3	113.9	103.3	56.6	9.5	43.4
Average Queue (m)	10.8	33.5	29.4	12.3	19.5	23.4	54.3	77.4	65.1	3.4	1.8	24.1
95th Queue (m)	24.1	50.6	49.4	25.8	35.8	39.2	86.3	104.7	94.0	25.6	7.1	39.5
Link Distance (m)		446.7	446.7		230.4	230.4		337.3	337.3			
Upstream Blk Time (%)												
Queuing Penalty (veh)												
Storage Bay Dist (m)	100.0			65.0			160.0			50.0	110.0	
Storage Blk Time (%)						0			14	0		
Queuing Penalty (veh)						0			2	0		

Intersection: 5: Tenth Line & St. Joseph

Movement	SB
Directions Served	T
Maximum Queue (m)	38.6
Average Queue (m)	11.5
95th Queue (m)	31.4
Link Distance (m)	
Upstream Blk Time (%)	
Queuing Penalty (veh)	
Storage Bay Dist (m)	
Storage Blk Time (%)	
Queuing Penalty (veh)	

Intersection: 6: Old Tenth Line & St. Joseph

Movement	EB	EB	WB	WB	WB	NB	NB	SB	SB	SB	SB	SB
Directions Served	T	TR	L	T	T	L	R	L	L	T	T	R
Maximum Queue (m)	56.8	60.0	37.4	35.9	37.5	0.6	8.8	5.1	16.4	73.0	65.9	1.3
Average Queue (m)	24.6	30.0	15.0	17.6	18.1	0.0	0.5	0.3	4.2	49.4	39.4	0.0
95th Queue (m)	50.1	56.7	30.6	30.1	31.9	0.6	4.4	3.0	12.0	68.5	61.6	1.3
Link Distance (m)	230.4	230.4		388.9	388.9	242.0				237.7	237.7	237.7
Upstream Blk Time (%)												
Queuing Penalty (veh)												
Storage Bay Dist (m)			60.0				10.0	90.0	90.0			
Storage Blk Time (%)						0	0					
Queuing Penalty (veh)						0	0					

Intersection: 7: Tenth Line & H174 WB on-off

Movement

Directions Served
Maximum Queue (m)
Average Queue (m)
95th Queue (m)
Link Distance (m)
Upstream Blk Time (%)
Queuing Penalty (veh)
Storage Bay Dist (m)
Storage Blk Time (%)
Queuing Penalty (veh)

Intersection: 8: West Access & Jeanne D'Arc

Movement

Directions Served
Maximum Queue (m)
Average Queue (m)
95th Queue (m)
Link Distance (m)
Upstream Blk Time (%)
Queuing Penalty (veh)
Storage Bay Dist (m)
Storage Blk Time (%)
Queuing Penalty (veh)

Intersection: 9: Center Access & Jeanne D'Arc

Movement

Directions Served
Maximum Queue (m)
Average Queue (m)
95th Queue (m)
Link Distance (m)
Upstream Blk Time (%)
Queuing Penalty (veh)
Storage Bay Dist (m)
Storage Blk Time (%)
Queuing Penalty (veh)

Intersection: 10: West Access & Jeanne D'Arc

Movement

Directions Served
Maximum Queue (m)
Average Queue (m)
95th Queue (m)
Link Distance (m)
Upstream Blk Time (%)
Queuing Penalty (veh)
Storage Bay Dist (m)
Storage Blk Time (%)
Queuing Penalty (veh)

Intersection: 14: Jeanne D'Arc

Movement

Directions Served
Maximum Queue (m)
Average Queue (m)
95th Queue (m)
Link Distance (m)
Upstream Blk Time (%)
Queuing Penalty (veh)
Storage Bay Dist (m)
Storage Blk Time (%)
Queuing Penalty (veh)

Network Summary

Network wide Queuing Penalty: 12

Intersection: 1: Trim & H174

Movement	EB	EB	EB	EB	WB	WB	WB	WB	WB	NB	NB	NB
Directions Served	L	L	T	TR	L	T	T	T	R	L	L	L
Maximum Queue (m)	74.6	87.4	183.6	178.9	58.1	61.9	59.3	49.9	18.7	45.8	64.9	71.8
Average Queue (m)	42.2	69.8	111.6	113.4	26.1	40.3	38.0	21.6	2.2	8.0	37.1	46.5
95th Queue (m)	67.7	108.2	167.9	166.5	48.6	55.8	55.8	46.3	10.3	32.6	60.4	65.6
Link Distance (m)			697.6	697.6		483.8	483.8	483.8				358.5
Upstream Blk Time (%)												
Queuing Penalty (veh)												
Storage Bay Dist (m)	80.0	80.0			150.0				30.0	200.0	200.0	
Storage Blk Time (%)	0	0	17					2	0			
Queuing Penalty (veh)	1	2	67					1	0			

Intersection: 1: Trim & H174

Movement	NB	NB	SB	SB	SB
Directions Served	T	R	L	T	R
Maximum Queue (m)	58.2	32.8	59.3	97.4	46.9
Average Queue (m)	23.7	3.2	29.0	29.3	7.2
95th Queue (m)	46.4	22.7	57.8	67.7	35.0
Link Distance (m)	358.5			176.5	
Upstream Blk Time (%)					
Queuing Penalty (veh)					
Storage Bay Dist (m)		40.0	150.0		40.0
Storage Blk Time (%)	2	0		4	0
Queuing Penalty (veh)	3	0		15	1

Intersection: 2: Trim & Jeanne D'Arc

Movement	EB	WB	NB	NB	SB
Directions Served	LTR	LTR	LT	TR	LTR
Maximum Queue (m)	48.3	45.8	79.3	99.3	20.1
Average Queue (m)	20.4	17.9	28.4	34.9	8.6
95th Queue (m)	37.8	32.6	56.0	70.1	16.6
Link Distance (m)	185.0	131.1	176.5	176.5	79.2
Upstream Blk Time (%)				0	
Queuing Penalty (veh)				0	
Storage Bay Dist (m)					
Storage Blk Time (%)					
Queuing Penalty (veh)					

Intersection: 3: Tweddle & Jeanne D'Arc

Movement	EB	WB	NB	SB
Directions Served	LTR	LTR	LTR	LTR
Maximum Queue (m)	25.5	25.3	9.1	9.9
Average Queue (m)	15.0	12.3	1.9	3.8
95th Queue (m)	22.1	19.8	7.8	11.2
Link Distance (m)	457.6	185.0	165.8	181.0
Upstream Blk Time (%)				
Queuing Penalty (veh)				
Storage Bay Dist (m)				
Storage Blk Time (%)				
Queuing Penalty (veh)				

Intersection: 4: Tenth Line & Jeanne D'Arc

Movement	EB	WB	WB	NB	NB
Directions Served	TR	L	T	L	R
Maximum Queue (m)	33.6	51.3	19.4	22.2	53.3
Average Queue (m)	15.6	24.3	8.5	10.7	21.2
95th Queue (m)	25.9	39.9	16.4	18.2	38.5
Link Distance (m)	181.9				
Upstream Blk Time (%)					
Queuing Penalty (veh)					
Storage Bay Dist (m)		145.0			
Storage Blk Time (%)					
Queuing Penalty (veh)					

Intersection: 5: Tenth Line & St. Joseph

Movement	EB	EB	EB	WB	WB	WB	WB	NB	NB	NB	NB	SB
Directions Served	L	T	T	L	T	T	R	L	LT	T	R	L
Maximum Queue (m)	39.0	56.3	54.6	33.1	41.1	46.6	2.5	99.2	118.3	105.2	57.3	11.7
Average Queue (m)	14.9	33.0	28.6	12.7	19.2	23.1	0.1	56.9	81.3	70.1	3.4	1.9
95th Queue (m)	30.5	49.5	48.3	26.1	35.1	40.2	2.4	92.1	107.9	96.6	25.6	7.7
Link Distance (m)		446.7	446.7		230.4	230.4	230.4		337.3	337.3		
Upstream Blk Time (%)												
Queuing Penalty (veh)												
Storage Bay Dist (m)	100.0			65.0				160.0			50.0	110.0
Storage Blk Time (%)										17	0	
Queuing Penalty (veh)										2	0	

Intersection: 5: Tenth Line & St. Joseph

Movement	SB	SB
Directions Served	T	T
Maximum Queue (m)	54.8	47.0
Average Queue (m)	33.5	21.6
95th Queue (m)	50.5	44.6
Link Distance (m)		
Upstream Blk Time (%)		
Queuing Penalty (veh)		
Storage Bay Dist (m)		
Storage Blk Time (%)		
Queuing Penalty (veh)		

Intersection: 6: Old Tenth Line & St. Joseph

Movement	EB	EB	WB	WB	WB	NB	NB	SB	SB	SB	SB
Directions Served	T	TR	L	T	T	L	R	L	L	T	T
Maximum Queue (m)	52.4	62.0	36.7	29.7	45.1	1.1	11.4	4.8	17.4	75.5	68.5
Average Queue (m)	23.9	30.2	14.9	13.5	22.3	0.0	0.5	0.2	5.0	49.5	37.7
95th Queue (m)	47.5	55.0	30.3	25.7	39.8	0.8	4.7	2.7	13.2	69.4	60.9
Link Distance (m)	230.4	230.4		388.9	388.9	242.0				237.7	237.7
Upstream Blk Time (%)											
Queuing Penalty (veh)											
Storage Bay Dist (m)			60.0				10.0	90.0	90.0		
Storage Blk Time (%)			0			0	0				
Queuing Penalty (veh)			0			0	0				

Intersection: 7: Tenth Line & H174 WB on-off

Movement	SB
Directions Served	R
Maximum Queue (m)	4.1
Average Queue (m)	0.1
95th Queue (m)	2.9
Link Distance (m)	
Upstream Blk Time (%)	
Queuing Penalty (veh)	
Storage Bay Dist (m)	50.0
Storage Blk Time (%)	
Queuing Penalty (veh)	

Intersection: 8: West Access & Jeanne D'Arc

Movement	EB	WB	NB
Directions Served	TR	LT	LR
Maximum Queue (m)	13.1	21.6	22.1
Average Queue (m)	0.7	3.2	10.3
95th Queue (m)	6.1	13.4	17.4
Link Distance (m)		135.3	85.7
Upstream Blk Time (%)			
Queuing Penalty (veh)			
Storage Bay Dist (m)			
Storage Blk Time (%)			
Queuing Penalty (veh)			

Intersection: 9: Center Access & Jeanne D'Arc

Movement	EB	WB	NB
Directions Served	TR	LT	LR
Maximum Queue (m)	19.8	23.5	37.2
Average Queue (m)	1.9	6.2	15.8
95th Queue (m)	10.6	18.0	28.8
Link Distance (m)	135.3	119.9	103.8
Upstream Blk Time (%)			
Queuing Penalty (veh)			
Storage Bay Dist (m)			
Storage Blk Time (%)			
Queuing Penalty (veh)			

Intersection: 10: West Access & Jeanne D'Arc

Movement	EB	WB	NB
Directions Served	TR	LT	LR
Maximum Queue (m)	14.9	25.4	37.0
Average Queue (m)	1.0	9.3	16.3
95th Queue (m)	7.0	21.5	29.0
Link Distance (m)	119.9	457.6	99.3
Upstream Blk Time (%)			
Queuing Penalty (veh)			
Storage Bay Dist (m)			
Storage Blk Time (%)			
Queuing Penalty (veh)			

Intersection: 14: Jeanne D'Arc

Movement
Directions Served
Maximum Queue (m)
Average Queue (m)
95th Queue (m)
Link Distance (m)
Upstream Blk Time (%)
Queuing Penalty (veh)
Storage Bay Dist (m)
Storage Blk Time (%)
Queuing Penalty (veh)

Network Summary

Network wide Queuing Penalty: 92