

50 Bayswater Avenue, 1088 Somerset Street West

Transportation Impact Assessment

Step 1 Screening Report

Step 2 Scoping Report

Step 3 Strategy Report

Prepared for:

Manor Park Management
231 Brittany Drive, Suite D
Ottawa, ON K1K 0R8

Prepared by:



6 Plaza Court
Ottawa, ON K2H 7W1

November 2023

PN: 2023-020

Table of Contents

1	Screening.....	1
2	Existing and Planned Conditions.....	1
2.1	Proposed Development.....	1
2.2	Existing Conditions.....	3
2.2.1	Area Road Network.....	3
2.2.2	Existing Intersections.....	4
2.2.3	Existing Driveways.....	4
2.2.4	Cycling and Pedestrian Facilities.....	5
2.2.5	Existing Transit.....	8
2.2.6	Existing Area Traffic Management Measures.....	10
2.2.7	Existing Peak Hour Travel Demand.....	10
2.2.8	Collision Analysis.....	12
2.3	Planned Conditions.....	14
2.3.2	Other Study Area Developments.....	14
3	Study Area and Time Periods.....	15
3.1	Study Area.....	15
3.2	Time Periods.....	15
3.3	Horizon Years.....	15
4	Development-Generated Travel Demand.....	15
4.1	Mode Shares.....	15
4.2	Trip Distribution.....	17
4.3	Trip Assignment.....	17
4.4	Trip Reductions.....	19
5	Exemption Review.....	21
6	Development Design.....	23
6.1	Design for Sustainable Modes.....	23
6.2	Circulation and Access.....	23
7	Parking.....	23
7.1	Parking Supply.....	23
8	Boundary Street Design.....	24
9	Transportation Demand Management.....	24
9.1	Context for TDM.....	24
9.2	Need and Opportunity.....	24
9.3	TDM Program.....	24
10	Summary of Improvements Indicated and Modifications Options.....	25
11	Conclusion.....	27

List of Figures

Figure 1:	Area Context Plan.....	1
Figure 2:	Concept Plan.....	2
Figure 3:	Existing Driveways.....	5

Figure 4: Study Area Pedestrian Facilities6
 Figure 5: Study Area Cycling Facilities6
 Figure 6: Existing Pedestrian Volumes7
 Figure 7: Existing Cyclist Volumes8
 Figure 8: Existing Study Area Transit Service.....9
 Figure 9: Existing Study Area Transit Stops9
 Figure 10: Existing Traffic Counts 11
 Figure 11: Study Area Collision Records..... 13
 Figure 12: New Site Generation Auto Volumes..... 18
 Figure 13: Pass-By Auto Volumes..... 19
 Figure 14: Estimated Trip Reductions..... 20
 Figure 15: Net Auto Volumes 21

Table of Tables

Table 1: Intersection Count Date..... 10
 Table 2: Existing Intersection Operations..... 11
 Table 3: Study Area Collision Summary, 2018-2022 13
 Table 4: Summary of Collision Locations, 2018-2022..... 13
 Table 5: TRANS Trip Generation Manual Recommended Mode Shares – Ottawa West 15
 Table 6: Proposed Development Mode Shares – Within 400 m of Rapid Transit..... 16
 Table 7: Total Person Trip Generation 16
 Table 8: Internal Capture Rates..... 16
 Table 9: Trip Generation by Mode 16
 Table 10: OD Survey Distribution – Ottawa West 17
 Table 11: Trip Assignment 17
 Table 12: Estimated Existing Auto Trip Volumes vs Forecasted Auto Trip Volumes..... 20
 Table 13: Exemption Review 21
 Table 14: Boundary Street MMLOS Analysis 24

List of Appendices

- Appendix A – TIA Screening Form and Certification Form
- Appendix B – Turning Movement Count Data
- Appendix C – Synchro Intersection Worksheets – Existing Conditions
- Appendix D – Collision Data
- Appendix E – TDM Checklist
- Appendix F – MMLOS Analysis

1 Screening

This study has been prepared according to the City of Ottawa’s 2017 Transportation Impact Assessment (TIA) Guidelines, incorporating the 2023 Revision to Transportation Impact Assessment Guidelines. Accordingly, a Step 1 Screening Form has been prepared and is included as Appendix A, along with the Certification Form for the TIA Study PM. As shown in the Screening Form, a TIA is required, and this study has been prepared to support zoning bylaw amendment and future site plan applications.

2 Existing and Planned Conditions

2.1 Proposed Development

The development site is located at 50 Bayswater Avenue and 1088 Somerset Street West and is zoned as traditional Mainstreet Zone (TM11) and Residential Fourth Density Zone (R4UB). The development proposed a new 15-storey mixed-used building extension on the existing residential tower to the front along Somerset Street West at 50 Bayswater Avenue with a total of 80 residential units and 2,620 sq. ft commercial space, and a new 6-storey mixed-used building with a total of 21 units at 1088 Somerset Street West. The two parcels are divided by an existing City Laneway. The existing access on Bayswater Avenue to the existing parking will remain and serve the proposed redevelopment. The relocation of access to the City Laneway to the existing parking is proposed for the existing buildings at 50 Bayswater Avenue. The development proposed 16 vehicle parking spaces and 522 bicycle parking spaces located underground at 50 Bayswater Avenue. No parking and new accesses are proposed for 1088 Somerset Street West. The anticipated full build-out and occupancy horizon is 2027. The development site is within the Wellington Street Community Design Plan area. Figure 1 illustrates the study area context. Figure 2 illustrates the proposed concept plan.

Figure 1: Area Context Plan

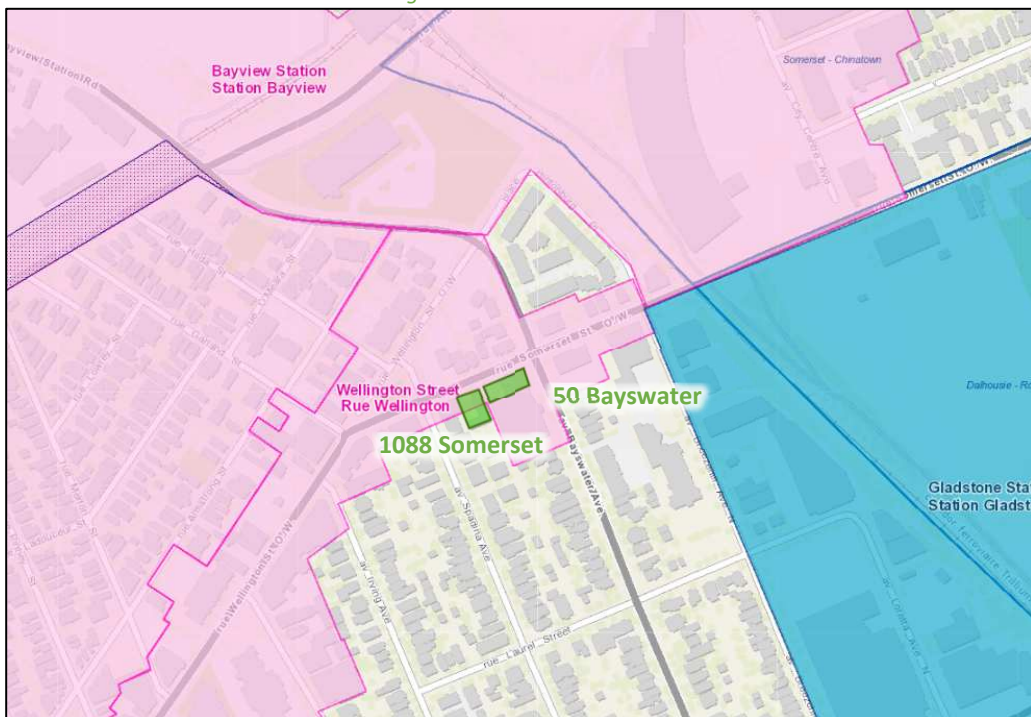

Source: <http://maps.ottawa.ca/geoOttawa/> Accessed: October 27, 2023

Figure 2: Concept Plan

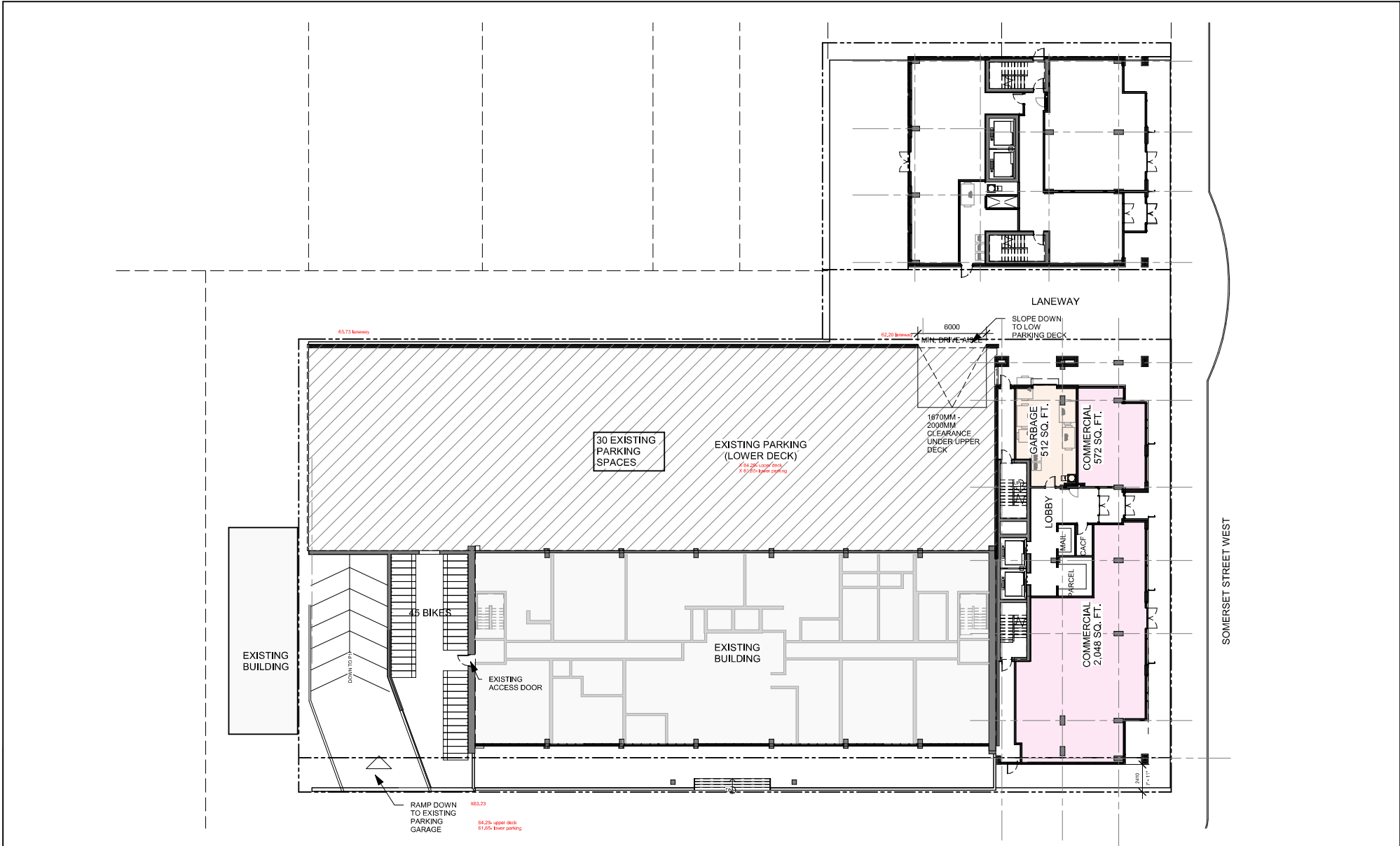

2.2 Existing Conditions

2.2.1 Area Road Network

Scott Street: Scott Street is a City of Ottawa arterial road with a four-lane urban cross-section including two outside-lane transit priority lanes. A sidewalk and a curbside bike lane are present on the south side of the road and a MUP is present on the north side of the road. Within the study area, the posted speed limit is 50 km/h, and the Official Plan reserves a right-of-way of 26.0 metres. Scott Street is designated as a truck route.

Albert Street: Albert Street is a City of Ottawa arterial road with a four-lane urban cross-section including two outside-lane transit priority lanes. Within the study area, sidewalks are present on both sides of the street. The posted speed limit is 50 km/h and the Official Plan right-of-way is subject to widening/easement policy on the north side. Albert Street is designated as a truck route.

Wellington Street West: Wellington Street West is a City of Ottawa arterial road with a two-lane urban cross-section and on-street parking lanes, with the exception of the north side between Garland Street and Irving Avenue. Sidewalks are present on both sides of the road. The posted speed limit is 50 km/h. The Official Plan reserves a right-of-way of 20.0 metres within the study area. Wellington Street West is designated as a truck route.

Somerset Street West: Somerset Street West is a City of Ottawa arterial road with a two-lane urban cross-section and on-street parking lanes, with the exception of the north side between Spadina Avenue and Garland Street and on the bridge east of Breezehill Avenue North. Sidewalks are provided on both sides of the road. Curbside bike lanes are present east of Breezehill Avenue North. The posted speed limit is 50 km/h. The Official Plan reserves a right-of-way of 20.0 metres east of Breezehill Avenue North within the study area, and the existing right-of-way is 20.0 metres west of Breezehill Avenue North. Somerset Street West is designated as a truck route.

Bayview Station Road: Bayview Station Road is a City of Ottawa collector road with a two-lane urban cross-section and on-street parking lanes. Sidewalks are provided on both sides of the road. The unposted speed limit is assumed to be 50 km/h. The Official Plan reserves a right-of-way of 24.0 metres.

Bayswater Avenue: Bayswater Avenue is a City of Ottawa collector road with a two-lane urban cross-section. Sidewalks are present on both sides of the road and on-street parking is permitted on the west side of the road starting approximately 90 metres south of Somerset Street West. The posted speed limit is 30 km/h south of Somerset Street West, and the unposted speed limit is assumed to be 50 km/h north of Somerset Street West. The Official Plan reserves a right-of-way of 24.0 metres north of Somerset Street West, and the existing right-of-way is 25.0 metres south of Somerset Street West. North of Somerset Street West, Bayswater Avenue is designated as a truck route.

Fairmont Avenue: Fairmont Avenue is a City of Ottawa local road with a two-lane urban cross-section. Sidewalks are present on both sides of the road and on-street parking is permitted on the west side of the road. The posted speed limit is 40 km/h and the existing right of way is 19.0 metres.

Garland Street: Garland Street is a City of Ottawa local road with a two-lane urban cross-section north of Armstrong Street, and a one-lane urban cross-section south of Armstrong Street where it is one-way (northbound) with a southbound curbside bike lane. Throughout the study area, sidewalks are on both sides of the road and on-street parking is permitted on the east side of the road. The posted speed limit is 40 km/h and the existing right of way is 12.0 metres.

Laurel Street: Laurel Street is a City of Ottawa local road with a two-lane urban cross-section with sidewalks on both sides of the road. On-street parking is permitted on both sides of the road west of Bayswater Avenue and on

the south side of the road east of Bayswater Avenue. The posted speed limit is 40 km/h and the existing right of way is 20.0 metres.

2.2.2 Existing Intersections

The existing signalized area key intersections within 400 metres of the site have been summarized below:

<i>Albert Street/Scott Street at Bayview Station Road</i>	The intersection of Albert Street/Scott Street and Bayview Station Road is a signalized intersection. The northbound approach consists of an auxiliary left-turn lane and a shared through/channelized right-turn lane, and the southbound approach consists of an auxiliary left-turn lane and a shared through/right-turn lane. The eastbound approach consists of a shared left-turn/through lane, a shared transit priority/right-turn lane, and a bike lane and the westbound approach consists of an auxiliary left-turn lane, a through lane, and a shared transit priority/right-turn lane. No turn restrictions were noted.
<i>Wellington Street West at Fairmont Avenue</i>	The intersection of Wellington Street West and Fairmont Avenue is a signalized intersection. The northbound approach consists of a shared left-turn/right-turn lane, the eastbound approach consists of a shared through/right-turn lane, and the westbound approach consists of a shared left-turn/through lane. No turn restrictions were noted.
<i>Wellington Street West/Somerset Street West at Garland Street</i>	The intersection of Wellington Street West/Somerset Street West at Garland Street is a signalized intersection. The eastbound approach consists of a shared left-turn/through lane, the westbound approach consists of a shared through/right-turn lane, and the north leg is inbound only with a southbound curbside bike lane. The slight-right, constituting the eastbound through movement is restricted on red.
<i>Somerset Street West at Bayswater Avenue</i>	The intersection of Somerset Street West and Bayswater Avenue is a signalized intersection. The northbound approach consists of a shared all-movements lane and the southbound approach consists of an auxiliary left-turn lane and a shared through/right-turn lane. The eastbound and westbound approaches each consist of a shared left-turn/through lane and an auxiliary right-turn lane. Trucks are restricted on the south leg.
<i>Laurel Street at Bayswater Avenue</i>	The intersection of Laurel Street at Bayswater Avenue is an all-way stop-controlled intersection. Each approach consists of a shared all-movement lane. No turn restrictions were noted.
<i>Somerset Street West at City Laneway</i>	A City Laneway intersects with Somerset Street West approximately 45 metres to the west of Bayswater Avenue. It functions similarly to a private approach and no turn restrictions are noted.

2.2.3 Existing Driveways

Within 200 metres of the site access, driveways to retail are on both sides of Somerset Street West, one driveway to an office is present on the south side of Bayview Station Road, driveways to a car dealer, offices, a restaurant, townhouses, low-density residential developments, mid-rise and high-rise residential buildings are present on both sides of Bayswater Avenue. Two existing accesses to the 50 Bayswater Avenue site, one on Bayswater Avenue and one onto the City Laneway will be maintained. Figure 3 illustrates the existing driveways.

Figure 3: Existing Driveways

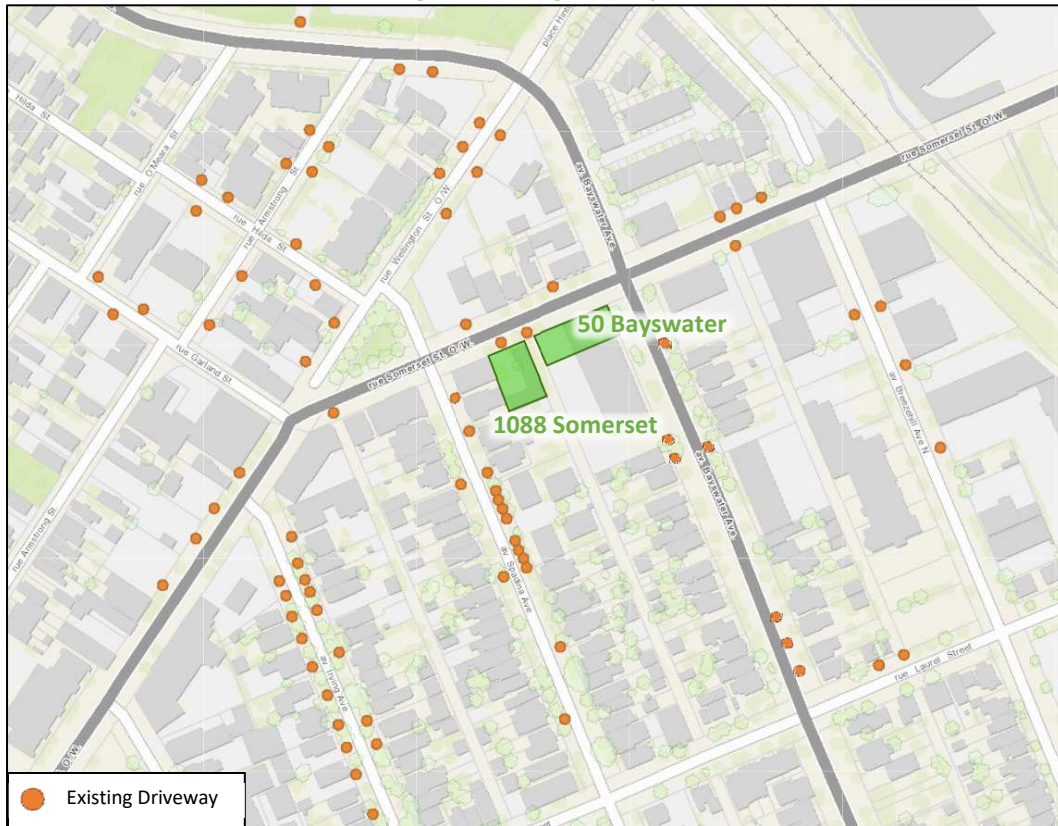

Source: <http://maps.ottawa.ca/geoOttawa/> Accessed: October 27, 2023

2.2.4 Cycling and Pedestrian Facilities

Sidewalks are provided along both sides of all study area roads and a pedestrian crossover is provided across Armstrong Street at Merton Street. MUPs are located along the north side of Scott Street and on the east side of the Trillium LRT corridor, with a connection to the Tom Brown Arena.

Cycling facilities include curbside bike lanes on the south side of Scott Street, on the west side of Garland Street south of Armstrong Street, and on both sides of Somerset Street West on the bridge over the Trillium LRT corridor. The Scott Street/Albert Street corridor and the Trillium Pathway south of Bayview Station are cross-town bikeways, Scott Street, Somerset Street West and Wellington Street West to the west of Garland Street are spine routes, Bayswater Avenue and Garland Street south of Armstrong Street are local routes.

Figure 4 illustrates the pedestrian facilities in the study area and Figure 5 illustrates the cycling facilities.

Sidewalks are provided along both sides of all study area roads and a pedestrian crossover is provided across Armstrong Street at Merton Street. MUPs are located along the north side of Scott Street and on the east side of the Trillium LRT corridor, with a connection to the Tom Brown Arena.

Cycling facilities include curbside bike lanes on the south side of Scott Street, on the west side of Garland Street south of Armstrong Street, and on both sides of Somerset Street West on the bridge over the Trillium LRT corridor. The Scott Street/Albert Street corridor and the Trillium Pathway south of Bayview Station are cross-town bikeways, Scott Street, Somerset Street West and Wellington Street West to the west of Garland Street are spine routes, Bayswater Avenue and Garland Street south of Armstrong Street are local routes.

Figure 4: Study Area Pedestrian Facilities

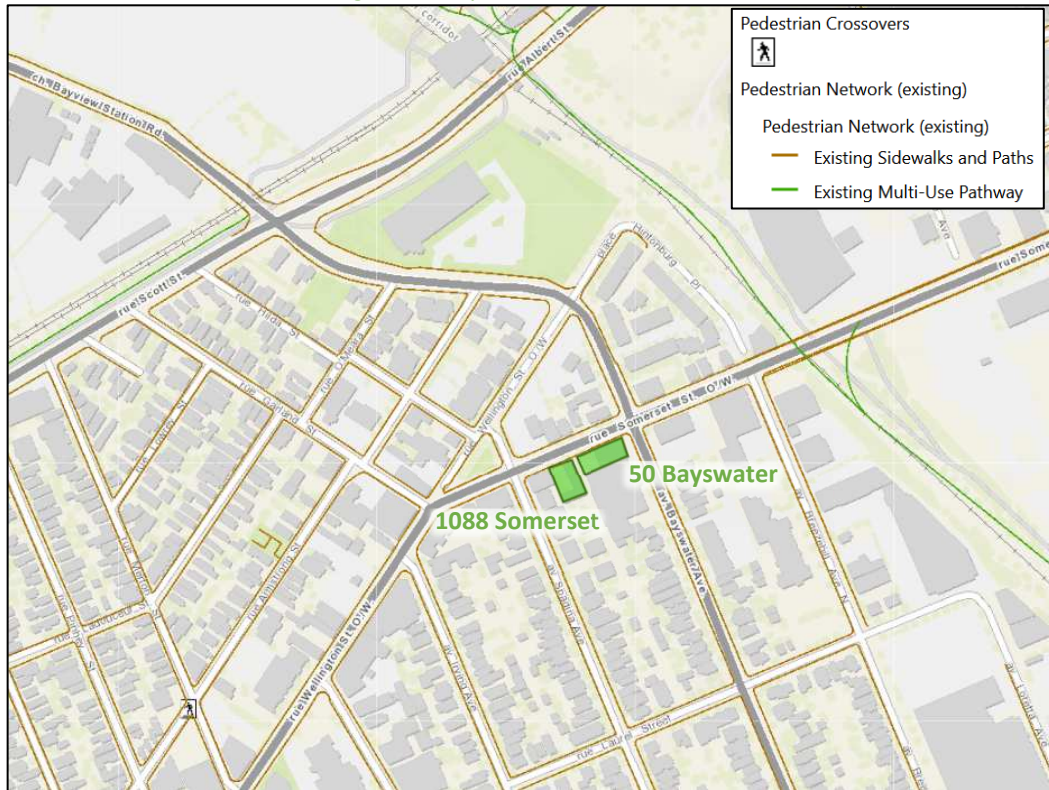

Source: <http://maps.ottawa.ca/geoOttawa/> Accessed: October 27, 2023

Figure 5: Study Area Cycling Facilities

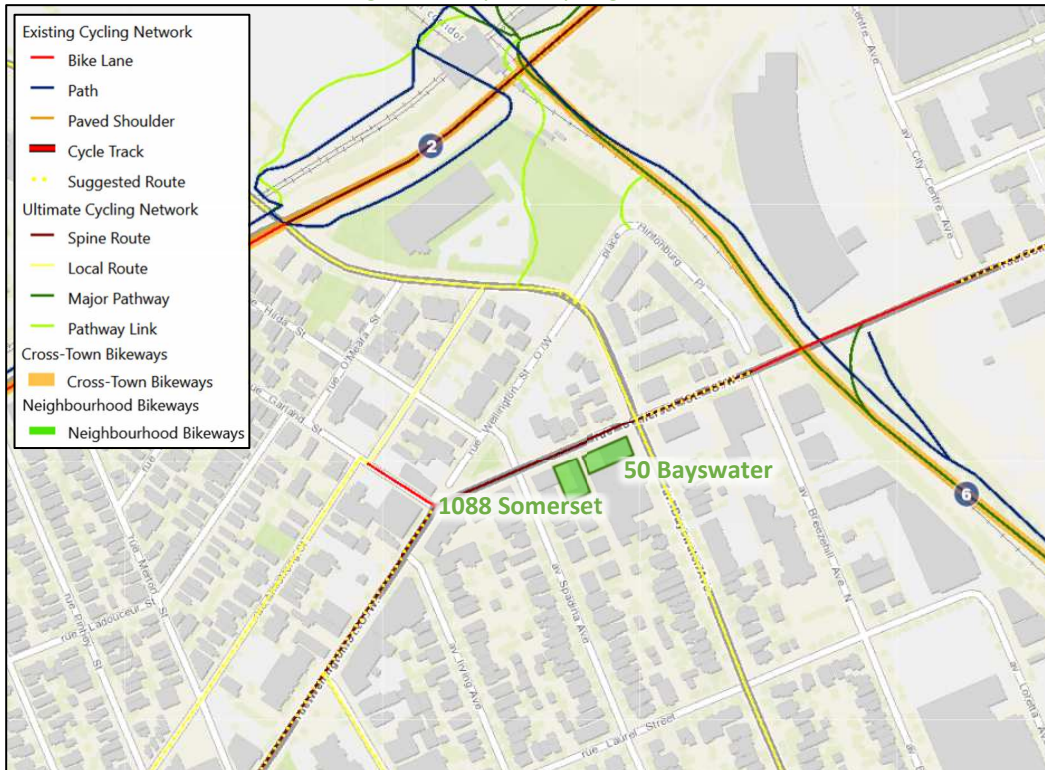

Source: <http://maps.ottawa.ca/geoOttawa/> Accessed: October 27, 2023

Pedestrian and cyclist volumes included in study area intersection counts, presented in Section 2.2.7, have been compiled and are illustrated in Figure 6 and Figure 7, respectively.

Figure 6: Existing Pedestrian Volumes

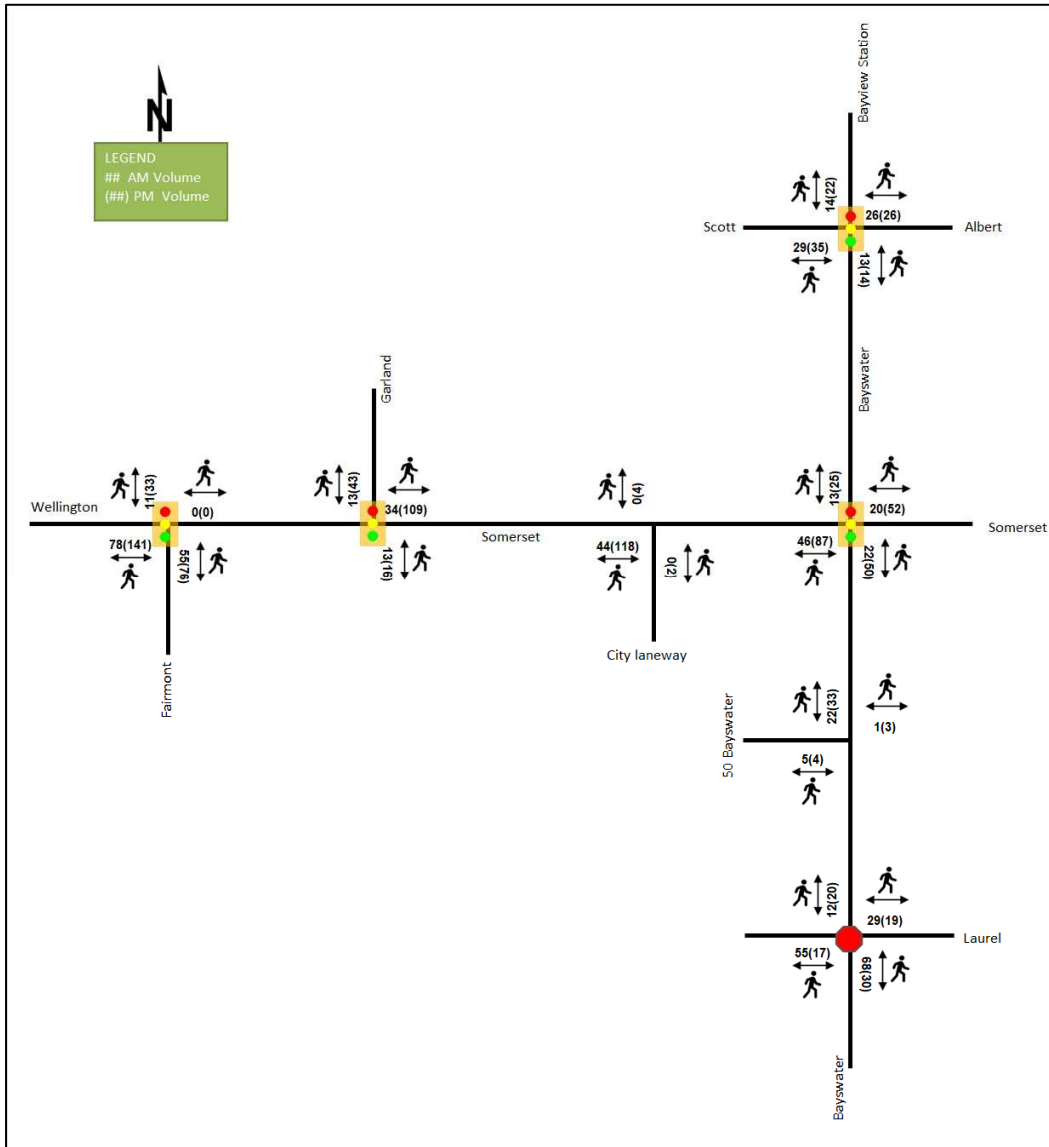
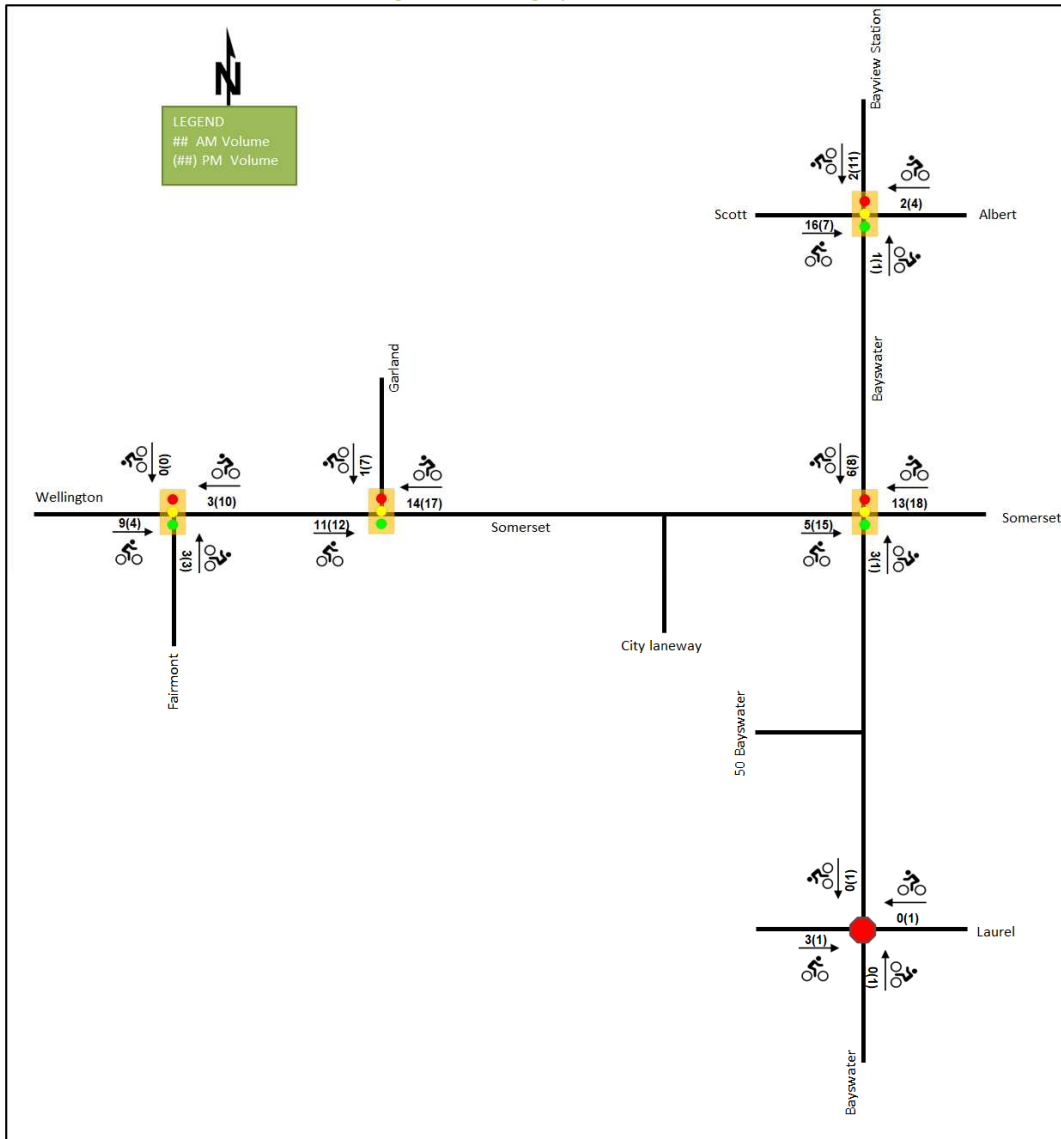

Figure 7: Existing Cyclist Volumes



2.2.5 Existing Transit

Figure 8 illustrates the transit system map in the study area and Figure 9 illustrates nearby transit stops. All transit information is from October 27, 2023, and is included for general information purposes and context to the surrounding area.

Within the study area, route #11 travels along Wellington Street West/Somerset Street West, and routes #16, 61, 63, 66, and 75 travel along Scott Street. The frequency of these routes within proximity of the proposed site based on October 27, 2023, service levels are:

- Route #11 – 15-minute service all day, 20-30-minute service after 9PM
- Route #16 – 15-minute before 3PM and 30-minute service after 3PM
- Route #61 – 10-30-minute service, operating during peak period/peak direction only
- Route #63 – 15-minute service, operating during peak period/peak direction only

- Route #66 – 30-minute service, operating during peak period/peak direction only
- Route #75 – 15-minute service, operating during peak period/peak direction only

Furthermore, Bayview Station is within 400 metres radially (670 metres walking distance) from the site, which in addition to having the routes listed as operating along Scott Street stop here, both O-Train LRT lines service this station. The future Corso Italia Station is within 800 metres radially from the site. It is noted that at the time of report creation, the Line 2 O-Train was running replacement bus service due to construction.

Figure 8: Existing Study Area Transit Service

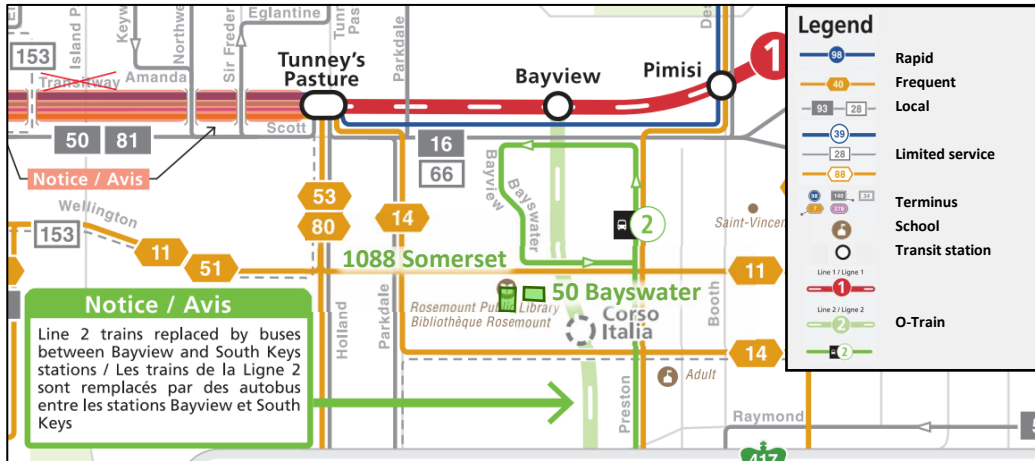

Source: <http://www.octranspo.com/> Accessed: October 27, 2023

Figure 9: Existing Study Area Transit Stops



Source: <http://maps.ottawa.ca/geoOttawa/> Accessed: October 27, 2023

2.2.6 Existing Area Traffic Management Measures

Extensive use of bulb-outs and on-street parking are found throughout the study area, with tight corner radii, vehicular directional closures, and textured crossings additionally present. Vertical centerline treatments are present on Bayswater Avenue south of Somerset Street West.

2.2.7 Existing Peak Hour Travel Demand

Existing turning movement counts were acquired from the City of Ottawa and The Traffic Specialist for the existing study area key intersections. Table 1 summarizes the intersection count dates.

Table 1: Intersection Count Date

Intersection	Count Date	Source
Albert Street/Scott Street at Bayview Station Road	Wednesday, March 01, 2023	The Traffic Specialist
Wellington Street West at Fairmont Avenue	Thursday, February 22, 2018	City of Ottawa
Wellington Street W/Somerset Street West at Garland Street	Tuesday, August 23, 2022	City of Ottawa
Somerset Street West at City Laneway	Wednesday, March 08, 2023	The Traffic Specialist
Somerset Street West at Bayswater Avenue	Tuesday, August 23, 2022	City of Ottawa
50 Bayswater at Bayswater Avenue	Wednesday, March 08, 2023	The Traffic Specialist
Laurel Street at Bayswater Avenue	Wednesday, March 08, 2023	The Traffic Specialist

Figure 10 illustrates the existing traffic counts and Table 2 summarizes the existing intersection operations. The level of service for signalized intersections is based on volume to capacity ratio (v/c) calculations for individual lane movements and HCM 2000 v/c calculations for the overall intersection, and average delay for unsignalized intersections. Detailed turning movement count data is included in Appendix B and the Synchro worksheets are provided in Appendix C.

Figure 10: Existing Traffic Counts

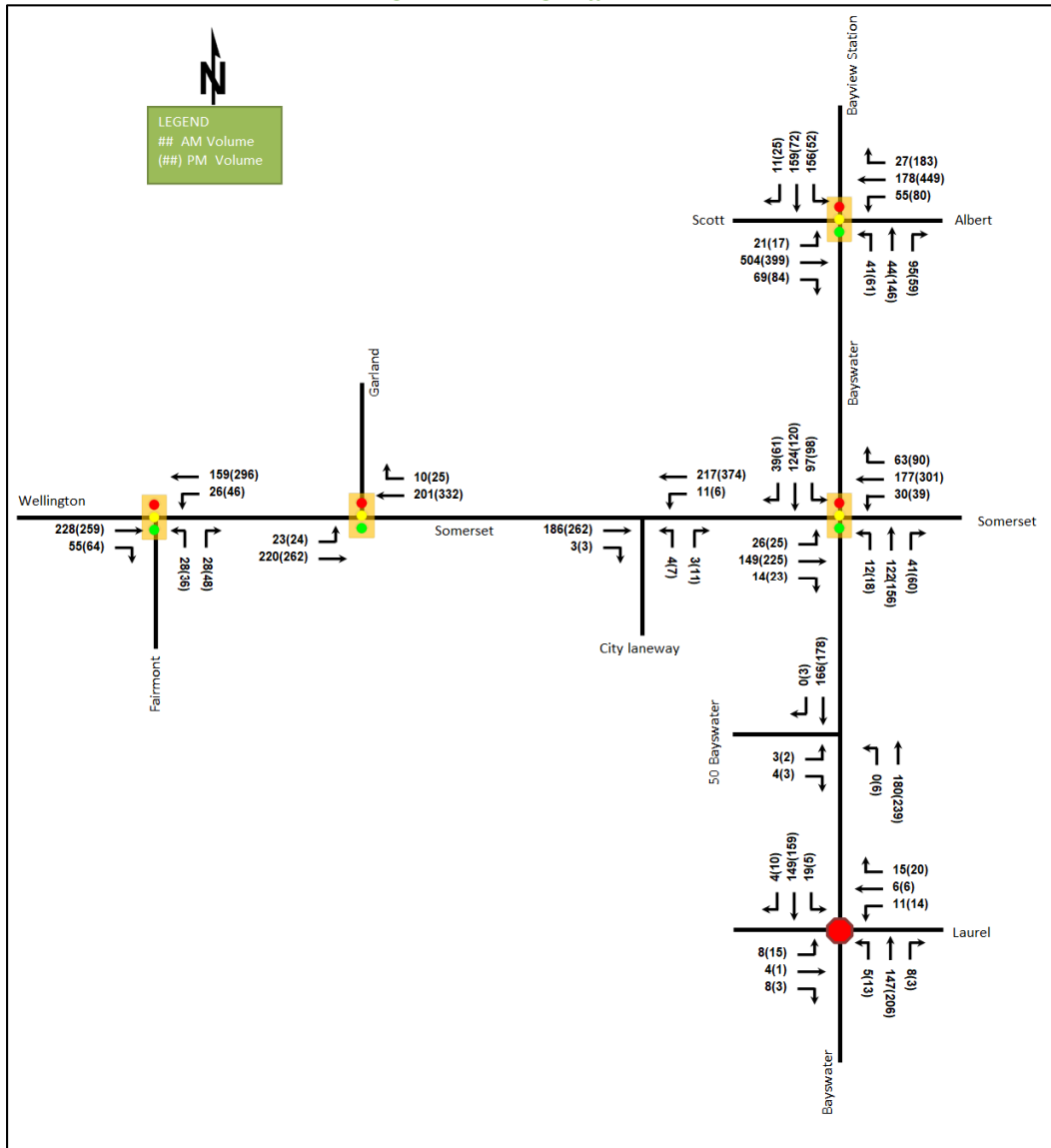

Table 2: Existing Intersection Operations

Intersection	Lane	AM Peak Hour				PM Peak Hour			
		LOS	V/C	Delay (s)	Q (95 th)	LOS	V/C	Delay (s)	Q (95 th)
Albert Street/Scott Street at Bayview Station Road <i>Signalized</i>	EBL/T	A	0.52	11.5	92.3	A	0.40	9.5	65.9
	EBR	A	0.08	2.1	5.2	A	0.10	2.0	5.6
	WBL	A	0.16	8.9	11.0	A	0.18	8.5	14.7
	WBT	A	0.18	7.5	25.7	A	0.43	9.7	71.8
	WBR	A	0.03	2.2	2.8	A	0.20	1.7	8.1
	NBL	A	0.25	35.0	16.5	A	0.31	36.0	21.8
	NBT/R	A	0.40	15.0	23.4	B	0.69	44.0	57.4
	SBL	D	0.81	64.9	52.8	A	0.40	41.1	20.4
	SBT/R	A	0.55	40.5	50.3	A	0.33	30.0	27.9
	Overall		A	0.59	21.0	-	A	0.48	15.8

Intersection	Lane	AM Peak Hour				PM Peak Hour			
		LOS	V/C	Delay (s)	Q (95 th)	LOS	V/C	Delay (s)	Q (95 th)
Wellington Street W at Fairmont Avenue <i>Signalized</i>	EBT/R	A	0.27	6.6	30.6	A	0.33	7.3	35.5
	WBL/T	A	0.19	6.7	21.6	A	0.35	5.0	24.3
	NBL/R	A	0.21	13.6	11.2	A	0.26	13.7	15.1
	Overall	A	0.25	7.4	-	A	0.32	6.9	-
Wellington Street W/Somerset Street W at Garland Street <i>Signalized</i>	EBL/T	A	0.17	0.2	0.0	A	0.24	2.0	9.8
	WBT/R	A	0.14	0.2	0.0	A	0.29	7.6	49.7
	Overall	A	0.19	0.2	-	A	0.27	5.1	-
Somerset Street W at City Laneway <i>Unsignalized</i>	EBT/R	-	-	-	-	-	-	-	-
	WBL/T	A	0.01	7.9	0.0	A	0.01	8.5	0.0
	NBL/R	B	0.01	11.3	0.0	B	0.05	13.9	0.8
	Overall	A	-	0.4	-	A	-	0.4	-
Somerset Street W at Bayswater Avenue <i>Signalized</i>	EBL/T	A	0.30	15.1	30.0	A	0.37	12.0	48.1
	EBR	A	0.03	1.0	0.9	A	0.04	4.4	4.2
	WBL/T	A	0.35	15.7	35.2	A	0.51	17.4	59.0
	WBR	A	0.12	4.2	6.4	A	0.15	3.4	7.3
	NB	A	0.30	13.2	27.3	A	0.42	17.5	41.8
	SBL	A	0.25	15.4	19.2	A	0.30	18.9	22.2
	SBT/R	A	0.26	12.5	24.8	A	0.31	14.2	29.7
	Overall	A	0.32	13.4	-	A	0.46	14.7	-
50 Bayswater at Bayswater Avenue <i>Unsignalized</i>	EBL/R	B	0.01	10.3	0.0	B	0.01	10.8	0.0
	NBL/T	A	-	0.0	0.0	A	0.01	7.8	0.0
	SBT/R	-	-	-	-	-	-	-	-
	Overall	A	-	0.2	-	A	-	0.2	-
Laurel Street at Bayswater Avenue <i>Unsignalized</i>	EB	A	0.03	7.9	0.8	A	0.03	8.2	0.8
	WB	A	0.05	8.0	0.8	A	0.06	8.0	1.5
	NB	A	0.24	9.5	6.8	A	0.29	9.1	9.0
	SB	A	0.23	8.6	6.8	A	0.23	8.6	6.8
	Overall	A	-	8.9	-	A	-	8.8	-

Notes: Saturation flow rate of 1800 veh/h/lane
 Queue is measured in metres
 Peak Hour Factor = 0.90

Delay = average vehicle delay in seconds
 m = metered queue
 # = volume for the 95th %ile cycle exceeds capacity

During both the AM and PM peak hours, the study area intersections operate well. No capacity issues are noted.

2.2.8 Collision Analysis

Collision data have been acquired from the City of Ottawa open data website (data.ottawa.ca) for five years prior to the commencement of this TIA for the surrounding study area road network. Table 3 summarizes the collision types and conditions in the study area, Figure 11 illustrates the intersections and segments analyzed, and Table 4 summarizes the total collisions for each of these locations. Collision data are included in Appendix D.

Table 3: Study Area Collision Summary, 2018-2022

		Number	%
Total Collisions		23	100%
Classification	Fatality	0	0%
	Non-Fatal Injury	7	30%
	Property Damage Only	16	70%
Initial Impact Type	Angle	8	35%
	Rear end	4	17%
	Turning Movement	3	13%
	SMV Unattended	4	17%
	SMV Other	1	4%
	Other	3	13%
Road Surface Condition	Dry	15	65%
	Wet	2	9%
	Slush	4	17%
	Packed Snow	1	4%
	Ice	1	4%
Pedestrian Involved		0	0%
Cyclists Involved		1	4%

Figure 11: Study Area Collision Records

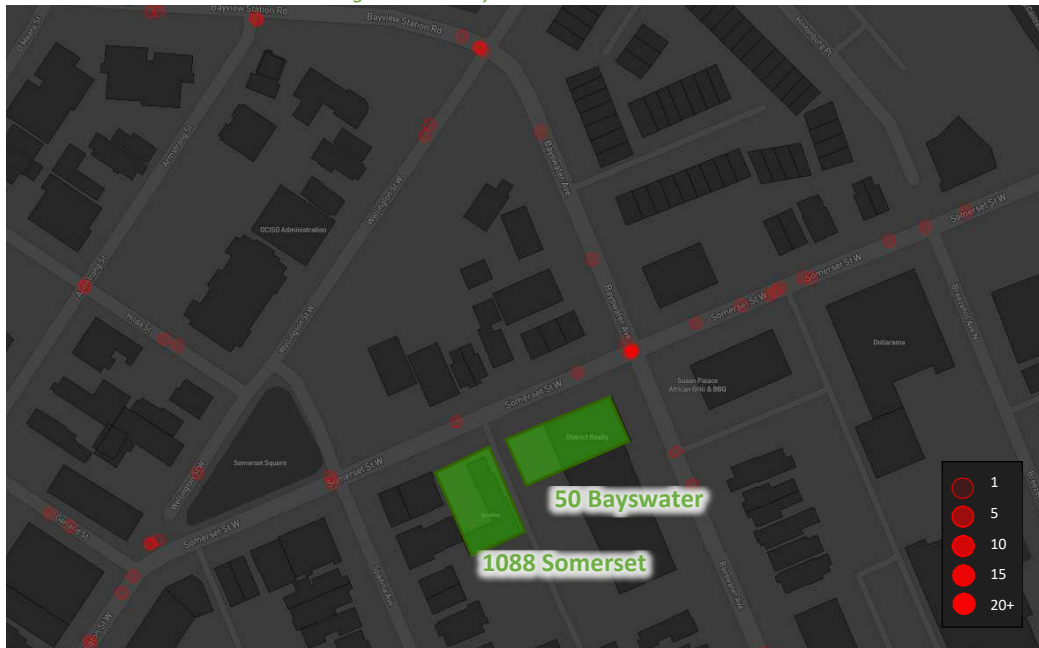

Table 4: Summary of Collision Locations, 2018-2022

Intersections / Segments	Number	%
	23	100%
Bayswater Ave @ Somerset St	9	39%
Somerset St W btwn Bayswater Ave & Breezehill Ave N	5	22%
Wellington St @ Bayswater Ave/Bayview Rd	3	13%
Somerset St W btwn Spadina Ave & Bayswater Ave	2	9%
Bayswater Ave btwn Somerset St W & Laurel St	2	9%
Bayswater Ave btwn Wellington St W & Somerset St W	1	4%
Somerset St @ Spadina Ave	1	4%

Within the study area, there are a total of 23 collisions during the 2018-2022 time period, with 16 involving property damage only and the remaining seven having non-fatal injuries. No further collision review is required as part of this study.

2.3 Planned Conditions

2.3.1.1 *New Official Plan (2021)*

Within the Transit and Network Ultimate diagram, transit priority corridor is identified along Wellington Street West and Somerset Street West. The Trillium line reconstruction is underway which includes the Trillium Pathway.

2.3.1.2 *City's Planned Construction Projects*

From the City's Planned Construction Projects portal, transitway renewal and cycling routes along Scott Street are planned this year.

2.3.1.3 *Stage 2 Light Rail Transit project - O-Train South Extension*

Future Corso Italia LRT station is within 800 metres of the site, which is one of the Trillium Line South extension stations in the Stage 2 Light Rail Transit project, and it is scheduled for completion in 2023.

2.3.2 Other Study Area Developments

1040 Somerset Street West

The proposed redevelopment includes a site plan application for the construction of a 30-storey mixed-use building with 268 residential dwelling units, and 141 m² of ground-floor commercial space. The development is anticipated to be built out in 2025 and to generate 24 new two-way AM peak hour auto trips and 26 new two-way PM peak hour auto trips. (Novatech, 2021)

1050 Somerset Street West

Last updated in 2012, the proposed development application includes a site plan for the construction of a 23-storey mixed-use building with 195 residential dwelling units, 5,020 sq. ft. of ground floor commercial retail space, 26,100 sq. ft. of commercial office space, and 244 underground parking spaces. Traffic generated by the site has not been explicitly provided in the 2012 traffic analysis. (Novatech, 2012)

935 Wellington Street West

The proposed development application is to demolish the existing structure and consolidate the property with the use on the adjacent property at 927 Wellington Street West. No TIA is available at this time.

26, 36, 40 Armstrong Street & 961, 967, 969, 973, 979 Wellington Street West

The proposed development application includes a site plan for the construction of a mixed-use building with 252 residential dwelling units and 8,498 sq. ft. of ground floor commercial development. The development is predicted to generate 30 new AM and 44 new PM two-way peak-hour auto trips, and the anticipated build-out horizon is assumed to be 2024. (CGH Transportation, 2022)

951 Gladstone Avenue and 145 Loretta Avenue North

The proposed development application includes a site plan for the construction of approximately 849 residential units, 193,015 sq. ft of office space (including the existing Standard Bread building, live-work space) and 17,611 sq. ft of retail space. The development is predicted to generate 136 new AM and 149 new PM two-way peak-hour auto trips, and the anticipated build-out horizon is assumed to be 2026. (CGH Transportation, 2022)

3 Study Area and Time Periods

3.1 Study Area

The study area will include the intersections of:

- Albert Street/Scott Street at:
 - Bayview Station Road
- Wellington Street West at:
 - Fairmont Avenue
 - Garland Street
- Somerset Street West at:
 - City Laneway
 - Bayswater Avenue
- Bayswater Avenue at:
 - Laurel Street
 - 50 Bayswater

The boundary road will be Somerset Street West and Bayswater Avenue, and the SL29 screenline is present within proximity to the site but will not be analyzed as part of this study.

3.2 Time Periods

As the proposed development is composed entirely of residential units the AM and PM peak hours will be examined.

3.3 Horizon Years

The anticipated build-out year is 2027. As a result, the full build-out plus five years horizon year is 2032.

4 Development-Generated Travel Demand

4.1 Mode Shares

Examining the mode shares recommended in the TRANS Trip Generation Manual (2020) for the subject district, derived from the most recent National Capital Region Origin-Destination survey (OD Survey), the existing average district mode shares by land use for Ottawa West have been summarized in Table 5.

Table 5: TRANS Trip Generation Manual Recommended Mode Shares – Ottawa West

Travel Mode	Multi-Unit (High-Rise)		Commercial Generator	
	AM	PM	AM	PM
Auto Driver	29%	33%	55%	50%
Auto Passenger	11%	11%	11%	16%
Transit	41%	26%	11%	11%
Cycling	3%	7%	0%	5%
Walking	16%	23%	23%	18%
Total	100%	100%	100%	100%

Being within 400 metres radially (670 metres walking distance) of the Bayview LRT station and 800 metres radially of the future Corso Italia Station, a higher transit mode is considered achievable at this location. A nine percent shift to transit mode from the auto mode is proposed for the land use of multi-Unit (high-rise). Modified mode share targets are proposed for the development and are summarized in Table 6.

Table 6: Proposed Development Mode Shares – Within 400 m of Rapid Transit

Travel Mode	Multi-Unit (High-Rise)		Commercial Generator	
	AM	PM	AM	PM
Auto Driver	20%	24%	55%	50%
Auto Passenger	11%	11%	11%	16%
Transit	50%	35%	11%	11%
Cycling	3%	7%	0%	5%
Walking	16%	23%	23%	18%
Total	100%	100%	100%	100%

Using the above person trip rates, the total person trip generation has been estimated. Table 7 summarizes the total person trip generation.

Table 7: Total Person Trip Generation

Land Use	Units	AM Peak Period			PM Peak Period		
		In	Out	Total	In	Out	Total
Multi-Unit (High-Rise)	101	25	56	81	53	38	91
Land Use	Units / GFA	AM Peak Hour			PM Peak Hour		
		In	Out	Total	In	Out	Total
Strip Retail Plaza (<40k)	2,620 sq ft	5	3	8	11	11	22

Internal capture rates from the ITE Trip Generation Handbook 3rd Edition have been assigned to the development’s retail component for mixed-use developments. The rates summarized in Table 8 represent the percentage of trips to/from retail use based on the residential component.

Table 8: Internal Capture Rates

Land Use	AM		PM	
	In	Out	In	Out
Residential to/from Strip Retail Plaza (<40k)	17%	14%	10%	26%

Pass-by reductions applied to the retail trip generation at a rate of 40% have been included using the recommended value presented in the ITE Trip Generation Manual 11th Edition (2021) for the most similar land use with a recommended rate, “Retail (40k – 150k sq. ft.)”.

Using the above mode share targets for an LRT area, the internal capture and pass-by rates, and the person trip rates, the person trips by mode have been projected. Trip generation by peak hour has been forecasted using the prescribed peak period conversion factors presented in the TRANS Trip Generation Manual (2020) for the residential component. Table 9 summarizes the residential trip generation and the non-residential trip generation by mode and peak hour.

Table 9: Trip Generation by Mode

Travel Mode	AM Peak Hour				PM Peak Hour				
	Mode Share	In	Out	Total	Mode Share	In	Out	Total	
Multi-Unit (High-Rise)	Auto Driver	20%	2	6	8	24%	6	4	10
	Auto Passenger	11%	1	3	4	11%	2	2	4
	Transit	50%	7	16	23	35%	8	7	15
	Cycling	3%	0	1	1	7%	2	1	3
	Walking	16%	2	6	8	23%	6	5	11
	Total	100%	12	32	44	100%	24	19	43

Travel Mode		AM Peak Hour				PM Peak Hour			
		Mode Share	In	Out	Total	Mode Share	In	Out	Total
Strip Retail Plaza (<40k)	Auto Driver	55%	0	1	1	50%	1	1	2
	Auto Passenger	11%	1	0	1	16%	2	1	3
	Transit	11%	0	0	0	11%	1	1	2
	Cycling	0%	0	0	0	5%	0	0	0
	Walking	23%	1	1	2	18%	2	2	4
	Total	100%	2	2	4	100%	6	5	11
	Pass-by	40%	-2	-1	-3	40%	-4	-4	-8
	Internal Capture	varies	-1	0	-1	varies	-1	-2	-3
Total	Auto Driver	-	2	7	9	-	7	5	12
	Auto Passenger	-	2	3	5	-	4	3	7
	Transit	-	7	16	23	-	9	8	17
	Cycling	-	0	1	1	-	2	1	3
	Walking	-	3	7	10	-	8	7	15
	Total	-	14	34	48	-	30	24	54
	Pass-by	40%	-2	-1	-3	40%	-4	-4	-8
	Internal Capture	varies	-1	0	-1	varies	-1	-2	-3

As shown above, a total of 9 AM and 12 PM new peak hour two-way vehicle trips are projected as a result of the proposed development.

4.2 Trip Distribution

To understand the travel patterns of the subject development, the OD Survey has been reviewed to determine the travel for the residential component, and these patterns were applied based on the build-out of Ottawa West. Table 10 below summarizes the distributions.

Table 10: OD Survey Distribution – Ottawa West

To/From	Residential % of Trips
North	5%
South	30%
East	30%
West	35%
Total	100%

4.3 Trip Assignment

Using the distribution outlined above, turning movement splits, and access to major transportation infrastructure, the trips generated by the site have been assigned to the study area road network. It is assumed that retail site-generated trips will be local. As no new accesses are being provided, and no parking is provided for 1088 Somerset Street West, all residential site-generated trips for 50 Bayswater Avenue are assumed to travel from/to the site via the existing access on Bayswater Avenue. Table 11 summarizes the proportional assignment to the study area roadways, Figure 12 illustrates the new site-generated volumes, and Figure 13 illustrates the pass-by volumes.

Table 11: Trip Assignment

To/From	Via
North	5% Albert Street (N)
South	30% Bayswater Avenue (S)
East	5% Somerset Street West (E)
	15% Albert Street
	10% Wellington Street West / Highway 417 (W)

50 Bayswater Avenue, 1088 Somerset Street West Transportation Impact Assessment

To/From	Via
West	25% Wellington Street West /Highway 417 (W) 10% Scott Street (W)
Total	100%

Figure 12: New Site Generation Auto Volumes

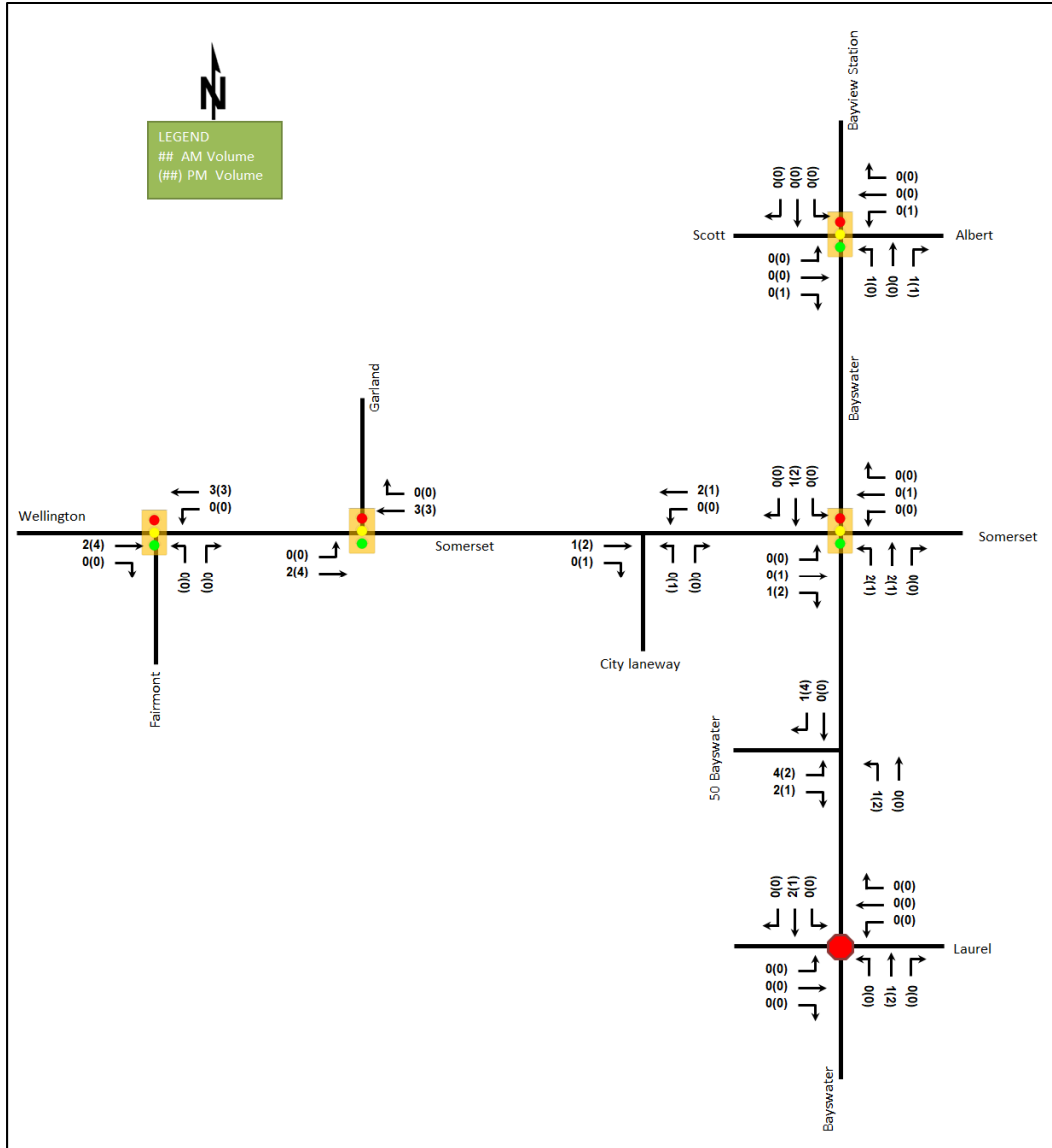
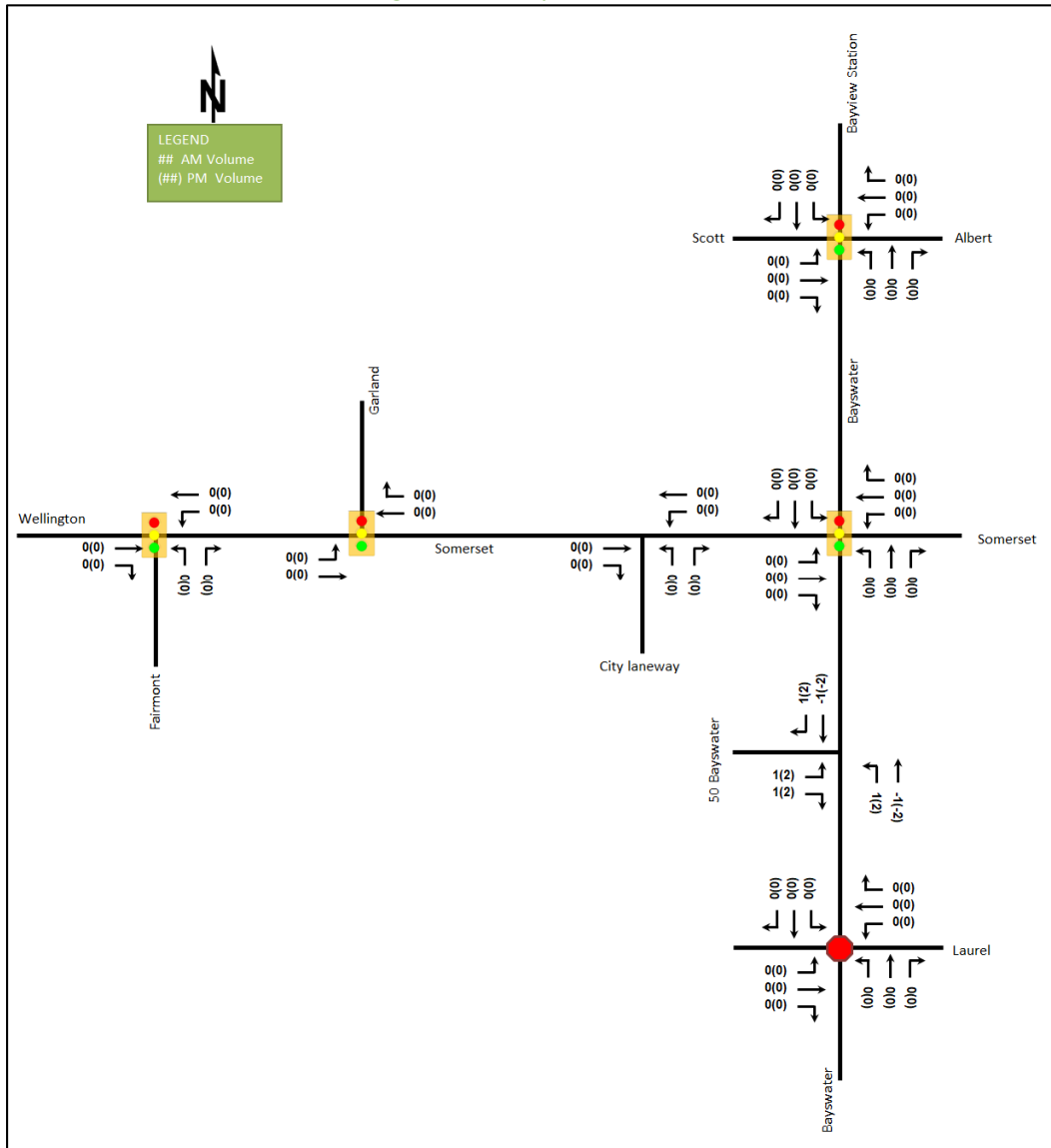

Figure 13: Pass-By Auto Volumes



4.4 Trip Reductions

Based on the existing office building of approximately 10,000 sq. ft. Using the ITE trip generation rates for the land use of small office building (ITE 712), and the employment generator mode shares for Ottawa West, the estimated trip generation of the existing site is 8 AM and 10 PM peak hour two-way vehicle trips. The trip assignment of the estimated reduced volumes is illustrated in Figure 14. Table 12 compares the estimated existing primary auto trips and forecasted site-generated primary auto trips.

Figure 14: Estimated Trip Reductions

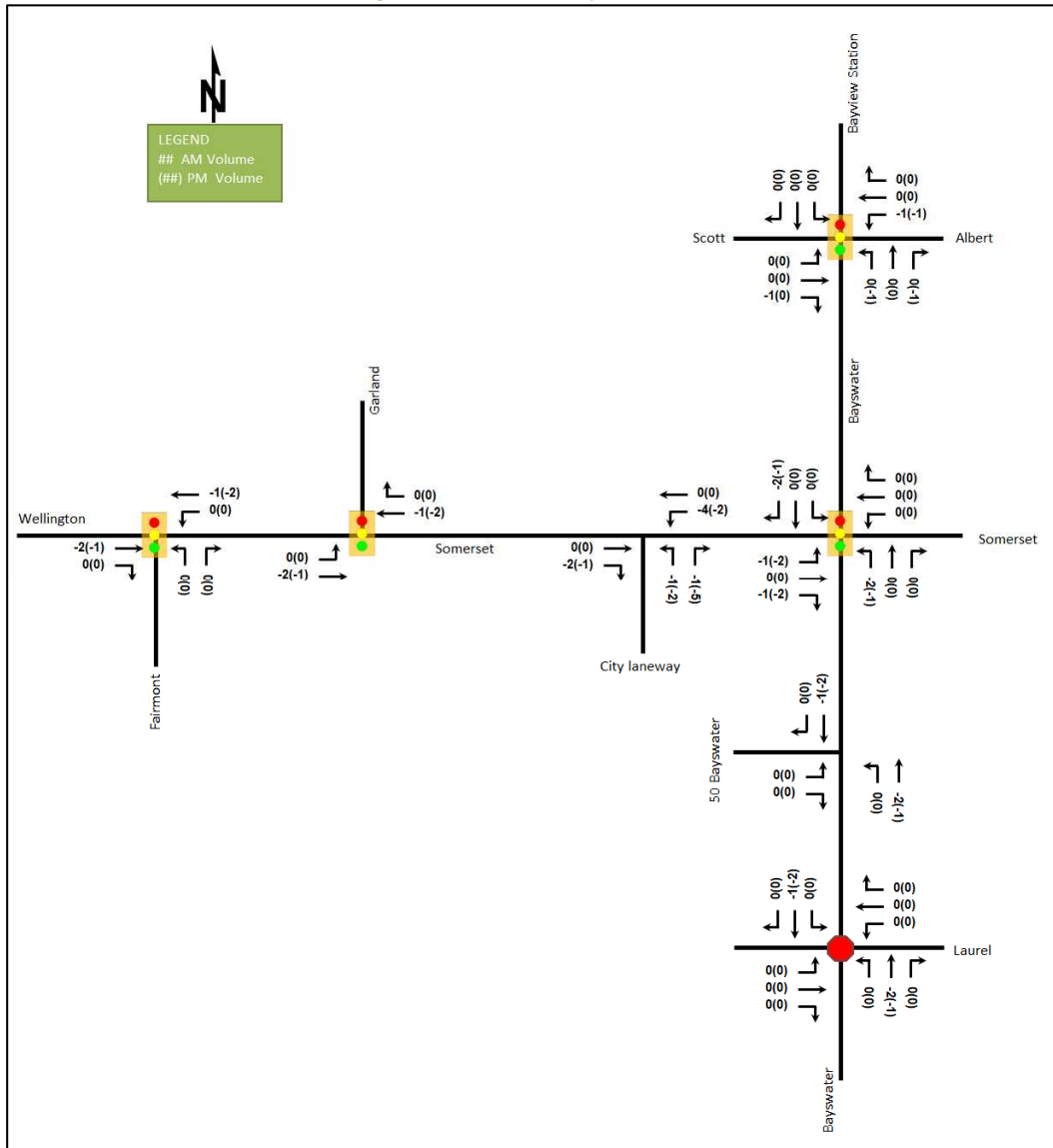
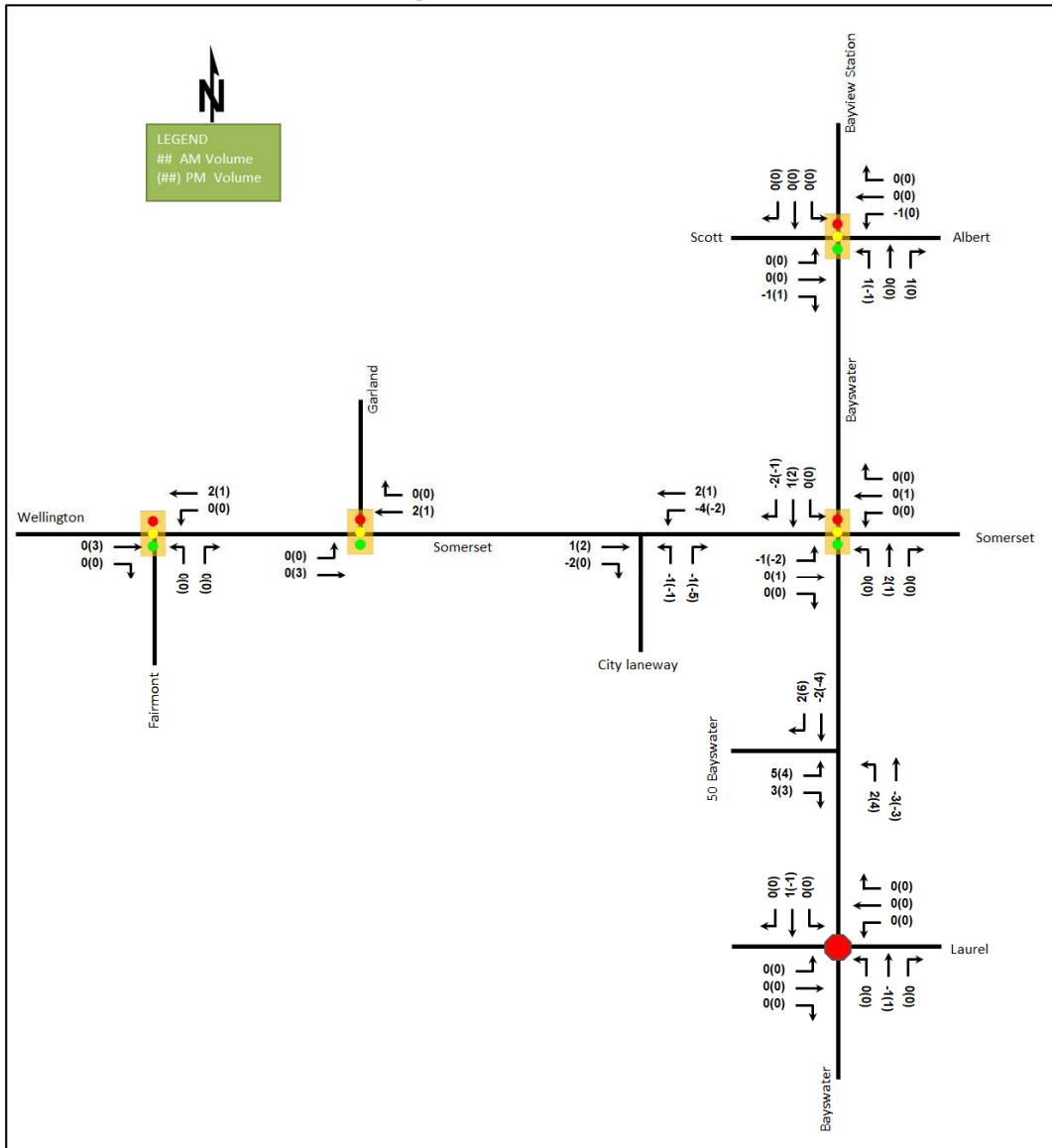

Table 12: Estimated Existing Auto Trip Volumes vs Forecasted Auto Trip Volumes

Scenario	AM Peak Hour				PM Peak Hour			
	Mode Share	In	Out	Total	Mode Share	In	Out	Total
Existing	54%	6	2	8	54%	3	7	10
Proposed	Varies	2	7	9	Varies	7	5	12
Difference	-	-4	+5	+1	-	+4	-2	+2

Figure 15: Net Auto Volumes



5 Exemption Review

Table 13 summarizes the exemptions for this TIA.

Table 13: Exemption Review

Module	Element	Explanation	Exempt/Required
Site Design and TDM			
4.1 Development Design	4.1.2 Circulation and Access	Only required for site plan and zoning by-law applications	Required
	4.1.3 New Street Networks	Only required for plans of subdivision	Exempt
4.2 Parking	4.2.1 Parking Supply	Only required for site plan and zoning by-law applications	Required
4.3 Boundary Street Design		All applications	Required

Module	Element	Explanation	Exempt/Required
4.5 Transportation Demand Management	All Elements	Only required when the development generates more than 60 person-trips	Required
Network Impact			
3.2 Background Network Travel Demand	All Elements	Only required when one or more other Network Impact Modules are triggered	Exempt
3.3 Demand Rationalization		Only required when one or more other Network Impact Modules are triggered	Exempt
4.6 Neighbourhood Traffic Calming	4.6.1 Adjacent Neighbourhoods	<p>If the development meets all of the following criteria along the route(s) site generated traffic is expected to utilize between an arterial road and the site's access:</p> <ol style="list-style-type: none"> 1. Access to Collector or Local; 2. "Significant sensitive land use presence" exists, where there is at least two of the following adjacent to the subject street segment: <ul style="list-style-type: none"> • School (within 250m walking distance); • Park; • Retirement / Older Adult Facility (i.e. long-term care and retirement homes); • Licenced Child Care Centre; • Community Centre; or • 50%, or greater, of adjacent property along the route(s) is occupied by residential lands and a minimum of 10 occupied residential units are present on the route. 3. Application is for Zoning By-Law Amendment or Draft Plan of Subdivision; 4. At least 75 site-generated auto trips; 5. Site Trip Infiltration is expected. Site traffic will increase peak hour vehicle volumes along the route by 50% or more. 	Exempt
4.7 Transit	4.7.1 Transit Route Capacity	Only required when the development generates more than 75 transit trips	Exempt
	4.7.2 Transit Priority Requirements	Only required when the development generates more than 75 auto trips	Exempt
4.8 Network Concept		Only required when proposed development generates more than 200 person-trips during the peak hour in excess	Exempt

Module	Element	Explanation	Exempt/Required
		of equivalent volume permitted by established zoning	
4.9 Intersection Design	4.9.1 Intersection Control	Only required when the development generates more than 75 auto trips	Exempt
	4.9.2 Intersection Design	Only required when the development generates more than 75 auto trips	Exempt

6 Development Design

6.1 Design for Sustainable Modes

The existing access on Bayswater Avenue to the existing parking will be maintained and used as the site access for resident, and the existing access on the City Laneway will be relocated for the existing parking access. A total of 16 vehicle parking spaces and 522 bicycle parking spaces are proposed underground. Existing pedestrian facilities are provided along the boundary streets of Bayswater Avenue and Somerset Street West. Local bus stops are located on the frontage on Somerset Street West closer to the intersection of Somerset Street West at Bayswater Avenue.

The infrastructure TDM checklist is provided in Appendix E.

6.2 Circulation and Access

The development proposes relocation of the existing access on the City Laneway to have a ramp off the laneway into the existing parking garage adjacent to the site. The access is 6.0 metres wide, and the ramp has a clearance between 1.67 metres and 2.0 metres under upper deck.

The existing access on Bayswater Avenue will maintain and serve the proposed redevelopment, and all residential trips are assumed to travel via existing access on Bayswater Avenue. It is assumed that retail site-generated trips will be local. No changes to the existing access on Bayswater Avenue are proposed.

The garbage collection will remain from the City Laneway.

7 Parking

7.1 Parking Supply

A total of 16 vehicle parking spaces and 522 bicycle parking spaces are proposed underground for 50 Bayswater Avenue residential use. No parking spaces are proposed for 1088 Somerset Street West.

The minimum residential vehicle parking provisions for Area X are five parking spaces for 1088 Somerset Street West and 31 parking spaces and three retail parking spaces for the underground parking at 50 Bayswater Avenue. The minimum visitor parking is one for 1088 Somerset Street West and seven spaces for 50 Bayswater Avenue.

As the site is considered within the TOD zone, the maximum vehicle parking provision for the site is 32 residential parking spaces for 1088 Somerset Street West, 120 residential parking spaces and nine commercial parking spaces for 50 Bayswater Avenue

The maximum parking requirements are satisfied for both 50 Bayswater Avenue and 1088 Somerset Street West. Although the development does not meet the minimum vehicle parking requirements, the site is located within 400 metres radially (670 metres walking distance) of the Bayview LRT station and 800 metres radially of the future Corso Italia Station, which can easily access public transit, and the development provides additional bicycle parking spaces for the resident. Furthermore, the site is expected to generate less than 12 vehicle trips during the peak

hours and can be satisfied by the 16 additional spaces being provided. The development is considered to have sufficient vehicle parking spaces.

The minimum bicycle parking provision is eleven spaces for 1088 Somerset Street West and 40 spaces for 50 Bayswater Avenue. The minimum bicycle parking requirements for 50 Bayswater Avenue are satisfied, and the minimum bicycle parking requirements for 1088 Somerset Street West are not satisfied.

8 Boundary Street Design

Table 14 summarizes the MMLOS analysis for the boundary streets of Somerset Street West and Bayswater Avenue. The existing and future conditions for both streets will be the same and are considered in one row. The boundary street analysis is based on the policy area of “within 600m of a rapid transit station” and “within 300 metres of a school”. The MMLOS worksheets have been provided in Appendix F.

Table 14: Boundary Street MMLOS Analysis

Segment	Pedestrian LOS		Bicycle LOS		Transit LOS		Truck LOS	
	PLOS	Target	BLOS	Target	TLOS	Target	TrLOS	Target
Somerset Street West	C	A	E	C	N/A	N/A	N/A	N/A
Bayswater Avenue	C	A	E	B	N/A	N/A	N/A	N/A

The pedestrian LOS will not be met along the segments of Somerset Street West and Bayswater Avenue. To meet the theoretical pedestrian LOS targets, the boulevards need to be at least 0.5 metres, and sidewalks would need to be at least 2.0 metres.

The bicycle LOS will not be met along the segments of Somerset Street West and Bayswater Avenue. To meet the theoretical bicycle LOS targets, the operating speed needs to be less or equal to 40 km/h along boundary streets.

No further improvements are required to meet the PLOS and BLOS targets. The City of Ottawa will be responsible for exploring options to address the boundary roads PLOS and BLOS deficiencies.

9 Transportation Demand Management

9.1 Context for TDM

The subject site has been assumed to rely predominantly on auto driver and transit mode shares due to being within 400 metres radially (670 metres walking distance) of the Bayview LRT station and 800 metres radially of the future Corso Italia Station. The convenience of the transit station should provide the opportunity to reach the forecast transit mode share.

Total bedrooms within the development is subject to the final unit count and layout selections by purchasers. No age restrictions are noted.

9.2 Need and Opportunity

The subject site has been assumed to rely predominantly on auto and transit travel, and those assumptions have been carried through the analysis.

9.3 TDM Program

The “suite of post occupancy TDM measures” has been summarized in the TDM checklists for the residential land uses. The checklist is provided in Appendix E. The key TDM measures recommended include:

- Display local area maps with walking/cycling access routes and key destinations at major entrances
- Display relevant transit schedules and route maps at entrances

- Provide a multimodal travel option information package to new/relocating employees and new residents
- Inclusion of a 1-month Presto card for first time new townhome purchase and apartment rental, with a set time frame for this offer (e.g. 6-months) from the initial opening of the site
- Unbundle parking cost from purchase or rental costs

10 Summary of Improvements Indicated and Modifications Options

The following summarizes the analysis and results presented in this TIA report:

Proposed Site and Screening

- The proposed site includes a total of 80 residential units and 2,620 sq. ft commercial space at 50 Bayswater Avenue and a total of 21 units at 1088 Somerset Street West
- The existing access on Bayswater Avenue to the existing parking will remain and serve the proposed redevelopment
- The relocation of access to the City Laneway to the existing parking is proposed for the existing buildings at 50 Bayswater Avenue
- The development proposed 16 vehicle parking spaces and 522 bicycle parking spaces located underground at 50 Bayswater Avenue
- No parking and new accesses are proposed for 1088 Somerset Street West
- The anticipated full build-out and occupancy horizon is 2027
- The trip generation and location triggers were met for the TIA Screening

Existing Conditions

- Scott Street, Albert Street, Wellington Street West, and Somerset Street West are arterial roads, and Bayview Station Road and Bayswater Avenue are collector roads in the study area
- Sidewalks are provided along both sides of all study area roads and a pedestrian crossover is provided across Armstrong Street at Merton Street
- MUPs are located along the north side of Scott Street and on the east side of the Trillium LRT corridor, with a connection to the Tom Brown Arena
- Curbside bike lanes are provided on the south side of Scott Street, on the west side of Garland Street south of Armstrong Street, and on both sides of Somerset Street West on the bridge over the Trillium LRT corridor
- The Scott Street/Albert Street corridor and the Trillium Pathway south of Bayview Station are cross-town bikeways, Scott Street, Somerset Street West and Wellington Street West to the west of Garland Street are spine routes, Bayswater Avenue and Garland Street south of Armstrong Street are local routes
- The intersection of Bayswater Avenue at Somerset Street is noted to have experienced higher collisions than other locations within the study area
- The City's Cycling Safety Review of High-Volume Intersections (March 2020) completed a review of Bayswater Avenue at Somerset Street intersection, and it does not recommend any changes to those planned for implementation by the City
- No further examination for collision is required as part of this study

Development Generated Travel Demand

- A total of 9 AM and 12 PM new peak hour two-way vehicle trips are projected as a result of the proposed development

- Of the forecasted trips, 5 % are anticipated to travel north, 35 % to the west, and 30 % to both the south and east
- The estimated trip generation of the existing site is 8 AM and 10 PM peak hour two-way vehicle trips

Development Design

- The existing access on Bayswater Avenue to the existing parking will remain and serve the proposed redevelopment, and the existing access on the City Laneway will be relocated for the existing parking access
- The relocated access on the City Laneway is 6.0 metres wide, and the ramp has a clearance between 1.67 metres and 2.0 metres under the upper deck
- The garbage collection will remain from the City Laneway
- Retail site-generated trips are assumed to be parked on-street
- Existing pedestrian facilities are provided along the boundary streets of Bayswater Avenue and Somerset Street West
- Local bus stops are located on the frontage on Somerset Street West closer to the intersection of Somerset Street West at Bayswater Avenue

Parking

- A total of 16 vehicle parking spaces and 522 bicycle parking spaces are proposed underground for 50 Bayswater Avenue residential use
- Retail site-generated trips is assumed to be local
- No parking spaces are proposed for 1088 Somerset Street West
- The maximum parking requirement is satisfied for both 50 Bayswater Avenue and 1088 Somerset Street West
- The development is considered to have sufficient parking spaces as it is closer to the LRT station and additional bicycle parking spaces are provided
- 50 Bayswater Avenue meets the minimum bicycle parking requirements, and the 1088 Somerset Street West does not meet the minimum bicycle parking requirements

Boundary Street Design

- The pedestrian LOS will not be met along the segments of Somerset Street West and Bayswater Avenue, and the boulevards and sidewalks would need to be at least 2.0 metres
- The bicycle LOS will not be met along the segments of Somerset Street West and Bayswater Avenue, and the operating speed needs to be less or equal to 40 km/h
- No further improvements are required to meet the PLOS and BLOS targets
- The City of Ottawa will be responsible for exploring options to address the boundary roads PLOS and BLOS deficiencies

TDM

- Supportive TDM measures to be included within the proposed development should include:
 - Display local area maps with walking/cycling access routes and key destinations at major entrances
 - Display relevant transit schedules and route maps at entrances

- Provide a multimodal travel option information package to new/relocating employees and new residents
- Inclusion of a 1-month Presto card for first time new townhome purchase and apartment rental, with a set time frame for this offer (e.g. 6-months) from the initial opening of the site
- Unbundle parking cost from purchase or rental costs

11 Conclusion

It is recommended that, from a transportation perspective, the proposed development applications proceed.

Prepared By:



Yu-Chu Chen, EIT
Transportation Engineering-Intern

Reviewed By:



Andrew Harte, P.Eng.
Senior Transportation Engineer

Appendix A

TIA Screening Form and PM Certification Form

City of Ottawa 2023 Revisions to 2017 TIA Guidelines
Step 1 - Screening Form

Date: 10-Aug-23
Project Number: 2023-020
Project Reference: 50 Bayswater 1088 Somerset

1.1 Description of Proposed Development	
Municipal Address	50 Bayswater Ave, 1088 Somerset St W
Description of Location	Southwest coner of Somerset Street West and Bayswater Avenue intersection
Land Use Classification	Traditional Mainstreet Zone (TM11) and Residential Fourth Density Zone (R4UB)
Development Size	Replacing two commercial buildings with two mixed use buildings with 105 dwelling units and a reduction in commercial GFA
Accesses	Use of existing rear lane on Somerset St W and use of existing underground parking structure accessing Bayswater Ave
Phase of Development	Single
Buildout Year	2027
TIA Requirement	Design Review Component

1.2 Trip Generation Trigger	
Land Use Type	Multi-Family (High-Rise)
Development Size	105 Units
Trip Generation Trigger	No

1.3 Location Triggers		
Does the development propose a new driveway to a boundary street that is designated as part of the Transit Priority Network, Rapid Transit network or Cross-Town Bikeways?	Yes	Somerset W isolated transit priority corridor
Is the development in a Hub, a Protected Major Transit Station Area (PMTSA), or a Design Priority Area (DPA)?	Yes	Somerset W Traditional Mainstreet DPA
Location Trigger	Yes	

1.4. Safety Triggers		
Are posted speed limits on a boundary street 80 km/hr or greater?	No	
Are there any horizontal/vertical curvatures on a boundary street limits sight lines at a proposed driveway?	No	
Is the proposed driveway within the area of influence of an adjacent traffic signal or roundabout (i.e. within 300 m of intersection in rural conditions, or within 150 m of intersection in urban/ suburban conditions)?	No	Existing Driveways
Is the proposed driveway within auxiliary lanes of an intersection?	No	
Does the proposed driveway make use of an existing median break that serves an existing site?	No	
Is there is a documented history of traffic operations or safety concerns on the boundary streets within 500 m of the development?	No	
Does the development include a drive-thru facility?	No	
Safety Trigger	No	



TIA Plan Reports

On 14 June 2017, the Council of the City of Ottawa adopted new Transportation Impact Assessment (TIA) Guidelines. In adopting the guidelines, Council established a requirement for those preparing and delivering transportation impact assessments and reports to sign a letter of certification.

Individuals submitting TIA reports will be responsible for all aspects of development-related transportation assessment and reporting, and undertaking such work, in accordance and compliance with the City of Ottawa's Official Plan, the Transportation Master Plan and the Transportation Impact Assessment (2017) Guidelines.

By submitting the attached TIA report (and any associated documents) and signing this document, the individual acknowledges that s/he meets the four criteria listed below.

CERTIFICATION

1. I have reviewed and have a sound understanding of the objectives, needs and requirements of the City of Ottawa's Official Plan, Transportation Master Plan and the Transportation Impact Assessment (2017) Guidelines;
2. I have a sound knowledge of industry standard practice with respect to the preparation of transportation impact assessment reports, including multi modal level of service review;
3. I have substantial experience (more than 5 years) in undertaking and delivering transportation impact studies (analysis, reporting and geometric design) with strong background knowledge in transportation planning, engineering or traffic operations; and
4. I am either a licensed¹ or registered² professional in good standing, whose field of expertise [check appropriate field(s)] is either transportation engineering or transportation planning .

1,2 License of registration body that oversees the profession is required to have a code of conduct and ethics guidelines that will ensure appropriate conduct and representation for transportation planning and/or transportation engineering works.

City Of Ottawa
Infrastructure Services and Community
Sustainability
Planning and Growth Management
110 Laurier Avenue West, 4th fl.
Ottawa, ON K1P 1J1
Tel. : 613-580-2424
Fax: 613-560-6006

Ville d'Ottawa
Services d'infrastructure et Viabilité des
collectivités
Urbanisme et Gestion de la croissance
110, avenue Laurier Ouest
Ottawa (Ontario) K1P 1J1
Tél. : 613-580-2424
Télécopieur: 613-560-6006

Dated at Ottawa this 20 day of September, 2018.
(City)

Name: Andrew Harte
(Please Print)

Professional Title: Professional Engineer



Signature of Individual certifier that s/he meets the above four criteria

Office Contact Information (Please Print)
Address: 6 Plaza Court
City / Postal Code: Ottawa / K2H 7W1
Telephone / Extension: (613) 697-3797
E-Mail Address: Andrew.Harte@CGHTransportation.com



Appendix B

Turning Movement Counts



Turning Movement Count Summary Report Including AM and PM Peak Hours All Vehicles Except Bicycles



Albert Street/Scott Street & Bayswater Avenue/Bayview Station Road Ottawa, ON

Survey Date: Wednesday, March 01, 2023 Start Time: 0700 AADT Factor: 1.0
 Weather AM: Mostly Cloudy -5° C Survey Duration: 6 Hrs. Survey Hours: 0700-1000 & 1500-1800
 Weather PM: Cloudy +1° C Surveyor(s): T. Carmody

Time Period	Scott St.				Albert St.				Bayswater Ave.				Bayview Stn. Rd.				Street Total	Grand Total					
	Eastbound		Westbound		Northbound		Southbound		Northbound		Southbound		Northbound		Southbound								
	LT	ST	RT	UT	LT	ST	RT	UT	LT	ST	RT	UT	LT	ST	RT	UT			LT	ST	RT	UT	S/B Tot
0700-0800	12	341	40	0	393	38	152	33	0	223	616	26	30	48	0	104	72	87	3	0	162	266	882
0800-0900	21	504	69	0	594	55	178	27	0	260	854	41	44	95	0	180	156	159	11	0	326	506	1360
0900-1000	15	308	45	0	368	39	172	45	0	256	624	33	45	57	0	135	84	96	15	0	195	330	954
1500-1600	10	320	84	0	414	46	337	92	0	475	889	61	113	61	0	235	50	64	14	0	128	363	1252
1600-1700	14	388	92	0	494	83	470	170	0	723	1217	60	141	57	0	258	44	71	25	0	140	398	1615
1700-1800	13	403	107	0	523	65	410	112	0	587	1110	63	107	63	0	233	54	53	16	0	123	356	1466
Totals	85	2264	437	0	2786	326	1719	479	0	2524	5310	284	480	381	0	1145	460	530	84	0	1074	2219	7529

**Equivalent 12 & 24-Hour Vehicle Volumes Including the Annual Average Daily Traffic (AADT) Factor
Applicable to the Day and Month of the Turning Movement Count**

Expansion factors are applied exclusively to standard weekday 8-hour turning movement counts conducted during the hours of 0700h - 1000h, 1130h - 1330h and 1500h - 1800h

Equivalent 12-hour vehicle volumes. These volumes are calculated by multiplying the 8-hour totals by the 8 → 12 expansion factor of 1.39																								
Equ. 12 Hr	n/a	n/a	n/a	n/a	n/a	n/a	n/a	n/a	n/a	n/a	n/a	n/a	n/a	n/a	n/a	n/a	n/a	n/a	n/a	n/a	n/a	n/a	n/a	n/a
Average daily 12-hour vehicle volumes. These volumes are calculated by multiplying the equivalent 12-hour totals by the AADT factor of: 1.0																								
AADT 12-hr	n/a	n/a	n/a	n/a	n/a	n/a	n/a	n/a	n/a	n/a	n/a	n/a	n/a	n/a	n/a	n/a	n/a	n/a	n/a	n/a	n/a	n/a	n/a	n/a
24-Hour AADT. These volumes are calculated by multiplying the average daily 12-hour vehicle volumes by the 12 → 24 expansion factor of 1.31																								
AADT 24 Hr	n/a	n/a	n/a	n/a	n/a	n/a	n/a	n/a	n/a	n/a	n/a	n/a	n/a	n/a	n/a	n/a	n/a	n/a	n/a	n/a	n/a	n/a	n/a	n/a

AADT and expansion factors provided by the City of Ottawa

AM Peak Hour Factor → 0.92														Highest Hourly Vehicle Volume Between 0700h & 1000h													
AM Peak Hr	LT	ST	RT	UT	Total	LT	ST	RT	UT	Total	Str. Tot.	LT	ST	RT	UT	Total	LT	ST	RT	UT	Total	Str. Tot.	Gr. Tot.				
0800-0900	21	504	69	0	594	55	178	27	0	260	854	41	44	95	0	180	156	159	11	0	326	506	1360				

PM Peak Hour Factor → 0.95														Highest Hourly Vehicle Volume Between 1500h & 1800h													
PM Peak Hr	LT	ST	RT	UT	Total	LT	ST	RT	UT	Total	Str. Tot.	LT	ST	RT	UT	Total	LT	ST	RT	UT	Total	Str. Tot.	Gr. Tot.				
1615-1715	17	399	84	0	500	80	449	183	0	712	1212	61	146	59	0	266	52	72	25	0	149	415	1627				

Comments:
 Para Transpo and OC Transpo buses, private buses and school buses comprise 51.41% of the heavy vehicle traffic.

- Notes:**
- Includes all vehicle types except bicycles, electric bicycles, and electric scooters.
 - When expansion and AADT factors are applied, the results will differ slightly due to rounding.



Turning Movement Count Summary, AM and PM Peak Hour Flow Diagrams All Vehicles Except Bicycles



Albert Street/Scott Street & Bayswater Avenue/Bayview Station Road Ottawa, ON

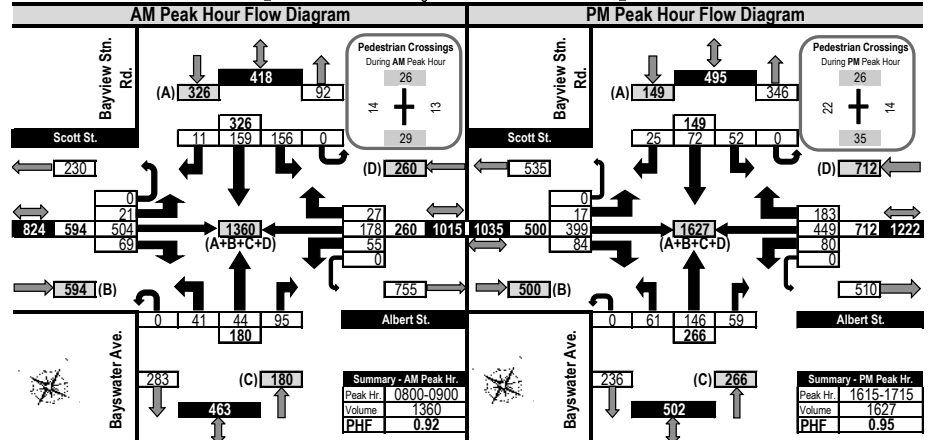
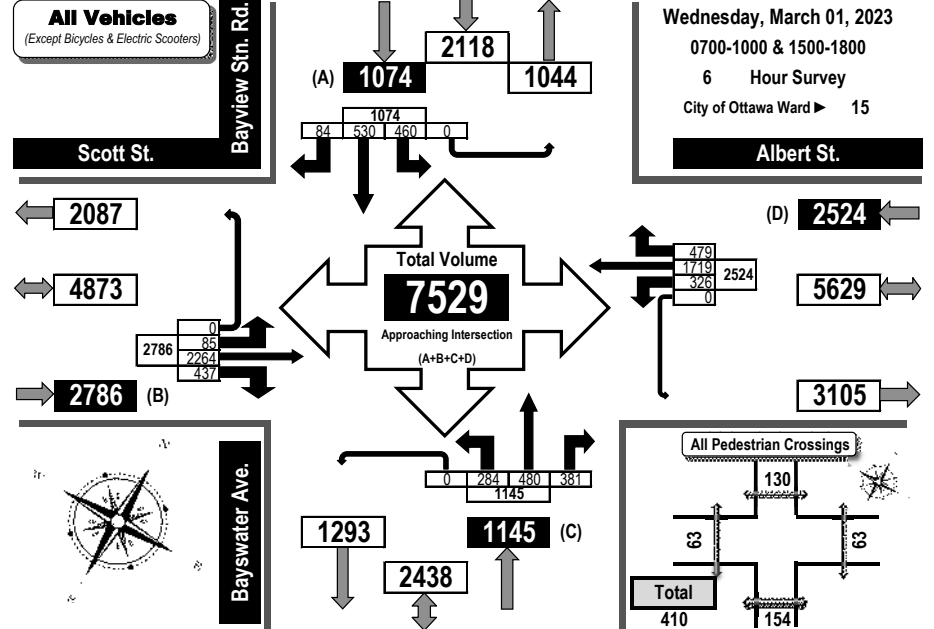



Turning Movement Count Heavy Vehicle Summary (FHWA Class 4-13) Flow Diagram

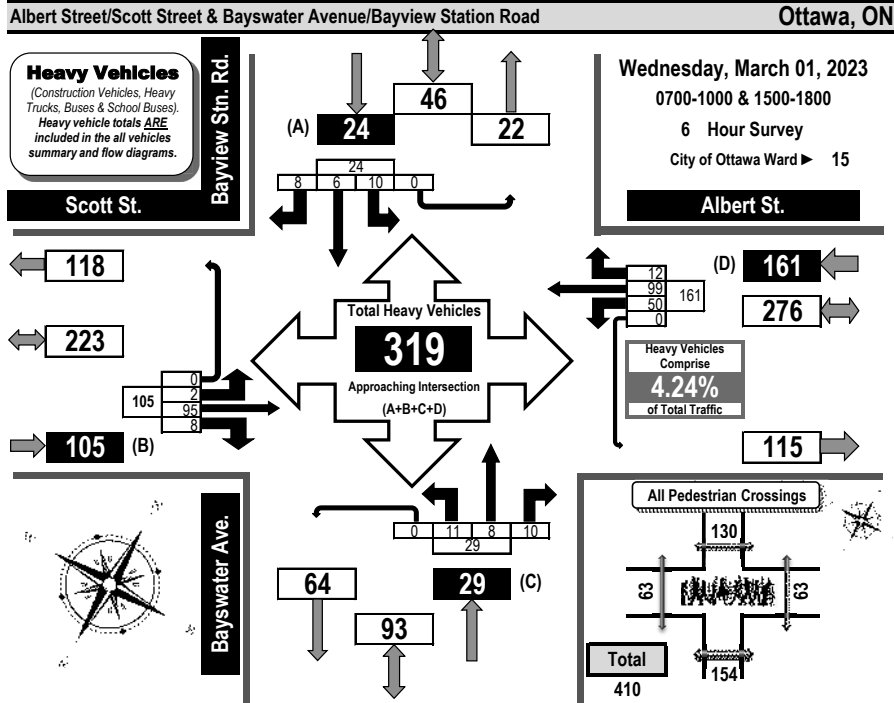

Time Period	Scott St. Eastbound				Albert St. Westbound				Bayswater Ave. Northbound				Bayview Stn. Rd. Southbound				GR Tot				
	LT	ST	RT	UT	LT	ST	RT	UT	LT	ST	RT	UT	LT	ST	RT	UT					
0700-0800	0	22	1	0	23	10	20	3	0	33	3	1	5	0	9	1	1	0	0	2	67
0800-0900	1	25	2	0	28	10	11	3	0	24	2	3	0	0	5	2	0	3	0	5	62
0900-1000	1	18	2	0	21	9	23	5	0	37	2	3	3	0	8	5	3	3	0	11	77
1500-1600	0	11	1	0	12	5	21	1	0	27	4	0	0	0	4	1	1	1	0	3	46
1600-1700	0	10	2	0	12	8	13	0	0	21	0	0	1	0	1	1	0	1	0	2	36
1700-1800	0	9	0	0	9	8	11	0	0	19	0	1	1	0	2	0	1	0	0	1	31
Totals	2	95	8	0	105	50	99	12	0	161	11	8	10	0	29	10	6	8	0	24	319

Comments:
Para Transpo and OC Transpo buses, private buses and school buses comprise 51.41% of the heavy vehicle traffic.



Turning Movement Count All Buses Summary (FHWA Class 4 ONLY) Flow Diagram

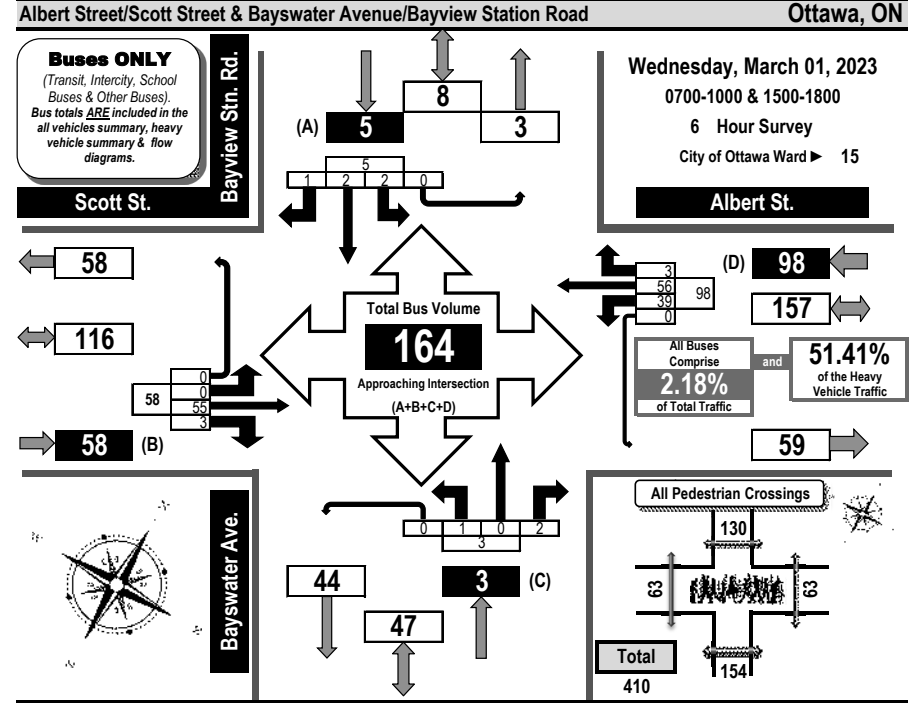

Time Period	Scott St. Eastbound				Albert St. Westbound				Bayswater Ave. Northbound				Bayview Stn. Rd. Southbound				GR Tot				
	LT	ST	RT	UT	LT	ST	RT	UT	LT	ST	RT	UT	LT	ST	RT	UT					
0700-0800	0	13	0	0	13	7	6	0	0	13	0	0	0	0	1	0	0	1	0	1	27
0800-0900	0	17	2	0	19	7	8	1	0	16	0	0	0	0	0	0	0	0	0	0	35
0900-1000	0	9	0	0	9	7	7	1	0	15	0	0	1	1	0	0	1	1	0	1	26
1500-1600	0	3	0	0	3	4	15	1	0	20	1	0	0	0	1	1	1	1	1	3	27
1600-1700	0	6	1	0	7	7	10	0	0	17	0	0	1	0	1	0	1	0	0	0	25
1700-1800	0	7	0	0	7	7	10	0	0	17	0	0	0	0	0	0	0	0	0	0	24
Totals	0	55	3	0	58	39	56	3	0	98	1	0	2	0	3	2	2	1	0	5	164

Comments:
Para Transpo and OC Transpo buses, private buses and school buses comprise 51.41% of the heavy vehicle traffic.



Turning Movement Count Bicycle Summary Flow Diagram



Albert Street/Scott Street & Bayswater Avenue/Bayview Station Road Ottawa, ON

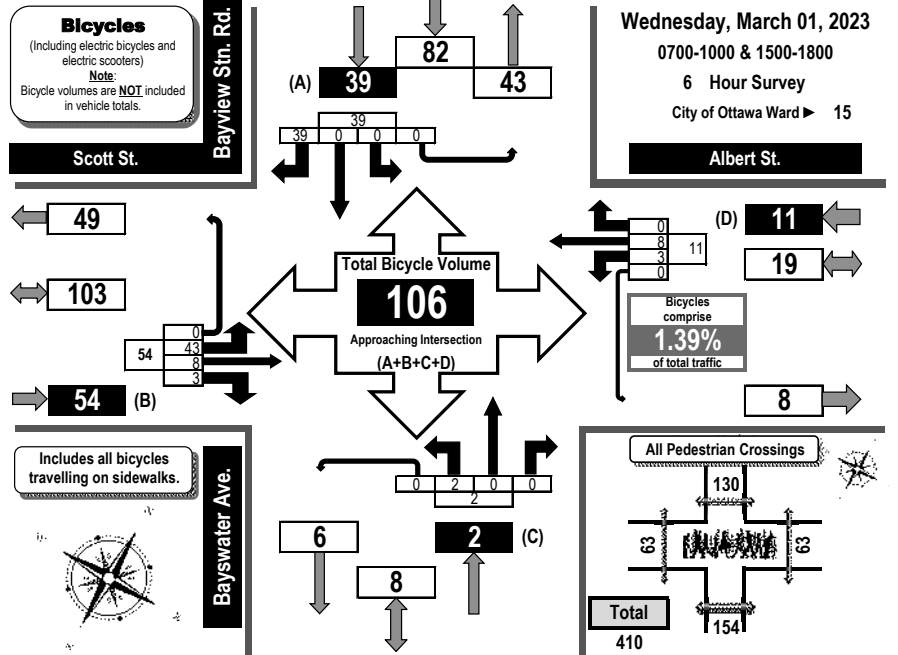

Time Period	Scott St.				Albert St.				Bayswater Ave.				Bayview Stn. Rd.				SB Tot	GR Tot	
	Eastbound		Westbound		Northbound		Southbound		Northbound		Southbound		Northbound		Southbound				
	LT	ST	RT	UT	LT	ST	RT	UT	LT	ST	RT	UT	LT	ST	RT	UT			
0700-0800	9	1	0	0	10	0	0	0	0	0	0	0	0	0	0	2	0	2	12
0800-0900	11	3	2	0	16	0	2	0	2	1	0	0	1	0	0	2	0	2	21
0900-1000	11	1	0	0	12	0	1	0	1	0	0	0	0	0	0	1	0	1	14
1500-1600	2	0	0	0	2	0	0	0	0	0	0	0	0	0	0	6	0	6	8
1600-1700	4	2	1	0	7	1	3	0	4	1	0	0	1	0	0	11	0	11	23
1700-1800	6	1	0	0	7	2	2	0	4	0	0	0	0	0	0	17	0	17	28
Totals	43	8	3	0	54	3	8	0	11	2	0	0	2	0	0	39	0	39	

Comments:
Para Transpo and OC Transpo buses, private buses and school buses comprise 51.41% of the heavy vehicle traffic.



Turning Movement Count Pedestrian Crossings Summary and Flow Diagram

Albert Street/Scott Street & Bayswater Avenue/Bayview Station Road Ottawa, ON

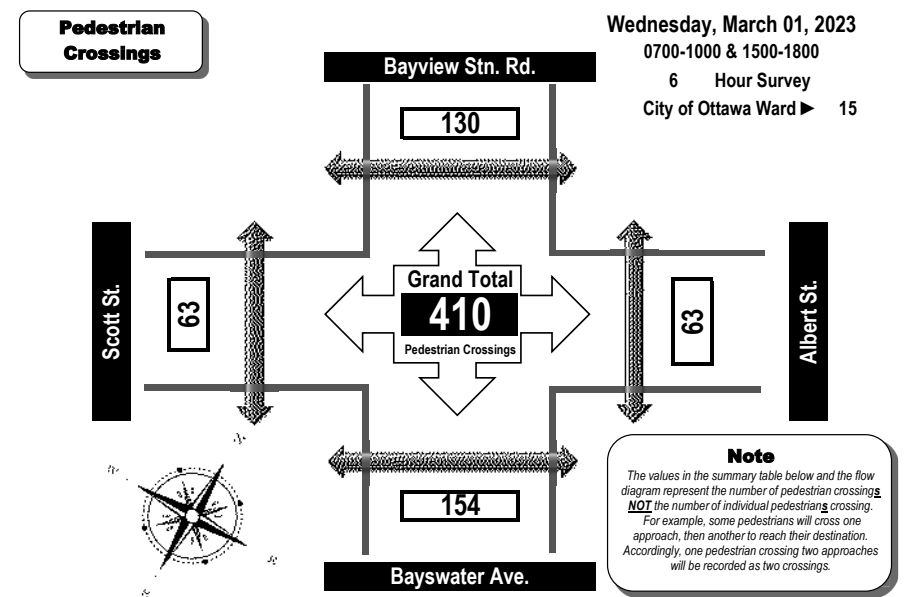

Time Period	West Side Crossing Scott St.	East Side Crossing Albert St.	Street Total	South Side Crossing Bayswater Ave.	North Side Crossing Bayview Stn. Rd.	Street Total	Grand Total
0700-0800	4	11	15	25	18	43	58
0800-0900	14	13	27	29	26	55	82
0900-1000	4	10	14	15	10	25	39
1500-1600	3	7	10	18	14	32	42
1600-1700	22	13	35	39	25	64	99
1700-1800	16	9	25	28	37	65	90
Totals	63	63	126	154	130	284	410

Comments:
Para Transpo and OC Transpo buses, private buses and school buses comprise 51.41% of the heavy vehicle traffic.



Transportation Services - Traffic Services

Turning Movement Count - Study Results

FAIRMONT AVE @ WELLINGTON ST

Survey Date: Thursday, February 22, 2018

WO No: 37566

Start Time: 07:00

Device: Miovision

Full Study Diagram

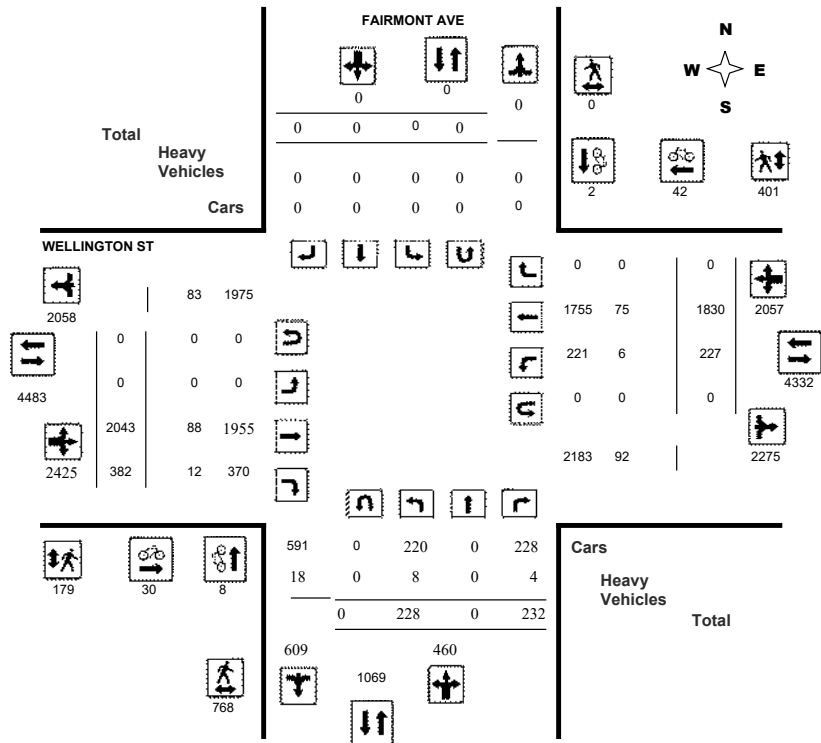

Transportation Services - Traffic Services

Turning Movement Count - Study Results

FAIRMONT AVE @ WELLINGTON ST

Survey Date: Thursday, February 22, 2018

WO No: 37566

Start Time: 07:00

Device: Miovision

Full Study Peak Hour Diagram

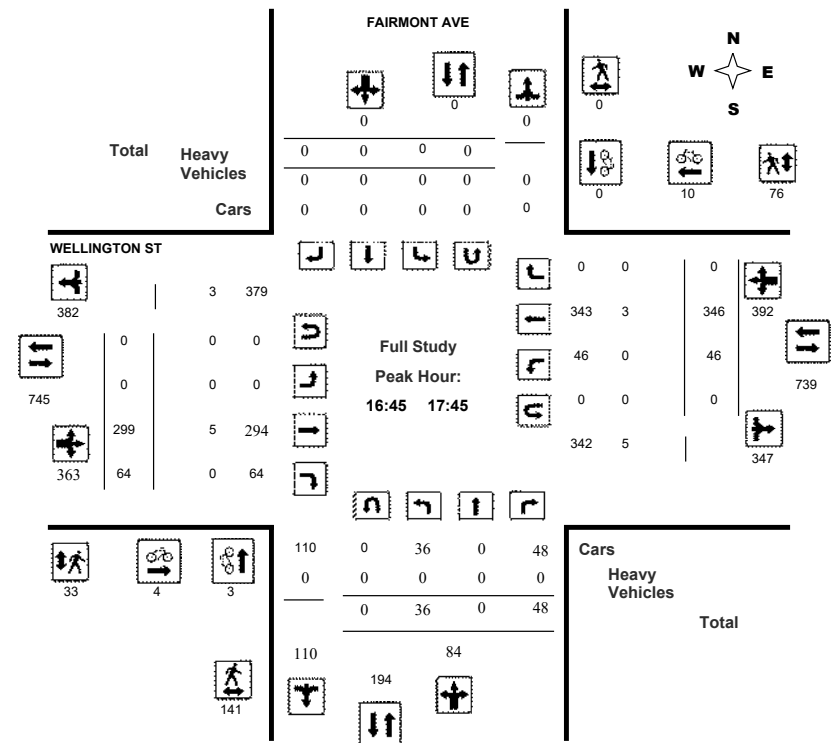



Transportation Services - Traffic Services

Turning Movement Count - Peak Hour Diagram

FAIRMONT AVE @ WELLINGTON ST

Survey Date: Thursday, February 22, 2018
Start Time: 07:00

WO No: 37566
Device: Miovision

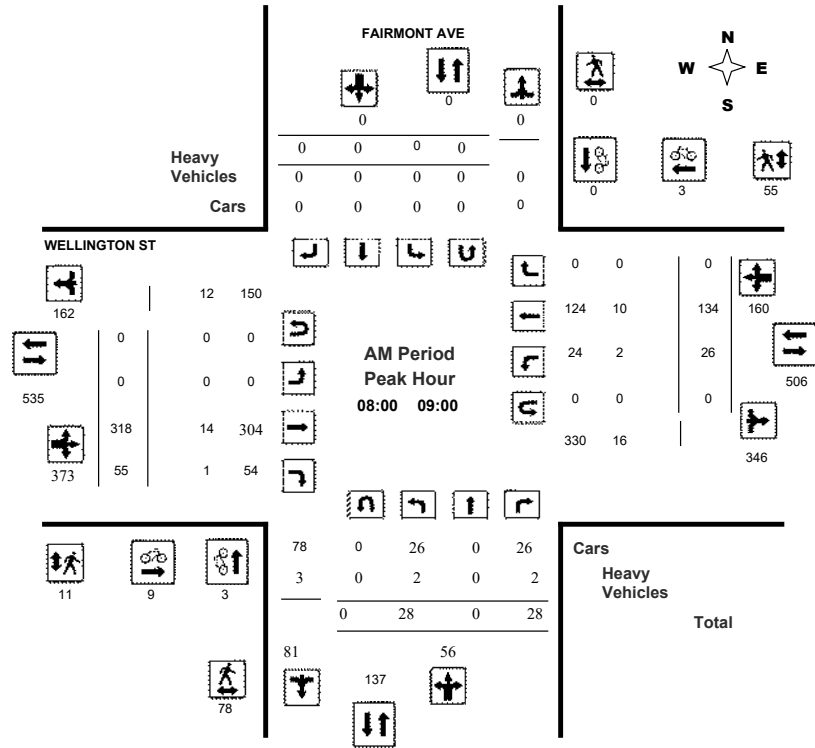

Transportation Services - Traffic Services

Turning Movement Count - Peak Hour Diagram

FAIRMONT AVE @ WELLINGTON ST

Survey Date: Thursday, February 22, 2018
Start Time: 07:00

WO No: 37566
Device: Miovision

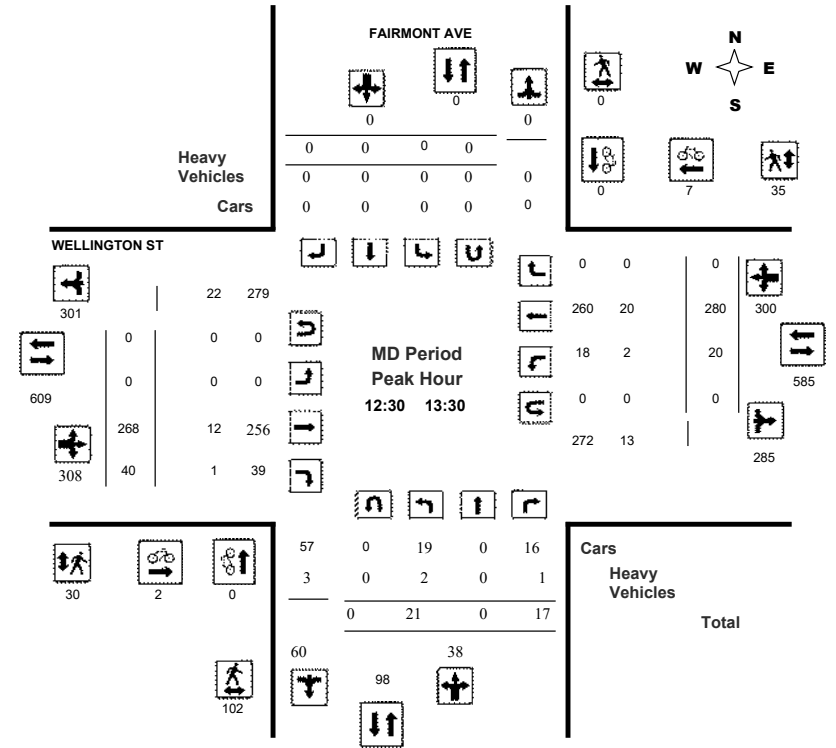



Transportation Services - Traffic Services

Turning Movement Count - Peak Hour Diagram

FAIRMONT AVE @ WELLINGTON ST

Survey Date: Thursday, February 22, 2018
Start Time: 07:00

WO No: 37566
Device: Miovision

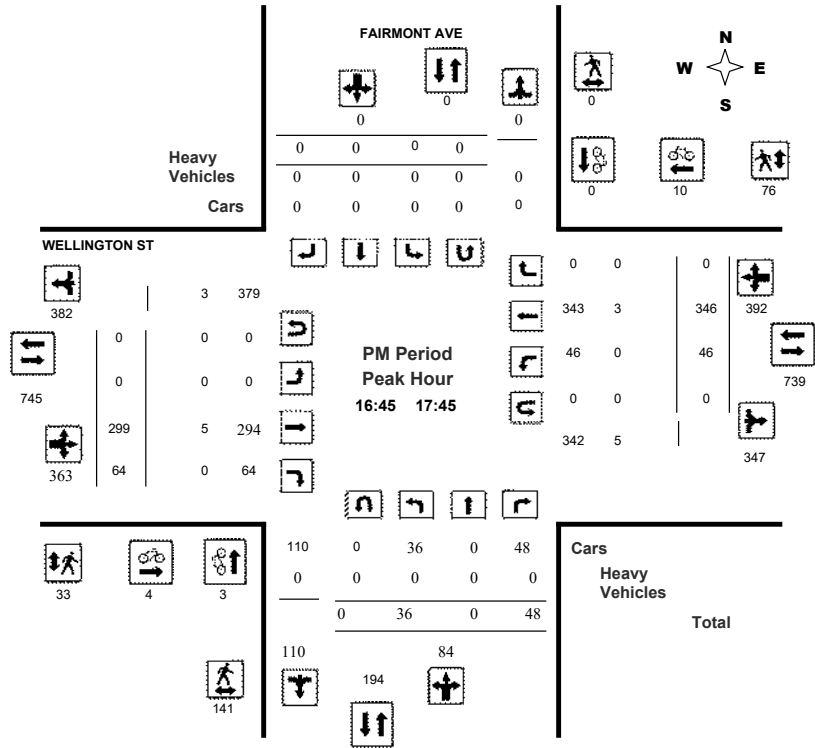

Comments



Transportation Services - Traffic Services

Turning Movement Count - Study Results

FAIRMONT AVE @ WELLINGTON ST

Survey Date: Thursday, February 22, 2018
Start Time: 07:00

WO No: 37566
Device: Miovision

Full Study Summary (8 HR Standard)

Survey Date: Thursday, February 22, 2018

Total Observed U-Turns

Northbound: 0 Southbound: 0

Eastbound: 0 Westbound: 0

AADT Factor

.90

Period	FAIRMONT AVE					WELLINGTON ST					Grand Total								
	Northbound		Southbound			Eastbound			Westbound										
	LT	ST	RT	SB TOT	STR TOT	LT	ST	RT	WB TOT	STR TOT									
07:00-08:00	11	0	12	23	0	0	0	0	23	0	194	26	220	28	115	0	143	363	386
08:00-09:00	28	0	28	56	0	0	0	0	56	0	318	55	373	26	134	0	160	533	589
09:00-10:00	15	0	34	49	0	0	0	0	49	0	201	27	228	17	169	0	186	414	463
11:30-12:30	34	0	26	60	0	0	0	0	60	0	280	46	326	18	220	0	238	564	624
12:30-13:30	21	0	17	38	0	0	0	0	38	0	268	40	308	20	280	0	300	608	646
15:00-16:00	38	0	37	75	0	0	0	0	75	0	221	63	284	29	262	0	291	575	650
16:00-17:00	49	0	28	77	0	0	0	0	77	0	280	67	347	47	315	0	362	709	786
17:00-18:00	32	0	50	82	0	0	0	0	82	0	281	58	339	42	335	0	377	716	798
Sub Total	228	0	232	460	0	0	0	0	460	0	2043	382	2425	227	1830	0	2057	4482	4942
U Turns	0																		
Total	228	0	232	460	0	0	0	0	460	0	2043	382	2425	227	1830	0	2057	4482	4942
EQ 12Hr	317	0	322	639	0	0	0	0	639	0	2840	531	3371	316	2544	0	2859	6230	6869
Note: These values are calculated by multiplying the totals by the appropriate expansion factor.																			
AVG 12Hr	269	0	274	542	0	0	0	0	575	0	2409	450	2859	268	2158	0	2425	5607	6182
Note: These volumes are calculated by multiplying the Equivalent 12 hr. totals by the AADT factor.																			
AVG 24Hr	352	0	358	710	0	0	0	0	710	0	3155	590	3745	351	2826	0	3177	6922	7632
Note: These volumes are calculated by multiplying the Average Daily 12 hr. totals by 12 to 24 expansion factor.																			
Note: U-Turns provided for approach totals. Refer to 'U-Turn' Report for specific breakdown.																			



Transportation Services - Traffic Services

Turning Movement Count - Study Results

FAIRMONT AVE @ WELLINGTON ST

Survey Date: Thursday, February 22, 2018

WO No: 37566

Start Time: 07:00

Device: Miovision

Full Study 15 Minute Increments

FAIRMONT AVE														WELLINGTON ST														Grand Total
Northbound				Southbound				Eastbound				Westbound																
Time Period	LT	ST	RT	N TOT	LT	ST	RT	S TOT	STR TOT	LT	ST	RT	E TOT	LT	ST	RT	W TOT	STR TOT										
07:00	07:15	1	0	1	2	0	0	0	0	0	0	0	36	3	39	4	27	0	31	0	72							
07:15	07:30	1	0	1	2	0	0	0	0	0	0	0	44	6	50	5	27	0	32	0	84							
07:30	07:45	2	0	3	5	0	0	0	0	0	0	0	51	5	56	9	28	0	37	0	98							
07:45	08:00	7	0	7	14	0	0	0	0	1	0	0	63	12	75	10	33	0	43	1	132							
08:00	08:15	8	0	7	15	0	0	0	0	0	0	0	88	19	107	6	26	0	32	0	154							
08:15	08:30	4	0	6	10	0	0	0	0	2	0	0	79	20	99	2	43	0	45	2	154							
08:30	08:45	7	0	5	12	0	0	0	0	1	0	0	80	8	88	7	38	0	45	1	145							
08:45	09:00	9	0	10	19	0	0	0	0	1	0	0	71	8	79	11	27	0	38	1	136							
09:00	09:15	2	0	11	13	0	0	0	0	0	0	0	48	6	54	2	45	0	47	0	114							
09:15	09:30	4	0	7	11	0	0	0	0	0	0	0	50	9	59	5	43	0	48	0	118							
09:30	09:45	4	0	3	7	0	0	0	0	0	0	0	58	6	64	5	40	0	45	0	116							
09:45	10:00	5	0	13	18	0	0	0	0	0	0	0	45	6	51	5	41	0	46	0	115							
11:30	11:45	10	0	7	17	0	0	0	0	0	0	0	71	10	81	3	55	0	58	0	156							
11:45	12:00	6	0	10	16	0	0	0	0	0	0	0	68	11	79	7	55	0	62	0	157							
12:00	12:15	13	0	3	16	0	0	0	0	1	0	0	63	14	77	4	57	0	61	1	154							
12:15	12:30	5	0	6	11	0	0	0	0	0	0	0	78	11	89	4	53	0	57	0	157							
12:30	12:45	2	0	6	8	0	0	0	0	1	0	0	52	8	60	6	75	0	81	1	149							
12:45	13:00	6	0	5	11	0	0	0	0	0	0	0	76	14	90	4	71	0	75	0	176							
13:00	13:15	9	0	5	14	0	0	0	0	1	0	0	58	11	69	7	64	0	71	1	154							
13:15	13:30	4	0	1	5	0	0	0	0	1	0	0	82	7	89	3	70	0	73	1	167							
15:00	15:15	11	0	8	19	0	0	0	0	1	0	0	57	18	75	5	49	0	54	1	148							
15:15	15:30	9	0	12	21	0	0	0	0	0	0	0	53	10	63	6	64	0	70	0	154							
15:30	15:45	12	0	12	24	0	0	0	0	1	0	0	46	18	64	11	77	0	88	1	176							
15:45	16:00	6	0	5	11	0	0	0	0	1	0	0	65	17	82	7	72	0	79	1	172							
16:00	16:15	15	0	9	24	0	0	0	0	0	0	0	68	21	89	14	79	0	93	0	206							
16:15	16:30	12	0	4	16	0	0	0	0	0	0	0	65	17	82	10	65	0	75	0	173							
16:30	16:45	11	0	8	19	0	0	0	0	0	0	0	70	17	87	10	81	0	91	0	197							
16:45	17:00	11	0	7	18	0	0	0	0	0	0	0	77	12	89	13	90	0	103	0	210							
17:00	17:15	13	0	14	27	0	0	0	0	0	0	0	67	14	81	11	83	0	94	0	202							
17:15	17:30	3	0	15	18	0	0	0	0	0	0	0	80	13	93	16	84	0	100	0	211							
17:30	17:45	9	0	12	21	0	0	0	0	0	0	0	75	25	100	6	89	0	95	0	216							
17:45	18:00	7	0	9	16	0	0	0	0	0	0	0	59	6	65	9	79	0	88	0	169							
Total:		228	0	232	460	0	0	0	0	12	0	0	2043	382	2425	227	1830	0	2057	12	4,942							

Note: U-Turns are included in Totals.



Transportation Services - Traffic Services

Turning Movement Count - Study Results

FAIRMONT AVE @ WELLINGTON ST

Survey Date: Thursday, February 22, 2018

WO No: 37566

Start Time: 07:00

Device: Miovision

Full Study Cyclist Volume

FAIRMONT AVE				WELLINGTON ST				Grand Total
Northbound		Southbound		Street Total		Street Total		
Time Period	Northbound	Southbound	Street Total	Eastbound	Westbound	Street Total		
07:00	07:15	0	0	0	2	0	2	
07:15	07:30	0	0	0	1	1	2	
07:30	07:45	0	0	0	3	0	3	
07:45	08:00	1	0	1	2	1	4	
08:00	08:15	1	0	1	4	1	6	
08:15	08:30	1	0	1	3	1	5	
08:30	08:45	0	0	0	1	1	2	
08:45	09:00	1	0	1	1	0	2	
09:00	09:15	0	0	0	0	0	0	
09:15	09:30	0	0	0	0	0	0	
09:30	09:45	0	0	0	1	0	1	
09:45	10:00	0	0	0	1	0	1	
11:30	11:45	0	0	0	0	1	1	
11:45	12:00	0	0	0	0	0	0	
12:00	12:15	0	0	0	1	0	1	
12:15	12:30	0	0	0	0	0	0	
12:30	12:45	0	0	0	0	1	1	
12:45	13:00	0	0	0	1	2	3	
13:00	13:15	0	0	0	1	2	3	
13:15	13:30	0	0	0	0	2	2	
15:00	15:15	0	2	2	1	2	5	
15:15	15:30	0	0	0	1	2	3	
15:30	15:45	0	0	0	0	3	3	
15:45	16:00	0	0	0	0	1	1	
16:00	16:15	0	0	0	0	6	6	
16:15	16:30	1	0	1	1	1	3	
16:30	16:45	0	0	0	1	0	1	
16:45	17:00	0	0	0	0	1	1	
17:00	17:15	1	0	1	1	2	4	
17:15	17:30	0	0	0	1	5	6	
17:30	17:45	2	0	2	2	2	6	
17:45	18:00	0	0	0	0	4	4	
Total		8	2	10	30	42	72	



Transportation Services - Traffic Services

Turning Movement Count - Study Results

FAIRMONT AVE @ WELLINGTON ST

Survey Date: Thursday, February 22, 2018

WO No: 37566

Start Time: 07:00

Device: Miovision

Full Study Pedestrian Volume

FAIRMONT AVE

WELLINGTON ST

Time Period	NB Approach (E or W Crossing)		Total	EB Approach (N or S Crossing)		Total	Grand Total
	SB Approach (E or W Crossing)	WB Approach (N or S Crossing)		WB Approach (N or S Crossing)	WB Approach (N or S Crossing)		
07:00 07:15	9	0	9	3	8	11	20
07:15 07:30	15	0	15	4	16	20	35
07:30 07:45	25	0	25	2	11	13	38
07:45 08:00	14	0	14	4	8	12	26
08:00 08:15	25	0	25	2	14	16	41
08:15 08:30	19	0	19	3	9	12	31
08:30 08:45	16	0	16	4	16	20	36
08:45 09:00	18	0	18	2	16	18	36
09:00 09:15	11	0	11	4	11	15	26
09:15 09:30	7	0	7	2	12	14	21
09:30 09:45	14	0	14	0	15	15	29
09:45 10:00	13	0	13	5	7	12	25
11:30 11:45	22	0	22	3	10	10	32
11:45 12:00	21	0	21	4	12	16	37
12:00 12:15	24	0	24	12	19	31	55
12:15 12:30	13	0	13	6	11	17	30
12:30 12:45	24	0	24	7	12	19	43
12:45 13:00	19	0	19	10	4	14	33
13:00 13:15	37	0	37	11	10	21	58
13:15 13:30	22	0	22	2	9	11	33
15:00 15:15	29	0	29	4	8	12	41
15:15 15:30	53	0	53	4	14	18	71
15:30 15:45	31	0	31	9	7	16	47
15:45 16:00	22	0	22	7	11	18	40
16:00 16:15	35	0	35	8	11	19	54
16:15 16:30	29	0	29	6	19	25	54
16:30 16:45	29	0	29	9	20	29	58
16:45 17:00	24	0	24	10	20	30	54
17:00 17:15	35	0	35	9	23	32	67
17:15 17:30	46	0	46	8	18	26	72
17:30 17:45	36	0	36	6	15	21	57
17:45 18:00	31	0	31	9	8	17	48
Total	768	0	768	179	401	580	1348



Transportation Services - Traffic Services

Turning Movement Count - Study Results

FAIRMONT AVE @ WELLINGTON ST

Survey Date: Thursday, February 22, 2018

WO No: 37566

Start Time: 07:00

Device: Miovision

Full Study Heavy Vehicles

FAIRMONT AVE

WELLINGTON ST

Time Period	Northbound				Southbound				Eastbound				Westbound				Grand Total			
	FAIRMONT AVE		WELLINGTON ST		FAIRMONT AVE		WELLINGTON ST		FAIRMONT AVE		WELLINGTON ST		FAIRMONT AVE		WELLINGTON ST					
	LT	ST	RT	N TOT	LT	ST	RT	S TOT	STR TOT	LT	ST	RT	E TOT	LT	ST	RT		W TOT	STR TOT	
07:00 07:15	0	0	0	0	0	0	0	0	0	0	0	4	0	4	0	3	0	3	7	7
07:15 07:30	0	0	0	0	0	0	0	0	0	0	0	2	0	2	0	1	0	1	3	3
07:30 07:45	0	0	0	0	0	0	0	0	0	0	0	1	1	2	0	2	0	2	4	4
07:45 08:00	1	0	0	1	0	0	0	0	1	0	0	3	2	5	1	3	0	4	9	10
08:00 08:15	0	0	0	0	0	0	0	0	0	0	5	0	5	0	2	0	2	7	7	
08:15 08:30	1	0	1	2	0	0	0	0	2	0	3	0	3	0	2	0	2	5	7	
08:30 08:45	1	0	0	1	0	0	0	0	1	0	1	0	1	0	4	0	4	5	6	
08:45 09:00	0	0	1	1	0	0	0	0	1	0	5	1	6	2	2	0	4	10	11	
09:00 09:15	0	0	0	0	0	0	0	0	0	0	2	1	3	0	4	0	4	7	7	
09:15 09:30	0	0	0	0	0	0	0	0	0	0	3	0	3	0	3	0	3	6	6	
09:30 09:45	0	0	0	0	0	0	0	0	0	0	4	0	4	0	0	0	0	4	4	
09:45 10:00	0	0	0	0	0	0	0	0	0	0	4	0	4	0	0	0	0	4	4	
11:30 11:45	0	0	0	0	0	0	0	0	0	0	5	0	5	0	1	0	1	6	6	
11:45 12:00	0	0	0	0	0	0	0	0	0	0	2	0	2	0	3	0	3	5	5	
12:00 12:15	1	0	0	1	0	0	0	0	1	0	4	2	6	1	4	0	5	11	12	
12:15 12:30	0	0	0	0	0	0	0	0	0	0	9	0	9	0	4	0	4	13	13	
12:30 12:45	1	0	0	1	0	0	0	0	1	0	2	0	2	1	4	0	5	7	8	
12:45 13:00	0	0	0	0	0	0	0	0	0	0	3	1	4	0	6	0	6	10	10	
13:00 13:15	0	0	1	1	0	0	0	0	1	0	1	0	1	1	8	0	9	10	11	
13:15 13:30	1	0	0	1	0	0	0	0	1	0	6	0	6	0	2	0	2	8	9	
15:00 15:15	1	0	0	1	0	0	0	0	1	0	1	1	2	0	2	0	2	4	5	
15:15 15:30	0	0	0	0	0	0	0	0	0	0	2	1	3	0	1	0	1	4	4	
15:30 15:45	1	0	0	1	0	0	0	0	1	0	2	0	2	0	1	0	1	3	4	
15:45 16:00	0	0	1	1	0	0	0	0	1	0	2	1	3	0	4	0	4	7	8	
16:00 16:15	0	0	0	0	0	0	0	0	0	0	2	0	2	0	0	0	0	2	2	
16:15 16:30	0	0	0	0	0	0	0	0	0	0	2	1	3	0	1	0	1	4	4	
16:30 16:45	0	0	0	0	0	0	0	0	0	0	1	0	1	0	1	0	1	2	2	
16:45 17:00	0	0	0	0	0	0	0	0	0	0	3	0	3	0	0	0	0	3	3	
17:00 17:15	0	0	0	0	0	0	0	0	0	0	0	0	0	0	0	0	0	0	0	0
17:15 17:30	0	0	0	0	0	0	0	0	0	0	2	0	2	0	1	0	1	3	3	
17:30 17:45	0	0	0	0	0	0	0	0	0	0	0	0	0	0	2	0	2	2	2	
17:45 18:00	0	0	0	0	0	0	0	0	0	0	2	0	2	0	4	0	4	6	6	
Total: None	8	0	4	12	0	0	0	0	12	0	88	12	100	6	75	0	81	181	193	



Transportation Services - Traffic Services

Turning Movement Count - Study Results

FAIRMONT AVE @ WELLINGTON ST

Survey Date: Thursday, February 22, 2018

WO No: 37566

Start Time: 07:00

Device: Miovision

Full Study 15 Minute U-Turn Total

Time Period	FAIRMONT AVE		WELLINGTON ST		Total
	Northbound U-Turn Total	Southbound U-Turn Total	Eastbound U-Turn Total	Westbound U-Turn Total	
07:00 - 07:15	0	0	0	0	0
07:15 - 07:30	0	0	0	0	0
07:30 - 07:45	0	0	0	0	0
07:45 - 08:00	0	0	0	0	0
08:00 - 08:15	0	0	0	0	0
08:15 - 08:30	0	0	0	0	0
08:30 - 08:45	0	0	0	0	0
08:45 - 09:00	0	0	0	0	0
09:00 - 09:15	0	0	0	0	0
09:15 - 09:30	0	0	0	0	0
09:30 - 09:45	0	0	0	0	0
09:45 - 10:00	0	0	0	0	0
11:30 - 11:45	0	0	0	0	0
11:45 - 12:00	0	0	0	0	0
12:00 - 12:15	0	0	0	0	0
12:15 - 12:30	0	0	0	0	0
12:30 - 12:45	0	0	0	0	0
12:45 - 13:00	0	0	0	0	0
13:00 - 13:15	0	0	0	0	0
13:15 - 13:30	0	0	0	0	0
15:00 - 15:15	0	0	0	0	0
15:15 - 15:30	0	0	0	0	0
15:30 - 15:45	0	0	0	0	0
15:45 - 16:00	0	0	0	0	0
16:00 - 16:15	0	0	0	0	0
16:15 - 16:30	0	0	0	0	0
16:30 - 16:45	0	0	0	0	0
16:45 - 17:00	0	0	0	0	0
17:00 - 17:15	0	0	0	0	0
17:15 - 17:30	0	0	0	0	0
17:30 - 17:45	0	0	0	0	0
17:45 - 18:00	0	0	0	0	0
Total	0	0	0	0	0



Transportation Services - Traffic Services

Turning Movement Count - Study Results

GARLAND ST @ SOMERSET ST W/WELLINGTON ST

Survey Date: Tuesday, August 23, 2022

WO No: 40519

Start Time: 07:00

Device: Miovision

Full Study Diagram

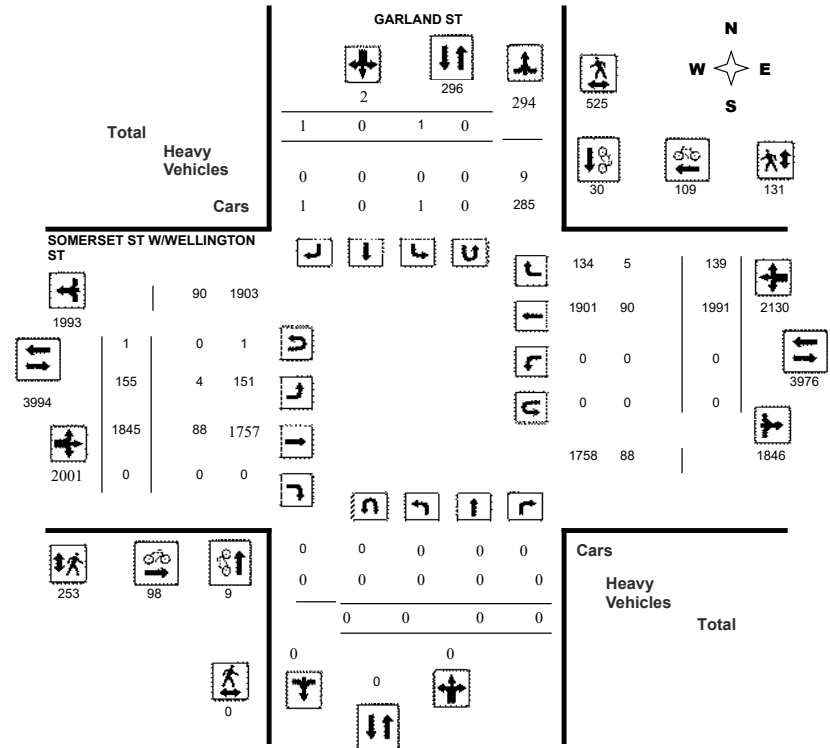



Transportation Services - Traffic Services

Turning Movement Count - Study Results

GARLAND ST @ SOMERSET ST W/WELLINGTON ST

Survey Date: Tuesday, August 23, 2022

WO No: 40519

Start Time: 07:00

Device: Miovision

Full Study Peak Hour Diagram

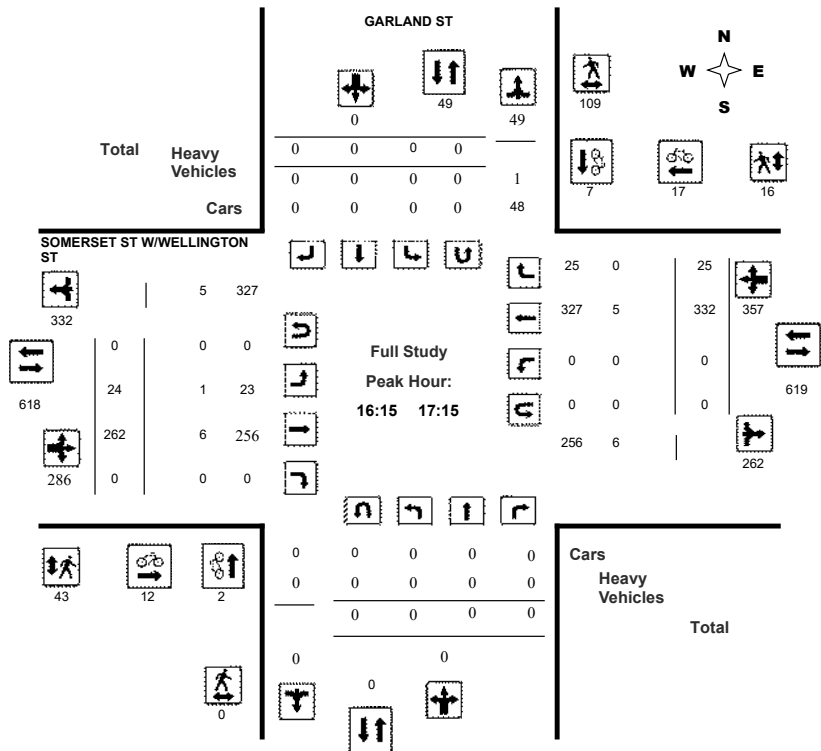

Transportation Services - Traffic Services

Turning Movement Count - Peak Hour Diagram

GARLAND ST @ SOMERSET ST W/WELLINGTON ST

Survey Date: Tuesday, August 23, 2022

WO No: 40519

Start Time: 07:00

Device: Miovision

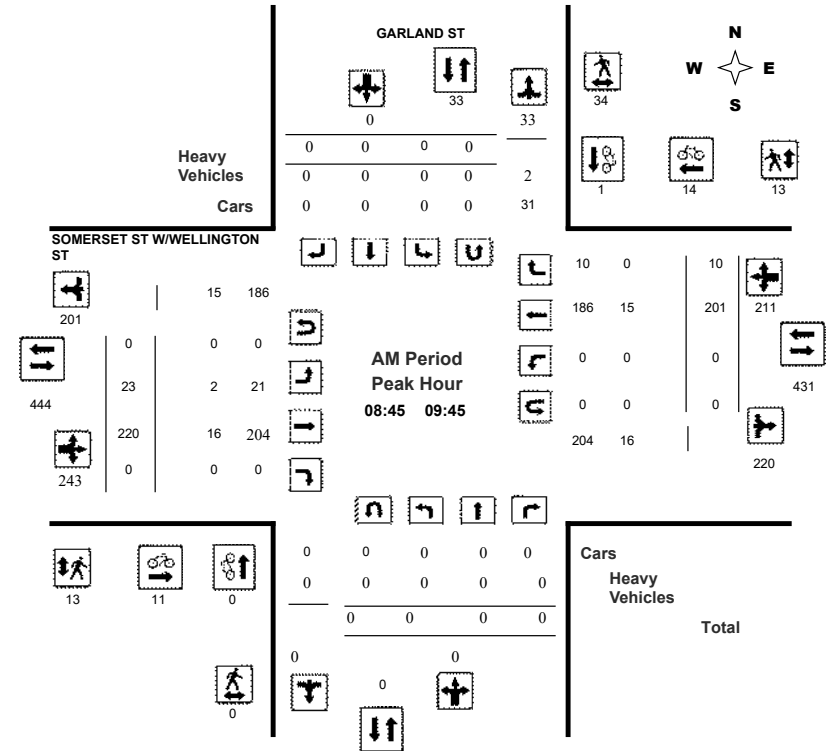

Comments



Transportation Services - Traffic Services

Turning Movement Count - Peak Hour Diagram

GARLAND ST @ SOMERSET ST W/WELLINGTON ST

Survey Date: Tuesday, August 23, 2022
Start Time: 07:00

WO No: 40519
Device: Miovision

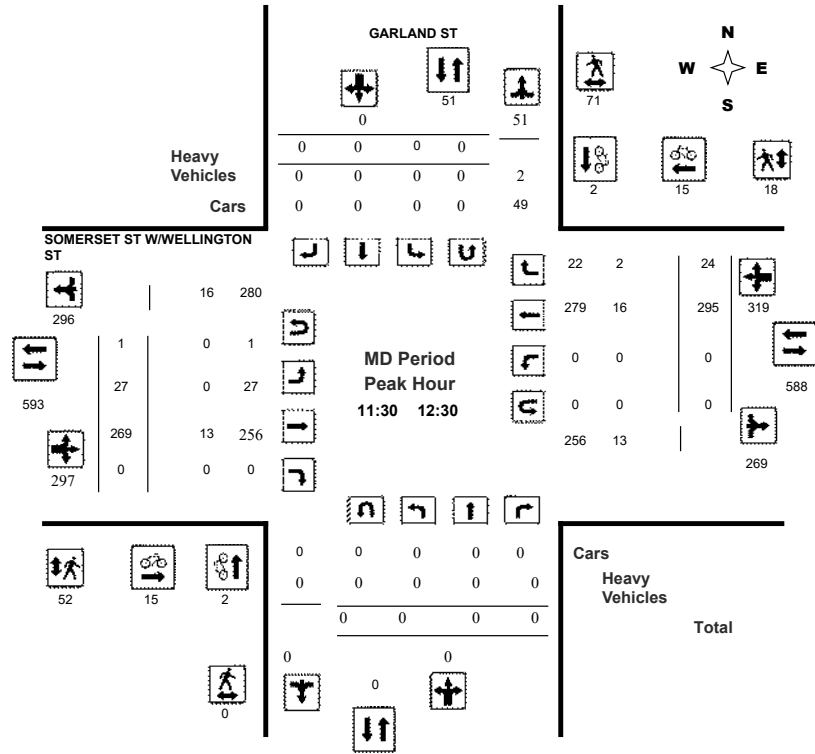

Comments



Transportation Services - Traffic Services

Turning Movement Count - Peak Hour Diagram

GARLAND ST @ SOMERSET ST W/WELLINGTON ST

Survey Date: Tuesday, August 23, 2022
Start Time: 07:00

WO No: 40519
Device: Miovision

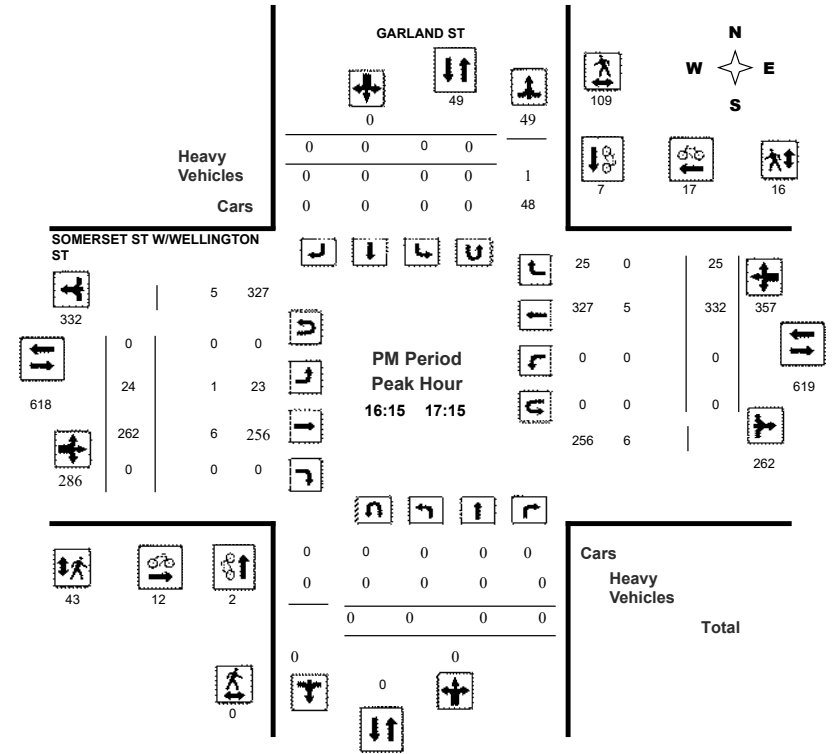

Comments



Transportation Services - Traffic Services

Turning Movement Count - Study Results

GARLAND ST @ SOMERSET ST W/WELLINGTON ST

Survey Date: Tuesday, August 23, 2022

WO No: 40519

Start Time: 07:00

Device: Miovision

Full Study Summary (8 HR Standard)

Survey Date: Tuesday, August 23, 2022

Total Observed U-Turns AADT Factor
 Northbound: 0 Southbound: 0
 Eastbound: 1 Westbound: 0 .90

Period	GARLAND ST									SOMERSET ST W/WELLINGTON ST									WB TOT	STR TOT	Grand Total
	Northbound				Southbound					Eastbound				Westbound							
	LT	ST	RT	NB TOT	LT	ST	RT	SB TOT	STR TOT	LT	ST	RT	EB TOT	LT	ST	RT	WB TOT	STR TOT			
07:00 08:00	0	0	0	0	0	0	1	1	1	9	119	0	128	0	122	9	131	259	260		
08:00 09:00	0	0	0	0	0	0	0	0	0	13	202	0	215	0	190	7	197	412	412		
09:00 10:00	0	0	0	0	0	0	0	0	0	22	234	0	256	0	186	11	197	453	453		
11:30 12:30	0	0	0	0	0	0	0	0	0	27	269	0	296	0	295	24	319	615	615		
12:30 13:30	0	0	0	0	1	0	0	1	1	25	243	0	268	0	269	22	291	559	560		
15:00 16:00	0	0	0	0	0	0	0	0	0	15	266	0	281	0	314	15	329	610	610		
16:00 17:00	0	0	0	0	0	0	0	0	0	21	258	0	279	0	325	24	349	628	628		
17:00 18:00	0	0	0	0	0	0	0	0	0	23	254	0	277	0	290	27	317	594	594		
Sub Total	0	0	0	0	1	0	1	2	2	155	1845	0	2000	0	1991	139	2130	4130	4132		
U Turns	0								0	0	1								0	1	1
Total	0	0	0	0	1	0	1	2	2	155	1845	0	2001	0	1991	139	2130	4131	4133		
EQ 12Hr	0	0	0	0	1	0	1	3	3	215	2565	0	2781	0	2767	193	2961	5742	5745		
Note: These values are calculated by multiplying the totals by the appropriate expansion factor.										1.39											
AVG 12Hr	0	0	0	0	1	0	2	3	3	194	2308	0	2503	0	2490	174	2665	5168	5170		
Note: These volumes are calculated by multiplying the Equivalent 12 hr. totals by the AADT factor.										.90											
AVG 24Hr	0	0	0	0	1	0	3	4	4	254	3023	0	3279	0	3262	228	3491	6770	6773		
Note: These volumes are calculated by multiplying the Average Daily 12 hr. totals by 12 to 24 expansion factor.										1.31											
Note: U-Turns provided for approach totals. Refer to 'U-Turn' Report for specific breakdown.																					



Transportation Services - Traffic Services

Turning Movement Count - Study Results

GARLAND ST @ SOMERSET ST W/WELLINGTON ST

Survey Date: Tuesday, August 23, 2022

WO No: 40519

Start Time: 07:00

Device: Miovision

Full Study 15 Minute Increments

Time Period	GARLAND ST									SOMERSET ST W/WELLINGTON ST									W TOT	STR TOT	Grand Total				
	Northbound				Southbound					Eastbound				Westbound											
	LT	ST	RT	N TOT	LT	ST	RT	S TOT	STR TOT	LT	ST	RT	E TOT	LT	ST	RT	W TOT	STR TOT							
07:00 07:15	0	0	0	0	0	0	0	0	0	0	0	0	0	0	0	27	0	27	0	29	1	30	57	57	
07:15 07:30	0	0	0	0	0	0	0	0	0	0	0	0	0	0	0	1	27	0	28	0	27	4	31	59	59
07:30 07:45	0	0	0	0	0	0	0	1	1	1	4	32	0	36	0	36	0	26	2	28	64	64	65		
07:45 08:00	0	0	0	0	0	0	0	0	0	0	0	0	0	0	0	4	33	0	37	0	40	2	42	79	79
08:00 08:15	0	0	0	0	0	0	0	0	0	0	0	0	0	0	0	3	61	0	64	0	39	1	40	104	104
08:15 08:30	0	0	0	0	0	0	0	0	0	0	0	0	0	0	0	4	41	0	45	0	49	1	50	95	95
08:30 08:45	0	0	0	0	0	0	0	0	0	0	0	0	0	0	0	1	50	0	51	0	44	1	45	96	96
08:45 09:00	0	0	0	0	0	0	0	0	0	0	0	0	0	0	0	5	50	0	55	0	58	4	62	117	117
09:00 09:15	0	0	0	0	0	0	0	0	0	0	0	0	0	0	0	7	59	0	66	0	48	1	49	115	115
09:15 09:30	0	0	0	0	0	0	0	0	0	0	0	0	0	0	0	7	60	0	67	0	45	1	46	113	113
09:30 09:45	0	0	0	0	0	0	0	0	0	0	0	0	0	0	0	4	51	0	55	0	50	4	54	109	109
09:45 10:00	0	0	0	0	0	0	0	0	0	0	0	0	0	0	0	4	64	0	68	0	43	5	48	116	116
11:30 11:45	0	0	0	0	0	0	0	0	0	0	0	0	0	0	0	8	68	0	77	0	71	7	78	155	155
11:45 12:00	0	0	0	0	0	0	0	0	0	0	0	0	0	0	0	2	64	0	66	0	75	4	79	145	145
12:00 12:15	0	0	0	0	0	0	0	0	0	0	0	0	0	0	0	9	73	0	82	0	74	6	80	162	162
12:15 12:30	0	0	0	0	0	0	0	0	0	0	0	0	0	0	0	8	64	0	72	0	75	7	82	154	154
12:30 12:45	0	0	0	0	0	0	0	0	0	0	0	0	0	0	0	8	53	0	61	0	67	6	73	134	134
12:45 13:00	0	0	0	0	0	0	0	0	0	0	0	0	0	0	0	6	68	0	74	0	63	3	66	140	140
13:00 13:15	0	0	0	0	0	1	0	0	1	1	7	58	0	65	0	67	6	73	138	139					
13:15 13:30	0	0	0	0	0	0	0	0	0	0	0	0	0	0	0	4	64	0	68	0	72	7	79	147	147
15:00 15:15	0	0	0	0	0	0	0	0	0	0	0	0	0	0	0	4	71	0	75	0	85	7	92	167	167
15:15 15:30	0	0	0	0	0	0	0	0	0	0	0	0	0	0	0	2	69	0	71	0	83	2	85	156	156
15:30 15:45	0	0	0	0	0	0	0	0	0	0	0	0	0	0	0	6	72	0	78	0	71	2	73	151	151
15:45 16:00	0	0	0	0	0	0	0	0	0	0	0	0	0	0	0	3	54	0	57	0	75	4	79	136	136
16:00 16:15	0	0	0	0	0	0	0	0	0	0	0	0	0	0	0	4	55	0	59	0	68	8	76	135	135
16:15 16:30	0	0	0	0	0	0	0	0	0	0	0	0	0	0	0	6	63	0	69	0	73	6	79	148	148
16:30 16:45	0	0	0	0	0	0	0	0	0	0	0	0	0	0	0	4	63	0	67	0	104	6	110	177	177
16:45 17:00	0	0	0	0	0	0	0	0	0	0	0	0	0	0	0	7	77	0	84	0	80	4	84	168	168
17:00 17:15	0	0	0	0	0	0	0	0	0	0	0	0	0	0	0	7	59	0	66	0	75	9	84	150	150
17:15 17:30	0	0	0	0	0	0	0	0	0	0	0	0	0	0	0	7	57	0	64	0	72	8	80	144	144
17:30 17:45	0	0	0	0	0	0	0	0	0	0	0	0	0	0	0	2	68	0	70	0	84	5	89	159	159
17:45 18:00	0	0	0	0	0	0	0	0	0	0	0	0	0	0	0	7	70	0	77	0	59	5	64	141	141
Total:	0	0	0	0	1	0	1	2	2	155	1845	0	2001	0	1991	139	2130	4131	4133						

Note: U-Turns are included in Totals.



Transportation Services - Traffic Services

Turning Movement Count - Study Results

GARLAND ST @ SOMERSET ST W/WELLINGTON ST

Survey Date: Tuesday, August 23, 2022

WO No: 40519

Start Time: 07:00

Device: Miovision

Full Study Cyclist Volume

Table with columns: Time Period, Northbound, Southbound, Street Total, Eastbound, Westbound, Street Total, Grand Total. Rows show cyclist counts from 07:00 to 18:00.



Transportation Services - Traffic Services

Turning Movement Count - Study Results

GARLAND ST @ SOMERSET ST W/WELLINGTON ST

Survey Date: Tuesday, August 23, 2022

WO No: 40519

Start Time: 07:00

Device: Miovision

Full Study Pedestrian Volume

Table with columns: Time Period, NB Approach, SB Approach, Total, EB Approach, WB Approach, Total, Grand Total. Rows show pedestrian counts from 07:00 to 18:00.



Transportation Services - Traffic Services

Turning Movement Count - Study Results

GARLAND ST @ SOMERSET ST W/WELLINGTON ST

Survey Date: Tuesday, August 23, 2022

WO No: 40519

Start Time: 07:00

Device: Miovision

Full Study Heavy Vehicles

Table with columns for Time Period, Northbound (LT, ST, RT, N TOT), Southbound (LT, ST, RT, S TOT, STR TOT), Eastbound (LT, ST, RT, E TOT), Westbound (LT, ST, RT, W TOT, STR TOT), and Grand Total. Rows show data for 15-minute intervals from 07:00 to 18:00.



Transportation Services - Traffic Services

Turning Movement Count - Study Results

GARLAND ST @ SOMERSET ST W/WELLINGTON ST

Survey Date: Tuesday, August 23, 2022

WO No: 40519

Start Time: 07:00

Device: Miovision

Full Study 15 Minute U-Turn Total

Table with columns for Time Period, Northbound U-Turn Total, Southbound U-Turn Total, Eastbound U-Turn Total, Westbound U-Turn Total, and Total. Rows show data for 15-minute intervals from 07:00 to 18:00.



Diagrams, Maps and Photographs



Somerset Street & City Lane

Wednesday, March 08, 2023

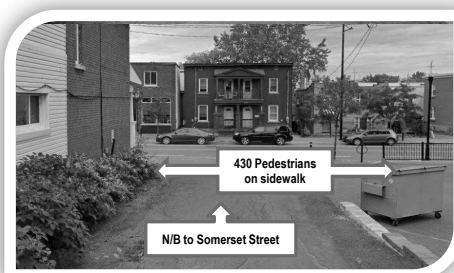
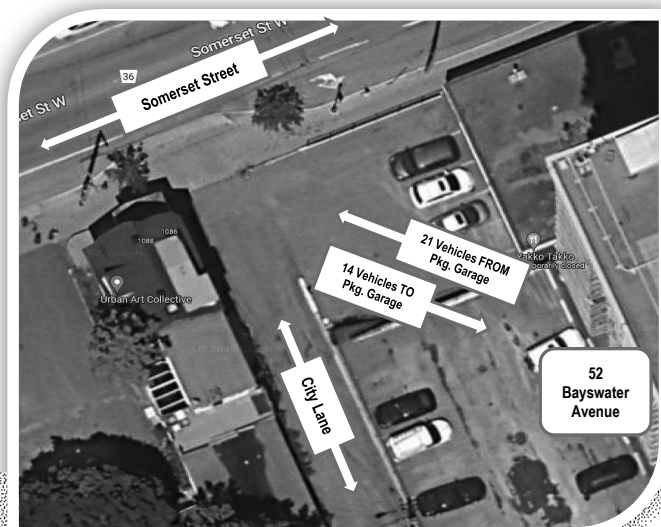

The City lane (unnamed) is located approximately 45 m west of Bayswater Ave. and runs between Laurel St. & Somerset St. There is an access to the parking garage for #52 Bayswater Street at the northerly end of the lane. There is also a small parking lot (5 parking spaces) at the northerly end of the lane that also serves as the access to and from the parking garage. A stop sign is not present facing N/B traffic on the lane at Somerset St. & the presence of a building on the S/W quadrant affords zero visibility of either pedestrians or bicycles on the sidewalk on the south side of Somerset Street. There were 430 pedestrians, including a large daycare group of children, on the south sidewalk.



Turning Movement Count Summary, AM and PM Peak Hour Flow Diagrams



Somerset Street & City Lane

Ottawa, ON

All Vehicles (Except Bicycles & Electric Scooters)

Total vehicle volume, all approaches. (B + C + D)

Wednesday, March 08, 2023
0700-1000 & 1500-1800
6 Hour Survey
City of Ottawa Ward 12

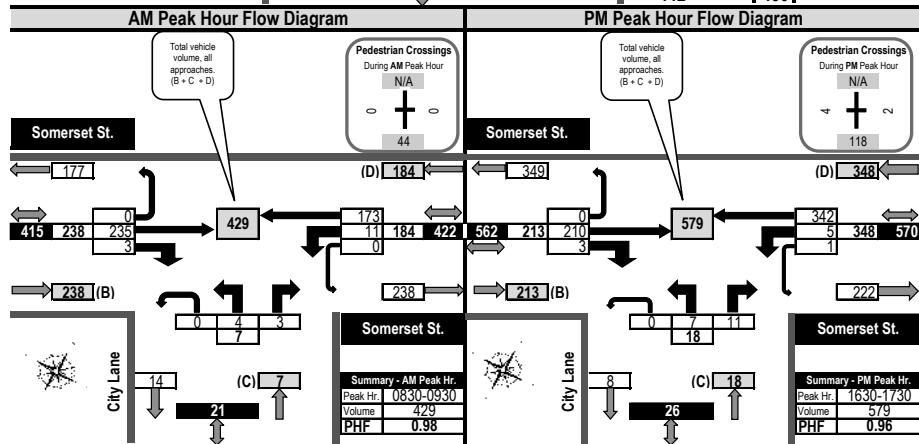
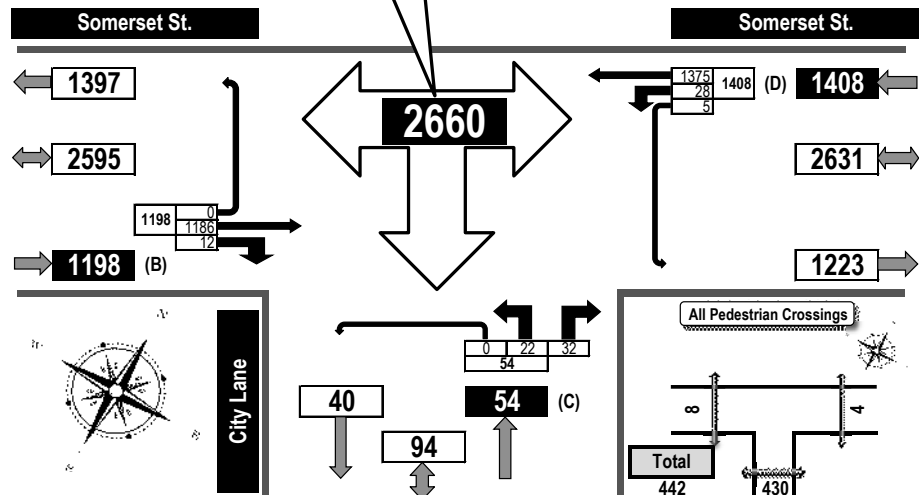



Turning Movement Count Summary Report Including Peak Hours, AADT and Expansion Factors All Vehicles Except Bicycles



Somerset Street & City Lane Ottawa, ON

Survey Date: Wednesday, March 08, 2023 **Start Time:** 0700 **AADT Factor:** 1.0
Weather AM: Mostly Sunny -7° C **Survey Duration:** 6 Hrs. **Survey Hours:** 0700-1000 & 1500-1800
Weather PM: Mostly Cloudy +1° C **Surveyor(s):** T. Carmody

Time Period	Somerset St. Eastbound					Somerset St. Westbound					City Lane Northbound					City Lane Southbound					Street Total	Grand Total
	LT	ST	RT	UT	E/B Tot	LT	ST	RT	UT	W/B Tot	LT	ST	RT	UT	N/B Tot	LT	ST	RT	UT	S/B Tot		
	0700-0800	121	3	0	0	124	1	121	0	0	122	246	2	6	0	8	2	4	0	0		
0800-0900	225	2	0	0	227	9	160	2	171	398	3	4	0	7	4	0	0	0	0	0	7	405
0900-1000	203	2	0	0	205	6	181	0	0	187	392	4	5	0	9	4	0	0	0	0	9	401
1500-1600	209	1	0	0	210	6	289	1	296	506	4	4	0	8	4	0	0	0	0	0	8	514
1600-1700	199	2	0	0	201	3	314	2	319	520	4	5	0	9	4	0	0	0	0	0	9	529
1700-1800	229	2	0	0	231	3	310	0	313	544	5	8	0	13	4	0	0	0	0	0	13	557
Totals	1186	12	0	0	1198	28	1375	5	1408	2606	22	32	0	54	54	0	0	0	0	0	54	2660

Equivalent 12 & 24-hour Vehicle Volumes including the Annual Average Daily Traffic (AADT) Factor
Applicable to the Day and Month of the Turning Movement Count
Expansion factors are applied exclusively to standard weekday 8-hour turning movement counts
conducted during the hours of 0700h - 1000h, 1130h - 1330h and 1500h - 1800h

Equivalent 12-hour vehicle volumes. These volumes are calculated by multiplying the 8-hour totals by the 8 → 12 expansion factor of 1.39

Equ. 12 Hr	n/a	n/a	n/a	n/a	n/a	n/a	n/a	n/a	n/a	n/a	n/a	n/a	n/a	n/a	n/a	n/a	n/a	n/a	n/a	n/a	n/a	n/a	n/a
------------	-----	-----	-----	-----	-----	-----	-----	-----	-----	-----	-----	-----	-----	-----	-----	-----	-----	-----	-----	-----	-----	-----	-----

Average daily 12-hour vehicle volumes. These volumes are calculated by multiplying the equivalent 12-hour totals by the AADT factor of: 1.0

AADT 12-hr	n/a	n/a	n/a	n/a	n/a	n/a	n/a	n/a	n/a	n/a	n/a	n/a	n/a	n/a	n/a	n/a	n/a	n/a	n/a	n/a	n/a	n/a	n/a
------------	-----	-----	-----	-----	-----	-----	-----	-----	-----	-----	-----	-----	-----	-----	-----	-----	-----	-----	-----	-----	-----	-----	-----

24-Hour AADT. These volumes are calculated by multiplying the average daily 12-hour vehicle volumes by the 12 → 24 expansion factor of 1.31

AADT 24 Hr	n/a	n/a	n/a	n/a	n/a	n/a	n/a	n/a	n/a	n/a	n/a	n/a	n/a	n/a	n/a	n/a	n/a	n/a	n/a	n/a	n/a	n/a	n/a
------------	-----	-----	-----	-----	-----	-----	-----	-----	-----	-----	-----	-----	-----	-----	-----	-----	-----	-----	-----	-----	-----	-----	-----

AADT and expansion factors provided by the City of Ottawa

AM Peak Hour Factor → 0.98					Highest Hourly Vehicle Volume Between 0700h & 1000h																		
AM Peak Hr	LT	ST	RT	UT	Total	LT	ST	RT	UT	Total	Str. Tot.	LT	ST	RT	UT	Total	LT	ST	RT	UT	Total	Str. Tot.	Gr. Tot.
0830-0930	0	235	3	0	238	11	173	0	0	184	422	4	0	3	0	7	0	0	0	0	0	7	429
OFF Peak Hour Factor → N/A					Highest Hourly Vehicle Volume Between 1130h & 1330h																		
OFF Peak Hr	LT	ST	RT	UT	Total	LT	ST	RT	UT	Total	Str. Tot.	LT	ST	RT	UT	Total	LT	ST	RT	UT	Total	Str. Tot.	Gr. Tot.
N/A	0	0	0	0	0	0	0	0	0	0	0	0	0	0	0	0	0	0	0	0	0	0	0
PM Peak Hour Factor → 0.96					Highest Hourly Vehicle Volume Between 1500h & 1800h																		
PM Peak Hr	LT	ST	RT	UT	Total	LT	ST	RT	UT	Total	Str. Tot.	LT	ST	RT	UT	Total	LT	ST	RT	UT	Total	Str. Tot.	Gr. Tot.
1630-1730	0	210	3	0	213	5	342	0	1	348	561	7	0	11	0	18	0	0	0	0	0	18	579

Comments:
 The City lane (unnamed) is located approximately 45 m west of Bayswater Ave. and runs between Laurel St. & Somerset St. There is an access to the parking garage for #52 Bayswater Street at the northerly end of the lane. There is also a small parking lot (5 parking spaces) at the northerly end of the lane that also serves as the access to and from the parking garage. A stop sign is not present facing N/B traffic on the lane at Somerset St. & the presence of a building on the S/W quadrant affords zero visibility of either pedestrians or bicycles on the sidewalk on the south side of Somerset Street. There were 430 pedestrians, including a large daycare group of children, on the south sidewalk.

- Notes:**
- Includes all vehicle types except bicycles, electric bicycles, and electric scooters.
 - When expansion and AADT factors are applied, the results will differ slightly due to rounding.



Turning Movement Count Pedestrian Crossings Summary and Flow Diagram

Somerset Street & City Lane Ottawa, ON

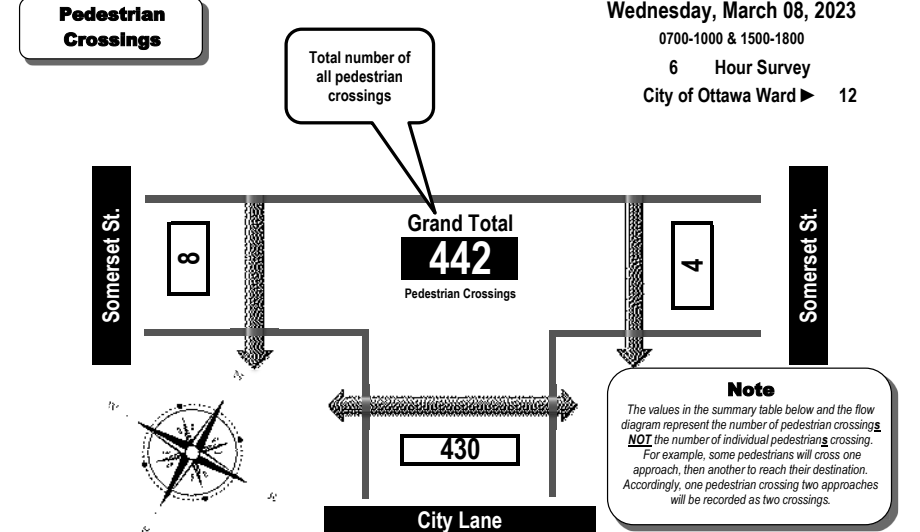

Time Period	West Side Crossing Somerset St.	East Side Crossing Somerset St.	Street Total	South Side Crossing City Lane	North Side Crossing N/A	Street Total	Grand Total
0700-0800	0	0	0	23		23	23
0800-0900	0	0	0	50		50	50
0900-1000	1	0	1	38		38	39
1500-1600	1	0	1	90		90	91
1600-1700	4	3	7	89		89	96
1700-1800	2	1	3	140		140	143
Totals	8	4	12	430		430	442

Comments:
 The City lane (unnamed) is located approximately 45 m west of Bayswater Ave. and runs between Laurel St. & Somerset St. There is an access to the parking garage for #52 Bayswater Street at the northerly end of the lane. There is also a small parking lot (5 parking spaces) at the northerly end of the lane that also serves as the access to and from the parking garage. A stop sign is not present facing N/B traffic on the lane at Somerset St. & the presence of a building on the S/W quadrant affords zero visibility of either pedestrians or bicycles on the sidewalk on the south side of Somerset Street. There were 430 pedestrians, including a large daycare group of children, on the south sidewalk.



Transportation Services - Traffic Services

Turning Movement Count - Study Results

BAYSWATER AVE @ SOMERSET ST

Survey Date: Tuesday, August 23, 2022

WO No: 40520

Start Time: 07:00

Device: Miovision

Full Study Diagram

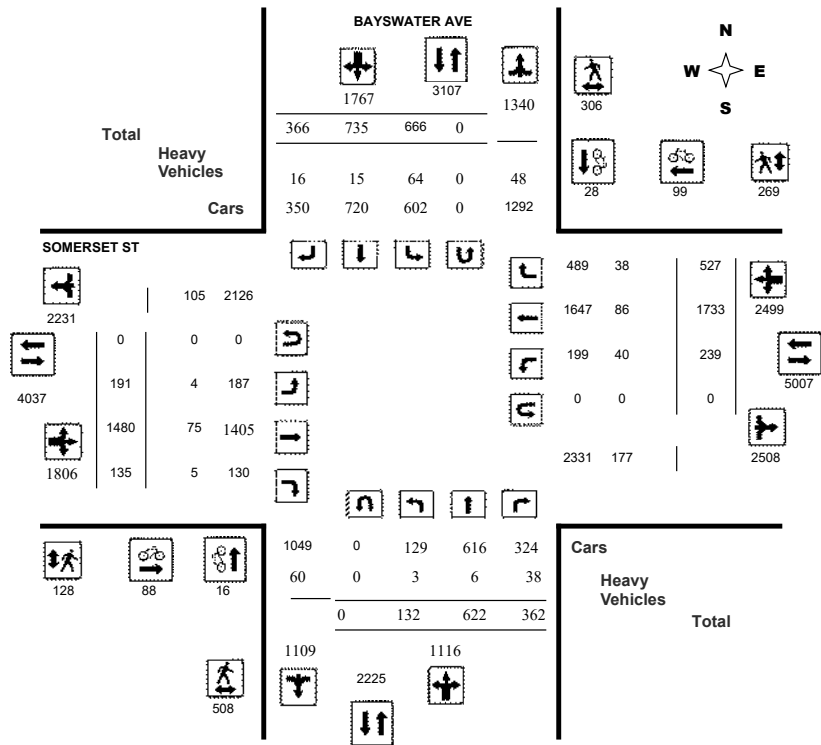

Transportation Services - Traffic Services

Turning Movement Count - Study Results

BAYSWATER AVE @ SOMERSET ST

Survey Date: Tuesday, August 23, 2022

WO No: 40520

Start Time: 07:00

Device: Miovision

Full Study Peak Hour Diagram

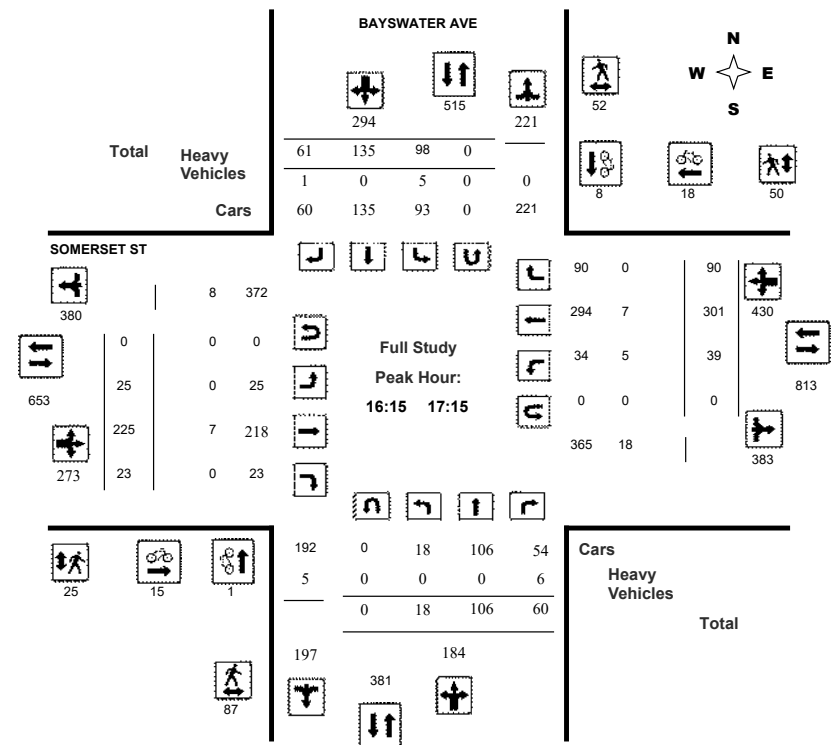



Transportation Services - Traffic Services

Turning Movement Count - Peak Hour Diagram

BAYSWATER AVE @ SOMERSET ST

Survey Date: Tuesday, August 23, 2022
Start Time: 07:00

WO No: 40520
Device: Miovision

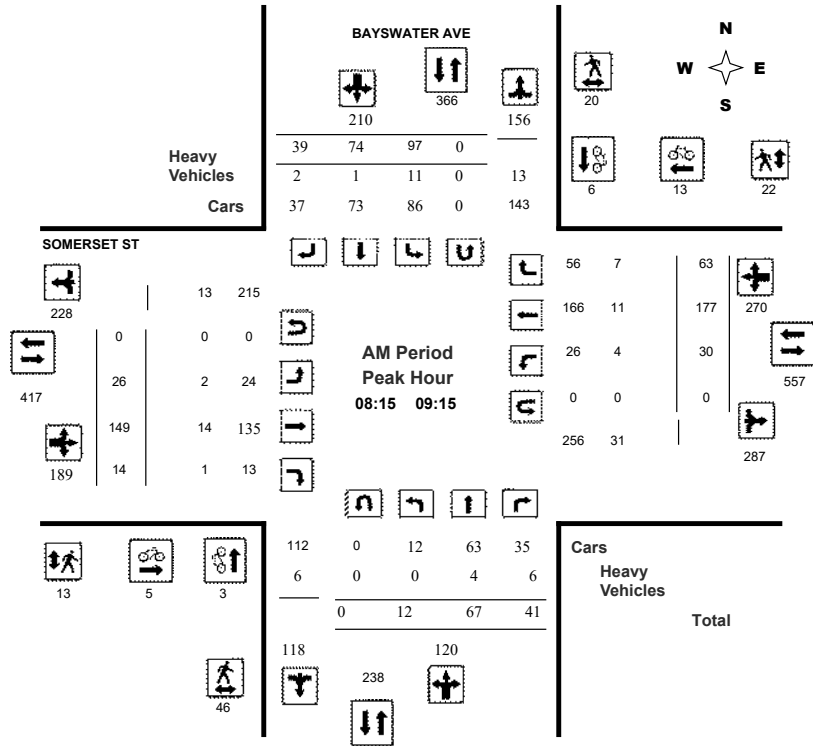

Transportation Services - Traffic Services

Turning Movement Count - Peak Hour Diagram

BAYSWATER AVE @ SOMERSET ST

Survey Date: Tuesday, August 23, 2022
Start Time: 07:00

WO No: 40520
Device: Miovision

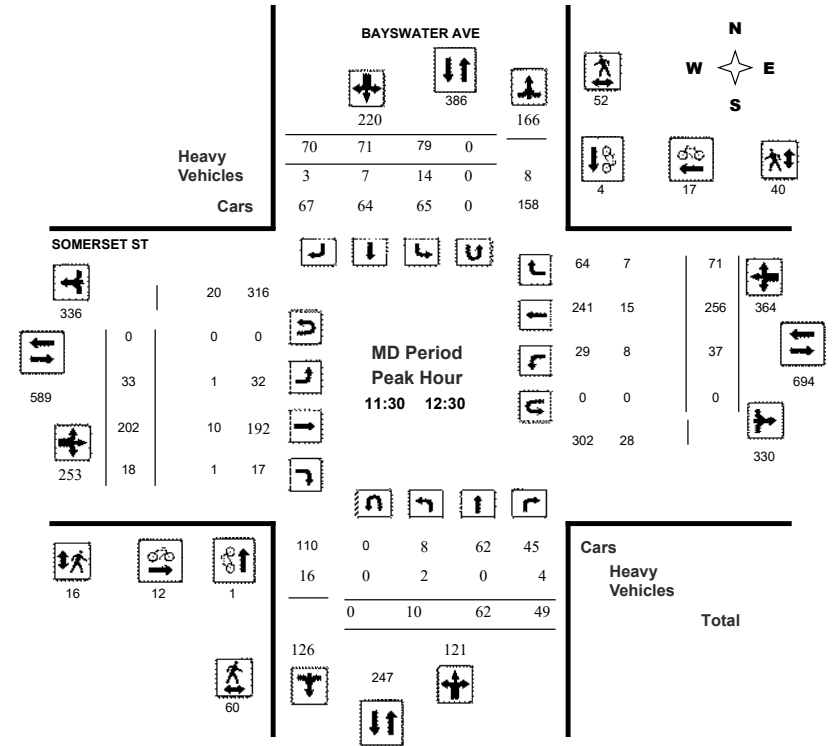



Transportation Services - Traffic Services

Turning Movement Count - Peak Hour Diagram

BAYSWATER AVE @ SOMERSET ST

Survey Date: Tuesday, August 23, 2022
Start Time: 07:00

WO No: 40520
Device: Miovision

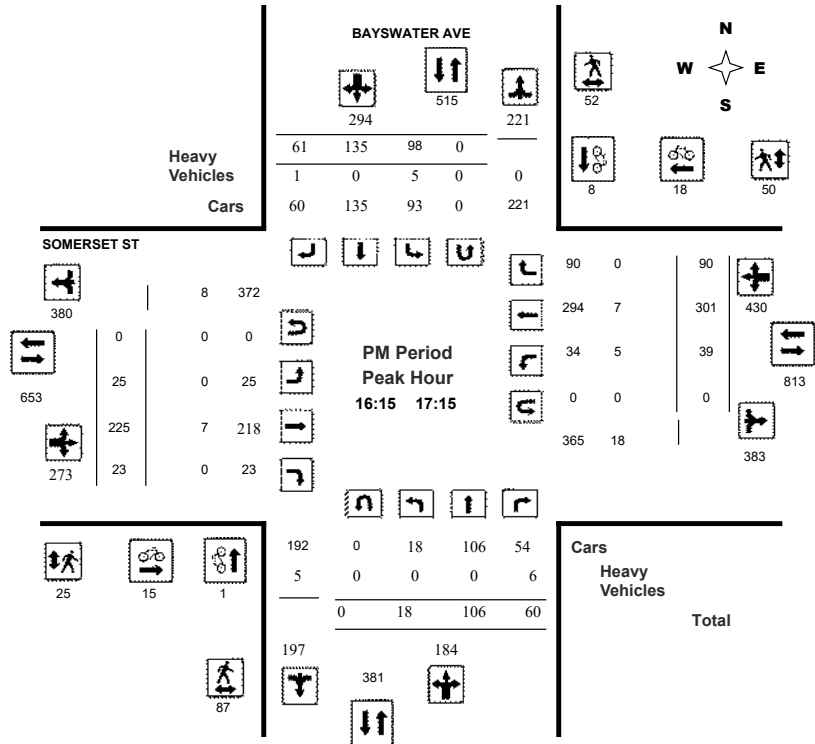

Comments



Transportation Services - Traffic Services

Turning Movement Count - Study Results

BAYSWATER AVE @ SOMERSET ST

Survey Date: Tuesday, August 23, 2022
Start Time: 07:00

WO No: 40520
Device: Miovision

Full Study Summary (8 HR Standard)

Survey Date: Tuesday, August 23, 2022

Total Observed U-Turns
Northbound: 0 Southbound: 0
Eastbound: 0 Westbound: 0

AADT Factor
.90

Period	BAYSWATER AVE								SOMERSET ST								WB TOT	STR TOT	Grand Total
	Northbound				Southbound				Eastbound				Westbound						
	LT	ST	RT	NB TOT	LT	ST	RT	SB TOT	STR TOT	LT	ST	RT	EB TOT	LT	ST	RT			
07:00 08:00	8	35	24	67	58	71	21	150	217	17	104	6	127	15	109	40	164	291	508
08:00 09:00	14	65	46	125	101	78	36	215	340	22	160	13	195	34	164	56	254	449	789
09:00 10:00	14	52	44	110	67	67	28	162	272	27	168	18	213	25	179	57	261	474	746
11:30 12:30	10	62	49	121	79	71	70	220	341	33	202	18	253	37	256	71	364	617	958
12:30 13:30	10	72	47	129	74	94	55	223	352	21	195	17	233	27	221	76	324	557	909
15:00 16:00	36	121	50	207	104	115	44	263	470	24	220	24	268	34	258	76	368	636	1106
16:00 17:00	22	107	56	185	105	134	57	296	481	20	213	17	250	34	300	86	420	670	1151
17:00 18:00	18	108	46	172	78	105	55	238	410	27	218	22	267	33	246	65	344	611	1021
Sub Total	132	622	362	1116	666	735	366	1767	2883	191	1480	135	1806	239	1733	527	2499	4305	7188
U Turns	0	0	0	0	0	0	0	0	0	0	0	0	0	0	0	0	0	0	0
Total	132	622	362	1116	666	735	366	1767	2883	191	1480	135	1806	239	1733	527	2499	4305	7188
EQ 12Hr	183	865	503	1551	926	1022	509	2456	4007	265	2057	188	2510	332	2409	733	3474	5984	9991
Note: These values are calculated by multiplying the totals by the appropriate expansion factor.	1.39																		
AVG 12Hr	165	778	453	1396	833	1205	600	2210	3606	238	1851	169	2259	299	2168	660	3127	5386	8992
Note: These volumes are calculated by multiplying the Equivalent 12 hr. totals by the AADT factor.	.90																		
AVG 24Hr	216	1019	593	1829	1091	1579	786	2895	4724	312	2425	221	2959	392	2840	865	4096	7056	11780
Note: These volumes are calculated by multiplying the Average Daily 12 hr. totals by 12 to 24 expansion factor.	1.31																		
Note: U-Turns provided for approach totals. Refer to 'U-Turn' Report for specific breakdown.																			



Transportation Services - Traffic Services

Turning Movement Count - Study Results

BAYSWATER AVE @ SOMERSET ST

Survey Date: Tuesday, August 23, 2022

WO No: 40520

Start Time: 07:00

Device: Miovision

Full Study 15 Minute Increments

Table with columns for Time Period, Northbound (LT, ST, RT, N TOT, STR TOT), Southbound (LT, ST, RT, S TOT, STR TOT), Eastbound (LT, ST, RT, E TOT, STR TOT), Westbound (LT, ST, RT, W TOT, STR TOT), and Grand Total. Rows represent 15-minute intervals from 07:00 to 17:45.

Note: U-Turns are included in Totals.



Transportation Services - Traffic Services

Turning Movement Count - Study Results

BAYSWATER AVE @ SOMERSET ST

Survey Date: Tuesday, August 23, 2022

WO No: 40520

Start Time: 07:00

Device: Miovision

Full Study Cyclist Volume

Table with columns for Time Period, Northbound, Southbound, Street Total, Eastbound, Westbound, Street Total, and Grand Total. Rows represent 15-minute intervals from 07:00 to 18:00.



Transportation Services - Traffic Services

Turning Movement Count - Study Results

BAYSWATER AVE @ SOMERSET ST

Survey Date: Tuesday, August 23, 2022

WO No: 40520

Start Time: 07:00

Device: Miovision

Full Study Pedestrian Volume

BAYSWATER AVE SOMERSET ST

Time Period	NB Approach (E or W Crossing)		Total	EB Approach (N or S Crossing)		Total	Grand Total
	SB Approach (E or W Crossing)	WB Approach (N or S Crossing)					
07:00 07:15	2	5	7	1	2	3	10
07:15 07:30	2	2	4	0	2	2	6
07:30 07:45	1	3	4	4	4	8	12
07:45 08:00	4	8	12	4	8	12	24
08:00 08:15	6	6	12	4	13	17	29
08:15 08:30	8	6	14	4	5	9	23
08:30 08:45	15	5	20	3	7	10	30
08:45 09:00	10	4	14	2	7	9	23
09:00 09:15	13	5	18	4	3	7	25
09:15 09:30	8	8	16	7	9	16	32
09:30 09:45	6	9	15	0	12	12	27
09:45 10:00	15	6	21	5	2	7	28
11:30 11:45	12	8	20	4	4	8	28
11:45 12:00	15	10	25	3	14	17	42
12:00 12:15	16	19	35	4	11	15	50
12:15 12:30	17	15	32	5	11	16	48
12:30 12:45	27	28	55	8	11	19	74
12:45 13:00	25	11	36	3	10	13	49
13:00 13:15	22	12	34	0	8	8	42
13:15 13:30	20	4	24	0	3	3	27
15:00 15:15	18	5	23	1	10	11	34
15:15 15:30	19	4	23	3	7	10	33
15:30 15:45	15	9	24	1	4	5	29
15:45 16:00	23	4	27	4	3	7	34
16:00 16:15	24	7	31	6	7	13	44
16:15 16:30	19	17	36	6	15	21	57
16:30 16:45	24	11	35	4	11	15	50
16:45 17:00	20	13	33	10	14	24	57
17:00 17:15	24	11	35	5	10	15	50
17:15 17:30	35	16	51	9	19	28	79
17:30 17:45	23	8	31	6	11	17	48
17:45 18:00	20	27	47	8	12	20	67
Total	508	306	814	128	269	397	1211



Transportation Services - Traffic Services

Turning Movement Count - Study Results

BAYSWATER AVE @ SOMERSET ST

Survey Date: Tuesday, August 23, 2022

WO No: 40520

Start Time: 07:00

Device: Miovision

Full Study Heavy Vehicles

BAYSWATER AVE SOMERSET ST

Time Period	Northbound						Southbound						Eastbound						Westbound						Grand Total
	LT		ST		RT		N TOT		S TOT		STR TOT		LT		ST		RT		E TOT		W TOT		STR TOT		
	LT	ST	RT	N TOT	LT	ST	RT	S TOT	STR TOT	LT	ST	RT	E TOT	LT	ST	RT	W TOT	STR TOT							
07:00 07:15	0	0	1	3	2	0	0	4	7	0	3	0	4	2	1	2	11	15	11						
07:15 07:30	0	0	3	4	3	0	1	4	8	0	2	0	6	1	3	0	12	18	13						
07:30 07:45	0	0	1	2	0	0	1	2	4	0	2	0	6	1	3	1	8	14	9						
07:45 08:00	0	0	0	1	2	0	1	5	6	0	1	0	4	1	2	2	8	12	9						
08:00 08:15	0	0	2	4	1	0	0	3	7	0	2	1	5	1	2	2	10	15	11						
08:15 08:30	0	3	3	7	4	0	0	8	15	0	2	0	6	1	4	1	15	21	18						
08:30 08:45	0	1	1	3	2	0	0	7	10	1	3	1	8	0	3	3	12	20	15						
08:45 09:00	0	0	1	4	3	0	1	5	9	0	7	0	10	3	2	2	17	27	18						
09:00 09:15	0	0	1	2	2	1	1	7	9	1	2	0	6	0	2	2	9	15	12						
09:15 09:30	0	0	1	2	2	0	1	5	7	0	1	0	8	1	6	2	13	21	14						
09:30 09:45	0	0	1	3	3	0	1	4	7	0	2	0	6	2	3	0	11	17	12						
09:45 10:00	0	0	1	3	3	1	0	5	8	1	4	0	9	1	4	0	13	22	15						
11:30 11:45	0	0	1	4	2	2	0	7	11	0	1	0	7	1	6	3	14	21	16						
11:45 12:00	1	0	2	6	6	1	2	12	18	1	3	0	10	2	3	2	18	28	23						
12:00 12:15	1	0	0	7	3	1	0	6	13	0	3	1	8	4	3	2	15	23	18						
12:15 12:30	0	0	1	5	3	3	1	7	12	0	3	0	7	1	3	0	11	18	15						
12:30 12:45	1	1	2	7	2	2	1	7	14	0	6	0	13	1	5	1	17	30	22						
12:45 13:00	0	1	3	5	2	0	2	6	11	0	2	1	8	0	3	1	11	19	15						
13:00 13:15	0	0	1	4	1	0	0	3	7	0	2	1	5	2	2	2	10	15	11						
13:15 13:30	0	0	0	1	1	0	1	6	7	0	2	0	3	1	0	4	8	11	9						
15:00 15:15	0	0	0	6	3	4	0	9	15	0	3	0	5	2	2	2	12	17	16						
15:15 15:30	0	0	2	2	3	0	0	5	7	0	3	0	6	0	3	2	13	19	13						
15:30 15:45	0	0	0	2	1	0	0	3	5	0	4	0	5	2	1	2	10	15	10						
15:45 16:00	0	0	1	1	0	0	0	1	2	0	1	0	4	0	3	1	6	10	6						
16:00 16:15	0	0	2	3	3	0	0	3	6	0	1	0	6	1	5	0	12	18	12						
16:15 16:30	0	0	1	3	2	0	0	2	5	0	4	0	6	2	2	0	11	17	11						
16:30 16:45	0	0	1	2	1	0	1	2	4	0	1	0	4	1	2	0	6	10	7						
16:45 17:00	0	0	2	3	1	0	0	1	4	0	2	0	4	1	2	0	8	12	8						
17:00 17:15	0	0	2	3	1	0	0	1	4	0	0	0	1	1	1	0	5	6	5						
17:15 17:30	0	0	0	0	1	0	1	2	2	0	2	0	5	0	2	0	5	10	6						
17:30 17:45	0	0	0	2	0	0	0	0	2	0	0	0	1	2	1	0	3	4	3						
17:45 18:00	0	0	1	3	1	0	0	1	4	0	1	0	3	2	2	0	7	10	7						
Total:	None	3	6	38	107	64	15	16	143	250	4	75	5	189	40	86	38	341	530	390					



Transportation Services - Traffic Services

Turning Movement Count - Study Results
BAYSWATER AVE @ SOMERSET ST

Survey Date: Tuesday, August 23, 2022
 Start Time: 07:00

WO No: 40520
 Device: Miovision

Full Study 15 Minute U-Turn Total
 BAYSWATER AVE SOMERSET ST

Time Period	Northbound U-Turn Total	Southbound U-Turn Total	Eastbound U-Turn Total	Westbound U-Turn Total	Total
07:00 - 07:15	0	0	0	0	0
07:15 - 07:30	0	0	0	0	0
07:30 - 07:45	0	0	0	0	0
07:45 - 08:00	0	0	0	0	0
08:00 - 08:15	0	0	0	0	0
08:15 - 08:30	0	0	0	0	0
08:30 - 08:45	0	0	0	0	0
08:45 - 09:00	0	0	0	0	0
09:00 - 09:15	0	0	0	0	0
09:15 - 09:30	0	0	0	0	0
09:30 - 09:45	0	0	0	0	0
09:45 - 10:00	0	0	0	0	0
11:30 - 11:45	0	0	0	0	0
11:45 - 12:00	0	0	0	0	0
12:00 - 12:15	0	0	0	0	0
12:15 - 12:30	0	0	0	0	0
12:30 - 12:45	0	0	0	0	0
12:45 - 13:00	0	0	0	0	0
13:00 - 13:15	0	0	0	0	0
13:15 - 13:30	0	0	0	0	0
15:00 - 15:15	0	0	0	0	0
15:15 - 15:30	0	0	0	0	0
15:30 - 15:45	0	0	0	0	0
15:45 - 16:00	0	0	0	0	0
16:00 - 16:15	0	0	0	0	0
16:15 - 16:30	0	0	0	0	0
16:30 - 16:45	0	0	0	0	0
16:45 - 17:00	0	0	0	0	0
17:00 - 17:15	0	0	0	0	0
17:15 - 17:30	0	0	0	0	0
17:30 - 17:45	0	0	0	0	0
17:45 - 18:00	0	0	0	0	0
Total	0	0	0	0	0



Turning Movement Count
 Summary, AM and PM Peak Hour
 Flow Diagrams
 All Vehicles Except Bicycles



Bayswater Avenue & 52 Bayswater Avenue Ottawa, ON

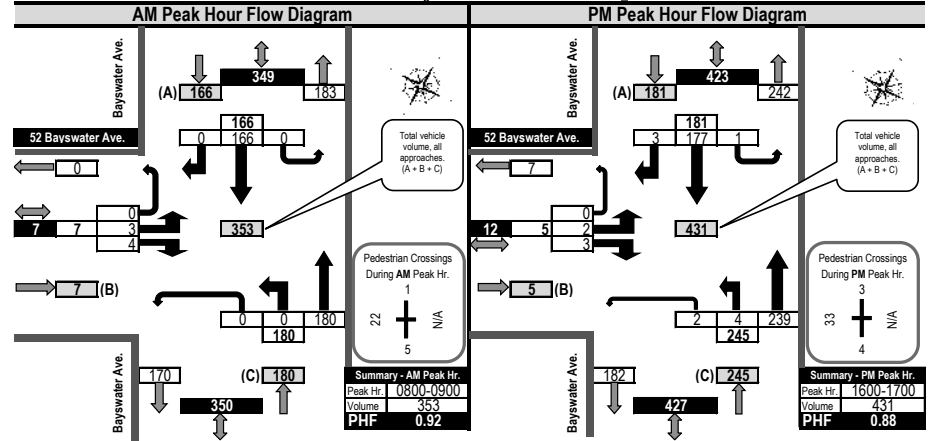
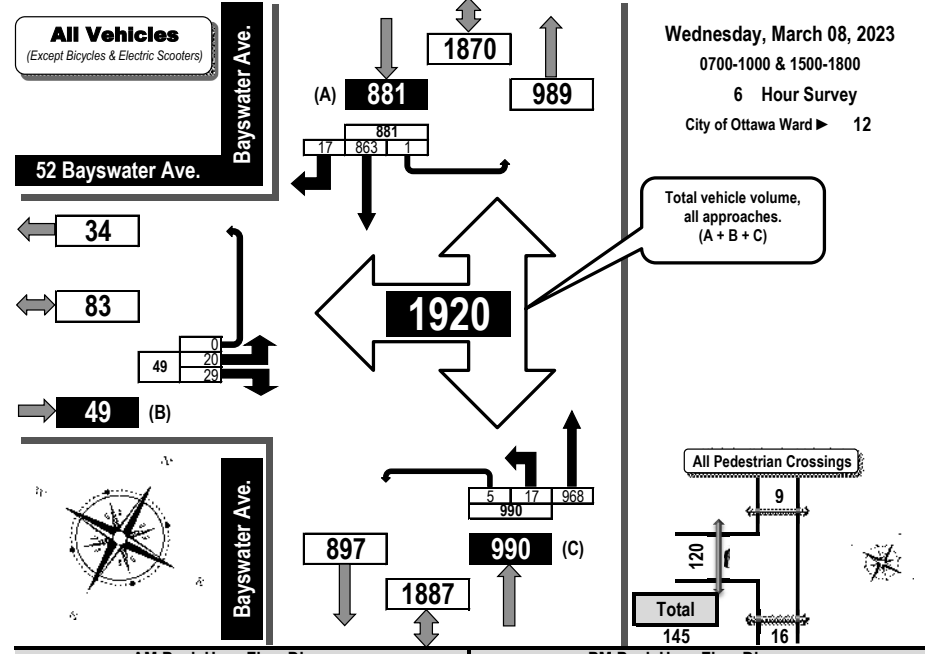



Turning Movement Count Summary Report Including Peak Hours, AADT and Expansion Factors All Vehicles Except Bicycles



Bayswater Avenue & 52 Bayswater Avenue Ottawa, ON

Survey Date: Wednesday, March 08, 2023 Start Time: 0700 AADT Factor: 1.0
 Weather AM: Mostly Sunny -7° C Survey Duration: 6 Hrs. Survey Hours: 0700-1000 & 1500-1800
 Weather PM: Mostly Cloudy +1° C Surveyor(s): T. Carmody

Time Period	52 Bayswater Ave.					N/A					Bayswater Ave.					Bayswater Ave.					Street Total	Grand Total
	Eastbound		Westbound			Northbound		Southbound			Northbound		Southbound			Northbound		Southbound				
	LT	ST	RT	UT	E/B Tot	LT	ST	RT	UT	W/B Tot	LT	ST	RT	UT	N/B Tot	LT	ST	RT	UT	S/B Tot		
0700-0800	4		5	0	9						9	3	70	0	73	108	0	0	108	181	190	
0800-0900	3		4	0	7						7	0	180	0	180	166	0	0	166	346	353	
0900-1000	3		9	0	12						12	0	108	1	109	107	1	0	108	217	229	
1500-1600	4		3	0	7						7	5	184	1	190	130	4	0	134	324	331	
1600-1700	2		3	0	5						5	4	239	2	245	177	3	1	181	426	431	
1700-1800	4		5	0	9						9	5	187	1	193	175	9	0	184	377	386	
Totals	20		29	0	49						49	17	968	5	990	863	17	1	881	1871	1920	

Equivalent 12 & 24-hour Vehicle Volumes Including the Annual Average Daily Traffic (AADT) Factor
Applicable to the Day and Month of the Turning Movement Count
 Expansion factors are applied exclusively to standard weekday 8-hour turning movement counts conducted during the hours of 0700h - 1000h, 1130h - 1330h and 1500h - 1800h

Equivalent 12-hour vehicle volumes. These volumes are calculated by multiplying the 8-hour totals by the 8 → 12 expansion factor of 1.39																							
Equ. 12 Hr	n/a	n/a	n/a	n/a	n/a	n/a	n/a	n/a	n/a	n/a	n/a	n/a	n/a	n/a	n/a	n/a	n/a	n/a	n/a	n/a	n/a	n/a	n/a
Average daily 12-hour vehicle volumes. These volumes are calculated by multiplying the equivalent 12-hour totals by the AADT factor of: 1.0																							
AADT 12-hr	n/a	n/a	n/a	n/a	n/a	n/a	n/a	n/a	n/a	n/a	n/a	n/a	n/a	n/a	n/a	n/a	n/a	n/a	n/a	n/a	n/a	n/a	n/a
24-Hour AADT. These volumes are calculated by multiplying the average daily 12-hour vehicle volumes by the 12 → 24 expansion factor of 1.31																							
AADT 24 Hr	n/a	n/a	n/a	n/a	n/a	n/a	n/a	n/a	n/a	n/a	n/a	n/a	n/a	n/a	n/a	n/a	n/a	n/a	n/a	n/a	n/a	n/a	n/a

AADT and expansion factors provided by the City of Ottawa

AM Peak Hour Factor → 0.92														Highest Hourly Vehicle Volume Between 0700h & 1000h													
AM Peak Hr	LT	ST	RT	UT	Total	LT	ST	RT	UT	Total	LT	ST	RT	UT	Total	LT	ST	RT	UT	Total	LT	ST	RT	UT	Total		
0800-0900	3	0	4	0	7	0	0	0	0	0	7	0	180	0	180	0	166	0	0	166	346	353					
OFF Peak Hour Factor → N/A														Highest Hourly Vehicle Volume Between 1130h & 1330h													
OFF Peak Hr	LT	ST	RT	UT	Total	LT	ST	RT	UT	Total	LT	ST	RT	UT	Total	LT	ST	RT	UT	Total	LT	ST	RT	UT	Total		
N/A	0	0	0	0	0	0	0	0	0	0	0	0	0	0	0	0	0	0	0	0	0	0	0	0	0		
PM Peak Hour Factor → 0.88														Highest Hourly Vehicle Volume Between 1500h & 1800h													
PM Peak Hr	LT	ST	RT	UT	Total	LT	ST	RT	UT	Total	LT	ST	RT	UT	Total	LT	ST	RT	UT	Total	LT	ST	RT	UT	Total		
1600-1700	2	0	3	0	5	0	0	0	0	0	5	4	239	0	245	0	177	3	1	181	426	431					

Comments:
 Foliage growing on the property frontage immediately south of the access to 52 Bayswater Avenue obstructs sightlines for drivers exiting the driveway. Drivers cannot see pedestrians or cyclists on the sidewalk when looking south. A total of 120 pedestrians were observed walking on the sidewalk along the west side of Bayswater Avenue.

- Notes:**
- Includes all vehicle types except bicycles, electric bicycles, and electric scooters.
 - When expansion and AADT factors are applied, the results will differ slightly due to rounding.



Turning Movement Count Pedestrian Crossings Summary and Flow Diagram

Bayswater Avenue & 52 Bayswater Avenue Ottawa, ON

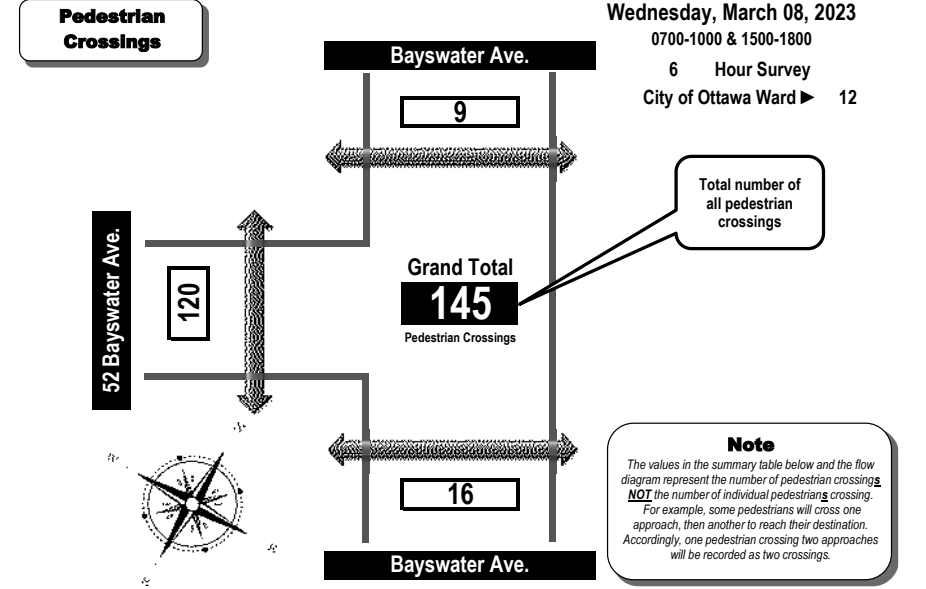

Time Period	West Side Crossing 52 Bayswater Ave.	East Side Crossing N/A	Street Total	South Side Crossing Bayswater Ave.	North Side Crossing Bayswater Ave.	Street Total	Grand Total
0700-0800	15		15	2	2	4	19
0800-0900	22		22	5	1	6	28
0900-1000	7		7	2	0	2	9
1500-1600	17		17	2	0	2	19
1600-1700	33		33	4	3	7	40
1700-1800	26		26	1	3	4	30
Totals	120		120	16	9	25	145

Comments:
 Foliage growing on the property frontage immediately south of the access to 52 Bayswater Avenue obstructs sightlines for drivers exiting the driveway. Drivers cannot see pedestrians or cyclists on the sidewalk when looking south. A total of 120 pedestrians were observed walking on the sidewalk along the west side of Bayswater Avenue.



Turning Movement Count Summary Report Including AM and PM Peak Hours All Vehicles Except Bicycles



Bayswater Avenue & Laurel Street Ottawa, ON

Survey Date: Wednesday, March 08, 2023 Start Time: 0700 AADT Factor: 1.0
 Weather AM: Mostly Sunny -7° C Survey Duration: 6 Hrs. Survey Hours: 0700-1000 & 1500-1800
 Weather PM: Mostly Cloudy +1° C Surveyor(s): T. Carmody

Time Period	Laurel St. Eastbound				Laurel St. Westbound				Bayswater Ave. Northbound				Bayswater Ave. Southbound				Street Total	Grand Total					
	LT	ST	RT	UT	LT	ST	RT	UT	LT	ST	RT	UT	LT	ST	RT	UT							
	E/B Tot				W/B Tot				S/B Tot														
0700-0800	4	6	5	0	15	3	1	4	0	8	23	3	64	2	0	69	10	101	5	0	116	185	208
0800-0900	8	4	8	0	20	11	6	15	0	32	52	5	147	8	0	160	19	149	4	0	172	332	384
0900-1000	5	4	6	0	15	11	1	11	0	23	38	3	96	7	0	106	11	106	6	0	123	229	267
1500-1600	4	7	4	0	15	7	4	15	0	26	41	4	171	4	0	179	3	120	9	0	132	311	352
1600-1700	15	1	3	0	19	14	6	20	0	40	59	13	206	3	0	222	5	159	10	0	174	396	455
1700-1800	11	1	7	0	19	4	11	15	0	30	49	9	166	1	1	177	8	168	7	0	183	360	409
Totals	47	23	33	0	103	50	29	80	0	159	262	37	850	25	1	913	56	803	41	0	900	1813	2075

**Equivalent 12 & 24-Hour Vehicle Volumes Including the Annual Average Daily Traffic (AADT) Factor
Applicable to the Day and Month of the Turning Movement Count**

Expansion factors are applied exclusively to standard weekday 8-hour turning movement counts conducted during the hours of 0700h - 1000h, 1130h - 1330h and 1500h - 1800h

Equivalent 12-hour vehicle volumes. These volumes are calculated by multiplying the 8-hour totals by the 8 → 12 expansion factor of 1.39																									
Equ. 12 Hr	n/a	n/a	n/a	n/a	n/a	n/a	n/a	n/a	n/a	n/a	n/a	n/a	n/a	n/a	n/a	n/a	n/a	n/a	n/a	n/a	n/a	n/a	n/a	n/a	n/a
Average daily 12-hour vehicle volumes. These volumes are calculated by multiplying the equivalent 12-hour totals by the AADT factor of: 1.0																									
AADT 12-hr	n/a	n/a	n/a	n/a	n/a	n/a	n/a	n/a	n/a	n/a	n/a	n/a	n/a	n/a	n/a	n/a	n/a	n/a	n/a	n/a	n/a	n/a	n/a	n/a	n/a
24-Hour AADT. These volumes are calculated by multiplying the average daily 12-hour vehicle volumes by the 12 → 24 expansion factor of 1.31																									
AADT 24 Hr	n/a	n/a	n/a	n/a	n/a	n/a	n/a	n/a	n/a	n/a	n/a	n/a	n/a	n/a	n/a	n/a	n/a	n/a	n/a	n/a	n/a	n/a	n/a	n/a	n/a

AADT and expansion factors provided by the City of Ottawa

AM Peak Hour Factor → 0.93												Highest Hourly Vehicle Volume Between 0700h & 1000h											
AM Peak Hr	LT	ST	RT	UT	Total	LT	ST	RT	UT	Total	Str. Tot.	LT	ST	RT	UT	Total	LT	ST	RT	UT	Total	Str. Tot.	Gr. Tot.
0800-0900	8	4	8	0	20	11	6	15	0	32	52	5	147	8	0	160	19	149	4	0	172	332	384

PM Peak Hour Factor → 0.84												Highest Hourly Vehicle Volume Between 1500h & 1800h											
PM Peak Hr	LT	ST	RT	UT	Total	LT	ST	RT	UT	Total	Str. Tot.	LT	ST	RT	UT	Total	LT	ST	RT	UT	Total	Str. Tot.	Gr. Tot.
1600-1700	15	1	3	0	19	14	6	20	0	40	59	13	206	3	0	222	5	159	10	0	174	396	455

Comments:
 Para Transpo buses and school buses comprise 30.00% of the heavy vehicle traffic. A school crossing guard was present assisting pedestrians in the north, east and south crossings during the morning and evening peak periods.

- Notes:**
- Includes all vehicle types except bicycles, electric bicycles, and electric scooters.
 - When expansion and AADT factors are applied, the results will differ slightly due to rounding.



Turning Movement Count Summary, AM and PM Peak Hour Flow Diagrams All Vehicles Except Bicycles



Bayswater Avenue & Laurel Street Ottawa, ON

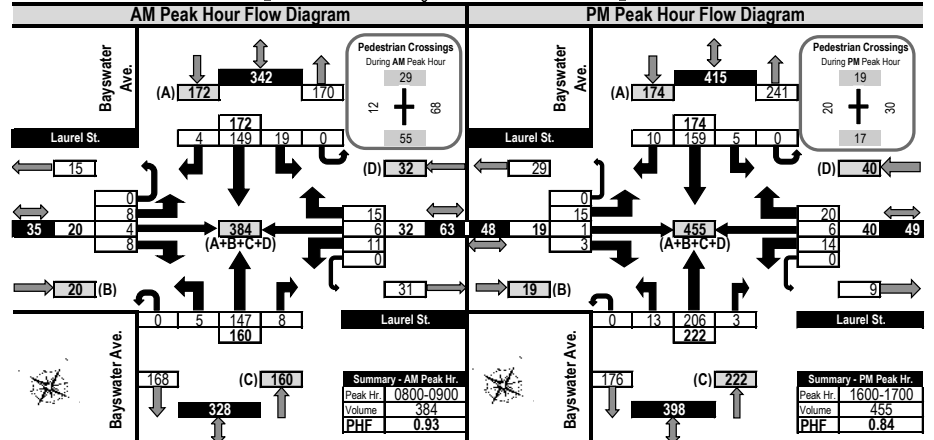
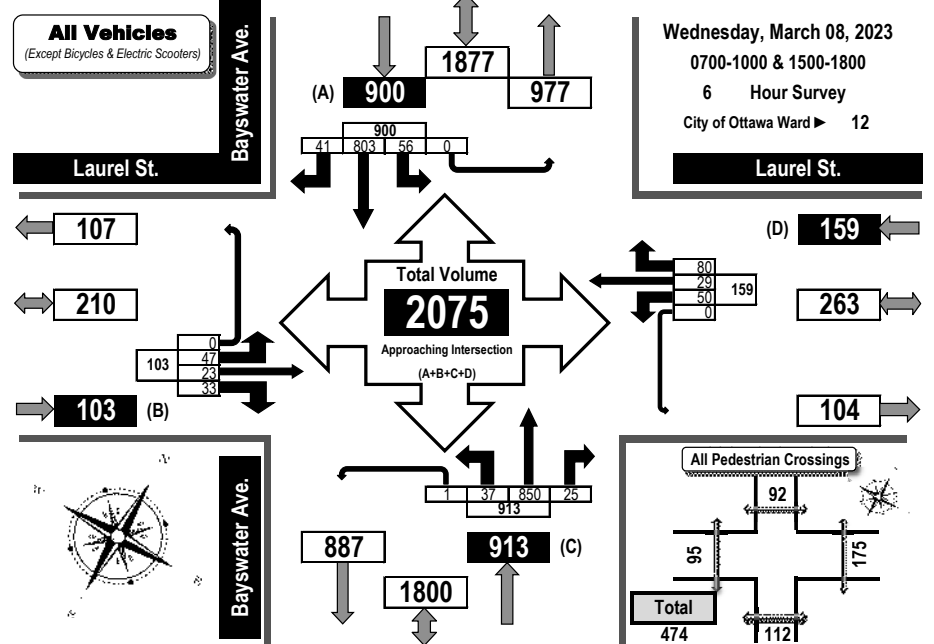



Turning Movement Count Heavy Vehicle Summary (FHWA Class 4-13) Flow Diagram

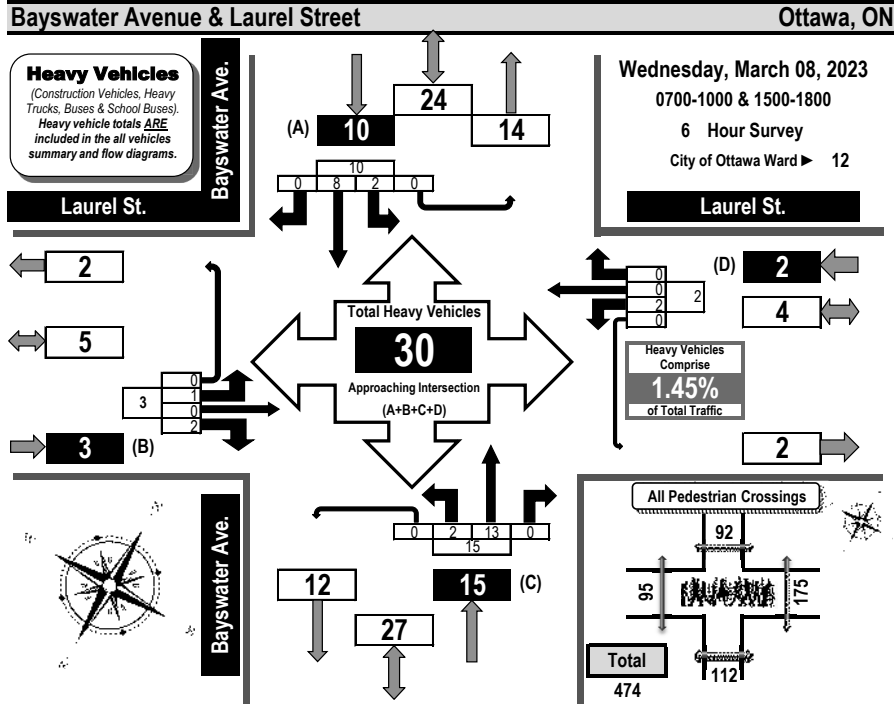

Time Period	Laurel St. Eastbound				EB Tot	Laurel St. Westbound				WB Tot	Bayswater Ave. Northbound				NB Tot	Bayswater Ave. Southbound				SB Tot	GR Tot	
	LT	ST	RT	UT		LT	ST	RT	UT		LT	ST	RT	UT		LT	ST	RT	UT			
0700-0800	0	0	2	0	2	0	0	0	0	0	0	2	0	0	2	0	0	0	0	0	0	4
0800-0900	0	0	0	0	0	1	0	0	0	1	2	4	0	0	6	1	1	0	0	2	9	
0900-1000	1	0	0	0	1	1	0	0	0	1	0	2	0	0	2	1	2	0	0	3	7	
1500-1600	0	0	0	0	0	0	0	0	0	0	0	2	0	0	2	0	1	0	0	1	3	
1600-1700	0	0	0	0	0	0	0	0	0	0	0	3	0	0	3	0	3	0	0	3	6	
1700-1800	0	0	0	0	0	0	0	0	0	0	0	0	0	0	0	0	1	0	0	1	1	
Totals	1	0	2	0	3	2	0	0	0	2	2	13	0	0	15	2	8	0	0	10	30	

Comments:
Para Transpo buses and school buses comprise 30.00% of the heavy vehicle traffic. A school crossing guard was present assisting pedestrians in the north, east and south crossings during the morning and evening peak periods.



Turning Movement Count All Buses Summary (FHWA Class 4 ONLY) Flow Diagram

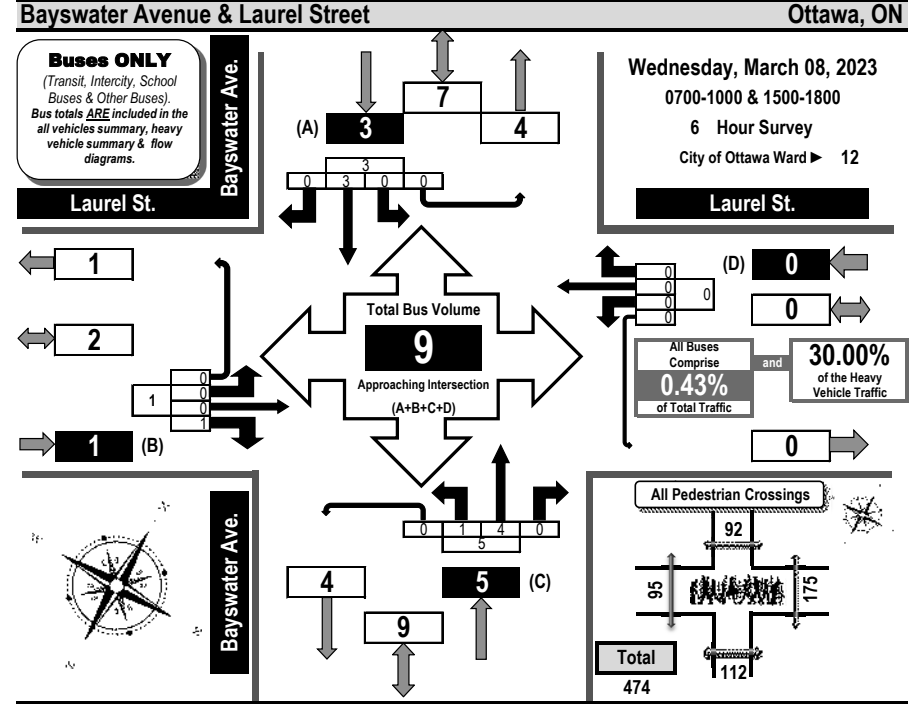

Time Period	Laurel St. Eastbound				EB Tot	Laurel St. Westbound				WB Tot	Bayswater Ave. Northbound				NB Tot	Bayswater Ave. Southbound				SB Tot	GR Tot
	LT	ST	RT	UT		LT	ST	RT	UT		LT	ST	RT	UT		LT	ST	RT	UT		
0700-0800	0	0	1	0	1	0	0	0	0	0	0	1	0	0	1	0	0	0	0	0	2
0800-0900	0	0	0	0	0	0	0	0	0	0	1	2	0	0	3	0	0	0	0	0	3
0900-1000	0	0	0	0	0	0	0	0	0	0	0	0	0	0	0	0	0	0	0	0	0
1500-1600	0	0	0	0	0	0	0	0	0	0	0	0	0	0	0	0	0	0	0	0	0
1600-1700	0	0	0	0	0	0	0	0	0	0	0	1	0	0	1	0	2	0	0	2	3
1700-1800	0	0	0	0	0	0	0	0	0	0	0	0	0	0	0	0	1	0	0	1	1
Totals	0	0	1	0	1	0	0	0	0	0	1	4	0	0	5	0	3	0	0	3	9

Comments:
Para Transpo buses and school buses comprise 30.00% of the heavy vehicle traffic. A school crossing guard was present assisting pedestrians in the north, east and south crossings during the morning and evening peak periods.



Turning Movement Count Bicycle Summary Flow Diagram



Bayswater Avenue & Laurel Street Ottawa, ON

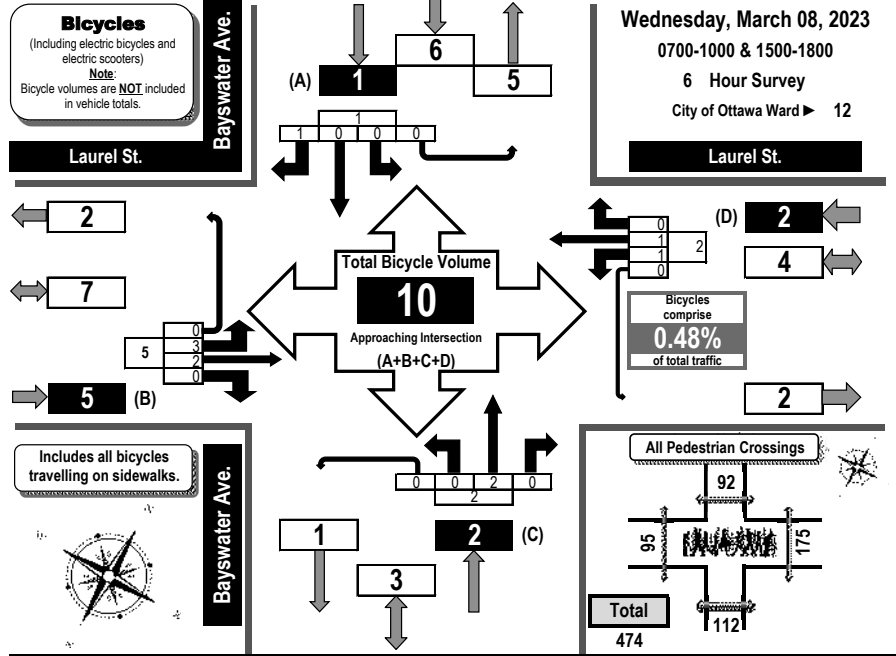

Time Period	Laurel St. Eastbound				Laurel St. Westbound				Bayswater Ave. Northbound				Bayswater Ave. Southbound				GR Tot
	LT	ST	RT	UT	LT	ST	RT	UT	LT	ST	RT	UT	LT	ST	RT	UT	
	EB Tot	WB Tot	NB Tot	SB Tot	EB Tot	WB Tot	NB Tot	SB Tot									
0700-0800	0	0	0	0	0	0	0	0	0	0	0	0	0	0	0	0	0
0800-0900	2	1	0	0	3	0	0	0	0	0	0	0	0	0	0	0	3
0900-1000	0	0	0	0	0	0	0	0	0	0	0	0	0	0	0	0	0
1500-1600	0	0	0	0	0	0	0	0	0	0	1	0	0	1	0	0	1
1600-1700	1	0	0	0	1	1	0	0	1	0	1	0	1	0	1	0	4
1700-1800	0	1	0	0	1	0	1	0	1	0	0	0	0	0	0	0	2
Totals	3	2	0	0	5	1	1	0	2	0	2	0	2	0	1	0	10

Comments:
Para Transpo buses and school buses comprise 30.00% of the heavy vehicle traffic. A school crossing guard was present assisting pedestrians in the north, east and south crossings during the morning and evening peak periods.



Turning Movement Count Pedestrian Crossings Summary and Flow Diagram

Bayswater Avenue & Laurel Street Ottawa, ON

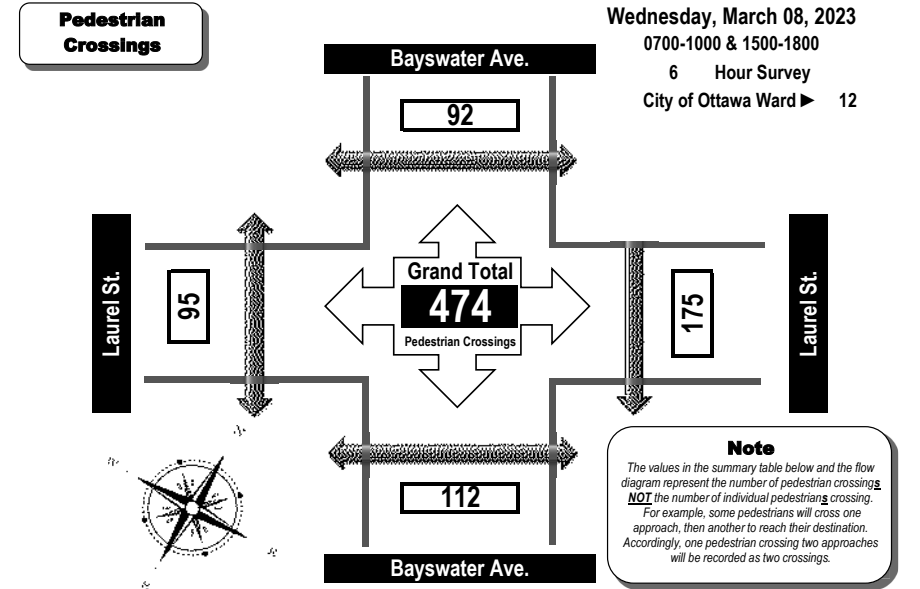

Note
The values in the summary table below and the flow diagram represent the number of pedestrian crossings. **NOT** the number of individual pedestrian crossing. For example, some pedestrians will cross one approach, then another to reach their destination. Accordingly, one pedestrian crossing two approaches will be recorded as two crossings.

Time Period	West Side Crossing		Street Total	South Side Crossing		North Side Crossing		Street Total	Grand Total
	Laurel St.	Laurel St.		Bayswater Ave.	Bayswater Ave.				
0700-0800	10	24	34	12	7	19	53		
0800-0900	12	68	80	55	29	84	164		
0900-1000	6	3	9	10	7	17	26		
1500-1600	30	19	49	8	17	25	74		
1600-1700	20	30	50	17	19	36	86		
1700-1800	17	31	48	10	13	23	71		
Totals	95	175	270	112	92	204	474		

Comments:
Para Transpo buses and school buses comprise 30.00% of the heavy vehicle traffic. A school crossing guard was present assisting pedestrians in the north, east and south crossings during the morning and evening peak periods.

Appendix C

Synchro Intersection Worksheets – Existing Conditions

Lanes, Volumes, Timings

1: Bayview Station Rd & Scott St/Albert St

Existing AM Peak Hour

50 Bayswater Avenue, 1088 Somerset Street West

Lane Group	EBL	EBT	EBR	WBL	WBT	WBR	NBL	NBT	NBR	SBL	SBT	SBR
Lane Configurations		↕	↕	↕	↕	↕	↕	↕	↕	↕	↕	↕
Traffic Volume (vph)	21	504	69	55	178	27	41	44	95	156	159	11
Future Volume (vph)	21	504	69	55	178	27	41	44	95	156	159	11
Satd. Flow (prot)	0	1692	1469	1433	1679	1363	1610	1493	0	1658	1696	0
Fit Permitted		0.985		0.383			0.544			0.622		
Satd. Flow (perm)	0	1667	1346	567	1679	1267	904	1493	0	1064	1696	0
Satd. Flow (RTOR)			77			37		105			3	
Lane Group Flow (vph)	0	583	77	61	198	30	46	155	0	173	189	0
Turn Type	Perm	NA	Perm	Perm	NA	Perm	Perm	NA	Perm	NA	NA	
Protected Phases		2			6			8			4	
Permitted Phases	2		2	6		6	8			4		
Detector Phase	2	2	2	6	6	6	8	8		4	4	
Switch Phase												
Minimum Initial (s)	10.0	10.0	10.0	10.0	10.0	10.0	10.0	10.0		10.0	10.0	
Minimum Split (s)	32.5	32.5	32.5	32.5	32.5	32.5	32.4	32.4		32.4	32.4	
Total Split (s)	67.6	67.6	67.6	67.6	67.6	67.6	32.4	32.4		32.4	32.4	
Total Split (%)	67.6%	67.6%	67.6%	67.6%	67.6%	67.6%	32.4%	32.4%		32.4%	32.4%	
Maximum Green (s)	61.1	61.1	61.1	61.1	61.1	61.1	26.0	26.0		26.0	26.0	
Yellow Time (s)	3.3	3.3	3.3	3.3	3.3	3.3	3.3	3.3		3.3	3.3	
All-Red Time (s)	3.2	3.2	3.2	3.2	3.2	3.2	3.1	3.1		3.1	3.1	
Lost Time Adjust (s)		0.0	0.0	0.0	0.0	0.0	0.0	0.0		0.0	0.0	
Total Lost Time (s)		6.5	6.5	6.5	6.5	6.5	6.4	6.4		6.4	6.4	
Lead/Lag												
Lead-Lag Optimize?												
Vehicle Extension (s)	3.0	3.0	3.0	3.0	3.0	3.0	3.0	3.0		3.0	3.0	
Recall Mode	C-Max	C-Max	C-Max	C-Max	C-Max	C-Max	None	None		None	None	
Walk Time (s)	7.0	7.0	7.0	7.0	7.0	7.0	7.0	7.0		7.0	7.0	
Flash Dont Walk (s)	19.0	19.0	19.0	19.0	19.0	19.0	19.0	19.0		19.0	19.0	
Pedestrian Calls (#/hr)	29	29	29	26	26	26	13	13		14	14	
Act Effct Green (s)	67.0	67.0	67.0	67.0	67.0	67.0	20.1	20.1		20.1	20.1	
Actuated g/C Ratio	0.67	0.67	0.67	0.67	0.67	0.67	0.20	0.20		0.20	0.20	
v/c Ratio	0.52	0.08	0.16	0.18	0.03	0.25	0.40	0.81		0.55	0.55	
Control Delay	11.5	2.1	8.9	7.5	2.2	35.0	15.0	64.9		40.5	40.5	
Queue Delay	0.0	0.0	0.0	0.0	0.0	0.0	0.0	0.0		0.0	0.0	
Total Delay	11.5	2.1	8.9	7.5	2.2	35.0	15.0	64.9		40.5	40.5	
LOS	B	A	A	A	A	C	B	B		E	D	
Approach Delay	10.4				7.3			19.6			52.2	
Approach LOS	B				A			B			D	
Queue Length 50th (m)	52.6	0.0	4.0	13.2	0.0	7.5	8.0	31.9		32.3	32.3	
Queue Length 95th (m)	92.3	5.2	11.0	25.7	2.8	16.5	23.4	52.8		50.3	50.3	
Internal Link Dist (m)	378.4			472.1			344.7	298.3			298.3	
Turn Bay Length (m)		40.0	62.0		40.0	52.0		42.0				
Base Capacity (vph)	1117	927	380	1125	861	235	465	276		443	443	
Starvation Cap Reductn	0	0	0	0	0	0	0	0		0	0	
Spillback Cap Reductn	0	0	0	0	0	0	0	0		0	0	
Storage Cap Reductn	0	0	0	0	0	0	0	0		0	0	
Reduced v/c Ratio	0.52	0.08	0.16	0.18	0.03	0.20	0.33	0.63		0.43	0.43	
Intersection Summary												

Lanes, Volumes, Timings

1: Bayview Station Rd & Scott St/Albert St

Existing AM Peak Hour

50 Bayswater Avenue, 1088 Somerset Street West

Cycle Length: 100	
Actuated Cycle Length: 100	
Offset: 40 (40%), Referenced to phase 2:EBTL and 6:WBTL, Start of Green	
Natural Cycle: 65	
Control Type: Actuated-Coordinated	
Maximum v/c Ratio: 0.81	
Intersection Signal Delay: 21.0	Intersection LOS: C
Intersection Capacity Utilization 87.2%	ICU Level of Service E
Analysis Period (min) 15	

Splits and Phases: 1: Bayview Station Rd & Scott St/Albert St



Lanes, Volumes, Timings
2: Fairmont Ave & Wellington St W

Existing AM Peak Hour
50 Bayswater Avenue, 1088 Somerset Street West

Lane Group	EBT	EBR	WBL	WBT	NBL	NBR
Lane Configurations	↔			↔	↔	
Traffic Volume (vph)	228	55	26	159	28	28
Future Volume (vph)	228	55	26	159	28	28
Satd. Flow (prot)	1619	0	0	1650	1420	0
Fit Permitted				0.936	0.976	
Satd. Flow (perm)	1619	0	0	1535	1406	0
Satd. Flow (RTOR)	29				31	
Lane Group Flow (vph)	314	0	0	206	62	0
Turn Type	NA		Perm	NA	Prot	
Protected Phases	2			6	8	
Permitted Phases			6			
Detector Phase	2		6	6	8	
Switch Phase						
Minimum Initial (s)	10.0		10.0	10.0	5.0	
Minimum Split (s)	24.4		15.4	15.4	24.2	
Total Split (s)	45.0		45.0	45.0	25.0	
Total Split (%)	64.3%		64.3%	64.3%	35.7%	
Maximum Green (s)	39.6		39.6	39.6	19.8	
Yellow Time (s)	3.3		3.3	3.3	3.3	
All-Red Time (s)	2.1		2.1	2.1	1.9	
Lost Time Adjust (s)	0.0		0.0	0.0	0.0	
Total Lost Time (s)	5.4		5.4	5.4	5.2	
Lead/Lag						
Lead-Lag Optimize?						
Vehicle Extension (s)	3.0		3.0	3.0	3.0	
Recall Mode	C-Max		C-Max	C-Max	None	
Walk Time (s)	7.0				7.0	
Flash Dont Walk (s)	12.0				12.0	
Pedestrian Calls (#/hr)	78				55	
Act Effct Green (s)	49.0			49.0	13.6	
Actuated g/C Ratio	0.70			0.70	0.19	
v/c Ratio	0.27			0.19	0.21	
Control Delay	6.6			6.7	13.6	
Queue Delay	0.0			0.0	0.0	
Total Delay	6.6			6.7	13.6	
LOS	A			A	B	
Approach Delay	6.6			6.7	13.6	
Approach LOS	A			A	B	
Queue Length 50th (m)	17.3			11.9	3.0	
Queue Length 95th (m)	30.6			21.6	11.2	
Internal Link Dist (m)	57.5			146.4	73.7	
Turn Bay Length (m)						
Base Capacity (vph)	1142			1074	423	
Starvation Cap Reductn	0			0	0	
Spillback Cap Reductn	0			0	0	
Storage Cap Reductn	0			0	0	
Reduced v/c Ratio	0.27			0.19	0.15	
Intersection Summary						

Lanes, Volumes, Timings
2: Fairmont Ave & Wellington St W

Existing AM Peak Hour
50 Bayswater Avenue, 1088 Somerset Street West

Cycle Length: 70	
Actuated Cycle Length: 70	
Offset: 65 (93%), Referenced to phase 2:EBT and 6:WBTL, Start of Green	
Natural Cycle: 50	
Control Type: Actuated-Coordinated	
Maximum v/c Ratio: 0.27	
Intersection Signal Delay: 7.4	Intersection LOS: A
Intersection Capacity Utilization 55.1%	ICU Level of Service B
Analysis Period (min) 15	

Splits and Phases: 2: Fairmont Ave & Wellington St W



Lanes, Volumes, Timings

3: Wellington St W/Somerset St W & Garland St

Existing AM Peak Hour

50 Bayswater Avenue, 1088 Somerset Street West

Lane Group	EBL	EBT	WBT	WBR	SBL	SBR
Lane Configurations		↕	↕			
Traffic Volume (vph)	23	220	201	10	0	0
Future Volume (vph)	23	220	201	10	0	0
Satd. Flow (prot)	0	1652	1652	0	0	0
Fit Permitted		0.967				
Satd. Flow (perm)	0	1601	1652	0	0	0
Satd. Flow (RTOR)						
Lane Group Flow (vph)	0	270	234	0	0	0
Turn Type	Perm	NA	NA			
Protected Phases		2	6			
Permitted Phases	2					
Detector Phase	2	2	6			
Switch Phase						
Minimum Initial (s)	10.0	10.0	10.0			
Minimum Split (s)	15.5	15.5	25.5			
Total Split (s)	52.0	52.0	52.0			
Total Split (%)	100.0%	100.0%	100.0%			
Maximum Green (s)	46.5	46.5	46.5			
Yellow Time (s)	3.3	3.3	3.3			
All-Red Time (s)	2.2	2.2	2.2			
Lost Time Adjust (s)		0.0	0.0			
Total Lost Time (s)		5.5	5.5			
Lead/Lag						
Lead-Lag Optimize?						
Vehicle Extension (s)	3.0	3.0	3.0			
Recall Mode	C-Max	C-Max	C-Max			
Walk Time (s)			14.0			
Flash Dont Walk (s)			5.0			
Pedestrian Calls (#/hr)			34			
Act Effct Green (s)		52.0	52.0			
Actuated g/C Ratio		1.00	1.00			
v/c Ratio		0.17	0.14			
Control Delay		0.2	0.2			
Queue Delay		0.0	0.0			
Total Delay		0.2	0.2			
LOS		A	A			
Approach Delay		0.2	0.2			
Approach LOS		A	A			
Queue Length 50th (m)		0.0	0.0			
Queue Length 95th (m)		0.0	0.0			
Internal Link Dist (m)		146.4	102.6		69.9	
Turn Bay Length (m)						
Base Capacity (vph)		1601	1652			
Starvation Cap Reductn		0	0			
Spillback Cap Reductn		0	0			
Storage Cap Reductn		0	0			
Reduced v/c Ratio		0.17	0.14			
Intersection Summary						

Lanes, Volumes, Timings

3: Wellington St W/Somerset St W & Garland St

Existing AM Peak Hour

50 Bayswater Avenue, 1088 Somerset Street West

Cycle Length: 52	
Actuated Cycle Length: 52	
Offset: 7 (13%), Referenced to phase 2:EBTL and 6:WBT, Start of Green	
Natural Cycle: 40	
Control Type: Actuated-Coordinated	
Maximum v/c Ratio: 0.17	
Intersection Signal Delay: 0.2	Intersection LOS: A
Intersection Capacity Utilization 47.2%	ICU Level of Service A
Analysis Period (min) 15	

Splits and Phases: 3: Wellington St W/Somerset St W & Garland St



HCM 2010 TWSC
4: City laneway & Somerset St W

Existing AM Peak Hour
50 Bayswater Avenue, 1088 Somerset Street West

Intersection						
Int Delay, s/veh	0.4					
Movement	EBT	EBR	WBL	WBT	NBL	NBR
Lane Configurations	↔		↔		↔	
Traffic Vol, veh/h	186	3	11	217	4	3
Future Vol, veh/h	186	3	11	217	4	3
Conflicting Peds, #/hr	0	44	44	0	0	0
Sign Control	Free	Free	Free	Free	Stop	Stop
RT Channelized	-	None	-	None	-	None
Storage Length	-	-	-	-	0	-
Veh in Median Storage, #	0	-	-	0	0	-
Grade, %	0	-	-	0	0	-
Peak Hour Factor	90	90	90	90	90	90
Heavy Vehicles, %	2	2	2	2	2	2
Mvmt Flow	207	3	12	241	4	3
Major/Minor	Major1	Major2	Minor1			
Conflicting Flow All	0	0	254	0	518	253
Stage 1	-	-	-	-	253	-
Stage 2	-	-	-	-	265	-
Critical Hdwy	-	-	4.12	-	6.42	6.22
Critical Hdwy Stg 1	-	-	-	-	5.42	-
Critical Hdwy Stg 2	-	-	-	-	5.42	-
Follow-up Hdwy	-	-	2.218	-	3.518	3.318
Pot Cap-1 Maneuver	-	-	1311	-	518	786
Stage 1	-	-	-	-	789	-
Stage 2	-	-	-	-	779	-
Platoon blocked, %	-	-	-	-	-	-
Mov Cap-1 Maneuver	-	-	1266	-	495	759
Mov Cap-2 Maneuver	-	-	-	-	495	-
Stage 1	-	-	-	-	762	-
Stage 2	-	-	-	-	770	-
Approach	EB	WB	NB			
HCM Control Delay, s	0	0.4	11.3			
HCM LOS			B			
Minor Lane/Major Mvmt	NBLn1	EBT	EBR	WBL	WBT	
Capacity (veh/h)	582	-	-	1266	-	
HCM Lane V/C Ratio	0.013	-	-	0.01	-	
HCM Control Delay (s)	11.3	-	-	7.9	0	
HCM Lane LOS	B	-	-	A	A	
HCM 95th %tile Q(veh)	0	-	-	0	-	

Lanes, Volumes, Timings
5: Baywater Ave & Somerset St W

Existing AM Peak Hour
50 Bayswater Avenue, 1088 Somerset Street West

Lane Group	EBL	EBT	EBR	WBL	WBT	WBR	NBL	NBT	NBR	SBL	SBT	SBR
Lane Configurations		↔	↔		↔	↔		↔	↔	↔	↔	↔
Traffic Volume (vph)	26	149	14	30	177	63	12	122	41	97	124	39
Future Volume (vph)	26	149	14	30	177	63	12	122	41	97	124	39
Satd. Flow (prot)	0	1624	1414	0	1652	1363	0	1572	0	1523	1653	0
Fit Permitted		0.936			0.940			0.978		0.664		
Satd. Flow (perm)	0	1526	1291	0	1553	1283	0	1540	0	1039	1653	0
Satd. Flow (RTOR)			45			70		27			27	
Lane Group Flow (vph)	0	195	16	0	230	70	0	195	0	108	181	0
Turn Type	Perm	NA	Perm	Perm	NA	Perm	Perm	NA	Perm	NA	Perm	NA
Protected Phases		2			6			8			4	
Permitted Phases	2		2	6		6	8			4		
Detector Phase	2	2	2	6	6	6	8	8		4	4	
Switch Phase												
Minimum Initial (s)	10.0	10.0	10.0	10.0	10.0	10.0	10.0	10.0		10.0	10.0	
Minimum Split (s)	33.5	33.5	33.5	33.5	33.5	33.5	29.9	29.9		29.9	29.9	
Total Split (s)	35.0	35.0	35.0	35.0	35.0	35.0	35.0	35.0		35.0	35.0	
Total Split (%)	50.0%	50.0%	50.0%	50.0%	50.0%	50.0%	50.0%	50.0%		50.0%	50.0%	
Maximum Green (s)	29.5	29.5	29.5	29.5	29.5	29.5	29.1	29.1		29.1	29.1	
Yellow Time (s)	3.3	3.3	3.3	3.3	3.3	3.3	3.3	3.3		3.3	3.3	
All-Red Time (s)	2.2	2.2	2.2	2.2	2.2	2.2	2.6	2.6		2.6	2.6	
Lost Time Adjust (s)		0.0	0.0		0.0	0.0		0.0		0.0	0.0	
Total Lost Time (s)		5.5	5.5		5.5	5.5		5.9		5.9	5.9	
Lead/Lag												
Lead-Lag Optimize?												
Vehicle Extension (s)	3.0	3.0	3.0	3.0	3.0	3.0	3.0	3.0		3.0	3.0	
Recall Mode	C-Max	C-Max	C-Max	C-Max	C-Max	C-Max	Max	Max		Max	Max	
Walk Time (s)	17.0	17.0	17.0	17.0	17.0	17.0	13.0	13.0		13.0	13.0	
Flash Dont Walk (s)	8.0	8.0	8.0	8.0	8.0	8.0	10.0	10.0		10.0	10.0	
Pedestrian Calls (#/hr)	46	46	46	20	20	20	22	22		13	13	
Act Effct Green (s)		29.5	29.5		29.5	29.5		29.1		29.1	29.1	
Actuated g/C Ratio		0.42	0.42		0.42	0.42		0.42		0.42	0.42	
v/c Ratio		0.30	0.03		0.35	0.12		0.30		0.25	0.26	
Control Delay		15.1	1.0		15.7	4.2		13.2		15.4	12.5	
Queue Delay		0.0	0.0		0.0	0.0		0.0		0.0	0.0	
Total Delay		15.1	1.0		15.7	4.2		13.2		15.4	12.5	
LOS		B	A		B	A		B		B	B	
Approach Delay		14.0			13.0			13.2			13.6	
Approach LOS		B			B			B			B	
Queue Length 50th (m)		16.3	0.0		19.7	0.0		13.9		8.9	12.5	
Queue Length 95th (m)		30.0	0.9		35.2	6.4		27.3		19.2	24.8	
Internal Link Dist (m)		29.3			373.3			51.0			344.7	
Turn Bay Length (m)			33.0			40.0				58.0		
Base Capacity (vph)		643	570		654	581		655		431	702	
Starvation Cap Reductn		0	0		0	0		0		0	0	
Spillback Cap Reductn		0	0		0	0		0		0	0	
Storage Cap Reductn		0	0		0	0		0		0	0	
Reduced v/c Ratio		0.30	0.03		0.35	0.12		0.30		0.25	0.26	

Intersection Summary

Lanes, Volumes, Timings
5: Baywater Ave & Somerset St W

Existing AM Peak Hour
50 Baywater Avenue, 1088 Somerset Street West

Cycle Length: 70
Actuated Cycle Length: 70
Offset: 19 (27%), Referenced to phase 2:EBTL and 6:WBTL, Start of Green
Natural Cycle: 65
Control Type: Actuated-Coordinated
Maximum v/c Ratio: 0.35
Intersection Signal Delay: 13.4 Intersection LOS: B
Intersection Capacity Utilization 88.2% ICU Level of Service E
Analysis Period (min) 15

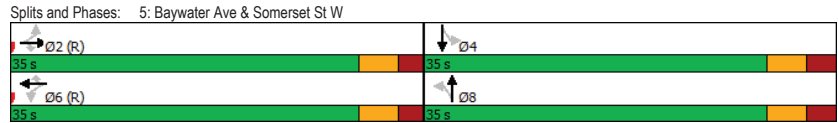

HCM 2010 TWSC
6: Baywater Ave & 50 Baywater

Existing AM Peak Hour
50 Baywater Avenue, 1088 Somerset Street West

Intersection						
Int Delay, s/veh	0.2					
Movement	EBL	EBR	NBL	NBT	SBT	SBR
Lane Configurations	↔		↔		↔	
Traffic Vol, veh/h	3	4	0	180	166	0
Future Vol, veh/h	3	4	0	180	166	0
Conflicting Peds, #/hr	1	5	5	0	0	22
Sign Control	Stop	Stop	Free	Free	Free	Free
RT Channelized	-	None	-	None	-	None
Storage Length	0	-	-	-	-	-
Veh in Median Storage, #	0	-	-	0	0	-
Grade, %	0	-	-	0	0	-
Peak Hour Factor	90	90	90	90	90	90
Heavy Vehicles, %	2	2	2	2	2	2
Mvmt Flow	3	4	0	200	184	0

Major/Minor	Minor2	Major1	Major2
Conflicting Flow All	407	211	206
Stage 1	206	-	-
Stage 2	201	-	-
Critical Hdwy	6.42	6.22	4.12
Critical Hdwy Stg 1	5.42	-	-
Critical Hdwy Stg 2	5.42	-	-
Follow-up Hdwy	3.518	3.318	2.218
Pot Cap-1 Maneuver	600	829	1365
Stage 1	829	-	-
Stage 2	833	-	-
Platoon blocked, %	-	-	-
Mov Cap-1 Maneuver	580	812	1342
Mov Cap-2 Maneuver	580	-	-
Stage 1	815	-	-
Stage 2	819	-	-

Approach	EB	NB	SB
HCM Control Delay, s	10.3	0	0
HCM LOS	B		

Minor Lane/Major Mvmt	NBL	NBT EBLn1	SBT	SBR
Capacity (veh/h)	1342	-	693	-
HCM Lane V/C Ratio	-	-	0.011	-
HCM Control Delay (s)	0	-	10.3	-
HCM Lane LOS	A	-	B	-
HCM 95th %tile Q(veh)	0	-	0	-

HCM 2010 AWSC
7: Baywater Ave & Laurel St

Existing AM Peak Hour
50 Baywater Avenue, 1088 Somerset Street West

Intersection												
Intersection Delay, s/veh	8.9											
Intersection LOS	A											

Movement	EBL	EBT	EBR	WBL	WBT	WBR	NBL	NBT	NBR	SBL	SBT	SBR
Lane Configurations		↔			↕			↕			↔	
Traffic Vol, veh/h	8	4	8	11	6	15	5	147	8	19	149	4
Future Vol, veh/h	8	4	8	11	6	15	5	147	8	19	149	4
Peak Hour Factor	0.90	0.90	0.90	0.90	0.90	0.90	0.90	0.90	0.90	0.90	0.90	0.90
Heavy Vehicles, %	2	2	2	9	2	2	40	3	2	5	2	2
Mvmt Flow	9	4	9	12	7	17	6	163	9	21	166	4
Number of Lanes	0	1	0	0	1	0	0	1	0	0	1	0

Approach	EB	WB	NB	SB
Opposing Approach	WB	EB	SB	NB
Opposing Lanes	1	1	1	1
Conflicting Approach Left	SB	NB	EB	WB
Conflicting Lanes Left	1	1	1	1
Conflicting Approach Right	NB	SB	WB	EB
Conflicting Lanes Right	1	1	1	1
HCM Control Delay	7.9	8	9.5	8.6
HCM LOS	A	A	A	A

Lane	NBLn1	EBLn1	WBLn1	SBLn1
Vol Left, %	3%	40%	34%	11%
Vol Thru, %	92%	20%	19%	87%
Vol Right, %	5%	40%	47%	2%
Sign Control	Stop	Stop	Stop	Stop
Traffic Vol by Lane	160	20	32	172
LT Vol	5	8	11	19
Through Vol	147	4	6	149
RT Vol	8	8	15	4
Lane Flow Rate	178	22	36	191
Geometry Grp	1	1	1	1
Degree of Util (X)	0.242	0.029	0.047	0.23
Departure Headway (Hd)	4.906	4.689	4.738	4.337
Convergence, Y/N	Yes	Yes	Yes	Yes
Cap	736	764	757	829
Service Time	2.906	2.711	2.758	2.351
HCM Lane V/C Ratio	0.242	0.029	0.048	0.23
HCM Control Delay	9.5	7.9	8	8.6
HCM Lane LOS	A	A	A	A
HCM 95th-tile Q	0.9	0.1	0.1	0.9

Lanes, Volumes, Timings
1: Bayview Station Rd & Scott St/Albert St

Existing PM Peak Hour
50 Baywater Avenue, 1088 Somerset Street West



Lane Group	EBL	EBT	EBR	WBL	WBT	WBR	NBL	NBT	NBR	SBL	SBT	SBR
Lane Configurations		↕	↕	↕	↕	↕	↕	↕	↕	↕	↕	↕
Traffic Volume (vph)	17	399	84	80	449	183	61	146	59	52	72	25
Future Volume (vph)	17	399	84	80	449	183	61	146	59	52	72	25
Satd. Flow (prot)	0	1725	1483	1537	1728	1483	1658	1647	0	1658	1635	0
Fit Permitted		0.973		0.464			0.687			0.446		
Satd. Flow (perm)	0	1681	1350	728	1728	1378	1155	1647	0	764	1635	0
Satd. Flow (RTOR)			93			203		20			17	
Lane Group Flow (vph)	0	462	93	89	499	203	68	228	0	58	108	0
Turn Type	Perm	NA	Perm	Perm	NA	Perm	Perm	NA		Perm	NA	
Protected Phases		2			6			8				4
Permitted Phases	2		2	6		6	8				4	
Detector Phase	2	2	2	6	6	6	8	8			4	4
Switch Phase												
Minimum Initial (s)	10.0	10.0	10.0	10.0	10.0	10.0	10.0	10.0		10.0	10.0	
Minimum Split (s)	32.5	32.5	32.5	32.5	32.5	32.5	32.4	32.4		32.4	32.4	
Total Split (s)	67.6	67.6	67.6	67.6	67.6	67.6	32.4	32.4		32.4	32.4	
Total Split (%)	67.6%	67.6%	67.6%	67.6%	67.6%	67.6%	32.4%	32.4%		32.4%	32.4%	
Yellow Time (s)	3.3	3.3	3.3	3.3	3.3	3.3	3.3	3.3		3.3	3.3	
All-Red Time (s)	3.2	3.2	3.2	3.2	3.2	3.2	3.1	3.1		3.1	3.1	
Lost Time Adjust (s)	0.0	0.0	0.0	0.0	0.0	0.0	0.0	0.0		0.0	0.0	
Total Lost Time (s)		6.5	6.5	6.5	6.5	6.5	6.4	6.4		6.4	6.4	
Lead/Lag												
Lead-Lag Optimize?												
Recall Mode	C-Max	C-Max	C-Max	C-Max	C-Max	C-Max	None	None		None	None	
Act Effct Green (s)	67.9	67.9	67.9	67.9	67.9	67.9	19.2	19.2		19.2	19.2	
Actuated g/C Ratio	0.68	0.68	0.68	0.68	0.68	0.68	0.19	0.19		0.19	0.19	
v/c Ratio	0.40	0.10	0.18	0.43	0.20	0.31	0.69			0.40	0.33	
Control Delay	9.5	2.0	8.5	9.7	1.7	36.0	44.0			41.1	30.0	
Queue Delay	0.0	0.0	0.0	0.0	0.0	0.0	0.0			0.0	0.0	
Total Delay	9.5	2.0	8.5	9.7	1.7	36.0	44.0			41.1	30.0	
LOS	A	A	A	A	A	A	D	D		D	C	
Approach Delay	8.2			7.5			42.2				33.9	
Approach LOS	A			A			D				C	
Queue Length 50th (m)	33.5	0.0	5.3	36.9	0.0	11.6	38.4			10.1	15.5	
Queue Length 95th (m)	65.9	5.6	14.7	71.8	8.1	21.8	57.4			20.4	27.9	
Internal Link Dist (m)	378.4			472.1			347.9				298.3	
Turn Bay Length (m)			40.0	62.0		40.0	52.0				42.0	
Base Capacity (vph)	1141	946	494	1173	1000	300	443			198	437	
Starvation Cap Reductn	0	0	0	0	0	0	0			0	0	
Spillback Cap Reductn	0	0	0	0	0	0	0			0	0	
Storage Cap Reductn	0	0	0	0	0	0	0			0	0	
Reduced v/c Ratio	0.40	0.10	0.18	0.43	0.20	0.23	0.51			0.29	0.25	

Intersection Summary												
Cycle Length: 100												
Actuated Cycle Length: 100												
Offset: 65 (65%), Referenced to phase 2:EBTL and 6:WBTL, Start of Green												
Natural Cycle: 65												
Control Type: Actuated-Coordinated												

Lanes, Volumes, Timings

1: Bayview Station Rd & Scott St/Albert St

Existing PM Peak Hour

50 Bayswater Avenue, 1088 Somerset Street West

Maximum v/c Ratio: 0.69

Intersection Signal Delay: 15.8

Intersection LOS: B

Intersection Capacity Utilization 93.7%

ICU Level of Service F

Analysis Period (min) 15

Splits and Phases: 1: Bayview Station Rd & Scott St/Albert St

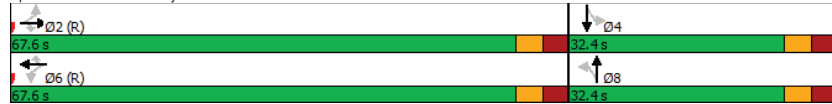

Lanes, Volumes, Timings

2: Fairmont Ave & Wellington St W

Existing PM Peak Hour

50 Bayswater Avenue, 1088 Somerset Street West



Lane Group	EBT	EBR	WBL	WBT	NBL	NBR
Lane Configurations	↔		↔		↔	
Traffic Volume (vph)	259	64	46	296	36	48
Future Volume (vph)	259	64	46	296	36	48
Satd. Flow (prot)	1599	0	0	1733	1424	0
Fit Permitted				0.917	0.979	
Satd. Flow (perm)	1599	0	0	1566	1384	0
Satd. Flow (RTOR)	29				53	
Lane Group Flow (vph)	359	0	0	380	93	0
Turn Type	NA		Perm	NA	Prot	
Protected Phases	2			6	8	
Permitted Phases			6			
Detector Phase	2		6	6	8	
Switch Phase						
Minimum Initial (s)	10.0		10.0	10.0	5.0	
Minimum Split (s)	24.4		15.4	15.4	24.2	
Total Split (s)	50.0		50.0	50.0	25.0	
Total Split (%)	66.7%		66.7%	66.7%	33.3%	
Yellow Time (s)	3.3		3.3	3.3	3.3	
All-Red Time (s)	2.1		2.1	2.1	1.9	
Lost Time Adjust (s)	0.0		0.0	0.0	0.0	
Total Lost Time (s)	5.4		5.4	5.4	5.2	
Lead/Lag						
Lead-Lag Optimize?						
Recall Mode	C-Max		C-Max	C-Max	None	
Act Effct Green (s)	51.3		51.3	51.3	16.3	
Actuated g/C Ratio	0.68		0.68	0.68	0.22	
v/c Ratio	0.33		0.35	0.35	0.26	
Control Delay	7.3		5.0	5.0	13.7	
Queue Delay	0.0		0.0	0.0	0.0	
Total Delay	7.3		5.0	5.0	13.7	
LOS	A		A	A	B	
Approach Delay	7.3		5.0	5.0	13.7	
Approach LOS	A		A	A	B	
Queue Length 50th (m)	20.7		23.5	23.5	4.3	
Queue Length 95th (m)	35.5		24.3	24.3	15.1	
Internal Link Dist (m)	57.5		146.4	146.4	73.7	
Turn Bay Length (m)						
Base Capacity (vph)	1103		1071	1071	414	
Starvation Cap Reductn	0		0	0	0	
Spillback Cap Reductn	0		0	0	0	
Storage Cap Reductn	0		0	0	0	
Reduced v/c Ratio	0.33		0.35	0.35	0.22	

Intersection Summary

Cycle Length: 75

Actuated Cycle Length: 75

Offset: 24 (32%), Referenced to phase 2:EBT and 6:WBTL, Start of Green

Natural Cycle: 50

Control Type: Actuated-Coordinated

Lanes, Volumes, Timings
2: Fairmont Ave & Wellington St W

Existing PM Peak Hour
50 Bayswater Avenue, 1088 Somerset Street West

Maximum v/c Ratio: 0.35	Intersection LOS: A
Intersection Signal Delay: 6.9	ICU Level of Service C
Intersection Capacity Utilization 67.6%	
Analysis Period (min) 15	

Splits and Phases: 2: Fairmont Ave & Wellington St W

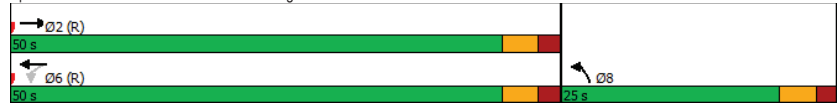

Lanes, Volumes, Timings
3: Wellington St W/Somerset St W & Garland St

Existing PM Peak Hour
50 Bayswater Avenue, 1088 Somerset Street West

Lane Group	EBL	EBT	WBT	WBR	SBL	SBR	Ø4
Lane Configurations		↕	↕				
Traffic Volume (vph)	24	262	332	25	0	0	
Future Volume (vph)	24	262	332	25	0	0	
Satd. Flow (prot)	0	1735	1699	0	0	0	
Fit Permitted		0.954					
Satd. Flow (perm)	0	1645	1699	0	0	0	
Satd. Flow (RTOR)			12				
Lane Group Flow (vph)	0	318	397	0	0	0	
Turn Type	Perm	NA	NA				
Protected Phases		2	6				4
Permitted Phases	2						
Detector Phase	2	2	6				
Switch Phase							
Minimum Initial (s)	10.0	10.0	10.0				5.0
Minimum Split (s)	15.5	15.5	25.5				17.7
Total Split (s)	57.0	57.0	57.0				18.0
Total Split (%)	76.0%	76.0%	76.0%				24%
Yellow Time (s)	3.3	3.3	3.3				3.0
All-Red Time (s)	2.2	2.2	2.2				2.7
Lost Time Adjust (s)		0.0	0.0				
Total Lost Time (s)		5.5	5.5				
Lead/Lag							
Lead-Lag Optimize?							
Recall Mode	C-Max	C-Max	C-Max				None
Act Effct Green (s)		61.1	61.1				
Actuated g/C Ratio		0.81	0.81				
v/c Ratio		0.24	0.29				
Control Delay		2.0	7.6				
Queue Delay		0.0	0.0				
Total Delay		2.0	7.6				
LOS		A	A				
Approach Delay		2.0	7.6				
Approach LOS		A	A				
Queue Length 50th (m)		5.2	26.9				
Queue Length 95th (m)		9.8	49.7				
Internal Link Dist (m)		146.4	98.8		48.7		
Turn Bay Length (m)							
Base Capacity (vph)		1340	1386				
Starvation Cap Reductn		0	0				
Spillback Cap Reductn		0	0				
Storage Cap Reductn		0	0				
Reduced v/c Ratio		0.24	0.29				
Intersection Summary							
Cycle Length: 75							
Actuated Cycle Length: 75							
Offset: 32 (43%), Referenced to phase 2:EBTL and 6:WBT, Start of Green							
Natural Cycle: 45							
Control Type: Actuated-Coordinated							

Lanes, Volumes, Timings
 3: Wellington St W/Somerset St W & Garland St

Existing PM Peak Hour
 50 Bayswater Avenue, 1088 Somerset Street West

Maximum v/c Ratio: 0.29	
Intersection Signal Delay: 5.1	Intersection LOS: A
Intersection Capacity Utilization 54.4%	ICU Level of Service A
Analysis Period (min) 15	

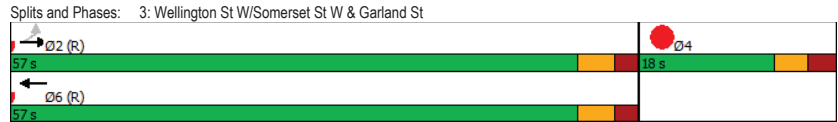

HCM 2010 TWSC
 4: City laneway & Somerset St W

Existing PM Peak Hour
 50 Bayswater Avenue, 1088 Somerset Street West

Intersection						
Int Delay, s/veh	0.4					
Movement	EBT	EBR	WBL	WBT	NBL	NBR
Lane Configurations	↔ ↗ ↘ ↙ ↘ ↗					
Traffic Vol, veh/h	262	3	6	374	7	11
Future Vol, veh/h	262	3	6	374	7	11
Conflicting Peds, #/hr	0	118	118	0	4	2
Sign Control	Free	Free	Free	Free	Stop	Stop
RT Channelized	- None	- None	- None	- None	- None	- None
Storage Length	-	-	-	-	0	-
Veh in Median Storage, #	0	-	-	0	0	-
Grade, %	0	-	-	0	0	-
Peak Hour Factor	90	90	90	90	90	90
Heavy Vehicles, %	2	2	2	2	2	2
Mvmt Flow	291	3	7	416	8	12

Major/Minor	Major1	Major2	Minor1
Conflicting Flow All	0	0	412
Stage 1	-	-	411
Stage 2	-	-	434
Critical Hdwy	-	4.12	6.42
Critical Hdwy Stg 1	-	-	5.42
Critical Hdwy Stg 2	-	-	5.42
Follow-up Hdwy	-	2.218	3.518
Pot Cap-1 Maneuver	-	1147	333
Stage 1	-	-	669
Stage 2	-	-	653
Platoon blocked, %	-	-	-
Mov Cap-1 Maneuver	-	1042	299
Mov Cap-2 Maneuver	-	-	299
Stage 1	-	-	607
Stage 2	-	-	645

Approach	EB	WB	NB
HCM Control Delay, s	0	0.1	13.9
HCM LOS			B

Minor Lane/Major Mvmt	NBLn1	EBT	EBR	WBL	WBT
Capacity (veh/h)	425	-	-	1042	-
HCM Lane V/C Ratio	0.047	-	-	0.006	-
HCM Control Delay (s)	13.9	-	-	8.5	0
HCM Lane LOS	B	-	-	A	A
HCM 95th %tile Q(veh)	0.1	-	-	0	-

Lanes, Volumes, Timings
5: Baywater Ave & Somerset St W

Existing PM Peak Hour
50 Baywater Avenue, 1088 Somerset Street West

Lane Group	EBL	EBT	EBR	WBL	WBT	WBR	NBL	NBT	NBR	SBL	SBT	SBR
Lane Configurations		↕	↕		↕	↕		↕	↕	↕	↕	↕
Traffic Volume (vph)	25	225	23	39	301	90	18	156	60	98	120	61
Future Volume (vph)	25	225	23	39	301	90	18	156	60	98	120	61
Satd. Flow (prot)	0	1721	1483	0	1714	1483	0	1601	0	1610	1618	0
Fit Permitted		0.942			0.938			0.970		0.574		
Satd. Flow (perm)	0	1623	1248	0	1601	1320	0	1556	0	923	1618	0
Satd. Flow (RTOR)			42			100		27			40	
Lane Group Flow (vph)	0	278	26	0	377	100	0	260	0	109	201	0
Turn Type	Perm	NA	Perm	Perm	NA	Perm	Perm	NA	Perm	NA	NA	
Protected Phases		2			6			8			4	
Permitted Phases	2		2	6		6	8			4		
Detector Phase	2	2	2	6	6	6	8	8		4	4	
Switch Phase												
Minimum Initial (s)	10.0	10.0	10.0	10.0	10.0	10.0	10.0	10.0		10.0	10.0	
Minimum Split (s)	30.5	30.5	30.5	30.5	30.5	30.5	28.9	28.9		28.9	28.9	
Total Split (s)	40.0	40.0	40.0	40.0	40.0	40.0	35.0	35.0		35.0	35.0	
Total Split (%)	53.3%	53.3%	53.3%	53.3%	53.3%	53.3%	46.7%	46.7%		46.7%	46.7%	
Yellow Time (s)	3.3	3.3	3.3	3.3	3.3	3.3	3.3	3.3		3.3	3.3	
All-Red Time (s)	2.2	2.2	2.2	2.2	2.2	2.2	2.6	2.6		2.6	2.6	
Lost Time Adjust (s)		0.0	0.0		0.0	0.0		0.0		0.0	0.0	
Total Lost Time (s)		5.5	5.5		5.5	5.5		5.9		5.9	5.9	
Lead/Lag												
Lead-Lag Optimize?												
Recall Mode	C-Max	C-Max	C-Max	C-Max	C-Max	C-Max	Max	Max		Max	Max	
Act Effct Green (s)	34.5	34.5	34.5	34.5	34.5	34.5	29.1	29.1		29.1	29.1	
Actuated g/C Ratio	0.46	0.46	0.46	0.46	0.46	0.46	0.39	0.39		0.39	0.39	
v/c Ratio	0.37	0.04	0.04	0.51	0.15	0.15	0.42	0.30		0.30	0.31	
Control Delay	12.0	4.4	4.4	17.4	3.4	3.4	17.5	18.9		14.2	14.2	
Queue Delay	0.0	0.0	0.0	0.0	0.0	0.0	0.0	0.0		0.0	0.0	
Total Delay	12.0	4.4	4.4	17.4	3.4	3.4	17.5	18.9		14.2	14.2	
LOS	B	A	A	B	A	A	B	B		B	B	
Approach Delay	11.4			14.5			17.5			15.9		
Approach LOS	B			B			B			B		
Queue Length 50th (m)	28.0	0.3	0.3	35.9	0.0	0.0	23.2	10.4		15.1		
Queue Length 95th (m)	48.1	4.2	4.2	59.0	7.3	7.3	41.8	22.2		29.7		
Internal Link Dist (m)	33.0			373.3			50.4			347.9		
Turn Bay Length (m)		33.0			40.0			58.0				
Base Capacity (vph)	746	596	596	736	661	661	620	358		652		
Starvation Cap Reductn	0	0	0	0	0	0	0	0		0	0	
Spillback Cap Reductn	0	0	0	0	0	0	0	0		0	0	
Storage Cap Reductn	0	0	0	0	0	0	0	0		0	0	
Reduced v/c Ratio	0.37	0.04	0.04	0.51	0.15	0.15	0.42	0.30		0.31		

Intersection Summary	
Cycle Length:	75
Actuated Cycle Length:	75
Offset:	63 (84%), Referenced to phase 2:EBTL and 6:WBTL, Start of Green
Natural Cycle:	60
Control Type:	Actuated-Coordinated

Lanes, Volumes, Timings
5: Baywater Ave & Somerset St W

Existing PM Peak Hour
50 Baywater Avenue, 1088 Somerset Street West

Maximum v/c Ratio: 0.51	Intersection LOS: B
Intersection Signal Delay: 14.7	ICU Level of Service F
Intersection Capacity Utilization 95.7%	
Analysis Period (min) 15	

Splits and Phases: 5: Baywater Ave & Somerset St W

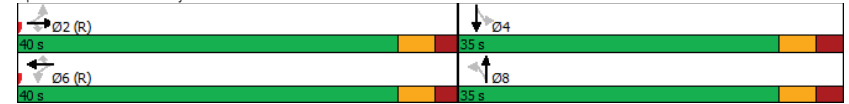

HCM 2010 TWSC
6: Baywater Ave & 50 Baywater

Existing PM Peak Hour
50 Baywater Avenue, 1088 Somerset Street West

Intersection						
Int Delay, s/veh	0.2					
Movement	EBL	EBR	NBL	NBT	SBT	SBR
Lane Configurations	↔			↕	↕	
Traffic Vol, veh/h	2	3	6	239	178	3
Future Vol, veh/h	2	3	6	239	178	3
Conflicting Peds, #/hr	3	4	4	0	0	33
Sign Control	Stop	Stop	Free	Free	Free	Free
RT Channelized	-	None	-	None	-	None
Storage Length	0	-	-	-	-	-
Veh in Median Storage, #	0	-	-	0	0	-
Grade, %	0	-	-	0	0	-
Peak Hour Factor	90	90	90	90	90	90
Heavy Vehicles, %	2	2	2	2	2	2
Mvmt Flow	2	3	7	266	198	3
Major/Minor	Minor2	Major1	Major2			
Conflicting Flow All	516	237	234	0	-	0
Stage 1	233	-	-	-	-	-
Stage 2	283	-	-	-	-	-
Critical Hdwy	6.42	6.22	4.12	-	-	-
Critical Hdwy Stg 1	5.42	-	-	-	-	-
Critical Hdwy Stg 2	5.42	-	-	-	-	-
Follow-up Hdwy	3.518	3.318	2.218	-	-	-
Pot Cap-1 Maneuver	519	802	1333	-	-	-
Stage 1	806	-	-	-	-	-
Stage 2	765	-	-	-	-	-
Platoon blocked, %	-	-	-	-	-	-
Mov Cap-1 Maneuver	489	779	1299	-	-	-
Mov Cap-2 Maneuver	489	-	-	-	-	-
Stage 1	780	-	-	-	-	-
Stage 2	745	-	-	-	-	-
Approach	EB	NB	SB			
HCM Control Delay, s	10.8	0.2	0			
HCM LOS	B					
Minor Lane/Major Mvmt	NBL	NBT	EBLn1	SBT	SBR	
Capacity (veh/h)	1299	-	630	-	-	
HCM Lane V/C Ratio	0.005	-	0.009	-	-	
HCM Control Delay (s)	7.8	0	10.8	-	-	
HCM Lane LOS	A	A	B	-	-	
HCM 95th %tile Q(veh)	0	-	0	-	-	

HCM 2010 AWSC
7: Baywater Ave & Laurel St

Existing PM Peak Hour
50 Baywater Avenue, 1088 Somerset Street West

Intersection												
Intersection Delay, s/veh	8.8											
Intersection LOS	A											
Movement	EBL	EBT	EBR	WBL	WBT	WBR	NBL	NBT	NBR	SBL	SBT	SBR
Lane Configurations		↕			↕			↕			↕	
Traffic Vol, veh/h	15	1	3	14	6	20	13	206	3	5	159	10
Future Vol, veh/h	15	1	3	14	6	20	13	206	3	5	159	10
Peak Hour Factor	0.90	0.90	0.90	0.90	0.90	0.90	0.90	0.90	0.90	0.90	0.90	0.90
Heavy Vehicles, %	2	2	2	2	2	2	2	2	2	2	2	2
Mvmt Flow	17	1	3	16	7	22	14	229	3	6	177	11
Number of Lanes	0	1	0	0	1	0	0	1	0	0	1	0
Approach	EB	WB	NB	SB								
Opposing Approach	WB	EB	SB	NB								
Opposing Lanes	1	1	1	1								
Conflicting Approach Left	SB	NB	EB	WB								
Conflicting Lanes Left	1	1	1	1								
Conflicting Approach Right	NB	SB	WB	EB								
Conflicting Lanes Right	1	1	1	1								
HCM Control Delay	8.2	8	9.1	8.6								
HCM LOS	A	A	A	A								
Lane	NBLn1	EBLn1	WBLn1	SBLn1								
Vol Left, %	6%	79%	35%	3%								
Vol Thru, %	93%	5%	15%	91%								
Vol Right, %	1%	16%	50%	6%								
Sign Control	Stop	Stop	Stop	Stop								
Traffic Vol by Lane	222	19	40	174								
LT Vol	13	15	14	5								
Through Vol	206	1	6	159								
RT Vol	3	3	20	10								
Lane Flow Rate	247	21	44	193								
Geometry Grp	1	1	1	1								
Degree of Util (X)	0.295	0.029	0.058	0.232								
Departure Headway (Hd)	4.309	5.022	4.696	4.317								
Convergence, Y/N	Yes	Yes	Yes	Yes								
Cap	839	713	763	833								
Service Time	2.309	3.049	2.721	2.332								
HCM Lane V/C Ratio	0.294	0.029	0.058	0.232								
HCM Control Delay	9.1	8.2	8	8.6								
HCM Lane LOS	A	A	A	A								
HCM 95th-tile Q	1.2	0.1	0.2	0.9								

Appendix D

Collision Data

Accident Date	Accident Year	Accident Time	Location	Environment Condition	Light	Traffic Control	Traffic Control Condition	Classification Of Accident	Initial Impact Type	Road Surface Condition	# Vehicles	# Motorcycles	# Bicycles	# Pedestrians
5/10/2018	2018	11:14	BAYSWATER AVE @ SOMERSET ST (0006486)	01 - Clear	01 - Daylight	01 - Traffic signal	0	03 - P.D. only	07 - SMV other	01 - Dry	0	0	0	0
12/4/2018	2018	18:28	BAYSWATER AVE @ SOMERSET ST (0006486)	01 - Clear	07 - Dark	01 - Traffic signal	0	03 - P.D. only	03 - Rear end	01 - Dry	0	0	0	0
3/31/2019	2019	10:01	BAYSWATER AVE @ SOMERSET ST (0006486)	02 - Rain	01 - Daylight	01 - Traffic signal	0	02 - Non-fatal injury	03 - Rear end	02 - Wet	0	0	0	0
4/21/2019	2019	10:43	BAYSWATER AVE @ SOMERSET ST (0006486)	01 - Clear	01 - Daylight	01 - Traffic signal	0	02 - Non-fatal injury	02 - Angle	01 - Dry	0	0	0	0
5/24/2019	2019	17:59	BAYSWATER AVE @ SOMERSET ST (0006486)	01 - Clear	01 - Daylight	01 - Traffic signal	0	03 - P.D. only	03 - Rear end	01 - Dry	0	0	0	0
11/20/2019	2019	12:39	BAYSWATER AVE @ SOMERSET ST (0006486)	01 - Clear	01 - Daylight	01 - Traffic signal	0	03 - P.D. only	99 - Other	01 - Dry	0	0	0	0
1/2/2020	2020	13:40	BAYSWATER AVE @ SOMERSET ST (0006486)	01 - Clear	01 - Daylight	01 - Traffic signal	0	03 - P.D. only	05 - Turning movement	06 - Ice	0	0	0	0
3/27/2020	2020	11:20	BAYSWATER AVE @ SOMERSET ST (0006486)	01 - Clear	01 - Daylight	01 - Traffic signal	0	03 - P.D. only	02 - Angle	01 - Dry	0	0	0	0
6/15/2020	2020	17:13	BAYSWATER AVE @ SOMERSET ST (0006486)	01 - Clear	01 - Daylight	01 - Traffic signal	0	03 - P.D. only	02 - Angle	01 - Dry	0	0	0	0
1/8/2018	2018	14:15	SOMERSET ST W btwn BAYSWATER AVE & BREEZEHILL AVE N (__32A31E)	03 - Snow	01 - Daylight	10 - No control	0	02 - Non-fatal injury	02 - Angle	04 - Slush	0	0	0	0
12/19/2018	2018	0:34	SOMERSET ST W btwn BAYSWATER AVE & BREEZEHILL AVE N (__32A31E)	01 - Clear	07 - Dark	10 - No control	0	03 - P.D. only	06 - SMV unattended vehicle	01 - Dry	0	0	0	0
1/8/2019	2019	11:36	SOMERSET ST W btwn BAYSWATER AVE & BREEZEHILL AVE N (__32A31E)	01 - Clear	01 - Daylight	10 - No control	0	03 - P.D. only	02 - Angle	04 - Slush	0	0	0	0
2/21/2020	2020	14:08	SOMERSET ST W btwn BAYSWATER AVE & BREEZEHILL AVE N (__32A31E)	01 - Clear	01 - Daylight	10 - No control	0	02 - Non-fatal injury	02 - Angle	01 - Dry	0	0	0	0
2/15/2022	2022	17:20	SOMERSET ST W btwn BAYSWATER AVE & BREEZEHILL AVE N (__32A31E)	01 - Clear	07 - Dark	10 - No control	0	03 - P.D. only	03 - Rear end	01 - Dry	0	0	0	0
1/6/2020	2020	12:08	WELLINGTON ST @ BAYSWATER AVE/BAYVIEW RD (0006489)	03 - Snow	01 - Daylight	02 - Stop sign	0	02 - Non-fatal injury	05 - Turning movement	04 - Slush	0	0	0	0
10/15/2020	2020	22:41	WELLINGTON ST @ BAYSWATER AVE/BAYVIEW RD (0006489)	01 - Clear	07 - Dark	02 - Stop sign	0	02 - Non-fatal injury	02 - Angle	02 - Wet	0	0	0	0
1/5/2022	2022	17:10	BAYSWATER AVE btwn SOMERSET ST W & WELLINGTON ST W (__32A31D)	01 - Clear	05 - Dusk	10 - No control	0	03 - P.D. only	99 - Other	01 - Dry	0	0	0	0
3/25/2021	2021	20:12	SOMERSET ST @ SPADINA AVE (0006484)	01 - Clear	07 - Dark	02 - Stop sign	0	02 - Non-fatal injury	05 - Turning movement	01 - Dry	0	0	1	0
7/31/2019	2019	9:52	SOMERSET ST W btwn BAYSWATER AVE & SPADINA AVE (__32A319)	01 - Clear	01 - Daylight	10 - No control	0	03 - P.D. only	02 - Angle	01 - Dry	0	0	0	0
1/34/2020	2020	16:15	SOMERSET ST W btwn BAYSWATER AVE & SPADINA AVE (__32A319)	03 - Snow	01 - Daylight	10 - No control	0	03 - P.D. only	06 - SMV unattended vehicle	04 - Slush	0	0	0	0
2/9/2018	2018	16:27	BAYSWATER AVE btwn LAUREL ST & SOMERSET ST W (__32AAI2)	03 - Snow	01 - Daylight	10 - No control	0	03 - P.D. only	99 - Other	05 - Packed snow	0	0	0	0
10/21/2019	2019	Unknown	BAYSWATER AVE btwn LAUREL ST & SOMERSET ST W (__32AAI2)	01 - Clear	00 - Unknown	10 - No control	0	03 - P.D. only	06 - SMV unattended vehicle	01 - Dry	0	0	0	0
5/10/2020	2020	Unknown	BAYSWATER AVE btwn LAUREL ST & SOMERSET ST W (__32AAI2)	01 - Clear	00 - Unknown	10 - No control	0	03 - P.D. only	06 - SMV unattended vehicle	01 - Dry	0	0	0	0

Appendix E

TDM Checklist

TDM-Supportive Development Design and Infrastructure Checklist:
Non-Residential Developments (office, institutional, retail or industrial)

Legend	
REQUIRED	The Official Plan or Zoning By-law provides related guidance that must be followed
BASIC	The measure is generally feasible and effective, and in most cases would benefit the development and its users
BETTER	The measure could maximize support for users of sustainable modes, and optimize development performance

TDM-supportive design & infrastructure measures: <i>Non-residential developments</i>		Check if completed & add descriptions, explanations or plan/drawing references
1. WALKING & CYCLING: ROUTES		
1.1 Building location & access points		
BASIC	1.1.1 Locate building close to the street, and do not locate parking areas between the street and building entrances	<input checked="" type="checkbox"/>
BASIC	1.1.2 Locate building entrances in order to minimize walking distances to sidewalks and transit stops/stations	<input checked="" type="checkbox"/>
BASIC	1.1.3 Locate building doors and windows to ensure visibility of pedestrians from the building, for their security and comfort	<input checked="" type="checkbox"/>
1.2 Facilities for walking & cycling		
REQUIRED	1.2.1 Provide convenient, direct access to stations or major stops along rapid transit routes within 600 metres; minimize walking distances from buildings to rapid transit; provide pedestrian-friendly, weather-protected (where possible) environment between rapid transit accesses and building entrances; ensure quality linkages from sidewalks through building entrances to integrated stops/stations (see <i>Official Plan policy 4.3.3</i>)	<input checked="" type="checkbox"/>
REQUIRED	1.2.2 Provide safe, direct and attractive pedestrian access from public sidewalks to building entrances through such measures as: reducing distances between public sidewalks and major building entrances; providing walkways from public streets to major building entrances; within a site, providing walkways along the front of adjoining buildings, between adjacent buildings, and connecting areas where people may congregate, such as courtyards and transit stops; and providing weather protection through canopies, colonnades, and other design elements wherever possible (see <i>Official Plan policy 4.3.12</i>)	<input checked="" type="checkbox"/>

TDM-supportive design & infrastructure measures: <i>Non-residential developments</i>		Check if completed & add descriptions, explanations or plan/drawing references
REQUIRED	1.2.3 Provide sidewalks of smooth, well-drained walking surfaces of contrasting materials or treatments to differentiate pedestrian areas from vehicle areas, and provide marked pedestrian crosswalks at intersection sidewalks (see <i>Official Plan policy 4.3.10</i>)	<input checked="" type="checkbox"/>
REQUIRED	1.2.4 Make sidewalks and open space areas easily accessible through features such as gradual grade transition, depressed curbs at street corners and convenient access to extra-wide parking spaces and ramps (see <i>Official Plan policy 4.3.10</i>)	<input checked="" type="checkbox"/>
REQUIRED	1.2.5 Include adequately spaced inter-block/street cycling and pedestrian connections to facilitate travel by active transportation. Provide links to the existing or planned network of public sidewalks, multi-use pathways and on-road cycle routes. Where public sidewalks and multi-use pathways intersect with roads, consider providing traffic control devices to give priority to cyclists and pedestrians (see <i>Official Plan policy 4.3.11</i>)	<input checked="" type="checkbox"/>
BASIC	1.2.6 Provide safe, direct and attractive walking routes from building entrances to nearby transit stops	<input type="checkbox"/>
BASIC	1.2.7 Ensure that walking routes to transit stops are secure, visible, lighted, shaded and wind-protected wherever possible	<input type="checkbox"/>
BASIC	1.2.8 Design roads used for access or circulation by cyclists using a target operating speed of no more than 30 km/h, or provide a separated cycling facility	<input type="checkbox"/>
1.3 Amenities for walking & cycling		
BASIC	1.3.1 Provide lighting, landscaping and benches along walking and cycling routes between building entrances and streets, sidewalks and trails	<input type="checkbox"/>
BASIC	1.3.2 Provide wayfinding signage for site access (where required, e.g. when multiple buildings or entrances exist) and egress (where warranted, such as when directions to reach transit stops/stations, trails or other common destinations are not obvious)	<input type="checkbox"/>

TDM-supportive design & infrastructure measures: <i>Non-residential developments</i>		Check if completed & add descriptions, explanations or plan/drawing references
2. WALKING & CYCLING: END-OF-TRIP FACILITIES		
2.1 Bicycle parking		
REQUIRED	2.1.1 Provide bicycle parking in highly visible and lighted areas, sheltered from the weather wherever possible (see <i>Official Plan policy 4.3.6</i>)	<input type="checkbox"/>
REQUIRED	2.1.2 Provide the number of bicycle parking spaces specified for various land uses in different parts of Ottawa; provide convenient access to main entrances or well-used areas (see <i>Zoning By-law Section 111</i>)	<input type="checkbox"/>
REQUIRED	2.1.3 Ensure that bicycle parking spaces and access aisles meet minimum dimensions; that no more than 50% of spaces are vertical spaces; and that parking racks are securely anchored (see <i>Zoning By-law Section 111</i>)	<input type="checkbox"/>
BASIC	2.1.4 Provide bicycle parking spaces equivalent to the expected number of commuter cyclists (assuming the cycling mode share target is met), plus the expected peak number of customer/visitor cyclists	<input type="checkbox"/>
BETTER	2.1.5 Provide bicycle parking spaces equivalent to the expected number of commuter and customer/visitor cyclists, plus an additional buffer (e.g. 25 percent extra) to encourage other cyclists and ensure adequate capacity in peak cycling season	<input type="checkbox"/>
2.2 Secure bicycle parking		
REQUIRED	2.2.1 Where more than 50 bicycle parking spaces are provided for a single office building, locate at least 25% of spaces within a building/structure, a secure area (e.g. supervised parking lot or enclosure) or bicycle lockers (see <i>Zoning By-law Section 111</i>)	<input type="checkbox"/>
BETTER	2.2.2 Provide secure bicycle parking spaces equivalent to the expected number of commuter cyclists (assuming the cycling mode share target is met)	<input type="checkbox"/>
2.3 Shower & change facilities		
BASIC	2.3.1 Provide shower and change facilities for the use of active commuters	<input type="checkbox"/>
BETTER	2.3.2 In addition to shower and change facilities, provide dedicated lockers, grooming stations, drying racks and laundry facilities for the use of active commuters	<input type="checkbox"/>
2.4 Bicycle repair station		
BETTER	2.4.1 Provide a permanent bike repair station, with commonly used tools and an air pump, adjacent to the main bicycle parking area (or secure bicycle parking area, if provided)	<input type="checkbox"/>

TDM-supportive design & infrastructure measures: <i>Non-residential developments</i>		Check if completed & add descriptions, explanations or plan/drawing references
3. TRANSIT		
3.1 Customer amenities		
BASIC	3.1.1 Provide shelters, lighting and benches at any on-site transit stops	<input type="checkbox"/>
BASIC	3.1.2 Where the site abuts an off-site transit stop and insufficient space exists for a transit shelter in the public right-of-way, protect land for a shelter and/or install a shelter	<input type="checkbox"/>
BETTER	3.1.3 Provide a secure and comfortable interior waiting area by integrating any on-site transit stops into the building	<input type="checkbox"/>
4. RIDESHARING		
4.1 Pick-up & drop-off facilities		
BASIC	4.1.1 Provide a designated area for carpool drivers (plus taxis and ride-hailing services) to drop off or pick up passengers without using fire lanes or other no-stopping zones	<input type="checkbox"/>
4.2 Carpool parking		
BASIC	4.2.1 Provide signed parking spaces for carpools in a priority location close to a major building entrance, sufficient in number to accommodate the mode share target for carpools	<input type="checkbox"/>
BETTER	4.2.2 At large developments, provide spaces for carpools in a separate, access-controlled parking area to simplify enforcement	<input type="checkbox"/>
5. CARSHARING & BIKESHARING		
5.1 Carshare parking spaces		
BETTER	5.1.1 Provide carshare parking spaces in permitted non-residential zones, occupying either required or provided parking spaces (see <i>Zoning By-law Section 94</i>)	<input type="checkbox"/>
5.2 Bikeshare station location		
BETTER	5.2.1 Provide a designated bikeshare station area near a major building entrance, preferably lighted and sheltered with a direct walkway connection	<input type="checkbox"/>

TDM-supportive design & infrastructure measures: <i>Non-residential developments</i>		Check if completed & add descriptions, explanations or plan/drawing references
6. PARKING		
6.1 Number of parking spaces		
REQUIRED	6.1.1 Do not provide more parking than permitted by zoning, nor less than required by zoning, unless a variance is being applied for	<input checked="" type="checkbox"/>
BASIC	6.1.2 Provide parking for long-term and short-term users that is consistent with mode share targets, considering the potential for visitors to use off-site public parking	<input type="checkbox"/>
BASIC	6.1.3 Where a site features more than one use, provide shared parking and reduce the cumulative number of parking spaces accordingly (see <i>Zoning By-law Section 104</i>)	<input type="checkbox"/>
BETTER	6.1.4 Reduce the minimum number of parking spaces required by zoning by one space for each 13 square metres of gross floor area provided as shower rooms, change rooms, locker rooms and other facilities for cyclists in conjunction with bicycle parking (see <i>Zoning By-law Section 111</i>)	<input type="checkbox"/>
6.2 Separate long-term & short-term parking areas		
BETTER	6.2.1 Separate short-term and long-term parking areas using signage or physical barriers, to permit access controls and simplify enforcement (i.e. to discourage employees from parking in visitor spaces, and vice versa)	<input type="checkbox"/>
7. OTHER		
7.1 On-site amenities to minimize off-site trips		
BETTER	7.1.1 Provide on-site amenities to minimize mid-day or mid-commute errands	<input type="checkbox"/>

**TDM-Supportive Development Design and Infrastructure Checklist:
Residential Developments (multi-family or condominium)**

Legend	
REQUIRED	The Official Plan or Zoning By-law provides related guidance that must be followed
BASIC	The measure is generally feasible and effective, and in most cases would benefit the development and its users
BETTER	The measure could maximize support for users of sustainable modes, and optimize development performance

TDM-supportive design & infrastructure measures: <i>Residential developments</i>		Check if completed & add descriptions, explanations or plan/drawing references
1. WALKING & CYCLING: ROUTES		
1.1 Building location & access points		
BASIC	1.1.1 Locate building close to the street, and do not locate parking areas between the street and building entrances	<input checked="" type="checkbox"/>
BASIC	1.1.2 Locate building entrances in order to minimize walking distances to sidewalks and transit stops/stations	<input checked="" type="checkbox"/>
BASIC	1.1.3 Locate building doors and windows to ensure visibility of pedestrians from the building, for their security and comfort	<input checked="" type="checkbox"/>
1.2 Facilities for walking & cycling		
REQUIRED	1.2.1 Provide convenient, direct access to stations or major stops along rapid transit routes within 600 metres; minimize walking distances from buildings to rapid transit; provide pedestrian-friendly, weather-protected (where possible) environment between rapid transit accesses and building entrances; ensure quality linkages from sidewalks through building entrances to integrated stops/stations (see <i>Official Plan policy 4.3.3</i>)	<input checked="" type="checkbox"/>
REQUIRED	1.2.2 Provide safe, direct and attractive pedestrian access from public sidewalks to building entrances through such measures as: reducing distances between public sidewalks and major building entrances; providing walkways from public streets to major building entrances; within a site, providing walkways along the front of adjoining buildings, between adjacent buildings, and connecting areas where people may congregate, such as courtyards and transit stops; and providing weather protection through canopies, colonnades, and other design elements wherever possible (see <i>Official Plan policy 4.3.12</i>)	<input checked="" type="checkbox"/>

TDM-supportive design & infrastructure measures: <i>Residential developments</i>		Check if completed & add descriptions, explanations or plan/drawing references
REQUIRED	1.2.3 Provide sidewalks of smooth, well-drained walking surfaces of contrasting materials or treatments to differentiate pedestrian areas from vehicle areas, and provide marked pedestrian crosswalks at intersection sidewalks (see <i>Official Plan policy 4.3.10</i>)	<input checked="" type="checkbox"/>
REQUIRED	1.2.4 Make sidewalks and open space areas easily accessible through features such as gradual grade transition, depressed curbs at street corners and convenient access to extra-wide parking spaces and ramps (see <i>Official Plan policy 4.3.10</i>)	<input checked="" type="checkbox"/>
REQUIRED	1.2.5 Include adequately spaced inter-block/street cycling and pedestrian connections to facilitate travel by active transportation. Provide links to the existing or planned network of public sidewalks, multi-use pathways and on-road cycle routes. Where public sidewalks and multi-use pathways intersect with roads, consider providing traffic control devices to give priority to cyclists and pedestrians (see <i>Official Plan policy 4.3.11</i>)	<input checked="" type="checkbox"/>
BASIC	1.2.6 Provide safe, direct and attractive walking routes from building entrances to nearby transit stops	<input type="checkbox"/>
BASIC	1.2.7 Ensure that walking routes to transit stops are secure, visible, lighted, shaded and wind-protected wherever possible	<input type="checkbox"/>
BASIC	1.2.8 Design roads used for access or circulation by cyclists using a target operating speed of no more than 30 km/h, or provide a separated cycling facility	<input type="checkbox"/>
1.3 Amenities for walking & cycling		
BASIC	1.3.1 Provide lighting, landscaping and benches along walking and cycling routes between building entrances and streets, sidewalks and trails	<input type="checkbox"/>
BASIC	1.3.2 Provide wayfinding signage for site access (where required, e.g. when multiple buildings or entrances exist) and egress (where warranted, such as when directions to reach transit stops/stations, trails or other common destinations are not obvious)	<input type="checkbox"/>

TDM-supportive design & infrastructure measures: <i>Residential developments</i>		Check if completed & add descriptions, explanations or plan/drawing references
2. WALKING & CYCLING: END-OF-TRIP FACILITIES		
2.1 Bicycle parking		
REQUIRED	2.1.1 Provide bicycle parking in highly visible and lighted areas, sheltered from the weather wherever possible (see <i>Official Plan policy 4.3.6</i>)	<input checked="" type="checkbox"/>
REQUIRED	2.1.2 Provide the number of bicycle parking spaces specified for various land uses in different parts of Ottawa; provide convenient access to main entrances or well-used areas (see <i>Zoning By-law Section 111</i>)	<input checked="" type="checkbox"/>
REQUIRED	2.1.3 Ensure that bicycle parking spaces and access aisles meet minimum dimensions; that no more than 50% of spaces are vertical spaces; and that parking racks are securely anchored (see <i>Zoning By-law Section 111</i>)	<input checked="" type="checkbox"/>
BASIC	2.1.4 Provide bicycle parking spaces equivalent to the expected number of resident-owned bicycles, plus the expected peak number of visitor cyclists	<input type="checkbox"/>
2.2 Secure bicycle parking		
REQUIRED	2.2.1 Where more than 50 bicycle parking spaces are provided for a single residential building, locate at least 25% of spaces within a building/structure, a secure area (e.g. supervised parking lot or enclosure) or bicycle lockers (see <i>Zoning By-law Section 111</i>)	<input checked="" type="checkbox"/>
BETTER	2.2.2 Provide secure bicycle parking spaces equivalent to at least the number of units at condominiums or multi-family residential developments	<input type="checkbox"/>
2.3 Bicycle repair station		
BETTER	2.3.1 Provide a permanent bike repair station, with commonly used tools and an air pump, adjacent to the main bicycle parking area (or secure bicycle parking area, if provided)	<input type="checkbox"/>
3. TRANSIT		
3.1 Customer amenities		
BASIC	3.1.1 Provide shelters, lighting and benches at any on-site transit stops	<input type="checkbox"/>
BASIC	3.1.2 Where the site abuts an off-site transit stop and insufficient space exists for a transit shelter in the public right-of-way, protect land for a shelter and/or install a shelter	<input type="checkbox"/>
BETTER	3.1.3 Provide a secure and comfortable interior waiting area by integrating any on-site transit stops into the building	<input type="checkbox"/>

TDM-supportive design & infrastructure measures: <i>Residential developments</i>		Check if completed & add descriptions, explanations or plan/drawing references
4. RIDESHARING		
4.1 Pick-up & drop-off facilities		
BASIC	4.1.1 Provide a designated area for carpool drivers (plus taxis and ride-hailing services) to drop off or pick up passengers without using fire lanes or other no-stopping zones	<input type="checkbox"/>
5. CARSHARING & BIKESHARING		
5.1 Carshare parking spaces		
BETTER	5.1.1 Provide up to three carshare parking spaces in an R3, R4 or R5 Zone for specified residential uses (see <i>Zoning By-law Section 94</i>)	<input type="checkbox"/>
5.2 Bikeshare station location		
BETTER	5.2.1 Provide a designated bikeshare station area near a major building entrance, preferably lighted and sheltered with a direct walkway connection	<input type="checkbox"/>
6. PARKING		
6.1 Number of parking spaces		
REQUIRED	6.1.1 Do not provide more parking than permitted by zoning, nor less than required by zoning, unless a variance is being applied for	<input checked="" type="checkbox"/>
BASIC	6.1.2 Provide parking for long-term and short-term users that is consistent with mode share targets, considering the potential for visitors to use off-site public parking	<input type="checkbox"/>
BASIC	6.1.3 Where a site features more than one use, provide shared parking and reduce the cumulative number of parking spaces accordingly (see <i>Zoning By-law Section 104</i>)	<input type="checkbox"/>
BETTER	6.1.4 Reduce the minimum number of parking spaces required by zoning by one space for each 13 square metres of gross floor area provided as shower rooms, change rooms, locker rooms and other facilities for cyclists in conjunction with bicycle parking (see <i>Zoning By-law Section 111</i>)	<input type="checkbox"/>
6.2 Separate long-term & short-term parking areas		
BETTER	6.2.1 Provide separate areas for short-term and long-term parking (using signage or physical barriers) to permit access controls and simplify enforcement (i.e. to discourage residents from parking in visitor spaces, and vice versa)	<input type="checkbox"/>

TDM Measures Checklist:
Non-Residential Developments (office, institutional, retail or industrial)

Legend	
BASIC	The measure is generally feasible and effective, and in most cases would benefit the development and its users
BETTER	The measure could maximize support for users of sustainable modes, and optimize development performance
★	The measure is one of the most dependably effective tools to encourage the use of sustainable modes

TDM measures: <i>Non-residential developments</i>		Check if proposed & add descriptions
1. TDM PROGRAM MANAGEMENT		
1.1 Program coordinator		
BASIC ★	1.1.1 Designate an internal coordinator, or contract with an external coordinator	<input type="checkbox"/>
1.2 Travel surveys		
BETTER	1.2.1 Conduct periodic surveys to identify travel-related behaviours, attitudes, challenges and solutions, and to track progress	<input type="checkbox"/>
2. WALKING AND CYCLING		
2.1 Information on walking/cycling routes & destinations		
BASIC	2.1.1 Display local area maps with walking/cycling access routes and key destinations at major entrances	<input checked="" type="checkbox"/>
2.2 Bicycle skills training		
<i>Commuter travel</i>		
BETTER ★	2.2.1 Offer on-site cycling courses for commuters, or subsidize off-site courses	<input type="checkbox"/>
2.3 Valet bike parking		
<i>Visitor travel</i>		
BETTER	2.3.1 Offer secure valet bike parking during public events when demand exceeds fixed supply (e.g. for festivals, concerts, games)	<input type="checkbox"/>

TDM measures: <i>Non-residential developments</i>		Check if proposed & add descriptions
3. TRANSIT		
3.1 Transit information		
BASIC	3.1.1 Display relevant transit schedules and route maps at entrances	<input checked="" type="checkbox"/>
BASIC	3.1.2 Provide online links to OC Transpo and STO information	<input type="checkbox"/>
BETTER	3.1.3 Provide real-time arrival information display at entrances	<input type="checkbox"/>
3.2 Transit fare incentives		
<i>Commuter travel</i>		
BETTER	3.2.1 Offer preloaded PRESTO cards to encourage commuters to use transit	<input type="checkbox"/>
BETTER ★	3.2.2 Subsidize or reimburse monthly transit pass purchases by employees	<input type="checkbox"/>
<i>Visitor travel</i>		
BETTER	3.2.3 Arrange inclusion of same-day transit fare in price of tickets (e.g. for festivals, concerts, games)	<input type="checkbox"/>
3.3 Enhanced public transit service		
<i>Commuter travel</i>		
BETTER	3.3.1 Contract with OC Transpo to provide enhanced transit services (e.g. for shift changes, weekends)	<input type="checkbox"/>
<i>Visitor travel</i>		
BETTER	3.3.2 Contract with OC Transpo to provide enhanced transit services (e.g. for festivals, concerts, games)	<input type="checkbox"/>
3.4 Private transit service		
<i>Commuter travel</i>		
BETTER	3.4.1 Provide shuttle service when OC Transpo cannot offer sufficient quality or capacity to serve demand (e.g. for shift changes, weekends)	<input type="checkbox"/>
<i>Visitor travel</i>		
BETTER	3.4.2 Provide shuttle service when OC Transpo cannot offer sufficient quality or capacity to serve demand (e.g. for festivals, concerts, games)	<input type="checkbox"/>

TDM measures: <i>Non-residential developments</i>		Check if proposed & add descriptions
4. RIDESHARING		
4.1 Ridematching service		
<i>Commuter travel</i>		
BASIC ★	4.1.1 Provide a dedicated ridematching portal at OttawaRideMatch.com	<input type="checkbox"/>
4.2 Carpool parking price incentives		
<i>Commuter travel</i>		
BETTER	4.2.1 Provide discounts on parking costs for registered carpools	<input type="checkbox"/>
4.3 Vanpool service		
<i>Commuter travel</i>		
BETTER	4.3.1 Provide a vanpooling service for long-distance commuters	<input type="checkbox"/>
5. CARSHARING & BIKESHARING		
5.1 Bikeshare stations & memberships		
BETTER	5.1.1 Contract with provider to install on-site bikeshare station for use by commuters and visitors	<input type="checkbox"/>
<i>Commuter travel</i>		
BETTER	5.1.2 Provide employees with bikeshare memberships for local business travel	<input type="checkbox"/>
5.2 Carshare vehicles & memberships		
<i>Commuter travel</i>		
BETTER	5.2.1 Contract with provider to install on-site carshare vehicles and promote their use by tenants	<input type="checkbox"/>
BETTER	5.2.2 Provide employees with carshare memberships for local business travel	<input type="checkbox"/>
6. PARKING		
6.1 Priced parking		
<i>Commuter travel</i>		
BASIC ★	6.1.1 Charge for long-term parking (daily, weekly, monthly)	<input type="checkbox"/>
BASIC	6.1.2 Unbundle parking cost from lease rates at multi-tenant sites	<input type="checkbox"/>
<i>Visitor travel</i>		
BETTER	6.1.3 Charge for short-term parking (hourly)	<input type="checkbox"/>

TDM measures: <i>Non-residential developments</i>		Check if proposed & add descriptions
7. TDM MARKETING & COMMUNICATIONS		
7.1 Multimodal travel information		
<i>Commuter travel</i>		
BASIC ★	7.1.1 Provide a multimodal travel option information package to new/relocating employees and students	<input checked="" type="checkbox"/>
<i>Visitor travel</i>		
BETTER ★	7.1.2 Include multimodal travel option information in invitations or advertising that attract visitors or customers (e.g. for festivals, concerts, games)	<input type="checkbox"/>
7.2 Personalized trip planning		
<i>Commuter travel</i>		
BETTER ★	7.2.1 Offer personalized trip planning to new/relocating employees	<input type="checkbox"/>
7.3 Promotions		
<i>Commuter travel</i>		
BETTER	7.3.1 Deliver promotions and incentives to maintain awareness, build understanding, and encourage trial of sustainable modes	<input type="checkbox"/>
8. OTHER INCENTIVES & AMENITIES		
8.1 Emergency ride home		
<i>Commuter travel</i>		
BETTER ★	8.1.1 Provide emergency ride home service to non-driving commuters	<input type="checkbox"/>
8.2 Alternative work arrangements		
<i>Commuter travel</i>		
BASIC ★	8.2.1 Encourage flexible work hours	<input type="checkbox"/>
BETTER	8.2.2 Encourage compressed workweeks	<input type="checkbox"/>
BETTER ★	8.2.3 Encourage telework	<input type="checkbox"/>
8.3 Local business travel options		
<i>Commuter travel</i>		
BASIC ★	8.3.1 Provide local business travel options that minimize the need for employees to bring a personal car to work	<input type="checkbox"/>
8.4 Commuter incentives		
<i>Commuter travel</i>		
BETTER	8.4.1 Offer employees a taxable, mode-neutral commuting allowance	<input type="checkbox"/>
8.5 On-site amenities		
<i>Commuter travel</i>		
BETTER	8.5.1 Provide on-site amenities/services to minimize mid-day or mid-commute errands	<input type="checkbox"/>

TDM Measures Checklist:
Residential Developments (multi-family, condominium or subdivision)

Legend	
BASIC	The measure is generally feasible and effective, and in most cases would benefit the development and its users
BETTER	The measure could maximize support for users of sustainable modes, and optimize development performance
★	The measure is one of the most dependably effective tools to encourage the use of sustainable modes

TDM measures: <i>Residential developments</i>		Check if proposed & add descriptions
1. TDM PROGRAM MANAGEMENT		
1.1 Program coordinator		
BASIC ★	1.1.1 Designate an internal coordinator, or contract with an external coordinator	<input type="checkbox"/>
1.2 Travel surveys		
BETTER	1.2.1 Conduct periodic surveys to identify travel-related behaviours, attitudes, challenges and solutions, and to track progress	<input type="checkbox"/>
2. WALKING AND CYCLING		
2.1 Information on walking/cycling routes & destinations		
BASIC	2.1.1 Display local area maps with walking/cycling access routes and key destinations at major entrances (<i>multi-family, condominium</i>)	<input checked="" type="checkbox"/>
2.2 Bicycle skills training		
BETTER	2.2.1 Offer on-site cycling courses for residents, or subsidize off-site courses	<input type="checkbox"/>

TDM measures: Residential developments		Check if proposed & add descriptions
3. TRANSIT		
3.1 Transit information		
BASIC	3.1.1 Display relevant transit schedules and route maps at entrances (<i>multi-family, condominium</i>)	<input checked="" type="checkbox"/>
BETTER	3.1.2 Provide real-time arrival information display at entrances (<i>multi-family, condominium</i>)	<input type="checkbox"/>
3.2 Transit fare incentives		
BASIC ★	3.2.1 Offer PRESTO cards preloaded with one monthly transit pass on residence purchase/move-in, to encourage residents to use transit	<input checked="" type="checkbox"/>
BETTER	3.2.2 Offer at least one year of free monthly transit passes on residence purchase/move-in	<input type="checkbox"/>
3.3 Enhanced public transit service		
BETTER ★	3.3.1 Contract with OC Transpo to provide early transit services until regular services are warranted by occupancy levels (<i>subdivision</i>)	<input type="checkbox"/>
3.4 Private transit service		
BETTER	3.4.1 Provide shuttle service for seniors homes or lifestyle communities (e.g. scheduled mall or supermarket runs)	<input type="checkbox"/>
4. CARSHARING & BIKESHARING		
4.1 Bikeshare stations & memberships		
BETTER	4.1.1 Contract with provider to install on-site bikeshare station (<i>multi-family</i>)	<input type="checkbox"/>
BETTER	4.1.2 Provide residents with bikeshare memberships, either free or subsidized (<i>multi-family</i>)	<input type="checkbox"/>
4.2 Carshare vehicles & memberships		
BETTER	4.2.1 Contract with provider to install on-site carshare vehicles and promote their use by residents	<input type="checkbox"/>
BETTER	4.2.2 Provide residents with carshare memberships, either free or subsidized	<input type="checkbox"/>
5. PARKING		
5.1 Priced parking		
BASIC ★	5.1.1 Unbundle parking cost from purchase price (<i>condominium</i>)	<input checked="" type="checkbox"/>
BASIC ★	5.1.2 Unbundle parking cost from monthly rent (<i>multi-family</i>)	<input checked="" type="checkbox"/>

TDM measures: Residential developments		Check if proposed & add descriptions
6. TDM MARKETING & COMMUNICATIONS		
6.1 Multimodal travel information		
BASIC ★	6.1.1 Provide a multimodal travel option information package to new residents	<input checked="" type="checkbox"/>
6.2 Personalized trip planning		
BETTER ★	6.2.1 Offer personalized trip planning to new residents	<input type="checkbox"/>

Appendix F

MMLOS Analysis

Multi-Modal Level of Service - Segments Form

Consultant Scenario Comments	CGH Transportation Inc.	Project Date	2023-020
	Existing/Future		10/31/2023

SEGMENTS			Somerset Street West	Bayswater Avenue
			1	2
Pedestrian	Sidewalk Width	-	≥ 2 m	1.8 m
	Boulevard Width		< 0.5	< 0.5 m
	Avg Daily Curb Lane Traffic Volume		≤ 3000	≤ 3000
	Operating Speed		> 50 to 60 km/h	> 50 to 60 km/h
	On-Street Parking		yes	no
	Exposure to Traffic PLoS		C	C
	Effective Sidewalk Width			
	Pedestrian Volume			
	Crowding PLoS	-	-	
	Level of Service	-	-	
Bicycle	Type of Cycling Facility	E	Mixed Traffic	Mixed Traffic
	Number of Travel Lanes		2-3 lanes total	2-3 lanes total
	Operating Speed		≥ 50 to 60 km/h	≥ 50 to 60 km/h
	# of Lanes & Operating Speed LoS		E	E
	Bike Lane (+ Parking Lane) Width			
	Bike Lane Width LoS		-	-
	Bike Lane Blockages			
	Blockage LoS		-	-
	Median Refuge Width (no median = < 1.8 m)		< 1.8 m refuge	< 1.8 m refuge
	No. of Lanes at Unsignalized Crossing		≤ 3 lanes	≤ 3 lanes
Sidestreet Operating Speed	≤ 40 km/h	≤ 40 km/h		
	Unsignalized Crossing - Lowest LoS	A	A	
	Level of Service	E	E	
Transit	Facility Type	-		
	Friction or Ratio Transit:Posted Speed			
	Level of Service		-	-
Truck	Truck Lane Width	-		
	Travel Lanes per Direction			
	Level of Service		-	-