



Geotechnical
Engineering

Environmental
Engineering

Hydrogeology

Geological
Engineering

Materials Testing

Building Science

Archaeological
Services

Phase II Environmental Site Assessment

Commercial Properties
1445 and 1451 Wellington Street West
Ottawa, Ontario

Prepared For

Mizrahi Developments

Paterson Group Inc.

Consulting Engineers
154 Colonnade Road South
Ottawa (Nepean), Ontario
Canada K2E 7J5

Tel: (613) 226-7381
Fax: (613) 226-6344
www.patersongroup.ca

June 11, 2013

Report: PE3003-2

Table of Contents

EXECUTIVE SUMMARY..... iii

2.0 INTRODUCTION..... 1

 2.1 Site Description 1

 2.2 Property Ownership..... 2

 2.3 Current and Proposed Future Uses..... 2

 2.4 Applicable Site Condition Standard 2

3.0 BACKGROUND INFORMATION..... 4

 3.1 Physical Setting 4

 3.2 Past Investigations 4

4.0 SCOPE OF INVESTIGATION 5

 4.1 Overview of Site Investigation 5

 4.2 Media Investigated 5

 4.3 Phase I Conceptual Site Model 5

 4.4 Deviations from Sampling and Analysis Plan 8

 4.5 Impediments 8

5.0 INVESTIGATION METHOD 9

 5.1 Subsurface Investigation 9

 5.2 Soil Sampling..... 9

 5.3 Field Screening Measurements 10

 5.4 Groundwater Monitoring Well Installation 10

 5.5 Field Measurement of Water Quality Parameters..... 11

 5.6 Groundwater Sampling..... 11

 5.7 Analytical Testing 11

 5.8 Residue Management..... 13

 5.9 Elevation Surveying 13

 5.10 Quality Assurance and Quality Control Measures 14

6.0 REVIEW AND EVALUATION 15

 6.1 Geology 15

 6.2 Groundwater Elevations, Flow Direction, and Hydraulic Gradient 15

 6.3 Fine-Medium Soil Texture..... 16

 6.4 Soil: Field Screening..... 16

 6.5 Soil Quality 16

 6.6 Groundwater Quality..... 19

 6.7 Quality Assurance and Quality Control Results 21

 6.8 Phase II Conceptual Site Model 22

7.0 CONCLUSIONS 28

8.0 STATEMENT OF LIMITATIONS 29

List of Figures

Figure 1 - Key Plan

Drawing PE3003-3 - Test Hole Location Plan

Drawing PE3003-4 - Groundwater Contour Plan

Drawing PE3003-5 - Cross-Section A-A'

List of Appendices

Appendix 1 Soil Profile and Test Data Sheets
 Laboratory Certificates of Analysis

EXECUTIVE SUMMARY

Assessment

A Phase II ESA was conducted for the properties at 1445 and 1451 Wellington Street West, Ottawa, Ontario. The purpose of the Phase II ESA was to address areas of potential environmental concern identified during the Phase I ESA, in particular the subject site's past use as an automotive service garage and retail fuel outlet, as well as the presence of a retail fuel outlet to the south and a former retail fuel outlet to the west. The Phase II ESA incorporates the findings of two (2) previous subsurface investigations at the site, completed in 2006 and 2009 respectively. The 2013 subsurface investigation at the subject site consisted of the drilling of four (4) boreholes and the installation of two (2) monitoring wells, for a total of three (3) bedrock and two (2) overburden monitoring wells at the subject site.

Soil samples were obtained from the boreholes and screened using visual observations and organic vapour measurements. A total of 10 soil samples were submitted for laboratory analysis of BTEX and PHCs. Six (6) of the soil samples exceeded MOE Table 3 standards for BTEX and PHC parameters, with the area of soil contamination generally present in the south and central portions of 1451 Wellington Street West.

Groundwater samples were obtained from the monitoring wells at BH2, BH6, BH12, BH1-13, and BH3-13 and analyzed for BTEX and PHCs. All groundwater sample locations exceeded MOE Table 3 standards for BTEX and PHC parameters with the exception of BH1-13, indicating that groundwater contamination is present over much of the site.

Recommendations

Based on the above results, soil and groundwater exist at the subject property with PHC concentrations which exceed the applicable MOE Table 3 soil standards. It is our understanding that the subject site is to be redeveloped as residential, and that the existing buildings are to be removed and demolished. It is our recommendation that an environmental site remediation program, involving the removal of all contaminated soil and groundwater from the subject site, be completed concurrently with site redevelopment.

2.0 INTRODUCTION

At the request of Mizrahi Developments, Paterson Group (Paterson) conducted a Phase II Environmental Site Assessment of the properties addressed as 1445 and 1451 Wellington Street West, in the City of Ottawa, Ontario. The purpose of this Phase II ESA was to address concerns identified in the Phase I ESA, including the historical presence of an automotive service garage and retail fuel outlet at 1451 Wellington Street and the presence of a retail fuel outlet at 369 Island Park Drive.

2.1 Site Description

Address:	1445 and 1451 Wellington Street West, Ottawa, Ontario.
Legal Description:	Lots 1, 2, 4 and the west half of Lot 4 north of Richmond Road, Registered Plan 145, in the City of Ottawa, Ontario.
Property Identification Number:	04030-0154; 04030-0155.
Location:	The subject site is located at the northeast corner of the intersection of Wellington Street West and Island Park Drive, in the City of Ottawa, Ontario. The subject site is shown on Figure 1 - Key Plan following the body of this report.
Latitude and Longitude:	45° 23' 51" N, 75° 44' 37" W.
Configuration:	Approximately rectangular.
Site Area:	0.18 hectares (approximate).

2.2 Property Ownership

The subject property addressed 1445 Wellington Street West is currently owned by Alfredo Giannuzzi, Mario Giannuzzi and Eugenio Milito. The subject property addressed 1451 Wellington Street West is currently owned by Mizrahi Development Group (1451 Wellington) Inc. Paterson was retained to complete this Phase II ESA by Dr. Mahdi Tajbakhsh of Mizrahi Developments. The offices of Mizrahi Developments are located at 126 Hazelton Avenue, Toronto, Ontario. Dr. Tajbakhsh can be reached by telephone at (416) 922-4200.

2.3 Current and Proposed Future Uses

The property addressed 1445 Wellington Street West is occupied by a two-storey residential building with basement converted to commercial use (restaurant). Based on the chain of title and the observed age of the subject building, the site appears to have been developed with the current building in approximately 1897.

The property addressed 1451 Wellington Street West is occupied by a single storey commercial building. The eastern (original) portion of the building consists of two (2) garage/car washports and detailing bays as well as storage areas and a furnace room. The western portion of the building consists of office space. The eastern (original) portion of the building appears to have been developed in the 1930s, with an addition to the west constructed during the 1970s.

It is our understanding that the subject site will be redeveloped as a residential property.

2.4 Applicable Site Condition Standard

The site condition standards for the property were obtained from Table 3 of the document entitled "Soil, Ground Water and Sediment Standards for Use Under Part XV.1 of the Environmental Protection Act", prepared by the Ontario Ministry of the Environment (MOE), April 2011. The MOE Table 3 Standards are based on the following considerations:

- Coarse-grained soil conditions
- Non-potable groundwater conditions
- Residential land use

Analytical results were also compared to the MOE Table 1 (background) standards for the purposes of classification of site soils for off-site disposal if required for construction/redevelopment purposes.

3.0 BACKGROUND INFORMATION

3.1 Physical Setting

The subject site is currently occupied by two commercial buildings: ProShine Car Wash (1451 Wellington Street West), and Bella's Bistro (1445 Wellington Street West) and associated paved asphalt parking areas. Site topography slopes gently downward towards the north. Drainage consists primarily of sheet flow to catch basins in the parking lot at 1451 Wellington Street West and along Wellington Street West.

No areas of stressed vegetation were noted on the subject site. No water wells or private sewage systems were observed on the subject property at the time of the site visit. No rail lines or loading areas were observed at the subject site. No unidentified substances were observed on-site. No water bodies are present on the subject site. The nearest significant water body is the Ottawa River, located approximately 1.0 km to the north of the site. No Areas of Natural or Scientific Interest (ANSIs) are present within 250 m of the subject site.

3.2 Past Investigations

Paterson has completed a Phase I ESA for the subject site, provided under separate cover. Paterson has also completed two (2) subsurface investigations at the subject property in 2006 and 2009. This report incorporates the findings of the previous subsurface investigations with those of the current subsurface investigation, in order to meet the requirements of O.Reg. 153/04 as amended by O.Reg. 269/11.

4.0 SCOPE OF INVESTIGATION

4.1 Overview of Site Investigation

The subsurface investigation conducted as a component of this Phase II ESA consisted of the drilling of four (4) boreholes at the property addressed 1445 Wellington Street West. Two (2) of these boreholes were cored into bedrock. Groundwater monitoring wells were installed in the two (2) boreholes that were cored into the bedrock. Boreholes were drilled through overburden soils to a maximum depth of 3.18 m below ground surface. Bedrock was cored to a maximum depth of 6.70 m below ground surface.

An additional twelve (12) boreholes were drilled during two previous subsurface investigations by Paterson for the property addressed 1451 Wellington Street West, in 2006 and 2009. Boreholes were drilled through overburden soils to a maximum depth of 4.78 m below ground surface. Bedrock was cored in four (4) boreholes to a maximum depth of 8.18 m. Groundwater monitoring wells were installed in three (3) of the boreholes. A total of five (5) groundwater monitoring wells have been installed on the properties.

4.2 Media Investigated

During the subsurface investigation, soil samples and groundwater samples were obtained and submitted for laboratory analysis. The rationale for sampling and analyzing these media is based on the Contaminants of Potential Concern identified in the Phase I ESA. Contaminants of concern for soil and groundwater are BTEX and PHCs.

4.3 Phase I Conceptual Site Model

Geological and Hydrogeological Setting

Based on information from the Geological Survey of Canada and previous subsurface investigations completed at the subject site, drift thickness in the area of the subject site is approximately 3 to 5 m. Overburden soils consist of fill over glacial till, and bedrock consists of middle Ordovician limestone and dolostone of the Gull River Formation.

Contaminants of Potential Concern

The following CPCs were identified with respect to the subject site:

- Petroleum Hydrocarbons Fractions 1 through 4 (PHCs F1-F4) – this suite of parameters encompasses gasoline (Fraction 1), diesel and fuel oil (Fraction 2), and heavy oils (Fractions 3 and 4). PHCs F1-F4 were selected as CPCs for the Phase I property based on the subject site's past use as a retail fuel outlet and automotive service garage, and based on the presence of the retail fuel outlet at 369 Island Park Drive. Gasoline and diesel are commonly used motor vehicle fuels, and diesel-fraction hydrocarbons were commonly used as heating oil. Heavy oils may be present in the form of lubricants and transmission or hydraulic fluids. PHCs may be present in the soil matrix, sorbed to soil particles, as well as in free or dissolved phase in the groundwater system. PHCs are generally considered to be LNAPLs – light non-aqueous phase liquids, indicating that when present in sufficient concentrations above the solubility limit, they will partition into a separate phase above the water table, due to their lower density.
- BTEX – this suite of parameters includes Benzene, Toluene, Ethylbenzene, and Xylenes (BTEX), associated with gasoline. These parameters were selected as CPCs for the Phase I study area based on the subject site's past use as an automotive service garage and retail fuel outlet, and based on the presence of the retail fuel outlet at 369 Island Park Drive. BTEX may be present in the soil matrix as well as in the dissolved phase in the groundwater system.

The mechanisms of contaminant transport within the site soils include physical transportation and leaching. Physical transportation includes any intentional or unintentional movement or distribution of soil by physical means. Contamination arising from localized spills or runoff from the washing area on-site may be physically transported by vehicle movement or site grading. Leaching may occur in areas where the ground surface consists of gravel or where asphalt quality is poor; precipitation infiltrating in these areas may transport surficial contaminants into lower strata. Leaching and physical transport as contaminant transport mechanisms are considered to be limited at the subject site due to the presence of asphaltic concrete pavement over much of the site.

The mechanisms of contaminant transport within the groundwater system include advection, dispersion, and diffusion. Advection and dispersion will be the dominant mechanisms of contaminant transport in soils with higher hydraulic conductivities, such as sands, gravels, silts, and some glacial till soils, whereas diffusion will dominate in soils with lower hydraulic conductivity, such as clays.

Existing Buildings and Structures

The subject site is occupied by the following buildings:

- 1445 Wellington Street West - a two-storey residential dwelling converted to a commercial building (restaurant) - wood-frame structure faced with brick, constructed in the late 1890s or early 1900s
- 1451 Wellington Street West - a single-storey commercial building (Pro-Shine Car Wash, formerly Joe's Car Audio and an automotive service garage/retail fuel outlet) - original portion constructed in the late 1930s to early 1940s with an addition constructed in the 1970s.

Water Bodies

There are no water bodies on the subject site or within the Phase I study area. The closest water body is the Ottawa River, located approximately 1.0 km to the north of the site.

Areas of Natural Significance

No areas of natural significance were identified on the site or in the Phase I study area.

Drinking Water Wells

No drinking water wells are located at the subject site or within the Phase I study area.

Neighbouring Land Use

Neighbouring land use in the Phase I study area is commercial, and residential.

Potentially Contaminating Activities and Areas of Potential Environmental Concern

Potentially Contaminating Activities and Areas of Potential Environmental Concern identified include historical use of the subject site as a retail fuel outlet and automotive service garage, as well as the presence of a retail fuel outlet to the south at 369 Island Park Drive. Additional Potentially Contaminating Activities were identified within the Phase I study area but were not considered to represent Areas of Potential Environmental Concern.

Assessment of Uncertainty and/or Absence of Information

The information available for review as part of the preparation of the Phase I ESA is considered to be sufficient to conclude that there are areas of potential environmental concern on the subject site and neighbouring properties which have the potential to have impacted the subject site. The presence of potentially contaminating activities was confirmed by a variety of independent sources, including, in some cases, observations made during the Phase I site visit. As such, the conclusions of this report are not affected by uncertainty which may be present with respect to the individual sources.

4.4 Deviations from Sampling and Analysis Plan

The Sampling and Analysis Plan for this project is included in Appendix 1 of this report. Field measurement of water quality parameters was not undertaken. No other deviations were noted.

4.5 Impediments

No physical impediments or denial of access were encountered during the Phase II Environmental Site Assessment.

5.0 INVESTIGATION METHOD

5.1 Subsurface Investigation

The subsurface investigation was conducted on May 13, 2013, and consisted of the drilling of four (4) boreholes on the subject site. The boreholes were placed to provide general coverage of 1445 Wellington Street West. The boreholes were advanced using a truck-mounted CME 55 power auger drill rig. The drilling contractor was George Downing Estate Drilling of Hawkesbury, Ontario. Drilling occurred under full-time supervision of Paterson personnel. Borehole locations are shown on Drawing No. PE3003-3 – Test Hole Location Plan, appended to this report.

The findings of two previous subsurface investigations at 1451 Wellington Street West conducted in October 2006 and November 2009 are incorporated into this report.

5.2 Soil Sampling

A total of 77 soil samples were obtained from the boreholes by means of split spoon sampling and the sampling of shallow soils directly from auger flights. Split spoon samples were taken at approximate 0.76 m intervals. The depths at which split spoon and auger flight samples were obtained from the boreholes are shown as “**SS**” and “**AU**” respectively on the Soil Profile and Test Data Sheets, appended to this report.

Upon refusal of the augers, several boreholes were advanced into bedrock using a diamond coring system. Rock core samples were recovered, and are shown as “**RC**” on the Soil Profile and Test Data Sheets.

Site soils consist of fill material underlain by an intermittent layer of glacial till over limestone bedrock. Practical refusal to augering was encountered at depths varying from 2.34 to 4.14 m below existing grade.

5.3 Field Screening Measurements

All soil samples collected underwent a preliminary screening procedure, which included visual screening for colour and evidence of deleterious fill, as well as screening with a RKI Eagle combustible gas detector. The detection limit is 5 ppm, with a precision of +/- 5 ppm.

The soil vapours were measured by inserting the analyzer probe into the nominal headspace above the soil sample. Samples were then agitated and the peak readings recorded. The combustible vapour readings ranged from 0 ppm to 100% of the lower explosive limit (LEL). Combustible vapour readings are noted on the Soil Profile and Test Data Sheets in Appendix 1.

Soil samples were selected for analysis based on visual appearance, location, and vapour readings.

5.4 Groundwater Monitoring Well Installation

One (1) groundwater monitoring well was installed during the 2006 drilling program, two (2) groundwater monitoring wells were installed during the 2009 drilling program and two (2) groundwater monitoring wells were installed during the drilling 2013 program by George Downing Estate Drilling of Hawkesbury, Ontario, or by Ohlmann Geotechnical Services (OGS) of Carleton Place, Ontario, under full-time supervision by Paterson personnel. The monitoring wells consisted of 32 mm (1¼") diameter Schedule 40 threaded PVC risers and screens. A sand pack consisting of silica sand was placed around the screen, and a bentonite seal was placed above the screen to minimize cross-contamination. Monitoring well construction details are provided on the Soil Profile and Test Data Sheets in Appendix 1. A summary of monitoring well construction details is provided below in Table 1.

The groundwater monitoring wells were developed upon completion using a dedicated inertial lift pump. A minimum of three (3) well volumes were removed from the wells.

Table 1: Monitoring Well Construction Details						
Well ID	Ground Surface Elevation	Total Depth (m BGS)	Screened Interval (m BGS)	Sand Pack (m BGS)	Bentonite Seal (m BGS)	Casing Type
2006 Drilling Program						
BH2	66.72	4.78	1.73 – 4.78	1.40 - 2.84	0.90 - 1.40	Flushmount
2009 Drilling Program						
BH6	66.32	5.21	3.69 – 5.21	3.39 – 5.21	0.60 – 2.17	Flushmount
BH12	66.61	3.00	1.48 - 3.00	1.18 - 3.00	0.00 - 1.18	Flushmount
2013 Drilling Program						
BH1-13	65.92	6.17	3.13 – 6.17	2.80 – 6.17	1.80 – 2.80	Flushmount
BH3-13	66.38	6.70	3.66 – 6.70	3.20 – 6.70	2.45 – 3.20	Flushmount

5.5 Field Measurement of Water Quality Parameters

Field measurement of water quality parameters was not undertaken as a part of this assessment.

5.6 Groundwater Sampling

Groundwater sampling protocols were followed using the MOE document entitled “Guidance on Sampling and Analytical Methods for Use at Contaminated Sites in Ontario”, dated May 1996. Groundwater samples were obtained from each monitoring well, using dedicated sampling equipment. Standing water was purged from each well prior to sampling. Samples were stored in coolers to reduce analyte volatilization during transportation. Details of our standard operating procedure for groundwater sampling are provided in the Sampling and Analysis Plan in Appendix 1.

5.7 Analytical Testing

Based on the guidelines outlined in the Sampling and Analysis Plan appended to this report, the following groundwater and soil samples were submitted for analysis:

Table 2: Soil Samples Submitted				
Sample ID	Sample Depth/ Stratigraphic Unit	Parameters Analyzed		Rationale
		PHCs F₁-F₄	BTEX	
BH1 – SS3	2.29 – 2.90 m; glacial till	X	X	High vapour reading, near former pump islands.
BH2 – SS3	2.29 – 2.90 m; glacial till	X	X	High vapour reading, upper water table, near former pump islands
BH7 – SS5	2.39 – 2.59 m; fill, brown clay with wood	X	X	Upper water table, general site coverage.
BH9 – SS4	3.04 – 3.65 m; glacial till	X	X	Upper water table, high vapour reading.
BH10 – SS3	1.52 – 2.90 m; fill, brown clay with gravel	X	X	Upper water table, high vapour reading, near former pump islands
BH11 – SS3	1.52 – 2.29 m; fill, brown sand with clay and gravel	X	X	Upper water table, high vapour reading, near former pump islands
BH12 – SS2	2.29 -3.00 m; glacial till	X	X	High vapour reading, general site coverage.
BH1-13 SS4	1.52 - 2.13 m; glacial till	X	X	Upper water table, near air groundwater interface. General site coverage.
BH3 -13 SS3	1.52 - 2.13 m; glacial till	X	X	Upper water table; high vapour readings. Address the retail fuel outlet located at 369 Island Park Drive.
BH4 -13 SS4	1.52 – 1.91 m; silty sand	X	X	Upper water table; high vapour reading; close to garage and outdoor drain.

Table 3: Groundwater Samples Submitted				
Sample ID	Screened Interval/ Stratigraphic Unit	Parameters Analyzed		Rationale
		PHCs F₁-F₄	BTEX	
BH2 – WS1	1.73 – 4.78 m; glacial till	X	X	Address former gas station usage of subject site.
BH2 – WS2	1.73 – 4.78 m; glacial till	X	X	Address former gas station usage of subject site.
BH6 – WS1	2.17 – 5.21 m; glacial till	X	X	Address furnace room and inground hoists.
BH12 – WS1	1.48 - 3.00; fill and glacial till	X	X	Address former usage of subject site.
BH1-13 GW1	3.13 - 6.17 m; limestone bedrock	X	X	Address concerns related to former use of neighbouring properties.
BH3 – 13 GW1	3.66 – 6.70 m; limestone bedrock	X	X	
Duplicate1	3.66 – 6.70 m; limestone bedrock	X	X	QA/QC

Paracel Laboratories (Paracel), of Ottawa, Ontario, performed the laboratory analysis on the samples submitted for analytical testing. Paracel is a member of the Standards Council of Canada/Canadian Association for Laboratory Accreditation (SCC/CALA). Paracel is accredited and certified by SCC/CALA for specific tests registered with the association.

5.8 Residue Management

Soil cuttings, purge water and fluids from equipment cleaning were retained on-site.

5.9 Elevation Surveying

Monitoring well locations were surveyed using a laser level. Elevations were surveyed relative to a job benchmark, a nail located within the sidewalk along Wellington Street West with an elevation of 66.47 m, provided by Annis, O’Sullivan, Vollebekk Limited. The location of the benchmark is shown on Drawing PE3003-3 – Test Hole Location Plan.

5.10 Quality Assurance and Quality Control Measures

A summary of quality assurance and quality control (QA/QC) measures, including sampling containers, preservation, labelling, handling, and custody, equipment cleaning procedures, and field quality control measurements is provided in the Sampling and Analysis Plan in Appendix 1.

6.0 REVIEW AND EVALUATION

6.1 Geology

Site geology details are provided in the Soil Profile and Test Data Sheets in Appendix 1. Site soils consist of fill, underlain by glacial till. The fill material varied in thickness between 0.5 and 3.8 m and consisted of sand and gravel with trace silt and crushed stone near the surface and a silty sand material with clay and gravel at depth. The fill material was not observed to contain any deleterious material and no visual or olfactory evidence of contamination was noted in the fill material.

The glacial till material, encountered in BH1, BH2, BH6, BH8, and BH9, varied in thickness between 0.5 and 2.3 m and consisted of a silty sand matrix with gravel and cobbles. Practical refusal to augering was encountered at depths ranging from 2.3 m to 4.8 m. Bedrock at the site consisted of grey limestone.

Groundwater monitoring wells were installed in the glacial till layer at BH2 and BH12 (upper unconfined aquifer/water table) and in the bedrock at BH6, BH1-13, and BH3-13. Site stratigraphy is shown on Drawing PE3003-5 - Cross-Section A-A'.

6.2 Groundwater Elevations, Flow Direction, and Hydraulic Gradient

Groundwater levels were measured during the groundwater sampling event on May 21, 2013 and June 11 and 13, 2013 using an electronic water level meter. Groundwater levels are summarized below in Table 4. All measurements are relative to the site temporary benchmark.

Table 4: Groundwater Level Measurements				
Borehole Location	Ground Surface Elevation (m)	Water Level Depth (m below grade)	Water Level Elevation (m ASL)	Date of Measurement
Overburden				
BH2	66.72	3.12	63.60	May 21, 2013
BH12	66.61	2.18	64.43	June 13 2013
Bedrock				
BH6	66.32	3.17	63.15	June 11, 2013
BH1-13	65.92	1.70	64.22	May 21, 2013
BH3-13	66.38	4.34	62.04	May 21, 2013

The water levels in BH2 and BH12 represent the water level in the upper, glacial till aquifer, while the water levels in BH6, BH1-13, and BH3-13 represent the water levels in the limestone bedrock aquifer. Seasonal variations in groundwater levels may occur.

Based on the groundwater elevations from the June 2013 monitoring event, groundwater contour mapping was completed for the bedrock aquifer. Groundwater contours are shown on Drawing PE3003-4 - Groundwater Contour Plan. Based on the contour mapping, groundwater flow at the subject site appears to be in a southwesterly direction. A horizontal hydraulic gradient of approximately 0.11 m/m was calculated.

No free product was observed in the monitoring wells sampled at the subject site.

6.3 Fine-Medium Soil Texture

Based on field soil observations, fine-grained soil standards are not applicable to the subject site.

6.4 Soil Field Screening

Field screening of the soil samples collected during drilling resulted in organic vapour readings of 0 ppm to 100% LEL. Field screening results of each individual soil sample are provided on the Soil Profile and Test Data Sheets appended to this report.

The organic vapour readings obtained from field screening of soil samples indicates that there is the potential for PHC F1, or PHC F2 hydrocarbon contamination in select soil samples with higher vapour readings.

6.5 Soil Quality

Ten (10) soil samples were submitted for analysis of BTEX and PHCs. The results of the analytical testing are presented below. The laboratory certificates of analysis are provided in Appendix 1.

**Table 5:
Analytical Test Results – Soil 2006 Sampling Program
BTEX/PHCs**

Parameter	MDL (µg/g)	Soil Samples (µg/g)		Table 3 Residential Coarse	Table 1 Residential
		October 6, 2006			
		BH1 – SS3	BH2 - SS3		
Benzene	0.03	nd	nd	0.21	0.02
Ethylbenzene	0.05	4.8	0.45	2	0.05
Toluene	0.05	2.7	nd	2.3	0.2
Xylenes	0.10	32.8	1.85	3.1	0.05
PHC F1	20	100	180	55	25
PHC F2	10	50	110	98	10
PHC F3	10	30	20	300	240
PHC F4	10	20	nd	2,800	120

Notes:

- MDL – Method Detection Limit (2006)
- nd – not detected above the MDL (2006)
- **Bold** – Value exceeds MOE Table 3 standards
- **Bold** - Value exceeds MOE Table 1 background standards

**Table 5:
Analytical Test Results – Soil 2009 Sampling Program
BTEX/PHCs**

Parameter	MDL (µg/g)	Soil Samples (µg/g)					Table 3 Residential Coarse	Table 1 Residential
		November 18-23, 2009						
		BH7- SS5	BH9- SS4	BH10- SS3	BH11- SS3	BH12- SS3		
Benzene	0.03	nd	nd	1.36	0.06	nd	0.21	0.02
Ethylbenzene	0.05	nd	0.27	30.7	0.53	62	2	0.05
Toluene	0.05	nd	0.21	31.8	0.28	28.9	2.3	0.2
Xylenes	0.10	nd	1.66	190.6	4.3	387	3.1	0.05
PHC F1	10	nd	17	760	151	1010	55	25
PHC F2	10	nd	nd	128	130	266	98	10
PHC F3	10	nd	nd	nd	nd	14	300	240
PHC F4	10	nd	nd	nd	nd	nd	2,800	120

Notes:

- MDL – Method Detection Limit (2009)
- nd – not detected above the MDL (2009)
- **Bold** – Value exceeds MOE Table 3 standards
- **Bold** - Value exceeds MOE Table 1 background standards

Table 5: Analytical Test Results – Soil 2013 Sampling Program BTEX/PHCs						
Parameter	MDL (µg/g)	Soil Samples (µg/g)			Table 3 Residential Coarse	Table 1 Residential
		May 13, 2013				
		BH1 – 13 SS4	BH3 - 14 SS3	BH4 – 13 SS4		
Benzene	0.02	nd	nd	nd	0.21	0.02
Ethylbenzene	0.05	nd	0.25	nd	2	0.05
Toluene	0.05	nd	nd	nd	2.3	0.2
Xylenes	0.05	nd	0.41	nd	3.1	0.05
PHC F1	7	nd	14	nd	55	25
PHC F2	4	nd	35	nd	98	10
PHC F3	8	39	nd	108	300	240
PHC F4	6	50	nd	398	2,800	120

Notes:

- MDL – Method Detection Limit (2013)
- nd – not detected above the MDL (2013)
- **Bold** – Value exceeds MOE Table 3 standards
- **Bold** - Value exceeds MOE Table 1 background standards

Test results exceed MOE Table 3 standards at multiple borehole locations. Concentrations of benzene, ethylbenzene, xylenes, PHC F1, and PHC F2 at BH1-SS3, and benzene, ethylbenzene, and xylenes at multiple locations exceed MOE Table 3 standards. In addition to exceeding MOE Table 3 Standards soils at multiple locations exceed the MOE Table 1 (Background) soil standards for benzene, ethylbenzene, xylenes, toluene, PHC F1, PHC F2 and PHC F4. As such, if this soil needs to be hauled off-site for the purpose of site redevelopment, it will not be considered clean fill.

Based on the analytical results, no contaminants were identified as being by-products of chemical or biological transformations which have or may have occurred.

The maximum concentrations of analyzed parameters in the soil at the site are summarized below in Table 6.

Table 6: Maximum Concentrations – Soil

Parameter	Maximum Concentration (µg/g)	Borehole	Depth Interval (m BGS)
Benzene	1.36	BH10-SS3	1.52 – 2.90 m; fill
Ethylbenzene	62	BH12-SS3	2.29 -3.00 m; glacial till
Toluene	318	BH10-SS3	1.52 – 2.90 m; fill
Xylenes	387	BH12-SS3	2.29 -3.00 m; glacial till
PHC F1	1010	BH12-SS3	2.29 -3.00 m; glacial till
PHC F2	266	BH12-SS3	2.29 -3.00 m; glacial till
PHC F3	108	BH4-13 SS4	1.52 – 1.91 m; glacial till
PHC F4	398	BH4-13 SS4	1.52 – 1.91 m; glacial till

Notes:

- **Bold** – Value exceeds MOE Table 3 standards
- **Bold** - Value exceeds MOE Table 1 background standards.

6.6 Groundwater Quality

Groundwater samples from the monitoring wells at BH2, BH6, BH12, BH1-13, and BH3-13 were submitted for laboratory analysis of BTEX, PHCs and VOCs. The groundwater samples were obtained from the screened intervals noted on Table 1, above. The results of the analytical testing are presented below in Tables 7 and 8. The laboratory certificates of analysis are provided in Appendix 1.

**Table 7:
Analytical Test Results – Groundwater 2006 and 2009 Sampling Program
BTEX and PHCs**

Parameter	MDL (µg/L)	Groundwater Samples (µg/L)				Table 3 Residential Coarse	Table 1 Residential
		October 10, 2006 and November 30, 2009					
		BH2-WS1	BH2-WS2	BH6-WS1	BH12-WS1		
Benzene	0.5	130	266	3,920	40,200	44	0.5
Ethylbenzene	0.5	1,100	958	2,200	19,700	2,300	0.5
Toluene	0.5	150	347	272	97,200	18,000	0.8
Xylenes	1.0	2,250	3,050	9,300	100,300	4,200	72
PHCs F1	200	10,000	10,000	19,000	145,000	750	420
PHCs F2	100	1,400	nd	30,600	459	150	150
PHCs F3	100	nd	nd	363,000	nd	500	500
PHCs F4	100	nd	nd	97,200	nd	500	500

Notes:

- MDL – Method Detection Limit (2006 and 2009)
- nd – not detected above the MDL

Bold – Value exceeds MOE Table 1 Standard
Bold – Value exceeds MOE Table 3 Standard

Table 8: Analytical Test Results – Groundwater 2013 Sampling Program BTEX and PHCs						
Parameter	MDL (µg/L)	Groundwater Samples (µg/L)			Table 3 Residential Coarse	Table 1 Residential
		May 21, 2013				
		BH1 - 13 GW1	BH3 - 13 GW1	DUPLICATE ¹		
Benzene	0.05	nd	96	92.8	44	0.5
Ethylbenzene	0.05	nd	585	589	2,300	0.5
Toluene	0.05	nd	7.7	8.1	18,000	0.8
Xylenes	0.05	nd	211	216	4,200	72
PHCs F1	25	312	1480	1400	750	420
PHCs F2	100	nd	nd	nd	150	150
PHCs F3	100	nd	nd	nd	500	500
PHCs F4	100	nd	nd	nd	500	500

Notes:

- MDL – Method Detection Limit (2013)
- nd – not detected above the MDL
- ¹ – Duplicate sample of BH3 -13 GW1 taken for QA/QC purposes

Bold – Value exceeds MOE Table 1 Standard
Bold – Value exceeds MOE Table 3 Standard

The following parameter concentrations exceed MOE Table 3 standards:

- Benzene, PHC F1, and PHC F2 at BH2 during the 2006 sampling event, and benzene and PHC F1 during the 2009 sampling event
- Benzene, xylenes, PHC F1, PHC F2, PHC F3, and PHC F4 at BH6 during the 2009 sampling event
- Benzene, toluene, ethylbenzene, xylenes, and PHC F1 at BH12 during the 2009 sampling event
- Benzene and PHC F1 at BH3-13 during the 2013 sampling event.

It is our interpretation that the analyzed parameter concentrations may indicate the potential presence of light non-aqueous phase liquids (LNAPLs), specifically gasoline- and diesel-fraction hydrocarbons (PHCs F1-F2). No free phase hydrocarbons were noted in the wells sampled at the time of sampling; however, hydrocarbon sheen and odour were noted in several samples.

The maximum concentrations of analyzed parameters in the groundwater at the site are summarized below in Table 9.

Parameter	Maximum Concentration (µg/g)	Borehole	Depth Interval (m BGS)
Benzene	40,200	BH12-WS1	1.48 - 3.00; fill and glacial till
Ethylbenzene	19,700	BH12-WS1	1.48 - 3.00; fill and glacial till
Toluene	97,200	BH12-WS1	1.48 - 3.00; fill and glacial till
Xylenes	100,300	BH12-WS1	1.48 - 3.00; fill and glacial till
PHC F1	145,000	BH12-WS1	1.48 - 3.00; fill and glacial till
PHC F2	30,600	BH6-WS1	2.17 – 5.21 m; glacial till
PHC F3	363,000	BH6-WS1	2.17 – 5.21 m; glacial till
PHC F4	97,200	BH6-WS1	2.17 – 5.21 m; glacial till

Notes:

- **Bold** – Value exceeds MOE Table 3 standards
- **Bold** - Value exceeds MOE Table 1 background standards.

6.7 Quality Assurance and Quality Control Results

As per the Sampling and Analysis Plan, a duplicate groundwater sample was obtained at BH3-13 during the sampling event and analyzed for BTEX and PHCs. The relative percent difference (RPD) calculations for the original and duplicate sample are provided below.

Parameter	MDL (µg/L)	BH3-13-GW1	DUPLICATE 1	RPD (%)	QA/QC Result
Benzene	0.05	96	92.8	3.4	Meets Target
Ethylbenzene	0.05	585	589	0.7	Meets Target
Toluene	0.05	7.7	8.1	5.1	Meets Target
Xylenes	0.05	211	216	2.3	Meets Target
PHCs F1	25	1480	1400	5.6	Meets Target

Notes:

- * All other parameter concentrations were below laboratory detection limits for both BH3-13-GW1 and Duplicate, and as such, are within acceptable QA/QC parameters.

All calculated RPD values meet the target value of 20%.

All samples submitted as part of the 2013 sampling event were handled in accordance with the Analytical Protocol with respect to holding time, preservation method, storage requirement, and container type.

As per Subsection 47(3) of O.Reg. 153/04 as amended by O.Reg. 269/11, a Certificate of Analysis has been received for each sample submitted for analysis during the 2013 sampling event, and all Certificates of Analysis are appended to this report.

Overall, the quality of the field data collected during this Phase II ESA is considered to be sufficient to meet the overall objectives of this assessment.

6.8 Phase II Conceptual Site Model

The following section has been prepared in accordance with the requirements of O.Reg. 269/11 amending O.Reg. 153/04 - Record of Site Condition regulation, made under the Environmental Protection Act. Conclusions and recommendations are discussed in a subsequent section.

Site Description

Potentially Contaminating Activity and Areas of Potential Environmental Concern

Potentially Contaminating Activities and Areas of Potential Environmental Concern identified include the former presence of a retail fuel outlet and automotive service garage on the subject site, a former retail fuel outlet 60 m to the west of the subject site, a former retail fuel outlet 50 m to the south west of the subject site, and a current retail fuel outlet operating 20m to the south of the subject site. Off-site APECs were selected based on their proximity to the subject site. Additional Potentially Contaminating Activities were identified within the Phase I study area but were not considered to represent Areas of Potential Environmental Concern.

BTEX and PHCs in soil and groundwater are identified as the Contaminants of Concern with respect to the subject site potentially resulting from these APECs.

Subsurface Structures and Utilities

Underground service locates were completed prior to the subsurface investigation. The property addressed 1451 Wellington Street West has a natural gas service running along the western property line, along with water, storm and sanitary services that run to the middle of the bay doors at the south side of the building. Electrical services are overhead. The property addressed 1445 Wellington Street West has natural gas, water and sanitary services running from the south east corner of the building south towards Wellington Street West. Electrical and telephone services are overhead. In general, trench backfill (generally sand) may provide a preferential pathway for contaminant transport; however, contamination was observed in the vicinity of the service trenches, but their role in contaminant transport is considered to be limited.

Physical Setting

Site Stratigraphy

The site stratigraphy, from ground surface to the deepest aquifer or aquitard investigated, is illustrated on Drawing PE3003-5 - Cross-Section A-A'. Stratigraphy consists of:

- Fill, consisting of sand and gravel with trace silt, crushed stone, clay, and gravel, varying in thickness from 0.5 to 3.8 m. Groundwater was not observed in this stratigraphic unit. The fill material was observed to extend to bedrock at BH6, BH7, BH10, and BH11.
- An intermittent layer of silty sand material was observed at BH2 and BH1-13. This layer varied in thickness between 0.8 and 1.1 m. Groundwater was not observed in this stratigraphic unit.
- An intermittent layer of glacial till, not observed in BH6, BH7, BH10, and BH11. The glacial till material consists of a silty sand matrix with gravel and cobbles. This layer varied in thickness from 0.7 m to 3.4 m. Groundwater was encountered in this unit in several boreholes, and the monitoring wells at BH2 and BH12 were screened in the glacial till unit. In areas of deeper overburden where groundwater was encountered in the glacial till, the glacial till is interpreted to function as a shallow unconfined aquifer.

- Limestone bedrock of the Gull River Formation, encountered at depths ranging from 2.3 to 4.8 m. Groundwater was encountered in the upper fractured bedrock, and the monitoring wells at BH6, BH1-13, and BH3-13 were screened in the bedrock unit. The upper fractured bedrock is considered to function as an aquifer at the subject site. This is the deepest unit investigated.

Hydrogeological Characteristics

Groundwater was encountered in glacial till and upper fractured bedrock units at the subject site. These units are interpreted to function as a local unconfined aquifer at the subject site.

Water levels were measured at the subject site in May and June, 2013. Water levels are summarized above in Section 6.2 of this report and are shown on Drawing PE3003-4 and PE3003-5.

Based on the groundwater elevations from the May and June 2013 monitoring events, groundwater contour mapping was completed and the horizontal hydraulic gradient for the subject site was calculated. Groundwater flow at the subject site was in a southwesterly. A hydraulic gradient of approximately 0.11 m/m was calculated.

Approximate Depth to Bedrock

Bedrock surface or practical refusal to augering (potential bedrock surface) were encountered at depths ranging from 2.3 to 4.8 m below ground surface.

Approximate Depth to Water Table

Depth to water table at the subject site varies between approximately 1.7 and 4.3 m below existing grade.

Sections 41 and 43.1 of the Regulation

Section 41 of the Regulation (Site Condition Standards, Environmentally Sensitive Areas) does not apply to the subject site.

Section 43.1 of the Regulation does not apply to the subject site in that the subject site is not a Shallow Soil Property or within 30 m of a water body.

Fill Placement

Fill material was identified at the subject site. Samples from the fill material were tested as discussed above. It is our understanding that all site soils will be hauled off-site concurrently with site redevelopment.

Proposed Buildings and Other Structures

It is our understanding that the site is to be redeveloped at a later date with a residential development. No further information is available regarding the proposed redevelopment.

Existing Buildings and Structures

The portion of the subject site addressed 1445 Wellington Street West is currently occupied by a two-storey wood-frame and brick faced residential dwelling, constructed in approximately 1900 that has been converted to a restaurant. The portion of the subject site addressed 1451 Wellington Street West has a single storey commercial building, constructed in approximately 1940, with an addition built during the 1970s.

Water Bodies

No creeks, rivers, streams, lakes or any other water body was identified on the subject site. The Ottawa River is the closest significant water body and is present approximately 1.0 km west of the site.

Areas of Natural Significance

No areas of natural significance are present on the subject site.

Environmental Condition

Areas Where Contaminants are Present

Based on screening and analytical results, the areas where contaminants are present in concentrations greater than the MOE Table 3 standards are shown on Drawing PE3003-3 and PE3003-5.

Types of Contaminants

Based on the Areas of Potential Environmental Concern identified as part of the Phase I ESA and analytical testing, contaminants found at concentrations greater than the MOE Table 3 standards at the subject site consist of BTEX and PHCs in soil. The groundwater at the subject site also had concentrations of BTEX and PHCS in excess of the MOE Table 3 standards at multiple locations within the subject site.

Contaminated Media

Based on the results of the Phase II ESA, the contaminants of concern are present in the soil on the subject site. Analytical testing indicates that the groundwater at the monitoring well locations is also contaminated.

What Is Known About Areas Where Contaminants Are Present

The area of impacted soil exceeding Table 3 standards discussed in the previous sections is interpreted to be centered around the southern portion of the site.

Distribution of Contaminants

The horizontal distribution of contaminants is considered to be centered around the southern portion of the site. The vertical distribution is considered to be in all layers of overburden soils. It is also possible that the contamination extends into the bedrock at certain locations where concentrations are elevated near the bedrock surface.

Discharge of Contaminants

It is our interpretation that the presence of contaminants on-site is a result of various historical leaks and spills over an extended period of time associated with vehicle maintenance, repair, and fuelling activities at the subject site and potentially also the adjacent property to the south across Island Park Drive.

Migration of Contaminants

Given the vapour survey results completed as part of the Phase II ESA, it is our interpretation that migration of contaminants within site soils is limited and areas of impacted soil are generally centered southern portion of the site.

Climatic and Meteorological Conditions

In general, climatic and meteorological conditions have the potential to affect contaminant distribution. Two ways by which climatic and meteorological conditions may affect contaminant distribution include the downward leaching of contaminants by means of the infiltration of precipitation, and the migration of contaminants via groundwater levels and/or flow, which may fluctuate seasonally.

Based on the results of the subsurface investigation, contaminants are present in both the soil and the groundwater at the subject site. In particular, fluctuation of groundwater levels and groundwater movement may affect contaminant transport at the subject site.

Potential for Vapour Intrusion

Concentrations of BTEX and PHC F1 were detected in site soils with concentrations in excess of Table 3 standards. The potential for vapour intrusion into the current site building is considered to be limited, given the site's current slab-on-grade construction with bay doors. It is our understanding that if the site is to be redeveloped, any impacted soils and groundwater encountered during redevelopment will be remediated, and as such the potential for vapour intrusion upon site redevelopment is considered negligible.

7.0 CONCLUSIONS

A Phase II ESA was conducted for the properties at 1445 and 1451 Wellington Street West, Ottawa, Ontario. The purpose of the Phase II ESA was to address areas of potential environmental concern identified during the Phase I ESA, in particular the subject site's past use as an automotive service garage and retail fuel outlet, as well as the presence of a retail fuel outlet to the south and a former retail fuel outlet to the west. The Phase II ESA incorporates the findings of two (2) previous subsurface investigations at the site, completed in 2006 and 2009 respectively. The 2013 subsurface investigation at the subject site consisted of the drilling of four (4) boreholes and the installation of two (2) monitoring wells, for a total of three (3) bedrock and two (2) overburden monitoring wells at the subject site.

Soil samples were obtained from the boreholes and screened using visual observations and organic vapour measurements. A total of 10 soil samples were submitted for laboratory analysis of BTEX and PHCs. Six (6) of the soil samples exceeded MOE Table 3 standards for BTEX and PHC parameters, with the area of soil contamination generally present in the south and central portions of 1451 Wellington Street West.

Groundwater samples were obtained from the monitoring wells at BH2, BH6, BH12, BH1-13, and BH3-13 and analyzed for BTEX and PHCs. All groundwater sample locations exceeded MOE Table 3 standards for BTEX and PHC parameters with the exception of BH1-13, indicating that groundwater contamination is present over much of the site.

Recommendations

Based on the above results, soil and groundwater exist at the subject property with PHC concentrations which exceed the applicable MOE Table 3 soil standards. It is our understanding that the subject site is to be redeveloped as residential, and that the existing buildings are to be removed and demolished. It is our recommendation that an environmental site remediation program, involving the removal of all contaminated soil and groundwater from the subject site, be completed concurrently with site redevelopment.

8.0 STATEMENT OF LIMITATIONS

This Phase II - Environmental Site Assessment report has been prepared in general accordance with the agreed scope-of-work, in compliance with O.Reg. 153/04 as amended by O.Reg. 269/11, and meets the requirements of CSA Z769-00. The conclusions presented herein are based on information gathered from a limited sampling and testing program. The test results represent conditions at specific test locations at the time of the field program.

The client should be aware that any information pertaining to soils and all test hole logs are furnished as a matter of general information only and test hole descriptions or logs are not to be interpreted as descriptive of conditions at locations other than those of the test holes themselves.

Should any conditions be encountered at the subject site and/or historical information that differ from our findings, we request that we be notified immediately in order to allow for a reassessment.

This report was prepared for the sole use of Mizrahi Developments. Permission and notification from Mizrahi Developments and Paterson will be required to release this report to any other party.

Paterson Group Inc.



Daniel J. Arnott, P.Eng.



Mark S. D'Arcy, P.Eng.

Report Distribution:

- Mizrahi Developments (2 copies)
- Paterson Group (1 copy)

FIGURES

FIGURE 1 – KEY PLAN

DRAWING PE3003-3 – TEST HOLE LOCATION PLAN

DRAWING PE3003-4 - GROUNDWATER CONTOUR PLAN

DRAWING PE3003-5 - CROSS-SECTION A-A'

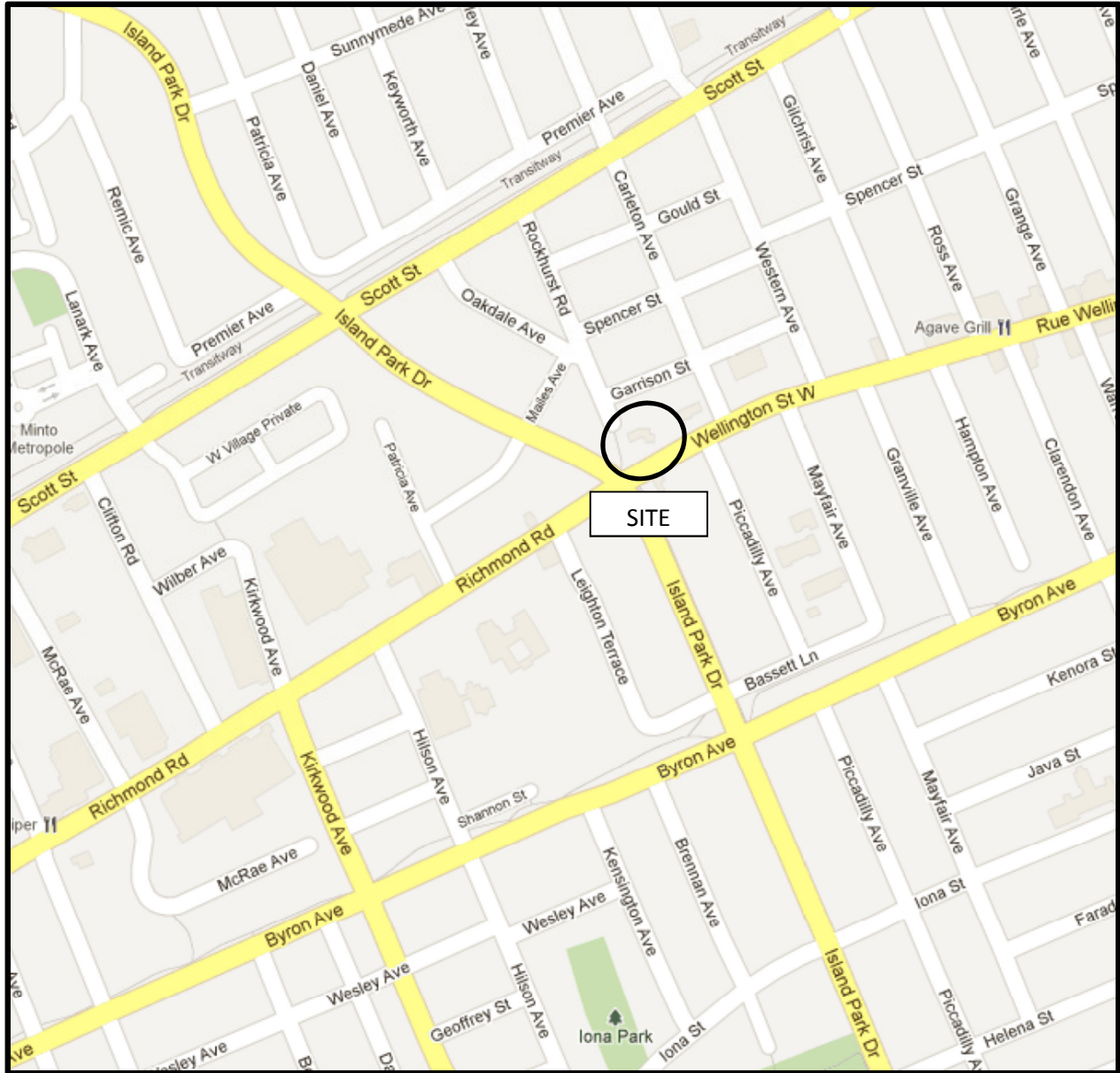
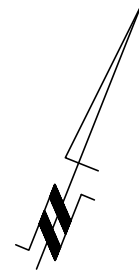

FIGURE 1
KEY PLAN



ROCKHURST ROAD

RESIDENTIAL DWELLINGS

PATHWAY

BH3
66.55

BH6-WS1 - 2.17-5.21 m
FAILS TABLE 3 STANDARDS
FOR BENZENE, XYLENES,
PHC F1, F2, F3, F4

BH1-13-SS4 - 1.52-2.13 m
MEETS TABLE 3 STANDARDS
BH1-13-GW1 - 3.66-6.17 m
MEETS TABLE 3 STANDARDS

BH6
66.32 BH8
66.54

#1451 WELLINGTON STREET WEST
PROSHINE CAR WASH

BH7-SS5 - 2.39-2.59 m
MEETS TABLE 3 STANDARDS

STORAGE SHED

BH1-13
65.92

#1445 WELLINGTON STREET WEST
BELLA'S BISTRO ITALIANO

BH2-13
66.15

BH2-SS3 - 2.29-2.90 m
FAILS TABLE 3 STANDARDS
FOR PHC F1, F2
BH2-WS1 - 1.73-4.78 m
FAILS TABLE 3 STANDARDS
FOR BENZENE, PHC F1, F2
BH2-WS2 - 1.73-4.78 m
FAILS TABLE 3 STANDARDS
FOR BENZENE, PHC F1

BH9-SS4 - 3.04-3.65 m
MEETS TABLE 3 STANDARDS

BH4
66.75

BH10-SS3 - 1.52-2.29 m
FAILS TABLE 3 STANDARDS
FOR BTEX, PHC F1, F2

BH4-13-SS4 - 1.52-2.13 m
MEETS TABLE 3 STANDARDS

BH3-13-SS4 - 1.52-2.13 m
MEETS TABLE 3 STANDARDS
BH3-13-GW1 - 3.66-6.70 m
FAILS TABLE 3 STANDARDS
FOR BENZENE, PHC F1

BH9
66.60

RESTAURANT SEATING/
KITCHEN SPACE

BH4-13
66.37

LEGEND

- BOREHOLE LOCATION, PREVIOUS INVESTIGATION
- BOREHOLE LOCATION WITH MONITORING WELL PREVIOUS INVESTIGATION
- BOREHOLE LOCATION, PATERSON (2013)
- BOREHOLE LOCATION WITH MONITORING WELL, (PATERSON, 2013)
- MONITORING WELL BY OTHERS

66.61 GROUND SURFACE ELEVATION (m)

A-A' HYDROSTRATIGRAPHIC CROSS-SECTION

TEMPORARY BENCHMARK - NAIL IN SIDEWALK ON NORTH SIDE OF WELLINGTON STREET WEST - GEODETIC ELEVATION 66.47 m ASL PROVIDED BY ANNIS, O'SULLIVAN, VOLLEBEKK LTD.

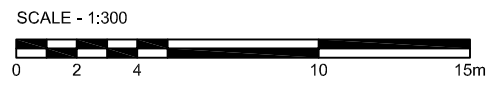

BH2
66.72

BH11
66.73

BH5
66.68

BH10
66.61

BH1
66.61

BH12
66.61

BH1-SS3 - 2.29-2.90 m
FAILS TABLE 3 STANDARDS
FOR ETHYLBENZENE,
TOLUENE, XYLENES, PHC F1

BH3-13
66.38

TBM - NAIL

BH11-SS3 - 1.52-2.29 m
FAILS TABLE 3 STANDARDS
FOR XYLENES, PHC F1, F2

BH12-SS2 - 2.29-3.00 m
FAILS TABLE 3 STANDARDS
FOR ETHYLBENZENE,
TOLUENE, XYLENES, PHC F1, F2
BH12-WS1 - 1.48-3.00 m
FAILS TABLE 3 STANDARDS
FOR BTEX, PHC F1, F2

WELLINGTON STREET WEST

paterson group
consulting engineers
154 Colonnade Road South, Ottawa, Ontario K2E 7J5

Scale:	1:250
Des.:	DJA
Dwn:	DJA
Chkd:	MSD

MIZRAHI DEVELOPMENTS
PHASE II - ENVIRONMENTAL SITE ASSESSMENT
1445 AND 1451 WELLINGTON STREET WEST
OTTAWA, ONTARIO

TEST HOLE LOCATION PLAN

Dwg. No.	PE3003-3
Report No.:	PE3003-2
Date:	05/2013

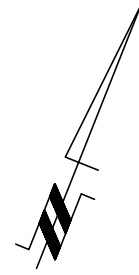

ROCKHURST ROAD

RESIDENTIAL DWELLINGS

PATHWAY

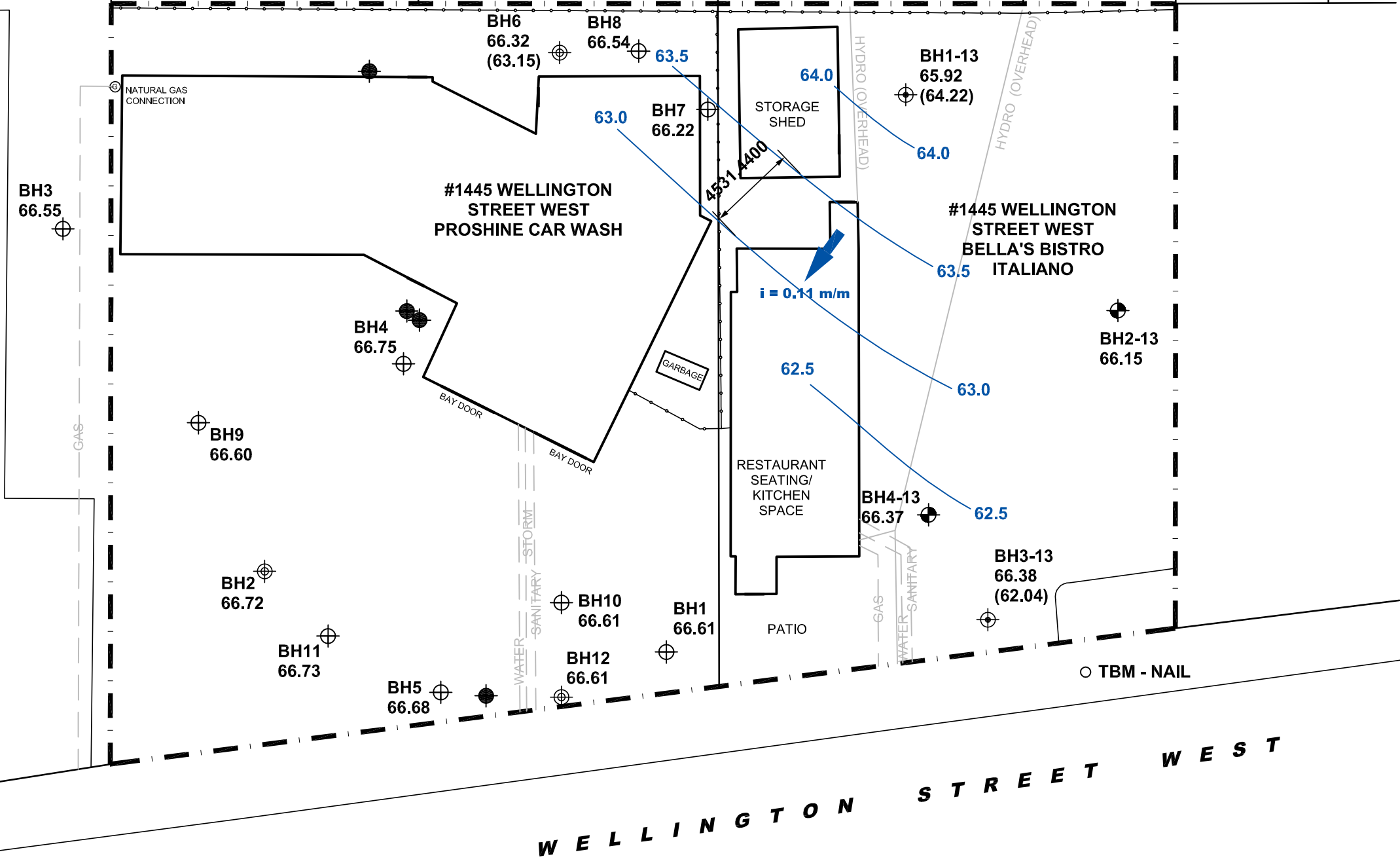

LEGEND

- BOREHOLE LOCATION, PREVIOUS INVESTIGATION
- BOREHOLE LOCATION WITH MONITORING WELL, PREVIOUS INVESTIGATION
- BOREHOLE LOCATION, PATERSON (2013)
- BOREHOLE LOCATION WITH MONITORING WELL, (PATERSON, 2013)
- MONITORING WELL BY OTHERS
- 65.92** GROUND SURFACE ELEVATION (m)
- (64.22)** GROUNDWATER ELEVATION (MAY/JUNE 2013)
- 64.0** GROUNDWATER ELEVATION CONTOUR
- GROUNDWATER FLOW DIRECTION AND HYDRAULIC GRADIENT
- i = 0.11 m/m**



patersongroup
consulting engineers
154 Colonnade Road South, Ottawa, Ontario K2E 7J5

Scale:	1:250
Des.:	DJA
Dwn:	DJA
Chkd:	MSD

MIZRAHI DEVELOPMENTS
PHASE II - ENVIRONMENTAL SITE ASSESSMENT
1445 AND 1451 WELLINGTON STREET WEST
OTTAWA, ONTARIO

GROUNDWATER CONTOUR PLAN

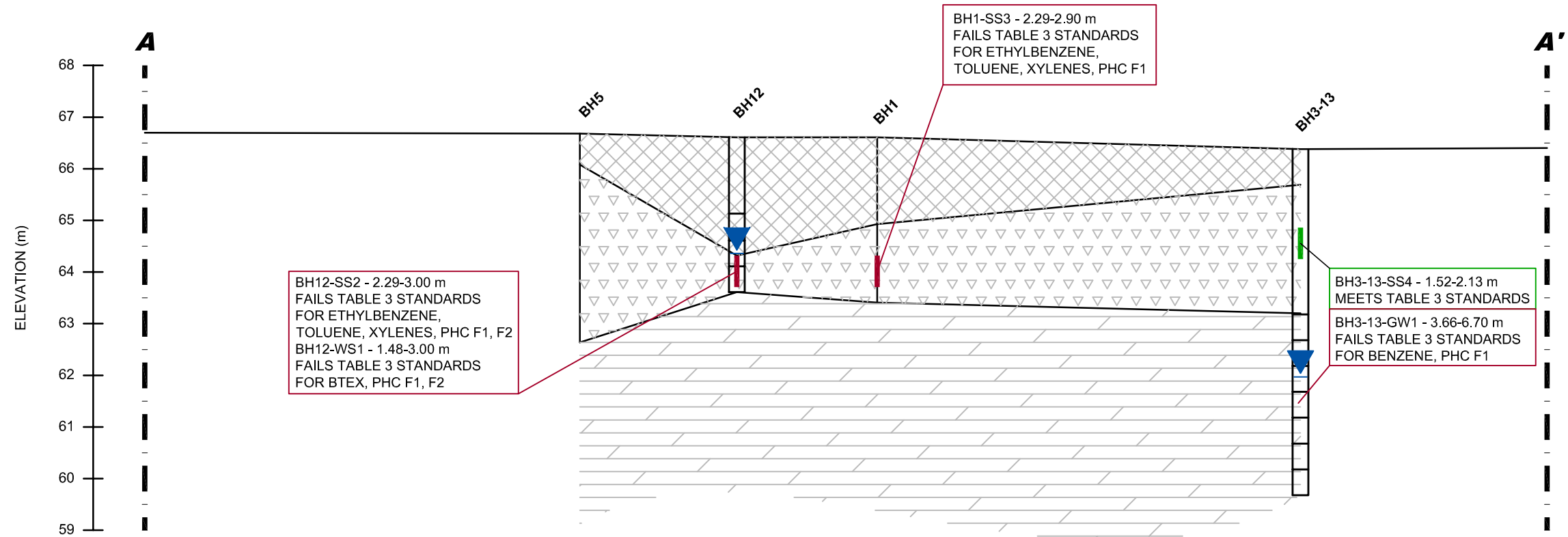

Dwg. No.	PE3003-4
Report No.:	PE3003-2
Date:	06/2013



BH12-SS2 - 2.29-3.00 m
 FAILS TABLE 3 STANDARDS
 FOR ETHYLBENZENE,
 TOLUENE, XYLENES, PHC F1, F2
 BH12-WS1 - 1.48-3.00 m
 FAILS TABLE 3 STANDARDS
 FOR BTEX, PHC F1, F2

BH1-SS3 - 2.29-2.90 m
 FAILS TABLE 3 STANDARDS
 FOR ETHYLBENZENE,
 TOLUENE, XYLENES, PHC F1

BH3-13-SS4 - 1.52-2.13 m
 MEETS TABLE 3 STANDARDS
 BH3-13-GW1 - 3.66-6.70 m
 FAILS TABLE 3 STANDARDS
 FOR BENZENE, PHC F1

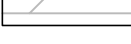
- LEGEND:**
-  **FILL: SILTY SAND WITH CLAY, GRAVEL, CRUSHED STONE, TRACE ORGANIC MATTER**
 -  **GLACIAL TILL: SILTY SAND WITH GRAVEL, COBBLES**
 -  **LIMESTONE BEDROCK**

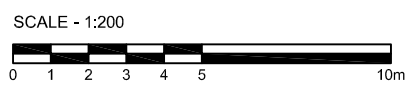

paterson group
 consulting engineers
 154 Colonnade Road South, Ottawa, Ontario K2E 7J5

Scale: 1:200
 Des.: DJA
 Dwn: DJA
 Chkd: MSD

MIZRAHI DEVELOPMENTS
 PHASE II - ENVIRONMENTAL SITE ASSESSMENT
 1445 AND 1451 WELLINGTON STREET WEST
 OTTAWA, ONTARIO

CROSS-SECTION A-A'

Dwg. No. **PE3003-5**
 Report No.: PE3003-2
 Date: 06/2013

APPENDIX 1

SAMPLING AND ANALYSIS PLAN

SOIL PROFILE AND TEST DATA SHEETS

LABORATORY CERTIFICATES OF ANALYSIS



Geotechnical
Engineering

Environmental
Engineering

Hydrogeology

Geological
Engineering

Materials Testing

Building Science

Archaeological
Services

Sampling & Analysis Plan

Commercial Properties
1445 and 1451 Wellington Street West
Ottawa, Ontario

Prepared For

Mizrahi Developments

Paterson Group Inc.

Consulting Engineers
154 Colonnade Road South
Ottawa (Nepean), Ontario
Canada K2E 7J5

Tel: (613) 226-7381
Fax: (613) 226-6344
www.patersongroup.ca

May 2013

Report: PE3003-SAP

Table of Contents

1.0	SAMPLING PROGRAM	1
2.0	ANALYTICAL TESTING PROGRAM.....	2
3.0	STANDARD OPERATING PROCEDURES	4
3.1	Environmental Drilling Procedure	4
3.2	Monitoring Well Installation Procedure	7
3.3	Monitoring Well Sampling Procedure	8
4.0	QUALITY ASSURANCE/QUALITY CONTROL (QA/QC)	10
5.0	DATA QUALITY OBJECTIVES	11
6.0	PHYSICAL IMPEDIMENTS TO SAMPLING & ANALYSIS PLAN	12

1.0 SAMPLING PROGRAM

Paterson Group Inc. (Paterson) was commissioned by Mizrahi Developments to conduct a Phase II Environmental Site Assessment (ESA) for the properties at 1445 and 1451 Wellington Street West, Ottawa, Ontario. Paterson has completed two previous subsurface investigations at 1451 Wellington Street West, in 2006 and 2009 respectively. Based on the results of the previous subsurface investigations, and in order to meet the requirements of O.Reg. 153/04 as amended by O.Reg. 269/11, the following subsurface investigation program was developed:

Borehole	Location & Rationale	Proposed Depth & Rationale
BH1-13	Located for general site coverage of 1445 Wellington Street West and for groundwater triangulation.	Screened in bedrock for groundwater quality assessment and triangulation. Monitoring well to be installed.
BH2-13	Located for general site coverage of 1445 Wellington Street West.	To be advanced to practical auger refusal to assess overburden quality.
BH3-13	Located for general site coverage of 1445 Wellington Street West and for groundwater triangulation.	Screened in bedrock for groundwater quality assessment and triangulation. Monitoring well to be installed.
BH4-13	Located for general site coverage of 1445 Wellington Street West.	To be advanced to practical auger refusal to assess overburden quality.

Borehole locations are shown on the Test Hole Location Plan appended to the main report.

At each borehole, auger-flight or split-spoon samples of overburden soils will be obtained at 0.76 m (2'6") intervals until practical refusal to augering. All soil samples will be retained, and samples will be selected for submission following a preliminary screening analysis.

It is considered necessary to drill into bedrock to intercept the long-term water table (groundwater was encountered intermittently in the overburden soils in the previous investigations). Boreholes will be advanced into bedrock as required using diamond coring equipment. Rock core samples will be retained for review, but not submitted for analysis.

Following borehole drilling, monitoring wells will be installed in selected boreholes (as above) for the measurement of water levels and the collection of groundwater samples.

2.0 ANALYTICAL TESTING PROGRAM

The analytical testing program for soil at the subject site is based on the following general considerations:

- At least one sample from each borehole should be submitted, in order to delineate the horizontal extent of contamination across the site.
- At least one sample from each stratigraphic unit should be submitted, in order to delineate the vertical extent of contamination at the site.
- In boreholes where there is visual or olfactory evidence of contamination, or where organic vapour meter or photoionization detector readings indicate the presence of contamination, the 'worst-case' sample from each borehole should be submitted for comparison with MOE site condition standards.
- In boreholes with evidence of contamination as described above, a sample should be submitted from the stratigraphic unit below the 'worst-case' sample to determine whether the contaminant(s) have migrated downward.
- Parameters analyzed should be consistent with the Contaminants of Potential Concern identified in the Phase I ESA.

The previous subsurface investigation completed in 2011 is considered to contribute to these objectives. During the 2013 investigation, attention will be given to further delineating the lead impacts encountered in BH5.

The analytical testing program for groundwater at the subject site is based on the following general considerations:

- Groundwater monitoring wells should be installed in all boreholes with visual or olfactory evidence of soil contamination, in stratigraphic units where soil contamination was encountered, where those stratigraphic units are at or below the water table (i.e. a water sample can be obtained).
- Groundwater monitoring well screens should straddle the water table at sites where the contaminants of concern are suspected to be LNAPLs.
- At least one groundwater monitoring well should be installed in a stratigraphic unit below the suspected contamination, where said stratigraphic unit is water-bearing.

- Parameters analyzed should be consistent with the Contaminants of Concern identified in the Phase I ESA and with the contaminants identified in the soil samples.

3.0 STANDARD OPERATING PROCEDURES

3.1 Environmental Drilling Procedure

Purpose

The purpose of environmental boreholes is to identify and/or delineate contamination within the soil and/or to install groundwater monitoring wells in order to identify contamination within the groundwater.

Equipment

The following is a list of equipment that is in addition to regular drilling equipment stated in the geotechnical drilling SOP:

- Glass soil sample jars
- two buckets
- cleaning brush (toilet brush works well)
- dish detergent
- methyl hydrate
- water (if not available on site - water jugs available in trailer)
- latex or nitrile gloves (depending on suspected contaminant)
- RKI Eagle organic vapour meter or MiniRae photoionization detector (depending on contamination suspected)

Determining Borehole Locations

If conditions on site are not as suspected, and planned borehole locations cannot be drilled, **call the office to discuss**. Alternative borehole locations will be determined in conversation with the field technician and supervising engineer.

After drilling is completed a plan with the borehole locations must be provided. Distances and orientations of boreholes with respect to site features (buildings, roadways, etc.) must be provided. Distances should be measured using a measuring tape or wheel rather than paced off. Ground surface elevations at each borehole should be surveyed relative to a geodetic benchmark, if one is available, or a temporary site benchmark which can be tied in at a later date if necessary.

Drilling Procedure

The actual drilling procedure for environmental boreholes is the same as geotechnical boreholes (see SOP for drilling and sampling) with a few exceptions as follows:

- Continuous split spoon samples (every 0.6 m or 2') or semi-continuous (every 0.76 m or 2'6") are required.
- Make sure samples are well sealed in plastic bags with no holes prior to screening and are kept cool but unfrozen.
- If sampling for VOCs, BTEX, or PHCs F1, a soil core from each soil sample which may be analyzed must be taken and placed in the laboratory-provided methanol vial.
- Note all and any odours or discolouration of samples.
- Split spoon samplers must be washed between samples.
- If obvious contamination is encountered, continue sampling until vertical extent of contamination is delineated.
- As a general rule, environmental boreholes should be deep enough to intercept the groundwater table (unless this is impossible/impractical - call project manager to discuss).
- If at all possible, soil samples should be submitted to a preliminary screening procedure on site, either using a RKI Eagle, PID, visual observations, etc. depending on type of suspected contamination.

Spoon Washing Procedure

All sampling equipment (spilt spoons, etc.) must be washed between samples in order to prevent cross contamination of soil samples.

- Obtain two buckets of water (preferably hot if available)
- Add a small amount of dish soap to one bucket
- Scrub spoons with brush in soapy water, inside and out, including tip
- Rinse in clean water
- Apply a small amount of methyl hydrate to the inside of the spoon. (A spray bottle or water bottle with a small hole in the cap works well)
- Allow to dry (takes seconds)
- Rinse with distilled water, a spray bottle works well.

The methyl hydrate eliminates any soap residue that may be on the spoon, and is especially important when dealing with suspected VOCs.

Screening Procedure

The RKI Eagle is used to screen most soil samples, particularly where petroleum hydrocarbon contamination is suspected. The MiniRae is used when VOCs are suspected, however it also can be useful for detecting petroleum. These tools are for screening purposes only and cannot be used in place of laboratory testing. Vapour results obtained from the RKI Eagle and the PID are relative and must be interpreted.

Screening equipment should be calibrated on an approximately monthly basis, more frequently if heavily used.

- Samples should be brought to room temperature; this is specifically important in colder weather. Soil must not be frozen.
- Turn instrument on and allow to come to zero - calibrate if necessary
- If using RKI Eagle, ensure instrument is in methane elimination mode unless otherwise directed.
- Ensure measurement units are ppm (parts per million) initially. RKI Eagle will automatically switch to %LEL (lower explosive limit) if higher concentrations are encountered.
- Break up large lumps of soil in the sample bag, taking care not to puncture bag.
- Insert probe into soil bag, creating a seal with your hand around the opening.
- Gently manipulate soil in bag while observing instrument readings.
- Record the highest value obtained in the first 15 to 25 seconds
- Make sure to indicate scale (ppm or LEL); also note which instrument was used (RKI Eagle 1 or 2, or MiniRae).
- Jar samples and refrigerate as per Sampling and Analysis Plan.

3.2 Monitoring Well Installation Procedure

Equipment

- 5' x 2" threaded sections of Schedule 40 PVC slotted well screen (5' x 1 ¼" if installing in cored hole in bedrock)
- 5' x 2" threaded sections of Schedule 40 PVC riser pipe (5' x 1 ¼" if installing in cored hole in bedrock)
- Threaded end-cap
- Slip-cap or J-plug
- Asphalt cold patch or concrete
- Silica Sand
- Bentonite chips (Holeplug)
- Steel flushmount casing

Procedure

- Drill borehole to required depth, using drilling and sampling procedures described above.
- If borehole is deeper than required monitoring well, backfill with bentonite chips to required depth. This should only be done on wells where contamination is not suspected, in order to prevent downward migration of contamination.
- Only one monitoring well should be installed per borehole.
- Monitoring wells should not be screened across more than one stratigraphic unit to prevent potential migration of contaminants between units.
- Where LNAPLs are the suspected contaminants of concern, monitoring wells should be screened straddling the water table in order to capture any free product floating on top of the water table.
- Thread the end cap onto a section of screen. Thread second section of screen if required. Thread risers onto screen. Lower into borehole to required depth. Ensure slip-cap or J-plug is inserted to prevent backfill materials entering well.
- As drillers remove augers, backfill borehole annulus with silica sand until the level of sand is approximately 0.3 m above the top of the screen.
- Backfill with holeplug until at least 0.3 m of holeplug is present above the top of the silica sand.

- Backfill remainder of borehole with holeplug or with auger cuttings (if contamination is not suspected).
- Install flushmount casing. Seal space between flushmount and borehole annulus with concrete, cold patch, or holeplug to match surrounding ground surface.

3.3 Monitoring Well Sampling Procedure

Equipment

- Water level metre or interface probe on hydrocarbon/LNAPL sites
- Spray bottles containing water and methanol to clean water level tape or interface probe
- Peristaltic pump
- Polyethylene tubing for peristaltic pump
- Flexible tubing for peristaltic pump
- Latex or nitrile gloves (depending on suspected contaminant)
- Allen keys and/or 9/16" socket wrench to remove well caps
- Graduated bucket with volume measurements
- Portable pH/Temperature/Conductivity analyzer
- Laboratory-supplied sample bottles

Sampling Procedure

- Locate well and use socket wrench or Allan key to open metal flush mount protector cap. Remove plastic well cap.
- Measure water level, with respect to existing ground surface, using water level meter or interface probe. If using interface probe on suspected NAPL site, measure the thickness of free product.
- Measure total depth of well.
- Clean water level tape or interface probe using methanol and water. Change gloves between wells.
- Calculate volume of standing water within well and record.
- Insert polyethylene tubing into well and attach to peristaltic pump. Turn on peristaltic pump and purge into graduated bucket. Purge at least three well volumes of water from the well. Measure and record field chemistry. Continue to purge, measuring field chemistry after every well volume purged, until appearance or field chemistry stabilizes.

- Note appearance of purge water, including colour, opacity (clear, cloudy, silty), sheen, presence of LNAPL, and odour. Note any other unusual features (particulate matter, effervescence (bubbling) of dissolved gas, etc.).
- Fill required sample bottles. If sampling for metals, attach 75-micron filter to discharge tube and filter metals sample. If sampling for VOCs, use low flow rate to ensure continuous stream of non-turbulent flow into sample bottles. Ensure no headspace is present in VOC vials.
- Replace well cap and flushmount casing cap.

4.0 QUALITY ASSURANCE/QUALITY CONTROL (QA/QC)

The QA/QC program for this Phase II ESA is as follows:

- All non-dedicated sampling equipment (split spoons) will be decontaminated according to the SOPs listed above.
- All groundwater sampling equipment is dedicated (polyethylene and flexible peristaltic tubing is replaced for each well).
- Where groundwater samples are to be analyzed for VOCs, one laboratory-provided trip blank will be submitted for analysis with every laboratory submission.
- Approximately one (1) field duplicate will be submitted for every ten (10) samples submitted for laboratory analysis. A minimum of one (1) field duplicate per project will be submitted. Field duplicates will be submitted for soil and groundwater samples where possible.
- Where multi-parameter analyzers are used to measure field chemistry, they will be calibrated on an approximately monthly basis, according to frequency of use.

5.0 DATA QUALITY OBJECTIVES

The purpose of setting data quality objectives (DQOs) is to ensure that the level of uncertainty in data collected during the Phase II ESA is low enough that decision-making is not affected, and that the overall objectives of the investigation are met.

The quality of data is assessed by comparing field duplicates with original samples. If the relative percent difference (RPD) between the duplicate and the sample is within 20%, the data are considered to be of sufficient quality so as not to affect decision-making. The RPD is calculated as follows:

$$RPD = \left| \frac{x_1 - x_2}{(x_1 + x_2)/2} \right| \times 100\%$$

Where x_1 is the concentration of a given parameter in an original sample and x_2 is the concentration of that same parameter in the field duplicate sample.

For the purpose of calculating the RPD, it is desirable to select field duplicates from samples for which parameters are present in concentrations above laboratory detection limits, i.e. samples which are expected to be contaminated. If parameters are below laboratory detection limits for selected samples or duplicates, the RPD may be calculated using a concentration equal to the laboratory detection limit.

It is also important to consider data quality in the overall context of the project. For example, if the DQOs are not met for a given sample, yet the concentrations of contaminants in both the sample and the duplicate exceed the MOE site remediation standards by a large margin, the decision-making usefulness of the sample may not be considered to be impaired. The proximity of other samples which meet the DQOs must also be considered in developing the Phase II Conceptual Site Model; often there are enough data available to produce a reliable Phase II Conceptual Site Model even if DQOs are not met for certain individual samples.

These considerations are discussed in the body of the report.

6.0 PHYSICAL IMPEDIMENTS TO SAMPLING & ANALYSIS PLAN

Physical impediments to the Sampling and Analysis plan may include:

- The location of underground utilities
- Poor recovery of split-spoon soil samples
- Insufficient groundwater volume for groundwater samples
- Breakage of sampling containers following sampling or while in transit to the laboratory
- Elevated detection limits due to matrix interference (generally related to soil colour or presence of organic material)
- Elevated detection limits due to high concentrations of certain parameters, necessitating dilution of samples in laboratory
- Drill rig breakdowns
- Winter conditions
- Other site-specific impediments

Site-specific impediments to the Sampling and Analysis plan are discussed in the body of the Phase II ESA report.

SOIL PROFILE AND TEST DATA

Phase II - Environmental Site Assessment
1445 and 1451 Wellington Street West
Ottawa, Ontario

DATUM TBM - Mag nail in sidewalk, located near the southwest corner of subject site, north side of Wellington Street West. Geodetic elevation = 66.47m, as per AOV.

REMARKS

FILE NO.
PE0982

HOLE NO.
BH 1

BORINGS BY CME 75 Power Auger

DATE October 6, 2006

SOIL DESCRIPTION	STRATA PLOT	SAMPLE				DEPTH (m)	ELEV. (m)	Photo Ionization Detector				Monitoring Well Construction	
		TYPE	NUMBER	RECOVERY %	N VALUE or RQD			<input type="radio"/> Volatile Organic Rdg. (ppm) <input type="radio"/> Lower Explosive Limit %					
GROUND SURFACE								20	40	60	80		
Asphaltic concrete	0.05					0	66.61						
FILL: Dark brown silty sand with gravel	0.46												
FILL: Sandy silt with clay		SS	1	50	10	1	65.61						
	1.68												
GLACIAL TILL: Very dense, brown silty sand with gravel, cobbles and boulders		SS	2	54	35	2	64.61						
		SS	3	62	56								
	3.20												
SS		SS	4	33	50+	3	63.61						
End of Borehole													
Practical refusal to augering @ 3.20m depth													
								100	200	300	400	500	
								RKI Eagle Rdg. (ppm)					
								▲ Full Gas Resp. △ Methane Elim.					

SOIL PROFILE AND TEST DATA

Phase II - Environmental Site Assessment
1445 and 1451 Wellington Street West
Ottawa, Ontario

DATUM TBM - Mag nail in sidewalk, located near the southwest corner of subject site, north side of Wellington Street West. Geodetic elevation = 66.47m, as per AOV.

FILE NO.
PE0982

REMARKS

HOLE NO.
BH 2

BORINGS BY CME 75 Power Auger

DATE October 6, 2006

SOIL DESCRIPTION	STRATA PLOT	SAMPLE				DEPTH (m)	ELEV. (m)	Photo Ionization Detector				Monitoring Well Construction	
		TYPE	NUMBER	RECOVERY %	N VALUE or RQD			● Volatile Organic Rdg. (ppm)					
GROUND SURFACE								○ Lower Explosive Limit %					
								20	40	60	80		
Asphaltic concrete FILL: Brown silty sand with gravel and crushed stone	0.05					0	66.72						
	0.53												
Compact, grey SILTY fine SAND		SS	1	4	4	1	65.72						
	1.62												
GLACIAL TILL: Dense to very dense, grey silty sand with gravel, cobbles and boulders		SS	2	54	18	2	64.72						
		SS	3	75	40								
		SS	4	17	50+	3	63.72						
		SS	5	25	50+	4	62.72						
	4.78												
End of Borehole (GWL @ 2.50m-Oct. 11, 2006)													
								100	200	300	400	500	
								RKI Eagle Rdg. (ppm)					
								▲ Full Gas Resp. △ Methane Elim.					

DATUM TBM - Mag nail in sidewalk, located near the southwest corner of subject site, north side of Wellington Street West. Geodetic elevation = 66.47m, as per AOV.

REMARKS

FILE NO. PE0982

HOLE NO. BH 3

BORINGS BY CME 75 Power Auger

DATE October 6, 2006

SOIL DESCRIPTION	STRATA PLOT	SAMPLE				DEPTH (m)	ELEV. (m)	Photo Ionization Detector				Monitoring Well Construction	
		TYPE	NUMBER	RECOVERY %	N VALUE or RQD			● Volatile Organic Rdg. (ppm)	○ Lower Explosive Limit %				
								20	40	60	80		
GROUND SURFACE						0	66.55						
Asphaltic concrete	0.05												
FILL: Brown silty sand with gravel	0.60												
GLACIAL TILL: Compact, brown silty sand with gravel, cobbles and boulders		SS	1	42	25	1	65.55						
		SS	2	62	17	2	64.55						
		SS	3	61	20								
		SS	4	20	50+	3	63.55						
End of Borehole	3.40												
Practical refusal to augering @ 3.40m depth													

100 200 300 400 500
RKI Eagle Rdg. (ppm)
▲ Full Gas Resp. △ Methane Elim.

SOIL PROFILE AND TEST DATA

Phase II - Environmental Site Assessment
1445 and 1451 Wellington Street West
Ottawa, Ontario

DATUM TBM - Mag nail in sidewalk, located near the southwest corner of subject site, north side of Wellington Street West. Geodetic elevation = 66.47m, as per AOV.

REMARKS

BORINGS BY CME 75 Power Auger

DATE October 6, 2006

FILE NO. PE0982

HOLE NO. BH 4

SOIL DESCRIPTION	STRATA PLOT	SAMPLE				DEPTH (m)	ELEV. (m)	Photo Ionization Detector				Monitoring Well Construction	
		TYPE	NUMBER	RECOVERY %	N VALUE or RQD			<input type="radio"/> Volatile Organic Rdg. (ppm) <input type="radio"/> Lower Explosive Limit %					
GROUND SURFACE								20	40	60	80		
Asphaltic concrete	0.05					0	66.75						
FILL: Dark brown silty sand with gravel and organic matter		SS	1	42	7	1	65.75						
	1.68												
GLACIAL TILL: Dense to very dense, brown silty sand with gravel, cobbles and boulders		SS	2	67	36	2	64.75						
		SS	3	50	24								
		SS	4	50	50+	3	63.75						
		SS	5	33	50+								
End of Borehole	3.99												
Practical refusal to augering @ 3.99m depth													

100 200 300 400 500
RKI Eagle Rdg. (ppm)
 ▲ Full Gas Resp. △ Methane Elim.

SOIL PROFILE AND TEST DATA

Phase II - Environmental Site Assessment
1445 and 1451 Wellington Street West
Ottawa, Ontario

DATUM TBM - Mag nail in sidewalk, located near the southwest corner of subject site, north side of Wellington Street West. Geodetic elevation = 66.47m, as per AOV.

REMARKS

FILE NO. PE0982

HOLE NO. BH 5

BORINGS BY CME 75 Power Auger

DATE October 6, 2006

SOIL DESCRIPTION	STRATA PLOT	SAMPLE				DEPTH (m)	ELEV. (m)	Photo Ionization Detector				Monitoring Well Construction	
		TYPE	NUMBER	RECOVERY %	N VALUE or RQD			● Volatile Organic Rdg. (ppm)					
GROUND SURFACE								○ Lower Explosive Limit %					
								20	40	60	80		
Asphaltic concrete	0.05					0	66.68						
FILL: Brown silty sand with gravel and crushed stone	0.60												
GLACIAL TILL: Dense, dark grey silty sand with gravel, cobbles and boulders		SS	1	58	12	1	65.68						
		SS	2	73	26	2	64.68						
		SS	3	67	31	3	63.68						
		SS	4	67	34	4	62.68						
		SS	5	44	50+	4	62.68						
End of Borehole	4.04					4	62.68						
Practical refusal to augering @ 4.04m depth													

100 200 300 400 500
RKI Eagle Rdg. (ppm)
▲ Full Gas Resp. △ Methane Elim.

DATUM TBM - Mag nail in sidewalk, located near the southwest corner of subject site, north side of Wellington Street West. Geodetic elevation = 66.47m, as per AOV.

REMARKS

FILE NO.
PE2526

HOLE NO.
BH 6

BORINGS BY Portable Drill

DATE November 18, 2009

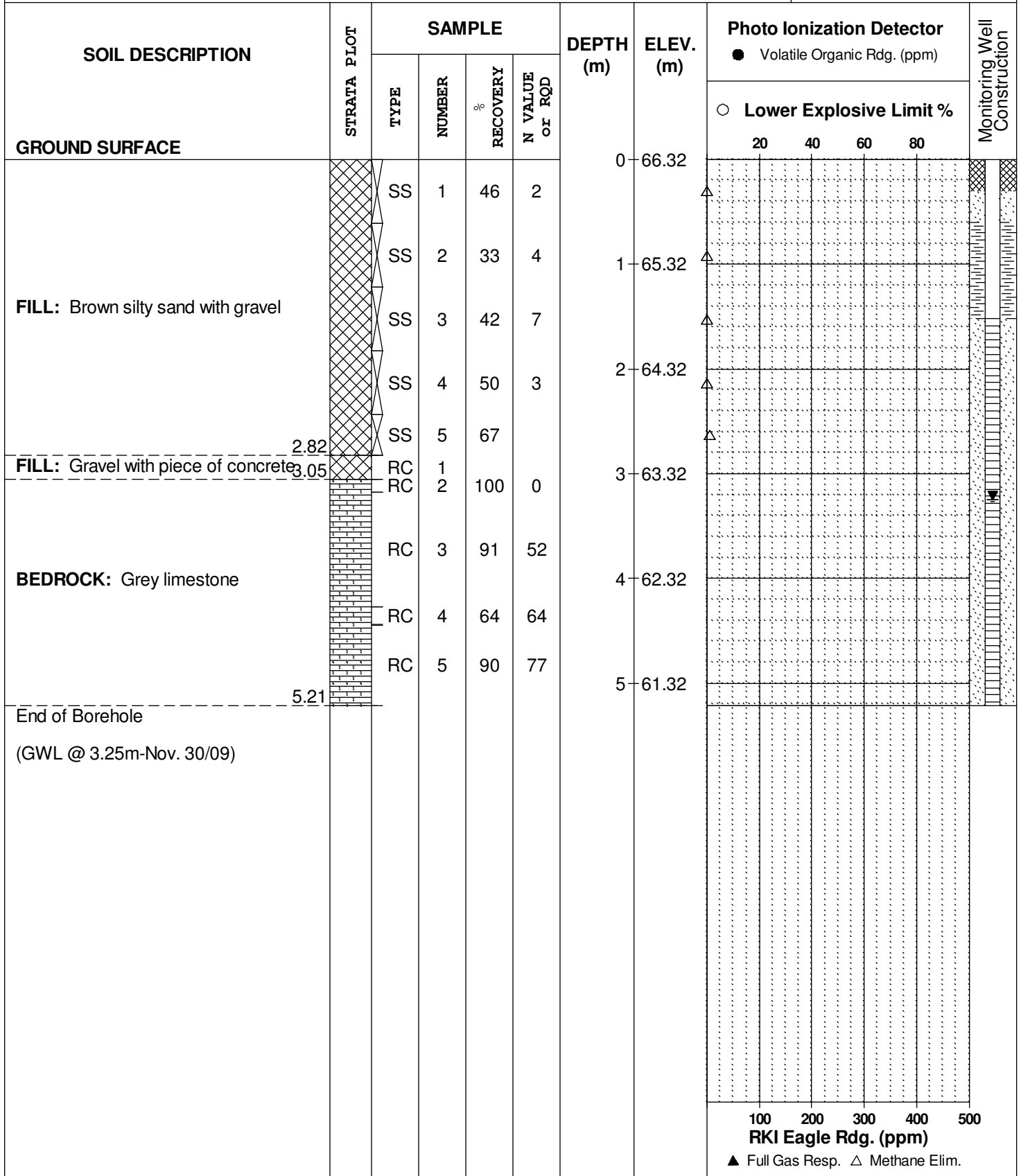

SOIL PROFILE AND TEST DATA

Phase II - Environmental Site Assessment
1445 and 1451 Wellington Street West
Ottawa, Ontario

DATUM TBM - Mag nail in sidewalk, located near the southwest corner of subject site, north side of Wellington Street West. Geodetic elevation = 66.47m, as per AOV.
REMARKS

FILE NO.
PE2526

HOLE NO.
BH 7

BORINGS BY Portable Drill

DATE November 18, 2009

SOIL DESCRIPTION	STRATA PLOT	SAMPLE				DEPTH (m)	ELEV. (m)	Photo Ionization Detector				Monitoring Well Construction	
		TYPE	NUMBER	RECOVERY %	N VALUE or RQD			● Volatile Organic Rdg. (ppm)					
GROUND SURFACE								○ Lower Explosive Limit %					
								20	40	60	80		
FILL: Brown silty sand with clay		SS	1	38	1	0	66.22						
		SS	2	29	2	1	65.22						
		1.22	SS	3	29	3							
FILL: Brown silty clay with piece of wood		SS	4	58	13	2	64.22						
		SS	5	100	17								
End of Borehole	2.59												
								100	200	300	400	500	
								RKI Eagle Rdg. (ppm)					
								▲ Full Gas Resp. △ Methane Elim.					

SOIL PROFILE AND TEST DATA

Phase II - Environmental Site Assessment
1445 and 1451 Wellington Street West
Ottawa, Ontario

DATUM TBM - Mag nail in sidewalk, located near the southwest corner of subject site, north side of Wellington Street West. Geodetic elevation = 66.47m, as per AOV.
REMARKS

FILE NO.
PE2526

HOLE NO.
BH 8

BORINGS BY Portable Drill

DATE November 18, 2009

SOIL DESCRIPTION	STRATA PLOT	SAMPLE				DEPTH (m)	ELEV. (m)	Photo Ionization Detector				Monitoring Well Construction	
		TYPE	NUMBER	RECOVERY %	N VALUE or RQD			● Volatile Organic Rdg. (ppm)					
GROUND SURFACE								○ Lower Explosive Limit %					
								20	40	60	80		
FILL: Brown silty sand with gravel		SS	1	21	4	0	66.54						
		SS	2	25	6	1	65.54						
		SS	3	12	7								
GLACIAL TILL: Compact to dense, brown silty sand with gravel		SS	4	62	5	2	64.54						
End of Borehole		RC	5	78	20								
								100	200	300	400	500	
								RKI Eagle Rdg. (ppm)					
								▲ Full Gas Resp. △ Methane Elim.					

DATUM TBM - Mag nail in sidewalk, located near the southwest corner of subject site, north side of Wellington Street West. Geodetic elevation = 66.47m, as per AOV.

FILE NO. PE2526

REMARKS

HOLE NO. BH 9

BORINGS BY CME 75 Power Auger

DATE November 23, 2009

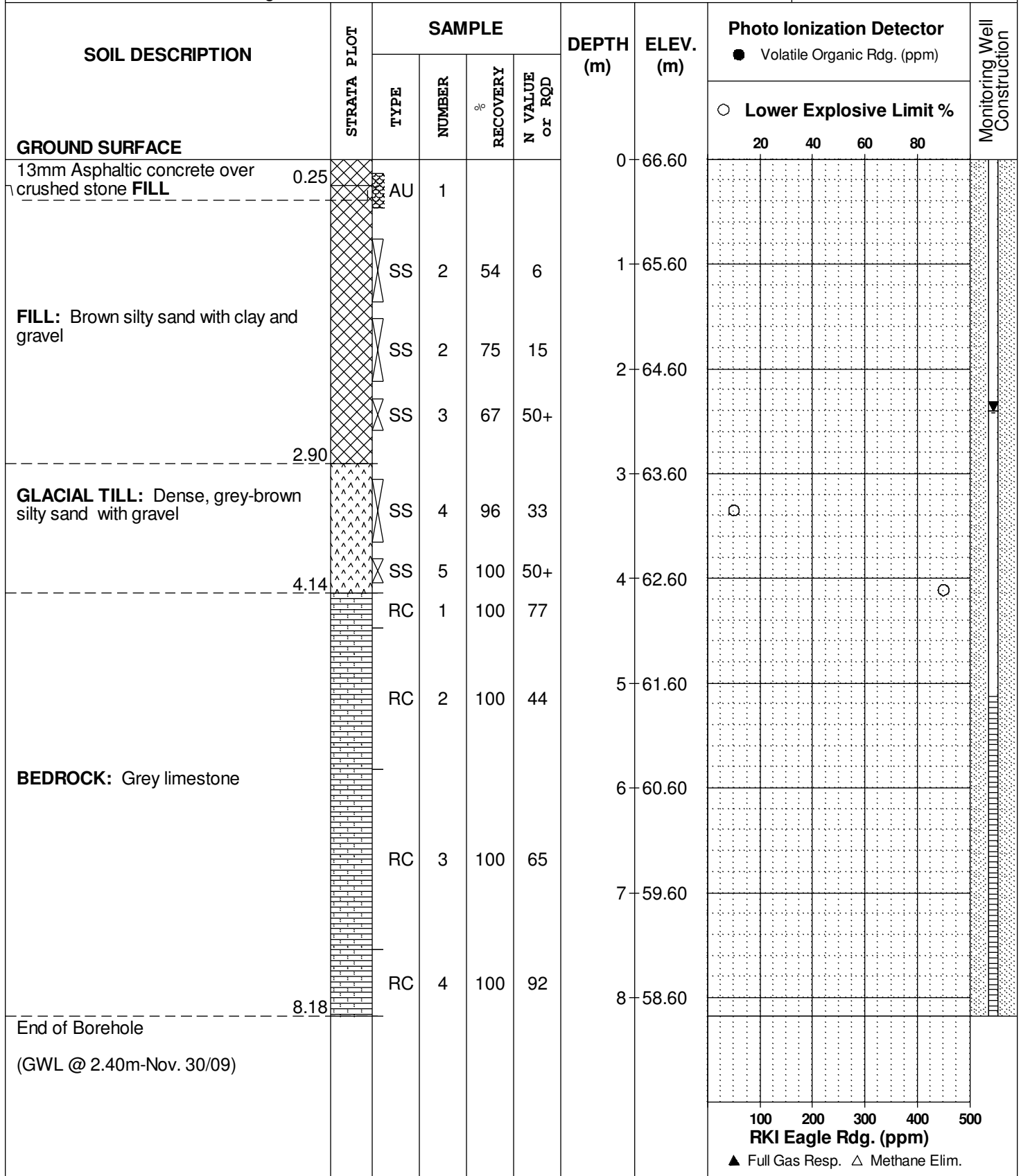

DATUM TBM - Mag nail in sidewalk, located near the southwest corner of subject site, north side of Wellington Street West. Geodetic elevation = 66.47m, as per AOV.

REMARKS

FILE NO.
PE2526

HOLE NO.
BH10

BORINGS BY CME 75 Power Auger

DATE November 23, 2009

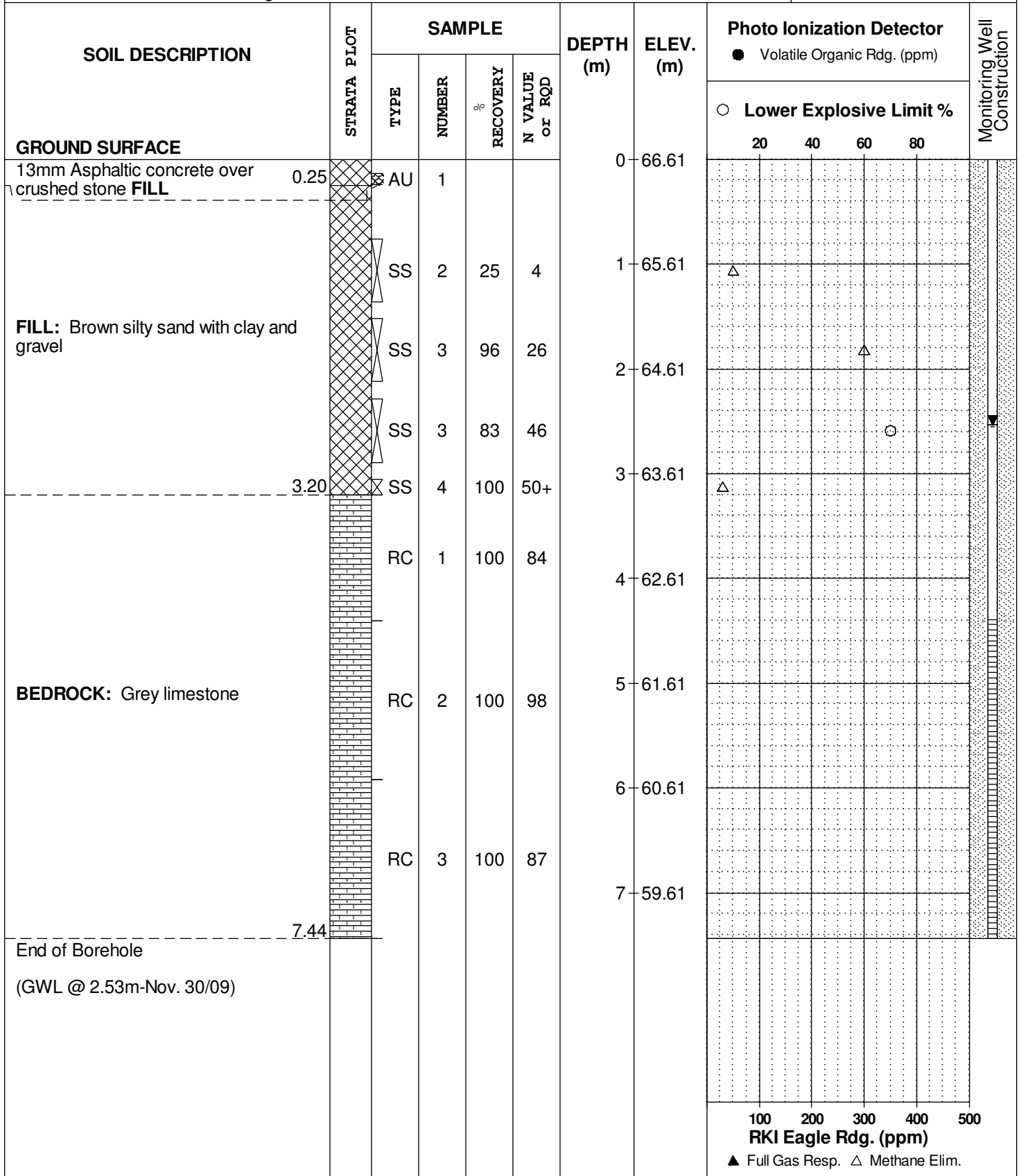

DATUM TBM - Mag nail in sidewalk, located near the southwest corner of subject site, north side of Wellington Street West. Geodetic elevation = 66.47m, as per AOV.

FILE NO. PE2526

REMARKS

HOLE NO. BH11

BORINGS BY CME 75 Power Auger

DATE November 23, 2009

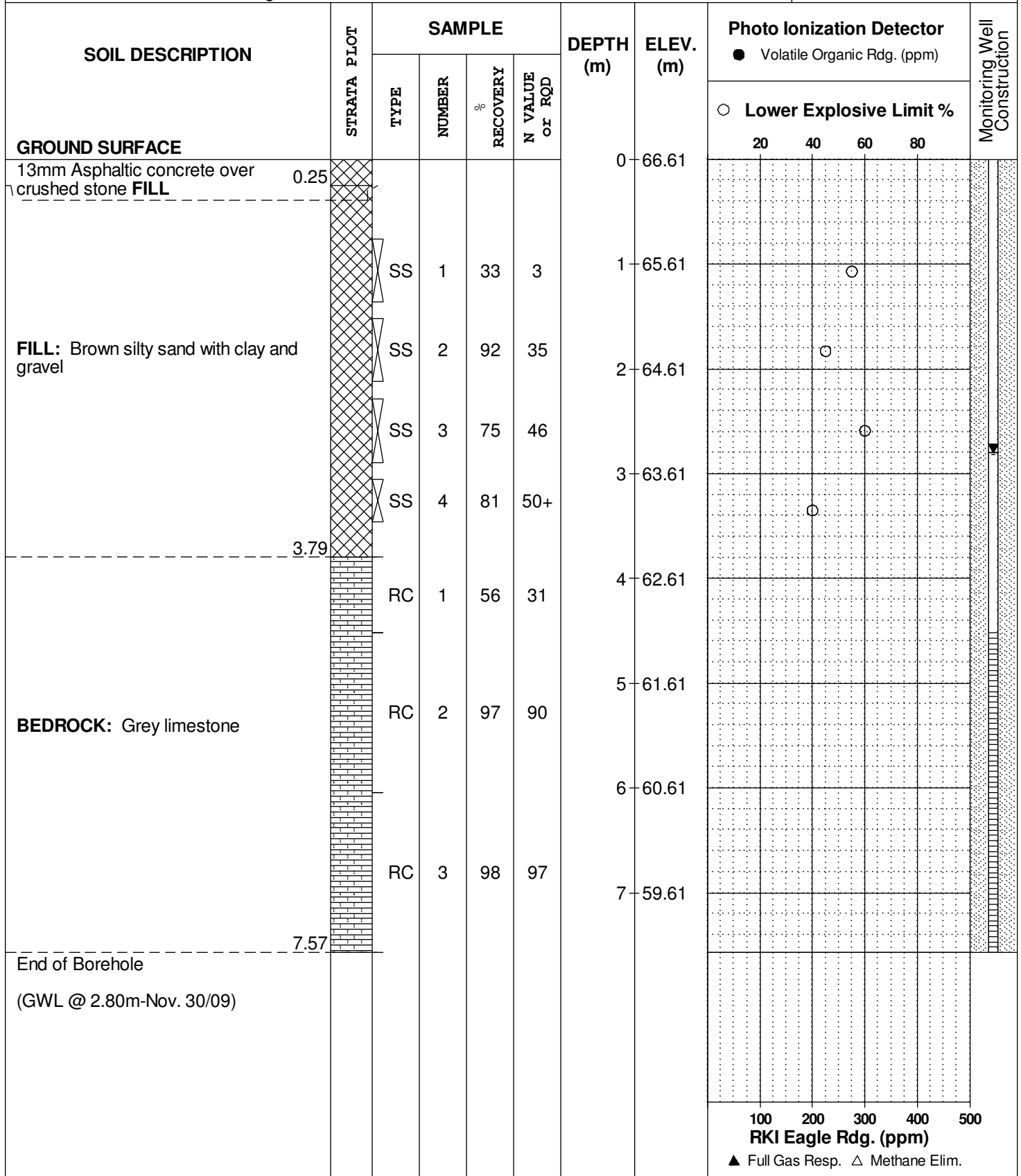

100 200 300 400 500
RKI Eagle Rdg. (ppm)
▲ Full Gas Resp. △ Methane Elim.

DATUM TBM - Mag nail in sidewalk, located near the southwest corner of subject site, north side of Wellington Street West. Geodetic elevation = 66.47m, as per AOV.

REMARKS

FILE NO.
PE2526

HOLE NO.
BH12

BORINGS BY CME 75 Power Auger

DATE November 23, 2009

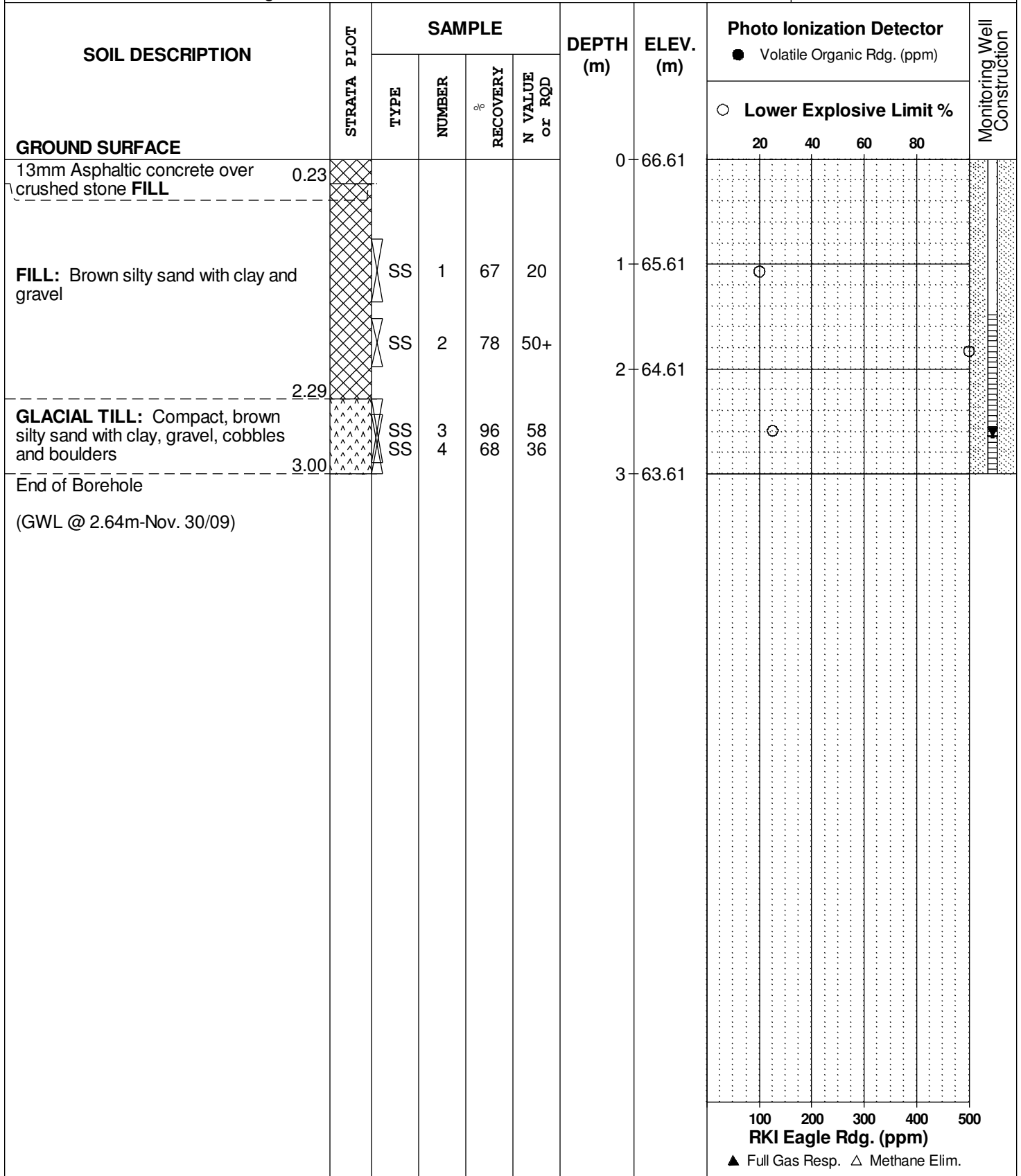

154 Colonnade Road South, Ottawa, Ontario K2E 7J5

Phase II - Environmental Site Assessment
1445 and 1451 Wellington Street West
Ottawa, Ontario

DATUM TBM - Mag nail in sidewalk, located near the southeast corner of subject site, north side of Wellington Street West. Geodetic elevation = 66.47m, as per Annis, O'Sullivan,
REMARKS Vollebekk Ltd.

FILE NO. PE3003

HOLE NO. BH 1

BORINGS BY CME 55 Power Auger

DATE May 13, 2013

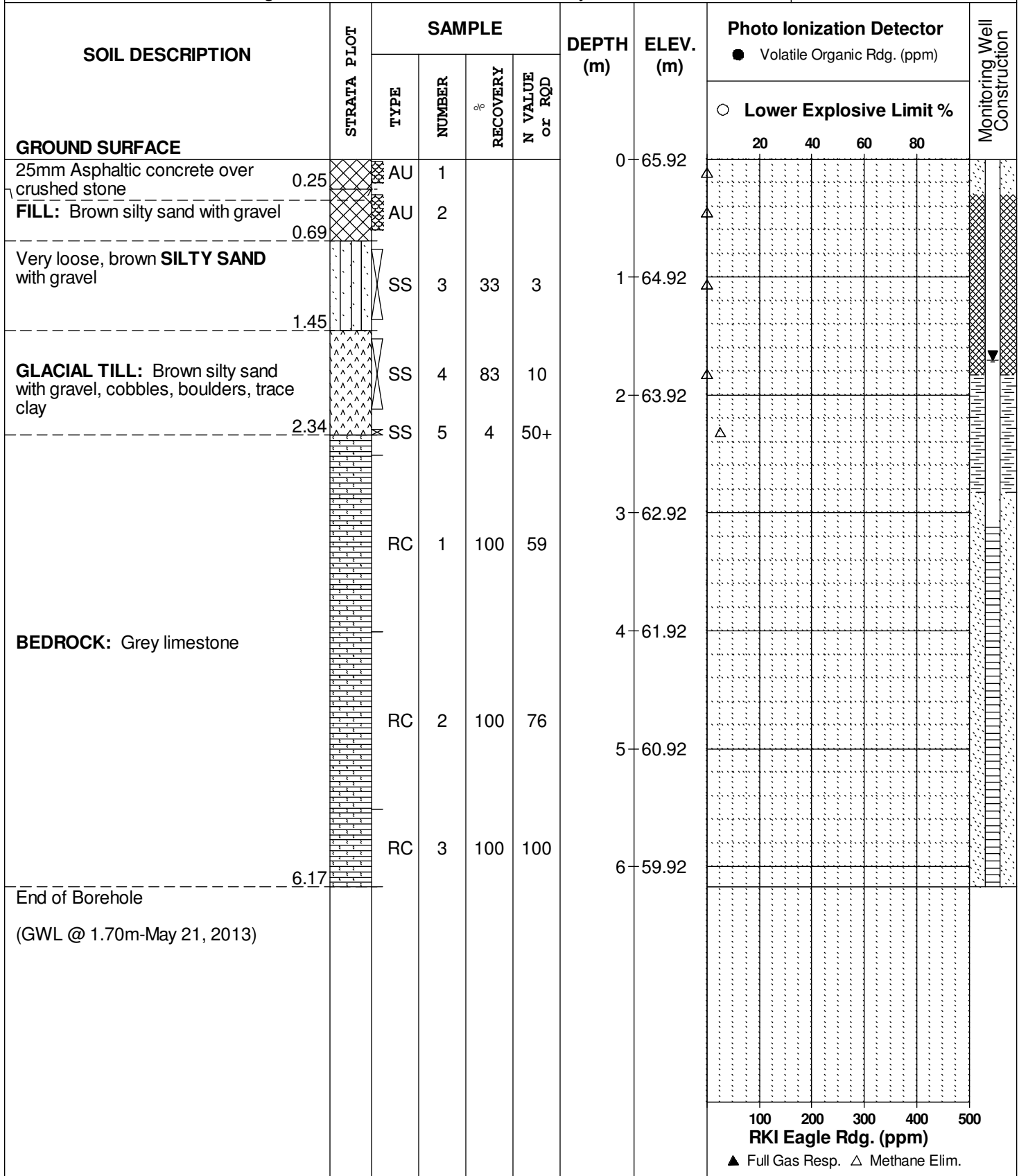

SOIL PROFILE AND TEST DATA

Phase II - Environmental Site Assessment
1445 and 1451 Wellington Street West
Ottawa, Ontario

DATUM TBM - Mag nail in sidewalk, located near the southeast corner of subject site, north side of Wellington Street West. Geodetic elevation = 66.47m, as per Annis, O'Sullivan,
REMARKS Vollebekk Ltd.

FILE NO. PE3003

HOLE NO. BH 2

BORINGS BY CME 55 Power Auger

DATE May 13, 2013

SOIL DESCRIPTION	STRATA PLOT	SAMPLE				DEPTH (m)	ELEV. (m)	Photo Ionization Detector				Monitoring Well Construction	
		TYPE	NUMBER	RECOVERY %	N VALUE or RQD			● Volatile Organic Rgd. (ppm)					
GROUND SURFACE								○ Lower Explosive Limit %					
								20	40	60	80		
50mm Asphaltic concrete over crushed stone	0.25	AU	1			0	66.15						
FILL: Brown silty sand with gravel		AU	2										
		SS	3		50+	1	65.15						
GLACIAL TILL: Brown silty sand with gravel, cobbles, boulders	1.45												
		SS	4	64	71	2	64.15						
		SS	5	100	50+								
End of Borehole	2.95												
Practical refusal to augering at 2.95m depth													
								100	200	300	400	500	
								RKI Eagle Rgd. (ppm)					
								▲ Full Gas Resp. △ Methane Elim.					

DATUM TBM - Mag nail in sidewalk, located near the southeast corner of subject site, north side of Wellington Street West. Geodetic elevation = 66.47m, as per Annis, O'Sullivan,
REMARKS Vollebekk Ltd.

FILE NO. PE3003

HOLE NO. BH 3

BORINGS BY CME 55 Power Auger

DATE May 13, 2013

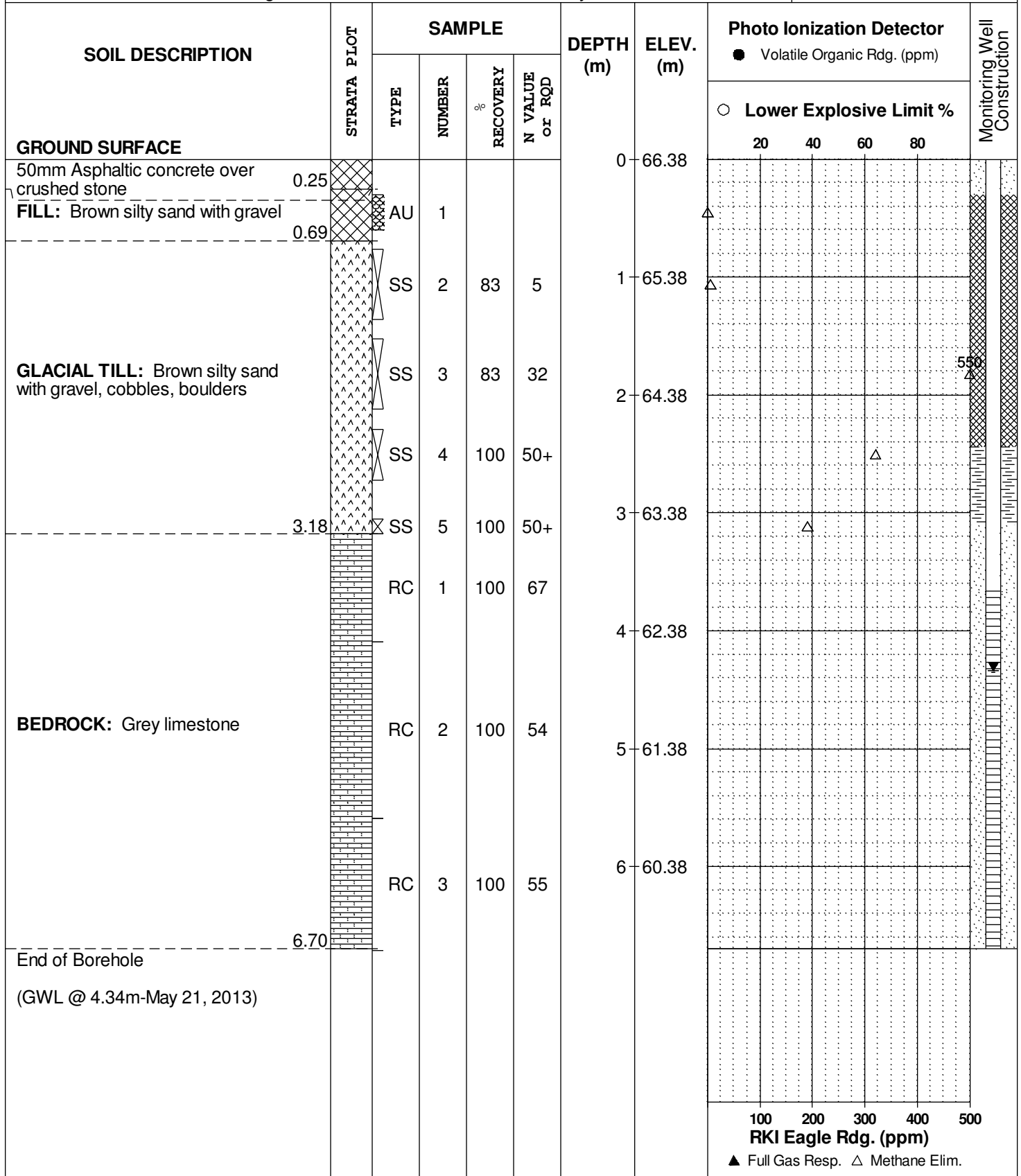

100 200 300 400 500
RKI Eagle Rdg. (ppm)
▲ Full Gas Resp. △ Methane Elim.

SYMBOLS AND TERMS

SOIL DESCRIPTION

Behavioural properties, such as structure and strength, take precedence over particle gradation in describing soils. Terminology describing soil structure are as follows:

Desiccated	-	having visible signs of weathering by oxidation of clay minerals, shrinkage cracks, etc.
Fissured	-	having cracks, and hence a blocky structure.
Varved	-	composed of regular alternating layers of silt and clay.
Stratified	-	composed of alternating layers of different soil types, e.g. silt and sand or silt and clay.
Well-Graded	-	Having wide range in grain sizes and substantial amounts of all intermediate particle sizes (see Grain Size Distribution).
Uniformly-Graded	-	Predominantly of one grain size (see Grain Size Distribution).

The standard terminology to describe the strength of cohesionless soils is the relative density, usually inferred from the results of the Standard Penetration Test (SPT) 'N' value. The SPT N value is the number of blows of a 63.5 kg hammer, falling 760 mm, required to drive a 51 mm O.D. split spoon sampler 300 mm into the soil after an initial penetration of 150 mm.

Relative Density	'N' Value	Relative Density %
Very Loose	<4	<15
Loose	4-10	15-35
Compact	10-30	35-65
Dense	30-50	65-85
Very Dense	>50	>85

The standard terminology to describe the strength of cohesive soils is the consistency, which is based on the undisturbed undrained shear strength as measured by the in situ or laboratory vane tests, penetrometer tests, unconfined compression tests, or occasionally by Standard Penetration Tests.

Consistency	Undrained Shear Strength (kPa)	'N' Value
Very Soft	<12	<2
Soft	12-25	2-4
Firm	25-50	4-8
Stiff	50-100	8-15
Very Stiff	100-200	15-30
Hard	>200	>30

SYMBOLS AND TERMS (continued)

SOIL DESCRIPTION (continued)

Cohesive soils can also be classified according to their "sensitivity". The sensitivity is the ratio between the undisturbed undrained shear strength and the remoulded undrained shear strength of the soil.

Terminology used for describing soil strata based upon texture, or the proportion of individual particle sizes present is provided on the Textural Soil Classification Chart at the end of this information package.

ROCK DESCRIPTION

The structural description of the bedrock mass is based on the Rock Quality Designation (RQD).

The RQD classification is based on a modified core recovery percentage in which all pieces of sound core over 100 mm long are counted as recovery. The smaller pieces are considered to be a result of closely-spaced discontinuities (resulting from shearing, jointing, faulting, or weathering) in the rock mass and are not counted. RQD is ideally determined from NXL size core. However, it can be used on smaller core sizes, such as BX, if the bulk of the fractures caused by drilling stresses (called "mechanical breaks") are easily distinguishable from the normal in situ fractures.

RQD %	ROCK QUALITY
90-100	Excellent, intact, very sound
75-90	Good, massive, moderately jointed or sound
50-75	Fair, blocky and seamy, fractured
25-50	Poor, shattered and very seamy or blocky, severely fractured
0-25	Very poor, crushed, very severely fractured

SAMPLE TYPES

SS	-	Split spoon sample (obtained in conjunction with the performing of the Standard Penetration Test (SPT))
TW	-	Thin wall tube or Shelby tube
PS	-	Piston sample
AU	-	Auger sample or bulk sample
WS	-	Wash sample
RC	-	Rock core sample (Core bit size AXT, BXL, etc.). Rock core samples are obtained with the use of standard diamond drilling bits.

SYMBOLS AND TERMS (continued)

GRAIN SIZE DISTRIBUTION

MC%	-	Natural moisture content or water content of sample, %
LL	-	Liquid Limit, % (water content above which soil behaves as a liquid)
PL	-	Plastic limit, % (water content above which soil behaves plastically)
PI	-	Plasticity index, % (difference between LL and PL)
Dxx	-	Grain size which xx% of the soil, by weight, is of finer grain sizes These grain size descriptions are not used below 0.075 mm grain size
D10	-	Grain size at which 10% of the soil is finer (effective grain size)
D60	-	Grain size at which 60% of the soil is finer
Cc	-	Concavity coefficient = $(D_{30})^2 / (D_{10} \times D_{60})$
Cu	-	Uniformity coefficient = D_{60} / D_{10}

Cc and Cu are used to assess the grading of sands and gravels:

Well-graded gravels have: $1 < Cc < 3$ and $Cu > 4$

Well-graded sands have: $1 < Cc < 3$ and $Cu > 6$

Sands and gravels not meeting the above requirements are poorly-graded or uniformly-graded.

Cc and Cu are not applicable for the description of soils with more than 10% silt and clay (more than 10% finer than 0.075 mm or the #200 sieve)

CONSOLIDATION TEST

p'_o	-	Present effective overburden pressure at sample depth
p'_c	-	Preconsolidation pressure of (maximum past pressure on) sample
Ccr	-	Recompression index (in effect at pressures below p'_c)
Cc	-	Compression index (in effect at pressures above p'_c)
OC Ratio		Overconsolidation ratio = p'_c / p'_o
Void Ratio		Initial sample void ratio = volume of voids / volume of solids
Wo	-	Initial water content (at start of consolidation test)

PERMEABILITY TEST

k	-	Coefficient of permeability or hydraulic conductivity is a measure of the ability of water to flow through the sample. The value of k is measured at a specified unit weight for (remoulded) cohesionless soil samples, because its value will vary with the unit weight or density of the sample during the test.
---	---	--

SYMBOLS AND TERMS (continued)

STRATA PLOT



Topsoil

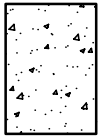

Asphalt

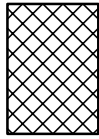

Fill



Peat

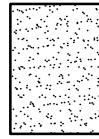

Sand

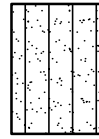

Silty Sand

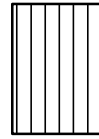

Silt



Sandy Silt

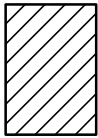

Clay

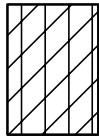

Silty Clay

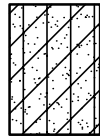

Clayey Silty Sand



Glacial Till

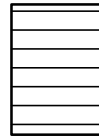

Shale

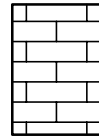

Bedrock

MONITORING WELL AND PIEZOMETER CONSTRUCTION

MONITORING WELL CONSTRUCTION

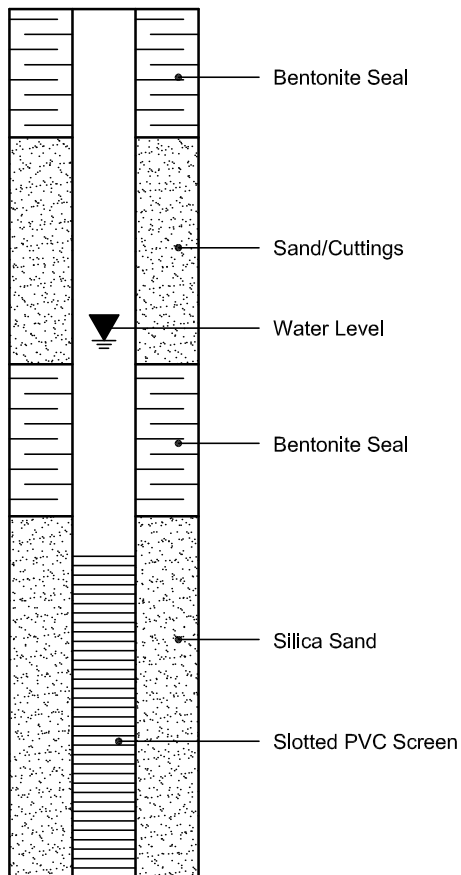

PIEZOMETER CONSTRUCTION

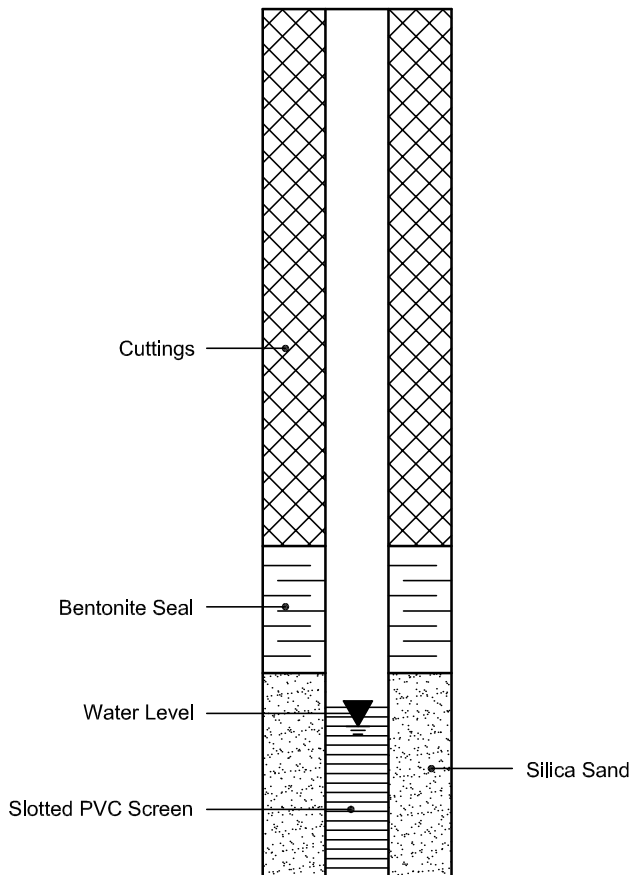

Certificate of Analysis

Client: Paterson Group Inc.

Client PO: 4500

Project: PE0982

Report Date: 13-Oct-2006

Order Date: 10-Oct-2006

Matrix: Soil

Parameter	MDL/Units	Sample ID:	BH1 SS3	BH2 SS3
		Sample Date:	06/10/2006	06/10/2006
			L8032.1	L8032.2
Benzene	0.03 ug/g		< 0.03	< 0.03
Ethylbenzene	0.05 ug/g		4.8	0.45
Toluene	0.05 ug/g		2.7	< 0.05
m/p-Xylene	0.05 ug/g		23	1.7
o-Xylene	0.05 ug/g		9.8	0.15
Toluene-d8	surrogate		110%	107%
F1 PHCs (C6-C10)	20 ug/g		100	180
F2 PHCs (C10-C16)	10 ug/g		50	110
F3 PHCs (C16-C34)	10 ug/g		30	20
F4 PHCs (C34-C50)	10 ug/g		20	< 10

Certificate of Analysis

Client: Paterson Group Inc.

Client PO: 2692

Project: PE0982

Report Date: 17-Oct-2006

Order Date: 11-Oct-2006

Matrix: Water		
	Sample ID:	BH2 WS1
	Sample Date:	11/10/2006
Parameter	MDL/Units	L8059.1
Benzene	0.0005 mg/L	0.13
Ethylbenzene	0.0005 mg/L	1.1
Toluene	0.0005 mg/L	0.15
m/p-Xylene	0.0005 mg/L	2.2
o-Xylene	0.0005 mg/L	0.05
Toluene-d8	surrogate	90%
F1 PHCs (C6-C10)	0.2 mg/L	10
F2 PHCs (C10-C16)	0.1 mg/L	1.4
F3 PHCs (C16-C34)	0.1 mg/L	< 0.1
F4 PHCs (C34-C50)	0.1 mg/L	< 0.1

Certificate of Analysis

Paterson Group Consulting Engineers

28 Concourse Gate, Unit 1
Nepean, ON K2E 7T7
Attn: Eric Leveque

Phone: (613) 226-7381
Fax: (613) 226-6344

Client PO: 8269
Project: PE1831
Custody: 60531

Report Date: 2-Dec-2009
Order Date: 24-Nov-2009

Order #: 0948072

This Certificate of Analysis contains analytical data applicable to the following samples as submitted:

Paracel ID	Client ID
0948072-01	BH9-SS4
0948072-02	BH10-SS3
0948072-03	BH11-SS3
0948072-04	BH12-SS2

Approved By:



Mark Foto, M.Sc. For Dale Robertson, BSc
Laboratory Director

Any use of these results implies your agreement that our total liability in connection with this work, however arising shall be limited to the amount paid by you for this work, and that our employees or agents shall not under circumstances be liable to you in connection with this work

Certificate of Analysis

Report Date: 02-Dec-2009

Client: **Paterson Group Consulting Engineers**

Order Date: 24-Nov-2009

Client PO: 8269

Project Description: PE1831

Analysis Summary Table

Analysis	Method Reference/Description	Extraction Date	Analysis Date
BTEX	EPA 8260 - P&T GC-MS	25-Nov-09	2-Dec-09
CCME PHC F1	CWS Tier 1 - P&T GC-FID	25-Nov-09	2-Dec-09
CCME PHC F2 - F4	CWS Tier 1 - GC-FID, extraction	27-Nov-09	27-Nov-09
Solids, %	Gravimetric, calculation	26-Nov-09	26-Nov-09

Certificate of Analysis

Report Date: 02-Dec-2009
Order Date: 24-Nov-2009

Client: **Paterson Group Consulting Engineers**
Client PO: 8269

Project Description: PE1831

	Client ID:	BH9-SS4	BH10-SS3	BH11-SS3	BH12-SS2
	Sample Date:	23-Nov-09	23-Nov-09	23-Nov-09	23-Nov-09
	Sample ID:	0948072-01	0948072-02	0948072-03	0948072-04
	MDL/Units	Soil	Soil	Soil	Soil

Physical Characteristics

	0.1 % by Wt.	93.1	93.6	92.2	92.6
% Solids					

Volatiles

Benzene	0.03 ug/g dry	<0.03	1.36	0.06	<0.30
Ethylbenzene	0.05 ug/g dry	0.27	30.7	0.53	62.0
Toluene	0.05 ug/g dry	0.21	31.8	0.28	28.9
m,p-Xylenes	0.05 ug/g dry	1.27	141	3.40	278
o-Xylene	0.05 ug/g dry	0.39	49.6	0.90	109
Toluene-d8	Surrogate	102%	104%	104%	101%

Hydrocarbons

F1 PHCs (C6-C10)	10 ug/g dry	17	760	151	1010
F2 PHCs (C10-C16)	10 ug/g dry	<10	128	130	266
F3 PHCs (C16-C34)	10 ug/g dry	<10	<10	<10	14
F4 PHCs (C34-C50)	10 ug/g dry	<10	<10	<10	<10

Certificate of Analysis

Report Date: 02-Dec-2009
Order Date: 24-Nov-2009

Client: **Paterson Group Consulting Engineers**

Client PO: 8269

Project Description: PE1831

Method Quality Control: Blank

Analyte	Result	Reporting Limit	Units	Source Result	%REC	%REC Limit	RPD	RPD Limit	Notes
Hydrocarbons									
F1 PHCs (C6-C10)	ND	10	ug/g						
F2 PHCs (C10-C16)	ND	10	ug/g						
F3 PHCs (C16-C34)	ND	10	ug/g						
F4 PHCs (C34-C50)	ND	10	ug/g						
Volatiles									
Benzene	ND	0.03	ug/g						
Ethylbenzene	ND	0.05	ug/g						
Toluene	ND	0.05	ug/g						
m,p-Xylenes	ND	0.05	ug/g						
o-Xylene	ND	0.05	ug/g						
Surrogate: Toluene-d8	8.36		ug/g		104	76-118			

Certificate of Analysis

Report Date: 02-Dec-2009

Order Date: 24-Nov-2009

Client: **Paterson Group Consulting Engineers**

Client PO: 8269

Project Description: PE1831

Method Quality Control: Duplicate

Analyte	Result	Reporting Limit	Units	Source Result	%REC	%REC Limit	RPD	RPD Limit	Notes
Hydrocarbons									
F1 PHCs (C6-C10)	ND	10	ug/g dry	ND				32	
F2 PHCs (C10-C16)	185	10	ug/g dry	266			35.7	50	
F3 PHCs (C16-C34)	12	10	ug/g dry	14			14.9	50	
F4 PHCs (C34-C50)	ND	10	ug/g dry	ND				50	
Physical Characteristics									
% Solids	93.1	0.1	% by Wt.	92.6			0.5	25	
Volatiles									
Benzene	ND	0.03	ug/g dry	ND				50	
Ethylbenzene	ND	0.05	ug/g dry	ND				34	
Toluene	ND	0.05	ug/g dry	ND				32	
m,p-Xylenes	ND	0.05	ug/g dry	ND				35	
o-Xylene	ND	0.05	ug/g dry	ND				50	
Surrogate: Toluene-d8	8.21		ug/g dry	ND	102	76-118			

Certificate of Analysis

Report Date: 02-Dec-2009

Client: **Paterson Group Consulting Engineers**

Order Date: 24-Nov-2009

Client PO: 8269

Project Description: PE1831

Method Quality Control: Spike

Analyte	Result	Reporting Limit	Units	Source Result	%REC	%REC Limit	RPD	RPD Limit	Notes
Hydrocarbons									
F1 PHCs (C6-C10)	98	10	ug/g	ND	97.8	80-120			
F2 PHCs (C10-C16)	52	10	ug/g	ND	64.5	61-129			
F3 PHCs (C16-C34)	177	10	ug/g	ND	88.7	61-129			
F4 PHCs (C34-C50)	136	10	ug/g	ND	113	61-129			
Volatiles									
Benzene	0.800	0.03	ug/g	ND	85.7	55-141			
Ethylbenzene	2.11	0.05	ug/g	ND	95.0	61-139			
Toluene	7.67	0.05	ug/g	ND	71.0	54-136			
m,p-Xylenes	7.01	0.05	ug/g	ND	104	61-139			
o-Xylene	2.74	0.05	ug/g	ND	101	60-142			
Surrogate: Toluene-d8	8.29		ug/g		104	76-118			

Certificate of Analysis

Report Date: 02-Dec-2009

Order Date: 24-Nov-2009

Client: **Paterson Group Consulting Engineers**

Client PO: 8269

Project Description: PE1831

Sample Data Revisions

None

Work Order Revisions/Comments:

None

Other Report Notes:

n/a: not applicable

MDL: Method Detection Limit

Source Result: Data used as source for matrix and duplicate samples

%REC: Percent recovery.

RPD: Relative percent difference.

Soil results are reported on a dry weight basis when the units are denoted with 'dry'.

Where %Solids is reported, moisture loss includes the loss of volatile hydrocarbons.

CCME PHC additional information:

- The method for the analysis of PHCs complies with the Reference Method for the CWS PHC and is validated for use in the laboratory. All prescribed quality criteria identified in the method has been met.
- F1 range corrected for BTEX.
- F2 to F3 ranges corrected for appropriate PAHs where available.
- The gravimetric heavy hydrocarbons (F4G) are not to be added to C6 to C50 hydrocarbons.
- In the case where F4 and F4G are both reported, the greater of the two results is to be used for comparison to CWS PHC criteria.

Company Name: <u>PATERSON GROUP</u>	Project Ref: <u>PIE1831</u>	Date Required: _____
Contact Name: <u>ERIC LEVEQUE</u>	PO# <u>8888 8269</u>	Turn Around Time: <input type="checkbox"/> 1-day <input type="checkbox"/> 2-day <input checked="" type="checkbox"/> Regular
Address: <u>28 CONTOURSE GARE UNIT 1</u>	Quote # _____ <input type="checkbox"/> Not Quoted	Regulatory/Guideline Requirements
Tel: <u>226-7381</u> Cell: _____	Preservative to be added by Paracel? <input type="checkbox"/> Yes <input type="checkbox"/> No	<u>NO TABLE 3</u>
Email: <u>leveque.e@patersongroup.ca</u>		

Matrix Types: S-Soil/Sed GW-Ground Water SW-Surface Water SS-Storm/Sanitary Sewer A-Air O-Other RDW-Regulated Drinking Water

Sample Information					Analysis Required																	
Parcel Order #	Sample Identification	Matrix	Air Volume	# Containers	Date Sampled dd/mm/yy	Analysis Required										Hazardous? (Y/N)						
	<u>0948072</u>																					
1	<u>BH9-SS4</u>	<u>S</u>		<u>1</u>	<u>Nov 23 2009</u>	<input checked="" type="checkbox"/>	<input checked="" type="checkbox"/>															
2	<u>BH10-SS3</u>	<u>S</u>		<u>1</u>	<u>↓</u>	<input checked="" type="checkbox"/>	<input checked="" type="checkbox"/>															
3	<u>BH11-SS3</u>	<u>S</u>		<u>1</u>	<u>↓</u>	<input checked="" type="checkbox"/>	<input checked="" type="checkbox"/>															
4	<u>BH12-SS2</u>	<u>S</u>		<u>1</u>	<u>↓</u>	<input checked="" type="checkbox"/>	<input checked="" type="checkbox"/>															
5																						
6																						
7																						
8																						
9																						
10																						

Comments: _____

J. Kagan

Requested by: <u>ES</u>	Received at Depot: _____	Received at Lab: <u>Uélex</u>	Verified By: <u>Uélex</u>
Date: <u>Nov 24/09</u> Time: _____	Date: <u>Nov. 24/09</u> Time: <u>11:30</u>	Date: <u>Nov 24/09</u> Time: <u>11:36</u>	Date: <u>Nov 24/09</u> Time: <u>12:19</u>

Certificate of Analysis

Paterson Group Consulting Engineers

28 Concourse Gate, Unit 1

Nepean, ON K2E 7T7

Attn: Eric Leveque

Phone: (613) 226-7381

Fax: (613) 226-6344

Client PO: 8269

Project: PE1831

Custody: 60527

Report Date: 24-Nov-2009

Order Date: 19-Nov-2009

Order #: 0947161

This Certificate of Analysis contains analytical data applicable to the following samples as submitted:

Paracel ID Client ID

0947161-01 BH7-SS5

Approved By:



Mark Foto, M.Sc. For Dale Robertson, BSc
Laboratory Director

Any use of these results implies your agreement that our total liability in connection with this work, however arising shall be limited to the amount paid by you for this work, and that our employees or agents shall not under circumstances be liable to you in connection with this work

Certificate of Analysis

Report Date: 24-Nov-2009

Order Date: 19-Nov-2009

Client: **Paterson Group Consulting Engineers**

Client PO: 8269

Project Description: PE1831

Analysis Summary Table

Analysis	Method Reference/Description	Extraction Date	Analysis Date
BTEX	EPA 8260 - P&T GC-MS	23-Nov-09	24-Nov-09
CCME PHC F1	CWS Tier 1 - P&T GC-FID	23-Nov-09	24-Nov-09
CCME PHC F2 - F4	CWS Tier 1 - GC-FID, extraction	23-Nov-09	24-Nov-09
Solids, %	Gravimetric, calculation	20-Nov-09	20-Nov-09

Certificate of Analysis

Report Date: 24-Nov-2009

Order Date: 19-Nov-2009

Client: **Paterson Group Consulting Engineers**

Client PO: 8269

Project Description: PE1831

Client ID:	BH7-SS5	-	-	-
Sample Date:	18-Nov-09	-	-	-
Sample ID:	0947161-01	-	-	-
MDL/Units	Soil	-	-	-

Physical Characteristics

% Solids	0.1 % by Wt.	81.6	-	-	-
----------	--------------	------	---	---	---

Volatiles

Benzene	0.03 ug/g dry	<0.03	-	-	-
Ethylbenzene	0.05 ug/g dry	<0.05	-	-	-
Toluene	0.05 ug/g dry	<0.05	-	-	-
m,p-Xylenes	0.05 ug/g dry	<0.05	-	-	-
o-Xylene	0.05 ug/g dry	<0.05	-	-	-
Toluene-d8	Surrogate	101%	-	-	-

Hydrocarbons

F1 PHCs (C6-C10)	10 ug/g dry	<10	-	-	-
F2 PHCs (C10-C16)	10 ug/g dry	<10	-	-	-
F3 PHCs (C16-C34)	10 ug/g dry	<10	-	-	-
F4 PHCs (C34-C50)	10 ug/g dry	<10	-	-	-

Certificate of Analysis

Report Date: 24-Nov-2009

Order Date: 19-Nov-2009

Client: **Paterson Group Consulting Engineers**

Client PO: 8269

Project Description: PE1831

Method Quality Control: Blank

Analyte	Result	Reporting Limit	Units	Source Result	%REC	%REC Limit	RPD	RPD Limit	Notes
Hydrocarbons									
F1 PHCs (C6-C10)	ND	10	ug/g						
F2 PHCs (C10-C16)	ND	10	ug/g						
F3 PHCs (C16-C34)	ND	10	ug/g						
F4 PHCs (C34-C50)	ND	10	ug/g						
Volatiles									
Benzene	ND	0.03	ug/g						
Ethylbenzene	ND	0.05	ug/g						
Toluene	ND	0.05	ug/g						
m,p-Xylenes	ND	0.05	ug/g						
o-Xylene	ND	0.05	ug/g						
Surrogate: Toluene-d8	8.17		ug/g		102	76-118			

Certificate of Analysis

Report Date: 24-Nov-2009

Order Date: 19-Nov-2009

Client: **Paterson Group Consulting Engineers**

Client PO: 8269

Project Description: PE1831

Method Quality Control: Duplicate

Analyte	Result	Reporting Limit	Units	Source Result	%REC	%REC Limit	RPD	RPD Limit	Notes
Hydrocarbons									
F1 PHCs (C6-C10)	ND	10	ug/g dry	ND				32	
F2 PHCs (C10-C16)	40	10	ug/g dry	33			17.3	50	
F3 PHCs (C16-C34)	57	10	ug/g dry	57			0.3	50	
F4 PHCs (C34-C50)	ND	10	ug/g dry	ND				50	
Physical Characteristics									
% Solids	10.6	0.1	% by Wt.	9.8			7.8	25	
Volatiles									
Benzene	ND	0.03	ug/g dry	ND				50	
Ethylbenzene	ND	0.05	ug/g dry	ND				34	
Toluene	ND	0.05	ug/g dry	ND				32	
m,p-Xylenes	ND	0.05	ug/g dry	ND				35	
o-Xylene	ND	0.05	ug/g dry	ND				50	
Surrogate: Toluene-d8	9.67		ug/g dry	ND	103	76-118			

Certificate of Analysis

Report Date: 24-Nov-2009

Client: **Paterson Group Consulting Engineers**

Order Date: 19-Nov-2009

Client PO: 8269

Project Description: PE1831

Method Quality Control: Spike

Analyte	Result	Reporting Limit	Units	Source Result	%REC	%REC Limit	RPD	RPD Limit	Notes
Hydrocarbons									
F1 PHCs (C6-C10)	100	10	ug/g	ND	99.6	80-120			
F2 PHCs (C10-C16)	53	10	ug/g	ND	66.5	61-129			
F3 PHCs (C16-C34)	179	10	ug/g	ND	89.5	61-129			
F4 PHCs (C34-C50)	99	10	ug/g	ND	82.2	61-129			
Volatiles									
Benzene	0.729	0.03	ug/g	ND	78.0	55-141			
Ethylbenzene	2.25	0.05	ug/g	ND	101	61-139			
Toluene	7.78	0.05	ug/g	ND	72.0	54-136			
m,p-Xylenes	7.49	0.05	ug/g	ND	111	61-139			
o-Xylene	3.02	0.05	ug/g	ND	112	60-142			
Surrogate: Toluene-d8	8.11		ug/g		101	76-118			

Certificate of Analysis

Report Date: 24-Nov-2009

Order Date: 19-Nov-2009

Client: **Paterson Group Consulting Engineers**

Client PO: 8269

Project Description: PE1831

Sample Data Revisions

None

Work Order Revisions/Comments:

None

Other Report Notes:

n/a: not applicable

MDL: Method Detection Limit

Source Result: Data used as source for matrix and duplicate samples

%REC: Percent recovery.

RPD: Relative percent difference.

Soil results are reported on a dry weight basis when the units are denoted with 'dry'.

Where %Solids is reported, moisture loss includes the loss of volatile hydrocarbons.

CCME PHC additional information:

- The method for the analysis of PHCs complies with the Reference Method for the CWS PHC and is validated for use in the laboratory. All prescribed quality criteria identified in the method has been met.
- F1 range corrected for BTEX.
- F2 to F3 ranges corrected for appropriate PAHs where available.
- The gravimetric heavy hydrocarbons (F4G) are not to be added to C6 to C50 hydrocarbons.
- In the case where F4 and F4G are both reported, the greater of the two results is to be used for comparison to CWS PHC criteria.



TRUSTED.
RESPONSIVE.
RELIABLE.

OTTAWA • NIAGARA FALLS • MISSISSAUGA • SARNIA

300-2319 St. Laurent Blvd
Ottawa, Ontario K1G 4J8
p: 1-800-749-1947
e: paracel@paracellabs.com
www.paracellabs.com

Chain of Custody Record

No. 60527

Pg. ___ of ___

Company Name: <u>PATERSON Group</u>	Project Ref: <u>PE1831</u>	Date Received: _____
Contact Name: <u>ERIC LEVEQUE</u>	PO#: <u>8269</u>	Turn Around Time: <input type="checkbox"/> 1-3 Days <input type="checkbox"/> 3-5 Days <input checked="" type="checkbox"/> Regular
Address: <u>28 CONCOURSE GATE UNIT 1</u>	Quote #: _____ <input type="checkbox"/> Not Quoted	Regulator: <input type="checkbox"/> Gas Detector <input type="checkbox"/> Recirculating
Tel: <u>226-7381</u> Cell: _____	Preservative to be added by Paracel? <input type="checkbox"/> Yes <input type="checkbox"/> No	<u>TABLE 3</u>
Email: <u>e.levaque@paterasongroup.ca</u>		

Matrix Types: S-Soil/Sed GW-Ground Water SW-Surface Water SS-Storm/Sanitary Sewer A-Air O-Other RDW-Regulated Drinking Water

Sample Information				Analysis Required														
Parcel Order #	Matrix	Air Volume	# Containers	Date Sampled (dd/mm/yy)	BT/EX	PHC	SCA	PAH	PCB	DDT	PCP	PCB	PCP	PCB	PCP	PCB	PCP	Hazardous: (Y/N)
<u>011712</u>																		
1	<u>BH7-SSS</u>	<u>S</u>	<u>1</u>	<u>Nov 18/09</u>	<input checked="" type="checkbox"/>	<input checked="" type="checkbox"/>												
2																		
3																		
4																		
5																		
6																		
7																		
8																		
9																		
10																		

Comments: _____

John

Prepared by: <u>g</u>	Reviewed by: <u>g</u>	Date: <u>Nov 19/09</u>	Date: <u>Nov 19/09</u>
-----------------------	-----------------------	------------------------	------------------------

Please refer to the back page for Locations and Sample Preservation, Container and Hold Time Requirements. WHITE - Lab Copy, PINK - Client Copy

Certificate of Analysis

Paterson Group Consulting Engineers

28 Concourse Gate, Unit 1
Nepean, ON K2E 7T7

Attn: Eric Leveque

Client PO: 8448

Project: PE1831

Custody: 60525

Phone: (613) 226-7381

Fax: (613) 226-6344

Report Date: 7-Dec-2009

Order Date: 30-Nov-2009

Order #: 0949025

This Certificate of Analysis contains analytical data applicable to the following samples as submitted:

Parcel ID	Client ID
0949025-01	BH2-WS2
0949025-02	BH6-WS1
0949025-03	BH12-WS1

Approved By:



Mark Foto, M.Sc. For Dale Robertson, BSc
Laboratory Director

Any use of these results implies your agreement that our total liability in connection with this work, however arising shall be limited to the amount paid by you for this work, and that our employees or agents shall not under circumstances be liable to you in connection with this work

Certificate of Analysis

Report Date: 07-Dec-2009
Order Date: 30-Nov-2009

Client: **Paterson Group Consulting Engineers**

Client PO: 8448

Project Description: PE1831

Analysis Summary Table

Analysis	Method Reference/Description	Extraction Date	Analysis Date
BTEX	EPA 624 - P&T GC-MS	2-Dec-09	5-Dec-09
CCME PHC F1	CWS Tier 1 - P&T GC-FID	2-Dec-09	5-Dec-09
CCME PHC F2 - F4	CWS Tier 1 - GC-FID, extraction	30-Nov-09	30-Nov-09

Certificate of Analysis

Report Date: 07-Dec-2009

Order Date: 30-Nov-2009

Client: **Paterson Group Consulting Engineers**

Client PO: 8448

Project Description: PE1831

Client ID:	BH2-WS2	BH6-WS1	BH12-WS1	-
Sample Date:	30-Nov-09	30-Nov-09	30-Nov-09	-
Sample ID:	0949025-01	0949025-02	0949025-03	-
MDL/Units	Water	Water	Water	-

Volatiles

Benzene	0.5 ug/L	266	3920	40200	-
Ethylbenzene	0.5 ug/L	958	2200	19700	-
Toluene	0.5 ug/L	347	272	97200	-
m,p-Xylenes	0.5 ug/L	3050	7190	67800	-
o-Xylene	0.5 ug/L	320	2110	32500	-
Toluene-d8	Surrogate	110%	111%	114%	-

Hydrocarbons

F1 PHCs (C6-C10)	200 ug/L	10000	19000	145000	-
F2 PHCs (C10-C16)	100 ug/L	<100	30600	459	-
F3 PHCs (C16-C34)	100 ug/L	<100	363000	<100	-
F4 PHCs (C34-C50)	100 ug/L	<100	97200	<100	-

Certificate of Analysis

Report Date: 07-Dec-2009
Order Date: 30-Nov-2009

Client: **Paterson Group Consulting Engineers**

Client PO: 8448

Project Description: PE1831

Method Quality Control: Blank

Analyte	Result	Reporting Limit	Units	Source Result	%REC	%REC Limit	RPD	RPD Limit	Notes
Hydrocarbons									
F1 PHCs (C6-C10)	ND	200	ug/L						
F2 PHCs (C10-C16)	ND	100	ug/L						
F3 PHCs (C16-C34)	ND	100	ug/L						
F4 PHCs (C34-C50)	ND	100	ug/L						
Volatiles									
Benzene	ND	0.5	ug/L						
Ethylbenzene	ND	0.5	ug/L						
Toluene	ND	0.5	ug/L						
m,p-Xylenes	ND	0.5	ug/L						
o-Xylene	ND	0.5	ug/L						
Surrogate: Toluene-d8	75.2		ug/L		94.1	76-118			

Certificate of Analysis

Report Date: 07-Dec-2009
Order Date: 30-Nov-2009

Client: **Paterson Group Consulting Engineers**

Client PO: 8448

Project Description: PE1831

Method Quality Control: Duplicate

Analyte	Result	Reporting Limit	Units	Source Result	%REC	%REC Limit	RPD	RPD Limit	Notes
Hydrocarbons									
F1 PHCs (C6-C10)	ND	200	ug/L	ND				32	
Volatiles									
Benzene	ND	0.5	ug/L	ND				20	
Ethylbenzene	ND	0.5	ug/L	ND				35	
Toluene	ND	0.5	ug/L	ND				30	
m,p-Xylenes	ND	0.5	ug/L	ND				34	
o-Xylene	ND	0.5	ug/L	ND				32	
Surrogate: Toluene-d8	75.8		ug/L	ND	94.8	76-118			

Certificate of Analysis

Report Date: 07-Dec-2009

Order Date: 30-Nov-2009

Client: **Paterson Group Consulting Engineers**

Client PO: 8448

Project Description: PE1831

Method Quality Control: Spike

Analyte	Result	Reporting Limit	Units	Source Result	%REC	%REC Limit	RPD	RPD Limit	Notes
Hydrocarbons									
F1 PHCs (C6-C10)	1800	200	ug/L	ND	90.0	68-117			
F2 PHCs (C10-C16)	1000	100	ug/L	ND	62.5	61-129			
F3 PHCs (C16-C34)	2840	100	ug/L	ND	71.0	61-129			
F4 PHCs (C34-C50)	1840	100	ug/L	ND	76.7	61-129			
Volatiles									
Benzene	33.3	0.5	ug/L	ND	83.2	55-141			
Ethylbenzene	41.6	0.5	ug/L	ND	104	61-139			
Toluene	34.8	0.5	ug/L	ND	86.9	54-136			
m,p-Xylenes	83.0	0.5	ug/L	ND	104	61-139			
o-Xylene	41.2	0.5	ug/L	ND	103	60-142			
Surrogate: Toluene-d8	80.6		ug/L		101	76-118			

Certificate of Analysis

Report Date: 07-Dec-2009

Order Date: 30-Nov-2009

Client: **Paterson Group Consulting Engineers**

Client PO: 8448

Project Description: PE1831

Sample Data Revisions

None

Work Order Revisions/Comments:

None

Other Report Notes:

n/a: not applicable

MDL: Method Detection Limit

Source Result: Data used as source for matrix and duplicate samples

%REC: Percent recovery.

RPD: Relative percent difference.

CCME PHC additional information:

- The method for the analysis of PHCs complies with the Reference Method for the CWS PHC and is validated for use in the laboratory. All prescribed quality criteria identified in the method has been met.
- F1 range corrected for BTEX.
- F2 to F3 ranges corrected for appropriate PAHs where available.
- The gravimetric heavy hydrocarbons (F4G) are not to be added to C6 to C50 hydrocarbons.
- In the case where F4 and F4G are both reported, the greater of the two results is to be used for comparison to CWS PHC criteria.

Company Name: PETERSON GROUP Project Ref: PE1831
 Contact Name: ERIC LEVEQUE PO# 8448
 Address: 28 CONCORSE GATE UNIT Quote # _____ Not Quoted
 Tel: 613-226-7781 / Cell: _____ Preservative to be added by Paracel? Yes No
 Email: eLeveque@petersongroup.ca

Date Required: _____
 Turn Around Time: 3-day | 12-day | Regular
 Regulatory/Guideline Requirements:
MOE TABLE III

Matrix Types: S-Soil/Sed GW-Ground Water SW-Surface Water SS-Storm/Sanitary Sewer A-Air O-Other RDW-Regulated Drinking Water

Sample Information				Analysis Required																			
Paracel Order #	Matrix	Air Volume	# Containers	Date Sampled dd/mm/yy	Hazardous? (Y/N)																		
0949025																							
1	BH2 - WS2	GW	3	3/11/09	X	X																	
2	BH6 - WS1	GW	3	3/11/09	X	X																	
3	BH2 - WS1	GW	3	3/11/09	X	X																	
4																							
5																							
6																							
7																							
8																							
9																							
10																							

Comments: Reg. Turn Around Time.
J. Kagan

Relinquished By: <u>[Signature]</u> Date: <u>10:00 AM</u> Time: <u>Nov 30/09</u>	Received at Depot Date: <u>Nov. 30/09</u> Time: <u>1:00</u>	Received at Lab <u>[Signature]</u> Date: <u>Nov 30/09</u> Time: <u>13:40</u>	Verified By: <u>[Signature]</u> Date: <u>Nov 30/09</u> Time: <u>13:53</u>
---	--	---	--

Certificate of Analysis

Paterson Group Consulting Engineers

154 Colonnade Road South
Nepean, ON K2E 7J5
Attn: Dan Arnott

Phone: (613) 226-7381
Fax: (613) 226-6344

Client PO: 14300
Project: PE3003
Custody: 97667

Report Date: 22-May-2013
Order Date: 15-May-2013

Order #: 1320166

This Certificate of Analysis contains analytical data applicable to the following samples as submitted:

Parcel ID	Client ID
1320166-01	BH1-SS4
1320166-02	BH3-SS3
1320166-03	BH4-SS4

Approved By:



Mark Foto, M.Sc. For Dale Robertson, BSc
Laboratory Director

Certificate of Analysis

Report Date: 22-May-2013

Client: **Paterson Group Consulting Engineers**

Order Date: 15-May-2013

Client PO: 14300

Project Description: PE3003

Analysis Summary Table

Analysis	Method Reference/Description	Extraction Date	Analysis Date
BTEX by P&T GC-MS	EPA 8260 - P&T GC-MS	17-May-13	20-May-13
PHC F1	CWS Tier 1 - P&T GC-FID	17-May-13	20-May-13
PHC F2 - F4	CWS Tier 1 - GC-FID, extraction	21-May-13	21-May-13
Solids, %	Gravimetric, calculation	22-May-13	22-May-13

P: 1-800-749-1947
E: PARACEL@PARACELLABS.COM

WWW.PARACELLABS.COM

OTTAWA
300-2319 St. Laurent Blvd.
Ottawa, ON K1G 4J8

MISSISSAUGA
6845 Kitimat Rd. Unit #27
Mississauga, ON L5N 6J3

NIAGARA FALLS
5415 Morning Glory Cr.
Niagara Falls, ON L2J 0A3

SARNIA
123 Christina St. N.
Sarnia, ON N7T 5T7

Certificate of Analysis

Report Date: 22-May-2013

Order Date: 15-May-2013

Client: Paterson Group Consulting Engineers

Client PO: 14300

Project Description: PE3003

Client ID:	BH1-SS4	BH3-SS3	BH4-SS4	-
Sample Date:	13-May-13	13-May-13	13-May-13	-
Sample ID:	1320166-01	1320166-02	1320166-03	-
MDL/Units	Soil	Soil	Soil	-

Physical Characteristics

% Solids	0.1 % by Wt.	87.4	92.4	91.1	-
----------	--------------	------	------	------	---

Volatiles

Benzene	0.02 ug/g dry	<0.02	<0.02	<0.02	-
Ethylbenzene	0.05 ug/g dry	<0.05	0.25	<0.05	-
Toluene	0.05 ug/g dry	<0.05	<0.05	<0.05	-
m,p-Xylenes	0.05 ug/g dry	<0.05	0.41	<0.05	-
o-Xylene	0.05 ug/g dry	<0.05	<0.05	<0.05	-
Xylenes, total	0.05 ug/g dry	<0.05	0.41	<0.05	-
Toluene-d8	Surrogate	110%	112%	111%	-

Hydrocarbons

F1 PHCs (C6-C10)	7 ug/g dry	<7	14	<7	-
F2 PHCs (C10-C16)	4 ug/g dry	<4	35	<4	-
F3 PHCs (C16-C34)	8 ug/g dry	39	<8	108	-
F4 PHCs (C34-C50)	6 ug/g dry	50	<6	398	-

Certificate of Analysis

Report Date: 22-May-2013
Order Date: 15-May-2013

Client: **Paterson Group Consulting Engineers**
Client PO: 14300

Project Description: PE3003

Method Quality Control: Blank

Analyte	Result	Reporting Limit	Units	Source Result	%REC	%REC Limit	RPD	RPD Limit	Notes
Hydrocarbons									
F1 PHCs (C6-C10)	ND	7	ug/g						
F2 PHCs (C10-C16)	ND	4	ug/g						
F3 PHCs (C16-C34)	ND	8	ug/g						
F4 PHCs (C34-C50)	ND	6	ug/g						
Volatiles									
Benzene	ND	0.02	ug/g						
Ethylbenzene	ND	0.05	ug/g						
Toluene	ND	0.05	ug/g						
m,p-Xylenes	ND	0.05	ug/g						
o-Xylene	ND	0.05	ug/g						
Xylenes, total	ND	0.05	ug/g						
Surrogate: Toluene-d8	8.46		ug/g		106	50-140			

Certificate of Analysis

Report Date: 22-May-2013

Client: Paterson Group Consulting Engineers

Order Date: 15-May-2013

Client PO: 14300

Project Description: PE3003

Method Quality Control: Duplicate

Analyte	Result	Reporting Limit	Units	Source Result	%REC	%REC Limit	RPD	RPD Limit	Notes
Hydrocarbons									
F1 PHCs (C6-C10)	ND	7	ug/g dry	ND				40	
F2 PHCs (C10-C16)	27	4	ug/g dry	27			0.0	30	
F3 PHCs (C16-C34)	114	8	ug/g dry	127			11.1	30	
F4 PHCs (C34-C50)	74	6	ug/g dry	74			0.0	30	
Physical Characteristics									
% Solids	85.3	0.1	% by Wt.	86.0			0.9	25	
Volatiles									
Benzene	ND	0.02	ug/g dry	ND				50	
Ethylbenzene	ND	0.05	ug/g dry	ND				50	
Toluene	ND	0.05	ug/g dry	ND				50	
m,p-Xylenes	ND	0.05	ug/g dry	ND				50	
o-Xylene	ND	0.05	ug/g dry	ND				50	
Surrogate: Toluene-d8	10.5		ug/g dry	ND	111	50-140			

Certificate of Analysis

Report Date: 22-May-2013
Order Date: 15-May-2013

Client: **Paterson Group Consulting Engineers**
Client PO: 14300

Project Description: PE3003

Method Quality Control: Spike

Analyte	Result	Reporting Limit	Units	Source Result	%REC	%REC Limit	RPD	RPD Limit	Notes
Hydrocarbons									
F1 PHCs (C6-C10)	196	7	ug/g	ND	98.2	80-120			
F2 PHCs (C10-C16)	85	4	ug/g	27	57.8	60-140			QM-06
F3 PHCs (C16-C34)	254	8	ug/g	127	61.3	60-140			
F4 PHCs (C34-C50)	169	6	ug/g	74	69.4	60-140			
Volatiles									
Benzene	3.61	0.02	ug/g	ND	90.3	60-130			
Ethylbenzene	3.94	0.05	ug/g	ND	98.4	60-130			
Toluene	3.74	0.05	ug/g	ND	93.5	60-130			
m,p-Xylenes	7.47	0.05	ug/g	ND	93.4	60-130			
o-Xylene	3.71	0.05	ug/g	ND	92.8	60-130			
Surrogate: Toluene-d8	6.53		ug/g		81.7	50-140			

Certificate of Analysis

Report Date: 22-May-2013

Client: Paterson Group Consulting Engineers

Order Date: 15-May-2013

Client PO: 14300

Project Description: PE3003

Qualifier Notes:

QC Qualifiers :

QM-06 : Due to noted non-homogeneity of the QC sample matrix, the spike recoveries were out side the accepted range. Batch data accepted based on other QC.

QS-02 : Spike level outside of control limits. Analysis batch accepted based on other QC included in the batch.

Sample Data Revisions

None

Work Order Revisions / Comments:

None

Other Report Notes:

n/a: not applicable
ND: Not Detected
MDL: Method Detection Limit
Source Result: Data used as source for matrix and duplicate samples
%REC: Percent recovery.
RPD: Relative percent difference.

Soil results are reported on a dry weight basis when the units are denoted with 'dry'.
Where %Solids is reported, moisture loss includes the loss of volatile hydrocarbons.

CCME PHC additional information:

- The method for the analysis of PHCs complies with the Reference Method for the CWS PHC and is validated for use in the laboratory. All prescribed quality criteria identified in the method has been met.
- F1 range corrected for BTEX.
- F2 to F3 ranges corrected for appropriate PAHs where available.
- The gravimetric heavy hydrocarbons (F4G) are not to be added to C6 to C50 hydrocarbons.
- In the case where F4 and F4G are both reported, the greater of the two results is to be used for comparison to CWS PHC criteria.



TRUSTED .
RESPONSIVE .
RELIABLE .

Head Office
300-2319 St. Laurent Blvd.
Ottawa, Ontario K1G 4J8
p: 1-800-749-1947
e: paracel@paracellabs.com
www.paracellabs.com

Chain of Custody
(Lab Use Only)
Nº 97667

OTTAWA • KINGSTON • NIAGARA • MISSISSAUGA • SARNIA

Client Name: <u>Paterson Group Inc.</u>	Project Reference: <u>PE 3003</u>	TAT: <input checked="" type="checkbox"/> Regular 13 Day
Contact Name: <u>Dan Arnott</u>	Quote #	12 Day 11 Day
Address: <u>54 Colonnade Rd K2E 7J5 Ottawa, ON K2E 7J5</u>	PO # <u>14300</u>	Date Required: _____
Telephone: <u>613. 226. 7391</u>	Email Address: <u>darnott@patersongroup.ca</u>	

Criteria: | | O. Reg. 153/04 Table | O. Reg. 153/11 (Current) Table 3 | | RSC Filing | | O. Reg. 558/00 | | PWQO | | CCME | | SUB (Storm) | | SUB (Sanitary) Municipality: _____ | | Other: _____

Matrix Type: S (Soil/Sed.) GW (Ground Water) SW (Surface Water) SS (Storm/Sanitary Sewer) P (Paint) A (Air) O (Other) **Required Analyses**

Parcel Order Number: <u>1320166</u>		Matrix	Air Volume	# of Containers	Sample Taken		PHCs F1-F4+BTEX	VOCs	PAHs	Metals by ICP/MS	Hg	CrVI	B (HWS)							
Sample ID/Location Name					Date	Time														
1	<u>BH1-SS4</u>	<u>S</u>		<u>2</u>	<u>13-May-13</u>		<input checked="" type="checkbox"/>													<u>- 120mL + 1ml -</u>
2	<u>BH3-SS3</u>	<u>S</u>		<u>2</u>	<u>↓</u>		<input checked="" type="checkbox"/>													<u>↓</u>
3	<u>BH4-SS4</u>	<u>S</u>		<u>2</u>	<u>↓</u>		<input checked="" type="checkbox"/>													
4																				
5																				
6																				
7																				
8																				
9																				
10																				

Comments: _____ Method of Delivery: Pick up

Relinquished By (Print & Sign): <u>DAN ARNOTT</u>	Received by Driver/Depot: <u>A. D'AMICO</u>	Received at Lab: <u>SUMMERS</u>	Verified By: <u>MLC</u>
Date/Time: <u>15/05/13 12:27 PM</u>	Temperature: _____ °C	Date/Time: <u>MAY 15 2013 03:00</u>	Temperature: <u>14.5 °C</u>
Date/Time: <u>14-May-13 5:00pm</u>		Date/Time: <u>May 15/13 4:29</u>	pH Verified By: <u>N/A</u>

Certificate of Analysis

Paterson Group Consulting Engineers

154 Colonnade Road South
Nepean, ON K2E 7J5
Attn: Dan Arnott

Phone: (613) 226-7381
Fax: (613) 226-6344

Client PO: 14425
Project: PE3003
Custody: 97676

Report Date: 28-May-2013
Order Date: 22-May-2013

Order #: 1321073

This Certificate of Analysis contains analytical data applicable to the following samples as submitted:

Paracel ID	Client ID
1321073-01	BH1-13-GW1
1321073-02	BH3-13-GW1
1321073-03	DUPLICATE 1

Approved By:



Mark Foto, M.Sc. For Dale Robertson, BSc
Laboratory Director

Certificate of Analysis

Report Date: 28-May-2013

Client: **Paterson Group Consulting Engineers**

Order Date: 22-May-2013

Client PO: 14425

Project Description: PE3003

Analysis Summary Table

Analysis	Method Reference/Description	Extraction Date	Analysis Date
BTEX by P&T GC-MS	EPA 624 - P&T GC-MS	23-May-13	24-May-13
PHC F1	CWS Tier 1 - P&T GC-FID	23-May-13	24-May-13
PHC F2 - F4	CWS Tier 1 - GC-FID, extraction	24-May-13	25-May-13

P: 1-800-749-1947
E: PARACEL@PARACELLABS.COM

WWW.PARACELLABS.COM

OTTAWA
300-2319 St. Laurent Blvd.
Ottawa, ON K1G 4J8

MISSISSAUGA
6845 Kitimat Rd. Unit #27
Mississauga, ON L5N 6J3

NIAGARA FALLS
5415 Morning Glory Cr.
Niagara Falls, ON L2J 0A3

SARNIA
123 Christina St. N.
Sarnia, ON N7T 5T7

Certificate of Analysis

Report Date: 28-May-2013

Order Date: 22-May-2013

Client: Paterson Group Consulting Engineers

Client PO: 14425

Project Description: PE3003

	Client ID:	BH1-13-GW1	BH3-13-GW1	DUPLICATE 1	-
	Sample Date:	21-May-13	21-May-13	21-May-13	-
	Sample ID:	1321073-01	1321073-02	1321073-03	-
	MDL/Units	Water	Water	Water	-

Volatiles

Benzene	0.5 ug/L	<0.5	96.0	92.8	-
Ethylbenzene	0.5 ug/L	<0.5	585	589	-
Toluene	0.5 ug/L	<0.5	7.7	8.1	-
m,p-Xylenes	0.5 ug/L	<0.5	203	208	-
o-Xylene	0.5 ug/L	<0.5	8.1	7.3	-
Xylenes, total	0.5 ug/L	<0.5	211	216	-
Toluene-d8	Surrogate	118%	111%	111%	-

Hydrocarbons

F1 PHCs (C6-C10)	25 ug/L	312	1480	1400	-
F2 PHCs (C10-C16)	100 ug/L	<100	<100	<100	-
F3 PHCs (C16-C34)	100 ug/L	<100	<100	<100	-
F4 PHCs (C34-C50)	100 ug/L	<100	<100	<100	-
F1 + F2 PHCs	125 ug/L	312	-	-	-
F1 + F2 PHCs	350 ug/L	-	1480	1400	-
F3 + F4 PHCs	200 ug/L	<200	<200	<200	-

Certificate of Analysis

Report Date: 28-May-2013
Order Date: 22-May-2013

Client: **Paterson Group Consulting Engineers**
Client PO: 14425

Project Description: PE3003

Method Quality Control: Blank

Analyte	Result	Reporting Limit	Units	Source Result	%REC	%REC Limit	RPD	RPD Limit	Notes
Hydrocarbons									
F1 PHCs (C6-C10)	ND	25	ug/L						
F2 PHCs (C10-C16)	ND	100	ug/L						
F3 PHCs (C16-C34)	ND	100	ug/L						
F4 PHCs (C34-C50)	ND	100	ug/L						
Volatiles									
Benzene	ND	0.5	ug/L						
Ethylbenzene	ND	0.5	ug/L						
Toluene	ND	0.5	ug/L						
m,p-Xylenes	ND	0.5	ug/L						
o-Xylene	ND	0.5	ug/L						
Xylenes, total	ND	0.5	ug/L						
Surrogate: Toluene-d8	95.3		ug/L		119	50-140			

Certificate of Analysis

Report Date: 28-May-2013
Order Date: 22-May-2013

Client: **Paterson Group Consulting Engineers**
Client PO: 14425

Project Description: PE3003

Method Quality Control: Duplicate

Analyte	Result	Reporting Limit	Units	Source Result	%REC	%REC Limit	RPD	RPD Limit	Notes
Hydrocarbons									
F1 PHCs (C6-C10)	ND	25	ug/L	ND				30	
Volatiles									
Benzene	ND	0.5	ug/L	ND				30	
Ethylbenzene	ND	0.5	ug/L	ND				30	
Toluene	ND	0.5	ug/L	ND				30	
m,p-Xylenes	ND	0.5	ug/L	ND				30	
o-Xylene	ND	0.5	ug/L	ND				30	
Surrogate: Toluene-d8	85.4		ug/L	ND	107	50-140			

Certificate of Analysis

Report Date: 28-May-2013
Order Date: 22-May-2013

Client: **Paterson Group Consulting Engineers**
Client PO: 14425

Project Description: PE3003

Method Quality Control: Spike

Analyte	Result	Reporting Limit	Units	Source Result	%REC	%REC Limit	RPD	RPD Limit	Notes
Hydrocarbons									
F1 PHCs (C6-C10)	1880	25	ug/L	ND	94.2	68-117			
F2 PHCs (C10-C16)	1560	100	ug/L	ND	86.6	60-140			
F3 PHCs (C16-C34)	3440	100	ug/L	ND	92.5	60-140			
F4 PHCs (C34-C50)	2220	100	ug/L	ND	89.6	60-140			
Volatiles									
Benzene	48.6	0.5	ug/L	ND	122	60-130			
Ethylbenzene	39.2	0.5	ug/L	ND	98.1	60-130			
Toluene	31.3	0.5	ug/L	ND	78.2	60-130			
m,p-Xylenes	81.7	0.5	ug/L	ND	102	60-130			
o-Xylene	29.6	0.5	ug/L	ND	74.1	60-130			
Surrogate: Toluene-d8	72.7		ug/L		90.8	50-140			

Certificate of Analysis

Client: **Paterson Group Consulting Engineers**
Client PO: 14425

Project Description: PE3003

Report Date: 28-May-2013
Order Date: 22-May-2013

Qualifier Notes:

None

Sample Data Revisions

None

Work Order Revisions / Comments:

None

Other Report Notes:

n/a: not applicable
ND: Not Detected
MDL: Method Detection Limit
Source Result: Data used as source for matrix and duplicate samples
%REC: Percent recovery.
RPD: Relative percent difference.

CCME PHC additional information:

- The method for the analysis of PHCs complies with the Reference Method for the CWS PHC and is validated for use in the laboratory. All prescribed quality criteria identified in the method has been met.
- F1 range corrected for BTEX.
- F2 to F3 ranges corrected for appropriate PAHs where available.
- The gravimetric heavy hydrocarbons (F4G) are not to be added to C6 to C50 hydrocarbons.
- In the case where F4 and F4G are both reported, the greater of the two results is to be used for comparison to CWS PHC criteria.

OTTAWA • KINGSTON • NIAGARA • MISSISSAUGA • SARNIA

Client Name: <u>PATERSON GROUP INC.</u>	Project Reference: <u>PE3003</u>	TAT: <input checked="" type="checkbox"/> Regular 13 Day <input type="checkbox"/> 12 Day 11 Day Date Required: _____
Contact Name: <u>DAN ARNOTT</u>	Quote #	
Address: <u>154 COLONNADE ROAD SOUTH</u>	PO # <u>14425</u>	
Telephone: <u>(613)226-7381</u>	Email Address: <u>DARNOTT@PATERSONGROUP.CA</u>	

Criteria: | O. Reg. 153/04 Table | O. Reg. 153/11 (Current) Table 3 | RSC Filing | O. Reg. 558/00 | PWQO | CCME | SUB (Storm) | SUB (Sanitary) Municipality: _____ | Other: _____

Matrix Type: S (Soil/Sed.) GW (Ground Water) SW (Surface Water) SS (Storm/Sanitary Sewer) P (Paint) A (Air) O (Other) Required Analyses

Parcel Order Number: <u>1321073</u>		Matrix	Air Volume	# of Containers	Sample Taken		PHCs FI-F4+BTEX	VOCs	PAHs	Metals by IC/P/MS	Hg	CrVI	B (HWS)	
Sample ID/Location Name	Date				Time									
1	BH1-13-GW1	GW		3	May 21, 2013	~10am	X							
2	BH3-13-GW1	↓		↓	"	~1030am	X							
3	DUPLICATE 1	↓		↓	"	~1030am	X							
4														
5														
6														
7														
8														
9														
10														

Comments: _____ Method of Delivery: Pick up

Relinquished By (Print & Sign): <u>DAN ARNOTT</u> <i>D. Arnot</i>	Received by Driver/Depot: <u>M. F. COUSE</u>	Received at Lab: <u>SUNEER PORN</u>	Verified By: <u>MJC</u>
Date/Time: <u>22/05/13 9:48AM</u>	Temperature: _____ °C	Date/Time: <u>MAY 22, 2013 11:21</u>	Date/Time: <u>May 22/13 12:41</u>
Date/Time: <u>22 May-13 9:48am</u>	Temperature: _____ °C	Temperature: <u>14.7 °C</u>	pH Verified By: <u>N/A</u>