



1981 MAPLE GROVE ROAD

TRANSPORTATION IMPACT ASSESSMENT (TIA) REPORT



Prepared for Claridge Homes
by IBI Group

February 2018



IBI GROUP
400-333 Preston Street
Ottawa ON K1S 5N4 Canada
tel 613 225 1311 fax 613 225 9868
ibigroup.com

February 23, 2018

Ms. Rosanna Baggs, CET
Project Manager
Infrastructure Approvals, Development Review
City of Ottawa
110 Laurier Avenue West
Ottawa, ON
K1P 1J1

Dear Ms. Baggs:

**RE: CLARIDGE HOMES – 1981 MAPLE GROVE ROAD
TIA STEP 4 SUBMISSION**

The enclosed submission for 1981 Maple Grove Road in the City of Ottawa includes six (6) hardcopies of the Transportation Impact Assessment (TIA), as well as a USB stick containing an electronic copy of the TIA report, appendices and the Synchro files. The following TIA represents Steps 1 – 4, as defined in the City TIA Guidelines. The report has address/ incorporated the required technical comments received over the course of the submission process. We have also enclosed these comments with for your reference.

If you have any questions regarding the contents of this submission, please do not hesitate to contact the undersigned at 613-225-1311 ext. 564.

Sincerely,

Austin Shih, M.A.Sc, P.Eng.
Project Engineer

Ben Pascolo-Neveu

From: Baggs, Rosanna <Rosanna.Baggs@ottawa.ca>
Sent: Friday, January 19, 2018 10:30 AM
To: Ben Pascolo-Neveu
Cc: Austin Shih
Subject: RE: 1981 Maple Grove Road TIA (Claridge)

Hi Ben,

It was a pleasure to meet you to. I'm glad that you found the meeting useful.

Please see the following comments for your submission of Steps 1 and 2 for 1981 Maple Grove Road TIA (Claridge):

- 1) Section 2.2.3 – Note any restrictions at any of the accesses (e.g., full movements, right-in/right-out, turning restrictions, etc.)
- 2) Section 2.3 – Include existing driveways to adjacent developments (both sides of all roads bordering the site) within 200 m of proposed site driveway, indicating the land use associated with the driveway.
- 3) Section 2.3.4 – make note of how close the nearest bus stops are to the development and how many unites would be within 400m of these stops.
- 4) Exhibit 5 – the two stops that are at Maple Grove and the northern intersection of Johnwoods are no longer there due to the closures. I know this is pulled from OC Website but is not reflective of what is there now.
- 5) Section 2.8 – Please layout in a table format for easy reference and include module number and a short rational as to why it is exempted.

If the above is incorporated into to report please proceed with step 3 – forecasting.

Things to keep in mind for this Traffic Impact Assessment:

- There may be a chance that this development is completed prior to the construction of the Kanata West Main Street (E-W) extension on the north boundary of the property, especially if you are relying on 195 Huntmar Development to construct it. What does this do to traffic?
- I have concerns with the number of roads (streets 1, 2 and 4) connecting to the Kanata West Main Street (N-S) extension on the west side of the property; the KWMS is intended to be a major collector. What kind of lane configurations will be needed? Traffic and pedestrian control requirement? Spacing? How will bus stops affect the operation if they are installed on this stretch?
- Internal traffic calming and controls will need to be reviewed to ensure street 6 (or others) doesn't become a cut through to get around the Maple Grove and KWMS intersection.
- Pedestrian movements through the site to get to the park will be important to keep in mind.

Please let me know if you have any questions or concerns.

Regards,

Rosanna Baggs, C.E.T.

Project Manager, Infrastructure Approvals | GPRJ Approbation demandes infrastructure
Development Review West Branch | Dir Services d'examen des dem d'amgt
Tel | Tél. : 613-580- 2424 ext. | poste 26388

From: Ben Pascolo-Neveu [mailto:Ben.Pascolo-Neveu@ibigroup.com]
Sent: Monday, January 15, 2018 3:15 PM
To: Baggs, Rosanna <Rosanna.Baggs@ottawa.ca>
Cc: Austin Shih <austin.shih@IBIGroup.com>
Subject: 1981 Maple Grove Road TIA (Claridge)

Hi Rosanna,

Please find attached a draft version of the Screening and Scoping for the subject site at 1981 Maple Grove Road (Claridge) for your review.

It was nice meeting last Wednesday at the Public Open House for 195 Huntmar Drive. I have incorporated the key points that we talked about into the Scoping document.

Regards,
Ben

Ben Pascolo-Neveu, EIT

IBI GROUP
Suite 400, 333 Preston Street
Ottawa ON K1S 5N4 Canada
tel +1 613 225 1311 ext 520 fax +1 613 225 9868

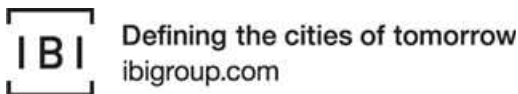

NOTE: This email message/attachments may contain privileged and confidential information. If received in error, please notify the sender and delete this e-mail message.
NOTE: Ce courriel peut contenir de l'information privilégiée et confidentielle. Si vous avez reçu ce message par erreur, veuillez le mentionner immédiatement à l'expéditeur et effacer ce courriel.

This e-mail originates from the City of Ottawa e-mail system. Any distribution, use or copying of this e-mail or the information it contains by other than the intended recipient(s) is unauthorized. Thank you.

Le présent courriel a été expédié par le système de courriels de la Ville d'Ottawa. Toute distribution, utilisation ou reproduction du courriel ou des renseignements qui s'y trouvent par une personne autre que son destinataire prévu est interdite. Je vous remercie de votre collaboration.

Ben Pascolo-Neveu

From: Baggs, Rosanna <Rosanna.Baggs@ottawa.ca>
Sent: Tuesday, February 20, 2018 2:32 PM
To: Ben Pascolo-Neveu
Cc: Austin Shih
Subject: RE: 1981 Maple Grove TIA - Forecasting

Hi Ben,

Table 6.3 for trip generation rates and Table 3.13 for mode shares.

Regards,

Rosanna Baggs, C.E.T.

Project Manager, Infrastructure Approvals | GPRJ Approbation demandes infrastructure
Development Review West Branch | Dir Services d'examen des demandes
Tel | Tél. : 613-580- 2424 ext. | poste 26388

From: Ben Pascolo-Neveu [mailto:Ben.Pascolo-Neveu@ibigroup.com]
Sent: Tuesday, February 20, 2018 10:32 AM
To: Baggs, Rosanna <Rosanna.Baggs@ottawa.ca>
Cc: Austin Shih <austin.shih@IBIGroup.com>
Subject: RE: 1981 Maple Grove TIA - Forecasting

Hi Rosanna,

Acknowledged, we will ensure that our future studies will incorporate the TRANS model. Do you know which table we should be using in the TRANS model?

We will send the Analysis section by the end of the week.

Regards,
Ben

From: Baggs, Rosanna [mailto:Rosanna.Baggs@Ottawa.ca]
Sent: Tuesday, February 20, 2018 9:48 AM
To: Ben Pascolo-Neveu
Cc: Austin Shih
Subject: RE: 1981 Maple Grove TIA - Forecasting

Hi Ben,

The comments for Steps 1-3 are as follows:

Transportation Engineering Services

- 1) For future reference, the City recommends using 2009 TRANS Trip Generation Manual for residential development.

Please let me know if you have any questions or concerns.

Regards,

Rosanna Baggs, C.E.T.

Project Manager, Infrastructure Approvals | GPRJ Approbation demandes infrastructure
Development Review West Branch | Dir Services d'exam des dem d'amgt
Tel | Tél. : 613-580- 2424 ext. | poste 26388

From: Ben Pascolo-Neveu [<mailto:Ben.Pascolo-Neveu@ibigroup.com>]

Sent: Friday, February 16, 2018 10:32 AM

To: Baggs, Rosanna <Rosanna.Baggs@ottawa.ca>

Cc: Austin Shih <austin.shih@IBIGroup.com>

Subject: RE: 1981 Maple Grove TIA - Forecasting

Hi Rosanna,

I'm just following up with you to see if there are any comments from the circulation of the Forecasting Report for 1981 Maple Grove (Claridge).

Just to let you know, we are also preparing the Screening and Scoping Report for the site directly east as well, which is located at 1919 Maple Grove. The developer's name for that site is Formasian.

Regards,
Ben

Ben Pascolo-Neveu, EIT

IBI GROUP

Suite 400, 333 Preston Street
Ottawa ON K1S 5N4 Canada
tel +1 613 225 1311 ext 520 fax +1 613 225 9868

From: Ben Pascolo-Neveu

Sent: Thursday, February 8, 2018 12:18 PM

To: 'rosanna.baggs@ottawa.ca'

Subject: 1981 Maple Grove TIA - Forecasting

Hi Rosanna,

Thank you for taking the time to review our Screening and Scoping submission. Please find attached the Forecasting submission for 1981 Maple Grove Claridge.

Regards,
Ben

Ben Pascolo-Neveu, EIT

IBI GROUP

Suite 400, 333 Preston Street
Ottawa ON K1S 5N4 Canada
tel +1 613 225 1311 ext 520 fax +1 613 225 9868

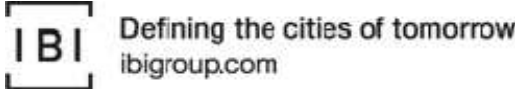

NOTE: This email message/attachments may contain privileged and confidential information. If received in error, please notify the sender and delete this e-mail message.
NOTE: Ce courriel peut contenir de l'information privilégiée et confidentielle. Si vous avez reçu ce message par erreur, veuillez le mentionner immédiatement à l'expéditeur et effacer ce courriel.

This e-mail originates from the City of Ottawa e-mail system. Any distribution, use or copying of this e-mail or the information it contains by other than the intended recipient(s) is unauthorized. Thank you.

Le présent courriel a été expédié par le système de courriels de la Ville d'Ottawa. Toute distribution, utilisation ou reproduction du courriel ou des renseignements qui s'y trouvent par une personne autre que son destinataire prévu est interdite. Je vous remercie de votre collaboration.

This e-mail originates from the City of Ottawa e-mail system. Any distribution, use or copying of this e-mail or the information it contains by other than the intended recipient(s) is unauthorized. Thank you.

Le présent courriel a été expédié par le système de courriels de la Ville d'Ottawa. Toute distribution, utilisation ou reproduction du courriel ou des renseignements qui s'y trouvent par une personne autre que son destinataire prévu est interdite. Je vous remercie de votre collaboration.



TIA Plan Reports - Certification

On 14 June 2017, the Council of the City of Ottawa adopted new Transportation Impact Assessment (TIA) Guidelines. In adopting the guidelines, Council established a requirement for those preparing and delivering transportation impact assessments and reports to sign a letter of certification.

Individuals submitting TIA reports will be responsible for all aspects of development-related transportation assessment and reporting, and undertaking such work, in accordance and compliance with the City of Ottawa's Official Plan, the Transportation Master Plan and the Transportation Impact Assessment (2017) Guidelines.

By submitting the attached TIA report (and any associate documents) and signing this document, the individual acknowledges that s/he meets the four criteria listed below:

CERTIFICATION

1. I have reviewed and have a sound understanding of the objectives, needs and requirements of the City of Ottawa's Official Plan, Transportation Master Plan and the Transportation Impact Assessment (2017) Guidelines;
2. I have a sound knowledge of industry standard practice with respect to the preparation of transportation impact assessment reports, including multi modal level of service review;
3. I have substantial experience (more than 5 years) in undertaking and delivering transportation impact studies (analysis, reporting and geometric design) with strong background knowledge in transportation planning, engineering or traffic operations; and
4. I am either a licensed¹ or registered¹ professional in good standing, whose field of expertise [check appropriate field(s)] is either transportation engineering or transportation planning .

¹ License or registration body that oversees the profession is required to have a code of conduct and ethics guidelines that will ensure appropriate conduct and representation for transportation planning and/or transportation engineering works.

Dated at Ottawa this 26th day of February, 2018.
(City)

Name: Austin Shih, M.A.Sc., P.Eng.

Professional Title: Project Engineer



Signature of Individual certifier that she/he meets the above four criteria

Office Contact Information (Please Print)
Address: 400-333 Preston Street
City / Postal Code: K1S 5N4
Telephone / Extension: 613-225-1311 ext. 564
E-Mail Address: austin.shih@ibigroup.com

Stamp





Document Control Page

CLIENT:	Claridge Homes
PROJECT NAME:	1981 Maple Grove Road, Kanata West TIA
REPORT TITLE:	TIA Report
IBI REFERENCE:	113480
VERSION:	4.0
DIGITAL MASTER:	J:\113480_MapleGrTIA\5.2 Reports\5.2.4 Transportation\5.2.4.5 Traffic Impact_TIA Submissions
ORIGINATOR:	Ben Pascolo-Neveu, E.I.T.
REVIEWER:	Austin Shih, M.A.Sc, P.Eng.
AUTHORIZATION:	Justin Date, P.Eng.
CIRCULATION LIST:	Rosanna Baggs, C.E.T.
HISTORY:	1.0. Screening and Scoping – January 2018 2.0. Screening and Scoping – revisions based on City comments – January 2018 3.0. Forecasting – February 2018 4.0. Analysis – February 2018



Table of Contents

Executive Summary

1	Introduction.....	1
2	Screening and Scoping	1
2.1	Screening Form	1
2.2	Description of Proposed Development	3
2.2.1	Site Location	3
2.2.2	Land Use	3
2.2.3	Site Layout.....	6
2.2.4	Transit, Pedestrian and Cycling Facilities	6
2.3	Existing Conditions	7
2.3.1	Existing Road Network	7
2.3.1.1	Roadways	7
2.3.1.2	Study Area Intersections.....	7
2.3.1.3	Traffic Management Measures	7
2.3.2	Existing Traffic Volumes	9
2.3.3	Existing Bicycle and Pedestrian Facilities	9
2.3.4	Existing Transit Facilities and Service	9
2.3.5	Collision Analysis.....	11
2.4	Planned Conditions.....	12
2.4.1	Changes to the Study Area Transportation Network	12
2.4.1.1	Future Road Network Projects.....	12
2.4.1.2	195 Huntmar Drive – Shenkman/ Cavanagh Development.....	13
2.4.1.3	Future Transit Facilities and Services	14
2.4.1.4	Future Cycling and Pedestrian Facilities	14
2.4.2	Future Adjacent Developments	15
2.4.3	Network Concept Screenline	18
2.5	Study Area	18
2.6	Time Periods	18
2.7	Horizon Years	18
2.8	Exemptions Review	19
3	Forecasting.....	20
3.1	Development Generated Traffic.....	20
3.1.1	Trip Generation Methodology	20



Table of Contents

3.1.2	Trip Generation Results.....	20
3.1.2.1	ITE Vehicle Trip Generation	20
3.1.2.2	Person Trip Generation	21
3.1.2.3	Mode Share Proportions.....	21
3.1.2.4	Trip Generation by Mode	22
3.1.3	Trip Distribution and Assignment.....	22
3.2	Background Network Traffic	23
3.2.1	Changes to the Background Transportation Network.....	23
3.2.2	General Background Growth Rates.....	23
3.2.3	Other Area Development.....	25
3.3	Demand Rationalization.....	25
3.3.1	Description of Capacity Issues	25
3.3.1.1	Maple Grove Road and Huntmar Drive	25
3.3.1.2	Maple Grove Road Extension.....	26
3.4	Traffic Volume Summary	27
3.4.1	Future Background Traffic Volumes	27
3.4.2	Future Total Traffic Volumes	27
4	Analysis.....	33
4.1	Development Design	33
4.1.1	Design for Sustainable Modes.....	33
4.1.2	New Street Networks.....	33
4.2	Parking	33
4.3	Boundary Streets.....	35
4.4	Access Intersections.....	36
4.4.1	Location and Design of Access	36
4.4.2	Intersection Control	36
4.4.2.1	Roundabout Analysis.....	36
4.4.2.2	Traffic Signal Warrants	36
4.4.3	Intersection Design.....	37
4.5	Transportation Demand Management.....	37
4.6	Neighbourhood Traffic Management	37
4.6.1	Adjacent Neighbourhoods	37
4.6.2	Local Intersection Requirements	38



Table of Contents

4.7	Transit.....	38
4.7.1	Route Capacity	38
4.8	Review of Network Concept	38
4.9	Intersection Design	39
4.9.1	Base Road Network.....	39
4.9.2	Intersection Analysis Criteria	39
4.9.2.1	Roundabout Analysis.....	39
4.9.2.2	Signalized Intersections.....	39
4.9.2.3	Unsignalized Intersections.....	40
4.9.3	Intersection Control	41
4.9.3.1	Traffic Signal Warrant Methodology	41
4.9.3.2	Traffic Signal Warrant Results	41
4.9.4	Intersection Design (Operations).....	41
4.9.4.1	Intersection Analysis Methodology	41
4.9.4.2	Existing (2018) Traffic Results.....	42
4.9.4.3	2021 Background Traffic Results.....	42
4.9.4.4	2026 Background Traffic Results.....	43
4.9.4.5	2021 Total Traffic Results.....	43
4.9.4.6	2026 Total Traffic Results.....	45
4.9.5	Intersection Design (MMLoS)	45
4.9.5.1	Intersection Pedestrian Level of Service (PLOS)	46
4.9.5.2	Intersection Bicycle Level of Service (BLOS)	46
4.9.5.3	Intersection Transit Level of Service (TLOS).....	47
4.9.5.4	Intersection Truck Level of Service (TKLOS)	47
4.10	Geometric Review	47
4.10.1	Sight Distance and Corner Clearances	47
4.10.2	Auxiliary Lane Analysis.....	47
4.10.2.1	Auxiliary Left-Turn Lane Requirements (Unsignalized)	47
4.10.2.2	Signalized Auxiliary Left-Turn Lane Requirements.....	48
4.10.2.3	Auxiliary Right-Turn Lane Requirements (Unsignalized).....	49
4.10.2.4	Signalized Auxiliary Right-Turn Lane Requirements	49
4.11	Summary of Improvements Indicated and Modification Options.....	50



Table of Contents

4.11.1	Maple Grove Road and Santolina Street; Maple Grove Road and Alon Street.....	50
4.11.2	Maple Grove Road and Huntmar Drive	50
4.11.3	Stittsville Main Street Extension and Maple Grove Road	51
4.11.4	Proposed Accesses/ Egresses.....	51
4.11.5	Summary of Recommendations	51

LIST OF EXHIBITS

EXHIBIT 1 – Site Location	4
EXHIBIT 2 – Proposed Development	5
EXHIBIT 3 – Existing (2018) Land Configurations and Intersection Controls.....	8
EXHIBIT 4 – Existing (2018) Pedestrian, Cycling and Vehicular Volumes	10
EXHIBIT 5 – Existing Transit Routes.....	11
EXHIBIT 6 – Future Road Network Projects.....	12
EXHIBIT 7 – Concept Plan for 195 Huntmar Drive Development (November 8, 2017	13
EXHIBIT 8 – Future ‘Affordable RTTP Network Projects’	14
EXHIBIT 9 – Affordable Cycling Network	15
EXHIBIT 10 – Future Adjacent Developments	17
EXHIBIT 11 – Site Generated AM & PM Peak Hour Traffic Volumes	24
EXHIBIT 12 – Traffic Diversion Capture Area for Maple Grove Road Extension	27
EXHIBIT 13 – Existing 2018 Auto, Cycling and Pedestrian AM & PM Peak Hour Traffic Volumes.....	28
EXHIBIT 14 – 2021 Background AM & PM Peak Hour Traffic Volumes	29
EXHIBIT 15 – 2026 Background AM & PM Peak Hour Traffic Volumes	30
EXHIBIT 16 – 2021 Total AM & PM Peak Hour Traffic Volumes.....	31
EXHIBIT 17 – 2026 Total AM & PM Peak Hour Traffic Volumes.....	32
EXHIBIT 18 – Existing and Future Potential Transit Routes	34
EXHIBIT 19 – 2026 Intersection Controls and Lane Configurations.....	54



Table of Contents

LIST OF TABLES

TABLE 1 – Land Use Statistics.....	3
TABLE 2 – Reported Collisions within Study Area	11
TABLE 3 – Developments Adjacent to Study Area.....	16
TABLE 4 – Exemption Considerations	19
TABLE 5 – ITE Development Trip Generation Results.....	21
TABLE 6 – Development Person Trip Generation Results.....	21
TABLE 7 – Proposed Mode Shares for Kanata/ Stittsville (2011 OD Survey).....	22
TABLE 8 – Development Generated Traffic by Mode	22
TABLE 9 – Future Adjacent Developments.....	25
TABLE 10 – Bandelier Way & Stittsville Main Street Diversion to Maple Grove Road Extension	27
TABLE 11 – Segment MMLOS – Existing (2018) Results.....	35
TABLE 12 – Segment MMLOS – Background and Total (2021 & 2026) Results.....	35
TABLE 13 – Road Classification Capacity.....	38
TABLE 14 – 2031 Development Generated Transit Demand.....	38
TABLE 15 – LOS Criteria for Signalized Intersections	40
TABLE 16 – LOS Criteria for Unsignalized Intersections	40
TABLE 17 – Intersection Capacity Analysis: Existing (2018) Traffic	42
TABLE 18 – Intersection Capacity Analysis: 2021 Background Traffic	42
TABLE 19 – Intersection Capacity Analysis: 2026 Background Traffic	43
TABLE 20 – Intersection Capacity Analysis: 2021 Total Traffic	44
TABLE 21 – Intersection Capacity Analysis: 2026 Total Traffic	45
TABLE 22 – Intersection MMLOS – Existing Conditions (2018).....	46
TABLE 23 – Intersection MMLOS – Future Background and Total Results.....	46
TABLE 24 – Auxiliary Left-Turn Lane Analysis at Unsignalized Intersections.....	48
TABLE 25 – Recommended Auxiliary Left-Turn Storage Lengths at Signalized Intersections	48
TABLE 26 – Recommended Auxiliary Right-Turn Storage Lengths at Signalized Intersections	50
TABLE 27 – Summary of Recommended Actions/ Modifications.....	52



Table of Contents

LIST OF APPENDICES

- Appendix A – Traffic Data
- Appendix B – OC Transpo Maps
- Appendix C – Collision Data
- Appendix D – ITE Trip Generation Manual
- Appendix E – 2011 OD Survey Data – Kanata & Stittsville
- Appendix F – Multi-Modal Level of Service (MMLOS)
- Appendix G – Roundabout Screening Tool
- Appendix H - Traffic Signal Warrants
- Appendix I – Synchro Output Files
- Appendix J – Existing Signal Timing Plans
- Appendix K – Technical Standards

EXECUTIVE SUMMARY

IBI Group (IBI) was retained by Claridge Homes to complete a Transportation Impact Assessment (TIA) in support of the 1981 Maple Grove Road residential subdivision in the City of Ottawa. This subject property is approximately 19 acres in size, and is generally bounded to the south by Maple Grove Road, to the west by the proposed extension of Stittsville Main Street and by undeveloped lands to the east and north.

Claridge Homes intends to develop approximately 200 residential units and a park at 1981 Maple Grove Road. The size and specifics of each facility were not known at the time of this study. The proposed development was assumed to be completed in one phase.

The general methodology used in this study was based on the City of Ottawa Transportation Impact Assessment Guidelines (2017). The first 3 steps of the TIA process have been followed and approved by the City. This report represents Step 4 and the Final Submission.

A Public Open House (POH) was held on January 10, 2018 to review the preliminary concept plan for 195 Huntmar Drive, and no target buildout date was given for the development. Therefore, since the concept plan has not been finalized, and the buildout of the site is unknown, as a worst case scenario, it was assumed that the lands at 195 Huntmar Drive, would not be built within the planning horizons proposed for this study, and that traffic generated from the subject site would need to rely on the existing transportation network. A transportation impact assessment (TIA) report will be prepared by Parsons in support of the 195 Huntmar Drive development, which will incorporate traffic generated from the subject site (1981 Maple Grove Road) as part of the background traffic. Parson's future TIA will define characteristics for 195 Huntmar Drive such as the road alignment, unit count and general layout of the site.

The key conclusions from the TIA Analysis Report are as follows:

- The study area transportation network is expected to accommodate site generated traffic volumes through to the 2026 horizon year.
- There is no requirement for an RMA.
- There is no requirement for a monitoring plan.

The overall conclusion of this TIA is that the traffic generated by the 1981 Maple Grove Road Development can be accommodated on the adjacent transportation network with the appropriate actions and modifications in place. Claridge Homes shall be responsible for constructing all required access intersections and internal transportation facilities as dictated by the proposed draft plan.

The key findings and recommendations from this TIA are as follows:

1981 Maple Grove Road Development Characteristics

- The proposed rights-of-way for internal roads within the 1981 Maple Grove Road development will be as follows:
 - Local Roads – 18.0m
- Some local roadways will have sidewalks to provide connections to local parks and pathways. No dedicated cycling facilities have been proposed within the development lands.
- TDM and non-auto mode provisions will be reinforced. Appropriate connections, both internal and to the regional network, have been provided to accommodate active transportation.
- The proposed development is expected to be constructed and fully builtout by 2021.

Existing Conditions Analysis

- The study area included the following existing intersections:
 - Maple Grove Road and Huntmar Drive
 - Maple Grove Road and Santolina Street
 - Maple Grove Road and Alon Street
- A review of the reported collisions showed a pattern of rear-end collisions at the Maple Grove Road and Huntmar Drive intersection. The majority of the 8 rear-end collisions occurred during the AM and PM peak periods, or during adverse weather conditions, and were likely not the result of the intersection design
- There are two existing transit service routes operating within the study area: 162 and 261. The 162 provides daily service; the 261 operates only on weekdays.
- Maple Grove Road is currently the only existing boundary street providing direct frontage to the proposed development. The section of Maple Grove Road fronting the subject property currently has a rural cross-section with gravel shoulders, and no formal cycling or pedestrian facilities.
- All existing study area intersections with the exception of the Maple Grove Road and Huntmar Drive intersection were shown to operate within City standards in 2018. These results coincided with previous traffic studies completed in the study area.

Future Background Traffic Demand

- Two future analysis horizons were established based on the expected development phases: 2021 and 2026.
- A 2.0% background traffic growth rate was applied to the following existing intersection within the study area:
 - Maple Grove Road and Huntmar Drive intersection, all movements
- Side street traffic from minor collector and local roadways within the study area were not factored since they provide access to local developments; all adjacent developments were accounted for separately in this analysis.
- Two known adjacent developments were accounted for in the future background traffic volumes. The unit counts and characteristics for each development were based on traffic studies and draft plans of subdivision that supported the development applications.

1981 Maple Grove Road Generated Traffic Volumes

- Development generated traffic volumes were derived using Institute of Transportation Engineers (ITE) Trip Generation Rates and converted to person trips according to the TIA Guidelines. The City Origin Destination (OD) Survey mode share for the Kanata/ Stittsville Zone was applied to determine the trips by mode.
- The 1981 Maple Grove Road development is expected to generate the following peak hour trips at each future horizon:
 - 2021 & 2026 - Auto Driver: 150 morning peak hour trips; 181 afternoon peak hour trips
Transit: 36 morning peak hour trips; 38 afternoon peak hour trips

Future Intersection Analysis

- Maple Grove Road and Huntmar Drive:

The Maple Grove Road and Huntmar Drive intersection is presently operating above its theoretical capacity, due to heavy eastbound left-turning movement in the AM peak period and a heavy southbound right-turning movement in the PM peak period.

The TIA prepared for the Fairwinds development at 33 Johnwoods Street (December 2012) assumed that auxiliary left and right turn lanes would be constructed on all approaches at the intersection of Maple Grove Road and Huntmar Drive by 2017. Despite these recommendations, all approaches of the existing intersection have remained as shared through-turning lanes with the exception of the northbound approach, which has a 15m left-turn storage lane.

Operational results from queuing analysis based on the 2026 total traffic condition indicated that the eastbound left-turn lane should have 80m of storage, the westbound left-turn lane should have 30m of storage, the southbound left-turn lane should have 15m of storage, and the northbound left-turn lane storage length should be extended from 15m to 40m. A southbound right-turn lane of 15m is also warranted in the existing condition and projected future traffic demand.

- Maple Grove Road and Santolina Street

The Maple Grove Road and Santolina Street intersection was shown to operate within City standards in the morning and afternoon peak periods through to the 2026 total traffic condition with the existing lane configurations and intersection control.

- Maple Grove Road and Alon Street

The Maple Grove Road and Alon Street intersection was shown to operate within City standards in the morning and afternoon peak periods through to the 2026 total traffic condition with the existing lane configurations and intersection control.

- Stittsville Main Street Extension and Maple Grove Road

The proposed Stittsville Main Street Extension and Maple Grove Road intersection was shown to operate within City operational standards with shared through-turning lanes on all approaches, and a stop-controlled minor approach through to the 2026 total traffic condition.

- Proposed Accesses/ Egresses

The proposed Street 1, Street 2 and Street 4 accesses/ egresses off of the proposed Stittsville Main Street extension, as well as the proposed Street 6 access off of Maple Grove Road were shown to operate within City operational standards with shared through-turning lanes on all approaches, and stop-controlled minor approaches through to the 2026 total traffic condition.

The geometric requirements for all intersections should be reviewed and confirmed during detailed design.

Geometric Analysis Results

- Geometric evaluations revealed no sight distance or corner clearance issues. Proper care should be taken to ensure no obstructions are placed in the line-of-sight in the vicinity of the proposed access points. The future access locations to the commercial blocks are expected to follow these guidelines, and will be assessed during the site plan application when more details are available.

Summary of Recommendations

A summary of all recommended actions/ modifications has been provided in Table ES-1.

TABLE ES-1 – Summary of Recommended Actions/ Modifications

HORIZON	RECOMMENDED ACTIONS/ MODIFICATIONS
Existing (2018)	<p>Maple Grove Road and Huntmar Drive</p> <ul style="list-style-type: none"> • Existing intersection configuration with signal optimization does not meet City intersection capacity requirements. • Construct southbound right-turn lane with 15m of storage • Construct left turn lanes with the following storage lengths: <ul style="list-style-type: none"> ◆ Extend northbound left-turn storage length by 25m (total storage length is 40m) ◆ Southbound left-turn lane with 15m storage ◆ Eastbound left-turn lane with 80m storage ◆ Westbound left-turn lane with 25m storage <p>Maple Grove Road and Santolina Street</p> <ul style="list-style-type: none"> • Meets City operational guidelines <p>Maple Grove Road and Alon Street</p> <ul style="list-style-type: none"> • Meets City operational guidelines
Future (2021) Background – No Site Generated Traffic	<p>Assume all actions and modifications from the Existing (2018) traffic conditions remain. Optimize all traffic signals.</p> <p>Maple Grove Road and Huntmar Drive</p> <ul style="list-style-type: none"> • Meets City operational guidelines <p>Maple Grove Road and Santolina Street</p> <ul style="list-style-type: none"> • Meets City operational guidelines <p>Maple Grove Road and Alon Street</p> <ul style="list-style-type: none"> • Meets City operational guidelines
Future (2021) Total – With Site Generated Traffic	<p>Assume all actions and modifications from the Existing (2018) traffic conditions remain. Optimize all traffic signals.</p> <p>Maple Grove Road and Huntmar Drive</p> <ul style="list-style-type: none"> • Meets City operational guidelines <p>Maple Grove Road and Santolina Street</p> <ul style="list-style-type: none"> • Meets City operational guidelines <p>Maple Grove Road and Alon Street</p> <ul style="list-style-type: none"> • Meets City operational guidelines <p>Stittsville Main Street Extension and Street 1</p> <ul style="list-style-type: none"> • Claridge Homes – Construct unsignalized access intersection • Westbound stop-controlled • Shared through-turn lanes on all approaches <p>Stittsville Main Street Extension and Street 2</p> <ul style="list-style-type: none"> • Claridge Homes – Construct unsignalized access intersection • Westbound stop-controlled • Shared through-turn lanes on all approaches <p>Stittsville Main Street Extension and Street 4</p> <ul style="list-style-type: none"> • Claridge Homes – Construct unsignalized access intersection • Westbound stop-controlled • Shared through-turn lanes on all approaches <p>Maple Grove Road and Stittsville Main Street Extension</p> <ul style="list-style-type: none"> • Construct unsignalized intersection • Westbound stop-controlled • Shared through-turn lanes on all approaches

HORIZON	RECOMMENDED ACTIONS/ MODIFICATIONS
	Maple Grove Road and Street 6 <ul style="list-style-type: none"> • Claridge Homes – Construct unsignalized access intersection • Southbound stop-controlled • Shared through-turn lanes on all approaches
Future (2026) Background – No Site Generated Traffic	Assume all modifications from the Future (2021) Background traffic conditions remain. Optimize all traffic signals.
Future (2026) Total – With Site Generated Traffic	Assume all modifications from the Future (2021) Total traffic conditions remain. Optimize all traffic signals.



1 Introduction

The following Transportation Impact Assessment (TIA) Report has been prepared on behalf of Claridge Homes in support of the draft plan of subdivision application for 1981 Maple Grove Road. The format of the TIA Report is based on the City of Ottawa 2017 Transportation Impact Assessment (TIA) Guidelines. The purpose of the TIA Report is to “identify on-site and off-site measures to be undertaken by a developer to align the transportation system’s performance with the City’s goals of creating an integrated land use and transportation system as expressed in the Official Plan and Transportation Master Plan” (Ottawa 2017 TIA Guidelines, p. 3).

2 Screening and Scoping

Section 2 summarizes the Screening Form and Scoping Report previously submitted and approved by the City. The Screening Form (Section 2.1) established the need to complete the study. The Scoping Report established the existing/ planned conditions of the study, key parameters and a review of possible exemptions.

2.1 Screening Form

STEP 1 - City of Ottawa 2017 TIA Guidelines Screening Form

1. Description of Proposed Development

Municipal Address	1981 Maple Grove Road, Kanata West
Description of Location	Site is bounded by Maple Grove Road to the south, the proposed extension of Stittsville Main Street to the west, proposed development lands to the east and undeveloped greenfield lands to the south
Land Use Classification	Residential
Development Size (units)	139 units (Townhomes/ Semi-detached Residential) 57 units (Single Family Homes)
Development Size (acres)	19
Number of Accesses and Locations	There are five (5) access/ egress locations proposed for this development to connect it to its boundary streets: (1) Maple Grove Road – access/ egress to the south (2) Proposed Stittsville Main Street extension – 3 accesses/ egresses located to the west (3) Proposed Kanata West Main Street – 1 access/ egress located to the north
Phase of Development	Single Phase
Buildout Year	2021

2. Trip Generation Trigger



Considering the Development's Land Use type and Size (as filled out in the previous section), please refer to the Trip Generation Trigger checks below.

Land Use Type	Minimum Development Size
Single-family homes	40 units ✓
Townhomes or apartments	90 units ✓
Office	3,500 m ²
Industrial	5,000 m ²
Fast-food restaurant or coffee shop	100 m ²
Destination retail	1,000 m ²
Gas station or convenience market	75 m ²

* If the development has a land use type other than what is presented in the table above, estimates of person-trip generation may be made based on average trip generation characteristics represented in the current edition of the Institute of Transportation Engineers (ITE) Trip Generation Manual.

If the proposed development size is greater than the sizes identified above, therefore the Trip Generation Trigger is satisfied.

3. Location Triggers

	Yes	No
Does the development propose a new driveway to a boundary street that is designated as part of the City's Transit Priority, Rapid Transit or Spine Bicycle Networks?		✓
Is the development in a Design Priority Area (DPA) or Transit-oriented Development (TOD) zone?*		✓

*DPA and TOD are identified in the City of Ottawa Official Plan (DPA in Section 2.5.1 and Schedules A and B; TOD in Annex 6). See Chapter 4 for a list of City of Ottawa Planning and Engineering documents that support the completion of TIA).

If any of the above questions were answered with 'Yes,' the Location Trigger is satisfied.

4. Safety Triggers

	Yes	No
Are posted speed limits on a boundary street are 80 km/h or greater?		✓
Are there any horizontal/vertical curvatures on a boundary street limits sight lines at a proposed driveway?		✓
Is the proposed driveway within the area of influence of an adjacent traffic signal or roundabout (i.e. within 300 m of intersection in rural conditions, or within 150 m of intersection in urban/ suburban conditions)?		✓
Is the proposed driveway within auxiliary lanes of an intersection?		✓



Does the proposed driveway make use of an existing median break that serves an existing site?		✓
Is there is a documented history of traffic operations or safety concerns on the boundary streets within 500 m of the development?		✓
Does the development include a drive-thru facility?		✓

If any of the above questions were answered with ‘Yes,’ the Safety Trigger is satisfied.

5. Summary

	Yes	No
Does the development satisfy the Trip Generation Trigger?	✓	
Does the development satisfy the Location Trigger?		✓
Does the development satisfy the Safety Trigger?		✓

The subject development satisfied the trip generation trigger for a Transportation Impact Assessment.

2.2 Description of Proposed Development

2.2.1 Site Location

The proposed residential development at 1981 Maple Grove Road is shown in **Exhibit 1**. This property is approximately 19 acres in size, and is currently a greenfield site. The subject site abuts the proposed extension of Stittsville Main Street to the west, Maple Grove Road to the south, future proposed residential development lands to the east and undeveloped lands to the north.

2.2.2 Land Use

The proposed draft plan for the subject site is shown in **Exhibit 2**. The land is currently undeveloped, and is zoned as development reserve. The proposed development will contain a mix of low and medium density residential land uses, as summarized in **Table 1**.

For the purposes of this study, full occupancy of the proposed development was assumed by the 2021 horizon year; however, the assumed buildout horizon year is highly dependent on market forces. It is possible full occupancy won't be achieved by the buildout horizon year.

TABLE 1 – Land Use Statistics

LAND USE	SIZE (# OF UNITS)
Townhome/ Semi-Detached Residential	139 units
Single Family Homes	57 units

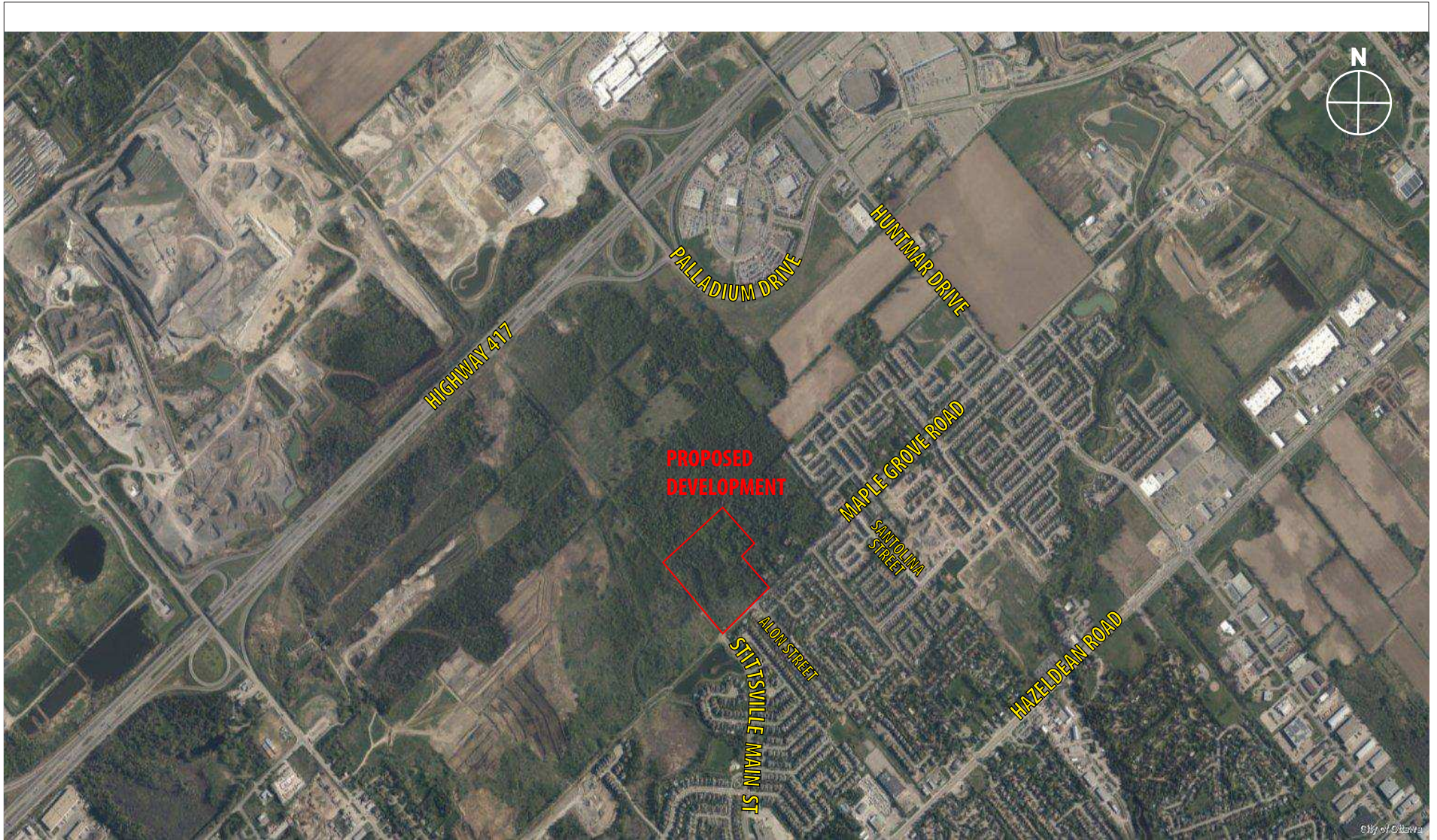

1981 Maple Grove Road
Transportation Impact Assessment

EXHIBIT 1
Site Location

PROJECT No.: 113480
DATE: FEBRUARY 2018
SCALE:



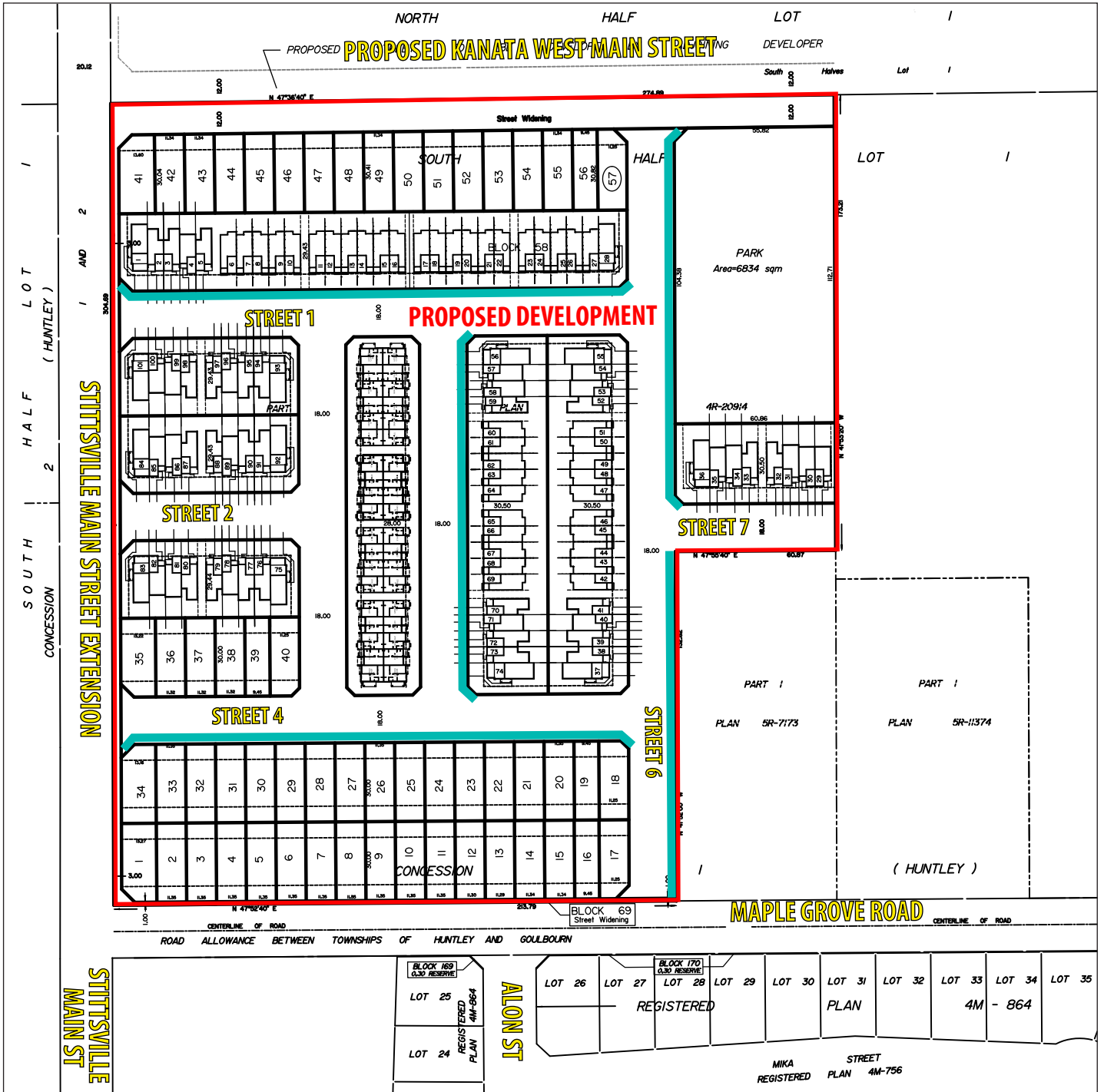
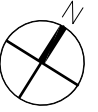

LEGEND

- Potential Sidewalk Location —
- Proposed Development Limit —





2.2.3 Site Layout

The subject site proposes five (5) new full movement access intersections connecting it to the adjacent road network, as shown in **Exhibit 2**, and described below:

- Maple Grove Road and Street 6
- Proposed Stittsville Main Street extension and Street 1
- Proposed Stittsville Main Street extension and Street 2
- Proposed Stittsville Main Street extension and Street 4
- Proposed Kanata West Main Street and Street 6

The internal road network for the proposed development will consist of local roads with 18m of right-of-way. Street 1, Street 2 and Street 4 will be oriented approximately east-west, and will provide access to the proposed Stittsville Main Street extension, proposed along the western property boundary. Street 7 will tie into the proposed development to the east of the subject property.

Street 6 will be oriented approximately north-south, providing a connection with Maple Grove Road to the south, and the proposed Kanata West Main Street to the north. A park is being proposed at the northeast corner of the subject site, bounded by Street 6 to the west, and the proposed Kanata West Main Street to the north.

2.2.4 Transit, Pedestrian and Cycling Facilities

The proposed development does not include any transit or cycling facilities. Sidewalks will be provided on select sections, as noted in **Exhibit 2**, to provide access to local amenities.



2.3 Existing Conditions

2.3.1 Existing Road Network

2.3.1.1 Roadways

Stittsville Main Street is a two-lane urban roadway that extends from south of Fernbank Road in the south, and terminates with a cul-de-sac near Maple Grove Road. South of Hazeldean Road, Stittsville Main Street is classified as an arterial road, and north of Hazeldean Road, it is classified as a major collector road. The available right-of-way along Stittsville Main Street north of Hazeldean Road is 26m, and the speed limit is 50km/h.

Maple Grove Road is classified as an arterial roadway, between Huntmar Drive and Terry Fox Drive, a collector road between Huntmar Drive and the proposed multi-use pathway (formerly Johnwoods Street), and a local road from the proposed multi-use pathway to Alon Street. The portion of Maple Grove Road fronting the subject property has a two-lane, rural cross-section with a posted speed limit of 50km/h and a 26m right-of-way. From Stittsville Main Street to Huntmar Drive, Maple Grove Road is a collector road with a 26m right-of-way, and east of Huntmar Drive, the right-of-way widens to 37.5m, as the road classification is upgraded to an arterial.

Huntmar Drive is a two-lane north-south arterial road that extends from March Road in the north to Hazeldean Road in the south, where it continues as Iber Road. The road has a posted speed limit of 50 km/h within the study area.

Santolina Street is a two-lane north-south collector road that extends from Maple Grove Road in the north and terminates at Rosehill Street in the south, before changing names to Eucalyptis Circle. The unposted speed limit is 50 km/h.

Alon Street is a two-lane north-south local street that extends from Maple Grove Road, before transitioning to an east-west alignment to connect up with Johnwoods Street. The unposted speed limit is 50 km/h.

2.3.1.2 Study Area Intersections

The following existing intersections will be evaluated in this report:

- Huntmar Drive and Maple Grove Road
- Maple Grove Road and Santolina Street
- Maple Grove Road and Alon Street

The intersection control and lane configurations of each intersection are shown in **Exhibit 3**.



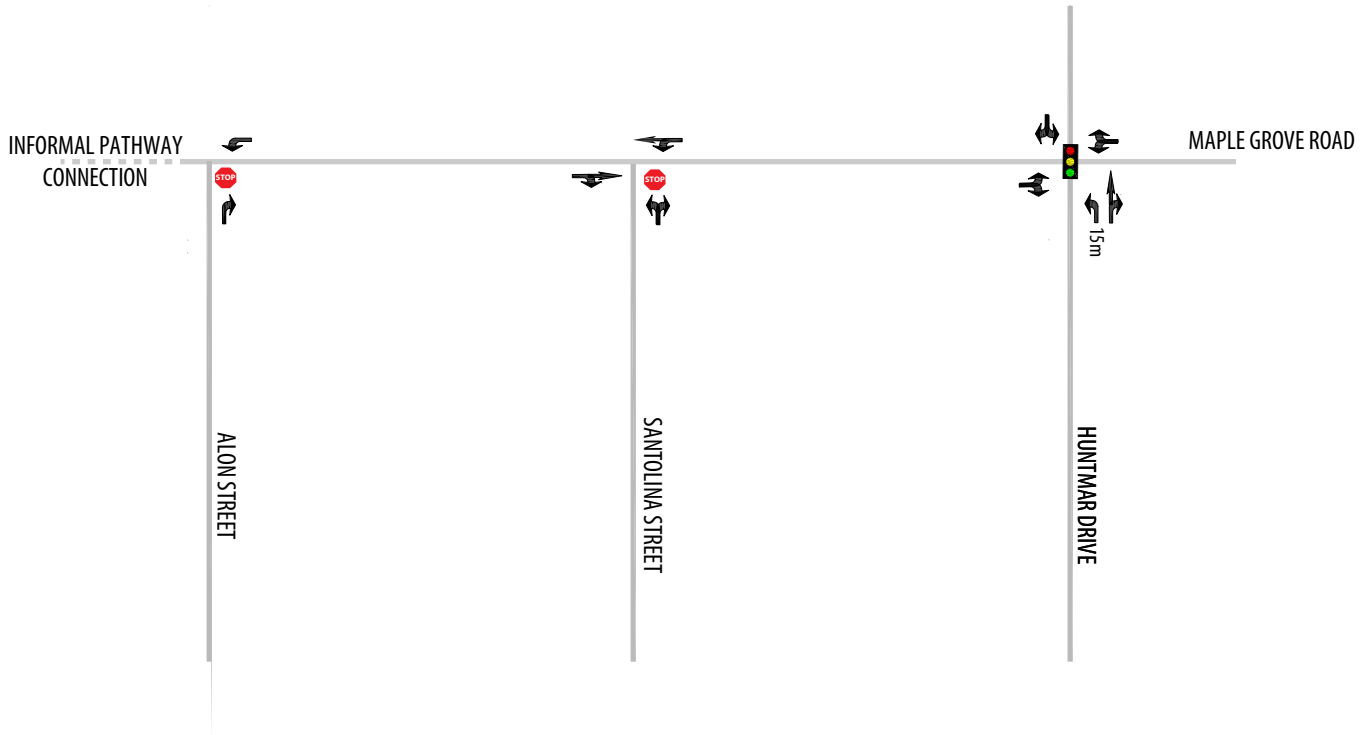
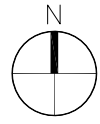

It should be noted that there are three (3) existing driveways serving single-family homes located on the north side of Maple Grove Road, immediately east of the proposed Street 6 access off of Maple Grove Road. These driveways currently allow for all-access movements onto Maple Grove Road. Traffic volumes at all three (3) of these existing residential accesses are assumed to be negligible, and are not expected to cause operational conflicts with the proposed access at Street 6 and Maple Grove Road.

2.3.1.3 Traffic Management Measures

There are currently no existing traffic management or traffic calming measures on any of the boundary roads located within the study area.



LEGEND

-  TRAVEL LANES AND PERMITTED MOVEMENTS
-  STOP CONTROL
-  TRAFFIC CONTROL SIGNAL
-  AUXILIARY STORAGE LENGTH (in metres)
DOES NOT INCLUDE TAPER LENGTH





2.3.2 Existing Traffic Volumes

Weekday morning and afternoon peak hour turning movement counts at the following study area intersections were obtained from the City of Ottawa. Where City data was not available, IBI Group completed manual traffic counts:

- Huntmar Drive and Maple Grove Road (City of Ottawa, November 2017)
- Maple Grove Road and Santolina Street (IBI Group – January 2018)
- Maple Grove Road and Alon Street (IBI Group – January 2018)

The existing (2018) peak hour traffic volumes are shown in **Exhibit 4**. Traffic count data is provided in **Appendix A**.

2.3.3 Existing Bicycle and Pedestrian Facilities

Maple Grove Road is located along the southern boundary of the subject site, and is the only existing boundary street providing direct frontage to the proposed development.

The section of Maple Grove Road fronting the subject property currently has a rural cross-section with gravel shoulders, and no formal pedestrian or cycling facilities.

2.3.4 Existing Transit Facilities and Service

There are currently two (2) OC Transpo service route that run through the study area:

- Route #162 operates from Fernbank Road in Stittsville to the Terry Fox Station (via the Tanger Outlet Mall). Week day bus services the study area only in off-peak times, and operates with approximately 60-minute headways. All-day service is offered on Saturdays with approximately 20-minute headways. Service is not offered on Sundays. Bus stops are located along Maple Grove Road from Santolina Street to Huntmar Drive.
- Route #261 is a weekday express bus that provides commuter service with 20 to 30-minute headways from Stittsville to the downtown core during the AM Peak, and the reverse in the PM Peak. This route does not provide weekend service.

Exhibit 5 shows the existing transit routes in the study area. Transit data is provided in **Appendix B**.

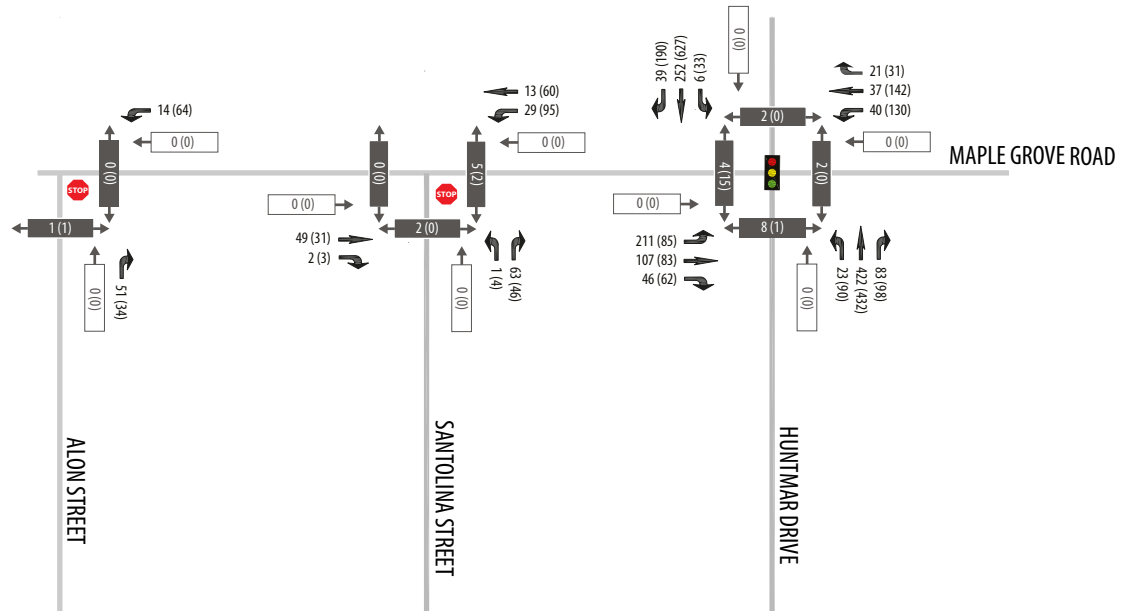
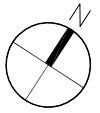

LEGEND

- STOP CONTROL
- TRAFFIC CONTROL SIGNAL
- TRAVEL LANES AND PERMITTED MOVEMENTS
- AM & PM PEAK HOUR VEHICULAR VOLUMES
- AM & PM PEAK HOUR PEDESTRIAN VOLUMES
- AM & PM PEAK HOUR CYCLING VOLUMES





EXHIBIT 5 – Existing Transit Routes



source: octranspo.com, Jan 19, 2018

2.3.5 Collision Analysis

A review of historical collision data has been provided. The City requires a safety review if at least six collisions for any one movement or of a discernible pattern, over a five year period have occurred. **Table 2** summarizes all reported collisions between January 1, 2012 and January 1, 2017 that have a discernible pattern.

TABLE 2 – Reported Collisions within Study Area

LOCATION	# OF REPORTED COLLISIONS
Huntmar Drive and Maple Grove Road	8
Alon Street and Maple Grove Road	1
Leveche Way and Maple Grove Road	2
Johnwoods Street and Maple Grove Road ¹	2
Maple Grove Road (Huntmar Drive to Johnwoods Street ¹)	3

¹ On November 15, 2017, Johnwoods Street from Maple Grove Road to Rosehill Avenue was permanently closed to vehicular traffic, and is being converted into a multi-use pathway (MUP)

Based on **Table 2**, collisions at Huntmar Drive and Maple Grove Road required further analysis to determine if there is a discernible collision pattern at the intersection. A copy of the City collision records is available in **Appendix C**.

Huntmar Drive and Maple Grove Road

- 8 of the collisions were described as ‘rear-end’ collisions
 - 5 of the collisions occurred during AM or PM peak periods and in the peak direction
 - 5 of the collisions occurred in adverse driving conditions (i.e. rain, freezing rain, snow-packed roads)

The majority of rear-end collisions were recorded in the peak direction during the AM and PM peak periods due to the higher volume of traffic travelling in the peak direction. It should also be noted that the majority of collisions occurred during adverse weather conditions, and were likely not a result of the intersection design.



2.4 Planned Conditions

2.4.1 Changes to the Study Area Transportation Network

2.4.1.1 Future Road Network Projects

The 2013 Transportation Master Plan (TMP) outlines future road network modifications required in the 2031 'Affordable Road Network,' as shown in **Exhibit 6**. The following projects were noted that may have an impact on study area traffic:

- Palladium Road realignment in vicinity of Huntmar Drive to proposed North-South Arterial. Phase 2 (2020-2025)
- Stittsville N-S Arterial Road – Proposed North-South Arterial between Palladium Drive and Fernbank Road. Phase 2 (2020-2025)
- Stittsville Main Street Extension – Proposed Stittsville Main Street extension to connect to the proposed North-South Arterial and continue to Palladium Drive. Phase 3 (2026-2031)
- Huntmar Drive – Widen Huntmar Drive from 2 lanes to 4 lanes between Campeau Drive and Maple Grove Road. Phase 3 (2026-2031)

The Development Charges Amendment Background Study: Transit and Roads and Related Services (March 24, 2017) identified funds set aside for the construction of the proposed Stittsville Main Street extension. This study indicates that construction will be complete between 2026 and 2031, which is consistent with the dates set out in the 2013 TMP.

EXHIBIT 6 – Future Road Network Projects

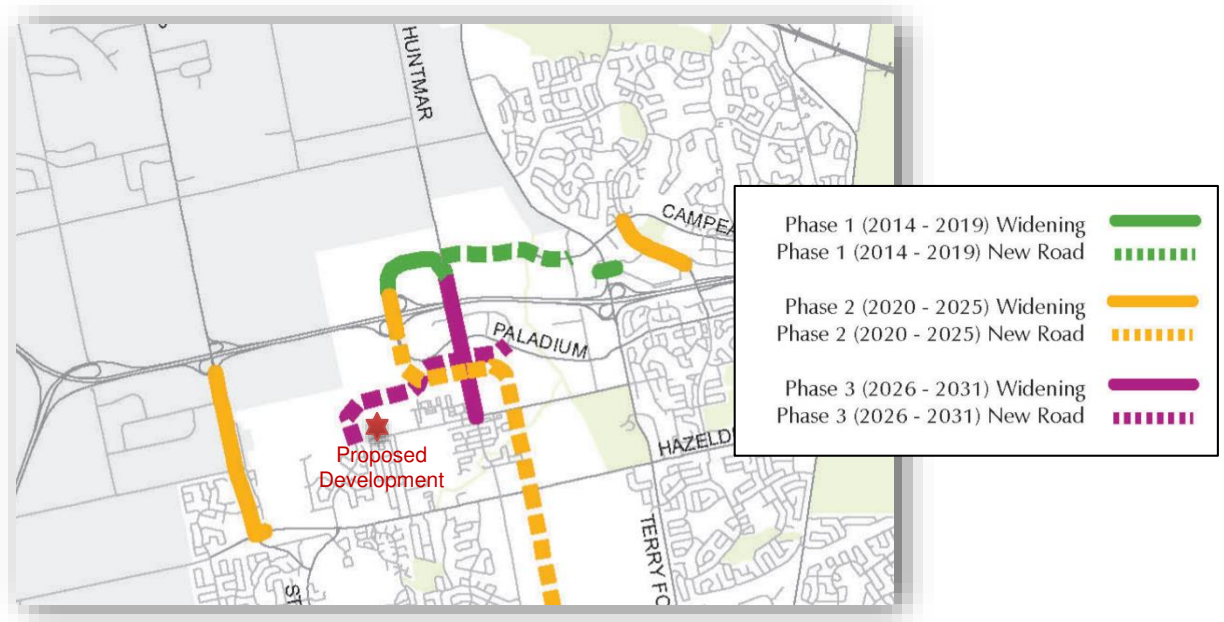



2.4.1.2 195 Huntmar Drive – Shenkman/ Cavanagh Development

The development of 195 Huntmar Drive is currently under review for Plan of Subdivision, Zoning Bylaw Amendment and Official Plan Amendment applications. A preliminary concept plan (dated November 8, 2017) is shown in **Exhibit 7**.

A Public Open House (POH) was held on January 10, 2018 to review the preliminary concept plan for 195 Huntmar Drive, and no target buildout date was given for the development. Since the concept plan has not been finalized and the buildout of the site is unknown, it was assumed that the lands at 195 Huntmar Drive would not be built within the planning horizons proposed for this study. Therefore, as a worst case scenario, traffic generated by the 1981 Maple Grove Road development would rely on the existing transportation network. A transportation impact assessment (TIA) report will be prepared by Parsons in support of the 195 Huntmar Drive development, which will incorporate traffic generated by 1981 Maple Grove Road as part of the background traffic. Parson's TIA will define characteristics for 195 Huntmar Drive such as the road alignment, unit count and general layout of the site.

EXHIBIT 7 – Concept Plan for 195 Huntmar Drive Development (November 8, 2017)

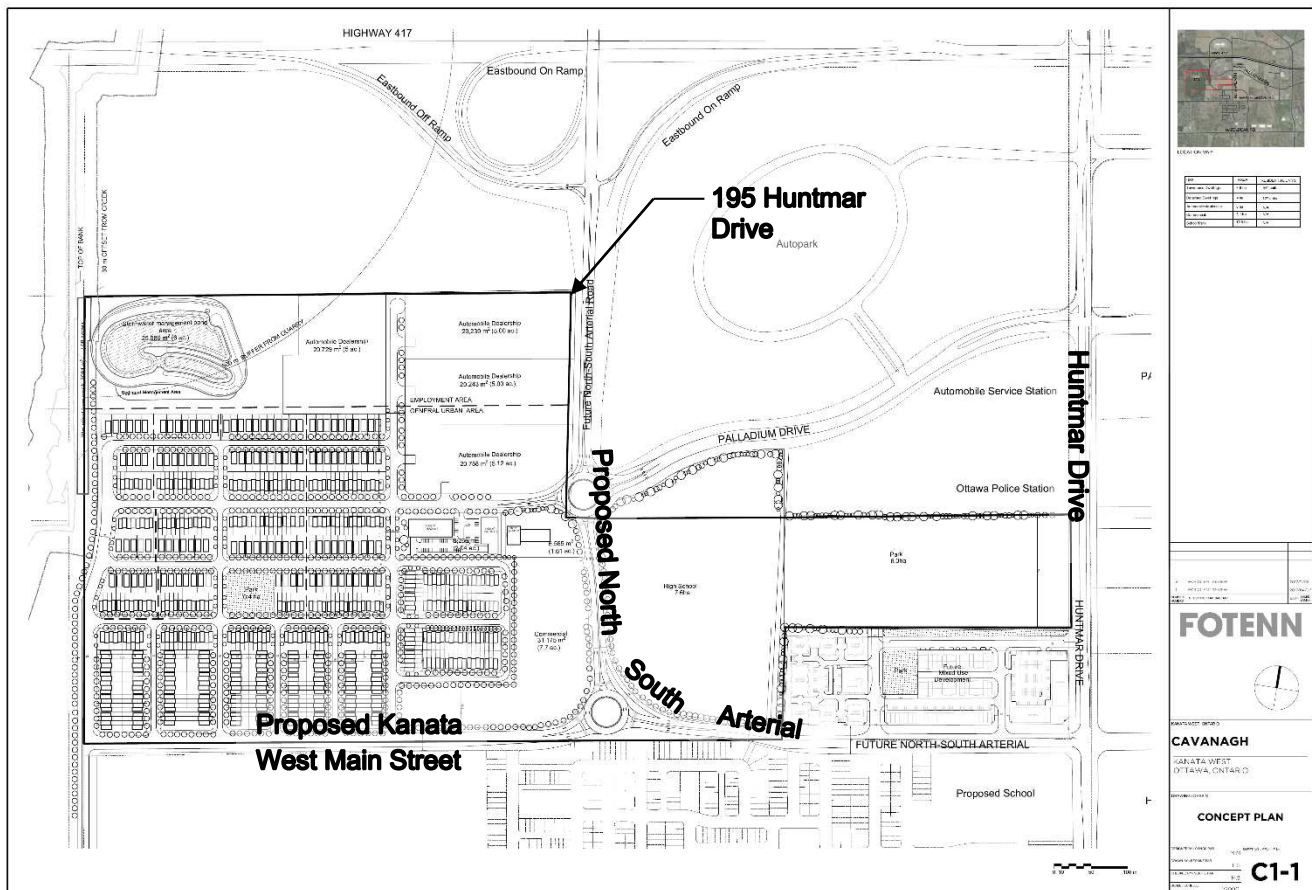



2.4.1.3 Future Transit Facilities and Services

The 2013 TMP outlines the future rapid transit and transit priority (RTTP) network. The 'Affordable RTTP Network' notes that North-South transit signal priority and queue jump lanes will be implemented at select intersections between Palladium Drive and Fernbank Road, located approximately 1km east of the study area. Along Hazeldean Road, transit signal priority and queue jump lanes will be implemented at select intersections between Stittsville Main Street and Palladium Drive is located approximately 1km south of the study area. **Exhibit 8** shows the transit infrastructure projects in the vicinity of the study area that are part of the affordable plan.

EXHIBIT 8 – Future 'Affordable RTTP Network Projects'

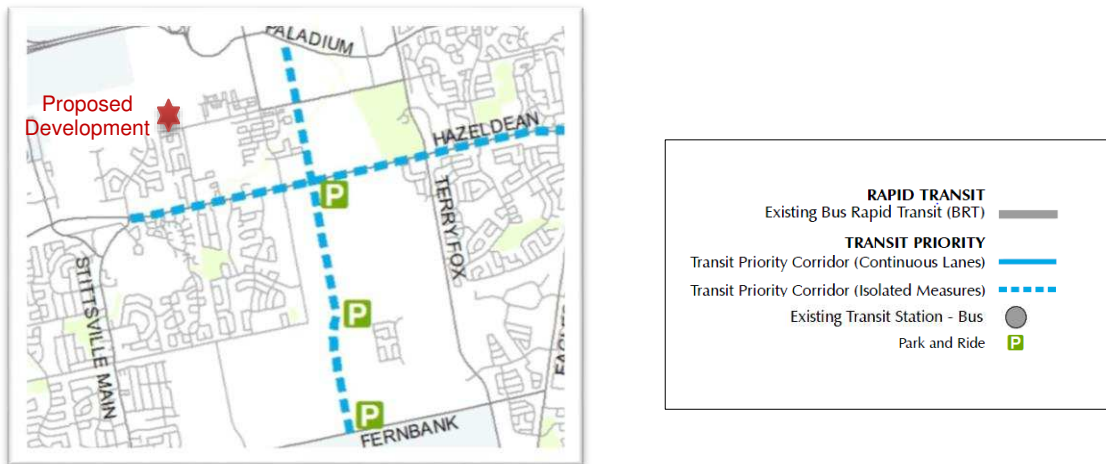

2.4.1.4 Future Cycling and Pedestrian Facilities

The Ultimate Cycling Network in the Transportation Master Plan (TMP) designates Maple Grove Road as a "Local Route" east of Stittsville Main Street, and a "Major Pathway" west of Stittsville Main Street.

The Ottawa Cycling Plan (2013), a long term strategic plan to strengthen and support cycling in the City, does not note any future modifications to the area cycling network based on the 'Affordable Cycling Network Plan' recommendations. **Exhibit 9** shows the future cycling network in the vicinity of the proposed development.

It is assumed that the proponent will provide continuous sidewalks along the frontage of Maple Grove Road to ensure pedestrian connectivity between the subject site and the adjacent boundary streets.



EXHIBIT 9 – Affordable Cycling Network



The Kanata West Transportation Master Plan shows pedestrian and cycling pathway linkages planned along Maple Grove Road and the proposed Stittsville Main Street extension that will link together the communities of Stittsville and Kanata West.

2.4.2 Future Adjacent Developments

The City of Ottawa Transportation Impact Assessment (TIA) Guidelines specifies all significant developments within the study area which are likely to occur within the horizon years must be identified and recognized in all TIA reports. **Table 3** summarizes the developments adjacent to the study area, which are also shown in **Exhibit 10**.

The proposed development at 173 Huntmar Drive is located approximately 1.2km east along Maple Grove Road and 300m north along Huntmar Drive.

The proposed development at 1919 Maple Grove Road is located immediately to the east of the subject development. The exact unit count was unknown when writing this report. An estimate is included, based on the latest site plan provided.

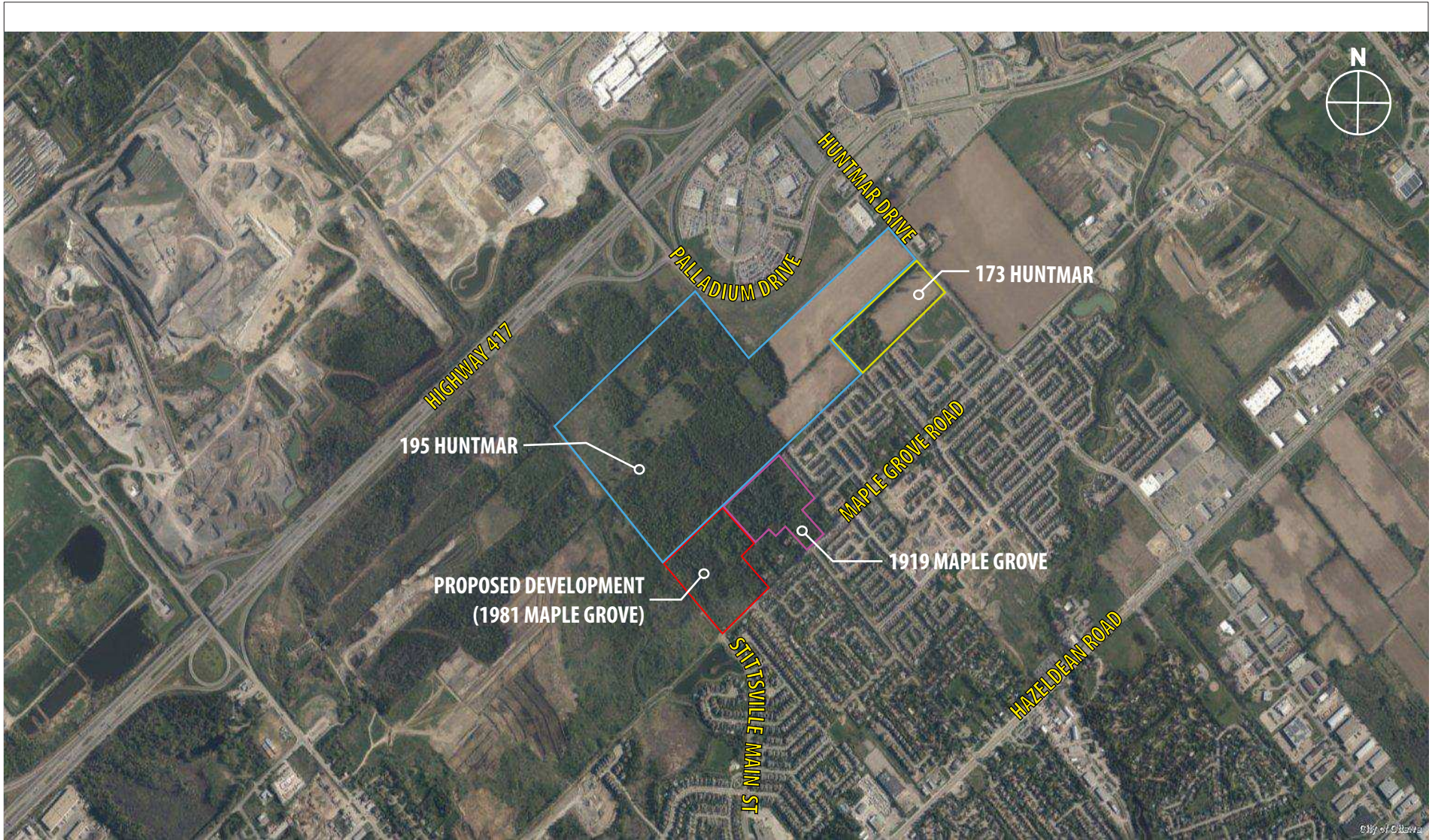

TABLE 3 – Developments Adjacent to Study Area

DEVELOPMENT LOCATION	DEVELOPER	TIA PREPARED BY (DATE)	SIZE/ NUMBER OF UNITS	EXPECTED BUILDOUT/ OCCUPANCY DATE	RECOMMENDED ROAD MODIFICATIONS
173 Huntmar Drive	Amazon Land Development Corp.	Parsons (2014)	345 townhome units	2021 ¹	Planned Road Modifications from TMP's 2031 Affordable Network will be sufficient to accommodate the development
			156 apartment units		
			65,930 ft ² office space		
			21,690 ft ² specialty retail		
1919 Maple Grove	Formasian	Not Complete Yet	79 townhome units	2021	TBD
			440 apartment units	2026	

¹ Full buildout/ occupancy date not noted in the Community Transportation Study (CTS). The buildout dates listed above should be considered conservative estimates.

As previously noted in Section 2.4.1.2, the development of 195 Huntmar Drive will not be included in the analysis of this TIA report. The concept plan for the site has not yet been finalized, and buildout horizons for the site have not been established. Once the concept plan is finalized, it is expected that a transportation impact assessment (TIA) report will be prepared by Parsons to define the roadway infrastructure required to support this development, as well as adjacent developments such as the subject site, as part of the background traffic.



1981 Maple Grove Road (Claridge)
Transportation Impact Assessment

EXHIBIT 10
Adjacent Developments

PROJECT No.: 113480
DATE: FEBRUARY 2018
SCALE:





2.4.3 Network Concept Screenline

Network screenline analysis is not expected to be necessary for this development, as it does not trigger threshold of 200 person trips or more during the peak hour, specified in Table 4: Module 4.8 – Network Concept of the 2017 TIA Guidelines.

Detailed trip generation calculations will be provided in Section 3.1: Development of Traffic Generation, as part of the Forecasting stage of the report.

2.5 Study Area

Based on the review of the nearest screenlines, transit routes and active transportation facilities, the proposed study area will be defined by Huntmar Drive to the east, the proposed Stittsville Main Street extension to the west, as well as Maple Grove Road to the south.

The following existing intersections will be assessed as part of this TIA:

- Maple Grove Road and Huntmar Drive
- Maple Grove Road and Santolina Street
- Maple Grove Road and Alon Street

The following proposed intersections will be assessed as part of this TIA:

- Street 1 and proposed Stittsville Main Street extension (2021 & 2026)
- Street 2 and proposed Stittsville Main Street extension (2021 & 2026)
- Street 4 and proposed Stittsville Main Street extension (2021 & 2026)
- Street 6 and Maple Grove Road (2021 & 2026)
- Maple Grove Road and proposed Stittsville Main Street extension (2021 & 2026)

The development lands at 195 Huntmar Drive will not be included in the project study area. This TIA will consider the worst case scenario, and rely on existing roadway infrastructure to service the subject development. It is expected that the roadway network to the north of the site will be defined by the future Parsons TIA report for 195 Huntmar Drive.

2.6 Time Periods

Traffic generated during the morning and afternoon week day peak hour is expected to result in the most significant impact to traffic operations on the adjacent network in terms of development-generated and background traffic. These two (2) analysis periods will be used for operational analysis in the TIA.

2.7 Horizon Years

Two (2) future horizons are proposed for analysis in the Transportation Impact Analysis (TIA) Report:

- Year 2021 – Opening Day; Full occupancy
- Year 2026 – Opening Day plus 5 years



2.8 Exemptions Review

Table 4 of the Transportation Impact Assessment (TIA) Guidelines provides exemption considerations for both the Design Review Component and Network Impact Component. Upon reviewing this list, the Circulation and Access, Parking Supply, Spillover Parking and Network Concept components were exempted from the TIA analysis. No other exemptions were considered for the TIA.

TABLE 4 – Exemption Considerations

TIA MODULE	ELEMENT	EXEMPTION CONSIDERATIONS	REQUIRED
Design Review Component			
4.1 Development Design	4.1.2 Circulation and Access	<ul style="list-style-type: none"> Only required for site plans 	
	4.1.3 New Street Networks	<ul style="list-style-type: none"> Only required for plans of subdivision 	
4.2 Parking	4.2.1 Parking Supply	<ul style="list-style-type: none"> Only required for site plans 	
	4.2.2 Spillover Parking	<ul style="list-style-type: none"> Only required for site plans where parking supply is 15% below unconstrained demand 	
Network Impact Component			
4.5 Transportation Demand Management	All Elements	<ul style="list-style-type: none"> Not required for site plans expected to have fewer than 60 employees and/or students on location at any given time 	
4.6 Neighbourhood Traffic Management	4.6.1 Adjacent Neighbourhoods	<ul style="list-style-type: none"> Only required when the development relies on local or collector streets for access and total volumes exceed ATM capacity thresholds 	
4.8 Network Concept	n/a	<ul style="list-style-type: none"> Only required when proposed development generates more than 200 person-trips during the peak hour in excess of the equivalent volume permitted by established zoning 	



3 Forecasting

The purpose of the Forecasting section is to “generate the future transportation demand number required to analyze pre and post-development network performance to determine if a network modification is required to offset development impacts” (City of Ottawa TIA Guidelines, p. 27).

3.1 Development Generated Traffic

3.1.1 Trip Generation Methodology

Peak hour development generated traffic volumes were developed using Institute of Transportation Engineers (ITE) Trip Generation Manual, 9th Edition, 2012. The Transportation Impact Assessment (TIA) Guidelines require ITE vehicle-trip rates to be adjusted to better reflect local travel patterns. The ITE trip generation rates are based on data collected from traffic surveys conducted across North America, but mostly in suburban areas of the United States where the level of transit use is traditionally very low (estimates show that ITE rates average approximately 96% auto mode split). This statistic is not representative of the City of Ottawa that has a well-established transit system and pedestrian/ cycling network.

The City recommends the ITE vehicle-trip rates be converted to person-trips split based on representative mode share proportions. This conversion factor was based on a recommended average vehicle occupancy of 1.15 and a 10% non-auto mode share. The person-trips were then split based on representative mode share percentages to determine the number of vehicle, transit, pedestrian, cycling and other trip types.

Local mode shares were based on the TRANS Committee: 2011 Origin-Destination (OD) Survey completed for the City of Ottawa. The OD Survey has mode share breakdowns for specific zones throughout the City; the Kanata/Stittsville Zone contained the subject site and was applied in this analysis.

3.1.2 Trip Generation Results

3.1.2.1 ITE Vehicle Trip Generation

The peak hour vehicular traffic volumes from the subject development were determined using peak hour trip generation rates from the ITE Manual. A summary of the vehicular trip generation results for the proposed development has been summarized in **Table 4**. The relevant extracts from the ITE Manual have been provided in **Appendix D**.



TABLE 5 – ITE Development Trip Generation Results

LAND USE (ITE CODE)	SIZE (DU)	PERIOD	GENERATED TRIPS (VPH)		
			IN	OUT	TOTAL
Single Detached Housing (210)	57	AM	12	37	49
		PM	40	23	63
Townhouse (230)	139	AM	11	56	67
		PM	53	26	79

Notes: DU = Dwelling Units

vph = vehicles per hour; DU = Dwelling Units

Formula Rate and Splits for Single Detached Homes

AM: $T = 0.7(X) + 9.74$

IN: 25%; OUT: 75%

PM: $T = e^{(0.9 \cdot \ln(X) + 0.51)}$ IN: 63%; OUT: 37%

vph = vehicles per hour; DU = Dwelling Units

Formula Rate and Splits for Townhomes

AM: $T = e^{(0.80 \cdot \ln(X) + 0.26)}$ IN: 17%; OUT: 83%

PM: $T = e^{(0.82 \cdot \ln(X) + 0.51)}$ IN: 67%; OUT: 33%

3.1.2.2 Person Trip Generation

The ITE vehicle-trip to person-trip conversion factor of 1.28 based on an average vehicle occupancy of 1.15 and a default 10% non-auto mode share was applied to vehicle-trip results in Table 5. The results after applying this factor have been summarized in Table 6.

TABLE 6 – Development Person Trip Generation Results

LAND USE (ITE CODE)	FACTOR	PERIOD	GENERATED TRIPS (PPH)		
			IN	OUT	TOTAL
Single Detached Housing (210)	1.28	AM	16	48	64
		PM	51	30	81
Townhouse (230)		AM	15	71	86
		PM	67	33	100
Total	AM	31	119	150	
	PM	118	63	181	

Notes:

pph = persons per hour; DU = dwelling units

3.1.2.3 Mode Share Proportions

The total person trips generated by the proposed development were stratified by mode, based on mode share proportions in the 2011 Origin-Destination (OD) Survey for the Kanata/ Stittsville Traffic Assessment Zone (TAZ). The relevant extracts from the 2011 OD Survey has been provided in Appendix E.

No adjustments were made to any sustainable modes of transportation such as transit, walking or cycling for future planning horizons. This approach should be considered conservative. The existing and proposed mode share targets for the Kanata/ Stittsville TAZ for each of the analysis horizons are outlined in Table 7.



TABLE 7 – Proposed Mode Shares for Kanata/ Stittsville (2011 OD Survey)

TRAVEL MODE	MODE SHARE	
	AM	PM
Auto Driver	60%	61%
Transit	24%	21%
Auto Passenger	9%	15%
Cycling	0%	0%
Walking	0%	0%
Other	7%	3%
Total	100%	100%

3.1.2.4 Trip Generation by Mode

The mode share target in **Table 7** were applied to person trips results from **Table 6** to estimate the number of development generated trips by mode, as shown in **Table 8**.

TABLE 8 – Development Generated Traffic by Mode

TRAVEL MODE	PEAK PERIOD TRIPS BY MODE					
	AM			PM		
	IN	OUT	TOTAL	IN	OUT	TOTAL
Auto Driver	18	71	89	72	39	111
Transit	7	29	36	25	13	38
Auto Passenger	3	11	14	18	9	27
Cycling	0	0	0	0	0	0
Walking	0	0	0	0	0	0
Other	2	8	10	4	2	6

The proposed development is expected to generate approximately 89 morning and 111 afternoon peak hour vehicular trips at full buildout.

3.1.3 Trip Distribution and Assignment

Since the land use of the proposed development will be residential, it is anticipated that the distribution of site-generated traffic in each of the four cardinal directions will be consistent with the commuter traffic flow, based on logical routings for each direction, and existing turning movement counts.

- 40% to/from the North
 - 40% via Huntmar Drive
- 35% to/from the South
 - 15% via Stittsville Main Street
 - 10% via Santolina Street



- 5% via Alon Street
- 5% via Huntmar Drive
- 25% to/from the East
 - 25% via Maple Grove Road

No traffic is expected to be headed to/from the west, as there are no existing or proposed roads that continue west of Stittsville Main Street, the westerly limit of the study area. Councillor Shad Qadri noted at the Public Open House (POH) for the draft plan of subdivision for 195 Huntmar Drive on January 10, 2018 that there are no plans to extend Maple Grove Road west of Stittsville Main Street, as the area to the west consists of wetlands that need to be protected.

The resulting development generated morning and afternoon peak hour traffic volumes has been provided in **Exhibit 11**.

3.2 Background Network Traffic

3.2.1 Changes to the Background Transportation Network

To properly assess future traffic conditions, the City requires that all anticipated changes to the transportation network over time, particularly road and transit route components, are accounted for through City planning documents. These changes would then be reflected in the future background demand volumes to develop an appropriate foundation for the TIA.

As noted in Section 2.4.1.2, it is expected that the development of the road network to the north of the subject site will be determined by Parsons in the future TIA for 195 Huntmar Drive. The TIA for the subject property will assume that the road network associated with 195 Huntmar Drive is not built out, as a worst case scenario, to provide a better evaluation of potential bottlenecks in the existing road network.

At the time of this study, the intersection of Maple Grove Road and Huntmar Drive operates with shared lanes on all approaches, except for the northbound approach, which consists of a separate left-turn lane and shared through-right lane. It is expected that the transportation network will be able to operate within City standards through to the 2026 total traffic condition with the addition of auxiliary lanes on all approaches at the intersection of Maple Grove Road and Huntmar Drive, which was previously recommended as part of the TIA for Fairwinds West (December 2012). The Fairwinds traffic study assumed that these modifications would be required by approximately 2017. These intersection modifications would support growth in both background and development traffic.



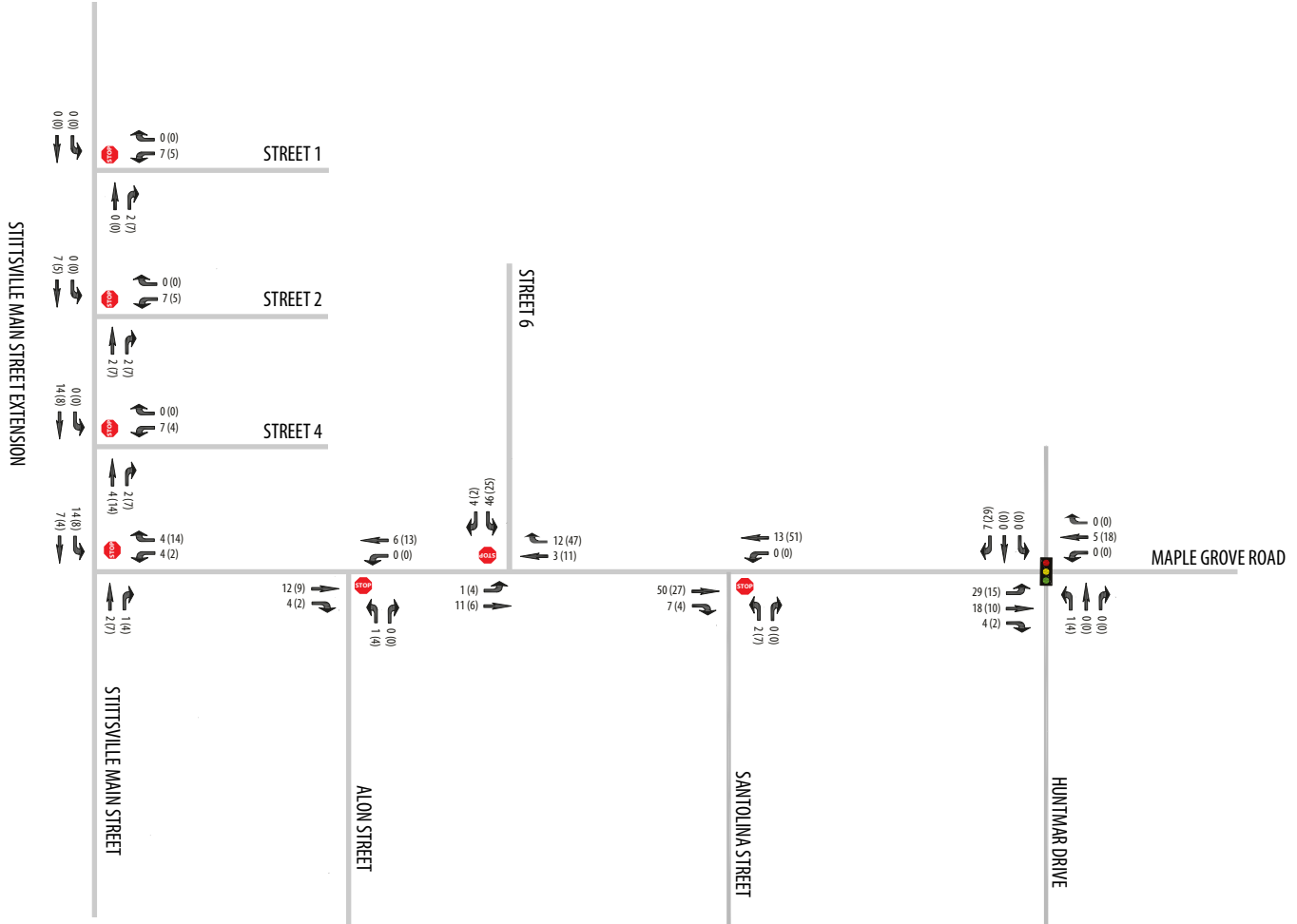
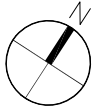

3.2.2 General Background Growth Rates

The background growth rate is meant to represent regional growth outside the study area, along the adjacent road network. The approved transportation impact assessment for the development of the Fairwinds West development at 33 Johnwoods Street that was prepared in December 2012 proposed a background growth rate of 2% should be applied to all turning movements at arterial and collector intersections. Similarly, a linear growth rate of 2% per annum was applied for existing traffic volumes at Maple Grove Road and Huntmar Drive to account regional growth in this traffic study.

The above assumptions were considered conservative, since other area developments have been captured separately in the TIA, as discussed in Section 3.2.3.



LEGEND

-  STOP CONTROL
-  TRAFFIC CONTROL SIGNAL
-  TRAVEL LANES AND PERMITTED MOVEMENTS
-  AM & PM PEAK HOUR VEHICULAR VOLUMES





3.2.3 Other Area Development

The City of Ottawa TIA Guidelines specifies all significant developments within the study area that are likely to occur within the horizon years must be identified and taken into consideration in all TIA reports. Since the traffic generated by these developments was not captured in the background traffic growth calculation, they must be added separately.

There are two (2) known developments expected to contribute traffic within the study area. These developments are currently in the development application approvals process. Construction has not begun for either of the developments; therefore, no units or retail space has been built or is currently occupied.

The adjacent developments have been summarized in **Table 9**, and their approximate locations in relation to subject site were shown in **Exhibit 9**.

TABLE 9 – Future Adjacent Developments

DEVELOPMENT NAME	LAND USE	UNITS or BUILDINGS NOT BUILT/ OCCUPIED
1919 Maple Grove Road	Townhome Units	79
	Apartment Units	440
173 Huntmar Drive	345 townhome units	345
	156 apartment units	156
	office space	65,930 ft ²
	specialty retail	21,690 ft ²

Notes: sf = square feet

As previously discussed in Section 2.4.1.2, the development of 195 Huntmar Drive has been excluded from this TIA report. The timing of the development is currently unknown, and the plan of subdivision is still undergoing revisions following a Public Open House held on January 10, 2018. As a worst case scenario, it was assumed that this development and key sections of the roadway network associated with it will not be constructed within the study horizons analysed in this report.

3.3 Demand Rationalization

The following section summarizes any adjustments made to future travel demands in the study area to account for capacity limitations of the transportation network.

3.3.1 Description of Capacity Issues

3.3.1.1 Maple Grove Road and Huntmar Drive

A review of previous TIAs reveals existing capacity issues with the intersection of Maple Grove Road and Huntmar Drive in ‘existing’ and ‘future’ planning scenarios. The TIA prepared for 33 Johnwoods Street in December 2012 notes that auxiliary left and right turn lanes were assumed to be provided by 2017 on all approaches at this intersection to accommodate future development in the area. The addition of auxiliary lanes at the intersection of Huntmar Drive and Maple Grove Road is expected to be sufficient to accommodate traffic generated from the subject site (1981 Maple Grove Road). There is 37.5m of right-of-way protection on the north, south and east legs of this intersection, and Maple Grove Road to the west of Huntmar Drive has 26m right-of-way protection, with an existing pavement width of 11m; therefore, left-turn auxiliary lanes can be accommodated on all approaches. The heavy



southbound right turn movement will require a right-turn lane to accommodate the nearly 200 vehicles that were recorded to have made this turn in the City's turning movement data during the PM Peak hour. The storage lengths required for the auxiliary lanes will be confirmed in Section 4.10: Geometric Review.

At the Public Open House (POH) held on January 10, 2018 to review the draft plan of subdivision for 195 Huntmar Drive, there were concerns raised from the public regarding existing congestion issues at the Huntmar Drive and Maple Grove Road intersection. Some residents noted that the 4-lane widening of Huntmar Drive from Campeau Drive to Maple Grove Road should be made a priority, and that the timing currently provided for the widening, as part of Phase 3 of the TMP's Affordable Network from 2026 to 2031, was insufficient to match development growth in the area.

The nearly 200 eastbound left-turning vehicles recorded at the intersection of Maple Grove Road and Huntmar Drive contributes to this congestion, as this approach consists of only a single shared through-left turn lane. There are also potential conflicts implementing an eastbound left-turn lane due to existing townhomes with direct frontage onto Maple Grove Road. Storage length requirements will be analysed for this intersection in Section 4.9: Intersection Design.

3.3.1.2 Maple Grove Road Extension

The existing Maple Grove Road terminates in a cul-de-sac just west of Alon Street approximately 110m from Stittsville Main Street. A gravel pathway currently connects Stittsville Main Street and Maple Grove Road. A future connection will significantly improve connectivity to the overall transportation network, especially for motorists travelling south to Stittsville or west to Carp.

As a result of this proposed extension, which is assumed to be completed by the 2021 planning horizon, a 50% diversion of trips from the neighbouring community southwest of the subject property was assumed. In this community, motorists are currently forced to access/ egress the subdivision via Stittsville Main Street and Hazeldean Road. A screenline traffic count was conducted by IBI staff on Thursday, January 25, 2018 at Bandelier Way and Stittsville Main Street to determine the number of trips that are currently heading north and south along Stittsville Main Street during the AM and PM Peak hours. **Table 10** provides a summary of results from the traffic count conducted at Bandelier Way and Stittsville Main Street, and the number of trips diverted to the Maple Grove Road extension. **Exhibit 12** highlights the community to the southwest of the subject development, referred to as the Traffic Diversion Capture Area, where most trips would originate or terminate.

The Official Plan (OP) currently classifies Maple Grove Road as a collector road from Huntmar Drive to the proposed multi-use pathway (formerly Johnwoods Street), and a local road further west towards Stittsville Main Street. The OP indicates that 26m of right-of-way has been protected along the entire corridor from Huntmar Drive to Stittsville Main Street; therefore, it is recommended that west of Huntmar Drive, Maple Grove Road should be upgraded to a collector road.



TABLE 10 – Bandelier Way & Stittsville Main Street Diversion to Maple Grove Road Extension

INTERSECTION	TRAFFIC COUNT DATA			50% DIVERSION OF TRAFFIC TO MAPLE GROVE ROAD EXTENSION		
	DIRECTION	AM PEAK HR	PM PEAK HR	DIVERSION DIRECTION	AM PEAK HR	PM PEAK HR
Stittsville Main Street & Bandelier Way	NBT	92	272	SBT	46	136
	SBT	248	193	NBT	124	97

EXHIBIT 12 – Traffic Diversion Capture Area for Maple Grove Road Extension



3.4 Traffic Volume Summary

3.4.1 Future Background Traffic Volumes

The existing 2018 peak hour traffic volumes from the Scoping Report has been provided in **Exhibit 13**. The future background traffic volumes developed in Section 3: Background Network Traffic for the 2021 and 2026 horizons have been provided in **Exhibits 14** and **15**, respectively.

3.4.2 Future Total Traffic Volumes

The site generated peak hour traffic volumes from **Exhibit 11** were added to corresponding background traffic volumes to create background plus site generated or total peak hour traffic volumes for the 2021 and 2026 horizon years, as shown in **Exhibits 16** and **17**, respectively.

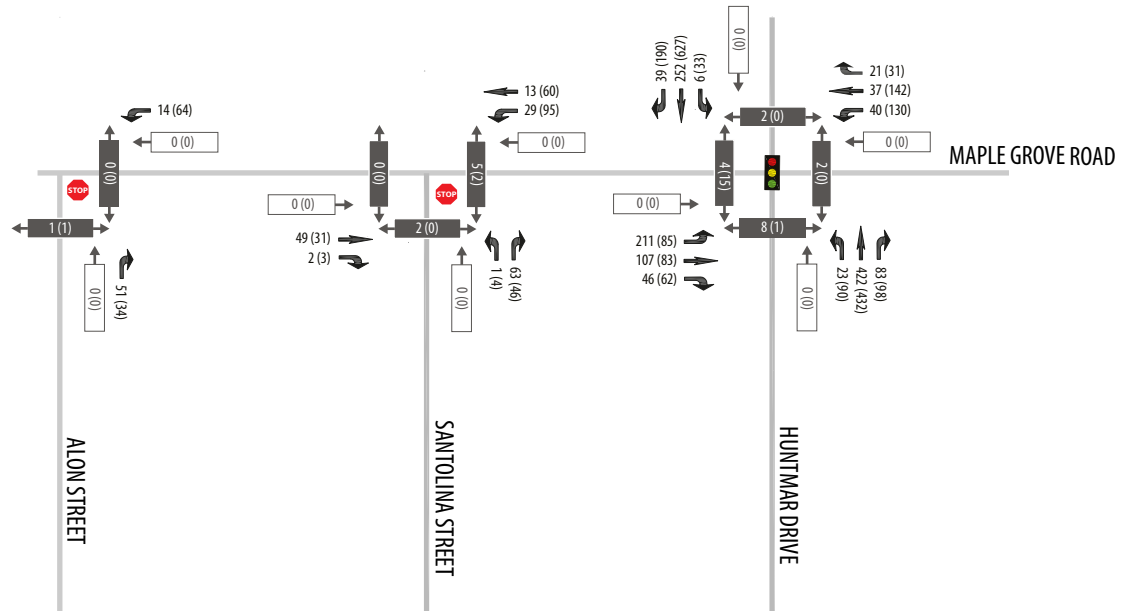
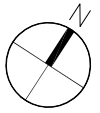



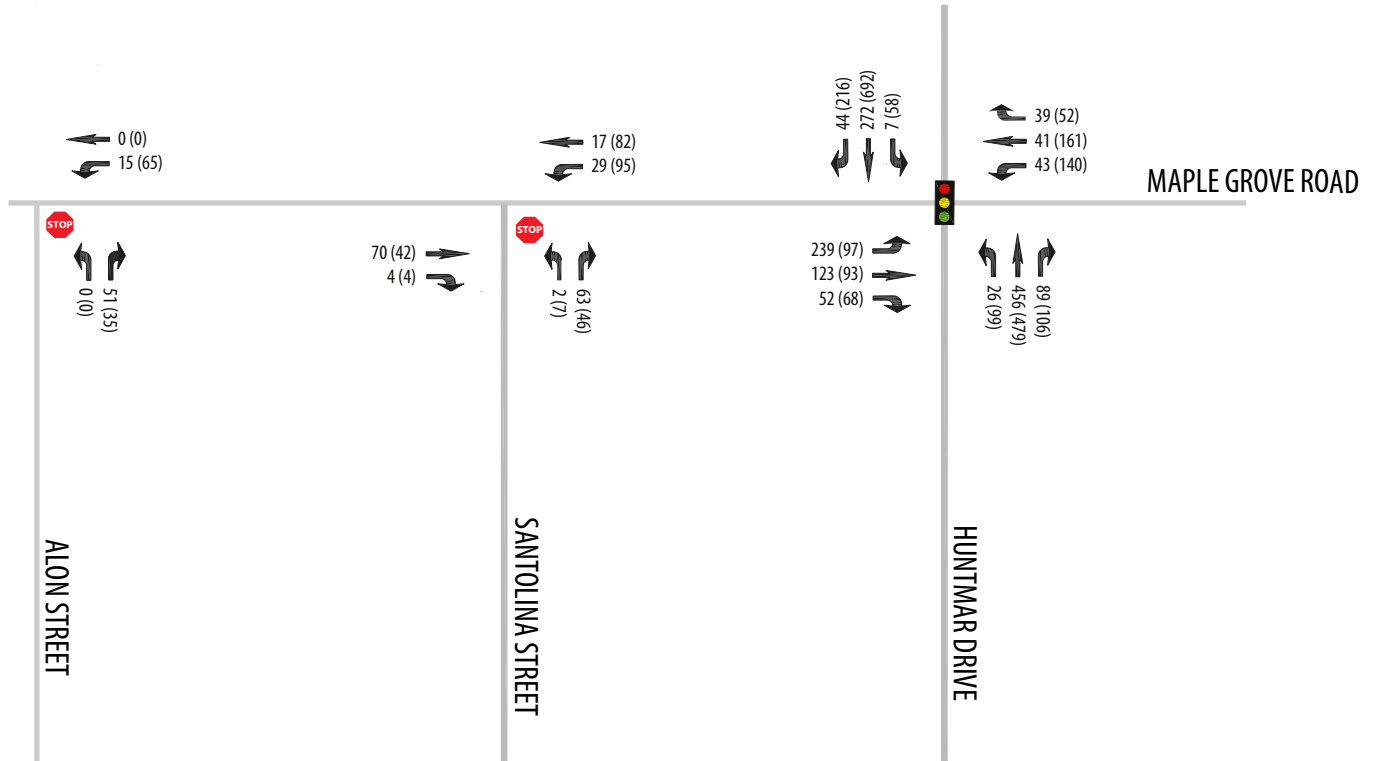
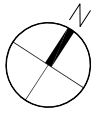

LEGEND

- STOP CONTROL
- TRAFFIC CONTROL SIGNAL
- TRAVEL LANES AND PERMITTED MOVEMENTS
- AM & PM PEAK HOUR VEHICULAR VOLUMES
- AM & PM PEAK HOUR PEDESTRIAN VOLUMES
- AM & PM PEAK HOUR CYCLING VOLUMES







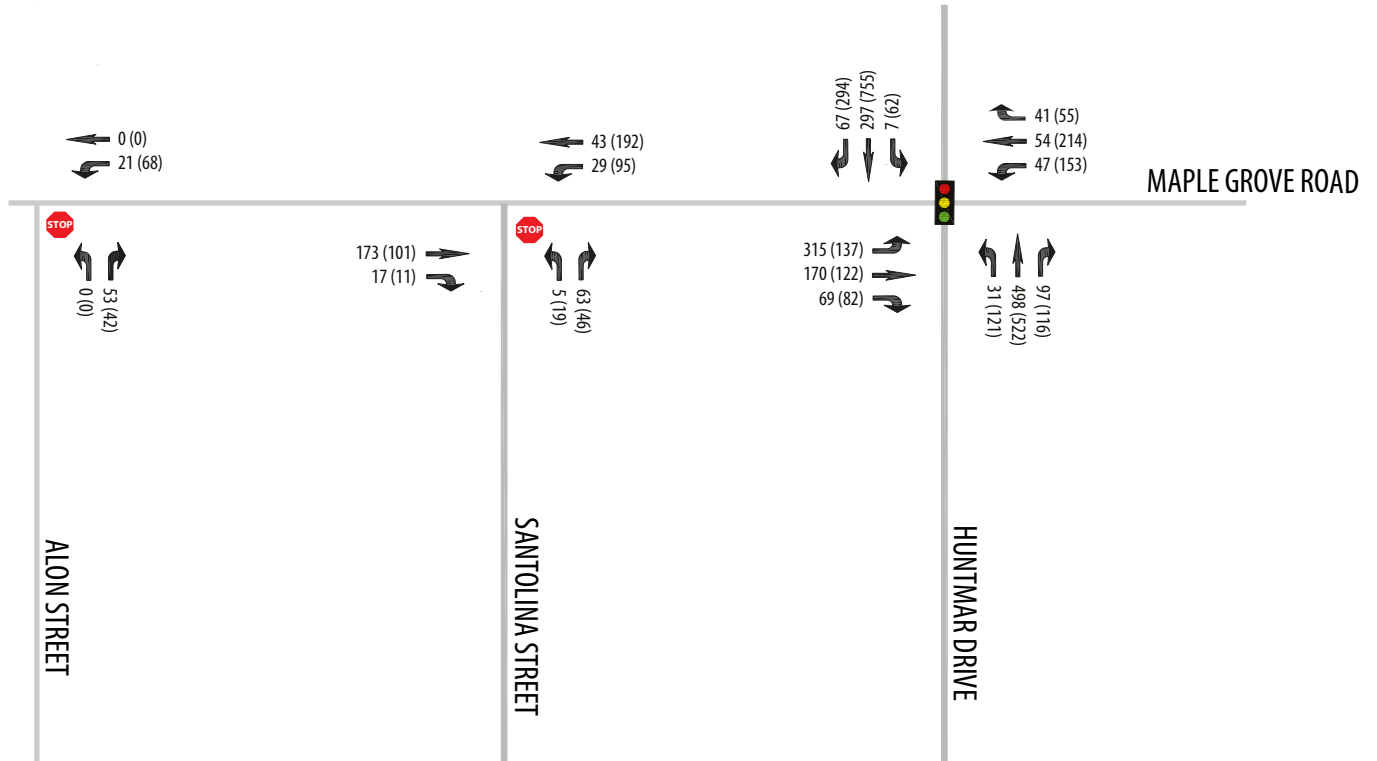
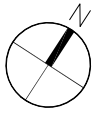

LEGEND

-  STOP CONTROL
-  TRAFFIC CONTROL SIGNAL
-  TRAVEL LANES AND PERMITTED MOVEMENTS
-  AM & PM PEAK HOUR VEHICULAR VOLUMES





LEGEND



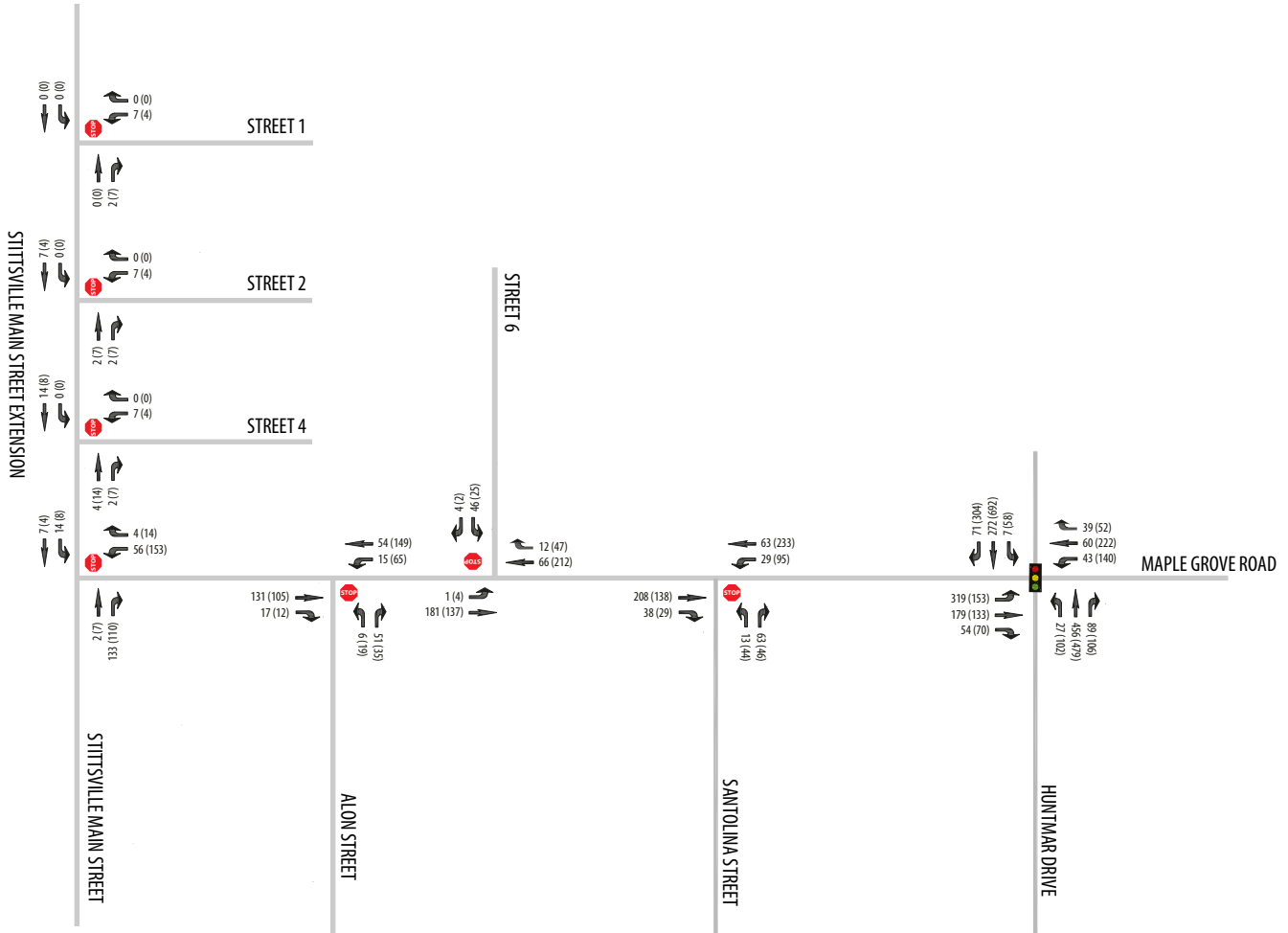
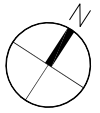

-  STOP CONTROL
-  TRAFFIC CONTROL SIGNAL
-  TRAVEL LANES AND PERMITTED MOVEMENTS
-  AM & PM PEAK HOUR VEHICULAR VOLUMES

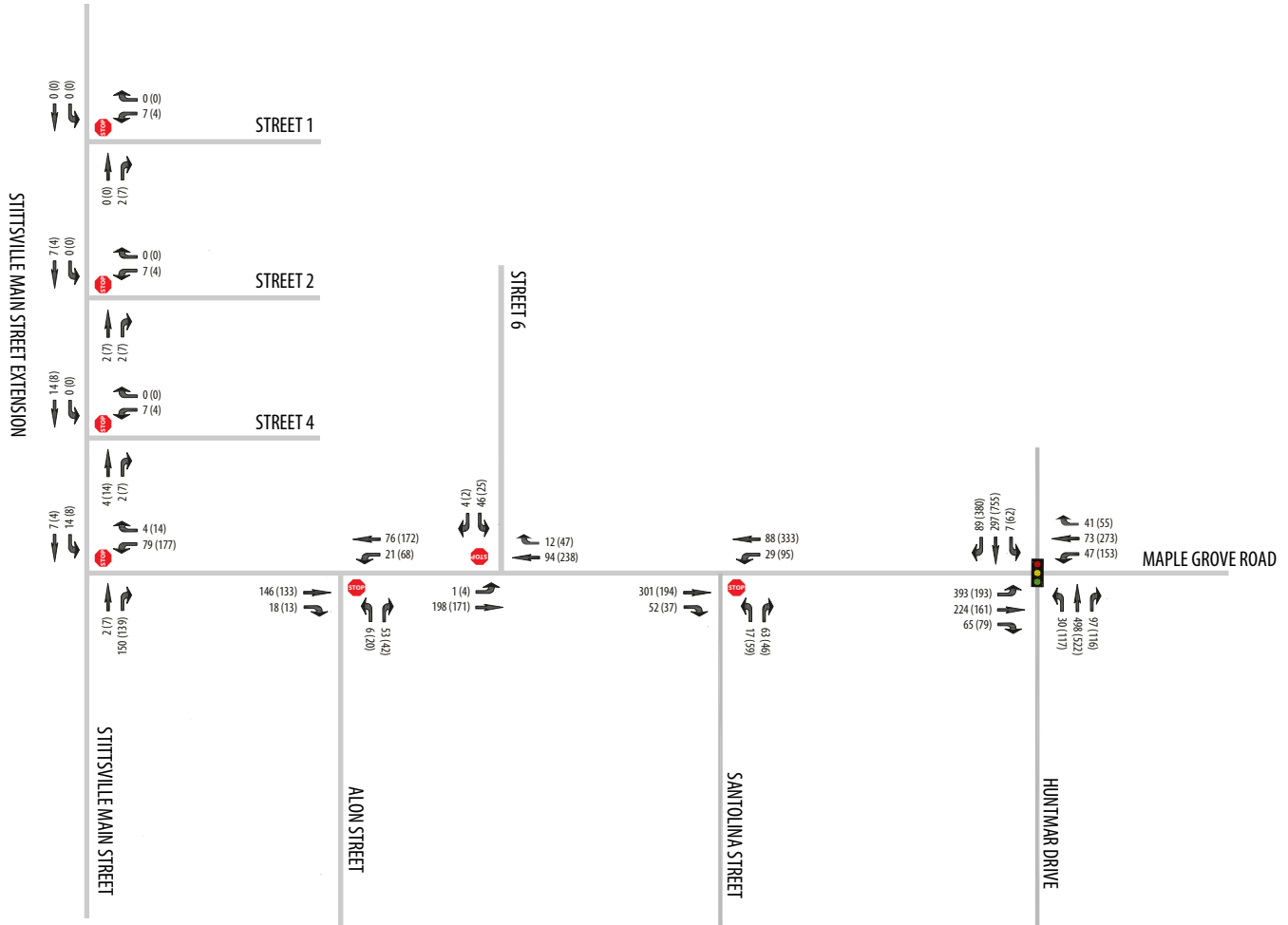
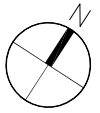





LEGEND

-  STOP CONTROL
-  TRAFFIC CONTROL SIGNAL
-  TRAVEL LANES AND PERMITTED MOVEMENTS
-  AM & PM PEAK HOUR VEHICULAR VOLUMES





4 Analysis

The purpose of the TIA Analysis is to “assess the alignment between the transportation elements of the proposed development and the City of Ottawa’s city-building objectives and identify any opportunities to improve alignment. It also evaluates the post-development performance of the planned transportation network based on the City’s established performance measures and targets and identifies potential mitigation measures to off-set development impacts” (Ottawa 2017 TIA Guidelines, p. 35).

4.1 Development Design

4.1.1 Design for Sustainable Modes

The nearest existing bus stops to the subject development are located south of the cul-de-sac on Stittsville Main Street, which provides transit service to approximately 90% of the development within the maximum 400m walking distance required by the City. Extending transit service along Maple Grove Road west towards Stittsville Main Street would ensure that 100% of the development is within the 400m walking distance of a transit stop, as shown in **Exhibit 18**.

There are no cycling facilities planned within the proposed development. Sidewalks have been strategically placed to ensure adequate accessibility to the adjacent road network and local amenities.

4.1.2 New Street Networks

The proposed development will provide new local streets with 18m right-of-way to connect with the greater community. Street 1, Street 2 and Street 4 will be oriented approximately east-west, and will tie into the proposed Stittsville Main Street extension. Street 7 will tie into the proposed development to the east of the subject property.

Street 6 will be oriented approximately north-south, providing a connection with Maple Grove Road to the south, and the proposed Stittsville Main Street extension to the north. A park is being proposed at the northeast corner of the subject site, bounded by Street 6 to the west, and the proposed Kanata West Main Street to the north.

4.2 Parking

The Parking Supply and Spillover Parking elements are exempt from this TIA, as indicated in Section 2.8: Exemptions Review. These elements are only required for site plan applications.

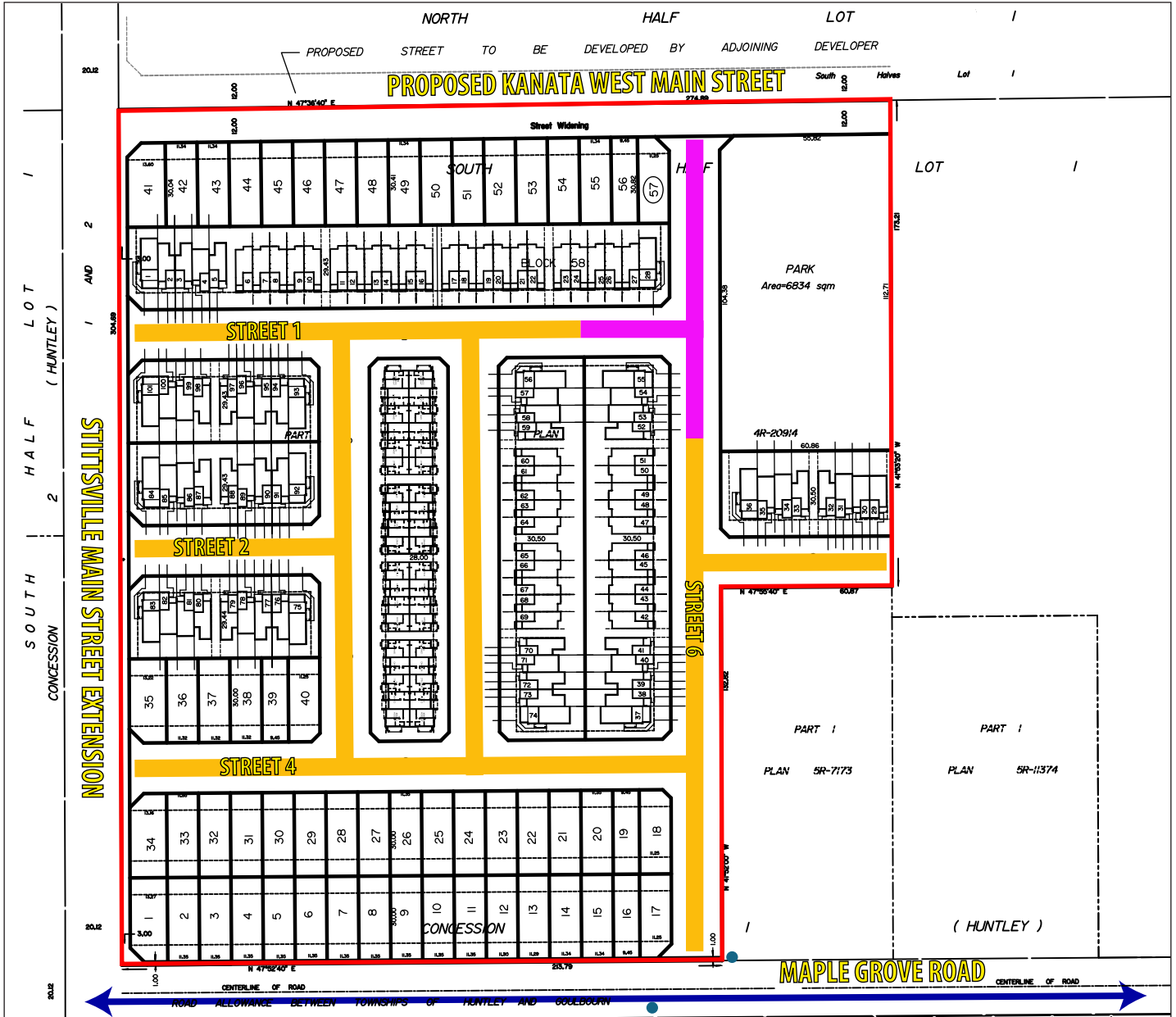

STITTSVILLE MAIN STREET EXTENSION

SOUTH HALF LOT 2 (HUNTLEY)

NORTH HALF LOT 1
 PROPOSED STREET TO BE DEVELOPED BY ADJOINING DEVELOPER
PROPOSED KANATA WEST MAIN STREET

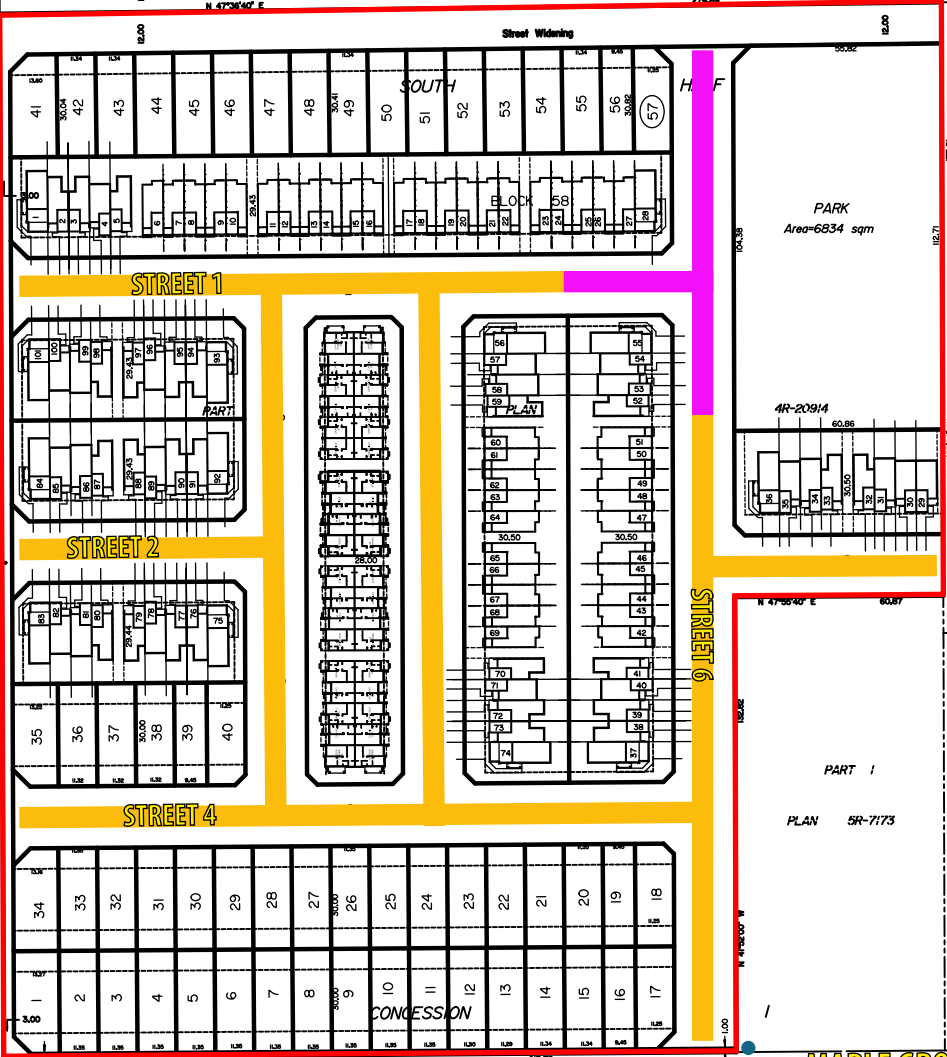

MAPLE GROVE ROAD

STITTSVILLE MAIN STREET

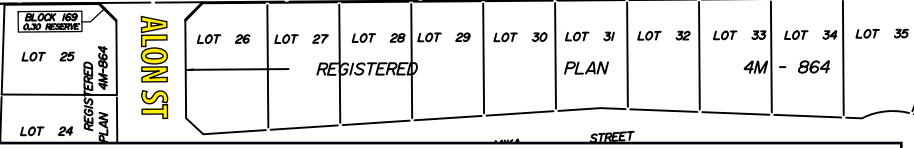

LEGEND

	EXISTING TRANSIT ROUTE		POTENTIAL TRANSIT ROUTE
	EXISTING TRANSIT STOP		POTENTIAL TRANSIT STOP
	EXISTING TRANSIT STOP COVERAGE (400m WALKING DISTANCE)		POTENTIAL TRANSIT STOP COVERAGE (400m WALKING DISTANCE)
	1981 MAPLE GROVE - PROPERTY LIMITS		





4.3 Boundary Streets

There are two (2) boundary streets associated with the subject development that will be analysed as part of the Segment Multi-Modal Level of Service (MMLOS) review. Maple Grove Road abuts the subject development to the south, and is the only existing boundary street associated with this property. The Stittsville Main Street extension is proposed immediately west of the subject property. Complete street concepts have not been prepared for either of these boundary streets.

Segment multi-modal level of service (MMLOS) was undertaken for both Maple Grove Road and the proposed Stittsville Main Street extension. Segment MMLOS is dependent on the roadway geometry; therefore, changes to the cross-section elements will trigger changes to the Segment MMLOS. For Maple Grove Road, it was assumed that the existing urban cross-section elements east of the proposed multi-use pathway (formerly Johnwoods Street) will be incorporated into future cross-section of Maple Grove Road west towards Stittsville Main Street. West of the proposed multi-use pathway, Maple Grove Road is currently classified as a local road with a rural cross-section and no formal pedestrian facilities. Similarly for the extension of Stittsville Main Street, it was assumed that the cross-section characteristics of Stittsville Main Street would continue north of Maple Grove Road.

The results of the Segment Multi-modal Level of Service (MMLOS) for Existing (2018) conditions are shown in **Table 11**, and for the Future Background and Total Traffic (2021 and 2026) results are shown in **Table 12**. **Appendix F** provides all detailed Segment MMLOS results.

TABLE 11 – Segment MMLOS – Existing (2018) Results

SEGMENT	LEVEL OF SERVICE			
	2018			
	P	B	T	TK
Maple Grove Road (Alon Street to proposed multi-use pathway ¹)	F ²	B	D	B

¹ Formerly Johnwoods Street

² This section of Maple Grove Road has a rural cross-section with gravel shoulders, and no formal pedestrian facilities

TABLE 12 – Segment MMLOS – Background and Total (2021 & 2026) Results

SEGMENT	LEVEL OF SERVICE			
	2021, 2026			
	P	B	T	TK
Maple Grove Road (Stittsville Main Street to multi-use pathway ¹)	B	B	D	B
Proposed Stittsville Main Street Extension (Maple Grove Road to Street 1)	B	B	D	B

¹ Formerly Johnwoods Street



4.4 Access Intersections

4.4.1 Location and Design of Access

The proposed vehicular accesses/ egresses for the subject site will be located to the south of the site via Maple Grove Road/ Street 6, to the west of the site via the proposed Stittsville Main Street and Street 1, Street 2 and Street 4, as well as to the north via the proposed Kanata West Main Street and Street 6.

According to TAC Section 9.2.4, the minimum spacing for successive local-to-local T-intersections is 40m. The proposed accesses/ egresses for this development all satisfy this requirement. The three (3) proposed accesses along the western property boundary of the subject site would tie in to the proposed Stittsville Main Street extension, each with a spacing of 80m centre-to-centre. In addition, the proposed access to Maple Grove Road via Street 6 is proposed approximately 55m centre-to-centre east of the existing Alon Street and Maple Grove Road intersection, and located on the opposite side of Maple Grove Road.

There is an existing driveway serving a single-family home located approximately 60m east of the proposed Street 6 access along Maple Grove Road. According to the Private Approach By-Law, the minimum distance between a private approach and the nearest intersecting street line is 6m, which meets this requirement. Furthermore, traffic volumes accessing/ egressing the residential access are expected to be very light, and are not expected to result in operational conflicts with the Street 6 access or vice versa.

4.4.2 Intersection Control

4.4.2.1 Roundabout Analysis

The Roundabout Screening Tool was completed for the following access intersections:

- Proposed Stittsville Main Street Extension and Street 1
- Proposed Stittsville Main Street Extension and Street 2
- Proposed Stittsville Main Street Extension and Street 4
- Maple Grove Road and Street 6

Based on the results of the analysis from the Roundabout Screening Tool, a roundabout was not warranted at any of the above intersections. The results of the Roundabout Screening Tool are shown in **Appendix G**.

4.4.2.2 Traffic Signal Warrants

The use of traffic signals was investigated at the following access intersections:

- Proposed Stittsville Main Street Extension and Street 1
- Proposed Stittsville Main Street Extension and Street 2
- Proposed Stittsville Main Street Extension and Street 4
- Maple Grove Road and Street 6

Traffic signal warrants specified in the Ontario Traffic Manual (OTM) Book 12 were completed for the above noted intersections in the 2026 total traffic condition, and the conclusion of the analysis indicated that signalization at all of the intersections would be unnecessary.

The results of the traffic signal warrant analysis are shown in **Appendix H**.



4.4.3 Intersection Design

The Multi-Modal Level of Service (MMLOS) Guidelines provide guidance on how to assess the various LOS for the different modes of transportation and specify target service levels for each mode, given the location and context of the transportation project. This all-in-one evaluation tool allows for comparisons using similar performance metrics for each non-auto mode.

The MMLOS procedure is only applied to signalized intersections and the worst-performing approach at the intersection for any mode represents the overall intersection MMLOS for that mode. As indicated in Section 1.4.2.2, none of the above proposed access intersections will require signalization in the 2026 total traffic condition; therefore, no MMLOS analysis is required for any of these intersections.

4.5 Transportation Demand Management

The City of Ottawa is committed to implementing Transportation Demand Management (TDM) measures on a City-wide basis in an effort to reduce the automobile dependence of Ottawa residents, particularly during the weekday peak travel periods. TDM initiatives are aimed at encouraging individuals to use non-auto modes of travel during the peak periods.

Mode shares used to estimate future development traffic were based on the 2011 TRANS OD Survey for the Traffic Assessment Zone where the proposed development is located. The non-auto transportation mode shares were left constant in the future, which was a conservative assumption.

There are no employment uses proposed onsite. However, the development will still conform to the City's TDM principles by providing direct connections to adjacent pedestrian, cycling and transit facilities where applicable.

4.6 Neighbourhood Traffic Management

4.6.1 Adjacent Neighbourhoods

The Neighbourhood Traffic Management future volume thresholds outlined in the TIA Guidelines are not expected to be exceeded for the internal roads within the proposed development or on the boundary roads fronting the subject lands. The contribution of traffic to each proposed access, as well as the boundary streets within the development are shown in **Table 13** with traffic volumes from the 2026 total traffic condition.

As previously discussed in Section 3.3.1.2, it is recommended that Maple Grove Road be upgraded to a collector road from the proposed multi-use pathway (formerly Johnwoods Street) to Stittsville Main Street. Therefore, the capacity of the roadway will be increased from 120 vehicles per hour per lane (vphpl) to 300 vphpl.

The proposed access roads for the subject site are Street 1, Street 2, Street 4 and Street 6, none of which are expected to exceed the threshold for local roads of 120 vphpl.

The City has expressed concerns about the possibility of cut-through traffic on Street 6 from Maple Grove Road to the proposed Kanata West Main Street. Traffic calming measures such as curb bulbouts, speed humps or pedestrian cross-overs may be implemented to address these potential issues. The need and location of any traffic calming measures will be determined during the detailed design stage; however, the desire for cut through traffic will be dependent on the development of the roadway network to the north of the subject lands, and will be analysed further in the TIA for 195 Huntmar Drive.



TABLE 13 – Road Classification Capacity

STREET	SEGMENT	CAPACITY (VPHPL)	PEAK HOUR DEMAND IN PEAK DIRECTION (VPHPL)	
			AM	PM
Maple Grove Road	Stittsville Main Street to	300	245	285
Street 1	East of proposed Stittsville Main Street extension	120	7	7
Street 2	East of proposed Stittsville Main Street extension	120	7	7
Street 4	East of proposed Stittsville Main Street extension	120	7	7
Street 6	North of Maple Grove Road	120	50	51

4.6.2 Local Intersection Requirements

Local road intersections are expected to be unsignalized (stop-controlled) on the side street movement. These requirements will be reviewed and confirmed at detailed design. All pavement marking and signage requirements are expected to follow City standards.

4.7 Transit

4.7.1 Route Capacity

The estimated future total transit passenger demand within the study area was provided in Section 3.1.2.4: Trip Generation by Mode. The results have been summarized in **Table 14**.

TABLE 14 – 2031 Development Generated Transit Demand

PERIOD	PEAK PERIOD DEMAND	
	IN	OUT
AM	7	29
PM	25	13

The proposed development will generate a marginal amount of transit demand. Additional capacity and service improvements via transit priority measures were not deemed necessary.

4.8 Review of Network Concept

The Network Concept Screenline analysis described in Section 2.4.3 is exempt from analysis as part of this TIA. The number of trips generated from the proposed development is expected to be 150 person trips in the AM Peak Hour, and 181 person trips in the PM Peak Hour, which are both below the 200 persons per hour required to trigger screenline analysis.



4.9 Intersection Design

The study area intersections were evaluated in the morning and afternoon peak hour traffic conditions at the following horizons:

- Existing Traffic (2018)
- Future (2021) Background Traffic
- Future (2026) Background Traffic
- Future (2021) Total Traffic
- Future (2026) Total Traffic

The following intersections were included in this analysis:

- Maple Grove Road and Huntmar Drive
- Santolina Street and Maple Grove Road
- Alon Street and Maple Grove Road
- Street 1 and proposed Stittsville Main Street extension (new intersection)
- Street 2 and proposed Stittsville Main Street extension (new intersection)
- Street 4 and proposed Stittsville Main Street extension (new intersection)
- Maple Grove Road and proposed Stittsville Main Street extension (new intersection)
- Street 6 and Maple Grove Road (new intersection)

4.9.1 Base Road Network

The base road network configuration for existing intersections in each horizon year was based on the existing road network, as shown in **Exhibit 3**. There were no future roadway modifications noted in the Transportation Master Plan (TMP) "Affordable Network," DC Background Study or Capital Budget Forecasts within the study area.

A roundabout was not considered at the intersection of Huntmar Drive and Maple Grove Road due to existing right-of-way restrictions.

Further discussion on the geometric requirements for auxiliary turn lanes and storage lengths at proposed access intersections has been provided in Section 4.10.1: Auxiliary Lane Analysis.

4.9.2 Intersection Analysis Criteria

4.9.2.1 Roundabout Analysis

The Roundabout Screening Tool was completed for the following access intersections:

- Stittsville Main Street Extension and Maple Grove Road

Based on the results of the analysis from the Roundabout Screening Tool, a roundabout was not warranted at any of the above intersections. The results of the Roundabout Screening Tool are shown in **Appendix G**.

4.9.2.2 Signalized Intersections

In qualitative terms, the Level-of-Service (LOS) defines operational conditions within a traffic stream and their perception by motorists. A LOS definition generally describes these conditions in terms of such factors as delay, speed and travel time, freedom to manoeuvre, traffic interruptions, safety, comfort and convenience. LOS can also be related to the ratio of the volume to capacity (v/c) which is simply the relationship of the traffic volume (either



measured or forecast) to the capability of the intersection or road section to accommodate a given traffic volume. This capability varies depending on the factors described above. LOS are given letter designations from A to F. LOS “A” represents the best operating conditions and LOS “E” represents the level at which the intersection or an approach to the intersection is carrying the maximum traffic volume that can, practicably, be accommodated. LOS F indicates that the intersection is operating beyond its theoretical capacity.

The City of Ottawa has developed criteria as part of the Transportation Impact Assessment Guidelines, which directly relate the volume to capacity (v/c) ratio of a signalized intersection to a LOS designation. These criteria are shown in **Table 15**.

TABLE 15 – LOS Criteria for Signalized Intersections

LOS	VOLUME TO CAPACITY RATIO (v/c)
A	0 to 0.60
B	0.61 to 0.70
C	0.71 to 0.80
D	0.81 to 0.90
E	0.91 to 1.00
F	> 1.00

The intersection capacity analysis technique provides an indication of the LOS for each movement at the intersection under consideration and for the intersection as a whole. The overall v/c ratio for an intersection is defined as the sum of equivalent volumes for all critical movements at the intersection divided by the sum of capacities for all critical movements.

4.9.2.3 Unsignalized Intersections

The capacity of an unsignalized intersection can also be expressed in terms of the LOS it provides. For an unsignalized intersection, the Level of Service is defined in terms of the average movement delays at the intersection. This is defined as the total elapsed time from when a vehicle stops at the end of the queue until the vehicle departs from the stop line; this includes the time required for a vehicle to travel from the last-in-queue position to the first-in-queue position. The average delay for any particular minor movement at the un-signalized intersection is a function of the capacity of the approach and the degree of saturation.

The Highway Capacity Manual 2010 (HCM), prepared by the Transportation Research Board, includes the following Levels of Service criteria for un-signalized intersections, related to average movement delays at the intersection, as indicated in **Table 16**.

TABLE 16 – LOS Criteria for Unsignalized Intersections

LOS	DELAY (seconds)
A	<10
B	>10 and <15
C	>15 and <25
D	>25 and <35
E	>35 and <50
F	>50

The unsignalized intersection capacity analysis technique included in the HCM and used in the current study provides an indication of the Level of Service for each movement of the intersection under consideration. By this technique,



the performance of the unsignalized intersection can be compared under varying traffic conditions, using the Level of Service concept in a qualitative sense. One unsignalized intersection can be compared with another unsignalized intersection using this concept. Level of Service 'E' represents the capacity of the movement under consideration and generally, in large urban areas, Level of Service 'D' is considered to represent an acceptable operating condition (Level of Service 'E' is considered an acceptable operating condition for planning purposes for intersections located within Ottawa's Urban Core— the downtown and its vicinity). Level of Service 'F' indicates that the movement is operating beyond its design capacity.

4.9.3 Intersection Control

4.9.3.1 Traffic Signal Warrant Methodology

Traffic control signal warrants were completed for all unsignalized stop or yield controlled intersections. The warrant procedures for both existing and future conditions were based on the established methodology outlined in the Ontario Traffic Manual, Book 12, Ministry of Transportation Ontario (MTO), 2012.

For future traffic conditions, an Average Hourly Volume (AHV) for each intersection approach is estimated using the following equation and applied to the warrant procedure:

$$\text{Average Hourly Volume} = \frac{(\text{AM Peak Hour Volume} + \text{PM Peak Hour Volume})}{4}$$

4.9.3.2 Traffic Signal Warrant Results

The traffic signal warrants were not triggered in the existing (2018) condition or the 2026 total traffic condition at either of the existing unsignalized intersections within the study area: Santolina Street and Maple Grove Road, Alon Street and Maple Grove Road.

The proposed Stittsville Main Street extension and Maple Grove Road intersection does not currently exist as a 3-legged intersection. Therefore, signal warrant analysis was only conducted in the future (2026) total traffic condition, which did not trigger the minimum warrants for traffic control signals.

As previously mentioned in Section 4.4.2.2, traffic signal warrant analysis did not trigger the need for signals at any of the proposed access locations.

Details of the traffic signal warrants analyses described above are included in **Appendix H**.

4.9.4 Intersection Design (Operations)

4.9.4.1 Intersection Analysis Methodology

Using the established intersection capacity analysis criteria described above, the existing and future conditions were analyzed during the weekday peak hour traffic volumes derived in the previous sections of this report.

The worst/ critical observed LOS movement at each study area intersection was recorded; if the LOS was E or lower, it was compared to the intersection LOS. If the intersection LOS was also indicated to be below City standards, potential roadway modifications or measures were considered and the intersection was re-evaluated. Any recommended modifications would be carried forward to the following horizon.



The following section presents the results of the intersection capacity analysis and roundabout capacity analysis. All tables summarize study area intersection LOS results during the morning and afternoon peak hour periods. The Synchro analysis output files have been provided in **Appendix I**.

4.9.4.2 Existing (2018) Traffic Results

The existing (2018) intersection capacity analysis was based on morning and afternoon peak hour traffic volumes. The existing signal timing plan provided by the City for the Maple Grove Road and Huntmar Drive intersection is included in **Appendix J**. A summary of the results has been provided in **Table 17**.

TABLE 17 – Intersection Capacity Analysis: Existing (2018) Traffic

INTERSECTION	CONTROL	PEAK HOUR	V/C RATIO		LEVEL OF SERVICE	
			CRITICAL MOVEMENT	INTERSECTION	CRITICAL MOVEMENT	INTERSECTION
Huntmar Drive and Maple Grove Road	Traffic Signals	AM	0.79	-	C	-
		PM	0.97	0.95	E	E
	Traffic Signals ¹	AM	0.76	-	C	-
		PM	0.79	-	C	-
Maple Grove Road and Santolina Street	NB stop	AM	0.07	-	A	-
		PM	0.07	-	A	-
Maple Grove Road and Alon Street	NB stop	AM	0.05	-	A	-
		PM	0.04	-	A	-

Notes: EB = eastbound; WB = westbound; NB = northbound; SB = southbound

¹ Construct the following auxiliary lanes at the Maple Grove Road and Huntmar Drive intersection:

- a. 80m EBL storage lane; 30m WBL storage lane; NBL 40m storage lane; 15m SBL storage lane
- b. Extend NBL storage lane by 25m (proposed storage length = 40m)
- c. 15m SBL storage lane

4.9.4.3 2021 Background Traffic Results

The 2021 background traffic condition intersection capacity analysis for total background traffic was completed using morning and afternoon peak hour traffic volumes. All recommended modifications from the existing (2018) traffic condition have been carried forward to this horizon. A summary of the results has been provided in **Table 18**.

TABLE 18 – Intersection Capacity Analysis: 2021 Background Traffic

INTERSECTION	CONTROL	PEAK HOUR	V/C RATIO		LEVEL OF SERVICE	
			CRITICAL MOVEMENT	INTERSECTION	CRITICAL MOVEMENT	INTERSECTION
Huntmar Drive and Maple Grove Road	Traffic Signals	AM	0.81	-	D	-
		PM	0.78	-	C	-
Maple Grove Road and Santolina Street	NB stop	AM	0.06	-	A	-
		PM	0.06	-	A	-
Maple Grove Road and Alon Street	NB stop	AM	0.05	-	A	-
		PM	0.04	-	A	-

Notes: EB = eastbound; WB = westbound; NB = northbound; SB = southbound



4.9.4.4 2026 Background Traffic Results

The 2026 background traffic condition intersection capacity for total background traffic analysis was completed using morning and afternoon peak hour traffic volumes. All recommended modifications from the 2021 background traffic condition have been carried forward to this horizon. A summary of the results has been provided in **Table 19**.

TABLE 19 – Intersection Capacity Analysis: 2026 Background Traffic

INTERSECTION	CONTROL	PEAK HOUR	V/C RATIO		LEVEL OF SERVICE	
			CRITICAL MOVEMENT	INTERSECTION	CRITICAL MOVEMENT	INTERSECTION
Huntmar Drive and Maple Grove Road	Traffic Signals	AM	0.85	-	D	-
		PM	0.82	-	D	-
Maple Grove Road and Santolina Street	NB stop	AM	0.08	-	A	-
		PM	0.09	-	B	-
Maple Grove Road and Alon Street	NB stop	AM	0.05	-	A	-
		PM	0.04	-	A	-

Notes: EB = eastbound; WB = westbound; NB = northbound; SB = southbound

4.9.4.5 2021 Total Traffic Results

The 2021 total traffic condition intersection capacity analysis was completed using morning and afternoon peak hour traffic volumes. All recommended modifications from the existing (2018) traffic condition have been carried forward to this horizon. A summary of the results has been provided in **Table 20**.



TABLE 20 – Intersection Capacity Analysis: 2021 Total Traffic

INTERSECTION	CONTROL	PEAK HOUR	V/C RATIO		LEVEL OF SERVICE	
			CRITICAL MOVEMENT	INTERSECTION	CRITICAL MOVEMENT	INTERSECTION
Huntmar Drive and Maple Grove Road	Traffic Signals	AM	0.82	-	D	-
		PM	0.80	-	D	-
Maple Grove Road and Santolina Street	NB stop	AM	0.10	-	B	-
		PM	0.15	-	B	-
Maple Grove Road and Alon Street	NB stop	AM	0.06	-	A	-
		PM	0.07	-	B	-
Maple Grove Road and Street 6	SB stop	AM	0.07	-	B	-
		PM	0.04	-	B	-
Stittsville Main Street Extension and Maple Grove Road	WB stop	AM	0.07	-	A	-
		PM	0.18	-	A	-
Maple Grove Road and Street 4	WB stop	AM	0.01	-	A	-
		PM	0.01	-	A	-
Maple Grove Road and Street 2	WB stop	AM	0.01	-	A	-
		PM	0.01	-	A	-
Maple Grove Road and Street 1	WB stop	AM	0.01	-	A	-
		PM	0.01	-	A	-

Notes: EB = eastbound; WB = westbound; NB = northbound; SB = southbound

The following intersections are expected to be constructed by 2021:

- a. Maple Grove Road and Street 6
- b. Stittsville Main Street extension Street and Maple Grove Road
- c. Maple Grove Road and Street 4
- d. Maple Grove Road and Street 2
- e. Maple Grove Road and Street 1



4.9.4.6 2026 Total Traffic Results

The 2026 total traffic condition intersection capacity analysis was completed using morning and afternoon peak hour traffic volumes. All recommended modifications from the 2021 total traffic condition have been carried forward to this horizon. A summary of the results has been provided in **Table 21**.

TABLE 21 – Intersection Capacity Analysis: 2026 Total Traffic

INTERSECTION	CONTROL	PEAK HOUR	V/C RATIO		LEVEL OF SERVICE	
			CRITICAL MOVEMENT	INTERSECTION	CRITICAL MOVEMENT	INTERSECTION
Huntmar Drive and Maple Grove Road	Traffic Signals	AM	0.86	-	D	-
		PM	0.89	-	D	-
Maple Grove Road and Santolina Street	NB stop	AM	0.12	-	B	-
		PM	0.22	-	B	-
Maple Grove Road and Alon Street	NB stop	AM	0.07	-	A	-
		PM	0.08	-	B	-
Maple Grove Road and Street 6	SB stop	AM	0.07	-	B	-
		PM	0.05	-	B	-
Stittsville Main Street Extension and Maple Grove Road	WB stop	AM	0.09	-	A	-
		PM	0.21	-	B	-
Maple Grove Road and Street 4	WB stop	AM	0.01	-	A	-
		PM	0.01	-	A	-
Maple Grove Road and Street 2	WB stop	AM	0.01	-	A	-
		PM	0.01	-	A	-
Maple Grove Road and Street 1	WB stop	AM	0.01	-	A	-
		PM	0.01	-	A	-

Notes: EB = eastbound; WB = westbound; NB = northbound; SB = southbound

4.9.5 Intersection Design (MMLOS)

The Multi-modal level of service (MMLOS) Guidelines provide guidance on how to assess the various LOS for the different modes of transportation and what the specific target service levels for each mode should be given the location and context of the transportation project. This all-in-one evaluation tool will allow comparisons using similar performance metrics for each non-auto mode. The MMLOS procedure is only applied to signalized intersections, and the worst-performing approach at the intersection for any mode represents the overall intersection MMLOS for that mode.

The Intersection MMLOS results for the Existing (2018) condition are shown in **Table 22**, and the Intersection MMLOS results for the Future (2021 and 2026) Background and Total Traffic condition are shown in **Table 23**. Detailed MMLOS results are provided in **Appendix F**.



TABLE 22 – Intersection MMLOS – Existing Conditions (2018)

INTERSECTION	SCENARIO	LEVEL OF SERVICE			
		PLOS	BLOS	TLOS	TKLOS
Maple Grove Road and Huntmar Drive	Existing (2018) Base	E	F	F	F
	Existing (2018) Modifications ¹	D	D	C	F

Notes: PLOS = Pedestrian LOS; BLOS = Bicycle LOS; TLOS = Transit LOS; TKLOS = Truck LOS

¹ Construct/ Modify the following auxiliary lanes:

- a. EBL with 80m storage; WBL with 40m of storage; SBL with 15m of storage
- b. Extend NBL storage lane by 25m (proposed storage length = 40m)
- c. SBR with 15m of storage

TABLE 23 – Intersection MMLOS – Future Background and Total Results

INTERSECTION	SCENARIO	LEVEL OF SERVICE							
		2021				2026			
		P	B	T	TK	P	B	T	TK
Maple Grove Road and Huntmar Drive	Future (2021) BG	D	D	D	F	D	D	D	F
	Future (2021) BGSG	D	D	D	F	D	D	D	F
	Future (2026) BG	D	D	D	F	D	D	D	F
	Future (2026) BGSG	D	D	D	F	D	D	D	F

Notes:

LOS = Level of Service; P = Pedestrian LOS; B = Bicycle LOS; T = Transit LOS; TK = Truck LOS

Future BG = Future Background Traffic; Future BGSG = Future Background and Site-Generated Traffic

4.9.5.1 Intersection Pedestrian Level of Service (PLOS)

The PLOS at intersections is based on several factors including the number of traffic lanes that pedestrians must cross, corner radii, and whether the crossing allows for permissive or protective right or left turns, among others. The City of Ottawa target for PLOS is C.

The intersection of Maple Grove Road and Huntmar Drive was tested in the Existing (2018), as well as the 2021 and 2026 background and total traffic conditions. The 2021 and 2026 background and total traffic conditions resulted in PLOS values of 'C' or 'D' at each approach, which either meet or just marginally exceed the City's PLOS target value.

4.9.5.2 Intersection Bicycle Level of Service (BLOS)

The BLOS at intersections is dependent on the number of lanes that the cyclist is required to cross to make a left-turn, the presence of a dedicated right-turn lane on the approach, as well as the operating speed of each approach. The City target for BLOS is C.

The BLOS analysis indicates that the Existing (2018), 2021 and 2026 background and total traffic conditions result in a BLOS of 'D' at the intersection of Maple Grove Road and Huntmar Drive Road, marginally exceeding the City's target. In this situation, cyclists are required to cross one lane of traffic with an operating speed of 50 km/hr.



4.9.5.3 Intersection Transit Level of Service (TLOS)

Intersection TLOS is based on the average signal delay experienced by transit vehicles at each intersection. The City Target TLOS is C.

The results of the analysis indicate that the 2026 total traffic condition experiences results in a TLOS of 'D' due to the longer cycle length required to achieve the City of Ottawa's vehicular capacity target. The 2021 background and total traffic conditions, as well as the 2026 background condition resulted TLOS values of 'C' or 'D' at each approach, which either meet or just marginally exceed the City's TLOS target value.

4.9.5.4 Intersection Truck Level of Service (TKLOS)

The TKLOS is based on the right-turn radii, as well as the number of receiving lanes for vehicles making a right-turn from the traffic lane being analyzed. The City of Ottawa target for TKLOS is D.

The intersection of the existing Maple Grove Road and Huntmar Drive intersection has a TKLOS of 'F', which is attributed to the tighter turning radii and single-receiving lanes on all approaches. The Transportation Master Plan (TMP) proposes to widen the section of Huntmar Drive north of the intersection from 2 to 4 lanes, as part of Phase 3 (2026-2031) of the Affordable Network, which satisfy the City target for TkLOS on the north leg of the intersection.

4.10 Geometric Review

The following section reviews all geometric requirements for the study area intersections. All relevant excerpts from referenced technical standards have been provided in **Appendix K**.

4.10.1 Sight Distance and Corner Clearances

The proposed development access intersections are located along sections with no significant horizontal or vertical alignment constraints. Sight distance and corner clearances are not expected to be a concern. All geometric design requirements should be reviewed and confirmed during detailed design.

4.10.2 Auxiliary Lane Analysis

Auxiliary turning lane lengths for all study area intersections were evaluated for all intersections within the study area.

4.10.2.1 Auxiliary Left-Turn Lane Requirements (Unsignalized)

The MTO Geometric Design Standards for Ontario Highways left-turn warrant was applied to main-street approaches at all unsignalized intersections using the highest left-turn volume from either the morning or afternoon peak hour. The MTO left-turn warrant did not recommend left-turn lanes be implemented at any unsignalized intersections located within the study area under the 2026 total traffic condition.

The results have been summarized below in **Table 24**.



TABLE 24 – Auxiliary Left-Turn Lane Analysis at Unsignalized Intersections

INTERSECTION	MOVEMENT	POSTED SPEED (KM/H)	DESIGN SPEED (KM/H)	LEFT-TURN VOLUME (VPH)	APPROACH VOLUME (VPH)	OPPOSING VOLUME (VPH)	LEFT-TURN STORAGE (M)
Stittsville Main Street Extension and Maple Grove Road	SBL	50	60	14	21	152	Not Required
Maple Grove Road and Street 6	EBL	50	60	4	175	285	Not Required

Notes:

Recommended storage lengths do not account for deceleration lane and taper lane lengths.

4.10.2.2 Signalized Auxiliary Left-Turn Lane Requirements

A review of auxiliary left-turn lane storage requirements was completed at the intersection of Maple Grove Road and Huntmar Drive, the only intersection within the study area expected to be signalized in the 2026 total traffic condition. The review compared the projected 95th percentile queue lengths from Synchro operational results, and the City of Ottawa queue length calculation based on the following equation:

$$\text{Storage Length, } S = \frac{NL}{C} \times 1.5$$

Where:

N = number of vehicles per hour

L = Length occupied by a vehicle in the queue = 7 m

C = number of traffic signal cycles per hour (3600 seconds per hour/cycle length)

The results of the auxiliary left-turn lane analysis storage lengths are summarized below in **Table 25**.

TABLE 25 – Recommended Auxiliary Left-Turn Storage Lengths at Signalized Intersections

INTERSECTION	APPROACH	95TH %ILE QUEUE LENGTH (M)	CITY QUEUE LENGTH (M)	EXISTING STORAGE LENGTH (M)	RECOMMENDED ADDITIONAL STORAGE LENGTH (M)
Maple Grove Road and Huntmar Drive	NB	#40	25	15	25
	SB	15	15	-	15
	EB	#80	75	-	80
	WB	25	30	-	30

Recommended storage lengths do not include deceleration lane and taper lengths. Units rounded to nearest 5m.

- Synchro extrapolated queue lengths at congested intersections. From Synchro 9 User Guide, "In practice, 95th percentile queue lengths will rarely be exceeded and the queues shown with the # footnote are acceptable in the design of storage bays."

As noted in Section 3.3.1.1, the Transportation Impact Assessment (TIA) prepared for the Fairwinds development at 33 Johnwoods Street (December 2012) assumed that auxiliary left and right turn lanes would be constructed on all approaches at the intersection of Maple Grove Road and Huntmar Drive by 2017. Despite these recommendations, all approaches of the existing intersection still have shared through-turning lanes with the exception of the 15m northbound left turning lane. The auxiliary left-turn lane analysis indicated that additional storage may be required on the northbound approach to accommodate future traffic demand.



A left-turn lane with 80m of storage should be constructed on the eastbound approach to satisfy the existing (2018) and future traffic demand at the Maple Grove Road and Huntmar Drive intersection. Currently, there are nearly 200 vehicles making the eastbound left-turn in the AM Peak hour, which is more than 50% of the vehicles originating from the eastbound approach. The existing pavement width along the eastbound approach is approximately 11m; therefore, there is sufficient width to accommodate a left-turn lane without widening the roadway. According to Section 9.1.2.3 of TAC, opposing southbound left-turn and westbound left-turn bays should be constructed in line with the existing northbound left-turn and the proposed eastbound left-turn lanes to ensure symmetry between corresponding approach and departure lanes, thereby, reducing the risk of collisions between left-turns and opposing through traffic.

The recommended left-turn storage lengths at proposed development access intersections above should be reviewed and confirmed during detailed design.

4.10.2.3 Auxiliary Right-Turn Lane Requirements (Unsignalized)

At this time, there is no formal City or MTO warrant procedure governing the application of auxiliary right-turn lanes at unsignalized intersections. Referring to TAC standards, Section 9.14.2 suggests an auxiliary right-turn lane be considered “when the volume of decelerating or accelerating vehicles compared with the through traffic volume causes undue hazard.”

Synchro analysis does not indicate that right-turn lanes are necessary, as all intersections are currently operating within City operational standards through to the 2026 total traffic condition.

The requirement for auxiliary right-turn lanes at proposed development access intersections should be reviewed and confirmed during detailed design.

4.10.2.4 Signalized Auxiliary Right-Turn Lane Requirements

A southbound right-turn lane is warranted at the Maple Grove Road and Huntmar Drive intersection, according to Section 9.14 of TAC, which suggests implementing a right-turn lane when more than 20% of vehicles on an approach are turning right, and generally when the peak hour demand exceeds 60 vehicles. In the existing (2018) condition through to the 2026 total traffic condition, the southbound right-turn volume triggers this requirement. Synchro results indicate that vehicular delay in excess of 60 seconds and queuing on the southbound approach of 300 metres is experienced without the implementation of a right-turn lane in the existing (2018) condition.

Right-turn lanes may also be warranted on the remaining approaches of the Maple Grove Road and Huntmar Drive intersection; between 10-20% of vehicles are expected to turn right on the eastbound, westbound and northbound approaches under the 2026 total traffic condition, and the right-turn volumes are expected to approach or marginally exceed the 60 vehicles per hour threshold on these approaches as well. However, Synchro results indicate that right-turn lanes on the eastbound, westbound and northbound approaches are not necessary for the intersection to operate within City standards.

Right-turn lane requirements should be reviewed and confirmed during detailed design. The results of the auxiliary right-turn lane analysis are summarized below in **Table 26**.



TABLE 26 – Recommended Auxiliary Right-Turn Storage Lengths at Signalized Intersections

INTERSECTION	APPROACH	RIGHT TURN VOLUME	APPROACH VEHICLES TURNING RIGHT (%)	95TH %ILE QUEUE LENGTH (M)	EXISTING STORAGE LENGTH (M)	RECOMMENDED ADDITIONAL STORAGE LENGTH (M)
Maple Grove Road and Huntmar Drive	EB	79	18%	<10	-	Not warranted at this time ¹
	WB	55	11%	<10	-	Not warranted at this time ¹
	NB	116	15%	<10	-	Not warranted at this time ¹
	SB	380	32%	15	-	15 ^{1,2}

¹ Right-turn lanes requirements will be reviewed during detailed design stage

² Recommended storage lengths do not include deceleration lane and taper lengths. Units rounded to nearest 5m.

4.11 Summary of Improvements Indicated and Modification Options

4.11.1 Maple Grove Road and Santolina Street; Maple Grove Road and Alon Street

The intersections of Maple Grove Road and Santolina Street, as well as Maple Grove Road and Alon Street were shown to operate within City standards through to the 2026 total traffic condition with the existing lane configurations and intersection control. Both intersections are expected to remain as stop-controlled intersections on the minor approach until at least 2026 with shared single lanes on each approach.

The geometric assessment of Maple Grove Road and Santolina Street intersection, as well as Maple Grove Road and Alon Street, did not trigger any auxiliary turning lane requirements to accommodate the 2026 total traffic condition. The existing shared lanes on all approaches were considered acceptable.

4.11.2 Maple Grove Road and Huntmar Drive

Maple Grove Road and Huntmar Drive was shown to operate above City standards in the existing (2018) condition. The TIA prepared for the Fairwinds development at 33 Johnwoods Street (December 2012) assumed that auxiliary left and right turn lanes would be constructed on all approaches at the intersection of Maple Grove Road and Huntmar Drive by 2017. Despite these recommendations, all approaches of the existing intersection have remained as shared through-turning lanes with the exception of the northbound approach, which has a 15m left-turn storage lane.

Operational results from Synchro 95th percentile queue length analysis and City of Ottawa queuing analysis based on the 2026 total traffic condition indicated that the eastbound left-turn lane should have 80m of storage, the westbound left-turn lane should have 30m of storage, the southbound left-turn lane should have 15m of storage, and the northbound left-turn lane storage length should be extended from 15m to 40m. A southbound right-turn lane of 15m is also warranted in the existing conditions, based on the heavy right turn volume of nearly 200 vehicles, and projected future traffic demand. Section 9.15.5 in TAC indicates that when a threshold of 60 right-turning vehicles per hour is exceeded, this is often used as an indicator that more detailed capacity analysis should be conducted on that movement.

As noted in Section 3.3.1.1, Huntmar Drive is expected to be widened from Campeau Drive to south of Maple Grove Road, as part of Phase 3 (2026-2031) of the City’s 2031 Affordable Network in the Transportation Master Plan (TMP).



This widening will provide additional capacity, and help to relieve traffic congestion created by existing and future traffic demand. At the Public Open House (POH) held on January 10, 2018 to discuss the draft concept plan for 195 Huntmar Drive, there were concerns raised from the public that the timing of the widening of Huntmar Drive was not in line with the traffic growth that is being experienced in the area, and that the project should be expedited. This TIA planned for the worst case scenario, and assumed that the widening would not be in place by the ultimate 2026 planning horizon.

4.11.3 Stittsville Main Street Extension and Maple Grove Road

The proposed Stittsville Main Street Extension and Maple Grove Road intersection was shown to operate within City operational standards with shared through-turning lanes on all approaches, and a stop-controlled minor approach through to the 2026 total traffic condition.

The geometric assessment of the proposed access intersections did not trigger any auxiliary turning lanes to accommodate the 2026 total traffic condition. The existing shared lanes on all approaches were considered acceptable.

4.11.4 Proposed Accesses/ Egresses

The proposed Street 1, Street 2 and Street 4 accesses/ egresses off of the proposed Stittsville Main Street extension, as well as the proposed Street 6 access off of Maple Grove Road were shown to operate within City operational standards with shared through-turning lanes on all approaches, and stop-controlled minor approaches through to the 2026 total traffic condition.

The geometric assessment of the proposed access intersections did not trigger any auxiliary turning lanes to accommodate the 2026 total traffic condition. The existing shared lanes on all approaches were considered acceptable.

4.11.5 Summary of Recommendations

The key conclusions from the TIA Analysis Report are as follows:

- The study area transportation network is expected to accommodate site generated traffic volumes through to the 2026 horizon year.
- There is no requirement for an RMA.
- There is no requirement for a monitoring plan.

A summary of all recommended actions/ modifications has been provided in **Table 27**. The recommended design for all off-site roadway modifications in the 2026 total traffic condition has been provided in **Exhibit 18**.

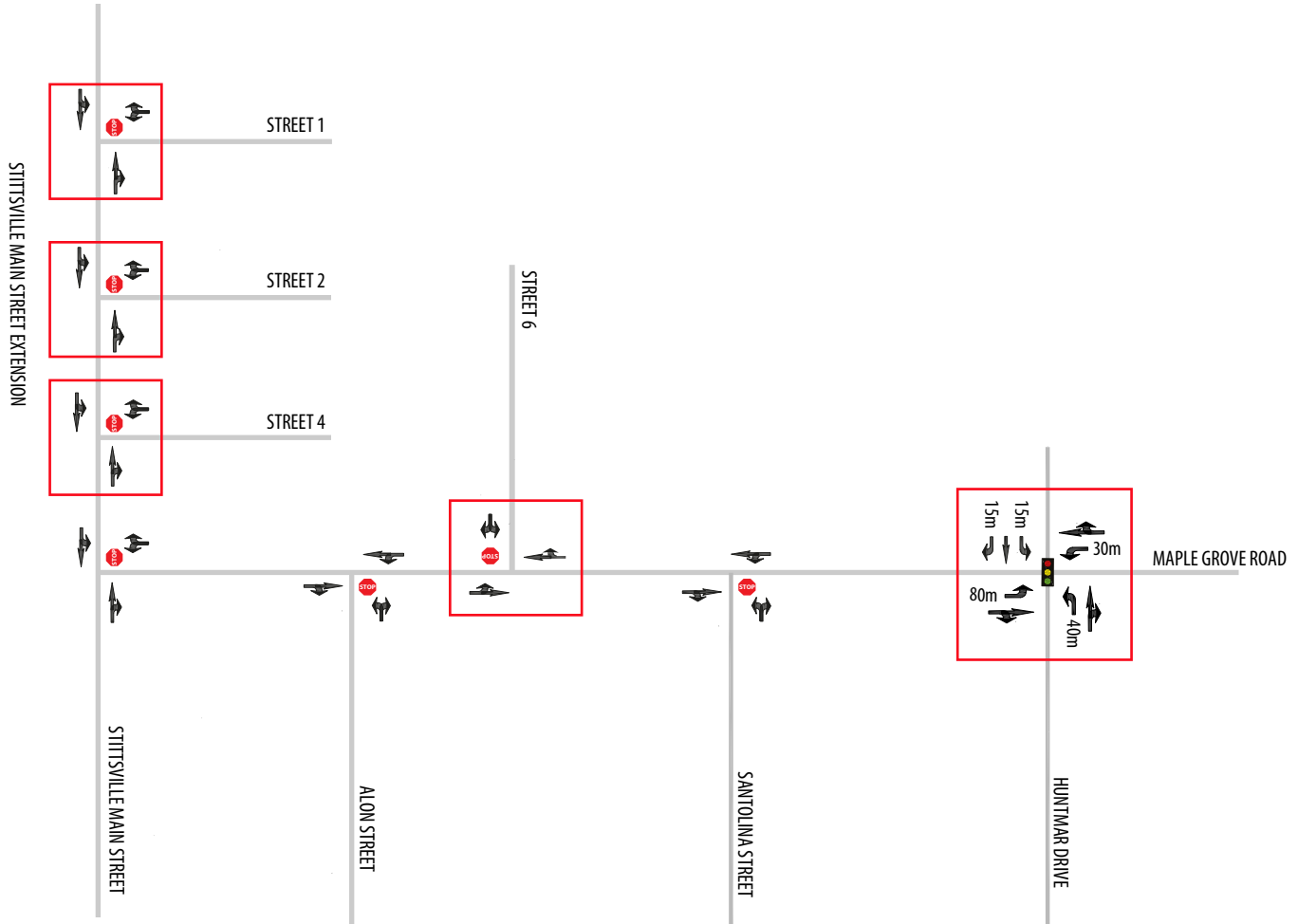
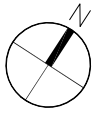

TABLE 27 – Summary of Recommended Actions/ Modifications





HORIZON	RECOMMENDED ACTIONS/ MODIFICATIONS
Existing (2018)	<p>Maple Grove Road and Huntmar Drive</p> <ul style="list-style-type: none"> Existing intersection configuration with signal optimization does not meet City intersection capacity requirements. Construct southbound right-turn lane with 15m of storage Construct left turn lanes with the following storage lengths: <ul style="list-style-type: none"> Extend northbound left-turn storage length by 25m (total storage length is 40m) Southbound left-turn lane with 15m storage Eastbound left-turn lane with 80m storage Westbound left-turn lane with 25m storage <p>Maple Grove Road and Santolina Street</p> <ul style="list-style-type: none"> Meets City operational guidelines <p>Maple Grove Road and Alon Street</p> <ul style="list-style-type: none"> Meets City operational guidelines
Future (2021) Background – No Site Generated Traffic	<p>Assume all actions and modifications from the Existing (2018) traffic conditions remain. Optimize all traffic signals.</p> <p>Maple Grove Road and Huntmar Drive</p> <ul style="list-style-type: none"> Meets City operational guidelines <p>Maple Grove Road and Santolina Street</p> <ul style="list-style-type: none"> Meets City operational guidelines <p>Maple Grove Road and Alon Street</p> <ul style="list-style-type: none"> Meets City operational guidelines
Future (2021) Total – With Site Generated Traffic	<p>Assume all actions and modifications from the Existing (2018) traffic conditions remain. Optimize all traffic signals.</p> <p>Maple Grove Road and Huntmar Drive</p> <ul style="list-style-type: none"> Meets City operational guidelines <p>Maple Grove Road and Santolina Street</p> <ul style="list-style-type: none"> Meets City operational guidelines <p>Maple Grove Road and Alon Street</p> <ul style="list-style-type: none"> Meets City operational guidelines <p>Stittsville Main Street Extension and Street 1</p> <ul style="list-style-type: none"> Claridge Homes – Construct unsignalized access intersection Westbound stop-controlled Shared through-turn lanes on all approaches <p>Stittsville Main Street Extension and Street 2</p> <ul style="list-style-type: none"> Claridge Homes – Construct unsignalized access intersection Westbound stop-controlled Shared through-turn lanes on all approaches <p>Stittsville Main Street Extension and Street 4</p> <ul style="list-style-type: none"> Claridge Homes – Construct unsignalized access intersection Westbound stop-controlled Shared through-turn lanes on all approaches <p>Maple Grove Road and Stittsville Main Street Extension</p> <ul style="list-style-type: none"> Construct unsignalized intersection Westbound stop-controlled Shared through-turn lanes on all approaches <p>Maple Grove Road and Street 6</p> <ul style="list-style-type: none"> Claridge Homes – Construct unsignalized access intersection Southbound stop-controlled



HORIZON	RECOMMENDED ACTIONS/ MODIFICATIONS
	<ul style="list-style-type: none"> Shared through-turn lanes on all approaches
Future (2026) Background – No Site Generated Traffic	Assume all modifications from the Future (2021) Background traffic conditions remain. Optimize all traffic signals.
Future (2026) Total – With Site Generated Traffic	Assume all modifications from the Future (2021) Total traffic conditions remain. Optimize all traffic signals.



LEGEND

-  TRAVEL LANES AND PERMITTED MOVEMENTS
-  STOP CONTROL
-  TRAFFIC CONTROL SIGNAL
-  XXm TRAVEL LANES AND PERMITTED MOVEMENTS
-  RECOMMENDED MODIFICATION





1981 Maple Grove Road

Transportation Impact Assessment Report

Appendix A: Traffic Data

February 2018





Turning Movement Count - 15 Minute Summary Report

HUNTMAR DR @ MAPLE GROVE RD

Survey Date: Thursday, November 23, 2017

Total Observed U-Turns

Northbound: 0 Southbound: 0
Eastbound: 0 Westbound: 0

HUNTMAR DR

MAPLE GROVE RD

Table with columns: Time Period, Northbound (LT, ST, RT, N TOT), Southbound (LT, ST, RT, S TOT, STR TOT), Eastbound (LT, ST, RT, E TOT), Westbound (LT, ST, RT, W TOT, STR TOT), Grand Total. Rows include 15-minute intervals from 07:00 to 18:00 and a final TOTAL row.

Note: U-Turns are included in Totals.

Comment:



Transportation Services - Traffic Services

Turning Movement Count - Cyclist Volume Report

Work Order
37335

HUNTMAR DR @ MAPLE GROVE RD

Count Date: Thursday, November 23, 2017

Start Time: 07:00

Time Period	HUNTMAR DR			MAPLE GROVE RD			Grand Total
	Northbound	Southbound	Street Total	Eastbound	Westbound	Street Total	
07:00 08:00	0	0	0	0	0	0	0
08:00 09:00	0	0	0	0	0	0	0
09:00 10:00	0	0	0	0	0	0	0
11:30 12:30	0	0	0	0	0	0	0
12:30 13:30	0	0	0	0	0	0	0
15:00 16:00	0	0	0	0	0	0	0
16:00 17:00	0	0	0	0	0	0	0
17:00 18:00	0	0	0	0	0	0	0
Total	0	0	0	0	0	0	0

Comment:

Note: These volumes consists of bicycles only (no mopeds or motorcycles) and ARE NOT included in the Turning Movement Count Summary.



Transportation Services - Traffic Services

Turning Movement Count - Full Study Diagram

HUNTMAR DR @ MAPLE GROVE RD

Survey Date: Thursday, November 23, 2017

WO#: 37335
Device: Miovision

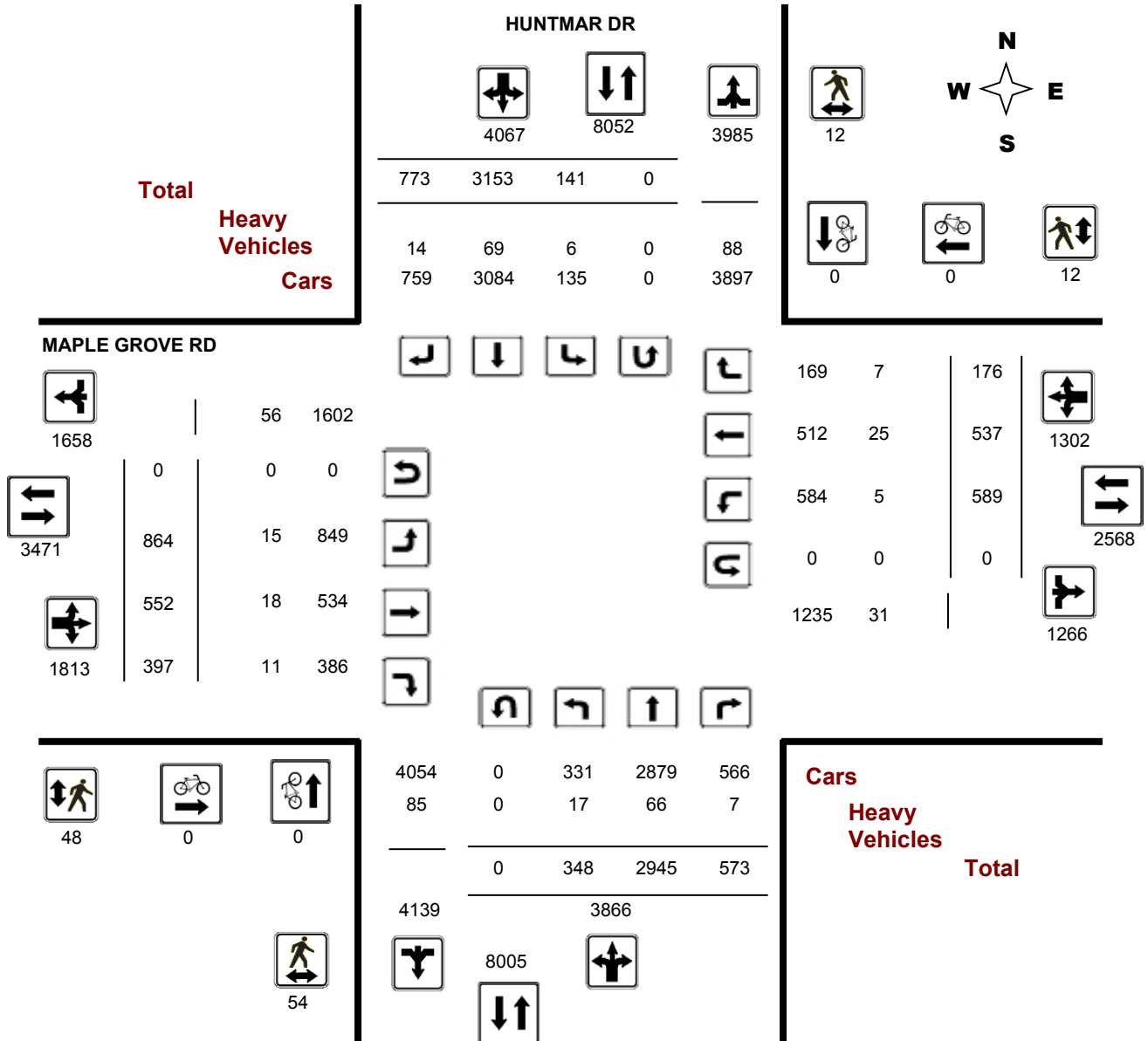

Comments



Transportation Services - Traffic Services

W.O.
37335

Turning Movement Count - Heavy Vehicle Report

HUNTMAR DR @ MAPLE GROVE RD

Survey Date: Thursday, November 23, 2017

Time Period	HUNTMAR DR									MAPLE GROVE RD									Grand Total
	Northbound			Southbound			S TOT	STR TOT	Eastbound			Westbound			W TOT	STR TOT			
	LT	ST	RT	N TOT	LT	ST			RT	LT	ST	RT	E TOT	LT			ST	RT	
07:00 08:00	2	21	1	24	1	4	5	10	34	2	3	1	6	0	7	2	9	15	49
08:00 09:00	6	4	2	12	1	12	0	13	25	3	2	3	8	0	4	1	5	13	38
09:00 10:00	0	10	1	11	2	9	2	13	24	2	0	2	4	1	3	0	4	8	32
11:30 12:30	0	6	0	6	2	11	3	16	22	2	4	2	8	1	3	3	7	15	37
12:30 13:30	1	8	0	9	0	5	2	7	16	2	1	0	3	1	2	0	3	6	22
15:00 16:00	4	10	3	17	0	13	1	14	31	4	3	1	8	2	3	1	6	14	45
16:00 17:00	3	4	0	7	0	6	0	6	13	0	4	2	6	0	3	0	3	9	22
17:00 18:00	1	3	0	4	0	9	1	10	14	0	1	0	1	0	0	0	0	1	15
Sub Total	17	66	7	90	6	69	14	89	179	15	18	11	44	5	25	7	37	81	260
U-Turns (Heavy Vehicles)				0				0	0				0				0	0	0
Total	17	66	7	0	6	69	14	89	179	15	18	11	44	5	25	7	37	81	260

Heavy Vehicles include Buses, Single-Unit Trucks and Articulated Trucks. Further, they ARE included in the Turning Movement Count Summary.



Transportation Services - Traffic Services

Work Order

37335

Turning Movement Count - Pedestrian Volume Report

HUNTMAR DR @ MAPLE GROVE RD

Count Date: Thursday, November 23, 2017

Start Time: 07:00

Time Period	NB Approach (E or W Crossing)	SB Approach (E or W Crossing)	Total	EB Approach (N or S Crossing)	WB Approach (N or S Crossing)	Total	Grand Total
07:00 07:15	8	0	8	3	1	4	12
07:15 07:30	8	1	9	2	1	3	12
07:30 07:45	4	0	4	0	1	1	5
07:45 08:00	8	1	9	4	1	5	14
07:00 08:00	28	2	30	9	4	13	43
08:00 08:15	0	0	0	0	0	0	0
08:15 08:30	0	1	1	0	1	1	2
08:30 08:45	0	0	0	0	0	0	0
08:45 09:00	2	2	4	1	1	2	6
08:00 09:00	2	3	5	1	2	3	8
09:00 09:15	0	1	1	0	1	1	2
09:15 09:30	1	1	2	0	1	1	3
09:30 09:45	1	0	1	0	0	0	1
09:45 10:00	0	0	0	0	0	0	0
09:00 10:00	2	2	4	0	2	2	6
11:30 11:45	0	0	0	0	0	0	0
11:45 12:00	0	0	0	0	0	0	0
12:00 12:15	3	1	4	1	0	1	5
12:15 12:30	2	0	2	1	0	1	3
11:30 12:30	5	1	6	2	0	2	8
12:30 12:45	1	0	1	0	0	0	1
12:45 13:00	0	0	0	2	0	2	2
13:00 13:15	2	0	2	0	0	0	2
13:15 13:30	1	0	1	0	0	0	1
12:30 13:30	4	0	4	2	0	2	6
15:00 15:15	3	0	3	2	0	2	5
15:15 15:30	1	0	1	0	0	0	1
15:30 15:45	2	0	2	1	2	3	5
15:45 16:00	2	3	5	5	2	7	12
15:00 16:00	8	3	11	8	4	12	23
16:00 16:15	1	0	1	5	0	5	6
16:15 16:30	2	0	2	4	0	4	6
16:30 16:45	0	1	1	1	0	1	2
16:45 17:00	1	0	1	5	0	5	6
16:00 17:00	4	1	5	15	0	15	20
17:00 17:15	0	0	0	5	0	5	5
17:15 17:30	0	0	0	5	0	5	5
17:30 17:45	0	0	0	0	0	0	0
17:45 18:00	1	0	1	1	0	1	2
17:00 18:00	1	0	1	11	0	11	12
Total	54	12	66	48	12	60	126

Comment:



Turning Movement Count - Full Study Summary Report

HUNTMAR DR @ MAPLE GROVE RD

Survey Date: Thursday, November 23, 2017

Total Observed U-Turns

Northbound: 0 Southbound: 0
Eastbound: 0 Westbound: 0

AADT Factor

.90

Full Study

Period	HUNTMAR DR									MAPLE GROVE RD									Grand Total	
	Northbound			Southbound			STR TOT	Eastbound			Westbound			WB TOT	STR TOT					
LT	ST	RT	NB TOT	LT	ST	RT		SB TOT	LT	ST	RT	EB TOT	LT			ST	RT	WB TOT	STR TOT	
07:00 08:00	14	385	52	451	15	238	54	307	758	224	93	45	362	11	38	14	63	425	1183	
08:00 09:00	32	385	80	497	5	251	33	289	786	186	93	58	337	45	37	23	105	442	1228	
09:00 10:00	27	359	57	443	18	265	46	329	772	108	56	48	212	33	24	17	74	286	1058	
11:30 12:30	36	286	76	398	16	324	61	401	799	63	64	37	164	77	50	21	148	312	1111	
12:30 13:30	41	341	56	438	14	335	60	409	847	60	42	26	128	88	59	22	169	297	1144	
15:00 16:00	44	411	83	538	19	566	142	727	1265	68	48	49	165	103	79	22	204	369	1634	
16:00 17:00	66	366	75	507	23	623	192	838	1345	67	75	72	214	118	125	29	272	486	1831	
17:00 18:00	88	412	94	594	31	551	185	767	1361	88	81	62	231	114	125	28	267	498	1859	
Sub Total	348	2945	573	3866	141	3153	773	4067	7933	864	552	397	1813	589	537	176	1302	3115	11048	
U Turns				0				0	0				0				0	0	0	0
Total	348	2945	573	3866	141	3153	773	4067	7933	864	552	397	1813	589	537	176	1302	3115	11048	
EQ 12Hr	484	4094	796	5374	196	4383	1074	5653	11027	1201	767	552	2520	819	746	245	1810	4330	15357	
Note: These values are calculated by multiplying the totals by the appropriate expansion factor.													1.39							
AVG 12Hr	435	3684	717	4836	176	3944	967	5088	9924	1081	691	497	2268	737	672	220	1629	3897	13821	
Note: These volumes are calculated by multiplying the Equivalent 12 hr. totals by the AADT factor.													.90							
AVG 24Hr	570	4826	939	6336	231	5167	1267	6665	13001	1416	905	651	2971	965	880	288	2134	5105	18106	
Note: These volumes are calculated by multiplying the Average Daily 12 hr. totals by 12 to 24 expansion factor.													1.31							

Comments:

Note: U-Turns provided for approach totals. Refer to 'U-Turn' Report for specific breakdown.



Transportation Services - Traffic Services

Turning Movement Count - Full Study Peak Hour Diagram

HUNTMAR DR @ MAPLE GROVE RD

Survey Date: Thursday, November 23, 2017

Start Time: 07:00

WO No: 37335

Device: Miovision

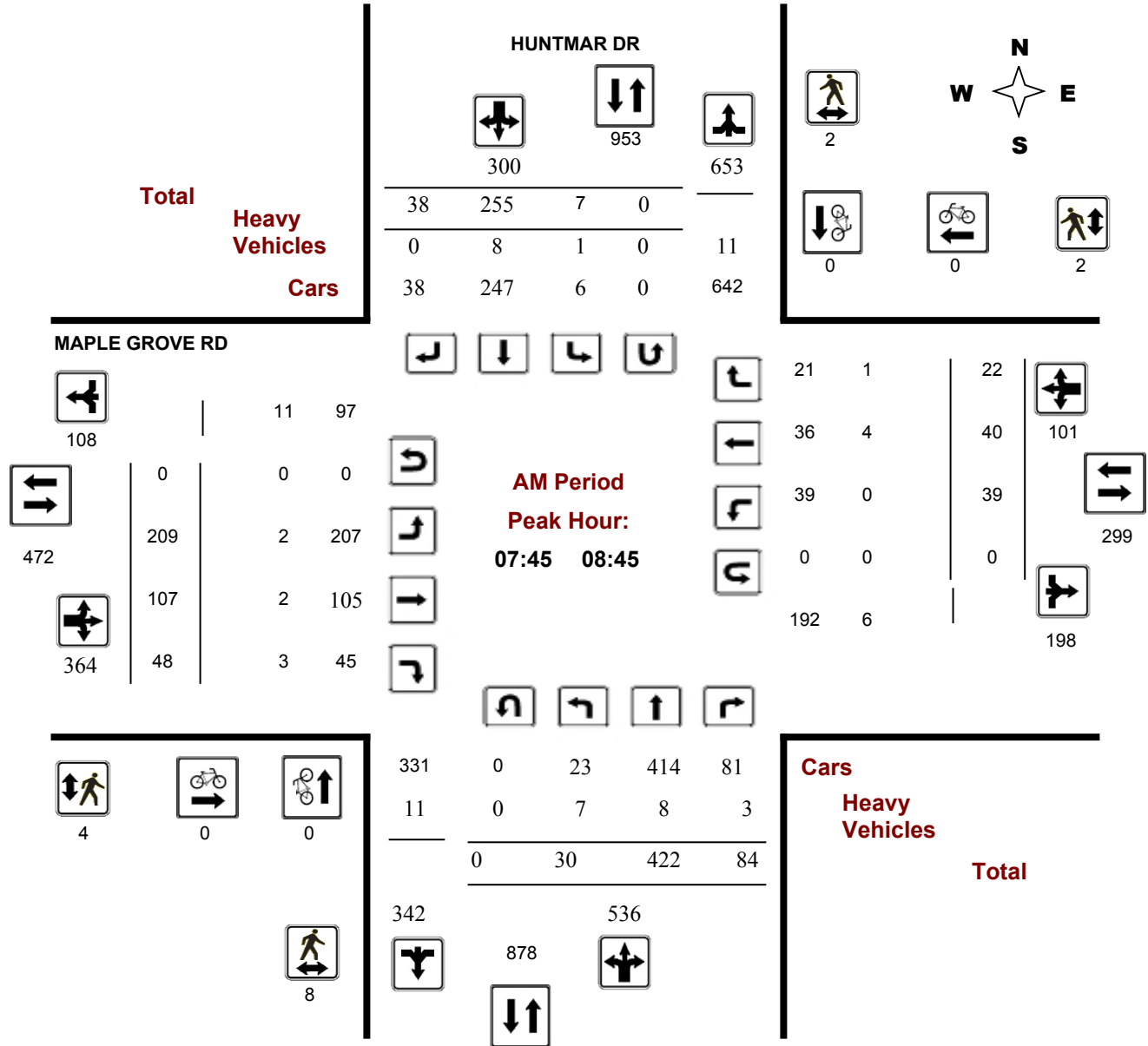

Survey Date: Thursday, November 23, 2017

Start Time: 07:00

WO No: 37335

Device: Miovision

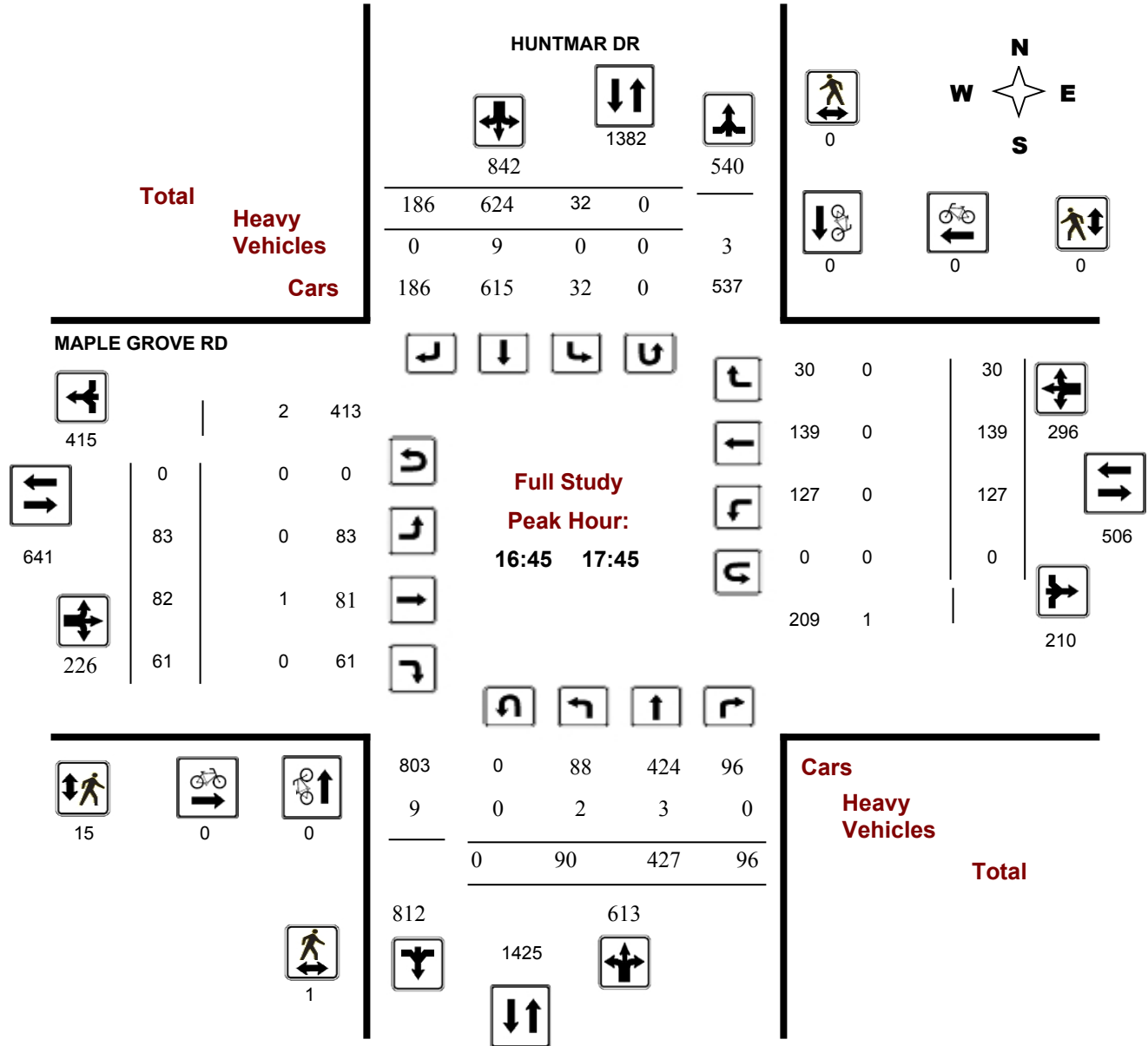



Transportation Services - Traffic Services

Turning Movement Count - Full Study Peak Hour Diagram

HUNTMAR DR @ MAPLE GROVE RD

Survey Date: Thursday, November 23, 2017

Start Time: 07:00

WO No: 37335

Device: Miovision

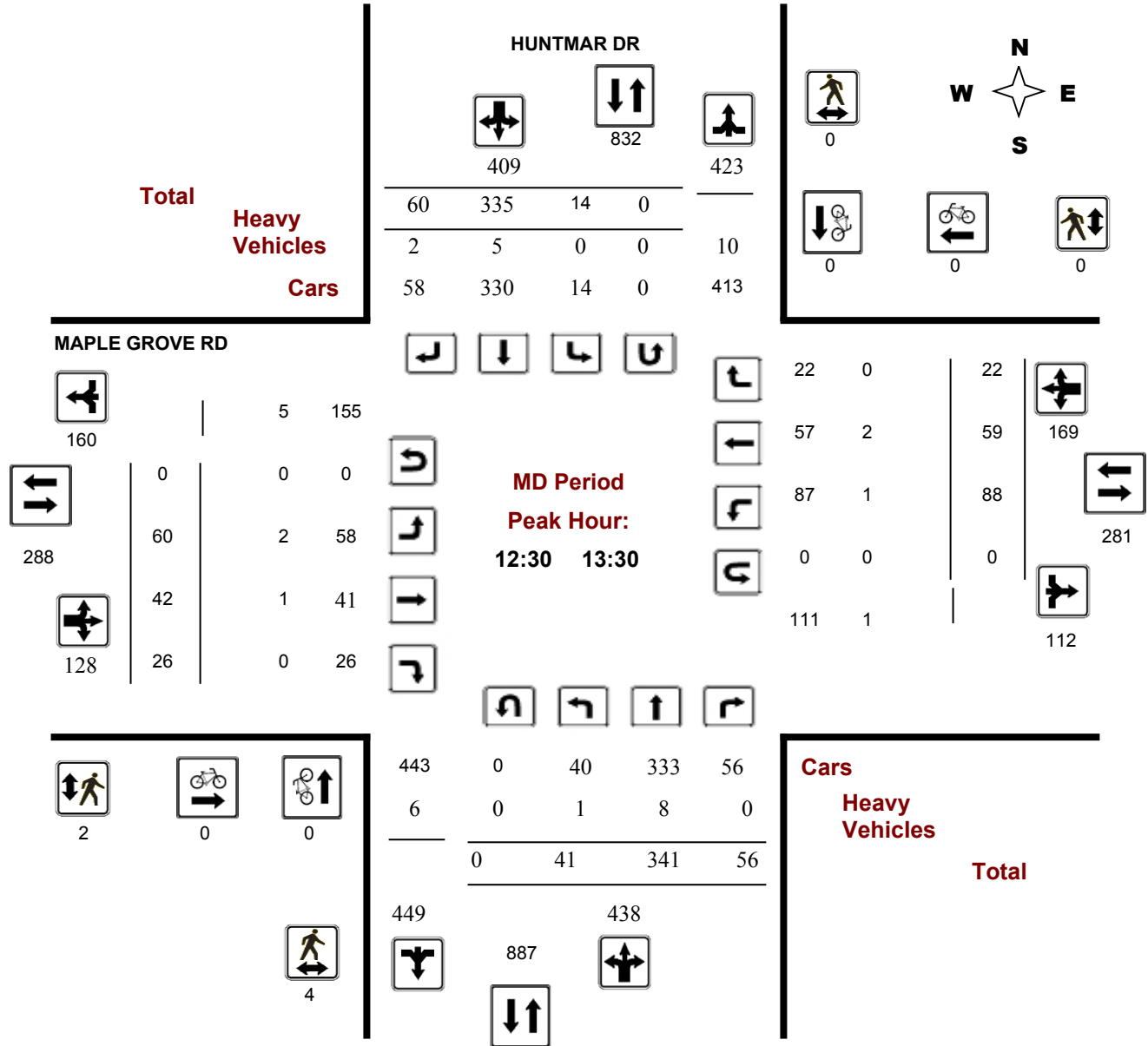

Survey Date: Thursday, November 23, 2017

Start Time: 07:00

WO No: 37335

Device: Miovision

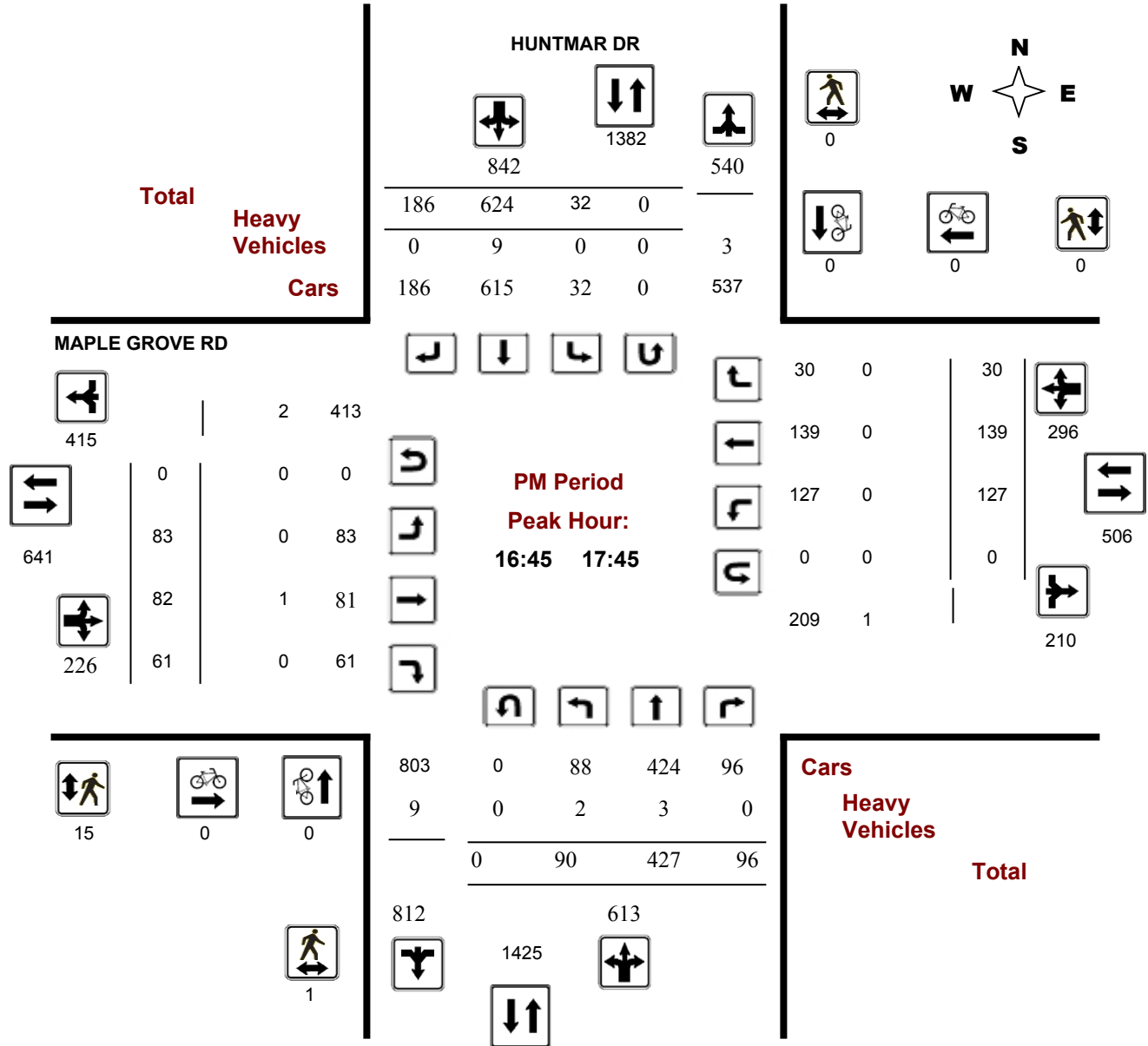

Turning Movement Count - 15 Min U-Turn Total Report

HUNTMAR DR @ MAPLE GROVE RD

Survey Date: Thursday, November 23, 2017

Time Period		Northbound U-Turn Total	Southbound U-Turn Total	Eastbound U-Turn Total	Westbound U-Turn Total	Total
07:00	07:15	0	0	0	0	0
07:15	07:30	0	0	0	0	0
07:30	07:45	0	0	0	0	0
07:45	08:00	0	0	0	0	0
08:00	08:15	0	0	0	0	0
08:15	08:30	0	0	0	0	0
08:30	08:45	0	0	0	0	0
08:45	09:00	0	0	0	0	0
09:00	09:15	0	0	0	0	0
09:15	09:30	0	0	0	0	0
09:30	09:45	0	0	0	0	0
09:45	10:00	0	0	0	0	0
11:30	11:45	0	0	0	0	0
11:45	12:00	0	0	0	0	0
12:00	12:15	0	0	0	0	0
12:15	12:30	0	0	0	0	0
12:30	12:45	0	0	0	0	0
12:45	13:00	0	0	0	0	0
13:00	13:15	0	0	0	0	0
13:15	13:30	0	0	0	0	0
15:00	15:15	0	0	0	0	0
15:15	15:30	0	0	0	0	0
15:30	15:45	0	0	0	0	0
15:45	16:00	0	0	0	0	0
16:00	16:15	0	0	0	0	0
16:15	16:30	0	0	0	0	0
16:30	16:45	0	0	0	0	0
16:45	17:00	0	0	0	0	0
17:00	17:15	0	0	0	0	0
17:15	17:30	0	0	0	0	0
17:30	17:45	0	0	0	0	0
17:45	18:00	0	0	0	0	0
Total		0	0	0	0	0

Survey Date: Tuesday January 9 2018
 Weather: Wet road (0 Celcius)

MAPLE GROVE ROAD & ALON SREET - ALL MODES



AM Peak Hour: 7:00 AM to 8:00 AM
 MD Peak Hour: 12:30 PM to 1:30 PM
 PM Peak Hour: 5:00 PM to 6:00 PM

AADT FACTOR: 1.1

Turning Movement Count - Full Study Summary Report (Vehicles)

Time Period	Alon Street					N/A					N/S STREET TOTAL	Maple Grove Cul-de-Sac					Maple Grove Road					E/W STREET TOTAL	Grand TOTAL
	Northbound					Southbound						Eastbound					Westbound						
	LT	ST	RT	U-Turns	NB TOTAL	LT	ST	RT	U-Turns	SB TOTAL		LT	ST	RT	U-Turns	EB TOTAL	LT	ST	RT	U-Turns	WB TOTAL		
7:00 8:00	0	0	38	0	38	0	0	0	0	0	38	0	0	0	0	0	14	0	0	0	14	14	52
8:00 9:00	0	0	35	0	35	0	0	0	0	0	35	0	0	0	0	0	8	0	0	0	8	8	43
9:00 10:00	0	0	20	0	20	0	0	0	0	0	20	0	0	0	0	0	14	0	0	1	15	15	35
AVG AM Pk HR	0	0	31	0	31	0	0	0	0	0	31	0	0	0	0	0	12	0	0	0	12	12	43
11:30 12:30	0	0	25	0	25	0	0	0	0	0	25	0	1	0	0	1	16	0	0	0	16	17	42
12:30 13:30	0	0	20	0	20	0	0	0	0	0	20	0	0	0	0	0	22	0	0	0	22	22	42
AVG MD Pk HR	0	0	23	0	23	0	0	0	0	0	23	0	1	0	0	1	19	0	0	0	19	20	42
15:00 16:00	0	0	26	0	26	0	0	0	0	0	26	0	0	0	0	0	41	0	0	0	41	41	67
16:00 17:00	0	0	27	0	27	0	0	0	0	0	27	0	0	0	0	0	29	0	0	0	29	29	56
17:00 18:00	0	0	24	0	24	0	0	0	0	0	24	0	0	0	0	0	44	0	0	0	44	44	68
AVG PM Pk HR	0	0	26	0	26	0	0	0	0	0	26	0	0	0	0	0	38	0	0	0	38	38	64
TOTAL	0	0	269	0	269	0	0	0	0	0	269	0	2	0	0	2	219	0	0	1	220	222	490
EQ 12Hr	0	0	373	0	373	0	0	0	0	0	373	0	2	0	0	2	304	0	0	2	306	308	682
Note: These volumes are calculated by multiplying the totals by the appropriate expansion factor.											1.39												
AVG 12Hr	0	0	411	0	411	0	0	0	0	0	411	0	2	0	0	2	335	0	0	2	337	339	750
Note: These volumes are calculated by multiplying the Equivalent 12 hr. totals by the AADT factor.											1.1												
AVG 24Hr	0	0	538	0	538	0	0	0	0	0	538	0	3	0	0	3	439	0	0	3	441	444	982
Note: These volumes are calculated by multiplying the Average Daily 12hr. totals by the 12 to 24 expansion factor.											1.31												

Turning Movement Count - Full Study Summary Report (Pedestrians)

Time Period	Alon Street			N/A			N/S STREET TOTAL	Maple Grove Cul-de-Sac			Maple Grove Road			E/W STREET TOTAL	Grand TOTAL
	NB Approach (East or West Crossing)			SB Approach (East or West Crossing)				EB Approach (North or South Crossing)			WB Approach (North or South Crossing)				
7:00 8:00	0			1			1	0			0			0	1
8:00 9:00	0			0			0	0			0			0	0
9:00 10:00	0			1			1	0			14			14	15
11:30 12:30	1			0			1	0			0			0	1
12:30 13:30	1			0			1	0			1			1	2
15:00 16:00	3			0			3	0			0			0	3
16:00 17:00	4			0			4	0			0			0	4
17:00 18:00	1			0			1	0			0			0	1
TOTAL:	10			2			12	0			15			15	27

Turning Movement Count - Full Study Summary Report (Cyclists)

Time Period	Alon Street		N/A		N/S STREET TOTAL	Maple Grove Cul-de-Sac		Maple Grove Road		E/W STREET TOTAL	Grand TOTAL
	Northbound		Southbound			Eastbound		Westbound			
7:00 8:00	0	0	0	0	0	0	0	0	0	0	0
8:00 9:00	0	0	0	0	0	0	0	0	0	0	0
9:00 10:00	0	0	0	0	0	0	0	0	0	0	0
11:30 12:30	0	0	0	0	0	0	0	0	0	0	0
12:30 13:30	0	0	0	0	0	0	0	0	0	0	0
15:00 16:00	0	0	0	0	0	0	0	0	0	0	0
16:00 17:00	0	0	0	0	0	0	0	0	0	0	0
17:00 18:00	0	0	0	0	0	0	0	0	0	0	0
TOTAL:	0	0	0	0	0	0	0	0	0	0	0

Turning Movement Count - Full Study Summary Report (Heavy Vehicles)

Time Period	Alon Street					N/A					N/S STREET TOTAL	Maple Grove Cul-de-Sac					Maple Grove Road					E/W STREET TOTAL	Grand TOTAL
	Northbound					Southbound						Eastbound					Westbound						
	LT	ST	RT	U-Turns	NB TOTAL	LT	ST	RT	U-Turns	SB TOTAL		LT	ST	RT	U-Turns	EB TOTAL	LT	ST	RT	U-Turns	WB TOTAL		
7:00 8:00	0	0	3	0	3	0	0	0	0	0	3	0	0	0	0	0	0	0	0	0	0	3	
8:00 9:00	0	0	2	0	2	0	0	0	0	0	2	0	0	0	0	1	0	0	0	0	1	3	
9:00 10:00	0	0	0	0	0	0	0	0	0	0	0	0	0	0	0	1	0	0	0	0	1	1	
11:30 12:30	0	0	0	0	0	0	0	0	0	0	0	0	0	0	0	0	0	0	0	0	0	0	
12:30 13:30	0	0	0	0	0	0	0	0	0	0	0	0	0	0	0	0	0	0	0	0	0	0	
15:00 16:00	0	0	1	0	1	0	0	0	0	0	1	0	0	0	0	1	0	0	0	0	1	2	
16:00 17:00	0	0	0	0	0	0	0	0	0	0	0	0	0	0	1	0	0	0	0	0	1	1	
17:00 18:00	0	0	1	0	1	0	0	0	0	0	1	0	0	0	0	0	0	0	0	0	0	1	
TOTAL:	0	0	7	0	7	0	0	0	0	0	7	0	0	0	0	4	0	0	0	0	4	11	

Survey Date: Thursday January 11 2018
 Weather: Wet road

MAPLE GROVE ROAD & SANTOLINA STREET - ALL MODES



AM Peak Hour: 7:00 AM to 8:00 AM
 MD Peak Hour: 12:00 PM to 1:00 PM
 PM Peak Hour: 5:00 PM to 6:00 PM

AADT FACTOR: 1.0

Turning Movement Count - Full Study Summary Report (Vehicles)

Time Period	Santolina Street					N/A					N/S STREET TOTAL	Maple Grove Road					Maple Grove Road					E/W STREET TOTAL	Grand TOTAL
	Northbound					Southbound						Eastbound					Westbound						
	LT	ST	RT	U-Turns	NB TOTAL	LT	ST	RT	U-Turns	SB TOTAL		LT	ST	RT	U-Turns	EB TOTAL	LT	ST	RT	U-Turns	WB TOTAL		
7:00 8:00	0	0	63	0	63	0	0	0	0	0	63	0	49	2	0	51	29	13	0	0	42	93	156
8:00 9:00	0	0	54	0	54	0	0	0	0	0	54	0	36	2	0	38	29	22	0	0	51	89	143
9:00 10:00	0	0	43	0	43	0	0	0	0	0	43	0	17	1	0	18	23	12	0	1	36	54	97
AVG AM Pk HR	0	0	53	0	53	0	0	0	0	0	53	0	34	2	0	36	27	16	0	0	43	79	132
11:30 12:30	1	0	65	0	66	0	0	0	0	0	66	0	20	2	0	22	31	18	0	0	49	71	137
12:30 13:30	2	0	51	0	53	0	0	0	0	0	53	0	22	1	0	23	30	21	0	0	51	74	127
AVG MD Pk HR	2	0	58	0	60	0	0	0	0	0	60	0	21	2	0	23	31	20	0	0	50	73	132
15:00 16:00	1	0	60	0	61	0	0	0	0	0	61	0	15	2	0	17	46	51	0	0	97	114	175
16:00 17:00	1	0	49	0	50	0	0	0	0	0	50	0	28	1	0	29	77	54	0	0	131	160	210
17:00 18:00	4	0	46	0	50	0	0	0	0	0	50	0	31	3	0	34	95	60	0	0	155	189	239
AVG PM Pk HR	2	0	52	0	54	0	0	0	0	0	54	0	25	2	0	27	73	55	0	0	128	154	208
TOTAL	11	0	542	0	553	0	0	0	0	0	553	0	273	17	0	290	418	286	0	1	705	995	1,548

EQ 12Hr 15 0 754 0 768 0 0 0 0 0 0 768 0 379 24 0 403 580 398 0 2 980 1383 2152

Note: These volumes are calculated by multiplying the totals by the appropriate expansion factor. 1.39

AVG 12Hr 15 0 754 0 768 0 0 0 0 0 0 768 0 379 24 0 403 580 398 0 2 980 1383 2152

Note: These volumes are calculated by multiplying the Equivalent 12 hr. totals by the AADT factor. 1.0

AVG 24Hr 19 0 988 0 1007 0 0 0 0 0 0 1007 0 497 31 0 528 760 521 0 2 1284 1812 2819

Note: These volumes are calculated by multiplying the Average Daily 12hr. totals by the 12 to 24 expansion factor. 1.31

Turning Movement Count - Full Study Summary Report (Pedestrians)

Time Period	Santolina Street		N/A		N/S STREET TOTAL	Maple Grove Road		Maple Grove Road		E/W STREET TOTAL	Grand TOTAL
	NB Approach (East or West Crossing)		SB Approach (East or West Crossing)			EB Approach (North or South Crossing)		WB Approach (North or South Crossing)			
7:00 8:00	2		2		4	0		5		5	9
8:00 9:00	0		0		0	0		0		0	0
9:00 10:00	0		0		0	0		23		23	23
11:30 12:30	0		1		1	0		1		1	2
12:30 13:30	0		0		0	0		1		1	1
15:00 16:00	0		1		1	0		0		0	1
16:00 17:00	0		0		0	0		3		3	3
17:00 18:00	0		0		0	0		2		2	2
TOTAL:	2		4		6	0		35		35	41

Turning Movement Count - Full Study Summary Report (Cyclists)

Time Period	Santolina Street		N/A		N/S STREET TOTAL	Maple Grove Road		Maple Grove Road		E/W STREET TOTAL	Grand TOTAL
	Northbound		Southbound			Eastbound		Westbound			
7:00 8:00	0	0	0	0	0	0	0	0	0	0	0
8:00 9:00	0	0	0	0	0	0	0	0	0	0	0
9:00 10:00	0	0	0	0	0	0	0	0	0	0	0
11:30 12:30	0	0	0	0	0	0	0	0	0	0	0
12:30 13:30	0	0	0	0	0	0	0	0	0	0	0
15:00 16:00	0	0	0	0	0	0	0	0	0	0	0
16:00 17:00	0	0	0	0	0	0	0	0	0	0	0
17:00 18:00	0	0	0	0	0	0	0	0	0	0	0
TOTAL:	0	0	0	0	0	0	0	0	0	0	0

Turning Movement Count - Full Study Summary Report (Heavy Vehicles)

Time Period	Santolina Street					N/A					N/S STREET TOTAL	Maple Grove Road					Maple Grove Road					E/W STREET TOTAL	Grand TOTAL
	Northbound					Southbound						Eastbound					Westbound						
	LT	ST	RT	U-Turns	NB TOTAL	LT	ST	RT	U-Turns	SB TOTAL		LT	ST	RT	U-Turns	EB TOTAL	LT	ST	RT	U-Turns	WB TOTAL		
7:00 8:00	0	0	1	0	1	0	0	0	0	0	1	0	0	0	0	0	0	0	0	0	0	0	1
8:00 9:00	0	0	0	0	0	0	0	0	0	0	0	0	0	1	0	1	1	0	0	2	3	3	3
9:00 10:00	1	0	0	0	1	0	0	0	0	0	1	0	0	1	0	0	1	0	0	1	2	3	3
11:30 12:30	0	0	0	0	0	0	0	0	0	0	0	0	0	0	0	1	0	0	0	1	1	1	1
12:30 13:30	0	0	3	0	3	0	0	0	0	0	3	0	0	1	0	2	0	0	0	2	3	6	6
15:00 16:00	0	0	2	0	2	0	0	0	0	0	2	0	0	0	0	2	1	0	0	3	3	5	5
16:00 17:00	0	0	0	0	0	0	0	0	0	0	0	0	1	0	0	0	0	0	0	0	1	1	1
17:00 18:00	0	0	0	0	0	0	0	0	0	0	0	0	0	0	0	0	0	0	0	0	0	0	0
TOTAL:	1	0	6	0	7	0	0	0	0	0	7	0	1	3	0	4	6	3	0	0	9	13	20



1981 Maple Grove Road

Transportation Impact Assessment Report

Appendix B: OC Transpo Maps

February 2018





162

TERRY FOX STITTSVILLE

Local

Monday to Friday/ Lundi au vendredi

Selected trips Mon. to Fri. All day Saturday. No Sunday service / Service limité du lun. au ven. Toute la journée le samedi. Aucun service le dimanche.

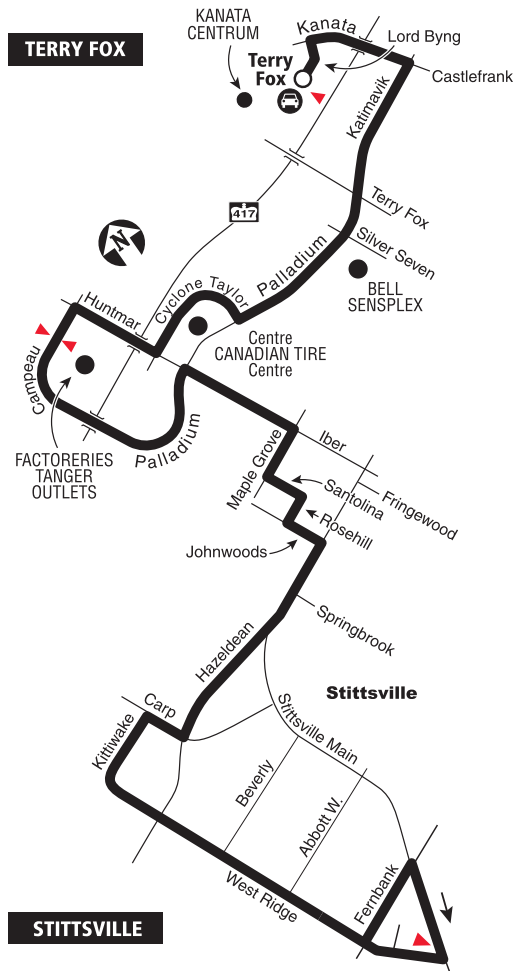

- Transitway Station / Station du Transitway
- Park & Ride / Parc-o-bus
- Timepoint / Heures de passage

2017.11

Schedule / Horaire..... 613-560-1000
Text / Texto560560
plus your four digit bus stop number / plus votre numéro d'arrêt à quatre chiffres

Customer Relations
 Service à la clientèle **613-842-3600**

Lost and Found / Objets perdus..... **613-563-4011**

Security / Sécurité **613-741-2478**

Effective November 15, 2017
En vigueur 15 novembre 2017

INFO 613-741-4390
 octranspo.com



261

MACKENZIE KING STITTSVILLE MAIN

Connexion

Monday to Friday / Lundi au vendredi

Peak periods only

Périodes de pointe seulement

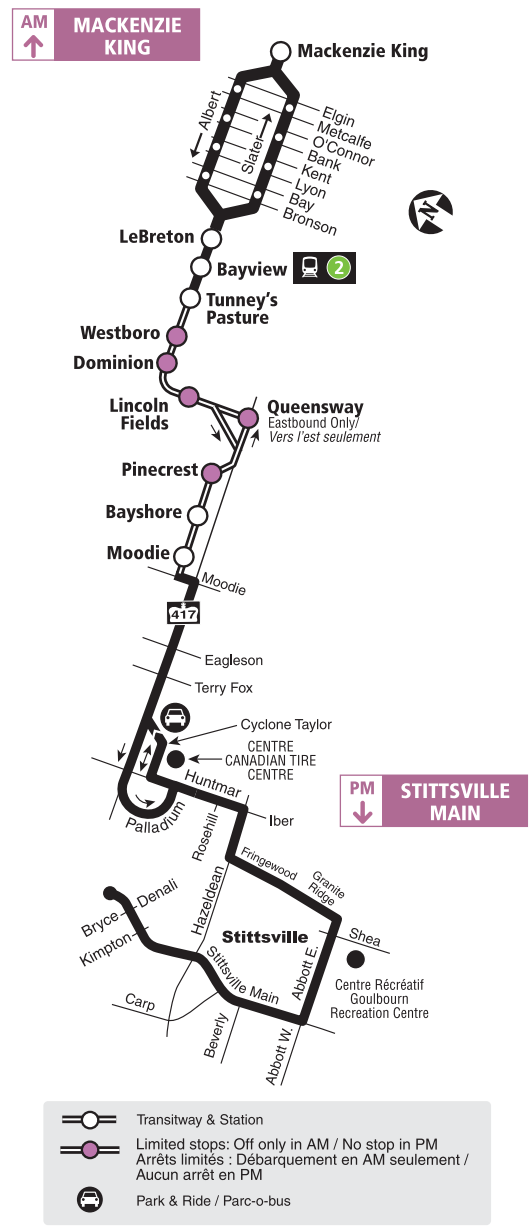

2017.12

Schedule / Horaire..... 613-560-1000
Text / Texto 560560
plus your four digit bus stop number / plus votre numéro d'arrêt à quatre chiffres

Customer Relations
 Service à la clientèle **613-842-3600**
 Lost and Found / Objets perdus..... **613-563-4011**
 Security / Sécurité **613-741-2478**

Effective December 24, 2017
En vigueur 24 décembre 2017

INFO 613-741-4390
 octranspo.com



1981 Maple Grove Road

Transportation Impact Assessment Report

Appendix C: Collision Data

February 2018



Collision Main Detail Summary

OnTRAC Reporting System

FROM: 2012-01-01 TO: 2014-01-01

ALON ST & MAPLE GROVE RD

Former Municipality: **Goulbourn**

Traffic Control: **Stop sign**

Number of Collisions: **1**

	DATE	DAY	TIME	ENV	LIGHT	IMPACT TYPE	CLASS	DIR	SURFACE COND'N	VEHICLE MANOEUVRE	VEHICLE TYPE	FIRST EVENT	No. PED
1	2012-06-07	Thu	20:28	Clear	Dusk	Single vehicle	P.D. only	V1 W	Dry	Going ahead	Automobile, station	Concrete guide wall	0

HUNTMAR DR & MAPLE GROVE RD

Former Municipality: **Goulbourn**

Traffic Control: **Stop sign**

Number of Collisions: **3**

	DATE	DAY	TIME	ENV	LIGHT	IMPACT TYPE	CLASS	DIR	SURFACE COND'N	VEHICLE MANOEUVRE	VEHICLE TYPE	FIRST EVENT	No. PED
2	2012-05-16	We	05:17	Clear	Dark	Rear end	P.D. only	V1 N V2 N	Dry Dry	Slowing or Slowing or	Tow truck Truck and trailer	Other motor vehicle Other motor vehicle	0
3	2013-02-12	Tue	23:40	Snow	Dark	Single vehicle	P.D. only	V1 N	Wet	Going ahead	Automobile, station	Curb	0
4	2013-10-08	Tue	07:20	Clear	Daylight	Angle	P.D. only	V1 N V2 E	Dry Dry	Going ahead Going ahead	Automobile, station Automobile, station	Other motor vehicle Other motor vehicle	0

MAPLE GROVE RD, ALON ST to JOHNWOODS ST

Former Municipality: **West Carleton**

Traffic Control: **No control**

Number of Collisions: **1**

	DATE	DAY	TIME	ENV	LIGHT	IMPACT TYPE	CLASS	DIR	SURFACE COND'N	VEHICLE MANOEUVRE	VEHICLE TYPE	FIRST EVENT	No. PED
5	2013-12-17	Tue	20:20	Snow	Dark	Single vehicle	P.D. only	V1 W	Loose snow	Going ahead	Automobile, station	Ran off road	0

MAPLE GROVE RD, HUNTMAR DR to JOHNWOODS ST

Former Municipality: **West Carleton**

Traffic Control: **No control**

Number of Collisions: **5**

	DATE	DAY	TIME	ENV	LIGHT	IMPACT TYPE	CLASS	DIR	SURFACE COND'N	VEHICLE MANOEUVRE	VEHICLE TYPE	FIRST EVENT	No. PED
6	2012-07-29	Sun	12:05	Clear	Daylight	Other	P.D. only	V1 U V2 U	Dry Dry	Reversing Going ahead	Automobile, station Pick-up truck	Other motor vehicle Other motor vehicle	0

(Note: Time of Day = "00:00" represents unknown collision time)

Thursday, December 28, 2017

Collision Main Detail Summary

OnTRAC Reporting System

FROM: 2012-01-01 TO: 2014-01-01

7	2012-08-26	Sun	14:44	Clear	Daylight	Turning	P.D. only	V1 W	Dry	Overtaking	Automobile, station	Other motor vehicle	0
								V2 W	Dry	Making U-Turn	Automobile, station	Other motor vehicle	
8	2012-10-16	Tue	11:00	Clear	Daylight	Approaching	P.D. only	V1 W	Dry	Going ahead	Construction	Other motor vehicle	0
								V2 E	Dry	Going ahead	Truck - dump	Other motor vehicle	
9	2013-03-26	Tue	16:43	Clear	Daylight	Rear end	P.D. only	V1 E	Dry	Going ahead	Pick-up truck	Other motor vehicle	0
								V2 E	Dry	Going ahead	Automobile, station	Other motor vehicle	
10	2013-12-01	Sun	18:11	Snow	Dark	Single vehicle	P.D. only	V1 E	Loose snow	Going ahead	Automobile, station	Unattended vehicle	0

(Note: Time of Day = "00:00" represents unknown collision time)

Thursday, December 28, 2017

Page 2 of 2



City Operations - Transportation Services

Collision Details Report - Public Version

From: January 1, 2014 **To:** December 31, 2016

Location: HUNTMAR DR @ MAPLE GROVE RD

Traffic Control: Stop sign

Total Collisions: 12

Date/Day/Time	Environment	Impact Type	Classification	Surface Cond'n	Veh. Dir	Vehicle Manoeuvre	Vehicle type	First Event	No. Ped
2015-Jan-29, Thu,22:30	Snow	Rear end	P.D. only	Packed snow	East	Slowing or stopping	Automobile, station wagon	Other motor vehicle	
					East	Stopped	Automobile, station wagon	Other motor vehicle	
					East	Stopped	Passenger van	Other motor vehicle	
2015-Apr-29, Wed,16:23	Clear	Rear end	P.D. only	Dry	South	Going ahead	Pick-up truck	Other motor vehicle	
					South	Stopped	Police vehicle	Other motor vehicle	
2015-Feb-24, Tue,18:00	Clear	Rear end	P.D. only	Ice	East	Slowing or stopping	Pick-up truck	Other motor vehicle	
					East	Stopped	Pick-up truck	Other motor vehicle	
2015-Aug-14, Fri,08:48	Clear	Angle	P.D. only	Wet	West	Going ahead	Automobile, station wagon	Other motor vehicle	
					South	Going ahead	Passenger van	Other motor vehicle	
2016-Feb-25, Thu,15:30	Rain	Turning movement	P.D. only	Wet	North	Making "U" turn	Automobile, station wagon	Other motor vehicle	
					North	Going ahead	Pick-up truck	Other motor vehicle	

2016-Oct-19, Wed,13:50	Clear	Rear end	P.D. only	Dry	South	Going ahead	Pick-up truck	Other motor vehicle
					South	Stopped	Automobile, station wagon	Other motor vehicle

2016-May-11, Wed,16:53	Clear	Rear end	P.D. only	Dry	South	Slowing or stopping	Automobile, station wagon	Other motor vehicle
					South	Slowing or stopping	Automobile, station wagon	Other motor vehicle

2016-Jul-03, Sun,14:52	Clear	Turning movement	Non-fatal injury	Dry	North	Turning left	Automobile, station wagon	Cyclist
					South	Going ahead	Bicycle	Other motor vehicle

2016-Oct-02, Sun,11:05	Rain	Rear end	P.D. only	Wet	West	Slowing or stopping	Automobile, station wagon	Other motor vehicle
					West	Stopped	Automobile, station wagon	Other motor vehicle

2016-Dec-16, Fri,09:19	Clear	Rear end	P.D. only	Ice	North	Going ahead	Passenger van	Other motor vehicle
					North	Stopped	Pick-up truck	Other motor vehicle
					South	Going ahead	Pick-up truck	Other motor vehicle

2016-Dec-26, Mon,10:17	Freezing Rain	Rear end	P.D. only	Wet	West	Slowing or stopping	Automobile, station wagon	Other motor vehicle
					West	Stopped	Automobile, station wagon	Other motor vehicle
					West	Stopped	Automobile, station wagon	Other motor vehicle

2016-Dec-30, Fri,16:38	Clear	SMV other	P.D. only	Wet	North	Going ahead	Automobile, station wagon	Curb
------------------------	-------	-----------	-----------	-----	-------	-------------	---------------------------	------

Location: JOHNWOODS ST @ MAPLE GROVE RD

Traffic Control: Stop sign

Total Collisions: 2

Date/Day/Time	Environment	Impact Type	Classification	Surface Cond'n	Veh. Dir	Vehicle Manoeuver	Vehicle type	First Event	No. Ped
2014-Jan-14, Tue,11:46	Clear	Angle	P.D. only	Wet	West	Turning left	Automobile, station wagon	Other motor vehicle	
					North	Turning right	Automobile, station wagon	Other motor vehicle	
2015-Aug-19, Wed,22:50	Clear	SMV other	P.D. only	Dry	West	Unknown	Automobile, station wagon	Pole (sign, parking meter)	

Location: LEVECHE WAY @ MAPLE GROVE RD

Traffic Control: Stop sign

Total Collisions: 2

Date/Day/Time	Environment	Impact Type	Classification	Surface Cond'n	Veh. Dir	Vehicle Manoeuver	Vehicle type	First Event	No. Ped
2014-Jan-06, Mon,16:36	Clear	Angle	P.D. only	Wet	South	Turning left	Automobile, station wagon	Other motor vehicle	
					West	Going ahead	Automobile, station wagon	Other motor vehicle	
2016-Sep-17, Sat,23:30	Rain	Angle	P.D. only	Wet	South	Going ahead	Automobile, station wagon	Other motor vehicle	
					East	Going ahead	Automobile, station wagon	Other motor vehicle	

Location: MAPLE GROVE RD @ GESNER CRT/JARLAN TER

Traffic Control: Stop sign

Total Collisions: 1

Date/Day/Time	Environment	Impact Type	Classification	Surface Cond'n	Veh. Dir	Vehicle Manoeuver	Vehicle type	First Event	No. Ped
2014-Mar-21, Fri,16:22	Clear	Turning movement	P.D. only	Dry	East	Making "U" turn	Pick-up truck	Other motor vehicle	
					East	Going ahead	Automobile, station wagon	Other motor vehicle	

Location: MAPLE GROVE RD btwn JOHNWOODS ST & MONTSERRAT ST

Traffic Control: No control

Total Collisions: 2

Date/Day/Time	Environment	Impact Type	Classification	Surface Cond'n	Veh. Dir	Vehicle Manoeuver	Vehicle type	First Event	No. Ped
2014-Aug-25, Mon,13:20	Clear	SMV unattended vehicle	P.D. only	Dry	South	Reversing	Pick-up truck	Unattended vehicle	
2016-Oct-05, Wed,00:00	Clear	SMV unattended vehicle	P.D. only	Dry	Unknown	Unknown	Unknown	Unattended vehicle	

Location: MAPLE GROVE RD btwn LEVECHE WAY & HUNTMAR DR

Traffic Control: No control

Total Collisions: 1

Date/Day/Time	Environment	Impact Type	Classification	Surface Cond'n	Veh. Dir	Vehicle Manoeuver	Vehicle type	First Event	No. Ped
2016-Aug-19, Fri,07:15	Clear	Sideswipe	P.D. only	Dry	East	Overtaking	Automobile, station wagon	Other motor vehicle	
					East	Stopped	Truck and trailer	Other motor vehicle	

Location: MAPLE GROVE RD btwn MONTSERRAT ST & LEVECHE WAY

Traffic Control: No control

Total Collisions: 1

Date/Day/Time	Environment	Impact Type	Classification	Surface Cond'n	Veh. Dir	Vehicle Manoeuver	Vehicle type	First Event	No. Ped
2016-Feb-18, Thu,00:00	Clear	SMV unattended vehicle	P.D. only	Wet	East	Unknown	Unknown	Unattended vehicle	



1981 Maple Grove Road

Transportation Impact Assessment Report

Appendix D: ITE Trip Generation Data

February 2018



Single-Family Detached Housing (210)

Average Vehicle Trip Ends vs: Dwelling Units
On a: Weekday,
Peak Hour of Adjacent Street Traffic,
One Hour Between 7 and 9 a.m.

Number of Studies: 292
 Avg. Number of Dwelling Units: 194
 Directional Distribution: 25% entering, 75% exiting

Trip Generation per Dwelling Unit

Average Rate	Range of Rates	Standard Deviation
0.75	0.33 - 2.27	0.90

Data Plot and Equation

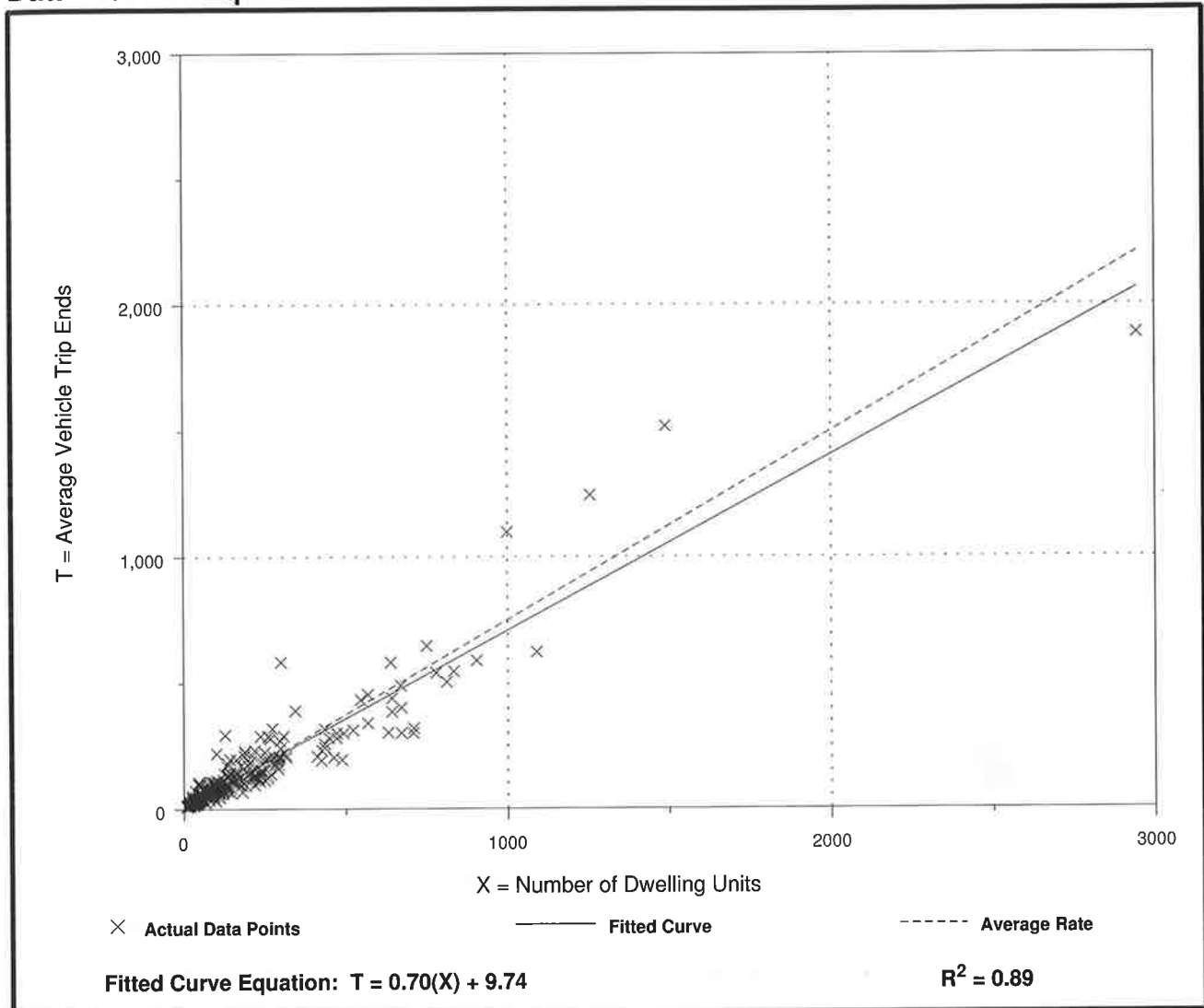

Single-Family Detached Housing (210)

Average Vehicle Trip Ends vs: Dwelling Units
On a: Weekday,
Peak Hour of Adjacent Street Traffic,
One Hour Between 4 and 6 p.m.

Number of Studies: 321
 Avg. Number of Dwelling Units: 207
 Directional Distribution: 63% entering, 37% exiting

Trip Generation per Dwelling Unit

Average Rate	Range of Rates	Standard Deviation
1.00	0.42 - 2.98	1.05

Data Plot and Equation

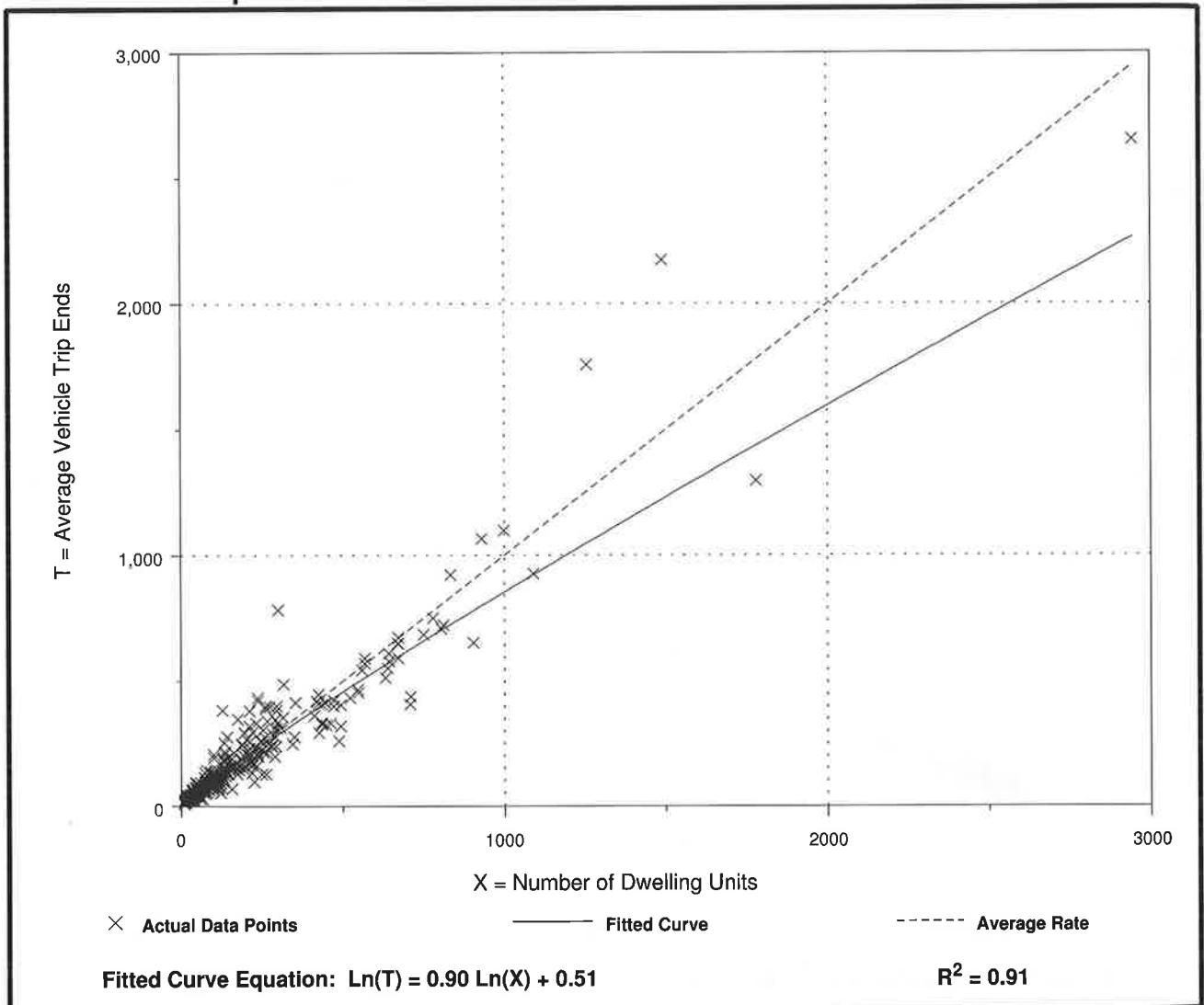

Residential Condominium/Townhouse (230)

Average Vehicle Trip Ends vs: Dwelling Units
On a: Weekday,
Peak Hour of Adjacent Street Traffic,
One Hour Between 7 and 9 a.m.

Number of Studies: 59
 Avg. Number of Dwelling Units: 213
 Directional Distribution: 17% entering, 83% exiting

Trip Generation per Dwelling Unit

Average Rate	Range of Rates	Standard Deviation
0.44	0.15 - 1.61	0.69

Data Plot and Equation

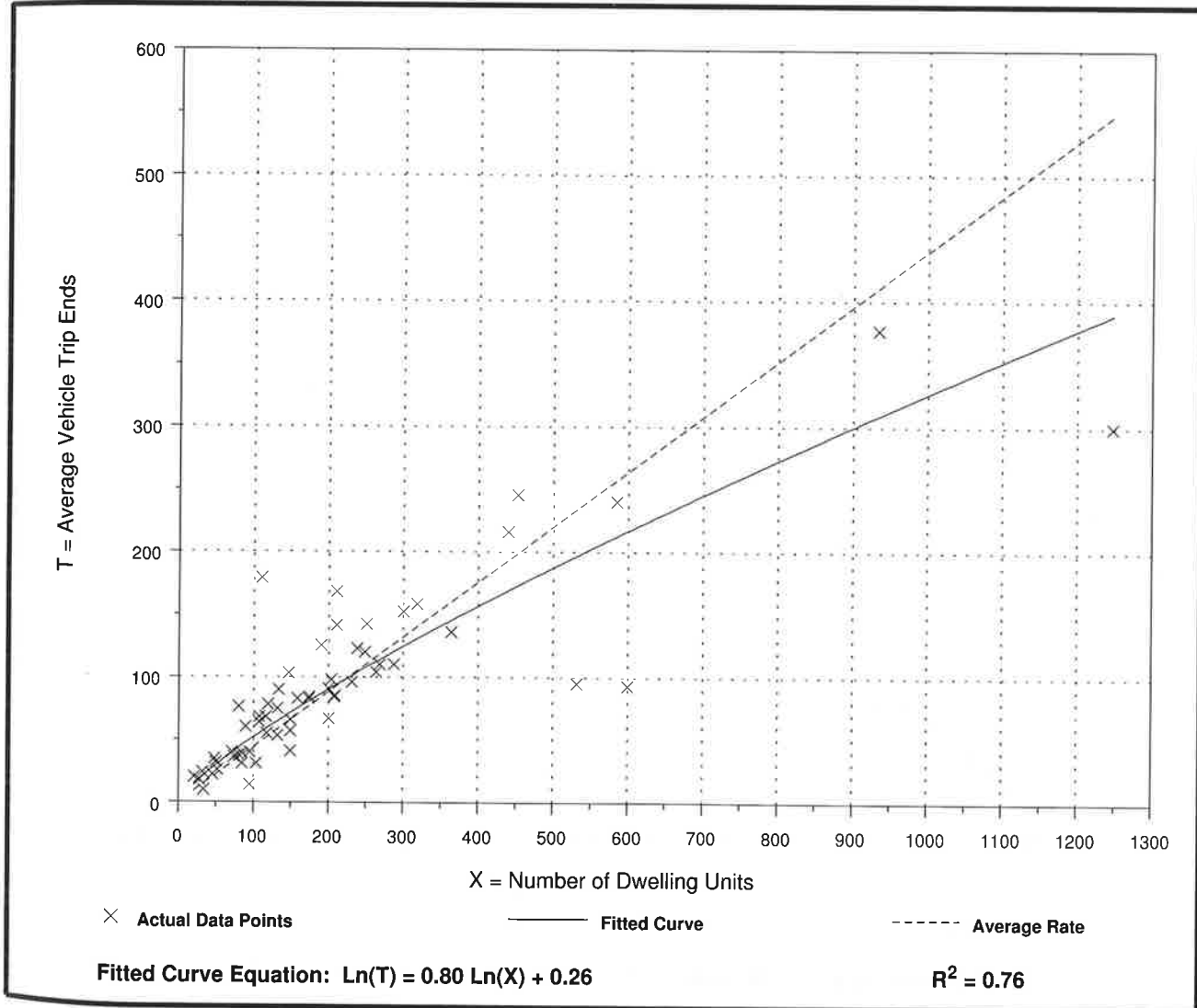

Residential Condominium/Townhouse (230)

Average Vehicle Trip Ends vs: Dwelling Units
On a: Weekday,
Peak Hour of Adjacent Street Traffic,
One Hour Between 4 and 6 p.m.

Number of Studies: 62
 Avg. Number of Dwelling Units: 205
 Directional Distribution: 67% entering, 33% exiting

Trip Generation per Dwelling Unit

Average Rate	Range of Rates	Standard Deviation
0.52	0.18 - 1.24	0.75

Data Plot and Equation

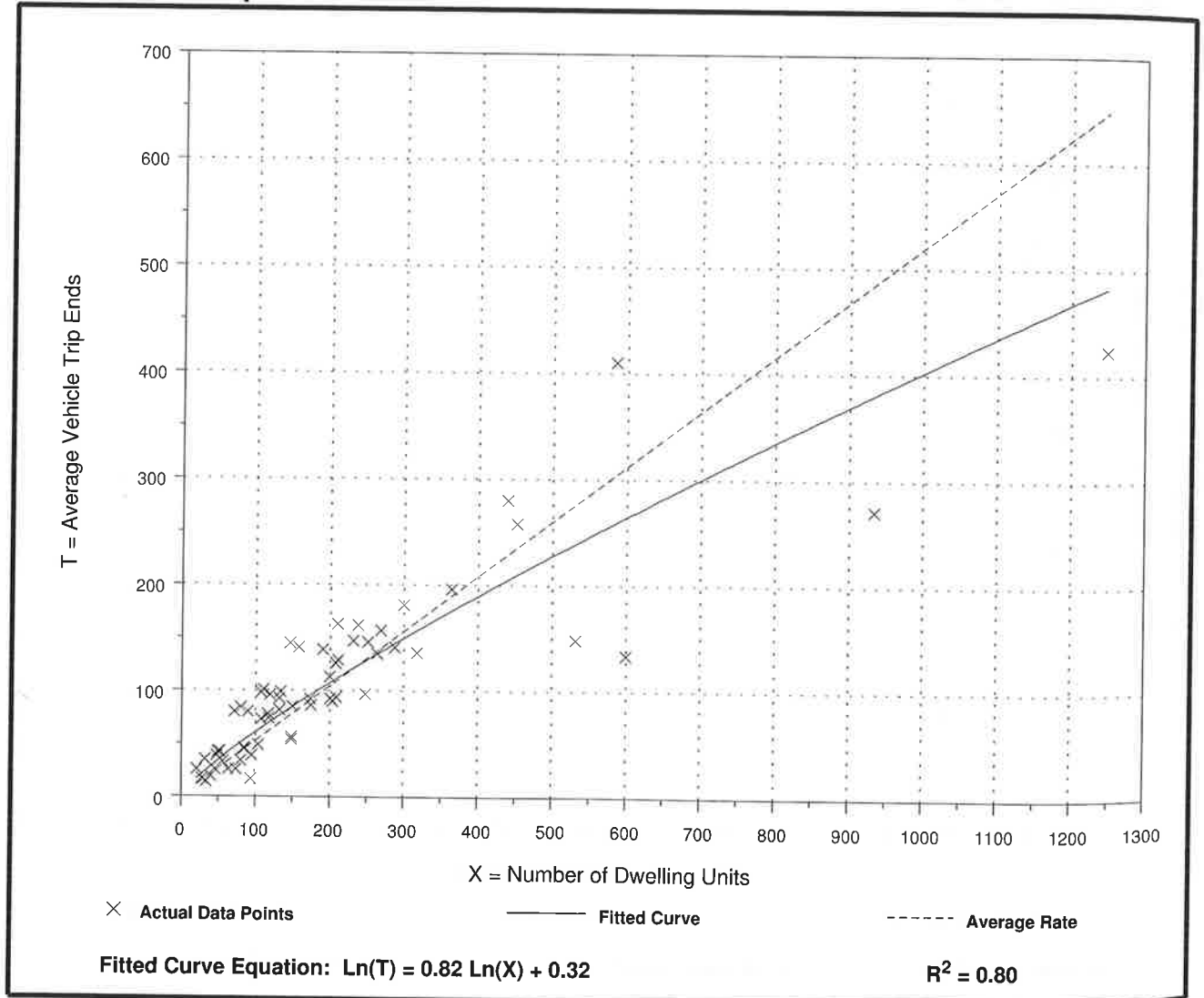



1981 Maple Grove Road

Transportation Impact Assessment Report

Appendix E: 2011 OD Survey Data – Kanata/ Stittsville

February 2018



Kanata - Stittsville

Demographic Characteristics

Population	105,210	Actively Travelled	83,460
Employed Population	49,640	Number of Vehicles	64,540
Households	38,010	Area (km ²)	82.6

Occupation Status (age 5+)	Male	Female	Total
Full Time Employed	24,670	19,590	44,260
Part Time Employed	1,540	3,840	5,380
Student	13,630	13,410	27,040
Retiree	6,480	8,350	14,820
Unemployed	850	940	1,790
Homemaker	160	3,310	3,470
Other	350	1,010	1,360
Total:	47,690	50,440	98,120

Traveller Characteristics	Male	Female	Total
Transit Pass Holders	5,940	6,920	12,860
Licensed Drivers	36,280	36,790	73,070
Telecommuters	200	380	580
Trips made by residents	135,300	143,330	278,630

Selected Indicators	
Daily Trips per Person (age 5+)	2.84
Vehicles per Person	0.61
Number of Persons per Household	2.77
Daily Trips per Household	7.33
Vehicles per Household	1.70
Workers per Household	1.31
Population Density (Pop/km ²)	1270

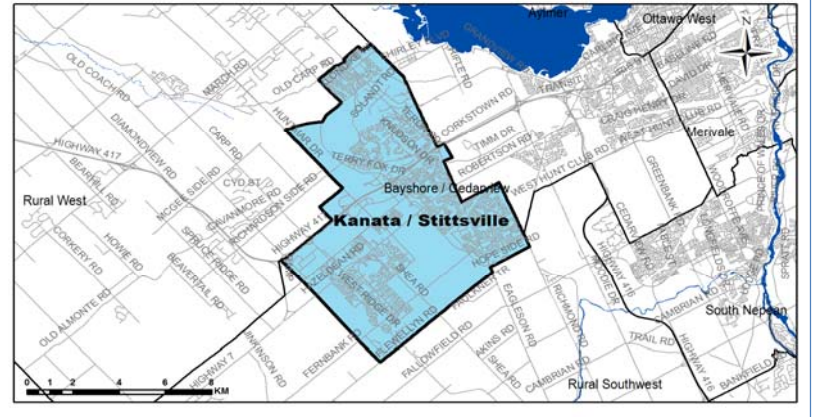

Household Size		
1 person	5,810	15%
2 persons	11,660	31%
3 persons	7,490	20%
4 persons	8,890	23%
5+ persons	4,160	11%
Total:	38,010	100%

Households by Vehicle Availability		
0 vehicles	1,050	3%
1 vehicle	14,090	37%
2 vehicles	19,110	50%
3 vehicles	3,000	8%
4+ vehicles	770	2%
Total:	38,010	100%

Households by Dwelling Type		
Single-detached	21,610	57%
Semi-detached	3,890	10%
Townhouse	10,550	28%
Apartment/Condo	1,960	5%
Total:	38,010	100%

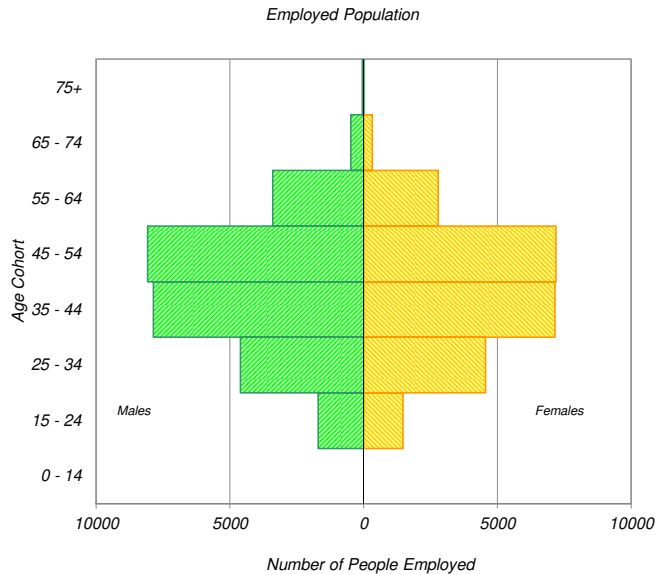
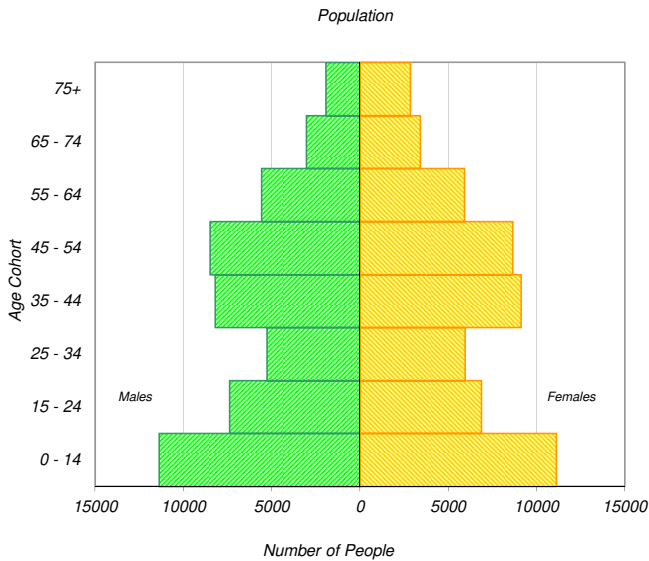

* In 2005 data was only collected for household members aged 11+ therefore these results cannot be compared to the 2011 data.

Travel Patterns

Top Five Destinations of Trips from Kanata - Stittsville

AM Peak Period

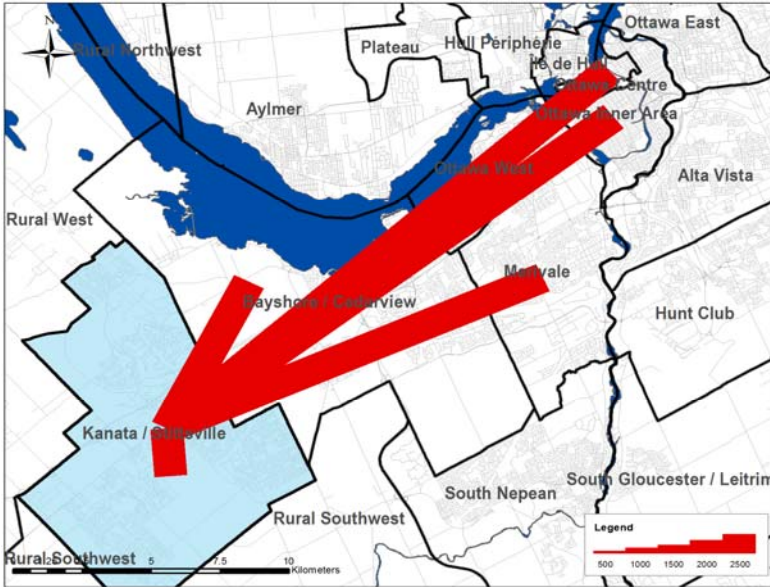

Summary of Trips to and from Kanata - Stittsville

AM Peak Period (6:30 - 8:59)

Districts	Destinations of Trips From		Origins of Trips To	
	District	% Total	District	% Total
Ottawa Centre	4,560	8%	140	0%
Ottawa Inner Area	3,350	6%	970	2%
Ottawa East	660	1%	260	1%
Beacon Hill	280	0%	170	0%
Alta Vista	1,810	3%	660	1%
Hunt Club	490	1%	420	1%
Merivale	3,410	6%	1,200	3%
Ottawa West	2,020	4%	840	2%
Bayshore / Cedarview	5,010	9%	2,420	5%
Orléans	290	1%	500	1%
Rural East	100	0%	30	0%
Rural Southeast	50	0%	260	1%
South Gloucester / Leirtrim	60	0%	140	0%
South Nepean	690	1%	1,800	4%
Rural Southwest	1,130	2%	1,850	4%
Kanata / Stittsville	30,360	54%	30,360	66%
Rural West	1,050	2%	3,250	7%
Île de Hull	670	1%	30	0%
Hull Périphérie	160	0%	30	0%
Plateau	100	0%	230	0%
Aylmer	0	0%	190	0%
Rural Northwest	20	0%	60	0%
Pointe Gatineau	20	0%	80	0%
Gatineau Est	0	0%	60	0%
Rural Northeast	30	0%	50	0%
Buckingham / Masson-Angers	30	0%	10	0%
Ontario Sub-Total:	55,320	98%	45,270	98%
Québec Sub-Total:	1,030	2%	740	2%
Total:	56,350	100%	46,010	100%

Trips by Trip Purpose

24 Hours	From District		To District		Within District	
Work or related	27,180	29%	17,020	18%	14,550	9%
School	7,070	7%	2,500	3%	15,110	9%
Shopping	6,070	6%	9,150	10%	22,480	14%
Leisure	8,450	9%	10,590	11%	17,090	11%
Medical	2,520	3%	1,170	1%	2,660	2%
Pick-up / drive passenger	6,570	7%	5,470	6%	15,190	9%
Return Home	33,610	35%	45,620	48%	65,770	41%
Other	3,560	4%	3,590	4%	8,440	5%
Total:	95,030	100%	95,110	100%	161,290	100%

AM Peak (06:30 - 08:59)	From District		To District		Within District	
Work or related	18,030	69%	11,020	70%	7,430	24%
School	4,890	19%	2,280	15%	11,740	39%
Shopping	170	1%	320	2%	760	3%
Leisure	340	1%	400	3%	780	3%
Medical	330	1%	230	1%	350	1%
Pick-up / drive passenger	1,260	5%	580	4%	4,760	16%
Return Home	290	1%	380	2%	1,980	7%
Other	670	3%	430	3%	2,560	8%
Total:	25,980	100%	15,640	100%	30,360	100%

PM Peak (15:30 - 17:59)	From District		To District		Within District	
Work or related	390	2%	350	1%	930	2%
School	370	2%	0	0%	90	0%
Shopping	1,030	5%	1,910	7%	5,100	14%
Leisure	2,140	11%	3,080	11%	4,130	11%
Medical	230	1%	180	1%	400	1%
Pick-up / drive passenger	1,980	10%	1,980	7%	3,410	9%
Return Home	12,130	64%	20,550	71%	21,560	58%
Other	680	4%	860	3%	1,850	5%
Total:	18,950	100%	28,910	100%	37,470	100%

Peak Period (%)	Total:	% of 24 Hours	Within District (%)
24 Hours	351,430		46%
AM Peak Period	71,980	20%	42%
PM Peak Period	85,330	24%	44%

Trips by Primary Travel Mode

24 Hours	From District		To District		Within District	
Auto Driver	63,470	67%	63,830	67%	92,190	57%
Auto Passenger	15,220	16%	14,920	16%	31,880	20%
Transit	12,200	13%	12,270	13%	4,050	3%
Bicycle	360	0%	410	0%	960	1%
Walk	40	0%	50	0%	21,080	13%
Other	3,730	4%	3,660	4%	11,130	7%
Total:	95,020	100%	95,140	100%	161,290	100%

AM Peak (06:30 - 08:59)	From District		To District		Within District	
Auto Driver	15,360	59%	11,530	74%	13,630	45%
Auto Passenger	2,450	9%	1,160	7%	5,050	17%
Transit	6,230	24%	1,290	8%	1,210	4%
Bicycle	30	0%	80	1%	220	1%
Walk	0	0%	40	0%	5,730	19%
Other	1,900	7%	1,560	10%	4,510	15%
Total:	25,970	100%	15,660	100%	30,350	100%

PM Peak (15:30 - 17:59)	From District		To District		Within District	
Auto Driver	13,850	73%	17,660	61%	21,240	57%
Auto Passenger	3,240	17%	4,270	15%	8,570	23%
Transit	1,270	7%	5,980	21%	670	2%
Bicycle	40	0%	100	0%	260	1%
Walk	40	0%	0	0%	4,570	12%
Other	520	3%	910	3%	2,160	6%
Total:	18,960	100%	28,920	100%	37,470	100%

Avg Vehicle Occupancy	From District		To District		Within District	
24 Hours	1.24		1.23		1.35	
AM Peak Period	1.16		1.10		1.37	
PM Peak Period	1.23		1.24		1.40	

Transit Modal Split	From District		To District		Within District	
24 Hours	13%		13%		3%	
AM Peak Period	26%		9%		6%	
PM Peak Period	7%		21%		2%	



1981 Maple Grove Road

Transportation Impact Assessment Report

Appendix F: Multi-Modal Level of Service (MMLOS)

February 2018





INTERSECTIONS		Maple Grove Road & Alon Street ¹				Maple Grove Road & Santolina Street ¹				Maple Grove Road & Huntmar Drive				
		NORTH leg	SOUTH leg	EAST leg	WEST leg	NORTH leg	SOUTH leg	EAST leg	WEST leg	NORTH leg	SOUTH leg	EAST leg	WEST leg	
Pedestrian	Lanes (do NOT include lanes protected by bulb-outs)									2	3	2	2	
	Median									No Median	No Median	No Median	No Median	
	Island Refuge													
	Conflicting Left Turns (from street to right)									Permissive	Permissive	Permissive	Permissive	
	Conflicting Right Turns (from street to left)									Permissive or yield control	Permissive or yield control	Permissive or yield control	Permissive or yield control	
	RTOR? (from street to left)									RTOR allowed	RTOR allowed	RTOR allowed	RTOR allowed	
	Ped Leading Interval? (on cross street)									No	No	No	No	
	Corner Radius									> 5m to 10m	> 5m to 10m	> 5m to 10m	> 5m to 10m	
	Right Turn Channel									No right turn channel	No right turn channel	No right turn channel	No right turn channel	
	Crosswalk Type									Standard transverse markings	Standard transverse markings	Standard transverse markings	Standard transverse markings	
LOS (PETS)										86 B	71 C	86 B	86 B	
Cycle Length (sec)										125	125	125	125	
Pedestrian Walk Time (solid white symbol) (sec)										7	7	7	7	
LOS (Delay,seconds)										55.7 E	55.7 E	55.7 E	55.7 E	
Overall Level of Service										E				
Cyclist	Type of Bikeway									Mixed Traffic Slow	Mixed Traffic Slow	Mixed Traffic Slow	Mixed Traffic Slow	
	Turning Speed (based on corner radius & angle)													
	Right Turn Storage Length									No	No	No	No	
	Dual Right Turn?									Yes	Yes	Yes	Yes	
	Shared Through-Right?									No	No	No	No	
	Bike Box?									No Lanes Crossed	1 Lane Crossed	No Lanes Crossed	No Lanes Crossed	
	Number of Lanes Crossed for Left Turns									50km/h	50km/h	50km/h	50km/h	
	Operating Speed on Approach									No	No	No	No	
	Dual Left Turn Lanes?													
	Level of Service										F			
Transit	Average Signal Delay									>40 sec	>40 sec	>40 sec	>40 sec	
	Level of Service										F			
Truck	Turning Radius (Right Turn)									< 10m	< 10m	< 10m	< 10m	
	Level of Service										F			
Auto	Level of Service		A (AM) / A (PM)				A (AM) / A (PM)				C (AM) / E (PM)			

SEGMENTS		Maple Grove Road & Alon Street	Section			Maple Grove Road & Prop. MUP	Section			Maple Grove Road & Huntmar Drive	
			1	2	3		1	2	3		
Pedestrian	Sidewalk Width		No Sidewalk	No Sidewalk	No Sidewalk		2.0 or more	2.0 or more	2.0 or more		
	Boulevard Width		N/A	N/A	N/A		> 2	> 2	> 2		
	AADT		N/A	N/A	N/A		> 3000	> 3000	> 3000		
	On-Street Parking		N/A	N/A	N/A		Yes	Yes	Yes		
Cyclist	Operating Speed		51 to 60 km/h	51 to 60 km/h	51 to 60 km/h		51 to 60 km/h	51 to 60 km/h	51 to 60 km/h		
	Level of Service		F			B			B		
	Type of Bikeway		Mixed Traffic				Mixed Traffic				
	Number of Travel Lanes (per direction)		1 Travel Lane Per Direction				1 Travel Lane Per Direction				
Transit	Raised Median?		No				No				
	Bike Lane Width		N/A				N/A				
	Operating Speed		50 km/h				50 km/h				
	Bike Lane Blockages (Commercial Areas)		Rare				Rare				
Truck	Median Refuge		No Median Refuge				No Median Refuge				
	Number of Travel Lanes on Sidestreet		2 Lanes Crossed				2 Lanes Crossed				
	Sidestreet Operating Speed		50 km/h				50 km/h				
	Level of Service		D			E			B		
Truck	Facility Type		Mixed Traffic				Mixed Traffic				
	Level of Service		D			E			B		
Truck	Curb Lane Width		>3.7	>3.7	>3.7		>3.7	>3.7	>3.7		
	Level of Service		B			B			B		

¹ Multi-Modal Level of Service does not apply to unsignalized intersections.

² Sidewalks must be 1.5m wide to meet Provincial accessibility standards. Sidewalks will be constructed along all boundary streets to the subject site to provide pedestrian connectivity.

Multi-Modal Level of Service

1981 Maple Grove Road Transportation Impact Assessment (TIA)

Existing Conditions (2018) - Modifications

February 15, 2018



INTERSECTIONS		Maple Grove Road & Alon Street ¹				Maple Grove Road & Santolina Street ¹				Maple Grove Road & Huntmar Drive			
		NORTH leg	SOUTH leg	EAST leg	WEST leg	NORTH leg	SOUTH leg	EAST leg	WEST leg	NORTH leg	SOUTH leg	EAST leg	WEST leg
Pedestrian	Lanes (do NOT include lanes protected by bulb-outs)									4	3	3	3
	Median									No Median	No Median	No Median	No Median
	Island Refuge												
	Conflicting Left Turns (from street to right)									Permissive	Permissive	Permissive	Permissive
	Conflicting Right Turns (from street to left)									Protected/permissive	Protected/permissive	Protected/permissive	Protected/permissive
	RTOR? (from street to left)									RTOR allowed	RTOR allowed	RTOR allowed	RTOR allowed
	Ped Leading Interval? (on cross street)									No	No	No	No
	Corner Radius									> 5m to 10m	> 5m to 10m	> 5m to 10m	> 5m to 10m
	Right Turn Channel									No right turn channel	No right turn channel	No right turn channel	No right turn channel
	Crosswalk Type									Standard transverse markings	Standard transverse markings	Standard transverse markings	Standard transverse markings
LOS (PETS)										54 D	71 C	71 C	71 C
Cycle Length (sec)										70	70	70	70
Pedestrian Walk Time (solid white symbol) (sec)										7	7	7	7
LOS (Delay,seconds)										28.4 C	28.4 C	28.4 C	28.4 C
Overall Level of Service										D			
Cyclist	Type of Bikeway									Mixed Traffic Slow	Mixed Traffic Slow	Mixed Traffic Slow	Mixed Traffic Slow
	Turning Speed (based on corner radius & angle)												
	Right Turn Storage Length												
	Dual Right Turn?									No	No	No	No
	Shared Through-Right?									No	Yes	Yes	Yes
	Bike Box?									No	No	No	No
	Number of Lanes Crossed for Left Turns									1 Lane Crossed	1 Lane Crossed	1 Lane Crossed	1 Lane Crossed
	Operating Speed on Approach									50km/h	50km/h	50km/h	50km/h
Dual Left Turn Lanes?									No	No	No	No	
Level of Service										D			
Transit	Average Signal Delay									≤20 sec	≤20 sec	≤20 sec	≤20 sec
	Level of Service									C			
Truck	Turning Radius (Right Turn)									< 10m	< 10m	< 10m	< 10m
	Number of Receiving Lanes									1	1	1	1
Level of Service										F			
Auto	Level of Service	A (AM) / A (PM)				A (AM) / A (PM)				C (AM) / C (PM)			

SEGMENTS		Maple Grove Road & Alon Street	Section			Maple Grove Road & Prop. MUP	Section			Maple Grove Road & Huntmar Drive
			1	2	3		1	2	3	
Pedestrian	Sidewalk Width		No Sidewalk	No Sidewalk	No Sidewalk		2.0 or more	2.0 or more	2.0 or more	
	Boulevard Width		N/A	N/A	N/A		> 2	> 2	> 2	
	AADT		N/A	N/A	N/A		> 3000	> 3000	> 3000	
	On-Street Parking		N/A	N/A	N/A		Yes	Yes	Yes	
	Operating Speed		51 to 60 km/h	51 to 60 km/h	51 to 60 km/h		51 to 60 km/h	51 to 60 km/h	51 to 60 km/h	
Level of Service			F	F ²	F		B	B	B	
Cyclist	Type of Bikeway		Mixed Traffic				Mixed Traffic			
	Number of Travel Lanes (per direction)		1 Travel Lane Per Direction				1 Travel Lane Per Direction			
	Raised Median?		No				No			
	Bike Lane Width		N/A				N/A			
	Operating Speed		50 km/h				50 km/h			
	Bike Lane Blockages (Commercial Areas)		Rare				Rare			
	Median Refuge		No Median Refuge				No Median Refuge			
Number of Travel Lanes on Sidestreet		2 Lanes Crossed				2 Lanes Crossed				
Sidestreet Operating Speed		50 km/h				50 km/h				
Level of Service			D				D			
Transit	Facility Type		Mixed Traffic				Mixed Traffic			
	Friction		Limited parking/driveway friction				Moderate parking/driveway friction			
Level of Service			D				E			
Truck	Curb Lane Width		>3.7	>3.7	>3.7		>3.7	>3.7	>3.7	
	Number of Travel Lanes		2	2	2		2	2	2	
	Level of Service			B	B	B		B	B	B
Level of Service			B				B			

¹ Multi-Modal Level of Service does not apply to unsignalized intersections.

² Sidewalks must be 1.5m wide to meet Provincial accessibility standards. Sidewalks will be constructed along all boundary streets to the subject site to provide pedestrian connectivity.

Multi-Modal Level of Service

1981 Maple Grove Road Transportation Impact Assessment (TIA)

2021 Background Traffic Conditions

February 15, 2018



INTERSECTIONS		Maple Grove Road & Alon Street ¹				Maple Grove Road & Santolina Street ¹				Maple Grove Road & Huntmar Drive				
		NORTH leg	SOUTH leg	EAST leg	WEST leg	NORTH leg	SOUTH leg	EAST leg	WEST leg	NORTH leg	SOUTH leg	EAST leg	WEST leg	
Pedestrian	Lanes (do NOT include lanes protected by bulb-outs)									4	3	3	3	
	Median									No Median	No Median	No Median	No Median	
	Island Refuge													
	Conflicting Left Turns (from street to right)									Permissive	Permissive	Permissive	Permissive	
	Conflicting Right Turns (from street to left)									Permissive or yield control	Permissive or yield control	Permissive or yield control	Permissive or yield control	
	RTOR? (from street to left)									RTOR allowed	RTOR allowed	RTOR allowed	RTOR allowed	
	Ped Leading Interval? (on cross street)									No	No	No	No	
	Corner Radius									> 5m to 10m	> 5m to 10m	> 5m to 10m	> 5m to 10m	
	Right Turn Channel									No right turn channel	No right turn channel	No right turn channel	No right turn channel	
	Crosswalk Type									Standard transverse markings	Standard transverse markings	Standard transverse markings	Standard transverse markings	
LOS (PETS)										D	C	C	C	
Cycle Length (sec)										70	70	70	70	
Pedestrian Walk Time (solid white symbol) (sec)										7	7	7	7	
LOS (Delay,seconds)										28.4	28.4	28.4	28.4	
Overall Level of Service										D				
Cyclist	Type of Bikeway									Mixed Traffic	Mixed Traffic	Mixed Traffic	Mixed Traffic	
	Turning Speed (based on corner radius & angle)									Fast	Fast	Fast	Fast	
	Right Turn Storage Length									≤ 50m	≤ 50m	≤ 50m	≤ 50m	
	Dual Right Turn?									No	No	No	No	
	Shared Through-Right?									No	Yes	Yes	Yes	
	Bike Box?									No	No	No	No	
	Number of Lanes Crossed for Left Turns									1 Lane Crossed	1 Lane Crossed	1 Lane Crossed	1 Lane Crossed	
	Operating Speed on Approach (Posted Speed + 10km/h)									50km/h	50km/h	50km/h	50km/h	
Dual Left Turn Lanes?									No	No	No	No		
Level of Service										D				
Transit	Average Signal Delay									≤20 sec	≤30 sec		≤30 sec	
	Level of Service									C	D		D	
Level of Service										D				
Truck	Turning Radius (Right Turn)									< 10m	< 10m	< 10m	< 10m	
	Number of Receiving Lanes									1	1	1	1	
Level of Service										F				
Auto	Level of Service		A (AM) / A (PM)				A (AM) / A (PM)				D (AM) / C (PM)			

SEGMENTS		Maple Grove Road & Alon Street	Section			Maple Grove Road & Santolina Street	Section			Maple Grove Road & Huntmar Drive
			1	2	3		1	2	3	
Pedestrian	Sidewalk Width		No Sidewalk	No Sidewalk	2.0 or more		2.0 or more	2.0 or more	2.0 or more	
	Boulevard Width		N/A	N/A	> 2		> 2	> 2	> 2	
	AADT		N/A	N/A	> 3000		> 3000	> 3000	> 3000	
	On-Street Parking		N/A	N/A	Yes		Yes	Yes	Yes	
	Operating Speed		51 to 60 km/h	51 to 60 km/h	51 to 60 km/h		51 to 60 km/h	51 to 60 km/h	51 to 60 km/h	
Level of Service			F 3	F 3	B		B	B	B	
Cyclist	Type of Bikeway		Mixed Traffic				Mixed Traffic			
	Number of Travel Lanes (per direction)		1 Travel Lane Per Direction				1 Travel Lane Per Direction			
	Raised Median?		No				No			
	Bike Lane Width		N/A				N/A			
	Operating Speed		50 km/h				60 km/h			
	Bike Lane Blockages (Commercial Areas)		Rare				Rare			
	Median Refuge		No Median Refuge				No Median Refuge			
	Number of Travel Lanes on Sidestreet		2 Lanes Crossed				2 Lanes Crossed			
Sidestreet Operating Speed		50 km/h				50 km/h				
Level of Service			F				F			
Transit	Facility Type		Mixed Traffic				Mixed Traffic			
	Friction		Limited parking/driveway friction				Limited parking/driveway friction			
Level of Service			D				D			
Truck	Curb Lane Width		>3.7	>3.7	>3.7		>3.7	>3.7	>3.7	
	Number of Travel Lanes		2	2	2		2	2	2	
	Level of Service			B	B	B		B	B	B
Level of Service			B				B			

¹ Multi-Modal Level of Service does not apply to unsignalized intersections.

² Sidewalks must be 1.5m wide to meet Provincial accessibility standards. Sidewalks will be constructed along all boundary streets to the subject site to provide pedestrian connectivity.



INTERSECTIONS	Kanata West Main & Street 1 ¹				Kanata West Main & Street 2 ¹				Kanata West Main & Street 4 ¹				Maple Grove & Stittsville/ Kanata West Main ¹				Maple Grove & Street 6 ¹				Maple Grove Road & Alon Street ¹				Maple Grove Road & Santolina Street ¹				Maple Grove Road & Huntmar Drive			
	NORTH leg	SOUTH leg	EAST leg	WEST leg	NORTH leg	SOUTH leg	EAST leg	WEST leg	NORTH leg	SOUTH leg	EAST leg	WEST leg	NORTH leg	SOUTH leg	EAST leg	WEST leg	NORTH leg	SOUTH leg	EAST leg	WEST leg	NORTH leg	SOUTH leg	EAST leg	WEST leg	NORTH leg	SOUTH leg	EAST leg	WEST leg	NORTH leg	SOUTH leg	EAST leg	WEST leg
Lanes (do NOT include lanes protected by bulb-outs)																																
Median																																
Island Refuge																																
Conflicting Left Turns (from street to right)																																
Conflicting Right Turns (from street to left)																																
RTOR? (from street to left)																																
Ped Leading Interval? (on cross street)																																
Corner Radius																																
Right Turn Channel																																
Crosswalk Type																																
LOS (PETS)																																
Cycle Length (sec)																																
Pedestrian Walk Time (solid white symbol) (sec)																																
LOS (Delay,seconds)																																
Overall Level of Service	D																															
Type of Bikeway																																
Turning Speed (based on corner radius & angle)																																
Right Turn Storage Length																																
Dual Right Turn?																																
Shared Through-Right?																																
Bike Box?																																
Number of Lanes Crossed for Left Turns																																
Operating Speed on Approach (Posted Speed + 10km/h)																																
Dual Left Turn Lanes?																																
Level of Service	D																															
Average Signal Delay																																
Level of Service	D																															
Turning Radius (Right Turn)																																
Number of Receiving Lanes																																
Level of Service	F																															
Level of Service	A (AM) / A (PM)				A (AM) / A (PM)				A (AM) / A (PM)				A (AM) / A (PM)				B (AM) / B (PM)				A (AM) / B (PM)				B (AM) / B (PM)				D (AM) / D (PM)			

SEGMENTS	Kanata West Main & Street 1			Kanata West Main & Street 2			Kanata West Main & Street 4			Maple Grove & Stittsville/ Kanata West Main			Maple Grove & Street 6			Maple Grove Road & Alon Street			Maple Grove Road & Santolina Street			Maple Grove Road & Huntmar Drive		
	1	2	3	1	2	3	1	2	3	1	2	3	1	2	3	1	2	3	1	2	3	1	2	3
Sidewalk Width	2.0 or more			2.0 or more			2.0 or more			2.0 or more			2.0 or more			2.0 or more			2.0 or more			2.0 or more		
Boulevard Width	> 2			> 2			> 2			> 2			> 2			> 2			> 2			> 2		
AADT	> 3000			> 3000			> 3000			> 3000			> 3000			> 3000			> 3000			> 3000		
On-Street Parking	Yes			Yes			Yes			Yes			Yes			Yes			Yes			Yes		
Operating Speed	51 to 60 km/h			51 to 60 km/h			51 to 60 km/h			51 to 60 km/h			51 to 60 km/h			51 to 60 km/h			51 to 60 km/h			51 to 60 km/h		
Level of Service	B			B			B			B			B			B			B			B		
Type of Bikeway	Mixed Traffic			Mixed Traffic			Mixed Traffic			Mixed Traffic			Mixed Traffic			Mixed Traffic			Mixed Traffic			Mixed Traffic		
Number of Travel Lanes (per direction)	1 Travel Lane Per Direction			1 Travel Lane Per Direction			1 Travel Lane Per Direction			1 Travel Lane Per Direction			1 Travel Lane Per Direction			1 Travel Lane Per Direction			1 Travel Lane Per Direction			1 Travel Lane Per Direction		
Raised Median?	No			No			No			No			No			No			No			No		
Bike Lane Width	N/A			N/A			N/A			N/A			N/A			N/A			N/A			N/A		
Operating Speed	50 km/h			50 km/h			50 km/h			50 km/h			50 km/h			50 km/h			50 km/h			50 km/h		
Bike Lane Blockages (Commercial Areas)	Rare			Rare			Rare			Rare			Rare			Rare			Rare			Rare		
Median Refuge	No Median Refuge			No Median Refuge			No Median Refuge			No Median Refuge			No Median Refuge			No Median Refuge			No Median Refuge			No Median Refuge		
Number of Travel Lanes on Sidestreet	2 Lanes Crossed			2 Lanes Crossed			2 Lanes Crossed			2 Lanes Crossed			2 Lanes Crossed			2 Lanes Crossed			2 Lanes Crossed			2 Lanes Crossed		
Sidestreet Operating Speed	50 km/h			50 km/h			50 km/h			50 km/h			50 km/h			50 km/h			50 km/h			50 km/h		
Level of Service	B			B			B			B			B			B			B			B		
Facility Type	Mixed Traffic			Mixed Traffic			Mixed Traffic			Mixed Traffic			Mixed Traffic			Mixed Traffic			Mixed Traffic			Mixed Traffic		
Friction	Limited parking/driveway friction			Limited parking/driveway friction			Limited parking/driveway friction			Limited parking/driveway friction			Limited parking/driveway friction			Limited parking/driveway friction			Limited parking/driveway friction			Moderate parking/driveway friction		
Level of Service	D			D			D			D			D			D			D			E		
Curb Lane Width	>3.7			>3.7			>3.7			>3.7			>3.7			>3.7			>3.7			>3.7		
Number of Travel Lanes	2			2			2			2			2			2			2			2		
Level of Service	B			B			B			B			B			B			B			B		

¹ Multi-Modal Level of Service does not apply to unsignalized intersections.
² Sidewalks must be 1.5m wide to meet Provincial accessibility standards. Sidewalks will be constructed along all boundary streets to the subject site to provide pedestrian connectivity.

Multi-Modal Level of Service

1981 Maple Grove Road Transportation Impact Assessment (TIA)

2026 Background Traffic Conditions

February 15, 2018



INTERSECTIONS		Maple Grove Road & Alon Street ¹				Maple Grove Road & Santolina Street ¹				Maple Grove Road & Huntmar Drive			
		NORTH leg	SOUTH leg	EAST leg	WEST leg	NORTH leg	SOUTH leg	EAST leg	WEST leg	NORTH leg	SOUTH leg	EAST leg	WEST leg
Pedestrian	Lanes (do NOT include lanes protected by bulb-outs)									4	3	3	3
	Median									No Median	No Median	No Median	No Median
	Island Refuge												
	Conflicting Left Turns (from street to right)									Permissive	Permissive	Permissive	Permissive
	Conflicting Right Turns (from street to left)									Permissive or yield control	Permissive or yield control	Permissive or yield control	Permissive or yield control
	RTOR? (from street to left)									RTOR allowed	RTOR allowed	RTOR allowed	RTOR allowed
	Ped Leading Interval? (on cross street)									No	No	No	No
	Corner Radius									> 5m to 10m	> 5m to 10m	> 5m to 10m	> 5m to 10m
	Right Turn Channel									No right turn channel	No right turn channel	No right turn channel	No right turn channel
	Crosswalk Type									Standard transverse markings	Standard transverse markings	Standard transverse markings	Standard transverse markings
LOS (PETS)										D	C	C	C
Cycle Length (sec)										75	75	75	75
Pedestrian Walk Time (solid white symbol) (sec)										7	7	7	7
LOS (Delay,seconds)										30.8	30.8	30.8	30.8
Overall Level of Service										D			
Cyclist	Type of Bikeway									Mixed Traffic	Bike Lanes/Cycle Track	Mixed Traffic	Mixed Traffic
	Turning Speed (based on corner radius & angle)									Fast	Fast	Fast	Fast
	Right Turn Storage Length									≤ 50m	≤ 50m	> 50m	> 50m
	Dual Right Turn?									No	No	No	No
	Shared Through-Right?									Yes	No	Yes	Yes
	Bike Box?									No	No	No	No
	Number of Lanes Crossed for Left Turns									1 Lane Crossed	1 Lane Crossed	1 Lane Crossed	1 Lane Crossed
	Operating Speed on Approach (Posted Speed + 10km/h)									50km/h	50km/h	50km/h	50km/h
	Dual Left Turn Lanes?									No	No	No	No
	Level of Service										D		
Transit	Average Signal Delay									≤20 sec	≤30 sec		≤30 sec
	Level of Service									D			
Truck	Turning Radius (Right Turn)									< 10m	< 10m	< 10m	< 10m
	Number of Receiving Lanes									1	1	1	1
Level of Service										F			
Auto	Level of Service	A (AM) / A (PM)				A (AM) / B (PM)				D (AM) / D (PM)			

SEGMENTS		Maple Grove Road & Alon Street	Section			Maple Grove Road & Santolina Street	Section			Maple Grove Road & Huntmar Drive
			1	2	3		1	2	3	
Pedestrian	Sidewalk Width		No Sidewalk	No Sidewalk	2.0 or more		2.0 or more	2.0 or more	2.0 or more	
	Boulevard Width		N/A	N/A	> 2		> 2	> 2	> 2	
	AADT		N/A	N/A	> 3000		> 3000	> 3000	> 3000	
	On-Street Parking		N/A	N/A	Yes		Yes	Yes	Yes	
	Operating Speed		51 to 60 km/h	51 to 60 km/h	51 to 60 km/h		51 to 60 km/h	51 to 60 km/h	51 to 60 km/h	
Level of Service			F 3	F 3	B		B	B	B	
Cyclist	Type of Bikeway		Mixed Traffic				Mixed Traffic			
	Number of Travel Lanes (per direction)		1 Travel Lane Per Direction				1 Travel Lane Per Direction			
	Raised Median?		No				No			
	Bike Lane Width		N/A				N/A			
	Operating Speed		50 km/h				50 km/h			
	Bike Lane Blockages (Commercial Areas)		Rare				Rare			
	Median Refuge		No Median Refuge				No Median Refuge			
	Number of Travel Lanes on Sidestreet		2 Lanes Crossed				2 Lanes Crossed			
Sidestreet Operating Speed		50 km/h				50 km/h				
Level of Service			D				D			
Transit	Facility Type		Mixed Traffic				Mixed Traffic			
	Friction		Limited parking/driveway friction				Moderate parking/driveway friction			
Level of Service			D				E			
Truck	Curb Lane Width		>3.7	>3.7	>3.7		>3.7	>3.7	>3.7	
	Number of Travel Lanes		2	2	2		2	2	2	
	Level of Service			B	B	B		B	B	B
Overall Level of Service			B				B			

¹ Multi-Modal Level of Service does not apply to unsignalized intersections.

² Sidewalks must be 1.5m wide to meet Provincial accessibility standards. Sidewalks will be constructed along all boundary streets to the subject site to provide pedestrian connectivity.



INTERSECTIONS	Kanata West Main & Street 1 ¹				Kanata West Main & Street 2 ¹				Kanata West Main & Street 4 ¹				Maple Grove & Stittsville/ Kanata West Main ¹				Maple Grove & Street 6 ¹				Maple Grove Road & Alon Street ¹				Maple Grove Road & Santolina Street ¹				Maple Grove Road & Huntmar Drive			
	NORTH leg	SOUTH leg	EAST leg	WEST leg	NORTH leg	SOUTH leg	EAST leg	WEST leg	NORTH leg	SOUTH leg	EAST leg	WEST leg	NORTH leg	SOUTH leg	EAST leg	WEST leg	NORTH leg	SOUTH leg	EAST leg	WEST leg	NORTH leg	SOUTH leg	EAST leg	WEST leg	NORTH leg	SOUTH leg	EAST leg	WEST leg	NORTH leg	SOUTH leg	EAST leg	WEST leg
Lanes (do NOT include lanes protected by bulb-outs)																																
Median																																
Island Refuge																																
Conflicting Left Turns (from street to right)																																
Conflicting Right Turns (from street to left)																																
RTOR? (from street to left)																																
Ped Leading Interval? (on cross street)																																
Corner Radius																																
Right Turn Channel																																
Crosswalk Type																																
LOS (PETS)																																
Cycle Length (sec)																																
Pedestrian Walk Time (solid white symbol) (sec)																																
LOS (Delay,seconds)																																
Overall Level of Service	D																															
Type of Bikeway																																
Turning Speed (based on corner radius & angle)																																
Right Turn Storage Length																																
Dual Right Turn?																																
Shared Through-Right?																																
Bike Box?																																
Number of Lanes Crossed for Left Turns																																
Operating Speed on Approach (Posted Speed + 10km/h)																																
Dual Left Turn Lanes?																																
Level of Service	D																															
Average Signal Delay																																
Level of Service	D																															
Turning Radius (Right Turn)																																
Number of Receiving Lanes																																
Level of Service	F																															
Level of Service	A (AM) / A (PM)				A (AM) / A (PM)				A (AM) / A (PM)				A (AM) / B (PM)				B (AM) / B (PM)				A (AM) / B (PM)				B (AM) / B (PM)				D (AM) / D (PM)			

SEGMENTS	Kanata West Main & Street 1			Kanata West Main & Street 2			Kanata West Main & Street 4			Kanata West Main & Stittsville/ Kanata West			Maple Grove & Street 6			Maple Grove Road & Alon Street			Maple Grove Road & Santolina Street			Maple Grove Road & Huntmar Drive		
	1	2	3	1	2	3	1	2	3	1	2	3	1	2	3	1	2	3	1	2	3	1	2	3
Sidewalk Width	2.0 or more			2.0 or more			2.0 or more			2.0 or more			2.0 or more			2.0 or more			2.0 or more			2.0 or more		
Boulevard Width	> 2			> 2			> 2			> 2			> 2			> 2			> 2			> 2		
ADDT	> 3000			> 3000			> 3000			> 3000			> 3000			> 3000			> 3000			> 3000		
On-Street Parking	Yes			Yes			Yes			Yes			Yes			Yes			Yes			Yes		
Operating Speed	51 to 60 km/h			51 to 60 km/h			51 to 60 km/h			51 to 60 km/h			51 to 60 km/h			51 to 60 km/h			51 to 60 km/h			51 to 60 km/h		
Level of Service	B			B			B			B			B			B			B			B		
Type of Bikeway	Mixed Traffic			Mixed Traffic			Mixed Traffic			Mixed Traffic			Mixed Traffic			Mixed Traffic			Mixed Traffic			Mixed Traffic		
Number of Travel Lanes (per direction)	1 Travel Lane Per Direction			1 Travel Lane Per Direction			1 Travel Lane Per Direction			1 Travel Lane Per Direction			1 Travel Lane Per Direction			1 Travel Lane Per Direction			1 Travel Lane Per Direction			1 Travel Lane Per Direction		
Raised Median?	No			No			No			No			No			No			No			No		
Bike Lane Width	N/A			N/A			N/A			N/A			N/A			N/A			N/A			N/A		
Operating Speed	50 km/h			50 km/h			50 km/h			50 km/h			50 km/h			50 km/h			50 km/h			50 km/h		
Bike Lane Blockages (Commercial Areas)	Rare			Rare			Rare			Rare			Rare			Rare			Rare			Rare		
Median Refuge	No Median Refuge			No Median Refuge			No Median Refuge			No Median Refuge			No Median Refuge			No Median Refuge			No Median Refuge			No Median Refuge		
Number of Travel Lanes on Sidewalk	2 Lanes Crossed			2 Lanes Crossed			2 Lanes Crossed			2 Lanes Crossed			2 Lanes Crossed			2 Lanes Crossed			2 Lanes Crossed			2 Lanes Crossed		
Sidewalk Operating Speed	50 km/h			50 km/h			50 km/h			50 km/h			50 km/h			50 km/h			50 km/h			50 km/h		
Level of Service	D			D			D			D			D			D			D			D		
Facility Type	Mixed Traffic			Mixed Traffic			Mixed Traffic			Mixed Traffic			Mixed Traffic			Mixed Traffic			Mixed Traffic			Mixed Traffic		
Friction	Limited parking/driveway friction			Limited parking/driveway friction			Limited parking/driveway friction			Limited parking/driveway friction			Limited parking/driveway friction			Limited parking/driveway friction			Limited parking/driveway friction			Moderate parking/driveway friction		
Level of Service	D			D			D			D			D			D			D			E		
Curb Lane Width	>3.7			>3.7			>3.7			>3.7			>3.7			>3.7			>3.7			>3.7		
Number of Travel Lanes	2			2			2			2			2			2			2			2		
Level of Service	B			B			B			B			B			B			B			B		

¹ Multi-Modal Level of Service does not apply to unsignalized intersections.
² Sidewalks must be 1.5m wide to meet Provincial accessibility standards. Sidewalks will be constructed along all boundary streets to the subject site to provide pedestrian connectivity.



1981 Maple Grove Road



Transportation Impact Assessment Report

Appendix G: Roundabout Screening Form

February 2018

City of Ottawa Roundabout Initial Feasibility Screening Tool

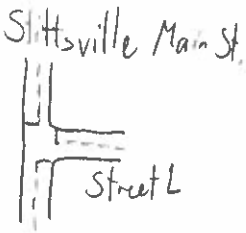
The intent of this screening tool is to provide a relatively quick assessment of the feasibility of a roundabout at a particular intersection in comparison to other appropriate forms of traffic control or road modifications including all-way stop control, traffic signals, auxiliary lanes, etc. The intended outcome of this tool is to provide enough information to assist staff in deciding whether or not to proceed with an Intersection Control Study to investigate the feasibility of a roundabout in more detail.

1	Project Name:	Maple Grove - Clridge 113480
2	Intersection:	Stittsville Main St (ext) + Street L
3	Location and Description of Intersection: Lane configuration, total or approach AADT, distance to nearby intersection(s), etc. Attach or sketch a diagram and include existing and/or horizon-year turning movements. If an existing intersection then indicate type of control.	AADT: Northbound: 45 Southbound: 0 Westbound: 55 
4	What traditional modifications are proposed? All-way stop control, traffic signals, auxiliary lanes, etc. Attach or sketch a diagram if necessary.	One-way stop sign heading West 
5	What size of roundabout is being considered? Describe, and attach a Roundabout Traffic Flow Worksheet.	Single lane
6	Why is a roundabout being considered?	New intersection

- 7 Are there contra-indications for a roundabout? If "Yes" is indicated for one or more of the contra-indications then a roundabout may be problematic at the subject intersection. That is not to say that a roundabout is not possible, just that there may be difficulties or high costs.

No.	Contra-Indication	Outcome
1	Is there insufficient property at the intersection (i.e. less than 44 metres diameter if considering a single-lane roundabout, and less than 60 metres if considering a two-lane roundabout) or property constraints that would require demolition of adjacent structures?	Yes <input checked="" type="checkbox"/> No <input type="checkbox"/>
2	Are there any instances where stopping sight distance (SSD) of a roundabout yield line may not be attainable (i.e. the intersection is on a crest vertical curve)?	Yes <input type="checkbox"/> No <input checked="" type="checkbox"/>
3	Is there an existing uncontrolled approach with a grade in excess of 4 percent?	Yes <input type="checkbox"/> No <input checked="" type="checkbox"/>
4	Is the intersection located within a coordinated signal system?	Yes <input type="checkbox"/> No <input checked="" type="checkbox"/>
5	Is there a closely-spaced traffic signal or railway crossing that could not be controlled with a nearby roundabout?	Yes <input type="checkbox"/> No <input checked="" type="checkbox"/>
6	Are significant differences in directional flows or any situations of sudden high demand expected?	Yes <input type="checkbox"/> No <input checked="" type="checkbox"/>
7	Are there known visually-impaired pedestrians that cross this intersection?	Yes <input type="checkbox"/> No <input checked="" type="checkbox"/>

- 8 Are there suitability factors for a roundabout? If "Yes" is indicated for two or more of the suitability factors then a roundabout should be technically feasible at the subject intersection.

No.	Suitability Factor	Outcome
1	Does the intersection currently experience an average collision frequency of more than 1.5 injury crashes per year, or a collision rate in excess of 1 injury crash per 1 million vehicles entering (MVE)?	Yes <input type="checkbox"/> No <input checked="" type="checkbox"/>
2	Has there been a fatal crash at the intersection in the last 10 years?	Yes <input type="checkbox"/> No <input checked="" type="checkbox"/>
3	Are capacity problems currently being experienced, or expected in the future?	Yes <input type="checkbox"/> No <input checked="" type="checkbox"/>
4	Are traffic signals warranted, or expected to be warranted in the future?	Yes <input type="checkbox"/> No <input checked="" type="checkbox"/>
5	Does the intersection have more than 4 legs, or unusual geometry?	Yes <input type="checkbox"/> No <input checked="" type="checkbox"/>
6	Will planned modifications to the intersection require that nearby structures be widened (i.e. to accommodate left-turn lanes)?	Yes <input type="checkbox"/> No <input checked="" type="checkbox"/>
7	Is the intersection located at a transition between rural and urban environments (i.e. an urban boundary) such that a roundabout could act as a means of speed transition?	Yes <input type="checkbox"/> No <input checked="" type="checkbox"/>

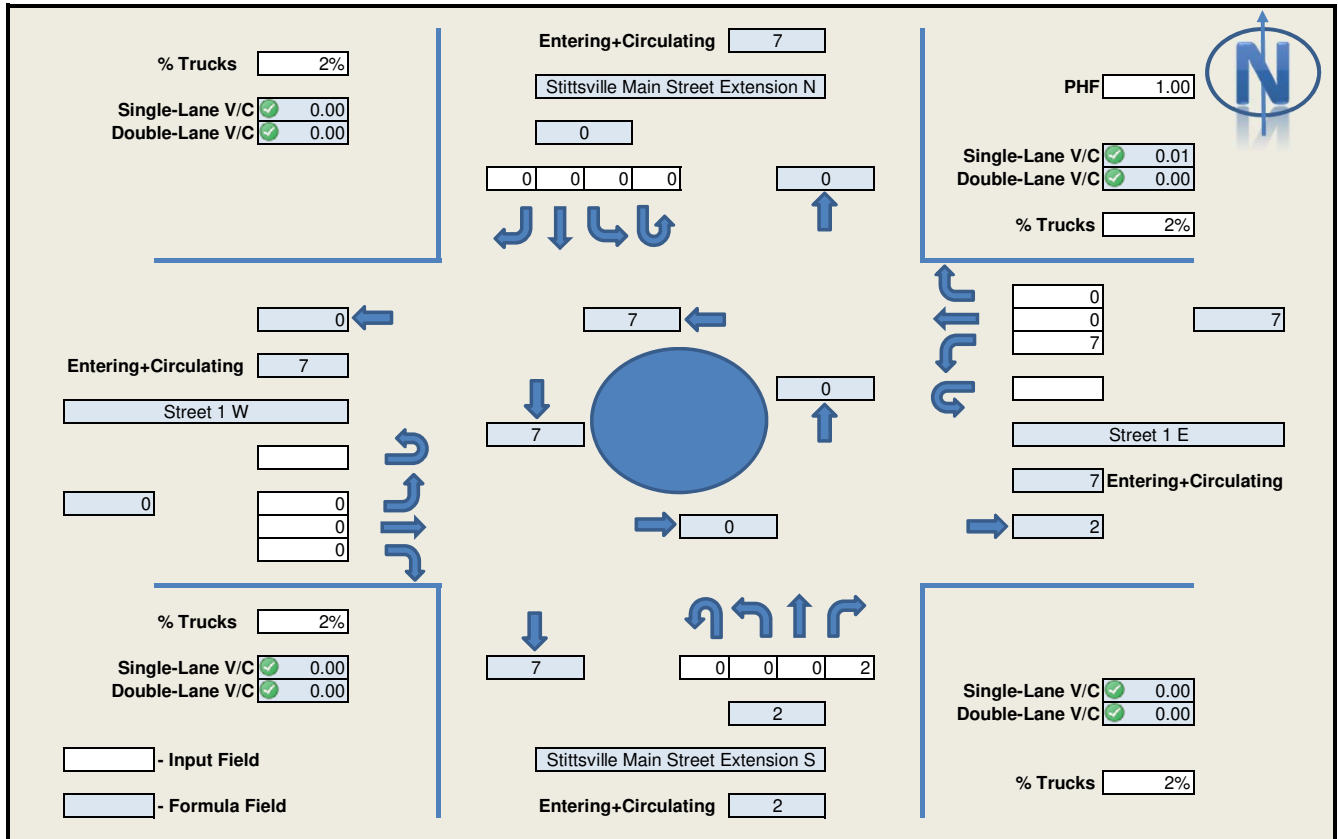

Capacity Guidelines for Single-Lane Roundabouts

1. Single-lane service volumes < 900 vph - 1200 vph
2. Exit flow < 900 vph - 1200 vph
3. Entry flow + circulating flow < 1400 vph - 1800 vph
4. Circulating flow downstream of any entry 1400 vph - 1800 vph
5. V/C > 0.85

RODEL Inputs					
Leg	PCU	1st Exit	2nd Exit	3rd Exit	U-Turn
Stittville Main Street Extension N	1.02	0	0	0	0
Street 1 W	1.02	0	0	0	0
Stittville Main Street Extension S	1.02	2	0	0	0
Street 1 E	1.02	0	0	7	0

Proposed Lane Arrangement

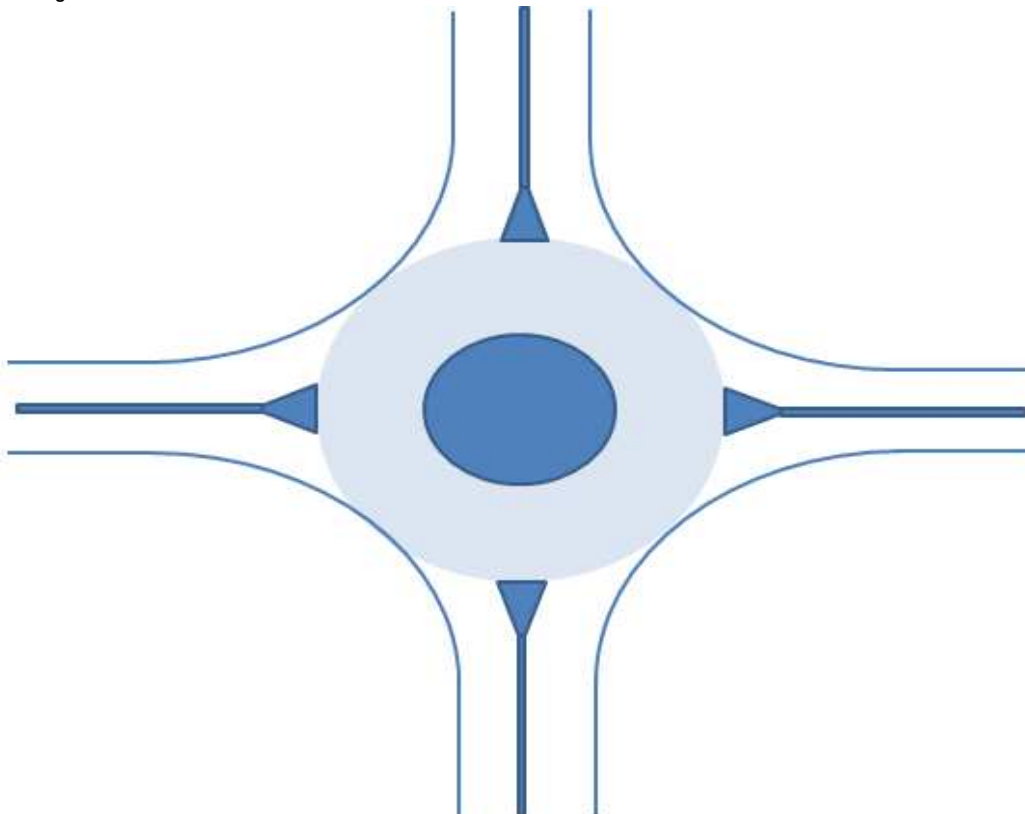

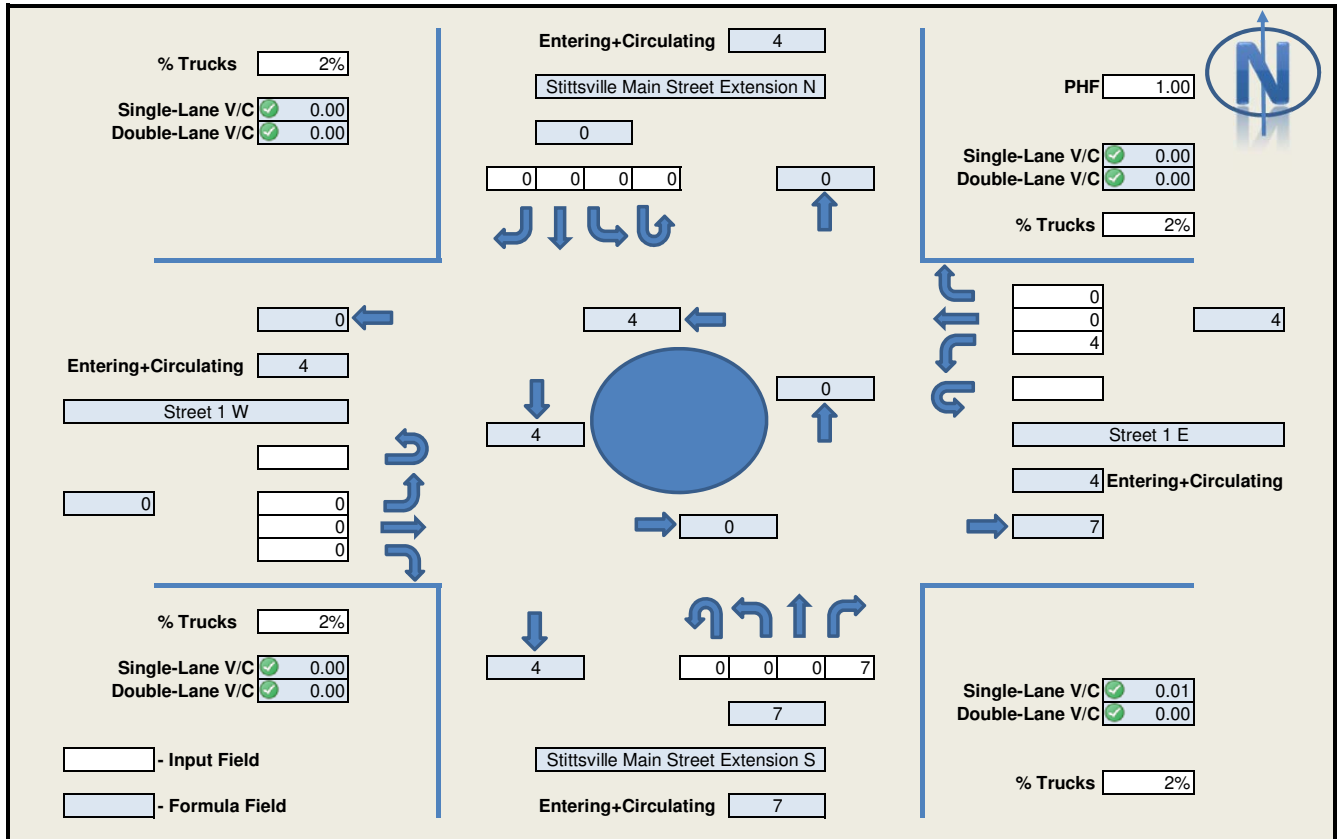

Capacity Guidelines for Single-Lane Roundabouts

1. Single-lane service volumes < 900 vph - 1200 vph
2. Exit flow < 900 vph - 1200 vph
3. Entry flow + circulating flow < 1400 vph - 1800 vph
4. Circulating flow downstream of any entry 1400 vph - 1800 vph
5. V/C > 0.85

RODEL Inputs					
Leg	PCU	1st Exit	2nd Exit	3rd Exit	U-Turn
Stittsville Main Street Extens	1.02	0	0	0	0
Street 1 W	1.02	0	0	0	0
Stittsville Main Street Extens	1.02	7	0	0	0
Street 1 E	1.02	0	0	4	0

Proposed Lane Arrangement

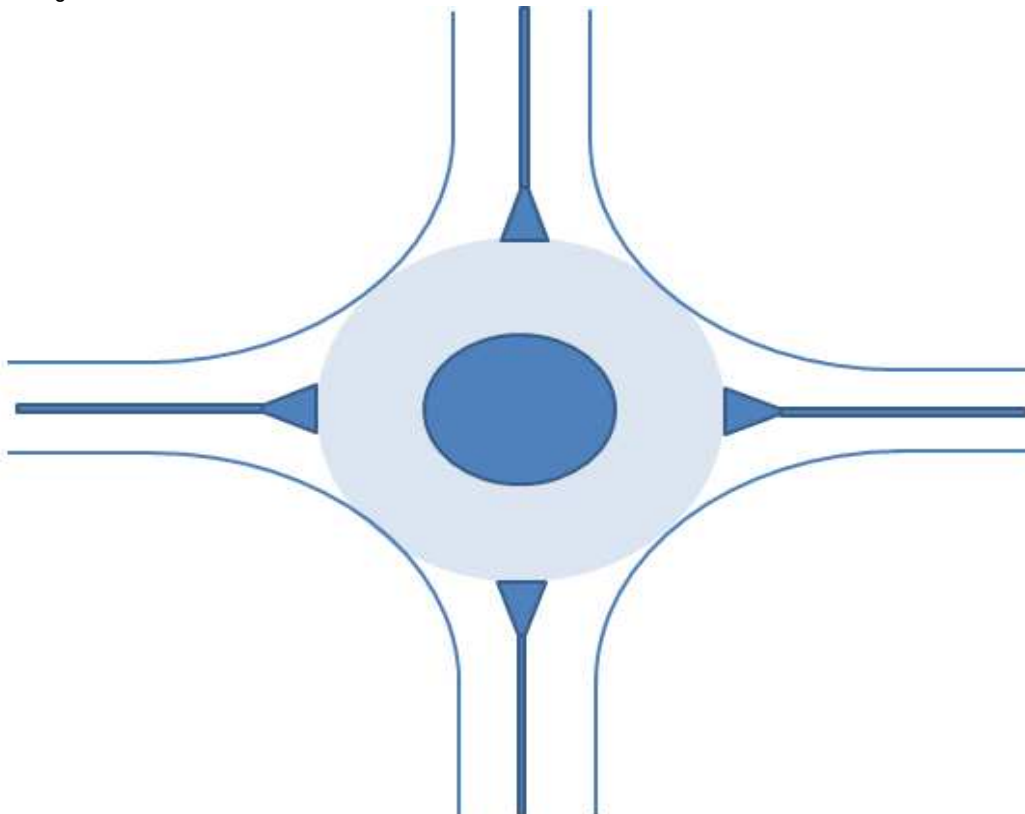

City of Ottawa Roundabout Initial Feasibility Screening Tool

The intent of this screening tool is to provide a relatively quick assessment of the feasibility of a roundabout at a particular intersection in comparison to other appropriate forms of traffic control or road modifications including all-way stop control, traffic signals, auxiliary lanes, etc. The intended outcome of this tool is to provide enough information to assist staff in deciding whether or not to proceed with an Intersection Control Study to investigate the feasibility of a roundabout in more detail.

1	Project Name:	Maple Grove - Claxidge 113480
2	Intersection:	Stittsville Main St (ext) + Street 2
3	Location and Description of Intersection: Lane configuration, total or approach AADT, distance to nearby intersection(s), etc. Attach or sketch a diagram and include existing and/or horizon-year turning movements. If an existing intersection then indicate type of control.	AADT: Northbound: 90 Southbound: 55 Westbound: 55
4	What traditional modifications are proposed? All-way stop control, traffic signals, auxiliary lanes, etc. Attach or sketch a diagram if necessary.	One way stop sign leading west
5	What size of roundabout is being considered? Describe, and attach a Roundabout Traffic Flow Worksheet.	Single lane
6	Why is a roundabout being considered?	New intersection

- 7 Are there contra-indications for a roundabout? If "Yes" is indicated for one or more of the contra-indications then a roundabout may be problematic at the subject intersection. That is not to say that a roundabout is not possible, just that there may be difficulties or high costs.

No.	Contra-Indication	Outcome
1	Is there insufficient property at the intersection (i.e. less than 44 metres diameter if considering a single-lane roundabout, and less than 60 metres if considering a two-lane roundabout) or property constraints that would require demolition of adjacent structures?	Yes <input checked="" type="checkbox"/> No <input type="checkbox"/>
2	Are there any instances where stopping sight distance (SSD) of a roundabout yield line may not be attainable (i.e. the intersection is on a crest vertical curve)?	Yes <input type="checkbox"/> No <input checked="" type="checkbox"/>
3	Is there an existing uncontrolled approach with a grade in excess of 4 percent?	Yes <input type="checkbox"/> No <input checked="" type="checkbox"/>
4	Is the intersection located within a coordinated signal system?	Yes <input type="checkbox"/> No <input checked="" type="checkbox"/>
5	Is there a closely-spaced traffic signal or railway crossing that could not be controlled with a nearby roundabout?	Yes <input type="checkbox"/> No <input checked="" type="checkbox"/>
6	Are significant differences in directional flows or any situations of sudden high demand expected?	Yes <input type="checkbox"/> No <input checked="" type="checkbox"/>
7	Are there known visually-impaired pedestrians that cross this intersection?	Yes <input type="checkbox"/> No <input checked="" type="checkbox"/>

- 8 Are there suitability factors for a roundabout? If "Yes" is indicated for two or more of the suitability factors then a roundabout should be technically feasible at the subject intersection.

No.	Suitability Factor	Outcome
1	Does the intersection currently experience an average collision frequency of more than 1.5 injury crashes per year, or a collision rate in excess of 1 injury crash per 1 million vehicles entering (MVE)?	Yes <input type="checkbox"/> No <input checked="" type="checkbox"/>
2	Has there been a fatal crash at the intersection in the last 10 years?	Yes <input type="checkbox"/> No <input checked="" type="checkbox"/>
3	Are capacity problems currently being experienced, or expected in the future?	Yes <input type="checkbox"/> No <input checked="" type="checkbox"/>
4	Are traffic signals warranted, or expected to be warranted in the future?	Yes <input type="checkbox"/> No <input checked="" type="checkbox"/>
5	Does the intersection have more than 4 legs, or unusual geometry?	Yes <input type="checkbox"/> No <input checked="" type="checkbox"/>
6	Will planned modifications to the intersection require that nearby structures be widened (i.e. to accommodate left-turn lanes)?	Yes <input type="checkbox"/> No <input checked="" type="checkbox"/>
7	Is the intersection located at a transition between rural and urban environments (i.e. an urban boundary) such that a roundabout could act as a means of speed transition?	Yes <input type="checkbox"/> No <input checked="" type="checkbox"/>

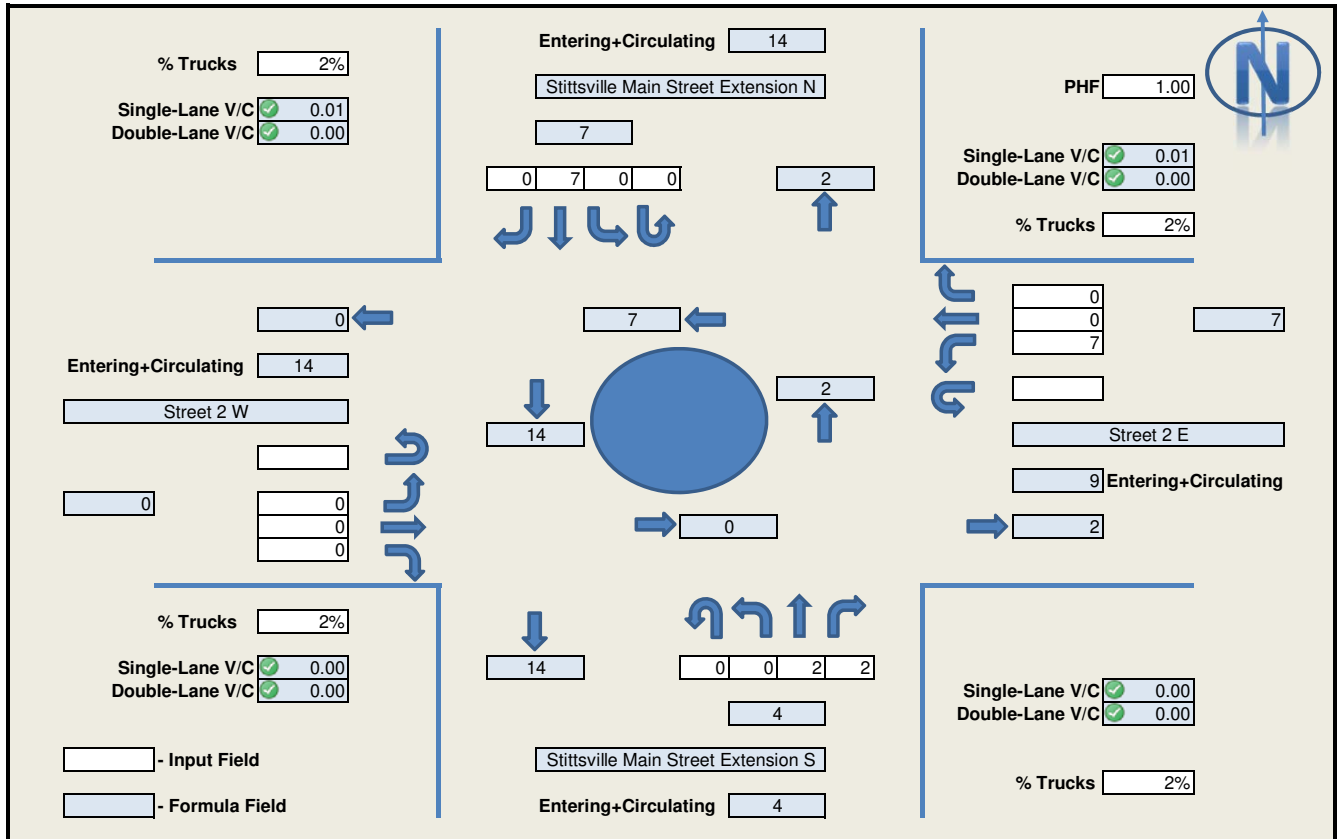

Capacity Guidelines for Single-Lane Roundabouts

1. Single-lane service volumes < 900 vph - 1200 vph
2. Exit flow < 900 vph - 1200 vph
3. Entry flow + circulating flow < 1400 vph - 1800 vph
4. Circulating flow downstream of any entry 1400 vph - 1800 vph
5. V/C > 0.85

RODEL Inputs					
Leg	PCU	1st Exit	2nd Exit	3rd Exit	U-Turn
Stittsville Main Street Extens	1.02	0	7	0	0
Street 2 W	1.02	0	0	0	0
Stittsville Main Street Extens	1.02	2	2	0	0
Street 2 E	1.02	0	0	7	0

Proposed Lane Arrangement

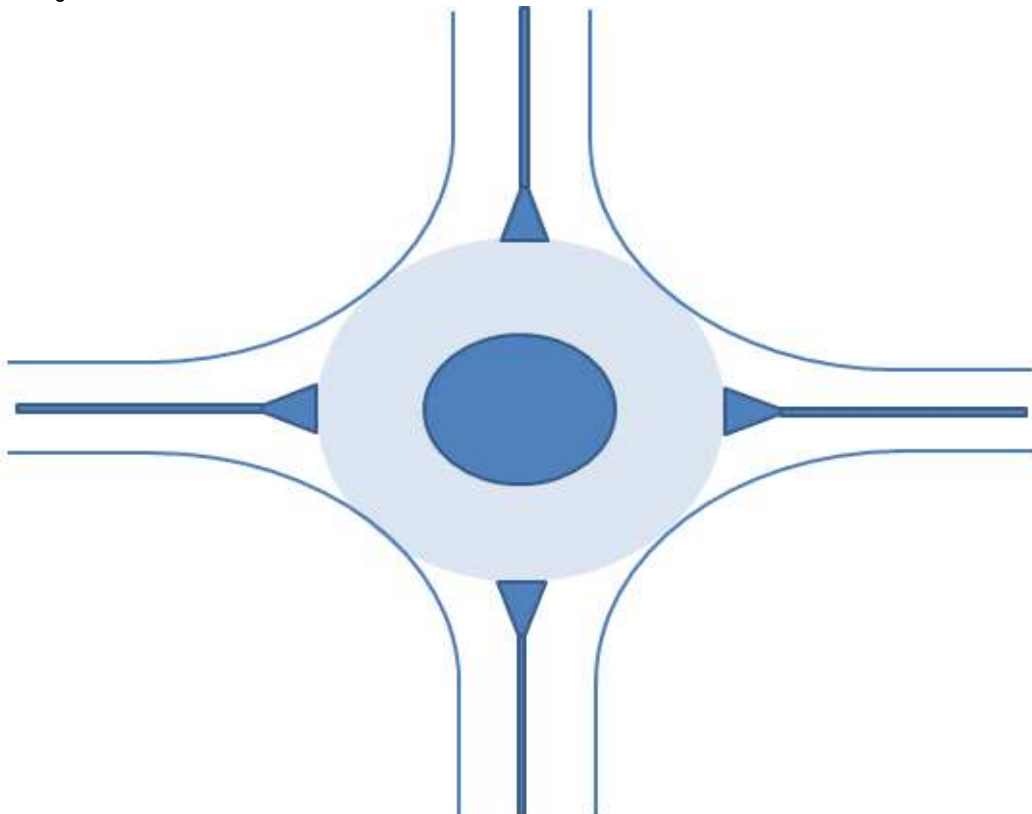

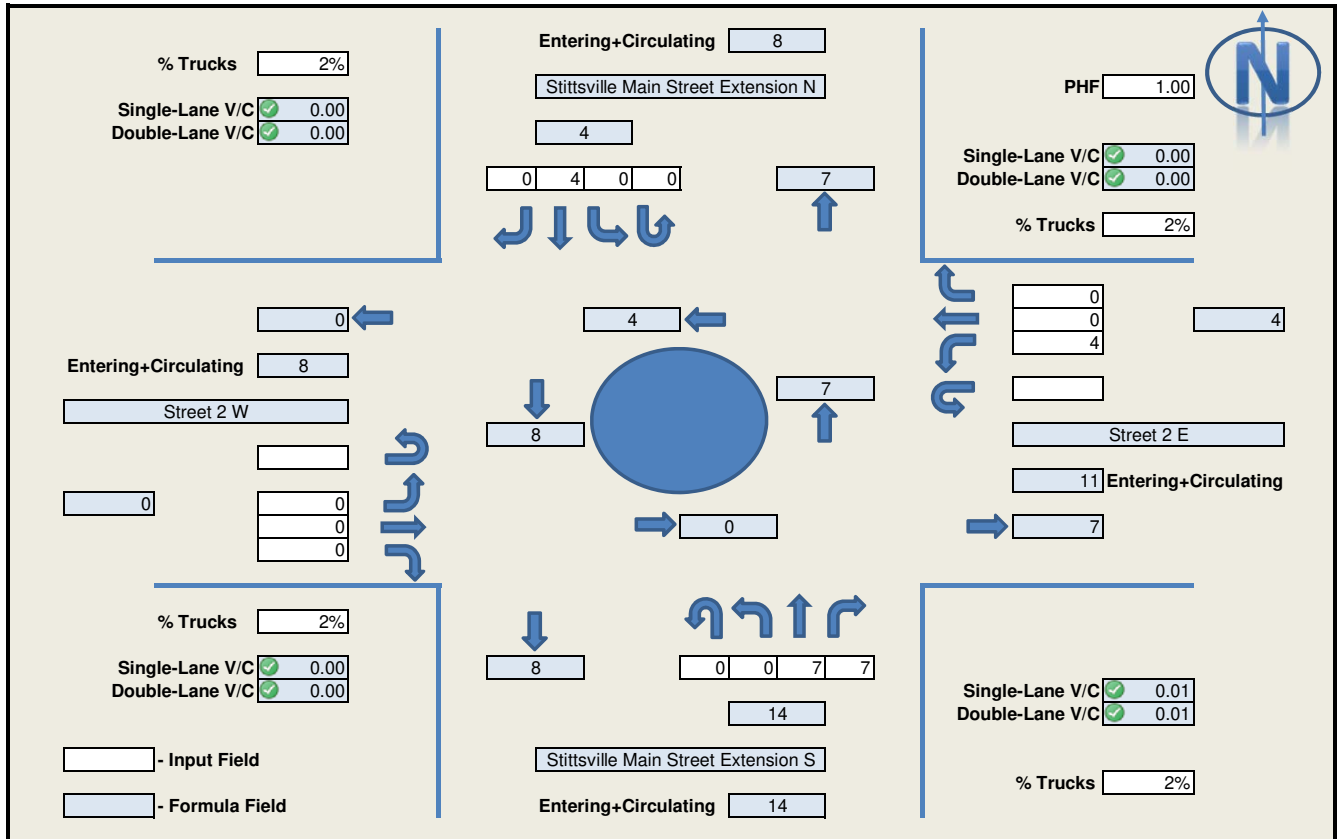

Capacity Guidelines for Single-Lane Roundabouts

1. Single-lane service volumes < 900 vph - 1200 vph
2. Exit flow < 900 vph - 1200 vph
3. Entry flow + circulating flow < 1400 vph - 1800 vph
4. Circulating flow downstream of any entry 1400 vph - 1800 vph
5. V/C > 0.85

RODEL Inputs					
Leg	PCU	1st Exit	2nd Exit	3rd Exit	U-Turn
Stittsville Main Street Extens	1.02	0	4	0	0
Street 2 W	1.02	0	0	0	0
Stittsville Main Street Extens	1.02	7	7	0	0
Street 2 E	1.02	0	0	4	0

Proposed Lane Arrangement

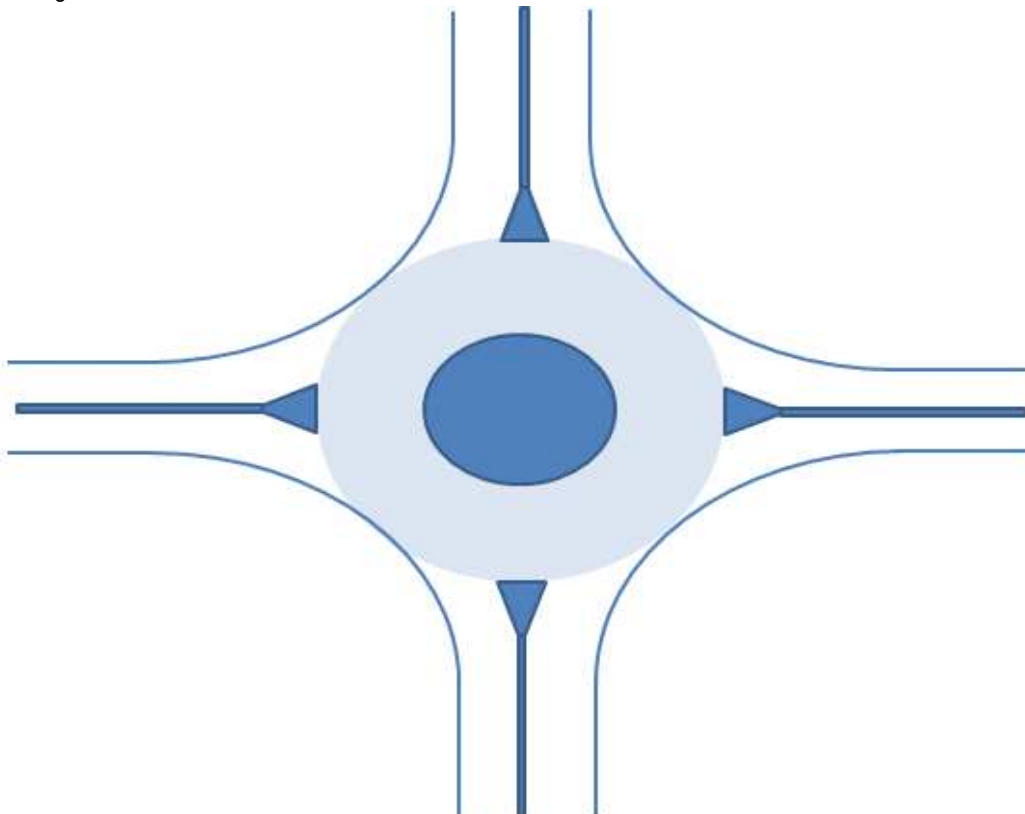

City of Ottawa Roundabout Initial Feasibility Screening Tool

The intent of this screening tool is to provide a relatively quick assessment of the feasibility of a roundabout at a particular intersection in comparison to other appropriate forms of traffic control or road modifications including all-way stop control, traffic signals, auxiliary lanes, etc. The intended outcome of this tool is to provide enough information to assist staff in deciding whether or not to proceed with an Intersection Control Study to investigate the feasibility of a roundabout in more detail.

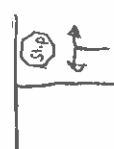
1	Project Name:	Maple Grove - Glaridge 113480
2	Intersection:	Stittsville Main St (ext) + Street 4
3	Location and Description of Intersection: Lane configuration, total or approach AADT, distance to nearby intersection(s), etc. Attach or sketch a diagram and include existing and/or horizon-year turning movements. If an existing intersection then indicate type of control.	AADT: Northbound: 140 Southbound: 110 Westbound: 55 
4	What traditional modifications are proposed? All-way stop control, traffic signals, auxiliary lanes, etc. Attach or sketch a diagram if necessary.	One way stop sign leading west, 
5	What size of roundabout is being considered? Describe, and attach a Roundabout Traffic Flow Worksheet.	Single lane
6	Why is a roundabout being considered?	New intersection

- 7 Are there contra-indications for a roundabout? If "Yes" is indicated for one or more of the contra-indications then a roundabout may be problematic at the subject intersection. That is not to say that a roundabout is not possible, just that there may be difficulties or high costs.

No.	Contra-Indication	Outcome
1	Is there insufficient property at the intersection (i.e. less than 44 metres diameter if considering a single-lane roundabout, and less than 60 metres if considering a two-lane roundabout) or property constraints that would require demolition of adjacent structures?	Yes <input checked="" type="checkbox"/> No <input type="checkbox"/>
2	Are there any instances where stopping sight distance (SSD) of a roundabout yield line may not be attainable (i.e. the intersection is on a crest vertical curve)?	Yes <input type="checkbox"/> No <input checked="" type="checkbox"/>
3	Is there an existing uncontrolled approach with a grade in excess of 4 percent?	Yes <input type="checkbox"/> No <input checked="" type="checkbox"/>
4	Is the intersection located within a coordinated signal system?	Yes <input type="checkbox"/> No <input checked="" type="checkbox"/>
5	Is there a closely-spaced traffic signal or railway crossing that could not be controlled with a nearby roundabout?	Yes <input type="checkbox"/> No <input checked="" type="checkbox"/>
6	Are significant differences in directional flows or any situations of sudden high demand expected?	Yes <input type="checkbox"/> No <input checked="" type="checkbox"/>
7	Are there known visually-impaired pedestrians that cross this intersection?	Yes <input type="checkbox"/> No <input checked="" type="checkbox"/>

- 8 Are there suitability factors for a roundabout? If "Yes" is indicated for two or more of the suitability factors then a roundabout should be technically feasible at the subject intersection.

No.	Suitability Factor	Outcome
1	Does the intersection currently experience an average collision frequency of more than 1.5 injury crashes per year, or a collision rate in excess of 1 injury crash per 1 million vehicles entering (MVE)?	Yes <input type="checkbox"/> No <input checked="" type="checkbox"/>
2	Has there been a fatal crash at the intersection in the last 10 years?	Yes <input type="checkbox"/> No <input checked="" type="checkbox"/>
3	Are capacity problems currently being experienced, or expected in the future?	Yes <input type="checkbox"/> No <input checked="" type="checkbox"/>
4	Are traffic signals warranted, or expected to be warranted in the future?	Yes <input type="checkbox"/> No <input checked="" type="checkbox"/>
5	Does the intersection have more than 4 legs, or unusual geometry?	Yes <input type="checkbox"/> No <input checked="" type="checkbox"/>
6	Will planned modifications to the intersection require that nearby structures be widened (i.e. to accommodate left-turn lanes)?	Yes <input type="checkbox"/> No <input checked="" type="checkbox"/>
7	Is the intersection located at a transition between rural and urban environments (i.e. an urban boundary) such that a roundabout could act as a means of speed transition?	Yes <input type="checkbox"/> No <input checked="" type="checkbox"/>

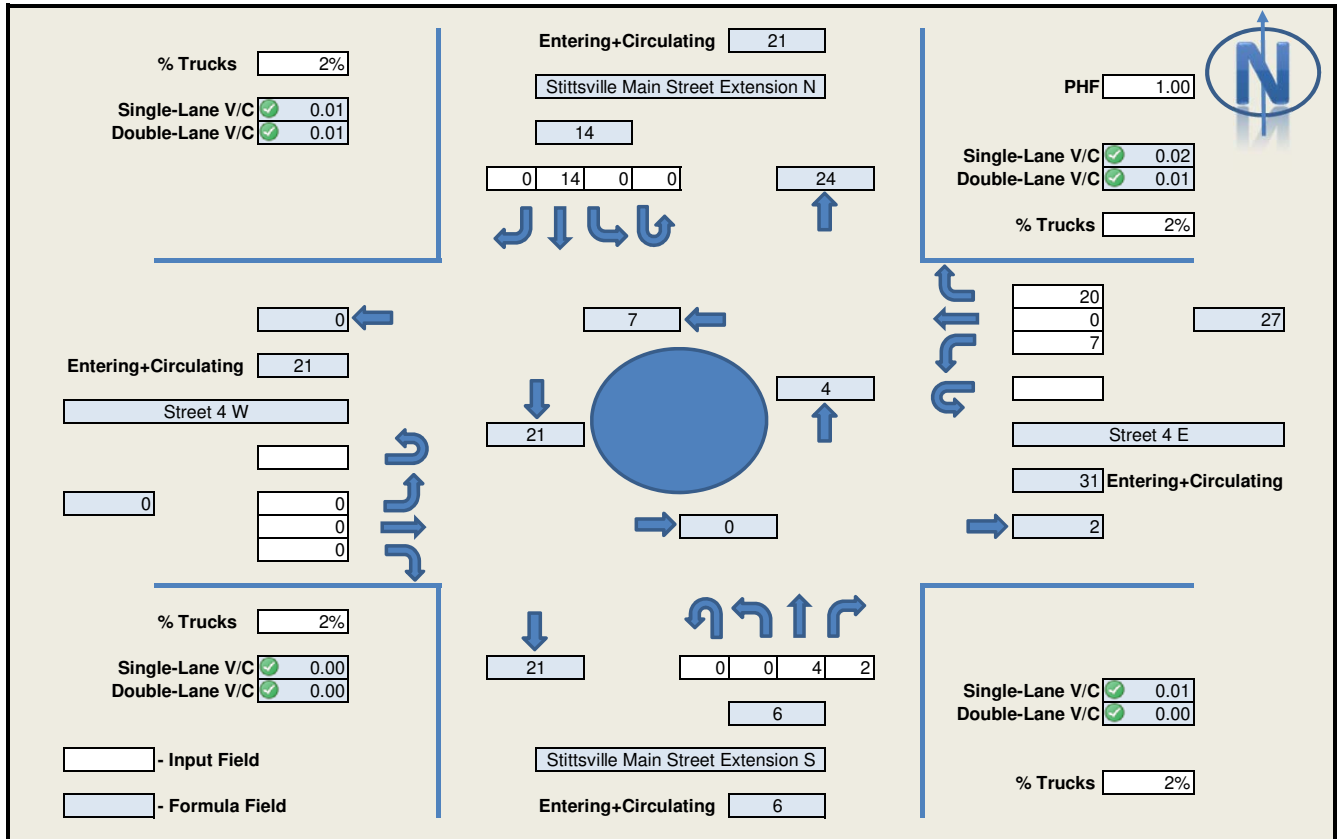

Capacity Guidelines for Single-Lane Roundabouts

1. Single-lane service volumes < 900 vph - 1200 vph
2. Exit flow < 900 vph - 1200 vph
3. Entry flow + circulating flow < 1400 vph - 1800 vph
4. Circulating flow downstream of any entry 1400 vph - 1800 vph
5. V/C > 0.85

RODEL Inputs					
Leg	PCU	1st Exit	2nd Exit	3rd Exit	U-Turn
Stittsville Main Street Extens	1.02	0	14	0	0
Street 4 W	1.02	0	0	0	0
Stittsville Main Street Extens	1.02	2	4	0	0
Street 4 E	1.02	20	0	7	0

Proposed Lane Arrangement

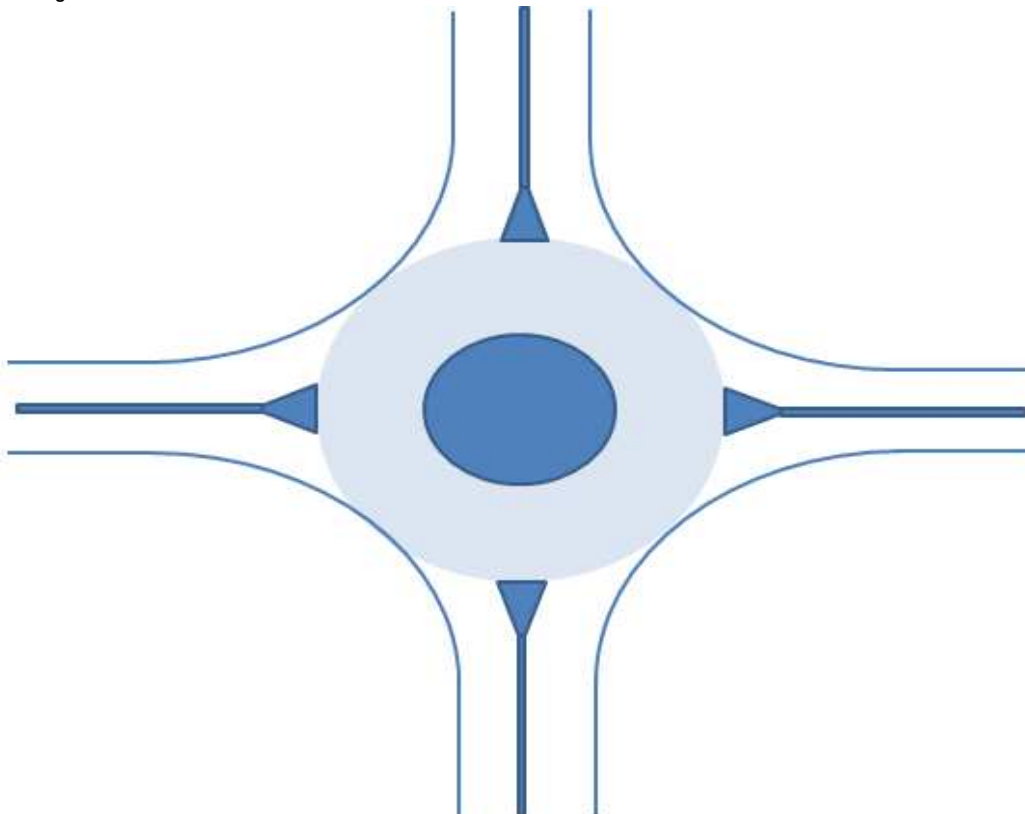

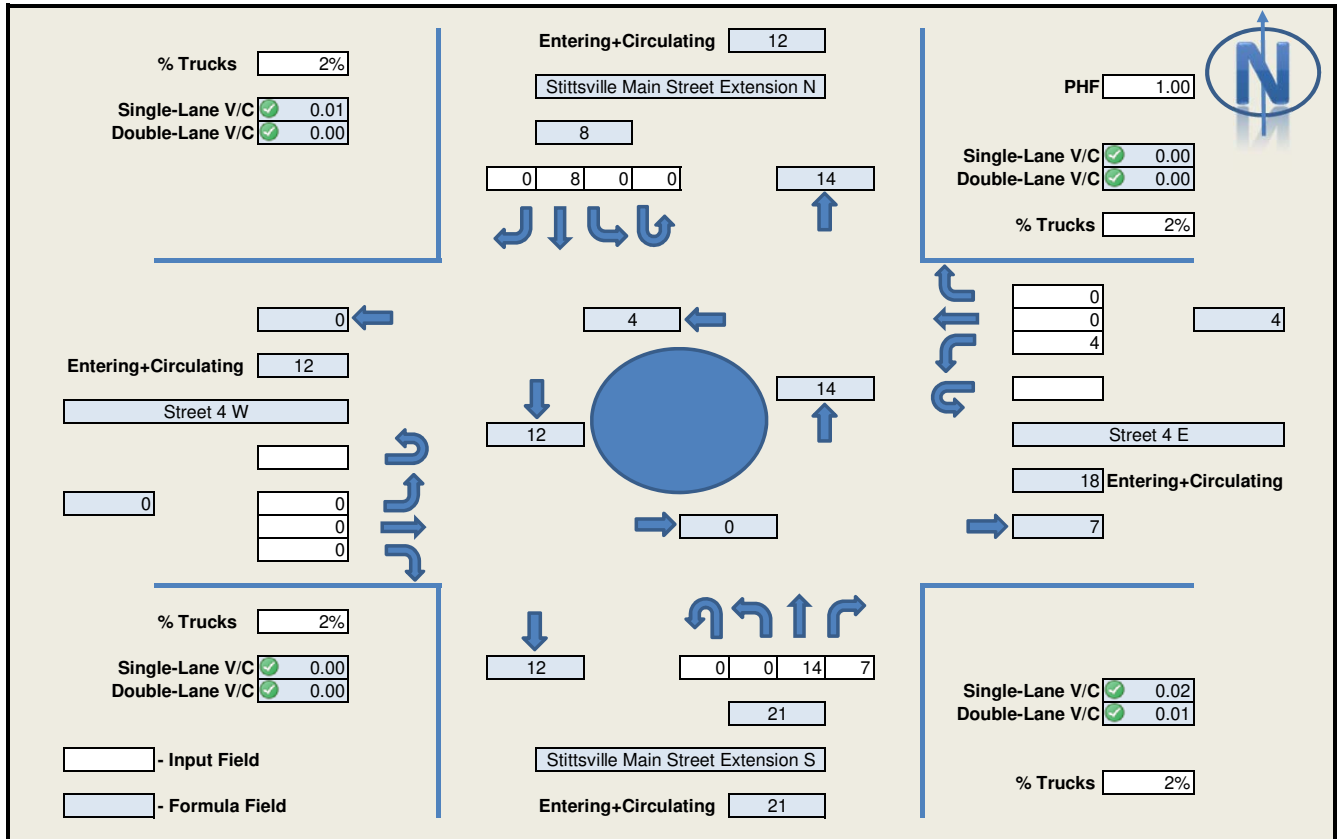

Capacity Guidelines for Single-Lane Roundabouts

1. Single-lane service volumes < 900 vph - 1200 vph
2. Exit flow < 900 vph - 1200 vph
3. Entry flow + circulating flow < 1400 vph - 1800 vph
4. Circulating flow downstream of any entry 1400 vph - 1800 vph
5. V/C > 0.85

RODEL Inputs					
Leg	PCU	1st Exit	2nd Exit	3rd Exit	U-Turn
Stittville Main Street Extens	1.02	0	8	0	0
Street 4 W	1.02	0	0	0	0
Stittville Main Street Extens	1.02	7	14	0	0
Street 4 E	1.02	0	0	4	0

Proposed Lane Arrangement

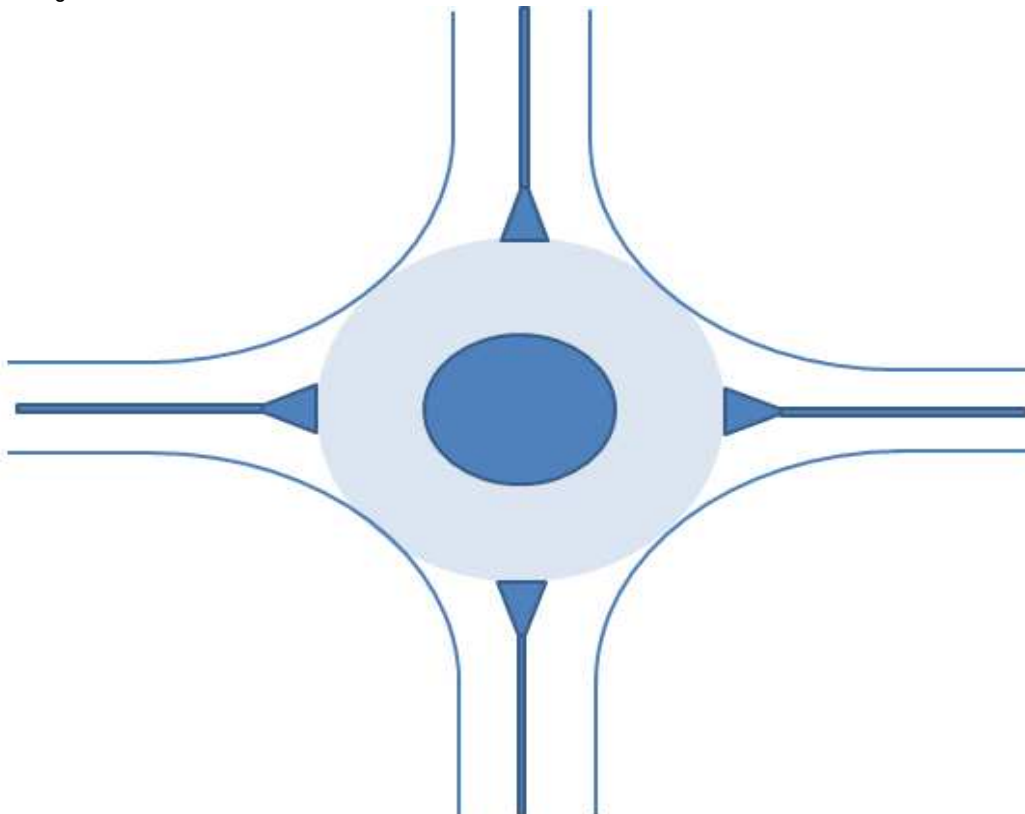

City of Ottawa Roundabout Initial Feasibility Screening Tool

The intent of this screening tool is to provide a relatively quick assessment of the feasibility of a roundabout at a particular intersection in comparison to other appropriate forms of traffic control or road modifications including all-way stop control, traffic signals, auxiliary lanes, etc. The intended outcome of this tool is to provide enough information to assist staff in deciding whether or not to proceed with an Intersection Control Study to investigate the feasibility of a roundabout in more detail.

1	Project Name:	Maple Grove - Clavidge 113480
2	Intersection:	Maple Grove + Stittsville Main St (ext)
3	Location and Description of Intersection: <small>Lane configuration, total or approach AADT, distance to nearby intersection(s), etc. Attach or sketch a diagram and include existing and/or horizon-year turning movements. If an existing intersection then indicate type of control.</small>	<p><u>AADT:</u></p> <p>Northbound: 1490 Southbound: 165 Westbound: 1370</p> <div style="text-align: right; margin-top: 10px;"> <p style="font-size: small;">Stittsville Main St Maple Grove Road</p> </div>
4	What traditional modifications are proposed? <small>All-way stop control, traffic signals, auxiliary lanes, etc. Attach or sketch a diagram if necessary.</small>	<p>One way stop sign along Westbound direction.</p> <div style="text-align: right; margin-top: 10px;"> </div>
5	What size of roundabout is being considered? <small>Describe, and attach a Roundabout Traffic Flow Worksheet.</small>	Single lane
6	Why is a roundabout being considered?	New intersection

- 7 Are there contra-indications for a roundabout? If "Yes" is indicated for one or more of the contra-indications then a roundabout may be problematic at the subject intersection. That is not to say that a roundabout is not possible, just that there may be difficulties or high costs.

No.	Contra-Indication	Outcome
1	Is there insufficient property at the intersection (i.e. less than 44 metres diameter if considering a single-lane roundabout, and less than 60 metres if considering a two-lane roundabout) or property constraints that would require demolition of adjacent structures?	Yes <input checked="" type="checkbox"/> No <input type="checkbox"/>
2	Are there any instances where stopping sight distance (SSD) of a roundabout yield line may not be attainable (i.e. the intersection is on a crest vertical curve)?	Yes <input type="checkbox"/> No <input checked="" type="checkbox"/>
3	Is there an existing uncontrolled approach with a grade in excess of 4 percent?	Yes <input type="checkbox"/> No <input checked="" type="checkbox"/>
4	Is the intersection located within a coordinated signal system?	Yes <input type="checkbox"/> No <input checked="" type="checkbox"/>
5	Is there a closely-spaced traffic signal or railway crossing that could not be controlled with a nearby roundabout?	Yes <input type="checkbox"/> No <input checked="" type="checkbox"/>
6	Are significant differences in directional flows or any situations of sudden high demand expected?	Yes <input type="checkbox"/> No <input checked="" type="checkbox"/>
7	Are there known visually-impaired pedestrians that cross this intersection?	Yes <input type="checkbox"/> No <input checked="" type="checkbox"/>

- 8 Are there suitability factors for a roundabout? If "Yes" is indicated for two or more of the suitability factors then a roundabout should be technically feasible at the subject intersection.

No.	Suitability Factor	Outcome
1	Does the intersection currently experience an average collision frequency of more than 1.5 injury crashes per year, or a collision rate in excess of 1 injury crash per 1 million vehicles entering (MVE)?	Yes <input type="checkbox"/> No <input checked="" type="checkbox"/>
2	Has there been a fatal crash at the intersection in the last 10 years?	Yes <input type="checkbox"/> No <input checked="" type="checkbox"/>
3	Are capacity problems currently being experienced, or expected in the future?	Yes <input type="checkbox"/> No <input checked="" type="checkbox"/>
4	Are traffic signals warranted, or expected to be warranted in the future?	Yes <input type="checkbox"/> No <input checked="" type="checkbox"/>
5	Does the intersection have more than 4 legs, or unusual geometry?	Yes <input type="checkbox"/> No <input checked="" type="checkbox"/>
6	Will planned modifications to the intersection require that nearby structures be widened (i.e. to accommodate left-turn lanes)?	Yes <input type="checkbox"/> No <input checked="" type="checkbox"/>
7	Is the intersection located at a transition between rural and urban environments (i.e. an urban boundary) such that a roundabout could act as a means of speed transition?	Yes <input type="checkbox"/> No <input checked="" type="checkbox"/>

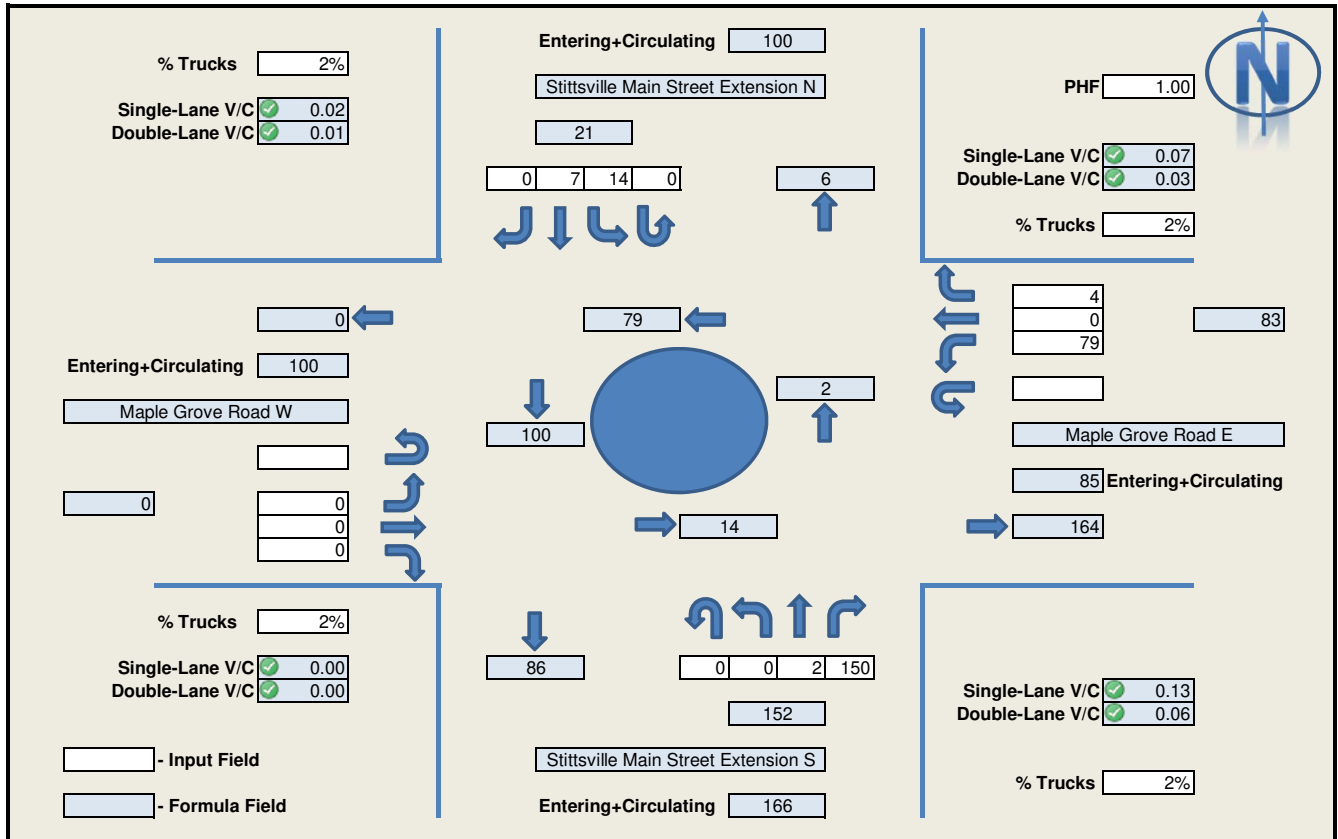

Capacity Guidelines for Single-Lane Roundabouts

1. Single-lane service volumes < 900 vph - 1200 vph
2. Exit flow < 900 vph - 1200 vph
3. Entry flow + circulating flow < 1400 vph - 1800 vph
4. Circulating flow downstream of any entry 1400 vph - 1800 vph
5. V/C > 0.85

RODEL Inputs					
Leg	PCU	1st Exit	2nd Exit	3rd Exit	U-Turn
Stittville Main Street Extens	1.02	0	7	14	0
Maple Grove Road W	1.02	0	0	0	0
Stittville Main Street Extens	1.02	150	2	0	0
Maple Grove Road E	1.02	4	0	79	0

Proposed Lane Arrangement

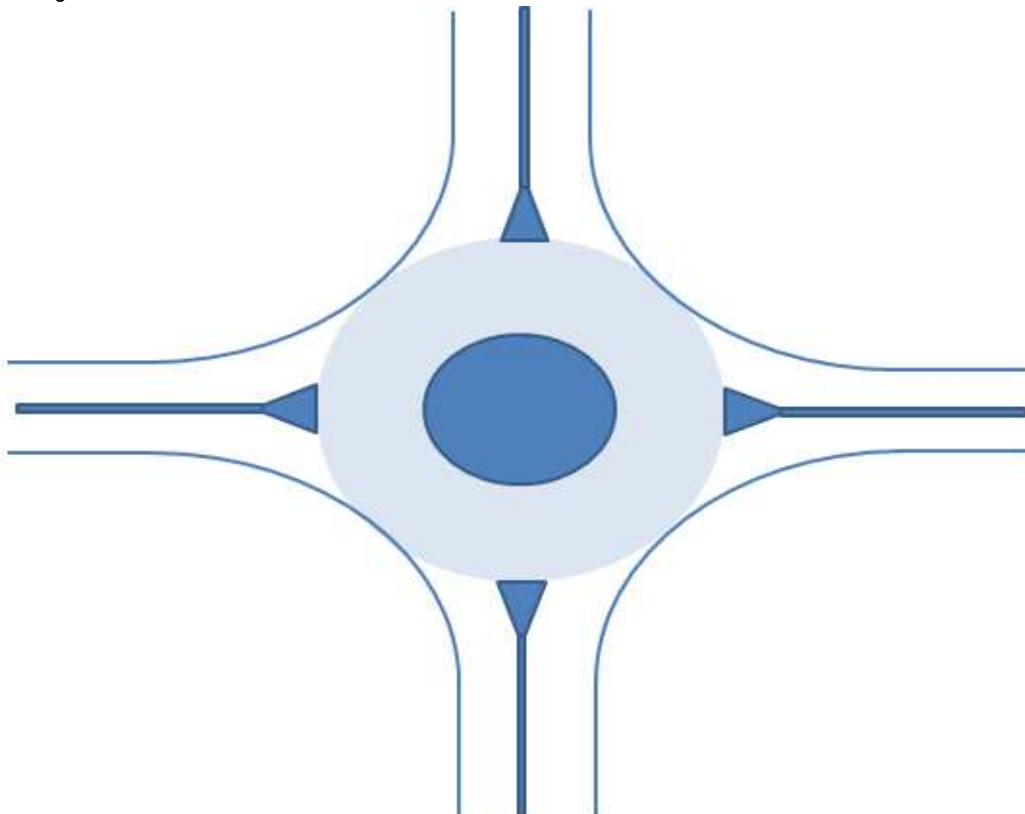

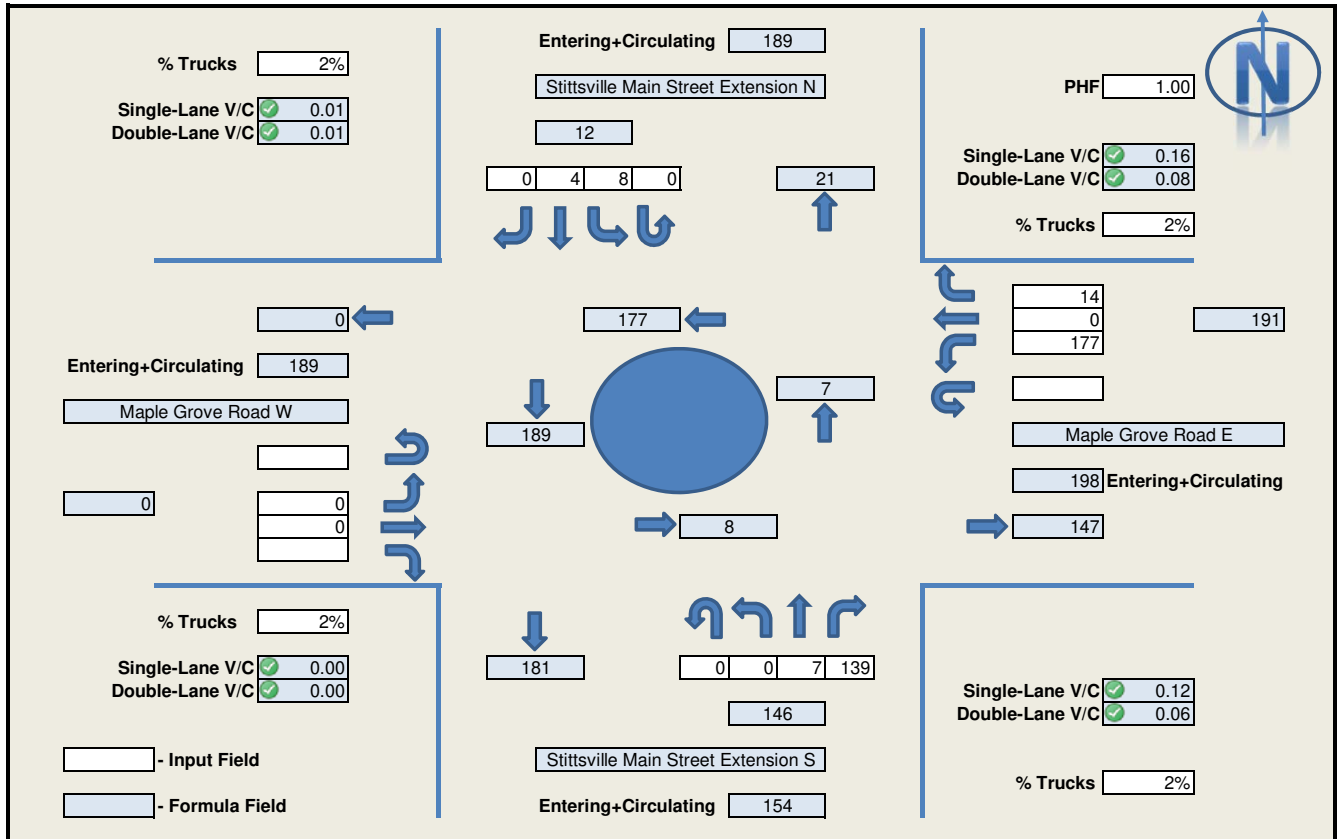

Capacity Guidelines for Single-Lane Roundabouts

1. Single-lane service volumes < 900 vph - 1200 vph
2. Exit flow < 900 vph - 1200 vph
3. Entry flow + circulating flow < 1400 vph - 1800 vph
4. Circulating flow downstream of any entry 1400 vph - 1800 vph
5. V/C > 0.85

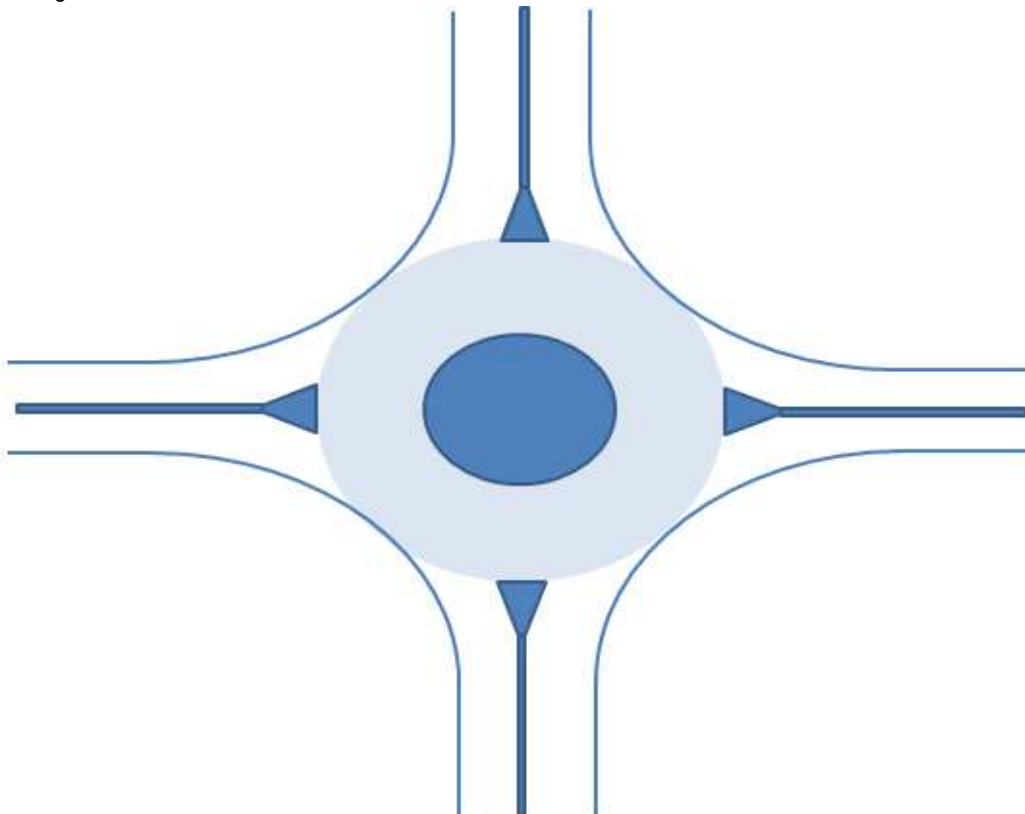

RODEL Inputs					
Leg	PCU	1st Exit	2nd Exit	3rd Exit	U-Turn
Stittsville Main Street Extens	1.02	0	4	8	0
Maple Grove Road W	1.02	0	0	0	0
Stittsville Main Street Extens	1.02	139	7	0	0
Maple Grove Road E	1.02	14	0	177	0

Proposed Lane Arrangement

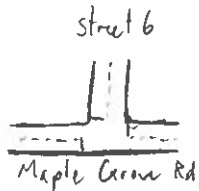

City of Ottawa Roundabout Initial Feasibility Screening Tool

The intent of this screening tool is to provide a relatively quick assessment of the feasibility of a roundabout at a particular intersection in comparison to other appropriate forms of traffic control or road modifications including all-way stop control, traffic signals, auxiliary lanes, etc. The intended outcome of this tool is to provide enough information to assist staff in deciding whether or not to proceed with an Intersection Control Study to investigate the feasibility of a roundabout in more detail.

1	Project Name:	Maple grove - Claxidge 113480
2	Intersection:	Maple Grove + Street 6
3	Location and Description of Intersection: Lane configuration, total or approach AADT, distance to nearby intersection(s), etc. Attach or sketch a diagram and include existing and/or horizon-year turning movements. If an existing intersection then indicate type of control.	<p><u>AADT:</u> Southbound: 385 veh Eastbound: 1870 veh Westbound: 1955 veh</p> <div style="text-align: right; margin-top: 20px;">  </div>
4	What traditional modifications are proposed? All-way stop control, traffic signals, auxiliary lanes, etc. Attach or sketch a diagram if necessary.	<p>One way stop signs are proposed on Southbound lane.</p> <div style="text-align: right; margin-top: 10px;">  </div>
5	What size of roundabout is being considered? Describe, and attach a Roundabout Traffic Flow Worksheet.	Single lane roundabout
6	Why is a roundabout being considered?	New intersection

- 7 Are there contra-indications for a roundabout? If "Yes" is indicated for one or more of the contra-indications then a roundabout may be problematic at the subject intersection. That is not to say that a roundabout is not possible, just that there may be difficulties or high costs.

No.	Contra-Indication	Outcome
1	Is there insufficient property at the intersection (i.e. less than 44 metres diameter if considering a single-lane roundabout, and less than 60 metres if considering a two-lane roundabout) or property constraints that would require demolition of adjacent structures?	Yes <input checked="" type="checkbox"/> No <input type="checkbox"/>
2	Are there any instances where stopping sight distance (SSD) of a roundabout yield line may not be attainable (i.e. the intersection is on a crest vertical curve)?	Yes <input type="checkbox"/> No <input checked="" type="checkbox"/>
3	Is there an existing uncontrolled approach with a grade in excess of 4 percent?	Yes <input type="checkbox"/> No <input checked="" type="checkbox"/>
4	Is the intersection located within a coordinated signal system?	Yes <input type="checkbox"/> No <input checked="" type="checkbox"/>
5	Is there a closely-spaced traffic signal or railway crossing that could not be controlled with a nearby roundabout?	Yes <input type="checkbox"/> No <input checked="" type="checkbox"/>
6	Are significant differences in directional flows or any situations of sudden high demand expected?	Yes <input type="checkbox"/> No <input checked="" type="checkbox"/>
7	Are there known visually-impaired pedestrians that cross this intersection?	Yes <input type="checkbox"/> No <input checked="" type="checkbox"/>

- 8 Are there suitability factors for a roundabout? If "Yes" is indicated for two or more of the suitability factors then a roundabout should be technically feasible at the subject intersection.

No.	Suitability Factor	Outcome
1	Does the intersection currently experience an average collision frequency of more than 1.5 injury crashes per year, or a collision rate in excess of 1 injury crash per 1 million vehicles entering (MVE)?	Yes <input type="checkbox"/> No <input checked="" type="checkbox"/>
2	Has there been a fatal crash at the intersection in the last 10 years?	Yes <input type="checkbox"/> No <input checked="" type="checkbox"/>
3	Are capacity problems currently being experienced, or expected in the future?	Yes <input type="checkbox"/> No <input checked="" type="checkbox"/>
4	Are traffic signals warranted, or expected to be warranted in the future?	Yes <input type="checkbox"/> No <input checked="" type="checkbox"/>
5	Does the intersection have more than 4 legs, or unusual geometry?	Yes <input type="checkbox"/> No <input checked="" type="checkbox"/>
6	Will planned modifications to the intersection require that nearby structures be widened (i.e. to accommodate left-turn lanes)?	Yes <input type="checkbox"/> No <input checked="" type="checkbox"/>
7	Is the intersection located at a transition between rural and urban environments (i.e. an urban boundary) such that a roundabout could act as a means of speed transition?	Yes <input type="checkbox"/> No <input checked="" type="checkbox"/>

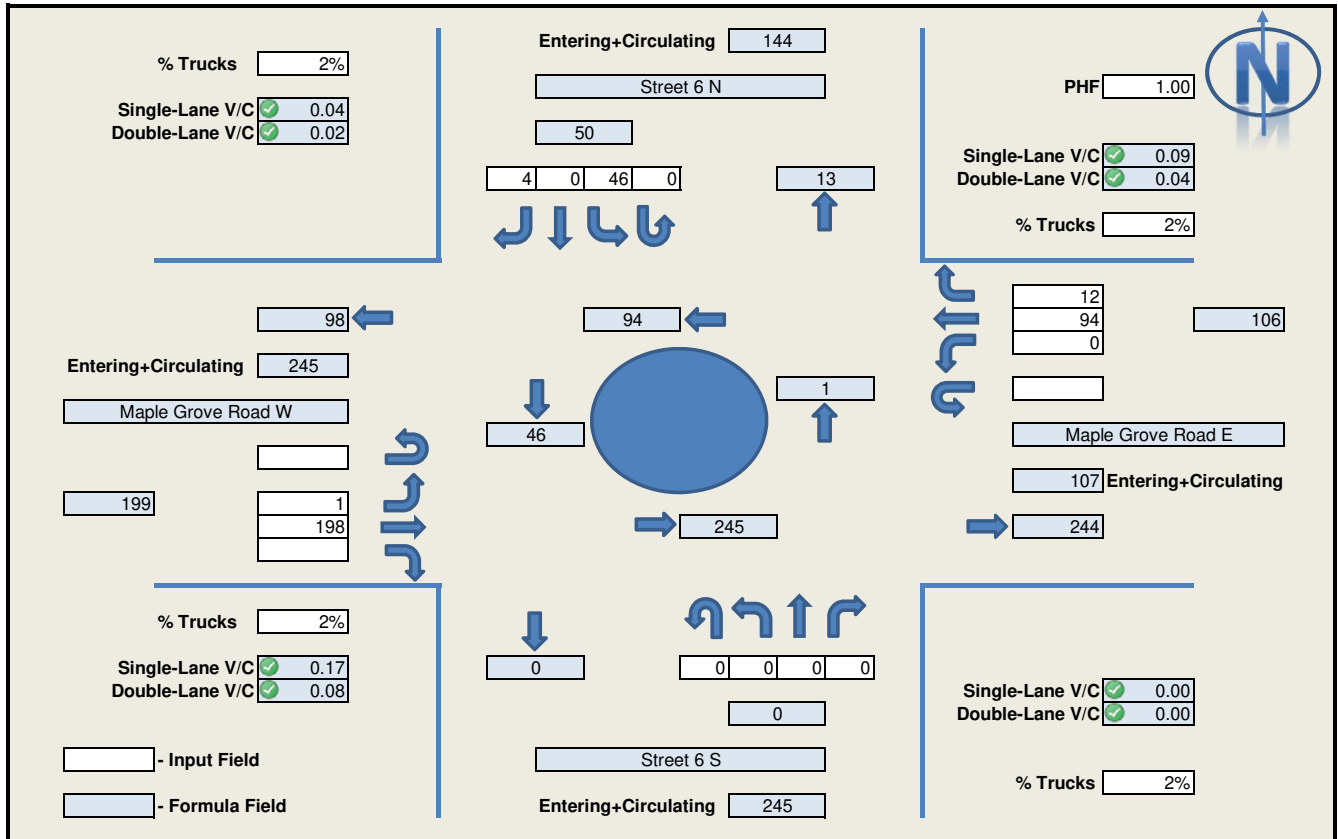

Capacity Guidelines for Single-Lane Roundabouts

1. Single-lane service volumes < 900 vph - 1200 vph
2. Exit flow < 900 vph - 1200 vph
3. Entry flow + circulating flow < 1400 vph - 1800 vph
4. Circulating flow downstream of any entry 1400 vph - 1800 vph
5. V/C > 0.85

RODEL Inputs					
Leg	PCU	1st Exit	2nd Exit	3rd Exit	U-Turn
Street 6 N	1.02	4	0	46	0
Maple Grove Road W	1.02	0	198	1	0
Street 6 S	1.02	0	0	0	0
Maple Grove Road E	1.02	12	94	0	0

Proposed Lane Arrangement

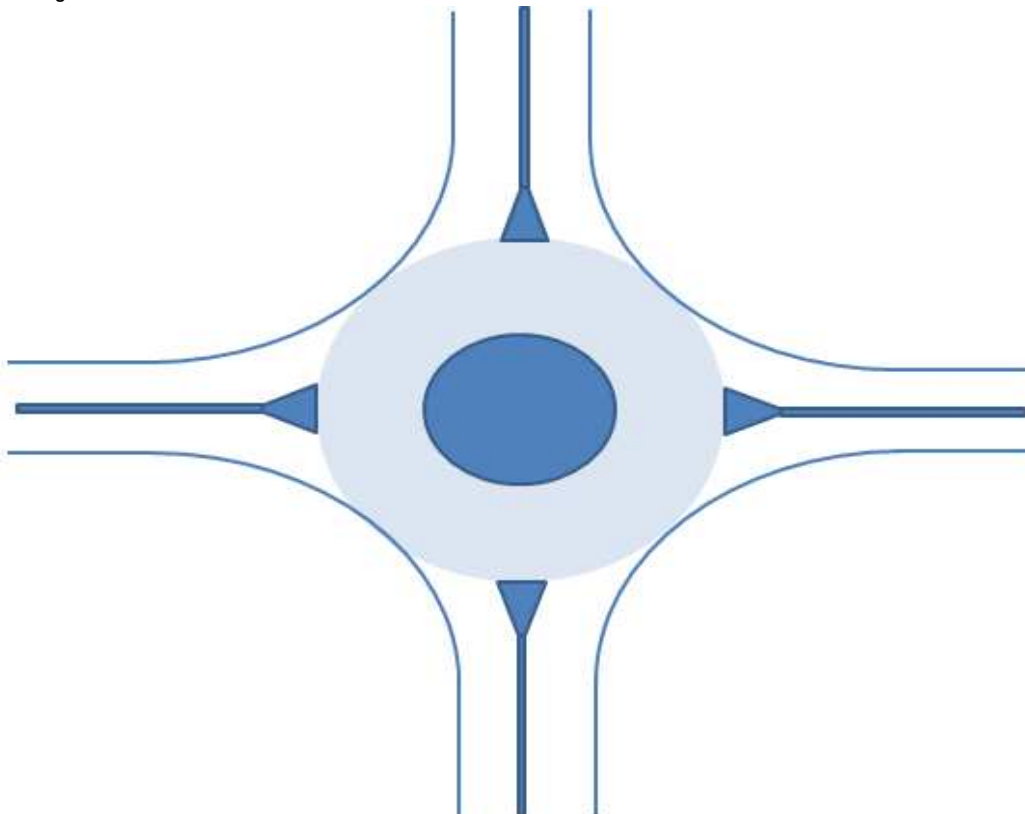

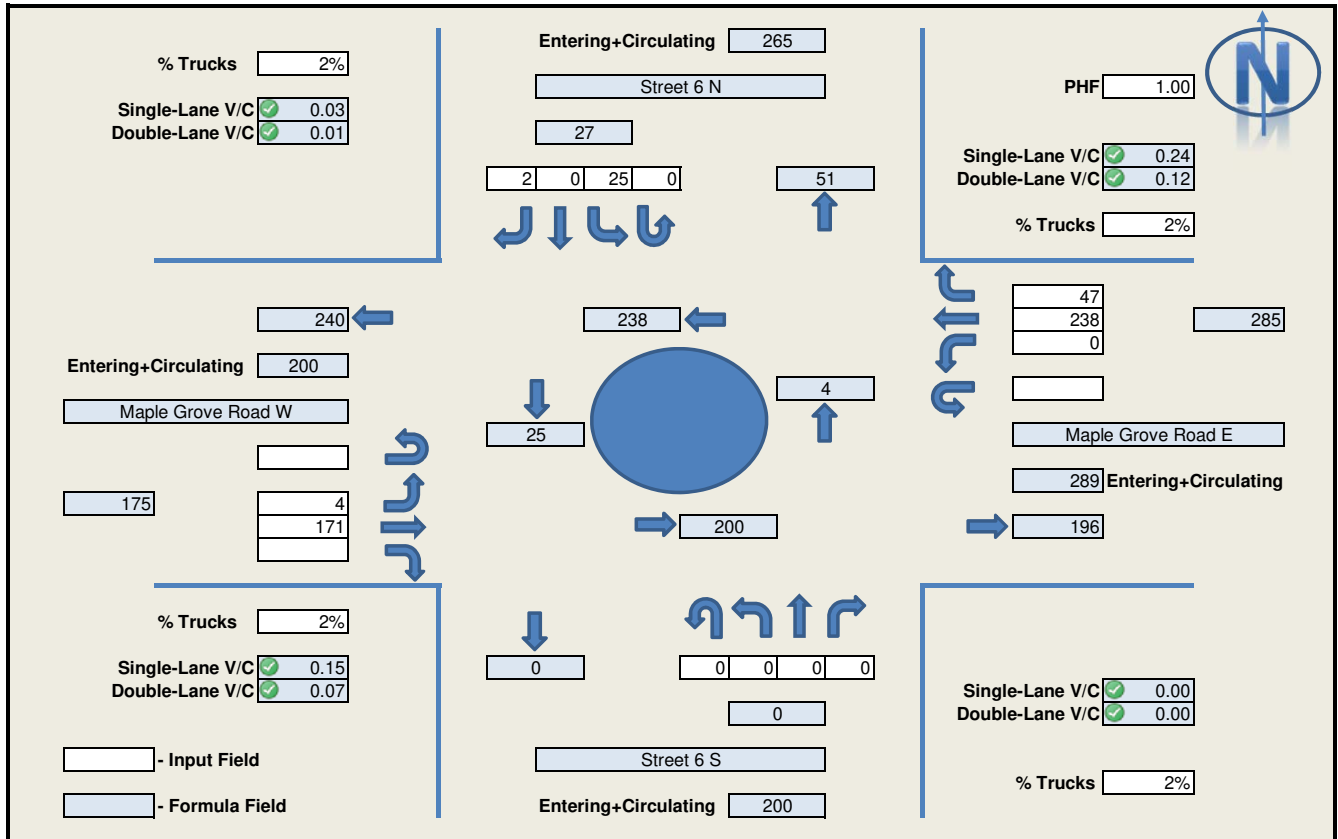

Capacity Guidelines for Single-Lane Roundabouts

1. Single-lane service volumes < 900 vph - 1200 vph
2. Exit flow < 900 vph - 1200 vph
3. Entry flow + circulating flow < 1400 vph - 1800 vph
4. Circulating flow downstream of any entry 1400 vph - 1800 vph
5. V/C > 0.85

RODEL Inputs					
Leg	PCU	1st Exit	2nd Exit	3rd Exit	U-Turn
Street 6 N	1.02	2	0	25	0
Maple Grove Road W	1.02	0	171	4	0
Street 6 S	1.02	0	0	0	0
Maple Grove Road E	1.02	47	238	0	0

Proposed Lane Arrangement

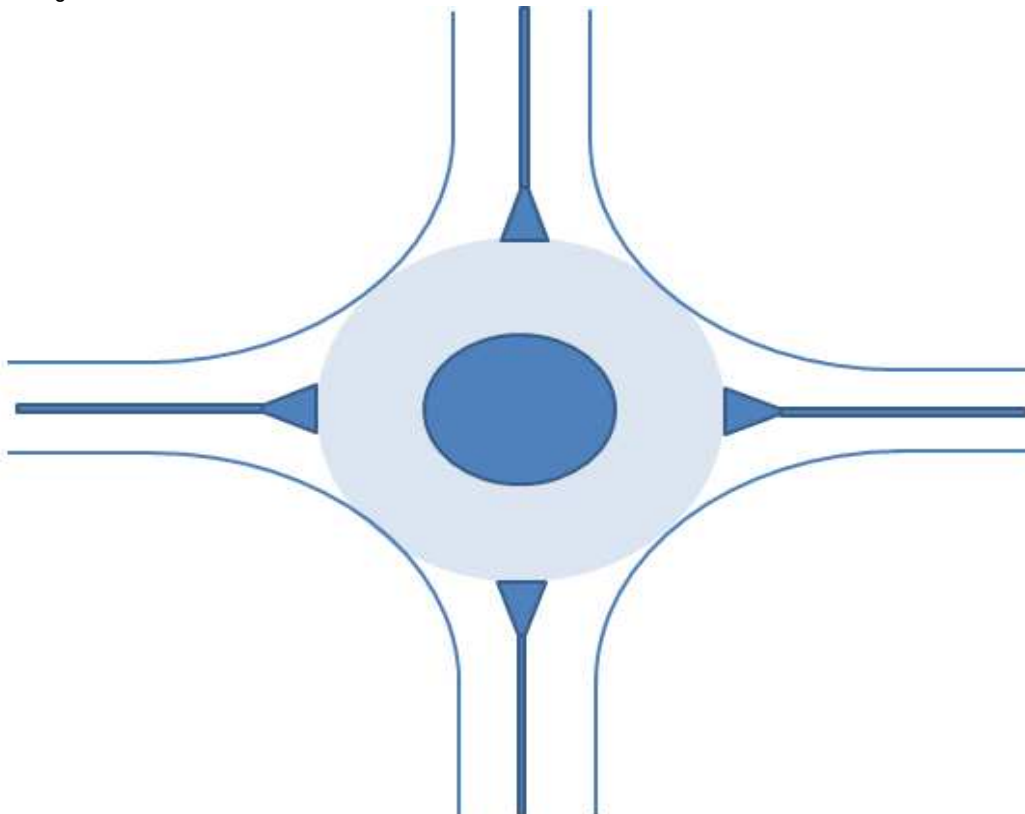



1981 Maple Grove Road

Transportation Impact Assessment Report

Appendix H: Traffic Signal Warrants

February 2018





MINIMUM WARRANTS FOR INSTALLATION OF TRAFFIC SIGNALS USING PROJECTED VOLUMES*

Project: Maple Grove TIA (Claridge)

Date: 2018-02-15

Project # 113480

Location Maple Grove Road
(Roadway)

at Santolina Street
(Intersecting Roadway)

Municipality Kanata

Projected Volume Future (2026) Total

Peak Hour AM & PM

WARRANT	DESCRIPTION	MINIMUM REQUIREMENT FOR 2 LANE HIGHWAYS				COMPLIANCE		
		FREE FLOW	RESTRICTED FLOW	ADJUSTED FREE FLOW	ADJUSTED RESTRICTED FLOW	SECTIONAL		ENTIRE %
						Number	%	
1. VEHICULAR VOLUME	A. Vehicle volumes, all approaches (Average Hour)	480	720	576	864	329	38%	15%
	B. Vehicle volume along minor roads (Average Hour)	120	170	216	306	46	15%	
2. DELAY TO CROSS TRAFFIC	A. Vehicle volumes, along artery (Average Hour)	480	720	576	864	283	33%	21%
	B. Combined vehicle and pedestrian volume crossing artery from minor roads (Average Hour)	50	75	60	90	19	21%	

Projected Traffic Volumes:

Approach Volume Input (vph)			
Artery V1	Artery V2	Minor V3	Minor V4
146.25	136.25	46.25	

Average Hourly Volume (AHV) = PHV/2 or (amPHV + pmPHV)/4
PHV = Either AM or PM Peak Hour Volume

Notes and Adjustment Factors:

	Adj. Factors
1. Vehicle volume warrants (1A) and (2A) for intersections of roadways having two or more moving lanes in one direction should be 25% higher than the values given above.	1
2. Warrant values for free flow apply when the 85th percentile speed of artery traffic equals or exceeds 70 km/h or when the intersection lies within the built-up area of an isolated community having a population of less than 10,000.	1
3. Warrant values for restricted flow apply to large urban communities when the 85th percentile speed of artery traffic does not exceed 70 km/h.	1
4. The lowest sectional percentage governs the entire warrant.	1
5. For "T" intersections the warrant values for the minor road should be increased by 50% (Warrant 1B only).	1.5
6. All flow values for Warrant 1 and Warrant 2 are to be increased by 20% for existing intersections and by 50% in the case of new intersections.	1.2
7. The crossing volumes are defined as:	
(a) Left-turns from both minor road approaches.	19 0
(b) The heaviest through volume from the minor road.	0
© 50% of the heavier left turn movement from major road when both of the following are met:	0
(i) the left-turn volume >120 vph	No
(ii) the left-turn volume plus the opposing volume >720 vph	No
(d) Pedestrians crossing the main road.	

CONCLUSION: The intersection does NOT meet the minimum warrants for traffic control signals.

* Ontario Traffic Manual, Book 12", Ontario Ministry of Transportation.



MINIMUM WARRANTS FOR INSTALLATION OF TRAFFIC SIGNALS USING PROJECTED VOLUMES*

Project: Maple Grove TIA (Claridge)

Date: 2018-02-15

Project # 113480

Location Maple Grove Road
(Roadway)

at Alon Street
(Intersecting Roadway)

Municipality Kanata

Projected Volume Future (2026) Total

Peak Hour AM & PM

WARRANT	DESCRIPTION	MINIMUM REQUIREMENT FOR 2 LANE HIGHWAYS				COMPLIANCE		
		FREE FLOW	RESTRICTED FLOW	ADJUSTED FREE FLOW	ADJUSTED RESTRICTED FLOW	SECTIONAL		ENTIRE %
						Number	%	
1. VEHICULAR VOLUME	A. Vehicle volumes, all approaches (Average Hour)	480	720	576	864	192	22%	10%
	B. Vehicle volume along minor roads (Average Hour)	120	170	216	306	30	10%	
2. DELAY TO CROSS TRAFFIC	A. Vehicle volumes, along artery (Average Hour)	480	720	576	864	162	19%	13%
	B. Combined vehicle and pedestrian volume crossing artery from minor roads (Average Hour)	50	75	60	90	12	13%	

Projected Traffic Volumes:

Approach Volume Input (vph)			
Artery V1	Artery V2	Minor V3	Minor V4
77.5	84.25	30.25	

Average Hourly Volume (AHV) = PHV/2 or (amPHV + pmPHV)/4
PHV = Either AM or PM Peak Hour Volume

Notes and Adjustment Factors:

- Vehicle volume warrants (1A) and (2A) for intersections of roadways having two or more moving lanes in one direction should be 25% higher than the values given above.
- Warrant values for free flow apply when the 85th percentile speed of artery traffic equals or exceeds 70 km/h or when the intersection lies within the built-up area of an isolated community having a population of less than 10,000.
- Warrant values for restricted flow apply to large urban communities when the 85th percentile speed of artery traffic does not exceed 70 km/h.
- The lowest sectional percentage governs the entire warrant.
- For "T" intersections the warrant values for the minor road should be increased by 50% (Warrant 1B only).
- All flow values for Warrant 1 and Warrant 2 are to be increased by 20% for existing intersections and by 50% in the case of new intersections.
- The crossing volumes are defined as:
 - Left-turns from both minor road approaches.
 - The heaviest through volume from the minor road.

© 50% of the heavier left turn movement from major road when both of the following are met:

 - the left-turn volume >120 vph
 - the left-turn volume plus the opposing volume >720 vph
 - Pedestrians crossing the main road.

Adj. Factors
1
1.5
1.2
0

CONCLUSION: The intersection does NOT meet the minimum warrants for traffic control signals.

* Ontario Traffic Manual, Book 12", Ontario Ministry of Transportation.



MINIMUM WARRANTS FOR INSTALLATION OF TRAFFIC SIGNALS USING PROJECTED VOLUMES*

Project: Maple Grove TIA (Claridge)

Date: 2018-02-09

Project # 113480

Location Stittsville Main Street
(Roadway)

at Street 1
(Intersecting Roadway)

Municipality Kanata

Projected Volume Future (2026) Total

Peak Hour AM & PM

WARRANT	DESCRIPTION	MINIMUM REQUIREMENT FOR 2 LANE HIGHWAYS				COMPLIANCE		
		FREE FLOW	RESTRICTED FLOW	ADJUSTED FREE FLOW	ADJUSTED RESTRICTED FLOW	SECTIONAL		ENTIRE %
						Number	%	
1. VEHICULAR VOLUME	A. Vehicle volumes, all approaches (Average Hour)	480	720	720	1080	5	0%	0%
	B. Vehicle volume along minor roads (Average Hour)	120	170	270	383	3	1%	
2. DELAY TO CROSS TRAFFIC	A. Vehicle volumes, along artery (Average Hour)	480	720	720	1080	2	0%	0%
	B. Combined vehicle and pedestrian volume crossing artery from minor roads (Average Hour)	50	75	75	113	8	7%	

Projected Traffic Volumes:

Approach Volume Input (vph)			
Artery V1	Artery V2	Minor V3	Minor V4
0	2.25	2.75	

Average Hourly Volume (AHV) = PHV/2 or (amPHV + pmPHV)/4
PHV = Either AM or PM Peak Hour Volume

Notes and Adjustment Factors:

- Vehicle volume warrants (1A) and (2A) for intersections of roadways having two or more moving lanes in one direction should be 25% higher than the values given above.
- Warrant values for free flow apply when the 85th percentile speed of artery traffic equals or exceeds 70 km/h or when the intersection lies within the built-up area of an isolated community having a population of less than 10,000.
- Warrant values for restricted flow apply to large urban communities when the 85th percentile speed of artery traffic does not exceed 70 km/h.
- The lowest sectional percentage governs the entire warrant.
- For "T" intersections the warrant values for the minor road should be increased by 50% (Warrant 1B only).
- All flow values for Warrant 1 and Warrant 2 are to be increased by 20% for existing intersections and by 50% in the case of new intersections.
- The crossing volumes are defined as:
 - Left-turns from both minor road approaches.
 - The heaviest through volume from the minor road.

© 50% of the heavier left turn movement from major road when both of the following are met:

 - the left-turn volume >120 vph
 - the left-turn volume plus the opposing volume >720 vph
 - Pedestrians crossing the main road.

Adj. Factors
1
1.5
1.5
0

CONCLUSION: The intersection does NOT meet the minimum warrants for traffic control signals.

* Ontario Traffic Manual, Book 12", Ontario Ministry of Transportation.



MINIMUM WARRANTS FOR INSTALLATION OF TRAFFIC SIGNALS USING PROJECTED VOLUMES*

Project: Maple Grove TIA (Claridge)

Date: 2018-02-09

Project # 113480

Location Stittsville Main Street
(Roadway)

at Street 2
(Intersecting Roadway)

Municipality Kanata

Projected Volume Future (2026) Total

Peak Hour AM & PM

WARRANT	DESCRIPTION	MINIMUM REQUIREMENT FOR 2 LANE HIGHWAYS				COMPLIANCE		
		FREE FLOW	RESTRICTED FLOW	ADJUSTED FREE FLOW	ADJUSTED RESTRICTED FLOW	SECTIONAL		ENTIRE %
						Number	%	
1. VEHICULAR VOLUME	A. Vehicle volumes, all approaches (Average Hour)	480	720	720	1080	10	1%	1%
	B. Vehicle volume along minor roads (Average Hour)	120	170	270	383	3	1%	
2. DELAY TO CROSS TRAFFIC	A. Vehicle volumes, along artery (Average Hour)	480	720	720	1080	7	1%	1%
	B. Combined vehicle and pedestrian volume crossing artery from minor roads (Average Hour)	50	75	75	113	8	7%	

Projected Traffic Volumes:

Approach Volume Input (vph)			
Artery V1	Artery V2	Minor V3	Minor V4
2.75	4.5	2.75	

Average Hourly Volume (AHV) = PHV/2 or (amPHV + pmPHV)/4
PHV = Either AM or PM Peak Hour Volume

Notes and Adjustment Factors:

- Vehicle volume warrants (1A) and (2A) for intersections of roadways having two or more moving lanes in one direction should be 25% higher than the values given above.
- Warrant values for free flow apply when the 85th percentile speed of artery traffic equals or exceeds 70 km/h or when the intersection lies within the built-up area of an isolated community having a population of less than 10,000.
- Warrant values for restricted flow apply to large urban communities when the 85th percentile speed of artery traffic does not exceed 70 km/h.
- The lowest sectional percentage governs the entire warrant.
- For "T" intersections the warrant values for the minor road should be increased by 50% (Warrant 1B only).
- All flow values for Warrant 1 and Warrant 2 are to be increased by 20% for existing intersections and by 50% in the case of new intersections.
- The crossing volumes are defined as:
 - Left-turns from both minor road approaches.
 - The heaviest through volume from the minor road.
 - © 50% of the heavier left turn movement from major road when both of the following are met:
 - the left-turn volume >120 vph
 - the left-turn volume plus the opposing volume >720 vph
 - Pedestrians crossing the main road.

Adj. Factors
1
1.5
1.5
0

CONCLUSION: The intersection does NOT meet the minimum warrants for traffic control signals.

* "Ontario Traffic Manual, Book 12", Ontario Ministry of Transportation.



MINIMUM WARRANTS FOR INSTALLATION OF TRAFFIC SIGNALS USING PROJECTED VOLUMES*

Project: Maple Grove TIA (Claridge)

Date: 2018-02-09

Project # 113480

Location Stittsville Main Street
(Roadway)

at Street 4
(Intersecting Roadway)

Municipality Kanata

Projected Volume Future (2026) Total

Peak Hour AM & PM

WARRANT	DESCRIPTION	MINIMUM REQUIREMENT FOR 2 LANE HIGHWAYS				COMPLIANCE		
		FREE FLOW	RESTRICTED FLOW	ADJUSTED FREE FLOW	ADJUSTED RESTRICTED FLOW	SECTIONAL		ENTIRE %
						Number	%	
1. VEHICULAR VOLUME	A. Vehicle volumes, all approaches (Average Hour)	480	720	720	1080	15	1%	1%
	B. Vehicle volume along minor roads (Average Hour)	120	170	270	383	3	1%	
2. DELAY TO CROSS TRAFFIC	A. Vehicle volumes, along artery (Average Hour)	480	720	720	1080	12	1%	1%
	B. Combined vehicle and pedestrian volume crossing artery from minor roads (Average Hour)	50	75	75	113	8	7%	

Projected Traffic Volumes:

Approach Volume Input (vph)			
Artery V1	Artery V2	Minor V3	Minor V4
5.5	6.5	2.75	

Average Hourly Volume (AHV) = PHV/2 or (amPHV + pmPHV)/4
PHV = Either AM or PM Peak Hour Volume

Notes and Adjustment Factors:

- 1. Vehicle volume warrants (1A) and (2A) for intersections of roadways having two or more moving lanes in one direction should be 25% higher than the values given above.
- 2. Warrant values for free flow apply when the 85th percentile speed of artery traffic equals or exceeds 70 km/h or when the intersection lies within the built-up area of an isolated community having a population of less than 10,000.
- 3. Warrant values for restricted flow apply to large urban communities when the 85th percentile speed of artery traffic does not exceed 70 km/h.
- 4. The lowest sectional percentage governs the entire warrant.
- 5. For "T" intersections the warrant values for the minor road should be increased by 50% (Warrant 1B only).
- 6. All flow values for Warrant 1 and Warrant 2 are to be increased by 20% for existing intersections and by 50% in the case of new intersections.
- 7. The crossing volumes are defined as:
 - (a) Left-turns from both minor road approaches.
 - (b) The heaviest through volume from the minor road.
 - © 50% of the heavier left turn movement from major road when both of the following are met:
 - (i) the left-turn volume >120 vph
 - (ii) the left-turn volume plus the opposing volume >720 vph
 - (d) Pedestrians crossing the main road.

Adj. Factors
1
1.5
1.5
0

CONCLUSION: The intersection does NOT meet the minimum warrants for traffic control signals.

* "Ontario Traffic Manual, Book 12", Ontario Ministry of Transportation.



MINIMUM WARRANTS FOR INSTALLATION OF TRAFFIC SIGNALS USING PROJECTED VOLUMES*

Project: Maple Grove TIA (Claridge)

Date: 2018-02-09

Project # 113480

Location Stittsville Main Street
(Roadway)

at Maple Grove Road
(Intersecting Roadway)

Municipality Kanata

Projected Volume Future (2026) Total

Peak Hour AM & PM

WARRANT	DESCRIPTION	MINIMUM REQUIREMENT FOR 2 LANE HIGHWAYS				COMPLIANCE		
		FREE FLOW	RESTRICTED FLOW	ADJUSTED FREE FLOW	ADJUSTED RESTRICTED FLOW	SECTIONAL		ENTIRE %
						Number	%	
1. VEHICULAR VOLUME	A. Vehicle volumes, all approaches (Average Hour)	480	720	720	1080	151	14%	14%
	B. Vehicle volume along minor roads (Average Hour)	120	170	270	383	69	18%	
2. DELAY TO CROSS TRAFFIC	A. Vehicle volumes, along artery (Average Hour)	480	720	720	1080	83	8%	8%
	B. Combined vehicle and pedestrian volume crossing artery from minor roads (Average Hour)	50	75	75	113	69	61%	

Projected Traffic Volumes:

Approach Volume Input (vph)			
Artery V1	Artery V2	Minor V3	Minor V4
8.25	74.5	68.5	

Average Hourly Volume (AHV) = PHV/2 or (amPHV + pmPHV)/4
PHV = Either AM or PM Peak Hour Volume

Notes and Adjustment Factors:

- 1. Vehicle volume warrants (1A) and (2A) for intersections of roadways having two or more moving lanes in one direction should be 25% higher than the values given above.
- 2. Warrant values for free flow apply when the 85th percentile speed of artery traffic equals or exceeds 70 km/h or when the intersection lies within the built-up area of an isolated community having a population of less than 10,000.
- 3. Warrant values for restricted flow apply to large urban communities when the 85th percentile speed of artery traffic does not exceed 70 km/h.
- 4. The lowest sectional percentage governs the entire warrant.
- 5. For "T" intersections the warrant values for the minor road should be increased by 50% (Warrant 1B only).
- 6. All flow values for Warrant 1 and Warrant 2 are to be increased by 20% for existing intersections and by 50% in the case of new intersections.
- 7. The crossing volumes are defined as:
 - (a) Left-turns from both minor road approaches.
 - (b) The heaviest through volume from the minor road.
 - © 50% of the heavier left turn movement from major road when both of the following are met:
 - (i) the left-turn volume >120 vph
 - (ii) the left-turn volume plus the opposing volume >720 vph
 - (d) Pedestrians crossing the main road.

Adj. Factors
1
1.5
1.5
0

CONCLUSION: The intersection does NOT meet the minimum warrants for traffic control signals.

* "Ontario Traffic Manual, Book 12", Ontario Ministry of Transportation.



MINIMUM WARRANTS FOR INSTALLATION OF TRAFFIC SIGNALS USING PROJECTED VOLUMES*

Project: Maple Grove TIA (Claridge)

Date: 2018-02-09

Project # 113480

Location Maple Grove Road
(Roadway)

at Street 6
(Intersecting Roadway)

Municipality Kanata

Projected Volume Future (2026) Total

Peak Hour AM & PM

WARRANT	DESCRIPTION	MINIMUM REQUIREMENT FOR 2 LANE HIGHWAYS				COMPLIANCE		
		FREE FLOW	RESTRICTED FLOW	ADJUSTED FREE FLOW	ADJUSTED RESTRICTED FLOW	SECTIONAL		ENTIRE %
						Number	%	
1. VEHICULAR VOLUME	A. Vehicle volumes, all approaches (Average Hour)	480	720	720	1080	211	19%	5%
	B. Vehicle volume along minor roads (Average Hour)	120	170	270	383	19	5%	
2. DELAY TO CROSS TRAFFIC	A. Vehicle volumes, along artery (Average Hour)	480	720	720	1080	191	18%	18%
	B. Combined vehicle and pedestrian volume crossing artery from minor roads (Average Hour)	50	75	75	113	23	20%	

Projected Traffic Volumes:

Approach Volume Input (vph)			
Artery V1	Artery V2	Minor V3	Minor V4
93.5	97.75	19.25	

Average Hourly Volume (AHV) = PHV/2 or (amPHV + pmPHV)/4
PHV = Either AM or PM Peak Hour Volume

Notes and Adjustment Factors:

- Vehicle volume warrants (1A) and (2A) for intersections of roadways having two or more moving lanes in one direction should be 25% higher than the values given above.
- Warrant values for free flow apply when the 85th percentile speed of artery traffic equals or exceeds 70 km/h or when the intersection lies within the built-up area of an isolated community having a population of less than 10,000.
- Warrant values for restricted flow apply to large urban communities when the 85th percentile speed of artery traffic does not exceed 70 km/h.
- The lowest sectional percentage governs the entire warrant.
- For "T" intersections the warrant values for the minor road should be increased by 50% (Warrant 1B only).
- All flow values for Warrant 1 and Warrant 2 are to be increased by 20% for existing intersections and by 50% in the case of new intersections.
- The crossing volumes are defined as:
 - Left-turns from both minor road approaches.
 - The heaviest through volume from the minor road.

© 50% of the heavier left turn movement from major road when both of the following are met:

 - the left-turn volume >120 vph
 - the left-turn volume plus the opposing volume >720 vph
 - Pedestrians crossing the main road.

Adj. Factors
1
1.5
1.5
0

CONCLUSION: The intersection does NOT meet the minimum warrants for traffic control signals.

* Ontario Traffic Manual, Book 12", Ontario Ministry of Transportation.



1981 Maple Grove Road

Transportation Impact Assessment Report

Appendix I: Synchro Output Files

February 2018



Existing (2018)

1: Huntmar Drive & Maple Grove Road

AM Peak Hour



Lane Group	EBL	EBT	EBR	WBL	WBT	WBR	NBL	NBT	NBR	SBL	SBT	SBR
Lane Configurations		↕			↕		↗	↘			↕	
Traffic Volume (vph)	211	107	46	40	37	21	23	422	83	6	252	39
Future Volume (vph)	211	107	46	40	37	21	23	422	83	6	252	39
Ideal Flow (vphpl)	1800	1800	1800	1800	1800	1800	1800	1800	1800	1800	1800	1800
Storage Length (m)	0.0		0.0	0.0		0.0	15.0		0.0	0.0		0.0
Storage Lanes	0		0	0		0	1		0	0		0
Taper Length (m)	7.6			7.6			7.6			7.6		
Lane Util. Factor	1.00	1.00	1.00	1.00	1.00	1.00	1.00	1.00	1.00	1.00	1.00	1.00
Fr _t		0.983			0.971			0.975			0.982	
Fl _t Protected		0.972			0.980		0.950				0.999	
Satd. Flow (prot)	0	1667	0	0	1661	0	1658	1701	0	0	1712	0
Fl _t Permitted		0.761			0.784		0.526				0.988	
Satd. Flow (perm)	0	1305	0	0	1328	0	918	1701	0	0	1693	0
Right Turn on Red			Yes			Yes			Yes			Yes
Satd. Flow (RTOR)		7			14			11			8	
Link Speed (k/h)		50			50			50			50	
Link Distance (m)		544.6			345.6			287.4			249.0	
Travel Time (s)		39.2			24.9			20.7			17.9	
Peak Hour Factor	0.90	0.90	0.90	0.90	0.90	0.90	0.90	0.90	0.90	0.90	0.90	0.90
Adj. Flow (vph)	234	119	51	44	41	23	26	469	92	7	280	43
Shared Lane Traffic (%)												
Lane Group Flow (vph)	0	404	0	0	108	0	26	561	0	0	330	0
Turn Type	Perm	NA		Perm	NA		Perm	NA		Perm	NA	
Protected Phases		4			8			2			6	
Permitted Phases	4			8			2			6		
Detector Phase	4	4		8	8		2	2		6	6	
Switch Phase												
Minimum Initial (s)	10.0	10.0		10.0	10.0		10.0	10.0		10.0	10.0	
Minimum Split (s)	31.1	31.1		29.1	29.1		24.1	24.1		21.1	21.1	
Total Split (s)	60.2	60.2		60.2	60.2		64.8	64.8		64.8	64.8	
Total Split (%)	48.2%	48.2%		48.2%	48.2%		51.8%	51.8%		51.8%	51.8%	
Maximum Green (s)	54.1	54.1		54.1	54.1		58.7	58.7		58.7	58.7	
Yellow Time (s)	3.3	3.3		3.3	3.3		3.3	3.3		3.3	3.3	
All-Red Time (s)	2.8	2.8		2.8	2.8		2.8	2.8		2.8	2.8	
Lost Time Adjust (s)		0.0			0.0		0.0	0.0			0.0	
Total Lost Time (s)		6.1			6.1		6.1	6.1			6.1	
Lead/Lag												
Lead-Lag Optimize?												
Vehicle Extension (s)	3.0	3.0		3.0	3.0		3.0	3.0		3.0	3.0	
Recall Mode	None	None		None	None		Min	Min		Min	Min	
Walk Time (s)	7.0	7.0		7.0	7.0		7.0	7.0		7.0	7.0	
Flash Dont Walk (s)	16.0	16.0		16.0	16.0		8.0	8.0		8.0	8.0	
Pedestrian Calls (#/hr)	0	0		0	0		0	0		0	0	
Act Effct Green (s)		30.9			30.9		33.6	33.6			33.6	
Actuated g/C Ratio		0.39			0.39		0.43	0.43			0.43	
v/c Ratio		0.78			0.20		0.07	0.76			0.45	
Control Delay		33.6			16.8		16.2	27.6			18.9	
Queue Delay		0.0			0.0		0.0	0.0			0.0	
Total Delay		33.6			16.8		16.2	27.6			18.9	



Lane Group	EBL	EBT	EBR	WBL	WBT	WBR	NBL	NBT	NBR	SBL	SBT	SBR
LOS		C			B		B	C				B
Approach Delay		33.6			16.8			27.1				18.9
Approach LOS		C			B			C				B
Queue Length 50th (m)		42.1			7.4		1.8	55.9				27.3
Queue Length 95th (m)		107.2			23.7		8.1	135.1				68.8
Internal Link Dist (m)		520.6			321.6			263.4				225.0
Turn Bay Length (m)							15.0					
Base Capacity (vph)		964			982		718	1334				1327
Starvation Cap Reductn		0			0		0	0				0
Spillback Cap Reductn		0			0		0	0				0
Storage Cap Reductn		0			0		0	0				0
Reduced v/c Ratio		0.42			0.11		0.04	0.42				0.25

Intersection Summary

Area Type:	Other
Cycle Length:	125
Actuated Cycle Length:	78.3
Natural Cycle:	60
Control Type:	Actuated-Uncoordinated
Maximum v/c Ratio:	0.78
Intersection Signal Delay:	26.3
Intersection LOS:	C
Intersection Capacity Utilization:	66.8%
ICU Level of Service:	C
Analysis Period (min):	15

Splits and Phases: 1: Huntmar Drive & Maple Grove Road

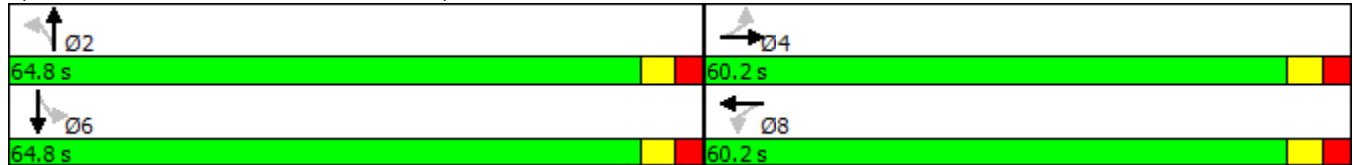



Lane Group	EBL	EBT	EBR	WBL	WBT	WBR	NBL	NBT	NBR	SBL	SBT	SBR
Lane Configurations		↕			↕		↗	↘			↕	
Traffic Volume (vph)	85	83	62	130	142	31	90	432	98	33	627	190
Future Volume (vph)	85	83	62	130	142	31	90	432	98	33	627	190
Ideal Flow (vphpl)	1800	1800	1800	1800	1800	1800	1800	1800	1800	1800	1800	1800
Storage Length (m)	0.0		0.0	0.0		0.0	15.0		0.0	0.0		0.0
Storage Lanes	0		0	0		0	1		0	0		0
Taper Length (m)	7.6			7.6			7.6			7.6		
Lane Util. Factor	1.00	1.00	1.00	1.00	1.00	1.00	1.00	1.00	1.00	1.00	1.00	1.00
Frt		0.963			0.986			0.972			0.970	
Flt Protected		0.982			0.979		0.950				0.998	
Satd. Flow (prot)	0	1650	0	0	1685	0	1658	1696	0	0	1689	0
Flt Permitted		0.715			0.704		0.262				0.960	
Satd. Flow (perm)	0	1202	0	0	1211	0	457	1696	0	0	1625	0
Right Turn on Red			Yes			Yes			Yes			Yes
Satd. Flow (RTOR)		16			5			15			19	
Link Speed (k/h)		50			50			50			50	
Link Distance (m)		544.6			345.6			287.4			249.0	
Travel Time (s)		39.2			24.9			20.7			17.9	
Peak Hour Factor	0.90	0.90	0.90	0.90	0.90	0.90	0.90	0.90	0.90	0.90	0.90	0.90
Adj. Flow (vph)	94	92	69	144	158	34	100	480	109	37	697	211
Shared Lane Traffic (%)												
Lane Group Flow (vph)	0	255	0	0	336	0	100	589	0	0	945	0
Turn Type	Perm	NA		Perm	NA		Perm	NA		Perm	NA	
Protected Phases		4			8			2			6	
Permitted Phases	4			8			2			6		
Detector Phase	4	4		8	8		2	2		6	6	
Switch Phase												
Minimum Initial (s)	10.0	10.0		10.0	10.0		10.0	10.0		10.0	10.0	
Minimum Split (s)	29.1	29.1		29.1	29.1		21.1	21.1		21.1	21.1	
Total Split (s)	49.0	49.0		49.0	49.0		76.0	76.0		76.0	76.0	
Total Split (%)	39.2%	39.2%		39.2%	39.2%		60.8%	60.8%		60.8%	60.8%	
Maximum Green (s)	42.9	42.9		42.9	42.9		69.9	69.9		69.9	69.9	
Yellow Time (s)	3.3	3.3		3.3	3.3		3.3	3.3		3.3	3.3	
All-Red Time (s)	2.8	2.8		2.8	2.8		2.8	2.8		2.8	2.8	
Lost Time Adjust (s)		0.0			0.0		0.0	0.0			0.0	
Total Lost Time (s)		6.1			6.1		6.1	6.1			6.1	
Lead/Lag												
Lead-Lag Optimize?												
Vehicle Extension (s)	3.0	3.0		3.0	3.0		3.0	3.0		3.0	3.0	
Recall Mode	None	None		None	None		Min	Min		Min	Min	
Walk Time (s)	7.0	7.0		7.0	7.0		7.0	7.0		7.0	7.0	
Flash Dont Walk (s)	16.0	16.0		16.0	16.0		8.0	8.0		8.0	8.0	
Pedestrian Calls (#/hr)	0	0		0	0		0	0		0	0	
Act Effct Green (s)		35.6			35.6		70.2	70.2			70.2	
Actuated g/C Ratio		0.30			0.30		0.59	0.59			0.59	
v/c Ratio		0.68			0.91		0.37	0.58			0.97	
Control Delay		43.6			68.8		19.3	18.5			47.1	
Queue Delay		0.0			0.0		0.0	0.0			0.0	
Total Delay		43.6			68.8		19.3	18.5			47.1	

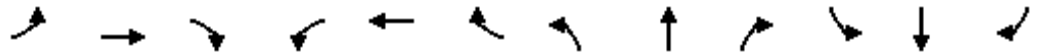

Lane Group	EBL	EBT	EBR	WBL	WBT	WBR	NBL	NBT	NBR	SBL	SBT	SBR
LOS		D			E		B	B			D	
Approach Delay		43.6			68.8			18.6			47.1	
Approach LOS		D			E		B	B			D	
Queue Length 50th (m)		44.7			67.7		11.1	75.7			190.8	
Queue Length 95th (m)		71.2			#111.7		25.6	117.5			#298.5	
Internal Link Dist (m)		520.6			321.6			263.4			225.0	
Turn Bay Length (m)							15.0					
Base Capacity (vph)		449			445		271	1015			974	
Starvation Cap Reductn		0			0		0	0			0	
Spillback Cap Reductn		0			0		0	0			0	
Storage Cap Reductn		0			0		0	0			0	
Reduced v/c Ratio		0.57			0.76		0.37	0.58			0.97	

Intersection Summary

Area Type:	Other
Cycle Length:	125
Actuated Cycle Length:	118
Natural Cycle:	90
Control Type:	Actuated-Uncoordinated
Maximum v/c Ratio:	0.97
Intersection Signal Delay:	41.2
Intersection LOS:	D
Intersection Capacity Utilization:	110.5%
ICU Level of Service:	H
Analysis Period (min):	15
# 95th percentile volume exceeds capacity, queue may be longer. Queue shown is maximum after two cycles.	

Splits and Phases: 1: Huntmar Drive & Maple Grove Road



1: Huntmar Drive & Maple Grove Road

AM Peak Hour

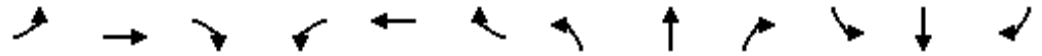

Lane Group	EBL	EBT	EBR	WBL	WBT	WBR	NBL	NBT	NBR	SBL	SBT	SBR
Lane Configurations												
Traffic Volume (vph)	211	107	46	40	37	21	23	422	83	6	252	39
Future Volume (vph)	211	107	46	40	37	21	23	422	83	6	252	39
Ideal Flow (vphpl)	1800	1800	1800	1800	1800	1800	1800	1800	1800	1800	1800	1800
Storage Length (m)	80.0		0.0	30.0		0.0	40.0		0.0	15.0		15.0
Storage Lanes	1		0	1		0	1		0	1		1
Taper Length (m)	7.6			7.6			7.6			7.6		
Lane Util. Factor	1.00	1.00	1.00	1.00	1.00	1.00	1.00	1.00	1.00	1.00	1.00	1.00
Frt		0.955			0.946			0.975				0.850
Flt Protected	0.950			0.950			0.950			0.950		
Satd. Flow (prot)	1658	1667	0	1658	1651	0	1658	1701	0	1658	1745	1483
Flt Permitted	0.715			0.650			0.588			0.314		
Satd. Flow (perm)	1248	1667	0	1134	1651	0	1026	1701	0	548	1745	1483
Right Turn on Red			Yes			Yes			Yes			Yes
Satd. Flow (RTOR)		35			23			19				48
Link Speed (k/h)		50			50			50				50
Link Distance (m)		544.6			345.6			287.4				249.0
Travel Time (s)		39.2			24.9			20.7				17.9
Peak Hour Factor	0.90	0.90	0.90	0.90	0.90	0.90	0.90	0.90	0.90	0.90	0.90	0.90
Adj. Flow (vph)	234	119	51	44	41	23	26	469	92	7	280	43
Shared Lane Traffic (%)												
Lane Group Flow (vph)	234	170	0	44	64	0	26	561	0	7	280	43
Turn Type	Perm	NA		Perm	NA		Perm	NA		Perm	NA	Perm
Protected Phases		4			8			2				6
Permitted Phases	4			8			2			6		6
Detector Phase	4	4		8	8		2	2		6	6	6
Switch Phase												
Minimum Initial (s)	10.0	10.0		10.0	10.0		10.0	10.0		10.0	10.0	10.0
Minimum Split (s)	31.1	31.1		31.1	31.1		24.1	24.1		24.1	24.1	24.1
Total Split (s)	31.4	31.4		31.4	31.4		38.6	38.6		38.6	38.6	38.6
Total Split (%)	44.9%	44.9%		44.9%	44.9%		55.1%	55.1%		55.1%	55.1%	55.1%
Maximum Green (s)	25.3	25.3		25.3	25.3		32.5	32.5		32.5	32.5	32.5
Yellow Time (s)	3.3	3.3		3.3	3.3		3.3	3.3		3.3	3.3	3.3
All-Red Time (s)	2.8	2.8		2.8	2.8		2.8	2.8		2.8	2.8	2.8
Lost Time Adjust (s)	0.0	0.0		0.0	0.0		0.0	0.0		0.0	0.0	0.0
Total Lost Time (s)	6.1	6.1		6.1	6.1		6.1	6.1		6.1	6.1	6.1
Lead/Lag												
Lead-Lag Optimize?												
Vehicle Extension (s)	3.0	3.0		3.0	3.0		3.0	3.0		3.0	3.0	3.0
Recall Mode	None	None		None	None		Min	Min		Min	Min	Min
Walk Time (s)	7.0	7.0		7.0	7.0		7.0	7.0		7.0	7.0	7.0
Flash Dont Walk (s)	18.0	18.0		18.0	18.0		11.0	11.0		11.0	11.0	11.0
Pedestrian Calls (#/hr)	0	0		0	0		0	0		0	0	0
Act Effct Green (s)	15.9	15.9		15.9	15.9		21.5	21.5		21.5	21.5	21.5
Actuated g/C Ratio	0.31	0.31		0.31	0.31		0.43	0.43		0.43	0.43	0.43
v/c Ratio	0.60	0.31		0.12	0.12		0.06	0.76		0.03	0.38	0.07
Control Delay	23.3	13.6		15.1	10.7		9.9	20.2		10.0	12.0	3.5
Queue Delay	0.0	0.0		0.0	0.0		0.0	0.0		0.0	0.0	0.0
Total Delay	23.3	13.6		15.1	10.7		9.9	20.2		10.0	12.0	3.5

1: Huntmar Drive & Maple Grove Road

AM Peak Hour



Lane Group	EBL	EBT	EBR	WBL	WBT	WBR	NBL	NBT	NBR	SBL	SBT	SBR
LOS	C	B		B	B		A	C		A	B	A
Approach Delay		19.2			12.5			19.7			10.9	
Approach LOS		B			B			B			B	
Queue Length 50th (m)	15.3	7.8		2.4	2.2		1.1	32.2		0.3	13.5	0.0
Queue Length 95th (m)	40.1	22.9		9.2	9.7		5.1	80.9		2.2	34.9	3.8
Internal Link Dist (m)		520.6			321.6			263.4			225.0	
Turn Bay Length (m)	80.0			30.0			40.0			15.0		15.0
Base Capacity (vph)	670	911		609	898		708	1180		378	1204	1038
Starvation Cap Reductn	0	0		0	0		0	0		0	0	0
Spillback Cap Reductn	0	0		0	0		0	0		0	0	0
Storage Cap Reductn	0	0		0	0		0	0		0	0	0
Reduced v/c Ratio	0.35	0.19		0.07	0.07		0.04	0.48		0.02	0.23	0.04

Intersection Summary

Area Type: Other
 Cycle Length: 70
 Actuated Cycle Length: 50.5
 Natural Cycle: 60
 Control Type: Actuated-Uncoordinated
 Maximum v/c Ratio: 0.76
 Intersection Signal Delay: 17.0
 Intersection LOS: B
 Intersection Capacity Utilization 64.7%
 ICU Level of Service C
 Analysis Period (min) 15

Splits and Phases: 1: Huntmar Drive & Maple Grove Road

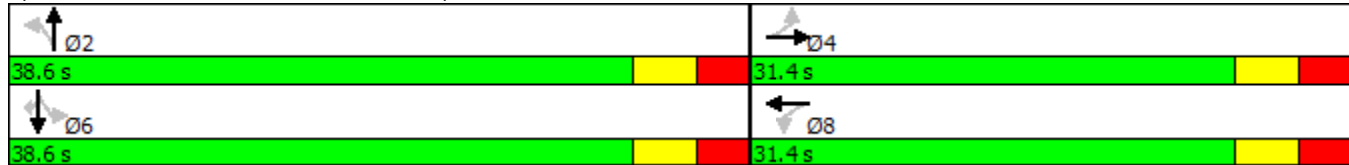

1: Huntmar Drive & Maple Grove Road

PM Peak Hour

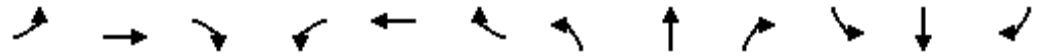

Lane Group	EBL	EBT	EBR	WBL	WBT	WBR	NBL	NBT	NBR	SBL	SBT	SBR
Lane Configurations												
Traffic Volume (vph)	85	83	62	130	142	31	90	432	98	33	627	190
Future Volume (vph)	85	83	62	130	142	31	90	432	98	33	627	190
Ideal Flow (vphpl)	1800	1800	1800	1800	1800	1800	1800	1800	1800	1800	1800	1800
Storage Length (m)	80.0		0.0	30.0		0.0	40.0		0.0	15.0		15.0
Storage Lanes	1		0	1		0	1		0	1		1
Taper Length (m)	7.6			7.6			7.6			7.6		
Lane Util. Factor	1.00	1.00	1.00	1.00	1.00	1.00	1.00	1.00	1.00	1.00	1.00	1.00
Frt		0.936			0.973			0.972				0.850
Flt Protected	0.950			0.950			0.950			0.950		
Satd. Flow (prot)	1658	1633	0	1658	1698	0	1658	1696	0	1658	1745	1483
Flt Permitted	0.637			0.655			0.250			0.338		
Satd. Flow (perm)	1112	1633	0	1143	1698	0	436	1696	0	590	1745	1483
Right Turn on Red			Yes			Yes			Yes			Yes
Satd. Flow (RTOR)		60			17			22				92
Link Speed (k/h)		50			50			50				50
Link Distance (m)		544.6			345.6			287.4				249.0
Travel Time (s)		39.2			24.9			20.7				17.9
Peak Hour Factor	0.90	0.90	0.90	0.90	0.90	0.90	0.90	0.90	0.90	0.90	0.90	0.90
Adj. Flow (vph)	94	92	69	144	158	34	100	480	109	37	697	211
Shared Lane Traffic (%)												
Lane Group Flow (vph)	94	161	0	144	192	0	100	589	0	37	697	211
Turn Type	Perm	NA		Perm	NA		Perm	NA		Perm	NA	Perm
Protected Phases		4			8			2				6
Permitted Phases	4			8			2			6		6
Detector Phase	4	4		8	8		2	2		6	6	6
Switch Phase												
Minimum Initial (s)	10.0	10.0		10.0	10.0		10.0	10.0		10.0	10.0	10.0
Minimum Split (s)	31.1	31.1		31.1	31.1		24.1	24.1		24.1	24.1	24.1
Total Split (s)	31.1	31.1		31.1	31.1		38.9	38.9		38.9	38.9	38.9
Total Split (%)	44.4%	44.4%		44.4%	44.4%		55.6%	55.6%		55.6%	55.6%	55.6%
Maximum Green (s)	25.0	25.0		25.0	25.0		32.8	32.8		32.8	32.8	32.8
Yellow Time (s)	3.3	3.3		3.3	3.3		3.3	3.3		3.3	3.3	3.3
All-Red Time (s)	2.8	2.8		2.8	2.8		2.8	2.8		2.8	2.8	2.8
Lost Time Adjust (s)	0.0	0.0		0.0	0.0		0.0	0.0		0.0	0.0	0.0
Total Lost Time (s)	6.1	6.1		6.1	6.1		6.1	6.1		6.1	6.1	6.1
Lead/Lag												
Lead-Lag Optimize?												
Vehicle Extension (s)	3.0	3.0		3.0	3.0		3.0	3.0		3.0	3.0	3.0
Recall Mode	None	None		None	None		Min	Min		Min	Min	Min
Walk Time (s)	7.0	7.0		7.0	7.0		7.0	7.0		7.0	7.0	7.0
Flash Dont Walk (s)	18.0	18.0		18.0	18.0		11.0	11.0		11.0	11.0	11.0
Pedestrian Calls (#/hr)	0	0		0	0		0	0		0	0	0
Act Effct Green (s)	13.3	13.3		13.3	13.3		26.7	26.7		26.7	26.7	26.7
Actuated g/C Ratio	0.25	0.25		0.25	0.25		0.51	0.51		0.51	0.51	0.51
v/c Ratio	0.34	0.35		0.50	0.44		0.45	0.68		0.12	0.79	0.26
Control Delay	21.3	14.2		25.2	19.7		17.1	14.4		8.7	19.3	5.6
Queue Delay	0.0	0.0		0.0	0.0		0.0	0.0		0.0	0.0	0.0
Total Delay	21.3	14.2		25.2	19.7		17.1	14.4		8.7	19.3	5.6

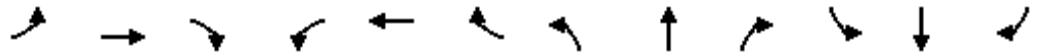

Lane Group	EBL	EBT	EBR	WBL	WBT	WBR	NBL	NBT	NBR	SBL	SBT	SBR
LOS	C	B		C	B		B	B		A	B	A
Approach Delay		16.8			22.1			14.8			15.8	
Approach LOS		B			C			B			B	
Queue Length 50th (m)	7.2	7.5		11.5	13.6		4.7	31.0		1.4	41.8	4.7
Queue Length 95th (m)	17.6	19.7		25.8	28.8		18.8	74.2		6.1	#113.4	15.9
Internal Link Dist (m)		520.6			321.6			263.4			225.0	
Turn Bay Length (m)	80.0			30.0			40.0			15.0		15.0
Base Capacity (vph)	547	834		562	844		281	1103		381	1127	990
Starvation Cap Reductn	0	0		0	0		0	0		0	0	0
Spillback Cap Reductn	0	0		0	0		0	0		0	0	0
Storage Cap Reductn	0	0		0	0		0	0		0	0	0
Reduced v/c Ratio	0.17	0.19		0.26	0.23		0.36	0.53		0.10	0.62	0.21

Intersection Summary

Area Type:	Other
Cycle Length:	70
Actuated Cycle Length:	52.6
Natural Cycle:	70
Control Type:	Actuated-Uncoordinated
Maximum v/c Ratio:	0.79
Intersection Signal Delay:	16.5
Intersection LOS:	B
Intersection Capacity Utilization:	81.7%
ICU Level of Service:	D
Analysis Period (min):	15

95th percentile volume exceeds capacity, queue may be longer.
 Queue shown is maximum after two cycles.

Splits and Phases: 1: Huntmar Drive & Maple Grove Road

38.9 s	31.1 s
38.9 s	31.1 s

Intersection

Int Delay, s/veh 5

Movement	EBT	EBR	WBL	WBT	NBL	NBR
Lane Configurations						
Traffic Vol, veh/h	49	2	29	13	1	63
Future Vol, veh/h	49	2	29	13	1	63
Conflicting Peds, #/hr	0	0	0	0	0	0
Sign Control	Free	Free	Free	Free	Stop	Stop
RT Channelized	-	None	-	None	-	None
Storage Length	-	-	-	-	0	-
Veh in Median Storage, #	0	-	-	0	0	-
Grade, %	0	-	-	0	0	-
Peak Hour Factor	90	90	90	90	90	90
Heavy Vehicles, %	2	2	2	2	2	2
Mvmt Flow	54	2	32	14	1	70

Major/Minor	Major1	Major2	Minor1
Conflicting Flow All	0	0	57
Stage 1	-	-	56
Stage 2	-	-	79
Critical Hdwy	-	4.12	6.42
Critical Hdwy Stg 1	-	-	5.42
Critical Hdwy Stg 2	-	-	5.42
Follow-up Hdwy	-	2.218	3.518
Pot Cap-1 Maneuver	-	1547	859
Stage 1	-	-	967
Stage 2	-	-	944
Platoon blocked, %	-	-	-
Mov Cap-1 Maneuver	-	1547	841
Mov Cap-2 Maneuver	-	-	841
Stage 1	-	-	967
Stage 2	-	-	924

Approach	EB	WB	NB
HCM Control Delay, s	0	5.1	8.8
HCM LOS			A

Minor Lane/Major Mvmt	NBLn1	EBT	EBR	WBL	WBT
Capacity (veh/h)	1008	-	-	1547	-
HCM Lane V/C Ratio	0.071	-	-	0.021	-
HCM Control Delay (s)	8.8	-	-	7.4	0
HCM Lane LOS	A	-	-	A	A
HCM 95th %tile Q(veh)	0.2	-	-	0.1	-

Intersection

Int Delay, s/veh 4.8

Movement	EBT	EBR	WBL	WBT	NBL	NBR
Lane Configurations						
Traffic Vol, veh/h	31	3	95	60	4	46
Future Vol, veh/h	31	3	95	60	4	46
Conflicting Peds, #/hr	0	0	0	0	0	0
Sign Control	Free	Free	Free	Free	Stop	Stop
RT Channelized	-	None	-	None	-	None
Storage Length	-	-	-	-	0	-
Veh in Median Storage, #	0	-	-	0	0	-
Grade, %	0	-	-	0	0	-
Peak Hour Factor	90	90	90	90	90	90
Heavy Vehicles, %	2	2	2	2	2	2
Mvmt Flow	34	3	106	67	4	51

Major/Minor	Major1	Major2	Minor1
Conflicting Flow All	0	0	38
Stage 1	-	-	-
Stage 2	-	-	-
Critical Hdwy	-	-	4.12
Critical Hdwy Stg 1	-	-	-
Critical Hdwy Stg 2	-	-	-
Follow-up Hdwy	-	-	2.218
Pot Cap-1 Maneuver	-	-	1572
Stage 1	-	-	-
Stage 2	-	-	-
Platoon blocked, %	-	-	-
Mov Cap-1 Maneuver	-	-	1572
Mov Cap-2 Maneuver	-	-	-
Stage 1	-	-	-
Stage 2	-	-	-

Approach	EB	WB	NB
HCM Control Delay, s	0	4.6	8.9
HCM LOS			A

Minor Lane/Major Mvmt	NBLn1	EBT	EBR	WBL	WBT
Capacity (veh/h)	986	-	-	1572	-
HCM Lane V/C Ratio	0.056	-	-	0.067	-
HCM Control Delay (s)	8.9	-	-	7.5	0
HCM Lane LOS	A	-	-	A	A
HCM 95th %tile Q(veh)	0.2	-	-	0.2	-

Intersection

Int Delay, s/veh 8.1

Movement	EBT	EBR	WBL	WBT	NBL	NBR
Lane Configurations	↑			↑	↑	
Traffic Vol, veh/h	0	0	14	0	0	51
Future Vol, veh/h	0	0	14	0	0	51
Conflicting Peds, #/hr	0	0	0	0	0	0
Sign Control	Free	Free	Free	Free	Stop	Stop
RT Channelized	-	None	-	None	-	None
Storage Length	-	-	-	-	0	-
Veh in Median Storage, #	0	-	-	0	0	-
Grade, %	0	-	-	0	0	-
Peak Hour Factor	90	90	90	90	90	90
Heavy Vehicles, %	2	2	2	2	2	2
Mvmt Flow	0	0	16	0	0	57

Major/Minor	Major1	Major2	Minor1
Conflicting Flow All	0	0	1
Stage 1	-	-	-
Stage 2	-	-	-
Critical Hdwy	-	-	4.12
Critical Hdwy Stg 1	-	-	-
Critical Hdwy Stg 2	-	-	-
Follow-up Hdwy	-	-	2.218
Pot Cap-1 Maneuver	-	-	1622
Stage 1	-	-	-
Stage 2	-	-	-
Platoon blocked, %	-	-	-
Mov Cap-1 Maneuver	-	-	1622
Mov Cap-2 Maneuver	-	-	-
Stage 1	-	-	-
Stage 2	-	-	-

Approach	EB	WB	NB
HCM Control Delay, s	0	7.2	8.5
HCM LOS			A

Minor Lane/Major Mvmt	NBLn1	EBT	EBR	WBL	WBT
Capacity (veh/h)	1084	-	-	1622	-
HCM Lane V/C Ratio	0.052	-	-	0.01	-
HCM Control Delay (s)	8.5	-	-	7.2	0
HCM Lane LOS	A	-	-	A	A
HCM 95th %tile Q(veh)	0.2	-	-	0	-

Intersection

Int Delay, s/veh 7.6

Movement	EBT	EBR	WBL	WBT	NBL	NBR
Lane Configurations						
Traffic Vol, veh/h	0	0	64	0	0	34
Future Vol, veh/h	0	0	64	0	0	34
Conflicting Peds, #/hr	0	0	0	0	0	0
Sign Control	Free	Free	Free	Free	Stop	Stop
RT Channelized	-	None	-	None	-	None
Storage Length	-	-	-	-	0	-
Veh in Median Storage, #	0	-	-	0	0	-
Grade, %	0	-	-	0	0	-
Peak Hour Factor	90	90	90	90	90	90
Heavy Vehicles, %	2	2	2	2	2	2
Mvmt Flow	0	0	71	0	0	38

Major/Minor	Major1	Major2	Minor1
Conflicting Flow All	0	0	143
Stage 1	-	-	1
Stage 2	-	-	142
Critical Hdwy	-	4.12	6.42
Critical Hdwy Stg 1	-	-	5.42
Critical Hdwy Stg 2	-	-	5.42
Follow-up Hdwy	-	2.218	3.518
Pot Cap-1 Maneuver	-	1622	850
Stage 1	-	-	1022
Stage 2	-	-	885
Platoon blocked, %	-	-	-
Mov Cap-1 Maneuver	-	1622	813
Mov Cap-2 Maneuver	-	-	813
Stage 1	-	-	1022
Stage 2	-	-	846

Approach	EB	WB	NB
HCM Control Delay, s	0	7.3	8.4
HCM LOS			A

Minor Lane/Major Mvmt	NBLn1	EBT	EBR	WBL	WBT
Capacity (veh/h)	1084	-	-	1622	-
HCM Lane V/C Ratio	0.035	-	-	0.044	-
HCM Control Delay (s)	8.4	-	-	7.3	0
HCM Lane LOS	A	-	-	A	A
HCM 95th %tile Q(veh)	0.1	-	-	0.1	-

Future (2021) Background



Lane Group	EBL	EBT	EBR	WBL	WBT	WBR	NBL	NBT	NBR	SBL	SBT	SBR
Lane Configurations												
Traffic Volume (vph)	239	123	52	43	41	39	26	456	89	7	272	44
Future Volume (vph)	239	123	52	43	41	39	26	456	89	7	272	44
Ideal Flow (vphpl)	1800	1800	1800	1800	1800	1800	1800	1800	1800	1800	1800	1800
Storage Length (m)	80.0		0.0	30.0		0.0	40.0		0.0	15.0		15.0
Storage Lanes	1		0	1		0	1		0	1		1
Taper Length (m)	7.6			7.6			7.6			7.6		
Lane Util. Factor	1.00	1.00	1.00	1.00	1.00	1.00	1.00	1.00	1.00	1.00	1.00	1.00
Frt		0.955			0.927			0.976				0.850
Flt Protected	0.950			0.950			0.950			0.950		
Satd. Flow (prot)	1658	1667	0	1658	1618	0	1658	1703	0	1658	1745	1483
Flt Permitted	0.705			0.647			0.592			0.323		
Satd. Flow (perm)	1230	1667	0	1129	1618	0	1033	1703	0	564	1745	1483
Right Turn on Red			Yes			Yes			Yes			Yes
Satd. Flow (RTOR)		37			39			17				48
Link Speed (k/h)		50			50			50				50
Link Distance (m)		544.6			345.6			287.4				249.0
Travel Time (s)		39.2			24.9			20.7				17.9
Peak Hour Factor	1.00	1.00	1.00	1.00	1.00	1.00	1.00	1.00	1.00	1.00	1.00	1.00
Adj. Flow (vph)	239	123	52	43	41	39	26	456	89	7	272	44
Shared Lane Traffic (%)												
Lane Group Flow (vph)	239	175	0	43	80	0	26	545	0	7	272	44
Turn Type	Perm	NA		Perm	NA		Perm	NA		Perm	NA	Perm
Protected Phases		4			8			2				6
Permitted Phases	4			8			2			6		6
Detector Phase	4	4		8	8		2	2		6	6	6
Switch Phase												
Minimum Initial (s)	10.0	10.0		10.0	10.0		10.0	10.0		10.0	10.0	10.0
Minimum Split (s)	31.1	31.1		31.1	31.1		24.1	24.1		24.1	24.1	24.1
Total Split (s)	35.0	35.0		35.0	35.0		35.0	35.0		35.0	35.0	35.0
Total Split (%)	50.0%	50.0%		50.0%	50.0%		50.0%	50.0%		50.0%	50.0%	50.0%
Maximum Green (s)	28.9	28.9		28.9	28.9		28.9	28.9		28.9	28.9	28.9
Yellow Time (s)	3.3	3.3		3.3	3.3		3.3	3.3		3.3	3.3	3.3
All-Red Time (s)	2.8	2.8		2.8	2.8		2.8	2.8		2.8	2.8	2.8
Lost Time Adjust (s)	0.0	0.0		0.0	0.0		0.0	0.0		0.0	0.0	0.0
Total Lost Time (s)	6.1	6.1		6.1	6.1		6.1	6.1		6.1	6.1	6.1
Lead/Lag												
Lead-Lag Optimize?												
Vehicle Extension (s)	3.0	3.0		3.0	3.0		3.0	3.0		3.0	3.0	3.0
Recall Mode	None	None		None	None		Min	Min		Min	Min	Min
Walk Time (s)	7.0	7.0		7.0	7.0		7.0	7.0		7.0	7.0	7.0
Flash Dont Walk (s)	18.0	18.0		18.0	18.0		11.0	11.0		11.0	11.0	11.0
Pedestrian Calls (#/hr)	0	0		0	0		0	0		0	0	0
Act Effct Green (s)	16.1	16.1		16.1	16.1		20.6	20.6		20.6	20.6	20.6
Actuated g/C Ratio	0.32	0.32		0.32	0.32		0.41	0.41		0.41	0.41	0.41
v/c Ratio	0.60	0.31		0.12	0.15		0.06	0.76		0.03	0.38	0.07
Control Delay	22.5	12.7		14.1	8.8		10.4	20.9		10.4	12.5	3.9
Queue Delay	0.0	0.0		0.0	0.0		0.0	0.0		0.0	0.0	0.0
Total Delay	22.5	12.7		14.1	8.8		10.4	20.9		10.4	12.5	3.9

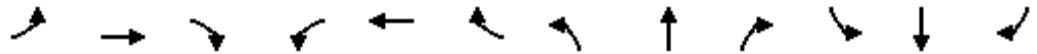

Lane Group	EBL	EBT	EBR	WBL	WBT	WBR	NBL	NBT	NBR	SBL	SBT	SBR
LOS	C	B		B	A		B	C		B	B	A
Approach Delay		18.4			10.7			20.4			11.3	
Approach LOS		B			B			C			B	
Queue Length 50th (m)	15.6	7.9		2.4	2.2		1.1	31.9		0.3	13.4	0.0
Queue Length 95th (m)	37.9	21.5		8.3	9.6		5.3	#81.0		2.3	35.2	4.2
Internal Link Dist (m)		520.6			321.6			263.4			225.0	
Turn Bay Length (m)	80.0			30.0			40.0			15.0		15.0
Base Capacity (vph)	762	1046		699	1017		640	1061		349	1081	937
Starvation Cap Reductn	0	0		0	0		0	0		0	0	0
Spillback Cap Reductn	0	0		0	0		0	0		0	0	0
Storage Cap Reductn	0	0		0	0		0	0		0	0	0
Reduced v/c Ratio	0.31	0.17		0.06	0.08		0.04	0.51		0.02	0.25	0.05

Intersection Summary

Area Type: Other
 Cycle Length: 70
 Actuated Cycle Length: 49.7
 Natural Cycle: 60
 Control Type: Actuated-Uncoordinated
 Maximum v/c Ratio: 0.76
 Intersection Signal Delay: 16.9
 Intersection LOS: B
 Intersection Capacity Utilization 68.6%
 ICU Level of Service C
 Analysis Period (min) 15
 # 95th percentile volume exceeds capacity, queue may be longer.
 Queue shown is maximum after two cycles.

Splits and Phases: 1: Huntmar Drive & Maple Grove Road

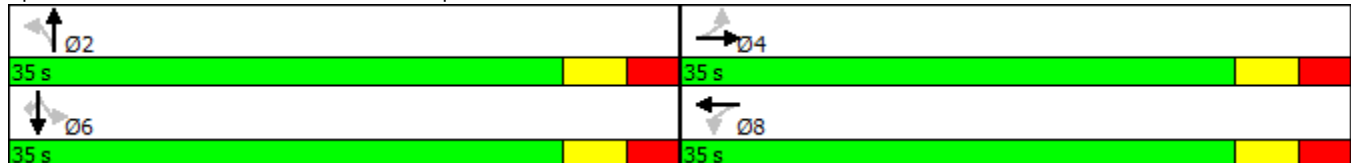



Lane Group	EBL	EBT	EBR	WBL	WBT	WBR	NBL	NBT	NBR	SBL	SBT	SBR
Lane Configurations												
Traffic Volume (vph)	97	93	68	140	161	52	99	479	106	58	692	216
Future Volume (vph)	97	93	68	140	161	52	99	479	106	58	692	216
Ideal Flow (vphpl)	1800	1800	1800	1800	1800	1800	1800	1800	1800	1800	1800	1800
Storage Length (m)	80.0		0.0	30.0		0.0	40.0		0.0	15.0		15.0
Storage Lanes	1		0	1		0	1		0	1		1
Taper Length (m)	7.6			7.6			7.6			7.6		
Lane Util. Factor	1.00	1.00	1.00	1.00	1.00	1.00	1.00	1.00	1.00	1.00	1.00	1.00
Frt		0.937			0.963			0.973				0.850
Flt Protected	0.950			0.950			0.950			0.950		
Satd. Flow (prot)	1658	1635	0	1658	1681	0	1658	1698	0	1658	1745	1483
Flt Permitted	0.625			0.655			0.254			0.342		
Satd. Flow (perm)	1091	1635	0	1143	1681	0	443	1698	0	597	1745	1483
Right Turn on Red			Yes			Yes			Yes			Yes
Satd. Flow (RTOR)		58			26			21				95
Link Speed (k/h)		50			50			50				50
Link Distance (m)		544.6			345.6			287.4				249.0
Travel Time (s)		39.2			24.9			20.7				17.9
Peak Hour Factor	1.00	1.00	1.00	1.00	1.00	1.00	1.00	1.00	1.00	1.00	1.00	1.00
Adj. Flow (vph)	97	93	68	140	161	52	99	479	106	58	692	216
Shared Lane Traffic (%)												
Lane Group Flow (vph)	97	161	0	140	213	0	99	585	0	58	692	216
Turn Type	Perm	NA		Perm	NA		Perm	NA		Perm	NA	Perm
Protected Phases		4			8			2				6
Permitted Phases	4			8			2			6		6
Detector Phase	4	4		8	8		2	2		6	6	6
Switch Phase												
Minimum Initial (s)	10.0	10.0		10.0	10.0		10.0	10.0		10.0	10.0	10.0
Minimum Split (s)	31.1	31.1		31.1	31.1		24.1	24.1		24.1	24.1	24.1
Total Split (s)	31.1	31.1		31.1	31.1		38.9	38.9		38.9	38.9	38.9
Total Split (%)	44.4%	44.4%		44.4%	44.4%		55.6%	55.6%		55.6%	55.6%	55.6%
Maximum Green (s)	25.0	25.0		25.0	25.0		32.8	32.8		32.8	32.8	32.8
Yellow Time (s)	3.3	3.3		3.3	3.3		3.3	3.3		3.3	3.3	3.3
All-Red Time (s)	2.8	2.8		2.8	2.8		2.8	2.8		2.8	2.8	2.8
Lost Time Adjust (s)	0.0	0.0		0.0	0.0		0.0	0.0		0.0	0.0	0.0
Total Lost Time (s)	6.1	6.1		6.1	6.1		6.1	6.1		6.1	6.1	6.1
Lead/Lag												
Lead-Lag Optimize?												
Vehicle Extension (s)	3.0	3.0		3.0	3.0		3.0	3.0		3.0	3.0	3.0
Recall Mode	None	None		None	None		Min	Min		Min	Min	Min
Walk Time (s)	7.0	7.0		7.0	7.0		7.0	7.0		7.0	7.0	7.0
Flash Dont Walk (s)	18.0	18.0		18.0	18.0		11.0	11.0		11.0	11.0	11.0
Pedestrian Calls (#/hr)	0	0		0	0		0	0		0	0	0
Act Effect Green (s)	13.1	13.1		13.1	13.1		26.4	26.4		26.4	26.4	26.4
Actuated g/C Ratio	0.25	0.25		0.25	0.25		0.51	0.51		0.51	0.51	0.51
v/c Ratio	0.35	0.35		0.49	0.48		0.44	0.67		0.19	0.78	0.27
Control Delay	21.8	14.4		24.8	19.9		16.5	14.2		9.5	18.9	5.5
Queue Delay	0.0	0.0		0.0	0.0		0.0	0.0		0.0	0.0	0.0
Total Delay	21.8	14.4		24.8	19.9		16.5	14.2		9.5	18.9	5.5



Lane Group	EBL	EBT	EBR	WBL	WBT	WBR	NBL	NBT	NBR	SBL	SBT	SBR
LOS	C	B		C	B		B	B		A	B	A
Approach Delay		17.2			21.8			14.5			15.4	
Approach LOS		B			C			B			B	
Queue Length 50th (m)	7.3	7.6		11.0	14.5		4.5	30.4		2.3	40.8	4.7
Queue Length 95th (m)	18.1	20.1		25.2	31.0		18.2	72.7		8.9	#103.7	16.0
Internal Link Dist (m)		520.6			321.6			263.4			225.0	
Turn Bay Length (m)	80.0			30.0			40.0			15.0		15.0
Base Capacity (vph)	541	840		567	847		302	1166		407	1191	1042
Starvation Cap Reductn	0	0		0	0		0	0		0	0	0
Spillback Cap Reductn	0	0		0	0		0	0		0	0	0
Storage Cap Reductn	0	0		0	0		0	0		0	0	0
Reduced v/c Ratio	0.18	0.19		0.25	0.25		0.33	0.50		0.14	0.58	0.21

Intersection Summary

Area Type: Other
 Cycle Length: 70
 Actuated Cycle Length: 52.2
 Natural Cycle: 70
 Control Type: Actuated-Uncoordinated
 Maximum v/c Ratio: 0.78
 Intersection Signal Delay: 16.3
 Intersection LOS: B
 Intersection Capacity Utilization 87.7%
 ICU Level of Service E
 Analysis Period (min) 15
 # 95th percentile volume exceeds capacity, queue may be longer.
 Queue shown is maximum after two cycles.

Splits and Phases: 1: Huntmar Drive & Maple Grove Road



Intersection

Int Delay, s/veh 4.3

Movement	EBT	EBR	WBL	WBT	NBL	NBR
Lane Configurations	↑			↑	↑	
Traffic Vol, veh/h	70	4	29	17	2	63
Future Vol, veh/h	70	4	29	17	2	63
Conflicting Peds, #/hr	0	0	0	0	0	0
Sign Control	Free	Free	Free	Free	Stop	Stop
RT Channelized	-	None	-	None	-	None
Storage Length	-	-	-	-	0	-
Veh in Median Storage, #	0	-	-	0	0	-
Grade, %	0	-	-	0	0	-
Peak Hour Factor	100	100	100	100	100	100
Heavy Vehicles, %	2	2	2	2	2	2
Mvmt Flow	70	4	29	17	2	63

Major/Minor	Major1	Major2	Minor1
Conflicting Flow All	0	0	74
Stage 1	-	-	72
Stage 2	-	-	75
Critical Hdwy	-	-	4.12
Critical Hdwy Stg 1	-	-	5.42
Critical Hdwy Stg 2	-	-	5.42
Follow-up Hdwy	-	-	2.218
Pot Cap-1 Maneuver	-	-	1526
Stage 1	-	-	951
Stage 2	-	-	948
Platoon blocked, %	-	-	-
Mov Cap-1 Maneuver	-	-	1526
Mov Cap-2 Maneuver	-	-	-
Stage 1	-	-	951
Stage 2	-	-	930

Approach	EB	WB	NB
HCM Control Delay, s	0	4.7	8.9
HCM LOS			A

Minor Lane/Major Mvmt	NBLn1	EBT	EBR	WBL	WBT
Capacity (veh/h)	984	-	-	1526	-
HCM Lane V/C Ratio	0.066	-	-	0.019	-
HCM Control Delay (s)	8.9	-	-	7.4	0
HCM Lane LOS	A	-	-	A	A
HCM 95th %tile Q(veh)	0.2	-	-	0.1	-

Intersection

Int Delay, s/veh 4.3

Movement	EBT	EBR	WBL	WBT	NBL	NBR
Lane Configurations						
Traffic Vol, veh/h	42	4	95	82	7	46
Future Vol, veh/h	42	4	95	82	7	46
Conflicting Peds, #/hr	0	0	0	0	0	0
Sign Control	Free	Free	Free	Free	Stop	Stop
RT Channelized	-	None	-	None	-	None
Storage Length	-	-	-	-	0	-
Veh in Median Storage, #	0	-	-	0	0	-
Grade, %	0	-	-	0	0	-
Peak Hour Factor	100	100	100	100	100	100
Heavy Vehicles, %	2	2	2	2	2	2
Mvmt Flow	42	4	95	82	7	46

Major/Minor	Major1	Major2	Minor1
Conflicting Flow All	0	0	46
Stage 1	-	-	-
Stage 2	-	-	-
Critical Hdwy	-	-	4.12
Critical Hdwy Stg 1	-	-	-
Critical Hdwy Stg 2	-	-	-
Follow-up Hdwy	-	-	2.218
Pot Cap-1 Maneuver	-	-	1562
Stage 1	-	-	-
Stage 2	-	-	-
Platoon blocked, %	-	-	-
Mov Cap-1 Maneuver	-	-	1562
Mov Cap-2 Maneuver	-	-	-
Stage 1	-	-	-
Stage 2	-	-	-

Approach	EB	WB	NB
HCM Control Delay, s	0	4	9.1
HCM LOS			A

Minor Lane/Major Mvmt	NBLn1	EBT	EBR	WBL	WBT
Capacity (veh/h)	940	-	-	1562	-
HCM Lane V/C Ratio	0.056	-	-	0.061	-
HCM Control Delay (s)	9.1	-	-	7.5	0
HCM Lane LOS	A	-	-	A	A
HCM 95th %tile Q(veh)	0.2	-	-	0.2	-

Intersection

Int Delay, s/veh 8.1

Movement	EBT	EBR	WBL	WBT	NBL	NBR
Lane Configurations	↑			↑	↑	
Traffic Vol, veh/h	0	0	15	0	0	51
Future Vol, veh/h	0	0	15	0	0	51
Conflicting Peds, #/hr	0	0	0	0	0	0
Sign Control	Free	Free	Free	Free	Stop	Stop
RT Channelized	-	None	-	None	-	None
Storage Length	-	-	-	-	0	-
Veh in Median Storage, #	0	-	-	0	0	-
Grade, %	0	-	-	0	0	-
Peak Hour Factor	100	100	100	100	100	100
Heavy Vehicles, %	2	2	2	2	2	2
Mvmt Flow	0	0	15	0	0	51

Major/Minor	Major1	Major2	Minor1			
Conflicting Flow All	0	0	1	0	31	1
Stage 1	-	-	-	-	1	-
Stage 2	-	-	-	-	30	-
Critical Hdwy	-	-	4.12	-	6.42	6.22
Critical Hdwy Stg 1	-	-	-	-	5.42	-
Critical Hdwy Stg 2	-	-	-	-	5.42	-
Follow-up Hdwy	-	-	2.218	-	3.518	3.318
Pot Cap-1 Maneuver	-	-	1622	-	983	1084
Stage 1	-	-	-	-	1022	-
Stage 2	-	-	-	-	993	-
Platoon blocked, %	-	-	-	-	-	-
Mov Cap-1 Maneuver	-	-	1622	-	974	1084
Mov Cap-2 Maneuver	-	-	-	-	974	-
Stage 1	-	-	-	-	1022	-
Stage 2	-	-	-	-	984	-

Approach	EB	WB	NB
HCM Control Delay, s	0	7.2	8.5
HCM LOS			A

Minor Lane/Major Mvmt	NBLn1	EBT	EBR	WBL	WBT
Capacity (veh/h)	1084	-	-	1622	-
HCM Lane V/C Ratio	0.047	-	-	0.009	-
HCM Control Delay (s)	8.5	-	-	7.2	0
HCM Lane LOS	A	-	-	A	A
HCM 95th %tile Q(veh)	0.1	-	-	0	-

Intersection

Int Delay, s/veh 7.6

Movement	EBT	EBR	WBL	WBT	NBL	NBR
Lane Configurations						
Traffic Vol, veh/h	0	0	65	0	0	35
Future Vol, veh/h	0	0	65	0	0	35
Conflicting Peds, #/hr	0	0	0	0	0	0
Sign Control	Free	Free	Free	Free	Stop	Stop
RT Channelized	-	None	-	None	-	None
Storage Length	-	-	-	-	0	-
Veh in Median Storage, #	0	-	-	0	0	-
Grade, %	0	-	-	0	0	-
Peak Hour Factor	100	100	100	100	100	100
Heavy Vehicles, %	2	2	2	2	2	2
Mvmt Flow	0	0	65	0	0	35

Major/Minor	Major1	Major2	Minor1
Conflicting Flow All	0	0	131
Stage 1	-	-	1
Stage 2	-	-	130
Critical Hdwy	-	4.12	6.42
Critical Hdwy Stg 1	-	-	5.42
Critical Hdwy Stg 2	-	-	5.42
Follow-up Hdwy	-	2.218	3.518
Pot Cap-1 Maneuver	-	1622	863
Stage 1	-	-	1022
Stage 2	-	-	896
Platoon blocked, %	-	-	-
Mov Cap-1 Maneuver	-	1622	828
Mov Cap-2 Maneuver	-	-	828
Stage 1	-	-	1022
Stage 2	-	-	860

Approach	EB	WB	NB
HCM Control Delay, s	0	7.3	8.4
HCM LOS			A

Minor Lane/Major Mvmt	NBLn1	EBT	EBR	WBL	WBT
Capacity (veh/h)	1084	-	-	1622	-
HCM Lane V/C Ratio	0.032	-	-	0.04	-
HCM Control Delay (s)	8.4	-	-	7.3	0
HCM Lane LOS	A	-	-	A	A
HCM 95th %tile Q(veh)	0.1	-	-	0.1	-

Future (2026) Background



Lane Group	EBL	EBT	EBR	WBL	WBT	WBR	NBL	NBT	NBR	SBL	SBT	SBR
Lane Configurations												
Traffic Volume (vph)	315	170	69	47	57	41	31	498	97	7	297	62
Future Volume (vph)	315	170	69	47	57	41	31	498	97	7	297	62
Ideal Flow (vphpl)	1800	1800	1800	1800	1800	1800	1800	1800	1800	1800	1800	1800
Storage Length (m)	80.0		0.0	30.0		0.0	40.0		0.0	15.0		15.0
Storage Lanes	1		0	1		0	1		0	1		1
Taper Length (m)	7.6			7.6			7.6			7.6		
Lane Util. Factor	1.00	1.00	1.00	1.00	1.00	1.00	1.00	1.00	1.00	1.00	1.00	1.00
Fr _t		0.957			0.937			0.976				0.850
Fl _t Protected	0.950			0.950			0.950			0.950		
Satd. Flow (prot)	1658	1670	0	1658	1635	0	1658	1703	0	1658	1745	1483
Fl _t Permitted	0.694			0.610			0.579			0.252		
Satd. Flow (perm)	1211	1670	0	1065	1635	0	1010	1703	0	440	1745	1483
Right Turn on Red			Yes			Yes			Yes			Yes
Satd. Flow (RTOR)		42			41			19				62
Link Speed (k/h)		50			50			50				50
Link Distance (m)		544.6			345.6			287.4				249.0
Travel Time (s)		39.2			24.9			20.7				17.9
Peak Hour Factor	1.00	1.00	1.00	1.00	1.00	1.00	1.00	1.00	1.00	1.00	1.00	1.00
Adj. Flow (vph)	315	170	69	47	57	41	31	498	97	7	297	62
Shared Lane Traffic (%)												
Lane Group Flow (vph)	315	239	0	47	98	0	31	595	0	7	297	62
Turn Type	Perm	NA		Perm	NA		Perm	NA		Perm	NA	Perm
Protected Phases		4			8			2				6
Permitted Phases	4			8			2			6		6
Detector Phase	4	4		8	8		2	2		6	6	6
Switch Phase												
Minimum Initial (s)	10.0	10.0		10.0	10.0		10.0	10.0		10.0	10.0	10.0
Minimum Split (s)	31.1	31.1		31.1	31.1		24.1	24.1		24.1	24.1	24.1
Total Split (s)	31.2	31.2		31.2	31.2		28.8	28.8		28.8	28.8	28.8
Total Split (%)	52.0%	52.0%		52.0%	52.0%		48.0%	48.0%		48.0%	48.0%	48.0%
Maximum Green (s)	25.1	25.1		25.1	25.1		22.7	22.7		22.7	22.7	22.7
Yellow Time (s)	3.3	3.3		3.3	3.3		3.3	3.3		3.3	3.3	3.3
All-Red Time (s)	2.8	2.8		2.8	2.8		2.8	2.8		2.8	2.8	2.8
Lost Time Adjust (s)	0.0	0.0		0.0	0.0		0.0	0.0		0.0	0.0	0.0
Total Lost Time (s)	6.1	6.1		6.1	6.1		6.1	6.1		6.1	6.1	6.1
Lead/Lag												
Lead-Lag Optimize?												
Vehicle Extension (s)	3.0	3.0		3.0	3.0		3.0	3.0		3.0	3.0	3.0
Recall Mode	None	None		None	None		Min	Min		Min	Min	Min
Walk Time (s)	7.0	7.0		7.0	7.0		7.0	7.0		7.0	7.0	7.0
Flash Dont Walk (s)	18.0	18.0		18.0	18.0		11.0	11.0		11.0	11.0	11.0
Pedestrian Calls (#/hr)	0	0		0	0		0	0		0	0	0
Act Effct Green (s)	18.4	18.4		18.4	18.4		21.1	21.1		21.1	21.1	21.1
Actuated g/C Ratio	0.35	0.35		0.35	0.35		0.40	0.40		0.40	0.40	0.40
v/c Ratio	0.74	0.39		0.12	0.16		0.08	0.85		0.04	0.42	0.10
Control Delay	26.2	12.2		12.0	8.0		12.2	30.0		12.4	14.7	4.4
Queue Delay	0.0	0.0		0.0	0.0		0.0	0.0		0.0	0.0	0.0
Total Delay	26.2	12.2		12.0	8.0		12.2	30.0		12.4	14.7	4.4

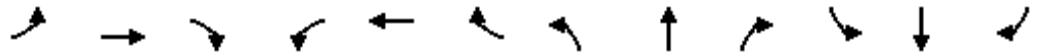

Lane Group	EBL	EBT	EBR	WBL	WBT	WBR	NBL	NBT	NBR	SBL	SBT	SBR
LOS	C	B		B	A		B	C		B	B	A
Approach Delay		20.1			9.3			29.1			12.9	
Approach LOS		C			A			C			B	
Queue Length 50th (m)	23.9	12.6		2.8	3.3		1.6	44.1		0.4	18.0	0.0
Queue Length 95th (m)	45.8	25.1		7.7	10.1		6.2	#106.0		2.5	38.7	5.4
Internal Link Dist (m)		520.6			321.6			263.4			225.0	
Turn Bay Length (m)	80.0			30.0			40.0			15.0		15.0
Base Capacity (vph)	601	850		528	832		453	775		197	783	700
Starvation Cap Reductn	0	0		0	0		0	0		0	0	0
Spillback Cap Reductn	0	0		0	0		0	0		0	0	0
Storage Cap Reductn	0	0		0	0		0	0		0	0	0
Reduced v/c Ratio	0.52	0.28		0.09	0.12		0.07	0.77		0.04	0.38	0.09

Intersection Summary

Area Type: Other
 Cycle Length: 60
 Actuated Cycle Length: 52.1
 Natural Cycle: 60
 Control Type: Actuated-Uncoordinated
 Maximum v/c Ratio: 0.85
 Intersection Signal Delay: 21.0 Intersection LOS: C
 Intersection Capacity Utilization 75.9% ICU Level of Service D
 Analysis Period (min) 15
 # 95th percentile volume exceeds capacity, queue may be longer.
 Queue shown is maximum after two cycles.

Splits and Phases: 1: Huntmar Drive & Maple Grove Road

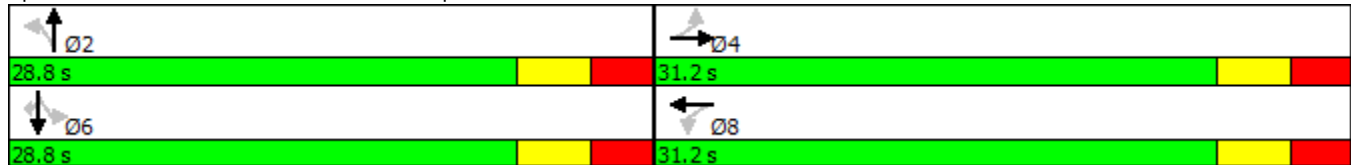

1: Huntmar Drive & Maple Grove Road

PM Peak Hour



Lane Group	EBL	EBT	EBR	WBL	WBT	WBR	NBL	NBT	NBR	SBL	SBT	SBR
Lane Configurations												
Traffic Volume (vph)	137	122	82	153	214	55	121	522	116	62	755	294
Future Volume (vph)	137	122	82	153	214	55	121	522	116	62	755	294
Ideal Flow (vphpl)	1800	1800	1800	1800	1800	1800	1800	1800	1800	1800	1800	1800
Storage Length (m)	80.0		0.0	30.0		0.0	40.0		0.0	15.0		15.0
Storage Lanes	1		0	1		0	1		0	1		1
Taper Length (m)	7.6			7.6			7.6			7.6		
Lane Util. Factor	1.00	1.00	1.00	1.00	1.00	1.00	1.00	1.00	1.00	1.00	1.00	1.00
Fr _t		0.940			0.969			0.973				0.850
Fl _t Protected	0.950			0.950			0.950			0.950		
Satd. Flow (prot)	1658	1640	0	1658	1691	0	1658	1698	0	1658	1745	1483
Fl _t Permitted	0.531			0.630			0.212			0.300		
Satd. Flow (perm)	927	1640	0	1099	1691	0	370	1698	0	524	1745	1483
Right Turn on Red			Yes			Yes			Yes			Yes
Satd. Flow (RTOR)		48			19			22				118
Link Speed (k/h)		50			50			50				50
Link Distance (m)		544.6			345.6			287.4				249.0
Travel Time (s)		39.2			24.9			20.7				17.9
Peak Hour Factor	1.00	1.00	1.00	1.00	1.00	1.00	1.00	1.00	1.00	1.00	1.00	1.00
Adj. Flow (vph)	137	122	82	153	214	55	121	522	116	62	755	294
Shared Lane Traffic (%)												
Lane Group Flow (vph)	137	204	0	153	269	0	121	638	0	62	755	294
Turn Type	Perm	NA		Perm	NA		Perm	NA		Perm	NA	Perm
Protected Phases		4			8			2				6
Permitted Phases	4			8			2			6		6
Detector Phase	4	4		8	8		2	2		6	6	6
Switch Phase												
Minimum Initial (s)	10.0	10.0		10.0	10.0		10.0	10.0		10.0	10.0	10.0
Minimum Split (s)	31.1	31.1		31.1	31.1		24.1	24.1		24.1	24.1	24.1
Total Split (s)	31.1	31.1		31.1	31.1		43.9	43.9		43.9	43.9	43.9
Total Split (%)	41.5%	41.5%		41.5%	41.5%		58.5%	58.5%		58.5%	58.5%	58.5%
Maximum Green (s)	25.0	25.0		25.0	25.0		37.8	37.8		37.8	37.8	37.8
Yellow Time (s)	3.3	3.3		3.3	3.3		3.3	3.3		3.3	3.3	3.3
All-Red Time (s)	2.8	2.8		2.8	2.8		2.8	2.8		2.8	2.8	2.8
Lost Time Adjust (s)	0.0	0.0		0.0	0.0		0.0	0.0		0.0	0.0	0.0
Total Lost Time (s)	6.1	6.1		6.1	6.1		6.1	6.1		6.1	6.1	6.1
Lead/Lag												
Lead-Lag Optimize?												
Vehicle Extension (s)	3.0	3.0		3.0	3.0		3.0	3.0		3.0	3.0	3.0
Recall Mode	None	None		None	None		Min	Min		Min	Min	Min
Walk Time (s)	7.0	7.0		7.0	7.0		7.0	7.0		7.0	7.0	7.0
Flash Dont Walk (s)	18.0	18.0		18.0	18.0		11.0	11.0		11.0	11.0	11.0
Pedestrian Calls (#/hr)	0	0		0	0		0	0		0	0	0
Act Effect Green (s)	15.6	15.6		15.6	15.6		31.9	31.9		31.9	31.9	31.9
Actuated g/C Ratio	0.26	0.26		0.26	0.26		0.53	0.53		0.53	0.53	0.53
v/c Ratio	0.57	0.44		0.54	0.60		0.62	0.70		0.22	0.82	0.35
Control Delay	31.4	18.6		28.5	25.2		29.3	16.0		11.2	22.0	6.6
Queue Delay	0.0	0.0		0.0	0.0		0.0	0.0		0.0	0.0	0.0
Total Delay	31.4	18.6		28.5	25.2		29.3	16.0		11.2	22.0	6.6



Lane Group	EBL	EBT	EBR	WBL	WBT	WBR	NBL	NBT	NBR	SBL	SBT	SBR
LOS	C	B		C	C		C	B		B	C	A
Approach Delay		23.7			26.4			18.2			17.3	
Approach LOS		C			C			B			B	
Queue Length 50th (m)	13.8	14.8		15.2	25.2		7.3	39.7		2.9	54.3	8.1
Queue Length 95th (m)	28.2	29.5		29.9	43.9		#35.2	95.8		11.2	#143.7	25.9
Internal Link Dist (m)		520.6			321.6			263.4			225.0	
Turn Bay Length (m)	80.0			30.0			40.0			15.0		15.0
Base Capacity (vph)	401	737		475	743		242	1119		343	1142	1011
Starvation Cap Reductn	0	0		0	0		0	0		0	0	0
Spillback Cap Reductn	0	0		0	0		0	0		0	0	0
Storage Cap Reductn	0	0		0	0		0	0		0	0	0
Reduced v/c Ratio	0.34	0.28		0.32	0.36		0.50	0.57		0.18	0.66	0.29

Intersection Summary

Area Type: Other
 Cycle Length: 75
 Actuated Cycle Length: 60.3
 Natural Cycle: 75
 Control Type: Actuated-Uncoordinated
 Maximum v/c Ratio: 0.82
 Intersection Signal Delay: 19.8
 Intersection LOS: B
 Intersection Capacity Utilization 94.4%
 ICU Level of Service F
 Analysis Period (min) 15
 # 95th percentile volume exceeds capacity, queue may be longer.
 Queue shown is maximum after two cycles.

Splits and Phases: 1: Huntmar Drive & Maple Grove Road

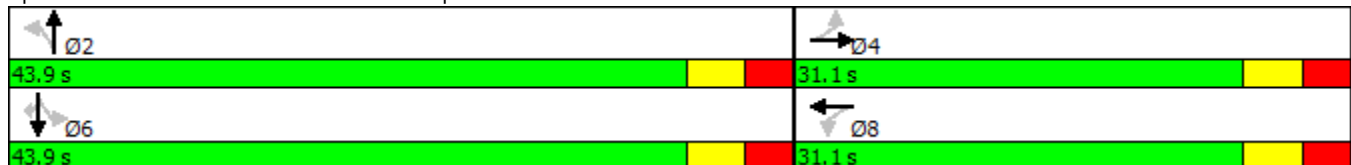

Intersection

Int Delay, s/veh 2.7

Movement	EBT	EBR	WBL	WBT	NBL	NBR
Lane Configurations	↑			↑	↑	
Traffic Vol, veh/h	173	17	29	43	5	63
Future Vol, veh/h	173	17	29	43	5	63
Conflicting Peds, #/hr	0	0	0	0	0	0
Sign Control	Free	Free	Free	Free	Stop	Stop
RT Channelized	-	None	-	None	-	None
Storage Length	-	-	-	-	0	-
Veh in Median Storage, #	0	-	-	0	0	-
Grade, %	0	-	-	0	0	-
Peak Hour Factor	100	100	100	100	100	100
Heavy Vehicles, %	2	2	2	2	2	2
Mvmt Flow	173	17	29	43	5	63

Major/Minor	Major1	Major2	Minor1
Conflicting Flow All	0	0	190
Stage 1	-	-	-
Stage 2	-	-	-
Critical Hdwy	-	-	4.12
Critical Hdwy Stg 1	-	-	-
Critical Hdwy Stg 2	-	-	-
Follow-up Hdwy	-	-	2.218
Pot Cap-1 Maneuver	-	-	1384
Stage 1	-	-	-
Stage 2	-	-	-
Platoon blocked, %	-	-	-
Mov Cap-1 Maneuver	-	-	1384
Mov Cap-2 Maneuver	-	-	-
Stage 1	-	-	-
Stage 2	-	-	-

Approach	EB	WB	NB
HCM Control Delay, s	0	3.1	9.6
HCM LOS			A

Minor Lane/Major Mvmt	NBLn1	EBT	EBR	WBL	WBT
Capacity (veh/h)	846	-	-	1384	-
HCM Lane V/C Ratio	0.08	-	-	0.021	-
HCM Control Delay (s)	9.6	-	-	7.7	0
HCM Lane LOS	A	-	-	A	A
HCM 95th %tile Q(veh)	0.3	-	-	0.1	-

Intersection

Int Delay, s/veh 3

Movement	EBT	EBR	WBL	WBT	NBL	NBR
Lane Configurations	↑			↑	↑	
Traffic Vol, veh/h	101	11	95	192	19	46
Future Vol, veh/h	101	11	95	192	19	46
Conflicting Peds, #/hr	0	0	0	0	0	0
Sign Control	Free	Free	Free	Free	Stop	Stop
RT Channelized	-	None	-	None	-	None
Storage Length	-	-	-	-	0	-
Veh in Median Storage, #	0	-	-	0	0	-
Grade, %	0	-	-	0	0	-
Peak Hour Factor	100	100	100	100	100	100
Heavy Vehicles, %	2	2	2	2	2	2
Mvmt Flow	101	11	95	192	19	46

Major/Minor	Major1	Major2	Minor1
Conflicting Flow All	0	0	112
Stage 1	-	-	-
Stage 2	-	-	-
Critical Hdwy	-	-	4.12
Critical Hdwy Stg 1	-	-	-
Critical Hdwy Stg 2	-	-	-
Follow-up Hdwy	-	-	2.218
Pot Cap-1 Maneuver	-	-	1478
Stage 1	-	-	-
Stage 2	-	-	-
Platoon blocked, %	-	-	-
Mov Cap-1 Maneuver	-	-	1478
Mov Cap-2 Maneuver	-	-	-
Stage 1	-	-	-
Stage 2	-	-	-

Approach	EB	WB	NB
HCM Control Delay, s	0	2.5	10.3
HCM LOS			B

Minor Lane/Major Mvmt	NBLn1	EBT	EBR	WBL	WBT
Capacity (veh/h)	750	-	-	1478	-
HCM Lane V/C Ratio	0.087	-	-	0.064	-
HCM Control Delay (s)	10.3	-	-	7.6	0
HCM Lane LOS	B	-	-	A	A
HCM 95th %tile Q(veh)	0.3	-	-	0.2	-

Intersection

Int Delay, s/veh 8

Movement	EBT	EBR	WBL	WBT	NBL	NBR
Lane Configurations	↑			↑	↑	
Traffic Vol, veh/h	0	0	21	0	0	53
Future Vol, veh/h	0	0	21	0	0	53
Conflicting Peds, #/hr	0	0	0	0	0	0
Sign Control	Free	Free	Free	Free	Stop	Stop
RT Channelized	-	None	-	None	-	None
Storage Length	-	-	-	-	0	-
Veh in Median Storage, #	0	-	-	0	0	-
Grade, %	0	-	-	0	0	-
Peak Hour Factor	100	100	100	100	100	100
Heavy Vehicles, %	2	2	2	2	2	2
Mvmt Flow	0	0	21	0	0	53

Major/Minor	Major1	Major2	Minor1
Conflicting Flow All	0	0	43
Stage 1	-	-	1
Stage 2	-	-	42
Critical Hdwy	-	4.12	6.42
Critical Hdwy Stg 1	-	-	5.42
Critical Hdwy Stg 2	-	-	5.42
Follow-up Hdwy	-	2.218	3.518
Pot Cap-1 Maneuver	-	1622	968
Stage 1	-	-	1022
Stage 2	-	-	980
Platoon blocked, %	-	-	-
Mov Cap-1 Maneuver	-	1622	955
Mov Cap-2 Maneuver	-	-	955
Stage 1	-	-	1022
Stage 2	-	-	967

Approach	EB	WB	NB
HCM Control Delay, s	0	7.2	8.5
HCM LOS			A

Minor Lane/Major Mvmt	NBLn1	EBT	EBR	WBL	WBT
Capacity (veh/h)	1084	-	-	1622	-
HCM Lane V/C Ratio	0.049	-	-	0.013	-
HCM Control Delay (s)	8.5	-	-	7.2	0
HCM Lane LOS	A	-	-	A	A
HCM 95th %tile Q(veh)	0.2	-	-	0	-

Intersection

Int Delay, s/veh 7.7

Movement	EBT	EBR	WBL	WBT	NBL	NBR
Lane Configurations	↑			↑	↑	
Traffic Vol, veh/h	0	0	68	0	0	42
Future Vol, veh/h	0	0	68	0	0	42
Conflicting Peds, #/hr	0	0	0	0	0	0
Sign Control	Free	Free	Free	Free	Stop	Stop
RT Channelized	-	None	-	None	-	None
Storage Length	-	-	-	-	0	-
Veh in Median Storage, #	0	-	-	0	0	-
Grade, %	0	-	-	0	0	-
Peak Hour Factor	100	100	100	100	100	100
Heavy Vehicles, %	2	2	2	2	2	2
Mvmt Flow	0	0	68	0	0	42

Major/Minor	Major1	Major2	Minor1
Conflicting Flow All	0	0	137
Stage 1	-	-	1
Stage 2	-	-	136
Critical Hdwy	-	4.12	6.42
Critical Hdwy Stg 1	-	-	5.42
Critical Hdwy Stg 2	-	-	5.42
Follow-up Hdwy	-	2.218	3.518
Pot Cap-1 Maneuver	-	1622	856
Stage 1	-	-	1022
Stage 2	-	-	890
Platoon blocked, %	-	-	-
Mov Cap-1 Maneuver	-	1622	820
Mov Cap-2 Maneuver	-	-	820
Stage 1	-	-	1022
Stage 2	-	-	853

Approach	EB	WB	NB
HCM Control Delay, s	0	7.3	8.5
HCM LOS			A

Minor Lane/Major Mvmt	NBLn1	EBT	EBR	WBL	WBT
Capacity (veh/h)	1084	-	-	1622	-
HCM Lane V/C Ratio	0.039	-	-	0.042	-
HCM Control Delay (s)	8.5	-	-	7.3	0
HCM Lane LOS	A	-	-	A	A
HCM 95th %tile Q(veh)	0.1	-	-	0.1	-

Future (2021) Background Plus
Site Generated

1: Huntmar Drive & Maple Grove Road

AM Peak Hour



Lane Group	EBL	EBT	EBR	WBL	WBT	WBR	NBL	NBT	NBR	SBL	SBT	SBR
Lane Configurations												
Traffic Volume (vph)	319	179	54	43	60	39	27	456	89	7	272	71
Future Volume (vph)	319	179	54	43	60	39	27	456	89	7	272	71
Ideal Flow (vphpl)	1800	1800	1800	1800	1800	1800	1800	1800	1800	1800	1800	1800
Storage Length (m)	80.0		0.0	30.0		0.0	40.0		0.0	15.0		15.0
Storage Lanes	1		0	1		0	1		0	1		1
Taper Length (m)	7.6			7.6			7.6			7.6		
Lane Util. Factor	1.00	1.00	1.00	1.00	1.00	1.00	1.00	1.00	1.00	1.00	1.00	1.00
Frt		0.965			0.941			0.976				0.850
Flt Protected	0.950			0.950			0.950			0.950		
Satd. Flow (prot)	1658	1684	0	1658	1642	0	1658	1703	0	1658	1745	1483
Flt Permitted	0.693			0.613			0.592			0.291		
Satd. Flow (perm)	1209	1684	0	1070	1642	0	1033	1703	0	508	1745	1483
Right Turn on Red			Yes			Yes			Yes			Yes
Satd. Flow (RTOR)		31			39			19				71
Link Speed (k/h)		50			50			50				50
Link Distance (m)		544.6			345.6			287.4				249.0
Travel Time (s)		39.2			24.9			20.7				17.9
Peak Hour Factor	1.00	1.00	1.00	1.00	1.00	1.00	1.00	1.00	1.00	1.00	1.00	1.00
Adj. Flow (vph)	319	179	54	43	60	39	27	456	89	7	272	71
Shared Lane Traffic (%)												
Lane Group Flow (vph)	319	233	0	43	99	0	27	545	0	7	272	71
Turn Type	Perm	NA		Perm	NA		Perm	NA		Perm	NA	Perm
Protected Phases		4			8			2			6	
Permitted Phases	4			8			2			6		6
Detector Phase	4	4		8	8		2	2		6	6	6
Switch Phase												
Minimum Initial (s)	10.0	10.0		10.0	10.0		10.0	10.0		10.0	10.0	10.0
Minimum Split (s)	31.1	31.1		31.1	31.1		24.1	24.1		24.1	24.1	24.1
Total Split (s)	31.2	31.2		31.2	31.2		28.8	28.8		28.8	28.8	28.8
Total Split (%)	52.0%	52.0%		52.0%	52.0%		48.0%	48.0%		48.0%	48.0%	48.0%
Maximum Green (s)	25.1	25.1		25.1	25.1		22.7	22.7		22.7	22.7	22.7
Yellow Time (s)	3.3	3.3		3.3	3.3		3.3	3.3		3.3	3.3	3.3
All-Red Time (s)	2.8	2.8		2.8	2.8		2.8	2.8		2.8	2.8	2.8
Lost Time Adjust (s)	0.0	0.0		0.0	0.0		0.0	0.0		0.0	0.0	0.0
Total Lost Time (s)	6.1	6.1		6.1	6.1		6.1	6.1		6.1	6.1	6.1
Lead/Lag												
Lead-Lag Optimize?												
Vehicle Extension (s)	3.0	3.0		3.0	3.0		3.0	3.0		3.0	3.0	3.0
Recall Mode	None	None		None	None		Min	Min		Min	Min	Min
Walk Time (s)	7.0	7.0		7.0	7.0		7.0	7.0		7.0	7.0	7.0
Flash Dont Walk (s)	18.0	18.0		18.0	18.0		11.0	11.0		11.0	11.0	11.0
Pedestrian Calls (#/hr)	0	0		0	0		0	0		0	0	0
Act Effect Green (s)	18.4	18.4		18.4	18.4		19.5	19.5		19.5	19.5	19.5
Actuated g/C Ratio	0.36	0.36		0.36	0.36		0.38	0.38		0.38	0.38	0.38
v/c Ratio	0.73	0.37		0.11	0.16		0.07	0.82		0.04	0.41	0.12
Control Delay	25.0	12.2		11.7	8.1		12.2	27.4		12.3	14.7	4.4
Queue Delay	0.0	0.0		0.0	0.0		0.0	0.0		0.0	0.0	0.0
Total Delay	25.0	12.2		11.7	8.1		12.2	27.4		12.3	14.7	4.4



Lane Group	EBL	EBT	EBR	WBL	WBT	WBR	NBL	NBT	NBR	SBL	SBT	SBR
LOS	C	B		B	A		B	C		B	B	A
Approach Delay		19.6			9.2			26.7			12.6	
Approach LOS		B			A			C			B	
Queue Length 50th (m)	24.4	12.9		2.5	3.5		1.4	38.9		0.4	16.4	0.0
Queue Length 95th (m)	46.7	25.3		7.2	10.3		5.6	#93.1		2.4	35.1	5.8
Internal Link Dist (m)		520.6			321.6			263.4			225.0	
Turn Bay Length (m)	80.0			30.0			40.0			15.0		15.0
Base Capacity (vph)	626	888		554	870		484	808		238	818	733
Starvation Cap Reductn	0	0		0	0		0	0		0	0	0
Spillback Cap Reductn	0	0		0	0		0	0		0	0	0
Storage Cap Reductn	0	0		0	0		0	0		0	0	0
Reduced v/c Ratio	0.51	0.26		0.08	0.11		0.06	0.67		0.03	0.33	0.10

Intersection Summary

Area Type: Other
 Cycle Length: 60
 Actuated Cycle Length: 50.7
 Natural Cycle: 60
 Control Type: Actuated-Uncoordinated
 Maximum v/c Ratio: 0.82
 Intersection Signal Delay: 19.7
 Intersection LOS: B
 Intersection Capacity Utilization 73.3%
 ICU Level of Service D
 Analysis Period (min) 15
 # 95th percentile volume exceeds capacity, queue may be longer.
 Queue shown is maximum after two cycles.

Splits and Phases: 1: Huntmar Drive & Maple Grove Road

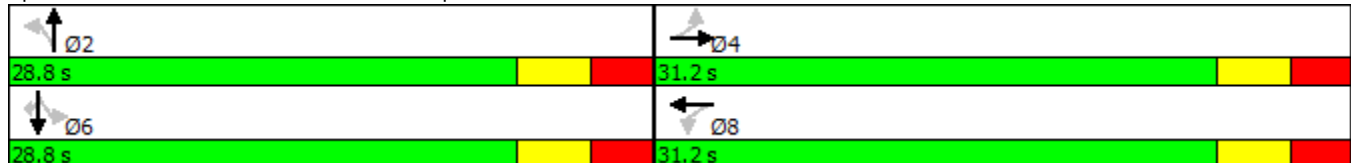

1: Huntmar Drive & Maple Grove Road

PM Peak Hour



Lane Group	EBL	EBT	EBR	WBL	WBT	WBR	NBL	NBT	NBR	SBL	SBT	SBR
Lane Configurations												
Traffic Volume (vph)	153	133	70	140	222	52	102	479	106	58	692	304
Future Volume (vph)	153	133	70	140	222	52	102	479	106	58	692	304
Ideal Flow (vphpl)	1800	1800	1800	1800	1800	1800	1800	1800	1800	1800	1800	1800
Storage Length (m)	80.0		0.0	30.0		0.0	40.0		0.0	15.0		15.0
Storage Lanes	1		0	1		0	1		0	1		1
Taper Length (m)	7.6			7.6			7.6			7.6		
Lane Util. Factor	1.00	1.00	1.00	1.00	1.00	1.00	1.00	1.00	1.00	1.00	1.00	1.00
Fr _t		0.948			0.972			0.973				0.850
Fl _t Protected	0.950			0.950			0.950			0.950		
Satd. Flow (prot)	1658	1654	0	1658	1696	0	1658	1698	0	1658	1745	1483
Fl _t Permitted	0.552			0.630			0.238			0.327		
Satd. Flow (perm)	963	1654	0	1099	1696	0	415	1698	0	571	1745	1483
Right Turn on Red			Yes			Yes			Yes			Yes
Satd. Flow (RTOR)		42			19			21				134
Link Speed (k/h)		50			50			50				50
Link Distance (m)		544.6			345.6			287.4				249.0
Travel Time (s)		39.2			24.9			20.7				17.9
Peak Hour Factor	1.00	1.00	1.00	1.00	1.00	1.00	1.00	1.00	1.00	1.00	1.00	1.00
Adj. Flow (vph)	153	133	70	140	222	52	102	479	106	58	692	304
Shared Lane Traffic (%)												
Lane Group Flow (vph)	153	203	0	140	274	0	102	585	0	58	692	304
Turn Type	Perm	NA		Perm	NA		Perm	NA		Perm	NA	Perm
Protected Phases		4			8			2				6
Permitted Phases	4			8			2			6		6
Detector Phase	4	4		8	8		2	2		6	6	6
Switch Phase												
Minimum Initial (s)	10.0	10.0		10.0	10.0		10.0	10.0		10.0	10.0	10.0
Minimum Split (s)	31.1	31.1		31.1	31.1		24.1	24.1		24.1	24.1	24.1
Total Split (s)	31.1	31.1		31.1	31.1		38.9	38.9		38.9	38.9	38.9
Total Split (%)	44.4%	44.4%		44.4%	44.4%		55.6%	55.6%		55.6%	55.6%	55.6%
Maximum Green (s)	25.0	25.0		25.0	25.0		32.8	32.8		32.8	32.8	32.8
Yellow Time (s)	3.3	3.3		3.3	3.3		3.3	3.3		3.3	3.3	3.3
All-Red Time (s)	2.8	2.8		2.8	2.8		2.8	2.8		2.8	2.8	2.8
Lost Time Adjust (s)	0.0	0.0		0.0	0.0		0.0	0.0		0.0	0.0	0.0
Total Lost Time (s)	6.1	6.1		6.1	6.1		6.1	6.1		6.1	6.1	6.1
Lead/Lag												
Lead-Lag Optimize?												
Vehicle Extension (s)	3.0	3.0		3.0	3.0		3.0	3.0		3.0	3.0	3.0
Recall Mode	Min	Min		Min	Min		Min	Min		Min	Min	Min
Walk Time (s)	7.0	7.0		7.0	7.0		7.0	7.0		7.0	7.0	7.0
Flash Dont Walk (s)	18.0	18.0		18.0	18.0		11.0	11.0		11.0	11.0	11.0
Pedestrian Calls (#/hr)	0	0		0	0		0	0		0	0	0
Act Effct Green (s)	15.5	15.5		15.5	15.5		27.4	27.4		27.4	27.4	27.4
Actuated g/C Ratio	0.28	0.28		0.28	0.28		0.49	0.49		0.49	0.49	0.49
v/c Ratio	0.57	0.41		0.46	0.56		0.50	0.69		0.21	0.81	0.38
Control Delay	27.9	16.6		23.3	21.8		21.5	16.4		11.5	22.2	7.0
Queue Delay	0.0	0.0		0.0	0.0		0.0	0.0		0.0	0.0	0.0
Total Delay	27.9	16.6		23.3	21.8		21.5	16.4		11.5	22.2	7.0



Lane Group	EBL	EBT	EBR	WBL	WBT	WBR	NBL	NBT	NBR	SBL	SBT	SBR
LOS	C	B		C	C		C	B		B	C	A
Approach Delay		21.5			22.3			17.2			17.2	
Approach LOS		C			C			B			B	
Queue Length 50th (m)	13.4	13.1		11.8	22.2		5.5	34.5		2.6	46.5	7.8
Queue Length 95th (m)	28.3	27.2		24.8	40.4		#24.3	85.3		10.5	#126.7	26.3
Internal Link Dist (m)		520.6			321.6			263.4			225.0	
Turn Bay Length (m)	80.0			30.0			40.0			15.0		15.0
Base Capacity (vph)	452	799		516	807		269	1108		370	1131	1008
Starvation Cap Reductn	0	0		0	0		0	0		0	0	0
Spillback Cap Reductn	0	0		0	0		0	0		0	0	0
Storage Cap Reductn	0	0		0	0		0	0		0	0	0
Reduced v/c Ratio	0.34	0.25		0.27	0.34		0.38	0.53		0.16	0.61	0.30

Intersection Summary

Area Type: Other
 Cycle Length: 70
 Actuated Cycle Length: 55.6
 Natural Cycle: 70
 Control Type: Actuated-Uncoordinated
 Maximum v/c Ratio: 0.81
 Intersection Signal Delay: 18.6
 Intersection LOS: B
 Intersection Capacity Utilization 91.7%
 ICU Level of Service F
 Analysis Period (min) 15
 # 95th percentile volume exceeds capacity, queue may be longer.
 Queue shown is maximum after two cycles.

Splits and Phases: 1: Huntmar Drive & Maple Grove Road

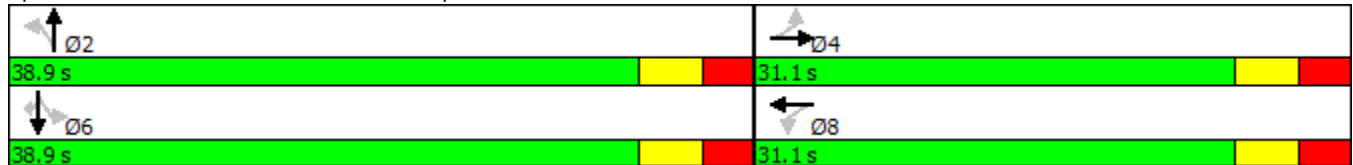

Intersection

Int Delay, s/veh 2.4

Movement	EBT	EBR	WBL	WBT	NBL	NBR
Lane Configurations						
Traffic Vol, veh/h	208	38	29	63	13	63
Future Vol, veh/h	208	38	29	63	13	63
Conflicting Peds, #/hr	0	0	0	0	0	0
Sign Control	Free	Free	Free	Free	Stop	Stop
RT Channelized	-	None	-	None	-	None
Storage Length	-	-	-	-	0	-
Veh in Median Storage, #	0	-	-	0	0	-
Grade, %	0	-	-	0	0	-
Peak Hour Factor	100	100	100	100	100	100
Heavy Vehicles, %	2	2	2	2	2	2
Mvmt Flow	208	38	29	63	13	63

Major/Minor	Major1	Major2	Minor1
Conflicting Flow All	0	0	246
Stage 1	-	-	-
Stage 2	-	-	-
Critical Hdwy	-	-	4.12
Critical Hdwy Stg 1	-	-	-
Critical Hdwy Stg 2	-	-	-
Follow-up Hdwy	-	-	2.218
Pot Cap-1 Maneuver	-	-	1320
Stage 1	-	-	-
Stage 2	-	-	-
Platoon blocked, %	-	-	-
Mov Cap-1 Maneuver	-	-	1320
Mov Cap-2 Maneuver	-	-	-
Stage 1	-	-	-
Stage 2	-	-	-

Approach	EB	WB	NB
HCM Control Delay, s	0	2.5	10.2
HCM LOS			B

Minor Lane/Major Mvmt	NBLn1	EBT	EBR	WBL	WBT
Capacity (veh/h)	775	-	-	1320	-
HCM Lane V/C Ratio	0.098	-	-	0.022	-
HCM Control Delay (s)	10.2	-	-	7.8	0
HCM Lane LOS	B	-	-	A	A
HCM 95th %tile Q(veh)	0.3	-	-	0.1	-

Intersection

Int Delay, s/veh 3.1

Movement	EBT	EBR	WBL	WBT	NBL	NBR
Lane Configurations						
Traffic Vol, veh/h	138	29	95	233	44	46
Future Vol, veh/h	138	29	95	233	44	46
Conflicting Peds, #/hr	0	0	0	0	0	0
Sign Control	Free	Free	Free	Free	Stop	Stop
RT Channelized	-	None	-	None	-	None
Storage Length	-	-	-	-	0	-
Veh in Median Storage, #	0	-	-	0	0	-
Grade, %	0	-	-	0	0	-
Peak Hour Factor	100	100	100	100	100	100
Heavy Vehicles, %	2	2	2	2	2	2
Mvmt Flow	138	29	95	233	44	46

Major/Minor	Major1	Major2	Minor1
Conflicting Flow All	0	0	167
Stage 1	-	-	-
Stage 2	-	-	-
Critical Hdwy	-	-	4.12
Critical Hdwy Stg 1	-	-	-
Critical Hdwy Stg 2	-	-	-
Follow-up Hdwy	-	-	2.218
Pot Cap-1 Maneuver	-	-	1411
Stage 1	-	-	-
Stage 2	-	-	-
Platoon blocked, %	-	-	-
Mov Cap-1 Maneuver	-	-	1411
Mov Cap-2 Maneuver	-	-	-
Stage 1	-	-	-
Stage 2	-	-	-

Approach	EB	WB	NB
HCM Control Delay, s	0	2.2	12.1
HCM LOS			B

Minor Lane/Major Mvmt	NBLn1	EBT	EBR	WBL	WBT
Capacity (veh/h)	596	-	-	1411	-
HCM Lane V/C Ratio	0.151	-	-	0.067	-
HCM Control Delay (s)	12.1	-	-	7.7	0
HCM Lane LOS	B	-	-	A	A
HCM 95th %tile Q(veh)	0.5	-	-	0.2	-

Intersection

Int Delay, s/veh 2.3

Movement	EBT	EBR	WBL	WBT	NBL	NBR
Lane Configurations						
Traffic Vol, veh/h	131	17	15	54	6	51
Future Vol, veh/h	131	17	15	54	6	51
Conflicting Peds, #/hr	0	0	0	0	0	0
Sign Control	Free	Free	Free	Free	Stop	Stop
RT Channelized	-	None	-	None	-	None
Storage Length	-	-	-	-	0	-
Veh in Median Storage, #	0	-	-	0	0	-
Grade, %	0	-	-	0	0	-
Peak Hour Factor	100	100	100	100	100	100
Heavy Vehicles, %	2	2	2	2	2	2
Mvmt Flow	131	17	15	54	6	51

Major/Minor	Major1	Major2	Minor1
Conflicting Flow All	0	0	148
Stage 1	-	-	140
Stage 2	-	-	84
Critical Hdwy	-	-	4.12
Critical Hdwy Stg 1	-	-	5.42
Critical Hdwy Stg 2	-	-	5.42
Follow-up Hdwy	-	-	2.218
Pot Cap-1 Maneuver	-	-	1434
Stage 1	-	-	887
Stage 2	-	-	939
Platoon blocked, %	-	-	-
Mov Cap-1 Maneuver	-	-	1434
Mov Cap-2 Maneuver	-	-	-
Stage 1	-	-	887
Stage 2	-	-	929

Approach	EB	WB	NB
HCM Control Delay, s	0	1.6	9.3
HCM LOS			A

Minor Lane/Major Mvmt	NBLn1	EBT	EBR	WBL	WBT
Capacity (veh/h)	889	-	-	1434	-
HCM Lane V/C Ratio	0.064	-	-	0.01	-
HCM Control Delay (s)	9.3	-	-	7.5	0
HCM Lane LOS	A	-	-	A	A
HCM 95th %tile Q(veh)	0.2	-	-	0	-

Intersection

Int Delay, s/veh 2.7

Movement	EBT	EBR	WBL	WBT	NBL	NBR
Lane Configurations						
Traffic Vol, veh/h	105	12	65	149	19	35
Future Vol, veh/h	105	12	65	149	19	35
Conflicting Peds, #/hr	0	0	0	0	0	0
Sign Control	Free	Free	Free	Free	Stop	Stop
RT Channelized	-	None	-	None	-	None
Storage Length	-	-	-	-	0	-
Veh in Median Storage, #	0	-	-	0	0	-
Grade, %	0	-	-	0	0	-
Peak Hour Factor	100	100	100	100	100	100
Heavy Vehicles, %	2	2	2	2	2	2
Mvmt Flow	105	12	65	149	19	35

Major/Minor	Major1	Major2	Minor1
Conflicting Flow All	0	0	117
Stage 1	-	-	111
Stage 2	-	-	279
Critical Hdwy	-	-	4.12
Critical Hdwy Stg 1	-	-	5.42
Critical Hdwy Stg 2	-	-	5.42
Follow-up Hdwy	-	-	2.218
Pot Cap-1 Maneuver	-	-	1471
Stage 1	-	-	914
Stage 2	-	-	768
Platoon blocked, %	-	-	-
Mov Cap-1 Maneuver	-	-	1471
Mov Cap-2 Maneuver	-	-	-
Stage 1	-	-	914
Stage 2	-	-	731

Approach	EB	WB	NB
HCM Control Delay, s	0	2.3	10
HCM LOS			B

Minor Lane/Major Mvmt	NBLn1	EBT	EBR	WBL	WBT
Capacity (veh/h)	775	-	-	1471	-
HCM Lane V/C Ratio	0.07	-	-	0.044	-
HCM Control Delay (s)	10	-	-	7.6	0
HCM Lane LOS	B	-	-	A	A
HCM 95th %tile Q(veh)	0.2	-	-	0.1	-

Intersection

Int Delay, s/veh	6					
Movement	WBL	WBR	NBT	NBR	SBL	SBT
Lane Configurations						
Traffic Vol, veh/h	7	0	0	2	0	0
Future Vol, veh/h	7	0	0	2	0	0
Conflicting Peds, #/hr	0	0	0	0	0	0
Sign Control	Stop	Stop	Free	Free	Free	Free
RT Channelized	-	None	-	None	-	None
Storage Length	0	-	-	-	-	-
Veh in Median Storage, #	0	-	0	-	-	0
Grade, %	0	-	0	-	-	0
Peak Hour Factor	100	100	100	100	100	100
Heavy Vehicles, %	2	2	2	2	2	2
Mvmt Flow	7	0	0	2	0	0

Major/Minor	Minor1		Major1		Major2	
Conflicting Flow All	2	1	0	0	2	0
Stage 1	1	-	-	-	-	-
Stage 2	1	-	-	-	-	-
Critical Hdwy	6.42	6.22	-	-	4.12	-
Critical Hdwy Stg 1	5.42	-	-	-	-	-
Critical Hdwy Stg 2	5.42	-	-	-	-	-
Follow-up Hdwy	3.518	3.318	-	-	2.218	-
Pot Cap-1 Maneuver	1021	1084	-	-	1620	-
Stage 1	1022	-	-	-	-	-
Stage 2	1022	-	-	-	-	-
Platoon blocked, %			-	-		-
Mov Cap-1 Maneuver	1021	1084	-	-	1620	-
Mov Cap-2 Maneuver	1021	-	-	-	-	-
Stage 1	1022	-	-	-	-	-
Stage 2	1022	-	-	-	-	-

Approach	WB	NB	SB
HCM Control Delay, s	8.6	0	0
HCM LOS	A		

Minor Lane/Major Mvmt	NBT	NBRWBLn1	SBL	SBT
Capacity (veh/h)	-	- 1021	1620	-
HCM Lane V/C Ratio	-	- 0.007	-	-
HCM Control Delay (s)	-	- 8.6	0	-
HCM Lane LOS	-	- A	A	-
HCM 95th %tile Q(veh)	-	- 0	0	-

Intersection

Int Delay, s/veh 2.9

Movement	WBL	WBR	NBT	NBR	SBL	SBT
Lane Configurations						
Traffic Vol, veh/h	4	0	0	7	0	0
Future Vol, veh/h	4	0	0	7	0	0
Conflicting Peds, #/hr	0	0	0	0	0	0
Sign Control	Stop	Stop	Free	Free	Free	Free
RT Channelized	-	None	-	None	-	None
Storage Length	0	-	-	-	-	-
Veh in Median Storage, #	0	-	0	-	-	0
Grade, %	0	-	0	-	-	0
Peak Hour Factor	100	100	100	100	100	100
Heavy Vehicles, %	2	2	2	2	2	2
Mvmt Flow	4	0	0	7	0	0

Major/Minor

	Minor1		Major1		Major2	
Conflicting Flow All	5	4	0	0	7	0
Stage 1	4	-	-	-	-	-
Stage 2	1	-	-	-	-	-
Critical Hdwy	6.42	6.22	-	-	4.12	-
Critical Hdwy Stg 1	5.42	-	-	-	-	-
Critical Hdwy Stg 2	5.42	-	-	-	-	-
Follow-up Hdwy	3.518	3.318	-	-	2.218	-
Pot Cap-1 Maneuver	1017	1080	-	-	1614	-
Stage 1	1019	-	-	-	-	-
Stage 2	1022	-	-	-	-	-
Platoon blocked, %			-	-		-
Mov Cap-1 Maneuver	1017	1080	-	-	1614	-
Mov Cap-2 Maneuver	1017	-	-	-	-	-
Stage 1	1019	-	-	-	-	-
Stage 2	1022	-	-	-	-	-

Approach

	WB		NB		SB
HCM Control Delay, s	8.6		0		0
HCM LOS	A				

Minor Lane/Major Mvmt

	NBT	NBRWBLn1	SBL	SBT	
Capacity (veh/h)	-	- 1017	1614	-	
HCM Lane V/C Ratio	-	- 0.004	-	-	
HCM Control Delay (s)	-	- 8.6	0	-	
HCM Lane LOS	-	- A	A	-	
HCM 95th %tile Q(veh)	-	- 0	0	-	

Intersection

Int Delay, s/veh 3.3

Movement	WBL	WBR	NBT	NBR	SBL	SBT
Lane Configurations						
Traffic Vol, veh/h	7	0	2	2	0	7
Future Vol, veh/h	7	0	2	2	0	7
Conflicting Peds, #/hr	0	0	0	0	0	0
Sign Control	Stop	Stop	Free	Free	Free	Free
RT Channelized	-	None	-	None	-	None
Storage Length	0	-	-	-	-	-
Veh in Median Storage, #	0	-	0	-	-	0
Grade, %	0	-	0	-	-	0
Peak Hour Factor	100	100	100	100	100	100
Heavy Vehicles, %	2	2	2	2	2	2
Mvmt Flow	7	0	2	2	0	7

Major/Minor	Minor1		Major1		Major2	
Conflicting Flow All	10	3	0	0	4	0
Stage 1	3	-	-	-	-	-
Stage 2	7	-	-	-	-	-
Critical Hdwy	6.42	6.22	-	-	4.12	-
Critical Hdwy Stg 1	5.42	-	-	-	-	-
Critical Hdwy Stg 2	5.42	-	-	-	-	-
Follow-up Hdwy	3.518	3.318	-	-	2.218	-
Pot Cap-1 Maneuver	1010	1081	-	-	1618	-
Stage 1	1020	-	-	-	-	-
Stage 2	1016	-	-	-	-	-
Platoon blocked, %			-	-		-
Mov Cap-1 Maneuver	1010	1081	-	-	1618	-
Mov Cap-2 Maneuver	1010	-	-	-	-	-
Stage 1	1020	-	-	-	-	-
Stage 2	1016	-	-	-	-	-

Approach	WB		NB		SB
HCM Control Delay, s	8.6		0		0
HCM LOS	A				

Minor Lane/Major Mvmt	NBT	NBRWBLn1	SBL	SBT	
Capacity (veh/h)	-	- 1010	1618	-	
HCM Lane V/C Ratio	-	- 0.007	-	-	
HCM Control Delay (s)	-	- 8.6	0	-	
HCM Lane LOS	-	- A	A	-	
HCM 95th %tile Q(veh)	-	- 0	0	-	

Intersection

Int Delay, s/veh 3.1

Movement	EBT	EBR	WBL	WBT	NBL	NBR
Lane Configurations						
Traffic Vol, veh/h	138	29	95	233	44	46
Future Vol, veh/h	138	29	95	233	44	46
Conflicting Peds, #/hr	0	0	0	0	0	0
Sign Control	Free	Free	Free	Free	Stop	Stop
RT Channelized	-	None	-	None	-	None
Storage Length	-	-	-	-	0	-
Veh in Median Storage, #	0	-	-	0	0	-
Grade, %	0	-	-	0	0	-
Peak Hour Factor	100	100	100	100	100	100
Heavy Vehicles, %	2	2	2	2	2	2
Mvmt Flow	138	29	95	233	44	46

Major/Minor	Major1	Major2	Minor1
Conflicting Flow All	0	0	167
Stage 1	-	-	-
Stage 2	-	-	-
Critical Hdwy	-	-	4.12
Critical Hdwy Stg 1	-	-	-
Critical Hdwy Stg 2	-	-	-
Follow-up Hdwy	-	-	2.218
Pot Cap-1 Maneuver	-	-	1411
Stage 1	-	-	-
Stage 2	-	-	-
Platoon blocked, %	-	-	-
Mov Cap-1 Maneuver	-	-	1411
Mov Cap-2 Maneuver	-	-	-
Stage 1	-	-	-
Stage 2	-	-	-

Approach	EB	WB	NB
HCM Control Delay, s	0	2.2	12.1
HCM LOS			B

Minor Lane/Major Mvmt	NBLn1	EBT	EBR	WBL	WBT
Capacity (veh/h)	596	-	-	1411	-
HCM Lane V/C Ratio	0.151	-	-	0.067	-
HCM Control Delay (s)	12.1	-	-	7.7	0
HCM Lane LOS	B	-	-	A	A
HCM 95th %tile Q(veh)	0.5	-	-	0.2	-

Intersection

Int Delay, s/veh 2.2

Movement	WBL	WBR	NBT	NBR	SBL	SBT
Lane Configurations						
Traffic Vol, veh/h	7	0	4	2	0	14
Future Vol, veh/h	7	0	4	2	0	14
Conflicting Peds, #/hr	0	0	0	0	0	0
Sign Control	Stop	Stop	Free	Free	Free	Free
RT Channelized	-	None	-	None	-	None
Storage Length	0	-	-	-	-	-
Veh in Median Storage, #	0	-	0	-	-	0
Grade, %	0	-	0	-	-	0
Peak Hour Factor	100	100	100	100	100	100
Heavy Vehicles, %	2	2	2	2	2	2
Mvmt Flow	7	0	4	2	0	14

Major/Minor	Minor1	Major1	Major2
Conflicting Flow All	19	5	0
Stage 1	5	-	-
Stage 2	14	-	-
Critical Hdwy	7.12	6.22	4.12
Critical Hdwy Stg 1	6.12	-	-
Critical Hdwy Stg 2	6.12	-	-
Follow-up Hdwy	3.518	3.318	2.218
Pot Cap-1 Maneuver	995	1078	1615
Stage 1	1017	-	-
Stage 2	1006	-	-
Platoon blocked, %			
Mov Cap-1 Maneuver	995	1078	1615
Mov Cap-2 Maneuver	995	-	-
Stage 1	1017	-	-
Stage 2	1006	-	-

Approach	WB	NB	SB
HCM Control Delay, s	8.6	0	0
HCM LOS	A		

Minor Lane/Major Mvmt	NBT	NBRWBLn1	SBL	SBT
Capacity (veh/h)	-	995	1615	-
HCM Lane V/C Ratio	-	0.007	-	-
HCM Control Delay (s)	-	8.6	0	-
HCM Lane LOS	-	A	A	-
HCM 95th %tile Q(veh)	-	0	0	-

Intersection

Int Delay, s/veh 1.1

Movement	WBL	WBR	NBT	NBR	SBL	SBT
Lane Configurations						
Traffic Vol, veh/h	4	0	14	7	0	8
Future Vol, veh/h	4	0	14	7	0	8
Conflicting Peds, #/hr	0	0	0	0	0	0
Sign Control	Stop	Stop	Free	Free	Free	Free
RT Channelized	-	None	-	None	-	None
Storage Length	0	-	-	-	-	-
Veh in Median Storage, #	0	-	0	-	-	0
Grade, %	0	-	0	-	-	0
Peak Hour Factor	100	100	100	100	100	100
Heavy Vehicles, %	2	2	2	2	2	2
Mvmt Flow	4	0	14	7	0	8

Major/Minor	Minor1	Major1	Major2
Conflicting Flow All	26	18	0
Stage 1	18	-	-
Stage 2	8	-	-
Critical Hdwy	6.42	6.22	4.12
Critical Hdwy Stg 1	5.42	-	-
Critical Hdwy Stg 2	5.42	-	-
Follow-up Hdwy	3.518	3.318	2.218
Pot Cap-1 Maneuver	989	1061	1595
Stage 1	1005	-	-
Stage 2	1015	-	-
Platoon blocked, %			
Mov Cap-1 Maneuver	989	1061	1595
Mov Cap-2 Maneuver	989	-	-
Stage 1	1005	-	-
Stage 2	1015	-	-

Approach	WB	NB	SB
HCM Control Delay, s	8.7	0	0
HCM LOS	A		

Minor Lane/Major Mvmt	NBT	NBRWBLn1	SBL	SBT
Capacity (veh/h)	-	989	1595	-
HCM Lane V/C Ratio	-	0.004	-	-
HCM Control Delay (s)	-	8.7	0	-
HCM Lane LOS	-	A	A	-
HCM 95th %tile Q(veh)	-	0	0	-

Intersection

Int Delay, s/veh 3.1

Movement	WBL	WBR	NBT	NBR	SBL	SBT
Lane Configurations						
Traffic Vol, veh/h	56	4	2	133	14	7
Future Vol, veh/h	56	4	2	133	14	7
Conflicting Peds, #/hr	0	0	0	0	0	0
Sign Control	Stop	Stop	Free	Free	Free	Free
RT Channelized	-	None	-	None	-	None
Storage Length	0	-	-	-	-	-
Veh in Median Storage, #	0	-	0	-	-	0
Grade, %	0	-	0	-	-	0
Peak Hour Factor	100	100	100	100	100	100
Heavy Vehicles, %	2	2	2	2	2	2
Mvmt Flow	56	4	2	133	14	7

Major/Minor	Minor1	Minor2	Major1	Major2	Major3	Major4
Conflicting Flow All	104	69	0	0	135	0
Stage 1	69	-	-	-	-	-
Stage 2	35	-	-	-	-	-
Critical Hdwy	6.42	6.22	-	-	4.12	-
Critical Hdwy Stg 1	5.42	-	-	-	-	-
Critical Hdwy Stg 2	5.42	-	-	-	-	-
Follow-up Hdwy	3.518	3.318	-	-	2.218	-
Pot Cap-1 Maneuver	894	994	-	-	1449	-
Stage 1	954	-	-	-	-	-
Stage 2	987	-	-	-	-	-
Platoon blocked, %			-	-		
Mov Cap-1 Maneuver	885	994	-	-	1449	-
Mov Cap-2 Maneuver	885	-	-	-	-	-
Stage 1	954	-	-	-	-	-
Stage 2	977	-	-	-	-	-

Approach	WB	NB	SB
HCM Control Delay, s	9.3	0	5
HCM LOS	A		

Minor Lane/Major Mvmt	NBT	NBR	WBLn1	SBL	SBT
Capacity (veh/h)	-	-	892	1449	-
HCM Lane V/C Ratio	-	-	0.067	0.01	-
HCM Control Delay (s)	-	-	9.3	7.5	0
HCM Lane LOS	-	-	A	A	A
HCM 95th %tile Q(veh)	-	-	0.2	0	-

Intersection

Int Delay, s/veh 5.7

Movement	WBL	WBR	NBT	NBR	SBL	SBT
Lane Configurations						
Traffic Vol, veh/h	153	14	7	110	8	4
Future Vol, veh/h	153	14	7	110	8	4
Conflicting Peds, #/hr	0	0	0	0	0	0
Sign Control	Stop	Stop	Free	Free	Free	Free
RT Channelized	-	None	-	None	-	None
Storage Length	0	-	-	-	-	-
Veh in Median Storage, #	0	-	0	-	-	0
Grade, %	0	-	0	-	-	0
Peak Hour Factor	100	100	100	100	100	100
Heavy Vehicles, %	2	2	2	2	2	2
Mvmt Flow	153	14	7	110	8	4

Major/Minor	Minor1	Major1	Major2
Conflicting Flow All	82	62	0 0 117 0
Stage 1	62	-	- - - -
Stage 2	20	-	- - - -
Critical Hdwy	6.42	6.22	- - 4.12 -
Critical Hdwy Stg 1	5.42	-	- - - -
Critical Hdwy Stg 2	5.42	-	- - - -
Follow-up Hdwy	3.518	3.318	- - 2.218 -
Pot Cap-1 Maneuver	920	1003	- - 1471 -
Stage 1	961	-	- - - -
Stage 2	1003	-	- - - -
Platoon blocked, %			- - - -
Mov Cap-1 Maneuver	915	1003	- - 1471 -
Mov Cap-2 Maneuver	915	-	- - - -
Stage 1	961	-	- - - -
Stage 2	998	-	- - - -

Approach	WB	NB	SB
HCM Control Delay, s	9.8	0	5
HCM LOS	A		

Minor Lane/Major Mvmt	NBT	NBRWBLn1	SBL	SBT
Capacity (veh/h)	-	- 922	1471	-
HCM Lane V/C Ratio	-	- 0.181	0.005	-
HCM Control Delay (s)	-	- 9.8	7.5	0
HCM Lane LOS	-	- A	A	A
HCM 95th %tile Q(veh)	-	- 0.7	0	-

Intersection

Int Delay, s/veh 1.6

Movement	EBL	EBT	WBT	WBR	SBL	SBR
Lane Configurations		↔	↔		↔	
Traffic Vol, veh/h	1	181	66	12	46	4
Future Vol, veh/h	1	181	66	12	46	4
Conflicting Peds, #/hr	0	0	0	0	0	0
Sign Control	Free	Free	Free	Free	Stop	Stop
RT Channelized	-	None	-	None	-	None
Storage Length	-	-	-	-	0	-
Veh in Median Storage, #	-	0	0	-	0	-
Grade, %	-	0	0	-	0	-
Peak Hour Factor	100	100	100	100	100	100
Heavy Vehicles, %	2	2	2	2	2	2
Mvmt Flow	1	181	66	12	46	4

Major/Minor	Major1	Major2	Minor2
Conflicting Flow All	78	0	255
Stage 1	-	-	72
Stage 2	-	-	183
Critical Hdwy	4.12	-	6.42
Critical Hdwy Stg 1	-	-	5.42
Critical Hdwy Stg 2	-	-	5.42
Follow-up Hdwy	2.218	-	3.518
Pot Cap-1 Maneuver	1520	-	734
Stage 1	-	-	951
Stage 2	-	-	848
Platoon blocked, %	-	-	-
Mov Cap-1 Maneuver	1520	-	733
Mov Cap-2 Maneuver	-	-	733
Stage 1	-	-	951
Stage 2	-	-	847

Approach	EB	WB	SB
HCM Control Delay, s	0	0	10.2
HCM LOS			B

Minor Lane/Major Mvmt	EBL	EBT	WBT	WBR	SBLn1
Capacity (veh/h)	1520	-	-	-	749
HCM Lane V/C Ratio	0.001	-	-	-	0.067
HCM Control Delay (s)	7.4	0	-	-	10.2
HCM Lane LOS	A	A	-	-	B
HCM 95th %tile Q(veh)	0	-	-	-	0.2

Intersection

Int Delay, s/veh 0.8

Movement	EBL	EBT	WBT	WBR	SBL	SBR
Lane Configurations		↔	↔		↔	
Traffic Vol, veh/h	4	137	212	47	25	2
Future Vol, veh/h	4	137	212	47	25	2
Conflicting Peds, #/hr	0	0	0	0	0	0
Sign Control	Free	Free	Free	Free	Stop	Stop
RT Channelized	-	None	-	None	-	None
Storage Length	-	-	-	-	0	-
Veh in Median Storage, #	-	0	0	-	0	-
Grade, %	-	0	0	-	0	-
Peak Hour Factor	100	100	100	100	100	100
Heavy Vehicles, %	2	2	2	2	2	2
Mvmt Flow	4	137	212	47	25	2

Major/Minor	Major1	Major2	Minor2
Conflicting Flow All	259	0	381
Stage 1	-	-	236
Stage 2	-	-	145
Critical Hdwy	4.12	-	6.42
Critical Hdwy Stg 1	-	-	5.42
Critical Hdwy Stg 2	-	-	5.42
Follow-up Hdwy	2.218	-	3.518
Pot Cap-1 Maneuver	1306	-	621
Stage 1	-	-	803
Stage 2	-	-	882
Platoon blocked, %	-	-	-
Mov Cap-1 Maneuver	1306	-	619
Mov Cap-2 Maneuver	-	-	619
Stage 1	-	-	803
Stage 2	-	-	879

Approach	EB	WB	SB
HCM Control Delay, s	0.2	0	11
HCM LOS			B

Minor Lane/Major Mvmt	EBL	EBT	WBT	WBR	SBLn1
Capacity (veh/h)	1306	-	-	-	630
HCM Lane V/C Ratio	0.003	-	-	-	0.043
HCM Control Delay (s)	7.8	0	-	-	11
HCM Lane LOS	A	A	-	-	B
HCM 95th %tile Q(veh)	0	-	-	-	0.1

Future (2026) Background Plus
Site Generated

1: Huntmar Drive & Maple Grove Road

AM Peak Hour

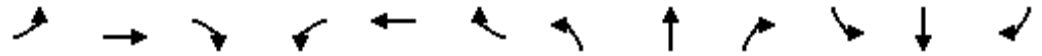

Lane Group	EBL	EBT	EBR	WBL	WBT	WBR	NBL	NBT	NBR	SBL	SBT	SBR
Lane Configurations												
Traffic Volume (vph)	393	224	65	47	73	41	30	498	97	7	297	89
Future Volume (vph)	393	224	65	47	73	41	30	498	97	7	297	89
Ideal Flow (vphpl)	1800	1800	1800	1800	1800	1800	1800	1800	1800	1800	1800	1800
Storage Length (m)	80.0		0.0	30.0		0.0	40.0		0.0	15.0		15.0
Storage Lanes	1		0	1		0	1		0	1		1
Taper Length (m)	7.6			7.6			7.6			7.6		
Lane Util. Factor	1.00	1.00	1.00	1.00	1.00	1.00	1.00	1.00	1.00	1.00	1.00	1.00
Fr _t		0.966			0.946			0.976				0.850
Fl _t Protected	0.950			0.950			0.950			0.950		
Satd. Flow (prot)	1658	1686	0	1658	1651	0	1658	1703	0	1658	1745	1483
Fl _t Permitted	0.684			0.564			0.559			0.231		
Satd. Flow (perm)	1194	1686	0	984	1651	0	976	1703	0	403	1745	1483
Right Turn on Red			Yes			Yes			Yes			Yes
Satd. Flow (RTOR)		27			41			18				89
Link Speed (k/h)		50			50			50				50
Link Distance (m)		544.6			345.6			287.4				249.0
Travel Time (s)		39.2			24.9			20.7				17.9
Peak Hour Factor	1.00	1.00	1.00	1.00	1.00	1.00	1.00	1.00	1.00	1.00	1.00	1.00
Adj. Flow (vph)	393	224	65	47	73	41	30	498	97	7	297	89
Shared Lane Traffic (%)												
Lane Group Flow (vph)	393	289	0	47	114	0	30	595	0	7	297	89
Turn Type	Perm	NA		Perm	NA		Perm	NA		Perm	NA	Perm
Protected Phases		4			8			2				6
Permitted Phases	4			8			2			6		6
Detector Phase	4	4		8	8		2	2		6	6	6
Switch Phase												
Minimum Initial (s)	10.0	10.0		10.0	10.0		10.0	10.0		10.0	10.0	10.0
Minimum Split (s)	31.1	31.1		31.1	31.1		24.1	24.1		24.1	24.1	24.1
Total Split (s)	32.0	32.0		32.0	32.0		33.0	33.0		33.0	33.0	33.0
Total Split (%)	49.2%	49.2%		49.2%	49.2%		50.8%	50.8%		50.8%	50.8%	50.8%
Maximum Green (s)	25.9	25.9		25.9	25.9		26.9	26.9		26.9	26.9	26.9
Yellow Time (s)	3.3	3.3		3.3	3.3		3.3	3.3		3.3	3.3	3.3
All-Red Time (s)	2.8	2.8		2.8	2.8		2.8	2.8		2.8	2.8	2.8
Lost Time Adjust (s)	0.0	0.0		0.0	0.0		0.0	0.0		0.0	0.0	0.0
Total Lost Time (s)	6.1	6.1		6.1	6.1		6.1	6.1		6.1	6.1	6.1
Lead/Lag												
Lead-Lag Optimize?												
Vehicle Extension (s)	3.0	3.0		3.0	3.0		3.0	3.0		3.0	3.0	3.0
Recall Mode	None	None		None	None		Min	Min		Min	Min	Min
Walk Time (s)	7.0	7.0		7.0	7.0		7.0	7.0		7.0	7.0	7.0
Flash Dont Walk (s)	18.0	18.0		18.0	18.0		11.0	11.0		11.0	11.0	11.0
Pedestrian Calls (#/hr)	0	0		0	0		0	0		0	0	0
Act Effct Green (s)	22.8	22.8		22.8	22.8		23.6	23.6		23.6	23.6	23.6
Actuated g/C Ratio	0.39	0.39		0.39	0.39		0.40	0.40		0.40	0.40	0.40
v/c Ratio	0.85	0.43		0.12	0.17		0.08	0.86		0.04	0.43	0.14
Control Delay	37.6	14.9		13.4	9.5		12.3	31.2		12.4	15.6	3.8
Queue Delay	0.0	0.0		0.0	0.0		0.0	0.0		0.0	0.0	0.0
Total Delay	37.6	14.9		13.4	9.5		12.3	31.2		12.4	15.6	3.8

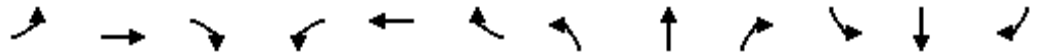

Lane Group	EBL	EBT	EBR	WBL	WBT	WBR	NBL	NBT	NBR	SBL	SBT	SBR
LOS	D	B		B	A		B	C		B	B	A
Approach Delay		28.0			10.7			30.3			12.8	
Approach LOS		C			B			C			B	
Queue Length 50th (m)	37.7	20.0		3.2	4.9		1.9	55.1		0.4	22.4	0.0
Queue Length 95th (m)	#79.3	36.4		8.6	13.0		6.0	#105.6		2.4	38.7	6.3
Internal Link Dist (m)		520.6			321.6			263.4			225.0	
Turn Bay Length (m)	80.0			30.0			40.0			15.0		15.0
Base Capacity (vph)	540	778		445	769		458	810		189	820	744
Starvation Cap Reductn	0	0		0	0		0	0		0	0	0
Spillback Cap Reductn	0	0		0	0		0	0		0	0	0
Storage Cap Reductn	0	0		0	0		0	0		0	0	0
Reduced v/c Ratio	0.73	0.37		0.11	0.15		0.07	0.73		0.04	0.36	0.12

Intersection Summary

Area Type: Other
 Cycle Length: 65
 Actuated Cycle Length: 59
 Natural Cycle: 65
 Control Type: Actuated-Uncoordinated
 Maximum v/c Ratio: 0.86
 Intersection Signal Delay: 24.1
 Intersection LOS: C
 Intersection Capacity Utilization 80.4%
 ICU Level of Service D
 Analysis Period (min) 15
 # 95th percentile volume exceeds capacity, queue may be longer.
 Queue shown is maximum after two cycles.

Splits and Phases: 1: Huntmar Drive & Maple Grove Road

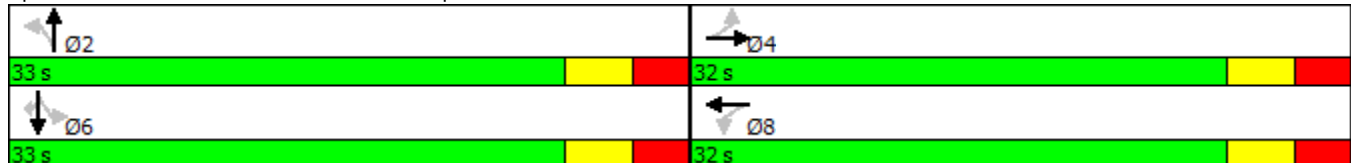



Lane Group	EBL	EBT	EBR	WBL	WBT	WBR	NBL	NBT	NBR	SBL	SBT	SBR
Lane Configurations												
Traffic Volume (vph)	193	161	79	153	273	55	117	522	116	62	755	380
Future Volume (vph)	193	161	79	153	273	55	117	522	116	62	755	380
Ideal Flow (vphpl)	1800	1800	1800	1800	1800	1800	1800	1800	1800	1800	1800	1800
Storage Length (m)	80.0		0.0	30.0		0.0	40.0		0.0	15.0		15.0
Storage Lanes	1		0	1		0	1		0	1		1
Taper Length (m)	7.6			7.6			7.6			7.6		
Lane Util. Factor	1.00	1.00	1.00	1.00	1.00	1.00	1.00	1.00	1.00	1.00	1.00	1.00
Fr _t		0.951			0.975			0.973				0.850
Fl _t Protected	0.950			0.950			0.950			0.950		
Satd. Flow (prot)	1658	1660	0	1658	1701	0	1658	1698	0	1658	1745	1483
Fl _t Permitted	0.470			0.606			0.172			0.269		
Satd. Flow (perm)	820	1660	0	1058	1701	0	300	1698	0	469	1745	1483
Right Turn on Red			Yes			Yes			Yes			Yes
Satd. Flow (RTOR)		44			18			22				153
Link Speed (k/h)		50			50			50				50
Link Distance (m)		544.6			345.6			287.4				249.0
Travel Time (s)		39.2			24.9			20.7				17.9
Peak Hour Factor	1.00	1.00	1.00	1.00	1.00	1.00	1.00	1.00	1.00	1.00	1.00	1.00
Adj. Flow (vph)	193	161	79	153	273	55	117	522	116	62	755	380
Shared Lane Traffic (%)												
Lane Group Flow (vph)	193	240	0	153	328	0	117	638	0	62	755	380
Turn Type	Perm	NA		Perm	NA		Perm	NA		Perm	NA	Perm
Protected Phases		4			8			2				6
Permitted Phases	4			8			2			6		6
Detector Phase	4	4		8	8		2	2		6	6	6
Switch Phase												
Minimum Initial (s)	10.0	10.0		10.0	10.0		10.0	10.0		10.0	10.0	10.0
Minimum Split (s)	31.1	31.1		31.1	31.1		24.1	24.1		24.1	24.1	24.1
Total Split (s)	31.1	31.1		31.1	31.1		33.9	33.9		33.9	33.9	33.9
Total Split (%)	47.8%	47.8%		47.8%	47.8%		52.2%	52.2%		52.2%	52.2%	52.2%
Maximum Green (s)	25.0	25.0		25.0	25.0		27.8	27.8		27.8	27.8	27.8
Yellow Time (s)	3.3	3.3		3.3	3.3		3.3	3.3		3.3	3.3	3.3
All-Red Time (s)	2.8	2.8		2.8	2.8		2.8	2.8		2.8	2.8	2.8
Lost Time Adjust (s)	0.0	0.0		0.0	0.0		0.0	0.0		0.0	0.0	0.0
Total Lost Time (s)	6.1	6.1		6.1	6.1		6.1	6.1		6.1	6.1	6.1
Lead/Lag												
Lead-Lag Optimize?												
Vehicle Extension (s)	3.0	3.0		3.0	3.0		3.0	3.0		3.0	3.0	3.0
Recall Mode	None	None		None	None		Min	Min		Min	Min	Min
Walk Time (s)	7.0	7.0		7.0	7.0		7.0	7.0		7.0	7.0	7.0
Flash Dont Walk (s)	18.0	18.0		18.0	18.0		11.0	11.0		11.0	11.0	11.0
Pedestrian Calls (#/hr)	0	0		0	0		0	0		0	0	0
Act Effect Green (s)	17.5	17.5		17.5	17.5		28.1	28.1		28.1	28.1	28.1
Actuated g/C Ratio	0.30	0.30		0.30	0.30		0.49	0.49		0.49	0.49	0.49
v/c Ratio	0.78	0.45		0.48	0.62		0.81	0.76		0.27	0.89	0.48
Control Delay	40.5	15.4		21.3	21.5		61.2	21.9		15.3	32.2	9.2
Queue Delay	0.0	0.0		0.0	0.0		0.0	0.0		0.0	0.0	0.0
Total Delay	40.5	15.4		21.3	21.5		61.2	21.9		15.3	32.2	9.2



Lane Group	EBL	EBT	EBR	WBL	WBT	WBR	NBL	NBT	NBR	SBL	SBT	SBR
LOS	D	B		C	C		E	C		B	C	A
Approach Delay		26.6			21.5			28.0			24.0	
Approach LOS		C			C			C			C	
Queue Length 50th (m)	16.7	14.7		11.8	25.2		8.8	45.1		3.3	61.5	12.4
Queue Length 95th (m)	#40.2	28.9		24.4	44.3		#38.0	#113.9		12.4	#144.6	36.4
Internal Link Dist (m)		520.6			321.6			263.4			225.0	
Turn Bay Length (m)	80.0			30.0			40.0			15.0		15.0
Base Capacity (vph)	357	749		461	752		145	835		227	846	798
Starvation Cap Reductn	0	0		0	0		0	0		0	0	0
Spillback Cap Reductn	0	0		0	0		0	0		0	0	0
Storage Cap Reductn	0	0		0	0		0	0		0	0	0
Reduced v/c Ratio	0.54	0.32		0.33	0.44		0.81	0.76		0.27	0.89	0.48

Intersection Summary

Area Type: Other
 Cycle Length: 65
 Actuated Cycle Length: 57.9
 Natural Cycle: 80
 Control Type: Actuated-Uncoordinated
 Maximum v/c Ratio: 0.89
 Intersection Signal Delay: 25.0
 Intersection LOS: C
 Intersection Capacity Utilization 100.6%
 ICU Level of Service G
 Analysis Period (min) 15
 # 95th percentile volume exceeds capacity, queue may be longer.
 Queue shown is maximum after two cycles.

Splits and Phases: 1: Huntmar Drive & Maple Grove Road

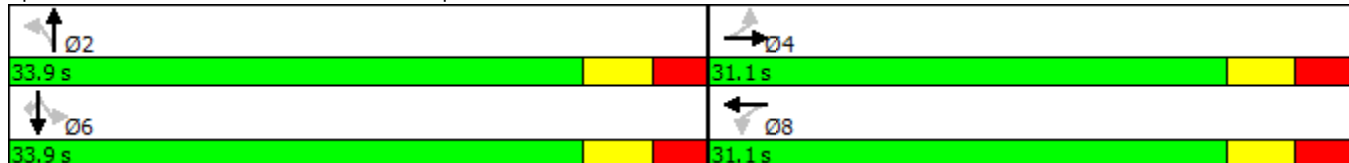

Intersection

Int Delay, s/veh 2

Movement	EBT	EBR	WBL	WBT	NBL	NBR
Lane Configurations						
Traffic Vol, veh/h	301	52	29	88	17	63
Future Vol, veh/h	301	52	29	88	17	63
Conflicting Peds, #/hr	0	0	0	0	0	0
Sign Control	Free	Free	Free	Free	Stop	Stop
RT Channelized	-	None	-	None	-	None
Storage Length	-	-	-	-	0	-
Veh in Median Storage, #	0	-	-	0	0	-
Grade, %	0	-	-	0	0	-
Peak Hour Factor	100	100	100	100	100	100
Heavy Vehicles, %	2	2	2	2	2	2
Mvmt Flow	301	52	29	88	17	63

Major/Minor	Major1	Major2	Minor1
Conflicting Flow All	0	0	353
Stage 1	-	-	-
Stage 2	-	-	-
Critical Hdwy	-	-	4.12
Critical Hdwy Stg 1	-	-	-
Critical Hdwy Stg 2	-	-	-
Follow-up Hdwy	-	-	2.218
Pot Cap-1 Maneuver	-	-	1206
Stage 1	-	-	-
Stage 2	-	-	-
Platoon blocked, %	-	-	-
Mov Cap-1 Maneuver	-	-	1206
Mov Cap-2 Maneuver	-	-	-
Stage 1	-	-	-
Stage 2	-	-	-

Approach	EB	WB	NB
HCM Control Delay, s	0	2	11.1
HCM LOS			B

Minor Lane/Major Mvmt	NBLn1	EBT	EBR	WBL	WBT
Capacity (veh/h)	667	-	-	1206	-
HCM Lane V/C Ratio	0.12	-	-	0.024	-
HCM Control Delay (s)	11.1	-	-	8.1	0
HCM Lane LOS	B	-	-	A	A
HCM 95th %tile Q(veh)	0.4	-	-	0.1	-

Intersection

Int Delay, s/veh 3

Movement	EBT	EBR	WBL	WBT	NBL	NBR
Lane Configurations						
Traffic Vol, veh/h	194	37	95	333	59	46
Future Vol, veh/h	194	37	95	333	59	46
Conflicting Peds, #/hr	0	0	0	0	0	0
Sign Control	Free	Free	Free	Free	Stop	Stop
RT Channelized	-	None	-	None	-	None
Storage Length	-	-	-	-	0	-
Veh in Median Storage, #	0	-	-	0	0	-
Grade, %	0	-	-	0	0	-
Peak Hour Factor	100	100	100	100	100	100
Heavy Vehicles, %	2	2	2	2	2	2
Mvmt Flow	194	37	95	333	59	46

Major/Minor	Major1	Major2	Minor1
Conflicting Flow All	0	0	231
Stage 1	-	-	213
Stage 2	-	-	523
Critical Hdwy	-	-	4.12
Critical Hdwy Stg 1	-	-	5.42
Critical Hdwy Stg 2	-	-	5.42
Follow-up Hdwy	-	-	2.218
Pot Cap-1 Maneuver	-	-	1337
Stage 1	-	-	823
Stage 2	-	-	595
Platoon blocked, %	-	-	-
Mov Cap-1 Maneuver	-	-	1337
Mov Cap-2 Maneuver	-	-	-
Stage 1	-	-	823
Stage 2	-	-	543

Approach	EB	WB	NB
HCM Control Delay, s	0	1.8	14.8
HCM LOS			B

Minor Lane/Major Mvmt	NBLn1	EBT	EBR	WBL	WBT
Capacity (veh/h)	470	-	-	1337	-
HCM Lane V/C Ratio	0.223	-	-	0.071	-
HCM Control Delay (s)	14.8	-	-	7.9	0
HCM Lane LOS	B	-	-	A	A
HCM 95th %tile Q(veh)	0.8	-	-	0.2	-

Intersection

Int Delay, s/veh 2.2

Movement	EBT	EBR	WBL	WBT	NBL	NBR
Lane Configurations						
Traffic Vol, veh/h	146	18	21	76	6	53
Future Vol, veh/h	146	18	21	76	6	53
Conflicting Peds, #/hr	0	0	0	0	0	0
Sign Control	Free	Free	Free	Free	Stop	Stop
RT Channelized	-	None	-	None	-	None
Storage Length	-	-	-	-	0	-
Veh in Median Storage, #	0	-	-	0	0	-
Grade, %	0	-	-	0	0	-
Peak Hour Factor	100	100	100	100	100	100
Heavy Vehicles, %	2	2	2	2	2	2
Mvmt Flow	146	18	21	76	6	53

Major/Minor	Major1	Major2	Minor1
Conflicting Flow All	0	0	164
Stage 1	-	-	-
Stage 2	-	-	-
Critical Hdwy	-	-	4.12
Critical Hdwy Stg 1	-	-	-
Critical Hdwy Stg 2	-	-	-
Follow-up Hdwy	-	-	2.218
Pot Cap-1 Maneuver	-	-	1414
Stage 1	-	-	-
Stage 2	-	-	-
Platoon blocked, %	-	-	-
Mov Cap-1 Maneuver	-	-	1414
Mov Cap-2 Maneuver	-	-	-
Stage 1	-	-	-
Stage 2	-	-	-

Approach	EB	WB	NB
HCM Control Delay, s	0	1.6	9.5
HCM LOS			A

Minor Lane/Major Mvmt	NBLn1	EBT	EBR	WBL	WBT
Capacity (veh/h)	868	-	-	1414	-
HCM Lane V/C Ratio	0.068	-	-	0.015	-
HCM Control Delay (s)	9.5	-	-	7.6	0
HCM Lane LOS	A	-	-	A	A
HCM 95th %tile Q(veh)	0.2	-	-	0	-

Intersection

Int Delay, s/veh 2.6

Movement	EBT	EBR	WBL	WBT	NBL	NBR
Lane Configurations						
Traffic Vol, veh/h	133	13	68	172	20	42
Future Vol, veh/h	133	13	68	172	20	42
Conflicting Peds, #/hr	0	0	0	0	0	0
Sign Control	Free	Free	Free	Free	Stop	Stop
RT Channelized	-	None	-	None	-	None
Storage Length	-	-	-	-	0	-
Veh in Median Storage, #	0	-	-	0	0	-
Grade, %	0	-	-	0	0	-
Peak Hour Factor	100	100	100	100	100	100
Heavy Vehicles, %	2	2	2	2	2	2
Mvmt Flow	133	13	68	172	20	42

Major/Minor	Major1	Major2	Minor1
Conflicting Flow All	0	0	146
Stage 1	-	-	-
Stage 2	-	-	-
Critical Hdwy	-	-	4.12
Critical Hdwy Stg 1	-	-	-
Critical Hdwy Stg 2	-	-	-
Follow-up Hdwy	-	-	2.218
Pot Cap-1 Maneuver	-	-	1436
Stage 1	-	-	-
Stage 2	-	-	-
Platoon blocked, %	-	-	-
Mov Cap-1 Maneuver	-	-	1436
Mov Cap-2 Maneuver	-	-	-
Stage 1	-	-	-
Stage 2	-	-	-

Approach	EB	WB	NB
HCM Control Delay, s	0	2.2	10.3
HCM LOS			B

Minor Lane/Major Mvmt	NBLn1	EBT	EBR	WBL	WBT
Capacity (veh/h)	743	-	-	1436	-
HCM Lane V/C Ratio	0.083	-	-	0.047	-
HCM Control Delay (s)	10.3	-	-	7.6	0
HCM Lane LOS	B	-	-	A	A
HCM 95th %tile Q(veh)	0.3	-	-	0.1	-

Intersection

Int Delay, s/veh 6

Movement	WBL	WBR	NBT	NBR	SBL	SBT
Lane Configurations						
Traffic Vol, veh/h	7	0	0	2	0	0
Future Vol, veh/h	7	0	0	2	0	0
Conflicting Peds, #/hr	0	0	0	0	0	0
Sign Control	Stop	Stop	Free	Free	Free	Free
RT Channelized	-	None	-	None	-	None
Storage Length	0	-	-	-	-	-
Veh in Median Storage, #	0	-	0	-	-	0
Grade, %	0	-	0	-	-	0
Peak Hour Factor	100	100	100	100	100	100
Heavy Vehicles, %	2	2	2	2	2	2
Mvmt Flow	7	0	0	2	0	0

Major/Minor	Minor1	Major1	Major2
Conflicting Flow All	2	1	0
Stage 1	1	-	-
Stage 2	1	-	-
Critical Hdwy	6.42	6.22	4.12
Critical Hdwy Stg 1	5.42	-	-
Critical Hdwy Stg 2	5.42	-	-
Follow-up Hdwy	3.518	3.318	2.218
Pot Cap-1 Maneuver	1021	1084	1620
Stage 1	1022	-	-
Stage 2	1022	-	-
Platoon blocked, %			
Mov Cap-1 Maneuver	1021	1084	1620
Mov Cap-2 Maneuver	1021	-	-
Stage 1	1022	-	-
Stage 2	1022	-	-

Approach	WB	NB	SB
HCM Control Delay, s	8.6	0	0
HCM LOS	A		

Minor Lane/Major Mvmt	NBT	NBRWBLn1	SBL	SBT
Capacity (veh/h)	-	- 1021	1620	-
HCM Lane V/C Ratio	-	- 0.007	-	-
HCM Control Delay (s)	-	- 8.6	0	-
HCM Lane LOS	-	- A	A	-
HCM 95th %tile Q(veh)	-	- 0	0	-

Intersection

Int Delay, s/veh 2.9

Movement	WBL	WBR	NBT	NBR	SBL	SBT
Lane Configurations						
Traffic Vol, veh/h	4	0	0	7	0	0
Future Vol, veh/h	4	0	0	7	0	0
Conflicting Peds, #/hr	0	0	0	0	0	0
Sign Control	Stop	Stop	Free	Free	Free	Free
RT Channelized	-	None	-	None	-	None
Storage Length	0	-	-	-	-	-
Veh in Median Storage, #	0	-	0	-	-	0
Grade, %	0	-	0	-	-	0
Peak Hour Factor	100	100	100	100	100	100
Heavy Vehicles, %	2	2	2	2	2	2
Mvmt Flow	4	0	0	7	0	0

Major/Minor	Minor1	Major1	Major2
Conflicting Flow All	5	4	0
Stage 1	4	-	-
Stage 2	1	-	-
Critical Hdwy	6.42	6.22	4.12
Critical Hdwy Stg 1	5.42	-	-
Critical Hdwy Stg 2	5.42	-	-
Follow-up Hdwy	3.518	3.318	2.218
Pot Cap-1 Maneuver	1017	1080	1614
Stage 1	1019	-	-
Stage 2	1022	-	-
Platoon blocked, %			
Mov Cap-1 Maneuver	1017	1080	1614
Mov Cap-2 Maneuver	1017	-	-
Stage 1	1019	-	-
Stage 2	1022	-	-

Approach	WB	NB	SB
HCM Control Delay, s	8.6	0	0
HCM LOS	A		

Minor Lane/Major Mvmt	NBT	NBRWBLn1	SBL	SBT
Capacity (veh/h)	-	- 1017	1614	-
HCM Lane V/C Ratio	-	- 0.004	-	-
HCM Control Delay (s)	-	- 8.6	0	-
HCM Lane LOS	-	- A	A	-
HCM 95th %tile Q(veh)	-	- 0	0	-

Intersection

Int Delay, s/veh 3.3

Movement	WBL	WBR	NBT	NBR	SBL	SBT
Lane Configurations						
Traffic Vol, veh/h	7	0	2	2	0	7
Future Vol, veh/h	7	0	2	2	0	7
Conflicting Peds, #/hr	0	0	0	0	0	0
Sign Control	Stop	Stop	Free	Free	Free	Free
RT Channelized	-	None	-	None	-	None
Storage Length	0	-	-	-	-	-
Veh in Median Storage, #	0	-	0	-	-	0
Grade, %	0	-	0	-	-	0
Peak Hour Factor	100	100	100	100	100	100
Heavy Vehicles, %	2	2	2	2	2	2
Mvmt Flow	7	0	2	2	0	7

Major/Minor	Minor1	Minor2	Major1	Major2	Major3	Major4
Conflicting Flow All	10	3	0	0	4	0
Stage 1	3	-	-	-	-	-
Stage 2	7	-	-	-	-	-
Critical Hdwy	6.42	6.22	-	-	4.12	-
Critical Hdwy Stg 1	5.42	-	-	-	-	-
Critical Hdwy Stg 2	5.42	-	-	-	-	-
Follow-up Hdwy	3.518	3.318	-	-	2.218	-
Pot Cap-1 Maneuver	1010	1081	-	-	1618	-
Stage 1	1020	-	-	-	-	-
Stage 2	1016	-	-	-	-	-
Platoon blocked, %			-	-		-
Mov Cap-1 Maneuver	1010	1081	-	-	1618	-
Mov Cap-2 Maneuver	1010	-	-	-	-	-
Stage 1	1020	-	-	-	-	-
Stage 2	1016	-	-	-	-	-

Approach	WB	NB	SB
HCM Control Delay, s	8.6	0	0
HCM LOS	A		

Minor Lane/Major Mvmt	NBT	NBR	WBLn1	SBL	SBT
Capacity (veh/h)	-	-	1010	1618	-
HCM Lane V/C Ratio	-	-	0.007	-	-
HCM Control Delay (s)	-	-	8.6	0	-
HCM Lane LOS	-	-	A	A	-
HCM 95th %tile Q(veh)	-	-	0	0	-

Intersection

Int Delay, s/veh 1.6

Movement	WBL	WBR	NBT	NBR	SBL	SBT
Lane Configurations						
Traffic Vol, veh/h	4	0	7	7	0	4
Future Vol, veh/h	4	0	7	7	0	4
Conflicting Peds, #/hr	0	0	0	0	0	0
Sign Control	Stop	Stop	Free	Free	Free	Free
RT Channelized	-	None	-	None	-	None
Storage Length	0	-	-	-	-	-
Veh in Median Storage, #	0	-	0	-	-	0
Grade, %	0	-	0	-	-	0
Peak Hour Factor	100	100	100	100	100	100
Heavy Vehicles, %	2	2	2	2	2	2
Mvmt Flow	4	0	7	7	0	4

Major/Minor	Minor1	Major1	Major2
Conflicting Flow All	15	11	0
Stage 1	11	-	-
Stage 2	4	-	-
Critical Hdwy	7.12	6.22	4.12
Critical Hdwy Stg 1	6.12	-	-
Critical Hdwy Stg 2	6.12	-	-
Follow-up Hdwy	3.518	3.318	2.218
Pot Cap-1 Maneuver	1001	1070	1604
Stage 1	1010	-	-
Stage 2	1018	-	-
Platoon blocked, %			
Mov Cap-1 Maneuver	1001	1070	1604
Mov Cap-2 Maneuver	1001	-	-
Stage 1	1010	-	-
Stage 2	1018	-	-

Approach	WB	NB	SB
HCM Control Delay, s	8.6	0	0
HCM LOS	A		

Minor Lane/Major Mvmt	NBT	NBRWBLn1	SBL	SBT
Capacity (veh/h)	-	- 1001	1604	-
HCM Lane V/C Ratio	-	- 0.004	-	-
HCM Control Delay (s)	-	- 8.6	0	-
HCM Lane LOS	-	- A	A	-
HCM 95th %tile Q(veh)	-	- 0	0	-

Intersection

Int Delay, s/veh 2.2

Movement	WBL	WBR	NBT	NBR	SBL	SBT
Lane Configurations						
Traffic Vol, veh/h	7	0	4	2	0	14
Future Vol, veh/h	7	0	4	2	0	14
Conflicting Peds, #/hr	0	0	0	0	0	0
Sign Control	Stop	Stop	Free	Free	Free	Free
RT Channelized	-	None	-	None	-	None
Storage Length	0	-	-	-	-	-
Veh in Median Storage, #	0	-	0	-	-	0
Grade, %	0	-	0	-	-	0
Peak Hour Factor	100	100	100	100	100	100
Heavy Vehicles, %	2	2	2	2	2	2
Mvmt Flow	7	0	4	2	0	14

Major/Minor	Minor1	Major1	Major2
Conflicting Flow All	19	5	0
Stage 1	5	-	-
Stage 2	14	-	-
Critical Hdwy	6.42	6.22	4.12
Critical Hdwy Stg 1	5.42	-	-
Critical Hdwy Stg 2	5.42	-	-
Follow-up Hdwy	3.518	3.318	2.218
Pot Cap-1 Maneuver	998	1078	1615
Stage 1	1018	-	-
Stage 2	1009	-	-
Platoon blocked, %			
Mov Cap-1 Maneuver	998	1078	1615
Mov Cap-2 Maneuver	998	-	-
Stage 1	1018	-	-
Stage 2	1009	-	-

Approach	WB	NB	SB
HCM Control Delay, s	8.6	0	0
HCM LOS	A		

Minor Lane/Major Mvmt	NBT	NBRWBLn1	SBL	SBT
Capacity (veh/h)	-	- 998	1615	-
HCM Lane V/C Ratio	-	- 0.007	-	-
HCM Control Delay (s)	-	- 8.6	0	-
HCM Lane LOS	-	- A	A	-
HCM 95th %tile Q(veh)	-	- 0	0	-

Intersection

Int Delay, s/veh 1.1

Movement	WBL	WBR	NBT	NBR	SBL	SBT
Lane Configurations						
Traffic Vol, veh/h	4	0	14	7	0	8
Future Vol, veh/h	4	0	14	7	0	8
Conflicting Peds, #/hr	0	0	0	0	0	0
Sign Control	Stop	Stop	Free	Free	Free	Free
RT Channelized	-	None	-	None	-	None
Storage Length	0	-	-	-	-	-
Veh in Median Storage, #	0	-	0	-	-	0
Grade, %	0	-	0	-	-	0
Peak Hour Factor	100	100	100	100	100	100
Heavy Vehicles, %	2	2	2	2	2	2
Mvmt Flow	4	0	14	7	0	8

Major/Minor	Minor1	Minor2	Major1	Major2	Major3	Major4
Conflicting Flow All	26	18	0	0	21	0
Stage 1	18	-	-	-	-	-
Stage 2	8	-	-	-	-	-
Critical Hdwy	6.42	6.22	-	-	4.12	-
Critical Hdwy Stg 1	5.42	-	-	-	-	-
Critical Hdwy Stg 2	5.42	-	-	-	-	-
Follow-up Hdwy	3.518	3.318	-	-	2.218	-
Pot Cap-1 Maneuver	989	1061	-	-	1595	-
Stage 1	1005	-	-	-	-	-
Stage 2	1015	-	-	-	-	-
Platoon blocked, %			-	-		-
Mov Cap-1 Maneuver	989	1061	-	-	1595	-
Mov Cap-2 Maneuver	989	-	-	-	-	-
Stage 1	1005	-	-	-	-	-
Stage 2	1015	-	-	-	-	-

Approach	WB	WB	NB	SB
HCM Control Delay, s	8.7		0	0
HCM LOS	A			

Minor Lane/Major Mvmt	NBT	NBR	WBLn1	SBL	SBT
Capacity (veh/h)	-	-	989	1595	-
HCM Lane V/C Ratio	-	-	0.004	-	-
HCM Control Delay (s)	-	-	8.7	0	-
HCM Lane LOS	-	-	A	A	-
HCM 95th %tile Q(veh)	-	-	0	0	-

Intersection

Int Delay, s/veh 3.5

Movement	WBL	WBR	NBT	NBR	SBL	SBT
Lane Configurations						
Traffic Vol, veh/h	79	4	2	150	14	7
Future Vol, veh/h	79	4	2	150	14	7
Conflicting Peds, #/hr	0	0	0	0	0	0
Sign Control	Stop	Stop	Free	Free	Free	Free
RT Channelized	-	None	-	None	-	None
Storage Length	0	-	-	-	-	-
Veh in Median Storage, #	0	-	0	-	-	0
Grade, %	0	-	0	-	-	0
Peak Hour Factor	100	100	100	100	100	100
Heavy Vehicles, %	2	2	2	2	2	2
Mvmt Flow	79	4	2	150	14	7

Major/Minor

	Minor1		Major1		Major2	
Conflicting Flow All	112	77	0	0	152	0
Stage 1	77	-	-	-	-	-
Stage 2	35	-	-	-	-	-
Critical Hdwy	6.42	6.22	-	-	4.12	-
Critical Hdwy Stg 1	5.42	-	-	-	-	-
Critical Hdwy Stg 2	5.42	-	-	-	-	-
Follow-up Hdwy	3.518	3.318	-	-	2.218	-
Pot Cap-1 Maneuver	885	984	-	-	1429	-
Stage 1	946	-	-	-	-	-
Stage 2	987	-	-	-	-	-
Platoon blocked, %			-	-		-
Mov Cap-1 Maneuver	876	984	-	-	1429	-
Mov Cap-2 Maneuver	876	-	-	-	-	-
Stage 1	946	-	-	-	-	-
Stage 2	977	-	-	-	-	-

Approach

	WB		NB		SB
HCM Control Delay, s	9.5		0		5
HCM LOS	A				

Minor Lane/Major Mvmt

	NBT	NBRWBLn1	SBL	SBT
Capacity (veh/h)	-	- 881	1429	-
HCM Lane V/C Ratio	-	- 0.094	0.01	-
HCM Control Delay (s)	-	- 9.5	7.5	0
HCM Lane LOS	-	- A	A	A
HCM 95th %tile Q(veh)	-	- 0.3	0	-

Intersection

Int Delay, s/veh 5.7

Movement	WBL	WBR	NBT	NBR	SBL	SBT
Lane Configurations						
Traffic Vol, veh/h	177	14	7	139	8	4
Future Vol, veh/h	177	14	7	139	8	4
Conflicting Peds, #/hr	0	0	0	0	0	0
Sign Control	Stop	Stop	Free	Free	Free	Free
RT Channelized	-	None	-	None	-	None
Storage Length	0	-	-	-	-	-
Veh in Median Storage, #	0	-	0	-	-	0
Grade, %	0	-	0	-	-	0
Peak Hour Factor	100	100	100	100	100	100
Heavy Vehicles, %	2	2	2	2	2	2
Mvmt Flow	177	14	7	139	8	4

Major/Minor	Minor1	Major1	Major2
Conflicting Flow All	97	77	0 0 146 0
Stage 1	77	-	- - - -
Stage 2	20	-	- - - -
Critical Hdwy	6.42	6.22	- - 4.12 -
Critical Hdwy Stg 1	5.42	-	- - - -
Critical Hdwy Stg 2	5.42	-	- - - -
Follow-up Hdwy	3.518	3.318	- - 2.218 -
Pot Cap-1 Maneuver	902	984	- - 1436 -
Stage 1	946	-	- - - -
Stage 2	1003	-	- - - -
Platoon blocked, %			- - - -
Mov Cap-1 Maneuver	897	984	- - 1436 -
Mov Cap-2 Maneuver	897	-	- - - -
Stage 1	946	-	- - - -
Stage 2	997	-	- - - -

Approach	WB	NB	SB
HCM Control Delay, s	10.1	0	5
HCM LOS	B		

Minor Lane/Major Mvmt	NBT	NBRWBLn1	SBL	SBT
Capacity (veh/h)	-	- 903	1436	-
HCM Lane V/C Ratio	-	- 0.212	0.006	-
HCM Control Delay (s)	-	- 10.1	7.5	0
HCM Lane LOS	-	- B	A	A
HCM 95th %tile Q(veh)	-	- 0.8	0	-

Intersection

Int Delay, s/veh 1.5

Movement	EBL	EBT	WBT	WBR	SBL	SBR
Lane Configurations		↔	↔		↔	
Traffic Vol, veh/h	1	198	94	12	46	4
Future Vol, veh/h	1	198	94	12	46	4
Conflicting Peds, #/hr	0	0	0	0	0	0
Sign Control	Free	Free	Free	Free	Stop	Stop
RT Channelized	-	None	-	None	-	None
Storage Length	-	-	-	-	0	-
Veh in Median Storage, #	-	0	0	-	0	-
Grade, %	-	0	0	-	0	-
Peak Hour Factor	100	100	100	100	100	100
Heavy Vehicles, %	2	2	2	2	2	2
Mvmt Flow	1	198	94	12	46	4

Major/Minor	Major1	Major2	Minor2
Conflicting Flow All	106	0	300
Stage 1	-	-	100
Stage 2	-	-	200
Critical Hdwy	4.12	-	6.42
Critical Hdwy Stg 1	-	-	5.42
Critical Hdwy Stg 2	-	-	5.42
Follow-up Hdwy	2.218	-	3.518
Pot Cap-1 Maneuver	1485	-	956
Stage 1	-	-	924
Stage 2	-	-	834
Platoon blocked, %	-	-	-
Mov Cap-1 Maneuver	1485	-	956
Mov Cap-2 Maneuver	-	-	956
Stage 1	-	-	924
Stage 2	-	-	833

Approach	EB	WB	SB
HCM Control Delay, s	0	0	10.5
HCM LOS			B

Minor Lane/Major Mvmt	EBL	EBT	WBT	WBR	SBLn1
Capacity (veh/h)	1485	-	-	-	706
HCM Lane V/C Ratio	0.001	-	-	-	0.071
HCM Control Delay (s)	7.4	0	-	-	10.5
HCM Lane LOS	A	A	-	-	B
HCM 95th %tile Q(veh)	0	-	-	-	0.2

Intersection

Int Delay, s/veh 0.7

Movement	EBL	EBT	WBT	WBR	SBL	SBR
Lane Configurations		↔	↔		↔	
Traffic Vol, veh/h	4	171	238	47	25	2
Future Vol, veh/h	4	171	238	47	25	2
Conflicting Peds, #/hr	0	0	0	0	0	0
Sign Control	Free	Free	Free	Free	Stop	Stop
RT Channelized	-	None	-	None	-	None
Storage Length	-	-	-	-	0	-
Veh in Median Storage, #	-	0	0	-	0	-
Grade, %	-	0	0	-	0	-
Peak Hour Factor	100	100	100	100	100	100
Heavy Vehicles, %	2	2	2	2	2	2
Mvmt Flow	4	171	238	47	25	2

Major/Minor	Major1	Major2	Minor2
Conflicting Flow All	285	0	441
Stage 1	-	-	262
Stage 2	-	-	179
Critical Hdwy	4.12	-	6.42
Critical Hdwy Stg 1	-	-	5.42
Critical Hdwy Stg 2	-	-	5.42
Follow-up Hdwy	2.218	-	3.518
Pot Cap-1 Maneuver	1277	-	574
Stage 1	-	-	782
Stage 2	-	-	852
Platoon blocked, %	-	-	-
Mov Cap-1 Maneuver	1277	-	572
Mov Cap-2 Maneuver	-	-	572
Stage 1	-	-	782
Stage 2	-	-	849

Approach	EB	WB	SB
HCM Control Delay, s	0.2	0	11.5
HCM LOS			B

Minor Lane/Major Mvmt	EBL	EBT	WBT	WBR	SBLn1
Capacity (veh/h)	1277	-	-	-	583
HCM Lane V/C Ratio	0.003	-	-	-	0.046
HCM Control Delay (s)	7.8	0	-	-	11.5
HCM Lane LOS	A	A	-	-	B
HCM 95th %tile Q(veh)	0	-	-	-	0.1



1981 Maple Grove Road

Transportation Impact Assessment Report

Appendix J: Existing Signal Timing Plans

February 2018



Traffic Signal Timing

City of Ottawa, Transportation Services Department

Traffic Signal Operations Unit

Intersection:	Main: Huntmar	Side: Maple Grove
Controller:	MS-3200	TSD: 5476
Author:	Spencer Willows	Date: 10-Jan-2018

Existing Timing Plans†

	Plan		Ped Minimum Time		
	Plan 3	Plan 4	Walk	DW	A+R
Cycle	125	100			
Offset	x	x			
NB Thru	76	45	7	8	3.3+2.8
SB Thru	76	45	7	8	3.3+2.8
EB Thru	49	55	7	16	3.3+2.8
WB Thru	49	55	7	16	3.3+2.8

Phasing Sequence‡

Plan: 3 and 4

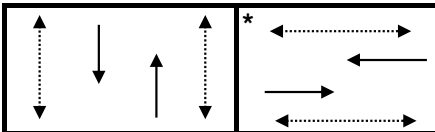

Schedule

Weekday

Time	Plan
0:10	4
15:00	3
23:00	4

Weekend

Time	Plan
All Day	4

Notes

†: Time for each direction includes amber and all red intervals

‡: Start of first phase should be used as reference point for offset

Asterisk (*) Indicates actuated phase

(fp): Fully Protected Left Turn

←.....→ Pedestrian signal

Cost is \$56.50 (\$50 + HST)



1981 Maple Grove Road

Transportation Impact Assessment Report

Appendix K: Technical Standards

February 2018



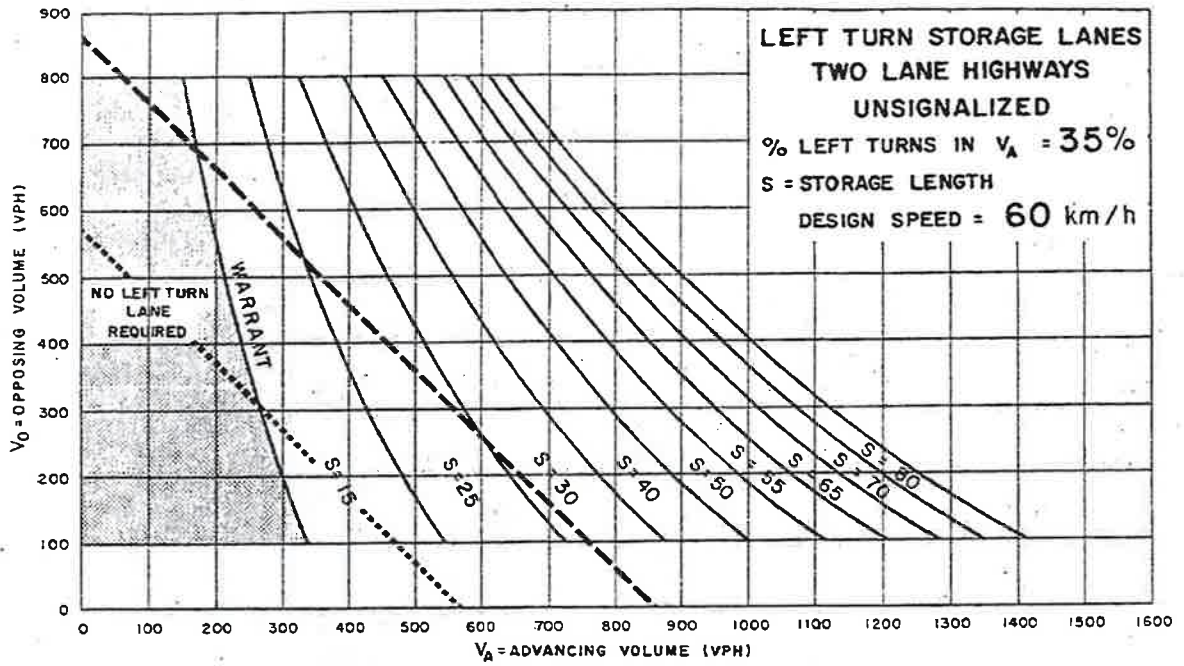

--- TRAFFIC SIGNALS MAY BE WARRANTED IN RURAL AREAS OR URBAN AREAS WITH RESTRICTED FLOW
 TRAFFIC SIGNALS MAY BE WARRANTED IN "FREE FLOW" URBAN AREAS

AM: Maple + Stittsville Main St. L

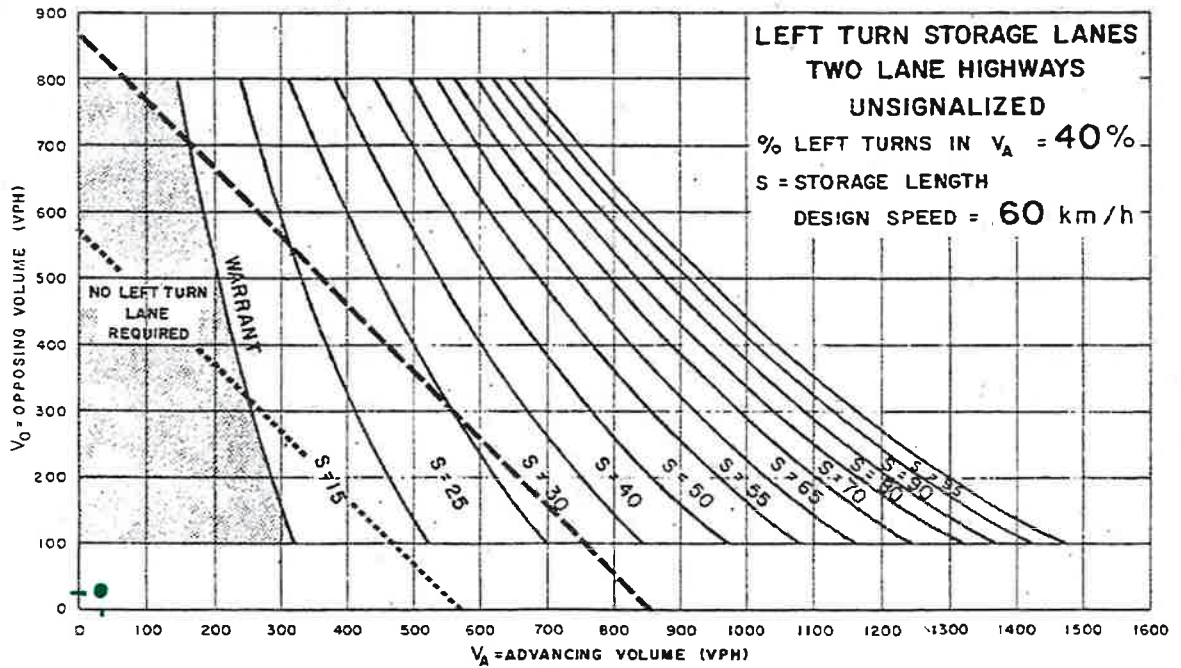

Figure EA-9

PM: Maple + Street 6 ↗

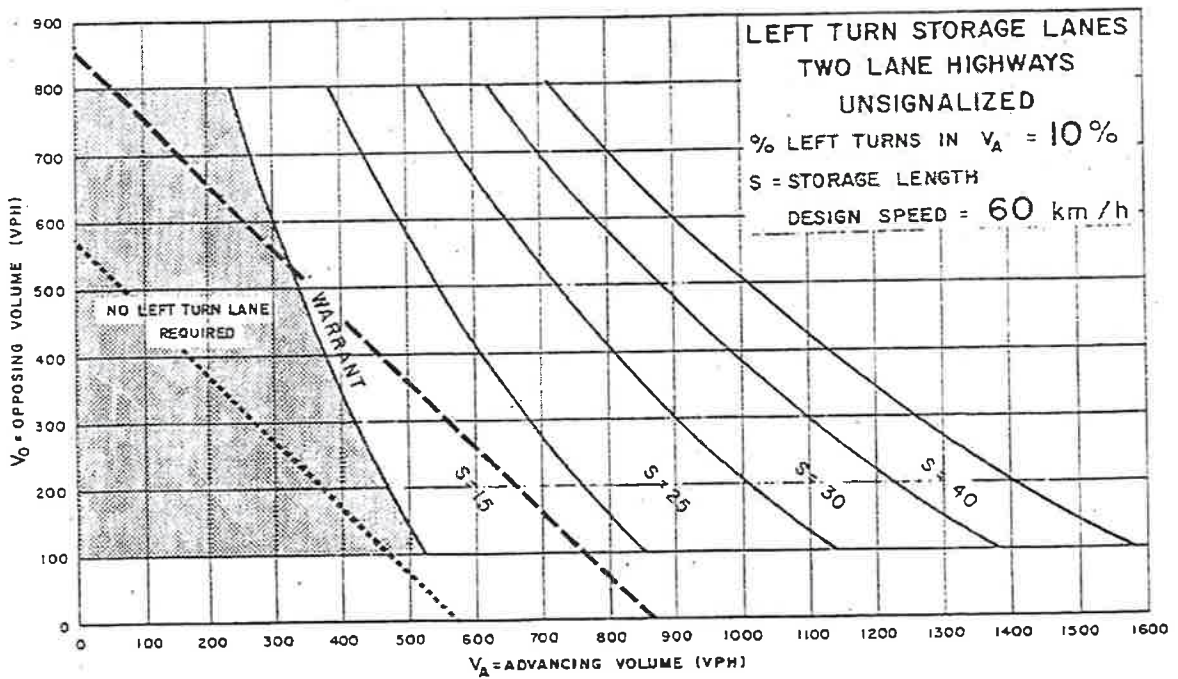
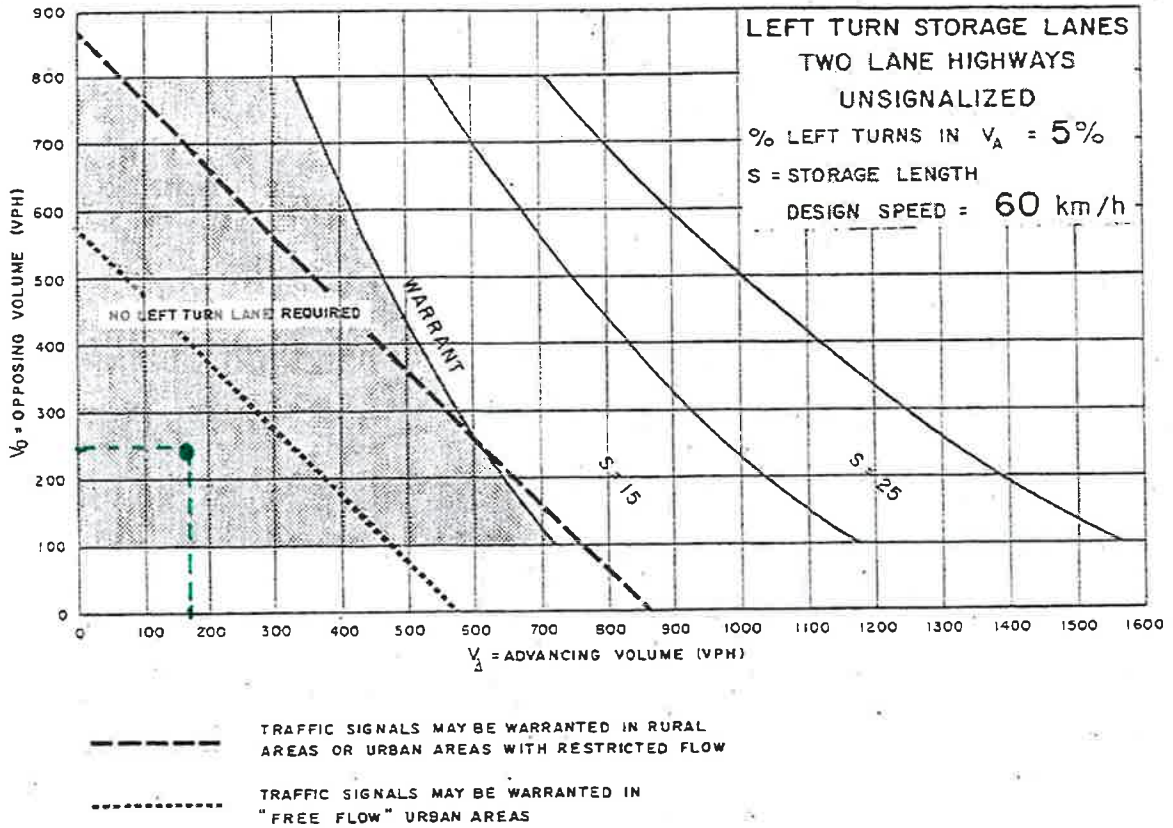
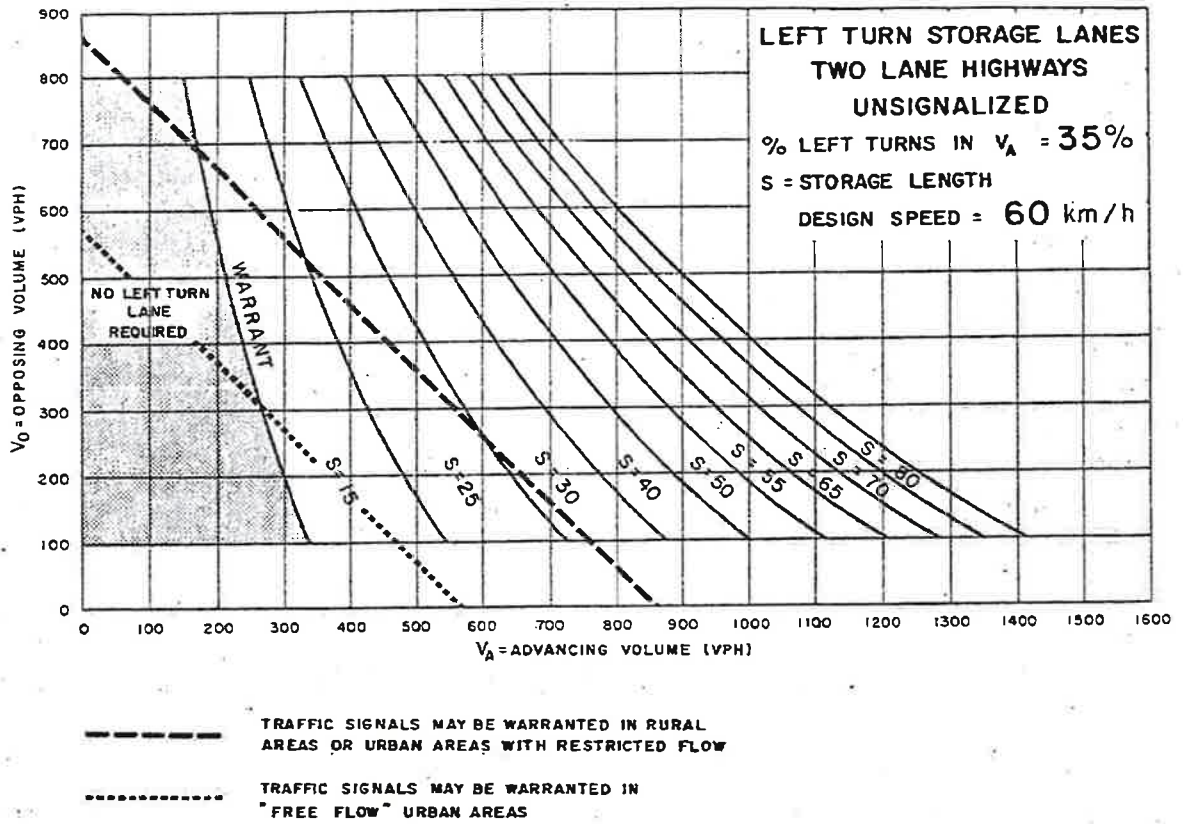

Figure EA-6



PM: Maple + Stittsville Main St. ↘

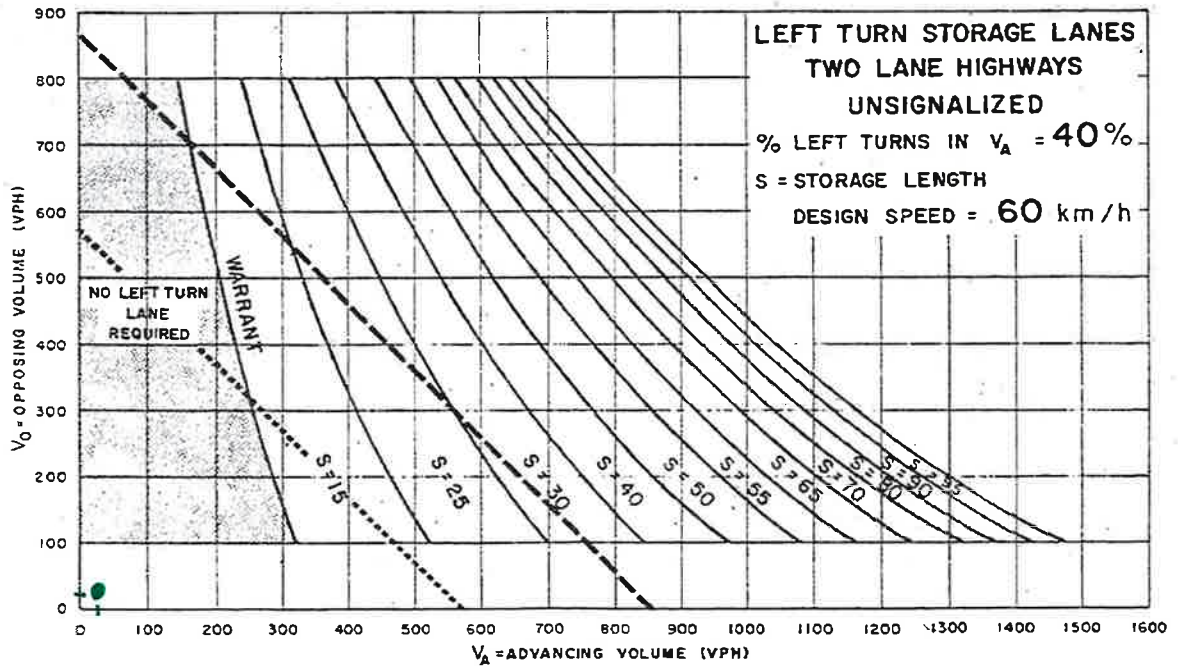

Figure EA-9