

770-774 Bronson Avenue

Transportation Impact Assessment

Step 1 Screening Report

Step 2 Scoping Report

Step 3 Forecasting Report

Step 4 Strategy Report (Revision #2)

Prepared for:

Katasa Group

69, rue Jean-Proulx unite #301

Gatineau, Québec J8Z 1W2

Prepared by:



6 Plaza Court

Ottawa, ON K2H 7W1

June 2023

PN: 2020-64

Table of Contents

1	Screening.....	1
2	Existing and Planned Conditions.....	1
2.1	Proposed Development.....	1
2.2	Existing Conditions.....	3
2.2.1	Area Road Network.....	3
2.2.2	Existing Intersections.....	4
2.2.3	Existing Driveways.....	4
2.2.4	Cycling and Pedestrian Facilities.....	5
2.2.5	Existing Transit.....	8
2.2.6	Existing Area Traffic Management Measures.....	10
2.2.7	Existing Peak Hour Travel Demand.....	10
2.2.8	Collision Analysis.....	12
2.3	Planned Conditions.....	15
2.3.1	Changes to the Area Transportation Network.....	15
2.3.2	Other Study Area Developments.....	16
3	Study Area and Time Periods.....	17
3.1	Study Area.....	17
3.2	Time Periods.....	17
3.3	Horizon Years.....	17
4	Exemption Review.....	18
5	Development-Generated Travel Demand.....	18
5.1	Mode Shares.....	18
5.2	Trip Generation.....	19
5.3	Trip Distribution.....	20
5.4	Trip Assignment.....	20
6	Background Network Travel Demands.....	21
6.1	Transportation Network Plans.....	21
6.2	Background Growth.....	21
6.3	Other Developments.....	22
7	Demand Rationalization.....	22
7.1	2025 Future Background Operations.....	22
7.2	2030 Future Background Operations.....	24
7.3	Modal Share Sensitivity.....	27
7.4	Network Demand Rationalization.....	27
8	Development Design.....	28
8.1	Design for Sustainable Modes.....	28
8.2	Circulation and Access.....	29
9	Parking.....	29
9.1	Parking Supply.....	29
10	Boundary Street Design.....	29
11	Access Intersections Design.....	30
11.1	Location and Design of Access.....	30

11.2 Intersection Control..... 30

11.3 Access Intersection Design 30

 11.3.1 2025 Future Total Access Intersection Operations 30

 11.3.2 2030 Future Total Access Intersection Operations 32

 11.3.3 Access Intersection MMLOS 33

 11.3.4 Recommended Design Elements..... 33

12 Transportation Demand Management 33

 12.1 Context for TDM 33

 12.2 Need and Opportunity..... 33

 12.3 TDM Program 33

13 Neighbourhood Traffic Management..... 34

14 Transit..... 34

 14.1 Route Capacity..... 34

 14.2 Transit Priority 34

15 Network Intersection Design..... 35

 15.1 Network Intersection Control..... 35

 15.2 Network Intersection Design..... 35

 15.2.1 2025 Future Total Network Intersection Operations 35

 15.2.2 2030 Future Total Network Intersection Operations 36

 15.2.3 Network Intersection MMLOS..... 37

 15.2.4 Recommended Design Elements..... 37

16 Summary of Improvements Indicated and Modifications Options..... 37

17 Conclusion 40

List of Figures

Figure 1: Area Context Plan1

Figure 2: Concept Plan.....2

Figure 3: Study Area Pedestrian Facilities5

Figure 4: Study Area Cycling Facilities6

Figure 5: Existing Pedestrian Volumes7

Figure 6: Existing Cyclist Volumes8

Figure 7: Existing Study Area Transit Service.....9

Figure 8: Existing Study Area Transit Stops9

Figure 9: Existing Traffic Counts 11

Figure 10: Study Area Collision Records..... 13

Figure 11: Carling Avenue - Planned Transit Priority Measures..... 16

Figure 12: New Site Generation Auto Volumes..... 21

Figure 13: 2025 Future Background Volumes 23

Figure 14: 2030 Future Background Volumes 25

Figure 15: 2025 Future Total Volumes 31

Figure 16: 2030 Future Total Volumes 32

Table of Tables

Table 1: Intersection Count Date.....	10
Table 2: Existing Intersection Operations.....	11
Table 3: Study Area Collision Summary, 2016-2020	13
Table 4: Summary of Collision Locations, 2016-2020.....	14
Table 5: Bronson Avenue at Carling Avenue/Glebe Avenue Collision Summary	14
Table 6: Bronson Avenue at First Avenue Collision Summary	15
Table 7: Exemption Review	18
Table 8: TRANS Trip Generation Manual Recommended Mode Shares – Ottawa Inner	18
Table 9: Trip Generation Person Trip Rates by Peak Period.....	19
Table 10: Total Residential Person Trip Generation by Peak Period.....	19
Table 11: Trip Generation by Mode	19
Table 12: OD Survey Distribution – Ottawa Inner	20
Table 13: TRANS Regional Model Projections – Study Area Growth Rates.....	22
Table 14: 2025 Future Background Intersection Operations	23
Table 15: 2030 Future Background Intersection Operations	25
Table 16: Boundary Street MMLOS Analysis	29
Table 17: 2025 Future Total Access Intersection Operations	31
Table 18: 2030 Future Total Access Intersection Operations	32
Table 19: Trip Generation by Transit Mode	34
Table 20: 2025 Future Total Network Intersection Operations	35
Table 21: 2030 Future Total Network Intersection Operations	36
Table 22: Network Intersection MMLOS Analysis.....	37

List of Appendices

Appendix A – TIA Screening Form and Certification Form
Appendix B – Turning Movement Count Data
Appendix C – Synchro Intersection Worksheets – Existing Conditions
Appendix D – Collision Data
Appendix E – TRANS Model Plots
Appendix F – Background Development Volumes
Appendix G – Synchro Intersection Worksheets – 2025 Future Background Conditions
Appendix H – Synchro Intersection Worksheets – 2030 Future Background Conditions
Appendix I – Turning Templates
Appendix J – MMLOS Analysis
Appendix K – Access Signage Plan
Appendix L – Synchro Intersection Worksheets – 2025 Future Total Conditions
Appendix M –Synchro Intersection Worksheets – 2030 Future Total Conditions
Appendix N – TDM Checklist

1 Screening

This study has been prepared according to the City of Ottawa's 2017 Transportation Impact Assessment (TIA) Guidelines. Accordingly, a Step 1 Screening Form has been prepared and is included as Appendix A, along with the Certification Form for TIA Study PM. As shown in the Screening Form, a TIA is required including the Design Review component and the Network Impact Component. This report accompanies a zoning by-law amendment/site plan application.

2 Existing and Planned Conditions

2.1 Proposed Development

The subject property, located at 770-774 Bronson Avenue and 557 Cambridge Street, is zoned as Arterial Mainstreet (AM10[2373], AM1[2003] S296) and is currently undeveloped. The proposed development includes a 22-storey residential building on the east side of the property comprising 117 apartment dwelling units and 71 student housing dwelling units to be built-out by 2024, connecting to a nine-storey residential building on the west side, comprising 90 apartment units to be built-out by 2025. The site is located along both the Bronson Traditional Mainstreet and Carling Arterial Mainstreet design priority corridors. The plan proposes use of an existing two-way access onto Bronson Avenue with a restriction of the outbound left-turn movement and an outlet onto Cambridge Street, both accessing underground parking with 133 vehicle parking stalls and 221 bicycle parking stalls. Figure 1 illustrates the Study Area Context. Figure 2 illustrates the proposed concept plan.

Figure 1: Area Context Plan



Source: <http://maps.ottawa.ca/geoOttawa/> Accessed: November 29, 2022

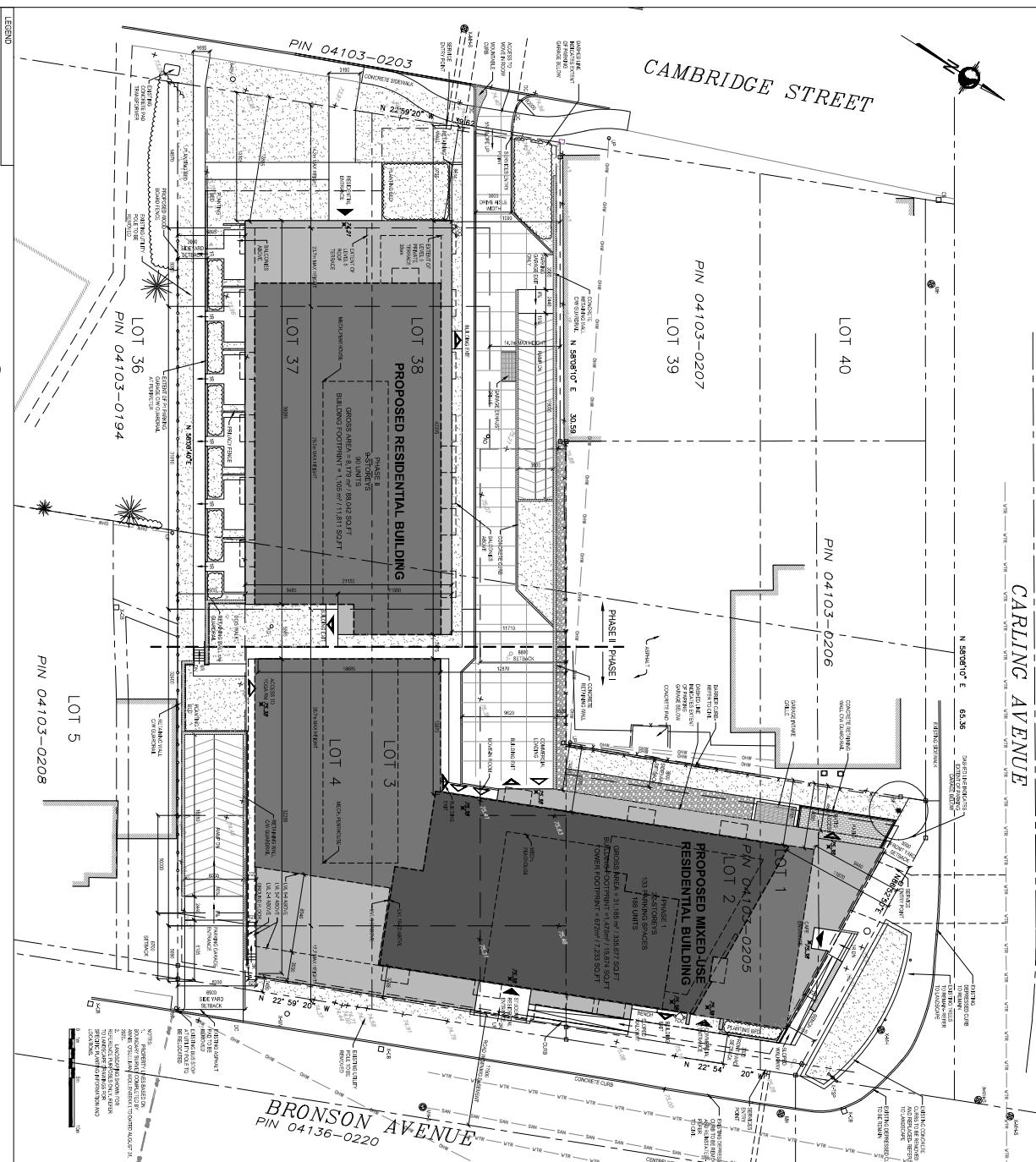
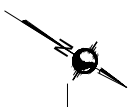

LEGEND

[Symbol]	EXISTING BUILDING
[Symbol]	PROPOSED BUILDING
[Symbol]	EXISTING DRIVEWAY
[Symbol]	PROPOSED DRIVEWAY
[Symbol]	EXISTING SIDEWALK
[Symbol]	PROPOSED SIDEWALK
[Symbol]	EXISTING CURB
[Symbol]	PROPOSED CURB
[Symbol]	EXISTING LOT LINE
[Symbol]	PROPOSED LOT LINE
[Symbol]	EXISTING EASEMENT
[Symbol]	PROPOSED EASEMENT
[Symbol]	EXISTING UTILITY
[Symbol]	PROPOSED UTILITY
[Symbol]	EXISTING TREE
[Symbol]	PROPOSED TREE
[Symbol]	EXISTING LANDSCAPE
[Symbol]	PROPOSED LANDSCAPE
[Symbol]	EXISTING MATERIAL
[Symbol]	PROPOSED MATERIAL
[Symbol]	EXISTING FENCE
[Symbol]	PROPOSED FENCE
[Symbol]	EXISTING SIGN
[Symbol]	PROPOSED SIGN
[Symbol]	EXISTING LIGHT
[Symbol]	PROPOSED LIGHT
[Symbol]	EXISTING OTHER
[Symbol]	PROPOSED OTHER



PROPERTY DESCRIPTION

22 STOREY APARTMENT RESIDENTIAL BUILDING

7707 BRONSON AVENUE, CAMBRIDGE, ONTARIO

7707 BRONSON AVENUE & 557 CARLING STREET

7707 BRONSON AVENUE & 557 CARLING STREET

7707 BRONSON AVENUE & 557 CARLING STREET

CONING TABLE

FLOOR	STUDENT	RESIDENTIAL	OFFICE	OTHER
FLOOR 1	0	0	0	0
FLOOR 2	0	0	0	0
FLOOR 3	0	0	0	0
FLOOR 4	0	0	0	0
FLOOR 5	0	0	0	0
FLOOR 6	0	0	0	0
FLOOR 7	0	0	0	0
FLOOR 8	0	0	0	0
FLOOR 9	0	0	0	0
FLOOR 10	0	0	0	0
FLOOR 11	0	0	0	0
FLOOR 12	0	0	0	0
FLOOR 13	0	0	0	0
FLOOR 14	0	0	0	0
FLOOR 15	0	0	0	0
FLOOR 16	0	0	0	0
FLOOR 17	0	0	0	0
FLOOR 18	0	0	0	0
FLOOR 19	0	0	0	0
FLOOR 20	0	0	0	0
FLOOR 21	0	0	0	0
FLOOR 22	0	0	0	0
FLOOR 23	0	0	0	0
FLOOR 24	0	0	0	0
FLOOR 25	0	0	0	0
FLOOR 26	0	0	0	0
FLOOR 27	0	0	0	0
FLOOR 28	0	0	0	0
FLOOR 29	0	0	0	0
FLOOR 30	0	0	0	0
FLOOR 31	0	0	0	0
FLOOR 32	0	0	0	0
FLOOR 33	0	0	0	0
FLOOR 34	0	0	0	0
FLOOR 35	0	0	0	0
FLOOR 36	0	0	0	0
FLOOR 37	0	0	0	0
FLOOR 38	0	0	0	0
FLOOR 39	0	0	0	0
FLOOR 40	0	0	0	0
FLOOR 41	0	0	0	0
FLOOR 42	0	0	0	0
FLOOR 43	0	0	0	0
FLOOR 44	0	0	0	0
FLOOR 45	0	0	0	0
FLOOR 46	0	0	0	0
FLOOR 47	0	0	0	0
FLOOR 48	0	0	0	0
FLOOR 49	0	0	0	0
FLOOR 50	0	0	0	0
FLOOR 51	0	0	0	0
FLOOR 52	0	0	0	0
FLOOR 53	0	0	0	0
FLOOR 54	0	0	0	0
FLOOR 55	0	0	0	0
FLOOR 56	0	0	0	0
FLOOR 57	0	0	0	0
FLOOR 58	0	0	0	0
FLOOR 59	0	0	0	0
FLOOR 60	0	0	0	0
FLOOR 61	0	0	0	0
FLOOR 62	0	0	0	0
FLOOR 63	0	0	0	0
FLOOR 64	0	0	0	0
FLOOR 65	0	0	0	0
FLOOR 66	0	0	0	0
FLOOR 67	0	0	0	0
FLOOR 68	0	0	0	0
FLOOR 69	0	0	0	0
FLOOR 70	0	0	0	0
FLOOR 71	0	0	0	0
FLOOR 72	0	0	0	0
FLOOR 73	0	0	0	0
FLOOR 74	0	0	0	0
FLOOR 75	0	0	0	0
FLOOR 76	0	0	0	0
FLOOR 77	0	0	0	0
FLOOR 78	0	0	0	0
FLOOR 79	0	0	0	0
FLOOR 80	0	0	0	0
FLOOR 81	0	0	0	0
FLOOR 82	0	0	0	0
FLOOR 83	0	0	0	0
FLOOR 84	0	0	0	0
FLOOR 85	0	0	0	0
FLOOR 86	0	0	0	0
FLOOR 87	0	0	0	0
FLOOR 88	0	0	0	0
FLOOR 89	0	0	0	0
FLOOR 90	0	0	0	0
FLOOR 91	0	0	0	0
FLOOR 92	0	0	0	0
FLOOR 93	0	0	0	0
FLOOR 94	0	0	0	0
FLOOR 95	0	0	0	0
FLOOR 96	0	0	0	0
FLOOR 97	0	0	0	0
FLOOR 98	0	0	0	0
FLOOR 99	0	0	0	0
FLOOR 100	0	0	0	0

CONING TABLE

FLOOR	STUDENT	RESIDENTIAL	OFFICE	OTHER
FLOOR 1	0	0	0	0
FLOOR 2	0	0	0	0
FLOOR 3	0	0	0	0
FLOOR 4	0	0	0	0
FLOOR 5	0	0	0	0
FLOOR 6	0	0	0	0
FLOOR 7	0	0	0	0
FLOOR 8	0	0	0	0
FLOOR 9	0	0	0	0
FLOOR 10	0	0	0	0
FLOOR 11	0	0	0	0
FLOOR 12	0	0	0	0
FLOOR 13	0	0	0	0
FLOOR 14	0	0	0	0
FLOOR 15	0	0	0	0
FLOOR 16	0	0	0	0
FLOOR 17	0	0	0	0
FLOOR 18	0	0	0	0
FLOOR 19	0	0	0	0
FLOOR 20	0	0	0	0
FLOOR 21	0	0	0	0
FLOOR 22	0	0	0	0
FLOOR 23	0	0	0	0
FLOOR 24	0	0	0	0
FLOOR 25	0	0	0	0
FLOOR 26	0	0	0	0
FLOOR 27	0	0	0	0
FLOOR 28	0	0	0	0
FLOOR 29	0	0	0	0
FLOOR 30	0	0	0	0
FLOOR 31	0	0	0	0
FLOOR 32	0	0	0	0
FLOOR 33	0	0	0	0
FLOOR 34	0	0	0	0
FLOOR 35	0	0	0	0
FLOOR 36	0	0	0	0
FLOOR 37	0	0	0	0
FLOOR 38	0	0	0	0
FLOOR 39	0	0	0	0
FLOOR 40	0	0	0	0
FLOOR 41	0	0	0	0
FLOOR 42	0	0	0	0
FLOOR 43	0	0	0	0
FLOOR 44	0	0	0	0
FLOOR 45	0	0	0	0
FLOOR 46	0	0	0	0
FLOOR 47	0	0	0	0
FLOOR 48	0	0	0	0
FLOOR 49	0	0	0	0
FLOOR 50	0	0	0	0
FLOOR 51	0	0	0	0
FLOOR 52	0	0	0	0
FLOOR 53	0	0	0	0
FLOOR 54	0	0	0	0
FLOOR 55	0	0	0	0
FLOOR 56	0	0	0	0
FLOOR 57	0	0	0	0
FLOOR 58	0	0	0	0
FLOOR 59	0	0	0	0
FLOOR 60	0	0	0	0
FLOOR 61	0	0	0	0
FLOOR 62	0	0	0	0
FLOOR 63	0	0	0	0
FLOOR 64	0	0	0	0
FLOOR 65	0	0	0	0
FLOOR 66	0	0	0	0
FLOOR 67	0	0	0	0
FLOOR 68	0	0	0	0
FLOOR 69	0	0	0	0
FLOOR 70	0	0	0	0
FLOOR 71	0	0	0	0
FLOOR 72	0	0	0	0
FLOOR 73	0	0	0	0
FLOOR 74	0	0	0	0
FLOOR 75	0	0	0	0
FLOOR 76	0	0	0	0
FLOOR 77	0	0	0	0
FLOOR 78	0	0	0	0
FLOOR 79	0	0	0	0
FLOOR 80	0	0	0	0
FLOOR 81	0	0	0	0
FLOOR 82	0	0	0	0
FLOOR 83	0	0	0	0
FLOOR 84	0	0	0	0
FLOOR 85	0	0	0	0
FLOOR 86	0	0	0	0
FLOOR 87	0	0	0	0
FLOOR 88	0	0	0	0
FLOOR 89	0	0	0	0
FLOOR 90	0	0	0	0
FLOOR 91	0	0	0	0
FLOOR 92	0	0	0	0
FLOOR 93	0	0	0	0
FLOOR 94	0	0	0	0
FLOOR 95	0	0	0	0
FLOOR 96	0	0	0	0
FLOOR 97	0	0	0	0
FLOOR 98	0	0	0	0
FLOOR 99	0	0	0	0
FLOOR 100	0	0	0	0

CONING TABLE

FLOOR	STUDENT	RESIDENTIAL	OFFICE	OTHER
FLOOR 1	0	0	0	0
FLOOR 2	0	0	0	0
FLOOR 3	0	0	0	0
FLOOR 4	0	0	0	0
FLOOR 5	0	0	0	0
FLOOR 6	0	0	0	0
FLOOR 7	0	0	0	0
FLOOR 8	0	0	0	0
FLOOR 9	0	0	0	0
FLOOR 10	0	0	0	0
FLOOR 11	0	0	0	0
FLOOR 12	0	0	0	0
FLOOR 13	0	0	0	0
FLOOR 14	0	0	0	0
FLOOR 15	0	0	0	0
FLOOR 16	0	0	0	0
FLOOR 17	0	0	0	0
FLOOR 18	0	0	0	0
FLOOR 19	0	0	0	0
FLOOR 20	0	0	0	0
FLOOR 21	0	0	0	0
FLOOR 22	0	0	0	0
FLOOR 23	0	0	0	0
FLOOR 24	0	0	0	0
FLOOR 25	0	0	0	0
FLOOR 26	0	0	0	0
FLOOR 27	0	0	0	0
FLOOR 28	0	0	0	0
FLOOR 29	0	0	0	0
FLOOR 30	0	0	0	0
FLOOR 31	0	0	0	0
FLOOR 32	0	0	0	0
FLOOR 33	0	0	0	0
FLOOR 34	0	0	0	0
FLOOR 35	0	0	0	0
FLOOR 36	0	0	0	0
FLOOR 37	0	0	0	0
FLOOR 38	0	0	0	0
FLOOR 39	0	0	0	0
FLOOR 40	0	0	0	0
FLOOR 41	0	0	0	0
FLOOR 42	0	0	0	0
FLOOR 43	0	0	0	0
FLOOR 44	0	0	0	0</

2.2 Existing Conditions

2.2.1 Area Road Network

Carling Avenue: Carling Avenue is a City of Ottawa arterial road with a divided six-lane urban cross-section including sidewalks on both sides of the road. The outside lanes are shared transit-bike priority lanes and on-street parking is prohibited within the study area on both sides of the road. The transit lane on the south side of Carling Avenue additionally permits tour bus parking at specified times of year. The posted speed limit is 60 km/h and the Ottawa Official Plan reserves a 44.5 metre right of way within the study area. Carling Avenue is a truck route.

Bronson Avenue: Bronson Avenue is a City of Ottawa arterial road with a four-lane urban cross-section including sidewalks on both sides of the road. Within the study area, stopping regulations alternate between no stopping and stopping prohibited from 7:00 – 9:00am, and 3:30 – 5:30pm during weekdays. The parking regulations during weekdays alternate between no parking and parking prohibited between 9:00am and 3:00 pm. The posted speed limit is 50 km/h and the Ottawa Official Plan reserves a 23.0 metre right of way within the study area. Bronson Avenue is a truck route.

Booth Street: Booth Street is a City of Ottawa major collector road with a two-lane urban cross-section including sidewalks on both sides of the road. On-street parking is permitted on both sides of the road, approximately 30 metres north of Carling Avenue. The unposted speed limit is 50 km/h and the measured right of way is 20.0 metres within the study area. Booth Street is a truck route.

Fifth Avenue: Fifth Avenue is a City of Ottawa collector road with a two shared-lane urban cross-section including sidewalks on both sides of the road. On-Street parking is permitted on the north side of the road, beyond approximately 90 metres east of Bronson Avenue. The posted speed limit is 30 km/h and the measured right of way is 20.0 metres within the study area.

Cambridge Street: Cambridge Street is a City of Ottawa local road with a two-lane urban cross-section including sidewalks on both sides of the road. North of Carling Avenue, on-street parking is permitted on both sides of the road between 7:00am and 6:00pm, (no parking is allowed between December 1st and March 31st). On-street parking is permitted on the east side of the road, and is permitted on the west side of the road from 7:00am and 7:00pm between Carling Avenue and Frederick Place. The unposted speed limit is 50 km/h, and the measured right of way is 20.0 metres within the study area.

Powell Avenue: Powell Avenue is a City of Ottawa local road with a two-lane urban cross-section and sidewalks on both sides of the road. On-street parking is permitted on north side of the road west of Bronson Avenue, and on alternating sides of the road to the east. The unposted speed limit is 50 km/h, a 40 km/h posted speed limit is present approximately 50 metres east of Cambridge Street, and a 30 km/h posted speed limit is present approximately 30 metres east of Bronson Avenue. The measured right of way is 18.0 metres east of Bronson Avenue, and between 14.0 metres and 14.5 metres to the west within the study area.

Glebe Avenue: Glebe Avenue is an eastbound City of Ottawa one-way local road with sidewalks on both sides of the street, eastbound and westbound bike lanes on the south side of the road, and a bike lane on the south side of the road east of Percy Street. On-street parking is permitted on the south side of the road, the posted speed limit is 30 km/h and the measured right of way width is 18.0 metres within the study area.

Madawaska Drive: Madawaska Drive is a City of Ottawa local road with a two-lane urban cross-section and sidewalks on both sides of the street. On-street parking is permitted on both sides of the road, the posted speed limit is 40 km/h and the measured right of way width is 16.0 metres within the study area.

2.2.2 Existing Intersections

The existing study area intersections within 400 metres of the site have been summarized below:

- Carling Avenue at Booth Street* The intersection of Carling Avenue at Booth Street is a signalized T-intersection. The southbound approach consists of an auxiliary right-turn lane and a left-turn lane. The eastbound approach consists of an auxiliary left turn lane, two through lanes, and a shared transit/cycle priority lane, and the westbound approach consists of two through lanes and a shared right-turn/transit/cycle priority lane. Westbound U-turns are prohibited at this intersection.
- Carling Avenue at Cambridge Street* The intersection of Carling Avenue at Cambridge Street is an unsignalized intersection, stop-controlled on the minor approaches. The minor northbound and the southbound approaches each consist of a right-turn lane with the Carling Avenue median preventing through or left-turn movements. The eastbound approach consists of two through lanes and a shared through/right-turn lane, and the westbound approach consists of two through lanes and a shared right-turn/transit/cycle priority lane. No turn restrictions were noted.
- Bronson Avenue at Powell Avenue* The intersection of Bronson Avenue at Powell Avenue is a signalized intersection. The northbound and southbound approaches each consist of a shared left-turn/through lane and a shared through/right-turn lane. The eastbound and the westbound approaches each consist of a shared all-movements lane. No turn restrictions were noted.
- Bronson Avenue at Carling Avenue / Glebe Avenue* The intersection of Bronson Avenue at Carling Avenue/Glebe Avenue is a signalized intersection. The northbound approach consists of an auxiliary left-turn lane, a left-turn lane, and a shared through/right-turn lane and the southbound approach consists of a through lane and a shared through/right-turn lane. The eastbound approach consists of an auxiliary left-turn lane, a shared movement left-turn/through lane, and a right-turn lane and the east leg is inbound only. Southbound left turns are prohibited at this intersection.
- Bronson Avenue at Fifth Avenue / Madawaska Drive* The intersection of Bronson Avenue at Fifth Avenue/Madawaska Drive is a signalized intersection. The northbound and southbound approaches each consist of a shared left-turn/through lane and a shared through/right-turn lane, and the eastbound and westbound approaches each consist of a shared all-movements lane. Northbound left turns are prohibited between 7:00am and 9:00am for all but authorized vehicles and bicycles.

2.2.3 Existing Driveways

Along Cambridge Street, a driveway to a private laneway is present directly across from the proposed site access and three driveways to single detached dwellings are on the west side of Cambridge Street and a drop off loop accessing parking to a mid-rise residential building south of the site. Along Bronson Avenue, driveways to residential and commercial land uses are present on both sides of the road within 200 metres of the proposed site access.

2.2.4 Cycling and Pedestrian Facilities

Figure 3 illustrates the pedestrian facilities in the study area and Figure 4 illustrates the cycling facilities. Sidewalks are provided along both sides of all study area roads. Cycling facilities include separated two-way bike lanes the south side of Glebe Avenue west of Percy Street, a bike lane on the south side of a Glebe Avenue east of Percy Street, a bike lane on the north side of a First Avenue east of Percy Street. Cycling paths are present in the Commissioners Park. In the Ultimate cycling network, Carling Avenue, Glebe Avenue, Booth Street, and Percy Street are spine routes, Madawaska Drive/Fifth Avenue and First Avenue east of Percy Street are local routes. Madawaska Drive/Fifth Avenue, Glebe Avenue, First Avenue, and Percy Street are neighbourhood bikeways.

Figure 3: Study Area Pedestrian Facilities

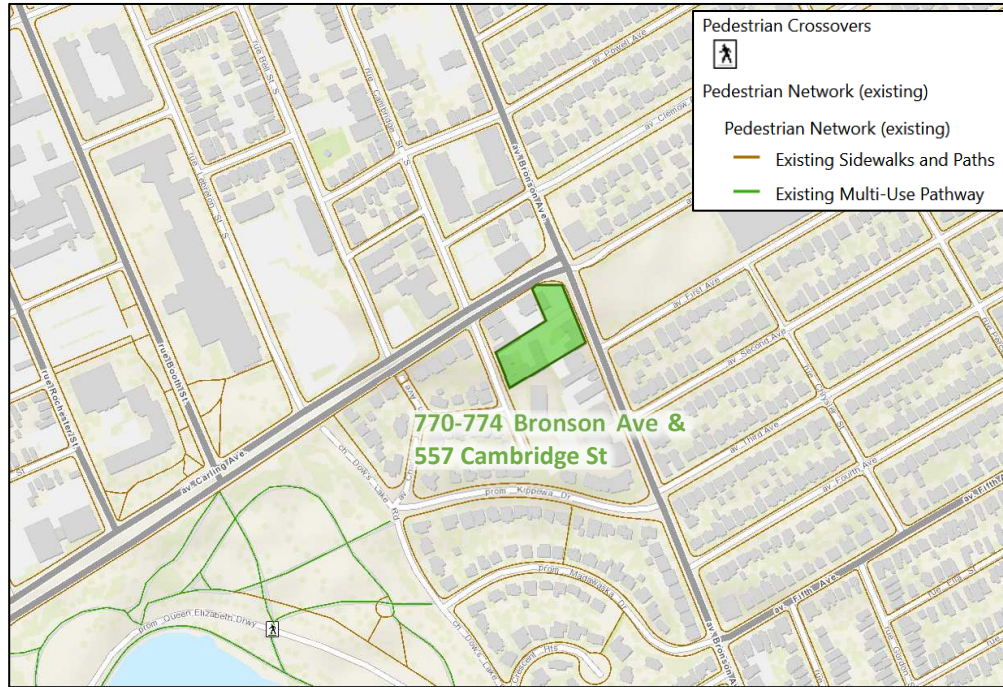

Source: <http://maps.ottawa.ca/geoOttawa/> Accessed: November 29, 2022

Figure 4: Study Area Cycling Facilities

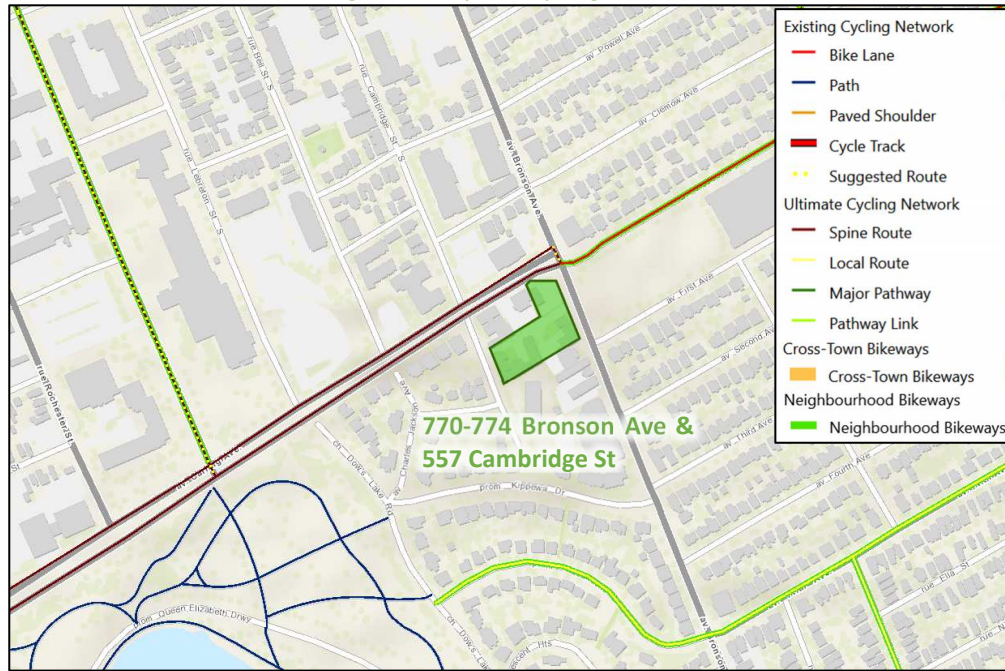

Source: <http://maps.ottawa.ca/geoOttawa/> Accessed: November 29, 2022

Additionally, the collected intersection counts presented in Section 2.2.7 provide existing pedestrian and cyclist demands at the five study area intersections for both AM and PM peak hours. Figure 5 illustrates the existing pedestrian volumes and Figure 6 illustrates the existing cyclist volumes within the study area.

Figure 5: Existing Pedestrian Volumes

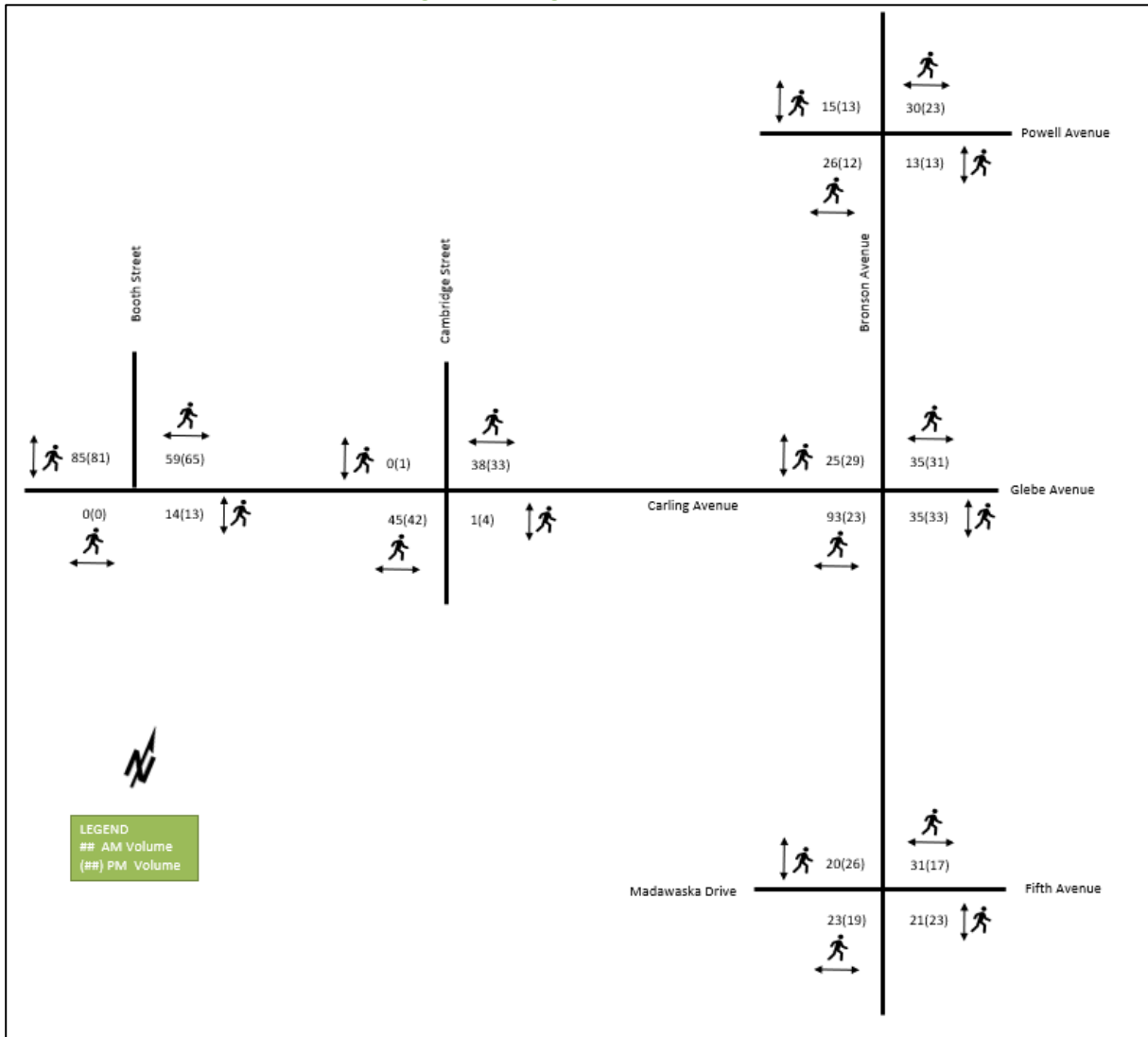
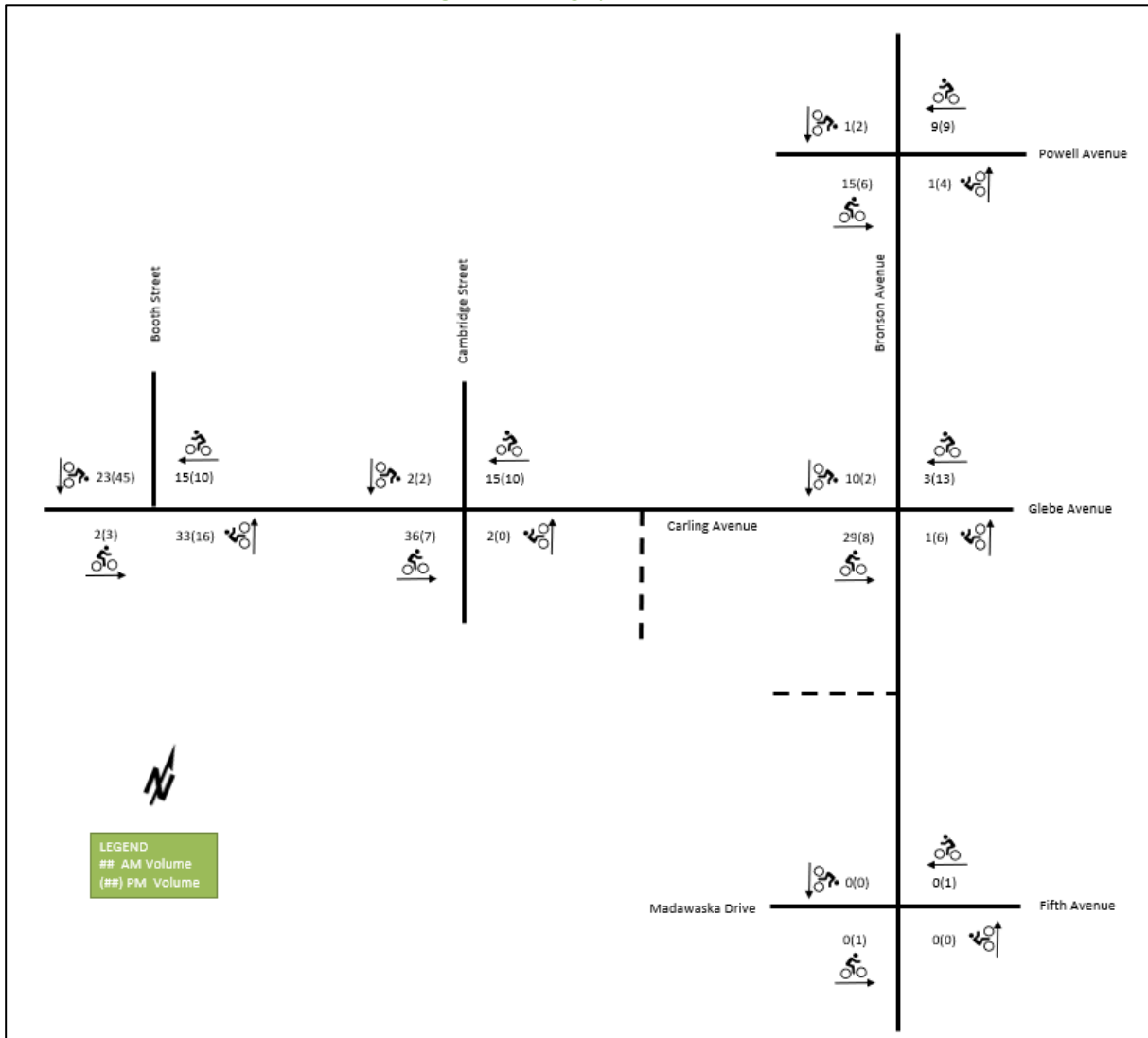

Figure 6: Existing Cyclist Volumes



2.2.5 Existing Transit

Figure 7 illustrates the transit system map in the study area and Figure 8 illustrates nearby transit stops. All transit information is from November 29, 2022 and is included for general information purposes and context to the surrounding area.

Within the study area, routes #2, 55, and 56 run along Carling Avenue. Route #55 also runs along Booth Street. At Bronson Avenue and Carling Avenue intersection, route #2 turns south and runs along Bronson Avenue, while route #56 continues running east along Glebe Avenue. Route #10 also runs along Bronson Avenue within vicinity of the subject site and the southbound route has a stop that is located within the existing site access. At the time of this report, due to construction, Line 2 LRT had been substituted with bus service. The frequency of these routes within proximity of the proposed site based on November 29, 2022 service levels are:

- Route #2 – 7–10-minute service during peak hours, 10-12-minute service all day on weekdays and Saturdays and every 15 minutes on Sundays
- Route #55 – 15-minute service all day and 30-minute service after 7:00pm

- Route #56 – Operating during peak hours only, 15-minute service in peak direction, 30-minute service in off-peak direction
- Route #10 – 15-minute service all day, 30-minute service after 7:00pm

Figure 7: Existing Study Area Transit Service

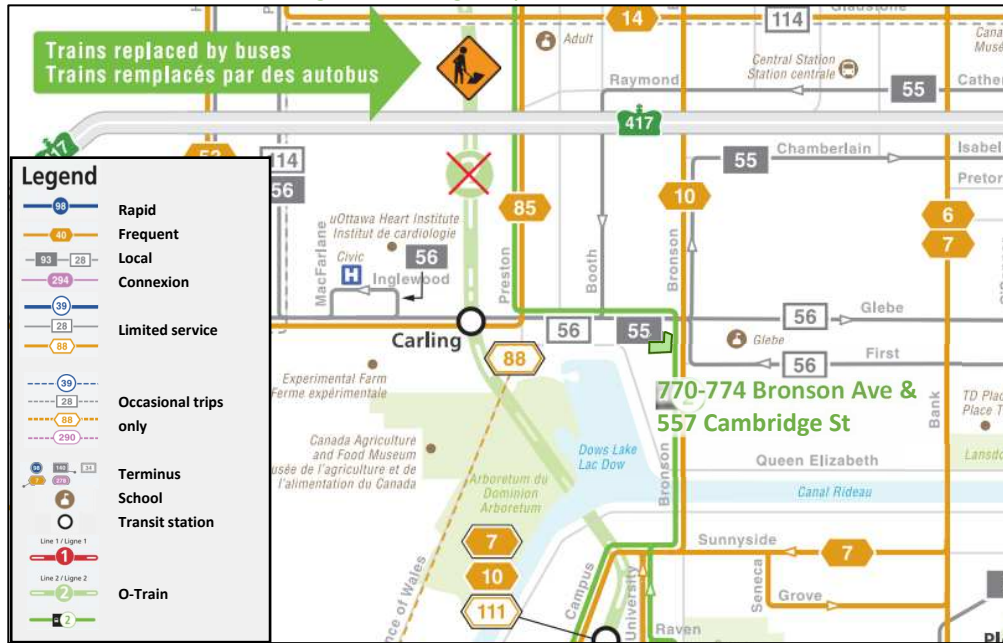

Source: <http://www.octranspo.com/> Accessed: November 29, 2022

Figure 8: Existing Study Area Transit Stops

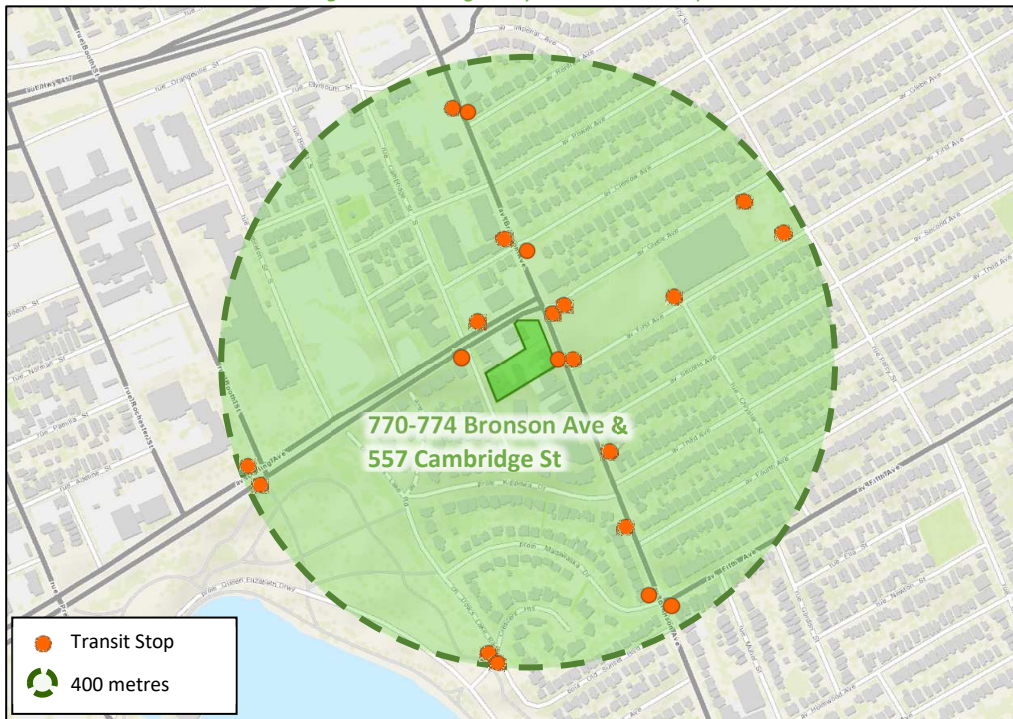

Source: <http://www.octranspo.com/> Accessed: November 29, 2022

2.2.6 Existing Area Traffic Management Measures

On-street parking is prevalent on local roads throughout the study area, bulb-outs are notably found on Cambridge Street at Carling Avenue, mid-block narrowing with alternating parking is found on Powell Avenue, direction control prevents inbound access to Clemow Avenue from Bronson Avenue, an extensive high-visibility gateway surface treatment is found on Glebe Avenue at Bronson Avenue, a radar speed driver feedback sign on Bronson Avenue southbound and a right-in/right-out island is found on Kippewa Drive at Bronson Avenue.

2.2.7 Existing Peak Hour Travel Demand

Existing turning movement counts were acquired from the City of Ottawa for the existing study area intersections. Table 1 summarizes the intersection count dates.

Table 1: Intersection Count Date

Intersection	Count Date
Carling Avenue at Booth Street	Thursday, September 12, 2019
	Tuesday, July 26, 2016
Carling Avenue at Cambridge Street	Thursday, May 17, 2018
Bronson Avenue at Powell Avenue	Thursday, August 8, 2019
	Friday, August 28, 2015
Bronson Avenue at Carling Avenue/Glebe Avenue	Thursday, September 12, 2019
	Wednesday, January 10, 2018
Bronson Avenue at Fifth Avenue/Madawaska Drive	Wednesday, January 10, 2018

The volumes within the counts provide are all subject to a number of construction projects that impact that direct applicability of them for the purposes of evaluating as typical conditions and forecasting to future horizons. The long-term construction along Highway 417 and the Bronson rehabilitation and reconstructions have altered the typical travel patterns along Bronson Avenue and Carling Avenue. For example, travel in both directions along Bronson Avenue have been affected, which would put greater demand along Carling Avenue, Booth Street and Powell Avenue. Given these impacts, the counts have been balanced with historic counts to normalize the operations and reflect more typical conditions.

Figure 9 illustrates the existing traffic counts and Table 2 summarizes the existing intersection operations. The level of service for signalized intersections is based on volume to capacity ratio (v/c) calculations for individual lane movements and HCM 2000 v/c calculations for the overall intersection, and average delay for unsignalized intersections. Detailed turning movement count data is included in Appendix B and the Synchro worksheets are provided in Appendix C.

Figure 9: Existing Traffic Counts

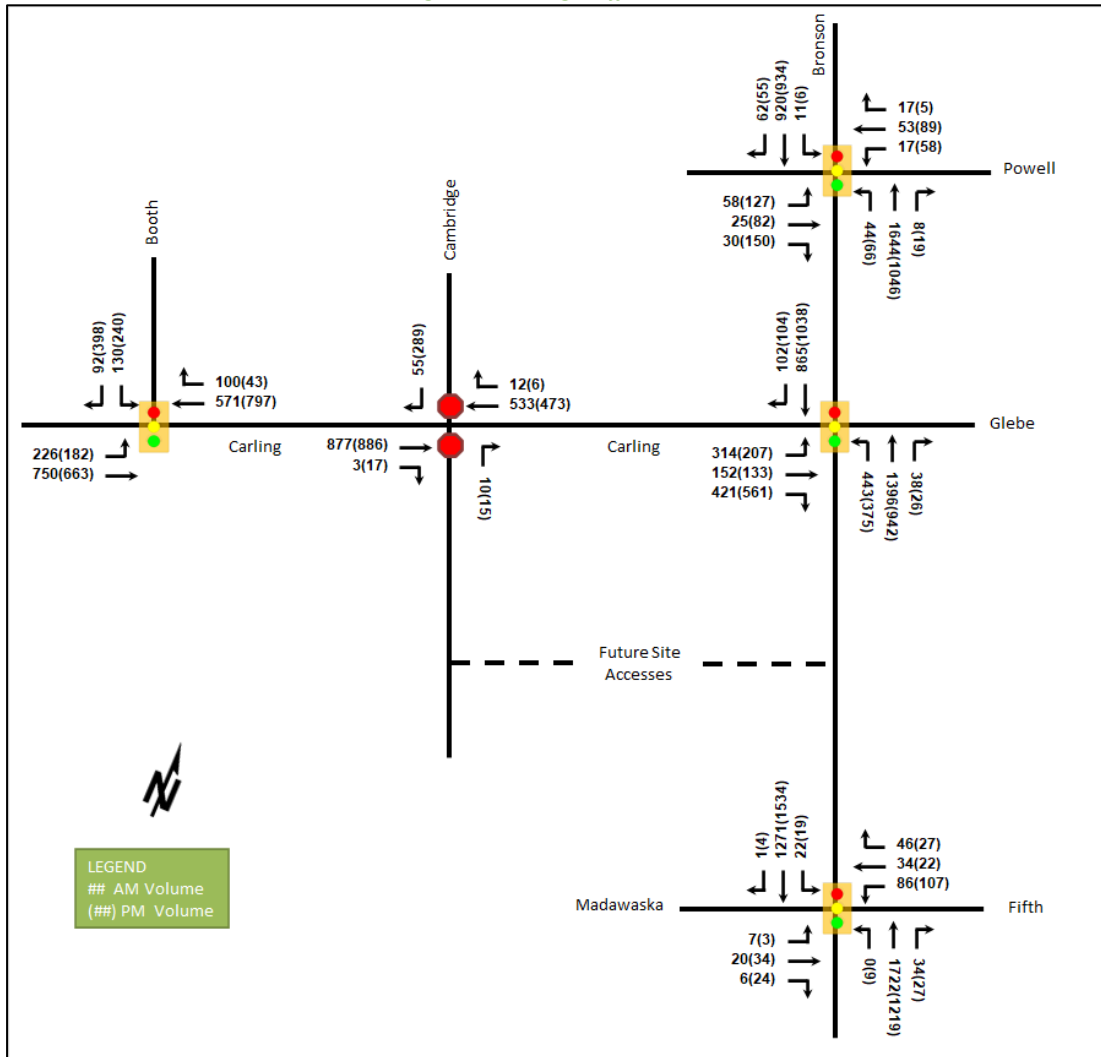

Table 2: Existing Intersection Operations

Intersection	Lane	AM Peak Hour				PM Peak Hour			
		LOS	V/C	Delay	Q (95 th)	LOS	V/C	Delay	Q (95 th)
Carling Avenue at Booth Street <i>Signalized</i>	EBL	C	0.80	65.2	82.0	E	0.93	100.7	#97.9
	EBT	A	0.40	11.9	60.4	A	0.35	10.9	52.7
	WBT/R	A	0.42	27.2	60.1	A	0.42	43.8	91.9
	SBL	A	0.32	37.1	45.1	B	0.63	50.0	90.0
	SBR	A	0.24	7.9	13.1	F	1.09	105.2	#169.3
	Overall	A	0.47	25.3	-	C	0.71	50.0	-
Bronson Avenue at Powell Avenue <i>Signalized</i>	EB	B	0.70	59.5	40.9	F	1.22	163.9	#183.2
	WB	A	0.45	44.5	31.9	A	0.60	53.2	63.2
	NB	D	0.86	36.1	m42.1	C	0.77	21.4	144.5
	SB	A	0.49	6.2	61.7	A	0.54	12.4	87.3
	Overall	C	0.83	27.0	-	D	0.90	39.2	-

Intersection	Lane	AM Peak Hour				PM Peak Hour			
		LOS	V/C	Delay	Q (95 th)	LOS	V/C	Delay	Q (95 th)
Bronson Avenue at Carling Avenue Street Signalized	EBL	C	0.77	56.7	#93.8	B	0.66	51.7	76.2
	EBL/T	C	0.74	53.5	#92.5	B	0.63	49.0	77.0
	EBR	C	0.74	28.4	103.4	F	1.08	92.1	#243.2
	NBL	C	0.75	37.9	m54.0	D	0.84	62.9	m#78.6
	NBT/R	F	1.39	204.8	#553.6	D	0.87	28.9	m230.5
	SBT/R	D	0.81	31.4	#156.3	C	0.75	20.6	m111.4
	Overall	F	1.33	101.5	-	F	1.03	42.5	-
Bronson Avenue at Fifth Avenue / Madawaska Drive Signalized	EB	A	0.14	32.6	14.1	A	0.29	39.1	24.9
	WB	C	0.79	63.1	57.8	E	0.95	106.6	#87.3
	NB	C	0.80	13.6	182.0	A	0.58	7.2	80.1
	SB	B	0.68	5.5	41.6	C	0.73	7.0	m75.4
	Overall	C	0.80	14.2	-	C	0.77	12.9	-
Carling Avenue at Cambridge Street Unsignalized	EBT/R	-	-	-	-	-	-	-	-
	WBT	-	-	-	-	-	-	-	-
	WBR	-	-	-	-	-	-	-	-
	NBR	B	0.03	14.2	0.8	B	0.04	14.6	0.8
	SBR	B	0.10	11.3	2.3	C	0.48	15.3	19.5
	Overall	A	-	0.5	-	A	-	2.8	-

Notes: Saturation flow rate of 1800 veh/h/lane
 Queue is measured in metres
 Peak Hour Factor = 0.90

Delay = average vehicle delay in seconds
 m = metered queue
 # = volume for the 95th %ile cycle exceeds capacity

The intersection of Carling Avenue and Booth Street shows capacity issues in the PM peak hour, with the eastbound left movement exhibiting high delays and extended queuing as well as the southbound right movement showing as being over capacity with high delays and extended queuing. The southbound right movement’s capacity issues are presently exacerbated by the high number of pedestrians using the west crossing the access the eastbound bus stop located on the south side of Carling Avenue. With planned future improvements, impacts from this interaction should be reduced.

During the PM peak hour, the eastbound right at the intersection of Bronson Avenue and Powell Avenue shows as being over capacity. The volume of eastbound left-turning movements impacts performance at this intersection, and if the eastbound approach had an auxiliary left-turn lane and a through/right lane, the v/cs of these lanes would be 0.73 and 0.72 respectively without excessive delay or queuing. Furthermore, during 2019, construction on Bronson Avenue North of Powell Avenue may have resulted in detour volumes in the flow of traffic, thus the operations at this intersection may be slightly better in reality than captured and modelled.

At the intersection of Bronson Avenue and Carling Avenue, during the AM peak hour the eastbound left, the eastbound left/through, the northbound through/right and the southbound through/right movements all exhibit extended queuing and the northbound through/right movement and the overall intersection additionally showing as being over capacity with high delays. Under the previous intersection approach configuration (a northbound auxiliary left-turn lane, a through lane, and a through/right-turn lane) the overall intersection v/c would have been 0.96. During the PM peak hour, the northbound left and eastbound right movement exhibit extended queuing, with the eastbound right movement additionally showing as being over capacity with high delays, and the overall intersection shows as being over capacity.

2.2.8 Collision Analysis

Collision data have been acquired from the City of Ottawa open data website (data.ottawa.ca) for five years prior to the commencement of this TIA for the surrounding study area road network. Table 3 summarizes the collisions

types and conditions in the study area, Figure 10 illustrates the intersections and segments analyzed, and Table 4 summarizes the total collisions for each of these locations. Collision data are included in Appendix D.

Table 3: Study Area Collision Summary, 2016-2020

Total Collisions		Number	%
		137	100%
Classification	Fatality	1	1%
	Non-Fatal Injury	21	15%
	Property Damage Only	115	84%
Initial Impact Type	Approaching	1	1%
	Angled	36	26%
	Rear end	37	27%
	Sideswipe	48	35%
	Turning Movement	8	6%
	SMV Unattended	1	1%
	SMV Other	5	4%
	Other	1	1%
Road Surface Condition	Dry	93	68%
	Wet	31	23%
	Loose Snow	4	3%
	Slush	5	4%
	Packed Snow	2	1%
	Ice	2	1%
Pedestrian Involved		2	1%
Cyclists Involved		1	1%

Figure 10: Study Area Collision Records



Table 4: Summary of Collision Locations, 2016-2020

	Number	%
Intersections / Segments	137	100%
Bronson Ave @ Carling Ave/Glebe Ave	71	52%
Bronson Ave @ First Ave	36	26%
Bronson Ave btwn Carling Ave & First Ave	8	6%
Bronson Ave btwn Clemow Ave & Carling Ave	8	6%
Bronson Ave btwn First Ave & Second Ave	7	5%
Cambridge St @ Carling Ave	3	2%
Carling Ave btwn Booth St & Cambridge St S	2	1%
Carling Ave btwn Cambridge St S & Bronson Ave	2	1%

Within the study area, the intersections of Bronson Avenue at Carling Avenue/Glebe Avenue and Bronson Avenue at First Avenue are noted to have experienced higher collisions than other locations. Carling Avenue between Cambridge Street South and Bronson Avenue has a fatality collision. Table 5 and Table 6 summarize the collision types and conditions for each of the locations mentioned above.

Table 5: Bronson Avenue at Carling Avenue/Glebe Avenue Collision Summary

		Number	%
Total Collisions		71	100%
Classification	Fatality	0	0%
	Non-Fatal Injury	12	17%
	Property Damage Only	59	83%
Initial Impact Type	Angle	5	7%
	Rear end	27	38%
	Sideswipe	30	42%
	Turning Movement	5	7%
	SMV Other	3	4%
	Other	1	1%
Road Surface Condition	Dry	49	69%
	Wet	15	21%
	Loose Snow	3	4%
	Slush	1	1%
	Packed Snow	2	3%
	Ice	1	1%
Pedestrian Involved		1	1%
Cyclists Involved		1	1%

The Bronson Avenue at Carling Avenue/Glebe Avenue intersection had a total of 71 collisions during the 2016-2020 time period, with 59 involving property damage only and the remaining twelve having non-fatal injuries. The collision types are most represented by sideswipe with 30 collisions, rear end with 27 collisions, angled and turning movement each with five collisions, SMV other with three collisions, and other with one collision. Rear end collisions are generally represented at congested intersections, and sideswipe collisions may be influenced by northbound vehicles caught in the left-turn trap changing lanes to continue through at the intersection. Weather conditions are not considered to impact collisions at this location. The City is recommended to review this intersection for reduction in collisions, along with active mode and transit operational improvements. No further review of collisions at this location is required as part of this study.

Table 6: Bronson Avenue at First Avenue Collision Summary

		Number	%
Total Collisions		36	100%
Classification	Fatality	0	0%
	Non-Fatal Injury	4	11%
	Property Damage Only	32	89%
Initial Impact Type	Angle	27	75%
	Rear end	3	8%
	Sideswipe	3	8%
	Turning Movement	3	8%
Road Surface Condition	Dry	22	61%
	Wet	10	28%
	Loose Snow	1	3%
	Slush	2	6%
	Ice	1	3%
Pedestrian Involved		0	0%
Cyclists Involved		0	0%

The Bronson Avenue at Frist Avenue intersection had a total of 36 collisions during the 2016-2020 time period, with 32 involving property damage only and the remaining four having non-fatal injuries. The collision types are most represented by angle with 27, followed by rear end, sideswipe, and turning movement each with three. Angle collisions may be influenced by westbound right-turning vehicles pushing gaps in the traffic stream, and restricted sight lines on the westbound approach. Conditions could be improved once the corner property redevelops. Weather conditions may influence collisions at this location. No further review of collisions at this location is required as part of this study.

2.3 Planned Conditions

2.3.1 Changes to the Area Transportation Network

The subject development is located in the Glebe-Dow’s Lake neighborhood. Currently, there are no Community Design Plans or Secondary Plans associated with this neighborhood.

Within the Transportation Master Plan, the Rapid Transit and Transit Priority Network’s Affordable Network diagram shows isolated transit priority measures on Carling Avenue, east of Booth Street, and Bronson Avenue, south of Carling Street. Furthermore, continuous transit-dedicated lanes would be extended on Carling Avenue, past Booth Street and towards Edgeworth Avenue. As a result, Carling Avenue will become a major east-west transit link, connecting the study area to western neighborhoods as well as major transit anchor points in future horizons.

The Carling Avenue Transit Priority Measures project includes detailed plans outlining the transit infrastructure proposed along the route. Within the study area, this includes changes to lane configuration at Carling Avenue and Bronson Avenue intersection as well as modifications to Carling Avenue cross-section. The exact timing of the Transit Priority implementation within the study area is not clear, with areas west of the study area slated for implementation by 2023, but the measures to the east have been confirmed by City staff as being implemented after 2031. The proposed plan of the Transit Priority Measures in the vicinity of the site can be seen in Figure 11 and is excerpted from the Carling Avenue Transit Priority Measures Open House from February of 2017.

Figure 11: Carling Avenue - Planned Transit Priority Measures

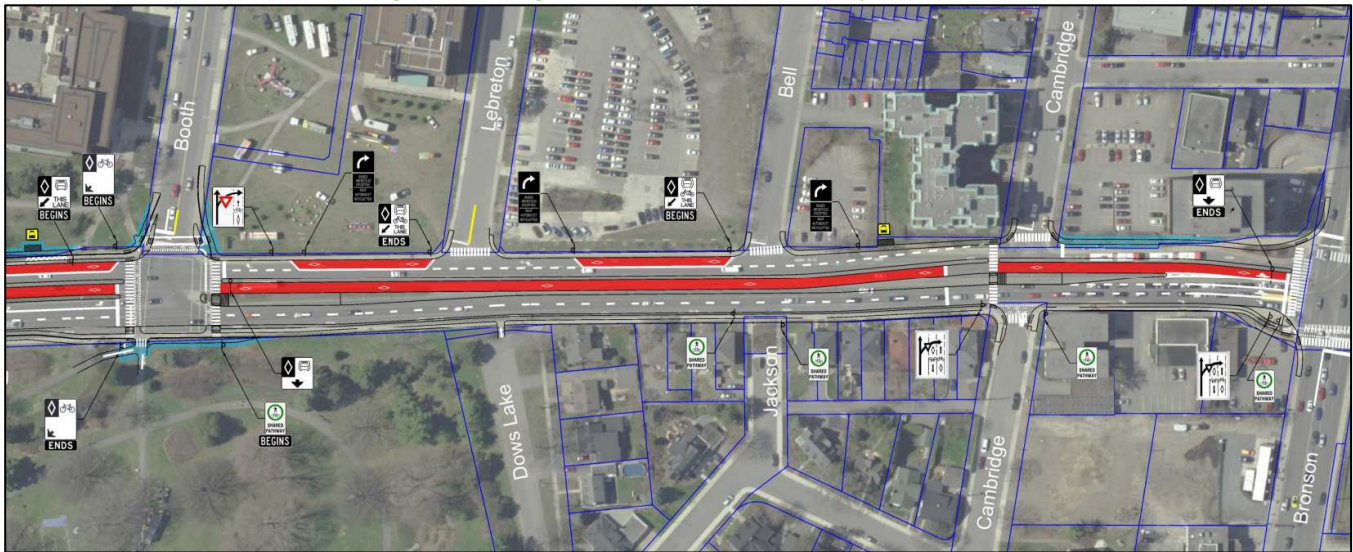

Source: Carling Avenue Transit Priority Measures Open House (February 2017)

Further, plans are in place to improve operational performance of Highway 417 and Bronson Avenue interchange, to the north of the subject site. As part of this project, the vehicle storage of the eastbound off-ramp at Bronson Avenue will increase.

The proposed development is also located in the Bronson Traditional Mainstreet Design Priority Area. However, currently no transportation projects are ongoing or planned in the vicinity of the subject site.

2.3.2 Other Study Area Developments

567 Cambridge Street

The proposed development application includes a site plan for an addition of a six-storey apartment building with 58 units to an already-existing six-storey apartment building with 70 units (Novatech 2017). No TIA was included as part of this application.

265 Carling Avenue

The proposed development application includes a 20-storey mixed-use building. As part of this development, 168 retirement units, a 1,160 square foot pharmacy and 1,206 square foot hair salon. The development is anticipated to generate 24 new two-way AM peak hour and 36 new two-way PM peak hour auto trips (Parsons 2019).

289 Carling Avenue

The proposed development application includes a site plan for 40 residential units with office support spaces totalling in 1000 square metres of gross floor area. The trip generation trigger was not met at this property, and the traffic generation was deemed have a minimal impact on network intersections (CGH 2019).

7 McLean Street

The proposed development application includes a site plan for a three-storey apartment building, with 7 units and a gross floor area of 600 square metres. No TIA was included as part of this application.

144 Renfrew Avenue

The proposed development application includes a site plan for a three-storey mixed use building. The building will have a total gross floor area of 972 square metres and include commercial use on ground floor and 14 residential

units on upper floor. One parking space is proposed as part of this development and no TIA was included as part of this application.

536 Rochester Street

The proposed development application includes a zoning by-law amendment permitting the conversion of existing dwelling use into a restaurant use with seating for approximately 20 customers. No new parking spaces are proposed as part of this zoning by-law amendment. The projected trip generation for this development is 6 PM peak hour vehicle trips (Novatech 2018).

552 Booth Street

The proposed development application includes a zoning by-law amendment permitting the construction of five buildings with approximately 1000 residential units. The proposed development also includes five existing heritage buildings which will consist of retail and office uses and add up to approximately 142,000 square feet (Parsons 2018). The forecasting report for this development is not yet available on the City's online development application search tool and thus, the projected trip generation of this development is unknown at this point in time.

450 Rochester Road

The proposed development application includes an official plan amendment permitting the construction of mixed-use development. This development will include 540 residential units, a 21,550 square foot grocery store, a 12,210 square foot liquor store, 15,062 square feet of retail on the ground floor and a total 10,360 square feet of retail on second and third floors. The development is anticipated to generate 80 new two-way AM peak hour and 75 new two-way PM peak hour auto trips (Parsons 2019).

3 Study Area and Time Periods

3.1 Study Area

The study area will include the intersections of:

- Bronson Avenue at:
 - Site Access
 - Powell Avenue
 - Carling Avenue/Glebe Avenue
 - Fifth Avenue/Madawaska Drive
- Carling Avenue at:
 - Booth Street
 - Cambridge Street
- Cambridge Street at Site Access

The boundary roads will be Bronson Avenue and Carling Avenue and screenline 28, while not considered within this TIA, intersects Carling Avenue at Trillium Pathway.

3.2 Time Periods

As the proposed development is composed entirely of residential units the AM and PM peak hours will be examined.

3.3 Horizon Years

The anticipated build-out year is 2025. As a result, the full build-out plus five years horizon year is 2030.

4 Exemption Review

Table 7 summarizes the exemptions for this TIA.

Table 7: Exemption Review

Module	Element	Explanation	Exempt/Required
Design Review Component			
4.1 Development Design	4.1.2 Circulation and Access	Only required for site plans	Required
	4.1.3 New Street Networks	Only required for plans of subdivision	Exempt
4.2 Parking	4.2.1 Parking Supply	Only required for site plans	Required
	4.2.2 Spillover Parking	Only required for site plans where parking supply is 15% below unconstrained demand	Exempt
Network Impact Component			
4.5 Transportation Demand Management	All Elements	Not required for site plans expected to have fewer than 60 employees and/or students on location at any given time	Required
4.6 Neighbourhood Traffic Management	4.6.1 Adjacent Neighbourhoods	Only required when the development relies on local or collector streets for access and total volumes exceed ATM capacity thresholds	Required
4.8 Network Concept		Only required when proposed development generates more than 200 person-trips during the peak hour in excess of equivalent volume permitted by established zoning	Exempt – trip generation in AM1 and AM10 zoning will not exceed 200 additional person-trips

5 Development-Generated Travel Demand

5.1 Mode Shares

Examining the mode shares recommended in the TRANS Trip Generation Manual (2020) for the subject district, derived from the most recent National Capital Region Origin-Destination survey (OD Survey), the existing average district mode shares by land use for Ottawa Inner have been summarized in Table 8. Additionally, proposed rates for the student housing component, modified from the district shared reflecting lower auto ownership and access to school transit passes are summarized in Table 8.

Table 8: TRANS Trip Generation Manual Recommended Mode Shares – Ottawa Inner

Travel Mode	Multi-Unit (High-Rise)		Off-Campus Student Apartments	
	AM	PM	AM	PM
Auto Driver	26%	25%	21%	20%
Auto Passenger	6%	8%	6%	8%
Transit	28%	21%	33%	26%
Cycling	5%	6%	5%	6%
Walking	35%	40%	35%	40%
Total	100%	100%	100%	100%

5.2 Trip Generation

This TIA has been prepared using the vehicle and person trip rates for the high-rise residential dwellings using the TRANS Trip Generation Manual (2020) and the vehicle trip rates and derived person trip rates for the Off-Campus Student Apartment average rate from the ITE Trip Generation Manual 10th Edition (2017) using the City-prescribed conversion factor of 1.28. Table 9 summarizes the person trip rates for the proposed high-rise residential dwellings for each peak period and the person trip rates for the student apartment bedrooms by peak hour.

Table 9: Trip Generation Person Trip Rates by Peak Period

Land Use	Land Use Code	Peak Period	Vehicle Trip Rate	Person Trip Rates
Multi-Unit High-Rise	221 & 222 (TRANS)	AM	-	0.80
		PM	-	0.90
Land Use	Land Use Code	Peak Hour	Vehicle Trip Rate	Person Trip Rates
Off-Campus Student Apartments	225 (ITE)	AM	0.16	0.20
		PM	0.30	0.38

Using the above person trip rates, the total person trip generation has been estimated. Table 10 summarizes the total person trip generation for the high-rise residential units by peak period and the student apartments by peak hour.

Table 10: Total Residential Person Trip Generation by Peak Period

Land Use	Units	AM Peak Period			PM Peak Period		
		In	Out	Total	In	Out	Total
Multi-Unit High-Rise	207	51	115	166	108	78	186
Land Use	Bedrooms	AM Peak Hour			PM Peak Hour		
		In	Out	Total	In	Out	Total
Student Apartments	225	13	32	45	45	41	86

Using the above mode share targets and the person trip rates, the person trips by mode have been projected. Trip generation by peak hour has been forecasted using the prescribed peak period conversion factors presented in the TRANS Trip Generation Manual (2020) for the high-rise residential units. Table 11 summarizes the residential trip generation by mode and peak hour.

Table 11: Trip Generation by Mode

Travel Mode		AM Peak Hour				PM Peak Hour			
		Mode Share	In	Out	Total	Mode Share	In	Out	Total
Multi-Unit (High-Rise)	Auto Driver	26%	6	14	21	25%	12	9	21
	Auto Passenger	6%	1	3	5	8%	4	3	7
	Transit	28%	8	18	25	21%	11	8	18
	Cycling	5%	2	3	5	6%	3	2	5
	Walking	35%	10	23	34	40%	22	16	38
	Total	100%	27	61	90	100%	52	38	89
Student Apartments	Auto Driver	21%	3	7	9	20%	9	8	17
	Auto Passenger	6%	1	2	3	8%	4	3	7
	Transit	33%	4	11	15	26%	12	11	22
	Cycling	5%	1	2	2	6%	3	2	5
	Walking	35%	5	11	16	40%	18	16	34

Travel Mode		AM Peak Hour				PM Peak Hour			
		Mode Share	In	Out	Total	Mode Share	In	Out	Total
Total		100%	13	32	45	100%	45	41	86
Total	Auto Driver	-	9	21	30	-	21	17	38
	Auto Passenger	-	2	5	8	-	8	6	14
	Transit	-	12	29	40	-	23	19	40
	Cycling	-	3	5	7	-	6	4	10
	Walking	-	15	34	50	-	40	32	72
	Total	-	40	93	135	-	97	79	175

As shown above, a total of 30 AM and 38 PM new peak hour two-way vehicle trips are projected as a result of the proposed development.

5.3 Trip Distribution

To understand the travel of the subject development, the OD Survey has been reviewed to determine the residential travel patterns for the study area’s district, which were applied based on the build-out of Ottawa Inner. Table 12 below summarizes the distributions.

Table 12: OD Survey Distribution – Ottawa Inner

To/From	Residential % of Trips	Via
North	35%	Bronson Ave
South	25%	Bronson Ave
East	20%	Bronson Ave (North)
West	20%	10% Carling Ave, 10% Bronson Ave (North)
Total	100%	-

5.4 Trip Assignment

Using the distribution outlined above, turning movement splits, and access to major transportation infrastructure, the trips generated by the site have been assigned to the study area road network. Figure 12 illustrates the new site generated volumes.

Figure 12: New Site Generation Auto Volumes

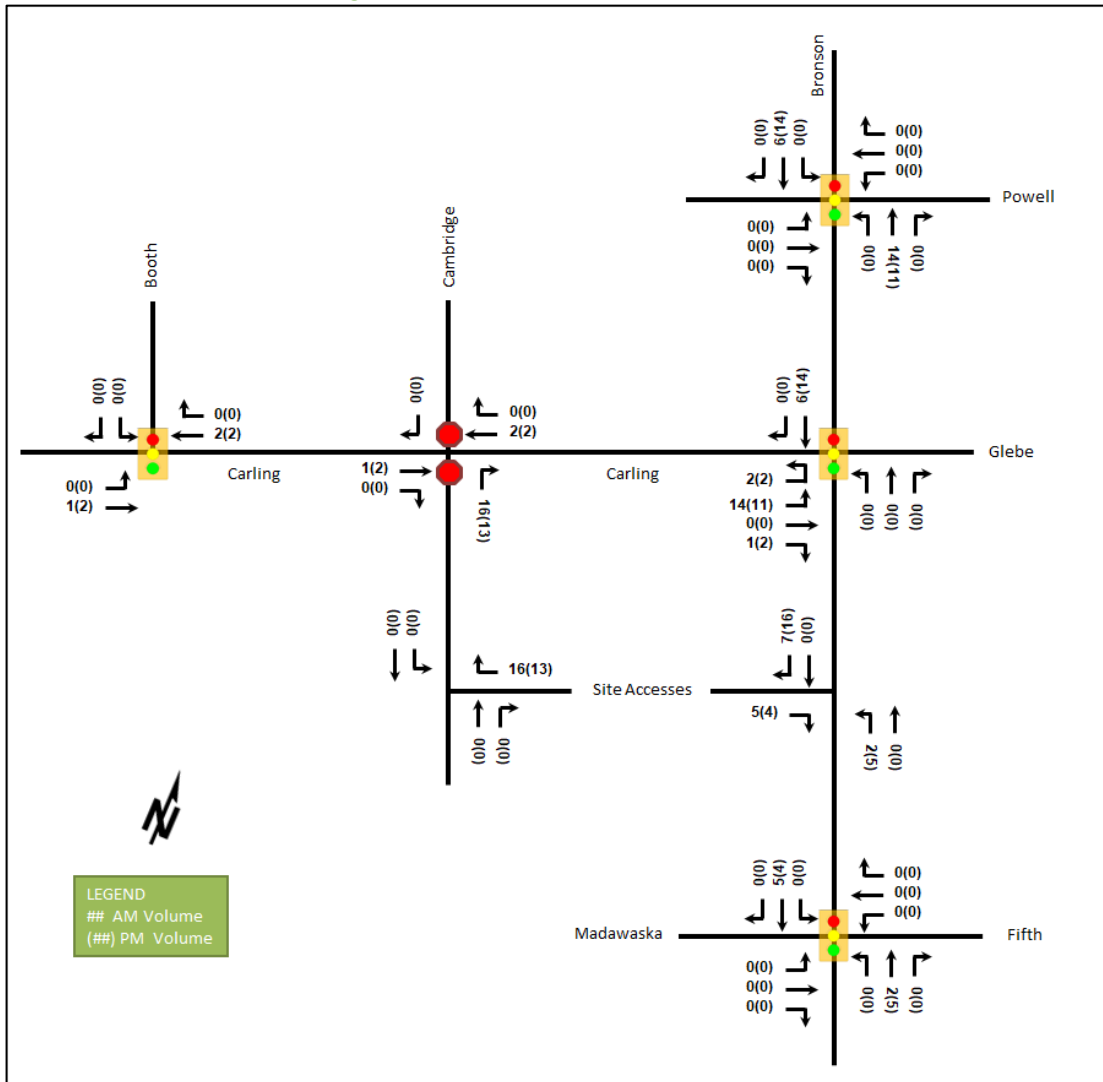

6 Background Network Travel Demands

6.1 Transportation Network Plans

The transportation network plans were discussed in Section 2.3. None of the planned improvements are currently scheduled to be completed by the 2030 horizon, which is the furthest horizon analyzed in this TIA.

6.2 Background Growth

A review of the background projections from the City’s TRANS Regional Model for the 2011 and 2031 horizons was completed to determine the background growth for each of the study area roadways. Table 13 summarizes the results of the model, and the projections are provided in Appendix E. To account for the change in volumes across intersections, the segments of Powell Avenue to the east and west of Bronson Avenue and the segments of Bronson Avenue to the north and south of Carling Avenue will be analyzed and grown as separate entities.

Table 13: TRANS Regional Model Projections – Study Area Growth Rates

Street	Direction Growth Percentage 2011 to 2031		Direction Growth Percentage Existing to 2031	
	Eastbound	Westbound	Eastbound	Westbound
Powell (E)	-2.59%	-1.11%	-0.93%	-13.24%
Powell (W)	5.22%	-	11.27%	-0.54%
Carling	0.94%	0.94%	4.56%	3.51%
Madawaska	N/A	N/A	18.96%	14.30%
Fifth	1.34%	-1.13%	2.57%	-4.97%
	Northbound	Southbound	Northbound	Southbound
Booth	-0.39%	0.68%	5.67%	4.16%
Cambridge	-	-	-	10.48%
Bronson (N)	0.95%	1.22%	-1.19%	1.48%
Bronson (S)	0.44%	1.06%	-0.44%	3.08%

Growth rates from the existing horizon will be peak-directionally applied to appropriate links’ mainline volumes and major turning movements, rounded to the nearest 0.25%.

6.3 Other Developments

The background developments explicitly considered in the background conditions (Section 6.2) include:

- 265 Carling Avenue
- 536 Rochester Street
- 450 Rochester Road

The developments at 567 Cambridge Street, 289 Carling Avenue, 7 McLean Street, and 144 Renfrew Avenue are considered to be negligible and will be accounted for through the background growth rates, and no TIA is currently available for the development at 552 Booth Street. The background development volumes within the study area have been provided in Appendix F.

7 Demand Rationalization

7.1 2025 Future Background Operations

Figure 13 illustrates the 2025 background volumes and Table 14 summarizes the 2025 background intersection operations. The level of service for signalized intersections is based on v/c calculations for individual lane movements and HCM 2000 v/c calculations for the overall intersection, and average delay for unsignalized intersections. The synchro worksheets for the 2025 future background horizon are provided in Appendix G.

Figure 13: 2025 Future Background Volumes

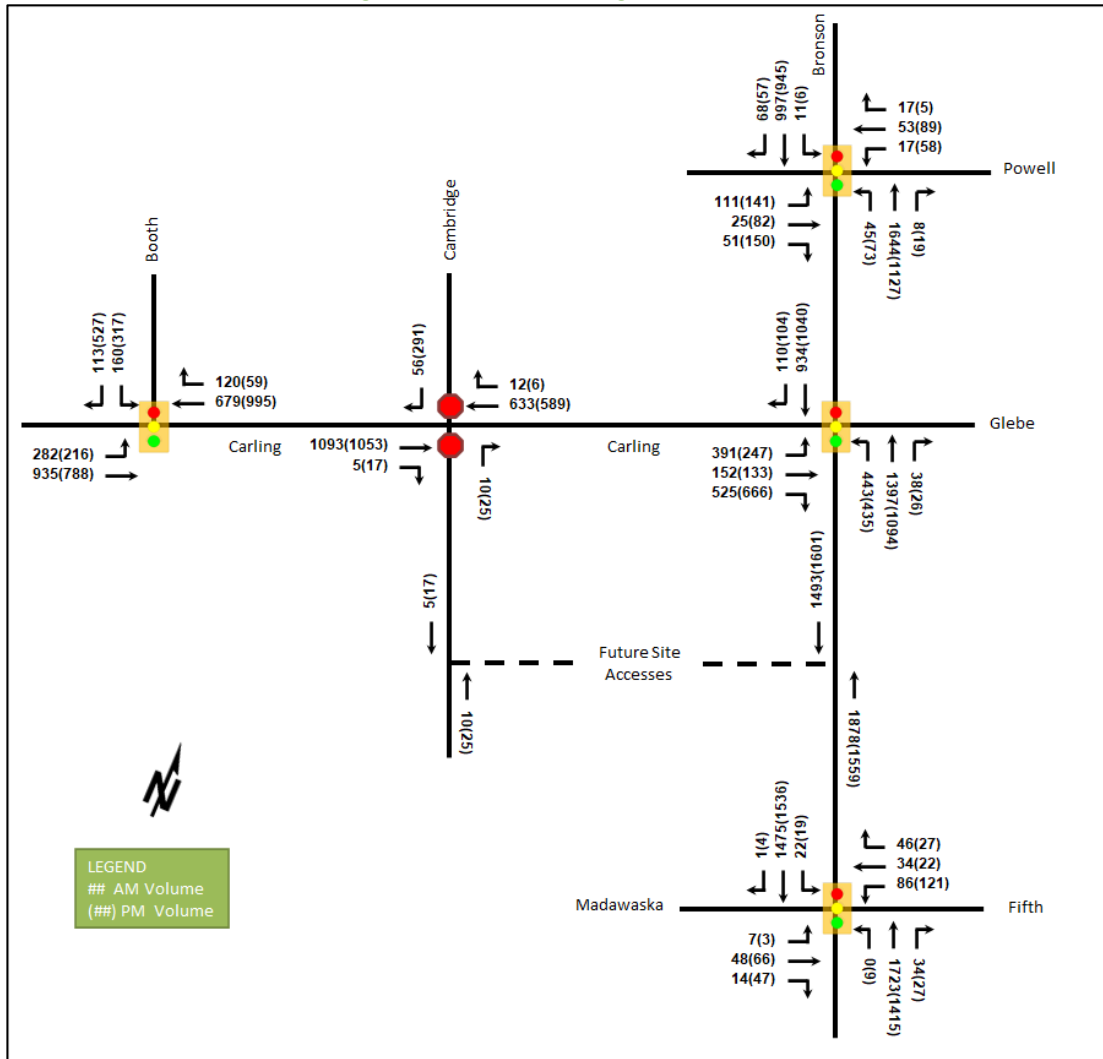

Table 14: 2025 Future Background Intersection Operations

Intersection	Lane	AM Peak Hour				PM Peak Hour			
		LOS	V/C	Delay	Q (95 th)	LOS	V/C	Delay	Q (95 th)
Carling Avenue at Booth Street <i>Signalized</i>	EBL	D	0.84	67.3	#93.1	E	0.99	114.8	#106.4
	EBT	A	0.45	12.5	70.3	A	0.37	11.2	57.1
	WBT/R	A	0.46	28.8	65.0	A	0.48	40.0	102.0
	SBL	A	0.36	37.8	49.8	C	0.74	56.0	108.8
	SBR	A	0.26	7.8	13.6	F	1.33	198.1	#224.2
	Overall	A	0.53	26.5	-	-	D	0.84	68.2
Bronson Avenue at Powell Avenue <i>Signalized</i>	EB	D	0.86	74.9	#71.3	F	1.14	135.9	#167.9
	WB	A	0.33	38.5	29.0	A	0.52	49.1	55.9
	NB	C	0.80	15.8	m48.2	C	0.73	19.9	34.6
	SB	A	0.49	7.2	59.1	A	0.49	11.6	75.9
	Overall	D	0.81	17.0	-	-	D	0.84	34.2

Intersection	Lane	AM Peak Hour				PM Peak Hour			
		LOS	V/C	Delay	Q (95 th)	LOS	V/C	Delay	Q (95 th)
Bronson Avenue at Carling Avenue Street <i>Signalized</i>	EBL	D	0.87	68.3	#102.4	C	0.78	61.8	m74.3
	EBL/T	D	0.82	61.8	#98.4	C	0.74	56.8	m75.2
	EBR	D	0.89	43.3	109.4	F	1.23	149.1	#212.9
	NBL	B	0.68	36.2	50.8	C	0.75	53.9	m#83.2
	NBT/R	F	1.22	136.7	#478.8	D	0.87	27.4	m#250.0
	SBT/R	C	0.76	28.1	#148.9	B	0.68	18.6	m79.7
	Overall	F	1.22	75.1	-	F	1.04	52.7	-
Bronson Avenue at Fifth Avenue / Madawaska Drive <i>Signalized</i>	EB	A	0.27	35.9	22.7	A	0.49	49.2	41.9
	WB	C	0.75	59.6	51.3	F	1.19	180.5	#97.0
	NB	C	0.71	10.4	141.7	A	0.60	7.4	85.7
	SB	B	0.68	5.6	50.3	B	0.66	6.2	m67.6
	Overall	C	0.72	11.2	-	C	0.75	17.3	-
Carling Avenue at Cambridge Street <i>Unsignalized</i>	EBT/R	-	-	-	-	-	-	-	-
	WBT	-	-	-	-	-	-	-	-
	WBR	-	-	-	-	-	-	-	-
	NBR	C	0.03	15.1	0.8	C	0.07	15.3	1.5
	SBR	B	0.09	11.5	2.3	C	0.46	15.3	18.0
	Overall	A	-	0.4	-	A	-	2.4	-

Notes: Saturation flow rate of 1800 veh/h/lane
Queue is measured in metres
Peak Hour Factor = 1.00

Delay = average vehicle delay in seconds
m = metered queue
= volume for the 95th %ile cycle exceeds capacity

During both the AM and PM peak hours, existing capacity issues at the study area intersections are exacerbated by area growth. The operational changes from the existing conditions are noted below.

The intersection of Carling Avenue and Booth Street is forecasted to exhibit extended queuing on the eastbound left movement during the AM peak hour and this movement is forecasted to be at capacity during the PM peak hour.

Similarly, the intersection of Bronson Avenue and Powell Avenue, the eastbound movement is forecasted to exhibit extended queuing during the AM peak hour.

Operational issues are forecasted to persist at the intersection of Bronson Avenue and Carling Avenue, and specifically, during the PM peak hour, the northbound through/right movement is forecasted to exhibit extended queuing and the eastbound right movement is forecasted to see its v/c, queuing and delays worsen at this horizon.

The intersection of Bronson Avenue at Fifth Avenue/Madawaska drive is forecasted to see the westbound movement become over capacity during the PM peak hour due to area growth.

7.2 2030 Future Background Operations

Figure 14 illustrates the 2030 background volumes and Table 15 summarizes the 2030 background intersection operations. The level of service for signalized intersections is based on v/c calculations for individual lane movements and HCM 2000 v/c calculations for the overall intersection, and average delay for unsignalized intersections. The synchro worksheets for the 2030 future background horizon are provided in Appendix H.

Figure 14: 2030 Future Background Volumes

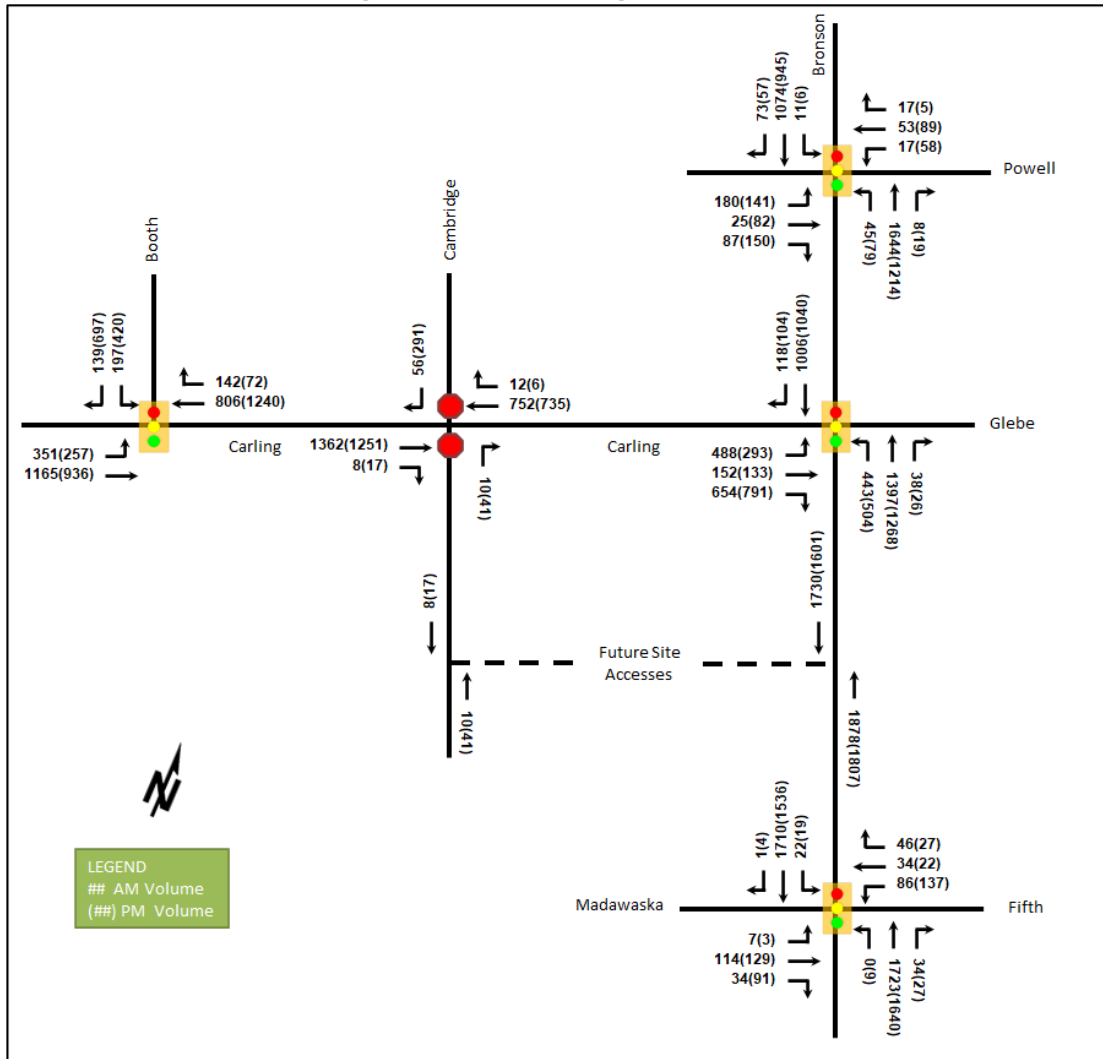

Table 15: 2030 Future Background Intersection Operations

Intersection	Lane	AM Peak Hour				PM Peak Hour			
		LOS	V/C	Delay	Q (95 th)	LOS	V/C	Delay	Q (95 th)
Carling Avenue at Booth Street <i>Signalized</i>	EBL	E	0.93	78.3	#134.2	F	1.18	165.9	#131.4
	EBT	A	0.57	14.2	95.6	A	0.44	12.0	71.1
	WBT/R	A	0.59	32.6	79.3	A	0.59	43.7	m126.6
	SBL	A	0.44	39.6	60.6	E	0.99	88.1	#172.2
	SBR	A	0.31	7.5	15.0	F	1.82	407.4	#328.8
	Overall	C	0.64	29.9	-	F	1.10	119.3	-
Bronson Avenue at Powell Avenue <i>Signalized</i>	EB	F	1.23	172.4	#127.6	F	1.14	135.9	#167.9
	WB	A	0.30	37.5	29.0	A	0.52	49.1	55.9
	NB	D	0.83	31.6	m60.0	C	0.80	30.3	m119.8
	SB	A	0.54	8.3	66.0	A	0.49	11.6	75.9
	Overall	E	0.91	36.1	-	D	0.89	38.5	-

Intersection	Lane	AM Peak Hour				PM Peak Hour			
		LOS	V/C	Delay	Q (95 th)	LOS	V/C	Delay	Q (95 th)
Bronson Avenue at Carling Avenue Signalized	EBL	E	0.96	83.4	#127.7	D	0.84	64.7	m77.0
	EBL/T	E	0.93	75.6	#126.5	C	0.80	58.9	m76.8
	EBR	E	0.97	55.4	#206.0	F	1.46	244.8	m#265.0
	NBL	A	0.56	29.5	50.8	D	0.90	63.5	m#103.4
	NBT/R	F	1.25	147.0	#479.1	F	1.02	68.1	m#426.6
	SBT/R	E	0.95	44.5	m#162.6	B	0.68	18.6	m79.4
	Overall	F	1.26	84.1	-	F	1.23	86.9	-
Bronson Avenue at Fifth Avenue / Madawaska Drive Signalized	EB	A	0.54	44.3	47.1	E	0.94	94.7	#101.1
	WB	D	0.88	79.3	#63.6	F	2.78	859.7	#128.3
	NB	C	0.73	11.6	141.7	B	0.69	9.0	114.4
	SB	C	0.80	8.8	m193.4	B	0.67	7.0	m71.5
	Overall	D	0.81	14.6	-	F	1.03	56.8	-
Carling Avenue at Cambridge Street Unsignalized	EBT/R	-	-	-	-	-	-	-	-
	WBT	-	-	-	-	-	-	-	-
	WBR	-	-	-	-	-	-	-	-
	NBR	C	0.03	17.5	0.8	C	0.13	17.8	3.0
	SBR	B	0.10	12.2	2.3	C	0.51	17.7	21.8
	Overall	A	-	0.4	-	A	-	2.5	-

Notes: Saturation flow rate of 1800 veh/h/lane
Queue is measured in metres
Peak Hour Factor = 1.00

Delay = average vehicle delay in seconds
m = metered queue
= volume for the 95th %ile cycle exceeds capacity

During both the AM and PM peak hours, the study area intersection operations are forecasted to degrade from the existing and 2025 future background conditions with area growth. The operational changes from the 2025 background conditions are noted below.

The intersection of Carling Avenue and Booth Street during the PM peak hour is forecasted to see the eastbound left movement become over capacity with longer delays and further extended queues, the southbound left movement is forecasted to see high delays and extended queues with the movement at capacity, and the southbound right movement is forecasted to see v/c, delay, and queuing degrade, with the overall intersection over capacity at this horizon. The eastbound left-turn can be reduced to a v/c of 1.00 with an additional 3 seconds allocated to the protected phase.

The intersection of Bronson Avenue and Powell Avenue during the AM peak hour shows the eastbound movement as over capacity with high delays and further extended queuing, where operations are forecasted to resemble existing PM peak hour conditions on this movement.

The intersection of Bronson Avenue and Carling Avenue during the AM peak hour shows the eastbound left movement experience high delay and the eastbound right movement exhibit extended queuing, where all movements but the northbound left (LOS A) and northbound through/right (LOS F) operate with LOS E at this horizon. During the PM peak hour at this intersection, the northbound through/right movement is over capacity with further extended queuing, capacity issues worsen for the eastbound right movement, and high average delay at the overall intersection.

The intersection of Bronson Avenue and Fifth Avenue/Madawaska Drive is forecasted to exhibit extended queuing on the westbound movement during the AM peak hour, and during the PM peak hour the overall intersection is over capacity with the westbound movement seeing capacity issues deteriorate. The decreasing operations are a result of the growth along Madawaska Drive towards Bronson Avenue, which is assumed to be cut through from Queen Elizabeth Drive. If this movement is to be permitted in the future background conditions, additional time

in the form of a protected westbound left-turn phase may address capacity concerns at the intersection, although may subsequently result in additional traffic utilizing this route. The intersection should be monitored by City staff.

The planned improvement of transit in the study area may mitigate some of the area capacity issues once implemented. The City will need to review the Carling Avenue improvements within the new TMP and the impacts on the surrounding area to continue the mode share shifts to transit.

7.3 Modal Share Sensitivity

Capacity constraints are noted to be present at the intersections of Bronson Avenue and Carling Avenue and Bronson Avenue and Powell Avenue. The development is anticipated to have a fraction of the net traffic increase on the surrounding network (e.g., eastbound Carling Avenue will see an approximate 230 vehicle increase by 2030 from background growth, and the development is forecasted to produce 70 total two-way auto trips during the AM peak). As the background conditions operate in a similar manner to the existing conditions, the sensitivity of additional auto trips from the proposed development is anticipated to have minimal impacts. Regardless of the sensitivity, transportation demand management measures will be required to further reinforce the target modal splits until such time the City expands the bus lanes along Carling Avenue. No further rationalization of the proposed modal shares is considered to be required.

7.4 Network Demand Rationalization

The network volumes illustrate a number of background constraints along Bronson Avenue and Carling Avenue. Specifically, the following locations are noted to have capacity constraints in the existing or are forecasted to become constrained by 2030:

- Booth Street:
 - Southbound right-turn at Carling Avenue during the PM peak
- Bronson Avenue:
 - Northbound through/right-turn at Carling during the AM and PM peaks
- Carling Avenue:
 - Eastbound left-turn at Booth Street during the PM peak
 - Eastbound right-turn at Bronson Avenue during the PM peak
- Fifth Avenue:
 - Westbound approach at Bronson Avenue during the PM peak
- Powell Avenue:
 - Eastbound approach at Bronson Avenue during the PM peak

The volumes forecast on Booth Street will be at the roadway capacity by 2030, as shown in the existing and background volume figures. The use of Booth Street as an alternate route to a signalized intersection on Carling Avenue, and its connection under Highway 417 make Booth Street a key connection in the area. The redevelopment of the area will also contribute to the near capacity volumes, although no factor has been applied to assess a potential reduction of the existing trips as travel along the corridor becomes more congested with local volumes. A reduction of approximately 130 vehicles from the southbound right-turn would reduce the v/c of the movement to 1.00. It is also noted that the volumes may reflect higher than normal turning movements as drivers have avoided the long-term construction along Highway 417, including various overpass replacements, widening and pre-widening projects, and the City's Jackie Holzman Bridge. The volumes may naturally reduce as travel patterns normalize and the barriers to previous routes have been removed. This intersection can be monitored by the City for operational adjustments, reviewed during the transit priority projects, and through adjacent developments applications to provide local improvements.

The volumes along Bronson Avenue are consistent with a 4-lane arterial roadway and, as shown at the adjacent intersections, can be supported. The northbound through/right-turn has been constrained by the re-allocation of the second through lane to a left-turn lane by the City. The City's change in lane arrangement effectively keeping the left-turn queue within a designated left-turn lane and eliminates the spill back previously experienced at this intersection into the through lanes. As this is an operational choice by the City, no further rationalization of the volumes on Bronson Avenue is required.

Carling Avenue eastbound left-turn at Booth Street is noted in Section 7.2 to require an additional 3 seconds or more to reduce the v/c to 1.00 or lower. The eastbound right-turn at Bronson Avenue is currently over capacity and will continue to be a primary movement for the eastbound approach. Given the existing and 2030 future background volumes, the City will need to provide alternative routes or reduce the auto demand along Carling Avenue by 290 vehicles to maintain existing operations. With the completion of the Highway 417 projects, a shift of volumes to the southbound approach on Bronson Avenue may be realized and use the residual capacity for southbound travel.

The Fifth Avenue westbound approach constraints at Bronson Avenue are a result of the City's TRANS growth forecasts on Madawaska Drive, presumably from cut through traffic from Queen Elizabeth Driveway. The westbound left-turn movement will have limited gaps to turn in this growth is realized. Any growth along Madawaska Drive will compromise the westbound approach and will need to be restricted from cutting through in the future.

The eastbound approach of Powell Avenue at Bronson Avenue is used as a cut through route from Highway 417 to Bronson Avenue using the Rochester Street off-ramp and traveling via Orangeville Street to Bell Street to Powell Avenue. Alternatively, some vehicles also detour via Plymouth Street to Cambridge Street to avoid Bell Street congestion or cut into the extended queueing along Powell Avenue. With the completion of the Highway 417 projects, a shift of volumes to the Bronson Avenue off-ramp may be realized and remove both the left-turn and right-turn movements from Powell Avenue. The further improvements along Chamberlain Street may also contribute to a shifting of these volumes as the Highway 417 off-ramp and intersection on Bronson Avenue is improved.

Overall, Powell Avenue, Booth Street and Madawaska Drive should be monitored by the City to determine if the travel patterns normalize as the Highway 417 construction activities have been completed and once Covid conditions are lifted. If the volumes do not shift to routes with residual capacity (e.g., eastbound right-turn on Carling Avenue to southbound through on Bronson Avenue), then the City will need to pursue additional modal shift programs to ease the forecasted burden and maintain existing volumes in the area.

8 Development Design

8.1 Design for Sustainable Modes

The proposed development is a mixed-use building with vehicle parking located underground and bicycle parking, located both on the ground floor and underground. Hard surface connections are provided between proposed building entrances on each side of the building, which connect to surrounding pedestrian facilities. The bus stop along Bronson Avenue will be shifted north of the proposed access and be in proximity to the main entrance, although given the limited right-of-way for expansion to City standards it will remain as a post and sign.

All transit routes listed in Section 2.2.5 stop within 400 metres walk of the site except for the westbound route #55 which stops approximately 500 metres walk from the site. Carling Station on the LRT Trillium line is approximately 950 metres walk from the site entrances.

8.2 Circulation and Access

Vehicle access is proposed through a two-way access on Bronson Avenue and a right-out-only access on Cambridge Street that permits full movements for truck access.

Garbage storage is within the parking levels, and collection may occur along Cambridge Street or within the loading area at the terminus of the drive aisle that connects to the Cambridge Street access. Emergency services are assumed to be able to access the site via the three public rights of way.

The ramp accessing the Bronson Avenue driveway includes 2.44-metre-long transition slopes with an 8% grade at both ends of its main slope of 16% and the ramp accessing the drive aisle off of Cambridge Street includes 2.44-metre-long transition slopes with an 8% grade at both ends of its main slope of 15%. Drive aisles support the intended site operations, and turning templates are provided in Appendix I.

9 Parking

9.1 Parking Supply

The development is proposed as including a total of 133 vehicle parking spaces, and 221 bicycle parking spaces.

As all parking is located underground, the zoning by-law minimums for parking is 114 vehicle spaces for tenants (74 for phase 1, 40 for phase 2), 27 vehicle spaces for visitors (18 for phase 1, nine for phase 2), and 139 bicycle parking spaces (94 for phase 1, 45 for phase 2).

The development is proposed as being below minimum vehicle parking rates from the zoning by-law by a total of eight spaces, and exceeding the minimum bicycle parking rate. A zoning by-law exemption for the vehicle and parking rate will be required.

10 Boundary Street Design

Table 16 summarizes the MMLOS analysis for the boundary streets of Cambridge Street, Carling Avenue, and Bronson Avenue. The existing and future conditions for both streets will be the same and are considered in one row. The boundary street analysis is based on the policy area of “Within 300m of a school” for the segments of Carling Avenue and Bronson Avenue, as they are within this distance Glebe Collegiate Institute, and for the land use designation of “General Urban Area” for the segment of Cambridge Street. The MMLOS worksheets has been provided in Appendix J.

Table 16: Boundary Street MMLOS Analysis

Segment	Pedestrian LOS		Bicycle LOS		Transit LOS		Truck LOS	
	PLOS	Target	BLOS	Target	TLOS	Target	TrLOS	Target
Cambridge Street	C	C	A	D	N/A	N/A	N/A	N/A
Carling Avenue	F	A	F	C	D	D	A	D
Bronson Avenue	F	A	E	D	D	D	A	D

Carling Avenue and Bronson Avenue do not meet the pedestrian and cycling MMLOS targets. As is typical throughout the city, the operating speeds and volumes along arterials prevent any sidewalk configuration from meeting targets. Bicycle LOS is limited by mixed traffic conditions as the shared bike/transit lane on Carling Avenue terminates upstream of the site frontage and becomes a right-turn lane, and Bronson Avenue does not have dedicated cycling facilities. To meet targets Carling Avenue and Bronson Avenue would each require at minimum a curbside bike lane to meet the BLOS targets. The remaining MMLOS targets are being met.

11 Access Intersections Design

11.1 Location and Design of Access

A two-way access is proposed at the southern limits of the 774 Bronson Avenue parcel in the location of an existing access, consisting of a 6.0-metre two-way driveway accessing the underground parking ramp on Bronson Avenue. This access is proposed as permitting both inbound movements and restricting the outbound left-turn movement through the addition of a No Left Turn sign (Rb-12 (OTM)) on the private eastbound approach. The proposed signage plan is provided in Appendix K.

The existing access on Cambridge Street will be shifted southward to comprise a 3.6-metre two-way lane that will primarily serve as a right-out lane for the underground garage but will additionally permit two-way traffic for loading and move-in operations.

The existing driveways at the north limit of the 774 Bronson Avenue parcel and on 770 Bronson Avenue will be removed and reinstated as full height curb.

Due to the proximity of the Bronson Avenue access to the southern property limits a private approach by-law exemption will be required. In addition, the access on Cambridge Street is proposed to include a 5.0% grade within 9.0 metres of the property line and will also require an exemption from the private approach by-law.

11.2 Intersection Control

The site access intersections are assumed to be stop controlled on the minor approaches with Bronson Avenue and Cambridge Street operating under free-flow conditions.

11.3 Access Intersection Design

11.3.1 2025 Future Total Access Intersection Operations

The 2025 future total intersection volumes are illustrated in Figure 15 and the access intersection operations are summarized below in Table 17. The level of service is based on HCM 2010 average delay for unsignalized intersections. The synchro worksheets have been provided in Appendix L.

Figure 15: 2025 Future Total Volumes

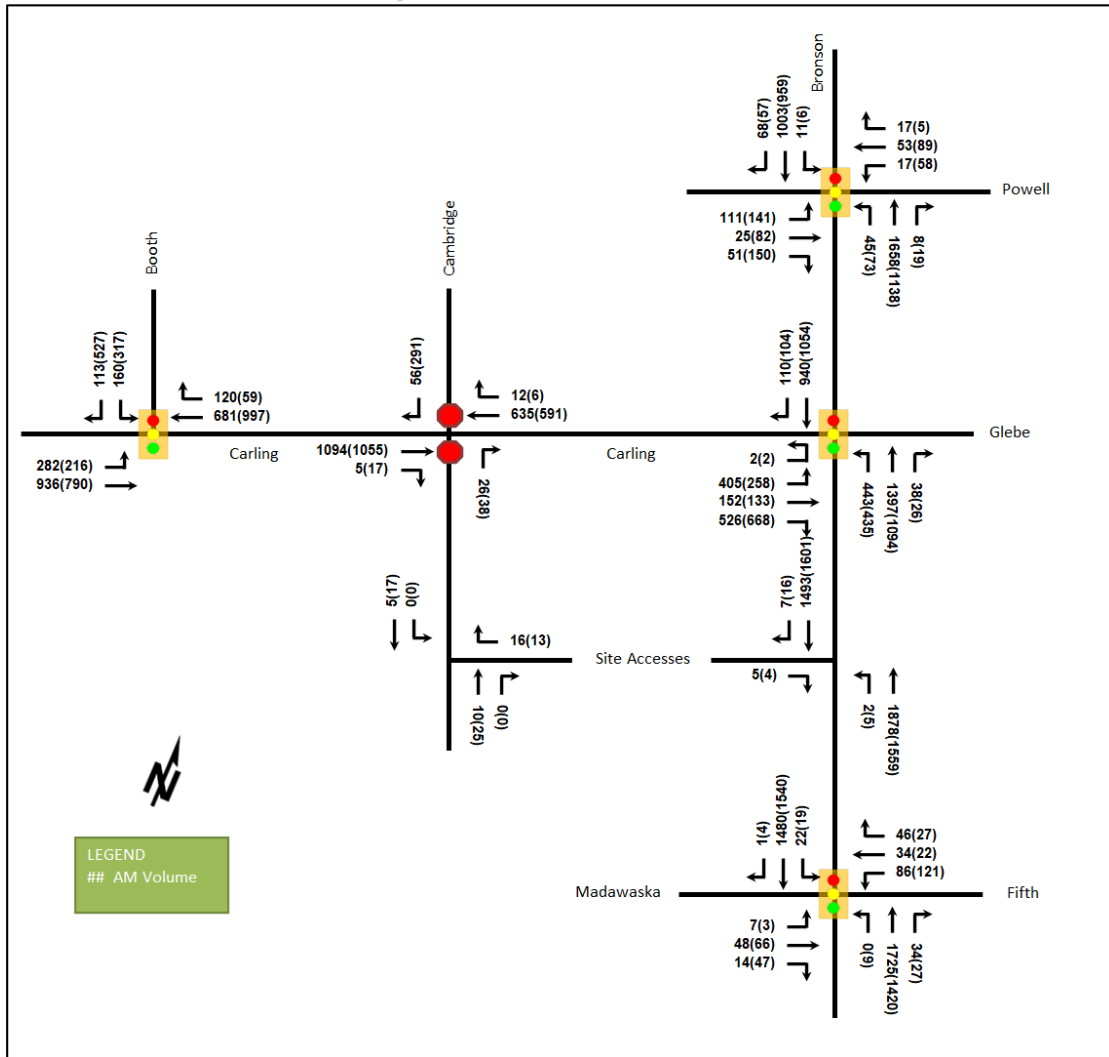

Table 17: 2025 Future Total Access Intersection Operations

Intersection	Lane	AM Peak Hour				PM Peak Hour			
		LOS	V/C	Delay	Q (95 th)	LOS	V/C	Delay	Q (95 th)
Cambridge Street at Site Access <i>Unsignalized</i>	WBR	A	0.01	8.4	0.0	A	0.01	8.5	0.0
	NBT/R	-	-	-	-	-	-	-	-
	SBL/T	-	-	-	-	-	-	-	-
	Overall	A	-	4.3	-	A	-	2.0	-
Bronson Avenue at Site Access <i>Unsignalized</i>	EBR	C	0.01	15.3	0.0	C	0.01	16.3	0.0
	NBL/T	B	0.01	13.2	0.0	B	0.01	14.1	0.0
	SBL/T	-	-	-	-	-	-	-	-
	Overall	A	-	0.0	-	A	-	0.4	-

Notes: Saturation flow rate of 1800 veh/h/lane
 Queue is measured in metres
 Peak Hour Factor = 1.00

Delay = average vehicle delay in seconds
 m = metered queue
 # = volume for the 95th %ile cycle exceeds capacity

The site accesses are forecast to perform well during both peak hours at the 2025 future total horizon.

11.3.2 2030 Future Total Access Intersection Operations

The 2030 future total intersection volumes are illustrated in Figure 16 and the access intersection operations are summarized below in Table 18. The level of service is based on HCM 2010 average delay for unsignalized intersections. The synchro worksheets have been provided in Appendix M.

Figure 16: 2030 Future Total Volumes

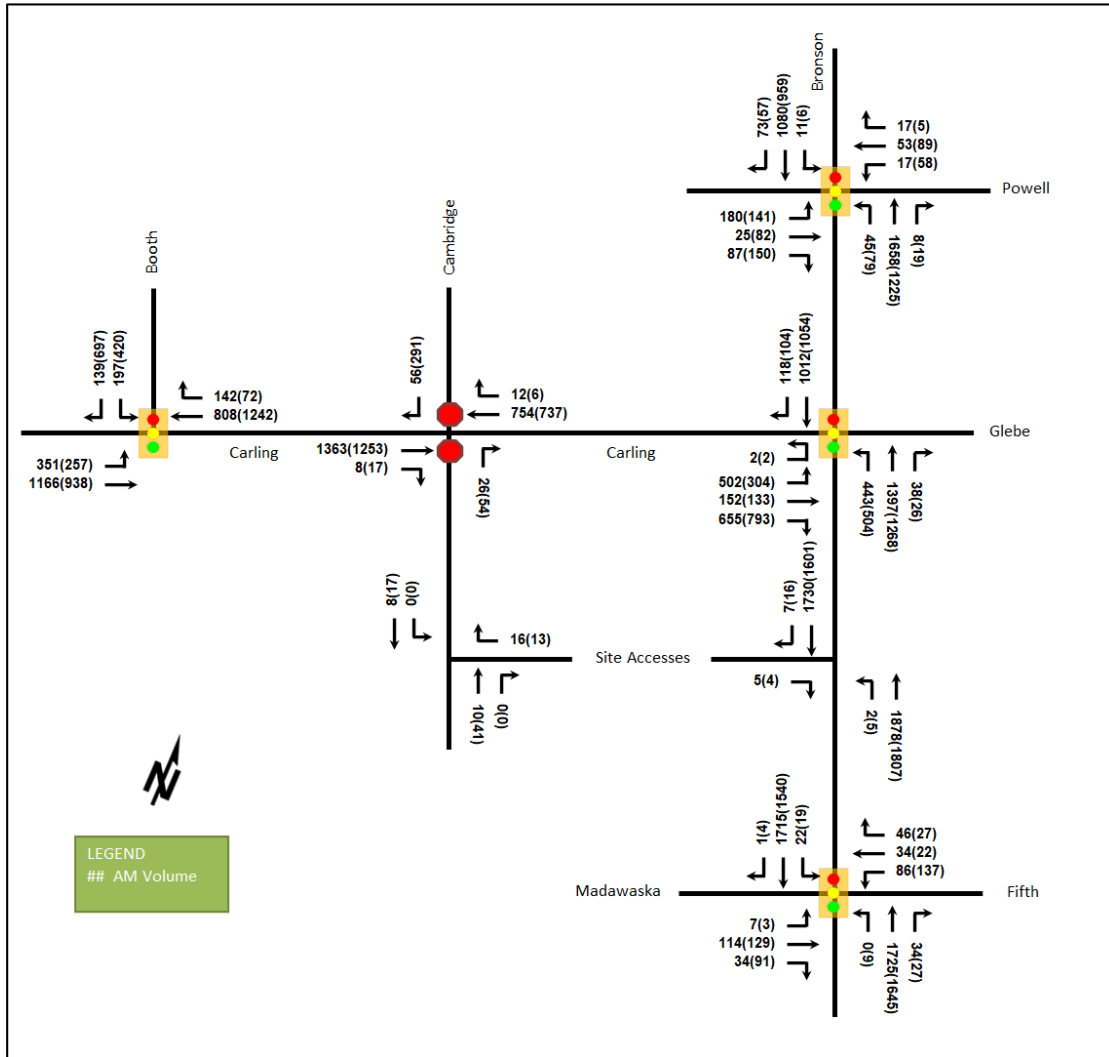

Table 18: 2030 Future Total Access Intersection Operations

Intersection	Lane	AM Peak Hour				PM Peak Hour			
		LOS	V/C	Delay	Q (95 th)	LOS	V/C	Delay	Q (95 th)
Cambridge Street at Site Access Unsignalized	WBR	A	0.02	8.4	0.0	A	0.01	8.5	0.0
	NBT/R	-	-	-	-	-	-	-	-
	SBL/T	-	-	-	-	-	-	-	-
	Overall	A	-	4.0	-	A	-	1.6	-

Intersection	Lane	AM Peak Hour				PM Peak Hour			
		LOS	V/C	Delay	Q (95 th)	LOS	V/C	Delay	Q (95 th)
Bronson Avenue at Site Access Unsignalized	EBR	C	0.02	17.4	0.8	C	0.01	16.3	0.0
	NBL/T	C	0.01	15.1	0.0	B	0.01	14.1	0.0
	SBL/T	-	-	-	-	-	-	-	-
	Overall	A	-	0.0	-	A	-	0.0	-

Notes: Saturation flow rate of 1800 veh/h/lane
 Queue is measured in metres
 Peak Hour Factor = 1.00

Delay = average vehicle delay in seconds
 m = metered queue
 # = volume for the 95th %ile cycle exceeds capacity

The site accesses are forecasted to perform well during both peak hours at the 2030 future total horizon.

11.3.3 Access Intersection MMLOS

The access intersections are not signalized and therefore no access intersection MMLOS analysis has been performed.

11.3.4 Recommended Design Elements

The access locations will be designed as typical private approaches, with depressed curbs and sidewalks per City standards. The private approach by-law exemptions noted previously will be required.

12 Transportation Demand Management

12.1 Context for TDM

The mode shares used within the TIA represent the unmodified district shares for the high-rise apartment component, with a 5% shift toward transit for the student housing component. Overall, the mode shares are likely to be achieved, and supporting TDM measures should be provided to further shift mode shares toward transit, walking, and cycling.

The subject site is within the Carling Arterial Mainstreet and Bronson Traditional Mainstreet Design Priority Areas.

Total bedrooms within the development are estimated as 147 one-bedroom/bachelor units, 81 two-bedroom units, 23 three-bedroom units, 21 four-bedroom units, and six five-bedroom units for a total of 492 bedrooms, where 71 of the units (225 bedrooms) are student housing. No age restrictions are noted.

12.2 Need and Opportunity

The subject site has been assumed to rely primarily on walking with roughly equal auto and transit shares for the apartment units and with a higher transit share for the student units.

If modal share targets are not met, the largest concentrated impacts will be during the AM peak hour using the residual capacity on the eastbound left-turn movement at the intersection of Bronson Avenue and Carling Avenue.

As such, a supportive TDM program should be provided to help ensure the auto mode share does not exceed the district averages, and to help steer further modal shift. It is noted that transit priority on Carling Avenue after 2031 may additionally shift mode share towards transit outside of the examined horizons.

12.3 TDM Program

The “suite of post occupancy TDM measures” has been summarized in the TDM checklists for the residential land uses. The checklist is provided in Appendix N. The key TDM measures recommended include:

- Designate an internal TDM program coordinator
- Display local area maps with walking cycling routes, and transit schedules and route maps at entrances

- Inclusion of a 6-month Presto card for first time apartment rental, with a set time frame for this offer (e.g., 6-months) from the initial opening of the site
- Unbundle parking cost from or rental costs
- Provide a multimodal travel option information package to new residents

The recommendation for the inclusion of a Presto pass would not apply to the student housing, where these tenants will have access to a university bus pass.

13 Neighbourhood Traffic Management

The proposed development will connect to the arterial road network at Bronson Avenue and at Carling Avenue via Cambridge Street, which is a local road. The forecasted volumes along Cambridge Street between the site access and Carling Avenue is in the range of 32-69 two-way vehicles per peak hour. These volumes are below the TIA Guidelines neighbourhood traffic management threshold for local roads of 120 vehicles per peak hour and thus no further examination is required.

14 Transit

14.1 Route Capacity

In Section 5.1 the trip generation by mode was estimated, including an estimate of the number of transit trips that will be generated by the proposed development. Table 19 summarizes the transit trip generation.

Table 19: Trip Generation by Transit Mode

Travel Mode	Mode Share	AM Peak Period			PM Peak Period		
		In	Out	Total	In	Out	Total
Transit	21%-33%	12	29	40	23	19	40

The proposed development is anticipated to generate an additional 40 AM and 40 PM peak hour two-way transit trips. Of these trips, 29 outbound AM trips and 23 inbound PM peak hour trips are anticipated. From the trip distribution found in Section 5.3 these values can be further broken down.

Site-generated outbound AM peak hour trips break down to ten trips to the north, seven trips to the south, and six trips to each the east and west and site-generated inbound PM peak hour trips break down to eight trips from the north, six trips from the south, and five trips from each the east and west. Northbound and southbound trips can be made via the route #10, and eastbound and westbound trips can be made via route #55 and 56 which additionally connect with Line 1 and Line 2 LRT. The north-south route #10 would see an increase of ridership averaged as two-to-three riders per bus per route, assuming no transit trips access the LRT at Carling O-Train Station, approximately 850 metres walk from the Cambridge Street site access, either via the west bus routes or by walking. The east-west routes would see an increase in ridership as an averaged one trip per bus per route. No service changes are anticipated as being required to accommodate site generated ridership.

14.2 Transit Priority

No transit priority is required explicitly for this study as the transit priority lanes on Carling Avenue are to be installed after the horizons analyzed within this TIA.

15 Network Intersection Design

15.1 Network Intersection Control

No change to the existing signalized control is recommended for the network intersections.

15.2 Network Intersection Design

15.2.1 2025 Future Total Network Intersection Operations

The 2025 future total network intersection operations are summarized below in Table 20. The level of service for signalized intersections is based on v/c calculations for individual lane movements and HCM 2000 v/c calculations for the overall intersection, and average delay for unsignalized intersections. The synchro worksheets have been provided in Appendix K.

Table 20: 2025 Future Total Network Intersection Operations

Intersection	Lane	AM Peak Hour				PM Peak Hour			
		LOS	V/C	Delay	Q (95 th)	LOS	V/C	Delay	Q (95 th)
Carling Avenue at Booth Street <i>Signalized</i>	EBL	D	0.84	67.3	#93.1	E	0.99	114.8	#106.4
	EBT	A	0.45	12.5	70.2	A	0.37	11.2	57.3
	WBT/R	A	0.46	28.8	65.0	A	0.48	41.1	102.0
	SBL	A	0.36	37.8	49.8	C	0.74	56.0	108.8
	SBR	A	0.26	7.8	13.6	F	1.33	198.1	#224.2
	Overall	A	0.53	26.5	-	D	0.84	68.6	-
Bronson Avenue at Powell Avenue <i>Signalized</i>	EB	D	0.86	74.9	#71.3	F	1.14	135.9	#167.9
	WB	A	0.33	38.5	29.0	A	0.52	49.1	55.9
	NB	D	0.81	17.6	m50.0	C	0.74	20.7	39.4
	SB	A	0.49	7.2	59.5	A	0.50	11.7	77.5
	Overall	D	0.82	18.0	-	D	0.85	34.4	-
Bronson Avenue at Carling Avenue <i>Signalized</i>	EBL	D	0.88	70.5	#106.1	D	0.82	66.8	m#80.9
	EBL/T	D	0.85	64.5	#103.7	C	0.75	57.6	m78.3
	EBR	D	0.89	43.1	109.8	F	1.24	152.0	#215.0
	NBL	B	0.68	36.2	50.8	C	0.77	55.1	m#83.2
	NBT/R	F	1.23	137.9	#478.6	D	0.88	28.0	m#249.7
	SBT/R	C	0.77	28.4	#150.5	B	0.69	18.7	m82.4
	Overall	F	1.22	75.8	-	F	1.05	53.8	-
Bronson Avenue at Fifth Avenue / Madawaska Drive <i>Signalized</i>	EB	A	0.27	35.9	22.7	A	0.49	49.2	41.9
	WB	C	0.75	59.6	51.3	F	1.19	180.5	#97.0
	NB	C	0.71	10.4	142.1	B	0.61	7.5	86.0
	SB	B	0.68	5.5	50.3	B	0.66	6.2	m67.2
	Overall	C	0.72	11.1	-	C	0.75	17.2	-
Carling Avenue at Cambridge Street <i>Unsignalized</i>	EBT/R	-	-	-	-	-	-	-	-
	WBT	-	-	-	-	-	-	-	-
	WBR	-	-	-	-	-	-	-	-
	NBR	C	0.07	15.6	1.5	C	0.10	15.7	2.3
	SBR	B	0.09	11.5	2.3	C	0.46	15.3	18.0
	Overall	A	-	0.6	-	A	-	2.5	-

Notes: Saturation flow rate of 1800 veh/h/lane
Queue is measured in metres
Peak Hour Factor = 1.00

Delay = average vehicle delay in seconds
m = metered queue
= volume for the 95th %ile cycle exceeds capacity

The network intersection operations for the 2025 future total horizon operate similarly to the 2025 future background conditions. During the PM peak hour, the intersection of Bronson Avenue at Carling Avenue’s

eastbound left movement 95th percentile queue length extends from 74.3 metres in the background conditions to 80.9 metres in the total condition, a value less than one car-length. No other new capacity issues are noted.

15.2.2 2030 Future Total Network Intersection Operations

The 2030 future total network intersection operations are summarized below in Table 21. The level of service for signalized intersections is based on v/c calculations for individual lane movements and HCM 2000 v/c calculations for the overall intersection, and average delay for unsignalized intersections. The synchro worksheets have been provided in Appendix L.

Table 21: 2030 Future Total Network Intersection Operations

Intersection	Lane	AM Peak Hour				PM Peak Hour			
		LOS	V/C	Delay	Q (95 th)	LOS	V/C	Delay	Q (95 th)
Carling Avenue at Booth Street <i>Signalized</i>	EBL	E	0.93	78.3	#134.2	F	1.18	165.9	#131.4
	EBT	A	0.57	14.3	95.8	A	0.44	12.0	71.3
	WBT/R	A	0.59	32.7	79.6	A	0.60	44.3	m124.9
	SBL	A	0.44	39.6	60.6	E	0.99	88.1	#172.2
	SBR	A	0.31	7.5	15.0	F	1.82	407.4	#328.8
	Overall	C	-	30.0	-	-	F	1.10	119.4
Bronson Avenue at Powell Avenue <i>Signalized</i>	EB	F	1.23	172.4	#127.6	F	1.14	135.9	#167.9
	WB	A	0.30	37.5	29.0	A	0.52	49.1	55.9
	NB	D	0.84	35.0	m61.9	D	0.81	33.4	m122.6
	SB	A	0.54	8.3	66.6	A	0.50	11.7	77.5
	Overall	E	0.92	37.9	-	D	0.90	39.8	-
Bronson Avenue at Carling Avenue <i>Signalized</i>	EBL	E	0.98	87.0	#130.6	D	0.89	71.3	m#86.2
	EBL/T	E	0.95	80.9	#132.2	C	0.80	58.5	m79.7
	EBR	E	0.98	55.6	#206.0	F	1.47	248.6	m#267.3
	NBL	A	0.56	29.5	50.8	E	0.93	68.5	m#103.4
	NBT/R	F	1.25	147.3	#478.9	F	1.02	73.4	m#427.5
	SBT/R	E	0.96	45.4	m#163.8	B	0.69	18.7	m82.4
	Overall	F	1.26	85.0	-	F	1.24	90.0	-
Bronson Avenue at Fifth Avenue / Madawaska Drive <i>Signalized</i>	EB	A	0.54	44.3	47.1	E	0.94	94.7	#101.1
	WB	D	0.88	79.3	#63.6	F	2.78	859.7	#128.3
	NB	C	0.73	11.7	142.1	B	0.70	9.1	115.2
	SB	C	0.80	8.9	m193.3	B	0.67	7.0	m71.3
	Overall	D	0.81	14.7	-	F	1.03	56.7	-
Carling Avenue at Cambridge Street <i>Unsignalized</i>	EBT/R	-	-	-	-	-	-	-	-
	WBT	-	-	-	-	-	-	-	-
	WBR	-	-	-	-	-	-	-	-
	NBR	C	0.09	18.2	2.3	C	0.17	18.4	4.5
	SBR	B	0.10	12.2	2.3	C	0.51	17.7	21.8
	Overall	A	-	0.5	-	A	-	2.6	-

Notes: Saturation flow rate of 1800 veh/h/lane
Queue is measured in metres
Peak Hour Factor = 1.00

Delay = average vehicle delay in seconds
m = metered queue
= volume for the 95th %ile cycle exceeds capacity

The network intersection operations for the 2030 future total horizon operate similarly to the 2030 future background conditions. As in the 2025 future total conditions, during the PM peak hour, the eastbound left movement at the intersection of Bronson Avenue at Carling Avenue may exhibit extended queues with the addition of site traffic. No new capacity issues are noted.

15.2.3 Network Intersection MMLOS

Table 22 summarizes the MMLOS analysis for the network intersections of Carling Avenue at Booth Street, Bronson Avenue at Powell Avenue, Bronson Avenue at Carling Avenue/Glebe Avenue, and Bronson Avenue at Fifth Avenue/Madawaska Drive. The existing and future conditions intersections will be considered in separate rows where they score differently. The intersection analysis is based on the policy area of “Within 300 m of a school” for both the intersections of Bronson Avenue at Carling Avenue/Glebe Avenue and Bronson Avenue at Powell Avenue, “Within 600m of a rapid transit station” for Carling Avenue at Booth Street, and “General Urban Area” for the intersection Bronson Avenue at Fifth Avenue/Madawaska Drive. The MMLOS worksheets has been provided in Appendix J.

Table 22: Network Intersection MMLOS Analysis

Intersection		Pedestrian LOS		Bicycle LOS		Transit LOS		Truck LOS		Auto LOS	
		PLOS	Target	BLOS	Target	TLOS	Target	TrLOS	Target	ALOS	Target
Carling Avenue at Booth Street	Ex.	F	A	F	C	F	D	D	D	C	E
	Fut.	F	A	F	C	F	D	D	D	F	E
Bronson Avenue at Powell Avenue	Ex.	D	A	C	D	E	D	N/A	N/A	D	E
	Fut.	D	A	C	D	F	D	N/A	N/A	E	E
Bronson Avenue at Carling Avenue	Ex./Fut.	F	A	F	C	F	D	D	D	F	E
Bronson Avenue at Fifth Avenue / Madawaska Drive	Ex.	E	C	C	B	C	D	N/A	N/A	C	E
	Fut.	E	C	C	B	C	D	N/A	N/A	F	E

The MMLOS targets will not be met for the pedestrian LOS at all network intersections and for the bicycle LOS at all network intersections except for Bronson Avenue at Powell Avenue. Transit LOS will not be met at the intersections of Carling Avenue at Booth Street and Bronson Avenue at Carling Avenue, and auto LOS will not be met at the intersection of Bronson Avenue at Carling Avenue and at the future horizon for the intersections of Bronson Avenue at Powell Avenue and Bronson Avenue at Fifth Avenue/Madawaska Drive.

The pedestrian level of service would require a maximum of two lanes at a crossing to meet a LOS A and a maximum of three lanes to meet LOS C.

The mixed traffic approaches for cyclists and left-turn arrangements at the study area intersections govern the bicycle LOS, requiring alternative left-turn configurations at the intersections of Carling Avenue at Booth Street, and Bronson Avenue at Fifth Avenue/Madawaska Drive and/or bike lanes without shifting across right-turn lanes to meet the targets at the intersection of Carling Avenue at Booth Street and Carling Avenue/Glebe Avenue at Bronson Avenue.

The transit LOS will not be met due to delays on the southbound and eastbound approaches at the intersection of Carling Avenue and Booth Street, the northbound approach at the intersection of Bronson Avenue and Powell Avenue, and all approaches at the intersection of Bronson Avenue and Carling Avenue/Glebe Avenue.

Auto LOS would require overall intersection v/c to be 1.00 or lower.

15.2.4 Recommended Design Elements

No study area intersection design elements are proposed as part of this study.

16 Summary of Improvements Indicated and Modifications Options

The following summarizes the analysis and results presented in this TIA report:

Proposed Site and Screening

- The proposed site includes 207 high-rise apartment units and 71 student housing units
- Accesses will be provided via a two-way access that restricts the outbound left movement onto Bronson Avenue, an outlet on Cambridge Street
- The development is proposed to be completed as two phases built-out by 2025
- The Trip Generation, Location, and Safety triggers were met for the TIA Screening
- This report accompanies and zoning by-law amendment and site plan application

Existing Conditions

- Carling Avenue and Bronson Avenue are arterial roads, Booth Street is a major collector road, and Fifth Avenue is a collector road in the study area
- Sidewalks are provided on both sides of the study area roadways, separated bike lanes are along Glebe Avenue, and cycling paths are located within Commissioners Park
- A high number of collisions were noted at the Bronson Avenue and Carling Avenue intersection, primarily occurring as sideswipe and rear end collisions which may be due to congested conditions and queueing from turn-lanes
- Capacity issues are noted at the intersection of Carling Avenue and Booth Street, Bronson Avenue and Powell Avenue, and at the intersection of Bronson Avenue and Carling Avenue
- The continuing Highway 417 construction projects and Bronson Avenue rehabilitation work are considered contributing factors to the high volumes and noted capacity constraints

Development Generated Travel Demand

- The proposed development is forecasted produce 135 two-way people trips during the AM peak hour and 175 two-way people trips during the PM peak hour
- Of the forecasted people trips, 30 two-way trips will be vehicle trips during the AM peak hour and 38 two-way trips will be vehicle trips during the PM peak hour based on a 25%-26% auto mode share target for the apartment units and 20%-21% auto mode share target for the student units
- Of the forecasted trips, 35% are anticipated to travel north, 25% to the south, and 20% to each the east and west

Background Conditions

- The background developments were explicitly included in the background conditions, along with a total background growth of derived from interpolation from the existing volumes to the forecasted volumes along mainlines and major turning movements
- The study area intersections are forecasted to degrade from the existing conditions with area growth where existing capacity issues are worsened and several new capacity issues are present at the future background horizons
- A review of the network constraints identified residual capacity southbound on Bronson Avenue during the PM peak that may serve to alleviate Carling Avenue eastbound right-turn capacity constraints and Powell Avenue cut through traffic now that the Highway 417 construction activities are complete
- The City should endeavour to restrict potential cut through traffic from Queen Elizabeth Driveway on Madawaska Drive

Development Design

- Vehicle parking is underground, cycling parking is both underground and on the ground floor
- Hard surface connections are provided between all building entrances and surrounding pedestrian facilities
- The bus stop along the site frontage is proposed as being shifted north of the site access
- Garbage collection may occur on Cambridge Street or within the loading area at the end of the drive aisle accessing Cambridge Street, and emergency services are assumed to access the three site frontages

Parking

- The site will provide 133 vehicle parking spaces and 221 bicycle spaces, where by-law minimums are 147 vehicle spaces and 139 bicycle spaces
- A zoning by-law exemption for the vehicle parking rates will be required

Boundary Street Design

- Carling Avenue and Bronson Avenue will not meet pedestrian and bicycle MMLOS targets, due to the arterial volumes for pedestrian LOS and lack of cycling facilities for bicycle LOS
- The City would need to reconstruct Bronson Avenue and reallocate road space along Carling Avenue to meet the boundary road targets, both of which are beyond the scope of this development

Access Intersections Design

- One two-way access is proposed onto Bronson Avenue in the location of an existing access with an outbound left-turn restriction through signage
- The existing access onto Cambridge Street is proposed as being shifted southward and being reduced to 3.6 metres in width, mainly facilitating the outbound right-turn movement for the underground garage, but permitting two-way access for garbage and move-in operations
- A private approach bylaw exemption, or acceptance from the City through site plan, will be required for the Cambridge Street access as the grade is 5% within nine metres of the property line
- A private approach bylaw exemption, or acceptance from the City through site plan, will be required for the Bronson Avenue access as it is less than 3.0 metres from the south property line
- The accesses are proposed as being stop-controlled on the minor approach
- The site accesses are forecast to perform well during both peak hours

TDM

- Given the network intersection operations, if the mode share targets are not achieved, the greatest impact of the increased auto travel would be using the residual capacity on the eastbound left-turn movement at the intersection of Carling Avenue and Bronson Avenue during the AM peak hour
- Supportive TDM measures to be included within the proposed development should include:
 - Designate an internal TDM program coordinator
 - Display local area maps with walking cycling routes, and transit schedules and route maps at entrances
 - Inclusion of a 6-month Presto card for first time new townhome purchase and apartment rental, with a set time frame for this offer (e.g., 6-months) from the initial opening of the site
 - Unbundle parking cost from or rental costs
 - Provide a multimodal travel option information package to new residents

NTM

- Volumes along Cambridge Street at all horizons do not exceed local road NTM thresholds

Transit

- The site is forecasted to generate 40 AM and 40 PM peak hour two-way transit trips
- To meet forecasted transit use, the forecasted average increase in transit demand is 2-3 riders per bus per route travelling north-south, and one rider per bus per route travelling east-west
- No impact on area bus routes is anticipated from site-generated ridership, and no specific transit priority measures were considered as part of this development

Network Intersection Design

- Generally, the future total network intersections will operate similarly to future background conditions with additional queuing on the eastbound left-turn movement at the intersection of Bronson Avenue and Carling Avenue during the PM peak hour, and this movement reaching capacity in the AM peak hour
- The MMLOS targets will not be met for the pedestrian LOS at all network intersections, the bicycle LOS at all but the intersection of Bronson Avenue and Powell Avenue, transit LOS at all but the intersection of Bronson Avenue and Fifth Avenue/Madawaska Drive, and auto LOS at the future horizons at the intersections of Carling Avenue and Booth Street, Bronson Avenue and Carling Avenue, and Bronson Avenue and Fifth Avenue/Madawaska Drive
- Pedestrian targets would require crossings of no more than three lanes at Bronson Avenue at Fifth Avenue/Madawaska Drive and two lanes elsewhere, the bicycle targets can be achieved through the construction of dedicated cycling facilities, shifting the left-turn configurations out of mixed flow and right-turn configurations that do not shift across turn lanes, and transit LOS would require significant delay reductions throughout the study area, which are unlikely to be achieved

17 Conclusion

It is recommended that, from a transportation perspective, the proposed development applications proceed.

Prepared By:



John Kingsley, EIT
Transportation Engineering-Intern

Reviewed By:



Andrew Harte, P.Eng.
Senior Transportation Engineer

Appendix A

TIA Screening Form and PM Certification Form

City of Ottawa 2017 TIA Guidelines
Step 1 - Screening Form

Date: 30-Sep-20
Project Number: 2020-64
Project Reference: Katasa 770-774 Bronson

1.1 Description of Proposed Development	
Municipal Address	770-774 Bronson Avenue and 557 Cambridge Street South
Description of Location	Existing garage and gravel lot
Land Use Classification	Arterial Mainstreet (AM10[2373], AM1[2003] S296)
Development Size	333 apartment units
Accesses	Existing Access onto Bronson Avenue, existing access onto Cambridge Avenue
Phase of Development	Two phases
Buildout Year	2025
TIA Requirement	Full TIA Required

1.2 Trip Generation Trigger	
Land Use Type	Townhomes or apartments
Development Size	333 Units
Trip Generation Trigger	Yes

1.3 Location Triggers	
Does the development propose a new driveway to a boundary street that is designated as part of the City's Transit Priority, Rapid Transit or Spine Bicycle Networks?	No
Is the development in a Design Priority Area (DPA) or Transit-oriented Development (TOD) zone?	Yes Bronson Traditional and Carling Arterial Mainstreet Design Priority
Location Trigger	Yes

1.4. Safety Triggers	
Are posted speed limits on a boundary street 80 km/hr or greater?	No
Are there any horizontal/vertical curvatures on a boundary street limits sight lines at a proposed driveway?	No
Is the proposed driveway within the area of influence of an adjacent traffic signal or roundabout (i.e. within 300 m of intersection in rural conditions, or within 150 m of intersection in urban/ suburban conditions)?	Yes
Is the proposed driveway within auxiliary lanes of an intersection?	Yes
Does the proposed driveway make use of an existing median break that serves an existing site?	No
Is there a documented history of traffic operations or safety concerns on the boundary streets within 500 m of the development?	Yes Collisions at Carling Avenue at Bronson Avenue
Does the development include a drive-thru facility?	No
Safety Trigger	Yes



TIA Plan Reports

On 14 June 2017, the Council of the City of Ottawa adopted new Transportation Impact Assessment (TIA) Guidelines. In adopting the guidelines, Council established a requirement for those preparing and delivering transportation impact assessments and reports to sign a letter of certification.

Individuals submitting TIA reports will be responsible for all aspects of development-related transportation assessment and reporting, and undertaking such work, in accordance and compliance with the City of Ottawa's Official Plan, the Transportation Master Plan and the Transportation Impact Assessment (2017) Guidelines.

By submitting the attached TIA report (and any associated documents) and signing this document, the individual acknowledges that s/he meets the four criteria listed below.

CERTIFICATION

1. I have reviewed and have a sound understanding of the objectives, needs and requirements of the City of Ottawa's Official Plan, Transportation Master Plan and the Transportation Impact Assessment (2017) Guidelines;
2. I have a sound knowledge of industry standard practice with respect to the preparation of transportation impact assessment reports, including multi modal level of service review;
3. I have substantial experience (more than 5 years) in undertaking and delivering transportation impact studies (analysis, reporting and geometric design) with strong background knowledge in transportation planning, engineering or traffic operations; and
4. I am either a licensed¹ or registered² professional in good standing, whose field of expertise [check appropriate field(s)] is either transportation engineering or transportation planning .

1,2 License of registration body that oversees the profession is required to have a code of conduct and ethics guidelines that will ensure appropriate conduct and representation for transportation planning and/or transportation engineering works.

City Of Ottawa
Infrastructure Services and Community
Sustainability
Planning and Growth Management
110 Laurier Avenue West, 4th fl.
Ottawa, ON K1P 1J1
Tel. : 613-580-2424
Fax: 613-560-6006

Ville d'Ottawa
Services d'infrastructure et Viabilité des
collectivités
Urbanisme et Gestion de la croissance
110, avenue Laurier Ouest
Ottawa (Ontario) K1P 1J1
Tél. : 613-580-2424
Télécopieur: 613-560-6006

Dated at Ottawa this 20 day of September, 2018.
(City)

Name: Andrew Harte
(Please Print)

Professional Title: Professional Engineer



Signature of Individual certifier that s/he meets the above four criteria

Office Contact Information (Please Print)
Address: 6 Plaza Court
City / Postal Code: Ottawa / K2H 7W1
Telephone / Extension: (613) 697-3797
E-Mail Address: Andrew.Harte@CGHTransportation.com



Appendix B

Turning Movement Counts



Transportation Services - Traffic Services

Turning Movement Count - Peak Hour Diagram

BOOTH ST @ CARLING AVE

Survey Date: Thursday, September 12, 2019
Start Time: 07:00

WO No: 38761
Device: Miovision

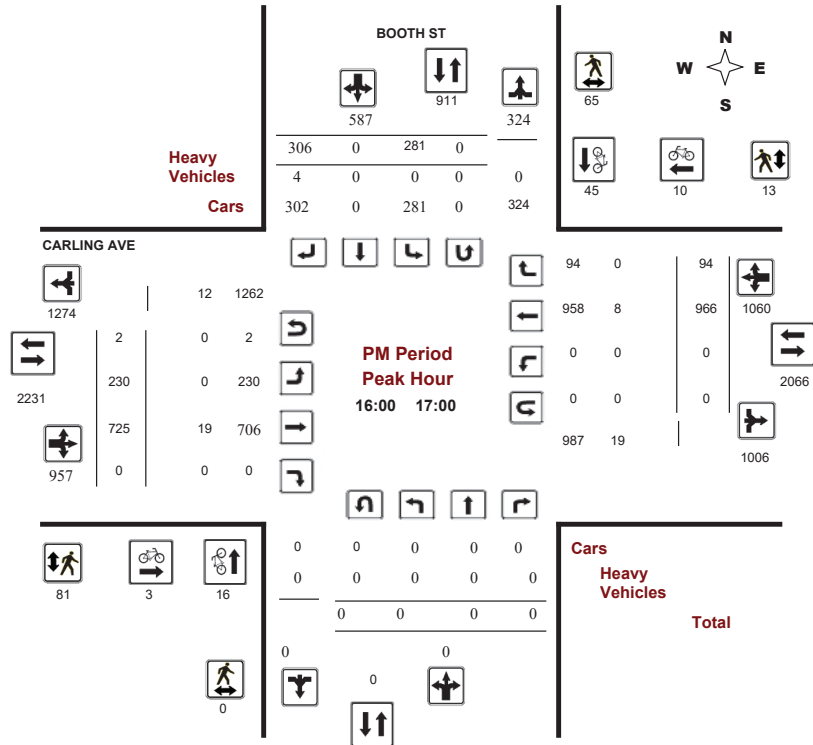

Comments



Transportation Services - Traffic Services

Turning Movement Count - Study Results

BOOTH ST @ CARLING AVE

Survey Date: Thursday, September 12, 2019
Start Time: 07:00

WO No: 38761
Device: Miovision

Full Study Summary (8 HR Standard)

Survey Date: Thursday, September 12, 2019

Total Observed U-Turns
Northbound: 0 Southbound: 0
Eastbound: 50 Westbound: 4

AADT Factor
1.00

Period	BOOTH ST								CARLING AVE								Grand Total		
	Northbound				Southbound				Eastbound				Westbound						
	LT	ST	RT	NB TOT	LT	ST	RT	SB TOT	LT	ST	RT	EB TOT	LT	ST	RT	WB TOT			
07:00-08:00	0	0	0	0	198	0	135	333	333	286	724	0	1010	0	576	182	758	1768	2101
08:00-09:00	0	0	0	0	197	0	130	327	327	408	877	0	1285	0	626	191	817	2102	2429
09:00-10:00	0	0	0	0	137	0	103	240	240	339	698	0	1037	0	511	159	670	1707	1947
11:30-12:30	0	0	0	0	218	0	110	328	328	182	656	0	838	0	491	116	607	1445	1773
12:30-13:30	0	0	0	0	179	0	128	307	307	170	649	0	819	0	412	94	506	1325	1632
15:00-16:00	0	0	0	0	269	0	281	550	550	216	710	0	926	0	733	117	850	1776	2326
16:00-17:00	0	0	0	0	281	0	306	587	587	230	725	0	955	0	966	94	1060	2015	2602
17:00-18:00	0	0	0	0	301	0	292	593	593	221	644	0	865	0	859	88	947	1812	2405
Sub Total	0	0	0	0	1780	0	1485	3265	3265	2052	5683	0	7735	0	5174	1041	6215	13950	17215
U Turns	0	0	0	0	0	0	0	0	0	0	50	0	50	0	4	4	54	54	54
Total	0	0	0	0	1780	0	1485	3265	3265	2052	5683	0	7785	0	5174	1041	6219	14004	17269
EQ 12Hr	0	0	0	0	2474	0	2064	4538	4538	2852	7899	0	10821	0	7192	1447	8644	19466	24004
Note: These values are calculated by multiplying the totals by the appropriate expansion factor.																	1.39		
AVG 12Hr	0	0	0	0	2332	0	1945	4277	4538	2688	7445	0	10198	0	6778	1364	8147	19466	24004
Note: These volumes are calculated by multiplying the Equivalent 12 hr. totals by the AADT factor.																	1		
AVG 24Hr	0	0	0	0	3055	0	2548	5603	5603	3521	9753	0	13360	0	8879	1786	10672	24032	29635
Note: These volumes are calculated by multiplying the Average Daily 12 hr. totals by 12 to 24 expansion factor.																	1.31		
Note: U-Turns provided for approach totals. Refer to 'U-Turn' Report for specific breakdown.																			



Transportation Services - Traffic Services

Turning Movement Count - Study Results

BOOTH ST @ CARLING AVE

Survey Date: Thursday, September 12, 2019

WO No: 38761

Start Time: 07:00

Device: Miovision

Full Study 15 Minute Increments

		BOOTH ST				CARLING AVE						BOOTH ST				CARLING AVE					
		Northbound		Southbound		Eastbound		Westbound				Northbound		Southbound		Eastbound		Westbound			
Time Period		LT	ST	RT	N TOT	LT	ST	RT	S TOT	STR TOT	LT	ST	RT	E TOT	LT	ST	RT	W TOT	STR TOT	Grand Total	
07:00	07:15	0	0	0	0	40	0	20	60	146	48	152	0	200	0	117	38	155	146	415	
07:15	07:30	0	0	0	0	47	0	37	84	208	72	155	0	227	0	139	52	191	208	502	
07:30	07:45	0	0	0	0	52	0	45	97	214	75	194	0	271	0	153	42	195	214	563	
07:45	08:00	0	0	0	0	59	0	33	92	233	91	223	0	316	0	167	50	217	233	625	
08:00	08:15	0	0	0	0	55	0	26	81	228	94	233	0	331	0	166	53	219	228	631	
08:15	08:30	0	0	0	0	42	0	30	72	230	100	238	0	340	0	155	58	213	230	625	
08:30	08:45	0	0	0	0	48	0	43	91	237	100	200	0	303	0	158	46	204	237	598	
08:45	09:00	0	0	0	0	52	0	31	83	231	114	206	0	325	0	147	34	181	231	589	
09:00	09:15	0	0	0	0	39	0	32	71	220	112	160	0	275	0	145	37	183	220	529	
09:15	09:30	0	0	0	0	24	0	27	51	200	94	185	0	284	0	129	55	184	200	519	
09:30	09:45	0	0	0	0	32	0	27	59	168	72	158	0	230	0	121	37	159	168	448	
09:45	10:00	0	0	0	0	42	0	17	59	150	61	195	0	261	0	116	30	146	150	466	
11:30	11:45	0	0	0	0	64	0	23	87	154	44	154	0	201	0	125	23	149	154	437	
11:45	12:00	0	0	0	0	44	0	24	68	162	55	183	0	239	0	122	39	161	162	468	
12:00	12:15	0	0	0	0	50	0	30	80	147	46	152	0	201	0	116	21	137	147	418	
12:15	12:30	0	0	0	0	60	0	33	93	163	37	167	0	204	0	128	33	162	163	459	
12:30	12:45	0	0	0	0	47	0	29	76	137	35	153	0	189	0	97	26	123	137	388	
12:45	13:00	0	0	0	0	54	0	36	90	155	51	179	0	232	0	105	14	119	155	441	
13:00	13:15	0	0	0	0	33	0	32	65	130	39	138	0	182	0	103	26	129	130	376	
13:15	13:30	0	0	0	0	45	0	31	76	149	45	179	0	224	0	107	28	135	149	435	
15:00	15:15	0	0	0	0	78	0	68	146	217	52	155	0	208	0	139	19	158	217	512	
15:15	15:30	0	0	0	0	62	0	63	125	221	58	195	0	253	0	172	38	210	221	588	
15:30	15:45	0	0	0	0	75	0	77	152	228	44	164	0	208	0	211	32	243	228	603	
15:45	16:00	0	0	0	0	54	0	73	127	217	62	196	0	258	0	211	28	239	217	624	
16:00	16:15	0	0	0	0	72	0	87	159	239	57	169	0	226	0	233	23	256	239	641	
16:15	16:30	0	0	0	0	75	0	56	131	208	53	190	0	243	0	241	24	265	208	639	
16:30	16:45	0	0	0	0	65	0	91	156	235	56	177	0	234	0	253	23	276	235	666	
16:45	17:00	0	0	0	0	69	0	72	141	229	64	189	0	254	0	239	24	263	229	658	
17:00	17:15	0	0	0	0	84	0	76	160	249	60	145	0	205	0	226	29	255	249	620	
17:15	17:30	0	0	0	0	74	0	75	149	218	51	189	0	240	0	230	18	248	218	637	
17:30	17:45	0	0	0	0	85	0	79	164	236	53	171	0	225	0	216	19	235	236	624	
17:45	18:00	0	0	0	0	58	0	62	120	199	57	139	0	196	0	187	22	209	199	525	
Total:		0	0	0	0	1780	0	1485	3265	6358	2052	5683	0	7785	0	5174	1041	6219	6358	17,269	

Note: U-Turns are included in Totals.



Transportation Services - Traffic Services

Turning Movement Count - Study Results

BOOTH ST @ CARLING AVE

Survey Date: Thursday, September 12, 2019

WO No: 38761

Start Time: 07:00

Device: Miovision

Full Study Cyclist Volume

		BOOTH ST			CARLING AVE				
		Northbound	Southbound	Street Total	Eastbound	Westbound	Street Total	Grand Total	
07:00	07:15	3	3	6	2	2	4	10	
07:15	07:30	1	4	5	2	1	3	8	
07:30	07:45	7	4	11	0	4	4	15	
07:45	08:00	6	8	14	0	4	4	18	
08:00	08:15	4	5	9	1	7	8	17	
08:15	08:30	12	4	16	0	2	2	18	
08:30	08:45	11	6	17	1	2	3	20	
08:45	09:00	14	3	17	0	5	5	22	
09:00	09:15	7	3	10	1	4	5	15	
09:15	09:30	2	1	3	1	3	4	7	
09:30	09:45	4	1	5	0	5	5	10	
09:45	10:00	4	1	5	1	2	3	8	
11:30	11:45	3	1	4	4	0	4	8	
11:45	12:00	2	2	4	2	2	4	8	
12:00	12:15	1	4	5	0	1	1	6	
12:15	12:30	0	1	1	2	3	5	6	
12:30	12:45	0	2	2	2	1	3	5	
12:45	13:00	0	0	0	0	1	1	1	
13:00	13:15	2	1	3	1	0	1	4	
13:15	13:30	1	1	2	0	3	3	5	
15:00	15:15	1	6	7	0	25	25	32	
15:15	15:30	0	7	7	0	5	5	12	
15:30	15:45	0	4	4	1	1	2	6	
15:45	16:00	1	8	9	1	1	2	11	
16:00	16:15	4	6	10	2	2	4	14	
16:15	16:30	4	18	22	1	4	5	27	
16:30	16:45	5	5	10	0	3	3	13	
16:45	17:00	3	16	19	0	1	1	20	
17:00	17:15	7	15	22	1	2	2	24	
17:15	17:30	1	15	16	0	6	6	22	
17:30	17:45	3	9	12	0	8	8	20	
17:45	18:00	0	10	10	1	5	6	16	
Total		113	174	287	27	114	141	428	



Transportation Services - Traffic Services

Turning Movement Count - Study Results

BOOTH ST @ CARLING AVE

Survey Date: Thursday, September 12, 2019

WO No: 38761

Start Time: 07:00

Device: Miovision

Full Study Pedestrian Volume

BOOTH ST CARLING AVE

Table with columns: Time Period, NB Approach, SB Approach, Total, EB Approach, WB Approach, Grand Total. Rows show pedestrian volume for various time intervals from 07:00 to 18:00.



Transportation Services - Traffic Services

Turning Movement Count - Study Results

BOOTH ST @ CARLING AVE

Survey Date: Thursday, September 12, 2019

WO No: 38761

Start Time: 07:00

Device: Miovision

Full Study Heavy Vehicles

BOOTH ST CARLING AVE

Table with columns: Time Period, Northbound (LT, ST, RT, N TOT), Southbound (LT, ST, RT, S TOT, STR TOT), Eastbound (LT, ST, RT, E TOT), Westbound (LT, ST, RT, W TOT, STR TOT), Grand Total. Rows show heavy vehicle volume for various time intervals from 07:00 to 18:00.



Transportation Services - Traffic Services

Turning Movement Count - Study Results

BOOTH ST @ CARLING AVE

Survey Date: Thursday, September 12, 2019

WO No: 38761

Start Time: 07:00

Device: Miovision

Full Study 15 Minute U-Turn Total

BOOTH ST CARLING AVE

Time Period	Northbound U-Turn Total	Southbound U-Turn Total	Eastbound U-Turn Total	Westbound U-Turn Total	Total
07:00 - 07:15	0	0	0	0	0
07:15 - 07:30	0	0	0	0	0
07:30 - 07:45	0	0	2	0	2
07:45 - 08:00	0	0	2	0	2
08:00 - 08:15	0	0	4	0	4
08:15 - 08:30	0	0	2	0	2
08:30 - 08:45	0	0	3	0	3
08:45 - 09:00	0	0	5	0	5
09:00 - 09:15	0	0	3	1	4
09:15 - 09:30	0	0	5	0	5
09:30 - 09:45	0	0	0	1	1
09:45 - 10:00	0	0	5	0	5
11:30 - 11:45	0	0	3	1	4
11:45 - 12:00	0	0	1	0	1
12:00 - 12:15	0	0	3	0	3
12:15 - 12:30	0	0	0	1	1
12:30 - 12:45	0	0	1	0	1
12:45 - 13:00	0	0	2	0	2
13:00 - 13:15	0	0	5	0	5
13:15 - 13:30	0	0	0	0	0
15:00 - 15:15	0	0	1	0	1
15:15 - 15:30	0	0	0	0	0
15:30 - 15:45	0	0	0	0	0
15:45 - 16:00	0	0	0	0	0
16:00 - 16:15	0	0	0	0	0
16:15 - 16:30	0	0	0	0	0
16:30 - 16:45	0	0	1	0	1
16:45 - 17:00	0	0	1	0	1
17:00 - 17:15	0	0	0	0	0
17:15 - 17:30	0	0	0	0	0
17:30 - 17:45	0	0	1	0	1
17:45 - 18:00	0	0	0	0	0
Total	0	0	50	4	54



Transportation Services - Traffic Services

Turning Movement Count - Study Results

CAMBRIDGE ST @ CARLING AVE

Survey Date: Thursday, May 17, 2018

WO No: 37836

Start Time: 07:00

Device: Miovision

Full Study Diagram

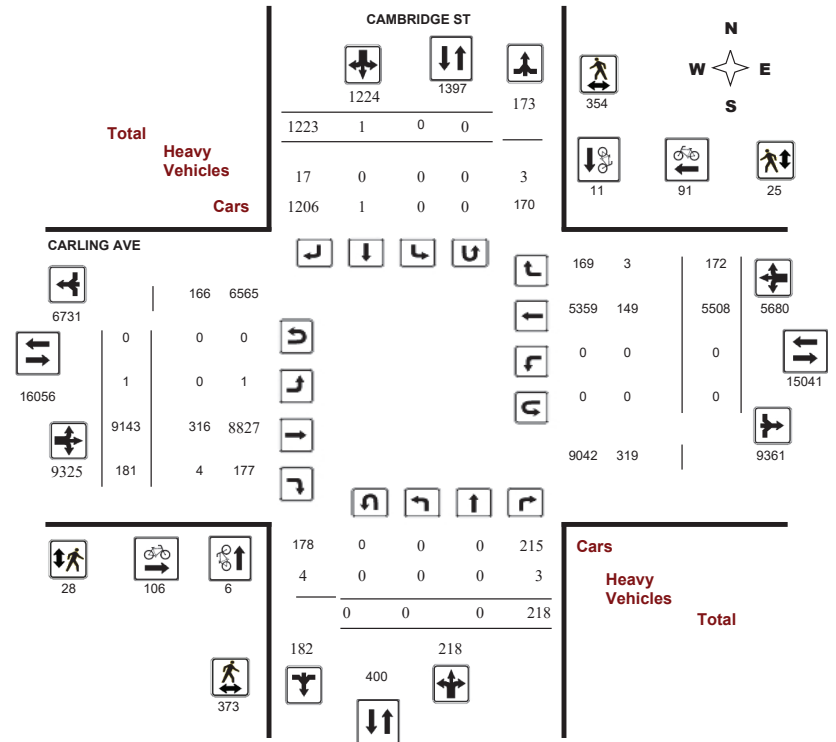



Transportation Services - Traffic Services

Turning Movement Count - Study Results

CAMBRIDGE ST @ CARLING AVE

Survey Date: Thursday, May 17, 2018

WO No: 37836

Start Time: 07:00

Device: Miovision

Full Study Peak Hour Diagram

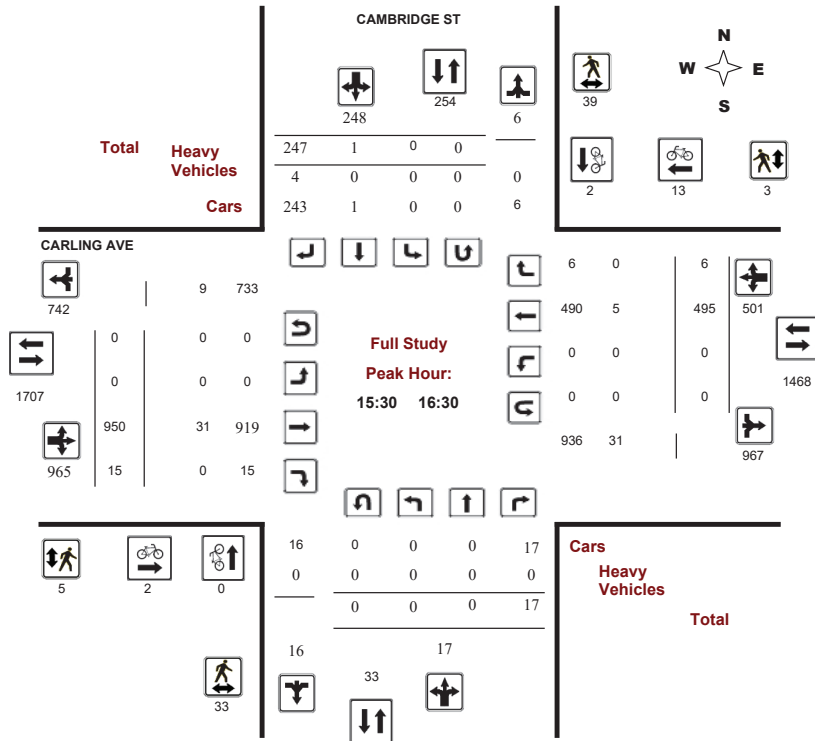

Transportation Services - Traffic Services

Turning Movement Count - Full Study Summary Report

CAMBRIDGE ST @ CARLING AVE

Survey Date: Thursday, May 17, 2018

Total Observed U-Turns

AADT Factor

Northbound: 0 Southbound: 0
Eastbound: 0 Westbound: 0
.90

Full Study

Period	CAMBRIDGE ST					CARLING AVE					Grand Total								
	Northbound		Southbound			Eastbound		Westbound											
	LT	ST	RT	NB TOT	LT	ST	RT	SB TOT	STR TOT	LT	ST	RT	EB TOT	LT	ST	RT	WB TOT	STR TOT	
07:00 08:00	0	0	8	8	0	0	69	69	77	0	687	2	689	0	492	9	501	1190	1267
08:00 09:00	0	0	9	9	0	0	57	57	66	1	900	3	904	0	527	18	545	1449	1515
09:00 10:00	0	0	17	17	0	0	50	50	67	0	689	12	701	0	515	18	533	1234	1301
10:00 11:00	0	0	12	12	0	0	35	35	47	0	559	15	574	0	401	19	420	994	1041
11:00 12:00	0	0	18	18	0	0	42	42	60	0	656	24	680	0	453	10	463	1143	1203
12:00 13:00	0	0	20	20	0	0	45	45	65	0	645	17	662	0	423	17	440	1102	1167
13:00 14:00	0	0	36	36	0	0	47	47	83	0	679	19	698	0	424	23	447	1145	1228
14:00 15:00	0	0	20	20	0	0	73	73	93	0	743	24	767	0	424	20	444	1211	1304
15:00 16:00	0	0	17	17	0	0	172	172	189	0	921	12	933	0	471	7	478	1411	1600
16:00 17:00	0	0	15	15	0	1	289	290	305	0	886	17	903	0	473	6	479	1382	1687
17:00 18:00	0	0	23	23	0	0	249	249	272	0	866	15	881	0	461	7	468	1349	1621
18:00 19:00	0	0	23	23	0	0	95	95	118	0	912	21	933	0	444	18	462	1395	1513
Sub Total	0	0	218	218	0	1	1223	1224	1442	1	9143	181	9325	0	5508	172	5680	15005	16447
U Turns	0	0	0	0	0	0	0	0	0	0	0	0	0	0	0	0	0	0	0
Total	0	0	218	218	0	1	1223	1224	1442	1	9143	181	9325	0	5508	172	5680	15005	16447
AVG 12Hr	0	0	196	196	0	1	1101	1102	1298	1	8229	163	8392	0	4957	155	5112	13504	14802
Note: These volumes are calculated by multiplying the Equivalent 12 hr. totals by the AADT factor.														.90					
AVG 24Hr	0	0	257	257	0	1	1442	1443	1700	1	10780	213	10994	0	6494	203	6697	17691	19391
Note: These volumes are calculated by multiplying the Average Daily 12 hr. totals by 12 to 24 expansion factor.														1.31					

Comments:

Note: U-Turns provided for approach totals. Refer to 'U-Turn' Report for specific breakdown.



Transportation Services - Traffic Services

Turning Movement Count - Study Results

CAMBRIDGE ST @ CARLING AVE

Survey Date: Thursday, May 17, 2018

WO No: 37836

Start Time: 07:00

Device: Miovision

Full Study 15 Minute Increments

Table with columns for Time Period, Northbound (LT, ST, RT, N TOT, STR TOT), Southbound (LT, ST, RT, S TOT, STR TOT), Eastbound (LT, ST, RT, E TOT), Westbound (LT, ST, RT, W TOT, STR TOT), and Grand Total. Rows represent 15-minute intervals from 07:00 to 17:15.



Transportation Services - Traffic Services

Turning Movement Count - Study Results

CAMBRIDGE ST @ CARLING AVE

Survey Date: Thursday, May 17, 2018

WO No: 37836

Start Time: 07:00

Device: Miovision

Summary table with columns for Time Period (17:30, 17:45, 18:00, 18:15, 18:30, 18:45, Total) and 18 columns of counts for various turning movements. Total counts are: 218, 218, 0, 1, 1223, 1224, 20, 1, 9143, 181, 9325, 0, 5508, 172, 5680, 20, 16,447.

Note: U-Turns are included in Totals.



Transportation Services - Traffic Services

Turning Movement Count - Study Results

CAMBRIDGE ST @ CARLING AVE

Survey Date: Thursday, May 17, 2018

WO No: 37836

Start Time: 07:00

Device: Miovision

Full Study Cyclist Volume

Time Period	CAMBRIDGE ST			CARLING AVE			Grand Total
	Northbound	Southbound	Street Total	Eastbound	Westbound	Street Total	
07:00 07:15	0	0	0	1	0	1	1
07:15 07:30	1	1	2	1	2	3	5
07:30 07:45	0	0	0	1	1	2	2
07:45 08:00	1	0	1	1	6	7	8
08:00 08:15	0	0	0	4	4	8	8
08:15 08:30	0	1	1	9	4	13	14
08:30 08:45	1	1	2	22	1	23	25
08:45 09:00	1	0	1	8	0	8	9
09:00 09:15	0	0	0	4	4	8	8
09:15 09:30	0	1	1	1	0	1	2
09:30 09:45	0	0	0	0	0	0	0
09:45 10:00	0	0	0	0	1	1	1
10:00 10:15	0	0	0	0	0	0	0
10:15 10:30	0	0	0	1	1	2	2
10:30 10:45	1	0	1	0	2	2	3
10:45 11:00	0	0	0	1	0	1	1
11:00 11:15	0	0	0	0	3	3	3
11:15 11:30	0	0	0	2	1	3	3
11:30 11:45	0	0	0	1	1	2	2
11:45 12:00	0	1	1	2	0	2	3
12:00 12:15	0	0	0	2	3	5	5
12:15 12:30	0	0	0	4	1	5	5
12:30 12:45	0	0	0	1	1	2	2
12:45 13:00	0	1	1	0	0	0	1
13:00 13:15	0	0	0	2	2	4	4
13:15 13:30	0	0	0	1	2	3	3
13:30 13:45	0	1	1	0	2	2	3
13:45 14:00	0	0	0	0	0	0	0
14:00 14:15	0	0	0	2	1	3	3
14:15 14:30	0	0	0	0	0	0	0
14:30 14:45	0	0	0	2	2	4	4
14:45 15:00	0	0	0	0	0	0	0
15:00 15:15	0	0	0	2	17	19	19
15:15 15:30	0	0	0	0	2	2	2
15:30 15:45	0	0	0	0	6	6	6
15:45 16:00	0	1	1	0	2	2	3
16:00 16:15	0	0	0	2	3	5	5
16:15 16:30	0	1	1	0	2	2	3
16:30 16:45	0	0	0	5	0	5	5
16:45 17:00	0	1	1	0	5	5	6
17:00 17:15	0	0	0	2	2	4	4
17:15 17:30	0	0	0	0	0	0	0
17:30 17:45	0	0	0	3	1	4	4
17:45 18:00	0	0	0	4	1	5	5
18:00 18:15	0	0	0	4	2	6	6



Transportation Services - Traffic Services

Turning Movement Count - Study Results

CAMBRIDGE ST @ CARLING AVE

Survey Date: Thursday, May 17, 2018

WO No: 37836

Start Time: 07:00

Device: Miovision

18:15 18:30	1	1	2	6	1	7	9
18:30 18:45	0	0	0	1	2	3	3
18:45 19:00	0	0	0	4	0	4	4
Total	6	11	17	106	91	197	214



Transportation Services - Traffic Services

Turning Movement Count - Study Results

CAMBRIDGE ST @ CARLING AVE

Survey Date: Thursday, May 17, 2018

WO No: 37836

Start Time: 07:00

Device: Miovision

Full Study Pedestrian Volume

CAMBRIDGE ST

CARLING AVE

Time Period	NB Approach (E or W Crossing)	SB Approach (E or W Crossing)	Total	EB Approach (N or S Crossing)	WB Approach (N or S Crossing)	Total	Grand Total
07:00 07:15	0	1	1	0	0	0	1
07:15 07:30	2	4	6	0	2	2	8
07:30 07:45	1	2	3	0	0	0	3
07:45 08:00	3	3	6	0	0	0	6
08:00 08:15	9	10	19	0	0	0	19
08:15 08:30	28	12	40	0	0	0	40
08:30 08:45	5	13	18	0	1	1	19
08:45 09:00	46	16	62	0	0	0	62
09:00 09:15	15	3	18	2	1	3	21
09:15 09:30	14	6	20	0	0	0	20
09:30 09:45	12	6	18	0	1	1	19
09:45 10:00	6	4	10	0	5	5	15
10:00 10:15	4	5	9	0	0	0	9
10:15 10:30	5	4	9	0	0	0	9
10:30 10:45	0	9	9	0	2	2	11
10:45 11:00	0	7	7	0	0	0	7
11:00 11:15	5	1	6	5	0	5	11
11:15 11:30	3	7	10	3	0	3	13
11:30 11:45	1	6	7	0	0	0	7
11:45 12:00	7	7	14	0	0	0	14
12:00 12:15	6	8	14	0	0	0	14
12:15 12:30	6	6	12	0	3	3	15
12:30 12:45	18	11	29	2	3	5	34
12:45 13:00	4	8	12	0	1	1	13
13:00 13:15	10	14	24	0	0	0	24
13:15 13:30	8	6	14	0	0	0	14
13:30 13:45	5	10	15	0	0	0	15
13:45 14:00	7	7	14	0	0	0	14
14:00 14:15	6	15	21	0	1	1	22
14:15 14:30	7	4	11	0	0	0	11
14:30 14:45	8	2	10	0	0	0	10
14:45 15:00	10	6	16	0	0	0	16
15:00 15:15	11	27	38	1	0	1	39
15:15 15:30	7	11	18	2	1	3	21
15:30 15:45	8	11	19	1	0	1	20
15:45 16:00	7	10	17	3	0	3	20
16:00 16:15	6	7	13	1	0	1	14
16:15 16:30	12	11	23	0	3	3	26
16:30 16:45	8	5	13	0	0	0	13
16:45 17:00	16	10	26	0	1	1	27
17:00 17:15	4	6	10	1	0	1	11
17:15 17:30	4	9	13	0	0	0	13
17:30 17:45	8	6	14	1	0	1	15



Transportation Services - Traffic Services

Turning Movement Count - Study Results

CAMBRIDGE ST @ CARLING AVE

Survey Date: Thursday, May 17, 2018

WO No: 37836

Start Time: 07:00

Device: Miovision

17:45 18:00	3	3	6	0	0	0	6
18:00 18:15	6	5	11	3	0	3	14
18:15 18:30	1	3	4	2	0	2	6
18:30 18:45	7	4	11	0	0	0	11
18:45 19:00	4	3	7	1	0	1	8
Total	373	354	727	28	25	53	780



Transportation Services - Traffic Services

Turning Movement Count - Study Results

CAMBRIDGE ST @ CARLING AVE

Survey Date: Thursday, May 17, 2018

WO No: 37836

Start Time: 07:00

Device: Miovision

Full Study Heavy Vehicles

Table with columns for Time Period, Northbound (LT, ST, RT, N TOT, STR TOT), Southbound (LT, ST, RT, S TOT, STR TOT), Eastbound (LT, ST, RT, E TOT), Westbound (LT, ST, RT, W TOT, STR TOT), and Grand Total. Rows represent 15-minute intervals from 07:00 to 17:15.



Transportation Services - Traffic Services

Turning Movement Count - Study Results

CAMBRIDGE ST @ CARLING AVE

Survey Date: Thursday, May 17, 2018

WO No: 37836

Start Time: 07:00

Device: Miovision

Summary table with columns for Time Period (17:30, 17:45, 18:00, 18:15, 18:30, 18:45, Total) and counts for various turning movements. Total counts are 3, 3, 0, 0, 17, 17, 20, 0, 316, 4, 320, 0, 149, 3, 152, 472, 492.



Transportation Services - Traffic Services

Turning Movement Count - Study Results

CAMBRIDGE ST @ CARLING AVE

Survey Date: Thursday, May 17, 2018

WO No: 37836

Start Time: 07:00

Device: Miovision

Full Study 15 Minute U-Turn Total

CAMBRIDGE ST CARLING AVE

Time Period	Northbound U-Turn Total	Southbound U-Turn Total	Eastbound U-Turn Total	Westbound U-Turn Total	Total
07:00 07:15	0	0	0	0	0
07:15 07:30	0	0	0	0	0
07:30 07:45	0	0	0	0	0
07:45 08:00	0	0	0	0	0
08:00 08:15	0	0	0	0	0
08:15 08:30	0	0	0	0	0
08:30 08:45	0	0	0	0	0
08:45 09:00	0	0	0	0	0
09:00 09:15	0	0	0	0	0
09:15 09:30	0	0	0	0	0
09:30 09:45	0	0	0	0	0
09:45 10:00	0	0	0	0	0
10:00 10:15	0	0	0	0	0
10:15 10:30	0	0	0	0	0
10:30 10:45	0	0	0	0	0
10:45 11:00	0	0	0	0	0
11:00 11:15	0	0	0	0	0
11:15 11:30	0	0	0	0	0
11:30 11:45	0	0	0	0	0
11:45 12:00	0	0	0	0	0
12:00 12:15	0	0	0	0	0
12:15 12:30	0	0	0	0	0
12:30 12:45	0	0	0	0	0
12:45 13:00	0	0	0	0	0
13:00 13:15	0	0	0	0	0
13:15 13:30	0	0	0	0	0
13:30 13:45	0	0	0	0	0
13:45 14:00	0	0	0	0	0
14:00 14:15	0	0	0	0	0
14:15 14:30	0	0	0	0	0
14:30 14:45	0	0	0	0	0
14:45 15:00	0	0	0	0	0
15:00 15:15	0	0	0	0	0
15:15 15:30	0	0	0	0	0
15:30 15:45	0	0	0	0	0
15:45 16:00	0	0	0	0	0
16:00 16:15	0	0	0	0	0
16:15 16:30	0	0	0	0	0
16:30 16:45	0	0	0	0	0
16:45 17:00	0	0	0	0	0
17:00 17:15	0	0	0	0	0
17:15 17:30	0	0	0	0	0



Transportation Services - Traffic Services

Turning Movement Count - Study Results

CAMBRIDGE ST @ CARLING AVE

Survey Date: Thursday, May 17, 2018

WO No: 37836

Start Time: 07:00

Device: Miovision

17:30 17:45	0	0	0	0	0
17:45 18:00	0	0	0	0	0
18:00 18:15	0	0	0	0	0
18:15 18:30	0	0	0	0	0
18:30 18:45	0	0	0	0	0
18:45 19:00	0	0	0	0	0
Total	0	0	0	0	0



Transportation Services - Traffic Services

Turning Movement Count - Study Results

BRONSON AVE @ POWELL AVE

Survey Date: Thursday, August 08, 2019

WO No: 38709

Start Time: 07:00

Device: Miovision

Full Study Diagram

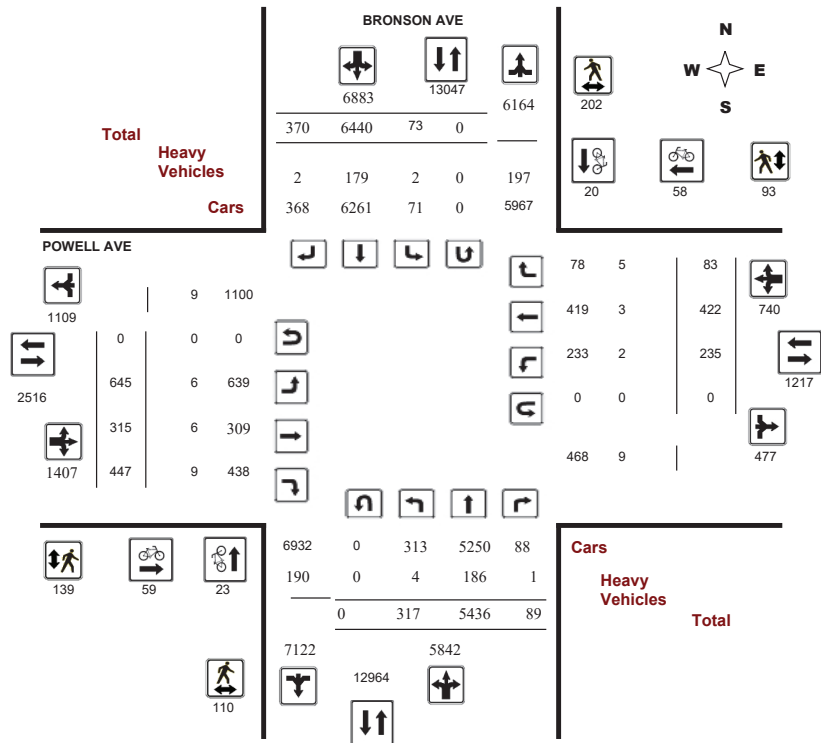

Transportation Services - Traffic Services

Turning Movement Count - Study Results

BRONSON AVE @ POWELL AVE

Survey Date: Thursday, August 08, 2019

WO No: 38709

Start Time: 07:00

Device: Miovision

Full Study Peak Hour Diagram

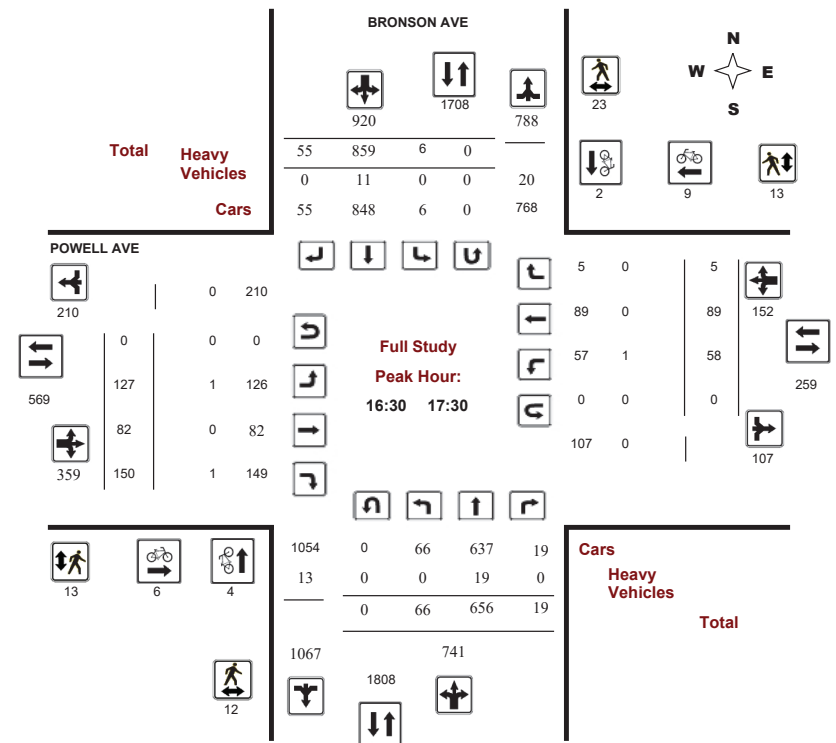



Transportation Services - Traffic Services

Turning Movement Count - Peak Hour Diagram

BRONSON AVE @ POWELL AVE

Survey Date: Thursday, August 08, 2019
Start Time: 07:00

WO No: 38709
Device: Miovision

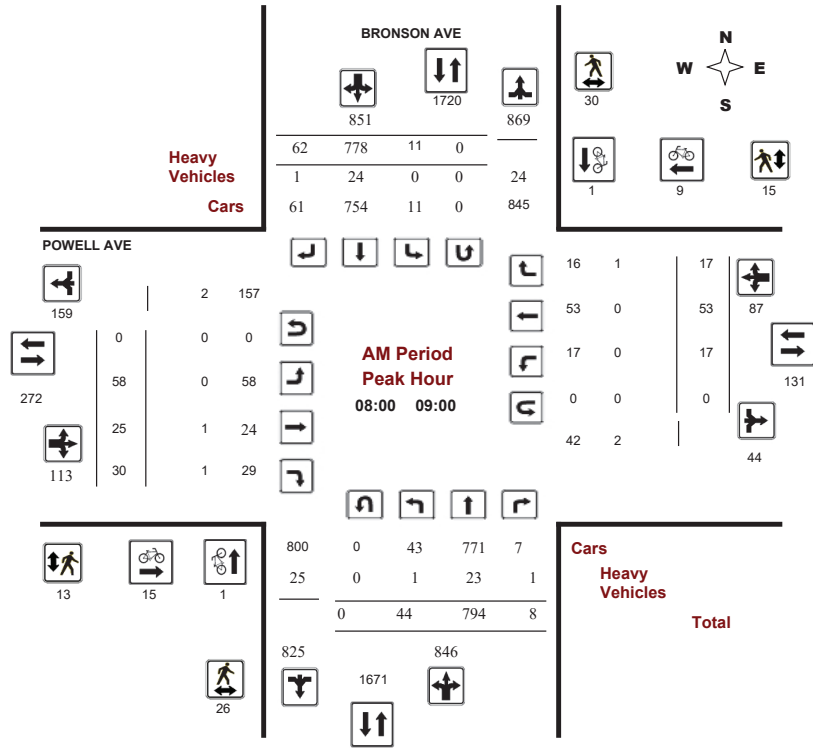

Comments



Transportation Services - Traffic Services

Turning Movement Count - Peak Hour Diagram

BRONSON AVE @ POWELL AVE

Survey Date: Thursday, August 08, 2019
Start Time: 07:00

WO No: 38709
Device: Miovision

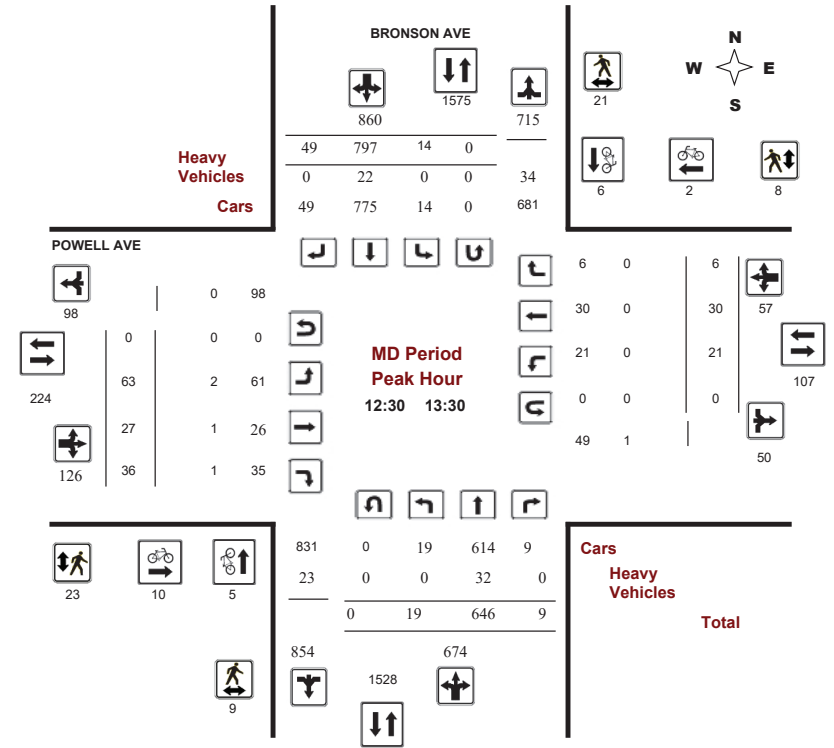

Comments



Transportation Services - Traffic Services

Turning Movement Count - Peak Hour Diagram

BRONSON AVE @ POWELL AVE

Survey Date: Thursday, August 08, 2019
Start Time: 07:00

WO No: 38709
Device: Miovision

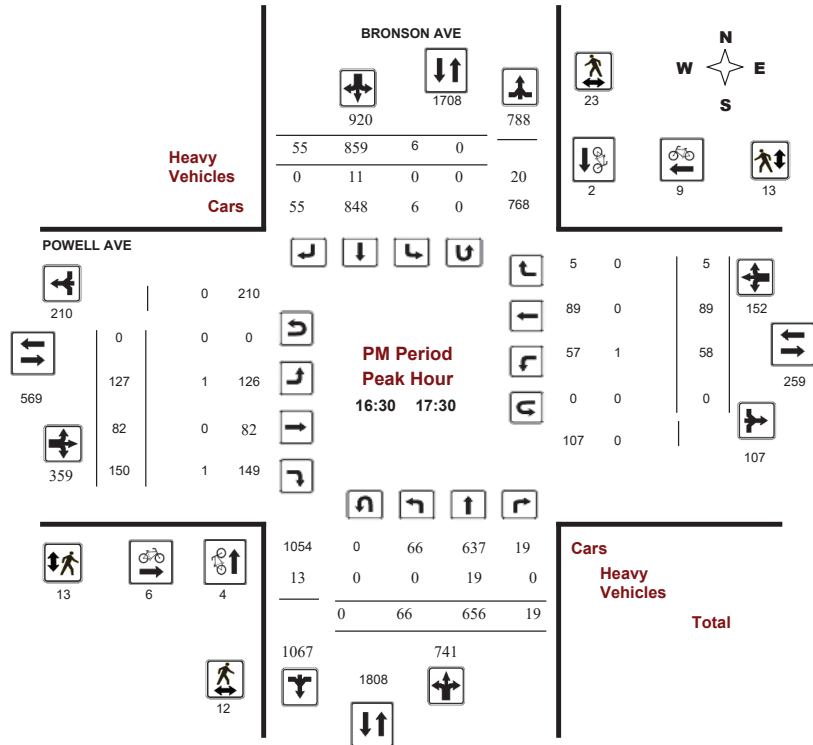

Transportation Services - Traffic Services

Turning Movement Count - Study Results

BRONSON AVE @ POWELL AVE

Survey Date: Thursday, August 08, 2019
Start Time: 07:00

WO No: 38709
Device: Miovision

Full Study Summary (8 HR Standard)

Survey Date: Thursday, August 08, 2019

Total Observed U-Turns
Northbound: 0 Southbound: 0
Eastbound: 0 Westbound: 0

AADT Factor
.90

Period	BRONSON AVE				POWELL AVE				Grand Total										
	Northbound		Southbound		Eastbound		Westbound												
	LT	ST	RT	NB TOT	LT	ST	RT	SB TOT	STR TOT	LT	ST	RT	EB TOT	LT	ST	RT	WB TOT	STR TOT	
07:00-08:00	39	714	5	758	6	796	40	842	1600	52	13	19	84	11	31	5	47	131	1731
08:00-09:00	44	794	8	846	11	778	62	851	1697	58	25	30	113	17	53	17	87	200	1897
09:00-10:00	33	640	11	684	7	733	42	782	1466	51	23	24	98	20	32	13	65	163	1629
11:30-12:30	21	617	13	651	13	757	38	808	1459	73	29	28	130	12	43	17	72	202	1661
12:30-13:30	19	646	9	674	14	797	49	860	1534	63	27	36	126	21	30	6	57	183	1717
15:00-16:00	42	713	8	763	7	875	33	915	1678	106	51	66	223	30	45	11	86	309	1987
16:00-17:00	62	674	21	757	7	771	49	827	1584	119	81	145	345	78	104	7	189	534	2118
17:00-18:00	57	638	14	709	8	933	57	998	1707	123	66	99	288	46	84	7	137	425	2132
Sub Total	317	5436	89	5842	73	6440	370	6883	12725	645	315	447	1407	235	422	83	740	2147	14872
U Turns				0				0	0				0				0	0	0
Total	317	5436	89	5842	73	6440	370	6883	12725	645	315	447	1407	235	422	83	740	2147	14872
EQ 12Hr	441	7556	124	8120	101	8952	514	9567	17688	897	438	621	1956	327	587	115	1029	2984	20672
Note: These values are calculated by multiplying the totals by the appropriate expansion factor.																			1.39
AVG 12Hr	374	6409	105	6888	86	7593	436	8115	15919	760	371	527	1659	277	498	98	872	2686	18605
Note: These volumes are calculated by multiplying the Equivalent 12 hr. totals by the AADT factor.																			0.9
AVG 24Hr	490	8396	137	9023	113	9947	571	10631	19654	996	487	690	2173	363	652	128	1143	3316	22970
Note: These volumes are calculated by multiplying the Average Daily 12 hr. totals by 12 to 24 expansion factor.																			1.31
Note: U-Turns provided for approach totals. Refer to 'U-Turn' Report for specific breakdown.																			



Transportation Services - Traffic Services

Turning Movement Count - Study Results

BRONSON AVE @ POWELL AVE

Survey Date: Thursday, August 08, 2019

WO No: 38709

Start Time: 07:00

Device: Miovision

Full Study 15 Minute Increments

Table with columns for Time Period, Northbound, Southbound, Eastbound, Westbound, and Grand Total. Rows show 15-minute intervals from 07:00 to 18:00.

Note: U-Turns are included in Totals.



Transportation Services - Traffic Services

Turning Movement Count - Study Results

BRONSON AVE @ POWELL AVE

Survey Date: Thursday, August 08, 2019

WO No: 38709

Start Time: 07:00

Device: Miovision

Full Study Cyclist Volume

Table with columns for Time Period, Northbound, Southbound, Street Total, Eastbound, Westbound, Street Total, and Grand Total. Rows show 15-minute intervals from 07:00 to 18:00.



Transportation Services - Traffic Services

Turning Movement Count - Study Results

BRONSON AVE @ POWELL AVE

Survey Date: Thursday, August 08, 2019

WO No: 38709

Start Time: 07:00

Device: Miovision

Full Study Pedestrian Volume

BRONSON AVE

POWELL AVE

Table with columns: Time Period, NB Approach (E or W Crossing), SB Approach (E or W Crossing), Total, EB Approach (N or S Crossing), WB Approach (N or S Crossing), Total, Grand Total. Rows show pedestrian counts from 07:00 to 18:00.



Transportation Services - Traffic Services

Turning Movement Count - Study Results

BRONSON AVE @ POWELL AVE

Survey Date: Thursday, August 08, 2019

WO No: 38709

Start Time: 07:00

Device: Miovision

Full Study Heavy Vehicles

BRONSON AVE

POWELL AVE

Table with columns: Time Period, Northbound (LT, ST, RT, N TOT, STR TOT), Southbound (LT, ST, RT, S TOT, STR TOT), Eastbound (LT, ST, RT, E TOT), Westbound (LT, ST, RT, W TOT, STR TOT), Grand Total. Rows show heavy vehicle counts from 07:00 to 18:00.



Transportation Services - Traffic Services

Turning Movement Count - Study Results

BRONSON AVE @ POWELL AVE

Survey Date: Thursday, August 08, 2019

WO No: 38709

Start Time: 07:00

Device: Miovision

Full Study 15 Minute U-Turn Total

Time Period	BRONSON AVE		POWELL AVE		Total
	Northbound U-Turn Total	Southbound U-Turn Total	Eastbound U-Turn Total	Westbound U-Turn Total	
07:00 - 07:15	0	0	0	0	0
07:15 - 07:30	0	0	0	0	0
07:30 - 07:45	0	0	0	0	0
07:45 - 08:00	0	0	0	0	0
08:00 - 08:15	0	0	0	0	0
08:15 - 08:30	0	0	0	0	0
08:30 - 08:45	0	0	0	0	0
08:45 - 09:00	0	0	0	0	0
09:00 - 09:15	0	0	0	0	0
09:15 - 09:30	0	0	0	0	0
09:30 - 09:45	0	0	0	0	0
09:45 - 10:00	0	0	0	0	0
11:30 - 11:45	0	0	0	0	0
11:45 - 12:00	0	0	0	0	0
12:00 - 12:15	0	0	0	0	0
12:15 - 12:30	0	0	0	0	0
12:30 - 12:45	0	0	0	0	0
12:45 - 13:00	0	0	0	0	0
13:00 - 13:15	0	0	0	0	0
13:15 - 13:30	0	0	0	0	0
15:00 - 15:15	0	0	0	0	0
15:15 - 15:30	0	0	0	0	0
15:30 - 15:45	0	0	0	0	0
15:45 - 16:00	0	0	0	0	0
16:00 - 16:15	0	0	0	0	0
16:15 - 16:30	0	0	0	0	0
16:30 - 16:45	0	0	0	0	0
16:45 - 17:00	0	0	0	0	0
17:00 - 17:15	0	0	0	0	0
17:15 - 17:30	0	0	0	0	0
17:30 - 17:45	0	0	0	0	0
17:45 - 18:00	0	0	0	0	0
Total	0	0	0	0	0



Transportation Services - Traffic Services

Turning Movement Count - Study Results

BRONSON AVE @ CARLING AVE/GLEBE AVE

Survey Date: Thursday, September 12, 2019

WO No: 38767

Start Time: 07:00

Device: Miovision

Full Study Diagram

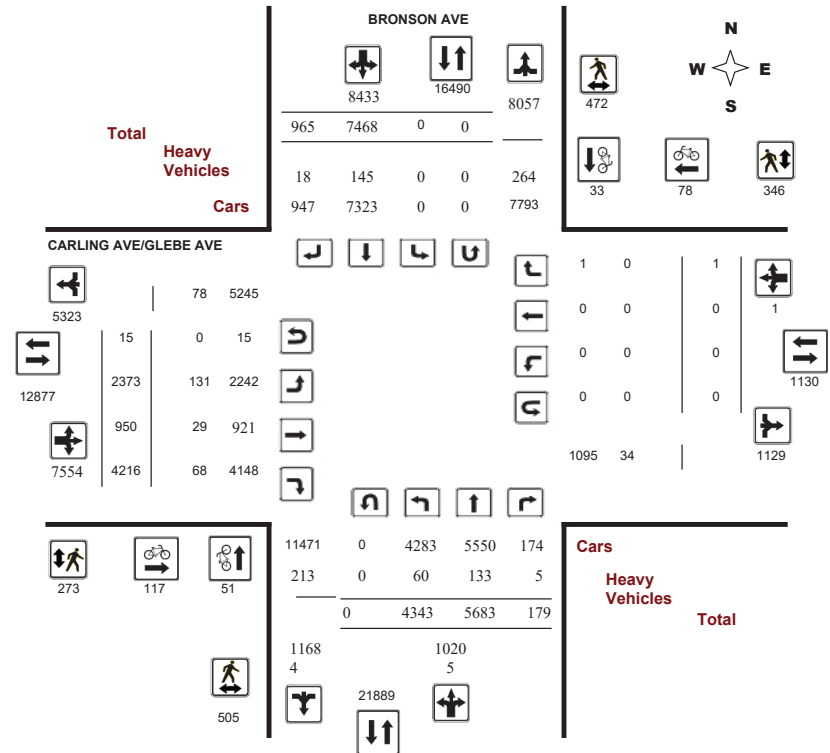



Transportation Services - Traffic Services

Turning Movement Count - Study Results

BRONSON AVE @ CARLING AVE/GLEBE AVE

Survey Date: Thursday, September 12, 2019

WO No: 38767

Start Time: 07:00

Device: Miovision

Full Study Peak Hour Diagram

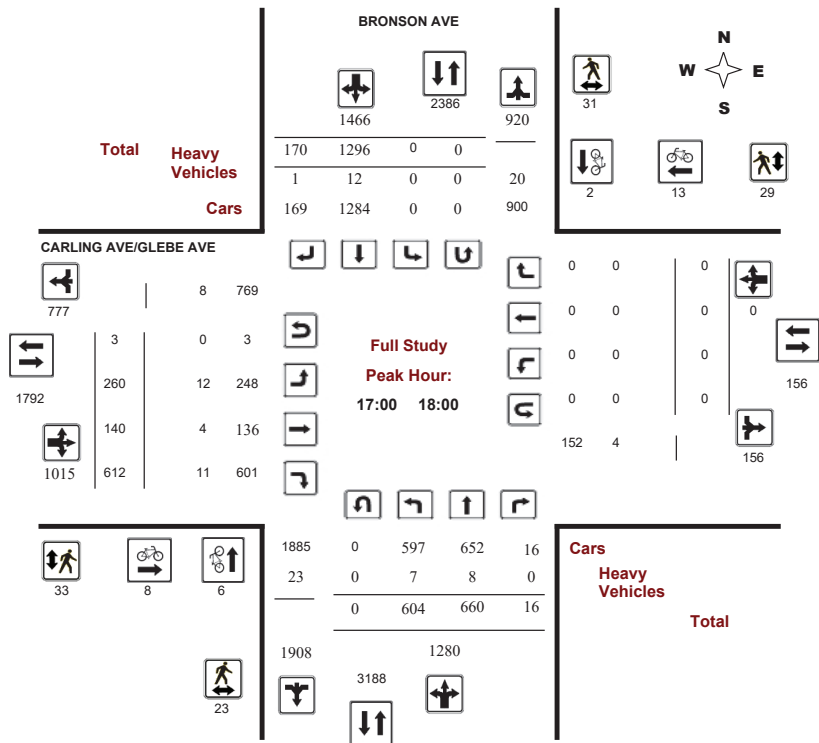

Transportation Services - Traffic Services

Turning Movement Count - Full Study Peak Hour Diagram

BRONSON AVE @ CARLING AVE/GLEBE AVE

Survey Date: Thursday, September 12, 2019

WO No: 38767

Start Time: 07:00

Device: Miovision

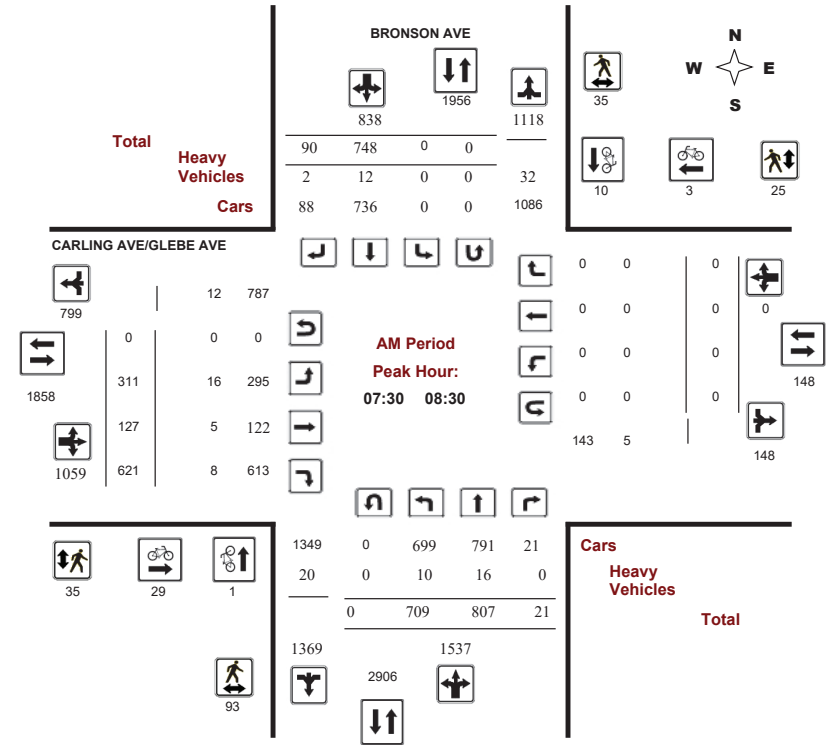

Comments



Transportation Services - Traffic Services

Turning Movement Count - Full Study Peak Hour Diagram

BRONSON AVE @ CARLING AVE/GLEBE AVE

Survey Date: Thursday, September 12, 2019

Start Time: 07:00

WO No: 38767

Device: Miovision

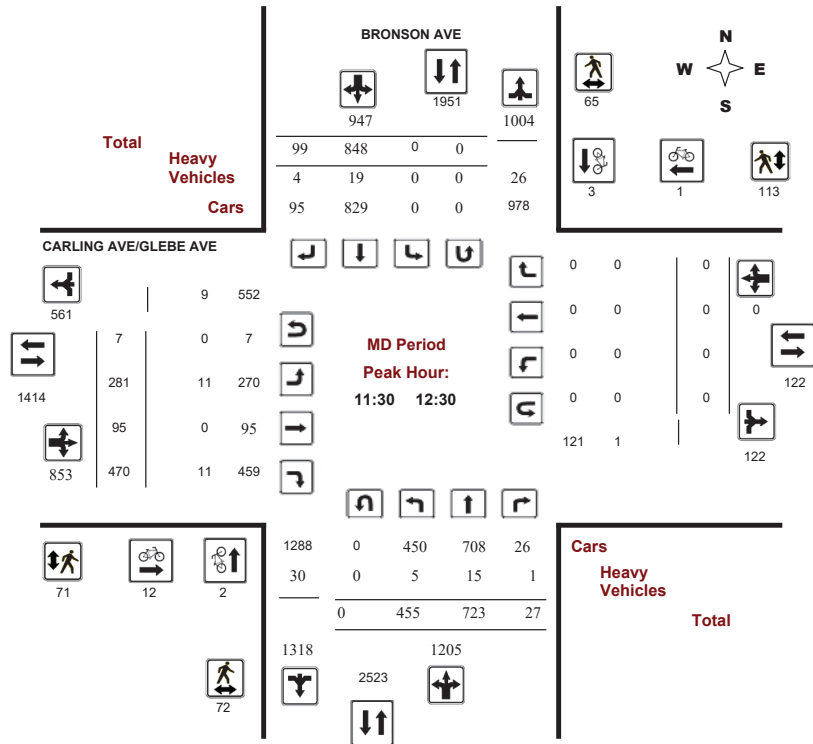

Transportation Services - Traffic Services

Turning Movement Count - Full Study Peak Hour Diagram

BRONSON AVE @ CARLING AVE/GLEBE AVE

Survey Date: Thursday, September 12, 2019

Start Time: 07:00

WO No: 38767

Device: Miovision

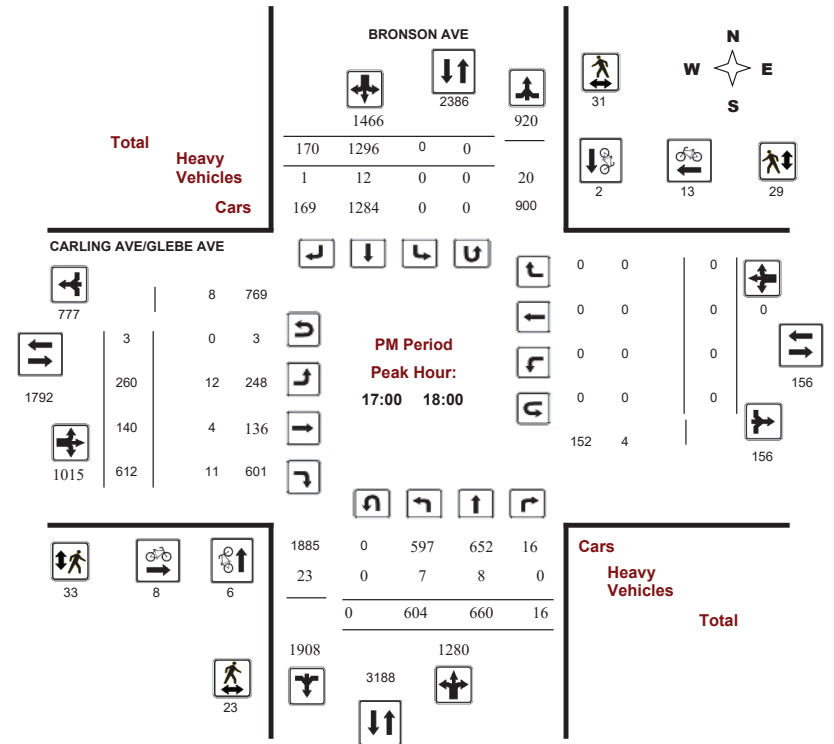



Transportation Services - Traffic Services

Turning Movement Count - Study Results

BRONSON AVE @ CARLING AVE/GLEBE AVE

Survey Date: Thursday, September 12, 2019

WO No: 38767

Start Time: 07:00

Device: Miovision

Full Study Summary (8 HR Standard)

Survey Date: Thursday, September 12, 2019

Total Observed U-Turns AADT Factor
Northbound: 0 Southbound: 0
Eastbound: 15 Westbound: 0 1.00

Table with columns for Period, Northbound, Southbound, Eastbound, Westbound, and Grand Total. Includes sub-totals for U Turns, EQ 12Hr, and AVG 24Hr.

Note: U-Turns provided for approach totals. Refer to 'U-Turn' Report for specific breakdown.



Transportation Services - Traffic Services

Turning Movement Count - Study Results

BRONSON AVE @ CARLING AVE/GLEBE AVE

Survey Date: Thursday, September 12, 2019

WO No: 38767

Start Time: 07:00

Device: Miovision

Full Study 15 Minute Increments

Table with columns for Time Period, Northbound, Southbound, Eastbound, Westbound, and Grand Total. Shows 15-minute increments from 07:00 to 18:00.

Note: U-Turns are included in Totals.



Transportation Services - Traffic Services

Turning Movement Count - Study Results

BRONSON AVE @ CARLING AVE/GLEBE AVE

Survey Date: Thursday, September 12, 2019

WO No: 38767

Start Time: 07:00

Device: Miovision

Full Study Cyclist Volume

Table with columns: Time Period, Northbound, Southbound, Street Total, Eastbound, Westbound, Street Total, Grand Total. Rows show cyclist volume data for Bronson Ave and Carling Ave/Glebe Ave.



Transportation Services - Traffic Services

Turning Movement Count - Study Results

BRONSON AVE @ CARLING AVE/GLEBE AVE

Survey Date: Thursday, September 12, 2019

WO No: 38767

Start Time: 07:00

Device: Miovision

Full Study Pedestrian Volume

Table with columns: Time Period, NB Approach, SB Approach, Total, EB Approach, WB Approach, Total, Grand Total. Rows show pedestrian volume data for Bronson Ave and Carling Ave/Glebe Ave.



Transportation Services - Traffic Services

Turning Movement Count - Study Results

BRONSON AVE @ CARLING AVE/GLEBE AVE

Survey Date: Thursday, September 12, 2019

WO No: 38767

Start Time: 07:00

Device: Miovision

Full Study Heavy Vehicles

BRONSON AVE CARLING AVE/GLEBE AVE

Table with columns for Time Period, Northbound (LT, ST, RT, N TOT, STR TOT), Southbound (LT, ST, RT, S TOT, STR TOT), Eastbound (LT, ST, RT, E TOT), Westbound (LT, ST, RT, W TOT, STR TOT), and Grand Total. Rows represent 15-minute intervals from 07:00 to 18:00.



Transportation Services - Traffic Services

Turning Movement Count - Study Results

BRONSON AVE @ CARLING AVE/GLEBE AVE

Survey Date: Thursday, September 12, 2019

WO No: 38767

Start Time: 07:00

Device: Miovision

Full Study 15 Minute U-Turn Total

BRONSON AVE CARLING AVE/GLEBE AVE

Table with columns for Time Period, Northbound U-Turn Total, Southbound U-Turn Total, Eastbound U-Turn Total, Westbound U-Turn Total, and Total. Rows represent 15-minute intervals from 07:00 to 18:00.



Transportation Services - Traffic Services

Turning Movement Count - Study Results

BRONSON AVE @ FIFTH AVE/MADAWASKA DR

Survey Date: Wednesday, January 10, 2018

WO No: 37405

Start Time: 07:00

Device: Miovision

Full Study Diagram

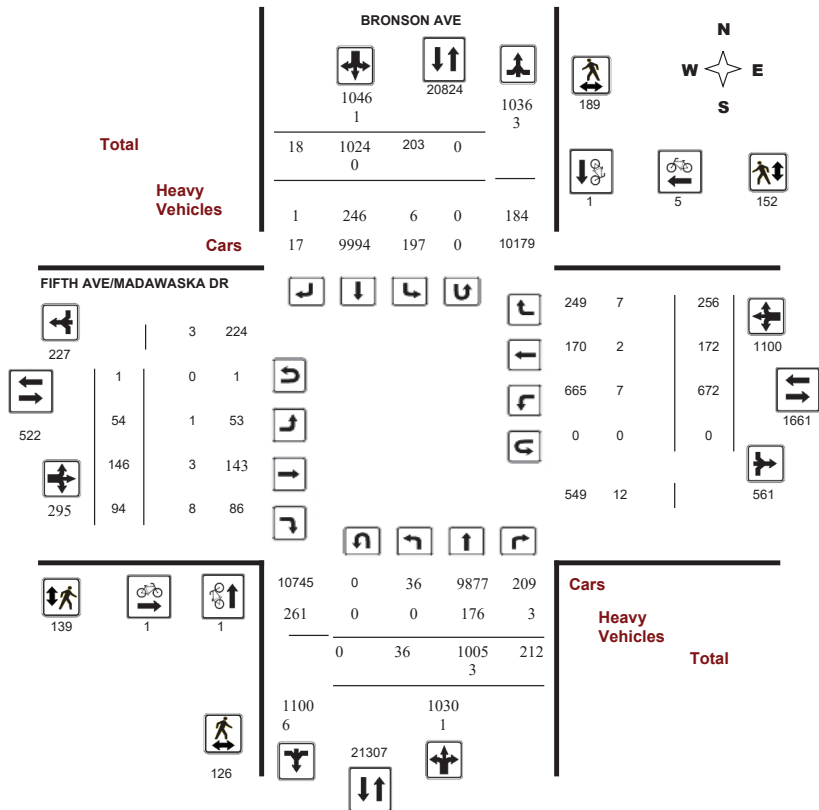

Transportation Services - Traffic Services

Turning Movement Count - Study Results

BRONSON AVE @ FIFTH AVE/MADAWASKA DR

Survey Date: Wednesday, January 10, 2018

WO No: 37405

Start Time: 07:00

Device: Miovision

Full Study Peak Hour Diagram

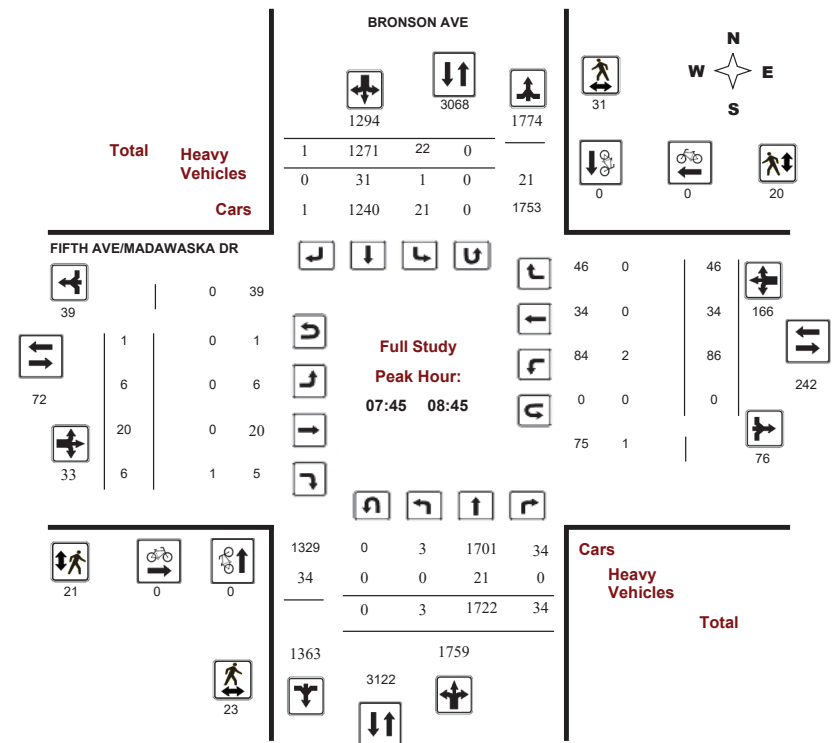



Transportation Services - Traffic Services

Turning Movement Count - Peak Hour Diagram

BRONSON AVE @ FIFTH AVE/MADAWASKA DR

Survey Date: Wednesday, January 10, 2018
Start Time: 07:00

WO No: 37405
Device: Miovision

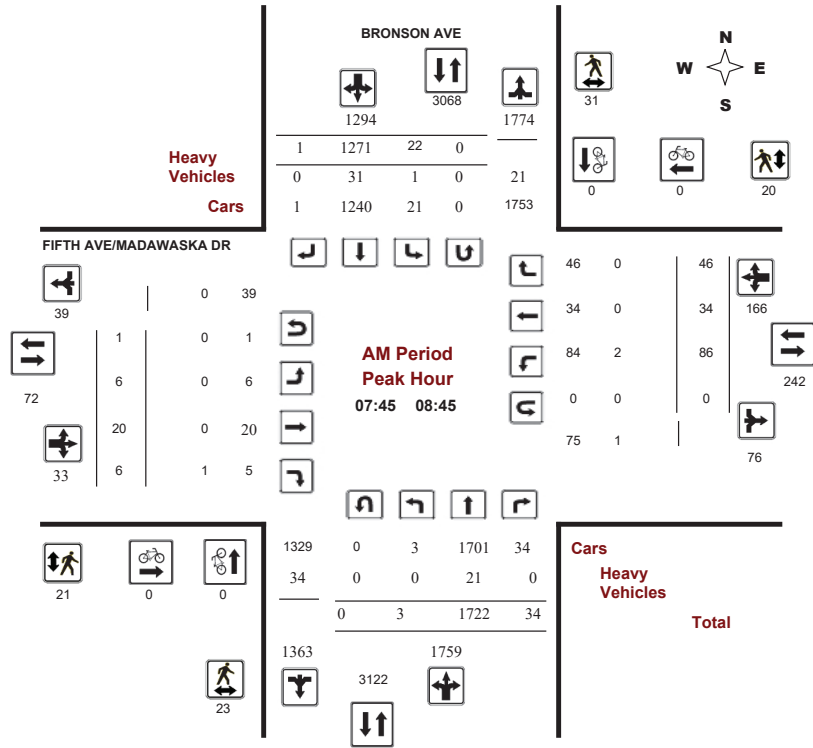

Comments



Transportation Services - Traffic Services

Turning Movement Count - Peak Hour Diagram

BRONSON AVE @ FIFTH AVE/MADAWASKA DR

Survey Date: Wednesday, January 10, 2018
Start Time: 07:00

WO No: 37405
Device: Miovision

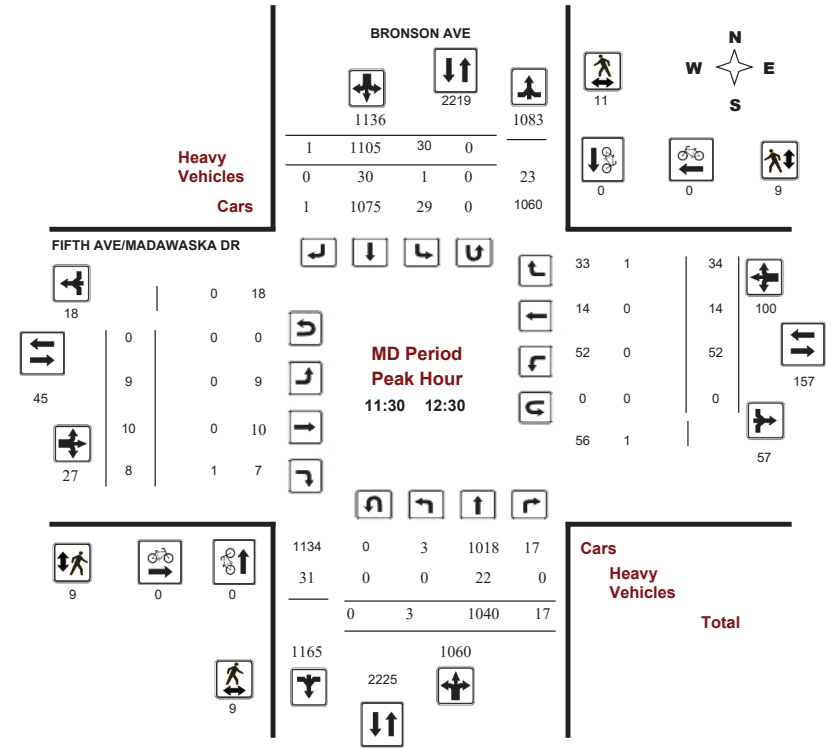

Comments



Transportation Services - Traffic Services

Turning Movement Count - Peak Hour Diagram

BRONSON AVE @ FIFTH AVE/MADAWASKA DR

Survey Date: Wednesday, January 10, 2018
Start Time: 07:00

WO No: 37405
Device: Miovision

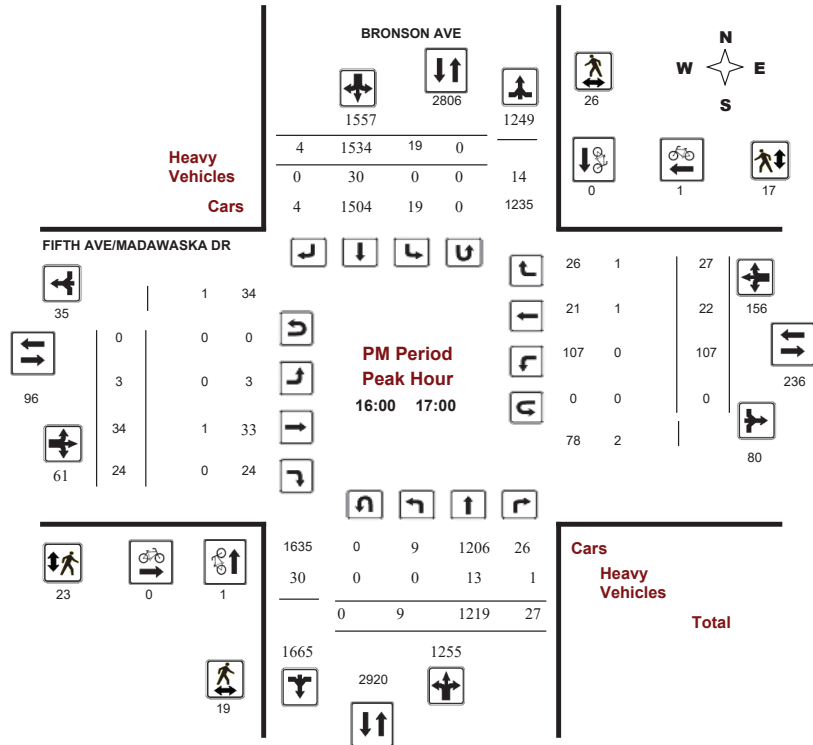

Comments



Transportation Services - Traffic Services

Turning Movement Count - Study Results

BRONSON AVE @ FIFTH AVE/MADAWASKA DR

Survey Date: Wednesday, January 10, 2018
Start Time: 07:00

WO No: 37405
Device: Miovision

Full Study Summary (8 HR Standard)

Survey Date: Wednesday, January 10, 2018

Total Observed U-Turns
Northbound: 0 Southbound: 0
Eastbound: 1 Westbound: 0

AADT Factor
1.00

Period	BRONSON AVE								FIFTH AVE/MADAWASKA DR								Grand Total		
	Northbound				Southbound				Eastbound				Westbound						
	LT	ST	RT	TOT	LT	ST	RT	TOT	STR TOT	LT	ST	RT	TOT	WB TOT	STR TOT				
07:00-08:00	1	1621	12	1634	25	1174	4	1203	2837	6	5	5	16	58	13	30	101	117	2954
08:00-09:00	3	1690	40	1733	20	1264	0	1284	3017	7	22	6	35	90	36	47	173	208	3225
09:00-10:00	2	1221	25	1248	36	1093	2	1131	2379	6	9	9	24	65	24	29	118	142	2521
11:30-12:30	3	1040	17	1060	30	1105	1	1136	2196	9	10	8	27	52	14	34	100	127	2323
12:30-13:30	5	929	15	949	30	1190	2	1222	2171	7	10	8	25	61	23	37	121	146	2317
15:00-16:00	5	1230	34	1269	22	1395	0	1417	2686	7	25	7	39	116	23	30	169	208	2894
16:00-17:00	9	1219	27	1255	19	1534	4	1557	2812	3	34	24	61	107	22	27	156	217	3029
17:00-18:00	8	1103	42	1153	21	1485	5	1511	2664	9	31	27	67	123	17	22	162	229	2893
Sub Total	36	10053	212	10301	203	10240	18	10461	20762	54	146	94	294	672	172	256	1100	1394	22156
U Turns	0				0				0				1				0	1	1
Total	36	10053	212	10301	203	10240	18	10461	20762	54	146	94	295	672	172	256	1100	1395	22157
EQ 12Hr	50	13974	295	14318	282	14234	25	14541	28859	75	203	131	410	934	239	356	1529	1939	30798
Note: These values are calculated by multiplying the totals by the appropriate expansion factor.															1.39				
AVG 12Hr	47	13169	278	13494	266	13414	24	13704	28859	71	191	123	386	880	225	335	1441	1939	30798
Note: These volumes are calculated by multiplying the Equivalent 12 hr. totals by the AADT factor.															1				
AVG 24Hr	62	17252	364	17678	348	17573	31	17952	35630	93	251	161	506	1153	295	439	1888	2394	38024
Note: These volumes are calculated by multiplying the Average Daily 12 hr. totals by 12 to 24 expansion factor.															1.31				
Note: U-Turns provided for approach totals. Refer to 'U-Turn' Report for specific breakdown.																			



Transportation Services - Traffic Services

Turning Movement Count - Study Results

BRONSON AVE @ FIFTH AVE/MADAWASKA DR

Survey Date: Wednesday, January 10, 2018

WO No: 37405

Start Time: 07:00

Device: Miovision

Full Study 15 Minute Increments

Table with columns for Time Period, Northbound, Southbound, Eastbound, Westbound, and Grand Total. Rows show 15-minute intervals from 07:00 to 17:45.

Note: U-Turns are included in Totals.



Transportation Services - Traffic Services

Turning Movement Count - Study Results

BRONSON AVE @ FIFTH AVE/MADAWASKA DR

Survey Date: Wednesday, January 10, 2018

WO No: 37405

Start Time: 07:00

Device: Miovision

Full Study Cyclist Volume

Table with columns for Time Period, Northbound, Southbound, Street Total, Eastbound, Westbound, Street Total, and Grand Total. Rows show 15-minute intervals from 07:00 to 17:45.



Transportation Services - Traffic Services

Turning Movement Count - Study Results

BRONSON AVE @ FIFTH AVE/MADAWASKA DR

Survey Date: Wednesday, January 10, 2018

WO No: 37405

Start Time: 07:00

Device: Miovision

Full Study Pedestrian Volume

BRONSON AVE FIFTH AVE/MADAWASKA DR

Table with columns: Time Period, NB Approach, SB Approach, Total, EB Approach, WB Approach, Grand Total. Rows show pedestrian counts for various time intervals from 07:00 to 18:00.



Transportation Services - Traffic Services

Turning Movement Count - Study Results

BRONSON AVE @ FIFTH AVE/MADAWASKA DR

Survey Date: Wednesday, January 10, 2018

WO No: 37405

Start Time: 07:00

Device: Miovision

Full Study Heavy Vehicles

BRONSON AVE FIFTH AVE/MADAWASKA DR

Table with columns: Time Period, Northbound (LT, ST, RT, N TOT, STR TOT), Southbound (LT, ST, RT, S TOT, STR TOT), Eastbound (LT, ST, RT, E TOT), Westbound (LT, ST, RT, W TOT, STR TOT), Grand Total. Rows show heavy vehicle counts for various time intervals from 07:00 to 18:00.



Transportation Services - Traffic Services

Turning Movement Count - Study Results

BRONSON AVE @ FIFTH AVE/MADAWASKA DR

Survey Date: Wednesday, January 10, 2018

WO No: 37405

Start Time: 07:00

Device: Miovision

Full Study 15 Minute U-Turn Total

BRONSON AVE FIFTH AVE/MADAWASKA DR

Time Period		Northbound U-Turn Total	Southbound U-Turn Total	Eastbound U-Turn Total	Westbound U-Turn Total	Total
07:00	07:15	0	0	0	0	0
07:15	07:30	0	0	0	0	0
07:30	07:45	0	0	0	0	0
07:45	08:00	0	0	1	0	1
08:00	08:15	0	0	0	0	0
08:15	08:30	0	0	0	0	0
08:30	08:45	0	0	0	0	0
08:45	09:00	0	0	0	0	0
09:00	09:15	0	0	0	0	0
09:15	09:30	0	0	0	0	0
09:30	09:45	0	0	0	0	0
09:45	10:00	0	0	0	0	0
11:30	11:45	0	0	0	0	0
11:45	12:00	0	0	0	0	0
12:00	12:15	0	0	0	0	0
12:15	12:30	0	0	0	0	0
12:30	12:45	0	0	0	0	0
12:45	13:00	0	0	0	0	0
13:00	13:15	0	0	0	0	0
13:15	13:30	0	0	0	0	0
15:00	15:15	0	0	0	0	0
15:15	15:30	0	0	0	0	0
15:30	15:45	0	0	0	0	0
15:45	16:00	0	0	0	0	0
16:00	16:15	0	0	0	0	0
16:15	16:30	0	0	0	0	0
16:30	16:45	0	0	0	0	0
16:45	17:00	0	0	0	0	0
17:00	17:15	0	0	0	0	0
17:15	17:30	0	0	0	0	0
17:30	17:45	0	0	0	0	0
17:45	18:00	0	0	0	0	0
Total		0	0	1	0	1

5245346 - Booth and Carling - July - 26th - TMC

Tue Jul 26, 2016

AM Peak (8AM - 9AM)

All Classes (Lights and Motorcycles, Heavy, Pedestrians, Bicycles on Road)

All Movements

ID: 334266, Location: 45.399071, -75.704256, Site Code: 36084103

Provided by: City of Ottawa

100 Constellation Dr, Nepean, ON, K2G 5J9, CA

[N] North

Total: 548

In: 222 Out: 326

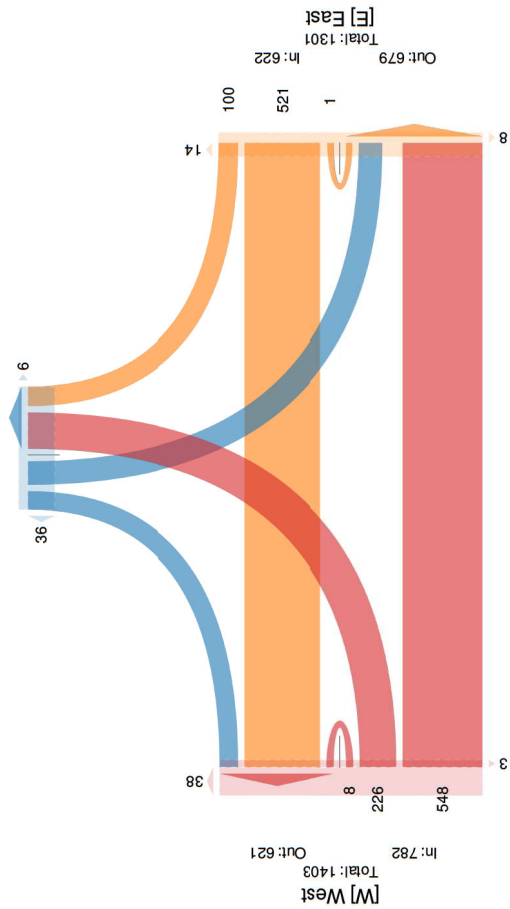

5245346 - Booth and Carling - July - 26th - TMC

Tue Jul 26, 2016

PM Peak (4:15PM - 5:15PM) - Overall Peak Hour

All Classes (Lights and Motorcycles, Heavy, Pedestrians, Bicycles on Road)

All Movements

ID: 334266, Location: 45.399071, -75.704256, Site Code: 36084103

Provided by: City of Ottawa

100 Constellation Dr, Nepean, ON, K2G 5J9, CA

[N] North

Total: 863

In: 638 Out: 225

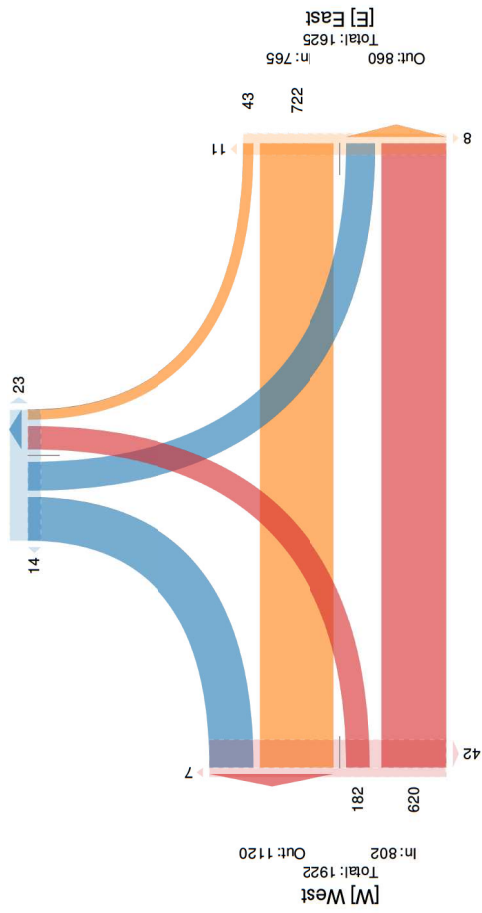



Transportation Services - Traffic Services
Turning Movement Count - Full Study Peak Hour Diagram
BRONSON AVE @ POWELL AVE

Survey Date: Friday, August 28, 2015
 Start Time: 07:00

WO No: 35323
 Device: Jamar Technologies, Inc

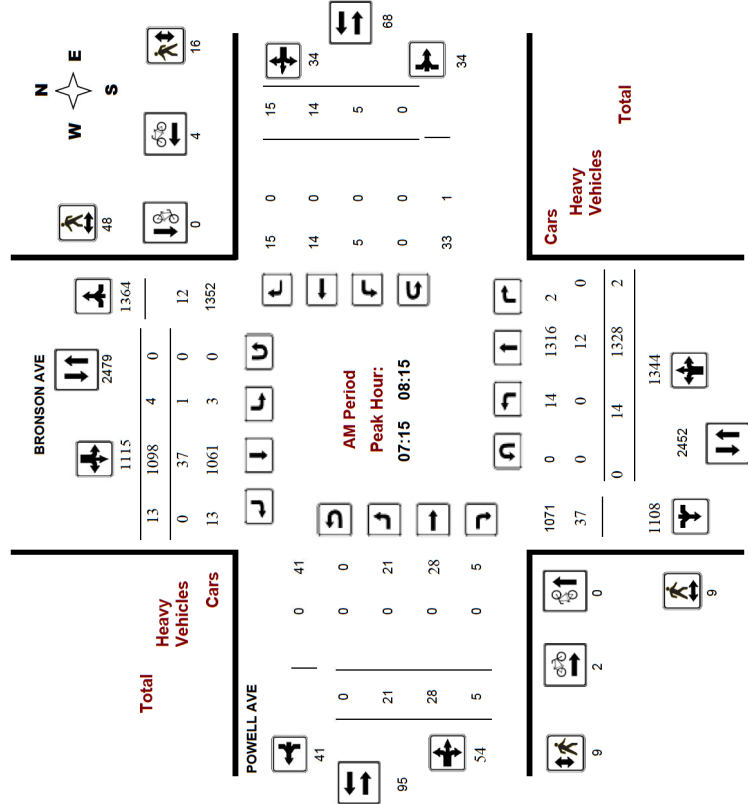

Transportation Services - Traffic Services
Turning Movement Count - Full Study Peak Hour Diagram
BRONSON AVE @ POWELL AVE

Survey Date: Friday, August 28, 2015
 Start Time: 07:00

WO No: 35323
 Device: Jamar Technologies, Inc

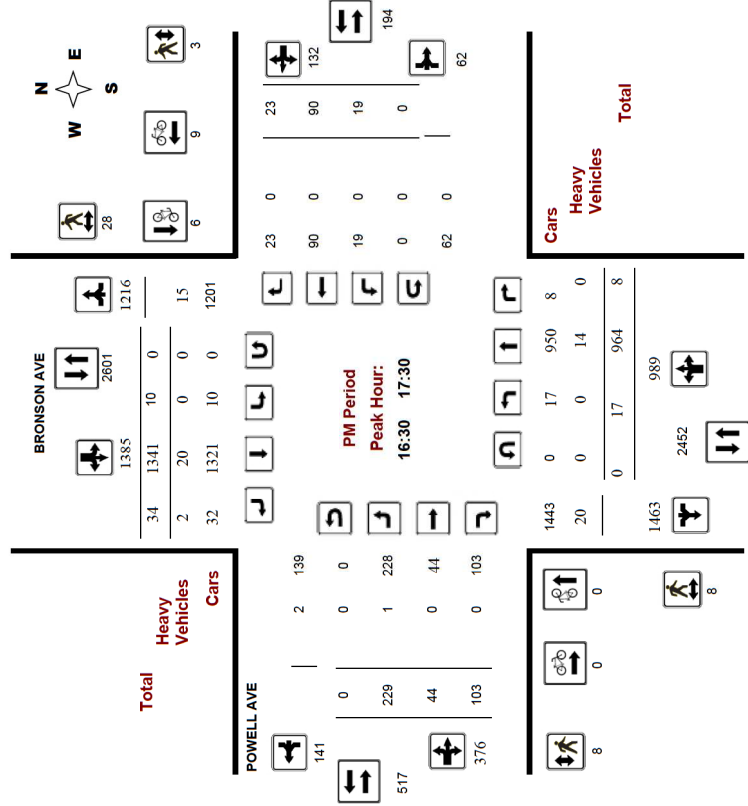

Appendix C

Synchro Intersection Worksheets – Existing Conditions

Lanes, Volumes, Timings
1: Carling Avenue & Booth Street

Existing - AM Peak Hour
770-774 Bronson Ave

Lane Group	EBL	EBT	WBT	WBR	SBL	SBR
Lane Configurations	↔	↕	↕	↔	↔	↕
Traffic Volume (vph)	226	750	571	100	130	92
Future Volume (vph)	226	750	571	100	130	92
Satd. Flow (prot)	1658	3283	4536	0	1658	1427
Fit Permitted	0.950				0.950	
Satd. Flow (perm)	1571	3283	4536	0	1633	1258
Satd. Flow (RTOR)			31			102
Lane Group Flow (vph)	251	833	745	0	144	102
Turn Type	Prot	NA	NA		Perm	Perm
Protected Phases	5	2	6			
Permitted Phases					4	4
Detector Phase	5	2	6		4	4
Switch Phase						
Minimum Initial (s)	5.0	10.0	10.0		10.0	10.0
Minimum Split (s)	10.9	22.5	29.7		39.0	39.0
Total Split (s)	34.0	81.0	47.0		39.0	39.0
Total Split (%)	28.3%	67.5%	39.2%		32.5%	32.5%
Yellow Time (s)	3.7	3.7	3.7		3.3	3.3
All-Red Time (s)	2.2	2.0	2.0		2.7	2.7
Lost Time Adjust (s)	0.0	0.0	0.0		0.0	0.0
Total Lost Time (s)	5.9	5.7	5.7		6.0	6.0
Lead/Lag	Lead		Lag			
Lead-Lag Optimize?	Yes		Yes			
Recall Mode	None	Max	C-Max		None	None
Act Effct Green (s)	22.7	75.3	46.7		33.0	33.0
Actuated g/C Ratio	0.19	0.63	0.39		0.28	0.28
v/c Ratio	0.80	0.40	0.42		0.32	0.24
Control Delay	65.2	11.9	27.2		37.1	7.9
Queue Delay	0.0	0.0	0.0		0.0	0.0
Total Delay	65.2	11.9	27.2		37.1	7.9
LOS	E	B	C		D	A
Approach Delay		24.2	27.2		25.0	
Approach LOS		C	C		C	
Queue Length 50th (m)	56.6	48.0	44.6		27.0	0.0
Queue Length 95th (m)	82.0	60.4	60.1		45.1	13.1
Internal Link Dist (m)		107.6	286.6		178.3	
Turn Bay Length (m)	40.0					30.0
Base Capacity (vph)	388	2060	1784		449	419
Starvation Cap Reductn	0	0	0		0	0
Spillback Cap Reductn	0	0	0		0	0
Storage Cap Reductn	0	0	0		0	0
Reduced v/c Ratio	0.65	0.40	0.42		0.32	0.24

Intersection Summary	
Cycle Length: 120	
Actuated Cycle Length: 120	
Offset: 116 (97%), Referenced to phase 6:WBT, Start of Green	
Natural Cycle: 90	
Control Type: Actuated-Coordinated	

Lanes, Volumes, Timings
1: Carling Avenue & Booth Street

Existing - AM Peak Hour
770-774 Bronson Ave

Maximum v/c Ratio: 0.80	Intersection LOS: C
Intersection Signal Delay: 25.4	ICU Level of Service D
Intersection Capacity Utilization 74.4%	
Analysis Period (min) 15	

Splits and Phases: 1: Carling Avenue & Booth Street

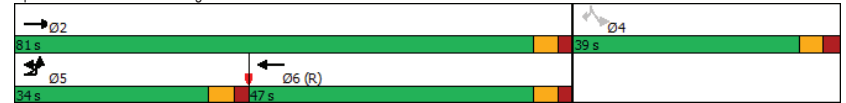

HCM 2010 TWSC
2: Cambridge Street & Carling Avenue

Existing - AM Peak Hour
770-774 Bronson Ave

Intersection												
Int Delay, s/veh	0.5											
Movement	EBL	EBT	EBR	WBL	WBT	WBR	NBL	NBT	NBR	SBL	SBT	SBR
Lane Configurations	↕↕↕			↕↕		↕			↕			↕
Traffic Vol, veh/h	0	877	3	0	533	12	0	0	10	0	0	55
Future Vol, veh/h	0	877	3	0	533	12	0	0	10	0	0	55
Conflicting Peds, #/hr	0	0	45	0	0	38	0	0	1	0	0	0
Sign Control	Free	Free	Free	Free	Free	Free	Stop	Stop	Stop	Stop	Stop	Stop
RT Channelized	-	-	None	-	-	None	-	-	None	-	-	None
Storage Length	-	-	1000	-	-	350	-	-	0	-	-	0
Veh in Median Storage, #	-	0	-	-	0	-	-	0	-	-	0	-
Grade, %	-	0	-	-	0	-	-	0	-	-	0	-
Peak Hour Factor	90	90	90	90	90	90	90	90	90	90	90	90
Heavy Vehicles, %	2	3	2	2	4	8	2	2	2	2	2	5
Mvmt Flow	0	974	3	0	592	13	0	0	11	0	0	61
Major/Minor	Major1		Major2		Minor1		Minor2					
Conflicting Flow All	-	0	0	-	-	0	-	-	535	-	-	334
Stage 1	-	-	-	-	-	-	-	-	-	-	-	-
Stage 2	-	-	-	-	-	-	-	-	-	-	-	-
Critical Hdwy	-	-	-	-	-	-	-	-	7.14	-	-	7
Critical Hdwy Stg 1	-	-	-	-	-	-	-	-	-	-	-	-
Critical Hdwy Stg 2	-	-	-	-	-	-	-	-	-	-	-	-
Follow-up Hdwy	-	-	-	-	-	-	-	-	3.92	-	-	3.35
Pot Cap-1 Maneuver	0	-	-	0	-	-	0	0	419	0	0	653
Stage 1	0	-	-	0	-	-	0	0	-	0	0	-
Stage 2	0	-	-	0	-	-	0	0	-	0	0	-
Platoon blocked, %	-	-	-	-	-	-	-	-	-	-	-	-
Mov Cap-1 Maneuver	-	-	-	-	-	-	-	-	401	-	-	630
Mov Cap-2 Maneuver	-	-	-	-	-	-	-	-	-	-	-	-
Stage 1	-	-	-	-	-	-	-	-	-	-	-	-
Stage 2	-	-	-	-	-	-	-	-	-	-	-	-
Approach	EB		WB		NB		SB					
HCM Control Delay, s	0		0		14.2		11.3					
HCM LOS					B		B					
Minor Lane/Major Mvmt	NBLn1	EBT	EBR	WBT	WBR	SBLn1						
Capacity (veh/h)	401	-	-	-	-	630						
HCM Lane V/C Ratio	0.028	-	-	-	-	0.097						
HCM Control Delay (s)	14.2	-	-	-	-	11.3						
HCM Lane LOS	B	-	-	-	-	B						
HCM 95th %tile Q(veh)	0.1	-	-	-	-	0.3						

Lanes, Volumes, Timings
3: Bronson Avenue & Powell Avenue

Existing - AM Peak Hour
770-774 Bronson Ave

Lane Group	EBL	EBT	EBR	WBL	WBT	WBR	NBL	NBT	NBR	SBL	SBT	SBR
Lane Configurations		↕↕			↕↕			↕↕			↕↕	
Traffic Volume (vph)	58	25	30	17	53	17	44	1644	8	11	920	62
Future Volume (vph)	58	25	30	17	53	17	44	1644	8	11	920	62
Satd. Flow (prot)	0	1593	0	0	1642	0	0	3275	0	0	3241	0
Fit Permitted		0.768			0.922			0.874			0.917	
Satd. Flow (perm)	0	1222	0	0	1517	0	0	2865	0	0	2975	0
Satd. Flow (RTOR)		14			10			1			16	
Lane Group Flow (vph)	0	125	0	0	97	0	0	1885	0	0	1103	0
Turn Type	Perm	NA		Perm	NA		Perm	NA		Perm	NA	
Protected Phases		4			8			2			6	
Permitted Phases	4				8			2			6	
Detector Phase	4	4			8			2	2		6	6
Switch Phase												
Minimum Initial (s)	10.0	10.0			10.0	10.0		10.0	10.0		10.0	10.0
Minimum Split (s)	23.7	23.7			23.7	23.7		32.3	32.3		32.3	32.3
Total Split (s)	26.0	26.0			26.0	26.0		84.0	84.0		84.0	84.0
Total Split (%)	23.6%	23.6%			23.6%	23.6%		76.4%	76.4%		76.4%	76.4%
Yellow Time (s)	3.0	3.0			3.0	3.0		3.3	3.3		3.3	3.3
All-Red Time (s)	2.7	2.7			2.7	2.7		2.0	2.0		2.0	2.0
Lost Time Adjust (s)		0.0			0.0	0.0		0.0	0.0		0.0	0.0
Total Lost Time (s)		5.7			5.7	5.7		5.3	5.3		5.3	5.3
Lead/Lag												
Lead-Lag Optimize?												
Recall Mode	None	None			None	None		C-Max	C-Max		C-Max	C-Max
Act Effct Green (s)		15.1			15.1	15.1		83.9	83.9		83.9	83.9
Actuated g/C Ratio		0.14			0.14	0.14		0.76	0.76		0.76	0.76
v/c Ratio		0.70			0.45	0.45		0.86	0.86		0.49	0.49
Control Delay		59.5			44.5	44.5		6.6	6.6		6.1	6.1
Queue Delay		0.0			0.0	0.0		29.4	29.4		0.0	0.0
Total Delay		59.5			44.5	44.5		36.1	36.1		6.2	6.2
LOS		E			D	D		D	D		A	A
Approach Delay		59.5			44.5	44.5		36.1	36.1		6.2	6.2
Approach LOS		E			D	D		D	D		A	A
Queue Length 50th (m)		23.0			17.3	17.3		53.6	53.6		38.4	38.4
Queue Length 95th (m)		40.9			31.9	31.9		m42.3	42.3		61.7	61.7
Internal Link Dist (m)		74.6			106.0	106.0		142.6	142.6		39.5	39.5
Turn Bay Length (m)												
Base Capacity (vph)		236			288	288		2184	2184		2271	2271
Starvation Cap Reductn		0			0	0		403	403		0	0
Spillback Cap Reductn		0			0	0		0	0		119	119
Storage Cap Reductn		0			0	0		0	0		0	0
Reduced v/c Ratio		0.53			0.34	0.34		1.06	1.06		0.51	0.51
Intersection Summary												
Cycle Length: 110												
Actuated Cycle Length: 110												
Offset: 21 (19%), Referenced to phase 2:NBT and 6:SBTL, Start of Green												
Natural Cycle: 90												
Control Type: Actuated-Coordinated												

Lanes, Volumes, Timings
3: Bronson Avenue & Powell Avenue

Existing - AM Peak Hour
770-774 Bronson Ave

Maximum v/c Ratio: 0.86	Intersection LOS: C
Intersection Signal Delay: 27.0	ICU Level of Service G
Intersection Capacity Utilization 104.8%	
Analysis Period (min) 15	

m Volume for 95th percentile queue is metered by upstream signal.

Splits and Phases: 3: Bronson Avenue & Powell Avenue



Lanes, Volumes, Timings
4: Bronson Avenue & Carling Avenue/Glebe Avenue

Existing - AM Peak Hour
770-774 Bronson Ave

Lane Group	EBL	EBT	EBR	WBL	WBT	WBR	NBL	NBT	NBR	SBL	SBT	SBR
Lane Configurations	↔	↕	↔				↕	↕			↕	↕
Traffic Volume (vph)	314	152	421	0	0	0	443	1396	38	0	865	102
Future Volume (vph)	314	152	421	0	0	0	443	1396	38	0	865	102
Satd. Flow (prot)	1530	1591	1483	0	0	0	3216	1730	0	0	3246	0
Fit Permitted	0.950	0.982					0.950					
Satd. Flow (perm)	1459	1565	1273	0	0	0	3179	1730	0	0	3246	0
Satd. Flow (RTOR)			30					3			13	
Lane Group Flow (vph)	255	263	468	0	0	0	492	1593	0	0	1074	0
Turn Type	Perm	NA	custom				Prot	NA			NA	
Protected Phases		4					5	2			6	
Permitted Phases	4		4 5									
Detector Phase	4	4	4 5				5	2			6	
Switch Phase												
Minimum Initial (s)	10.0	10.0					5.0	10.0			10.0	
Minimum Split (s)	31.0	31.0					11.0	24.0			33.0	
Total Split (s)	31.0	31.0					34.0	79.0			45.0	
Total Split (%)	28.2%	28.2%					30.9%	71.8%			40.9%	
Yellow Time (s)	3.3	3.3					3.3	3.3			3.3	
All-Red Time (s)	2.7	2.7					2.7	2.7			2.7	
Lost Time Adjust (s)	0.0	0.0					0.0	0.0			0.0	
Total Lost Time (s)	6.0	6.0					6.0	6.0			6.0	
Lead/Lag							Lead				Lag	
Lead-Lag Optimize?							Yes				Yes	
Recall Mode	None	None					Min	C-Max			C-Max	
Act Effct Green (s)	25.0	25.0	53.6				22.6	73.0			44.4	
Actuated g/C Ratio	0.23	0.23	0.49				0.21	0.66			0.40	
v/c Ratio	0.77	0.74	0.74				0.75	1.39			0.81	
Control Delay	56.7	53.5	28.4				37.8	205.3			31.3	
Queue Delay	0.0	0.0	0.0				0.0	0.2			0.1	
Total Delay	56.7	53.5	28.4				37.8	205.4			31.4	
LOS	E	D	C				D	F			C	
Approach Delay		42.4						165.9			31.4	
Approach LOS		D						F			C	
Queue Length 50th (m)	54.3	55.4	72.7				50.5	~471.6			107.0	
Queue Length 95th (m)	#93.8	#92.5	103.4				m57.3	#553.7			#156.3	
Internal Link Dist (m)		82.5				112.6		392.2			142.6	
Turn Bay Length (m)							40.0					
Base Capacity (vph)	331	355	696				818	1149			1318	
Starvation Cap Reductn	0	0	0				0	0			14	
Spillback Cap Reductn	0	0	0				0	42			0	
Storage Cap Reductn	0	0	0				0	0			0	
Reduced v/c Ratio	0.77	0.74	0.67				0.60	1.44			0.82	

Intersection Summary		
Cycle Length: 110		
Actuated Cycle Length: 110		
Offset: 53 (48%), Referenced to phase 2:NBT and 6:SBT, Start of Green		
Natural Cycle: 150		
Control Type: Actuated-Coordinated		

Lanes, Volumes, Timings
4: Bronson Avenue & Carling Avenue/Glebe Avenue

Existing - AM Peak Hour
770-774 Bronson Ave

Maximum v/c Ratio: 1.39	Intersection LOS: F
Intersection Signal Delay: 101.7	ICU Level of Service H
Intersection Capacity Utilization 110.6%	
Analysis Period (min) 15	
~ Volume exceeds capacity, queue is theoretically infinite.	
Queue shown is maximum after two cycles.	
# 95th percentile volume exceeds capacity, queue may be longer.	
Queue shown is maximum after two cycles.	
m Volume for 95th percentile queue is metered by upstream signal.	

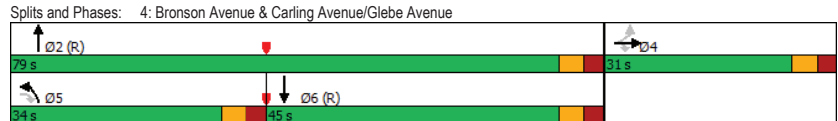

Lanes, Volumes, Timings
5: Bronson Avenue & Madawaska Drive/Fifth Avenue

Existing - AM Peak Hour
770-774 Bronson Ave

Lane Group	EBL	EBT	EBR	WBL	WBT	WBR	NBL	NBT	NBR	SBL	SBT	SBR
Lane Configurations		↕			↕			↕			↕	
Traffic Volume (vph)	7	20	6	86	34	46	0	1722	34	22	1271	1
Future Volume (vph)	7	20	6	86	34	46	0	1722	34	22	1271	1
Satd. Flow (prot)	0	1619	0	0	1608	0	0	3302	0	0	3311	0
Fit Permitted		0.939			0.817						0.868	
Satd. Flow (perm)	0	1526	0	0	1319	0	0	3302	0	0	2876	0
Satd. Flow (RTOR)		7			16			4				
Lane Group Flow (vph)	0	37	0	0	185	0	0	1951	0	0	1437	0
Turn Type	Perm	NA		Perm	NA			NA		Perm	NA	
Protected Phases		4			8			2			6	
Permitted Phases	4			8						6		
Detector Phase	4	4		8	8			2		6	6	
Switch Phase												
Minimum Initial (s)	10.0	10.0		10.0	10.0			10.0		10.0	10.0	
Minimum Split (s)	23.3	23.3		23.3	23.3			30.3		30.3	30.3	
Total Split (s)	28.0	28.0		28.0	28.0			82.0		82.0	82.0	
Total Split (%)	25.5%	25.5%		25.5%	25.5%			74.5%		74.5%	74.5%	
Yellow Time (s)	3.3	3.3		3.3	3.3			3.3		3.3	3.3	
All-Red Time (s)	2.0	2.0		2.0	2.0			2.0		2.0	2.0	
Lost Time Adjust (s)		0.0			0.0			0.0		0.0	0.0	
Total Lost Time (s)		5.3			5.3			5.3		5.3	5.3	
Lead/Lag												
Lead-Lag Optimize?												
Recall Mode	None	None		None	None			C-Max		C-Max	C-Max	
Act Effct Green (s)		18.4			18.4			81.0			81.0	
Actuated g/C Ratio		0.17			0.17			0.74			0.74	
v/c Ratio		0.14			0.79			0.80			0.68	
Control Delay		32.6			63.1			13.6			5.5	
Queue Delay		0.0			0.0			0.0			0.0	
Total Delay		32.6			63.1			13.6			5.5	
LOS		C			E			B			A	
Approach Delay		32.6			63.1			13.6			5.5	
Approach LOS		C			E			B			A	
Queue Length 50th (m)		5.5			34.9			127.2			28.4	
Queue Length 95th (m)		14.1			57.8			182.0			41.6	
Internal Link Dist (m)		190.1			132.1			94.8			392.2	
Turn Bay Length (m)												
Base Capacity (vph)		320			284			2431			2117	
Starvation Cap Reductn		0			0			0			0	
Spillback Cap Reductn		0			0			0			0	
Storage Cap Reductn		0			0			0			0	
Reduced v/c Ratio		0.12			0.65			0.80			0.68	

Intersection Summary		
Cycle Length:	110	
Actuated Cycle Length:	110	
Offset:	70 (64%), Referenced to phase 2:NBT and 6:SBTL, Start of Green	
Natural Cycle:	80	
Control Type:	Actuated-Coordinated	

Lanes, Volumes, Timings
5: Bronson Avenue & Madawaska Drive/Fifth Avenue

Existing - AM Peak Hour
770-774 Bronson Ave

Maximum v/c Ratio: 0.80	Intersection LOS: B
Intersection Signal Delay: 13.1	ICU Level of Service D
Intersection Capacity Utilization 79.8%	
Analysis Period (min) 15	

Splits and Phases: 5: Bronson Avenue & Madawaska Drive/Fifth Avenue

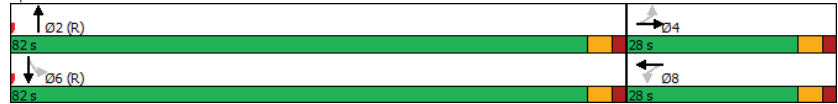

Lanes, Volumes, Timings
1: Carling Avenue & Booth Street

2020 Existing-PM Peak Hour
770-774 Bronson Ave

Lane Group	EBL	EBT	WBT	WBR	SBL	SBR
Lane Configurations	↔	↕	↕↕	↕	↔	↕
Traffic Volume (vph)	182	663	797	43	240	398
Future Volume (vph)	182	663	797	43	240	398
Satd. Flow (prot)	1658	3283	4678	0	1658	1427
Fit Permitted	0.950				0.950	
Satd. Flow (perm)	1578	3283	4678	0	1632	1230
Satd. Flow (RTOR)			9			114
Lane Group Flow (vph)	202	737	934	0	267	442
Turn Type	Prot	NA	NA		Perm	Perm
Protected Phases	5	2	6			
Permitted Phases					4	4
Detector Phase	5	2	6		4	4
Switch Phase						
Minimum Initial (s)	5.0	10.0	10.0		10.0	10.0
Minimum Split (s)	10.9	22.5	29.7		39.0	39.0
Total Split (s)	23.0	90.0	67.0		40.0	40.0
Total Split (%)	17.7%	69.2%	51.5%		30.8%	30.8%
Yellow Time (s)	3.7	3.7	3.7		3.3	3.3
All-Red Time (s)	2.2	2.0	2.0		2.7	2.7
Lost Time Adjust (s)	0.0	0.0	0.0		0.0	0.0
Total Lost Time (s)	5.9	5.7	5.7		6.0	6.0
Lead/Lag	Lead		Lag			
Lead-Lag Optimize?	Yes		Yes			
Recall Mode	None	Max	C-Max		None	None
Act Effct Green (s)	17.1	84.3	61.3		34.0	34.0
Actuated g/C Ratio	0.13	0.65	0.47		0.26	0.26
v/c Ratio	0.93	0.35	0.42		0.63	1.09
Control Delay	100.7	10.9	43.8		50.0	105.2
Queue Delay	0.0	0.0	0.0		0.0	0.0
Total Delay	100.7	10.9	43.8		50.0	105.2
LOS	F	B	D		D	F
Approach Delay		30.2	43.8		84.4	
Approach LOS		C	D		F	
Queue Length 50th (m)	51.9	42.0	78.1		60.6	~104.4
Queue Length 95th (m)	#97.9	52.7	91.9		90.0	#169.3
Internal Link Dist (m)		107.6	286.6		178.3	
Turn Bay Length (m)	40.0					30.0
Base Capacity (vph)	218	2128	2211		426	405
Starvation Cap Reductn	0	0	0		0	0
Spillback Cap Reductn	0	0	0		0	0
Storage Cap Reductn	0	0	0		0	0
Reduced v/c Ratio	0.93	0.35	0.42		0.63	1.09

Intersection Summary

Cycle Length: 130
 Actuated Cycle Length: 130
 Offset: 110 (85%), Referenced to phase 6:WBT, Start of Green
 Natural Cycle: 80
 Control Type: Actuated-Coordinated

Lanes, Volumes, Timings
1: Carling Avenue & Booth Street

2020 Existing-PM Peak Hour
770-774 Bronson Ave

Maximum v/c Ratio: 1.09	Intersection LOS: D
Intersection Signal Delay: 50.0	ICU Level of Service D
Intersection Capacity Utilization 76.7%	
Analysis Period (min) 15	
~ Volume exceeds capacity, queue is theoretically infinite.	
Queue shown is maximum after two cycles.	
# 95th percentile volume exceeds capacity, queue may be longer.	
Queue shown is maximum after two cycles.	

Splits and Phases: 1: Carling Avenue & Booth Street

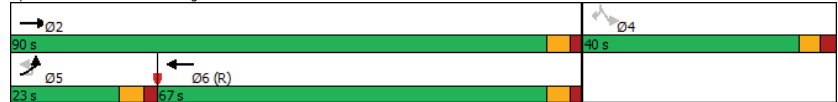

HCM 2010 TWSC
2: Cambridge Street & Carling Avenue

2020 Existing-PM Peak Hour
770-774 Bronson Ave

Intersection												
Int Delay, s/veh	2.8											
Movement	EBL	EBT	EBR	WBL	WBT	WBR	NBL	NBT	NBR	SBL	SBT	SBR
Lane Configurations		↑↑↑			↑↑	↑				↑		↑
Traffic Vol, veh/h	0	886	17	0	473	6	0	0	15	0	0	289
Future Vol, veh/h	0	886	17	0	473	6	0	0	15	0	0	289
Conflicting Peds, #/hr	0	0	42	0	0	33	0	0	4	0	0	1
Sign Control	Free	Free	Free	Free	Free	Free	Stop	Stop	Stop	Stop	Stop	Stop
RT Channelized	-	-	None	-	-	None	-	-	None	-	-	None
Storage Length	-	-	1000	-	-	350	-	-	0	-	-	0
Veh in Median Storage, #	-	0	-	-	0	-	-	0	-	-	0	-
Grade, %	-	0	-	-	0	-	-	0	-	-	0	-
Peak Hour Factor	90	90	90	90	90	90	90	90	90	90	90	90
Heavy Vehicles, %	2	3	2	2	4	8	2	2	2	2	2	5
Mvmt Flow	0	984	19	0	526	7	0	0	17	0	0	321

Major/Minor	Major1	Major2	Minor1	Minor2
Conflicting Flow All	-	0	0	-
Stage 1	-	-	-	-
Stage 2	-	-	-	-
Critical Hdwy	-	-	-	7.14
Critical Hdwy Stg 1	-	-	-	-
Critical Hdwy Stg 2	-	-	-	-
Follow-up Hdwy	-	-	-	3.92
Pot Cap-1 Maneuver	0	-	0	0
Stage 1	0	-	0	0
Stage 2	0	-	0	0
Platoon blocked, %	-	-	-	-
Mov Cap-1 Maneuver	-	-	-	393
Mov Cap-2 Maneuver	-	-	-	-
Stage 1	-	-	-	-
Stage 2	-	-	-	-

Approach	EB	WB	NB	SB
HCM Control Delay, s	0	0	14.6	15.3
HCM LOS			B	C

Minor Lane/Major Mvmt	NBLn1	EBT	EBR	WBT	WBR	SBLn1
Capacity (veh/h)	393	-	-	-	-	668
HCM Lane V/C Ratio	0.042	-	-	-	-	0.481
HCM Control Delay (s)	14.6	-	-	-	-	15.3
HCM Lane LOS	B	-	-	-	-	C
HCM 95th %tile Q(veh)	0.1	-	-	-	-	2.6

Lanes, Volumes, Timings
3: Bronson Avenue & Powell Avenue

2020 Existing-PM Peak Hour
770-774 Bronson Ave

	↖	→	↘	↙	←	↖	↙	↑	↗	↘	↓	↙
Lane Group	EBL	EBT	EBR	WBL	WBT	WBR	NBL	NBT	NBR	SBL	SBT	SBR
Lane Configurations		↕			↕			↕			↕	
Traffic Volume (vph)	127	82	150	58	89	5	66	1046	19	6	934	55
Future Volume (vph)	127	82	150	58	89	5	66	1046	19	6	934	55
Satd. Flow (prot)	0	1572	0	0	1696	0	0	3257	0	0	3249	0
Fit Permitted		0.779			0.654			0.744			0.945	
Satd. Flow (perm)	0	1231	0	0	1131	0	0	2430	0	0	3070	0
Satd. Flow (RTOR)		27			1			3			10	
Lane Group Flow (vph)	0	399	0	0	169	0	0	1256	0	0	1106	0
Turn Type	Perm	NA		Perm	NA		Perm	NA		Perm	NA	
Protected Phases		4			8			2			6	
Permitted Phases	4			8			2			6		
Detector Phase	4	4		8	8		2	2		6	6	
Switch Phase												
Minimum Initial (s)	10.0	10.0		10.0	10.0		10.0	10.0		10.0	10.0	
Minimum Split (s)	23.7	23.7		23.7	23.7		32.3	32.3		32.3	32.3	
Total Split (s)	38.0	38.0		38.0	38.0		92.0	92.0		92.0	92.0	
Total Split (%)	29.2%	29.2%		29.2%	29.2%		70.8%	70.8%		70.8%	70.8%	
Yellow Time (s)	3.0	3.0		3.0	3.0		3.3	3.3		3.3	3.3	
All-Red Time (s)	2.7	2.7		2.7	2.7		2.0	2.0		2.0	2.0	
Lost Time Adjust (s)		0.0			0.0			0.0			0.0	
Total Lost Time (s)		5.7			5.7			5.3			5.3	
Lead/Lag												
Lead-Lag Optimize?												
Recall Mode	None	None		None	None		C-Max	C-Max		C-Max	C-Max	
Act Effct Green (s)		32.3			32.3			86.7			86.7	
Actuated g/C Ratio		0.25			0.25			0.67			0.67	
v/c Ratio		1.22			0.60			0.77			0.54	
Control Delay		163.9			53.2			17.7			12.3	
Queue Delay		0.0			0.0			3.8			0.1	
Total Delay		163.9			53.2			21.5			12.4	
LOS		F			D			C			B	
Approach Delay		163.9			53.2			21.5			12.4	
Approach LOS		F			D			C			B	
Queue Length 50th (m)		-120.6			38.2			124.8			71.0	
Queue Length 95th (m)		#183.3			63.2			144.6			87.3	
Internal Link Dist (m)		74.6			106.0			142.6			39.5	
Turn Bay Length (m)												
Base Capacity (vph)		326			281			1621			2050	
Starvation Cap Reductn		0			0			277			0	
Spillback Cap Reductn		0			0			0			134	
Storage Cap Reductn		0			0			0			0	
Reduced v/c Ratio		1.22			0.60			0.93			0.58	

Intersection Summary	
Cycle Length:	130
Actuated Cycle Length:	130
Offset:	46 (35%), Referenced to phase 2:NBT and 6:SBTL, Start of Green
Natural Cycle:	65
Control Type:	Actuated-Coordinated

Lanes, Volumes, Timings
3: Bronson Avenue & Powell Avenue

2020 Existing-PM Peak Hour
770-774 Bronson Ave

Maximum v/c Ratio: 1.22	Intersection Signal Delay: 39.3	Intersection LOS: D
Intersection Capacity Utilization 104.0%	ICU Level of Service G	
Analysis Period (min) 15		
~ Volume exceeds capacity, queue is theoretically infinite.		
Queue shown is maximum after two cycles.		
# 95th percentile volume exceeds capacity, queue may be longer.		
Queue shown is maximum after two cycles.		

Splits and Phases: 3: Bronson Avenue & Powell Avenue



Lanes, Volumes, Timings
4: Bronson Avenue & Carling Avenue/Glebe Avenue

2020 Existing-PM Peak Hour
770-774 Bronson Ave

Lane Group	EBL	EBT	EBR	WBL	WBT	WBR	NBL	NBT	NBR	SBL	SBT	SBR
Lane Configurations	↔	↔	↔				↔	↔			↔	↔
Traffic Volume (vph)	207	133	561	0	0	0	375	942	26	0	1038	104
Future Volume (vph)	207	133	561	0	0	0	375	942	26	0	1038	104
Satd. Flow (prot)	1530	1605	1483	0	0	0	3216	1729	0	0	3253	0
Fit Permitted	0.950	0.989					0.950					
Satd. Flow (perm)	1456	1587	1407	0	0	0	3178	1729	0	0	3253	0
Satd. Flow (RTOR)			46					3			12	
Lane Group Flow (vph)	186	192	623	0	0	0	417	1076	0	0	1269	0
Turn Type	Perm	NA	custom				Prot	NA			NA	
Protected Phases		4					5	2			6	
Permitted Phases	4		4 5									
Detector Phase	4	4	4 5				5	2			6	
Switch Phase												
Minimum Initial (s)	10.0	10.0					5.0	10.0			10.0	
Minimum Split (s)	31.0	31.0					11.0	24.0			33.0	
Total Split (s)	31.0	31.0					26.0	99.0			73.0	
Total Split (%)	23.8%	23.8%					20.0%	76.2%			56.2%	
Yellow Time (s)	3.3	3.3					3.3	3.3			3.3	
All-Red Time (s)	2.7	2.7					2.7	2.7			2.7	
Lost Time Adjust (s)	0.0	0.0					0.0	0.0			0.0	
Total Lost Time (s)	6.0	6.0					6.0	6.0			6.0	
Lead/Lag							Lead				Lag	
Lead-Lag Optimize?							Yes				Yes	
Recall Mode	None	None					Min	C-Max			C-Max	
Act Effct Green (s)	25.0	25.0	51.0				20.0	93.0			67.0	
Actuated g/C Ratio	0.19	0.19	0.39				0.15	0.72			0.52	
v/c Ratio	0.66	0.63	1.08				0.84	0.87			0.75	
Control Delay	51.6	48.9	92.0				62.9	27.7			20.3	
Queue Delay	0.0	0.0	0.0				0.0	1.1			0.3	
Total Delay	51.6	48.9	92.0				62.9	28.9			20.6	
LOS	D	D	F				E	C			C	
Approach Delay		76.3						38.4			20.6	
Approach LOS		E						D			C	
Queue Length 50th (m)	48.8	50.2	~161.5				54.1	185.1			99.5	
Queue Length 95th (m)	76.2	77.0	#243.3				m#78.6	m230.5			m110.7	
Internal Link Dist (m)		82.5			112.6			392.2			142.6	
Turn Bay Length (m)							40.0					
Base Capacity (vph)	280	305	579				494	1237			1682	
Starvation Cap Reductn	0	0	0				0	0			78	
Spillback Cap Reductn	0	0	0				0	47			0	
Storage Cap Reductn	0	0	0				0	0			0	
Reduced v/c Ratio	0.66	0.63	1.08				0.84	0.90			0.79	

Intersection Summary												
Cycle Length: 130												
Actuated Cycle Length: 130												
Offset: 46 (35%), Referenced to phase 2:NBT and 6:SBT, Start of Green												
Natural Cycle: 90												
Control Type: Actuated-Coordinated												

Lanes, Volumes, Timings
4: Bronson Avenue & Carling Avenue/Glebe Avenue

2020 Existing-PM Peak Hour
770-774 Bronson Ave

Maximum v/c Ratio: 1.08	Intersection LOS: D
Intersection Signal Delay: 42.5	ICU Level of Service E
Intersection Capacity Utilization 82.9%	
Analysis Period (min) 15	
~ Volume exceeds capacity, queue is theoretically infinite.	
Queue shown is maximum after two cycles.	
# 95th percentile volume exceeds capacity, queue may be longer.	
Queue shown is maximum after two cycles.	
m Volume for 95th percentile queue is metered by upstream signal.	

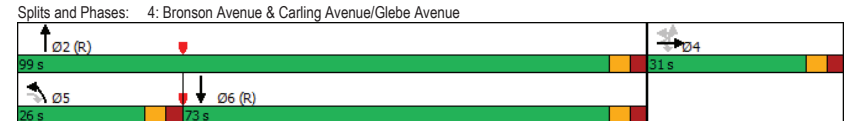

Lanes, Volumes, Timings

2020 Existing-PM Peak Hour

5: Bronson Avenue & Madawaska Drive/Fifth Avenue

770-774 Bronson Ave

	↖	→	↘	↙	←	↖	↙	↑	↗	↘	↓	↙
Lane Group	EBL	EBT	EBR	WBL	WBT	WBR	NBL	NBT	NBR	SBL	SBT	SBR
Lane Configurations		↕			↕			↕			↕	
Traffic Volume (vph)	3	34	24	107	22	27	9	1219	27	19	1534	4
Future Volume (vph)	3	34	24	107	22	27	9	1219	27	19	1534	4
Satd. Flow (prot)	0	1523	0	0	1635	0	0	3300	0	0	3311	0
Fit Permitted		0.990			0.751			0.933			0.916	
Satd. Flow (perm)	0	1510	0	0	1239	0	0	3079	0	0	3035	0
Satd. Flow (RTOR)		21			7			5			1	
Lane Group Flow (vph)	0	68	0	0	173	0	0	1394	0	0	1729	0
Turn Type	Perm	NA		Perm	NA		Perm	NA		Perm	NA	
Protected Phases		4			8			2			6	
Permitted Phases	4			8			2			6		
Detector Phase	4	4		8	8		2	2		6	6	
Switch Phase												
Minimum Initial (s)	10.0	10.0		10.0	10.0		10.0	10.0		10.0	10.0	
Minimum Split (s)	23.3	23.3		23.3	23.3		30.3	30.3		30.3	30.3	
Total Split (s)	24.0	24.0		24.0	24.0		106.0	106.0		106.0	106.0	
Total Split (%)	18.5%	18.5%		18.5%	18.5%		81.5%	81.5%		81.5%	81.5%	
Yellow Time (s)	3.3	3.3		3.3	3.3		3.3	3.3		3.3	3.3	
All-Red Time (s)	2.0	2.0		2.0	2.0		2.0	2.0		2.0	2.0	
Lost Time Adjust (s)		0.0			0.0			0.0			0.0	
Total Lost Time (s)		5.3			5.3			5.3			5.3	
Lead/Lag												
Lead-Lag Optimize?												
Recall Mode	None	None		None	None		C-Max	C-Max		C-Max	C-Max	
Act Effct Green (s)		18.6			18.6			100.8			100.8	
Actuated g/C Ratio		0.14			0.14			0.78			0.78	
v/c Ratio		0.29			0.95			0.58			0.73	
Control Delay		39.1			106.6			7.2			7.0	
Queue Delay		0.0			0.0			0.0			0.0	
Total Delay		39.1			106.6			7.2			7.0	
LOS		D			F			A			A	
Approach Delay		39.1			106.6			7.2			7.0	
Approach LOS		D			F			A			A	
Queue Length 50th (m)		10.8			42.8			65.7			73.1	
Queue Length 95th (m)		24.9			#87.3			80.1			m75.4	
Internal Link Dist (m)		190.1			132.1			94.8			392.2	
Turn Bay Length (m)												
Base Capacity (vph)		235			184			2388			2353	
Starvation Cap Reductn		0			0			0			0	
Spillback Cap Reductn		0			0			0			0	
Storage Cap Reductn		0			0			0			0	
Reduced v/c Ratio		0.29			0.94			0.58			0.73	

Intersection Summary	
Cycle Length:	130
Actuated Cycle Length:	130
Offset:	55 (42%), Referenced to phase 2:NBT and 6:SBTL, Start of Green
Natural Cycle:	75
Control Type:	Actuated-Coordinated

Lanes, Volumes, Timings

2020 Existing-PM Peak Hour

5: Bronson Avenue & Madawaska Drive/Fifth Avenue

770-774 Bronson Ave

Maximum v/c Ratio: 0.95	Intersection LOS: B
Intersection Signal Delay: 12.9	ICU Level of Service E
Intersection Capacity Utilization 84.0%	
Analysis Period (min) 15	
# 95th percentile volume exceeds capacity, queue may be longer.	
Queue shown is maximum after two cycles.	
m Volume for 95th percentile queue is metered by upstream signal.	

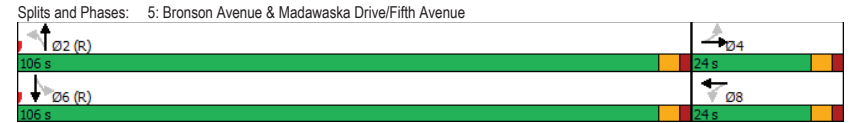

Appendix D

Collision Data

Accident Date	Accident Year	Accident Time	Location	Environment Condition	Light	Traffic Control	Traffic Control Condition	Classification Of Accident	Initial Impact Type	Road Surface Condition
2014-04-01	2014	14:00	BRONSON AVE @ CARLING AVE/GLEBE AVE	01 - Clear	01 - Daylight	01 - Traffic signal		03 - P.D. only	03 - Rear end	01 - Dry
2014-08-16	2014	13:20	BRONSON AVE @ CARLING AVE/GLEBE AVE	02 - Rain	01 - Daylight	01 - Traffic signal		03 - P.D. only	04 - Sideswipe	02 - Wet
2014-08-20	2014	10:52	BRONSON AVE @ CARLING AVE/GLEBE AVE	01 - Clear	01 - Daylight	01 - Traffic signal		03 - P.D. only	02 - Angle	01 - Dry
2014-10-11	2014	16:46	BRONSON AVE @ CARLING AVE/GLEBE AVE	01 - Clear	01 - Daylight	01 - Traffic signal		03 - P.D. only	04 - Sideswipe	01 - Dry
2014-11-28	2014	17:06	BRONSON AVE @ CARLING AVE/GLEBE AVE	01 - Clear	07 - Dark	01 - Traffic signal		03 - P.D. only	03 - Rear end	01 - Dry
2015-05-19	2015	17:23	BRONSON AVE @ CARLING AVE/GLEBE AVE	01 - Clear	01 - Daylight	01 - Traffic signal		02 - Non-fatal injury	07 - SMV other	01 - Dry
2015-07-06	2015	14:24	BRONSON AVE @ CARLING AVE/GLEBE AVE	01 - Clear	01 - Daylight	01 - Traffic signal		02 - Non-fatal injury	07 - SMV other	01 - Dry
2015-09-30	2015	15:00	BRONSON AVE @ CARLING AVE/GLEBE AVE	01 - Clear	01 - Daylight	01 - Traffic signal		02 - Non-fatal injury	07 - SMV other	01 - Dry
2015-01-20	2015	14:12	BRONSON AVE @ CARLING AVE/GLEBE AVE	01 - Clear	01 - Daylight	01 - Traffic signal		03 - P.D. only	03 - Rear end	02 - Wet
2015-02-19	2015	8:45	BRONSON AVE @ CARLING AVE/GLEBE AVE	03 - Snow	01 - Daylight	01 - Traffic signal		03 - P.D. only	04 - Sideswipe	04 - Slush
2015-07-18	2015	12:33	BRONSON AVE @ CARLING AVE/GLEBE AVE	01 - Clear	01 - Daylight	01 - Traffic signal		03 - P.D. only	04 - Sideswipe	01 - Dry
2015-01-29	2015	15:45	BRONSON AVE @ CARLING AVE/GLEBE AVE	03 - Snow	01 - Daylight	01 - Traffic signal		03 - P.D. only	04 - Sideswipe	03 - Loose snow
2015-02-10	2015	17:15	BRONSON AVE @ CARLING AVE/GLEBE AVE	01 - Clear	01 - Daylight	01 - Traffic signal		03 - P.D. only	03 - Rear end	01 - Dry
2015-02-21	2015	21:53	BRONSON AVE @ CARLING AVE/GLEBE AVE	03 - Snow	07 - Dark	01 - Traffic signal		03 - P.D. only	02 - Angle	03 - Loose snow
2015-01-14	2015	21:10	BRONSON AVE @ CARLING AVE/GLEBE AVE	03 - Snow	07 - Dark	01 - Traffic signal		03 - P.D. only	03 - Rear end	03 - Loose snow
2015-08-04	2015	9:56	BRONSON AVE @ CARLING AVE/GLEBE AVE	01 - Clear	01 - Daylight	01 - Traffic signal		03 - P.D. only	04 - Sideswipe	01 - Dry
2015-09-16	2015	13:00	BRONSON AVE @ CARLING AVE/GLEBE AVE	01 - Clear	01 - Daylight	01 - Traffic signal		03 - P.D. only	04 - Sideswipe	01 - Dry
2015-09-30	2015	18:13	BRONSON AVE @ CARLING AVE/GLEBE AVE	01 - Clear	01 - Daylight	01 - Traffic signal		03 - P.D. only	04 - Sideswipe	01 - Dry
2016-05-17	2016	18:07	BRONSON AVE @ CARLING AVE/GLEBE AVE	01 - Clear	01 - Daylight	01 - Traffic signal		02 - Non-fatal injury	02 - Angle	01 - Dry
2016-05-17	2016	11:45	BRONSON AVE @ CARLING AVE/GLEBE AVE	01 - Clear	01 - Daylight	01 - Traffic signal		02 - Non-fatal injury	03 - Rear end	01 - Dry
2016-09-23	2016	14:46	BRONSON AVE @ CARLING AVE/GLEBE AVE	01 - Clear	01 - Daylight	01 - Traffic signal		02 - Non-fatal injury	02 - Angle	01 - Dry
2016-09-19	2016	22:29	BRONSON AVE @ CARLING AVE/GLEBE AVE	01 - Clear	07 - Dark	01 - Traffic signal		03 - P.D. only	02 - Angle	01 - Dry
2016-10-28	2016	16:45	BRONSON AVE @ CARLING AVE/GLEBE AVE	01 - Clear	01 - Daylight	01 - Traffic signal		03 - P.D. only	03 - Rear end	02 - Wet
2016-01-27	2016	11:59	BRONSON AVE @ CARLING AVE/GLEBE AVE	01 - Clear	01 - Daylight	01 - Traffic signal		03 - P.D. only	03 - Rear end	02 - Wet
2016-09-16	2016	15:58	BRONSON AVE @ CARLING AVE/GLEBE AVE	01 - Clear	01 - Daylight	01 - Traffic signal		03 - P.D. only	05 - Turning movement	01 - Dry
2016-04-15	2016	18:13	BRONSON AVE @ CARLING AVE/GLEBE AVE	01 - Clear	01 - Daylight	01 - Traffic signal		03 - P.D. only	04 - Sideswipe	01 - Dry
2016-12-12	2016	17:05	BRONSON AVE @ CARLING AVE/GLEBE AVE	03 - Snow	07 - Dark	01 - Traffic signal		03 - P.D. only	04 - Sideswipe	02 - Wet
2016-12-28	2016	19:19	BRONSON AVE @ CARLING AVE/GLEBE AVE	01 - Clear	07 - Dark	01 - Traffic signal		03 - P.D. only	03 - Rear end	01 - Dry
2016-11-24	2016	9:26	BRONSON AVE @ CARLING AVE/GLEBE AVE	03 - Snow	01 - Daylight	01 - Traffic signal		03 - P.D. only	04 - Sideswipe	03 - Loose snow
2016-11-25	2016	18:29	BRONSON AVE @ CARLING AVE/GLEBE AVE	01 - Clear	07 - Dark	01 - Traffic signal		03 - P.D. only	03 - Rear end	01 - Dry
2016-11-30	2016	20:00	BRONSON AVE @ CARLING AVE/GLEBE AVE	02 - Rain	07 - Dark	01 - Traffic signal		03 - P.D. only	04 - Sideswipe	02 - Wet
2016-09-29	2016	23:15	BRONSON AVE @ CARLING AVE/GLEBE AVE	01 - Clear	07 - Dark	01 - Traffic signal		03 - P.D. only	04 - Sideswipe	01 - Dry
2017-05-30	2017	12:13	BRONSON AVE @ CARLING AVE/GLEBE AVE	01 - Clear	01 - Daylight	01 - Traffic signal		03 - P.D. only	03 - Rear end	01 - Dry
2017-11-09	2017	19:10	BRONSON AVE @ CARLING AVE/GLEBE AVE	01 - Clear	01 - Daylight	01 - Traffic signal		03 - P.D. only	03 - Rear end	01 - Dry
2017-05-14	2017	9:47	BRONSON AVE @ CARLING AVE/GLEBE AVE	02 - Rain	01 - Daylight	01 - Traffic signal		03 - P.D. only	02 - Angle	02 - Wet
2017-07-06	2017	13:20	BRONSON AVE @ CARLING AVE/GLEBE AVE	01 - Clear	01 - Daylight	01 - Traffic signal		03 - P.D. only	04 - Sideswipe	01 - Dry
2017-09-14	2017	18:43	BRONSON AVE @ CARLING AVE/GLEBE AVE	01 - Clear	01 - Daylight	01 - Traffic signal		03 - P.D. only	05 - Turning movement	01 - Dry
2017-08-12	2017	11:00	BRONSON AVE @ CARLING AVE/GLEBE AVE	01 - Clear	01 - Daylight	01 - Traffic signal		03 - P.D. only	03 - Rear end	01 - Dry
2017-10-10	2017	10:53	BRONSON AVE @ CARLING AVE/GLEBE AVE	01 - Clear	01 - Daylight	01 - Traffic signal		03 - P.D. only	04 - Sideswipe	01 - Dry
2017-10-02	2017	19:43	BRONSON AVE @ CARLING AVE/GLEBE AVE	01 - Clear	07 - Dark	01 - Traffic signal		03 - P.D. only	04 - Sideswipe	01 - Dry
2017-11-09	2017	10:57	BRONSON AVE @ CARLING AVE/GLEBE AVE	01 - Clear	01 - Daylight	01 - Traffic signal		03 - P.D. only	04 - Sideswipe	01 - Dry
2017-11-14	2017	18:16	BRONSON AVE @ CARLING AVE/GLEBE AVE	01 - Clear	07 - Dark	01 - Traffic signal		03 - P.D. only	04 - Sideswipe	01 - Dry
2017-12-11	2017	16:40	BRONSON AVE @ CARLING AVE/GLEBE AVE	01 - Clear	05 - Dusk	01 - Traffic signal		03 - P.D. only	03 - Rear end	01 - Dry
2017-01-05	2017	14:06	BRONSON AVE @ CARLING AVE/GLEBE AVE	01 - Clear	01 - Daylight	01 - Traffic signal		03 - P.D. only	04 - Sideswipe	02 - Wet
2017-01-13	2017	9:55	BRONSON AVE @ CARLING AVE/GLEBE AVE	01 - Clear	01 - Daylight	01 - Traffic signal		03 - P.D. only	04 - Sideswipe	02 - Wet
2017-12-23	2017	13:28	BRONSON AVE @ CARLING AVE/GLEBE AVE	03 - Snow	01 - Daylight	01 - Traffic signal		03 - P.D. only	03 - Rear end	05 - Packed snow
2018-02-21	2018	16:27	BRONSON AVE @ CARLING AVE/GLEBE AVE (0002134)	01 - Clear	01 - Daylight	01 - Traffic signal		03 - P.D. only	04 - Sideswipe	01 - Dry
2018-03-26	2018	18:54	BRONSON AVE @ CARLING AVE/GLEBE AVE (0002134)	01 - Clear	05 - Dusk	01 - Traffic signal		03 - P.D. only	03 - Rear end	01 - Dry
2018-04-03	2018	15:20	BRONSON AVE @ CARLING AVE/GLEBE AVE (0002134)	01 - Clear	01 - Daylight	01 - Traffic signal		03 - P.D. only	03 - Rear end	01 - Dry
2018-05-18	2018	2:11	BRONSON AVE @ CARLING AVE/GLEBE AVE (0002134)	01 - Clear	07 - Dark	01 - Traffic signal		02 - Non-fatal injury	03 - Rear end	01 - Dry
2018-09-09	2018	12:43	BRONSON AVE @ CARLING AVE/GLEBE AVE (0002134)	01 - Clear	01 - Daylight	01 - Traffic signal		02 - Non-fatal injury	07 - SMV other	01 - Dry
2018-10-09	2018	7:36	BRONSON AVE @ CARLING AVE/GLEBE AVE (0002134)	01 - Clear	01 - Daylight	01 - Traffic signal		03 - P.D. only	03 - Rear end	01 - Dry
2018-11-30	2018	8:50	BRONSON AVE @ CARLING AVE/GLEBE AVE (0002134)	01 - Clear	01 - Daylight	01 - Traffic signal		03 - P.D. only	04 - Sideswipe	01 - Dry
2014-05-15	2014	18:45	BRONSON AVE @ FIRST AVE	01 - Clear	01 - Daylight	02 - Stop sign		02 - Non-fatal injury	05 - Turning movement	01 - Dry
2014-01-31	2014	11:16	BRONSON AVE @ FIRST AVE	01 - Clear	01 - Daylight	02 - Stop sign		03 - P.D. only	02 - Angle	02 - Wet
2014-04-02	2014	8:30	BRONSON AVE @ FIRST AVE	01 - Clear	01 - Daylight	02 - Stop sign		03 - P.D. only	04 - Sideswipe	01 - Dry
2014-12-04	2014	12:57	BRONSON AVE @ FIRST AVE	01 - Clear	01 - Daylight	02 - Stop sign		03 - P.D. only	04 - Sideswipe	01 - Dry
2015-03-27	2015	13:36	BRONSON AVE @ FIRST AVE	01 - Clear	01 - Daylight	02 - Stop sign		03 - P.D. only	02 - Angle	03 - Loose snow
2015-08-13	2015	18:18	BRONSON AVE @ FIRST AVE	01 - Clear	01 - Daylight	02 - Stop sign		03 - P.D. only	02 - Angle	01 - Dry
2016-01-29	2016	12:42	BRONSON AVE @ FIRST AVE	03 - Snow	01 - Daylight	02 - Stop sign		03 - P.D. only	02 - Angle	02 - Wet
2016-10-20	2016	11:59	BRONSON AVE @ FIRST AVE	02 - Rain	01 - Daylight	02 - Stop sign		03 - P.D. only	04 - Sideswipe	02 - Wet
2016-11-16	2016	15:00	BRONSON AVE @ FIRST AVE	01 - Clear	01 - Daylight	02 - Stop sign		03 - P.D. only	02 - Angle	01 - Dry
2017-06-05	2017	17:10	BRONSON AVE @ FIRST AVE	01 - Clear	01 - Daylight	02 - Stop sign		02 - Non-fatal injury	03 - Rear end	01 - Dry
2017-05-13	2017	10:56	BRONSON AVE @ FIRST AVE	02 - Rain	01 - Daylight	02 - Stop sign		03 - P.D. only	05 - Turning movement	02 - Wet
2017-11-30	2017	15:47	BRONSON AVE @ FIRST AVE	04 - Freezing Rain	01 - Daylight	02 - Stop sign		03 - P.D. only	04 - Sideswipe	06 - Ice
2017-12-12	2017	13:45	BRONSON AVE @ FIRST AVE	03 - Snow	01 - Daylight	02 - Stop sign		03 - P.D. only	02 - Angle	03 - Loose snow
2018-02-11	2018	16:45	BRONSON AVE @ FIRST AVE (0007719)	04 - Freezing Rain	05 - Dusk	02 - Stop sign		03 - P.D. only	04 - Sideswipe	02 - Wet
2018-08-21	2018	12:39	BRONSON AVE @ FIRST AVE (0007719)	01 - Clear	01 - Daylight	02 - Stop sign		03 - P.D. only	05 - Turning movement	01 - Dry
2018-08-31	2018	19:23	BRONSON AVE @ FIRST AVE (0007719)	01 - Clear	05 - Dusk	02 - Stop sign		02 - Non-fatal injury	02 - Angle	01 - Dry
2018-10-01	2018	19:56	BRONSON AVE @ FIRST AVE (0007719)	01 - Clear	07 - Dark	02 - Stop sign		03 - P.D. only	02 - Angle	01 - Dry
2018-11-09	2018	10:15	BRONSON AVE @ FIRST AVE (0007719)	01 - Clear	01 - Daylight	02 - Stop sign		03 - P.D. only	02 - Angle	01 - Dry
2018-11-23	2018	16:05	BRONSON AVE @ FIRST AVE (0007719)	01 - Clear	01 - Daylight	02 - Stop sign		03 - P.D. only	02 - Angle	01 - Dry
2014-04-29	2014	12:30	BRONSON AVE btwn CARLING AVE & FIRST AVE	01 - Clear	01 - Daylight	10 - No control		02 - Non-fatal injury	03 - Rear end	01 - Dry
2014-08-08	2014	15:50	BRONSON AVE btwn CARLING AVE & FIRST AVE	01 - Clear	01 - Daylight	10 - No control		03 - P.D. only	04 - Sideswipe	01 - Dry
2014-10-24	2014	19:15	BRONSON AVE btwn CARLING AVE & FIRST AVE	01 - Clear	07 - Dark	10 - No control		03 - P.D. only	02 - Angle	01 - Dry
2015-06-01	2015	19:53	BRONSON AVE btwn CARLING AVE & FIRST AVE	01 - Clear	01 - Daylight	10 - No control		03 - P.D. only	04 - Sideswipe	01 - Dry
2015-04-27	2015	15:20	BRONSON AVE btwn CARLING AVE & FIRST AVE	01 - Clear	01 - Daylight	10 - No control		03 - P.D. only	03 - Rear end	01 - Dry
2015-06-22	2015	8:46	BRONSON AVE btwn CARLING AVE & FIRST AVE	01 - Clear	01 - Daylight	10 - No control		03 - P.D. only	03 - Rear end	01 - Dry
2015-10-15	2015	22:10	BRONSON AVE btwn CARLING AVE & FIRST AVE	01 - Clear	07 - Dark	10 - No control		03 - P.D. only	04 - Sideswipe	01 - Dry
2016-03-09	2016	16:50	BRONSON AVE btwn CARLING AVE & FIRST AVE	01 - Clear	01 - Daylight	10 - No control		03 - P.D. only	03 - Rear end	02 - Wet
2016-06-17	2016	19:09	BRONSON AVE btwn CARLING AVE & FIRST AVE	01 - Clear	01 - Daylight	10 - No control		03 - P.D. only	04 - Sideswipe	01 - Dry
2017-05-24	2017	9:14	BRONSON AVE btwn CARLING AVE & FIRST AVE	01 - Clear	01 - Daylight	10 - No control		02 - Non-fatal injury	04 - Sideswipe	01 - Dry
2017-03-22	2017	21:32	BRONSON AVE btwn CARLING AVE & FIRST AVE	01 - Clear	07 - Dark	10 - No control		03 - P.D. only	06 - SMV unattended vehicle	01 - Dry
2018-06-29	2018	14:30	BRONSON AVE btwn CARLING AVE & FIRST AVE (___3ZA30Q)	01 - Clear	01 - Daylight	10 - No control		03 - P.D. only	04 - Sideswipe	01 - Dry
2018-11-09	2018	17:37	BRONSON AVE btwn CARLING AVE & FIRST AVE (___3ZA30Q)	02 - Rain	07 - Dark	10 - No control		03 - P.D. only	04 - Sideswipe	02 - Wet
2014-12-02	2014	11:02	BRONSON AVE btwn CLEMORE AVE & CARLING AVE	01 - Clear	01 - Daylight	10 - No control		02 - Non-fatal injury	02 - Angle	01 - Dry
2014-04-08	2014	15:30	BRONSON AVE btwn CLEMORE AVE & CARLING AVE	02 - Rain	01 - Daylight	10 - No control		02 - Non-fatal injury	04 - Sideswipe	02 - Wet
2016-02-18	2016	12:15	BRONSON AVE btwn CLEMORE AVE & CARLING AVE	01 - Clear	01 - Daylight	10 - No control		02 - Non-fatal injury	01 - Approaching	01 - Dry
2017-06-19	2017	12:45	BRONSON AVE btwn CLEMORE AVE & CARLING AVE	01 - Clear	01 - Daylight	10 - No control		03 - P.D. only	02 - Angle	01 - Dry
2018-04-16	2018	13:43	BRONSON AVE btwn CLEMORE AVE & CARLING AVE (___3ZA30V)	04 - Freezing Rain	01 - Daylight	10 - No control		03 - P.D. only	04 - Sideswipe	02 - Wet
2018-04-18	2018	7:42	BRONSON AVE btwn CLEMORE AVE & CARLING AVE (___3ZA30V)	01 - Clear	01 - Daylight	10 - No control		03 - P.D. only	04 - Sideswipe	01 - Dry
2018-06-15	2018	12:34	BRONSON AVE btwn CLEMORE AVE & CARLING AVE (___3ZA30V)	01 - Clear	01 - Daylight	10 - No control		03 - P.D. only	03 - Rear end	01 - Dry
2014-05-08	2014	8:30	BRONSON AVE btwn FIRST AVE & SECOND AVE	01 - Clear	01 - Daylight	10 - No control		02 - Non-fatal injury	03 - Rear end	01 - Dry
2014-08-07	2014	16:35	BRONSON AVE btwn FIRST AVE & SECOND AVE	01 - Clear	01 - Daylight	10 - No control		03 - P.D. only	03 - Rear end	01 - Dry
2015-05-10	2015	19:30	BRONSON AVE btwn FIRST AVE & SECOND AVE	01 - Clear	01 - Daylight	10 - No control		03 - P.D. only	02 - Angle	01 - Dry

2016-07-05	2016	14:05	BRONSON AVE btwn FIRST AVE & SECOND AVE	01 - Clear	01 - Daylight	10 - No control	02 - Non-fatal injury	04 - Sideswipe	01 - Dry
2016-05-22	2016	17:54	BRONSON AVE btwn FIRST AVE & SECOND AVE	01 - Clear	01 - Daylight	10 - No control	03 - P.D. only	03 - Rear end	01 - Dry
2017-11-16	2017	9:09	BRONSON AVE btwn FIRST AVE & SECOND AVE	02 - Rain	01 - Daylight	10 - No control	03 - P.D. only	03 - Rear end	02 - Wet
2018-08-16	2018	12:57	BRONSON AVE btwn FIRST AVE & SECOND AVE (_32A300)	01 - Clear	01 - Daylight	10 - No control	03 - P.D. only	03 - Rear end	01 - Dry
2014-01-07	2014	16:40	CAMBRIDGE ST @ CARLING AVE	01 - Clear	05 - Dusk	02 - Stop sign	03 - P.D. only	03 - Rear end	06 - Ice
2014-04-23	2014	16:17	CAMBRIDGE ST @ CARLING AVE	01 - Clear	01 - Daylight	02 - Stop sign	03 - P.D. only	03 - Rear end	01 - Dry
2014-09-04	2014	18:11	CAMBRIDGE ST @ CARLING AVE	01 - Clear	01 - Daylight	02 - Stop sign	03 - P.D. only	03 - Rear end	01 - Dry
2015-07-08	2015	9:16	CAMBRIDGE ST @ CARLING AVE	01 - Clear	01 - Daylight	02 - Stop sign	03 - P.D. only	03 - Rear end	01 - Dry
2016-07-12	2016	20:54	CAMBRIDGE ST @ CARLING AVE	01 - Clear	05 - Dusk	02 - Stop sign	02 - Non-fatal injury	04 - Sideswipe	01 - Dry
2015-05-06	2015	15:22	CARLING AVE btwn BOOTH ST & CAMBRIDGE ST S	01 - Clear	01 - Daylight	10 - No control	03 - P.D. only	03 - Rear end	01 - Dry
2017-05-15	2017	17:09	CARLING AVE btwn CAMBRIDGE ST S & BRONSON AVE	01 - Clear	01 - Daylight	10 - No control	02 - Non-fatal injury	04 - Sideswipe	01 - Dry
2018-02-09	2018	9:47	CARLING AVE btwn CAMBRIDGE ST S & BRONSON AVE (_32A453)	01 - Clear	01 - Daylight	10 - No control	01 - Fatal injury	07 - SMV other	01 - Dry

Appendix E

TRANS Model Plots

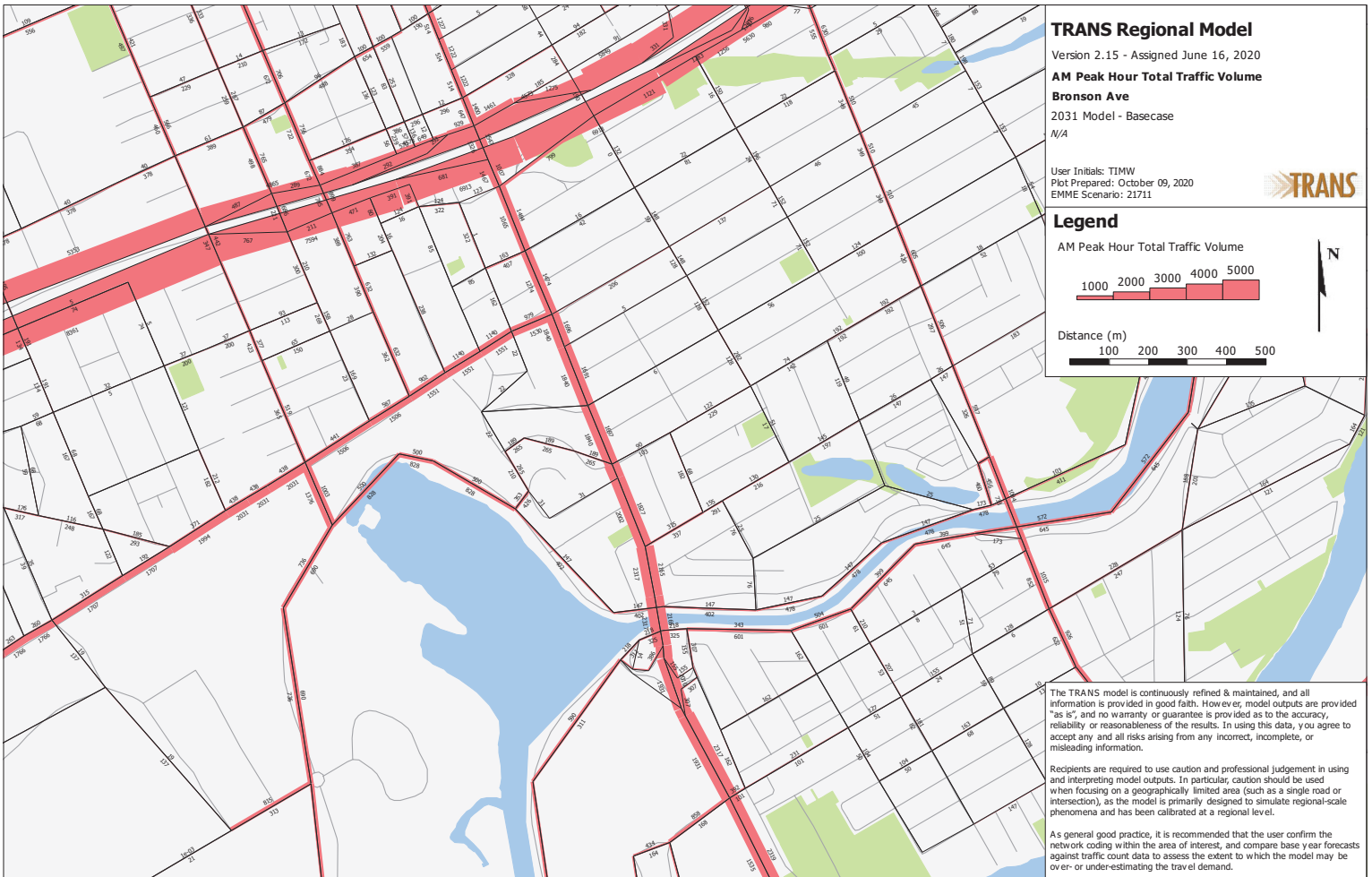
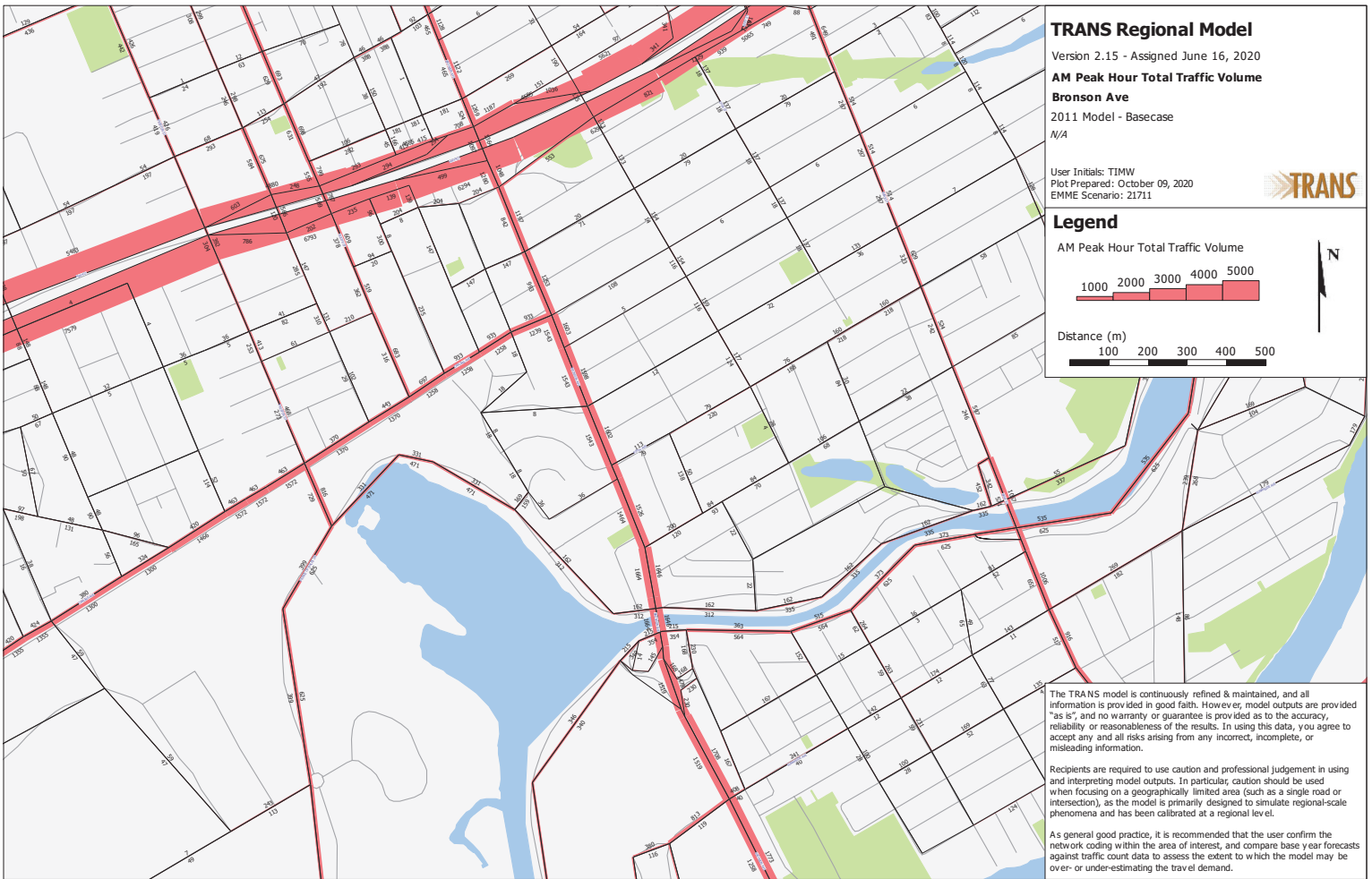

Appendix F

Background Development Volumes

The 'new' auto trips generated by the proposed development are depicted in Figure 4.

Figure 4: 'New' Auto Trips

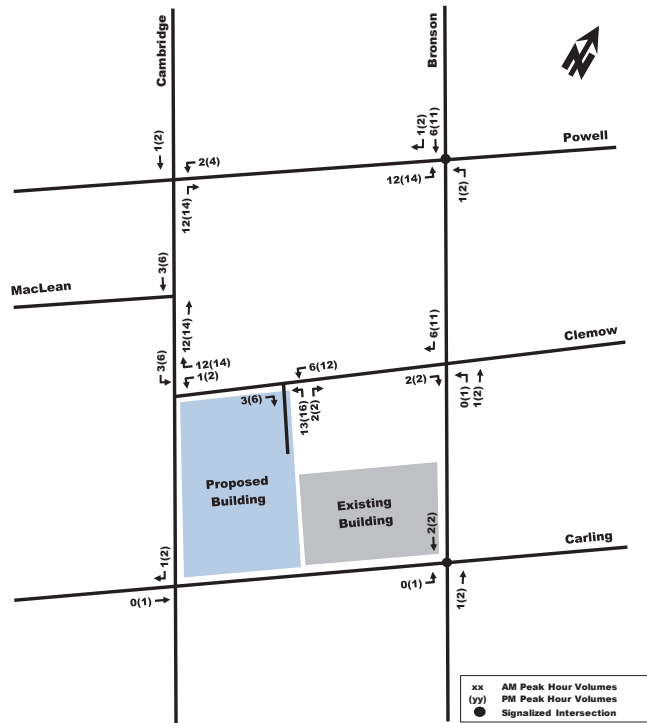
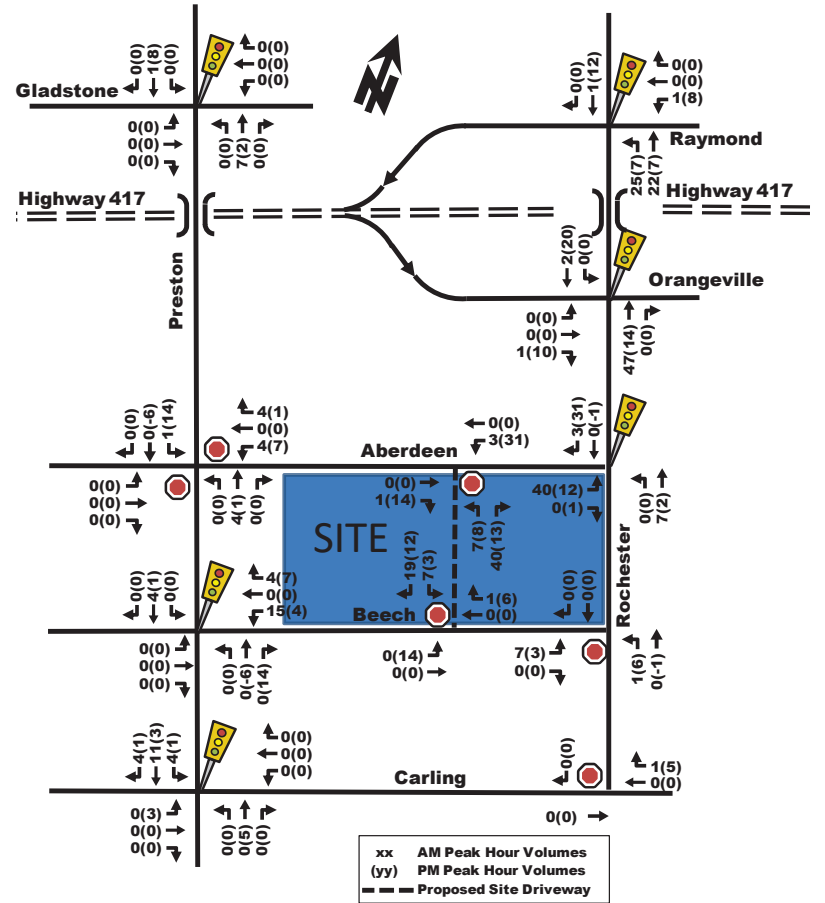
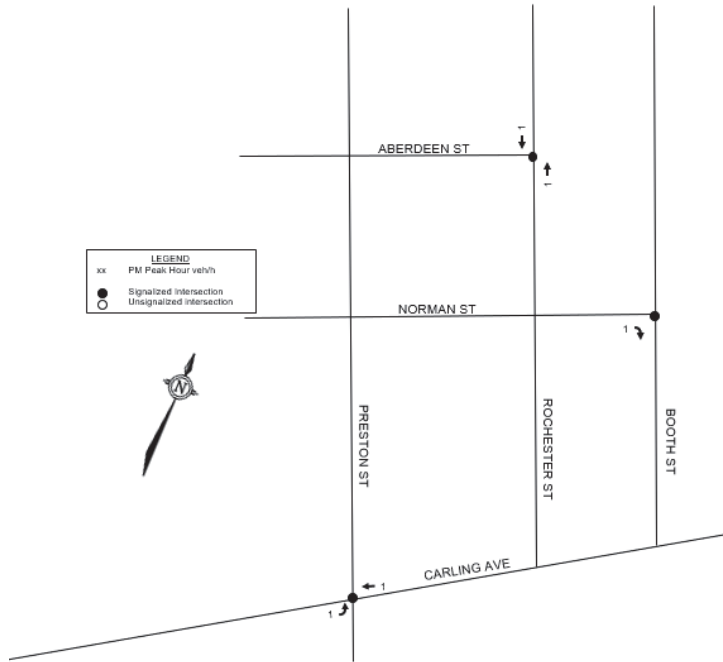

Figure 11: Site-Generated Traffic at Full Buildout (Phase 1 & 2)



Note: values in negative reflect changes in routes based on pass-by trips or net change between trips generated and reduction in public parking lot.

Figure 5: Site Generated Traffic Volumes



Appendix G

Synchro Intersection Worksheets – 2025 Future Background Conditions

Lanes, Volumes, Timings
1: Carling Avenue & Booth Street

2025 Future Background - AM Peak Hour
770-774 Bronson Ave

Lane Group	EBL	EBT	WBT	WBR	SBL	SBR
Lane Configurations	↔	↕	↕↕	↕	↔	↕
Traffic Volume (vph)	282	935	679	120	160	113
Future Volume (vph)	282	935	679	120	160	113
Satd. Flow (prot)	1658	3283	4530	0	1658	1427
Fit Permitted	0.950				0.950	
Satd. Flow (perm)	1592	3283	4530	0	1633	1258
Satd. Flow (RTOR)			32			113
Lane Group Flow (vph)	282	935	799	0	160	113
Turn Type	Prot	NA	NA		Perm	Perm
Protected Phases	5	2	6			
Permitted Phases					4	4
Detector Phase	5	2	6		4	4
Switch Phase						
Minimum Initial (s)	5.0	10.0	10.0		10.0	10.0
Minimum Split (s)	10.9	22.5	29.7		39.0	39.0
Total Split (s)	34.0	81.0	47.0		39.0	39.0
Total Split (%)	28.3%	67.5%	39.2%		32.5%	32.5%
Yellow Time (s)	3.7	3.7	3.7		3.3	3.3
All-Red Time (s)	2.2	2.0	2.0		2.7	2.7
Lost Time Adjust (s)	0.0	0.0	0.0		0.0	0.0
Total Lost Time (s)	5.9	5.7	5.7		6.0	6.0
Lead/Lag	Lead		Lag			
Lead-Lag Optimize?	Yes		Yes			
Recall Mode	None	Max	C-Max		None	None
Act Effct Green (s)	24.3	75.3	45.1		33.0	33.0
Actuated g/C Ratio	0.20	0.63	0.38		0.28	0.28
v/c Ratio	0.84	0.45	0.46		0.36	0.26
Control Delay	67.3	12.5	28.8		37.8	7.8
Queue Delay	0.0	0.0	0.0		0.0	0.0
Total Delay	67.3	12.5	28.8		37.8	7.8
LOS	E	B	C		D	A
Approach Delay		25.2	28.8		25.3	
Approach LOS		C	C		C	
Queue Length 50th (m)	63.4	56.1	50.4		30.4	0.0
Queue Length 95th (m)	#93.1	70.3	65.0		49.8	13.6
Internal Link Dist (m)		107.6	286.6		178.3	
Turn Bay Length (m)	40.0					30.0
Base Capacity (vph)	388	2060	1722		449	427
Starvation Cap Reductn	0	0	0		0	0
Spillback Cap Reductn	0	0	0		0	0
Storage Cap Reductn	0	0	0		0	0
Reduced v/c Ratio	0.73	0.45	0.46		0.36	0.26

Intersection Summary	
Cycle Length:	120
Actuated Cycle Length:	120
Offset:	116 (97%), Referenced to phase 6:WBT, Start of Green
Natural Cycle:	90
Control Type:	Actuated-Coordinated

Lanes, Volumes, Timings
1: Carling Avenue & Booth Street

2025 Future Background - AM Peak Hour
770-774 Bronson Ave

Maximum v/c Ratio: 0.84	Intersection LOS: C
Intersection Signal Delay: 26.5	ICU Level of Service D
Intersection Capacity Utilization 77.8%	
Analysis Period (min) 15	
# 95th percentile volume exceeds capacity, queue may be longer.	
Queue shown is maximum after two cycles.	

Splits and Phases: 1: Carling Avenue & Booth Street

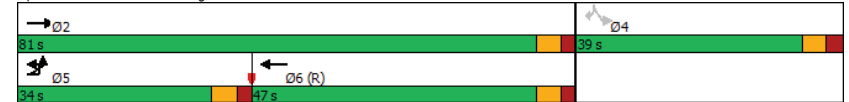

HCM 2010 TWSC
2: Cambridge Street & Carling Avenue

2025 Future Background - AM Peak Hour
770-774 Bronson Ave

Intersection												
Int Delay, s/veh	0.4											
Movement	EBL	EBT	EBR	WBL	WBT	WBR	NBL	NBT	NBR	SBL	SBT	SBR
Lane Configurations	↔↔↔			↔↔		↔			↔			↔
Traffic Vol, veh/h	0	1093	5	0	633	12	0	0	10	0	0	56
Future Vol, veh/h	0	1093	5	0	633	12	0	0	10	0	0	56
Conflicting Peds, #/hr	0	0	45	0	0	38	0	0	1	0	0	0
Sign Control	Free	Free	Free	Free	Free	Free	Stop	Stop	Stop	Stop	Stop	Stop
RT Channelized	-	-	None	-	-	None	-	-	None	-	-	None
Storage Length	-	-	1000	-	-	350	-	-	0	-	-	0
Veh in Median Storage, #	-	0	-	-	0	-	-	0	-	-	0	-
Grade, %	-	0	-	-	0	-	-	0	-	-	0	-
Peak Hour Factor	100	100	100	100	100	100	100	100	100	100	100	100
Heavy Vehicles, %	2	3	2	2	4	8	2	2	2	2	2	5
Mvmt Flow	0	1093	5	0	633	12	0	0	10	0	0	56
Major/Minor	Major1	Major2	Minor1	Minor2								
Conflicting Flow All	-	0	0	-	-	0	-	-	595	-	-	355
Stage 1	-	-	-	-	-	-	-	-	-	-	-	-
Stage 2	-	-	-	-	-	-	-	-	-	-	-	-
Critical Hdwy	-	-	-	-	-	-	-	-	7.14	-	-	7
Critical Hdwy Stg 1	-	-	-	-	-	-	-	-	-	-	-	-
Critical Hdwy Stg 2	-	-	-	-	-	-	-	-	-	-	-	-
Follow-up Hdwy	-	-	-	-	-	-	-	-	3.92	-	-	3.35
Pot Cap-1 Maneuver	0	-	-	0	-	-	0	0	383	0	0	633
Stage 1	0	-	-	0	-	-	0	0	-	0	0	-
Stage 2	0	-	-	0	-	-	0	0	-	0	0	-
Platoon blocked, %	-	-	-	-	-	-	-	-	-	-	-	-
Mov Cap-1 Maneuver	-	-	-	-	-	-	-	-	367	-	-	611
Mov Cap-2 Maneuver	-	-	-	-	-	-	-	-	-	-	-	-
Stage 1	-	-	-	-	-	-	-	-	-	-	-	-
Stage 2	-	-	-	-	-	-	-	-	-	-	-	-
Approach	EB	WB	NB	SB								
HCM Control Delay, s	0	0	15.1	11.5								
HCM LOS			C	B								
Minor Lane/Major Mvmt	NBLn1	EBT	EBR	WBT	WBR	SBLn1						
Capacity (veh/h)	367	-	-	-	-	611						
HCM Lane V/C Ratio	0.027	-	-	-	-	0.092						
HCM Control Delay (s)	15.1	-	-	-	-	11.5						
HCM Lane LOS	C	-	-	-	-	B						
HCM 95th %tile Q(veh)	0.1	-	-	-	-	0.3						

Lanes, Volumes, Timings
3: Bronson Avenue & Powell Avenue

2025 Future Background - AM Peak Hour
770-774 Bronson Ave

Lane Group	EBL	EBT	EBR	WBL	WBT	WBR	NBL	NBT	NBR	SBL	SBT	SBR
Lane Configurations		↕			↕			↕			↕	
Traffic Volume (vph)	111	25	51	17	53	17	45	1644	8	11	997	68
Future Volume (vph)	111	25	51	17	53	17	45	1644	8	11	997	68
Satd. Flow (prot)	0	1586	0	0	1642	0	0	3275	0	0	3241	0
Fit Permitted		0.776			0.921			0.879			0.926	
Satd. Flow (perm)	0	1227	0	0	1518	0	0	2882	0	0	3004	0
Satd. Flow (RTOR)		15			10			1			16	
Lane Group Flow (vph)	0	187	0	0	87	0	0	1697	0	0	1076	0
Turn Type	Perm	NA		Perm	NA		Perm	NA		Perm	NA	
Protected Phases		4			8			2			6	
Permitted Phases	4			8			2			6		
Detector Phase	4	4		8	8		2	2		6	6	
Switch Phase												
Minimum Initial (s)	10.0	10.0		10.0	10.0		10.0	10.0		10.0	10.0	
Minimum Split (s)	23.7	23.7		23.7	23.7		32.3	32.3		32.3	32.3	
Total Split (s)	26.0	26.0		26.0	26.0		84.0	84.0		84.0	84.0	
Total Split (%)	23.6%	23.6%		23.6%	23.6%		76.4%	76.4%		76.4%	76.4%	
Yellow Time (s)	3.0	3.0		3.0	3.0		3.3	3.3		3.3	3.3	
All-Red Time (s)	2.7	2.7		2.7	2.7		2.0	2.0		2.0	2.0	
Lost Time Adjust (s)		0.0			0.0			0.0			0.0	
Total Lost Time (s)		5.7			5.7			5.3			5.3	
Lead/Lag												
Lead-Lag Optimize?												
Recall Mode	None	None		None	None		C-Max	C-Max		C-Max	C-Max	
Act Effct Green (s)		18.4			18.4			80.6			80.6	
Actuated g/C Ratio		0.17			0.17			0.73			0.73	
v/c Ratio		0.86			0.33			0.80			0.49	
Control Delay		74.9			38.5			7.2			7.2	
Queue Delay		0.0			0.0			8.6			0.0	
Total Delay		74.9			38.5			15.8			7.2	
LOS		E			D			B			A	
Approach Delay		74.9			38.5			15.8			7.2	
Approach LOS		E			D			B			A	
Queue Length 50th (m)		35.6			14.4			63.8			46.3	
Queue Length 95th (m)		#71.3			29.0			m48.2			59.1	
Internal Link Dist (m)		74.6			106.0			142.6			39.5	
Turn Bay Length (m)												
Base Capacity (vph)		238			288			2112			2205	
Starvation Cap Reductn		0			0			396			0	
Spillback Cap Reductn		0			0			0			97	
Storage Cap Reductn		0			0			0			0	
Reduced v/c Ratio		0.79			0.30			0.99			0.51	
Intersection Summary												
Cycle Length: 110												
Actuated Cycle Length: 110												
Offset: 21 (19%), Referenced to phase 2:NBT and 6:SBTL, Start of Green												
Natural Cycle: 80												
Control Type: Actuated-Coordinated												

Lanes, Volumes, Timings
3: Bronson Avenue & Powell Avenue

2025 Future Background - AM Peak Hour
770-774 Bronson Ave

Maximum v/c Ratio: 0.86	Intersection LOS: B
Intersection Signal Delay: 17.0	ICU Level of Service H
Intersection Capacity Utilization 110.1%	
Analysis Period (min) 15	
# 95th percentile volume exceeds capacity, queue may be longer.	
Queue shown is maximum after two cycles.	
m Volume for 95th percentile queue is metered by upstream signal.	

Splits and Phases: 3: Bronson Avenue & Powell Avenue

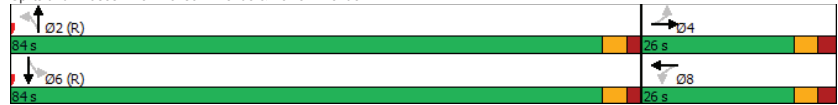

Lanes, Volumes, Timings
4: Bronson Avenue & Carling Avenue/Glebe Avenue

2025 Future Background - AM Peak Hour
770-774 Bronson Ave

Lane Group	EBL	EBT	EBR	WBL	WBT	WBR	NBL	NBT	NBR	SBL	SBT	SBR
Lane Configurations	↔	↕	↔				↕	↕			↕	↕
Traffic Volume (vph)	391	152	525	0	0	0	443	1397	38	0	934	110
Future Volume (vph)	391	152	525	0	0	0	443	1397	38	0	934	110
Satd. Flow (prot)	1530	1583	1483	0	0	0	3216	1730	0	0	3246	0
Fit Permitted	0.950	0.978					0.950					
Satd. Flow (perm)	1459	1551	1271	0	0	0	3182	1730	0	0	3246	0
Satd. Flow (RTOR)			30					3			13	
Lane Group Flow (vph)	270	273	525	0	0	0	443	1435	0	0	1044	0
Turn Type	Perm	NA	pm+ov				Prot	NA			NA	
Protected Phases		4	5				5	2			6	
Permitted Phases	4		4									
Detector Phase	4	4	5				5	2			6	
Switch Phase												
Minimum Initial (s)	10.0	10.0	5.0				5.0	10.0			10.0	
Minimum Split (s)	31.0	31.0	11.0				11.0	24.0			33.0	
Total Split (s)	31.0	31.0	34.0				34.0	79.0			45.0	
Total Split (%)	28.2%	28.2%	30.9%				30.9%	71.8%			40.9%	
Yellow Time (s)	3.3	3.3	3.3				3.3	3.3			3.3	
All-Red Time (s)	2.7	2.7	2.7				2.7	2.7			2.7	
Lost Time Adjust (s)	0.0	0.0	0.0				0.0	0.0			0.0	
Total Lost Time (s)	6.0	6.0	6.0				6.0	6.0			6.0	
Lead/Lag			Lead				Lead				Lag	
Lead-Lag Optimize?			Yes				Yes				Yes	
Recall Mode	None	None	Min				Min	C-Max			C-Max	
Act Effct Green (s)	23.5	23.5	45.9				22.3	74.5			46.1	
Actuated g/C Ratio	0.21	0.21	0.42				0.20	0.68			0.42	
v/c Ratio	0.87	0.82	0.89				0.68	1.22			0.76	
Control Delay	68.3	61.8	43.3				36.2	136.6			28.0	
Queue Delay	0.0	0.0	0.0				0.0	0.1			0.1	
Total Delay	68.3	61.8	43.3				36.2	136.7			28.1	
LOS	E	E	D				D	F			C	
Approach Delay		54.4						113.0			28.1	
Approach LOS		D						F			C	
Queue Length 50th (m)	58.2	58.2	81.5				45.9	~398.4			102.4	
Queue Length 95th (m)	#102.4	#98.4	109.4				50.8	#478.8			#148.9	
Internal Link Dist (m)		82.5				112.6		392.2			142.6	
Turn Bay Length (m)							40.0					
Base Capacity (vph)	331	352	665				818	1172			1368	
Starvation Cap Reductn	0	0	0				0	0			15	
Spillback Cap Reductn	0	0	0				0	24			0	
Storage Cap Reductn	0	0	0				0	0			0	
Reduced v/c Ratio	0.82	0.78	0.79				0.54	1.25			0.77	

Intersection Summary		
Cycle Length: 110		
Actuated Cycle Length: 110		
Offset: 53 (48%), Referenced to phase 2:NBT and 6:SBT, Start of Green		
Natural Cycle: 140		
Control Type: Actuated-Coordinated		

Lanes, Volumes, Timings 2025 Future Background - AM Peak Hour
 4: Bronson Avenue & Carling Avenue/Glebe Avenue 770-774 Bronson Ave

Maximum v/c Ratio: 1.22	Intersection LOS: E
Intersection Signal Delay: 75.1	ICU Level of Service H
Intersection Capacity Utilization 110.7%	
Analysis Period (min) 15	
~ Volume exceeds capacity, queue is theoretically infinite.	
Queue shown is maximum after two cycles.	
# 95th percentile volume exceeds capacity, queue may be longer.	
Queue shown is maximum after two cycles.	

Splits and Phases: 4: Bronson Avenue & Carling Avenue/Glebe Avenue



Lanes, Volumes, Timings 2025 Future Background - AM Peak Hour
 5: Bronson Avenue & Madawaska Drive/Fifth Avenue 770-774 Bronson Ave

Lane Group	EBL	EBT	EBR	WBL	WBT	WBR	NBL	NBT	NBR	SBL	SBT	SBR
Lane Configurations		↕			↕			↕			↕	
Traffic Volume (vph)	7	48	14	86	34	46	0	1723	34	22	1475	1
Future Volume (vph)	7	48	14	86	34	46	0	1723	34	22	1475	1
Satd. Flow (prot)	0	1623	0	0	1608	0	0	3302	0	0	3311	0
Fit Permitted		0.971			0.824						0.892	
Satd. Flow (perm)	0	1578	0	0	1333	0	0	3302	0	0	2956	0
Satd. Flow (RTOR)		10			16			4				
Lane Group Flow (vph)	0	69	0	0	166	0	0	1757	0	0	1498	0
Turn Type	Perm	NA		Perm	NA			NA		Perm	NA	
Protected Phases		4			8			2			6	
Permitted Phases	4			8						6		
Detector Phase	4	4		8	8			2		6	6	
Switch Phase												
Minimum Initial (s)	10.0	10.0		10.0	10.0			10.0		10.0	10.0	
Minimum Split (s)	23.3	23.3		23.3	23.3			34.3		34.3	34.3	
Total Split (s)	28.0	28.0		28.0	28.0			82.0		82.0	82.0	
Total Split (%)	25.5%	25.5%		25.5%	25.5%			74.5%		74.5%	74.5%	
Yellow Time (s)	3.3	3.3		3.3	3.3			3.3		3.3	3.3	
All-Red Time (s)	2.0	2.0		2.0	2.0			2.0		2.0	2.0	
Lost Time Adjust (s)		0.0			0.0			0.0		0.0	0.0	
Total Lost Time (s)		5.3			5.3			5.3		5.3	5.3	
Lead/Lag												
Lead-Lag Optimize?												
Recall Mode	None	None		None	None			C-Max		C-Max	C-Max	
Act Effct Green (s)		17.2			17.2			82.2			82.2	
Actuated g/C Ratio		0.16			0.16			0.75			0.75	
v/c Ratio		0.27			0.75			0.71			0.68	
Control Delay		35.9			59.6			10.4			5.6	
Queue Delay		0.0			0.0			0.0			0.0	
Total Delay		35.9			59.6			10.4			5.6	
LOS		D			E			B			A	
Approach Delay		35.9			59.6			10.4			5.6	
Approach LOS		D			E			B			A	
Queue Length 50th (m)		11.1			30.9			94.0			37.4	
Queue Length 95th (m)		22.7			51.3			141.7			50.3	
Internal Link Dist (m)		190.1			132.1			94.8			392.2	
Turn Bay Length (m)												
Base Capacity (vph)		333			287			2467			2207	
Starvation Cap Reductn		0			0			0			0	
Spillback Cap Reductn		0			0			0			0	
Storage Cap Reductn		0			0			0			0	
Reduced v/c Ratio		0.21			0.58			0.71			0.68	

Intersection Summary												
Cycle Length: 110												
Actuated Cycle Length: 110												
Offset: 70 (64%), Referenced to phase 2:NBT and 6:SBTL, Start of Green												
Natural Cycle: 70												
Control Type: Actuated-Coordinated												

Lanes, Volumes, Timings
 5: Bronson Avenue & Madawaska Drive/Fifth Avenue
 2025 Future Background - AM Peak Hour
 770-774 Bronson Ave

Maximum v/c Ratio: 0.75	Intersection LOS: B
Intersection Signal Delay: 11.2	ICU Level of Service E
Intersection Capacity Utilization 85.7%	
Analysis Period (min) 15	

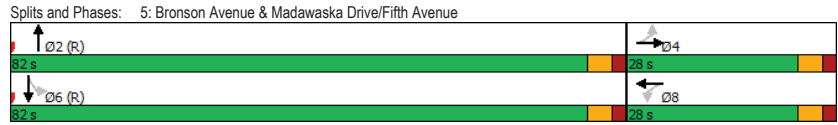

Lanes, Volumes, Timings
 1: Carling Avenue & Booth Street
 2025 Future Background-PM Peak Hour
 770-774 Bronson Ave

Lane Group	EBL	EBT	WBT	WBR	SBL	SBR
Lane Configurations	↔	↕	↕↕	↕	↔	↕
Traffic Volume (vph)	216	788	995	59	317	527
Future Volume (vph)	216	788	995	59	317	527
Satd. Flow (prot)	1658	3283	4673	0	1658	1427
Fit Permitted	0.950				0.950	
Satd. Flow (perm)	1581	3283	4673	0	1632	1230
Satd. Flow (RTOR)			9			100
Lane Group Flow (vph)	216	788	1054	0	317	527
Turn Type	Prot	NA	NA		Perm	Perm
Protected Phases	5	2	6			
Permitted Phases					4	4
Detector Phase	5	2	6		4	4
Switch Phase						
Minimum Initial (s)	5.0	10.0	10.0		10.0	10.0
Minimum Split (s)	10.9	22.5	29.7		39.0	39.0
Total Split (s)	23.0	90.0	67.0		40.0	40.0
Total Split (%)	17.7%	69.2%	51.5%		30.8%	30.8%
Yellow Time (s)	3.7	3.7	3.7		3.3	3.3
All-Red Time (s)	2.2	2.0	2.0		2.7	2.7
Lost Time Adjust (s)	0.0	0.0	0.0		0.0	0.0
Total Lost Time (s)	5.9	5.7	5.7		6.0	6.0
Lead/Lag	Lead		Lag			
Lead-Lag Optimize?	Yes		Yes			
Recall Mode	None	Max	C-Max		None	None
Act Effct Green (s)	17.1	84.3	61.3		34.0	34.0
Actuated g/C Ratio	0.13	0.65	0.47		0.26	0.26
v/c Ratio	0.99	0.37	0.48		0.74	1.33
Control Delay	114.8	11.2	40.0		56.0	198.1
Queue Delay	0.0	0.0	0.0		0.0	0.0
Total Delay	114.8	11.2	40.0		56.0	198.1
LOS	F	B	D		E	F
Approach Delay		33.5	40.0		144.8	
Approach LOS		C	D		F	
Queue Length 50th (m)	56.1	45.7	87.5		74.8	~156.1
Queue Length 95th (m)	#106.4	57.1	102.0		108.8	#224.2
Internal Link Dist (m)		107.6	286.6		178.3	
Turn Bay Length (m)	40.0					30.0
Base Capacity (vph)	218	2128	2208		426	395
Starvation Cap Reductn	0	0	0		0	0
Spillback Cap Reductn	0	0	0		0	0
Storage Cap Reductn	0	0	0		0	0
Reduced v/c Ratio	0.99	0.37	0.48		0.74	1.33

Intersection Summary

Cycle Length: 130
Actuated Cycle Length: 130
Offset: 110 (85%), Referenced to phase 6:WBT, Start of Green
Natural Cycle: 90
Control Type: Actuated-Coordinated

Lanes, Volumes, Timings
1: Carling Avenue & Booth Street

2025 Future Background-PM Peak Hour
770-774 Bronson Ave

Maximum v/c Ratio: 1.33	Intersection LOS: E
Intersection Signal Delay: 68.2	ICU Level of Service E
Intersection Capacity Utilization 89.0%	
Analysis Period (min) 15	
~ Volume exceeds capacity, queue is theoretically infinite.	
Queue shown is maximum after two cycles.	
# 95th percentile volume exceeds capacity, queue may be longer.	
Queue shown is maximum after two cycles.	

Splits and Phases: 1: Carling Avenue & Booth Street

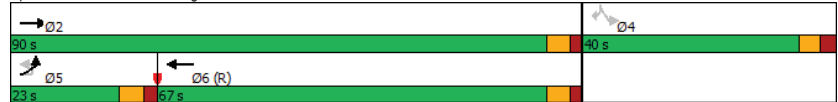

HCM 2010 TWSC
2: Cambridge Street & Carling Avenue

2025 Future Background-PM Peak Hour
770-774 Bronson Ave

Intersection												
Int Delay, s/veh	2.4											
Movement	EBL	EBT	EBR	WBL	WBT	WBR	NBL	NBT	NBR	SBL	SBT	SBR
Lane Configurations		↑↑↑			↑↑	↑				↑		↑
Traffic Vol, veh/h	0	1053	17	0	589	6	0	0	25	0	0	291
Future Vol, veh/h	0	1053	17	0	589	6	0	0	25	0	0	291
Conflicting Peds, #/hr	0	0	42	0	0	33	0	0	4	0	0	1
Sign Control	Free	Free	Free	Free	Free	Free	Stop	Stop	Stop	Stop	Stop	Stop
RT Channelized	-	-	None	-	-	None	-	-	None	-	-	None
Storage Length	-	-	1000	-	-	350	-	-	0	-	-	0
Veh in Median Storage, #	-	0	-	-	0	-	-	0	-	-	0	-
Grade, %	-	0	-	-	0	-	-	0	-	-	0	-
Peak Hour Factor	100	100	100	100	100	100	100	100	100	100	100	100
Heavy Vehicles, %	2	3	2	2	4	8	2	2	2	2	2	5
Mvmt Flow	0	1053	17	0	589	6	0	0	25	0	0	291

Major/Minor	Major1	Major2	Minor1	Minor2
Conflicting Flow All	-	0	0	-
Stage 1	-	-	-	-
Stage 2	-	-	-	-
Critical Hdwy	-	-	-	-
Critical Hdwy Stg 1	-	-	-	-
Critical Hdwy Stg 2	-	-	-	-
Follow-up Hdwy	-	-	-	-
Pot Cap-1 Maneuver	0	-	0	-
Stage 1	0	-	0	-
Stage 2	0	-	0	-
Platoon blocked, %	-	-	-	-
Mov Cap-1 Maneuver	-	-	-	-
Mov Cap-2 Maneuver	-	-	-	-
Stage 1	-	-	-	-
Stage 2	-	-	-	-

Approach	EB	WB	NB	SB
HCM Control Delay, s	0	0	15.3	15.3
HCM LOS			C	C

Minor Lane/Major Mvmt	NBLn1	EBT	EBR	WBT	WBR	SBLn1
Capacity (veh/h)	374	-	-	-	-	637
HCM Lane V/C Ratio	0.067	-	-	-	-	0.457
HCM Control Delay (s)	15.3	-	-	-	-	15.3
HCM Lane LOS	C	-	-	-	-	C
HCM 95th %tile Q(veh)	0.2	-	-	-	-	2.4

Lanes, Volumes, Timings
3: Bronson Avenue & Powell Avenue

2025 Future Background-PM Peak Hour
770-774 Bronson Ave

	↖	→	↘	↙	←	↖	↙	↑	↗	↘	↓	↙
Lane Group	EBL	EBT	EBR	WBL	WBT	WBR	NBL	NBT	NBR	SBL	SBT	SBR
Lane Configurations		↕			↕			↕			↕	
Traffic Volume (vph)	141	82	150	58	89	5	73	1127	19	6	945	57
Future Volume (vph)	141	82	150	58	89	5	73	1127	19	6	945	57
Satd. Flow (prot)	0	1575	0	0	1699	0	0	3261	0	0	3248	0
Fit Permitted		0.782			0.684			0.768			0.947	
Satd. Flow (perm)	0	1239	0	0	1184	0	0	2511	0	0	3076	0
Satd. Flow (RTOR)		25			1			3			10	
Lane Group Flow (vph)	0	373	0	0	152	0	0	1219	0	0	1008	0
Turn Type	Perm	NA		Perm	NA		Perm	NA		Perm	NA	
Protected Phases		4			8			2			6	
Permitted Phases	4			8			2			6		
Detector Phase	4	4		8	8		2	2		6	6	
Switch Phase												
Minimum Initial (s)	10.0	10.0		10.0	10.0		10.0	10.0		10.0	10.0	
Minimum Split (s)	23.7	23.7		23.7	23.7		32.3	32.3		32.3	32.3	
Total Split (s)	38.0	38.0		38.0	38.0		92.0	92.0		92.0	92.0	
Total Split (%)	29.2%	29.2%		29.2%	29.2%		70.8%	70.8%		70.8%	70.8%	
Yellow Time (s)	3.0	3.0		3.0	3.0		3.3	3.3		3.3	3.3	
All-Red Time (s)	2.7	2.7		2.7	2.7		2.0	2.0		2.0	2.0	
Lost Time Adjust (s)		0.0			0.0			0.0			0.0	
Total Lost Time (s)		5.7			5.7			5.3			5.3	
Lead/Lag												
Lead-Lag Optimize?												
Recall Mode	None	None		None	None		C-Max	C-Max		C-Max	C-Max	
Act Effct Green (s)		32.3			32.3			86.7			86.7	
Actuated g/C Ratio		0.25			0.25			0.67			0.67	
v/c Ratio		1.14			0.52			0.73			0.49	
Control Delay		135.9			49.1			17.2			11.6	
Queue Delay		0.0			0.0			2.8			0.0	
Total Delay		135.9			49.1			19.9			11.6	
LOS		F			D			B			B	
Approach Delay		135.9			49.1			19.9			11.6	
Approach LOS		F			D			B			B	
Queue Length 50th (m)		~106.8			33.5			110.3			61.4	
Queue Length 95th (m)		#167.9			55.9			34.6			75.9	
Internal Link Dist (m)		74.6			106.0			142.6			39.5	
Turn Bay Length (m)												
Base Capacity (vph)		326			294			1675			2054	
Starvation Cap Reductn		0			0			332			0	
Spillback Cap Reductn		0			0			0			44	
Storage Cap Reductn		0			0			0			0	
Reduced v/c Ratio		1.14			0.52			0.91			0.50	

Intersection Summary	
Cycle Length:	130
Actuated Cycle Length:	130
Offset:	46 (35%), Referenced to phase 2:NBT and 6:SBTL, Start of Green
Natural Cycle:	65
Control Type:	Actuated-Coordinated

Lanes, Volumes, Timings
3: Bronson Avenue & Powell Avenue

2025 Future Background-PM Peak Hour
770-774 Bronson Ave

Maximum v/c Ratio: 1.14	Intersection LOS: C
Intersection Signal Delay: 34.2	ICU Level of Service G
Intersection Capacity Utilization 108.7%	
Analysis Period (min) 15	
~ Volume exceeds capacity, queue is theoretically infinite.	
Queue shown is maximum after two cycles.	
# 95th percentile volume exceeds capacity, queue may be longer.	
Queue shown is maximum after two cycles.	

Splits and Phases: 3: Bronson Avenue & Powell Avenue



Lanes, Volumes, Timings
 4: Bronson Avenue & Carling Avenue/Glebe Avenue
 2025 Future Background-PM Peak Hour
 770-774 Bronson Ave

Lane Group	EBL	EBT	EBR	WBL	WBT	WBR	NBL	NBT	NBR	SBL	SBT	SBR
Lane Configurations	↔	↔	↔				↔	↔			↔	↔
Traffic Volume (vph)	247	133	666	0	0	0	435	1094	26	0	1040	104
Future Volume (vph)	247	133	666	0	0	0	435	1094	26	0	1040	104
Satd. Flow (prot)	1530	1597	1483	0	0	0	3216	1732	0	0	3253	0
Fit Permitted	0.950	0.985					0.950					
Satd. Flow (perm)	1456	1573	1406	0	0	0	3175	1732	0	0	3253	0
Satd. Flow (RTOR)			63					2				12
Lane Group Flow (vph)	188	192	666	0	0	0	435	1120	0	0	1144	0
Turn Type	Perm	NA	pm+ov				Prot	NA			NA	
Protected Phases		4	5				5	2				6
Permitted Phases	4		4									
Detector Phase	4	4	5				5	2				6
Switch Phase												
Minimum Initial (s)	10.0	10.0	5.0				5.0	10.0			10.0	
Minimum Split (s)	31.0	31.0	11.0				11.0	24.0			33.0	
Total Split (s)	31.0	31.0	26.0				26.0	99.0			73.0	
Total Split (%)	23.8%	23.8%	20.0%				20.0%	76.2%			56.2%	
Yellow Time (s)	3.3	3.3	3.3				3.3	3.3			3.3	
All-Red Time (s)	2.7	2.7	2.7				2.7	2.7			2.7	
Lost Time Adjust (s)	0.0	0.0	0.0				0.0	0.0			0.0	
Total Lost Time (s)	6.0	6.0	6.0				6.0	6.0			6.0	
Lead/Lag			Lead				Lead				Lag	
Lead-Lag Optimize?			Yes				Yes				Yes	
Recall Mode	None	None	Min				Min	C-Max			C-Max	
Act Effct Green (s)	21.5	21.5	45.0				23.5	96.5			67.0	
Actuated g/C Ratio	0.17	0.17	0.35				0.18	0.74			0.52	
v/c Ratio	0.78	0.74	1.23				0.75	0.87			0.68	
Control Delay	61.8	56.8	149.1				53.9	27.4			18.4	
Queue Delay	0.0	0.0	0.0				0.0	0.0			0.2	
Total Delay	61.8	56.8	149.1				53.9	27.4			18.6	
LOS	E	E	F				D	C			B	
Approach Delay		116.5						34.8			18.6	
Approach LOS		F						C			B	
Queue Length 50th (m)	49.5	50.3	~204.9				57.0	198.9			61.7	
Queue Length 95th (m)	m74.3	m75.2	#212.9				m#83.2	m#250.0			m79.7	
Internal Link Dist (m)		82.5			112.6			392.2				142.6
Turn Bay Length (m)							40.0					
Base Capacity (vph)		280	302	541			581	1286			1682	
Starvation Cap Reductn	0	0	0				0	0			93	
Spillback Cap Reductn	0	0	0				0	0			0	
Storage Cap Reductn	0	0	0				0	0			0	
Reduced v/c Ratio	0.67	0.64	1.23				0.75	0.87			0.72	

Intersection Summary
 Cycle Length: 130
 Actuated Cycle Length: 130
 Offset: 46 (35%), Referenced to phase 2:NBT and 6:SBT, Start of Green
 Natural Cycle: 100
 Control Type: Actuated-Coordinated

Lanes, Volumes, Timings
 4: Bronson Avenue & Carling Avenue/Glebe Avenue
 2025 Future Background-PM Peak Hour
 770-774 Bronson Ave

Maximum v/c Ratio: 1.23
 Intersection Signal Delay: 52.7
 Intersection Capacity Utilization 89.8%
 Analysis Period (min) 15
 Intersection LOS: D
 ICU Level of Service E
 ~ Volume exceeds capacity, queue is theoretically infinite.
 Queue shown is maximum after two cycles.
 # 95th percentile volume exceeds capacity, queue may be longer.
 Queue shown is maximum after two cycles.
 m Volume for 95th percentile queue is metered by upstream signal.

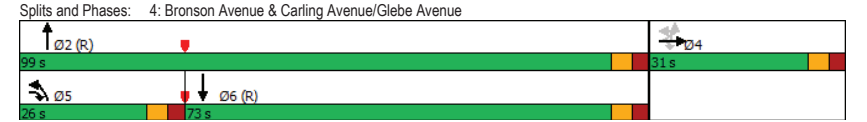

Lanes, Volumes, Timings
 5: Bronson Avenue & Madawaska Drive/Fifth Avenue
 2025 Future Background-PM Peak Hour
 770-774 Bronson Ave

Lane Group	EBL	EBT	EBR	WBL	WBT	WBR	NBL	NBT	NBR	SBL	SBT	SBR
Lane Configurations		↔			↔			↔			↔	
Traffic Volume (vph)	3	66	47	121	22	27	9	1415	27	19	1536	4
Future Volume (vph)	3	66	47	121	22	27	9	1415	27	19	1536	4
Satd. Flow (prot)	0	1521	0	0	1637	0	0	3301	0	0	3310	0
Fit Permitted		0.994			0.580			0.940			0.916	
Satd. Flow (perm)	0	1513	0	0	963	0	0	3103	0	0	3035	0
Satd. Flow (RTOR)		22			6			5			1	
Lane Group Flow (vph)	0	116	0	0	170	0	0	1451	0	0	1559	0
Turn Type	Perm	NA		Perm	NA		Perm	NA		Perm	NA	
Protected Phases		4			8			2			6	
Permitted Phases	4			8			2			6		
Detector Phase	4	4		8	8		2	2		6	6	
Switch Phase												
Minimum Initial (s)	10.0	10.0		10.0	10.0		10.0	10.0		10.0	10.0	
Minimum Split (s)	23.3	23.3		23.3	23.3		34.3	34.3		34.3	34.3	
Total Split (s)	24.0	24.0		24.0	24.0		106.0	106.0		106.0	106.0	
Total Split (%)	18.5%	18.5%		18.5%	18.5%		81.5%	81.5%		81.5%	81.5%	
Yellow Time (s)	3.3	3.3		3.3	3.3		3.3	3.3		3.3	3.3	
All-Red Time (s)	2.0	2.0		2.0	2.0		2.0	2.0		2.0	2.0	
Lost Time Adjust (s)		0.0			0.0			0.0			0.0	
Total Lost Time (s)		5.3			5.3			5.3			5.3	
Lead/Lag												
Lead-Lag Optimize?												
Recall Mode	None	None		None	None		C-Max	C-Max		C-Max	C-Max	
Act Effct Green (s)		18.7			18.7			100.7			100.7	
Actuated g/C Ratio		0.14			0.14			0.77			0.77	
v/c Ratio		0.49			1.19			0.60			0.66	
Control Delay		49.2			180.5			7.4			6.2	
Queue Delay		0.0			0.0			0.0			0.0	
Total Delay		49.2			180.5			7.4			6.2	
LOS		D			F			A			A	
Approach Delay		49.2			180.5			7.4			6.2	
Approach LOS		D			F			A			A	
Queue Length 50th (m)		22.3			~51.1			70.3			70.1	
Queue Length 95th (m)		41.9			#97.0			85.7			m67.6	
Internal Link Dist (m)		190.1			132.1			94.8			392.2	
Turn Bay Length (m)												
Base Capacity (vph)		236			143			2404			2351	
Starvation Cap Reductn		0			0			0			0	
Spillback Cap Reductn		0			0			0			0	
Storage Cap Reductn		0			0			0			0	
Reduced v/c Ratio		0.49			1.19			0.60			0.66	

Intersection Summary	
Cycle Length:	130
Actuated Cycle Length:	130
Offset:	55 (42%), Referenced to phase 2:NBT and 6:SBTL, Start of Green
Natural Cycle:	65
Control Type:	Actuated-Coordinated

Lanes, Volumes, Timings
 5: Bronson Avenue & Madawaska Drive/Fifth Avenue
 2025 Future Background-PM Peak Hour
 770-774 Bronson Ave

Maximum v/c Ratio:	1.19
Intersection Signal Delay:	17.3
Intersection LOS:	B
Intersection Capacity Utilization:	84.9%
ICU Level of Service:	E
Analysis Period (min):	15
~	Volume exceeds capacity, queue is theoretically infinite.
	Queue shown is maximum after two cycles.
#	95th percentile volume exceeds capacity, queue may be longer.
	Queue shown is maximum after two cycles.
m	Volume for 95th percentile queue is metered by upstream signal.

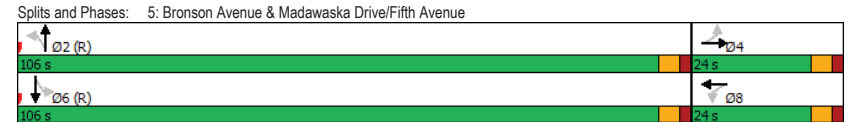

Appendix H

Synchro Intersection Worksheets – 2030 Future Background Conditions

Lanes, Volumes, Timings
1: Carling Avenue & Booth Street

2030 Future Background - AM Peak Hour
770-774 Bronson Ave

Lane Group	EBL	EBT	WBT	WBR	SBL	SBR
Lane Configurations	↔	↕	↕↔	↔	↔	↕
Traffic Volume (vph)	351	1165	806	142	197	139
Future Volume (vph)	351	1165	806	142	197	139
Satd. Flow (prot)	1658	3283	4535	0	1658	1427
Fit Permitted	0.950				0.950	
Satd. Flow (perm)	1575	3283	4535	0	1633	1258
Satd. Flow (RTOR)			32			139
Lane Group Flow (vph)	351	1165	948	0	197	139
Turn Type	Prot	NA	NA		Perm	Perm
Protected Phases	5	2	6			
Permitted Phases					4	4
Detector Phase	5	2	6		4	4
Switch Phase						
Minimum Initial (s)	5.0	10.0	10.0		10.0	10.0
Minimum Split (s)	10.9	22.5	29.7		39.0	39.0
Total Split (s)	34.0	81.0	47.0		39.0	39.0
Total Split (%)	28.3%	67.5%	39.2%		32.5%	32.5%
Yellow Time (s)	3.7	3.7	3.7		3.3	3.3
All-Red Time (s)	2.2	2.0	2.0		2.7	2.7
Lost Time Adjust (s)	0.0	0.0	0.0		0.0	0.0
Total Lost Time (s)	5.9	5.7	5.7		6.0	6.0
Lead/Lag	Lead		Lag			
Lead-Lag Optimize?	Yes		Yes			
Recall Mode	None	Max	C-Max		None	None
Act Effct Green (s)	27.2	75.3	42.2		33.0	33.0
Actuated g/C Ratio	0.23	0.63	0.35		0.28	0.28
v/c Ratio	0.93	0.57	0.59		0.44	0.31
Control Delay	78.3	14.2	32.6		39.6	7.5
Queue Delay	0.0	0.0	0.0		0.0	0.0
Total Delay	78.3	14.2	32.6		39.6	7.5
LOS	E	B	C		D	A
Approach Delay		29.1	32.6		26.3	
Approach LOS		C	C		C	
Queue Length 50th (m)	80.8	77.6	64.8		38.3	0.0
Queue Length 95th (m)	#134.2	95.6	79.3		60.6	15.0
Internal Link Dist (m)		107.6	286.6		178.3	
Turn Bay Length (m)	40.0					30.0
Base Capacity (vph)	388	2060	1614		449	446
Starvation Cap Reductn	0	0	0		0	0
Spillback Cap Reductn	0	0	0		0	0
Storage Cap Reductn	0	0	0		0	0
Reduced v/c Ratio	0.90	0.57	0.59		0.44	0.31

Intersection Summary	
Cycle Length:	120
Actuated Cycle Length:	120
Offset:	116 (97%), Referenced to phase 6:WBT, Start of Green
Natural Cycle:	90
Control Type:	Actuated-Coordinated

Lanes, Volumes, Timings
1: Carling Avenue & Booth Street

2030 Future Background - AM Peak Hour
770-774 Bronson Ave

Maximum v/c Ratio: 0.93	Intersection LOS: C
Intersection Signal Delay: 29.9	ICU Level of Service E
Intersection Capacity Utilization 82.4%	
Analysis Period (min) 15	
# 95th percentile volume exceeds capacity, queue may be longer.	
Queue shown is maximum after two cycles.	

Splits and Phases: 1: Carling Avenue & Booth Street

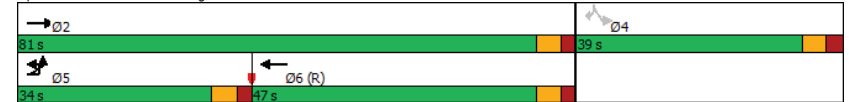

HCM 2010 TWSC
2: Cambridge Street & Carling Avenue

2030 Future Background - AM Peak Hour
770-774 Bronson Ave

Intersection												
Int Delay, s/veh	0.4											
Movement	EBL	EBT	EBR	WBL	WBT	WBR	NBL	NBT	NBR	SBL	SBT	SBR
Lane Configurations	↕↕↕			↕↕		↕			↕			↕
Traffic Vol, veh/h	0	1362	8	0	752	12	0	0	10	0	0	56
Future Vol, veh/h	0	1362	8	0	752	12	0	0	10	0	0	56
Conflicting Peds, #/hr	0	0	45	0	0	38	0	0	1	0	0	0
Sign Control	Free	Free	Free	Free	Free	Free	Stop	Stop	Stop	Stop	Stop	Stop
RT Channelized	-	-	None	-	-	None	-	-	None	-	-	None
Storage Length	-	-	1000	-	-	350	-	-	0	-	-	0
Veh in Median Storage, #	-	0	-	-	0	-	-	0	-	-	0	-
Grade, %	-	0	-	-	0	-	-	0	-	-	0	-
Peak Hour Factor	100	100	100	100	100	100	100	100	100	100	100	100
Heavy Vehicles, %	2	3	2	2	4	8	2	2	2	2	2	5
Mvmt Flow	0	1362	8	0	752	12	0	0	10	0	0	56
Major/Minor	Major1		Major2		Minor1		Minor2					
Conflicting Flow All	-	0	0	-	-	0	-	-	731	-	-	414
Stage 1	-	-	-	-	-	-	-	-	-	-	-	-
Stage 2	-	-	-	-	-	-	-	-	-	-	-	-
Critical Hdwy	-	-	-	-	-	-	-	-	7.14	-	-	7
Critical Hdwy Stg 1	-	-	-	-	-	-	-	-	-	-	-	-
Critical Hdwy Stg 2	-	-	-	-	-	-	-	-	-	-	-	-
Follow-up Hdwy	-	-	-	-	-	-	-	-	3.92	-	-	3.35
Pot Cap-1 Maneuver	0	-	-	0	-	-	0	0	312	0	0	579
Stage 1	0	-	-	0	-	-	0	0	-	0	0	-
Stage 2	0	-	-	0	-	-	0	0	-	0	0	-
Platoon blocked, %	-	-	-	-	-	-	-	-	-	-	-	-
Mov Cap-1 Maneuver	-	-	-	-	-	-	-	-	299	-	-	559
Mov Cap-2 Maneuver	-	-	-	-	-	-	-	-	-	-	-	-
Stage 1	-	-	-	-	-	-	-	-	-	-	-	-
Stage 2	-	-	-	-	-	-	-	-	-	-	-	-
Approach	EB		WB		NB		SB					
HCM Control Delay, s	0		0		17.5		12.2					
HCM LOS					C		B					
Minor Lane/Major Mvmt	NBLn1	EBT	EBR	WBT	WBR	SBLn1						
Capacity (veh/h)	299	-	-	-	-	559						
HCM Lane V/C Ratio	0.033	-	-	-	-	0.1						
HCM Control Delay (s)	17.5	-	-	-	-	12.2						
HCM Lane LOS	C	-	-	-	-	B						
HCM 95th %tile Q(veh)	0.1	-	-	-	-	0.3						

Lanes, Volumes, Timings
3: Bronson Avenue & Powell Avenue

2030 Future Background - AM Peak Hour
770-774 Bronson Ave

Lane Group	EBL	EBT	EBR	WBL	WBT	WBR	NBL	NBT	NBR	SBL	SBT	SBR
Lane Configurations		↕↕			↕↕			↕↕			↕↕	
Traffic Volume (vph)	180	25	87	17	53	17	45	1644	8	11	1074	73
Future Volume (vph)	180	25	87	17	53	17	45	1644	8	11	1074	73
Satd. Flow (prot)	0	1577	0	0	1642	0	0	3275	0	0	3244	0
Fit Permitted		0.772			0.915			0.871			0.928	
Satd. Flow (perm)	0	1214	0	0	1517	0	0	2855	0	0	3011	0
Satd. Flow (RTOR)		17			10			1			16	
Lane Group Flow (vph)	0	292	0	0	87	0	0	1697	0	0	1158	0
Turn Type	Perm	NA		Perm	NA		Perm	NA		Perm	NA	
Protected Phases		4			8			2			6	
Permitted Phases	4			8			2			6		
Detector Phase	4	4		8	8		2	2		6	6	
Switch Phase												
Minimum Initial (s)	10.0	10.0		10.0	10.0		10.0	10.0		10.0	10.0	
Minimum Split (s)	23.7	23.7		23.7	23.7		32.3	32.3		32.3	32.3	
Total Split (s)	26.0	26.0		26.0	26.0		84.0	84.0		84.0	84.0	
Total Split (%)	23.6%	23.6%		23.6%	23.6%		76.4%	76.4%		76.4%	76.4%	
Yellow Time (s)	3.0	3.0		3.0	3.0		3.3	3.3		3.3	3.3	
All-Red Time (s)	2.7	2.7		2.7	2.7		2.0	2.0		2.0	2.0	
Lost Time Adjust (s)		0.0			0.0			0.0			0.0	
Total Lost Time (s)		5.7			5.7			5.3			5.3	
Lead/Lag												
Lead-Lag Optimize?												
Recall Mode	None	None		None	None		C-Max	C-Max		C-Max	C-Max	
Act Effct Green (s)		20.3			20.3			78.7			78.7	
Actuated g/C Ratio		0.18			0.18			0.72			0.72	
v/c Ratio		1.23			0.30			0.83			0.54	
Control Delay		172.4			37.5			9.3			8.2	
Queue Delay		0.0			0.0			22.3			0.1	
Total Delay		172.4			37.5			31.6			8.3	
LOS		F			D			C			A	
Approach Delay		172.4			37.5			31.6			8.3	
Approach LOS		F			D			C			A	
Queue Length 50th (m)		~74.7			14.4			86.7			52.0	
Queue Length 95th (m)		#127.6			29.0			m60.0			66.0	
Internal Link Dist (m)		74.6			106.0			142.6			39.5	
Turn Bay Length (m)												
Base Capacity (vph)		237			288			2042			2158	
Starvation Cap Reductn		0			0			407			0	
Spillback Cap Reductn		0			0			0			165	
Storage Cap Reductn		0			0			0			0	
Reduced v/c Ratio		1.23			0.30			1.04			0.58	
Intersection Summary												
Cycle Length: 110												
Actuated Cycle Length: 110												
Offset: 21 (19%), Referenced to phase 2:NBTL and 6:SBTL, Start of Green												
Natural Cycle: 80												
Control Type: Actuated-Coordinated												

Lanes, Volumes, Timings
3: Bronson Avenue & Powell Avenue

2030 Future Background - AM Peak Hour
770-774 Bronson Ave

Maximum v/c Ratio: 1.23	Intersection Signal Delay: 36.1	Intersection LOS: D
Intersection Capacity Utilization 116.5%	ICU Level of Service H	
Analysis Period (min) 15		
~ Volume exceeds capacity, queue is theoretically infinite.		
Queue shown is maximum after two cycles.		
# 95th percentile volume exceeds capacity, queue may be longer.		
Queue shown is maximum after two cycles.		
m Volume for 95th percentile queue is metered by upstream signal.		

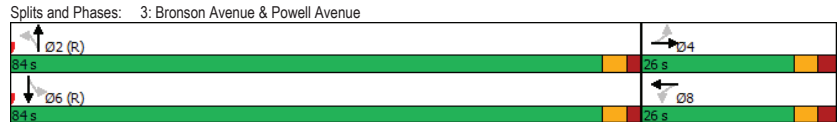

Lanes, Volumes, Timings
4: Bronson Avenue & Carling Avenue/Glebe Avenue

2030 Future Background - AM Peak Hour
770-774 Bronson Ave

Lane Group	EBL	EBT	EBR	WBL	WBT	WBR	NBL	NBT	NBR	SBL	SBT	SBR
Lane Configurations	↔	↕	↔				↕	↕			↕	↕
Traffic Volume (vph)	488	152	654	0	0	0	443	1397	38	0	1006	118
Future Volume (vph)	488	152	654	0	0	0	443	1397	38	0	1006	118
Satd. Flow (prot)	1530	1576	1483	0	0	0	3216	1730	0	0	3246	0
Fit Permitted	0.950	0.974					0.950					
Satd. Flow (perm)	1459	1537	1271	0	0	0	3187	1730	0	0	3246	0
Satd. Flow (RTOR)			30					3			13	
Lane Group Flow (vph)	317	323	654	0	0	0	443	1435	0	0	1124	0
Turn Type	Perm	NA	pm+ov				Prot	NA			NA	
Protected Phases		4	5				5	2			6	
Permitted Phases	4		4									
Detector Phase	4	4	5				5	2			6	
Switch Phase												
Minimum Initial (s)	10.0	10.0	5.0				5.0	10.0			10.0	
Minimum Split (s)	31.0	31.0	11.0				11.0	24.0			33.0	
Total Split (s)	31.0	31.0	34.0				34.0	79.0			45.0	
Total Split (%)	28.2%	28.2%	30.9%				30.9%	71.8%			40.9%	
Yellow Time (s)	3.3	3.3	3.3				3.3	3.3			3.3	
All-Red Time (s)	2.7	2.7	2.7				2.7	2.7			2.7	
Lost Time Adjust (s)	0.0	0.0	0.0				0.0	0.0			0.0	
Total Lost Time (s)	6.0	6.0	6.0				6.0	6.0			6.0	
Lead/Lag			Lead				Lead				Lag	
Lead-Lag Optimize?			Yes				Yes				Yes	
Recall Mode	None	None	Min				Min	C-Max			C-Max	
Act Effct Green (s)	25.0	25.0	52.2				27.3	73.0			39.8	
Actuated g/C Ratio	0.23	0.23	0.47				0.25	0.66			0.36	
v/c Ratio	0.96	0.93	0.97				0.56	1.25			0.95	
Control Delay	83.4	75.6	55.4				29.5	146.8			44.5	
Queue Delay	0.0	0.0	0.0				0.0	0.1			0.0	
Total Delay	83.4	75.6	55.4				29.5	147.0			44.5	
LOS	F	E	E				C	F			D	
Approach Delay		67.3						119.3			44.5	
Approach LOS		E						F			D	
Queue Length 50th (m)	71.1	71.7	105.5				42.7	~398.3			124.3	
Queue Length 95th (m)	#127.7	#126.5	#206.0				50.8	#479.1			m#162.6	
Internal Link Dist (m)		82.5				112.6		392.2			142.6	
Turn Bay Length (m)							40.0					
Base Capacity (vph)	331	349	681				818	1150			1182	
Starvation Cap Reductn	0	0	0				0	0			0	
Spillback Cap Reductn	0	0	0				0	37			0	
Storage Cap Reductn	0	0	0				0	0			0	
Reduced v/c Ratio	0.96	0.93	0.96				0.54	1.29			0.95	

Intersection Summary		
Cycle Length: 110		
Actuated Cycle Length: 110		
Offset: 53 (48%), Referenced to phase 2:NBT and 6:SBT, Start of Green		
Natural Cycle: 140		
Control Type: Actuated-Coordinated		

Lanes, Volumes, Timings 2030 Future Background - AM Peak Hour
 4: Bronson Avenue & Carling Avenue/Glebe Avenue 770-774 Bronson Ave

Maximum v/c Ratio: 1.25	Intersection LOS: F
Intersection Signal Delay: 84.1	ICU Level of Service H
Intersection Capacity Utilization 110.8%	
Analysis Period (min) 15	
~ Volume exceeds capacity, queue is theoretically infinite.	
Queue shown is maximum after two cycles.	
# 95th percentile volume exceeds capacity, queue may be longer.	
Queue shown is maximum after two cycles.	
m Volume for 95th percentile queue is metered by upstream signal.	

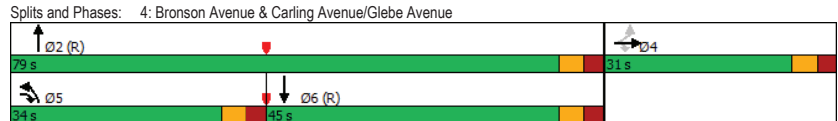

Lanes, Volumes, Timings 2030 Future Background - AM Peak Hour
 5: Bronson Avenue & Madawaska Drive/Fifth Avenue 770-774 Bronson Ave

Lane Group	EBL	EBT	EBR	WBL	WBT	WBR	NBL	NBT	NBR	SBL	SBT	SBR
Lane Configurations		↕			↕			↕			↕	
Traffic Volume (vph)	7	114	34	86	34	46	0	1723	34	22	1710	1
Future Volume (vph)	7	114	34	86	34	46	0	1723	34	22	1710	1
Satd. Flow (prot)	0	1617	0	0	1608	0	0	3302	0	0	3311	0
Fit Permitted		0.984			0.619						0.899	
Satd. Flow (perm)	0	1592	0	0	1006	0	0	3302	0	0	2980	0
Satd. Flow (RTOR)		12			16			4				
Lane Group Flow (vph)	0	155	0	0	166	0	0	1757	0	0	1733	0
Turn Type	Perm	NA		Perm	NA			NA		Perm	NA	
Protected Phases		4			8			2			6	
Permitted Phases	4			8						6		
Detector Phase	4	4		8	8			2		6	6	
Switch Phase												
Minimum Initial (s)	10.0	10.0		10.0	10.0			10.0		10.0	10.0	
Minimum Split (s)	23.3	23.3		23.3	23.3			34.3		34.3	34.3	
Total Split (s)	28.0	28.0		28.0	28.0			82.0		82.0	82.0	
Total Split (%)	25.5%	25.5%		25.5%	25.5%			74.5%		74.5%	74.5%	
Yellow Time (s)	3.3	3.3		3.3	3.3			3.3		3.3	3.3	
All-Red Time (s)	2.0	2.0		2.0	2.0			2.0		2.0	2.0	
Lost Time Adjust (s)		0.0			0.0			0.0		0.0	0.0	
Total Lost Time (s)		5.3			5.3			5.3		5.3	5.3	
Lead/Lag												
Lead-Lag Optimize?												
Recall Mode	None	None		None	None			C-Max		C-Max	C-Max	
Act Effct Green (s)		19.3			19.3			80.1			80.1	
Actuated g/C Ratio		0.18			0.18			0.73			0.73	
v/c Ratio		0.54			0.88			0.73			0.80	
Control Delay		44.3			79.3			11.6			8.8	
Queue Delay		0.0			0.0			0.0			0.0	
Total Delay		44.3			79.3			11.6			8.8	
LOS		D			E			B			A	
Approach Delay		44.3			79.3			11.6			8.8	
Approach LOS		D			E			B			A	
Queue Length 50th (m)		27.4			31.0			109.1			56.0	
Queue Length 95th (m)		47.1			#63.6			141.7			m193.4	
Internal Link Dist (m)		190.1			132.1			94.8			392.2	
Turn Bay Length (m)												
Base Capacity (vph)		338			220			2405			2169	
Starvation Cap Reductn		0			0			0			0	
Spillback Cap Reductn		0			0			0			0	
Storage Cap Reductn		0			0			0			0	
Reduced v/c Ratio		0.46			0.75			0.73			0.80	

Intersection Summary		
Cycle Length:	110	
Actuated Cycle Length:	110	
Offset:	70 (64%), Referenced to phase 2:NBT and 6:SBTL, Start of Green	
Natural Cycle:	80	
Control Type:	Actuated-Coordinated	

Lanes, Volumes, Timings
 5: Bronson Avenue & Madawaska Drive/Fifth Avenue

2030 Future Background - AM Peak Hour
 770-774 Bronson Ave

Maximum v/c Ratio: 0.88	Intersection LOS: B
Intersection Signal Delay: 14.6	ICU Level of Service G
Intersection Capacity Utilization 105.4%	
Analysis Period (min) 15	
# 95th percentile volume exceeds capacity, queue may be longer.	
Queue shown is maximum after two cycles.	
m Volume for 95th percentile queue is metered by upstream signal.	

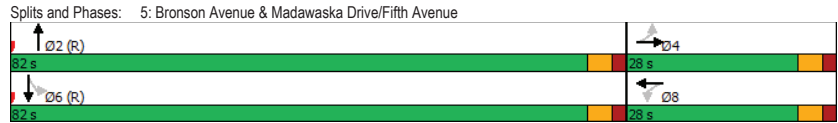

Lanes, Volumes, Timings
 1: Carling Avenue & Booth Street

2030 Future Background-PM Peak Hour
 770-774 Bronson Ave

Lane Group	EBL	EBT	WBT	WBR	SBL	SBR
Lane Configurations	↔	↕	↕↕	↕	↔	↕
Traffic Volume (vph)	257	936	1240	72	420	697
Future Volume (vph)	257	936	1240	72	420	697
Satd. Flow (prot)	1658	3283	4674	0	1658	1427
Fit Permitted	0.950				0.950	
Satd. Flow (perm)	1594	3283	4674	0	1632	1230
Satd. Flow (RTOR)			9			82
Lane Group Flow (vph)	257	936	1312	0	420	697
Turn Type	Prot	NA	NA		Perm	Perm
Protected Phases	5	2	6			
Permitted Phases					4	4
Detector Phase	5	2	6		4	4
Switch Phase						
Minimum Initial (s)	5.0	10.0	10.0		10.0	10.0
Minimum Split (s)	10.9	22.5	29.7		39.0	39.0
Total Split (s)	23.0	90.0	67.0		40.0	40.0
Total Split (%)	17.7%	69.2%	51.5%		30.8%	30.8%
Yellow Time (s)	3.7	3.7	3.7		3.3	3.3
All-Red Time (s)	2.2	2.0	2.0		2.7	2.7
Lost Time Adjust (s)	0.0	0.0	0.0		0.0	0.0
Total Lost Time (s)	5.9	5.7	5.7		6.0	6.0
Lead/Lag	Lead		Lag			
Lead-Lag Optimize?	Yes		Yes			
Recall Mode	None	Max	C-Max		None	None
Act Effct Green (s)	17.1	84.3	61.3		34.0	34.0
Actuated g/C Ratio	0.13	0.65	0.47		0.26	0.26
v/c Ratio	1.18	0.44	0.59		0.99	1.82
Control Delay	165.9	12.0	43.7		88.1	407.4
Queue Delay	0.0	0.0	0.0		0.0	0.0
Total Delay	165.9	12.0	43.7		88.1	407.4
LOS	F	B	D		F	F
Approach Delay		45.2	43.7		287.3	
Approach LOS		D	D		F	
Queue Length 50th (m)	-78.8	57.7	111.2		107.5	-255.2
Queue Length 95th (m)	#131.4	71.1	m126.6		#172.2	#328.8
Internal Link Dist (m)		107.6	286.6		178.3	
Turn Bay Length (m)	40.0					30.0
Base Capacity (vph)	218	2128	2208		426	382
Starvation Cap Reductn	0	0	0		0	0
Spillback Cap Reductn	0	0	0		0	0
Storage Cap Reductn	0	0	0		0	0
Reduced v/c Ratio	1.18	0.44	0.59		0.99	1.82

Intersection Summary

Cycle Length: 130
Actuated Cycle Length: 130
Offset: 110 (85%), Referenced to phase 6:WBT, Start of Green
Natural Cycle: 100
Control Type: Actuated-Coordinated

Lanes, Volumes, Timings
1: Carling Avenue & Booth Street

2030 Future Background-PM Peak Hour
770-774 Bronson Ave

Maximum v/c Ratio: 1.82	
Intersection Signal Delay: 119.3	Intersection LOS: F
Intersection Capacity Utilization 107.9%	ICU Level of Service G
Analysis Period (min) 15	
~ Volume exceeds capacity, queue is theoretically infinite.	
Queue shown is maximum after two cycles.	
# 95th percentile volume exceeds capacity, queue may be longer.	
Queue shown is maximum after two cycles.	
m Volume for 95th percentile queue is metered by upstream signal.	

Splits and Phases: 1: Carling Avenue & Booth Street

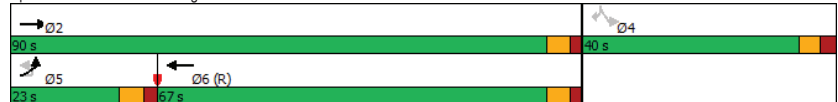

HCM 2010 TWSC
2: Cambridge Street & Carling Avenue

2030 Future Background-PM Peak Hour
770-774 Bronson Ave

Intersection												
Int Delay, s/veh	2.5											
Movement	EBL	EBT	EBR	WBL	WBT	WBR	NBL	NBT	NBR	SBL	SBT	SBR
Lane Configurations		↑↑↑			↑↑	↑				↑		↑
Traffic Vol, veh/h	0	1251	17	0	735	6	0	0	41	0	0	291
Future Vol, veh/h	0	1251	17	0	735	6	0	0	41	0	0	291
Conflicting Peds, #/hr	0	0	42	0	0	33	0	0	4	0	0	1
Sign Control	Free	Free	Free	Free	Free	Free	Stop	Stop	Stop	Stop	Stop	Stop
RT Channelized	-	-	None	-	-	None	-	-	None	-	-	None
Storage Length	-	-	1000	-	-	350	-	-	0	-	-	0
Veh in Median Storage, #	-	0	-	-	0	-	-	0	-	-	0	-
Grade, %	-	0	-	-	0	-	-	0	-	-	0	-
Peak Hour Factor	100	100	100	100	100	100	100	100	100	100	100	100
Heavy Vehicles, %	2	3	2	2	4	8	2	2	2	2	2	5
Mvmt Flow	0	1251	17	0	735	6	0	0	41	0	0	291

Major/Minor	Major1	Major2	Minor1	Minor2
Conflicting Flow All	-	0	0	-
Stage 1	-	-	-	-
Stage 2	-	-	-	-
Critical Hdwy	-	-	-	-
Critical Hdwy Stg 1	-	-	-	-
Critical Hdwy Stg 2	-	-	-	-
Follow-up Hdwy	-	-	-	-
Pot Cap-1 Maneuver	0	-	0	-
Stage 1	0	-	0	-
Stage 2	0	-	0	-
Platoon blocked, %	-	-	-	-
Mov Cap-1 Maneuver	-	-	-	-
Mov Cap-2 Maneuver	-	-	-	-
Stage 1	-	-	-	-
Stage 2	-	-	-	-

Approach	EB	WB	NB	SB
HCM Control Delay, s	0	0	17.8	17.7
HCM LOS			C	C

Minor Lane/Major Mvmt	NBLn1	EBT	EBR	WBT	WBR	SBLn1
Capacity (veh/h)	323	-	-	-	-	571
HCM Lane V/C Ratio	0.127	-	-	-	-	0.51
HCM Control Delay (s)	17.8	-	-	-	-	17.7
HCM Lane LOS	C	-	-	-	-	C
HCM 95th %tile Q(veh)	0.4	-	-	-	-	2.9

Lanes, Volumes, Timings
3: Bronson Avenue & Powell Avenue

2030 Future Background-PM Peak Hour
770-774 Bronson Ave

Lane Group	EBL	EBT	EBR	WBL	WBT	WBR	NBL	NBT	NBR	SBL	SBT	SBR
Lane Configurations		↔			↔			↔			↔	
Traffic Volume (vph)	141	82	150	58	89	5	79	1214	19	6	945	57
Future Volume (vph)	141	82	150	58	89	5	79	1214	19	6	945	57
Satd. Flow (prot)	0	1575	0	0	1699	0	0	3262	0	0	3248	0
Fit Permitted		0.782			0.684			0.756			0.946	
Satd. Flow (perm)	0	1239	0	0	1184	0	0	2472	0	0	3073	0
Satd. Flow (RTOR)		25			1			2			10	
Lane Group Flow (vph)	0	373	0	0	152	0	0	1312	0	0	1008	0
Turn Type	Perm	NA		Perm	NA		Perm	NA		Perm	NA	
Protected Phases		4			8			2			6	
Permitted Phases	4			8			2			6		
Detector Phase	4	4		8	8		2	2		6	6	
Switch Phase												
Minimum Initial (s)	10.0	10.0		10.0	10.0		10.0	10.0		10.0	10.0	
Minimum Split (s)	23.7	23.7		23.7	23.7		32.3	32.3		32.3	32.3	
Total Split (s)	38.0	38.0		38.0	38.0		92.0	92.0		92.0	92.0	
Total Split (%)	29.2%	29.2%		29.2%	29.2%		70.8%	70.8%		70.8%	70.8%	
Yellow Time (s)	3.0	3.0		3.0	3.0		3.3	3.3		3.3	3.3	
All-Red Time (s)	2.7	2.7		2.7	2.7		2.0	2.0		2.0	2.0	
Lost Time Adjust (s)		0.0			0.0			0.0			0.0	
Total Lost Time (s)		5.7			5.7			5.3			5.3	
Lead/Lag												
Lead-Lag Optimize?												
Recall Mode	None	None		None	None		C-Max	C-Max		C-Max	C-Max	
Act Effct Green (s)		32.3			32.3			86.7			86.7	
Actuated g/C Ratio		0.25			0.25			0.67			0.67	
v/c Ratio		1.14			0.52			0.80			0.49	
Control Delay		135.9			49.1			17.8			11.6	
Queue Delay		0.0			0.0			12.5			0.0	
Total Delay		135.9			49.1			30.3			11.6	
LOS		F			D			C			B	
Approach Delay		135.9			49.1			30.3			11.6	
Approach LOS		F			D			C			B	
Queue Length 50th (m)		-106.8			33.5			114.6			61.5	
Queue Length 95th (m)		#167.9			55.9			m119.8			75.9	
Internal Link Dist (m)		74.6			106.0			142.6			39.5	
Turn Bay Length (m)												
Base Capacity (vph)		326			294			1649			2052	
Starvation Cap Reductn		0			0			338			0	
Spillback Cap Reductn		0			0			0			44	
Storage Cap Reductn		0			0			0			0	
Reduced v/c Ratio		1.14			0.52			1.00			0.50	

Intersection Summary	
Cycle Length:	130
Actuated Cycle Length:	130
Offset:	46 (35%), Referenced to phase 2:NBT and 6:SBTL, Start of Green
Natural Cycle:	70
Control Type:	Actuated-Coordinated

Lanes, Volumes, Timings
3: Bronson Avenue & Powell Avenue

2030 Future Background-PM Peak Hour
770-774 Bronson Ave

Maximum v/c Ratio: 1.14	Intersection Signal Delay: 38.5	Intersection LOS: D
Intersection Capacity Utilization 111.4%	ICU Level of Service H	
Analysis Period (min) 15		
~ Volume exceeds capacity, queue is theoretically infinite.		
Queue shown is maximum after two cycles.		
# 95th percentile volume exceeds capacity, queue may be longer.		
Queue shown is maximum after two cycles.		
m Volume for 95th percentile queue is metered by upstream signal.		

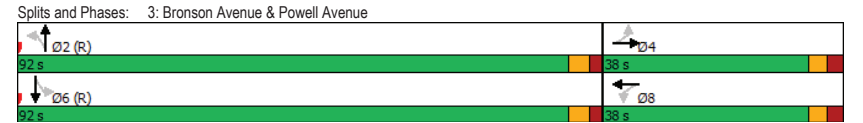

Lanes, Volumes, Timings
 4: Bronson Avenue & Carling Avenue/Glebe Avenue
 2030 Future Background-PM Peak Hour
 770-774 Bronson Ave

Lane Group	EBL	EBT	EBR	WBL	WBT	WBR	NBL	NBT	NBR	SBL	SBT	SBR
Lane Configurations	↔	↔	↔	↔	↔	↔	↔	↔	↔	↔	↔	↔
Traffic Volume (vph)	293	133	791	0	0	0	504	1268	26	0	1040	104
Future Volume (vph)	293	133	791	0	0	0	504	1268	26	0	1040	104
Satd. Flow (prot)	1530	1589	1483	0	0	0	3216	1733	0	0	3253	0
Fit Permitted	0.950	0.981					0.950					
Satd. Flow (perm)	1456	1560	1406	0	0	0	3179	1733	0	0	3253	0
Satd. Flow (RTOR)			63					2				12
Lane Group Flow (vph)	211	215	791	0	0	0	504	1294	0	0	1144	0
Turn Type	Perm	NA	pm+ov				Prot	NA			NA	
Protected Phases		4	5				5	2				6
Permitted Phases	4		4									
Detector Phase	4	4	5				5	2				6
Switch Phase												
Minimum Initial (s)	10.0	10.0	5.0				5.0	10.0				10.0
Minimum Split (s)	31.0	31.0	11.0				11.0	24.0				33.0
Total Split (s)	31.0	31.0	26.0				26.0	99.0				73.0
Total Split (%)	23.8%	23.8%	20.0%				20.0%	76.2%				56.2%
Yellow Time (s)	3.3	3.3	3.3				3.3	3.3				3.3
All-Red Time (s)	2.7	2.7	2.7				2.7	2.7				2.7
Lost Time Adjust (s)	0.0	0.0	0.0				0.0	0.0				0.0
Total Lost Time (s)	6.0	6.0	6.0				6.0	6.0				6.0
Lead/Lag			Lead				Lead					Lag
Lead-Lag Optimize?			Yes				Yes					Yes
Recall Mode	None	None	Min				Min	C-Max				C-Max
Act Effct Green (s)	22.4	22.4	45.0				22.6	95.6				67.0
Actuated g/C Ratio	0.17	0.17	0.35				0.17	0.74				0.52
v/c Ratio	0.84	0.80	1.46				0.90	1.02				0.68
Control Delay	64.7	58.9	244.8				63.5	51.0				18.4
Queue Delay	0.0	0.0	0.0				0.0	17.1				0.2
Total Delay	64.7	58.9	244.8				63.5	68.1				18.6
LOS	E	E	F				E	E				B
Approach Delay		180.8						66.8				18.6
Approach LOS		F						E				B
Queue Length 50th (m)	56.5	56.5	~207.7				~70.7	~266.7				61.7
Queue Length 95th (m)	m77.0	m76.8	m#265.0				m#103.4	m#426.6				m79.4
Internal Link Dist (m)		82.5				112.6		392.2				142.6
Turn Bay Length (m)							40.0					
Base Capacity (vph)		280	300	541			558	1274				1682
Starvation Cap Reductn	0	0	0				0	0				93
Spillback Cap Reductn	0	0	0				0	58				0
Storage Cap Reductn	0	0	0				0	0				0
Reduced v/c Ratio	0.75	0.72	1.46				0.90	1.06				0.72

Intersection Summary
 Cycle Length: 130
 Actuated Cycle Length: 130
 Offset: 46 (35%), Referenced to phase 2:NBT and 6:SBT, Start of Green
 Natural Cycle: 130
 Control Type: Actuated-Coordinated

Lanes, Volumes, Timings
 4: Bronson Avenue & Carling Avenue/Glebe Avenue
 2030 Future Background-PM Peak Hour
 770-774 Bronson Ave

Maximum v/c Ratio: 1.46
 Intersection Signal Delay: 86.9
 Intersection Capacity Utilization 99.0%
 Analysis Period (min) 15
 ~ Volume exceeds capacity, queue is theoretically infinite.
 Queue shown is maximum after two cycles.
 # 95th percentile volume exceeds capacity, queue may be longer.
 Queue shown is maximum after two cycles.
 m Volume for 95th percentile queue is metered by upstream signal.

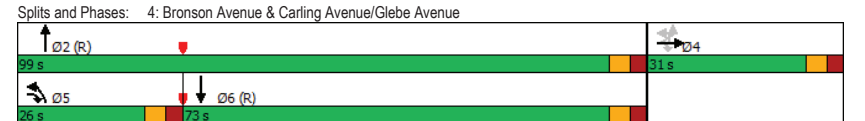

Lanes, Volumes, Timings
 2030 Future Background-PM Peak Hour
 5: Bronson Avenue & Madawaska Drive/Fifth Avenue
 770-774 Bronson Ave

Lane Group	EBL	EBT	EBR	WBL	WBT	WBR	NBL	NBT	NBR	SBL	SBT	SBR
Lane Configurations		↕			↕			↕			↕	
Traffic Volume (vph)	3	129	91	137	22	27	9	1640	27	19	1536	4
Future Volume (vph)	3	129	91	137	22	27	9	1640	27	19	1536	4
Satd. Flow (prot)	0	1520	0	0	1637	0	0	3305	0	0	3310	0
Fit Permitted		0.997			0.264			0.942			0.905	
Satd. Flow (perm)	0	1517	0	0	442	0	0	3113	0	0	2999	0
Satd. Flow (RTOR)		22			5			4			1	
Lane Group Flow (vph)	0	223	0	0	186	0	0	1676	0	0	1559	0
Turn Type	Perm	NA		Perm	NA		Perm	NA		Perm	NA	
Protected Phases		4			8			2			6	
Permitted Phases	4			8			2			6		
Detector Phase	4	4		8	8		2	2		6	6	
Switch Phase												
Minimum Initial (s)	10.0	10.0		10.0	10.0		10.0	10.0		10.0	10.0	
Minimum Split (s)	23.3	23.3		23.3	23.3		34.3	34.3		34.3	34.3	
Total Split (s)	24.0	24.0		24.0	24.0		106.0	106.0		106.0	106.0	
Total Split (%)	18.5%	18.5%		18.5%	18.5%		81.5%	81.5%		81.5%	81.5%	
Yellow Time (s)	3.3	3.3		3.3	3.3		3.3	3.3		3.3	3.3	
All-Red Time (s)	2.0	2.0		2.0	2.0		2.0	2.0		2.0	2.0	
Lost Time Adjust (s)		0.0			0.0			0.0			0.0	
Total Lost Time (s)		5.3			5.3			5.3			5.3	
Lead/Lag												
Lead-Lag Optimize?												
Recall Mode	None	None		None	None		C-Max	C-Max		C-Max	C-Max	
Act Effct Green (s)		18.7			18.7			100.7			100.7	
Actuated g/C Ratio		0.14			0.14			0.77			0.77	
v/c Ratio		0.94			2.78			0.69			0.67	
Control Delay		94.7			859.7			9.0			7.0	
Queue Delay		0.0			0.0			0.0			0.0	
Total Delay		94.7			859.7			9.0			7.0	
LOS		F			F			A			A	
Approach Delay		94.7			859.7			9.0			7.0	
Approach LOS		F			F			A			A	
Queue Length 50th (m)		52.1			~80.8			93.8			78.0	
Queue Length 95th (m)		#101.1			#128.3			114.4			m71.5	
Internal Link Dist (m)		190.1			132.1			94.8			392.2	
Turn Bay Length (m)												
Base Capacity (vph)		237			67			2412			2323	
Starvation Cap Reductn		0			0			0			0	
Spillback Cap Reductn		0			0			0			0	
Storage Cap Reductn		0			0			0			0	
Reduced v/c Ratio		0.94			2.78			0.69			0.67	

Intersection Summary	
Cycle Length:	130
Actuated Cycle Length:	130
Offset:	55 (42%), Referenced to phase 2:NBT and 6:SBTL, Start of Green
Natural Cycle:	80
Control Type:	Actuated-Coordinated

Lanes, Volumes, Timings
 2030 Future Background-PM Peak Hour
 5: Bronson Avenue & Madawaska Drive/Fifth Avenue
 770-774 Bronson Ave

Maximum v/c Ratio:	2.78
Intersection Signal Delay:	56.8
Intersection Capacity Utilization:	99.6%
Analysis Period (min):	15
Intersection LOS:	E
ICU Level of Service:	F
~ Volume exceeds capacity, queue is theoretically infinite. Queue shown is maximum after two cycles.	
# 95th percentile volume exceeds capacity, queue may be longer. Queue shown is maximum after two cycles.	
m Volume for 95th percentile queue is metered by upstream signal.	

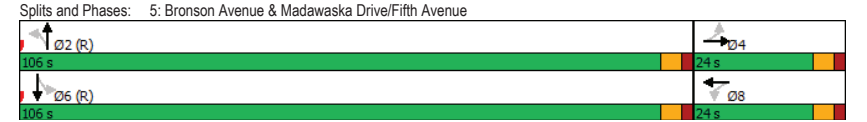

Appendix I

Turning Templates

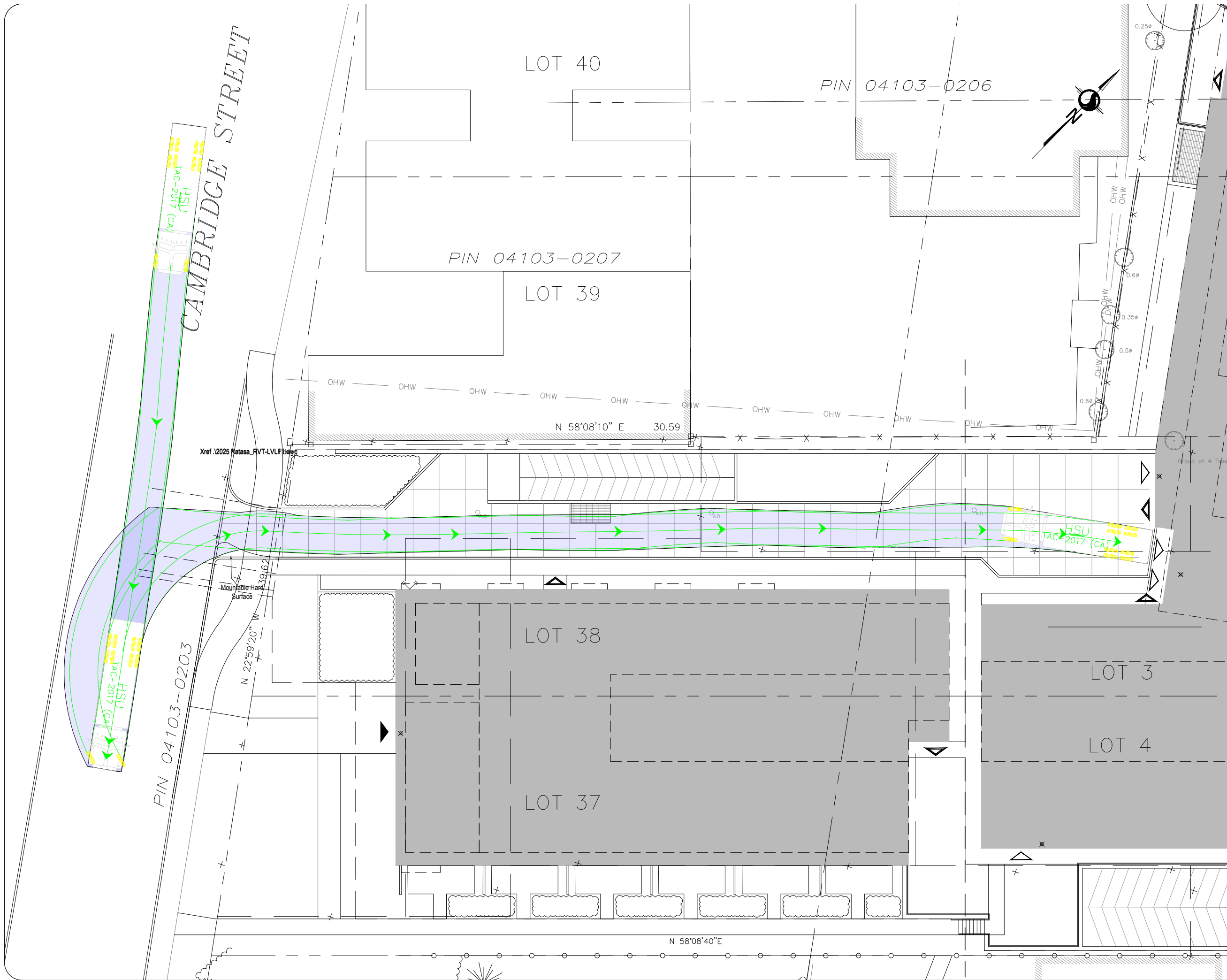

Notes:

HSU

Width : 2.60 meters
 Track : 2.60
 Lock to Lock Time : 6.0
 Steering Angle : 40.0

02	Issued for Review	AN	2022-08-22
01	Issued for Review	AN	2022-07-18
REV:	DESCRIPTION:	BY:	DATE:
STATUS:			

CGH Transportation
 6 Plaza Court
 Ottawa, ON
 K2H 7W1
 (343) 999-9117

CLIENT: **Katasa Group**
 69, rue Jean-Proulx unité #301
 Gatineau (Québec)
 J8Z 1W2

ARCHITECT:

SITE: **770-774 Bronson**

TITLE: **Turning Movement Analysis
 HSU Turning Movements (1)**

SCALE AT A3:	DATE:	DRAWN:	CHECKED:
NTS	2022-08-22	AN	AH
PROJECT NO:	DRAWING NO:	REVISION:	
2020-064	001	02	

CAMBRIDGE STREET

LOT 40

PIN 04103-0206

PIN 04103-0207

LOT 39

N 58°08'10" E 30.59

LOT 38

LOT 3

LOT 37

LOT 4

N 58°08'40" E

Notes:

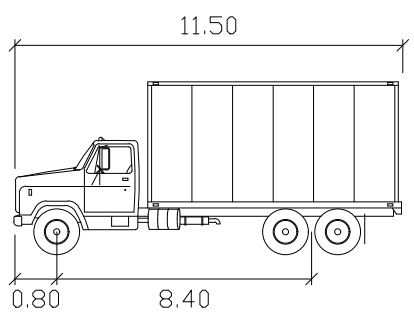

HSU
 meters
 Width : 2.60
 Track : 2.60
 Lock to Lock Time : 6.0
 Steering Angle : 40.0

02	Issued for Review	AN	2022-08-22
01	Issued for Review	AN	2022-07-18
REV:	DESCRIPTION:	BY:	DATE:
STATUS:			

CGH Transportation
 6 Plaza Court
 Ottawa, ON
 K2H 7W1
 (343) 999-9117

CLIENT: **Katasa Group**
 69, rue Jean-Proulx unité #301
 Gatineau (Québec)
 J8Z 1W2

SITE:
770-774 Bronson

TITLE:
**Turning Movement Analysis
 HSU Turning Movements (2)**

SCALE AT A3:	DATE:	DRAWN:	CHECKED:
NTS	2022-08-22	AN	AH
PROJECT NO:	DRAWING NO:	REVISION:	
2020-064	002	02	

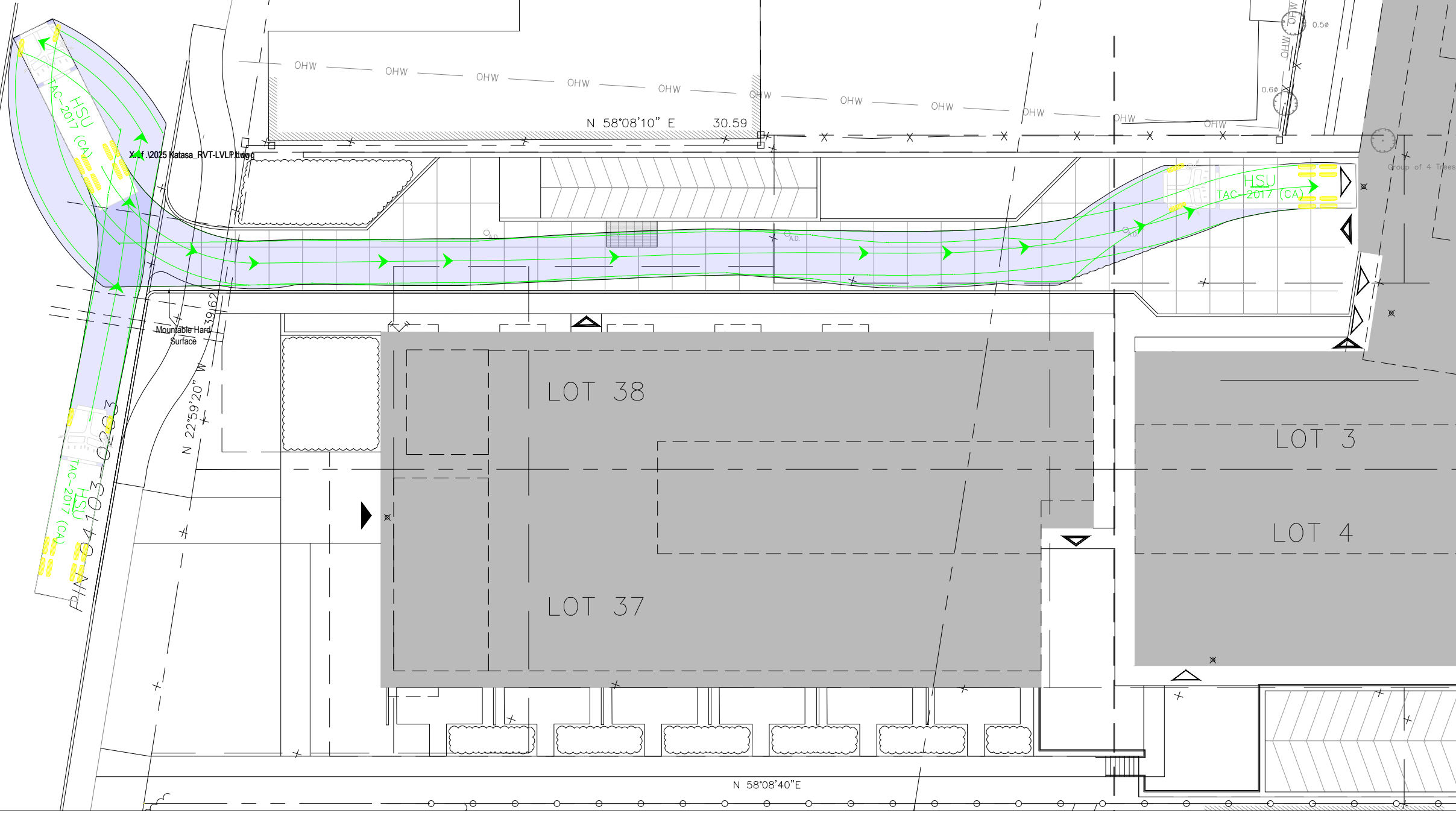

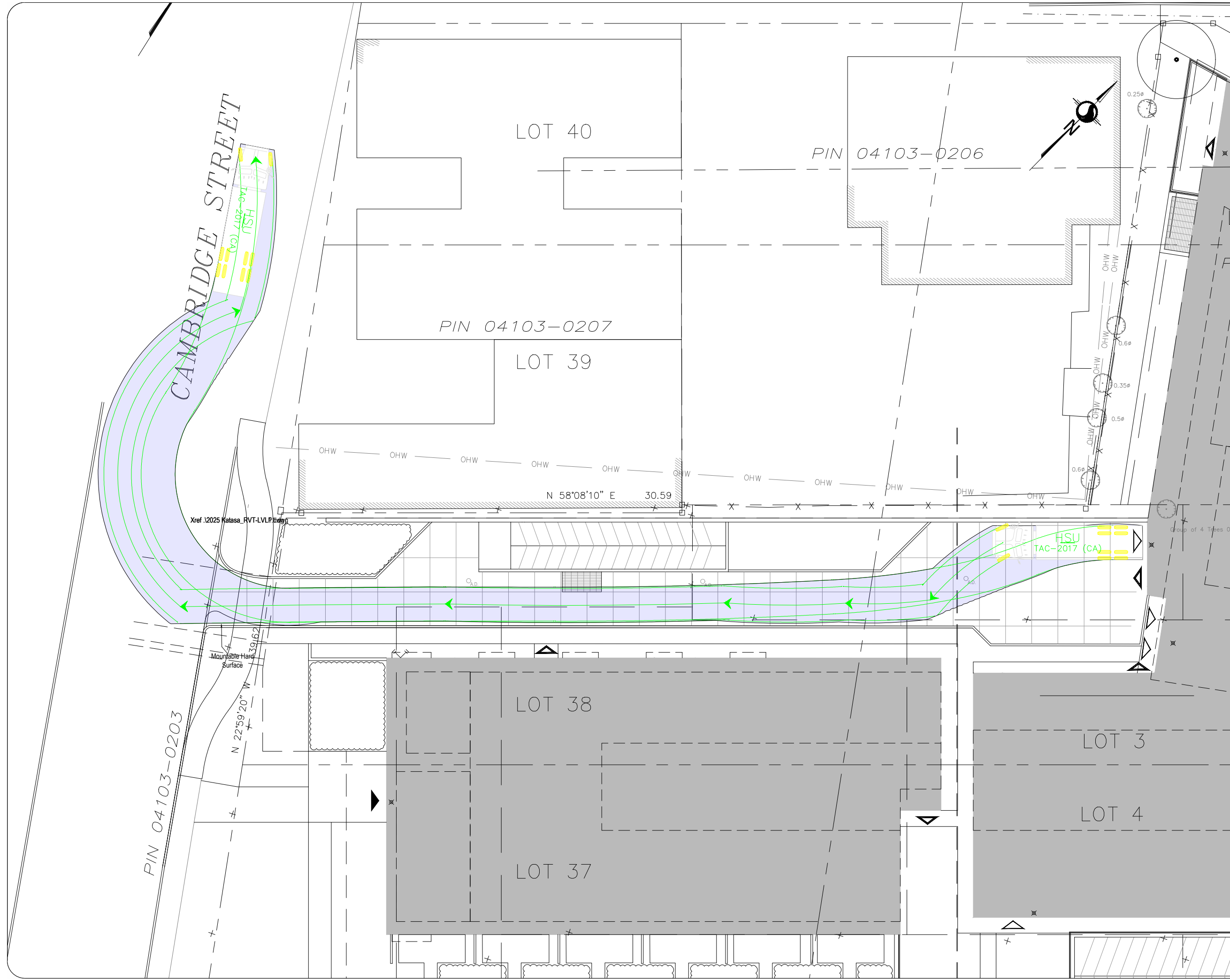

Notes:

HSU

Width : 2.60 meters
 Track : 2.60
 Lock to Lock Time : 6.0
 Steering Angle : 40.0

02	Issued for Review	AN	2022-08-22
01	Issued for Review	AN	2022-07-18
REV:	DESCRIPTION:	BY:	DATE:
STATUS:			

CGH Transportation
 6 Plaza Court
 Ottawa, ON
 K2H 7W1
 (343) 999-9117

CLIENT: Katasa Group
 69, rue Jean-Proulx unité #301
 Gatineau (Québec)
 J8Z 1W2

ARCHITECT:

SITE: 770-774 Bronson

TITLE: Turning Movement Analysis
 HSU Turning Movements (3)

SCALE AT A3:	DATE:	DRAWN:	CHECKED:
NTS	2022-08-22	AN	AH
PROJECT NO:	DRAWING NO:	REVISION:	
2020-064	003	02	

CAMBRIDGE STREET

LOT 40

PIN 04103-0207

LOT 39

N 58°08'10" E 30.59

Xref. \2025 Katasa_RVT-LVLP.dwg

Honda Accord 2017
CITY - PASSENGER

Mountable Hard Surface

LOT 38

23-0203

N 22°59'20" W

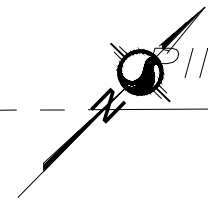

Notes:

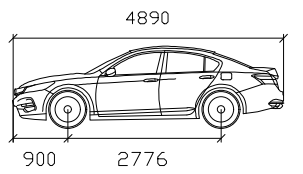

Honda Accord 2017
 Width : 1849 mm
 Track : 1827
 Lock to Lock Time : 6.0
 Steering Angle : 31.9

02	Issued for Review	AN	2022-08-22
01	Issued for Review	AN	2022-07-18
REV:	DESCRIPTION:	BY:	DATE:
STATUS:			

CGH Transportation
 6 Plaza Court
 Ottawa, ON
 K2H 7W1
 (343) 999-9117

CLIENT: **Katasa Group**
 69, rue Jean-Proulx unité #301
 Gatineau (Québec)
 J8Z 1W2

ARCHITECT:

SITE:
770-774 Bronson

TITLE:
**Turning Movement Analysis
 P Turning Movements (1)**

SCALE AT A3: NTS	DATE: 2022-08-22	DRAWN: AN	CHECKED: AH
PROJECT NO: 2020-064	DRAWING NO: 004	REVISION: 02	

Appendix J

MMLOS Analysis

Multi-Modal Level of Service - Segments Form

Consultant	CGH Transportation Inc.
Scenario	Existing/Future Conditions
Comments	

Project Date	2020-64
	2020-10-31

SEGMENTS		Street A	Cambridge St bwtm Carling Ave & Frederick Pl 1	Carling Ave btwn Cambridge St & Bronson Ave 2	Bronson Ave btwn Carling Ave & First Ave 3
Pedestrian	Sidewalk Width	F	1.8 m	1.5 m	1.5 m
	Boulevard Width		< 0.5 m	< 0.5 m	< 0.5 m
	Avg Daily Curb Lane Traffic Volume		≤ 3000	> 3000	> 3000
	Operating Speed		> 50 to 60 km/h	> 60 km/h	> 60 km/h
	On-Street Parking		yes	no	no
	Exposure to Traffic PLoS		C	F	F
	Effective Sidewalk Width				
Pedestrian Volume					
Crowding PLoS	A	A	A		
Level of Service	C	F	F		
Bicycle	Type of Cycling Facility	F	Mixed Traffic	Mixed Traffic	Mixed Traffic
	Number of Travel Lanes		≤ 2 (no centreline)	≥ 6 lanes total	4-5 lanes total
	Operating Speed		≤ 40 km/h	≥ 50 to 60 km/h	≥ 50 to 60 km/h
	# of Lanes & Operating Speed LoS		A	F	E
	Bike Lane (+ Parking Lane) Width				
	Bike Lane Width LoS		-	-	-
	Bike Lane Blockages				
	Blockage LoS		-	-	-
	Median Refuge Width (no median = < 1.8 m)		< 1.8 m refuge	< 1.8 m refuge	< 1.8 m refuge
	No. of Lanes at Unsignalized Crossing		≤ 3 lanes	≤ 3 lanes	≤ 3 lanes
Sidestreet Operating Speed	≤ 40 km/h	≤ 40 km/h	≤ 40 km/h		
Unsignalized Crossing - Lowest LoS	A	A	A		
Level of Service	A	F	E		
Transit	Facility Type	D		Mixed Traffic	Mixed Traffic
	Friction or Ratio Transit:Posted Speed			Vt/Vp ≥ 0.8	Vt/Vp ≥ 0.8
	Level of Service		-	D	D
Truck	Truck Lane Width	A		≤ 3.5 m	≤ 3.5 m
	Travel Lanes per Direction			> 1	> 1
	Level of Service		-	A	A

Multi-Modal Level of Service - Intersections Form

Consultant
Scenario
Comments

CGH Transportation Inc.
Existing Conditions

Project
Date

2020-64
2020-10-31

Unlocked Rows for Replicating

INTERSECTIONS		Carling Ave at Booth St				Bronson Ave at Powell Ave				Bronson Ave at Carling Ave / Glebe Ave				Bronson Ave at Fifth Ave / Madawaska Dr			
Crossing Side		NORTH	SOUTH	EAST	WEST	NORTH	SOUTH	EAST	WEST	NORTH	SOUTH	EAST	WEST	NORTH	SOUTH	EAST	WEST
Pedestrian	Lanes	5	0-2	8	8	4	4	3	4	5	6	0-2	7	5	5	4	4
	Median	No Median - 2.4 m	Median > 2.4 m	Median > 2.4 m	No Median - 2.4 m	No Median - 2.4 m	No Median - 2.4 m	No Median - 2.4 m	No Median - 2.4 m	No Median - 2.4 m	No Median - 2.4 m	No Median - 2.4 m	No Median - 2.4 m	No Median - 2.4 m	No Median - 2.4 m	No Median - 2.4 m	No Median - 2.4 m
	Conflicting Left Turns	Protected	No left turn / Prohib.	Protected	No left turn / Prohib.	Permissive	Permissive	Permissive	Permissive	No left turn / Prohib.	Permissive	No left turn / Prohib.	Protected	Permissive	Permissive	Permissive	No left turn / Prohib.
	Conflicting Right Turns	Permissive or yield control	No right turn	No right turn	Permissive or yield control	Permissive or yield control	Permissive or yield control	Permissive or yield control	Permissive or yield control	No right turn	Protected/ Permissive	Permissive or yield control	Permissive or yield control	Permissive or yield control	Permissive or yield control	Permissive or yield control	Permissive or yield control
	Right Turns on Red (RTOR) ?	RTOR allowed	RTOR prohibited	RTOR prohibited	RTOR allowed	RTOR allowed	RTOR allowed	RTOR allowed	RTOR allowed	RTOR prohibited	RTOR allowed	RTOR allowed	RTOR allowed	RTOR allowed	RTOR allowed	RTOR allowed	RTOR allowed
	Ped Signal Leading Interval?	No	No	No	No	No	No	Yes	Yes	No	No	Yes	Yes	No	No	No	No
	Right Turn Channel	No Channel	No Right Turn	No Right Turn	No Channel	No Channel	No Channel	No Channel	No Channel	No Right Turn	No Channel	No Channel	No Channel	No Channel	No Channel	No Channel	No Channel
	Corner Radius	3-5m	No Right Turn	No Right Turn	3-5m	3-5m	3-5m	5-10m	3-5m	No Right Turn	5-10m	5-10m	5-10m	3-5m	3-5m	3-5m	3-5m
	Crosswalk Type	Std transverse markings	Raised crosswalk	Std transverse markings	Std transverse markings	Std transverse markings	Std transverse markings	Std transverse markings	Std transverse markings	Zebra stripe hi-vis markings	Zebra stripe hi-vis markings	Std transverse markings	Zebra stripe hi-vis markings	Zebra stripe hi-vis markings	Zebra stripe hi-vis markings	Zebra stripe hi-vis markings	Std transverse markings
	PETSI Score	47	118	21	-2	55	55	73	57	66	24	96	18	42	42	58	63
	Ped. Exposure to Traffic LoS	D	A	F	F	D	D	C	D	C	F	A	F	E	E	D	C
	Cycle Length																
	Effective Walk Time																
	Average Pedestrian Delay																
Pedestrian Delay LoS	-	-	-	-	-	-	-	-	-	-	-	-	-	-	-	-	
Level of Service	D	A	F	F	D	D	C	D	C	F	A	F	E	E	D	C	
	F				D				F				E				
Approach From		NORTH	SOUTH	EAST	WEST	NORTH	SOUTH	EAST	WEST	NORTH	SOUTH	EAST	WEST	NORTH	SOUTH	EAST	WEST
Bicycle	Bicycle Lane Arrangement on Approach	Mixed Traffic		Mixed Traffic									Mixed Traffic				
	Right Turn Lane Configuration	≤ 50 m		≤ 50 m									> 50 m				
	Right Turning Speed	≤ 25 km/h		≤ 25 km/h									≤ 25 km/h				
	Cyclist relative to RT motorists	D	-	D	A	A	A	A	A	-	-	-	F	A	A	A	A
	Separated or Mixed Traffic	Mixed Traffic	-	Mixed Traffic	-	-	-	-	-	-	-	-	Mixed Traffic	-	-	-	-
	Left Turn Approach	No lane crossed		No lane crossed		≥ 2 lanes crossed		No lane crossed		No lane crossed		No lane crossed		No lane crossed		No lane crossed	
	Operating Speed	> 50 to < 60 km/h		≥ 60 km/h		≥ 60 km/h		> 50 to < 60 km/h		> 50 to < 60 km/h		> 50 to < 60 km/h		≥ 60 km/h		> 50 to < 60 km/h	
Left Turning Cyclist	C	-	C	F	C	C	C	C	-	C	-	C	C	C	B	B	
Level of Service	D	-	D	F	C	C	C	C	-	-	-	F	C	C	B	B	
	F				C				F				C				
Transit	Average Signal Delay	> 40 sec		≤ 20 sec		> 40 sec		≤ 20 sec		≤ 40 sec		> 40 sec		≤ 40 sec		≤ 20 sec	
	Level of Service	F	-	C	F	C	E	-	-	E	F	-	F	B	C	-	-
	F				E				F				C				
Truck	Effective Corner Radius	< 10 m		< 10 m		< 10 m		< 10 m		10 - 15 m		< 10 m		< 10 m		< 10 m	
	Number of Receiving Lanes on Departure from Intersection	≥ 2		≥ 2		1		1		≥ 2		≥ 2		1		1	
Level of Service	D	-	D	-	F	F	-	-	B	-	-	D	-	F	-	-	
	D				F				D				F				
Auto	Volume to Capacity Ratio	0.71 - 0.80				0.81 - 0.90				> 1.00				0.71 - 0.80			
	Level of Service	C				D				F				C			

Multi-Modal Level of Service - Intersections Form

Consultant	CGH Transportation Inc.	Project	2020-64
Scenario	Future Conditions	Date	2020-10-31
Comments			

Unlocked Rows for Replicating

INTERSECTIONS		Carling Ave at Booth St				Bronson Ave at Powell Ave				Bronson Ave at Carling Ave / Glebe Ave				Bronson Ave at Fifth Ave / Madawaska Dr			
Crossing Side		NORTH	SOUTH	EAST	WEST	NORTH	SOUTH	EAST	WEST	NORTH	SOUTH	EAST	WEST	NORTH	SOUTH	EAST	WEST
Pedestrian	Lanes	5	0-2	8	8	4	4	3	4	5	6	0-2	7	5	5	4	4
	Median	No Median - 2.4 m	Median > 2.4 m	Median > 2.4 m	No Median - 2.4 m	No Median - 2.4 m	No Median - 2.4 m	No Median - 2.4 m	No Median - 2.4 m	No Median - 2.4 m	No Median - 2.4 m	No Median - 2.4 m	No Median - 2.4 m	No Median - 2.4 m	No Median - 2.4 m	No Median - 2.4 m	No Median - 2.4 m
	Conflicting Left Turns	Protected	No left turn / Prohib.	Protected	No left turn / Prohib.	Permissive	Permissive	Permissive	Permissive	No left turn / Prohib.	Permissive	No left turn / Prohib.	Protected	Permissive	Permissive	Permissive	No left turn / Prohib.
	Conflicting Right Turns	Permissive or yield control	No right turn	No right turn	Permissive or yield control	Permissive or yield control	Permissive or yield control	Permissive or yield control	Permissive or yield control	No right turn	Protected/ Permissive	Permissive or yield control	Permissive or yield control	Permissive or yield control	Permissive or yield control	Permissive or yield control	Permissive or yield control
	Right Turns on Red (RTOR) ?	RTOR allowed	RTOR prohibited	RTOR prohibited	RTOR allowed	RTOR allowed	RTOR allowed	RTOR allowed	RTOR allowed	RTOR prohibited	RTOR allowed	RTOR allowed	RTOR allowed	RTOR allowed	RTOR allowed	RTOR allowed	RTOR allowed
	Ped Signal Leading Interval?	No	No	No	No	No	No	Yes	Yes	No	No	Yes	Yes	No	No	No	No
	Right Turn Channel	No Channel	No Right Turn	No Right Turn	No Channel	No Channel	No Channel	No Channel	No Channel	No Right Turn	No Channel	No Channel	No Channel	No Channel	No Channel	No Channel	No Channel
	Corner Radius	3-5m	No Right Turn	No Right Turn	3-5m	3-5m	3-5m	5-10m	3-5m	No Right Turn	5-10m	5-10m	5-10m	3-5m	3-5m	3-5m	3-5m
	Crosswalk Type	Std transverse markings	Raised crosswalk	Std transverse markings	Std transverse markings	Std transverse markings	Std transverse markings	Std transverse markings	Std transverse markings	Zebra stripe hi-vis markings	Zebra stripe hi-vis markings	Std transverse markings	Zebra stripe hi-vis markings	Zebra stripe hi-vis markings	Zebra stripe hi-vis markings	Zebra stripe hi-vis markings	Std transverse markings
	PETS I Score		47	118	21	-2	55	55	73	57	66	24	96	18	42	42	58
Ped. Exposure to Traffic LoS		D	A	F	F	D	D	C	D	C	F	A	F	E	E	D	C
Cycle Length																	
Effective Walk Time																	
Average Pedestrian Delay																	
Pedestrian Delay LoS		-	-	-	-	-	-	-	-	-	-	-	-	-	-	-	-
Level of Service		D	A	F	F	D	D	C	D	C	F	A	F	E	E	D	C
		F				D				F				E			
Approach From		NORTH	SOUTH	EAST	WEST	NORTH	SOUTH	EAST	WEST	NORTH	SOUTH	EAST	WEST	NORTH	SOUTH	EAST	WEST
Bicycle	Bicycle Lane Arrangement on Approach	Mixed Traffic		Mixed Traffic									Mixed Traffic				
	Right Turn Lane Configuration	≤ 50 m		≤ 50 m										> 50 m			
	Right Turning Speed	≤ 25 km/h		≤ 25 km/h										≤ 25 km/h			
	Cyclist relative to RT motorists	D	-	D	A	A	A	A	A	-	-	-	F	A	A	A	A
	Separated or Mixed Traffic	Mixed Traffic	-	Mixed Traffic	-	-	-	-	-	-	-	-	Mixed Traffic	-	-	-	-
	Left Turn Approach	No lane crossed		No lane crossed		≥ 2 lanes crossed		No lane crossed	No lane crossed	No lane crossed	No lane crossed		No lane crossed	No lane crossed	No lane crossed	No lane crossed	No lane crossed
	Operating Speed	> 50 to < 60 km/h		≥ 60 km/h		≥ 60 km/h		> 50 to < 60 km/h	> 50 to < 60 km/h	> 50 to < 60 km/h	> 50 to < 60 km/h		> 50 to < 60 km/h	≥ 60 km/h	> 50 to < 60 km/h	> 50 to < 60 km/h	> 40 to ≤ 50 km/h
Left Turning Cyclist	C	-	C	F	C	C	C	C	-	C	-	C	C	C	B	B	
Level of Service	D	-	D	F	C	C	C	C	-	-	-	F	C	C	B	B	
		F				C				F				C			
Transit	Average Signal Delay	≤ 40 sec		≤ 20 sec		> 40 sec		≤ 20 sec	> 40 sec	> 40 sec	≤ 40 sec	> 40 sec	≤ 10 sec	≤ 20 sec			
	Level of Service	E	-	C	F	C	F	-	-	F	E	-	F	B	C	-	-
		F				F				F				C			
Truck	Effective Corner Radius	< 10 m		< 10 m		< 10 m	< 10 m			10 - 15 m			< 10 m	< 10 m			
	Number of Receiving Lanes on Departure from Intersection	≥ 2		≥ 2		1	1			≥ 2			≥ 2	-	F	-	-
Level of Service	D	-	D	-	F	F	-	-	B	-	-	D	-	F	-	-	
		D				F				D				F			
Auto	Volume to Capacity Ratio	0.71 - 0.80				> 1.00				> 1.00				> 1.00			
	Level of Service	C				F				F				F			

Appendix K

Access Signage Plan

Notes:

Key Map:

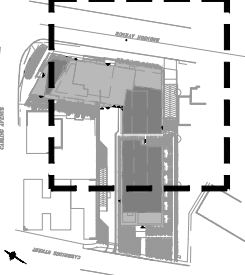

BRONSON AVENUE



Rb-12 (OTM)
 "NO LEFT TURN"
 600mmx600mm

NO.	DESCRIPTION	BY	DATE
01	Issued for Review		2023-06-23

CGH Transportation
 6 Plaza Court
 Ottawa, ON
 K2H 7W1
 (343) 999-9117

CLIENT: Katasa Group
 69, rue Jean-Proulx suite #301
 Gatineau (Quebec)
 J8Z 1W2

ARCHITECT:

SITE: 770-774 Bronson	
TITLE: Signage Plan	
SCALE: 1/4" = 1'-0"	DATE: 2023-06-23
DRAWN: AN	CHECKED: AH
PROJECT NO: 2020-064	REVISION: 01

Appendix L

Synchro Intersection Worksheets – 2025 Future Total Conditions

Lanes, Volumes, Timings
1: Carling Avenue & Booth Street

2025 Future Total - AM Peak Hour
770-774 Bronson Ave

Lane Group	EBL	EBT	WBT	WBR	SBL	SBR
Lane Configurations	↔	↕	↕↕	↕	↔	↕
Traffic Volume (vph)	282	936	681	120	160	113
Future Volume (vph)	282	936	681	120	160	113
Satd. Flow (prot)	1658	3283	4535	0	1658	1427
Fit Permitted	0.950				0.950	
Satd. Flow (perm)	1577	3283	4535	0	1633	1258
Satd. Flow (RTOR)			32			113
Lane Group Flow (vph)	282	936	801	0	160	113
Turn Type	Prot	NA	NA		Perm	Perm
Protected Phases	5	2	6			
Permitted Phases					4	4
Detector Phase	5	2	6		4	4
Switch Phase						
Minimum Initial (s)	5.0	10.0	10.0		10.0	10.0
Minimum Split (s)	10.9	22.5	29.7		39.0	39.0
Total Split (s)	34.0	81.0	47.0		39.0	39.0
Total Split (%)	28.3%	67.5%	39.2%		32.5%	32.5%
Yellow Time (s)	3.7	3.7	3.7		3.3	3.3
All-Red Time (s)	2.2	2.0	2.0		2.7	2.7
Lost Time Adjust (s)	0.0	0.0	0.0		0.0	0.0
Total Lost Time (s)	5.9	5.7	5.7		6.0	6.0
Lead/Lag	Lead		Lag			
Lead-Lag Optimize?	Yes		Yes			
Recall Mode	None	Max	C-Max		None	None
Act Effct Green (s)	24.3	75.3	45.1		33.0	33.0
Actuated g/C Ratio	0.20	0.63	0.38		0.28	0.28
v/c Ratio	0.84	0.45	0.46		0.36	0.26
Control Delay	67.3	12.5	28.8		37.8	7.8
Queue Delay	0.0	0.0	0.0		0.0	0.0
Total Delay	67.3	12.5	28.8		37.8	7.8
LOS	E	B	C		D	A
Approach Delay		25.2	28.8		25.3	
Approach LOS		C	C		C	
Queue Length 50th (m)	63.4	56.3	50.6		30.4	0.0
Queue Length 95th (m)	#93.1	70.2	65.0		49.8	13.6
Internal Link Dist (m)		107.6	286.6		178.3	
Turn Bay Length (m)	40.0					30.0
Base Capacity (vph)	388	2060	1723		449	427
Starvation Cap Reductn	0	0	0		0	0
Spillback Cap Reductn	0	0	0		0	0
Storage Cap Reductn	0	0	0		0	0
Reduced v/c Ratio	0.73	0.45	0.46		0.36	0.26

Intersection Summary	
Cycle Length:	120
Actuated Cycle Length:	120
Offset:	116 (97%), Referenced to phase 6:WBT, Start of Green
Natural Cycle:	90
Control Type:	Actuated-Coordinated

Lanes, Volumes, Timings
1: Carling Avenue & Booth Street

2025 Future Total - AM Peak Hour
770-774 Bronson Ave

Maximum v/c Ratio: 0.84	Intersection LOS: C
Intersection Signal Delay: 26.5	ICU Level of Service D
Intersection Capacity Utilization 77.8%	
Analysis Period (min) 15	
# 95th percentile volume exceeds capacity, queue may be longer.	
Queue shown is maximum after two cycles.	

Splits and Phases: 1: Carling Avenue & Booth Street

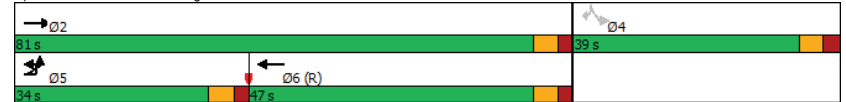

HCM 2010 TWSC
2: Cambridge Street & Carling Avenue

2025 Future Total - AM Peak Hour
770-774 Bronson Ave

Intersection												
Int Delay, s/veh	0.6											
Movement	EBL	EBT	EBR	WBL	WBT	WBR	NBL	NBT	NBR	SBL	SBT	SBR
Lane Configurations	↕↕↕			↕↕		↕			↕			↕
Traffic Vol, veh/h	0	1094	5	0	635	12	0	0	26	0	0	56
Future Vol, veh/h	0	1094	5	0	635	12	0	0	26	0	0	56
Conflicting Peds, #/hr	0	0	45	0	0	38	0	0	1	0	0	0
Sign Control	Free	Free	Free	Free	Free	Free	Stop	Stop	Stop	Stop	Stop	Stop
RT Channelized	-	-	None	-	-	None	-	-	None	-	-	None
Storage Length	-	-	100	-	-	35	-	-	0	-	-	0
Veh in Median Storage, #	-	0	-	-	0	-	-	0	-	-	0	-
Grade, %	-	0	-	-	0	-	-	0	-	-	0	-
Peak Hour Factor	100	100	100	100	100	100	100	100	100	100	100	100
Heavy Vehicles, %	2	3	2	2	4	8	2	2	2	2	2	5
Mvmt Flow	0	1094	5	0	635	12	0	0	26	0	0	56
Major/Minor	Major1		Major2		Minor1		Minor2					
Conflicting Flow All	-	0	0	-	-	0	-	-	596	-	-	356
Stage 1	-	-	-	-	-	-	-	-	-	-	-	-
Stage 2	-	-	-	-	-	-	-	-	-	-	-	-
Critical Hdwy	-	-	-	-	-	-	-	-	7.14	-	-	7
Critical Hdwy Stg 1	-	-	-	-	-	-	-	-	-	-	-	-
Critical Hdwy Stg 2	-	-	-	-	-	-	-	-	-	-	-	-
Follow-up Hdwy	-	-	-	-	-	-	-	-	3.92	-	-	3.35
Pot Cap-1 Maneuver	0	-	-	0	-	-	0	0	383	0	0	632
Stage 1	0	-	-	0	-	-	0	0	-	0	0	-
Stage 2	0	-	-	0	-	-	0	0	-	0	0	-
Platoon blocked, %	-	-	-	-	-	-	-	-	-	-	-	-
Mov Cap-1 Maneuver	-	-	-	-	-	-	-	-	367	-	-	610
Mov Cap-2 Maneuver	-	-	-	-	-	-	-	-	-	-	-	-
Stage 1	-	-	-	-	-	-	-	-	-	-	-	-
Stage 2	-	-	-	-	-	-	-	-	-	-	-	-
Approach	EB		WB		NB		SB					
HCM Control Delay, s	0		0		15.6		11.5					
HCM LOS					C		B					
Minor Lane/Major Mvmt	NBLn1	EBT	EBR	WBT	WBR	SBLn1						
Capacity (veh/h)	367	-	-	-	-	610						
HCM Lane V/C Ratio	0.071	-	-	-	-	0.092						
HCM Control Delay (s)	15.6	-	-	-	-	11.5						
HCM Lane LOS	C	-	-	-	-	B						
HCM 95th %tile Q(veh)	0.2	-	-	-	-	0.3						

Lanes, Volumes, Timings
3: Bronson Avenue & Powell Avenue

2025 Future Total - AM Peak Hour
770-774 Bronson Ave



Lane Group	EBL	EBT	EBR	WBL	WBT	WBR	NBL	NBT	NBR	SBL	SBT	SBR
Lane Configurations		↕↕			↕↕			↕↕			↕↕	
Traffic Volume (vph)	111	25	51	17	53	17	45	1658	8	11	1003	68
Future Volume (vph)	111	25	51	17	53	17	45	1658	8	11	1003	68
Satd. Flow (prot)	0	1586	0	0	1642	0	0	3275	0	0	3241	0
Fit Permitted		0.776			0.921			0.879			0.926	
Satd. Flow (perm)	0	1227	0	0	1518	0	0	2882	0	0	3004	0
Satd. Flow (RTOR)		15			10			1			16	
Lane Group Flow (vph)	0	187	0	0	87	0	0	1711	0	0	1082	0
Turn Type	Perm	NA		Perm	NA		Perm	NA		Perm	NA	
Protected Phases		4			8			2			6	
Permitted Phases	4			8			2			6		
Detector Phase	4	4		8	8		2	2		6	6	
Switch Phase												
Minimum Initial (s)	10.0	10.0		10.0	10.0		10.0	10.0		10.0	10.0	
Minimum Split (s)	23.7	23.7		23.7	23.7		32.3	32.3		32.3	32.3	
Total Split (s)	26.0	26.0		26.0	26.0		84.0	84.0		84.0	84.0	
Total Split (%)	23.6%	23.6%		23.6%	23.6%		76.4%	76.4%		76.4%	76.4%	
Yellow Time (s)	3.0	3.0		3.0	3.0		3.3	3.3		3.3	3.3	
All-Red Time (s)	2.7	2.7		2.7	2.7		2.0	2.0		2.0	2.0	
Lost Time Adjust (s)		0.0			0.0			0.0			0.0	
Total Lost Time (s)		5.7			5.7			5.3			5.3	
Lead/Lag												
Lead-Lag Optimize?												
Recall Mode	None	None		None	None		C-Max	C-Max		C-Max	C-Max	
Act Effct Green (s)		18.4			18.4			80.6			80.6	
Actuated g/C Ratio		0.17			0.17			0.73			0.73	
v/c Ratio		0.86			0.33			0.81			0.49	
Control Delay		74.9			38.5			7.5			7.2	
Queue Delay		0.0			0.0			10.0			0.0	
Total Delay		74.9			38.5			17.6			7.2	
LOS		E			D			B			A	
Approach Delay		74.9			38.5			17.6			7.2	
Approach LOS		E			D			B			A	
Queue Length 50th (m)		35.6			14.4			69.3			46.7	
Queue Length 95th (m)		#71.3			29.0			m50.0			59.5	
Internal Link Dist (m)		74.6			106.0			142.6			39.5	
Turn Bay Length (m)												
Base Capacity (vph)		238			288			2112			2205	
Starvation Cap Reductn		0			0			395			0	
Spillback Cap Reductn		0			0			0			102	
Storage Cap Reductn		0			0			0			0	
Reduced v/c Ratio		0.79			0.30			1.00			0.51	
Intersection Summary												
Cycle Length: 110												
Actuated Cycle Length: 110												
Offset: 21 (19%), Referenced to phase 2:NBTL and 6:SBTL, Start of Green												
Natural Cycle: 80												
Control Type: Actuated-Coordinated												

Lanes, Volumes, Timings
3: Bronson Avenue & Powell Avenue

2025 Future Total - AM Peak Hour
770-774 Bronson Ave

Maximum v/c Ratio: 0.86	Intersection LOS: B
Intersection Signal Delay: 18.0	ICU Level of Service H
Intersection Capacity Utilization 110.5%	
Analysis Period (min) 15	
# 95th percentile volume exceeds capacity, queue may be longer.	
Queue shown is maximum after two cycles.	
m Volume for 95th percentile queue is metered by upstream signal.	

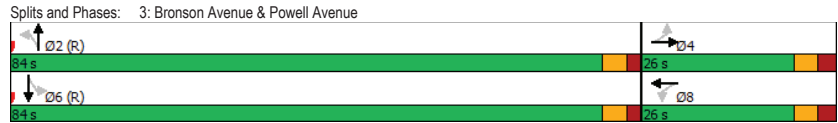

Lanes, Volumes, Timings
4: Bronson Avenue & Carling Avenue/Glebe Avenue

2025 Future Total - AM Peak Hour
770-774 Bronson Ave

Lane Group	EBU	EBL	EBT	EBR	WBL	WBT	WBR	NBL	NBT	NBR	SBL	SBT
Lane Configurations												
Traffic Volume (vph)	2	405	152	526	0	0	0	443	1397	38	0	940
Future Volume (vph)	2	405	152	526	0	0	0	443	1397	38	0	940
Satd. Flow (prot)	0	1530	1582	1483	0	0	0	3216	1730	0	0	3246
Fit Permitted		0.950	0.977					0.950				
Satd. Flow (perm)	0	1460	1548	1271	0	0	0	3178	1730	0	0	3246
Satd. Flow (RTOR)				30					3			13
Lane Group Flow (vph)	0	277	282	526	0	0	0	443	1435	0	0	1050
Turn Type	Perm	Perm	NA	pm+ov				Prot	NA			NA
Protected Phases			4	5				5	2			6
Permitted Phases	4	4		4								
Detector Phase	4	4	4	5				5	2			6
Switch Phase												
Minimum Initial (s)	10.0	10.0	10.0	5.0				5.0	10.0			10.0
Minimum Split (s)	31.0	31.0	31.0	11.0				11.0	24.0			33.0
Total Split (s)	31.0	31.0	31.0	34.0				34.0	79.0			45.0
Total Split (%)	28.2%	28.2%	28.2%	30.9%				30.9%	71.8%			40.9%
Yellow Time (s)	3.3	3.3	3.3	3.3				3.3	3.3			3.3
All-Red Time (s)	2.7	2.7	2.7	2.7				2.7	2.7			2.7
Lost Time Adjust (s)		0.0	0.0	0.0				0.0	0.0			0.0
Total Lost Time (s)		6.0	6.0	6.0				6.0	6.0			6.0
Lead/Lag				Lead				Lead				Lag
Lead-Lag Optimize?				Yes				Yes				Yes
Recall Mode	None	None	None	Min				Min	C-Max			C-Max
Act Effct Green (s)		23.7	23.7	46.1				22.4	74.3			45.9
Actuated g/C Ratio		0.22	0.22	0.42				0.20	0.68			0.42
v/c Ratio		0.88	0.85	0.89				0.68	1.23			0.77
Control Delay		70.5	64.5	43.1				36.2	137.8			28.3
Queue Delay		0.0	0.0	0.0				0.0	0.1			0.1
Total Delay		70.5	64.5	43.1				36.2	137.9			28.4
LOS		E	E	D				D	F			C
Approach Delay			55.6						113.9			28.4
Approach LOS			E						F			C
Queue Length 50th (m)		60.1	60.5	81.5				45.8	~398.5			103.4
Queue Length 95th (m)		#106.1	#103.7	109.8				50.8	#478.6			#150.5
Internal Link Dist (m)			82.5			112.6			59.6			142.6
Turn Bay Length (m)								40.0				
Base Capacity (vph)		331	351	666				818	1169			1363
Starvation Cap Reductn		0	0	0				0	0			14
Spillback Cap Reductn		0	0	0				0	28			0
Storage Cap Reductn		0	0	0				0	0			0
Reduced v/c Ratio		0.84	0.80	0.79				0.54	1.26			0.78

Intersection Summary												
Cycle Length: 110												
Actuated Cycle Length: 110												
Offset: 53 (48%), Referenced to phase 2:NBT and 6:SBT, Start of Green												
Natural Cycle: 140												
Control Type: Actuated-Coordinated												

Lanes, Volumes, Timings
 4: Bronson Avenue & Carling Avenue/Glebe Avenue

2025 Future Total - AM Peak Hour
 770-774 Bronson Ave

Lane Group	SBR
Lane Configurations	
Traffic Volume (vph)	110
Future Volume (vph)	110
Satd. Flow (prot)	0
Fit Permitted	
Satd. Flow (perm)	0
Satd. Flow (RTOR)	
Lane Group Flow (vph)	0
Turn Type	
Protected Phases	
Permitted Phases	
Detector Phase	
Switch Phase	
Minimum Initial (s)	
Minimum Split (s)	
Total Split (s)	
Total Split (%)	
Yellow Time (s)	
All-Red Time (s)	
Lost Time Adjust (s)	
Total Lost Time (s)	
Lead/Lag	
Lead-Lag Optimize?	
Recall Mode	
Act Effct Green (s)	
Actuated g/C Ratio	
v/c Ratio	
Control Delay	
Queue Delay	
Total Delay	
LOS	
Approach Delay	
Approach LOS	
Queue Length 50th (m)	
Queue Length 95th (m)	
Internal Link Dist (m)	
Turn Bay Length (m)	
Base Capacity (vph)	
Starvation Cap Reductn	
Spillback Cap Reductn	
Storage Cap Reductn	
Reduced v/c Ratio	
Intersection Summary	

Lanes, Volumes, Timings
 4: Bronson Avenue & Carling Avenue/Glebe Avenue

2025 Future Total - AM Peak Hour
 770-774 Bronson Ave

Maximum v/c Ratio: 1.23	Intersection LOS: E
Intersection Signal Delay: 75.8	ICU Level of Service H
Intersection Capacity Utilization 110.7%	
Analysis Period (min) 15	
~ Volume exceeds capacity, queue is theoretically infinite. Queue shown is maximum after two cycles.	
# 95th percentile volume exceeds capacity, queue may be longer. Queue shown is maximum after two cycles.	

Splits and Phases: 4: Bronson Avenue & Carling Avenue/Glebe Avenue

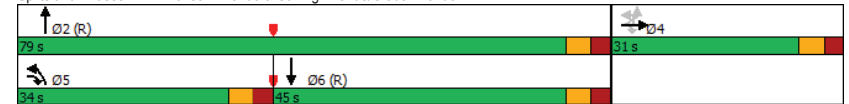

Lanes, Volumes, Timings
 5: Bronson Avenue & Madawaska Drive/Fifth Avenue
 2025 Future Total - AM Peak Hour
 770-774 Bronson Ave

Lane Group	EBL	EBT	EBR	WBL	WBT	WBR	NBL	NBT	NBR	SBL	SBT	SBR
Lane Configurations		↔			↔			↔			↔	
Traffic Volume (vph)	7	48	14	86	34	46	0	1725	34	22	1480	1
Future Volume (vph)	7	48	14	86	34	46	0	1725	34	22	1480	1
Satd. Flow (prot)	0	1623	0	0	1608	0	0	3302	0	0	3311	0
Fit Permitted		0.971			0.824						0.892	
Satd. Flow (perm)	0	1578	0	0	1333	0	0	3302	0	0	2956	0
Satd. Flow (RTOR)		10			16			4				
Lane Group Flow (vph)	0	69	0	0	166	0	0	1759	0	0	1503	0
Turn Type	Perm	NA		Perm	NA			NA		Perm	NA	
Protected Phases		4			8			2			6	
Permitted Phases	4			8						6		
Detector Phase	4	4		8	8			2		6	6	
Switch Phase												
Minimum Initial (s)	10.0	10.0		10.0	10.0			10.0		10.0	10.0	
Minimum Split (s)	23.3	23.3		23.3	23.3			34.3		34.3	34.3	
Total Split (s)	28.0	28.0		28.0	28.0			82.0		82.0	82.0	
Total Split (%)	25.5%	25.5%		25.5%	25.5%			74.5%		74.5%	74.5%	
Yellow Time (s)	3.3	3.3		3.3	3.3			3.3		3.3	3.3	
All-Red Time (s)	2.0	2.0		2.0	2.0			2.0		2.0	2.0	
Lost Time Adjust (s)		0.0			0.0			0.0			0.0	
Total Lost Time (s)		5.3			5.3			5.3			5.3	
Lead/Lag												
Lead-Lag Optimize?												
Recall Mode	None	None		None	None			C-Max		C-Max	C-Max	
Act Effct Green (s)		17.2			17.2			82.2			82.2	
Actuated g/C Ratio		0.16			0.16			0.75			0.75	
v/c Ratio		0.27			0.75			0.71			0.68	
Control Delay		35.9			59.6			10.4			5.5	
Queue Delay		0.0			0.0			0.0			0.0	
Total Delay		35.9			59.6			10.4			5.5	
LOS		D			E			B			A	
Approach Delay		35.9			59.6			10.4			5.5	
Approach LOS		D			E			B			A	
Queue Length 50th (m)		11.1			30.9			94.3			37.4	
Queue Length 95th (m)		22.7			51.3			142.1			50.3	
Internal Link Dist (m)		190.1			132.1			94.8			308.6	
Turn Bay Length (m)												
Base Capacity (vph)		333			287			2467			2207	
Starvation Cap Reductn		0			0			0			0	
Spillback Cap Reductn		0			0			0			0	
Storage Cap Reductn		0			0			0			0	
Reduced v/c Ratio		0.21			0.58			0.71			0.68	

Intersection Summary												
Cycle Length: 110												
Actuated Cycle Length: 110												
Offset: 70 (64%), Referenced to phase 2:NBT and 6:SBL, Start of Green												
Natural Cycle: 70												
Control Type: Actuated-Coordinated												

Lanes, Volumes, Timings
 5: Bronson Avenue & Madawaska Drive/Fifth Avenue
 2025 Future Total - AM Peak Hour
 770-774 Bronson Ave

Maximum v/c Ratio: 0.75	Intersection LOS: B
Intersection Signal Delay: 11.1	ICU Level of Service E
Intersection Capacity Utilization 85.8%	
Analysis Period (min) 15	

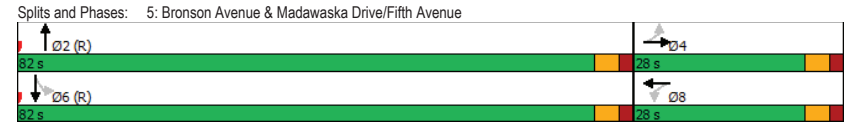

HCM 2010 TWSC
6: Cambridge Street & Site Access

2025 Future Total - AM Peak Hour
770-774 Bronson Ave

Intersection						
Int Delay, s/veh	4.3					
Movement	WBL	WBR	NBT	NBR	SBL	SBT
Lane Configurations		↑	↑			↑
Traffic Vol, veh/h	0	16	10	0	0	5
Future Vol, veh/h	0	16	10	0	0	5
Conflicting Peds, #/hr	0	0	0	0	0	0
Sign Control	Stop	Stop	Free	Free	Free	Free
RT Channelized	-	None	-	None	-	None
Storage Length	-	0	-	-	-	-
Veh in Median Storage, #	0	-	0	-	-	0
Grade, %	0	-	0	-	-	0
Peak Hour Factor	100	100	100	100	100	100
Heavy Vehicles, %	2	2	2	2	2	2
Mvmt Flow	0	16	10	0	0	5

Major/Minor	Minor1	Major1	Major2
Conflicting Flow All	-	10	0
Stage 1	-	-	-
Stage 2	-	-	-
Critical Hdwy	-	6.22	-
Critical Hdwy Stg 1	-	-	-
Critical Hdwy Stg 2	-	-	-
Follow-up Hdwy	-	3.318	-
Pot Cap-1 Maneuver	0	1071	0
Stage 1	0	-	0
Stage 2	0	-	0
Platoon blocked, %	-	-	-
Mov Cap-1 Maneuver	-	1071	-
Mov Cap-2 Maneuver	-	-	-
Stage 1	-	-	-
Stage 2	-	-	-

Approach	WB	NB	SB
HCM Control Delay, s	8.4	0	0
HCM LOS	A		

Minor Lane/Major Mvmt	NBTWBLn1	SBT
Capacity (veh/h)	-	1071
HCM Lane V/C Ratio	-	0.015
HCM Control Delay (s)	-	8.4
HCM Lane LOS	-	A
HCM 95th %tile Q(veh)	-	0

HCM 2010 TWSC
7: Bronson Avenue & Site Access

2025 Future Total - AM Peak Hour
770-774 Bronson Ave

Intersection						
Int Delay, s/veh	0					
Movement	EBL	EBR	NBL	NBT	SBT	SBR
Lane Configurations		↑		↔↔	↔↔	
Traffic Vol, veh/h	0	5	2	1878	1493	7
Future Vol, veh/h	0	5	2	1878	1493	7
Conflicting Peds, #/hr	0	0	0	0	0	0
Sign Control	Stop	Stop	Free	Free	Free	Free
RT Channelized	-	None	-	None	-	None
Storage Length	-	0	-	-	-	-
Veh in Median Storage, #	0	-	-	0	0	-
Grade, %	0	-	-	0	0	-
Peak Hour Factor	100	100	100	100	100	100
Heavy Vehicles, %	2	2	2	2	2	2
Mvmt Flow	0	5	2	1878	1493	7

Major/Minor	Minor2	Major1	Major2
Conflicting Flow All	-	750	1500
Stage 1	-	-	-
Stage 2	-	-	-
Critical Hdwy	-	6.94	4.14
Critical Hdwy Stg 1	-	-	-
Critical Hdwy Stg 2	-	-	-
Follow-up Hdwy	-	3.32	2.22
Pot Cap-1 Maneuver	0	354	443
Stage 1	0	-	-
Stage 2	0	-	-
Platoon blocked, %	-	-	-
Mov Cap-1 Maneuver	-	354	443
Mov Cap-2 Maneuver	-	-	-
Stage 1	-	-	-
Stage 2	-	-	-

Approach	EB	NB	SB
HCM Control Delay, s	15.3	0	0
HCM LOS	C		

Minor Lane/Major Mvmt	NBL	NBT EBLn1	SBT	SBR
Capacity (veh/h)	443	-	354	-
HCM Lane V/C Ratio	0.005	-	0.014	-
HCM Control Delay (s)	13.2	0	15.3	-
HCM Lane LOS	B	A	C	-
HCM 95th %tile Q(veh)	0	-	0	-

Lanes, Volumes, Timings
1: Carling Avenue & Booth Street

2025 Future Total-PM Peak Hour
770-774 Bronson Ave

Lane Group	EBL	EBT	WBT	WBR	SBL	SBR
Lane Configurations	↔	↕	↕↕	↕	↔	↕
Traffic Volume (vph)	216	790	997	59	317	527
Future Volume (vph)	216	790	997	59	317	527
Satd. Flow (prot)	1658	3283	4673	0	1658	1427
Fit Permitted	0.950				0.950	
Satd. Flow (perm)	1591	3283	4673	0	1632	1230
Satd. Flow (RTOR)			9			100
Lane Group Flow (vph)	216	790	1056	0	317	527
Turn Type	Prot	NA	NA		Perm	Perm
Protected Phases	5	2	6			
Permitted Phases					4	4
Detector Phase	5	2	6		4	4
Switch Phase						
Minimum Initial (s)	5.0	10.0	10.0		10.0	10.0
Minimum Split (s)	10.9	22.5	29.7		39.0	39.0
Total Split (s)	23.0	90.0	67.0		40.0	40.0
Total Split (%)	17.7%	69.2%	51.5%		30.8%	30.8%
Yellow Time (s)	3.7	3.7	3.7		3.3	3.3
All-Red Time (s)	2.2	2.0	2.0		2.7	2.7
Lost Time Adjust (s)	0.0	0.0	0.0		0.0	0.0
Total Lost Time (s)	5.9	5.7	5.7		6.0	6.0
Lead/Lag	Lead		Lag			
Lead-Lag Optimize?	Yes		Yes			
Recall Mode	None	Max	C-Max		None	None
Act Effct Green (s)	17.1	84.3	61.3		34.0	34.0
Actuated g/C Ratio	0.13	0.65	0.47		0.26	0.26
v/c Ratio	0.99	0.37	0.48		0.74	1.33
Control Delay	114.8	11.2	41.1		56.0	198.1
Queue Delay	0.0	0.0	0.0		0.0	0.0
Total Delay	114.8	11.2	41.1		56.0	198.1
LOS	F	B	D		E	F
Approach Delay		33.4	41.1		144.8	
Approach LOS		C	D		F	
Queue Length 50th (m)	56.1	45.8	87.7		74.8	~156.1
Queue Length 95th (m)	#106.4	57.3	102.0		108.8	#224.2
Internal Link Dist (m)		107.6	286.6		178.3	
Turn Bay Length (m)	40.0					30.0
Base Capacity (vph)	218	2128	2208		426	395
Starvation Cap Reductn	0	0	0		0	0
Spillback Cap Reductn	0	0	0		0	0
Storage Cap Reductn	0	0	0		0	0
Reduced v/c Ratio	0.99	0.37	0.48		0.74	1.33

Intersection Summary	
Cycle Length:	130
Actuated Cycle Length:	130
Offset:	110 (85%), Referenced to phase 6:WBT, Start of Green
Natural Cycle:	90
Control Type:	Actuated-Coordinated

Lanes, Volumes, Timings
1: Carling Avenue & Booth Street

2025 Future Total-PM Peak Hour
770-774 Bronson Ave

Maximum v/c Ratio:	1.33
Intersection Signal Delay:	68.6
Intersection LOS:	E
Intersection Capacity Utilization:	89.1%
ICU Level of Service:	E
Analysis Period (min):	15
~ Volume exceeds capacity, queue is theoretically infinite. Queue shown is maximum after two cycles.	
# 95th percentile volume exceeds capacity, queue may be longer. Queue shown is maximum after two cycles.	

Splits and Phases: 1: Carling Avenue & Booth Street

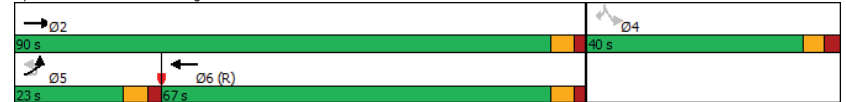

HCM 2010 TWSC
2: Cambridge Street & Carling Avenue

2025 Future Total-PM Peak Hour
770-774 Bronson Ave

Intersection												
Int Delay, s/veh	2.5											
Movement	EBL	EBT	EBR	WBL	WBT	WBR	NBL	NBT	NBR	SBL	SBT	SBR
Lane Configurations	↕↕↕			↕↕		↕			↕			↕
Traffic Vol, veh/h	0	1055	17	0	591	6	0	0	38	0	0	291
Future Vol, veh/h	0	1055	17	0	591	6	0	0	38	0	0	291
Conflicting Peds, #/hr	0	0	42	0	0	33	0	0	4	0	0	1
Sign Control	Free	Free	Free	Free	Free	Free	Stop	Stop	Stop	Stop	Stop	Stop
RT Channelized	-	-	None	-	-	None	-	-	None	-	-	None
Storage Length	-	-	100	-	-	35	-	-	0	-	-	0
Veh in Median Storage, #	-	0	-	-	0	-	-	0	-	-	0	-
Grade, %	-	0	-	-	0	-	-	0	-	-	0	-
Peak Hour Factor	100	100	100	100	100	100	100	100	100	100	100	100
Heavy Vehicles, %	2	3	2	2	4	8	2	2	2	2	2	5
Mvmt Flow	0	1055	17	0	591	6	0	0	38	0	0	291
Major/Minor	Major1		Major2		Minor1		Minor2					
Conflicting Flow All	-	0	0	-	-	0	-	-	582	-	-	330
Stage 1	-	-	-	-	-	-	-	-	-	-	-	-
Stage 2	-	-	-	-	-	-	-	-	-	-	-	-
Critical Hdwy	-	-	-	-	-	-	-	-	7.14	-	-	7
Critical Hdwy Stg 1	-	-	-	-	-	-	-	-	-	-	-	-
Critical Hdwy Stg 2	-	-	-	-	-	-	-	-	-	-	-	-
Follow-up Hdwy	-	-	-	-	-	-	-	-	3.92	-	-	3.35
Pot Cap-1 Maneuver	0	-	-	0	-	-	0	0	391	0	0	657
Stage 1	0	-	-	0	-	-	0	0	-	0	0	-
Stage 2	0	-	-	0	-	-	0	0	-	0	0	-
Platoon blocked, %	-	-	-	-	-	-	-	-	-	-	-	-
Mov Cap-1 Maneuver	-	-	-	-	-	-	-	-	374	-	-	636
Mov Cap-2 Maneuver	-	-	-	-	-	-	-	-	-	-	-	-
Stage 1	-	-	-	-	-	-	-	-	-	-	-	-
Stage 2	-	-	-	-	-	-	-	-	-	-	-	-
Approach	EB		WB		NB		SB					
HCM Control Delay, s	0		0		15.7		15.3					
HCM LOS					C		C					
Minor Lane/Major Mvmt	NBLn1	EBT	EBR	WBT	WBR	SBLn1						
Capacity (veh/h)	374	-	-	-	-	636						
HCM Lane V/C Ratio	0.102	-	-	-	-	0.458						
HCM Control Delay (s)	15.7	-	-	-	-	15.3						
HCM Lane LOS	C	-	-	-	-	C						
HCM 95th %tile Q(veh)	0.3	-	-	-	-	2.4						

Lanes, Volumes, Timings
3: Bronson Avenue & Powell Avenue

2025 Future Total-PM Peak Hour
770-774 Bronson Ave

Lane Group	EBL	EBT	EBR	WBL	WBT	WBR	NBL	NBT	NBR	SBL	SBT	SBR
Lane Configurations		↕↕			↕↕			↕↕			↕↕	
Traffic Volume (vph)	141	82	150	58	89	5	73	1138	19	6	959	57
Future Volume (vph)	141	82	150	58	89	5	73	1138	19	6	959	57
Satd. Flow (prot)	0	1575	0	0	1699	0	0	3261	0	0	3249	0
Fit Permitted		0.782			0.684			0.765			0.947	
Satd. Flow (perm)	0	1239	0	0	1184	0	0	2501	0	0	3076	0
Satd. Flow (RTOR)		25			1			3			10	
Lane Group Flow (vph)	0	373	0	0	152	0	0	1230	0	0	1022	0
Turn Type	Perm	NA		Perm	NA		Perm	NA		Perm	NA	
Protected Phases		4			8			2			6	
Permitted Phases	4				8			2			6	
Detector Phase	4	4			8			2	2		6	6
Switch Phase												
Minimum Initial (s)	10.0	10.0			10.0			10.0	10.0		10.0	10.0
Minimum Split (s)	23.7	23.7			23.7			32.3	32.3		32.3	32.3
Total Split (s)	38.0	38.0			38.0			92.0	92.0		92.0	92.0
Total Split (%)	29.2%	29.2%			29.2%			70.8%	70.8%		70.8%	70.8%
Yellow Time (s)	3.0	3.0			3.0			3.3	3.3		3.3	3.3
All-Red Time (s)	2.7	2.7			2.7			2.0	2.0		2.0	2.0
Lost Time Adjust (s)		0.0			0.0			0.0	0.0		0.0	0.0
Total Lost Time (s)		5.7			5.7			5.3	5.3		5.3	5.3
Lead/Lag												
Lead-Lag Optimize?												
Recall Mode	None	None			None			C-Max	C-Max		C-Max	C-Max
Act Effct Green (s)		32.3			32.3			86.7	86.7		86.7	86.7
Actuated g/C Ratio		0.25			0.25			0.67	0.67		0.67	0.67
v/c Ratio		1.14			0.52			0.74	0.74		0.50	0.50
Control Delay		135.9			49.1			17.6	17.6		11.7	11.7
Queue Delay		0.0			0.0			3.2	3.2		0.0	0.0
Total Delay		135.9			49.1			20.7	20.7		11.7	11.7
LOS		F			D			C	C		B	B
Approach Delay		135.9			49.1			20.7	20.7		11.7	11.7
Approach LOS		F			D			C	C		B	B
Queue Length 50th (m)		-106.8			33.5			115.4	115.4		62.8	62.8
Queue Length 95th (m)		#167.9			55.9			39.4	39.4		77.5	77.5
Internal Link Dist (m)		74.6			106.0			142.6	142.6		39.5	39.5
Turn Bay Length (m)												
Base Capacity (vph)		326			294			1668	1668		2054	2054
Starvation Cap Reductn		0			0			329	329		0	0
Spillback Cap Reductn		0			0			0	0		46	46
Storage Cap Reductn		0			0			0	0		0	0
Reduced v/c Ratio		1.14			0.52			0.92	0.92		0.51	0.51
Intersection Summary												
Cycle Length: 130												
Actuated Cycle Length: 130												
Offset: 46 (35%), Referenced to phase 2:NBTL and 6:SBTL, Start of Green												
Natural Cycle: 70												
Control Type: Actuated-Coordinated												

Lanes, Volumes, Timings
3: Bronson Avenue & Powell Avenue

2025 Future Total-PM Peak Hour
770-774 Bronson Ave

Maximum v/c Ratio: 1.14	Intersection LOS: C
Intersection Signal Delay: 34.4	ICU Level of Service H
Intersection Capacity Utilization 109.4%	
Analysis Period (min) 15	
~ Volume exceeds capacity, queue is theoretically infinite.	
Queue shown is maximum after two cycles.	
# 95th percentile volume exceeds capacity, queue may be longer.	
Queue shown is maximum after two cycles.	

Splits and Phases: 3: Bronson Avenue & Powell Avenue



Lanes, Volumes, Timings
4: Bronson Avenue & Carling Avenue/Glebe Avenue

2025 Future Total-PM Peak Hour
770-774 Bronson Ave

Lane Group	EBU	EBL	EBT	EBR	WBL	WBT	WBR	NBL	NBT	NBR	SBL	SBT
Lane Configurations												
Traffic Volume (vph)	2	258	133	668	0	0	0	435	1094	26	0	1054
Future Volume (vph)	2	258	133	668	0	0	0	435	1094	26	0	1054
Satd. Flow (prot)	0	1530	1595	1483	0	0	0	3216	1732	0	0	3257
Fit Permitted		0.950	0.984					0.950				
Satd. Flow (perm)	0	1387	1569	1406	0	0	0	3171	1732	0	0	3257
Satd. Flow (RTOR)				61					2			12
Lane Group Flow (vph)	0	193	200	668	0	0	0	435	1120	0	0	1158
Turn Type	Perm	Perm	NA	pm+ov				Prot	NA			NA
Protected Phases				4	5			5	2			6
Permitted Phases	4	4		4								
Detector Phase	4	4	4	5				5	2			6
Switch Phase												
Minimum Initial (s)	10.0	10.0	10.0	5.0				5.0	10.0			10.0
Minimum Split (s)	31.0	31.0	31.0	11.0				11.0	24.0			33.0
Total Split (s)	31.0	31.0	31.0	26.0				26.0	99.0			73.0
Total Split (%)	23.8%	23.8%	23.8%	20.0%				20.0%	76.2%			56.2%
Yellow Time (s)	3.3	3.3	3.3	3.3				3.3	3.3			3.3
All-Red Time (s)	2.7	2.7	2.7	2.7				2.7	2.7			2.7
Lost Time Adjust (s)		0.0	0.0	0.0				0.0	0.0			0.0
Total Lost Time (s)		6.0	6.0	6.0				6.0	6.0			6.0
Lead/Lag				Lead				Lead				Lag
Lead-Lag Optimize?				Yes				Yes				Yes
Recall Mode	None	None	None	Min				Min	C-Max			C-Max
Act Effct Green (s)		22.1	22.1	45.0				22.9	95.9			67.0
Actuated g/C Ratio		0.17	0.17	0.35				0.18	0.74			0.52
v/c Ratio		0.82	0.75	1.24				0.77	0.88			0.69
Control Delay		66.8	57.6	152.0				55.1	28.0			18.6
Queue Delay		0.0	0.0	0.0				0.0	0.0			0.2
Total Delay		66.8	57.6	152.0				55.1	28.0			18.7
LOS		E	E	F				E	C			B
Approach Delay			118.7						35.6			18.7
Approach LOS			F						D			B
Queue Length 50th (m)		51.3	52.7	~206.5				57.0	199.0			62.2
Queue Length 95th (m)		m#80.9	m#78.3	#215.0				m#83.2	m#249.7			m#82.4
Internal Link Dist (m)			82.5				112.6		62.3			142.6
Turn Bay Length (m)								40.0				
Base Capacity (vph)		266	301	540				567	1278			1684
Starvation Cap Reductn		0	0	0				0	0			85
Spillback Cap Reductn		0	0	0				0	0			0
Storage Cap Reductn		0	0	0				0	0			0
Reduced v/c Ratio		0.73	0.66	1.24				0.77	0.88			0.72

Intersection Summary												
Cycle Length: 130												
Actuated Cycle Length: 130												
Offset: 46 (35%), Referenced to phase 2:NBT and 6:SBT, Start of Green												
Natural Cycle: 100												
Control Type: Actuated-Coordinated												

Lanes, Volumes, Timings
 4: Bronson Avenue & Carling Avenue/Glebe Avenue

2025 Future Total-PM Peak Hour
 770-774 Bronson Ave

Lane Group	SBR
Lane Configurations	
Traffic Volume (vph)	104
Future Volume (vph)	104
Satd. Flow (prot)	0
Fit Permitted	
Satd. Flow (perm)	0
Satd. Flow (RTOR)	
Lane Group Flow (vph)	0
Turn Type	
Protected Phases	
Permitted Phases	
Detector Phase	
Switch Phase	
Minimum Initial (s)	
Minimum Split (s)	
Total Split (s)	
Total Split (%)	
Yellow Time (s)	
All-Red Time (s)	
Lost Time Adjust (s)	
Total Lost Time (s)	
Lead/Lag	
Lead-Lag Optimize?	
Recall Mode	
Act Effct Green (s)	
Actuated g/C Ratio	
v/c Ratio	
Control Delay	
Queue Delay	
Total Delay	
LOS	
Approach Delay	
Approach LOS	
Queue Length 50th (m)	
Queue Length 95th (m)	
Internal Link Dist (m)	
Turn Bay Length (m)	
Base Capacity (vph)	
Starvation Cap Reductn	
Spillback Cap Reductn	
Storage Cap Reductn	
Reduced v/c Ratio	
Intersection Summary	

Lanes, Volumes, Timings
 4: Bronson Avenue & Carling Avenue/Glebe Avenue

2025 Future Total-PM Peak Hour
 770-774 Bronson Ave

Maximum v/c Ratio: 1.24	Intersection LOS: D
Intersection Signal Delay: 53.8	ICU Level of Service E
Intersection Capacity Utilization 90.3%	
Analysis Period (min) 15	
~ Volume exceeds capacity, queue is theoretically infinite. Queue shown is maximum after two cycles.	
# 95th percentile volume exceeds capacity, queue may be longer. Queue shown is maximum after two cycles.	
m Volume for 95th percentile queue is metered by upstream signal.	

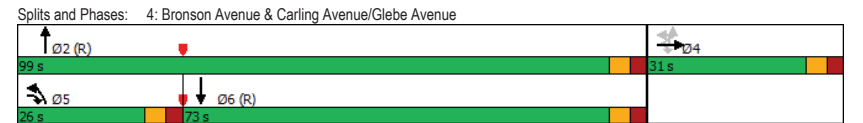

Lanes, Volumes, Timings
 5: Bronson Avenue & Madawaska Drive/Fifth Avenue
 2025 Future Total-PM Peak Hour
 770-774 Bronson Ave

Lane Group	EBL	EBT	EBR	WBL	WBT	WBR	NBL	NBT	NBR	SBL	SBT	SBR
Lane Configurations		↔			↔			↔			↔	
Traffic Volume (vph)	3	66	47	121	22	27	9	1420	27	19	1540	4
Future Volume (vph)	3	66	47	121	22	27	9	1420	27	19	1540	4
Satd. Flow (prot)	0	1521	0	0	1637	0	0	3301	0	0	3310	0
Fit Permitted		0.994			0.580			0.940			0.916	
Satd. Flow (perm)	0	1513	0	0	963	0	0	3103	0	0	3035	0
Satd. Flow (RTOR)		22			6			4			1	
Lane Group Flow (vph)	0	116	0	0	170	0	0	1456	0	0	1563	0
Turn Type	Perm	NA		Perm	NA		Perm	NA		Perm	NA	
Protected Phases		4			8			2			6	
Permitted Phases	4			8			2			6		
Detector Phase	4	4		8	8		2	2		6	6	
Switch Phase												
Minimum Initial (s)	10.0	10.0		10.0	10.0		10.0	10.0		10.0	10.0	
Minimum Split (s)	23.3	23.3		23.3	23.3		34.3	34.3		34.3	34.3	
Total Split (s)	24.0	24.0		24.0	24.0		106.0	106.0		106.0	106.0	
Total Split (%)	18.5%	18.5%		18.5%	18.5%		81.5%	81.5%		81.5%	81.5%	
Yellow Time (s)	3.3	3.3		3.3	3.3		3.3	3.3		3.3	3.3	
All-Red Time (s)	2.0	2.0		2.0	2.0		2.0	2.0		2.0	2.0	
Lost Time Adjust (s)		0.0			0.0			0.0			0.0	
Total Lost Time (s)		5.3			5.3			5.3			5.3	
Lead/Lag												
Lead-Lag Optimize?												
Recall Mode	None	None		None	None		C-Max	C-Max		C-Max	C-Max	
Act Effct Green (s)		18.7			18.7			100.7			100.7	
Actuated g/C Ratio		0.14			0.14			0.77			0.77	
v/c Ratio		0.49			1.19			0.61			0.66	
Control Delay		49.2			180.5			7.5			6.2	
Queue Delay		0.0			0.0			0.0			0.0	
Total Delay		49.2			180.5			7.5			6.2	
LOS		D			F			A			A	
Approach Delay		49.2			180.5			7.5			6.2	
Approach LOS		D			F			A			A	
Queue Length 50th (m)		22.3			~51.1			71.0			70.0	
Queue Length 95th (m)		41.9			#97.0			86.0			m67.2	
Internal Link Dist (m)		190.1			132.1			94.8			305.9	
Turn Bay Length (m)												
Base Capacity (vph)		236			143			2404			2351	
Starvation Cap Reductn		0			0			0			0	
Spillback Cap Reductn		0			0			0			0	
Storage Cap Reductn		0			0			0			0	
Reduced v/c Ratio		0.49			1.19			0.61			0.66	

Intersection Summary												
Cycle Length: 130												
Actuated Cycle Length: 130												
Offset: 55 (42%), Referenced to phase 2:NBTL and 6:SBTL, Start of Green												
Natural Cycle: 65												
Control Type: Actuated-Coordinated												

Lanes, Volumes, Timings
 5: Bronson Avenue & Madawaska Drive/Fifth Avenue
 2025 Future Total-PM Peak Hour
 770-774 Bronson Ave

Maximum v/c Ratio: 1.19	Intersection Signal Delay: 17.2	Intersection LOS: B
Intersection Capacity Utilization 85.0%	ICU Level of Service E	
Analysis Period (min) 15		
~ Volume exceeds capacity, queue is theoretically infinite.		
Queue shown is maximum after two cycles.		
# 95th percentile volume exceeds capacity, queue may be longer.		
Queue shown is maximum after two cycles.		
m Volume for 95th percentile queue is metered by upstream signal.		

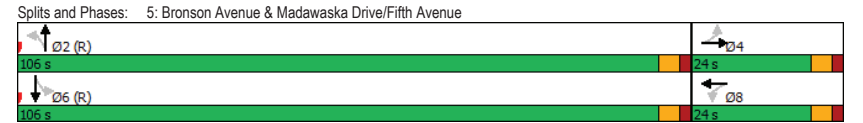

HCM 2010 TWSC
6: Cambridge Street & Site Access

2025 Future Total-PM Peak Hour
770-774 Bronson Ave

Intersection						
Int Delay, s/veh	2					
Movement	WBL	WBR	NBT	NBR	SBL	SBT
Lane Configurations		↑	↑			↑
Traffic Vol, veh/h	0	13	25	0	0	17
Future Vol, veh/h	0	13	25	0	0	17
Conflicting Peds, #/hr	0	0	0	0	0	0
Sign Control	Stop	Stop	Free	Free	Free	Free
RT Channelized	-	None	-	None	-	None
Storage Length	-	0	-	-	-	-
Veh in Median Storage, #	0	-	0	-	-	0
Grade, %	0	-	0	-	-	0
Peak Hour Factor	100	100	100	100	100	100
Heavy Vehicles, %	2	2	2	2	2	2
Mvmt Flow	0	13	25	0	0	17

Major/Minor	Minor1	Major1	Major2
Conflicting Flow All	-	25	0
Stage 1	-	-	-
Stage 2	-	-	-
Critical Hdwy	-	6.22	-
Critical Hdwy Stg 1	-	-	-
Critical Hdwy Stg 2	-	-	-
Follow-up Hdwy	-	3.318	-
Pot Cap-1 Maneuver	0	1051	0
Stage 1	0	-	0
Stage 2	0	-	0
Platoon blocked, %	-	-	-
Mov Cap-1 Maneuver	-	1051	-
Mov Cap-2 Maneuver	-	-	-
Stage 1	-	-	-
Stage 2	-	-	-

Approach	WB	NB	SB
HCM Control Delay, s	8.5	0	0
HCM LOS	A		

Minor Lane/Major Mvmt	NBTWBLn1	SBT
Capacity (veh/h)	-	1051
HCM Lane V/C Ratio	-	0.012
HCM Control Delay (s)	-	8.5
HCM Lane LOS	-	A
HCM 95th %tile Q(veh)	-	0

HCM 2010 TWSC
7: Bronson Avenue & Site Access

2025 Future Total-PM Peak Hour
770-774 Bronson Ave

Intersection						
Int Delay, s/veh	0.4					
Movement	EBL	EBR	NBL	NBT	SBT	SBR
Lane Configurations		↑		↑↑	↑↑	
Traffic Vol, veh/h	0	4	5	1559	1601	16
Future Vol, veh/h	0	4	5	1559	1601	16
Conflicting Peds, #/hr	0	0	0	0	0	0
Sign Control	Stop	Stop	Free	Free	Free	Free
RT Channelized	-	None	-	None	-	None
Storage Length	-	0	-	-	-	-
Veh in Median Storage, #	0	-	-	0	0	-
Grade, %	0	-	-	0	0	-
Peak Hour Factor	100	100	100	100	100	100
Heavy Vehicles, %	2	2	2	2	2	2
Mvmt Flow	0	4	5	1559	1601	16

Major/Minor	Minor2	Major1	Major2
Conflicting Flow All	-	809	1617
Stage 1	-	-	-
Stage 2	-	-	-
Critical Hdwy	-	6.94	4.14
Critical Hdwy Stg 1	-	-	-
Critical Hdwy Stg 2	-	-	-
Follow-up Hdwy	-	3.32	2.22
Pot Cap-1 Maneuver	0	323	399
Stage 1	0	-	-
Stage 2	0	-	-
Platoon blocked, %	-	-	-
Mov Cap-1 Maneuver	-	323	399
Mov Cap-2 Maneuver	-	-	-
Stage 1	-	-	-
Stage 2	-	-	-

Approach	EB	NB	SB
HCM Control Delay, s	16.3	0.7	0
HCM LOS	C		

Minor Lane/Major Mvmt	NBL	NBT EBLn1	SBT	SBR
Capacity (veh/h)	399	-	323	-
HCM Lane V/C Ratio	0.013	-	0.012	-
HCM Control Delay (s)	14.1	0.7	16.3	-
HCM Lane LOS	B	A	C	-
HCM 95th %tile Q(veh)	0	-	0	-

Appendix M

Synchro Intersection Worksheets – 2030 Future Total Conditions

Lanes, Volumes, Timings
1: Carling Avenue & Booth Street

2030 Future Total - AM Peak Hour
770-774 Bronson Ave

Lane Group	EBL	EBT	WBT	WBR	SBL	SBR
Lane Configurations	↔	↕	↕↔	↔	↔	↕
Traffic Volume (vph)	351	1166	808	142	197	139
Future Volume (vph)	351	1166	808	142	197	139
Satd. Flow (prot)	1658	3283	4535	0	1658	1427
Fit Permitted	0.950				0.950	
Satd. Flow (perm)	1592	3283	4535	0	1633	1258
Satd. Flow (RTOR)			32			139
Lane Group Flow (vph)	351	1166	950	0	197	139
Turn Type	Prot	NA	NA		Perm	Perm
Protected Phases	5	2	6			
Permitted Phases					4	4
Detector Phase	5	2	6		4	4
Switch Phase						
Minimum Initial (s)	5.0	10.0	10.0		10.0	10.0
Minimum Split (s)	10.9	22.5	29.7		39.0	39.0
Total Split (s)	34.0	81.0	47.0		39.0	39.0
Total Split (%)	28.3%	67.5%	39.2%		32.5%	32.5%
Yellow Time (s)	3.7	3.7	3.7		3.3	3.3
All-Red Time (s)	2.2	2.0	2.0		2.7	2.7
Lost Time Adjust (s)	0.0	0.0	0.0		0.0	0.0
Total Lost Time (s)	5.9	5.7	5.7		6.0	6.0
Lead/Lag	Lead		Lag			
Lead-Lag Optimize?	Yes		Yes			
Recall Mode	None	Max	C-Max		None	None
Act Effct Green (s)	27.2	75.3	42.2		33.0	33.0
Actuated g/C Ratio	0.23	0.63	0.35		0.28	0.28
v/c Ratio	0.93	0.57	0.59		0.44	0.31
Control Delay	78.3	14.3	32.7		39.6	7.5
Queue Delay	0.0	0.0	0.0		0.0	0.0
Total Delay	78.3	14.3	32.7		39.6	7.5
LOS	E	B	C		D	A
Approach Delay		29.1	32.7		26.3	
Approach LOS		C	C		C	
Queue Length 50th (m)	80.8	77.7	65.0		38.3	0.0
Queue Length 95th (m)	#134.2	95.8	79.6		60.6	15.0
Internal Link Dist (m)		107.6	286.6		178.3	
Turn Bay Length (m)	40.0					30.0
Base Capacity (vph)	388	2060	1614		449	446
Starvation Cap Reductn	0	0	0		0	0
Spillback Cap Reductn	0	0	0		0	0
Storage Cap Reductn	0	0	0		0	0
Reduced v/c Ratio	0.90	0.57	0.59		0.44	0.31

Intersection Summary	
Cycle Length:	120
Actuated Cycle Length:	120
Offset:	116 (97%), Referenced to phase 6:WBT, Start of Green
Natural Cycle:	90
Control Type:	Actuated-Coordinated

Lanes, Volumes, Timings
1: Carling Avenue & Booth Street

2030 Future Total - AM Peak Hour
770-774 Bronson Ave

Maximum v/c Ratio: 0.93	Intersection LOS: C
Intersection Signal Delay: 30.0	ICU Level of Service E
Intersection Capacity Utilization 82.4%	
Analysis Period (min) 15	
# 95th percentile volume exceeds capacity, queue may be longer.	
Queue shown is maximum after two cycles.	

Splits and Phases: 1: Carling Avenue & Booth Street

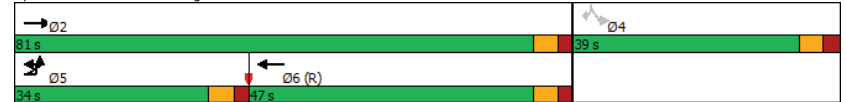

HCM 2010 TWSC
2: Cambridge Street & Carling Avenue

2030 Future Total - AM Peak Hour
770-774 Bronson Ave

Intersection												
Int Delay, s/veh	0.5											
Movement	EBL	EBT	EBR	WBL	WBT	WBR	NBL	NBT	NBR	SBL	SBT	SBR
Lane Configurations	↕↕↕			↕↕		↕			↕			↕
Traffic Vol, veh/h	0	1363	8	0	754	12	0	0	26	0	0	56
Future Vol, veh/h	0	1363	8	0	754	12	0	0	26	0	0	56
Conflicting Peds, #/hr	0	0	45	0	0	38	0	0	1	0	0	0
Sign Control	Free	Free	Free	Free	Free	Free	Stop	Stop	Stop	Stop	Stop	Stop
RT Channelized	-	-	None	-	-	None	-	-	None	-	-	None
Storage Length	-	-	100	-	-	35	-	-	0	-	-	0
Veh in Median Storage, #	-	0	-	-	0	-	-	0	-	-	0	-
Grade, %	-	0	-	-	0	-	-	0	-	-	0	-
Peak Hour Factor	100	100	100	100	100	100	100	100	100	100	100	100
Heavy Vehicles, %	2	3	2	2	4	8	2	2	2	2	2	5
Mvmt Flow	0	1363	8	0	754	12	0	0	26	0	0	56
Major/Minor	Major1		Major2		Minor1		Minor2					
Conflicting Flow All	-	0	0	-	-	0	-	-	732	-	-	415
Stage 1	-	-	-	-	-	-	-	-	-	-	-	-
Stage 2	-	-	-	-	-	-	-	-	-	-	-	-
Critical Hdwy	-	-	-	-	-	-	-	-	7.14	-	-	7
Critical Hdwy Stg 1	-	-	-	-	-	-	-	-	-	-	-	-
Critical Hdwy Stg 2	-	-	-	-	-	-	-	-	-	-	-	-
Follow-up Hdwy	-	-	-	-	-	-	-	-	3.92	-	-	3.35
Pot Cap-1 Maneuver	0	-	-	0	-	-	0	0	312	0	0	578
Stage 1	0	-	-	0	-	-	0	0	-	0	0	-
Stage 2	0	-	-	0	-	-	0	0	-	0	0	-
Platoon blocked, %	-	-	-	-	-	-	-	-	-	-	-	-
Mov Cap-1 Maneuver	-	-	-	-	-	-	-	-	299	-	-	558
Mov Cap-2 Maneuver	-	-	-	-	-	-	-	-	-	-	-	-
Stage 1	-	-	-	-	-	-	-	-	-	-	-	-
Stage 2	-	-	-	-	-	-	-	-	-	-	-	-
Approach	EB		WB		NB		SB					
HCM Control Delay, s	0		0		18.2		12.2					
HCM LOS					C		B					
Minor Lane/Major Mvmt	NBLn1	EBT	EBR	WBT	WBR	SBLn1						
Capacity (veh/h)	299	-	-	-	-	558						
HCM Lane V/C Ratio	0.087	-	-	-	-	0.1						
HCM Control Delay (s)	18.2	-	-	-	-	12.2						
HCM Lane LOS	C	-	-	-	-	B						
HCM 95th %tile Q(veh)	0.3	-	-	-	-	0.3						

Lanes, Volumes, Timings
3: Bronson Avenue & Powell Avenue

2030 Future Total - AM Peak Hour
770-774 Bronson Ave



Lane Group	EBL	EBT	EBR	WBL	WBT	WBR	NBL	NBT	NBR	SBL	SBT	SBR
Lane Configurations		↕↕			↕↕			↕↕			↕↕	
Traffic Volume (vph)	180	25	87	17	53	17	45	1658	8	11	1080	73
Future Volume (vph)	180	25	87	17	53	17	45	1658	8	11	1080	73
Satd. Flow (prot)	0	1577	0	0	1642	0	0	3275	0	0	3245	0
Fit Permitted		0.772			0.915			0.871			0.928	
Satd. Flow (perm)	0	1214	0	0	1517	0	0	2855	0	0	3011	0
Satd. Flow (RTOR)		17			10			1			16	
Lane Group Flow (vph)	0	292	0	0	87	0	0	1711	0	0	1164	0
Turn Type	Perm	NA		Perm	NA		Perm	NA		Perm	NA	
Protected Phases		4			8			2			6	
Permitted Phases	4			8			2			6		
Detector Phase	4	4		8	8		2	2		6	6	
Switch Phase												
Minimum Initial (s)	10.0	10.0		10.0	10.0		10.0	10.0		10.0	10.0	
Minimum Split (s)	23.7	23.7		23.7	23.7		32.3	32.3		32.3	32.3	
Total Split (s)	26.0	26.0		26.0	26.0		84.0	84.0		84.0	84.0	
Total Split (%)	23.6%	23.6%		23.6%	23.6%		76.4%	76.4%		76.4%	76.4%	
Yellow Time (s)	3.0	3.0		3.0	3.0		3.3	3.3		3.3	3.3	
All-Red Time (s)	2.7	2.7		2.7	2.7		2.0	2.0		2.0	2.0	
Lost Time Adjust (s)		0.0			0.0			0.0			0.0	
Total Lost Time (s)		5.7			5.7			5.3			5.3	
Lead/Lag												
Lead-Lag Optimize?												
Recall Mode	None	None		None	None		C-Max	C-Max		C-Max	C-Max	
Act Effct Green (s)		20.3			20.3			78.7			78.7	
Actuated g/C Ratio		0.18			0.18			0.72			0.72	
v/c Ratio		1.23			0.30			0.84			0.54	
Control Delay		172.4			37.5			9.6			8.2	
Queue Delay		0.0			0.0			25.4			0.1	
Total Delay		172.4			37.5			35.0			8.3	
LOS		F			D			C			A	
Approach Delay		172.4			37.5			35.0			8.3	
Approach LOS		F			D			C			A	
Queue Length 50th (m)		~74.7			14.4			91.4			52.5	
Queue Length 95th (m)		#127.6			29.0			m61.9			66.6	
Internal Link Dist (m)		74.6			106.0			142.6			39.5	
Turn Bay Length (m)												
Base Capacity (vph)		237			288			2042			2158	
Starvation Cap Reductn		0			0			407			0	
Spillback Cap Reductn		0			0			0			169	
Storage Cap Reductn		0			0			0			0	
Reduced v/c Ratio		1.23			0.30			1.05			0.59	
Intersection Summary												
Cycle Length: 110												
Actuated Cycle Length: 110												
Offset: 21 (19%), Referenced to phase 2:NBTL and 6:SBTL, Start of Green												
Natural Cycle: 80												
Control Type: Actuated-Coordinated												

Lanes, Volumes, Timings
3: Bronson Avenue & Powell Avenue

2030 Future Total - AM Peak Hour
770-774 Bronson Ave

Maximum v/c Ratio: 1.23	Intersection LOS: D
Intersection Signal Delay: 37.9	ICU Level of Service H
Intersection Capacity Utilization 116.9%	
Analysis Period (min) 15	
~ Volume exceeds capacity, queue is theoretically infinite.	
Queue shown is maximum after two cycles.	
# 95th percentile volume exceeds capacity, queue may be longer.	
Queue shown is maximum after two cycles.	
m Volume for 95th percentile queue is metered by upstream signal.	



Lanes, Volumes, Timings
4: Bronson Avenue & Carling Avenue/Glebe Avenue

2030 Future Total - AM Peak Hour
770-774 Bronson Ave

Lane Group	EBU	EBL	EBT	EBR	WBL	WBT	WBR	NBL	NBT	NBR	SBL	SBT
Lane Configurations												
Traffic Volume (vph)	2	502	152	655	0	0	0	443	1397	38	0	1012
Future Volume (vph)	2	502	152	655	0	0	0	443	1397	38	0	1012
Satd. Flow (prot)	0	1530	1575	1483	0	0	0	3216	1730	0	0	3246
Fit Permitted		0.950	0.974					0.950				
Satd. Flow (perm)	0	1460	1536	1271	0	0	0	3182	1730	0	0	3246
Satd. Flow (RTOR)				30					3			13
Lane Group Flow (vph)	0	323	333	655	0	0	0	443	1435	0	0	1130
Turn Type	Perm	Perm	NA	pm+ov				Prot	NA			NA
Protected Phases				4	5			5	2			6
Permitted Phases	4	4		4								
Detector Phase	4	4	4	5				5	2			6
Switch Phase												
Minimum Initial (s)	10.0	10.0	10.0	5.0				5.0	10.0			10.0
Minimum Split (s)	31.0	31.0	31.0	11.0				11.0	24.0			33.0
Total Split (s)	31.0	31.0	31.0	34.0				34.0	79.0			45.0
Total Split (%)	28.2%	28.2%	28.2%	30.9%				30.9%	71.8%			40.9%
Yellow Time (s)	3.3	3.3	3.3	3.3				3.3	3.3			3.3
All-Red Time (s)	2.7	2.7	2.7	2.7				2.7	2.7			2.7
Lost Time Adjust (s)		0.0	0.0	0.0				0.0	0.0			0.0
Total Lost Time (s)		6.0	6.0	6.0				6.0	6.0			6.0
Lead/Lag				Lead				Lead				Lag
Lead-Lag Optimize?				Yes				Yes				Yes
Recall Mode	None	None	None	Min				Min	C-Max			C-Max
Act Effct Green (s)		25.0	25.0	52.2				27.2	73.0			39.8
Actuated g/C Ratio		0.23	0.23	0.47				0.25	0.66			0.36
v/c Ratio		0.98	0.95	0.98				0.56	1.25			0.96
Control Delay		87.0	80.9	55.6				29.5	147.1			45.4
Queue Delay		0.0	0.0	0.0				0.0	0.2			0.0
Total Delay		87.0	80.9	55.6				29.5	147.3			45.4
LOS		F	F	E				C	F			D
Approach Delay			69.8					119.5				45.4
Approach LOS			E					F				D
Queue Length 50th (m)		72.8	74.7	105.7				42.7	~398.3			125.3
Queue Length 95th (m)		#130.6	#132.2	#206.0				50.8	#478.9			m#163.8
Internal Link Dist (m)			82.5			112.6			59.6			142.6
Turn Bay Length (m)								40.0				
Base Capacity (vph)		331	349	681				818	1149			1181
Starvation Cap Reductn		0	0	0				0	0			0
Spillback Cap Reductn		0	0	0				0	41			0
Storage Cap Reductn		0	0	0				0	0			0
Reduced v/c Ratio		0.98	0.95	0.96				0.54	1.30			0.96

Intersection Summary		
Cycle Length: 110		
Actuated Cycle Length: 110		
Offset: 53 (48%), Referenced to phase 2:NBT and 6:SBT, Start of Green		
Natural Cycle: 140		
Control Type: Actuated-Coordinated		

Lanes, Volumes, Timings
 4: Bronson Avenue & Carling Avenue/Glebe Avenue

2030 Future Total - AM Peak Hour
 770-774 Bronson Ave

Lane Group	SBR
Lane Configurations	
Traffic Volume (vph)	118
Future Volume (vph)	118
Satd. Flow (prot)	0
Fit Permitted	
Satd. Flow (perm)	0
Satd. Flow (RTOR)	
Lane Group Flow (vph)	0
Turn Type	
Protected Phases	
Permitted Phases	
Detector Phase	
Switch Phase	
Minimum Initial (s)	
Minimum Split (s)	
Total Split (s)	
Total Split (%)	
Yellow Time (s)	
All-Red Time (s)	
Lost Time Adjust (s)	
Total Lost Time (s)	
Lead/Lag	
Lead-Lag Optimize?	
Recall Mode	
Act Effct Green (s)	
Actuated g/C Ratio	
v/c Ratio	
Control Delay	
Queue Delay	
Total Delay	
LOS	
Approach Delay	
Approach LOS	
Queue Length 50th (m)	
Queue Length 95th (m)	
Internal Link Dist (m)	
Turn Bay Length (m)	
Base Capacity (vph)	
Starvation Cap Reductn	
Spillback Cap Reductn	
Storage Cap Reductn	
Reduced v/c Ratio	
Intersection Summary	

Lanes, Volumes, Timings
 4: Bronson Avenue & Carling Avenue/Glebe Avenue

2030 Future Total - AM Peak Hour
 770-774 Bronson Ave

Maximum v/c Ratio: 1.25	
Intersection Signal Delay: 85.0	Intersection LOS: F
Intersection Capacity Utilization 110.9%	ICU Level of Service H
Analysis Period (min) 15	
~ Volume exceeds capacity, queue is theoretically infinite. Queue shown is maximum after two cycles.	
# 95th percentile volume exceeds capacity, queue may be longer. Queue shown is maximum after two cycles.	
m Volume for 95th percentile queue is metered by upstream signal.	

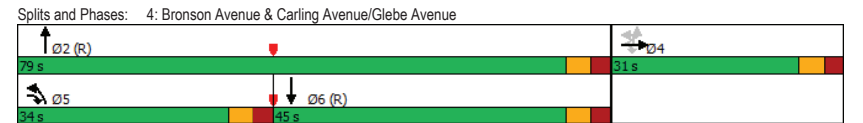

Lanes, Volumes, Timings
 5: Bronson Avenue & Madawaska Drive/Fifth Avenue
 2030 Future Total - AM Peak Hour
 770-774 Bronson Ave

Lane Group	EBL	EBT	EBR	WBL	WBT	WBR	NBL	NBT	NBR	SBL	SBT	SBR
Lane Configurations		↔			↔			↔			↔	
Traffic Volume (vph)	7	114	34	86	34	46	0	1725	34	22	1715	1
Future Volume (vph)	7	114	34	86	34	46	0	1725	34	22	1715	1
Satd. Flow (prot)	0	1617	0	0	1608	0	0	3302	0	0	3311	0
Fit Permitted		0.984			0.619						0.899	
Satd. Flow (perm)	0	1592	0	0	1006	0	0	3302	0	0	2980	0
Satd. Flow (RTOR)		12			16			4				
Lane Group Flow (vph)	0	155	0	0	166	0	0	1759	0	0	1738	0
Turn Type	Perm	NA		Perm	NA			NA		Perm	NA	
Protected Phases		4			8			2			6	
Permitted Phases	4			8						6		
Detector Phase	4	4		8	8			2		6	6	
Switch Phase												
Minimum Initial (s)	10.0	10.0		10.0	10.0			10.0		10.0	10.0	
Minimum Split (s)	23.3	23.3		23.3	23.3			34.3		34.3	34.3	
Total Split (s)	28.0	28.0		28.0	28.0			82.0		82.0	82.0	
Total Split (%)	25.5%	25.5%		25.5%	25.5%			74.5%		74.5%	74.5%	
Yellow Time (s)	3.3	3.3		3.3	3.3			3.3		3.3	3.3	
All-Red Time (s)	2.0	2.0		2.0	2.0			2.0		2.0	2.0	
Lost Time Adjust (s)		0.0			0.0			0.0		0.0	0.0	
Total Lost Time (s)		5.3			5.3			5.3		5.3	5.3	
Lead/Lag												
Lead-Lag Optimize?												
Recall Mode	None	None		None	None			C-Max		C-Max	C-Max	
Act Effct Green (s)		19.3			19.3			80.1		80.1	80.1	
Actuated g/C Ratio		0.18			0.18			0.73		0.73	0.73	
v/c Ratio		0.54			0.88			0.73		0.80	0.80	
Control Delay		44.3			79.3			11.7		8.9	8.9	
Queue Delay		0.0			0.0			0.0		0.0	0.0	
Total Delay		44.3			79.3			11.7		8.9	8.9	
LOS		D			E			B		A	A	
Approach Delay		44.3			79.3			11.7		8.9	8.9	
Approach LOS		D			E			B		A	A	
Queue Length 50th (m)		27.4			31.0			109.4		56.0	56.0	
Queue Length 95th (m)		47.1			#63.6			142.1		m193.3	193.3	
Internal Link Dist (m)		190.1			132.1			94.8		308.6	308.6	
Turn Bay Length (m)												
Base Capacity (vph)		338			220			2405		2169	2169	
Starvation Cap Reductn		0			0			0		0	0	
Spillback Cap Reductn		0			0			0		0	0	
Storage Cap Reductn		0			0			0		0	0	
Reduced v/c Ratio		0.46			0.75			0.73		0.80	0.80	

Intersection Summary
 Cycle Length: 110
 Actuated Cycle Length: 110
 Offset: 70 (64%), Referenced to phase 2:NBT and 6:SBL, Start of Green
 Natural Cycle: 80
 Control Type: Actuated-Coordinated

Lanes, Volumes, Timings
 5: Bronson Avenue & Madawaska Drive/Fifth Avenue
 2030 Future Total - AM Peak Hour
 770-774 Bronson Ave

Maximum v/c Ratio: 0.88
 Intersection Signal Delay: 14.7
 Intersection Capacity Utilization 105.6%
 Analysis Period (min) 15
 # 95th percentile volume exceeds capacity, queue may be longer.
 Queue shown is maximum after two cycles.
 m Volume for 95th percentile queue is metered by upstream signal.

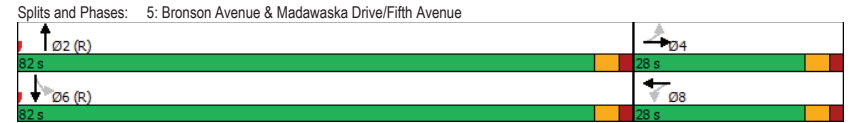

HCM 2010 TWSC
6: Cambridge Street & Site Access

2030 Future Total - AM Peak Hour
770-774 Bronson Ave

Intersection						
Int Delay, s/veh	4					
Movement	WBL	WBR	NBT	NBR	SBL	SBT
Lane Configurations		↑	↑			↑
Traffic Vol, veh/h	0	16	10	0	0	8
Future Vol, veh/h	0	16	10	0	0	8
Conflicting Peds, #/hr	0	0	0	0	0	0
Sign Control	Stop	Stop	Free	Free	Free	Free
RT Channelized	-	None	-	None	-	None
Storage Length	-	0	-	-	-	-
Veh in Median Storage, #	0	-	0	-	-	0
Grade, %	0	-	0	-	-	0
Peak Hour Factor	100	100	100	100	100	100
Heavy Vehicles, %	2	2	2	2	2	2
Mvmt Flow	0	16	10	0	0	8

Major/Minor	Minor1	Major1	Major2
Conflicting Flow All	-	10	0
Stage 1	-	-	-
Stage 2	-	-	-
Critical Hdwy	-	6.22	-
Critical Hdwy Stg 1	-	-	-
Critical Hdwy Stg 2	-	-	-
Follow-up Hdwy	-	3.318	-
Pot Cap-1 Maneuver	0	1071	0
Stage 1	0	-	0
Stage 2	0	-	0
Platoon blocked, %	-	-	-
Mov Cap-1 Maneuver	-	1071	-
Mov Cap-2 Maneuver	-	-	-
Stage 1	-	-	-
Stage 2	-	-	-

Approach	WB	NB	SB
HCM Control Delay, s	8.4	0	0
HCM LOS	A		

Minor Lane/Major Mvmt	NBTWBLn1	SBT
Capacity (veh/h)	-	1071
HCM Lane V/C Ratio	-	0.015
HCM Control Delay (s)	-	8.4
HCM Lane LOS	-	A
HCM 95th %tile Q(veh)	-	0

HCM 2010 TWSC
7: Bronson Avenue & Site Access

2030 Future Total - AM Peak Hour
770-774 Bronson Ave

Intersection						
Int Delay, s/veh	0					
Movement	EBL	EBR	NBL	NBT	SBT	SBR
Lane Configurations		↑		↔	↔	
Traffic Vol, veh/h	0	5	2	1878	1730	7
Future Vol, veh/h	0	5	2	1878	1730	7
Conflicting Peds, #/hr	0	0	0	0	0	0
Sign Control	Stop	Stop	Free	Free	Free	Free
RT Channelized	-	None	-	None	-	None
Storage Length	-	0	-	-	-	-
Veh in Median Storage, #	0	-	-	0	0	-
Grade, %	0	-	-	0	0	-
Peak Hour Factor	100	100	100	100	100	100
Heavy Vehicles, %	2	2	2	2	2	2
Mvmt Flow	0	5	2	1878	1730	7

Major/Minor	Minor2	Major1	Major2
Conflicting Flow All	-	869	1737
Stage 1	-	-	-
Stage 2	-	-	-
Critical Hdwy	-	6.94	4.14
Critical Hdwy Stg 1	-	-	-
Critical Hdwy Stg 2	-	-	-
Follow-up Hdwy	-	3.32	2.22
Pot Cap-1 Maneuver	0	295	358
Stage 1	0	-	-
Stage 2	0	-	-
Platoon blocked, %	-	-	-
Mov Cap-1 Maneuver	-	295	358
Mov Cap-2 Maneuver	-	-	-
Stage 1	-	-	-
Stage 2	-	-	-

Approach	EB	NB	SB
HCM Control Delay, s	17.4	0	0
HCM LOS	C		

Minor Lane/Major Mvmt	NBL	NBT EBLn1	SBT	SBR
Capacity (veh/h)	358	-	295	-
HCM Lane V/C Ratio	0.006	-	0.017	-
HCM Control Delay (s)	15.1	0	17.4	-
HCM Lane LOS	C	A	C	-
HCM 95th %tile Q(veh)	0	-	0.1	-

Lanes, Volumes, Timings
1: Carling Avenue & Booth Street

2030 Future Total-PM Peak Hour
770-774 Bronson Ave

Lane Group	EBL	EBT	WBT	WBR	SBL	SBR
Lane Configurations	↔	↕	↕↕	↕	↔	↕
Traffic Volume (vph)	257	938	1242	72	420	697
Future Volume (vph)	257	938	1242	72	420	697
Satd. Flow (prot)	1658	3283	4674	0	1658	1427
Fit Permitted	0.950				0.950	
Satd. Flow (perm)	1611	3283	4674	0	1632	1230
Satd. Flow (RTOR)			9			82
Lane Group Flow (vph)	257	938	1314	0	420	697
Turn Type	Prot	NA	NA		Perm	Perm
Protected Phases	5	2	6			
Permitted Phases					4	4
Detector Phase	5	2	6		4	4
Switch Phase						
Minimum Initial (s)	5.0	10.0	10.0		10.0	10.0
Minimum Split (s)	10.9	22.5	29.7		39.0	39.0
Total Split (s)	23.0	90.0	67.0		40.0	40.0
Total Split (%)	17.7%	69.2%	51.5%		30.8%	30.8%
Yellow Time (s)	3.7	3.7	3.7		3.3	3.3
All-Red Time (s)	2.2	2.0	2.0		2.7	2.7
Lost Time Adjust (s)	0.0	0.0	0.0		0.0	0.0
Total Lost Time (s)	5.9	5.7	5.7		6.0	6.0
Lead/Lag	Lead		Lag			
Lead-Lag Optimize?	Yes		Yes			
Recall Mode	None	Max	C-Max		None	None
Act Effct Green (s)	17.1	84.3	61.3		34.0	34.0
Actuated g/C Ratio	0.13	0.65	0.47		0.26	0.26
v/c Ratio	1.18	0.44	0.60		0.99	1.82
Control Delay	165.9	12.0	44.3		88.1	407.4
Queue Delay	0.0	0.0	0.0		0.0	0.0
Total Delay	165.9	12.0	44.3		88.1	407.4
LOS	F	B	D		F	F
Approach Delay		45.1	44.3		287.3	
Approach LOS		D	D		F	
Queue Length 50th (m)	~78.8	57.8	111.4		107.5	~255.2
Queue Length 95th (m)	#131.4	71.3	m124.9		#172.2	#328.8
Internal Link Dist (m)		107.6	286.6		178.3	
Turn Bay Length (m)	40.0					30.0
Base Capacity (vph)	218	2128	2208		426	382
Starvation Cap Reductn	0	0	0		0	0
Spillback Cap Reductn	0	0	0		0	0
Storage Cap Reductn	0	0	0		0	0
Reduced v/c Ratio	1.18	0.44	0.60		0.99	1.82

Intersection Summary	
Cycle Length:	130
Actuated Cycle Length:	130
Offset:	110 (85%), Referenced to phase 6:WBT, Start of Green
Natural Cycle:	100
Control Type:	Actuated-Coordinated

Lanes, Volumes, Timings
1: Carling Avenue & Booth Street

2030 Future Total-PM Peak Hour
770-774 Bronson Ave

Maximum v/c Ratio:	1.82
Intersection Signal Delay:	119.4
Intersection LOS:	F
Intersection Capacity Utilization:	107.9%
ICU Level of Service:	G
Analysis Period (min):	15
~ Volume exceeds capacity, queue is theoretically infinite. Queue shown is maximum after two cycles.	
# 95th percentile volume exceeds capacity, queue may be longer. Queue shown is maximum after two cycles.	
m Volume for 95th percentile queue is metered by upstream signal.	



HCM 2010 TWSC
2: Cambridge Street & Carling Avenue

2030 Future Total-PM Peak Hour
770-774 Bronson Ave

Intersection												
Int Delay, s/veh	2.6											
Movement	EBL	EBT	EBR	WBL	WBT	WBR	NBL	NBT	NBR	SBL	SBT	SBR
Lane Configurations	↔↔↔			↔↔		↔			↔			↔
Traffic Vol, veh/h	0	1253	17	0	737	6	0	0	54	0	0	291
Future Vol, veh/h	0	1253	17	0	737	6	0	0	54	0	0	291
Conflicting Peds, #/hr	0	0	42	0	0	33	0	0	4	0	0	1
Sign Control	Free	Free	Free	Free	Free	Free	Stop	Stop	Stop	Stop	Stop	Stop
RT Channelized	-	-	None	-	-	None	-	-	None	-	-	None
Storage Length	-	-	100	-	-	35	-	-	0	-	-	0
Veh in Median Storage, #	-	0	-	-	0	-	-	0	-	-	0	-
Grade, %	-	0	-	-	0	-	-	0	-	-	0	-
Peak Hour Factor	100	100	100	100	100	100	100	100	100	100	100	100
Heavy Vehicles, %	2	3	2	2	4	8	2	2	2	2	2	5
Mvmt Flow	0	1253	17	0	737	6	0	0	54	0	0	291
Major/Minor	Major1		Major2		Minor1		Minor2					
Conflicting Flow All	-	0	0	-	-	0	-	-	681	-	-	403
Stage 1	-	-	-	-	-	-	-	-	-	-	-	-
Stage 2	-	-	-	-	-	-	-	-	-	-	-	-
Critical Hdwy	-	-	-	-	-	-	-	-	7.14	-	-	7
Critical Hdwy Stg 1	-	-	-	-	-	-	-	-	-	-	-	-
Critical Hdwy Stg 2	-	-	-	-	-	-	-	-	-	-	-	-
Follow-up Hdwy	-	-	-	-	-	-	-	-	3.92	-	-	3.35
Pot Cap-1 Maneuver	0	-	-	0	-	-	0	0	337	0	0	589
Stage 1	0	-	-	0	-	-	0	0	-	0	0	-
Stage 2	0	-	-	0	-	-	0	0	-	0	0	-
Platoon blocked, %	-	-	-	-	-	-	-	-	-	-	-	-
Mov Cap-1 Maneuver	-	-	-	-	-	-	-	-	323	-	-	570
Mov Cap-2 Maneuver	-	-	-	-	-	-	-	-	-	-	-	-
Stage 1	-	-	-	-	-	-	-	-	-	-	-	-
Stage 2	-	-	-	-	-	-	-	-	-	-	-	-
Approach	EB		WB		NB		SB					
HCM Control Delay, s	0		0		18.4		17.7					
HCM LOS					C		C					
Minor Lane/Major Mvmt	NBLn1	EBT	EBR	WBT	WBR	SBLn1						
Capacity (veh/h)	323	-	-	-	-	570						
HCM Lane V/C Ratio	0.167	-	-	-	-	0.511						
HCM Control Delay (s)	18.4	-	-	-	-	17.7						
HCM Lane LOS	C	-	-	-	-	C						
HCM 95th %tile Q(veh)	0.6	-	-	-	-	2.9						

Lanes, Volumes, Timings
3: Bronson Avenue & Powell Avenue

2030 Future Total-PM Peak Hour
770-774 Bronson Ave

Lane Group	EBL	EBT	EBR	WBL	WBT	WBR	NBL	NBT	NBR	SBL	SBT	SBR
Lane Configurations		↔↔			↔↔			↔↔			↔↔	
Traffic Volume (vph)	141	82	150	58	89	5	79	1225	19	6	959	57
Future Volume (vph)	141	82	150	58	89	5	79	1225	19	6	959	57
Satd. Flow (prot)	0	1575	0	0	1699	0	0	3262	0	0	3249	0
Fit Permitted		0.782			0.684			0.753			0.946	
Satd. Flow (perm)	0	1239	0	0	1184	0	0	2462	0	0	3073	0
Satd. Flow (RTOR)		25			1			2			10	
Lane Group Flow (vph)	0	373	0	0	152	0	0	1323	0	0	1022	0
Turn Type	Perm	NA		Perm	NA		Perm	NA		Perm	NA	
Protected Phases		4			8			2			6	
Permitted Phases	4				8			2			6	
Detector Phase	4	4			8			2	2		6	6
Switch Phase												
Minimum Initial (s)	10.0	10.0		10.0	10.0		10.0	10.0		10.0	10.0	
Minimum Split (s)	23.7	23.7		23.7	23.7		32.3	32.3		32.3	32.3	
Total Split (s)	38.0	38.0		38.0	38.0		92.0	92.0		92.0	92.0	
Total Split (%)	29.2%	29.2%		29.2%	29.2%		70.8%	70.8%		70.8%	70.8%	
Yellow Time (s)	3.0	3.0		3.0	3.0		3.3	3.3		3.3	3.3	
All-Red Time (s)	2.7	2.7		2.7	2.7		2.0	2.0		2.0	2.0	
Lost Time Adjust (s)		0.0			0.0			0.0			0.0	
Total Lost Time (s)		5.7			5.7			5.3			5.3	
Lead/Lag												
Lead-Lag Optimize?												
Recall Mode	None	None		None	None		C-Max	C-Max		C-Max	C-Max	
Act Effct Green (s)		32.3			32.3			86.7			86.7	
Actuated g/C Ratio		0.25			0.25			0.67			0.67	
v/c Ratio		1.14			0.52			0.81			0.50	
Control Delay		135.9			49.1			18.0			11.7	
Queue Delay		0.0			0.0			15.4			0.0	
Total Delay		135.9			49.1			33.4			11.7	
LOS		F			D			C			B	
Approach Delay		135.9			49.1			33.4			11.7	
Approach LOS		F			D			C			B	
Queue Length 50th (m)		-106.8			33.5			119.5			62.8	
Queue Length 95th (m)		#167.9			55.9			m122.6			77.5	
Internal Link Dist (m)		74.6			106.0			142.6			39.5	
Turn Bay Length (m)												
Base Capacity (vph)		326			294			1642			2052	
Starvation Cap Reductn		0			0			335			0	
Spillback Cap Reductn		0			0			0			46	
Storage Cap Reductn		0			0			0			0	
Reduced v/c Ratio		1.14			0.52			1.01			0.51	
Intersection Summary												
Cycle Length: 130												
Actuated Cycle Length: 130												
Offset: 46 (35%), Referenced to phase 2:NBTL and 6:SBTL, Start of Green												
Natural Cycle: 70												
Control Type: Actuated-Coordinated												

Lanes, Volumes, Timings
3: Bronson Avenue & Powell Avenue

2030 Future Total-PM Peak Hour
770-774 Bronson Ave

Maximum v/c Ratio: 1.14	Intersection LOS: D
Intersection Signal Delay: 39.8	ICU Level of Service H
Intersection Capacity Utilization 112.1%	
Analysis Period (min) 15	
~ Volume exceeds capacity, queue is theoretically infinite.	
Queue shown is maximum after two cycles.	
# 95th percentile volume exceeds capacity, queue may be longer.	
Queue shown is maximum after two cycles.	
m Volume for 95th percentile queue is metered by upstream signal.	

Splits and Phases: 3: Bronson Avenue & Powell Avenue

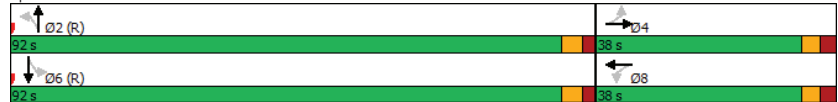

Lanes, Volumes, Timings
4: Bronson Avenue & Carling Avenue/Glebe Avenue

2030 Future Total-PM Peak Hour
770-774 Bronson Ave

Lane Group	EBU	EBL	EBT	EBR	WBL	WBT	WBR	NBL	NBT	NBR	SBL	SBT
Lane Configurations												
Traffic Volume (vph)	2	304	133	793	0	0	0	504	1268	26	0	1054
Future Volume (vph)	2	304	133	793	0	0	0	504	1268	26	0	1054
Satd. Flow (prot)	0	1530	1587	1483	0	0	0	3216	1733	0	0	3257
Fit Permitted		0.950	0.980					0.950				
Satd. Flow (perm)	0	1387	1557	1406	0	0	0	3171	1733	0	0	3257
Satd. Flow (RTOR)				61					2			12
Lane Group Flow (vph)	0	218	221	793	0	0	0	504	1294	0	0	1158
Turn Type	Perm	Perm	NA	pm+ov				Prot	NA			NA
Protected Phases				4	5			5	2			6
Permitted Phases	4	4		4								
Detector Phase	4	4	4	5				5	2			6
Switch Phase												
Minimum Initial (s)	10.0	10.0	10.0	5.0				5.0	10.0			10.0
Minimum Split (s)	31.0	31.0	31.0	11.0				11.0	24.0			33.0
Total Split (s)	31.0	31.0	31.0	26.0				26.0	99.0			73.0
Total Split (%)	23.8%	23.8%	23.8%	20.0%				20.0%	76.2%			56.2%
Yellow Time (s)	3.3	3.3	3.3	3.3				3.3	3.3			3.3
All-Red Time (s)	2.7	2.7	2.7	2.7				2.7	2.7			2.7
Lost Time Adjust (s)		0.0	0.0	0.0				0.0	0.0			0.0
Total Lost Time (s)		6.0	6.0	6.0				6.0	6.0			6.0
Lead/Lag				Lead				Lead				Lag
Lead-Lag Optimize?				Yes				Yes				Yes
Recall Mode	None	None	None	Min				Min	C-Max			C-Max
Act Effct Green (s)		23.2	23.2	45.0				21.8	94.8			67.0
Actuated g/C Ratio		0.18	0.18	0.35				0.17	0.73			0.52
v/c Ratio		0.89	0.80	1.47				0.93	1.02			0.69
Control Delay		71.3	58.5	248.6				68.5	53.5			18.6
Queue Delay		0.0	0.0	0.0				0.0	19.9			0.2
Total Delay		71.3	58.5	248.6				68.5	73.4			18.7
LOS		E	E	F				E	E			B
Approach Delay			183.1						72.0			18.7
Approach LOS			F						E			B
Queue Length 50th (m)		59.0	58.9	~209.7				~70.7	~266.6			62.3
Queue Length 95th (m)		m#86.2	m79.7	m#267.3				m#103.4	m#427.5			m82.4
Internal Link Dist (m)			82.5			112.6			62.3			142.6
Turn Bay Length (m)								40.0				
Base Capacity (vph)		266	299	539				540	1264			1684
Starvation Cap Reductn		0	0	0				0	0			85
Spillback Cap Reductn		0	0	0				0	63			0
Storage Cap Reductn		0	0	0				0	0			0
Reduced v/c Ratio		0.82	0.74	1.47				0.93	1.08			0.72

Intersection Summary

Cycle Length: 130
Actuated Cycle Length: 130
Offset: 46 (35%), Referenced to phase 2:NBT and 6:SBT, Start of Green
Natural Cycle: 130
Control Type: Actuated-Coordinated

Lanes, Volumes, Timings
4: Bronson Avenue & Carling Avenue/Glebe Avenue

2030 Future Total-PM Peak Hour
770-774 Bronson Ave

Lane Group	SBR
Lane Configurations	
Traffic Volume (vph)	104
Future Volume (vph)	104
Satd. Flow (prot)	0
Fit Permitted	
Satd. Flow (perm)	0
Satd. Flow (RTOR)	
Lane Group Flow (vph)	0
Turn Type	
Protected Phases	
Permitted Phases	
Detector Phase	
Switch Phase	
Minimum Initial (s)	
Minimum Split (s)	
Total Split (s)	
Total Split (%)	
Yellow Time (s)	
All-Red Time (s)	
Lost Time Adjust (s)	
Total Lost Time (s)	
Lead/Lag	
Lead-Lag Optimize?	
Recall Mode	
Act Effct Green (s)	
Actuated g/C Ratio	
v/c Ratio	
Control Delay	
Queue Delay	
Total Delay	
LOS	
Approach Delay	
Approach LOS	
Queue Length 50th (m)	
Queue Length 95th (m)	
Internal Link Dist (m)	
Turn Bay Length (m)	
Base Capacity (vph)	
Starvation Cap Reductn	
Spillback Cap Reductn	
Storage Cap Reductn	
Reduced v/c Ratio	
Intersection Summary	

Lanes, Volumes, Timings
4: Bronson Avenue & Carling Avenue/Glebe Avenue

2030 Future Total-PM Peak Hour
770-774 Bronson Ave

Maximum v/c Ratio: 1.47	
Intersection Signal Delay: 90.0	Intersection LOS: F
Intersection Capacity Utilization 99.2%	ICU Level of Service F
Analysis Period (min) 15	
~ Volume exceeds capacity, queue is theoretically infinite. Queue shown is maximum after two cycles.	
# 95th percentile volume exceeds capacity, queue may be longer. Queue shown is maximum after two cycles.	
m Volume for 95th percentile queue is metered by upstream signal.	

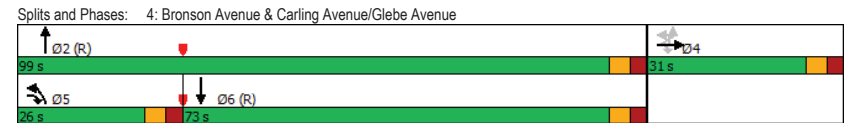

Lanes, Volumes, Timings
 5: Bronson Avenue & Madawaska Drive/Fifth Avenue
 2030 Future Total-PM Peak Hour
 770-774 Bronson Ave

Lane Group	EBL	EBT	EBR	WBL	WBT	WBR	NBL	NBT	NBR	SBL	SBT	SBR
Lane Configurations		↔			↔			↔			↔	
Traffic Volume (vph)	3	129	91	137	22	27	9	1645	27	19	1540	4
Future Volume (vph)	3	129	91	137	22	27	9	1645	27	19	1540	4
Satd. Flow (prot)	0	1520	0	0	1637	0	0	3305	0	0	3310	0
Fit Permitted		0.997			0.264			0.942			0.905	
Satd. Flow (perm)	0	1517	0	0	442	0	0	3113	0	0	2999	0
Satd. Flow (RTOR)		22			5			4			1	
Lane Group Flow (vph)	0	223	0	0	186	0	0	1681	0	0	1563	0
Turn Type	Perm	NA		Perm	NA		Perm	NA		Perm	NA	
Protected Phases		4			8			2			6	
Permitted Phases	4			8			2			6		
Detector Phase	4	4		8	8		2	2		6	6	
Switch Phase												
Minimum Initial (s)	10.0	10.0		10.0	10.0		10.0	10.0		10.0	10.0	
Minimum Split (s)	23.3	23.3		23.3	23.3		34.3	34.3		34.3	34.3	
Total Split (s)	24.0	24.0		24.0	24.0		106.0	106.0		106.0	106.0	
Total Split (%)	18.5%	18.5%		18.5%	18.5%		81.5%	81.5%		81.5%	81.5%	
Yellow Time (s)	3.3	3.3		3.3	3.3		3.3	3.3		3.3	3.3	
All-Red Time (s)	2.0	2.0		2.0	2.0		2.0	2.0		2.0	2.0	
Lost Time Adjust (s)		0.0			0.0			0.0			0.0	
Total Lost Time (s)		5.3			5.3			5.3			5.3	
Lead/Lag												
Lead-Lag Optimize?												
Recall Mode	None	None		None	None		C-Max	C-Max		C-Max	C-Max	
Act Effct Green (s)		18.7			18.7			100.7			100.7	
Actuated g/C Ratio		0.14			0.14			0.77			0.77	
v/c Ratio		0.94			2.78			0.70			0.67	
Control Delay		94.7			859.7			9.1			7.0	
Queue Delay		0.0			0.0			0.0			0.0	
Total Delay		94.7			859.7			9.1			7.0	
LOS		F			F			A			A	
Approach Delay		94.7			859.7			9.1			7.0	
Approach LOS		F			F			A			A	
Queue Length 50th (m)		52.1			~80.8			94.4			77.9	
Queue Length 95th (m)		#101.1			#128.3			115.2			m71.3	
Internal Link Dist (m)		190.1			132.1			94.8			305.9	
Turn Bay Length (m)												
Base Capacity (vph)		237			67			2412			2323	
Starvation Cap Reductn		0			0			0			0	
Spillback Cap Reductn		0			0			0			0	
Storage Cap Reductn		0			0			0			0	
Reduced v/c Ratio		0.94			2.78			0.70			0.67	

Intersection Summary	
Cycle Length:	130
Actuated Cycle Length:	130
Offset:	55 (42%), Referenced to phase 2:NBTL and 6:SBTL, Start of Green
Natural Cycle:	80
Control Type:	Actuated-Coordinated

Lanes, Volumes, Timings
 5: Bronson Avenue & Madawaska Drive/Fifth Avenue
 2030 Future Total-PM Peak Hour
 770-774 Bronson Ave

Maximum v/c Ratio:	2.78
Intersection Signal Delay:	56.7
Intersection Capacity Utilization:	99.8%
Analysis Period (min):	15
Intersection LOS:	E
ICU Level of Service:	F
~ Volume exceeds capacity, queue is theoretically infinite. Queue shown is maximum after two cycles.	
# 95th percentile volume exceeds capacity, queue may be longer. Queue shown is maximum after two cycles.	
m Volume for 95th percentile queue is metered by upstream signal.	

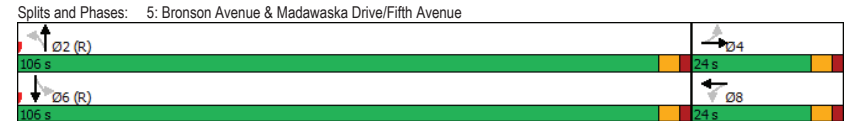

HCM 2010 TWSC
6: Cambridge Street & Site Access

2030 Future Total-PM Peak Hour
770-774 Bronson Ave

Intersection						
Int Delay, s/veh	1.6					
Movement	WBL	WBR	NBT	NBR	SBL	SBT
Lane Configurations		↗	↖			↖
Traffic Vol, veh/h	0	13	41	0	0	17
Future Vol, veh/h	0	13	41	0	0	17
Conflicting Peds, #/hr	0	0	0	0	0	0
Sign Control	Stop	Stop	Free	Free	Free	Free
RT Channelized	-	None	-	None	-	None
Storage Length	-	0	-	-	-	-
Veh in Median Storage, #	0	-	0	-	-	0
Grade, %	0	-	0	-	-	0
Peak Hour Factor	100	100	100	100	100	100
Heavy Vehicles, %	2	2	2	2	2	2
Mvmt Flow	0	13	41	0	0	17
Major/Minor	Minor1	Major1	Major2			
Conflicting Flow All	-	41	0	-	-	-
Stage 1	-	-	-	-	-	-
Stage 2	-	-	-	-	-	-
Critical Hdwy	-	6.22	-	-	-	-
Critical Hdwy Stg 1	-	-	-	-	-	-
Critical Hdwy Stg 2	-	-	-	-	-	-
Follow-up Hdwy	-	3,318	-	-	-	-
Pot Cap-1 Maneuver	0	1030	-	0	0	-
Stage 1	0	-	-	0	0	-
Stage 2	0	-	-	0	0	-
Platoon blocked, %	-	-	-	-	-	-
Mov Cap-1 Maneuver	-	1030	-	-	-	-
Mov Cap-2 Maneuver	-	-	-	-	-	-
Stage 1	-	-	-	-	-	-
Stage 2	-	-	-	-	-	-
Approach	WB	NB	SB			
HCM Control Delay, s	8.5	0	0			
HCM LOS	A					
Minor Lane/Major Mvmt	NBTWBLn1	SBT				
Capacity (veh/h)	-	1030	-			
HCM Lane V/C Ratio	-	0.013	-			
HCM Control Delay (s)	-	8.5	-			
HCM Lane LOS	-	A	-			
HCM 95th %tile Q(veh)	-	0	-			

HCM 2010 TWSC
7: Bronson Avenue & Site Access

2030 Future Total-PM Peak Hour
770-774 Bronson Ave

Intersection						
Int Delay, s/veh	0					
Movement	EBL	EBR	NBL	NBT	SBT	SBR
Lane Configurations		↗		↖↗	↖↗	
Traffic Vol, veh/h	0	4	5	1807	1601	16
Future Vol, veh/h	0	4	5	1807	1601	16
Conflicting Peds, #/hr	0	0	0	0	0	0
Sign Control	Stop	Stop	Free	Free	Free	Free
RT Channelized	-	None	-	None	-	None
Storage Length	-	0	-	-	-	-
Veh in Median Storage, #	0	-	-	0	0	-
Grade, %	0	-	-	0	0	-
Peak Hour Factor	100	100	100	100	100	100
Heavy Vehicles, %	2	2	2	2	2	2
Mvmt Flow	0	4	5	1807	1601	16
Major/Minor	Minor2	Major1	Major2			
Conflicting Flow All	-	809	1617	0	-	0
Stage 1	-	-	-	-	-	-
Stage 2	-	-	-	-	-	-
Critical Hdwy	-	6.94	4.14	-	-	-
Critical Hdwy Stg 1	-	-	-	-	-	-
Critical Hdwy Stg 2	-	-	-	-	-	-
Follow-up Hdwy	-	3.32	2.22	-	-	-
Pot Cap-1 Maneuver	0	323	399	-	-	-
Stage 1	0	-	-	-	-	-
Stage 2	0	-	-	-	-	-
Platoon blocked, %	-	-	-	-	-	-
Mov Cap-1 Maneuver	-	323	399	-	-	-
Mov Cap-2 Maneuver	-	-	-	-	-	-
Stage 1	-	-	-	-	-	-
Stage 2	-	-	-	-	-	-
Approach	EB	NB	SB			
HCM Control Delay, s	16.3	0	0			
HCM LOS	C					
Minor Lane/Major Mvmt	NBL	NBT EBLn1	SBT	SBR		
Capacity (veh/h)	399	-	323	-		
HCM Lane V/C Ratio	0.013	-	0.012	-		
HCM Control Delay (s)	14.1	0	16.3	-		
HCM Lane LOS	B	A	C	-		
HCM 95th %tile Q(veh)	0	-	0	-		

Appendix N

TDM Checklist

TDM Measures Checklist:
Residential Developments (multi-family, condominium or subdivision)

Legend	
BASIC	The measure is generally feasible and effective, and in most cases would benefit the development and its users
BETTER	The measure could maximize support for users of sustainable modes, and optimize development performance
★	The measure is one of the most dependably effective tools to encourage the use of sustainable modes

TDM measures: Residential developments		Check if proposed & add descriptions
1. TDM PROGRAM MANAGEMENT		
1.1 Program coordinator		
BASIC ★	1.1.1 Designate an internal coordinator, or contract with an external coordinator	<input checked="" type="checkbox"/>
1.2 Travel surveys		
BETTER	1.2.1 Conduct periodic surveys to identify travel-related behaviours, attitudes, challenges and solutions, and to track progress	<input type="checkbox"/>
2. WALKING AND CYCLING		
2.1 Information on walking/cycling routes & destinations		
BASIC	2.1.1 Display local area maps with walking/cycling access routes and key destinations at major entrances (<i>multi-family, condominium</i>)	<input checked="" type="checkbox"/>
2.2 Bicycle skills training		
BETTER	2.2.1 Offer on-site cycling courses for residents, or subsidize off-site courses	<input type="checkbox"/>

TDM measures: Residential developments		Check if proposed & add descriptions
3. TRANSIT		
3.1 Transit information		
BASIC	3.1.1 Display relevant transit schedules and route maps at entrances (<i>multi-family, condominium</i>)	<input checked="" type="checkbox"/>
BETTER	3.1.2 Provide real-time arrival information display at entrances (<i>multi-family, condominium</i>)	<input type="checkbox"/>
3.2 Transit fare incentives		
BASIC ★	3.2.1 Offer PRESTO cards preloaded with one monthly transit pass on residence purchase/move-in, to encourage residents to use transit	<input checked="" type="checkbox"/> Not applicable to the student housing component
BETTER	3.2.2 Offer at least one year of free monthly transit passes on residence purchase/move-in	<input type="checkbox"/>
3.3 Enhanced public transit service		
BETTER ★	3.3.1 Contract with OC Transpo to provide early transit services until regular services are warranted by occupancy levels (<i>subdivision</i>)	<input type="checkbox"/>
3.4 Private transit service		
BETTER	3.4.1 Provide shuttle service for seniors homes or lifestyle communities (e.g. scheduled mall or supermarket runs)	<input type="checkbox"/>
4. CARSHARING & BIKESHARING		
4.1 Bikeshare stations & memberships		
BETTER	4.1.1 Contract with provider to install on-site bikeshare station (<i>multi-family</i>)	<input type="checkbox"/>
BETTER	4.1.2 Provide residents with bikeshare memberships, either free or subsidized (<i>multi-family</i>)	<input type="checkbox"/>
4.2 Carshare vehicles & memberships		
BETTER	4.2.1 Contract with provider to install on-site carshare vehicles and promote their use by residents	<input type="checkbox"/>
BETTER	4.2.2 Provide residents with carshare memberships, either free or subsidized	<input type="checkbox"/>
5. PARKING		
5.1 Priced parking		
BASIC ★	5.1.1 Unbundle parking cost from purchase price (<i>condominium</i>)	<input type="checkbox"/>
BASIC ★	5.1.2 Unbundle parking cost from monthly rent (<i>multi-family</i>)	<input checked="" type="checkbox"/>

TDM measures: Residential developments		Check if proposed & add descriptions
6. TDM MARKETING & COMMUNICATIONS		
6.1 Multimodal travel information		
BASIC ★	6.1.1 Provide a multimodal travel option information package to new residents	<input checked="" type="checkbox"/>
6.2 Personalized trip planning		
BETTER ★	6.2.1 Offer personalized trip planning to new residents	<input type="checkbox"/>

TDM-Supportive Development Design and Infrastructure Checklist:
Residential Developments (multi-family or condominium)

Legend	
REQUIRED	The Official Plan or Zoning By-law provides related guidance that must be followed
BASIC	The measure is generally feasible and effective, and in most cases would benefit the development and its users
BETTER	The measure could maximize support for users of sustainable modes, and optimize development performance

TDM-supportive design & infrastructure measures: Residential developments		Check if completed & add descriptions, explanations or plan/drawing references
1. WALKING & CYCLING: ROUTES		
1.1 Building location & access points		
BASIC	1.1.1 Locate building close to the street, and do not locate parking areas between the street and building entrances	<input checked="" type="checkbox"/>
BASIC	1.1.2 Locate building entrances in order to minimize walking distances to sidewalks and transit stops/stations	<input checked="" type="checkbox"/>
BASIC	1.1.3 Locate building doors and windows to ensure visibility of pedestrians from the building, for their security and comfort	<input checked="" type="checkbox"/>
1.2 Facilities for walking & cycling		
REQUIRED	1.2.1 Provide convenient, direct access to stations or major stops along rapid transit routes within 600 metres; minimize walking distances from buildings to rapid transit; provide pedestrian-friendly, weather-protected (where possible) environment between rapid transit accesses and building entrances; ensure quality linkages from sidewalks through building entrances to integrated stops/stations (see Official Plan policy 4.3.3)	<input type="checkbox"/>
REQUIRED	1.2.2 Provide safe, direct and attractive pedestrian access from public sidewalks to building entrances through such measures as: reducing distances between public sidewalks and major building entrances; providing walkways from public streets to major building entrances; within a site, providing walkways along the front of adjoining buildings, between adjacent buildings, and connecting areas where people may congregate, such as courtyards and transit stops; and providing weather protection through canopies, colonnades, and other design elements wherever possible (see Official Plan policy 4.3.12)	<input checked="" type="checkbox"/>

TDM-supportive design & infrastructure measures: <i>Residential developments</i>		Check if completed & add descriptions, explanations or plan/drawing references
REQUIRED	1.2.3 Provide sidewalks of smooth, well-drained walking surfaces of contrasting materials or treatments to differentiate pedestrian areas from vehicle areas, and provide marked pedestrian crosswalks at intersection sidewalks (see <i>Official Plan policy 4.3.10</i>)	<input type="checkbox"/>
REQUIRED	1.2.4 Make sidewalks and open space areas easily accessible through features such as gradual grade transition, depressed curbs at street corners and convenient access to extra-wide parking spaces and ramps (see <i>Official Plan policy 4.3.10</i>)	<input type="checkbox"/>
REQUIRED	1.2.5 Include adequately spaced inter-block/street cycling and pedestrian connections to facilitate travel by active transportation. Provide links to the existing or planned network of public sidewalks, multi-use pathways and on-road cycle routes. Where public sidewalks and multi-use pathways intersect with roads, consider providing traffic control devices to give priority to cyclists and pedestrians (see <i>Official Plan policy 4.3.11</i>)	<input type="checkbox"/>
BASIC	1.2.6 Provide safe, direct and attractive walking routes from building entrances to nearby transit stops	<input checked="" type="checkbox"/>
BASIC	1.2.7 Ensure that walking routes to transit stops are secure, visible, lighted, shaded and wind-protected wherever possible	<input type="checkbox"/>
BASIC	1.2.8 Design roads used for access or circulation by cyclists using a target operating speed of no more than 30 km/h, or provide a separated cycling facility	<input type="checkbox"/>
1.3 Amenities for walking & cycling		
BASIC	1.3.1 Provide lighting, landscaping and benches along walking and cycling routes between building entrances and streets, sidewalks and trails	<input type="checkbox"/>
BASIC	1.3.2 Provide wayfinding signage for site access (where required, e.g. when multiple buildings or entrances exist) and egress (where warranted, such as when directions to reach transit stops/stations, trails or other common destinations are not obvious)	<input type="checkbox"/>

TDM-supportive design & infrastructure measures: <i>Residential developments</i>		Check if completed & add descriptions, explanations or plan/drawing references
2. WALKING & CYCLING: END-OF-TRIP FACILITIES		
2.1 Bicycle parking		
REQUIRED	2.1.1 Provide bicycle parking in highly visible and lighted areas, sheltered from the weather wherever possible (see <i>Official Plan policy 4.3.6</i>)	<input checked="" type="checkbox"/>
REQUIRED	2.1.2 Provide the number of bicycle parking spaces specified for various land uses in different parts of Ottawa; provide convenient access to main entrances or well-used areas (see <i>Zoning By-law Section 111</i>)	<input checked="" type="checkbox"/>
REQUIRED	2.1.3 Ensure that bicycle parking spaces and access aisles meet minimum dimensions; that no more than 50% of spaces are vertical spaces; and that parking racks are securely anchored (see <i>Zoning By-law Section 111</i>)	<input checked="" type="checkbox"/>
BASIC	2.1.4 Provide bicycle parking spaces equivalent to the expected number of resident-owned bicycles, plus the expected peak number of visitor cyclists	<input type="checkbox"/>
2.2 Secure bicycle parking		
REQUIRED	2.2.1 Where more than 50 bicycle parking spaces are provided for a single residential building, locate at least 25% of spaces within a building/structure, a secure area (e.g. supervised parking lot or enclosure) or bicycle lockers (see <i>Zoning By-law Section 111</i>)	<input checked="" type="checkbox"/>
BETTER	2.2.2 Provide secure bicycle parking spaces equivalent to at least the number of units at condominiums or multi-family residential developments	<input checked="" type="checkbox"/>
2.3 Bicycle repair station		
BETTER	2.3.1 Provide a permanent bike repair station, with commonly used tools and an air pump, adjacent to the main bicycle parking area (or secure bicycle parking area, if provided)	<input type="checkbox"/>
3. TRANSIT		
3.1 Customer amenities		
BASIC	3.1.1 Provide shelters, lighting and benches at any on-site transit stops	<input type="checkbox"/>
BASIC	3.1.2 Where the site abuts an off-site transit stop and insufficient space exists for a transit shelter in the public right-of-way, protect land for a shelter and/or install a shelter	<input type="checkbox"/>
BETTER	3.1.3 Provide a secure and comfortable interior waiting area by integrating any on-site transit stops into the building	<input type="checkbox"/>

TDM-supportive design & infrastructure measures: <i>Residential developments</i>		Check if completed & add descriptions, explanations or plan/drawing references
4. RIDESHARING		
4.1 Pick-up & drop-off facilities		
BASIC	4.1.1 Provide a designated area for carpool drivers (plus taxis and ride-hailing services) to drop off or pick up passengers without using fire lanes or other no-stopping zones	<input type="checkbox"/>
5. CARSHARING & BIKESHARING		
5.1 Carshare parking spaces		
BETTER	5.1.1 Provide up to three carshare parking spaces in an R3, R4 or R5 Zone for specified residential uses (see <i>Zoning By-law Section 94</i>)	<input type="checkbox"/>
5.2 Bikeshare station location		
BETTER	5.2.1 Provide a designated bikeshare station area near a major building entrance, preferably lighted and sheltered with a direct walkway connection	<input type="checkbox"/>
6. PARKING		
6.1 Number of parking spaces		
REQUIRED	6.1.1 Do not provide more parking than permitted by zoning, nor less than required by zoning, unless a variance is being applied for	<input checked="" type="checkbox"/>
BASIC	6.1.2 Provide parking for long-term and short-term users that is consistent with mode share targets, considering the potential for visitors to use off-site public parking	<input type="checkbox"/>
BASIC	6.1.3 Where a site features more than one use, provide shared parking and reduce the cumulative number of parking spaces accordingly (see <i>Zoning By-law Section 104</i>)	<input type="checkbox"/>
BETTER	6.1.4 Reduce the minimum number of parking spaces required by zoning by one space for each 13 square metres of gross floor area provided as shower rooms, change rooms, locker rooms and other facilities for cyclists in conjunction with bicycle parking (see <i>Zoning By-law Section 111</i>)	<input type="checkbox"/>
6.2 Separate long-term & short-term parking areas		
BETTER	6.2.1 Provide separate areas for short-term and long-term parking (using signage or physical barriers) to permit access controls and simplify enforcement (i.e. to discourage residents from parking in visitor spaces, and vice versa)	<input type="checkbox"/>