

**Functional Site Servicing and
Stormwater Management Report
Rev.03 – 1987 Robertson Road
(Stillwater Station)**

Stantec Job #160401686

City of Ottawa File Numbers:

D01-01-21-0021

D02-02-21-0120



Prepared for:

The Properties Group Management Ltd.

Prepared by:

Stantec Consulting Ltd.

300 - 1331 Clyde Avenue

Ottawa ON K2C 3G4

February 28, 2024

Revision Record							
Revision	Description	Prepared by		Checked by		Approved by	
3	4 th Submission	A. Gladish	02/28/2024	D. Thiffault	02/27/2024	N. Cody	02/29/2024
2	3 rd Submission	M. Wu	04/06/2023	K. Kilborn	04/20/2023	N. Cody	04/21/2023
		A. Gladish	04/20/2023	R. Brandrick	04/21/2023		
1	2 nd Submission	N. Nwanise	03/28/2022	A. Gladish	03/29/2022	N. Cody	03/29/2022
0	1 st Submission	A. Gladish	09/17/2021	D. Thiffault	09/22/2021	T. Rathnasooriya	09/22/2021

Sign-off Sheet

The conclusions in the Report titled Functional Site Servicing and Stormwater Management Report Rev.03 – 1987 Robertson Road (Stillwater Station) are Stantec’s professional opinion, as of the time of the Report, and concerning the scope described in the Report. The opinions in the document are based on conditions and information existing at the time the document was published and do not take into account any subsequent changes. The Report relates solely to the specific project for which Stantec was retained and the stated purpose for which the Report was prepared. The Report is not to be used or relied on for any variation or extension of the project, or for any other project or purpose, and any unauthorized use or reliance is at the recipient’s own risk.

Stantec has assumed all information received from The Properties Group Management Ltd. (the “Client”) and third parties in the preparation of the Report to be correct. While Stantec has exercised a customary level of judgement or due diligence in the use of such information, Stantec assumes no responsibility for the consequences of any error or omission contained therein.

This Report is intended solely for use by the Client in accordance with Stantec’s contract with the Client. While the Report may be provided to applicable authorities having jurisdiction and others for whom the Client is responsible, Stantec does not warrant the services to any third party. The report may not be relied upon by any other party without the express written consent of Stantec, which may be withheld at Stantec’s discretion.

Authored by Michael Wu

Michael Wu, E.I.T.

Revised by Alyssa Gladish

Alyssa Gladish, E.I.T.

Approved by Neal Cody

Neal Cody, P.Eng.

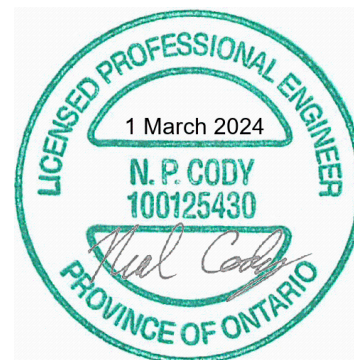

FUNCTIONAL SITE SERVICING AND STORMWATER MANAGEMENT REPORT REV.03 – 1987 ROBERTSON ROAD (STILLWATER STATION)

TABLE OF CONTENTS

1.0	INTRODUCTION	1
1.1	BACKGROUND	2
1.2	EXISTING CONDITIONS.....	3
1.3	OBJECTIVE	3
1.4	BACKGROUND RESOURCES	4
2.0	WATER SERVICING	5
2.1	BACKGROUND	5
2.2	WATER DEMANDS	6
2.2.1	Domestic Water Demands.....	6
2.2.2	Allowable Pressures	7
2.2.3	Fire Flow	8
2.2.4	Boundary Conditions	8
2.3	PROPOSED WATER SERVICING.....	9
3.0	WASTEWATER SERVICING	10
3.1	BACKGROUND	10
3.2	DESIGN CRITERIA.....	10
3.3	PROPOSED SANITARY SERVICING.....	12
4.0	STORMWATER MANAGEMENT	14
4.1	SWM OBJECTIVES	14
4.2	SWM CRITERIA AND CONSTRAINTS	14
4.3	STORMWATER MANAGEMENT DESIGN	15
4.3.1	Pre-Development Drainage Conditions.....	15
4.3.2	Post-Development Stormwater Management and Drainage Conditions	16
4.4	PROPOSED STORM SERVICING (MINOR SYSTEM)	24
5.0	GEOTECHNICAL CONSIDERATIONS AND GRADING	24
5.1	PRELIMINARY GEOTECHNICAL INVESTIGATION	24
5.1.1	Overburden.....	25
5.1.2	Bedrock.....	25
5.1.3	Groundwater	25
5.2	SLOPE STABILITY ASSESSMENT	25
5.2.1	Slope Stability Analysis	26
5.2.2	Seismic Loading Analysis.....	26
5.2.3	Erosion and Access Allowances	26
5.3	GEOTECHNICAL CONSIDERATIONS	26
5.4	FUNCTIONAL GRADING PLAN	28
6.0	EROSION CONTROL DURING CONSTRUCTION	29
7.0	ENVIRONMENTAL CONSIDERATIONS	29
8.0	UTILITIES	30



FUNCTIONAL SITE SERVICING AND STORMWATER MANAGEMENT REPORT REV.03 – 1987 ROBERTSON ROAD (STILLWATER STATION)

9.0 APPROVALS..... 31
10.0 CORRESPONDENCE 32
11.0 CONCLUSIONS..... 33

LIST OF TABLES

Table 2.1: Estimated Water Demands 7
Table 2.2: Minimum and Maximum HGL at Connection Points 8
Table 3.1: Sanitary Sewer Design Criteria 11
Table 3.2: Estimated Wastewater Peak Flows 12
Table 4.1: Rational Method Target Release Rates 16
Table 4.2: Summary of Post-Development Subdrainage Areas 17
Table 4.3: 100-Year Storage Requirements for Block Areas 19
Table 4.4: Potential Dry Pond Geometry 20
Table 4.5: Hydraulic Characteristics of a Potential Dry Pond Outlet Control Structure 21
Table 4.6: Dry Pond Facility Controlled Release Rates and Storage Volume Requirements 22
Table 4.7: Summary of 5- and 100-Year Event Peak Release Rates for Overall Site 23

LIST OF FIGURES

Figure 1: Stillwater Station Site Location Plan 2

LIST OF APPENDICES

APPENDIX A POTABLE WATER SERVICING A.1
A.1 Domestic Water Demand CalculationsA.1
A.2 FUS CalculationsA.2
A.3 FUS Exposure MapA.3
A.4 Hydraulic Boundary Conditions 4-January-2024A.4
A.5 Hydraulic AnalysisA.5
APPENDIX B SANITARY SEWER CALCULATIONS B.1
B.1 Conceptual Sanitary Sewer Design SheetB.1
APPENDIX C STORMWATER MANAGEMENT CALCULATIONS C.1
C.1 Conceptual Storm Sewer Design Sheet C.1
C.2 Existing Conditions Rational Method Calculations C.2
C.3 Pre-development Time of Concentration Calculation C.3
C.4 Modified Rational Method Calculations C.4



FUNCTIONAL SITE SERVICING AND STORMWATER MANAGEMENT REPORT REV.03 – 1987 ROBERTSON ROAD (STILLWATER STATION)

C.4.1	Common Areas – Area Summary	C.4
C.4.2	Block Sites – Area Summary.....	C.5
C.4.3	Modified Rational Method (MRM) for Overall Site Post-Development Conditions.....	C.6
C.4.4	Example of Modified Rational Method Calculations for Block Onsite Stormwater Management (Block A)	C.7
C.5	Preliminary Oil- Grit Separator Sizing	C.8
APPENDIX D EXTERNAL DOCUMENTS		D.1
D.1	Master Plan – RLA Architecture – 21-FEB-2024	D.1
D.2	Stillwater Creek 2013, Existing Habitat Condition, Channel Structure, Thermal Stability and Opportunities for restoration for stillwater Creek – RVCA	D.2
D.3	Stillwater Creek 2015 Summary Report – City Stream Watch	D.3
D.4	Preliminary Geotechnical Investigation, Proposed Mixed Use Development 1987 Robertson Road, Ottawa, Ontario – Paterson Group, Revision 5, Oct 13, 2023	D.4
D.5	Sketch Illustrating Topographic Information for Stillwater Station, AOV, March 7, 2023.	D.5
D.6	Existing Sanitary Sewer Ownership Documents	D.6
APPENDIX E CORRESPONDENCE.....		E.1
E.1	2018 Pre-Consultation City of Ottawa.....	E.1
E.2	2018 Plan and Study List	E.2
E.3	2020 Pre-Consultation City of Ottawa.....	E.3
E.4	2020 Plan and Study List	E.4
E.5	Correspondence between CIMA and RVCA, 2021-09-02	E.5
E.6	Correspondence between CIMA and RVCA, 2021-09-08	E.6
E.7	Correspondence between Stantec and RVCA, 2021-09-07	E.7
E.8	Correspondence between Stantec and RVCA, 2021-09-17	E.8
E.9	Correspondence Between Stantec and Paterson, 2023-11-24	E.9



FUNCTIONAL SITE SERVICING AND STORMWATER MANAGEMENT REPORT REV.03 – 1987 ROBERTSON ROAD (STILLWATER STATION)

Introduction
February 28, 2024

1.0 INTRODUCTION

Stantec Consulting Ltd. has been retained by The Properties Group. (Stillwater Station) to provide a functional site servicing and stormwater management plan in support of their application for draft plan approval, Zoning Bylaw Amendment (ZBA) and Official Plan Amendment (OPA) to permit a combination of mid- and high-rise apartment dwellings and at-grade commercial developments in the proposed mixed-use block in Bells Corners (1987 Robertson Road). The intent of this report is to provide a functional servicing design that meets the requirements of the City of Ottawa ZBA/OPA approval, pre-consultation design criteria, and responds to the City of Ottawa ZBA/OPA 3rd submission comments (engineering comments dated May 29, 2023, and full comment set dated July 31, 2023).

The functional site servicing and stormwater management report aims to demonstrate the serviceability of the site, the adequacy of the available municipal infrastructure to support the proposed development, provide a servicing scenario for the proposed development that is free of conflicts, includes any contributing external areas, and is in accordance with the available background studies and all relevant City of Ottawa and MECP Guidelines, policies, and design parameters.

The Properties Group is proposing a mixed-use development with a site area that measures approximately 9.59 ha (23.69 ac). Stillwater Creek passes through the northwest corner of the site, which is located north of Robertson Road and east of Moodie Drive within the City of Ottawa's Bells Corners Community as shown in **Figure 1**.

The proposed Master Plan (provided by RLA Architecture, February 21, 2024 – see **Appendix D.1**) consists of 11 buildings including seven high-rise apartment towers with 6-storey podiums, five 6-storey buildings and one 4-storey building arranged in 6 apartment plots identified as A-F. The heights of the high-rise towers range from 18 to 32 storeys. Each apartment plot corresponds to a proposed phase of development (Phases 1-6). The proposed multi-unit buildings will provide a total of 2,086 residential apartment units and 3,002 m² of commercial space. The residential population of the site is forecast to be 3,755 people. The community will also include designated parkland area, hazard lands adjacent to the creek where development is restricted, and general greenspace. The community features numerous pathways for pedestrian linkages and a multiuse pathway providing connection along the east boundary to Robertson Road.

Access to the site is proposed via the construction of a road from the intersection of Timm Drive and Moodie Drive (a proposed 4-way intersection) across the north side of the subject site. The proposed access road traverses an approximately 0.221 ha (0.545 ac.) parcel that has been purchased by the Owner from the NCC. The roads proposed consist of a 26 m wide right of way (ROW) collector road (the access road), and an internal looped local roadway. The west internal local roadway is to have a 24 m wide ROW to facilitate the commercial spaces. The east and south internal local roadways are to have 22 m wide ROWs. The access road from Moodie Drive and all local roads in the subdivision are ultimately to be assumed (ownership, maintenance, and operation) by the City of Ottawa, hence they are identified as



FUNCTIONAL SITE SERVICING AND STORMWATER MANAGEMENT REPORT REV.03 – 1987 ROBERTSON ROAD (STILLWATER STATION)

Introduction
February 28, 2024

“City Roads”. One small portion of private roadways is proposed within the site – the circular driveway for access to Block F, located on the southwest corner.

Figure 1: Stillwater Station Site Location Plan



1.1 BACKGROUND

The development of the Stillwater Station site is governed by the City of Ottawa’s new Draft Official Plan. The site requires ZBA and an OPA to alter the land use from employment lands to a mixed-use development. The Rideau Valley Conservation Authority (RVCA) administers development regulations in areas subject to natural hazards (such as flooding, erosion, and unstable slopes) and in environmentally sensitive areas (such as wetlands, shorelines, and waterways). The RVCA also reviews development proposals and municipal planning applications within or adjacent to natural areas. Due to the presence of



FUNCTIONAL SITE SERVICING AND STORMWATER MANAGEMENT REPORT REV.03 – 1987 ROBERTSON ROAD (STILLWATER STATION)

Introduction
February 28, 2024

the Stillwater Creek on this site, servicing criteria for the site has been established through pre-application consultation with the City of Ottawa and the RVCA.

The NCC commissioned a study of Stillwater Creek by the RVCA and the University of Ottawa that examined the physical habitat, channel structure, substrate, bank conditions, biological communities, water chemistry, hydrology, and thermal stability of Stillwater Creek. The resulting report Stillwater Creek – 2013 describes some of the opportunities to restore Stillwater Creek and some of the development requirements for reaches of concern. The report also presents general watershed recommendations and enhancement opportunities that are relevant to the functional servicing of the Stillwater Station site such as:

- improving stormwater management
- improving water quality in Stillwater Creek / Ottawa River
- reducing erosion/flood potential (Stillwater Creek is identified as a high-erosion creek)
- maintaining thermal stability (Stillwater Creek is identified as a cold-water creek)

1.2 EXISTING CONDITIONS

The site is predominantly an unused industrial yard with both asphalt paved and gravel access lanes and parking pads as well as an abandoned aluminum-sided warehouse. Lands adjacent to Stillwater Creek are treed and vegetated under existing conditions. The site is bound by the Bellwood Estates mobile home community to the south; Stillwater Creek to the west; the Canadian National (CN) Railway Beachburg line and abandoned CN spur line to the north; and an existing business park to the east (General Dynamics). The land to the north of the railway is an NCC Greenbelt corridor.

The proposed development is located within the jurisdiction of the Rideau Valley Conservation Authority (RVCA) and within the Stillwater Creek sub-watershed. As per the Stillwater Creek 2015 Summary Report, the surveyed stream originates at the Vanier (Private) Road crossing just west of the Stillwater Station site; although, this branch of the stream network originates much further south down Moodie Drive in the NCC's Stony Swamp. The Creek crosses the northwest corner of the site and proceeds northwest across the spur and railway line, as shown in Figure 1.

The existing elevations within the site range from 90 m to 76 m and generally drain from southeast to northwest. The creek ravine is relatively steep, while the rest of the site features gently sloped to flat topography.

1.3 OBJECTIVE

This functional servicing report is being prepared in support of draft plan approval, ZBA, and OPA for the Stillwater Station Development. This report will provide a recommended servicing plan for the major municipal infrastructure needed to support development of the subject property. The review will be a macro level study with further details to be confirmed and provided during the detailed design process. This report will demonstrate how proposed municipal servicing is in conformance with the Stillwater Creek – 2013 Report and the City of Ottawa recommendations. Any deviation from the background documents will also be identified with rationalization for the change.



FUNCTIONAL SITE SERVICING AND STORMWATER MANAGEMENT REPORT REV.03 – 1987 ROBERTSON ROAD (STILLWATER STATION)

Introduction
February 28, 2024

1.4 BACKGROUND RESOURCES

The following documents were referenced in the preparation of this report:

- Environmental Impact Statement - Proposed Site Redevelopment - Stillwater Station, 1987 Robertson Road, Ottawa, Ontario, CIMA+, Rev. 04, February 28, 2024
- Stillwater Creek – 2013 Existing Habitat Condition, Channel Structure, Thermal Stability and Opportunities for Restoration for Stillwater Creek, Rideau Valley Conservation Authority
- Stillwater Creek 2015 Summary Report, City Stream Watch
- Preliminary Geotechnical Investigation Proposed Mixed Use Development 1987 Robertson Road, Ottawa, Ontario, Paterson Group Inc., Revision 5, October 13, 2023

Additional documents referenced in designing the functional servicing plans for the proposed development include:

- *Erosion and Sediment Control Guidelines for Urban Construction*, Greater Golden Horseshoe Area Conservation Authorities, December 2006
- *Stormwater Management Planning and Design Manual*, Ministry of the Environment (Ontario), March 2003
- Ottawa Design Guidelines – Water Distribution, City of Ottawa, July 2010
 - *Technical Bulletin ISD-2010-2*, City of Ottawa, December 15, 2010
 - *Technical Bulletin ISDTB-2014-02*, City of Ottawa, May 27, 2014
 - *Technical Bulletin ISTB-2018-02*, City of Ottawa, March 21, 2018
 - *Technical Bulletin ISD-2021-03*, City of Ottawa, August 18, 2021
- *City of Ottawa Sewer Design Guidelines*, 2nd Ed., City of Ottawa, October 2012
 - *Technical Bulletin ISDTB-2014-01*, Revisions to Ottawa Design Guidelines – Sewer, City of Ottawa, February 5, 2014. (ISDTB-2014-01)
 - *Technical Bulletin PIEDTB-2016-01*, Revisions to Ottawa Design Guidelines – Sewer, City of Ottawa, September 6, 2016. (PIEDTB-2016-01)
 - *Technical Bulletin ISTB-2018-01*, Revisions to Ottawa Design Guidelines – Sewer, City of Ottawa, March 21, 2018. (ISTB-2018-01)



Water Servicing
February 28, 2024

2.0 WATER SERVICING

2.1 BACKGROUND

Stillwater Station is located within the existing City of Ottawa 2W2C pressure zone. The proposed site will be serviced through an existing 305 mm diameter watermain on Moodie Drive ROW west of the subject site which services the adjacent commercial area. Two connections will be made to the Moodie Drive 305 mm diameter watermain, one at the intersection of Timm Drive, and the second at the location the former rail spur intersects Moodie Drive. This will result in twinned watermains along a portion of the 26 m ROW access road that splits at the former rail spur, with one watermain aligned with the access road out to Timm Drive, and the second along the former rail spur. The conceptual alignments of the proposed watermains and connections are shown in **Drawing WTR-1**.

The proposed access road watermain crosses an existing 1,220 mm diameter backbone watermain (in the former NCC parcel) and crosses another portion of the backbone watermain (1,067 mm diameter running north-south) on the Moodie Drive ROW. Typically, direct connections are not permitted to backbone watermains; as such, the two watermain connections are proposed to be directly connected to the 305 mm diameter local watermain within the Moodie Drive ROW. There are several existing valves located on the 305 mm diameter local watermain between the two proposed connections.

The alignment of the proposed “former rail spur” watermain is shown conceptually at this functional level of design. It is our understanding that CN retains an easement through the former rail spur for the operation and maintenance of several utilities; and Zayo Communication has a fibre optic cable that runs along the south side of the former rail spur. The locations of these utilities will be carefully considered during the detailed design of the former rail spur watermain alignment.

Two watermain connections to the site have been proposed to provide a looped watermain system as per the City of Ottawa Water Distribution Guidelines which state that looping shall be provided where there are more than 49 dwelling units to provide redundancy and avoid the creation of a Vulnerable Service Area as per Technical Bulletin ISTB-2021-03.

We acknowledge that the portion of twinned (parallel) watermains along the proposed access road is not an ideal design, but we believe that this is the best option to minimize potential environmental impacts by introducing an additional creek crossing which would be extremely costly to construct and would introduce numerous risks to the creek and watermain in the long term. The proposed watermain network will be designed in accordance with City of Ottawa Design Guidelines (2010), Ministry of Environment Conservation and Parks (MECP) Guidelines, and the pre-application meeting requirements summarized as follows.

- The number of dwelling units exceeds 49; thus, a looped watermain system shall be provided as per the City of Ottawa Water Distribution Guidelines.
- The watermains will be designed to provide adequate flows. The consumption rates for subdivisions of 501 to 3,000 persons shall be utilized for the residential average day demand amount (280 L/c/d)



FUNCTIONAL SITE SERVICING AND STORMWATER MANAGEMENT REPORT REV.03 – 1987 ROBERTSON ROAD (STILLWATER STATION)

Water Servicing
February 28, 2024

as per Technical Bulletin ISTB-2021-03 and other commercial amount (28,000 L/gross ha/d) as per Ottawa Design Guidelines – Water Distribution (2010).

- Individual residential facilities with a basic day demand greater than 50 m³/day (0.57 L/s) shall have a minimum of two water services, separated by an isolation valve, to avoid the creation of a vulnerable service area as per Technical Bulletin ISTB-2021-03. The basic day demand for each apartment plot is anticipated to exceed 50 m³/day; therefore, water supply redundancy shall be provided to each proposed apartment plot.
- A minimum 9.0 m wide corridor within the site access road ROW (former NCC lands) centered along the backbone watermain crossing will be transferred to the city, with no construction (i.e., foundations) to be permitted within the 9.0 m corridor.
- A minimum 6.0 m wide easement centered along the proposed former rail spur watermain will be provided in favour of the city.
- Fire hydrants are to be provided throughout the site to ensure ample coverage as per Technical Bulletin ISTB-2018-02 and serve fire flow requirements for each building within 45 m of the proposed Siamese connections as per OBC. Hydrant locations are to be determined at the detailed design phase, and a hydrant coverage figure shall be provided at that time.
- Additional fire hydrants (exceeding the OBC and fire flow requirements) may be located along the south local road to supplement and facilitate fire suppression within the underserviced Bellwood Estates mobile home community. Details regarding any additional hydrants are to be determined at detailed design.

2.2 WATER DEMANDS

2.2.1 Domestic Water Demands

Water demands for the development were estimated using the Ministry of Environment's Design Guidelines for Drinking Water Systems (2008) and the Ottawa Design Guidelines – Water Distribution (2010). A demand rate of 280 L/cap/day was applied for the population of the proposed site, while a demand rate of 28,000 L/gross ha/day was applied for proposed the gross commercial areas. For this analysis, we have considered the gross area to be represented by the plot (site) areas for each plot containing commercial space. The average daily (AVDY) residential demand was estimated with a density of 1.8 persons per apartment unit as per the City of Ottawa Guidelines. See **Appendix A.1** for preliminary domestic water demand calculations.

Maximum day (MXDY) demands were determined by multiplying the AVDY demands by a factor of 2.5 for residential areas and 1.5 for commercial areas. Peak hourly (PKHR) demands were determined by multiplying the MXDY by a factor of 2.2 for residential areas and 1.8 for commercial areas. The estimated demands for each commercial and residential plot are summarized in **Table 2.1** below.



FUNCTIONAL SITE SERVICING AND STORMWATER MANAGEMENT REPORT REV.03 – 1987 ROBERTSON ROAD (STILLWATER STATION)

Water Servicing
February 28, 2024

Table 2.1: Estimated Water Demands

Demand Type	Population	Gross Parcel Area (ha)	AVDY (L/s)	MXDY (L/s)	PKHR (L/s)
Plot A Commercial	-	0.81	0.3	0.4	0.7
Plot B Commercial	-	0.75	0.2	0.4	0.7
Plot E Commercial	-	0.43	0.1	0.2	0.4
Plot F Commercial	-	0.71	0.2	0.3	0.6
Commercial Subtotal	-	2.71	0.9	1.3	2.4
Plot A Residential	1397	-	4.5	11.3	24.9
Plot B Residential	1022	-	3.3	8.3	18.2
Plot C Residential	752	-	2.4	6.1	13.4
Plot D Residential	113	-	0.4	0.9	2.0
Plot E Residential	266	-	0.9	2.2	4.7
Plot F Residential	203	-	0.7	1.6	3.6
Residential Subtotal	3,755	-	12.2	30.4	66.9
Total Site:	3,755	-	13.0	31.7	69.3

2.2.2 Allowable Pressures

The City of Ottawa Water Distribution Design Guidelines state that the desired range of system pressures under normal demand conditions (i.e., basic day, maximum day, and peak hour) should be in the range of 350 to 552 kPa (50 to 80 psi) and no less than 275 kPa (40 psi) at the ground elevation in the streets (i.e., at hydrant level). The maximum pressure at any point in the distribution system in occupied areas outside of the public right-of-way is 552 kPa (80 psi). As per the Ontario Building Code (OBC) and Guide for Plumbing, if pressures greater than 552 kPa (80 psi) are anticipated, pressure relief measures are required. The maximum pressure at any point in the distribution system in unoccupied areas shall not exceed 689 kPa (100 psi). Under emergency fire flow conditions, the minimum pressure objective in the distribution system is 138 kPa (20 psi). Available boundary conditions indicate that there is adequate flow and residual pressures in the range of 34 psi – 53 psi under maximum day and fire flow conditions. Refer to **Appendix A.4** for boundary conditions.

At the detailed design stage, a complete hydraulic analysis will be prepared for the proposed development water distribution network to confirm that water supply is available within the required pressure range under the anticipated demands during average day, peak hour, and maximum day plus fire flow conditions prior to full buildout of Stillwater Station. For this feasibility-level study, a hydraulic analysis has been conducted using the City's boundary conditions and the worst-case scenario buildings (Blocks A2/A3 and C1/C2). Refer to **Appendix A.5** for the hydraulic analysis calculation sheet.



FUNCTIONAL SITE SERVICING AND STORMWATER MANAGEMENT REPORT REV.03 – 1987 ROBERTSON ROAD (STILLWATER STATION)

Water Servicing
February 28, 2024

2.2.3 Fire Flow

Fire flow requirements were estimated using the Fire Underwriters Survey (FUS) 2020 methodology. Refer to **Appendix A2** for spreadsheet calculations. A detailed hydraulic model and analysis of the site to assess fire flow demands will be provided in the detailed design phase.

The following variables were considered in the assessment of the fire flow requirements for the site as per the FUS 2020 Guidelines:

- Non-combustible construction type with no fire separation between each floor was assumed. This conservative approach was adopted to identify the worst-case fire flow scenario for our boundary conditions request.
- The low hazard occupancy / limited combustible building contents credit was applied as the predominant occupancy of the site is residential.
- The credit was applied for fully supervised sprinkler systems with standard water supply and conforming to NFPA 13.
- Exposure distances to the adjacent buildings were determined as shown in the FUS exposure Map (**Appendix A.3**).
- Conservative assumptions were made regarding the existing buildings adjacent to the site such as:
 - Existing mobile homes were assumed to be single-storey, Type V construction, with no sprinklers or firewalls.
 - The existing garage (east of the site, General Dynamics campus) was assumed to be a single-storey, Type V construction, with no sprinklers or firewalls.

The maximum required fire flow for this development is **150.0 L/s (9,000 L/min)**.

2.2.4 Boundary Conditions

Updated hydraulic boundary conditions were received from the City on January 4, 2024, under the assumption that the site is to be serviced by a looped watermain with two connections to the 305 mm watermain on Moodie Drive. Refer to **Drawing WTR-1** for connection points, while **Table 2.2** summarizes the boundary conditions.

Table 2.2: Minimum and Maximum HGL at Connection Points

	Minimum HGL	Maximum HGL	Max Day + FF
Moodie Drive @ Timm	126.9 m	132.2 m	128.8 m
Moodie Drive @ Rail Spur	126.9 m	132.2 m	128.8 m



FUNCTIONAL SITE SERVICING AND STORMWATER MANAGEMENT REPORT REV.03 – 1987 ROBERTSON ROAD (STILLWATER STATION)

Water Servicing
February 28, 2024

The hydraulic analysis (see **Appendix A.5**) based on the provided boundary conditions for the worst-case fire flow scenario (Block C2/3 used for this example) indicates that there is adequate flow and residual pressures in the range of 376.3 kPa – 394.9 kPa (54.6 psi – 57.3 psi) under normal and emergency (maximum day and fire flow) conditions considering the block's ground floor elevation of approximately 88.52 m. It is likely that each building will require booster pumps to achieve the normal operating range of 345 kPa to 552 kPa (50 psi to 80 psi) and no less than 140 kPa (20 psi) under fire flow conditions at all levels.

2.3 PROPOSED WATER SERVICING

The proposed water servicing is shown on **Drawing WTR-1**. The development will be serviced by a looped 203 mm diameter watermain network, with each apartment plot serviced by two 150 mm building service laterals separated by an isolation valve. It is expected that the proposed pipe alignment and sizing will achieve the required level of service within the Stillwater Station development. Our civil team will confirm the locations of the proposed fire hydrants on site at the detailed design phase.

Preliminary hydraulic analysis completed with the available boundary conditions, has shown that at the ground level, the available municipal watermain connections will be adequate to provide minimum pressure objectives during peak hour conditions and provide sufficient fire flows while maintaining minimum pressure objectives during emergency conditions. Detailed hydraulic analysis and fire flow modelling is expected during the detailed design phase to assess the proposed watermain network.

The mechanical consultant or plumbing contractor will ultimately be responsible to confirm the building service lateral sizing; booster pump requirements and designs; and demonstrate that the water pressures within each building are adequate to meet building code requirements. Locations of Siamese (Fire Department) Connections and fire routes for each building will be coordinated with the architects at detailed design.



3.0 WASTEWATER SERVICING

3.1 BACKGROUND

An existing 300 mm diameter public sanitary trunk sewer passes through the proposed Stillwater Station site, conveying the sanitary flows from the Bellwood Estates mobile home community south of the site to the northeast corner of the site. Documentation regarding the municipal ownership of this sewer has been provided in **Appendix D.6**. The 300 mm sanitary sewer currently leaves the site and enters an existing manhole (EX SAN 1) where flows from an existing 200 mm sanitary sewer servicing the business park to the east (General Dynamics Canada) are incorporated. Downstream of EX SAN 1, the sewer increases to a 400 mm diameter trunk sewer, which crosses the existing Beachburg railway corridor and connects to the Nepean Collector sewer (900 mm diameter) northeast of the site. Currently there are no known issues with the Nepean Collector's capacity to receive the proposed flows from this development.

The proposed site will be serviced by realigning the existing sanitary trunk sewer along the proposed east internal municipal road ROW to pass through the site and installing a new sewer network within the local internal roadway ROWs as shown on **Drawing SAN-1**. The invert elevations at the inlet manhole in Bellwood Estates (EX SAN 4) and the outlet manhole at the northeast corner (EX SAN 1) were confirmed in the field in March 2023, and are shown in **Drawing SAN-1** as well as the latest topographic survey sketch provided by Annis, O'Sullivan, Vollebekk Ltd. (AOV) included in **Appendix D.5**. To conform to these design constraints on the proposed sanitary sewer system, the sanitary trunk sewer realignment has been shifted to the east internal local roadway (previously shown on the west roadway) as this is the shortest route and allows for the maximum pipe slopes.

3.2 DESIGN CRITERIA

The preliminary sanitary sewer design sheet is included in **Appendix B.1**. The sewers are to be designed in conformance with all relevant City of Ottawa and MECP Guidelines, policies, and design parameters as summarized in **Table 3-1** below.

The Stillwater Station dwelling unit count was derived from the Master Plan, with an assumed population density of 1.8 persons/unit as per the average apartment density parameter. The projected population of the community was found to be 3,755 people. The commercial area on ground floor and gross construction area for each Plot was also provided in the Master Plan.



FUNCTIONAL SITE SERVICING AND STORMWATER MANAGEMENT REPORT REV.03 – 1987 ROBERTSON ROAD (STILLWATER STATION)

Wastewater Servicing
February 28, 2024

Table 3.1: Sanitary Sewer Design Criteria

Design Parameters	Revised Design Criteria (City of Ottawa Guidelines - 2018)
Minimum Velocity (m/s)	0.6
Maximum Velocity (m/s)	3.0
Manning Roughness Coefficient (for all smooth wall pipes)	0.013
Minimum Size	200mm dia. for residential areas, 250mm for commercial areas
Average Apartment (Persons per unit)	1.8
Extraneous Flow Allowance (L/s/ha)	0.33
Manhole Spacing (m)	120 m
Minimum Cover (m)	2.5 m
Average Daily Discharge per Person (L/cap/day)	280
Harmon Correction Factor	0.8
Mobile Home Park Daily Flow (L/space/day)	1,000
Commercial Daily Flow (L/gross ha/day)	28,000
Light Industrial Flow (L/gross ha/day)	35,000

The following is a summary of the wastewater servicing assumptions.

- In the absence of existing sanitary flow data from the Bellwood Estates mobile home park, the following assumptions were made to estimate the external sanitary flows:
 - 11.37 ha of contributing area
 - 254 mobile home units (assumed from aerial imagery)
 - the mobile home park generation rate (1000 L/space/day as per MECP and Appendix 4-A of the City of Ottawa SDG) and typical infiltration rate (0.33 L/s/ha) is representative of this established community.
- In the absence of existing sanitary flow data from the business park to the east of the site (General Dynamics Canada), the following assumptions were made to estimate the external sanitary flows entering EX SAN 1:
 - 200 mm diameter sewer pipe (as per GeoOttawa)
 - 7.3 ha contributing area
 - the light industrial generation rate (35,000 L/gross ha/day as per City of Ottawa SDG) and typical infiltration rate (0.33 L/s/ha) is representative of this facility.
- The invert elevations at the tie-in points were measured to be:



FUNCTIONAL SITE SERVICING AND STORMWATER MANAGEMENT REPORT REV.03 – 1987 ROBERTSON ROAD (STILLWATER STATION)

Wastewater Servicing
February 28, 2024

- The northwest invert elevation at EX SAN 4 (south tie-in manhole) is 85.45 m
- The southwest (incoming) invert elevation at EX SAN 1(northeast tie-in manhole) is 84.74 m, the east (incoming) invert elevation is 84.69, and the north (outgoing) invert elevation is 84.41 m
- The new (re-aligned) sanitary trunk sewer coming from the site (375 mm diameter) has been dropped to a new EX SAN 1 southwest invert elevation of 84.44 m

At the detailed design phase, monitoring data for the existing flow rates from EX SAN 4 and from the east business park should be obtained to substantiate the above assumptions and confirm the adequacy of the downstream 400 mm diameter sanitary trunk sewer to the Nepean Collector. In contingency, if during detailed design this sewer is found to be inadequate there may be an opportunity to lower this offsite sewer line and increase its capacity.

3.3 PROPOSED SANITARY SERVICING

Drawing SAN-1 illustrates the proposed trunk main realignment, functional sanitary sewer alignment, and sanitary drainage areas.

The proposed development will be serviced by the existing public sanitary trunk sewer, which will be realigned within the site and upsized to 375 mm diameter, and a new network of gravity sewers ranging from 250 mm to 300 mm in diameter, designed in accordance with the wastewater design parameters from ISTB-2018-01 and the Sewer Design Guidelines, summarized in **Table 3.1**. The conceptual sanitary sewer design sheet can be found in **Appendix B.1**. A breakdown of the estimated sewage peak flows from the proposed development and existing developments that will be directed to the northeastern outlet (EX SAN 1) is shown in **Table 3.2**:

Table 3.2: Estimated Wastewater Peak Flows

Outlet	Developable Site Infiltration Flow - (L/s)	Site Residential Population (persons)	Site Residential Peak Flow (L/s)	Site Commercial Peak Flow ² (L/s)	External Flows ¹ (L/s)	Total Peak Flow to EX SAN 1 (L/s)
Northeastern Outlet (EX SAN 1)	3.0	3,755	35.1	1.3	24.4	62.9

Notes:

1. External flows are from Bellwood Estates mobile home park and the business park to the east (General Dynamics Canada), including infiltration flows.
2. From SAN MH 2 to EX SAN 1, the C+I+I areas constitute less than 20% of the total contributing area; consequently, a commercial peaking factor of 1.0 is used for this segment. At EX SAN 1, the additional industrial area from General Dynamics Canada increases the C+I+I areas, and they



FUNCTIONAL SITE SERVICING AND STORMWATER MANAGEMENT REPORT REV.03 – 1987 ROBERTSON ROAD (STILLWATER STATION)

Wastewater Servicing
February 28, 2024

constitute more than 20% of the total contributing area. Consequently, a commercial peaking factor of 1.5 is used downstream of EX SAN 1.

3. For the external sanitary flows generated from the General Dynamics Canada, the light industrial peaking factor of 2.4 was applied, as per the MOE recommended range of 2 to 4.

Based on sanitary sewer design sheet, the peak flows from the proposed development and the peak flows from the external areas can be accommodated within the existing downstream 400 mm diameter municipal sanitary sewer.

A 200 mm sanitary service has been proposed to each building. It is assumed that sanitary sump pits and sump pumps will be required to accommodate the sewage from the basement (underground) parking levels. The mechanical consultant or plumbing contractor will ultimately be responsible to confirm the building service lateral sizing; sump pump requirements and designs; and ensure conformance to building code requirements. It is assumed that the building service sizing and sanitary pump requirements will be confirmed at the detailed design phase.



4.0 STORMWATER MANAGEMENT

4.1 SWM OBJECTIVES

The objective of this stormwater management (SWM) plan is to determine the measures necessary to control the quantity, quality, and temperature of stormwater released from the proposed development to the established SWM criteria.

4.2 SWM CRITERIA AND CONSTRAINTS

Criteria were established by combining current design practices outlined by the City of Ottawa Design Guidelines (2012), and through consultation with the RVCA and City of Ottawa staff. The following summarizes the criteria, with the source of each criterion indicated in brackets:

General

- Use of the dual drainage principle (City of Ottawa).
- Wherever feasible and practical, site-level measures should be used to reduce and control the volume and rate of runoff. (City of Ottawa).
- Assess impact of 100-year event outlined in the City of Ottawa Sewer Design Guidelines on major and minor drainage system (City of Ottawa)
- Enhanced quality control (80 % TSS removal) to be provided on-site for the (RVCA).

Storm Sewer and Inlet Controls

- Site discharge to be controlled to pre-development rates and is proposed to outlet to Stillwater Creek (City of Ottawa).
- Size collector road storm sewers to convey the 5-year storm event under free-flow conditions and size local road storm sewers to convey the 2-year storm event under free-flow conditions using City of Ottawa I-D-F parameters (City of Ottawa)
- 100-year Storm HGL to be a minimum of 0.30 m below building foundation footing (City of Ottawa).
- No capacity constraints have been identified for stormwater into Stillwater Creek by the City. Most of the property currently drains to Stillwater Creek under existing conditions. Pre-development release rates for the 5- and 100-year storm events will need to be met under post-development conditions (i.e 5-year post-development discharge (Q) = 5-year pre-development Q and 100-year post-development Q = 100-year pre-development Q).

Surface Storage and Overland Flow

- Building openings to be minimum of 0.30 m above the 100-year water level (City of Ottawa)
- Maximum depth of flow under either static or dynamic conditions shall be less than 0.35 m in the 100-year event (City of Ottawa)
- Provide adequate emergency overflow conveyance off-site (City of Ottawa)



FUNCTIONAL SITE SERVICING AND STORMWATER MANAGEMENT REPORT REV.03 – 1987 ROBERTSON ROAD (STILLWATER STATION)

Stormwater Management
February 28, 2024

4.3 STORMWATER MANAGEMENT DESIGN

The intent of the stormwater management plan presented herein is to mitigate any negative impact that the proposed development will have on the existing outlet (Stillwater Creek) and downstream system, while providing adequate capacity to service the proposed buildings and amenity areas. The proposed stormwater management plan follows:

- Control the release rate of all Blocks (Plots) to the 5-year pre-development discharge rate. This is to be achieved by providing rooftop storage, cistern(s) located in the underground parking areas; underground tank(s) and/or oversized pipe(s); surface storage; or a combination thereof.
- Utilize surface storage within streets and parking areas.
- Provide a Dry Pond in a dedicated stormwater management block to control and store the runoff from the common areas prior to release at a controlled flow rate.
- Two oil-grit separator units (OGS) are proposed as end-of-pipe treatments to provide enhanced water quality improvement for runoff from local and collector streets as well as parking areas.
- Direct major flows to the Dry Pond where grading permits.
- Provide emergency overland flow routes to the outlet (creek).

Available topographic information and the existing drainage conditions for the site are shown on **Drawing EX STM-1**. A summary of subareas, runoff coefficients and the proposed storm servicing plan is shown on **Drawing STM-1**.

4.3.1 Pre-Development Drainage Conditions

Based on consultation with City of Ottawa staff, the peak post-development discharge from the subject site is to be controlled to the pre-development release rate for the 5- and 100-year storm events, to a maximum runoff coefficient (C) of 0.5 i.e. Pre-development release rates for the 5- and 100-year storm events will need to be met under post-development conditions (i.e. 5-year post-Q = 5-year pre-Q, 100-year post-C = 100-year pre-Q).

The existing drainage conditions for the site have been determined by evaluating 1.0 m LiDAR Digital Elevation Model (DEM) data to delineate the existing flow paths and subdrainage areas, splitting the study area into 13 subcatchments. The runoff coefficients for the existing subdrainage areas have been determined based on the relative imperviousness of the respective areas. Most of the site drains toward Stillwater Creek, except for a small subcatchment area EXT-12 on the proposed collector road that drains west toward Moodie Drive; and at the northeast corner of the site (EXT-4 and EXT-5) which drain east along the CN rail line. Ultimately, these three subdrainage areas that drain offsite ultimately drain into Stillwater Creek further downstream.

A significant upstream area contributes to this reach of Stillwater Creek, however only small external areas drain through the proposed development area of the site. These are identified as EXT-8 and EXT-9 and are situated on the southeast corner of the site. The pre-development subdrainage areas are shown



FUNCTIONAL SITE SERVICING AND STORMWATER MANAGEMENT REPORT REV.03 – 1987 ROBERTSON ROAD (STILLWATER STATION)

Stormwater Management
February 28, 2024

on the **EX STM-1 Drawing** and summarized in **Appendix C.2**. Including the external drainage areas and the additional area for the proposed segment of collector road (access roadway) through the former NCC lands, the total study area for the drainage and SWM evaluation is 10.58 ha with a combined pre-development runoff coefficient of 0.34.

The LiDAR data and watershed delineation was also used to improve the estimate of the pre-development time of concentration for the site. This was calculated to be 29.7 minutes. The calculations for the time of concentration are shown in **Appendix C.2**. The rational method and the City of Ottawa IDF curves were used to calculate the pre-development (target) release rates for the site, as shown in **Appendix C.2**. The rational method equation follows.

- $Q = 2.78 CiA$
- Where:
- Q = peak flow rate, L/s
- A = drainage area, ha
- I = rainfall intensity, mm/hr (per Ottawa IDF curves)
- C = site runoff coefficient

The release rates are summarized in **Table 4.1**. The post-development peak flows for the study area for the 5-year and the 100-year event must be restricted to be less than or equal to their respective pre-development target flow rates.

Table 4.1: Rational Method Target Release Rates

Design Storm	Target Flow Rate (L/s)
5-Year	547.3
100-Year	932.3

These target rates vary slightly compared to previous submissions because of:

- the clear identification of the Study Area, including uncontrolled and external areas.
- the improved estimate of the pre-development time of concentration.

We are confident that these target release rates accurately represent the pre-development area and provide conservative objectives for the SWM design.

4.3.2 Post-Development Stormwater Management and Drainage Conditions

The post-development drainage patterns for the site were established based on the Master Plan development concept, the functional grading plan, and the existing drainage conditions in the undeveloped areas. The post-development drainage conditions are shown in the **STM-1 Drawing**, where 35 subdrainage areas have been delineated based on their drainage outlet, storage treatment, and design criteria. The subdrainage areas have been grouped into four categories.



FUNCTIONAL SITE SERVICING AND STORMWATER MANAGEMENT REPORT REV.03 – 1987 ROBERTSON ROAD (STILLWATER STATION)

Stormwater Management
February 28, 2024

Table 4.2: Summary of Post-Development Subdrainage Areas

Category	Description	Subdrainage Areas
Uncontrolled Areas (Non-Tributary)	Areas that drain directly to the creek and that are to remain relatively undeveloped, or areas that drain offsite and can't readily be controlled or captured by the proposed stormwater management infrastructure.	UNC-1, UNC-2, UNC-3 2.14 ha
Uncontrolled Areas Tributary to Outlet 2	Areas that drain to the proposed minor storm sewer system in the collector road, major system along the collector road, and outlet directly to the creek at Outlet 2.	C109A and C109B 1.48 ha
Block Areas Tributary to Outlet 1	Block areas include both proposed roof areas and landscaped areas that are part of each Block (plot) A, B, C, D, E, and F. Onsite storage shall be provided on these blocks such that the release rate for all events up to and including the 100-year event are restricted to the 5-year pre-development rate, which is taken to be conservatively 50 L/s/ha. The Block sites will also be prescribed storage targets that must be met at detailed design. Restricted/controlled flows from the Block sites are released to the minor storm sewer system tributary to Outlet 1.	L102B, L102D, L102F, L103A, L104B, L104C, R101A, R101B, R102A, R102B, R102C, R102D, R102E, R103A, R104A, R104B, R104C, R104D, & R106A 3.49 ha
Common Areas Tributary to Outlet 1	Common areas include the collector roads, local roads, park areas, and the SWM Block. The two small external drainage areas have also been lumped into this category. In the collector road areas, the minor system will be designed to accommodate the 5-year post-development flow rates and the in the local road areas, the minor system will be designed to the 2-year post-development flow rate.	EX-1, EX-2, C106A, C105A, L104A, L102C, L102A, L101A, L102E, L110A, & L100A 3.46 ha

The latter two subdrainage area categories are both tributary to Outlet 1, and consequently both the minor and major flows from these areas will be directed to the dry pond stormwater management facility. The post-development subdrainage areas and runoff coefficients are summarized for the overall site in **Appendix C.4.1** and the Block Areas in **Appendix C.4.2**.



FUNCTIONAL SITE SERVICING AND STORMWATER MANAGEMENT REPORT REV.03 – 1987 ROBERTSON ROAD (STILLWATER STATION)

Stormwater Management
February 28, 2024

4.3.2.1 Quantity Control

The Stillwater Station development will lead to a significant increase in the site's overall runoff coefficient from the 0.34 pre-development coefficient to the 0.56 post-development coefficient. In addition, the C coefficient values have been increased by 25 % for the post-development 100-year storm event based on MTO Drainage Manual recommendations and City of Ottawa Sewer Design Guidelines. Quantity control measures are required on this site to meet the restrictive stormwater release criteria.

The release rate from the dry pond shall be controlled such that the release rate from the overall study area does not exceed the design targets outlined in **Table 4.1**. In other words, the flows from the uncontrolled areas must be summed with the release rate from the dry pond to determine the overall site release rate. To allow for the discharge from the uncontrolled areas, the discharge from the block sites and dry pond must be over-controlled. It is proposed that the outflow from the site is restricted using a control structure that includes a circular orifice for the 5-year event and a combination of the orifice and a rectangular weir for the 100-year event. The storage provided at the dry pond location will be sufficient to allow for the required controlled release rate.

4.3.2.1.1 Block-Level Storage Requirements

The 5-year pre-development release rate for the 10.58 ha study area was determined to be 51.7 L/s/ha. We have prescribed a conservative restricted release rate of 50 L/s/ha for all Block (plot) Areas. It is our understanding that in the future the Block (plot) areas may be independently owned (subdivided) parcels, and consequently the detailed design for each Block would be approved through individual Site Plan Control (SPC) processes. To demonstrate the serviceability of the Stillwater Station subdivision, the Block areas have been treated as a single consolidated area with a combined runoff coefficient, overall storage requirements, and a single outflow rate that satisfies the 50 L/s/ha restricted release rate. To demonstrate the serviceability of each individual Block, the stormwater management design calculations in also provide the required release rates and examples of the storage requirements at the Block (plot) level.

Storage is to be provided on each Block site to meet the restricted release rate. Block onsite storage methods may include controlled rooftop storage; cistern(s) located in the underground parking areas; underground tanks or oversized pipes; surface storage; or a combination thereof. The restricted release rate from the onsite Block storage may be achieved using an inlet control device (ICD) providing a variable release rate correlating to the storage depth (head), or a submersible pump may be used to provide a constant outflow rate, provided the total release rate from each Block satisfies the 50 L/s/ha restriction. A detailed stormwater management plan should be prepared for each Block at the time of individual Block SPC and Development.

In addition to the restricted release rate targets, we have provided a restricted storage rate (RSR) for each Block which has been calculated based on the proposed densities in the current Master Plan. It is imperative the release rate for each Block is restricted to the 50 L/s/ha criteria, and consequently sufficient storage must be provided onsite. These RSR values provide an example of the storage rate that will be required on the Block Sites to achieve the release rate criterion. In the future, the building



FUNCTIONAL SITE SERVICING AND STORMWATER MANAGEMENT REPORT REV.03 – 1987 ROBERTSON ROAD (STILLWATER STATION)

Stormwater Management
February 28, 2024

footprints, roof areas, or hard versus soft landscaped areas may change on some of the Block sites; hence, the imperviousness (and consequently the overall runoff coefficient) may also differ from the current Master Plan proposal. By providing adequate onsite storage to comply with the restricted outflow criterion, the effectiveness of the dry pond and overall site stormwater quantity controls will be preserved regardless of the changes to the surfaces at the Block level. The RSR for each Block is to be confirmed at detailed design when a dynamic model will be used to evaluate the post-development conditions and storage requirements.

The storage requirements for the current Block configurations were determined using the modified rational method (MRM). The detailed MRM calculations have been provided in **Appendix C.4.3**. The 100-year stormwater management requirements for the Block areas are summarized in **Table 4.3**, where:

- Qactual is the 100-year rainfall runoff rate generated from the Block area as determined by the Rational Method Calculation at $t_c = 40\text{min}$ (this was found to be the average time of concentration that the peak storage volume was required for the Block areas).
- Qcontrol is the allowable release rate at the 50 L/s/ha restriction.
- Vstored is the volume of storage required.
- RSR is the minimum prescribed restricted storage rate for each block.

Table 4.3: 100-Year Storage Requirements for Block Areas

BLOCK ID	Area (ha)	C (5-yr)	C (100-yr)	Qactual (L/s)	Qcontrol (L/s)	Vstored (m3)	RSR (m3/ha)
BLOCK A	0.86	0.64	0.80	145	43	244	283
BLOCK B	0.75	0.76	0.95	150	38	270	359
BLOCK C	0.48	0.77	0.96	96	24	173	361
BLOCK D	0.22	0.65	0.82	38	11	65	289
BLOCK E	0.43	0.81	1.00	90	22	165	381
BLOCK F	0.74	0.59	0.73	114	37	184	248

The restricted outflow rate and storage requirements are achievable within each Block area. As an example, detailed MRM calculations have been provided for Block A (see **Appendix C.4.4**). Per the current Master Plan, the total roof area in Block A is 0.38 ha. Assuming the roof storage is maximized (80% of the roof area, 0.15 m maximum storage depth per OBC, conical-shaped storage area), 153 m³ of storage should be available on the roof areas alone. With the roof release rates restricted using standard Watts Roof Drains with Adjustable Accutrol Weirs (or equivalent roof drain product) set to 50% open, the roof would theoretically detain 151 m³ at a release rate of 18 L/s at a time of concentration of 50 minutes during the 100-year event. To meet the restricted release rate (Qcontrol) for the overall Block A area, additional onsite storage must be provided with a release rate of less than 25 L/s at 50 minutes to meet the Block's overall restricted release rate of 43 L/s. With a constant outflow rate of 25 L/s (achieved with a submersible pump) the peak storage requirement occurs at 30 minutes and an additional 75 m³ of



FUNCTIONAL SITE SERVICING AND STORMWATER MANAGEMENT REPORT REV.03 – 1987 ROBERTSON ROAD (STILLWATER STATION)

Stormwater Management
February 28, 2024

storage will be required onsite. This volume could reasonably be managed onsite with a combination of storage techniques. The total storage required for the example storage configuration on Block A is 226 m³ which equates to an RSR of 263 m³/ha. Note that this RSR differs from the value in **Table 4.3**, above, because it serves as an example of how onsite Block storage can be achieved while still meeting the overall Block target release rate. Actual onsite Block storage methods will be determined at the detailed design phase.

In summary:

- The release rate from each Block is to be restricted to 50 L/s/ha.
- Adequate onsite storage is to be provided within each Block to satisfy the restricted release rate.
- The configuration of the Block onsite storage is to be determined at detailed design.

4.3.2.1.2 Dry Pond Requirements

The stormwater management requirements for the Dry Pond were also determined in the MRM calculation sheet in **Appendix C.4.3**. The major system provides storage in the dry pond as well as the sags of local and collector roads and parking areas. The storage rate within the ROW is estimated as:

- 50 L/s/ha for local streets and
- 25 L/s/ha for collector streets

This results in 120 m³ of available storage within the roadway areas for the current Master Plan layout. In the MRM calculations, 64 m³ and 83 m³ of roadway surface storage is used during the 5-year and 100-year events, respectively. These estimates will be modelled to greater accuracy at the detailed design phase. Onsite Block storage and storage within the roadway ROWs lessen the Dry Pond storage requirements in the dedicated SWM Block. Controlled discharge from the Block sites, the minor system flows, and the major system run-off collected from the common tributary areas will all be directed to the centralized Dry Pond (refer to **Drawing STM-1**).

The MRM sheet provided in **Appendix C.4.3** showed that during a 100-year event 1,050 m³ of storage is required in the major system during the 100-year event. This can be achieved with 83 m³ storage in the roadways and parking areas, and 967m³ in the Dry Pond, or the entire volume can be detained in the SWM pond. **Table 4.4** summarizes the preliminary pond geometry.

Table 4.4: Potential Dry Pond Geometry

Maximum Ponding Area	1,084 m ²
Maximum Ponding Depth	1.5 m
Maximum Available Storage	1,290 m ³
100-year HWL Elevation	85.90 m
Freeboard Elevation	86.29 m



FUNCTIONAL SITE SERVICING AND STORMWATER MANAGEMENT REPORT REV.03 – 1987 ROBERTSON ROAD (STILLWATER STATION)

Stormwater Management
February 28, 2024

In the current Master Plan, sufficient area has been provided within the SWM Block to situate the Dry Pond and a gravel access road for operations and maintenance access (refer to **Drawing STM-1**).

The preliminary pond geometry was used to develop a stage-storage table. In the MRM sheet, the pond stage-storage table is related to the stage-storage discharge curve of the proposed outlet structure to calculate the discharge rates and pond storage requirements depending on the water level. Refer to the MRM sheet (**Appendix C.4.3**) for details.

The MRM calculations demonstrate that the storage requirements and restricted release rate criteria for this site can be achieved by utilizing an outlet structure with the hydraulic characteristics summarized in **Table 4.5**. This is an example of a potential Dry Pond and outlet control structure configuration that establishes the feasibility of stormwater servicing for this site. The actual configuration of the Dry Pond and control structure will be determined at detailed design when a dynamic stormwater model is used to represent the proposed stormwater management system.

Table 4.5: Hydraulic Characteristics of a Potential Dry Pond Outlet Control Structure

Circular Orifice Diameter	340 mm
Circular Orifice Invert	84.8 m
Rectangular Weir, Crest Width	825 mm
Rectangular Weir Invert	85.8 m

The MRM calculations use an iterative analysis process to relate the storage inflow rate, discharge rate, storage volume, and head within the Dry Pond. The MRM method provides very conservative estimates since travel time is neglected, and all subcatchment areas are assumed to reach the outlet at the post-development time of concentration of 10 minutes. We acknowledge that a dynamic stormwater model will be required at the detailed design phase to accurately size the Dry Pond storage and stormwater sewer system and model the hydraulic grade lines. Storage redundancy has been provided in the Dry Pond design by providing a total storage capacity of volume of 1,290 m³ at the freeboard elevation which provides a factor of safety of 1.3 when compared to the actual storage requirements of 967 m³.

Since the Dry Pond is situated at a centralized location in the site there is very little grade difference available between the proposed storm sewer system and the pond. To ensure the proposed storm sewer network meets the minimum slopes and cover requirements, the bottom of the pond needed to be lowered. To achieve these excavation depths in the restricted SWM Block area, a retaining wall is required on the north, south, and east sides of the pond.

The maximum exposed height of the preliminary retaining wall is 3.38 m and will require design by the Geotechnical Consultants at the detailed design phase. Paterson was consulted regarding the pond location and the preliminary retaining wall requirements. From a geotechnical perspective, Paterson did not have any initial concerns regarding the proposed wall and pond (refer to **Appendix E.9** for email correspondence); however, they indicated that no grade raises are permitted at the Limit of Geotechnical



FUNCTIONAL SITE SERVICING AND STORMWATER MANAGEMENT REPORT REV.03 – 1987 ROBERTSON ROAD (STILLWATER STATION)

Stormwater Management
February 28, 2024

Hazard Lands. The proposed creekside MUP separates the west side of the Dry Pond from the hazard lands; and the pond grading proposes a cut along the west side. Consequently, the pond grading respects the grade raise restriction along the Limit of Hazard Lands. Due to the grading restrictions along the Limit of Hazard Lands, the grade of the MUP is also not to exceed the existing ground elevations.

The City of Ottawa SDG requires the 100-year storm HGL to be a minimum of 0.30 m below building foundation footing. Due to the centralized location of the SWM facility, the proximity of the adjacent buildings, and the proposed underground (basement-level) parking proposed in the adjacent buildings, it will not be possible for the pond to meet this HGL requirement. Consequently, the Dry Pond will need to be lined to prevent hydraulic connectivity between the pond and the adjacent foundation drains. Lining the pond will prevent infiltration to the disbenefit of the site's SWM goals; however, it will also limit the additional soil moisture introduced to the Hazard Lands and top of slope which will ultimately reduce the risk of introducing geotechnical instabilities. The pond lining will be designed by the Geotechnical Consultant at Detailed Design.

As a public safety measure, the pond will require a perimeter fence. The functional design shows a fence/railing along the top of the retaining wall as a minimum barrier requirement. A minimum 0.3 m freeboard has been provided between the preliminary 100-year HWL (85.9 m) and the pond spill elevation (86.3 m) to provide storage redundancy. In case of emergency, an overflow/spill location has been established at the northwest of the pond at a preliminary elevation of 86.2 m. The overflow route traverses the proposed MUP. At detailed design, careful attention should be paid to the design and armoring of the overflow route to ensure that there is no erosion or degradation to the MUP, Hazard Lands, nor the creek ravine.

The proposed controlled release rates to Outlet 1 (HWL-1) and required storage volumes for the Dry Pond facility are summarized in **Table 4.6** below. Note that the critical design criteria for the proposed outlet control structure is the minimum release rates for both the 5-year and 100-year events, while the critical design criteria for the storage volume of the Dry Pond is the maximum storage requirements during the 100-year event.

Table 4.6: Dry Pond Facility Controlled Release Rates and Storage Volume Requirements

	5-Year		100-Year	
		Peak		Peak
Time of Concentration	10 min	30 min	10 min	50 min
Release Rate (L/s)	159	189	223	311
Storage Required (m³)	390	564	786	1050
Head (m)	0.42	0.59	0.82	1.11

Table 4.7 identifies the release rates associated with the overall SWMP study area and Stillwater Station site. The proposed stormwater management plan and demonstrates adherence to target peak outflow rates of the site established in **Table 4.1**.



Stormwater Management
February 28, 2024

Table 4.7: Summary of 5- and 100-Year Event Peak Release Rates for Overall Site

	5-Year Peak Discharge (L/s)	100-Year Peak Discharge (L/s)
Uncontrolled Areas – Non-Tributary	158	338
Uncontrolled – Tributary to Outlet 2	202	371
Controlled – Tributary to Outlet 1	159	223
Total	519	932
Target	547.3	932.3

4.3.2.2 Quality Control

On-site quality control measures are expected for the proposed development per pre-consultation with RVCA and City of Ottawa staff. An enhanced protection (80 % removal of total suspended solids) will be required for the site before discharging to Stillwater Creek. An Oil-Grit Separator is proposed as an end-of-pipe solution to achieve this criterion. Two (2) OGS units are proposed to treat runoff from the site’s minor storm sewer system.

One OGS unit has been proposed immediately upstream of the Dry Pond SWM facility (OGS 1) and the second (OGS 2) is proposed immediately upstream of Outlet 2 (HWL-2). OGS 1 is to be located downstream of the dry pond to minimize the pond maintenance requirements for the removal of sediments and debris and reduce the risk of blockage of the outlet/control structure. Additional quality treatment can be achieved through the deposition of sediments in the Dry Pond and potentially through intentional design of the outfall area. Access to OGS 1 for O&M is to be provided by the pond’s maintenance road. A pullout will be incorporated into the design of the collector roadway for O&M access to OGS 2 at detailed design.

The OGS units will be sized to provide enhanced quality treatment and protection during detailed design. A preliminary sizing of the OGS units has been provided in **Appendix C.4.4**. The preliminary sizing indicates that a Stormceptor EFO12 model is required for OGS1 and a Stormceptor EFO4 model is required for OGS 2. These models can achieve up to 85% and 80% TSS removal respectively, thereby satisfying the 80% TSS removal quality control design criteria.

As the first flush of most impervious surfaces are directed to the Dry Pond and OGS units, suspended solids within runoff generated by the site are not anticipated to have a deleterious impact on Stillwater Creek or the downstream watercourses.

4.3.2.3 Thermal Control

Based on the NCC Stillwater Creek reports (2013) and the creek’s classification as a cool-water system, the thermal stability of the discharged stormwater must be controlled, and additional mitigation methods adopted. Underground storage was originally proposed for this site to facilitate a portion of the required thermal controls; however, since a dry pond has been adopted as the SWM facility, thermal mitigation must be achieved with different controls and mitigation measures. We acknowledge the site requirement



FUNCTIONAL SITE SERVICING AND STORMWATER MANAGEMENT REPORT REV.03 – 1987 ROBERTSON ROAD (STILLWATER STATION)

Geotechnical Considerations and Grading
February 28, 2024

for thermal control and will address the issue at the detailed design phase. Some thermal controls may be achieved through architectural aspects of the site design such as high-albedo rooftops, others through civil design components such as underground storage on the Block sites, a clearstone layer in the pond bottom (embedded outlet), etc., and other methods may include environmental design, such as re-vegetation of the creek channel. These methods will be further explored, coordinated, and incorporated at detailed design.

4.4 PROPOSED STORM SERVICING (MINOR SYSTEM)

Drawing STM-1 illustrates the functional storm sewer design, conceptual sewer alignments, and storm drainage areas. Calculations for the functional sewer design are provided in **Appendix C.1**. The sewers are to be designed in conformance with all relevant City of Ottawa and MECP Guidelines, policies, and design parameters. The storm sewers in the local roads (24 m ROW and 22m ROW) have been sized to convey the 2-year storm event and the collector road (26 m ROW) has been sized to sized to convey the 5-year storm event under free-flow conditions using City of Ottawa IDF parameters and the rational method design sheet. The proposed roadways will have urban cross sections complete with curb, gutter, and catch basins to inlet to the minor storm system. Design of the storm sewer (including catch basin design and locations) are to be determined at the detailed design phase when a dynamic model will be developed to evaluate the post-development conditions and sewer design. At present, the functional sewer design is free of conflicts with other services (SAN and WTR) and has adequate cover for frost protection.

A 200 mm storm service has been proposed to each building that will accommodate the controlled release of rooftop runoff, building foundation drain flow, and release of stormwater runoff from building area drains or stormwater storage cistern(s). It is assumed that sump pits and pumps will be required to accommodate the foundation drains and the possible stormwater storage cistern(s) at the basement (underground) parking levels. The mechanical consultant or plumbing contractor will ultimately be responsible to confirm the building service lateral sizing; sump pump requirements and designs; and ensure conformance to building code requirements. It is assumed that the building service sizing and sump pump requirements will be confirmed at the detailed design phase.

5.0 GEOTECHNICAL CONSIDERATIONS AND GRADING

5.1 PRELIMINARY GEOTECHNICAL INVESTIGATION

A preliminary geotechnical field investigation of the subject site was conducted by Paterson Group (Paterson) in March 2021, and the report entitled Preliminary Geotechnical Investigation Proposed Mixed Use Development 1987 Robertson Road, Ottawa, Ontario, was prepared in May 2021. The latest revision of the geotechnical report (Rev. 5, October 13, 2023) is included with the external reports in **Appendix D.4**. The objectives of the preliminary geotechnical investigation were to:

- Determine the subsoil and groundwater conditions at this site by means of boreholes.



FUNCTIONAL SITE SERVICING AND STORMWATER MANAGEMENT REPORT REV.03 – 1987 ROBERTSON ROAD (STILLWATER STATION)

Geotechnical Considerations and Grading
February 28, 2024

- Provide preliminary geotechnical recommendations for the design of the proposed development including construction considerations which may affect its design.

5.1.1 Overburden

Seven boreholes were drilled in 2021 to 10.1 m depth. The 0.4 to 1.8 m surface layer of the site was found to be topsoil and/or a silty sand to silty clay fill layer. The underlying subsurface profile consisted of several meters of stiff to very stiff brown clay, underlain by grey silty clay (BH 1-3 and 7), and a thick glacial till deposit (BH1-2, and 4). In BH 6 the thick glacial till underlaid the fill layer. With exception of BH 7, practical refusal to augering or DCPT (dynamic cone penetration test) was encountered in all boreholes at depths of 1.0 to 13.0 m.

Two boreholes were drilled during the 2007 field investigation (BH 8 and BH 9) revealing a thick layer of glacial till to the practical refusal to augering encountered at depths of 0.7 to 3.1 m.

5.1.2 Bedrock

Geological mapping was reviewed to characterize the site bedrock. Most of the site was found to consist of the Nepean formation sandstone while the north portion consists of the Oxford formation dolomite. The bedrock drift thickness varies from 2 to 10 m. A good to excellent quality sandstone bedrock was encountered in BH 4 and BH 6 at approximate depths of 1.0 to 1.9 m.

5.1.3 Groundwater

Groundwater levels, determined from monitoring wells and piezometers installed at six borehole locations, varied in depths ranging from 0.21 to 1.93 m below the original ground surface as recorded March 24, 2021. These instantaneous levels may have been artificially high due to perching within the backfilled borehole column or regionally perched on the shallow bedrock.; hence, the long-term groundwater levels were also estimated by analyzing field observations of the recovered soil samples, such as moisture levels, undrained shear strength, and coloring. Based on the soil sample characteristics the long-term groundwater table was estimated to be at an elevation of 81.5 to 82.5 m throughout most of the subject site, and in the southeast portion of the site (including the location of the dry pond), the long-term groundwater level is believed to be below the bedrock surface. However, it was noted that groundwater levels are subject to seasonal fluctuations and could vary at the time of construction. It is also noted that development of the site (foundation and basement excavations into the bedrock) may allow for equalization of the groundwater table below the bedrock.

5.2 SLOPE STABILITY ASSESSMENT

Adjacent to the subject site, the slope condition along the Stillwater Creek ravine was reviewed as part of the geotechnical investigation. Four slope cross-sections (A-D from north to south) were studied as the worst-case scenarios, where the watercourse has meandered close to the proximity of the toe of the upper slope. The slope profiles were generally inclined 2H:1V with limited areas at 1H:1V with a 10 to 12 m high stable slope. The slope faces are generally vegetated (grass to mature trees) with some minor toe erosion observed at some locations. Historical aerial images and field observations identified significant



FUNCTIONAL SITE SERVICING AND STORMWATER MANAGEMENT REPORT REV.03 – 1987 ROBERTSON ROAD (STILLWATER STATION)

Geotechnical Considerations and Grading
February 28, 2024

in-filling along the creek which has changed the meander shapes and shifted the watercourse west. The infill conditions and observed erosion issues triggered the need for a slope stability assessment. The assessment explored traditional slope stability analysis; seismic loading analysis; and toe erosion and erosion access allowances.

5.2.1 Slope Stability Analysis

A slope stability analysis of the upper slope was carried out at the four cross-section locations to delineate the geotechnical setback (hazard lands) from the top of bank using the computer program SLIDE. The software uses several analysis methods including the widely accepted Bishop's method. A factor of safety of 1.0 represents a stable slope, so 1.5 was utilized as recommended when permanent structures would be impacted by a slope failure. The subsoil conditions were inferred from the nearby boreholes. The silty clay deposit was assumed to be saturated and exiting the toe of the slope.

The factor of safety for the slope at Section A was 1.53 while at Sections B-D the factor of safety was less than 1.5 beyond the top of slope. Based on these results, stable slope setbacks varying between 9 and 15 m were required for all sections to achieve a factor of safety of 1.5. The stable slope setbacks were used to delineate the hazard lands adjacent to the subject site.

5.2.2 Seismic Loading Analysis

An analysis considering seismic loading and the groundwater at ground surface loading analysis was also conducted for the four cross sections. A factor of safety of 1.1 and a horizontal acceleration of 0.16 g were used for the analysis. The factor of safety at Sections A and D exceeded the target factor of safety, whereas Sections B and C did not achieve the safety factor. The required stable slope setbacks due to seismic loading were found to be less than those identified from the slope stability analysis; hence, they have taken precedence for the setback requirements.

5.2.3 Erosion and Access Allowances

Within the valley corridor, the watercourse may subject the anticipated soils (silty sand fill, firm to very stiff silty clay and/or glacial till) to erosion activity. An allowance of 5 m should be applied from the watercourse edge for toe erosion and 6 m is required from the top of slope or geotechnical setback for access. In locations where the watercourse edge is within 5 m of the existing toe of slope, both the toe erosion and access allowances are required from the top of the slope or geotechnical setback limit. This is reflected in the limit of hazard lands shown.

5.3 GEOTECHNICAL CONSIDERATIONS

At the time of detailed geotechnical investigation and detailed design, several geotechnical considerations and provisions should be made on the subject site:

- Buildings with basement levels below the long-term groundwater table or structures extending below the building foundations should be provided a groundwater suppression system to direct groundwater to the proposed buildings' sump pit.



FUNCTIONAL SITE SERVICING AND STORMWATER MANAGEMENT REPORT REV.03 – 1987 ROBERTSON ROAD (STILLWATER STATION)

Geotechnical Considerations and Grading
February 28, 2024

- Backfill against the exterior sides of the foundation walls should consist of free draining, non frost susceptible granular materials or site excavated materials used in conjunction with a drainage geocomposite and perimeter foundation drainage system.
- Protection against frost action (minimum soil cover or insulation) is to be provided to perimeter foundations of heated structures and exterior unheated foundations.
- Pipe bedding should be OPSS Granular A material with a minimum 150 mm thickness or minimum 300 mm thickness where bedrock is encountered.
- Pipe cover should be OPSS Granular A crushed stone extending from the spring line to at least 300mm above the pipe obvert.
- Pipe bedding and cover materials should be placed in maximum 300mm thick loose lifts and compacted to a minimum of 99 % SPMDD.
- If excavating and backfilling in dry weather conditions, the site-generated brown silty clay material can be cleaned of stones (greater than 300 mm) and placed above the cover material as backfill.
- Protection against differential frost heave should be used where hard surface areas are considered above the trench backfill such as placing in maximum 300 mm thick loose lifts and compacting to a minimum 95 % SPMDD within the 1.8m frost zone.
- Infiltration levels through the excavation face are anticipated to be low and manageable with open sumps and pumps during the construction phase.
 - A Permit to Take Water (PTTW) may be required if more than 400,000 L/day of ground and/or surface water is to be pumped.
 - For typical ground or surface water pumping (50,000 to 400,000 L/day) registration on the Environmental Activity and Sector Registry (EASR) is required.
- Long-term groundwater flow to the infiltration control systems (foundation drains) is expected to be low, at less than 50,000 L/day. The accuracy of this estimate can be improved at the time of construction.
- Based on subsurface profiles, the groundwater infiltration control system will not impact neighbouring structures; however, impacts can be assessed based on specific design details.
- The site has low corrosion potential at a sulphate content less than 0.1 %; hence, the use of normal Portland cement will be appropriate.
- No development is to take place within the limits of the hazard lands. No grade raises are to take place within or at the limits of the hazard lands. The hazard lands cannot be further reduced without providing erosional protection and seeking approval of the RVCA.
- The existing vegetation on the creek/ravine slope faces should not be removed as it contributes to the stability of the slope and reduces erosion.



FUNCTIONAL SITE SERVICING AND STORMWATER MANAGEMENT REPORT REV.03 – 1987 ROBERTSON ROAD (STILLWATER STATION)

Geotechnical Considerations and Grading
February 28, 2024

At the time of construction, several geotechnical considerations and provisions should be made on the subject site:

- Temporary excavation side slopes should be excavated to acceptable slopes or retained by shoring systems, and safe stockpile practices for Type 2 and 3 soils as per the Occupational Health and Safety Act and Regulations for Construction Projects. This should include:
 - Periodic observation of slopes more than 3m in height and vertical bedrock faces by the geotechnical consultant.
 - Design, approval, and monitoring of temporary shoring by a shoring contractor and shoring engineer, including consideration of a full hydrostatic condition and minimum factor of safety of 1.5 for calculated earth pressures.
- Observation of all bearing surfaces prior to the placement of concrete.
- Observation of all subgrades prior to backfilling.
- Sampling and testing of the concrete and fill materials used.
- Field density tests to determine the level of compaction achieved.
- Sampling and testing of the bituminous concrete including mix design reviews.

5.4 FUNCTIONAL GRADING PLAN

Refer to **Drawing GP-1** for conceptual grading plan of the development. The objective of the grading design strategy is to satisfy the stormwater management and drainage requirements; and provide for minimum cover requirements for storm and sanitary sewers. The grading design utilizes grades no less than 0.1 % to provide adequate buffer should small variances arise in the pipe elevations during detailed design. For most of the site, the grading endeavors to provide major overland flow routes to the outlets and Stillwater Creek. West of Plot A, the grading generally follows the design profile of the access road. For the most part, grades at the project boundaries will remain unchanged to avoid impacting adjacent developments.

Due to the presence of a silty clay deposit, Paterson recommended a permissible grade raise restriction of 2.0 m for the Stillwater Station development. The 2.0 m permissible grade raise may be subject to change during the detailed geotechnical investigation. If the permissible grade raise is increased, mitigation measures should be investigated to lessen the risks of unacceptable long-term post construction total and differential settlements of the soils surrounding the buildings.

Paterson was consulted regarding the pond location and the preliminary retaining wall requirements, as described in Section 4.3.2. From a geotechnical perspective, Paterson did not have any initial concerns regarding the proposed wall and pond (refer to **Appendix E.9** for email correspondence); however, they reiterated that no grade raises are permitted at the Limit of Geotechnical Hazard Lands. Grades along the proposed creekside MUP and the west edge of the Dry Pond are not to exceed the existing ground elevations. The proposed grades function within the permissible grade raise restrictions for the site.



FUNCTIONAL SITE SERVICING AND STORMWATER MANAGEMENT REPORT REV.03 – 1987 ROBERTSON ROAD (STILLWATER STATION)

Erosion Control During Construction
February 28, 2024

6.0 EROSION CONTROL DURING CONSTRUCTION

Erosion and sediment controls must be in place during construction. The following recommendations to the contractor will be included in the contract documents.

1. Until the local storm sewer and SWM facility are constructed, groundwater in trenches will be pumped into a filter mechanism prior to release to the environment. After construction of the SWM facility, any construction dewatering will be routed to the nearest storm sewer.
2. Seepage barriers to be constructed in any temporary drainage ditches.
3. Install a silt fence along the site perimeter.
4. Limit extent of exposed soils at any given time.
5. Re-vegetate exposed areas as soon as possible.
6. Minimize the area to be cleared and grubbed.
7. Protect exposed slopes with plastic or synthetic mulches.
8. Provide sediment traps and basins during dewatering.
9. Install sediment traps (such as SiltSack® by Terrafix) between catch basins and frames.
10. Plan construction at proper time to avoid flooding.

The RVCA has been consulted to identify any additional erosion and sediment controls that may be required to protect Stillwater Creek during construction.

The contractor will, at every rainfall, complete inspections and guarantee proper performance. The inspection is to include:

1. Clean and change silt traps at catch basins.
2. Verify that runoff is not flowing under silt barriers.

7.0 ENVIRONMENTAL CONSIDERATIONS

As part of the Environmental Impact Statement (EIS) and study by CIMA+, the watercourse, existing wetland, top of bank, and top of bank 30 m buffer were delineated. The linework for these development constraint boundaries have been included in the latest civil drawings and the current Master Plan. The Master Plan was revised to avoid all developments within these environmentally sensitive areas. From the civil perspective, there are three key locations where impacts within the environmental development constraints will be required:

1. Outlet 1 – works may include but are not limited to access pathway, outlet pipe, headwall 1, outlet armouring/erosion control, emergency overflow path (armouring), and slope stability.
2. Outlet 2 – works may include but are not limited to access pathway, outlet pipe, headwall 2, outlet armouring/erosion control, emergency overflow path (armouring), and slope stability.



FUNCTIONAL SITE SERVICING AND STORMWATER MANAGEMENT REPORT REV.03 – 1987 ROBERTSON ROAD (STILLWATER STATION)

Utilities

February 28, 2024

3. Access Road Creek Crossing – works may include but are not limited to bridge-sized culvert design/improvements, backslope and/or retaining wall design, erosion control, and slope stability.

These three critical areas will require collaboration between the civil, geotechnical, and environmental consultants to minimize environmental impacts, while satisfying the design criteria for the site. Thorough analysis and designs for these areas will be determined at the detailed design phase.

8.0 UTILITIES

There are few existing utilities on the development site. An overhead Hydro corridor parallels the abandoned spur line on the northwest side of the site. Upon construction of the access road, this will need to be re-aligned.

In the absence of loading values for gas and hydro, future coordination with Hydro Ottawa and Enbridge Gas will be required when additional details are available. Given the existing zoning of the site as employment lands, we anticipate that services will be available the site from either Moodie Drive or Robertson Road; however further coordination is required to identify grid capacity and coordinate offsite infrastructure improvements as needed.

Due to the presence of the commercial, industrial, and residential developments surrounding the site, we are confident that telecommunications services must be readily available in the area. At this time, it is unknown if the existing infrastructure will require upgrading to service Stillwater Station. Early engagement of these companies during the detailed design process will provide ample and opportunity to coordinate necessary improvements.

It is our understanding that CN retains an easement through the former rail spur for the operation and maintenance of several utilities; and Zayo Communication has a fibre optic cable that runs along the south side of the former rail spur. The locations of these utilities will be carefully considered during the detailed design of the former rail spur watermain alignment, construction of the access (collector) roadway and the installation of watermain and storm sewers along the access roadway.



FUNCTIONAL SITE SERVICING AND STORMWATER MANAGEMENT REPORT REV.03 – 1987 ROBERTSON ROAD (STILLWATER STATION)

Approvals
February 28, 2024

9.0 APPROVALS

The City of Ottawa will review and approve most development applications as they relate to provision of water supply, wastewater collection and disposal, and stormwater conveyance and treatment. The City of Ottawa will issue a commence work notification for construction of the sanitary, storm sewers, and SWM facility once an Environmental Compliance Approval (ECA) is issued by the Ontario Ministry of Environment, Conservation, and Parks (MECP).

MECP Environmental Compliance Approvals (ECA) will be required for the proposed subdivision works related to stormwater management, the SWM facility, inlet control devices, storm sewers and sanitary sewers. The MECP is expected to review the proposed servicing works by direct submission given multiple party ownership of lands related to the proposed sewer systems. The MECP may be approached at detailed design and under exception basis to allow review of the submission through the City of Ottawa's transfer of review program.

The site is situated outside of both the RVCA's Regulation Limit as well as the RVCA's identified 1:100-year floodplain. As the site is outside of the Regulation Limit, the RVCA is not required to review and approve the subdivision development application (as per RVCA correspondence). As per the pre-application meeting with the City of Ottawa, pre-consultation has been conducted with the RVCA regarding the proposed stormwater management, erosion control, and development setbacks (buffers) for the creek.

Due to the presence of NCC lands downstream of the site and surrounding the site's proposed access road, pre-consultation will also be conducted with the NCC regarding the proposed stormwater management and erosion control. Stricter requirements from either the RVCA or NCC will take precedence over the City's requirements.

A Permit under Ontario Regulation 174/06, Interference with Wetlands and Alterations to Shorelines and Watercourses Regulation is expected to be required from the RVCA for the extension of the existing spur line crossing culvert to accommodate the access road as part of the proposed development.

An MECP Permit to Take Water (PTTW) may be required for the site. The geotechnical consultant shall confirm at the time of application that a PTTW is required. A minimum of 4 to 5 months should be allocated for completion of the PTTW application package and issuance of the permit by the MECP. Registration on the Environmental Activity and Sector Registry (EASR) is required for typical ground or surface water pumping (50,000 to 400,000 L/day). A minimum of two to four weeks should be allotted for completion of the EASR registration and the Water Taking and Discharge Plan to be prepared by a Qualified Person as stipulated under O.Reg. 63/16. If a project qualifies for a PTTW based upon anticipated conditions, an EASR will not be allowed as a temporary dewatering measure while awaiting the MECP review of the PTTW application.

The area required for the Dry Pond SWM facility will be dedicated as a public SWM Block, assumed by the City, since this facility accepts stormwater from the future municipal road right of ways. The SWM Block will include the Dry Pond, maintenance road, and the area up to Outlet 1 (Headwall 1) at minimum.



FUNCTIONAL SITE SERVICING AND STORMWATER MANAGEMENT REPORT REV.03 – 1987 ROBERTSON ROAD (STILLWATER STATION)

Correspondence
February 28, 2024

10.0 CORRESPONDENCE

Several items of correspondence have been referenced in this report. The following provides a summary of each item included in **Appendix E**.

Pre-consultation correspondences, City of Ottawa:

1. The City of Ottawa's comments from the pre-consultation meeting held on Wednesday September 26, 2018, for the Official Plan and Zoning By-law Amendment of 1987 Robertson Road. The email correspondence outlines the engineering requirements for the adequacy of services report including STM/SWM/Erosion/SAN/WM.
2. The City of Ottawa's Applicant's Study and Plan Identification List as per the Wednesday September 26, 2018, pre-consultation meeting. Engineering plans indicated were a Site Servicing Plan; Site Servicing Brief; and Grade Control and Drainage Plan.
3. The City of Ottawa's comments from the second pre-consultation meeting held in December 2020, for the Official Plan and Zoning By-law Amendment of 1987 Robertson Road. The email correspondence outlines the engineering requirements for the adequacy of services report including STM/SWM/Erosion/SAN/WM/Geotech.
4. The City of Ottawa's Applicant's Study and Plan Identification List as per the second pre-consultation meeting held in December 2020. Required engineering plans were a Site Servicing Plan; Site Servicing Study; Grade Control and Drainage Plan; Geotechnical Study; Erosion and Sediment Control Plan; and Stormwater Management Report.

Pre-consultation correspondences, RVCA:

5. Pre-consultation correspondence between the RVCA and CIMA in response to a request for information to support the EIS. Emails confirm the project site is not within the RVCA Regulation Limit; however, if any alteration, diversion, interference, or disturbance of the watercourse is planned, then a permit is required from the RVCA under Ontario Regulation 174/06. 2021-09-02
6. Second pre-consultation correspondence between the RVCA and CIMA providing detailed report for Stillwater Creek catchment and link for City Stream Watch program Stillwater Creek summary report. 2021-09-08
7. Pre-consultation correspondence between Stantec and RVCA requesting details for stormwater management and quality of treatment required for the site, and any further background reports. 2021-09-07
8. Pre-consultation correspondence between Stantec and RVCA confirming site is not within the regulation limit, confirming 30m setback above 100-year high water level, and inquiring if there are any additional requirements for sediment and erosion control for the site during construction. 2021-09-17



FUNCTIONAL SITE SERVICING AND STORMWATER MANAGEMENT REPORT REV.03 – 1987 ROBERTSON ROAD (STILLWATER STATION)

Conclusions
February 28, 2024

11.0 CONCLUSIONS

We trust that this report and the accompanying civil drawing set has provided a functional servicing design that meets the requirements of the City of Ottawa ZBA/OPA approval, pre-consultation design criteria, and satisfies the City of Ottawa ZBA/OPA 3rd Submission comments (engineering comments dated May 29, 2023, and full comment set dated July 31, 2023).

The functional site servicing and stormwater management report has demonstrated the serviceability of the site and the adequacy of the available municipal infrastructure to support the proposed development. The functional design has provided a servicing scenario for the proposed development that is free of conflicts, includes any contributing external areas, and is in accordance with the available background studies and all relevant City of Ottawa and MECP Guidelines, policies, and design parameters.

If you have any questions or concerns regarding this report, please contact the signing engineer, Neal Cody (email Neal.Cody@stantec.com, direct 780-969-3263), or one of the authors of this report, Alyssa Gladish (email Alyssa.Gladish@stantec.com, direct 780-917-8567).



FUNCTIONAL SITE SERVICING AND STORMWATER MANAGEMENT REPORT REV.03 – 1987 ROBERTSON ROAD (STILLWATER STATION)

Conclusions
February 28, 2024

APPENDICES



Appendix A POTABLE WATER SERVICING

A.1 DOMESTIC WATER DEMAND CALCULATIONS



Stillwater Station - Domestic Water Demand Estimates

Site Plan provided by RLA Architecture (2024-02-21)

Project Number: 160401686

Population densities as per MECP Guidelines:		
Average Apartment	1.8	ppu



Demand conversion factors as per MECP Guidelines and Ottawa Design Guidelines - Water Distribution:		
Residential	280	L/cap/day
Commercial	28000	L/gross ha/day

Building ID	Gross Parcel Area (ha)	Number of Apt Units ³	Estimated Population	Daily Rate of Demand	Avg. Day Demand		Max. Day Demand ^{1,2}		Peak Hour Demand ^{1,2}	
					(L/min)	(L/s)	(L/min)	(L/s)	(L/min)	(L/s)
Plot A Commercial	0.811	-	-	28,000	15.8	0.26	23.7	0.39	42.6	0.71
Plot B Commercial	0.754	-	-	28,000	14.7	0.24	22.0	0.37	39.6	0.66
Plot E Commercial	0.432	-	-	28,000	8.4	0.14	12.6	0.21	22.7	0.38
Plot F Commercial	0.714	-	-	28,000	13.9	0.23	20.8	0.35	37.5	0.62
SUBTOTAL COMMERCIAL	2.711					0.88		1.32		2.37
Plot A Residential	-	776	1,397	280	271.6	4.53	679.0	11.32	1493.8	24.90
Plot B Residential	-	568	1,022	280	198.8	3.31	497.0	8.28	1093.4	18.22
Plot C Residential	-	418	752	280	146.3	2.44	365.8	6.10	804.7	13.41
Plot D Residential	-	63	113	280	22.1	0.37	55.1	0.92	121.3	2.02
Plot E Residential	-	148	266	280	51.8	0.86	129.5	2.16	284.9	4.75
Plot F Residential	-	113	203	280	39.6	0.66	98.9	1.65	217.5	3.63
SUBTOTAL RESIDENTIAL						12.17		30.42		66.93
Total Site :	2.711	2,086	3,755		782.8	13.0	1,904.3	31.7	4,157.9	69.3

Notes:

1 Water demand criteria used to estimate peak demand rates for residential areas are as follows:

maximum day demand rate = 2.5 x average day demand rate

peak hour demand rate = 2.2 x maximum day demand rate

2 Water demand criteria used to estimate peak demand rates for commercial/amenity areas are as follows:

maximum day demand rate = 1.5 x average day demand rate

peak hour demand rate = 1.8 x maximum day demand rate

3 Number of apartment units as per **RLA Architecture Master Plan** development statistics table (2024-02-21).

FUNCTIONAL SITE SERVICING AND STORMWATER MANAGEMENT REPORT REV.03 – 1987 ROBERTSON ROAD (STILLWATER STATION)

Appendix A Potable Water Servicing
February 28, 2024

A.2 FUS CALCULATIONS





FUS Fire Flow Calculation Sheet - 2020 FUS Guidelines

Stantec Project #: 160401686

Project Name: 1987 Robertson Road (Stillwater Station)

Date: 27-Feb-2024

Revision: 03

Description: Plots 'A2' and 'A3', 6-Storey Podium. A2 - 32-Storey High-Rise Tower. A3 - 24-Storey High-Rise Tower

Podium Footprint: 2571.0 m². Tower A2 Footprint: 792.1 m². Tower A3 Footprint: 792.1 m².

Notes: Footprint areas as per RLA Architecture Site Plan provided February 21, 2024.

Step	Task	Notes										Value Used	Req'd Fire Flow (L/min)
1	Determine Type of Construction	Type II - Noncombustible Construction / Type IV-A - Mass Timber Construction										0.8	-
2	Determine Effective Floor Area	Sum of Two Largest Floors + 50% of Eight Additional Floors					Vertical Openings Protected?					NO	-
		2571.0	2571.0	2571.0	2571.0	2571.0	2571.0	1584.1	1584.1	1584.1	1584.1	13452.38	-
3	Determine Required Fire Flow	(F = 220 x C x A ^{1/2}). Round to nearest 1000 L/min										-	20000
4	Determine Occupancy Charge	Limited Combustible										-15%	17000
5	Determine Sprinkler Reduction	Conforms to NFPA 13										-30%	-8500
		Standard Water Supply										-10%	
		Fully Supervised										-10%	
		% Coverage of Sprinkler System										100%	
6	Determine Increase for Exposures (Max. 75%)	Direction	Exposure Distance (m)	Exposed Length (m)	Exposed Height (Stories)	Length-Height Factor (m x stories)	Construction of Adjacent Wall	Firewall / Sprinklered ?				-	-
		North	> 30	0	0	0-20	Type V	NO				0%	0
		East	20.1 to 30	49.41	20	> 100	Type I-II - Unprotected Openings	YES				0%	
		South	> 30	0	0	0-20	Type I-II - Unprotected Openings	YES				0%	
		West	10.1 to 20	24.5	6	> 100	Type I-II - Unprotected Openings	YES				0%	
7	Determine Final Required Fire Flow	Total Required Fire Flow in L/min, Rounded to Nearest 1000L/min											9000
		Total Required Fire Flow in L/s											150.0
		Required Duration of Fire Flow (hrs)											2.00
		Required Volume of Fire Flow (m ³)											1080



FUS Fire Flow Calculation Sheet - 2020 FUS Guidelines

Stantec Project #: 160401686

Project Name: 1987 Robertson Road (Stillwater Station)

Date: 27-Feb-2024

Revision: 03

Description: Plots 'C1' and 'C2', 6-Storey Podium. C1 - 24-Storey High-Rise Tower. C2 - 18-Storey High-Rise Tower

Podium Footprint: 2524.0 m². C1 Tower Footprint: 792 m². C2 Tower Footprint: 792 m².

Notes: Footprint areas as per RLA Architecture Site Plan provided February 21, 2024.

Step	Task	Notes										Value Used	Req'd Fire Flow (L/min)
1	Determine Type of Construction	Type II - Noncombustible Construction / Type IV-A - Mass Timber Construction										0.8	-
2	Determine Effective Floor Area	Sum of Two Largest Floors + 50% of Eight Additional Floors					Vertical Openings Protected?					NO	-
		2524.0	2524.0	2524.0	2524.0	2524.0	2524.0	1584.0	1584.0	1584.0	1584.0	13264.15	-
3	Determine Required Fire Flow	(F = 220 x C x A ^{1/2}). Round to nearest 1000 L/min										-	20000
4	Determine Occupancy Charge	Limited Combustible										-15%	17000
5	Determine Sprinkler Reduction	Conforms to NFPA 13										-30%	-8500
		Standard Water Supply										-10%	
		Fully Supervised										-10%	
		% Coverage of Sprinkler System										100%	
6	Determine Increase for Exposures (Max. 75%)	Direction	Exposure Distance (m)	Exposed Length (m)	Exposed Height (Stories)	Length-Height Factor (m x stories)	Construction of Adjacent Wall	Firewall / Sprinklered ?			-	-	
		North	> 30	0	0	0-20	Type V	NO			0%	0	
		East	20.1 to 30	4.93	1	0-20	Type V	NO			0%		
		South	> 30	0	0	0-20	Type I-II - Unprotected Openings	YES			0%		
		West	20.1 to 30	59.01	24	> 100	Type I-II - Unprotected Openings	YES			0%		
Total Required Fire Flow in L/min, Rounded to Nearest 1000L/min											9000		
7	Determine Final Required Fire Flow	Total Required Fire Flow in L/s										150.0	
		Required Duration of Fire Flow (hrs)										2.00	
		Required Volume of Fire Flow (m ³)										1080	

FUNCTIONAL SITE SERVICING AND STORMWATER MANAGEMENT REPORT REV.03 – 1987 ROBERTSON ROAD (STILLWATER STATION)

Appendix A Potable Water Servicing
February 28, 2024

A.3 FUS EXPOSURE MAP



W:\active\160401686\design\drawing\160401686 FUS Exposures Updated MP.dwg
2024/02/27 6:00 AM By: Gladish, Alyssa

ORIGINAL SHEET - ANS1B

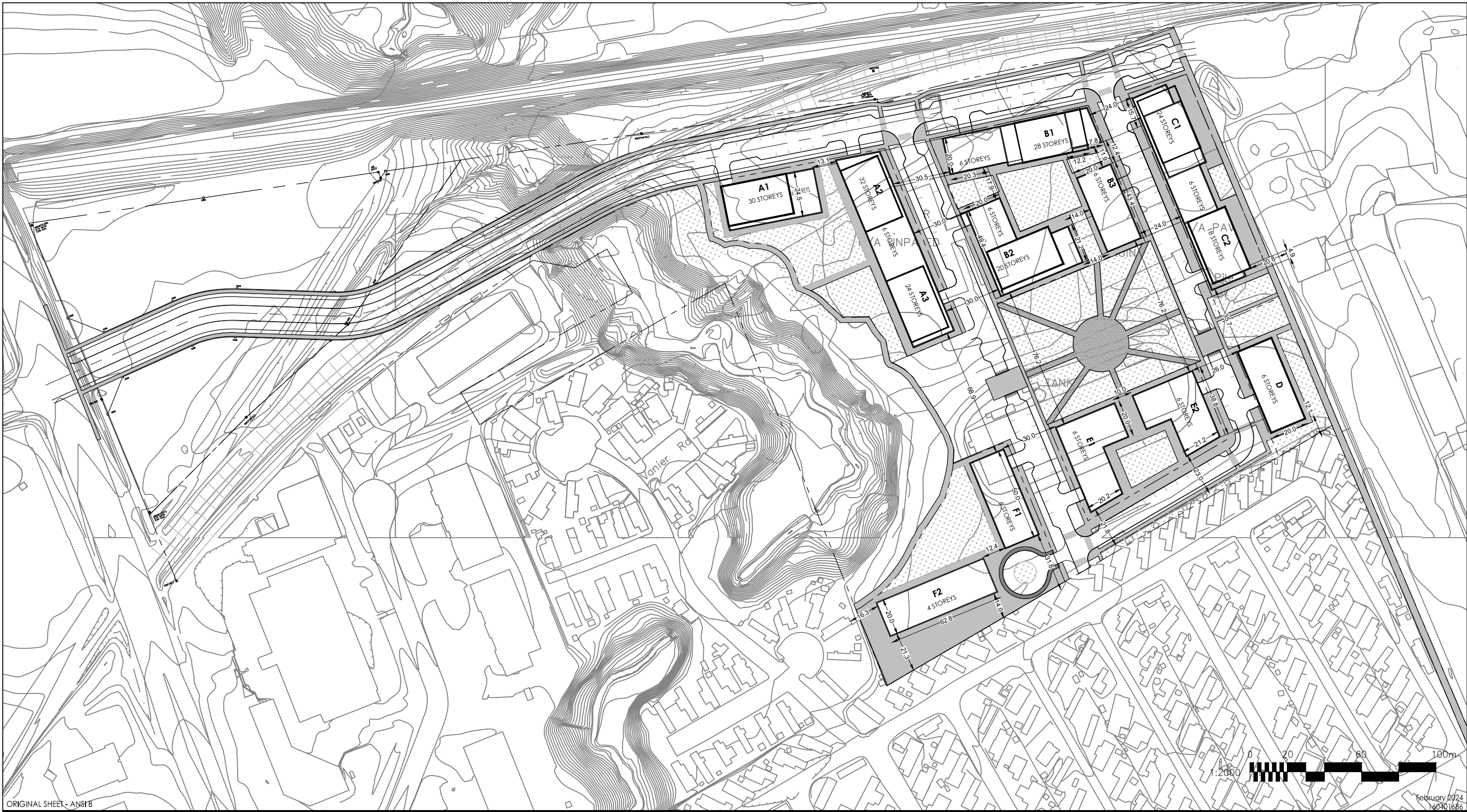

February 2024
160401686



Stantec Consulting Ltd.
300 - 1331 Clyde Avenue
Ottawa ON
Tel. 613.722.4420
www.stantec.com

Legend

Notes

SITE PLAN PROVIDED BY RLA ARCHITECTURE (2024-02-21).

Client/Project
THE PROPERTIES GROUP
MANAGEMENT LTD.
STILLWATER STATION
Figure No.
1.0
Title
FUS EXPOSURES

FUNCTIONAL SITE SERVICING AND STORMWATER MANAGEMENT REPORT REV.03 – 1987 ROBERTSON ROAD (STILLWATER STATION)

Appendix A Potable Water Servicing
February 28, 2024

A.4 HYDRAULIC BOUNDARY CONDITIONS 4-JANUARY-2024



Gladish, Alyssa

From: Brault, Ryan <ryan.brault@ottawa.ca>
Sent: Thursday, January 4, 2024 7:39 AM
To: Gladish, Alyssa
Cc: Armstrong, Justin; Andrew Glass
Subject: RE: Updated Boundary Condition Request - 1987 Robertson Road (Stillwater Station)
Attachments: 1987 Robertson Road December 2023.pdf

Follow Up Flag: Follow up
Flag Status: Flagged

You don't often get email from ryan.brault@ottawa.ca. [Learn why this is important](#)

Good Morning Alyssa,

We have received the following from our Water Resources team regarding the updated boundary conditions request for 1987 Robertson Road (Stillwater Station):

The following are boundary conditions, HGL, for hydraulic analysis at 1987 Robertson Road (zone 2W2C) assumed to be a looped private watermain, connecting to the 305 mm watermain on Moodie Drive (see attached PDF for location).

Both Connections:

Minimum HGL: 126.9 m

Maximum HGL: 132.2 m

Connection 1:

Max Day+ Fire Flow (150 L/s): 127.7 m

Connection 2:

Max Day+ Fire Flow (150 L/s): 128.8 m

These are for current conditions and are based on computer model simulation.

Disclaimer: The boundary condition information is based on current operation of the city water distribution system. The computer model simulation is based on the best information available at the time. The operation of the water distribution system can change on a regular basis, resulting in a variation in boundary conditions. The physical properties of watermains deteriorate over time, as such must be assumed in the absence of actual field test data. The variation in physical watermain properties can therefore alter the results of the computer model simulation.

Per the email correspondence below, it is understood that the City has not provided full approval/agreement regarding the second connection at the proposed location (abandoned rail spur). The City reserves the right to review and approve the proposed location when further details are provided, however, will preemptively begin discussions with the Asset Management Team. I will update you as needed throughout these discussions.

Please let me know if you have any questions or concerns.

Regards,

Ryan Brault, M.Eng., P.Eng
Project Manager - Infrastructure Approvals

City of Ottawa
Development Review - West Branch
Planning, Real Estate and Economic Development Department
110 Laurier Ave West, 4th Floor East;
Ottawa ON K1P 1J1
Tel: 613-580-2424 x 32540

From: Gladish, Alyssa <Alyssa.Gladish@stantec.com>
Sent: December 19, 2023 3:05 PM
To: Brault, Ryan <ryan.brault@ottawa.ca>
Cc: Armstrong, Justin <justin.armstrong@ottawa.ca>; Andrew Glass <aglass@prpgrp.com>
Subject: RE: Updated Boundary Condition Request - 1987 Robertson Road (Stillwater Station)

CAUTION: This email originated from an External Sender. Please do not click links or open attachments unless you recognize the source.

ATTENTION : Ce courriel provient d'un expéditeur externe. Ne cliquez sur aucun lien et n'ouvrez pas de pièce jointe, excepté si vous connaissez l'expéditeur.

Hello Ryan,

Thanks for passing that on to the Water Services for processing.

For the connection at (1) Moodie Drive and Timm Drive, we have the discussions/boundary conditions received during the previous request. But no other specific correspondence.

I do not have any other discussions/information related to the proposed connection at
(2) Moodie Drive and the Abandoned Rail Spur.

Thank you,
Alyssa

Alyssa Gladish E.I.T.
Project Manager, Community Development

Direct: 780 917-8567
Mobile: 587 721-1241
Alyssa.Gladish@stantec.com

Stantec
300-1331 Clyde Avenue
Ottawa ON K2C 3G4



The content of this email is the confidential property of Stantec and should not be copied, modified, retransmitted, or used for any purpose except with Stantec's written authorization. If you are not the intended recipient, please delete all copies and notify us immediately.

From: Brault, Ryan <ryan.brault@ottawa.ca>
Sent: Tuesday, December 19, 2023 2:38 PM

To: Gladish, Alyssa <Alyssa.Gladish@stantec.com>
Cc: Armstrong, Justin <justin.armstrong@ottawa.ca>
Subject: RE: Updated Boundary Condition Request - 1987 Robertson Road (Stillwater Station)

You don't often get email from ryan.brault@ottawa.ca. [Learn why this is important](#)

Hi Alyssa,

Thank you for the additional information – the background is helpful. I have forwarded the request for boundary conditions to our Water Services department for processing.

While that is being processed, are you able to share any additional discussions/information related specifically to the proposed connection(s)? Has any agreement been provided by the City regarding the location of the second connection? If not, I can start the discussions with our Asset Management team as well. I just don't want to duplicate/delay anything that has already been completed.

Regards,

Ryan Brault, M.Eng., P.Eng
Project Manager - Infrastructure Approvals

City of Ottawa
Development Review - West Branch
Planning, Real Estate and Economic Development Department
110 Laurier Ave West, 4th Floor East;
Ottawa ON K1P 1J1
Tel: 613-580-2424 x 32540

From: Gladish, Alyssa <Alyssa.Gladish@stantec.com>
Sent: December 13, 2023 1:27 PM
To: Brault, Ryan <ryan.brault@ottawa.ca>
Cc: Armstrong, Justin <justin.armstrong@ottawa.ca>
Subject: RE: Updated Boundary Condition Request - 1987 Robertson Road (Stillwater Station)

CAUTION: This email originated from an External Sender. Please do not click links or open attachments unless you recognize the source.

ATTENTION : Ce courriel provient d'un expéditeur externe. Ne cliquez sur aucun lien et n'ouvrez pas de pièce jointe, excepté si vous connaissez l'expéditeur.

Hello Ryan,

Yes, several other layouts were evaluated. As per the email chain with Julie included below.

I will attach all the options again for your reference. The PDF 1987 Robertson Road February 2023.pdf, attached, shows the previous connection locations that were explored.

- Location 1. 305 mm diameter watermain on Moodie Drive (at the Timm Road intersection),
- Location 2. 203 mm diameter watermain on Robertson Road (at the easement),
- Location 3. 406 mm diameter watermain on Stafford Road (south of the railway tracks), and
- Location 4. 305 mm diameter watermain on Menten Place (at the stub – if available, or at the end of the municipal line/existing hydrant)

Option A - (Location 1 & 2)

Option E - (Location 1 & 4)

Option C - Option C (both connections at Location 1 separated by an isolation valve):

Option B - (Location 1 & 4)

Option D - (Location 1 & 3)

Option C was the least preferable option from the City's perspective.

Option B was the least preferable option from a construction cost perspective due to the required creek crossing.

Option A and Option E were both preferable options. However, these options are no longer feasible, as the Owner has been unable to obtain the necessary easements.

The new proposed location will be Option E. This new layout was selected because the owner has the legal rights and ownership of the abandoned rail spur land (you can see it is within the property boundary in the first attached pdf WTR-1_Moodie_Dr_02) and an appropriate easement can be dedicated over this new alignment. There are no concerns or future implications for the O&M of the watermain through these lands. After installation of the WM, the railbed is intended to be restored as a gravel access road over the WM.

I realize there is a lot of history to this project, so please let me know if you have any other questions or concerns, and feel free to give me a call.

Best regards,

Alyssa

Alyssa Gladish E.I.T.

Project Manager, Community Development

Direct: 780 917-8567

Mobile: 587 721-1241

Alyssa.Gladish@stantec.com

Stantec

300-1331 Clyde Avenue

Ottawa ON K2C 3G4



The content of this email is the confidential property of Stantec and should not be copied, modified, retransmitted, or used for any purpose except with Stantec's written authorization. If you are not the intended recipient, please delete all copies and notify us immediately.

From: Brault, Ryan <ryan.brault@ottawa.ca>

Sent: Wednesday, December 13, 2023 10:37 AM

To: Gladish, Alyssa <Alyssa.Gladish@stantec.com>

Cc: Armstrong, Justin <justin.armstrong@ottawa.ca>

Subject: RE: Updated Boundary Condition Request - 1987 Robertson Road (Stillwater Station)

You don't often get email from ryan.brault@ottawa.ca. [Learn why this is important](#)

Good Morning Alyssa,

Thank you for the information provided below. Before I send the request to our water services department, are you able to clarify the following:

- Why was this alternative layout selected? Were there any other alternatives evaluated?

- Does the applicant have legal rights/ownership of the abandoned rail spur land? If not, are further agreements/easements required for the installation of the watermain over the new alignment?
 - o Will there be any future implications in the operation and maintenance of the watermain over these lands?

Please let me know if you have any questions or concerns.

Regards,

Ryan Brault, M.Eng., P.Eng
Project Manager - Infrastructure Approvals

City of Ottawa
Development Review - West Branch
Planning, Real Estate and Economic Development Department
110 Laurier Ave West, 4th Floor East;
Ottawa ON K1P 1J1
Tel: 613-580-2424 x 32540

From: Gladish, Alyssa <Alyssa.Gladish@stantec.com>
Sent: December 12, 2023 3:39 PM
To: Armstrong, Justin <justin.armstrong@ottawa.ca>
Cc: Brault, Ryan <ryan.brault@ottawa.ca>
Subject: RE: Updated Boundary Condition Request - 1987 Robertson Road (Stillwater Station)

CAUTION: This email originated from an External Sender. Please do not click links or open attachments unless you recognize the source.

ATTENTION : Ce courriel provient d'un expéditeur externe. Ne cliquez sur aucun lien et n'ouvrez pas de pièce jointe, excepté si vous connaissez l'expéditeur.

Good day Justin,

We are requesting updated hydraulic boundary conditions for the Stillwater Station Development.

The Stillwater Station Owner has been unable to obtain the required permissions/easements for the Menton Place connection as described in the 3rd submission; hence, an alternate connection is proposed as shown in the attached PDF (WTR-1_Moodie_Dr_02), with the looped 203 mm diameter watermain connecting at two locations:

1. To the 305 mm diameter watermain on Moodie Drive - Timm Road and Moodie Drive intersection (as originally proposed)
2. To the 305 mm diameter watermain on Moodie Drive - Abandoned rail spur and Moodie Drive intersection (new second connection) as shown in the detail below:

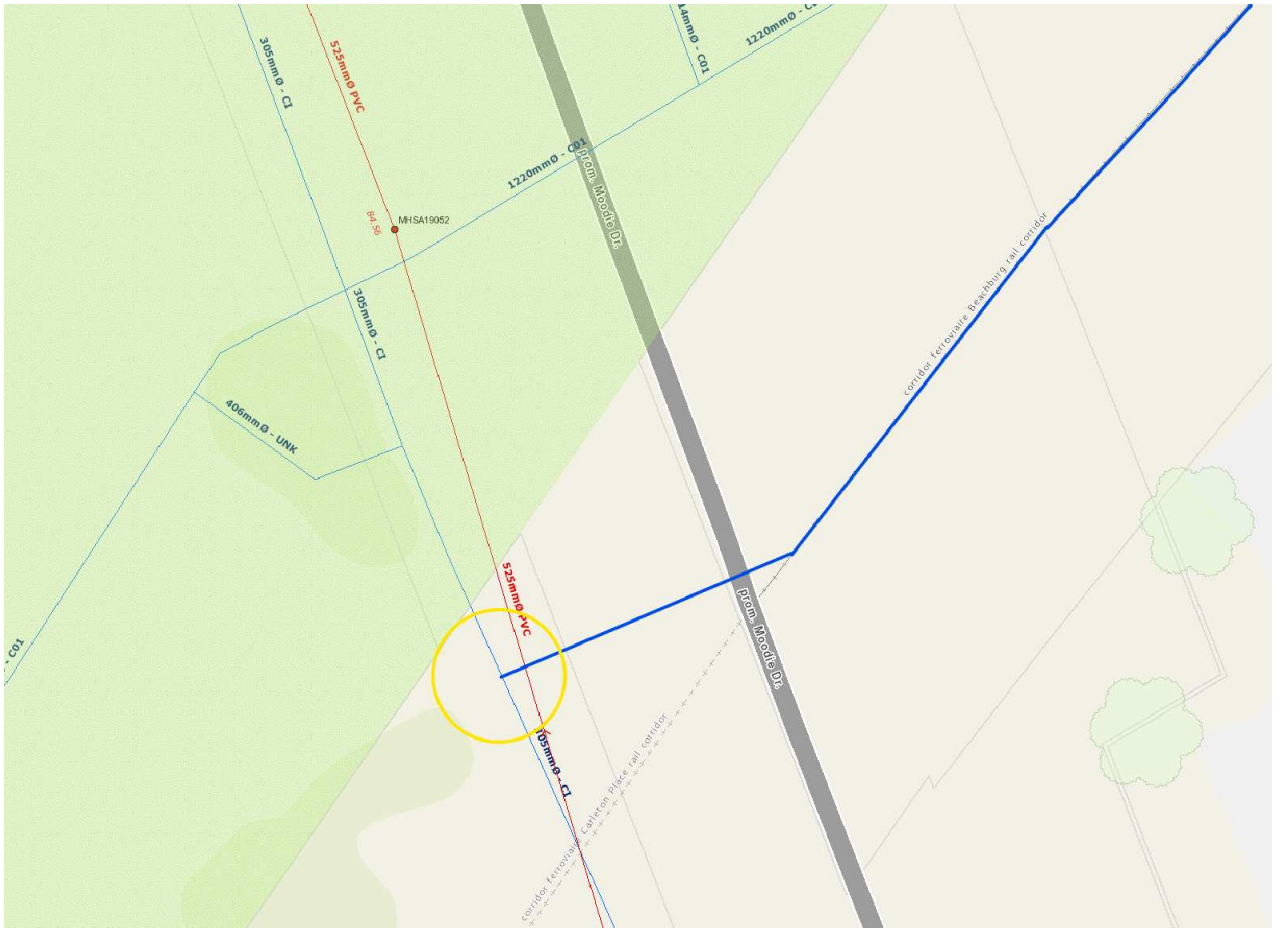

The demands are as follows:

- Average Day Demand: 13.3 L/s (799.8 L/min)
- Maximum Day Demand: 32.4 L/s (1,944.9 L/min)
- Peak Hour Demand: 70.8 L/s (4,246.0 L/min)
- Fire Flow Demand: 150.0 L/s (9,000.0 L/min) (2020 FUS)

Attached are the:

1. Watermain Drawing with two connection locations identified.
2. Potable water demand calculation sheet,
3. 2020 FUS fire flow demand calculation sheet for the worst-case Buildings A2 and A3; C1 and C2, and the
4. FUS exposure sketch in support of the fire flow demand calculations

Best Regards,
Alyssa

Alyssa Gladish E.I.T.
Project Manager, Community Development

Direct: 780 917-8567
Mobile: 587 721-1241
Alyssa.Gladish@stantec.com

Stantec
300-1331 Clyde Avenue
Ottawa ON K2C 3G4



The content of this email is the confidential property of Stantec and should not be copied, modified, retransmitted, or used for any purpose except with Stantec's written authorization. If you are not the intended recipient, please delete all copies and notify us immediately.

From: Candow, Julie <julie.candow@ottawa.ca>
Sent: Monday, February 27, 2023 3:13 PM
To: Wu, Michael <Michael.Wu@stantec.com>
Cc: Gladish, Alyssa <Alyssa.Gladish@stantec.com>
Subject: RE: Updated Boundary Condition Request - 1987 Robertson Road (Stillwater Station)

Hi Michael,

Please see attached and below boundary condition results. Please note, this site considers two connections looped to provide the available fire flow noted below. Although not specifically apart of our guidelines, given the distance of watermain required for each connection location, the City recommends you consider what the available fire flow would be within the site with only one connection. This is assuming that there was a watermain break within your private site, would there be sufficient fire flow for the units?

The following are boundary conditions, HGL, for hydraulic analysis at 1987 Robertson Road (zone 2W2C) assumed to be looped and connected via the options provided by the Consultant - connection locations shown on the attached PDF.

Option A (Location 1 & 2):

Minimum HGL: 126.9 m (Moodie) and 126.5 m (Robertson)
Maximum HGL: 132.2 m (Moodie) and 131.9 m (Robertson)
Max Day + FF (150 L/s): 128.5 m (Moodie), 126.1 m (Robertson)

Option B (Location 1 & 4):

Minimum HGL: 126.9 m (Moodie) and 126.7 m (Menten)
Maximum HGL: 132.2 m (Moodie) and 132.0 m (Menten)
Max Day + FF (150 L/s): 128.4 m (Moodie), 127.2 m (Menten)

Option C (both connections at Location 1 separated by an isolation valve):

Minimum HGL: 126.9 m (Moodie)
Maximum HGL: 132.1 m (Moodie)
Max Day + FF (150 L/s): 127.7m (Moodie)

Option D (Location 1 & 3):

Minimum HGL: 126.8 m (Moodie) and 126.9 m (Bexley Pl.)
Maximum HGL: 132.5 m (Moodie) and 132.2 m (Bexley Pl.)
Max Day + FF (150 L/s): 128.4 m (Moodie), 129.2 m (Bexley Pl.)

Option E (Location 1 & 4):

Minimum HGL: 126.9 m (Moodie) and 126.7 m (Menten)

Maximum HGL: 132.2 m (Moodie) and 132.0 m (Menten)

Max Day + FF (150 L/s): 128.4 m (Moodie), 127.2 m (Menten)

Julie Candow, P.Eng

Project Manager

Planning, Real Estate and Economic Development Department - West Branch

City of Ottawa

110 Laurier Avenue West Ottawa, ON

613.580.2424 ext. 13850

Please take note that due to the current COVID situation, I am working remotely and phone communication may not be reliable at this time. The best way to reach me is by email.

From: Wu, Michael <Michael.Wu@stantec.com>

Sent: February 22, 2023 11:00 AM

To: Candow, Julie <julie.candow@ottawa.ca>

Cc: Gladish, Alyssa <Alyssa.Gladish@stantec.com>; Bourke, Simone <simone.bourke@ottawa.ca>

Subject: RE: Updated Boundary Condition Request - 1987 Robertson Road (Stillwater Station)

CAUTION: This email originated from an External Sender. Please do not click links or open attachments unless you recognize the source.

ATTENTION : Ce courriel provient d'un expéditeur externe. Ne cliquez sur aucun lien et n'ouvrez pas de pièce jointe, excepté si vous connaissez l'expéditeur.

Good morning, Julie:

In response to Simone's question pertaining to the two additional locations for the boundary condition request, it boils down to Engineering Comment #17, where the City has requested a 6.0 m width easement for the east watermain connection from the proposed development to Robertson Road. The existing easement is 3.66 m wide, and it is my understanding that to date the Owner has been unable to obtain the required additional easement width from the landowners to the east or west. Consequently, the owner has asked us to explore alternate looping options. The additional boundary conditions requested correspond to the alternate looping options.

We are set to review these alternate options with the Owner this week, to discuss which options they wish to pursue. We have attached the preliminary options for your review. Our recommendations in order from most to least favourable are as follows:

Option A (status quo)

Option E

Option C

Option B

Option D

We would appreciate your input regarding these Options, especially if there are any options that the city will veto, and that we should not explore further.

We acknowledge that the boundary condition requested at Location 4 (Menten Place) in the attached map would need to be at the public watermain.

Please let me know if you have any further questions or comments.

Thanks,

Michael Wu, EIT

Civil Engineering Intern, Community Development

Work: (613) 738-6033

Mobile: (613) 858-0548

michael.wu@stantec.com

Stantec

300 - 1331 Clyde Avenue

Ottawa ON K2C 3G4



The content of this email is the confidential property of Stantec and should not be copied, modified, retransmitted, or used for any purpose except with Stantec's written authorization. If you are not the intended recipient, please delete all copies and notify us immediately.

From: Candow, Julie <julie.candow@ottawa.ca>

Sent: Tuesday, 21 February, 2023 08:28

To: Wu, Michael <Michael.Wu@stantec.com>

Subject: FW: Updated Boundary Condition Request - 1987 Robertson Road (Stillwater Station)

Hi Michael,

Can you please provide clarification to Simone's question below.

Thanks,

Julie Candow, P.Eng

Project Manager

Planning, Real Estate and Economic Development Department - West Branch

City of Ottawa

110 Laurier Avenue West Ottawa, ON

613.580.2424 ext. 13850

Please take note that due to the current COVID situation, I am working remotely and phone communication may not be reliable at this time. The best way to reach me is by email.

From: Bourke, Simone <simone.bourke@ottawa.ca>

Sent: February 21, 2023 7:51 AM

To: Candow, Julie <julie.candow@ottawa.ca>

Subject: RE: Updated Boundary Condition Request - 1987 Robertson Road (Stillwater Station)

Hi Julie,

I'm requesting clarification regarding the two additional boundary condition locations: Are locations 3 and 4 new proposed watermain connections, or does the consultant simply want HGL results at these locations while the connection points remain at Moodie Drive and Robertson Road?

For connection 4, we would provide BC results at the public watermain.

Thank you,

Simone Bourke, M.Sc., P.Eng. (she/her)
Water Resources Engineer
Infrastructure and Water Services
City of Ottawa
100 Constellation Drive, Ottawa, ON K2G 6J8
P: 613-580-2424 ext. 23570

From: Candow, Julie <julie.candow@ottawa.ca>
Sent: 2023/02/16 10:51 AM
To: Steele, Matt <Matt.Steele@ottawa.ca>; Bourke, Simone <simone.bourke@ottawa.ca>
Subject: FW: Updated Boundary Condition Request - 1987 Robertson Road (Stillwater Station)

Hi Matt and Simone,

Please see attached and below revised boundary condition request for Stillwater Station at 1987 Robertson Road.

Julie Candow, P.Eng
Project Manager
Planning, Real Estate and Economic Development Department - West Branch
City of Ottawa
110 Laurier Avenue West Ottawa, ON
613.580.2424 ext. 13850

Please take note that due to the current COVID situation, I am working remotely and phone communication may not be reliable at this time. The best way to reach me is by email.

From: Wu, Michael <Michael.Wu@stantec.com>
Sent: February 16, 2023 8:42 AM
To: Candow, Julie <julie.candow@ottawa.ca>
Cc: Gladish, Alyssa <Alyssa.Gladish@stantec.com>; Kilborn, Kris <kris.kilborn@stantec.com>
Subject: RE: Updated Boundary Condition Request - 1987 Robertson Road (Stillwater Station)

CAUTION: This email originated from an External Sender. Please do not click links or open attachments unless you recognize the source.

ATTENTION : Ce courriel provient d'un expéditeur externe. Ne cliquez sur aucun lien et n'ouvrez pas de pièce jointe, excepté si vous connaissez l'expéditeur.

Thank you for the comments, please see below for our responses (in **blue**). We have also adjusted the calculations for the boundary condition request accordingly.

As part of the adjustment, we are requesting boundary conditions at a total of four locations (two additional locations) as shown on the attached map:

1. 203 mm diameter watermain on Moodie Drive (at the Timm Road intersection),

2. 203 mm diameter watermain on Robertson Road (at the easement),
3. 406 mm diameter watermain on Stafford Road (south of the railway tracks), and
4. 305 mm diameter watermain on Menten Place (at the stub – if available, or at the end of the municipal line/existing hydrant)

The revised demands are as follows:

- Average Day Demand: 13.0 L/s (777.8 L/min)
- Maximum Day Demand: 31.5 L/s (1,889.8 L/min)
- Peak Hour Demand: 68.7 L/s (4,124.7 L/min)
- Fire Flow Demand: 150.0 L/s (9,000.0 L/min) (2020 FUS)

Attached are the:

1. Boundary condition map,
2. Stillwater Station Updated Master Plan,
3. Potable water demand calculation sheet,
4. 2020 FUS fire flow demand calculation sheet, and the
5. FUS exposure figure in support of the fire flow demand calculations

We appreciate your time looking into this for us, and please do not hesitate to contact me if you have any questions or require additional information.

Thanks,

Michael Wu, EIT

Civil Engineering Intern, Community Development

Work: (613) 738-6033

Mobile: (613) 858-0548

michael.wu@stantec.com

Stantec

300 - 1331 Clyde Avenue
Ottawa ON K2C 3G4



The content of this email is the confidential property of Stantec and should not be copied, modified, retransmitted, or used for any purpose except with Stantec's written authorization. If you are not the intended recipient, please delete all copies and notify us immediately.

From: Candow, Julie <julie.candow@ottawa.ca>

Sent: Monday, 13 February, 2023 10:04

To: Wu, Michael <Michael.Wu@stantec.com>

Cc: Gladish, Alyssa <Alyssa.Gladish@stantec.com>; Kilborn, Kris <kris.kilborn@stantec.com>

Subject: RE: Updated Boundary Condition Request - 1987 Robertson Road (Stillwater Station)

Hi Michael,

I have reviewed the boundary condition request and calculations and have the following comments:

1. As per the 2020 FUS Guidelines, the effective floor area should be calculated using the two largest adjoining floor areas plus 50% of all floors immediately above them up to a maximum of **eight**. In your FUS calculations it appears you have used six floors instead of eight. In addition, please provide a breakdown of the floor area for each Plot and Phase (A1, A2, A3, etc.) which outlines the podium floor areas and the tower floor areas. This will help us verify your effective floor area calculations.

Total Effective Area (A)

To determine a required fire flow for an individual building, the Total Effective Area that would be during the design fire must be determined. The Total Effective Area is the largest Floor Area (i metres) plus the following percentages of the total area of the other floors:

- 1) For a building classified with a Construction Coefficient from 1.0 to 1.5:
 - a) 100% of all Floor Areas are considered in determining the Total Effective Area to be used in the formula.
- 2) For a building classified with a Construction Coefficient below 1.0:
 - a) if any vertical openings in the building (ex. interconnected floor spaces, atria, elevators, escalators, etc.) are unprotected, consider the two largest adjoining floor areas plus **5 floors immediately above them up to a maximum of eight; or**
 - b) if all vertical openings and exterior vertical communications are properly protected in accordance with the National Building Code, consider only the single largest Floor Area plus 25% of the two immediately adjoining floors.

We agree. We misread the FUS Total Effective Area (A) - Section 2) a). We have now included the two largest floor areas plus 50% the areas of all floors immediately above them to a maximum of eight [additional floors at 50%]. This applies to Block A1, Blocks A2 and A3, Block B1, Block B2, Blocks C1 and C2. All other buildings have six or less total stories.

2. From my review, it appears that all buildings are to be designed with fully protected automatic sprinkler systems. As such, you do not have to add an exposure charge to any building (see below). This is based off my review of the submitted material however if this is not the case please keep the exposure charges in place.

Items of Note for Exposure Charge

- i. Automatic Sprinkler Protection in Exposed Buildings
If the exposed building is fully protected with an automatic sprinkler system (Recognition of Automatic Sprinkler Protection), the Exposure Adjustment Charge determined from Table 6 may be reduced by up to 50% of the value determined.
- ii. Automatic Sprinkler Protection in both Subject and Exposed Buildings
 - **If both the subject building and the exposed building are fully protected with sprinkler systems (see note below regarding recognition of sprinkler protection) the Exposure Adjustment Charge should be applied.**

We agree that the exposure adjustment charge should not be applied for the buildings with automatic sprinklers. Our spreadsheet includes a field for the sprinklers in the increase for exposures section, which, when selected as "YES" eliminates the exposure charge. In some cases, existing (exposed) buildings located on the adjacent properties are within 30m of the proposed buildings (such as in the trailer park to the south, and an existing garage to the east). Exposure charges have been retained for these cases.

3. The attached FUS CLASSIFICATION DECLARATION FOR MULTI-STOREY BUILDINGS will have to be signed by the civil and architectural consultant at the time of Site Plan Approval. I am providing the form to you now as a heads up – I do not require it to be signed prior to your design submission. **We agree to include the FUS**

CLASSIFICATION DECLARATION FOR MULTI-STOREY BUILDINGS as an appendix in the design submission and indicate that it is to be completed at the time of Site Plan Approval.

Let me know if you have any questions.

Julie Candow, P.Eng

Project Manager

Planning, Real Estate and Economic Development Department - West Branch

City of Ottawa

110 Laurier Avenue West Ottawa, ON

613.580.2424 ext. 13850

Please take note that due to the current COVID situation, I am working remotely and phone communication may not be reliable at this time. The best way to reach me is by email.

From: Wu, Michael <Michael.Wu@stantec.com>

Sent: February 09, 2023 9:03 AM

To: Candow, Julie <julie.candow@ottawa.ca>

Cc: Gladish, Alyssa <Alyssa.Gladish@stantec.com>; Kilborn, Kris <kris.kilborn@stantec.com>

Subject: Updated Boundary Condition Request - 1987 Robertson Road (Stillwater Station)

CAUTION: This email originated from an External Sender. Please do not click links or open attachments unless you recognize the source.

ATTENTION : Ce courriel provient d'un expéditeur externe. Ne cliquez sur aucun lien et n'ouvrez pas de pièce jointe, excepté si vous connaissez l'expéditeur.

We would like to request updated hydraulic boundary conditions for the proposed mixed-use development at 1987 Robertson Road (Stillwater Station) in Bells Corners (File Numbers: D01-01-21-0021 and D02-02-21-0120).

The updated master plan for the development consists of 11 blocks of apartment buildings with a total of 2066 apartment units and commercial space.

While the proposed watermain connections remain the same from our previous boundary conditions request, connecting to the existing 203 mm diameter watermains on Moodie Drive (at the Timm Road intersection) and Robertson Road, the water and fire flow demands have been revised based on the new master plan and the 2020 FUS. The revised demands are as follows:

- Average Day Demand: 13.0 L/s (777.8 L/min)
- Maximum Day Demand: 31.5 L/s (1889.8 L/min)
- Peak Hour Demand: 68.7 L/s (4124.7 L/min)
- Fire Flow Demand: 216.7 L/s (13000.0 L/min) (2020 FUS)

Attached are the water and fire flow demand calculation sheets, the updated master plan, the FUS exposure figure in support of the fire flow demand calculations, and the boundary condition map.

We appreciate your time looking into this for us, and please do not hesitate to contact me if you have any questions or require additional information.

Thanks,

Michael Wu, EIT

Civil Engineering Intern, Community Development

Work: (613) 738-6033

Mobile: (613) 858-0548

michael.wu@stantec.com

Stantec

300 - 1331 Clyde Avenue

Ottawa ON K2C 3G4



The content of this email is the confidential property of Stantec and should not be copied, modified, retransmitted, or used for any purpose except with Stantec's written authorization. If you are not the intended recipient, please delete all copies and notify us immediately.

This e-mail originates from the City of Ottawa e-mail system. Any distribution, use or copying of this e-mail or the information it contains by other than the intended recipient(s) is unauthorized. Thank you.

Le présent courriel a été expédié par le système de courriels de la Ville d'Ottawa. Toute distribution, utilisation ou reproduction du courriel ou des renseignements qui s'y trouvent par une personne autre que son destinataire prévu est interdite. Je vous remercie de votre collaboration.

Caution: This email originated from outside of Stantec. Please take extra precaution.

Attention: Ce courriel provient de l'extérieur de Stantec. Veuillez prendre des précautions supplémentaires.

Atención: Este correo electrónico proviene de fuera de Stantec. Por favor, tome precauciones adicionales.

This e-mail originates from the City of Ottawa e-mail system. Any distribution, use or copying of this e-mail or the information it contains by other than the intended recipient(s) is unauthorized. Thank you.

Le présent courriel a été expédié par le système de courriels de la Ville d'Ottawa. Toute distribution, utilisation ou reproduction du courriel ou des renseignements qui s'y trouvent par une personne autre que son destinataire prévu est interdite. Je vous remercie de votre collaboration.

Caution: This email originated from outside of Stantec. Please take extra precaution.

Attention: Ce courriel provient de l'extérieur de Stantec. Veuillez prendre des précautions supplémentaires.

Atención: Este correo electrónico proviene de fuera de Stantec. Por favor, tome precauciones adicionales.

FUNCTIONAL SITE SERVICING AND STORMWATER MANAGEMENT REPORT REV.03 – 1987 ROBERTSON ROAD (STILLWATER STATION)

Appendix A Potable Water Servicing
February 28, 2024

A.5 HYDRAULIC ANALYSIS





Project:	1987 Robertson Road	No.	160401686
DRAFT PLAN HYDRAULIC ANALYSIS			
Revision:	02	Prepared By:	AG
Revision Date:	27-Feb-2024	Checked By:	NC

BOUNDARY CONDITIONS (BC)

Connection at Moodie Drive and Timm Drive

Site Plan Revision Date	21-Feb-2024
Date Hydraulic Boundary Conditions Received	4-Jan-2024
Min. HGL (m)	126.9
Max. HGL (m)	132.2
Max. Day + Fire Flow (150 L/s)	128.8

Ground Floor Elevation (GFE) (Level 01) (m)	88.52
---	-------

GROUND FLOOR (GF) PRESSURE RANGE

	GF HGL (m)	GF Pressure (kPa)	GF Pressure (psi)	Outcome
	= BC HGL (m) - FFE (m)	= GF HGL (m) x 9.804 (kPa/m)	= GF Pressure (kPa) x 0.145 (psi/kPa)	If min <50 psi: booster pump If max >100 psi: pressure reducer
Minimum Normal	38.38	376.3	54.6	No Booster Pump Required
Maximum Normal	43.68	428.2	62.1	No Pressure Reducer Required

Number of Floors Above Ground	24
Approximate Height of One Storey (m)	3
Pressure Drop Per Floor (kPa)	29.4
Pressure Drop Per Floor (psi)	4.3

RESIDUAL PRESSURE RANGE IN MULTI-LEVEL BUILDINGS

	Residual Pressure (kPa)	Residual Pressure (psi)	Outcome
Top Floor Min	0.0	0.0	Booster Pump Required
Top Floor Max	0.0	0.0	
Maximum Number of Floors Above Ground at Minimum Pressure	3		

RESIDUAL PRESSURE UNDER FIRE FLOW CONDITIONS

	Residual HGL (m)	Residual Pressure (kPa)	Residual Pressure (psi)
Ground Floor	40.28	394.9	57.3
Top Floor	0	0.0	0.0

PRESSURE CHECK

	Pressure (kPa)	Pressure (psi)
UNDER NORMAL OPERATING CONDITIONS		
Pressure Below Minimum	<276	<40
Pressure Below Normal	276-345	40-50
Pressure Within Normal Range	345-552	50-80
Pressure Above Normal Range	552-690	80-100
Pressure Above Maximum	>690	>100
UNDER FIRE FLOW CONDITIONS		
Pressure Below Minimum	<140	<20
Acceptable Pressure	≥140	≥20

FUNCTIONAL SITE SERVICING AND STORMWATER MANAGEMENT REPORT REV.03 – 1987 ROBERTSON ROAD (STILLWATER STATION)

Appendix B Sanitary Sewer Calculations
February 28, 2024

Appendix B **SANITARY SEWER CALCULATIONS**

B.1 **CONCEPTUAL SANITARY SEWER DESIGN SHEET**





SUBDIVISION:
**Stillwater Station
 (1987 Robertson Road)**
 DATE: 27-Feb-2024
 REVISION: 4
 DESIGNED BY: MJS
 CHECKED BY: AG

**SANITARY SEWER
 DESIGN SHEET
 (City of Ottawa)**

FILE NUMBER: 160401686

DESIGN PARAMETERS			
MAX PEAK FACTOR (RES.):	4.0	AVG. DAILY FLOW / PERSON	280 l/p/day
MIN PEAK FACTOR (RES.):	2.0	COMMERCIAL	28,000 l/ha/day
PEAKING FACTOR (INDUSTRIAL):	2.4	INDUSTRIAL (HEAVY)	55,000 l/ha/day
PEAKING FACTOR (ICI >20%):	1.5	INDUSTRIAL (LIGHT)	35,000 l/ha/day
PERSONS / SINGLE	3.4	INSTITUTIONAL	28,000 l/ha/day
PERSONS / TOWNHOME	1.4	INFILTRATION	0.33 l/s/ha
PERSONS / APARTMENT	1.8	MOBILE HOMES ²	1000 l/space/day
		MINIMUM VELOCITY	0.60 m/s
		MAXIMUM VELOCITY	3.00 m/s
		MANNINGS n	0.013
		BEDDING CLASS	B
		MINIMUM COVER	2.50 m
		HARMON CORRECTION FACTOR	0.8

LOCATION			RESIDENTIAL AREA AND POPULATION								COMMERCIAL		MOBILE HOME PARK			INDUSTRIAL (I)		INSTITUTIONAL		GREEN / UNUSED		C+H	INFILTRATION			TOTAL	PIPE											
AREA ID NUMBER	FROM M.H.	TO M.H.	AREA (ha)	SINGLE	UNITS TOWN	APT	POP.	CUMULATIVE AREA (ha)	POP.	PEAK FACT.	PEAK FLOW (l/s)	GROSS AREA (ha)	ACCU. AREA (ha)	MOBILE SPACES	ACCU. SPACES	PEAK FLOW (l/s)	AREA (ha)	ACCU. AREA (ha)	AREA (ha)	ACCU. AREA (ha)	AREA (ha)	ACCU. AREA (ha)	PEAK FLOW (l/s)	TOTAL AREA ¹ (ha)	ACCU. AREA (ha)	INFILT. FLOW (l/s)	FLOW (l/s)	LENGTH (m)	DIA (mm)	MATERIAL	CLASS	SLOPE (%)	CAP. (FULL) (l/s)	CAP. V PEAK FLOW (%)	VEL. (FULL) (m/s)	VEL. (ACT.) (m/s)		
Ex. Trailer Park	Ex. 4	4	11.37	0	0	0	0	11.37	0	3.80	0.0	0.00	0.00	254.00	254.00	11.17	0.00	0.00	0.00	0.00	0.00	0.00	0.00	0.0	11.37	11.37	3.8	14.9	22.4	300	PVC	SDR 35	0.18	40.7	36.63%	0.58	0.45	
BLOCK F2 - R4A	4	3	0.13	0	0	54	97	11.50	97	3.60	1.1	0.00	0.00	0.00	254.00	11.17	0.00	0.00	0.00	0.00	0.00	0.00	0.0	0.13	11.50	3.8	16.1	167.8	375	PVC	SDR 35	0.18	68.9	23.38%	0.65	0.44		
BLOCK B1&B3 - R3A, R3C, BLOCK C - R3B, BLOCK E2 - R3D, BLOCK D - R3E, GATEWAY- G3A	3	2	0.71	0	0	902	1624	12.20	1721	3.11	17.3	0.00	0.00	0.00	254.00	11.17	0.00	0.00	0.00	0.00	1.14	1.14	0.0	1.85	13.34	4.4	32.9	218.1	375	PVC	SDR 35	0.19	70.7	46.52%	0.67	0.56		
BLOCK A1 - R6A	6	5	0.09	0	0	250	450	0.09	450	3.40	5.0	0.00	0.00	0.00	0.00	0.00	0.00	0.00	0.00	0.00	0.00	0.00	0.0	0.09	0.09	0.0	5.0	94.0	250	PVC	SDR 35	0.50	42.9	11.63%	0.86	0.48		
BLOCK F1 - R7A, BLOCK E1 - R7B, BLOCK B2 - R7C, BLOCK A2&A3 - R7D, PARKLAND- G7A, COMMERCIAL - C-A, C-B, C-E, & C-F	7	5	0.66	0	0	880	1584	0.66	1584	3.13	16.1	2.71	2.71	0.00	0.00	0.00	0.00	0.00	0.00	0.00	0.00	3.73	3.73	1.3	4.38	4.38	1.4	18.8	197.6	250	PVC	SDR 35	0.35	35.9	52.50%	0.72	0.63	
	5	2	0.00	0	0	0	0	0.74	2034	3.06	20.2	0.00	2.71	0.00	0.00	0.00	0.00	0.00	0.00	0.00	0.00	3.73	1.3	0.00	4.38	1.4	23.0	110.8	300	PVC	SDR 35	0.25	48.0	47.83%	0.68	0.58		
	2	Ex. 1	0.00	0	0	0	0	12.86	3755	2.89	35.1	0.00	2.71	0.00	254.00	11.17	0.00	0.00	0.00	0.00	0.00	4.87	0.9	0.00	17.73	5.9	53.0	42.6	375	PVC	SDR 35	0.20	72.6	73.04%	0.69	0.66		
EX.LIGHT INDUSTRIAL (GENERAL DYNAMICS CAMPUS- OFFICES, RESEARCH & DEVELOPMENT)	EX. 1	NCS	0.00	0	0	0	0	12.86	3755	2.89	35.12	0.00	2.71	0.00	254.00	11.17	7.26	7.26	0.00	0.00	0.00	4.87	8.4	7.26	24.99	8.25	62.9	104.8	400	PVC	SDR 35	0.20	69.5	90.48%	0.66	0.67		
TOTAL							2086	3755																														

NOTES:
 1. INFILTRATION AREA G7A EXCLUDES STM SUBCATCHMENTS UNC2, UNC3, C109A AND C109B, AS THESE AREAS DO NOT DRAIN TOWARD THE SANITARY SEWER.
 2. DAILY SEWAGE FLOW RATE FOR MOBILE HOMES -2 BEDROOMS CITED FROM APPENDIX 4-A CITY OF OTTAWA SEWER DESIGN GUIDELINES, OCTOBER 2012

FUNCTIONAL SITE SERVICING AND STORMWATER MANAGEMENT REPORT REV.03 – 1987 ROBERTSON ROAD (STILLWATER STATION)

Appendix C Stormwater Management Calculations
February 28, 2024

Appendix C **STORMWATER MANAGEMENT CALCULATIONS**

C.1 CONCEPTUAL STORM SEWER DESIGN SHEET





STILLWATER STATION
 DATE: 27-Feb-2024
 REVISION: 4
 DESIGNED BY: MJS
 CHECKED BY: ALG

STORM SEWER
 DESIGN SHEET
 (City of Ottawa)
 FILE NUMBER: 160401686

DESIGN PARAMETERS
 $I = a / (t+b)^c$ (As per City of Ottawa Guidelines, 2012)
 a = 732.951, 998.071, 1174.184, 1735.688
 b = 6.199, 6.053, 6.014, 6.014
 c = 0.810, 0.814, 0.816, 0.820
 MANNING'S n = 0.013
 BEDDING CLASS = B
 MINIMUM COVER: 2.00 m
 TIME OF ENTRY: 10 min

AREA ID NUMBER	LOCATION		DRAINAGE AREA												PIPE SELECTION																								
	FROM M.H.	TO M.H.	AREA (2-YEAR)	AREA (5-YEAR)	AREA (10-YEAR)	AREA (100-YEAR)	AREA (BLOCK)	C (2-YEAR)	C (5-YEAR)	C (10-YEAR)	C (100-YEAR)	A x C (2-YEAR)	ACCUM (2YR)	A x C (5-YEAR)	ACCUM (5YR)	A x C (10-YEAR)	ACCUM (10YR)	A x C (100-YEAR)	ACCUM (100YR)	T of C (min)	I ₂ -YEAR (mm/h)	I ₅ -YEAR (mm/h)	I ₁₀ -YEAR (mm/h)	I ₁₀₀ -YEAR (mm/h)	Q _{CONTROL} (L/s)	ACCUM. Q _{CONTROL} (L/s)	Q _{ACT} (CIA/360) (L/s)	LENGTH (m)	PIPE WIDTH OR DIAMETER (mm)	PIPE HEIGHT (mm)	PIPE SHAPE (-)	MATERIAL (-)	CLASS (-)	SLOPE (%)	Q _{cap} (FULL) (L/s)	% FULL (-)	VEL (FULL) (m/s)	VEL (ACT) (m/s)	TIME OF FLOW (min)
L102A BLOCK E - R102A, L102B	102	101	0.22	0.00	0.00	0.00	0.31	0.71	0.00	0.00	0.00	0.153	0.153	0.000	0.000	0.000	0.000	0.000	0.000	10.00	76.81	104.19	122.14	178.56	15.3	15.3	48.0	109.0	525	525	CIRCULAR	PVC	-	0.30	245.7	19.52%	1.10	0.71	2.55
BLOCK F - L103A, R103A	103	101	0.00	0.00	0.00	0.00	0.64	0.00	0.00	0.00	0.000	0.000	0.000	0.000	0.000	0.000	0.000	0.000	0.000	10.00	76.81	104.19	122.14	178.56	32.1	32.1	32.1	30.9	375	375	CIRCULAR	PVC	-	0.50	116.6	27.53%	1.11	0.79	0.66
L101A BLOCK F - R101B, BLOCK E - R101A	101	100	0.31	0.00	0.00	0.00	0.23	0.78	0.00	0.00	0.00	0.240	0.393	0.000	0.000	0.000	0.000	0.000	0.000	12.55	68.24	92.42	108.28	158.21	11.3	58.7	133.2	78.3	675	675	CIRCULAR	CONCRETE	-	0.10	277.3	48.02%	0.75	0.64	2.05
L102C, GATEWAY - L102E, BLOCK D R102B, L102D, BLOCK C - L102F, R102C, R102D, BLOCK B - R102E, EXTERNAL AREAS EX-1 & EX-2 C105A	102	105	1.12	0.00	0.00	0.00	0.79	0.57	0.00	0.00	0.00	0.641	0.641	0.000	0.000	0.000	0.000	0.000	0.000	10.00	76.81	104.19	122.14	178.56	39.5	39.5	176.1	216.0	525	525	CIRCULAR	PVC	-	0.20	200.6	87.79%	0.90	0.91	3.96
C106A, BLOCK A - R106A	105	104	0.00	0.40	0.00	0.00	0.00	0.00	0.71	0.00	0.00	0.000	0.641	0.283	0.283	0.000	0.000	0.000	0.000	13.96	64.32	87.06	101.97	148.94	0.0	39.5	222.4	109.7	600	600	CIRCULAR	CONCRETE	-	0.15	248.1	89.64%	0.85	0.87	2.11
L104A, BLOCK A - L104C, R104A, R104B, BLOCK B - R104C, R104D, L104B	106	104	0.00	0.32	0.00	0.00	0.13	0.00	0.67	0.00	0.00	0.000	0.000	0.217	0.217	0.000	0.000	0.000	0.000	10.00	76.81	104.19	122.14	178.56	6.3	6.3	69.2	112.4	450	450	CIRCULAR	PVC	-	0.20	133.0	52.01%	0.81	0.70	2.68
PARKLAND - L110A	104	100	0.29	0.00	0.00	0.00	1.40	0.77	0.00	0.00	0.00	0.221	0.861	0.000	0.500	0.000	0.000	0.000	0.000	16.07	59.35	80.25	93.96	137.18	70.2	115.9	369.5	171.9	750	750	CIRCULAR	CONCRETE	-	0.15	449.8	82.14%	0.99	0.98	2.93
OGS 1	110	100	0.61	0.00	0.00	0.00	0.00	0.40	0.00	0.00	0.00	0.242	0.242	0.000	0.000	0.000	0.000	0.000	0.000	10.00	76.81	104.19	122.14	178.56	0.0	0.0	51.7	12.5	375	375	CIRCULAR	PVC	-	0.50	116.6	44.35%	1.11	0.91	0.23
MINOR SYSTEM FLOWS	100	OGS 1	0.21	0.00	0.00	0.00	0.00	0.90	0.00	0.00	0.00	0.192	1.689	0.000	0.500	0.000	0.000	0.000	0.000	19.00	53.69	72.51	84.87	123.85	0.0	174.6	527.3	16.1	825	825	CIRCULAR	CONCRETE	-	0.20	670.2	78.67%	1.21	1.19	0.23
MAJOR SYSTEM FLOWS	OGS 1	DRY POND	0.00	0.00	0.00	0.00	0.00	0.00	0.00	0.00	0.00	0.000	1.689	0.000	0.500	0.000	0.000	0.000	0.000	19.23	53.30	71.99	84.25	122.94	0.0	174.6	524.7	5.5	825	825	CIRCULAR	CONCRETE	-	0.20	670.2	78.29%	1.21	1.19	0.08
CONTROL (DRY POND HEADWALL 1 OUTLET)	ROAD	DRY POND	0.00	0.00	0.00	3.47	0.00	0.00	0.00	0.00	0.63	0.000	1.689	0.000	0.500	0.000	0.000	2.189	2.189	19.31	53.17	71.81	84.04	122.63	0.0	0.0	1094.9	14.2	1050	1050	CIRCULAR	CONCRETE	-	0.20	1275.0	85.87%	1.43	1.44	0.16
C109A, C109B	109	108	0.00	1.48	0.00	0.00	0.00	0.00	0.41	0.00	0.00	0.000	0.000	0.601	0.601	0.000	0.000	0.000	0.000	10.00	76.81	104.19	122.14	178.56	0.0	0.0	174.0	302.6	600	600	CIRCULAR	PVC	-	0.15	248.1	70.13%	0.85	0.81	6.25
TOTAL	108	107 (OGS 2)	0.00	0.00	0.00	0.00	0.00	0.00	0.00	0.00	0.000	0.000	0.000	0.601	0.601	0.000	0.000	0.000	0.000	16.25	58.96	79.72	93.34	136.28	0.0	0.0	133.1	4.2	600	600	CIRCULAR	PVC	-	2.00	905.9	14.69%	3.10	1.84	0.04
TOTAL	107	HEADWALL 2	0.00	0.00	0.00	0.00	0.00	0.00	0.00	0.00	0.000	0.000	0.000	0.601	0.601	0.000	0.000	0.000	0.000	16.29	58.88	79.61	93.21	136.09	0.0	0.0	132.9	22.5	600	600	CIRCULAR	PVC	-	2.00	905.9	14.67%	3.10	1.84	0.20

NOTE:
 UNCONTROLLED SUBCATCHMENT AREAS UNC-1 (0.11 ha), UNC-2 (1.68 ha), AND UNC-3 (0.35 ha) ARE EXCLUDED FROM THIS DESIGN SHEET.

FUNCTIONAL SITE SERVICING AND STORMWATER MANAGEMENT REPORT REV.03 – 1987 ROBERTSON ROAD (STILLWATER STATION)

Appendix C Stormwater Management Calculations
February 28, 2024

C.2 EXISTING CONDITIONS RATIONAL METHOD CALCULATIONS

C.3 PRE-DEVELOPMENT TIME OF CONCENTRATION CALCULATION



Stormwater Management Calculations: Pre-development Subcatchment Area Summary

File No: 160401686
 Project: 1987 Robertson Road (Stillwater Station)
 Date: 14-Apr-2023

Created By: MW
 Checked By: AG
 Revision: 1

Pre-development (Existing) Site Conditions:

Overall Runoff Coefficient for Site and Sub-Catchment Areas

Runoff Coefficient Table							
Catchment Type	Sub-catchment Area ID / Description		Area (ha) "A"	Runoff Coefficient "C"	"A x C"		Overall Runoff Coefficient
Uncontrolled - Tributary	EXT-1	Hard	0.000	0.9	0.000		
		Soft	4.823	0.2	0.965		
	Subtotal			4.82		0.965	0.20
Uncontrolled - Tributary	EXT-2	Hard	0.193	0.9	0.173		
		Soft	0.000	0.2	0.000		
	Subtotal			0.19		0.173	0.90
Uncontrolled - Tributary	EXT-3	Hard	1.409	0.9	1.268		
		Soft	0.000	0.2	0.000		
	Subtotal			1.41		1.268	0.90
Uncontrolled - Non-Tributary	EXT-4	Hard	0.195	0.9	0.176		
		Soft	0.000	0.2	0.000		
	Subtotal			0.20		0.176	0.90
Uncontrolled - Non-Tributary	EXT-5	Hard	0.000	0.9	0.000		
		Soft	0.382	0.2	0.076		
	Subtotal			0.38		0.076	0.20
Uncontrolled - Tributary	EXT-6	Hard	0.000	0.9	0.000		
		Soft	1.694	0.2	0.339		
	Subtotal			1.69		0.339	0.20
Uncontrolled - Tributary	EXT-7	Hard	0.000	0.9	0.000		
		Soft	0.303	0.2	0.061		
	Subtotal			0.30		0.061	0.20
External - Tributary	EXT-8	Hard	0.068	0.9	0.061		
		Soft	0.054	0.2	0.011		
	Subtotal			0.12		0.072	0.59
External - Tributary	EXT-9	Hard	0.186	0.9	0.168		
		Soft	0.279	0.2	0.056		
	Subtotal			0.47		0.223	0.48
Uncontrolled - Tributary	EXT-10	Hard	0.105	0.9	0.095		
		Soft	0.000	0.2	0.000		
	Subtotal			0.11		0.095	0.90
Uncontrolled - Tributary	EXT-11	Hard	0.000	0.9	0.000		
		Soft	0.190	0.2	0.038		
	Subtotal			0.19		0.038	0.20
Uncontrolled - Non-Tributary	EXT-12	Hard	0.000	0.9	0.000		
		Soft	0.221	0.2	0.044		
	Subtotal			0.22		0.044	0.20
Uncontrolled - Tributary	EXT-13	Hard	0.000	0.9	0.000		
		Soft	0.483	0.2	0.097		
	Subtotal			0.48		0.097	0.20
Total			10.58		3.626		0.34
Overall Runoff Coefficient= C:							

	A	A*C	C
Tributary to Stillwater Creek:			
Total External Tributary Areas (EX-7 & EX-8)	0.59 ha	0.29	
Total Controlled Tributary Surface Areas	0.00 ha	0.00	
Total Uncontrolled Tributary Surface Areas (EXT-1, -2, -3, -6, -7, -10, -11, & -13)	9.20 ha	3.03	
Total Tributary Area to Outlet (Stillwater Creek)	9.79 ha	3.33	0.34
Total Uncontrolled Non-Tributary Areas (EXT-4, -5, & -12)	0.80 ha	0.30	0.37
Total Study Area	10.58 ha		0.34

Stormwater Management RM Calculations: Pre-Development Site Conditions

File No: 160401686
 Project: 1987 Robertson Road (Stillwater Station)
 Date: 14-Apr-2023

Created By: MW
 Checked By: AG
 Revision: 1

Rational Method for Pre-development Release Rates

5-Year Intensity		$I = a/(t + b)^c$		a =	998.071	t (min)	I (mm/hr)
City of Ottawa		b =	6.053			5	141.18
		c =	0.814			10	104.19
						15	83.56
						20	70.25
						25	60.90
						30	53.93
						35	48.52
						40	44.18
						45	40.63
						50	37.65
						55	35.12
						60	32.94

5-YEAR Pre-development Release Rate			
Subdrainage Area: Pre-development Area Tributary to Creek			
Area (ha):	9.79		
C:	0.34		

tc	I (5 yr)	Qtarget
(min)	(mm/hr)	(L/s)
29.7	54.30	502.54

Subdrainage Area: Pre-development Non-Tributary Area - Outlet to Moodie Drive			
Area (ha):	0.22		
C:	0.20		

tc	I (5 yr)	Qtarget
(min)	(mm/hr)	(L/s)
29.7	54.30	6.66

Subdrainage Area: Pre-development Non-Tributary Area - Outlet Northeast of the Site			
Area (ha):	0.58		
C:	0.44		

tc	I (5 yr)	Qtarget
(min)	(mm/hr)	(L/s)
29.7	54.30	38.06

Subdrainage Area: Pre-development Overall Study Area			
Area (ha):	10.58		
C:	0.34		

tc	I (5 yr)	Qtarget
(min)	(mm/hr)	(L/s)
29.7	54.30	547.26

100-Year Intensity		$I = a/(t + b)^c$		a =	1735.688	t (min)	I (mm/hr)
City of Ottawa		b =	6.014			5	242.70
		c =	0.820			10	178.56
						15	142.89
						20	119.95
						25	103.85
						30	91.87
						35	82.58
						40	75.15
						45	69.05
						50	63.95
						55	59.62
						60	55.89

100-YEAR Pre-development Release Rate			
Subdrainage Area: Pre-development Area Tributary to Creek			
Area (ha):	9.79		
C:	0.34		

tc	I (100 yr)	Q100yr
(min)	(mm/hr)	(L/s)
29.7	92.50	856.16

Subdrainage Area: Pre-development Non-Tributary Area - Outlet to Moodie Drive			
Area (ha):	0.22		
C:	0.20		

tc	I (100 yr)	Q100yr
(min)	(mm/hr)	(L/s)
29.7	92.50	11.35

Subdrainage Area: Pre-development Non-Tributary Area - Outlet Northeast of the Site			
Area (ha):	0.58		
C:	0.44		

tc	I (100 yr)	Q100yr
(min)	(mm/hr)	(L/s)
29.7	92.50	64.84

Subdrainage Area: Pre-development Overall Study Area			
Area (ha):	10.58		
C:	0.34		

tc	I (100 yr)	Q100yr
(min)	(mm/hr)	(L/s)
29.7	92.50	932.34

FUNCTIONAL SITE SERVICING AND STORMWATER MANAGEMENT REPORT REV.03 – 1987 ROBERTSON ROAD (STILLWATER STATION)

Appendix C Stormwater Management Calculations
February 28, 2024

C.3 PRE-DEVELOPMENT TIME OF CONCENTRATION CALCULATION





Project	Stillwater Station 1987 Robertson Road	No.	160401686
PRE-DEVELOPMENT CONDITIONS Calculation of Time of Concentration			
Revision:	02	Prepared By:	MW
Revision Date	10-Apr-2023	Checked By:	AG

OVERLAND SHEET FLOW TIME

Runoff Coefficient =

Length = m (longest overland flow path)

DEM Slope = (along overland flow path)

C > 0.4 Bransby Williams Method

$$t_c = 0.057 \times L / (S_w^{0.2} \times A^{0.1})$$

L = 198 m (longest flow path)
 S_w = 1.14%
 A = 0.98 ha
 t_c = 11.02 min

C ≤ 0.4 Airport Method

$$t_c = [3.26 \times (1.1-C) \times L^{0.5}] / S_w^{0.33}$$

L = 0 m
 S_w = 0.66%
 C = 0.46
 t_c = 0.0 min

SHALLOW CONCENTRATED FLOW TIME

Uplands Method

1. Channel Segment 1 - Overland

Length = m (longest flow path)

DEM Slope = (along overland flow path)

Channel Type =

k =

$$V = k \times S^{(1/2)}$$

Velocity = 0.16 m/s

Channel Length = 145 m

Travel time = 14.7 min

2. Channel Segment 2 - Overland within creek channel

Length = m (longest flow path)

DEM Slope = (along overland flow path)

Channel Type =

k =

$$V = k \times S^{(1/2)}$$

Velocity = 0.25 m/s

Channel Length = 58 m

Travel time = 3.9 min

Therefore, Total T_c = min

hrs

Uplands Method Chart

118 STEEL DRAINAGE AND HIGHWAY CONSTRUCTION PRODUCTS

Table 3.9 V/S^{0.5} relationship for various land covers

Land Cover	V/S ^{0.5} (m/s)
Forest with heavy ground litter, hay meadow (overland flow)	0.6
Trash fallow or minimum tillage cultivation, contour, strip cropped woodland (overland flow)	1.5
Short grass pasture (overland flow)	2.3
Cultivated, straight row (overland flow)	2.7
Nearly bare and untilled (overland flow) or alluvial fans in Western mountain regions	3.0
Grassed waterway	4.6
Paved areas (sheet flow); small upland gullies	6.1

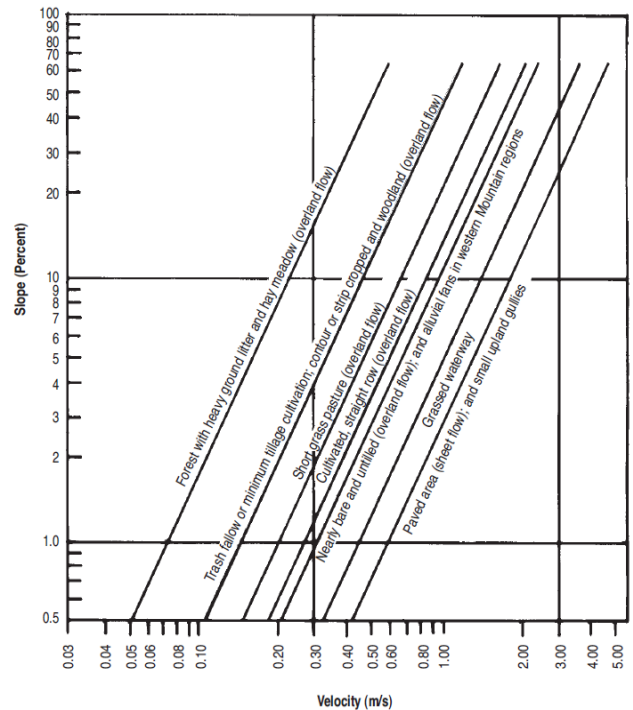

FUNCTIONAL SITE SERVICING AND STORMWATER MANAGEMENT REPORT REV.03 – 1987 ROBERTSON ROAD (STILLWATER STATION)

Appendix C Stormwater Management Calculations
February 28, 2024

C.4 MODIFIED RATIONAL METHOD CALCULATIONS

C.4.1 Common Areas – Area Summary



Stormwater Management Calculations: Post-development Subcatchment Area Summary

File No: 160401686
 Project: 1987 Robertson Road (Stillwater Station)
 Date: 27-Feb-2024

Created By: AG
 Checked By: NC
 Revision: 2

SWM Quantity Approach:
Post-development to Pre-development Flows (100-year to 100-year and 5-year to 5-year)

Post-Development Site Conditions - Overall Study Area

Overall Runoff Coefficient for Site and Sub-Catchment Areas

Runoff Coefficient Table								
Sub-catchment Area	ID / Description		Area (ha) "A"	Runoff Coefficient "C"	"A x C"			Overall Runoff Coefficient
Catchment Type								
Undevelopped Area - Tributary to Collector Road Outlet 2	C109B	Hard	0.000	0.9	0.000			
		Soft	0.482	0.2	0.096			
	Subtotal			0.48			0.096	0.20
Collector Road - Tributary to Outlet 2	C109A	Hard	0.572	0.9	0.515			
		Soft	0.429	0.2	0.086			
	Subtotal			1.00			0.601	0.60
Uncontrolled (Undevelopped) - Non-Tributary	UNC-3	Hard	0.000	0.9	0.000			
		Soft	0.346	0.2	0.069			
	Subtotal			0.35			0.069	0.20
Uncontrolled (Undevelopped) - Non-Tributary	UNC-2	Hard	0.096	0.9	0.087			
		Soft	1.586	0.2	0.317			
	Subtotal			1.68			0.404	0.24
Pathway to Robertson (Uncontrolled) - Non-Tributary	UNC-1	Hard	0.072	0.9	0.065			
		Soft	0.035	0.2	0.007			
	Subtotal			0.11			0.072	0.67
Controlled Blocks (A,B,C,D,E,&F) - Tributary to Outlet 1	BLOCKS	Hard	2.493	0.9	2.244			
		Soft	0.997	0.2	0.199			
	Subtotal			3.49			2.443	0.70
External Area (to Local Road) - Tributary to Outlet 1	EX-2	Hard	0.186	0.9	0.168			
		Soft	0.279	0.2	0.056			
	Subtotal			0.47			0.223	0.48
External Area (to Local Road) - Tributary to Outlet 1	EX-1	Hard	0.068	0.9	0.061			
		Soft	0.054	0.2	0.011			
	Subtotal			0.12			0.072	0.59
Collector Road - Tributary to Outlet 1	C106A	Hard	0.218	0.9	0.196			
		Soft	0.107	0.2	0.021			
	Subtotal			0.32			0.218	0.67
Collector Road - Tributary to Outlet 1	C105A	Hard	0.290	0.9	0.261			
		Soft	0.108	0.2	0.022			
	Subtotal			0.40			0.283	0.71
Local Road - Tributary to Outlet 1	L104A	Hard	0.233	0.9	0.210			
		Soft	0.053	0.2	0.011			
	Subtotal			0.29			0.221	0.77
Local Road - Tributary to Outlet 1	L102C	Hard	0.336	0.9	0.302			
		Soft	0.144	0.2	0.029			
	Subtotal			0.48			0.331	0.69
Local Road - Tributary to Outlet 1	L102A	Hard	0.157	0.9	0.141			
		Soft	0.058	0.2	0.012			
	Subtotal			0.22			0.153	0.71
Local Road - Tributary to Outlet 1	L101A	Hard	0.255	0.9	0.229			
		Soft	0.053	0.2	0.011			
	Subtotal			0.31			0.240	0.78
Park (to Local Road) - Tributary to Outlet 1	L102E	Hard	0.005	0.9	0.005			
		Soft	0.049	0.2	0.010			
	Subtotal			0.05			0.015	0.27
Park (to Local Road) - Tributary to Outlet 1	L110A	Hard	0.173	0.9	0.156			
		Soft	0.433	0.2	0.087			
	Subtotal			0.61			0.242	0.40
SWM BLOCK - Tributary to Outlet 1	L100A	Hard	0.214	0.9	0.192			
		Soft	0.000	0.2	0.000			
	Subtotal			0.21			0.192	0.90
Total				10.58		5.87		0.56

Tributary to Outlet 1:	
Total External Tributary Areas (EX-1 & EX-2)	0.59 ha
Total Controlled Tributary Surface Areas (BLOCKS, C106A, C105A, L104A, L102C, L102A, L101A, L102E, L110A, & L100A)	6.38 ha
Total Tributary Area to Outlet 1	6.96 ha
Tributary to Outlet 2:	
Total External Areas	0.000 ha
Total Controlled Tributary Surface Areas (C109A,C109B)	1.48 ha
Total Uncontrolled Tributary Surface Areas	0.000 ha
Total Tributary Area to Outlet 2	1.48 ha
Total Uncontrolled Non-Tributary Areas (UNC-1, UNC-2 & UNC-3)	2.14 ha
Total Site and Subcatchment Areas	10.58 ha

FUNCTIONAL SITE SERVICING AND STORMWATER MANAGEMENT REPORT REV.03 – 1987 ROBERTSON ROAD (STILLWATER STATION)

Appendix C Stormwater Management Calculations
February 28, 2024

C.4.2 Block Sites – Area Summary



Stormwater Management Calculations

File No: 160401686
 Project: 1987 Robertson Road (Stillwater Station) - Block Sites
 Date: 27-Feb-2024

Created By: AG
 Checked By: NC
 Revision: 2

SWM Approach: Post-development to Predetermined Release Rate (50L/s/ha)
--

Blocks Post-Development Site Conditions:

Overall Runoff Coefficient for Block Sites and Sub-Catchment Areas

Runoff Coefficient Table							
Catchment Type	Sub-catchment Area ID / Description		Area (ha) "A"	Runoff Coefficient "C"	"A x C"		Overall Runoff Coefficient
Controlled - Tributary to Block A Onsite Storage	L104C	Hard	0.165	0.9	0.148		
		Soft	0.315	0.2	0.063		
	Subtotal		0.480			0.211	0.44
Roof - A	R104B	Hard	0.093	0.9	0.083		
		Soft	0.000	0.2	0.000		
	Subtotal		0.093			0.083	0.90
Roof - A	R104A	Hard	0.164	0.9	0.148		
		Soft	0.000	0.2	0.000		
	Subtotal		0.164			0.148	0.90
Roof - A	R106A	Hard	0.125	0.9	0.113		
		Soft	0.000	0.2	0.000		
	Subtotal		0.125			0.113	0.90
Controlled - Tributary to Block B Onsite Storage	L104B	Hard	0.185	0.9	0.166		
		Soft	0.147	0.2	0.029		
	Subtotal		0.331			0.195	0.59
Roof - B	R102E	Hard	0.087	0.9	0.078		
		Soft	0.000	0.2	0.000		
	Subtotal		0.087			0.078	0.90
Roof - B	R104D	Hard	0.165	0.9	0.149		
		Soft	0.000	0.2	0.000		
	Subtotal		0.165			0.149	0.90
Roof - B	R104C	Hard	0.170	0.9	0.153		
		Soft	0.000	0.2	0.000		
	Subtotal		0.170			0.153	0.90
Controlled - Tributary to Block C Onsite Storage	L102F	Hard	0.136	0.9	0.123		
		Soft	0.091	0.2	0.018		
	Subtotal		0.227			0.141	0.62
Roof - C	R102C	Hard	0.092	0.9	0.083		
		Soft	0.000	0.2	0.000		
	Subtotal		0.092			0.083	0.90
Roof - C	R102D	Hard	0.160	0.9	0.144		
		Soft	0.000	0.2	0.000		
	Subtotal		0.160			0.144	0.90
Controlled - Tributary to Block D Onsite Storage	L102D	Hard	0.050	0.9	0.045		
		Soft	0.079	0.2	0.016		
	Subtotal		0.129			0.060	0.47
Roof - D	R102B	Hard	0.095	0.9	0.085		
		Soft	0.000	0.2	0.000		
	Subtotal		0.095			0.085	0.90
Controlled - Tributary to Block E Onsite Storage	L102B	Hard	0.135	0.9	0.122		
		Soft	0.058	0.2	0.012		
	Subtotal		0.193			0.133	0.69
Roof - E	R102A	Hard	0.113	0.9	0.102		
		Soft	0.000	0.2	0.000		
	Subtotal		0.113			0.102	0.90
Roof - E	R101A	Hard	0.126	0.9	0.113		
		Soft	0.000	0.2	0.000		
	Subtotal		0.126			0.113	0.90
Controlled - Tributary to Block F Onsite Storage	L103A	Hard	0.184	0.9	0.166		
		Soft	0.332	0.2	0.066		
	Subtotal		0.516			0.232	0.45
Roof - F	R103A	Hard	0.126	0.9	0.113		
		Soft	0.000	0.2	0.000		
	Subtotal		0.126			0.113	0.90
Roof - F	R101B	Hard	0.100	0.9	0.090		
		Soft	0.000	0.2	0.000		
	Subtotal		0.100			0.090	0.90
Total			3.493			2.428	
Overall Runoff Coefficient= C:							0.70

Total Roof Areas	1.62 ha
Total Controlled Tributary Surface Areas	1.88 ha
Total Uncontrolled Tributary Surface Areas	0.00 ha
Total Tributary Area to Outlet	3.49 ha
Total Uncontrolled Areas (Non-Tributary)	0.00 ha
Total Block Sites	3.49 ha

File No: **160401686**
 Project: **1987 Robertson Road (Stillwater Station) - Block Sites**
 Date: **27-Feb-2024**

Created By: AG
 Checked By: NC
 Revision: 2

100-YEAR SUMMARY OF BLOCK (SITE) STORAGE

SWM Approach: **Post-development to Predetermined Release Rate (50L/s/ha)**

100-year IDF
 City of Ottawa

$I = a/(t + b)^c$	a =	1735.688	t (min)	I (mm/hr)
	b =	6.014		
	c =	0.820		
			10	178.56
			20	119.95
			30	91.87
			40	75.15
			50	63.95
			60	55.89
			70	49.79
			80	44.99
			90	41.11
			100	37.90
			110	35.20
			120	32.89

All Blocks (Site) Post-Development Conditions:

Total Area:	3.49
Overall C:	0.87

t_c	Runoff Rate @ 30 min	Maximum Allowable Discharge	Required Storage Volume	Required Storage Rate
(min)	(L/s)	(L/s)	(m ³)	(m ³ /ha)
10	1507	175	799	229
20	1012	175	1005	288
30	775	175	1081	310
40	634	175	1103	316
50	540	175	1095	314
60	472	175	1069	306

The maximum storage requirements occurs on average at a time of concentration (t_c) of: **40 minutes**

BLOCK ID	Area	C	C	Runoff Rate @ 40 min	Maximum Allowable Discharge	Required Storage Volume	Required Storage Rate
	(ha)	(5-yr)	(100-yr)	(L/s)	(L/s)	(m ³)	(m ³ /ha)
BLOCK A	0.86	0.64	0.80	145	43	244	283
BLOCK B	0.75	0.76	0.95	150	38	270	359
BLOCK C	0.48	0.77	0.96	96	24	173	361
BLOCK D	0.22	0.65	0.82	38	11	65	289
BLOCK E	0.43	0.81	1.00	90	22	165	381
BLOCK F	0.74	0.59	0.73	114	37	184	248

FUNCTIONAL SITE SERVICING AND STORMWATER MANAGEMENT REPORT REV.03 – 1987 ROBERTSON ROAD (STILLWATER STATION)

Appendix C Stormwater Management Calculations
February 28, 2024

C.4.3 Modified Rational Method (MRM) for Overall Site Post-Development Conditions



Stormwater Management MRM Calculations

File No: 160401686
 Project: 1987 Robertson Road (Stillwater Station)
 Date: 27-Feb-2024

Created By: AG
 Checked By: NC
 Revision: 2

Modified Rational Method Calculations for Post-Development Storage Requirements

2-YEAR				
2-Year Intensity City of Ottawa	$I = a/(t + b)^c$	a =	732.951	
		b =	6.199	
		c =	0.81	
	t (min)	I (mm/hr)		
	10	76.81		
	20	52.03		
	30	40.04		
	40	32.86		
	50	28.04		
	60	24.56		
	70	21.91		
	80	19.83		
	90	18.14		
	100	16.75		
	110	15.57		
	120	14.56		

5-YEAR				
5-Year Intensity City of Ottawa	$I = a/(t + b)^c$	a =	998.071	
		b =	6.053	
		c =	0.814	
	t (min)	I (mm/hr)		
	10	104.19		
	20	70.25		
	30	53.93		
	40	44.18		
	50	37.65		
	60	32.94		
	70	29.37		
	80	26.56		
	90	24.29		
	100	22.41		
	110	20.82		
	120	19.47		

100-YEAR				
100-Year Intensity City of Ottawa	$I = a/(t + b)^c$	a =	1735.688	
		b =	6.014	
		c =	0.820	
	t (min)	I (mm/hr)		
	10	178.56		
	20	119.95		
	30	91.87		
	40	75.15		
	50	63.95		
	60	55.89		
	70	49.79		
	80	44.99		
	90	41.11		
	100	37.90		
	110	35.20		
	120	32.89		

Notes:

- For uncontrolled areas, $Q_{release} = Q_{actual}$
- C-value escalated by 25%

5-YEAR Predevelopment Target Release Rate for Entire Site				
Refer to Existing Conditions Rational Method Calculation for Details				
Subdrainage Area: Predevelopment Overall Study Area				
Area (ha): 10.58				
C: 0.34				
	tc (min)	I (5 yr) (mm/hr)	Qtarget (L/s)	Qtarget (L/s/ha)
	29.7	54	547.3	51.7

100-YEAR Predevelopment Target Release Rate for Entire Site				
Refer to Existing Conditions Rational Method Calculation for Details				
Subdrainage Area: Predevelopment Overall Study Area				
Area (ha): 10.58				
C: 0.34				
	tc (min)	I (5 yr) (mm/hr)	Qtarget (L/s)	Qtarget (L/s/ha)
	29.7	93	932.3	88.1

5-YEAR Modified Rational Method for Uncontrolled Areas				
Subdrainage Areas: UNC-1, UNC-2, & UNC-3			Outlet: Uncontrolled - Non-Tributary	
Area (ha): 2.14			Storage: None	
C: 0.26				
	tc (min)	I (5 yr) (mm/hr)	Qactual (L/s)	Qrelease ^a (L/s)
	10	104	158	158
	20	70	106	106
	30	54	82	82
	40	44	67	67
	50	38	57	57
	60	33	50	50
	70	29	44	44
	80	27	40	40
	90	24	37	37
	100	22	34	34
	110	21	32	32
	120	19	29	29

100-YEAR Modified Rational Method for Uncontrolled Areas				
Subdrainage Areas: UNC-1, UNC-2, & UNC-3			Outlet: Uncontrolled - Non-Tributary	
Area (ha): 2.14			Storage: None	
C ^b : 0.32				
	tc (min)	I (100 yr) (mm/hr)	Qactual (L/s)	Qrelease ^a (L/s)
	10	179	338	338
	20	120	227	227
	30	92	174	174
	40	75	142	142
	50	64	121	121
	60	56	106	106
	70	50	94	94
	80	45	85	85
	90	41	78	78
	100	38	72	72
	110	35	67	67
	120	33	62	62

5-YEAR Modified Rational Method for Uncontrolled Areas to Outlet 2				
Subdrainage Areas: C109A & C109B			Outlet: Tributary to Collector Road and Outlet 2	
Area (ha): 1.48			Storage: Collector Roadway	
C: 0.47			Vavailable ^a (m ³): 37.10	
	tc (min)	I (5 yr) (mm/hr)	Qactual (L/s)	Qminor ^c (L/s)
	10	104	202	202
	20	70	136	136
	30	54	105	105
	40	44	86	86
	50	38	73	73
	60	33	64	64
	70	29	57	57
	80	27	52	52
	90	24	47	47
	100	22	43	43
	110	21	40	40
	120	19	38	38

100-YEAR Modified Rational Method for Uncontrolled Areas to Outlet 2									
Subdrainage Areas: C109A & C109B			Outlet: Tributary to Collector Road and Outlet 2						
Area (ha): 1.48			Storage: Roadway						
C ^b : 0.59			Vavailable ^a (m ³): 37.10						
	tc (min)	I (100 yr) (mm/hr)	Qactual (L/s)	Qminor ^c (L/s)	Qmajor ^d (L/s)	Vrunoff ^e (m ³)	Vused ^f (m ³)	Qstored ^g (L/s)	Qrelease ^h (L/s)
	10	179	433	202	231	138	37	62	371
	20	120	291	202	89	106	37	62	229
	30	92	223	202	21	37	37	62	161
	40	75	182	182	0	0	0	0	182
	50	64	155	155	0	0	0	0	155
	60	56	135	135	0	0	0	0	135
	70	50	121	121	0	0	0	0	121
	80	45	109	109	0	0	0	0	109
	90	41	100	100	0	0	0	0	100
	100	38	92	92	0	0	0	0	92
	110	35	85	85	0	0	0	0	85
	120	33	80	80	0	0	0	0	80

5-YEAR Modified Rational Method for Uncontrolled Areas to Outlet 2				
Subdrainage Areas: C109A & C109B			Outlet: Tributary to Collector Road and Outlet 2	
Area (ha): 1.48			Storage: Collector Roadway	
C: 0.47			Vavailable ^a (m ³): 37.10	
	tc (min)	I (5 yr) (mm/hr)	Qactual (L/s)	Qminor ^c (L/s)
	10	104	202	202
	20	70	136	136
	30	54	105	105
	40	44	86	86
	50	38	73	73
	60	33	64	64
	70	29	57	57
	80	27	52	52
	90	24	47	47
	100	22	43	43
	110	21	40	40
	120	19	38	38

100-YEAR Modified Rational Method for Uncontrolled Areas to Outlet 2				
Subdrainage Areas: C109A & C109B			Outlet: Tributary to Collector Road and Outlet 2	
Area (ha): 1.48			Storage: Roadway	
C ^b : 0.59			Vavailable ^a (m ³): 37.10	
	tc (min)	I (100 yr) (mm/hr)	Qactual (L/s)	Qminor ^c (L/s)
	10	179	338	338
	20	120	227	227
	30	92	174	174
	40	75	142	142
	50	64	121	121
	60	56	106	106
	70	50	94	94
	80	45	85	85
	90	41	78	78
	100	38	72	72
	110	35	67	67
	120	33	62	62

5-YEAR Modified Rational Method for Uncontrolled Areas to Outlet 2				
Subdrainage Areas: C109A & C109B			Outlet: Tributary to Collector Road and Outlet 2	
Area (ha): 1.48			Storage: Collector Roadway	
C: 0.47			Vavailable ^a (m ³): 37.10	
	tc (min)	I (5 yr) (mm/hr)	Qactual (L/s)	Qminor ^c (L/s)
	10	104	202	202
	20	70	136	136
	30	54	105	105
	40	44	86	86
	50	38	73	73
	60	33	64	64
	70	29	57	57
	80	27	52	52
	90	24	47	47
	100	22	43	43
	110	21	40	40
	120	19	38	38

Stormwater Management MRM Calculations

Modified Rational Method Calculations for Post-Development Storage Requirements

2-YEAR	
Notes:	
<p>a. Post-development release rate of all events up to and including the 100-year event are controlled in the Block areas to 50 L/s/ha (the 5-year predevelopment release rate).</p> <p>b. C-value escalated by 25%</p> <p>c. The Qcontrol is the total controlled release rate from the Block sites to meet the 50 L/s/ha restricted release criteria (5-year pre-development release rate). Storage is to be provided on each Block site to allow for Qcontrol. Block onsite storage methods may include rooftop storage, cistern(s) located in the underground parking areas; underground tanks or oversized pipes; surface storage; or a combination thereof, to be determined at detailed design when a dynamic model will be used to evaluate the storage requirements. For individual Block areas in the summary, Qcontrol is the target release rate for the site based on the 50L/s/ha discharge criteria. It is calculated as: Qcontrol = 50L/s/ha *Gross Block Area.</p> <p>d. Qactual is the release rate as calculated by the rational method for each time step. For the individual Blocks in the summary, tc=20min is used for the 5-year and tc=40min is used for the 100-year Qactual calculations as this was when the peak storage occurred for the combined Block areas.</p> <p>e. Qminor is the combined release rate from all Block sites that is discharged to the minor system. If Qactual>Qcontrol, Qminor = Qcontrol If Qactual<Qcontrol, Qminor = Qactual</p> <p>f. Qstored represents the difference between the incoming (Qactual) and outgoing (Qrelease) flow rates.</p> <p>g. Vstored is the cumulative volume of water that must be stored onsite at each time step. Vstored =Qstored*tc*60(s/min)=1000(L/m³)</p> <p>h. RSR is the anticipated Required Storage Rate for each block. Block configurations (areas attributed to buildings/roofs vs. landscaping) can be changed at detailed design/Site Plan control, sufficient storage must be provided onsite to meet the target release rate of 50L/s/ha. These RSR values provide an example of what the storage rates could be for each block. RSR=Vstored+Gross Area, and is rounded up to the nearest integer.</p>	

5-YEAR	
Notes:	
<p>a. Available volume on local road is estimated to be 50m³/ha.</p> <p>b. C-value escalated by 25%</p> <p>c. Minor system on local road is controlled to the 2-year post-development rate</p> <p>d. Major system flows are calculated by Qactual-Qminor. If Qactual<Qminor, no major flows.</p> <p>e. Vrunoff is the volume of major system runoff. It is calculated by: Vrunoff =Qmajor*tc*60(s/min)=1000(L/m³)</p> <p>f. Vused is the actual volume of major system runoff stored in the roadway If Vrunoff>Vavailable, Vused = Vavailable If Vrunoff<Vavailable, Vused = Vrunoff</p> <p>g. Qstored is the equivalent flow rate of the Vused. It is calculated by: Qstored =Vused+[tc*60(s/min)]*1000(L/m³)</p>	

100-YEAR	
Notes:	
<p>a. Available volume on collector road is estimated to be 25m³/ha</p> <p>b. C-value escalated by 25%</p> <p>c. Minor system on collector road is controlled to the 5-year post-development rate</p> <p>d. Major system flows are calculated by Qactual-Qminor. If Qactual<Qminor, no major flows.</p> <p>e. Vrunoff is the volume of major system runoff. It is calculated by: Vrunoff =Qmajor*tc*60(s/min)=1000(L/m³)</p> <p>f. Vused is the actual volume of major system runoff stored in the roadway If Vrunoff>Vavailable, Vused = Vavailable If Vrunoff<Vavailable, Vused = Vrunoff</p> <p>g. Qstored is the equivalent flow rate of the Vused. It is calculated by: Qstored =Vused+[tc*60(s/min)]*1000(L/m³)</p>	

5-YEAR Modified Rational Method for Block Areas							
Subdrainage Areas: BLOCKS (A,B,C,D,E, & F)			Outlet: Tributary to Outlet 1				
Area (ha):	3.49	Qrelease (L/s/ha) ^a :	50				
C:	0.35	Qcontrol (L/s) ^c :	174.50				
tc (min)	I (5 yr) (mm/hr)	Qactual ^d (L/s)	Qminor ^e (L/s)	Qstored ^f (L/s)	Vstored ^g (m ³)		
10	104	354	175	179	108		
20	70	239	175	64	77		
30	54	183	175	9	16		
40	44	150	150	0	0		
50	38	128	128	0	0		
60	33	112	112	0	0		
70	29	100	100	0	0		
80	27	90	90	0	0		
90	24	82	82	0	0		
100	22	76	76	0	0		
110	21	71	71	0	0		
120	19	66	66	0	0		
Summary of 5-Year Block Storage							
Block	Area (ha)	C	Qactual ^d (L/s)	Qcontrol ^c (L/s)	Qstored ^f (L/s)	Vstored ^g (m ³)	RSR ^h (m ³ /ha)
A	0.88	0.60	103	44	59	71	81
B	0.75	0.74	109	38	71	86	114
C	0.48	0.75	70	24	46	55	116
D	0.22	0.65	28	11	17	21	93
E	0.43	0.81	68	22	46	56	129
F	0.74	0.59	85	37	48	57	78

5-YEAR Modified Rational Method for Common Areas									
Subdrainage Areas: EX-1, EX-2, L110A, L104A, L102C, L102A, L102E, L101A, & L100A					Outlet: Tributary to Outlet 1				
Area (ha):	2.75				Storage: Local Roadways				
C:	0.61				Vavailable ^a (m ³): 64.44				
Roadway Area (ha):	1.29								
tc (min)	I (5 yr) (mm/hr)	Q (5 yr) (L/s)	I (2 yr) (mm/hr)	Q (2 yr) (L/s)	Qminor ^c (L/s)	Qmajor ^d (L/s)	Vrunoff ^e (m ³)	Vused ^f (m ³)	Qstored ^g (L/s)
10	104	489	77	361	129	77	64	107	
20	70	330	52	244	330	0	0	0	
30	54	253	40	188	253	0	0	0	
40	44	207	33	154	207	0	0	0	
50	38	177	28	132	177	0	0	0	
60	33	155	25	115	155	0	0	0	
70	29	138	22	103	138	0	0	0	
80	27	125	20	93	125	0	0	0	
90	24	114	18	85	114	0	0	0	
100	22	105	17	79	105	0	0	0	
110	21	98	16	73	98	0	0	0	
120	19	91	15	68	91	0	0	0	

100-YEAR Modified Rational Method for Common Areas							
Subdrainage Areas: EX-1, EX-2, L110A, L104A, L102C, L102A, L102E, L101A, & L100A				Outlet: Tributary to Outlet 1			
Area (ha):	2.75			Storage: Local Roadways			
C ^b :	0.77			Vavailable ^a (m ³): 64.44			
Roadway Area (ha):	1.29						
tc (min)	I (100 yr) (mm/hr)	Q(100 yr) (L/s)	Qminor ^c (L/s)	Qmajor ^d (L/s)	Vrunoff ^e (m ³)	Vused ^f (m ³)	Qstored ^g (L/s)
10	179	1048	361	687	412	64	107
20	120	704	361	343	412	64	107
30	92	539	361	179	321	64	107
40	75	441	361	80	193	64	107
50	64	375	361	15	44	44	74
60	56	328	328	0	0	0	0
70	50	292	292	0	0	0	0
80	45	264	264	0	0	0	0
90	41	241	241	0	0	0	0
100	38	222	222	0	0	0	0
110	35	207	207	0	0	0	0
120	33	193	193	0	0	0	0

100-YEAR Modified Rational Method for Block Areas							
Subdrainage Areas: BLOCKS (A,B,C,D,E, & F)			Outlet: Tributary to Outlet 1				
Area (ha):	3.49	Qrelease (L/s/ha) ^a :	50				
C ^b :	0.88	Qcontrol (L/s) ^c :	174.50				
tc (min)	I (100 yr) (mm/hr)	Qactual ^d (L/s)	Qminor ^e (L/s)	Qstored ^f (L/s)	Vstored ^g (m ³)		
10	179	1516	175	1341	805		
20	120	1018	175	844	1013		
30	92	780	175	605	1090		
40	75	638	175	463	1112		
50	64	543	175	368	1105		
60	56	475	175	300	1080		
70	50	423	175	248	1042		
80	45	382	175	207	996		
90	41	349	175	175	942		
100	38	322	175	147	884		
110	35	299	175	124	821		
120	33	279	175	105	754		
Summary of 100-Year Block Storage							
Block	Area (ha)	C ^b (100-yr)	Qactual ^d (L/s)	Qcontrol ^c (L/s)	Qstored ^f (L/s)	Vstored ^g (m ³)	RSR ^h (m ³ /ha)
A	0.88	0.75	138	44	94	113	128
B	0.75	0.93	146	38	108	130	173
C	0.48	0.94	94	24	70	84	175
D	0.22	0.82	38	11	27	32	145
E	0.43	1.00	90	22	69	82	191
F	0.74	0.73	114	37	77	92	124

100-YEAR Modified Rational Method for Common Areas									
Subdrainage Areas: EX-1, EX-2, L110A, L104A, L102C, L102A, L102E, L101A, & L100A					Outlet: Tributary to Outlet 1				
Area (ha):	2.75				Storage: Local Roadways				
C ^b :	0.77				Vavailable ^a (m ³): 64.44				
Roadway Area (ha):	1.29								
tc (min)	I (100 yr) (mm/hr)	Q(100 yr) (L/s)	Qminor ^c (L/s)	Qmajor ^d (L/s)	Vrunoff ^e (m ³)	Vused ^f (m ³)	Qstored ^g (L/s)		
10	179	1048	361	687	412	64	107		
20	120	704	361	343	412	64	107		
30	92	539	361	179	321	64	107		
40	75	441	361	80	193	64	107		
50	64	375	361	15	44	44	74		
60	56	328	328	0	0	0	0		
70	50	292	292	0	0	0	0		
80	45	264	264	0	0	0	0		
90	41	241	241	0	0	0	0		
100	38	222	222	0	0	0	0		
110	35	207	207	0	0	0	0		
120	33	193	193	0	0	0	0		

100-YEAR Modified Rational Method for Common Areas							
Subdrainage Areas: C106A & C105A				Outlet: Tributary to Outlet 1			
Area (ha):	0.72			Storage: Collector Roadway			
C ^b :	0.87			Vavailable ^a (m ³): 18.09			
tc (min)	I (100 yr) (mm/hr)	Qactual (L/s)	Qminor ^c (L/s)	Qmajor ^d (L/s)	Vrunoff ^e (m ³)	Vused ^f (m ³)	Qstored ^g (L/s)
10	179	311	145	166	99	18	30
20	120	209	145	64	76	18	30
30	92	160	145	15	27	18	30
40	75	131	131	0	0	0	0
50	64	111	111	0	0	0	0
60	56	97	97	0	0	0	0
70	50	87	87	0	0	0	0
80	45	78	78	0	0	0	0
90	41	72	72	0	0	0	0
100	38	66	66	0	0	0	0
110	35	61	61	0	0	0	0
120	33	57	57	0	0	0	0

Stormwater Management MRM Calculations

Modified Rational Method Calculations for Post-Development Storage Requirements

2-YEAR

Notes:

- C-value escalated by 25%
- Qactual - rational method calculation for runoff for entire Outlet 1 tributary area.
- Qminor is the sum of the minor flows from all Outlet 1 tributary areas.
- Qmajor is the sum of the major flows from all Outlet 1 tributary areas.
- Qallowable is the target release rate for the site less the peak release rates from the uncontrolled areas and areas to Outlet 2.
- Qrelease is the rate of discharge from the control structure (combination of circular orifice and rectangular weir). Qrelease was determined iteratively using the stage-storage-discharge curve/table for the control structure.
- Qstored represents the difference between the incoming (Qactual) and outgoing (Qrelease) flow rates.
- Vstored is the cumulative volume of water that must be stored at each time step.
 $V_{stored} = Q_{stored} \times t_c \times 60 (s/min) \div 1000 (L/m^3)$
- Head represents the water level above the invert of the outlet (in this case, the invert of the circular orifice.) It is determined by interpolating the stage-storage-discharge table.

Control Structure Stage-Storage-Discharge Curve

Stage-Storage-Discharge Curve for Control Structure

Stage (Head) (m)	Storage		Discharge (L/s)		
	Rectangular Weir (m)	Volume (m³)	Orifice dia. (mm)	Weir width (mm)	Orifice and Weir
0.10	0	60	77.58	0.00	77.58
0.20	0	164	109.71	0.00	109.71
0.30	0	268	134.37	0.00	134.37
0.40	0	370	155.15	0.00	155.15
0.50	0	471	173.47	0.00	173.47
0.60	0	570	190.02	0.00	190.02
0.70	0	667	205.25	0.00	205.25
0.80	0	763	219.42	0.00	219.42
0.90	0	857	232.73	0.00	232.73
1.0	0	950	245.32	0.00	245.32
1.1	0.1	1040	257.29	43.91	301.20
1.2	0.2	1128	268.73	124.20	392.93
1.3	0.3	1195	279.70	228.18	507.88
1.4	0.4	1245	290.26	351.30	641.56
1.5	0.5	1290	300.45	490.96	791.41

Cd

0.61

Cd

0.57

5-YEAR

5-YEAR Modified Rational Method for Dry Pond

Subdrainage Areas: All Areas Tributary to Outlet 1: BLOCKS (A,B,C,D,E, & F), EX-1, EX-2, L110A, L104A, L102C, L102A, L102E, L101A, L100A, C106A, & C105A

Area (ha): 6.96 Vavailable^a (m³): 1290 Outlet: Tributary to Outlet 1
C: 0.49 Storage: Dry Pond

tc (min)	I (5 yr) (mm/hr)	Qactual ^b (L/s)	Qminor ^c (L/s)	Qmajor ^d (L/s)	Qallowable ^e (L/s)	Qrelease ^f (L/s)	Qstored ^g (L/s)	Vstored ^h (m³)	Head ⁱ (m)
10	104	988	680	129	187	159	650	390	0.42
20	70	666	602	0	305	179	423	507	0.54
30	54	511	503	0	361	189	314	564	0.59
40	44	419	419	0	395	188	231	555	0.59
50	38	357	357	0	417	182	175	524	0.55
60	33	312	312	0	433	176	136	489	0.52
70	29	278	278	0	446	170	108	454	0.48
80	27	252	252	0	456	164	88	420	0.45
90	24	230	230	0	463	158	72	388	0.42
100	22	212	212	0	470	153	60	358	0.39
110	21	197	197	0	475	147	50	331	0.36
120	19	185	185	0	480	142	42	306	0.34

Control: Orifice
Circular Orifice Equation: $Q = C_d A (2gh)^{0.5}$
Where C_d = coefficient 0.61
A = orifice area (m²) 0.091
g = gravitational constant (m/s²) 9.81
h = head (m) varies

Storage: Dry Pond

5-year total storage required (m³)	564
Orifice diameter (mm)	340
Orifice invert above storage bottom (mm)	0
Minimum depth of storage required (m)	0.59
Surface storage used on collector and local streets (m³)	64
5-year storage required in Dry Pond (m³)	500

2.58 Factor of Safety

Storage area provided (m²)	1084
Depth of storage provided (m)	1.50
Dry pond storage capacity provided (m³)	1290

OK
OK

5-YEAR SUMMARY

Areas Tributary to Outlet 1	6.96 ha		
Release Rate Outlet 1 @ Tc=10min	159 L/s	Tc = 30 min	189 L/s
Areas Tributary to Outlet 2	1.48 ha		
Peak Release Rate Outlet 2 (@Tc=10min)	202 L/s	Tc = 30 min	105 L/s
Non-Tributary Areas	2.14 ha		
Peak Release Rate Non-Tributary Areas (@Tc=10min)	158 L/s	Tc = 30 min	82 L/s
Total Site Area	10.58 ha		
Total 5yr Release Rate from Entire Site	519 L/s		375 L/s
Target	547 L/s	OK	547 L/s

OK

100-YEAR

100-YEAR Modified Rational Method for Dry Pond

Subdrainage Area: All Areas Tributary to Outlet 1: BLOCKS (A,B,C,D,E, & F), EX-1, EX-2, L110A, L104A, L102C, L102A, L102E, L101A, L100A, C106A, & C105A

Area (ha): 6.96 Vavailable^a (m³): 1290 Outlet: Tributary to Outlet 1
C: 0.61 Storage: Dry Pond

tc (min)	I (100 yr) (mm/hr)	Qactual ^b (L/s)	Qminor ^c (L/s)	Qmajor ^d (L/s)	Qallowable ^e (L/s)	Qrelease ^f (L/s)	Qstored ^g (L/s)	Vstored ^h (m³)	Head ⁱ (m)
10	179	2116	680	853	223	223	1310	786	0.82
20	120	1422	680	407	476	267	820	984	1.04
30	92	1089	680	193	598	298	575	1035	1.09
40	75	891	666	80	608	309	437	1048	1.11
50	64	758	646	15	656	311	350	1050	1.11
60	56	662	600	0	691	309	291	1047	1.11
70	50	590	553	0	717	305	248	1043	1.10
80	45	533	517	0	738	300	216	1039	1.10
90	41	487	487	0	755	296	191	1032	1.09
100	38	449	463	0	769	292	171	1025	1.08
110	35	417	442	0	780	288	154	1019	1.08
120	33	390	425	0	790	284	141	1012	1.07

Control: Orifice and Weir
Rectangular Weir Equation: $Q = (2/3) C_d b (2g)^{1/2} h^{3/2}$
Where C_d = coefficient 0.57
b = weir width (m) 0.83
g = gravitational constant (m/s²) 9.81
h = head (m) varies

Storage: Dry Pond

100-year total storage required (m³)	1050
Width of rectangular weir (mm)	825
Rectangular weir invert above storage bottom (mm)	1000
Minimum depth of storage required (m)	1.11
Surface storage used on collector and local streets (m³)	83
100-year storage required in Dry Pond (m³)	967

120 Available
1.33 Factor of Safety

Storage area provided (m²)	1084
Depth of storage provided (m)	1.50
Dry pond storage capacity provided (m³)	1290

OK
OK

100-YEAR SUMMARY

Areas Tributary to Outlet 1	6.96 ha		
Release Rate Outlet 1 @ Tc=10min	223 L/s	Tc = 30 min	298 L/s
Areas Tributary to Outlet 2	1.48 ha		
Peak Release Rate Outlet 2 (@Tc=10min)	371 L/s	Tc = 30 min	202 L/s
Non-Tributary Areas	2.14 ha		
Peak Release Rate Non-Tributary Areas (@Tc=10min)	338 L/s	Tc = 30 min	174 L/s
Total Site Area	10.58 ha		
Total 100yr Release Rate from Entire Site	932 L/s		674 L/s
Target	932 L/s	OK	932 L/s

OK

FUNCTIONAL SITE SERVICING AND STORMWATER MANAGEMENT REPORT REV.03 – 1987 ROBERTSON ROAD (STILLWATER STATION)

Appendix C Stormwater Management Calculations
February 28, 2024

C.4.4 Example of Modified Rational Method Calculations for Block Onsite Stormwater Management (Block A)



Stormwater Management Calculations

File No: 160401686
 Project: 1987 Robertson Road (Stillwater Station) - Block A
 Date: 27-Feb-2024

Created By: AG
 Checked By: NC
 Revision: 2

SWM Approach:
 Post-development to Predetermined Release Rate (50L/s/ha)

Block A Post-Development Site Conditions:

Overall Runoff Coefficient for Block A Site and Sub-Catchment Areas

Runoff Coefficient Table									
Catchment Type	Sub-catchment Area	ID / Description		Area (ha) "A"		Runoff Coefficient "C"		"A x C"	Overall Runoff Coefficient
Controlled - Tributary to Onsite Storage		L104C	Hard	0.165		0.9		0.148	
			Soft	0.315		0.2		0.063	
		Subtotal			0.480			0.211	0.44
Roof		R104B	Hard	0.093		0.9		0.083	
			Soft	0.000		0.2		0.000	
		Subtotal			0.093			0.083	0.90
Roof		R104A	Hard	0.164		0.9		0.148	
			Soft	0.000		0.2		0.000	
		Subtotal			0.164			0.148	0.90
Roof		R106A	Hard	0.125		0.9		0.113	
			Soft	0.000		0.2		0.000	
		Subtotal			0.125			0.113	0.90
Total					0.862			0.555	
								0.64	

Overall Runoff Coefficient= C:

Total Roof Areas	0.38 ha
Total Controlled Tributary Surface Areas	0.48 ha
Total Uncontrolled Tributary Surface Areas	0.00 ha
<hr/> Total Tributary Area to Outlet	<hr/> 0.86 ha
 Total Uncontrolled Areas (Non-Tributary)	 0.00 ha
 <hr/> Total Block A Site	 <hr/> 0.86 ha

Roof Drain Design Calculation Sheet

Rating Curve				Volume Estimation				Water Depth (m)
Elevation (m)	Discharge Rate (cu.m/s)	Outlet Discharge (cu.m/s)	Storage (cu. m)	Elevation (m)	Area (sq. m)	Volume (cu. m)		
						Increment	Accumulated	
0.000	0.00000	0.000	0.00	0.000	0	0.00	0.00	0.000
0.025	0.00032	0.004	0.71	0.025	84.86	0.71	0.71	0.025
0.050	0.00063	0.009	5.66	0.050	339.45	4.95	5.66	0.050
0.075	0.00079	0.011	19.09	0.075	763.77	13.44	19.09	0.075
0.100	0.00095	0.013	45.26	0.100	1357.81	26.17	45.26	0.100
0.125	0.00110	0.015	88.40	0.125	2121.57	43.14	88.40	0.125
0.150	0.00126	0.018	152.75	0.150	3055.06	64.35	152.75	0.150

Drawdown Estimate			
Total Volume (cu.m)	Total Time (sec)	Vol (cu.m)	Detention Time (hr)
0.0	0.0	0.0	0
5.0	560.5	5.0	0.1557
18.4	1217.1	13.4	0.49379
44.6	1975.2	26.2	1.04245
87.7	2791.2	43.1	1.81777
152.0	3643.4	64.4	2.82983

Rooftop Storage Summary			
Total Building Area (sq.m)			3818.83
Assume Available Roof Area (sq.m)	80%		3055.064
Roof Imperviousness			0.99
Roof Drain Requirement (sq.m/Notch)			232
Number of Roof Notches*			14
Max. Allowable Depth of Roof Ponding (m)			0.15
Max. Allowable Storage (cu.m)			153
Estimated 100 Year Drawdown Time (h)			2.8

* As per Ontario Building Code section OBC 7.4.10.4.(2)(c).

* Note: Number of drains can be reduced if multiple-notch drain used.

Adjustable Accutrol Weir Flow Rate Settings From Watts Drain Catalogue					
Head (m)	L/s				
	Open	75%	50%	25%	Closed
0.025	0.31542	0.31542	0.31542	0.31542	0.31542
0.05	0.63083	0.63083	0.63083	0.63083	0.31542
0.075	0.94625	0.8674	0.78854	0.70969	0.31542
0.1	1.26167	1.10396	0.94625	0.78854	0.31542
0.125	1.57708	1.34052	1.10396	0.8674	0.31542
0.15	1.8925	1.57708	1.26167	0.94625	0.31542

Calculation Results	5yr	100yr	Available
Qresult (cu.m/s)	0.014	0.018	-
Depth (m)	0.113	0.149	0.150
Volume (cu.m)	66.9	150.9	152.8
Draintime (hrs)	1.4	2.8	

Stormwater Management Calculations

Modified Rational Method Calculations for Storage Block A

5-year Intensity City of Ottawa	$I = a/(t + b)^c$	a =	998.071	t (min)	I (mm/hr)
		b =	6.053	10	104.19
		c =	0.814	20	70.25
				30	53.93
			40	44.18	
			50	37.65	
			60	32.94	
			70	29.37	
			80	26.56	
			90	24.29	
			100	22.41	
			110	20.82	
			120	19.47	

100-yr Intensity City of Ottawa	$I = a/(t + b)^c$	a =	1735.688	t (min)	I (mm/hr)
		b =	6.014	10	178.56
		c =	0.820	20	119.95
				30	91.87
			40	75.15	
			50	63.95	
			60	55.89	
			70	49.79	
			80	44.99	
			90	41.11	
			100	37.90	
			110	35.20	
			120	32.89	

5-YEAR Predevelopment Target Release for Block Area

Subdrainage Area: Block A
Area (ha): 0.862
C: 0.64

tc (min)	Qrelease (L/s/ha)	Qtarget (L/s)
30	50	43.1

100-YEAR Predevelopment Target Release for Block Area

Subdrainage Area: Block A
Area (ha): 0.862
C: 0.64

tc (min)	Qrelease (L/s/ha)	Qtarget (L/s)
30	50	43.1

5-YEAR Post-Development Modified Rational Method for Block A

Subdrainage Area: L104C
Area (ha): 0.48
C: 0.44
Controlled - Tributary to Onsite Storage

tc (min)	I (5 yr) (mm/hr)	Qactual (L/s)	Qrelease (L/s)	Qstored (L/s)	Vstored (m ³)
10	104.19	61	25	36	21
20	70.25	41	25	16	19
30	53.93	32	25	6	11
40	44.18	26	25	0	1
50	37.65	22	22	0	0
60	32.94	19	19	0	0
70	29.37	17	17	0	0
80	26.56	16	16	0	0
90	24.29	14	14	0	0
100	22.41	13	13	0	0
110	20.82	12	12	0	0
120	19.47	11	11	0	0

100-YEAR Post-Development Modified Rational Method for Block A

Subdrainage Area: L104C
Area (ha): 0.862
C: 0.55
Controlled - Tributary to Onsite Storage

tc (min)	I (100 yr) (mm/hr)	Qactual (L/s)	Qrelease (L/s)	Qstored (L/s)	Vstored (m ³)
10	178.56	131	25	106	63
20	119.95	88	25	63	75
30	91.87	67	25	42	75
40	75.15	55	25	30	71
50	63.95	47	25	21	64
60	55.89	41	25	16	56
70	49.79	37	25	11	46
80	44.99	33	25	8	36
90	41.11	30	25	5	25
100	37.90	28	25	2	14
110	35.20	26	25	0	2
120	32.89	24	24	0	0

Storage: Block A Onsite

Design Discharge		Onsite Storage			
Storage ¹ (L/s)	Roof (L/s)	5-year Vreq (m ³)	Vavail (m ³)	Volume Check	Excess Volume (m ³)
25	14	21	76	OK	55

Storage: Block A Onsite

Design Discharge		Onsite Storage				Theoretical Footprint ² (m ²)
Storage ¹ (L/s)	Roof (L/s)	100-year Vreq (m ³)	Vminimum (m ³)	Volume Check	Excess Volume (m ³)	
25	17.6	75	76	OK	0.5	51

Notes:

- A submersible pump may be required to provide constant release rate. This will be revisited at detailed design when a dynamic model will be used to evaluate the storage requirements.
- The theoretical footprint for the onsite storage assumes a 1.5m depth of storage. Onsite storage methods may include cistern(s) located in the underground parking area, underground tank/oversized pipes, surface storage, or a combination thereof, to be determined at detailed design when a dynamic model will be used to evaluate the storage requirements.

Subdrainage Area: R104A, R104B, R106A
Area (ha): 0.38
C: 0.90
Maximum Storage Depth: 150 mm
Roof

tc (min)	I (5 yr) (mm/hr)	Qactual (L/s)	Qrelease (L/s)	Qstored (L/s)	Vstored (m ³)	Depth (mm)
10	104.19	100	14	86	52	104
20	70.25	67	14	53	64	111
30	53.93	52	14	37	67	113
40	44.18	42	14	28	67	113
50	37.65	36	14	22	65	112
60	32.94	31	14	17	62	110
70	29.37	28	14	14	59	108
80	26.56	25	14	12	56	106
90	24.29	23	14	10	52	104
100	22.41	21	13	8	48	102
110	20.82	20	13	7	44	99
120	19.47	19	13	6	41	96

Storage: Roof Storage

Depth (mm)	Head (m)	Discharge (L/s)	Vreq (cu. m)	Vavail (cu. m)	Discharge Check
113	0.11	14	67	153	0.00

5-year Water Level

Subdrainage Area: R104B
Area (ha): 0.38
C: 1.00
Maximum Storage Depth: 150 mm
Roof

tc (min)	I (100 yr) (mm/hr)	Qactual (L/s)	Qrelease (L/s)	Qstored (L/s)	Vstored (m ³)	Depth (mm)
10	178.56	190	16	174	104	131
20	119.95	127	17	110	132	142
30	91.87	98	17	80	144	147
40	75.15	80	18	62	149	149
50	63.95	68	18	50	151	149
60	55.89	59	18	42	150	149
70	49.79	53	18	35	148	148
80	44.99	48	17	30	146	147
90	41.11	44	17	26	142	146
100	37.90	40	17	23	138	144
110	35.20	37	17	20	134	143
120	32.89	35	17	18	130	141

Storage: Roof Storage

Depth (mm)	Head (m)	Discharge (L/s)	Vreq (cu. m)	Vavail (cu. m)	Discharge Check
149	0.15	18	151	153	0.00

100-year Water Level

SUMMARY TO OUTLET

Release Rates		Storage Roof:	
Area Tributary to Outlet 1	0.862 ha	Vestimated	Vavailable*
5yr Flow from Roof	14 L/s	67	153
5yr Flow from Onsite Storage	25 L/s		OK
Discharge to Minor System (Outlet 1)	40 L/s		
Non-Tributary Area		Total:	
Total 5yr Flow Uncontrolled	0.000 ha	Vrequired	Vavailable*
	0.0 L/s	88	229
			OK
Total Area	0.862 ha		
Total 5yr Flow from Site	40 L/s		
Overall Target Release from Site	43 L/s		
	OK		

SUMMARY TO OUTLET

Release Rates		Storage Roof:	
Area Tributary to Outlet 1	0.862 ha	Vestimated	Vavailable*
100yr Flow from Roof	18 L/s	151	153
100yr Flow from Onsite Storage	25 L/s		OK
Discharge to Minor System (Outlet 1)	43 L/s		
Non-Tributary Area		Total:	
Total 100yr Flow Uncontrolled	0.000 ha	Vrequired	Vavailable*
	0.00 L/s	226	229
			OK
Total Area	0.862 ha		
Total 100yr Flow from Site	43 L/s		
Overall Target Release from Site	43 L/s		RSR:
	OK		263

Storage Rate Achieved in Block A

FUNCTIONAL SITE SERVICING AND STORMWATER MANAGEMENT REPORT REV.03 – 1987 ROBERTSON ROAD (STILLWATER STATION)

Appendix C Stormwater Management Calculations
February 28, 2024

C.5 PRELIMINARY OIL- GRIT SEPARATOR SIZING



Stormceptor® EF Sizing Report

Imbrium® Systems

ESTIMATED NET ANNUAL SEDIMENT (TSS) LOAD REDUCTION

02/29/2024

Province:	Ontario
City:	Ottawa
Nearest Rainfall Station:	OTTAWA CDA RCS
Climate Station Id:	6105978
Years of Rainfall Data:	20

Project Name:	Stillwater Station
Project Number:	160401686
Designer Name:	Alyssa Gladish
Designer Company:	Stantec Consulting Ltd.
Designer Email:	alyssa.gladish@stantec.com
Designer Phone:	587-721-1241
EOR Name:	Neal Cody
EOR Company:	Stantec Consulting Ltd.
EOR Email:	neal.cody@stantec.com
EOR Phone:	780-884-9523

Site Name:	Outlet 1 (HW1)
Drainage Area (ha):	6.96
Runoff Coefficient 'c':	0.67

Particle Size Distribution:	Fine
Target TSS Removal (%):	80.0

Required Water Quality Runoff Volume Capture (%):	90.00
Estimated Water Quality Flow Rate (L/s):	150.51
Oil / Fuel Spill Risk Site?	Yes
Upstream Flow Control?	Yes
Upstream Orifice Control Flow Rate to Stormceptor (L/s):	527.30
Peak Conveyance (maximum) Flow Rate (L/s):	
Influent TSS Concentration (mg/L):	
Estimated Average Annual Sediment Volume (L/yr):	4036

Net Annual Sediment (TSS) Load Reduction Sizing Summary	
Stormceptor Model	TSS Removal Provided (%)
EFO4	41
EFO6	57
EFO8	69
EFO10	77
EFO12	85

Recommended Stormceptor EFO Model:	EFO12
Estimated Net Annual Sediment (TSS) Load Reduction (%):	85
Water Quality Runoff Volume Capture (%):	> 90

THIRD-PARTY TESTING AND VERIFICATION

► **Stormceptor® EF and Stormceptor® EFO** are the latest evolutions in the Stormceptor® oil-grit separator (OGS) technology series, and are designed to remove a wide variety of pollutants from stormwater and snowmelt runoff. These technologies have been third-party tested in accordance with the Canadian ETV **Procedure for Laboratory Testing of Oil-Grit Separators** and performance has been third-party verified in accordance with the **ISO 14034 Environmental Technology Verification (ETV)** protocol.

PERFORMANCE

► **Stormceptor® EF and EFO** remove stormwater pollutants through gravity separation and floatation, and feature a patent-pending design that generates positive removal of total suspended solids (TSS) throughout each storm event, including high-intensity storms. Captured pollutants include sediment, free oils, and sediment-bound pollutants such as nutrients, heavy metals, and petroleum hydrocarbons. Stormceptor is sized to remove a high level of TSS from the frequent rainfall events that contribute the vast majority of annual runoff volume and pollutant load. The technology incorporates an internal bypass to convey excessive stormwater flows from high-intensity storms through the device without resuspension and washout (scour) of previously captured pollutants. Proper routine maintenance ensures high pollutant removal performance and protection of downstream waterways.

PARTICLE SIZE DISTRIBUTION (PSD)

► The **Canadian ETV PSD** shown in the table below was used, or in part, for this sizing. This is the identical PSD that is referenced in the Canadian ETV **Procedure for Laboratory Testing of Oil-Grit Separators** for both sediment removal testing and scour testing. The Canadian ETV PSD contains a wide range of particle sizes in the sand and silt fractions, and is considered reasonably representative of the particle size fractions found in typical urban stormwater runoff.

Particle Size (µm)	Percent Less Than	Particle Size Fraction (µm)	Percent
1000	100	500-1000	5
500	95	250-500	5
250	90	150-250	15
150	75	100-150	15
100	60	75-100	10
75	50	50-75	5
50	45	20-50	10
20	35	8-20	15
8	20	5-8	10
5	10	2-5	5
2	5	<2	5

Stormceptor® EF Sizing Report

Upstream Flow Controlled Results

Rainfall Intensity (mm / hr)	Percent Rainfall Volume (%)	Cumulative Rainfall Volume (%)	Flow Rate (L/s)	Flow Rate (L/min)	Surface Loading Rate (L/min/m²)	Removal Efficiency (%)	Incremental Removal (%)	Cumulative Removal (%)
0.50	8.6	8.6	6.48	389.0	31.0	100	8.6	8.6
1.00	20.3	29.0	12.96	778.0	62.0	100	20.3	29.0
2.00	16.2	45.2	25.93	1556.0	124.0	93	15.1	44.1
3.00	12.0	57.2	38.89	2333.0	187.0	86	10.3	54.4
4.00	8.4	65.6	51.85	3111.0	249.0	81	6.9	61.2
5.00	5.9	71.6	64.82	3889.0	311.0	78	4.6	65.9
6.00	4.6	76.2	77.78	4667.0	373.0	75	3.5	69.4
7.00	3.1	79.3	90.75	5445.0	436.0	72	2.2	71.6
8.00	2.7	82.0	103.71	6223.0	498.0	70	1.9	73.5
9.00	3.3	85.3	116.67	7000.0	560.0	66	2.2	75.7
10.00	2.3	87.6	129.64	7778.0	622.0	64	1.5	77.2
11.00	1.6	89.2	142.60	8556.0	684.0	64	1.0	78.2
12.00	1.3	90.5	155.56	9334.0	747.0	64	0.8	79.0
13.00	1.7	92.2	168.53	10112.0	809.0	63	1.1	80.1
14.00	1.2	93.5	181.49	10890.0	871.0	63	0.8	80.9
15.00	1.2	94.6	194.46	11667.0	933.0	62	0.7	81.6
16.00	0.7	95.3	207.42	12445.0	996.0	62	0.4	82.0
17.00	0.7	96.1	220.38	13223.0	1058.0	60	0.4	82.5
18.00	0.4	96.5	233.35	14001.0	1120.0	59	0.2	82.7
19.00	0.4	96.9	246.31	14779.0	1182.0	57	0.2	82.9
20.00	0.2	97.1	259.27	15556.0	1245.0	56	0.1	83.1
21.00	0.5	97.5	272.24	16334.0	1307.0	55	0.3	83.3
22.00	0.2	97.8	285.20	17112.0	1369.0	53	0.1	83.4
23.00	1.0	98.8	298.17	17890.0	1431.0	51	0.5	84.0
24.00	0.3	99.1	311.13	18668.0	1493.0	49	0.1	84.1
25.00	0.9	100.0	324.09	19446.0	1556.0	47	0.4	84.5
30.00	0.9	100.9	388.91	23335.0	1867.0	39	0.4	84.9
35.00	-0.9	100.0	453.73	27224.0	2178.0	34	N/A	84.6
40.00	0.0	100.0	518.55	31113.0	2489.0	29	0.0	84.6
45.00	0.0	100.0	527.00	31620.0	2530.0	29	0.0	84.6
Estimated Net Annual Sediment (TSS) Load Reduction =								85 %

Climate Station ID: 6105978 Years of Rainfall Data: 20



Stormceptor[®] EF Sizing Report

RAINFALL DATA FROM OTTAWA CDA RCS RAINFALL STATION

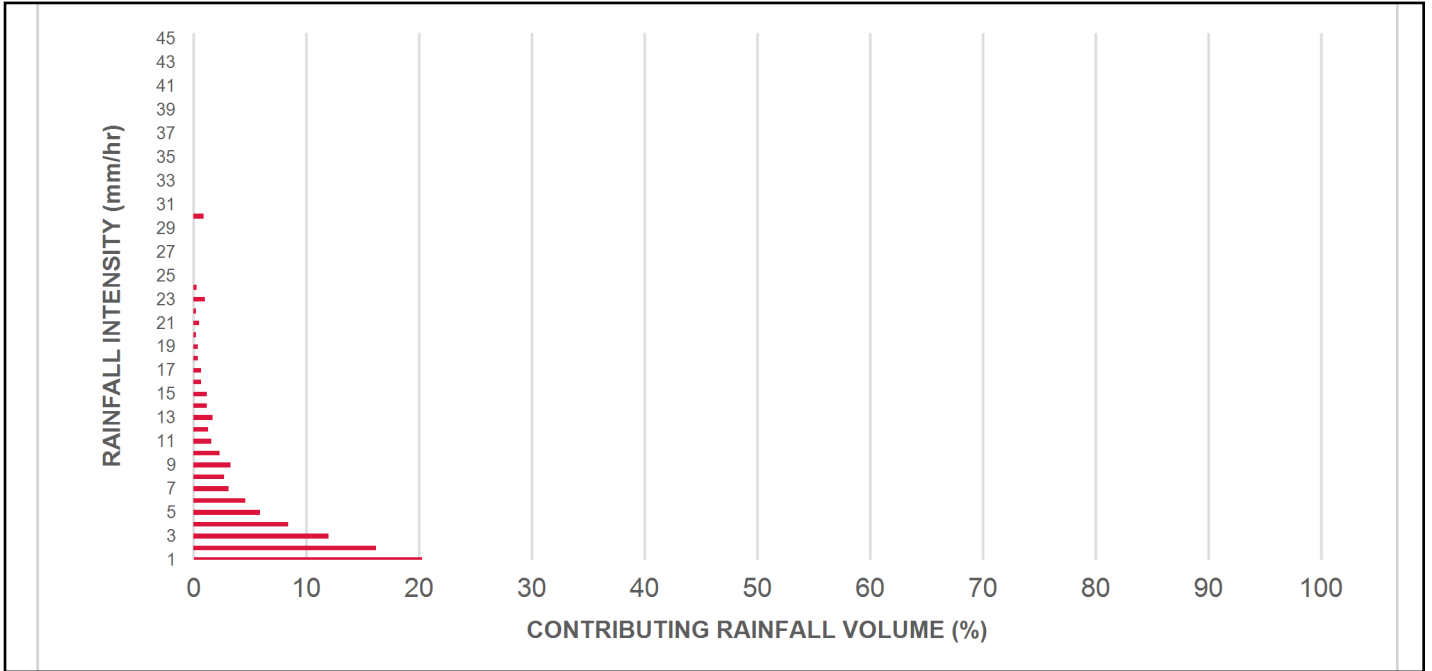

INCREMENTAL AND CUMULATIVE TSS REMOVAL FOR THE RECOMMENDED STORMCEPTOR[®] MODEL

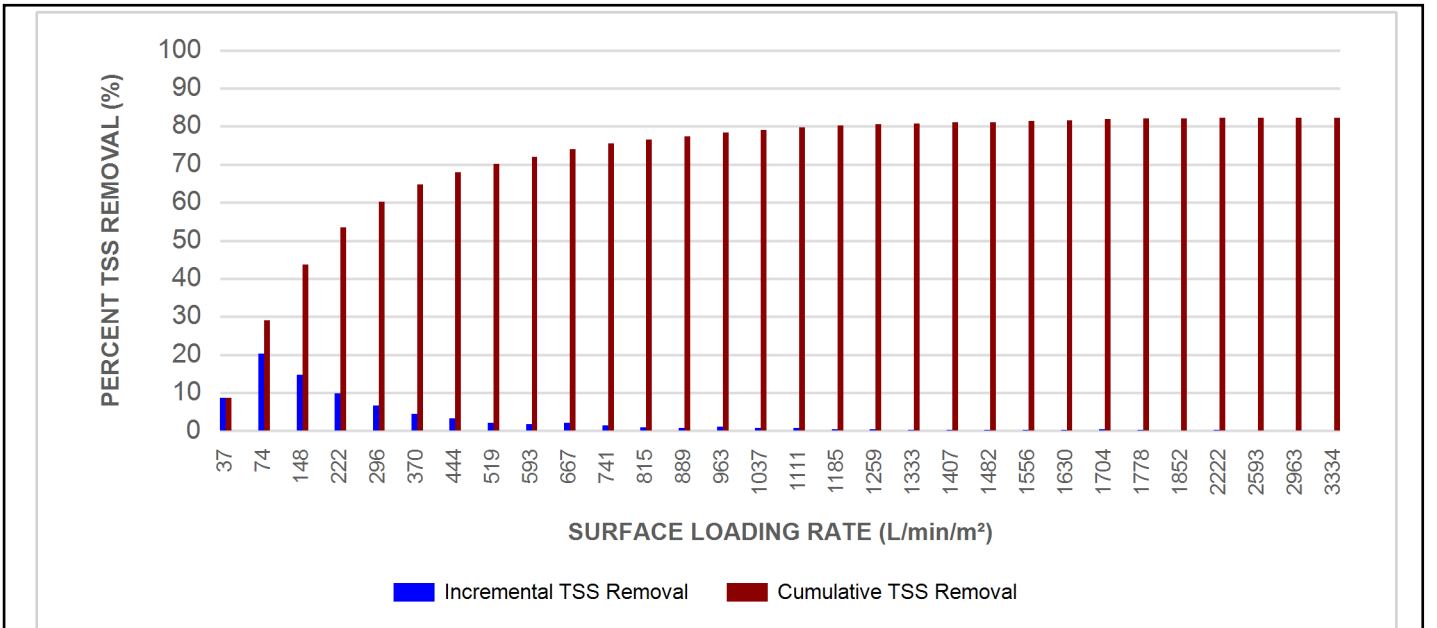

Stormceptor® EF Sizing Report

Maximum Pipe Diameter / Peak Conveyance

Stormceptor EF / EFO	Model Diameter		Min Angle Inlet / Outlet Pipes	Max Inlet Pipe Diameter		Max Outlet Pipe Diameter		Peak Conveyance Flow Rate	
	(m)	(ft)		(mm)	(in)	(mm)	(in)	(L/s)	(cfs)
EF4 / EFO4	1.2	4	90	609	24	609	24	425	15
EF6 / EFO6	1.8	6	90	914	36	914	36	990	35
EF8 / EFO8	2.4	8	90	1219	48	1219	48	1700	60
EF10 / EFO10	3.0	10	90	1828	72	1828	72	2830	100
EF12 / EFO12	3.6	12	90	1828	72	1828	72	2830	100

SCOUR PREVENTION AND ONLINE CONFIGURATION

► Stormceptor® EF and EFO feature an internal bypass and superior scour prevention technology that have been demonstrated in third-party testing according to the scour testing provisions of the Canadian ETV **Procedure for Laboratory Testing of Oil-Grit Separators**, and the exceptional scour test performance has been third-party verified in accordance with the ISO 14034 ETV protocol. As a result, Stormceptor EF and EFO are approved for online installation, eliminating the need for costly additional bypass structures, piping, and installation expense.

DESIGN FLEXIBILITY

► Stormceptor® EF and EFO offers design flexibility in one simplified platform, accepting stormwater flow from a single inlet pipe or multiple inlet pipes, and/or surface runoff through an inlet grate. The device can also serve as a junction structure, accommodate a 90-degree inlet-to-outlet bend angle, and can be modified to ensure performance in submerged conditions.

OIL CAPTURE AND RETENTION

► While Stormceptor® EF will capture and retain oil from dry weather spills and low intensity runoff, Stormceptor® EFO has demonstrated superior oil capture and greater than 99% oil retention in third-party testing according to the light liquid re-entrainment testing provisions of the Canadian ETV **Procedure for Laboratory Testing of Oil-Grit Separators**. Stormceptor EFO is recommended for sites where oil capture and retention is a requirement.

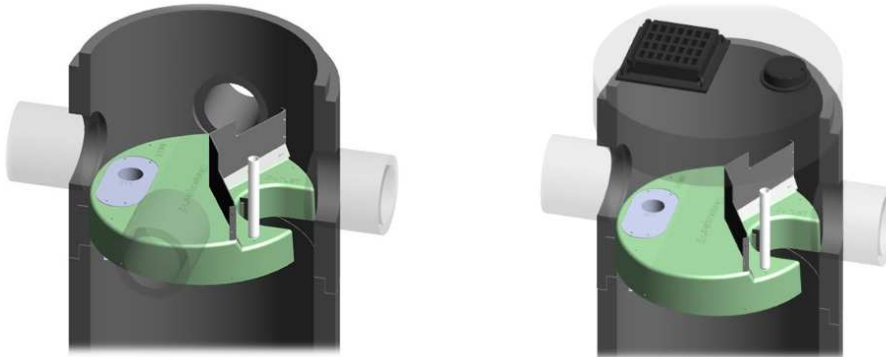

Stormceptor® EF Sizing Report

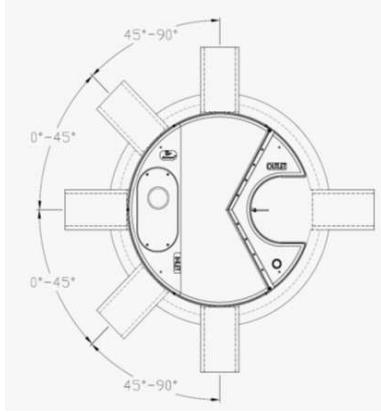

INLET-TO-OUTLET DROP

Elevation differential between inlet and outlet pipe inverts is dictated by the angle at which the inlet pipe(s) enters the unit.

0° - 45° : The inlet pipe is 1-inch (25mm) higher than the outlet pipe.

45° - 90° : The inlet pipe is 2-inches (50mm) higher than the outlet pipe.

HEAD LOSS

The head loss through Stormceptor EF is similar to that of a 60-degree bend structure. The applicable K value for calculating minor losses through the unit is 1.1. For submerged conditions the applicable K value is 3.0.

Pollutant Capacity

Stormceptor EF / EFO	Model Diameter		Depth (Outlet Pipe Invert to Sump Floor)		Oil Volume		Recommended Sediment Maintenance Depth *		Maximum Sediment Volume *		Maximum Sediment Mass **	
	(m)	(ft)	(m)	(ft)	(L)	(Gal)	(mm)	(in)	(L)	(ft³)	(kg)	(lb)
EF4 / EFO4	1.2	4	1.52	5.0	265	70	203	8	1190	42	1904	5250
EF6 / EFO6	1.8	6	1.93	6.3	610	160	305	12	3470	123	5552	15375
EF8 / EFO8	2.4	8	2.59	8.5	1070	280	610	24	8780	310	14048	38750
EF10 / EFO10	3.0	10	3.25	10.7	1670	440	610	24	17790	628	28464	78500
EF12 / EFO12	3.6	12	3.89	12.8	2475	655	610	24	31220	1103	49952	137875

*Increased sump depth may be added to increase sediment storage capacity

** Average density of wet packed sediment in sump = 1.6 kg/L (100 lb/ft³)

Feature	Benefit	Feature Appeals To
Patent-pending enhanced flow treatment and scour prevention technology	Superior, verified third-party performance	Regulator, Specifying & Design Engineer
Third-party verified light liquid capture and retention for EFO version	Proven performance for fuel/oil hotspot locations	Regulator, Specifying & Design Engineer, Site Owner
Functions as bend, junction or inlet structure	Design flexibility	Specifying & Design Engineer
Minimal drop between inlet and outlet	Site installation ease	Contractor
Large diameter outlet riser for inspection and maintenance	Easy maintenance access from grade	Maintenance Contractor & Site Owner

STANDARD STORMCEPTOR EF/EFO DRAWINGS

For standard details, please visit <http://www.imbriumsystems.com/stormwater-treatment-solutions/stormceptor-ef>

STANDARD STORMCEPTOR EF/EFO SPECIFICATION

For specifications, please visit <http://www.imbriumsystems.com/stormwater-treatment-solutions/stormceptor-ef>

STANDARD PERFORMANCE SPECIFICATION FOR “OIL GRIT SEPARATOR” (OGS) STORMWATER QUALITY TREATMENT DEVICE

PART 1 – GENERAL

1.1 WORK INCLUDED

This section specifies requirements for selecting, sizing, and designing an underground Oil Grit Separator (OGS) device for stormwater quality treatment, with third-party testing results and a Statement of Verification in accordance with ISO 14034 Environmental Management – Environmental Technology Verification (ETV).

1.2 REFERENCE STANDARDS & PROCEDURES

ISO 14034:2016 Environmental management – Environmental technology verification (ETV)

Canadian Environmental Technology Verification (ETV) Program’s **Procedure for Laboratory Testing of Oil-Grit Separators**

1.3 SUBMITTALS

1.3.1 All submittals, including sizing reports & shop drawings, shall be submitted upon request with each order to the contractor then forwarded to the Engineer of Record for review and acceptance. Shop drawings shall detail all OGS components, elevations, and sequence of construction.

1.3.2 Alternative devices shall have features identical to or greater than the specified device, including: treatment chamber diameter, treatment chamber wet volume, sediment storage volume, and oil storage volume.

1.3.3 Unless directed otherwise by the Engineer of Record, OGS stormwater quality treatment product substitutions or alternatives submitted within ten days prior to project bid shall not be accepted. All alternatives or substitutions submitted shall be signed and sealed by a local registered Professional Engineer, based on the exact same criteria detailed in Section 3, in entirety, subject to review and approval by the Engineer of Record.

PART 2 – PRODUCTS

2.1 OGS POLLUTANT STORAGE

The OGS device shall include a sump for sediment storage, and a protected volume for the capture and storage of petroleum hydrocarbons and buoyant gross pollutants. The minimum sediment & petroleum hydrocarbon storage capacity shall be as follows:

2.1.1	4 ft (1219 mm) Diameter OGS Units:	1.19 m ³ sediment / 265 L oil
	6 ft (1829 mm) Diameter OGS Units:	3.48 m ³ sediment / 609 L oil
	8 ft (2438 mm) Diameter OGS Units:	8.78 m ³ sediment / 1,071 L oil
	10 ft (3048 mm) Diameter OGS Units:	17.78 m ³ sediment / 1,673 L oil
	12 ft (3657 mm) Diameter OGS Units:	31.23 m ³ sediment / 2,476 L oil

PART 3 – PERFORMANCE & DESIGN

3.1 GENERAL

The OGS stormwater quality treatment device shall be verified in accordance with ISO 14034:2016 Environmental management – Environmental technology verification (ETV). The OGS stormwater quality treatment device shall

Stormceptor[®] EF Sizing Report

remove oil, sediment and gross pollutants from stormwater runoff during frequent wet weather events, and retain these pollutants during less frequent high flow wet weather events below the insert within the OGS for later removal during maintenance. The Manufacturer shall have at least ten (10) years of local experience, history and success in engineering design, manufacturing and production and supply of OGS stormwater quality treatment device systems, acceptable to the Engineer of Record.

3.2 SIZING METHODOLOGY

The OGS device shall be engineered, designed and sized to provide stormwater quality treatment based on treating a minimum of 90 percent of the average annual runoff volume and a minimum removal of an annual average 60% of the sediment (TSS) load based on the Particle Size Distribution (PSD) specified in the sizing report for the specified device. Sizing of the OGS shall be determined by use of a minimum ten (10) years of local historical rainfall data provided by Environment Canada. Sizing shall also be determined by use of the sediment removal performance data derived from the ISO 14034 ETV third-party verified laboratory testing data from testing conducted in accordance with the Canadian ETV protocol Procedure for Laboratory Testing of Oil-Grit Separators, as follows:

3.2.1 Sediment removal efficiency for a given surface loading rate and its associated flow rate shall be based on sediment removal efficiency demonstrated at the seven (7) tested surface loading rates specified in the protocol, ranging 40 L/min/m² to 1400 L/min/m², and as stated in the ISO 14034 ETV Verification Statement for the OGS device.

3.2.2 Sediment removal efficiency for surface loading rates between 40 L/min/m² and 1400 L/min/m² shall be based on linear interpolation of data between consecutive tested surface loading rates.

3.2.3 Sediment removal efficiency for surface loading rates less than the lowest tested surface loading rate of 40 L/min/m² shall be assumed to be identical to the sediment removal efficiency at 40 L/min/m². No extrapolation shall be allowed that results in a sediment removal efficiency that is greater than that demonstrated at 40 L/min/m².

3.2.4 Sediment removal efficiency for surface loading rates greater than the highest tested surface loading rate of 1400 L/min/m² shall assume zero sediment removal for the portion of flow that exceeds 1400 L/min/m², and shall be calculated using a simple proportioning formula, with 1400 L/min/m² in the numerator and the higher surface loading rate in the denominator, and multiplying the resulting fraction times the sediment removal efficiency at 1400 L/min/m².

The OGS device shall also have sufficient annual sediment storage capacity as specified and calculated in Section 2.1.

3.3 CANADIAN ETV or ISO 14034 ETV VERIFICATION OF SCOUR TESTING

The OGS device shall have Canadian ETV or ISO 14034 ETV Verification of third-party scour testing conducted in accordance with the Canadian ETV Program's **Procedure for Laboratory Testing of Oil-Grit Separators**.

3.3.1 To be acceptable for on-line installation, the OGS device must demonstrate an average scour test effluent concentration less than 10 mg/L at each surface loading rate tested, up to and including 2600 L/min/m².

3.4 LIGHT LIQUID RE-ENTRAINMENT SIMULATION TESTING

The OGS device shall have Canadian ETV or ISO 14034 ETV Verification of completed third-party Light Liquid Re-entrainment Simulation Testing in accordance with the Canadian ETV **Program's Procedure for Laboratory Testing of Oil-Grit Separators**, with results reported within the Canadian ETV or ISO 14034 ETV verification. This re-entrainment testing is conducted with the device pre-loaded with low density polyethylene (LDPE) plastic beads as a surrogate for light liquids such as oil and fuel. Testing is conducted on the same OGS unit tested for sediment removal to

Stormceptor® EF Sizing Report

assess whether light liquids captured after a spill are effectively retained at high flow rates.

3.4.1 For an OGS device to be an acceptable stormwater treatment device on a site where vehicular traffic occurs and the potential for an oil or fuel spill exists, the OGS device must have reported verified performance results of greater than 99% cumulative retention of LDPE plastic beads for the five specified surface loading rates (ranging 200 L/min/m² to 2600 L/min/m²) in accordance with the Light Liquid Re-entrainment Simulation Testing within the Canadian ETV Program's **Procedure for Laboratory Testing of Oil-Grit Separators**. However, an OGS device shall not be allowed if the Light Liquid Re-entrainment Simulation Testing was performed with screening components within the OGS device that are effective at retaining the LDPE plastic beads, but would not be expected to retain light liquids such as oil and fuel.

Stormceptor® EF Sizing Report

Imbrium® Systems

ESTIMATED NET ANNUAL SEDIMENT (TSS) LOAD REDUCTION

02/29/2024

Province:	Ontario
City:	Ottawa
Nearest Rainfall Station:	OTTAWA CDA RCS
Climate Station Id:	6105978
Years of Rainfall Data:	20

Project Name:	Stillwater Station
Project Number:	160401686
Designer Name:	Alyssa Gladish
Designer Company:	Stantec Consulting Ltd.
Designer Email:	alyssa.gladish@stantec.com
Designer Phone:	587-721-1241
EOR Name:	Neal Cody
EOR Company:	Stantec Consulting Ltd.
EOR Email:	neal.cody@stantec.com
EOR Phone:	780-884-9523

Site Name:	Outlet 2 (HW2)
Drainage Area (ha):	1.48
Runoff Coefficient 'c':	0.41

Particle Size Distribution:	Fine
Target TSS Removal (%):	80.0

Required Water Quality Runoff Volume Capture (%):	90.00
Estimated Water Quality Flow Rate (L/s):	19.58
Oil / Fuel Spill Risk Site?	Yes
Upstream Flow Control?	No
Peak Conveyance (maximum) Flow Rate (L/s):	174.00
Influent TSS Concentration (mg/L):	
Estimated Average Annual Sediment Volume (L/yr):	240

Net Annual Sediment (TSS) Load Reduction Sizing Summary	
Stormceptor Model	TSS Removal Provided (%)
EFO4	80
EFO6	90
EFO8	95
EFO10	97
EFO12	99

Recommended Stormceptor EFO Model:	EFO4
Estimated Net Annual Sediment (TSS) Load Reduction (%):	80
Water Quality Runoff Volume Capture (%):	> 90

THIRD-PARTY TESTING AND VERIFICATION

► **Stormceptor® EF and Stormceptor® EFO** are the latest evolutions in the Stormceptor® oil-grit separator (OGS) technology series, and are designed to remove a wide variety of pollutants from stormwater and snowmelt runoff. These technologies have been third-party tested in accordance with the Canadian ETV **Procedure for Laboratory Testing of Oil-Grit Separators** and performance has been third-party verified in accordance with the **ISO 14034 Environmental Technology Verification (ETV)** protocol.

PERFORMANCE

► **Stormceptor® EF and EFO** remove stormwater pollutants through gravity separation and floatation, and feature a patent-pending design that generates positive removal of total suspended solids (TSS) throughout each storm event, including high-intensity storms. Captured pollutants include sediment, free oils, and sediment-bound pollutants such as nutrients, heavy metals, and petroleum hydrocarbons. Stormceptor is sized to remove a high level of TSS from the frequent rainfall events that contribute the vast majority of annual runoff volume and pollutant load. The technology incorporates an internal bypass to convey excessive stormwater flows from high-intensity storms through the device without resuspension and washout (scour) of previously captured pollutants. Proper routine maintenance ensures high pollutant removal performance and protection of downstream waterways.

PARTICLE SIZE DISTRIBUTION (PSD)

► The **Canadian ETV PSD** shown in the table below was used, or in part, for this sizing. This is the identical PSD that is referenced in the Canadian ETV **Procedure for Laboratory Testing of Oil-Grit Separators** for both sediment removal testing and scour testing. The Canadian ETV PSD contains a wide range of particle sizes in the sand and silt fractions, and is considered reasonably representative of the particle size fractions found in typical urban stormwater runoff.

Particle Size (µm)	Percent Less Than	Particle Size Fraction (µm)	Percent
1000	100	500-1000	5
500	95	250-500	5
250	90	150-250	15
150	75	100-150	15
100	60	75-100	10
75	50	50-75	5
50	45	20-50	10
20	35	8-20	15
8	20	5-8	10
5	10	2-5	5
2	5	<2	5

Stormceptor® EF Sizing Report

Rainfall Intensity (mm / hr)	Percent Rainfall Volume (%)	Cumulative Rainfall Volume (%)	Flow Rate (L/s)	Flow Rate (L/min)	Surface Loading Rate (L/min/m ²)	Removal Efficiency (%)	Incremental Removal (%)	Cumulative Removal (%)
0.50	8.6	8.6	0.84	51.0	42.0	100	8.6	8.6
1.00	20.3	29.0	1.69	101.0	84.0	98	20.0	28.6
2.00	16.2	45.2	3.37	202.0	169.0	88	14.3	43.0
3.00	12.0	57.2	5.06	304.0	253.0	81	9.7	52.6
4.00	8.4	65.6	6.75	405.0	337.0	77	6.5	59.2
5.00	5.9	71.6	8.43	506.0	422.0	73	4.3	63.5
6.00	4.6	76.2	10.12	607.0	506.0	69	3.2	66.7
7.00	3.1	79.3	11.81	708.0	590.0	65	2.0	68.7
8.00	2.7	82.0	13.50	810.0	675.0	64	1.8	70.4
9.00	3.3	85.3	15.18	911.0	759.0	63	2.1	72.6
10.00	2.3	87.6	16.87	1012.0	843.0	63	1.4	74.0
11.00	1.6	89.2	18.56	1113.0	928.0	62	1.0	75.0
12.00	1.3	90.5	20.24	1215.0	1012.0	61	0.8	75.8
13.00	1.7	92.2	21.93	1316.0	1096.0	59	1.0	76.8
14.00	1.2	93.5	23.62	1417.0	1181.0	57	0.7	77.5
15.00	1.2	94.6	25.30	1518.0	1265.0	56	0.6	78.1
16.00	0.7	95.3	26.99	1619.0	1350.0	53	0.4	78.5
17.00	0.7	96.1	28.68	1721.0	1434.0	51	0.4	78.9
18.00	0.4	96.5	30.36	1822.0	1518.0	48	0.2	79.1
19.00	0.4	96.9	32.05	1923.0	1603.0	46	0.2	79.3
20.00	0.2	97.1	33.74	2024.0	1687.0	44	0.1	79.4
21.00	0.5	97.5	35.42	2125.0	1771.0	41	0.2	79.6
22.00	0.2	97.8	37.11	2227.0	1856.0	40	0.1	79.7
23.00	1.0	98.8	38.80	2328.0	1940.0	38	0.4	80.0
24.00	0.3	99.1	40.49	2429.0	2024.0	36	0.1	80.1
25.00	0.0	99.1	42.17	2530.0	2109.0	35	0.0	80.1
30.00	0.9	100.0	50.61	3036.0	2530.0	29	0.3	80.4
35.00	0.0	100.0	59.04	3542.0	2952.0	25	0.0	80.4
40.00	0.0	100.0	67.48	4049.0	3374.0	22	0.0	80.4
45.00	0.0	100.0	75.91	4555.0	3796.0	20	0.0	80.4
Estimated Net Annual Sediment (TSS) Load Reduction =								80 %

Climate Station ID: 6105978 Years of Rainfall Data: 20

Stormceptor® EF Sizing Report

RAINFALL DATA FROM OTTAWA CDA RCS RAINFALL STATION

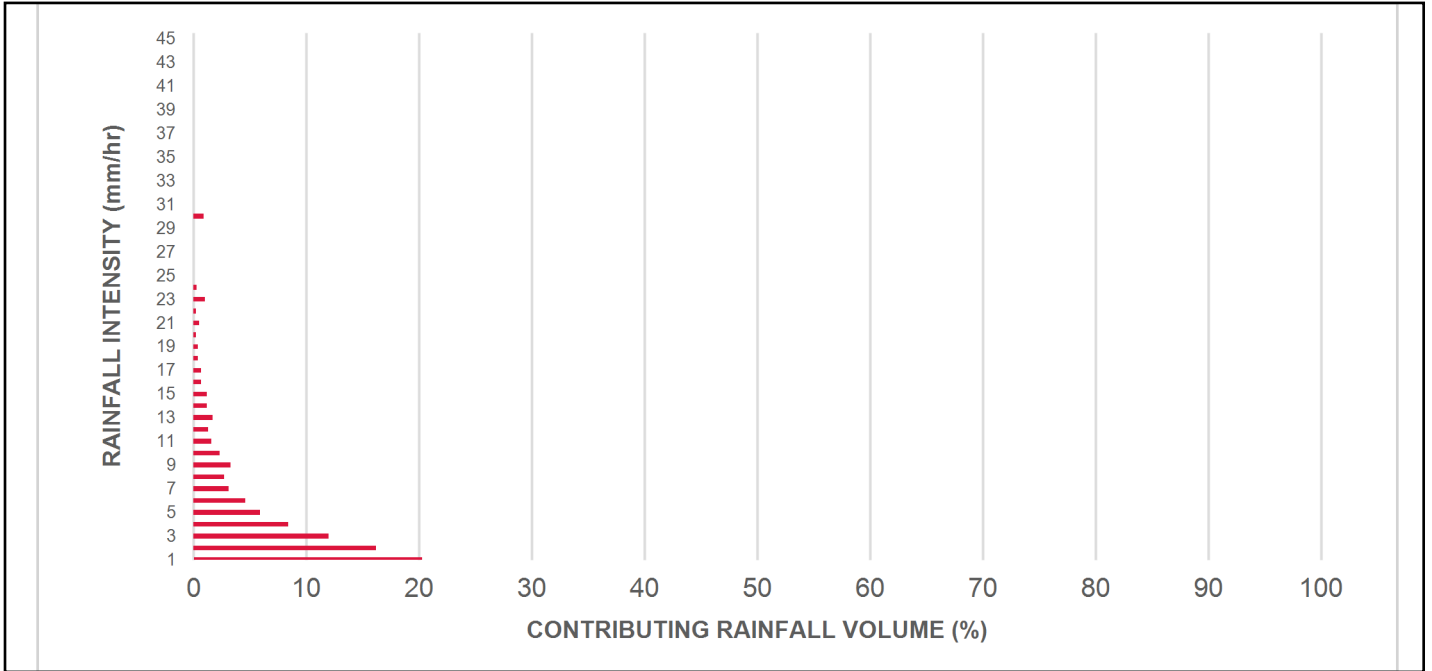

INCREMENTAL AND CUMULATIVE TSS REMOVAL FOR THE RECOMMENDED STORMCEPTOR® MODEL

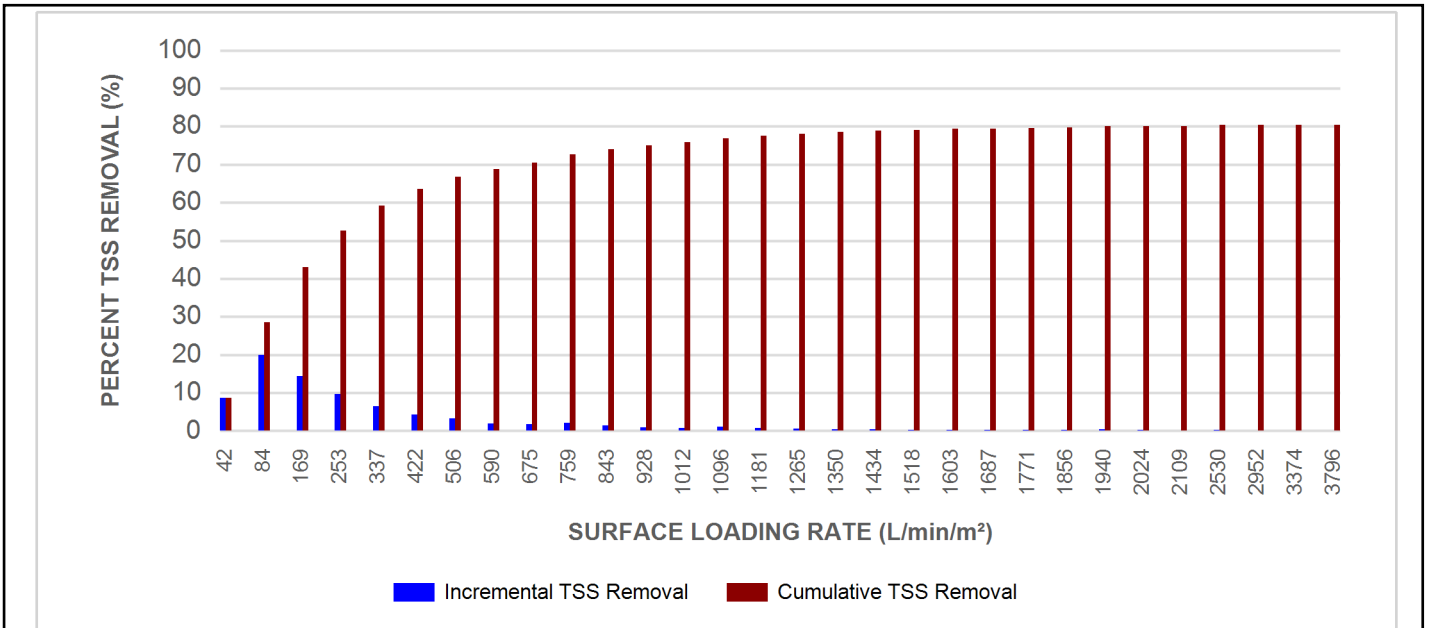

Stormceptor® EF Sizing Report

Maximum Pipe Diameter / Peak Conveyance

Stormceptor EF / EFO	Model Diameter		Min Angle Inlet / Outlet Pipes	Max Inlet Pipe Diameter		Max Outlet Pipe Diameter		Peak Conveyance Flow Rate	
	(m)	(ft)		(mm)	(in)	(mm)	(in)	(L/s)	(cfs)
EF4 / EFO4	1.2	4	90	609	24	609	24	425	15
EF6 / EFO6	1.8	6	90	914	36	914	36	990	35
EF8 / EFO8	2.4	8	90	1219	48	1219	48	1700	60
EF10 / EFO10	3.0	10	90	1828	72	1828	72	2830	100
EF12 / EFO12	3.6	12	90	1828	72	1828	72	2830	100

SCOUR PREVENTION AND ONLINE CONFIGURATION

► Stormceptor® EF and EFO feature an internal bypass and superior scour prevention technology that have been demonstrated in third-party testing according to the scour testing provisions of the Canadian ETV **Procedure for Laboratory Testing of Oil-Grit Separators**, and the exceptional scour test performance has been third-party verified in accordance with the ISO 14034 ETV protocol. As a result, Stormceptor EF and EFO are approved for online installation, eliminating the need for costly additional bypass structures, piping, and installation expense.

DESIGN FLEXIBILITY

► Stormceptor® EF and EFO offers design flexibility in one simplified platform, accepting stormwater flow from a single inlet pipe or multiple inlet pipes, and/or surface runoff through an inlet grate. The device can also serve as a junction structure, accommodate a 90-degree inlet-to-outlet bend angle, and can be modified to ensure performance in submerged conditions.

OIL CAPTURE AND RETENTION

► While Stormceptor® EF will capture and retain oil from dry weather spills and low intensity runoff, Stormceptor® EFO has demonstrated superior oil capture and greater than 99% oil retention in third-party testing according to the light liquid re-entrainment testing provisions of the Canadian ETV **Procedure for Laboratory Testing of Oil-Grit Separators**. Stormceptor EFO is recommended for sites where oil capture and retention is a requirement.

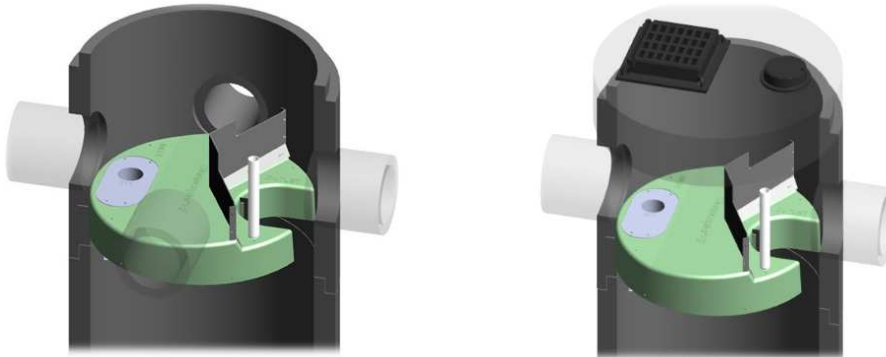

Stormceptor® EF Sizing Report

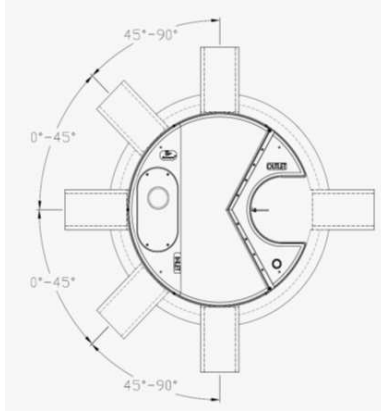

INLET-TO-OUTLET DROP

Elevation differential between inlet and outlet pipe inverts is dictated by the angle at which the inlet pipe(s) enters the unit.

0° - 45° : The inlet pipe is 1-inch (25mm) higher than the outlet pipe.

45° - 90° : The inlet pipe is 2-inches (50mm) higher than the outlet pipe.

HEAD LOSS

The head loss through Stormceptor EF is similar to that of a 60-degree bend structure. The applicable K value for calculating minor losses through the unit is 1.1. For submerged conditions the applicable K value is 3.0.

Pollutant Capacity

Stormceptor EF / EFO	Model Diameter		Depth (Outlet Pipe Invert to Sump Floor)		Oil Volume		Recommended Sediment Maintenance Depth *		Maximum Sediment Volume *		Maximum Sediment Mass **	
	(m)	(ft)	(m)	(ft)	(L)	(Gal)	(mm)	(in)	(L)	(ft³)	(kg)	(lb)
EF4 / EFO4	1.2	4	1.52	5.0	265	70	203	8	1190	42	1904	5250
EF6 / EFO6	1.8	6	1.93	6.3	610	160	305	12	3470	123	5552	15375
EF8 / EFO8	2.4	8	2.59	8.5	1070	280	610	24	8780	310	14048	38750
EF10 / EFO10	3.0	10	3.25	10.7	1670	440	610	24	17790	628	28464	78500
EF12 / EFO12	3.6	12	3.89	12.8	2475	655	610	24	31220	1103	49952	137875

*Increased sump depth may be added to increase sediment storage capacity

** Average density of wet packed sediment in sump = 1.6 kg/L (100 lb/ft³)

Feature	Benefit	Feature Appeals To
Patent-pending enhanced flow treatment and scour prevention technology	Superior, verified third-party performance	Regulator, Specifying & Design Engineer
Third-party verified light liquid capture and retention for EFO version	Proven performance for fuel/oil hotspot locations	Regulator, Specifying & Design Engineer, Site Owner
Functions as bend, junction or inlet structure	Design flexibility	Specifying & Design Engineer
Minimal drop between inlet and outlet	Site installation ease	Contractor
Large diameter outlet riser for inspection and maintenance	Easy maintenance access from grade	Maintenance Contractor & Site Owner

STANDARD STORMCEPTOR EF/EFO DRAWINGS

For standard details, please visit <http://www.imbriumsystems.com/stormwater-treatment-solutions/stormceptor-ef>

STANDARD STORMCEPTOR EF/EFO SPECIFICATION

For specifications, please visit <http://www.imbriumsystems.com/stormwater-treatment-solutions/stormceptor-ef>

STANDARD PERFORMANCE SPECIFICATION FOR “OIL GRIT SEPARATOR” (OGS) STORMWATER QUALITY TREATMENT DEVICE

PART 1 – GENERAL

1.1 WORK INCLUDED

This section specifies requirements for selecting, sizing, and designing an underground Oil Grit Separator (OGS) device for stormwater quality treatment, with third-party testing results and a Statement of Verification in accordance with ISO 14034 Environmental Management – Environmental Technology Verification (ETV).

1.2 REFERENCE STANDARDS & PROCEDURES

ISO 14034:2016 Environmental management – Environmental technology verification (ETV)

Canadian Environmental Technology Verification (ETV) Program’s **Procedure for Laboratory Testing of Oil-Grit Separators**

1.3 SUBMITTALS

1.3.1 All submittals, including sizing reports & shop drawings, shall be submitted upon request with each order to the contractor then forwarded to the Engineer of Record for review and acceptance. Shop drawings shall detail all OGS components, elevations, and sequence of construction.

1.3.2 Alternative devices shall have features identical to or greater than the specified device, including: treatment chamber diameter, treatment chamber wet volume, sediment storage volume, and oil storage volume.

1.3.3 Unless directed otherwise by the Engineer of Record, OGS stormwater quality treatment product substitutions or alternatives submitted within ten days prior to project bid shall not be accepted. All alternatives or substitutions submitted shall be signed and sealed by a local registered Professional Engineer, based on the exact same criteria detailed in Section 3, in entirety, subject to review and approval by the Engineer of Record.

PART 2 – PRODUCTS

2.1 OGS POLLUTANT STORAGE

The OGS device shall include a sump for sediment storage, and a protected volume for the capture and storage of petroleum hydrocarbons and buoyant gross pollutants. The minimum sediment & petroleum hydrocarbon storage capacity shall be as follows:

2.1.1	4 ft (1219 mm) Diameter OGS Units:	1.19 m ³ sediment / 265 L oil
	6 ft (1829 mm) Diameter OGS Units:	3.48 m ³ sediment / 609 L oil
	8 ft (2438 mm) Diameter OGS Units:	8.78 m ³ sediment / 1,071 L oil
	10 ft (3048 mm) Diameter OGS Units:	17.78 m ³ sediment / 1,673 L oil
	12 ft (3657 mm) Diameter OGS Units:	31.23 m ³ sediment / 2,476 L oil

PART 3 – PERFORMANCE & DESIGN

3.1 GENERAL

The OGS stormwater quality treatment device shall be verified in accordance with ISO 14034:2016 Environmental management – Environmental technology verification (ETV). The OGS stormwater quality treatment device shall

Stormceptor[®] EF Sizing Report

remove oil, sediment and gross pollutants from stormwater runoff during frequent wet weather events, and retain these pollutants during less frequent high flow wet weather events below the insert within the OGS for later removal during maintenance. The Manufacturer shall have at least ten (10) years of local experience, history and success in engineering design, manufacturing and production and supply of OGS stormwater quality treatment device systems, acceptable to the Engineer of Record.

3.2 SIZING METHODOLOGY

The OGS device shall be engineered, designed and sized to provide stormwater quality treatment based on treating a minimum of 90 percent of the average annual runoff volume and a minimum removal of an annual average 60% of the sediment (TSS) load based on the Particle Size Distribution (PSD) specified in the sizing report for the specified device. Sizing of the OGS shall be determined by use of a minimum ten (10) years of local historical rainfall data provided by Environment Canada. Sizing shall also be determined by use of the sediment removal performance data derived from the ISO 14034 ETV third-party verified laboratory testing data from testing conducted in accordance with the Canadian ETV protocol Procedure for Laboratory Testing of Oil-Grit Separators, as follows:

3.2.1 Sediment removal efficiency for a given surface loading rate and its associated flow rate shall be based on sediment removal efficiency demonstrated at the seven (7) tested surface loading rates specified in the protocol, ranging 40 L/min/m² to 1400 L/min/m², and as stated in the ISO 14034 ETV Verification Statement for the OGS device.

3.2.2 Sediment removal efficiency for surface loading rates between 40 L/min/m² and 1400 L/min/m² shall be based on linear interpolation of data between consecutive tested surface loading rates.

3.2.3 Sediment removal efficiency for surface loading rates less than the lowest tested surface loading rate of 40 L/min/m² shall be assumed to be identical to the sediment removal efficiency at 40 L/min/m². No extrapolation shall be allowed that results in a sediment removal efficiency that is greater than that demonstrated at 40 L/min/m².

3.2.4 Sediment removal efficiency for surface loading rates greater than the highest tested surface loading rate of 1400 L/min/m² shall assume zero sediment removal for the portion of flow that exceeds 1400 L/min/m², and shall be calculated using a simple proportioning formula, with 1400 L/min/m² in the numerator and the higher surface loading rate in the denominator, and multiplying the resulting fraction times the sediment removal efficiency at 1400 L/min/m².

The OGS device shall also have sufficient annual sediment storage capacity as specified and calculated in Section 2.1.

3.3 CANADIAN ETV or ISO 14034 ETV VERIFICATION OF SCOUR TESTING

The OGS device shall have Canadian ETV or ISO 14034 ETV Verification of third-party scour testing conducted in accordance with the Canadian ETV Program's **Procedure for Laboratory Testing of Oil-Grit Separators**.

3.3.1 To be acceptable for on-line installation, the OGS device must demonstrate an average scour test effluent concentration less than 10 mg/L at each surface loading rate tested, up to and including 2600 L/min/m².

3.4 LIGHT LIQUID RE-ENTRAINMENT SIMULATION TESTING

The OGS device shall have Canadian ETV or ISO 14034 ETV Verification of completed third-party Light Liquid Re-entrainment Simulation Testing in accordance with the Canadian ETV **Program's Procedure for Laboratory Testing of Oil-Grit Separators**, with results reported within the Canadian ETV or ISO 14034 ETV verification. This re-entrainment testing is conducted with the device pre-loaded with low density polyethylene (LDPE) plastic beads as a surrogate for light liquids such as oil and fuel. Testing is conducted on the same OGS unit tested for sediment removal to

Stormceptor® EF Sizing Report

assess whether light liquids captured after a spill are effectively retained at high flow rates.

3.4.1 For an OGS device to be an acceptable stormwater treatment device on a site where vehicular traffic occurs and the potential for an oil or fuel spill exists, the OGS device must have reported verified performance results of greater than 99% cumulative retention of LDPE plastic beads for the five specified surface loading rates (ranging 200 L/min/m² to 2600 L/min/m²) in accordance with the Light Liquid Re-entrainment Simulation Testing within the Canadian ETV Program's **Procedure for Laboratory Testing of Oil-Grit Separators**. However, an OGS device shall not be allowed if the Light Liquid Re-entrainment Simulation Testing was performed with screening components within the OGS device that are effective at retaining the LDPE plastic beads, but would not be expected to retain light liquids such as oil and fuel.

FUNCTIONAL SITE SERVICING AND STORMWATER MANAGEMENT REPORT REV.03 – 1987 ROBERTSON ROAD (STILLWATER STATION)

Appendix D External Documents
February 28, 2024

Appendix D **EXTERNAL DOCUMENTS**

D.1 MASTER PLAN – RLA ARCHITECTURE – 21-FEB-2024



DEVELOPMENT STATISTICS:				
Total Site Area = 95,882.125 sq m (23.69 acres) (as per survey drawing)				
Total Developable Land = 63,563 sq m (15.71 acres) (including parkland)				
Public Roads, M.U.P. & Open Space = 21,473 sq m (5.31 acres) (to be ceded to N.C.C.)				
Total Building Coverage of Developable Land = 15,884 sq m				
Total Greenspace Coverage of Developable Land (incl parkland) = 17,955 sq m				
PLOT ID	PROPOSED DEVELOPMENT	GROSS CONSTRUCTION AREA	COMMERCIAL AREA ON GR. LVL. (m ² /sq. ft.)	DWELLING UNITS
Plot 'A' Phase - 1	A1 30-STORY TOWER WITH 6-STORY POOLUM	249,647 sq. ft.	---	250
	A2 32-STORY TOWER WITH 6-STORY POOLUM	303,015 sq. ft.	6,490 sq. ft.	296
	A3 24-STORY TOWER WITH 6-STORY POOLUM	236,375 sq. ft.	6,491 sq. ft.	230
Plot 'B' Phase - 2	B1 28-STORY TOWER WITH 6-STORY POOLUM	296,244 sq. ft.	2,152 sq. ft.	294
	B2 20-STORY TOWER WITH 6-STORY POOLUM	225,579 sq. ft.	6,404 sq. ft.	219
	B3 6-STORY BUILDING	54,691 sq. ft.	---	55
Plot 'C' Phase - 3	C1 24-STORY TOWER WITH 6-STORY POOLUM	233,587 sq. ft.	---	234
	C2 18-STORY TOWER WITH 6-STORY POOLUM	183,998 sq. ft.	---	184
Plot 'D' Phase - 4	D 6-STORY BUILDING	63,087 sq. ft.	---	63
Plot 'E' Phase - 5	E1 6-STORY BUILDING	81,429 sq. ft.	5,360 sq. ft.	76
	E2 6-STORY BUILDING	71,591 sq. ft.	---	72
Plot 'F' Phase - 6	F1 6-STORY BUILDING	64,314 sq. ft.	5,414 sq. ft.	59
	F2 4-STORY BUILDING	54,379 sq. ft.	---	54
TOTAL		2,117,936 sq. ft. 196,763 sq. m. (including commercial area)	32,311 sq. ft. 3,002 sq. m.	2,086

Tower Floor Plate = 792 sq m (8,525 sq ft)
Average Dwelling Unit Size = 92.9 sq m (1,000 sq ft)
Total Parking Spaces = 1,631 (0.78 per DU)
(2 levels underground + on-street surface parking)

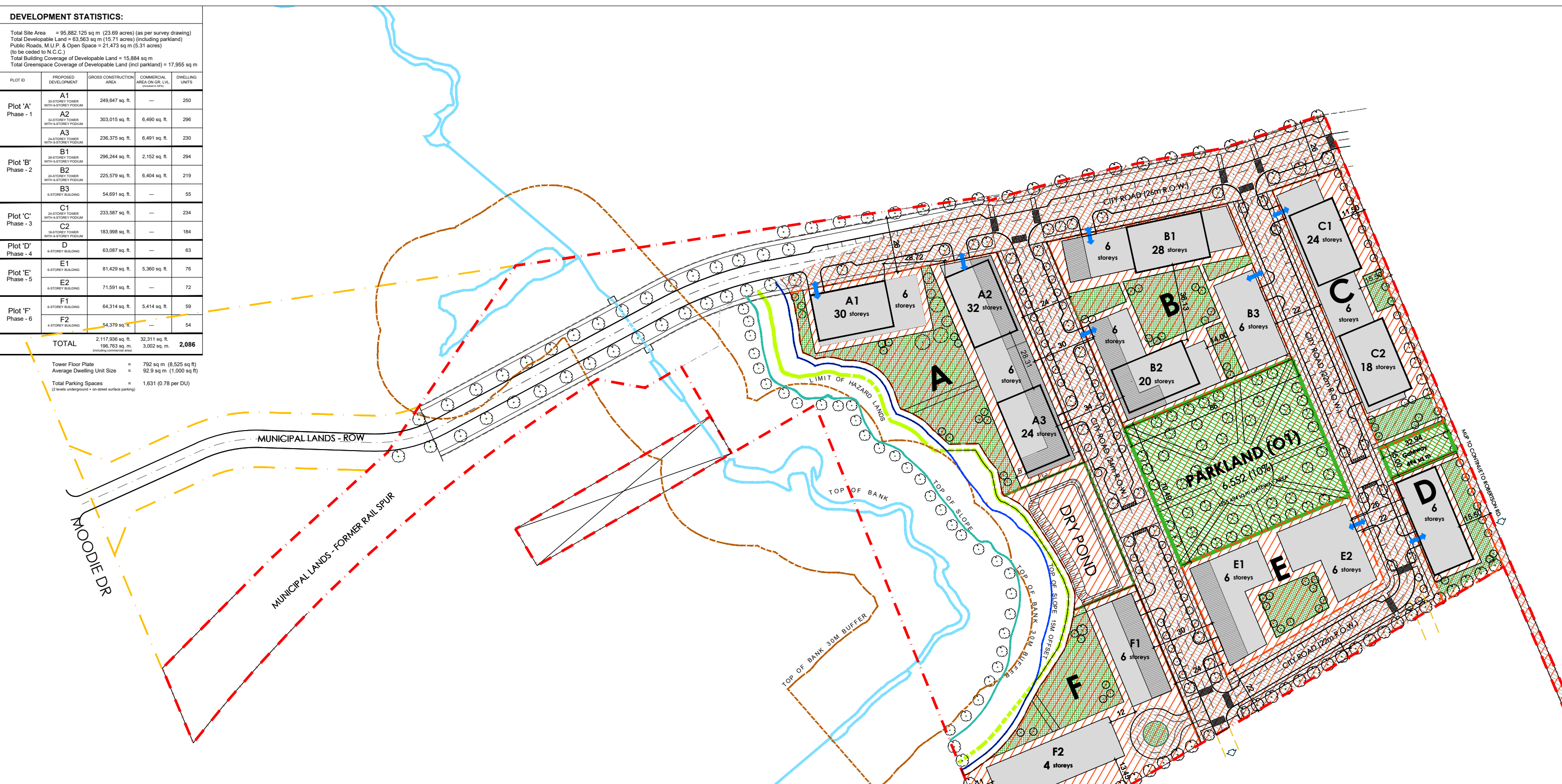

TOTAL SITE AREA:
- - - - - 95,882.125 sq m (23.69 acres)

Area Distribution in the Total Developable Land:

PARKLAND DEDICATION (@ 10% OF DEVELOPABLE LAND)
 = 6,552 sq m (1.62 acres) (PARKLAND AREA+GATEWAY)

AREA OF MUNICIPAL ROADS and M.U.P.
 = 21,473 sq m (5.31 acres) 34%

TOTAL DEVELOPABLE LAND (INCLUDING PARKLAND, MUP, PUBLIC ROAD)
 = 63,563 sq m (15.71 acres)

- ENCLOSED WATERCOURSE
- TOP OF BANK
- TOP OF BANK 30M BUFFER
- TOP OF SLOPE
- TOP OF SLOPE 15M OFFSET
- LIMIT OF HAZARD LANDS

STILLWATER STATION
1987 Robertson Road, Ottawa ON

DEVELOPABLE LAND - AREA DISTRIBUTION

MASTER PLAN
PLOT DATE: Wednesday, February 21, 2024

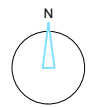

FUNCTIONAL SITE SERVICING AND STORMWATER MANAGEMENT REPORT REV.03 – 1987 ROBERTSON ROAD (STILLWATER STATION)

Appendix D External Documents
February 28, 2024

**D.2 STILLWATER CREEK 2013, EXISTING HABITAT CONDITION,
CHANNEL STRUCTURE, THERMAL STABILITY AND OPPORTUNITIES
FOR RESTORATION FOR STILLWATER CREEK – RVCA**



Prepared For:

National Capital Commission



Stillwater Creek – 2013

Existing Habitat Condition, Channel Structure, Thermal Stability and Opportunities for Restoration for Stillwater Creek

DISCLAIMER

This document entitled Stillwater Creek – Existing Habitat Condition, Channel Structure, Thermal Stability and Opportunities for Restoration for Stillwater Creek was prepared by the Rideau Valley Conservation Authority (RVCA) for the National Capital Commission (NCC). The material in it reflects the RVCA’s best judgment in light of the information available to it at the time of preparation. Any use which a third party makes of this report, or any reliance on or decisions made based on it, are the responsibilities of such third parties. The RVCA accepts no responsibility for damages, if any, suffered by any third party as a result of decisions made or actions based on this report.

Prepared By:

Jennifer Lamoureux – Aquatic and Fish Habitat Biologist – jennifer.lamoureux@rvca.ca

Justin Robert – Resource Technician – justin.robert@rvca.ca

Rideau Valley Conservation Authority – Watershed Science and Engineering Services

3889 Rideau Valley Dr PO Box 599 - Manotick, ON K4M 1A5

Tel: (613) 692-3571 - Fax: (613) 692-0831

Table of Contents

Introduction (1.0) 4
 Background (1.1) 4
 Study Area (1.2) 6
 Study Objectives (1.3) 6
 Methodology (2.0) 7
 Site Identification/Features (2.1) 7
 Temperature Profiling/Thermal Stability (2.2) 8
 Water Chemistry (2.3) 8
 Benthic Community Assessment (2.4) 8
 Fish Community Assessment (2.5) 9
 Fish Habitat Assessment (2.6) 9
 Analysis of Fish and Fish Habitat Sensitivity (2.7) 9
 Results & Discussion (3.0) 10
 Site Features (3.1) 10
 Thermal Classification (3.2) 10
 Water Chemistry Analysis (3.3) 11
 Benthic Community Assessment (3.4) 13
 Fish Community Assessment (3.5) 14
 CK7-03SH (3.5.1) 14
 CK7-04SH (3.5.2) 15
 CK7-05SH (3.5.3) 16
 CK7-06SH (3.5.4) 17
 CK7-07SH (3.5.5) 17
 CK7-08SH (3.5.6) 18
 CK7-11SH (3.5.7) 19
 CK7-13SH (3.5.8) 19
 CK7-14SH (3.5.9) 20
 CK7-15SH (3.5.10) 20
 Fish Habitat Assessment (3.6) 21
 CK7-03SH (3.6.1) 21
 CK7-04SH (3.6.2) 22
 CK7-05SH (3.6.3) 23
 CK7-06SH (3.6.4) 23
 CK7-07SH (3.6.5) 24
 CK7-08SH (3.6.6) 25
 CK7-11SH (3.6.7) 26
 CK7-13SH (3.6.8) 27
 CK7-14SH (3.6.9) 27
 CK7-15SH (3.6.10) 28
 Analysis of Fish and Fish Habitat Sensitivity (3.7) 29
 CK7-03SH (3.7.1) 30
 CK7-04SH (3.7.2) 33
 CK7-05SH (3.7.3) 35
 CK7-06SH (3.7.4) 38
 CK7-07SH (3.7.5) 40
 CK7-08SH (3.7.6) 43
 CK7-11SH (3.7.7) 46
 CK7-13SH (3.7.8) 47
 CK7-14SH (3.7.9) 49
 CK7-15SH (3.7.10) 51
 Migration Barriers (3.8) 54
 Conclusions & Recommendations (4.0) 55
 Restoration Plan (4.1) 55
 References (5.0) 73

INTRODUCTION (1.0)

Monitoring activities were conducted by the RVCA as a component of ongoing research put forth by the National Capital Commission and the University of Ottawa. The proposed investigation; outlined by Dr. Colin Rennie (Associate Professor, Department of Civil Engineering, University of Ottawa) aims to establish local erodibility standards, as they relate to the channel stability and habitat dynamics on Stillwater Creek .

In order to support the described research initiative, the RVCA has collected information on the physical habitat, channel structure, substrate, bank conditions, biological communities, water chemistry, hydrology and thermal stability of Stillwater Creek. This information was collected with the intent of establishing baseline conditions, identifying points of concern/enhancement and monitoring change within the system.

BACKGROUND (1.1)

Stillwater Creek is located towards the west end of Ottawa, with its headwaters extending into the Stony Swamp Conservation Area. The Stony Swamp Conservation Area is comprised of woodland, wetland and regenerative landscapes, spanning a range of over 2000 hectares. The region is known to support over 700 plant species, and is the most ecologically diverse protected area in the Ottawa Valley.

Downstream of Stony Swamp, the creek has been subject to a variety of alterations and impacts. Urbanization and agricultural pressures have contributed to diminished water quality, loss of riparian cover/aquatic habitat, and shoreline destabilization. The City of Ottawa completed benthos sampling on Stillwater Creek in 2001 and concluded that substantial to severe levels of organic pollutants were likely present (Ecoplans, DRAFT, 2009)

Previous monitoring efforts conducted by our organization indicate that approximately 46% of the system remains in a natural state, while the remainder has been altered to varying extents (*City Stream Watch*, 2009). Recent efforts have been undertaken to improve the current conditions and to mitigate against further damage. This has been accomplished through extensive riparian planting, habitat enhancement/creation and invasive species removal.

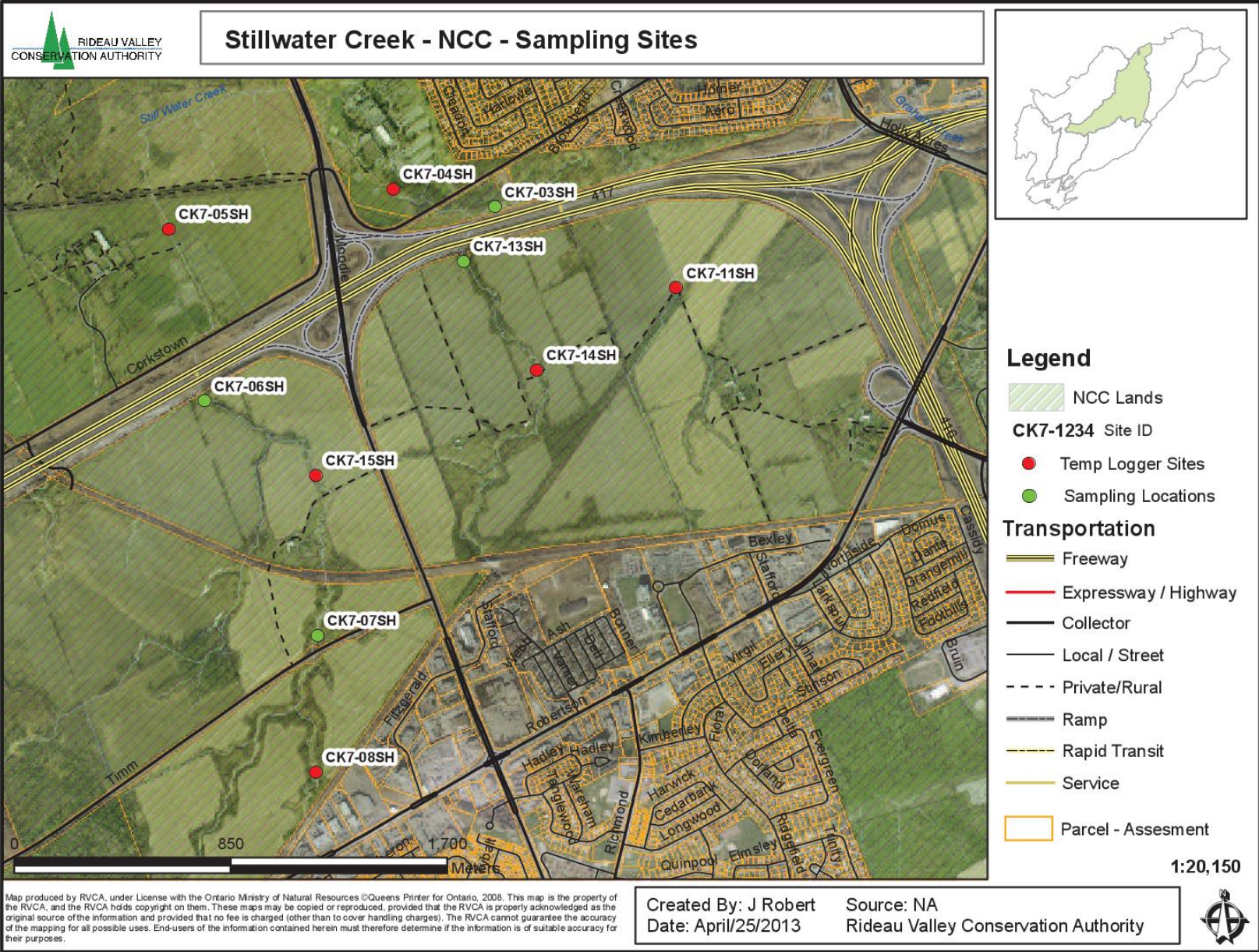

Figure 1. Stillwater Creek OSAP sampling and thermal classification sites.

STUDY AREA (1.2)

Sampling locations were established based on existing City of Ottawa OSAP sites. A data request was submitted for all historical records within the catchment extents. Site selection was refined to a total of 10 locations (Table 1). These locations were selected to encompass a variety of physical and biological characteristics. Of the 10 study locations, 7 were located along the main branch of the creek, and 3 along adjacent tributaries. Furthermore, temperature loggers were deployed at 6 of the 10 sites (Figure 1). Site extents were established based upon typical OSAP objectives. When available, site marker information was utilized as a point of reference. If this information was not available, the site extents were redefined within the contexts of the study protocol.

Table 1. Stillwater Creek site locations (NAD 83 Zone: 18N)

Stream Code	Site Code	Stream Name	UTM East	UTM North	Site Length (m)
CK7	CK7-03SH	Stillwater Creek	434696	5021241	54.2
CK7	CK7-04SH	Stillwater Creek	434297	5021311	54.1
CK7	CK7-05SH	Stillwater Creek	433416	5021156	47.9
CK7	CK7-06SH	Stillwater Creek	433556	5020480	41.5
CK7	CK7-07SH	Stillwater Creek	433999	5019560	40.0
CK7	CK7-08SH	Stillwater Creek	433992	5019025	44.2
CK7	CK7-11SH	Stillwater Creek	435405	5020928	88.0
CK7	CK7-13SH	Stillwater Creek	434573	5021029	40.0
CK7	CK7-14SH	Stillwater Creek	434860	5020601	44.6
CK7	CK7-15SH	Stillwater Creek	433990	5020176	42.0

STUDY OBJECTIVES (1.3)

An identified element of the “*Linking Sediment Erodibility, Channel Stability, and Habitat in Stillwater Creek Watershed*” research proposal outlined by Dr. Colin Rennie, requires an understanding of the existing conditions of fish and fish habitat within the study area. Based on the limited availability of fish community and habitat data within the study area, the RVCA proposed to:

- Confirm direct fish usage of habitat via fish community sampling (OSAP S3.M1)
- Provide information regarding spawning, nursery, rearing, feeding and migration habitat requirements for species found within the study area
- Identify species with particular habitat dependencies and/or sensitivities

- Define community structure to assess potential species sensitivities and mitigation requirements for proposed in-water works
- Utilize temperature logging equipment to define the thermal stability of the stream
- Sample for benthic macro-invertebrates as an indicator of aquatic habitat conditions and water quality (OSAP S2.M3)
- Record water chemistry parameters via a YSI sampling probe
- Assess channel structure, substrate and bank conditions (OSAP S4.M2)
- Identify areas of concern and propose enhancement when appropriate

METHODOLOGY (2.0)

Field sampling was completed by RVCA staff between May 1st and September 9th. A land access permit (NCC) and scientific fish collectors permit (Kemptville District – MNR) were acquired prior to commencing field activities. The majority of sampling methodologies utilized in this study were developed by the Ministry of Natural Resources as a series of standardized protocols for identifying sites, evaluating benthic macro-invertebrates, fish communities, physical habitat, geomorphology, hydrology and water temperature in wadeable streams (Ontario Stream Assessment Protocol Ver 8.0, 2010). Specific methods are described below.

SITE IDENTIFICATION/FEATURES – OSAP S1.M1-3 (2.1)

Site extents were defined within meander sequences along the stream. Each sampling site encompassed at least one riffle-pool sequence; was a minimum of 40m in length and began and ended at a crossover point. A “crossover” point can be defined as the location where the thalweg (main concentration of flow) of the stream crosses over the center of the channel (OSAP, 2010).

Once the site boundaries had been defined, various qualitative observations were recorded. Features such as contaminant sources, anthropogenic alterations, shoreline destabilization, sedimentation, migratory obstructions, groundwater input and habitat modifications were outlined and described in detail.

TEMPERATURE PROFILING/THERMAL STABILITY (2.2)

Temperature probes were deployed in late April at six of the ten sampling locations and retrieved in the early fall (Model: Tidbit v2 Temp Logger UTBI-001). The loggers were set to record a temperature every 10 minutes for the duration of the study period. Upon retrieval, the data was uploaded and analyzed via nomogram. Sampling reaches were then classified into one of three categories based upon their corresponding thermal properties (Table 2). For a complete description of the sampling protocol, please refer to:

Stoneman, C.L. & M.L. Jones. 1996. *A simple method to evaluate the thermal stability of trout streams*. North American Journal of Fisheries Management

Table 2. Temperature Classifications (Minns et al. 2001)

Status	Water Temperature
Cold	<19 Degrees Celsius
Cool	19-25 Degrees Celsius

WATER CHEMISTRY (2.3)

Water chemistry data was taken prior to fish sampling using a YSI probe (Model: ProPlus) and recorded at two different intervals throughout the study period. Measurements were taken for water/air temperature, dissolved oxygen (DO), pH and conductivity.

BENTHIC COMMUNITY ASSESSMENT - OSAP: S2.M3 (2.4)

An important indicator of aquatic habitat conditions and water quality is the benthic invertebrate community found within a given system. Benthic invertebrates represent the larger organisms that inhabit the bottom substrates (the benthos) such as sediments, snags and aquatic plants, of aquatic habitats for at least part of their life cycle. Typically this fauna includes aquatic insects (e.g. stoneflies, mayflies, caddisflies, beetles, true bugs, true flies), crustaceans (e.g. isopods, amphipods, crayfishes), molluscs (e.g. snails, clams, mussels), annelids (e.g. leeches, oligochaetes), and a few other groups (e.g. proboscis worms, flatworms). Sampling for the benthic invertebrates was done using the standard kick and sweep method outlined in Section 2 – Module 3 of the Ontario Stream Assessment Protocol. Sampling was conducted in riffle habitat (when available), and all processing was performed in-field. All taxa were collected using 500 micron D-nets and identified to order-27 level.

FISH COMMUNITY ASSESSMENT - OSAP: S3.M1 (2.5)

Fish community assessment was accomplished via single pass electrofishing, with an average shocking effort of approximately 13 seconds/m² (Model: Halltech HT-2000). Sampling was conducted over two sessions (May and July) in an effort to identify both resident and spawning species. All taxa were identified to species level in-field, with one specimen taken as a voucher for later verification.

FISH HABITAT ASSESSMENT - OSAP: S4.M2 (2.6)

Fish habitat attributes were defined based on the “Physical Processes and Channel Structure” module of the Ontario Stream Assessment Protocol. Transects were established throughout the study reaches, with measurements taken incrementally at points along these transects. The number of points and transects were determined based on the overall dimensions of the site. The most common standard used was ten transects, with six observation points. Each observation point included measures of depth, velocity, substrate, cover materials and aquatic vegetation. Furthermore, the profile of the left and right bank was recorded at each transect by measuring the height from the top of bank to the slope at four standard intervals.

ANALYSIS OF FISH AND FISH HABITAT SENSITIVITY (2.7)

Fish/fish habitat sensitivity analysis was carried out as per the recommendations outlined in the Environmental Guide for Fish and Fish Habitat (MTO, 2009). Fish sensitivity was assessed via individual species physiology, life strategy characteristics and overall community structure. Metrics included thermal preference, reproductive guild and turbidity sensitivity.

Habitat dependency was assessed by means of a habitat association model. Species-specific habitat requirements were researched and compiled into a model detailing their corresponding associations with particular vegetation/substrate types. These habitat suitability metrics were then compared to the identified substrate/vegetation to reveal if the supporting habitat was present. Present and previous monitoring information was utilized in the analysis as this increased the resolution of the model over the same study reaches. Furthermore, the differences in these protocols helped to further detail the presence of different vegetation types and substrate compositions.

Habitat stability was measured as a function of the sites flow regime, physical characteristics, and thermal attributes. Metrics included groundwater presence, riparian cover, sedimentation, and thermal classification.

RESULTS & DISCUSSION (3.0)

SITE FEATURES (3.1)

Initial site inspection revealed a variety of factors which may negatively impact the overall health of the system (Table 3). Potential nutrient input from agricultural land-use was common among sites, although this conclusion can only be drawn from proximity and not from direct nutrient testing. Lack of adequate buffer habitat was also common to several of the study sites, as the encroachment of adjacent land-use has reduced diversity, and in some instances, destabilized the shorelines. Evidence of groundwater input was observed at two of the sampling sites. The results of this assessment are summarized in Table 3.

THERMAL CLASSIFICATION (3.2)

Six temperature loggers were deployed throughout the catchment area (Figure 1). Temperature data was taken between 16:00 and 16:30pm, between July 1 and September 10, on days where maximum air temperature exceeds 24.5 °C and after two previous days without precipitation and temperatures surpassing 24.5 °C.

Table 4. Thermal classification summary of Stillwater Creek study sites

SITE ID	SOURCE_ID	Y_WATER	X_AIR	CLASSIFICATION	PROGRAM	YEAR
Stillwater Creek	CK7-04SH	20.126	28.606	COOLWATER	OSAP	2013
Stillwater Creek	CK7-11SH	20.126	28.606	COOLWATER	OSAP	2013
Stillwater Creek	CK7-14SH	20.357	28.606	COOLWATER	OSAP	2013
Stillwater Creek	CK7-05SH	22.135	28.606	COOLWATER	OSAP	2013
Stillwater Creek	CK7-15SH	19.418	28.606	COOLWATER	OSAP	2013
Stillwater Creek	CK7-08SH	17.85	28.606	COOLWATER	OSAP	2013

Based on the stream temperature methodology outlined by Stoneman & Jones, Stillwater Creek is classified as a coolwater system (Table 4). As represented in Figure 2, sampling reaches CK7-05SH and CK7-08SH lie along the boundaries of these classification limits and indicate a divergence from the coolwater class. Site CK7-05SH represents a transition towards warmer temperatures, although this trend is not common throughout the rest of the system. It is likely that this shift in temperatures is due to the lack of adequate buffer present in this sampling reach, as both solar input and potential runoff are uninhibited. Site CK7-08SH represents a transition towards colder temperatures and is likely due to groundwater/infrastructure influences.

Thermal Classification – Stillwater Creek 2013

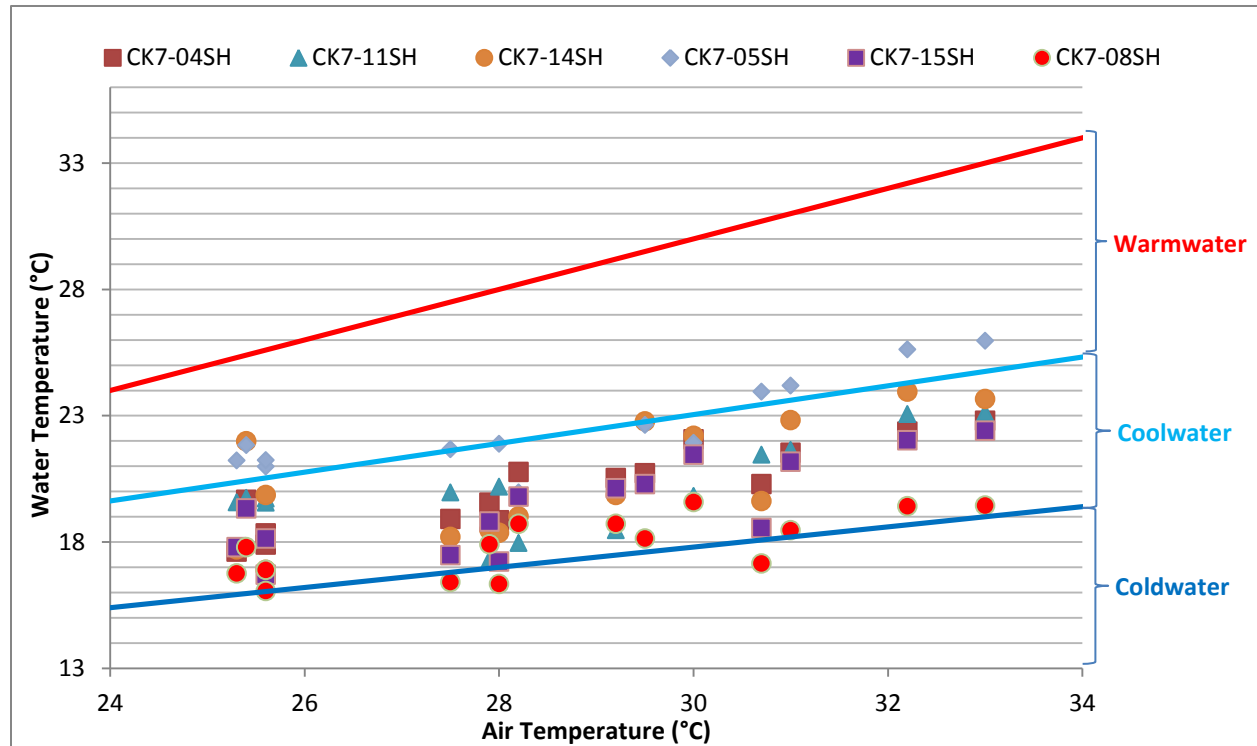

Figure 2. Thermal classification nomogram of Stillwater Creek

WATER CHEMISTRY ANALYSIS (3.3)

Water chemistry parameters were measured periodically between May and August, prior to conducting any other sampling for that day. These parameters include pH, conductivity and dissolved oxygen. Water quality standards have been outlined for these parameters by the Ministry of the Environment and are defined under the Provincial Water Quality Objective (PWQO) guidelines.

Based on the PWQO for pH, a range of 6.5 to 8.5 should be maintained in order to protect aquatic life. pH values for all sampled sites ranged between approximately 6.7 and 8.3, and thereby meet the provincial standard (Figure 3).

Conductivity in streams/ivers is primarily influence by the geology of the surrounding environment, but can vary drastically as a function of surface-water runoff. The average conductance observed across all sites was approximately 880 $\mu\text{s}/\text{cm}$ (Figure 4). Relative to this value, three sampling locations (CK7-03SH, CK7-13SH, CK7-14SH) revealed higher than average readings and may indicate a source of unmitigated discharge and/or stormwater input.

Table 3. Summary of site features identified throughout Stillwater Creek

CK7-03SH		CK7-04SH	
Category	Feature Description	Category	Feature Description
Contaminant Source	Proximity to HWY 417 (Stormwater/Runoff)	Contaminant Source	Proximity to Industrial Complex
Nutrient Input	Proximity to Agricultural Lands	Nutrient Input	Proximity to Agricultural Lands
Groundwater	Evidence of Groundwater Input	Migratory Obstructions	Concrete Weir Upstream of Study Site
Channel Modification	Channel straightening between 1958-1965	Channel Modification	Stream Realignment Between 1976-1991
CK7-05SH		CK7-06SH	
Category	Feature Description	Category	Feature Description
Contaminant Source	Extensive Waterfowl Use	Contaminant Source	Proximity to HWY 417 (Stormwater/Runoff)
Nutrient Input	Pasture/Agricultural Landuse	Nutrient Input	Proximity to Agricultural Lands
Sedimentation	High Levels of Sediment Present	Migratory Obstructions	Small Seasonal Obstructions/Minor Debris Dams
Habitat Modifications	Degraded Riparian Zone		
CK7-07SH		CK7-08SH	
Category	Feature Description	Category	Feature Description
Contaminant Source	Proximity to Timm Rd (Stormwater/Runoff)	Contaminant Source	Proximity to Industrial Complex
Nutrient Input	Proximity to Agricultural Lands	Migratory Obstructions	Minor Grade Barriers Present (knick points)
Migratory Obstructions	Perched Culvert at Timm Rd Crossing	Other	Snow Dumping Observed
Groundwater	Evidence of Groundwater Input (Iron Staining)		
CK7-11SH		CK7-13SH	
Category	Feature Description	Category	Feature Description
Contaminant Source	Active Agriculture	Contaminant Source	Proximity to HWY 417 (Stormwater/Runoff)
Nutrient Input	Proximity to Agricultural Lands	Nutrient Input	Proximity to Agricultural Lands
Habitat Modifications	Minimal Buffer Present/Prone to Flushing	Migratory Obstructions	Significant Grade Barrier Present (knick point)
Channel Modification	Highly Channelized	Habitat Modifications	Minimal Buffer Present
CK7-14SH		CK7-15SH	
Category	Feature Description	Category	Feature Description
Contaminant Source	Active Agriculture	Nutrient Input	Proximity to Agricultural Lands
Shoreline Destabilization	Field Erosion Evident	Channel Modification	Riprap Shoreline Stabilization (Minimal)
Other	Beavers Present		

Stillwater Creek – pH (2013)

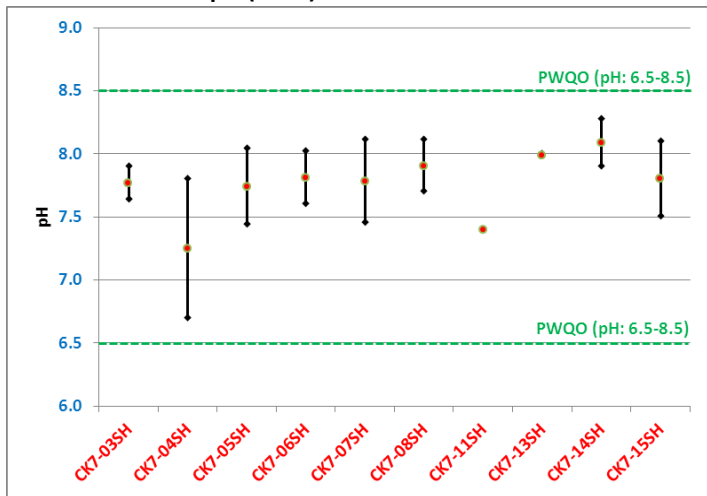

Figure 3. pH ranges recorded at each sampling site along Stillwater Creek. (PWQO outlined in green)

Stillwater Creek – Conductivity (2013)

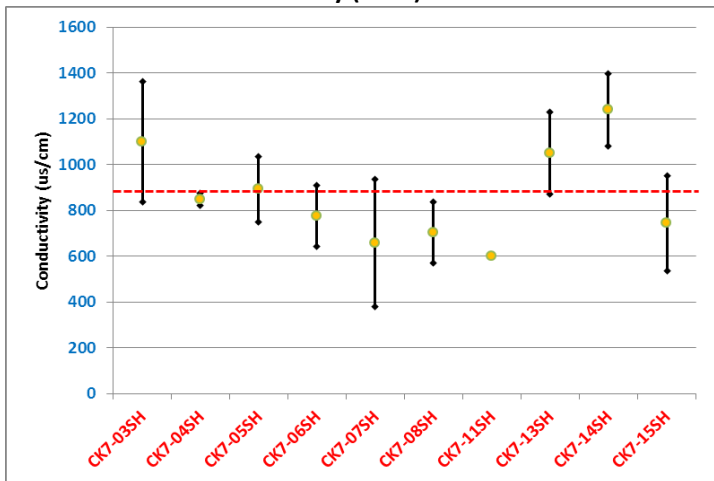

Figure 4. Conductivity ranges recorded at each sampling site along Stillwater Creek (Average conductance outlined in red)

Stillwater Creek – Dissolved Oxygen (2013)

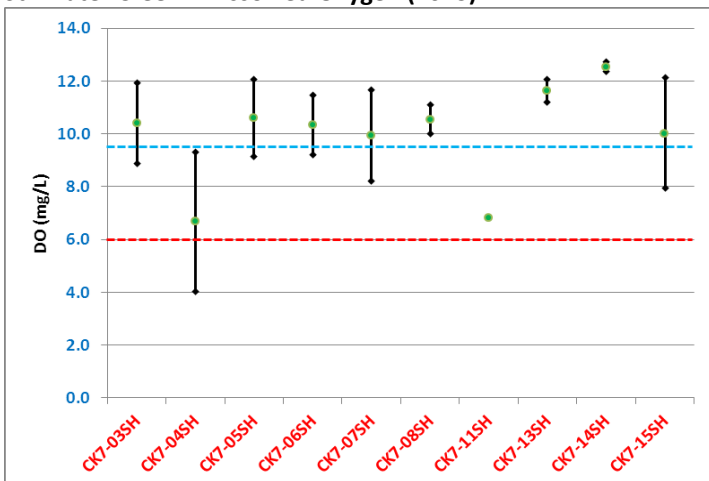

Figure 5. Dissolved oxygen ranges recorded at each sampling site along Stillwater Creek (CEQG: Red-Warmwater biota minimum tolerance – Blue: Coldwater biota minimum tolerance)

The Canadian Environmental Quality Guidelines (CEQG) indicate that for the protection of aquatic life, the lowest acceptable dissolved oxygen concentration is 6 mg/L for warmwater biota and 9.5 mg/L for coldwater biota. This standard was achieved at 8 of the 10 sites, with 2 sites falling below the coldwater threshold (Figure 5). Site CK7-04SH did not meet the lowest acceptable value for coldwater biota, and in some instances had concentrations which fell below the warmwater threshold. Since Stillwater Creek is a coolwater system, the biota may be particularly sensitive to these conditions, as this represents a significant stressor. This may be due in part to the presence of a weir structure upstream of the site. Site CK7-11SH was also below the coldwater standard, as this status was further substantiated by the lack of biota captured through sampling.

BENTHIC COMMUNITY ASSESSMENT (3.4)

A total of 18 benthos orders were sampled on Stillwater Creek, including Acari, Amphipoda, Coleoptera, Decapoda, Diptera, Ephemeroptera, Gastropoda, Hemiptera, Hirudinea, Isopoda, Megaloptera, Nematoda, Odonata, Oligochaeta, Pelecypoda, Plecoptera, Trichoptera and Turbellaria. Benthos analysis conducted by the City of Ottawa in 2001 concluded that substantial to severe levels of organic pollutants were likely present based on the taxa identified.

Potential impairment was analyzed across all sites based on five biological indices (Table 4). These metrics included low taxa richness, low EPT(%), and low Simpson Diversity relative to all sites. Sites CK7-11SH, CK7-13SH, and CK7-14SH were among the most impacted sites observed; all within tributary locations. Conversely, two sites were identified as least impaired. Sites CK7-07SH and CK7-15SH showed significantly higher diversity over the tributary sites, with moderate levels of EPT(%), richness and Simpson Diversity.

Table 4. Benthos community summary statistics/biological indices for Stillwater Creek

Site Code	Richness	Dominance	Abundance	Simpson Diversity	EPT
CK7-03SH	12	55.8%	40.3	0.65	3.7%
CK7-04SH	11	62.5%	7.9	0.59	1.8%
CK7-05SH	11	38.5%	6.8	0.74	1.9%
CK7-06SH	11	42.7%	32.0	0.73	10.2%
CK7-07SH	10	40.3%	11.7	0.73	29.1%
CK7-08SH	10	52.1%	39.2	0.67	12.8%
CK7-11SH	9	68.9%	4.9	0.50	0.8%
CK7-13SH	5	66.6%	4.5	0.47	0.0%
CK7-14SH	4	80.4%	26.6	0.33	0.0%
CK7-15SH	13	35.7%	13.7	0.79	36.3%

FISH COMMUNITY ASSESSMENT (3.5)

CK7-03SH (3.5.1)

a) May 16 2013 – Sample 1

A total of 863 shocker seconds were expended via electrofisher at a voltage of 350 V and a frequency of 80 Hz. A total of 36 fish were captured, comprised of the following 6 species:

- 8 brook stickleback *Culaea inconstans*
- 7 creek chub *Semotilus atromaculatus*
- 2 log perch *Percina caprodes*
- 3 longnose dace *Rhinichthys cataractae*
- 15 mottled sculpin *Cottus bairdii*
- 1 white sucker *Catostomus commersonii*

b) July 19 2013 – Sample 2

A total of 1063 shocker seconds were expended via electrofisher at a voltage of 150 V and a frequency of 80 Hz. A total of 65 fish were captured, comprised of the following 7 species:

- 4 brook stickleback *Culaea inconstans*
- 25 creek chub *Semotilus atromaculatus*
- 1 log perch *Percina caprodes*
- 2 longnose dace *Rhinichthys cataractae*
- 23 mottled sculpin *Cottus bairdii*
- 2 pearl dace *Margariscus nachtriebi*
- 8 white sucker *Catostomus commersonii*

CK7-04SH (3.5.2)

a) May 7 2013 – Sample 1

A total of 735 shocker seconds were expended via electrofisher at a voltage of 250 V and a frequency of 100 Hz. A total of 38 fish were captured, comprised of the following 6 species:

- 12 brook stickleback *Culaea inconstans*
- 9 central mudminnow *Umbra limi*
- 10 creek chub *Semotilus atromaculatus*
- 4 hybrid minnow spp *Cyprinid spp*
- 2 fathead minnow *Pimephales promelas*
- 1 northern redbelly dace *Chrosomus eos*

b) July 22 2013 – Sample 2

A total of 601 shocker seconds were expended via electrofisher at a voltage of 150 V and a frequency of 80 Hz. A total of 170 fish were captured, comprised of the following 7 species:

- 21 brook stickleback *Culaea inconstans*
- 2 central mudminnow *Umbra limi*
- 8 creek chub *Semotilus atromaculatus*
- 53 minnow spp *Cyprinid spp*
- 12 fathead minnow *Pimephales promelas*
- 10 northern redbelly dace *Chrosomus eos*

- 64 white sucker *Catostomus commersonii*

CK7-05SH (3.5.3)

a) May 16 2013 – Sample 1

A total of 883 shocker seconds were expended via electrofisher at a voltage of 250 V and a frequency of 80 Hz. A total of 135 fish were captured, comprised of the following 7 species:

- 30 brook stickleback *Culaea inconstans*
- 2 central mudminnow *Umbra limi*
- 62 creek chub *Semotilus atromaculatus*
- 17 fathead minnow *Pimephales promelas*
- 2 lepomis spp *Lepomis spp*
- 19 northern redbelly dace *Chrosomus eos*
- 3 white sucker *Catostomus commersonii*

b) July 23 2013 – Sample 2

A total of 1024 shocker seconds were expended via electrofisher at a voltage of 150 V and a frequency of 80 Hz. A total of 392 fish were captured, comprised of the following 8 species:

- 3 brassy minnow *Hybognathus hankinsoni*
- 40 brook stickleback *Culaea inconstans*
- 70 central mudminnow *Umbra limi*
- 22 creek chub *Semotilus atromaculatus*
- 233 cyprinid spp (YOY) *Cyprinid spp*
- 7 fathead minnow *Pimephales promelas*
- 3 northern redbelly dace *Chrosomus eos*
- 14 white sucker *Catostomus commersonii*

CK7-06SH (3.5.4)

a) May 7 2013 – Sample 1

A total of 449 shocker seconds were expended via electrofisher at a voltage of 250 V and a frequency of 100 Hz. A total of 144 fish were captured, comprised of the following 6 species:

- 16 brook stickleback *Culaea inconstans*
- 2 central mudminnow *Umbra limi*
- 111 creek chub *Semotilus atromaculatus*
- 5 fathead minnow *Pimephales promelas*
- 3 northern redbelly dace *Chrosomus eos*
- 7 white sucker *Catostomus commersonii*

b) July 30 2013 – Sample 2

A total of 418 shocker seconds were expended via electrofisher at a voltage of 150 V and a frequency of 100 Hz. A total of 77 fish were captured, comprised of the following 5 species:

- 11 brook stickleback *Culaea inconstans*
- 53 creek chub *Semotilus atromaculatus*
- 1 fathead minnow *Pimephales promelas*
- 10 northern redbelly dace *Chrosomus eos*
- 2 white sucker *Catostomus commersonii*

CK7-07SH (3.5.5)

a) May 15 2013 – Sample 1

A total of 439 shocker seconds were expended via electrofisher at a voltage of 250 V and a frequency of 60 Hz. A total of 291 fish were captured, comprised of the following 8 species:

- 75 brook stickleback *Culaea inconstans*
- 28 central mudminnow *Umbra limi*
- 1 common shiner *Luxilus cornutus*
- 38 creek chub *Semotilus atromaculatus*
- 1 minnow spp *Cyprinid spp*

- 54 fathead minnow *Pimephales promelas*
- 93 northern redbelly dace *Chrosomus eos*
- 1 white sucker *Catostomus commersonii*

b) July 29 2013 – Sample 2

A total of 468 shocker seconds were expended via electrofisher at a voltage of 150 V and a frequency of 80 Hz. A total of 121 fish were captured, comprised of the following 8 species:

- 3 brassy minnow *Hybognathus hankinsoni*
- 22 brook stickleback *Culaea inconstans*
- 1 brown bullhead *Ameiurus nebulosus*
- 12 central mudminnow *Umbra limi*
- 4 common shiner *Luxilus cornutus*
- 37 creek chub *Semotilus atromaculatus*
- 14 fathead minnow *Pimephales promelas*
- 28 northern redbelly dace *Chrosomus eos*

CK7-08SH (3.5.6)

a) May 15 2013 – Sample 1

A total of 411 shocker seconds were expended via electrofisher at a voltage of 250 V and a frequency of 60 Hz. A total of 126 fish were captured, comprised of the following 7 species:

- 8 brook stickleback *Culaea inconstans*
- 27 central mudminnow *Umbra limi*
- 1 common shiner *Luxilus cornutus*
- 22 creek chub *Semotilus atromaculatus*
- 15 fathead minnow *Pimephales promelas*
- 51 northern redbelly dace *Chrosomus eos*
- 2 white sucker *Catostomus commersonii*

b) July 31 2013 – Sample 2

A total of 504 shocker seconds were expended via electrofisher at a voltage of 150 V and a frequency of 80 Hz. A total of 140 fish were captured, comprised of the following 5 species:

- 38 brook stickleback *Culaea inconstans*
- 23 central mudminnow *Umbra limi*
- 57 creek chub *Semotilus atromaculatus*
- 11 fathead minnow *Pimephales promelas*
- 11 northern redbelly dace *Chrosomus eos*

CK7-11SH (3.5.7)

a) May 7 2013 – Sample 1

A total of 521 shocker seconds were expended via electrofisher at a voltage of 150 V and a frequency of 80 Hz.

No fish were captured.

b) July 18 2013 – Sample 2

A total of 562 shocker seconds were expended via electrofisher at a voltage of 150 V and a frequency of 80 Hz.

No fish were captured.

CK7-13SH (3.5.8)

a) May 15 2013 – Sample 1

A total of 705 shocker seconds were expended via electrofisher at a voltage of 350 V and a frequency of 80 Hz. A total of 4 fish were captured, comprised of the following species:

- 4 creek chub *Semotilus atromaculatus*

b) July 25 2013 – Sample 2

A total of 811 shocker seconds were expended via electrofisher at a voltage of 150 V and a frequency of 80 Hz. A total of 5 fish were captured, comprised of the following species:

- 5 creek chub *Semotilus atromaculatus*

CK7-14SH (3.5.9)

a) May 7 2013 – Sample 1

A total of 910 shocker seconds were expended via electrofisher at a voltage of 150 V and a frequency of 100 Hz. A total of 52 fish were captured, comprised of the following 3 species:

- 3 brook stickleback *Culaea inconstans*
- 23 creek chub *Semotilus atromaculatus*
- 26 fathead minnow *Pimephales promelas*

b) July 23 2013 – Sample 2

A total of 400 shocker seconds were expended via electrofisher at a voltage of 150 V and a frequency of 100 Hz. A total of 13 fish were captured, comprised of the following 5 species:

- 1 brook stickleback *Culaea inconstans*
- 1 central mudminnow *Umbra limi*
- 2 creek chub *Semotilus atromaculatus*
- 8 minnow spp *Cyprinid spp*
- 1 northern redbelly dace *Chrosomus eos*

CK7-15SH (3.5.10)

a) May 7 2013 – Sample 1

A total of 530 shocker seconds were expended via electrofisher at a voltage of 250 V and a frequency of 100 Hz. A total of 89 fish were captured, comprised of the following 3 species:

- 5 common shiner *Luxilus cornutus*
- 79 creek chub *Semotilus atromaculatus*
- 5 white sucker *Catostomus commersonii*

b) July 24 2013 – Sample 2

A total of 517 shocker seconds were expended via electrofisher at a voltage of 150 V and a frequency of 80 Hz. A total of 51 fish were captured, comprised of the following 4 species:

- 1 common shiner *Luxilus cornutus*

- 43 creek chub *Semotilus atromaculatus*
- 3 minnow spp (YOY) *Cyprinid spp*
- 4 northern redbelly dace *Chrosomus eos*

FISH HABITAT ASSESSMENT (3.6)

Point transect habitat assessments were carried out across all study sites. Habitat types (ie. Pools, glides & riffles) were defined as a function of stream velocity (Pools: 0-3mm; Glides: 3-7mm; Riffles: >8mm), and summarized at 100mm intervals. Features such as cover materials and vegetation were measured at each transect and distinguished as being either embedded or unembedded to the substrate.

CK7-03SH (3.6.1)

The results of the habitat assessment for site CK7-03SH are summarized in Figure 6. The analysis revealed a total habitat area of approximately 170.3m², consisting of 89% pool habitat, 8% glides and 3% riffles. Embedded cover was observed over approximately 30% of the site, and consisted primarily of rocks and macrophytes. Unembedded cover included rocks, macrophytes and wood, and was observed over approximately 70% of the site (Appendix IV).

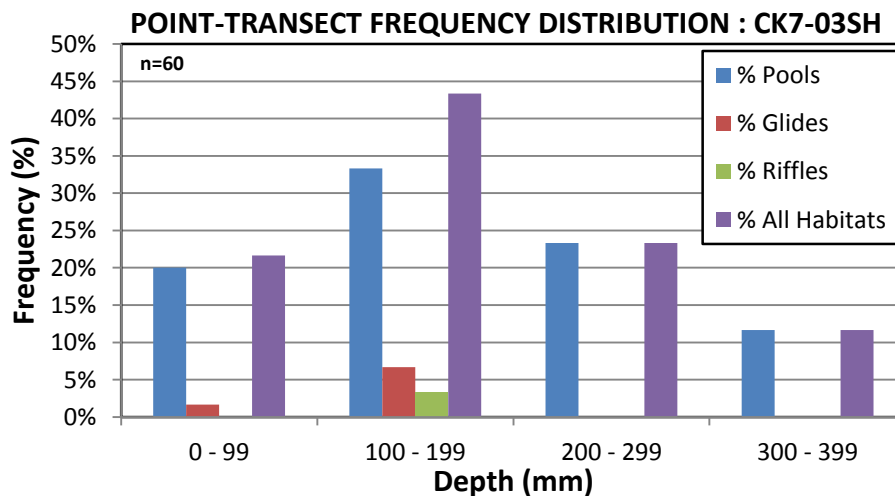

Figure 6. Frequency distribution of habitat types/stream velocities at 100mm intervals for site CK7-03SH

The maximum depth recorded did not exceed 400mm, with the most frequent range being between 100-199mm (43%). Pool habitat was the most prominent feature found within

this depth range, with the majority of available cover found within this same strata (Appendix IV).

A comparison across study years indicates that the proportion of habitat types/features have remained fairly consistent, although potential shifts in cover structure may have occurred. An increase of approximately 30% in embedded rock cover was observed and may be a result of gradual sedimentation.

CK7-04SH (3.6.2)

The results of the habitat assessment for site CK7-04SH are summarized in Figure 7. The analysis revealed a total habitat area of approximately 298.6m², consisting of 100% pool habitat. Embedded cover was observed over approximately 13% of the site, and consisted primarily of rocks, wood and macrophytes. Unembedded cover included rocks and wood, with the majority being macrophytes (66%); and was observed over approximately 86% of the site (Appendix IV).

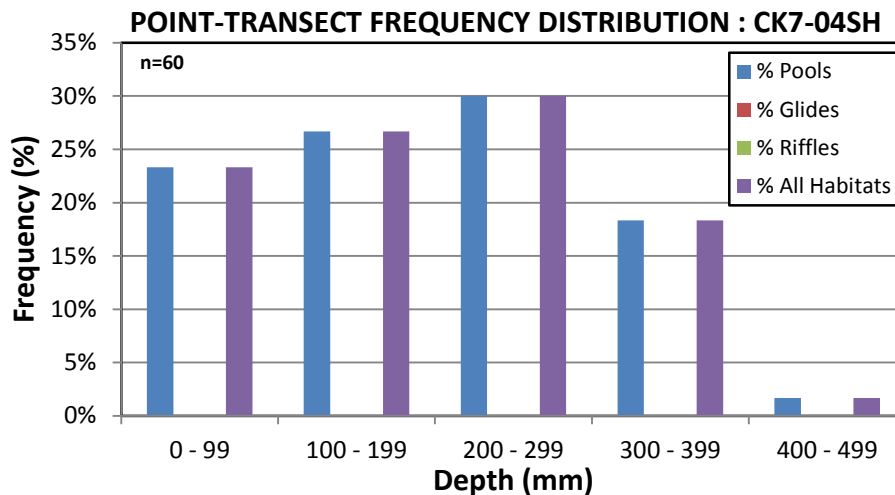

Figure 7. Frequency distribution of habitat types/stream velocities at 100mm intervals for site CK7-04SH

The maximum depth recorded did not exceed 500mm, with the most frequent range being between 200-299mm (30%). Pool habitat was the only habitat type found within this reach, as extensive macrophyte growth severely restricted stream flow (Appendix IV).

A comparison across study years indicates that the proportion of habitat types/features have remained fairly consistent, although potential shifts in cover structure may have occurred. An increase of approximately 32% in unembedded cover was observed with the majority being macrophyte and wood materials (Appendix IV).

CK7-05SH (3.6.3)

The results of the habitat assessment for site CK7-05SH are summarized in Figure 8. The analysis revealed a total habitat area of approximately 154.3m², consisting of 95% pool habitat, and 5% glides. Embedded cover was observed over approximately 17% of the site, and consisted primarily of wood, rocks and macrophytes. Unembedded cover included rocks, macrophytes and wood, and was observed over approximately 77% of the site (Appendix IV).

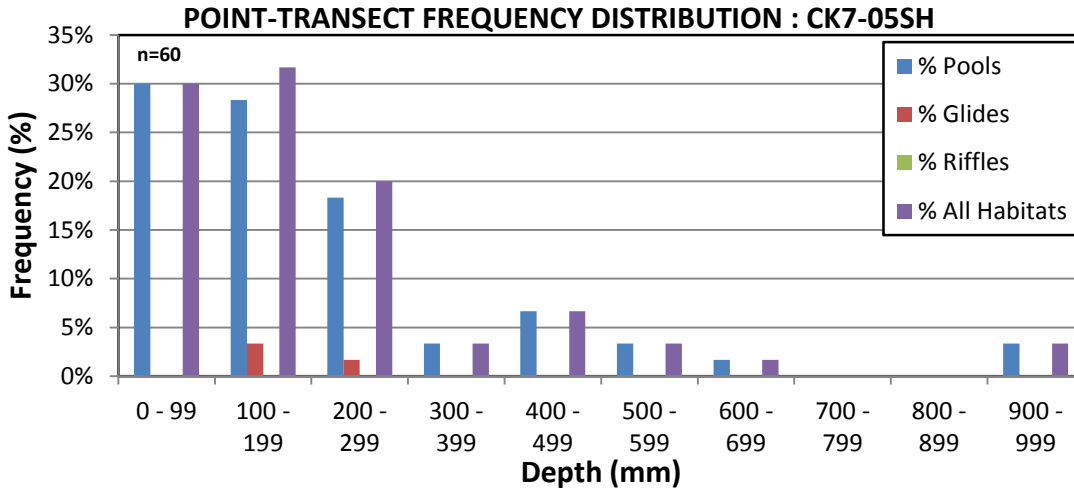

Figure 8. Frequency distribution of habitat types/stream velocities at 100mm intervals for site CK7-05SH

The maximum depth recorded did not exceed 1000 mm, with the most frequent range being between 100-199mm (32%). Pool habitat was the most prominent feature found within all depth ranges, accounting for the vast majority of habitat present (Appendix IV). The outlying depth strata (from 300-1000mm) occurred towards the end of the reach, in proximity to a culvert crossing. This deepening of the channel bed may be a result of concentrated flows at/or near the culvert during peak events.

Insufficient data exists for an accurate comparison between study years.

CK7-06SH (3.6.4)

The results of the habitat assessment for site CK7-06SH are summarized in Figure 9. The analysis revealed a total habitat area of approximately 56.9m², consisting of 97% pool habitat, and 3% glides. Embedded cover was observed over approximately 5% of the site, and consisted solely of macrophytes. Unembedded cover included primarily macrophytes and wood, and was observed over approximately 68% of the site (Appendix IV).

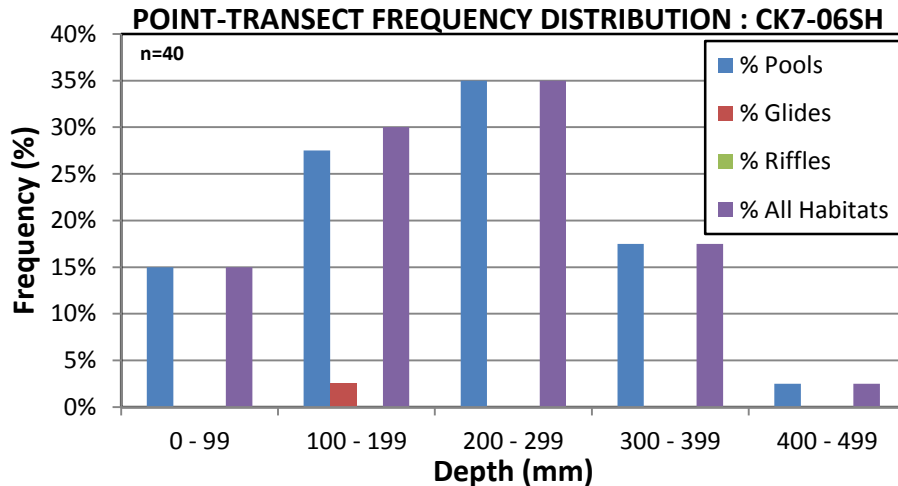

Figure 9. Frequency distribution of habitat types/stream velocities at 100mm intervals for site CK7-06SH

The maximum depth recorded did not exceed 500mm, with the most frequent range being between 200-299mm (35%). Pool habitat was the most prominent feature found within this depth range, with the majority of available cover found within this habitat (Appendix IV).

A comparison across study years indicates that the proportion of habitat types/features have remained fairly consistent, although potential shifts in cover structure may have occurred. An increase of approximately 44% in unembedded macrophytes was observed between 2001 and 2013 (Appendix IV).

CK7-07SH (3.6.5)

The results of the habitat assessment for site CK7-07SH are summarized in Figure 10.

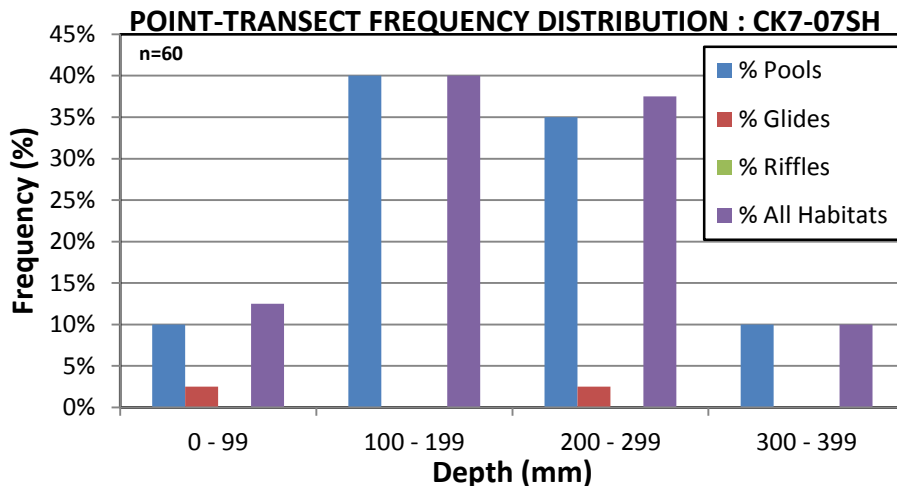

Figure 10. Frequency distribution of habitat types/stream velocities at 100mm intervals for site CK7-07SH

The analysis revealed a total habitat area of approximately 52.2m², consisting of 95% pool habitat, and 5% glides. Embedded cover was observed over approximately 28% of the site, consisting primarily of wood and rock materials. Unembedded cover included wood and macrophytes, and was observed over approximately 12% of the site (Appendix IV).

The maximum depth recorded did not exceed 400mm, with the most frequent range being between 100-199mm (40%). Pool habitat was the most prominent feature found within this depth range, with the majority of available cover found within this habitat (Appendix IV).

A comparison across study years indicates that the proportion of habitat types/features have remained fairly consistent, although potential shifts in cover structure may have occurred. An increase of approximately 20% embedded flat rock/wood cover was observed and may be a result of sedimentation of unembedded materials or additions to the stream.

CK7-08SH (3.6.6)

The results of the habitat assessment for site CK7-08SH are summarized in Figure 11. The analysis revealed a total habitat area of approximately 48.2m², consisting of 97% pool habitat, and 3% glides. Embedded cover was observed over approximately 15% of the site, and consisted primarily of rocks and macrophytes. Unembedded cover included rock, macrophytes and wood, and was observed over approximately 10% of the site (Appendix IV).

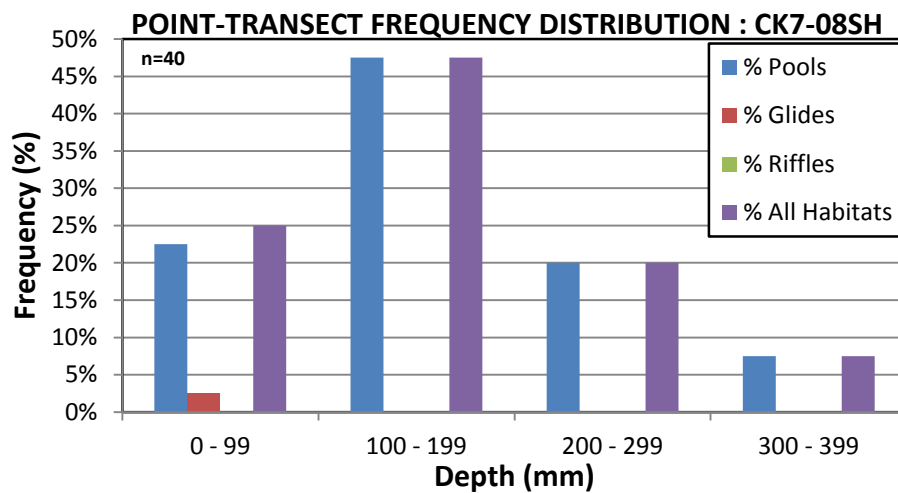

Figure 11. Frequency distribution of habitat types/stream velocities at 100mm intervals for site CK7-08SH

The maximum depth recorded did not exceed 400mm, with the most frequent range being between 100-199mm (48%). Pool habitat was the most prominent feature found within this depth range, with the majority of available cover found within this habitat (Appendix IV).

A comparison across study years indicates that the proportion of habitat types/features have remained fairly consistent, although potential shifts in cover structure may have occurred. A decrease of approximately 30% in unembedded rock materials was observed between 2001 and 2013 (Appendix IV). This may be a result of gradual stream loading and deposition outside the reach.

CK7-11SH (3.6.7)

The results of the habitat assessment for site CK7-11SH are summarized in Figure 12. The analysis revealed a total habitat area of approximately 94.6m², consisting of 95% pool habitat, and 5% riffles. Embedded cover was observed over approximately 30% of the site, and consisted solely of wood materials. Unembedded cover included rock, macrophytes and wood, and was observed over approximately 10% of the site (Appendix IV).

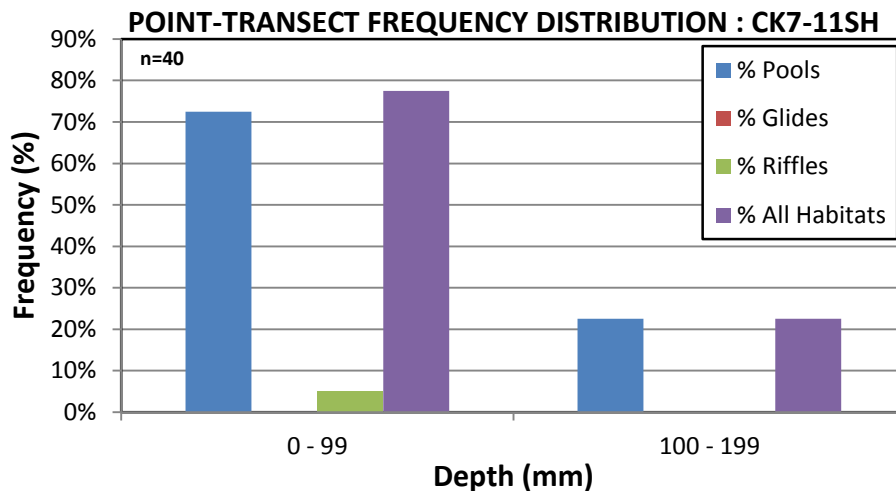

Figure 12. Frequency distribution of habitat types/stream velocities at 100mm intervals for site CK7-11SH

The maximum depth recorded did not exceed 200mm, with the most frequent range being between 0-99mm (78%). Pool habitat was the most prominent feature found within this depth range, with the majority of available cover found within this habitat (Appendix IV).

A comparison across study years indicates that the proportion of habitat types/features have remained fairly consistent, although potential shifts in cover structure may have occurred. An increase of approximately 20% embedded wood cover was observed and may be a result of sedimentation of unembedded materials or additions to the stream.

CK7-13SH (3.6.8)

The results of the habitat assessment for site CK7-13SH are summarized in Figure 13. The analysis revealed a total habitat area of approximately 131.6m², consisting of 95% pool habitat, 2% glides and 3% riffles. Embedded cover was observed over approximately 12% of the site, and consisted solely of rock materials. Unembedded cover included flat and round rock, and was observed over approximately 57% of the site (Appendix IV).

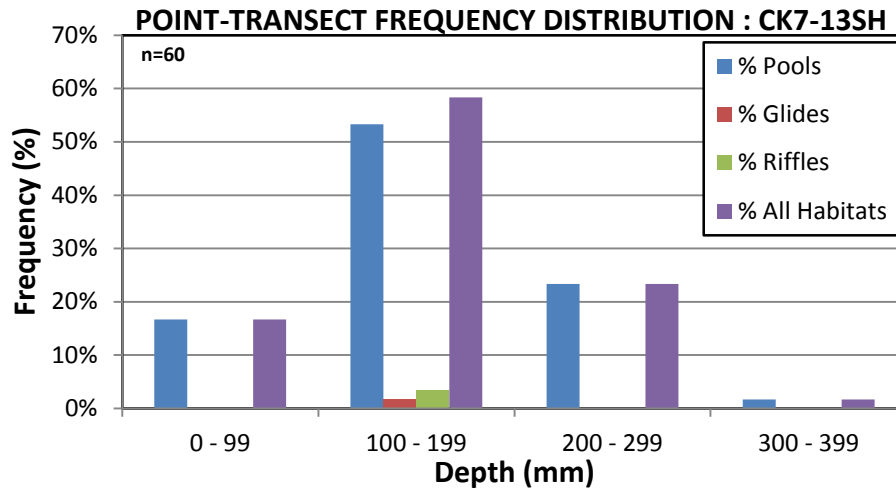

Figure 13. Frequency distribution of habitat types/stream velocities at 100mm intervals for site CK7-13SH

The maximum depth recorded did not exceed 400mm, with the most frequent range being between 100-199mm (58%). Pool habitat was the most prominent feature found within this depth range, with the majority of available cover found within this habitat (Appendix IV).

A comparison across study years indicates that the proportion of habitat types/features have remained fairly consistent, with no significant changes noted in cover structure (Appendix IV).

CK7-14SH (3.6.9)

The results of the habitat assessment for site CK7-14SH are summarized in Figure 14. The analysis revealed a total habitat area of approximately 93.6m², consisting of 92% pool habitat, and 8% glides. Embedded cover was observed over approximately 23% of the site, and consisted of rock and woody materials. Unembedded cover included the same base materials, and was observed over approximately 30% of the site (Appendix IV).

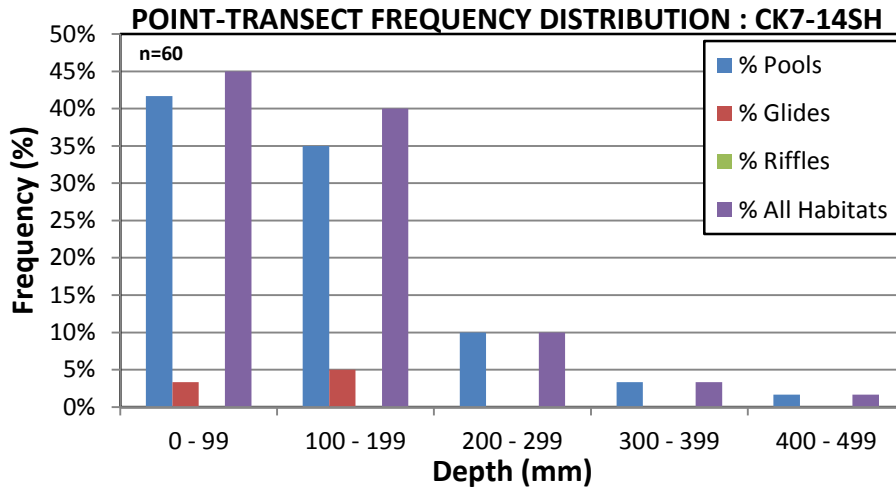

Figure 14. Frequency distribution of habitat types/stream velocities at 100mm intervals for site CK7-14SH

The maximum depth recorded did not exceed 500mm, with the most frequent range being between 0-199mm (85%). Pool habitat was the most prominent feature found within this depth range, with the majority of available cover found within this habitat (Appendix IV).

A comparison across study years indicates that the proportion of habitat types/features have remained fairly consistent, with no significant changes noted in cover structure (Appendix IV).

CK7-15SH (3.6.10)

The results of the habitat assessment for site CK7-15SH are summarized in Figure 15. The analysis revealed a total habitat area of approximately 84.3m², consisting of 78% pool habitat, 20% glides and 2% riffles. Embedded cover was observed over approximately 9% of the site, and consisted solely of rock materials.

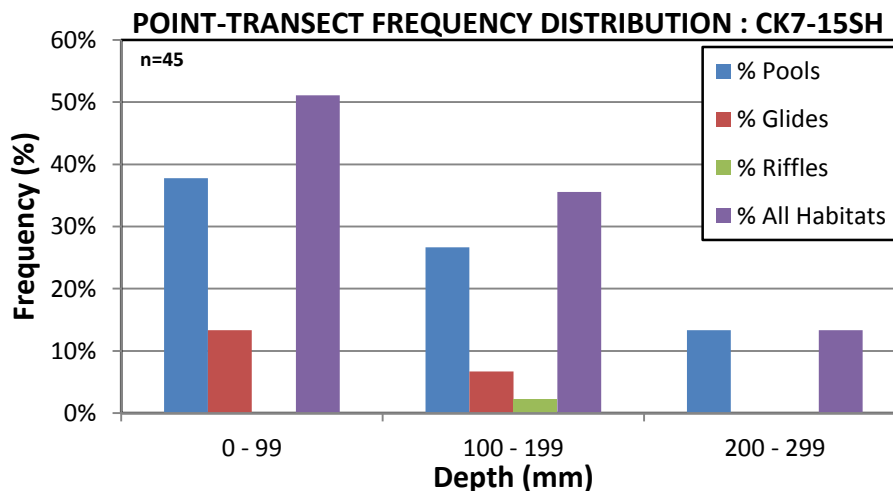

Figure 15. Frequency distribution of habitat types/stream velocities at 100mm intervals for site CK7-15SH

Unembedded cover included rock and woody materials, and was observed over approximately 73% of the site (Appendix IV).

The maximum depth recorded did not exceed 300mm, with the most frequent range being between 0-99mm (51%). This site was comprised of a variety of habitat types, and offered the greatest level of heterogeneity observed.

This site was not previously sampled through the City of Ottawa's 2001 study of Stillwater Creek, and therefore no comparative data exists.

ANALYSIS OF FISH AND FISH HABITAT SENSITIVITY (3.7)

RATIONALE:

Fish species can and have adapted to widely ranging environmental conditions, and can adapt to a certain amount of change or stress. However, when conditions change beyond their tolerance both individual species and populations experience stress. Similarly, different fish habitats exhibit varying tolerance or resilience to impacts. Therefore, the same activity can have a greater effect if it occurs in more sensitive fish habitat than it would if it occurred in less sensitive habitat. (Environmental Guide for Fish and Fish Habitat – MTO, 2009)

In order to accurately assess for the sensitivity of fish and fish habitat, the *Environmental Guide for Fish and Fish Habitat* recommends the analysis of four attributes:

- 1) Species Sensitivity
- 2) Species Dependence on Habitat
- 3) Species/Habitat Rarity
- 4) Habitat Stability

Based upon the conditions/status of these attributes, the *RMF Guide* (Section 2.2.3 – Determine Sensitivity of Fish and Fish Habitat) outlines five relative levels of sensitivity:

- 1) Rare – Includes SAR
- 2) Highly Sensitive
- 3) Moderately Sensitive
- 4) Low Sensitivity
- 5) Not Fish Habitat

CK7-03SH (3.7.1)

a) Species Sensitivity

Table 5. Summarized fish sensitivity attributes for species captured at site CK7-03SH

Species	Thermal Classification	*DO (mg/L) Low Tolerance	Sensitivity to Sediment/Turbidity			Feeding Strategy	Reproductive Strategy
			Reproduction	Feeding	Respiration		
brook stickleback	Coolwater	6.5	Moderate	High	NA	Insectivore	Nest
central mudminnow	Coolwater	6.5	Moderate	Moderate	Low	Omnivore	Broadcast
creek chub	Coolwater	6.5	Moderate	High	High	Generalist	Hide
log perch	Warmwater	5.5	Moderate	Moderate	High	Insectivore	Hide
longnose dace	Coolwater	6.5	Moderate	Moderate	High	Insectivore	Hide
mottled sculpin	Coldwater	8	Moderate	Moderate	High	Insectivore	Nest
northern redbelly dace	Coolwater	6.5	Moderate	Low	Low	Herbivore	Broadcast
pearl dace	Coldwater	8	Moderate	Moderate	High	Insectivore	Broadcast
white sucker	Coolwater	6.5	Moderate	Low	High	Omnivore	Broadcast

*DO(mg/L) Low Tolerance values do not represent species-specific life strategies/adaptations to low oxygen environments, as species may be able to tolerate levels below these thresholds. These values represent general tolerance levels for fish within the specified thermal classes.

The presence of pearl dace and mottled sculpin indicate relatively high thermal sensitivity, as these species are restricted to a limited range of temperature/oxygen conditions. Several of the identified species are also insectivores; feeding primarily on invertebrates, and are therefore sensitive to changes in the benthic community.

Species reproductive strategies can be categorized into two guilds:

- Non-Guarders (Broadcast, Hide)
- Guarders (Nest)

Mottled sculpin and brook stickleback employ a reproductive strategy known as “nest building”. Species that rely on brood guarding techniques tend to be more prone to disturbance compared to broadcast spawning, as the incubation period for their eggs is generally much longer.



Pearl dace (*Margariscus nachtriebi*) captured at site CK7-03SH

b) Species Dependence on Habitat

Table 6. Habitat association model for species captured at site CK7-03SH

Species	Vegetation Association (X)					Substrate Association (Low, Moderate, High)						
	Macrophytes			Algae		Bedrock	Boulder	Cobble	Gravel	Sand	Silt	Clay
	Submergents	Emergents	Floating	Filamentous	Non-Filamentous							
brook stickleback	X	X	-	-	-	-	-	-	M	H	H	-
central mudminnow	X	X	-	-	-	-	-	-	-	-	H	-
creek chub	-	-	-	-	-	-	-	-	H	H	-	-
log perch	X	X	-	-	-	M	M	H	H	H	-	-
longnose dace	-	-	-	-	-	-	-	M	H	M	-	-
mottled sculpin	-	-	-	-	-	-	H	H	H	H	-	-
northern redbelly dace	X	X	-	X	-	-	-	-	M	H	H	-
pearl dace	-	-	-	-	-	-	-	-	H	H	-	-
white sucker	X	X	-	-	-	-	-	-	H	M	-	-
OSAP ASSESSMENT	51.7%			100.0%	96.7%	0.0%	10.0%	50.0%	20.0%	1.7%	3.3%	15.0%
CSW (2009)	40.0%	10.0%	0.0%	50.0%		30.0%	0.0%	40.0%	20.0%	5.0%	5.0%	0.0%

Based on the species identified, varying levels of association were found among the following substrate types:

- Bedrock, Boulder, Cobble, Gravel, Sand and Silt

Point-transect analysis of the cover materials revealed the presence of:

- Boulder, Cobble, Gravel, Sand, Silt and Clay

Previous assessment undertaken by the RVCA identified the presence of:

- Bedrock, Cobble, Gravel, Sand and Silt

The substrate types identified at this site appear to meet the requirements of the apparent community. Furthermore, several species captured at this site were of a reproductive state (gravid female/spawning males), and thereby dependent on the surrounding habitat.

Based on the species identified, varying levels of association were found among the following vegetation types:

- Submergents, Emergents and Filamentous Algae

Vegetation community assessment revealed the presence of:

- Macrophytes (Sumergents & Emergents) and Algae (Filamentous & Non-Filamentous)

The vegetation types identified at this site appear to meet the requirements of the apparent community. These requirements (substrate/vegetation) represent usage by the species over varying life stages, ranging from spawning/incubation to adulthood.

c) Species/Habitat Rarity

All species captured at this site are of common abundance in the region. Evidence of groundwater input was identified in the vicinity through previous monitoring by the RVCA (CSW, 2009). This habitat element may represent a limited supporting feature for regional biota.

d) Habitat Stability

Table 7. General stream/riparian attributes for site CK7-03SH

Flow Regime	Physical Characteristics				Thermal Regime
Groundwater Influence	Riparian Cover (1.5-10m)	Riparian Cover (10-30m)	Riparian Cover (30-100m)	Sedimentation	Thermal Class
Potential	Meadow	Infrastructure/Forest	Infrastructure/Forest	No Evidence	Coolwater

Flow Regime:

- Groundwater in the vicinity may support habitat functions that may be negatively impacted if the source is disturbed

Physical Characteristics:

- Well established buffers protect against erosion, improve habitat and help to maintain water quality. It is generally recommended to maintain a buffer width of 30 meters or greater, as riparian losses can negatively impact fish/fish habitat.

Thermal Regime:

- Coolwater systems are moderately sensitive to changes in thermal regime as they are generally capable of buffering temperatures.

OVERALL SENSITIVITY:

Highly Sensitive

- Presence of highly sensitive indicator species (pearl dace, mottled sculpin)
- Species dependence on habitat is high as spawning individuals were identified and all associated habitat features were present
- Uncommon habitat types/features were identified which may represent limited supporting habitat (ie. evidence of groundwater input)
- Habitat stability is moderate as the flow, thermal and physical characteristics of the stream are capable of buffering moderate levels of disturbance (ie. partial buffer, coolwater environment)

CK7-04SH (3.7.2)

a) Species Sensitivity

Table 8. Summarized fish sensitivity attributes for species captured at site CK7-04SH

Species	Thermal Classification	*DO (mg/L) Low Tolerance	Sensitivity to Sediment/Turbidity			Feeding Strategy	Reproductive Strategy
			Reproduction	Feeding	Respiration		
brook stickleback	Coolwater	6.5	Moderate	High	NA	Insectivore	Nest
central mudminnow	Coolwater	6.5	Moderate	Moderate	Low	Omnivore	Broadcast
creek chub	Coolwater	6.5	Moderate	High	High	Generalist	Hide
fathead minnow	Warmwater	5.5	Low	Low	NA	Omnivore	Nest
northern redbelly dace	Coolwater	6.5	Moderate	Low	Low	Herbivore	Broadcast
white sucker	Coolwater	6.5	Moderate	Low	High	Omnivore	Broadcast

*DO(mg/L) Low Tolerance values do not represent species-specific life strategies/adaptations to low oxygen environments, as species may be able to tolerate levels below these thresholds. These values represent general tolerance levels for fish within the specified thermal classes.

The presence of coolwater species indicates a moderate level of sensitivity, as these species are generally tolerant to minor temperature variation. Furthermore, several of the identified species exhibit differential tolerance to turbidity, with high levels of respiratory sensitivity observed in both creek chub and white sucker. Despite their varying sensitivities, the fish community identified at this site is primarily dominated by generalist species capable of adapting to a broad range of habitat conditions.

b) Species Dependence on Habitat

Table 9. Habitat association model for species captured at site CK7-04SH

Species	Vegetation Association (X)					Substrate Association (Low, Moderate, High)						
	Macrophytes			Algae		Bedrock	Boulder	Cobble	Gravel	Sand	Silt	Clay
	Submergents	Emergents	Floating	Filamentous	Non-Filamentous							
brook stickleback	X	X	-	-	-	-	-	-	M	H	H	-
central mudminnow	X	X	-	-	-	-	-	-	-	-	H	-
creek chub	-	-	-	-	-	-	-	-	H	H	-	-
fathead minnow	X	X	X	-	-	-	-	-	M	H	H	-
northern redbelly dace	X	X	-	X	-	-	-	-	M	H	H	-
white sucker	X	X	-	-	-	-	-	-	H	M	-	-

OSAP ASSESSMENT	88.3%			31.7%	0.0%	3.3%	0.0%	1.7%	16.7%	0.0%	78.3%	0.0%
CSW (2009)	0.0%	50.0%	10.0%	40.0%		0.0%	5.0%	10.0%	40.0%	35.0%	10.0%	0.0%

Based on the species identified, varying levels of association were found among the following substrate types:

- Gravel, Sand and Silt

Point-transect analysis of the cover materials revealed the presence of:

- Bedrock, Cobble, Gravel and Silts

Previous assessment undertaken by the RVCA identified the presence of:

- Boulder, Cobble, Gravel, Sand and Silts

The substrate types identified at this site appear to meet the requirements of the apparent community. Furthermore, several species captured at this site were of a reproductive state (gravid female/spawning males), and thereby dependent on the surrounding habitat.

Based on the species identified, varying levels of association were found among the following vegetation types:

- Submergents, Emergents, Floating Vegetation and Filamentous Algae

Vegetation community assessment revealed the presence of:

- Macrophytes (Sumergents, Emergents & Floating Vegetation) and Algae (Filamentous)

The vegetation types identified at this site appear to meet the requirements of the apparent community. These requirements (substrate/vegetation) represent usage by the species over varying life stages, ranging from spawning/incubation to adulthood.

c) Species/Habitat Rarity

All species/habitats at this site are of common abundance in the region.

d) Habitat Stability

Table 10. General stream/riparian attributes for site CK7-04SH

Flow Regime	Physical Characteristics				Thermal Regime
Groundwater Influence	Riparian Cover (1.5-10m)	Riparian Cover (10-30m)	Riparian Cover (30-100m)	Sedimentation	Thermal Class
No Evidence	Meadow	Lawn/Scrubland	Lawn/Infrastructure	No Evidence	Coolwater

Physical Characteristics:

- Well established buffers protect against erosion, improve habitat and help to maintain water quality. It is generally recommended to maintain a buffer width of 30 meters or greater, as riparian losses can negatively impact fish/fish habitat (ie. Lawn).

Thermal Regime:

- Coolwater systems are moderately sensitive to changes in thermal regime as they are generally capable of buffering temperatures.

OVERALL SENSITIVITY:

Moderately Sensitive

- Species sensitivity is moderate (Varying sensitivities to turbidity, but overall dominated by generalist species)
- Species dependence on habitat is high as spawning individuals were identified and all associated habitat features were present
- Habitat and species rarity is/are low (no rare species/uncommon habitats)
- Habitat stability is moderate as the flow, thermal and physical characteristics of the stream are capable of buffering moderate levels of disturbance (ie. Partial buffer, coolwater environment)

CK7-05SH (3.7.3)

a) Species Sensitivity

Table 11. Summarized fish sensitivity attributes for species captured at site CK7-05SH

Species	Thermal Classification	*DO (mg/L) Low Tolerance	Sensitivity to Sediment/Turbidity			Feeding Strategy	Reproductive Strategy
			Reproduction	Feeding	Respiration		
brassy minnow	Coolwater	6.5	Moderate	Low	NA	Omnivore	Broadcast
brook stickleback	Coolwater	6.5	Moderate	High	NA	Insectivore	Nest
central mudminnow	Coolwater	6.5	Moderate	Moderate	Low	Omnivore	Broadcast
common shiner	Coolwater	6.5	Moderate	Moderate	NA	Insectivore	Hide
creek chub	Coolwater	6.5	Moderate	High	High	Generalist	Hide
fathead minnow	Warmwater	5.5	Low	Low	NA	Omnivore	Nest
northern redbelly dace	Coolwater	6.5	Moderate	Low	Low	Herbivore	Broadcast
white sucker	Coolwater	6.5	Moderate	Low	High	Omnivore	Broadcast

*DO(mg/L) Low Tolerance values do not represent species-specific life strategies/adaptations to low oxygen environments, as species may be able to tolerate levels below these thresholds. These values represent general tolerance levels for fish within the specified thermal classes.

The presence of coolwater species indicates a moderate level of sensitivity, as these species are generally tolerant to minor temperature variation. Furthermore, several of the identified species exhibit differential tolerance to turbidity, with high levels of respiratory sensitivity observed in both creek chub and white sucker.

Despite their varying sensitivities, the fish community identified at this site is primarily dominated by generalist species capable of adapting to a broad range of habitat conditions.

b) Species Dependence on Habitat

Table 12. Habitat association model for species captured at site CK7-05SH

Species	Vegetation Association (X)					Substrate Association (Low, Moderate, High)						
	Macrophytes			Algae		Bedrock	Boulder	Cobble	Gravel	Sand	Silt	Clay
	Submergents	Emergents	Floating	Filamentous	Non-Filamentous							
Brassy minnow	X	X	-	-	-	-	-	-	M	H	H	-
Brook stickleback	X	X	-	-	-	-	-	-	M	H	H	-
Central mudminnow	X	X	-	-	-	-	-	-	-	-	H	-
Common shiner	-	-	-	-	-	-	-	-	H	M	-	-
Creek chub	-	-	-	-	-	-	-	-	H	H	-	-
Fathead minnow	X	X	X	-	-	-	-	-	M	H	H	-
Northern redbelly dace	X	X	-	X	-	-	-	-	M	H	H	-
White sucker	X	X	-	-	-	-	-	-	H	M	-	-

OSAP ASSESSMENT	66.7%			75.0%	0.0%	0.0%	1.7%	3.3%	28.3%	18.3%	46.7%	1.7%
CSW (2009)	30.0%	35.0%	5.0%	30.0%		0.0%	0.0%	5.0%	15.0%	25.0%	5.0%	25.0%

Based on the species identified, varying levels of association were found among the following substrate types:

- Gravel, Sand and Silt

Point-transect analysis of the cover materials revealed the presence of:

- Boulder, Cobble, Gravel, Sand, Silt and Clay

Previous assessment undertaken by the RVCA identified the presence of:

- Cobble, Gravel, Sand, Silt and Clay

The substrate types identified at this site appear to meet the requirements of the apparent community.

Based on the species identified, varying levels of association were found among the following vegetation types:

- Submergents, Emergents, Floating Vegetation and Filamentous Algae

Vegetation community assessment revealed the presence of:

- Macrophytes (Sumergents, Emergents & Floating Vegetation) and Algae (Filamentous)

The vegetation types identified at this site appear to meet the requirements of the apparent community. These requirements (substrate/vegetation) represent usage by the species over varying life stages, ranging from spawning/incubation to adulthood.

c) Species/Habitat Rarity

All species/habitats at this site are of common abundance in the region.

d) Habitat Stability

Table 13. General stream/riparian attributes for site CK7-05SH

Flow Regime	Physical Characteristics				Thermal Regime
Groundwater Influence	Riparian Cover (1.5-10m)	Riparian Cover (10-30m)	Riparian Cover (30-100m)	Sedimentation	Thermal Class
No Evidence	Meadow	Lawn/Pasture	Lawn/Pasture	Ongoing/Active	Coolwater

Physical Characteristics:

- Well established buffers protect against erosion, improve habitat and help to maintain water quality. It is generally recommended to maintain a buffer width of 30 meters or greater, as riparian losses can negatively impact fish/fish habitat (ie. Lawn/Pasture).
- Fine materials/sediments are highly prone to movement upon disturbance or fluctuation in flow. Stream sedimentation is a highly detrimental process and represents a significant loss of environmental stability.

Thermal Regime:

- Coolwater systems are moderately sensitive to changes in thermal regime as they are generally capable of buffering temperatures.

OVERALL SENSITIVITY:

Moderately Sensitive

- Species sensitivity is moderate (Varying sensitivities to turbidity; complex community)
- Species dependence on habitat is moderate as all associated habitat features were present, but no spawning individuals were identified
- Habitat and species rarity is/are low (no rare species/uncommon habitats)
- Habitat stability is low as the flow, thermal and physical characteristics of the stream are prone to fluctuation (ie. Degraded buffer, evident sedimentation)

CK7-06SH (3.7.4)

a) Species Sensitivity

Table 14. Summarized fish sensitivity attributes for species captured at site CK7-06SH

Species	Thermal Classification	*DO (mg/L) Low Tolerance	Sensitivity to Sediment/Turbidity			Feeding Strategy	Reproductive Strategy
			Reproduction	Feeding	Respiration		
blackchin shiner (2001)	Coolwater	6.5	Moderate	Moderate	NA	Insectivore	Broadcast
brook stickleback	Coolwater	6.5	Moderate	High	NA	Insectivore	Nest
central mudminnow	Coolwater	6.5	Moderate	Moderate	Low	Omnivore	Broadcast
common shiner	Coolwater	6.5	Moderate	Moderate	NA	Insectivore	Hide
creek chub	Coolwater	6.5	Moderate	High	High	Generalist	Hide
northern redbelly dace	Coolwater	6.5	Moderate	Low	Low	Herbivore	Broadcast
white sucker	Coolwater	6.5	Moderate	Low	High	Omnivore	Broadcast

*DO(mg/L) Low Tolerance values do not represent species-specific life strategies/adaptations to low oxygen environments, as species may be able to tolerate levels below these thresholds. These values represent general tolerance levels for fish within the specified thermal classes.

The presence of coolwater species indicates a moderate level of sensitivity, as these species are generally tolerant to minor temperature variation. Furthermore, several of the identified species exhibit differential tolerance to turbidity, with high levels of respiratory sensitivity observed in both creek chub and white sucker.

Despite their varying sensitivities, the fish community identified at this site is primarily dominated by generalist species capable of adapting to a broad range of habitat conditions.

b) Species Dependence on Habitat

Table 15. Habitat association model for species captured at site CK7-06SH

Species	Vegetation Association (X)					Substrate Association (Low, Moderate, High)						
	Macrophytes			Algae		Bedrock	Boulder	Cobble	Gravel	Sand	Silt	Clay
	Submergents	Emergents	Floating	Filamentous	Non-Filamentous							
Blackchin shiner	X	X	-	-	-	-	-	-	H	H	-	-
Brook stickleback	X	X	-	-	-	-	-	-	M	H	H	-
Central mudminnow	X	X	-	-	-	-	-	-	-	-	H	-
Common shiner	-	-	-	-	-	-	-	-	H	M	-	-
Creek chub	-	-	-	-	-	-	-	-	H	H	-	-
Northern redbelly dace	X	X	-	X	-	-	-	-	M	H	H	-
White sucker	X	X	-	-	-	-	-	-	H	M	-	-
OSAP ASSESSMENT	32.5%			50.0%	0.0%	0.0%	0.0%	2.5%	2.5%	20.0%	0.0%	75.0%
CSW (2009)	0.0%	5.0%	0.0%	95.0%		0.0%	10.0%	5.0%	5.0%	60.0%	20.0%	0.0%

Based on the species identified, varying levels of association were found among the following substrate types:

- Gravel, Sand and Silt

Point-transect analysis of the cover materials revealed the presence of:

- Cobble, Gravel, Sand and Clay

Previous assessment undertaken by the RVCA identified the presence of:

- Boulder, Cobble, Gravel, Sand and Silt

The substrate types identified at this site appear to meet the requirements of the apparent community. Furthermore, several species captured at this site were of a reproductive state (gravid female/spawning males), and thereby dependent on the surrounding habitat.

Based on the species identified, varying levels of association were found among the following vegetation types:

- Submergents, Emergents, and Filamentous Algae

Vegetation community assessment revealed the presence of:

- Macrophytes (Sumergents & Emergents) and Algae (Filamentous)

The vegetation types identified at this site appear to meet the requirements of the apparent community. These requirements (substrate/vegetation) represent usage by the species over varying life stages, ranging from spawning/incubation to adulthood.

c) Species/Habitat Rarity

All species/habitats at this site are of common abundance in the region.

d) Habitat Stability

Table 16. General stream/riparian attributes for site CK7-06SH

Flow Regime	Physical Characteristics			Thermal Regime	
Groundwater Influence	Riparian Cover (1.5-10m)	Riparian Cover (10-30m)	Riparian Cover (30-100m)	Sedimentation	Thermal Class
No Evidence	Meadow	Scrubland	Cropland	No Evidence	Coolwater

Physical Characteristics:

- Well established buffers protect against erosion, improve habitat and help to maintain water quality. A natural buffer of 30m or greater is generally considered adequate for maintaining habitat stability (ie. Meadow/Scrubland).

Thermal Regime:

- Coolwater systems are moderately sensitive to changes in thermal regime as they are generally capable of buffering temperatures.

OVERALL SENSITIVITY:

Moderately Sensitive

- Species sensitivity is moderate (Varying sensitivities to turbidity, but overall dominated by generalist species)
- Species dependence on habitat is high as spawning individuals were identified and all associated habitat features were present
- Habitat and species rarity is/are low (no rare species/uncommon habitats)
- Habitat stability is moderate as the flow, thermal and physical characteristics of the stream are capable of buffering moderate levels of disturbance (ie. Partial buffer, coolwater environment)

CK7-07SH (3.7.5)

a) Species Sensitivity

Table 17. Summarized fish sensitivity attributes for species captured at site CK7-07SH

Species	Thermal Classification	*DO (mg/L) Low Tolerance	Sensitivity to Sediment/Turbidity			Feeding Strategy	Reproductive Strategy
			Reproduction	Feeding	Respiration		
brassy minnow	Coolwater	6.5	Moderate	Low	NA	Omnivore	Broadcast
brook stickleback	Coolwater	6.5	Moderate	High	NA	Insectivore	Nest
central mudminnow	Coolwater	6.5	Moderate	Moderate	Low	Omnivore	Broadcast
common shiner	Coolwater	6.5	Moderate	Moderate	NA	Insectivore	Hide
creek chub	Coolwater	6.5	Moderate	High	High	Generalist	Hide
fathead minnow	Warmwater	5.5	Low	Low	NA	Omnivore	Nest
northern redbelly dace	Coolwater	6.5	Moderate	Low	Low	Herbivore	Broadcast
pearl dace (2001)	Coldwater	8	Moderate	Moderate	High	Insectivore	Broadcast
white sucker	Coolwater	6.5	Moderate	Low	High	Omnivore	Broadcast

*DO(mg/L) Low Tolerance values do not represent species-specific life strategies/adaptations to low oxygen environments, as species may be able to tolerate levels below these thresholds. These values represent general tolerance levels for fish within the specified thermal classes.

The presence of pearl dace indicates relatively high thermal sensitivity, as this species is restricted to a limited range of temperature/oxygen conditions. Furthermore, a significant proportion of the community exhibits differential tolerance to turbidity, with high levels of respiratory sensitivity observed in creek chub, white sucker and pearl dace.

Several of the identified species are also insectivores; feeding primarily on invertebrates, and are therefore sensitive to changes in the benthic community.

b) Species Dependence on Habitat

Table 18. Habitat association model for species captured at site CK7-07SH

Species	Vegetation Association (X)					Substrate Association (Low, Moderate, High)						
	Macrophytes			Algae		Bedrock	Boulder	Cobble	Gravel	Sand	Silt	Clay
	Submergents	Emergents	Floating	Filamentous	Non-Filamentous							
brassy minnow	X	X	-	-	-	-	-	-	M	H	H	-
brook stickleback	X	X	-	-	-	-	-	-	M	H	H	-
central mudminnow	X	X	-	-	-	-	-	-	-	-	H	-
common shiner	-	-	-	-	-	-	-	-	H	M	-	-
creek chub	-	-	-	-	-	-	-	-	H	H	-	-
fathead minnow	X	X	X	-	-	-	-	-	M	H	H	-
northern redbelly dace	X	X	-	X	-	-	-	-	M	H	H	-
pearl dace	-	-	-	-	-	-	-	-	H	H	-	-
white sucker	X	X	-	-	-	-	-	-	H	M	-	-
OSAP ASSESSMENT	5.0%			10.0%	5.0%	0.0%	5.0%	5.0%	17.5%	37.5%	2.5%	32.5%
CSW (2009)	20.0%	10.0%	0.0%	70.0%		0.0%	20.0%	35.0%	15.0%	20.0%	0.0%	10.0%

Based on the species identified, varying levels of association were found among the following substrate types:

- Gravel, Sand and Silt

Point-transect analysis of the cover materials revealed the presence of:

- Boulder, Cobble, Gravel, Sand, Silt and Clay

Previous assessment undertaken by the RVCA identified the presence of:

- Boulder, Cobble, Gravel, Sand and Clay

The substrate types identified at this site appear to meet the requirements of the apparent community. Furthermore, several species captured at this site were of a reproductive state (gravid female/spawning males), and thereby dependent on the surrounding habitat.

Based on the species identified, varying levels of association were found among the following vegetation types:

- Submergents, Emergents, Floating Vegetation and Filamentous Algae

Vegetation community assessment revealed the presence of:

- Macrophytes (Submergents, Emergents & Floating Vegetation) and Algae (Filamentous & Non-Filamentous)

The vegetation types identified at this site appear to meet the requirements of the apparent community. These requirements (substrate/vegetation) represent usage by the species over varying life stages, ranging from spawning/incubation to adulthood.

c) Species/Habitat Rarity

All species captured at this site are of common abundance in the region. Evidence of groundwater input was observed at one location across the reach (ie. Iron staining). This habitat element may represent a limited supporting feature for regional biota.

d) Habitat Stability

Table 19. General stream/riparian attributes for site CK7-07SH

Flow Regime	Physical Characteristics			Sedimentation	Thermal Regime
Groundwater Influence	Riparian Cover (1.5-10m)	Riparian Cover (10-30m)	Riparian Cover (30-100m)		Thermal Class
Ongoing/Active	Meadow	Meadow	Cropland	No Evidence	Coolwater

Flow Regime:

- Groundwater in the vicinity may support habitat functions that would be negatively impacted if the source is disturbed

Physical Characteristics:

- Well established buffers protect against erosion, improve habitat and help to maintain water quality. A natural buffer of 30m or greater is generally considered adequate for maintaining habitat stability (ie. Meadow).

Thermal Regime:

- Coolwater systems are moderately sensitive to changes in thermal regime as they are generally capable of buffering temperatures.

OVERALL SENSITIVITY:

Highly Sensitive

- Presence of highly sensitive indicator species (pearl dace)
- Species dependence on habitat is high as spawning individuals were identified and all associated habitat features were present
- Uncommon habitat types/features were identified which may represent limited supporting habitat (ie. Evidence of groundwater input)
- Habitat stability is moderate as the flow, thermal and physical characteristics of the stream are capable of buffering moderate levels of disturbance (ie. Partial buffer, coolwater environment)

CK7-08SH (3.7.6)

a) Species Sensitivity

Table 20. Summarized fish sensitivity attributes for species captured at site CK7-08SH

Species	Thermal Classification	*DO (mg/L) Low Tolerance	Sensitivity to Sediment/Turbidity			Feeding Strategy	Reproductive Strategy
			Reproduction	Feeding	Respiration		
blackchin shiner (2001)	Coolwater	6.5	Moderate	Moderate	NA	Insectivore	Broadcast
brook stickleback	Coolwater	6.5	Moderate	High	NA	Insectivore	Nest
central mudminnow	Coolwater	6.5	Moderate	Moderate	Low	Omnivore	Broadcast
common shiner	Coolwater	6.5	Moderate	Moderate	NA	Insectivore	Hide
creek chub	Coolwater	6.5	Moderate	High	High	Generalist	Hide
fathead minnow	Warmwater	5.5	Low	Low	NA	Omnivore	Nest
northern redbelly dace	Coolwater	6.5	Moderate	Low	Low	Herbivore	Broadcast
white sucker	Coolwater	6.5	Moderate	Low	High	Omnivore	Broadcast

*DO(mg/L) Low Tolerance values do not represent species-specific life strategies/adaptations to low oxygen environments, as species may be able to tolerate levels below these thresholds. These values represent general tolerance levels for fish within the specified thermal classes.

The presence of coolwater species indicates a moderate level of sensitivity, as these species are generally tolerant to minor temperature variation. Furthermore, several of the identified species exhibit differential tolerance to turbidity, with high levels of respiratory sensitivity observed in both creek chub and white sucker.

Despite their varying sensitivities, the fish community identified at this site is primarily dominated by generalist species capable of adapting to a broad range of habitat conditions.

b) Species Dependence on Habitat

Table 21. Habitat association model for species captured at site CK7-08SH

Species	Vegetation Association (X)					Substrate Association (Low, Moderate, High)						
	Macrophytes			Algae		Bedrock	Boulder	Cobble	Gravel	Sand	Silt	Clay
	Submergents	Emergents	Floating	Filamentous	Non-Filamentous							
blackchin shiner	X	X	-	-	-	-	-	-	H	H	-	-
brook stickleback	X	X	-	-	-	-	-	-	M	H	H	-
central mudminnow	X	X	-	-	-	-	-	-	-	-	H	-
common shiner	-	-	-	-	-	-	-	-	H	M	-	-
creek chub	-	-	-	-	-	-	-	-	H	H	-	-
fathead minnow	X	X	X	-	-	-	-	-	M	H	H	-
northern redbelly dace	X	X	-	X	-	-	-	-	M	H	H	-
white sucker	X	X	-	-	-	-	-	-	H	M	-	-
OSAP ASSESSMENT	2.5%			7.5%	40.0%	0.0%	2.5%	15.0%	42.5%	30.0%	2.5%	7.5%
CSW (2009)	0.0%	100.0%	0.0%	0.0%		0.0%	20.0%	30.0%	30.0%	0.0%	0.0%	0.0%

Based on the species identified, varying levels of association were found among the following substrate types:

- Gravel, Sand and Silt

Point-transect analysis of the cover materials revealed the presence of:

- Boulder, Cobble, Gravel, Sand, Silt and Clay

Previous assessment undertaken by the RVCA identified the presence of:

- Boulder, Cobble and Gravel

The substrate types identified at this site appear to meet the requirements of the apparent community.

Based on the species identified, varying levels of association were found among the following vegetation types:

- Submergents, Emergents, Floating Vegetation and Filamentous Algae

Vegetation community assessment revealed the presence of:

- Macrophytes (Submergents, Emergents & Floating Vegetation) and Algae (Filamentous & Non-Filamentous)

The vegetation types identified at this site appear to meet the requirements of the apparent community. These requirements (substrate/vegetation) represent usage by the species over varying life stages, ranging from spawning/incubation to adulthood.

c) Species/Habitat Rarity

All species captured at this site are of common abundance in the region. Evidence of groundwater input was identified in the vicinity through previous monitoring by the RVCA (CSW, 2009). This habitat element may represent a limited supporting feature for regional biota.

d) Habitat Stability

Table 22. General stream/riparian attributes for site CK7-08SH

Flow Regime	Physical Characteristics				Thermal Regime
Groundwater Influence	Riparian Cover (1.5-10m)	Riparian Cover (10-30m)	Riparian Cover (30-100m)	Sedimentation	Thermal Class
Potential	Meadow	Scrubland	Scrubland	No Evidence	Coolwater

Flow Regime:

- Groundwater in the vicinity may support habitat functions that will be negatively impacted if the source is disturbed.

Physical Characteristics:

- Well established buffers protect against erosion, improve habitat and help to maintain water quality. A natural buffer of 30m or greater is generally considered adequate for maintaining habitat stability (ie. Meadow/Scrubland).

Thermal Regime:

- Coolwater systems are moderately sensitive to changes in thermal regime as they are generally capable of buffering temperatures.

OVERALL SENSITIVITY:

Moderately Sensitive

- Species sensitivity is moderate (Varying sensitivities to turbidity; complex community)
- Species dependence on habitat is moderate as all associated habitat features were present, but no spawning individuals were identified
- Uncommon habitat types/features were identified which may represent limited supporting habitat (ie. Evidence of groundwater input)
- Habitat stability is moderate as the flow, thermal and physical characteristics of the stream are capable of buffering moderate levels of disturbance (ie. Extensive buffer, coolwater environment)

CK7-11SH (3.7.7)

a) Species Sensitivity

No fish were captured at site CK7-11SH

b) Species Dependence on Habitat

Table 23. Habitat association model for species captured at site CK7-11SH

Species	Vegetation Association (X)					Substrate Association (Low, Moderate, High)						
	Macrophytes			Algae		Bedrock	Boulder	Cobble	Gravel	Sand	Silt	Clay
	Submergents	Emergents	Floating	Filamentous	Non-Filamentous							
OSAP ASSESSMENT	0.0%			0.0%	7.5%	0.0%	0.0%	0.0%	70.0%	0.0%	0.0%	30.0%
CSW (2009)	-	-	-	-	-	-	-	-	-	-	-	-

Point-transect analysis of the cover materials revealed the presence of:

- Gravel and Clay

Vegetation community assessment revealed the presence of:

- Algae (Non-Filamentous)

c) Species/Habitat Rarity

All habitats at this site are of common abundance in the region.

d) Habitat Stability

Table 24. General stream/riparian attributes for site CK7-11SH

Flow Regime	Physical Characteristics			Sedimentation	Thermal Regime
Groundwater Influence	Riparian Cover (1.5-10m)	Riparian Cover (10-30m)	Riparian Cover (30-100m)		Thermal Class
No Evidence	Scrubland/Cropland	Cropland	Cropland	Ongoing/Active	Coolwater

Physical Characteristics:

- Well established buffers protect against erosion, improve habitat and help to maintain water quality. It is generally recommended to maintain a buffer width of 30 meters or greater, as riparian losses can negatively impact fish/fish habitat (ie. Cropland).
- Fine materials/sediments are highly prone to movement upon disturbance or fluctuation in flow. Stream sedimentation is a highly detrimental process and represents a significant loss of environmental stability.

Thermal Regime:

- Coolwater systems are moderately sensitive to changes in thermal regime as they are generally capable of buffering temperatures.

OVERALL SENSITIVITY:

Low Sensitivity

- Species sensitivity is low (no fish captured or observed)
- Species dependence on habitat is low (indirect fish habitat)
- Habitat and species rarity is/are low (no rare species/uncommon habitats)
- Habitat stability is low as the flow, thermal and physical characteristics of the stream are prone to fluctuation (ie. Degraded buffer, evident sedimentation)

CK7-13SH (3.7.8)

a) Species Sensitivity

Table 25. Summarized fish sensitivity attributes for species captured at site CK7-13SH

Species	Thermal Classification	*DO (mg/L) Low Tolerance	Sensitivity to Sediment/Turbidity			Feeding Strategy	Reproductive Strategy
			Reproduction	Feeding	Respiration		
creek chub	Coolwater	6.5	Moderate	High	High	Generalist	Hide

*DO(mg/L) Low Tolerance values do not represent species-specific life strategies/adaptations to low oxygen environments, as species may be able to tolerate levels below these thresholds. These values represent general tolerance levels for fish within the specified thermal classes.

The presence of a coolwater species indicates a moderate level of sensitivity, as these fish are generally tolerant to minor temperature variation. Furthermore, the identified species is highly susceptible to respiratory impairment through sedimentation. Despite its varying sensitivities, the identified species is capable of adapting to a broad range of habitat conditions.

b) Species Dependence on Habitat

Table 26. Habitat association model for species captured at site CK7-13SH

Species	Vegetation Association (X)					Substrate Association (Low, Moderate, High)						
	Macrophytes			Algae		Bedrock	Boulder	Cobble	Gravel	Sand	Silt	Clay
	Submergents	Emergents	Floating	Filamentous	Non-Filamentous							
creek chub	-	-	-	-	-	-	-	-	H	H	-	-
OSAP ASSESSMENT	0.0%			0.0%	26.7%	18.3%	3.3%	8.3%	45.0%	21.7%	0.0%	3.3%
CSW (2009)	-	-	-	-	-	-	-	-	-	-	-	-

Based on the species identified, varying levels of association were found among the following substrate types:

- Gravel and Sand

Point-transect analysis of the cover materials revealed the presence of:

- Bedrock, Boulder, Cobble, Gravel, Sand and Clay

The substrate types identified at this site appear to meet the requirements of the apparent community. These requirements (substrate/vegetation) represent usage by the species over varying life stages, ranging from spawning/incubation to adulthood.

c) Species/Habitat Rarity

All species/habitats at this site are of common abundance in the region.

d) Habitat Stability

Table 26. General stream/riparian attributes for site CK7-13SH

Flow Regime	Physical Characteristics				Thermal Regime
Groundwater Influence	Riparian Cover (1.5-10m)	Riparian Cover (10-30m)	Riparian Cover (30-100m)	Sedimentation	Thermal Class
No Evidence	Cropland/Forest	Cropland	Cropland	No Evidence	Coolwater

Physical Characteristics:

- Well established buffers protect against erosion, improve habitat and help to maintain water quality. It is generally recommended to maintain a buffer width of 30 meters or greater, as riparian losses can negatively impact fish/fish habitat (ie. Cropland).

Thermal Regime:

- Coolwater systems are moderately sensitive to changes in thermal regime as they are generally capable of buffering temperatures.

OVERALL SENSITIVITY:

Low Sensitivity

- Species sensitivity is low (simple community structure)
- Species dependence on habitat is low (indirect fish habitat; generalist species)
- Habitat and species rarity is/are low (no rare species/uncommon habitats)
- Habitat stability is moderate as the flow, thermal and physical characteristics of the stream are capable of buffering moderate levels of disturbance (ie. Partial buffer, coolwater environment)

CK7-14SH (3.7.9)

a) Species Sensitivity

Table 27. Summarized fish sensitivity attributes for species captured at site CK7-14SH

Species	Thermal Classification	*DO (mg/L) Low Tolerance	Sensitivity to Sediment/Turbidity			Feeding Strategy	Reproductive Strategy
			Reproduction	Feeding	Respiration		
brook stickleback	Coolwater	6.5	Moderate	High	NA	Insectivore	Nest
central mudminnow	Coolwater	6.5	Moderate	Moderate	Low	Omnivore	Broadcast
creek chub	Coolwater	6.5	Moderate	High	High	Generalist	Hide
fathead minnow	Warmwater	5.5	Low	Low	NA	Omnivore	Nest
northern redbelly dace	Coolwater	6.5	Moderate	Low	Low	Herbivore	Broadcast

*DO(mg/L) Low Tolerance values do not represent species-specific life strategies/adaptations to low oxygen environments, as species may be able to tolerate levels below these thresholds. These values represent general tolerance levels for fish within the specified thermal classes.

The presence of coolwater species indicates a moderate level of sensitivity, as these species are generally tolerant to minor temperature variation. Furthermore, several of the identified species exhibit differential tolerance to turbidity, with high levels of respiratory and feeding sensitivity observed in both creek chub and brook stickleback.

Despite their varying sensitivities, the fish community identified at this site is primarily dominated by generalist species capable of adapting to a broad range of habitat conditions.

b) Species Dependence on Habitat

Table 28. Habitat association model for species captured at site CK7-14SH

Species	Vegetation Association (X)					Substrate Association (Low, Moderate, High)						
	Macrophytes			Algae		Bedrock	Boulder	Cobble	Gravel	Sand	Silt	Clay
	Submergents	Emergents	Floating	Filamentous	Non-Filamentous							
brook stickleback	X	X	-	-	-	-	-	-	M	H	H	-
central mudminnow	X	X	-	-	-	-	-	-	-	-	H	-
creek chub	-	-	-	-	-	-	-	-	H	H	-	-
fathead minnow	X	X	X	-	-	-	-	-	M	H	H	-
northern redbelly dace	X	X	-	X	-	-	-	-	M	H	H	-
OSAP ASSESSMENT	0.0%			68.3%	0.0%	0.0%	0.0%	26.7%	10.0%	25.0%	1.7%	36.6%
CSW (2009)	-	-	-	-	-	-	-	-	-	-	-	-

Based on the species identified, varying levels of association were found among the following substrate types:

- Gravel, Sand and Silt

Point-transect analysis of the cover materials revealed the presence of:

- Cobble, Gravel, Sand, Silt and Clay

The substrate types identified at this site appear to meet the requirements of the apparent community.

Based on the species identified, varying levels of association were found among the following vegetation types:

- Submergents, Emergents, Floating Vegetation and Filamentous Algae

Vegetation community assessment revealed the presence of:

- Algae (Filamentous)

The vegetation types identified at this site do not appear to meet the requirements of the apparent community. This lack of supporting habitat may cause potential impairment within the community, as the biota will be forced to seek out alternative habitat to complete their life cycle.

These requirements (substrate/vegetation) represent usage by the species over varying life stages, ranging from spawning/incubation to adulthood.

c) Species/Habitat Rarity

All species/habitats at this site are of common abundance in the region.

d) Habitat Stability

Table 29. General stream/riparian attributes for site CK7-14SH

Flow Regime	Physical Characteristics				Thermal Regime
Groundwater Influence	Riparian Cover (1.5-10m)	Riparian Cover (10-30m)	Riparian Cover (30-100m)	Sedimentation	Thermal Class
No Evidence	Scrubland	Cropland	Cropland	Ongoing/Active	Coolwater

Physical Characteristics:

- Well established buffers protect against erosion, improve habitat and help to maintain water quality. It is generally recommended to maintain a buffer width of 30 meters or greater, as riparian losses can negatively impact fish/fish habitat (ie. Cropland).
- Fine materials/sediments are highly prone to movement upon disturbance or fluctuation in flow. Stream sedimentation is a highly detrimental process and represents a significant loss of environmental stability.

Thermal Regime:

- Coolwater systems are moderately sensitive to changes in thermal regime as they are generally capable of buffering temperatures.

OVERALL SENSITIVITY:

***Moderate/Low Sensitivity**

- Species sensitivity is moderate (Varying sensitivities to turbidity; simple community)
- Species dependence on habitat is moderate/low as supporting habitat features were limited within the reach.
- Habitat and species rarity is/are low (no rare species/uncommon habitats)
- Habitat stability is low as the flow, thermal and physical characteristics of the stream are prone to fluctuation/disturbance (ie. Degraded buffer, evident sedimentation)

*Opportunities should be explored to improve current conditions within this reach

CK7-15SH (3.7.10)

a) Species Sensitivity

Table 30. Summarized fish sensitivity attributes for species captured at site CK7-15SH

Species	Thermal Classification	*DO (mg/L) Low Tolerance	Sensitivity to Sediment/Turbidity			Feeding Strategy	Reproductive Strategy
			Reproduction	Feeding	Respiration		
common shiner	Coolwater	6.5	Moderate	Moderate	NA	Insectivore	Hide
creek chub	Coolwater	6.5	Moderate	High	High	Generalist	Hide
northern redbelly dace	Coolwater	6.5	Moderate	Low	Low	Herbivore	Broadcast
white sucker	Coolwater	6.5	Moderate	Low	High	Omnivore	Broadcast

*DO(mg/L) Low Tolerance values do not represent species-specific life strategies/adaptations to low oxygen environments, as species may be able to tolerate levels below these thresholds. These values represent general tolerance levels for fish within the specified thermal classes.

The presence of coolwater species indicates a moderate level of sensitivity, as these species are generally tolerant to minor temperature variation. Furthermore, several of the identified species exhibit differential tolerance to turbidity, with high levels of respiratory sensitivity observed in both creek chub and white sucker.

Despite their varying sensitivities, the fish community identified at this site is primarily dominated by generalist species capable of adapting to a broad range of habitat conditions.

b) Species Dependence on Habitat

Table 31. Habitat association model for species captured at site CK7-15SH

Species	Vegetation Association (X)					Substrate Association (Low, Moderate, High)						
	Macrophytes			Algae		Bedrock	Boulder	Cobble	Gravel	Sand	Silt	Clay
	Submergents	Emergents	Floating	Filamentous	Non-Filamentous							
common shiner	-	-	-	-	-	-	-	-	H	M	-	-
creek chub	-	-	-	-	-	-	-	-	H	H	-	-
northern redbelly dace	X	X	-	X	-	-	-	-	M	H	H	-
white sucker	X	X	-	-	-	-	-	-	H	M	-	-

OSAP ASSESSMENT	0.0%		0.0%	6.7%	0.0%	2.2%	11.1%	51.1%	2.2%	6.7%	26.7%
CSW (2009)	0.0%	0.0%	0.0%	90.0%	0.0%	20.0%	20.0%	15.0%	10.0%	10.0%	25.0%

Based on the species identified, varying levels of association were found among the following substrate types:

- Gravel, Sand and Silt

Point-transect analysis of the cover materials revealed the presence of:

- Boulder, Cobble, Gravel, Sand, Silt and Clay

Previous assessment undertaken by the RVCA identified the presence of:

- Boulder, Cobble, Gravel, Sand, Silt and Clay

The substrate types identified at this site appear to meet the requirements of the apparent community.

Based on the species identified, varying levels of association were found among the following vegetation types:

- Submergents, Emergents and Filamentous Algae

Vegetation community assessment revealed the presence of:

- Algae (Non-Filamentous)

The vegetation types identified at this site do not appear to meet the requirements of the apparent community. This lack of supporting habitat may cause potential impairment within the community, as the biota will be forced to seek out alternative habitat to complete their life cycle.

These requirements (substrate/vegetation) represent usage by the species over varying life stages, ranging from spawning/incubation to adulthood.

c) Species/Habitat Rarity

All species/habitats at this site are of common abundance in the region.

d) Habitat Stability

Table 32. General stream/riparian attributes for site CK7-15SH

	Physical Characteristics				Thermal Regime
Groundwater Influence	Riparian Cover (1.5-10m)	Riparian Cover (10-30m)	Riparian Cover (30-100m)	Sedimentation	Thermal Class
No Evidence	Scrubland	Cropland	Cropland	No Evidence	Coolwater

Physical Characteristics:

- Well established buffers protect against erosion, improve habitat and help to maintain water quality. It is generally recommended to maintain a buffer width of 30 meters or greater, as riparian losses can negatively impact fish/fish habitat (ie. Cropland).

Thermal Regime:

- Coolwater systems are moderately sensitive to changes in thermal regime as they are generally capable of buffering temperatures.

OVERALL SENSITIVITY:

Moderately Sensitive

- Species sensitivity is moderate (Varying sensitivities to turbidity; simple community)
- Species dependence on habitat is moderate/low as supporting habitat features were limited within the reach.
- Habitat and species rarity is/are low (no rare species/uncommon habitats)
- Habitat stability is moderate as the flow, thermal and physical characteristics of the stream are capable of buffering moderate levels of disturbance (ie. Partial buffer, coolwater environment)

MIGRATION BARRIERS (3.8)

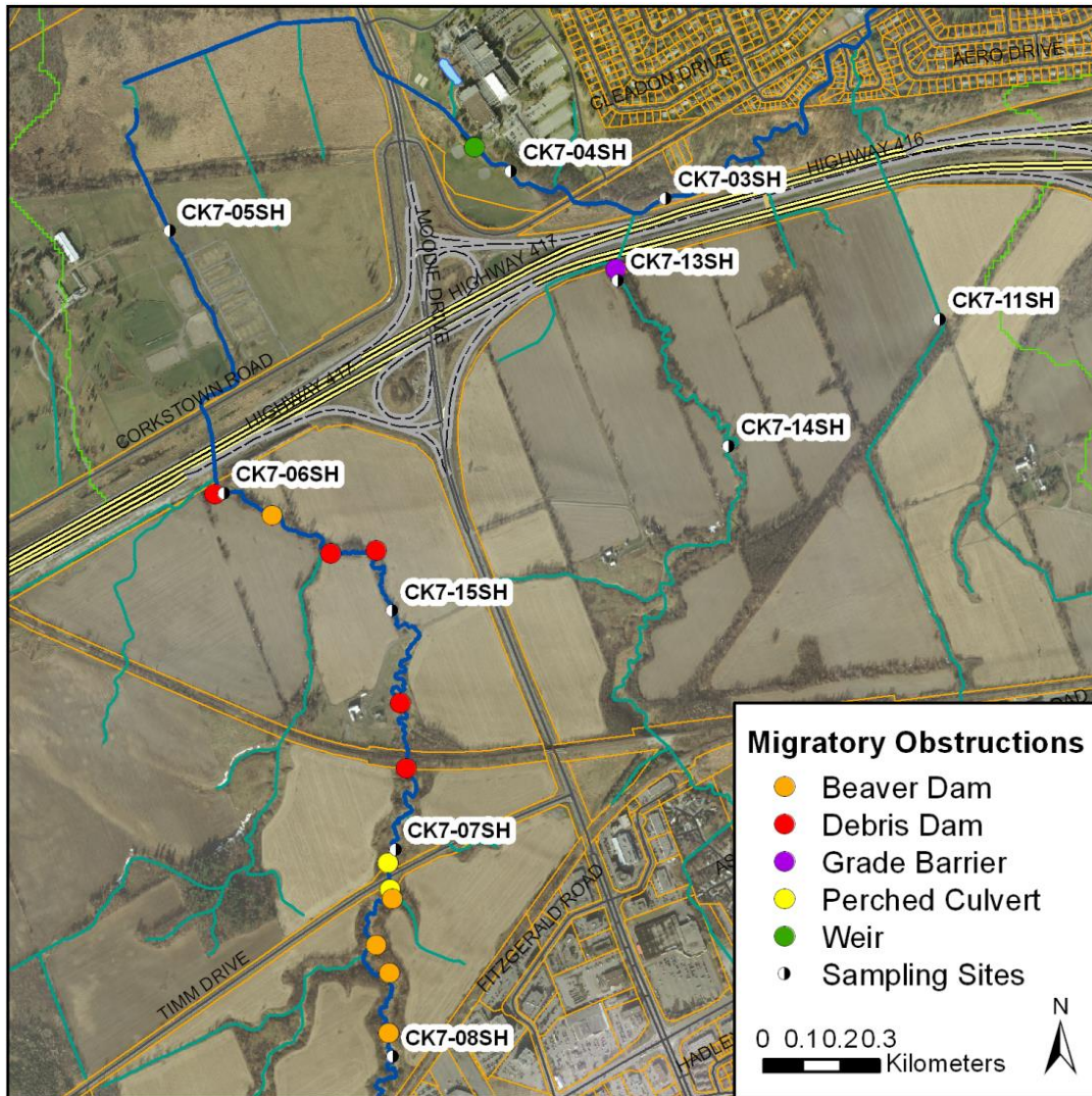

Figure 16. Migration barriers identified on Stillwater Creek

Migratory barrier information was compiled from the RVCA’s 2009 *City Stream Watch* study as well as current study observations. These barriers represent limitations to fish dispersal within the system and may restrict movement to alternate habitat. These features were categorized into 5 classes:

Beaver Dam: An obstruction built by beavers composed primarily of woody materials and sediment. These features often tend to be seasonal obstructions, and do not necessarily represent permanent barriers.

Debris Dam: An accumulation of natural (logs, branches, mud etc.) or human (garbage etc.) debris that holds back water. These features often tend to be seasonal obstructions, and do not necessarily represent permanent barriers.

Grade Barrier: A significant change in the elevation of the stream bed, often associated with waterfall/bedrock features.

Perched Culvert: Culvert degradation/installation where the bottom of the culvert is above the stream bed resulting in a drop from the culvert to the water level.

Weir: A human made barrier across a stream designed to alter its flow characteristics.

The location of these barriers is of particular importance as they may prevent fish from seeking out refuge habitat during low water conditions/overwintering.

CONCLUSIONS & RECOMMENDATIONS (4.0)

All recommendations/proposals were identified through direct field observation and derived on the basis of improving habitat/water quality, promoting the linkages of natural corridors and protecting aquatic life. These recommendations represent potential restoration at the site-specific level and have therefore not been applied across the entire watershed.

General points of concern included:

- Reduced/degraded riparian buffers
- Migratory obstructions
- Stream hardening/channelization
- Shoreline destabilization
- Sedimentation

General Watershed Recommendations and Enhancement Opportunities

- a) improve storm water management
- b) improve water quality in Stillwater Creek / Ottawa River
- c) reduce erosion/flood potential
- d) improve riparian and instream conditions
- e) maintain thermal stability
- f) improve connectivity

STILLWATER CREEK: RESTORATION PLAN – CK703SH

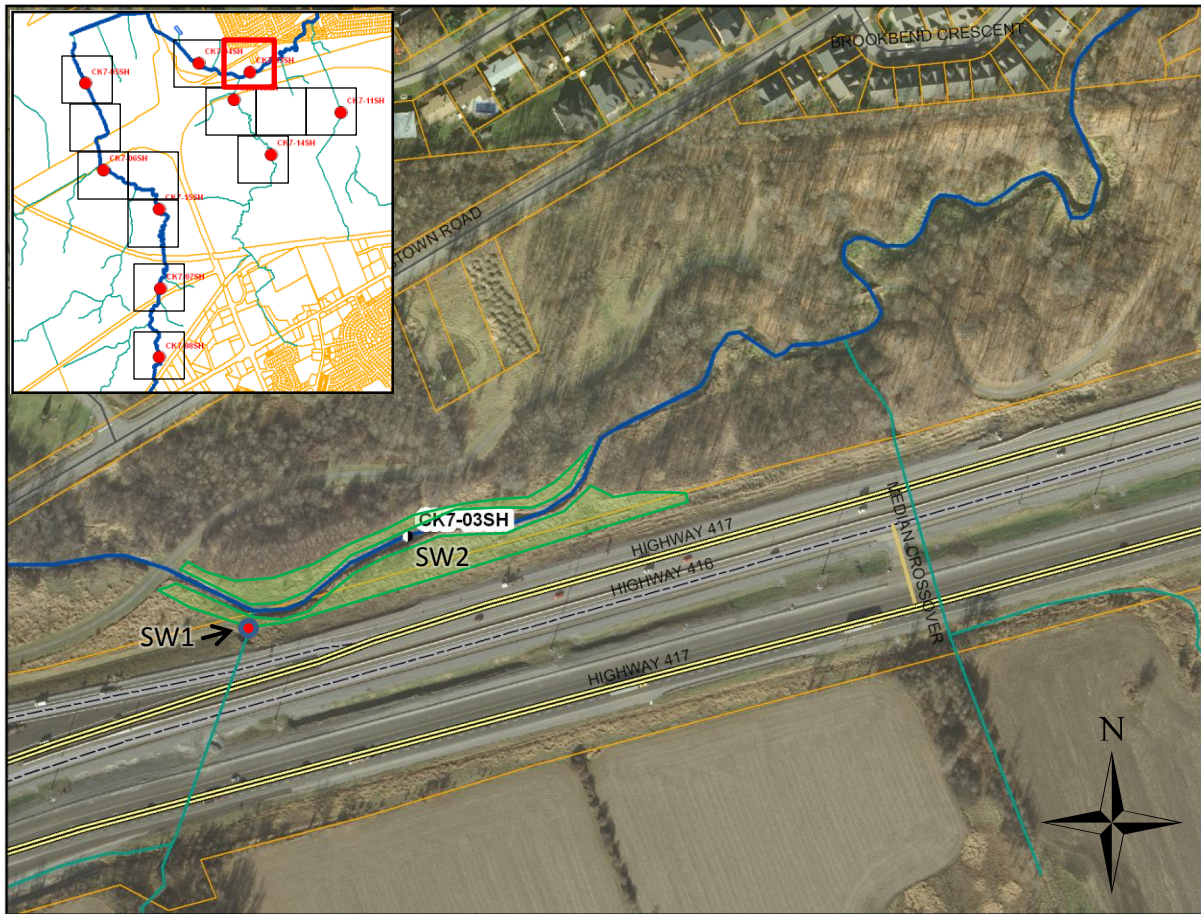

RESTORATION PROPOSAL

	STILLWATER CREEK			
	STREAM REACH	EASTING	NORTHING	COST
	SW1	434616	5021201	HIGH
EXISTING PROBLEM	Potential source of storm-water input from adjacent tributary. This site is particularly susceptible due to its “High sensitivity” classification.			
CONSTRAINTS	Requires further study to determine impacts/potential management options			
SOLUTION	Consult with the City of Ottawa/Ministry of Transportation to examine opportunities to improve storm water management within the watershed			
WATERSHED OBJECTIVE	Protection/enhancement of Aquatic Habitat			

RESTORATION PROPOSAL

	STILLWATER CREEK			
	STREAM REACH	EASTING	NORTHING	COST
	SW2	-	-	LOW
EXISTING PROBLEM	Surrounding buffer is dominated by low diversity grassland, with little to no shoreline cover available. Overland drainage may occur from adjacent highway.			
CONSTRAINTS	Access to the site may be limited			
SOLUTION	Re-vegetation with native trees/shrubs to create riparian habitat. Plants considered for buffer enhancement should meet the following criteria: <ul style="list-style-type: none"> - Native - Adapted to site soil/moisture/light conditions - Provide for specific habitat objectives (e.g Stabilization, habitat enhancement, ect) - Support for the development of natural vegetation communities 			
WATERSHED OBJECTIVE	Protection and enhancement of Terrestrial/Riparian Habitat Promotion of Linkages and Natural Corridors			

STILLWATER CREEK: RESTORATION PLAN – CK704SH

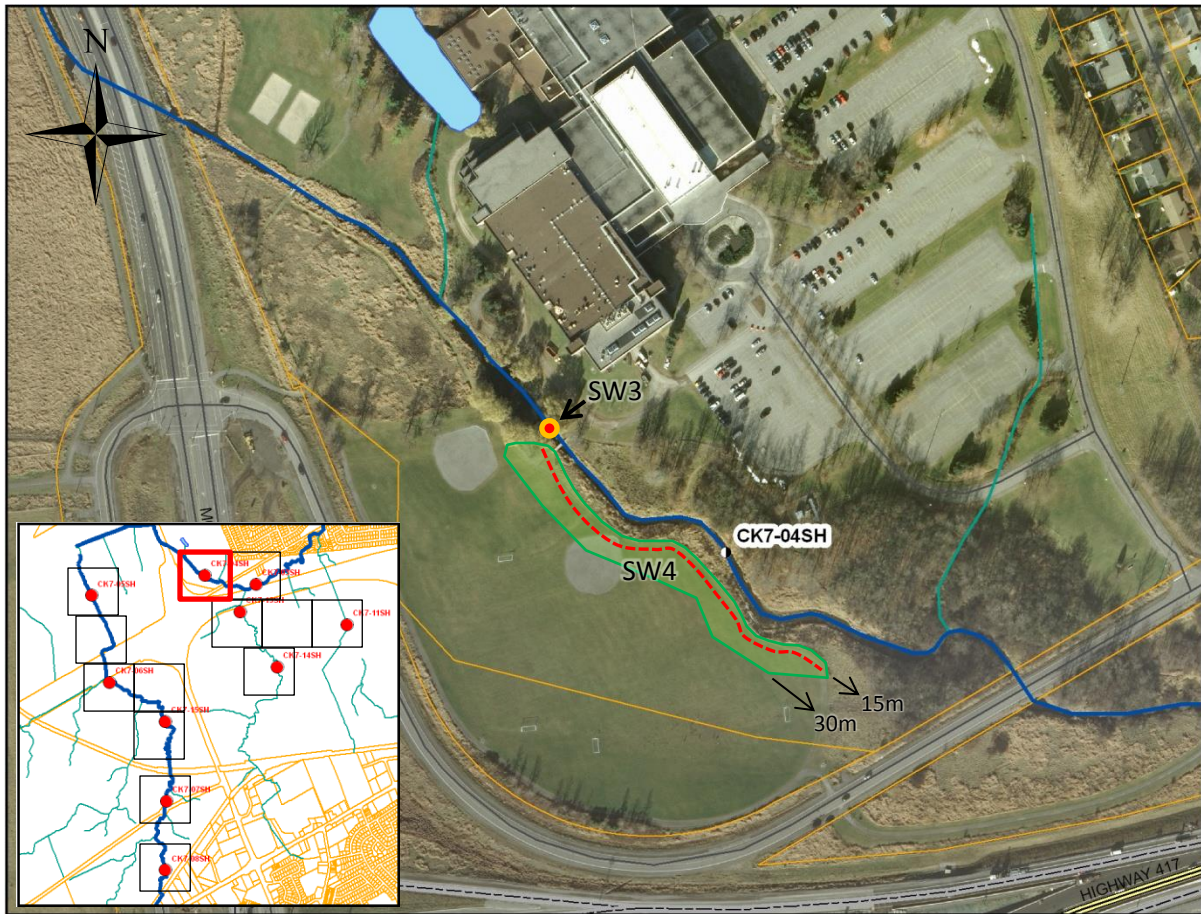

RESTORATION PROPOSAL

	STILLWATER CREEK			
	STREAM REACH	EASTING	NORTHING	COST
	SW3	434202	5021374	MODERATE
EXISTING PROBLEM	Migratory obstruction upstream of study site. Altered flows have resulted in depleted oxygen concentrations (Section 3.3), reduced water levels, and extensive levels of algae/aquatic vegetation.			
CONSTRAINTS	Long-standing structure, with those who may have become accustomed to it			
SOLUTION	Removal of weir and implement natural channel design to improve oxygen/habitat conditions and fish dispersal. Improve plant community structure by introducing favorable species/varieties.			
WATERSHED OBJECTIVE	Protection/enhancement of Aquatic Habitat Promotion of Linkages and Natural Corridors			

RESTORATION PROPOSAL

	STILLWATER CREEK			
	STREAM REACH	EASTING	NORTHING	COST
	SW4	-	-	LOW
EXISTING PROBLEM	The buffer setback is not adequate for the complete protection of the stream. Recommended buffer guidelines are as follows: <ul style="list-style-type: none"> - 10 meters for the stabilization of bank materials - 15 meters for the protection of water quality through interception of surface runoff/contaminants - 30 meters for the maintenance of thermal/environmental stability (SW4) 			
CONSTRAINTS	Proposed buffer enhancement zone encroaches into recreational area			
SOLUTION	Re-vegetation with native trees/shrubs to create riparian habitat. Plants considered for buffer enhancement should meet the following criteria: <ul style="list-style-type: none"> - Native - Adapted to site soil/moisture/light conditions - Provide for specific habitat objectives (e.g Stabilization, habitat enhancement, ect) - Support for the development of natural vegetation communities 			
WATERSHED OBJECTIVE	Protection and enhancement of Terrestrial/Riparian Habitat Promotion of Linkages and Natural Corridors			

STILLWATER CREEK: RESTORATION PLAN – CK705SH

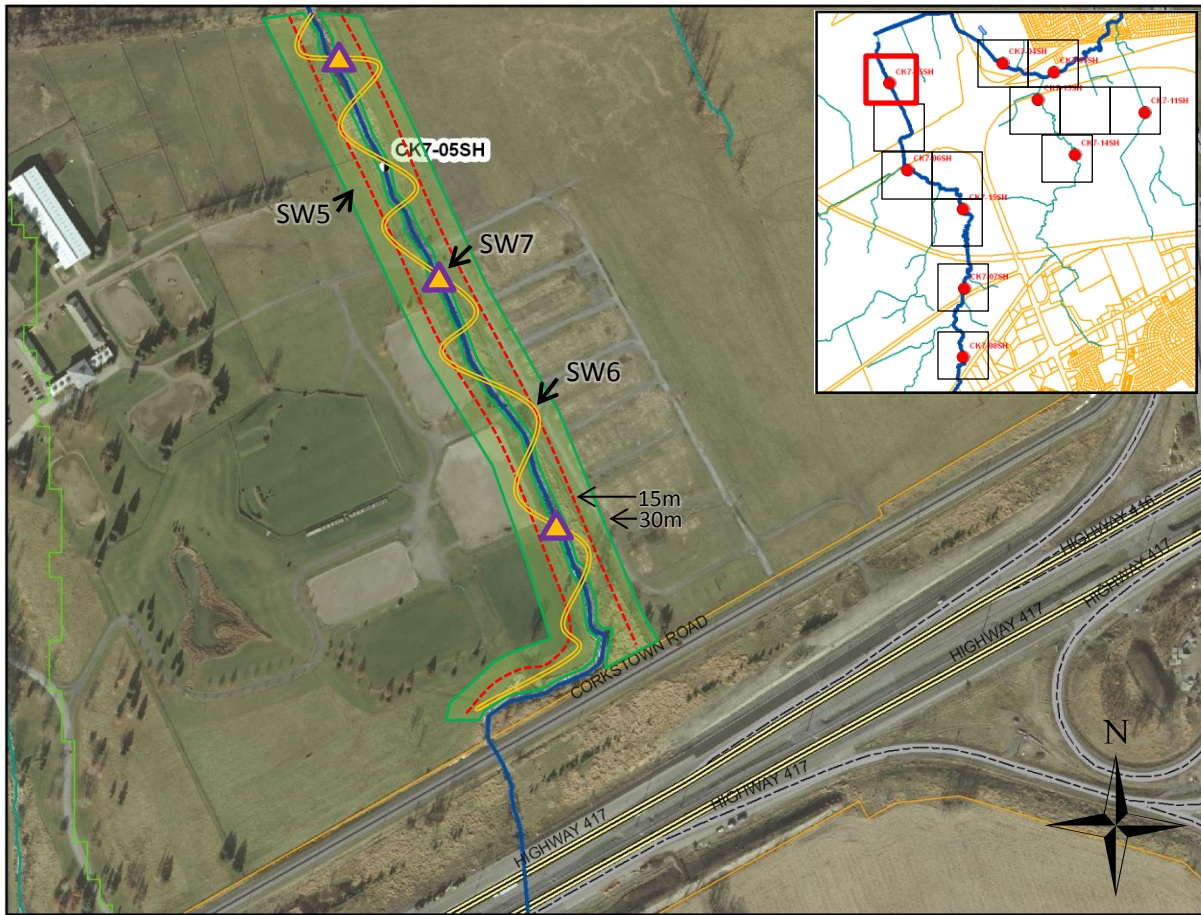

RESTORATION PROPOSAL

	STILLWATER CREEK			
	STREAM REACH	EASTING	NORTHING	COST
	SW6, SW7	-	-	HIGH
EXISTING PROBLEM	Site is highly channelized with little or no structure available for aquatic biota. Sedimentation is prevalent throughout the reach.			
CONSTRAINTS	Future use of land is under review			
SOLUTION	Reconstruct channel and recreate floodplain connection by reintroducing natural stream meander sequences and restoring form/function. Install woody structure as habitat features for aquatic biota.			
WATERSHED OBJECTIVE	Protection/enhancement of Natural Processes Protection/enhancement of Aquatic Habitat			

RESTORATION PROPOSAL

	STILLWATER CREEK			
	STREAM REACH	EASTING	NORTHING	COST
	SW5	-	-	LOW
EXISTING PROBLEM	<p>The buffer setback is not adequate for the complete protection of the stream. Recommended buffer guidelines are as follows:</p> <ul style="list-style-type: none"> - 10 meters for the stabilization of bank materials - 15 meters for the protection of water quality through interception of surface runoff/contaminants - 30 meters for the maintenance of thermal/environmental stability (SW5) 			
CONSTRAINTS	Current landuse may restrict proposed setbacks			
SOLUTION	<p>Re-vegetation with native trees/shrubs to create riparian habitat. Plants considered for buffer enhancement should meet the following criteria:</p> <ul style="list-style-type: none"> - Native - Adapted to site soil/moisture/light conditions - Provide for specific habitat objectives (e.g Stabilization, habitat enhancement, ect) - Support for the development of natural vegetation communities 			
WATERSHED OBJECTIVE	<p>Protection and enhancement of Terrestrial/Riparian Habitat Promotion of Linkages and Natural Corridors</p>			

STILLWATER CREEK: RESTORATION PLAN – CK706SH

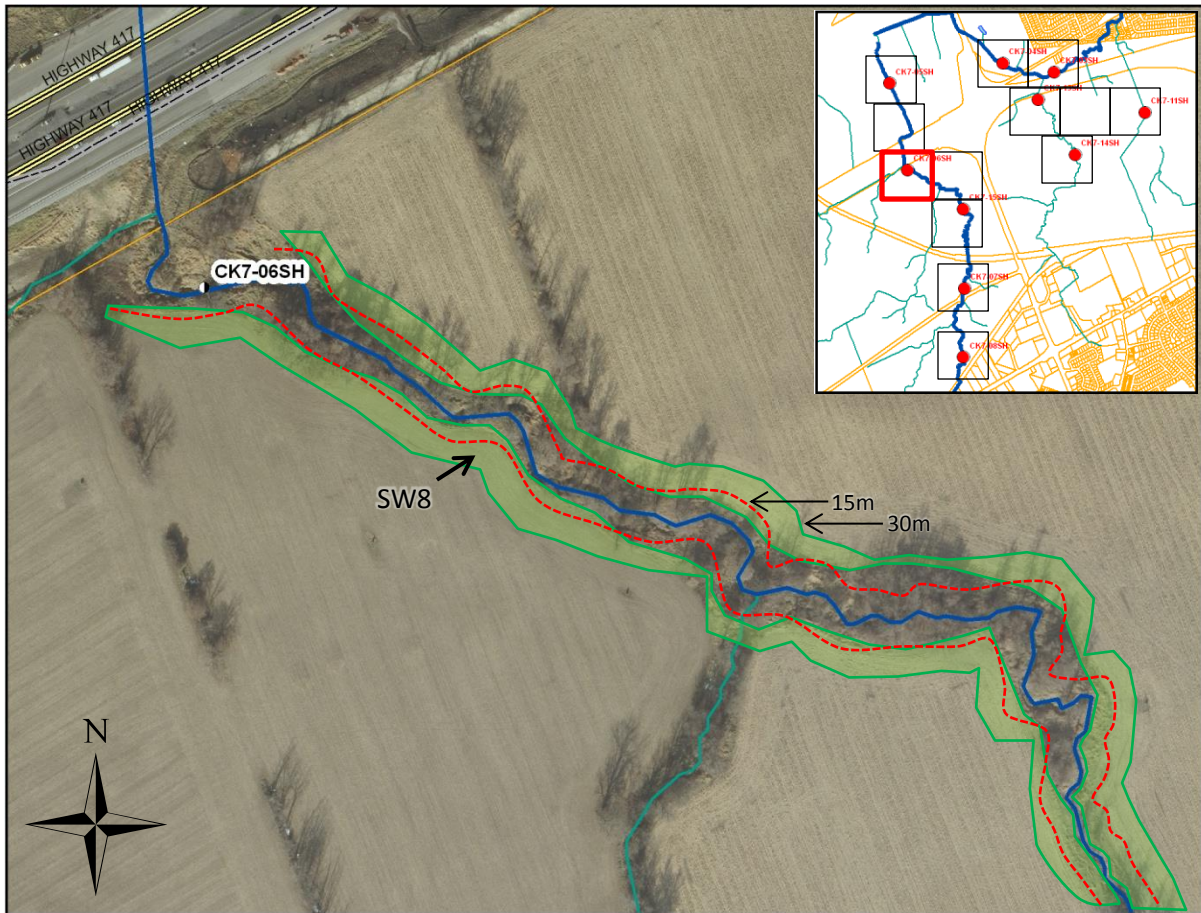

RESTORATION PROPOSAL

	STILLWATER CREEK			
	STREAM REACH	EASTING	NORTHING	COST
	SW8	-	-	LOW
EXISTING PROBLEM	The buffer setback is not adequate for the complete protection of the stream. Recommended buffer guidelines are as follows: <ul style="list-style-type: none"> - 10 meters for the stabilization of bank materials - 15 meters for the protection of water quality through interception of surface runoff/contaminants - 30 meters for the maintenance of thermal/environmental stability (SW8) 			
CONSTRAINTS	Proposed buffer enhancement zone encroaches into agricultural field			
SOLUTION	Re-vegetation with native trees/shrubs to create riparian habitat. Plants considered for buffer enhancement should meet the following criteria: <ul style="list-style-type: none"> - Native - Adapted to site soil/moisture/light conditions - Provide for specific habitat objectives (e.g Stabilization, habitat enhancement, ect) - Support for the development of natural vegetation communities 			
WATERSHED OBJECTIVE	Protection and enhancement of Terrestrial/Riparian Habitat Promotion of Linkages and Natural Corridors			

STILLWATER CREEK: RESTORATION PLAN – CK707SH

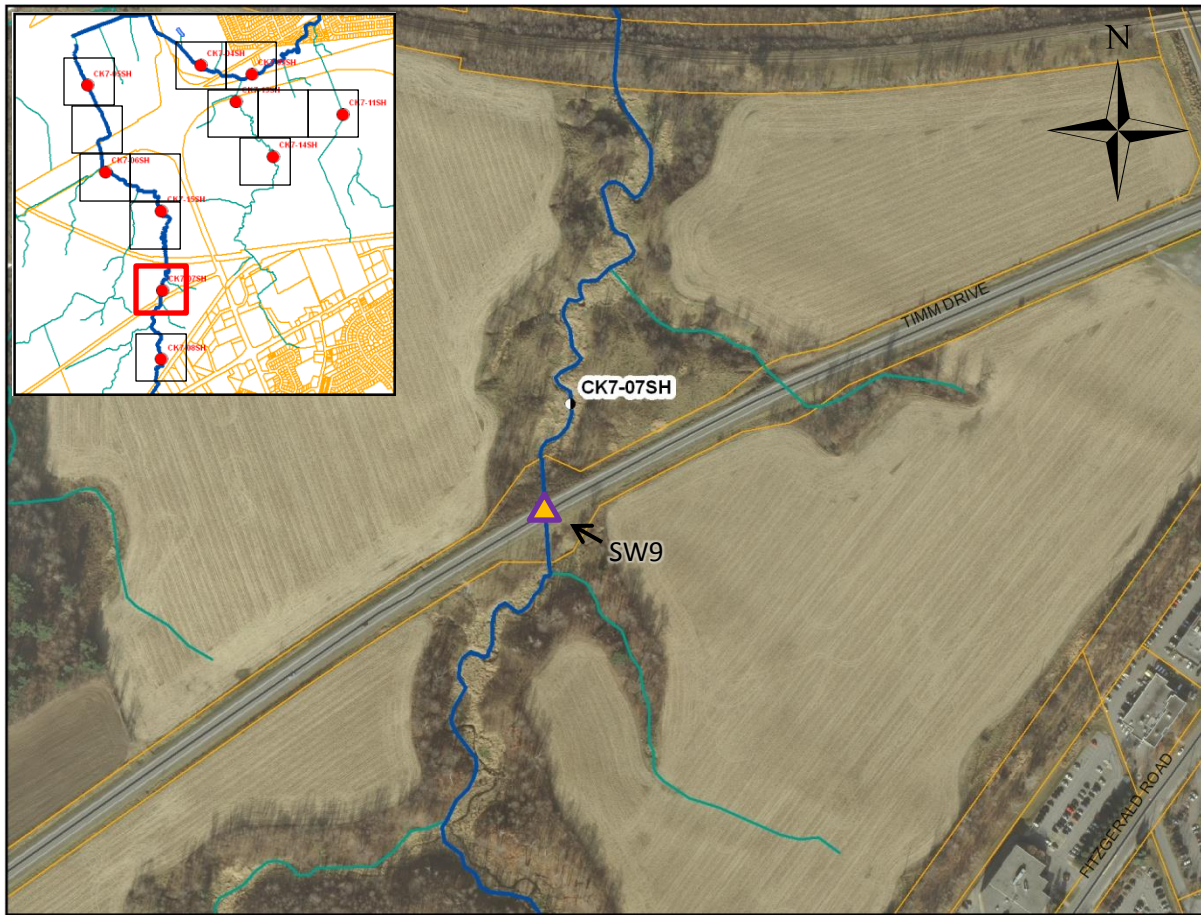

RESTORATION PROPOSAL

	STILLWATER CREEK			
	STREAM REACH	EASTING	NORTHING	COST
	SW9	433978	5019525	HIGH
EXISTING PROBLEM	Culvert at Timm Dr. has been identified as a migration barrier (perched culvert)			
CONSTRAINTS	City of Ottawa culvert replacement maintenance program determines timing of replacement			
SOLUTION	Culvert would require replacement to mitigate migratory obstruction			
WATERSHED OBJECTIVE	Promotion of Linkages and Natural Corridors			

STILLWATER CREEK: RESTORATION PLAN – CK708SH

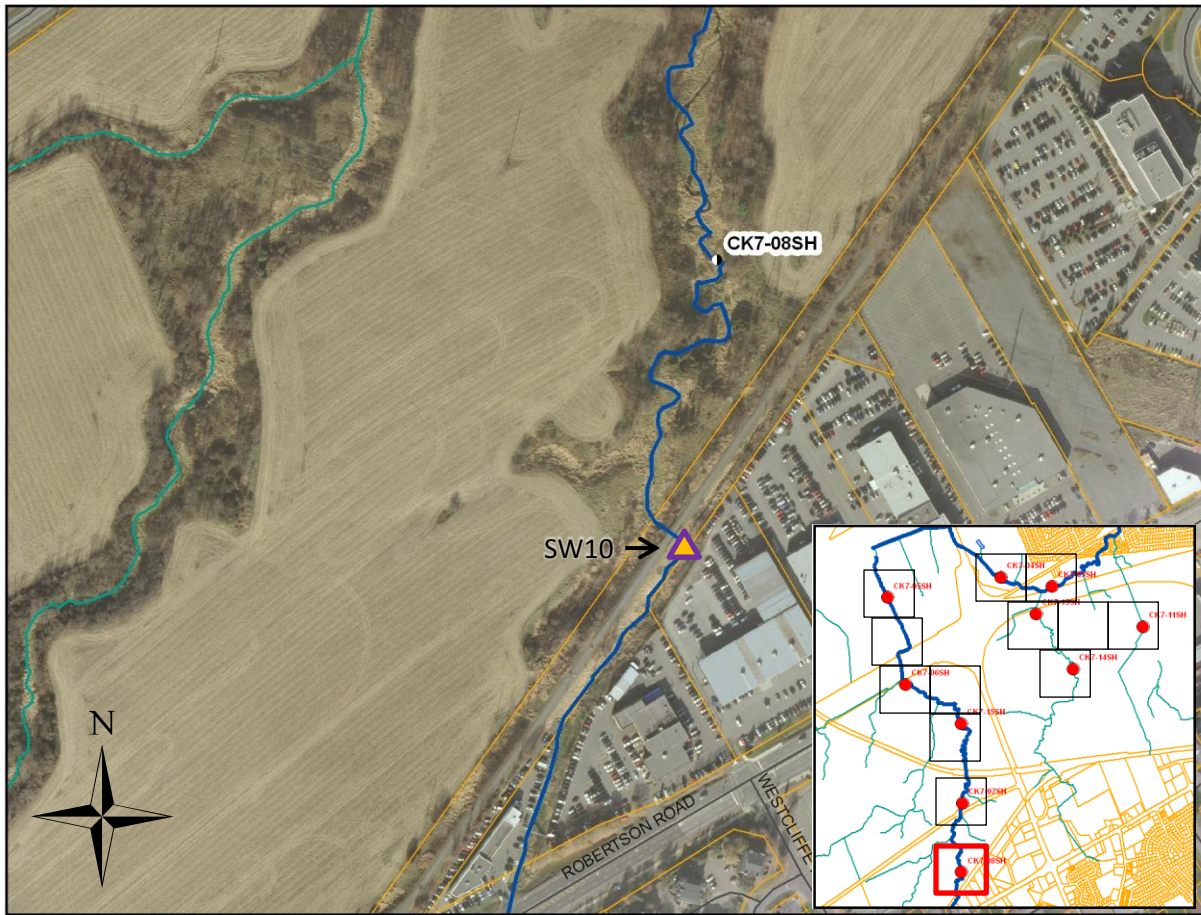

Snow dumping observed adjacent to study reach CK7-08SH

RESTORATION PROPOSAL

	STILLWATER CREEK			
	STREAM REACH	EASTING	NORTHING	COST
	SW10	433969	5018839	LOW
EXISTING PROBLEM	Snow dumping/debris accumulation from adjacent commercial property			
CONSTRAINTS	Awareness of potential impacts to stream health from improper snow disposal practices			
SOLUTION	Sign installation along the fence line will inform contractors/property owners that snow dumping is not permitted into the watercourse. If this activity continues, potential enforcement measures may be utilized.			
WATERSHED OBJECTIVE	Protection of Water Quality/Aquatic Habitat			

STILLWATER CREEK: RESTORATION PLAN – CK711SH

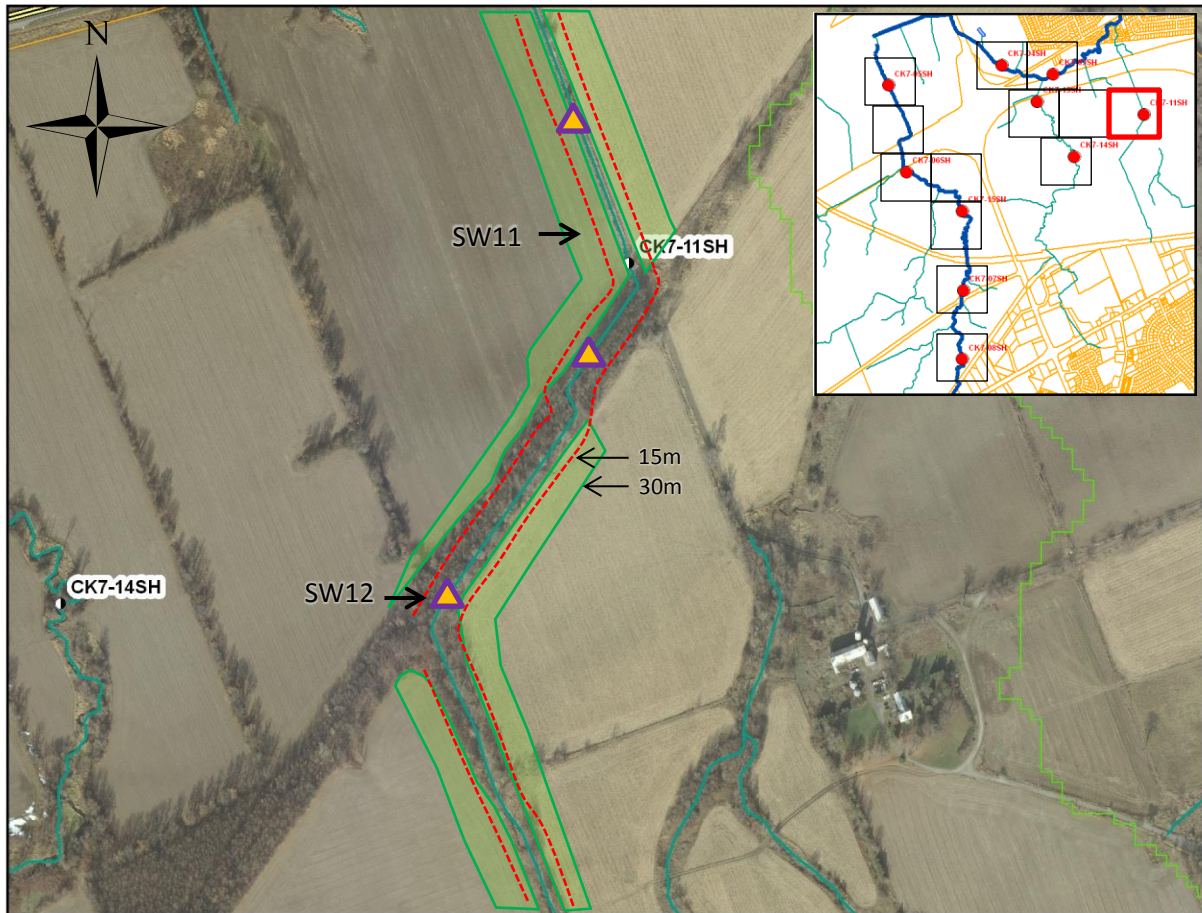

RESTORATION PROPOSAL

	STILLWATER CREEK			
	STREAM REACH	EASTING	NORTHING	COST
	SW12			LOW
EXISTING PROBLEM	Site is highly channelized with little or no structure available for aquatic biota. Sedimentation is prevalent throughout the reach.			
CONSTRAINTS	Current landuse may restrict proposed restoration			
SOLUTION	Install woody structures as habitat features for aquatic biota.			
WATERSHED OBJECTIVE	Protection/enhancement of Aquatic Habitat			

RESTORATION PROPOSAL

	STILLWATER CREEK			
	STREAM REACH	EASTING	NORTHING	COST
	SW11	-	-	LOW
EXISTING PROBLEM	The buffer setback is not adequate for the complete protection of the stream. Recommended buffer guidelines are as follows: <ul style="list-style-type: none"> - 10 meters for the stabilization of bank materials - 15 meters for the protection of water quality through interception of surface runoff/contaminants - 30 meters for the maintenance of thermal/environmental stability (SW11) 			
CONSTRAINTS	Proposed buffer enhancement zone encroaches into agricultural field			
SOLUTION	Re-vegetation with native trees/shrubs to create riparian habitat. Plants considered for buffer enhancement should meet the following criteria: <ul style="list-style-type: none"> - Native - Adapted to site soil/moisture/light conditions - Provide for specific habitat objectives (e.g Stabilization, habitat enhancement, ect) - Support for the development of natural vegetation communities 			
WATERSHED OBJECTIVE	Protection and enhancement of Terrestrial/Riparian Habitat Promotion of Linkages and Natural Corridors			

STILLWATER CREEK: RESTORATION PLAN – CK713SH

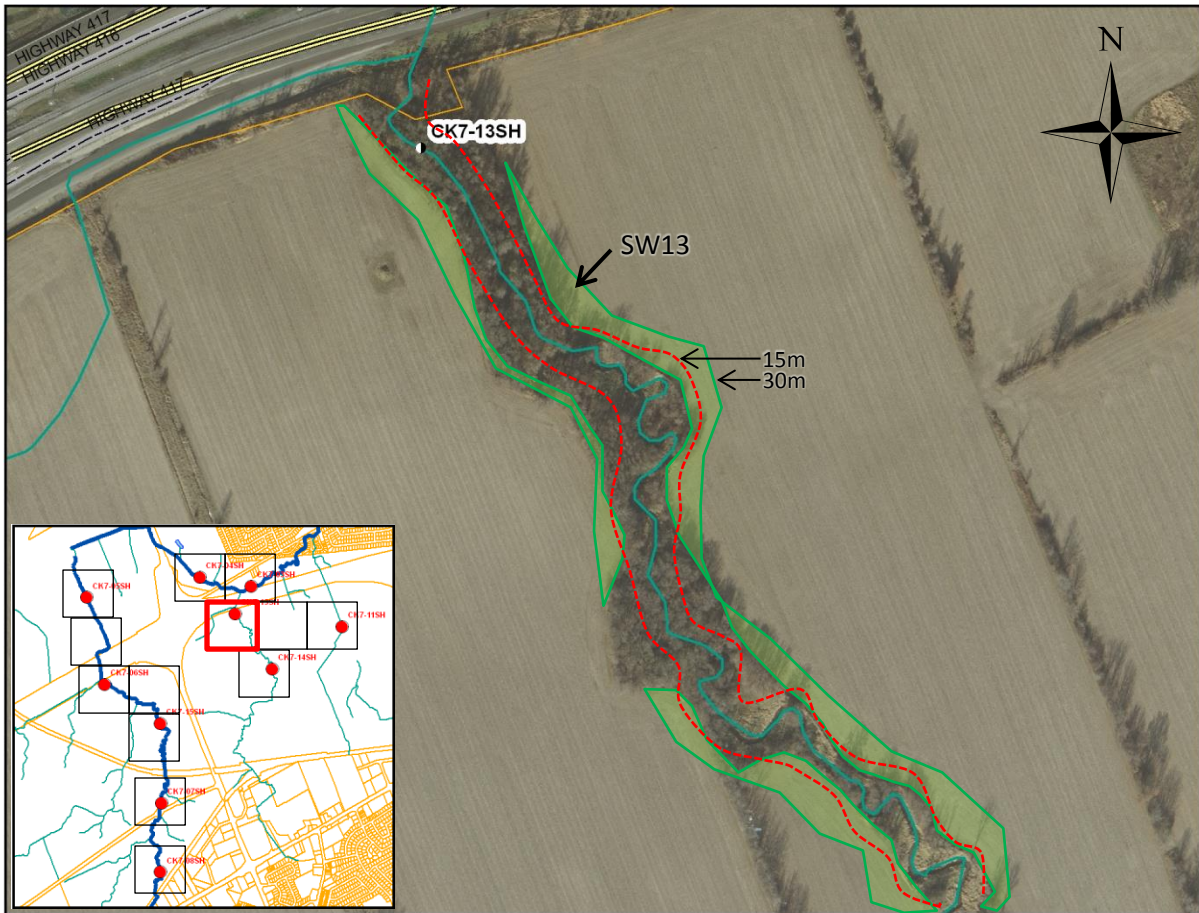

RESTORATION PROPOSAL

	STILLWATER CREEK			
	STREAM REACH	EASTING	NORTHING	COST
	SW13	-	-	LOW
EXISTING PROBLEM	The buffer setback is not adequate for the complete protection of the stream. Recommended buffer guidelines are as follows: <ul style="list-style-type: none"> - 10 meters for the stabilization of bank materials - 15 meters for the protection of water quality through interception of surface runoff/contaminants - 30 meters for the maintenance of thermal/environmental stability (SW13) 			
CONSTRAINTS	Proposed buffer enhancement zone encroaches into agricultural field			
SOLUTION	Re-vegetation with native trees/shrubs to create riparian habitat. Plants considered for buffer enhancement should meet the following criteria: <ul style="list-style-type: none"> - Native - Adapted to site soil/moisture/light conditions - Provide for specific habitat objectives (e.g Stabilization, habitat enhancement, ect) - Support for the development of natural vegetation communities 			
WATERSHED OBJECTIVE	Protection and enhancement of Terrestrial/Riparian Habitat Promotion of Linkages and Natural Corridors			

STILLWATER CREEK: RESTORATION PLAN – CK714SH

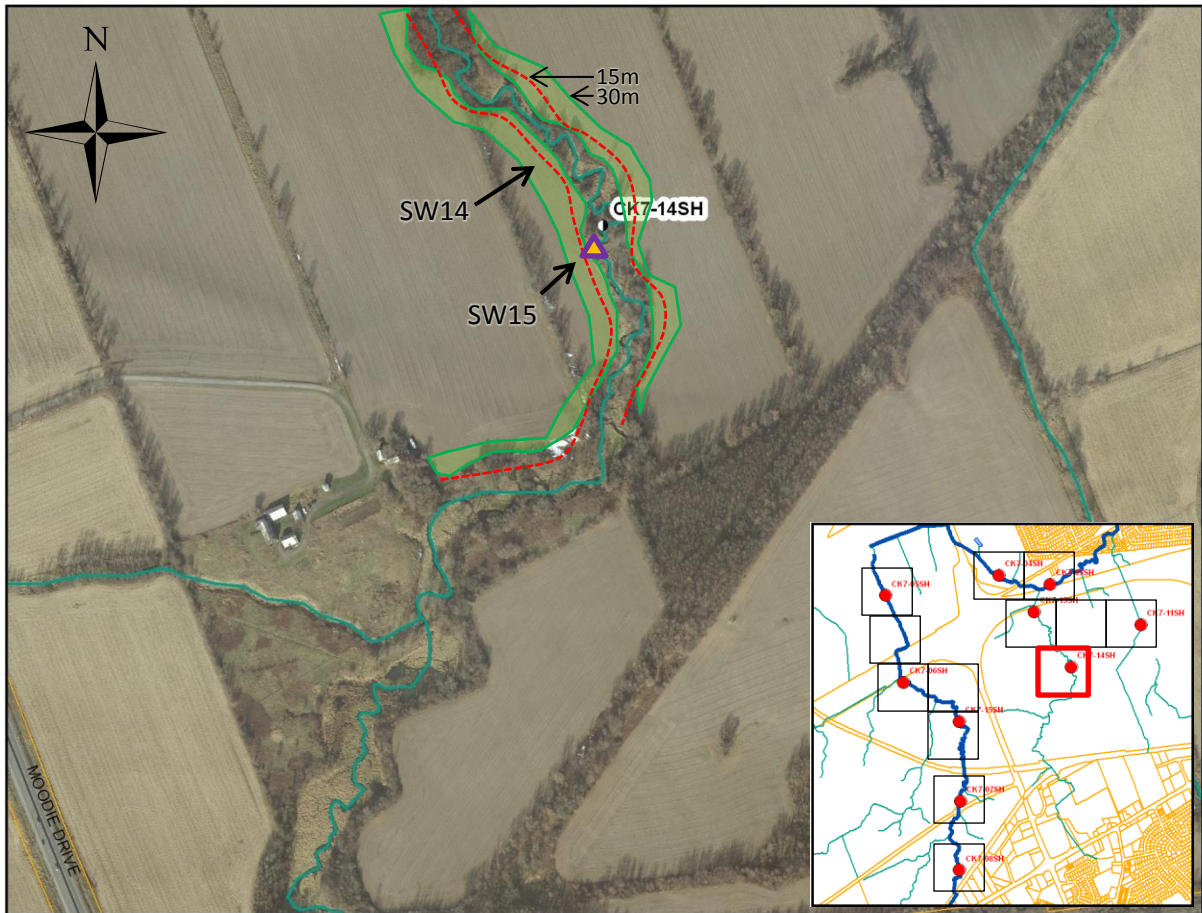

RESTORATION PROPOSAL

	STILLWATER CREEK			
	STREAM REACH	EASTING	NORTHING	COST
	SW15	434855	5020575	
EXISTING PROBLEM	The orientation of the existing culvert has resulted in degraded instream habitat stability downstream			
CONSTRAINTS	Requires research as to the optimal orientation/design. Additional challenges include the presence of beaver dams within the reach			
SOLUTION	Realignment of the culvert and instream habitat improvements			
WATERSHED OBJECTIVE	Protection of Natural Processes Protection/enhancement of Aquatic Habitat			

RESTORATION PROPOSAL

	STILLWATER CREEK			
	STREAM REACH	EASTING	NORTHING	COST
	SW14	-	-	LOW/MODERATE
EXISTING PROBLEM	The buffer setback is not adequate for the complete protection of the stream. Bank destabilization is also evident. Recommended buffer guidelines are as follows: <ul style="list-style-type: none"> - 10 meters for the stabilization of bank materials - 15 meters for the protection of water quality through interception of surface runoff/contaminants - 30 meters for the maintenance of thermal/environmental stability (SW14) 			
CONSTRAINTS	Proposed buffer enhancement zone encroaches into agricultural field			
SOLUTION	Re-vegetation with native trees/shrubs to create riparian habitat as well as bioengineering design to stabilize shorelines. Plants considered for buffer enhancement should meet the following criteria: <ul style="list-style-type: none"> - Native - Adapted to site soil/moisture/light conditions - Provide for specific habitat objectives (e.g Stabilization, habitat enhancement, ect) - Support for the development of natural vegetation communities 			
WATERSHED OBJECTIVE	Protection and enhancement of Terrestrial/Riparian Habitat Promotion of Linkages and Natural Corridors			

STILLWATER CREEK: RESTORATION PLAN – CK715SH

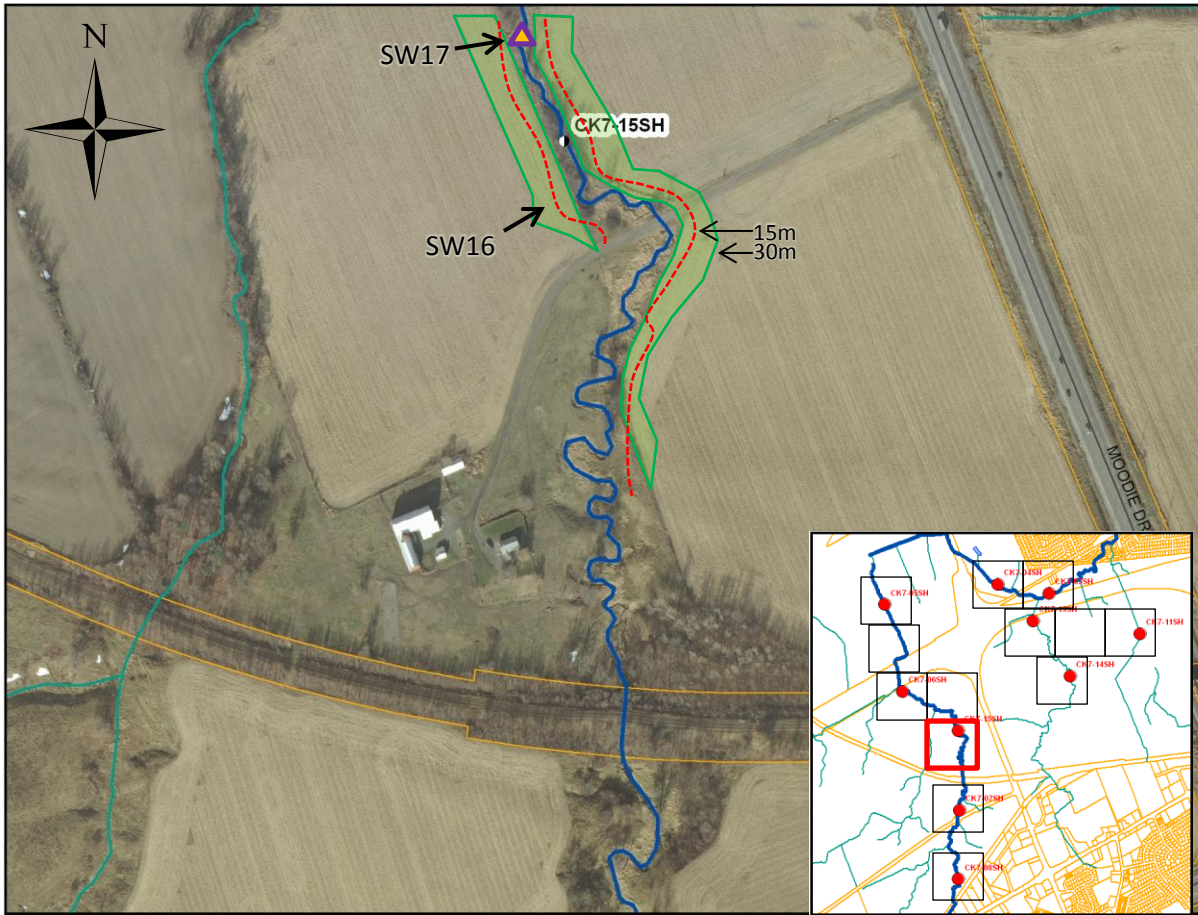

RESTORATION PROPOSAL

	STILLWATER CREEK			
	STREAM REACH	EASTING	NORTHING	COST
	SW17	-	-	HIGH
EXISTING PROBLEM	Exposed sewer pipe identified along creek-bed.			
CONSTRAINTS	City of Ottawa maintenance program/alternate organization mandate			
SOLUTION	Notify City of Ottawa for the need to repair and/or the modify channel to avoid further exposure of infrastructure.			
WATERSHED OBJECTIVE	Protection/enhancement of Aquatic Habitat			

RESTORATION PROPOSAL

	STILLWATER CREEK			
	STREAM REACH	EASTING	NORTHING	COST
	SW16	-	-	LOW
EXISTING PROBLEM	The buffer setback is not adequate for the complete protection of the stream. Recommended buffer guidelines are as follows: <ul style="list-style-type: none"> - 10 meters for the stabilization of bank materials - 15 meters for the protection of water quality through interception of surface runoff/contaminants - 30 meters for the maintenance of thermal/environmental stability (SW16) 			
CONSTRAINTS	Proposed buffer enhancement zone encroaches into agricultural field			
SOLUTION	Re-vegetation with native trees/shrubs to create riparian habitat. Plants considered for buffer enhancement should meet the following criteria: <ul style="list-style-type: none"> - Native - Adapted to site soil/moisture/light conditions - Provide for specific habitat objectives (e.g Stabilization, habitat enhancement, ect) - Support for the development of natural vegetation communities 			
WATERSHED OBJECTIVE	Protection and enhancement of Terrestrial/Riparian Habitat Promotion of Linkages and Natural Corridors			

REFERENCES (5.0)

- C. Chu, N.E. Jones, A.R. Piggott, & J.M. Buttle. 2009. Evaluation of a Simple Method to Classify the Thermal Characteristics of Streams Using a Nomogram of Daily Maximum Air and Water Temperatures. *North American Journal of Fisheries Management* (29: 1605-1619)
- C. Jones, K.M. Somers, B. Craig, & T.B. Reynoldson. 2007. Ontario Benthos Biomonitoring Network: Protocol Manual. Ontario Ministry of the Environment. Dorset, Ontario. 109 pages.
- Canadian Council of Ministers of the Environment. 1999. Canadian water quality guidelines for the protection of aquatic life: Dissolved oxygen (freshwater). In: Canadian environmental quality guidelines, 1999, Canadian Council of Ministers of the Environment, Winnipeg.
- Canadian Wildlife Service (CWS), Environment Canada. 2004. *How Much Habitat is Enough? Second Edition*.
- Coker, G.A. Portt, C.B. & C.K. Minns. 2001. Morphological and Ecological Characteristics of Canadian Freshwater Fishes. Canadian Manuscript Report of Fisheries and Aquatic Sciences. 2554: iv+89p.
- Cudmore-Vokey, B. and C.K. Minns. 2002. Reproductive ecology and vegetation association databases for Lake Ontario Fishes. Canadian Manuscript Report of Fisheries and Aquatic Sciences. 2607: ix+42p.
- E.K. Balon. 1981. Additions and amendments to the classification of reproductive styles in fishes. *Environment Biology of Fishes* (6: 377-389)
- Ecoplans, Limited. September 2009. *West Transitway Expansion Bayshore Station to Moodie Drive: Preliminary Characterization of Existing Natural Environmental Conditions*. **DRAFT**.
- Environmental Guide for Fish and Fish Habitat, Section 6: Analysis of Fish and Fish Habitat Sensitivity, June 2009. Ministry of Transportation Ontario
- Lane, J.A., C.B. Portt and C.K. Minns. 1996. Spawning habitat characteristics of Great Lakes fishes. Canadian Manuscript Report of Fisheries and Aquatic Sciences. 2368: v+48p.
- Ontario Ministry of the Environment. 1994. Provincial Water Quality Objectives.
- Rennie, C.D. 2012. Linking Sediment Erodibility, Channel Stability, and Habitat in Stillwater Creek Watershed. University of Ottawa – Research Proposal Prepared for the National Capital Commission

Rideau Valley Conservation Authority (RVCA). 2009. City Stream Watch Annual Report. Manotick, ON: Julia Sutton

Stanfield L. (editor). 2010. Ontario Stream Assessment Protocol. Version 8.0. Fisheries Policy Section. Ontario Ministry of Natural Resources. Peterborough, Ontario. 376 pages.

Stoneman, C.L. & M.L. Jones. 1996. A Simple Method to Evaluate the Thermal Stability of Trout Streams. *North American Journal of Fisheries Management*. (16: 728-737)

United States Environmental Protection Agency. 2013. Dissolved Oxygen and Biological Oxygen Demand. Retrieved from: <http://water.epa.gov/type/rs/monitoring/vms52.cfm>

APPENDIX I – THERMAL/TEMPERATURE DATA

Thermal Spectrum – CK704SH

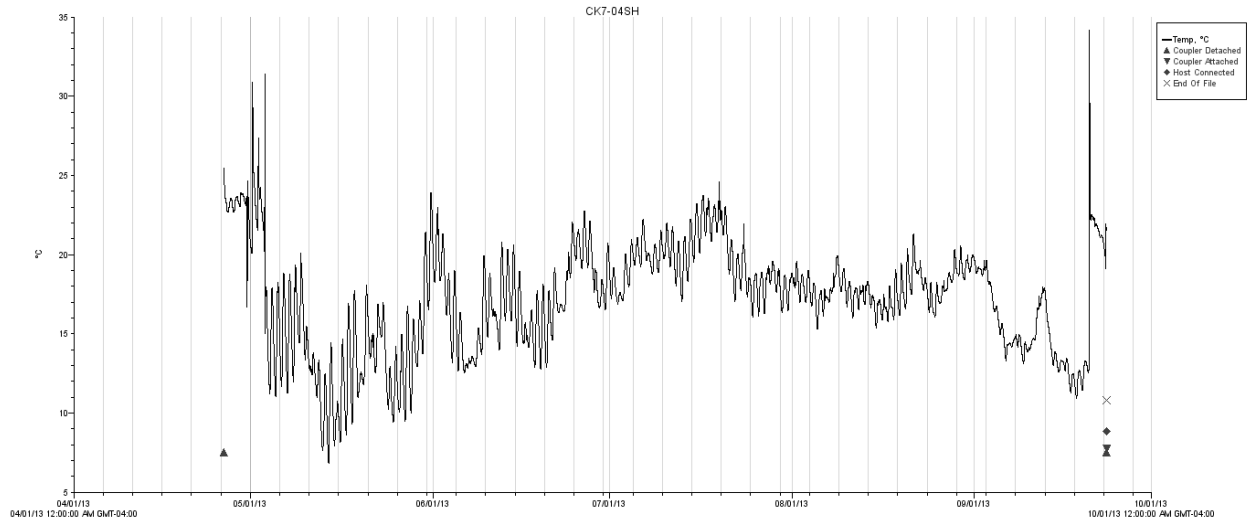

Thermal Spectrum – CK705SH

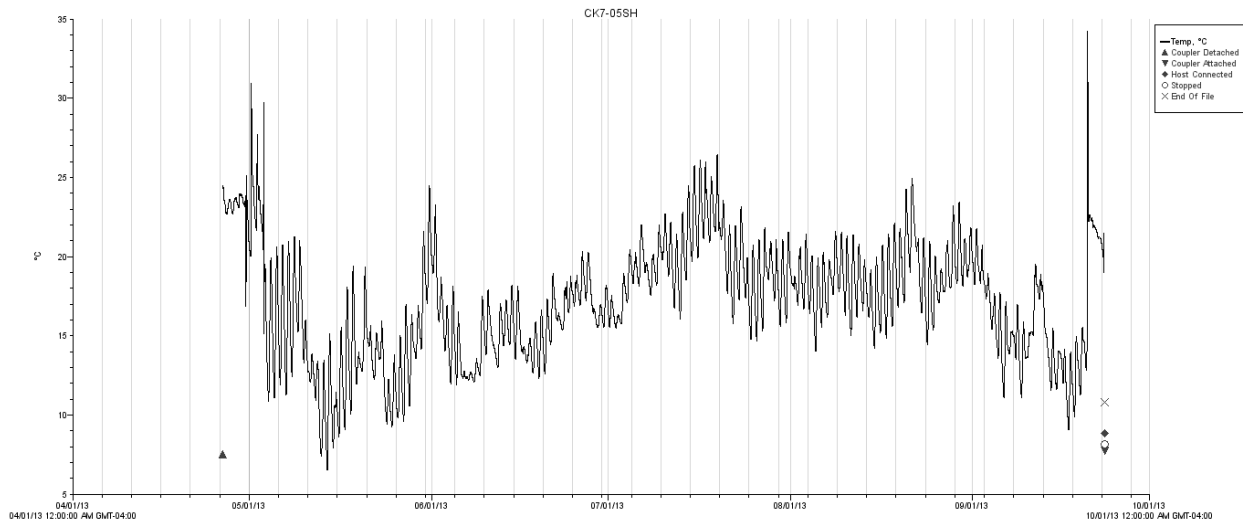

Thermal Spectrum – CK708SH

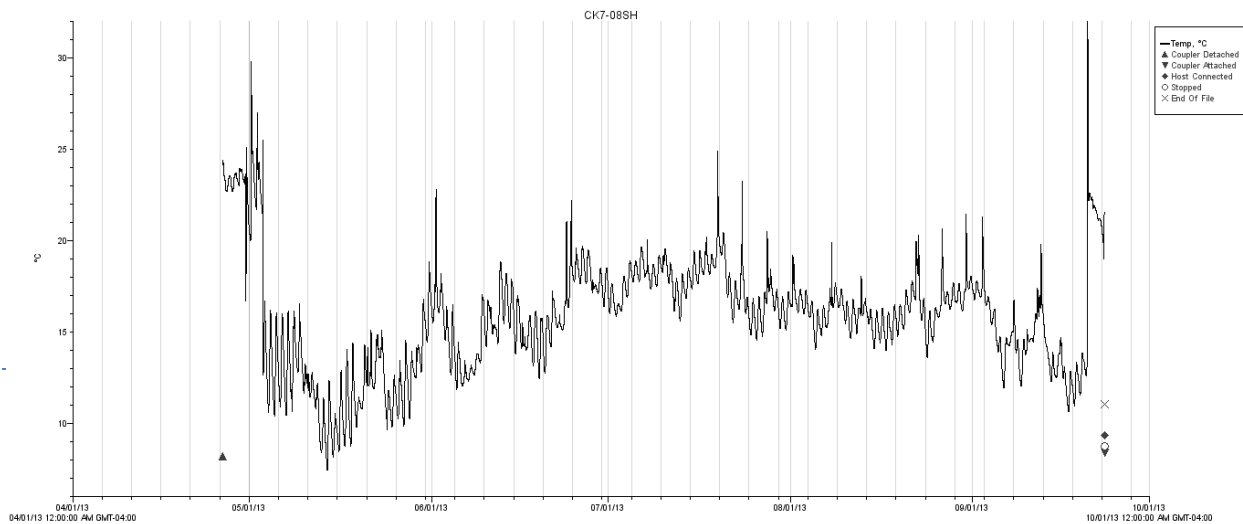

Thermal Spectrum – CK711SH

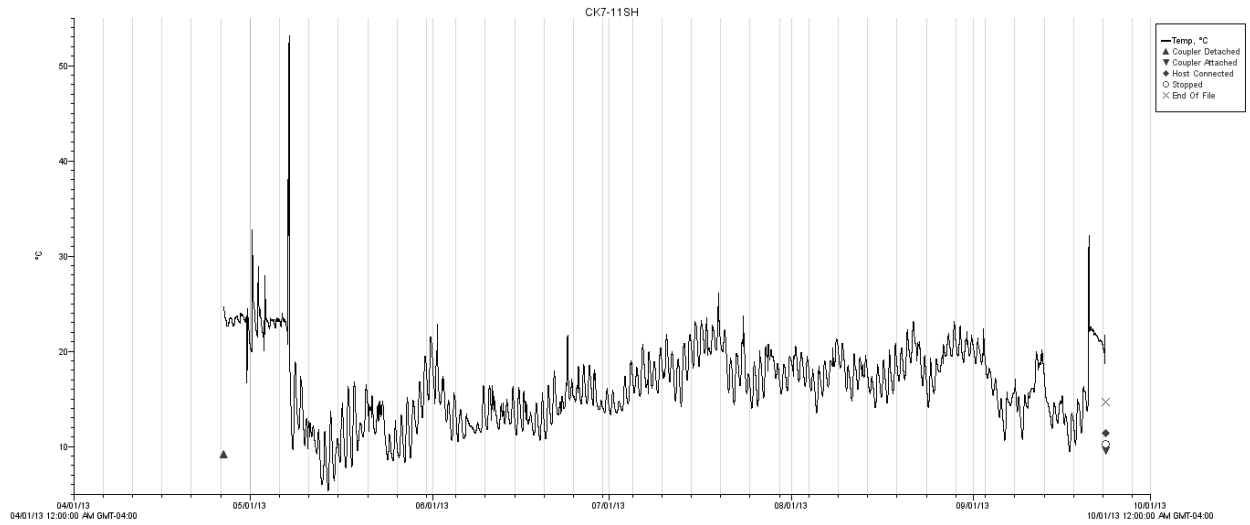

Thermal Spectrum – CK714SH

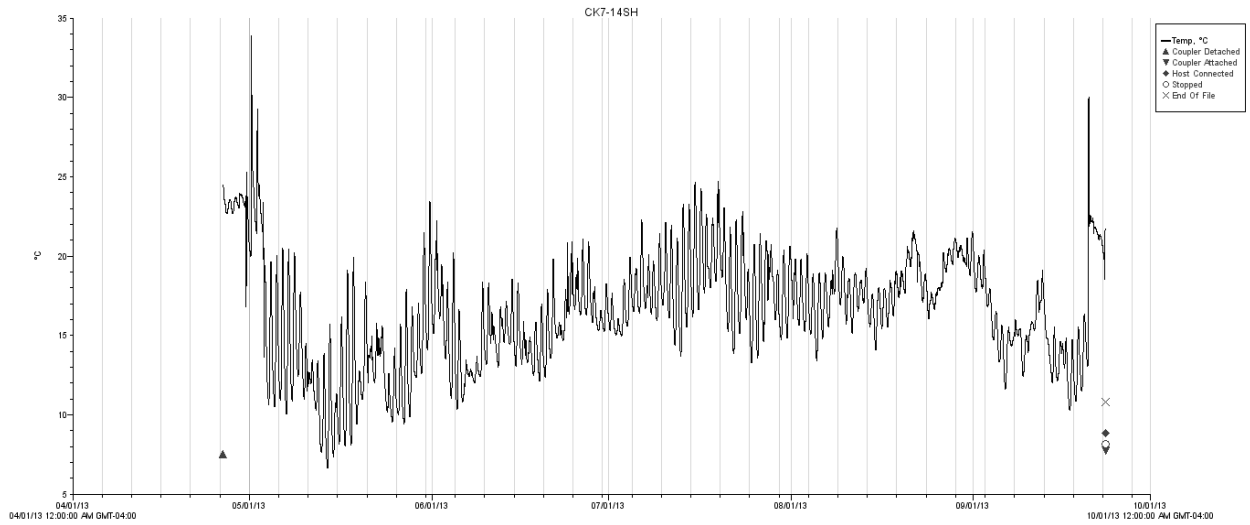

Thermal Spectrum – CK715SH

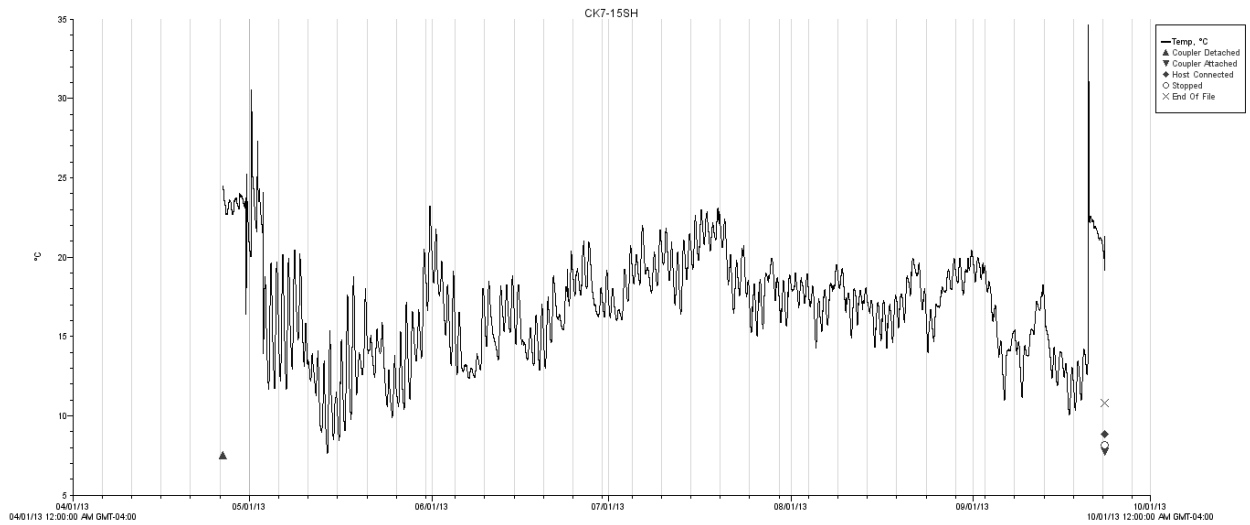

Temperature Classification Data Points (CK7-04SH)

CK7-04SH	Air	Water
3-Jul	27.9	19.55
4-Jul	29.2	20.53
5-Jul	28.2	20.77
6-Jul	30	22.06
13-Jul	29.5	20.72
14-Jul	31	21.53
15-Jul	32.2	22.36
16-Jul	33	22.8
22-Jul	25.4	19.67
26-Jul	25.6	18.34
11-Aug	25.3	17.62
17-Aug	25.6	17.89
18-Aug	28	18.86
19-Aug	27.5	18.91
20-Aug	30.7	20.29

Temperature Classification Data Points (CK7-05SH)

CK7-05SH	Air	Water
3-Jul	27.9	18.84
4-Jul	29.2	20.12
5-Jul	28.2	19.96
6-Jul	30	21.92
13-Jul	29.5	22.63
14-Jul	31	24.19
15-Jul	32.2	25.62
16-Jul	33	25.96
22-Jul	25.4	21.84
26-Jul	25.6	20.98
11-Aug	25.3	21.22
17-Aug	25.6	21.24
18-Aug	28	21.89
19-Aug	27.5	21.67
20-Aug	30.7	23.95

Temperature Classification Data Points (CK7-08SH)

CK7-08SH	Air	Water
3-Jul	27.9	17.91
4-Jul	29.2	18.72
5-Jul	28.2	18.72
6-Jul	30	19.58
13-Jul	29.5	18.13
14-Jul	31	18.46
15-Jul	32.2	19.41
16-Jul	33	19.44
22-Jul	25.4	17.79
26-Jul	25.6	16.89
11-Aug	25.3	16.75
17-Aug	25.6	16.06
18-Aug	28	16.34
19-Aug	27.5	16.41
20-Aug	30.7	17.15

Temperature Classification Data Points (CK7-11SH)

CK7-11SH	Air	Water
3-Jul	27.9	17.3
4-Jul	29.2	18.46
5-Jul	28.2	17.96
6-Jul	30	19.82
13-Jul	29.5	20.34
14-Jul	31	21.65
15-Jul	32.2	23.06
16-Jul	33	23.11
22-Jul	25.4	19.74
26-Jul	25.6	19.72
11-Aug	25.3	19.57
17-Aug	25.6	19.55
18-Aug	28	20.19
19-Aug	27.5	19.96
20-Aug	30.7	21.46

Temperature Classification Data Points (CK7-14SH)

CK7-14SH	Air	Water
3-Jul	27.9	18.48
4-Jul	29.2	19.86
5-Jul	28.2	19.01
6-Jul	30	22.2
13-Jul	29.5	22.77
14-Jul	31	22.82
15-Jul	32.2	23.95
16-Jul	33	23.66
22-Jul	25.4	21.98
26-Jul	25.6	19.86
11-Aug	25.3	17.7
17-Aug	25.6	16.89
18-Aug	28	18.36
19-Aug	27.5	18.2
20-Aug	30.7	19.62

Temperature Classification Data Points (CK7-15SH)

CK7-15SH	Air	Water
3-Jul	27.9	18.81
4-Jul	29.2	20.12
5-Jul	28.2	19.79
6-Jul	30	21.46
13-Jul	29.5	20.29
14-Jul	31	21.17
15-Jul	32.2	22.03
16-Jul	33	22.41
22-Jul	25.4	19.32
26-Jul	25.6	18.13
11-Aug	25.3	17.79
17-Aug	25.6	16.7
18-Aug	28	17.22
19-Aug	27.5	17.48
20-Aug	30.7	18.55

APPENDIX II – BENTHIC DATA

Benthic Survey

Stream_Code	Site_Code	Date	Time	Water Temp	Conductivity (us/cm)	pH	DO (mg/l)	Sub_1	Sub_2	B_Width	Gear_Type	Sorting Method
CK7	CK7-08SH	17-Jul-13	10:50	19.1	823	7.7	10	Bedrock	Clay	2.9	Square Net	Unsorted
CK7	CK7-06SH	16-Jul-13	11:30	21.4	911	7.6	9.9	Clay	Silt	3	Square Net	Unsorted
CK7	CK7-04SH	15-Jul-13	9:33	20.5	877	6.7	5.5	Silt	Clay	8.5	Square Net	Unsorted
CK7	CK7-03SH	15-Jul-13	11:45	20.7	1183	7.9	11.9	Bedrock	Cobble	4.5	Square Net	Unsorted
CK7	CK7-11SH	18-Jul-13	9:40	20	599	7.4	6.8	Clay	Silt	2.2	Square Net	Unsorted
CK7	CK7-15SH	17-Jul-13	9:09	20.8	953	7.5	8.1	Clay	Gravel	3.9	Square Net	Unsorted
CK7	CK7-05SH	16-Jul-13	9:16	20.4	963	7.6	10.3	Clay	Silt	6.6	Square Net	Unsorted
CK7	CK7-14SH	17-Jul-13	13:00	21.4	1399	7.9	14.4	Cobble	Gravel	3.6	Square Net	Unsorted
CK7	CK7-07SH	16-Jul-13	13:30	22.4	936	7.6	9.7	Sand	Cobble	3.6	Square Net	Unsorted
CK7	CK7-13SH	15-Jul-13	13:12	20.8	1229	8	11.2	Bedrock	Sand	4.4	Square Net	Unsorted

Identification	Collect_Method	Mesh_Size	Canopy_Cover	Candidate_Ref	Macro_Emergent	Macro_Root	Macro_Sub
In-Field	Stationary Kick Survey	500	3	No	Present	Absent	Absent
In-Field	Stationary Kick Survey	500	2	No	Abundant	Absent	Present
In-Field	Stationary Kick Survey	500	3	No	Abundant	Absent	Present
In-Field	Stationary Kick Survey	500	3	No	Absent	Abundant	Present
In-Field	Stationary Kick Survey	500	4	No	Absent	Absent	Absent
In-Field	Stationary Kick Survey	500	2	No	Present	Absent	Absent
In-Field	Stationary Kick Survey	500	1	No	Present	Absent	Present
In-Field	Stationary Kick Survey	500	1	No	Present	Absent	Absent
In-Field	Stationary Kick Survey	500	3	No	Present	Absent	Absent
In-Field	Stationary Kick Survey	500	4	No	Present	Absent	Absent

Macro_Free	Algae_Float	Algae_Fil	Algae_Attach	RipA_LB	RipB_LB	RipC_LB	RipA_RB	RipB_RB	RipC_RB	Pool/Riffle
Absent	Absent	Absent	Present	Meadow	Scrubland	Scrubland	Meadow	Scrubland	Scrubland	Riffle
Absent	Absent	Abundant	Absent	Meadow	Scrubland	Cropland	Meadow	Scrubland	Cropland	Riffle
Present	Present	Absent	Absent	Meadow	Lawn	Lawn	Meadow	Scrubland	None	Riffle
Absent	Absent	Abundant	Absent	Meadow	None	None	Meadow	Forest	Forest	Riffle
Absent	Absent	Absent	Present	Scrubland	Cropland	Cropland	Scrubland	Cropland	Cropland	Pool
Absent	Absent	Absent	Present	Scrubland	Cropland	Cropland	Scrubland	Cropland	Cropland	Riffle
Absent	Absent	Abundant	Absent	Meadow	Lawn	Lawn	Meadow	Lawn	Lawn	Pool
Absent	Absent	Present	Present	Scrubland	Cropland	Cropland	Scrubland	Cropland	Cropland	Riffle
Absent	Absent	Present	Present	Meadow	Meadow	Cropland	Meadow	Meadow	Cropland	Riffle
Absent	Absent	Abundant	Present	Scrubland	Cropland	Cropland	Meadow	Cropland	Cropland	Riffle

Sample_Dist	Sample_Time	Max_Depth	Hyd_Head	W_Width	Crew_Leader	Crew
1	2:00	60	4	1	J Robert	GM MP JR
1	2:00	230	2	1.3	J Robert	HM MP JR
1	2:00	290	0	5.9	J Robert	EP HM JR
1	2:00	170	20	2.4	J Robert	EP HM JR
1	2:00	230	0	1.5	J Robert	EP HM JR
1	2:00	200	0	2.5	J Robert	GM MP JR
1	2:00	940	0	5.3	J Robert	HM MP JR
1	2:00	145	5	1.9	J Robert	GM MP JR
1	2:00	170	3	1.6	J Robert	HM MP JR
1	2:00	190	0	3.9	J Robert	EP HM JR

Benthic Tally / Taxa Information

Stream_Code	Site_Code	Date	Season	Group	Family	Count	Percent	Richness
CK7	CK7-08SH	17-Jul-13	Summer	Turbellaria		1	4.8	10
CK7	CK7-08SH	17-Jul-13	Summer	Nematoda		2	4.8	10
CK7	CK7-08SH	17-Jul-13	Summer	Isopoda		98	4.8	10
CK7	CK7-08SH	17-Jul-13	Summer	Pelecypoda		1	4.8	10
CK7	CK7-08SH	17-Jul-13	Summer	Odonata	Anisoptera	1	4.8	10
CK7	CK7-08SH	17-Jul-13	Summer	Trichoptera		24	4.8	10
CK7	CK7-08SH	17-Jul-13	Summer	Coleoptera		35	4.8	10
CK7	CK7-08SH	17-Jul-13	Summer	Diptera	Chironomidae	20	4.8	10
CK7	CK7-08SH	17-Jul-13	Summer	Diptera	Simuliidae	4	4.8	10
CK7	CK7-08SH	17-Jul-13	Summer	Diptera	Misc Diptera	2	4.8	10
CK7	CK7-06SH	16-Jul-13	Summer	Nematoda		3	4.9	11
CK7	CK7-06SH	16-Jul-13	Summer	Isopoda		67	4.9	11
CK7	CK7-06SH	16-Jul-13	Summer	Amphipoda		37	4.9	11
CK7	CK7-06SH	16-Jul-13	Summer	Decapoda		1	4.9	11
CK7	CK7-06SH	16-Jul-13	Summer	Odonata	Anisoptera	1	4.9	11
CK7	CK7-06SH	16-Jul-13	Summer	Trichoptera		16	4.9	11
CK7	CK7-06SH	16-Jul-13	Summer	Coleoptera		9	4.9	11
CK7	CK7-06SH	16-Jul-13	Summer	Diptera	Chironomidae	19	4.9	11

Stream_Code	Site_Code	Date	Season	Group	Family	Count	Percent	Richness
CK7	CK7-06SH	16-Jul-13	Summer	Diptera	Tabanidae	1	4.9	11
CK7	CK7-06SH	16-Jul-13	Summer	Diptera	Tipulidae	2	4.9	11
CK7	CK7-06SH	16-Jul-13	Summer	Diptera	Simuliidae	1	4.9	11
CK7	CK7-04SH	15-Jul-13	Summer	Nematoda		1	14.2	11
CK7	CK7-04SH	15-Jul-13	Summer	Isopoda		8	14.2	11
CK7	CK7-04SH	15-Jul-13	Summer	Amphipoda		5	14.2	11
CK7	CK7-04SH	15-Jul-13	Summer	Acari		6	14.2	11
CK7	CK7-04SH	15-Jul-13	Summer	Odonata	Anisoptera	1	14.2	11
CK7	CK7-04SH	15-Jul-13	Summer	Megaloptera		1	14.2	11
CK7	CK7-04SH	15-Jul-13	Summer	Trichoptera		2	14.2	11
CK7	CK7-04SH	15-Jul-13	Summer	Coleoptera		10	14.2	11
CK7	CK7-04SH	15-Jul-13	Summer	Gastropoda		4	14.2	11
CK7	CK7-04SH	15-Jul-13	Summer	Diptera	Chironomidae	70	14.2	11
CK7	CK7-04SH	15-Jul-13	Summer	Diptera	Culicidae	4	14.2	11
CK7	CK7-03SH	15-Jul-13	Summer	Hirudinea		6	6	12
CK7	CK7-03SH	15-Jul-13	Summer	Isopoda		135	6	12
CK7	CK7-03SH	15-Jul-13	Summer	Pelecypoda		5	6	12
CK7	CK7-03SH	15-Jul-13	Summer	Amphipoda		28	6	12
CK7	CK7-03SH	15-Jul-13	Summer	Trichoptera		9	6	12
CK7	CK7-03SH	15-Jul-13	Summer	Coleoptera		26	6	12
CK7	CK7-03SH	15-Jul-13	Summer	Gastropoda		2	6	12
CK7	CK7-03SH	15-Jul-13	Summer	Diptera	Chironomidae	15	6	12
CK7	CK7-03SH	15-Jul-13	Summer	Diptera	Tabanidae	1	6	12
CK7	CK7-03SH	15-Jul-13	Summer	Diptera	Culicidae	2	6	12
CK7	CK7-03SH	15-Jul-13	Summer	Diptera	Ceratopogonidae	1	6	12
CK7	CK7-03SH	15-Jul-13	Summer	Diptera	Simuliidae	12	6	12
CK7	CK7-11SH	18-Jul-13	Summer	Nematoda		3	24.1	9
CK7	CK7-11SH	18-Jul-13	Summer	Oligochaeta		1	24.1	9
CK7	CK7-11SH	18-Jul-13	Summer	Isopoda		82	24.1	9
CK7	CK7-11SH	18-Jul-13	Summer	Odonata	Anisoptera	2	24.1	9
CK7	CK7-11SH	18-Jul-13	Summer	Plecoptera		1	24.1	9
CK7	CK7-11SH	18-Jul-13	Summer	Coleoptera		6	24.1	9
CK7	CK7-11SH	18-Jul-13	Summer	Gastropoda		2	24.1	9
CK7	CK7-11SH	18-Jul-13	Summer	Diptera	Chironomidae	17	24.1	9
CK7	CK7-11SH	18-Jul-13	Summer	Diptera	Culicidae	5	24.1	9
CK7	CK7-15SH	17-Jul-13	Summer	Turbellaria		4	11.5	13

Stream_Code	Site_Code	Date	Season	Group	Family	Count	Percent	Richness
CK7	CK7-15SH	17-Jul-13	Summer	Hirudinea		2	11.5	13
CK7	CK7-15SH	17-Jul-13	Summer	Isopoda		27	11.5	13
CK7	CK7-15SH	17-Jul-13	Summer	Amphipoda		16	11.5	13
CK7	CK7-15SH	17-Jul-13	Summer	Ephemeroptera		1	11.5	13
CK7	CK7-15SH	17-Jul-13	Summer	Odonata	Zygoptera	1	11.5	13
CK7	CK7-15SH	17-Jul-13	Summer	Hemiptera		1	11.5	13
CK7	CK7-15SH	17-Jul-13	Summer	Trichoptera		56	11.5	13
CK7	CK7-15SH	17-Jul-13	Summer	Coleoptera		27	11.5	13
CK7	CK7-15SH	17-Jul-13	Summer	Gastropoda		1	11.5	13
CK7	CK7-15SH	17-Jul-13	Summer	Diptera	Chironomidae	6	11.5	13
CK7	CK7-15SH	17-Jul-13	Summer	Diptera	Simuliidae	2	11.5	13
CK7	CK7-15SH	17-Jul-13	Summer	Diptera	Misc Diptera	13	11.5	13
CK7	CK7-05SH	16-Jul-13	Summer	Nematoda		6	15.4	11
CK7	CK7-05SH	16-Jul-13	Summer	Oligochaeta		2	15.4	11
CK7	CK7-05SH	16-Jul-13	Summer	Hirudinea		2	15.4	11
CK7	CK7-05SH	16-Jul-13	Summer	Isopoda		1	15.4	11
CK7	CK7-05SH	16-Jul-13	Summer	Amphipoda		32	15.4	11
CK7	CK7-05SH	16-Jul-13	Summer	Decapoda		1	15.4	11
CK7	CK7-05SH	16-Jul-13	Summer	Acari		11	15.4	11
CK7	CK7-05SH	16-Jul-13	Summer	Ephemeroptera		2	15.4	11
CK7	CK7-05SH	16-Jul-13	Summer	Coleoptera		6	15.4	11
CK7	CK7-05SH	16-Jul-13	Summer	Diptera	Chironomidae	40	15.4	11
CK7	CK7-05SH	16-Jul-13	Summer	Diptera	Ceratopogonidae	1	15.4	11
CK7	CK7-14SH	17-Jul-13	Summer	Isopoda		19	5	4
CK7	CK7-14SH	17-Jul-13	Summer	Amphipoda		107	5	4
CK7	CK7-14SH	17-Jul-13	Summer	Coleoptera		2	5	4
CK7	CK7-14SH	17-Jul-13	Summer	Diptera	Chironomidae	5	5	4
CK7	CK7-07SH	16-Jul-13	Summer	Turbellaria		2	11.4	10
CK7	CK7-07SH	16-Jul-13	Summer	Hirudinea		4	11.4	10
CK7	CK7-07SH	16-Jul-13	Summer	Isopoda		54	11.4	10
CK7	CK7-07SH	16-Jul-13	Summer	Amphipoda		5	11.4	10
CK7	CK7-07SH	16-Jul-13	Summer	Trichoptera		39	11.4	10
CK7	CK7-07SH	16-Jul-13	Summer	Coleoptera		5	11.4	10
CK7	CK7-07SH	16-Jul-13	Summer	Diptera	Chironomidae	13	11.4	10
CK7	CK7-07SH	16-Jul-13	Summer	Diptera	Tipulidae	1	11.4	10
CK7	CK7-07SH	16-Jul-13	Summer	Diptera	Simuliidae	10	11.4	10

Stream_Code	Site_Code	Date	Season	Group	Family	Count	Percent	Richness
CK7	CK7-07SH	16-Jul-13	Summer	Diptera	Misc Diptera	1	11.4	10
CK7	CK7-13SH	15-Jul-13	Summer	Nematoda		2	33.7	5
CK7	CK7-13SH	15-Jul-13	Summer	Isopoda		102	33.7	5
CK7	CK7-13SH	15-Jul-13	Summer	Amphipoda		44	33.7	5
CK7	CK7-13SH	15-Jul-13	Summer	Coleoptera		2	33.7	5
CK7	CK7-13SH	15-Jul-13	Summer	Diptera	Chironomidae	3	33.7	5

Particle/Pebble Count

Stream_Code	Site_Code	Particle_1	Particle_2	Particle_3	Particle_4	Particle_5	Particle_6	Particle_7	Particle_8	Particle_9	Particle_10	AVG
CK7	CK7-13SH	44	42	32	34	33	58	45	8	38	104	43.8
CK7	CK7-07SH	8	23	3	220	11	35	130	8	14	230	68.2
CK7	CK7-14SH	195	160	175	94	235	131	135	100	94	198	151.7
CK7	CK7-05SH	0.01	0.01	0.01	0.01	0.01	0.01	0.01	0.01	0.01	0.01	0.01
CK7	CK7-15SH	23	14	215	31	140	9	26	21	124	22	62.5
CK7	CK7-11SH	0.01	0.01	0.01	0.01	0.01	0.01	0.01	0.01	0.01	0.01	0.01
CK7	CK7-03SH	33	50	14	57	58	13	9	81	68	55	43.8
CK7	CK7-04SH	40	35	10	42	14	15	34	33	19	18	26
CK7	CK7-06SH	0.01	0.01	0.01	0.01	0.01	0.01	0.01	0.01	0.01	0.01	0.01
CK7	CK7-08SH	60	38	6	7	24	8	19	36	4	5	20.7

APPENDIX III – FISH COMMUNITY DATA

Fish Community (2001/2013)

Species	CK7-03SH				CK7-04SH				CK7-05SH			
	Total Abundance		Relative Abundance		Total Abundance		Relative Abundance		Total Abundance		Relative Abundance	
	2001	2013	2001	2013	2001	2013	2001	2013	2001	2013	2001	2013
Blackchin shiner	0	0	0.0%	0.0%	0	0	0.0%	0.0%	0	0	0.0%	0.0%
Brassy minnow	0	0	0.0%	0.0%	0	0	0.0%	0.0%	0	3	0.0%	0.6%
Brook stickleback	175	12	33.8%	11.9%	65	33	24.5%	15.9%	8	70	1.8%	13.3%
Central mudminnow	143	0	27.7%	0.0%	198	11	74.7%	5.3%	1	72	0.2%	13.7%
Common shiner	0	0	0.0%	0.0%	0	0	0.0%	0.0%	10	0	2.3%	0.0%
Creek chub	60	32	11.6%	31.7%	0	18	0.0%	8.7%	414	84	95.2%	15.9%
Cyprinid hybrid (Hy600)	0	0	0.0%	0.0%	0	4	0.0%	1.9%	2	0	0.5%	0.0%
Cyprinid spp (YOY)	0	0	0.0%	0.0%	0	53	0.0%	25.5%	0	233	0.0%	44.2%
Fathead minnow	0	0	0.0%	0.0%	0	14	0.0%	6.7%	0	24	0.0%	4.6%
Lepomis spp	0	0	0.0%	0.0%	0	0	0.0%	0.0%	0	2	0.0%	0.4%
Log perch	0	3	0.0%	3.0%	0	0	0.0%	0.0%	0	0	0.0%	0.0%
Longnose dace	38	5	7.4%	5.0%	0	0	0.0%	0.0%	0	0	0.0%	0.0%
Mottled sculpin	17	38	3.3%	37.6%	0	0	0.0%	0.0%	0	0	0.0%	0.0%
Northern redbelly dace	45	0	8.7%	0.0%	2	11	0.8%	5.3%	0	22	0.0%	4.2%
Pearl dace	35	2	6.8%	2.0%	0	0	0.0%	0.0%	0	0	0.0%	0.0%
White sucker	4	9	0.8%	8.9%	0	64	0.0%	30.8%	0	17	0.0%	3.2%
TOTAL	517	101	100%	100%	265	208	100%	100%	435	527	100%	100%
Species Richness	8	7			3	8			5	9		
Simpson Diversity Index	0.78	0.73			0.38	0.80			0.09	0.74		
Shannon(H) Index	1.71	1.53			0.60	1.78			0.25	1.63		
Area (m2)	155.6	170.18			140.5	298.63			95.08	154		
Shocker Seconds	7947	1926			5834	1336			2354	1907		
Effort (Seconds/m2)	51.07	11.32			41.52	4.47			24.76	12.38		

Species	CK7-06SH				CK7-07SH				CK7-08SH			
	Total Abundance		Relative Abundance		Total Abundance		Relative Abundance		Total Abundance		Relative Abundance	
	2001	2013	2001	2013	2001	2013	2001	2013	2001	2013	2001	2013
Blackchin shiner	1	0	0.6%	0.0%	0	0	0.0%	0.0%	33	0	5.0%	0.0%
Brassy minnow	0	0	0.0%	0.0%	0	3	0.0%	0.7%	0	0	0.0%	0.0%
Brook stickleback	35	27	22.6%	12.2%	23	97	9.7%	23.6%	145	46	22.0%	17.3%
Central mudminnow	39	2	25.2%	0.9%	29	40	12.2%	9.7%	13	50	2.0%	18.8%
Common shiner	2	0	1.3%	0.0%	3	5	1.3%	1.2%	0	1	0.0%	0.4%
Creek chub	66	164	42.6%	74.2%	112	75	47.1%	18.2%	20	79	3.0%	29.7%
Cyprinid hybrid (Hy600)	0	0	0.0%	0.0%	0	0	0.0%	0.0%	0	0	0.0%	0.0%
Cyprinid spp (YOY)	0	0	0.0%	0.0%	32	1	13.4%	0.2%	0	0	0.0%	0.0%
Fathead minnow	0	6	0.0%	2.7%	0	68	0.0%	16.5%	17	26	2.6%	9.8%
Lepomis spp	0	0	0.0%	0.0%	0	0	0.0%	0.0%	0	0	0.0%	0.0%
Log perch	0	0	0.0%	0.0%	0	0	0.0%	0.0%	0	0	0.0%	0.0%
Longnose dace	0	0	0.0%	0.0%	0	0	0.0%	0.0%	0	0	0.0%	0.0%
Mottled sculpin	0	0	0.0%	0.0%	0	0	0.0%	0.0%	0	0	0.0%	0.0%
Northern redbelly dace	9	13	5.8%	5.9%	19	121	8.0%	29.4%	430	62	65.3%	23.3%
Pearl dace	0	0	0.0%	0.0%	20	0	8.4%	0.0%	1	0	0.2%	0.0%
White sucker	3	9	1.9%	4.1%	0	1	0.0%	0.2%	0	2	0.0%	0.8%
TOTAL	155	221	100%	100%	238	411	100%	100%	659	266	100%	100%
Species Richness	7	6			7	9			7	7		
Simpson Diversity Index	0.70	0.43			0.72	0.79			0.52	0.78		
Shannon(H) Index	1.38	0.92			1.57	1.65			1.05	1.60		
Area (m2)	55.13	56.85			40.7	52.2			59.18	48.178		
Shocker Seconds	3214	867			3074	907			3655	915		
Effort (Seconds/m2)	58.30	15.25			75.53	17.38			61.76	18.99		

Species	CK7-13SH				CK7-14SH				CK7-15SH			
	Total Abundance		Relative Abundance		Total Abundance		Relative Abundance		Total Abundance		Relative Abundance	
	2001	2013	2001	2013	2001	2013	2001	2013	2001	2013	2001	2013
Blackchin shiner	0	0	0.0%	0.0%	0	0	0.0%	0.0%	X	0	X	0.0%
Brassy minnow	0	0	0.0%	0.0%	0	0	0.0%	0.0%	X	0	X	0.0%
Brook stickleback	7	0	41.2%	0.0%	3	4	10.7%	6.2%	X	0	X	0.0%
Central mudminnow	0	0	0.0%	0.0%	16	1	57.1%	1.5%	X	0	X	0.0%
Common shiner	0	0	0.0%	0.0%	0	0	0.0%	0.0%	X	6	X	4.3%
Creek chub	10	9	58.8%	100.0%	9	25	32.1%	38.5%	X	122	X	87.1%
Cyprinid hybrid (Hy600)	0	0	0.0%	0.0%	0	0	0.0%	0.0%	X	0	X	0.0%
Cyprinid spp (YOY)	0	0	0.0%	0.0%	0	8	0.0%	12.3%	X	3	X	2.1%
Fathead minnow	0	0	0.0%	0.0%	0	26	0.0%	40.0%	X	0	X	0.0%
Lepomis spp	0	0	0.0%	0.0%	0	0	0.0%	0.0%	X	0	X	0.0%
Log perch	0	0	0.0%	0.0%	0	0	0.0%	0.0%	X	0	X	0.0%
Longnose dace	0	0	0.0%	0.0%	0	0	0.0%	0.0%	X	0	X	0.0%
Mottled sculpin	0	0	0.0%	0.0%	0	0	0.0%	0.0%	X	0	X	0.0%
Northern redbelly dace	0	0	0.0%	0.0%	0	1	0.0%	1.5%	X	4	X	2.9%
Pearl dace	0	0	0.0%	0.0%	0	0	0.0%	0.0%	X	0	X	0.0%
White sucker	0	0	0.0%	0.0%	0	0	0.0%	0.0%	X	5	X	3.6%
TOTAL	17	9	100%	100%	28	65	100%	100%	0	140	0%	100%
Species Richness	2	1			3	6			X	5		
Simpson Diversity Index	0.48	0.00			0.56	0.67			X	0.24		
Shannon(H) Index	0.68	0.00			0.92	1.29			X	0.56		
Area (m2)	93.03	131.64			84.29	93.64			X	84		
Shocker Seconds	2471	1516			1957	1310			X	1047		
Effort (Seconds/m2)	26.56	11.52			23.22	13.99			X	12.46		

Fish Sampling Survey Data (2013)

Stream_Name	Stream_Code	Site_Code	Date	Sample	Water_Temp	Air_Temp	DO	DO(%)	Cond	pH	Science_Permit	Start_Time
Stillwater Creek	CK7	CK7-14SH	7-May-13	1	19.03	24.4	12.73	NA	1080	8.28	1072871	14:36
Stillwater Creek	CK7	CK7-04SH	7-May-13	1	15.5	30.8	9.28	NA	821	7.8	1072871	13:30
Stillwater Creek	CK7	CK7-06SH	7-May-13	1	12.05	27	11.44	NA	642	7.9	1072871	9:46
Stillwater Creek	CK7	CK7-15SH	7-May-13	1	14.7	24.3	12.1	NA	698	8.1	1072871	11:18
Stillwater Creek	CK7	CK7-07SH	15-May-13	1	10.85	13.5	11.64	NA	664	8.11	1072871	12:36
Stillwater Creek	CK7	CK7-07SH	29-Jul-13	2	17.6	20.2	8.2	NA	382	7.45	1072871	9:35
Stillwater Creek	CK7	CK7-13SH	15-May-13	1	8.4	8.5	12.06	NA	871	7.97	1072871	10:50
Stillwater Creek	CK7	CK7-13SH	25-Jul-13	2	NA	NA	NA	NA	NA	NA	1072871	9:35
Stillwater Creek	CK7	CK7-14SH	23-Jul-13	2	20.8	NA	12.34	NA	1234	8.12	1072871	14:20
Stillwater Creek	CK7	CK7-05SH	16-May-13	1	9.78	12	12.05	NA	750	8.04	1072871	9:03
Stillwater Creek	CK7	CK7-05SH	23-Jul-13	2	17.34	19.96	9.13	NA	1034	7.44	1072871	9:20
Stillwater Creek	CK7	CK7-15SH	24-Jul-13	2	17.68	NA	7.92	83.9	536	7.7	1072871	9:10
Stillwater Creek	CK7	CK7-11SH	18-Jul-13	1	NA	NA	NA	NA	NA	NA	1072871	11:00
Stillwater Creek	CK7	CK7-03SH	16-May-13	1	8.5	8	11.57	NA	837	7.64	1072871	9:38
Stillwater Creek	CK7	CK7-03SH	19-Jul-13	2	22.26	26.56	8.87	NA	1364	7.72	1072871	9:25
Stillwater Creek	CK7	CK7-04SH	22-Jul-13	2	17.08	19.75	4.05	NA	845	6.95	1072871	9:35
Stillwater Creek	CK7	CK7-06SH	30-Jul-13	2	15.9	19.5	9.2	NA	749	8.02	1072871	9:50
Stillwater Creek	CK7	CK7-08SH	15-May-13	1	9.93	11.4	11.08	NA	570	8.11	1072871	14:45
Stillwater Creek	CK7	CK7-08SH	31-Jul-13	2	15.43	NA	10	NA	838	7.75	1072871	9:30

STILLWATER CREEK - 2013 REPORT

Stop_Time	Elapsed_Time	Shocker_Secs	Model_No	Voltage	Frequency	Crew_Leader	Field_ID	Crew	Comments
15:10	34	910	HT-2000	150	100	J Robert	J Robert	CE JR AL	Gravid Creek chub and sticklebacks
13:54	24	735	HT-2000	250	100	J Robert	J Robert	CE JR AL	Gravid Creek chub - Potential hybrid spp (Creek chub x Northern redbelly dace)
10:12	26	449	HT-2000	250	100	J Robert	J Robert	CE JR AL	High proportion of gravid females amongst Creek chub, Brook stickleback
11:48	30	530	HT-2000	250	100	J Robert	J Robert	CE JR AL	Juvenile mud puppy captured while sampling
13:00	24	439	HT-2000	250	60	J Robert	J Robert	CE GM JR	
9:58	23	468	HT-2000	150	80	J Robert	J Robert	MP HM JR	
11:12	22	705	HT-2000	350	80	J Robert	J Robert	GM CE JR	Battery power may have been low - Voltage increased to compensate
9:57	22	811	HT-2000	150	80	G Melvin	J Robert	GM HM JR	
14:35	15	400	HT-2000	150	100	M Peterman	J Robert	GM MP JR	
9:31	28	883	HT-2000	250	80	J Robert	J Robert	CE AL JR	
9:40	20	1024	HT-2000	150	80	J Robert	J Robert	MM MP JR	
9:31	21	517	HT-2000	150	80	J Robert	J Robert	CE MP JR	
11:16	16	562	HT-2000	150	80	J Robert	J Robert	EP HM JR	No fish captured/present
10:00	22	863	HT-2000	350	80	J Robert	J Robert	GM CE JR	Gravid Chub/Stickleback
9:50	25	1063	HT-2000	150	80	J Robert	J Robert	HM MP JR	
10:00	25	601	HT-2000	150	80	J Robert	J Robert	HM EP JR	Batteries low - Electrofisher was not shocking effectively Extensive plant growth made sampling difficult
10:15	25	418	HT-2000	150	100	J Robert	J Robert	HM EP JR	
15:10	25	411	HT-2000	250	60	J Robert	J Robert	CE GM JR	Juvenile mud puppy captured while sampling
9:51	21	504	HT-2000	150	80	J Robert	J Robert	MP GM JR	

APPENDIX IV – CHANNEL MORPHOLOGY/POINT TRANSECT DATA

Habitat Distribution – Point Transect Analysis (CK7-03SH)

CK7-03SH (2013)						CK7-03SH (2001)					
Habitat Type						Habitat Type					
Depth (mm)	Pools	Glides	Slow Riffles	Fast Riffles	Totals	Depth (mm)	Pools	Glides	Slow Riffles	Fast Riffles	Totals
0 - 100	21.7%	1.7%	1.7%	0.0%	25.0%	0 - 100	26.7%	8.3%	1.7%	1.7%	38.3%
101 - 600	66.7%	6.7%	0.0%	1.7%	75.0%	101 - 600	50.0%	8.3%	1.7%	0.0%	60.0%
601 - 1000	0.0%	0.0%	0.0%	0.0%	0.0%	601 - 1000	0.0%	0.0%	0.0%	0.0%	0.0%
> 1000	0.0%	0.0%	0.0%	0.0%	0.0%	> 1000	0.0%	0.0%	0.0%	0.0%	0.0%
Totals	88.3%	8.3%	1.7%	1.7%	100.0%	Totals	76.7%	16.7%	3.3%	1.7%	98.3%
				Islands	0.0%					Islands	1.7%
Unembedded Cover						Unembedded Cover					
	Pools	Glides	Slow Riffle	Fast Riffle	Totals		Pools	Glides	Slow Riffle	Fast Riffle	Totals
0 - 100	11.7%	1.7%	1.7%	0.0%	15.0%	0 - 100	17.0%	8.5%	1.7%	1.7%	28.8%
101 - 600	46.7%	6.7%	0.0%	1.7%	55.0%	101 - 600	39.0%	8.5%	1.7%	0.0%	49.1%
601 - 1000	0.0%	0.0%	0.0%	0.0%	0.0%	601 - 1000	0.0%	0.0%	0.0%	0.0%	0.0%
> 1000	0.0%	0.0%	0.0%	0.0%	0.0%	> 1000	0.0%	0.0%	0.0%	0.0%	0.0%
Totals	58.3%	8.3%	1.7%	1.7%	70.0%	Totals	55.9%	16.9%	3.4%	1.7%	77.9%
Cover Type Distribution	Wood	Flat Rock	Round Rock	Macrophyte	Bank	Cover Type Distribution	Wood	Flat Rock	Round Rock	Macrophyte	Bank
	2.3%	30.0%	20.0%	17.7%	0.0%		0.0%	40.7%	11.9%	27.1%	0.0%
Embedded Cover						Embedded Cover					
	Pools	Glides	Slow Riffles	Fast Riffles	Totals		Pools	Glides	Slow Riffles	Fast Riffles	Totals
0 - 100	10.0%	0.0%	0.0%	0.0%	10.0%	0 - 100	0.0%	0.0%	0.0%	0.0%	0.0%
101 - 600	20.0%	0.0%	0.0%	0.0%	20.0%	101 - 600	3.4%	0.0%	0.0%	0.0%	3.4%
601 - 1000	0.0%	0.0%	0.0%	0.0%	0.0%	601 - 1000	0.0%	0.0%	0.0%	0.0%	0.0%
> 1000	0.0%	0.0%	0.0%	0.0%	0.0%	> 1000	0.0%	0.0%	0.0%	0.0%	0.0%
Totals	30.0%	0.0%	0.0%	0.0%	30.0%	Totals	3.4%	0.0%	0.0%	0.0%	3.4%
Cover Type Distribution	Wood	Flat Rock	Round Rock	Macrophyte	Bank	Cover Type Distribution	Wood	Flat Rock	Round Rock	Macrophyte	Bank
	0.8%	10.0%	9.2%	10.0%	0.0%		0.0%	3.4%	0.0%	0.0%	0.0%
Instream Vegetation						Instream Vegetation					
Filamentous Algae	Non-Filamentous	Moss	Macrophytes	Grass	Terrestrial Plants	Filamentous Algae	Non-Filamentous	Moss	Macrophytes	Grass	Terrestrial Plants
100.0%	96.7%	0.0%	51.7%	13.3%	3.3%	28.8%	37.0%	33.9%	64.4%	0.0%	0.0%

Habitat Distribution – Point Transect Analysis (CK7-04SH)

CK7-04SH (2013)						CK7-04SH (2001)					
Habitat Type						Habitat Type					
Depth (mm)	Pools	Glides	Slow Riffles	Fast Riffles	Totals	Depth (mm)	Pools	Glides	Slow Riffles	Fast Riffles	Totals
0 - 100	28.3%	0.0%	0.0%	0.0%	28.3%	0 - 100	41.7%	0.0%	0.0%	0.0%	41.7%
101 - 600	71.7%	0.0%	0.0%	0.0%	71.7%	101 - 600	56.7%	0.0%	0.0%	0.0%	56.7%
601 - 1000	0.0%	0.0%	0.0%	0.0%	0.0%	601 - 1000	0.0%	0.0%	0.0%	0.0%	0.0%
> 1000	0.0%	0.0%	0.0%	0.0%	0.0%	> 1000	0.0%	0.0%	0.0%	0.0%	0.0%
Totals	100.0%	0.0%	0.0%	0.0%	100.0%	Totals	98.3%	0.0%	0.0%	0.0%	98.3%
				Islands	0.0%					Islands	1.7%
Unembedded Cover						Unembedded Cover					
	Pools	Glides	Slow Riffle	Fast Riffle	Totals		Pools	Glides	Slow Riffle	Fast Riffle	Totals
0 - 100	26.7%	0.0%	0.0%	0.0%	26.7%	0 - 100	15.3%	0.0%	0.0%	0.0%	15.3%
101 - 600	60.0%	0.0%	0.0%	0.0%	60.0%	101 - 600	39.0%	0.0%	0.0%	0.0%	39.0%
601 - 1000	0.0%	0.0%	0.0%	0.0%	0.0%	601 - 1000	0.0%	0.0%	0.0%	0.0%	0.0%
> 1000	0.0%	0.0%	0.0%	0.0%	0.0%	> 1000	0.0%	0.0%	0.0%	0.0%	0.0%
Totals	86.7%	0.0%	0.0%	0.0%	86.7%	Totals	54.2%	0.0%	0.0%	0.0%	54.2%
Cover Type Distribution	Wood	Flat Rock	Round Rock	Macrophyte	Bank	Cover Type Distribution	Wood	Flat Rock	Round Rock	Macrophyte	Bank
	10.2%	3.8%	6.4%	66.3%	0.0%		0.0%	3.4%	6.8%	50.9%	0.0%
Embedded Cover						Embedded Cover					
	Pools	Glides	Slow Riffles	Fast Riffles	Totals		Pools	Glides	Slow Riffles	Fast Riffles	Totals
0 - 100	1.7%	0.0%	0.0%	0.0%	1.7%	0 - 100	6.8%	0.0%	0.0%	0.0%	6.8%
101 - 600	11.7%	0.0%	0.0%	0.0%	11.7%	101 - 600	11.9%	0.0%	0.0%	0.0%	11.9%
601 - 1000	0.0%	0.0%	0.0%	0.0%	0.0%	601 - 1000	0.0%	0.0%	0.0%	0.0%	0.0%
> 1000	0.0%	0.0%	0.0%	0.0%	0.0%	> 1000	0.0%	0.0%	0.0%	0.0%	0.0%
Totals	13.3%	0.0%	0.0%	0.0%	13.3%	Totals	18.6%	0.0%	0.0%	0.0%	18.6%
Cover Type Distribution	Wood	Flat Rock	Round Rock	Macrophyte	Bank	Cover Type Distribution	Wood	Flat Rock	Round Rock	Macrophyte	Bank
	1.4%	2.1%	4.9%	4.9%	0.0%		0.0%	11.9%	5.1%	1.7%	0.0%
Instream Vegetation						Instream Vegetation					
Filamentous Algae	Non-Filamentous	Moss	Macrophytes	Grass	Terrestrial Plants	Filamentous Algae	Non-Filamentous	Moss	Macrophytes	Grass	Terrestrial Plants
31.7%	0.0%	0.0%	88.3%	98.3%	98.3%	64.4%	67.9%	30.6%	72.9%	1.7%	1.7%

Habitat Distribution – Point Transect Analysis (CK7-05SH)

CK7-05SH (2013)						CK7-05SH (2001)					
Habitat Type						Habitat Type					
Depth (mm)	Pools	Glides	Slow Riffles	Fast Riffles	Totals	Depth (mm)	Pools	Glides	Slow Riffles	Fast Riffles	Totals
0 - 100	35.0%	0.0%	0.0%	0.0%	35.0%	0 - 100	72.5%	17.5%	0.0%	0.0%	90.0%
101 - 600	55.0%	5.0%	0.0%	0.0%	60.0%	101 - 600	2.5%	2.5%	0.0%	0.0%	5.0%
601 - 1000	5.0%	0.0%	0.0%	0.0%	5.0%	601 - 1000	0.0%	0.0%	0.0%	0.0%	0.0%
> 1000	0.0%	0.0%	0.0%	0.0%	0.0%	> 1000	0.0%	0.0%	0.0%	0.0%	0.0%
Totals	95.0%	5.0%	0.0%	0.0%	100.0%	Totals	75.0%	20.0%	0.0%	0.0%	95.0%
				Islands	0.0%					Islands	0.0%
Unembedded Cover						Unembedded Cover					
	Pools	Glides	Slow Riffle	Fast Riffle	Totals		Pools	Glides	Slow Riffle	Fast Riffle	Totals
0 - 100	28.3%	0.0%	0.0%	0.0%	28.3%	0 - 100	2.5%	0.0%	0.0%	0.0%	2.5%
101 - 600	40.0%	5.0%	0.0%	0.0%	45.0%	101 - 600	0.0%	0.0%	0.0%	0.0%	0.0%
601 - 1000	3.3%	0.0%	0.0%	0.0%	3.3%	601 - 1000	0.0%	0.0%	0.0%	0.0%	0.0%
> 1000	0.0%	0.0%	0.0%	0.0%	0.0%	> 1000	0.0%	0.0%	0.0%	0.0%	0.0%
Totals	71.7%	5.0%	0.0%	0.0%	76.7%	Totals	2.5%	0.0%	0.0%	0.0%	2.5%
Cover Type Distribution	Wood	Flat Rock	Round Rock	Macrophyte	Bank	Cover Type Distribution	Wood	Flat Rock	Round Rock	Macrophyte	Bank
	1.5%	0.0%	13.8%	61.3%	0.0%		NA	NA	NA	NA	NA
Embedded Cover						Embedded Cover					
	Pools	Glides	Slow Riffles	Fast Riffles	Totals		Pools	Glides	Slow Riffles	Fast Riffles	Totals
0 - 100	6.7%	0.0%	0.0%	0.0%	6.7%	0 - 100	NA	NA	NA	NA	NA
101 - 600	10.0%	0.0%	0.0%	0.0%	10.0%	101 - 600	NA	NA	NA	NA	NA
601 - 1000	0.0%	0.0%	0.0%	0.0%	0.0%	601 - 1000	NA	NA	NA	NA	NA
> 1000	0.0%	0.0%	0.0%	0.0%	0.0%	> 1000	NA	NA	NA	NA	NA
Totals	16.7%	0.0%	0.0%	0.0%	16.7%	Totals	NA	NA	NA	NA	NA
Cover Type Distribution	Wood	Flat Rock	Round Rock	Macrophyte	Bank	Cover Type Distribution	Wood	Flat Rock	Round Rock	Macrophyte	Bank
	3.1%	5.2%	2.1%	6.3%	0.0%		NA	NA	NA	NA	NA
Instream Vegetation						Instream Vegetation					
Filamentous Algae	Non-Filamentous	Moss	Macrophytes	Grass	Terrestrial Plants	Filamentous Algae	Non-Filamentous	Moss	Macrophytes	Grass	Terrestrial Plants
75.0%	0.0%	0.0%	66.7%	13.3%	0.0%	75.0%	0.0%	20.0%	2.5%	12.5%	0.0%

Habitat Distribution – Point Transect Analysis (CK7-06SH)

CK7-06SH (2013)						CK7-06SH (2001)					
Habitat Type						Habitat Type					
Depth (mm)	Pools	Glides	Slow Riffles	Fast Riffles	Totals	Depth (mm)	Pools	Glides	Slow Riffles	Fast Riffles	Totals
0 - 100	17.5%	0.0%	0.0%	0.0%	17.5%	0 - 100	38.1%	0.0%	0.0%	0.0%	38.1%
101 - 600	77.5%	2.5%	0.0%	0.0%	80.0%	101 - 600	61.9%	0.0%	0.0%	0.0%	61.9%
601 - 1000	0.0%	0.0%	0.0%	0.0%	0.0%	601 - 1000	0.0%	0.0%	0.0%	0.0%	0.0%
> 1000	0.0%	0.0%	0.0%	0.0%	0.0%	> 1000	0.0%	0.0%	0.0%	0.0%	0.0%
Totals	95.0%	2.5%	0.0%	0.0%	97.5%	Totals	100.0%	0.0%	0.0%	0.0%	100.0%
				Islands	2.5%					Islands	0.0%
Unembedded Cover						Unembedded Cover					
	Pools	Glides	Slow Riffle	Fast Riffle	Totals		Pools	Glides	Slow Riffle	Fast Riffle	Totals
0 - 100	7.5%	0.0%	0.0%	0.0%	7.5%	0 - 100	0.0%	0.0%	0.0%	0.0%	0.0%
101 - 600	57.5%	2.5%	0.0%	0.0%	60.0%	101 - 600	2.4%	0.0%	0.0%	0.0%	2.4%
601 - 1000	0.0%	0.0%	0.0%	0.0%	0.0%	601 - 1000	0.0%	0.0%	0.0%	0.0%	0.0%
> 1000	0.0%	0.0%	0.0%	0.0%	0.0%	> 1000	0.0%	0.0%	0.0%	0.0%	0.0%
Totals	65.0%	2.5%	0.0%	0.0%	67.5%	Totals	2.4%	0.0%	0.0%	0.0%	2.4%
Cover Type Distribution	Wood	Flat Rock	Round Rock	Macrophyte	Bank	Cover Type Distribution	Wood	Flat Rock	Round Rock	Macrophyte	Bank
	18.8%	0.0%	1.9%	46.9%	0.0%		2.4%	0.0%	0.0%	0.0%	0.0%
Embedded Cover						Embedded Cover					
	Pools	Glides	Slow Riffles	Fast Riffles	Totals		Pools	Glides	Slow Riffles	Fast Riffles	Totals
0 - 100	5.0%	0.0%	0.0%	0.0%	5.0%	0 - 100	NA	NA	NA	NA	NA
101 - 600	0.0%	0.0%	0.0%	0.0%	0.0%	101 - 600	NA	NA	NA	NA	NA
601 - 1000	0.0%	0.0%	0.0%	0.0%	0.0%	601 - 1000	NA	NA	NA	NA	NA
> 1000	0.0%	0.0%	0.0%	0.0%	0.0%	> 1000	NA	NA	NA	NA	NA
Totals	5.0%	0.0%	0.0%	0.0%	5.0%	Totals	NA	NA	NA	NA	NA
Cover Type Distribution	Wood	Flat Rock	Round Rock	Macrophyte	Bank	Cover Type Distribution	Wood	Flat Rock	Round Rock	Macrophyte	Bank
	0.0%	0.0%	0.0%	5.0%	0.0%		NA	NA	NA	NA	NA
Instream Vegetation						Instream Vegetation					
Filamentous Algae	Non-Filamentous	Moss	Macrophytes	Grass	Terrestrial Plants	Filamentous Algae	Non-Filamentous	Moss	Macrophytes	Watercress	Grass
50.0%	0.0%	0.0%	32.5%	75.0%	0.0%	2.4%	0.0%	0.0%	7.1%	2.4%	0.0%

Habitat Distribution – Point Transect Analysis (CK7-07SH)

CK7-07SH (2013)						CK7-07SH (2001)					
Habitat Type						Habitat Type					
Depth (mm)	Pools	Glides	Slow Riffles	Fast Riffles	Totals	Depth (mm)	Pools	Glides	Slow Riffles	Fast Riffles	Totals
0 - 100	10.0%	2.5%	0.0%	0.0%	12.5%	0 - 100	25.0%	2.5%	5.0%	0.0%	32.5%
101 - 600	85.0%	2.5%	0.0%	0.0%	87.5%	101 - 600	67.5%	0.0%	0.0%	0.0%	67.5%
601 - 1000	0.0%	0.0%	0.0%	0.0%	0.0%	601 - 1000	0.0%	0.0%	0.0%	0.0%	0.0%
> 1000	0.0%	0.0%	0.0%	0.0%	0.0%	> 1000	0.0%	0.0%	0.0%	0.0%	0.0%
Totals	95.0%	5.0%	0.0%	0.0%	100.0%	Totals	92.5%	2.5%	5.0%	0.0%	100.0%
				Islands	0.0%					Islands	0.0%
Unembedded Cover						Unembedded Cover					
	Pools	Glides	Slow Riffle	Fast Riffle	Totals		Pools	Glides	Slow Riffle	Fast Riffle	Totals
0 - 100	2.5%	0.0%	0.0%	0.0%	2.5%	0 - 100	2.5%	2.5%	0.0%	0.0%	5.0%
101 - 600	10.0%	0.0%	0.0%	0.0%	10.0%	101 - 600	10.0%	0.0%	0.0%	0.0%	10.0%
601 - 1000	0.0%	0.0%	0.0%	0.0%	0.0%	601 - 1000	0.0%	0.0%	0.0%	0.0%	0.0%
> 1000	0.0%	0.0%	0.0%	0.0%	0.0%	> 1000	0.0%	0.0%	0.0%	0.0%	0.0%
Totals	12.5%	0.0%	0.0%	0.0%	12.5%	Totals	12.5%	2.5%	0.0%	0.0%	15.0%
Cover Type Distribution	Wood	Flat Rock	Round Rock	Macrophyte	Bank	Cover Type Distribution	Wood	Flat Rock	Round Rock	Macrophyte	Bank
	2.5%	0.0%	0.0%	10.0%	0.0%		0.0%	2.5%	12.5%	0.0%	0.0%
Embedded Cover						Embedded Cover					
	Pools	Glides	Slow Riffles	Fast Riffles	Totals		Pools	Glides	Slow Riffles	Fast Riffles	Totals
0 - 100	2.5%	2.5%	0.0%	0.0%	5.0%	0 - 100	0.0%	0.0%	0.0%	0.0%	0.0%
101 - 600	20.0%	2.5%	0.0%	0.0%	22.5%	101 - 600	7.5%	0.0%	0.0%	0.0%	7.5%
601 - 1000	0.0%	0.0%	0.0%	0.0%	0.0%	601 - 1000	0.0%	0.0%	0.0%	0.0%	0.0%
> 1000	0.0%	0.0%	0.0%	0.0%	0.0%	> 1000	0.0%	0.0%	0.0%	0.0%	0.0%
Totals	22.5%	5.0%	0.0%	0.0%	27.5%	Totals	7.5%	0.0%	0.0%	0.0%	7.5%
Cover Type Distribution	Wood	Flat Rock	Round Rock	Macrophyte	Bank	Cover Type Distribution	Wood	Flat Rock	Round Rock	Macrophyte	Bank
	10.0%	10.0%	7.5%	0.0%	0.0%		2.5%	0.0%	5.0%	0.0%	0.0%
Instream Vegetation						Instream Vegetation					
Filamentous Algae	Non-Filamentous	Moss	Macrophytes	Grass	Terrestrial Plants	Filamentous Algae	Non-Filamentous	Moss	Macrophytes	Watercress	Grass
10.0%	5.0%	0.0%	5.0%	97.5%	0.0%	2.5%	0.0%	5.0%	2.5%	0.0%	0.0%

Habitat Distribution – Point Transect Analysis (CK7-08SH)

CK7-08SH (2013)						CK7-08SH (2001)					
Habitat Type						Habitat Type					
Depth (mm)	Pools	Glides	Slow Riffles	Fast Riffles	Totals	Depth (mm)	Pools	Glides	Slow Riffles	Fast Riffles	Totals
0 - 100	22.5%	2.5%	0.0%	0.0%	25.0%	0 - 100	55.0%	7.5%	2.5%	0.0%	65.0%
101 - 600	72.5%	0.0%	0.0%	0.0%	72.5%	101 - 600	27.5%	0.0%	2.5%	0.0%	30.0%
601 - 1000	0.0%	0.0%	0.0%	0.0%	0.0%	601 - 1000	0.0%	0.0%	0.0%	0.0%	0.0%
> 1000	0.0%	0.0%	0.0%	0.0%	0.0%	> 1000	0.0%	0.0%	0.0%	0.0%	0.0%
Totals	95.0%	2.5%	0.0%	0.0%	97.5%	Totals	82.5%	7.5%	5.0%	0.0%	95.0%
				Islands	2.5%					Islands	5.0%
Unembedded Cover						Unembedded Cover					
	Pools	Glides	Slow Riffle	Fast Riffle	Totals		Pools	Glides	Slow Riffle	Fast Riffle	Totals
0 - 100	0.0%	0.0%	0.0%	0.0%	0.0%	0 - 100	18.4%	5.3%	2.6%	0.0%	26.3%
101 - 600	10.0%	0.0%	0.0%	0.0%	10.0%	101 - 600	10.5%	0.0%	2.6%	0.0%	13.2%
601 - 1000	0.0%	0.0%	0.0%	0.0%	0.0%	601 - 1000	0.0%	0.0%	0.0%	0.0%	0.0%
> 1000	0.0%	0.0%	0.0%	0.0%	0.0%	> 1000	0.0%	0.0%	0.0%	0.0%	0.0%
Totals	10.0%	0.0%	0.0%	0.0%	10.0%	Totals	29.0%	5.3%	5.3%	0.0%	39.5%
Cover Type Distribution	Wood	Flat Rock	Round Rock	Macrophyte	Bank	Cover Type Distribution	Wood	Flat Rock	Round Rock	Macrophyte	Bank
	2.5%	5.0%	0.0%	2.5%	0.0%		2.6%	21.1%	10.5%	0.0%	0.0%
Embedded Cover						Embedded Cover					
	Pools	Glides	Slow Riffles	Fast Riffles	Totals		Pools	Glides	Slow Riffles	Fast Riffles	Totals
0 - 100	2.5%	0.0%	0.0%	0.0%	2.5%	0 - 100	2.6%	2.6%	0.0%	0.0%	5.3%
101 - 600	12.5%	0.0%	0.0%	0.0%	12.5%	101 - 600	0.0%	0.0%	0.0%	0.0%	0.0%
601 - 1000	0.0%	0.0%	0.0%	0.0%	0.0%	601 - 1000	0.0%	0.0%	0.0%	0.0%	0.0%
> 1000	0.0%	0.0%	0.0%	0.0%	0.0%	> 1000	0.0%	0.0%	0.0%	0.0%	0.0%
Totals	15.0%	0.0%	0.0%	0.0%	15.0%	Totals	2.6%	2.6%	0.0%	0.0%	5.3%
Cover Type Distribution	Wood	Flat Rock	Round Rock	Macrophyte	Bank	Cover Type Distribution	Wood	Flat Rock	Round Rock	Macrophyte	Bank
	0.0%	7.5%	5.0%	2.5%	0.0%		0.0%	2.6%	2.6%	0.0%	0.0%
Instream Vegetation						Instream Vegetation					
Filamentous Algae	Non-Filamentous	Moss	Macrophytes	Watercress	Grass	Filamentous Algae	Non-Filamentous	Moss	Macrophytes	Grass	Terrestrial Plants
7.5%	40.0%	0.0%	2.5%	0.0%	100.0%	10.5%	0.0%	18.4%	5.3%	2.6%	10.5%

Habitat Distribution – Point Transect Analysis (CK7-11SH)

CK7-11SH (2013)						CK7-11SH (2001)					
Habitat Type						Habitat Type					
Depth (mm)	Pools	Glides	Slow Riffles	Fast Riffles	Totals	Depth (mm)	Pools	Glides	Slow Riffles	Fast Riffles	Totals
0 - 100	77.5%	0.0%	2.5%	2.5%	82.5%	0 - 100	67.5%	7.5%	2.5%	2.5%	80.0%
101 - 600	17.5%	0.0%	0.0%	0.0%	17.5%	101 - 600	12.5%	0.0%	0.0%	0.0%	12.5%
601 - 1000	0.0%	0.0%	0.0%	0.0%	0.0%	601 - 1000	0.0%	0.0%	0.0%	0.0%	0.0%
> 1000	0.0%	0.0%	0.0%	0.0%	0.0%	> 1000	0.0%	0.0%	0.0%	0.0%	0.0%
Totals	95.0%	0.0%	2.5%	2.5%	100.0%	Totals	80.0%	7.5%	2.5%	2.5%	92.5%
				Islands	0.0%					Islands	7.5%
Unembedded Cover						Unembedded Cover					
	Pools	Glides	Slow Riffle	Fast Riffle	Totals		Pools	Glides	Slow Riffle	Fast Riffle	Totals
0 - 100	0.0%	0.0%	0.0%	0.0%	0.0%	0 - 100	NA	NA	NA	NA	NA
101 - 600	10.0%	0.0%	0.0%	0.0%	10.0%	101 - 600	NA	NA	NA	NA	NA
601 - 1000	0.0%	0.0%	0.0%	0.0%	0.0%	601 - 1000	NA	NA	NA	NA	NA
> 1000	0.0%	0.0%	0.0%	0.0%	0.0%	> 1000	NA	NA	NA	NA	NA
Totals	10.0%	0.0%	0.0%	0.0%	10.0%	Totals	NA	NA	NA	NA	NA
Cover Type Distribution	Wood	Flat Rock	Round Rock	Macrophyte	Bank	Cover Type Distribution	Wood	Flat Rock	Round Rock	Macrophyte	Bank
	5.0%	2.5%	2.5%	0.0%	0.0%		NA	NA	NA	NA	NA
Embedded Cover						Embedded Cover					
	Pools	Glides	Slow Riffles	Fast Riffles	Totals		Pools	Glides	Slow Riffles	Fast Riffles	Totals
0 - 100	25.0%	0.0%	2.5%	2.5%	30.0%	0 - 100	5.4%	2.7%	0.0%	0.0%	8.1%
101 - 600	0.0%	0.0%	0.0%	0.0%	0.0%	101 - 600	0.0%	0.0%	0.0%	0.0%	0.0%
601 - 1000	0.0%	0.0%	0.0%	0.0%	0.0%	601 - 1000	0.0%	0.0%	0.0%	0.0%	0.0%
> 1000	0.0%	0.0%	0.0%	0.0%	0.0%	> 1000	0.0%	0.0%	0.0%	0.0%	0.0%
Totals	25.0%	0.0%	2.5%	2.5%	30.0%	Totals	5.4%	2.7%	0.0%	0.0%	8.1%
Cover Type Distribution	Wood	Flat Rock	Round Rock	Macrophyte	Bank	Cover Type Distribution	Wood	Flat Rock	Round Rock	Macrophyte	Bank
	30.0%	0.0%	0.0%	0.0%	0.0%		8.1%	0.0%	0.0%	0.0%	0.0%
Instream Vegetation						Instream Vegetation					
Filamentous Algae	Non-Filamentous	Moss	Macrophytes	Watercress	Grass	Filamentous Algae	Non-Filamentous	Moss	Macrophytes	Watercress	Grass
0.0%	7.5%	0.0%	0.0%	0.0%	0.0%	0.0%	0.0%	0.0%	16.2%	0.0%	0.0%

Habitat Distribution – Point Transect Analysis (CK7-13SH)

CK7-13SH (2013)						CK7-13SH (2001)							
Habitat Type						Habitat Type							
Depth (mm)	Pools	Glides	Slow Riffles	Fast Riffles	Totals	Depth (mm)	Pools	Glides	Slow Riffles	Fast Riffles	Totals		
0 - 100	20.0%	0.0%	0.0%	0.0%	20.0%	0 - 100	42.2%	4.4%	0.0%	0.0%	46.7%		
101 - 600	73.3%	1.7%	1.7%	1.7%	78.3%	101 - 600	48.9%	0.0%	0.0%	0.0%	48.9%		
601 - 1000	0.0%	0.0%	0.0%	0.0%	0.0%	601 - 1000	2.2%	0.0%	0.0%	0.0%	2.2%		
> 1000	0.0%	0.0%	0.0%	0.0%	0.0%	> 1000	0.0%	0.0%	0.0%	0.0%	0.0%		
Totals	93.3%	1.7%	1.7%	1.7%	98.3%	Totals	93.3%	4.4%	0.0%	0.0%	97.8%		
				Islands	1.7%					Islands	2.2%		
Unembedded Cover						Unembedded Cover							
	Pools	Glides	Slow Riffle	Fast Riffle	Totals		Pools	Glides	Slow Riffle	Fast Riffle	Totals		
0 - 100	11.7%	0.0%	0.0%	0.0%	11.7%	0 - 100	20.5%	2.3%	0.0%	0.0%	22.7%		
101 - 600	41.7%	1.7%	0.0%	1.7%	45.0%	101 - 600	18.2%	0.0%	0.0%	0.0%	18.2%		
601 - 1000	0.0%	0.0%	0.0%	0.0%	0.0%	601 - 1000	2.3%	0.0%	0.0%	0.0%	2.3%		
> 1000	0.0%	0.0%	0.0%	0.0%	0.0%	> 1000	0.0%	0.0%	0.0%	0.0%	0.0%		
Totals	53.3%	1.7%	0.0%	1.7%	56.7%	Totals	40.9%	2.3%	0.0%	0.0%	43.2%		
Cover Type Distribution	Wood	Flat Rock	Round Rock	Macrophyte	Bank	Cover Type Distribution	Wood	Flat Rock	Round Rock	Macrophyte	Bank		
	0.0%	22.4%	32.9%	0.0%	1.3%		2.3%	15.9%	25.0%	0.0%	0.0%		
Embedded Cover						Embedded Cover							
	Pools	Glides	Slow Riffles	Fast Riffles	Totals		Pools	Glides	Slow Riffles	Fast Riffles	Totals		
0 - 100	5.0%	0.0%	0.0%	0.0%	5.0%	0 - 100	15.9%	2.3%	0.0%	0.0%	18.2%		
101 - 600	5.0%	0.0%	1.7%	0.0%	6.7%	101 - 600	11.4%	0.0%	0.0%	0.0%	11.4%		
601 - 1000	0.0%	0.0%	0.0%	0.0%	0.0%	601 - 1000	0.0%	0.0%	0.0%	0.0%	0.0%		
> 1000	0.0%	0.0%	0.0%	0.0%	0.0%	> 1000	0.0%	0.0%	0.0%	0.0%	0.0%		
Totals	10.0%	0.0%	1.7%	0.0%	11.7%	Totals	27.3%	2.3%	0.0%	0.0%	29.5%		
Cover Type Distribution	Wood	Flat Rock	Round Rock	Macrophyte	Bank	Cover Type Distribution	Wood	Flat Rock	Round Rock	Macrophyte	Bank		
	0.0%	7.8%	3.9%	0.0%	0.0%		0.0%	15.9%	13.6%	0.0%	0.0%		
Instream Vegetation						Instream Vegetation							
	Filamentous Algae	Non-Filamentous	Moss	Macrophytes	Grass	Terrestrial Plants		Filamentous Algae	Non-Filamentous	Moss	Macrophytes	Watercress	Grass
	0.0%	26.7%	1.7%	0.0%	0.0%	6.7%	11.4%	2.3%	15.9%	0.0%	0.0%	0.0%	0.0%

Habitat Distribution – Point Transect Analysis (CK7-14SH)

CK7-14SH (2013)						CK7-14SH (2001)					
Habitat Type						Habitat Type					
Depth (mm)	Pools	Glides	Slow Riffles	Fast Riffles	Totals	Depth (mm)	Pools	Glides	Slow Riffles	Fast Riffles	Totals
0 - 100	45.0%	3.3%	0.0%	0.0%	48.3%	0 - 100	77.5%	0.0%	0.0%	0.0%	77.5%
101 - 600	45.0%	5.0%	0.0%	0.0%	50.0%	101 - 600	22.5%	0.0%	0.0%	0.0%	22.5%
601 - 1000	0.0%	0.0%	0.0%	0.0%	0.0%	601 - 1000	0.0%	0.0%	0.0%	0.0%	0.0%
> 1000	0.0%	0.0%	0.0%	0.0%	0.0%	> 1000	0.0%	0.0%	0.0%	0.0%	0.0%
Totals	90.0%	8.3%	0.0%	0.0%	98.3%	Totals	100.0%	0.0%	0.0%	0.0%	100.0%
				Islands	1.7%					Islands	0.0%
Unembedded Cover						Unembedded Cover					
	Pools	Glides	Slow Riffle	Fast Riffle	Totals		Pools	Glides	Slow Riffle	Fast Riffle	Totals
0 - 100	18.3%	0.0%	0.0%	0.0%	18.3%	0 - 100	17.5%	0.0%	0.0%	0.0%	17.5%
101 - 600	11.7%	0.0%	0.0%	0.0%	11.7%	101 - 600	2.5%	0.0%	0.0%	0.0%	2.5%
601 - 1000	0.0%	0.0%	0.0%	0.0%	0.0%	601 - 1000	0.0%	0.0%	0.0%	0.0%	0.0%
> 1000	0.0%	0.0%	0.0%	0.0%	0.0%	> 1000	0.0%	0.0%	0.0%	0.0%	0.0%
Totals	30.0%	0.0%	0.0%	0.0%	30.0%	Totals	20.0%	0.0%	0.0%	0.0%	20.0%
Cover Type Distribution	Wood	Flat Rock	Round Rock	Macrophyte	Bank	Cover Type Distribution	Wood	Flat Rock	Round Rock	Macrophyte	Bank
	3.0%	16.5%	10.5%	0.0%	0.0%		0.0%	10.0%	10.0%	0.0%	0.0%
Embedded Cover						Embedded Cover					
	Pools	Glides	Slow Riffles	Fast Riffles	Totals		Pools	Glides	Slow Riffles	Fast Riffles	Totals
0 - 100	6.7%	0.0%	0.0%	0.0%	6.7%	0 - 100	7.5%	0.0%	0.0%	0.0%	7.5%
101 - 600	13.3%	3.3%	0.0%	0.0%	16.7%	101 - 600	7.5%	0.0%	0.0%	0.0%	7.5%
601 - 1000	0.0%	0.0%	0.0%	0.0%	0.0%	601 - 1000	0.0%	0.0%	0.0%	0.0%	0.0%
> 1000	0.0%	0.0%	0.0%	0.0%	0.0%	> 1000	0.0%	0.0%	0.0%	0.0%	0.0%
Totals	20.0%	3.3%	0.0%	0.0%	23.3%	Totals	15.0%	0.0%	0.0%	0.0%	15.0%
Cover Type Distribution	Wood	Flat Rock	Round Rock	Macrophyte	Bank	Cover Type Distribution	Wood	Flat Rock	Round Rock	Macrophyte	Bank
	1.6%	14.0%	7.8%	0.0%	0.0%		0.0%	7.5%	7.5%	0.0%	0.0%
Instream Vegetation						Instream Vegetation					
Filamentous Algae	Non-Filamentous	Moss	Macrophytes	Watercress	Grass	Filamentous Algae	Non-Filamentous	Moss	Macrophytes	Watercress	Grass
68.3%	0.0%	0.0%	0.0%	0.0%	0.0%	57.5%	37.5%	12.5%	0.0%	0.0%	0.0%

Habitat Distribution – Point Transect Analysis (CK7-15SH)

CK7-15SH (2013)						CK7-15SH (2001)					
Habitat Type						Habitat Type					
Depth (mm)	Pools	Glides	Slow Riffles	Fast Riffles	Totals	Depth (mm)	Pools	Glides	Slow Riffles	Fast Riffles	Totals
0 - 100	35.6%	17.8%	0.0%	0.0%	53.3%	0 - 100	NA	NA	NA	NA	NA
101 - 600	40.0%	2.2%	2.2%	0.0%	44.4%	101 - 600	NA	NA	NA	NA	NA
601 - 1000	0.0%	0.0%	0.0%	0.0%	0.0%	601 - 1000	NA	NA	NA	NA	NA
> 1000	0.0%	0.0%	0.0%	0.0%	0.0%	> 1000	NA	NA	NA	NA	NA
Totals	75.6%	20.0%	2.2%	0.0%	97.8%	Totals	NA	NA	NA	NA	NA
				Islands	2.2%					Islands	NA
Unembedded Cover						Unembedded Cover					
	Pools	Glides	Slow Riffle	Fast Riffle	Totals		Pools	Glides	Slow Riffle	Fast Riffle	Totals
0 - 100	20.0%	17.8%	0.0%	0.0%	37.8%	0 - 100	NA	NA	NA	NA	NA
101 - 600	31.1%	2.2%	2.2%	0.0%	35.6%	101 - 600	NA	NA	NA	NA	NA
601 - 1000	0.0%	0.0%	0.0%	0.0%	0.0%	601 - 1000	NA	NA	NA	NA	NA
> 1000	0.0%	0.0%	0.0%	0.0%	0.0%	> 1000	NA	NA	NA	NA	NA
Totals	51.1%	20.0%	2.2%	0.0%	73.3%	Totals	NA	NA	NA	NA	NA
Cover Type Distribution	Wood	Flat Rock	Round Rock	Macrophyte	Bank	Cover Type Distribution	Wood	Flat Rock	Round Rock	Macrophyte	Bank
	12.2%	24.4%	36.7%	0.0%	0.0%		NA	NA	NA	NA	NA
Embedded Cover						Embedded Cover					
	Pools	Glides	Slow Riffles	Fast Riffles	Totals		Pools	Glides	Slow Riffles	Fast Riffles	Totals
0 - 100	6.7%	0.0%	0.0%	0.0%	6.7%	0 - 100	NA	NA	NA	NA	NA
101 - 600	2.2%	0.0%	0.0%	0.0%	2.2%	101 - 600	NA	NA	NA	NA	NA
601 - 1000	0.0%	0.0%	0.0%	0.0%	0.0%	601 - 1000	NA	NA	NA	NA	NA
> 1000	0.0%	0.0%	0.0%	0.0%	0.0%	> 1000	NA	NA	NA	NA	NA
Totals	8.9%	0.0%	0.0%	0.0%	8.9%	Totals	NA	NA	NA	NA	NA
Cover Type Distribution	Wood	Flat Rock	Round Rock	Macrophyte	Bank	Cover Type Distribution	Wood	Flat Rock	Round Rock	Macrophyte	Bank
	0.0%	4.4%	2.2%	0.0%	2.2%		NA	NA	NA	NA	NA
Instream Vegetation						Instream Vegetation					
Filamentous Algae	Non-Filamentous	Moss	Macrophytes	Watercress	Grass	Filamentous Algae	Non-Filamentous	Moss	Macrophytes	Watercress	Grass
0.0%	6.7%	0.0%	0.0%	0.0%	2.2%	NA	NA	NA	NA	NA	NA

FUNCTIONAL SITE SERVICING AND STORMWATER MANAGEMENT REPORT REV.03 – 1987 ROBERTSON ROAD (STILLWATER STATION)

Appendix D External Documents
February 28, 2024

D.3 STILLWATER CREEK 2015 SUMMARY REPORT – CITY STREAM WATCH





Stillwater Creek 2015 Summary Report

Watershed Features

Area	23.48 square kilometres 0.55% of the Rideau Valley watershed
Land Use	33% forest 23% urban 19% agriculture 19% wetland 6% rural
Surficial Geology	35% clay 35% Paleozoic bedrock 14% organic deposits 12% diamicton 2% gravel 2% sand
Watercourse Type	<i>Watercourse Type:</i> 83% natural 17% channelized <i>Flow Type:</i> 96% permanent 4% intermittent
Invasive Species	There were twelve invasive species observed in 2015: purple loosestrife, common buckthorn, Manitoba maple, Himalayan balsam, flowering rush, wild parsnip, European frogbit, glossy buckthorn, garlic mustard, honey suckle, Japanese knotweed, yellow iris
Fish Community	41 fish species have been captured in Stillwater Creek historically including eight game fish species

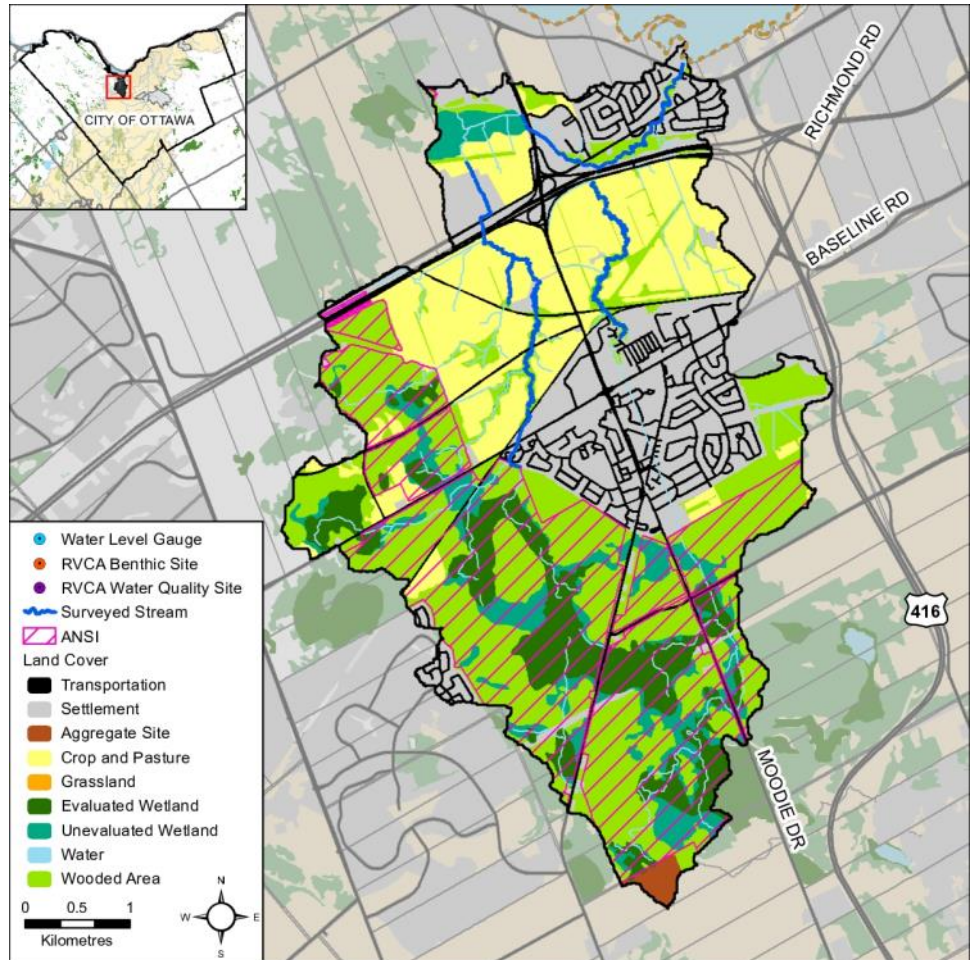

Figure 1 Land cover in the Stillwater Creek catchment

Woodlot Cover

Size Category	Number of Woodlots	% of Woodlot Cover
10-30 ha	10	12
>30 ha	7	8

Wetland Cover

19% of the catchment is wetland



Wetland vegetation along Stillwater Creek

The Rideau Valley Conservation Authority, in partnership with seven other agencies in Ottawa (City of Ottawa, Heron Park Community Association, Ottawa Flyfishers Society, Ottawa Stewardship Council, Rideau Roundtable, National Defence HQ - Fish and Game Club, and the National Capital Commission) form the 2015 City Stream Watch collaborative.



Introduction

The headwaters of Stillwater Creek begin in the National Capital Commission's (NCC) Stony Swamp. Stony Swamp is almost 2000 hectares in size, and is a mix of woodland, wetland and regenerating fields. Over 700 plant species have been recorded in the conservation area. From Stony Swamp, Stillwater Creek runs through a heavily channelized and impacted area adjacent to Roberston Road. The creek returns to its natural morphology downstream of Robertson Road until the Highway 417 crossing. It then becomes channelized again, as it runs through the Wesley Clover Park on Corkstown Road. The creek flows through another large wetland before the Moodie Drive crossing, and from there runs parallel between Highway 417 and Corkstown Road until it turns north flowing through residential neighborhoods before emptying into the Ottawa River between the Nepean Sailing Club and Andrew Haydon Park.

Although large sections of Stillwater Creek are quite natural, it still has many impacts, including urbanization and agricultural pressures which have contributed to diminished water quality, loss of riparian cover/aquatic habitat, and shoreline destabilization (RVCA, 2013). The section of Stillwater Creek that flows between Corkstown Road and Highway 417 was designated a Life Science Site by the Ontario Ministry of Natural Resources containing regionally uncommon and regionally significant species (Ecoplans, DRAFT, 2009). Construction of a transitway expansion is planned for the area between Corkstown Road and Highway 417 which may cause impacts to this significant reach of Stillwater Creek, appropriate measures should be taken to ensure this area is not negatively impacted by future developments.

In 2015, 100 sections (10 km) of Stillwater Creek including its tributaries were surveyed as part of the City Stream Watch monitoring activities. The following is a summary of observations made by staff and volunteers.

Stillwater Creek Overbank Zone

Riparian Buffer Width Evaluation

The riparian or shoreline zone is that special area where the land meets the water. Well-vegetated shorelines are critically important in protecting water quality and creating healthy aquatic habitats, lakes and rivers. Natural shorelines intercept sediments and contaminants that could impact water quality conditions and harm fish habitat in streams. Well established buffers protect the banks against erosion, improve habitat for fish by shading and cooling the water and provide protection for birds and other wildlife that feed and rear young near water. A recommended target (from Environment Canada's Guideline: How Much Habitat is Enough?) is to maintain a minimum 30 meter wide vegetated buffer along at least 75 percent of the length of both sides of rivers, creeks and streams. Stillwater Creek does not meet the target above as it has a buffer of greater than 30 meters along 40 percent of the right bank and 41 percent of the left bank. Figure 2 demonstrates the buffer conditions of the left and right banks separately.

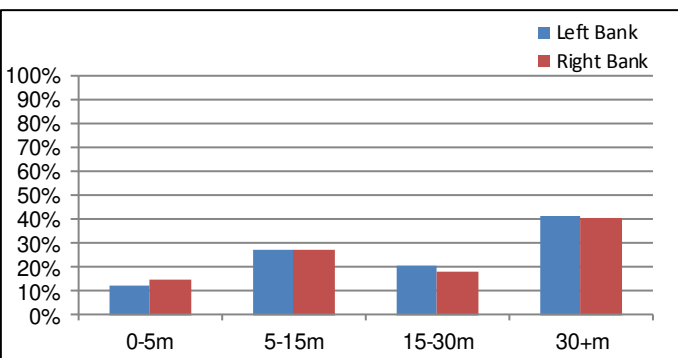

Figure 2 Vegetated buffer width along Stillwater Creek

Adjacent Land Use

The RVCA's City Stream Watch Program identifies 10 different land uses beside Stillwater Creek (Figure 3). Surrounding land use is considered from the beginning to end of each survey section (100m) and up to 100m on each side of the creek. Land use outside of this area is not considered for the surveys but is nonetheless part of the subwatershed and will influence the creek. Natural areas made up 36 percent of the surveyed stream, characterized by forest, scrubland, meadow and wetland. Thirty three percent of the land use along the surveyed sections of the stream was made up of agriculture and pasture. The remaining 31 percent of the land use surveyed was composed of residential, recreational and infrastructure uses at nine percent each, as well as industrial/commercial which was recorded as four percent of the land use.

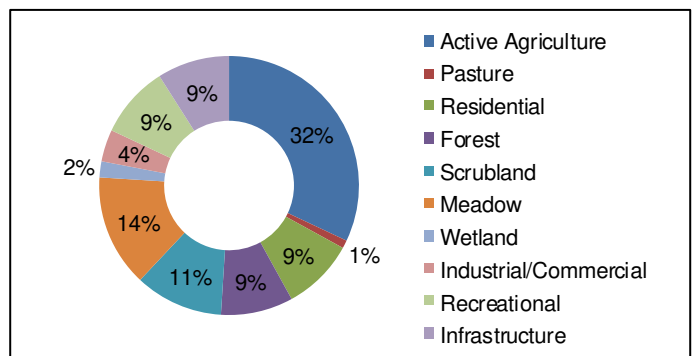

Figure 3 Land use along Stillwater Creek

Stillwater Creek Shoreline Zone

Erosion

Erosion is a normal, important stream process and may not affect actual bank stability; however, excessive erosion and deposition of sediment within a stream can have a detrimental effect on important fish and wildlife habitat. Poor bank stability can greatly contribute to the amount of sediment carried in a waterbody as well as loss of bank vegetation due to bank failure, resulting in trees falling into the stream and the potential to impact instream migration. Figure 4 shows low to moderate levels of bank erosion were observed along many sections of Stillwater Creek. Most of the areas where erosion was observed were in the agricultural lands south of Highway 417 on the main channel of the creek and its tributary. Shoreline stability in this area could be improved by increasing the vegetated buffer width along the creek.

Undercut Stream Banks

Undercut banks are a normal and natural part of stream function and can provide excellent refuge areas for fish. Figure 5 shows that the bank undercutting on Stillwater Creek varied considerably. Much of the creek had low levels of bank undercutting but these were interspersed with areas of moderate to high level undercutting. The highest levels of undercutting were observed where highway 417 crosses Stillwater Creek. The bank and substrate composition in this area is dominated by clay and the riparian vegetation is predominantly grasses so there is a possibility that the bank undercutting in section of the creek may lead to bank failure over time.

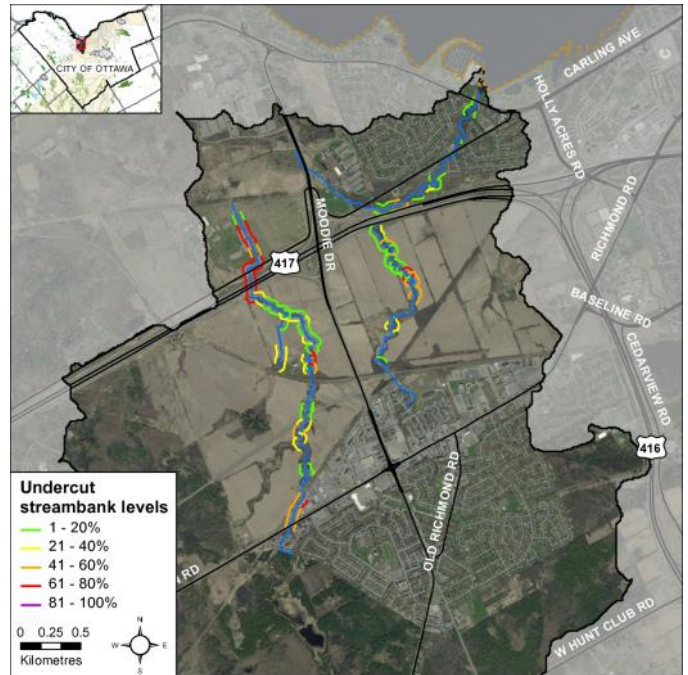
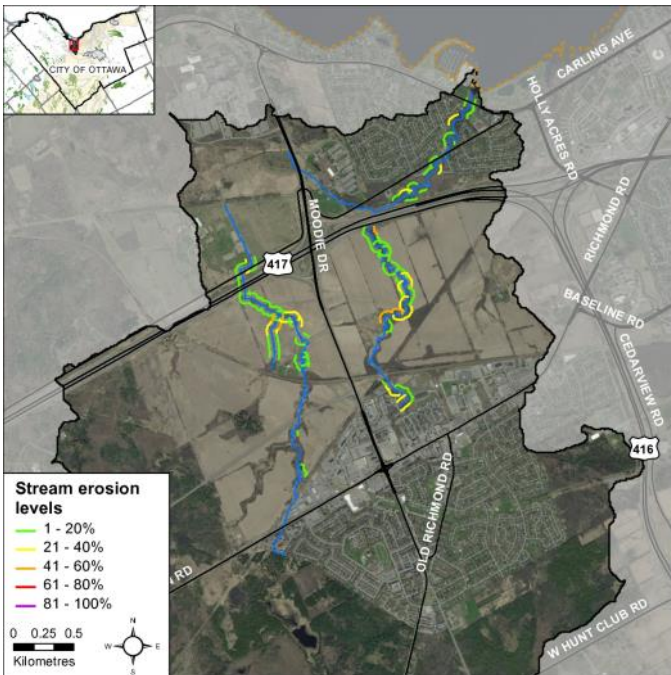

Figure 4 Erosion along Stillwater Creek

Figure 5 Undercut stream banks along Stillwater Creek



Stream bank erosion along Stillwater Creek



Section downstream of Hwy 417 with high levels of undercutting

Stream Shading

Grasses, shrubs and trees all contribute towards shading a stream. Shade is important in moderating stream temperature, contributing to food supply and helping with nutrient reduction within a stream. Figure 6 shows stream shading along Stillwater Creek. High levels of shading were seen along most of the creek with some sections having more moderate shading. In areas where trees and shrubs were not present in the buffer zone, tall overhanging grasses serve to shade the sections of Stillwater Creek with narrow stream width.

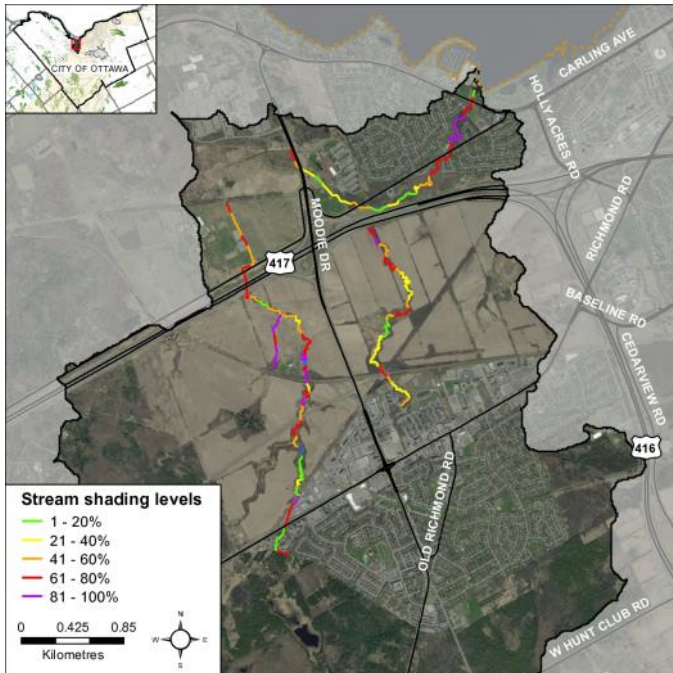

Figure 6 Stream shading along Stillwater Creek

Instream Woody Debris

Figure 7 shows that overall, the surveyed sections along Stillwater Creek had moderate levels of instream woody debris in the form of branches and trees. Instream woody debris is important for fish and benthic habitat, by providing refuge and feeding areas.

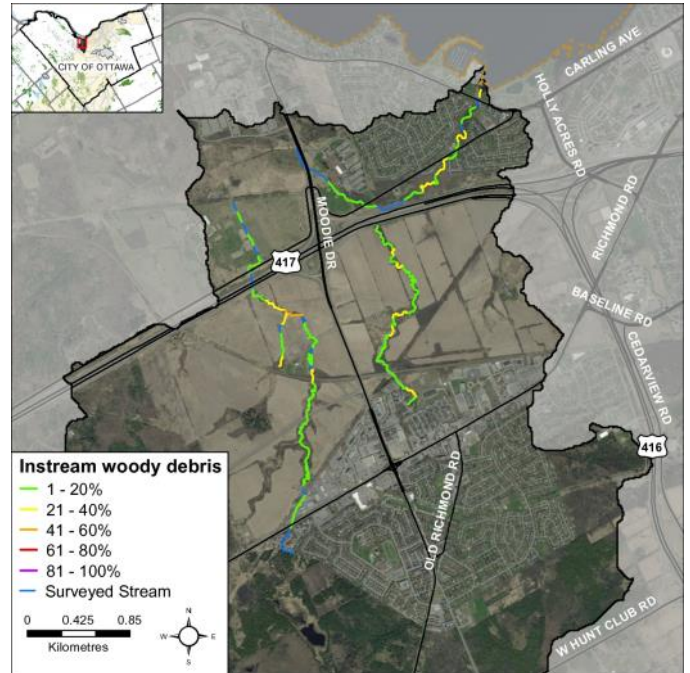
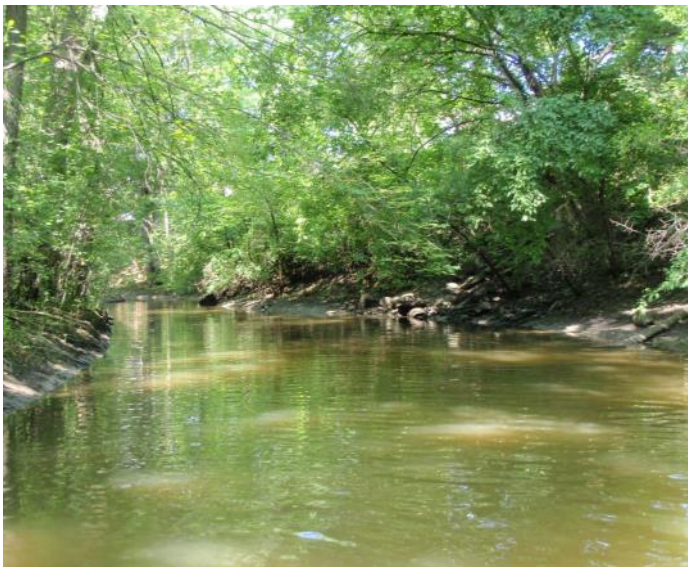

Figure 7 Instream woody debris along Stillwater Creek



Stream shade along Stillwater Creek



Instream woody debris along Stillwater Creek

Overhanging Trees and Branches

Figure 8 shows that Stillwater Creek had highly variable levels of overhanging branches and trees ranging from low to high levels. Trees and branches that are less than one meter from the surface of the water are defined as overhanging. At this proximity to the water branches and trees provide a food source, nutrients and shade which helps to moderate instream water temperatures.

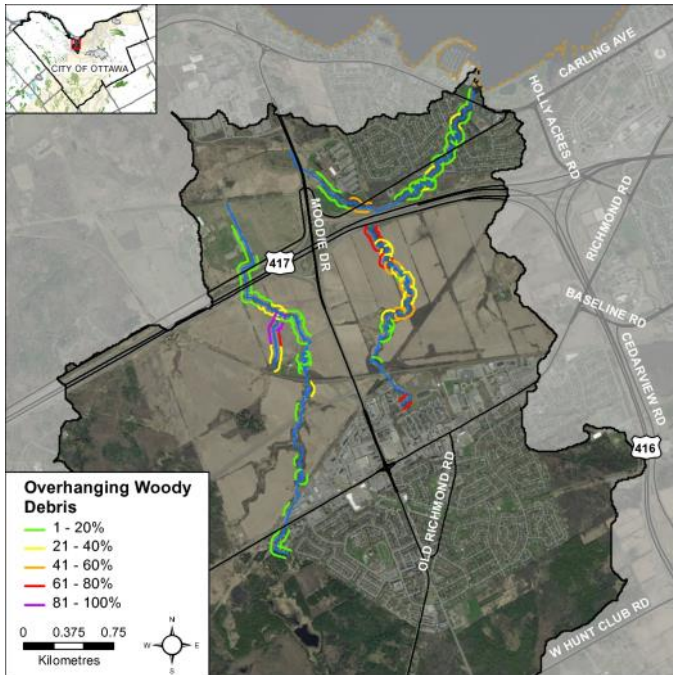
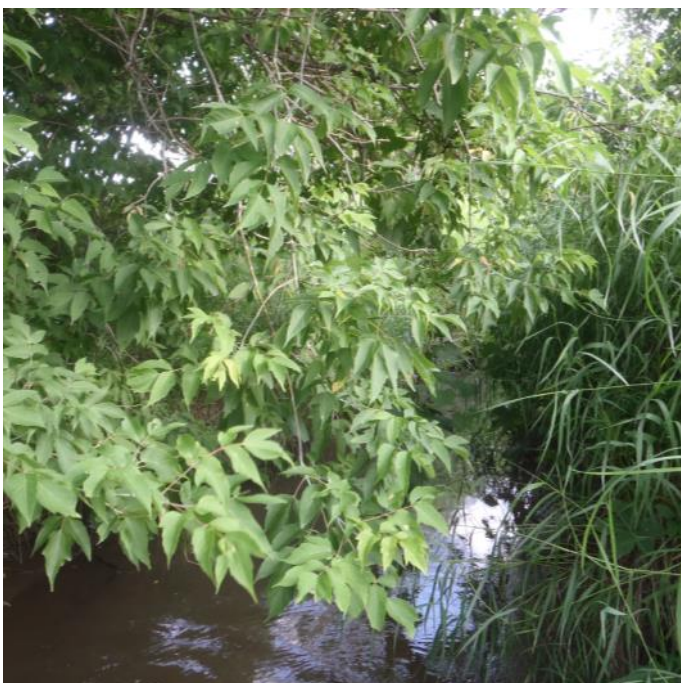

Figure 8 Overhanging trees and branches



Overhanging trees and branches on Stillwater Creek

Anthropogenic Alterations

Figure 9 demonstrates that 63 percent of the sections on Stillwater Creek remain “unaltered” or “natural”. Sections considered “altered” account for 23 percent of the stream, while 14 percent of the sections sampled were considered “highly altered”. The highly altered sections of Stillwater Creek refer to those that are channelized as well as those that run through a culvert or road crossing with associated instream and shoreline modifications.

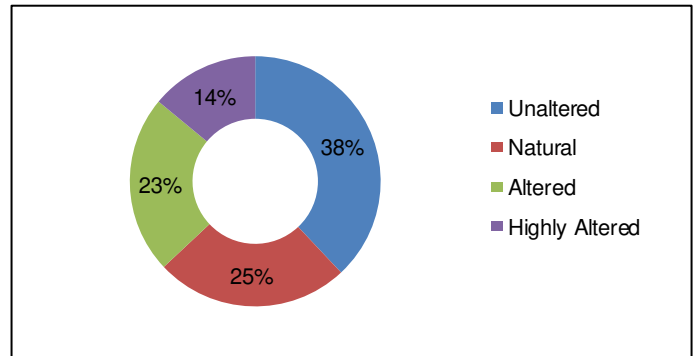

Figure 9 Anthropogenic alterations along Stillwater Creek



A highly altered section of Stillwater Creek at the Corkstown Road crossing

Stillwater Creek Instream Aquatic Habitat

Habitat Complexity

Streams are naturally meandering systems that move over time with varying degrees of habitat complexity. Examples of habitat complexity include habitat types such as pools and riffles as well as substrate variability and woody debris structure. A high percentage of habitat complexity (heterogeneity) typically increases the biodiversity of aquatic organisms within a system. The complexity of Stillwater Creek was high as demonstrated by the fact that 83 percent of the system was considered heterogeneous. Homogeneous areas were not extensive, typically lasting for only a section of two before becoming heterogeneous again. Overall, homogeneous sections made up 17 percent of the system.

Instream Substrate

Diverse substrate is important for fish and benthic invertebrate habitat because some species have specific substrate requirements and, for example, will only reproduce on certain types of substrate. Figure 11 shows that the substrate composition of Stillwater Creek was very diverse. Thirty three percent of the instream substrate observed on Stillwater Creek was clay. Thirty two percent of the substrate was recorded as silt and sand. Twenty one percent was cobble and boulder, while eight percent was gravel. The remaining six percent was made up of bedrock. Figure 12 shows the distribution of the dominant substrate types along the system. Clay was recorded most often as the dominant substrate, with outcroppings of bedrock between Corkstown Road and Highway 417 as well as near Robertson Road. A significant amount of silt substrate was also recorded between Corkstown Road and Moodie Drive.

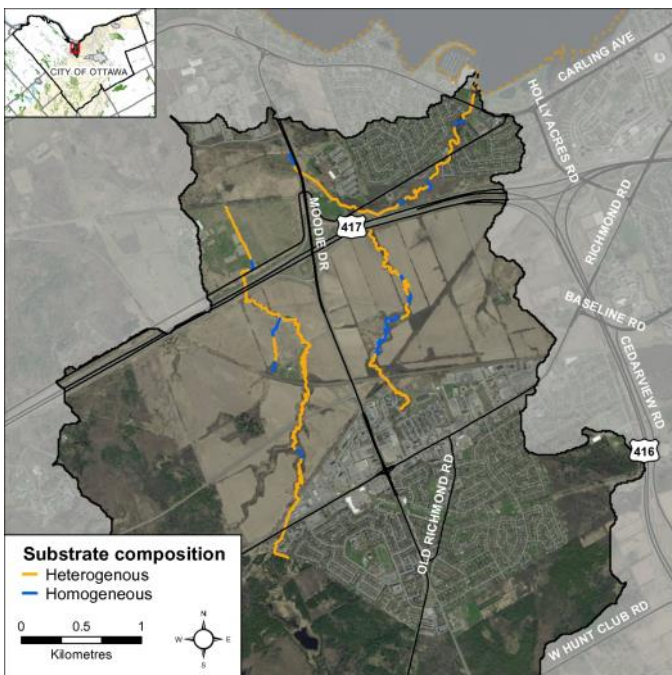

Figure 10 Instream habitat complexity in Stillwater Creek



Habitat complexity observed on Stillwater Creek

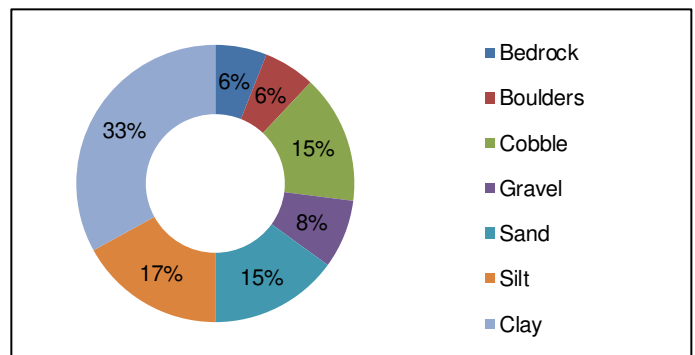

Figure 11 Instream substrate along Stillwater Creek

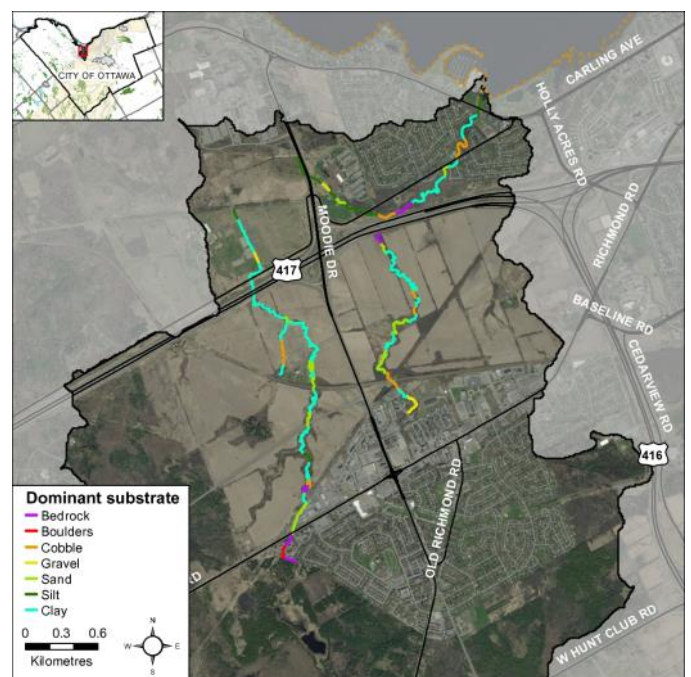

Figure 12 Dominant instream substrate in Stillwater Creek

Cobble and Boulder Habitat

Boulders create instream cover and back eddies for large fish to hide and/or rest out of the current. Cobble provides important over-wintering and/or spawning habitat for small or juvenile fish. Cobble can also provide habitat conditions for benthic invertebrates that are a key food source for many fish and wildlife species. Figure 13 shows the distribution of cobble and boulder habitat along Stillwater Creek. Areas of cobble and boulder habitat are well distributed along the entire length of the creek.

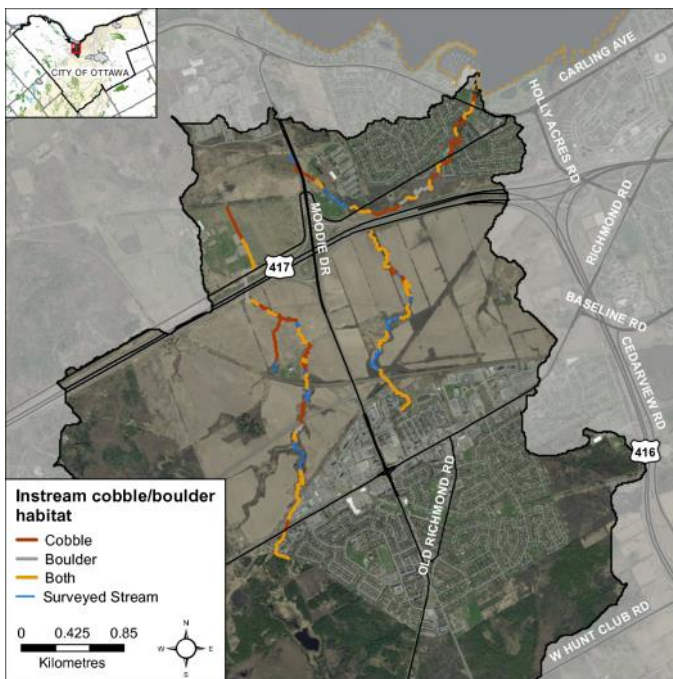

Figure 13 Cobble and boulder habitat in Stillwater Creek



Cobble and boulder habitat observed along Stillwater Creek upstream of Highway 417

Instream Morphology

Pools and riffles are important habitat features for fish. Riffles are areas of agitated water and they contribute higher dissolved oxygen to the stream and act as spawning substrate for some species of fish, such as sauger and walleye. Pools provide shelter for fish and can be refuge areas in the summer if water levels drop and water temperature in the creek increases. Pools also provide important over-wintering areas for fish. Runs are usually moderately shallow, with unagitated surfaces of water and areas where the thalweg (deepest part of the channel) is in the center of the channel.

Figure 14 shows that Stillwater Creek has good variability in instream morphology; 55 percent consists of runs, 40 percent consists of pools and five percent consists of riffles. Figure 15 shows where areas of riffle habitat was observed in Stillwater Creek. Although the riffle habitat was only five percent it was dispersed well across most of the creek.

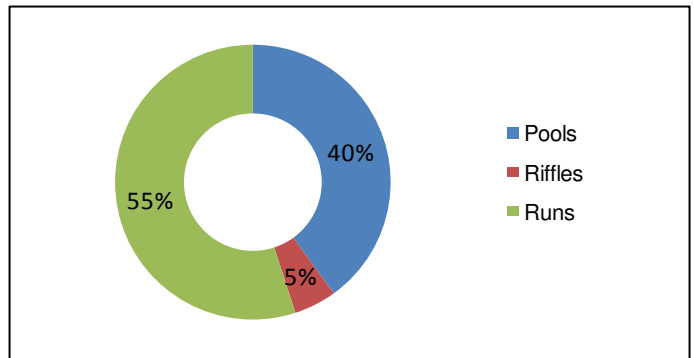

Figure 14 Instream morphology along Stillwater Creek

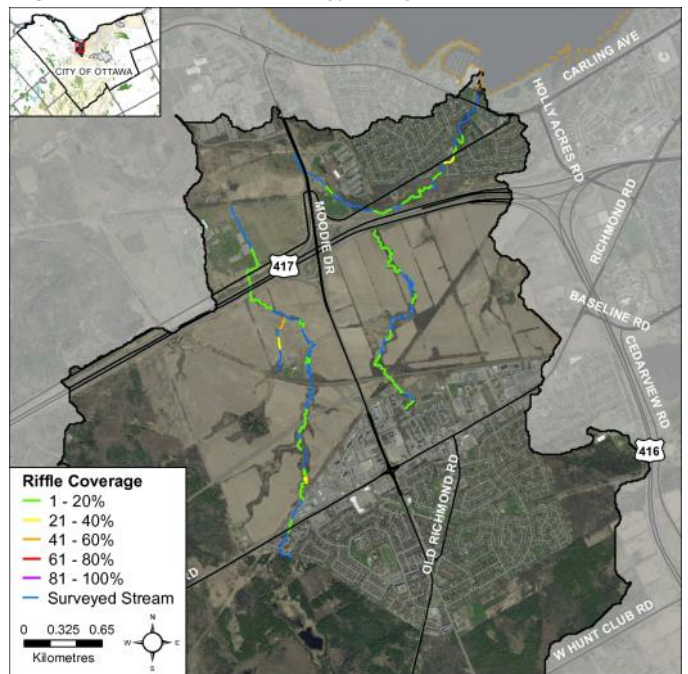

Figure 15 Riffle coverage in Stillwater Creek

Vegetation Type

Instream vegetation provides a variety of functions and is a critical component of the aquatic ecosystem. For example, emergent plants along the shoreline can provide shoreline protection from wave action and important rearing habitat for species of waterfowl. Submerged plants provide habitat for fish to find shelter from predator fish while they feed. Floating plants such as water lilies shade the water and can keep temperatures cool while reducing algae growth. Figure 16 depicts the high diversity of plant community structure in Stillwater Creek. Even though the diversity was high in most stream sections, areas with no vegetation were recorded most often, at 37 percent. Areas with no vegetation were dominated by bedrock and clay substrates where plants have difficulty establishing. Algae, submerged plants and narrow-leaved emergents were also recorded in high percentage at 28 percent, 13 percent and 10 percent respectively.

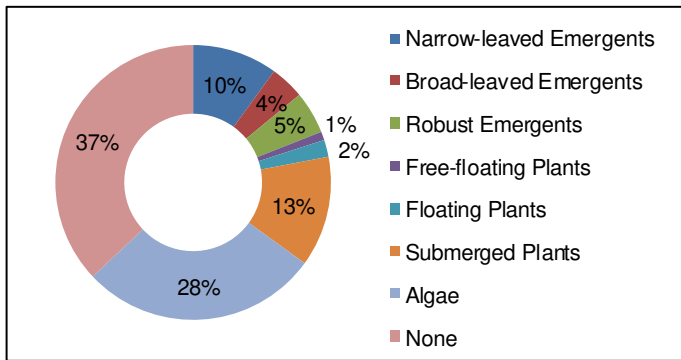

Figure 16 Vegetation types along Stillwater Creek

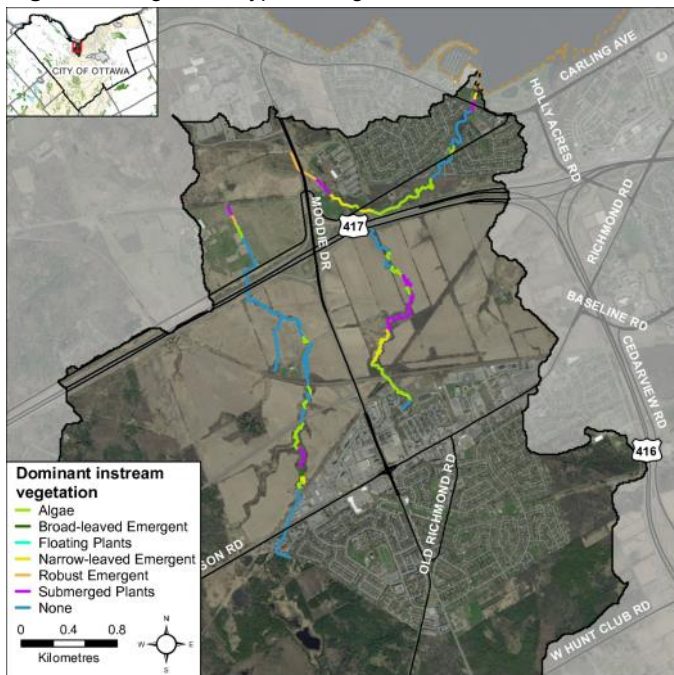

Figure 17 Dominant instream vegetation types

Instream Vegetation Abundance

Instream vegetation is an important factor for a healthy stream ecosystem. Vegetation helps to remove contaminants from the water, contributes oxygen to the stream, and provides habitat for fish and wildlife. Too much vegetation can also be detrimental. Figure 18 demonstrates that the vegetation abundance of Stillwater Creek varied considerably from extensive to rare and no vegetation. Rare and low levels were recorded most often and accounted for 58 percent, normal levels accounted for 21 percent, common levels accounted for seven percent and extensive levels accounted for 10 percent. The remaining four percent were areas with no vegetation. The vegetation levels varied considerably depending on the substrate types which were highly variable along Stillwater Creek. Areas with rare and low levels of vegetation were dominated by high flows as well as clay and bedrock substrates. Most types of vegetation have difficulty establishing in these conditions.

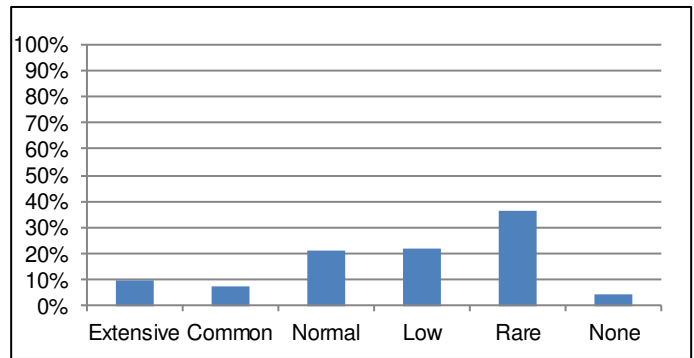

Figure 18 Instream vegetation abundance in Stillwater Creek



Bedrock substrate with instream low vegetation abundance

Stillwater Creek Stream Health

Invasive Species

Invasive species can have major implications on streams and species diversity. Invasive species are one of the largest threats to ecosystems throughout Ontario and can outcompete native species, having negative effects on local wildlife, fish and plant populations. Invasive species were observed along 94 percent of the sections surveyed along Stillwater Creek (Figure 19). Figure 20 shows the variety of invasive species observed along Stillwater Creek. The invasive species that were observed most often were purple loosestrife (*Lythrum salicaria*), common buckthorn (*Rhamnus cathartica*), and Manitoba maple (*Acer negundo*). Most of the sections where invasive species were present had more than one invasive species recorded.

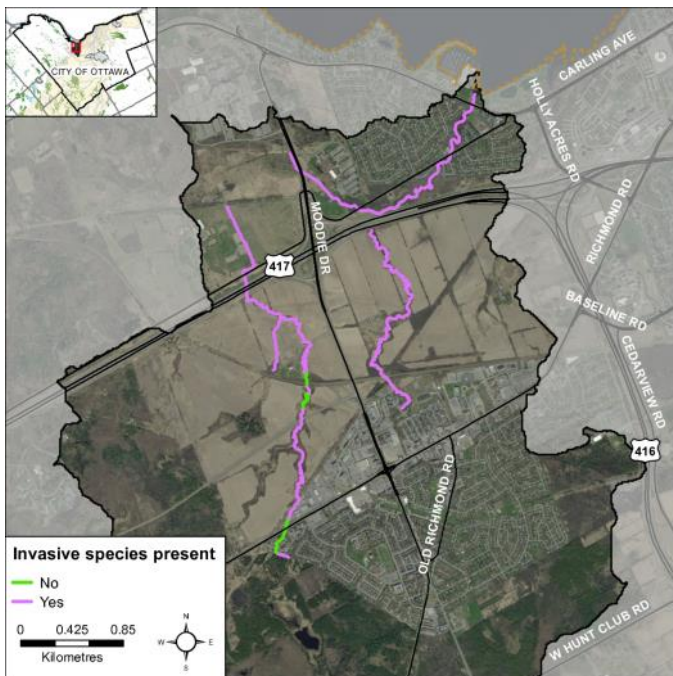

Figure 19 Presence of invasive species along Stillwater Creek

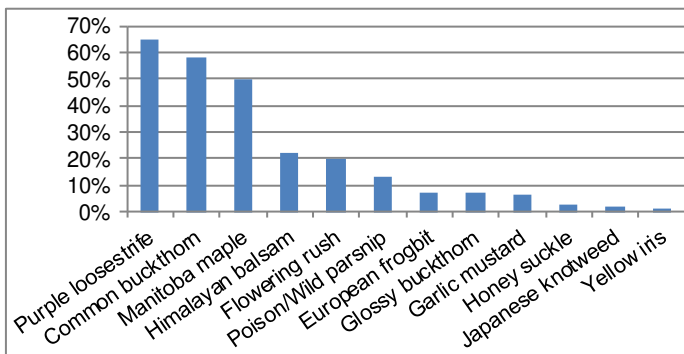

Figure 20 Invasive species observed along Stillwater Creek

Pollution

Figure 21 demonstrates the incidence of pollution/garbage in Stillwater Creek. Thirty six percent of the sections surveyed did not have any observable garbage. Forty two percent had garbage on the stream bottom and 41 percent had floating garbage. Many of the sections had both garbage on the stream bottom and floating garbage. These areas were located near road crossings or in the developed areas near Robertson Road and Corkstown Road.

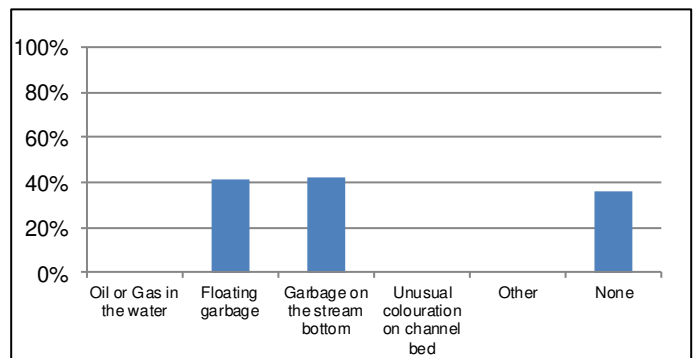

Figure 21 Pollution observed along Stillwater Creek

Wildlife

The diversity of fish and wildlife populations can be an indicator of water quality and overall stream health.

Wildlife	Observed
Birds	mallard, great blue heron, black-crowned night heron, american crow, american goldfinch, northern cardinal, gray catbird, american yellow warbler, field sparrow, sparrow spp., red-winged black bird, killdeer, american robin, mourning dove, starling, woodpecker spp., barn swallow, tree swallow, grackle, phoebe, Canada goose
Mammals	white tailed deer, north american beaver, coyote, chipmunk, raccoon, red squirrel, black squirrel, grey squirrel
Reptiles	green frog, tadpoles, bull frog, leopard frog, american toad
Aquatic Insects	freshwater mussel, water strider, crayfish spp., leech, chironomidae, isopods, water boatmen
Other	ebony jewelwing, dragonfly exuvia, dragonfly spp., cabbage white butterfly, yellow sulfur butterfly, mosquito, grasshopper spp., bumblebee, cicada, crane fly, spider spp., beetle spp., snail, dock spider

Table 1 Wildlife observed along Stillwater Creek

Stillwater Creek Water Chemistry

Water Chemistry Measurement

During the stream characterization survey, a YSI probe is used to collect water chemistry information. Dissolved oxygen, conductivity and pH are measured at the start and end of each section.



A volunteer measuring water chemistry using a YSI

Dissolved Oxygen

Dissolved oxygen is a measure of the amount of oxygen dissolved in water. The Canadian Environmental Quality Guidelines of the Canadian Council of Ministers of the Environment (CCME) suggest that for the protection of aquatic life the lowest acceptable dissolved oxygen concentration should be 6 mg/L for warmwater biota (red line in Figure 22) and 9.5 mg/L for coldwater biota (blue line in Figure 22) (CCME, 1999). Figure 22 shows that most of the stretches of Stillwater Creek meet the standard for warmwater biota. With an average dissolved oxygen level of 3.8 mg/L, the stretch of creek between Corkstown Road and Moodie Drive had much lower average dissolved oxygen compared to other stretches of the creek. This section is influenced by a weir and doesn't meet standard of 6 mg/L for warmwater biota.

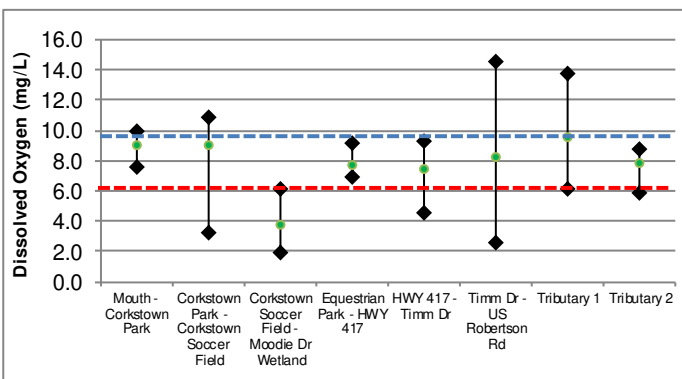

Figure 22 Dissolved oxygen ranges in Stillwater Creek

Conductivity

Conductivity in streams is primarily influenced by the geology of the surrounding environment, but can vary drastically as a function of surface water runoff. Currently there are no CCME guideline standards for stream conductivity, however readings which are outside the normal range observed within the system are often an indication of unmitigated discharge and/or stormwater input. The average specific conductivity observed within Stillwater Creek was 1309 $\mu\text{s}/\text{cm}$. Figure 23 shows that the conductivity readings varied moderately along the course of the creek. The lowest average specific conductivity reading at 717 $\mu\text{s}/\text{cm}$, was observed on the tributary of Stillwater Creek surveyed to the west of Moodie Drive. There is a significant spike in conductivity in the tributary east of Moodie Drive where the average recorded conductivity was 1813 $\mu\text{s}/\text{cm}$. The tributary east of Moodie Drive conveys flow from the highly developed area of Bells Corners around Robertson Road. As a result, the water chemistry of the tributary is significantly influenced by stormwater runoff.

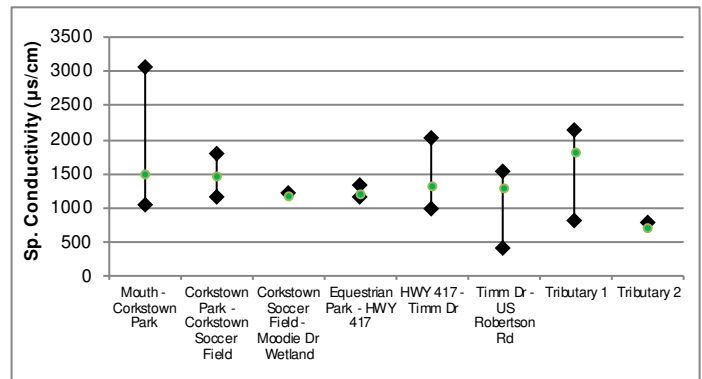

Figure 23 Conductivity ranges in Stillwater Creek

pH

Based on the PWQO for pH, a range of 6.5 to 8.5 should be maintained for the protection of aquatic life. Average pH values for Stillwater Creek ranged between 7.7 and 8.1, thereby meeting the provincial standard.

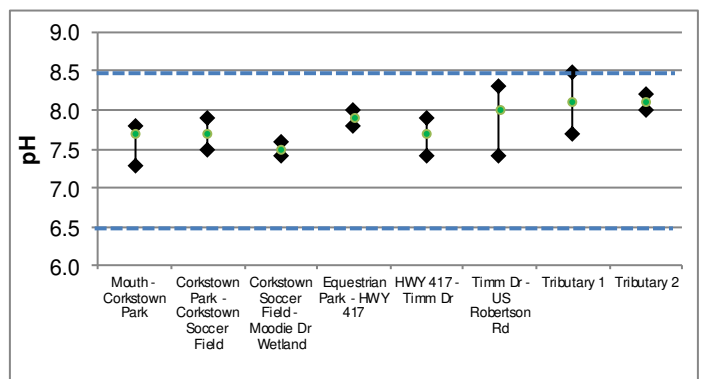

Figure 24 pH ranges in Stillwater Creek

Stillwater Creek Thermal Classification

Thermal Classification

Many factors can influence fluctuations in stream temperature, including springs, tributaries, precipitation runoff, discharge pipes and stream shading from riparian vegetation. Seven temperature loggers were deployed in late April to monitor water temperature in Stillwater Creek. Water temperature is used along with the maximum air temperature (using a revised Stoneman and Jones method) to classify sampling reaches into one of five categories that correspond to the thermal preferences of local fish communities (figure 27). Figure 25 shows the locations where temperature loggers were installed on Stillwater Creek.

Analysis of the data collected indicates that the thermal classification of Stillwater Creek is cool water with a cool-warm water reach towards Robertson Road. (Figure 27). The site of logger 3 between Corkstown Road and Moodie Drive represents a colder reach of the creek and is likely influenced by groundwater input.

Groundwater

Groundwater discharge areas can influence stream temperature, contribute nutrients, and provide important stream habitat for fish and other biota. During stream surveys, indicators of groundwater discharge are noted when observed. Figure 26 shows areas where one or more groundwater indicators were observed during stream surveys on Stillwater Creek. Most of the groundwater indicators were observed downstream of Moodie Drive and in the tributary surveyed east of Moodie Drive.

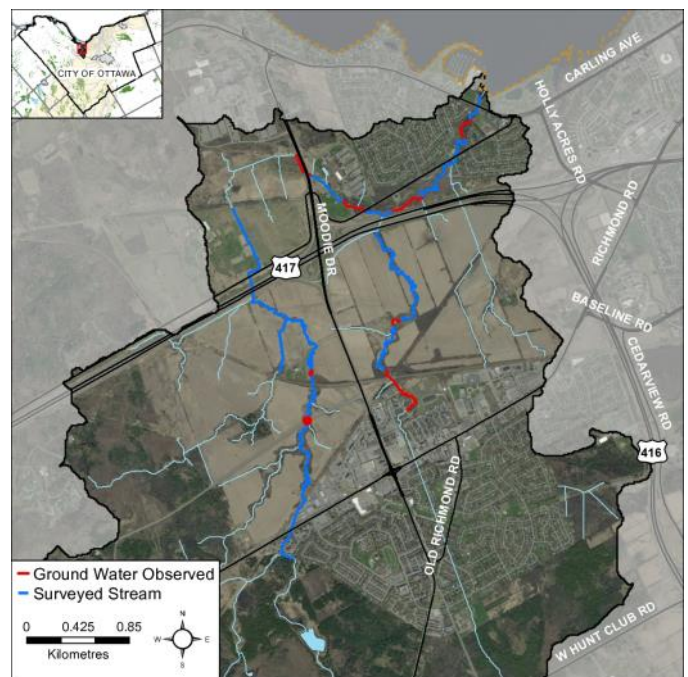
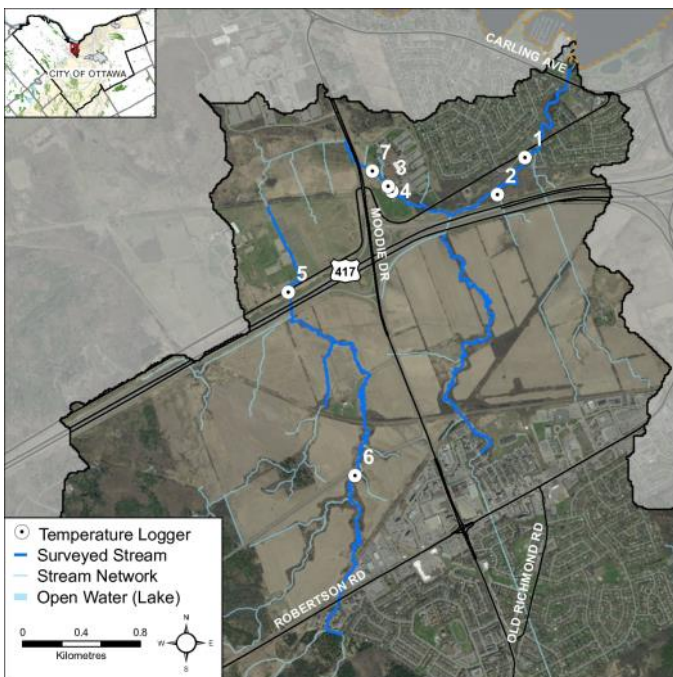

Figure 25 Temperature loggers along Stillwater Creek

Figure 26 Groundwater indicators observed

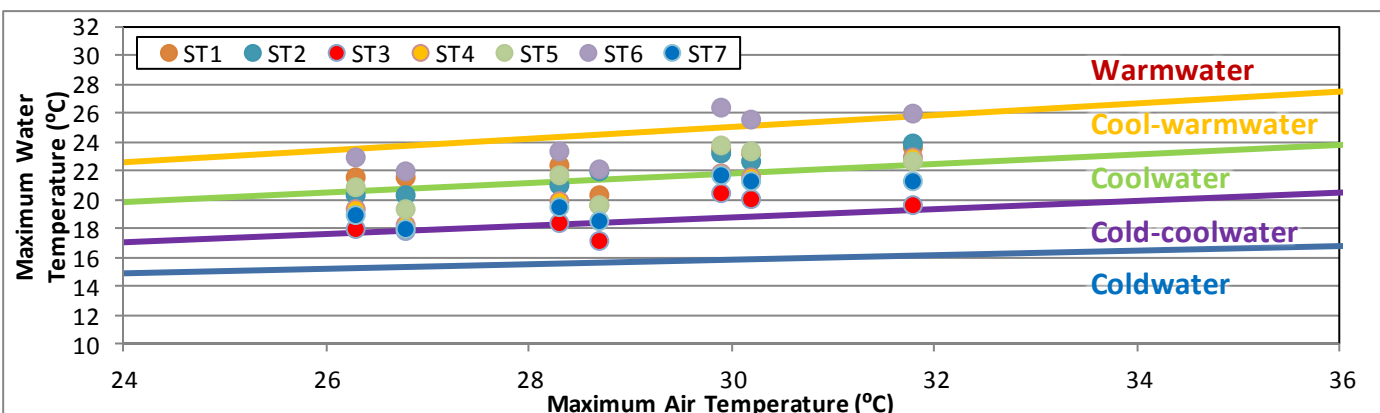

Figure 27 Thermal Classification for Stillwater Creek

Stillwater Creek Fish Community

Fish Community

Fish sampling sites located along Stillwater Creek are shown in Figure 28. The provincial fish codes shown in Figure 28 are listed (in Table 2) beside the common name of those fish species identified in Stillwater Creek. The thermal classification of Stillwater Creek is cool water, with 41 fish species having been observed historically including eight game fish species.

Species observed in Stillwater Creek (with fish code)			
banded killifish.....	BaKil	largemouth bass.....	LmBas
black crappie.....	BICra	Lepomis sp.....	LepSp
blackchin shiner.....	BcShi	logperch.....	LogPe
blacknose shiner....	BnShi	longnose dace.....	LnDac
bluegill.....	Blueg	mimic shiner.....	MiShi
bluntnose minnow..	BnMin	minnow hybrid.....	Hy600
brassy minnow.....	BrMin	mottled sculpin.....	MoScu
brook stickleback...	BrSti	muskellunge.....	Muske
brown bullhead.....	BrBul	northern pearl dace....	PeDac
burbot.....	Burbo	northern pike.....	NoPik
carps and minnows	CA_MI	northern redbelly dace	NRDac
central mudminnow.	CeMud	pumpkinseed.....	Pumpk
common carp.....	CoCar	pumpkinseed x bluegil	Hy702
common shiner.....	CoShi	Rhinichthys sp.....	RhiSp
Cottus sp.....	CotSp	rock bass.....	RoBas
creek chub.....	CrChu	spotfin shiner.....	SfShi
emerald shiner.....	EmShi	spottail shiner.....	SpShi
Etheostoma sp.....	EthSp	white sucker.....	WhSuc
fathead minnow.....	FhMin	yellow bullhead.....	YeBul
finescape dace.....	FsDac	yellow perch.....	YePer
golden shiner.....	GoShi		

Table 2 Fish species observed in Stillwater Creek

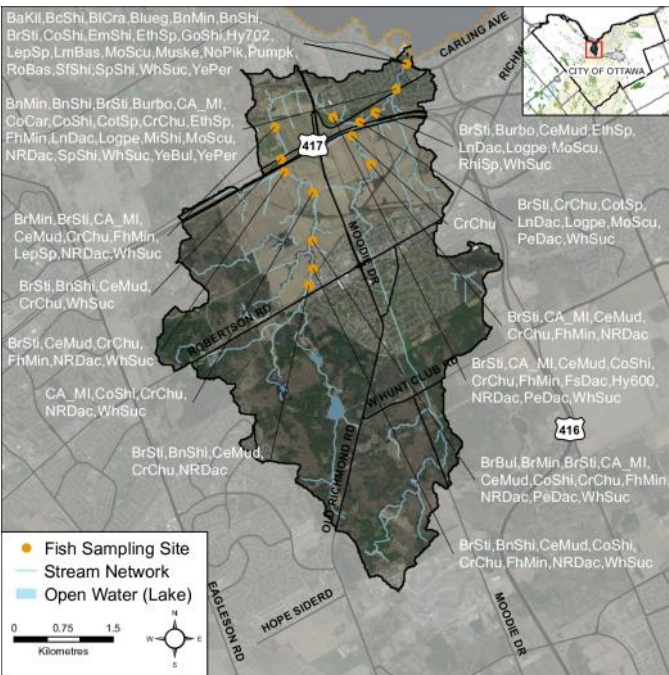

Figure 28 Stillwater Creek fish community



Fyke net set at the mouth of Stillwater Creek near the Ottawa River



Burbot captured on Stillwater Creek



Northern pearl dace captured on Stillwater Creek

Migratory Obstructions

It is important to know locations of migratory obstructions because these can prevent fish from accessing important spawning and rearing habitat. Migratory obstructions can be natural or manmade, and they can be permanent or seasonal. Figure 29 shows that along Stillwater Creek, two perched culverts, two debris dams, one grade barrier and one weir were observed. Fish migration is currently being impacted by the weir near Moodie Drive and the perched culverts identified on the main channel of the creek at Timm Drive and the tributary east of Moodie Drive at the old railway line.

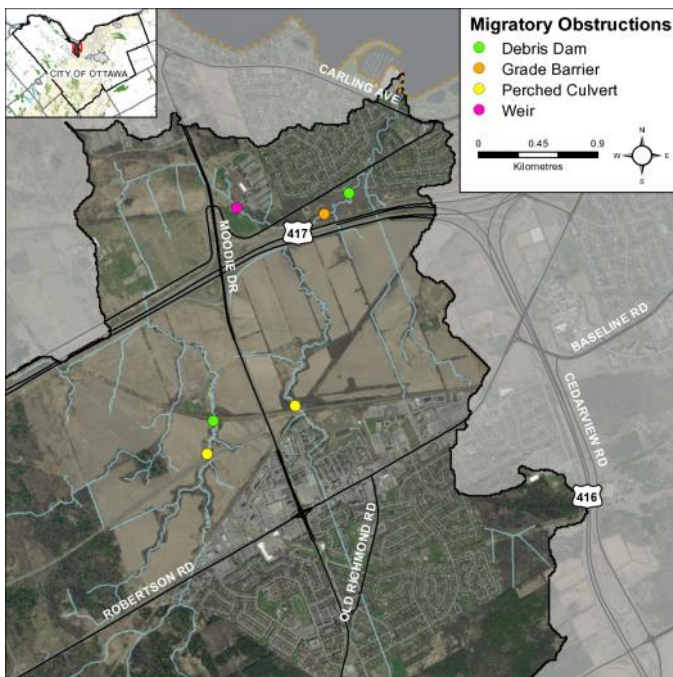

Figure 29 Stillwater Creek migratory obstructions



A perched culvert observed along a tributary of Stillwater Creek

Beaver Dams

Beaver dams can also act as obstructions to fish migration. Figure 30 shows that a number of active, abandoned and breached beaver dams were observed on Stillwater Creek. Most of the beaver activity was observed between Highway 417 and Robertson Road as well as on the tributary east of Moodie Drive. The head, or difference between the water level up and down stream, of the beaver dams ranged from 0 cm to 60 cm.

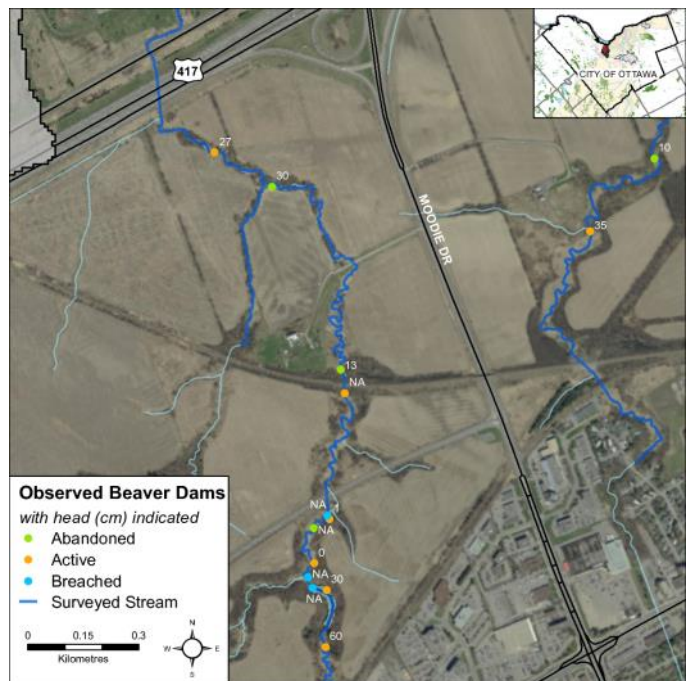

Figure 30 Beaver dams observed on Stillwater Creek



A large beaver dam observed on Stillwater Creek

Headwater Drainage Feature Assessment

Headwaters Sampling

The RVCA City Stream Watch program assessed Headwater Drainage Features for Barrhaven Creek, Bilberry Creek, Mosquito Creek and Stillwater Creek in 2015. This protocol measures zero, first and second order headwater drainage features (HDF). It is a rapid assessment method characterizing the amount of water, sediment transport, and storage capacity within headwater drainage features (HDF). RVCA is working with other Conservation Authorities and the Ministry of Natural Resources and Forestry to implement the protocol with the goal of providing standard datasets to support science development and monitoring of headwater drainage features. An HDF is a depression in the land that conveys surface flow. Additionally, this module provides a means of characterizing the connectivity, form and unique features associated with each HDF (OSAP Protocol, 2013). In 2015 the program sampled 13 sites in the Stillwater Creek catchment area. Figure 31 demonstrates the 2015 Stillwater Creek sampling locations.

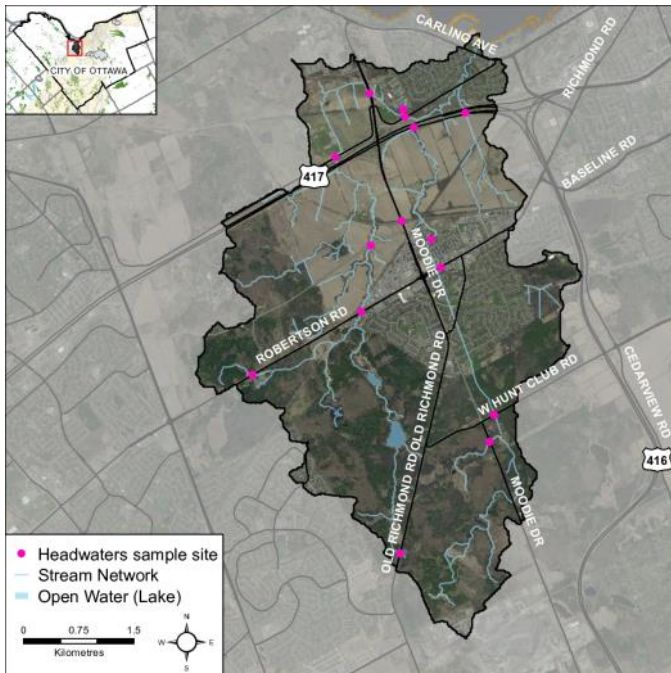

Figure 31 Stillwater Creek HDF sampling sites

Feature Type

The headwater sampling protocol assesses the feature type in order to understand the function of each feature. The evaluation includes the following classifications: defined natural channel, channelized or constrained, multi-thread, no defined feature, tiled, wetland, swale, roadside ditch and pond outlet. By assessing the values associated with the headwater drainage features in the catchment area we can understand the ecosystem services that they provide to the watershed in the form of hydrology, sediment transport, and aquatic and terrestrial functions. The Stillwater Creek catchment is dominated by natural channel and wetland headwater drainage feature types with two channelized sites and one tiled site. Figure 32 shows the feature type of the primary feature at the sampling locations on Stillwater Creek.

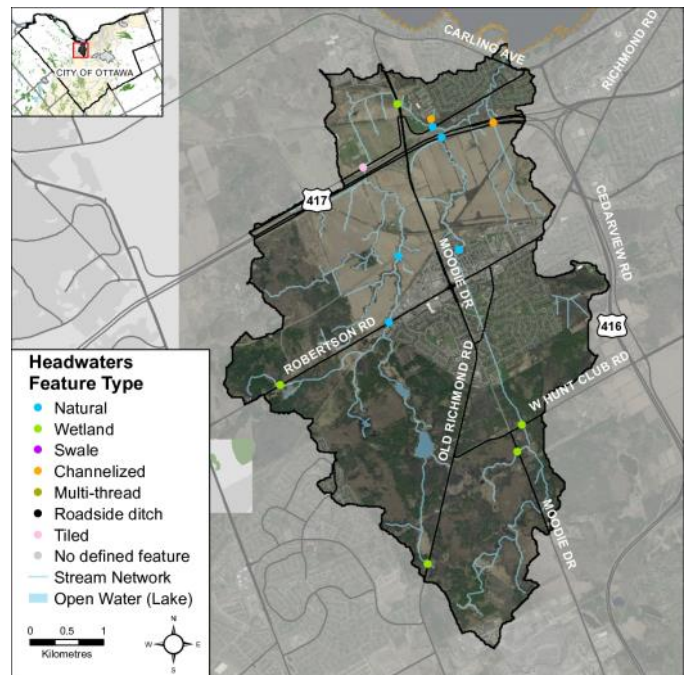

Figure 32 Stillwater Creek HDF feature types



Wetland feature type observed along Moodie Drive

Headwater Feature Flow

The observed flow condition within headwater drainage features can be highly variable depending on timing relative to the spring freshet, recent rainfall, soil moisture, etc. Flow conditions are assessed in the spring and in the summer to determine if features are perennial and flow year round, if they are intermittent and dry up during the summer months or if they are ephemeral systems that do not flow regularly and generally respond to specific rainstorm events or snowmelt. Flow conditions in headwater systems can change from year to year depending on local precipitation patterns. Figure 33 shows the observed flow conditions at the sampling locations in the Stillwater Creek catchment.

Feature Channel Modifications

Channel modifications were assessed at each headwater drainage feature sampling location. Modifications include channelization, dredging, hardening and realignments. Land use in the Stillwater Creek catchment varies widely from developed land to agriculture and natural forested and wetland areas. The majority of the sampling locations for the Stillwater Creek catchment area had no channel modifications but one site had mixed modifications, one site had channel hardening and one site had dredging. Figure 34 shows the channel modifications observed at the sampling locations for Stillwater Creek.

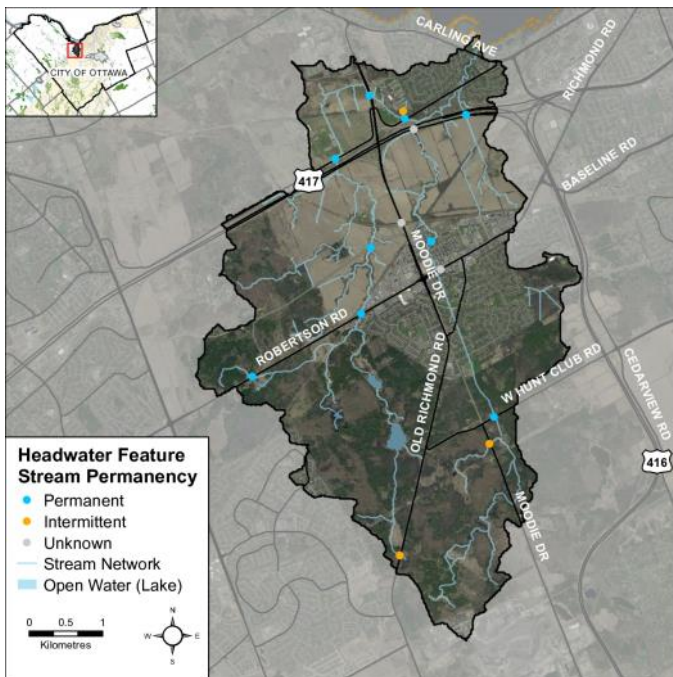

Figure 33 Stillwater Creek HDF flow conditions

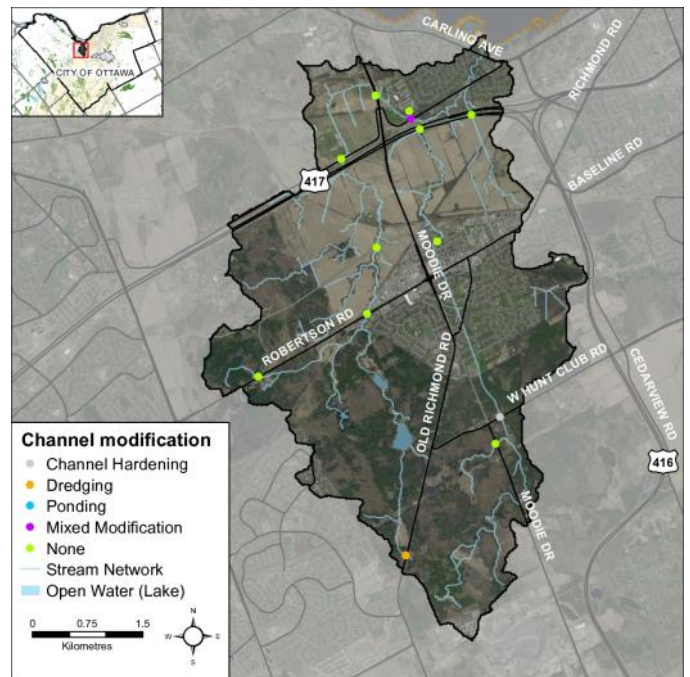

Figure 34 Mosquito Creek HDF channel modifications



Permanent HDF sampling site along Robertson Road



Channel hardening at an HDF site along Corkstown Road

Headwater Feature Vegetation

Headwater feature vegetation evaluates the type of vegetation that is found within the drainage feature. The type of vegetation within the channel influences the aquatic and terrestrial ecosystem values that the feature provides. For some types of headwater features the vegetation within the feature plays a very important role in flow and sediment movement and provides wildlife habitat. The following classifications are evaluated no vegetation, lawn, wetland, meadow, scrubland and forest. Headwaters features in the Stillwater Creek catchment were dominated by meadow, wetland and scrubland vegetation. Figure 35 depicts the dominant vegetation observed at the sampled headwater sites in the Stillwater Creek catchment.

Headwater Feature Riparian Vegetation

Headwater riparian vegetation evaluates the type of vegetation that is found along the headwater drainage feature. The type of vegetation within the riparian corridor influences the aquatic and terrestrial ecosystem values that the feature provides to the watershed. All of the sample locations in the Stillwater Creek catchment area were dominated by natural vegetation in the form of scrubland, meadow, wetland and forest. Figure 36 depicts the type of riparian vegetation observed at the sampled headwater sites in the Stillwater Creek catchment.

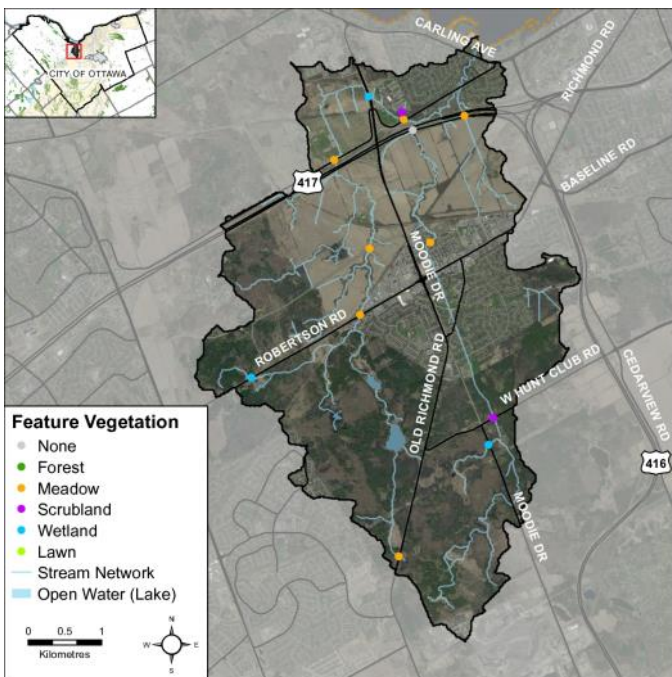

Figure 35 Stillwater Creek HDF feature vegetation

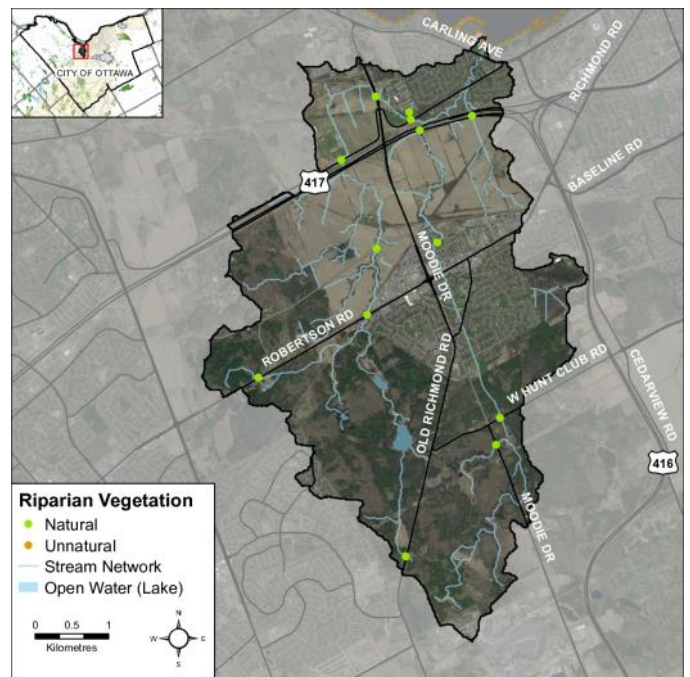

Figure 36 Stillwater Creek HDF riparian vegetation



Wetland feature vegetation observed at Robertson Road



A natural forested riparian buffer upstream of Highway 417

Headwater Feature Sediment Deposition

Assessing the amount of recent sediment deposited in a channel provides an index of the degree to which the feature could be transporting sediment to downstream reaches (OSAP, 2013). Evidence of excessive sediment deposition might indicate the requirement to follow up with more detailed targeted assessments upstream of the site location to identify potential best management practices to be implemented. Conditions ranged from no deposition observed to moderate levels of sediment deposition observed. Overall, most sites had minimal or moderate levels of sediment deposition. Figure 37 depicts the degree of sediment deposition observed at the sampled headwater sites in the Stillwater Creek catchment.

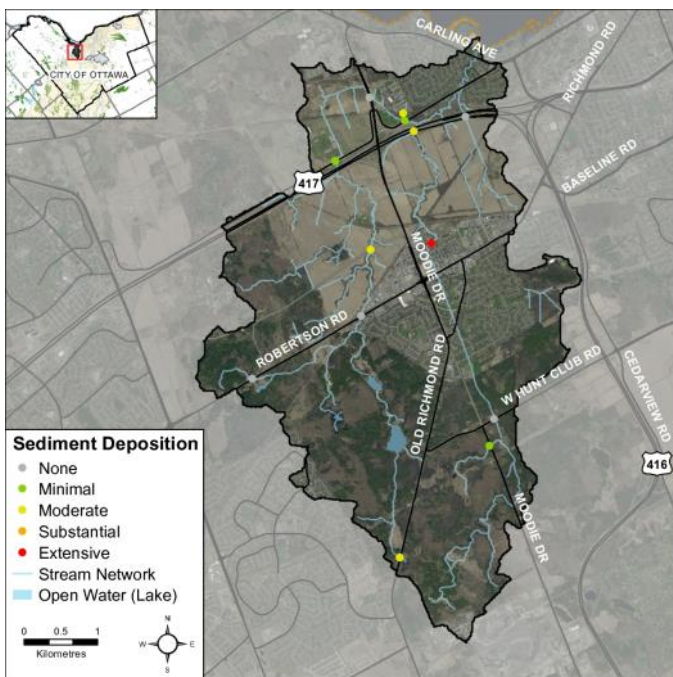

Figure 37 Stillwater Creek HDF sediment deposition

Headwater Feature Upstream Roughness

Feature roughness will provide a measure of the amount of materials within the bankfull channel that could slow down the velocity of water flowing within the headwater feature (OSAP, 2013). Materials on the channel bottom that provide roughness include vegetation, woody debris and boulders/cobble substrates. Roughness can provide benefits in mitigating downstream erosion on the headwater drainage feature and the receiving watercourse by reducing velocities. Roughness also provides important habitat conditions to aquatic organisms. Most of the feature roughness of the sample locations in the Stillwater Creek catchment were classified as either moderate or extreme levels. Figure 38 shows the feature roughness conditions at the sampling locations in the Stillwater Creek catchment.

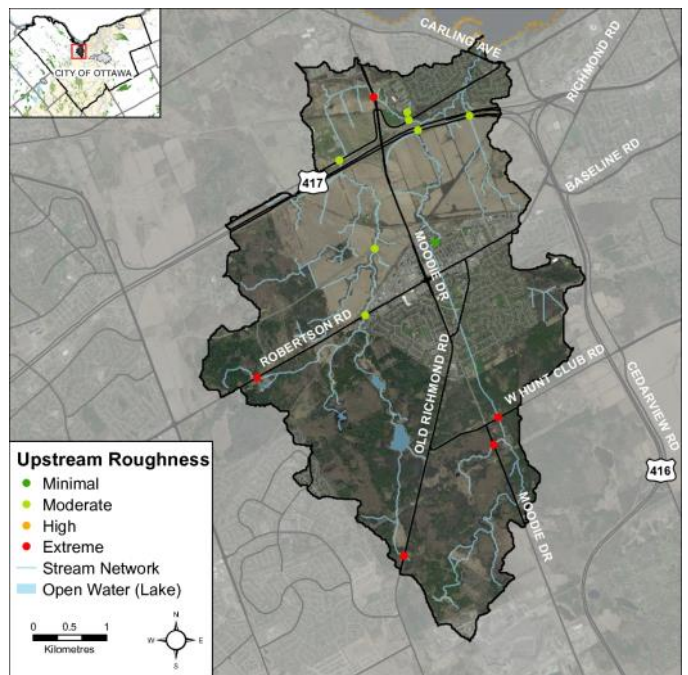

Figure 38 Stillwater Creek HDF feature roughness



Spring conditions at a sampling site along Robertson Rd



Summer conditions at the same site along Robertson Rd

Stream Comparison Between 2009 and 2015

The following tables provide a comparison of observations on Stillwater Creek between the 2009 and 2015 survey years. Stillwater Creek was also surveyed in 2004, but the surveying protocol has changed significantly since that time so data from 2004 cannot be compared to data from 2009 and 2015. In order to accurately represent current and historical information, the site data was only compared for those locations which were surveyed in both reporting periods. In some instances, this resulted in changes to our overall summary information. This information is therefore only a comparative evaluation and does not represent the entirety of our assessment.

Anthropogenic Changes

Table 3 shows that between 2009 and 2015 anthropogenic alterations along Stillwater Creek have decreased. In 2009, 20 percent of the sections had no anthropogenic alterations, in 2015 that number has increased to 37 percent. This change may be caused by changes in the stream survey protocol. In 2010 anthropogenic alterations were further defined in the protocol, which has caused some land uses to shift categories.

Anthropogenic Alterations	2009 (%)	2015 (%)
No anthropogenic alterations	20	37
"Natural" conditions with minor human alterations	26	25
"Altered" with considerable human impact but significant natural portions	33	22
"Highly altered" by humans with few natural portions	21	16

Table 3 Comparison of anthropogenic alterations along Stillwater Creek between 2009 and 2015



A weir constructed along Stillwater Creek downstream of Moodie Drive that was observed in 2009 and 2015

Bank Stability Changes

According to observations bank stability on Stillwater Creek has improved overall since 2009. In 2009, 89 percent of the left and right bank were considered stable. In 2015, 96 percent of the left and right bank were stable.

Bank Stability	2009 (%) Left Bank	2009 (%) Right Bank	2015 (%) Left Bank	2015 (%) Right Bank
Stable	89	89	96	96
Unstable	11	11	4	4

Table 4 Comparison of bank stability along Stillwater Creek between 2009 and 2015

Changes in Instream Vegetation

Figure 39 shows that there has been a decrease in instream vegetation in Stillwater Creek since 2009. The amount of areas with no vegetation and rare levels of vegetation totaled 30 percent in 2009, and that number has increased to 43 percent in 2015. Low levels have remained the same at 20 percent in both 2009 and 2015. Normal levels of vegetation have decreased from 22 percent in 2009 to 14 percent in 2015. Finally, the number of areas classified as having common and extensive levels of vegetation has decreased from 28 percent in 2009 to 23 percent in 2015. The decrease in instream vegetation may be in part attributed to increased sedimentation in the system but vegetation growth is also dependent on climatic variables as well as the stage of the growing season when observations took place.

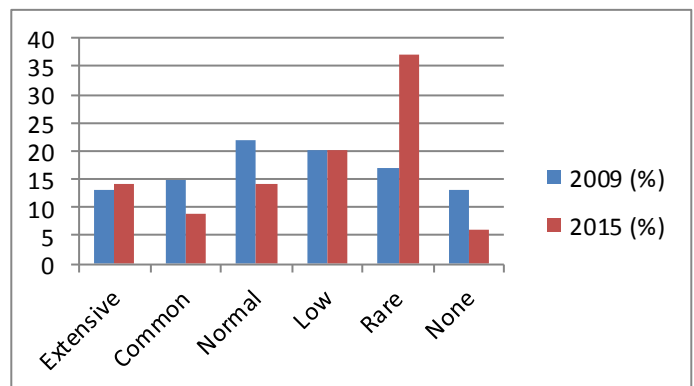

Figure 39 Comparison of instream vegetation levels between 2009 and 2015

Changes in Pollution and Garbage

Overall the amount of pollution and garbage in Stillwater Creek has decreased since 2009. Table 5 shows that the number of sections surveyed that were free from garbage has increased from 14 to 38 percent since 2009.

Pollution/Garbage	2009 (%)	2015 (%)
None	14	38
Floating garbage	66	38
Garbage on stream bottom	41	32
Oil or gas trails	1	0
Discoloration of channel bed	0	0

Table 5 Comparison of pollution/garbage levels between 2009 and 2015

Fish Community

Fish sampling was conducted on Stillwater Creek by the City Stream Watch program in 2004, 2009 and 2015. In total, 35 species of fish have been captured through City Stream Watch fish sampling efforts.

In 2004, 17 species were captured in five sampling sessions using a seine net downstream of Carling Avenue. In 2009, fish sampling effort was significantly increased sampling 4 sites downstream of Corkstown Road using a variety of methods (seine net, electrofisher, fyke net, windemere trap) resulting in 18 species caught. In 2015, 24 species were caught using a variety of methods (electrofishing, seining, fyke nets) at 10 sites throughout the system.

Five species caught in 2009 were not found in 2015. This does not mean the species have disappeared from Stillwater Creek but could be influenced by location, weather conditions, time of sampling and sampling method.



Mottled sculpin captured on Stillwater Creek

Species	Code	2004	2009	2015
banded killifish.....	BaKil	X	X	X
black crappie.....	BICra	X		
blackchin shiner.....	BcShi	X	X	
blacknose shiner.....	BnShi		X	
bluegill.....	Blueg	X		
bluntnose minnow.....	BnMin	X		X
brassy minnow.....	BrMin			X
brook stickleback.....	BrSti	X	X	X
burbot.....	Burbo			X
carps and minnows...	CA_MI		X	X
central mudminnow..	CeMud		X	X
common shiner.....	CoShi	X	X	X
creek chub.....	CrChu		X	X
emerald shiner.....	EmShi	X		X
Etheostoma sp.....	EthSp	X	X	X
fathead minnow.....	FhMin		X	X
finescale dace.....	FsDac			X
golden shiner.....	GoShi	X		
largemouth bass.....	LmBas	X		
Lepomis sp.....	LepSp		X	X
logperch.....	LogPe			X
longnose dace.....	LnDac			X
mottled sculpin.....	MoScu		X	X
muskellunge.....	Muske	X		
northern pearl dace....	PeDac			X
northern pike.....	NoPik		X	
northern redbelly dace	NRDac		X	X
pumpkinseed.....	Pumpk	X		X
pumpkinseed x bluegill	Hy702		X	
Rhinichthys sp.....	RhiSp			X
rock bass.....	RoBas	X		
spotfin shiner.....	SfShi	X	X	
spottail shiner.....	SpShi			X
white sucker.....	WhSuc	X	X	X
yellow perch.....	YePer	X	X	X
Total Species		17	18	24

Table 6 Comparison of fish species caught in 2004, 2009 and 2015

Monitoring and Restoration

Monitoring and Restoration Projects on Stillwater Creek

Table 7 below highlights the monitoring and restoration work that has been done on Stillwater Creek to date by the Rideau Valley Conservation Authority. Potential restoration opportunities are listed on the following page.

Accomplishment	Year	Description
City Stream Watch Stream Characterization Monitoring	2004	65 stream surveys were completed on Stillwater Creek
	2009	79 stream surveys were completed on Stillwater Creek
	2015	100 stream surveys were completed on Stillwater Creek
City Stream Watch Fish Sampling	2004	Five sites were sampled on Stillwater Creek
	2009	Four sites were sampled on Stillwater Creek
	2015	Ten sites were sampled on Stillwater Creek
City Stream Watch Thermal Classification	2004	Two temperature loggers were deployed
	2009	Four temperature loggers were deployed
	2015	Seven temperature loggers were deployed
City Stream Watch Headwater Drainage Feature Sampling	2015	13 headwater drainage feature sites were sampled in the Stillwater Creek catchment
City Stream Watch Stream Cleanup	2009	City Stream Watch volunteers removed debris of human origin from the mouth of Stillwater Creek
Shoreline Naturalization Program Planting	2011	City Stream Watch volunteers planted native trees and shrubs along Stillwater Creek at the Nepean Equestrian Park and Robertson Road
	2013	City Stream Watch volunteers planted native trees and shrubs at the mouth of Stillwater Creek in Andrew Haydon Park
	2013, 2015	Shoreline Naturalization Program staff and volunteers planted shrubs and trees along Stillwater Creek at Abbot-Point-of-Care
City Stream Watch Invasive Species Removal	2010, 2011, 2012, 2013	Volunteers removed invasive yellow iris from the mouth of Stillwater Creek, returning each year to remove any new growth

Table 7 Monitoring and Restoration on Stillwater Creek



Volunteers performing stream surveys on Stillwater Creek



Volunteers planting trees along Stillwater Creek at Abbott-Point-of-Care

Potential Riparian Restoration Opportunities

Figure 40 depicts the locations where City Stream Watch staff and volunteers observed areas where the riparian zone could be restored or enhanced using one or more of the following techniques: riparian planting, erosion control, invasive species control and wildlife habitat creation.

The majority of the opportunities listed were riparian planting and invasive species control. Himalayan balsam is prolific along the tributary east of Moodie Drive and numerous riparian planting opportunities were observed along the main channel of the creek and the tributaries surveyed.

Potential Instream Restoration Opportunities

Figure 41 depicts the locations where City Stream Watch staff and volunteers made note of areas where there were one or more of the following instream restoration opportunities: fish habitat enhancement, garbage cleanup and channel modification.

Three areas were identified for stream cleanups, all near road crossings in the developed areas of Stillwater Creek. In addition, two locations where stream channelization had occurred were identified for channel modifications. An additional opportunity exists to remove the weir located downstream of Moodie Drive.

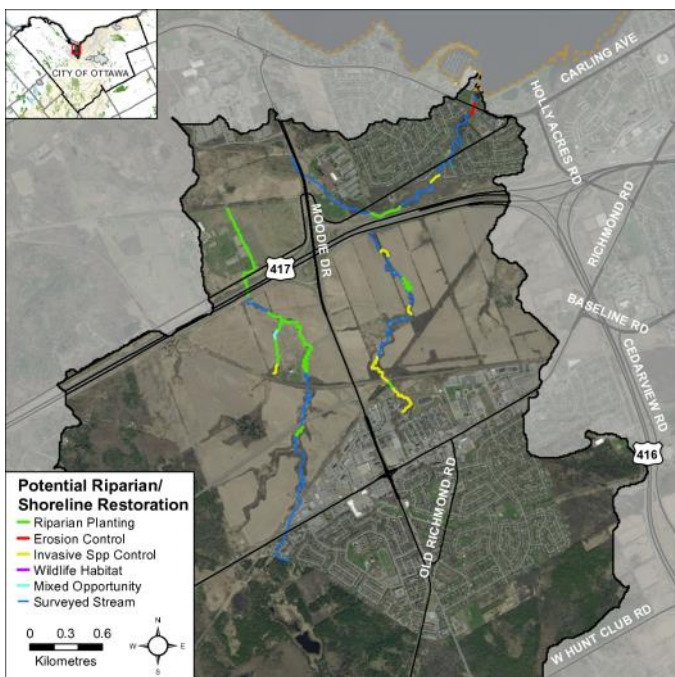

Figure 40 Potential riparian/shoreline restoration opportunities

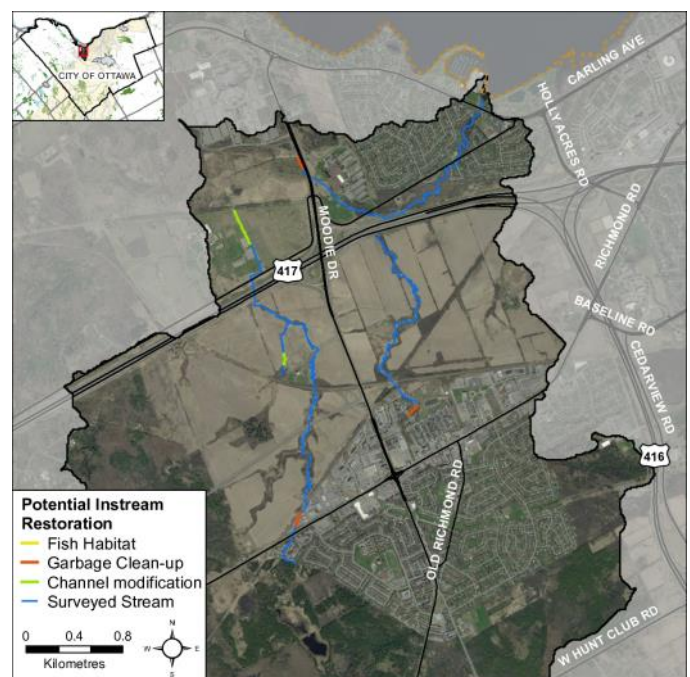

Figure 41 Potential instream restoration opportunities



Dense stands of Himalayan balsam observed on the tributary east of Moodie Drive



Location where channel modification opportunity was identified on Stillwater Creek



References

1. Canadian Council of Ministers of the Environment (CCME), 1999. *Canadian Environmental Quality Guidelines and Summary Table* Retrieved From: http://www.ccme.ca/pulications/ceqg_rcqe.html
2. Canadian Wildlife Service (CWS), Environment Canada. 2013. *How Much Habitat Is Enough? Third Edition* Retrieved from: http://www.ec.gc.ca/nature/E33B007C-5C69-4980-8F7B-3AD02B030D8C/894_How_much_habitat_is_enough_E_WEB_05.pdf
3. Chu, C., N.E. Jones, A.R. Piggot and J.M. Buttle. 2009. Evaluation of a Simple Method to Classify the Thermal Characteristics of Streams Using a Nomogram of Daily Maximum Air and Water Temperatures. *North American Journal of Fisheries Management*. 29: 1605-1619
4. Coker, G.A, C.B. Portt, and C.K. Minns. 2001. Morphological and Ecological Characteristics of Canadian Freshwater Fishes. *Can. MS Rpt. Fish. Aquat. Sci.* 2554: iv+89p.
5. Ecoplans, Limited. September 2009. *West Transitway Expansion Bayshore to Moodie Drive: Preliminary Characterization of Existing Natural Environmental Conditions. DRAFT.*
6. Rideau Valley Conservation Authority (RVCA). 2009. *City Stream Watch Annual Report*. Manotick, ON: Julia Sutton
7. Rideau Valley Conservation Authority (RVCA). 2013. *Existing Habitat Condition, Channel Structure, Thermal Stability and Opportunities for Restoration for Stillwater Creek*. Manotick, ON: Justin Robert
8. Scott, W.B. and E.J. Crossman. 1973. *Freshwater Fishes of Canada*. Fisheries Research Board of Canada Bulletin 184: 966 pages
9. Stanfield, L. (editor). 2013. *Ontario Stream Assessment Protocol. Version 9.0*. Fisheries Policy Section. Ontario Ministry of Natural Resources. Peterborough, Ontario. 505 Pages
10. Stoneman, C.L. and M.L. Jones. 1996. *A Simple Method to Evaluate the Thermal Stability of Trout Streams*

For more information on the overall 2015 City Stream Watch Program and the volunteer activities, please refer to the City Stream Watch 2015 Summary Report.



FUNCTIONAL SITE SERVICING AND STORMWATER MANAGEMENT REPORT REV.03 – 1987 ROBERTSON ROAD (STILLWATER STATION)

Appendix D External Documents
February 28, 2024

D.4 PRELIMINARY GEOTECHNICAL INVESTIGATION, PROPOSED MIXED USE DEVELOPMENT 1987 ROBERTSON ROAD, OTTAWA, ONTARIO – PATERSON GROUP, REVISION 5, OCT 13, 2023



Preliminary Geotechnical Investigation

Proposed Mixed Use Development

1987 Robertson Road
Ottawa, Ontario

Prepared for The Properties Group

Report PG5715-1 Revision 5 dated October 13, 2023

Table of Contents

	PAGE
1.0 Introduction	1
2.0 Proposed Development	1
3.0 Method of Investigation	2
3.1 Field Investigation	2
3.2 Field Survey	4
3.3 Laboratory Testing	4
3.4 Analytical Testing	4
4.0 Observations	5
4.1 Surface Conditions	5
4.2 Subsurface Profile	5
4.3 Groundwater	6
5.0 Discussion	8
5.1 Geotechnical Assessment	8
5.2 Groundwater Infiltration and Control	9
5.3 Preliminary Foundation Design	11
5.4 Preliminary Design for Earthquakes	15
5.5 Slab on Grade and Basement Slab	15
5.6 Preliminary Pavement Structure	16
6.0 Design and Construction Precautions	18
6.1 Foundation Drainage and Backfill	18
6.2 Foundation Drainage and Backfill	19
6.3 Excavation Side Slopes	19
6.4 Pipe Bedding and Backfill	21
6.5 Groundwater Control	21
6.6 Corrosion Potential and Sulphate	22
6.7 Slope Stability Assessment	23
7.0 Recommendations	26
8.0 Statement of Limitations	27

Appendices

- Appendix 1** Soil Profile and Test Data Sheets
 Symbols and Terms
 Analytical Testing Results
- Appendix 2** Figure 1 - Key Plan
 Figures 2 to 4 - Aerial Images
 Photos 1 to 4 - Photographs from Site Visit
 Figures 5 to 16 - Slope Stability Analysis Sections
 Drawing PG5715-1 - Test Hole Location Plan

1.0 Introduction

Paterson Group (Paterson) was commissioned by The Properties Group to conduct a preliminary geotechnical investigation for the proposed mixed use development to be located at 1987 Robertson Road in the City of Ottawa (refer to Figure 1 - Key Plan presented in Appendix 2).

The objectives of the geotechnical investigation were to:

- Determine the subsoil and groundwater conditions at this site by means of boreholes.
- Provide preliminary geotechnical recommendations for the design of the proposed development including construction considerations which may affect its design.

The following report has been prepared specifically and solely for the aforementioned project which is described herein. It contains our findings and includes geotechnical recommendations pertaining to the design and construction of the subject development as they are understood at the time of writing this report.

2.0 Proposed Development

Based on concept plans available at the time of preparation of the current report, it is our understanding that the proposed mixed-use development will consist of 1 four-storey building, 5 six-storey buildings, 1 eighteen-storey building, 1 twenty-storey building, 1 twenty-storey building, 2 twenty-four-storey buildings, 1 twenty-eight-storey building, 1 thirty-storey building, and 1 thirty-two-storey building.

Details of underground parking and basement levels were not known at the time of preparation of this report. Access lanes, right-of-ways, parking areas, parkland and landscaped areas are also anticipated for the subject development. It is further anticipated that the proposed development will be municipally serviced.

3.0 Method of Investigation

3.1 Field Investigation

Field Program

The field program for the geotechnical investigation was carried out on March 16, 17 and 18, 2021. At that time, a total of seven (7) boreholes were advanced to a maximum depth of 10.1 m. A previous investigation was completed by Paterson on December 21, 2007 which consisted of two (2) boreholes advanced to a maximum depth of 3.1 m within the subject site. The borehole locations were determined by Paterson personnel to provide general coverage of the subject site taking into consideration site features and underground services. The locations of the boreholes are shown on Drawing PG5715-1 - Test Hole Location Plan included in Appendix 2.

The boreholes were advanced using a track-mounted auger drill rig operated by a two person crew. All fieldwork was conducted under the full-time supervision of personnel from Paterson's geotechnical division under the direction of a senior engineer. The testing procedure consisted of augering and rock coring to the required depths at the selected locations and sampling the overburden.

Sampling and In Situ Testing

Soil samples were collected from the boreholes either directly from the auger flights or using a 50 mm diameter split-spoon sampler. Rock cores were obtained using 47.6 mm inside diameter coring equipment. All samples were visually inspected and initially classified on site. The auger and split-spoon samples were placed in sealed plastic bags, and rock cores were placed securely in cardboard core boxes. All samples were transported to our laboratory for further examination and classification. The depths at which the auger, split spoon and rock core samples were recovered from the boreholes are shown as AU, SS and RC, respectively, on the Soil Profile and Test Data sheets presented in Appendix 1.

The Standard Penetration Test (SPT) was conducted in conjunction with the recovery of the split-spoon samples. The SPT results are recorded as "N" values on the Soil Profile and Test Data sheets. The "N" value is the number of blows required to drive the split-spoon sampler 300 mm into the soil after a 150 mm initial penetration using a 63.5 kg hammer falling from a height of 760 mm.

Undrained shear strength testing was carried out in cohesive soils using a field vane apparatus.

The recovery value and a Rock Quality Designation (RQD) value were calculated for each drilled section of bedrock and are presented on the borehole logs. The recovery value is the length of the bedrock sample recovered over the length of the drilled section. The RQD value is the total length of intact rock pieces longer than 100 mm over the length of the core run. The values indicate the bedrock quality.

The overburden thickness was evaluated by a dynamic cone penetration test (DCPT) completed at BH 1 and BH 3. The DCPT consists of driving a steel drill rod, equipped with a 50 mm diameter cone at the tip, using a 63.5 kg hammer falling from a height of 760 mm. The number of blows required to drive the cone into the soil is recorded for each 300 mm increment.

The subsurface conditions observed in the boreholes were recorded in detail in the field. The soil profiles are presented on the Soil Profile and Test Data sheets in Appendix 1 of this report.

Groundwater

Monitoring wells were installed in BH 4, BH 6 and BH 7 and piezometers were installed in all other boreholes to permit monitoring of the groundwater levels subsequent to the completion of the sampling program.

Monitoring Well Installation

Typical monitoring well construction details are described below:

- 3.0 m of slotted 51 mm diameter PVC screen at base the base of the boreholes.
- 51 mm diameter PVC riser pipe from the top of the screen to the ground surface.
- No.3 silica sand backfill within annular space around screen.
- 300 mm thick bentonite hole plug directly above PVC slotted screen.
- Clean backfill from top of bentonite plug to the ground surface.

Refer to the Soil Profile and Test Data sheets in Appendix 1 for specific well construction details.

Sample Storage

All samples will be stored in the laboratory for a period of one month after issuance of this report. They will then be discarded unless Paterson is otherwise directed.

3.2 Field Survey

The borehole locations were determined by Paterson personnel taking into consideration the presence of underground and aboveground features and services. The location and ground surface elevation at each borehole location was surveyed by Paterson personnel. The ground surface elevation at each borehole location was referenced to a geodetic datum. The borehole locations and ground surface elevation at each borehole location are presented on Drawing PG5715-1 - Test Hole Location Plan in Appendix 2.

3.3 Laboratory Testing

The soil samples and rock cores recovered from the subject site were examined in our laboratory to review the results of the field logging.

3.4 Analytical Testing

One (1) soil sample was submitted for analytical testing to assess the potential for exposed ferrous metals and the potential of sulphate attacks against subsurface concrete structures. The sample was analyzed to determine its concentration of sulphate and chloride along with its resistivity and pH. The laboratory test results are shown in Appendix 1 and the results are discussed in Subsection 6.6.

4.0 Observations

4.1 Surface Conditions

Subject Site

The subject site is currently occupied by an equipment rental business and consists of an associated one-storey warehouse building, asphalt paved and gravel surfaced access lanes and parking, and grass covered areas. The site is bordered to the north by a rail corridor and further by agricultural land, to the east by a commercial building campus, to the south by a residential trailer park, and to the west by Stillwater Creek and further by a residential trailer park.

The ground surface across the site gradually slopes downward from south to north between approximate geodetic elevations of 89.0 to 87.5 m.

Stillwater Creek

Generally, Stillwater Creek runs approximately north-south along western portions of the subject site. The slope bordering Stillwater Creek was reviewed in the field by Paterson personnel as part of our slope stability assessment. Detailed observations at the time of our field reconnaissance are presented in Section 6.7 - Slope Stability Assessment.

4.2 Subsurface Profile

Overburden

Generally, the subsurface profile encountered at the borehole locations consists of a

0.4 to 1.8 m thick layer of fill and/or topsoil. The fill was generally observed to consist of brown silty sand to silty clay with crushed stone and some organics.

A deposit of very stiff to stiff brown silty clay was encountered underlying the above- noted fill and topsoil layer extending to depths of approximately 1.8 to 6.9 m. The brown silty clay was further underlain by a layer of grey silty clay in BH 1, BH 2, BH 3 and BH 7 extending to depths of up to 9.8 m.

A 0.6 to 1.3 m thick glacial till deposit was encountered underlying the deposit of silty clay in BH 1, BH 2 and BH 4 and below the fill layer encountered in BH 6. The glacial till generally consisted of silty clay to silty sand with gravel, cobbles, and boulders.

Practical refusal to augering or DCPT was encountered in all boreholes with the exception of BH 7 at depths of 1.0 to 13.0 m.

In BH 8 and BH 9 from the 2007 field investigation, a 0.6 to 3.0 m thick layer of glacial till was encountered. At that time, practical refusal to augering was encountered at depths of 0.7 to 3.1 m.

Reference should be made to the Soil Profile and Test Data sheets in Appendix 1 for specific details of the soil profiles encountered at each test hole location.

Bedrock

A good to excellent quality sandstone bedrock was encountered in BH 4 and BH 6 underlying the glacial till deposit at approximate depths of 1.0 to 1.9 m.

Based on available geological mapping, the majority of the subject site is located in an area where the bedrock consists of sandstone of the Nepean formation and the north portion of the site consists of dolomite of the Oxford formation, with a drift thickness of 2 to 10 m.

4.3 Groundwater

Groundwater levels were recorded in the monitoring wells and piezometers installed at the borehole locations on March 24, 2021. The groundwater level readings noted at that time are presented in Table 1.

Table 1 – Summary of Groundwater Level Readings				
Borehole Number	Ground Surface Elevation (m)	Measured Groundwater Level		Date Recorded
		Depth (m)	Elevation (m)	
BH 1	87.47	0.31	87.16	March 24, 2021
BH 2	87.52	0.21	87.31	
BH 3	88.69	0.21	88.48	
BH 4	88.85	1.37	87.48	
BH 5	89.12	NA	NA	
BH 6	89.04	1.28	87.76	
BH 7	88.82	1.93	86.89	
Note: The test hole locations were located in the field and surveyed by Paterson Group. The elevations are referenced to a geodetic datum.				

It should be noted that the groundwater level readings can be influenced by surface water perching within a backfilled borehole column, which can lead to higher than normal groundwater level readings.

The long- term groundwater level can also be estimated by field observations of the recovered soil samples, such as moisture levels, undrained shear strength and colouring of the soil samples. Based on these observations and the color of the recovered soil samples, the long-term groundwater table can be anticipated at an elevation of **81.5 to 82.5 m** throughout the majority of the subject site. The groundwater level can be considered to be below the bedrock surface throughout the south-east portion of the subject site. However, it should be noted that groundwater levels are subject to seasonal fluctuations and could vary at the time of construction.

5.0 Discussion

5.1 Geotechnical Assessment

From a geotechnical perspective, the subject site is considered adequate for the proposed development. Detailed plans for founding depths and underground levels were not available at the time of preparation of this report. Since design details of the proposed mixed-use buildings are not known at this time, geotechnical design information provided in this report may only be considered preliminary. Once design details have been developed for the subject site, development-specific recommendations may be provided at that time. Preliminary recommendations have been provided herein for future consideration. Further, due to the size of the subject site and the nature of the proposed buildings, a supplemental geotechnical field investigation will be required to provide specific design details.

For preliminary design purposes, it is expected that the proposed mid-rise buildings may be founded on conventional shallow spread footings placed on an undisturbed stiff silty clay or compact glacial till bearing surface, or a surface sounded bedrock bearing surface. The proposed high-rise buildings may be founded on conventional shallow spread footings placed on a surface sounded bedrock bearing surface.

However, for cases where loads exerted by proposed mid-rise buildings founded on a silty clay or glacial till bearing surface exceed the bearing resistance values provided herein, or where proposed high rise buildings are expected to be founded within the overburden soils, it is recommended that the proposed buildings be supported on end-bearing piles extending to the bedrock surface or a raft foundation.

Depending on founding depths for the buildings, bedrock removal may be required to complete underground levels. Line drilling and controlled blasting is recommended where large quantities of bedrock need to be removed. The blasting operations should be planned and completed under the guidance of a professional engineer with experience in blasting operations.

Due to the presence of a silty clay deposit, the subject site will be subjected to a permissible grade raise restriction.

The above and other considerations are further discussed in the following sections.

5.2 Groundwater Infiltration and Control

Stripping Depth

Asphalt, topsoil, and any deleterious fill, such as those containing organic materials, should be removed from within the perimeter of the proposed buildings and other settlement sensitive structures.

Existing foundation walls and other construction debris should be entirely removed from within the perimeter of the proposed buildings. Under paved areas, existing construction remnants such as foundation walls should be excavated to a minimum of 1 m below final grade.

Fill Placement

Fill used for grading beneath the building areas should consist, unless otherwise specified, of clean imported granular fill, such as Ontario Provincial Standard Specifications (OPSS) Granular A or Granular B Type II. This material should be tested and approved prior to delivery to the site. The fill should be placed in lifts no greater than 300 mm thick and compacted using suitable compaction equipment for the lift thickness. Fill placed beneath the proposed building areas should be compacted to at least 98% of its standard Proctor maximum dry density (SPMDD).

Non-specified existing fill along with site-excavated soil can be used as general landscaping fill and beneath exterior parking areas where settlement of the ground surface is of minor concern. In landscaped areas, these materials should be spread in thin lifts and at least compacted by the tracks of the spreading equipment to minimize voids. If these materials are to be used to build up the subgrade level for areas to be paved, they should be compacted in thin lifts to a minimum density of 95% of their respective SPMDD. Non-specified existing fill and site-excavated soils are not suitable for use as backfill against foundation walls unless a composite drainage blanket connected to a perimeter drainage system is provided.

Bedrock Removal

Based on the bedrock encountered in the area, it is expected that line-drilling in conjunction with hoe-ramming or controlled blasting will be required to remove the bedrock where necessary. In areas of weathered bedrock and where only a small quantity of bedrock is to be removed, bedrock removal may be possible by hoe-ramming.

Prior to considering blasting operations, the effects on the existing services, buildings and other structures should be addressed. A pre-blast or construction survey located in the proximity of the blasting operations should be conducted prior to commencing construction. The extent of the survey should be determined by the blasting consultant and sufficient to respond to any inquiries/claims related to the blasting operations.

As a general guideline, peak particle velocity (measured at the structures) should not exceed 25 mm/s during the blasting program to reduce the risks of damage to the existing structures. The blasting operations should be planned and conducted under the supervision of a licensed professional engineer who is an experienced blasting consultant.

Excavation side slopes in sound bedrock could be completed with almost vertical side walls. Where bedrock is of lower quality, the excavation face should be free of any loose rock. An area specific review should be completed by the geotechnical consultant at the time of construction to determine if rock bolting or other remedial measures are required to provide a safe excavation face for areas where low quality bedrock is encountered.

Vibration Considerations

Construction operations could cause vibrations, and possibly, sources of nuisance to the community. Therefore, means to reduce the vibration levels as much as possible should be incorporated in the construction operations to maintain a cooperative environment with the residents.

The following construction equipment could cause vibrations: piling equipment, hoe ram, compactor, dozer, crane, truck traffic, etc. The construction of a temporary shoring system with soldier piles or sheet piling would require these pieces of equipment. Vibrations, caused by blasting or construction operations, could cause detrimental vibrations on the adjoining buildings and structures. Therefore, it is recommended that all vibrations be limited.

Two parameters determine the recommended vibration limit: the maximum peak particle velocity and the frequency. For low frequency vibrations, the maximum allowable peak particle velocity is less than that for high frequency vibrations. As a guideline, the peak particle velocity should be less than 15 mm/s between frequencies of 4 to 12 Hz, and 50 mm/s above a frequency of 40 Hz (interpolate between 12 and 40 Hz). These guidelines are for current construction standards. These guidelines are above perceptible human level and, in some cases, could be very disturbing to some people, a pre-construction survey is recommended to minimize the risks of claims during or following the construction of the proposed building.

5.3 Preliminary Foundation Design

Bearing Resistance Values

Spread Footing Foundations - Commercial and Low to Mid-Rise Buildings

Foundations for the proposed low to mid-rise buildings, portions of underground parking levels (if considered) extending beyond the overlying high-rise buildings and other light-loaded ancillary structures may consist of conventional spread footing foundations.

For preliminary design purposes, strip footings, up to 3 m wide, and pad footings, up to 5 m wide, placed on an undisturbed, very stiff silty clay bearing surface can be designed using a bearing resistance value at serviceability limit state (SLS) of **150 kPa** and a factored bearing resistance value at ultimate limit state (ULS) of **225 kPa**.

Conventional spread footings placed on an undisturbed, compact to very dense glacial till bearing surface can be designed using a bearing resistance value at serviceability limit state (SLS) of **200 kPa** and a factored bearing resistance value at ultimate limit states (ULS) of **300 kPa**.

An undisturbed soil bearing surface consists of a surface from which all topsoil and deleterious materials, such as loose, frozen or disturbed soil, whether in situ or not, have been removed, in dry conditions, prior to the placement of concrete for footings.

Footings placed on a clean, surface sounded sandstone bedrock surface can be designed using a factored bearing resistance value at ultimate limit states (ULS) of **3,000 kPa**, incorporating a geotechnical resistance factor of 0.5.

A clean, surface-sounded bedrock bearing surface should be free of loose materials, and have no near surface seams, voids, fissures or open joints which can be detected from surface sounding with a rock hammer.

Lateral Support

The bearing medium under footing-supported structures is required to be provided with adequate lateral support with respect to excavations and different foundation levels. Adequate lateral support is provided to a silty clay and/or glacial till above the groundwater table when a plane extending down and out from the bottom edge of the footing at a minimum of 1.5H:1V passes only through in situ soil of the same or higher capacity as the bearing medium soil.

The bearing medium under footing-supported structures is required to be provided with adequate lateral support with respect to excavations and different foundation levels. Adequate lateral support is provided to a sound bedrock bearing medium when a plane extending down and out from the bottom edge of the footing at a minimum of 1H:6V (or flatter) passes only through sound bedrock or a material of the same or higher capacity as the bedrock, such as concrete. A weathered bedrock bearing medium will require a lateral support zone of 1H:1V (or flatter).

Settlement

Strip footings placed on a soil bearing surface and designed using the bearing resistance values at SLS given above will be subjected to potential post construction total and differential settlements of 25 and 20 mm, respectively.

Footings bearing on an acceptable bedrock bearing surface and designed for the bearing resistance values provided herein will be subjected to negligible potential post- construction total and differential settlements.

Raft and Deep Foundations - Mid to High-Rise Buildings

Raft Foundation

Should the proposed bearing resistance values for conventional footings be deemed insufficient for support of the proposed mid to high-rise buildings, consideration may be given to foundation support by raft slab foundation structure. However, the geotechnical design of a raft slab is dependant on the number of below grade levels that are to be provided for the proposed buildings and the anticipated founding medium. Therefore, two scenarios have been considered for the purposes of this report (one and two levels of underground parking). Based on this review, a contact pressure of 150 kPa (SLS) for a one basement level scenario with a subgrade modulus of 6.0 MPa/m. A contact pressure of 190 kPa (SLS) for a two basement level scenario with a subgrade modulus of 7.0 MPa/m.

Further, discussions and recommendations regarding the design of raft foundations can be provided in a supplemental geotechnical report for the subject site, as based on the results of a supplemental investigation and further review of detailed grading and site plans for the subject site. As a preliminary recommendation, where a raft slab is utilized, it is recommended that a minimum 50 mm thick lean concrete mud slab be placed on an undisturbed silty clay and/or glacial till subgrade shortly after the excavation and preparation of the bearing medium. The main purpose of the raft slab is to reduce the risk of disturbance of the subgrade under the traffic of workers and equipment.

The final excavation to the raft slab bearing surface level and the placing of the mud slab should be done in smaller sections to avoid exposing large areas of the silty clay to potential disturbance due to drying. The raft slab should incorporate a waterproofing membrane system along with the perimeter foundation walls if the basement slab is expected to be below the long term groundwater level.

Pile Foundation

If the raft slab bearing resistance values provided are insufficient for the proposed high rise buildings, a deep foundation system driven to refusal in the bedrock will be recommended for foundation support of the proposed high-rise buildings. For deep foundations, concrete-filled steel pipe piles are generally utilized in the Ottawa area.

It should also be noted that end-bearing piles are only considered suitable if sufficient space for embedment below the foundation is available for end-fixity and lateral load resistance. End-bearing caissons would instead be considered if sufficient embedment cannot be accomplished. Additional foundation alternatives may also be provided at that time as based on the results of a supplemental investigation. However, as previously noted detailed design information may be provided once additional details are known for the proposed development. Buildings founded on piles driven to refusal in the bedrock will have negligible post-construction settlement.

End-Bearing Piles

Applicable pile resistance values at ultimate limit states (ULS) are given in Table 2. A resistance factor of 0.4 has been incorporated into the factored at ULS values. Note that these are all geotechnical axial resistance values. The geotechnical pile resistance values were estimated using the Hiley dynamic formula, to be confirmed during pile installation with a program of dynamic monitoring. Re-striking of all piles at least once will also be required after at least 48 hours have elapsed since initial driving.

Table 2 – Pile Foundation Design Data			
Pile Outside Diameter (mm)	Pile Wall Thickness (mm)	Geotechnical Axial Resistance	Geotechnical Uplift Resistance
		Factored at ULS (kN)	Factored at ULS (kN) (assumed 12 m pile)
245	9	1350	200
245	11	1425	200
245	13	1500	200

Caissons

End bearing cast-in-place caissons can be used where supplemental axial resistance is required for structural design for the proposed building. The caisson should be installed by driving a temporary steel casing and excavating the soil through the casing. A minimum of 35 MPa concrete should be used to in fill the caissons. The caissons are to be structurally reinforced over their entire length.

Two conditions for drilled shafts are applicable for this site. The first alternative is a caisson installed on the sound bedrock, augering through the weathered bedrock (end bearing). The compressive resistance for such piles is directly related to the compressive strength of the bedrock. It is recommended that the entire capacity be derived from the end bearing capacity.

The second alternative is a concrete caisson socketed into bedrock. The axial capacity is increased by the shear capacity of the concrete/rock interface. Furthermore, the tensile resistance of the caisson is increased by the rock capacity. It should be noted that the rock socket should be reinforced.

Table 3 below presents the estimated capacity for different typical caisson sizes for a rock bearing caisson and rock socketed caisson extending 3 m into sound bedrock.

Table 3 - Caisson Pile Capacities					
Caisson Diameter		Axial Capacity (kN)		Factored Capacity Tension at ULS (kN)	
inch	mm	End Bearing	Rock Socket	End Bearing	Rock Socket
36	900	10000	14500	920	2700
42	1000	15000	19000	1050	3450
48	1200	19000	24500	1200	4500
54	1375	24000	31000	1350	5300
60	1500	30000	38000	1500	6000

Notes:

- 3 m rock socket in sound bedrock
- Reinforced caisson and rock socket when applicable
- 0.4 geotechnical factor applied to the shaft capacity

Permissible Grade Raise

A permissible grade raise restriction of **2 m** is recommended for the subject site. It should be noted that the permissible grade raise provided is subject to change based on the results of the supplemental geotechnical investigation. If greater permissible grade raises are required, preloading with or without a surcharge, lightweight fill, and/or other measures should be investigated to reduce the risks of unacceptable long-term post construction total and differential settlements of the soils surrounding the buildings.

5.4 Preliminary Design for Earthquakes

The site class for seismic site response can be taken as **Class D** for foundations founded upon a silty clay bearing medium and as **Class C** for foundations founded upon a glacial till or bedrock bearing medium for foundation considered at the subject site.

Higher site classes such as Class A or Class B may be provided for buildings founded upon or within 3 m of the bedrock surface. However, they would have to be confirmed by site specific shear wave velocity testing. Such testing may be considered once more detailed plans are available for the proposed development. The soils underlying the subject site are not susceptible to liquefaction. Reference should be made to the latest version of the Ontario Building Code (OBC) 2012 for a full discussion of the earthquake design requirements.

5.5 Slab on Grade and Basement Slab

With the removal of all topsoil and deleterious materials, within the footprint of the proposed buildings, the native soil or existing fill as approved by the geotechnical consultant will be considered to be an acceptable subgrade surface on which to commence backfilling for basement floor slab.

If a raft slab is utilized, a granular layer of OPSS Granular A will required to allow for the installation of sub-floor services above the raft slab foundation. The thickness of the OPSS Granular A crushed stone will be dependent on the piping requirements.

For the buildings founded on footings or piles, it is recommended that the upper 200 mm of sub-slab fill consists of 19 mm clear crushed stone. All backfill material within the footprint of the proposed buildings should be placed in maximum 300 mm thick loose layers and compacted to at least 98% of its SPMDD.

For buildings of slab-on-grade construction, it is recommended that the upper 300 mm of sub-slab fill consists of OPSS Granular A crushed stone.

A sub-slab drainage system, consisting of lines of perforated drainage pipe sub-drains connected to a positive outlet, should be provided under the lowest level floor slab. The spacing of the sub-slab drainage pipes can be determined at the time of construction to confirm groundwater infiltration levels, if any. This is discussed further in Subsection 6.1.

Any soft areas should be removed and backfilled with appropriate backfill material prior to placing any fill. OPSS Granular B Type II, with a maximum particle size of 50 mm, are recommended for backfilling below the floor slab.

5.6 Preliminary Pavement Structure

Although detailed design plans were not available at the time of preparation of this report, the following pavement structures may be considered for planning purposes of the proposed development.

Table 4 - Recommended Pavement Structure – Car Only Parking Areas	
Thickness (mm)	Material Description
50	Wear Course – HL-3 or Superpave 12.5 Asphaltic Concrete
150	BASE - OPSS Granular A Crushed Stone
300	SUBBASE - OPSS Granular B Type II
SUBGRADE - Either fill, in situ soil or OPSS Granular B Type I or II material placed over in situ soil or fill.	

Table 5 - Recommended Pavement Structure – Access Lanes	
Thickness (mm)	Material Description
40	Wear Course – HL-3 or Superpave 12.5 Asphaltic Concrete
50	Binder Course – HL-8 or Superpave 19.0 Asphaltic Concrete
150	BASE - OPSS Granular A Crushed Stone
400	SUBBASE - OPSS Granular B Type II
SUBGRADE - Either fill, in situ soil or OPSS Granular B Type I or II material placed over in situ soil or fill.	

Minimum Performance Graded (PG) 58-34 asphalt cement should be used for this project.

If soft spots develop in the subgrade during compaction or due to construction traffic, the affected areas should be excavated to a competent layer and replaced with OPSS Granular B Type II material. Weak subgrade conditions may be experienced over service trench fill materials. This may require the use of a geotextile, such as Terratrack 200 or equivalent, thicker subbase or other measures that can be recommended at the time of construction as part of the field observation program.

The pavement granular base and subbase should be placed in maximum 300 mm thick lifts and compacted to a minimum of 100% of the material's SPMD using suitable vibratory equipment, noting that excessive compaction can result in subgrade softening.

Pavement Structure Drainage

Satisfactory performance of the pavement structure is largely dependent on maintaining the contact zone between the subgrade material and the base stone in a dry condition. Failure to provide adequate drainage under conditions of heavy wheel loading can result in the fine subgrade soil being pumped into the voids in the stone subbase, thereby reducing load carrying capacity.

Due to the low permeability of the subgrade materials consideration should be given to installing subdrains during the pavement construction as per City of Ottawa standards. The subdrain inverts should be approximately 300 mm below subgrade level. The subgrade surface should be crowned to promote water flow to the drainage lines.

6.0 Design and Construction Precautions

6.1 Foundation Drainage and Backfill

Foundation Drainage and Waterproofing

Buildings proposed throughout the development of the subject site whose basement levels are founded below the long-term groundwater table should be provided a groundwater suppression system. The groundwater suppression system would consist of installing a waterproofing membrane over a drainage geocomposite installed on the exterior portion of the foundation wall. The waterproofing membrane is recommended to extend between the bottom of the foundation and up to a minimum of 1 m above the long-term groundwater level. A groundwater suppression system would also be recommended for structures located below the buildings foundations (i.e.- elevator shafts, sump pits, etc).

Due to the preliminary nature of the development, the requirement for groundwater suppression systems will be assessed once the number of proposed basement levels the future mid and high-rise buildings will be provided is known. Details pertaining to the groundwater suppression system may also be provided at that time.

Foundation Backfill

Backfill against the exterior sides of the foundation walls should consist of free-draining non frost susceptible granular materials. The greater part of the site excavated materials will be frost susceptible and, as such, are not recommended for re-use as backfill against the foundation walls, unless used in conjunction with a drainage geocomposite, such as Miradrain G100N or Delta Drain 6000, connected to the perimeter foundation drainage system. Imported granular materials, such as clean sand or OPSS Granular B Type I granular material, should otherwise be used for this purpose.

Backfill material below sidewalk or asphalt paved subgrade areas or other settlement sensitive structures should consist of free draining, non-frost susceptible material placed in maximum 300 mm thick loose lifts and compacted to at least 98% of its SPMDD under dry and above freezing conditions.

6.2 Foundation Drainage and Backfill

Perimeter foundations of heated structures are required to be insulated against the deleterious effects of frost action. A minimum of 1.5 m of soil cover is required unless placed in conjunction with adequate foundation insulation.

Exterior unheated foundations, such as those for isolated exterior piers, are more prone to deleterious movement associated with frost action than the exterior walls of the heated structure and require additional protection, such as soil cover of 2.1 m or an equivalent combination of soil cover and foundation insulation.

6.3 Excavation Side Slopes

Temporary Side Slopes

The temporary excavation side slopes anticipated should either be excavated to acceptable slopes or retained by shoring systems from the beginning of the excavation until the structures are backfilled.

The excavation side slopes above the groundwater level extending to a maximum depth of 3 m should be cut back at 1H:1V or flatter. The flatter slope is required for excavation below the groundwater level. The subsurface soil is considered to be mainly a Type 2 and 3 soil according to the Occupational Health and Safety Act and Regulations for Construction Projects. Excavated soil should not be stockpiled directly at the top of excavations and heavy equipment should maintain safe working distance from the excavation sides.

Slopes in excess of 3 m in height should be periodically inspected by the geotechnical consultant in order to detect if the slopes are exhibiting signs of distress.

Temporary Shoring

The design and approval of the temporary shoring system will be the responsibility of the shoring contractor and the shoring designer who is a licensed professional engineer and is hired by the shoring contractor. It is the responsibility of the shoring contractor to ensure that the temporary shoring system is in compliance with safety requirements, designed to avoid any damage to adjacent structures and include dewatering control measures. In the event that subsurface conditions differ from the approved design during the actual installation, it is the responsibility of the shoring contractor to commission the required experts to re-assess the design and implement the required changes.

Furthermore, the design of the temporary shoring system should take into consideration a full hydrostatic condition which can occur during significant precipitation events.

The temporary shoring system could consist of a soldier pile and lagging system or interlocking steel sheet piling. Any additional loading due to street traffic, neighboring buildings, construction equipment, adjacent structures and facilities, etc., should be included to the earth pressures described below. These systems could be cantilevered, anchored or braced. The shoring system is recommended to be adequately supported to resist toe failure, if required, by means of extending the piles into the bedrock through pre-augered holes if a soldier pile and lagging system is the preferred method.

The earth pressures acting on the temporary shoring system may be calculated with the following parameters.

Table 6 - Soil Parameters	
Parameters	Values
Active Earth Pressure Coefficient (K_a)	0.33
Passive Earth Pressure Coefficient (K_p)	3
At-Rest Earth Pressure Coefficient (K_o)	0.5
Dry Unit Weight (γ), kN/m ³	20
Effective Unit Weight (γ), kN/m ³	13

The active earth pressure should be calculated where wall movements are permissible while the at-rest pressure should be calculated if no movement is permissible. The dry unit weight should be calculated above the groundwater level while the effective unit weight should be calculated below the groundwater level.

The hydrostatic groundwater pressure should be included to the earth pressure distribution wherever the effective unit weight are calculated for earth pressures. If the groundwater level is lowered, the dry unit weight for the soil/bedrock should be calculated full weight, with no hydrostatic groundwater pressure component.

For design purposes, the minimum factor of safety of 1.5 should be calculated.

6.4 Pipe Bedding and Backfill

The pipe bedding for sewer and water pipes should consist of at least 150 mm of OPSS Granular A material. The bedding should be increased to a minimum thickness of 300 mm where bedrock is encountered at the subgrade level. The material should be placed in maximum 300 mm thick lifts and compacted to a minimum of 99% of the SPMDD. The bedding material should extend at least to the spring line of the pipe.

The cover material, which should consist of OPSS Granular A crushed stone, should extend from the spring line of the pipe to at least 300 mm above the obvert of the pipe. The material should be placed in maximum 300 mm thick lifts and compacted to a minimum of 99% of the SPMDD.

Generally, the brown silty clay should be possible to place above the cover material if the excavation and backfilling operations are completed in dry weather conditions. Wet silty clay materials will be difficult for placement, as the high water content are impractical for the desired compaction without an extensive drying period. All stones greater than 300 mm in their largest dimension should be removed prior to reuse of site-generated backfill materials.

Where hard surface areas are considered above the trench backfill, the trench backfill material within the frost zone (about 1.8 m below finished grade) should match the soils exposed at the trench walls to minimize differential frost heaving. The trench backfill should be placed in maximum 300 mm thick loose lifts and compacted to a minimum of 95% of the SPMDD.

6.5 Groundwater Control

Groundwater Control for Building Construction

The contractor should be prepared to direct water away from all bearing surfaces and subgrades, regardless of the source, to prevent disturbance to the founding medium.

Infiltration levels are anticipated to be low through the excavation face, and the groundwater infiltration is anticipated to be controllable with open sumps and pumps. A temporary Ministry of the Environment, Conservation and Parks (MECP) permit to take water (PTTW) may be required for this project if more than 400,000 L/day of ground and/or surface water is to be pumped during the construction phase. A minimum of 4 to 5 months should be allocated for completion of the PTTW application package and issuance of the permit by the MECP.

For typical ground or surface water volumes being pumped during the construction phase, typically between 50,000 to 400,000 L/day, it is required to register on the Environmental Activity and Sector Registry (EASR). A minimum of two to four weeks should be allotted for completion of the EASR registration and the Water Taking and Discharge Plan to be prepared by a Qualified Person as stipulated under O.Reg. 63/16. If a project qualifies for a PTTW based upon anticipated conditions, an EASR will not be allowed as a temporary dewatering measure while awaiting the MECP review of the PTTW application.

Long-term Groundwater Control

Our recommendations for the proposed building's long-term groundwater control are presented in Subsection 6.1. Any groundwater encountered along the building's perimeter or underfloor drainage system will be directed to the proposed building's cistern/sump pit. Provided the proposed groundwater infiltration control system is properly implemented and approved by the geotechnical consultant at the time of construction, it is expected that groundwater flow will be low (i.e. - less than 50,000 L/day) with peak periods noted after rain events. A more accurate estimate can be provided at the time of construction, once groundwater infiltration levels are observed.

Impacts on Neighboring Structures

Detailed plans of the development were not available at the time of preparation of this report, details regarding impacts on neighboring structures can be provided based on specific design details for the proposed development.

Generally, the design of the foundation with a groundwater infiltration control system in place will not impact neighboring structures based on the subsurface profiles.

6.6 Corrosion Potential and Sulphate

The results of analytical testing show that the sulphate content is less than 0.1%. This result is indicative that Type 10 Portland cement (normal cement) would be appropriate for this site. The chloride content and the pH of the sample indicate that they are not significant factors in creating a corrosive environment for exposed ferrous metals at this site, whereas the resistivity is indicative of a non aggressive to slightly aggressive corrosive environment.

6.7 Slope Stability Assessment

A steep ravine is observed running in a north-south direction across the west portion of the site. A segment of Stillwater Creek runs within the valley corridor of the ravine slopes adjacent to the subject site. The slope condition was reviewed by Paterson field personnel as part of the geotechnical investigation. Five (5) slope cross-sections were studied as the worst case scenarios, where the watercourse has meandered in close proximity of the toe of the upper slope. A 8 to 12 m high stable slope inclined generally 2H:1V with limited areas shaped to a 1H:1V profile. The watercourse was confined within the approximately 2 to 4 m wide watercourse banks and the water flow rate was noted to be low. One (1) additional slope cross-section was completed at the north portion of the property where the watercourse meanders 15 m or greater from the toe of the slope.

Generally, the overall slope face was observed to be grass covered with some mature trees, minor toe erosion was observed along the edges of the meanders at some locations. Significant in-filling was observed at the top of the slope and down the slope face. Photographs taken during our site visit to assess the slope condition can be found in Appendix 2.

Based on historical aerial images of the slope face obtained from GeoOttawa, the natural course of the creek has been altered due to fill placement within the subject site. When aerial images of the creek from 1958 and 2011, shown in Figures 2 to 4 in Appendix 2, are compared the natural course of the creek was observed to have shifted to the west and the meander shapes were altered. In-filling at the site has forced the water course to re-establish further west. The original top of slope is set back further from the apparent existing top of slope as under existing conditions what appears to be the top of slope has been infilled and does not represent the natural top of slope.

A slope stability analysis was carried out to determine the required geotechnical setback from the top of the bank based on a factor of safety of 1.5. Toe erosion and erosion access allowances were also considered in the determination of limits of hazard lands setback line and are discussed on the following pages. If limits of hazard lands need to be further reduced, erosional protection, such as rip rap or alternative means, would need to be provided and is subject to the approval of the conservation authority with jurisdiction of this watercourse.

Slope Stability Analysis

The analysis of the stability of the upper slope was carried out using SLIDE, a computer program which permits a two-dimensional slope stability analysis using several methods including the Bishop's method, which is a widely used and accepted analysis method. The program calculates a factor of safety, which represents the ratio of the forces resisting failure to those favoring failure. Theoretically, a factor of safety of 1.0 represents a condition where the slope is stable. However, due to intrinsic limitations of the calculation methods and the variability of the subsoil and groundwater conditions, a factor of safety greater than one is usually required to ascertain that the risks of failure are acceptable. A minimum factor of safety of 1.5 is generally recommended for conditions where the failure of the slope would endanger permanent structures.

Subsoil conditions at the cross-sections were inferred based on nearby boreholes. For a conservative review of the groundwater conditions, the silty clay deposit was noted to be fully saturated for our analysis and existing at the toe of the slope. The results are shown in Figures 5, 7, 9, 11, 13, and 15 in Appendix 2. The results indicate a slope with a factor of safety of 1.53 at Section A, a slope with a factor of safety of 13.98 at Section F, and slopes with factors of safety less than 1.5 beyond the top of slope at Section B, C, D, and E. Based on these results, a stable slope setback varying between 9 and 15 m from the top of the slope are required to achieve a factor of safety of 1.5 for the limit of the hazard lands in the area of Sections B, C and D. It should be noted that the failure planes with a factor of safety of less than 1.5 on Section E did not pass the top of slope, therefore a stable slope setback from the top of slope was not needed.

It should be noted that development and/or raising the grade above the existing grade within the limit of hazard lands is not acceptable from a geotechnical perspective, therefore development at the site outside of the limit of hazard lands will not impact the overall slope stability. However, Paterson must review final grading plans for the site from a geotechnical perspective when available.

Seismic Loading Analysis

An analysis considering seismic loading and the groundwater at ground surface was also completed. A horizontal acceleration of 0.16g was considered for all slopes. A factor of safety of 1.1 is considered to be satisfactory for stability analyses including seismic loading.

The results of the analyses including seismic loading are shown in Figures 6, 8, 10, 12, 14, and 16 in Appendix 2. The results indicate a slope with a factor of safety of

1.36 at Section A, 1.30 at Section D, 2.74 at Section F, and slopes with factors of safety less than 1.1 beyond the top of slope at Sections B, C, and E. Based on these results, a stable slope setback varying between 1 and 5 m from the top of the slope is required to achieve a factor of safety of 1.1 for the limit of the hazard lands.

It should be noted that the failure planes with a factor of safety of less than 1.1 on Section E did not pass the top of slope, therefore a stable slope setback from the top of slope was not needed. However, it should be further noted that the stable slope setback associated with our seismic loading analysis is superceded by the required stable slope setback required for static conditions.

Erosion and Access Allowances

Based on the soil profiles encountered at the borehole locations, silty sand fill, firm to very stiff silty clay and/or glacial till are anticipated to be subject to erosion activity by the watercourse within the valley corridor. Based on the anticipated soils, a toe erosion allowance of 5 m should be applied from the watercourse edge and an access allowance of 6 m is required from the top of slope or geotechnical setback (where applicable). In areas where the watercourse edge has meandered to within 15 m of the toe of the existing slope, the toe erosion and access allowances should be applied in addition to geotechnical setback limit from the top of slope. For areas where the watercourse has meandered 15 m away or greater from the toe of the slope, such as at Section E, the toe erosion allowance can be applied to the edge of the watercourse and does not have to be applied to the top of slope.

The existing vegetation on the slope faces should not be removed as it contributes to the stability of the slope and reduces erosion.

7.0 Recommendations

It is recommended that the following be carried out once the master plan and site development are determined:

- Supplemental investigation to be provided once final development design has been established.
- Observation of all bearing surfaces prior to the placement of concrete.
- Sampling and testing of the concrete and fill materials used.
- Periodic observation of the condition of unsupported excavation side slopes in excess of 3 m in height, if applicable.
- Periodic observation of the condition of the vertical bedrock face during excavation.
- Observation of all subgrades prior to backfilling.
- Field density tests to determine the level of compaction achieved.
- Sampling and testing of the bituminous concrete including mix design reviews.

A report confirming that these works have been conducted in general accordance with our recommendations could be issued upon request, following the completion of a satisfactory material testing and observation program by the geotechnical consultant.

All excess soils, with the exception of engineered crushed stone fill, generated by construction activities that will be transported on-site or off-site should be handled as per *Ontario Regulation 406/19: On-Site and Excess Soil Management*.

8.0 Statement of Limitations

The recommendations made in this report are in accordance with our present understanding of the project. Our recommendations should be reviewed when the drawings and specifications are complete.

A geotechnical investigation is a limited sampling of a site. Should any conditions at the site be encountered which differ from those at the test hole locations, we request immediate notification in order to reassess our recommendations.

The recommendations provided should only be used by the design professionals associated with this project. The recommendations are not intended for contractors bidding on or constructing the project. The contractor should evaluate the factual information provided in the report. The contractor should also determine the suitability and completeness for the intended construction schedule and methods. Additional testing may be required for the contractors' purpose.

The present report applies only to the project described in this document. Use of this report for purposes other than those described herein or by person(s) other than The Properties Group or their agent(s) is not authorized without review by this firm for the applicability of our recommendations to the altered use of the report.

Paterson Group Inc.



Nicole R.L. Patey, B.Eng.



David J. Gilbert, P.Eng.

Report Distribution:

- The Properties Group (e-mail copy)
- Paterson Group (1 copy)

APPENDIX 1

SOIL PROFILE AND TEST DATA SHEETS

SYMBOLS AND TERMS

ANALYTICAL TESTING RESULTS

DATUM Geodetic

REMARKS

BORINGS BY CME 55 Power Auger

DATE March 18, 2021

FILE NO. **PG5715**

HOLE NO. **BH 1-21**

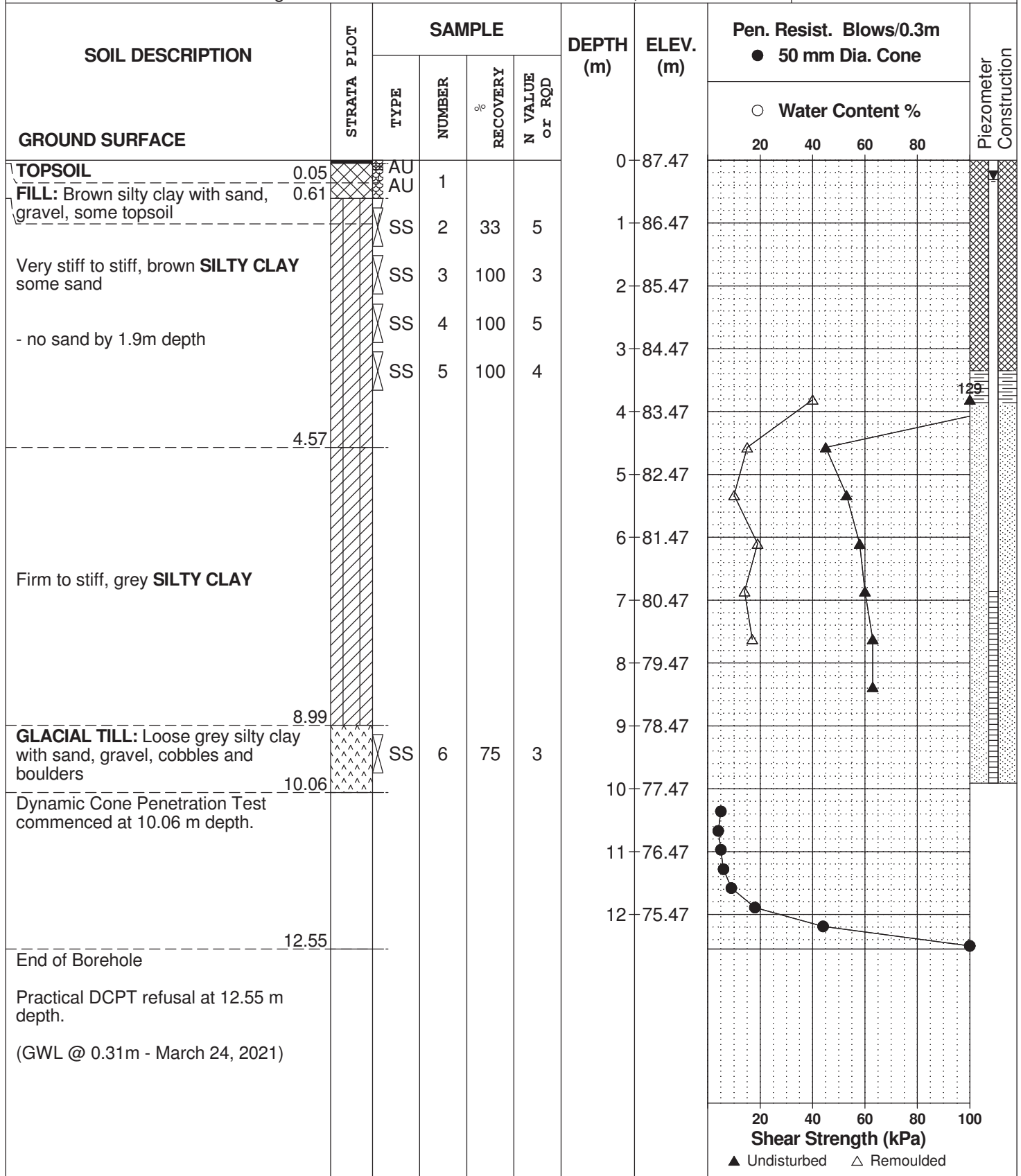

DATUM Geodetic

FILE NO. **PG5715**

REMARKS

HOLE NO. **BH 2-21**

BORINGS BY CME 55 Power Auger

DATE March 17, 2021

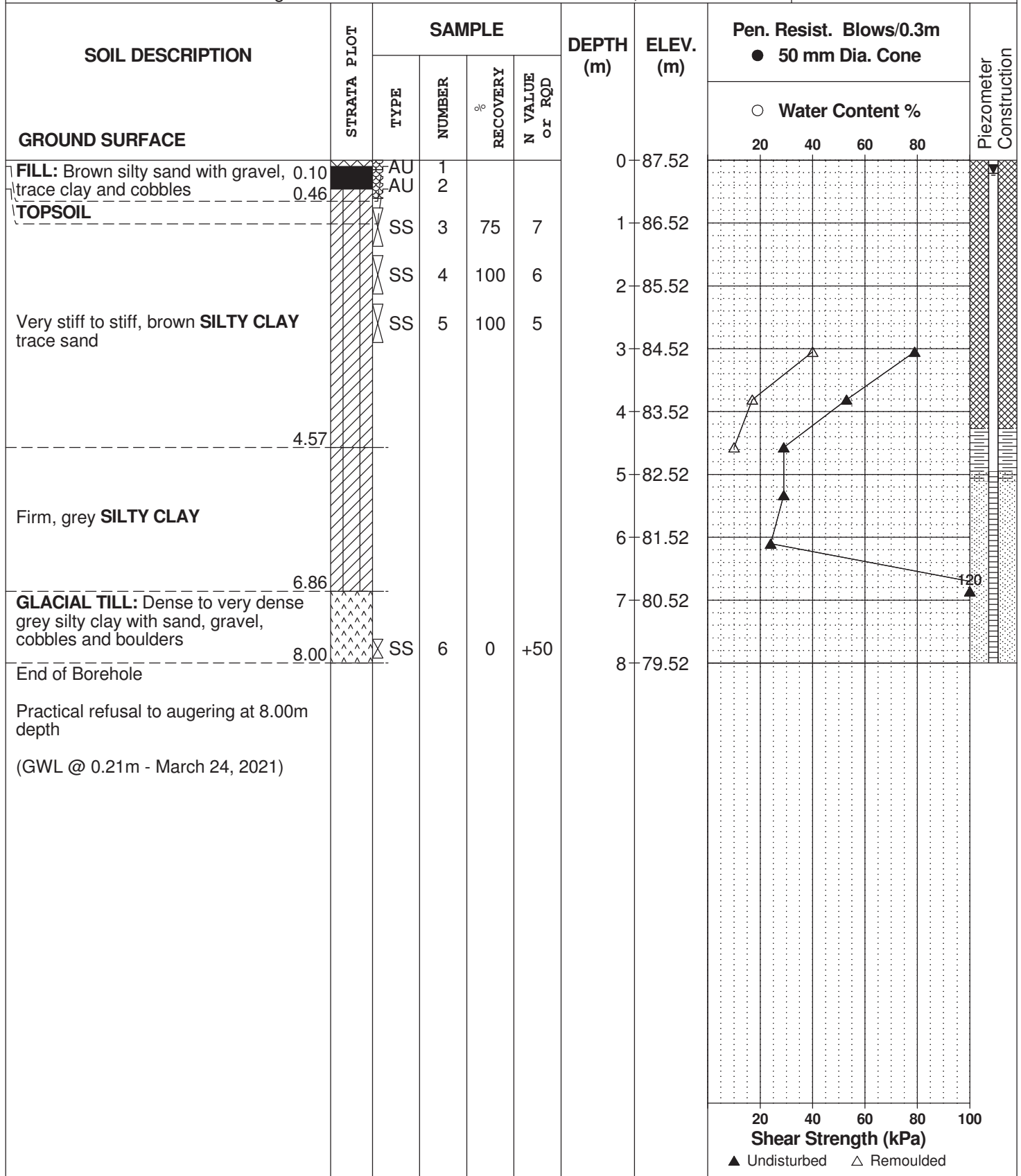

DATUM Geodetic

FILE NO. **PG5715**

REMARKS

HOLE NO. **BH 3-21**

BORINGS BY CME 55 Power Auger

DATE March 17, 2021

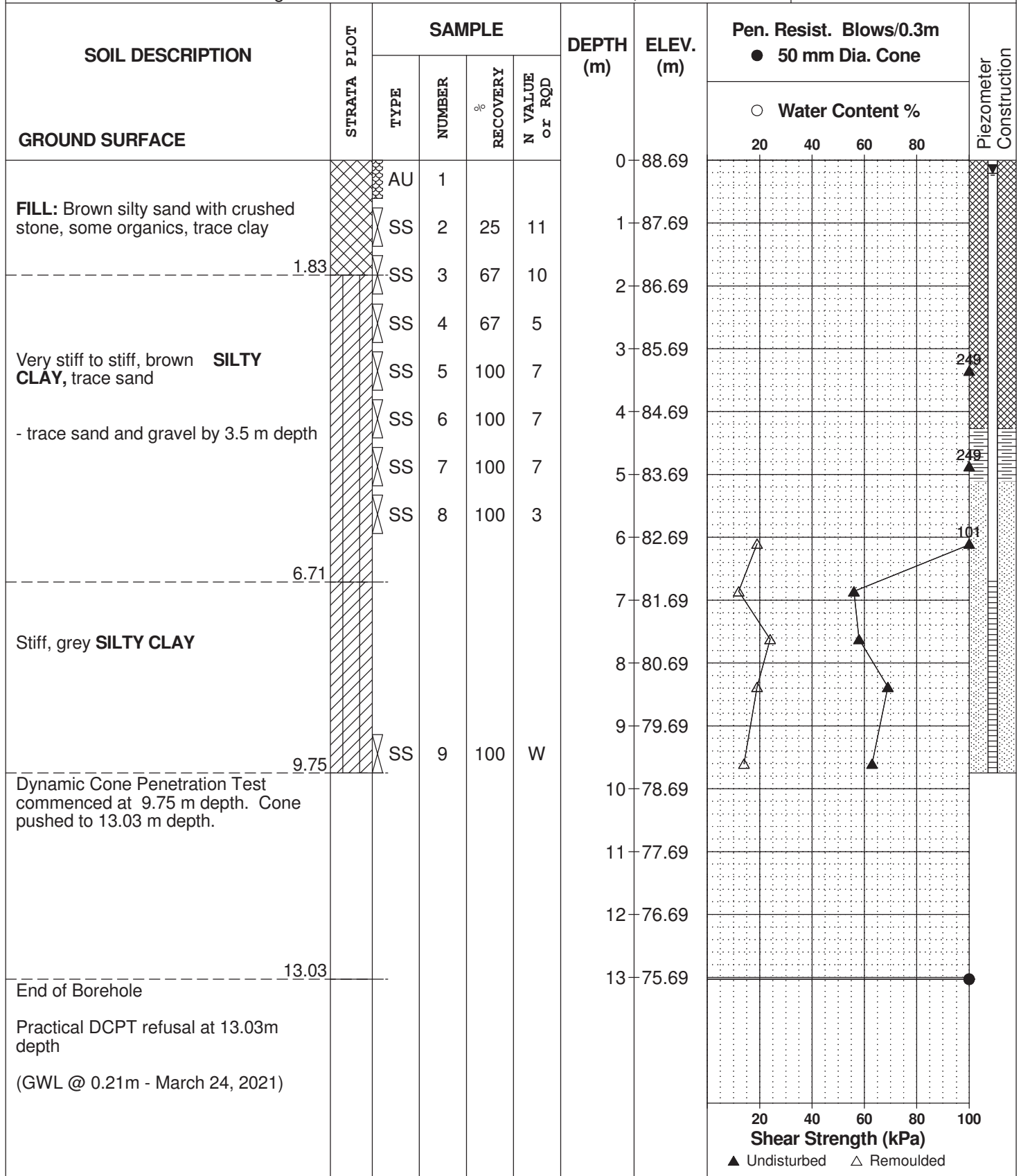

SOIL PROFILE AND TEST DATA

Preliminary Geotechnical Investigation
 Prop. Mixed-Use Development - 1987 Robertson Rd.
 Ottawa, Ontario

DATUM Geodetic

REMARKS

BORINGS BY CME 55 Power Auger

DATE March 16, 2021

FILE NO. **PG5715**

HOLE NO. **BH 4-21**

SOIL DESCRIPTION	STRATA PLOT	SAMPLE				DEPTH (m)	ELEV. (m)	Pen. Resist. Blows/0.3m ● 50 mm Dia. Cone				Monitoring Well Construction	
		TYPE	NUMBER	RECOVERY %	N VALUE or RQD			○ Water Content %					
								20	40	60	80		
GROUND SURFACE													
FILL: Crushed stone with brown silty sand	0.15 0.61	AU	1			0	88.85						
FILL: Brown silty clay some sand trace gravel		AU	2										
GLACIAL TILL: Dense to very dense grey silty clay with sand, gravel, cobbles and boulders	1.93	SS	3	42	7	1	87.85						
		SS	4	100	+50	2	86.85						
		RC	1	100	100								
		RC	2	100	100	3	85.85						
		RC	3	100	88	4	84.85						
BEDROCK Good to excellent quality, grey quartz sandstone		RC	4	100	71	5	83.85						
		RC	5	100	90	6	82.85						
		RC	6	100	95	7	81.85						
		RC	6	100	95	8	80.85						
		RC	6	100	95	9	79.85						
End of Borehole	9.93												
(GWL @ 1.37m - March 24, 2021)													

20 40 60 80 100
Shear Strength (kPa)
 ▲ Undisturbed △ Remoulded

SOIL PROFILE AND TEST DATA

Preliminary Geotechnical Investigation
 Prop. Mixed-Use Development - 1987 Robertson Rd.
 Ottawa, Ontario

DATUM Geodetic

REMARKS

BORINGS BY CME 55 Power Auger

DATE March 18, 2021

FILE NO. **PG5715**

HOLE NO. **BH 6-21**

SOIL DESCRIPTION	STRATA PLOT	SAMPLE				DEPTH (m)	ELEV. (m)	Pen. Resist. Blows/0.3m ● 50 mm Dia. Cone				Monitoring Well Construction
		TYPE	NUMBER	RECOVERY %	N VALUE or RQD			○ Water Content %				
								20	40	60	80	
GROUND SURFACE						0	89.04					
FILL: Brown silty sand with crushed stone, some clay, trace organics	0.43	AU	1									
GLACIAL TILL: Dense to very dense, brown silty sand with gravel, cobbles and boulders	0.99	SS	2	50	+50	1	88.04					
		RC	1	100	80	2	87.04					
		RC	2	90	65	3	86.04					
		RC	3	98	87	5	84.04					
		RC	4	100	80	6	83.04					
		RC	5	100	78	8	81.04					
		RC	6	100	92	9	80.04					
BEDROCK: Good to excellent quality, grey quartz sandstone						10	79.04					
End of Borehole	10.13											
(GWL @ 1.28m - March 24, 2021)												

20 40 60 80 100
Shear Strength (kPa)
 ▲ Undisturbed △ Remoulded

DATUM Geodetic

FILE NO. **PG5715**

REMARKS

HOLE NO. **BH 7-21**

BORINGS BY CME 55 Power Auger

DATE March 16, 2021

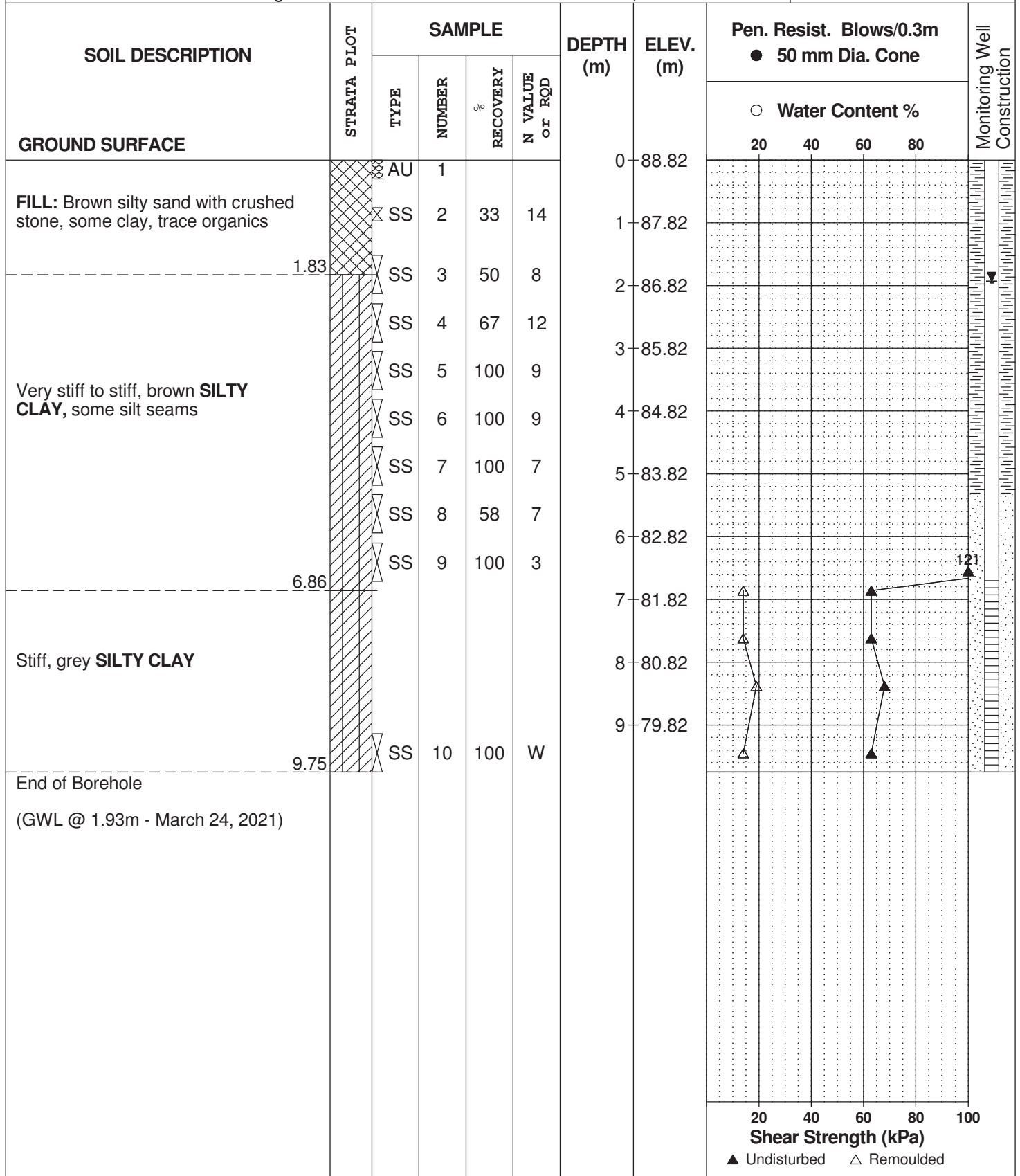

SOIL PROFILE & TEST DATA

Preliminary Geotechnical Investigation
Proposed Development, Bellwood Trailer Park
Ottawa, Ontario

DATUM Approximate geodetic

FILE NO. **PG1593**

REMARKS

HOLE NO. **BH 8**

BORINGS BY CME 55 Power Auger

DATE 21 DEC 07

SOIL DESCRIPTION	STRATA PLOT	SAMPLE				DEPTH (m)	ELEV. (m)	Pen. Resist. Blows/0.3m ● 50 mm Dia. Cone				Piezometer Construction
		TYPE	NUMBER	% RECOVERY	N VALUE or RQD			○ Water Content %				
								20	40	60	80	
GROUND SURFACE						0	86.80					
TOPSOIL												
GLACIAL TILL: Brown silty sand with gravel and cobbles	RC	AU	1									
End of Borehole												
Practical refusal to augering @ 0.69m depth												
(BH dry upon completion)												

20 40 60 80 100
Shear Strength (kPa)
▲ Undisturbed △ Remoulded

SOIL PROFILE & TEST DATA

Preliminary Geotechnical Investigation
Proposed Development, Bellwood Trailer Park
Ottawa, Ontario

DATUM Approximate geodetic

FILE NO. **PG1593**

REMARKS

HOLE NO. **BH 9**

BORINGS BY CME 55 Power Auger

DATE 21 DEC 07

SOIL DESCRIPTION	STRATA PLOT	SAMPLE				DEPTH (m)	ELEV. (m)	Pen. Resist. Blows/0.3m ● 50 mm Dia. Cone				Piezometer Construction
		TYPE	NUMBER	% RECOVERY	N VALUE or RQD			○ Water Content %				
								20	40	60	80	
GROUND SURFACE						0	87.83					
TOPSOIL	0.10											
GLACIAL TILL: Brown silty clay with sand, gravel and cobbles		AU	1			1	86.83					
		SS	2	100	15	2	85.83					
		SS	3	0	50+	3	84.83					
End of Borehole	3.10											
Practical refusal to augering @ 3.10m depth (GWL @ 2.89m-Jan. 2/08)												

20 40 60 80 100

Shear Strength (kPa)

▲ Undisturbed △ Remoulded

SYMBOLS AND TERMS

SOIL DESCRIPTION

Behavioural properties, such as structure and strength, take precedence over particle gradation in describing soils. Terminology describing soil structure are as follows:

Desiccated	-	having visible signs of weathering by oxidation of clay minerals, shrinkage cracks, etc.
Fissured	-	having cracks, and hence a blocky structure.
Varved	-	composed of regular alternating layers of silt and clay.
Stratified	-	composed of alternating layers of different soil types, e.g. silt and sand or silt and clay.
Well-Graded	-	Having wide range in grain sizes and substantial amounts of all intermediate particle sizes (see Grain Size Distribution).
Uniformly-Graded	-	Predominantly of one grain size (see Grain Size Distribution).

The standard terminology to describe the strength of cohesionless soils is the relative density, usually inferred from the results of the Standard Penetration Test (SPT) 'N' value. The SPT N value is the number of blows of a 63.5 kg hammer, falling 760 mm, required to drive a 51 mm O.D. split spoon sampler 300 mm into the soil after an initial penetration of 150 mm.

Relative Density	'N' Value	Relative Density %
Very Loose	<4	<15
Loose	4-10	15-35
Compact	10-30	35-65
Dense	30-50	65-85
Very Dense	>50	>85

The standard terminology to describe the strength of cohesive soils is the consistency, which is based on the undisturbed undrained shear strength as measured by the in situ or laboratory vane tests, penetrometer tests, unconfined compression tests, or occasionally by Standard Penetration Tests.

Consistency	Undrained Shear Strength (kPa)	'N' Value
Very Soft	<12	<2
Soft	12-25	2-4
Firm	25-50	4-8
Stiff	50-100	8-15
Very Stiff	100-200	15-30
Hard	>200	>30

SYMBOLS AND TERMS (continued)

SOIL DESCRIPTION (continued)

Cohesive soils can also be classified according to their "sensitivity". The sensitivity is the ratio between the undisturbed undrained shear strength and the remoulded undrained shear strength of the soil.

Terminology used for describing soil strata based upon texture, or the proportion of individual particle sizes present is provided on the Textural Soil Classification Chart at the end of this information package.

ROCK DESCRIPTION

The structural description of the bedrock mass is based on the Rock Quality Designation (RQD).

The RQD classification is based on a modified core recovery percentage in which all pieces of sound core over 100 mm long are counted as recovery. The smaller pieces are considered to be a result of closely-spaced discontinuities (resulting from shearing, jointing, faulting, or weathering) in the rock mass and are not counted. RQD is ideally determined from NXL size core. However, it can be used on smaller core sizes, such as BX, if the bulk of the fractures caused by drilling stresses (called "mechanical breaks") are easily distinguishable from the normal in situ fractures.

RQD %	ROCK QUALITY
90-100	Excellent, intact, very sound
75-90	Good, massive, moderately jointed or sound
50-75	Fair, blocky and seamy, fractured
25-50	Poor, shattered and very seamy or blocky, severely fractured
0-25	Very poor, crushed, very severely fractured

SAMPLE TYPES

SS	-	Split spoon sample (obtained in conjunction with the performing of the Standard Penetration Test (SPT))
TW	-	Thin wall tube or Shelby tube
PS	-	Piston sample
AU	-	Auger sample or bulk sample
WS	-	Wash sample
RC	-	Rock core sample (Core bit size AXT, BXL, etc.). Rock core samples are obtained with the use of standard diamond drilling bits.

SYMBOLS AND TERMS (continued)

GRAIN SIZE DISTRIBUTION

MC%	-	Natural moisture content or water content of sample, %
LL	-	Liquid Limit, % (water content above which soil behaves as a liquid)
PL	-	Plastic limit, % (water content above which soil behaves plastically)
PI	-	Plasticity index, % (difference between LL and PL)
Dxx	-	Grain size which xx% of the soil, by weight, is of finer grain sizes These grain size descriptions are not used below 0.075 mm grain size
D10	-	Grain size at which 10% of the soil is finer (effective grain size)
D60	-	Grain size at which 60% of the soil is finer
Cc	-	Concavity coefficient = $(D_{30})^2 / (D_{10} \times D_{60})$
Cu	-	Uniformity coefficient = D_{60} / D_{10}

Cc and Cu are used to assess the grading of sands and gravels:

Well-graded gravels have: $1 < Cc < 3$ and $Cu > 4$

Well-graded sands have: $1 < Cc < 3$ and $Cu > 6$

Sands and gravels not meeting the above requirements are poorly-graded or uniformly-graded.

Cc and Cu are not applicable for the description of soils with more than 10% silt and clay (more than 10% finer than 0.075 mm or the #200 sieve)

CONSOLIDATION TEST

p'_o	-	Present effective overburden pressure at sample depth
p'_c	-	Preconsolidation pressure of (maximum past pressure on) sample
Ccr	-	Recompression index (in effect at pressures below p'_c)
Cc	-	Compression index (in effect at pressures above p'_c)
OC Ratio		Overconsolidation ratio = p'_c / p'_o
Void Ratio		Initial sample void ratio = volume of voids / volume of solids
Wo	-	Initial water content (at start of consolidation test)

PERMEABILITY TEST

k	-	Coefficient of permeability or hydraulic conductivity is a measure of the ability of water to flow through the sample. The value of k is measured at a specified unit weight for (remoulded) cohesionless soil samples, because its value will vary with the unit weight or density of the sample during the test.
---	---	--

SYMBOLS AND TERMS (continued)

STRATA PLOT



Topsoil



Asphalt

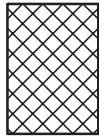

Fill



Peat

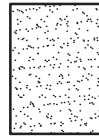

Sand

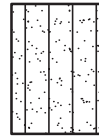

Silty Sand

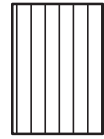

Silt

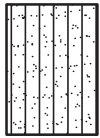

Sandy Silt

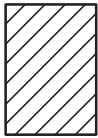

Clay

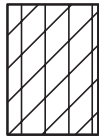

Silty Clay



Clayey Silty Sand



Glacial Till

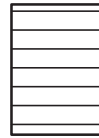

Shale

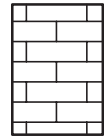

Bedrock

MONITORING WELL AND PIEZOMETER CONSTRUCTION

MONITORING WELL CONSTRUCTION

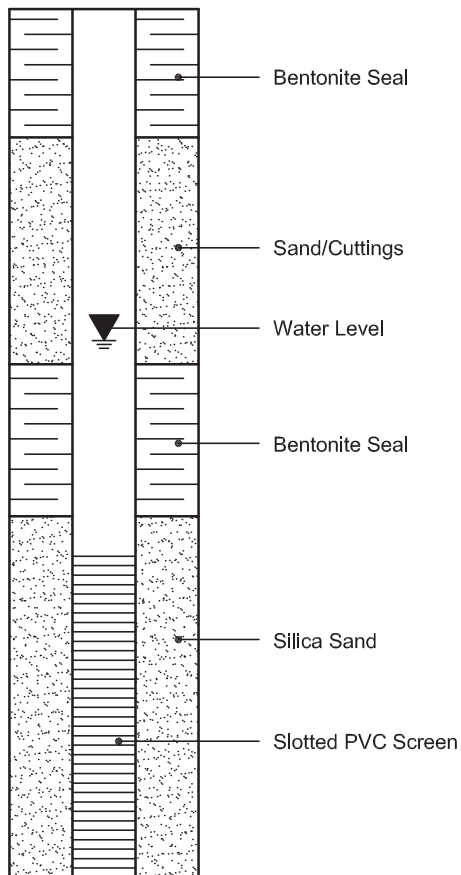

PIEZOMETER CONSTRUCTION

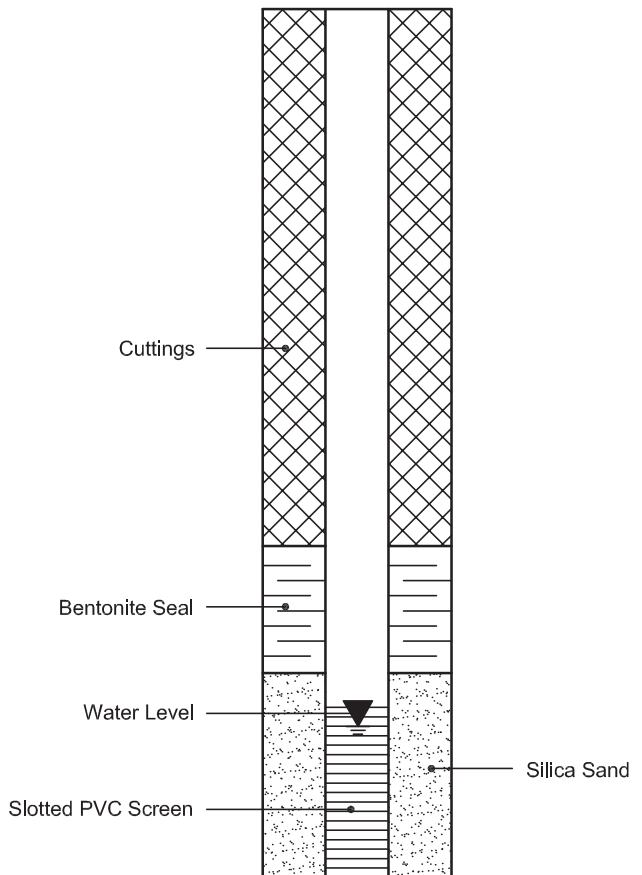

Certificate of Analysis

Report Date: 24-Mar-2021

Client: Paterson Group Consulting Engineers

Order Date: 18-Mar-2021

Client PO: 29744

Project Description: PG5715

Client ID:	BH3-21 SS4	-	-	-
Sample Date:	17-Mar-21 09:00	-	-	-
Sample ID:	2112531-01	-	-	-
MDL/Units	Soil	-	-	-

Physical Characteristics

% Solids	0.1 % by Wt.	72.9	-	-	-
----------	--------------	------	---	---	---

General Inorganics

pH	0.05 pH Units	7.42	-	-	-
Resistivity	0.10 Ohm.m	43.7	-	-	-

Anions

Chloride	5 ug/g dry	61	-	-	-
Sulphate	5 ug/g dry	22	-	-	-

APPENDIX 2

FIGURE 1 - KEY PLAN

FIGURES 2 TO 4 - AERIAL IMAGES

PHOTOS 1 TO 4 - PHOTOGRAPHS FROM SITE VISIT

FIGURES 5 TO 16 - SLOPE STABILITY ANALYSIS SECTIONS

DRAWING PG5715-1 - TEST HOLE LOCATION PLAN



FIGURE 2

1958 AERIAL IMAGE

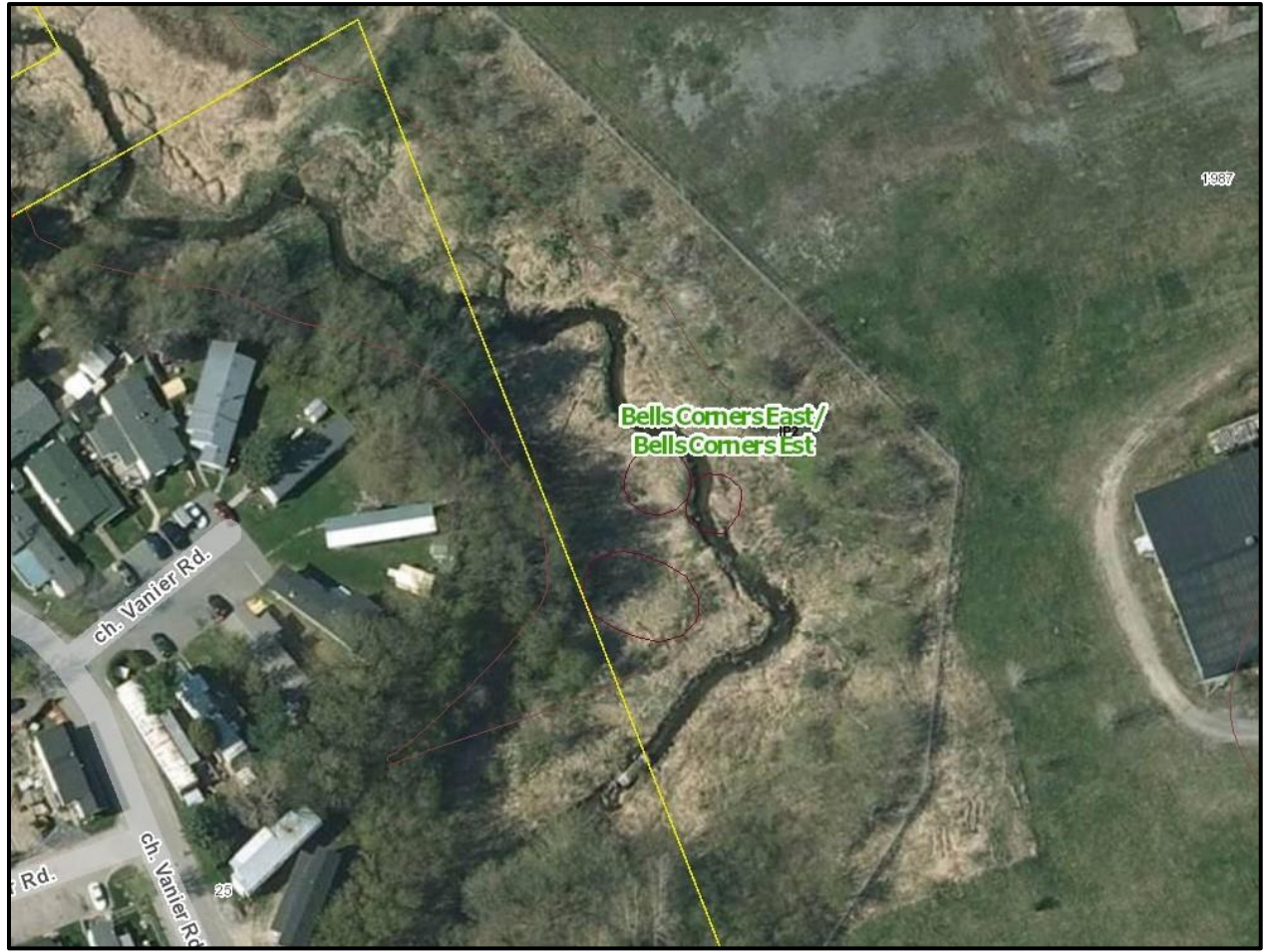

FIGURE 3

2011 AERIAL IMAGE



FIGURE 4

OVERLAY OF 1958 & 2011 AERIAL IMAGES

Photographs from Site Visit – March 31, 2021

Photo 1: Photograph of Stillwater Creek and toe of slope taken at the west portion of the site towards the north illustrating grass covered side slopes, no toe erosion was observed.



Photo 2: Photograph of Stillwater Creek and toe of slope taken at the west portion of the site towards the north illustrating grass covered side slopes, minor toe erosion was observed.



Photographs from Site Visit – March 31, 2021

Photo 3: Photograph from the creek looking east towards the top of slope illustrating fill on the slope.



Photo 4: Photograph from the top of slope looking west towards the creek illustrating fill on the slope.



Figure 5 - Section A - Static Conditions

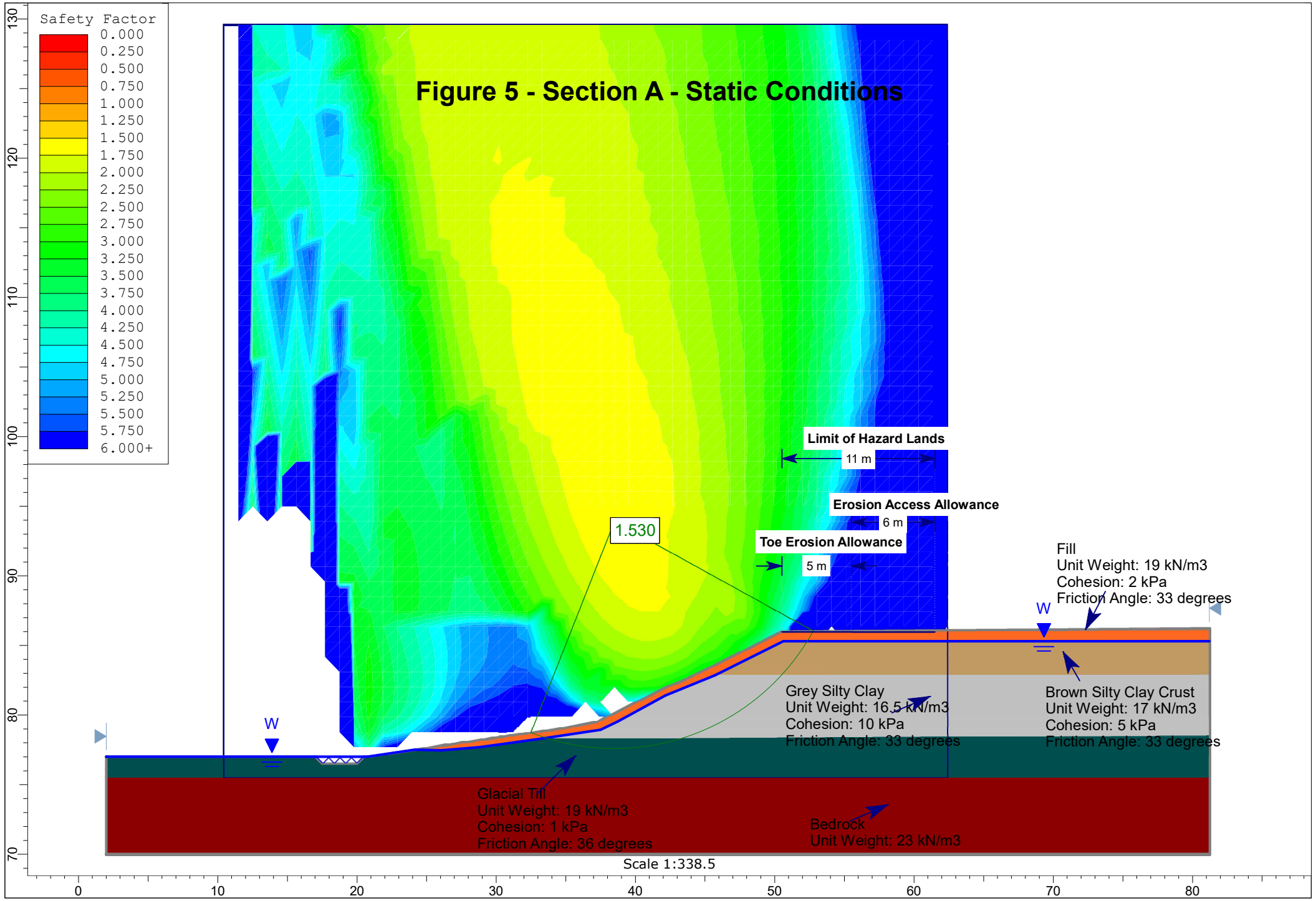
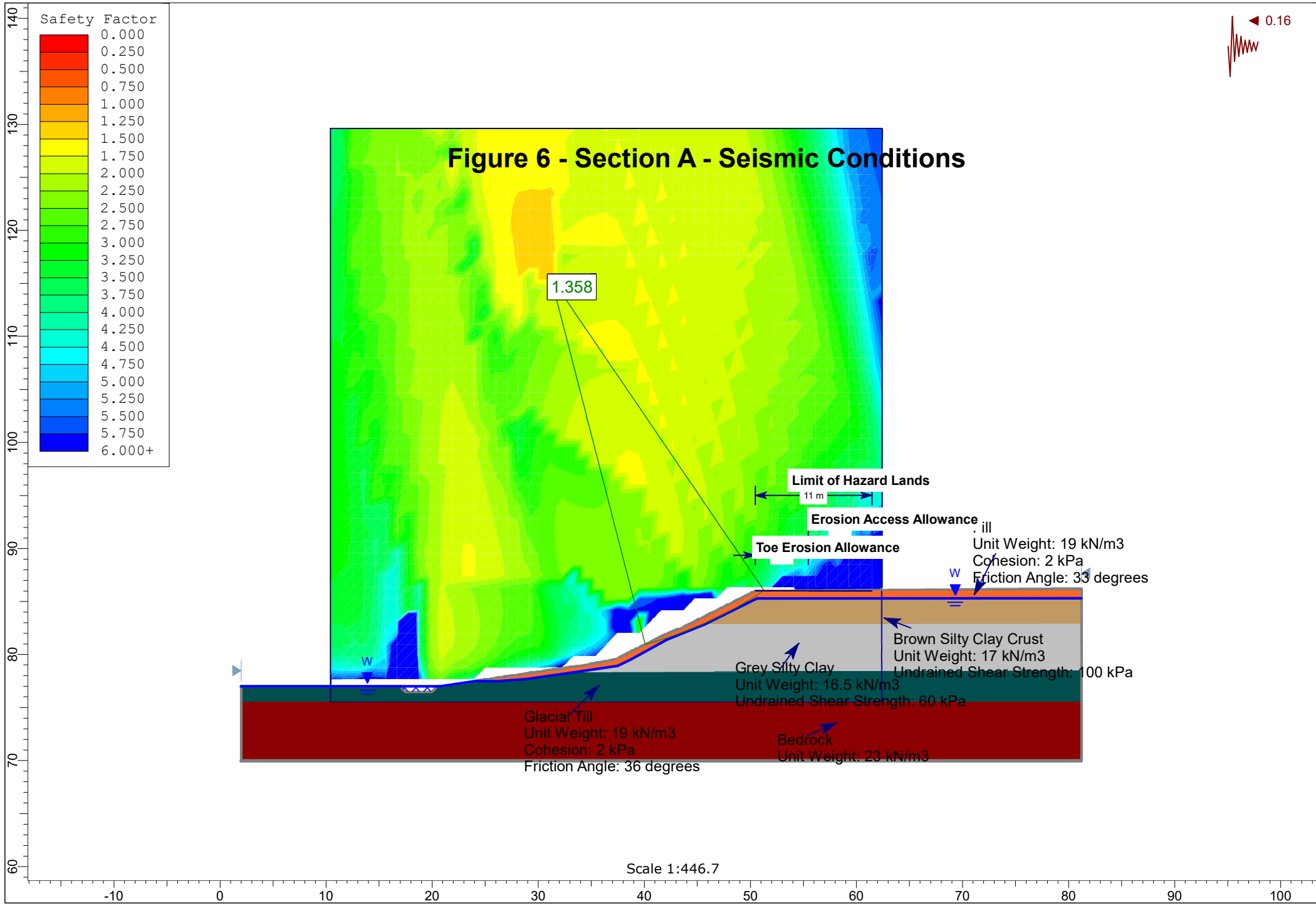
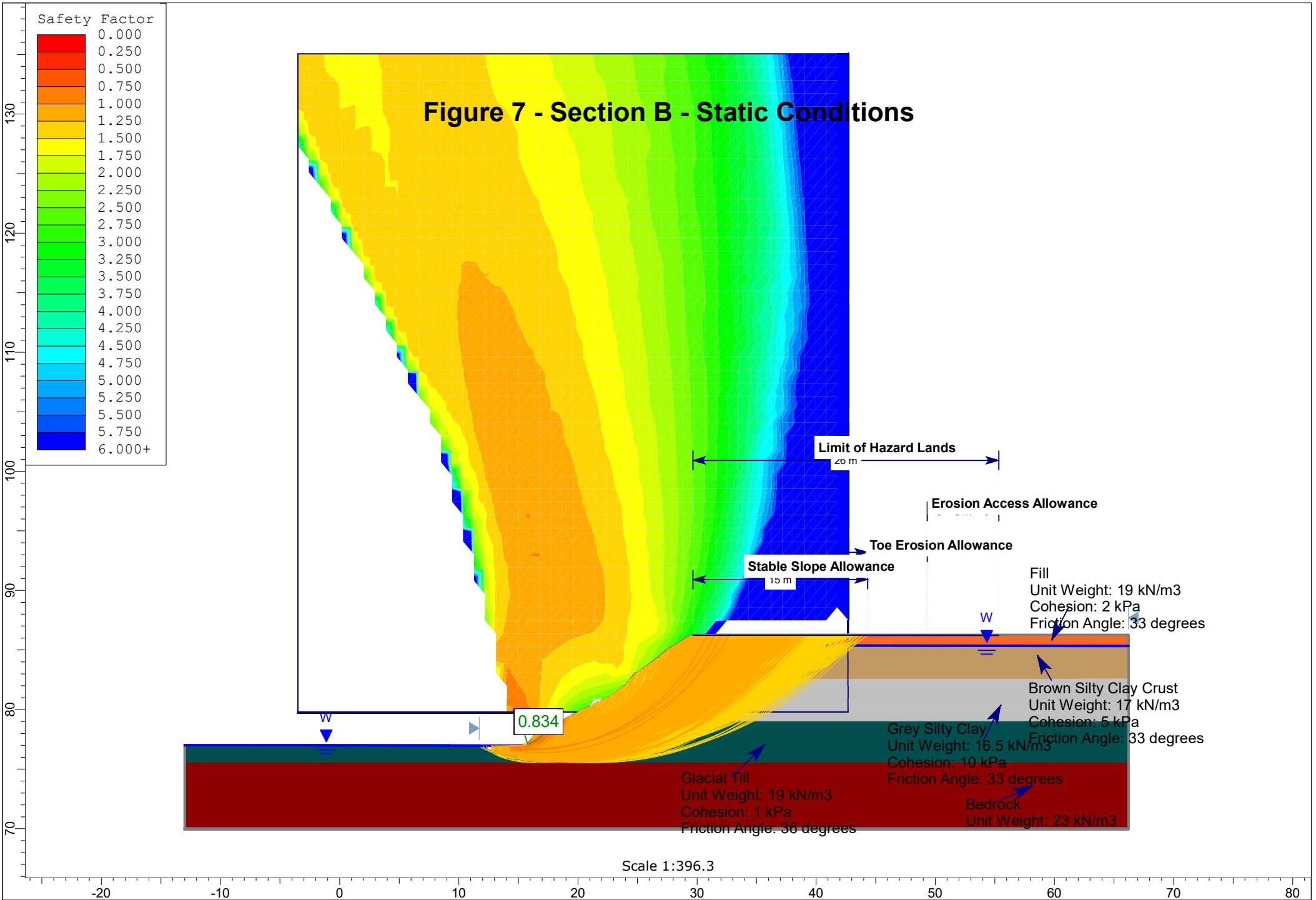
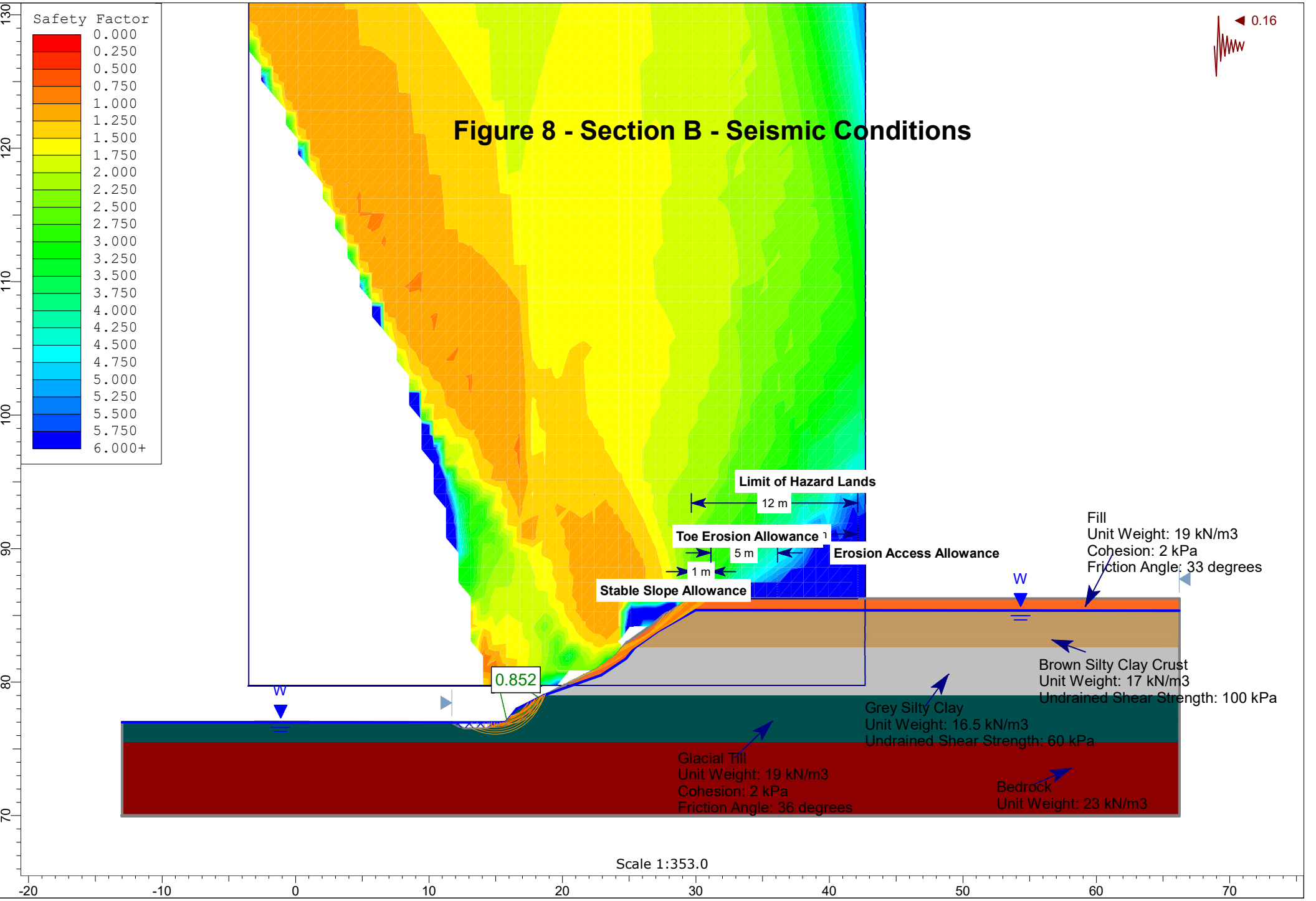
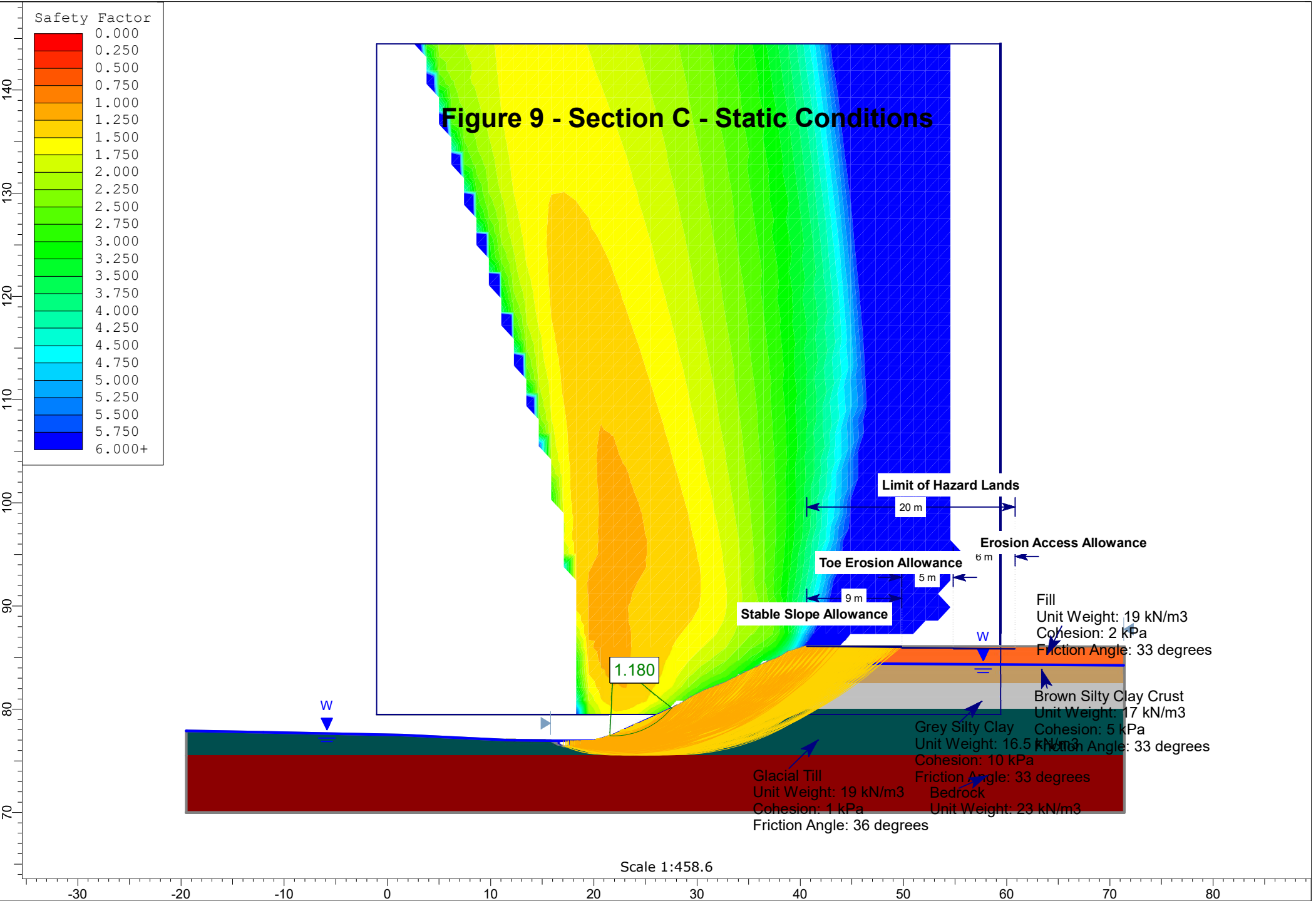

Figure 6 - Section A - Seismic Conditions









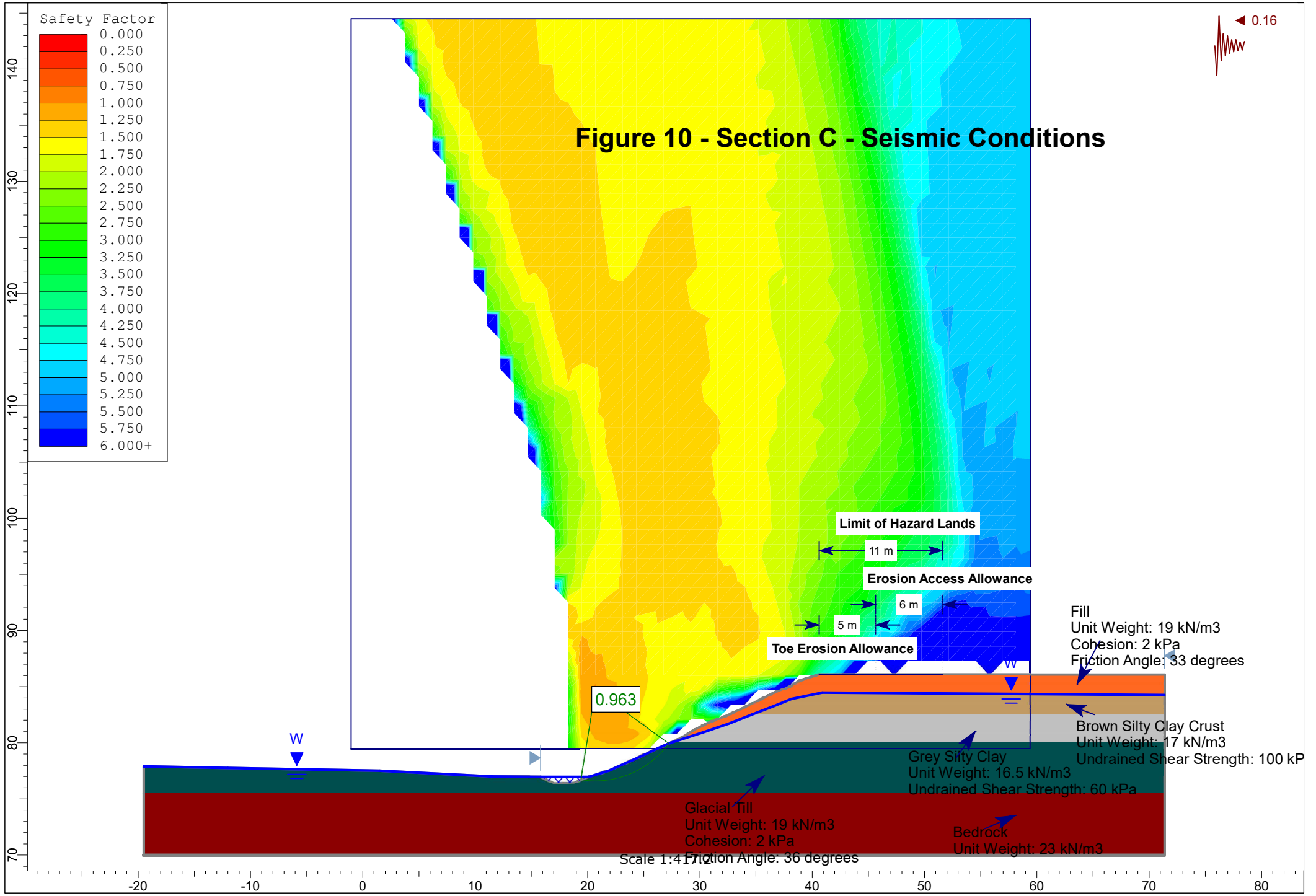

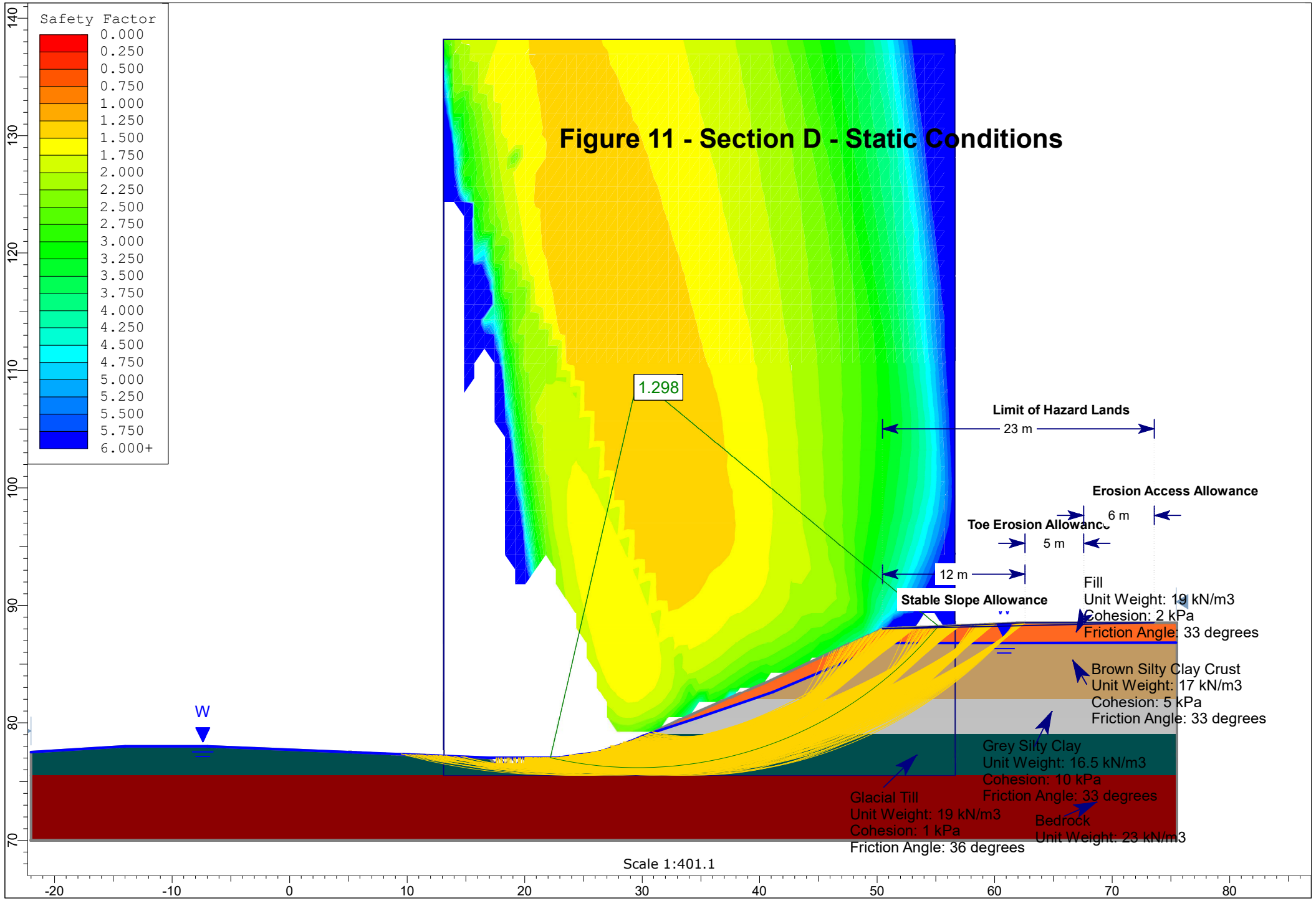
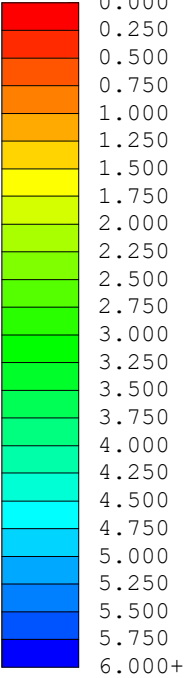

Figure 11 - Section D - Static Conditions

Safety Factor



1.298

Limit of Hazard Lands

23 m

Erosion Access Allowance

6 m

Toe Erosion Allowance

5 m

12 m

Stable Slope Allowance

Fill

Unit Weight: 19 kN/m³

Cohesion: 2 kPa

Friction Angle: 33 degrees

Brown Silty Clay Crust

Unit Weight: 17 kN/m³

Cohesion: 5 kPa

Friction Angle: 33 degrees

Grey Silty Clay

Unit Weight: 16.5 kN/m³

Cohesion: 10 kPa

Friction Angle: 33 degrees

Glacial Till

Unit Weight: 19 kN/m³

Cohesion: 1 kPa

Friction Angle: 36 degrees

Bedrock

Unit Weight: 23 kN/m³

Scale 1:401.1

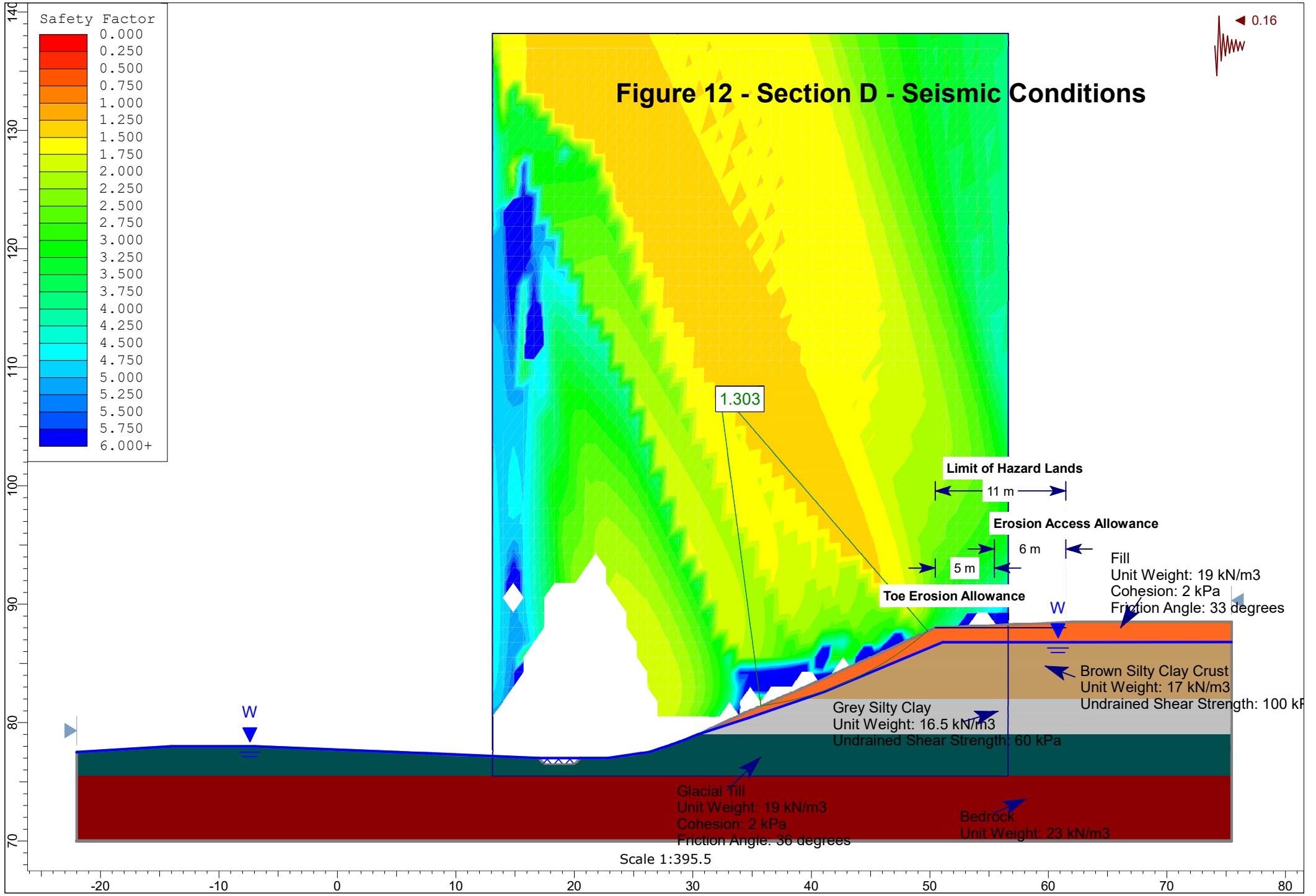

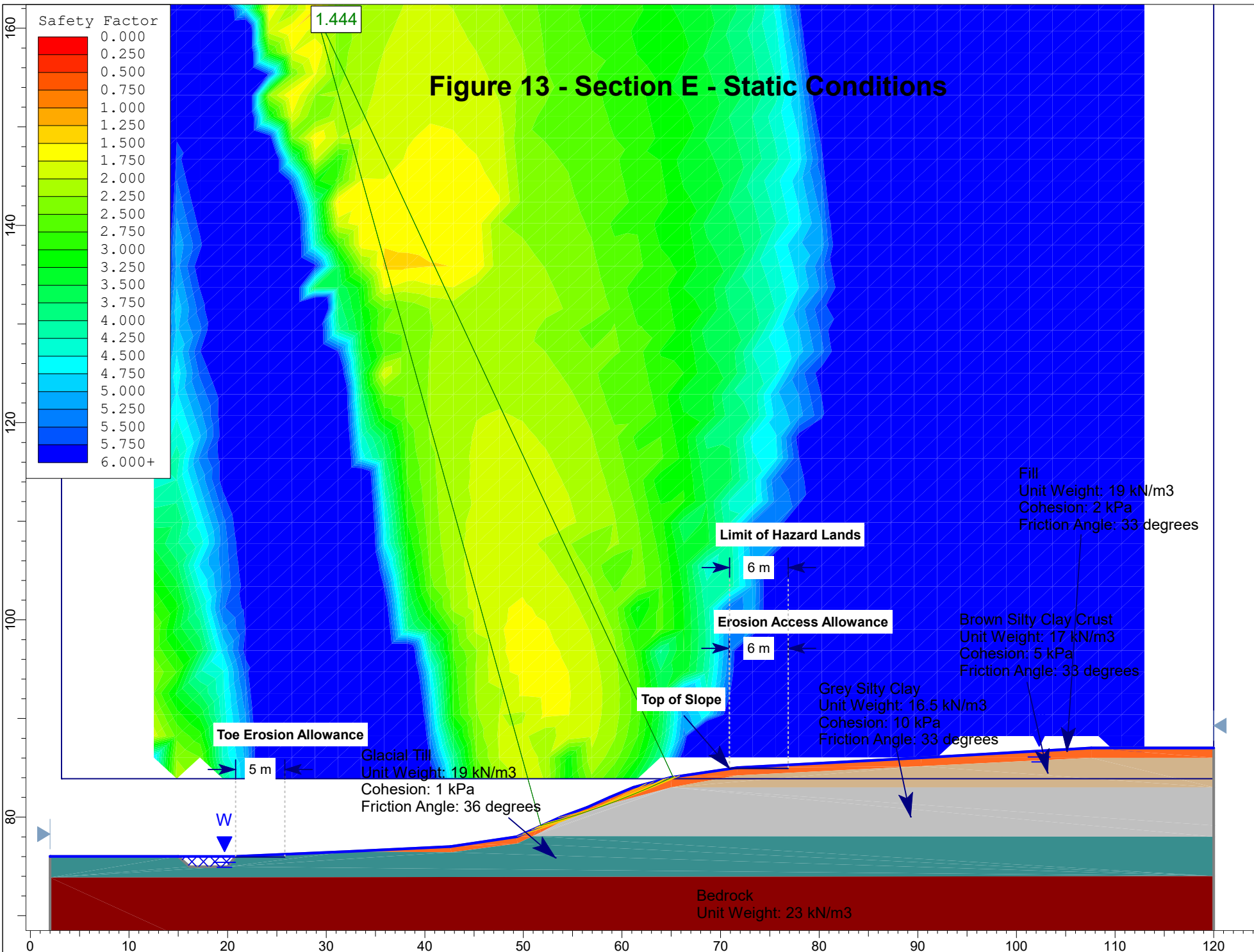

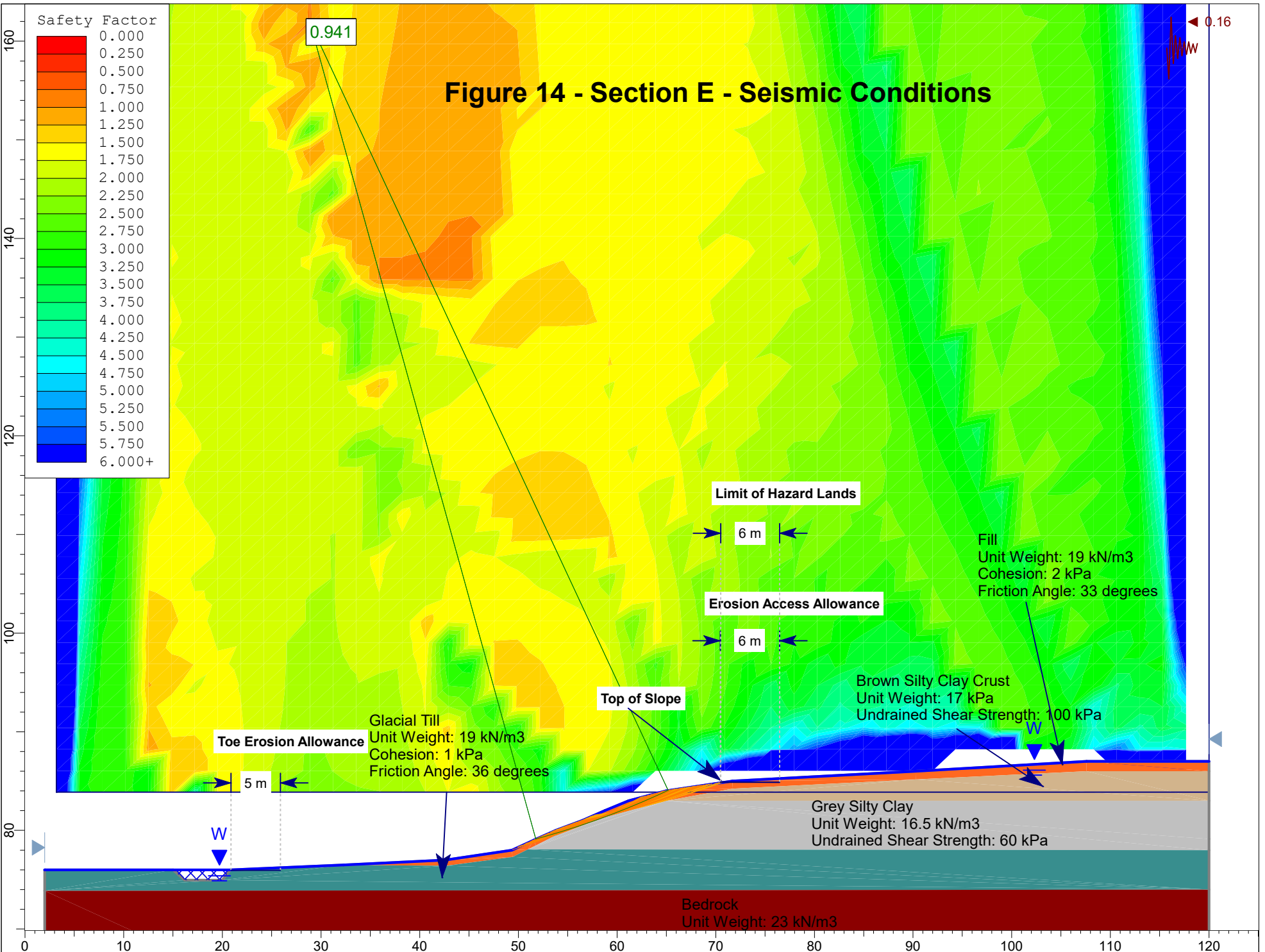

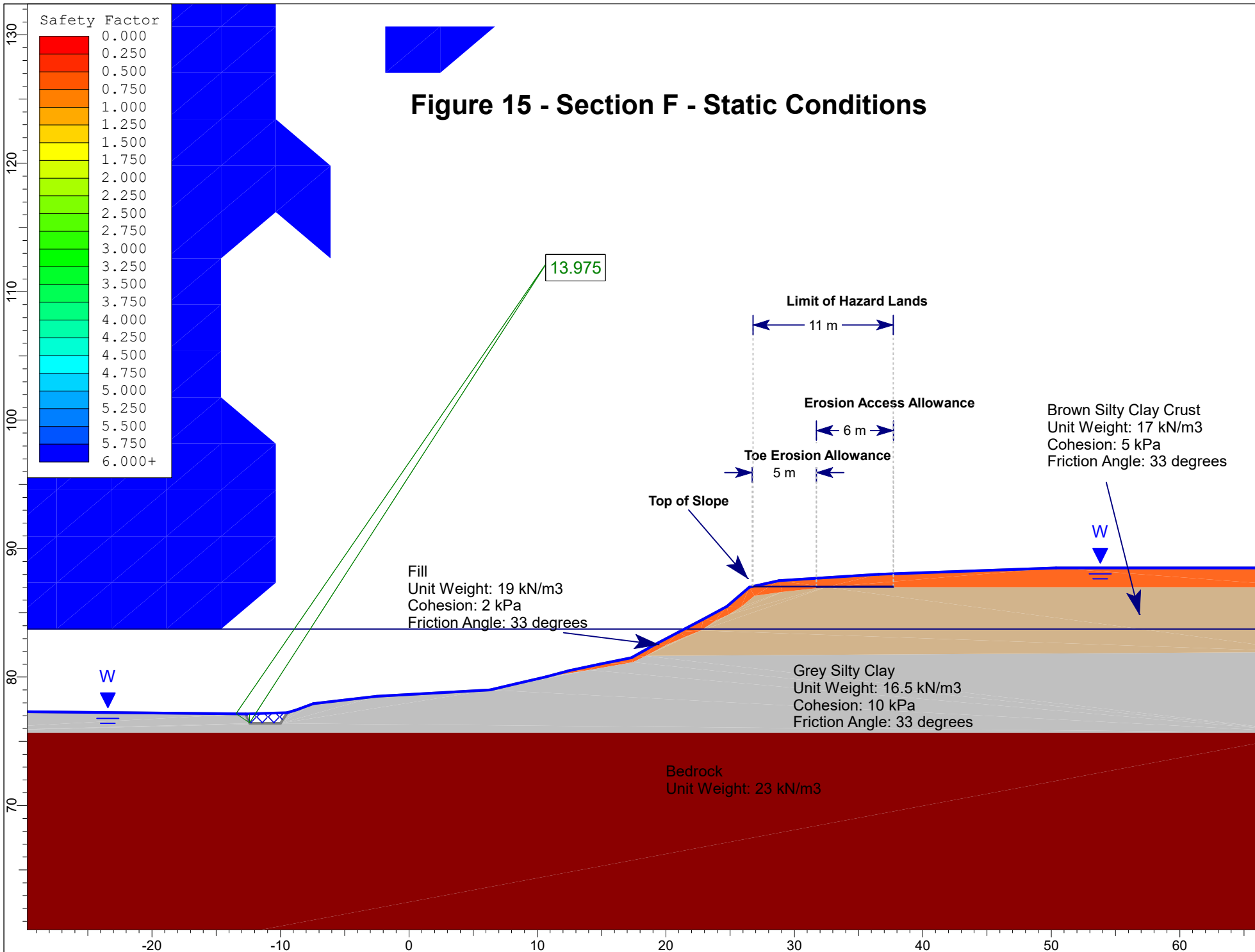

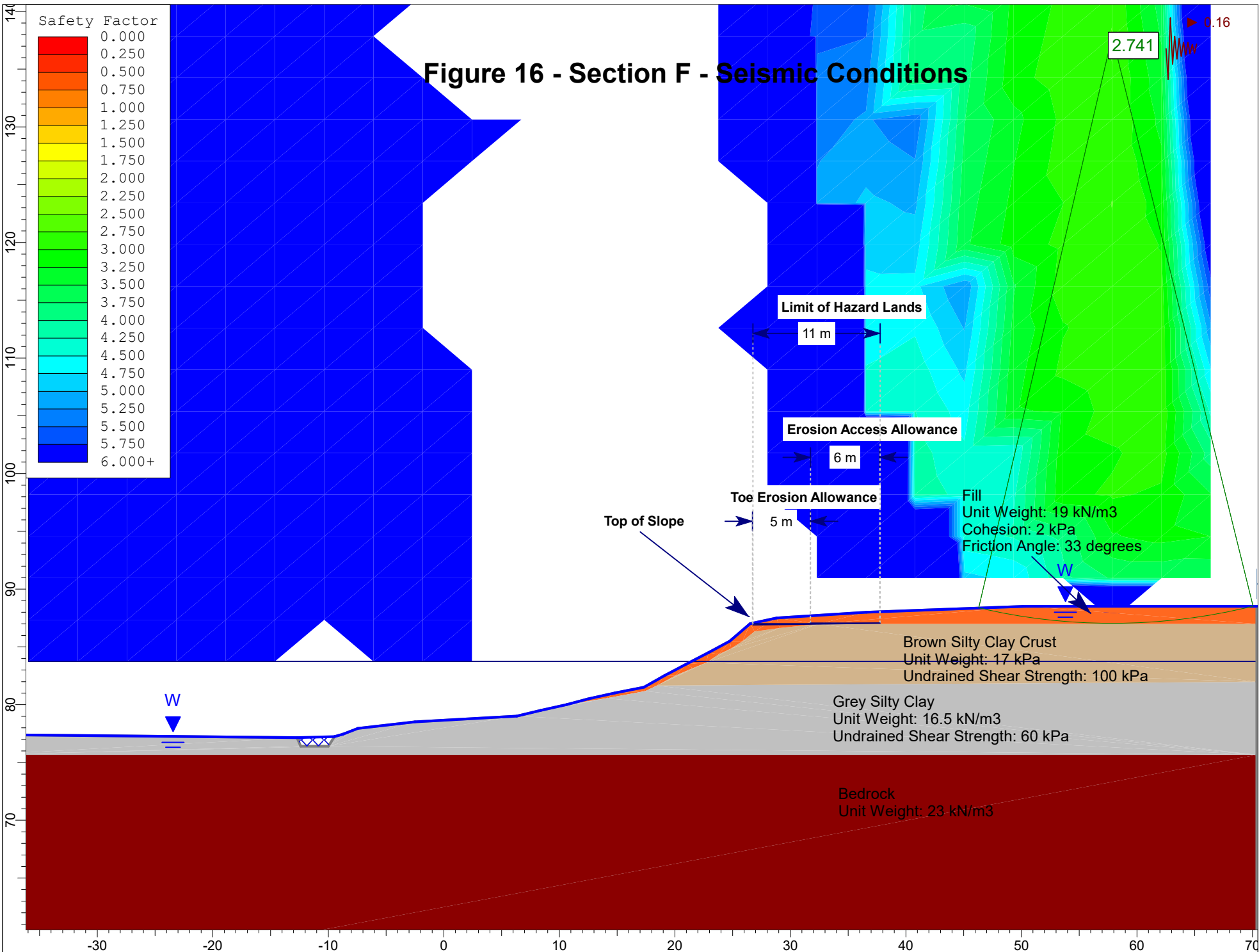

KEY PLAN:
SCALE 1:10,000

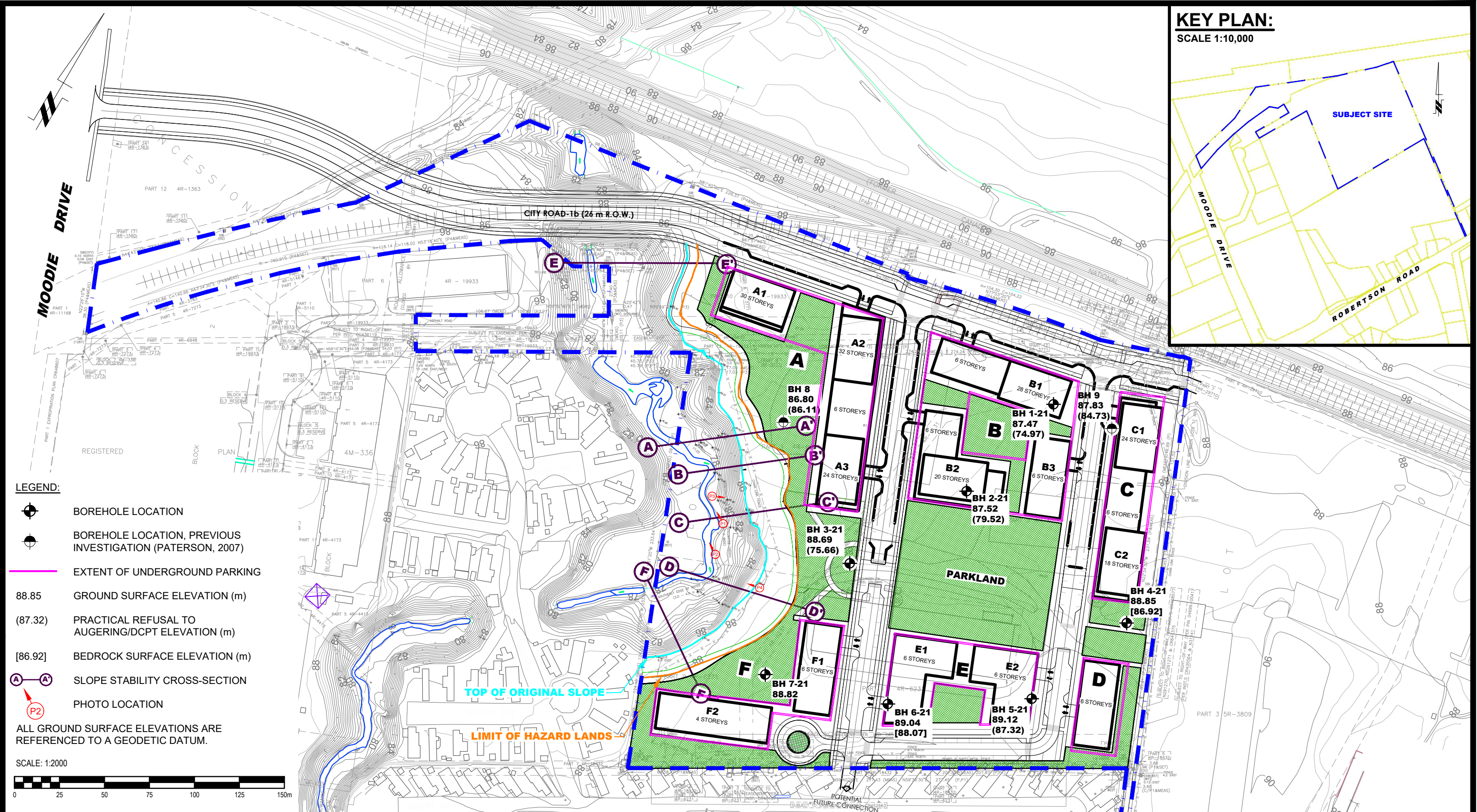
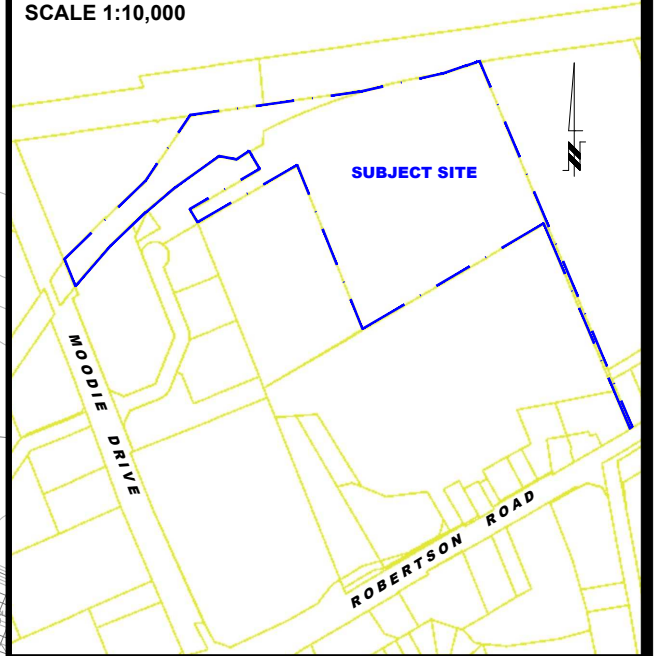

- LEGEND:**
- BOREHOLE LOCATION
 - BOREHOLE LOCATION, PREVIOUS INVESTIGATION (PATERSON, 2007)
 - EXTENT OF UNDERGROUND PARKING
 - 88.85 GROUND SURFACE ELEVATION (m)
 - (87.32) PRACTICAL REFUSAL TO AUGERING/DCPT ELEVATION (m)
 - [86.92] BEDROCK SURFACE ELEVATION (m)
 - SLOPE STABILITY CROSS-SECTION
 - PHOTO LOCATION
- ALL GROUND SURFACE ELEVATIONS ARE REFERENCED TO A GEODETIC DATUM.

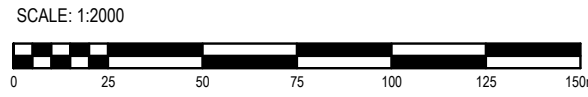

9 AURIGA DRIVE
OTTAWA, ON
K2E 7T9
TEL: (613) 226-7381

NO.	REVISIONS	DATE	INITIAL
5	UPDATED TO NEW CONCEPTUAL PLAN	08/09/2023	NP
4	UPDATED TO NEW CONCEPTUAL PLAN	01/26/2022	YZ
3	UPDATED TO NEW CONCEPTUAL PLAN UPDATED LIMIT OF HAZARD LANDS SECTION F ADDED TO PLAN	03/03/2022	NP
2	UPDATED TO NEW CONCEPTUAL PLAN UPDATED LIMIT OF HAZARD LANDS SECTION E ADDED TO PLAN	02/14/2022	NP
1	REVISED TO INCLUDE TOP OF SLOPE AND LIMIT OF HAZARD LANDS EXTENSION	07/07/2021	RCG

THE PROPERTIES GROUP
PRELIMINARY GEOTECHNICAL INVESTIGATION
PROPOSED MIXED USE DEVELOPMENT
1987 ROBERTSON ROAD
ONTARIO

OTTAWA, ONTARIO
Title: **TEST HOLE LOCATION PLAN**

Scale:	1:2000	Date:	04/2021
Drawn by:	RCG	Report No.:	PG5715-1
Checked by:	NP	Dwg. No.:	PG5715-1
Approved by:	DJG	Revision No.:	5

p:\autocad\drawings\geotechnical\pg5715\pg5715-1.dwg (rev.05)

FUNCTIONAL SITE SERVICING AND STORMWATER MANAGEMENT REPORT REV.03 – 1987 ROBERTSON ROAD (STILLWATER STATION)

Appendix D External Documents
February 28, 2024

D.5 SKETCH ILLUSTRATING TOPOGRAPHIC INFORMATION FOR STILLWATER STATION, AOV, MARCH 7, 2023.



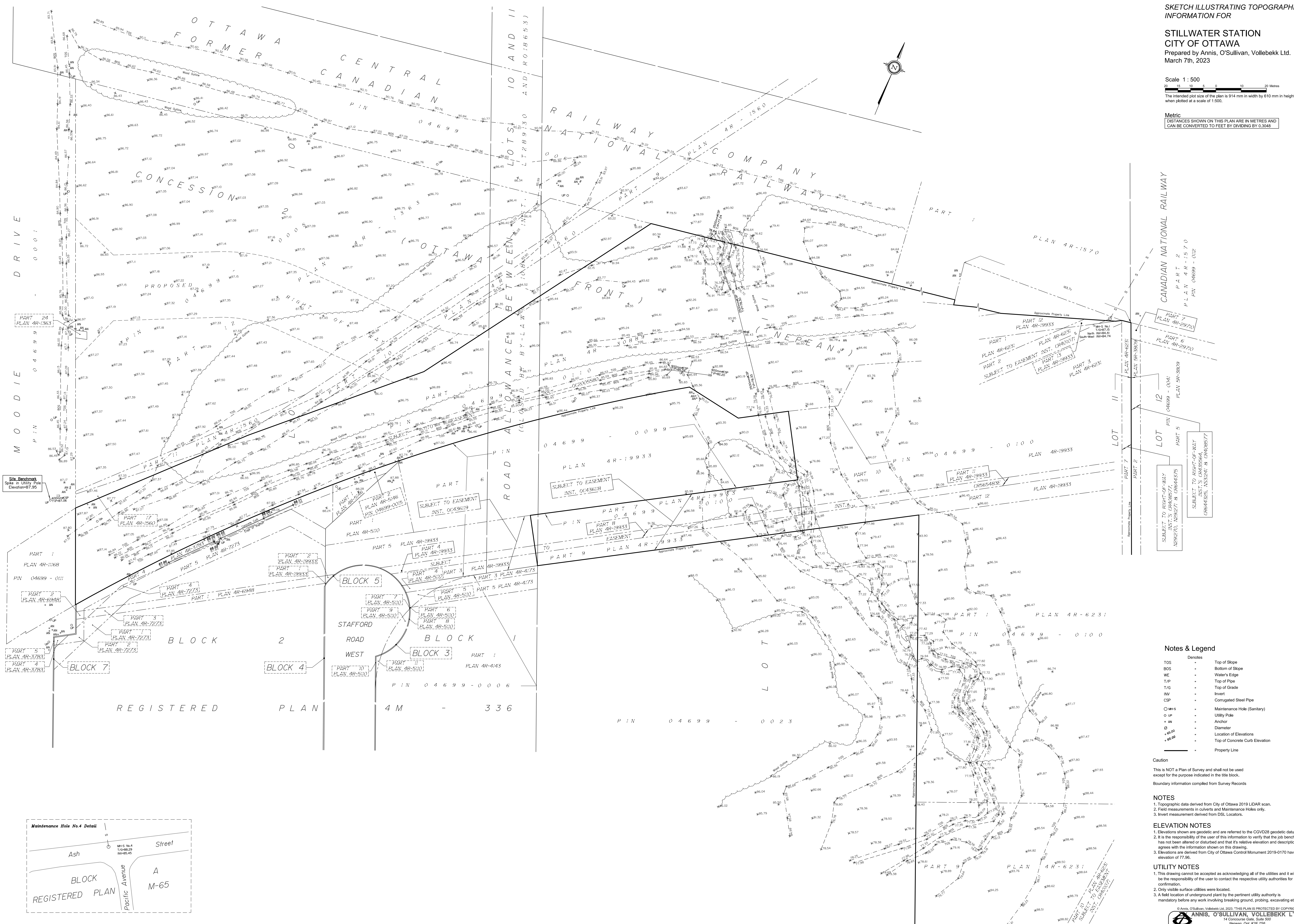

Notes & Legend

Denotes	
TOS	Top of Slope
BOS	Bottom of Slope
WE	Water's Edge
T/P	Top of Pipe
T/G	Top of Grade
INV	Invert
CSP	Corrugated Steel Pipe
○ M+S	Maintenance Hole (Sanitary)
○ U P	Utility Pole
• AN	Anchor
∅	Diameter
• 68.00	Location of Elevations
• 68.00	Top of Concrete Curb Elevation
—	Property Line

Caution
This is NOT a Plan of Survey and shall not be used except for the purpose indicated in the title block.
Boundary information compiled from Survey Records

NOTES
1. Topographic data derived from City of Ottawa 2019 LIDAR scan.
2. Field measurements in culverts and Maintenance Holes only.
3. Invert measurement derived from DSL Locators.

ELEVATION NOTES
1. Elevations shown are geoidetic and are referred to the CGVD28 geoidetic datum.
2. It is the responsibility of the user of this information to verify that the job benchmark has not been altered or disturbed and that its relative elevation and description agrees with the information shown on this drawing.
3. Elevations are derived from City of Ottawa Control Monument 2019-0170 having an elevation of 77.96.

UTILITY NOTES
1. This drawing cannot be accepted as acknowledging all of the utilities and it will be the responsibility of the user to contact the respective utility authorities for confirmation.
2. Only visible surface utilities were located.
3. A field location of underground plant by the pertinent utility authority is mandatory before any work involving breaking ground, probing, excavating etc.

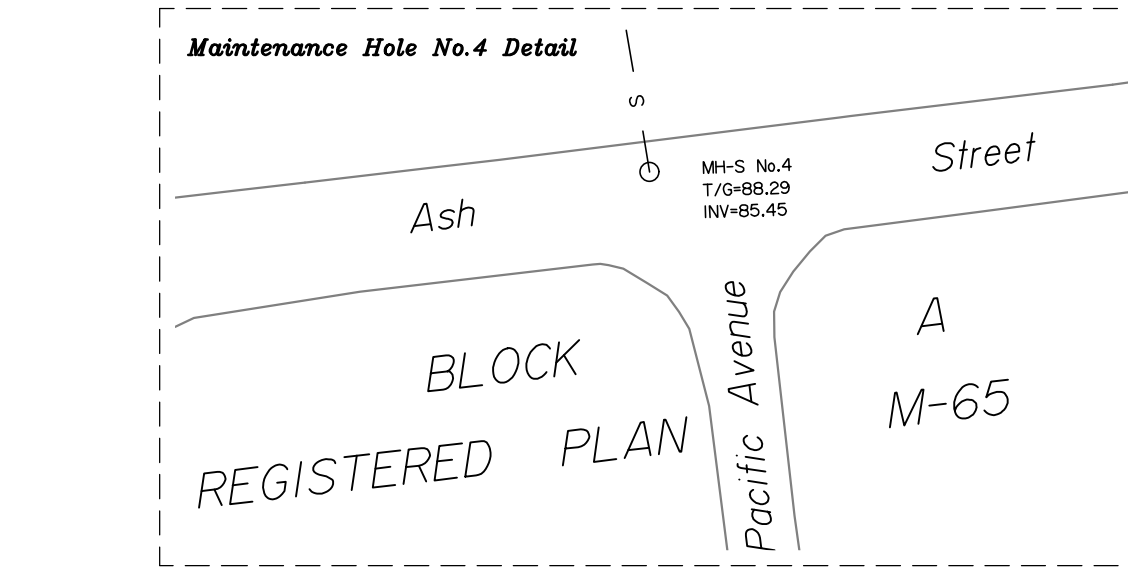



AREA CERTIFICATE

Re: Reference Plan 4R-35528
Stillwater Station
City of Ottawa

ONTARIO LAND SURVEYORS

T.J. Allison
J. C. Anderson
J.E. Anderson
M. M. Aradau
S.S. Bazar
A.J. Broxham
G.T. Hartwick
E.H. Herweyer
E.K. Ketchum
V.A. Shelp
J. P. Shipman
W.C. Storey
D.R. Vollebakk

G.D. Annis (1939-2013)

CANADA LAND SURVEYORS

R.A. Denis

DEVELOPMENT

J.F. Penney

CONDOMINIUMS

A.Z. Pichette

To Whom It May Concern:

Please be advised we have completed the area of individual parts on Plan 4R-35528 to be as follows:

Part	Area (m ²)
1	11,345
2	4,101
3	5,358

V. Andrew Shelp
Ontario Land Surveyor

OTTAWA, Ontario
June 22, 2023
Our Reference: 22627-22

OTTAWA
14 Concourse Gate
Suite 500
Nepean, Ontario
K2E 7S6
613 727-0850
613 727-1079 Fax
nepean@aovltd.com

EMBRUN
165 Bay Street
Embrun, Ontario
K0A 1W1
613 443-3364
embrun@aovltd.com

KEMPTVILLE
113 Prescott Street
P.O. Box 1340
Kemptonville, ON
K0G 1J0
613 258-1717
kemptonville@aovltd.com

FUNCTIONAL SITE SERVICING AND STORMWATER MANAGEMENT REPORT REV.03 – 1987 ROBERTSON ROAD (STILLWATER STATION)

Appendix D External Documents
February 28, 2024

D.6 EXISTING SANITARY SEWER OWNERSHIP DOCUMENTS



401071

I CERTIFY THAT THE WITHIN INSTRUMENT IS DULY ENTERED AND REGISTERED IN THE REGISTRY OFFICE FOR THE REGISTRY DIVISION OF THE CITY OF OTTAWA ON JULY 22 FOR THE MUNICIPALITY OF Nepean AT 2:35 O'CLOCK P.M. OF THIS 26 DAY OF July 1960 NUMBER 401071

W.M. Dale

DEP. REGISTRAR

J

Thomson

BY-LAW NO. 42-59

A By-Law of the Corporation of the Township of Nepean expropriating certain easements for the purposes of the Corporation.

WHEREAS the Municipality is empowered by the Municipal Act, being R.S.O. 1950, Chapter 243 and amendments thereto, to appropriate easements in certain lands for installation and maintenance

of a sewer or sewers;
AND WHEREAS it is deemed expedient to appropriate certain easements in certain lands for installation and maintenance of a sewer or sewers in part of Lot 11, Concession 2, Ottawa Front;

THEREFORE the Council of the Township of Nepean enacts as follows:

1. The easements described in Schedule "A" hereto annexed and forming a part of this by-law, are hereby expropriated.

GIVEN under the Corporate seal of the Township of Nepean this 10th day of November, A.D. 1959.

Andrew G. McLean
Clerk

D. A. Moodie
Reeve

I, Andrew G. McLean, Clerk of the Municipal Corporation of the Township of Nepean, do hereby certify that the foregoing is a true and accurate copy of By-Law No. 42-59 passed on the 10th day of November, 1959.

[Signature]
Clerk

401071

SCHEDULE "A"

ALL AND SINGULAR that certain parcel or tract of land and premises, situate, lying and being in the Township of Nepean, County of Carleton, Province of Ontario and being composed of part of Lot 11, Concession 2, Ottawa Front and consisting of a strip of land twenty-four feet (24') in perpendicular width being twelve feet (12') on either side of a centre line. The said centre line may be described as follows: or sewers;

COMMENCING at a point in the northerly boundary of Block "A" as shown on a Registered Plan Number M-65, the said point being distant six hundred and ninety-four feet (694') westerly measured along the northerly boundary of the said Block "A" from the North-East angle thereof;

THENCE N. 29 degrees 56' 10" W. a distance of One Hundred and sixty-six and seven one-hundredths feet (166.07');

THENCE N. 7 degrees 04' 40" E. a distance of Five hundred and ninety-five and twenty-seven one-hundredths feet (595.27');

THENCE N. 44 degrees 51' 50" E. a distance of Four hundred and forty-one and thirty-six one-hundredths feet (441.36') to the southerly boundary of the Right-of-Way of the Canadian National Railway.

The above described parcel of land is outlined RED on the attached plan.

of the Corporation of the City of Nepean, Ontario, hereby certify that the foregoing is a true and accurate copy of By-Law No. 42-59 passed on the 10th day of November, 1959.

Clerk

OTTAWA OCT. 13th 1959.

410/071

CANADIAN NATIONAL RAILWAY

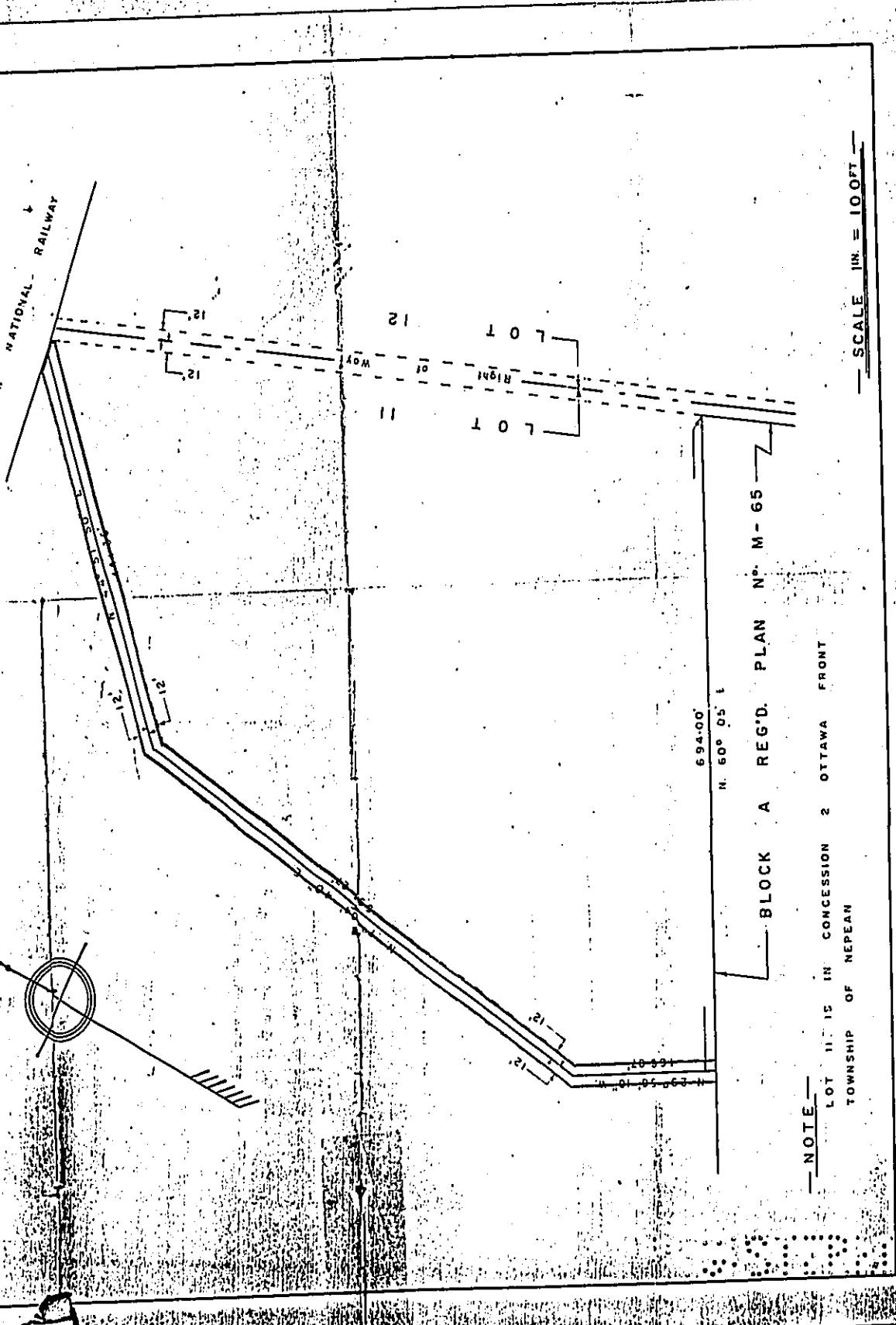

BLOCK A REG'D. PLAN N^o. M-65

NOTE
LOT 11 IS IN CONCESSION 2 OTTAWA FRONT
TOWNSHIP OF NEPEAN

SCALE 1IN. = 100FT



Meters

IP2

IP3

IP1



Meters

IP41

IP2

IP1



IP2

IP1

IP1

Center Rd

Ash St

Reifern Ave

Meters

Appendix E **CORRESPONDENCE**

E.1 2018 PRE-CONSULTATION CITY OF OTTAWA



Kilborn, Kris

From: Miguel Tremblay <tremblay@fotenn.com>
Sent: Wednesday, October 24, 2018 12:10 PM
To: Brian Lahey; Michel Pilon; Roderick Lahey; Kilborn, Kris
Cc: Jaime Posen; Scott Alain
Subject: FW: Pre-Consultation Follow-Up: 1987 Robertson Road
Attachments: Plan & Study List.pdf

Importance: High

Good day all:

Please find attached the City's comments for the pre-application meeting with Staff for the Bells Corners lands.

Of particular interest, the following tasks would be critical path:

- / Fotenn to prepare a terms of reference document for the preparation of a Secondary Plan document, circulate to Staff and confirm process and timelines. The intent is to limit the scope of the Secondary Plan to only the PG lands.
- / PG, Rod Lahey and Fotenn to revise Concept Plan to incorporate preliminary Staff comments including a public park (If supported by PG), roadway alignments and configuration. PG needs to determine if roadways will be public or private in ownership. The decision will impact widths and design. Recall that if a public park is proposed, it typically requires frontage onto two (2) public roads.
- / Staff is requesting some consideration of incorporating the spur line as a future rail corridor and station. The Concept Plan should reflect the opportunity, and would help from a policy perspective. Fotenn will seek additional direction from Staff on location and preliminary corridor design.
- / The Transportation Consultant would need to initiate work on the RMA application as soon as the Concept Plan is finalized, and consider the other comments from Staff and the plan changes.
- / Additional discussions are required with RPAM to identify a service group and initiate further discussions on the transfer of the road segment from the NCC.
- / Kris / Stantec to review servicing comments and advise on implications.

I would suggest a team meeting to review comments and design changes, if any. Rod, can you please circulate an electronic version of the most recent design drawings.

Thanks all,

Miguel Tremblay, MCIP RPP
Director Planning and Development
T 613.730.5709 ext. 233

From: McCreight, Laurel [mailto:Laurel.McCreight@ottawa.ca]
Sent: October-16-18 1:18 PM
To: Scott Alain <alain@fotenn.com>
Cc: Paul Black <black@fotenn.com>; Miguel Tremblay <tremblay@fotenn.com>
Subject: Pre-Consultation Follow-Up: 1987 Robertson Road

Hi Scott,

Please refer to the below regarding the Pre-Consultation Meeting held on Wednesday September 26, 2018 for the property at 1987 Robertson Road for an Official Plan and Zoning By-law Amendment. I have also attached the Plans & Study List.

General

- Creation of a new mixed use community in Bells Corner
- Between 2,000 and 2,200 units will be provided on the site through the development of a combination of mid- and high-rise buildings (between 4 and 32 storeys)
- This development is being approached from the perspective that this project is the start of a new urban grid, with the potential to expand on to surrounding lands.
- The development will be ground-oriented and pedestrian-friendly, with commercial at grade
- There is a desire to build upon the idea of the “Winter City” so that the site can be used year-round
 - The utilization of heated sidewalks, and covered areas are being explored for this project
- A review has been conducted in order to determine potential accesses into the site
 - There is a desire to explore the possibility of a land transfer from the NCC to the City of Ottawa in order to allow for a public access road to cross over NCC lands into the site
 - This would improve the intersection along the old Spur Rail Line
 - Would be a 4-way intersection at Moodie and Timm
- Roads will be placed along the exterior of the site in order to provide appropriate buffers and required setbacks from the rail corridor and the existing trailer park, adjacent to the subject site
- These roads will have 20-metre right-of-ways to allow for parking and landscape elements, and to achieve design aspirations for streetscapes
- All parking for residents will be provided below grade, with at-grade parking kept available for visitors
- There is an existing 3-metre strip of land that leads to Robertson Road, which also abuts the trailer park
 - There is a prescriptive easement along this strip that might be suitable for a pathway
- Stillwater Creek passes through the site, which may provide an opportunity for public greenspace on the site
 - Significant greenspace will be provided through this development
- Potential transfer of greenspace to the NCC
- The current trailer park has trailers that encroach onto the subject site
- Current and former policy pertaining to the site contemplates redevelopment on the subject lands
- Official Plan policies contemplate the location of pathways, and express a desire to connect residential areas with surrounding employment and commercial lands
- A secondary planning exercise will need to be created for the site
 - OPA 150 allows for developer-initiated Secondary Plans
 - Further discussion will need to be had on the scope of such an exercise
 - The City has a number of concerns related to the scale of this development at this location that would need to be addressed as part of any application (community facilities, transit, schools, parking, etc.)

Planning & Urban Design

- Official Plan Policies that state a secondary planning process must be completed for PIN 04699-0100 (the subject parcel) and, the community commonly known as “Bellwood Estates” identified by PIN 04699-0023 and 04699-0025
- Discussion surrounding the approach when going through the exercise of creating a Secondary Plan for the site
 - Applicant is requesting to solely include their parcel in the secondary planning process and not the adjacent lands
- Height and density will be further reviewed through the secondary planning process
 - It is recommended to review Sections 2.5.1 and 4.11 for design and compatibility
 - If high rise buildings are to be pursued as part of the of the application, please consult the high rise design guidelines
- Section 37 may be applicable

- Please provide an as-of-right analysis to confirm the proposed versus permitted gross floor area in accordance with the [Section 37 guidelines](#)
- A 30-metre setback from the rail line will be required
- Please consider possible pedestrian connections within the site
- Although the site is not located within a Design Priority Area, given the scale and density of the proposed development, it may be worthwhile to involve the Urban Design Review Panel in the site design process
- Please provide a plan that would illustrate how the spur line could operate as a future rail line in conjunction with the proposed access for this site

Real Estate

- A land transfer from the NCC to the City is preferred by the applicant
- The NCC will likely be more willing to transfer the land to a municipality than a private developer, however, please be aware that it may be a long, onerous and expensive process
- A client service group will need to be formed by the City, who will require all necessary information from the applicant before they approach the NCC
 - More internal discussion is needed at the City to determine the most appropriate group to take on this task
 - Once a position has been finalized I will get back to you on the next steps

Transportation

- Follow Traffic Impact Assessment Guidelines – Screening form to start, full Traffic Impact Assessment if any of the triggers on the screening form are satisfied
 - Start this process as soon as possible
 - ***The Applicant is advised that their application will not be deemed complete until the submission of the draft step 1-4, including the functional draft RMA package (if applicable) and/or monitoring report (if applicable)***
- ROW protection on Moodie between Bell’s Corners-urban area limit and Richmond is 37.5 metres
- ROW protection on Robertson between Bell’s Corners-urban area west limit and Eagleson is G (see below)
 - “G” – signifies Greenbelt for which unique rights-of-way protection policy apply as follows: For arterial road segments located entirely within the Greenbelt, the right-of-way requirements vary depending on: the number and width of travel lanes; the treatment of curbs, medians, and road drainage; and other amenities to be provided in the corridor. On this basis, the right-of-way to be acquired by the City and the means to acquire the land will be determined with involvement of the National Capital Commission on a case-by-case basis a road modifications are being planned. In the event that a portion of Greenbelt land is conveyed to another owner, a minimum road-widening requirement of 42.5 m shall apply for an arterial road segment adjacent to that land. For segments adjacent to the Greenbelt along only one side, the ROW dimension for the urban area side should be protected, with an additional 5.0 m widening requested along the Greenbelt side (to construct the wider rural cross-section). As always, the widening requirements are to be measured from the existing road centerline.
- Any modifications to the intersection of Moodie Drive and Timm Drive would be considered local service and would not be DC eligible. All cost related to modifications (traffic signals, median, line painting, etc) at the intersection will be the responsibility of the proponent and will **require the submission of an RMA** (please see bullet 2 of comment number 1).
- Noise Impact Studies required for the following:
 - Road
 - Rail
- For transportation related questions please contact [Rosanna Baggs](#)

Environment

- There is an unevaluated wetland in the greenbelt lands adjacent to the trail in the passive open space area

- Stillwater creek watercourse runs through the property and a 30 metre setback is required from the normal high water mark or 15 metres to top of bank, whichever is greater and with the recommendations from the geotechnical report
- A permit from RVCA may be required
- A TCR will be required where there is a tree of 10 cm in diameter or greater on the site
- An EIS is required as there is a natural heritage system feature on the subject property, the valleyland associated with the watercourse is part of this feature
- There are also species at risk observations in the vicinity for grassland birds (eastern meadowlark, barn swallow and bobolink), Blanding's turtle and eastern milksnake
- There is potential for butternut where trees are present

Parks

- Parkland Dedication
 - Parkland dedication will be required
 - Parkland dedication is calculated at 1ha per 300 units to a maximum of 10% of the gross block area
 - Parkland dedication is to be free of any encumbrances
 - Parkland dedication is to be provided beyond required private amenity space
 - Parkland ceded to the NCC will not be counted towards parkland dedication
- Park Location
 - Please consult the Park Development Manual for Guidelines and Criteria for Park Development and location.
 - <https://ottawa.ca/en/park-development-manual-second-edition-2017>
- Park Construction Funding:
 - To be discussed: funding possibility through Section 37 (if applicable) of the Planning Act (community benefit)
- For parks related questions please contact [Jennifer Shepherd](#)

Engineering

General

- An adequacy of Services report will need to be provided covering all engineering aspects of the site (i.e. STM/SWM/Erosion/SAN/WM)

STM/SWM/Erosion

- Please address the issue of encroachment on the creek
- Please note that the conservation authorities recently updated their floodplain mapping which has established conservative setbacks. Consultation with RVCA is regarding their erosion and stormwater requirements is required
- Erosion issues have been identified by the City along Stillwater Creek near Corkstown Road, therefore a slope stability analysis will be required.
- No capacity constraints have been identified for stormwater into Stillwater Creek from the City's perspective
 - The property currently drains to Stillwater Creek along the west of the site
 - Pre-development release rates for the 5 and 100 year storm events will need to be met under post development conditions (i.e 5 yr post Q = 5 year pre Q, 100 year post C = 100 year pre Q)
 - This should be a simple exercise unless erosion issues are identified
- The conservation authority and NCC may have stricter SWM and/or erosion requirements that override the City's requirements, therefore pre-consultations with both agencies is encouraged
- Please note that lands required for a stormwater management pond cannot be used in parkland dedication calculations
- An MOECP ECA for municipal sewage works, likely through transfer of review, will need to be provided at the end of the subdivision or site plan stage for the proposed sewers and SWM facility

WM

- The NCC parcel being pursued contains a backbone watermain easement in favour of the City
 - If this parcel were to be obtained by the applicant, the City will require a 9m wide corridor centred along the backbone pipe to be transferred to the City
 - No construction within this 9m corridor will be permitted (i.e. foundations)
 - If there is shallow bedrock, mitigation measures and monitoring systems will have to be properly designed to ensure construction does not have a negative impact on the backbone watermain
- Watermain will need to be looped
 - The applicant indicated the intention is to provide a WM loop from Moodie Drive to Robertson Road.
 - The applicant has indicated they have a 12ft easement to the east of their 12ft sliver of property to Robertson Road. The City will require a minimum of a 6m wide easement centred along the proposed WM
- Crossing of the backbone watermain to get to the Moodie Drive infrastructure may be complicated
 - Please notify the City early if you wish to explore connection to the backbone watermain
 - Typically, direct connections are not permitted, but given the size of development, this option could be explored further, only if requested
- As per Technical Bulletin ISTB-2018-02, please ensure that enough fire hydrants are provided throughout the site to ensure ample coverage; there should be enough hydrants to serve fire flow requirements for each building within 150 metres.
- Please provide your request for boundary conditions once the 'site' plan is finalized. In your request please provide the following:
 - Location of service on plan or map
 - draft site plan
 - brief description of the type of development proposed,
 - the fire flow required (as per FUS, 1999) complete with supporting calculations,
 - average daily demand (L/s) complete with supporting calculations,
 - maximum daily demand (L/s) complete with supporting calculations,
 - maximum hourly daily demand (L/s) complete with supporting calculations.

SAN

- The existing sanitary sewer servicing this property, along with the existing trailer park to the south and other properties to the east, is identified as private
 - During the pre-consultation meeting the applicant identified that the sewer has become public
 - Documentation is required to prove the sewer system is now public
- If the sanitary sewer is found to be private, correspondence from all property owners impacted by site construction, specifically sanitary sewer reconstruction will need to be provided
 - The correspondence will need to indicate that an agreeable arrangement has been established between both parties regarding service during construction
 - This is a requirement for the subdivision or site plan stage of the project
- Currently, there are no known issues with the Nepean Collector's capacity
- If the sanitary sewer is found to be private, an MOECP ECA for private sewage works, direct submission, will need to be completed at the end of the subdivision or site plan stage
- For engineering related questions please contact [Gabrielle Schaeffer](#)

Please do not hesitate to contact me if you have any questions.

Regards,
Laurel

Laurel McCreight MCIP, RPP
Planner
Development Review West
Urbaniste

Examen des demandes d'aménagement ouest

City of Ottawa | Ville d'Ottawa

☎ 613.580.2424 ext./poste 16587

ottawa.ca/planning / ottawa.ca/urbanisme

FUNCTIONAL SITE SERVICING AND STORMWATER MANAGEMENT REPORT REV.03 – 1987 ROBERTSON ROAD (STILLWATER STATION)

Appendix E Correspondence
February 28, 2024

E.2 2018 PLAN AND STUDY LIST



APPLICANT'S STUDY AND PLAN IDENTIFICATION LIST

Legend: **S** indicates that the study or plan is required with application submission.

A indicates that the study or plan may be required to satisfy a condition of approval/draft approval.

For information and guidance on preparing required studies and plans refer to:

<http://ottawa.ca/en/development-application-review-process-0/guide-preparing-studies-and-plans>

S/A	Number of copies	ENGINEERING		S/A	Number of copies
	10	1. Site Servicing Plan	2. Site Servicing Brief	S	4
A	10	3. Grade Control and Drainage Plan	4. Geotechnical Study		4
	2	5. Composite Utility Plan	6. Groundwater Impact Study		6
	5	7. Servicing Options Report	8. Wellhead Protection Study		6
S	9	9. Transportation Impact Brief	10. Erosion and Sediment Control Plan / Brief		6
	6	11. Storm water Management Brief	12. Hydro geological and Terrain Analysis		8
	3	13. Hydraulic Water main Analysis	14. Noise	S	3
	35/50/55	15. Roadway Modification Design Plan	16. Confederation Line Proximity Study		9
S/A	Number of copies	PLANNING / DESIGN / SURVEY		S/A	Number of copies
	10	17. Draft Plan of Subdivision	18. Plan Showing Layout of Parking Garage		2
	30	19. Draft Plan of Condominium	20. Planning Rationale	S	3
	20	21. Site Plan	22. Minimum Distance Separation (MDS)		3
S	10	23. Concept Plan Showing Proposed Land Uses and Landscaping	24. Agrology and Soil Capability Study		5
S	3	25. Concept Plan Showing Ultimate Use of Land	26. Cultural Heritage Impact Statement		3
	10	27. Landscape Plan	28. Archaeological Resource Assessment Requirements: S (site plan) A (subdivision, condo)		3
S	2	29. Survey Plan	30. Shadow Analysis		3
	3	31. Architectural Building Elevation Drawings (dimensioned)	32. Design Brief (includes the Design Review Panel Submission Requirements)		Available online
	6	33. Wind Analysis			
S/A	Number of copies	ENVIRONMENTAL		S/A	Number of copies
S	3	34. Phase 1 Environmental Site Assessment	35. Impact Assessment of Adjacent Waste Disposal/Former Landfill Site		6
	5	36. Phase 2 Environmental Site Assessment (depends on the outcome of Phase 1)	37. Assessment of Landform Features		7
	4	38. Record of Site Condition	39. Mineral Resource Impact Assessment		4
S	3	40. Tree Conservation Report	41. Environmental Impact Statement / Impact Assessment of Endangered Species	S	3
	4	42. Mine Hazard Study / Abandoned Pit or Quarry Study	43. Integrated Environmental Review (Draft, as part of Planning Rationale)	S	3
S/A	Number of copies	ADDITIONAL REQUIREMENTS		S/A	Number of copies
		44.	45.		

Meeting Date: September 26, 2018

File Lead (Assigned Planner): Laurel McCreight

Site Address (Municipal Address): 1987 Robertson Road

Application Type: *Zoning By-Law Amendment & Official Plan Amendment*

Infrastructure Approvals Project Manager: Gabrielle Schaeffer

*Preliminary Assessment: 1 2 3 4 5

*One (1) indicates that considerable major revisions are required before a planning application is submitted, while five (5) suggests that proposal appears to meet the City's key land use policies and guidelines. **This assessment is purely advisory and does not consider technical aspects of the proposal or in any way guarantee application approval.**

It is important to note that the need for additional studies and plans may result during application review. If following the submission of your application, it is determined that material that is not identified in this checklist is required to achieve complete application status, in accordance with the Planning Act and Official Plan requirements, the Planning, Infrastructure and Economic Development Department will notify you of outstanding material required within the required 30 day period. Mandatory pre-application consultation will not shorten the City's standard processing timelines, or guarantee that an application will be approved. It is intended to help educate and inform the applicant about submission requirements as well as municipal processes, policies, and key issues in advance of submitting a formal development application. This list is valid for one year following the meeting date. If the application is not submitted within this timeframe the applicant must again pre-consult with the Planning, Infrastructure and Economic Development Department.

FUNCTIONAL SITE SERVICING AND STORMWATER MANAGEMENT REPORT REV.03 – 1987 ROBERTSON ROAD (STILLWATER STATION)

Appendix E Correspondence
February 28, 2024

E.3 2020 PRE-CONSULTATION CITY OF OTTAWA



Hi Paul,

Please refer to the below regarding the Pre-Application for 1987 Robertson Road for an Official Plan Amendment, Plan of Subdivision and Zoning By-law Amendment for a mixed-use development. I have also attached the required Plans & Study List for application submission. Thank you for the open dialogue on this project and spirit of cooperation sought.

Below are staff's preliminary comments based on the information available at the time of the pre-consultation meeting:

Planning / Urban Design

- Official Plan (OP) Policies that state a secondary planning process must be completed for PIN 04699-0100 (the subject parcel) and, the community commonly known as "Bellwood Estates" identified by PIN 04699-0023 and 04699-0025.
 - The secondary plan will inform element of public realm, connectivity, built form, density and land use.
 - It is pre-mature to comment on the proposed design and layout until such time as this process is underway.
- It is recommended to review Sections 2.5.1 and 4.11 for design and compatibility.
- The OP is directing high-rise to where infrastructure already exists or is targeted – this is an urban employment lands site currently – please address what level of employment is contemplated here.
- If availability of future transportation is part of rationale for proposed density, but transit is not in place now to ensure appropriate modal share, the City will look to early servicing agreements with OC Transpo to get transit here earlier than warranted, which may be of greater requirement than peak hour service only.
- If high rise buildings are to be pursued as part of the of the application, please consult the high-rise design guidelines and ensure that they are followed in the conceptual massing, and address particularly whether these buildings will be designed as background or landmark buildings.
- Consideration of compatibility and connectivity to the adjacent community as part of the first phases of development are pivotal to the success of the project.
- A minimum of one additional public right of way should be considered in a north-south orientation to allow for a public road connection to Robertson Road in the future.
- Please ensure that the pathway linkages proposed to Robertson Road are celebrated and well connected to the new community.
- A range of housing typologies is encouraged and should be required to ensure the proposal meets a variety of demographic needs.
 - The current proposal appears to only include apartments in mid and high-rise typologies.
- Establishment of an appropriate density for the lands based on infrastructure and transportation capacity is imperative and will help inform the ultimate built form.
 - Tools such as FSI should be considered as part of the ultimate zoning for the lands.
- Although the site is not located within a Design Priority Area, given the scale and density of the proposed development, it may be worthwhile to involve the Urban Design Review Panel in the site design process
- A design brief will be required in support of future applications (please see attached requirements).
- A 30-metre setback from the rail line will be required.
- Please confirm if Section 37 is applicable.
 - Please provide an as-of-right analysis to confirm the proposed versus permitted gross floor area in accordance with the Section 37 guidelines.
- Please consult the new [Draft Official Plan](#) for emerging directions.

- Please refer to the recently approved [Bird-Friendly Design Guidelines](#).
- You are encouraged to contact the Ward Councillor, Councillor [Rick Chiarelli](#), about the proposal.

Real Estate

- The City will not engage the NCC on behalf of the developer to acquire the triangular parcel of land to create a new public road.
- Should the developer wish to move forward it would be incumbent upon them to negotiate and acquire the parcel (it could be on behalf of the City – whereby the land would transfer to the City), however, the City will not take part in the acquisition process.
- In so far as the spur connecting the Beachburg Subdivision to the Carleton Place Subdivision – the City needs this to make the connection of the two rail corridors in the future.
- If however the proponent (developer) uses the spur as their access road and dedicates this to the City, the City would be in a position to build an elevated rail system within this spur (allowing cars at ground level) with trains above from the Beachburg across Moodie Drive.
- In the event this road remains private, it would be good to ensure it is built as a boulevard allowing for a large median which in turn could be dedicated to the City along with the air rights above the remainder of the corridor (road) so as to allow the construction of this elevated train in this corridor

Please contact Program Manager, Acquisitions, [Stephen O'Brien](#) for follow-up questions.

Environment

- The Subject property has a watercourse and part of the Natural Heritage System. As such, an EIS will be required which should cover the following,
 - Natural Heritage System feature- the valleyland associated with the watercourse is part of this feature
 - Species at Risk
 - Watercourse setbacks (OP 4.7.3)
 - Further details of EIS requirements can be found in OP 4.7.8 or the [EIS guidelines](#)
- There is an unevaluated wetland in the greenbelt lands adjacent to the trail in the passive open space area.
- Stillwater creek watercourse runs through the property and a 30 metre setback is required from the normal high-water mark or 15 metres to top of bank, whichever is greater and with the recommendations from the geotechnical report.
- The City may look at the dedication of Stillwater Creek lands through the subdivision process.
- Schedule K of the Official Plan identifies the ravine as an unstable slope.
- Please consult with the RVCA- permits may be required.
- There is potential for butternut where trees are present

Please contact Environmental Planner, [Sami Rehman](#) for follow-up questions.

Forestry

- A tree Conservation Report (TCR) must be supplied for review along with the suite of other plans/reports required by the City; an approved TCR is a requirement of Site Plan approval.
- Any removal of privately-owned trees 10cm or larger in diameter requires a tree permit issued under the Urban Tree Conservation Bylaw; the permit is based on the approved TCR
- Any removal of City-owned trees will require the permission of Forestry Services who will also review the submitted TCR
 - After January 1, 2021, permission to remove City trees will be included in the tree permit for the site

- Compensation may be required for city owned trees – if so, it will need to be paid prior to the release of the tree permit
- The TCR must list all trees on site by species, diameter and health condition
- The TCR must list all trees on adjacent sites if they have a critical root zone that extends onto the development site
- If trees are to be removed, the TCR must clearly show where they are, and document the reason they cannot be retained
- All retained trees must be shown and all retained trees within the area impacted by the development process must be protected as per City guidelines listed on Ottawa.ca
- the location of tree protection fencing must be shown on a plan
- include distance indicators from the trunk of the retained tree to the nearest part of the tree protection fencing
- show the critical root zone of the retained trees
- if excavation will occur within the critical root zone, please show the limits of excavation and calculate the percentage of the area that will be disturbed
- The City encourages the retention of healthy trees; if possible, please seek opportunities for retention of trees that will contribute to the design/function of the site.
- Please ensure newly planted trees have an adequate soil volume for their size at maturity. Here are the recommended soil volumes:

Tree Type/Size	Single Tree Soil Volume (m3)	Multiple Tree Soil Volume (m3/tree)
Ornamental	15	9
Columnar	15	9
Small	20	12
Medium	25	15
Large	30	18
Conifer	25	15

Please contact Forester, [Mark Richardson](#) for follow-up questions.

Parks

- The location of the park is unacceptable as it contains steep slopes and natural heritage features (significant valleyland, significant woodland and watercourse), which is in contravention of Section 5(1) of [Parkland Dedication By-law No. 2009-95](#) and Section 2.2 of the [Park Development Manual](#)
 - As discussed, please move the park east along the northern boundary of the site so that it is more central to the community while maintaining the required 50% frontage onto a public street.
 - Consider shadowing impacts on the park from adjacent high-rises if proposed.
- Please reconfigure the park so that it rectangular.
- Please provide the area of the park.
 - Based on rough calculations, a minimum 0.93-hectare parkette is required (based on the current proposal).
 - When calculating parkland, use the gross land area of the site as the basis, which is defined as “the total area of the land to be developed excluding constraint lands such as: wetlands, unstable slopes, ravines, water courses, flood plains and other similar constraint lands, that normally would be conveyed to the City through the development process” by the By-law.
 - Include the commercial uses in the parkland calculation, referring to the mixed-use development requirement in Section 3 of the By-law.

- As a reminder, the outdoor amenity areas will not contribute to the parkland requirement
- Consider noise and vibration impacts from the adjacent active rail line when relocating and designing the park.
- Refer to Section 2.4.4 of the manual for further information on parkette design.
- Please submit a Fit Plan with a cost estimate as part of the draft plan approval of the plan of subdivision. Refer to the manual for more information about these requirements.

Please contact Parks Planner, [Justyna Garbos](#) for follow-up questions.

Engineering

General

- An adequacy of Services report will need to be provided covering all engineering aspects of the site (i.e. STM/SWM/Erosion/SAN/WM).
- It is the sole responsibility of the consultant to investigate the location of existing underground utilities in the proposed servicing area and submit a request for locates. The location of existing utilities and services shall be documented on an Existing Conditions Plan.
- All underground and above ground building footprints and permanent walls need to be shown on the plans to confirm that any permanent structure does not encroach within the right-of-way.
- Any easements on the subject site shall be identified and respected by any development proposal and shall adhere to the conditions identified in the easement agreement. A legal survey plan shall be provided and all easements shall be shown on the engineering plans.
- Please provide an Existing Conditions/Removals Plan as part of the engineering drawing set. Any existing services are to be removed or abandoned in accordance with City standards.

STM/SWM/Erosion

- Please address the issue of encroachment on the creek.
- Please note that the conservation authorities recently updated their floodplain mapping which has established conservative setbacks. Consultation with RVCA is regarding their erosion and stormwater requirements is required.
- Erosion issues have been identified by the City along Stillwater Creek near Corkstown Road, therefore a slope stability analysis will be required.
- No capacity constraints have been identified for stormwater into Stillwater Creek from the City's perspective. The property currently drains to Stillwater Creek along the west of the site. Pre-development release rates for the 5 and 100 year storm events will need to be met under post development conditions (i.e 5 yr post Q = 5 year pre Q, 100 year post C = 100 year pre Q) This should be a simple exercise unless erosion issues are identified.
- The conservation authority and NCC may have stricter SWM and/or erosion requirements that override the City's requirements, therefore pre-consultations with both agencies is encouraged.
- Please note that lands required for a stormwater management pond cannot be used in parkland dedication calculations.
- Please note that foundation drain is to be independently connected to sewer main unless being pumped with appropriate back up power, sufficient sized pump and back flow prevention.
- Please note that as per Technical Bulletin PIEDTB-2016-01 section 8.3.11.1 (p.12 of 14) there shall be no surface ponding on private parking areas during the 2-year storm rainfall event. Depending on the SWM strategy proposed underground or additional underground storage may be required to satisfy this requirement.
- Underground Storage: Please note that the Modified Rational Method for storage computation in the Sewer Design Guidelines was originally intended to be used for above ground storage (i.e. parking lot) where the change in head over the orifice varied from 1.5 m to 1.2 m (assuming a 1.2 m deep CB and a

max ponding depth of 0.3 m). This change in head was small and hence the release rate fluctuated little, therefore there was no need to use an average release rate.

- When underground storage is used, the release rate fluctuates from a maximum peak flow based on maximum head down to a release rate of zero. This difference is large and has a significant impact on storage requirements. We therefore require that an average release rate equal to 50% of the peak allowable rate shall be applied to estimate the required volume. Alternatively, the consultant may choose to use a submersible pump in the design to ensure a constant release rate.
- In the event that there is a disagreement from the designer regarding the required storage, The City will require that the designer demonstrate their rationale utilizing dynamic modelling, that will then be reviewed by City modellers in the Water Resources Group.
- Note that the above will added to upcoming revised Sewer Design Guidelines to account for underground storage, which is now widely used.
- Provide sufficient details and information on any proposed underground storage system. A cross-section of any underground storage system is to be provided with sufficient details and information. In case of a pump failure or blockage an overflow should be provided. Backup power supply is required if using a pump.
- Please note that the minimum orifice dia. for a plug style ICD is 83mm and the minimum flow rate from a vortex ICD is 6 L/s in order to reduce the likelihood of plugging.
- Post-development site grading shall match existing property line grades in order to minimize disruption to the adjacent residential properties. A topographical plan of survey shall be provided as part of the submission and a note provided on the plans.
- Please provide a Pre-Development Drainage Area Plan to define the pre-development drainage areas/patterns. Existing drainage patterns shall be maintained and discussed as part of the proposed SWM solution.
- If rooftop control and storage is proposed as part of the SWM solutions sufficient details (Cl. 8.3.8.4) shall be discussed and document in the report and on the plans. Roof drains are to be connected downstream of any incorporated ICDs within the SWM system and not to the foundation drain system.
- An MOECP ECA for municipal sewage works, can be done through transfer of review (ToR), will need to be provided at the end of the subdivision or site plan stage for the proposed sewers and SWM facility.

Watermain

- The NCC parcel being pursued contains a backbone watermain easement in favour of the City. If this parcel were to be obtained by the applicant, the City will require a 9m wide corridor centred along the backbone pipe to be transferred to the City. No construction within this 9m corridor will be permitted (i.e. foundations). Also, if there is shallow bedrock, mitigation measures and monitoring systems will have to be properly designed to ensure construction does not have a negative impact on the backbone watermain.
- Watermain will need to be looped. The applicant indicated the intention is to provide a WM loop from Moodie Drive to Robertson Road. The applicant has indicated they have a 12ft easement to the east of their 12ft sliver of property to Robertson Road. The City will require a minimum of a 6m wide easement centred along the proposed WM.
- Crossing of the backbone watermain to get to the Moodie Drive infrastructure may be complicated. Please notify the City early if you wish to explore connection to the backbone watermain. Typically, direct connections are not permitted, but given the size of development, this option could be explored further, only if requested.
- Water Supply Redundancy: Residential buildings with a basic day demand greater than 50m³/day (0.57 L/s) are required to be connected to a minimum of two water services separated by an isolation valve to avoid a vulnerable service area as per the Ottawa Design Guidelines - Water Distribution, WDG001, July 2010 Clause 4.3.1 Configuration. The basic day demand for each site anticipated to exceed 50m³/day

therefore 2 water services will be required. There shall be primary water service and a secondary connection.

- Please review Technical Bulletin ISTB-2018-0, maximum fire flow hydrant capacity is provided in Section 3 Table 1 of Appendix I. A hydrant coverage figure shall be provided and demonstrate there is adequate fire protection.
- Boundary conditions are required to confirm that the require fire flows can be achieved as well as availability of the domestic water pressure on the City street in front of the development. Use Table 3-3 of the MOE Design Guidelines for Drinking-Water System to determine Maximum Day and Maximum Hour peaking factors for 0 to 500 persons and use Table 4.2 of the Ottawa Design Guidelines, Water Distribution for 501 to 3,000 persons. Please provide the following information to the City of Ottawa via email to request water distribution network boundary conditions for the subject site. Please note that once this information has been provided to the City of Ottawa it takes approximately 5-10 business days to receive boundary conditions.
 - i. Type of Development and Units
 - ii. Site Address
 - iii. A plan showing the proposed water service connection locations.
 - iv. Average Daily Demand (L/s)
 - v. Maximum Daily Demand (L/s)
 - vi. Peak Hour Demand (L/s)
 - vii. Fire Flow (L/min)
 - viii. [Fire flow demand requirements shall be based on Fire Underwriters Survey (FUS) Water Supply for Public Fire Protection 1999]
 - ix. Exposure separation distances shall be defined on a figure to support the FUS calculation and required fore flow (RFF).
 - x. Hydrant capacity shall be assessed to demonstrate the RFF can be achieved. Please identify which hydrants are being considered to meet the RFF on a fire hydrant coverage plan as part of the boundary conditions request.

Sanitary Sewer

- The existing sanitary sewer servicing this property, along with the existing trailer park to the south and other properties to the east, is identified as private. During the pre-consultation meeting the applicant identified that the sewer has become public. Documentation is required to prove the sewer system is now public.
- If the sanitary sewer is found to be private, correspondence from all property owners impacted by site construction, specifically sanitary sewer reconstruction will need to be provided. The correspondence will need to indicate that an agreeable arrangement has be established between both parties regarding service during construction. This is a requirement for the subdivision or site plan stage of the project.
- Currently, there are no known issues with the Nepean Collector's capacity.
- If the sanitary sewer is found to be private, an MOECP ECA for private sewage works, can be done through the Transfer of Review , will need to be completed at the end of the subdivision or site plan stage.

Geotechnical Investigation:

- A Geotechnical Study/Investigation shall be prepared in support of this development proposal.
- Reducing the groundwater level in this area can lead to potential damages to surrounding structures due to excessive differential settlements of the ground. The impact of groundwater lowering on adjacent properties needs to be discussed and investigated to ensure there will be no short term and long term damages associated with lowering the groundwater in this area.
- Geotechnical Study shall be consistent with the Geotechnical Investigation and Reporting Guidelines for Development Applications. <https://documents.ottawa.ca/sites/default/files/documents/cap137602.pdf>

Please contact Infrastructure Project Manager [Ahmed Elsayed](#) for follow-up questions.

Transportation

- Follow Traffic Impact Assessment Guidelines.
 - A TIA is required.
 - Submit Scoping report at your earliest convenience.
 - Start this process as soon as possible. The application will not be deemed complete until the submission of the draft step 2-4, including the functional draft RMA package (if applicable) and/or monitoring report (if applicable).
 - Although a full review of the TIA Strategy report (Step 4) is not required prior to an application, it is strongly recommended.
 - Request base mapping asap if RMA is required. Contact [Engineering Services](#).
- ROW protection on Richmond is 26m- 7.5m north side and 18.5m south side.
- On plans please provide:
 - Show all details of the roads abutting the site up to and including the opposite curb; include such items as pavement markings, accesses and/or sidewalks.
 - Turning movement diagrams required for all accesses showing the largest vehicle to access/egress the site.
 - Turning movement diagrams required for internal movements (loading areas, garbage).
 - Show all curb radii measurements; ensure that all curb radii are reduced as much as possible
 - Show lane/aisle widths.
 - Sidewalk is to be continuous across access as per City Specification 7.1.
 - Grey out any area that will not be impacted by this application.
- ROW protection on Moodie between Bell's Corners-urban area limit and Richmond is 37.5 metres
- ROW protection on Robertson between Bell's Corners-urban area west limit and Eagleson is G (see below)
 - "G" – signifies Greenbelt for which unique rights-of-way protection policy apply as follows: For arterial road segments located entirely within the Greenbelt, the right-of-way requirements vary depending on: the number and width of travel lanes; the treatment of curbs, medians, and road drainage; and other amenities to be provided in the corridor. On this basis, the right-of-way to be acquired by the City and the means to acquire the land will be determined with involvement of the National Capital Commission on a case-by-case basis a road modifications are being planned. In the event that a portion of Greenbelt land is conveyed to another owner, a minimum road-widening requirement of 42.5 m shall apply for an arterial road segment adjacent to that land. For segments adjacent to the Greenbelt along only one side, the ROW dimension for the urban area side should be protected, with an additional 5.0 m widening requested along the Greenbelt side (to construct the wider rural cross-section). As always, the widening requirements are to be measured from the existing road centerline.
- A public road connection to Moodie Drive is required and must be constructed to City Road standards for a 20m local (at Timm) or a 26m collector (Menten Place).
 - Sidewalks and cycle tracks regardless of which option is selected.
- Any modifications to the intersection of Moodie Drive and Timm Drive would be considered local service and would not be DC eligible. All cost related to modifications (traffic signals, median, line painting, etc) at the intersection will be the responsibility of the proponent and will **require the submission of an RMA**,
- Noise Impact Studies required for the following:
 - Road
 - Rail

- If the Beachburg railway spur is pursued for access and dedication, the City has concerns with maintenance requirements for another large box culvert
 - With its alignment, the railway spurline could intersect Moodie between the intersections of Moodie Drive/Timm Drive and Moodie and Fitzgerald/Menten Place.
- The preferred alternative for access would be an extension of the Menten Place collector and associated required road modifications.
 - The traffic signal at Moodie and Fitzgerald should be reviewed for its future capacity.
- Whereas a secondary access is concerned, the City would prefer one from Robertson Road.
 - Active transportation alternatives were being proposed. However, vehicular access should be considered in addition to the active transportation modes.

Please contact Transportation Project Manager, [Mike Giampa](#) for follow-up questions.

Other

Please refer to the links to “[Guide to preparing studies and plans](#)” and [fees](#) for general information. Additional information is available related to [building permits, development charges, and the Accessibility Design Standards](#). Be aware that other fees and permits may be required, outside of the development review process. You may obtain background drawings by contacting informationcentre@ottawa.ca.

Staff encourage a second meeting prior to application submission once the design has evolved in response to comments received to date.

These pre-consultation comments are valid for one year. If you submit a development application(s) after this time, you may be required to meet for another pre-consultation meeting and/or the submission requirements may change. You are as well encouraged to contact us for a follow-up meeting if the plan/concept will be further refined.

Please do not hesitate to contact me if you have any questions.

Regards,
Laurel

Laurel McCreight MCIP, RPP
Planner
Development Review West
Urbaniste
Examen des demandes d'aménagement ouest

City of Ottawa | Ville d'Ottawa
 613.580.2424 ext./poste 16587
ottawa.ca/planning / ottawa.ca/urbanisme

FUNCTIONAL SITE SERVICING AND STORMWATER MANAGEMENT REPORT REV.03 – 1987 ROBERTSON ROAD (STILLWATER STATION)

Appendix E Correspondence
February 28, 2024

E.4 2020 PLAN AND STUDY LIST



APPLICANT'S STUDY AND PLAN IDENTIFICATION LIST

Legend: **S** indicates that the study or plan is required with application submission.

A indicates that the study or plan may be required to satisfy a condition of approval/draft approval.

For information and guidance on preparing required studies and plans refer [here](#):

S/A	Number of copies	ENGINEERING		S/A	Number of copies
S	5	1. Site Servicing Plan	2. Site Servicing Study	S	3
S	5	3. Grade Control and Drainage Plan	4. Geotechnical Study	S	3
■	2	5. Composite Utility Plan	6. Groundwater Impact Study	■	3
■	3	7. Servicing Options Report	8. Wellhead Protection Study	■	3
S	4	9. Transportation Impact Assessment (TIA)	10. Erosion and Sediment Control Plan	S	3
S	3	11. Storm water Management Report	12. Hydro geological and Terrain Analysis	■	3
■	3	13. Hydraulic Water main Analysis	14. Noise	S	3
S	PDF only	15. Roadway Modification Functional Design	16. Confederation Line Proximity Study	■	3

S/A	Number of copies	PLANNING / DESIGN / SURVEY		S/A	Number of copies
S	15	17. Draft Plan of Subdivision	18. Plan Showing Layout of Parking Garage	S	2
■	5	19. Draft Plan of Condominium	20. Planning Rationale	S	3
■	10	21. Site Plan	22. Minimum Distance Separation (MDS)	■	3
S	15	23. Concept Plan Showing Proposed Land Uses and Landscaping	24. Agrology and Soil Capability Study	■	3
■	3	25. Concept Plan Showing Ultimate Use of Land	26. Cultural Heritage Impact Statement	■	3
S	3	27. Landscape Plan	28. Archaeological Resource Assessment Requirements: S (site plan) A (subdivision, condo)	■	3
S	1	29. Survey Plan	30. Shadow Analysis	S	3
S	3	31. Architectural Building Elevation Drawings (dimensioned)	32. Design Brief (includes the Design Review Panel Submission Requirements)	S	Available online
■	3	33. Wind Analysis		■	

S/A	Number of copies	ENVIRONMENTAL		S/A	Number of copies
S	3	34. Phase 1 Environmental Site Assessment	35. Impact Assessment of Adjacent Waste Disposal/Former Landfill Site	■	3
■	3	36. Phase 2 Environmental Site Assessment (depends on the outcome of Phase 1)	37. Assessment of Landform Features	■	3
■	3	38. Record of Site Condition	39. Mineral Resource Impact Assessment	■	3
S	3	40. Tree Conservation Report	41. Environmental Impact Statement / Impact Assessment of Endangered Species	S	3
■	3	42. Mine Hazard Study / Abandoned Pit or Quarry Study	43. Integrated Environmental Review (Draft, as part of Planning Rationale)	■	3

S/A	Number of copies	ADDITIONAL REQUIREMENTS		S/A	Number of copies
S	1	44. Applicant's Public Consultation Strategy (may be provided as part of the Planning Rationale)	45. Site Lighting Plan & Certificate		1

Meeting Date: December 9, 2020

Application Type: *Official Plan Amendment & Zoning By-law & Plan of Subdivision*

File Lead (Assigned Planner): Laurel McCreight

Infrastructure Approvals PM: Ahmed Elsayed

Site Address (Municipal Address): 1987 Robertson Road

*Preliminary Assessment: 1 2 3 4 5

*One (1) indicates that considerable major revisions are required before a planning application is submitted, while five (5) suggests that proposal appears to meet the City's key land use policies and guidelines. **This assessment is purely advisory and does not consider technical aspects of the proposal or in any way guarantee application approval.**

It is important to note that the need for additional studies and plans may result during application review. If following the submission of your application, it is determined that material that is not identified in this checklist is required to achieve complete application status, in accordance with the Planning Act and Official Plan requirements, the Planning, Infrastructure and Economic Development Department will notify you of outstanding material required within the required 30 day period. Mandatory pre-application consultation will not shorten the City's standard processing timelines, or guarantee that an application will be approved. It is intended to help educate and inform the applicant about submission requirements as well as municipal processes, policies, and key issues in advance of submitting a formal development application. This list is valid for one year following the meeting date. If the application is not submitted within this timeframe the applicant must again pre-consult with the Planning, Infrastructure and Economic Development Department.

FUNCTIONAL SITE SERVICING AND STORMWATER MANAGEMENT REPORT REV.03 – 1987 ROBERTSON ROAD (STILLWATER STATION)

Appendix E Correspondence
February 28, 2024

E.5 CORRESPONDENCE BETWEEN CIMA AND RVCA, 2021-09-02



From: [Jamieson-Lee Scott](#)
To: [Casey Little](#)
Subject: FW: Stillwater Station - EIS Request for Information
Date: Thursday, September 2, 2021 9:20:37 AM
Attachments: [image004.jpg](#)
[image005.jpg](#)
[image006.jpg](#)
[image007.jpg](#)
[Capture.JPG](#)

From: Matt Jokiel <matt.jokiel@rvca.ca>
Sent: September 2, 2021 11:09 AM
To: Jamieson-Lee Scott <Jamieson-Lee.Scott@cima.ca>
Subject: RE: Stillwater Station - EIS Request for Information

EXTERNAL EMAIL

Hello,

Thank you again for your email. To clarify, the property itself is not located within the Regulation Limit, per se, however, all watercourses – whether in a regulated area or not – are subject to the alteration to waterways component of Ontario Regulation 174/06. The parcel description – as seen in the provided screenshot – was auto generated as RVCA’s GIS software recognizes that an identified watercourse (indicated by the light blue line) is present on the subject property. If any alteration, disturbance, diverting, etc. of the identified watercourse is proposed, a permit will be required from the RVCA prior to any work commencing.

If you require any further clarification, please let me know.

Regards,

Matt Jokiel
Resource Specialist
matt.jokiel@rvca.ca, ext. 1193

RVCA COVID-19 UPDATE: The health, safety and well-being of our clients and staff is our top priority. Our offices and facilities are closed to clients. Staff are working remotely and we do not anticipate any service disruptions. Visit www.rvca.ca/covid-19 for more.

email footer

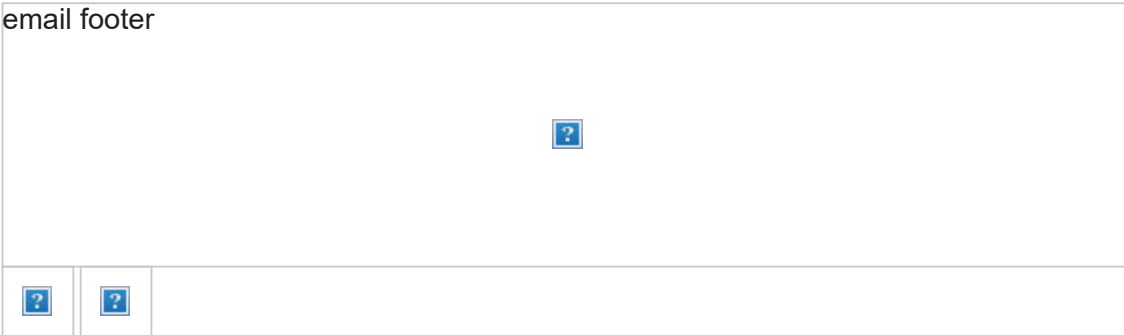

From: Jamieson-Lee Scott <Jamieson-Lee.Scott@cima.ca>
Sent: Wednesday, September 1, 2021 3:43 PM
To: Matt Jokiel <matt.jokiel@rvca.ca>

Subject: RE: Stillwater Station - EIS Request for Information

Thanks Matt,

Just to confirm, the part of Stillwater Creek falling within the property boundary is not within the regulatory limit and does not require a permit from your organization.

I apologize for the confusion, but when viewing the online mapping, it brings up the following text (image attached). Could you provide a bit more clarification?

Much appreciated,

JAMIESON-LEE SCOTT, B.A. Anth.
Technologist / Environnement et urbanisme
Technologiste / Environnement et urbanisme

T 613-860-2462 ext. 6662 **M** 343-961-3309 **F** 613-860-1870
110–240 Catherine Street, Ottawa, ON K2P 2G8 CANADA



Do you really need to print this email? Let's protect the environment!
Devez-vous vraiment imprimer ce courriel? Pensons à l'environnement!

CONFIDENTIALITY WARNING This email is confidential. If you are not the intended recipient, please notify the sender immediately and delete it in its entirety.

AVERTISSEMENT CONCERNANT LA CONFIDENTIALITÉ Ce message est confidentiel. S'il ne vous est pas destiné, veuillez en informer l'émetteur immédiatement et le détruire intégralement.

From: Matt Jokiel <matt.jokiel@rvca.ca>
Sent: September 1, 2021 2:42 PM
To: Jamieson-Lee Scott <Jamieson-Lee.Scott@cima.ca>
Cc: Eric Lalande <eric.lalande@rvca.ca>; Jennifer Lamoureux <jennifer.lamoureux@rvca.ca>
Subject: RE: Stillwater Station - EIS Request for Information

EXTERNAL EMAIL

Hi again Jaimeson,

Yes, my apologies – the below information and mapping is related to 1987 Robertson Rd., Nepean. Apologies for the confusion. I have re-circulated the mapping and email below with the **corrected address**.

Thank you for your email regarding the property noted as **1987 Robertson Rd., Nepean**. Please note that I have attached a copy of RVCA's mapping highlighting the subject property. Please advise if the highlighted parcel does not represent the correct lot. For additional circulation and comment, if necessary, I have cc'ed additional RVCA staff who may have additional input regarding your inquiry.

With this said, please note the following information regarding this particular lot:

- The RVCA administers development regulations (Conservation Authorities Act – Ontario Regulation 174/06 “*Development, Interference with Wetlands and Alterations to Shorelines and Watercourses*”) in areas subject to natural hazards (flooding, erosion, and unstable slopes) and in environmentally sensitive areas (wetlands, shorelines, and waterways). The RVCA also reviews development proposals (Municipal Planning applications) within or adjacent to natural areas in an effort to conserve and protect natural resources in the Rideau River valley.
- Our mapping, attached, indicates the property is located within the jurisdiction of the Rideau Valley Conservation Authority (RVCA) but is outside of both RVCA's Regulation Limit, as well as any identified 1:100 year floodplain. The Regulation Limit is the area to which the Conservation Authority is required to review development and alteration applications under the Conservation Authorities Act (O.Reg. 174/06). A permit is required from our office for development proposals within the Regulation Limit. Development outside of the Regulation Limit does not require approval from our office.
 - Development includes, but is not limited to; construction, reconstruction, pools, decks, foundations, additions, auxiliary buildings, sewage systems, placing fill, shoreline works, regrading of any type, etc.
 - Altering, straightening, diverting, or interfering with the channel of any watercourse within RVCA's jurisdiction must also receive prior approval (whether in a regulated area or not) and the proposal must meet the below policies.
 - To note, for Species at Risk inquiries, it is recommend to direct these to sarontario@ontario.ca

Applications submitted to the RVCA must demonstrate that the development proposal meets RVCA policies. The applicable policies and application requirements are found at the following links:

- Development Policies:
https://www.rvca.ca/media/k2/attachments/Development__Interference_Regs_MASTER_policy_doc_Feb_2018_extended.pdf
- Application documents can be found at: <https://www.rvca.ca/regulations-planning/rvca-permits-section-28/forms-fees-resources>

I trust this information is helpful. Please let me know if you have any further questions.

Regards,

Matt Jokiel
Resource Specialist
matt.jokiel@rvca.ca, ext. 1193

RVCA COVID-19 UPDATE: The health, safety and well-being of our clients and staff is our top priority. Our offices and facilities are closed to clients. Staff are working remotely and we do not anticipate any service disruptions. Visit www.rvca.ca/covid-19 for more.

email footer



From: Jamieson-Lee Scott <Jamieson-Lee.Scott@cima.ca>
Sent: Wednesday, September 1, 2021 2:30 PM
To: Matt Jokiel <matt.jokiel@rvca.ca>
Subject: RE: Stillwater Station - EIS Request for Information

Good afternoon Mr. Jokiel,

Could I confirm that the address is showing up as 1987 Robertson Rd, Ottawa, ON for your search? The RVCA map is showing the correct property boundary, but the address you provided doesn't match our records.

Cheers,

JAMIESON-LEE SCOTT, B.A. Anth.
Technologist / Environnement et urbanisme
Technologiste / Environnement et urbanisme

T 613-860-2462 ext. 6662 **M** 343-961-3309 **F** 613-860-1870
110-240 Catherine Street, Ottawa, ON K2P 2G8 CANADA



Do you really need to print this email? Let's protect the environment!
Devez-vous vraiment imprimer ce courriel? Pensons à l'environnement!

CONFIDENTIALITY WARNING This email is confidential. If you are not the intended recipient, please notify the sender immediately and delete it in its entirety.

AVERTISSEMENT CONCERNANT LA CONFIDENTIALITÉ Ce message est confidentiel. S'il ne vous est pas destiné, veuillez en informer l'émetteur immédiatement et le détruire intégralement.

From: Matt Jokiel <matt.jokiel@rvca.ca>
Sent: September 1, 2021 1:58 PM
To: Jamieson-Lee Scott <Jamieson-Lee.Scott@cima.ca>
Cc: Eric Lalande <eric.lalande@rvca.ca>; Jennifer Lamoureux <jennifer.lamoureux@rvca.ca>
Subject: RE: Stillwater Station - EIS Request for Information

EXTERNAL EMAIL

Good afternoon,

Thank you for your email regarding the property noted as 126 Sutcliffe Lane, North Elmsley. Please note that I have attached a copy of RVCA's mapping highlighting the subject property. Please advise if the highlighted parcel does not represent the correct lot. For additional circulation and comment, if necessary, I have cc'ed additional RVCA staff who may have additional input regarding your inquiry.

With this said, please note the following information regarding this particular lot:

- The RVCA administers development regulations (Conservation Authorities Act – Ontario Regulation 174/06 “*Development, Interference with Wetlands and Alterations to Shorelines and Watercourses*”) in areas subject to natural hazards (flooding, erosion, and unstable slopes) and in environmentally sensitive areas (wetlands, shorelines, and waterways). The RVCA also reviews development proposals (Municipal Planning applications) within or adjacent to natural areas in an effort to conserve and protect natural resources in the Rideau River valley.
- Our mapping, attached, indicates the property is located within the jurisdiction of the Rideau Valley Conservation Authority (RVCA) but is outside of both RVCA's Regulation Limit, as well as any identified 1:100 year floodplain. The Regulation Limit is the area to which the Conservation Authority is required to review development and alteration applications under the Conservation Authorities Act (O.Reg. 174/06). A permit is required from our office for development proposals within the Regulation Limit. Development outside of the Regulation Limit does not require approval from our office.
 - Development includes, but is not limited to; construction, reconstruction, pools, decks, foundations, additions, auxiliary buildings, sewage systems, placing fill, shoreline works, regrading of any type, etc.
 - Altering, straightening, diverting, or interfering with the channel of any watercourse within RVCA's jurisdiction must also receive prior approval (whether in a regulated area or not) and the proposal must meet the below policies.
 - To note, for Species at Risk inquiries, it is recommend to direct these to sarontario@ontario.ca

Applications submitted to the RVCA must demonstrate that the development proposal meets RVCA policies. The applicable policies and application requirements are found at the following links:

- Development Policies:
https://www.rvca.ca/media/k2/attachments/Development__Interference_Regs_MASTER_policy_doc_Feb_2018_extended.pdf
- Application documents can be found at: <https://www.rvca.ca/regulations-planning/rvca-permits-section-28/forms-fees-resources>

I trust this information is helpful. Please let me know if you have any further questions.

Regards,

Matt Jokiel
Resource Specialist
matt.jokiel@rvca.ca, ext. 1193

RVCA COVID-19 UPDATE: The health, safety and well-being of our clients and staff is our top priority. Our offices and facilities are closed to clients. Staff are working remotely and we do not anticipate any service disruptions. Visit www.rvca.ca/covid-19 for more.

email footer



From: LRC Info <info@lrconline.com>
Sent: Tuesday, August 31, 2021 4:27 PM
To: Matt Jokiel <matt.jokiel@rvca.ca>
Subject: FW: Stillwater Station - EIS Request for Information

From: RVCA Info <info@rvca.ca>
Sent: Tuesday, August 31, 2021 2:32 PM
To: LRC Info <info@lrconline.com>
Subject: Fw: Stillwater Station - EIS Request for Information

From: Jamieson-Lee Scott <Jamieson-Lee.Scott@cima.ca>
Sent: August 31, 2021 2:07 PM
To: RVCA Info <info@rvca.ca>
Subject: Stillwater Station - EIS Request for Information

Good day,

CIMA+ has been contracted by The Properties Group Management Ltd. to prepare an Environmental Impact Study (EIS) in support of the Secondary Plan for the proposed residential development of the property referred to Stillwater Station, located at 1987 Robertson Rd, Ottawa, ON.

The proposed development will involve a combination of commercial and residential buildings located 1987 Robertson Rd, Ottawa, ON, part of Lot 11, Concession 2 of Nepean Geographic Township. The Study Area is approximately 23.68 acres, in the neighbourhood of Bells Corners and is situated south of the Beachburg Rail Corridor and Carleton Place Rail Corridor. The site can be accessed from Robertson Road to the south and Moodie Drive to the west.

Refer to the included map for the Study Area boundaries.

We have reviewed relevant background data and have determined the following natural heritage constraints within or adjacent to the site:

- Stillwater Creek;
- RVCA regulatory limit;
- Unevaluated wetlands;
- Woodlands; and
- SAR habitat.

We are contacting you to obtain any further information on environmental features and/or conditions for and adjacent (within 120 meters) to the site prior to us drafting the EIS for this project.

Do not hesitate to contact me should you want to discuss this request or require further information.

Respectfully,

JAMIESON-LEE SCOTT, B.A. Anth.
Technologist / Environnement et urbanisme
Technologiste / Environnement et urbanisme

T 613-860-2462 ext. 6662 **M** 343-961-3309 **F** 613-860-1870
110–240 Catherine Street, Ottawa, ON K2P 2G8 CANADA



Do you really need to print this email? Let's protect the environment!
Devez-vous vraiment imprimer ce courriel? Pensons à l'environnement!

CONFIDENTIALITY WARNING This email is confidential. If you are not the intended recipient, please notify the sender immediately and delete it in its entirety.

AVERTISSEMENT CONCERNANT LA CONFIDENTIALITÉ Ce message est confidentiel. S'il ne vous est pas destiné, veuillez en informer l'émetteur immédiatement et le détruire intégralement.

FUNCTIONAL SITE SERVICING AND STORMWATER MANAGEMENT REPORT REV.03 – 1987 ROBERTSON ROAD (STILLWATER STATION)

Appendix E Correspondence
February 28, 2024

E.6 CORRESPONDENCE BETWEEN CIMA AND RVCA, 2021-09-08



From: [Casey Little](#)
To: [Casey Little](#)
Subject: FW: Stillwater Station - EIS Request for Information - Background Report
Date: Wednesday, September 8, 2021 7:46:44 AM
Attachments: [image001.jpg](#)
[image006.jpg](#)
[image007.jpg](#)
[image008.jpg](#)
[image009.jpg](#)
[image010.jpg](#)
[image002.jpg](#)
[NCC_Stillwater_Report2013_Final.pdf](#)

CASEY LITTLE

Biologist / Urban Planning and Environment

T 613-860-2462 M 343-575-0098 F 613-860-1870
110–240 Catherine Street, Ottawa, ON K2P 2G8 CANADA 415 Baseline Road West, 2nd Floor, Bowmanville,
ON L1C 5M2 CANADA



Do you really need to print this email? Let's protect the environment!

CONFIDENTIALITY WARNING This email is confidential. If you are not the intended recipient, please notify the sender immediately and delete it in its entirety.

From: Jamieson-Lee Scott <Jamieson-Lee.Scott@cima.ca>
Sent: September 2, 2021 9:23 AM
To: Casey Little <Casey.Little@cima.ca>
Subject: FW: Stillwater Station - EIS Request for Information

From: Jennifer Lamoureux <jennifer.lamoureux@rvca.ca>
Sent: September 2, 2021 8:39 AM
To: Jamieson-Lee Scott <Jamieson-Lee.Scott@cima.ca>
Cc: Eric Lalande <eric.lalande@rvca.ca>; Matt Jokiel <matt.jokiel@rvca.ca>
Subject: RE: Stillwater Station - EIS Request for Information

EXTERNAL EMAIL

Good Morning Jaimeson,
I have attached a detailed report for the Stillwater Creek catchment.

Also I have included a link below to our latest City Stream Watch program.
https://www.rvca.ca/media/k2/attachments/CSW2015_Stillwater_FINAL.pdf

Both reports should provide important background information for an EIS. If you have any questions about the reports please let me know.

Jennifer Lamoureux
Aquatic and Fish Habitat Biologist
Ext. 1108

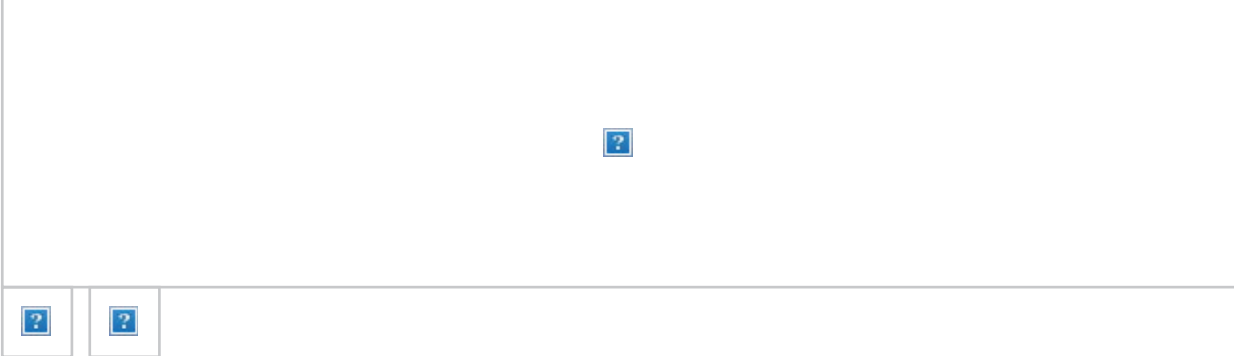

RVCA COVID-19 UPDATE: The health, safety and well-being of our clients and staff is our top priority. Our offices and facilities are closed to clients. Staff are working remotely and we do not anticipate any service disruptions. Visit www.rvca.ca/covid-19 for more.

From: Matt Jokiel <matt.jokiel@rvca.ca>
Sent: Wednesday, September 1, 2021 2:42 PM
To: 'Jamieson-Lee Scott' <Jamieson-Lee.Scott@cima.ca>
Cc: Eric Lalande <eric.lalande@rvca.ca>; Jennifer Lamoureux <jennifer.lamoureux@rvca.ca>
Subject: RE: Stillwater Station - EIS Request for Information

Hi again Jaimeson,

Yes, my apologies – the below information and mapping is related to 1987 Robertson Rd., Nepean. Apologies for the confusion. I have re-circulated the mapping and email below with the **corrected address**.

Thank you for your email regarding the property noted as **1987 Robertson Rd., Nepean**. Please note that I have attached a copy of RVCA's mapping highlighting the subject property. Please advise if the highlighted parcel does not represent the correct lot. For additional circulation and comment, if necessary, I have cc'ed additional RVCA staff who may have additional input regarding your inquiry.

With this said, please note the following information regarding this particular lot:

- The RVCA administers development regulations (Conservation Authorities Act – Ontario Regulation 174/06 “*Development, Interference with Wetlands and Alterations to Shorelines and Watercourses*”) in areas subject to natural hazards (flooding, erosion, and unstable slopes) and in environmentally sensitive areas (wetlands, shorelines, and waterways). The RVCA also reviews development proposals (Municipal Planning applications) within or adjacent to natural areas in an effort to conserve and protect natural resources in the Rideau River valley.
- Our mapping, attached, indicates the property is located within the jurisdiction of the Rideau

Valley Conservation Authority (RVCA) but is outside of both RVCA's Regulation Limit, as well as any identified 1:100 year floodplain. The Regulation Limit is the area to which the Conservation Authority is required to review development and alteration applications under the Conservation Authorities Act (O.Reg. 174/06). A permit is required from our office for development proposals within the Regulation Limit. Development outside of the Regulation Limit does not require approval from our office.

- Development includes, but is not limited to; construction, reconstruction, pools, decks, foundations, additions, auxiliary buildings, sewage systems, placing fill, shoreline works, regrading of any type, etc.
- Altering, straightening, diverting, or interfering with the channel of any watercourse within RVCA's jurisdiction must also receive prior approval (whether in a regulated area or not) and the proposal must meet the below policies.
- To note, for Species at Risk inquiries, it is recommend to direct these to sarontario@ontario.ca

Applications submitted to the RVCA must demonstrate that the development proposal meets RVCA policies. The applicable policies and application requirements are found at the following links:

- Development Policies:
https://www.rvca.ca/media/k2/attachments/Development__Interference_Regs_MASTER_policy_doc_Feb_2018_extended.pdf
- Application documents can be found at: <https://www.rvca.ca/regulations-planning/rvca-permits-section-28/forms-fees-resources>

I trust this information is helpful. Please let me know if you have any further questions.

Regards,

Matt Jokiel
Resource Specialist
matt.jokiel@rvca.ca, ext. 1193

RVCA COVID-19 UPDATE: The health, safety and well-being of our clients and staff is our top priority. Our offices and facilities are closed to clients. Staff are working remotely and we do not anticipate any service disruptions. Visit www.rvca.ca/covid-19 for more.

email footer



From: Jamieson-Lee Scott <Jamieson-Lee.Scott@cima.ca>
Sent: Wednesday, September 1, 2021 2:30 PM
To: Matt Jokiel <matt.jokiel@rvca.ca>
Subject: RE: Stillwater Station - EIS Request for Information

Good afternoon Mr. Jokiel,

Could I confirm that the address is showing up as 1987 Robertson Rd, Ottawa, ON for your search? The RVCA map is showing the correct property boundary, but the address you provided doesn't match our records.

Cheers,

JAMIESON-LEE SCOTT, B.A. Anth.
Technologist / Environnement et urbanisme
Technologiste / Environnement et urbanisme

T 613-860-2462 ext. 6662 **M** 343-961-3309 **F** 613-860-1870
110–240 Catherine Street, Ottawa, ON K2P 2G8 CANADA



Do you really need to print this email? Let's protect the environment!
Devez-vous vraiment imprimer ce courriel? Pensons à l'environnement!

CONFIDENTIALITY WARNING This email is confidential. If you are not the intended recipient, please notify the sender immediately and delete it in its entirety.
AVERTISSEMENT CONCERNANT LA CONFIDENTIALITÉ Ce message est confidentiel. S'il ne vous est pas destiné, veuillez en informer l'émetteur immédiatement et le détruire intégralement.

From: Matt Jokiel <matt.jokiel@rvca.ca>
Sent: September 1, 2021 1:58 PM
To: Jamieson-Lee Scott <Jamieson-Lee.Scott@cima.ca>
Cc: Eric Lalande <eric.lalande@rvca.ca>; Jennifer Lamoureux <jennifer.lamoureux@rvca.ca>
Subject: RE: Stillwater Station - EIS Request for Information

EXTERNAL EMAIL

Good afternoon,

Thank you for your email regarding the property noted as 126 Sutcliffe Lane, North Elmsley. Please note that I have attached a copy of RVCA's mapping highlighting the subject property. Please advise if the highlighted parcel does not represent the correct lot. For additional circulation and comment, if necessary, I have cc'ed additional RVCA staff who may have additional input regarding your inquiry.

With this said, please note the following information regarding this particular lot:

- The RVCA administers development regulations (Conservation Authorities Act – Ontario Regulation 174/06 “*Development, Interference with Wetlands and Alterations to Shorelines and Watercourses*”) in areas subject to natural hazards (flooding, erosion, and unstable slopes) and in environmentally sensitive areas (wetlands, shorelines, and waterways). The RVCA also reviews development proposals (Municipal Planning applications) within or adjacent to natural

areas in an effort to conserve and protect natural resources in the Rideau River valley.

- Our mapping, attached, indicates the property is located within the jurisdiction of the Rideau Valley Conservation Authority (RVCA) but is outside of both RVCA's Regulation Limit, as well as any identified 1:100 year floodplain. The Regulation Limit is the area to which the Conservation Authority is required to review development and alteration applications under the Conservation Authorities Act (O.Reg. 174/06). A permit is required from our office for development proposals within the Regulation Limit. Development outside of the Regulation Limit does not require approval from our office.
 - Development includes, but is not limited to; construction, reconstruction, pools, decks, foundations, additions, auxiliary buildings, sewage systems, placing fill, shoreline works, regrading of any type, etc.
 - Altering, straightening, diverting, or interfering with the channel of any watercourse within RVCA's jurisdiction must also receive prior approval (whether in a regulated area or not) and the proposal must meet the below policies.
 - To note, for Species at Risk inquiries, it is recommend to direct these to sarontario@ontario.ca

Applications submitted to the RVCA must demonstrate that the development proposal meets RVCA policies. The applicable policies and application requirements are found at the following links:

- Development Policies:
https://www.rvca.ca/media/k2/attachments/Development__Interference_Regs_MASTER_policy_doc_Feb_2018_extended.pdf
- Application documents can be found at: <https://www.rvca.ca/regulations-planning/rvca-permits-section-28/forms-fees-resources>

I trust this information is helpful. Please let me know if you have any further questions.

Regards,

Matt Jokiel
Resource Specialist
matt.jokiel@rvca.ca, ext. 1193

RVCA COVID-19 UPDATE: The health, safety and well-being of our clients and staff is our top priority. Our offices and facilities are closed to clients. Staff are working remotely and we do not anticipate any service disruptions. Visit www.rvca.ca/covid-19 for more.

email footer



From: LRC Info <info@lrconline.com>

Sent: Tuesday, August 31, 2021 4:27 PM

To: Matt Jokiel <matt.jokiel@rvca.ca>

Subject: FW: Stillwater Station - EIS Request for Information

From: RVCA Info <info@rvca.ca>

Sent: Tuesday, August 31, 2021 2:32 PM

To: LRC Info <info@lrconline.com>

Subject: Fw: Stillwater Station - EIS Request for Information

From: Jamieson-Lee Scott <Jamieson-Lee.Scott@cima.ca>

Sent: August 31, 2021 2:07 PM

To: RVCA Info <info@rvca.ca>

Subject: Stillwater Station - EIS Request for Information

Good day,

CIMA+ has been contracted by The Properties Group Management Ltd. to prepare an Environmental Impact Study (EIS) in support of the Secondary Plan for the proposed residential development of the property referred to Stillwater Station, located at 1987 Robertson Rd, Ottawa, ON.

The proposed development will involve a combination of commercial and residential buildings located 1987 Robertson Rd, Ottawa, ON, part of Lot 11, Concession 2 of Nepean Geographic Township. The Study Area is approximately 23.68 acres, in the neighbourhood of Bells Corners and is situated south of the Beachburg Rail Corridor and Carleton Place Rail Corridor. The site can be accessed from Robertson Road to the south and Moodie Drive to the west.

Refer to the included map for the Study Area boundaries.

We have reviewed relevant background data and have determined the following natural heritage constraints within or adjacent to the site:

- Stillwater Creek;
- RVCA regulatory limit;
- Unevaluated wetlands;
- Woodlands; and
- SAR habitat.

We are contacting you to obtain any further information on environmental features and/or conditions for and adjacent (within 120 meters) to the site prior to us drafting the EIS for this project.

Do not hesitate to contact me should you want to discuss this request or require further information.

Respectfully,

JAMIESON-LEE SCOTT, B.A. Anth.
Technologist / Environnement et urbanisme
Technologiste / Environnement et urbanisme

T 613-860-2462 ext. 6662 **M** 343-961-3309 **F** 613-860-1870
110-240 Catherine Street, Ottawa, ON K2P 2G8 CANADA



Do you really need to print this email? Let's protect the environment!
Devez-vous vraiment imprimer ce courriel? Pensons à l'environnement!

CONFIDENTIALITY WARNING This email is confidential. If you are not the intended recipient, please notify the sender immediately and delete it in its entirety.

AVERTISSEMENT CONCERNANT LA CONFIDENTIALITÉ Ce message est confidentiel. S'il ne vous est pas destiné, veuillez en informer l'émetteur immédiatement et le détruire intégralement.

FUNCTIONAL SITE SERVICING AND STORMWATER MANAGEMENT REPORT REV.03 – 1987 ROBERTSON ROAD (STILLWATER STATION)

Appendix E Correspondence
February 28, 2024

E.7 CORRESPONDENCE BETWEEN STANTEC AND RVCA, 2021-09-07



From: [Eric Lalande](#)
To: [Rathnasooriya, Thakshika](#)
Cc: [Kilborn, Kris](#)
Subject: RE: Bells Corners Inquiry
Date: Wednesday, September 8, 2021 8:40:09 AM
Attachments: [~WRD0004.jpg](#)
[image001.jpg](#)
[image002.jpg](#)

Hi Shika,

The RVCA will require on-site enhanced water quality protection (80% TSS removal), as part of the overall site design.

Thank you,

Eric Lalande, MCIP, RPP
Planner, RVCA
613-692-3571 x1137

From: Rathnasooriya, Thakshika <Thakshika.Rathnasooriya@stantec.com>
Sent: Tuesday, September 7, 2021 4:19 PM
To: Eric Lalande <eric.lalande@rvca.ca>
Cc: Kilborn, Kris <kris.kilborn@stantec.com>
Subject: RE: Bells Corners Inquiry

Hi Eric,

We are helping to develop the same site as previously discussed in the correspondence below (1987 Robertson Road). Please find attached a high level site plan of the proposed property. Are you able to confirm the level of quality treatment required for the site?

Additionally, I understand you do not have floodplain mapping information for Stillwater Creek where we intend to discharge. However, we would appreciate if you could send along any further background reports you may have available for Stillwater Creek to help with our design.

Thank you,

Shika Rathnasooriya , P.Eng.

Direct: 613-668-9635
Thakshika.Rathnasooriya@stantec.com

Stantec
400 - 1331 Clyde Avenue
Ottawa ON K2C 3G4



The content of this email is the confidential property of Stantec and should not be copied, modified, retransmitted, or used for any purpose except with Stantec's written authorization. If you are not the intended recipient, please delete all copies and notify us immediately.

From: Kilborn, Kris <kris.kilborn@stantec.com>
Sent: Tuesday, September 7, 2021 3:32 PM
To: Rathnasooriya, Thakshika <Thakshika.Rathnasooriya@stantec.com>
Subject: FW: Bells Corners Inquiry

From: Kilborn, Kris
Sent: Thursday, February 7, 2019 9:51 AM
To: Eric Lalande <eric.lalande@rvca.ca>
Subject: RE: Bells Corners Inquiry

Eric

Thanks for getting back to me. The City might have been confused on the availability of mapping on this upstream area of Stillwater creek.

I have attached the preconsultation notes identifying the above under the engineering bullet three and bullet six.

I would like to clarify that we would be looking at a 30 meter setback from normal high water mark or 15m from top of bank. Subject of course to any additional geotechnical considerations for slope stability etc.

Thanks for your help

Sincerely

Kris Kilborn

Senior Associate, Community Development

Direct: 613 724-4337

Mobile: 613 297-0571

Fax: 613 722-2799

kris.kilborn@stantec.com

Stantec

400 - 1331 Clyde Avenue

Ottawa ON K2C 3G4



The content of this email is the confidential property of Stantec and should not be copied, modified, retransmitted, or used for any purpose except with Stantec's written authorization. If you are not the intended recipient, please delete all copies and notify us immediately.

From: Eric Lalande <eric.lalande@rvca.ca>
Sent: Monday, February 04, 2019 3:34 PM
To: Kilborn, Kris <kris.kilborn@stantec.com>
Subject: RE: Bells Corners Inquiry

Hi Kris,

We do not have mapping for the Stillwater Creek portion in Bells Corners. The information

we have available is north of the, 417 as part of the Ottawa River Floodplain mapping as well as a small section near the Moodie interchange (attached).

Sorry I am not aware of what the City of Ottawa has suggested. Let me know if there is anything else I can help with.

Thanks,

Eric Lalande, MCIP, RPP

Planner, Rideau Valley Conservation Authority
613-692-3571 x1137

From: Kilborn, Kris <kris.kilborn@stantec.com>

Sent: Monday, February 04, 2019 2:48 PM

To: Eric Lalande <eric.lalande@rvca.ca>

Cc: Jamie Batchelor <jamie.batchelor@rvca.ca>

Subject: RE: Bells Corners Inquiry

Good afternoon Eric

Wondering if the RVCA has any updated floodplain mapping or conservation setbacks within the Stillwater Creek Corridor in Bells Corners.

Stantec is working for a client looking to develop a vacant parcel of land east of Moodie Drive and North of Robertson Road.

Preconsultation with the City of Ottawa was completed and it was identified that updating mapping is available.

Please find attached a sketch identifying the site location.

Give me a call if you have any questions

Sincerely

Kris Kilborn

Senior Associate, Community Development

Direct: 613 724-4337

Mobile: 613 297-0571

Fax: 613 722-2799

kris.kilborn@stantec.com

Stantec

400 - 1331 Clyde Avenue

Ottawa ON K2C 3G4



From: Jamie Batchelor <jamie.batchelor@rvca.ca>

Sent: Monday, February 04, 2019 1:30 PM

To: Kilborn, Kris <kris.kilborn@stantec.com>

Cc: Eric Lalande <eric.lalande@rvca.ca>

Subject: Bells Corners Inquiry

Hi Kris,

I got your voicemail regarding an inquiry for a property in Bells Corners. I would suggest contacting Eric Lalande at our office regarding inquiries for this area as he is the RVCA Planner for west Ottawa. I have copied him on this e-mail.

Jamie Batchelor, MCIP,RPP

Planner, ext. 1191

jamie.batchelor@rvca.ca

email footer



FUNCTIONAL SITE SERVICING AND STORMWATER MANAGEMENT REPORT REV.03 – 1987 ROBERTSON ROAD (STILLWATER STATION)

Appendix E Correspondence
February 28, 2024

E.8 CORRESPONDENCE BETWEEN STANTEC AND RVCA, 2021-09-17



Gladish, Alyssa

From: Eric Lalande <eric.lalande@rvca.ca>
Sent: Friday, September 17, 2021 1:21 PM
To: Gladish, Alyssa
Subject: RE: Stillwater Station

Follow Up Flag: Follow up
Flag Status: Completed

Hi Alyssa,

The only other thing I would add is meeting enhanced water quality protection minimum 80% TSS removal (which is what I believe you meant below).

Cheers,

Eric Lalande, MCIP, RPP
Planner, RVCA
613-692-3571 x1137

From: Gladish, Alyssa <Alyssa.Gladish@stantec.com>
Sent: Friday, September 17, 2021 1:34 PM
To: Matt Jokiel <matt.jokiel@rvca.ca>
Cc: Jennifer Lamoureux <jennifer.lamoureux@rvca.ca>; Eric Lalande <eric.lalande@rvca.ca>
Subject: RE: Stillwater Station

Good day Matt,

That is correct, the original correspondence was with regards to the proposed mixed-use development (residential and commercial buildings) at that address.

I understand that the site is outside of the regulated area, but that the watercourse is subject to the policies and requires RVCA approval.

To provide some additional context. Stantec is conducting the functional servicing study for this site. The design intent is to discharge quality, quantity, and temperature-controlled stormwater to Stillwater Creek, and the City of Ottawa has requested pre-consultation with the RVCA to identify your requirements for the stormwater management, erosion protection during construction and development setbacks.

Thank you for confirming the 30 m setback from the highwater mark of the watercourse. I look forward to receiving Eric's input from the planning perspective.

Best regards,

Alyssa Gladish E.I.T.
Project Manager
Direct: 780 917-8567
Mobile: 587 721-1241
Alyssa.Gladish@stantec.com

Stantec
400 - 1331 Clyde Avenue
Ottawa ON K2C 3G4



The content of this email is the confidential property of Stantec and should not be copied, modified, retransmitted, or used for any purpose except with Stantec's written authorization. If you are not the intended recipient, please delete all copies and notify us immediately.

Please consider the environment before printing this email.

From: Matt Jokiel <matt.jokiel@rvca.ca>
Sent: Friday, September 17, 2021 10:16 AM
To: Gladish, Alyssa <Alyssa.Gladish@stantec.com>
Cc: Jennifer Lamoureux <jennifer.lamoureux@rvca.ca>; Eric Lalande <eric.lalande@rvca.ca>
Subject: RE: Stillwater Station

Hello Alyssa,

Thank you for your email. If I recall correctly, the original correspondence from Jamieson-Lee was with regards to a proposed residential development (residential and commercial buildings) located at 1987 Robertson Rd., Ottawa.

To note, the subject site (as seen in the attached mapping) is located outside an area regulated by the RVCA and, thus, upland development does not require additional approval under the Conservation Authorities Act ([Ont. Reg. 174/06](#)). With this said, any and all watercourses located within the Rideau watershed – whether in a regulated area or not – are subject to the aforementioned policies and requires prior approval from our office.

With regards to development setbacks, generally speaking, the minimum setback required for new development is 30 metres from the highwater mark of any adjacent watercourse. For additional circulation and comment I have cc'ed RVCA Planner, Eric Lalande, who may have additional input regarding your inquiry. Eric is RVCA's Planner for this particular area of the watershed any would likely be circulated on any future Planning Act applications that may be associated with this particular site.

If you have any further questions, please contact our office.

Regards,

Matt Jokiel
Regulations Inspector
matt.jokiel@rvca.ca, ext. 1215

RVCA COVID-19 UPDATE: The health, safety and well-being of our clients and staff is our top priority. Our offices and facilities are closed to clients. Staff are working remotely and we do not anticipate any service disruptions. Visit www.rvca.ca/covid-19 for more.



3889 Rideau Valley Drive
PO Box 599, Manotick ON K4M 1A5
T 613-692-3571 | 1-800-267-3504 F 613-692-0831 | www.rvca.ca

This message may contain information that is privileged or confidential and is intended to be for the use of the individual(s) or entity named above. This material may contain confidential or personal information which may be subject to the provisions of the *Municipal Freedom of Information & Protection of Privacy Act*. If you are not the intended recipient of this e-mail, any use, review, revision, retransmission, distribution, dissemination, copying, printing or otherwise use of, or taking of any action in reliance upon this e-mail, is strictly prohibited. If you have received this e-mail in error, please contact the sender and delete the original and any copy of the e-mail and any printout thereof, immediately. Your cooperation is appreciated.



From: Gladish, Alyssa <Alyssa.Gladish@stantec.com>
Sent: Thursday, September 16, 2021 6:09 PM

To: Matt Jokiel <matt.jokiel@rvca.ca>
Cc: Jennifer Lamoureux <jennifer.lamoureux@rvca.ca>
Subject: Stillwater Station

Good Evening Matt and Jennifer,

I believe you were in corresponding with Casey Little and Jaimeson-Lee Scott at CIMA regarding the Stillwater Station EIS.

I was just wondering if the RVCA has any other requirements for the Stillwater Station development and the adjacent reach of Stillwater Creek regarding:

- Erosion protection during construction
- Development setbacks

I noticed in the 2013 report that the nearest reach with buffer guidelines was SW14 (approximately 1km north of the project site), but there were no general recommendations for minimum buffering from the creek in reaches not included in the study area. Please let me know if I have missed anything.

Thank you kindly,

Alyssa Gladish E.I.T.
Project Manager

Direct: 780 917-8567
Mobile: 587 721-1241
Alyssa.Gladish@stantec.com

Stantec
400 - 1331 Clyde Avenue
Ottawa ON K2C 3G4



The content of this email is the confidential property of Stantec and should not be copied, modified, retransmitted, or used for any purpose except with Stantec's written authorization. If you are not the intended recipient, please delete all copies and notify us immediately.

Please consider the environment before printing this email.

FUNCTIONAL SITE SERVICING AND STORMWATER MANAGEMENT REPORT REV.03 – 1987 ROBERTSON ROAD (STILLWATER STATION)

Appendix E Correspondence
February 28, 2024

E.9 CORRESPONDENCE BETWEEN STANTEC AND PATERSON, 2023-11-24



From: Nicole Patey
To: Gladish, Alyssa
Subject: Re: Stillwater Station - Dry Pond Option.
Date: Friday, November 24, 2023 2:04:06 PM
Attachments: [image001.png](#)
[image002.png](#)
[image003.png](#)
[image004.png](#)
[Outlook-Paterson G.png](#)

Hi Alyssa,

Following our meeting earlier this week I discussed the dry pond design internally with one of our senior engineers who handles retaining wall designs. We do not see any red flags with the proposed design from a geotechnical perspective. There is no issue with having the pond permanent pool level against a stone strong wall and having a portion of the wall be submerged provided that it is incorporated into the design of the wall. The proposed outlet can be implemented into the design of the wall as well if the bedding material is properly protected. We have completed retaining wall designs for ponds in the past with box culverts in the middle of the wall.

I hope this answers the questions you had at a high-level, hopefully the meeting with the city goes well! If you have any other questions or need to discuss anything further on this in more detail, please let us know.

Thanks,



NICOLE PATEY, B.ENG.
Project Manager - Geotechnical
TEL: (613) 226-7381 ext. 248
Direct: (613)-909-4787
9 AURIGA DRIVE
OTTAWA ON K2E 7T9
patersongroup.ca

From: Gladish, Alyssa <Alyssa.Gladish@stantec.com>
Sent: Monday, November 20, 2023 1:15 PM
To: Nicole Patey <NPatey@patersongroup.ca>
Cc: David Gilbert <DGilbert@patersongroup.ca>
Subject: RE: Stillwater Station - Dry Pond Option.

Hello Nicole,

Thank you so much for these responses.

For the groundwater levels, our concerns/hesitations arose from the elevations presented in Table 1.

Groundwater levels were recorded in the monitoring wells and piezometers installed at the borehole locations on March 24, 2021. The groundwater level readings noted at that time are presented in Table 1.

Borehole Number	Ground Surface Elevation (m)	Measured Groundwater Level		Date Recorded
		Depth (m)	Elevation (m)	
BH 1	87.47	0.31	87.16	March 24, 2021
BH 2	87.52	0.21	87.31	
BH 3	88.69	0.21	88.48	
BH 4	88.85	1.37	87.48	
BH 5	89.12	NA	NA	
BH 6	89.04	1.28	87.76	
BH 7	88.82	1.93	86.89	

Note: The test hole locations were located in the field and surveyed by Paterson Group. The elevations are referenced to a geodetic datum.

I did see the warning that these levels might be perched, and the long-term levels ranging from 81.5 to 82.5 throughout the site. Is there little concern that the elevations from Table 1 could represent potential high groundwater levels? Or is it fairly typical to see these perched water levels in the boreholes with the shallow bedrock? I will mention to Andrew Glass that it will be helpful to have some additional groundwater readings from the existing 3 wells, to see if we can get that approved.

Please see attached for the preliminary dry pond design that would be feasible on this site. Let me know if it raises any red flags geotechnically.

Best regards,
Alyssa

Alyssa Gladish E.I.T.
Project Manager, Community Development

Direct: 780 917-8567
Mobile: 587 721-1241
Alyssa.Gladish@stantec.com

Stantec
300-1331 Clyde Avenue
Ottawa ON K2C 3G4

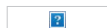

The content of this email is the confidential property of Stantec and should not be copied, modified, retransmitted, or used for any purpose except with Stantec's written authorization. If you are not the intended recipient, please delete all copies and notify us immediately.

From: Nicole Patey <NPatey@patersongroup.ca>

Sent: Friday, November 17, 2023 3:39 PM
To: Gladish, Alyssa <Alyssa.Gladish@stantec.com>
Cc: David Gilbert <DGilbert@patersongroup.ca>
Subject: Re: Stillwater Station - Dry Pond Option.

Hi Alyssa,

I have added our responses to your questions below in blue. We can discuss further in our meeting next week if you have any questions.

Thanks,



NICOLE PATEY, B.ENG.
Project Manager - Geotechnical
TEL: (613) 226-7381 ext. 248
Direct: (613)-909-4787
9 AURIGA DRIVE
OTTAWA ON K2E 7T9
patersongroup.ca

From: Gladish, Alyssa <Alyssa.Gladish@stantec.com>
Sent: Friday, November 17, 2023 12:17 PM
To: Nicole Patey <NPatey@patersongroup.ca>; David Gilbert <DGilbert@patersongroup.ca>
Subject: RE: Stillwater Station - Dry Pond Option.

Hello Nicole and David.

The owner has asked us to provide a functional sketch of a dry pond scenario within the celebratory space, since the City is unwilling to accept an underground storage facility.

The feasibility of the pond in this space will depend on several geotechnical aspects:

1. Can we lower the elevation along the hazard lands/top of slope by 1.0m? (we need to know this answer as soon as possible). Lowering the elevation within the limit of hazard lands should not be an issue as it reduces soil loading at the top of slope, however it should be noted that the slope can not be re-shaped in any way that increases the steepness. We recommend that a slope stability section be completed at the location of the dry pond once the design details are finalized to ensure that there are no negative impacts to the overall slope stability from a geotechnical perspective. Although it is not an issue from a geotechnical perspective, it should also be noted that the City may not accept a dry pond design that impacts the limit of hazard lands.

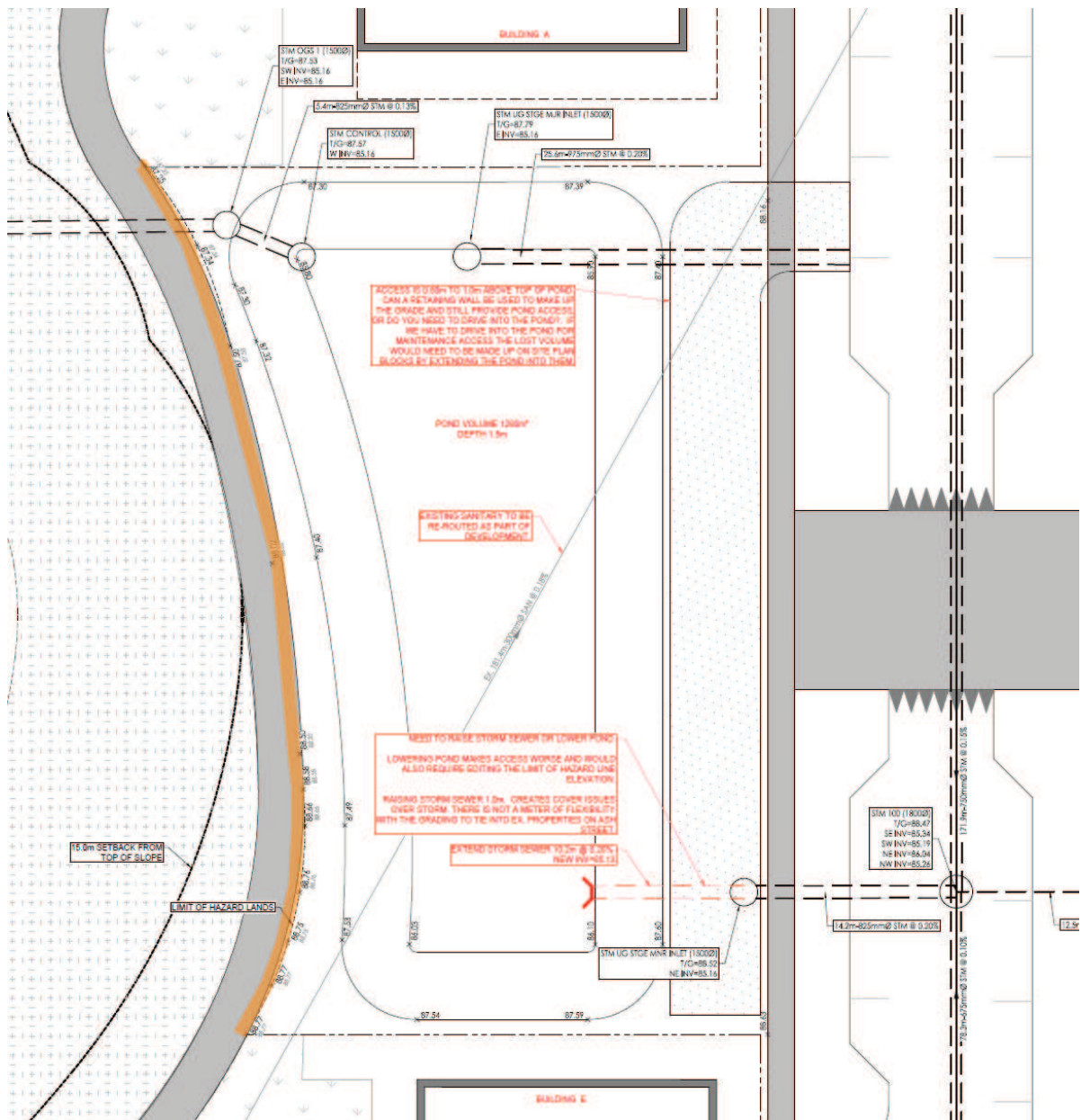

2. If we are to lower a portion of the Limit of Hazard lands, would there be slope limitations to tie-in to the existing Limit of Hazard Lands on either side? Or other considerations? As noted above, lowering the elevation within the limit of hazard lands should not be an issue as long as the slope is not re-shaped in any way that increases the steepness. We recommend that a slope stability section be completed at the location of the dry pond once the design details are finalized to ensure that there are no negative impacts to the overall slope stability from a geotechnical perspective.
3. Have any additional groundwater levels been measured since the site investigation? At this time, we are assuming the pond will need to be lined to avoid infiltration and short-circuit into the foundation drains of the adjacent buildings, but it would be good to have a sense of whether the lining is required for a groundwater component as well. The proposed bottom of the pond will be 84.80m to 85.10m. No additional groundwater levels have been obtained from the site since the initial investigation in March 2021. Based on the initial investigation, the long-term groundwater level was noted to be at an elevation of 81.5 to 82.5 m. Therefore, it is expected that the long-term groundwater level will be located well below the pond bottom elevation, it is not expected that a liner will be required from a geotechnical perspective. However, Paterson has recommended that a supplemental geotechnical investigation be completed for the subject site, our recommendations may change based on the results of the subsurface profile encountered in the supplemental investigation. If required at the present time, Paterson could obtain additional water level readings from the 3 monitoring wells installed on site during the investigation.
4. We will need retaining walls within the pond to achieve the depths required and allow for a sufficiently deep upstream storm sewer network. Is this feasible with the groundwater levels in this area? This is not anticipated to be an issue as the retaining walls can be designed to have sufficient drainage based on the conditions at the location of the retaining walls. Further, based on the details known at this time and the existing grades at the site, it is expected that retaining walls near the dry pond will be constructed well above the anticipated long term groundwater table.

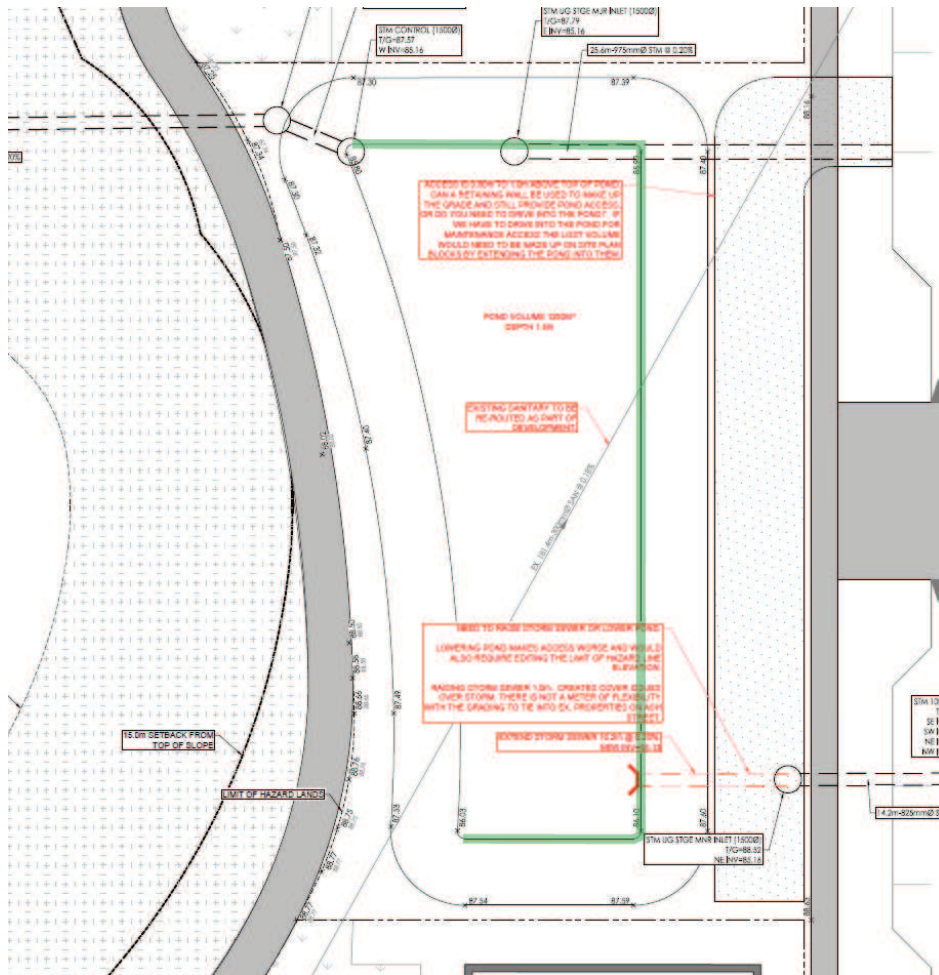

Thank you,
Alyssa

Alyssa Gladish E.I.T.
Project Manager, Community Development

Direct: 780 917-8567
Mobile: 587 721-1241
Alyssa.Gladish@stantec.com

Stantec
300-1331 Clyde Avenue
Ottawa ON K2C 3G4



The content of this email is the confidential property of Stantec and should not be copied, modified, retransmitted, or used for any purpose except with Stantec's written authorization. If you are not the intended recipient, please delete all copies and notify us immediately.

From: Nicole Patey <NPatey@patersongroup.ca>
Sent: Friday, November 17, 2023 9:11 AM
To: Gladish, Alyssa <Alyssa.Gladish@stantec.com>
Subject: Re: Stillwater Station - Dry Pond Option.

Hi Alyssa,

No problem, we are available Tuesday afternoon next week for a call if that works for you. Could you please also add Dave Gilbert, dgilbert@patersongroup.ca to the invite as well.

Thanks,



NICOLE PATEY, B.ENG.
Project Manager - Geotechnical
TEL: (613) 226-7381 ext. 248
Direct: (613) 909-4787
9 AURIGA DRIVE
OTTAWA ON K2E 7T9
patersongroup.ca

From: Gladish, Alyssa <Alyssa.Gladish@stantec.com>
Sent: Thursday, November 16, 2023 6:20 PM

To: Nicole Patey <NPatey@patersongroup.ca>
Subject: Stillwater Station - Dry Pond Option.

Hello Nicole,

I have some questions regarding the limit of hazard lands and some other geotechnical considerations for the Stillwater Station site, for which we are exploring the dry pond option.

Would you be available for a quick call to discuss? Possibly early next week?

Thank you,
Alyssa

Alyssa Gladish E.I.T.
Project Manager, Community Development

Direct: 780 917-8567
Mobile: 587 721-1241
Alyssa.Gladish@stantec.com

Stantec
300-1331 Clyde Avenue
Ottawa ON K2C 3G4



The content of this email is the confidential property of Stantec and should not be copied, modified, retransmitted, or used for any purpose except with Stantec's written authorization. If you are not the intended recipient, please delete all copies and notify us immediately.

Caution: This email originated from outside of Stantec. Please take extra precaution.
Attention: Ce courriel provient de l'extérieur de Stantec. Veuillez prendre des précautions supplémentaires.
Atención: Este correo electrónico proviene de fuera de Stantec. Por favor, tome precauciones adicionales.

Caution: This email originated from outside of Stantec. Please take extra precaution.
Attention: Ce courriel provient de l'extérieur de Stantec. Veuillez prendre des précautions supplémentaires.
Atención: Este correo electrónico proviene de fuera de Stantec. Por favor, tome precauciones adicionales.

Caution: This email originated from outside of Stantec. Please take extra precaution.
Attention: Ce courriel provient de l'extérieur de Stantec. Veuillez prendre des précautions supplémentaires.
Atención: Este correo electrónico proviene de fuera de Stantec. Por favor, tome precauciones adicionales.