



Enhancing our communities



# 5497 Manotick Main Street

**SITE SERVICING & STORMWATER MANAGEMENT REPORT**

12213559 Canada Inc.

# Document Control

|               |  |   |
|---------------|--|---|
| File:         | Prepared by:   | Prepared for:   |
| 522679        | Tatham Engineering Limited<br>5335 Canotek Road, Unit 103<br>Ottawa, Ontario K1J 9L4 | 12213559 Canada Inc.<br>996 St-Augustin Road, Unit B<br>Embrun, Ontario K0A 1W0 |
| Date:         | T 613-747-3636<br>tathameng.com  |   |
| July 17, 2023 |  |   |

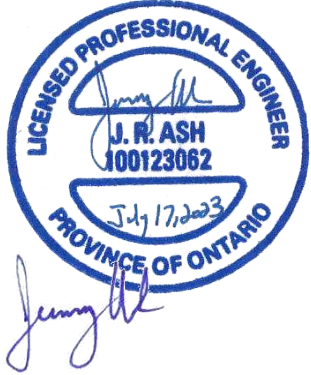
|  |  |
|--|--|
| <p><b>Authored by:</b></p> <div style="text-align: center;">  </div> | <p><b>Reviewed by:</b></p> <div style="text-align: center;">  </div> |
| <p>Guillaume M. Courtois, C.E.T.<br/>Senior Technologist, Project Manager</p>  | <p>Jeremy Ash, B.Sc.Eng., P.Eng.<br/>Director, Manager - Ottawa Office</p>   |

|  |   |
|--|---|
| <p><b>Disclaimer</b></p> <p>The information contained in this document is solely for the use of the Client identified on the cover sheet for the purpose for which it has been prepared and Tatham Engineering Limited undertakes no duty to or accepts any responsibility to any third party who may rely upon this document.</p> | <p><b>Copyright</b></p> <p>This document may not be used for any purpose other than that provided in the contract between the Owner/Client and the Engineer nor may any section or element of this document be removed, reproduced, electronically stored or transmitted in any form without the express written consent of Tatham Engineering Limited.</p> |
|--|---|

| Issue | Date          | Description  |
|-------|---------------|--------------|
| 1     | July 17, 2023 | Final Report |

# Document Contents

|          |   |           |
|----------|---|-----------|
| <b>1</b> | <b>Introduction .....</b>                     | <b>1</b>  |
| <b>2</b> | <b>Water Supply and Fire Protection .....</b> | <b>2</b>  |
| 2.1      | Existing Site Condition .....                 | 2         |
| 2.2      | Domestic Water Demands .....                  | 2         |
| 2.3      | Water Service Sizing .....                    | 2         |
| 2.4      | Fire Protection .....                         | 3         |
| <b>3</b> | <b>Sewage Collection .....</b>                | <b>5</b>  |
| 3.1      | Existing Site Condition .....                 | 5         |
| 3.2      | Sewage Flows .....                            | 5         |
| 3.3      | Sanitary Service Sizing .....                 | 5         |
| <b>4</b> | <b>Stormwater Management .....</b>            | <b>7</b>  |
| 4.1      | Stormwater Management Design Criteria.....    | 7         |
| 4.2      | Existing Site Drainage Conditions.....        | 8         |
| 4.3      | Existing Condition Hydrologic Analysis.....   | 8         |
| 4.4      | Proposed SWM PPlan .....                      | 9         |
| 4.5      | Water Quantity Control.....                   | 10        |
| 4.6      | Water Quality Control .....                   | 11        |
| <b>5</b> | <b>Erosion and Sediment Control.....</b>      | <b>12</b> |
| <b>6</b> | <b>Summary.....</b>                           | <b>13</b> |

## Tables

|   |    |
|---|----|
| Table 1: Hydrants Required for Fire Flow .....      | 4  |
| Table 2: Existing Condition Peak Flow Summary ..... | 9  |
| Table 3: Proposed Condition Peak Flow Summary ..... | 11 |



## **Appendices**

Appendix A: Water Supply Calculations

Appendix B: Sewage Flow Calculations

Appendix C: Stormwater Management Calculations



# 1 Introduction

Tatham Engineering Limited (Tatham) has been retained by 12213559 Canada Inc. to prepare a Site Servicing & Stormwater Management (SWM) Report in support of Site Plan Approval (SPA) to allow for a proposed 599 m<sup>2</sup> three-storey 21-unit residential building and associated underground and aboveground parking areas located at 5497 Manotick Main Street in the City of Ottawa. The site is legally described as Part of Lot 3 and 4, Registered Plan 547, City of Ottawa. Specifically, this report has been prepared to confirm the servicing and SWM designs for the site.

The site is approximately 0.21 ha and currently consists of a one-storey ±250 m<sup>2</sup> building structure to be demolished, a paved parking area, and green space. There is one entrance to the site from Manotick Main Street along the southwest property limit.

The site and the adjacent properties are zoned Village Mixed Use (VM9). The site is bounded by the Rideau River to the northeast, a commercial plaza to the southeast, Manotick Main Street to the southwest, and a residential dwelling to the northwest. A key plan illustrating the site location is provided on the drawings enclosed at the back of this report.

The servicing and SWM designs included herein are based on a topographic survey completed by Annis, O'Sullivan, Vollebakk Ltd. on July 26, 2022.



## 2 Water Supply and Fire Protection

### 2.1 EXISTING SITE CONDITION

In the existing condition, domestic water supply for the site is provided from the City's municipal water system. The existing building is serviced by the existing 406 mm diameter watermain on Manotick Main Street via a 19 mm diameter water service. The existing service will be abandoned and blanked at the main.

Based on geoOttawa online mapping, there are three municipal fire hydrants within 150 m of the site, on Manotick Main Street, Echelon Private, and Highcroft Drive, which can be used for fire protection for the proposed development. The contributions of the existing nearby fire hydrants toward the proposed development's required fire flow are described in further detail in the sections below.

### 2.2 DOMESTIC WATER DEMANDS

The average day water consumption rate and maximum day and peak hour peaking factors used to calculate the water supply demands for the proposed development are based on the 2010 City of Ottawa Design Guidelines for Water Distribution, the 2010 City of Ottawa Technical Bulletin ISD-2010-2 and the 2018 City of Ottawa Technical Bulletin ISTB-2018-01.

Based on an average day water consumption rate of 280 L/c/d and maximum day and peak hour peaking factors of 2.5 and 2.2 respectively, the water demand calculations for the proposed 21-unit residential building confirm an average daily water demand of 0.12 L/s, a maximum daily demand of 0.29 L/s, and a peak hourly demand of 0.64 L/s.

The above water demands do not include allowances for fire protection (i.e. sprinkler systems, etc.), irrigation, etc.

It is assumed that the City's water treatment plant and emergency storage are sufficient to service to proposed development, however, these are to be confirmed by the City.

The water demand calculations are included in Appendix A.

### 2.3 WATER SERVICE SIZING

Water service sizing calculations for the proposed condition have been completed using the Fixture Method from Section 7 of the 2012 Ontario Building Code (OBC), which is representative of peak instantaneous conditions that are typically used for plumbing design.

Based on a total of 178.5 fixture units within the 21-unit residential building, and assuming all fixtures are in use at the same time, the required water service capacity is 3.83 L/s. As such, a



100 mm diameter water service, from the existing municipal watermain on Manotick Main Street to the 21-unit residential building is proposed and shall be re-confirmed by the mechanical engineer at the building permit phase.

The above-mentioned service capacity does not include allowances for fire protection (i.e. sprinkler systems, etc.), irrigation, etc.

The water service sizing calculations are included in Appendix A.

The existing municipal watermain on Manotick Main Street and the required 100 mm diameter water service to the 21-unit residential building are shown on the Site Servicing Plan (Drawing C300).

## 2.4 FIRE PROTECTION

The required fire flow rate was calculated in accordance with the 2020 Fire Underwriters Survey (FUS). This method is based on the type of building construction and the floor area of the building to be protected while accounting for reductions and surcharges related to combustibility of contents and the presence of a sprinkler system as well as building exposure of surrounding structures. The required fire flow rate is 5,000 L/min.

The proposed building is located within 90 m of a hydrant, in compliance with OBC requirements. Fire flow protection can be provided by the following three hydrants, which are within 150 m (uninterrupted path) of the building:

- One existing Class AA blue bonnet hydrant located 57 m southeast of the proposed building structure on the north side of Manotick Main Street;
- One existing unclassified hydrant located approximately 109 m south of the proposed building structure on the north side of Echelon Private; and
- One existing unclassified hydrant located approximately 149 m southwest of the proposed building structure on the south side of Highcroft Drive.

All fire hydrant bonnets are color coded to indicate the available flow at a residual pressure of 150 kPa (20 psi), in accordance with the NFPA 291 Fire Flow Testing and Marking of Hydrants Code. The existing hydrant near the site, on Manotick Main Street, consists of a blue bonnet and as such is a Class AA-rated hydrant. The other two existing hydrants, on Echelon Private and Highcroft Drive, are unclassified. Accordingly, fire flow contributions from these hydrants have not been considered. As is summarized in Table 1, the required 5,000 L/min fire flow to the proposed buildings is available from the existing hydrant on Manotick Main Street, while the existing hydrants on Echelon Private and Highcroft Drive will further contribute to the available fire flow.



**Table 1: Hydrants Required for Fire Flow**

| HYDRANT CLASS | DISTANCE TO BUILDING (m) <sup>1</sup> | CONTRIBUTION TO REQUIRED FIRE FLOW (L/min) | NUMBER OF USABLE NEARBY HYDRANTS | MAXIMUM FLOW TO BE CONSIDERED (L/min) | CUMULATIVE MAXIMUM FLOW TO BE CONSIDERED (L/min) |
|---------------|---------------------------------------|--|----------------------------------|---------------------------------------|--|
| AA            | ≤ 75                                  | 5,700                                      | 1                                | 5,700                                 |  |
| AA            | > 75 & ≤ 150                          | 3,800                                      | 0                                | 0                                     |  |
| A             | ≤ 75                                  | 3,800                                      | 0                                | 0                                     |  |
| A             | > 75 & ≤ 150                          | 2,850                                      | 0                                | 0                                     | 5,700  |
| B             | ≤ 75                                  | 1,900                                      | 0                                | 0                                     |  |
| B             | > 75 & ≤ 150                          | 1,500                                      | 0                                | 0                                     |  |
| C             | ≤ 75                                  | 800  | 0                                | 0                                     |  |
| C             | > 75 & ≤ 150                          | 800  | 0                                | 0                                     |  |

Notes: 1. Distance of contributing hydrant from the structure, measured in accordance with NFPA 1.

A hydrant flow test is recommended to confirm the hydrant classes, thereby confirming adequate flow and pressure is available for fire protection.

The fire flow calculations are included in Appendix A.





## 3 Sewage Collection

### 3.1 EXISTING SITE CONDITION

In the existing condition, sewage from the site discharges into the City's municipal sewage collection system. Sewage flows from the existing building discharge to the existing 600 mm diameter sanitary sewer on Manotick Main Street via a 135 mm diameter sanitary service. The existing service will be abandoned, grouted and capped at the property line.

### 3.2 SEWAGE FLOWS

Sewage flow calculations for the proposed development have been completed using the 2012 City of Ottawa Sewer Design Guidelines and the 2018 City of Ottawa Technical Bulletin ISTB-2018-01.

The average daily sewage design flow for the proposed development was determined to be 0.18 L/s, inclusive of extraneous flow.

The sewage flow calculations are included in Appendix B.

### 3.3 SANITARY SERVICE SIZING

The design criteria used to size the sanitary service from the proposed building structure to the existing 600 mm diameter sanitary sewer on Manotick Main Street are as per the 2012 City of Ottawa Sewer Design Guidelines, the 2008 Ministry of the Environment, Conservation and Parks (MECP) Design Guidelines for Sewage Works, and the 2012 OBC. The design criteria are summarized as follows:

- Peak sewage flow derived from the Harmon formula;
- Permissible sewage velocity within MECP range of 0.6 and 3.0 m/s;
- Peak extraneous flow of 0.28 L/s/ha per City of Ottawa Sewer Design Guidelines; and
- Minimum sanitary sewer depth of 2.5 m as per City of Ottawa Sewer Design Guidelines.

Based on the above criteria, the peak sewage flow was calculated to be 0.70 L/s, inclusive of extraneous flow. A 150 mm diameter sanitary service is proposed and will be sufficient to convey the peak sewage flows to the existing municipal sewage collection system on Manotick Main Street. We have assumed the existing municipal collection system and the municipal wastewater treatment plant have adequate capacity to service the proposed development, however, these are required to be confirmed by the City.

The sanitary service sizing calculations are included in Appendix B.



The proposed 150 mm diameter sanitary service is shown on the Site Servicing Plan (Drawing C300).



## 4 Stormwater Management

The primary objective of the SWM plan is to demonstrate that post-development conditions will not adversely impact the hydrologic cycle and surface water runoff characteristics of the area. This will be accomplished by evaluating the effects of the proposed development on local drainage conditions. Where necessary, solutions will be provided to mitigate any adverse impacts. The following sections of the report will present the following:

- Existing runoff conditions including constraints and opportunities for improvement;
- Criteria to be applied in the SWM design;
- An overall SWM plan that complies with appropriate technical SWM guidelines; and
- Erosion and sediment control strategies.

The SWM plan was prepared recognizing provincial guidelines on water resources and the environment, including the following publications:

- Design Criteria for Sanitary Sewers, Storm Sewers and Forcemains for Alterations Authorized under Environmental Compliance Approval (The Ministry of the Environment, Conservation and Parks, 2022);
- O. Reg. 174/06: Rideau Valley Conservation Authority: Regulation of Development, Interference with Wetlands and Alterations to Shorelines and Watercourses (2022);
- The City of Ottawa Sewer Design Guidelines (2012); and
- Erosion and Sediment Control Guide for Urban Construction (Toronto and Region Conservation Authority, 2019).

### 4.1 STORMWATER MANAGEMENT DESIGN CRITERIA

Criteria to be met regarding drainage and stormwater management on the site are summarized as follows:

- The site will be developed in accordance with applicable municipal and agency guidelines and standards;
- Attenuation of proposed condition peak flow rates to existing condition peak flow rates or target peak flow rates, as applicable, will occur during all design storm events;
- MECP “Enhanced” level water quality control will be provided, to ensure the development will have no negative impacts on the downstream receivers;



- Safe conveyance of storm flows from all design storm events will be confirmed;
- The proposed storm sewers will be sized for conveyance of the 5-year design storm; and
- Site development will include implementation of erosion and sediment control measures during and following construction to minimize erosion and sediment transport off-site.

#### **4.2 EXISTING SITE DRAINAGE CONDITIONS**

The existing topography, ground cover, and drainage patterns were obtained through a review of available plans, base mapping and site investigation. A detailed topographic survey of the site was completed by Annis, O'Sullivan, Vollebakk Ltd. on July 26, 2022 to confirm the existing features and elevations.

The site is approximately 0.21 ha and currently consists of a one-storey  $\pm 250$  m<sup>2</sup> building structure, a paved parking area, and green space. A well-defined ridge extending across the site from the northwest to the southeast bisects the site into two drainage areas with two distinct outlets.

Runoff from Drainage Area 101 (0.06 ha) drains overland, from the drainage area limits to the centre of the existing parking area, where it is captured by an existing catchbasin and conveyed to the existing municipal storm sewer system on Manotick Main Street via an existing storm pipe.

Runoff from Drainage Area 102 (0.15 ha) drains overland, generally from southwest to northeast, and discharges directly into the Rideau River which is located immediately beyond the northeast property limit.

The Ontario Soil Survey Complex characterizes the native soils onsite as North Gower, having a corresponding hydrologic soil group D.

The Existing Condition Drainage Plan (Drawing C400), illustrating the existing condition drainage characteristics of the site, is attached at the back of this report.

#### **4.3 EXISTING CONDITION HYDROLOGIC ANALYSIS**

A Visual OTTHYMO hydrologic model (V06) scenario was developed to quantify the existing condition peak flows from Drainage Area 101.

Since runoff from Drainage Area 102 discharges directly to the Rideau River and since runoff from Drainage Area 202 (described in detail in Section 4.4) will also discharge directly to the Rideau River, water quantity control for this portion of the site is not required. Accordingly, Drainage Area 102 has been excluded from the hydrologic modelling analysis included herein.

The catchment delineations were determined based on the topographic survey.



A summary of all hydrologic parameters established for the existing condition hydrologic model has been included in Appendix C.

The peak flow for the 5-year storm event was calculated for the 3-hour Chicago, 6-hour Chicago and 24-hour SCS Type II design storms using IDF data derived from Meteorological Services of Canada (MSC) rainfall data taken from the MacDonald-Cartier Airport. Detailed calculations and Visual OTTHYMO modeling output are included in Appendix C with the results summarized below in Table 2.

**Table 2: Existing Condition Peak Flow Summary**

| DESIGN STORM | CATCHMENT AREA 101<br>0.06 ha<br>(m <sup>3</sup> /s) |          |                   |
|--------------|--|----------|-------------------|
|              | 3-hr CHI   | 6-hr CHI | 24-hr SCS Type II |
| 5-Year       | 0.012  | 0.012    | 0.010             |

#### 4.4 PROPOSED SWM PLAN

The SWM plan recognizes the SWM requirements for the site and has been developed to follow the existing topography of the land as much as possible to maintain the existing condition drainage patterns, while safely conveying stormwater runoff overland.

In the proposed condition, the site will consist of a 599 m<sup>2</sup> three-storey 21-unit residential building, associated underground and aboveground parking areas, and vegetated areas. The existing site entrance near the southeast corner of the site will be decommissioned and a new site entrance near the southwest corner of the site on Manotick Main Street will provide access to the site.

Treated and controlled runoff from the southwest portion of the site (Drainage Area 201) will discharge to the existing 375 mm diameter storm sewer on Manotick Main Street (Outlet 1). Runoff from the northeast portion of the site (Drainage Area 202), consisting of clean runoff from roof and vegetated areas, will discharge to the Rideau River (Outlet 2), unchanged from the existing condition.

The proposed SWM plan is summarized as follows:

- Controlled runoff from Drainage Area 201 (0.06 ha) will discharge to the existing 375 mm diameter storm sewer on Manotick Main Street (Outlet 1). The 100-year post development peak flow rate from this area will be controlled to the 5-year pre-development peak flow from Drainage Area 101 (0.06 ha). The above reflects typical stormwater quantity control for sites fronting onto municipal roads serviced with municipal storm sewer.



- Runoff from Drainage Area 201 will be captured by two surface inlets, stored in an underground storage system consisting of underground storage chambers (Stormtech Model SC-740) and controlled by an orifice plate flow restrictor located in CBMH 2.
- Downstream of the orifice flow control, runoff will be treated by a proposed Stormceptor Model EFO4 oil-grit separator (OGS) to provided MECP “Enhanced” level water quality treatment including 80% TSS removal from on-site runoff.
- Runoff from Drainage Area 202, which is clean and unimpaired, will discharge uncontrolled to the Rideau River (Outlet 2), unchanged from the existing condition.
- All internal storm sewers will be sized based on the 5-year design storm.

The Proposed Condition Drainage Plan (Drawing C401), illustrating the proposed condition drainage characteristics of the site, is attached at the back of this report.

#### **4.5 WATER QUANTITY CONTROL**

A 80 mm diameter orifice, installed in CBMH2, is proposed to control peak flows from Drainage Areas 201 underground to ensure the 100-year post development peak flow is less than or equal to the existing 5-year peak flow rate from Drainage Area 101.

A VO6 model scenario was developed to quantify the proposed condition peak flow from the site. The peak flow for the 100-year storm event was calculated for the 3-hour Chicago, 6-hour Chicago, and 24-hour SCS Type II design storms using the previously described IDF data.

The drainage area delineation for the contributing lands was completed according to the proposed site grading illustrated on Drawing C200, which is included at the back of this report. The proposed surface cover and the existing soil type were used to establish the percent imperviousness, curve numbers, and other hydrologic parameters used in the hydrologic model. Summaries of all hydrologic parameters and stage-storage-discharge tables, established for the post-development hydrologic model, have been included in Appendix C.

Peak runoff rates are shown in the table below and the results of the modelling are included in Appendix C.



**Table 3: Proposed Condition Peak Flow Summary**

| DESIGN STORM | DRAINAGE AREA 201<br>0.06 ha<br>CONTROLLED<br>(m <sup>3</sup> /s) |                  |                   |
|--------------|---|------------------|-------------------|
|              | 3-hr CHI  | 6-hr CHI         | 24-hr SCS TYPE II |
| 100-Year     | 0.010<br>(0.012)  | 0.011<br>(0.012) | 0.010<br>(0.010)  |

Note: (0.100) refers to existing condition 5-year peak flow rate.

Table 3 above confirms the proposed SWM plan will attenuate the proposed condition 100-year peak flow at or below the existing condition 5-year peak flow. The maximum storage required during the 100-year storm was determined to be 15 m<sup>3</sup> which is provided underground, within the underground storage chambers shown on Drawing C300. Additional details related to the Stormtech chamber system are included in Appendix C.

#### 4.6 WATER QUALITY CONTROL

The proposed water quality treatment objective under the proposed condition is to provide MECP enhanced level treatment including 80% TSS removal from on-site runoff.

Water quality control for the development will be provided via a proposed Stormceptor Model EFO4 oil-grit-separator.

##### 4.6.1 Oil-grit-separator

All runoff from Drainage Area 201 will be treated by a Stormceptor Model EFO4 OGS prior to discharging into the 375 mm diameter storm sewer on Manotick Main Street. The OGS has been sized to treat a minimum of 90% of annual runoff and provide 80% TSS removal based on a fine particle size distribution. The specified Stormceptor Model EFO4 will provide 99% TSS removal from the contributing drainage area, thus exceeding the MECP's requirement for enhanced level water quality control. The Stormceptor EFO Sizing Report is included in Appendix C.



## 5 Erosion and Sediment Control

Erosion and sediment control will be implemented for all construction activities within the development site, including vegetation clearing, topsoil stripping, road and parking area construction, and stockpiling of materials. The basic principles considered to minimize erosion and sedimentation and resultant negative environmental impacts include:

- Minimize disturbance activities where possible;
- Expose the smallest possible land area to erosion for the shortest possible time;
- Institute erosion control measures as-required immediately;
- Implement sediment control measures before the outset of construction activities;
- Carry out regular inspections of erosion/sediment control measures and repair or maintain as necessary; and
- Seed or sod exposed soils as soon as possible after construction and keep chemical applications to suppress dust and control pests and vegetation to a minimum.

The proposed grading and building construction should be carried out in such a manner that a minimum amount of erosion occurs and such that sedimentation facilities control any erosion that does occur. Additional erosion, sediment, and pollution control measures should include the following:

- Erecting silt fences around all construction sites;
- Providing sediment traps (e.g. berms, geotextile and straw bale barriers in swales);
- Confining refuelling/servicing of equipment to areas well away from the Rideau River and the minor/major drainage system elements; and
- Bi-weekly inspections of control measures to be instituted through a monitoring and mitigation plan and repairs made as necessary.

The proposed erosion and sediment controls are shown on the Siltation and Erosion Control Plan (Drawing C100).





## 6 Summary

The proposed site development has been designed recognizing the pertinent Municipal, Agency, and Provincial guidelines along with site specific constraints and criteria.

The domestic water supply to the proposed building will be provided via a 100 mm diameter water service connected to the existing 406 mm diameter watermain on Manotick Main Street. The available fire flow from the nearest hydrant on Manotick Main Street alone is sufficient to protect the proposed structure from fire. We have assumed that the City's water treatment plant and emergency storage are sufficient to service to proposed development, however, these are to be confirmed by the City.

A 150 mm diameter sanitary service is required from the building structure to the existing 600 mm diameter municipal sanitary sewage system on Manotick Main Street. We have assumed the existing municipal sanitary sewer system and the municipal wastewater treatment plant have adequate capacity to service the proposed development, however, these are required to be confirmed by the City.

The SWM plan for the site includes an underground storage system consisting of underground storage chambers to store runoff. Runoff from the southwest portion of the site (Drainage Area 201 – 0.06 ha) will be controlled underground by an orifice plate flow control prior to discharging to the 375 mm diameter storm sewer on Manotick Main Street. The 100-year post development peak flow from this portion of the site will be controlled to the 5-year existing condition peak flow (from Drainage Area 101 – 0.06 ha). Runoff from the northeast portion of the site (Drainage Area 202 – 0.15 ha), which is clean and unimpaired, will discharge uncontrolled to the Rideau River, unchanged from the existing condition. Water quality control for runoff from Drainage Area 201 is proposed to be provided by means of a Stormceptor Model EFO4 OGS, which achieves MECP enhanced level water quality control.

We trust this report is sufficient to confirm the proposed development can be adequately serviced with domestic and fire water supply and sewage collection services and will have no negative impact with regards to SWM.



# Appendix A: Water Supply Calculations

### Water Service Calculations

Tatham File No. : 522679  
 Project : 5497 Manotick Main Street  
 Date : July 17, 2023  
 Designed by : GC  
 Reviewed by : JA

#### Water Demands

| Population                 |                  |                 |            |
|----------------------------|------------------|-----------------|------------|
| Unit Type                  | Persons Per Unit | Number of Units | Population |
| Studio/1 Bedroom Apartment | 1.4              | 12              | 16.8       |
| 2 Bedroom Apartment        | 2.1              | 9               | 18.9       |
| 3 Bedroom Apartment        | 3.1              | 0               | 0          |
|                            |                  | 21              | 35.7       |

Population 36 Persons  
 Average Day Consumption Rate 280 L/c/d  
 Maximum Day Peaking Factor 2.5  
 Peak Hour Peaking Factor 2.2  
 Average Day Demand 10,080 L/d 0.12 L/s  
 Maximum Day Demand 25,200 L/d 0.29 L/s  
 Peak Hour Demand 55,440 L/d 0.64 L/s

(# of units is in accordance with architectural plans)  
 (Population per unit is in accordance with Table 4.1 of 2010 City of Ottawa Design Guidelines for Water Distribution)

(per table above)  
 (per 2018 City of Ottawa Technical Bulletin ISTB-2018-01)  
 (per Table 4.2 of 2010 City of Ottawa Design Guidelines for Water Distribution)  
 (per Table 4.2 of 2010 City of Ottawa Design Guidelines for Water Distribution and 2010 City of Ottawa Technical Bulletin ISD-2010-2)

#### Required Water Service Capacity

| Fixture Count           |                      |   |       |
|-------------------------|----------------------|---|-------|
| Fixture or Device       | Fixture/Device Count | Private Use Hydraulic Load, Fixture Units | Total |
| Bathub with shower head | 21                   | 1.4                                       | 29.4  |
| Clothes washer          | 21                   | 1.4                                       | 29.4  |
| Dishwasher              | 21                   | 1.4                                       | 29.4  |
| Lavatory                | 21                   | 0.7                                       | 14.7  |
| Kitchen sink            | 21                   | 1.4                                       | 29.4  |
| Water closet            | 21                   | 2.2                                       | 46.2  |
|                         |                      |   | 178.5 |

Total Fixture Units 178.5  
 Peak Flow 60.70 gpm  
 330,875 L/d  
 3.83 L/s

(Fixture count is in accordance with Table 7.6.3.2.A of 2012 Ontario Building Code)

(Conversion of fixture units to gpm as per PS&D Table 13-4)

#### Water Service Pipe Sizing

Q = VA Where: V = design velocity of 1.5 m/s x 3600 = 5400 m/h  
 A = area of pipe =  $(\pi/4) \times D^2$   
 Q = water supply flow rate to be accounted for in m<sup>3</sup>/h

(as per OBC guidelines)

(required water service capacity based on fixture method)

Required pipe diameter d =  $(4Q/\pi V)^{1/2}$   
 d = 0.057 m  
 d = 57 mm

(derived from Q = VA formula)

Proposed pipe diameter: 100 mm

(Due to high pressure, IPEX "Pipe with the Stripe" (green stripe: rated for 100 psi) is preferred and is CSA certified)



**FUS Fire Flow Calculations**

Tatham File no.: 522679  
 Project: 5497 Manotick Main Street  
 Date: 17-Jul-23  
 Designed by: GC  
 Checked by: JA

$$RFF = 220C\sqrt{A}$$

Where:

RFF = the Required Fire Flow in litres per minutes (LPM)  
 C = the Construction Coefficient is related to the type of construction of the building  
 A = the Total Effective Floor Area (effective building area) in square metres of the building

**Determine the Construction Coefficient (C)**

|   |                                |   |                                     |     |                                     |     |
|---|--------------------------------|---|-------------------------------------|-----|-------------------------------------|-----|
| 1 | Choose frame used for building | Coefficient C related to the type of construction | Type V Wood Frame Construction      | 1.5 | Type II Noncombustible Construction | 0.8 |
|   |                                |   | Type IV-A Mass Timber Construction  | 0.8 |                                     |     |
|   |                                |   | Type IV-B Mass Timber Construction  | 0.9 |                                     |     |
|   |                                |   | Type IV-C Mass Timber Construction  | 1.0 |                                     |     |
|   |                                |   | Type IV-D Mass Timber Construction  | 1.5 |                                     |     |
|   |                                |   | Type III Ordinary Construction      | 1.0 |                                     |     |
|   |                                |   | Type II Noncombustible Construction | 0.8 |                                     |     |
|   |                                |   | Type I Fire Resistive Construction  | 0.6 |                                     |     |

**Determine Total Effective Floor Area (A)**

|   |                                    |   |   |     |                      |   |       |
|---|------------------------------------|---|---|-----|----------------------|---|-------|
| Option 1  |                                    |   |   |     |                      |   |       |
| The Construction coefficient is greater or equal to 1 | FALSE                              | 100% of all floor area (Excluding basements at least 50% below grade)                                       |   |     | Total Effective Area | 0   | sq.m. |
| Option 2  |                                    |   |   |     |                      |   |       |
| The Construction coefficient is less than 1           | TRUE                               | Are vertical openings in the building protected? (Per NBC Division B, Section 3.5. Vertical Transportation) |   |     | YES                  | Are the floor areas uniform throughout the building | YES   |
| Unprotected Vertical Openings, Uniform Floor Area     |                                    |   |   |     |                      |   |       |
| FALSE   | Number of Floors                   |   | Area of Floor(s)  |     | Total Effective Area | 0   | sq.m. |
| Unprotected Vertical Openings, Dissimilar Floor Area  |                                    |   |   |     |                      |   |       |
| FALSE   | Area of 2 largest adjoining floors |   | Area of floors above 2 largest adjoining floors (up to a maximum of 8 floors) |     | Total Effective Area | 0   | sq.m. |
| Protected Vertical Openings, Uniform Floor Area       |                                    |   |   |     |                      |   |       |
| TRUE  | Number of Floors                   | 3   | Area of Floor   | 599 | Total Effective Area | 898.5   | sq.m. |
| Protected Vertical Openings, Dissimilar Floor Area    |                                    |   |   |     |                      |   |       |
| FALSE   | Area of the largest floor          |   | Area of floor directly above largest floor                                    |     | Total Effective Area | 0   | sq.m. |
|   |                                    |   | Area of floor directly below largest floor                                    |     |                      |   |       |

**Determine the Required Fire Flow**

|   |                           |                      |                    |       |       |
|---|---------------------------|----------------------|--------------------|-------|-------|
| 3 | Obtain Required Fire Flow | $RFF = 220C\sqrt{A}$ | Required Fire Flow | 5,000 | L/min |
|   |                           |                      |                    | 83.3  | L/s   |

**Reduction or Surcharge Due to Factors Affecting Burning**

|   |                                   |   |  |       |                     |       |       |       |
|---|-----------------------------------|---|--|-------|---------------------|-------|-------|-------|
| 4 | Choose combustibility of contents | Occupancy hazard reduction or surcharge | Non-combustible  | -0.25 | Limited combustible | -0.15 |       |       |
|   |                                   |   | Limited combustible  | -0.15 |                     |       |       |       |
|   |                                   |   | Combustible  | 0     |                     |       |       |       |
|   |                                   |   | Free burning   | 0.15  |                     |       | 4,250 | L/min |
|   |                                   |   | Rapid burning  | 0.25  |                     |       | 70.8  | L/s   |
| 5 | Choose reduction for sprinklers   | Sprinkler reduction                     | Sprinklers conforming to NFPA13 (wet or dry system)  | -0.30 | NO                  | 0     |       |       |
|   |                                   |   | Water supply is standard for both the system and fire department hose lines (siamese connection) | -0.10 | NO                  | 0     |       |       |
|   |                                   |   | Fully supervised system (electronic monitoring system on at all times)                           | -0.10 | NO                  | 0     |       |       |
|   |                                   |   | All buildings within 30m of the proposed structure are confirmed to have a sprinkler system      | -0.25 | NO                  | 0     | 4,250 | L/min |
|   |                                   |   |  |       |                     | 70.8  | L/s   |       |

**Exposure Adjustment Charge**

|                               |                                 |            |             |   |      |                            |       |       |
|-------------------------------|---------------------------------|------------|-------------|---|------|----------------------------|-------|-------|
| 6                             | Exposure distance between units | North side | Over 30m    | Length - Height Value Assumed worst case exposed building facing wall | >100 | Exposure Adjustment Charge | 0     |       |
|                               |                                 | East side  | 20.1 to 30m |   | >100 | Exposure Adjustment Charge | 0     |       |
|                               |                                 | South side | Over 30m    |   | >100 | Exposure Adjustment Charge | 0.00  |       |
|                               |                                 | West side  | 3.1 to 10m  |   | >100 | Exposure Adjustment Charge | 0.04  |       |
|                               |                                 |            |             |   |      |                            |       |       |
| Cumulative Required Fire Flow |                                 |            |             |   |      |                            | 4,420 | L/min |
|                               |                                 |            |             |   |      |                            | 73.7  | L/s   |

**Total Required Fire Flow**

|   |                            |   |       |       |
|---|----------------------------|---|-------|-------|
| 7 | Obtain fire flow, duration | Minimum required fire flow rate (rounded to nearest 1000) | 5,000 | L/min |
|   |                            | Minimum required fire flow rate                           | 83.3  | L/s   |
|   |                            | Required duration of fire flow                            | 2     | Hrs   |



### Water Pressure Calculations (Existing Condition)

**Tatham File No. :** 522679  
**Project :** 5497 Manotick Main Street  
**Date :** May 10, 2023  
**Designed by :** GC  
**Reviewed by :** JA

#### Piezometric Head Equation (Derived from Bernoulli's Equation)

$$h = \frac{p}{\gamma} + z$$

Where:

h = HGL (m)

p = Pressure (Pa)

$\gamma$  = Specific weight (N/m<sup>3</sup>) = 9810

z = Elevation of centreline of pipe (m) = 85.30

#### Water Pressure at Manotick Main Street Connection

| HGL (m)           | Pressure |        |
|-------------------|----------|--------|
|                   | kPa      | psi    |
| Max Day           | 155.7    | 690.62 |
| Peak Hour         | 138.5    | 521.89 |
| Max. Day + Fire = | 114.2    | 283.51 |

#### Hazen Williams Equation

$$h_f = \frac{10.67 \times Q^{1.85} \times L}{C^{1.85} \times d^{4.87}}$$

Where:

$h_f$  = Head loss over the length of pipe (m)

Q = Volumetric flow rate (m<sup>3</sup>/s)

L = Length of pipe (m)

C = Pipe roughness coefficient

d = Pipe diameter (m)

#### Scenario 1: maximum daily demand

|  |        |   |
|--|--------|---|
| Q (L/s)                                | 0.29   |   |
| C                                      | 150    |   |
| L (m.)                                 | 42.2   |   |
| I.D. (mm)                              | 100    |   |
| V (m/s)                                | 0.037  |   |
| $h_f$ (m)                              | 0.001  |   |
| Head Loss (psi)                        | 0.001  |   |
| Pressure (psi)                         | 100.17 |   |
| Service Obv. @ Street Connection (m)   | 85.35  |   |
| Service Obv. @ Building Connection (m) | 85.80  |   |
| Pressure Adjustment (psi)              | -0.64  | (due to service elevation difference from street to building) |
| Adjusted Min. Pressure (psi)           | 99.53  | (must not be less than 50 psi; must not be more than 80 psi)  |

#### Scenario 2: maximum hourly demand

|  |       |   |
|--|-------|---|
| Q (L/s)                                | 0.64  |   |
| C                                      | 150   |   |
| L (m.)                                 | 42.2  |   |
| I.D. (mm)                              | 100   |   |
| V (m/s)                                | 0.081 |   |
| $h_f$ (m)                              | 0.004 |   |
| Head Loss (psi)                        | 0.006 |   |
| Pressure (psi)                         | 75.69 |   |
| Service Obv. @ Street Connection (m)   | 85.35 |   |
| Service Obv. @ Building Connection (m) | 85.80 |   |
| Pressure Adjustment (psi)              | -0.64 | (due to service elevation difference from street to building) |
| Adjusted Min. Pressure (psi)           | 75.05 | (must not be less than 40 psi; must not be more than 80 psi)  |

**Note: A pressure reducing valve will be required due to Scenario 1 maximum daily demand results**



**Water Pressure Calculations (SUC Zone Reconfiguration)**

Tatham File No. : 522679  
 Project : 5497 Manotick Main Street  
 Date : July 17, 2023  
 Designed by : GC  
 Reviewed by : JA

**Piezometric Head Equation (Derived from Bernoulli's Equation)**

$$h = \frac{p}{\gamma} + z$$

Where:

h = HGL (m)

p = Pressure (Pa)

$\gamma$  = Specific weight (N/m<sup>3</sup>) = 9810

z = Elevation of centreline of pipe (m) = 85.30

| Water Pressure at Manotick Main Street Connection |          |        |       |
|---|----------|--------|-------|
| HGL (m)   | Pressure |        |       |
|   |          | kPa    | psi   |
| Max Day   | 147.2    | 607.24 | 88.07 |
| Peak Hour   | 142.3    | 559.17 | 81.10 |
| Max. Day + Fire =                                 | 123.9    | 378.67 | 54.92 |

**Hazen Williams Equation**

$$h_f = \frac{10.67 \times Q^{1.85} \times L}{C^{1.85} \times d^{4.87}}$$

Where:

$h_f$  = Head loss over the length of pipe (m)

Q = Volumetric flow rate (m<sup>3</sup>/s)

L = Length of pipe (m)

C = Pipe roughness coefficient

d = Pipe diameter (m)

**Scenario 1: maximum daily demand**

|  |       |   |
|--|-------|---|
| Q (L/s)                                | 0.29  |   |
| C                                      | 150   |   |
| L (m.)                                 | 42.2  |   |
| I.D. (mm)                              | 100   |   |
| V (m/s)                                | 0.037 |   |
| $h_f$ (m)                              | 0.001 |   |
| Head Loss (psi)                        | 0.001 |   |
| Pressure (psi)                         | 88.07 |   |
| Service Obv. @ Street Connection (m)   | 85.35 |   |
| Service Obv. @ Building Connection (m) | 85.80 |   |
| Pressure Adjustment (psi)              | -0.64 | (due to service elevation difference from street to building) |
| Adjusted Min. Pressure (psi)           | 87.43 | (must not be less than 50 psi; must not be more than 80 psi)  |

**Scenario 2: maximum hourly demand**

|  |       |   |
|--|-------|---|
| Q (L/s)                                | 0.64  |   |
| C                                      | 150   |   |
| L (m.)                                 | 42.2  |   |
| I.D. (mm)                              | 100   |   |
| V (m/s)                                | 0.081 |   |
| $h_f$ (m)                              | 0.004 |   |
| Head Loss (psi)                        | 0.006 |   |
| Pressure (psi)                         | 81.10 |   |
| Service Obv. @ Street Connection (m)   | 85.35 |   |
| Service Obv. @ Building Connection (m) | 85.80 |   |
| Pressure Adjustment (psi)              | -0.64 | (due to service elevation difference from street to building) |
| Adjusted Min. Pressure (psi)           | 80.46 | (must not be less than 40 psi; must not be more than 80 psi)  |

**Note: A pressure reducing valve will be required due to Scenario 1 maximum daily demand and Scenario 2 maximum hourly demand results**

## Boundary Conditions 5497 Manotick Main

### Provided Information

| Scenario             | Demand   |        |
|----------------------|----------|--------|
|                      | L/min    | L/s    |
| Average Daily Demand | 6.60     | 0.11   |
| Maximum Daily Demand | 16.20    | 0.27   |
| Peak Hour            | 35.40    | 0.59   |
| Fire Flow Demand 1   | 8,500.20 | 141.67 |

### Location

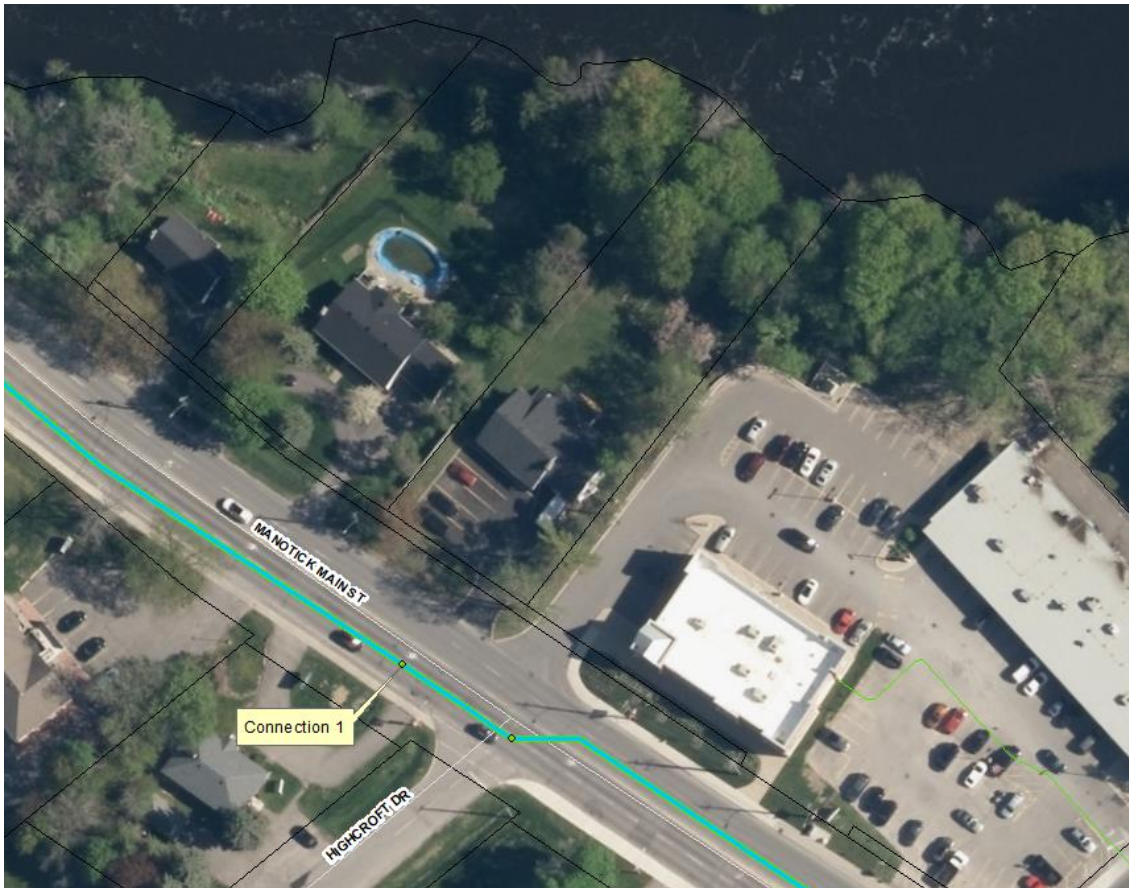

### Results – Existing Conditions

#### Connection 1 – Manotick Main St.

| Demand Scenario     | Head (m) | Pressure <sup>1</sup> (psi) |
|---------------------|----------|-----------------------------|
| Maximum HGL         | 155.7    | 96.5                        |
| Peak Hour           | 138.5    | 72.1                        |
| Max Day plus Fire 1 | 114.2    | 37.6                        |

<sup>1</sup> Ground Elevation = 87.8 m

## **Results – SUC Zone Reconfiguration**

### **Connection 1 – Manotick Main St.**

| <b>Demand Scenario</b> | <b>Head (m)</b> | <b>Pressure<sup>1</sup> (psi)</b> |
|------------------------|-----------------|-----------------------------------|
| Maximum HGL            | 147.2           | 84.5                              |
| Peak Hour              | 142.3           | 77.5                              |
| Max Day plus Fire 1    | 123.9           | 51.4                              |

<sup>1</sup> Ground Elevation = 87.8 m

### **Notes**

1. A second connection to the watermain is required to decrease vulnerability of the water system in case of breaks.
2. As per the Ontario Building Code in areas that may be occupied, the static pressure at any fixture shall not exceed 552 kPa (80 psi.) Pressure control measures to be considered are as follows, in order of preference:
  - a. If possible, systems to be designed to residual pressures of 345 to 552 kPa (50 to 80 psi) in all occupied areas outside of the public right-of-way without special pressure control equipment.
  - b. Pressure reducing valves to be installed immediately downstream of the isolation valve in the home/ building, located downstream of the meter so it is owner maintained.

### **Disclaimer**

*The boundary condition information is based on current operation of the city water distribution system. The computer model simulation is based on the best information available at the time. The operation of the water distribution system can change on a regular basis, resulting in a variation in boundary conditions. The physical properties of watermains deteriorate over time, as such must be assumed in the absence of actual field test data. The variation in physical watermain properties can therefore alter the results of the computer model simulation. Fire Flow analysis is a reflection of available flow in the watermain; there may be additional restrictions that occur between the watermain and the hydrant that the model cannot take into account.*



## **Appendix B: Sewage Flow Calculations**

### Sanitary Flow Calculations

**Tatham File No. :** 522679  
**Project :** 5497 Manotick Main Street  
**Date :** July 17, 2023  
**Designed by :** GC  
**Reviewed by :** JA

#### Sewage Design Flow

##### Sewage Design Flow (Excluding Extraneous Flow)

| Unit Type                  | Population       |                 |            |
|----------------------------|------------------|-----------------|------------|
|                            | Persons Per Unit | Number of Units | Population |
| Studio/1 Bedroom Apartment | 1.4              | 12              | 16.8       |
| 2 Bedroom Apartment        | 2.1              | 9               | 18.9       |
| 3 Bedroom Apartment        | 3.1              | 0               | 0          |
|                            |                  | 21              | 35.7       |

(# of units is in accordance with architectural plans)  
 (Population per unit is in accordance with Table 4.2 of 2012 City of Ottawa Sewer Design Guidelines)

Population 36 Persons  
 Sewage Design Flow Rate 280 L/c/d  
 Sewage Design Flow 10,080 L/d 0.12 L/s

(per table above)  
 (per 2018 City of Ottawa Technical Bulletin ISTB-2018-01)

##### Sewage Design Flow (Including Extraneous Flow)

Extraneous flow 0.28 L/s/ha  
 0.28 L/s \* 0.21 ha 5,080 L/d 0.06 L/s  
 Sewage Design Flow 15,160 L/d 0.18 L/s

(per Figure 4.3 of 2012 City of Ottawa Sewer Design Guidelines)  
 (tributary area accounts for entire site (conservative))

#### Sewage Peak Flow

Peaking factor Harmon formula =  $M = 1 + \frac{14}{4 + \sqrt{\frac{P}{1000}}} \geq 2.0$  Where: P = 35.7 Persons  
 = 4.34  
 = 4.00

(maximum permissible peaking factor per Section 4.4.1.1 of 2012 City of Ottawa Sewer Design Guidelines)

Peak Sewage Flow 60,641 L/s 0.70 L/s



### Sanitary Service Sizing Calculations

**Tatham File No. :** 522679  
**Project :** 5497 Manotick Main Street  
**Date :** July 17, 2023  
**Designed by :** GC  
**Checked by :** JA

#### Design Parameters:

|                           |              |          |  |
|---------------------------|--------------|----------|--|
| Design flow               | 15,160 L/day | 0.18 L/s | (Inclusive of extraneous flow allowance) |
| Peaking factor            | 4.00         |          | (Derived from Harmon formula)            |
| Peak flow                 | 60,641 L/day | 0.70 L/s |  |
| Manning's coefficient (n) | 0.013        |          |  |
| Minimum velocity          | 0.6 m/s      |          |  |
| Maximum velocity          | 3.0 m/s      |          |  |

| From |                 |                  |           | To          |                 |                  |           | Peak Flow         |                 | Pipe       |           |           |                     |                     |                         |
|------|-----------------|------------------|-----------|-------------|-----------------|------------------|-----------|-------------------|-----------------|------------|-----------|-----------|---------------------|---------------------|-------------------------|
| Tag  | Grade level (m) | Invert level (m) | Cover (m) | Tag         | Grade level (m) | Invert level (m) | Cover (m) | Peak Flow (L/day) | Peak Flow (L/s) | Length (m) | Dia. (mm) | Slope (%) | Full Capacity (L/s) | Velocity Full (m/s) | Q/Q <sub>full</sub> (%) |
| BLDG | 88.20           | 85.55            | 2.50      | TRUNK SEWER | 87.80           | 84.89            | 2.76      | 60,641            | 0.70            | 33.6       | 150       | 2.0%      | 21.34               | 1.2                 | 3.29                    |

# Appendix C: Stormwater Management Calculations

## Visual OTTHYMO Model Parameter Calculations (NasHYD)

### Project Details

|                |        |
|----------------|--------|
| Project Number | 522679 |
|----------------|--------|

### Data Sources

|   |
|---|
| Detailed Soil Survey Reports for Ontario, MTO Drainage Management Manual (1997) |
|---|

### Prepared By

|      |    |
|------|----|
| Name | HY |
|------|----|

### Pre-Development Condition

|                      |      |
|----------------------|------|
| Watershed:           | N/A  |
| Catchment ID:        | 101  |
| Catchment Area (ha): | 0.06 |
| Impervious %:        | 67%  |

### Average Curve Number (CN), Runoff Coefficient (C) and Initial Abstraction (IA)

| Soil Symbol             | Ng          |        |    |      |        |    |   |        |    |   |        |    |   |
|-------------------------|-------------|--------|----|------|--------|----|---|--------|----|---|--------|----|---|
| Soil Series             | North Gower |        |    |      |        |    |   |        |    |   |        |    |   |
| Hydrologic Soils Group  | D           |        |    |      |        |    |   |        |    |   |        |    |   |
| Soil Texture            | Clay        |        |    |      |        |    |   |        |    |   |        |    |   |
| Runoff Coefficient Type | 3           |        |    |      |        |    |   |        |    |   |        |    |   |
| Area (ha)               | 0.06        |        |    |      |        |    |   |        |    |   |        |    |   |
| Percentage of Catchment | 100%        |        |    |      |        |    |   |        |    |   |        |    |   |
| Land Cover Category     | IA          | A (ha) | CN | C    | A (ha) | CN | C | A (ha) | CN | C | A (ha) | CN | C |
| Impervious              | 2           | 0.04   | 98 | 0.95 |        |    |   |        |    |   |        |    |   |
| Gravel                  | 3           |        | 89 | 0.38 |        |    |   |        |    |   |        |    |   |
| Woodland                | 10          |        | 79 | 0.35 |        |    |   |        |    |   |        |    |   |
| Pasture/Lawns           | 5           | 0.02   | 84 | 0.40 |        |    |   |        |    |   |        |    |   |
| Meadows                 | 8           |        | 81 | 0.38 |        |    |   |        |    |   |        |    |   |
| Cultivated              | 7           |        | 86 | 0.55 |        |    |   |        |    |   |        |    |   |
| Waterbody               | 12          |        | 50 | 0.05 |        |    |   |        |    |   |        |    |   |
| Average CN              | 93.33       |        |    |      |        |    |   |        |    |   |        |    |   |
| Average C               | 0.77        |        |    |      |        |    |   |        |    |   |        |    |   |
| Average IA              | 3.00        |        |    |      |        |    |   |        |    |   |        |    |   |

### Time to Peak Calculations

|                               |                          |
|-------------------------------|--------------------------|
| Max. Catchment Elev. (m):     | 88.00                    |
| Min. Catchment Elev. (m):     | 87.62                    |
| Catchment Length (m):         | 22                       |
| Catchment Slope (%):          | 1.73%                    |
| Method:                       | Bransby-Williams Formula |
| Time of Concentration (mins): | 1.49                     |

### Summary

|                               |      |
|-------------------------------|------|
| Catchment CN:                 | 93.3 |
| Catchment C:                  | 0.77 |
| Catchment IA (mm):            | 3.00 |
| Time of Concentration (hrs):  | 0.02 |
| Catchment Time to Peak (hrs): | 0.02 |
| Catchment Time Step (mins):   | 0.20 |

# Visual OTTHYMO Model Parameter Calculations (NasHYD)

## Project Details

|                |        |
|----------------|--------|
| Project Number | 522679 |
|----------------|--------|

## Data Sources

|   |
|---|
| Detailed Soil Survey Reports for Ontario, MTO Drainage Management Manual (1997) |
|---|

## Prepared By

|      |    |
|------|----|
| Name | HY |
|------|----|

## Pre-Development Condition

|                      |      |
|----------------------|------|
| Watershed:           | N/A  |
| Catchment ID:        | 102  |
| Catchment Area (ha): | 0.15 |
| Impervious %:        | 7%   |

## Average Curve Number (CN), Runoff Coefficient (C) and Initial Abstraction (IA)

| Soil Symbol             | Ng          |        |    |      |        |    |   |        |    |   |        |    |   |
|-------------------------|-------------|--------|----|------|--------|----|---|--------|----|---|--------|----|---|
| Soil Series             | North Gower |        |    |      |        |    |   |        |    |   |        |    |   |
| Hydrologic Soils Group  | D           |        |    |      |        |    |   |        |    |   |        |    |   |
| Soil Texture            | Clay        |        |    |      |        |    |   |        |    |   |        |    |   |
| Runoff Coefficient Type | 3           |        |    |      |        |    |   |        |    |   |        |    |   |
| Area (ha)               | 0.15        |        |    |      |        |    |   |        |    |   |        |    |   |
| Percentage of Catchment | 100%        |        |    |      |        |    |   |        |    |   |        |    |   |
| Land Cover Category     | IA          | A (ha) | CN | C    | A (ha) | CN | C | A (ha) | CN | C | A (ha) | CN | C |
| Impervious              | 2           | 0.01   | 98 | 0.95 |        |    |   |        |    |   |        |    |   |
| Gravel                  | 3           |        | 89 | 0.54 |        |    |   |        |    |   |        |    |   |
| Woodland                | 10          |        | 79 | 0.52 |        |    |   |        |    |   |        |    |   |
| Pasture/Lawns           | 5           | 0.14   | 84 | 0.55 |        |    |   |        |    |   |        |    |   |
| Meadows                 | 8           |        | 81 | 0.54 |        |    |   |        |    |   |        |    |   |
| Cultivated              | 7           |        | 86 | 0.70 |        |    |   |        |    |   |        |    |   |
| Waterbody               | 12          |        | 50 | 0.05 |        |    |   |        |    |   |        |    |   |
| Average CN              | 84.93       |        |    |      |        |    |   |        |    |   |        |    |   |
| Average C               | 0.58        |        |    |      |        |    |   |        |    |   |        |    |   |
| Average IA              | 4.80        |        |    |      |        |    |   |        |    |   |        |    |   |

## Time to Peak Calculations

|                               |                          |
|-------------------------------|--------------------------|
| Max. Catchment Elev. (m):     | 88.00                    |
| Min. Catchment Elev. (m):     | 81.03                    |
| Catchment Length (m):         | 57                       |
| Catchment Slope (%):          | 12.23%                   |
| Method:                       | Bransby-Williams Formula |
| Time of Concentration (mins): | 2.38                     |

## Summary

|                               |      |
|-------------------------------|------|
| Catchment CN:                 | 84.9 |
| Catchment C:                  | 0.58 |
| Catchment IA (mm):            | 4.80 |
| Time of Concentration (hrs):  | 0.04 |
| Catchment Time to Peak (hrs): | 0.03 |
| Catchment Time Step (mins):   | 0.32 |

## Visual OTTHYMO Model Parameter Calculations (NasHYD)

### Project Details

|                |        |
|----------------|--------|
| Project Number | 522679 |
|----------------|--------|

### Data Sources

|   |
|---|
| Detailed Soil Survey Reports for Ontario, MTO Drainage Management Manual (1997) |
|---|

### Prepared By

|      |    |
|------|----|
| Name | HY |
|------|----|

### Pre-Development Condition

|                      |      |
|----------------------|------|
| Watershed:           | N/A  |
| Catchment ID:        | 201  |
| Catchment Area (ha): | 0.06 |
| Impervious %:        | 90%  |

### Average Curve Number (CN), Runoff Coefficient (C) and Initial Abstraction (IA)

| Soil Symbol             | Ng          |        |    |      |        |    |   |        |    |   |        |    |   |
|-------------------------|-------------|--------|----|------|--------|----|---|--------|----|---|--------|----|---|
| Soil Series             | North Gower |        |    |      |        |    |   |        |    |   |        |    |   |
| Hydrologic Soils Group  | D           |        |    |      |        |    |   |        |    |   |        |    |   |
| Soil Texture            | Clay        |        |    |      |        |    |   |        |    |   |        |    |   |
| Runoff Coefficient Type | 3           |        |    |      |        |    |   |        |    |   |        |    |   |
| Area (ha)               | 0.06        |        |    |      |        |    |   |        |    |   |        |    |   |
| Percentage of Catchment | 100%        |        |    |      |        |    |   |        |    |   |        |    |   |
| Land Cover Category     | IA          | A (ha) | CN | C    | A (ha) | CN | C | A (ha) | CN | C | A (ha) | CN | C |
| Impervious              | 2           | 0.05   | 98 | 0.95 |        |    |   |        |    |   |        |    |   |
| Gravel                  | 3           |        | 89 | 0.38 |        |    |   |        |    |   |        |    |   |
| Woodland                | 10          |        | 79 | 0.35 |        |    |   |        |    |   |        |    |   |
| Pasture/Lawns           | 5           | 0.01   | 84 | 0.40 |        |    |   |        |    |   |        |    |   |
| Meadows                 | 8           |        | 81 | 0.38 |        |    |   |        |    |   |        |    |   |
| Cultivated              | 7           |        | 86 | 0.55 |        |    |   |        |    |   |        |    |   |
| Waterbody               | 12          |        | 50 | 0.05 |        |    |   |        |    |   |        |    |   |
| Average CN              | 96.60       |        |    |      |        |    |   |        |    |   |        |    |   |
| Average C               | 0.90        |        |    |      |        |    |   |        |    |   |        |    |   |
| Average IA              | 2.30        |        |    |      |        |    |   |        |    |   |        |    |   |

### Time to Peak Calculations

|                               |                          |
|-------------------------------|--------------------------|
| Max. Catchment Elev. (m):     | 87.95                    |
| Min. Catchment Elev. (m):     | 87.60                    |
| Catchment Length (m):         | 12                       |
| Catchment Slope (%):          | 2.92%                    |
| Method:                       | Bransby-Williams Formula |
| Time of Concentration (mins): | 0.73                     |

### Summary

|                               |      |
|-------------------------------|------|
| Catchment CN:                 | 96.6 |
| Catchment C:                  | 0.90 |
| Catchment IA (mm):            | 2.30 |
| Time of Concentration (hrs):  | 0.01 |
| Catchment Time to Peak (hrs): | 0.01 |
| Catchment Time Step (mins):   | 0.10 |

## Visual OTTHYMO Model Parameter Calculations (NasHYD)

### Project Details

|                |        |
|----------------|--------|
| Project Number | 522679 |
|----------------|--------|

### Data Sources

|   |
|---|
| Detailed Soil Survey Reports for Ontario, MTO Drainage Management Manual (1997) |
|---|

### Prepared By

|      |    |
|------|----|
| Name | HY |
|------|----|

### Pre-Development Condition

|                      |      |
|----------------------|------|
| Watershed:           | N/A  |
| Catchment ID:        | 202  |
| Catchment Area (ha): | 0.15 |
| Impervious %:        | 47%  |

### Average Curve Number (CN), Runoff Coefficient (C) and Initial Abstraction (IA)

| Soil Symbol             | Ng          |        |    |      |        |    |   |        |    |   |        |    |   |
|-------------------------|-------------|--------|----|------|--------|----|---|--------|----|---|--------|----|---|
| Soil Series             | North Gower |        |    |      |        |    |   |        |    |   |        |    |   |
| Hydrologic Soils Group  | D           |        |    |      |        |    |   |        |    |   |        |    |   |
| Soil Texture            | Clay        |        |    |      |        |    |   |        |    |   |        |    |   |
| Runoff Coefficient Type | 3           |        |    |      |        |    |   |        |    |   |        |    |   |
| Area (ha)               | 0.15        |        |    |      |        |    |   |        |    |   |        |    |   |
| Percentage of Catchment | 100%        |        |    |      |        |    |   |        |    |   |        |    |   |
| Land Cover Category     | IA          | A (ha) | CN | C    | A (ha) | CN | C | A (ha) | CN | C | A (ha) | CN | C |
| Impervious              | 2           | 0.07   | 98 | 0.95 |        |    |   |        |    |   |        |    |   |
| Gravel                  | 3           |        | 89 | 0.54 |        |    |   |        |    |   |        |    |   |
| Woodland                | 10          |        | 79 | 0.52 |        |    |   |        |    |   |        |    |   |
| Pasture/Lawns           | 5           | 0.08   | 84 | 0.55 |        |    |   |        |    |   |        |    |   |
| Meadows                 | 8           |        | 81 | 0.54 |        |    |   |        |    |   |        |    |   |
| Cultivated              | 7           |        | 86 | 0.70 |        |    |   |        |    |   |        |    |   |
| Waterbody               | 12          |        | 50 | 0.05 |        |    |   |        |    |   |        |    |   |
| Average CN              | 90.53       |        |    |      |        |    |   |        |    |   |        |    |   |
| Average C               | 0.74        |        |    |      |        |    |   |        |    |   |        |    |   |
| Average IA              | 3.60        |        |    |      |        |    |   |        |    |   |        |    |   |

### Time to Peak Calculations

|                               |                          |
|-------------------------------|--------------------------|
| Max. Catchment Elev. (m):     | 88.00                    |
| Min. Catchment Elev. (m):     | 81.03                    |
| Catchment Length (m):         | 57                       |
| Catchment Slope (%):          | 12.23%                   |
| Method:                       | Bransby-Williams Formula |
| Time of Concentration (mins): | 2.38                     |

### Summary

|                               |      |
|-------------------------------|------|
| Catchment CN:                 | 90.5 |
| Catchment C:                  | 0.74 |
| Catchment IA (mm):            | 3.60 |
| Time of Concentration (hrs):  | 0.04 |
| Catchment Time to Peak (hrs): | 0.03 |
| Catchment Time Step (mins):   | 0.32 |





|              |                     |
|--------------|---------------------|
| Project :    | 5497 Manotick       |
| File No.     | 522679              |
| Date:        | Jul-23              |
| Designed By: | HY                  |
| Checked By:  | GC                  |
| Subject:     | SWM Discharge Table |

**OUTLET CONTROL**

**Orifice Control**

|                              | Orifice  | Pipe     |
|------------------------------|----------|----------|
| Orifice Size (mm):           | 80       | 250      |
| Cross-Sectional Area (sq.m): | 0.005027 | 0.049087 |
| Orifice Coefficient:         | 0.61     | 0.80     |
| Invert Elevation (m):        | 86.45    | 86.45    |
| Outlet Pipe Size (mm):       | 250      | 250      |

**STAGE DISCHARGE TABLE & CONTROL STRUCTURE CONFIGURATION**

| Water Level | 80 mm dia. Orifice |           | 250 mm dia. PVC STM | Total Discharge | Total Provided Active Storage |
|-------------|--------------------|-----------|---------------------|-----------------|-------------------------------|
|             | Head               | Discharge | Capacity            |                 |                               |
| (m)         | (m)                | (cms)     | (cms)               | (cms)           | (cm)                          |
| 86.45       | 0.00               | 0.000     | 0.042               | 0.000           | 0.0                           |
| 86.50       | 0.01               | 0.001     | 0.042               | 0.001           | 1.4                           |
| 86.55       | 0.06               | 0.003     | 0.042               | 0.003           | 2.7                           |
| 86.60       | 0.11               | 0.005     | 0.042               | 0.005           | 4.1                           |
| 86.65       | 0.16               | 0.005     | 0.042               | 0.005           | 5.4                           |
| 86.70       | 0.21               | 0.006     | 0.042               | 0.006           | 6.7                           |
| 86.75       | 0.26               | 0.007     | 0.042               | 0.007           | 7.9                           |
| 86.80       | 0.31               | 0.008     | 0.042               | 0.008           | 9.2                           |
| 86.85       | 0.36               | 0.008     | 0.042               | 0.008           | 10.4                          |
| 86.90       | 0.41               | 0.009     | 0.042               | 0.009           | 11.6                          |
| 86.95       | 0.46               | 0.009     | 0.042               | 0.009           | 12.7                          |
| 87.00       | 0.51               | 0.010     | 0.042               | 0.010           | 13.8                          |
| 87.05       | 0.56               | 0.010     | 0.042               | 0.010           | 14.8                          |
| 87.10       | 0.61               | 0.011     | 0.042               | 0.011           | 15.8                          |
| 87.15       | 0.66               | 0.011     | 0.042               | 0.011           | 16.6                          |
| 87.20       | 0.71               | 0.011     | 0.042               | 0.011           | 17.3                          |
| 87.25       | 0.76               | 0.012     | 0.042               | 0.012           | 17.3                          |
| 87.30       | 0.81               | 0.012     | 0.042               | 0.012           | 17.3                          |
| 87.35       | 0.86               | 0.013     | 0.042               | 0.013           | 17.3                          |
| 87.40       | 0.91               | 0.013     | 0.042               | 0.013           | 17.3                          |
| 87.45       | 0.96               | 0.013     | 0.042               | 0.013           | 17.3                          |
| 87.50       | 1.01               | 0.014     | 0.042               | 0.014           | 17.3                          |
| 87.55       | 1.06               | 0.014     | 0.042               | 0.014           | 17.3                          |
| 87.60       | 1.11               | 0.014     | 0.042               | 0.014           | 17.3                          |
| 87.65       | 1.16               | 0.015     | 0.042               | 0.015           | 17.3                          |
| 87.70       | 1.21               | 0.015     | 0.042               | 0.015           | 17.3                          |
| 87.75       | 1.26               | 0.015     | 0.042               | 0.015           | 17.3                          |

**Proposed Condition (Controlled area)**

| Design Storm      | SWM Facility Operating Characteristics |                                   |                 |
|-------------------|--|-----------------------------------|-----------------|
|                   | Provided Storage (m <sup>3</sup> )     | Total Outflow (m <sup>3</sup> /s) | Water Level (m) |
| 5yr 24hr SCS      | 7                                      | 0.007                             | 86.71           |
| 5yr 3hr Chicago   | 8                                      | 0.007                             | 86.75           |
| 5yr 6hr Chicago   | 7                                      | 0.007                             | 86.71           |
| 100yr 24hr SCS    | 15                                     | 0.010                             | 87.06           |
| 100yr 3hr Chicago | 15                                     | 0.010                             | 87.06           |
| 100yr 6hr Chicago | 15                                     | 0.011                             | 87.06           |



|              |                        |
|--------------|------------------------|
| Project :    | 5497 Manotick Main st. |
| File No.     | 523650                 |
| Date:        | Jul-23                 |
| Designed By: | HY                     |
| Checked By:  | GC                     |
| Subject:     | SWM Facility Storage   |

Underground Chamber Storage

| Elevation | Depth | Quantity Volume   | Total # Chambers | Total Volume      |
|-----------|-------|-------------------|------------------|-------------------|
| (m)       | (m)   | (m <sup>3</sup> ) |                  | (m <sup>3</sup> ) |
| 86.45     | 0.00  | 0.00              | 9.00             | 0.00              |
| 86.50     | 0.05  | 0.14              | 9.00             | 1.25              |
| 86.55     | 0.10  | 0.28              | 9.00             | 2.49              |
| 86.60     | 0.15  | 0.42              | 9.00             | 3.75              |
| 86.65     | 0.20  | 0.55              | 9.00             | 4.91              |
| 86.70     | 0.25  | 0.68              | 9.00             | 6.10              |
| 86.75     | 0.30  | 0.81              | 9.00             | 7.25              |
| 86.80     | 0.35  | 0.93              | 9.00             | 8.39              |
| 86.85     | 0.40  | 1.06              | 9.00             | 9.50              |
| 86.90     | 0.45  | 1.17              | 9.00             | 10.57             |
| 86.95     | 0.50  | 1.29              | 9.00             | 11.59             |
| 87.00     | 0.55  | 1.40              | 9.00             | 12.56             |
| 87.05     | 0.60  | 1.50              | 9.00             | 13.48             |
| 87.10     | 0.65  | 1.59              | 9.00             | 14.33             |
| 87.15     | 0.70  | 1.67              | 9.00             | 15.04             |
| 87.20     | 0.75  | 1.74              | 9.00             | 15.64             |

Storm Structure Storage

| Elevation | Depth | Quantity Volume   | Total Structure | Total Volume      |
|-----------|-------|-------------------|-----------------|-------------------|
| (m)       | (m)   | (m <sup>3</sup> ) | (ea)            | (m <sup>3</sup> ) |
| 86.45     | 0.00  | 0.00              | 2.00            | 0.00              |
| 86.50     | 0.05  | 0.06              | 2.00            | 0.11              |
| 86.55     | 0.10  | 0.11              | 2.00            | 0.23              |
| 86.60     | 0.15  | 0.17              | 2.00            | 0.34              |
| 86.65     | 0.20  | 0.23              | 2.00            | 0.45              |
| 86.70     | 0.25  | 0.28              | 2.00            | 0.57              |
| 86.75     | 0.30  | 0.34              | 2.00            | 0.68              |
| 86.80     | 0.35  | 0.40              | 2.00            | 0.79              |
| 86.85     | 0.40  | 0.45              | 2.00            | 0.90              |
| 86.90     | 0.45  | 0.51              | 2.00            | 1.02              |
| 86.95     | 0.50  | 0.57              | 2.00            | 1.13              |
| 87.00     | 0.55  | 0.62              | 2.00            | 1.24              |
| 87.05     | 0.60  | 0.68              | 2.00            | 1.36              |
| 87.10     | 0.65  | 0.74              | 2.00            | 1.47              |
| 87.15     | 0.70  | 0.79              | 2.00            | 1.58              |
| 87.20     | 0.75  | 0.85              | 2.00            | 1.70              |

PRE SCS

=====

```

V   V   I   SSSSS U   U   A   L           (v 6.1.2001)
V   V   I   SS   U   U   A A  L
V   V   I   SS   U   U   AAAAA L
V   V   I   SS   U   U   A   A  L
  VV   I   SSSSS UUUUU A   A  LLLLL

```

```

  000   TTTTT   TTTTT   H   H   Y   Y   M   M   000   TM
  0   0   T       T   H   H   Y Y   MM MM  0   0
  0   0   T       T   H   H   Y   M   M   0   0
  000   T       T   H   H   Y   M   M   000

```

Developed and Distributed by Smart City Water Inc  
 Copyright 2007 - 2020 Smart City Water Inc  
 All rights reserved.

\*\*\*\*\* S U M M A R Y O U T P U T \*\*\*\*\*

Input filename: C:\Program Files (x86)\Visual OTTHYMO 6.1\V02\voin.dat

Output filename:

C:\Users\hyu\AppData\Local\Civica\XH5\e2c2d2be-418b-4c4d-a4c4-d228733f752c\b7c673a3-d93a-420f-bf9f-618013aa73aa\scenario

Summary filename:

C:\Users\hyu\AppData\Local\Civica\XH5\e2c2d2be-418b-4c4d-a4c4-d228733f752c\b7c673a3-d93a-420f-bf9f-618013aa73aa\scenario

DATE: 07/17/2023

TIME: 04:14:34

USER:

COMMENTS: \_\_\_\_\_

```

*****
** SIMULATION : Run 01           **
*****

```

| W/E COMMAND | HYD ID | DT<br>min | AREA<br>ha | ' Qpeak<br>' cms | Tpeak<br>hrs | R.V.<br>mm | R.C. | Qbase<br>cms |
|-------------|--------|-----------|------------|------------------|--------------|------------|------|--------------|
|-------------|--------|-----------|------------|------------------|--------------|------------|------|--------------|

START @ 0.00 hrs

-----  
READ STORM 5.0

[ Ptot= 49.09 mm ]

fname :

C:\Users\hyu\AppData\Local\Temp\8d3a8f4f-a0b3-478a-8497-9d891abc2745\a83aa445-7986-4108-a295-abaadc5

remark: Ottawa Macdonald Cartier SCS 24 2yr

\*

\*\* CALIB NASHYD 0102 1 5.0 0.15 0.01 12.00 21.85 0.45 0.000

[CN=84.9 ]

[ N = 3.0:Tp 0.17]

\*

READ STORM 5.0

[ Ptot= 49.09 mm ]

fname :

C:\Users\hyu\AppData\Local\Temp\8d3a8f4f-a0b3-478a-8497-9d891abc2745\a83aa445-7986-4108-a295-abaadc5

remark: Ottawa Macdonald Cartier SCS 24 2yr

\*

\* CALIB STANDHYD 0101 1 5.0 0.06 0.01 12.00 37.01 0.75 0.000

[I%=67.0:S%= 2.00]

\*

=====  
=====

V V I SSSSS U U A L (v 6.1.2001)  
V V I SS U U A A L  
V V I SS U U AAAAA L  
V V I SS U U A A L  
VV I SSSSS UUUUU A A LLLLL

000 TTTTT TTTTT H H Y Y M M 000 TM  
0 0 T T H H Y Y MM MM 0 0  
0 0 T T H H Y M M 0 0  
000 T T H H Y M M 000

Developed and Distributed by Smart City Water Inc  
Copyright 2007 - 2020 Smart City Water Inc  
All rights reserved.

\*\*\*\*\* S U M M A R Y O U T P U T \*\*\*\*\*

Input filename: C:\Program Files (x86)\Visual OTTHYMO 6.1\V02\voin.dat

Output filename:

C:\Users\hyu\AppData\Local\Civica\H5\2c2d2be-418b-4c4d-a4c4-d228733f752c\4761ae12-

6660-4e1c-9676-d871b8093e32\scenario

Summary filename:

C:\Users\hyu\AppData\Local\Civica\XH5\2c2d2be-418b-4c4d-a4c4-d228733f752c\4761ae12-6660-4e1c-9676-d871b8093e32\scenario

DATE: 07/17/2023

TIME: 04:14:34

USER:

COMMENTS: \_\_\_\_\_

\*\*\*\*\*  
\*\* SIMULATION : Run 02 \*\*  
\*\*\*\*\*

| W/E COMMAND | HYD ID | DT<br>min | AREA<br>ha | Qpeak<br>cms | Tpeak<br>hrs | R.V.<br>mm | R.C. | Qbase<br>cms |
|-------------|--------|-----------|------------|--------------|--------------|------------|------|--------------|
|-------------|--------|-----------|------------|--------------|--------------|------------|------|--------------|

START @ 0.00 hrs

-----  
READ STORM 5.0  
[ Ptot= 65.91 mm ]  
fname :

C:\Users\hyu\AppData\Local\Temp\8d3a8f4f-a0b3-478a-8497-9d891abc2745\5aca6ac2-ef25-4c6b-b023-6eea581

remark: Ottawa Macdonald Cartier SCS 24 5yr

\*  
\*\* CALIB NASHYD 0102 1 5.0 0.15 0.01 12.00 35.01 0.53 0.000  
[CN=84.9 ]  
[ N = 3.0:Tp 0.17]  
\*

READ STORM 5.0  
[ Ptot= 65.91 mm ]  
fname :

C:\Users\hyu\AppData\Local\Temp\8d3a8f4f-a0b3-478a-8497-9d891abc2745\5aca6ac2-ef25-4c6b-b023-6eea581

remark: Ottawa Macdonald Cartier SCS 24 5yr

\*  
\* CALIB STANDHYD 0101 1 5.0 0.06 0.01 12.00 54.64 0.83 0.000  
[I%=67.0:S%= 2.00]  
\*

=====  
=====

```

V   V   I   SSSSS U   U   A   L           (v 6.1.2001)
V   V   I   SS    U   U   A A  L
V   V   I   SS    U   U   AAAAA L
V   V   I   SS    U   U   A   A  L
  WV    I   SSSSS UUUUU A   A  LLLLL

```

```

000  TTTTT  TTTTT  H   H   Y   Y   M   M   000  TM
0   0   T    T    H   H   Y Y   MM MM  0   0
0   0   T    T    H   H   Y   M   M   0   0
000   T    T    H   H   Y   M   M   000

```

Developed and Distributed by Smart City Water Inc  
 Copyright 2007 - 2020 Smart City Water Inc  
 All rights reserved.

\*\*\*\*\* S U M M A R Y O U T P U T \*\*\*\*\*

Input filename: C:\Program Files (x86)\Visual OTTHYMO 6.1\V02\voin.dat

Output filename:

C:\Users\hyu\AppData\Local\Civica\XH5\e2c2d2be-418b-4c4d-a4c4-d228733f752c\c92f24e4-8db6-46b0-88af-6f3a6a3a6952\scenario

Summary filename:

C:\Users\hyu\AppData\Local\Civica\XH5\e2c2d2be-418b-4c4d-a4c4-d228733f752c\c92f24e4-8db6-46b0-88af-6f3a6a3a6952\scenario

DATE: 07/17/2023

TIME: 04:14:34

USER:

COMMENTS: \_\_\_\_\_

```

*****
** SIMULATION : Run 03          **
*****

```

| W/E COMMAND | HYD ID | DT  | AREA | Qpeak | Tpeak | R.V. | R.C. | Qbase |
|-------------|--------|-----|------|-------|-------|------|------|-------|
|             |        | min | ha   | cms   | hrs   | mm   |      | cms   |

START @ 0.00 hrs

```

-----
READ STORM          5.0
[ Ptot= 77.00 mm ]
fname :

```

C:\Users\hyu\AppData\Local\Temp\8d3a8f4f-a0b3-478a-8497-9d891abc2745\937e7433-4342-40da-96a5-67c3cdf

remark: Ottawa Macdonald Cartier SCS 24 10yr

\*

\*\* CALIB NASHYD 0102 1 5.0 0.15 0.02 12.00 44.25 0.57 0.000  
[CN=84.9 ]  
[ N = 3.0:Tp 0.17]

\*

READ STORM 5.0  
[ Ptot= 77.00 mm ]  
fname :

C:\Users\hyu\AppData\Local\Temp\8d3a8f4f-a0b3-478a-8497-9d891abc2745\937e7433-4342-40da-96a5-67c3cdf

remark: Ottawa Macdonald Cartier SCS 24 10yr

\*

\* CALIB STANDHYD 0101 1 5.0 0.06 0.01 12.00 65.08 0.85 0.000  
[I%=67.0:S%= 2.00]

\*

=====  
=====

V V I SSSSS U U A L (v 6.1.2001)  
V V I SS U U A A L  
V V I SS U U AAAAA L  
V V I SS U U A A L  
VV I SSSSS UUUUU A A LLLLL

000 TTTTT TTTTT H H Y Y M M 000 TM  
0 0 T T H H Y Y MM MM 0 0  
0 0 T T H H Y M M 0 0  
000 T T H H Y M M 000

Developed and Distributed by Smart City Water Inc  
Copyright 2007 - 2020 Smart City Water Inc  
All rights reserved.

\*\*\*\*\* S U M M A R Y O U T P U T \*\*\*\*\*

Input filename: C:\Program Files (x86)\Visual OTTHYMO 6.1\V02\voin.dat

Output filename:

C:\Users\hyu\AppData\Local\Civica\H5\2c2d2be-418b-4c4d-a4c4-d228733f752c\47b3e90-6d5b-4b5b-a0dd-45c31ff72924\scenario

Summary filename:

C:\Users\hyu\AppData\Local\Civica\H5\2c2d2be-418b-4c4d-a4c4-d228733f752c\47b3e90-6d5b-4b5b-a0dd-45c31ff72924\scenario

DATE: 07/17/2023

TIME: 04:14:34

USER:

COMMENTS: \_\_\_\_\_

\*\*\*\*\*  
\*\* SIMULATION : Run 04 \*\*  
\*\*\*\*\*

| W/E COMMAND | HYD ID | DT  | AREA | Qpeak | Tpeak | R.V. | R.C. | Qbase |
|-------------|--------|-----|------|-------|-------|------|------|-------|
|             |        | min | ha   | cms   | hrs   | mm   |      | cms   |

START @ 0.00 hrs

-----

READ STORM 5.0

[ Ptot= 91.08 mm ]

fname :

C:\Users\hyu\AppData\Local\Temp\8d3a8f4f-a0b3-478a-8497-9d891abc2745\8677e260-0877-4303-925b-23f8544

remark: Ottawa Macdonald Cartier SCS 24 25yr

\*

|                 |      |   |     |      |      |       |       |      |       |
|-----------------|------|---|-----|------|------|-------|-------|------|-------|
| ** CALIB NASHYD | 0102 | 1 | 5.0 | 0.15 | 0.02 | 12.00 | 56.42 | 0.62 | 0.000 |
|-----------------|------|---|-----|------|------|-------|-------|------|-------|

[CN=84.9 ]

[ N = 3.0:Tp 0.17]

\*

READ STORM 5.0

[ Ptot= 91.08 mm ]

fname :

C:\Users\hyu\AppData\Local\Temp\8d3a8f4f-a0b3-478a-8497-9d891abc2745\8677e260-0877-4303-925b-23f8544

remark: Ottawa Macdonald Cartier SCS 24 25yr

\*

|                  |      |   |     |      |      |       |       |      |       |
|------------------|------|---|-----|------|------|-------|-------|------|-------|
| * CALIB STANDHYD | 0101 | 1 | 5.0 | 0.06 | 0.01 | 12.00 | 78.49 | 0.86 | 0.000 |
|------------------|------|---|-----|------|------|-------|-------|------|-------|

[I%=67.0:S%= 2.00]

\*

=====  
=====

|   |   |   |       |       |   |       |       |  |              |
|---|---|---|-------|-------|---|-------|-------|--|--------------|
| V | V | I | SSSSS | U     | U | A     | L     |  | (v 6.1.2001) |
| V | V | I | SS    | U     | U | A A   | L     |  |              |
| V | V | I | SS    | U     | U | AAAAA | L     |  |              |
| V | V | I | SS    | U     | U | A A   | L     |  |              |
| V | V | I | SSSSS | UUUUU | A | A     | LLLLL |  |              |



```
    000  TTTT  TTTT  H   H  Y   Y  M   M  000  TM
    0   0   T    T   H   H   Y Y   MM MM  0   0
    0   0   T    T   H   H   Y   M   M  0   0
    000    T    T   H   H   Y   M   M  000
```

Developed and Distributed by Smart City Water Inc  
Copyright 2007 - 2020 Smart City Water Inc  
All rights reserved.

\*\*\*\*\* S U M M A R Y O U T P U T \*\*\*\*\*

Input filename: C:\Program Files (x86)\Visual OTTHYMO 6.1\V02\voin.dat

Output filename:

C:\Users\hyu\AppData\Local\Civica\VH5\e2c2d2be-418b-4c4d-a4c4-d228733f752c\f68a9a6e-b8dc-491f-bbd5-38b0c62db25c\scenario

Summary filename:

C:\Users\hyu\AppData\Local\Civica\VH5\e2c2d2be-418b-4c4d-a4c4-d228733f752c\f68a9a6e-b8dc-491f-bbd5-38b0c62db25c\scenario

DATE: 07/17/2023

TIME: 04:14:34

USER:

COMMENTS: \_\_\_\_\_

```
*****
** SIMULATION : Run 05                      **
*****
```

| W/E COMMAND | HYD ID | DT<br>min | AREA<br>ha | Qpeak<br>cms | Tpeak<br>hrs | R.V.<br>mm | R.C. | Qbase<br>cms |
|-------------|--------|-----------|------------|--------------|--------------|------------|------|--------------|
|-------------|--------|-----------|------------|--------------|--------------|------------|------|--------------|

START @ 0.00 hrs

-----

READ STORM 5.0

[ Ptot=101.52 mm ]

fname :

C:\Users\hyu\AppData\Local\Temp\8d3a8f4f-a0b3-478a-8497-9d891abc2745\55c88cf1-c07d-4de2-b4c7-fa9ea96

remark: Ottawa Macdonald Cartier SCS 24 50yr

\*

```
** CALIB NASHYD      0102  1  5.0    0.15    0.03 12.00  65.69 0.65   0.000
   [CN=84.9         ]
   [ N = 3.0:Tp 0.17]
```

\*

READ STORM 5.0

[ Ptot=101.52 mm ]

fname :

C:\Users\hyu\AppData\Local\Temp\8d3a8f4f-a0b3-478a-8497-9d891abc2745\55c88cf1-c07d-4de2-b4c7-fa9ea96

remark: Ottawa Macdonald Cartier SCS 24 50yr

\*

\* CALIB STANDHYD 0101 1 5.0 0.06 0.02 12.00 88.51 0.87 0.000

[I%=67.0:S%= 2.00]

\*

=====

|   |   |   |       |       |     |       |   |  |  |              |
|---|---|---|-------|-------|-----|-------|---|--|--|--------------|
| V | V | I | SSSSS | U     | U   | A     | L |  |  | (v 6.1.2001) |
| V | V | I | SS    | U     | U   | A A   | L |  |  |              |
| V | V | I | SS    | U     | U   | AAAAA | L |  |  |              |
| V | V | I | SS    | U     | U   | A A   | L |  |  |              |
| V | V | I | SSSSS | UUUUU | A A | LLLL  |   |  |  |              |

|     |      |      |   |   |   |     |    |     |     |    |
|-----|------|------|---|---|---|-----|----|-----|-----|----|
| 000 | TTTT | TTTT | H | H | Y | Y   | M  | M   | 000 | TM |
| 0   | 0    | T    | T | H | H | Y Y | MM | MM  | 0   | 0  |
| 0   | 0    | T    | T | H | H | Y   | M  | M   | 0   | 0  |
| 000 | T    | T    | H | H | Y | M   | M  | 000 |     |    |

Developed and Distributed by Smart City Water Inc  
Copyright 2007 - 2020 Smart City Water Inc  
All rights reserved.

\*\*\*\*\* SUMMARY OUTPUT \*\*\*\*\*

Input filename: C:\Program Files (x86)\Visual OTTHYMO 6.1\V02\voin.dat

Output filename:

C:\Users\hyu\AppData\Local\Civica\XH5\82c2d2be-418b-4c4d-a4c4-d228733f752c\f81c5622-08d5-48bf-bca3-1eb71c45cbd7\scenario

Summary filename:

C:\Users\hyu\AppData\Local\Civica\XH5\82c2d2be-418b-4c4d-a4c4-d228733f752c\f81c5622-08d5-48bf-bca3-1eb71c45cbd7\scenario

DATE: 07/17/2023

TIME: 04:14:34

USER:

COMMENTS: \_\_\_\_\_

\*\*\*\*\*  
 \*\* SIMULATION : Run 06 \*\*  
 \*\*\*\*\*

| W/E COMMAND | HYD ID | DT<br>min | AREA<br>ha | Qpeak<br>cms | Tpeak<br>hrs | R.V.<br>mm | R.C. | Qbase<br>cms |
|-------------|--------|-----------|------------|--------------|--------------|------------|------|--------------|
|-------------|--------|-----------|------------|--------------|--------------|------------|------|--------------|

START @ 0.00 hrs

-----  
 READ STORM 5.0  
 [ Ptot=111.87 mm ]  
 fname :

C:\Users\hyu\AppData\Local\Temp\8d3a8f4f-a0b3-478a-8497-9d891abc2745\e20e7578-d439-4ffb-8edc-8fe2588

remark: Ottawa Macdonald Cartier SCS 24 100yr

\*  
 \*\* CALIB NASHYD 0102 1 5.0 0.15 0.03 12.00 75.03 0.67 0.000  
 [CN=84.9 ]  
 [ N = 3.0:Tp 0.17]

\*  
 READ STORM 5.0  
 [ Ptot=111.87 mm ]  
 fname :

C:\Users\hyu\AppData\Local\Temp\8d3a8f4f-a0b3-478a-8497-9d891abc2745\e20e7578-d439-4ffb-8edc-8fe2588

remark: Ottawa Macdonald Cartier SCS 24 100yr

\*  
 \* CALIB STANDHYD 0101 1 5.0 0.06 0.02 12.00 98.52 0.88 0.000  
 [I%=67.0:S%= 2.00]

\*  
 FINISH

=====  
 =====

PRE CHI

=====

```

V   V   I   SSSSS  U   U   A   L           (v 6.1.2001)
V   V   I   SS    U   U   A A  L
V   V   I   SS    U   U   AAAAA L
V   V   I   SS    U   U   A   A  L
  VV    I   SSSSS  UUUUU  A   A  LLLLL

```

```

  000  TTTTT  TTTTT  H   H  Y   Y  M   M   000  TM
  0   0   T    T    H   H   Y Y  MM MM  0   0
  0   0   T    T    H   H   Y   M   M  0   0
  000   T    T    H   H   Y   M   M  000

```

Developed and Distributed by Smart City Water Inc  
 Copyright 2007 - 2020 Smart City Water Inc  
 All rights reserved.

\*\*\*\*\* S U M M A R Y O U T P U T \*\*\*\*\*

Input filename: C:\Program Files (x86)\Visual OTTHYMO 6.1\V02\voin.dat

Output filename:

C:\Users\JAsh\AppData\Local\Civica\XH5\e2c2d2be-418b-4c4d-a4c4-d228733f752c\51d2b20a-c962-46f2-b46d-0bcb89b18572\scenari

Summary filename:

C:\Users\JAsh\AppData\Local\Civica\XH5\e2c2d2be-418b-4c4d-a4c4-d228733f752c\51d2b20a-c962-46f2-b46d-0bcb89b18572\scenari

DATE: 07-17-2023

TIME: 10:29:30

USER:

COMMENTS: \_\_\_\_\_

```

*****
** SIMULATION : Run 01          **
*****

```

| W/E COMMAND | HYD ID | DT<br>min | AREA<br>ha | ' Qpeak<br>' cms | Tpeak<br>hrs | R.V.<br>mm | R.C. | Qbase<br>cms |
|-------------|--------|-----------|------------|------------------|--------------|------------|------|--------------|
|-------------|--------|-----------|------------|------------------|--------------|------------|------|--------------|

START @ 0.00 hrs

-----

```

CHIC STORM                10.0
[ Ptot= 42.51 mm ]
*
* CALIB STANDHYD          0101  1  5.0   0.06   0.01  1.00  33.09  0.78   0.000
[ I%=67.0:S%= 2.00]
*
CHIC STORM                10.0
[ Ptot= 42.51 mm ]
*
* CALIB NASHYD            0003  1  5.0   0.15   0.01  1.17  17.09  0.40   0.000
[ CN=84.9          ]
[ N = 3.0:Tp 0.17]
*

```

```

=====
=====

```

```

V  V  I  SSSSS  U  U  A  L                (v 6.1.2001)
V  V  I  SS    U  U  A  A  L
V  V  I  SS    U  U  AAAAA  L
V  V  I  SS    U  U  A  A  L
WV   I  SSSSS  UUUUU  A  A  LLLLL

```

```

000  TTTTT  TTTTT  H  H  Y  Y  M  M  000  TM
0  0  T  T  H  H  Y  Y  MM  MM  0  0
0  0  T  T  H  H  Y  M  M  0  0
000  T  T  H  H  Y  M  M  000

```

Developed and Distributed by Smart City Water Inc  
 Copyright 2007 - 2020 Smart City Water Inc  
 All rights reserved.

\*\*\*\*\* S U M M A R Y O U T P U T \*\*\*\*\*

Input filename: C:\Program Files (x86)\Visual OTTHYMO 6.1\V02\voin.dat

Output filename:

C:\Users\JAsh\AppData\Local\Civica\VH5\e2c2d2be-418b-4c4d-a4c4-d228733f752c\8106252e-7f91-4954-a690-56795e9b7e1d\scenari

Summary filename:

C:\Users\JAsh\AppData\Local\Civica\VH5\e2c2d2be-418b-4c4d-a4c4-d228733f752c\8106252e-7f91-4954-a690-56795e9b7e1d\scenari

DATE: 07-17-2023

TIME: 10:29:30

USER:

COMMENTS: \_\_\_\_\_

\*\*\*\*\*  
\*\* SIMULATION : Run 02 \*\*  
\*\*\*\*\*

| W/E COMMAND | HYD ID | DT<br>min | AREA<br>ha | Qpeak<br>cms | Tpeak<br>hrs | R.V.<br>mm | R.C. | Qbase<br>cms |
|-------------|--------|-----------|------------|--------------|--------------|------------|------|--------------|
|-------------|--------|-----------|------------|--------------|--------------|------------|------|--------------|

START @ 0.00 hrs

-----  
CHIC STORM 10.0  
[ Ptot= 49.04 mm ]

\*  
\* CALIB STANDHYD 0101 1 5.0 0.06 0.01 2.00 39.01 0.80 0.000  
[ I%=67.0:S%= 2.00 ]

\*  
CHIC STORM 10.0  
[ Ptot= 49.04 mm ]

\*  
\* CALIB NASHYD 0003 1 5.0 0.15 0.01 2.17 21.81 0.44 0.000  
[ CN=84.9 ]  
[ N = 3.0:Tp 0.17 ]

\*  
FINISH

=====  
=====

POST SCS

=====

```

V   V   I   SSSSS  U   U   A   L           (v 6.1.2001)
V   V   I   SS     U   U   A A  L
V   V   I   SS     U   U   AAAAA L
V   V   I   SS     U   U   A   A  L
  VV    I   SSSSS  UUUUU  A   A  LLLLL

```

```

  000  TTTTT  TTTTT  H   H  Y   Y  M   M   000  TM
  0   0   T    T    H   H   Y Y  MM MM  0   0
  0   0   T    T    H   H   Y   M   M  0   0
  000   T    T    H   H   Y   M   M  000

```

Developed and Distributed by Smart City Water Inc  
 Copyright 2007 - 2020 Smart City Water Inc  
 All rights reserved.

\*\*\*\*\* S U M M A R Y O U T P U T \*\*\*\*\*

Input filename: C:\Program Files (x86)\Visual OTTHYMO 6.1\V02\voin.dat

Output filename:

C:\Users\hyu\AppData\Local\Civica\XH5\e2c2d2be-418b-4c4d-a4c4-d228733f752c\dead66f3-c7bd-44fa-ab3e-b90bcaf4653d\scenario

Summary filename:

C:\Users\hyu\AppData\Local\Civica\XH5\e2c2d2be-418b-4c4d-a4c4-d228733f752c\dead66f3-c7bd-44fa-ab3e-b90bcaf4653d\scenario

DATE: 07/17/2023

TIME: 04:15:19

USER:

COMMENTS: \_\_\_\_\_

```

*****
** SIMULATION : Run 01           **
*****

```

| W/E COMMAND | HYD ID | DT<br>min | AREA<br>ha | ' Qpeak<br>' cms | Tpeak<br>hrs | R.V.<br>mm | R.C. | Qbase<br>cms |
|-------------|--------|-----------|------------|------------------|--------------|------------|------|--------------|
|-------------|--------|-----------|------------|------------------|--------------|------------|------|--------------|

START @ 0.00 hrs

-----

READ STORM 5.0

[ Ptot= 49.09 mm ]

fname :

C:\Users\hyu\AppData\Local\Temp\7503162c-ebcd-4ef7-8a90-d5ffbc430b8e\a83aa445-7986-4108-a295-abaadc5

remark: Ottawa Macdonald Cartier SCS 24 2yr

\*

\* CALIB STANDHYD 0060 1 5.0 0.15 0.01 12.00 33.68 0.69 0.000  
[I%=47.0:S%= 2.00]

\*

READ STORM 5.0

[ Ptot= 49.09 mm ]

fname :

C:\Users\hyu\AppData\Local\Temp\7503162c-ebcd-4ef7-8a90-d5ffbc430b8e\a83aa445-7986-4108-a295-abaadc5

remark: Ottawa Macdonald Cartier SCS 24 2yr

\*

\* CALIB STANDHYD 0061 1 5.0 0.06 0.01 12.00 43.09 0.88 0.000  
[I%=90.0:S%= 2.00]

\*

\*\* Reservoir

OUTFLOW: 0062 1 5.0 0.06 0.01 12.00 42.91 n/a 0.000

\*

=====  
=====

V V I SSSSS U U A L (v 6.1.2001)  
V V I SS U U A A L  
V V I SS U U AAAAA L  
V V I SS U U A A L  
VV I SSSSS UUUUU A A LLLLL

000 TTTTT TTTTT H H Y Y M M 000 TM  
O O T T H H Y Y MM MM O O  
O O T T H H Y M M O O  
000 T T H H Y M M 000

Developed and Distributed by Smart City Water Inc  
Copyright 2007 - 2020 Smart City Water Inc  
All rights reserved.

\*\*\*\*\* SUMMARY OUTPUT \*\*\*\*\*

Input filename: C:\Program Files (x86)\Visual OTTHYMO 6.1\V02\voin.dat

Output filename:



C:\Users\hyu\AppData\Local\Civica\XH5\e2c2d2be-418b-4c4d-a4c4-d228733f752c\3e1f6bf3-ccfb-4f8c-872e-40caa5f9ed93\scenario

Summary filename:

C:\Users\hyu\AppData\Local\Civica\XH5\e2c2d2be-418b-4c4d-a4c4-d228733f752c\3e1f6bf3-ccfb-4f8c-872e-40caa5f9ed93\scenario

DATE: 07/17/2023

TIME: 04:15:19

USER:

COMMENTS: \_\_\_\_\_

\*\*\*\*\*  
\*\* SIMULATION : Run 02 \*\*  
\*\*\*\*\*

| W/E COMMAND | HYD ID | DT  | AREA | Qpeak | Tpeak | R.V. | R.C. | Qbase |
|-------------|--------|-----|------|-------|-------|------|------|-------|
|             |        | min | ha   | cms   | hrs   | mm   |      | cms   |

START @ 0.00 hrs

-----  
READ STORM 5.0  
[ Ptot= 65.91 mm ]  
fname :

C:\Users\hyu\AppData\Local\Temp\7503162c-ebcd-4ef7-8a90-d5ffbc430b8e\5aca6ac2-ef25-4c6b-b023-6eea581

remark: Ottawa Macdonald Cartier SCS 24 5yr

\*  
\* CALIB STANDHYD 0060 1 5.0 0.15 0.02 12.00 48.46 0.74 0.000  
[I%=47.0:S%= 2.00]

\*  
READ STORM 5.0  
[ Ptot= 65.91 mm ]  
fname :

C:\Users\hyu\AppData\Local\Temp\7503162c-ebcd-4ef7-8a90-d5ffbc430b8e\5aca6ac2-ef25-4c6b-b023-6eea581

remark: Ottawa Macdonald Cartier SCS 24 5yr

\*  
\* CALIB STANDHYD 0061 1 5.0 0.06 0.01 12.00 61.81 0.94 0.000  
[I%=90.0:S%= 2.00]

\*\* Reservoir  
OUTFLOW: 0062 1 5.0 0.06 0.01 12.00 61.65 n/a 0.000

=====

=====

```

V   V   I   SSSSS U   U   A   L           (v 6.1.2001)
V   V   I   SS   U   U   A A   L
V   V   I   SS   U   U   AAAAA L
V   V   I   SS   U   U   A   A   L
  WV   I   SSSSS UUUUU A   A   LLLLL

```

```

  000   TTTT   TTTT   H   H   Y   Y   M   M   000   TM
0   0   T     T   H   H   Y Y   MM MM   0   0
0   0   T     T   H   H   Y   M   M   0   0
  000   T     T   H   H   Y   M   M   000

```

Developed and Distributed by Smart City Water Inc  
 Copyright 2007 - 2020 Smart City Water Inc  
 All rights reserved.

\*\*\*\*\* S U M M A R Y O U T P U T \*\*\*\*\*

Input filename: C:\Program Files (x86)\Visual OTTHYMO 6.1\V02\voin.dat

Output filename:

C:\Users\hyu\AppData\Local\Civica\XH5\e2c2d2be-418b-4c4d-a4c4-d228733f752c\20983300-3dd2-4350-9aff-ecc9603591ad\scenario

Summary filename:

C:\Users\hyu\AppData\Local\Civica\XH5\e2c2d2be-418b-4c4d-a4c4-d228733f752c\20983300-3dd2-4350-9aff-ecc9603591ad\scenario

DATE: 07/17/2023

TIME: 04:15:19

USER:

COMMENTS: \_\_\_\_\_

```

*****
** SIMULATION : Run 03           **
*****

```

| W/E COMMAND | HYD ID | DT<br>min | AREA<br>ha | Qpeak<br>' cms | Tpeak<br>hrs | R.V.<br>mm | R.C. | Qbase<br>cms |
|-------------|--------|-----------|------------|----------------|--------------|------------|------|--------------|
|-------------|--------|-----------|------------|----------------|--------------|------------|------|--------------|

START @ 0.00 hrs

-----

READ STORM 5.0

[ Ptot= 77.00 mm ]

fname :  
 C:\Users\hyu\AppData\Local\Temp\7503162c-ebcd-4ef7-8a90-d5ffbc430b8e\937e7433-4342-40da-96a5-67c3cdf  
 remark: Ottawa Macdonald Cartier SCS 24 10yr

\*  
 \* CALIB STANDHYD           0060 1 5.0    0.15    0.02 12.00  58.50 0.76    0.000  
 [I%=47.0:S%= 2.00]

\*  
 READ STORM                           5.0  
 [ Ptot= 77.00 mm ]  
 fname :

C:\Users\hyu\AppData\Local\Temp\7503162c-ebcd-4ef7-8a90-d5ffbc430b8e\937e7433-4342-40da-96a5-67c3cdf  
 remark: Ottawa Macdonald Cartier SCS 24 10yr

\*  
 \* CALIB STANDHYD           0061 1 5.0    0.06    0.01 12.00  72.70 0.94    0.000  
 [I%=90.0:S%= 2.00]

\*  
 \*\* Reservoir  
 OUTFLOW:                   0062 1 5.0    0.06    0.01 12.08  72.51 n/a    0.000  
 \*

=====  
 =====

```

V  V  I  SSSSS  U  U  A  L           (v 6.1.2001)
V  V  I  SS    U  U  A  A  L
V  V  I  SS    U  U  AAAAA  L
V  V  I  SS    U  U  A  A  L
VV   I  SSSSS  UUUUU  A  A  LLLLL

```

```

000  TTTT  TTTT  H  H  Y  Y  M  M  000  TM
0  0  T    T    H  H  Y  Y  MM MM  0  0
0  0  T    T    H  H  Y  M  M  0  0
000  T    T    H  H  Y  M  M  000

```

Developed and Distributed by Smart City Water Inc  
 Copyright 2007 - 2020 Smart City Water Inc  
 All rights reserved.

\*\*\*\*\* S U M M A R Y O U T P U T \*\*\*\*\*

Input filename: C:\Program Files (x86)\Visual OTTHYM0 6.1\V02\voin.dat

Output filename:

C:\Users\hyu\AppData\Local\Civica\H5\2c2d2be-418b-4c4d-a4c4-d228733f752c\cb864a73-4fb4-4f10-b511-fe2fc736f640\scenario

Summary filename:  
 C:\Users\hyu\AppData\Local\Civica\XH5\e2c2d2be-418b-4c4d-a4c4-d228733f752c\cb864a73-4fb4-4f10-b511-fe2fc736f640\scenario

DATE: 07/17/2023

TIME: 04:15:19

USER:

COMMENTS: \_\_\_\_\_

\*\*\*\*\*  
 \*\* SIMULATION : Run 04 \*\*  
 \*\*\*\*\*

| W/E COMMAND | HYD ID | DT  | AREA | Qpeak | Tpeak | R.V. | R.C. | Qbase |
|-------------|--------|-----|------|-------|-------|------|------|-------|
|             |        | min | ha   | cms   | hrs   | mm   |      | cms   |

START @ 0.00 hrs

-----  
 READ STORM 5.0  
 [ Ptot= 91.08 mm ]  
 fname :

C:\Users\hyu\AppData\Local\Temp\7503162c-ebcd-4ef7-8a90-d5ffbc430b8e\8677e260-0877-4303-925b-23f8544  
 remark: Ottawa Macdonald Cartier SCS 24 25yr

\*  
 \* CALIB STANDHYD 0060 1 5.0 0.15 0.03 12.00 71.51 0.79 0.000  
 [I%=47.0:S%= 2.00]

\*  
 READ STORM 5.0  
 [ Ptot= 91.08 mm ]  
 fname :

C:\Users\hyu\AppData\Local\Temp\7503162c-ebcd-4ef7-8a90-d5ffbc430b8e\8677e260-0877-4303-925b-23f8544  
 remark: Ottawa Macdonald Cartier SCS 24 25yr

\*  
 \* CALIB STANDHYD 0061 1 5.0 0.06 0.02 12.00 86.58 0.95 0.000  
 [I%=90.0:S%= 2.00]

\*  
 \*\* Reservoir  
 OUTFLOW: 0062 1 5.0 0.06 0.01 12.08 86.35 n/a 0.000

\*  
 FINISH

=====

=====

=====

=====

```

V   V   I   SSSSS U   U   A   L           (v 6.1.2001)
V   V   I   SS    U   U   A A  L
V   V   I   SS    U   U   AAAAA L
V   V   I   SS    U   U   A   A  L
  VV    I   SSSSS UUUUU A   A  LLLLL

```

```

  000   TTTTT   TTTTT   H   H   Y   Y   M   M   000   TM
  0   0   T     T     H   H   Y Y   MM MM  0   0
  0   0   T     T     H   H   Y   M   M   0   0
  000   T     T     H   H   Y   M   M   000

```

Developed and Distributed by Smart City Water Inc  
 Copyright 2007 - 2020 Smart City Water Inc  
 All rights reserved.

\*\*\*\*\* S U M M A R Y O U T P U T \*\*\*\*\*

Input filename: C:\Program Files (x86)\Visual OTTHYM0 6.1\V02\voin.dat

Output filename:

C:\Users\hyu\AppData\Local\Civica\XH5\e2c2d2be-418b-4c4d-a4c4-d228733f752c\3592b175-6811-4e92-acdf-1c90c60f3294\scenario

Summary filename:

C:\Users\hyu\AppData\Local\Civica\XH5\e2c2d2be-418b-4c4d-a4c4-d228733f752c\3592b175-6811-4e92-acdf-1c90c60f3294\scenario

DATE: 07/17/2023

TIME: 04:15:19

USER:

COMMENTS: \_\_\_\_\_

```

*****
** SIMULATION : Run 05          **
*****

```

| W/E COMMAND | HYD ID | DT<br>min | AREA<br>ha | ' Qpeak<br>' cms | Tpeak<br>hrs | R.V.<br>mm | R.C. | Qbase<br>cms |
|-------------|--------|-----------|------------|------------------|--------------|------------|------|--------------|
|-------------|--------|-----------|------------|------------------|--------------|------------|------|--------------|

START @ 0.00 hrs

-----  
READ STORM 5.0

[ Ptot=101.52 mm ]

fname :

C:\Users\hyu\AppData\Local\Temp\7503162c-ebcd-4ef7-8a90-d5ffbc430b8e\55c88cf1-c07d-4de2-b4c7-fa9ea96

remark: Ottawa Macdonald Cartier SCS 24 50yr

\*

\* CALIB STANDHYD 0060 1 5.0 0.15 0.04 12.00 81.29 0.80 0.000  
[I%=47.0:S%= 2.00]

\*

READ STORM 5.0

[ Ptot=101.52 mm ]

fname :

C:\Users\hyu\AppData\Local\Temp\7503162c-ebcd-4ef7-8a90-d5ffbc430b8e\55c88cf1-c07d-4de2-b4c7-fa9ea96

remark: Ottawa Macdonald Cartier SCS 24 50yr

\*

\* CALIB STANDHYD 0061 1 5.0 0.06 0.02 12.00 96.89 0.95 0.000  
[I%=90.0:S%= 2.00]

\*

\*\* Reservoir

OUTFLOW: 0062 1 5.0 0.06 0.01 12.08 96.63 n/a 0.000

\*

=====  
=====

V V I SSSSS U U A L (v 6.1.2001)  
V V I SS U U A A L  
V V I SS U U AAAAA L  
V V I SS U U A A L  
VV I SSSSS UUUUU A A LLLLL

000 TTTTT TTTTT H H Y Y M M 000 TM  
0 0 T T H H Y Y MM MM 0 0  
0 0 T T H H Y M M 0 0  
000 T T H H Y M M 000

Developed and Distributed by Smart City Water Inc  
Copyright 2007 - 2020 Smart City Water Inc  
All rights reserved.

\*\*\*\*\* S U M M A R Y O U T P U T \*\*\*\*\*

Input filename: C:\Program Files (x86)\Visual OTTHYMO 6.1\V02\voin.dat

Output filename:  
C:\Users\hyu\AppData\Local\Civica\XH5\e2c2d2be-418b-4c4d-a4c4-d228733f752c\4fd264b8-2922-458d-bc51-3b763d71b179\scenario

Summary filename:  
C:\Users\hyu\AppData\Local\Civica\XH5\e2c2d2be-418b-4c4d-a4c4-d228733f752c\4fd264b8-2922-458d-bc51-3b763d71b179\scenario

DATE: 07/17/2023 TIME: 04:15:19

USER:

COMMENTS: \_\_\_\_\_

\*\*\*\*\*  
\*\* SIMULATION : Run 06 \*\*  
\*\*\*\*\*

| W/E COMMAND | HYD ID | DT<br>min | AREA<br>ha | Qpeak<br>cms | Tpeak<br>hrs | R.V.<br>mm | R.C. | Qbase<br>cms |
|-------------|--------|-----------|------------|--------------|--------------|------------|------|--------------|
|-------------|--------|-----------|------------|--------------|--------------|------------|------|--------------|

START @ 0.00 hrs

-----  
READ STORM 5.0  
[ Ptot=111.87 mm ]  
fname :

C:\Users\hyu\AppData\Local\Temp\7503162c-ebcd-4ef7-8a90-d5ffbc430b8e\20e7578-d439-4ffb-8edc-8fe2588

remark: Ottawa Macdonald Cartier SCS 24 100yr

\*  
\* CALIB STANDHYD 0060 1 5.0 0.15 0.04 12.00 91.07 0.81 0.000  
[ I%=47.0:S%= 2.00 ]

\*  
READ STORM 5.0  
[ Ptot=111.87 mm ]  
fname :

C:\Users\hyu\AppData\Local\Temp\7503162c-ebcd-4ef7-8a90-d5ffbc430b8e\20e7578-d439-4ffb-8edc-8fe2588

remark: Ottawa Macdonald Cartier SCS 24 100yr

\*  
\* CALIB STANDHYD 0061 1 5.0 0.06 0.02 12.00 107.14 0.96 0.000  
[ I%=90.0:S%= 2.00 ]

\*  
\*\* Reservoir  
OUTFLOW: 0062 1 5.0 0.06 0.01 12.08 106.86 n/a 0.000

\*

POST CHI

=====

```

V   V   I   SSSSS U   U   A   L           (v 6.1.2001)
V   V   I   SS    U   U   A A  L
V   V   I   SS    U   U   AAAAA L
V   V   I   SS    U   U   A   A  L
  VV    I   SSSSS UUUUU A   A  LLLLL

```

```

  000  TTTTT  TTTTT  H   H  Y   Y  M   M   000  TM
  0   0   T    T    H   H   Y Y  MM MM  0   0
  0   0   T    T    H   H   Y   M   M   0   0
  000   T    T    H   H   Y   M   M   000

```

Developed and Distributed by Smart City Water Inc  
 Copyright 2007 - 2020 Smart City Water Inc  
 All rights reserved.

\*\*\*\*\* S U M M A R Y O U T P U T \*\*\*\*\*

Input filename: C:\Program Files (x86)\Visual OTTHYMO 6.1\V02\voin.dat

Output filename:

C:\Users\JAsh\AppData\Local\Civica\XH5\e2c2d2be-418b-4c4d-a4c4-d228733f752c\ba4b3151-3434-4d95-884c-1dfe096b7b54\scenari

Summary filename:

C:\Users\JAsh\AppData\Local\Civica\XH5\e2c2d2be-418b-4c4d-a4c4-d228733f752c\ba4b3151-3434-4d95-884c-1dfe096b7b54\scenari

DATE: 07-17-2023

TIME: 10:49:09

USER:

COMMENTS: \_\_\_\_\_

```

*****
** SIMULATION : Ottawa 100yr 3hr Chicago **
*****

```

| W/E COMMAND | HYD ID | DT<br>min | AREA<br>ha | ' Qpeak<br>' cms | Tpeak<br>hrs | R.V.<br>mm | R.C. | Qbase<br>cms |
|-------------|--------|-----------|------------|------------------|--------------|------------|------|--------------|
|-------------|--------|-----------|------------|------------------|--------------|------------|------|--------------|

START @ 0.00 hrs

-----



```

CHIC STORM                    10.0
[ Ptot= 71.66 mm ]
*
* CALIB STANDHYD              0060  1  5.0   0.15   0.05  1.00  53.66  0.75   0.000
[ I%=47.0:S%= 2.00 ]
*
CHIC STORM                    10.0
[ Ptot= 71.66 mm ]
*
* CALIB STANDHYD              0061  1  5.0   0.06   0.03  1.00  67.45  0.94   0.000
[ I%=90.0:S%= 2.00 ]
*
** Reservoir
   OUTFLOW:                    0062  1  5.0   0.06   0.01  1.08  67.10  n/a    0.000
*

```

```

=====
=====

```

```

V  V  I  SSSSS  U  U  A  L                (v 6.1.2001)
V  V  I  SS    U  U  A  A  L
V  V  I  SS    U  U  AAAAA L
V  V  I  SS    U  U  A  A  L
  VV   I  SSSSS  UUUUU  A  A  LLLLL

```

```

000  TTTT  TTTT  H  H  Y  Y  M  M  000  TM
0  0  T  T  H  H  Y  Y  MM  MM  0  0
0  0  T  T  H  H  Y  M  M  0  0
000  T  T  H  H  Y  M  M  000

```

Developed and Distributed by Smart City Water Inc  
Copyright 2007 - 2020 Smart City Water Inc  
All rights reserved.

\*\*\*\*\* S U M M A R Y O U T P U T \*\*\*\*\*

Input filename: C:\Program Files (x86)\Visual OTTHYM0 6.1\V02\voin.dat

Output filename:

C:\Users\JAsh\AppData\Local\Civica\XH5\e2c2d2be-418b-4c4d-a4c4-d228733f752c\89d27013  
-c96f-46e4-82e5-cbf43459bb00\scenari

Summary filename:

C:\Users\JAsh\AppData\Local\Civica\XH5\e2c2d2be-418b-4c4d-a4c4-d228733f752c\89d27013  
-c96f-46e4-82e5-cbf43459bb00\scenari

DATE: 07-17-2023

TIME: 10:49:09

USER:

COMMENTS: \_\_\_\_\_

\*\*\*\*\*  
 \*\* SIMULATION : Ottawa 100yr 6hr Chicago \*\*  
 \*\*\*\*\*

| W/E COMMAND          | HYD ID | DT<br>min | AREA<br>ha | Qpeak<br>cms | Tpeak<br>hrs | R.V.<br>mm | R.C. | Qbase<br>cms |
|----------------------|--------|-----------|------------|--------------|--------------|------------|------|--------------|
| START @ 0.00 hrs     |        |           |            |              |              |            |      |              |
| -----                |        |           |            |              |              |            |      |              |
| CHIC STORM           |        | 10.0      |            |              |              |            |      |              |
| [ Ptot= 82.32 mm ]   |        |           |            |              |              |            |      |              |
| * CALIB STANDHYD     | 0060   | 1 5.0     | 0.15       | 0.05         | 2.00         | 63.40      | 0.77 | 0.000        |
| [ I%=47.0:S%= 2.00 ] |        |           |            |              |              |            |      |              |
| CHIC STORM           |        | 10.0      |            |              |              |            |      |              |
| [ Ptot= 82.32 mm ]   |        |           |            |              |              |            |      |              |
| * CALIB STANDHYD     | 0061   | 1 5.0     | 0.06       | 0.03         | 2.00         | 77.94      | 0.95 | 0.000        |
| [ I%=90.0:S%= 2.00 ] |        |           |            |              |              |            |      |              |
| ** Reservoir         |        |           |            |              |              |            |      |              |
| OUTFLOW:             | 0062   | 1 5.0     | 0.06       | 0.01         | 2.08         | 77.61      | n/a  | 0.000        |

=====  
 =====

```

V  V  I  SSSSS  U  U  A  L          (v 6.1.2001)
V  V  I  SS    U  U  A  A  L
V  V  I  SS    U  U  AAAAA  L
V  V  I  SS    U  U  A  A  L
  VV   I  SSSSS  UUUUU  A  A  LLLLL
  
```

```

000  TTTT  TTTT  H  H  Y  Y  M  M  000  TM
0  0  T    T  H  H  Y  Y  MM MM  0  0
0  0  T    T  H  H  Y  M  M  0  0
000  T    T  H  H  Y  M  M  000
  
```

Developed and Distributed by Smart City Water Inc  
 Copyright 2007 - 2020 Smart City Water Inc  
 All rights reserved.

\*\*\*\*\* SUMMARY OUTPUT \*\*\*\*\*

Input filename: C:\Program Files (x86)\Visual OTTHYMO 6.1\V02\voin.dat

Output filename:

C:\Users\JAsh\AppData\Local\Civica\XH5\e2c2d2be-418b-4c4d-a4c4-d228733f752c\0f30a6d4-6b80-4051-9316-a065cb681355\scenari

Summary filename:

C:\Users\JAsh\AppData\Local\Civica\XH5\e2c2d2be-418b-4c4d-a4c4-d228733f752c\0f30a6d4-6b80-4051-9316-a065cb681355\scenari

DATE: 07-17-2023

TIME: 10:49:09

USER:

COMMENTS: \_\_\_\_\_

\*\*\*\*\*  
\*\* SIMULATION : Ottawa 5yr 3 hr Chicago \*\*  
\*\*\*\*\*

| W/E COMMAND          | HYD ID | DT min | AREA ha | Qpeak cms | Tpeak hrs | R.V. mm | R.C. | Qbase cms |
|----------------------|--------|--------|---------|-----------|-----------|---------|------|-----------|
| START @ 0.00 hrs     |        |        |         |           |           |         |      |           |
| -----                |        |        |         |           |           |         |      |           |
| CHIC STORM           |        | 10.0   |         |           |           |         |      |           |
| [ Ptot= 42.51 mm ]   |        |        |         |           |           |         |      |           |
| * CALIB STANDHYD     | 0060   | 1 5.0  | 0.15    | 0.02      | 1.00      | 28.15   | 0.66 | 0.000     |
| [ I%=47.0:S%= 2.00 ] |        |        |         |           |           |         |      |           |
| * CHIC STORM         |        | 10.0   |         |           |           |         |      |           |
| [ Ptot= 42.51 mm ]   |        |        |         |           |           |         |      |           |
| * CALIB STANDHYD     | 0061   | 1 5.0  | 0.06    | 0.02      | 1.00      | 38.99   | 0.92 | 0.000     |
| [ I%=90.0:S%= 2.00 ] |        |        |         |           |           |         |      |           |
| ** Reservoir         |        |        |         |           |           |         |      |           |
| OUTFLOW:             | 0062   | 1 5.0  | 0.06    | 0.01      | 1.08      | 38.70   | n/a  | 0.000     |

=====  
=====

|   |   |   |       |   |   |       |   |              |
|---|---|---|-------|---|---|-------|---|--------------|
| V | V | I | SSSSS | U | U | A     | L | (v 6.1.2001) |
| V | V | I | SS    | U | U | A A   | L |              |
| V | V | I | SS    | U | U | AAAAA | L |              |

V V I SS U U A A L  
VV I SSSSS UUUUU A A LLLLL

000 TTTTT TTTT H H Y Y M M 000 TM  
O O T T H H Y Y MM MM O O  
O O T T H H Y M M O O  
000 T T H H Y M M 000

Developed and Distributed by Smart City Water Inc  
Copyright 2007 - 2020 Smart City Water Inc  
All rights reserved.

\*\*\*\*\* S U M M A R Y O U T P U T \*\*\*\*\*

Input filename: C:\Program Files (x86)\Visual OTTHYMO 6.1\V02\voin.dat

Output filename:

C:\Users\JAsh\AppData\Local\Civica\XH5\e2c2d2be-418b-4c4d-a4c4-d228733f752c\47c7f878-1036-49da-9920-545bcf030f6f\scenari

Summary filename:

C:\Users\JAsh\AppData\Local\Civica\XH5\e2c2d2be-418b-4c4d-a4c4-d228733f752c\47c7f878-1036-49da-9920-545bcf030f6f\scenari

DATE: 07-17-2023

TIME: 10:49:09

USER:

COMMENTS: \_\_\_\_\_

\*\*\*\*\*  
\*\* SIMULATION : Ottawa 5yr 6hr Chicago \*\*  
\*\*\*\*\*

| W/E COMMAND | HYD ID | DT  | AREA | Qpeak | Tpeak | R.V. | R.C. | Qbase |
|-------------|--------|-----|------|-------|-------|------|------|-------|
|             |        | min | ha   | cms   | hrs   | mm   |      | cms   |

START @ 0.00 hrs

-----  
READ STORM 5.0  
[ Ptot= 65.91 mm ]  
fname :

C:\Users\JAsh\AppData\Local\Temp\9adf7c72-058d-42f0-b3de-09220de4425f\5aca6ac2-ef25-4c6b-b023-6eea58

remark: Ottawa Macdonald Cartier SCS 24 5yr

\*

\* CALIB STANDHYD 0060 1 5.0 0.15 0.02 12.00 48.46 0.74 0.000  
[I%=47.0:S%= 2.00]

\*

READ STORM 5.0  
[ Ptot= 65.91 mm ]  
fname :

C:\Users\JAsh\AppData\Local\Temp\9adf7c72-058d-42f0-b3de-09220de4425f\5aca6ac2-ef25-4c6b-b023-6eea58

remark: Ottawa Macdonald Cartier SCS 24 5yr

\*

\* CALIB STANDHYD 0061 1 5.0 0.06 0.01 12.00 61.81 0.94 0.000  
[I%=90.0:S%= 2.00]

\*

\*\* Reservoir  
OUTFLOW: 0062 1 5.0 0.06 0.01 12.00 61.65 n/a 0.000

\*

FINISH

=====  
=====

# Stormceptor<sup>®</sup> EF Sizing Report

## STORMCEPTOR<sup>®</sup> ESTIMATED NET ANNUAL SEDIMENT (TSS) LOAD REDUCTION

05/29/2023

|                           |                |
|---------------------------|----------------|
| Province:                 | Ontario        |
| City:                     | Ottawa         |
| Nearest Rainfall Station: | OTTAWA CDA RCS |
| Climate Station Id:       | 6105978        |
| Years of Rainfall Data:   | 20             |

|                   |                           |
|-------------------|---------------------------|
| Project Name:     | 5497 Manotick Main Street |
| Project Number:   | 522679                    |
| Designer Name:    | Guillaume Courtois        |
| Designer Company: | Tatham Engineering        |
| Designer Email:   | gcourtois@tathameng.com   |
| Designer Phone:   | 613-747-3636              |
| EOR Name:         |                           |
| EOR Company:      |                           |
| EOR Email:        |                           |
| EOR Phone:        |                           |

|            |  |
|------------|--|
| Site Name: |  |
|------------|--|

|                     |       |
|---------------------|-------|
| Drainage Area (ha): | 0.06  |
| % Imperviousness:   | 90.00 |

Runoff Coefficient 'c': 0.84

|                             |      |
|-----------------------------|------|
| Particle Size Distribution: | Fine |
| Target TSS Removal (%):     | 80.0 |

|  |       |
|--|-------|
| Required Water Quality Runoff Volume Capture (%):        | 90.00 |
| Estimated Water Quality Flow Rate (L/s):                 | 1.63  |
| Oil / Fuel Spill Risk Site?                              | Yes   |
| Upstream Flow Control?                                   | Yes   |
| Upstream Orifice Control Flow Rate to Stormceptor (L/s): | 7.00  |
| Peak Conveyance (maximum) Flow Rate (L/s):               |       |
| Site Sediment Transport Rate (kg/ha/yr):                 |       |

| Net Annual Sediment (TSS) Load Reduction Sizing Summary |                          |
|---|--------------------------|
| Stormceptor Model                                       | TSS Removal Provided (%) |
| EFO4  | 99                       |
| EFO6  | 100                      |
| EFO8  | 100                      |
| EFO10   | 100                      |
| EFO12   | 100                      |

**Recommended Stormceptor EFO Model: EFO4**  
**Estimated Net Annual Sediment (TSS) Load Reduction (%): 99**  
**Water Quality Runoff Volume Capture (%): > 90**

## Stormceptor® EF Sizing Report

### THIRD-PARTY TESTING AND VERIFICATION

► **Stormceptor® EF and Stormceptor® EFO** are the latest evolutions in the Stormceptor® oil-grit separator (OGS) technology series, and are designed to remove a wide variety of pollutants from stormwater and snowmelt runoff. These technologies have been third-party tested in accordance with the Canadian ETV **Procedure for Laboratory Testing of Oil-Grit Separators** and performance has been third-party verified in accordance with the **ISO 14034 Environmental Technology Verification (ETV)** protocol.

### PERFORMANCE

► **Stormceptor® EF and EFO** remove stormwater pollutants through gravity separation and floatation, and feature a patent-pending design that generates positive removal of total suspended solids (TSS) throughout each storm event, including high-intensity storms. Captured pollutants include sediment, free oils, and sediment-bound pollutants such as nutrients, heavy metals, and petroleum hydrocarbons. Stormceptor is sized to remove a high level of TSS from the frequent rainfall events that contribute the vast majority of annual runoff volume and pollutant load. The technology incorporates an internal bypass to convey excessive stormwater flows from high-intensity storms through the device without resuspension and washout (scour) of previously captured pollutants. Proper routine maintenance ensures high pollutant removal performance and protection of downstream waterways.

### PARTICLE SIZE DISTRIBUTION (PSD)

► The **Canadian ETV PSD** shown in the table below was used, or in part, for this sizing. This is the identical PSD that is referenced in the Canadian ETV **Procedure for Laboratory Testing of Oil-Grit Separators** for both sediment removal testing and scour testing. The Canadian ETV PSD contains a wide range of particle sizes in the sand and silt fractions, and is considered reasonably representative of the particle size fractions found in typical urban stormwater runoff.

| Particle Size (µm) | Percent Less Than | Particle Size Fraction (µm) | Percent |
|--------------------|-------------------|-----------------------------|---------|
| 1000               | 100               | 500-1000                    | 5       |
| 500                | 95                | 250-500                     | 5       |
| 250                | 90                | 150-250                     | 15      |
| 150                | 75                | 100-150                     | 15      |
| 100                | 60                | 75-100                      | 10      |
| 75                 | 50                | 50-75                       | 5       |
| 50                 | 45                | 20-50                       | 10      |
| 20                 | 35                | 8-20                        | 15      |
| 8                  | 20                | 5-8                         | 10      |
| 5                  | 10                | 2-5                         | 5       |
| 2                  | 5                 | <2                          | 5       |



## Stormceptor<sup>®</sup> EF Sizing Report

### Upstream Flow Controlled Results

| Rainfall Intensity (mm / hr)                                | Percent Rainfall Volume (%) | Cumulative Rainfall Volume (%) | Flow Rate (L/s) | Flow Rate (L/min) | Surface Loading Rate (L/min/m <sup>2</sup> ) | Removal Efficiency (%) | Incremental Removal (%) | Cumulative Removal (%) |
|---|-----------------------------|--------------------------------|-----------------|-------------------|--|------------------------|-------------------------|------------------------|
| 0.5   | 8.6                         | 8.6                            | 0.07            | 4.0               | 4.0  | 100                    | 8.6                     | 8.6                    |
| 1   | 20.3                        | 29.0                           | 0.14            | 8.0               | 7.0  | 100                    | 20.3                    | 29.0                   |
| 2   | 16.2                        | 45.2                           | 0.28            | 17.0              | 14.0   | 100                    | 16.2                    | 45.2                   |
| 3   | 12.0                        | 57.2                           | 0.42            | 25.0              | 21.0   | 100                    | 12.0                    | 57.2                   |
| 4   | 8.4                         | 65.6                           | 0.56            | 34.0              | 28.0   | 100                    | 8.4                     | 65.6                   |
| 5   | 5.9                         | 71.6                           | 0.70            | 42.0              | 35.0   | 100                    | 5.9                     | 71.6                   |
| 6   | 4.6                         | 76.2                           | 0.84            | 50.0              | 42.0   | 100                    | 4.6                     | 76.2                   |
| 7   | 3.1                         | 79.3                           | 0.98            | 59.0              | 49.0   | 100                    | 3.1                     | 79.3                   |
| 8   | 2.7                         | 82.0                           | 1.12            | 67.0              | 56.0   | 100                    | 2.7                     | 82.0                   |
| 9   | 3.3                         | 85.3                           | 1.26            | 76.0              | 63.0   | 100                    | 3.3                     | 85.3                   |
| 10  | 2.3                         | 87.6                           | 1.40            | 84.0              | 70.0   | 100                    | 2.3                     | 87.6                   |
| 11  | 1.6                         | 89.2                           | 1.54            | 92.0              | 77.0   | 100                    | 1.6                     | 89.2                   |
| 12  | 1.3                         | 90.5                           | 1.68            | 101.0             | 84.0   | 98                     | 1.3                     | 90.5                   |
| 13  | 1.7                         | 92.2                           | 1.82            | 109.0             | 91.0   | 97                     | 1.7                     | 92.2                   |
| 14  | 1.2                         | 93.5                           | 1.96            | 118.0             | 98.0   | 97                     | 1.2                     | 93.4                   |
| 15  | 1.2                         | 94.6                           | 2.10            | 126.0             | 105.0  | 96                     | 1.1                     | 94.5                   |
| 16  | 0.7                         | 95.3                           | 2.24            | 135.0             | 112.0  | 95                     | 0.7                     | 95.1                   |
| 17  | 0.7                         | 96.1                           | 2.38            | 143.0             | 119.0  | 93                     | 0.7                     | 95.8                   |
| 18  | 0.4                         | 96.5                           | 2.52            | 151.0             | 126.0  | 93                     | 0.4                     | 96.2                   |
| 19  | 0.4                         | 96.9                           | 2.66            | 160.0             | 133.0  | 92                     | 0.4                     | 96.6                   |
| 20  | 0.2                         | 97.1                           | 2.80            | 168.0             | 140.0  | 91                     | 0.2                     | 96.8                   |
| 21  | 0.5                         | 97.5                           | 2.94            | 177.0             | 147.0  | 91                     | 0.4                     | 97.2                   |
| 22  | 0.2                         | 97.8                           | 3.08            | 185.0             | 154.0  | 89                     | 0.2                     | 97.4                   |
| 23  | 1.0                         | 98.8                           | 3.22            | 193.0             | 161.0  | 88                     | 0.9                     | 98.3                   |
| 24  | 0.3                         | 99.1                           | 3.36            | 202.0             | 168.0  | 88                     | 0.2                     | 98.5                   |
| 25  | 0.9                         | 100.0                          | 3.50            | 210.0             | 175.0  | 87                     | 0.8                     | 99.3                   |
| 30  | 0.9                         | 100.9                          | 4.20            | 252.0             | 210.0  | 83                     | 0.8                     | 100.1                  |
| 35  | -0.9                        | 100.0                          | 4.90            | 294.0             | 245.0  | 81                     | N/A                     | 99.4                   |
| 40  | 0.0                         | 100.0                          | 5.60            | 336.0             | 280.0  | 79                     | 0.0                     | 99.4                   |
| 45  | 0.0                         | 100.0                          | 6.31            | 378.0             | 315.0  | 78                     | 0.0                     | 99.4                   |
| <b>Estimated Net Annual Sediment (TSS) Load Reduction =</b> |                             |                                |                 |                   |  |                        |                         | <b>99 %</b>            |

Climate Station ID: 6105978 Years of Rainfall Data: 20



## Stormceptor<sup>®</sup> EF Sizing Report

### RAINFALL DATA FROM OTTAWA CDA RCS RAINFALL STATION

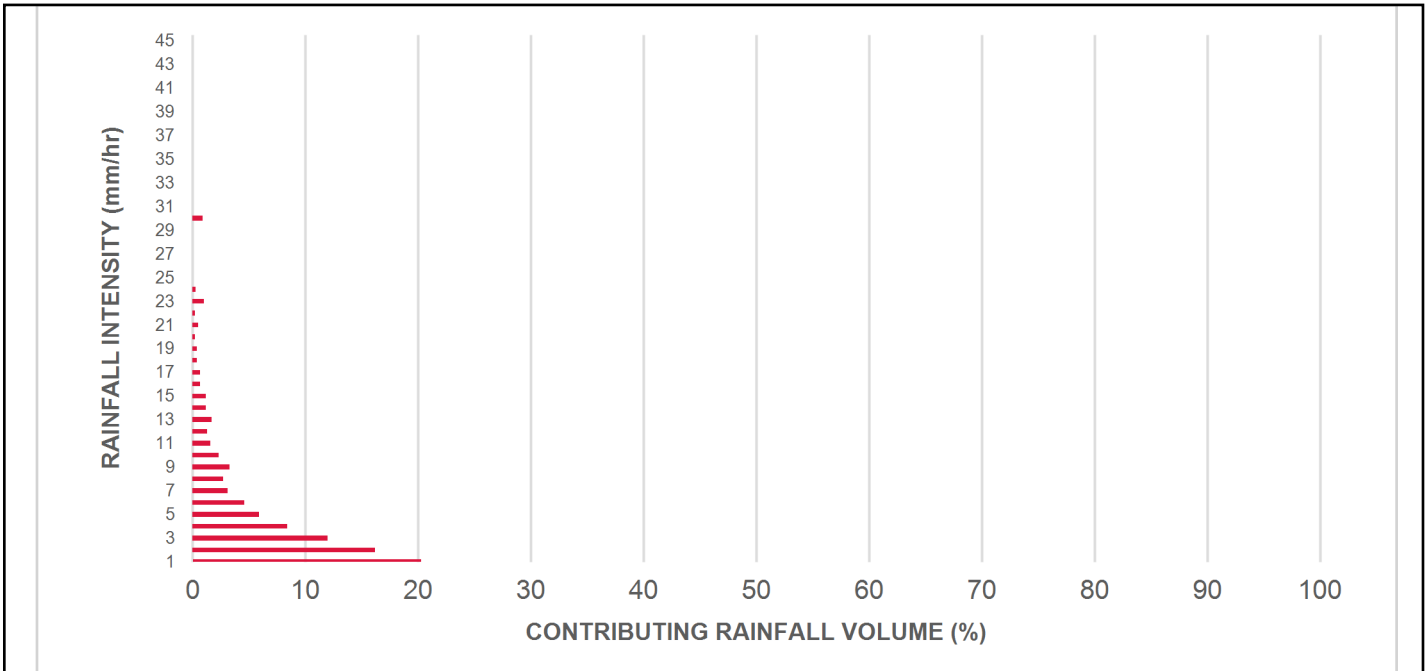

### INCREMENTAL AND CUMULATIVE TSS REMOVAL FOR THE RECOMMENDED STORMCEPTOR<sup>®</sup> MODEL

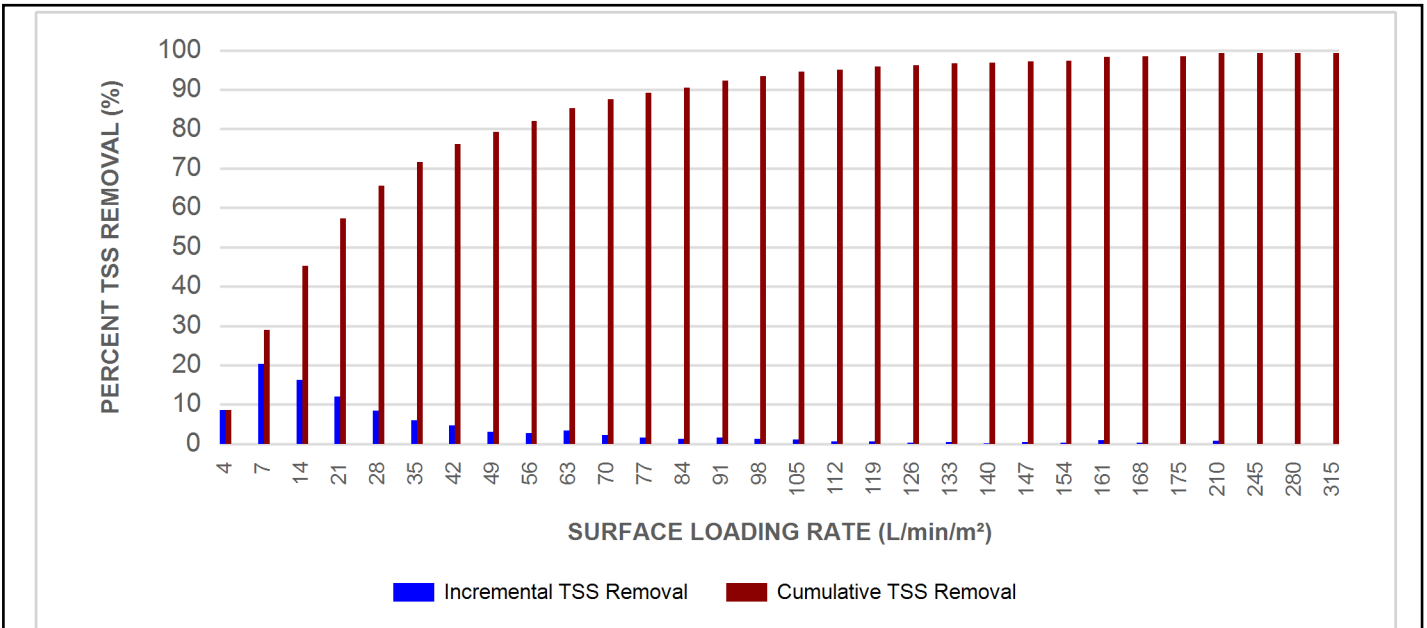

## Stormceptor® EF Sizing Report

### Maximum Pipe Diameter / Peak Conveyance

| Stormceptor<br>EF / EFO | Model Diameter |      | Min Angle Inlet /<br>Outlet Pipes | Max Inlet Pipe<br>Diameter |      | Max Outlet Pipe<br>Diameter |      | Peak Conveyance<br>Flow Rate |       |
|-------------------------|----------------|------|-----------------------------------|----------------------------|------|-----------------------------|------|------------------------------|-------|
|                         | (m)            | (ft) |                                   | (mm)                       | (in) | (mm)                        | (in) | (L/s)                        | (cfs) |
| EF4 / EFO4              | 1.2            | 4    | 90                                | 609                        | 24   | 609                         | 24   | 425                          | 15    |
| EF6 / EFO6              | 1.8            | 6    | 90                                | 914                        | 36   | 914                         | 36   | 990                          | 35    |
| EF8 / EFO8              | 2.4            | 8    | 90                                | 1219                       | 48   | 1219                        | 48   | 1700                         | 60    |
| EF10 / EFO10            | 3.0            | 10   | 90                                | 1828                       | 72   | 1828                        | 72   | 2830                         | 100   |
| EF12 / EFO12            | 3.6            | 12   | 90                                | 1828                       | 72   | 1828                        | 72   | 2830                         | 100   |

### SCOUR PREVENTION AND ONLINE CONFIGURATION

► **Stormceptor® EF and EFO** feature an internal bypass and superior scour prevention technology that have been demonstrated in third-party testing according to the scour testing provisions of the Canadian ETV **Procedure for Laboratory Testing of Oil-Grit Separators**, and the exceptional scour test performance has been third-party verified in accordance with the ISO 14034 ETV protocol. As a result, Stormceptor EF and EFO are approved for online installation, eliminating the need for costly additional bypass structures, piping, and installation expense.

### DESIGN FLEXIBILITY

► **Stormceptor® EF and EFO** offers design flexibility in one simplified platform, accepting stormwater flow from a single inlet pipe or multiple inlet pipes, and/or surface runoff through an inlet grate. The device can also serve as a junction structure, accommodate a 90-degree inlet-to-outlet bend angle, and can be modified to ensure performance in submerged conditions.

### OIL CAPTURE AND RETENTION

► While Stormceptor® EF will capture and retain oil from dry weather spills and low intensity runoff, **Stormceptor® EFO** has demonstrated superior oil capture and greater than 99% oil retention in third-party testing according to the light liquid re-entrainment testing provisions of the Canadian ETV **Procedure for Laboratory Testing of Oil-Grit Separators**. Stormceptor EFO is recommended for sites where oil capture and retention is a requirement.

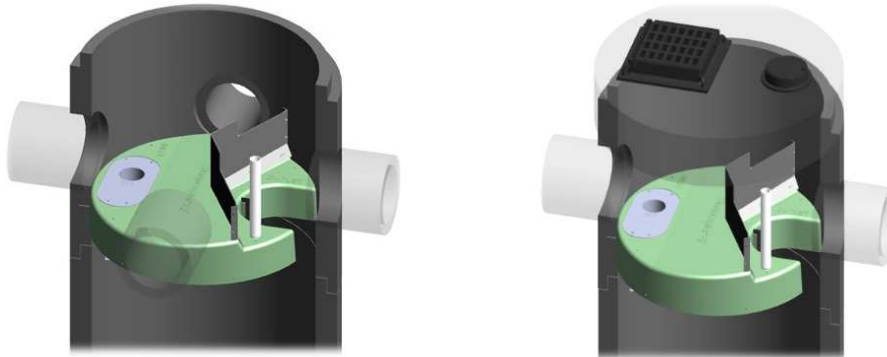

## Stormceptor® EF Sizing Report

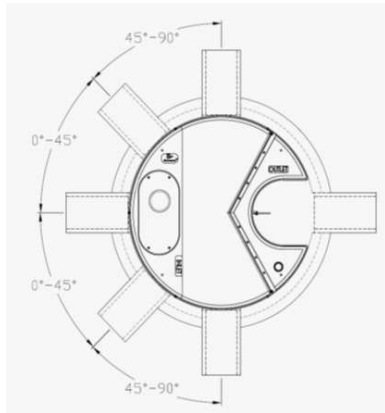

### INLET-TO-OUTLET DROP

Elevation differential between inlet and outlet pipe inverts is dictated by the angle at which the inlet pipe(s) enters the unit.

0° - 45° : The inlet pipe is 1-inch (25mm) higher than the outlet pipe.

45° - 90° : The inlet pipe is 2-inches (50mm) higher than the outlet pipe.

### HEAD LOSS

The head loss through Stormceptor EF is similar to that of a 60-degree bend structure. The applicable K value for calculating minor losses through the unit is 1.1.

For submerged conditions the applicable K value is 3.0.

### Pollutant Capacity

| Stormceptor EF / EFO | Model Diameter |      | Depth (Outlet Pipe Invert to Sump Floor) |      | Oil Volume |       | Recommended Sediment Maintenance Depth * |      | Maximum Sediment Volume * |                    | Maximum Sediment Mass ** |        |
|----------------------|----------------|------|--|------|------------|-------|--|------|---------------------------|--------------------|--------------------------|--------|
|                      | (m)            | (ft) | (m)                                      | (ft) | (L)        | (Gal) | (mm)                                     | (in) | (L)                       | (ft <sup>3</sup> ) | (kg)                     | (lb)   |
| EF4 / EFO4           | 1.2            | 4    | 1.52                                     | 5.0  | 265        | 70    | 203                                      | 8    | 1190                      | 42                 | 1904                     | 5250   |
| EF6 / EFO6           | 1.8            | 6    | 1.93                                     | 6.3  | 610        | 160   | 305                                      | 12   | 3470                      | 123                | 5552                     | 15375  |
| EF8 / EFO8           | 2.4            | 8    | 2.59                                     | 8.5  | 1070       | 280   | 610                                      | 24   | 8780                      | 310                | 14048                    | 38750  |
| EF10 / EFO10         | 3.0            | 10   | 3.25                                     | 10.7 | 1670       | 440   | 610                                      | 24   | 17790                     | 628                | 28464                    | 78500  |
| EF12 / EFO12         | 3.6            | 12   | 3.89                                     | 12.8 | 2475       | 655   | 610                                      | 24   | 31220                     | 1103               | 49952                    | 137875 |

\*Increased sump depth may be added to increase sediment storage capacity

\*\* Average density of wet packed sediment in sump = 1.6 kg/L (100 lb/ft<sup>3</sup>)

| Feature   | Benefit   | Feature Appeals To                                  |
|---|---|---|
| Patent-pending enhanced flow treatment and scour prevention technology  | Superior, verified third-party performance        | Regulator, Specifying & Design Engineer             |
| Third-party verified light liquid capture and retention for EFO version | Proven performance for fuel/oil hotspot locations | Regulator, Specifying & Design Engineer, Site Owner |
| Functions as bend, junction or inlet structure                          | Design flexibility                                | Specifying & Design Engineer                        |
| Minimal drop between inlet and outlet                                   | Site installation ease                            | Contractor  |
| Large diameter outlet riser for inspection and maintenance              | Easy maintenance access from grade                | Maintenance Contractor & Site Owner                 |

### STANDARD STORMCEPTOR EF/EFO DRAWINGS

For standard details, please visit <http://www.imbriumsystems.com/stormwater-treatment-solutions/stormceptor-ef>

### STANDARD STORMCEPTOR EF/EFO SPECIFICATION

For specifications, please visit <http://www.imbriumsystems.com/stormwater-treatment-solutions/stormceptor-ef>

## Stormceptor<sup>®</sup> EF Sizing Report

# STANDARD PERFORMANCE SPECIFICATION FOR “OIL GRIT SEPARATOR” (OGS) STORMWATER QUALITY TREATMENT DEVICE

## PART 1 – GENERAL

### 1.1 WORK INCLUDED

This section specifies requirements for selecting, sizing, and designing an underground Oil Grit Separator (OGS) device for stormwater quality treatment, with third-party testing results and a Statement of Verification in accordance with ISO 14034 Environmental Management – Environmental Technology Verification (ETV).

### 1.2 REFERENCE STANDARDS & PROCEDURES

ISO 14034:2016 Environmental management – Environmental technology verification (ETV)

Canadian Environmental Technology Verification (ETV) Program’s **Procedure for Laboratory Testing of Oil-Grit Separators**

### 1.3 SUBMITTALS

1.3.1 All submittals, including sizing reports & shop drawings, shall be submitted upon request with each order to the contractor then forwarded to the Engineer of Record for review and acceptance. Shop drawings shall detail all OGS components, elevations, and sequence of construction.

1.3.2 Alternative devices shall have features identical to or greater than the specified device, including: treatment chamber diameter, treatment chamber wet volume, sediment storage volume, and oil storage volume.

1.3.3 Unless directed otherwise by the Engineer of Record, OGS stormwater quality treatment product substitutions or alternatives submitted within ten days prior to project bid shall not be accepted. All alternatives or substitutions submitted shall be signed and sealed by a local registered Professional Engineer, based on the exact same criteria detailed in Section 3, in entirety, subject to review and approval by the Engineer of Record.

## PART 2 – PRODUCTS

### 2.1 OGS POLLUTANT STORAGE

The OGS device shall include a sump for sediment storage, and a protected volume for the capture and storage of petroleum hydrocarbons and buoyant gross pollutants. The minimum sediment & petroleum hydrocarbon storage capacity shall be as follows:

|       |                                     |   |
|-------|-------------------------------------|---|
| 2.1.1 | 4 ft (1219 mm) Diameter OGS Units:  | 1.19 m <sup>3</sup> sediment / 265 L oil    |
|       | 6 ft (1829 mm) Diameter OGS Units:  | 3.48 m <sup>3</sup> sediment / 609 L oil    |
|       | 8 ft (2438 mm) Diameter OGS Units:  | 8.78 m <sup>3</sup> sediment / 1,071 L oil  |
|       | 10 ft (3048 mm) Diameter OGS Units: | 17.78 m <sup>3</sup> sediment / 1,673 L oil |
|       | 12 ft (3657 mm) Diameter OGS Units: | 31.23 m <sup>3</sup> sediment / 2,476 L oil |

## PART 3 – PERFORMANCE & DESIGN

### 3.1 GENERAL

The OGS stormwater quality treatment device shall be verified in accordance with ISO 14034:2016 Environmental management – Environmental technology verification (ETV). The OGS stormwater quality treatment device shall



## Stormceptor<sup>®</sup> EF Sizing Report

remove oil, sediment and gross pollutants from stormwater runoff during frequent wet weather events, and retain these pollutants during less frequent high flow wet weather events below the insert within the OGS for later removal during maintenance. The Manufacturer shall have at least ten (10) years of local experience, history and success in engineering design, manufacturing and production and supply of OGS stormwater quality treatment device systems, acceptable to the Engineer of Record.

### 3.2 SIZING METHODOLOGY

The OGS device shall be engineered, designed and sized to provide stormwater quality treatment based on treating a minimum of 90 percent of the average annual runoff volume and a minimum removal of an annual average 60% of the sediment (TSS) load based on the Particle Size Distribution (PSD) specified in the sizing report for the specified device. Sizing of the OGS shall be determined by use of a minimum ten (10) years of local historical rainfall data provided by Environment Canada. Sizing shall also be determined by use of the sediment removal performance data derived from the ISO 14034 ETV third-party verified laboratory testing data from testing conducted in accordance with the Canadian ETV protocol Procedure for Laboratory Testing of Oil-Grit Separators, as follows:

3.2.1 Sediment removal efficiency for a given surface loading rate and its associated flow rate shall be based on sediment removal efficiency demonstrated at the seven (7) tested surface loading rates specified in the protocol, ranging 40 L/min/m<sup>2</sup> to 1400 L/min/m<sup>2</sup>, and as stated in the ISO 14034 ETV Verification Statement for the OGS device.

3.2.2 Sediment removal efficiency for surface loading rates between 40 L/min/m<sup>2</sup> and 1400 L/min/m<sup>2</sup> shall be based on linear interpolation of data between consecutive tested surface loading rates.

3.2.3 Sediment removal efficiency for surface loading rates less than the lowest tested surface loading rate of 40 L/min/m<sup>2</sup> shall be assumed to be identical to the sediment removal efficiency at 40 L/min/m<sup>2</sup>. No extrapolation shall be allowed that results in a sediment removal efficiency that is greater than that demonstrated at 40 L/min/m<sup>2</sup>.

3.2.4 Sediment removal efficiency for surface loading rates greater than the highest tested surface loading rate of 1400 L/min/m<sup>2</sup> shall assume zero sediment removal for the portion of flow that exceeds 1400 L/min/m<sup>2</sup>, and shall be calculated using a simple proportioning formula, with 1400 L/min/m<sup>2</sup> in the numerator and the higher surface loading rate in the denominator, and multiplying the resulting fraction times the sediment removal efficiency at 1400 L/min/m<sup>2</sup>.

The OGS device shall also have sufficient annual sediment storage capacity as specified and calculated in Section 2.1.

### 3.3 CANADIAN ETV or ISO 14034 ETV VERIFICATION OF SCOUR TESTING

The OGS device shall have Canadian ETV or ISO 14034 ETV Verification of third-party scour testing conducted in accordance with the Canadian ETV Program's **Procedure for Laboratory Testing of Oil-Grit Separators**.

3.3.1 To be acceptable for on-line installation, the OGS device must demonstrate an average scour test effluent concentration less than 10 mg/L at each surface loading rate tested, up to and including 2600 L/min/m<sup>2</sup>.

### 3.4 LIGHT LIQUID RE-ENTRAINMENT SIMULATION TESTING

The OGS device shall have Canadian ETV or ISO 14034 ETV Verification of completed third-party Light Liquid Re-entrainment Simulation Testing in accordance with the Canadian ETV **Program's Procedure for Laboratory Testing of Oil-Grit Separators**, with results reported within the Canadian ETV or ISO 14034 ETV verification. This re-entrainment testing is conducted with the device pre-loaded with low density polyethylene (LDPE) plastic beads as a surrogate for light liquids such as oil and fuel. Testing is conducted on the same OGS unit tested for sediment removal to

## Stormceptor<sup>®</sup> EF Sizing Report

assess whether light liquids captured after a spill are effectively retained at high flow rates.

3.4.1 For an OGS device to be an acceptable stormwater treatment device on a site where vehicular traffic occurs and the potential for an oil or fuel spill exists, the OGS device must have reported verified performance results of greater than 99% cumulative retention of LDPE plastic beads for the five specified surface loading rates (ranging 200 L/min/m<sup>2</sup> to 2600 L/min/m<sup>2</sup>) in accordance with the Light Liquid Re-entrainment Simulation Testing within the Canadian ETV Program's **Procedure for Laboratory Testing of Oil-Grit Separators**. However, an OGS device shall not be allowed if the Light Liquid Re-entrainment Simulation Testing was performed with screening components within the OGS device that are effective at retaining the LDPE plastic beads, but would not be expected to retain light liquids such as oil and fuel.