

1209 St Laurent Boulevard & 1200 Lemieux Street Transportation Impact Assessment

Step 1 Screening Report

Step 2 Scoping Report

Step 3 Forecasting Report

Step 4 Strategy Report

Step 4 Strategy Report (Revision #2)

Prepared for:

1209 St Laurent Partnership Inc
2000 Peel Street, Suite 900,
Montreal, QC, H3A 2W5

Prepared by:



6 Plaza Court
Ottawa, ON K2H 7W1

December 2022

PN: 2022-026

Table of Contents

1	Screening.....	1
2	Existing and Planned Conditions.....	1
2.1	Proposed Development.....	1
2.2	Existing Conditions.....	3
2.2.1	Area Road Network.....	3
2.2.2	Existing Intersections.....	4
2.2.3	Existing Driveways.....	5
2.2.4	Cycling and Pedestrian Facilities.....	6
2.2.5	Existing Transit.....	9
2.2.6	Existing Area Traffic Management Measures.....	10
2.2.7	Existing Peak Hour Travel Demand.....	11
2.2.8	Collision Analysis.....	14
2.3	Planned Conditions.....	17
2.3.1	Changes to the Area Transportation Network.....	17
2.3.2	Other Study Area Developments.....	19
3	Study Area and Time Periods.....	20
3.1	Study Area.....	20
3.2	Time Periods.....	20
3.3	Horizon Years.....	20
4	Exemption Review.....	20
5	Development-Generated Travel Demand.....	21
5.1	Mode Shares.....	21
5.2	Trip Generation.....	22
5.3	Trip Distribution.....	22
5.4	Trip Assignment.....	23
6	Background Network Travel Demands.....	24
6.1	Transportation Network Plans.....	24
6.2	Background Growth.....	24
6.3	Other Developments.....	25
7	Demand Rationalization.....	26
7.1	2026 Future Background Operations.....	26
7.2	2031 Future Background Operations.....	29
7.3	2026 Future Total Operations.....	32
7.4	2031 Future Total Operations.....	35
7.5	Modal Share Sensitivity and Demand Rationalization Conclusions.....	38
8	Development Design.....	38
8.1	Design for Sustainable Modes.....	38
8.2	Circulation and Access.....	39
9	Parking.....	39
9.1	Parking Supply.....	39
10	Boundary Street Design.....	39
11	Access Intersections Design.....	40

11.1 Location and Design of Access..... 40

11.2 Intersection Control..... 40

11.3 Access Intersection Design 40

 11.3.1 Future Access Intersection Operations 40

 11.3.2 Access Intersection MMLOS 40

 11.3.3 Recommended Design Elements..... 40

12 Transportation Demand Management 41

 12.1 Context for TDM 41

 12.2 Need and Opportunity..... 41

 12.3 TDM Program 41

13 Neighbourhood Traffic Management..... 41

14 Transit..... 42

 14.1 Route Capacity..... 42

 14.2 Transit Priority 42

15 Network Intersection Design..... 42

 15.1 Network Intersection Control..... 42

 15.2 Network Intersection Design..... 42

 15.2.1 2026 & 2031 Future Total Network Intersection Operations 42

 15.2.2 Network Intersection MMLOS..... 43

 15.2.3 Recommended Design Elements..... 43

16 Summary of Improvements Indicated and Modifications Options..... 43

17 Conclusion 47

List of Figures

Figure 1: Area Context Plan1

Figure 2: Concept Plan.....2

Figure 3: Existing Driveways6

Figure 4: Study Area Pedestrian Facilities7

Figure 5: Study Area Cycling Facilities7

Figure 6: Existing Pedestrian Volumes8

Figure 7: Existing Cyclist Volumes9

Figure 8: Existing Study Area Transit Service..... 10

Figure 9: Existing Study Area Transit Stops 10

Figure 10: Existing Traffic Counts 12

Figure 11: Representation of Study Area Collisions 15

Figure 12: St. Laurent TOD Pedestrian Network 18

Figure 13: St. Laurent TOD Bicycle Network 18

Figure 14: New Site Generation Auto Volumes..... 24

Figure 15: Total Background Development Volumes..... 26

Figure 16: 2026 Future Background Volumes 27

Figure 17: 2031 Future Background Volumes 30

Figure 18: 2026 Future Total Volumes 33

Figure 19: 2031 Future Total Volumes 36

Table of Tables

Table 1: Intersection Count Date.....	11
Table 2: Existing Intersection Operations.....	13
Table 3: Study Area Collision Summary, 2016-2020	15
Table 4: Summary of Collision Locations, 2016-2020.....	16
Table 5: Lemieux Street at St. Laurent Boulevard Collision Summary	16
Table 6: Labelle Street at Lemieux Street/Highway 417 IC115 Ramp Collision Summary	17
Table 7: Exemption Review	21
Table 8: TRANS Trip Generation Manual Recommended Mode Shares – Ottawa East.....	21
Table 9: Proposed Development Mode Shares – Within 600m of St Laurent LRT station.....	22
Table 10: Trip Generation Person Trip Rates by Peak Period.....	22
Table 11: Total Residential Person Trip Generation by Peak Period.....	22
Table 12: Trip Generation by Mode	22
Table 13: OD Survey Distribution – Ottawa East.....	23
Table 14: Trip Assignment	23
Table 15: TRANS Regional Model Projections – Study Area Growth Rates.....	25
Table 16: Recommended Area Growth Rates	25
Table 17: 2026 Future Background Intersection Operations	28
Table 18: 2031 Future Background Intersection Operations	31
Table 19: 2026 Future Total Intersection Operations	34
Table 20: 2031 Future Total Intersection Operations	37
Table 21: Boundary Street MMLOS Analysis.....	39
Table 22: Stopping Sight Distance and Departure Sight Requirements.....	40
Table 23: Trip Generation by Transit Mode	42
Table 24: Forecasted Site-Generated Transit Ridership.....	42
Table 25: Study Area Intersection MMLOS Analysis	43

List of Appendices

Appendix A – TIA Screening Form and Certification Form
Appendix B – Turning Movement Count Data
Appendix C – Synchro Intersection Worksheets – Existing Conditions
Appendix D – Collision Data
Appendix E – TRANS Model Plots
Appendix F – Background Development Volumes
Appendix G – Synchro Intersection Worksheets – 2026 Future Background Conditions
Appendix H – Synchro Intersection Worksheets – 2031 Future Background Conditions
Appendix I – Synchro Intersection Worksheets – 2026 Future Total Conditions
Appendix J – Synchro Intersection Worksheets – 2031 Future Total Conditions
Appendix K – Turning Templates
Appendix L – MMLOS Analysis
Appendix M – Sight Line Review
Appendix N – TDM Checklist

1 Screening

This study has been prepared according to the City of Ottawa's 2017 Transportation Impact Assessment (TIA) Guidelines. Accordingly, a Step 1 Screening Form has been prepared and is included as Appendix A, along with the Certification Form for the TIA Study PM. As shown in the Screening Form, a TIA is required including the Design Review component and the Network Impact Component. This study is supporting a site plan application.

2 Existing and Planned Conditions

2.1 Proposed Development

The development site is located at 1209 St. Laurent Boulevard within the Industrial Avenue/Trainyards/Cyrville Mixed Use Centre, Tremblay, St Laurent and Cyrville secondary plan, and St Laurent TOD areas, and zoned as Transit Oriented Development Zone (TD3). The development is proposed as two 30-storey residential buildings including 644 units to be built by 2026. The site plan proposes 299 residential parking and 60 visitor parking spaces with 351 spaces provided below ground and eight spaces at ground level. A total of 660 bicycle parking spaces are proposed located below ground with 646 spaces provided below ground and 14 spaces at ground level. The plan includes an existing full-movement access onto Lemieux Street. Figure 1 illustrates the study area context. Figure 2 illustrates the proposed concept plan.

Figure 1: Area Context Plan



Source: <http://maps.ottawa.ca/geoOttawa/> Accessed: March 7, 2022

Figure 2: Concept Plan

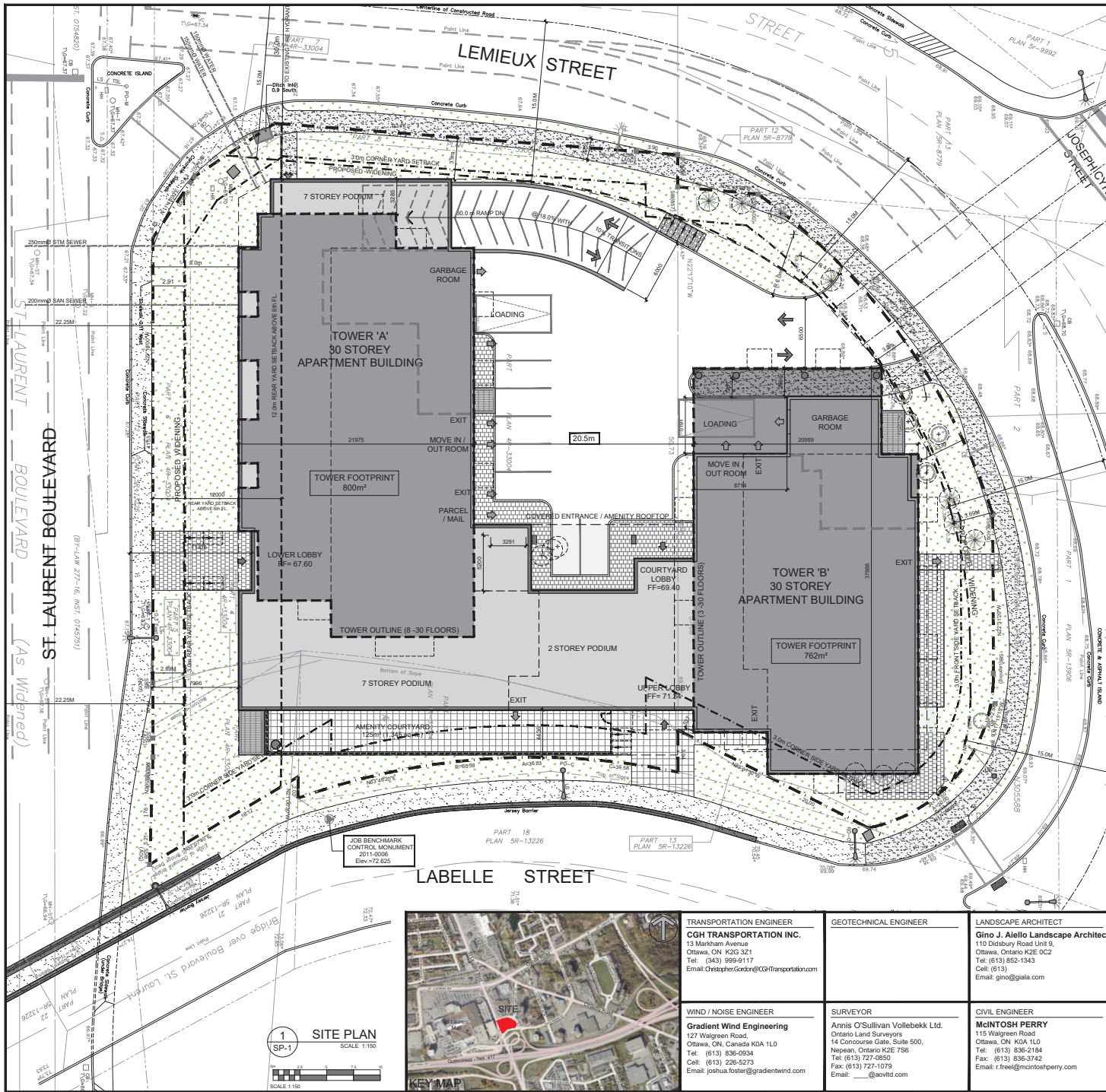

PROJECT INFORMATION	
ZONING BY-LAW 2008-250	T03
SITE AREA	6,428 ha, 4,279.77 m ² or 21,368 s.f.
REQUIRED	PROVIDED
MINIMUM BUILDING HEIGHT	90.0m
DENSITY - MINIMUM 300 units/hectare	122 UNITS
TOWER SEPARATION	24.0m
FRONT YARD SETBACK	3.0m
CORNER YARD SETBACK	3.0m
REAR YARD SETBACK	0.0m
REAR YARD SETBACK	0.0m
AGENCY AREA - PER UNIT	6.0 sq. m
VEHICLE PARKING - RESIDENTIAL	NOT REQUIRED
VEHICLE PARKING - VISITOR ONLY	50
BICYCLE PARKING - RESIDENTIAL PER UNIT	0.5
ABLE & DRIVEWAY MINIMUM / MAXIMUM WIDTH	6.0m / 6.7m

DRAWING NOTES	
1	PROPERTY LINE
2	BUILDING SETBACKS
3	PROPOSED ROAD WIDENING
4	PAVING SURFACE FINISH, SEE LANDSCAPE PLAN FOR PATTERN AND TYPE
5	DEPRESSED CURB AND SIDEWALK TO CITY STANDARDS, SEE CIVIL
6	EXISTING STREET CURB AND SIDEWALK
7	SOFT LANDSCAPING, SEE LANDSCAPE PLAN
8	ASPHALT DRIVING SURFACE / PARKING LOT WITH 1% MINIMUM DRAINAGE
9	INTERNAL GARAGE ROOM
10	2.5m WIDE CONCRETE SIDEWALK
11	OUTLINE OF PRIVATE BALCONY ABOVE
12	OUTLINE OF TOWER ABOVE
13	STRUCTURAL SUPPORT FOR BUILDING ABOVE
14	SURFACE PARKING SPACE 2.6 X 5.2 M
15	EXISTING TREE TO BE REMOVED
16	EXISTING STORM GRATE
17	EXISTING UTILITY HOSE
18	PROPOSED SERVICES
19	RETAINING WALL, SEE CIVIL FOR HEIGHT
20	EXISTING CONCRETE / ASPHALT SLAND
21	EXISTING UTILITY / LIGHT POLE
22	2.2 X 1.8 CONCRETE PAD FOR GAS EQUIPMENT (SEE SANITARY CIVIL)
23	1.5 X 7.5m LOADING SPACE
24	WALKWAY CONNECTION
25	EXISTING CROSSWALK WITH DEPRESSED CURBS
26	EXISTING CONCRETE JERSEY BARRIER
27	EXISTING CONCRETE OVERPASS GUARDRAIL WITH METAL PIPE BALANCING
28	EXISTING FIRE HYDRANT
29	INTAKE / EXHAUST GRILL
30	PARKING SPACE WITH RACK
31	SMALL CAR PARKING SPACE
32	HEATED GARAGE RAMP WITH TRENCH DRAIN
33	CONCRETE RETAINING WALL WITH GUARD RAILING
34	RELOCATE UTILITY / LIGHT POLE AS NEEDED
35	TEMPORARY SNOW STORAGE
36	PRIVACY FENCE
37	WASHED PEA-STONE SURFACE

GROSS BUILDING FLOOR AREA	
BELOW GRADE PARKING LEVEL	0.0 sq. m
GROUND FLOOR	109.8 sq. m
2nd FLOOR - TOWER 'A'	654.5 sq. m
3rd FLOOR - TOWER 'A'	485.5 sq. m
4th - 7th FLOOR - TOWER 'A'	5,186.8 sq. m
8th - 11th FLOOR - TOWER 'A'	4,944.8 sq. m
12th - 15th FLOOR - TOWER 'A'	5,184.8 sq. m
16th FLOOR - TOWER 'A'	6,485 sq. m
17th FLOOR - TOWER 'A'	6,817.8 sq. m
18th FLOOR - TOWER 'A'	6,322 sq. m
19th - 20th FLOOR - TOWER 'A'	11,462.8 sq. m
21st - 30th FLOOR - TOWER 'A'	10,086.8 sq. m
31st FLOOR - TOWER 'A'	10,106.8 sq. m
32nd FLOOR - TOWER 'A'	10,106.8 sq. m
33rd FLOOR - TOWER 'A'	10,106.8 sq. m
34th FLOOR - TOWER 'A'	10,106.8 sq. m
35th FLOOR - TOWER 'A'	10,106.8 sq. m
36th FLOOR - TOWER 'A'	10,106.8 sq. m
37th FLOOR - TOWER 'A'	10,106.8 sq. m
38th FLOOR - TOWER 'A'	10,106.8 sq. m
39th FLOOR - TOWER 'A'	10,106.8 sq. m
40th FLOOR - TOWER 'A'	10,106.8 sq. m
TOTAL AREA ABOVE GRADE	36,397.9 sq. m
TOTAL AREA BELOW GRADE	380.0 sq. m

UNIT STATISTICS	
STUDIO	15
1 BEDROOM UNIT	154
2 BEDROOM UNIT	158
TOTAL	327

CAR PARKING	
REQUIRED	
VISITOR - TOWER A	-0.1 PER UNIT AFTER 12 UNITS
VISITOR - TOWER B	-0.1 PER UNIT AFTER 12 UNITS
TOTAL	30
PROVIDED	
STANDARD PARKING SPACE	2.6m x 5.2m
SMALL CAR PARKING SPACE	2.4m x 4.6m
LOADING SPACE	3.0m x 7.0m
TOTAL	300

BICYCLE PARKING	
REQUIRED	
RESIDENCE	-0.5 PER UNIT (644 UNITS)
INTERIOR	646
EXTERIOR	14
TOTAL	660

AMENITY AREA	
GRADE EXTERIOR - COMMUNAL	125.0 sq. m
4th FLOOR INTERIOR - COMMUNAL	540.0 sq. m
2nd FLOOR INTERIOR - COMMUNAL	487.0 sq. m
3rd FLOOR TERRACE - COMMUNAL	114.0 sq. m
31st FLOOR INTERIOR - COMMUNAL	245.0 sq. m
31st FLOOR TERRACE - COMMUNAL	540.0 sq. m
BALCONIES / TERRACE - PRIVATE	2,300.0 sq. m
TOTAL	4,345.0 sq. m
REQUIRED (644 UNITS @ 6.7m ² + 3.88 sq. m)	4,353.8 sq. m
REQUIRED COMMUNAL @ 90% + 1.82 sq. m	2,045.0 sq. m

SITE COVERAGE	
BUILDING FOOTPRINT	46.3%
DRIVING SURFACE	17.9%
LANDSCAPE AREA	35.8%
TOTAL	100.0%

REFUGE REQUIREMENT	
GARAGE	-0.11 PER UNIT
RECYCLING GMP	-0.018 PER UNIT
RECYCLING FIBER	-0.028 PER UNIT
COMPOST	-0.041 PER 30 UNITS

SITE PLAN SYMBOLS	
[Symbol]	CONCRETE UNIT PAVERS SURFACE
[Symbol]	PROPOSED CONCRETE SURFACE
[Symbol]	SOFT LANDSCAPING
[Symbol]	BIKE RACK
[Symbol]	TWO WAY VEHICLE CIRCULATION
[Symbol]	MAIN ENTRANCE
[Symbol]	UNIT BALCONY DOOR / FIRE EXIT
[Symbol]	PROPERTY LINE
[Symbol]	PROPOSED WIDENING
[Symbol]	EXISTING TREE TO BE REMOVED

SITE PLAN	
ARCHITECT'S SEAL	NORTH ARROW
CLIENT	FENGATE Asset Management
ARCHITECT	RODERICK LAHEY ARCHITECT INC.
PROJECT TITLE	1209 St Laurent Blvd.
DATE	2023-11-16
SCALE	1:150
DRAWN	2203

2.2 Existing Conditions

2.2.1 Area Road Network

St Laurent Boulevard: St Laurent Boulevard is a City of Ottawa arterial road with a six-lane, divided urban cross-section with sidewalks on both sides of the road. The posted speed limit is 60 km/h and the City-protected right of way is 44.5 metres within the study area. St Laurent Boulevard is designated as a truck route.

Ogilvie Road: Ogilvie Road is a City of Ottawa arterial road with a four-lane, divided urban cross-section with curbside bike lanes and sidewalks on both sides of the road. The posted speed limit is 60 km/h and the City-protected right of way is 44.5 metres within the study area. Ogilvie Road is designated as a truck route.

Coventry Road: Coventry Road is a City of Ottawa arterial road with a four-lane, divided urban cross-section with curbside bike lanes and sidewalks on both sides of the road within the study area. The posted speed limit is 60 km/h and the City-protected right of way is 30.0 metres within the study area. Coventry Road is designated as a truck route.

Cyrville Road: Cyrville Road is a City of Ottawa arterial road southeast of Labelle Street, and a collector road northwest of Labelle Street, each with a two-lane cross-section. Between St. Laurent Boulevard and Ogilvie Road, the cross-section includes a curb with a sidewalk on the northeast side and is uncurbed on the southwest side. Between Ogilvie Road and Cummings Avenue, the cross-section is urban and includes a sidewalk and curb-side bike lane on each side of the road. Between Cummings Avenue and Beauparc Private, the cross-section is rural and includes a bike lane and sidewalk on the south side of the road and a mixed-use path on the north side of the road. South of Beauparc Private, the cross-section is urban and includes a bike lane and sidewalk on both sides of the road. The posted speed limit is 60 km/h and the existing right of way varies between 18.0 metres and 23.0 metres within the study area. Cyrville Road is designated as a truck route.

Labelle Street: Labelle Street is a City of Ottawa major collector road with a two-lane urban cross-section with sidewalks on both sides of the road east of Michael Street North, and on the north side of the road to the west. The unposted speed limit is assumed to be 50 km/h and the existing right of way varies between 20.0 metres and 22.5 metres within the study area.

Lemieux Street: Lemieux Street is a City of Ottawa major collector road with a three-lane urban cross-section with a sidewalk on the north/east side of the road. The posted speed limit is 50 km/h. The City-protected right-of-way is 30.0 metres. Lemieux Street is designated as a truck route.

Joseph Cyr Street: Joseph Cyr Street is a City of Ottawa local road with a two-lane urban cross-section with sidewalks on both sides of the road and on-street parking permitted on the east side of the road. The unposted speed limit is 50 km/h and the City-protected right of way is 20.0 metres.

Highway 417: Highway 417 is a Ministry of Transportation of Ontario urban freeway with a seven-lane cross-section within the study area. The posted speed limit is 100 km/h and the existing right of way is 60.0 metres.

OR 174: OR 174 is City of Ottawa urban freeway with a six-lane rural cross-section east of the study area. The posted speed limit is 100 km/h and the right of way is generally 91.5 metres east of the study area and is Existing Corridor Protected.

Transitway Access: The Transitway Access is a bus-only road that connects St-Laurent Station to St. Laurent Boulevard. It has a two-lane urban cross-section, and it is largely within the Highway 417 interchange right of way.

2.2.2 Existing Intersections

The existing key area intersections within 400 metre of the site have been summarized below:

St Laurent Boulevard at Coventry Road/Ogilvie Road

The intersection of St Laurent Boulevard at Coventry Road/Ogilvie Road is a signalized intersection. The northbound approach consists of an auxiliary left-turn lane, two through lanes, and a shared through/channelized right-turn lane, and the southbound approach consists of an auxiliary left-turn lane, three through lanes and an auxiliary channelized right-turn lane. The eastbound and westbound approaches each consist of two auxiliary left-turn lanes, two through lanes, a bike lane, and an auxiliary channelized right-turn lane. U-turns on all approaches are restricted at this intersection.

St Laurent Boulevard at Lemieux Street

The intersection of St Laurent Boulevard at Lemieux Street is a signalized T-intersection. The northbound approach consists of three through lanes and an auxiliary channelized right-turn lane, and the southbound approach consists of an auxiliary left-turn lane and three through lanes. The westbound approach consists of two left-turn lanes and an auxiliary right-turn lane. Northbound U-turns are restricted at this intersection.

St Laurent at Transitway Access

The intersection of St Laurent at the Transitway access is a signalized T-intersection. The northbound approach consists of three through lanes and a channelized transit-only right-turn, and the southbound approach consists of an auxiliary transit-only left-turn lane and three through lanes. Approximately 80 metres north and 100 metres south of the intersection are on-ramps to the westbound Highway 471. The westbound approach consists of transit only left-turn lane and transit only right-turn lane. Northbound U-turns are restricted at this intersection. Northbound right-turns and southbound left-turns are restricted except for authorized vehicles.

St Laurent at Hwy 417 EB Off-Ramp

The intersection of St Laurent at Hwy 417 Eastbound Off-Ramp is a signalized T-intersection. The northbound and southbound approaches consist of three through lanes. Approximately 45 metres south of the intersection, a transit-only on-ramp to the eastbound Highway 417 and approximately 80 metres north of the intersection an on-ramp to the westbound Highway 417 are provided. The eastbound approach consists of two left-turn lanes and an auxiliary channelized right-turn lane.

Cyrville Road at Ogilvie Road

The intersection of Cyrville Road at Ogilvie Road is a signalized intersection. The northbound approach consists of an auxiliary left-turn lane, a shared through/right-turn lane, and a bike lane, and the southbound consists of an auxiliary left-turn lane and a shared through/channelized right-turn lane. The eastbound approach consists of two through lanes, a bike lane, and a right-turn lane, and the westbound approach consist of an auxiliary left-turn lane, two through lanes, a bike lane, and an auxiliary right-turn lane. Eastbound left-turns are restricted at this intersection.

Cyrville Road at Joseph Cyr Street

The intersection of Cyrville Road at Joseph Cyr Street is a stop-controlled T-intersection on the minor approach of Joseph Cyr. The northbound approach consists of a shared left-turn/right-turn lane. The eastbound approach consists of a shared through/right-turn lane, and the westbound consists of an auxiliary left-turn lane and a through lane. The north leg is a private access. No turn restrictions were noted.

Lemieux Street at Joseph Cyr Street

The intersection of Lemieux Street at Joseph Cyr Street is a stop-controlled intersection on the minor approach of Joseph Cyr Street and the private access to a parking lot. The northbound and southbound approaches consist of shared all movement lanes. The eastbound approach consists of an auxiliary left-turn lane and a shared through/right/turn lane, and the westbound consists of a shared left-turn/through lane and a shared through/right-turn lane. No turn restrictions were noted.

Lemieux Street at Labelle Street

The intersection of Lemieux Street at Labelle Street is a stop-controlled intersection on the minor approach of Labelle Street. The northbound approach consists of a shared left-turn/through and a shared through/channelized right-turn lane, and the southbound approach consists of a channelized right-turn lane. The eastbound approach consists of a left-turn lane, and the westbound approach consists of a channelized right-turn lane. Westbound through movements and eastbound through and right-turn movements are restricted at this intersection.

2.2.3 Existing Driveways

Within 200 metres of the site accesses, one driveway to a retail plaza, one driveway to a car dealership, one driveway to a private residence, and two to hotels and a restaurant are located on Joseph Cyr Street. One driveway to a restaurant, and one to a rear alley for a retail plaza, are located on Lemieux Street. On St. Laurent Boulevard, four driveways to a retail plaza and two to a shopping plaza are present. On Labelle Street, two driveways to a restaurant and one to an office building are present. Figure 3 illustrates the existing driveways.

Figure 3: Existing Driveways

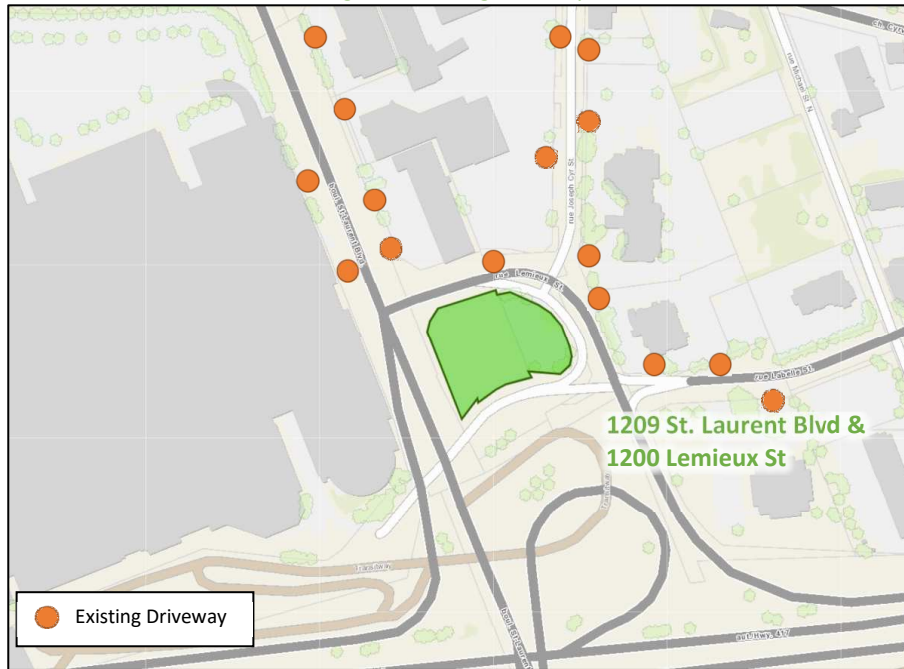

Source: <http://maps.ottawa.ca/geoOttawa/> Accessed: March 7, 2022

2.2.4 Cycling and Pedestrian Facilities

Figure 4 illustrates the pedestrian facilities in the study area and Figure 5 illustrates the cycling facilities.

Sidewalks are provided along both sides of St Laurent Boulevard, Ogilvie Road, Coventry Road, Cyrville Road, Labelle Street east of Michael Street N, Joseph Cyr Street, and on the north side of Labelle Street west of Michael Street N and Lemieux Street.

Cycling facilities include bike lanes along Ogilvie Road, Coventry Road, Cyrville Road south of Ogilvie Road, and Joseph Cyr Street. Ogilvie Road west of Cyrville Road and Cyrville Road south of Ogilvie Road are cross-town bikeways. St Laurent Boulevard, Ogilvie Road, Coventry Road, and Cyrville Road are cycling spine routes, and Labelle Street and Lemieux Street are local cycling routes.

Figure 4: Study Area Pedestrian Facilities

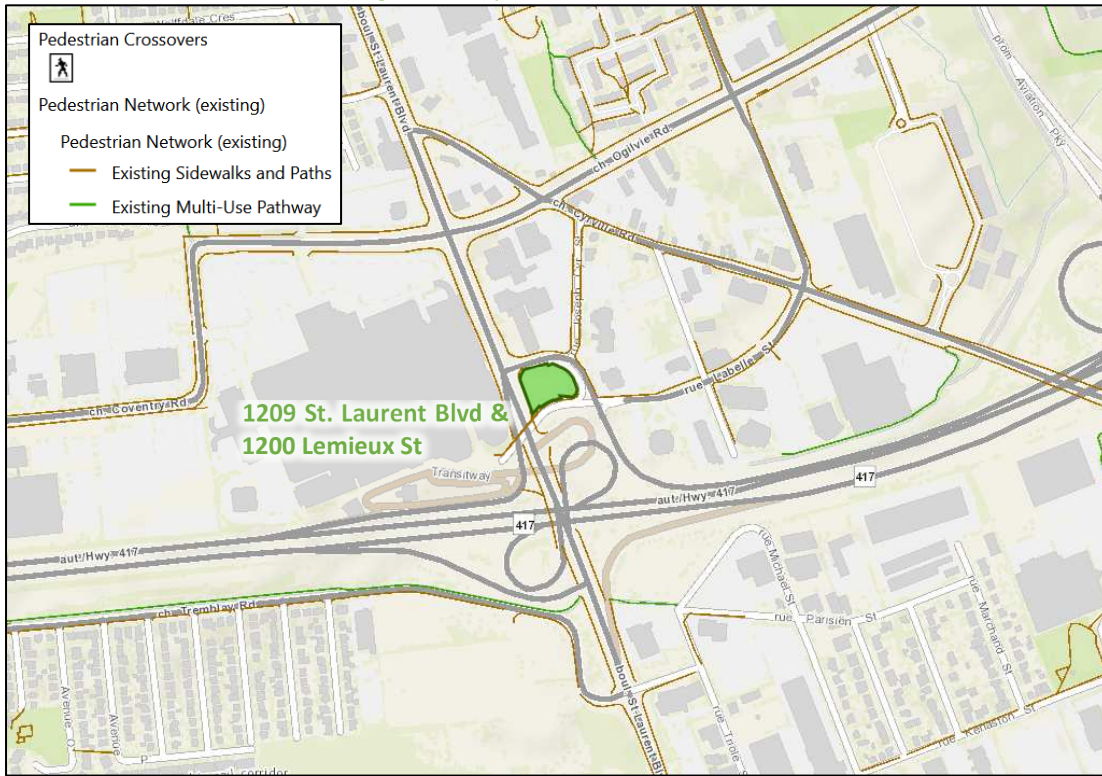

Source: <http://maps.ottawa.ca/geoOttawa/> Accessed: March 7, 2022

Figure 5: Study Area Cycling Facilities



Source: <http://maps.ottawa.ca/geoOttawa/> Accessed: March 7, 2022

Pedestrian and cyclist volumes included in study area intersection counts, presented in Section 2.2.7, have been compiled and are illustrated in Figure 6 and Figure 7, respectively.

Figure 6: Existing Pedestrian Volumes

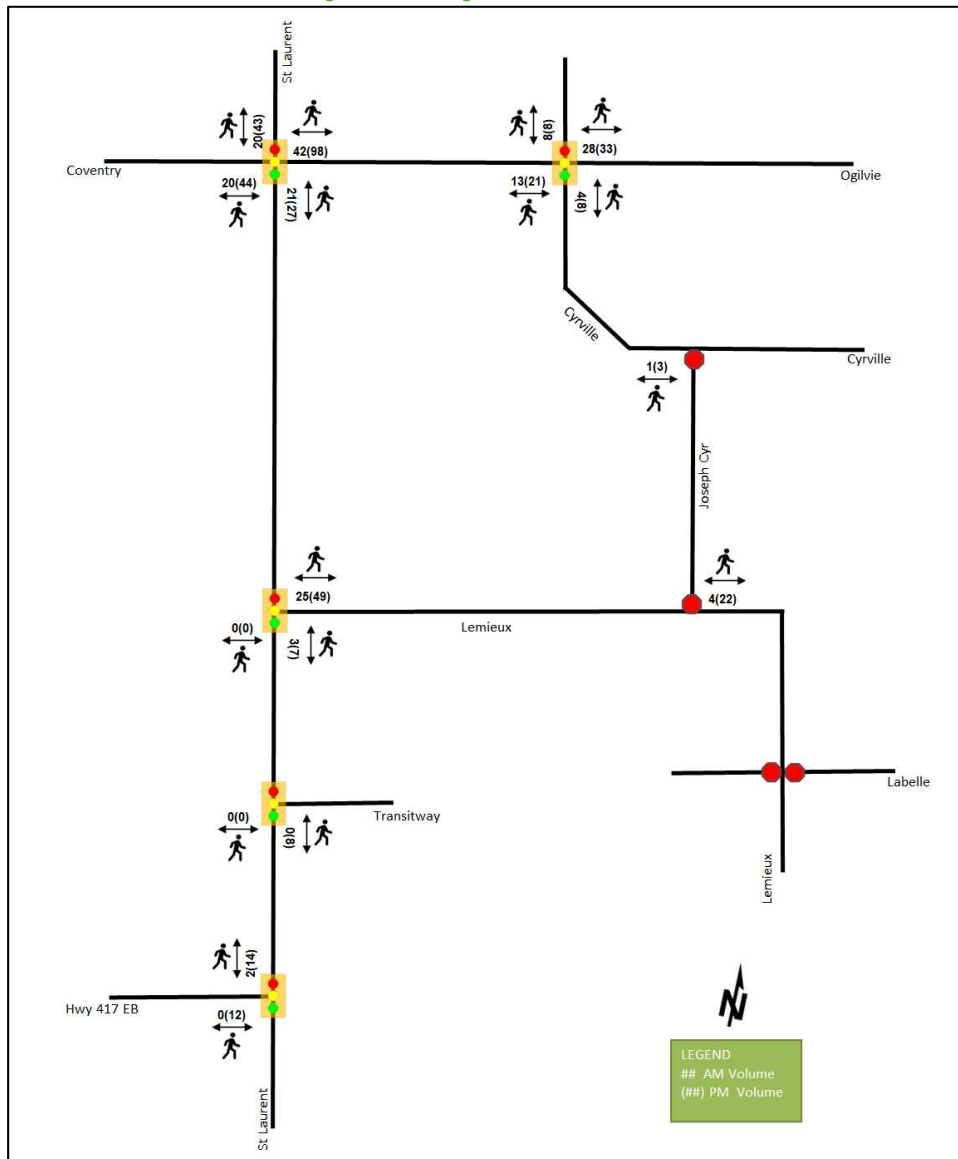
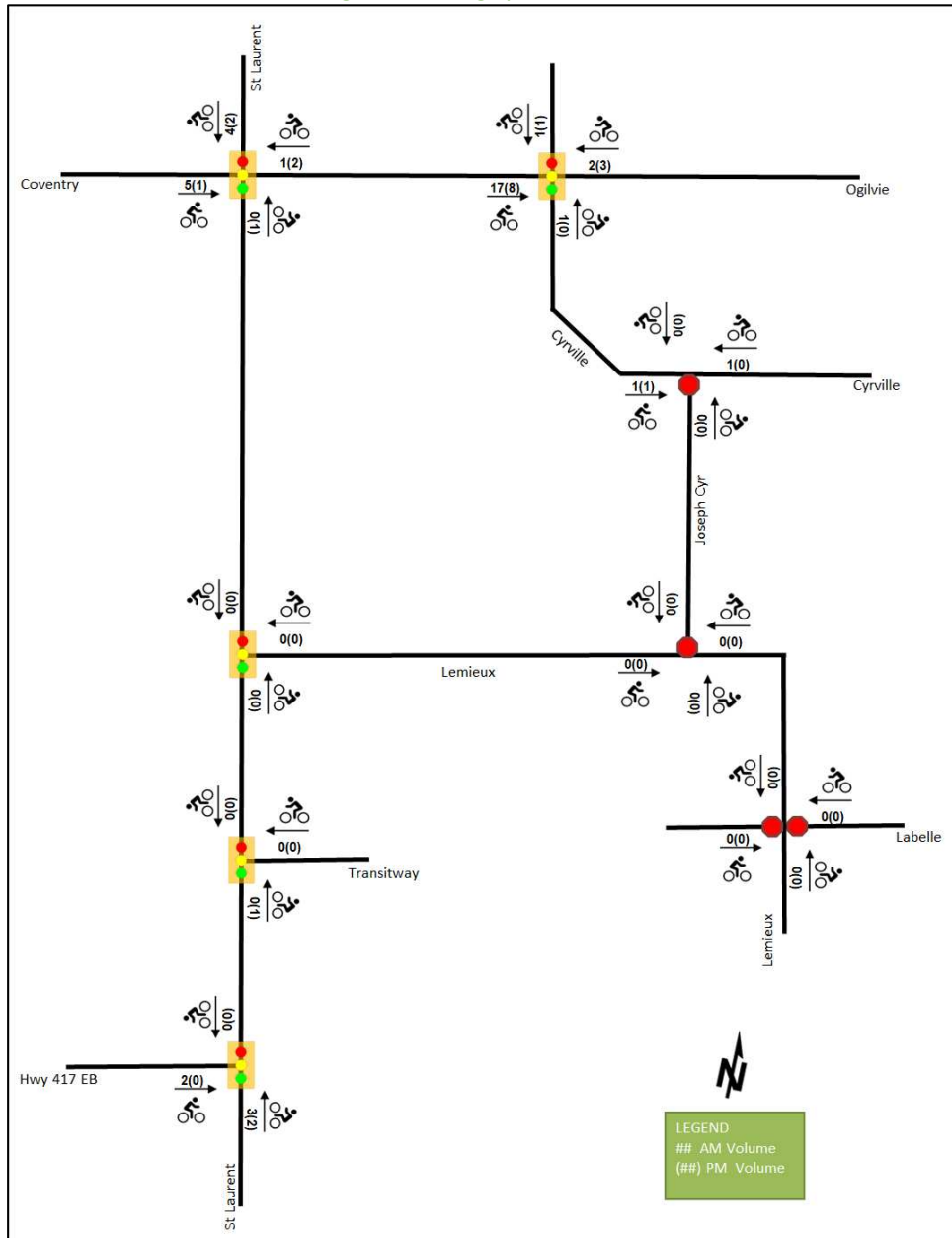

Figure 7: Existing Cyclist Volumes



2.2.5 Existing Transit

Figure 8 illustrates the transit system map in the study area and Figure 9 illustrates nearby transit stops. All transit information is from March 7, 2022 and is included for general information purposes and context to the surrounding area.

Within the study area, routes #7, #12, #14, #19, and #20 travel along St Laurent Boulevard and route #24 travels along Ogilvie Road. The frequency of these routes within proximity of the proposed site based on March 7, 2022 service levels are:

- Route # 7 – 15-minute service all day, 30-minute service after 7:00 PM
- Route # 12 – 15-minute service all day
- Route # 14 – 15-minute service all day, 30-minute service after 7:00 PM

- Route # 19 – 30-minute service all day
- Route # 20 – 30-minute service all day

Additionally, the site is approximately a 450-metre walk to St Laurent LRT Station. The following routes stop at St Laurent Station: #7, 12, 14, 18, 19, 20, 24, 27, 40, 47.

Figure 8: Existing Study Area Transit Service



Source: <http://www.octranspo.com/> Accessed: March 7, 2022

Figure 9: Existing Study Area Transit Stops

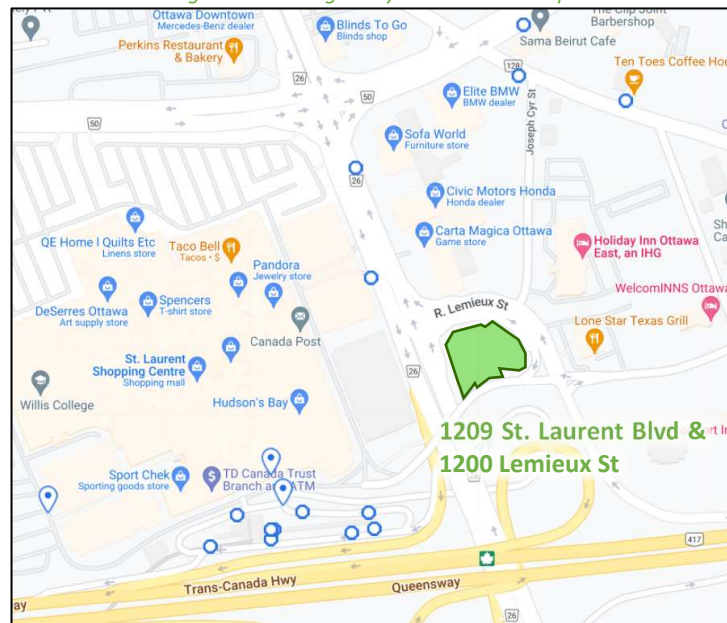

Source: <http://www.octranspo.com/> Accessed: March 7, 2022

2.2.6 Existing Area Traffic Management Measures

On-street parking permitted on Joseph Cyr Street is the only area traffic management measure.

2.2.7 Existing Peak Hour Travel Demand

Existing turning movement counts were acquired from the City of Ottawa, The Traffic Specialist, and 1098 Ogilvie Road TIA (Parson, 2020) for the existing study area key intersections, and the volumes were balanced along the roadway corridors. Table 1 summarizes the intersection count dates and sources.

Table 1: Intersection Count Date

Intersection	Count Date	Source
St Laurent Boulevard at Coventry Road/Ogilvie Road	Thursday, June 01, 2017	City of Ottawa
St Laurent Boulevard at Lemieux Street	Wednesday, March 21, 2018	City of Ottawa
St Laurent Boulevard at Transitway Access	Wednesday, January 30, 2019	City of Ottawa
St Laurent Boulevard at Hwy 417 EB Off-Ramp	Wednesday, January 30, 2019	City of Ottawa
Cyrville Road at Ogilvie Road	Wednesday, April 11, 2018	City of Ottawa
Cyrville Road at Joseph Cyr Street	Wednesday, March 23, 2022	The Traffic Specialist
Lemieux Street at Joseph Cyr Street	Wednesday, March 23, 2022	The Traffic Specialist
Lemieux Street at Labelle Street	-	1098 Ogilvie Road TIA (Parsons, 2020)

Figure 10 illustrates the existing traffic counts and Table 2 summarizes the existing intersection operations. The level of service for signalized intersections is based on v/c calculations for individual lane movements and HCM 2000 v/c calculations for the overall intersection, and average delay for unsignalized intersections. The northbound shared through/right-turn lane at the intersection of St Laurent Boulevard at Coventry Road/Ogilvie Road is a de facto right lane, and it is coded as a right turn lane in Synchro. The intersection counts were balanced along Lemieux Street. Detailed turning movement count data is included in Appendix B and the Synchro worksheets are provided in Appendix C.

Figure 10: Existing Traffic Counts

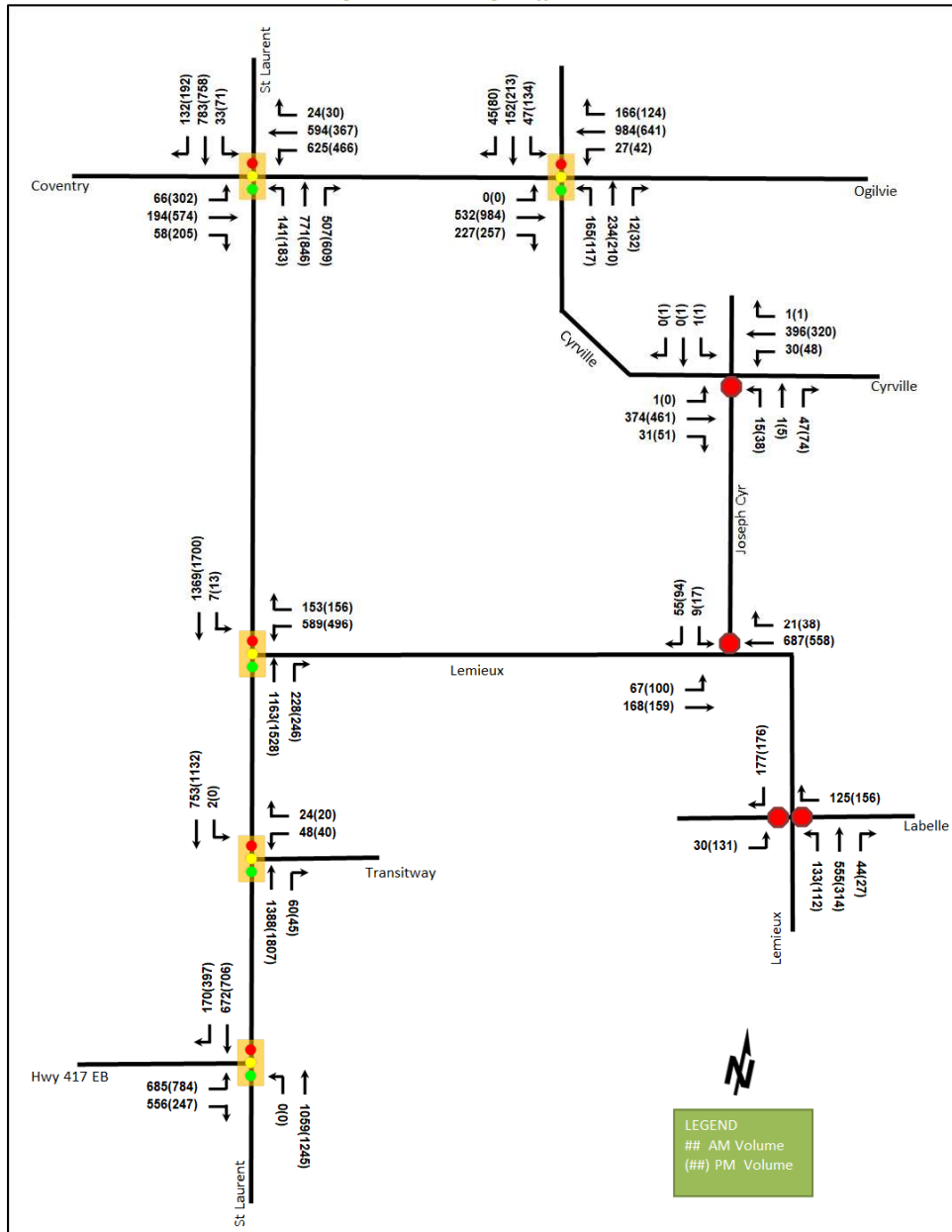

Table 2: Existing Intersection Operations

Intersection	Lane	AM Peak Hour				PM Peak Hour			
		LOS	V/C	Delay(s)	Q (95 th)	LOS	V/C	Delay(s)	Q (95 th)
St Laurent Boulevard at Coventry Road/Ogilvie Road <i>Signalized</i>	EBL	A	0.18	49.2	15.9	C	0.76	61.6	#56.5
	EBT	A	0.37	47.1	35.2	C	0.79	50.3	93.9
	EBR	A	0.16	0.9	0.0	A	0.46	9.1	22.9
	WBL	E	0.93	68.6	#133.4	F	1.07	109.4	#110.6
	WBT	C	0.72	39.9	101.3	A	0.51	35.5	62.3
	WBR	A	0.06	0.2	m0.0	A	0.07	0.3	m0.0
	NBL	D	0.87	102.9	#81.7	E	0.92	104.9	#92.4
	NBT	C	0.75	38.3	#162.7	E	0.92	49.1	#155.6
	NBR	B	0.69	15.7	59.2	E	0.96	41.8	#96.1
	SBL	A	0.35	66.5	20.2	B	0.69	84.5	#41.0
	SBT	B	0.68	46.9	94.5	C	0.73	46.0	82.4
	SBR	A	0.29	3.2	6.4	A	0.43	7.9	19.4
Overall	D	0.88	43.4	-	E	0.96	52.6	-	
St Laurent Boulevard at Lemieux Street <i>Signalized</i>	WBL	D	0.85	54.7	96.5	C	0.77	50.4	79.6
	WBR	A	0.39	27.2	41.1	A	0.51	37.9	50.2
	NBT	A	0.45	8.5	68.4	A	0.54	10.5	86.9
	NBR	A	0.25	1.9	9.5	A	0.26	2.1	7.1
	SBL	A	0.04	11.1	m1.3	A	0.12	6.3	m1.8
	SBT	A	0.52	15.0	m74.5	B	0.61	7.9	m75.0
	Overall	B	0.62	19.2	-	B	0.65	14.7	-
St Laurent Boulevard at Transitway Access <i>Signalized</i>	WBL/R	A	0.48	30.4	17.6	A	0.38	27.2	15.1
	NBT/R	A	0.47	4.3	36.6	A	0.58	10.0	113.0
	SBL	A	0.02	7.5	m0.4	-	-	-	-
	SBT	A	0.26	6.4	51.2	A	0.35	4.3	40.9
	Overall	A	0.54	5.5	-	B	0.64	8.3	-
St Laurent Boulevard at Hwy 417 EB Off-Ramp <i>Signalized</i>	EBL	B	0.67	37.8	104.6	D	0.86	47.1	116.7
	EBR	E	0.98	61.6	#202.7	A	0.50	17.2	45.6
	NBT	A	0.50	20.3	80.9	A	0.51	17.0	88.6
	SBT/R	A	0.40	16.2	31.5	A	0.49	10.9	90.5
	Overall	B	0.70	30.5	-	B	0.64	22.0	-
Cyrville Road at Ogilvie Road <i>Signalized</i>	EBT	A	0.28	7.1	33.2	A	0.51	5.7	m55.4
	EBR	A	0.26	1.0	0.0	A	0.29	0.6	m1.2
	WBL	A	0.06	11.2	8.1	A	0.20	13.7	13.3
	WBT	A	0.50	13.9	110.6	A	0.33	11.0	60.7
	WBR	A	0.20	3.2	13.1	A	0.15	2.3	8.7
	NBL	E	0.94	97.3	#73.3	F	1.05	138.2	#60.9
	NBT/R	B	0.65	50.1	81.4	B	0.65	46.0	73.6
	SBL	A	0.32	42.3	20.8	D	0.87	84.5	54.2
	SBT/R	A	0.55	44.2	63.6	C	0.80	54.1	89.9
	Overall	B	0.62	22.2	-	B	0.66	24.1	-

Intersection	Lane	AM Peak Hour				PM Peak Hour			
		LOS	V/C	Delay(s)	Q (95 th)	LOS	V/C	Delay(s)	Q (95 th)
Cyrville Road at Joseph Cyr Street <i>Unsignalized</i>	EB	A	0.00	8.2	0.0	A	-	0.0	0.0
	WB	A	0.03	8.4	0.8	A	0.05	8.8	1.5
	NB	C	0.16	15.0	4.5	C	0.38	22.1	12.8
	SB	C	0.01	22.8	0.0	C	0.01	22.8	0.0
	Overall	A	-	1.4	-	A	-	3.1	-
Lemieux Street at Joseph Cyr Street <i>Unsignalized</i>	EBL	A	0.09	9.9	2.3	A	0.12	9.4	3.0
	EBT	-	-	-	-	-	-	-	-
	WBL	-	-	-	-	-	-	-	-
	WBT/R	-	-	-	-	-	-	-	-
	SBL/R	B	0.15	14.2	3.8	B	0.25	14.6	7.5
	Overall	A	-	1.6	-	A	-	2.6	-
Lemieux Street at Labelle Street <i>Unsignalized</i>	EBL	C	0.11	18.2	3.0	C	0.36	18.6	12.0
	WBR	B	0.20	11.6	6.0	B	0.21	10.4	6.0
	NB	-	-	-	-	-	-	-	-
	SBL	-	-	-	-	-	-	-	-
	Overall	A	-	2.4	-	A	-	5.7	-

Notes: Saturation flow rate of 1800 veh/h/lane
Queue is measured in metres
Peak Hour Factor = 0.90

m = metered queue
= volume for the 95th %ile cycle exceeds capacity

In the existing conditions, the study area intersections generally operate well with the exception of St Laurent Boulevard at Coventry Road/Ogilvie Road and Cyrville Road at Ogilvie Road.

At the intersection of St Laurent Boulevard at Coventry Road/Ogilvie Road, during the AM peak hour, the westbound left-turn, northbound left-turn, and northbound through movements may exhibit extended queues, and northbound left-turn may be subject to high delays and extended queues. During the PM peak hour, the westbound left-turn movement is over theoretical capacity and may be subject to high delays and extended queues. The eastbound left-turn and northbound through and right-turn movements may exhibit extended queues, and the northbound and southbound left-turn movements may be subject to high delays and extended queues.

The intersection of Cyrville Road and Ogilvie Road’s northbound left-turn movement may exhibit high delays and extended queues during the AM peak hour and is over theoretical capacity with high delays and extended queues during the PM peak hour. At this intersection residual capacity is available on all conflicting movements, however, and the reallocation of split to the overcapacity movement may reduce the v/c of all movements to 1.00 or below.

In addition, the eastbound right-turn movement at the intersection of St Laurent Boulevard at Highway 417 EB Off-Ramp may exhibit extended queues during the AM peak hour.

2.2.8 Collision Analysis

Collision data have been acquired from the City of Ottawa open data website (data.ottawa.ca) for five years prior to the commencement of this TIA for the surrounding study area road network. Table 3 summarizes the collision types and conditions in the study area, Figure 11 illustrates the intersections and segments analyzed, and Table 4 summarizes the total collisions for each of these locations. Collision data are included in Appendix D.

Table 3: Study Area Collision Summary, 2016-2020

		Number	%
Total Collisions		135	100%
Classification	Fatality	0	0%
	Non-Fatal Injury	22	16%
	Property Damage Only	113	84%
Initial Impact Type	Approaching	2	1%
	Angle	42	31%
	Rear end	48	36%
	Sideswipe	23	17%
	Turning Movement	15	11%
	SMV Unattended	0	0%
	SMV Other	2	1%
	Other	3	2%
Road Surface Condition	Dry	96	71%
	Wet	25	19%
	Loose Snow	4	3%
	Slush	3	2%
	Packed Snow	2	1%
	Ice	4	3%
	Unknown	1	1%
Pedestrian Involved		1	1%
Cyclists Involved		0	0%

Figure 11: Representation of Study Area Collisions



Table 4: Summary of Collision Locations, 2016-2020

	Number	%
Intersections / Segments	135	100%
Lemieux St @ St. Laurent Blvd	75	56%
Labelle St @ Lemieux St/Hwy417 IC115 Ramp	30	22%
St. Laurent Blvd btwn Hwy417 IC115 Ramp36 & Transit	11	8%
Lemieux St @ Joseph Cyr St	8	6%
St. Laurent Blvd @ Transitway	7	5%
Lemieux St btwn Joseph Cyr St & Ramp	3	2%
Lemieux St btwn St. Laurent Blvd & Lemieux St	1	1%

Within the study area, the intersections of Lemieux Street at St. Laurent Boulevard and Labelle Street at Lemieux Street/the Highway 417 interchange 115 Ramp are noted to have experienced higher collisions than other locations. Table 5 and Table 6 summarize the collision types and conditions for each of the location, respectively.

Table 5: Lemieux Street at St. Laurent Boulevard Collision Summary

	Number	%	
Total Collisions	75	100%	
Classification	Fatality	0	0%
	Non-Fatal Injury	13	17%
	Property Damage Only	62	83%
Initial Impact Type	Approaching	2	3%
	Angle	14	19%
	Rear end	36	48%
	Sideswipe	12	16%
	Turning Movement	11	15%
Road Surface Condition	Dry	54	72%
	Wet	11	15%
	Loose Snow	3	4%
	Slush	3	4%
	Packed Snow	2	3%
	Ice	1	1%
	Unknown	1	1%
Pedestrian Involved	0	0%	
Cyclists Involved	0	0%	

The Lemieux Street at St. Laurent Boulevard intersection had a total of 75 collisions during the 2016-2020 time period, with 62 involving property damage only and the remaining 13 having non-fatal injuries. Rear end comprised the majority of collision types at this intersection with 36 collisions, followed by 14 angled, 12 sideswipe, and 11 turning movement collisions with the remaining two collisions represented as approaching. The detailed collision records outline the rear end collisions are predominantly due to the congested conditions along St Laurent Boulevard, with eight on Lemieux Street resulting from improper driver behaviour. The angled, side swiped and turning movement predominantly are the result of northbound and southbound vehicles violating the signal control, failure to yield and improper lane changes. It is noted that collisions involving westbound left-turn movements interacting with southbound vehicles and other westbound vehicles appear to be influenced by the t-intersection configuration and the dual left-turn movement entering three receiving lanes. Weather conditions do not affect collisions at this location.

Overall, the City review the intersection to increase signal compliance to reduce the interaction of north or south bound vehicles with the westbound left-turn movement. As this is likely influenced by the OR-174 on-ramps, close

proximity of signals on the corridor and the overpass to the south of the intersection, it is beyond the purview of the proposed development.

Table 6: Labelle Street at Lemieux Street/Highway 417 IC115 Ramp Collision Summary

Total Collisions		Number	%
		30	100%
Classification	Fatality	0	0%
	Non-Fatal Injury	2	7%
	Property Damage Only	28	93%
Initial Impact Type	Angle	21	70%
	Rear end	1	3%
	Sideswipe	4	13%
	Turning Movement	3	10%
	Other	1	3%
Road Surface Condition	Dry	22	73%
	Wet	8	27%
Pedestrian Involved		0	0%
Cyclists Involved		0	0%

The Labelle Street at Lemieux Street/the Highway 417 interchange 115 Ramp intersection had a total of 30 collisions during the 2016-2020 time period, with 28 involving property damage only and the remaining two having non-fatal injuries. The collision types are most represented by angle with 21 collisions, followed by four sideswipe, three turning movement collisions and with the remaining collisions split between rear end and other. The detailed collision report identifies 23 collisions including improper turns, failure to yield and following too closely, with the remaining seven collisions classified as unknown, lost control or other. Nine of the above collisions are also noted to be a result of drivers violating the turning restrictions and concrete islands. Weather conditions may influence driver speed at this location as the clear and dry conditions could increase driver comfort for travelling at higher speeds. At speeds at or above 70 km/h, the sight lines may begin to be limited for the westbound movements. The MTO and City should review the intersection and speeds to determine if any advanced signage or other improvements, can be included in during the other scheduled 2022 work in this area.

2.3 Planned Conditions

2.3.1 Changes to the Area Transportation Network

The subject development is within the Industrial Avenue/Trainyards/Cyrville Mixed Use Centre, Tremblay, St Laurent and Cyrville secondary plan, and St Laurent Transit Oriented Development (TOD) areas.

The St. Laurent TOD plan outlines a new pedestrian overpass over Highway 417 from Tremblay Road to the St Laurent LRT station, along with dedicated cycling facilities along St Laurent Boulevard and shared use lanes on Lemieux Road. Figure 12 and Figure 13 illustrate the St Laurent pedestrian and cycling TOD plans.

Figure 12: St. Laurent TOD Pedestrian Network

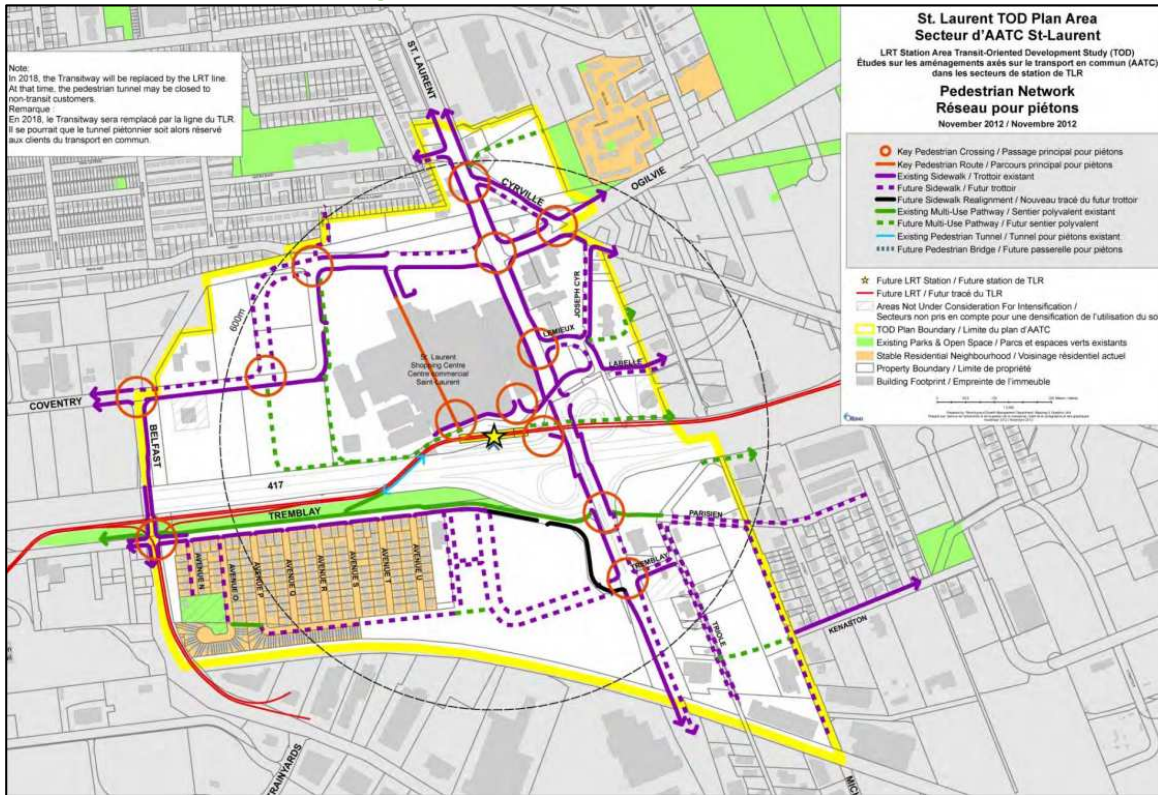
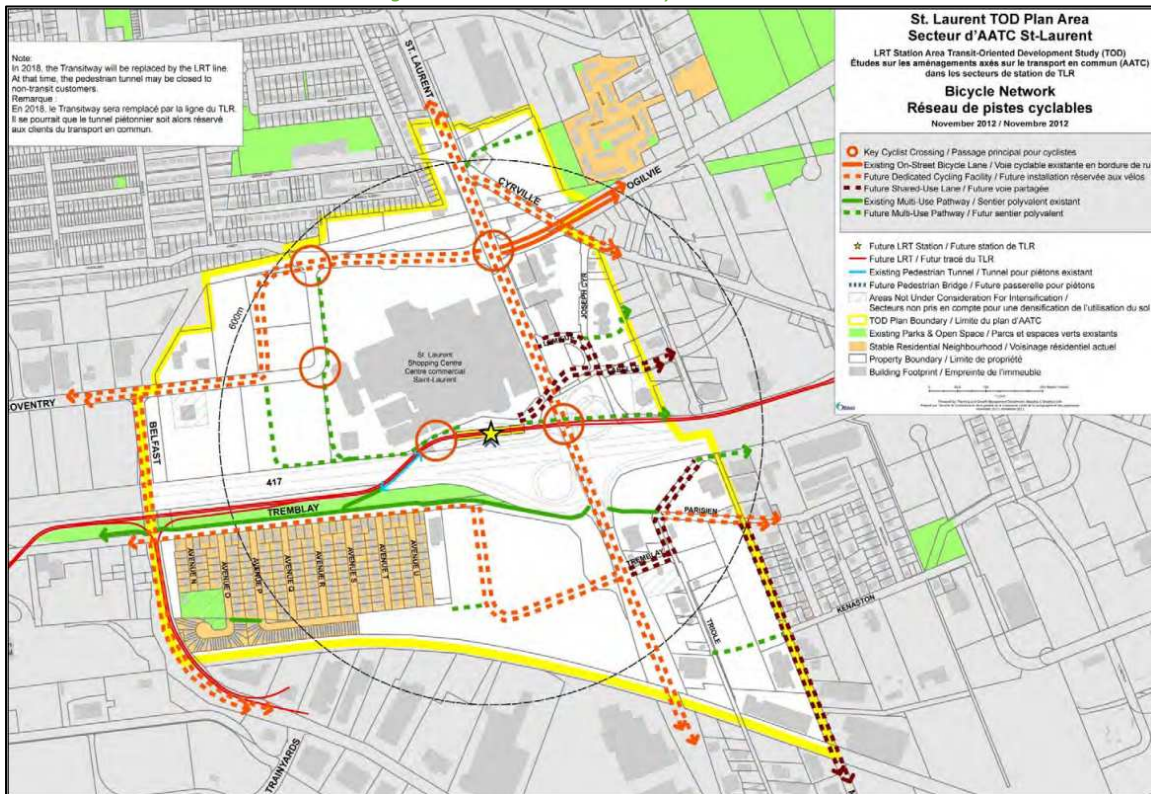

Figure 13: St. Laurent TOD Bicycle Network



Within the Transportation Master Plan, the Road Network's Network Concept diagram shows Cyrville Road between St Laurent Boulevard and Labelle Street as a widened collector, and Coventry Road and Cyrville Road south of Labelle Street as widened arterials. Within the Affordable Network diagram, these sections are shown as segments for phase 3 (2026-2031) widening. The scope of the work per the Affordable Network is the urbanization of the existing two-lane rural cross-section of Cyrville Road between Star Top Road and St Laurent Boulevard, and the widening of Coventry Road from two lanes to four between Belfast Road and the St Laurent Shopping Centre.

Within the Rapid Transit and Transit Priority Network's Network Concept diagram, isolated transit priority measures are shown along Ogilvie Road, however these are not included in the Affordable Network. Both Networks include an isolated measures transit priority corridor along St Laurent Boulevard.

Ottawa construction and infrastructure projects identify bridge renewal along St Laurent LRT station is in progress, the bridge renewal between Lemieux Street and St Laurent LRT station is planned for 2022, and resurfacing Lemieux Street east of St Laurent Boulevard is planned for 2022.

2.3.2 Other Study Area Developments

1098 Ogilvie Road, 1178 Cummings Avenue

The proposed development application includes a site plan for a two-phase development with occupancy horizons of 2022 and 2024, comprising three residential towers and one hotel for 850 residential dwelling units and 175 hotel rooms. The development is expected to generate 148 new AM and 130 new PM peak hour two-way auto trips. (Parsons, 2020)

1298 Ogilvie Road

The proposed development application includes a site plan for seven townhome buildings comprising 78 residential units. The development is expected to generate 39 new AM and 40 new PM peak hour two-way auto trips based upon a 50% auto mode share. The build-out horizon is assumed to be 2023. (Parsons, 2018)

1125 - 1149 Cyrville Road

The proposed development application includes a site plan to construct two residential buildings with a total of 354 units. The development is predicted to generate 22 new AM and 21 new PM two-way peak-hour auto trips. The anticipated build-out horizon is 2023. (Stantec, 2021)

453 and 455 Coventry Road

The proposed development application includes a zoning by-law amendment to permit the construction of a mixed-use mid-rise and three mixed-use high-rise buildings with a combined total of 574 parking spaces. No TIA is included as part of this application, and the file was last updated in 2021.

500, 525, 535 Coventry Road, 1200 St Laurent Boulevard

The proposed development application includes a zoning by-law amendment to permit the construction of freestanding retail buildings with associated surface parking areas. No TIA is included as part of this application, and the file was last updated in 2014.

599 Tremblay Road

The proposed development application includes a draft plan of subdivision application for the construction of 500 apartment units and 150,000 m² of federal Office in three phases. Phase one is to construct 200 units and 150,000 m² of office space by 2025, phase two is 200 units by 2029, and the remaining 100 units by 2033.

Phase one is predicted to generate 321 new AM and 330 new PM two-way peak-hour auto trips, phase two is predicted to generate 19 new AM and 20 new PM two-way peak-hour auto trips, and phase three is predicted to generate 10 new AM and PM two-way peak-hour auto trips. (WSP, 2021)

530 Tremblay Road & 2098 Avenue P & 1399 Avenue U

The proposed development application includes a site plan to construct two apartment buildings with a total of 124 units. The development is predicted to generate 16 new AM and 17 new PM two-way peak-hour auto trips, and the anticipated build-out horizon is assumed to be 2023. (CGH Transportation, 2019)

1155 Joseph Cyr Road & 1082 Cyrville Road

The proposed development includes a Zoning by-law amendment and site plan application to construct a six-storey mixed-use building with 116 residential dwelling units and a 1425 sq. ft. ground floor commercial component to be built in a single phase by 2023. The development is predicted to generate eight new AM and nine new PM two-way peak-hour auto trips. (CGH Transportation, 2020)

3 Study Area and Time Periods

3.1 Study Area

The study area will include the intersections of:

- St Laurent Boulevard at:
 - Coventry Road/Ogilvie Road
 - Lemieux Street
 - Transitway access
 - Hwy 417 EB Off-Ramp
- Lemieux Street at:
 - Joseph Cyr Street
 - Labelle Street
- Cyrville Road at:
 - Ogilvie Road
 - Joseph Cyr Street

The boundary road will be Lemieux Street, St Laurent Boulevard, and Labelle Street, and no screenlines are present within proximity to the site and none will be reviewed as part of this study.

3.2 Time Periods

As the proposed development is composed entirely of residential units the AM and PM peak hours will be examined.

3.3 Horizon Years

The anticipated build-out year is 2026. As a result, the full build-out plus five years horizon year is 2031.

4 Exemption Review

Table 7 summarizes the exemptions for this TIA.

Table 7: Exemption Review

Module	Element	Explanation	Exempt/Required
Design Review Component			
4.1 Development Design	4.1.2 Circulation and Access	Only required for site plans	Required
	4.1.3 New Street Networks	Only required for plans of subdivision	Exempt
4.2 Parking	4.2.1 Parking Supply	Only required for site plans	Required
	4.2.2 Spillover Parking	Only required for site plans where parking supply is 15% below unconstrained demand	Exempt
Network Impact Component			
4.5 Transportation Demand Management	All Elements	Not required for site plans expected to have fewer than 60 employees and/or students on location at any given time	Required
4.6 Neighbourhood Traffic Management	4.6.1 Adjacent Neighbourhoods	Only required when the development relies on local or collector streets for access and total volumes exceed ATM capacity thresholds	Required
4.8 Network Concept		Only required when proposed development generates more than 200 person-trips during the peak hour in excess of equivalent volume permitted by established zoning	Exempt

5 Development-Generated Travel Demand

5.1 Mode Shares

Examining the mode shares recommended in the TRANS Trip Generation Manual (2020) for the subject district, derived from the most recent National Capital Region Origin-Destination survey (OD Survey), the existing average district mode shares by land use for Ottawa East have been summarized in Table 8.

Table 8: TRANS Trip Generation Manual Recommended Mode Shares – Ottawa East

Travel Mode	Multi-Unit (High-Rise)	
	AM	PM
Auto Driver	39%	40%
Auto Passenger	7%	14%
Transit	38%	28%
Cycling	2%	3%
Walking	13%	15%
Total	100%	100%

Being within 600 metres-walk of the St. Laurent LRT station, a higher transit mode is considered achievable at this location. A 25% shift to transit mode taken from the auto mode and a 2% shift to transit mode taken from the auto passenger mode are proposed. The proposed modified mode share targets are summarized in Table 9.

Table 9: Proposed Development Mode Shares – Within 600m of St Laurent LRT station

Travel Mode	Multi-Unit (High-Rise)	
	AM	PM
Auto Driver	14%	15%
Auto Passenger	5%	12%
Transit	65%	55%
Cycling	2%	3%
Walking	13%	15%
Total	100%	100%

5.2 Trip Generation

This TIA has been prepared using the vehicle and person trip rates for the residential dwellings using the TRANS Trip Generation Manual (2020). Table 10 summarizes the person trip rates for the proposed residential land uses for each peak period.

Table 10: Trip Generation Person Trip Rates by Peak Period

Land Use	Land Use Code	Peak Period	Person Trip Rates
Multi-Unit (High-Rise)	221 & 222 (TRANS)	AM	0.80
		PM	0.90

Using the above person trip rates, the total person trip generation has been estimated. Table 11 summarizes the total person trip generation for the residential land uses.

Table 11: Total Residential Person Trip Generation by Peak Period

Land Use	Units	AM Peak Period			PM Peak Period		
		In	Out	Total	In	Out	Total
Multi-Unit (High-Rise)	644	160	355	515	336	244	580

Using the above mode share targets for an LRT area, and the person trip rates, the person trips by mode have been projected. Trip generation by peak hour has been forecasted using the prescribed peak period conversion factors presented in the TRANS Trip Generation Manual (2020) for the residential component. Table 12 summarizes the residential trip generation by mode and peak hour.

Table 12: Trip Generation by Mode

Travel Mode		AM Peak Hour				PM Peak Hour			
		Mode Share	In	Out	Total	Mode Share	In	Out	Total
Multi-Unit (High-Rise)	Auto Driver	14%	11	24	35	15%	22	16	38
	Auto Passenger	5%	4	9	13	12%	18	13	31
	Transit	65%	57	127	184	55%	87	63	150
	Cycling	2%	2	4	6	3%	5	3	8
	Walking	13%	12	27	39	15%	26	19	45
	Total	100%	86	197	277	100%	158	114	272

As shown above, a total of 35 AM and 38 PM new peak hour two-way vehicle trips are projected as a result of the proposed development.

5.3 Trip Distribution

To understand the travel patterns of the subject development, the OD Survey has been reviewed to determine the travel for the residential component, and these patterns were applied based on the build-out of Ottawa East. Table 13 below summarizes the distributions.

Table 13: OD Survey Distribution – Ottawa East

To/From	Residential % of Trips
North	10%
South	30%
East	20%
West	40%
Total	100%

5.4 Trip Assignment

Using the distribution outlined above, turning movement splits, and access to major transportation infrastructure, the trips generated by the site have been assigned to the study area road network. Table 14 summarizes the proportional assignment to the study area roadways, and Figure 14 illustrates the new site-generated volumes.

Table 14: Trip Assignment

To/From	Inbound Via	Outbound Via
North	5% Cyrville (N) (via Joseph Cyr)	5% Cyrville (N) (via Joseph Cyr)
	5% St Laurent (N) (via Lemieux)	5% St Laurent (N) (via Lemieux)
South	30% St Laurent (S) (via Lemieux)	30% St Laurent (S) (via Lemieux)
East	10% OR 174/Lemieux	10% Ogilvie (E) (via St Laurent)
	10% Ogilvie (E) (via Cyrville)	10% Ogilvie (E) (via Cyrville)
West	10% Ogilvie (W) (via Cyrville)	10% Ogilvie (W) (via Cyrville)
	15% Ogilvie (W) (via St Laurent)	15% Ogilvie (W) (via St Laurent)
	15% St Laurent (S) (via Lemieux)	15% St Laurent (S) (via Lemieux)
Total	100%	100%

Figure 14: New Site Generation Auto Volumes

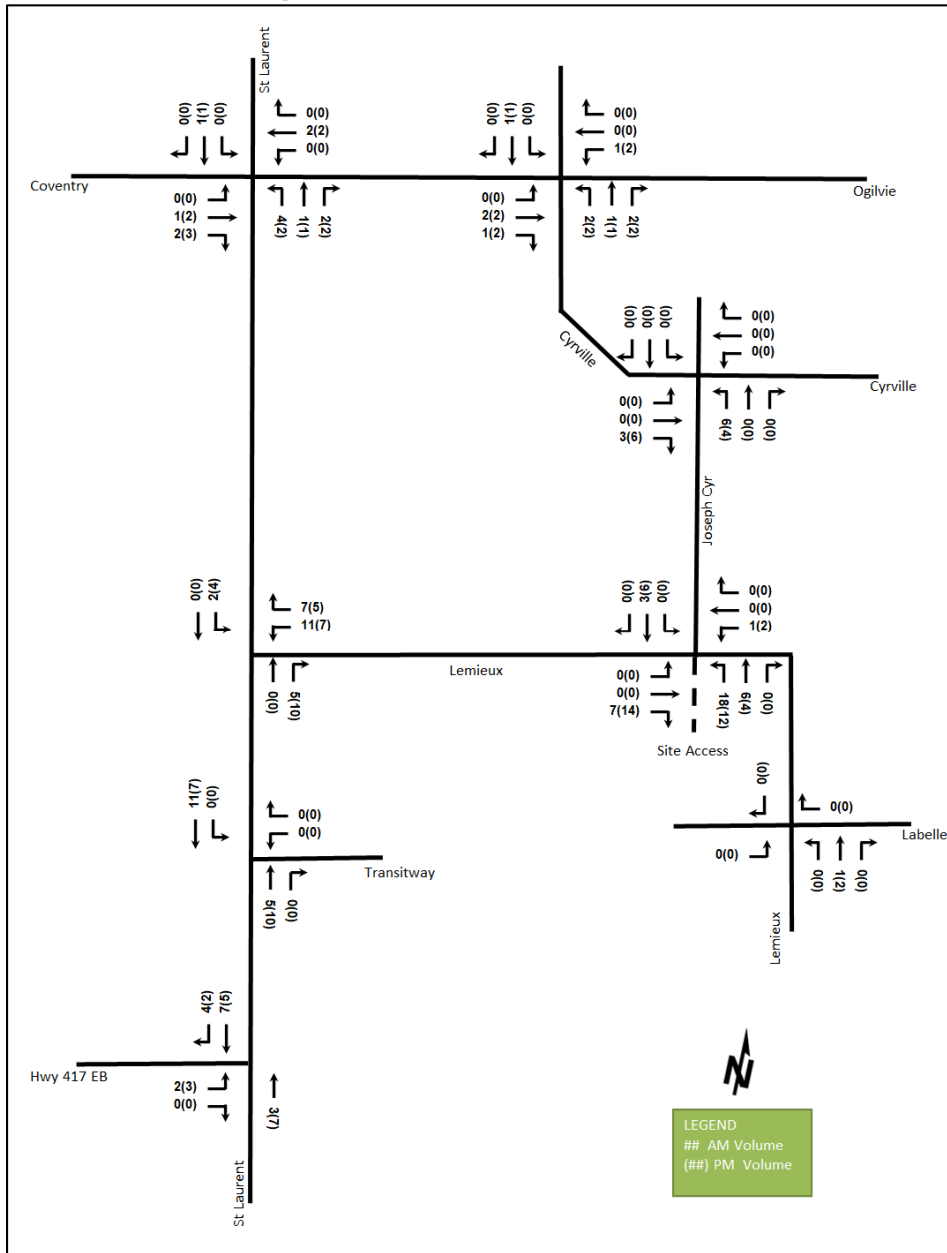

6 Background Network Travel Demands

6.1 Transportation Network Plans

The transportation network plans were discussed in Section 2.3. The widening of Cyrville Road is assumed to be beyond 2031, and none of the proposed changes are considered to have any notable impact on the study area traffic volumes and travel patterns.

6.2 Background Growth

A review of the background projections from the City's TRANS Regional Model for the 2011 and 2031 horizons was completed to determine the background growth for each of the study area roadways. The background TRANS model growth rates are summarized in Table 15 and the TRANS model plots are provided in Appendix E.

Table 15: TRANS Regional Model Projections – Study Area Growth Rates

Street	TRANS Rate		2011 to Existing		Existing to 2031	
	Eastbound	Westbound	Eastbound	Westbound	Eastbound	Westbound
Ogilvie Rd	0.11%	0.36%	0.98%	-0.55%	-1.19%	1.74%
Lemieux St	3.11%	1.44%	11.99%	1.44%	-8.90%	0.02%
	Northbound	Southbound	Northbound	Southbound	Northbound	Southbound
St Laurent Blvd	1.21%	0.49%	1.40%	0.61%	0.92%	0.30%
Cyrville Rd	0.40%	1.93%	0.26%	1.04%	0.61%	3.30%

In general, the growth rates in the study area derived from the two TRANS model horizons are projected to be positive along all roadways. A comparison of the 2011 to Existing volumes and the Existing to 2031 volumes illustrates a situation that development has not progressed linearly. It is unlikely that the growth rates will decrease or become negative as the Existing to 2031 summary outlines, therefore it is expected that they will be lower than the 2011 to Existing rates that have been experienced. Table 16 summarizes the recommended growth rates to be considered within the study area.

Table 16: Recommended Area Growth Rates

Street	AM Peak Hour		PM Peak Hour	
	Eastbound	Westbound	Eastbound	Westbound
Ogilvie Rd	0.50%	1.00%	1.00%	0.50%
Lemieux St	0%	0%	0%	0%
	Northbound	Southbound	Northbound	Southbound
St Laurent Blvd	1.00%	0.50%	0.50%	1.00%
Cyrville Rd	0.50%	2.00%	2.00%	0.50%

6.3 Other Developments

The background developments explicitly considered beyond the above noted background growth rates (Section 6.2) include:

- 1098 Ogilvie Road, 1178 Cummings Avenue
- 599 Tremblay Road
- 1125 - 1149 Cyrville Road
- 530 Tremblay Road & 2098 Avenue P & 1399 Avenue U
- 1155 Joseph Cyr Road & 1082 Cyrville Road

The total background development volumes have been illustrated in Figure 15, and each background development volumes are provided in Appendix F.

Figure 15: Total Background Development Volumes

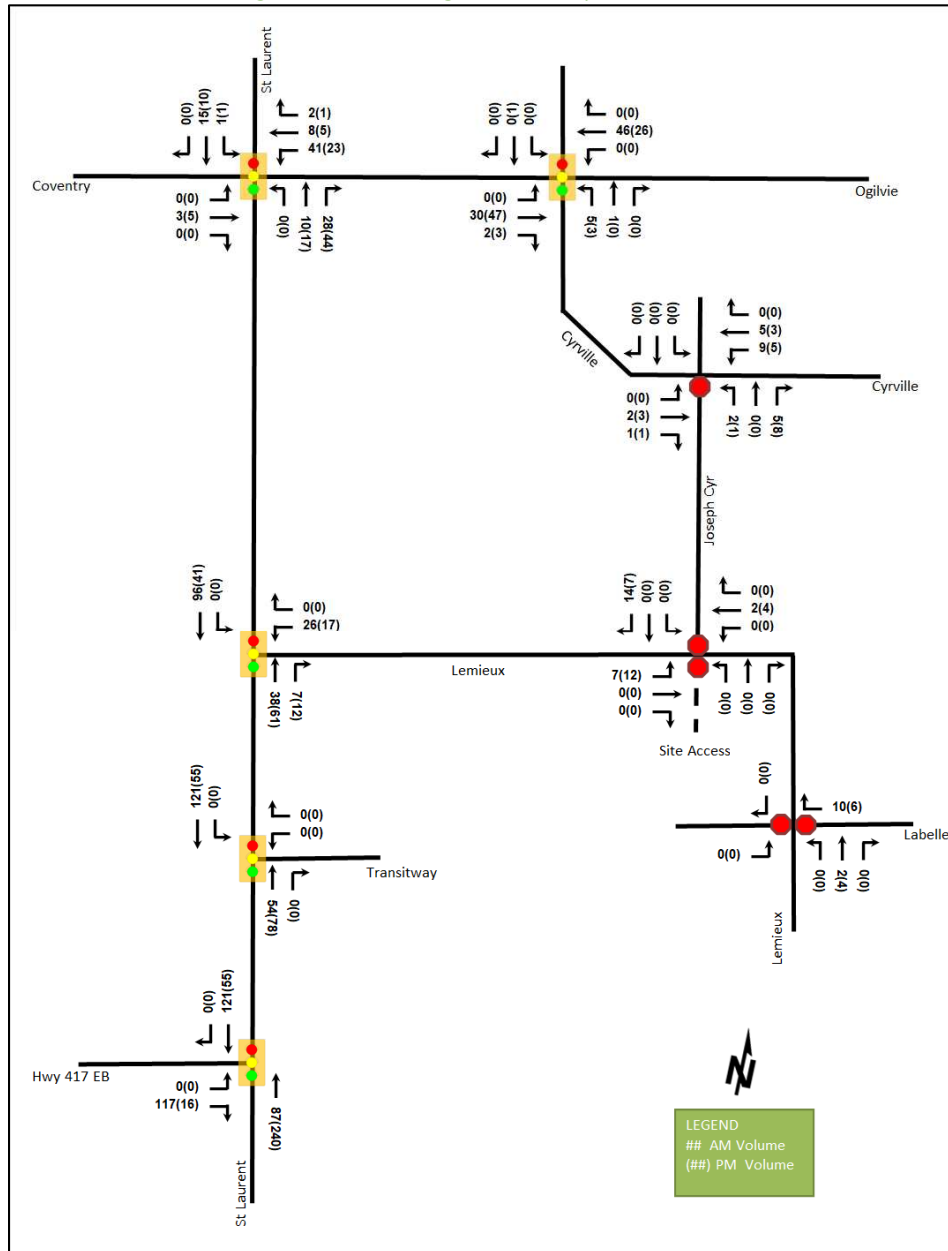

7 Demand Rationalization

7.1 2026 Future Background Operations

Figure 16 illustrates the 2026 background volumes and Table 17 summarizes the 2026 background intersection operations. The level of service for signalized intersections is based on v/c calculations for individual lane movements and HCM 2000 v/c calculations for the overall intersection, and average delay for unsignalized intersections. The northbound shared through/right-turn lane at the intersection of St Laurent Boulevard at Coventry Road/Ogilvie Road is a de facto right lane, and it is coded as a right turn lane in Synchro. The synchro worksheets for the 2026 future background horizon are provided in Appendix G.

Figure 16: 2026 Future Background Volumes

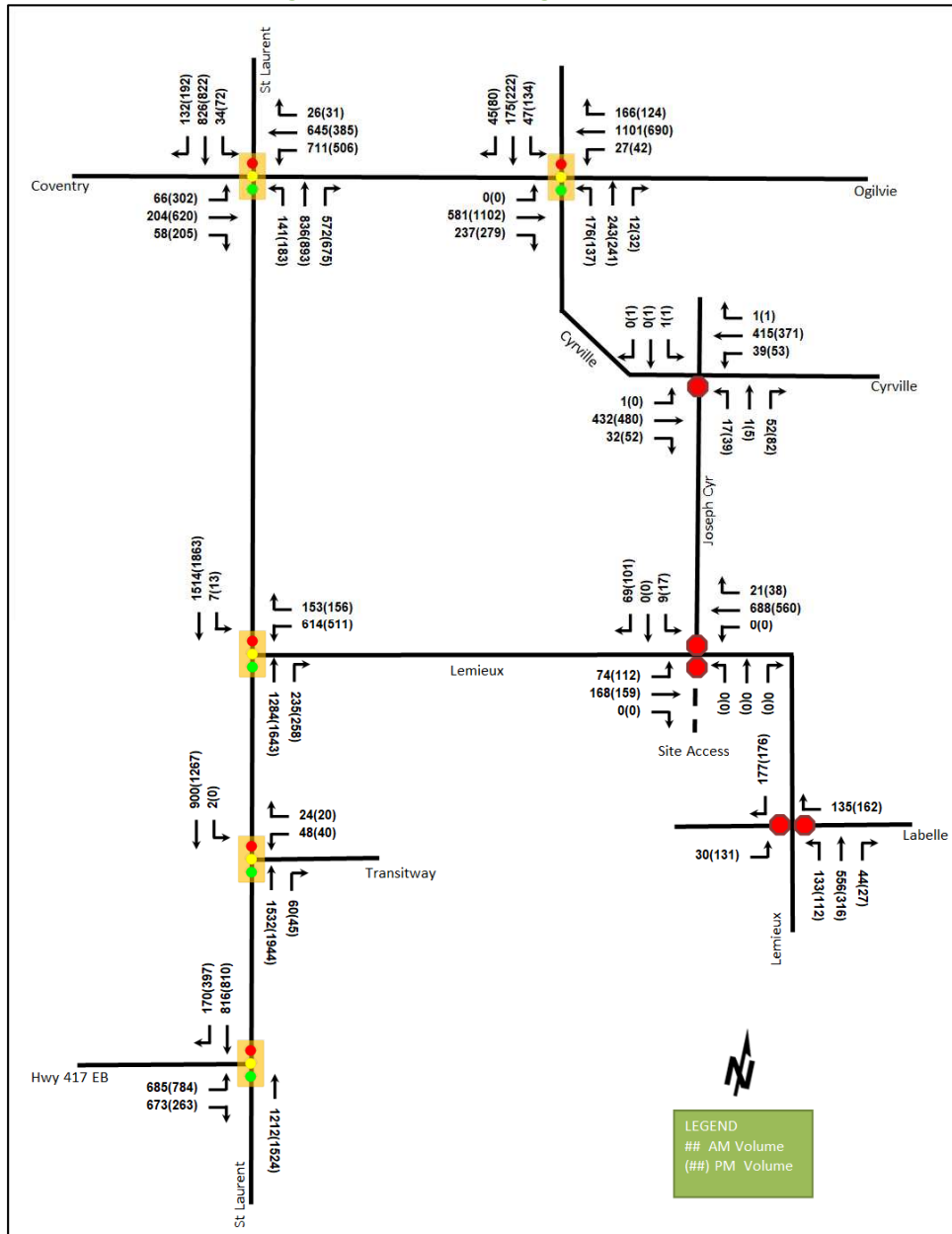

Table 17: 2026 Future Background Intersection Operations

Intersection	Lane	AM Peak Hour				PM Peak Hour			
		LOS	V/C	Delay(s)	Q (95 th)	LOS	V/C	Delay(s)	Q (95 th)
St Laurent Boulevard at Coventry Road/Ogilvie Road <i>Signalized</i>	EBL	A	0.16	48.1	14.5	B	0.68	57.7	50.2
	EBT	A	0.35	46.8	33.4	C	0.77	49.3	90.8
	EBR	A	0.15	0.8	0.0	A	0.41	7.1	17.1
	WBL	E	0.93	66.8	#138.9	F	1.04	101.3	#107.3
	WBT	B	0.70	39.3	99.3	A	0.48	35.3	58.9
	WBR	A	0.06	0.2	m0.0	A	0.06	0.2	m0.0
	NBL	D	0.82	100.6	#71.7	D	0.86	97.4	#80.8
	NBT	C	0.74	37.8	#159.2	D	0.81	39.6	#142.7
	NBR	B	0.70	15.3	61.0	E	0.92	34.1	#97.4
	SBL	A	0.33	66.1	19.0	B	0.64	79.5	#36.1
	SBT	B	0.64	46.0	89.2	B	0.70	44.9	80.3
	SBR	A	0.26	2.1	2.4	A	0.38	6.0	14.0
Overall	D	0.87	42.5	-	E	0.92	48.0	-	
St Laurent Boulevard at Lemieux Street <i>Signalized</i>	WBL	D	0.84	55.3	90.8	C	0.73	48.5	73.4
	WBR	A	0.37	26.0	36.4	A	0.47	34.8	43.9
	NBT	A	0.44	8.3	63.6	A	0.52	10.4	63.2
	NBR	A	0.23	1.9	9.4	A	0.25	2.1	8.1
	SBL	A	0.04	10.6	m1.2	A	0.10	5.6	m1.5
	SBT	A	0.50	14.8	m77.3	A	0.60	7.8	m73.7
	Overall	A	0.60	18.8	-	B	0.63	14.0	-
St Laurent Boulevard at Transitway Access <i>Signalized</i>	WBL/R	A	0.50	32.8	16.2	A	0.41	29.9	14.1
	NBT/R	A	0.46	3.6	30.4	A	0.56	9.4	118.9
	SBL	A	0.02	7.0	m0.3	-	-	-	-
	SBT	A	0.25	5.3	57.9	A	0.35	4.2	40.0
	Overall	A	0.53	5.0	-	B	0.61	7.8	-
St Laurent Boulevard at Hwy 417 EB Off-Ramp <i>Signalized</i>	EBL	A	0.60	35.6	92.1	D	0.83	46.8	101.9
	EBR	F	1.10	96.3	#243.6	A	0.51	18.7	44.6
	NBT	A	0.52	20.8	83.9	A	0.54	16.3	101.2
	SBT/R	A	0.42	18.2	33.6	A	0.47	9.7	89.4
	Overall	C	0.76	37.2	-	B	0.64	20.7	-
Cyrville Road at Ogilvie Road <i>Signalized</i>	EBT	A	0.27	7.0	33.0	A	0.51	5.8	m58.5
	EBR	A	0.25	0.9	0.0	A	0.28	0.7	m1.5
	WBL	A	0.06	10.9	7.6	A	0.17	13.0	11.9
	WBT	A	0.50	13.6	111.7	A	0.32	10.6	58.6
	WBR	A	0.18	3.2	12.5	A	0.14	2.4	8.3
	NBL	E	0.94	98.8	#67.8	F	1.05	135.0	#60.8
	NBT/R	B	0.62	49.4	76.0	B	0.68	48.3	75.0
	SBL	A	0.27	41.0	18.7	D	0.85	83.0	48.9
	SBT/R	A	0.56	45.4	64.1	C	0.76	52.3	82.4
	Overall	A	0.62	22.1	-	B	0.65	23.8	-

Intersection	Lane	AM Peak Hour				PM Peak Hour			
		LOS	V/C	Delay(s)	Q (95 th)	LOS	V/C	Delay(s)	Q (95 th)
Cyrville Road at Joseph Cyr Street <i>Unsignalized</i>	EB	A	0.00	8.2	0.0	A	-	0.0	0.0
	WB	A	0.04	8.4	0.8	A	0.05	8.7	1.5
	NB	C	0.17	15.2	4.5	C	0.35	20.4	11.3
	SB	C	0.01	23.0	0.0	C	0.01	19.9	0.0
	Overall	A	-	1.4	-	A	-	2.9	-
Lemieux Street at Joseph Cyr Street <i>Unsignalized</i>	EBL	A	0.09	9.6	2.3	A	0.12	9.2	3.0
	EBT	-	-	-	-	-	-	-	-
	WBL	-	-	-	-	-	-	-	-
	WBT/R	-	-	-	-	-	-	-	-
	SBL/R	B	0.15	13.1	3.8	B	0.22	13.4	6.0
	Overall	A	-	1.7	-	A	-	2.6	-
Lemieux Street at Labelle Street <i>Unsignalized</i>	EBL	C	0.09	16.5	2.3	C	0.29	16.4	9.0
	WBR	B	0.19	11.2	5.3	B	0.19	10.2	5.3
	NB	-	-	-	-	-	-	-	-
	SBL	-	-	-	-	-	-	-	-
	Overall	A	-	2.4	-	A	-	5.3	-

Notes: Saturation flow rate of 1800 veh/h/lane
 Queue is measured in metres
 Peak Hour Factor = 1.00
 m = metered queue
 # = volume for the 95th %ile cycle exceeds capacity

Intersections within the study area will operate similar to existing condition with the incremental improvement to the intersection operations. It is predominantly a result of the peak hour factor adjustment to 1.00 for forecasted conditions.

The eastbound right-turn movement at St Laurent Boulevard and Hwy 417 EB Off-Ramp intersection is expected to be over theoretical capacity and may be subject to high delays and extended queues due to the background developments in the area.

7.2 2031 Future Background Operations

Figure 17 illustrates the 2031 background volumes and Table 18 summarizes the 2031 background intersection operations. The level of service for signalized intersections is based on v/c calculations for individual lane movements and HCM 2000 v/c calculations for the overall intersection, and average delay for unsignalized intersections. The northbound shared through/right-turn lane at the intersection of St Laurent Boulevard at Coventry Road/Ogilvie Road is a de facto right lane, and it is coded as a right turn lane in Synchro. The synchro worksheets for the 2031 future background horizon are provided in Appendix H.

Figure 17: 2031 Future Background Volumes

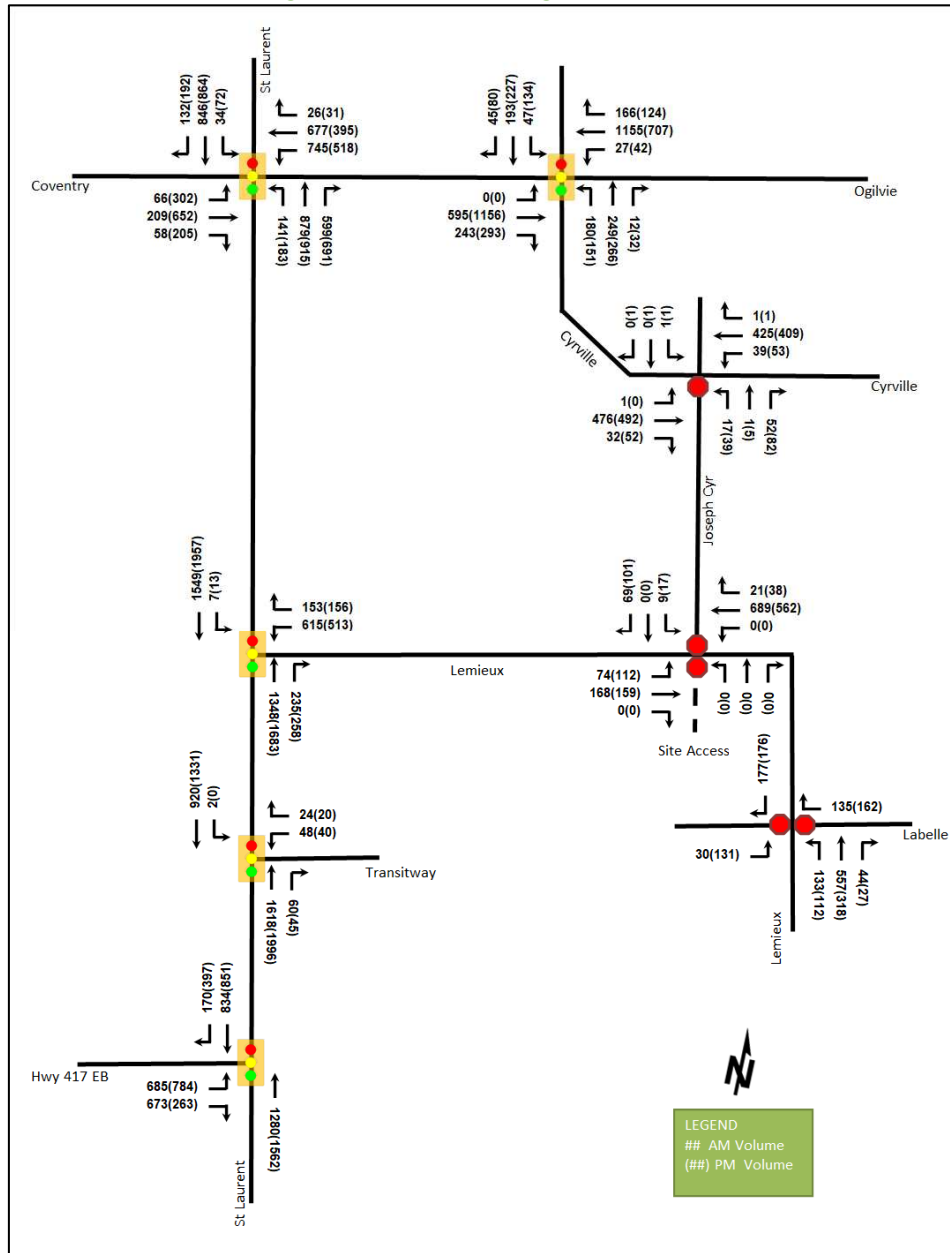

Table 18: 2031 Future Background Intersection Operations

Intersection	Lane	AM Peak Hour				PM Peak Hour			
		LOS	V/C	Delay(s)	Q (95 th)	LOS	V/C	Delay(s)	Q (95 th)
St Laurent Boulevard at Coventry Road/Ogilvie Road <i>Signalized</i>	EBL	A	0.16	49.2	14.7	B	0.68	57.7	50.2
	EBT	A	0.36	46.9	34.2	D	0.81	51.1	96.3
	EBR	A	0.15	0.8	0.0	A	0.41	7.1	17.1
	WBL	E	0.91	62.5	#148.6	F	1.08	110.7	#111.0
	WBT	B	0.69	36.8	103.0	A	0.50	34.6	57.1
	WBR	A	0.05	0.2	m0.0	A	0.06	0.2	m0.0
	NBL	D	0.82	101.5	#71.6	D	0.86	97.4	#80.8
	NBT	D	0.81	40.5	#168.3	D	0.83	40.3	#149.1
	NBR	C	0.74	17.6	#66.0	E	0.95	38.0	#103.7
	SBL	A	0.33	66.1	19.0	B	0.64	79.5	#36.1
	SBT	B	0.70	48.3	91.5	C	0.73	45.9	84.9
	SBR	A	0.27	2.2	2.4	A	0.38	6.0	14.0
Overall	D	0.89	42.7	-	D	0.95	49.9	-	
St Laurent Boulevard at Lemieux Street <i>Signalized</i>	WBL	D	0.84	55.3	91.0	C	0.73	48.6	73.6
	WBR	A	0.37	27.9	37.9	A	0.47	35.7	44.6
	NBT	A	0.46	9.2	72.8	A	0.53	10.8	75.5
	NBR	A	0.23	2.0	11.6	A	0.25	2.0	7.8
	SBL	A	0.04	10.9	m1.1	A	0.10	5.8	m1.5
	SBT	A	0.52	15.1	m80.5	B	0.63	8.2	m76.3
Overall	B	0.61	19.1	-	B	0.65	14.3	-	
St Laurent Boulevard at Transitway Access <i>Signalized</i>	WBL/R	A	0.50	33.6	16.5	A	0.41	29.9	14.1
	NBT/R	A	0.49	3.9	35.4	A	0.57	9.8	124.6
	SBL	A	0.02	7.0	m0.4	-	-	-	-
	SBT	A	0.26	5.5	58.8	A	0.37	4.3	44.8
Overall	A	0.55	5.2	-	B	0.62	8.0	-	
St Laurent Boulevard at Hwy 417 EB Off-Ramp <i>Signalized</i>	EBL	A	0.60	35.6	92.1	D	0.83	46.8	101.9
	EBR	F	1.10	99.2	#245.7	A	0.52	20.8	47.6
	NBT	A	0.55	21.3	90.2	A	0.55	16.5	104.8
	SBT/R	A	0.43	17.7	33.7	A	0.48	9.8	92.6
Overall	C	0.78	37.4	-	B	0.65	20.8	-	
Cyrville Road at Ogilvie Road <i>Signalized</i>	EBT	A	0.28	7.2	33.7	A	0.54	6.6	m66.1
	EBR	A	0.26	0.9	m0.0	A	0.30	0.7	m1.5
	WBL	A	0.06	11.4	7.6	A	0.19	15.0	12.8
	WBT	A	0.54	14.7	119.8	A	0.33	11.7	63.2
	WBR	A	0.18	3.6	13.4	A	0.14	2.6	8.7
	NBL	E	0.97	105.2	#75.5	F	1.04	128.9	#65.1
	NBT/R	B	0.61	48.0	77.8	B	0.69	47.4	80.0
	SBL	A	0.26	39.7	18.7	D	0.85	82.3	48.9
	SBT/R	A	0.59	45.7	70.1	C	0.73	48.5	81.7
Overall	B	0.65	22.9	-	B	0.68	23.8	-	
Cyrville Road at Joseph Cyr Street <i>Unsignalized</i>	EB	A	0.00	8.2	0.0	A	-	0.0	0.0
	WB	A	0.04	8.6	0.8	A	0.05	8.8	1.5
	NB	C	0.18	16.2	4.5	C	0.37	21.8	12.8
	SB	C	0.01	24.7	0.0	C	0.01	21.0	0.0
Overall	A	-	1.4	-	A	-	2.9	-	

Intersection	Lane	AM Peak Hour				PM Peak Hour			
		LOS	V/C	Delay(s)	Q (95 th)	LOS	V/C	Delay(s)	Q (95 th)
Lemieux Street at Joseph Cyr Street <i>Unsignalized</i>	EBL	A	0.09	9.6	2.3	A	0.12	9.2	3.0
	EBT	-	-	-	-	-	-	-	-
	WBL	-	-	-	-	-	-	-	-
	WBT/R	-	-	-	-	-	-	-	-
	SBL/R	B	0.15	13.1	3.8	B	0.22	13.5	6.0
	Overall	A	-	1.7	-	-	A	-	2.7
Lemieux Street at Labelle Street <i>Unsignalized</i>	EBL	C	0.09	16.5	2.3	C	0.29	16.4	9.0
	WBR	B	0.19	11.2	5.3	B	0.19	10.2	5.3
	NB	-	-	-	-	-	-	-	-
	SBL	-	-	-	-	-	-	-	-
	Overall	A	-	2.3	-	-	A	-	5.3

Notes: Saturation flow rate of 1800 veh/h/lane
 Queue is measured in metres
 Peak Hour Factor = 1.00

m = metered queue
 # = volume for the 95th %ile cycle exceeds capacity

During both peak hours, the study area intersections operate similar to the 2026 background condition, with the exception of the northbound right-turn movement at St Laurent Boulevard and Coventry Road/Ogilvie Road intersection may be subject to extended queues during the AM peak hour.

7.3 2026 Future Total Operations

Figure 18 illustrates the 2026 future total volumes and Table 19 summarizes the 2026 future total intersection operations. The level of service for signalized intersections is based on v/c calculations for individual lane movements and HCM 2000 v/c calculations for the overall intersection, and average delay for unsignalized intersections. The northbound shared through/right-turn lane at the intersection of St Laurent Boulevard at Coventry Road/Ogilvie Road is a de facto right lane, and it is coded as a right turn lane in Synchro. The synchro worksheets for the 2026 future total horizon are provided in Appendix I.

Figure 18: 2026 Future Total Volumes

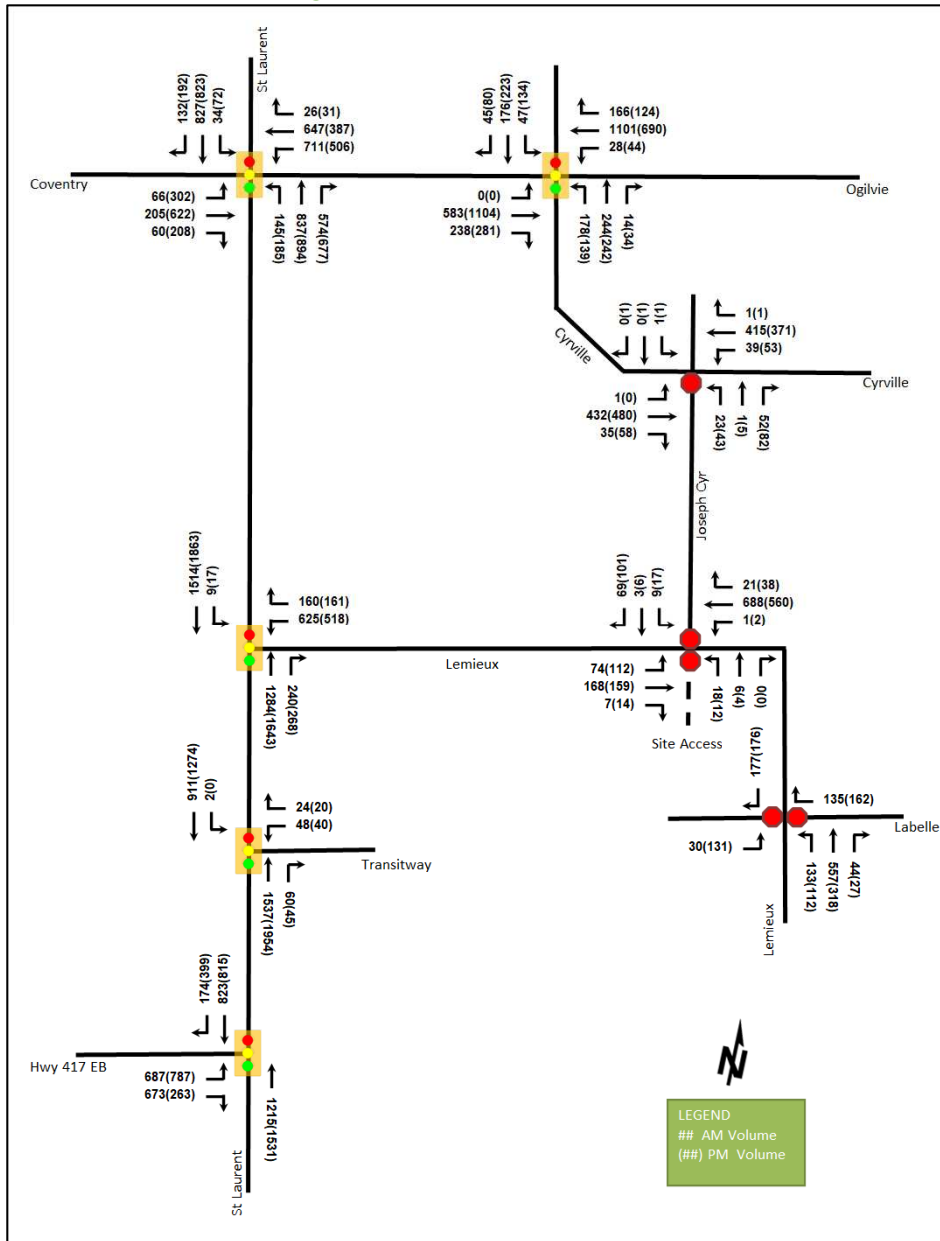

Table 19: 2026 Future Total Intersection Operations

Intersection	Lane	AM Peak Hour				PM Peak Hour			
		LOS	V/C	Delay(s)	Q (95 th)	LOS	V/C	Delay(s)	Q (95 th)
St Laurent Boulevard at Coventry Road/Ogilvie Road <i>Signalized</i>	EBL	A	0.16	48.2	14.5	B	0.68	57.7	50.2
	EBT	A	0.35	46.8	33.6	C	0.77	49.4	91.2
	EBR	A	0.15	0.8	0.0	A	0.42	7.3	17.7
	WBL	E	0.93	66.7	#139.0	F	1.04	101.6	#107.2
	WBT	B	0.70	39.2	99.2	A	0.49	35.3	59.1
	WBR	A	0.06	0.2	m0.0	A	0.06	0.2	m0.0
	NBL	D	0.84	101.6	#73.9	D	0.86	98.2	#81.8
	NBT	C	0.74	37.7	#157.7	D	0.81	39.7	#143.1
	NBR	B	0.70	15.4	60.9	E	0.93	34.5	#98.6
	SBL	A	0.33	66.1	19.0	B	0.64	79.5	#36.1
	SBT	B	0.65	46.2	89.2	B	0.70	45.0	80.4
	SBR	A	0.26	2.1	2.4	A	0.38	6.0	14.0
Overall	D	0.87	42.6	-	E	0.92	48.1	-	
St Laurent Boulevard at Lemieux Street <i>Signalized</i>	WBL	D	0.84	55.1	92.0	C	0.74	48.9	74.4
	WBR	A	0.38	26.6	38.1	A	0.48	35.4	45.4
	NBT	A	0.44	8.5	64.7	A	0.52	10.4	63.6
	NBR	A	0.24	1.9	9.6	A	0.26	2.1	8.2
	SBL	A	0.05	11.3	m1.4	A	0.13	6.4	m2.1
	SBT	A	0.51	15.1	m77.3	A	0.60	7.8	m73.8
	Overall	B	0.61	19.0	-	B	0.63	14.1	-
St Laurent Boulevard at Transitway Access <i>Signalized</i>	WBL/R	A	0.50	32.8	16.2	A	0.41	29.9	14.1
	NBT/R	A	0.46	3.7	30.6	A	0.56	9.5	119.8
	SBL	A	0.02	7.0	m0.3	-	-	-	-
	SBT	A	0.26	5.4	58.2	A	0.35	4.2	40.2
	Overall	A	0.53	5.1	-	B	0.61	7.8	-
St Laurent Boulevard at Hwy 417 EB Off-Ramp <i>Signalized</i>	EBL	A	0.60	35.6	92.4	D	0.83	46.8	102.5
	EBR	F	1.10	97.7	#244.7	A	0.51	18.9	45.0
	NBT	A	0.52	20.8	84.1	A	0.54	16.4	102.1
	SBT/R	A	0.43	18.2	33.7	A	0.47	9.8	90.7
	Overall	C	0.76	37.4	-	B	0.64	20.8	-
Cyrville Road at Ogilvie Road <i>Signalized</i>	EBT	A	0.27	7.1	33.2	A	0.51	5.8	m58.5
	EBR	A	0.25	0.9	0.0	A	0.28	0.7	m1.5
	WBL	A	0.06	11.1	7.8	A	0.18	13.3	12.6
	WBT	A	0.51	13.7	111.7	A	0.32	10.7	58.6
	WBR	A	0.18	3.2	12.5	A	0.14	2.4	8.3
	NBL	E	0.94	99.0	#69.4	F	1.05	136.0	#62.2
	NBT/R	B	0.63	49.3	76.8	B	0.68	48.1	75.6
	SBL	A	0.27	40.8	18.8	D	0.85	82.9	49.0
	SBT/R	A	0.56	45.2	64.7	C	0.76	51.9	82.7
	Overall	B	0.62	22.2	-	B	0.65	23.9	-
Cyrville Road at Joseph Cyr Street <i>Unsignalized</i>	EB	A	0.00	8.2	0.0	A	-	0.0	0.0
	WB	A	0.04	8.4	0.8	A	0.05	8.7	1.5
	NB	C	0.19	16.3	5.3	C	0.37	21.3	12.8
	SB	C	0.01	23.0	0.0	C	0.01	19.9	0.0
	Overall	A	-	1.6	-	A	-	3.0	-

Intersection	Lane	AM Peak Hour				PM Peak Hour			
		LOS	V/C	Delay(s)	Q (95 th)	LOS	V/C	Delay(s)	Q (95 th)
Lemieux Street at Joseph Cyr Street <i>Unsignalized</i>	EBL	A	0.09	9.6	2.3	A	0.12	9.2	3.0
	EBT/R	-	-	-	-	-	-	-	-
	WBL/T	A	0.00	7.6	0.0	A	0.00	7.6	0.0
	WBT/R	A	-	0.0	0.0	A	-	0.0	0.0
	NB	C	0.09	19.8	2.3	C	0.06	20.2	1.5
	SB	B	0.17	14.3	4.5	C	0.26	15.1	7.5
	Overall	A	-	2.2	-	A	-	3.1	-
Lemieux Street at Labelle Street <i>Unsignalized</i>	EBL	C	0.09	16.5	2.3	C	0.29	16.4	9.0
	WBR	B	0.19	11.2	5.3	B	0.19	10.2	5.3
	NB	-	-	-	-	-	-	-	-
	SBL	-	-	-	-	-	-	-	-
	Overall	A	-	2.3	-	A	-	5.3	-

Notes: Saturation flow rate of 1800 veh/h/lane
 Queue is measured in metres
 Peak Hour Factor = 1.00

m = metered queue
 # = volume for the 95th %ile cycle exceeds capacity

During both peak hours, the study area intersection operates similar to the 2026 future background horizon.

7.4 2031 Future Total Operations

Figure 19 illustrates the 2031 future total volumes and Table 20 summarizes the 2031 future total intersection operations. The level of service for signalized intersections is based on v/c calculations for individual lane movements and HCM 2000 v/c calculations for the overall intersection, and average delay for unsignalized intersections. The northbound shared through/right-turn lane at the intersection of St Laurent Boulevard at Coventry Road/Ogilvie Road is a de facto right lane, and it is coded as a right turn lane in Synchro. The synchro worksheets for the 2031 future total horizon are provided in Appendix J.

Figure 19: 2031 Future Total Volumes

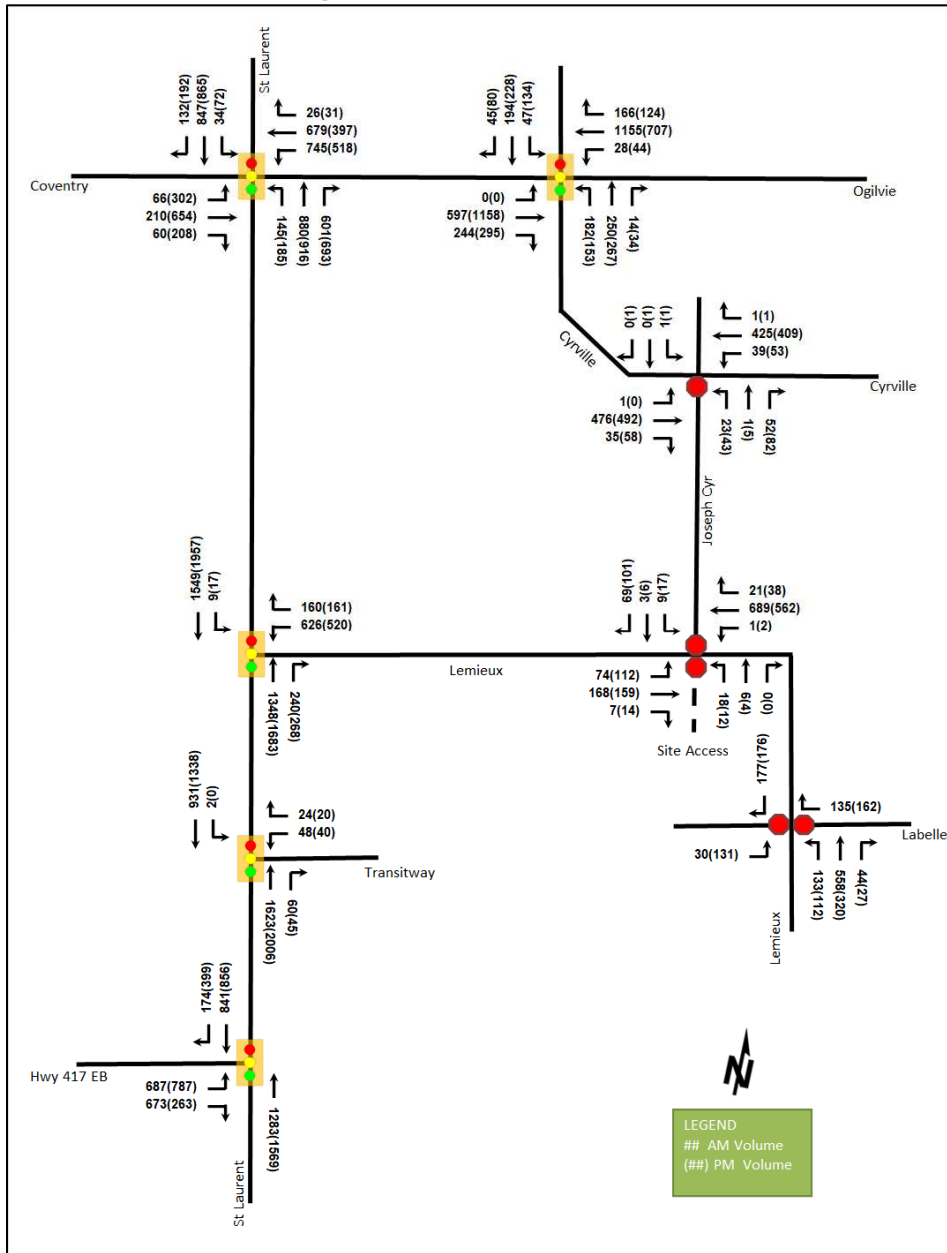

Table 20: 2031 Future Total Intersection Operations

Intersection	Lane	AM Peak Hour				PM Peak Hour			
		LOS	V/C	Delay(s)	Q (95 th)	LOS	V/C	Delay(s)	Q (95 th)
St Laurent Boulevard at Coventry Road/Ogilvie Road <i>Signalized</i>	EBL	A	0.16	49.2	14.8	B	0.68	57.7	50.2
	EBT	A	0.36	46.9	34.3	D	0.81	51.2	96.6
	EBR	A	0.15	0.8	0.0	A	0.42	7.3	17.7
	WBL	E	0.91	62.5	#147.9	F	1.08	110.6	#111.1
	WBT	B	0.69	36.6	103.3	A	0.50	34.5	56.0
	WBR	A	0.05	0.2	m0.0	A	0.06	0.2	m0.0
	NBL	D	0.84	102.4	#73.6	D	0.86	98.3	#81.9
	NBT	D	0.81	40.7	#168.2	D	0.83	40.2	#149.4
	NBR	C	0.74	17.7	#67.8	E	0.95	38.4	#104.3
	SBL	A	0.33	66.1	19.0	B	0.64	79.5	#36.1
	SBT	B	0.70	48.6	91.6	C	0.73	46.0	84.9
	SBR	A	0.27	2.2	2.4	A	0.38	6.0	14.0
Overall	D	0.90	42.8	-	D	0.96	50.0	-	
St Laurent Boulevard at Lemieux Street <i>Signalized</i>	WBL	D	0.84	55.0	92.3	C	0.74	49.0	74.7
	WBR	A	0.38	28.4	39.6	A	0.48	36.3	46.1
	NBT	A	0.46	9.4	74.2	A	0.53	10.9	76.5
	NBR	A	0.24	2.0	12.0	A	0.26	2.1	7.9
	SBL	A	0.05	11.4	m1.5	A	0.14	6.6	m2.1
	SBT	A	0.52	15.4	m80.5	B	0.63	8.3	m76.4
Overall	B	0.62	19.3	-	B	0.66	14.4	-	
St Laurent Boulevard at Transitway Access <i>Signalized</i>	WBL/R	A	0.50	33.6	16.5	A	0.41	29.9	14.1
	NBT/R	A	0.49	3.9	35.8	A	0.57	9.9	125.4
	SBL	A	0.02	7.0	m0.4	-	-	-	-
	SBT	A	0.26	5.5	59.4	A	0.37	4.3	44.9
Overall	A	0.55	5.3	-	B	0.63	8.1	-	
St Laurent Boulevard at Hwy 417 EB Off-Ramp <i>Signalized</i>	EBL	A	0.60	35.6	92.4	D	0.83	46.8	102.5
	EBR	F	1.11	100.0	#246.7	A	0.52	20.9	47.9
	NBT	A	0.55	21.4	90.5	A	0.56	16.6	105.5
	SBT/R	A	0.44	17.6	33.7	A	0.49	9.9	94.1
Overall	C	0.78	37.5	-	B	0.65	20.9	-	
Cyrville Road at Ogilvie Road <i>Signalized</i>	EBT	A	0.28	7.3	34.0	A	0.55	6.7	m67.4
	EBR	A	0.26	0.9	m0.0	A	0.30	0.7	m1.5
	WBL	A	0.06	11.5	7.9	A	0.21	15.5	13.8
	WBT	A	0.54	14.9	119.8	A	0.33	11.9	63.8
	WBR	A	0.19	3.6	13.4	A	0.14	2.6	8.8
	NBL	E	0.97	105.1	#77.1	F	1.03	126.4	#65.1
	NBT/R	B	0.61	47.8	79.0	B	0.69	47.2	80.0
	SBL	A	0.26	39.5	18.8	D	0.84	80.7	48.6
	SBT/R	A	0.58	45.3	70.3	C	0.73	47.8	81.1
Overall	B	0.66	23.0	-	B	0.69	23.7	-	
Cyrville Road at Joseph Cyr Street <i>Unsignalized</i>	EB	A	0.00	8.2	0.0	A	-	0.0	0.0
	WB	A	0.04	8.6	0.8	A	0.04	8.6	0.8
	NB	C	0.21	17.4	6.0	C	0.39	22.7	13.5
	SB	C	0.01	24.8	0.0	C	0.01	21.1	0.0
Overall	A	-	1.6	-	A	-	3.0	-	

Intersection	Lane	AM Peak Hour				PM Peak Hour			
		LOS	V/C	Delay(s)	Q (95 th)	LOS	V/C	Delay(s)	Q (95 th)
Lemieux Street at Joseph Cyr Street <i>Unsignalized</i>	EBL	A	0.09	9.6	2.3	A	0.12	9.2	3.0
	EBT/R	-	-	-	-	-	-	-	-
	WBL/T	A	0.00	7.6	0.0	A	0.00	7.6	0.0
	WBT/R	A	-	0.0	0.0	A	-	0.0	0.0
	NB	C	0.09	19.8	2.3	C	0.06	20.3	1.5
	SB	B	0.17	14.3	4.5	C	0.26	15.2	7.5
	Overall	A	-	2.2	-	A	-	3.2	-
Lemieux Street at Labelle Street <i>Unsignalized</i>	EBL	C	0.09	16.5	2.3	C	0.29	16.4	9.0
	WBR	B	0.19	11.2	5.3	B	0.19	10.2	5.3
	NB	-	-	-	-	-	-	-	-
	SBL	-	-	-	-	-	-	-	-
	Overall	A	-	2.3	-	A	-	5.2	-

Notes: Saturation flow rate of 1800 veh/h/lane
 Queue is measured in metres
 Peak Hour Factor = 1.00

m = metered queue
 # = volume for the 95th %ile cycle exceeds capacity

During both the AM and PM peak hours, the study area intersection operates similar to the 2031 future background horizon.

7.5 Modal Share Sensitivity and Demand Rationalization Conclusions

Capacity constraints have been noted at St Laurent Boulevard on the eastbound right-turn movement at Hwy 417 EB Off-Ramp intersection during the AM peak hour, on the westbound left-turn movement at St Laurent Boulevard at Coventry Road/Ogilvie Road intersection during PM peak hour, and on the northbound left-turn movement at Cyrville Road at Ogilvie Road intersection during the PM peak hour.

During the AM peak hour, a network reduction in volumes of approximately 61 vehicles making the eastbound right-turn movement at St Laurent Boulevard at Hwy 417 EB Off-Ramp intersection or further optimized signal timings may address the constraints and reduce the v/c of all movements to be 1.00 or below. During the PM peak hour, a network reduction in volumes of approximately 35 vehicles making the westbound left-turn movement or further signal optimization at St Laurent Boulevard and Coventry Road/Ogilvie Road intersection may address the constraints. A network reduction in volumes of approximately 25 vehicles making the northbound left-turn movement during PM peak hour may address the constraints at Cyrville Road at Ogilvie Road intersection.

The constraints noted above for the St Laurent Boulevard at Coventry Road/Ogilvie Road and St Laurent Boulevard at Hwy 417 EB Off-Ramp intersections will not be impacted by the site generated volumes and will need to be addressed by City operations. At the Cyrville Road at Ogilvie Road intersection, the proposed site is anticipated to generate less than a 2% increase on the existing volumes on the northbound left-turn movement. As the site-generated volumes are not anticipated to be a contributing factor to the existing network constraints, no further demand rationalization is required for this development.

8 Development Design

8.1 Design for Sustainable Modes

The proposed development includes two high-rise apartment buildings with a two-way access. The vehicle and bicycle parking are proposed as accessing the parking garage ramp with a 10% to 18% slope. The site plan proposes 299 residential parking and 60 visitor parking spaces, with 351 spaces provided below ground and eight spaces at ground level. A total of 660 bicycle parking spaces are proposed located below ground with 646 spaces provided

below ground and 14 spaces at ground level. Hard surface connections are provided from the building entrances to St. Laurent Boulevard and surround the site.

8.2 Circulation and Access

The proposed development will repurpose the existing full-movement access on the south leg of Lemieux Street at Joseph Cyr Street intersection. The two-way access onto Lemieux Street is 6.5 m wide. The loading area is provided for each building, and it provides garbage collection and move-in truck parking.

The delivery, move-in, garbage collection vehicles, and Para Transpo bus turning templates were reviewed to confirm movements will be permitted on site. Delivery and move-in vehicles, approximated by an MSU, will be able to navigate the site and access the loading zones provided. The garbage collection vehicle, approximated by an HSU, will require to collect at Tower A loading zone. Para Transpo bus will be able to enter the site through the Lemieux access and navigate the internal drive aisle. The turning templates are provided in Appendix K.

Further to the internal circulation, due to the turning movement requirements for an HSU vehicle on the inside radius of the Lemieux Street curvature, inbound movements for larger vehicles will be restricted to enter from Joseph Cyr Street only.

9 Parking

9.1 Parking Supply

The site plan proposes 299 residential parking and 60 visitor parking spaces with 351 spaces provided below ground and eight spaces at ground level. A total of 660 bicycle parking spaces are proposed located below ground with 646 spaces provided below ground and 14 spaces at ground level.

From the zoning by-law, the maximum vehicle parking provision for the site is 1,175 resident parking spaces, and the minimum visitor parking provision for the site is 60 visitor parking spaces. The minimum bicycle parking provision is 322 spaces. Therefore, the maximum residential parking, minimum visitor parking, and minimum bicycle parking requirements are satisfied.

10 Boundary Street Design

Table 21 summarizes the MMLOS analysis for the boundary streets of Lemieux Street and St. Laurent Boulevard. The boundary street analysis is based on the policy area of within 600 metres of a rapid transit station. The MMLOS worksheets have been provided in Appendix L.

Table 21: Boundary Street MMLOS Analysis

Segment	Horizon	Pedestrian LOS		Bicycle LOS		Transit LOS		Truck LOS	
		PLOS	Target	BLOS	Target	TLOS	Target	TrLOS	Target
Lemieux Street	Existing	F	A	F	B	-	-	B	D
	Future	A							
St Laurent Boulevard	Existing/ Future	F	A	F	C	D	D	A	D

The pedestrian LOS will not be met along the segment of St. Laurent Boulevard. To meet the theoretical pedestrian LOS targets, the boulevards would need to be at least 0.5 metres along boundary streets and the operating speed would need to be lower than 30 km/h. The pedestrian LOS is not met along the segment of Lemieux Street in the existing condition but will be met in the future condition once the sidewalk and boulevard are improved along the site frontage.

The bicycle LOS will not be met along the segment of Lemieux Street and St. Laurent Boulevard. To meet the theoretical bicycle LOS targets, operating speeds would need to be decreased to less than 40 km/h and travel lanes be decreased to be 2-3 lanes total. Physically separated facilities would also score a LOS of A.

11 Access Intersections Design

11.1 Location and Design of Access

The development will maintain an existing full-movements access onto Lemieux Street as the south leg of Lemieux Street at Joseph Cyr Street intersection.

The access connects to a drop-off loop and surface visitor parking spaces. The access is 6.5 metres wide. The throat length for the access is 19.0 metres for inbound movements and 21.5 metres for outbound movements, and it does not meet the suggested minimum 25 metres from Table 8.9.3 of the TAC Geometric Design Guidelines. It is noted that the total vehicle trips during peak hours would be 35 AM and 38 PM two-way vehicle trips. Therefore, the throat length is not anticipated to be an issue.

11.2 Intersection Control

Based upon the projected volumes, the site access will have stop-control on the minor approaches.

11.3 Access Intersection Design

11.3.1 Future Access Intersection Operations

The operations are noted in Section 7.4 and both 2026 and 2031 future total access intersections operate well with all movements and the overall intersection operating at LOS A.

11.3.2 Access Intersection MMLoS

Based upon the projected volumes, the site access will have stop-control on the minor approaches.

11.3.3 Recommended Design Elements

The access is proposed on the inside of the curve along Lemieux Street and the sight lines were reviewed to determine any additional daylight requirements for the access. Table 22 outlines the stopping sight distance and departure sight requirements for the proposed access, and Appendix M provides the sight line review.

Table 22: Stopping Sight Distance and Departure Sight Requirements

Design Speed (km/hr)	Stopping Sight Distance (m)	Departure Sight line -Left Turn (m)	Departure Sight line - Right Turn (m)
30	35	65	55
40	50	85	75
50	65	105	95
60	85	130	110
70	105	150	130

The intersection of St Laurent Boulevard and Lemieux Street is located within the departure sight distance requirements to the north/west of the site. The 85-metre approximate distance will meet the stopping sight distance requirements for 60 km/h and will need a clear sight line to the intersection from the access. The estimated height for any plantings and ramp wall is 0.2m of the proposed grade at the top of the underground ramp, increasing to 0.8m at the intersection.

To the south of the site, a sight distance of 92.7 metres is provided along Lemieux Street and the OR-174 off-ramp. This distance would meet the departure sight distance requirements for a vehicle speed up to 30 km/h traveling onto Lemieux Street, and the stopping distance requirements for a vehicle speed of 60 km/h.

The intersection of Labelle Street is located approximately 85 metres to the south of the access and will meet the stopping sight distance requirements for a vehicle speed of 50 km/h.

The stopping sight distances from the St Laurent Boulevard intersection and the Labelle Street intersections are considered sufficient, if kept clear, as vehicles are not anticipated to be traveling 50km/h as they are turning onto Lemieux Street. For vehicles travelling along Lemieux Street from the OR 174 off-ramp, a hidden intersection warning signage is recommended, and it is included in Appendix M.

12 Transportation Demand Management

12.1 Context for TDM

The subject site is within the St Laurent TOD area, the mode shares used within the TIA represent a shift from auto mode to transit mode. Overall, the modal shares are likely to be achieved and supporting TDM measures should be provided.

Total bedrooms within the development are 917 bedrooms across both buildings with 363 studio/one-bedroom units and 277 two-bedroom units.

12.2 Need and Opportunity

The subject site has been assumed to rely predominantly on transit due to the proximity to the St Laurent LRT Station. The convenience of the transit station should provide the opportunity to reach the forecast transit mode share.

12.3 TDM Program

The “suite of post occupancy TDM measures” has been summarized in the TDM checklists for the residential land uses. The checklist is provided in Appendix N. The key TDM measures recommended include:

- Display local area maps with walking and cycling routes, and transit route information and schedules at major entrances
- Provide a multimodal travel option information package to new residents
- Contract with providers to install on-site bikeshare (or other micromobility alternatives) and carshare spaces
- Inclusion of a 1-year Presto card for first time apartment rental, with a set time frame for this offer (e.g. 6-months) from the initial opening of the site
- Unbundle parking cost from rental costs

13 Neighbourhood Traffic Management

Site traffic is proposed to access the arterial network via Joseph Cyr Street (a local road) and Lemieux Street (a collector road). The TIA Guidelines propose a neighbourhood traffic management threshold of 120 vehicles per peak hour for local roads and 300 vehicles per peak hour for collector roads, equivalent to two cars and five cars per minute in both directions total, respectively.

The existing volumes on Joseph Cyr Street are 152 two-way vehicles in the AM peak hour and 249 two-way vehicles in the PM peak hour and are above the local road thresholds. Overall, the site is forecasted to generate 9 new AM and 10 new PM two-way vehicle trips along Joseph Cyr Street, resulting in volumes of 161 two-way vehicles in the AM and 259 two-way vehicles in the PM peak hour.

The existing volumes on Lemieux Street east of Joseph Cyr Street are 885 two-way vehicles in the AM peak hour and 772 two-way vehicles in the PM peak hour, both above the collector road thresholds. The site is forecasted to generate 1 new AM and 2 new PM two-way vehicle trips on Lemieux Street east of Joseph Cyr Street, resulting in volumes of 886 two-way vehicles in the AM and 774 two-way vehicles in the PM peak hour.

The existing volumes on Lemieux Street west of Joseph Cyr Street are 977 two-way vehicles in the AM peak hour and 911 two-way vehicles in the PM peak hour, both above the collector road thresholds. The site is forecasted to generate 25 new AM and 26 new PM two-way vehicle trips on Lemieux Street west of Joseph Cyr Street, resulting in volumes of 1,002 two-way vehicles in the AM and 937 two-way vehicles in the PM peak hour.

While over the prescribed theoretical local and collector road thresholds, this volume increase is low, and has negligible impact on Joseph Cyr Street or Lemieux Street.

14 Transit

14.1 Route Capacity

In Section 5.1 the trip generation by mode was estimated, including an estimate of the number of transit trips that will be generated by the proposed development. Table 23 summarizes the transit trip generation.

Table 23: Trip Generation by Transit Mode

Travel Mode	Mode Share	AM Peak Hour			PM Peak Hour		
		In	Out	Total	In	Out	Total
Transit	65% (55%)	57	127	184	87	63	150

The proposed development is anticipated to generate an additional 184 AM and 150 PM peak hour two-way transit trips. From the trip distribution found in section 5.3, these values can be further broken down. Table 24 summarizes forecasted site-generated transit ridership trips by direction and the equivalent bus loads.

Table 24: Forecasted Site-Generated Transit Ridership

Direction	AM Peak Hour		PM Peak Hour		Service Type	Approximate Equivalent Peak Hour/Direction Bus Loads
	In	Out	In	Out		
North	6	13	9	6	Bus	One quarter of a standard bus
South	17	38	26	19	LRT, Bus	Two-thirds of a standard bus
East	11	25	17	13	LRT, Bus	Half of a standard bus
West	23	51	35	25	LRT, Bus	A standard bus

14.2 Transit Priority

Examining the study area intersection delays, negligible impacts are noted on the transit movements at the study area intersections. No change in transit LOS is noted throughout the study area.

15 Network Intersection Design

15.1 Network Intersection Control

No change to the existing signalized control is recommended for the network intersections.

15.2 Network Intersection Design

15.2.1 2026 & 2031 Future Total Network Intersection Operations

The operations are noted in Section 7.4 and no mitigation of conditions is required for the subject site traffic.

15.2.2 Network Intersection MMLOS

Table 25 summarizes the MMLOS analysis for the network intersections. The existing and future conditions for both intersections will be the same and are considered in one row. The intersection analysis is based on the policy area of “within 600 metres of a rapid transit station”. The MMLOS worksheets have been provided in Appendix L.

Table 25: Study Area Intersection MMLOS Analysis

Intersection	Pedestrian LOS		Bicycle LOS		Transit LOS		Truck LOS		Auto LOS	
	PLOS	Target	BLOS	Target	TLOS	Target	TrLOS	Target	ALOS	Target
St Laurent Boulevard at Coventry Road/Ogilvie Road	F	A	F	A	F	D	B	D	E	E
St Laurent Boulevard at Lemieux Street	F	A	F	B	C	D	A	D	B	E
St Laurent Boulevard at Transitway Access	F	A	F	B	C	D	C	D	B	E
St Laurent Boulevard at Hwy 417 EB Off-Ramp	F	A	-	-	D	D	A	D	B	E
Cyrville Road at Ogilvie Road	F	A	F	A	-	-	B	D	B	E

The pedestrian LOS targets will not be met at the study area intersections. As typical for arterial roads, the crossing distance does not permit the targets to be met. To meet pedestrian LOS targets, the maximum crossing distance on all pedestrian crossings would need to be reduced to two lane-widths.

The bicycle LOS targets will not be met at the study area intersections. To meet bicycle LOS targets, the left-turn configurations would need to be two-stage or include turn boxes. It is noted that the St. Laurent TOD plan outlines dedicated cycling facilities along St Laurent Boulevard, and the bicycle LOS targets might be met once cycling facilities are provided.

The transit LOS will not be met at St Laurent Boulevard at Coventry Road/Ogilvie Road intersection and the delay would need to be reduced to below 30 seconds.

15.2.3 Recommended Design Elements

No study area intersection design elements are proposed as part of this study.

16 Summary of Improvements Indicated and Modifications Options

The following summarizes the analysis and results presented in this TIA report:

Proposed Site and Screening

- The development is proposed as two 30-storey residential buildings including 644 units
- The site plan proposes 299 residential parking and 60 visitor parking spaces, with 351 spaces provided below ground and eight spaces at ground level
- A total of 660 bicycle parking spaces are proposed located below ground
- The plan includes an existing full-movement access onto Lemieux Street
- Build-out is anticipated to be in a single phase by 2026
- The trip generation trigger, location trigger, and safety trigger were met for the TIA Screening

Existing Conditions

- St Laurent Boulevard, Ogilvie Road, Coventry Road, and Cyrville Road are arterial roads, and Labelle Street and Lemieux Street are major collector roads in the study area
- Sidewalks are provided along both sides of St Laurent Boulevard, Ogilvie Road, Coventry Road, Cyrville Road, Labelle Street east of Michael Street N, Joseph Cyr Street, and on the north side of Labelle Street west of Michael Street N and Lemieux Street
- Bike lanes are provided along Ogilvie Road, Coventry Road, Cyrville Road south of Ogilvie Road, and Joseph Cyr Street
- Ogilvie Road west of Cyrville Road and Cyrville Road south of Ogilvie Road are cross-town bikeways
- St Laurent Boulevard, Ogilvie Road, Coventry Road, and Cyrville Road are cycling spine routes, and Labelle Street and Lemieux Street are local cycling routes
- The high volumes roadways have produced a high number of collisions at the study area intersections, primarily at Lemieux Street at St. Laurent Boulevard intersection, which has 56% of the collisions (75 of 135) within the study area
- The collisions are predominantly rear end collisions due to the congestion along St Laurent Boulevard, and the angled, side swiped and turning movement predominantly are the result of northbound and southbound vehicles violating the signal control, failure to yield and improper lane changes
- The study area intersections generally operate well with the exception of the westbound left-turn movement at St Laurent Boulevard at Coventry Road/Ogilvie Road and the northbound left-turn movement at Cyrville Road at Ogilvie Road during the PM peak hour

Development Generated Travel Demand

- The proposed development is forecasted produce 277 two-way people trips during the AM peak hour and 272 two-way people trips during the PM peak hour
- Of the forecasted people trips, 35 two-way trips will be vehicle trips during the AM peak hour and 38 two-way trips will be vehicle trips during the PM peak hour based on a 14% AM and 15% PM modal share targets
- Of the forecasted trips, 10% are anticipated to travel north, 30% to the south, 20 % to the east, and 40 % to the west

Background Conditions

- The background developments were explicitly included in the background conditions, along with growth rates rounded to the nearest 0.25% and applied to mainline volumes and major turning movements along Ogilvie Road, St Laurent Boulevard, and Cyrville Road peak-directions
- The study area intersections in 2026 future background horizon will operate similar to the existing conditions
- The eastbound right-turn movement at St Laurent Boulevard and Hwy 417 EB Off-Ramp intersection will be over theoretical capacity and may be subject to high delays and extended queues due to other background developments

Development Design

- The vehicle and bicycle parking are proposed as accessing the parking garage ramp with a 10%-18% slope
- The site plan proposes 299 residential parking and 60 visitor parking spaces with 351 spaces provided below ground and eight spaces at ground level

- Hard surface connections are provided from the building entrances to St. Laurent Boulevard and surround the site
- Delivery and move-in vehicles will be able to navigate the site and access the loading zones provided
- The garbage collection vehicle will require to collect at Tower A loading zone
- Para Transpo bus will be able to navigate the site
- Inbound movements for larger vehicles will be restricted to enter from Joseph Cyr Street only

Parking

- The site plan proposes 299 residential parking and 60 visitor parking spaces with 351 spaces provided below ground and eight spaces at ground level
- A total of 660 bicycle parking spaces are proposed located below ground with 646 spaces provided below ground and 14 spaces at ground level
- The maximum residential parking, minimum visitor parking, and minimum bicycle parking requirements are satisfied

Boundary Street Design

- The pedestrian LOS will not be met along the segment of St. Laurent Boulevard, and need the boulevards to be at least 0.5 metres along both segments and operating to be lower than 30 km/h
- The pedestrian LOS is not met along the segment of Lemieux Street in the existing condition but will be met in the future condition
- The bicycle LOS will not be met along the segment of Lemieux Street and St. Laurent Boulevard, and requires operating speeds to be decreased to less than 40 km/h and travel lanes be decreased to be 2-3 lanes total

Access Intersections Design

- The development will maintain an existing full-movements access onto Lemieux Street as the south leg of Lemieux Street at Joseph Cyr Street intersection
- The access is 6.5 m wide, and connects to a drop-off loop and surface visitor parking spaces
- The throat length for the access is 19.0 metres for inbound movements and 21.5 metres for outbound movements, which does not meet the suggested minimum 25 metres, and it is not anticipated to be an issue due to low site-generated volumes
- The 85-metre approximate distance between the access and St Laurent Boulevard will meet the stopping sight distance requirements for 60 km/h and will need a clear sight line to the intersection from the access
- A sight distance of 92.7 metres is provided along Lemieux Street and the OR-174 off-ramp to the south of the site, and would meet the departure sight distance requirements for a vehicle speed up to 30 km/h traveling onto Lemieux Street, and the stopping distance requirements for a vehicle speed of 60 km/h
- A hidden intersection warning signage is recommended for vehicles travelling along Lemieux Street from the OR 174 off-ramp

TDM

- Supportive TDM measures to be included within the proposed development should include:
 - Display local area maps with walking and cycling routes, and transit route information and schedules at major entrances
 - Provide a multimodal travel option information package to new residents

- Contract with providers to install on-site bikeshare (or other micromobility alternatives) and carshare spaces
- Inclusion of a 1-year Presto card for first time apartment rental, with a set time frame for this offer (e.g. 6-months) from the initial opening of the site
- Unbundle parking cost from rental costs

Neighbourhood Traffic Management

- The existing volumes on Joseph Cyr Street, Lemieux Street west of Joseph Cyr Street, and Lemieux Street east of Joseph Cyr Street are above the thresholds
- The site is forecasted to generate 9 new AM and 10 new PM two-way vehicle trips along Joseph Cyr Street, generate 1 new AM and 2 new PM two-way vehicle trips on Uplands Drive east of North Bowesville Road, and generate 25 new AM and 26 new PM two-way vehicle trips on Lemieux Street west of Joseph Cyr Street
- This increased volume is low, and it is not considered a significant impact on Joseph Cyr Street or Lemieux Street requiring of traffic management

Transit

- The forecasted transit trips will include 184 two-way trips during the AM peak and 150 two-way trips during the PM peak
- Peak hour increases in transit ridership resulting from the site equate to a quarter of bus load northerly of the site, two-thirds of a standard bus load southerly of the site, half of a standard bus load easterly of the site and a standard bus load westerly of the site
- Negligible impacts are noted on the transit movements at the study area intersections, and no change in transit LOS is noted throughout the study area

Network Intersection Design

- Generally, the network intersections will operate similar to background horizons
- The pedestrian LOS targets will not be met at the existing or future intersections within the study area, and the maximum crossing distance on all pedestrian crossings are required to be reduced to two lane-widths
- The bicycle LOS targets will not be met at the existing or future intersections within the study area, and the left-turn configurations are required to be two-stage or include turn boxes
- The bicycle LOS will need to be reviewed by the City once the design and implementation of cycling facilities along St Laurent Boulevard are initiated
- The transit LOS will not be met at St Laurent Boulevard at Coventry Road/Ogilvie Road intersection and the delay is required to be below 30 seconds

17 Conclusion

It is recommended that, from a transportation perspective, the proposed development applications proceed.

Prepared By:



Yu-Chu Chen, EIT
Transportation Engineering-Intern

Reviewed By:



Andrew Harte, P.Eng.
Senior Transportation Engineer

Appendix A

TIA Screening Form and PM Certification Form

City of Ottawa 2017 TIA Guidelines
Step 1 - Screening Form

Date: 19-May-22
Project Number: 2022-026
Project Reference: 1209 St. Laurent Boulevard

1.1 Description of Proposed Development	
Municipal Address	1209 St. Laurent Boulevard and 1200 Lemieux Street
Description of Location	East-south corner of St. Laurent boulevard at Lemieux Street intersection
Land Use Classification	Transit Oriented Development Zone (TD3)
Development Size	Approximately 640 residential units
Accesses	An existing full-movement access onto Lemieux Street
Phase of Development	Single Phase
Buildout Year	2026
TIA Requirement	Full TIA Required

1.2 Trip Generation Trigger	
Land Use Type	Townhomes or apartments
Development Size	640 Units
Trip Generation Trigger	Yes

1.3 Location Triggers	
Does the development propose a new driveway to a boundary street that is designated as part of the City's Transit Priority, Rapid Transit or Spine Bicycle Networks?	No
Is the development in a Design Priority Area (DPA) or Transit-oriented Development (TOD) zone?	Yes St. Laurent TOD
Location Trigger	Yes

1.4. Safety Triggers	
Are posted speed limits on a boundary street 80 km/hr or greater?	No
Are there any horizontal/vertical curvatures on a boundary street limits sight lines at a proposed driveway?	Yes
Is the proposed driveway within the area of influence of an adjacent traffic signal or roundabout (i.e. within 300 m of intersection in rural conditions, or within 150 m of intersection in urban/ suburban conditions)?	Yes
Is the proposed driveway within auxiliary lanes of an intersection?	No
Does the proposed driveway make use of an existing median break that serves an existing site?	No
Is there is a documented history of traffic operations or safety concerns on the boundary streets within 500 m of the development?	Yes
Does the development include a drive-thru facility?	No
Safety Trigger	Yes



TIA Plan Reports

On 14 June 2017, the Council of the City of Ottawa adopted new Transportation Impact Assessment (TIA) Guidelines. In adopting the guidelines, Council established a requirement for those preparing and delivering transportation impact assessments and reports to sign a letter of certification.

Individuals submitting TIA reports will be responsible for all aspects of development-related transportation assessment and reporting, and undertaking such work, in accordance and compliance with the City of Ottawa's Official Plan, the Transportation Master Plan and the Transportation Impact Assessment (2017) Guidelines.

By submitting the attached TIA report (and any associated documents) and signing this document, the individual acknowledges that s/he meets the four criteria listed below.

CERTIFICATION

1. I have reviewed and have a sound understanding of the objectives, needs and requirements of the City of Ottawa's Official Plan, Transportation Master Plan and the Transportation Impact Assessment (2017) Guidelines;
2. I have a sound knowledge of industry standard practice with respect to the preparation of transportation impact assessment reports, including multi modal level of service review;
3. I have substantial experience (more than 5 years) in undertaking and delivering transportation impact studies (analysis, reporting and geometric design) with strong background knowledge in transportation planning, engineering or traffic operations; and
4. I am either a licensed¹ or registered² professional in good standing, whose field of expertise [check appropriate field(s)] is either transportation engineering or transportation planning .

1,2 License of registration body that oversees the profession is required to have a code of conduct and ethics guidelines that will ensure appropriate conduct and representation for transportation planning and/or transportation engineering works.

City Of Ottawa
Infrastructure Services and Community
Sustainability
Planning and Growth Management
110 Laurier Avenue West, 4th fl.
Ottawa, ON K1P 1J1
Tel. : 613-580-2424
Fax: 613-560-6006

Ville d'Ottawa
Services d'infrastructure et Viabilité des
collectivités
Urbanisme et Gestion de la croissance
110, avenue Laurier Ouest
Ottawa (Ontario) K1P 1J1
Tél. : 613-580-2424
Télécopieur: 613-560-6006

Dated at Ottawa this 20 day of September, 2018.
(City)

Name: Andrew Harte
(Please Print)

Professional Title: Professional Engineer

Signature of Individual certifier that s/he meets the above four criteria

Office Contact Information (Please Print)
Address: 6 Plaza Court
City / Postal Code: Ottawa / K2H 7W1
Telephone / Extension: (613) 697-3797
E-Mail Address: Andrew.Harte@CGHTransportation.com



Appendix B

Turning Movement Counts



Transportation Services - Traffic Services

Turning Movement Count - Full Study Peak Hour Diagram

ST. LAURENT BLVD @ COVENTRY RD/OGILVIE RD

Survey Date: Thursday, June 01, 2017
Start Time: 07:00

WO No: 37069
Device: Miovision

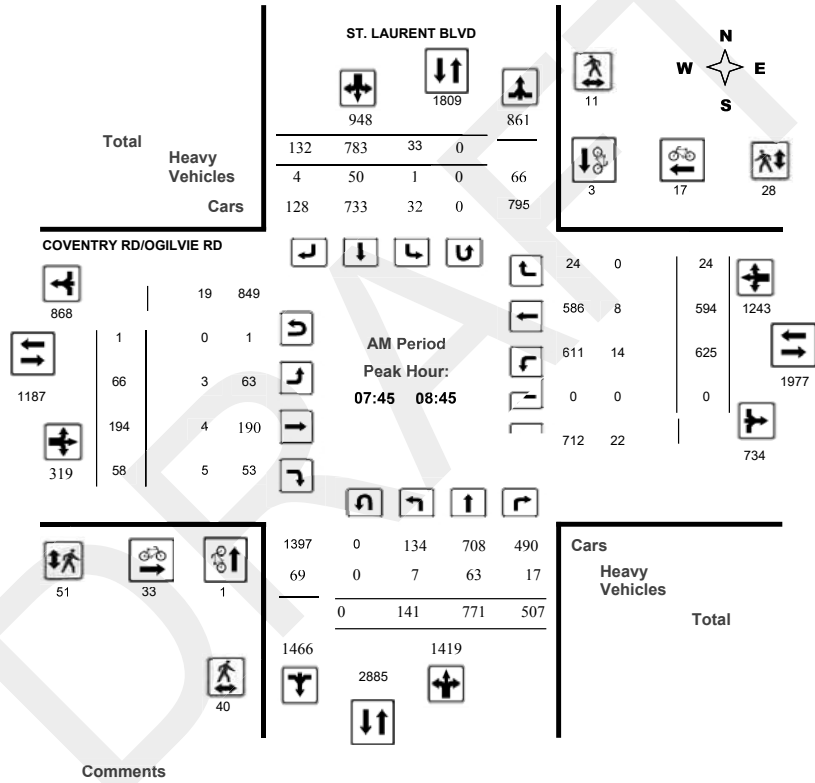

Transportation Services - Traffic Services

Turning Movement Count - Full Study Peak Hour Diagram

ST. LAURENT BLVD @ COVENTRY RD/OGILVIE RD

Survey Date: Thursday, June 01, 2017
Start Time: 07:00

WO No: 37069
Device: Miovision

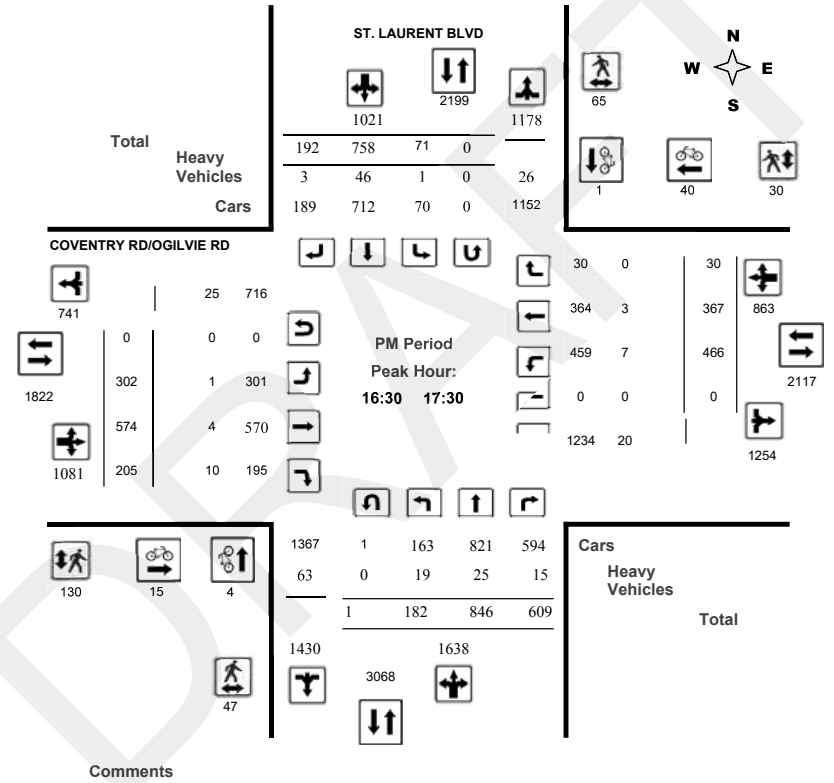



Transportation Services - Traffic Services

Turning Movement Count - Study Results

LEMIEUX ST @ ST. LAURENT BLVD

Survey Date: Wednesday, March 21, 2018

WO No: 37620

Start Time: 07:00

Device: Miovision

Full Study Diagram

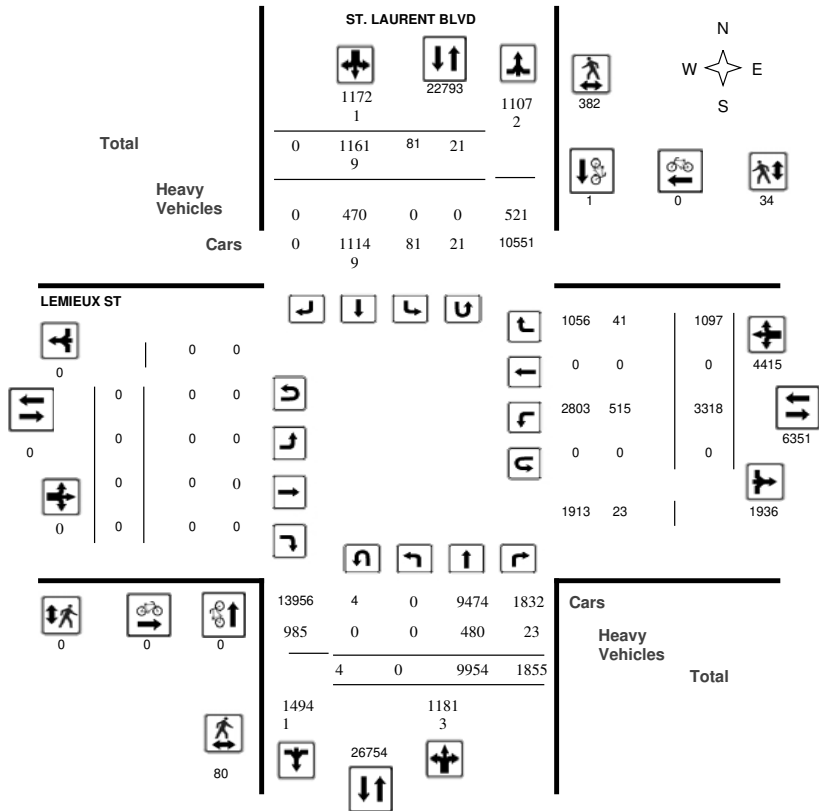

Transportation Services - Traffic Services

Turning Movement Count - Study Results

LEMIEUX ST @ ST. LAURENT BLVD

Survey Date: Wednesday, March 21, 2018

WO No: 37620

Start Time: 07:00

Device: Miovision

Full Study Peak Hour Diagram

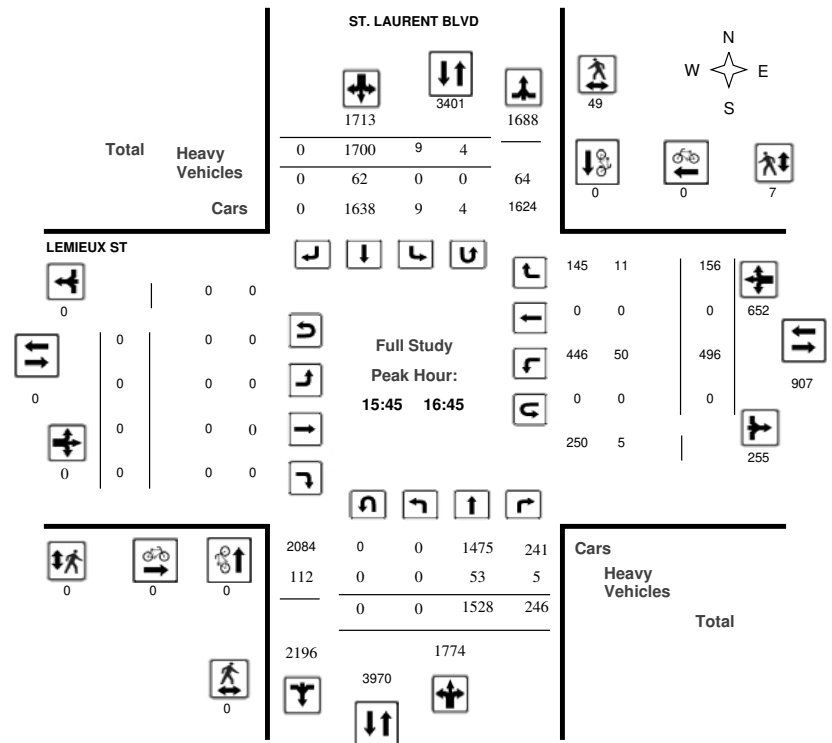



Transportation Services - Traffic Services

Turning Movement Count - Peak Hour Diagram

LEMIEUX ST @ ST. LAURENT BLVD

Survey Date: Wednesday, March 21, 2018
Start Time: 07:00

WO No: 37620
Device: Miovision

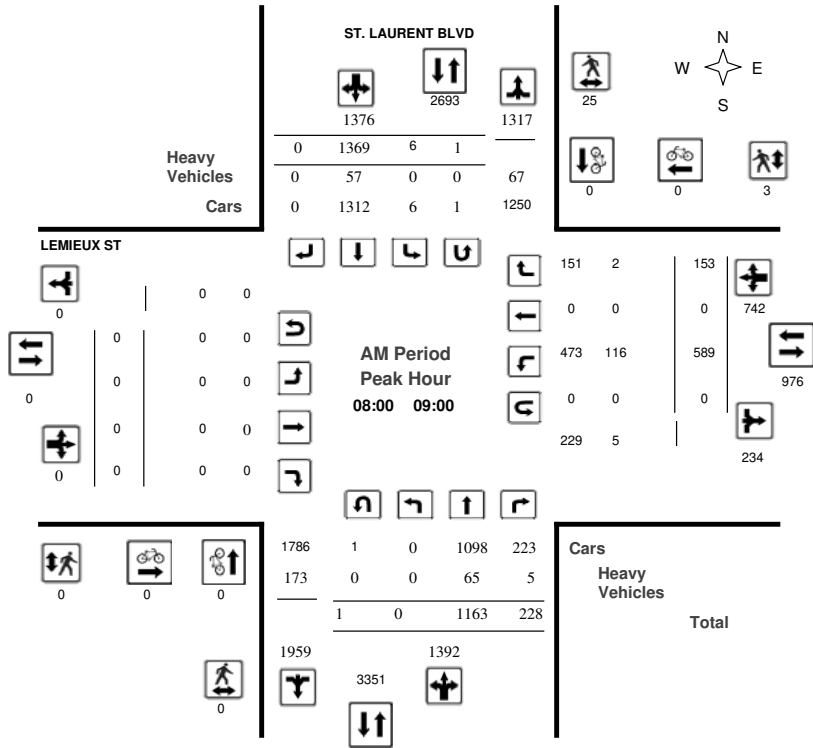

Comments



Transportation Services - Traffic Services

Turning Movement Count - Peak Hour Diagram

LEMIEUX ST @ ST. LAURENT BLVD

Survey Date: Wednesday, March 21, 2018
Start Time: 07:00

WO No: 37620
Device: Miovision

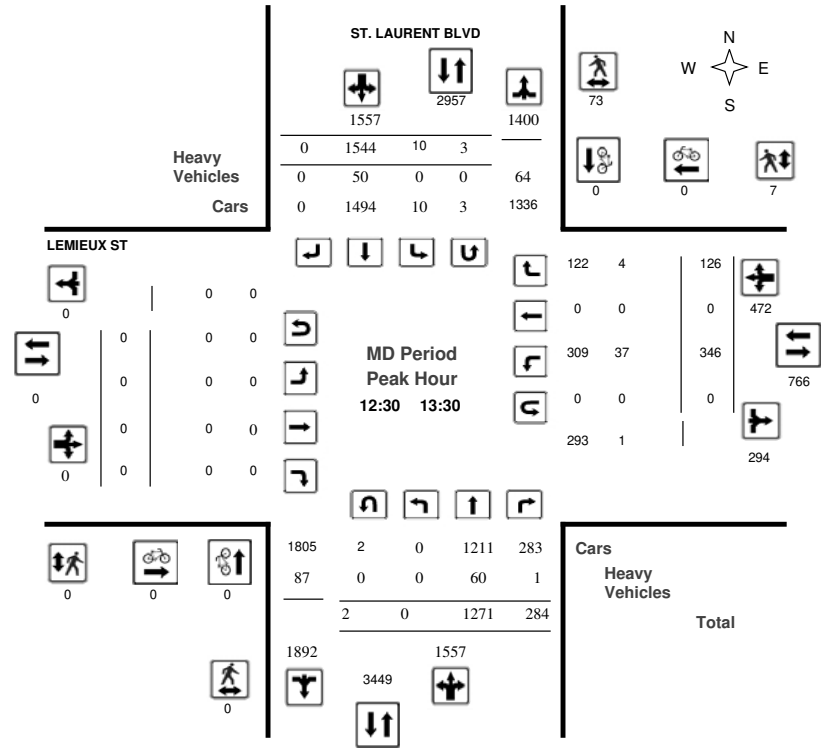

Comments



Transportation Services - Traffic Services

Turning Movement Count - Study Results

LEMIEUX ST @ ST. LAURENT BLVD

Survey Date: Wednesday, March 21, 2018

WO No: 37620

Start Time: 07:00

Device: Miovision

Full Study 15 Minute Increments

		ST. LAURENT BLVD								LEMIEUX ST										
		Northbound				Southbound				Eastbound				Westbound						
Time Period		LT	ST	RT	N TOT	LT	ST	RT	S TOT	STR TOT	LT	ST	RT	E TOT	LT	ST	RT	W TOT	STR TOT	Grand Total
07:00	07:15	0	201	39	240	1	249	0	250	33	0	0	0	0	94	0	25	119	33	609
07:15	07:30	0	251	51	302	4	280	0	284	37	0	0	0	119	0	23	142	37	728	
07:30	07:45	0	277	46	323	0	352	0	352	35	0	0	0	138	0	30	168	35	843	
07:45	08:00	0	288	51	339	2	353	0	355	41	0	0	0	138	0	27	165	41	859	
08:00	08:15	0	286	56	342	1	327	0	328	37	0	0	0	167	0	34	201	37	871	
08:15	08:30	0	291	52	343	2	317	0	320	27	0	0	0	171	0	33	204	27	867	
08:30	08:45	0	297	44	342	2	355	0	357	29	0	0	0	134	0	45	179	29	878	
08:45	09:00	0	289	76	365	1	370	0	371	34	0	0	0	117	0	41	158	34	894	
09:00	09:15	0	252	66	318	3	288	0	291	39	0	0	0	75	0	38	113	39	722	
09:15	09:30	0	257	54	311	1	251	0	252	37	0	0	0	71	0	29	100	37	663	
09:30	09:45	0	278	46	324	2	250	0	252	39	0	0	0	65	0	32	97	39	673	
09:45	10:00	0	282	55	337	0	295	0	296	37	0	0	0	76	0	31	107	37	740	
11:30	11:45	0	295	55	350	3	349	0	352	30	0	0	0	72	0	23	95	30	797	
11:45	12:00	0	255	65	320	4	349	0	353	34	0	0	0	83	0	36	119	34	792	
12:00	12:15	0	324	65	389	4	360	0	364	25	0	0	0	57	0	35	92	25	845	
12:15	12:30	0	286	67	353	3	385	0	388	29	0	0	0	87	0	37	124	29	865	
12:30	12:45	0	342	73	417	4	419	0	424	20	0	0	0	92	0	37	129	20	970	
12:45	13:00	0	325	82	407	3	396	0	400	22	0	0	0	73	0	25	98	22	905	
13:00	13:15	0	308	68	376	1	360	0	362	24	0	0	0	81	0	27	108	24	846	
13:15	13:30	0	296	61	357	2	369	0	371	45	0	0	0	100	0	37	137	45	865	
15:00	15:15	0	348	41	389	1	475	0	476	39	0	0	0	110	0	34	144	39	1009	
15:15	15:30	0	312	47	359	4	381	0	387	29	0	0	0	100	0	31	131	29	877	
15:30	15:45	0	321	37	358	0	443	0	446	24	0	0	0	113	0	58	171	24	975	
15:45	16:00	0	402	47	449	1	403	0	404	35	0	0	0	103	0	31	134	35	987	
16:00	16:15	0	387	61	448	1	457	0	458	32	0	0	0	147	0	40	187	32	1093	
16:15	16:30	0	353	63	416	3	395	0	399	28	0	0	0	140	0	45	185	28	1000	
16:30	16:45	0	386	75	461	4	445	0	452	25	0	0	0	106	0	40	146	25	1059	
16:45	17:00	0	386	69	455	3	384	0	390	22	0	0	0	88	0	45	133	22	978	
17:00	17:15	0	394	60	454	3	421	0	425	22	0	0	0	105	0	35	140	22	1019	
17:15	17:30	0	379	57	437	3	409	0	413	24	0	0	0	120	0	37	157	24	1007	
17:30	17:45	0	308	66	374	6	399	0	405	20	0	0	0	82	0	25	107	20	886	
17:45	18:00	0	298	60	358	9	333	0	344	19	0	0	0	94	0	31	125	19	827	
Total:		0	9954	1855	1181	81	11619	0	11721	973	0	0	0	3318	0	1097	4415	973	27,949	

Note: U-Turns are included in Totals.



Transportation Services - Traffic Services

Turning Movement Count - Study Results

LEMIEUX ST @ ST. LAURENT BLVD

Survey Date: Wednesday, March 21, 2018

WO No: 37620

Start Time: 07:00

Device: Miovision

Full Study Cyclist Volume

		ST. LAURENT BLVD			LEMIEUX ST				
		Northbound	Southbound	Street Total	Eastbound	Westbound	Street Total	Grand Total	
07:00	07:15	0	0	0	0	0	0	0	
07:15	07:30	0	0	0	0	0	0	0	
07:30	07:45	0	0	0	0	0	0	0	
07:45	08:00	0	0	0	0	0	0	0	
08:00	08:15	0	0	0	0	0	0	0	
08:15	08:30	0	0	0	0	0	0	0	
08:30	08:45	0	0	0	0	0	0	0	
08:45	09:00	0	33	0	0	0	0	33	
09:00	09:15	0	0	0	0	0	0	0	
09:15	09:30	0	0	0	0	0	0	0	
09:30	09:45	0	1	1	0	0	0	2	
09:45	10:00	0	0	0	0	0	0	0	
11:30	11:45	0	0	0	0	0	0	0	
11:45	12:00	0	0	0	0	0	0	0	
12:00	12:15	0	0	0	0	0	0	0	
12:15	12:30	0	36	0	0	0	0	36	
12:30	12:45	0	0	0	0	0	0	0	
12:45	13:00	0	0	0	0	0	0	0	
13:00	13:15	0	0	0	0	0	0	0	
13:15	13:30	0	0	0	0	0	0	0	
15:00	15:15	0	0	0	0	0	0	0	
15:15	15:30	0	0	0	0	0	0	0	
15:30	15:45	0	0	0	0	0	0	0	
15:45	16:00	0	0	0	0	0	0	0	
16:00	16:15	0	0	0	0	0	0	0	
16:15	16:30	0	0	0	0	0	0	0	
16:30	16:45	0	0	0	0	0	0	0	
16:45	17:00	0	0	0	0	0	0	0	
17:00	17:15	0	0	0	0	0	0	0	
17:15	17:30	0	0	0	0	0	0	0	
17:30	17:45	0	0	0	0	0	0	0	
17:45	18:00	0	0	0	0	0	0	0	
Total		0	1	1	0	0	0	1	



Transportation Services - Traffic Services

Turning Movement Count - Study Results

LEMIEUX ST @ ST. LAURENT BLVD

Survey Date: Wednesday, March 21, 2018

WO No: 37620

Start Time: 07:00

Device: Miovision

Full Study Pedestrian Volume

ST. LAURENT BLVD

LEMIEUX ST

Table with columns: Time Period, NB Approach, SB Approach, Total, EB Approach, WB Approach, Grand Total. Rows show pedestrian counts for various time intervals from 07:00 to 18:00.



Transportation Services - Traffic Services

Turning Movement Count - Study Results

LEMIEUX ST @ ST. LAURENT BLVD

Survey Date: Wednesday, March 21, 2018

WO No: 37620

Start Time: 07:00

Device: Miovision

Full Study Heavy Vehicles

ST. LAURENT BLVD

LEMIEUX ST

Table with columns: Time Period, Northbound (LT, ST, RT, N TOT), Southbound (LT, ST, RT, S TOT), Eastbound (LT, ST, RT, E TOT), Westbound (LT, ST, RT, W TOT), STR TOT, Grand Total. Rows show heavy vehicle counts for various time intervals from 07:00 to 18:00.



Transportation Services - Traffic Services

Turning Movement Count - Study Results

LEMIEUX ST @ ST. LAURENT BLVD

Survey Date: Wednesday, March 21, 2018

WO No: 37620

Start Time: 07:00

Device: Miovision

Full Study 15 Minute U-Turn Total

ST. LAURENT BLVD LEMIEUX ST

Time Period		Northbound U-Turn Total	Southbound U-Turn Total	Eastbound U-Turn Total	Westbound U-Turn Total	Total
07:00	07:15	0	0	0	0	0
07:15	07:30	0	0	0	0	0
07:30	07:45	0	0	0	0	0
07:45	08:00	0	0	0	0	0
08:00	08:15	0	0	0	0	0
08:15	08:30	0	1	0	0	1
08:30	08:45	1	0	0	0	1
08:45	09:00	0	0	0	0	0
09:00	09:15	0	0	0	0	0
09:15	09:30	0	0	0	0	0
09:30	09:45	0	0	0	0	0
09:45	10:00	0	1	0	0	1
11:30	11:45	0	0	0	0	0
11:45	12:00	0	0	0	0	0
12:00	12:15	0	0	0	0	0
12:15	12:30	0	0	0	0	0
12:30	12:45	2	1	0	0	3
12:45	13:00	0	1	0	0	1
13:00	13:15	0	1	0	0	1
13:15	13:30	0	0	0	0	0
15:00	15:15	0	0	0	0	0
15:15	15:30	0	2	0	0	2
15:30	15:45	0	3	0	0	3
15:45	16:00	0	0	0	0	0
16:00	16:15	0	0	0	0	0
16:15	16:30	0	1	0	0	1
16:30	16:45	0	3	0	0	3
16:45	17:00	0	3	0	0	3
17:00	17:15	0	1	0	0	1
17:15	17:30	1	1	0	0	2
17:30	17:45	0	0	0	0	0
17:45	18:00	0	2	0	0	2
Total		4	21	0	0	25



Transportation Services - Traffic Services

Turning Movement Count - Study Results

ST. LAURENT BLVD @ TRANSITWAY

Survey Date: Wednesday, January 30, 2019

WO No: 38337

Start Time: 07:00

Device: Miovision

Full Study Diagram

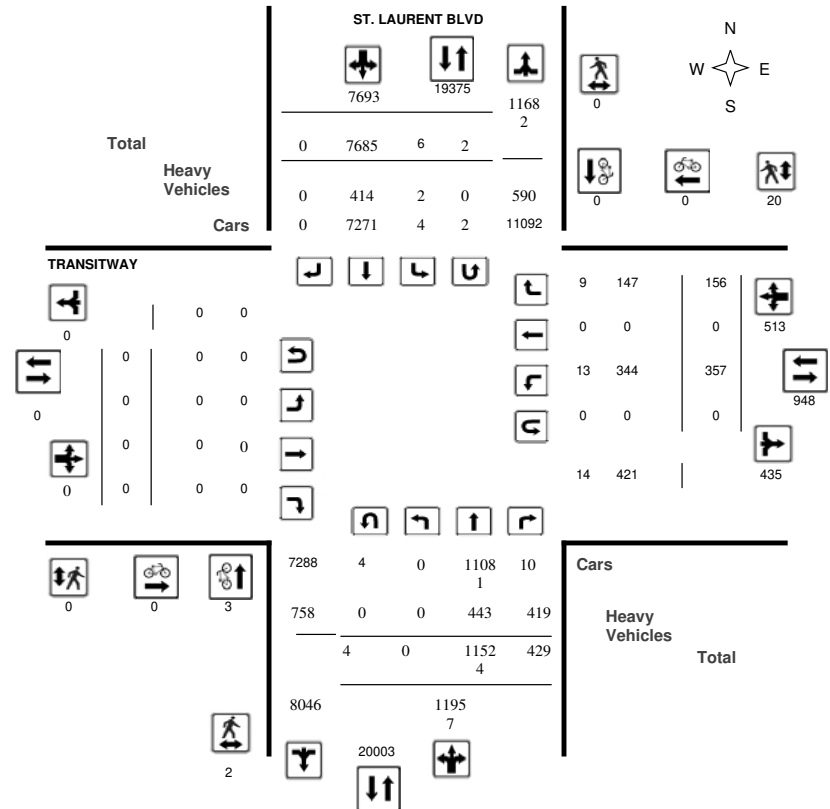



Transportation Services - Traffic Services

Turning Movement Count - Study Results

ST. LAURENT BLVD @ TRANSITWAY

Survey Date: Wednesday, January 30, 2019

WO No: 38337

Start Time: 07:00

Device: Miovision

Full Study Peak Hour Diagram

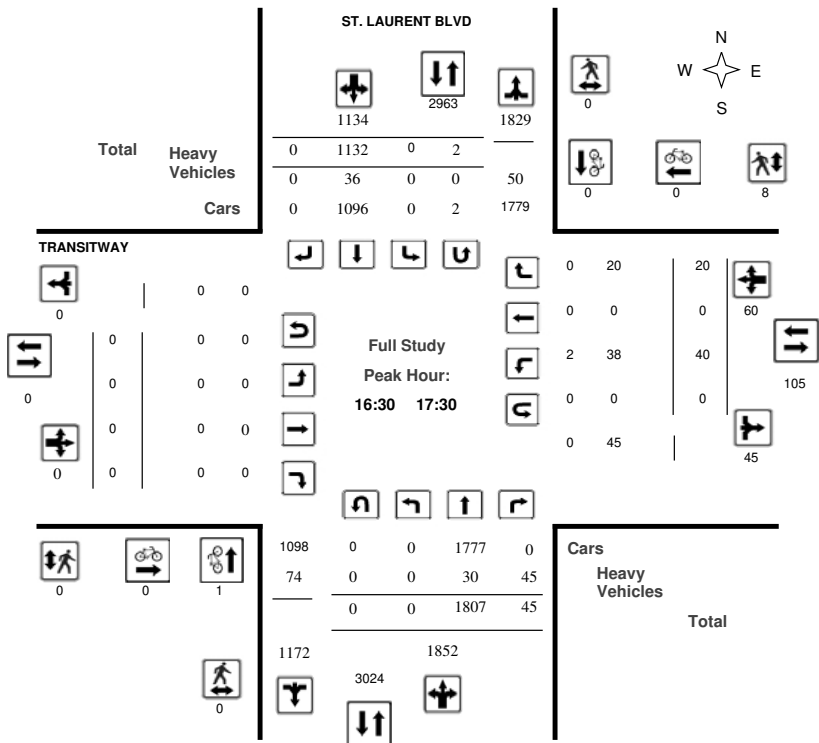

Transportation Services - Traffic Services

Turning Movement Count - Peak Hour Diagram

ST. LAURENT BLVD @ TRANSITWAY

Survey Date: Wednesday, January 30, 2019

WO No: 38337

Start Time: 07:00

Device: Miovision

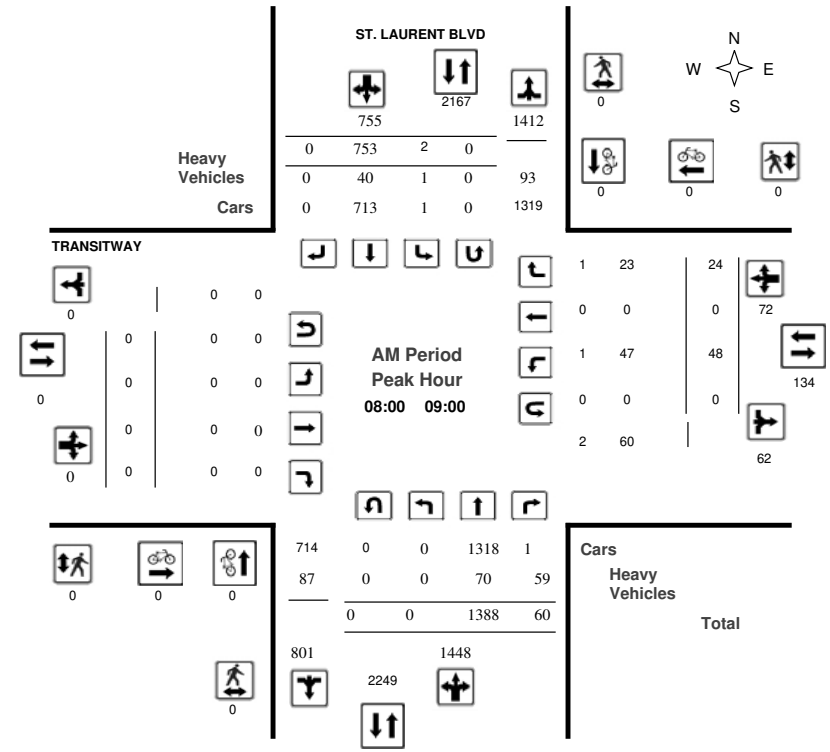

Comments



Transportation Services - Traffic Services

Turning Movement Count - Peak Hour Diagram

ST. LAURENT BLVD @ TRANSITWAY

Survey Date: Wednesday, January 30, 2019
Start Time: 07:00

WO No: 38337
Device: Miovision

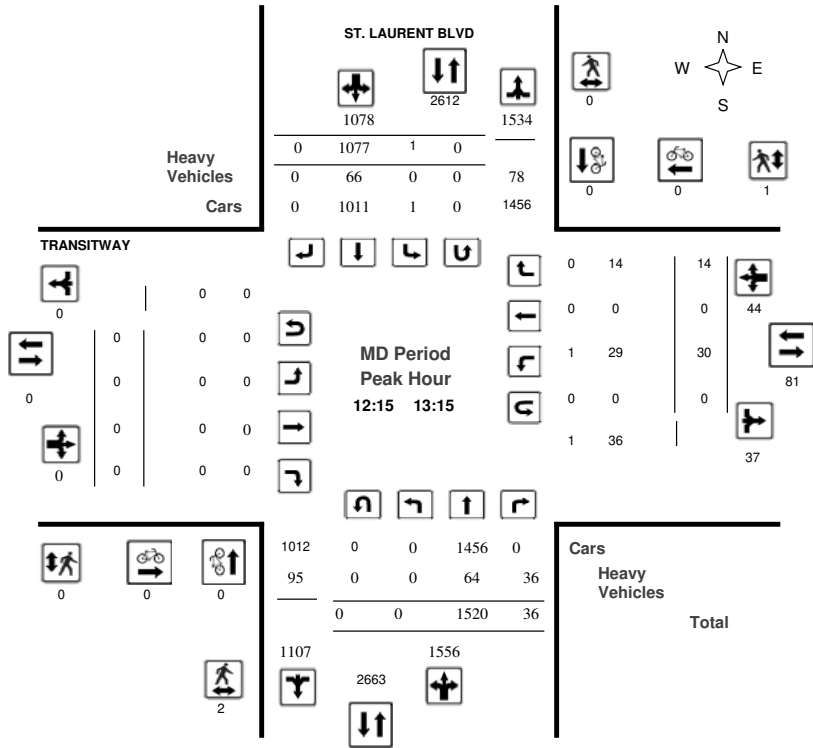

Transportation Services - Traffic Services

Turning Movement Count - Peak Hour Diagram

ST. LAURENT BLVD @ TRANSITWAY

Survey Date: Wednesday, January 30, 2019
Start Time: 07:00

WO No: 38337
Device: Miovision

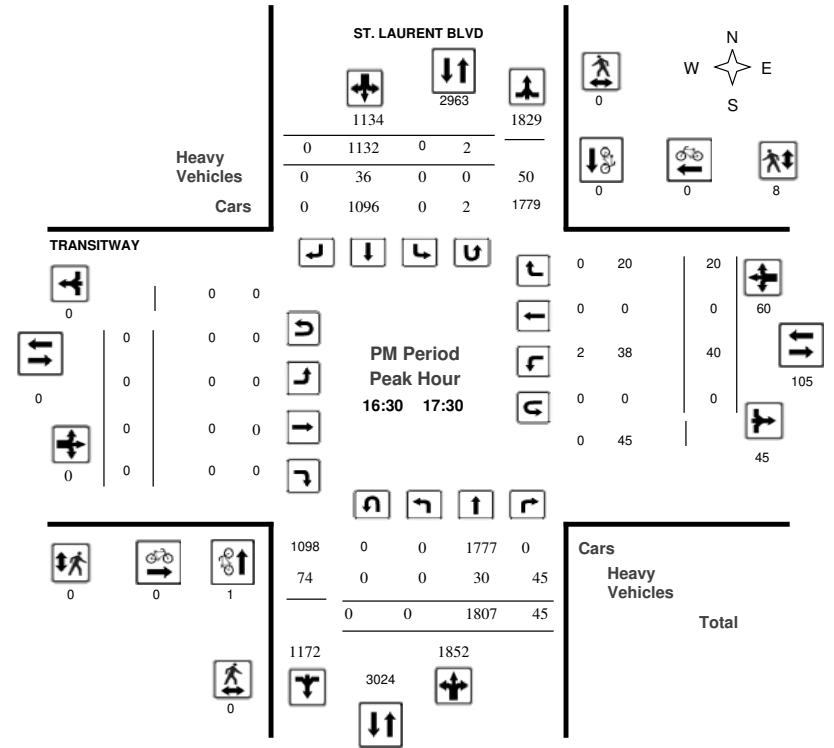



Transportation Services - Traffic Services

Turning Movement Count - Study Results

ST. LAURENT BLVD @ TRANSITWAY

Survey Date: Wednesday, January 30, 2019

WO No: 38337

Start Time: 07:00

Device: Miovision

Full Study Summary (8 HR Standard)

Survey Date: Wednesday, January 30, 2019

Total Observed U-Turns AADT Factor
 Northbound: 4 Southbound: 2 1.00
 Eastbound: 0 Westbound: 0

Period	ST. LAURENT BLVD								TRANSITWAY								WB TOT	STR TOT	Grand Total
	Northbound				Southbound				Eastbound				Westbound						
	LT	ST	RT	NB TOT	LT	ST	RT	SB TOT	LT	ST	RT	EB TOT	LT	ST	RT	WB TOT			
07:00-08:00	0	1185	58	1243	1	714	0	715	1958	0	0	0	0	54	0	17	71	71	2029
08:00-09:00	0	1388	60	1448	2	753	0	755	2203	0	0	0	0	48	0	24	72	72	2275
09:00-10:00	0	1215	69	1284	2	717	0	719	2003	0	0	0	0	59	0	17	76	76	2079
11:30-12:30	0	1457	38	1495	1	943	0	944	2439	0	0	0	0	43	0	15	58	58	2497
12:30-13:30	0	1395	44	1439	0	1097	0	1097	2536	0	0	0	0	34	0	16	50	50	2586
15:00-16:00	0	1530	54	1584	0	1210	0	1210	2794	0	0	0	0	36	0	24	60	60	2854
16:00-17:00	0	1671	56	1727	0	1172	0	1172	2899	0	0	0	0	45	0	21	66	66	2965
17:00-18:00	0	1683	50	1733	0	1079	0	1079	2812	0	0	0	0	38	0	22	60	60	2872
Sub Total	0	11524	429	11953	6	7685	0	7691	19644	0	0	0	0	357	0	156	513	513	20157
U Turns	4			4	2			2	6	0				0			0	0	6
Total	4	11524	429	11957	8	7685	0	7693	19650	0	0	0	0	357	0	156	513	513	20163
EQ 12hr	6	16018	596	16620	11	10682	0	10693	27313	0	0	0	0	496	0	217	713	713	28026
Note: These values are calculated by multiplying the totals by the appropriate expansion factor.										1.39									
AVG 12hr	6	16018	596	16620	11	10682	0	10693	27313	0	0	0	0	496	0	217	713	713	28026
Note: These volumes are calculated by multiplying the Equivalent 12 hr. totals by the AADT factor.										1.00									
AVG 24hr	8	20984	781	21773	14	13993	0	14007	35780	0	0	0	0	650	0	284	934	934	36714
Note: These volumes are calculated by multiplying the Average Daily 12 hr. totals by 12 to 24 expansion factor.										1.31									
Note: U-Turns provided for approach totals. Refer to 'U-Turn' Report for specific breakdown.																			



Transportation Services - Traffic Services

Turning Movement Count - Study Results

ST. LAURENT BLVD @ TRANSITWAY

Survey Date: Wednesday, January 30, 2019

WO No: 38337

Start Time: 07:00

Device: Miovision

Full Study 15 Minute Increments

Time Period	ST. LAURENT BLVD								TRANSITWAY								W TOT	STR TOT	Grand Total
	Northbound				Southbound				Eastbound				Westbound						
	LT	ST	RT	N TOT	LT	ST	RT	S TOT	STR TOT	LT	ST	RT	E TOT	LT	ST	RT			
07:00-07:15	0	234	14	248	1	178	0	179	427	0	0	0	0	13	0	5	18	18	445
07:15-07:30	0	271	12	283	0	153	0	153	436	0	0	0	0	11	0	4	15	15	451
07:30-07:45	0	327	17	344	0	201	0	201	545	0	0	0	0	16	0	4	20	20	565
07:45-08:00	0	353	15	368	0	182	0	182	550	0	0	0	0	14	0	4	18	18	568
08:00-08:15	0	345	16	361	1	172	0	173	534	0	0	0	0	16	0	5	21	21	555
08:15-08:30	0	323	16	339	0	166	0	166	505	0	0	0	0	10	0	2	12	12	517
08:30-08:45	0	366	13	379	0	203	0	203	582	0	0	0	0	13	0	6	19	19	601
08:45-09:00	0	354	15	369	1	212	0	213	582	0	0	0	0	9	0	11	20	20	602
09:00-09:15	0	325	20	345	0	184	0	184	529	0	0	0	0	11	0	4	15	15	544
09:15-09:30	0	267	14	281	0	184	0	184	465	0	0	0	0	23	0	2	25	25	490
09:30-09:45	0	310	17	327	1	180	0	181	508	0	0	0	0	11	0	8	19	19	527
09:45-10:00	0	313	18	331	1	169	0	170	501	0	0	0	0	14	0	3	17	17	518
11:30-11:45	1	334	13	348	0	224	0	224	572	0	0	0	0	14	0	6	20	20	592
11:45-12:00	0	371	9	380	0	247	0	247	627	0	0	0	0	11	0	3	14	14	641
12:00-12:15	0	343	12	355	0	224	0	224	579	0	0	0	0	9	0	5	14	14	593
12:15-12:30	0	409	4	413	1	248	0	249	662	0	0	0	0	9	0	1	10	10	672
12:30-12:45	0	358	12	370	0	285	0	285	655	0	0	0	0	8	0	6	14	14	669
12:45-13:00	0	371	11	382	0	298	0	298	680	0	0	0	0	9	0	2	11	11	691
13:00-13:15	0	382	9	391	0	246	0	246	637	0	0	0	0	4	0	5	9	9	646
13:15-13:30	0	284	12	296	0	268	0	268	564	0	0	0	0	13	0	3	16	16	580
15:00-15:15	0	360	14	374	0	315	0	315	689	0	0	0	0	6	0	7	13	13	702
15:15-15:30	2	400	15	417	0	297	0	297	714	0	0	0	0	13	0	2	15	15	729
15:30-15:45	0	394	11	405	0	318	0	318	723	0	0	0	0	6	0	9	15	15	738
15:45-16:00	0	376	14	390	0	280	0	280	670	0	0	0	0	11	0	6	17	17	687
16:00-16:15	0	392	17	409	0	304	0	304	713	0	0	0	0	8	0	8	16	16	729
16:15-16:30	0	383	9	392	0	298	0	298	690	0	0	0	0	13	0	3	16	16	706
16:30-16:45	0	456	14	470	0	281	0	281	751	0	0	0	0	7	0	9	16	16	767
16:45-17:00	0	440	16	456	1	289	0	290	746	0	0	0	0	17	0	1	18	18	764
17:00-17:15	0	430	11	441	0	306	0	306	747	0	0	0	0	9	0	7	16	16	763
17:15-17:30	0	481	4	485	1	256	0	257	742	0	0	0	0	7	0	3	10	10	752
17:30-17:45	0	416	20	436	0	258	0	258	694	0	0	0	0	9	0	6	15	15	709
17:45-18:00	1	356	15	372	0	259	0	259	631	0	0	0	0	13	0	6	19	19	650
Total	4	11524	429	11953	8	7685	0	7693	19650	0	0	0	0	357	0	156	513	19650	20,163

Note: U-Turns are included in Totals.



Transportation Services - Traffic Services

Turning Movement Count - Study Results

ST. LAURENT BLVD @ TRANSITWAY

Survey Date: Wednesday, January 30, 2019

WO No: 38337

Start Time: 07:00

Device: Miovision

Full Study Cyclist Volume

Time Period	ST. LAURENT BLVD			TRANSITWAY			Grand Total
	Northbound	Southbound	Street Total	Eastbound	Westbound	Street Total	
07:00 07:15	0	0	0	0	0	0	0
07:15 07:30	0	0	0	0	0	0	0
07:30 07:45	0	0	0	0	0	0	0
07:45 08:00	0	0	0	0	0	0	0
08:00 08:15	0	0	0	0	0	0	0
08:15 08:30	0	0	0	0	0	0	0
08:30 08:45	0	0	0	0	0	0	0
08:45 09:00	0	0	0	0	0	0	0
09:00 09:15	0	0	0	0	0	0	0
09:15 09:30	0	0	0	0	0	0	0
09:30 09:45	1	0	1	0	0	0	1
09:45 10:00	0	0	0	0	0	0	0
11:30 11:45	0	0	0	0	0	0	0
11:45 12:00	0	0	0	0	0	0	0
12:00 12:15	0	0	0	0	0	0	0
12:15 12:30	0	0	0	0	0	0	0
12:30 12:45	0	0	0	0	0	0	0
12:45 13:00	0	0	0	0	0	0	0
13:00 13:15	0	0	0	0	0	0	0
13:15 13:30	0	0	0	0	0	0	0
15:00 15:15	0	0	0	0	0	0	0
15:15 15:30	0	0	0	0	0	0	0
15:30 15:45	0	0	0	0	0	0	0
15:45 16:00	1	0	1	0	0	0	1
16:00 16:15	0	0	0	0	0	0	0
16:15 16:30	0	0	0	0	0	0	0
16:30 16:45	0	0	0	0	0	0	0
16:45 17:00	0	0	0	0	0	0	0
17:00 17:15	0	0	0	0	0	0	0
17:15 17:30	1	0	1	0	0	0	1
17:30 17:45	0	0	0	0	0	0	0
17:45 18:00	0	0	0	0	0	0	0
Total	3	0	3	0	0	0	3



Transportation Services - Traffic Services

Turning Movement Count - Study Results

ST. LAURENT BLVD @ TRANSITWAY

Survey Date: Wednesday, January 30, 2019

WO No: 38337

Start Time: 07:00

Device: Miovision

Full Study Pedestrian Volume

Time Period	ST. LAURENT BLVD			TRANSITWAY			Grand Total
	NB Approach (E or W Crossing)	SB Approach (E or W Crossing)	Total	EB Approach (N or S Crossing)	WB Approach (N or S Crossing)	Total	
07:00 07:15	0	0	0	0	2	2	2
07:15 07:30	0	0	0	0	0	0	0
07:30 07:45	0	0	0	0	0	0	0
07:45 08:00	0	0	0	0	0	0	0
08:00 08:15	0	0	0	0	0	0	0
08:15 08:30	0	0	0	0	0	0	0
08:30 08:45	0	0	0	0	0	0	0
08:45 09:00	0	0	0	0	0	0	0
09:00 09:15	0	0	0	0	1	1	1
09:15 09:30	0	0	0	0	0	0	0
09:30 09:45	0	0	0	0	0	0	0
09:45 10:00	0	0	0	0	0	0	0
11:30 11:45	0	0	0	0	0	0	0
11:45 12:00	0	0	0	0	0	0	0
12:00 12:15	0	0	0	0	1	1	1
12:15 12:30	0	0	0	0	0	0	0
12:30 12:45	0	0	0	0	1	1	1
12:45 13:00	0	0	0	0	0	0	0
13:00 13:15	2	0	2	0	0	0	2
13:15 13:30	0	0	0	0	0	0	0
15:00 15:15	0	0	0	0	2	2	2
15:15 15:30	0	0	0	0	0	0	0
15:30 15:45	0	0	0	0	1	1	1
15:45 16:00	0	0	0	0	0	0	0
16:00 16:15	0	0	0	0	1	1	1
16:15 16:30	0	0	0	0	3	3	3
16:30 16:45	0	0	0	0	1	1	1
16:45 17:00	0	0	0	0	4	4	4
17:00 17:15	0	0	0	0	2	2	2
17:15 17:30	0	0	0	0	1	1	1
17:30 17:45	0	0	0	0	0	0	0
17:45 18:00	0	0	0	0	0	0	0
Total	2	0	2	0	20	20	22



Transportation Services - Traffic Services

Turning Movement Count - Study Results

ST. LAURENT BLVD @ TRANSITWAY

Survey Date: Wednesday, January 30, 2019

WO No: 38337

Start Time: 07:00

Device: Miovision

Full Study Heavy Vehicles

		ST. LAURENT BLVD						TRANSITWAY												
		Northbound			Southbound			Eastbound			Westbound									
Time Period		LT	ST	RT	N TOT	LT	ST	RT	S TOT	STR TOT	LT	ST	RT	E TOT	LT	ST	RT	W TOT	STR TOT	Grand Total
07:00	07:15	0	15	14	29	0	6	0	6	35	0	0	0	0	12	0	5	17	17	52
07:15	07:30	0	12	12	24	0	7	0	7	31	0	0	0	0	11	0	4	15	15	46
07:30	07:45	0	18	16	34	0	9	0	9	43	0	0	0	0	16	0	4	20	20	63
07:45	08:00	0	8	15	23	0	7	0	7	30	0	0	0	0	14	0	4	18	18	48
08:00	08:15	0	20	15	35	0	13	0	13	48	0	0	0	0	16	0	5	21	21	69
08:15	08:30	0	16	16	32	0	7	0	7	39	0	0	0	0	10	0	2	12	12	51
08:30	08:45	0	15	13	28	0	5	0	5	33	0	0	0	0	12	0	6	18	18	51
08:45	09:00	0	19	15	34	1	15	0	16	50	0	0	0	0	9	0	10	19	19	69
09:00	09:15	0	22	18	40	0	19	0	19	59	0	0	0	0	11	0	4	15	15	74
09:15	09:30	0	20	14	34	0	23	0	23	57	0	0	0	0	22	0	2	24	24	81
09:30	09:45	0	18	17	35	1	16	0	17	52	0	0	0	0	10	0	7	17	17	69
09:45	10:00	0	23	18	41	0	14	0	14	55	0	0	0	0	14	0	3	17	17	72
11:30	11:45	0	15	11	26	0	11	0	11	37	0	0	0	0	13	0	5	18	18	55
11:45	12:00	0	17	9	26	0	14	0	14	40	0	0	0	0	10	0	2	12	12	52
12:00	12:15	0	12	12	24	0	13	0	13	37	0	0	0	0	7	0	4	11	11	48
12:15	12:30	0	16	4	20	0	11	0	11	31	0	0	0	0	8	0	1	9	9	40
12:30	12:45	0	16	12	28	0	16	0	16	44	0	0	0	0	8	0	6	14	14	58
12:45	13:00	0	11	11	22	0	21	0	21	43	0	0	0	0	9	0	2	11	11	54
13:00	13:15	0	21	9	30	0	18	0	18	48	0	0	0	0	4	0	5	9	9	57
13:15	13:30	0	11	11	22	0	16	0	16	38	0	0	0	0	12	0	2	14	14	52
15:00	15:15	0	22	14	36	0	26	0	26	62	0	0	0	0	6	0	7	13	13	75
15:15	15:30	0	15	15	30	0	19	0	19	49	0	0	0	0	13	0	2	15	15	64
15:30	15:45	0	16	9	25	0	17	0	17	42	0	0	0	0	6	0	7	13	13	55
15:45	16:00	0	13	13	26	0	13	0	13	39	0	0	0	0	11	0	6	17	17	56
16:00	16:15	0	12	17	29	0	18	0	18	47	0	0	0	0	8	0	8	16	16	63
16:15	16:30	0	2	9	11	0	10	0	10	21	0	0	0	0	12	0	3	15	15	36
16:30	16:45	0	6	14	20	0	12	0	12	32	0	0	0	0	7	0	9	16	16	48
16:45	17:00	0	8	16	24	0	8	0	8	32	0	0	0	0	16	0	1	17	17	49
17:00	17:15	0	6	11	17	0	10	0	10	27	0	0	0	0	8	0	7	15	15	42
17:15	17:30	0	10	4	14	0	6	0	6	20	0	0	0	0	7	0	3	10	10	30
17:30	17:45	0	3	20	23	0	8	0	8	31	0	0	0	0	9	0	6	15	15	46
17:45	18:00	0	5	15	20	0	6	0	6	26	0	0	0	0	13	0	5	18	18	44
Total:	None	0	443	419	862	2	414	0	416	1278	0	0	0	0	344	0	147	491	491	1,769



Transportation Services - Traffic Services

Turning Movement Count - Study Results

ST. LAURENT BLVD @ TRANSITWAY

Survey Date: Wednesday, January 30, 2019

WO No: 38337

Start Time: 07:00

Device: Miovision

Full Study 15 Minute U-Turn Total

		ST. LAURENT BLVD				
		Northbound	Southbound	Eastbound	Westbound	Total
Time Period		U-Turn Total	U-Turn Total	U-Turn Total	U-Turn Total	
07:00	07:15	0	0	0	0	0
07:15	07:30	0	0	0	0	0
07:30	07:45	0	0	0	0	0
07:45	08:00	0	0	0	0	0
08:00	08:15	0	0	0	0	0
08:15	08:30	0	0	0	0	0
08:30	08:45	0	0	0	0	0
08:45	09:00	0	0	0	0	0
09:00	09:15	0	0	0	0	0
09:15	09:30	0	0	0	0	0
09:30	09:45	0	0	0	0	0
09:45	10:00	0	0	0	0	0
11:30	11:45	1	0	0	0	1
11:45	12:00	0	0	0	0	0
12:00	12:15	0	0	0	0	0
12:15	12:30	0	0	0	0	0
12:30	12:45	0	0	0	0	0
12:45	13:00	0	0	0	0	0
13:00	13:15	0	0	0	0	0
13:15	13:30	0	0	0	0	0
13:30	13:45	0	0	0	0	0
13:45	14:00	0	0	0	0	0
14:00	14:15	0	0	0	0	0
14:15	14:30	0	0	0	0	0
14:30	14:45	0	0	0	0	0
14:45	15:00	0	0	0	0	0
15:00	15:15	0	0	0	0	0
15:15	15:30	2	0	0	0	2
15:30	15:45	0	0	0	0	0
15:45	16:00	0	0	0	0	0
16:00	16:15	0	0	0	0	0
16:15	16:30	0	0	0	0	0
16:30	16:45	0	0	0	0	0
16:45	17:00	0	1	0	0	1
17:00	17:15	0	0	0	0	0
17:15	17:30	0	1	0	0	1
17:30	17:45	0	0	0	0	0
17:45	18:00	1	0	0	0	1
Total		4	2	0	0	6



Transportation Services - Traffic Services

Turning Movement Count - Study Results

HWY 417 ST.LAURE IC115R51 @ ST. LAURENT BLVD

Survey Date: Wednesday, January 30, 2019

WO No: 38334

Start Time: 07:00

Device: Miovision

Full Study Diagram

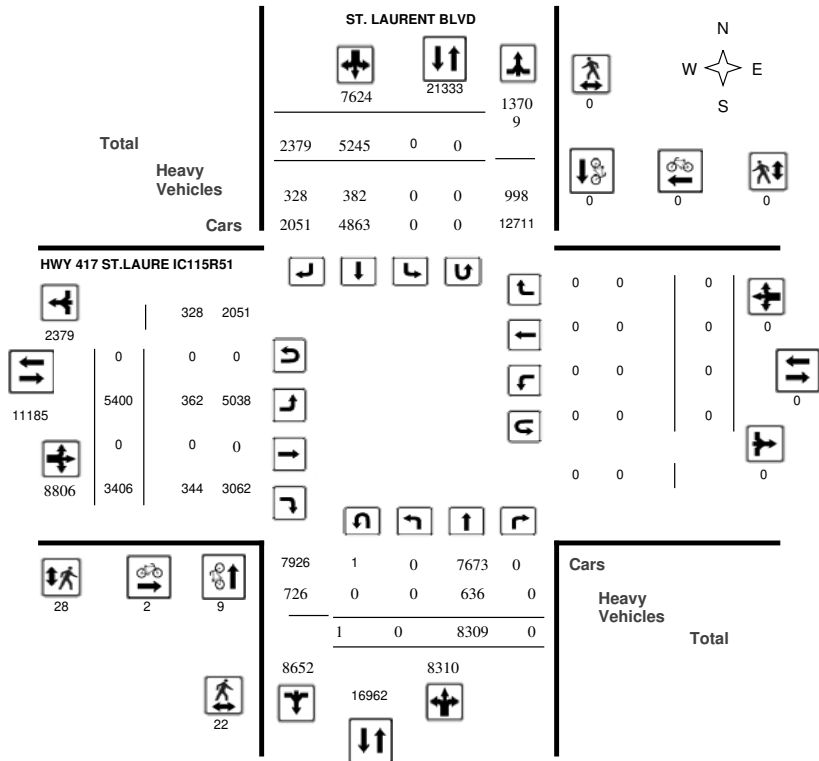

Transportation Services - Traffic Services

Turning Movement Count - Study Results

HWY 417 ST.LAURE IC115R51 @ ST. LAURENT BLVD

Survey Date: Wednesday, January 30, 2019

WO No: 38334

Start Time: 07:00

Device: Miovision

Full Study Peak Hour Diagram

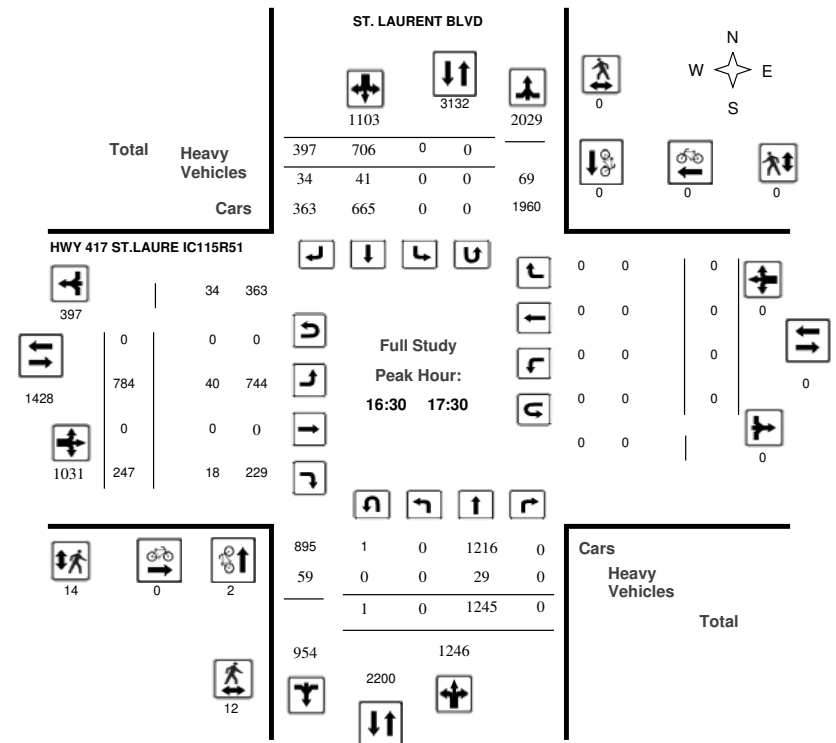



Transportation Services - Traffic Services

Turning Movement Count - Peak Hour Diagram

HWY 417 ST.LAURE IC115R51 @ ST. LAURENT BLVD

Survey Date: Wednesday, January 30, 2019
Start Time: 07:00

WO No: 38334
Device: Miovision

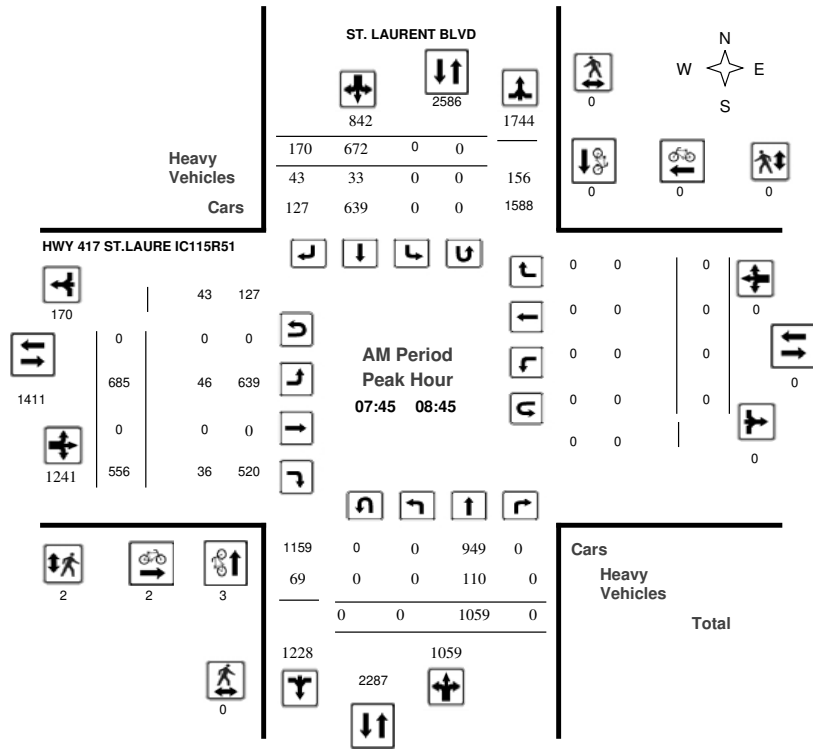

Comments



Transportation Services - Traffic Services

Turning Movement Count - Peak Hour Diagram

HWY 417 ST.LAURE IC115R51 @ ST. LAURENT BLVD

Survey Date: Wednesday, January 30, 2019
Start Time: 07:00

WO No: 38334
Device: Miovision

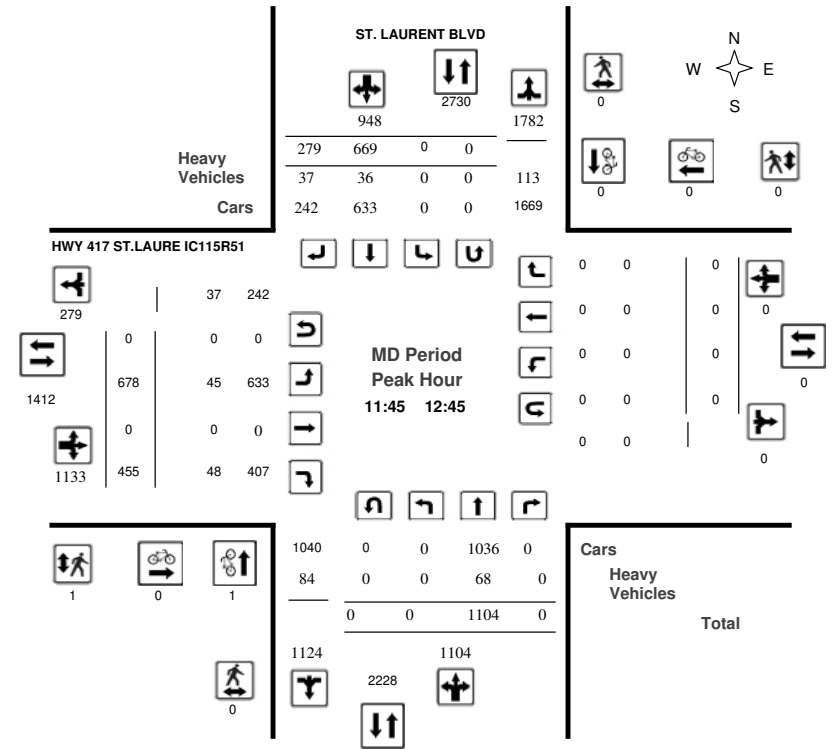

Comments



Transportation Services - Traffic Services

Turning Movement Count - Peak Hour Diagram

HWY 417 ST.LAURE IC115R51 @ ST. LAURENT BLVD

Survey Date: Wednesday, January 30, 2019
Start Time: 07:00

WO No: 38334
Device: Miovision

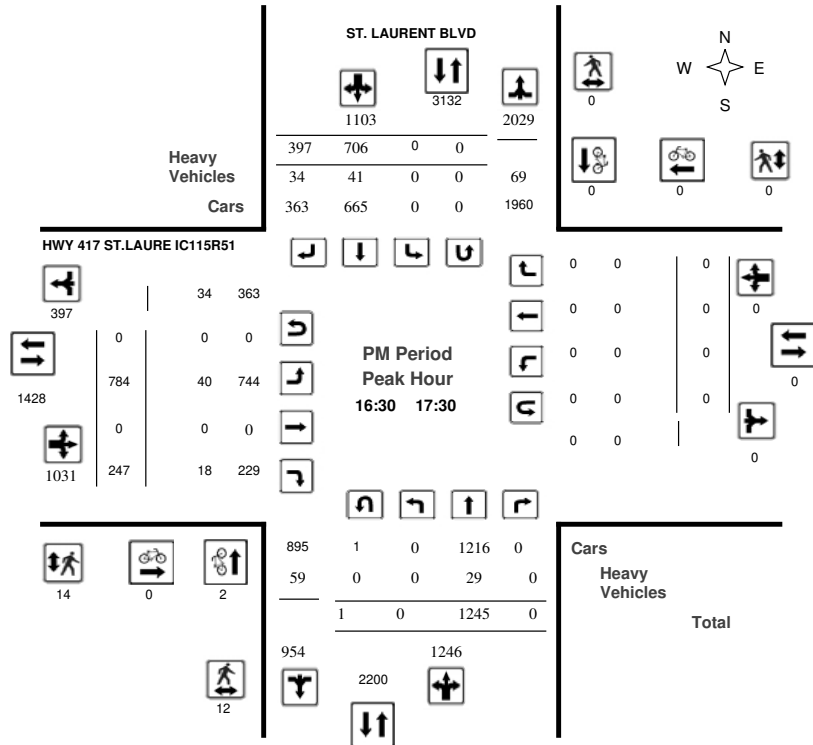

Comments



Transportation Services - Traffic Services

Turning Movement Count - Study Results

HWY 417 ST.LAURE IC115R51 @ ST. LAURENT BLVD

Survey Date: Wednesday, January 30, 2019
Start Time: 07:00

WO No: 38334
Device: Miovision

Full Study Summary (8 HR Standard)

Survey Date: Wednesday, January 30, 2019

Total Observed U-Turns
Northbound: 1 Southbound: 0
Eastbound: 0 Westbound: 0

AADT Factor
1.00

Period	ST. LAURENT BLVD								HWY 417 ST.LAURE IC115R51								WB TOT	STR TOT	Grand Total
	Northbound				Southbound				Eastbound				Westbound						
	LT	ST	RT	TOT	LT	ST	RT	TOT	LT	ST	RT	TOT	LT	ST	RT	TOT			
07:00-08:00	0	796	0	796	0	634	152	786	1582	717	0	546	1263	0	0	0	0	1263	2845
08:00-09:00	0	1066	0	1066	0	684	162	846	1912	663	0	529	1192	0	0	0	0	1192	3104
09:00-10:00	0	982	0	982	0	606	185	791	1773	688	0	540	1228	0	0	0	0	1228	3001
11:30-12:30	0	1114	0	1114	0	668	255	923	2037	658	0	455	1113	0	0	0	0	1113	3150
12:30-13:30	0	960	0	960	0	598	349	947	1907	641	0	427	1068	0	0	0	0	1068	2975
15:00-16:00	0	1086	0	1086	0	741	442	1183	2269	527	0	330	857	0	0	0	0	857	3126
16:00-17:00	0	1150	0	1150	0	664	424	1088	2238	721	0	275	996	0	0	0	0	996	3234
17:00-18:00	0	1155	0	1155	0	650	410	1060	2215	785	0	304	1089	0	0	0	0	1089	3304
Sub Total	0	8309	0	8309	0	5245	2379	7624	15933	5400	0	3406	8806	0	0	0	0	8806	24739
U Turns	1			1	0			0	1	0		0	0					0	1
Total	1	8309	0	8310	0	5245	2379	7624	15934	5400	0	3406	8806	0	0	0	0	8806	24740
EQ 12hr	1	11550	0	11551	0	7291	3307	10598	22149	7506	0	4734	12240	0	0	0	0	12240	34389
Note: These values are calculated by multiplying the totals by the appropriate expansion factor.																			1.39
AVG 12hr	1	11550	0	11551	0	7291	3307	10598	22149	7506	0	4734	12240	0	0	0	0	12240	34389
Note: These volumes are calculated by multiplying the Equivalent 12 hr. totals by the AADT factor.																			1.00
AVG 24hr	1	15130	0	15131	0	9551	4332	13883	29014	9833	0	6202	16035	0	0	0	0	16035	45049
Note: These volumes are calculated by multiplying the Average Daily 12 hr. totals by 12 to 24 expansion factor.																			1.31
Note: U-Turns provided for approach totals. Refer to 'U-Turn' Report for specific breakdown.																			



Transportation Services - Traffic Services

Turning Movement Count - Study Results

HWY 417 ST.LAURE IC115R51 @ ST. LAURENT BLVD

Survey Date: Wednesday, January 30, 2019

WO No: 38334

Start Time: 07:00

Device: Miovision

Full Study 15 Minute Increments

		ST. LAURENT BLVD									HWY 417 ST.LAURE IC115R51										
		Northbound			Southbound			Eastbound			Westbound										
Time Period		LT	ST	RT	N TOT	LT	ST	RT	S TOT	STR TOT	LT	ST	RT	E TOT	LT	ST	RT	W TOT	STR TOT	Grand Total	
07:00	07:15	0	152	0	152	0	152	32	184	336	140	0	125	265	0	0	0	0	265	601	
07:15	07:30	0	181	0	181	0	146	27	173	354	179	0	146	325	0	0	0	0	325	679	
07:30	07:45	0	214	0	214	0	171	38	209	423	196	0	123	319	0	0	0	0	319	742	
07:45	08:00	0	249	0	249	0	165	55	220	469	202	0	152	354	0	0	0	0	354	823	
08:00	08:15	0	277	0	277	0	168	47	215	492	156	0	126	282	0	0	0	0	282	774	
08:15	08:30	0	253	0	253	0	156	32	188	441	163	0	133	296	0	0	0	0	296	737	
08:30	08:45	0	280	0	280	0	183	36	219	499	164	0	145	309	0	0	0	0	309	808	
08:45	09:00	0	256	0	256	0	177	47	224	480	180	0	125	305	0	0	0	0	305	785	
09:00	09:15	0	220	0	220	0	149	43	192	412	153	0	147	300	0	0	0	0	300	712	
09:15	09:30	0	256	0	256	0	172	38	210	466	163	0	110	273	0	0	0	0	273	739	
09:30	09:45	0	265	0	265	0	138	46	184	449	192	0	158	350	0	0	0	0	350	799	
09:45	10:00	0	241	0	241	0	147	58	205	446	180	0	125	305	0	0	0	0	305	751	
11:30	11:45	0	260	0	260	0	152	60	212	472	166	0	116	282	0	0	0	0	282	754	
11:45	12:00	0	295	0	295	0	171	73	244	539	161	0	124	285	0	0	0	0	285	824	
12:00	12:15	0	267	0	267	0	156	57	213	480	160	0	110	270	0	0	0	0	270	750	
12:15	12:30	0	292	0	292	0	189	65	254	546	171	0	105	276	0	0	0	0	276	822	
12:30	12:45	0	250	0	250	0	153	84	237	487	186	0	116	302	0	0	0	0	302	789	
12:45	13:00	0	230	0	230	0	166	94	260	490	141	0	97	238	0	0	0	0	238	728	
13:00	13:15	0	255	0	255	0	127	80	207	462	180	0	107	287	0	0	0	0	287	749	
13:15	13:30	0	225	0	225	0	152	91	243	468	134	0	107	241	0	0	0	0	241	709	
15:00	15:15	0	284	0	284	0	158	107	265	549	121	0	92	213	0	0	0	0	213	762	
15:15	15:30	0	282	0	282	0	174	116	290	572	133	0	75	208	0	0	0	0	208	780	
15:30	15:45	0	260	0	260	0	198	109	307	567	133	0	97	230	0	0	0	0	230	797	
15:45	16:00	0	260	0	260	0	211	110	321	581	140	0	66	206	0	0	0	0	206	787	
16:00	16:15	0	312	0	312	0	136	126	262	574	170	0	81	251	0	0	0	0	251	825	
16:15	16:30	0	250	0	250	0	158	116	274	524	158	0	69	227	0	0	0	0	227	751	
16:30	16:45	0	292	0	292	0	176	93	269	561	197	0	61	258	0	0	0	0	258	819	
16:45	17:00	1	296	0	297	0	194	89	283	580	196	0	64	260	0	0	0	0	260	840	
17:00	17:15	0	329	0	329	0	175	118	293	622	196	0	58	254	0	0	0	0	254	876	
17:15	17:30	0	328	0	328	0	161	97	258	586	195	0	64	259	0	0	0	0	259	845	
17:30	17:45	0	252	0	252	0	149	93	242	494	217	0	83	300	0	0	0	0	300	794	
17:45	18:00	0	246	0	246	0	165	102	267	513	177	0	99	276	0	0	0	0	276	789	
Total:		1	8309	0	8310	0	5245	2379	7624	15934	5400	0	3406	8806	0	0	0	0	15934	24,740	

Note: U-Turns are included in Totals.



Transportation Services - Traffic Services

Turning Movement Count - Study Results

HWY 417 ST.LAURE IC115R51 @ ST. LAURENT BLVD

Survey Date: Wednesday, January 30, 2019

WO No: 38334

Start Time: 07:00

Device: Miovision

Full Study Cyclist Volume

		ST. LAURENT BLVD			HWY 417 ST.LAURE IC115R51				
		Northbound	Southbound	Street Total	Eastbound	Westbound	Street Total	Grand Total	
07:00	07:15	0	0	0	0	0	0	0	
07:15	07:30	0	0	0	0	0	0	0	
07:30	07:45	0	0	0	0	0	0	0	
07:45	08:00	0	0	0	0	0	0	0	
08:00	08:15	0	0	0	0	0	0	0	
08:15	08:30	3	0	3	2	0	2	5	
08:30	08:45	0	0	0	0	0	0	0	
08:45	09:00	0	0	0	0	0	0	0	
09:00	09:15	0	0	0	0	0	0	0	
09:15	09:30	0	0	0	0	0	0	0	
09:30	09:45	1	0	1	0	0	0	1	
09:45	10:00	0	0	0	0	0	0	0	
11:30	11:45	0	0	0	0	0	0	0	
11:45	12:00	0	0	0	0	0	0	0	
12:00	12:15	0	0	0	0	0	0	0	
12:15	12:30	0	0	0	0	0	0	0	
12:30	12:45	1	0	1	0	0	0	1	
12:45	13:00	1	0	1	0	0	0	1	
13:00	13:15	1	0	1	0	0	0	1	
13:15	13:30	0	0	0	0	0	0	0	
15:00	15:15	0	0	0	0	0	0	0	
15:15	15:30	0	0	0	0	0	0	0	
15:30	15:45	0	0	0	0	0	0	0	
15:45	16:00	0	0	0	0	0	0	0	
16:00	16:15	0	0	0	0	0	0	0	
16:15	16:30	0	0	0	0	0	0	0	
16:30	16:45	1	0	1	0	0	0	1	
16:45	17:00	1	0	1	0	0	0	1	
17:00	17:15	0	0	0	0	0	0	0	
17:15	17:30	0	0	0	0	0	0	0	
17:30	17:45	0	0	0	0	0	0	0	
17:45	18:00	0	0	0	0	0	0	0	
Total		9	0	9	2	0	2	11	



Transportation Services - Traffic Services

Turning Movement Count - Study Results

HWY 417 ST.LAURE IC115R51 @ ST. LAURENT BLVD

Survey Date: Wednesday, January 30, 2019

WO No: 38334

Start Time: 07:00

Device: Miovision

Full Study Pedestrian Volume

ST. LAURENT BLVD

HWY 417 ST.LAURE IC115R51

Table with columns: Time Period, NB Approach, SB Approach, Total, EB Approach, WB Approach, Grand Total. Rows show pedestrian counts for various time intervals from 07:00 to 17:45.



Transportation Services - Traffic Services

Turning Movement Count - Study Results

HWY 417 ST.LAURE IC115R51 @ ST. LAURENT BLVD

Survey Date: Wednesday, January 30, 2019

WO No: 38334

Start Time: 07:00

Device: Miovision

Full Study Heavy Vehicles

ST. LAURENT BLVD

HWY 417 ST.LAURE IC115R51

Table with columns: Time Period, Northbound (LT, ST, RT, N TOT), Southbound (LT, ST, RT, S TOT), Eastbound (LT, ST, RT, E TOT), Westbound (LT, ST, RT, W TOT), STR TOT, Grand Total. Rows show heavy vehicle counts for various time intervals from 07:00 to 17:45.



Transportation Services - Traffic Services

Turning Movement Count - Study Results

HWY 417 ST.LAURE IC115R51 @ ST. LAURENT BLVD

Survey Date: Wednesday, January 30, 2019

WO No: 38334

Start Time: 07:00

Device: Miovision

Full Study 15 Minute U-Turn Total

Time Period	ST. LAURENT BLVD		HWY 417 ST.LAURE IC115R51		Total
	Northbound U-Turn Total	Southbound U-Turn Total	Eastbound U-Turn Total	Westbound U-Turn Total	
07:00 - 07:15	0	0	0	0	0
07:15 - 07:30	0	0	0	0	0
07:30 - 07:45	0	0	0	0	0
07:45 - 08:00	0	0	0	0	0
08:00 - 08:15	0	0	0	0	0
08:15 - 08:30	0	0	0	0	0
08:30 - 08:45	0	0	0	0	0
08:45 - 09:00	0	0	0	0	0
09:00 - 09:15	0	0	0	0	0
09:15 - 09:30	0	0	0	0	0
09:30 - 09:45	0	0	0	0	0
09:45 - 10:00	0	0	0	0	0
11:30 - 11:45	0	0	0	0	0
11:45 - 12:00	0	0	0	0	0
12:00 - 12:15	0	0	0	0	0
12:15 - 12:30	0	0	0	0	0
12:30 - 12:45	0	0	0	0	0
12:45 - 13:00	0	0	0	0	0
13:00 - 13:15	0	0	0	0	0
13:15 - 13:30	0	0	0	0	0
15:00 - 15:15	0	0	0	0	0
15:15 - 15:30	0	0	0	0	0
15:30 - 15:45	0	0	0	0	0
15:45 - 16:00	0	0	0	0	0
16:00 - 16:15	0	0	0	0	0
16:15 - 16:30	0	0	0	0	0
16:30 - 16:45	0	0	0	0	0
16:45 - 17:00	1	0	0	0	1
17:00 - 17:15	0	0	0	0	0
17:15 - 17:30	0	0	0	0	0
17:30 - 17:45	0	0	0	0	0
17:45 - 18:00	0	0	0	0	0
Total	1	0	0	0	1



Transportation Services - Traffic Services

Turning Movement Count - Study Results

CYRVILLE RD @ OGILVIE RD

Survey Date: Wednesday, April 11, 2018

WO No: 37723

Start Time: 07:00

Device: Miovision

Full Study Diagram

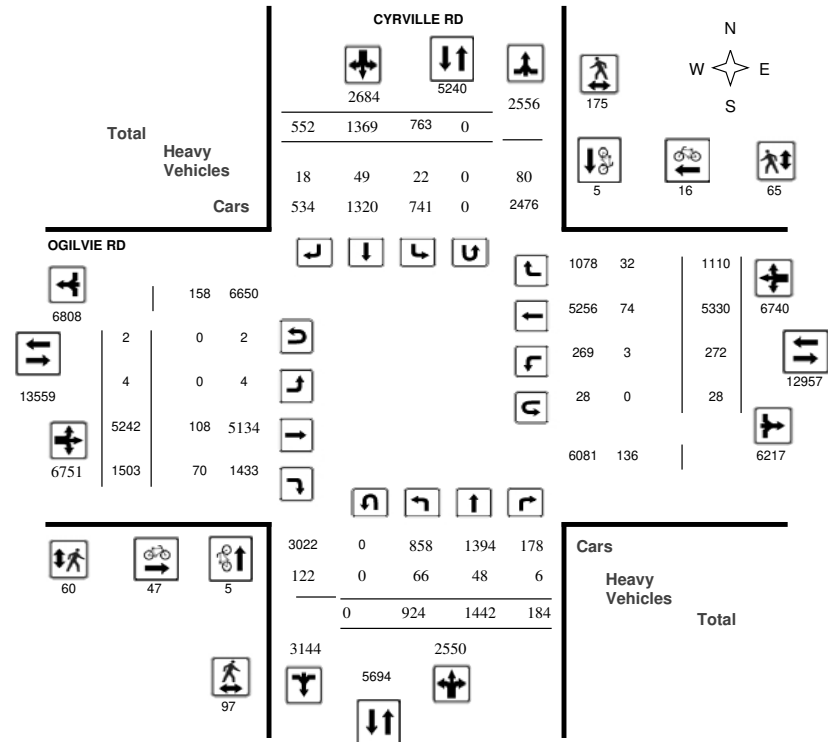



Transportation Services - Traffic Services

Turning Movement Count - Study Results

CYRVILLE RD @ OGILVIE RD

Survey Date: Wednesday, April 11, 2018

WO No: 37723

Start Time: 07:00

Device: Miovision

Full Study Peak Hour Diagram

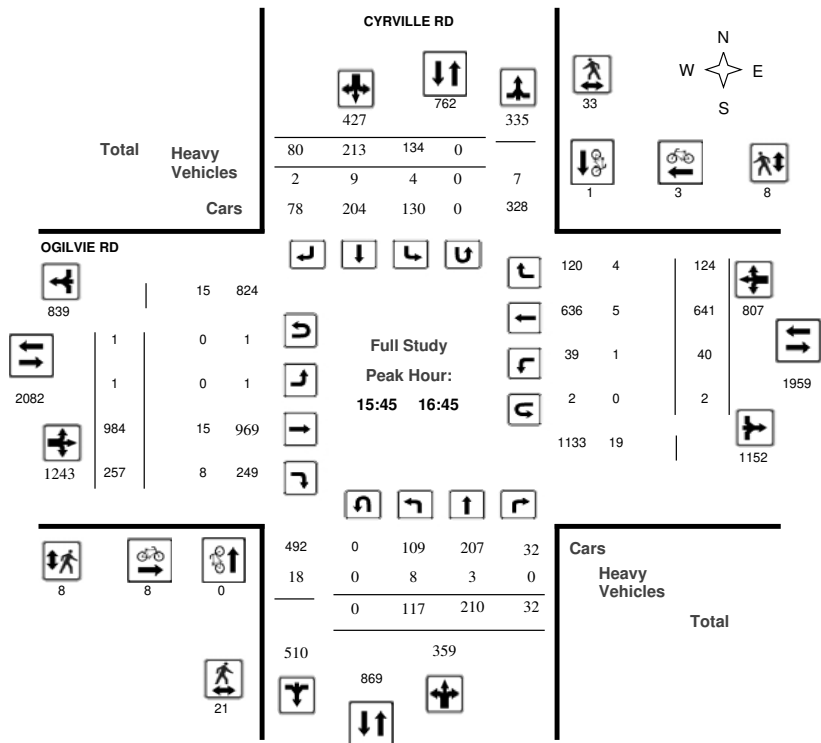

Transportation Services - Traffic Services

Turning Movement Count - Peak Hour Diagram

CYRVILLE RD @ OGILVIE RD

Survey Date: Wednesday, April 11, 2018

WO No: 37723

Start Time: 07:00

Device: Miovision

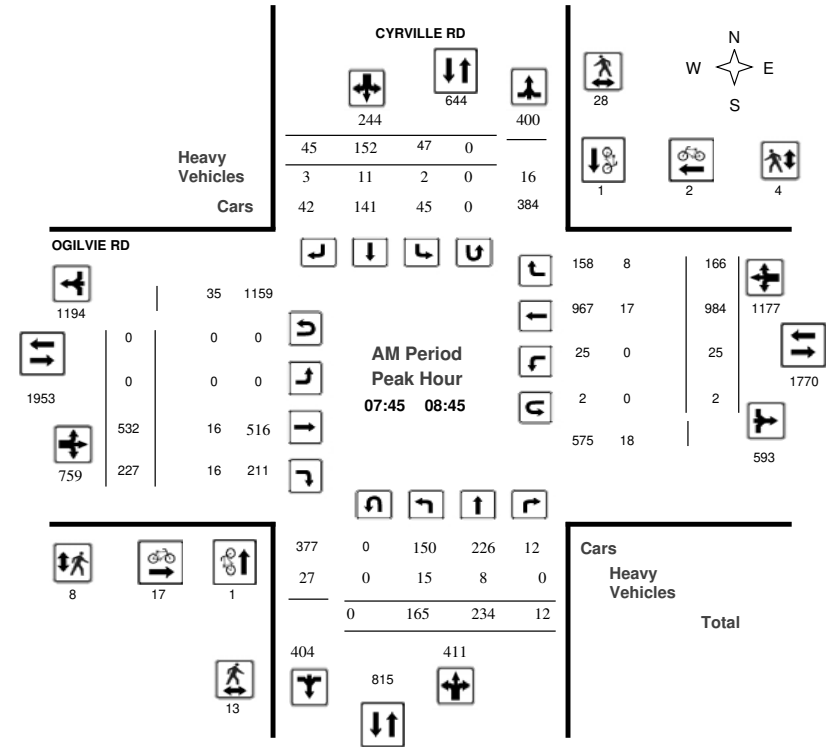

Comments



Transportation Services - Traffic Services

Turning Movement Count - Peak Hour Diagram

CYRVILLE RD @ OGILVIE RD

Survey Date: Wednesday, April 11, 2018
Start Time: 07:00

WO No: 37723
Device: Miovision

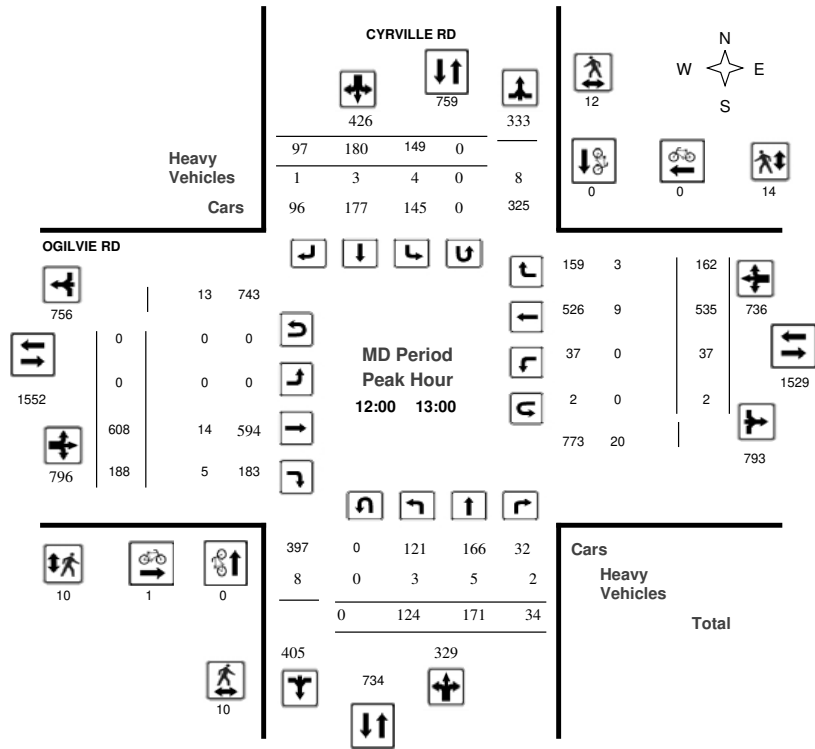

Transportation Services - Traffic Services

Turning Movement Count - Peak Hour Diagram

CYRVILLE RD @ OGILVIE RD

Survey Date: Wednesday, April 11, 2018
Start Time: 07:00

WO No: 37723
Device: Miovision

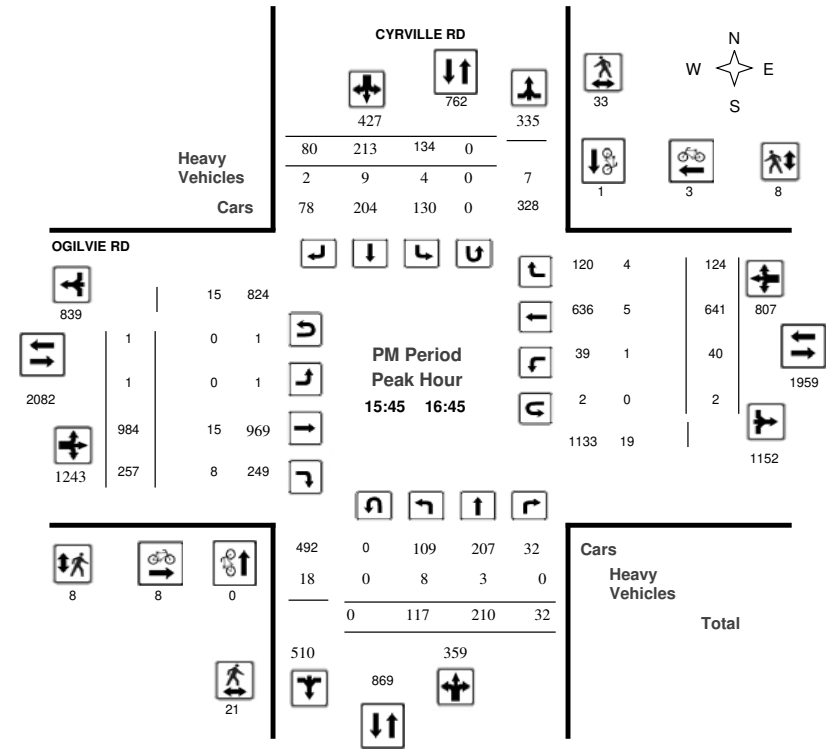



Transportation Services - Traffic Services

Turning Movement Count - Study Results

CYRVILLE RD @ OGILVIE RD

Survey Date: Wednesday, April 11, 2018

WO No: 37723

Start Time: 07:00

Device: Miovision

Full Study Summary (8 HR Standard)

Survey Date: Wednesday, April 11, 2018

Total Observed U-Turns AADT Factor
 Northbound: 0 Southbound: 0 .90
 Eastbound: 2 Westbound: 28

Period	CYRVILLE RD								OGILVIE RD								WB TOT	STR TOT	Grand Total
	Northbound				Southbound				Eastbound				Westbound						
	LT	ST	RT	NB TOT	LT	ST	RT	SB TOT	LT	ST	RT	EB TOT	LT	ST	RT	WB TOT			
07:00-08:00	144	156	10	310	27	172	35	234	544	0	556	185	741	24	838	146	1008	1749	2293
08:00-09:00	157	230	13	400	64	144	49	257	657	0	545	201	746	31	921	172	1124	1870	2527
09:00-10:00	86	133	12	231	74	144	52	270	501	1	475	145	621	38	576	126	740	1361	1862
11:30-12:30	113	173	36	322	92	156	105	353	675	0	654	174	828	27	523	152	702	1530	2205
12:30-13:30	113	151	35	299	146	179	90	415	714	0	563	188	751	44	535	138	717	1468	2182
15:00-16:00	109	178	29	316	122	227	64	413	729	2	828	205	1035	33	632	143	808	1843	2572
16:00-17:00	124	215	16	355	129	189	86	404	759	1	736	256	993	34	656	117	807	1800	2559
17:00-18:00	78	206	33	317	109	158	71	338	655	0	885	149	1034	41	649	116	806	1840	2495
Sub Total	924	1442	184	2550	763	1369	552	2684	5234	4	5242	1503	6749	272	5330	1110	6712	13461	18695
U Turns				0				0	0				2				28	30	30
Total	924	1442	184	2550	763	1369	552	2684	5234	4	5242	1503	6751	272	5330	1110	6740	13491	18725
EQ 12hr	1284	2004	256	3544	1061	1903	767	3731	7275	6	7286	2089	9384	378	7409	1543	9369	18752	26028
Note: These values are calculated by multiplying the totals by the appropriate expansion factor.																			1.39
AVG 12hr	1089	1700	217	3006	900	1614	651	3164	6548	5	6180	1772	7959	321	6284	1309	7946	16877	23425
Note: These volumes are calculated by multiplying the Equivalent 12 hr. totals by the AADT factor.																			0.9
AVG 24hr	1427	2227	284	3938	1178	2114	853	4145	8083	6	8096	2321	10427	420	8232	1714	10410	20837	28920
Note: These volumes are calculated by multiplying the Average Daily 12 hr. totals by 12 to 24 expansion factor.																			1.31
Note: U-Turns provided for approach totals. Refer to 'U-Turn' Report for specific breakdown.																			



Transportation Services - Traffic Services

Turning Movement Count - Study Results

CYRVILLE RD @ OGILVIE RD

Survey Date: Wednesday, April 11, 2018

WO No: 37723

Start Time: 07:00

Device: Miovision

Full Study 15 Minute Increments

Time Period	CYRVILLE RD										OGILVIE RD										W TOT	STR TOT	Grand Total
	Northbound					Southbound					Eastbound					Westbound							
	LT	ST	RT	N TOT	STR TOT	LT	ST	RT	S TOT	STR TOT	LT	ST	RT	E TOT	STR TOT	LT	ST	RT	W TOT				
07:00-07:15	26	39	1	66	4	36	9	49	5	0	128	42	170	6	162	37	206	5	491				
07:15-07:30	44	28	3	75	6	36	10	52	8	0	146	40	186	3	188	39	230	8	543				
07:30-07:45	31	37	3	71	7	53	6	66	9	0	148	39	187	12	236	31	279	9	603				
07:45-08:00	43	52	3	98	10	47	10	67	10	0	134	64	198	3	252	39	294	10	657				
08:00-08:15	32	50	3	85	12	28	7	47	10	0	131	52	183	6	270	38	314	10	629				
08:15-08:30	44	73	3	120	10	31	13	54	8	0	140	58	198	8	252	33	295	8	667				
08:30-08:45	46	59	3	108	15	46	15	76	11	0	127	53	180	8	210	56	274	11	638				
08:45-09:00	35	48	4	87	27	39	14	80	11	0	147	38	185	9	189	45	243	11	595				
09:00-09:15	21	31	3	55	16	48	10	74	7	0	126	40	166	12	163	52	227	7	522				
09:15-09:30	26	35	1	62	15	27	15	57	4	0	130	32	162	9	140	26	175	4	456				
09:30-09:45	16	35	5	56	27	46	19	92	10	1	126	39	166	14	150	24	188	10	502				
09:45-10:00	23	32	3	58	16	23	8	47	9	0	93	34	127	3	123	24	153	9	385				
11:30-11:45	30	40	9	79	31	33	25	89	3	0	166	41	207	7	128	28	163	3	538				
11:45-12:00	23	45	8	76	16	37	22	75	12	0	160	44	204	7	126	35	179	12	534				
12:00-12:15	32	46	11	89	24	38	30	92	2	0	150	33	183	7	144	37	189	2	553				
12:15-12:30	28	42	8	78	21	48	28	97	3	0	178	56	234	6	125	52	184	3	593				
12:30-12:45	30	40	7	77	73	36	15	124	8	0	130	44	174	11	143	34	188	8	563				
12:45-13:00	34	43	8	85	31	58	24	113	5	0	150	55	205	13	123	39	175	5	578				
13:00-13:15	29	39	12	80	27	42	28	97	10	0	139	49	188	10	126	29	165	10	530				
13:15-13:30	20	29	8	57	15	43	23	81	5	0	144	40	184	10	143	36	190	5	512				
15:00-15:15	34	40	5	79	35	55	23	113	5	0	195	47	243	12	158	28	198	5	633				
15:15-15:30	23	49	3	75	30	53	14	97	4	2	206	36	244	6	143	38	187	4	603				
15:30-15:45	25	48	5	78	26	46	16	88	3	0	179	46	225	9	184	38	232	3	623				
15:45-16:00	27	41	16	84	31	73	11	115	9	0	248	76	324	6	147	39	192	9	715				
16:00-16:15	31	70	3	104	40	45	15	100	6	0	259	55	315	13	171	23	207	6	726				
16:15-16:30	22	48	4	74	30	47	28	105	5	0	233	78	311	14	154	32	201	5	691				
16:30-16:45	37	51	9	97	33	48	26	107	6	1	244	48	293	7	169	30	207	6	704				
16:45-17:00	34	46	0	80	26	49	17	92	5	0	75	75	0	162	32	194	5	441					
17:00-17:15	17	63	9	89	28	49	12	89	5	0	283	44	327	11	167	26	205	5	710				
17:15-17:30	19	47	7	73	34	43	17	94	4	0	245	38	283	16	182	31	231	4	681				
17:30-17:45	22	55	8	85	31	38	20	89	2	0	197	29	226	5	145	27	177	2	577				
17:45-18:00	20	41	9	70	16	28	22	66	5	0	160	38	198	9	155	32	198	5	532				
Total:	924	1442	184	2550	763	1369	552	2684	209	4	5242	1503	6751	272	5330	1110	6740	209	18,725				

Note: U-Turns are included in Totals.



Transportation Services - Traffic Services

Turning Movement Count - Study Results

CYRVILLE RD @ OGILVIE RD

Survey Date: Wednesday, April 11, 2018

WO No: 37723

Start Time: 07:00

Device: Miovision

Full Study Cyclist Volume

Time Period	CYRVILLE RD			OGILVIE RD			Grand Total
	Northbound	Southbound	Street Total	Eastbound	Westbound	Street Total	
07:00 07:15	0	0	0	1	0	1	1
07:15 07:30	1	0	1	1	1	2	3
07:30 07:45	0	1	1	1	2	3	4
07:45 08:00	1	0	1	3	1	4	5
08:00 08:15	0	0	0	8	0	8	8
08:15 08:30	0	1	1	4	1	5	6
08:30 08:45	0	0	0	2	0	2	2
08:45 09:00	0	1	1	3	0	3	4
09:00 09:15	1	0	1	1	0	1	2
09:15 09:30	0	0	0	2	0	2	2
09:30 09:45	0	0	0	1	1	2	2
09:45 10:00	0	0	0	1	0	1	1
11:30 11:45	1	0	1	0	0	0	1
11:45 12:00	0	0	0	0	0	0	0
12:00 12:15	0	0	0	0	0	0	0
12:15 12:30	0	0	0	0	0	0	0
12:30 12:45	0	0	0	1	0	1	1
12:45 13:00	0	0	0	0	0	0	0
13:00 13:15	0	0	0	0	0	0	0
13:15 13:30	0	0	0	0	0	0	0
15:00 15:15	0	0	0	1	1	2	2
15:15 15:30	0	0	0	0	0	0	0
15:30 15:45	0	0	0	2	0	2	2
15:45 16:00	0	0	0	2	0	2	2
16:00 16:15	0	0	0	0	0	0	0
16:15 16:30	0	1	1	2	1	3	4
16:30 16:45	0	0	0	4	2	6	6
16:45 17:00	0	0	0	0	1	1	1
17:00 17:15	0	0	0	4	2	6	6
17:15 17:30	0	1	1	1	1	2	3
17:30 17:45	1	0	1	1	2	3	4
17:45 18:00	0	0	0	1	0	1	1
Total	5	5	10	47	16	63	73



Transportation Services - Traffic Services

Turning Movement Count - Study Results

CYRVILLE RD @ OGILVIE RD

Survey Date: Wednesday, April 11, 2018

WO No: 37723

Start Time: 07:00

Device: Miovision

Full Study Pedestrian Volume

Time Period	CYRVILLE RD			OGILVIE RD			Grand Total
	NB Approach (E or W Crossing)	SB Approach (E or W Crossing)	Total	EB Approach (N or S Crossing)	WB Approach (N or S Crossing)	Total	
07:00 07:15	2	3	5	1	2	3	8
07:15 07:30	2	6	8	2	1	3	11
07:30 07:45	1	5	6	2	2	4	10
07:45 08:00	5	8	13	0	1	1	14
08:00 08:15	3	5	8	3	1	4	12
08:15 08:30	3	7	10	2	0	2	12
08:30 08:45	2	8	10	3	2	5	15
08:45 09:00	6	7	13	4	1	5	18
09:00 09:15	4	7	11	3	2	5	16
09:15 09:30	3	3	6	0	2	2	8
09:30 09:45	0	2	2	0	2	2	4
09:45 10:00	0	2	2	0	0	0	2
11:30 11:45	7	3	10	0	2	2	12
11:45 12:00	4	4	8	1	2	3	11
12:00 12:15	7	1	8	3	4	7	15
12:15 12:30	1	4	5	6	2	8	13
12:30 12:45	1	4	5	0	3	3	8
12:45 13:00	1	3	4	1	5	6	10
13:00 13:15	2	6	8	1	1	2	10
13:15 13:30	1	7	8	3	2	5	13
15:00 15:15	6	4	10	1	1	2	12
15:15 15:30	6	5	11	7	3	10	21
15:30 15:45	0	4	4	1	2	3	7
15:45 16:00	2	6	8	4	1	5	13
16:00 16:15	8	16	24	2	5	7	31
16:15 16:30	5	3	8	2	2	4	12
16:30 16:45	6	8	14	0	0	0	14
16:45 17:00	0	8	8	4	6	10	18
17:00 17:15	2	7	9	1	1	2	11
17:15 17:30	5	7	12	1	3	4	16
17:30 17:45	1	7	8	0	1	1	9
17:45 18:00	1	5	6	2	3	5	11
Total	97	175	272	60	65	125	397



Transportation Services - Traffic Services

Turning Movement Count - Study Results

CYRVILLE RD @ OGILVIE RD

Survey Date: Wednesday, April 11, 2018

WO No: 37723

Start Time: 07:00

Device: Miovision

Full Study Heavy Vehicles

		CYRVILLE RD				OGILVIE RD														
		Northbound		Southbound		Eastbound		Westbound												
Time Period		LT	ST	RT	N TOT	LT	ST	RT	S TOT	STR TOT	LT	ST	RT	E TOT	LT	ST	RT	W TOT	STR TOT	Grand Total
07:00	07:15	1	2	0	3	1	1	0	2	5	0	7	2	9	0	3	1	4	13	18
07:15	07:30	4	1	0	5	1	1	1	3	8	0	4	1	5	0	1	1	2	7	15
07:30	07:45	4	4	1	9	0	0	0	0	9	0	5	2	7	0	3	0	3	10	19
07:45	08:00	6	3	0	9	0	0	1	1	10	0	6	3	9	0	7	2	9	18	28
08:00	08:15	1	3	0	4	1	4	1	6	10	0	5	3	8	0	4	0	4	12	22
08:15	08:30	3	0	0	3	1	4	0	5	8	0	4	4	8	0	1	1	2	10	18
08:30	08:45	5	2	0	7	0	3	1	4	11	0	1	6	7	0	5	5	10	17	28
08:45	09:00	3	0	1	4	1	5	1	7	11	0	3	1	4	0	2	1	3	7	18
09:00	09:15	3	1	1	5	0	2	0	2	7	0	5	3	8	0	3	1	4	12	19
09:15	09:30	1	2	0	3	0	0	1	1	4	0	4	4	8	0	2	0	2	10	14
09:30	09:45	3	4	0	7	1	2	0	3	10	0	3	3	6	0	4	1	5	11	21
09:45	10:00	4	5	0	9	0	0	0	0	9	0	3	2	5	0	5	2	7	12	21
11:30	11:45	1	1	0	2	1	0	0	1	3	0	7	2	9	0	1	1	2	11	14
11:45	12:00	2	5	0	7	0	1	4	5	12	0	1	1	2	0	3	2	5	7	19
12:00	12:15	1	0	0	1	1	0	0	1	2	0	3	0	3	0	2	1	3	6	8
12:15	12:30	1	2	0	3	0	0	0	0	3	0	3	2	5	0	2	0	2	7	10
12:30	12:45	0	2	2	4	2	2	0	4	8	0	6	3	9	0	4	1	5	14	22
12:45	13:00	1	1	0	2	1	1	1	3	5	0	2	0	2	0	1	1	2	4	9
13:00	13:15	2	4	0	6	1	1	2	4	10	0	2	3	5	1	6	1	8	13	23
13:15	13:30	3	0	0	3	1	1	0	2	5	0	0	1	1	0	1	2	3	4	9
15:00	15:15	1	0	1	2	0	2	1	3	5	0	10	2	12	0	4	2	6	18	23
15:15	15:30	2	0	0	2	0	2	0	2	4	0	5	3	8	0	1	1	2	10	14
15:30	15:45	1	0	0	1	1	1	0	2	3	0	1	1	2	1	0	0	1	3	6
15:45	16:00	5	0	0	5	0	4	0	4	9	0	2	2	4	0	1	3	4	8	17
16:00	16:15	1	3	0	4	1	1	0	2	6	0	8	1	9	0	3	1	4	13	19
16:15	16:30	0	0	0	0	1	3	1	5	5	0	3	2	5	1	0	0	1	6	11
16:30	16:45	2	0	0	2	2	1	1	4	6	0	2	3	5	0	1	0	1	6	12
16:45	17:00	1	0	0	1	0	4	0	4	5	0	0	4	4	0	1	0	1	5	10
17:00	17:15	1	1	0	2	1	2	0	3	5	0	1	2	3	0	1	0	1	4	9
17:15	17:30	1	1	0	2	1	0	1	2	4	0	1	1	2	0	0	1	1	3	7
17:30	17:45	1	1	0	2	0	0	0	2	0	1	2	3	0	2	0	2	5	7	
17:45	18:00	1	0	0	1	2	1	1	4	5	0	0	1	1	0	0	0	1	6	6
Total:	None	66	48	6	120	22	49	18	89	209	0	108	70	178	3	74	32	109	287	496



Transportation Services - Traffic Services

Turning Movement Count - Study Results

CYRVILLE RD @ OGILVIE RD

Survey Date: Wednesday, April 11, 2018

WO No: 37723

Start Time: 07:00

Device: Miovision

Full Study 15 Minute U-Turn Total

		CYRVILLE RD		OGILVIE RD				
		Northbound	Southbound	Eastbound	Westbound			Total
Time Period		U-Turn Total	U-Turn Total	U-Turn Total	U-Turn Total			
07:00	07:15	0	0	0	1			1
07:15	07:30	0	0	0	0			0
07:30	07:45	0	0	0	0			0
07:45	08:00	0	0	0	0			0
08:00	08:15	0	0	0	0			0
08:15	08:30	0	0	0	2			2
08:30	08:45	0	0	0	0			0
08:45	09:00	0	0	0	0			0
09:00	09:15	0	0	0	0			0
09:15	09:30	0	0	0	0			0
09:30	09:45	0	0	0	0			0
09:45	10:00	0	0	0	3			3
11:30	11:45	0	0	0	0			0
11:45	12:00	0	0	0	11			11
12:00	12:15	0	0	0	1			1
12:15	12:30	0	0	0	1			1
12:30	12:45	0	0	0	0			0
12:45	13:00	0	0	0	0			0
13:00	13:15	0	0	0	0			0
13:15	13:30	0	0	0	0			0
13:30	13:45	0	0	0	1			1
15:00	15:15	0	0	0	0			0
15:15	15:30	0	0	1	0			1
15:30	15:45	0	0	0	0			0
15:45	16:00	0	0	0	1			1
16:00	16:15	0	0	0	0			0
16:15	16:30	0	0	1	0			1
16:30	16:45	0	0	0	1			1
16:45	17:00	0	0	0	0			0
17:00	17:15	0	0	0	1			1
17:15	17:30	0	0	0	2			2
17:30	17:45	0	0	0	0			0
17:45	18:00	0	0	0	2			2
Total		0	0	2	28			30



Turning Movement Count Summary, AM and PM Peak Hour Flow Diagrams



Cyrville Road & Joseph Cyr Street Ottawa, ON

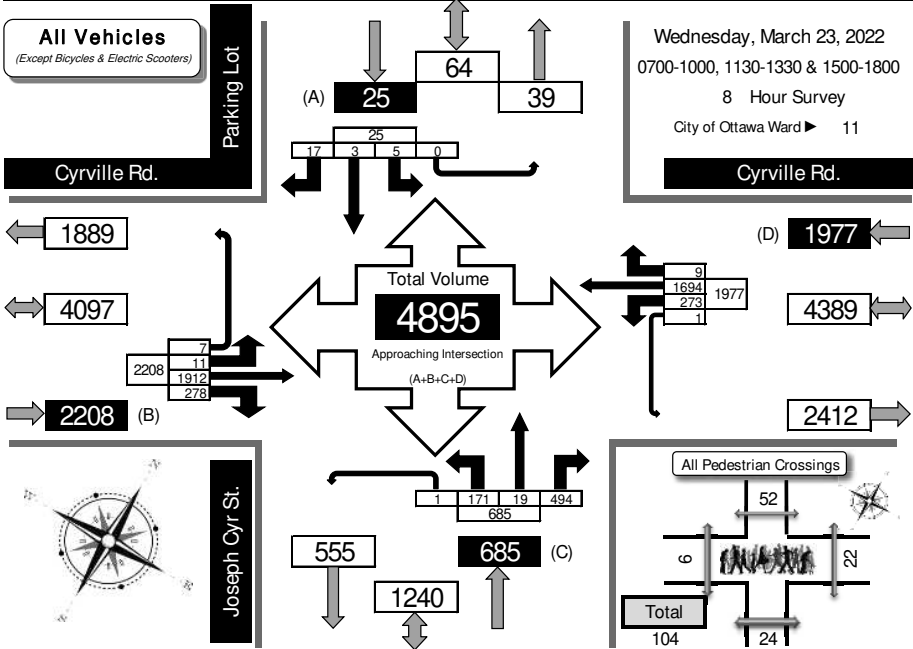

AM Peak Hour Flow Diagram

PM Peak Hour Flow Diagram

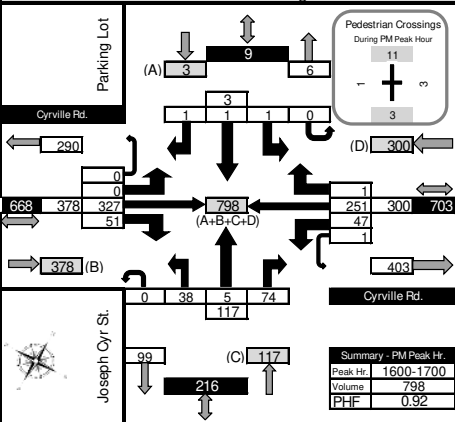
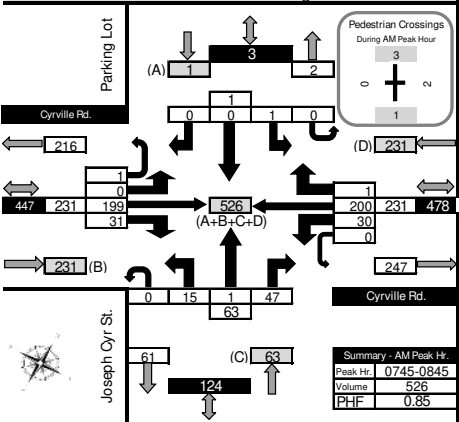

Turning Movement Count Summary, OFF and EVENING Peak Hour Flow Diagrams



Cyrville Road & Joseph Cyr Street Ottawa, ON

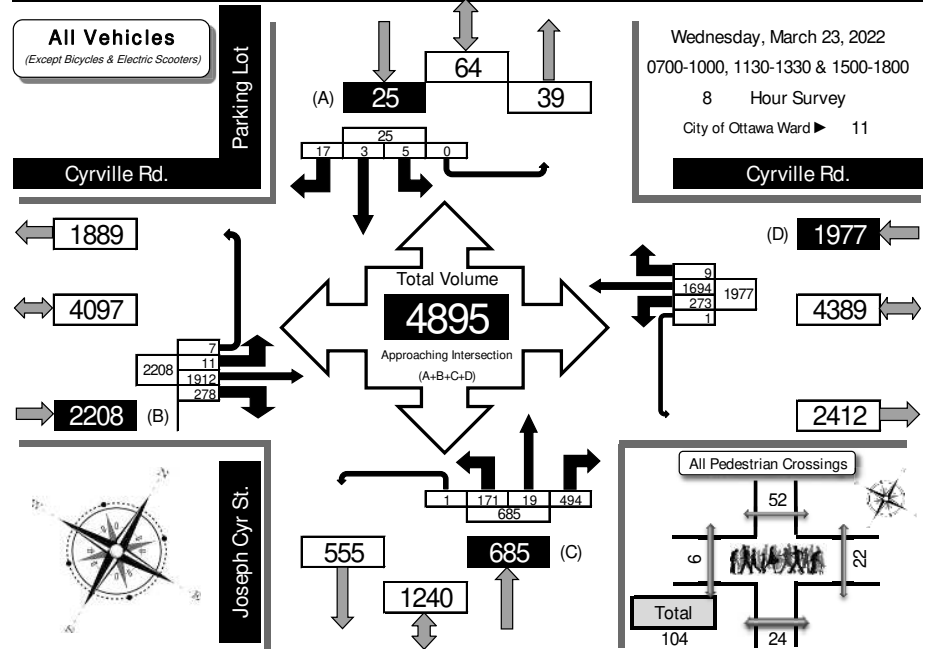

Off Peak Hour Flow Diagram

Evening Peak Hour Flow Diagram

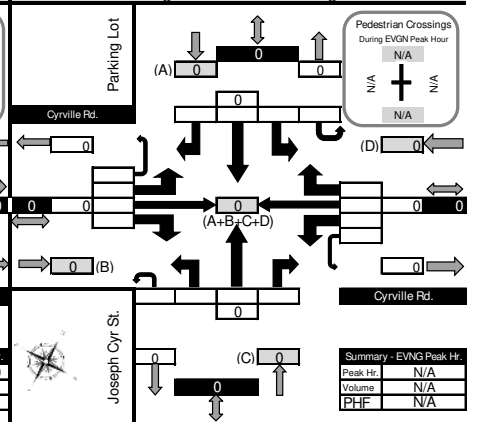
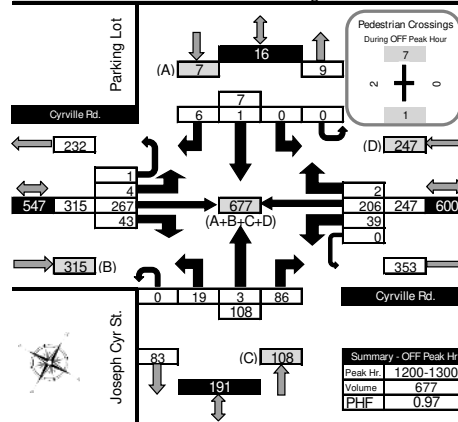



Turning Movement Count Heavy Vehicle Summary (FHWA Class 4-13) Flow Diagram

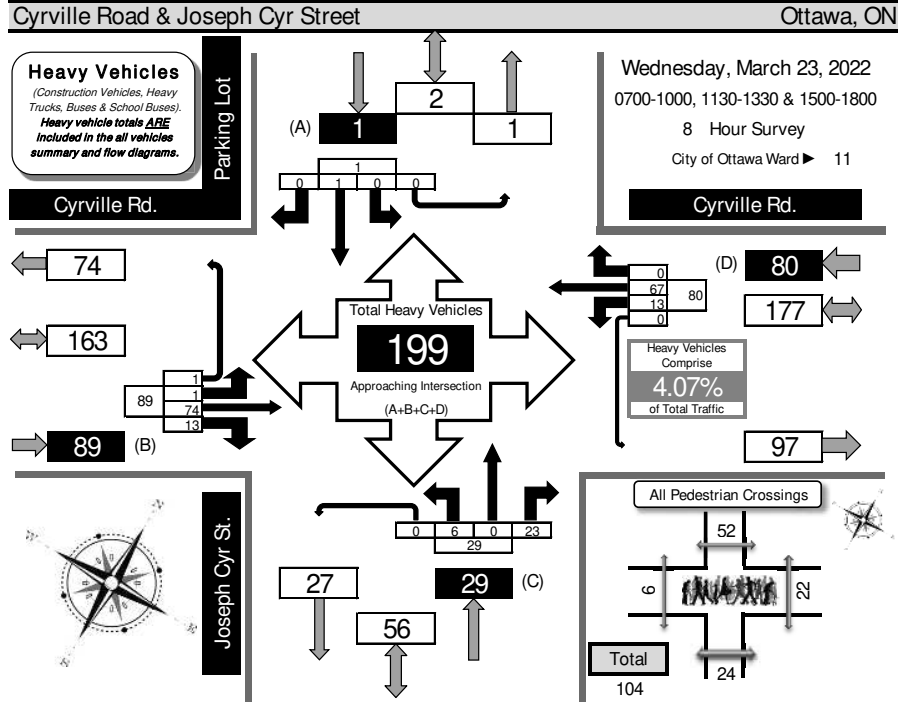

Time Period	Cyrville Rd. Eastbound				Cyrville Rd. Westbound				Joseph Cyr St. Northbound				Parking Lot Southbound				GR Tot				
	LT	ST	RT	UT	LT	ST	RT	UT	LT	ST	RT	UT	LT	ST	RT	UT					
	EB Tot				WB Tot				NB Tot				SB Tot								
0700-0800	0	5	1	0	6	2	19	0	0	21	1	0	1	0	2	0	0	0	0	0	29
0800-0900	0	6	2	0	8	1	6	0	0	7	1	0	4	0	5	0	0	0	0	0	20
0900-1000	0	8	4	0	12	1	10	0	0	11	3	0	4	0	7	0	0	0	0	0	30
1130-1230	1	6	1	0	8	1	10	0	0	11	1	0	3	0	4	0	1	0	0	1	24
1230-1330	0	15	1	1	17	4	11	0	0	15	0	0	3	0	3	0	0	0	0	0	35
1500-1600	0	14	0	0	14	2	4	0	0	6	0	0	3	0	3	0	0	0	0	0	23
1600-1700	0	11	0	0	11	2	4	0	0	6	0	0	1	0	1	0	0	0	0	0	18
1700-1800	0	9	4	0	13	0	3	0	0	3	0	0	4	0	4	0	0	0	0	0	20
Totals	1	74	13	1	89	13	67	0	0	80	6	0	23	0	29	0	1	0	0	1	199

Comments:
Buses, private buses and school buses comprise 13.57% of the heavy vehicle traffic. The bicycle totals include 1 E-bicycle and 1 E-scooter (stand-up).



Turning Movement Count Pedestrian Crossings Summary and Flow Diagram

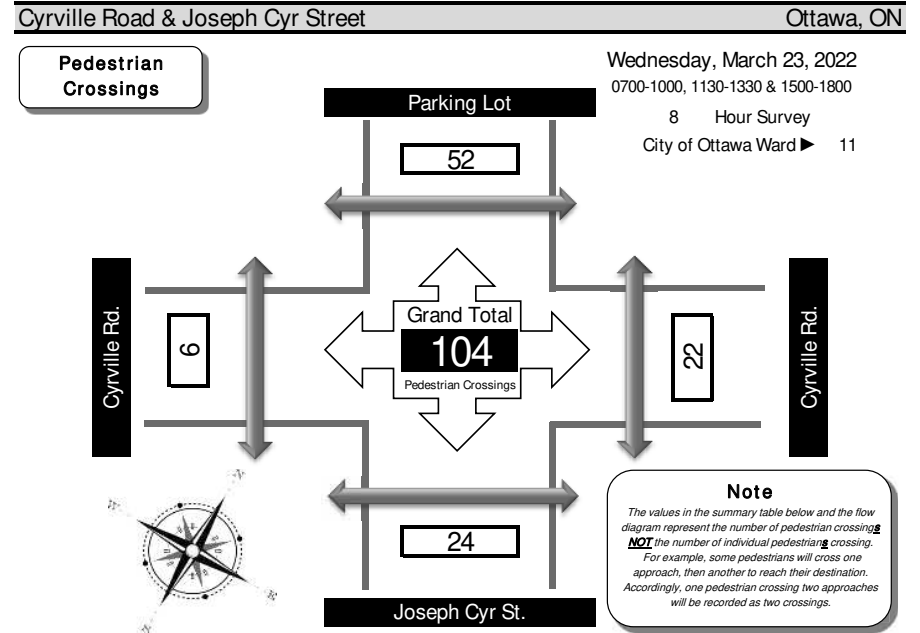

Note
The values in the summary table below and the flow diagram represent the number of pedestrian crossings. **NOT** the number of individual pedestrian crossing. For example, some pedestrians will cross one approach, then another to reach their destination. Accordingly, one pedestrian crossing two approaches will be recorded as two crossings.

Time Period	West Side Crossing	East Side Crossing	Street Total	South Side Crossing	North Side Crossing	Street Total	Grand Total
	Cyrville Rd.	Cyrville Rd.		Joseph Cyr St.	Parking Lot		
0700-0800	1	2	3	2	1	3	6
0800-0900	0	1	1	1	3	4	5
0900-1000	0	0	0	2	3	5	5
1130-1230	0	0	0	3	5	8	8
1230-1330	2	1	3	2	11	13	16
1500-1600	1	15	16	9	15	24	40
1600-1700	1	3	4	3	11	14	18
1700-1800	1	0	1	2	3	5	6
Totals	6	22	28	24	52	76	104

Comments:
Buses, private buses and school buses comprise 13.57% of the heavy vehicle traffic. The bicycle totals include 1 E-bicycle and 1 E-scooter (stand-up).



Turning Movement Count Summary Report Including Peak Hours, AADT and Expansion Factors All Vehicles Except Bicycles



Cyrville Road & Joseph Cyr Street Ottawa, ON

Survey Date: Wednesday, March 23, 2022 **Start Time:** 0700 **AADT Factor:** 1.0
Weather AM: Mostly cloudy -2° C **Survey Duration:** 8 Hrs. **Survey Hours:** 0700-1000, 1130-1330 & 1500-1800
Weather PM: Overcast +3° C **Surveyor(s):** T. Carmody

Time Period	Cyrville Rd. Eastbound				Cyrville Rd. Westbound				Joseph Cyr St. Northbound				Parking Lot Southbound				S/B Tot	Street Total	Grand Total					
	LT	ST	RT	UT	LT	ST	RT	UT	LT	ST	RT	UT	LT	ST	RT	UT								
	E/B Tot				W/B Tot				Street Total				S/B Tot											
0700-0800	0	187	14	0	201	37	146	0	0	183	384	14	2	40	0	56	0	0	0	0	0	56	440	
0800-0900	0	187	36	2	225	27	197	1	0	225	450	14	0	41	0	55	2	0	0	0	0	2	57	507
0900-1000	1	184	30	2	217	20	164	1	0	185	402	19	0	61	1	81	0	0	0	0	0	0	81	483
1130-1230	2	240	30	1	273	36	224	2	0	262	535	18	2	64	0	84	0	1	5	0	6	90	625	
1230-1330	6	256	41	2	305	29	204	1	0	234	539	23	2	81	0	106	1	0	4	0	5	111	650	
1500-1600	0	278	32	0	310	37	265	1	0	303	613	20	5	73	0	98	0	1	4	0	3	103	716	
1600-1700	0	327	51	0	378	47	251	1	1	300	678	38	5	74	0	117	1	1	1	0	3	120	798	
1700-1800	2	253	44	0	299	40	243	2	0	285	584	25	3	60	0	88	1	0	3	0	4	92	676	
Totals	11	1912	278	7	2208	273	1694	9	1	1977	4185	171	19	494	1	685	5	3	17	0	25	710	4895	

Equivalent 12 & 24-hour Vehicle Volumes Including the Annual Average Daily Traffic (AADT) Factor
Applicable to the Day and Month of the Turning Movement Count

Expansion factors are applied exclusively to standard weekday 8-hour turning movement counts conducted during the hours of 0700h - 1000h, 1130h - 1330h and 1500h - 1800h

Equivalent 12-hour vehicle volumes. These volumes are calculated by multiplying the 8-hour totals by the 8 → 12 expansion factor of 1.39																							
Equ. 12 Hr	15	2658	386	10	3069	379	2355	13	1	2748	5817	238	26	687	1	952	7	4	24	0	35	987	6804

Average daily 12-hour vehicle volumes. These volumes are calculated by multiplying the equivalent 12-hour totals by the AADT factor of: 1.0																							
AADT 12-hr	15	2658	386	10	3069	379	2355	13	1	2748	5817	238	26	687	1	952	7	4	24	0	35	987	6804

24-Hour AADT. These volumes are calculated by multiplying the average daily 12-hour vehicle volumes by the 12 → 24 expansion factor of 1.31																							
AADT 24 Hr	20	3482	506	13	4021	497	3085	16	2	3600	7620	311	35	900	2	1247	9	5	31	0	46	1293	8913

AADT and expansion factors provided by the City of Ottawa

AM Peak Hour Factor → 0.85					Highest Hourly Vehicle Volume Between 0700h & 1000h																		
AM Peak Hr	LT	ST	RT	UT	LT	ST	RT	UT	Total	Str. Tot.	LT	ST	RT	UT	Total	Str. Tot.	Gr. Tot.						
0745-0845	0	199	31	1	231	30	200	1	0	231	462	15	1	47	0	63	1	0	0	0	1	64	526
OFF Peak Hour Factor → 0.97					Highest Hourly Vehicle Volume Between 1130h & 1330h																		
OFF Peak Hr	LT	ST	RT	UT	LT	ST	RT	UT	Total	Str. Tot.	LT	ST	RT	UT	Total	Str. Tot.	Gr. Tot.						
1200-1300	4	267	43	1	315	39	206	2	0	247	562	19	3	86	0	108	0	1	6	0	7	115	677
PM Peak Hour Factor → 0.92					Highest Hourly Vehicle Volume Between 1500h & 1800h																		
PM Peak Hr	LT	ST	RT	UT	LT	ST	RT	UT	Total	Str. Tot.	LT	ST	RT	UT	Total	Str. Tot.	Gr. Tot.						
1600-1700	0	327	51	0	378	47	251	1	1	300	678	38	5	74	0	117	1	1	1	0	3	120	798

Comments:
 Buses, private buses and school buses comprise 13.57% of the heavy vehicle traffic. The bicycle totals include 1 E-bicycle and 1 E-scooter (stand-up).

Notes:
 1. Includes all vehicle types except bicycles, electric bicycles, and electric scooters.
 2. When expansion and AADT factors are applied, the results will differ slightly due to rounding.



Turning Movement Count Summary, AM and PM Peak Hour Flow Diagrams All Vehicles Except Bicycles



Joseph Cyr Street & Lemieux Street Ottawa, ON

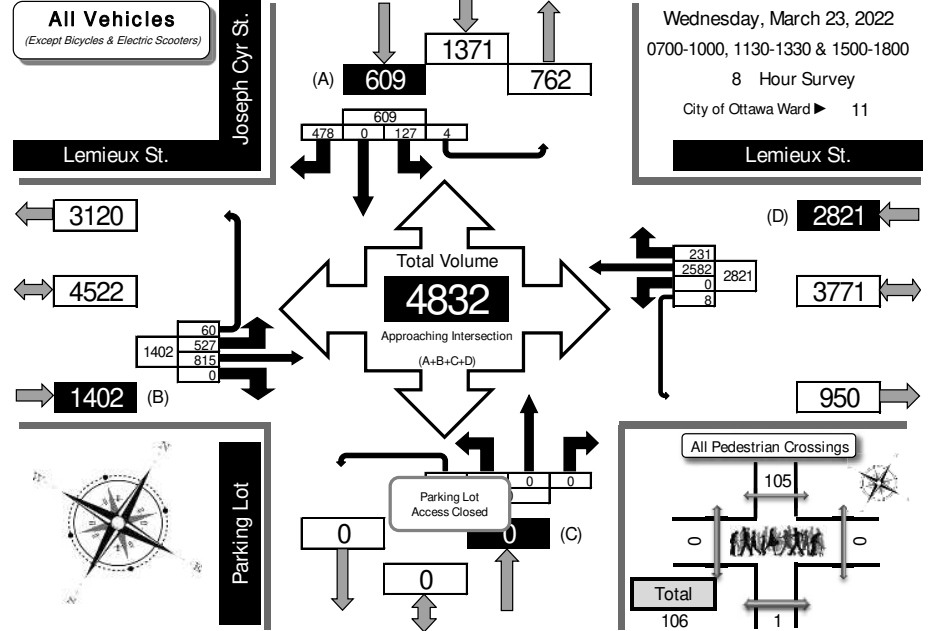

AM Peak Hour Flow Diagram PM Peak Hour Flow Diagram

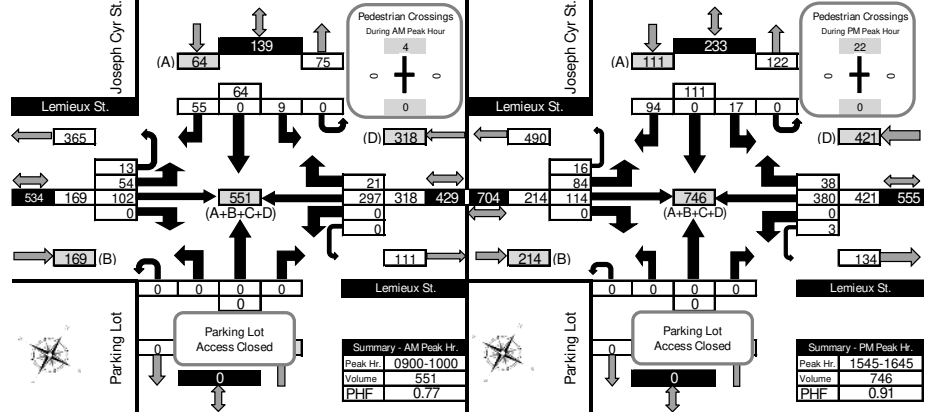



Turning Movement Count Summary, OFF and EVENING Peak Hour Flow Diagrams All Vehicles Except Bicycles

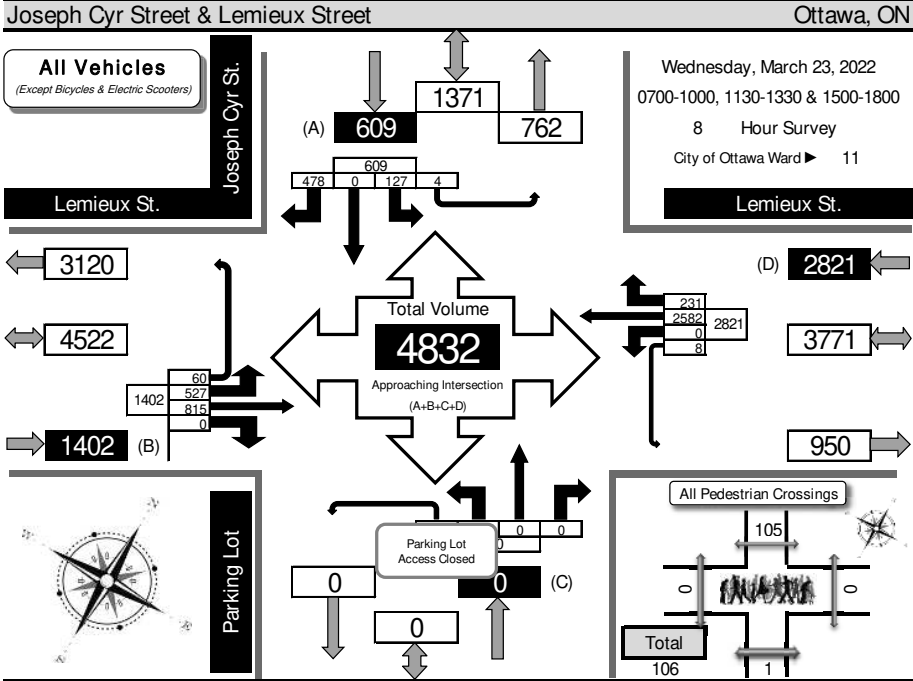

Off Peak Hour Flow Diagram

Evening Peak Hour Flow Diagram

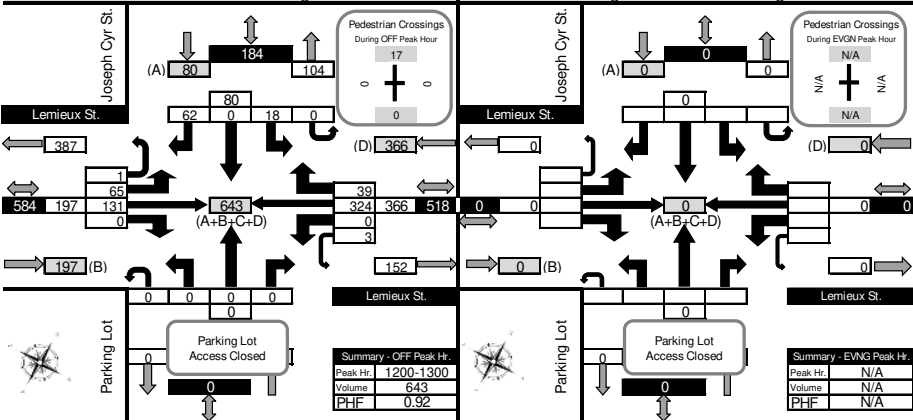

Turning Movement Count Heavy Vehicle Summary (FHWA Class 4-13) Flow Diagram

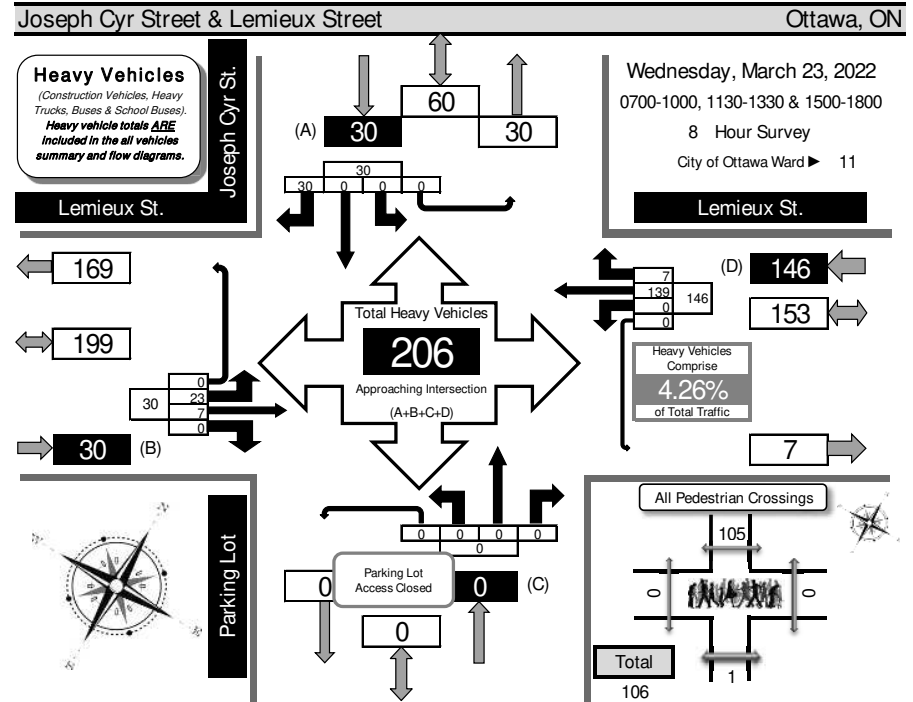

Time Period	Lemieux St. Eastbound				Lemieux St. Westbound				Parking Lot Northbound				Joseph Cyr St. Southbound				SB Tot	GR Tot				
	LT	ST	RT	UT	EB Tot	LT	ST	RT	UT	WB Tot	LT	ST	RT	UT	NB Tot	LT			ST	RT	UT	
0700-0800	3	0	0	0	3	0	14	1	0	15	0	0	0	0	0	0	0	0	3	0	3	21
0800-0900	3	1	0	0	4	0	25	3	0	28	0	0	0	0	0	0	0	0	4	0	4	36
0900-1000	4	0	0	0	4	0	29	0	0	29	0	0	0	0	0	0	0	0	3	0	3	36
1130-1230	2	1	0	0	3	0	5	1	0	6	0	0	0	0	0	0	0	0	3	0	3	12
1230-1330	2	2	0	0	4	0	23	0	0	23	0	0	0	0	0	0	0	0	7	0	7	34
1500-1600	4	1	0	0	5	0	11	0	0	11	0	0	0	0	0	0	0	0	4	0	4	20
1600-1700	1	1	0	0	2	0	16	1	0	17	0	0	0	0	0	0	0	0	3	0	3	22
1700-1800	4	1	0	0	5	0	16	1	0	17	0	0	0	0	0	0	0	0	3	0	3	25
Totals	23	7	0	0	30	0	139	7	0	146	0	0	0	0	0	0	0	0	30	0	30	206

Comments:

Buses, private buses and school buses comprise 40.29% of the heavy vehicle traffic. The bicycle totals include 1 E-bicycle. In the eastbound direction, 3 drivers drove on the wrong side of the median east of Joseph Cyr Street.



Turning Movement Count Pedestrian Crossings Summary and Flow Diagram



Joseph Cyr Street & Lemieux Street Ottawa, ON

Pedestrian Crossings

Wednesday, March 23, 2022
0700-1000, 1130-1330 & 1500-1800
8 Hour Survey
City of Ottawa Ward 11

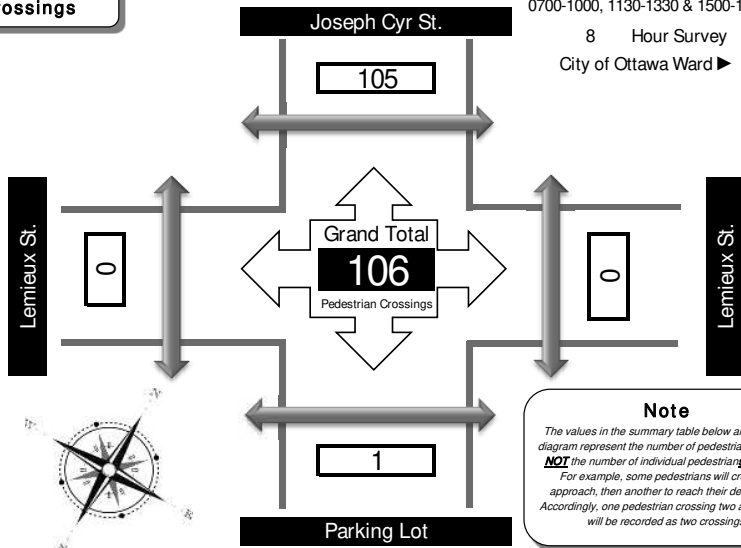

Note
The values in the summary table below and the flow diagram represent the number of pedestrian crossings, NOT the number of individual pedestrians crossing. For example, some pedestrians will cross one approach, then another to reach their destination. Accordingly, one pedestrian crossing two approaches will be recorded as two crossings.

Time Period	West Side Crossing Lemieux St.	East Side Crossing Lemieux St.	Street Total	South Side Crossing Parking Lot	North Side Crossing Joseph Cyr St.	Street Total	Grand Total
0700-0800	0	0	0	0	8	8	8
0800-0900	0	0	0	1	10	11	11
0900-1000	0	0	0	0	4	4	4
1130-1230	0	0	0	0	21	21	21
1230-1330	0	0	0	0	9	9	9
1500-1600	0	0	0	0	14	14	14
1600-1700	0	0	0	0	18	18	18
1700-1800	0	0	0	0	21	21	21
Totals	0	0	0	1	105	106	106

Comments:

Buses, private buses and school buses comprise 40.29% of the heavy vehicle traffic. The bicycle totals include 1 E-bicycle. In the eastbound direction, 3 drivers drove on the wrong side of the median east of Joseph Cyr Street.



Turning Movement Count Summary Report Including Peak Hours, AADT and Expansion Factors All Vehicles Except Bicycles



Joseph Cyr Street & Lemieux Street Ottawa, ON

Survey Date: Wednesday, March 23, 2022 Start Time: 0700 AADT Factor: 1.0
Weather AM: Mostly cloudy -2° C Survey Duration: 8 Hrs. Survey Hours: 0700-1000, 1130-1330 & 1500-1800
Weather PM: Overcast +3° C Surveyor(s): T. Carmody

Time Period	Lemieux St. Eastbound					Lemieux St. Westbound					Parking Lot Northbound					Joseph Cyr St. Southbound					Grand Total		
	LT	ST	RT	UT	E/B Tot	LT	ST	RT	UT	W/B Tot	LT	ST	RT	UT	N/B Tot	LT	ST	RT	UT	S/B Tot		Street Total	
	0700-0800	66	39	0	3	108	0	287	13	1	301	409	0	0	0	0	0	18	0	35		0	53
0800-0900	54	50	0	5	109	0	283	17	0	300	409	0	0	0	0	0	9	0	48	0	57	57	466
0900-1000	54	102	0	13	169	0	297	21	0	318	487	0	0	0	0	0	9	0	55	0	64	64	551
1130-1230	64	127	0	5	196	0	303	35	3	341	537	0	0	0	0	0	23	0	47	0	70	70	607
1230-1330	69	123	0	4	196	0	331	32	1	364	560	0	0	0	0	0	13	0	57	0	70	70	630
1500-1600	83	130	0	9	222	0	389	34	0	423	645	0	0	0	0	0	10	0	69	1	80	80	725
1600-1700	78	116	0	14	208	0	352	44	3	399	607	0	0	0	0	0	17	0	95	0	112	112	719
1700-1800	59	128	0	7	194	0	340	35	0	375	569	0	0	0	0	0	28	0	72	3	103	103	672
Totals	527	815	0	60	1402	0	2582	231	8	2821	4223	0	0	0	0	0	127	0	478	4	609	609	4832

Equivalent 12 & 24-hour Vehicle Volumes Including the Annual Average Daily Traffic (AADT) Factor
Applicable to the Day and Month of the Turning Movement Count
Expansion factors are applied exclusively to standard weekday 8-hour turning movement counts
conducted during the hours of 0700h - 1000h, 1130h - 1330h and 1500h - 1800h

Equivalent 12-hour vehicle volumes. These volumes are calculated by multiplying the 8-hour totals by the 8 → 12 expansion factor of 1.39

Equ. 12 Hr	733	1133	0	83	1949	0	3589	321	11	3921	5870	0	0	0	0	0	177	0	664	6	847	847	6716
------------	-----	------	---	----	------	---	------	-----	----	------	------	---	---	---	---	---	-----	---	-----	---	-----	-----	------

Average daily 12-hour vehicle volumes. These volumes are calculated by multiplying the equivalent 12-hour totals by the AADT factor of: 1.0

AADT 12-hr	733	1133	0	83	1949	0	3589	321	11	3921	5870	0	0	0	0	0	177	0	664	6	847	847	6716
------------	-----	------	---	----	------	---	------	-----	----	------	------	---	---	---	---	---	-----	---	-----	---	-----	-----	------

24-Hour AADT. These volumes are calculated by multiplying the average daily 12-hour vehicle volumes by the 12 → 24 expansion factor of 1.31

AADT 24 Hr	960	1484	0	109	2553	0	4702	421	15	5137	7690	0	0	0	0	0	231	0	870	7	1108	1108	8798
------------	-----	------	---	-----	------	---	------	-----	----	------	------	---	---	---	---	---	-----	---	-----	---	------	------	------

AADT and expansion factors provided by the City of Ottawa

AM Peak Hour Factor	Highest Hourly Vehicle Volume Between 0700h & 1000h																						
AM Peak Hr	LT	ST	RT	UT	Total	Str. Tot.	LT	ST	RT	UT	Total	Str. Tot.	Gr. Tot.										
0.77	54	102	0	13	169	0	297	21	0	318	487	0	0	0	0	0	9	0	55	0	64	64	551
OFF Peak Hour Factor	Highest Hourly Vehicle Volume Between 1130h & 1330h																						
OFF Peak Hr	LT	ST	RT	UT	Total	Str. Tot.	LT	ST	RT	UT	Total	Str. Tot.	Gr. Tot.										
0.92	65	131	0	1	197	0	324	39	3	366	563	0	0	0	0	0	18	0	62	0	80	80	643
PM Peak Hour Factor	Highest Hourly Vehicle Volume Between 1500h & 1800h																						
PM Peak Hr	LT	ST	RT	UT	Total	Str. Tot.	LT	ST	RT	UT	Total	Str. Tot.	Gr. Tot.										
0.91	84	114	0	16	214	0	380	38	3	421	635	0	0	0	0	0	17	0	94	0	111	111	746

Comments:

Buses, private buses and school buses comprise 40.29% of the heavy vehicle traffic. The bicycle totals include 1 E-bicycle. In the eastbound direction, 3 drivers drove on the wrong side of the median east of Joseph Cyr Street.

Notes:

- Includes all vehicle types except bicycles, electric bicycles, and electric scooters.
- When expansion and AADT factors are applied, the results will differ slightly due to rounding.

Figure 4: Existing Peak Hour Traffic Volumes

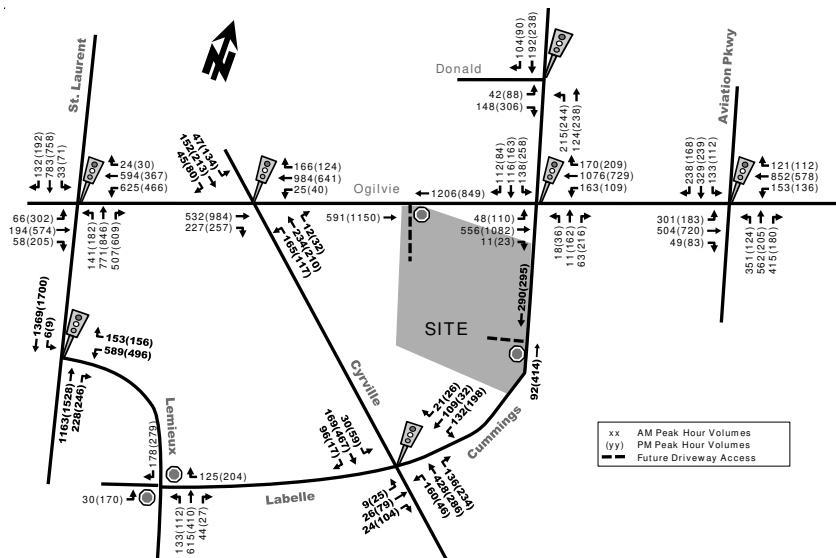

Appendix C

Synchro Intersection Worksheets – Existing Conditions

Lanes, Volumes, Timings
1: St Laurent & Coventry /Ogilvie

Existing
AM Peak Hour

Lane Group	EBL	EBT	EBR	WBL	WBT	WBR	NBL	NBT	NBR	SBL	SBT	SBR
Lane Configurations	↔	↕	↔	↔	↕	↔	↔	↕	↔	↔	↕	↔
Traffic Volume (vph)	66	194	58	625	594	24	141	771	507	33	783	132
Future Volume (vph)	66	194	58	625	594	24	141	771	507	33	783	132
Satd. Flow (prot)	3010	3283	1388	3216	3103	1339	1523	3161	1441	1642	4764	1427
Fit Permitted	0.950			0.950			0.950			0.950		
Satd. Flow (perm)	2904	3283	1331	3156	3103	1253	1511	3161	1384	1628	4764	1367
Satd. Flow (RTOR)			195			140			489			196
Lane Group Flow (vph)	73	216	64	694	660	27	157	857	563	37	870	147
Turn Type	Prot	NA	Perm	Prot	NA	Perm	Prot	NA	Perm	Prot	NA	Perm
Protected Phases	7	4		3	8		5	2		1	6	
Permitted Phases			4			8			2			6
Detector Phase	7	4	4	3	8	8	5	2	2	1	6	6
Switch Phase												
Minimum Initial (s)	5.0	10.0	10.0	5.0	10.0	10.0	5.0	10.0	10.0	5.0	10.0	10.0
Minimum Split (s)	11.9	37.5	37.5	11.9	37.5	37.5	11.4	35.4	35.4	11.4	35.4	35.4
Total Split (s)	15.0	37.5	37.5	35.5	58.0	58.0	21.6	35.4	35.4	21.6	35.4	35.4
Total Split (%)	11.5%	28.8%	28.8%	27.3%	44.6%	44.6%	16.6%	27.2%	27.2%	16.6%	27.2%	27.2%
Yellow Time (s)	3.7	3.7	3.7	3.7	3.7	3.7	3.7	3.7	3.7	3.7	3.7	3.7
All-Red Time (s)	3.2	2.8	2.8	3.2	2.8	2.8	2.7	2.7	2.7	2.7	2.7	2.7
Lost Time Adjust (s)	0.0	0.0	0.0	0.0	0.0	0.0	0.0	0.0	0.0	0.0	0.0	0.0
Total Lost Time (s)	6.9	6.5	6.5	6.9	6.5	6.5	6.4	6.4	6.4	6.4	6.4	6.4
Lead/Lag	Lag	Lead	Lead	Lag	Lead	Lead	Lead	Lag	Lag	Lead	Lag	Lag
Lead-Lag Optimize?	Yes	Yes	Yes	Yes	Yes	Yes	Yes	Yes	Yes	Yes	Yes	Yes
Recall Mode	None	None	None	None	None	None	C-Max	C-Max	None	C-Max	C-Max	C-Max
Act Effct Green (s)	17.6	23.1	23.1	30.1	38.2	38.2	15.5	47.3	47.3	8.4	35.1	35.1
Actuated g/C Ratio	0.14	0.18	0.18	0.23	0.29	0.29	0.12	0.36	0.36	0.06	0.27	0.27
v/c Ratio	0.18	0.37	0.16	0.93	0.72	0.06	0.87	0.75	0.69	0.35	0.68	0.29
Control Delay	49.2	47.1	0.9	68.6	39.9	0.2	102.9	38.3	15.7	66.5	46.9	3.2
Queue Delay	0.0	0.0	0.0	0.0	0.0	0.0	0.0	0.0	0.0	0.0	0.0	0.0
Total Delay	49.2	47.1	0.9	68.6	39.9	0.2	102.9	38.3	15.7	66.5	46.9	3.2
LOS	D	D	A	E	D	A	F	D	B	E	D	A
Approach Delay		39.2			53.6			36.7			41.5	
Approach LOS		D			D			D			D	
Queue Length 50th (m)	7.9	23.8	0.0	96.3	87.0	0.0	42.5	119.8	38.3	9.3	78.2	0.0
Queue Length 95th (m)	15.9	35.2	0.0	#133.4	101.3	m0.0	#81.7	#162.7	59.2	20.2	94.5	6.4
Internal Link Dist (m)		213.9			123.7			114.3			252.7	
Turn Bay Length (m)	100.0		64.0	75.0			47.5		40.0			45.0
Base Capacity (vph)	415	782	465	744	1229	580	184	1150	814	191	1287	512
Starvation Cap Reductn	0	0	0	0	17	0	0	0	0	0	0	0
Spillback Cap Reductn	0	0	0	0	0	0	0	0	0	0	0	0
Storage Cap Reductn	0	0	0	0	0	0	0	0	0	0	0	0
Reduced v/c Ratio	0.18	0.28	0.14	0.93	0.54	0.05	0.85	0.75	0.69	0.19	0.68	0.29

Intersection Summary	
Cycle Length:	130
Actuated Cycle Length:	130
Offset:	0 (0%), Referenced to phase 2:NBT and 6:SBT, Start of Green
Natural Cycle:	120
Control Type:	Actuated-Coordinated

Lanes, Volumes, Timings
1: St Laurent & Coventry /Ogilvie

Existing
AM Peak Hour

Maximum v/c Ratio: 0.93	Intersection LOS: D
Intersection Signal Delay: 43.4	ICU Level of Service E
Intersection Capacity Utilization 89.9%	
Analysis Period (min) 15	
# 95th percentile volume exceeds capacity, queue may be longer.	
Queue shown is maximum after two cycles.	
m Volume for 95th percentile queue is metered by upstream signal.	

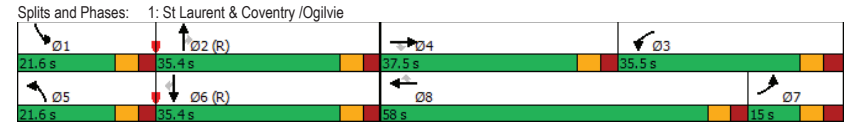

Lanes, Volumes, Timings
2: Lemieux St & St Laurent

Existing
AM Peak Hour

	↖	↗	↑	↘	↙	↓
Lane Group	WBL	WBR	NBT	NBR	SBL	SBT
Lane Configurations	↖↗	↖	↑↑↑	↖	↖	↑↑↑
Traffic Volume (vph)	589	153	1163	228	7	1369
Future Volume (vph)	589	153	1163	228	7	1369
Satd. Flow (prot)	2734	1483	4584	1483	1658	4672
Fit Permitted	0.950				0.173	
Satd. Flow (perm)	2734	1418	4584	1444	302	4672
Satd. Flow (RTOR)		52	253			
Lane Group Flow (vph)	654	170	1292	253	8	1521
Turn Type	Prot	Perm	NA	Perm	Perm	NA
Protected Phases	8		2			6
Permitted Phases		8		2	6	
Detector Phase	8	8	2	2	6	6
Switch Phase						
Minimum Initial (s)	10.0	10.0	10.0	10.0	10.0	10.0
Minimum Split (s)	36.1	36.1	43.5	43.5	16.0	16.0
Total Split (s)	50.0	50.0	80.0	80.0	80.0	80.0
Total Split (%)	38.5%	38.5%	61.5%	61.5%	61.5%	61.5%
Yellow Time (s)	3.3	3.3	3.7	3.7	3.7	3.7
All-Red Time (s)	2.8	2.8	1.8	1.8	1.8	1.8
Lost Time Adjust (s)	0.0	0.0	0.0	0.0	0.0	0.0
Total Lost Time (s)	6.1	6.1	5.5	5.5	5.5	5.5
Lead/Lag						
Lead-Lag Optimize?						
Recall Mode	None	None	C-Max	C-Max	C-Max	C-Max
Act Effct Green (s)	36.7	36.7	81.7	81.7	81.7	81.7
Actuated g/C Ratio	0.28	0.28	0.63	0.63	0.63	0.63
v/c Ratio	0.85	0.39	0.45	0.25	0.04	0.52
Control Delay	54.7	27.2	8.3	1.9	11.1	15.0
Queue Delay	0.0	0.0	0.2	0.0	0.0	0.0
Total Delay	54.7	27.2	8.5	1.9	11.1	15.0
LOS	D	C	A	A	B	B
Approach Delay	49.0		7.4			15.0
Approach LOS	D		A			B
Queue Length 50th (m)	81.0	23.8	29.7	0.3	0.9	68.0
Queue Length 95th (m)	96.5	41.1	68.4	9.5	m1.3	m74.5
Internal Link Dist (m)	80.2		117.1			60.0
Turn Bay Length (m)		51.5		53.5	115.0	
Base Capacity (vph)	923	513	2880	1001	189	2936
Starvation Cap Reductn	0	0	625	0	0	0
Spillback Cap Reductn	0	0	0	0	0	0
Storage Cap Reductn	0	0	0	0	0	0
Reduced v/c Ratio	0.71	0.33	0.57	0.25	0.04	0.52

Intersection Summary

Cycle Length: 130
 Actuated Cycle Length: 130
 Offset: 124 (95%), Referenced to phase 2:NBT and 6:SBTL, Start of Green
 Natural Cycle: 80
 Control Type: Actuated-Coordinated

Lanes, Volumes, Timings
2: Lemieux St & St Laurent

Existing
AM Peak Hour

Maximum v/c Ratio: 0.85
 Intersection Signal Delay: 19.2
 Intersection Capacity Utilization 59.4%
 Analysis Period (min) 15
 m Volume for 95th percentile queue is metered by upstream signal.

Intersection LOS: B
 ICU Level of Service B

Splits and Phases: 2: Lemieux St & St Laurent



Lanes, Volumes, Timings
3: St Laurent & Transitway

Existing
AM Peak Hour

Lane Group	WBL	WBR	NBT	NBR	SBL	SBT
Lane Configurations	↔	↔	↑↑↑	↔	↔	↑↑↑
Traffic Volume (vph)	48	24	1388	60	2	753
Future Volume (vph)	48	24	1388	60	2	753
Satd. Flow (prot)	833	0	4437	0	1127	4628
Fit Permitted	0.968				0.133	
Satd. Flow (perm)	833	0	4437	0	158	4628
Satd. Flow (RTOR)	9		13			
Lane Group Flow (vph)	80	0	1609	0	2	837
Turn Type	Prot		NA		Perm	NA
Protected Phases	8		2			6
Permitted Phases					6	
Detector Phase	8		2		6	6
Switch Phase						
Minimum Initial (s)	10.0		10.0		10.0	10.0
Minimum Split (s)	29.5		30.0		22.5	22.5
Total Split (s)	30.0		35.0		35.0	35.0
Total Split (%)	46.2%		53.8%		53.8%	53.8%
Yellow Time (s)	3.3		3.7		3.7	3.7
All-Red Time (s)	2.2		2.3		2.3	2.3
Lost Time Adjust (s)	0.0		0.0		0.0	0.0
Total Lost Time (s)	5.5		6.0		6.0	6.0
Lead/Lag						
Lead-Lag Optimize?						
Recall Mode	None		C-Max		C-Max	C-Max
Act Effct Green (s)	12.4		49.7		49.7	49.7
Actuated g/C Ratio	0.19		0.76		0.76	0.76
v/c Ratio	0.48		0.47		0.02	0.24
Control Delay	30.4		4.3		7.5	5.5
Queue Delay	0.0		0.0		0.0	0.0
Total Delay	30.4		4.3		7.5	5.5
LOS	C		A		A	A
Approach Delay	30.4		4.3			5.5
Approach LOS	C		A			A
Queue Length 50th (m)	7.9		23.1		0.1	21.3
Queue Length 95th (m)	17.6		36.6		m0.4	51.2
Internal Link Dist (m)	43.2		196.1			117.1
Turn Bay Length (m)					13.0	
Base Capacity (vph)	319		3393		120	3536
Starvation Cap Reductn	0		0		0	0
Spillback Cap Reductn	0		0		0	0
Storage Cap Reductn	0		0		0	0
Reduced v/c Ratio	0.25		0.47		0.02	0.24

Intersection Summary

Cycle Length: 65
 Actuated Cycle Length: 65
 Offset: 38 (58%), Referenced to phase 2:NBT and 6:SBTL, Start of Green
 Natural Cycle: 60
 Control Type: Actuated-Coordinated

Lanes, Volumes, Timings
3: St Laurent & Transitway

Existing
AM Peak Hour

Maximum v/c Ratio: 0.48	Intersection LOS: A
Intersection Signal Delay: 5.5	ICU Level of Service A
Intersection Capacity Utilization 47.6%	
Analysis Period (min) 15	
m Volume for 95th percentile queue is metered by upstream signal.	

Splits and Phases: 3: St Laurent & Transitway

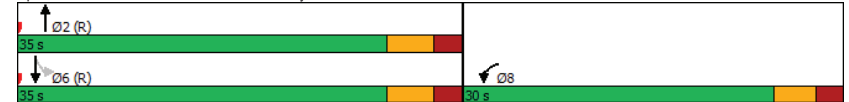

Lanes, Volumes, Timings
4: Hwy 417 EB Off-Ramp & St Laurent

Existing
AM Peak Hour

Lane Group	EBL	EBR	NBL	NBT	SBT	SBR
Lane Configurations	↔↔	↔		↑↑↑	↑↑↑	
Traffic Volume (vph)	685	556	0	1059	672	170
Future Volume (vph)	685	556	0	1059	672	170
Satd. Flow (prot)	3066	1427	0	4418	4302	0
Fit Permitted	0.950					
Satd. Flow (perm)	3066	1409	0	4418	4302	0
Satd. Flow (RTOR)		170			72	
Lane Group Flow (vph)	761	618	0	1177	936	0
Turn Type	Prot	Perm		NA	NA	
Protected Phases	4			2	6	
Permitted Phases		4				
Detector Phase	4	4		2	6	
Switch Phase						
Minimum Initial (s)	10.0	10.0		10.0	10.0	
Minimum Split (s)	34.5	34.5		24.1	42.1	
Total Split (s)	55.0	55.0		75.0	75.0	
Total Split (%)	42.3%	42.3%		57.7%	57.7%	
Yellow Time (s)	3.3	3.3		3.7	3.7	
All-Red Time (s)	3.2	3.2		2.4	2.4	
Lost Time Adjust (s)	0.0	0.0		0.0	0.0	
Total Lost Time (s)	6.5	6.5		6.1	6.1	
Lead/Lag						
Lead-Lag Optimize?						
Recall Mode	None	None		C-Max	C-Max	
Act Effct Green (s)	48.2	48.2		69.2	69.2	
Actuated g/C Ratio	0.37	0.37		0.53	0.53	
v/c Ratio	0.67	0.98		0.50	0.40	
Control Delay	37.8	61.6		20.3	16.8	
Queue Delay	0.0	0.0		0.0	0.0	
Total Delay	37.8	61.6		20.3	16.8	
LOS	D	E		C	B	
Approach Delay	48.4			20.3	16.8	
Approach LOS	D			C	B	
Queue Length 50th (m)	83.1	123.5		68.3	33.4	
Queue Length 95th (m)	104.6	#202.7		80.9	31.5	
Internal Link Dist (m)	73.5			158.0	196.1	
Turn Bay Length (m)						
Base Capacity (vph)	1143	632		2353	2324	
Starvation Cap Reductn	0	0		0	0	
Spillback Cap Reductn	0	0		0	0	
Storage Cap Reductn	0	0		0	0	
Reduced v/c Ratio	0.67	0.98		0.50	0.40	

Intersection Summary	
Cycle Length:	130
Actuated Cycle Length:	130
Offset:	25 (19%), Referenced to phase 2:NBT and 6:SBT, Start of Green
Natural Cycle:	90
Control Type:	Actuated-Coordinated

Lanes, Volumes, Timings
4: Hwy 417 EB Off-Ramp & St Laurent

Existing
AM Peak Hour

Maximum v/c Ratio: 0.98	Intersection LOS: C
Intersection Signal Delay: 30.5	ICU Level of Service D
Intersection Capacity Utilization 75.2%	
Analysis Period (min) 15	
# 95th percentile volume exceeds capacity, queue may be longer.	
Queue shown is maximum after two cycles.	

Splits and Phases: 4: Hwy 417 EB Off-Ramp & St Laurent

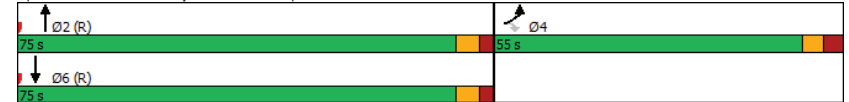

Lanes, Volumes, Timings
5: Cyrville & Ogilvie

Existing
AM Peak Hour

Lane Group	EBL	EBT	EBR	WBL	WBT	WBR	NBL	NBT	NBR	SBL	SBT	SBR
Lane Configurations		↑↑	↑	↑	↑↑	↑	↑	↑	↑	↑	↑	↑
Traffic Volume (vph)	0	532	227	27	984	166	165	234	12	47	152	45
Future Volume (vph)	0	532	227	27	984	166	165	234	12	47	152	45
Satd. Flow (prot)	0	3283	1414	1658	3316	1441	1551	1716	0	1626	1600	0
Fit Permitted				0.413			0.494			0.396		
Satd. Flow (perm)	0	3283	1326	712	3316	1312	802	1716	0	676	1600	0
Satd. Flow (RTOR)			252			158		2			12	
Lane Group Flow (vph)	0	591	252	30	1093	184	183	273	0	52	219	0
Turn Type	NA	Perm	Perm	NA	Perm	Perm	NA	Perm	NA	Perm	NA	
Protected Phases		2		6		6	4			8		
Permitted Phases			2	6		6	4			8		
Detector Phase		2	2	6	6	6	4	4		8	8	
Switch Phase												
Minimum Initial (s)		10.0	10.0	10.0	10.0	10.0	10.0			10.0	10.0	
Minimum Split (s)		32.2	32.2	32.2	32.2	32.2	47.1	47.1		47.1	47.1	
Total Split (s)		80.0	80.0	80.0	80.0	80.0	50.0	50.0		50.0	50.0	
Total Split (%)		61.5%	61.5%	61.5%	61.5%	61.5%	38.5%	38.5%		38.5%	38.5%	
Yellow Time (s)		3.7	3.7	3.7	3.7	3.7	3.7	3.7		3.7	3.7	
All-Red Time (s)		2.5	2.5	2.5	2.5	2.5	3.4	3.4		3.4	3.4	
Lost Time Adjust (s)		0.0	0.0	0.0	0.0	0.0	0.0	0.0		0.0	0.0	
Total Lost Time (s)		6.2	6.2	6.2	6.2	6.2	7.1	7.1		7.1	7.1	
Lead/Lag												
Lead-Lag Optimize?												
Recall Mode		C-Max	C-Max	C-Max	C-Max	C-Max	None	None		None	None	
Act Effct Green (s)		85.0	85.0	85.0	85.0	85.0	31.7	31.7		31.7	31.7	
Actuated g/C Ratio		0.65	0.65	0.65	0.65	0.65	0.24	0.24		0.24	0.24	
v/c Ratio		0.28	0.26	0.06	0.50	0.20	0.94	0.65		0.32	0.55	
Control Delay		7.1	1.0	11.2	13.9	3.2	97.3	50.1		42.3	44.2	
Queue Delay		0.0	0.0	0.0	0.0	0.0	0.0	0.0		0.0	0.0	
Total Delay		7.1	1.0	11.2	13.9	3.2	97.3	50.1		42.3	44.2	
LOS		A	A	B	B	A	F	D		D	D	
Approach Delay		5.3			12.3			69.0			43.9	
Approach LOS		A			B			E			D	
Queue Length 50th (m)		22.2	0.0	2.6	71.8	2.2	45.9	62.4		10.9	46.3	
Queue Length 95th (m)		33.2	0.0	8.1	110.6	13.1	#73.3	81.4		20.8	63.6	
Internal Link Dist (m)		123.7			139.9			46.0			76.2	
Turn Bay Length (m)				53.5		51.0	42.5			77.0		
Base Capacity (vph)		2146	954	465	2168	912	264	567		223	536	
Starvation Cap Reductn		0	0	0	0	0	0	0		0	0	
Spillback Cap Reductn		0	0	0	0	0	0	0		0	0	
Storage Cap Reductn		0	0	0	0	0	0	0		0	0	
Reduced v/c Ratio		0.28	0.26	0.06	0.50	0.20	0.69	0.48		0.23	0.41	

Intersection Summary

Cycle Length: 130
Actuated Cycle Length: 130
Offset: 10 (8%), Referenced to phase 2:EBT and 6:WBTL, Start of Green
Natural Cycle: 80
Control Type: Actuated-Coordinated

Lanes, Volumes, Timings
5: Cyrville & Ogilvie

Existing
AM Peak Hour

Maximum v/c Ratio: 0.94	Intersection LOS: C
Intersection Signal Delay: 22.2	ICU Level of Service C
Intersection Capacity Utilization 72.0%	
Analysis Period (min) 15	
# 95th percentile volume exceeds capacity, queue may be longer.	
Queue shown is maximum after two cycles.	

Splits and Phases: 5: Cyrville & Ogilvie

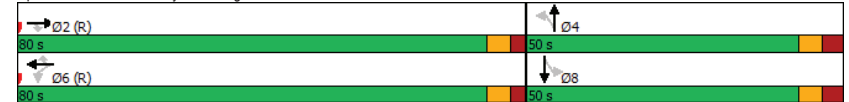

HCM 2010 TWSC
6: Lemieux & Labelle

Existing
AM Peak Hour

Intersection												
Int Delay, s/veh	2.4											
Movement	EBL	EBT	EBR	WBL	WBT	WBR	NBL	NBT	NBR	SBL	SBT	SBR
Lane Configurations	↔ ↕ ↕ ↕ ↕ ↕ ↕ ↕ ↕ ↕ ↕ ↕ ↕											
Traffic Vol, veh/h	30	0	0	0	0	125	133	555	44	0	0	177
Future Vol, veh/h	30	0	0	0	0	125	133	555	44	0	0	177
Conflicting Peds, #/hr	0	0	0	0	0	0	0	0	0	0	0	0
Sign Control	Stop	Stop	Stop	Stop	Stop	Stop	Free	Free	Free	Free	Free	Free
RT Channelized	-	-	None	-	-	None	-	-	Free	-	-	Yield
Storage Length	0	-	-	-	-	0	-	-	-	-	-	0
Veh in Median Storage, #	-	0	-	-	0	-	-	0	-	-	-	-
Grade, %	-	0	-	-	0	-	-	0	-	-	-	0
Peak Hour Factor	90	90	90	90	90	90	90	90	90	90	90	90
Heavy Vehicles, %	2	2	2	2	2	2	2	2	2	2	2	2
Mvmt Flow	33	0	0	0	0	139	148	617	49	0	0	197

Major/Minor	Minor2	Minor1	Major1					
Conflicting Flow All	605	-	-	-	309	0	0	-
Stage 1	0	-	-	-	-	-	-	-
Stage 2	605	-	-	-	-	-	-	-
Critical Hdwy	7.54	-	-	-	6.94	4.14	-	-
Critical Hdwy Stg 1	-	-	-	-	-	-	-	-
Critical Hdwy Stg 2	6.54	-	-	-	-	-	-	-
Follow-up Hdwy	3.52	-	-	-	3.32	2.22	-	-
Pot Cap-1 Maneuver	382	0	0	0	687	-	-	0
Stage 1	-	0	0	0	-	-	-	0
Stage 2	451	0	0	0	-	-	-	0
Platoon blocked, %	-	-	-	-	-	-	-	-
Mov Cap-1 Maneuver	305	-	-	-	687	-	-	-
Mov Cap-2 Maneuver	305	-	-	-	-	-	-	-
Stage 1	-	-	-	-	-	-	-	-
Stage 2	360	-	-	-	-	-	-	-

Approach	EB	WB	NB
HCM Control Delay, s	18.2	11.6	
HCM LOS	C	B	

Minor Lane/Major Mvmt	NBL	NBT	EBLn1	WBLn1
Capacity (veh/h)	-	-	305	687
HCM Lane V/C Ratio	-	-	0.109	0.202
HCM Control Delay (s)	-	-	18.2	11.6
HCM Lane LOS	-	-	C	B
HCM 95th %tile Q(veh)	-	-	0.4	0.8

HCM 2010 TWSC
7: Lemieux St/Lemieux & Joseph Cyr

Existing
AM Peak Hour

Intersection						
Int Delay, s/veh	1.6					
Movement	EBL	EBT	WBT	WBR	SBL	SBR
Lane Configurations	↔ ↕ ↕ ↕ ↕ ↕ ↕ ↕ ↕ ↕ ↕ ↕ ↕					
Traffic Vol, veh/h	67	168	687	21	9	55
Future Vol, veh/h	67	168	687	21	9	55
Conflicting Peds, #/hr	4	0	0	4	0	0
Sign Control	Free	Free	Free	Free	Stop	Stop
RT Channelized	-	None	-	None	-	None
Storage Length	22	-	-	-	0	-
Veh in Median Storage, #	-	0	0	-	0	-
Grade, %	-	0	0	-	0	-
Peak Hour Factor	90	90	90	90	90	90
Heavy Vehicles, %	6	2	10	2	2	5
Mvmt Flow	74	187	763	23	10	61

Major/Minor	Major1	Major2	Minor2			
Conflicting Flow All	790	0	-	0	1114	397
Stage 1	-	-	-	-	779	-
Stage 2	-	-	-	-	335	-
Critical Hdwy	4.19	-	-	-	6.63	6.975
Critical Hdwy Stg 1	-	-	-	-	5.83	-
Critical Hdwy Stg 2	-	-	-	-	5.43	-
Follow-up Hdwy	2.257	-	-	-	3.519	3.3475
Pot Cap-1 Maneuver	806	-	-	-	216	596
Stage 1	-	-	-	-	414	-
Stage 2	-	-	-	-	724	-
Platoon blocked, %	-	-	-	-	-	-
Mov Cap-1 Maneuver	803	-	-	-	195	594
Mov Cap-2 Maneuver	-	-	-	-	195	-
Stage 1	-	-	-	-	375	-
Stage 2	-	-	-	-	722	-

Approach	EB	WB	SB
HCM Control Delay, s	2.8	0	14.2
HCM LOS			B

Minor Lane/Major Mvmt	EBL	EBT	WBT	WBR	SBLn1
Capacity (veh/h)	803	-	-	-	461
HCM Lane V/C Ratio	0.093	-	-	-	0.154
HCM Control Delay (s)	9.9	-	-	-	14.2
HCM Lane LOS	A	-	-	-	B
HCM 95th %tile Q(veh)	0.3	-	-	-	0.5

HCM 2010 TWSC
8: Joseph Cyr & Cyrville

Existing
AM Peak Hour

Intersection												
Int Delay, s/veh	1.4											
Movement	EBL	EBT	EBR	WBL	WBT	WBR	NBL	NBT	NBR	SBL	SBT	SBR
Lane Configurations	↔		↔		↔		↔		↔		↔	
Traffic Vol, veh/h	1	374	31	30	396	1	15	1	47	1	0	0
Future Vol, veh/h	1	374	31	30	396	1	15	1	47	1	0	0
Conflicting Peds, #/hr	3	0	1	1	0	3	0	0	2	2	0	0
Sign Control	Free	Free	Free	Free	Free	Free	Stop	Stop	Stop	Stop	Stop	Stop
RT Channelized	-	-	None	-	-	None	-	-	None	-	-	None
Storage Length	-	-	-	-	-	-	-	-	-	-	-	-
Veh in Median Storage, #	-	0	-	-	0	-	-	0	-	-	0	-
Grade, %	-	0	-	-	0	-	-	0	-	-	0	-
Peak Hour Factor	90	90	90	90	90	90	90	90	90	90	90	90
Heavy Vehicles, %	2	3	6	3	3	2	7	2	9	2	2	2
Mvmt Flow	1	416	34	33	440	1	17	1	52	1	0	0
Major/Minor	Major1	Major2	Minor1	Minor2								
Conflicting Flow All	444	0	0	451	0	0	943	946	436	974	963	444
Stage 1	-	-	-	-	-	-	436	436	-	510	510	-
Stage 2	-	-	-	-	-	-	507	510	-	464	453	-
Critical Hdwy	4.12	-	-	4.13	-	-	7.17	6.52	6.29	7.12	6.52	6.22
Critical Hdwy Stg 1	-	-	-	-	-	-	6.17	5.52	-	6.12	5.52	-
Critical Hdwy Stg 2	-	-	-	-	-	-	6.17	5.52	-	6.12	5.52	-
Follow-up Hdwy	2.218	-	-	2.227	-	-	3.563	4.018	3.381	3.518	4.018	3.318
Pot Cap-1 Maneuver	1116	-	-	1104	-	-	238	262	606	231	256	614
Stage 1	-	-	-	-	-	-	589	580	-	546	538	-
Stage 2	-	-	-	-	-	-	539	538	-	578	570	-
Platoon blocked, %	-	-	-	-	-	-	-	-	-	-	-	-
Mov Cap-1 Maneuver	1113	-	-	1103	-	-	230	250	605	203	245	613
Mov Cap-2 Maneuver	-	-	-	-	-	-	230	250	-	203	245	-
Stage 1	-	-	-	-	-	-	588	579	-	544	515	-
Stage 2	-	-	-	-	-	-	517	515	-	526	569	-
Approach	EB	WB	NB	SB								
HCM Control Delay, s	0	0.6	15	22.8								
HCM LOS			C	C								
Minor Lane/Major Mvmt	NBLn1	EBL	EBT	EBR	WBL	WBT	WBR	SBLn1				
Capacity (veh/h)	429	1113	-	-	1103	-	-	203				
HCM Lane V/C Ratio	0.163	0.001	-	-	0.03	-	-	0.005				
HCM Control Delay (s)	15	8.2	0	-	8.4	0	-	22.8				
HCM Lane LOS	C	A	A	-	A	A	-	C				
HCM 95th %tile Q(veh)	0.6	0	-	-	0.1	-	-	0				

Lanes, Volumes, Timings
1: St Laurent & Coventry/Ogilvie

Existing
PM Peak Hour

Lane Group	EBL	EBT	EBR	WBL	WBT	WBR	NBL	NBT	NBR	SBL	SBT	SBR
Lane Configurations	↔	↔	↔	↔	↔	↔	↔	↔	↔	↔	↔	↔
Traffic Volume (vph)	302	574	205	466	367	30	183	846	609	71	758	192
Future Volume (vph)	302	574	205	466	367	30	183	846	609	71	758	192
Satd. Flow (prot)	3216	3316	1483	3154	3075	1469	1566	3252	1483	1658	4764	1483
Fit Permitted	0.950			0.950			0.950			0.950		
Satd. Flow (perm)	2870	3316	1390	3088	3075	1285	1540	3252	1416	1643	4764	1385
Satd. Flow (RTOR)			213			210			375			211
Lane Group Flow (vph)	336	638	228	518	408	33	203	940	677	79	842	213
Turn Type	Prot	NA	Perm	Prot	NA	Perm	Prot	NA	Perm	Prot	NA	Perm
Protected Phases	7	4	4	3	8	8	5	2	2	1	6	6
Permitted Phases			4			8			2			6
Detector Phase	7	4	4	3	8	8	5	2	2	1	6	6
Switch Phase												
Minimum Initial (s)	5.0	10.0	10.0	5.0	10.0	10.0	5.0	10.0	10.0	5.0	10.0	10.0
Minimum Split (s)	11.9	37.5	37.5	11.9	37.5	37.5	11.4	35.4	35.4	11.4	35.4	35.4
Total Split (%)	23.5	37.5	37.5	23.5	37.5	37.5	23.6	44.0	44.0	15.0	35.4	35.4
Total Split (%)	19.6%	31.3%	31.3%	19.6%	31.3%	31.3%	19.7%	36.7%	36.7%	12.5%	29.5%	29.5%
Yellow Time (s)	3.7	3.7	3.7	3.7	3.7	3.7	3.7	3.7	3.7	3.7	3.7	3.7
All-Red Time (s)	3.2	2.8	2.8	3.2	2.8	2.8	2.7	2.7	2.7	2.7	2.7	2.7
Lost Time Adjust (s)	0.0	0.0	0.0	0.0	0.0	0.0	0.0	0.0	0.0	0.0	0.0	0.0
Total Lost Time (s)	6.9	6.5	6.5	6.9	6.5	6.5	6.4	6.4	6.4	6.4	6.4	6.4
Lead/Lag	Lag	Lead	Lead	Lag	Lead	Lead	Lag	Lag	Lag	Lag	Lag	Lag
Lead-Lag Optimize?	Yes	Yes	Yes	Yes	Yes	Yes	Yes	Yes	Yes	Yes	Yes	Yes
Recall Mode	None	None	None	None	None	None	None	C-Max	C-Max	None	C-Max	C-Max
Act Effct Green (s)	16.6	29.2	29.2	18.4	31.0	31.0	17.0	37.9	37.9	8.3	29.2	29.2
Actuated g/C Ratio	0.14	0.24	0.24	0.15	0.26	0.26	0.14	0.32	0.32	0.07	0.24	0.24
v/c Ratio	0.76	0.79	0.46	1.07	0.51	0.07	0.92	0.92	0.96	0.69	0.73	0.43
Control Delay	61.6	50.3	9.1	109.4	35.5	0.3	104.9	49.1	41.8	84.5	46.0	7.9
Queue Delay	0.0	0.0	0.0	0.0	0.0	0.0	0.0	0.0	0.0	0.0	0.0	0.0
Total Delay	61.6	50.3	9.1	109.4	35.5	0.3	104.9	49.1	41.8	84.5	46.0	7.9
LOS	E	D	A	F	D	A	F	D	D	F	D	A
Approach Delay	45.6			74.2			52.6			41.6		
Approach LOS	D			E			D			D		
Queue Length 50th (m)	39.7	72.8	2.7	~76.8	46.2	0.0	47.9	124.6	111.1	18.5	67.2	0.4
Queue Length 95th (m)	#56.5	93.9	22.9	#110.6	62.3	m0.0	#92.4	#155.6	#96.1	#41.0	82.4	19.4
Internal Link Dist (m)		213.9			123.7			114.3			252.7	
Turn Bay Length (m)	100.0		64.0	75.0			47.5			40.0		45.0
Base Capacity (vph)	444	856	517	483	794	487	224	1026	704	118	1160	496
Starvation Cap Reductn	0	0	0	0	0	0	0	0	0	0	0	0
Spillback Cap Reductn	0	0	0	0	0	0	0	0	0	0	0	0
Storage Cap Reductn	0	0	0	0	0	0	0	0	0	0	0	0
Reduced v/c Ratio	0.76	0.75	0.44	1.07	0.51	0.07	0.91	0.92	0.96	0.67	0.73	0.43
Intersection Summary												
Cycle Length: 120												
Actuated Cycle Length: 120												
Offset: 0 (0%), Referenced to phase 2:NBT and 6:SBT, Start of Green												
Natural Cycle: 120												
Control Type: Actuated-Coordinated												

Lanes, Volumes, Timings
1: St Laurent & Coventry/Ogilvie

Existing
PM Peak Hour

Maximum v/c Ratio: 1.07	Intersection LOS: D
Intersection Signal Delay: 52.6	ICU Level of Service F
Intersection Capacity Utilization 94.5%	
Analysis Period (min) 15	
~ Volume exceeds capacity, queue is theoretically infinite.	
Queue shown is maximum after two cycles.	
# 95th percentile volume exceeds capacity, queue may be longer.	
Queue shown is maximum after two cycles.	
m Volume for 95th percentile queue is metered by upstream signal.	

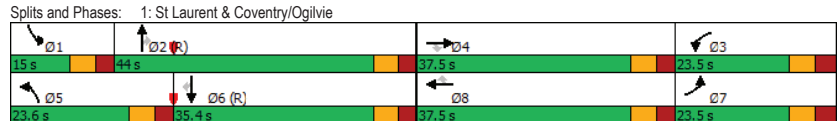

Lanes, Volumes, Timings
2: Lemieux & St Laurent

Existing
PM Peak Hour

Lane Group	WBL	WBR	NBT	NBR	SBL	SBT
Lane Configurations	↔↔	↔	↑↑↑	↔	↔	↑↑↑
Traffic Volume (vph)	496	156	1528	246	13	1700
Future Volume (vph)	496	156	1528	246	13	1700
Satd. Flow (prot)	2982	1414	4718	1483	1658	4672
Fit Permitted	0.950				0.105	
Satd. Flow (perm)	2982	1316	4718	1433	183	4672
Satd. Flow (RTOR)		29		273		
Lane Group Flow (vph)	551	173	1698	273	14	1889
Turn Type	Prot	Perm	NA	Perm	Perm	NA
Protected Phases	7		2			6
Permitted Phases		7		2	6	
Detector Phase	7	7	2	2	6	6
Switch Phase						
Minimum Initial (s)	10.0	10.0	10.0	10.0	10.0	10.0
Minimum Split (s)	36.1	36.1	43.5	43.5	16.0	16.0
Total Split (s)	38.0	38.0	82.0	82.0	82.0	82.0
Total Split (%)	31.7%	31.7%	68.3%	68.3%	68.3%	68.3%
Yellow Time (s)	3.3	3.3	3.7	3.7	3.7	3.7
All-Red Time (s)	2.8	2.8	1.8	1.8	1.8	1.8
Lost Time Adjust (s)	0.0	0.0	0.0	0.0	0.0	0.0
Total Lost Time (s)	6.1	6.1	5.5	5.5	5.5	5.5
Lead/Lag						
Lead-Lag Optimize?						
Recall Mode	None	None	C-Max	C-Max	C-Max	C-Max
Act Effct Green (s)	28.7	28.7	79.7	79.7	79.7	79.7
Actuated g/C Ratio	0.24	0.24	0.66	0.66	0.66	0.66
v/c Ratio	0.77	0.51	0.54	0.26	0.12	0.61
Control Delay	50.4	37.9	10.2	2.1	6.3	7.9
Queue Delay	0.0	0.0	0.3	0.0	0.0	0.0
Total Delay	50.4	37.9	10.5	2.1	6.3	7.9
LOS	D	D	B	A	A	A
Approach Delay	47.4		9.3			7.9
Approach LOS	D		A			A
Queue Length 50th (m)	61.8	29.0	88.3	8.0	0.7	70.4
Queue Length 95th (m)	79.6	50.2	86.9	7.1	m1.8	m75.0
Internal Link Dist (m)	75.1		117.1			60.0
Turn Bay Length (m)		51.5		53.5	115.0	
Base Capacity (vph)	792	371	3134	1043	121	3103
Starvation Cap Reductn	0	0	707	0	0	0
Spillback Cap Reductn	0	0	0	0	0	0
Storage Cap Reductn	0	0	0	0	0	0
Reduced v/c Ratio	0.70	0.47	0.70	0.26	0.12	0.61

Intersection Summary						
Cycle Length:	120					
Actuated Cycle Length:	120					
Offset:	99 (83%), Referenced to phase 2:NBT and 6:SBTL, Start of Green					
Natural Cycle:	80					
Control Type:	Actuated-Coordinated					

Lanes, Volumes, Timings
2: Lemieux & St Laurent

Existing
PM Peak Hour

Maximum v/c Ratio: 0.77	Intersection LOS: B
Intersection Signal Delay: 14.7	ICU Level of Service C
Intersection Capacity Utilization 67.4%	
Analysis Period (min) 15	

m Volume for 95th percentile queue is metered by upstream signal.

Splits and Phases: 2: Lemieux & St Laurent



Lanes, Volumes, Timings
3: St Laurent & Transitway

Existing
PM Peak Hour

Lane Group	WBL	WBR	NBT	NBR	SBL	SBT
Lane Configurations	↔	↔	↑↑↑	↔	↔	↑↑↑
Traffic Volume (vph)	40	20	1807	45	0	1132
Future Volume (vph)	40	20	1807	45	0	1132
Satd. Flow (prot)	914	0	4633	0	1745	4718
Fit Permitted	0.968					
Satd. Flow (perm)	914	0	4633	0	1745	4718
Satd. Flow (RTOR)	1		7			
Lane Group Flow (vph)	66	0	2058	0	0	1258
Turn Type	Prot		NA		Perm	NA
Protected Phases	8		2			6
Permitted Phases					6	
Detector Phase	8		2		6	6
Switch Phase						
Minimum Initial (s)	10.0		10.0		10.0	10.0
Minimum Split (s)	29.5		30.0		24.0	24.0
Total Split (s)	29.5		30.5		30.5	30.5
Total Split (%)	49.2%		50.8%		50.8%	50.8%
Yellow Time (s)	3.3		3.7		3.7	3.7
All-Red Time (s)	2.2		2.3		2.3	2.3
Lost Time Adjust (s)	0.0		0.0		0.0	0.0
Total Lost Time (s)	5.5		6.0		6.0	6.0
Lead/Lag						
Lead-Lag Optimize?						
Recall Mode	None		C-Max		C-Max	C-Max
Act Effct Green (s)	11.3		45.8			45.8
Actuated g/C Ratio	0.19		0.76			0.76
v/c Ratio	0.38		0.58			0.35
Control Delay	27.2		10.0			4.4
Queue Delay	0.0		0.0			0.0
Total Delay	27.2		10.0			4.4
LOS	C		B			A
Approach Delay	27.2		10.0			4.4
Approach LOS	C		B			A
Queue Length 50th (m)	6.5		82.5			26.7
Queue Length 95th (m)	15.1		113.0			40.9
Internal Link Dist (m)	43.2		196.1			117.1
Turn Bay Length (m)						
Base Capacity (vph)	366		3535			3598
Starvation Cap Reductn	0		0			0
Spillback Cap Reductn	0		0			0
Storage Cap Reductn	0		0			0
Reduced v/c Ratio	0.18		0.58			0.35

Intersection Summary						
Cycle Length:	60					
Actuated Cycle Length:	60					
Offset:	28 (47%), Referenced to phase 2:NBT and 6:SBTL, Start of Green					
Natural Cycle:	65					
Control Type:	Actuated-Coordinated					

Lanes, Volumes, Timings
3: St Laurent & Transitway

Existing
PM Peak Hour

Maximum v/c Ratio: 0.58	Intersection LOS: A
Intersection Signal Delay: 8.3	ICU Level of Service B
Intersection Capacity Utilization 55.8%	
Analysis Period (min) 15	

Splits and Phases: 3: St Laurent & Transitway

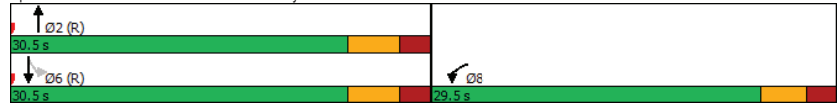

Lanes, Volumes, Timings
4: Hwy 417 EB Off-Ramp & St Laurent

Existing
PM Peak Hour

Lane Group	EBL	EBR	NBL	NBT	SBT	SBR
Lane Configurations	↔↔	↔		↑↑↑	↑↑↑	
Traffic Volume (vph)	784	247	0	1245	706	397
Future Volume (vph)	784	247	0	1245	706	397
Satd. Flow (prot)	3124	1414	0	4764	4225	0
Fit Permitted	0.950					
Satd. Flow (perm)	3124	1376	0	4764	4225	0
Satd. Flow (RTOR)		147			181	
Lane Group Flow (vph)	871	274	0	1383	1225	0
Turn Type	Prot	Perm		NA	NA	
Protected Phases	4			2	6	
Permitted Phases		4				
Detector Phase	4	4		2	6	
Switch Phase						
Minimum Initial (s)	10.0	10.0		10.0	10.0	
Minimum Split (s)	34.5	34.5		24.1	42.1	
Total Split (s)	50.0	50.0		70.0	70.0	
Total Split (%)	41.7%	41.7%		58.3%	58.3%	
Yellow Time (s)	3.3	3.3		3.7	3.7	
All-Red Time (s)	3.2	3.2		2.4	2.4	
Lost Time Adjust (s)	0.0	0.0		0.0	0.0	
Total Lost Time (s)	6.5	6.5		6.1	6.1	
Lead/Lag						
Lead-Lag Optimize?						
Recall Mode	None	None		C-Max	C-Max	
Act Effct Green (s)	39.0	39.0		68.4	68.4	
Actuated g/C Ratio	0.32	0.32		0.57	0.57	
v/c Ratio	0.86	0.50		0.51	0.49	
Control Delay	47.1	17.2		17.0	10.9	
Queue Delay	0.0	0.0		0.0	0.0	
Total Delay	47.1	17.2		17.0	10.9	
LOS	D	B		B	B	
Approach Delay	39.9			17.0	10.9	
Approach LOS	D			B	B	
Queue Length 50th (m)	97.1	22.4		70.4	59.5	
Queue Length 95th (m)	116.7	45.6		88.6	90.5	
Internal Link Dist (m)	73.5			158.0	196.1	
Turn Bay Length (m)						
Base Capacity (vph)	1132	592		2716	2486	
Starvation Cap Reductn	0	0		0	0	
Spillback Cap Reductn	0	0		0	0	
Storage Cap Reductn	0	0		0	0	
Reduced v/c Ratio	0.77	0.46		0.51	0.49	

Intersection Summary

Cycle Length: 120
Actuated Cycle Length: 120
Offset: 40 (33%), Referenced to phase 2:NBT and 6:SBT, Start of Green
Natural Cycle: 80
Control Type: Actuated-Coordinated

Lanes, Volumes, Timings
4: Hwy 417 EB Off-Ramp & St Laurent

Existing
PM Peak Hour

Maximum v/c Ratio: 0.86	Intersection LOS: C
Intersection Signal Delay: 22.0	ICU Level of Service B
Intersection Capacity Utilization 62.4%	
Analysis Period (min) 15	

Splits and Phases: 4: Hwy 417 EB Off-Ramp & St Laurent

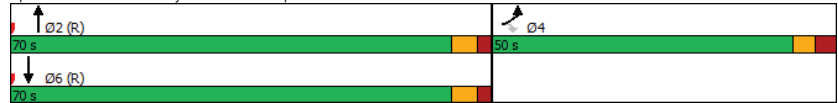

Lanes, Volumes, Timings
5: Cyrville & Ogilvie

Existing
PM Peak Hour

Lane Group	EBL	EBT	EBR	WBL	WBT	WBR	NBL	NBT	NBR	SBL	SBT	SBR
Lane Configurations		↑↑	↑	↓	↑↑	↑	↓	↑	↓	↓	↓	↓
Traffic Volume (vph)	0	984	257	42	641	124	117	210	32	134	213	80
Future Volume (vph)	0	984	257	42	641	124	117	210	32	134	213	80
Satd. Flow (prot)	0	3316	1469	1658	3316	1469	1580	1706	0	1642	1637	0
Fit Permitted				0.215			0.310			0.412		
Satd. Flow (perm)	0	3316	1362	373	3316	1327	514	1706	0	709	1637	0
Satd. Flow (RTOR)			286			138		7			18	
Lane Group Flow (vph)	0	1093	286	47	712	138	130	269	0	149	326	0
Turn Type		NA	Perm	Perm	NA	Perm	Perm	NA		Perm	NA	
Protected Phases		2			6		4		4		8	
Permitted Phases			2	6		6	4			8		
Detector Phase		2	2	6	6	6	4	4		8	8	
Switch Phase												
Minimum Initial (s)		10.0	10.0	10.0	10.0	10.0	10.0	10.0		10.0	10.0	
Minimum Split (s)		32.2	32.2	32.2	32.2	32.2	47.1	47.1		47.1	47.1	
Total Split (s)		70.0	70.0	70.0	70.0	70.0	50.0	50.0		50.0	50.0	
Total Split (%)		58.3%	58.3%	58.3%	58.3%	58.3%	41.7%	41.7%		41.7%	41.7%	
Yellow Time (s)		3.7	3.7	3.7	3.7	3.7	3.7	3.7		3.7	3.7	
All-Red Time (s)		2.5	2.5	2.5	2.5	2.5	3.4	3.4		3.4	3.4	
Lost Time Adjust (s)		0.0	0.0	0.0	0.0	0.0	0.0	0.0		0.0	0.0	
Total Lost Time (s)		6.2	6.2	6.2	6.2	6.2	7.1	7.1		7.1	7.1	
Lead/Lag												
Lead-Lag Optimize?												
Recall Mode		C-Max	C-Max	C-Max	C-Max	C-Max	None	None		None	None	
Act Effct Green (s)		77.7	77.7	77.7	77.7	77.7	29.0	29.0		29.0	29.0	
Actuated g/C Ratio		0.65	0.65	0.65	0.65	0.65	0.24	0.24		0.24	0.24	
v/c Ratio		0.51	0.29	0.20	0.33	0.15	1.05	0.65		0.87	0.80	
Control Delay		5.5	0.6	13.7	11.0	2.3	138.2	46.0		84.5	54.1	
Queue Delay		0.2	0.0	0.0	0.0	0.0	0.0	0.0		0.0	0.0	
Total Delay		5.7	0.6	13.7	11.0	2.3	138.2	46.0		84.5	54.1	
LOS		A	A	B	B	A	F	D		F	D	
Approach Delay		4.7			9.8		76.0			63.7		
Approach LOS		A			A		E			E		
Queue Length 50th (m)		29.1	0.1	4.1	36.1	0.0	~33.8	56.0		34.1	69.1	
Queue Length 95th (m)		m55.4	m1.2	13.3	60.7	8.7	#60.9	73.6		54.2	89.9	
Internal Link Dist (m)		123.7			139.9		44.2				76.2	
Turn Bay Length (m)				53.5		51.0	42.5			77.0		
Base Capacity (vph)		2147	982	241	2147	907	183	614		253	596	
Starvation Cap Reductn		391	0	0	0	0	0	0		0	0	
Spillback Cap Reductn		0	0	0	0	0	0	0		0	0	
Storage Cap Reductn		0	0	0	0	0	0	0		0	0	
Reduced v/c Ratio		0.62	0.29	0.20	0.33	0.15	0.71	0.44		0.59	0.55	

Intersection Summary												
Cycle Length: 120												
Actuated Cycle Length: 120												
Offset: 20 (17%), Referenced to phase 2:EBT and 6:WBTL, Start of Green												
Natural Cycle: 80												
Control Type: Actuated-Coordinated												

Lanes, Volumes, Timings
5: Cyrville & Ogilvie

Existing
PM Peak Hour

Maximum v/c Ratio: 1.05
 Intersection Signal Delay: 24.1 Intersection LOS: C
 Intersection Capacity Utilization 83.2% ICU Level of Service E
 Analysis Period (min) 15
 ~ Volume exceeds capacity, queue is theoretically infinite.
 Queue shown is maximum after two cycles.
 # 95th percentile volume exceeds capacity, queue may be longer.
 Queue shown is maximum after two cycles.
 m Volume for 95th percentile queue is metered by upstream signal.

Splits and Phases: 5: Cyrville & Ogilvie

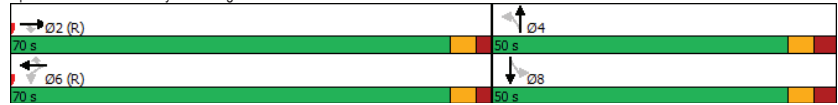

HCM 2010 TWSC
6: Labelle & Lemieux

Existing
PM Peak Hour

Intersection												
Int Delay, s/veh	5.7											
Movement	EBL	EBT	EBR	WBL	WBT	WBR	NBL	NBT	NBR	SBL	SBT	SBR
Lane Configurations	↔ ↕ ↕ ↕ ↕ ↕ ↕ ↕ ↕ ↕ ↕ ↕ ↕											
Traffic Vol, veh/h	131	0	0	0	0	156	112	314	27	0	0	176
Future Vol, veh/h	131	0	0	0	0	156	112	314	27	0	0	176
Conflicting Peds, #/hr	0	0	0	0	0	0	0	0	0	0	0	0
Sign Control	Stop	Stop	Stop	Stop	Stop	Stop	Free	Free	Free	Free	Free	Free
RT Channelized	-	-	None	-	-	None	-	-	Free	-	-	Yield
Storage Length	0	-	-	-	-	0	-	-	-	-	-	0
Veh in Median Storage, #	-	0	-	-	0	-	-	0	-	-	-	-
Grade, %	-	0	-	-	0	-	-	0	-	-	-	0
Peak Hour Factor	90	90	90	90	90	90	90	90	90	90	90	90
Heavy Vehicles, %	2	2	2	2	2	2	2	2	2	2	2	2
Mvmt Flow	146	0	0	0	0	173	124	349	30	0	0	196

Major/Minor	Minor2	Minor1	Major1
Conflicting Flow All	423	-	-
Stage 1	0	-	-
Stage 2	423	-	-
Critical Hdwy	7.54	-	-
Critical Hdwy Stg 1	-	-	-
Critical Hdwy Stg 2	6.54	-	-
Follow-up Hdwy	3.52	-	-
Pot Cap-1 Maneuver	515	0	0
Stage 1	-	0	0
Stage 2	579	0	0
Platoon blocked, %	-	-	-
Mov Cap-1 Maneuver	408	-	-
Mov Cap-2 Maneuver	408	-	-
Stage 1	-	-	-
Stage 2	459	-	-

Approach	EB	WB	NB
HCM Control Delay, s	18.6	10.4	
HCM LOS	C	B	

Minor Lane/Major Mvmt	NBL	NBT	EBLn1	WBLn1
Capacity (veh/h)	-	-	408	838
HCM Lane V/C Ratio	-	-	0.357	0.207
HCM Control Delay (s)	-	-	18.6	10.4
HCM Lane LOS	-	-	C	B
HCM 95th %tile Q(veh)	-	-	1.6	0.8

HCM 2010 TWSC
7: Lemieux & Joseph Cyr

Existing
PM Peak Hour

Intersection						
Int Delay, s/veh	2.6					
Movement	EBL	EBT	WBT	WBR	SBL	SBR
Lane Configurations	↖	↑	↗		↖	
Traffic Vol, veh/h	100	159	558	38	17	94
Future Vol, veh/h	100	159	558	38	17	94
Conflicting Peds, #/hr	0	0	0	0	0	0
Sign Control	Free	Free	Free	Free	Stop	Stop
RT Channelized	-	None	-	None	-	None
Storage Length	22	-	-	-	0	-
Veh in Median Storage, #	-	0	0	-	0	-
Grade, %	-	0	0	-	0	-
Peak Hour Factor	90	90	90	90	90	90
Heavy Vehicles, %	2	2	4	3	2	3
Mvmt Flow	111	177	620	42	19	104
Major/Minor	Major1	Major2	Minor2			
Conflicting Flow All	662	0	0	1040	331	
Stage 1	-	-	-	641	-	
Stage 2	-	-	-	399	-	
Critical Hdwy	4.13	-	-	6.63	6.945	
Critical Hdwy Stg 1	-	-	-	5.83	-	
Critical Hdwy Stg 2	-	-	-	5.43	-	
Follow-up Hdwy	2.219	-	-	3.519	3.3285	
Pot Cap-1 Maneuver	925	-	-	240	663	
Stage 1	-	-	-	488	-	
Stage 2	-	-	-	677	-	
Platoon blocked, %	-	-	-	-	-	
Mov Cap-1 Maneuver	925	-	-	211	663	
Mov Cap-2 Maneuver	-	-	-	211	-	
Stage 1	-	-	-	429	-	
Stage 2	-	-	-	677	-	
Approach	EB	WB	SB			
HCM Control Delay, s	3.6	0	14.6			
HCM LOS			B			
Minor Lane/Major Mvmt	EBL	EBT	WBT	WBR	SBLn1	SBR
Capacity (veh/h)	925	-	-	-	499	
HCM Lane V/C Ratio	0.12	-	-	-	0.247	
HCM Control Delay (s)	9.4	-	-	-	14.6	
HCM Lane LOS	A	-	-	-	B	
HCM 95th %tile Q(veh)	0.4	-	-	-	1	

HCM 2010 TWSC
8: Joseph Cyr & Cyrville

Existing
PM Peak Hour

Intersection												
Int Delay, s/veh	3.1											
Movement	EBL	EBT	EBR	WBL	WBT	WBR	NBL	NBT	NBR	SBL	SBT	SBR
Lane Configurations		↕			↕			↕			↕	
Traffic Vol, veh/h	0	461	51	48	320	1	38	5	74	1	1	1
Future Vol, veh/h	0	461	51	48	320	1	38	5	74	1	1	1
Conflicting Peds, #/hr	11	0	3	3	0	11	1	0	3	3	0	1
Sign Control	Free	Free	Free	Free	Free	Free	Stop	Stop	Stop	Stop	Stop	Stop
RT Channelized	-	-	None	-	-	None	-	-	None	-	-	None
Storage Length	-	-	-	-	-	-	-	-	-	-	-	-
Veh in Median Storage, #	-	0	-	-	0	-	-	0	-	-	0	-
Grade, %	-	0	-	-	0	-	-	0	-	-	0	-
Peak Hour Factor	90	90	90	90	90	90	90	90	90	90	90	90
Heavy Vehicles, %	2	3	2	4	2	2	2	2	2	2	2	2
Mvmt Flow	0	512	57	53	356	1	42	6	82	1	1	1
Major/Minor	Major1	Major2	Minor1	Minor2								
Conflicting Flow All	368	0	0	572	0	0	1009	1018	547	1062	1046	369
Stage 1	-	-	-	-	-	-	544	544	-	474	474	-
Stage 2	-	-	-	-	-	-	465	474	-	588	572	-
Critical Hdwy	4.12	-	-	4.14	-	-	7.12	6.52	6.22	7.12	6.52	6.22
Critical Hdwy Stg 1	-	-	-	-	-	-	6.12	5.52	-	6.12	5.52	-
Critical Hdwy Stg 2	-	-	-	-	-	-	6.12	5.52	-	6.12	5.52	-
Follow-up Hdwy	2.218	-	-	2.236	-	-	3.518	4.018	3.318	3.518	4.018	3.318
Pot Cap-1 Maneuver	1191	-	-	991	-	-	219	237	537	201	228	677
Stage 1	-	-	-	-	-	-	523	519	-	571	558	-
Stage 2	-	-	-	-	-	-	578	558	-	495	504	-
Platoon blocked, %	-	-	-	-	-	-	-	-	-	-	-	-
Mov Cap-1 Maneuver	1181	-	-	989	-	-	206	219	535	157	210	671
Mov Cap-2 Maneuver	-	-	-	-	-	-	206	219	-	157	210	-
Stage 1	-	-	-	-	-	-	522	518	-	566	516	-
Stage 2	-	-	-	-	-	-	537	516	-	413	503	-
Approach	EB	WB	NB	SB								
HCM Control Delay, s	0	1.2	22.1	20.3								
HCM LOS			C	C								
Minor Lane/Major Mvmt	NBLn1	EBL	EBT	EBR	WBL	WBT	WBR	SBLn1	SBR			
Capacity (veh/h)	339	1181	-	-	989	-	-	238				
HCM Lane V/C Ratio	0.383	-	-	-	0.054	-	-	0.014				
HCM Control Delay (s)	22.1	0	-	-	8.8	0	-	20.3				
HCM Lane LOS	C	A	-	-	A	A	-	C				
HCM 95th %tile Q(veh)	1.7	0	-	-	0.2	-	-	0				

Appendix D

Collision Data

Accident Date	Accident Year	Accident Time	Location	Environment Condition	Light	Traffic Control	Traffic Control Condition	Classification Of Accident	Initial Impact Type	Road Surface Condition	# Vehicles	# Motorcycles	# Bicycles	# Pedestrians
10/6/2016	2016	10:18	LEMUEX ST @ ST. LAURENT BLVD (0002021)	01 - Clear	01 - Daylight	01 - Traffic signal	01 - Functioning	02 - Non-fatal injury	05 - Turning movement	01 - Dry	3	0	0	0
10/11/2016	2016	15:35	LEMUEX ST @ ST. LAURENT BLVD (0002021)	01 - Clear	01 - Daylight	01 - Traffic signal	00 - Unknown	03 - P.D. only	03 - Rear end	01 - Dry	3	0	0	0
11/9/2016	2016	18:23	LEMUEX ST @ ST. LAURENT BLVD (0002021)	01 - Clear	07 - Dark	01 - Traffic signal	01 - Functioning	02 - Non-fatal injury	03 - Rear end	01 - Dry	3	0	0	0
11/10/2016	2016	17:35	LEMUEX ST @ ST. LAURENT BLVD (0002021)	01 - Clear	07 - Dark	01 - Traffic signal	01 - Functioning	03 - P.D. only	03 - Rear end	01 - Dry	3	0	0	0
10/21/2016	2016	21:55	LEMUEX ST @ ST. LAURENT BLVD (0002021)	02 - Rain	07 - Dark	01 - Traffic signal	01 - Functioning	03 - P.D. only	03 - Rear end	02 - Wet	2	0	0	0
11/23/2016	2016	11:53	LEMUEX ST @ ST. LAURENT BLVD (0002021)	01 - Clear	01 - Daylight	01 - Traffic signal	01 - Functioning	02 - Non-fatal injury	02 - Angle	01 - Dry	2	0	0	0
11/23/2016	2016	16:43	LEMUEX ST @ ST. LAURENT BLVD (0002021)	01 - Clear	05 - Duak	01 - Traffic signal	01 - Functioning	03 - P.D. only	05 - Turning movement	01 - Dry	2	0	0	0
12/1/2016	2016	18:05	LEMUEX ST @ ST. LAURENT BLVD (0002021)	03 - Snow	07 - Dark	01 - Traffic signal	01 - Functioning	03 - P.D. only	03 - Rear end	04 - Slush	3	0	0	0
12/14/2016	2016	9:29	LEMUEX ST @ ST. LAURENT BLVD (0002021)	01 - Clear	01 - Daylight	01 - Traffic signal	01 - Functioning	02 - Non-fatal injury	02 - Angle	01 - Dry	2	0	0	0
9/11/2016	2016	13:18	LEMUEX ST @ ST. LAURENT BLVD (0002021)	01 - Clear	01 - Daylight	01 - Traffic signal	01 - Functioning	03 - P.D. only	05 - Turning movement	01 - Dry	2	0	0	0
2/16/2016	2016	19:18	LEMUEX ST @ ST. LAURENT BLVD (0002021)	03 - Snow	07 - Dark	01 - Traffic signal	01 - Functioning	03 - P.D. only	02 - Angle	04 - Slush	2	0	0	0
2/25/2016	2016	14:29	LEMUEX ST @ ST. LAURENT BLVD (0002021)	03 - Snow	01 - Daylight	01 - Traffic signal	01 - Functioning	03 - P.D. only	02 - Angle	03 - Loose snow	2	0	0	0
2/14/2016	2016	14:31	LEMUEX ST @ ST. LAURENT BLVD (0002021)	01 - Clear	01 - Daylight	01 - Traffic signal	01 - Functioning	02 - Non-fatal injury	03 - Rear end	01 - Dry	2	0	0	0
3/18/2016	2016	15:45	LEMUEX ST @ ST. LAURENT BLVD (0002021)	01 - Clear	01 - Daylight	01 - Traffic signal	01 - Functioning	03 - P.D. only	03 - Rear end	01 - Dry	2	0	0	0
3/17/2016	2016	12:05	LEMUEX ST @ ST. LAURENT BLVD (0002021)	01 - Clear	01 - Daylight	01 - Traffic signal	01 - Functioning	03 - P.D. only	03 - Rear end	01 - Dry	2	0	0	0
4/2/2016	2016	12:46	LEMUEX ST @ ST. LAURENT BLVD (0002021)	01 - Clear	01 - Daylight	01 - Traffic signal	01 - Functioning	03 - P.D. only	03 - Rear end	01 - Dry	2	0	0	0
4/16/2016	2016	9:45	LEMUEX ST @ ST. LAURENT BLVD (0002021)	01 - Clear	01 - Daylight	01 - Traffic signal	01 - Functioning	03 - P.D. only	03 - Rear end	01 - Dry	2	0	0	0
4/16/2016	2016	13:03	LEMUEX ST @ ST. LAURENT BLVD (0002021)	01 - Clear	01 - Daylight	01 - Traffic signal	01 - Functioning	03 - P.D. only	03 - Rear end	01 - Dry	2	0	0	0
6/28/2016	2016	0:11	LEMUEX ST @ ST. LAURENT BLVD (0002021)	01 - Clear	07 - Dark	01 - Traffic signal	01 - Functioning	03 - P.D. only	03 - Rear end	01 - Dry	2	0	0	0
6/13/2016	2016	20:43	LEMUEX ST @ ST. LAURENT BLVD (0002021)	01 - Clear	05 - Duak	01 - Traffic signal	01 - Functioning	03 - P.D. only	02 - Angle	01 - Dry	2	0	0	0
7/24/2016	2016	16:45	LEMUEX ST @ ST. LAURENT BLVD (0002021)	01 - Clear	01 - Daylight	01 - Traffic signal	01 - Functioning	03 - P.D. only	05 - Turning movement	01 - Dry	2	0	0	0
9/11/2016	2016	13:18	LEMUEX ST @ ST. LAURENT BLVD (0002021)	01 - Clear	01 - Daylight	01 - Traffic signal	01 - Functioning	03 - P.D. only	05 - Turning movement	01 - Dry	2	0	0	0
11/4/2017	2017	17:15	LEMUEX ST @ ST. LAURENT BLVD (0002021)	03 - Snow	05 - Duak	01 - Traffic signal	00 - Unknown	03 - P.D. only	04 - Skewspce	02 - Wet	2	0	0	0
10/28/2017	2017	18:45	LEMUEX ST @ ST. LAURENT BLVD (0002021)	01 - Clear	05 - Duak	01 - Traffic signal	01 - Functioning	03 - P.D. only	03 - Rear end	01 - Dry	2	0	0	0
1/31/2017	2017	11:00	LEMUEX ST @ ST. LAURENT BLVD (0002021)	01 - Clear	01 - Daylight	01 - Traffic signal	01 - Functioning	03 - P.D. only	03 - Rear end	01 - Dry	2	0	0	0
1/15/2017	2017	17:00	LEMUEX ST @ ST. LAURENT BLVD (0002021)	01 - Clear	07 - Dark	01 - Traffic signal	01 - Functioning	03 - P.D. only	05 - Turning movement	01 - Dry	2	0	0	0
12/18/2017	2017	12:10	LEMUEX ST @ ST. LAURENT BLVD (0002021)	01 - Clear	01 - Daylight	01 - Traffic signal	03 - Snow	03 - P.D. only	05 - Turning movement	04 - Skewspce	2	0	0	0
2/15/2017	2017	8:17	LEMUEX ST @ ST. LAURENT BLVD (0002021)	03 - Snow	01 - Daylight	01 - Traffic signal	01 - Functioning	03 - P.D. only	02 - Angle	05 - Packed snow	2	0	0	0
4/10/2017	2017	18:32	LEMUEX ST @ ST. LAURENT BLVD (0002021)	01 - Clear	01 - Daylight	01 - Traffic signal	01 - Functioning	03 - P.D. only	03 - Rear end	01 - Dry	2	1	0	0
5/5/2017	2017	8:30	LEMUEX ST @ ST. LAURENT BLVD (0002021)	02 - Rain	01 - Daylight	01 - Traffic signal	01 - Functioning	03 - P.D. only	04 - Skewspce	02 - Wet	2	0	0	0
5/9/2017	2017	20:47	LEMUEX ST @ ST. LAURENT BLVD (0002021)	01 - Clear	07 - Dark	01 - Traffic signal	00 - Unknown	03 - P.D. only	04 - Skewspce	01 - Dry	2	0	0	0
5/26/2017	2017	13:22	LEMUEX ST @ ST. LAURENT BLVD (0002021)	01 - Clear	01 - Daylight	01 - Traffic signal	01 - Functioning	03 - P.D. only	03 - Rear end	01 - Dry	2	0	0	0
8/14/2017	2017	17:42	LEMUEX ST @ ST. LAURENT BLVD (0002021)	01 - Clear	01 - Daylight	01 - Traffic signal	01 - Functioning	03 - P.D. only	03 - Rear end	01 - Dry	4	0	0	0
9/5/2017	2017	16:40	LEMUEX ST @ ST. LAURENT BLVD (0002021)	01 - Clear	01 - Daylight	01 - Traffic signal	01 - Functioning	03 - P.D. only	05 - Turning movement	01 - Dry	2	0	0	0
11/9/2018	2018	12:30	LEMUEX ST @ ST. LAURENT BLVD (0002021)	01 - Clear	01 - Daylight	01 - Traffic signal	01 - Functioning	03 - P.D. only	03 - Rear end	00 - Unknown	2	0	0	0
11/23/2018	2018	15:01	LEMUEX ST @ ST. LAURENT BLVD (0002021)	01 - Clear	01 - Daylight	01 - Traffic signal	01 - Functioning	03 - P.D. only	03 - Rear end	01 - Dry	2	0	0	0
11/7/2018	2018	14:14	LEMUEX ST @ ST. LAURENT BLVD (0002021)	01 - Clear	01 - Daylight	01 - Traffic signal	01 - Functioning	03 - P.D. only	02 - Angle	01 - Dry	2	0	0	0
11/7/2018	2018	14:15	LEMUEX ST @ ST. LAURENT BLVD (0002021)	01 - Clear	01 - Daylight	01 - Traffic signal	01 - Functioning	03 - P.D. only	04 - Skewspce	01 - Dry	2	0	0	0
12/25/2018	2018	21:43	LEMUEX ST @ ST. LAURENT BLVD (0002021)	01 - Clear	07 - Dark	01 - Traffic signal	01 - Functioning	03 - P.D. only	03 - Rear end	01 - Dry	2	0	0	0
12/18/2018	2018	Unknown	LEMUEX ST @ ST. LAURENT BLVD (0002021)	01 - Clear	00 - Unknown	01 - Traffic signal	01 - Functioning	03 - P.D. only	03 - Rear end	01 - Dry	2	0	0	0
12/14/2018	2018	21:20	LEMUEX ST @ ST. LAURENT BLVD (0002021)	04 - Freezing Rain	07 - Dark	01 - Traffic signal	01 - Functioning	02 - Non-fatal injury	03 - Rear end	06 - Ice	2	0	0	0
1/6/2018	2018	19:13	LEMUEX ST @ ST. LAURENT BLVD (0002021)	01 - Clear	07 - Dark	01 - Traffic signal	01 - Functioning	03 - P.D. only	04 - Skewspce	02 - Wet	2	0	0	0
3/1/2018	2018	23:30	LEMUEX ST @ ST. LAURENT BLVD (0002021)	03 - Snow	01 - Daylight	01 - Traffic signal	01 - Functioning	03 - P.D. only	04 - Skewspce	02 - Wet	2	0	0	0
3/28/2018	2018	15:44	LEMUEX ST @ ST. LAURENT BLVD (0002021)	01 - Clear	01 - Daylight	01 - Traffic signal	01 - Functioning	02 - Non-fatal injury	05 - Turning movement	01 - Dry	2	0	0	0
1/6/2018	2018	18:56	LEMUEX ST @ ST. LAURENT BLVD (0002021)	01 - Clear	07 - Dark	01 - Traffic signal	01 - Functioning	03 - P.D. only	04 - Skewspce	01 - Dry	2	0	0	0
1/6/2018	2018	19:06	LEMUEX ST @ ST. LAURENT BLVD (0002021)	01 - Clear	07 - Dark	01 - Traffic signal	01 - Functioning	03 - P.D. only	04 - Skewspce	01 - Dry	3	0	0	0
4/25/2018	2018	10:17	LEMUEX ST @ ST. LAURENT BLVD (0002021)	02 - Rain	02 - Rain	01 - Traffic signal	01 - Functioning	03 - P.D. only	03 - Rear end	01 - Dry	2	0	0	0
4/9/2018	2018	9:28	LEMUEX ST @ ST. LAURENT BLVD (0002021)	01 - Clear	01 - Daylight	01 - Traffic signal	01 - Functioning	03 - P.D. only	03 - Rear end	01 - Dry	2	0	0	0
1/8/2018	2018	8:27	LEMUEX ST @ ST. LAURENT BLVD (0002021)	03 - Snow	01 - Daylight	01 - Traffic signal	01 - Functioning	03 - P.D. only	01 - Approaching	03 - Loose snow	2	0	0	0
5/17/2018	2018	7:47	LEMUEX ST @ ST. LAURENT BLVD (0002021)	01 - Clear	01 - Daylight	01 - Traffic signal	01 - Functioning	03 - P.D. only	03 - Rear end	01 - Dry	2	0	0	0
6/1/2018	2018	14:57	LEMUEX ST @ ST. LAURENT BLVD (0002021)	01 - Clear	01 - Daylight	01 - Traffic signal	01 - Functioning	03 - P.D. only	02 - Angle	01 - Dry	2	0	0	0
8/29/2018	2018	20:29	LEMUEX ST @ ST. LAURENT BLVD (0002021)	01 - Clear	05 - Duak	01 - Traffic signal	01 - Functioning	03 - P.D. only	03 - Rear end	01 - Dry	2	0	0	0
7/28/2018	2018	17:58	LEMUEX ST @ ST. LAURENT BLVD (0002021)	01 - Clear	01 - Daylight	01 - Traffic signal	01 - Functioning	03 - P.D. only	03 - Rear end	01 - Dry	2	0	0	0
8/22/2018	2018	16:45	LEMUEX ST @ ST. LAURENT BLVD (0002021)	01 - Clear	01 - Daylight	01 - Traffic signal	01 - Functioning	03 - P.D. only	03 - Rear end	01 - Dry	3	0	0	0
9/3/2019	2019	9:11	LEMUEX ST @ ST. LAURENT BLVD (0002021)	01 - Clear	01 - Daylight	01 - Traffic signal	01 - Functioning	02 - Non-fatal injury	03 - Rear end	01 - Dry	2	0	0	0
9/1/2019	2019	18:31	LEMUEX ST @ ST. LAURENT BLVD (0002021)	01 - Clear	05 - Duak	01 - Traffic signal	01 - Functioning	02 - Non-fatal injury	01 - Approaching	01 - Dry	2	0	0	0
8/26/2019	2019	20:25	LEMUEX ST @ ST. LAURENT BLVD (0002021)	01 - Clear	07 - Dark	01 - Traffic signal	01 - Functioning	03 - P.D. only	03 - Rear end	01 - Dry	2	1	0	0
10/11/2019	2019	16:45	LEMUEX ST @ ST. LAURENT BLVD (0002021)	01 - Clear	01 - Daylight	01 - Traffic signal	01 - Functioning	03 - P.D. only	02 - Angle	01 - Dry	2	0	0	0
10/22/2019	2019	15:40	LEMUEX ST @ ST. LAURENT BLVD (0002021)	02 - Rain	01 - Daylight	01 - Traffic signal	01 - Functioning	03 - P.D. only	02 - Angle	02 - Wet	2	0	0	0
11/9/2019	2019	15:40	LEMUEX ST @ ST. LAURENT BLVD (0002021)	01 - Clear	01 - Daylight	01 - Traffic signal	01 - Functioning	02 - Non-fatal injury	04 - Skewspce	01 - Dry	2	0	0	0
11/27/2019	2019	9:45	LEMUEX ST @ ST. LAURENT BLVD (0002021)	02 - Rain	01 - Daylight	01 - Traffic signal	01 - Functioning	03 - P.D. only	03 - Rear end	02 - Wet	2	0	0	0
1/29/2019	2019	9:07	LEMUEX ST @ ST. LAURENT BLVD (0002021)	03 - Snow	01 - Daylight	01 - Traffic signal	01 - Functioning	03 - P.D. only	03 - Rear end	03 - Loose snow	2	0	0	0
4/13/2019	2019	14:17	LEMUEX ST @ ST. LAURENT BLVD (0002021)	01 - Clear	01 - Daylight	01 - Traffic signal	01 - Functioning	02 - Non-fatal injury	05 - Turning movement	01 - Dry	2	0	0	0
4/30/2019	2019	17:47	LEMUEX ST @ ST. LAURENT BLVD (0002021)	01 - Clear	05 - Duak	01 - Traffic signal	01 - Functioning	03 - P.D. only	04 - Skewspce	01 - Dry	2	0	0	0
6/8/2019	2019	20:05	LEMUEX ST @ ST. LAURENT BLVD (0002021)	01 - Clear	01 - Daylight	01 - Traffic signal	01 - Functioning	03 - P.D. only	02 - Angle	01 - Dry	2	0	0	0
8/5/2019	2019	15:45	LEMUEX ST @ ST. LAURENT BLVD (0002021)	01 - Clear	01 - Daylight	01 - Traffic signal	00 - Unknown	03 - P.D. only	03 - Rear end	01 - Dry	2	0	0	0
1/22/2020	2020	9:16	LEMUEX ST @ ST. LAURENT BLVD (0002021)	01 - Clear	01 - Daylight	01 - Traffic signal	01 - Functioning	03 - P.D. only	02 - Angle	02 - Wet	2	0	0	0
1/1/2020	2020	18:00	LEMUEX ST @ ST. LAURENT BLVD (0002021)	01 - Clear	07 - Dark	01 - Traffic signal	01 - Functioning	03 - P.D. only	05 - Turning movement	02 - Wet	2	0	0	0
2/14/2020	2020	17:00	LEMUEX ST @ ST. LAURENT BLVD (0002021)	01 - Clear	01 - Daylight	01 - Traffic signal	01 - Functioning	03 - P.D. only	03 - Rear end	01 - Dry	2	0	0	0
2/26/2020	2020	18:28	LEMUEX ST @ ST. LAURENT BLVD (0002021)	03 - Snow	07 - Dark	01 - Traffic signal	01 - Functioning	03 - P.D. only	03 - Rear end	05 - Packed snow	2	0	0	0
4/2/2020	2020	11:30	LEMUE											

6/9/2016	2016	8:00	LABELLE ST/ RAMP @ LEMIELUX ST/HWV617 ICI 15 RAMP (0012538)	01 - Clear	01 - Daylight	02 - Stop sign	01 - Functioning	03 - P.D. only	02 - Angle	01 - Dry	2	0	0	0
6/3/2016	2016	15:30	LABELLE ST/ RAMP @ LEMIELUX ST/HWV617 ICI 15 RAMP (0012538)	01 - Clear	01 - Daylight	02 - Stop sign	01 - Functioning	03 - P.D. only	99 - Other	01 - Dry	2	0	0	0
1/14/2016	2016	16:35	LABELLE ST/ RAMP @ LEMIELUX ST/HWV617 ICI 15 RAMP (0012538)	01 - Clear	05 - Dark	02 - Stop sign	01 - Functioning	02 - Non-fatal injury	02 - Angle	02 - Wet	2	0	0	0
8/11/2016	2016	17:47	LABELLE ST/ RAMP @ LEMIELUX ST/HWV617 ICI 15 RAMP (0012538)	01 - Clear	01 - Daylight	02 - Stop sign	01 - Functioning	03 - P.D. only	02 - Angle	01 - Dry	2	0	0	0
2/23/2017	2017	11:04	LABELLE ST/ RAMP @ LEMIELUX ST/HWV617 ICI 15 RAMP (0012538)	01 - Clear	01 - Daylight	02 - Stop sign	01 - Functioning	03 - P.D. only	02 - Angle	01 - Dry	2	0	0	0
3/24/2017	2017	12:40	LABELLE ST/ RAMP @ LEMIELUX ST/HWV617 ICI 15 RAMP (0012538)	03 - Snow	01 - Daylight	02 - Stop sign	01 - Functioning	03 - P.D. only	02 - Angle	02 - Wet	2	0	0	0
4/7/2017	2017	17:21	LABELLE ST/ RAMP @ LEMIELUX ST/HWV617 ICI 15 RAMP (0012538)	02 - Rain	01 - Daylight	02 - Stop sign	01 - Functioning	03 - P.D. only	02 - Angle	02 - Wet	2	0	0	0
4/1/2017	2017	17:00	LABELLE ST/ RAMP @ LEMIELUX ST/HWV617 ICI 15 RAMP (0012538)	01 - Clear	01 - Daylight	02 - Stop sign	01 - Functioning	03 - P.D. only	02 - Angle	01 - Dry	2	0	0	0
5/10/2017	2017	18:38	LABELLE ST/ RAMP @ LEMIELUX ST/HWV617 ICI 15 RAMP (0012538)	01 - Clear	01 - Daylight	02 - Stop sign	01 - Functioning	02 - Non-fatal injury	05 - Turning movement	01 - Dry	2	0	0	0
6/6/2017	2017	9:31	LABELLE ST/ RAMP @ LEMIELUX ST/HWV617 ICI 15 RAMP (0012538)	01 - Clear	01 - Daylight	02 - Stop sign	01 - Functioning	03 - P.D. only	02 - Angle	01 - Dry	2	0	0	0
9/29/2017	2017	8:56	LABELLE ST/ RAMP @ LEMIELUX ST/HWV617 ICI 15 RAMP (0012538)	01 - Clear	01 - Daylight	02 - Stop sign	01 - Functioning	03 - P.D. only	02 - Angle	01 - Dry	2	0	0	0
10/4/2018	2018	17:19	LABELLE ST/ RAMP @ LEMIELUX ST/HWV617 ICI 15 RAMP (0012538)	01 - Clear	01 - Daylight	02 - Stop sign	01 - Functioning	03 - P.D. only	02 - Angle	01 - Dry	2	0	0	0
11/29/2018	2018	16:46	LABELLE ST/ RAMP @ LEMIELUX ST/HWV617 ICI 15 RAMP (0012538)	01 - Clear	05 - Dark	02 - Stop sign	01 - Functioning	03 - P.D. only	04 - Sideswipe	02 - Wet	2	0	0	0
2/27/2018	2018	12:53	LABELLE ST/ RAMP @ LEMIELUX ST/HWV617 ICI 15 RAMP (0012538)	01 - Clear	01 - Daylight	02 - Stop sign	01 - Functioning	03 - P.D. only	02 - Angle	02 - Wet	2	0	0	0
4/5/2018	2018	8:58	LABELLE ST/ RAMP @ LEMIELUX ST/HWV617 ICI 15 RAMP (0012538)	01 - Clear	01 - Daylight	02 - Stop sign	01 - Functioning	03 - P.D. only	04 - Sideswipe	01 - Dry	2	0	0	0
5/3/2018	2018	17:07	LABELLE ST/ RAMP @ LEMIELUX ST/HWV617 ICI 15 RAMP (0012538)	01 - Clear	01 - Daylight	02 - Stop sign	00 - Unknown	03 - P.D. only	02 - Angle	02 - Wet	2	0	0	0
5/24/2018	2018	16:38	LABELLE ST/ RAMP @ LEMIELUX ST/HWV617 ICI 15 RAMP (0012538)	01 - Clear	01 - Daylight	02 - Stop sign	01 - Functioning	03 - P.D. only	02 - Angle	01 - Dry	2	0	0	0
6/27/2018	2018	15:15	LABELLE ST/ RAMP @ LEMIELUX ST/HWV617 ICI 15 RAMP (0012538)	01 - Clear	01 - Daylight	02 - Stop sign	01 - Functioning	03 - P.D. only	03 - Rear end	01 - Dry	2	0	0	0
9/21/2018	2018	11:40	LABELLE ST/ RAMP @ LEMIELUX ST/HWV617 ICI 15 RAMP (0012538)	01 - Clear	01 - Daylight	02 - Stop sign	01 - Functioning	03 - P.D. only	02 - Angle	01 - Dry	2	0	0	0
10/18/2019	2019	18:10	LABELLE ST/ RAMP @ LEMIELUX ST/HWV617 ICI 15 RAMP (0012538)	01 - Clear	01 - Daylight	02 - Stop sign	01 - Functioning	03 - P.D. only	02 - Angle	01 - Dry	2	0	0	0
12/14/2019	2019	20:30	LABELLE ST/ RAMP @ LEMIELUX ST/HWV617 ICI 15 RAMP (0012538)	02 - Rain	07 - Dark	02 - Stop sign	01 - Functioning	03 - P.D. only	02 - Angle	02 - Wet	2	0	0	0
2/23/2019	2019	14:11	LABELLE ST/ RAMP @ LEMIELUX ST/HWV617 ICI 15 RAMP (0012538)	01 - Clear	01 - Daylight	02 - Stop sign	01 - Functioning	03 - P.D. only	02 - Angle	01 - Dry	2	0	0	0
5/18/2019	2019	13:07	LABELLE ST/ RAMP @ LEMIELUX ST/HWV617 ICI 15 RAMP (0012538)	01 - Clear	01 - Daylight	02 - Stop sign	01 - Functioning	03 - P.D. only	02 - Angle	01 - Dry	2	0	0	0
7/3/2019	2019	8:17	LABELLE ST/ RAMP @ LEMIELUX ST/HWV617 ICI 15 RAMP (0012538)	01 - Clear	01 - Daylight	02 - Stop sign	01 - Functioning	03 - P.D. only	05 - Turning movement	01 - Dry	2	0	0	0
1/18/2019	2019	15:00	LABELLE ST/ RAMP @ LEMIELUX ST/HWV617 ICI 15 RAMP (0012538)	01 - Clear	01 - Daylight	02 - Stop sign	01 - Functioning	03 - P.D. only	05 - Turning movement	02 - Wet	2	0	0	0
2/5/2020	2020	14:45	LABELLE ST/ RAMP @ LEMIELUX ST/HWV617 ICI 15 RAMP (0012538)	01 - Clear	01 - Daylight	02 - Stop sign	01 - Functioning	03 - P.D. only	04 - Sideswipe	01 - Dry	2	0	0	0

Appendix E

TRANS Model Plots

TRANS Regional Model

Version 2.15 - Assigned June 16, 2020

AM Peak Hour Total Traffic Volume

Cyrville - St. Laurent Area Growth

2011 Model - Basecase

N/A

User Initials: TIMW
Plot Prepared: August 10, 2020
EMME Scenario: 21711



Legend

AM Peak Hour Total Traffic Volume

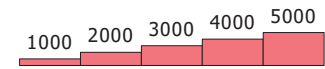

Distance (m)



The TRANS model is continuously refined & maintained, and all information is provided in good faith. However, model outputs are provided "as is", and no warranty or guarantee is provided as to the accuracy, reliability or reasonableness of the results. In using this data, you agree to accept any and all risks arising from any incorrect, incomplete, or misleading information.

Recipients are required to use caution and professional judgement in using and interpreting model outputs. In particular, caution should be used when focusing on a geographically limited area (such as a single road or intersection), as the model is primarily designed to simulate regional-scale phenomena and has been calibrated at a regional level.

As general good practice, it is recommended that the user confirm the network coding within the area of interest, and compare base year forecasts against traffic count data to assess the extent to which the model may be over- or under-estimating the travel demand.



TRANS Regional Model

Version 2.15 - Assigned June 16, 2020

AM Peak Hour Total Traffic Volume Cyrville - St. Laurent Area Growth

2031 Model - Basecase

N/A

User Initials: TIMW
Plot Prepared: August 10, 2020
EMME Scenario: 21711



Legend

AM Peak Hour Total Traffic Volume

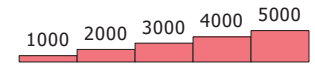

The TRANS model is continuously refined & maintained, and all information is provided in good faith. However, model outputs are provided "as is", and no warranty or guarantee is provided as to the accuracy, reliability or reasonableness of the results. In using this data, you agree to accept any and all risks arising from any incorrect, incomplete, or misleading information.

Recipients are required to use caution and professional judgement in using and interpreting model outputs. In particular, caution should be used when focusing on a geographically limited area (such as a single road or intersection), as the model is primarily designed to simulate regional-scale phenomena and has been calibrated at a regional level.

As general good practice, it is recommended that the user confirm the network coding within the area of interest, and compare base year forecasts against traffic count data to assess the extent to which the model may be over- or under-estimating the travel demand.

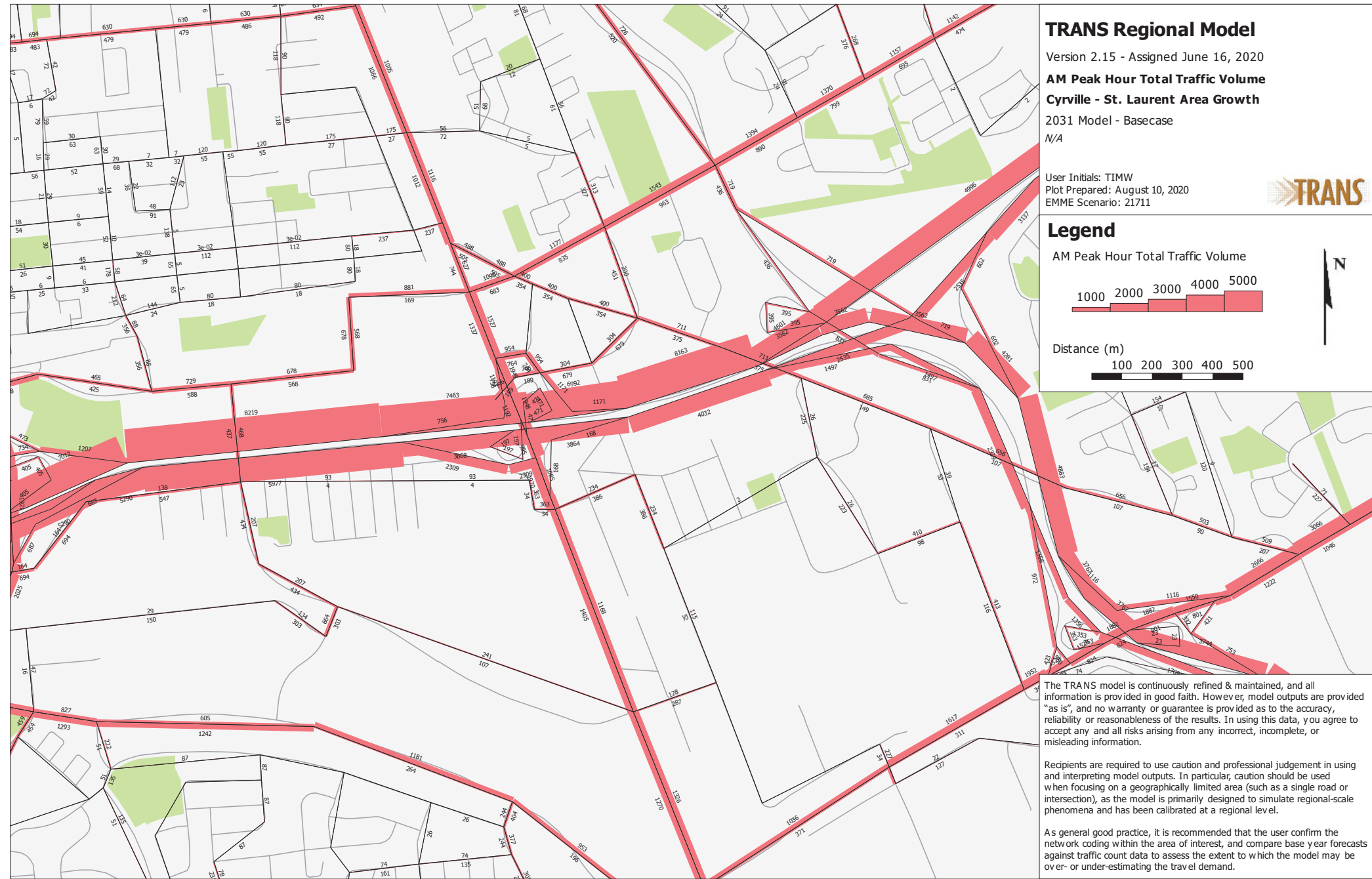

Appendix F

Background Development Volumes

Figure 7: Total Phase 1 and 2 Site Generated Traffic

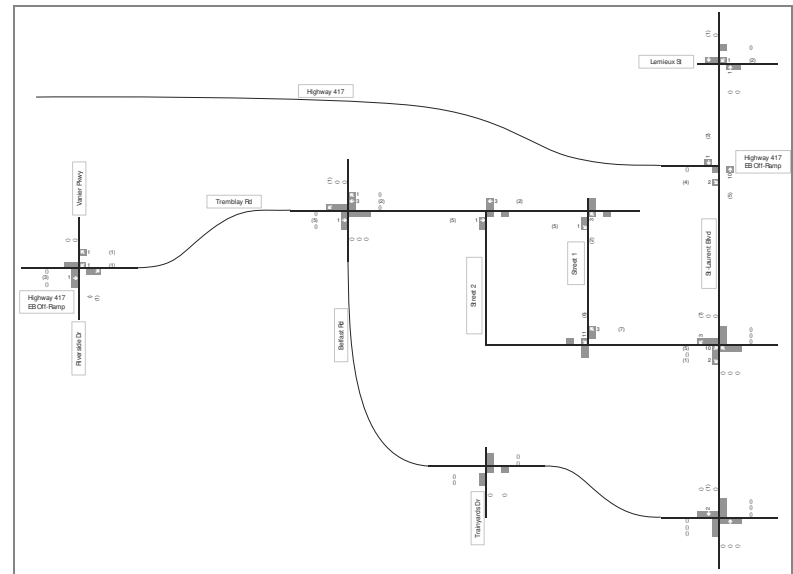
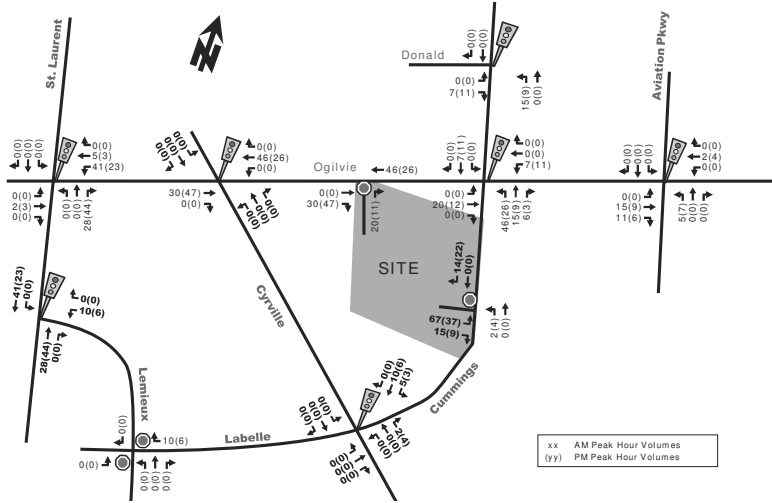

Figure 3-2: 2025 Residential Trips Generated

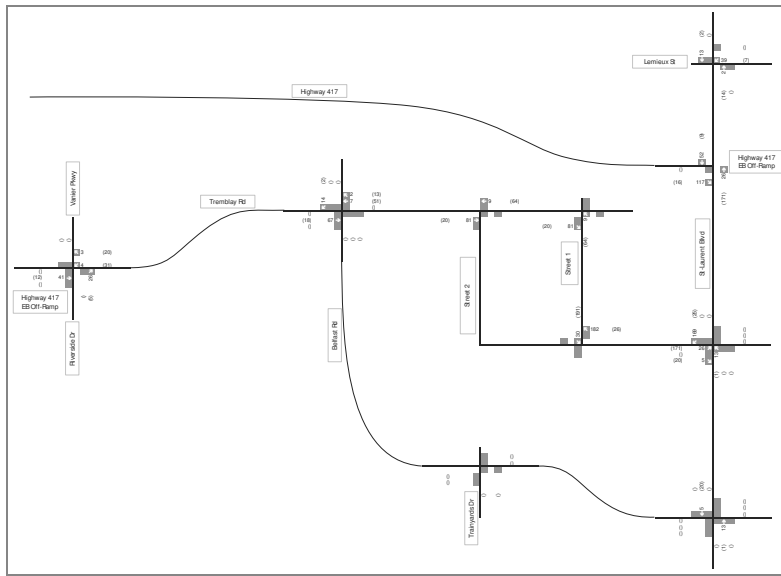

Figure 3-3
2025 Office Trips
Generated



Legend
 w AM Peak Hour Traffic Volume
 o PM Peak Hour Traffic Volume

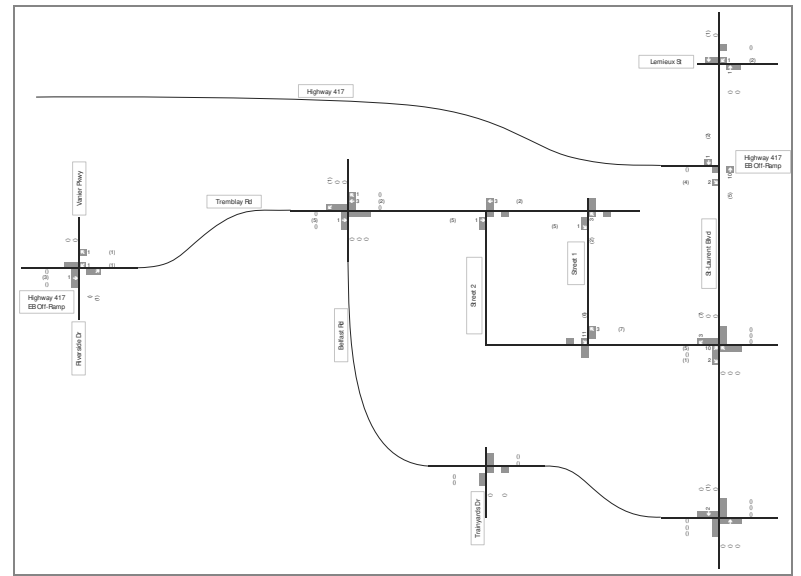

Figure 3-4
2025 Residential Trip
Generation



Legend
 w AM Peak Hour Traffic Volume
 o PM Peak Hour Traffic Volume

Figure 10 - Site Traffic Assignment

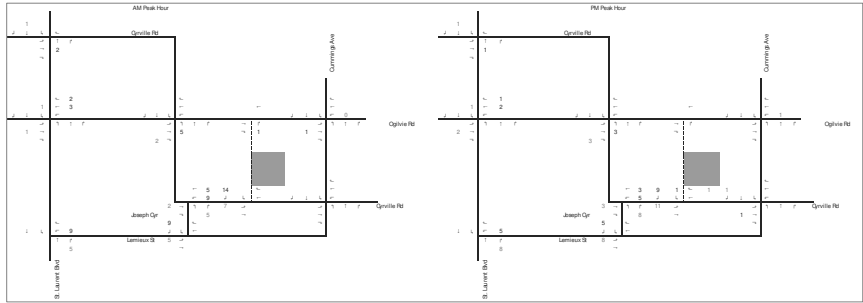

Figure 18: New Site Generation Auto Volumes Scenario 1

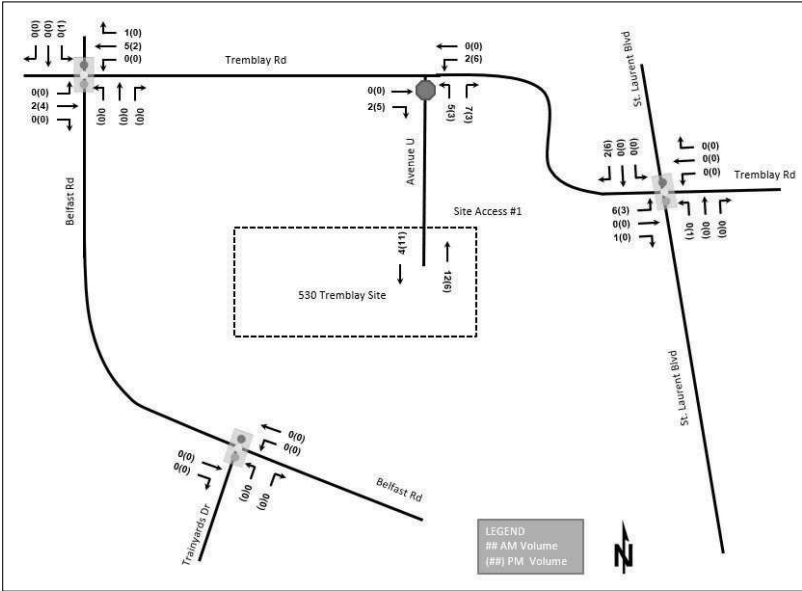

Figure 20: New Site Generation Auto Volumes Scenario 2

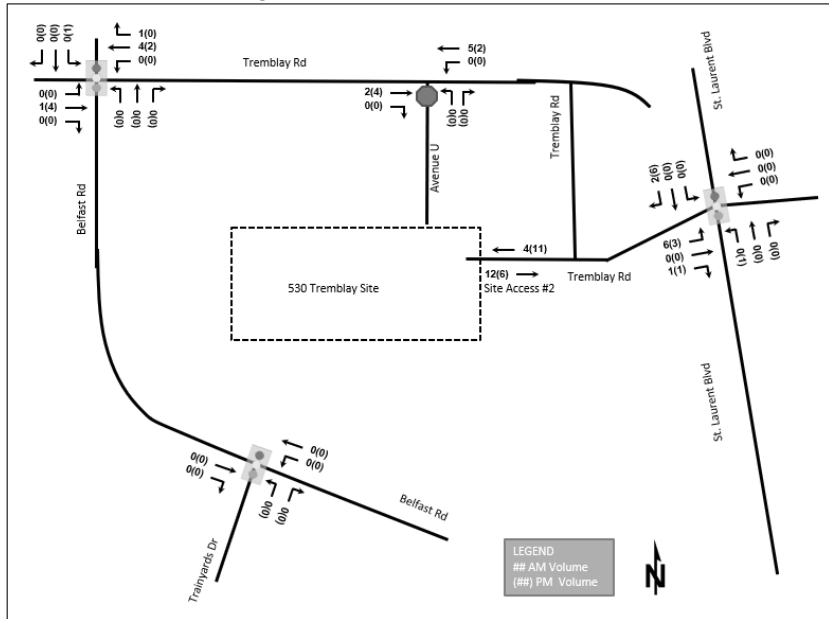
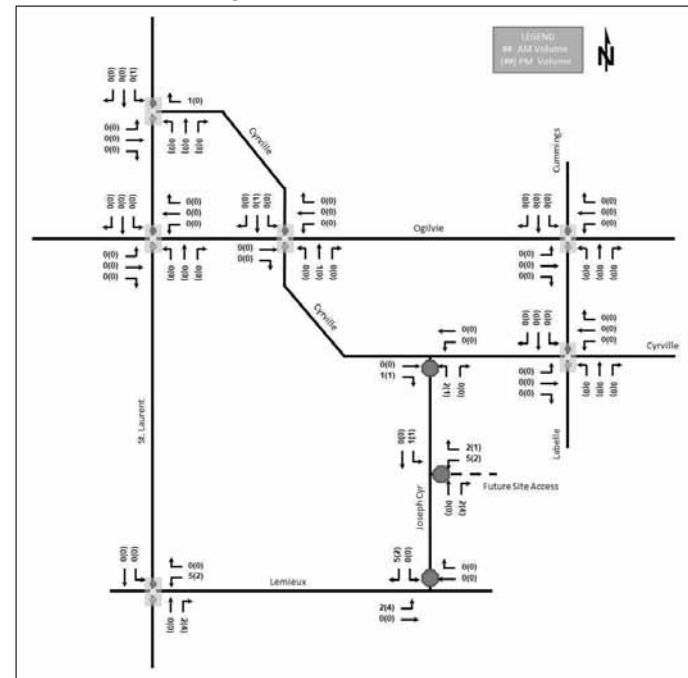

Figure 9: New Site Generation Auto Volumes



Appendix G

Synchro Intersection Worksheets – 2026 Future Background Conditions

Lanes, Volumes, Timings
1: St Laurent & Coventry/Ogilvie

2026 Future Background
AM Peak Hour

Lane Group	EBL	EBT	EBR	WBL	WBT	WBR	NBL	NBT	NBR	SBL	SBT	SBR
Lane Configurations	↔	↔	↔	↔	↔	↔	↔	↔	↔	↔	↔	↔
Traffic Volume (vph)	66	204	58	711	645	26	141	836	572	34	826	132
Future Volume (vph)	66	204	58	711	645	26	141	836	572	34	826	132
Satd. Flow (prot)	3010	3283	1388	3216	3103	1339	1523	3161	1441	1642	4764	1427
Fit Permitted	0.950			0.950			0.950			0.950		
Satd. Flow (perm)	2901	3283	1331	3155	3103	1253	1510	3161	1384	1627	4764	1367
Satd. Flow (RTOR)			195			140			510			196
Lane Group Flow (vph)	66	204	58	711	645	26	141	836	572	34	826	132
Turn Type	Prot	NA	Perm	Prot	NA	Perm	Prot	NA	Perm	Prot	NA	Perm
Protected Phases	7	4		3	8		5	2		1	6	
Permitted Phases			4			8			2			6
Detector Phase	7	4	4	3	8	8	5	2	2	1	6	6
Switch Phase												
Minimum Initial (s)	5.0	10.0	10.0	5.0	10.0	10.0	5.0	10.0	10.0	5.0	10.0	10.0
Minimum Split (s)	11.9	37.5	37.5	11.9	37.5	37.5	11.4	35.4	35.4	11.4	35.4	35.4
Total Split (s)	15.0	37.5	37.5	35.5	58.0	58.0	21.6	35.4	35.4	21.6	35.4	35.4
Total Split (%)	11.5%	28.8%	28.8%	27.3%	44.6%	44.6%	16.6%	27.2%	27.2%	16.6%	27.2%	27.2%
Yellow Time (s)	3.7	3.7	3.7	3.7	3.7	3.7	3.7	3.7	3.7	3.7	3.7	3.7
All-Red Time (s)	3.2	2.8	2.8	3.2	2.8	2.8	2.7	2.7	2.7	2.7	2.7	2.7
Lost Time Adjust (s)	0.0	0.0	0.0	0.0	0.0	0.0	0.0	0.0	0.0	0.0	0.0	0.0
Total Lost Time (s)	6.9	6.5	6.5	6.9	6.5	6.5	6.4	6.4	6.4	6.4	6.4	6.4
Lead/Lag	Lag	Lead	Lead	Lag	Lead	Lead	Lead	Lag	Lag	Lead	Lag	Lag
Lead-Lag Optimize?	Yes	Yes	Yes	Yes	Yes	Yes	Yes	Yes	Yes	Yes	Yes	Yes
Recall Mode	None	None	None	None	None	None	C-Max	C-Max	None	C-Max	C-Max	C-Max
Act Effct Green (s)	18.2	23.0	23.0	31.1	38.4	38.4	14.6	46.6	46.6	8.2	35.2	35.2
Actuated g/C Ratio	0.14	0.18	0.18	0.24	0.30	0.30	0.11	0.36	0.36	0.06	0.27	0.27
v/c Ratio	0.16	0.35	0.15	0.93	0.70	0.06	0.82	0.74	0.70	0.33	0.64	0.26
Control Delay	48.1	46.8	0.8	66.8	39.3	0.2	100.6	37.8	14.8	66.1	46.0	2.1
Queue Delay	0.0	0.0	0.0	0.0	0.0	0.0	0.0	0.0	0.5	0.0	0.0	0.0
Total Delay	48.1	46.8	0.8	66.8	39.3	0.2	100.6	37.8	15.3	66.1	46.0	2.1
LOS	D	D	A	E	D	A	F	D	B	E	D	A
Approach Delay		38.9			52.7			35.2			40.8	
Approach LOS		D			D			D			D	
Queue Length 50th (m)	7.1	22.4	0.0	-99.4	85.1	0.0	38.2	114.5	32.7	8.5	73.4	0.0
Queue Length 95th (m)	14.5	33.4	0.0	#138.9	99.3	m0.0	#71.7	#159.2	61.0	19.0	89.2	2.4
Internal Link Dist (m)		213.9			123.7			114.3			252.7	
Turn Bay Length (m)	100.0		64.0	75.0			47.5		40.0		45.0	
Base Capacity (vph)	431	782	465	768	1229	580	179	1133	823	191	1288	512
Starvation Cap Reductn	0	0	0	0	0	0	0	0	55	0	0	0
Spillback Cap Reductn	0	0	0	0	0	0	0	0	0	0	0	0
Storage Cap Reductn	0	0	0	0	0	0	0	0	0	0	0	0
Reduced v/c Ratio	0.15	0.26	0.12	0.93	0.52	0.04	0.79	0.74	0.74	0.18	0.64	0.26

Intersection Summary

Cycle Length: 130
Actuated Cycle Length: 130
Offset: 0 (0%), Referenced to phase 2:NBT and 6:SBT, Start of Green
Natural Cycle: 120
Control Type: Actuated-Coordinated

Lanes, Volumes, Timings
1: St Laurent & Coventry/Ogilvie

2026 Future Background
AM Peak Hour

Maximum v/c Ratio: 0.93	Intersection LOS: D
Intersection Signal Delay: 42.5	ICU Level of Service F
Intersection Capacity Utilization 92.5%	
Analysis Period (min) 15	
~ Volume exceeds capacity, queue is theoretically infinite.	
Queue shown is maximum after two cycles.	
# 95th percentile volume exceeds capacity, queue may be longer.	
Queue shown is maximum after two cycles.	
m Volume for 95th percentile queue is metered by upstream signal.	

Splits and Phases: 1: St Laurent & Coventry/Ogilvie

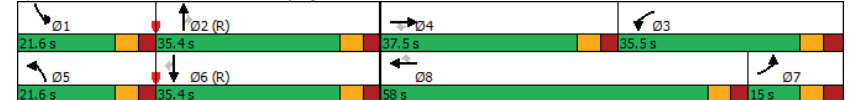

Lanes, Volumes, Timings
2: Lemieux & St Laurent

2026 Future Background
AM Peak Hour

	WBL	WBR	NBT	NBR	SBL	SBT
Lane Configurations	↔↔	↔	↑↑↑	↔	↔	↑↑↑
Traffic Volume (vph)	614	153	1284	235	7	1514
Future Volume (vph)	614	153	1284	235	7	1514
Satd. Flow (prot)	2734	1483	4584	1483	1658	4672
Fit Permitted	0.950				0.177	
Satd. Flow (perm)	2734	1418	4584	1444	309	4672
Satd. Flow (RTOR)		53		235		
Lane Group Flow (vph)	614	153	1284	235	7	1514
Turn Type	Prot	Perm	NA	Perm	Perm	NA
Protected Phases	8		2			6
Permitted Phases		8		2	6	
Detector Phase	8	8	2	2	6	6
Switch Phase						
Minimum Initial (s)	5.0	5.0	10.0	10.0	10.0	10.0
Minimum Split (s)	36.1	36.1	43.5	43.5	16.0	16.0
Total Split (s)	50.0	50.0	80.0	80.0	80.0	80.0
Total Split (%)	38.5%	38.5%	61.5%	61.5%	61.5%	61.5%
Yellow Time (s)	3.3	3.3	3.7	3.7	3.7	3.7
All-Red Time (s)	2.8	2.8	1.8	1.8	1.8	1.8
Lost Time Adjust (s)	0.0	0.0	0.0	0.0	0.0	0.0
Total Lost Time (s)	6.1	6.1	5.5	5.5	5.5	5.5
Lead/Lag						
Lead-Lag Optimize?						
Recall Mode	None	None	C-Max	C-Max	C-Max	C-Max
Act Effct Green (s)	34.9	34.9	83.5	83.5	83.5	83.5
Actuated g/C Ratio	0.27	0.27	0.64	0.64	0.64	0.64
v/c Ratio	0.84	0.37	0.44	0.23	0.04	0.50
Control Delay	55.3	26.0	8.1	1.9	10.6	14.8
Queue Delay	0.0	0.0	0.2	0.0	0.0	0.0
Total Delay	55.3	26.0	8.3	1.9	10.6	14.8
LOS	E	C	A	A	B	B
Approach Delay	49.4		7.3			14.8
Approach LOS	D		A			B
Queue Length 50th (m)	76.8	20.4	32.3	0.4	0.7	70.4
Queue Length 95th (m)	90.8	36.4	63.6	9.4	m1.2	m77.3
Internal Link Dist (m)	80.2		117.1			60.0
Turn Bay Length (m)		51.5		53.5	115.0	
Base Capacity (vph)	923	513	2943	1011	198	3000
Starvation Cap Reductn	0	0	666	0	0	0
Spillback Cap Reductn	0	0	0	0	0	0
Storage Cap Reductn	0	0	0	0	0	0
Reduced v/c Ratio	0.67	0.30	0.56	0.23	0.04	0.50

Intersection Summary	
Cycle Length:	130
Actuated Cycle Length:	130
Offset:	124 (95%), Referenced to phase 2:NBT and 6:SBTL, Start of Green
Natural Cycle:	80
Control Type:	Actuated-Coordinated

Lanes, Volumes, Timings
2: Lemieux & St Laurent

2026 Future Background
AM Peak Hour

Maximum v/c Ratio: 0.84	Intersection LOS: B
Intersection Signal Delay: 18.8	ICU Level of Service B
Intersection Capacity Utilization 62.7%	
Analysis Period (min) 15	
m Volume for 95th percentile queue is metered by upstream signal.	

Splits and Phases: 2: Lemieux & St Laurent



Lanes, Volumes, Timings
3: St Laurent & Transitway

2026 Future Background
AM Peak Hour

Lane Group	WBL	WBR	NBT	NBR	SBL	SBT
Lane Configurations	↔	↔	↑↑↑	↔	↔	↑↑↑
Traffic Volume (vph)	48	24	1532	60	2	900
Future Volume (vph)	48	24	1532	60	2	900
Satd. Flow (prot)	834	0	4452	0	1127	4628
Fit Permitted	0.968				0.136	
Satd. Flow (perm)	834	0	4452	0	161	4628
Satd. Flow (RTOR)	10		11			
Lane Group Flow (vph)	72	0	1592	0	2	900
Turn Type	Prot		NA		Perm	NA
Protected Phases	8		2			6
Permitted Phases					6	
Detector Phase	8		2		6	6
Switch Phase						
Minimum Initial (s)	5.0		10.0		10.0	10.0
Minimum Split (s)	29.5		30.0		22.5	22.5
Total Split (s)	30.0		35.0		35.0	35.0
Total Split (%)	46.2%		53.8%		53.8%	53.8%
Yellow Time (s)	3.3		3.7		3.7	3.7
All-Red Time (s)	2.2		2.3		2.3	2.3
Lost Time Adjust (s)	0.0		0.0		0.0	0.0
Total Lost Time (s)	5.5		6.0		6.0	6.0
Lead/Lag						
Lead-Lag Optimize?						
Recall Mode	None		C-Max		C-Max	C-Max
Act Effct Green (s)	10.6		50.2		50.2	50.2
Actuated g/C Ratio	0.16		0.77		0.77	0.77
v/c Ratio	0.50		0.46		0.02	0.25
Control Delay	32.8		3.6		7.0	5.3
Queue Delay	0.0		0.0		0.0	0.0
Total Delay	32.8		3.6		7.0	5.3
LOS	C		A		A	A
Approach Delay	32.8		3.6			5.3
Approach LOS	C		A			A
Queue Length 50th (m)	6.9		16.0		0.1	18.4
Queue Length 95th (m)	16.2		30.4		m0.3	57.9
Internal Link Dist (m)	43.2		196.1			117.1
Turn Bay Length (m)					13.0	
Base Capacity (vph)	320		3439		124	3572
Starvation Cap Reductn	0		0		0	0
Spillback Cap Reductn	0		0		0	0
Storage Cap Reductn	0		0		0	0
Reduced v/c Ratio	0.23		0.46		0.02	0.25

Intersection Summary	
Cycle Length:	65
Actuated Cycle Length:	65
Offset:	38 (58%), Referenced to phase 2:NBT and 6:SBTL, Start of Green
Natural Cycle:	60
Control Type:	Actuated-Coordinated

Lanes, Volumes, Timings
3: St Laurent & Transitway

2026 Future Background
AM Peak Hour

Maximum v/c Ratio: 0.50	Intersection LOS: A
Intersection Signal Delay: 5.0	ICU Level of Service A
Intersection Capacity Utilization 46.6%	
Analysis Period (min) 15	
m Volume for 95th percentile queue is metered by upstream signal.	

Splits and Phases: 3: St Laurent & Transitway

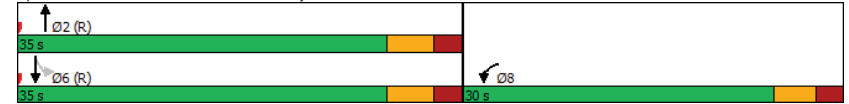

Lanes, Volumes, Timings
4: Hwy 417 EB Off-Ramp & St Laurent

2026 Future Background
AM Peak Hour

Lane Group	EBL	EBR	NBL	NBT	SBT	SBR
Lane Configurations	↔↔	↔		↑↑↑	↑↑↑	
Traffic Volume (vph)	685	673	0	1212	816	170
Future Volume (vph)	685	673	0	1212	816	170
Satd. Flow (prot)	3066	1427	0	4418	4346	0
Fit Permitted	0.950					
Satd. Flow (perm)	3066	1409	0	4418	4346	0
Satd. Flow (RTOR)		142			52	
Lane Group Flow (vph)	685	673	0	1212	986	0
Turn Type	Prot	Perm		NA	NA	
Protected Phases	4			2	6	
Permitted Phases		4				
Detector Phase	4	4		2	6	
Switch Phase						
Minimum Initial (s)	5.0	5.0		10.0	10.0	
Minimum Split (s)	34.5	34.5		24.1	42.1	
Total Split (s)	55.0	55.0		75.0	75.0	
Total Split (%)	42.3%	42.3%		57.7%	57.7%	
Yellow Time (s)	3.3	3.3		3.7	3.7	
All-Red Time (s)	3.2	3.2		2.4	2.4	
Lost Time Adjust (s)	0.0	0.0		0.0	0.0	
Total Lost Time (s)	6.5	6.5		6.1	6.1	
Lead/Lag						
Lead-Lag Optimize?						
Recall Mode	None	None		C-Max	C-Max	
Act Effct Green (s)	48.5	48.5		68.9	68.9	
Actuated g/C Ratio	0.37	0.37		0.53	0.53	
v/c Ratio	0.60	1.10		0.52	0.42	
Control Delay	35.6	96.3		20.8	18.2	
Queue Delay	0.0	0.0		0.0	0.0	
Total Delay	35.6	96.3		20.8	18.2	
LOS	D	F		C	B	
Approach Delay	65.7			20.8	18.2	
Approach LOS	E			C	B	
Queue Length 50th (m)	72.4	~170.7		71.1	39.5	
Queue Length 95th (m)	92.1	#243.6		83.9	33.6	
Internal Link Dist (m)	73.5			158.0	196.1	
Turn Bay Length (m)						
Base Capacity (vph)	1143	614		2341	2327	
Starvation Cap Reductn	0	0		0	0	
Spillback Cap Reductn	0	0		0	0	
Storage Cap Reductn	0	0		0	0	
Reduced v/c Ratio	0.60	1.10		0.52	0.42	

Intersection Summary	
Cycle Length:	130
Actuated Cycle Length:	130
Offset:	25 (19%), Referenced to phase 2:NBT and 6:SBT, Start of Green
Natural Cycle:	90
Control Type:	Actuated-Coordinated

Lanes, Volumes, Timings
4: Hwy 417 EB Off-Ramp & St Laurent

2026 Future Background
AM Peak Hour

Maximum v/c Ratio: 1.10	Intersection Signal Delay: 37.2	Intersection LOS: D
Intersection Capacity Utilization 82.8%	ICU Level of Service E	
Analysis Period (min) 15		
~ Volume exceeds capacity, queue is theoretically infinite. Queue shown is maximum after two cycles.		
# 95th percentile volume exceeds capacity, queue may be longer. Queue shown is maximum after two cycles.		

Splits and Phases: 4: Hwy 417 EB Off-Ramp & St Laurent



Lanes, Volumes, Timings
5: Cyrville & Ogilvie

2026 Future Background
AM Peak Hour

Lane Group	EBL	EBT	EBR	WBL	WBT	WBR	NBL	NBT	NBR	SBL	SBT	SBR
Lane Configurations		↕↕	↕	↕	↕↕	↕	↕	↕	↕	↕	↕	↕
Traffic Volume (vph)	0	581	237	27	1101	166	176	243	12	47	175	45
Future Volume (vph)	0	581	237	27	1101	166	176	243	12	47	175	45
Satd. Flow (prot)	0	3283	1414	1658	3316	1441	1551	1716	0	1626	1605	0
Fit Permitted				0.419			0.486			0.421		
Satd. Flow (perm)	0	3283	1326	722	3316	1312	789	1716	0	719	1605	0
Satd. Flow (RTOR)			237			142		2			11	
Lane Group Flow (vph)	0	581	237	27	1101	166	176	255	0	47	220	0
Turn Type	NA	Perm	Perm	NA	Perm	Perm	NA	Perm	NA	Perm	NA	
Protected Phases		2		6		6	4		8			8
Permitted Phases			2	6		6	4		8			
Detector Phase		2	2	6	6	6	4	4		8	8	
Switch Phase												
Minimum Initial (s)		10.0	10.0	10.0	10.0	10.0	10.0		10.0	10.0		
Minimum Split (s)		32.2	32.2	32.2	32.2	32.2	47.1	47.1		47.1	47.1	
Total Split (s)		80.0	80.0	80.0	80.0	80.0	50.0	50.0		50.0	50.0	
Total Split (%)		61.5%	61.5%	61.5%	61.5%	61.5%	38.5%	38.5%		38.5%	38.5%	
Yellow Time (s)		3.7	3.7	3.7	3.7	3.7	3.7	3.7		3.7	3.7	
All-Red Time (s)		2.5	2.5	2.5	2.5	2.5	3.4	3.4		3.4	3.4	
Lost Time Adjust (s)		0.0	0.0	0.0	0.0	0.0	0.0	0.0		0.0	0.0	
Total Lost Time (s)		6.2	6.2	6.2	6.2	6.2	7.1	7.1		7.1	7.1	
Lead/Lag												
Lead-Lag Optimize?												
Recall Mode		C-Max	C-Max	C-Max	C-Max	C-Max	None	None		None	None	
Act Effct Green (s)		85.8	85.8	85.8	85.8	85.8	30.9	30.9		30.9	30.9	
Actuated g/C Ratio		0.66	0.66	0.66	0.66	0.66	0.24	0.24		0.24	0.24	
v/c Ratio		0.27	0.25	0.06	0.50	0.18	0.94	0.62		0.27	0.56	
Control Delay		7.0	0.9	10.9	13.6	3.2	98.8	49.4		41.0	45.4	
Queue Delay		0.0	0.0	0.0	0.0	0.0	0.0	0.0		0.0	0.0	
Total Delay		7.0	0.9	10.9	13.6	3.2	98.8	49.4		41.0	45.4	
LOS		A	A	B	B	A	F	D		D	D	
Approach Delay		5.2			12.2		69.5			44.7		
Approach LOS		A			B		E			D		
Queue Length 50th (m)		21.7	0.0	2.3	70.7	2.0	44.4	58.1		9.9	47.3	
Queue Length 95th (m)		33.0	0.0	7.6	111.7	12.5	#67.8	76.0		18.7	64.1	
Internal Link Dist (m)		123.7			139.9			46.0			76.2	
Turn Bay Length (m)				53.5		51.0	42.5			77.0		
Base Capacity (vph)		2165	955	476	2187	913	260	567		237	537	
Starvation Cap Reductn		0	0	0	0	0	0	0		0	0	
Spillback Cap Reductn		0	0	0	0	0	0	0		0	0	
Storage Cap Reductn		0	0	0	0	0	0	0		0	0	
Reduced v/c Ratio		0.27	0.25	0.06	0.50	0.18	0.68	0.45		0.20	0.41	

Intersection Summary	
Cycle Length:	130
Actuated Cycle Length:	130
Offset:	10 (8%), Referenced to phase 2:EBT and 6:WBTL, Start of Green
Natural Cycle:	80
Control Type:	Actuated-Coordinated

Lanes, Volumes, Timings
5: Cyrville & Ogilvie

2026 Future Background
AM Peak Hour

Maximum v/c Ratio: 0.94	Intersection LOS: C
Intersection Signal Delay: 22.1	ICU Level of Service D
Intersection Capacity Utilization 77.0%	
Analysis Period (min) 15	
# 95th percentile volume exceeds capacity, queue may be longer.	
Queue shown is maximum after two cycles.	

Splits and Phases: 5: Cyrville & Ogilvie

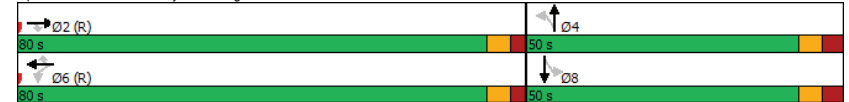

Intersection												
Int Delay, s/veh	2.4											
Movement	EBL	EBT	EBR	WBL	WBT	WBR	NBL	NBT	NBR	SBL	SBT	SBR
Lane Configurations	↔ ↗ ↘ ↙ ↘ ↗ ↙ ↘ ↙ ↘ ↙ ↘ ↙ ↘											
Traffic Vol, veh/h	30	0	0	0	0	135	133	556	44	0	0	177
Future Vol, veh/h	30	0	0	0	0	135	133	556	44	0	0	177
Conflicting Peds, #/hr	0	0	0	0	0	0	0	0	0	0	0	0
Sign Control	Stop	Stop	Stop	Stop	Stop	Free	Free	Free	Free	Free	Free	Free
RT Channelized	-	-	None	-	-	None	-	-	Free	-	-	Yield
Storage Length	0	-	-	-	-	0	-	-	-	-	-	0
Veh in Median Storage, #	-	0	-	-	0	-	-	0	-	-	-	-
Grade, %	-	0	-	-	0	-	-	0	-	-	-	-
Peak Hour Factor	100	100	100	100	100	100	100	100	100	100	100	100
Heavy Vehicles, %	2	2	2	2	2	2	2	2	2	2	2	2
Mvmt Flow	30	0	0	0	0	135	133	556	44	0	0	177

Major/Minor	Minor2	Minor1	Major1				
Conflicting Flow All	544	-	-	278	0	0	-
Stage 1	0	-	-	-	-	-	-
Stage 2	544	-	-	-	-	-	-
Critical Hdwy	7.54	-	-	6.94	4.14	-	-
Critical Hdwy Stg 1	-	-	-	-	-	-	-
Critical Hdwy Stg 2	6.54	-	-	-	-	-	-
Follow-up Hdwy	3.52	-	-	3.32	2.22	-	-
Pot Cap-1 Maneuver	422	0	0	0	719	-	0
Stage 1	-	0	0	0	-	-	0
Stage 2	491	0	0	0	-	-	0
Platoon blocked, %	-	-	-	-	-	-	-
Mov Cap-1 Maneuver	343	-	-	-	719	-	-
Mov Cap-2 Maneuver	343	-	-	-	-	-	-
Stage 1	-	-	-	-	-	-	-
Stage 2	399	-	-	-	-	-	-

Approach	EB	WB	NB
HCM Control Delay, s	16.5	11.2	
HCM LOS	C	B	

Minor Lane/Major Mvmt	NBL	NBT	EBLn1	WBLn1
Capacity (veh/h)	-	-	343	719
HCM Lane V/C Ratio	-	-	0.087	0.188
HCM Control Delay (s)	-	-	16.5	11.2
HCM Lane LOS	-	-	C	B
HCM 95th %tile Q(veh)	-	-	0.3	0.7

Intersection						
Int Delay, s/veh	1.7					
Movement	EBL	EBT	WBT	WBR	SBL	SBR
Lane Configurations	↔ ↗ ↘ ↙ ↘ ↗ ↙ ↘ ↙ ↘ ↙ ↘					
Traffic Vol, veh/h	74	168	688	21	9	69
Future Vol, veh/h	74	168	688	21	9	69
Conflicting Peds, #/hr	4	0	0	4	0	0
Sign Control	Free	Free	Free	Free	Stop	Stop
RT Channelized	-	None	-	None	-	None
Storage Length	22	-	-	-	0	-
Veh in Median Storage, #	-	0	0	-	0	-
Grade, %	-	0	0	-	0	-
Peak Hour Factor	100	100	100	100	100	100
Heavy Vehicles, %	6	2	10	2	2	5
Mvmt Flow	74	168	688	21	9	69

Major/Minor	Major1	Major2	Minor2		
Conflicting Flow All	713	0	0	1019	359
Stage 1	-	-	-	703	-
Stage 2	-	-	-	316	-
Critical Hdwy	4.19	-	-	6.63	6.975
Critical Hdwy Stg 1	-	-	-	5.83	-
Critical Hdwy Stg 2	-	-	-	5.43	-
Follow-up Hdwy	2.257	-	-	3.519	3.3475
Pot Cap-1 Maneuver	863	-	-	247	631
Stage 1	-	-	-	453	-
Stage 2	-	-	-	738	-
Platoon blocked, %	-	-	-	-	-
Mov Cap-1 Maneuver	860	-	-	225	629
Mov Cap-2 Maneuver	-	-	-	225	-
Stage 1	-	-	-	413	-
Stage 2	-	-	-	736	-

Approach	EB	WB	SB
HCM Control Delay, s	2.9	0	13.1
HCM LOS			B

Minor Lane/Major Mvmt	EBL	EBT	WBT	WBR	SBLn1
Capacity (veh/h)	860	-	-	-	521
HCM Lane V/C Ratio	0.086	-	-	-	0.15
HCM Control Delay (s)	9.6	-	-	-	13.1
HCM Lane LOS	A	-	-	-	B
HCM 95th %tile Q(veh)	0.3	-	-	-	0.5

Intersection												
Int Delay, s/veh	1.4											
Movement	EBL	EBT	EBR	WBL	WBT	WBR	NBL	NBT	NBR	SBL	SBT	SBR
Lane Configurations	↔			↔			↔			↔		
Traffic Vol, veh/h	1	432	32	39	415	1	17	1	52	1	0	0
Future Vol, veh/h	1	432	32	39	415	1	17	1	52	1	0	0
Conflicting Peds, #/hr	3	0	1	1	0	3	0	0	2	2	0	0
Sign Control	Free	Free	Free	Free	Free	Free	Stop	Stop	Stop	Stop	Stop	Stop
RT Channelized	-	-	None	-	-	None	-	-	None	-	-	None
Storage Length	-	-	-	-	-	-	-	-	-	-	-	-
Veh in Median Storage, #	-	0	-	-	0	-	-	0	-	-	0	-
Grade, %	-	0	-	-	0	-	-	0	-	-	0	-
Peak Hour Factor	100	100	100	100	100	100	100	100	100	100	100	100
Heavy Vehicles, %	2	3	6	3	3	2	7	2	9	2	2	2
Mvmt Flow	1	432	32	39	415	1	17	1	52	1	0	0
Major/Minor	Major1	Major2	Minor1	Minor2								
Conflicting Flow All	419	0	0	465	0	0	945	948	451	976	964	419
Stage 1	-	-	-	-	-	-	451	451	-	497	497	-
Stage 2	-	-	-	-	-	-	494	497	-	479	467	-
Critical Hdwy	4.12	-	-	4.13	-	-	7.17	6.52	6.29	7.12	6.52	6.22
Critical Hdwy Stg 1	-	-	-	-	-	-	6.17	5.52	-	6.12	5.52	-
Critical Hdwy Stg 2	-	-	-	-	-	-	6.17	5.52	-	6.12	5.52	-
Follow-up Hdwy	2.218	-	-	2.227	-	-	3.563	4.018	3.381	3.518	4.018	3.318
Pot Cap-1 Maneuver	1140	-	-	1091	-	-	237	261	594	230	255	634
Stage 1	-	-	-	-	-	-	578	571	-	555	545	-
Stage 2	-	-	-	-	-	-	548	545	-	568	562	-
Platoon blocked, %	-	-	-	-	-	-	-	-	-	-	-	-
Mov Cap-1 Maneuver	1137	-	-	1090	-	-	228	248	593	201	242	633
Mov Cap-2 Maneuver	-	-	-	-	-	-	228	248	-	201	242	-
Stage 1	-	-	-	-	-	-	577	570	-	553	518	-
Stage 2	-	-	-	-	-	-	522	518	-	516	561	-
Approach	EB	WB	NB	SB								
HCM Control Delay, s	0	0.7	15.2	23								
HCM LOS			C	C								
Minor Lane/Major Mvmt	NBLn1	EBL	EBT	EBR	WBL	WBT	WBR	SBLn1				
Capacity (veh/h)	421	1137	-	-	1090	-	-	201				
HCM Lane V/C Ratio	0.166	0.001	-	-	0.036	-	-	0.005				
HCM Control Delay (s)	15.2	8.2	0	-	8.4	0	-	23				
HCM Lane LOS	C	A	A	-	A	A	-	C				
HCM 95th %tile Q(veh)	0.6	0	-	-	0.1	-	-	0				

Lane Group	EBL	EBT	EBR	WBL	WBT	WBR	NBL	NBT	NBR	SBL	SBT	SBR
Lane Configurations	↔	↔	↔	↔	↔	↔	↔	↔	↔	↔	↔	↔
Traffic Volume (vph)	302	620	205	506	385	31	183	893	675	72	822	192
Future Volume (vph)	302	620	205	506	385	31	183	893	675	72	822	192
Satd. Flow (prot)	3216	3316	1483	3154	3075	1469	1566	3252	1483	1658	4764	1483
Fit Permitted	0.950			0.950			0.950			0.950		
Satd. Flow (perm)	2859	3316	1390	3086	3075	1285	1539	3252	1416	1642	4764	1385
Satd. Flow (RTOR)			210			210			382			211
Lane Group Flow (vph)	302	620	205	506	385	31	183	893	675	72	822	192
Turn Type	Prot	NA	Perm	Prot	NA	Perm	Prot	NA	Perm	Prot	NA	Perm
Protected Phases	7	4	4	3	8	8	5	2	2	1	6	6
Permitted Phases			4			8			2			6
Detector Phase	7	4	4	3	8	8	5	2	2	1	6	6
Switch Phase												
Minimum Initial (s)	5.0	10.0	10.0	5.0	10.0	10.0	5.0	10.0	10.0	5.0	10.0	10.0
Minimum Split (s)	11.9	37.5	37.5	11.9	37.5	37.5	11.4	35.4	35.4	11.4	35.4	35.4
Total Split (%)	23.5	37.5	37.5	23.5	37.5	37.5	23.6	44.0	44.0	15.0	35.4	35.4
Total Split (%)	19.6%	31.3%	31.3%	19.6%	31.3%	31.3%	19.7%	36.7%	36.7%	12.5%	29.5%	29.5%
Yellow Time (s)	3.7	3.7	3.7	3.7	3.7	3.7	3.7	3.7	3.7	3.7	3.7	3.7
All-Red Time (s)	3.2	2.8	2.8	3.2	2.8	2.8	2.7	2.7	2.7	2.7	2.7	2.7
Lost Time Adjust (s)	0.0	0.0	0.0	0.0	0.0	0.0	0.0	0.0	0.0	0.0	0.0	0.0
Total Lost Time (s)	6.9	6.5	6.5	6.9	6.5	6.5	6.4	6.4	6.4	6.4	6.4	6.4
Lead/Lag	Lag	Lead	Lead	Lag	Lead	Lead	Lag	Lag	Lag	Lag	Lag	Lag
Lead-Lag Optimize?	Yes	Yes	Yes	Yes	Yes	Yes	Yes	Yes	Yes	Yes	Yes	Yes
Recall Mode	None	None	None	None	None	None	None	C-Max	C-Max	None	C-Max	C-Max
Act Effct Green (s)	16.6	29.1	29.1	18.5	31.0	31.0	16.4	40.6	40.6	8.2	29.8	29.8
Actuated g/C Ratio	0.14	0.24	0.24	0.15	0.26	0.26	0.14	0.34	0.34	0.07	0.25	0.25
v/c Ratio	0.68	0.77	0.41	1.04	0.48	0.06	0.86	0.81	0.92	0.64	0.70	0.38
Control Delay	57.7	49.3	7.1	101.3	35.3	0.2	97.4	39.6	34.1	79.5	44.9	6.0
Queue Delay	0.0	0.0	0.0	0.0	0.0	0.0	0.0	0.0	0.0	0.0	0.0	0.0
Total Delay	57.7	49.3	7.1	101.3	35.3	0.2	97.4	39.6	34.1	79.5	44.9	6.0
LOS	E	D	A	F	D	A	F	D	C	E	D	A
Approach Delay	43.9			70.3			43.6			40.3		
Approach LOS	D			E			D			D		
Queue Length 50th (m)	35.3	70.3	0.0	~73.5	43.4	0.0	43.0	118.3	108.5	16.8	65.3	0.0
Queue Length 95th (m)	50.2	90.8	17.1	#107.3	58.9	m0.0	#80.8	#142.7	#97.4	#36.1	80.3	14.0
Internal Link Dist (m)	213.9			123.7			114.3			252.7		
Turn Bay Length (m)	100.0		64.0	75.0			47.5		40.0			45.0
Base Capacity (vph)	444	856	514	486	794	487	224	1099	731	118	1181	501
Starvation Cap Reductn	0	0	0	0	0	0	0	0	0	0	0	0
Spillback Cap Reductn	0	0	0	0	0	0	0	0	0	0	0	0
Storage Cap Reductn	0	0	0	0	0	0	0	0	0	0	0	0
Reduced v/c Ratio	0.68	0.72	0.40	1.04	0.48	0.06	0.82	0.81	0.92	0.61	0.70	0.38

Intersection Summary												
Cycle Length: 120												
Actuated Cycle Length: 120												
Offset: 0 (0%), Referenced to phase 2:NBT and 6:SBT, Start of Green												
Natural Cycle: 120												
Control Type: Actuated-Coordinated												

Lanes, Volumes, Timings
1: St Laurent & Coventry/Ogilvie

2026 Future Background
PM Peak Hour

Maximum v/c Ratio: 1.04	Intersection LOS: D
Intersection Signal Delay: 48.0	ICU Level of Service F
Intersection Capacity Utilization 96.0%	
Analysis Period (min) 15	
~ Volume exceeds capacity, queue is theoretically infinite. Queue shown is maximum after two cycles.	
# 95th percentile volume exceeds capacity, queue may be longer. Queue shown is maximum after two cycles.	
m Volume for 95th percentile queue is metered by upstream signal.	

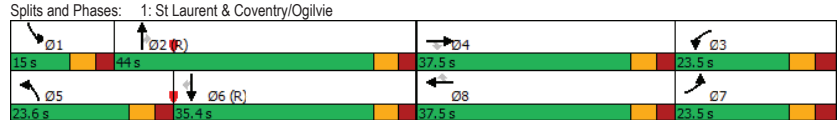

Lanes, Volumes, Timings
2: Lemieux & St Laurent

2026 Future Background
PM Peak Hour

Lane Group	WBL	WBR	NBT	NBR	SBL	SBT
Lane Configurations	↔↔	↔	↑↑↑	↔	↔	↑↑↑
Traffic Volume (vph)	511	156	1643	258	13	1863
Future Volume (vph)	511	156	1643	258	13	1863
Satd. Flow (prot)	2982	1414	4718	1483	1658	4672
Fit Permitted	0.950				0.114	
Satd. Flow (perm)	2982	1316	4718	1433	199	4672
Satd. Flow (RTOR)		33		258		
Lane Group Flow (vph)	511	156	1643	258	13	1863
Turn Type	Prot	Perm	NA	Perm	Perm	NA
Protected Phases	7		2			6
Permitted Phases		7		2	6	
Detector Phase	7	7	2	2	6	6
Switch Phase						
Minimum Initial (s)	5.0	5.0	10.0	10.0	10.0	10.0
Minimum Split (s)	36.1	36.1	43.5	43.5	16.0	16.0
Total Split (s)	38.0	38.0	82.0	82.0	82.0	82.0
Total Split (%)	31.7%	31.7%	68.3%	68.3%	68.3%	68.3%
Yellow Time (s)	3.3	3.3	3.7	3.7	3.7	3.7
All-Red Time (s)	2.8	2.8	1.8	1.8	1.8	1.8
Lost Time Adjust (s)	0.0	0.0	0.0	0.0	0.0	0.0
Total Lost Time (s)	6.1	6.1	5.5	5.5	5.5	5.5
Lead/Lag						
Lead-Lag Optimize?						
Recall Mode	None	None	C-Max	C-Max	C-Max	C-Max
Act Effct Green (s)	28.3	28.3	80.1	80.1	80.1	80.1
Actuated g/C Ratio	0.24	0.24	0.67	0.67	0.67	0.67
v/c Ratio	0.73	0.47	0.52	0.25	0.10	0.60
Control Delay	48.5	34.8	10.1	2.1	5.6	7.8
Queue Delay	0.0	0.0	0.2	0.0	0.0	0.0
Total Delay	48.5	34.8	10.4	2.1	5.6	7.8
LOS	D	C	B	A	A	A
Approach Delay	45.3		9.2			7.7
Approach LOS	D		A			A
Queue Length 50th (m)	56.3	24.3	90.2	8.8	0.6	69.8
Queue Length 95th (m)	73.4	43.9	63.2	8.1	m1.5	m73.7
Internal Link Dist (m)	75.1		117.1			60.0
Turn Bay Length (m)		51.5		53.5	115.0	
Base Capacity (vph)	792	374	3150	1042	133	3119
Starvation Cap Reductn	0	0	680	0	0	0
Spillback Cap Reductn	0	0	0	0	0	0
Storage Cap Reductn	0	0	0	0	0	0
Reduced v/c Ratio	0.65	0.42	0.67	0.25	0.10	0.60

Intersection Summary						
Cycle Length:	120					
Actuated Cycle Length:	120					
Offset:	99 (83%), Referenced to phase 2:NBT and 6:SBTL, Start of Green					
Natural Cycle:	80					
Control Type:	Actuated-Coordinated					

Lanes, Volumes, Timings
2: Lemieux & St Laurent

2026 Future Background
PM Peak Hour

Maximum v/c Ratio: 0.73	Intersection LOS: B
Intersection Signal Delay: 14.0	ICU Level of Service C
Intersection Capacity Utilization 70.8%	
Analysis Period (min) 15	

m Volume for 95th percentile queue is metered by upstream signal.

Splits and Phases: 2: Lemieux & St Laurent



Lanes, Volumes, Timings
3: St Laurent & Transitway

2026 Future Background
PM Peak Hour

Lane Group	WBL	WBR	NBT	NBR	SBL	SBT
Lane Configurations	↔	↔	↑↑↑	↔	↔	↑↑↑
Traffic Volume (vph)	40	20	1944	45	0	1267
Future Volume (vph)	40	20	1944	45	0	1267
Satd. Flow (prot)	914	0	4646	0	1745	4718
Fit Permitted	0.968					
Satd. Flow (perm)	914	0	4646	0	1745	4718
Satd. Flow (RTOR)	1		7			
Lane Group Flow (vph)	60	0	1989	0	0	1267
Turn Type	Prot		NA		Perm	NA
Protected Phases	8		2			6
Permitted Phases					6	
Detector Phase	8		2		6	6
Switch Phase						
Minimum Initial (s)	5.0		10.0		10.0	10.0
Minimum Split (s)	29.5		30.0		24.0	24.0
Total Split (s)	29.5		30.5		30.5	30.5
Total Split (%)	49.2%		50.8%		50.8%	50.8%
Yellow Time (s)	3.3		3.7		3.7	3.7
All-Red Time (s)	2.2		2.3		2.3	2.3
Lost Time Adjust (s)	0.0		0.0		0.0	0.0
Total Lost Time (s)	5.5		6.0		6.0	6.0
Lead/Lag						
Lead-Lag Optimize?						
Recall Mode	None		C-Max		C-Max	C-Max
Act Effct Green (s)	9.5		46.2		46.2	46.2
Actuated g/C Ratio	0.16		0.77		0.77	0.77
v/c Ratio	0.41		0.56		0.35	0.35
Control Delay	29.9		9.4		4.2	4.2
Queue Delay	0.0		0.0		0.0	0.0
Total Delay	29.9		9.4		4.2	4.2
LOS	C		A		A	A
Approach Delay	29.9		9.4		4.2	4.2
Approach LOS	C		A		A	A
Queue Length 50th (m)	6.0		71.1		27.5	27.5
Queue Length 95th (m)	14.1		118.9		40.0	40.0
Internal Link Dist (m)	43.2		196.1		117.1	117.1
Turn Bay Length (m)						
Base Capacity (vph)	366		3576		3630	3630
Starvation Cap Reductn	0		0		0	0
Spillback Cap Reductn	0		0		0	0
Storage Cap Reductn	0		0		0	0
Reduced v/c Ratio	0.16		0.56		0.35	0.35

Intersection Summary	
Cycle Length:	60
Actuated Cycle Length:	60
Offset:	28 (47%), Referenced to phase 2:NBT and 6:SBTL, Start of Green
Natural Cycle:	65
Control Type:	Actuated-Coordinated

Lanes, Volumes, Timings
3: St Laurent & Transitway

2026 Future Background
PM Peak Hour

Maximum v/c Ratio: 0.56	Intersection LOS: A
Intersection Signal Delay: 7.8	ICU Level of Service A
Intersection Capacity Utilization 54.5%	
Analysis Period (min) 15	

Splits and Phases: 3: St Laurent & Transitway

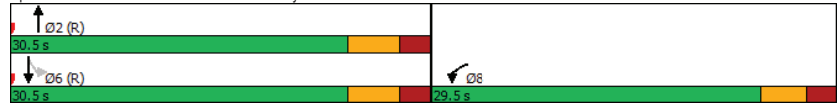

Lanes, Volumes, Timings
4: Hwy 417 EB Off-Ramp & St Laurent

2026 Future Background
PM Peak Hour

Lane Group	EBL	EBR	NBL	NBT	SBT	SBR
Lane Configurations	↔↔	↔		↑↑↑	↑↑↑	
Traffic Volume (vph)	784	263	0	1524	810	397
Future Volume (vph)	784	263	0	1524	810	397
Satd. Flow (prot)	3124	1414	0	4764	4257	0
Fit Permitted	0.950					
Satd. Flow (perm)	3124	1376	0	4764	4257	0
Satd. Flow (RTOR)		137			157	
Lane Group Flow (vph)	784	263	0	1524	1207	0
Turn Type	Prot	Perm		NA	NA	
Protected Phases	4			2	6	
Permitted Phases		4				
Detector Phase	4	4		2	6	
Switch Phase						
Minimum Initial (s)	5.0	5.0		10.0	10.0	
Minimum Split (s)	34.5	34.5		24.1	42.1	
Total Split (s)	50.0	50.0		70.0	70.0	
Total Split (%)	41.7%	41.7%		58.3%	58.3%	
Yellow Time (s)	3.3	3.3		3.7	3.7	
All-Red Time (s)	3.2	3.2		2.4	2.4	
Lost Time Adjust (s)	0.0	0.0		0.0	0.0	
Total Lost Time (s)	6.5	6.5		6.1	6.1	
Lead/Lag						
Lead-Lag Optimize?						
Recall Mode	None	None		C-Max	C-Max	
Act Effct Green (s)	36.3	36.3		71.1	71.1	
Actuated g/C Ratio	0.30	0.30		0.59	0.59	
v/c Ratio	0.83	0.51		0.54	0.47	
Control Delay	46.8	18.7		16.3	9.7	
Queue Delay	0.0	0.0		0.0	0.0	
Total Delay	46.8	18.7		16.3	9.7	
LOS	D	B		B	A	
Approach Delay	39.7			16.3	9.7	
Approach LOS	D			B	A	
Queue Length 50th (m)	88.2	23.4		74.6	49.1	
Queue Length 95th (m)	101.9	44.6		101.2	89.4	
Internal Link Dist (m)	73.5			158.0	196.1	
Turn Bay Length (m)						
Base Capacity (vph)	1132	586		2820	2584	
Starvation Cap Reductn	0	0		0	0	
Spillback Cap Reductn	0	0		0	0	
Storage Cap Reductn	0	0		0	0	
Reduced v/c Ratio	0.69	0.45		0.54	0.47	

Intersection Summary	
Cycle Length:	120
Actuated Cycle Length:	120
Offset:	40 (33%), Referenced to phase 2:NBT and 6:SBT, Start of Green
Natural Cycle:	80
Control Type:	Actuated-Coordinated

Lanes, Volumes, Timings
4: Hwy 417 EB Off-Ramp & St Laurent

2026 Future Background
PM Peak Hour

Maximum v/c Ratio: 0.83	Intersection LOS: C
Intersection Signal Delay: 20.7	ICU Level of Service C
Intersection Capacity Utilization 65.2%	
Analysis Period (min) 15	

Splits and Phases: 4: Hwy 417 EB Off-Ramp & St Laurent

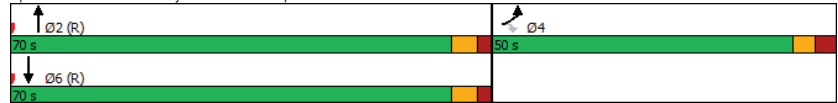

Lanes, Volumes, Timings
5: Cyrville & Ogilvie

2026 Future Background
PM Peak Hour

Lane Group	EBL	EBT	EBR	WBL	WBT	WBR	NBL	NBT	NBR	SBL	SBT	SBR
Lane Configurations		↑↑	↑	↓	↑↑	↑	↓	↓	↓	↓	↓	↓
Traffic Volume (vph)	0	1102	279	42	690	124	137	241	32	134	222	80
Future Volume (vph)	0	1102	279	42	690	124	137	241	32	134	222	80
Satd. Flow (prot)	0	3316	1469	1658	3316	1469	1580	1710	0	1642	1639	0
Fit Permitted				0.215			0.340			0.394		
Satd. Flow (perm)	0	3316	1362	373	3316	1327	563	1710	0	678	1639	0
Satd. Flow (RTOR)			279			124		6			17	
Lane Group Flow (vph)	0	1102	279	42	690	124	137	273	0	134	302	0
Turn Type		NA	Perm	Perm	NA	Perm	Perm	NA		Perm	NA	
Protected Phases		2			6		4		4		8	
Permitted Phases			2	6		6	4			8		
Detector Phase		2	2	6	6	6	4	4		8	8	
Switch Phase												
Minimum Initial (s)		10.0	10.0	10.0	10.0	10.0	10.0	10.0		10.0	10.0	
Minimum Split (s)		32.2	32.2	32.2	32.2	32.2	47.1	47.1		47.1	47.1	
Total Split (s)		70.0	70.0	70.0	70.0	70.0	50.0	50.0		50.0	50.0	
Total Split (%)		58.3%	58.3%	58.3%	58.3%	58.3%	41.7%	41.7%		41.7%	41.7%	
Yellow Time (s)		3.7	3.7	3.7	3.7	3.7	3.7	3.7		3.7	3.7	
All-Red Time (s)		2.5	2.5	2.5	2.5	2.5	3.4	3.4		3.4	3.4	
Lost Time Adjust (s)		0.0	0.0	0.0	0.0	0.0	0.0	0.0		0.0	0.0	
Total Lost Time (s)		6.2	6.2	6.2	6.2	6.2	7.1	7.1		7.1	7.1	
Lead/Lag												
Lead-Lag Optimize?												
Recall Mode		C-Max	C-Max	C-Max	C-Max	C-Max	None	None		None	None	
Act Effct Green (s)		78.7	78.7	78.7	78.7	78.7	28.0	28.0		28.0	28.0	
Actuated g/C Ratio		0.66	0.66	0.66	0.66	0.66	0.23	0.23		0.23	0.23	
v/c Ratio		0.51	0.28	0.17	0.32	0.14	1.05	0.68		0.85	0.76	
Control Delay		5.5	0.7	13.0	10.6	2.4	135.0	48.3		83.0	52.3	
Queue Delay		0.2	0.0	0.0	0.0	0.0	0.0	0.0		0.0	0.0	
Total Delay		5.8	0.7	13.0	10.6	2.4	135.0	48.3		83.0	52.3	
LOS		A	A	B	B	A	F	D		F	D	
Approach Delay		4.7			9.5		77.3			61.7		
Approach LOS		A			A		E			E		
Queue Length 50th (m)		27.3	0.1	3.5	33.3	0.0	~36.0	58.2		30.6	63.9	
Queue Length 95th (m)		m58.5	m1.5	11.9	58.6	8.3	#60.8	75.0		48.9	82.4	
Internal Link Dist (m)		123.7			139.9			44.2			76.2	
Turn Bay Length (m)				53.5		51.0	42.5			77.0		
Base Capacity (vph)		2174	989	244	2174	912	201	615		242	596	
Starvation Cap Reductn		397	0	0	0	0	0	0		0	0	
Spillback Cap Reductn		0	0	0	0	0	0	0		0	0	
Storage Cap Reductn		0	0	0	0	0	0	0		0	0	
Reduced v/c Ratio		0.62	0.28	0.17	0.32	0.14	0.68	0.44		0.55	0.51	

Intersection Summary												
Cycle Length: 120												
Actuated Cycle Length: 120												
Offset: 20 (17%), Referenced to phase 2:EBT and 6:WBTL, Start of Green												
Natural Cycle: 80												
Control Type: Actuated-Coordinated												

Lanes, Volumes, Timings
5: Cyrville & Ogilvie

2026 Future Background
PM Peak Hour

Maximum v/c Ratio: 1.05	Intersection LOS: C
Intersection Signal Delay: 23.8	ICU Level of Service E
Intersection Capacity Utilization 83.5%	
Analysis Period (min) 15	
~ Volume exceeds capacity, queue is theoretically infinite.	
Queue shown is maximum after two cycles.	
# 95th percentile volume exceeds capacity, queue may be longer.	
Queue shown is maximum after two cycles.	
m Volume for 95th percentile queue is metered by upstream signal.	

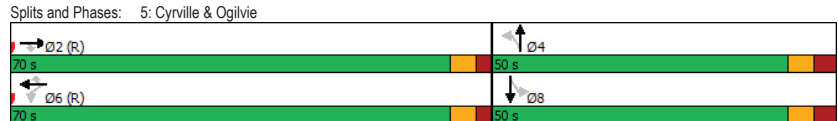

HCM 2010 TWSC
6: Labelle & Lemieux

2026 Future Background
PM Peak Hour

Intersection												
Int Delay, s/veh	5.3											
Movement	EBL	EBT	EBR	WBL	WBT	WBR	NBL	NBT	NBR	SBL	SBT	SBR
Lane Configurations	↔ ↕ ↕ ↕ ↕ ↕ ↕ ↕ ↕ ↕ ↕ ↕ ↕											
Traffic Vol, veh/h	131	0	0	0	0	162	112	316	27	0	0	176
Future Vol, veh/h	131	0	0	0	0	162	112	316	27	0	0	176
Conflicting Peds, #/hr	0	0	0	0	0	0	0	0	0	0	0	0
Sign Control	Stop	Stop	Stop	Stop	Stop	Stop	Free	Free	Free	Free	Free	Free
RT Channelized	-	-	None	-	-	None	-	-	Free	-	-	Yield
Storage Length	0	-	-	-	-	0	-	-	-	-	-	0
Veh in Median Storage, #	-	0	-	-	0	-	-	0	-	-	-	-
Grade, %	-	0	-	-	0	-	-	0	-	-	0	-
Peak Hour Factor	100	100	100	100	100	100	100	100	100	100	100	100
Heavy Vehicles, %	2	2	2	2	2	2	2	2	2	2	2	2
Mvmt Flow	131	0	0	0	0	162	112	316	27	0	0	176

Major/Minor	Minor2	Minor1	Major1
Conflicting Flow All	382	-	-
Stage 1	0	-	-
Stage 2	382	-	-
Critical Hdwy	7.54	-	-
Critical Hdwy Stg 1	-	-	-
Critical Hdwy Stg 2	6.54	-	-
Follow-up Hdwy	3.52	-	-
Pot Cap-1 Maneuver	551	0	0
Stage 1	-	0	0
Stage 2	612	0	0
Platoon blocked, %	-	-	-
Mov Cap-1 Maneuver	447	-	-
Mov Cap-2 Maneuver	447	-	-
Stage 1	-	-	-
Stage 2	497	-	-

Approach	EB	WB	NB
HCM Control Delay, s	16.4	10.2	
HCM LOS	C	B	

Minor Lane/Major Mvmt	NBL	NBT	EBLn1	WBLn1
Capacity (veh/h)	-	-	447	859
HCM Lane V/C Ratio	-	-	0.293	0.189
HCM Control Delay (s)	-	-	16.4	10.2
HCM Lane LOS	-	-	C	B
HCM 95th %tile Q(veh)	-	-	1.2	0.7

HCM 2010 TWSC
7: Lemieux & Joseph Cyr

2026 Future Background
PM Peak Hour

Intersection						
Int Delay, s/veh	2.6					
Movement	EBL	EBT	WBT	WBR	SBL	SBR
Lane Configurations	↖	↑	↑↑		↘	
Traffic Vol, veh/h	112	159	560	38	17	101
Future Vol, veh/h	112	159	560	38	17	101
Conflicting Peds, #/hr	0	0	0	0	0	0
Sign Control	Free	Free	Free	Free	Stop	Stop
RT Channelized	-	None	-	None	-	None
Storage Length	22	-	-	-	0	-
Veh in Median Storage, #	-	0	0	-	0	-
Grade, %	-	0	0	-	0	-
Peak Hour Factor	100	100	100	100	100	100
Heavy Vehicles, %	2	2	4	3	2	3
Mvmt Flow	112	159	560	38	17	101

Major/Minor	Major1	Major2	Minor2
Conflicting Flow All	598	0	962
Stage 1	-	-	579
Stage 2	-	-	383
Critical Hdwy	4.13	-	6.63
Critical Hdwy Stg 1	-	-	5.83
Critical Hdwy Stg 2	-	-	5.43
Follow-up Hdwy	2.219	-	3.3285
Pot Cap-1 Maneuver	977	-	268
Stage 1	-	-	525
Stage 2	-	-	688
Platoon blocked, %	-	-	-
Mov Cap-1 Maneuver	977	-	237
Mov Cap-2 Maneuver	-	-	237
Stage 1	-	-	465
Stage 2	-	-	688

Approach	EB	WB	SB
HCM Control Delay, s	3.8	0	13.4
HCM LOS			B

Minor Lane/Major Mvmt	EBL	EBT	WBT	WBR	SBLn1
Capacity (veh/h)	977	-	-	-	544
HCM Lane V/C Ratio	0.115	-	-	-	0.217
HCM Control Delay (s)	9.2	-	-	-	13.4
HCM Lane LOS	A	-	-	-	B
HCM 95th %tile Q(veh)	0.4	-	-	-	0.8

HCM 2010 TWSC
8: Joseph Cyr & Cyrville

2026 Future Background
PM Peak Hour

Intersection												
Int Delay, s/veh	2.9											
Movement	EBL	EBT	EBR	WBL	WBT	WBR	NBL	NBT	NBR	SBL	SBT	SBR
Lane Configurations		↕			↕			↕			↕	
Traffic Vol, veh/h	0	480	52	53	371	1	39	5	82	1	1	1
Future Vol, veh/h	0	480	52	53	371	1	39	5	82	1	1	1
Conflicting Peds, #/hr	11	0	3	3	0	11	1	0	3	3	0	1
Sign Control	Free	Free	Free	Free	Free	Free	Stop	Stop	Stop	Stop	Stop	Stop
RT Channelized	-	-	None	-	-	None	-	-	None	-	-	None
Storage Length	-	-	-	-	-	-	-	-	-	-	-	-
Veh in Median Storage, #	-	0	-	-	0	-	-	0	-	-	0	-
Grade, %	-	0	-	-	0	-	-	0	-	-	0	-
Peak Hour Factor	100	100	100	100	100	100	100	100	100	100	100	100
Heavy Vehicles, %	2	3	2	4	2	2	2	2	2	2	2	2
Mvmt Flow	0	480	52	53	371	1	39	5	82	1	1	1

Major/Minor	Major1	Major2	Minor1	Minor2
Conflicting Flow All	383	0	535	989
Stage 1	-	-	-	509
Stage 2	-	-	-	480
Critical Hdwy	4.12	-	4.14	7.12
Critical Hdwy Stg 1	-	-	-	6.12
Critical Hdwy Stg 2	-	-	-	6.12
Follow-up Hdwy	2.218	-	2.236	3.518
Pot Cap-1 Maneuver	1175	-	1023	226
Stage 1	-	-	-	547
Stage 2	-	-	-	567
Platoon blocked, %	-	-	-	-
Mov Cap-1 Maneuver	1165	-	1021	213
Mov Cap-2 Maneuver	-	-	-	213
Stage 1	-	-	-	546
Stage 2	-	-	-	528

Approach	EB	WB	NB	SB
HCM Control Delay, s	0	1.1	20.4	19.9
HCM LOS			C	C

Minor Lane/Major Mvmt	NBLn1	EBL	EBT	EBR	WBL	WBT	WBR	SBLn1
Capacity (veh/h)	358	1165	-	-	1021	-	-	245
HCM Lane V/C Ratio	0.352	-	-	-	0.052	-	-	0.012
HCM Control Delay (s)	20.4	0	-	-	8.7	0	-	19.9
HCM Lane LOS	C	A	-	-	A	A	-	C
HCM 95th %tile Q(veh)	1.5	0	-	-	0.2	-	-	0

Appendix H

Synchro Intersection Worksheets – 2031 Future Background Conditions

Lanes, Volumes, Timings
1: St Laurent & Coventry/Ogilvie

2031 Future Background
AM Peak Hour

Lane Group	EBL	EBT	EBR	WBL	WBT	WBR	NBL	NBT	NBR	SBL	SBT	SBR
Lane Configurations	↔	↕	↔	↔	↕	↔	↔	↕	↔	↔	↕	↔
Traffic Volume (vph)	66	209	58	745	677	26	141	879	599	34	846	132
Future Volume (vph)	66	209	58	745	677	26	141	879	599	34	846	132
Satd. Flow (prot)	3010	3283	1388	3216	3103	1339	1523	3161	1441	1642	4764	1427
Fit Permitted	0.950			0.950			0.950			0.950		
Satd. Flow (perm)	2906	3283	1331	3156	3103	1253	1511	3161	1384	1628	4764	1367
Satd. Flow (RTOR)			195			140			507			196
Lane Group Flow (vph)	66	209	58	745	677	26	141	879	599	34	846	132
Turn Type	Prot	NA	Perm	Prot	NA	Perm	Prot	NA	Perm	Prot	NA	Perm
Protected Phases	7	4		3	8		5	2		1	6	
Permitted Phases			4			8			2			6
Detector Phase	7	4	4	3	8	8	5	2	2	1	6	6
Switch Phase												
Minimum Initial (s)	5.0	10.0	10.0	5.0	10.0	10.0	5.0	10.0	10.0	5.0	10.0	10.0
Minimum Split (s)	11.9	37.5	37.5	11.9	37.5	37.5	11.4	35.4	35.4	11.4	35.4	35.4
Total Split (s)	15.0	37.5	37.5	35.5	58.0	58.0	21.6	35.4	35.4	21.6	35.4	35.4
Total Split (%)	11.5%	28.8%	28.8%	27.3%	44.6%	44.6%	16.6%	27.2%	27.2%	16.6%	27.2%	27.2%
Yellow Time (s)	3.7	3.7	3.7	3.7	3.7	3.7	3.7	3.7	3.7	3.7	3.7	3.7
All-Red Time (s)	3.2	2.8	2.8	3.2	2.8	2.8	2.7	2.7	2.7	2.7	2.7	2.7
Lost Time Adjust (s)	0.0	0.0	0.0	0.0	0.0	0.0	0.0	0.0	0.0	0.0	0.0	0.0
Total Lost Time (s)	6.9	6.5	6.5	6.9	6.5	6.5	6.4	6.4	6.4	6.4	6.4	6.4
Lead/Lag	Lag	Lead	Lead	Lag	Lead	Lead	Lead	Lag	Lag	Lead	Lag	Lag
Lead-Lag Optimize?	Yes	Yes	Yes	Yes	Yes	Yes	Yes	Yes	Yes	Yes	Yes	Yes
Recall Mode	None	None	None	None	None	None	C-Max	C-Max	None	C-Max	C-Max	C-Max
Act Effct Green (s)	17.6	23.0	23.0	33.0	41.0	41.0	14.6	44.6	44.6	8.2	33.2	33.2
Actuated g/C Ratio	0.14	0.18	0.18	0.25	0.32	0.32	0.11	0.34	0.34	0.06	0.26	0.26
v/c Ratio	0.16	0.36	0.15	0.91	0.69	0.05	0.82	0.81	0.74	0.33	0.70	0.27
Control Delay	49.2	46.9	0.8	62.5	36.7	0.2	101.5	40.5	16.8	66.1	48.3	2.2
Queue Delay	0.0	0.0	0.0	0.0	0.0	0.0	0.0	0.0	0.8	0.0	0.0	0.0
Total Delay	49.2	46.9	0.8	62.5	36.8	0.2	101.5	40.5	17.6	66.1	48.3	2.2
LOS	D	D	A	E	D	A	F	D	B	E	D	A
Approach Delay		39.3			49.4			37.3			42.9	
Approach LOS		D			D			D			D	
Queue Length 50th (m)	7.3	23.0	0.0	~109.0	88.2	0.0	38.2	~126.8	34.4	8.5	75.6	0.0
Queue Length 95th (m)	14.7	34.2	0.0	#148.6	103.0	m0.0	#71.6	#168.3	#66.0	19.0	91.5	2.4
Internal Link Dist (m)		213.9			123.7			114.3			252.7	
Turn Bay Length (m)	100.0		64.0	75.0			47.5			40.0		45.0
Base Capacity (vph)	418	782	465	816	1258	590	179	1085	808	191	1216	495
Starvation Cap Reductn	0	0	0	0	20	0	0	0	52	0	0	0
Spillback Cap Reductn	0	0	0	0	0	0	0	0	0	0	0	0
Storage Cap Reductn	0	0	0	0	0	0	0	0	0	0	0	0
Reduced v/c Ratio	0.16	0.27	0.12	0.91	0.55	0.04	0.79	0.81	0.79	0.18	0.70	0.27

Intersection Summary

Cycle Length: 130

Actuated Cycle Length: 130

Offset: 0 (0%), Referenced to phase 2:NBT and 6:SBT, Start of Green

Natural Cycle: 130

Control Type: Actuated-Coordinated

Lanes, Volumes, Timings
1: St Laurent & Coventry/Ogilvie

2031 Future Background
AM Peak Hour

Maximum v/c Ratio: 0.91	Intersection LOS: D
Intersection Signal Delay: 42.7	ICU Level of Service F
Intersection Capacity Utilization 93.5%	
Analysis Period (min) 15	
~ Volume exceeds capacity, queue is theoretically infinite.	
Queue shown is maximum after two cycles.	
# 95th percentile volume exceeds capacity, queue may be longer.	
Queue shown is maximum after two cycles.	
m Volume for 95th percentile queue is metered by upstream signal.	

Splits and Phases: 1: St Laurent & Coventry/Ogilvie

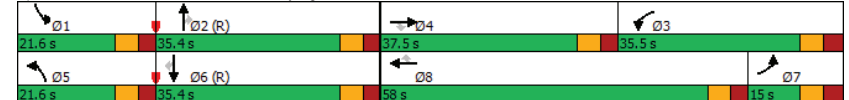

Lanes, Volumes, Timings
2: Lemieux & St Laurent

2031 Future Background
AM Peak Hour

	↖	↗	↑	↘	↙	↓
Lane Group	WBL	WBR	NBT	NBR	SBL	SBT
Lane Configurations	↖↗	↗	↑↑↑	↖	↙	↑↑↑
Traffic Volume (vph)	615	153	1348	235	7	1549
Future Volume (vph)	615	153	1348	235	7	1549
Satd. Flow (prot)	2734	1483	4584	1483	1658	4672
Fit Permitted	0.950				0.163	
Satd. Flow (perm)	2734	1418	4584	1444	284	4672
Satd. Flow (RTOR)		46		235		
Lane Group Flow (vph)	615	153	1348	235	7	1549
Turn Type	Prot	Perm	NA	Perm	Perm	NA
Protected Phases	8		2			6
Permitted Phases		8		2	6	
Detector Phase	8	8	2	2	6	6
Switch Phase						
Minimum Initial (s)	5.0	5.0	10.0	10.0	10.0	10.0
Minimum Split (s)	36.1	36.1	43.5	43.5	16.0	16.0
Total Split (s)	50.0	50.0	80.0	80.0	80.0	80.0
Total Split (%)	38.5%	38.5%	61.5%	61.5%	61.5%	61.5%
Yellow Time (s)	3.3	3.3	3.7	3.7	3.7	3.7
All-Red Time (s)	2.8	2.8	1.8	1.8	1.8	1.8
Lost Time Adjust (s)	0.0	0.0	0.0	0.0	0.0	0.0
Total Lost Time (s)	6.1	6.1	5.5	5.5	5.5	5.5
Lead/Lag						
Lead-Lag Optimize?						
Recall Mode	None	None	C-Max	C-Max	C-Max	C-Max
Act Effct Green (s)	34.9	34.9	83.5	83.5	83.5	83.5
Actuated g/C Ratio	0.27	0.27	0.64	0.64	0.64	0.64
v/c Ratio	0.84	0.37	0.46	0.23	0.04	0.52
Control Delay	55.3	27.9	9.0	2.0	10.9	15.1
Queue Delay	0.0	0.0	0.2	0.0	0.0	0.0
Total Delay	55.3	27.9	9.2	2.0	10.9	15.1
LOS	E	C	A	A	B	B
Approach Delay	49.9		8.1			15.1
Approach LOS	D		A			B
Queue Length 50th (m)	77.0	21.9	37.6	1.2	0.7	72.9
Queue Length 95th (m)	91.0	37.9	72.8	11.6	m1.1	m80.5
Internal Link Dist (m)	80.2		117.1			60.0
Turn Bay Length (m)		51.5		53.5	115.0	
Base Capacity (vph)	923	509	2942	1011	182	2999
Starvation Cap Reductn	0	0	669	0	0	0
Spillback Cap Reductn	0	0	0	0	0	0
Storage Cap Reductn	0	0	0	0	0	0
Reduced v/c Ratio	0.67	0.30	0.59	0.23	0.04	0.52

Intersection Summary	
Cycle Length:	130
Actuated Cycle Length:	130
Offset:	124 (95%), Referenced to phase 2:NBT and 6:SBTL, Start of Green
Natural Cycle:	80
Control Type:	Actuated-Coordinated

Lanes, Volumes, Timings
2: Lemieux & St Laurent

2031 Future Background
AM Peak Hour

Maximum v/c Ratio: 0.84	Intersection LOS: B
Intersection Signal Delay: 19.1	ICU Level of Service B
Intersection Capacity Utilization 63.4%	
Analysis Period (min) 15	
m Volume for 95th percentile queue is metered by upstream signal.	

Splits and Phases: 2: Lemieux & St Laurent



Lanes, Volumes, Timings
3: St Laurent & Transitway

2031 Future Background
AM Peak Hour

	WBL	WBR	NBT	NBR	SBL	SBT
Lane Configurations	↔	↔	↑↑↑	↔	↔	↑↑↑
Traffic Volume (vph)	48	24	1618	60	2	920
Future Volume (vph)	48	24	1618	60	2	920
Satd. Flow (prot)	834	0	4463	0	1127	4628
Fit Permitted	0.968				0.122	
Satd. Flow (perm)	834	0	4463	0	145	4628
Satd. Flow (RTOR)	7		11			
Lane Group Flow (vph)	72	0	1678	0	2	920
Turn Type	Prot		NA		Perm	NA
Protected Phases	8		2			6
Permitted Phases					6	
Detector Phase	8		2		6	6
Switch Phase						
Minimum Initial (s)	5.0		10.0		10.0	10.0
Minimum Split (s)	29.5		30.0		22.5	22.5
Total Split (s)	30.0		35.0		35.0	35.0
Total Split (%)	46.2%		53.8%		53.8%	53.8%
Yellow Time (s)	3.3		3.7		3.7	3.7
All-Red Time (s)	2.2		2.3		2.3	2.3
Lost Time Adjust (s)	0.0		0.0		0.0	0.0
Total Lost Time (s)	5.5		6.0		6.0	6.0
Lead/Lag						
Lead-Lag Optimize?						
Recall Mode	None		C-Max		C-Max	C-Max
Act Effct Green (s)	10.7		50.1		50.1	50.1
Actuated g/C Ratio	0.16		0.77		0.77	0.77
v/c Ratio	0.50		0.49		0.02	0.26
Control Delay	33.6		3.9		7.0	5.5
Queue Delay	0.0		0.0		0.0	0.0
Total Delay	33.6		3.9		7.0	5.5
LOS	C		A		A	A
Approach Delay	33.6		3.9			5.5
Approach LOS	C		A			A
Queue Length 50th (m)	7.2		17.6		0.1	21.2
Queue Length 95th (m)	16.5		35.4		m0.4	58.8
Internal Link Dist (m)	43.2		196.1			117.1
Turn Bay Length (m)					13.0	
Base Capacity (vph)	318		3439		111	3564
Starvation Cap Reductn	0		0		0	0
Spillback Cap Reductn	0		0		0	0
Storage Cap Reductn	0		0		0	0
Reduced v/c Ratio	0.23		0.49		0.02	0.26

Intersection Summary	
Cycle Length:	65
Actuated Cycle Length:	65
Offset:	38 (58%), Referenced to phase 2:NBT and 6:SBTL, Start of Green
Natural Cycle:	60
Control Type:	Actuated-Coordinated

Lanes, Volumes, Timings
3: St Laurent & Transitway

2031 Future Background
AM Peak Hour

Maximum v/c Ratio: 0.50	Intersection LOS: A
Intersection Signal Delay: 5.2	ICU Level of Service A
Intersection Capacity Utilization 48.3%	
Analysis Period (min) 15	
m Volume for 95th percentile queue is metered by upstream signal.	

Splits and Phases: 3: St Laurent & Transitway

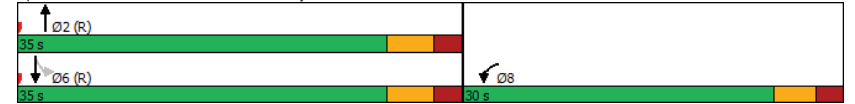

Lanes, Volumes, Timings
4: Hwy 417 EB Off-Ramp & St Laurent

2031 Future Background
AM Peak Hour

Lane Group	EBL	EBR	NBL	NBT	SBT	SBR
Lane Configurations	↔↔	↔		↑↑↑	↑↑↑	
Traffic Volume (vph)	685	673	0	1280	834	170
Future Volume (vph)	685	673	0	1280	834	170
Satd. Flow (prot)	3066	1427	0	4418	4354	0
Fit Permitted	0.950					
Satd. Flow (perm)	3066	1409	0	4418	4354	0
Satd. Flow (RTOR)		136			51	
Lane Group Flow (vph)	685	673	0	1280	1004	0
Turn Type	Prot	Perm		NA	NA	
Protected Phases	4			2	6	
Permitted Phases		4				
Detector Phase	4	4		2	6	
Switch Phase						
Minimum Initial (s)	5.0	5.0		10.0	10.0	
Minimum Split (s)	34.5	34.5		24.1	42.1	
Total Split (s)	55.0	55.0		75.0	75.0	
Total Split (%)	42.3%	42.3%		57.7%	57.7%	
Yellow Time (s)	3.3	3.3		3.7	3.7	
All-Red Time (s)	3.2	3.2		2.4	2.4	
Lost Time Adjust (s)	0.0	0.0		0.0	0.0	
Total Lost Time (s)	6.5	6.5		6.1	6.1	
Lead/Lag						
Lead-Lag Optimize?						
Recall Mode	None	None		C-Max	C-Max	
Act Effct Green (s)	48.5	48.5		68.9	68.9	
Actuated g/C Ratio	0.37	0.37		0.53	0.53	
v/c Ratio	0.60	1.10		0.55	0.43	
Control Delay	35.6	99.2		21.3	17.7	
Queue Delay	0.0	0.0		0.0	0.0	
Total Delay	35.6	99.2		21.3	17.7	
LOS	D	F		C	B	
Approach Delay	67.1			21.3	17.7	
Approach LOS	E			C	B	
Queue Length 50th (m)	72.4	-172.7		76.8	39.4	
Queue Length 95th (m)	92.1	#245.7		90.2	33.7	
Internal Link Dist (m)	73.5			158.0	196.1	
Turn Bay Length (m)						
Base Capacity (vph)	1143	610		2341	2331	
Starvation Cap Reductn	0	0		0	0	
Spillback Cap Reductn	0	0		0	0	
Storage Cap Reductn	0	0		0	0	
Reduced v/c Ratio	0.60	1.10		0.55	0.43	

Intersection Summary	
Cycle Length:	130
Actuated Cycle Length:	130
Offset:	25 (19%), Referenced to phase 2:NBT and 6:SBT, Start of Green
Natural Cycle:	90
Control Type:	Actuated-Coordinated

Lanes, Volumes, Timings
4: Hwy 417 EB Off-Ramp & St Laurent

2031 Future Background
AM Peak Hour

Maximum v/c Ratio: 1.10	Intersection LOS: D
Intersection Signal Delay: 37.4	ICU Level of Service E
Intersection Capacity Utilization 82.8%	
Analysis Period (min) 15	
~ Volume exceeds capacity, queue is theoretically infinite. Queue shown is maximum after two cycles.	
# 95th percentile volume exceeds capacity, queue may be longer. Queue shown is maximum after two cycles.	

Splits and Phases: 4: Hwy 417 EB Off-Ramp & St Laurent

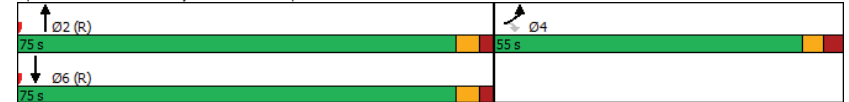

Lanes, Volumes, Timings
5: Cyrville & Ogilvie

2031 Future Background
AM Peak Hour

Lane Group	EBL	EBT	EBR	WBL	WBT	WBR	NBL	NBT	NBR	SBL	SBT	SBR
Lane Configurations		↑↑	↑	↑	↑↑	↑	↑	↑	↑	↑	↑	↑
Traffic Volume (vph)	0	595	243	27	1155	166	180	249	12	47	193	45
Future Volume (vph)	0	595	243	27	1155	166	180	249	12	47	193	45
Satd. Flow (prot)	0	3283	1414	1658	3316	1441	1551	1716	0	1626	1611	0
Fit Permitted				0.410			0.463			0.422		
Satd. Flow (perm)	0	3283	1326	706	3316	1312	752	1716	0	720	1611	0
Satd. Flow (RTOR)			243			135		2			10	
Lane Group Flow (vph)	0	595	243	27	1155	166	180	261	0	47	238	0
Turn Type	NA	Perm	Perm	NA	Perm	Perm	NA	Perm	NA	Perm	NA	
Protected Phases	2			6			4				8	
Permitted Phases			2	6		6	4			8		
Detector Phase	2	2	6	6	6	4	4			8	8	
Switch Phase												
Minimum Initial (s)		10.0	10.0	10.0	10.0	10.0	10.0			10.0	10.0	
Minimum Split (s)		32.2	32.2	32.2	32.2	32.2	47.1	47.1		47.1	47.1	
Total Split (s)		80.0	80.0	80.0	80.0	80.0	50.0	50.0		50.0	50.0	
Total Split (%)		61.5%	61.5%	61.5%	61.5%	61.5%	38.5%	38.5%		38.5%	38.5%	
Yellow Time (s)		3.7	3.7	3.7	3.7	3.7	3.7	3.7		3.7	3.7	
All-Red Time (s)		2.5	2.5	2.5	2.5	2.5	3.4	3.4		3.4	3.4	
Lost Time Adjust (s)		0.0	0.0	0.0	0.0	0.0	0.0	0.0		0.0	0.0	
Total Lost Time (s)		6.2	6.2	6.2	6.2	6.2	7.1	7.1		7.1	7.1	
Lead/Lag												
Lead-Lag Optimize?												
Recall Mode		C-Max	C-Max	C-Max	C-Max	C-Max	None	None		None	None	
Act Effct Green (s)		84.5	84.5	84.5	84.5	84.5	32.2	32.2		32.2	32.2	
Actuated g/C Ratio		0.65	0.65	0.65	0.65	0.65	0.25	0.25		0.25	0.25	
v/c Ratio		0.28	0.26	0.06	0.54	0.18	0.97	0.61		0.26	0.59	
Control Delay		7.2	0.9	11.4	14.7	3.6	105.2	48.0		39.7	45.7	
Queue Delay		0.0	0.0	0.0	0.0	0.0	0.0	0.0		0.0	0.0	
Total Delay		7.2	0.9	11.4	14.7	3.6	105.2	48.0		39.7	45.7	
LOS		A	A	B	B	A	F	D		D	D	
Approach Delay		5.3			13.3		71.4			44.7		
Approach LOS		A			B		E			D		
Queue Length 50th (m)		21.9	0.0	2.4	79.5	2.7	45.4	58.6		9.7	51.2	
Queue Length 95th (m)		33.7	m0.0	7.6	119.8	13.4	#75.5	77.8		18.7	70.1	
Internal Link Dist (m)		123.7			139.9			46.0			76.2	
Turn Bay Length (m)				53.5		51.0	42.5			77.0		
Base Capacity (vph)		2133	946	458	2154	899	248	567		237	538	
Starvation Cap Reductn		0	0	0	0	0	0	0		0	0	
Spillback Cap Reductn		0	0	0	0	0	0	0		0	0	
Storage Cap Reductn		0	0	0	0	0	0	0		0	0	
Reduced v/c Ratio		0.28	0.26	0.06	0.54	0.18	0.73	0.46		0.20	0.44	

Intersection Summary	
Cycle Length:	130
Actuated Cycle Length:	130
Offset:	10 (8%), Referenced to phase 2:EBT and 6:WBTL, Start of Green
Natural Cycle:	80
Control Type:	Actuated-Coordinated

Lanes, Volumes, Timings
5: Cyrville & Ogilvie

2031 Future Background
AM Peak Hour

Maximum v/c Ratio: 0.97	Intersection LOS: C
Intersection Signal Delay: 22.9	ICU Level of Service D
Intersection Capacity Utilization 79.6%	
Analysis Period (min) 15	
# 95th percentile volume exceeds capacity, queue may be longer.	
Queue shown is maximum after two cycles.	
m Volume for 95th percentile queue is metered by upstream signal.	

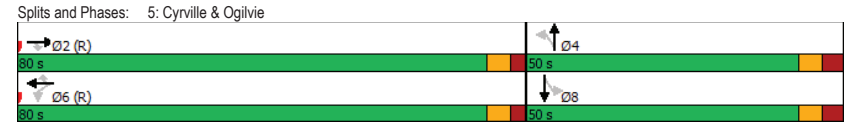

Intersection												
Int Delay, s/veh	2.3											
Movement	EBL	EBT	EBR	WBL	WBT	WBR	NBL	NBT	NBR	SBL	SBT	SBR
Lane Configurations	↔ ↕ ↕ ↕ ↕ ↕ ↕ ↕ ↕ ↕ ↕ ↕ ↕											
Traffic Vol, veh/h	30	0	0	0	0	135	133	557	44	0	0	177
Future Vol, veh/h	30	0	0	0	0	135	133	557	44	0	0	177
Conflicting Peds, #/hr	0	0	0	0	0	0	0	0	0	0	0	0
Sign Control	Stop	Stop	Stop	Stop	Stop	Stop	Free	Free	Free	Free	Free	Free
RT Channelized	-	-	None	-	-	None	-	-	Free	-	-	Yield
Storage Length	0	-	-	-	-	0	-	-	-	-	-	0
Veh in Median Storage, #	-	0	-	-	0	-	-	0	-	-	-	-
Grade, %	-	0	-	-	0	-	-	0	-	-	-	-
Peak Hour Factor	100	100	100	100	100	100	100	100	100	100	100	100
Heavy Vehicles, %	2	2	2	2	2	2	2	2	2	2	2	2
Mvmt Flow	30	0	0	0	0	135	133	557	44	0	0	177

Major/Minor	Minor2	Minor1	Major1				
Conflicting Flow All	545	-	-	279	0	0	-
Stage 1	0	-	-	-	-	-	-
Stage 2	545	-	-	-	-	-	-
Critical Hdwy	7.54	-	-	6.94	4.14	-	-
Critical Hdwy Stg 1	-	-	-	-	-	-	-
Critical Hdwy Stg 2	6.54	-	-	-	-	-	-
Follow-up Hdwy	3.52	-	-	3.32	2.22	-	-
Pot Cap-1 Maneuver	421	0	0	0	718	-	0
Stage 1	-	0	0	0	-	-	0
Stage 2	490	0	0	0	-	-	0
Platoon blocked, %	-	-	-	-	-	-	-
Mov Cap-1 Maneuver	342	-	-	-	718	-	-
Mov Cap-2 Maneuver	342	-	-	-	-	-	-
Stage 1	-	-	-	-	-	-	-
Stage 2	398	-	-	-	-	-	-

Approach	EB	WB	NB
HCM Control Delay, s	16.5	11.2	
HCM LOS	C	B	

Minor Lane/Major Mvmt	NBL	NBT	EBLn1	WBLn1
Capacity (veh/h)	-	-	342	718
HCM Lane V/C Ratio	-	-	0.088	0.188
HCM Control Delay (s)	-	-	16.5	11.2
HCM Lane LOS	-	-	C	B
HCM 95th %tile Q(veh)	-	-	0.3	0.7

Intersection						
Int Delay, s/veh	1.7					
Movement	EBL	EBT	WBT	WBR	SBL	SBR
Lane Configurations	↔ ↕ ↕ ↕ ↕ ↕ ↕					
Traffic Vol, veh/h	74	168	689	21	9	69
Future Vol, veh/h	74	168	689	21	9	69
Conflicting Peds, #/hr	4	0	0	4	0	0
Sign Control	Free	Free	Free	Free	Stop	Stop
RT Channelized	-	None	-	None	-	None
Storage Length	22	-	-	-	0	-
Veh in Median Storage, #	-	0	0	-	0	-
Grade, %	-	0	0	-	0	-
Peak Hour Factor	100	100	100	100	100	100
Heavy Vehicles, %	6	2	10	2	2	5
Mvmt Flow	74	168	689	21	9	69

Major/Minor	Major1	Major2	Minor2		
Conflicting Flow All	714	0	0	1020	359
Stage 1	-	-	-	704	-
Stage 2	-	-	-	316	-
Critical Hdwy	4.19	-	-	6.63	6.975
Critical Hdwy Stg 1	-	-	-	5.83	-
Critical Hdwy Stg 2	-	-	-	5.43	-
Follow-up Hdwy	2.257	-	-	3.519	3.3475
Pot Cap-1 Maneuver	862	-	-	247	631
Stage 1	-	-	-	453	-
Stage 2	-	-	-	738	-
Platoon blocked, %	-	-	-	-	-
Mov Cap-1 Maneuver	859	-	-	225	629
Mov Cap-2 Maneuver	-	-	-	225	-
Stage 1	-	-	-	413	-
Stage 2	-	-	-	736	-

Approach	EB	WB	SB
HCM Control Delay, s	2.9	0	13.1
HCM LOS			B

Minor Lane/Major Mvmt	EBL	EBT	WBT	WBR	SBLn1
Capacity (veh/h)	859	-	-	-	521
HCM Lane V/C Ratio	0.086	-	-	-	0.15
HCM Control Delay (s)	9.6	-	-	-	13.1
HCM Lane LOS	A	-	-	-	B
HCM 95th %tile Q(veh)	0.3	-	-	-	0.5

Intersection												
Int Delay, s/veh	1.4											
Movement	EBL	EBT	EBR	WBL	WBT	WBR	NBL	NBT	NBR	SBL	SBT	SBR
Lane Configurations	↔		↔		↔		↔		↔		↔	
Traffic Vol, veh/h	1	476	32	39	425	1	17	1	52	1	0	0
Future Vol, veh/h	1	476	32	39	425	1	17	1	52	1	0	0
Conflicting Peds, #/hr	3	0	1	1	0	3	0	0	2	2	0	0
Sign Control	Free	Free	Free	Free	Free	Free	Stop	Stop	Stop	Stop	Stop	Stop
RT Channelized	-	-	None	-	-	None	-	-	None	-	-	None
Storage Length	-	-	-	-	-	-	-	-	-	-	-	-
Veh in Median Storage, #	-	0	-	-	0	-	-	0	-	-	0	-
Grade, %	-	0	-	-	0	-	-	0	-	-	0	-
Peak Hour Factor	100	100	100	100	100	100	100	100	100	100	100	100
Heavy Vehicles, %	2	3	6	3	3	2	7	2	9	2	2	2
Mvmt Flow	1	476	32	39	425	1	17	1	52	1	0	0
Major/Minor	Major1	Major2	Minor1	Minor2								
Conflicting Flow All	429	0	0	509	0	0	999	1002	495	1030	1018	429
Stage 1	-	-	-	-	-	-	495	495	-	507	507	-
Stage 2	-	-	-	-	-	-	504	507	-	523	511	-
Critical Hdwy	4.12	-	-	4.13	-	-	7.17	6.52	6.29	7.12	6.52	6.22
Critical Hdwy Stg 1	-	-	-	-	-	-	6.17	5.52	-	6.12	5.52	-
Critical Hdwy Stg 2	-	-	-	-	-	-	6.17	5.52	-	6.12	5.52	-
Follow-up Hdwy	2.218	-	-	2.227	-	-	3.563	4.018	3.381	3.518	4.018	3.318
Pot Cap-1 Maneuver	1130	-	-	1051	-	-	218	242	561	212	237	626
Stage 1	-	-	-	-	-	-	547	546	-	548	539	-
Stage 2	-	-	-	-	-	-	541	539	-	537	537	-
Platoon blocked, %	-	-	-	-	-	-	-	-	-	-	-	-
Mov Cap-1 Maneuver	1127	-	-	1050	-	-	209	229	560	184	224	625
Mov Cap-2 Maneuver	-	-	-	-	-	-	209	229	-	184	224	-
Stage 1	-	-	-	-	-	-	546	545	-	546	512	-
Stage 2	-	-	-	-	-	-	514	512	-	485	536	-
Approach	EB	WB	NB	SB								
HCM Control Delay, s	0	0.7	16.2	24.7								
HCM LOS			C	C								
Minor Lane/Major Mvmt	NBLn1	EBL	EBT	EBR	WBL	WBT	WBR	SBLn1				
Capacity (veh/h)	392	1127	-	-	1050	-	-	184				
HCM Lane V/C Ratio	0.179	0.001	-	-	0.037	-	-	0.005				
HCM Control Delay (s)	16.2	8.2	0	-	8.6	0	-	24.7				
HCM Lane LOS	C	A	A	-	A	A	-	C				
HCM 95th %tile Q(veh)	0.6	0	-	-	0.1	-	-	0				

Lane Group	EBL	EBT	EBR	WBL	WBT	WBR	NBL	NBT	NBR	SBL	SBT	SBR
Lane Configurations	↔	↔	↔	↔	↔	↔	↔	↔	↔	↔	↔	↔
Traffic Volume (vph)	302	652	205	518	395	31	183	915	691	72	864	192
Future Volume (vph)	302	652	205	518	395	31	183	915	691	72	864	192
Satd. Flow (prot)	3216	3316	1483	3154	3075	1469	1566	3252	1483	1658	4764	1483
Fit Permitted	0.950			0.950			0.950			0.950		
Satd. Flow (perm)	2864	3316	1390	3089	3075	1285	1541	3252	1416	1642	4764	1385
Satd. Flow (RTOR)			210			210			379			211
Lane Group Flow (vph)	302	652	205	518	395	31	183	915	691	72	864	192
Turn Type	Prot	NA	Perm	Prot	NA	Perm	Prot	NA	Perm	Prot	NA	Perm
Protected Phases	7	4	4	3	8	8	5	2	2	1	6	6
Permitted Phases			4			8			2			6
Detector Phase	7	4	4	3	8	8	5	2	2	1	6	6
Switch Phase												
Minimum Initial (s)	5.0	10.0	10.0	5.0	10.0	10.0	5.0	10.0	10.0	5.0	10.0	10.0
Minimum Split (s)	11.9	37.5	37.5	11.9	37.5	37.5	11.4	35.4	35.4	11.4	35.4	35.4
Total Split (s)	23.5	37.5	37.5	23.5	37.5	37.5	23.6	44.0	44.0	15.0	35.4	35.4
Total Split (%)	19.6%	31.3%	31.3%	19.6%	31.3%	31.3%	19.7%	36.7%	36.7%	12.5%	29.5%	29.5%
Yellow Time (s)	3.7	3.7	3.7	3.7	3.7	3.7	3.7	3.7	3.7	3.7	3.7	3.7
All-Red Time (s)	3.2	2.8	2.8	3.2	2.8	2.8	2.7	2.7	2.7	2.7	2.7	2.7
Lost Time Adjust (s)	0.0	0.0	0.0	0.0	0.0	0.0	0.0	0.0	0.0	0.0	0.0	0.0
Total Lost Time (s)	6.9	6.5	6.5	6.9	6.5	6.5	6.4	6.4	6.4	6.4	6.4	6.4
Lead/Lag	Lag	Lead	Lead	Lag	Lead	Lead	Lag	Lag	Lag	Lag	Lag	Lag
Lead-Lag Optimize?	Yes	Yes	Yes	Yes	Yes	Yes	Yes	Yes	Yes	Yes	Yes	Yes
Recall Mode	None	None	None	None	None	None	None	C-Max	C-Max	None	C-Max	C-Max
Act Effct Green (s)	16.6	29.3	29.3	18.3	31.0	31.0	16.4	40.6	40.6	8.2	29.8	29.8
Actuated g/C Ratio	0.14	0.24	0.24	0.15	0.26	0.26	0.14	0.34	0.34	0.07	0.25	0.25
v/c Ratio	0.68	0.81	0.41	1.08	0.50	0.06	0.86	0.83	0.95	0.64	0.73	0.38
Control Delay	57.7	51.1	7.1	110.7	34.6	0.2	97.4	40.3	38.0	79.5	45.9	6.0
Queue Delay	0.0	0.0	0.0	0.0	0.0	0.0	0.0	0.0	0.0	0.0	0.0	0.0
Total Delay	57.7	51.1	7.1	110.7	34.6	0.2	97.4	40.3	38.0	79.5	45.9	6.0
LOS	E	D	A	F	C	A	F	D	D	E	D	A
Approach Delay	45.0			75.2			45.2			41.3		
Approach LOS	D			E			D			D		
Queue Length 50th (m)	35.3	74.8	0.0	~76.7	44.8	0.0	43.2	121.7	113.4	16.8	69.3	0.0
Queue Length 95th (m)	50.2	96.3	17.1	#111.0	57.1	m0.0	#80.8	#149.1	#103.7	#36.1	84.9	14.0
Internal Link Dist (m)	213.9			123.7			114.3			252.7		
Turn Bay Length (m)	100.0		64.0	75.0			47.5			40.0		45.0
Base Capacity (vph)	444	856	514	481	794	487	224	1099	729	118	1181	501
Starvation Cap Reductn	0	0	0	0	0	0	0	0	0	0	0	0
Spillback Cap Reductn	0	0	0	0	0	0	0	0	0	0	0	0
Storage Cap Reductn	0	0	0	0	0	0	0	0	0	0	0	0
Reduced v/c Ratio	0.68	0.76	0.40	1.08	0.50	0.06	0.82	0.83	0.95	0.61	0.73	0.38

Intersection Summary												
Cycle Length: 120												
Actuated Cycle Length: 120												
Offset: 0 (0%), Referenced to phase 2:NBT and 6:SBT, Start of Green												
Natural Cycle: 120												
Control Type: Actuated-Coordinated												

Lanes, Volumes, Timings
1: St Laurent & Coventry/Ogilvie

2031 Future Background
PM Peak Hour

Maximum v/c Ratio: 1.08	Intersection LOS: D
Intersection Signal Delay: 49.9	ICU Level of Service F
Intersection Capacity Utilization 96.6%	
Analysis Period (min) 15	
~ Volume exceeds capacity, queue is theoretically infinite. Queue shown is maximum after two cycles.	
# 95th percentile volume exceeds capacity, queue may be longer. Queue shown is maximum after two cycles.	
m Volume for 95th percentile queue is metered by upstream signal.	

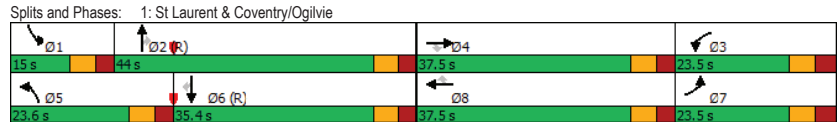

Lanes, Volumes, Timings
2: St Laurent & Lemieux

2031 Future Background
PM Peak Hour

Lane Group	WBL	WBR	NBT	NBR	SBL	SBT
Lane Configurations	↔↔	↔	↑↑↑	↔	↔	↑↑↑
Traffic Volume (vph)	513	156	1683	258	13	1957
Future Volume (vph)	513	156	1683	258	13	1957
Satd. Flow (prot)	2982	1414	4718	1483	1658	4672
Fit Permitted	0.950				0.108	
Satd. Flow (perm)	2982	1316	4718	1433	188	4672
Satd. Flow (RTOR)		30		258		
Lane Group Flow (vph)	513	156	1683	258	13	1957
Turn Type	Prot	Perm	NA	Perm	Perm	NA
Protected Phases	7		2			6
Permitted Phases		7		2	6	
Detector Phase	7	7	2	2	6	6
Switch Phase						
Minimum Initial (s)	5.0	5.0	10.0	10.0	10.0	10.0
Minimum Split (s)	36.1	36.1	43.5	43.5	16.0	16.0
Total Split (s)	38.0	38.0	82.0	82.0	82.0	82.0
Total Split (%)	31.7%	31.7%	68.3%	68.3%	68.3%	68.3%
Yellow Time (s)	3.3	3.3	3.7	3.7	3.7	3.7
All-Red Time (s)	2.8	2.8	1.8	1.8	1.8	1.8
Lost Time Adjust (s)	0.0	0.0	0.0	0.0	0.0	0.0
Total Lost Time (s)	6.1	6.1	5.5	5.5	5.5	5.5
Lead/Lag						
Lead-Lag Optimize?						
Recall Mode	None	None	C-Max	C-Max	C-Max	C-Max
Act Effct Green (s)	28.3	28.3	80.1	80.1	80.1	80.1
Actuated g/C Ratio	0.24	0.24	0.67	0.67	0.67	0.67
v/c Ratio	0.73	0.47	0.53	0.25	0.10	0.63
Control Delay	48.6	35.7	10.5	2.0	5.8	8.0
Queue Delay	0.0	0.0	0.3	0.0	0.0	0.2
Total Delay	48.6	35.7	10.8	2.0	5.8	8.2
LOS	D	D	B	A	A	A
Approach Delay	45.6		9.6			8.2
Approach LOS	D		A			A
Queue Length 50th (m)	56.6	24.9	94.2	8.5	0.7	73.0
Queue Length 95th (m)	73.6	44.6	75.5	7.8	m1.5	m76.3
Internal Link Dist (m)	75.1		117.1			60.0
Turn Bay Length (m)		51.5		53.5	115.0	
Base Capacity (vph)	792	371	3149	1042	125	3118
Starvation Cap Reductn	0	0	682	0	0	404
Spillback Cap Reductn	0	0	0	0	0	0
Storage Cap Reductn	0	0	0	0	0	0
Reduced v/c Ratio	0.65	0.42	0.68	0.25	0.10	0.72

Intersection Summary						
Cycle Length:	120					
Actuated Cycle Length:	120					
Offset:	99 (83%), Referenced to phase 2:NBT and 6:SBTL, Start of Green					
Natural Cycle:	80					
Control Type:	Actuated-Coordinated					

Lanes, Volumes, Timings
2: St Laurent & Lemieux

2031 Future Background
PM Peak Hour

Maximum v/c Ratio: 0.73	Intersection LOS: B
Intersection Signal Delay: 14.3	ICU Level of Service C
Intersection Capacity Utilization 72.7%	
Analysis Period (min) 15	

m Volume for 95th percentile queue is metered by upstream signal.

Splits and Phases: 2: St Laurent & Lemieux



Lanes, Volumes, Timings
3: St Laurent & Transitway

2031 Future Background
PM Peak Hour

Lane Group	WBL	WBR	NBT	NBR	SBL	SBT
Lane Configurations	↔	↔	↑↑↑	↔	↔	↑↑↑
Traffic Volume (vph)	40	20	1996	45	0	1331
Future Volume (vph)	40	20	1996	45	0	1331
Satd. Flow (prot)	914	0	4648	0	1745	4718
Fit Permitted	0.968					
Satd. Flow (perm)	914	0	4648	0	1745	4718
Satd. Flow (RTOR)	1		6			
Lane Group Flow (vph)	60	0	2041	0	0	1331
Turn Type	Prot		NA		Perm	NA
Protected Phases	8		2			6
Permitted Phases					6	
Detector Phase	8		2		6	6
Switch Phase						
Minimum Initial (s)	5.0		10.0		10.0	10.0
Minimum Split (s)	29.5		30.0		24.0	24.0
Total Split (s)	29.5		30.5		30.5	30.5
Total Split (%)	49.2%		50.8%		50.8%	50.8%
Yellow Time (s)	3.3		3.7		3.7	3.7
All-Red Time (s)	2.2		2.3		2.3	2.3
Lost Time Adjust (s)	0.0		0.0		0.0	0.0
Total Lost Time (s)	5.5		6.0		6.0	6.0
Lead/Lag						
Lead-Lag Optimize?						
Recall Mode	None		C-Max		C-Max	C-Max
Act Effct Green (s)	9.5		46.2		46.2	46.2
Actuated g/C Ratio	0.16		0.77		0.77	0.77
v/c Ratio	0.41		0.57		0.37	0.37
Control Delay	29.9		9.8		4.3	4.3
Queue Delay	0.0		0.0		0.0	0.0
Total Delay	29.9		9.8		4.3	4.3
LOS	C		A		A	A
Approach Delay	29.9		9.8		4.3	4.3
Approach LOS	C		A		A	A
Queue Length 50th (m)	6.0		75.4		29.6	29.6
Queue Length 95th (m)	14.1		124.6		44.8	44.8
Internal Link Dist (m)	43.2		196.1		117.1	117.1
Turn Bay Length (m)						
Base Capacity (vph)	366		3577		3630	3630
Starvation Cap Reductn	0		0		0	0
Spillback Cap Reductn	0		0		0	0
Storage Cap Reductn	0		0		0	0
Reduced v/c Ratio	0.16		0.57		0.37	0.37

Intersection Summary	
Cycle Length:	60
Actuated Cycle Length:	60
Offset:	28 (47%), Referenced to phase 2:NBT and 6:SBTL, Start of Green
Natural Cycle:	65
Control Type:	Actuated-Coordinated

Lanes, Volumes, Timings
3: St Laurent & Transitway

2031 Future Background
PM Peak Hour

Maximum v/c Ratio: 0.57	Intersection LOS: A
Intersection Signal Delay: 8.0	ICU Level of Service B
Intersection Capacity Utilization 55.5%	
Analysis Period (min) 15	

Splits and Phases: 3: St Laurent & Transitway

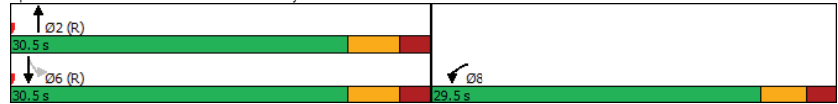

Lanes, Volumes, Timings
4: Hwy 417 EB Off-Ramp & St Laurent

2031 Future Background
PM Peak Hour

Lane Group	EBL	EBR	NBL	NBT	SBT	SBR
Lane Configurations	↔↔	↔		↑↑↑	↑↑↑	
Traffic Volume (vph)	784	263	0	1562	851	397
Future Volume (vph)	784	263	0	1562	851	397
Satd. Flow (prot)	3124	1414	0	4764	4265	0
Fit Permitted	0.950					
Satd. Flow (perm)	3124	1376	0	4764	4265	0
Satd. Flow (RTOR)		123			150	
Lane Group Flow (vph)	784	263	0	1562	1248	0
Turn Type	Prot	Perm		NA	NA	
Protected Phases	4			2	6	
Permitted Phases		4				
Detector Phase	4	4		2	6	
Switch Phase						
Minimum Initial (s)	5.0	5.0		10.0	10.0	
Minimum Split (s)	34.5	34.5		24.1	42.1	
Total Split (s)	50.0	50.0		70.0	70.0	
Total Split (%)	41.7%	41.7%		58.3%	58.3%	
Yellow Time (s)	3.3	3.3		3.7	3.7	
All-Red Time (s)	3.2	3.2		2.4	2.4	
Lost Time Adjust (s)	0.0	0.0		0.0	0.0	
Total Lost Time (s)	6.5	6.5		6.1	6.1	
Lead/Lag						
Lead-Lag Optimize?						
Recall Mode	None	None		C-Max	C-Max	
Act Effct Green (s)	36.3	36.3		71.1	71.1	
Actuated g/C Ratio	0.30	0.30		0.59	0.59	
v/c Ratio	0.83	0.52		0.55	0.48	
Control Delay	46.8	20.8		16.5	9.8	
Queue Delay	0.0	0.0		0.0	0.0	
Total Delay	46.8	20.8		16.5	9.8	
LOS	D	C		B	A	
Approach Delay	40.3			16.5	9.8	
Approach LOS	D			B	A	
Queue Length 50th (m)	88.2	26.4		77.4	52.5	
Queue Length 95th (m)	101.9	47.6		104.8	92.6	
Internal Link Dist (m)	73.5			158.0	196.1	
Turn Bay Length (m)						
Base Capacity (vph)	1132	577		2820	2586	
Starvation Cap Reductn	0	0		0	0	
Spillback Cap Reductn	0	0		0	0	
Storage Cap Reductn	0	0		0	0	
Reduced v/c Ratio	0.69	0.46		0.55	0.48	

Intersection Summary

Cycle Length: 120
Actuated Cycle Length: 120
Offset: 40 (33%), Referenced to phase 2:NBT and 6:SBT, Start of Green
Natural Cycle: 80
Control Type: Actuated-Coordinated

Lanes, Volumes, Timings
4: Hwy 417 EB Off-Ramp & St Laurent

2031 Future Background
PM Peak Hour

Maximum v/c Ratio: 0.83	Intersection LOS: C
Intersection Signal Delay: 20.8	ICU Level of Service C
Intersection Capacity Utilization 66.0%	
Analysis Period (min) 15	

Splits and Phases: 4: Hwy 417 EB Off-Ramp & St Laurent

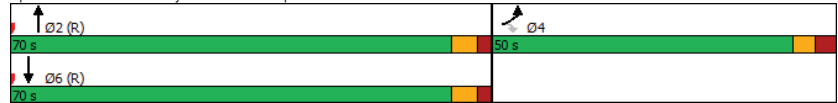

Lanes, Volumes, Timings
5: Cyrville & Ogilvie

2031 Future Background
PM Peak Hour

Lane Group	EBL	EBT	EBR	WBL	WBT	WBR	NBL	NBT	NBR	SBL	SBT	SBR
Lane Configurations		↑↑	↑	↑	↑↑	↑	↑	↑	↑	↑	↑	↑
Traffic Volume (vph)	0	1156	293	42	707	124	151	266	32	134	227	80
Future Volume (vph)	0	1156	293	42	707	124	151	266	32	134	227	80
Satd. Flow (prot)	0	3316	1469	1658	3316	1469	1580	1714	0	1642	1640	0
Fit Permitted			0.195				0.353			0.369		
Satd. Flow (perm)	0	3316	1362	338	3316	1327	585	1714	0	635	1640	0
Satd. Flow (RTOR)			293			124		6			16	
Lane Group Flow (vph)	0	1156	293	42	707	124	151	298	0	134	307	0
Turn Type		NA	Perm	Perm	NA	Perm	Perm	NA		Perm	NA	
Protected Phases		2			6		4		4		8	
Permitted Phases			2	6		6	4			8		
Detector Phase		2	2	6	6	6	4	4		8	8	
Switch Phase												
Minimum Initial (s)		10.0	10.0	10.0	10.0	10.0	10.0	10.0		10.0	10.0	
Minimum Split (s)		32.2	32.2	32.2	32.2	32.2	47.1	47.1		47.1	47.1	
Total Split (s)		70.0	70.0	70.0	70.0	70.0	50.0	50.0		50.0	50.0	
Total Split (%)		58.3%	58.3%	58.3%	58.3%	58.3%	41.7%	41.7%		41.7%	41.7%	
Yellow Time (s)		3.7	3.7	3.7	3.7	3.7	3.7	3.7		3.7	3.7	
All-Red Time (s)		2.5	2.5	2.5	2.5	2.5	3.4	3.4		3.4	3.4	
Lost Time Adjust (s)		0.0	0.0	0.0	0.0	0.0	0.0	0.0		0.0	0.0	
Total Lost Time (s)		6.2	6.2	6.2	6.2	6.2	7.1	7.1		7.1	7.1	
Lead/Lag												
Lead-Lag Optimize?												
Recall Mode		C-Max	C-Max	C-Max	C-Max	C-Max	None	None		None	None	
Act Effct Green (s)		76.9	76.9	76.9	76.9	76.9	29.8	29.8		29.8	29.8	
Actuated g/C Ratio		0.64	0.64	0.64	0.64	0.64	0.25	0.25		0.25	0.25	
v/c Ratio		0.54	0.30	0.19	0.33	0.14	1.04	0.69		0.85	0.73	
Control Delay		6.3	0.7	15.0	11.7	2.6	128.9	47.4		82.3	48.5	
Queue Delay		0.3	0.0	0.0	0.0	0.0	0.0	0.0		0.0	0.0	
Total Delay		6.6	0.7	15.0	11.7	2.6	128.9	47.4		82.3	48.5	
LOS		A	A	B	B	A	F	D		F	D	
Approach Delay		5.4			10.5		74.8			58.8		
Approach LOS		A			B		E			E		
Queue Length 50th (m)		33.3	0.0	3.8	36.9	0.0	~38.5	62.8		30.2	63.5	
Queue Length 95th (m)		m66.1	m1.5	12.8	63.2	8.7	#65.1	80.0		48.9	81.7	
Internal Link Dist (m)		123.7			139.9		44.2				76.2	
Turn Bay Length (m)				53.5		51.0	42.5			77.0		
Base Capacity (vph)		2123	977	216	2123	894	209	616		227	596	
Starvation Cap Reductn		345	0	0	0	0	0	0		0	0	
Spillback Cap Reductn		0	0	0	0	0	0	0		0	0	
Storage Cap Reductn		0	0	0	0	0	0	0		0	0	
Reduced v/c Ratio		0.65	0.30	0.19	0.33	0.14	0.72	0.48		0.59	0.52	

Intersection Summary												
Cycle Length: 120												
Actuated Cycle Length: 120												
Offset: 20 (17%), Referenced to phase 2:EBT and 6:WBTL, Start of Green												
Natural Cycle: 80												
Control Type: Actuated-Coordinated												

Lanes, Volumes, Timings
5: Cyrville & Ogilvie

2031 Future Background
PM Peak Hour

Maximum v/c Ratio: 1.04	Intersection LOS: C
Intersection Signal Delay: 23.8	ICU Level of Service E
Intersection Capacity Utilization 84.2%	
Analysis Period (min) 15	
~ Volume exceeds capacity, queue is theoretically infinite. Queue shown is maximum after two cycles.	
# 95th percentile volume exceeds capacity, queue may be longer. Queue shown is maximum after two cycles.	
m Volume for 95th percentile queue is metered by upstream signal.	

Splits and Phases: 5: Cyrville & Ogilvie

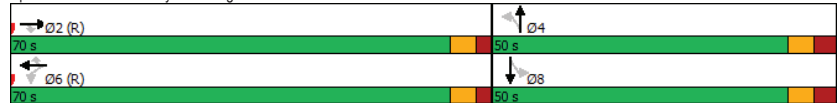

HCM 2010 TWSC
6: Labelle & Lemieux

2031 Future Background
PM Peak Hour

Intersection												
Int Delay, s/veh	5.3											
Movement	EBL	EBT	EBR	WBL	WBT	WBR	NBL	NBT	NBR	SBL	SBT	SBR
Lane Configurations	↔ ↕ ↕ ↕ ↕ ↕ ↕ ↕ ↕ ↕ ↕ ↕ ↕											
Traffic Vol, veh/h	131	0	0	0	0	162	112	318	27	0	0	176
Future Vol, veh/h	131	0	0	0	0	162	112	318	27	0	0	176
Conflicting Peds, #/hr	0	0	0	0	0	0	0	0	0	0	0	0
Sign Control	Stop	Stop	Stop	Stop	Stop	Stop	Free	Free	Free	Free	Free	Free
RT Channelized	-	-	None	-	-	None	-	-	Free	-	-	Yield
Storage Length	0	-	-	-	-	0	-	-	-	-	-	0
Veh in Median Storage, #	-	0	-	-	0	-	-	0	-	-	-	-
Grade, %	-	0	-	-	0	-	-	0	-	-	-	0
Peak Hour Factor	100	100	100	100	100	100	100	100	100	100	100	100
Heavy Vehicles, %	2	2	2	2	2	2	2	2	2	2	2	2
Mvmt Flow	131	0	0	0	0	162	112	318	27	0	0	176

Major/Minor	Minor2	Minor1	Major1
Conflicting Flow All	383	-	-
Stage 1	0	-	-
Stage 2	383	-	-
Critical Hdwy	7.54	-	-
Critical Hdwy Stg 1	-	-	-
Critical Hdwy Stg 2	6.54	-	-
Follow-up Hdwy	3.52	-	-
Pot Cap-1 Maneuver	550	0	0
Stage 1	-	0	0
Stage 2	611	0	0
Platoon blocked, %	-	-	-
Mov Cap-1 Maneuver	446	-	-
Mov Cap-2 Maneuver	446	-	-
Stage 1	-	-	-
Stage 2	496	-	-

Approach	EB	WB	NB
HCM Control Delay, s	16.4	10.2	
HCM LOS	C	B	

Minor Lane/Major Mvmt	NBL	NBT	EBLn1	WBLn1
Capacity (veh/h)	-	-	446	858
HCM Lane V/C Ratio	-	-	0.294	0.189
HCM Control Delay (s)	-	-	16.4	10.2
HCM Lane LOS	-	-	C	B
HCM 95th %tile Q(veh)	-	-	1.2	0.7

Intersection						
Int Delay, s/veh	2.7					
Movement	EBL	EBT	WBT	WBR	SBL	SBR
Lane Configurations	↖	↑	↗		↖	
Traffic Vol, veh/h	112	159	562	38	17	101
Future Vol, veh/h	112	159	562	38	17	101
Conflicting Peds, #/hr	0	0	0	0	0	0
Sign Control	Free	Free	Free	Free	Stop	Stop
RT Channelized	-	None	-	None	-	None
Storage Length	22	-	-	-	0	-
Veh in Median Storage, #	-	0	0	-	0	-
Grade, %	-	0	0	-	0	-
Peak Hour Factor	100	100	100	100	100	100
Heavy Vehicles, %	2	2	4	3	2	3
Mvmt Flow	112	159	562	38	17	101

Major/Minor	Major1	Major2	Minor2
Conflicting Flow All	600	0	964
Stage 1	-	-	581
Stage 2	-	-	383
Critical Hdwy	4.13	-	6.63
Critical Hdwy Stg 1	-	-	5.83
Critical Hdwy Stg 2	-	-	5.43
Follow-up Hdwy	2.219	-	3.519
Pot Cap-1 Maneuver	975	-	268
Stage 1	-	-	523
Stage 2	-	-	688
Platoon blocked, %	-	-	-
Mov Cap-1 Maneuver	975	-	237
Mov Cap-2 Maneuver	-	-	237
Stage 1	-	-	463
Stage 2	-	-	688

Approach	EB	WB	SB
HCM Control Delay, s	3.8	0	13.5
HCM LOS			B

Minor Lane/Major Mvmt	EBL	EBT	WBT	WBR	SBLn1
Capacity (veh/h)	975	-	-	-	543
HCM Lane V/C Ratio	0.115	-	-	-	0.217
HCM Control Delay (s)	9.2	-	-	-	13.5
HCM Lane LOS	A	-	-	-	B
HCM 95th %tile Q(veh)	0.4	-	-	-	0.8

Intersection												
Int Delay, s/veh	2.9											
Movement	EBL	EBT	EBR	WBL	WBT	WBR	NBL	NBT	NBR	SBL	SBT	SBR
Lane Configurations		↕			↕			↕			↕	
Traffic Vol, veh/h	0	492	52	53	409	1	39	5	82	1	1	1
Future Vol, veh/h	0	492	52	53	409	1	39	5	82	1	1	1
Conflicting Peds, #/hr	11	0	3	3	0	11	1	0	3	3	0	1
Sign Control	Free	Free	Free	Free	Free	Free	Stop	Stop	Stop	Stop	Stop	Stop
RT Channelized	-	None	-	-	None	-	-	None	-	-	-	None
Storage Length	-	-	-	-	-	-	-	-	-	-	-	-
Veh in Median Storage, #	-	0	-	-	0	-	-	0	-	-	0	-
Grade, %	-	0	-	-	0	-	-	0	-	-	0	-
Peak Hour Factor	100	100	100	100	100	100	100	100	100	100	100	100
Heavy Vehicles, %	2	3	2	4	2	2	2	2	2	2	2	2
Mvmt Flow	0	492	52	53	409	1	39	5	82	1	1	1

Major/Minor	Major1	Major2	Minor1	Minor2
Conflicting Flow All	421	0	547	1039
Stage 1	-	-	-	521
Stage 2	-	-	-	518
Critical Hdwy	4.12	-	4.14	7.12
Critical Hdwy Stg 1	-	-	-	6.12
Critical Hdwy Stg 2	-	-	-	6.12
Follow-up Hdwy	2.218	-	2.236	3.518
Pot Cap-1 Maneuver	1138	-	1012	209
Stage 1	-	-	-	539
Stage 2	-	-	-	541
Platoon blocked, %	-	-	-	-
Mov Cap-1 Maneuver	1128	-	1010	196
Mov Cap-2 Maneuver	-	-	-	196
Stage 1	-	-	-	538
Stage 2	-	-	-	502

Approach	EB	WB	NB	SB
HCM Control Delay, s	0	1	21.8	21
HCM LOS			C	C

Minor Lane/Major Mvmt	NBLn1	EBL	EBT	EBR	WBL	WBT	WBR	SBLn1
Capacity (veh/h)	339	1128	-	-	1010	-	-	228
HCM Lane V/C Ratio	0.372	-	-	-	0.052	-	-	0.013
HCM Control Delay (s)	21.8	0	-	-	8.8	0	-	21
HCM Lane LOS	C	A	-	-	A	A	-	C
HCM 95th %tile Q(veh)	1.7	0	-	-	0.2	-	-	0

Appendix I

Synchro Intersection Worksheets – 2026 Future Total Conditions

Lanes, Volumes, Timings
1: St Laurent & Coventry/Ogilvie

2026 Future Total
AM Peak Hour

Lane Group	EBL	EBT	EBR	WBL	WBT	WBR	NBL	NBT	NBR	SBL	SBT	SBR
Lane Configurations	↔	↕	↔	↔	↕	↔	↔	↕	↔	↔	↕	↔
Traffic Volume (vph)	66	205	60	711	647	26	145	837	574	34	827	132
Future Volume (vph)	66	205	60	711	647	26	145	837	574	34	827	132
Satd. Flow (prot)	3010	3283	1388	3216	3103	1339	1523	3161	1441	1642	4764	1427
Fit Permitted	0.950			0.950			0.950			0.950		
Satd. Flow (perm)	2902	3283	1331	3155	3103	1253	1510	3161	1384	1627	4764	1367
Satd. Flow (RTOR)			195			140			510			196
Lane Group Flow (vph)	66	205	60	711	647	26	145	837	574	34	827	132
Turn Type	Prot	NA	Perm	Prot	NA	Perm	Prot	NA	Perm	Prot	NA	Perm
Protected Phases	7	4		3	8		5	2		1	6	
Permitted Phases			4			8			2			6
Detector Phase	7	4	4	3	8	8	5	2	2	1	6	6
Switch Phase												
Minimum Initial (s)	5.0	10.0	10.0	5.0	10.0	10.0	5.0	10.0	10.0	5.0	10.0	10.0
Minimum Split (s)	11.9	37.5	37.5	11.9	37.5	37.5	11.4	35.4	35.4	11.4	35.4	35.4
Total Split (s)	15.0	37.5	37.5	35.5	58.0	58.0	21.6	35.4	35.4	21.6	35.4	35.4
Total Split (%)	11.5%	28.8%	28.8%	27.3%	44.6%	44.6%	16.6%	27.2%	27.2%	16.6%	27.2%	27.2%
Maximum Green (s)	8.1	31.0	31.0	28.6	51.5	51.5	15.2	29.0	29.0	15.2	29.0	29.0
Yellow Time (s)	3.7	3.7	3.7	3.7	3.7	3.7	3.7	3.7	3.7	3.7	3.7	3.7
All-Red Time (s)	3.2	2.8	2.8	3.2	2.8	2.8	2.7	2.7	2.7	2.7	2.7	2.7
Lost Time Adjust (s)	0.0	0.0	0.0	0.0	0.0	0.0	0.0	0.0	0.0	0.0	0.0	0.0
Total Lost Time (s)	6.9	6.5	6.5	6.9	6.5	6.5	6.4	6.4	6.4	6.4	6.4	6.4
Lead/Lag	Lag	Lead	Lead	Lag	Lead	Lead	Lag	Lag	Lag	Lead	Lag	Lag
Lead-Lag Optimize?	Yes	Yes	Yes	Yes	Yes	Yes	Yes	Yes	Yes	Yes	Yes	Yes
Vehicle Extension (s)	3.0	3.0	3.0	3.0	3.0	3.0	3.0	3.0	3.0	3.0	3.0	3.0
Recall Mode	None	None	None	None	None	None	C-Max	C-Max	None	C-Max	C-Max	C-Max
Walk Time (s)		7.0	7.0		7.0	7.0		7.0	7.0		7.0	7.0
Flash Dont Walk (s)		24.0	24.0		24.0	24.0		22.0	22.0		22.0	22.0
Pedestrian Calls (#/hr)		20	20		42	42		21	21		20	20
Act Effct Green (s)	18.1	23.0	23.0	31.1	38.5	38.5	14.8	46.6	46.6	8.2	34.9	34.9
Actuated g/C Ratio	0.14	0.18	0.18	0.24	0.30	0.30	0.11	0.36	0.36	0.06	0.27	0.27
v/c Ratio	0.16	0.35	0.15	0.93	0.70	0.06	0.84	0.74	0.70	0.33	0.65	0.26
Control Delay	48.2	46.8	0.8	66.7	39.2	0.2	101.6	37.7	14.9	66.1	46.2	2.1
Queue Delay	0.0	0.0	0.0	0.0	0.0	0.0	0.0	0.0	0.5	0.0	0.0	0.0
Total Delay	48.2	46.8	0.8	66.7	39.2	0.2	101.6	37.7	15.4	66.1	46.2	2.1
LOS	D	D	A	E	D	A	F	D	B	E	D	A
Approach Delay		38.8			52.6			35.4			41.0	
Approach LOS		D			D			D			D	
Queue Length 50th (m)	7.1	22.5	0.0	-99.5	85.4	0.0	39.3	115.1	32.7	8.5	73.5	0.0
Queue Length 95th (m)	14.5	33.6	0.0	#139.0	99.2	m0.0	#73.9	#157.7	60.9	19.0	89.2	2.4
Internal Link Dist (m)		213.9			123.7			114.3			252.7	
Turn Bay Length (m)	100.0		64.0	75.0			47.5			40.0		45.0
Base Capacity (vph)	430	782	465	768	1229	580	180	1133	823	191	1280	510
Starvation Cap Reductn	0	0	0	0	0	0	0	0	50	0	0	0
Spillback Cap Reductn	0	0	0	0	0	0	0	0	0	0	0	0
Storage Cap Reductn	0	0	0	0	0	0	0	0	0	0	0	0
Reduced v/c Ratio	0.15	0.26	0.13	0.93	0.53	0.04	0.81	0.74	0.74	0.18	0.65	0.26

Intersection Summary

Lanes, Volumes, Timings
1: St Laurent & Coventry/Ogilvie

2026 Future Total
AM Peak Hour

Cycle Length: 130
Actuated Cycle Length: 130
Offset: 0 (0%), Referenced to phase 2:NBT and 6:SBT, Start of Green
Natural Cycle: 120
Control Type: Actuated-Coordinated
Maximum v/c Ratio: 0.93
Intersection Signal Delay: 42.6 Intersection LOS: D
Intersection Capacity Utilization 92.7% ICU Level of Service F
Analysis Period (min) 15
~ Volume exceeds capacity, queue is theoretically infinite.
Queue shown is maximum after two cycles.
95th percentile volume exceeds capacity, queue may be longer.
Queue shown is maximum after two cycles.
m Volume for 95th percentile queue is metered by upstream signal.

Splits and Phases: 1: St Laurent & Coventry/Ogilvie

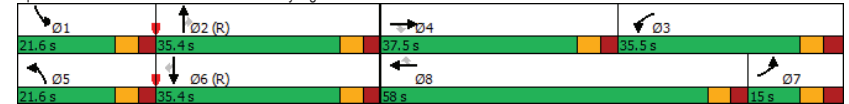

Lanes, Volumes, Timings
2: Lemieux & St Laurent

2026 Future Total
AM Peak Hour

Lane Group	WBL	WBR	NBT	NBR	SBL	SBT
Lane Configurations	↔↔	↔	↑↑↑	↔	↔	↑↑↑
Traffic Volume (vph)	625	160	1284	240	9	1514
Future Volume (vph)	625	160	1284	240	9	1514
Satd. Flow (prot)	2734	1483	4584	1483	1658	4672
Fit Permitted	0.950				0.176	
Satd. Flow (perm)	2734	1418	4584	1444	307	4672
Satd. Flow (RTOR)		53		240		
Lane Group Flow (vph)	625	160	1284	240	9	1514
Turn Type	Prot	Perm	NA	Perm	Perm	NA
Protected Phases	8		2			6
Permitted Phases		8		2	6	
Detector Phase	8	8	2	2	6	6
Switch Phase						
Minimum Initial (s)	5.0	5.0	10.0	10.0	10.0	10.0
Minimum Split (s)	36.1	36.1	43.5	43.5	16.0	16.0
Total Split (s)	50.0	50.0	80.0	80.0	80.0	80.0
Total Split (%)	38.5%	38.5%	61.5%	61.5%	61.5%	61.5%
Maximum Green (s)	43.9	43.9	74.5	74.5	74.5	74.5
Yellow Time (s)	3.3	3.3	3.7	3.7	3.7	3.7
All-Red Time (s)	2.8	2.8	1.8	1.8	1.8	1.8
Lost Time Adjust (s)	0.0	0.0	0.0	0.0	0.0	0.0
Total Lost Time (s)	6.1	6.1	5.5	5.5	5.5	5.5
Lead/Lag						
Lead-Lag Optimize?						
Vehicle Extension (s)	3.0	3.0	3.0	3.0	3.0	3.0
Recall Mode	None	None	C-Max	C-Max	C-Max	C-Max
Walk Time (s)	7.0	7.0	21.0	21.0		
Flash Dont Walk (s)	23.0	23.0	9.0	9.0		
Pedestrian Calls (#/hr)	25	25	3	3		
Act Effct Green (s)	35.4	35.4	83.0	83.0	83.0	83.0
Actuated g/C Ratio	0.27	0.27	0.64	0.64	0.64	0.64
v/c Ratio	0.84	0.38	0.44	0.24	0.05	0.51
Control Delay	55.1	26.6	8.3	1.9	11.3	15.1
Queue Delay	0.0	0.0	0.2	0.0	0.0	0.0
Total Delay	55.1	26.6	8.5	1.9	11.3	15.1
LOS	E	C	A	A	B	B
Approach Delay	49.3		7.4			15.0
Approach LOS	D		A			B
Queue Length 50th (m)	78.1	21.8	32.4	0.4	0.9	70.4
Queue Length 95th (m)	92.0	38.1	64.7	9.6	m1.4	m77.3
Internal Link Dist (m)	80.2		117.1			60.0
Turn Bay Length (m)		51.5		53.5	115.0	
Base Capacity (vph)	923	513	2926	1008	196	2982
Starvation Cap Reductn	0	0	652	0	0	0
Spillback Cap Reductn	0	0	0	0	0	0
Storage Cap Reductn	0	0	0	0	0	0
Reduced v/c Ratio	0.68	0.31	0.56	0.24	0.05	0.51

Intersection Summary

Lanes, Volumes, Timings
2: Lemieux & St Laurent

2026 Future Total
AM Peak Hour

Cycle Length: 130	
Actuated Cycle Length: 130	
Offset: 124 (95%), Referenced to phase 2:NBT and 6:SBTL, Start of Green	
Natural Cycle: 80	
Control Type: Actuated-Coordinated	
Maximum v/c Ratio: 0.84	
Intersection Signal Delay: 19.0	Intersection LOS: B
Intersection Capacity Utilization 62.9%	ICU Level of Service B
Analysis Period (min) 15	
m Volume for 95th percentile queue is metered by upstream signal.	

Splits and Phases: 2: Lemieux & St Laurent

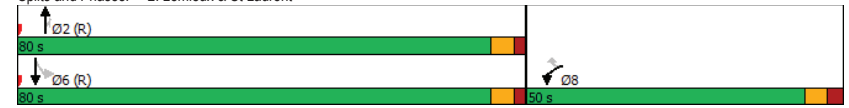

Lanes, Volumes, Timings
3: St Laurent & Transitway

2026 Future Total
AM Peak Hour

Lane Group	WBL	WBR	NBT	NBR	SBL	SBT
Lane Configurations	↔	↔	↑↑↑	↔	↔	↑↑↑
Traffic Volume (vph)	48	24	1537	60	2	911
Future Volume (vph)	48	24	1537	60	2	911
Satd. Flow (prot)	834	0	4452	0	1127	4628
Fit Permitted	0.968				0.136	
Satd. Flow (perm)	834	0	4452	0	161	4628
Satd. Flow (RTOR)	10		11			
Lane Group Flow (vph)	72	0	1597	0	2	911
Turn Type	Prot		NA		Perm	NA
Protected Phases	8		2			6
Permitted Phases					6	
Detector Phase	8		2		6	6
Switch Phase						
Minimum Initial (s)	5.0		10.0		10.0	10.0
Minimum Split (s)	29.5		30.0		22.5	22.5
Total Split (s)	30.0		35.0		35.0	35.0
Total Split (%)	46.2%		53.8%		53.8%	53.8%
Maximum Green (s)	24.5		29.0		29.0	29.0
Yellow Time (s)	3.3		3.7		3.7	3.7
All-Red Time (s)	2.2		2.3		2.3	2.3
Lost Time Adjust (s)	0.0		0.0		0.0	0.0
Total Lost Time (s)	5.5		6.0		6.0	6.0
Lead/Lag						
Lead-Lag Optimize?						
Vehicle Extension (s)	3.0		3.0		3.0	3.0
Recall Mode	None		C-Max		C-Max	C-Max
Walk Time (s)	7.0		7.0			
Flash Dont Walk (s)	17.0		17.0			
Pedestrian Calls (#/hr)	0		0			
Act Effct Green (s)	10.6		50.2		50.2	50.2
Actuated g/C Ratio	0.16		0.77		0.77	0.77
v/c Ratio	0.50		0.46		0.02	0.26
Control Delay	32.8		3.7		7.0	5.4
Queue Delay	0.0		0.0		0.0	0.0
Total Delay	32.8		3.7		7.0	5.4
LOS	C		A		A	A
Approach Delay	32.8		3.7			5.4
Approach LOS	C		A			A
Queue Length 50th (m)	6.9		16.2		0.1	20.0
Queue Length 95th (m)	16.2		30.6		m0.3	58.2
Internal Link Dist (m)	43.2		196.1			117.1
Turn Bay Length (m)					13.0	
Base Capacity (vph)	320		3439		124	3572
Starvation Cap Reductn	0		0		0	0
Spillback Cap Reductn	0		0		0	0
Storage Cap Reductn	0		0		0	0
Reduced v/c Ratio	0.23		0.46		0.02	0.26
Intersection Summary						

Lanes, Volumes, Timings
3: St Laurent & Transitway

2026 Future Total
AM Peak Hour

Cycle Length: 65	
Actuated Cycle Length: 65	
Offset: 38 (58%), Referenced to phase 2:NBT and 6:SBTL, Start of Green	
Natural Cycle: 60	
Control Type: Actuated-Coordinated	
Maximum v/c Ratio: 0.50	
Intersection Signal Delay: 5.1	Intersection LOS: A
Intersection Capacity Utilization 46.7%	ICU Level of Service A
Analysis Period (min) 15	
m Volume for 95th percentile queue is metered by upstream signal.	

Splits and Phases: 3: St Laurent & Transitway

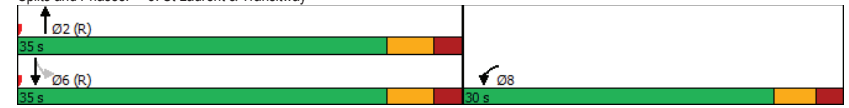

Lanes, Volumes, Timings
4: Hwy 417 EB Off-Ramp & St Laurent

2026 Future Total
AM Peak Hour

Lane Group	EBL	EBR	NBL	NBT	SBT	SBR
Lane Configurations	↔↔	↔		↑↑↑	↑↑↑	
Traffic Volume (vph)	687	673	0	1215	823	174
Future Volume (vph)	687	673	0	1215	823	174
Satd. Flow (prot)	3066	1427	0	4418	4345	0
Fit Permitted	0.950					
Satd. Flow (perm)	3066	1409	0	4418	4345	0
Satd. Flow (RTOR)		139			54	
Lane Group Flow (vph)	687	673	0	1215	997	0
Turn Type	Prot	Perm		NA	NA	
Protected Phases	4			2	6	
Permitted Phases		4				
Detector Phase	4	4		2	6	
Switch Phase						
Minimum Initial (s)	5.0	5.0		10.0	10.0	
Minimum Split (s)	34.5	34.5		24.1	42.1	
Total Split (s)	55.0	55.0		75.0	75.0	
Total Split (%)	42.3%	42.3%		57.7%	57.7%	
Maximum Green (s)	48.5	48.5		68.9	68.9	
Yellow Time (s)	3.3	3.3		3.7	3.7	
All-Red Time (s)	3.2	3.2		2.4	2.4	
Lost Time Adjust (s)	0.0	0.0		0.0	0.0	
Total Lost Time (s)	6.5	6.5		6.1	6.1	
Lead/Lag						
Lead-Lag Optimize?						
Vehicle Extension (s)	3.0	3.0		3.0	3.0	
Recall Mode	None	None		C-Max	C-Max	
Walk Time (s)	7.0	7.0			25.0	
Flash Dont Walk (s)	21.0	21.0			9.0	
Pedestrian Calls (#/hr)	0	0			2	
Act Effct Green (s)	48.5	48.5		68.9	68.9	
Actuated g/C Ratio	0.37	0.37		0.53	0.53	
v/c Ratio	0.60	1.10		0.52	0.43	
Control Delay	35.6	97.7		20.8	18.2	
Queue Delay	0.0	0.0		0.0	0.0	
Total Delay	35.6	97.7		20.8	18.2	
LOS	D	F		C	B	
Approach Delay	66.4			20.8	18.2	
Approach LOS	E			C	B	
Queue Length 50th (m)	72.7	-171.7		71.3	39.3	
Queue Length 95th (m)	92.4	#244.7		84.1	33.7	
Internal Link Dist (m)	73.5			158.0	196.1	
Turn Bay Length (m)						
Base Capacity (vph)	1143	612		2341	2328	
Starvation Cap Reductn	0	0		0	0	
Spillback Cap Reductn	0	0		0	0	
Storage Cap Reductn	0	0		0	0	
Reduced v/c Ratio	0.60	1.10		0.52	0.43	
Intersection Summary						

Lanes, Volumes, Timings
4: Hwy 417 EB Off-Ramp & St Laurent

2026 Future Total
AM Peak Hour

Cycle Length: 130
Actuated Cycle Length: 130
Offset: 25 (19%), Referenced to phase 2:NBT and 6:SBT, Start of Green
Natural Cycle: 90
Control Type: Actuated-Coordinated
Maximum v/c Ratio: 1.10
Intersection Signal Delay: 37.4 Intersection LOS: D
Intersection Capacity Utilization 82.8% ICU Level of Service E
Analysis Period (min) 15
~ Volume exceeds capacity, queue is theoretically infinite.
Queue shown is maximum after two cycles.
95th percentile volume exceeds capacity, queue may be longer.
Queue shown is maximum after two cycles.

Splits and Phases: 4: Hwy 417 EB Off-Ramp & St Laurent

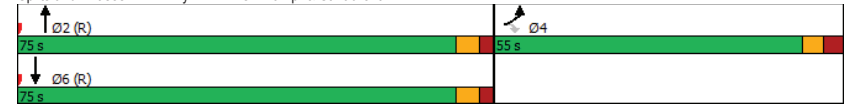

Lanes, Volumes, Timings
5: Cyrville & Ogilvie

2026 Future Total
AM Peak Hour

Lane Group	EBL	EBT	EBR	WBL	WBT	WBR	NBL	NBT	NBR	SBL	SBT	SBR
Lane Configurations		↑↑	↑	↑	↑↑	↑	↑	↑	↑	↑	↑	↑
Traffic Volume (vph)	0	583	238	28	1101	166	178	244	14	47	176	45
Future Volume (vph)	0	583	238	28	1101	166	178	244	14	47	176	45
Satd. Flow (prot)	0	3283	1414	1658	3316	1441	1551	1714	0	1626	1605	0
Fit Permitted			0.417			0.486		0.418				
Satd. Flow (perm)	0	3283	1326	718	3316	1312	789	1714	0	714	1605	0
Satd. Flow (RTOR)			238			142		2			11	
Lane Group Flow (vph)	0	583	238	28	1101	166	178	258	0	47	221	0
Turn Type	NA	Perm	Perm	NA	Perm	Perm	NA	Perm	NA	Perm	NA	
Protected Phases		2		6		6	4		8		8	
Permitted Phases			2	6		6	4		8		8	
Detector Phase		2	2	6	6	6	4	4		8	8	
Switch Phase												
Minimum Initial (s)		10.0	10.0	10.0	10.0	10.0	10.0	10.0		10.0	10.0	
Minimum Split (s)		32.2	32.2	32.2	32.2	32.2	47.1	47.1		47.1	47.1	
Total Split (s)		80.0	80.0	80.0	80.0	80.0	50.0	50.0		50.0	50.0	
Total Split (%)		61.5%	61.5%	61.5%	61.5%	61.5%	38.5%	38.5%		38.5%	38.5%	
Maximum Green (s)		73.8	73.8	73.8	73.8	73.8	42.9	42.9		42.9	42.9	
Yellow Time (s)		3.7	3.7	3.7	3.7	3.7	3.7	3.7		3.7	3.7	
All-Red Time (s)		2.5	2.5	2.5	2.5	2.5	3.4	3.4		3.4	3.4	
Lost Time Adjust (s)		0.0	0.0	0.0	0.0	0.0	0.0	0.0		0.0	0.0	
Total Lost Time (s)		6.2	6.2	6.2	6.2	6.2	7.1	7.1		7.1	7.1	
Lead/Lag												
Lead-Lag Optimize?												
Vehicle Extension (s)		3.0	3.0	3.0	3.0	3.0	3.0	3.0		3.0	3.0	
Recall Mode		C-Max	C-Max	C-Max	C-Max	C-Max	None	None		None	None	
Walk Time (s)		9.0	9.0	9.0	9.0	9.0	7.0	7.0		7.0	7.0	
Flash Dont Walk (s)		17.0	17.0	17.0	17.0	17.0	33.0	33.0		33.0	33.0	
Pedestrian Calls (#/hr)		13	13	28	28	28	4	4		8	8	
Act Effct Green (s)		85.5	85.5	85.5	85.5	85.5	31.2	31.2		31.2	31.2	
Actuated g/C Ratio		0.66	0.66	0.66	0.66	0.66	0.24	0.24		0.24	0.24	
v/c Ratio		0.27	0.25	0.06	0.51	0.18	0.94	0.63		0.27	0.56	
Control Delay		7.1	0.9	11.1	13.7	3.2	99.0	49.3		40.8	45.2	
Queue Delay		0.0	0.0	0.0	0.0	0.0	0.0	0.0		0.0	0.0	
Total Delay		7.1	0.9	11.1	13.7	3.2	99.0	49.3		40.8	45.2	
LOS		A	A	B	B	A	F	D		D	D	
Approach Delay		5.3			12.3			69.6			44.4	
Approach LOS		A			B			E			D	
Queue Length 50th (m)		21.9	0.0	2.4	71.5	2.0	44.8	58.7		9.8	47.3	
Queue Length 95th (m)		33.2	0.0	7.8	111.7	12.5	#69.4	76.8		18.8	64.7	
Internal Link Dist (m)		123.7			139.9			46.0			76.2	
Turn Bay Length (m)				53.5		51.0	42.5			77.0		
Base Capacity (vph)		2159	953	472	2180	911	260	566		235	537	
Starvation Cap Reductn		0	0	0	0	0	0	0		0	0	
Spillback Cap Reductn		0	0	0	0	0	0	0		0	0	
Storage Cap Reductn		0	0	0	0	0	0	0		0	0	
Reduced v/c Ratio		0.27	0.25	0.06	0.51	0.18	0.68	0.46		0.20	0.41	

Intersection Summary

Lanes, Volumes, Timings
5: Cyrville & Ogilvie

2026 Future Total
AM Peak Hour

Cycle Length: 130
Actuated Cycle Length: 130
Offset: 10 (8%), Referenced to phase 2:EBT and 6:WBT, Start of Green
Natural Cycle: 80
Control Type: Actuated-Coordinated
Maximum v/c Ratio: 0.94
Intersection Signal Delay: 22.2 Intersection LOS: C
Intersection Capacity Utilization 77.2% ICU Level of Service D
Analysis Period (min) 15
95th percentile volume exceeds capacity, queue may be longer.
Queue shown is maximum after two cycles.

Splits and Phases: 5: Cyrville & Ogilvie



HCM 2010 TWSC
6: Labelle & Lemieux

2026 Future Total
AM Peak Hour

Intersection												
Int Delay, s/veh	2.3											
Movement	EBL	EBT	EBR	WBL	WBT	WBR	NBL	NBT	NBR	SBL	SBT	SBR
Lane Configurations	↔ ↗ ↘ ↖ ↗ ↘ ↖ ↗ ↘ ↖ ↗ ↘ ↖											
Traffic Vol, veh/h	30	0	0	0	0	135	133	557	44	0	0	177
Future Vol, veh/h	30	0	0	0	0	135	133	557	44	0	0	177
Conflicting Peds, #/hr	0	0	0	0	0	0	0	0	0	0	0	0
Sign Control	Stop	Stop	Stop	Stop	Stop	Free	Free	Free	Free	Free	Free	Free
RT Channelized	-	-	None	-	-	None	-	-	Free	-	-	Yield
Storage Length	0	-	-	-	-	0	-	-	-	-	-	0
Veh in Median Storage, #	-	0	-	-	0	-	-	0	-	-	-	-
Grade, %	-	0	-	-	0	-	-	0	-	-	-	0
Peak Hour Factor	100	100	100	100	100	100	100	100	100	100	100	100
Heavy Vehicles, %	2	2	2	2	2	2	2	2	2	2	2	2
Mvmt Flow	30	0	0	0	0	135	133	557	44	0	0	177
Major/Minor	Minor2	Minor1	Major1									
Conflicting Flow All	545	-	-	-	279	0	0	-				
Stage 1	0	-	-	-	-	-	-	-				
Stage 2	545	-	-	-	-	-	-	-				
Critical Hdwy	7.54	-	-	-	6.94	4.14	-	-				
Critical Hdwy Stg 1	-	-	-	-	-	-	-	-				
Critical Hdwy Stg 2	6.54	-	-	-	-	-	-	-				
Follow-up Hdwy	3.52	-	-	-	3.32	2.22	-	-				
Pot Cap-1 Maneuver	421	0	0	0	718	-	-	0				
Stage 1	-	0	0	0	0	-	-	0				
Stage 2	490	0	0	0	0	-	-	0				
Platoon blocked, %	-	-	-	-	-	-	-	-				
Mov Cap-1 Maneuver	342	-	-	-	718	-	-	-				
Mov Cap-2 Maneuver	342	-	-	-	-	-	-	-				
Stage 1	-	-	-	-	-	-	-	-				
Stage 2	398	-	-	-	-	-	-	-				
Approach	EB	WB	NB									
HCM Control Delay, s	16.5	11.2										
HCM LOS	C	B										
Minor Lane/Major Mvmt	NBL	NBT	EBLn1	WBLn1								
Capacity (veh/h)	-	-	342	718								
HCM Lane V/C Ratio	-	-	0.088	0.188								
HCM Control Delay (s)	-	-	16.5	11.2								
HCM Lane LOS	-	-	C	B								
HCM 95th %tile Q(veh)	-	-	0.3	0.7								

HCM 2010 TWSC
7: Access/Joseph Cyr & Lemieux

2026 Future Total
AM Peak Hour

Intersection												
Int Delay, s/veh	2.2											
Movement	EBL	EBT	EBR	WBL	WBT	WBR	NBL	NBT	NBR	SBL	SBT	SBR
Lane Configurations	↔ ↗ ↘ ↖ ↗ ↘ ↖ ↗ ↘ ↖ ↗ ↘ ↖											
Traffic Vol, veh/h	74	168	7	1	688	21	18	6	0	9	3	69
Future Vol, veh/h	74	168	7	1	688	21	18	6	0	9	3	69
Conflicting Peds, #/hr	4	0	0	0	0	4	0	0	0	0	0	0
Sign Control	Free	Free	Free	Free	Free	Free	Stop	Stop	Stop	Stop	Stop	Stop
RT Channelized	-	-	None	-	-	None	-	-	None	-	-	None
Storage Length	22	-	-	-	-	-	-	-	-	-	-	-
Veh in Median Storage, #	-	0	-	-	0	-	-	0	-	-	-	0
Grade, %	-	0	-	-	0	-	-	0	-	-	-	0
Peak Hour Factor	100	100	100	100	100	100	100	100	100	100	100	100
Heavy Vehicles, %	6	2	2	2	10	2	2	2	2	2	2	5
Mvmt Flow	74	168	7	1	688	21	18	6	0	9	3	69
Major/Minor	Major1	Major2	Minor1	Minor2								
Conflicting Flow All	713	0	0	175	0	668	1035	172	1028	1028	359	-
Stage 1	-	-	-	-	-	320	320	-	705	705	-	-
Stage 2	-	-	-	-	-	348	715	-	323	323	-	-
Critical Hdwy	4.19	-	-	4.13	-	7.33	6.53	6.23	7.33	6.53	6.975	-
Critical Hdwy Stg 1	-	-	-	-	-	6.13	5.53	-	6.53	5.53	-	-
Critical Hdwy Stg 2	-	-	-	-	-	6.53	5.53	-	6.13	5.53	-	-
Follow-up Hdwy	2.257	-	-	2.219	-	3.519	4.019	3.319	3.519	4.019	3.3475	-
Pot Cap-1 Maneuver	863	-	-	1400	-	358	231	871	200	233	631	-
Stage 1	-	-	-	-	-	691	652	-	394	438	-	-
Stage 2	-	-	-	-	-	642	434	-	688	650	-	-
Platoon blocked, %	-	-	-	-	-	-	-	-	-	-	-	-
Mov Cap-1 Maneuver	860	-	-	1400	-	294	210	871	182	212	629	-
Mov Cap-2 Maneuver	-	-	-	-	-	294	210	-	182	212	-	-
Stage 1	-	-	-	-	-	632	596	-	359	436	-	-
Stage 2	-	-	-	-	-	567	432	-	622	594	-	-
Approach	EB	WB	NB									
HCM Control Delay, s	2.8	0	19.8									
HCM LOS	-	-	C									
HCM LOS	-	-	B									
Minor Lane/Major Mvmt	NBLn1	EBL	EBT	EBR	WBL	WBT	WBR	SBLn1				
Capacity (veh/h)	267	860	-	-	1400	-	-	467				
HCM Lane V/C Ratio	0.09	0.086	-	-	0.001	-	-	0.173				
HCM Control Delay (s)	19.8	9.6	-	-	7.6	0	-	14.3				
HCM Lane LOS	C	A	-	-	A	A	-	B				
HCM 95th %tile Q(veh)	0.3	0.3	-	-	0	-	-	0.6				

Intersection												
Int Delay, s/veh	1.6											
Movement	EBL	EBT	EBR	WBL	WBT	WBR	NBL	NBT	NBR	SBL	SBT	SBR
Lane Configurations	↔		↔		↔		↔		↔		↔	
Traffic Vol, veh/h	1	432	35	39	415	1	23	1	52	1	0	0
Future Vol, veh/h	1	432	35	39	415	1	23	1	52	1	0	0
Conflicting Peds, #/hr	3	0	1	1	0	3	0	0	2	2	0	0
Sign Control	Free	Free	Free	Free	Free	Free	Stop	Stop	Stop	Stop	Stop	Stop
RT Channelized	-	-	None	-	-	None	-	-	None	-	-	None
Storage Length	-	-	-	-	-	-	-	-	-	-	-	-
Veh in Median Storage, #	-	0	-	-	0	-	-	0	-	-	0	-
Grade, %	-	0	-	-	0	-	-	0	-	-	0	-
Peak Hour Factor	100	100	100	100	100	100	100	100	100	100	100	100
Heavy Vehicles, %	2	3	6	3	3	2	7	2	9	2	2	2
Mvmt Flow	1	432	35	39	415	1	23	1	52	1	0	0
Major/Minor	Major1	Major2		Minor1		Minor2						
Conflicting Flow All	419	0	0	468	0	0	947	950	453	977	967	419
Stage 1	-	-	-	-	-	-	453	453	-	497	497	-
Stage 2	-	-	-	-	-	-	494	497	-	480	470	-
Critical Hdwy	4.12	-	-	4.13	-	-	7.17	6.52	6.29	7.12	6.52	6.22
Critical Hdwy Stg 1	-	-	-	-	-	-	6.17	5.52	-	6.12	5.52	-
Critical Hdwy Stg 2	-	-	-	-	-	-	6.17	5.52	-	6.12	5.52	-
Follow-up Hdwy	2.218	-	-	2.227	-	-	3.563	4.018	3.381	3.518	4.018	3.318
Pot Cap-1 Maneuver	1140	-	-	1088	-	-	236	260	592	230	254	634
Stage 1	-	-	-	-	-	-	577	570	-	555	545	-
Stage 2	-	-	-	-	-	-	548	545	-	567	560	-
Platoon blocked, %	-	-	-	-	-	-	-	-	-	-	-	-
Mov Cap-1 Maneuver	1137	-	-	1087	-	-	227	247	591	201	241	633
Mov Cap-2 Maneuver	-	-	-	-	-	-	227	247	-	201	241	-
Stage 1	-	-	-	-	-	-	576	569	-	553	518	-
Stage 2	-	-	-	-	-	-	522	518	-	515	559	-
Approach	EB	WB		NB		SB						
HCM Control Delay, s	0	0.7		16.3		23						
HCM LOS				C		C						
Minor Lane/Major Mvmt	NBLn1	EBL	EBT	EBR	WBL	WBT	WBR	SBLn1				
Capacity (veh/h)	393	1137	-	-	1087	-	-	201				
HCM Lane V/C Ratio	0.193	0.001	-	-	0.036	-	-	0.005				
HCM Control Delay (s)	16.3	8.2	0	-	8.4	0	-	23				
HCM Lane LOS	C	A	A	-	A	A	-	C				
HCM 95th %tile Q(veh)	0.7	0	-	-	0.1	-	-	0				

Lane Group	EBL	EBT	EBR	WBL	WBT	WBR	NBL	NBT	NBR	SBL	SBT	SBR
Lane Configurations	↔	↔	↔	↔	↔	↔	↔	↔	↔	↔	↔	↔
Traffic Volume (vph)	302	622	208	506	387	31	185	894	677	72	823	192
Future Volume (vph)	302	622	208	506	387	31	185	894	677	72	823	192
Satd. Flow (prot)	3216	3316	1483	3154	3075	1469	1566	3252	1483	1658	4764	1483
Fit Permitted	0.950			0.950			0.950			0.950		
Satd. Flow (perm)	2860	3316	1390	3086	3075	1285	1539	3252	1416	1642	4764	1385
Satd. Flow (RTOR)			210			210			382			211
Lane Group Flow (vph)	302	622	208	506	387	31	185	894	677	72	823	192
Turn Type	Prot	NA	Perm	Prot	NA	Perm	Prot	NA	Perm	Prot	NA	Perm
Protected Phases	7	4	4	3	8	8	5	2	2	1	6	6
Permitted Phases			4			8			2			6
Detector Phase	7	4	4	3	8	8	5	2	2	1	6	6
Switch Phase												
Minimum Initial (s)	5.0	10.0	10.0	5.0	10.0	10.0	5.0	10.0	10.0	5.0	10.0	10.0
Minimum Split (s)	11.9	37.5	37.5	11.9	37.5	37.5	11.4	35.4	35.4	11.4	35.4	35.4
Total Split (s)	23.5	37.5	37.5	23.5	37.5	37.5	23.6	44.0	44.0	15.0	35.4	35.4
Total Split (%)	19.6%	31.3%	31.3%	19.6%	31.3%	31.3%	19.7%	36.7%	36.7%	12.5%	29.5%	29.5%
Yellow Time (s)	3.7	3.7	3.7	3.7	3.7	3.7	3.7	3.7	3.7	3.7	3.7	3.7
All-Red Time (s)	3.2	2.8	2.8	3.2	2.8	2.8	2.7	2.7	2.7	2.7	2.7	2.7
Lost Time Adjust (s)	0.0	0.0	0.0	0.0	0.0	0.0	0.0	0.0	0.0	0.0	0.0	0.0
Total Lost Time (s)	6.9	6.5	6.5	6.9	6.5	6.5	6.4	6.4	6.4	6.4	6.4	6.4
Lead/Lag	Lag	Lead	Lead	Lag	Lead	Lead	Lag	Lag	Lag	Lag	Lag	Lag
Lead-Lag Optimize?	Yes	Yes	Yes	Yes	Yes	Yes	Yes	Yes	Yes	Yes	Yes	Yes
Recall Mode	None	None	None	None	None	None	None	C-Max	C-Max	None	C-Max	C-Max
Act Effct Green (s)	16.6	29.1	29.1	18.5	31.0	31.0	16.5	40.6	40.6	8.2	29.7	29.7
Actuated g/C Ratio	0.14	0.24	0.24	0.15	0.26	0.26	0.14	0.34	0.34	0.07	0.25	0.25
v/c Ratio	0.68	0.77	0.42	1.04	0.49	0.06	0.86	0.81	0.93	0.64	0.70	0.38
Control Delay	57.7	49.4	7.3	101.6	35.3	0.2	98.2	39.7	34.5	79.5	45.0	6.0
Queue Delay	0.0	0.0	0.0	0.0	0.0	0.0	0.0	0.0	0.0	0.0	0.0	0.0
Total Delay	57.7	49.4	7.3	101.6	35.3	0.2	98.2	39.7	34.5	79.5	45.0	6.0
LOS	E	D	A	F	D	A	F	D	C	E	D	A
Approach Delay	43.9			70.5			43.9			40.4		
Approach LOS	D			E			D			D		
Queue Length 50th (m)	35.3	70.5	0.0	~73.5	43.6	0.0	43.5	118.4	109.0	16.8	65.4	0.0
Queue Length 95th (m)	50.2	91.2	17.7	#107.2	59.1	m0.0	#81.8	#143.1	#98.6	#36.1	80.4	14.0
Internal Link Dist (m)	213.9			123.7			114.3			252.7		
Turn Bay Length (m)	100.0		64.0	75.0			47.5			40.0		45.0
Base Capacity (vph)	444	856	514	486	794	487	224	1099	731	118	1180	501
Starvation Cap Reductn	0	0	0	0	0	0	0	0	0	0	0	0
Spillback Cap Reductn	0	0	0	0	0	0	0	0	0	0	0	0
Storage Cap Reductn	0	0	0	0	0	0	0	0	0	0	0	0
Reduced v/c Ratio	0.68	0.73	0.40	1.04	0.49	0.06	0.83	0.81	0.93	0.61	0.70	0.38

Intersection Summary												
Cycle Length: 120												
Actuated Cycle Length: 120												
Offset: 0 (0%), Referenced to phase 2:NBT and 6:SBT, Start of Green												
Natural Cycle: 120												
Control Type: Actuated-Coordinated												

Lanes, Volumes, Timings
1: St Laurent & Coventry/Ogilvie

2026 Future Total
PM Peak Hour

Maximum v/c Ratio: 1.04	Intersection LOS: D
Intersection Signal Delay: 48.1	ICU Level of Service F
Intersection Capacity Utilization 96.1%	
Analysis Period (min) 15	
~ Volume exceeds capacity, queue is theoretically infinite. Queue shown is maximum after two cycles.	
# 95th percentile volume exceeds capacity, queue may be longer. Queue shown is maximum after two cycles.	
m Volume for 95th percentile queue is metered by upstream signal.	

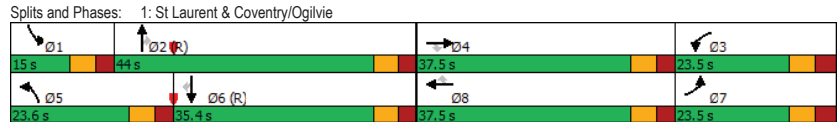

Lanes, Volumes, Timings
2: Lemieux & St Laurent

2026 Future Total
PM Peak Hour

Lane Group	WBL	WBR	NBT	NBR	SBL	SBT
Lane Configurations	↔↔	↔	↑↑↑	↔	↔↔	↑↑↑
Traffic Volume (vph)	518	161	1643	268	17	1863
Future Volume (vph)	518	161	1643	268	17	1863
Satd. Flow (prot)	2982	1414	4718	1483	1658	4672
Fit Permitted	0.950				0.114	
Satd. Flow (perm)	2982	1316	4718	1433	199	4672
Satd. Flow (RTOR)		33		268		
Lane Group Flow (vph)	518	161	1643	268	17	1863
Turn Type	Prot	Perm	NA	Perm	Perm	NA
Protected Phases	7		2			6
Permitted Phases		7		2	6	
Detector Phase	7	7	2	2	6	6
Switch Phase						
Minimum Initial (s)	5.0	5.0	10.0	10.0	10.0	10.0
Minimum Split (s)	36.1	36.1	43.5	43.5	16.0	16.0
Total Split (s)	38.0	38.0	82.0	82.0	82.0	82.0
Total Split (%)	31.7%	31.7%	68.3%	68.3%	68.3%	68.3%
Yellow Time (s)	3.3	3.3	3.7	3.7	3.7	3.7
All-Red Time (s)	2.8	2.8	1.8	1.8	1.8	1.8
Lost Time Adjust (s)	0.0	0.0	0.0	0.0	0.0	0.0
Total Lost Time (s)	6.1	6.1	5.5	5.5	5.5	5.5
Lead/Lag						
Lead-Lag Optimize?						
Recall Mode	None	None	C-Max	C-Max	C-Max	C-Max
Act Effct Green (s)	28.3	28.3	80.1	80.1	80.1	80.1
Actuated g/C Ratio	0.24	0.24	0.67	0.67	0.67	0.67
v/c Ratio	0.74	0.48	0.52	0.26	0.13	0.60
Control Delay	48.9	35.4	10.1	2.1	6.4	7.8
Queue Delay	0.0	0.0	0.3	0.0	0.0	0.0
Total Delay	48.9	35.4	10.4	2.1	6.4	7.8
LOS	D	D	B	A	A	A
Approach Delay	45.7		9.2			7.7
Approach LOS	D		A			A
Queue Length 50th (m)	57.3	25.4	90.5	9.2	0.9	69.8
Queue Length 95th (m)	74.4	45.4	63.6	8.2	m2.1	m73.8
Internal Link Dist (m)	75.1		117.1			60.0
Turn Bay Length (m)		51.5		53.5	115.0	
Base Capacity (vph)	792	374	3148	1045	133	3117
Starvation Cap Reductn	0	0	685	0	0	0
Spillback Cap Reductn	0	0	0	0	0	0
Storage Cap Reductn	0	0	0	0	0	0
Reduced v/c Ratio	0.65	0.43	0.67	0.26	0.13	0.60

Intersection Summary						
Cycle Length:	120					
Actuated Cycle Length:	120					
Offset:	99 (83%), Referenced to phase 2:NBT and 6:SBTL, Start of Green					
Natural Cycle:	80					
Control Type:	Actuated-Coordinated					

Lanes, Volumes, Timings
2: Lemieux & St Laurent

2026 Future Total
PM Peak Hour

Maximum v/c Ratio: 0.74	Intersection LOS: B
Intersection Signal Delay: 14.1	ICU Level of Service C
Intersection Capacity Utilization 70.8%	
Analysis Period (min) 15	

m Volume for 95th percentile queue is metered by upstream signal.

Splits and Phases: 2: Lemieux & St Laurent



Lanes, Volumes, Timings
3: St Laurent & Transitway

2026 Future Total
PM Peak Hour

Lane Group	WBL	WBR	NBT	NBR	SBL	SBT
Lane Configurations	↔	↔	↑↑↑	↔	↔	↑↑↑
Traffic Volume (vph)	40	20	1954	45	0	1274
Future Volume (vph)	40	20	1954	45	0	1274
Satd. Flow (prot)	914	0	4646	0	1745	4718
Fit Permitted	0.968					
Satd. Flow (perm)	914	0	4646	0	1745	4718
Satd. Flow (RTOR)	1		7			
Lane Group Flow (vph)	60	0	1999	0	0	1274
Turn Type	Prot		NA		Perm	NA
Protected Phases	8		2			6
Permitted Phases					6	
Detector Phase	8		2		6	6
Switch Phase						
Minimum Initial (s)	5.0		10.0		10.0	10.0
Minimum Split (s)	29.5		30.0		24.0	24.0
Total Split (s)	29.5		30.5		30.5	30.5
Total Split (%)	49.2%		50.8%		50.8%	50.8%
Yellow Time (s)	3.3		3.7		3.7	3.7
All-Red Time (s)	2.2		2.3		2.3	2.3
Lost Time Adjust (s)	0.0		0.0		0.0	0.0
Total Lost Time (s)	5.5		6.0		6.0	6.0
Lead/Lag						
Lead-Lag Optimize?						
Recall Mode	None		C-Max		C-Max	C-Max
Act Effct Green (s)	9.5		46.2		46.2	46.2
Actuated g/C Ratio	0.16		0.77		0.77	0.77
v/c Ratio	0.41		0.56		0.35	0.35
Control Delay	29.9		9.5		4.2	4.2
Queue Delay	0.0		0.0		0.0	0.0
Total Delay	29.9		9.5		4.2	4.2
LOS	C		A		A	A
Approach Delay	29.9		9.5		4.2	4.2
Approach LOS	C		A		A	A
Queue Length 50th (m)	6.0		72.1		27.5	27.5
Queue Length 95th (m)	14.1		119.8		40.2	40.2
Internal Link Dist (m)	43.2		196.1		117.1	117.1
Turn Bay Length (m)						
Base Capacity (vph)	366		3576		3630	3630
Starvation Cap Reductn	0		0		0	0
Spillback Cap Reductn	0		0		0	0
Storage Cap Reductn	0		0		0	0
Reduced v/c Ratio	0.16		0.56		0.35	0.35

Intersection Summary						
Cycle Length:	60					
Actuated Cycle Length:	60					
Offset:	28 (47%), Referenced to phase 2:NBT and 6:SBTL, Start of Green					
Natural Cycle:	65					
Control Type:	Actuated-Coordinated					

Lanes, Volumes, Timings
3: St Laurent & Transitway

2026 Future Total
PM Peak Hour

Maximum v/c Ratio: 0.56	Intersection LOS: A
Intersection Signal Delay: 7.8	ICU Level of Service A
Intersection Capacity Utilization 54.7%	
Analysis Period (min) 15	

Splits and Phases: 3: St Laurent & Transitway

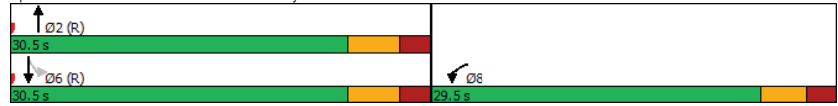

Lanes, Volumes, Timings
4: Hwy 417 EB Off-Ramp & St Laurent

2026 Future Total
PM Peak Hour

Lane Group	EBL	EBR	NBL	NBT	SBT	SBR
Lane Configurations	↔↔	↔		↑↑↑	↑↑↑	
Traffic Volume (vph)	787	263	0	1531	815	399
Future Volume (vph)	787	263	0	1531	815	399
Satd. Flow (prot)	3124	1414	0	4764	4257	0
Fit Permitted	0.950					
Satd. Flow (perm)	3124	1376	0	4764	4257	0
Satd. Flow (RTOR)		135			157	
Lane Group Flow (vph)	787	263	0	1531	1214	0
Turn Type	Prot	Perm		NA	NA	
Protected Phases	4			2	6	
Permitted Phases		4				
Detector Phase	4	4		2	6	
Switch Phase						
Minimum Initial (s)	5.0	5.0		10.0	10.0	
Minimum Split (s)	34.5	34.5		24.1	42.1	
Total Split (s)	50.0	50.0		70.0	70.0	
Total Split (%)	41.7%	41.7%		58.3%	58.3%	
Yellow Time (s)	3.3	3.3		3.7	3.7	
All-Red Time (s)	3.2	3.2		2.4	2.4	
Lost Time Adjust (s)	0.0	0.0		0.0	0.0	
Total Lost Time (s)	6.5	6.5		6.1	6.1	
Lead/Lag						
Lead-Lag Optimize?						
Recall Mode	None	None		C-Max	C-Max	
Act Effct Green (s)	36.4	36.4		71.0	71.0	
Actuated g/C Ratio	0.30	0.30		0.59	0.59	
v/c Ratio	0.83	0.51		0.54	0.47	
Control Delay	46.8	18.9		16.4	9.8	
Queue Delay	0.0	0.0		0.0	0.0	
Total Delay	46.8	18.9		16.4	9.8	
LOS	D	B		B	A	
Approach Delay	39.8			16.4	9.8	
Approach LOS	D			B	A	
Queue Length 50th (m)	88.6	23.7		75.3	49.8	
Queue Length 95th (m)	102.5	45.0		102.1	90.7	
Internal Link Dist (m)	73.5			158.0	196.1	
Turn Bay Length (m)						
Base Capacity (vph)	1132	584		2817	2582	
Starvation Cap Reductn	0	0		0	0	
Spillback Cap Reductn	0	0		0	0	
Storage Cap Reductn	0	0		0	0	
Reduced v/c Ratio	0.70	0.45		0.54	0.47	

Intersection Summary

Cycle Length: 120
Actuated Cycle Length: 120
Offset: 40 (33%), Referenced to phase 2:NBT and 6:SBT, Start of Green
Natural Cycle: 80
Control Type: Actuated-Coordinated

Lanes, Volumes, Timings
4: Hwy 417 EB Off-Ramp & St Laurent

2026 Future Total
PM Peak Hour

Maximum v/c Ratio: 0.83	Intersection LOS: C
Intersection Signal Delay: 20.8	ICU Level of Service C
Intersection Capacity Utilization 65.4%	
Analysis Period (min) 15	

Splits and Phases: 4: Hwy 417 EB Off-Ramp & St Laurent

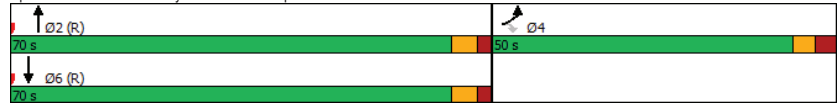

Lanes, Volumes, Timings
5: Cyrville & Ogilvie

2026 Future Total
PM Peak Hour

Lane Group	EBL	EBT	EBR	WBL	WBT	WBR	NBL	NBT	NBR	SBL	SBT	SBR
Lane Configurations		↑↑	↑	↓	↑↑	↑	↓	↓	↓	↓	↓	↓
Traffic Volume (vph)	0	1104	281	44	690	124	139	242	34	134	223	80
Future Volume (vph)	0	1104	281	44	690	124	139	242	34	134	223	80
Satd. Flow (prot)	0	3316	1469	1658	3316	1469	1580	1710	0	1642	1639	0
Fit Permitted				0.214			0.341			0.391		
Satd. Flow (perm)	0	3316	1362	371	3316	1327	565	1710	0	673	1639	0
Satd. Flow (RTOR)			281			124		7			17	
Lane Group Flow (vph)	0	1104	281	44	690	124	139	276	0	134	303	0
Turn Type		NA	Perm	Perm	NA	Perm	Perm	NA		Perm	NA	
Protected Phases		2			6		4		4		8	
Permitted Phases			2	6		6	4			8		
Detector Phase		2	2	6	6	6	4	4		8	8	
Switch Phase												
Minimum Initial (s)		10.0	10.0	10.0	10.0	10.0	10.0	10.0		10.0	10.0	
Minimum Split (s)		32.2	32.2	32.2	32.2	32.2	47.1	47.1		47.1	47.1	
Total Split (s)		70.0	70.0	70.0	70.0	70.0	50.0	50.0		50.0	50.0	
Total Split (%)		58.3%	58.3%	58.3%	58.3%	58.3%	41.7%	41.7%		41.7%	41.7%	
Yellow Time (s)		3.7	3.7	3.7	3.7	3.7	3.7	3.7		3.7	3.7	
All-Red Time (s)		2.5	2.5	2.5	2.5	2.5	3.4	3.4		3.4	3.4	
Lost Time Adjust (s)		0.0	0.0	0.0	0.0	0.0	0.0	0.0		0.0	0.0	
Total Lost Time (s)		6.2	6.2	6.2	6.2	6.2	7.1	7.1		7.1	7.1	
Lead/Lag												
Lead-Lag Optimize?												
Recall Mode		C-Max	C-Max	C-Max	C-Max	C-Max	None	None		None	None	
Act Effct Green (s)		78.5	78.5	78.5	78.5	78.5	28.2	28.2		28.2	28.2	
Actuated g/C Ratio		0.65	0.65	0.65	0.65	0.65	0.24	0.24		0.24	0.24	
v/c Ratio		0.51	0.28	0.18	0.32	0.14	1.05	0.68		0.85	0.76	
Control Delay		5.6	0.7	13.3	10.7	2.4	136.0	48.1		82.9	51.9	
Queue Delay		0.2	0.0	0.0	0.0	0.0	0.0	0.0		0.0	0.0	
Total Delay		5.8	0.7	13.3	10.7	2.4	136.0	48.1		82.9	51.9	
LOS		A	A	B	B	A	F	D		F	D	
Approach Delay		4.8			9.6		77.5			61.4		
Approach LOS		A			A		E			E		
Queue Length 50th (m)		28.0	0.1	3.7	33.6	0.0	~36.4	58.5		30.6	63.9	
Queue Length 95th (m)		m58.5	m1.5	12.6	58.6	8.3	#62.2	75.6		49.0	82.7	
Internal Link Dist (m)		123.7			139.9			44.2			76.2	
Turn Bay Length (m)				53.5		51.0	42.5			77.0		
Base Capacity (vph)		2168	987	242	2168	910	201	615		240	596	
Starvation Cap Reductn		391	0	0	0	0	0	0		0	0	
Spillback Cap Reductn		0	0	0	0	0	0	0		0	0	
Storage Cap Reductn		0	0	0	0	0	0	0		0	0	
Reduced v/c Ratio		0.62	0.28	0.18	0.32	0.14	0.69	0.45		0.56	0.51	

Intersection Summary

Cycle Length: 120
Actuated Cycle Length: 120
Offset: 20 (17%), Referenced to phase 2:EBT and 6:WBTL, Start of Green
Natural Cycle: 80
Control Type: Actuated-Coordinated

Lanes, Volumes, Timings
5: Cyrville & Ogilvie

2026 Future Total
PM Peak Hour

Maximum v/c Ratio: 1.05	Intersection Signal Delay: 23.9	Intersection LOS: C
Intersection Capacity Utilization 85.3%	ICU Level of Service E	
Analysis Period (min) 15		
~ Volume exceeds capacity, queue is theoretically infinite.		
Queue shown is maximum after two cycles.		
# 95th percentile volume exceeds capacity, queue may be longer.		
Queue shown is maximum after two cycles.		
m Volume for 95th percentile queue is metered by upstream signal.		

Splits and Phases: 5: Cyrville & Ogilvie

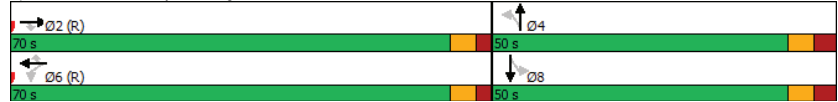

HCM 2010 TWSC
6: Labelle & Lemieux

2026 Future Total
PM Peak Hour

Intersection												
Int Delay, s/veh	5.3											
Movement	EBL	EBT	EBR	WBL	WBT	WBR	NBL	NBT	NBR	SBL	SBT	SBR
Lane Configurations	↔ ↕ ↕ ↕ ↕ ↕ ↕ ↕ ↕ ↕ ↕ ↕ ↕											
Traffic Vol, veh/h	131	0	0	0	0	162	112	318	27	0	0	176
Future Vol, veh/h	131	0	0	0	0	162	112	318	27	0	0	176
Conflicting Peds, #/hr	0	0	0	0	0	0	0	0	0	0	0	0
Sign Control	Stop	Stop	Stop	Stop	Stop	Stop	Free	Free	Free	Free	Free	Free
RT Channelized	-	-	None	-	-	None	-	-	Free	-	-	Yield
Storage Length	0	-	-	-	-	0	-	-	-	-	-	0
Veh in Median Storage, #	-	0	-	-	0	-	-	0	-	-	-	-
Grade, %	-	0	-	-	0	-	-	0	-	-	0	-
Peak Hour Factor	100	100	100	100	100	100	100	100	100	100	100	100
Heavy Vehicles, %	2	2	2	2	2	2	2	2	2	2	2	2
Mvmt Flow	131	0	0	0	0	162	112	318	27	0	0	176

Major/Minor	Minor2	Minor1	Major1
Conflicting Flow All	383	-	-
Stage 1	0	-	-
Stage 2	383	-	-
Critical Hdwy	7.54	-	-
Critical Hdwy Stg 1	-	-	-
Critical Hdwy Stg 2	6.54	-	-
Follow-up Hdwy	3.52	-	-
Pot Cap-1 Maneuver	550	0	0
Stage 1	-	0	0
Stage 2	611	0	0
Platoon blocked, %	-	-	-
Mov Cap-1 Maneuver	446	-	-
Mov Cap-2 Maneuver	446	-	-
Stage 1	-	-	-
Stage 2	496	-	-

Approach	EB	WB	NB
HCM Control Delay, s	16.4	10.2	
HCM LOS	C	B	

Minor Lane/Major Mvmt	NBL	NBT	EBLn1	WBLn1
Capacity (veh/h)	-	-	446	858
HCM Lane V/C Ratio	-	-	0.294	0.189
HCM Control Delay (s)	-	-	16.4	10.2
HCM Lane LOS	-	-	C	B
HCM 95th %tile Q(veh)	-	-	1.2	0.7

HCM 2010 TWSC
7: Access/Joseph Cyr & Lemieux

2026 Future Total
PM Peak Hour

Intersection												
Int Delay, s/veh	3.1											
Movement	EBL	EBT	EBR	WBL	WBT	WBR	NBL	NBT	NBR	SBL	SBT	SBR
Lane Configurations	↔		↔		↔		↔		↔		↔	
Traffic Vol, veh/h	112	159	14	2	560	38	12	4	0	17	6	101
Future Vol, veh/h	112	159	14	2	560	38	12	4	0	17	6	101
Conflicting Peds, #/hr	0	0	0	0	0	0	0	0	0	0	0	0
Sign Control	Free	Free	Free	Free	Free	Free	Stop	Stop	Stop	Stop	Stop	Stop
RT Channelized	-	-	None	-	-	None	-	-	None	-	-	None
Storage Length	22	-	-	-	-	-	-	-	-	-	-	-
Veh in Median Storage, #	-	0	-	-	0	-	-	0	-	-	0	-
Grade, %	-	0	-	-	0	-	-	0	-	-	0	-
Peak Hour Factor	100	100	100	100	100	100	100	100	100	100	100	100
Heavy Vehicles, %	2	2	2	2	4	3	2	2	2	2	2	3
Mvmt Flow	112	159	14	2	560	38	12	4	0	17	6	101

Major/Minor	Major1	Major2	Minor1	Minor2
Conflicting Flow All	598	0	173	0
Stage 1	-	-	-	-
Stage 2	-	-	-	-
Critical Hdwy	4.13	-	4.13	-
Critical Hdwy Stg 1	-	-	-	-
Critical Hdwy Stg 2	-	-	-	-
Follow-up Hdwy	2.219	-	2.219	-
Pot Cap-1 Maneuver	977	-	1402	-
Stage 1	-	-	-	-
Stage 2	-	-	-	-
Platoon blocked, %	-	-	-	-
Mov Cap-1 Maneuver	977	-	1402	-
Mov Cap-2 Maneuver	-	-	-	-
Stage 1	-	-	-	-
Stage 2	-	-	-	-

Approach	EB	WB	NB	SB
HCM Control Delay, s	3.6	0	20.2	15.1
HCM LOS			C	C

Minor Lane/Major Mvmt	NBLn1	EBL	EBT	EBR	WBL	WBT	WBR	SBLn1
Capacity (veh/h)	253	977	-	-	1402	-	-	478
HCM Lane V/C Ratio	0.063	0.115	-	-	0.001	-	-	0.259
HCM Control Delay (s)	20.2	9.2	-	-	7.6	0	-	15.1
HCM Lane LOS	C	A	-	-	A	A	-	C
HCM 95th %tile Q(veh)	0.2	0.4	-	-	0	-	-	1

HCM 2010 TWSC
8: Joseph Cyr & Cyrville

2026 Future Total
PM Peak Hour

Intersection												
Int Delay, s/veh	3											
Movement	EBL	EBT	EBR	WBL	WBT	WBR	NBL	NBT	NBR	SBL	SBT	SBR
Lane Configurations	↔		↔		↔		↔		↔		↔	
Traffic Vol, veh/h	0	480	58	53	371	1	43	5	82	1	1	1
Future Vol, veh/h	0	480	58	53	371	1	43	5	82	1	1	1
Conflicting Peds, #/hr	11	0	3	3	0	11	1	0	3	3	0	1
Sign Control	Free	Free	Free	Free	Free	Free	Stop	Stop	Stop	Stop	Stop	Stop
RT Channelized	-	-	None	-	-	None	-	-	None	-	-	None
Storage Length	-	-	-	-	-	-	-	-	-	-	-	-
Veh in Median Storage, #	-	0	-	-	0	-	-	0	-	-	0	-
Grade, %	-	0	-	-	0	-	-	0	-	-	0	-
Peak Hour Factor	100	100	100	100	100	100	100	100	100	100	100	100
Heavy Vehicles, %	2	3	2	4	2	2	2	2	2	2	2	2
Mvmt Flow	0	480	58	53	371	1	43	5	82	1	1	1

Major/Minor	Major1	Major2	Minor1	Minor2
Conflicting Flow All	383	0	541	0
Stage 1	-	-	-	-
Stage 2	-	-	-	-
Critical Hdwy	4.12	-	4.14	-
Critical Hdwy Stg 1	-	-	-	-
Critical Hdwy Stg 2	-	-	-	-
Follow-up Hdwy	2.218	-	2.236	-
Pot Cap-1 Maneuver	1175	-	1018	-
Stage 1	-	-	-	-
Stage 2	-	-	-	-
Platoon blocked, %	-	-	-	-
Mov Cap-1 Maneuver	1165	-	1016	-
Mov Cap-2 Maneuver	-	-	-	-
Stage 1	-	-	-	-
Stage 2	-	-	-	-

Approach	EB	WB	NB	SB
HCM Control Delay, s	0	1.1	21.3	19.9
HCM LOS			C	C

Minor Lane/Major Mvmt	NBLn1	EBL	EBT	EBR	WBL	WBT	WBR	SBLn1
Capacity (veh/h)	349	1165	-	-	1016	-	-	244
HCM Lane V/C Ratio	0.372	-	-	-	0.052	-	-	0.012
HCM Control Delay (s)	21.3	0	-	-	8.7	0	-	19.9
HCM Lane LOS	C	A	-	-	A	A	-	C
HCM 95th %tile Q(veh)	1.7	0	-	-	0.2	-	-	0

Appendix J

Synchro Intersection Worksheets – 2031 Future Total Conditions

Lanes, Volumes, Timings
1: St Laurent & Coventry/Ogilvie

2031 Future Total
AM Peak Hour

Lane Group	EBL	EBT	EBR	WBL	WBT	WBR	NBL	NBT	NBR	SBL	SBT	SBR
Lane Configurations	↔	↔	↔	↔	↔	↔	↔	↔	↔	↔	↔	↔
Traffic Volume (vph)	66	210	60	745	679	26	145	880	601	34	847	132
Future Volume (vph)	66	210	60	745	679	26	145	880	601	34	847	132
Satd. Flow (prot)	3010	3283	1388	3216	3103	1339	1523	3161	1441	1642	4764	1427
Fit Permitted	0.950			0.950			0.950			0.950		
Satd. Flow (perm)	2902	3283	1331	3156	3103	1253	1510	3161	1384	1628	4764	1367
Satd. Flow (RTOR)			195			140			509			196
Lane Group Flow (vph)	66	210	60	745	679	26	145	880	601	34	847	132
Turn Type	Prot	NA	Perm	Prot	NA	Perm	Prot	NA	Perm	Prot	NA	Perm
Protected Phases	7	4		3	8		5	2		1	6	
Permitted Phases			4			8			2			6
Detector Phase	7	4	4	3	8	8	5	2	2	1	6	6
Switch Phase												
Minimum Initial (s)	5.0	10.0	10.0	5.0	10.0	10.0	5.0	10.0	10.0	5.0	10.0	10.0
Minimum Split (s)	11.9	37.5	37.5	11.9	37.5	37.5	11.4	35.4	35.4	11.4	35.4	35.4
Total Split (s)	15.0	37.5	37.5	35.5	58.0	58.0	21.6	35.4	35.4	21.6	35.4	35.4
Total Split (%)	11.5%	28.8%	28.8%	27.3%	44.6%	44.6%	16.6%	27.2%	27.2%	16.6%	27.2%	27.2%
Yellow Time (s)	3.7	3.7	3.7	3.7	3.7	3.7	3.7	3.7	3.7	3.7	3.7	3.7
All-Red Time (s)	3.2	2.8	2.8	3.2	2.8	2.8	2.7	2.7	2.7	2.7	2.7	2.7
Lost Time Adjust (s)	0.0	0.0	0.0	0.0	0.0	0.0	0.0	0.0	0.0	0.0	0.0	0.0
Total Lost Time (s)	6.9	6.5	6.5	6.9	6.5	6.5	6.4	6.4	6.4	6.4	6.4	6.4
Lead/Lag	Lag	Lead	Lead	Lag	Lead	Lead	Lead	Lag	Lag	Lead	Lag	Lag
Lead-Lag Optimize?	Yes	Yes	Yes	Yes	Yes	Yes	Yes	Yes	Yes	Yes	Yes	Yes
Recall Mode	None	None	None	None	None	None	C-Max	C-Max	None	C-Max	C-Max	C-Max
Act Effct Green (s)	17.6	23.0	23.0	33.0	41.0	41.0	14.8	44.6	44.6	8.2	33.0	33.0
Actuated g/C Ratio	0.14	0.18	0.18	0.25	0.32	0.32	0.11	0.34	0.34	0.06	0.25	0.25
v/c Ratio	0.16	0.36	0.15	0.91	0.69	0.05	0.84	0.81	0.74	0.33	0.70	0.27
Control Delay	49.2	46.9	0.8	62.8	37.0	0.2	102.4	40.7	16.9	66.1	48.6	2.2
Queue Delay	0.0	0.0	0.0	0.0	0.0	0.0	0.0	0.0	0.7	0.0	0.0	0.0
Total Delay	49.2	46.9	0.8	62.8	37.0	0.2	102.4	40.7	17.7	66.1	48.6	2.2
LOS	D	D	A	E	D	A	F	D	B	E	D	A
Approach Delay		39.2			49.6			37.7			43.2	
Approach LOS		D			D			D			D	
Queue Length 50th (m)	7.3	23.2	0.0	~109.2	88.4	0.0	39.4	~127.1	34.2	8.5	75.6	0.0
Queue Length 95th (m)	14.8	34.3	0.0	#147.8	103.2	m0.0	#73.6	#168.2	#67.8	19.0	91.6	2.4
Internal Link Dist (m)		213.9			123.7			114.3			252.7	
Turn Bay Length (m)	100.0		64.0	75.0			47.5			40.0		45.0
Base Capacity (vph)	417	782	465	816	1258	590	180	1084	809	191	1207	493
Starvation Cap Reductn	0	0	0	0	20	0	0	0	49	0	0	0
Spillback Cap Reductn	0	0	0	0	0	0	0	0	0	0	0	0
Storage Cap Reductn	0	0	0	0	0	0	0	0	0	0	0	0
Reduced v/c Ratio	0.16	0.27	0.13	0.91	0.55	0.04	0.81	0.81	0.79	0.18	0.70	0.27

Intersection Summary

Cycle Length: 130
Actuated Cycle Length: 130
Offset: 0 (0%), Referenced to phase 2:NBT and 6:SBT, Start of Green
Natural Cycle: 130
Control Type: Actuated-Coordinated

Lanes, Volumes, Timings
1: St Laurent & Coventry/Ogilvie

2031 Future Total
AM Peak Hour

Maximum v/c Ratio: 0.91	Intersection LOS: D
Intersection Signal Delay: 43.0	ICU Level of Service F
Intersection Capacity Utilization 93.8%	
Analysis Period (min) 15	
~ Volume exceeds capacity, queue is theoretically infinite.	
Queue shown is maximum after two cycles.	
# 95th percentile volume exceeds capacity, queue may be longer.	
Queue shown is maximum after two cycles.	
m Volume for 95th percentile queue is metered by upstream signal.	

Splits and Phases: 1: St Laurent & Coventry/Ogilvie

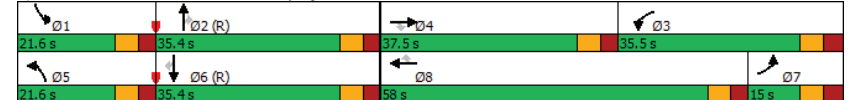

Lanes, Volumes, Timings
2: Lemieux & St Laurent

2031 Future Total
AM Peak Hour

	↖	↗	↑	↘	↙	↓
Lane Group	WBL	WBR	NBT	NBR	SBL	SBT
Lane Configurations	↖↗	↖	↑↑↑	↖	↖	↑↑↑
Traffic Volume (vph)	626	160	1348	240	9	1549
Future Volume (vph)	626	160	1348	240	9	1549
Satd. Flow (prot)	2734	1483	4584	1483	1658	4672
Fit Permitted	0.950				0.162	
Satd. Flow (perm)	2734	1418	4584	1444	282	4672
Satd. Flow (RTOR)		46		240		
Lane Group Flow (vph)	626	160	1348	240	9	1549
Turn Type	Prot	Perm	NA	Perm	Perm	NA
Protected Phases	8		2			6
Permitted Phases		8		2	6	
Detector Phase	8	8	2	2	6	6
Switch Phase						
Minimum Initial (s)	5.0	5.0	10.0	10.0	10.0	10.0
Minimum Split (s)	36.1	36.1	43.5	43.5	16.0	16.0
Total Split (s)	50.0	50.0	80.0	80.0	80.0	80.0
Total Split (%)	38.5%	38.5%	61.5%	61.5%	61.5%	61.5%
Yellow Time (s)	3.3	3.3	3.7	3.7	3.7	3.7
All-Red Time (s)	2.8	2.8	1.8	1.8	1.8	1.8
Lost Time Adjust (s)	0.0	0.0	0.0	0.0	0.0	0.0
Total Lost Time (s)	6.1	6.1	5.5	5.5	5.5	5.5
Lead/Lag						
Lead-Lag Optimize?						
Recall Mode	None	None	C-Max	C-Max	C-Max	C-Max
Act Effct Green (s)	35.5	35.5	82.9	82.9	82.9	82.9
Actuated g/C Ratio	0.27	0.27	0.64	0.64	0.64	0.64
v/c Ratio	0.84	0.38	0.46	0.24	0.05	0.52
Control Delay	55.0	28.4	9.2	2.0	11.4	15.4
Queue Delay	0.0	0.0	0.2	0.0	0.0	0.0
Total Delay	55.0	28.4	9.4	2.0	11.4	15.4
LOS	E	C	A	A	B	B
Approach Delay	49.6		8.3			15.4
Approach LOS	D		A			B
Queue Length 50th (m)	78.2	23.4	37.6	1.2	1.0	72.9
Queue Length 95th (m)	92.3	39.6	74.2	12.0	m1.5	m80.5
Internal Link Dist (m)	80.2		117.1			60.0
Turn Bay Length (m)		51.5		53.5	115.0	
Base Capacity (vph)	923	509	2924	1008	180	2980
Starvation Cap Reductn	0	0	655	0	0	0
Spillback Cap Reductn	0	0	0	0	0	0
Storage Cap Reductn	0	0	0	0	0	0
Reduced v/c Ratio	0.68	0.31	0.59	0.24	0.05	0.52

Intersection Summary	
Cycle Length:	130
Actuated Cycle Length:	130
Offset:	124 (95%), Referenced to phase 2:NBT and 6:SBTL, Start of Green
Natural Cycle:	80
Control Type:	Actuated-Coordinated

Lanes, Volumes, Timings
2: Lemieux & St Laurent

2031 Future Total
AM Peak Hour

Maximum v/c Ratio: 0.84	Intersection LOS: B
Intersection Signal Delay: 19.3	ICU Level of Service B
Intersection Capacity Utilization 63.6%	
Analysis Period (min) 15	
m Volume for 95th percentile queue is metered by upstream signal.	

Splits and Phases: 2: Lemieux & St Laurent



Lanes, Volumes, Timings
3: St Laurent & Transitway

2031 Future Total
AM Peak Hour

Lane Group	WBL	WBR	NBT	NBR	SBL	SBT
Lane Configurations	↔	↔	↑↑↑	↔	↔	↑↑↑
Traffic Volume (vph)	48	24	1623	60	2	931
Future Volume (vph)	48	24	1623	60	2	931
Satd. Flow (prot)	834	0	4464	0	1127	4628
Fit Permitted	0.968				0.121	
Satd. Flow (perm)	834	0	4464	0	144	4628
Satd. Flow (RTOR)	7		11			
Lane Group Flow (vph)	72	0	1683	0	2	931
Turn Type	Prot		NA		Perm	NA
Protected Phases	8		2			6
Permitted Phases					6	
Detector Phase	8		2		6	6
Switch Phase						
Minimum Initial (s)	5.0		10.0		10.0	10.0
Minimum Split (s)	29.5		30.0		22.5	22.5
Total Split (s)	30.0		35.0		35.0	35.0
Total Split (%)	46.2%		53.8%		53.8%	53.8%
Yellow Time (s)	3.3		3.7		3.7	3.7
All-Red Time (s)	2.2		2.3		2.3	2.3
Lost Time Adjust (s)	0.0		0.0		0.0	0.0
Total Lost Time (s)	5.5		6.0		6.0	6.0
Lead/Lag						
Lead-Lag Optimize?						
Recall Mode	None		C-Max		C-Max	C-Max
Act Effct Green (s)	10.7		50.1		50.1	50.1
Actuated g/C Ratio	0.16		0.77		0.77	0.77
v/c Ratio	0.50		0.49		0.02	0.26
Control Delay	33.6		3.9		7.0	5.5
Queue Delay	0.0		0.0		0.0	0.0
Total Delay	33.6		3.9		7.0	5.5
LOS	C		A		A	A
Approach Delay	33.6		3.9			5.5
Approach LOS	C		A			A
Queue Length 50th (m)	7.2		17.6		0.1	22.7
Queue Length 95th (m)	16.5		35.8		m0.4	59.4
Internal Link Dist (m)	43.2		196.1			117.1
Turn Bay Length (m)					13.0	
Base Capacity (vph)	318		3440		111	3564
Starvation Cap Reductn	0		0		0	0
Spillback Cap Reductn	0		0		0	0
Storage Cap Reductn	0		0		0	0
Reduced v/c Ratio	0.23		0.49		0.02	0.26

Intersection Summary	
Cycle Length:	65
Actuated Cycle Length:	65
Offset:	38 (58%), Referenced to phase 2:NBT and 6:SBTL, Start of Green
Natural Cycle:	60
Control Type:	Actuated-Coordinated

Lanes, Volumes, Timings
3: St Laurent & Transitway

2031 Future Total
AM Peak Hour

Maximum v/c Ratio: 0.50	Intersection LOS: A
Intersection Signal Delay: 5.3	ICU Level of Service A
Intersection Capacity Utilization 48.4%	
Analysis Period (min) 15	
m Volume for 95th percentile queue is metered by upstream signal.	

Splits and Phases: 3: St Laurent & Transitway



Lanes, Volumes, Timings
4: Hwy 417 EB Off-Ramp & St Laurent

2031 Future Total
AM Peak Hour

Lane Group	EBL	EBR	NBL	NBT	SBT	SBR
Lane Configurations	↔↔	↔		↑↑↑	↑↑↑	
Traffic Volume (vph)	687	673	0	1283	841	174
Future Volume (vph)	687	673	0	1283	841	174
Satd. Flow (prot)	3066	1427	0	4418	4347	0
Fit Permitted	0.950					
Satd. Flow (perm)	3066	1409	0	4418	4347	0
Satd. Flow (RTOR)		133			52	
Lane Group Flow (vph)	687	673	0	1283	1015	0
Turn Type	Prot	Perm		NA	NA	
Protected Phases	4			2	6	
Permitted Phases		4				
Detector Phase	4	4		2	6	
Switch Phase						
Minimum Initial (s)	5.0	5.0		10.0	10.0	
Minimum Split (s)	34.5	34.5		24.1	42.1	
Total Split (s)	55.0	55.0		75.0	75.0	
Total Split (%)	42.3%	42.3%		57.7%	57.7%	
Yellow Time (s)	3.3	3.3		3.7	3.7	
All-Red Time (s)	3.2	3.2		2.4	2.4	
Lost Time Adjust (s)	0.0	0.0		0.0	0.0	
Total Lost Time (s)	6.5	6.5		6.1	6.1	
Lead/Lag						
Lead-Lag Optimize?						
Recall Mode	None	None		C-Max	C-Max	
Act Effct Green (s)	48.5	48.5		68.9	68.9	
Actuated g/C Ratio	0.37	0.37		0.53	0.53	
v/c Ratio	0.60	1.11		0.55	0.44	
Control Delay	35.6	100.0		21.4	17.6	
Queue Delay	0.0	0.0		0.0	0.0	
Total Delay	35.6	100.0		21.4	17.6	
LOS	D	F		C	B	
Approach Delay	67.5			21.4	17.6	
Approach LOS	E			C	B	
Queue Length 50th (m)	72.7	~173.8		77.1	39.3	
Queue Length 95th (m)	92.4	#246.7		90.5	33.7	
Internal Link Dist (m)	73.5			158.0	196.1	
Turn Bay Length (m)						
Base Capacity (vph)	1143	609		2341	2328	
Starvation Cap Reductn	0	0		0	0	
Spillback Cap Reductn	0	0		0	0	
Storage Cap Reductn	0	0		0	0	
Reduced v/c Ratio	0.60	1.11		0.55	0.44	

Intersection Summary	
Cycle Length:	130
Actuated Cycle Length:	130
Offset:	25 (19%), Referenced to phase 2:NBT and 6:SBT, Start of Green
Natural Cycle:	90
Control Type:	Actuated-Coordinated

Lanes, Volumes, Timings
4: Hwy 417 EB Off-Ramp & St Laurent

2031 Future Total
AM Peak Hour

Maximum v/c Ratio: 1.11	Intersection Signal Delay: 37.5	Intersection LOS: D
Intersection Capacity Utilization 82.8%	ICU Level of Service E	
Analysis Period (min) 15		
~ Volume exceeds capacity, queue is theoretically infinite. Queue shown is maximum after two cycles.		
# 95th percentile volume exceeds capacity, queue may be longer. Queue shown is maximum after two cycles.		

Splits and Phases: 4: Hwy 417 EB Off-Ramp & St Laurent

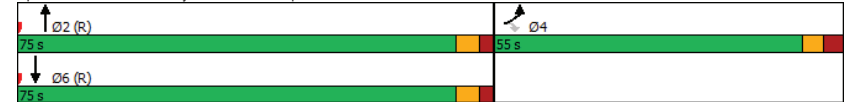

Lanes, Volumes, Timings
5: Cyrville & Ogilvie

2031 Future Total
AM Peak Hour

Lane Group	EBL	EBT	EBR	WBL	WBT	WBR	NBL	NBT	NBR	SBL	SBT	SBR
Lane Configurations		↑↑	↑	↑	↑↑	↑	↑	↑	↑	↑	↑	↑
Traffic Volume (vph)	0	597	244	28	1155	166	182	250	14	47	194	45
Future Volume (vph)	0	597	244	28	1155	166	182	250	14	47	194	45
Satd. Flow (prot)	0	3283	1414	1658	3316	1441	1551	1714	0	1626	1611	0
Fit Permitted				0.410			0.456			0.411		
Satd. Flow (perm)	0	3283	1326	706	3316	1312	741	1714	0	702	1611	0
Satd. Flow (RTOR)			244			135		2			10	
Lane Group Flow (vph)	0	597	244	28	1155	166	182	264	0	47	239	0
Turn Type	NA	Perm	Perm	NA	Perm	Perm	NA	Perm	NA	Perm	NA	
Protected Phases	2			6			4				8	
Permitted Phases			2	6		6	4			8		
Detector Phase	2	2	6	6	6	4	4			8	8	
Switch Phase												
Minimum Initial (s)		10.0	10.0	10.0	10.0	10.0	10.0			10.0	10.0	
Minimum Split (s)		32.2	32.2	32.2	32.2	32.2	47.1	47.1		47.1	47.1	
Total Split (s)		80.0	80.0	80.0	80.0	80.0	50.0	50.0		50.0	50.0	
Total Split (%)		61.5%	61.5%	61.5%	61.5%	61.5%	38.5%	38.5%		38.5%	38.5%	
Yellow Time (s)		3.7	3.7	3.7	3.7	3.7	3.7	3.7		3.7	3.7	
All-Red Time (s)		2.5	2.5	2.5	2.5	2.5	3.4	3.4		3.4	3.4	
Lost Time Adjust (s)		0.0	0.0	0.0	0.0	0.0	0.0	0.0		0.0	0.0	
Total Lost Time (s)		6.2	6.2	6.2	6.2	6.2	7.1	7.1		7.1	7.1	
Lead/Lag												
Lead-Lag Optimize?												
Recall Mode		C-Max	C-Max	C-Max	C-Max	C-Max	None	None		None	None	
Act Effct Green (s)		85.1	85.1	85.1	85.1	85.1	31.6	31.6		31.6	31.6	
Actuated g/C Ratio		0.65	0.65	0.65	0.65	0.65	0.24	0.24		0.24	0.24	
v/c Ratio		0.28	0.26	0.06	0.53	0.18	1.01	0.63		0.28	0.60	
Control Delay		7.0	0.9	11.2	14.4	3.5	117.5	49.2		40.7	46.6	
Queue Delay		0.0	0.0	0.0	0.0	0.0	0.0	0.0		0.0	0.0	
Total Delay		7.0	0.9	11.2	14.4	3.5	117.5	49.2		40.7	46.6	
LOS		A	A	B	B	A	F	D		D	D	
Approach Delay		5.2			13.0		77.1			45.6		
Approach LOS		A			B		E			D		
Queue Length 50th (m)		21.6	0.0	2.4	77.9	2.7	46.8	59.9		9.8	52.0	
Queue Length 95th (m)		34.0	m0.0	7.9	119.8	13.4	#78.1	79.0		18.8	70.3	
Internal Link Dist (m)		123.7			139.9		46.0				76.2	
Turn Bay Length (m)				53.5		51.0	42.5			77.0		
Base Capacity (vph)		2148	952	461	2169	905	244	566		231	538	
Starvation Cap Reductn		0	0	0	0	0	0	0		0	0	
Spillback Cap Reductn		0	0	0	0	0	0	0		0	0	
Storage Cap Reductn		0	0	0	0	0	0	0		0	0	
Reduced v/c Ratio		0.28	0.26	0.06	0.53	0.18	0.75	0.47		0.20	0.44	

Intersection Summary

Cycle Length: 130
 Actuated Cycle Length: 130
 Offset: 10 (8%), Referenced to phase 2:EBT and 6:WBTL, Start of Green
 Natural Cycle: 80
 Control Type: Actuated-Coordinated

Lanes, Volumes, Timings
5: Cyrville & Ogilvie

2031 Future Total
AM Peak Hour

Maximum v/c Ratio: 1.01
 Intersection Signal Delay: 23.7
 Intersection Capacity Utilization 79.7%
 Analysis Period (min) 15
 # 95th percentile volume exceeds capacity, queue may be longer.
 Queue shown is maximum after two cycles.
 m Volume for 95th percentile queue is metered by upstream signal.

Splits and Phases: 5: Cyrville & Ogilvie

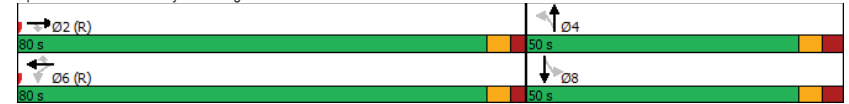

HCM 2010 TWSC
6: Labelle & Lemieux

2031 Future Total
AM Peak Hour

Intersection												
Int Delay, s/veh	2.3											
Movement	EBL	EBT	EBR	WBL	WBT	WBR	NBL	NBT	NBR	SBL	SBT	SBR
Lane Configurations	↔					↔		↔↔				↔
Traffic Vol, veh/h	30	0	0	0	0	135	133	558	44	0	0	177
Future Vol, veh/h	30	0	0	0	0	135	133	558	44	0	0	177
Conflicting Peds, #/hr	0	0	0	0	0	0	0	0	0	0	0	0
Sign Control	Stop	Stop	Stop	Stop	Stop	Free	Free	Free	Free	Free	Free	Free
RT Channelized	-	-	None	-	-	None	-	-	Free	-	-	Yield
Storage Length	0	-	-	-	-	0	-	-	-	-	-	0
Veh in Median Storage, #	-	0	-	-	0	-	-	0	-	-	-	-
Grade, %	-	0	-	-	0	-	-	0	-	-	-	0
Peak Hour Factor	100	100	100	100	100	100	100	100	100	100	100	100
Heavy Vehicles, %	2	2	2	2	2	2	2	2	2	2	2	2
Mvmt Flow	30	0	0	0	0	135	133	558	44	0	0	177

Major/Minor	Minor2	Minor1	Major1				
Conflicting Flow All	545	-	-	279	0	0	-
Stage 1	0	-	-	-	-	-	-
Stage 2	545	-	-	-	-	-	-
Critical Hdwy	7.54	-	-	6.94	4.14	-	-
Critical Hdwy Stg 1	-	-	-	-	-	-	-
Critical Hdwy Stg 2	6.54	-	-	-	-	-	-
Follow-up Hdwy	3.52	-	-	3.32	2.22	-	-
Pot Cap-1 Maneuver	421	0	0	0	718	-	0
Stage 1	-	0	0	0	-	-	0
Stage 2	490	0	0	0	-	-	0
Platoon blocked, %	-	-	-	-	-	-	-
Mov Cap-1 Maneuver	342	-	-	-	718	-	-
Mov Cap-2 Maneuver	342	-	-	-	-	-	-
Stage 1	-	-	-	-	-	-	-
Stage 2	398	-	-	-	-	-	-

Approach	EB	WB	NB
HCM Control Delay, s	16.5	11.2	-
HCM LOS	C	B	-

Minor Lane/Major Mvmt	NBL	NBT	EBLn1	WBLn1
Capacity (veh/h)	-	-	342	718
HCM Lane V/C Ratio	-	-	0.088	0.188
HCM Control Delay (s)	-	-	16.5	11.2
HCM Lane LOS	-	-	C	B
HCM 95th %tile Q(veh)	-	-	0.3	0.7

HCM 2010 TWSC
7: Access/Joseph Cyr & Lemieux

2031 Future Total
AM Peak Hour

Intersection												
Int Delay, s/veh	2.2											
Movement	EBL	EBT	EBR	WBL	WBT	WBR	NBL	NBT	NBR	SBL	SBT	SBR
Lane Configurations	↔	↔			↔↔			↔			↔	↔
Traffic Vol, veh/h	74	168	7	1	689	21	18	6	0	9	3	69
Future Vol, veh/h	74	168	7	1	689	21	18	6	0	9	3	69
Conflicting Peds, #/hr	4	0	0	0	0	4	0	0	0	0	0	0
Sign Control	Free	Free	Free	Free	Free	Free	Stop	Stop	Stop	Stop	Stop	Stop
RT Channelized	-	-	None	-	-	None	-	-	None	-	-	None
Storage Length	22	-	-	-	-	-	-	-	-	-	-	-
Veh in Median Storage, #	-	0	-	-	0	-	-	0	-	-	-	0
Grade, %	-	0	-	-	0	-	-	0	-	-	-	0
Peak Hour Factor	100	100	100	100	100	100	100	100	100	100	100	100
Heavy Vehicles, %	6	2	2	2	10	2	2	2	2	2	2	5
Mvmt Flow	74	168	7	1	689	21	18	6	0	9	3	69

Major/Minor	Major1	Major2	Minor1	Minor2							
Conflicting Flow All	714	0	0	175	0	668	1036	172	1029	1029	359
Stage 1	-	-	-	-	-	320	320	-	706	706	-
Stage 2	-	-	-	-	-	348	716	-	323	323	-
Critical Hdwy	4.19	-	-	4.13	-	7.33	6.53	6.23	7.33	6.53	6.975
Critical Hdwy Stg 1	-	-	-	-	-	6.13	5.53	-	6.53	5.53	-
Critical Hdwy Stg 2	-	-	-	-	-	6.53	5.53	-	6.13	5.53	-
Follow-up Hdwy	2.257	-	-	2.219	-	3.519	4.019	3.319	3.519	4.019	3.3475
Pot Cap-1 Maneuver	862	-	-	1400	-	358	231	871	200	233	631
Stage 1	-	-	-	-	-	691	652	-	394	438	-
Stage 2	-	-	-	-	-	642	433	-	688	650	-
Platoon blocked, %	-	-	-	-	-	-	-	-	-	-	-
Mov Cap-1 Maneuver	859	-	-	1400	-	294	210	871	182	212	629
Mov Cap-2 Maneuver	-	-	-	-	-	294	210	-	182	212	-
Stage 1	-	-	-	-	-	632	596	-	359	436	-
Stage 2	-	-	-	-	-	567	431	-	622	594	-

Approach	EB	WB	NB	SB
HCM Control Delay, s	2.8	0	19.8	14.3
HCM LOS	-	-	C	B

Minor Lane/Major Mvmt	NBLn1	EBL	EBT	EBR	WBL	WBT	WBR	SBLn1
Capacity (veh/h)	267	859	-	-	1400	-	-	467
HCM Lane V/C Ratio	0.09	0.086	-	-	0.001	-	-	0.173
HCM Control Delay (s)	19.8	9.6	-	-	7.6	0	-	14.3
HCM Lane LOS	C	A	-	-	A	A	-	B
HCM 95th %tile Q(veh)	0.3	0.3	-	-	0	-	-	0.6

HCM 2010 TWSC
8: Joseph Cyr & Cyrville

2031 Future Total
AM Peak Hour

Intersection												
Int Delay, s/veh	1.6											
Movement	EBL	EBT	EBR	WBL	WBT	WBR	NBL	NBT	NBR	SBL	SBT	SBR
Lane Configurations	↔		↔		↔		↔		↔		↔	
Traffic Vol, veh/h	1	476	35	39	425	1	23	1	52	1	0	0
Future Vol, veh/h	1	476	35	39	425	1	23	1	52	1	0	0
Conflicting Peds, #/hr	3	0	1	1	0	3	0	0	2	2	0	0
Sign Control	Free	Free	Free	Free	Free	Free	Stop	Stop	Stop	Stop	Stop	Stop
RT Channelized	-	-	None	-	-	None	-	-	None	-	-	None
Storage Length	-	-	-	-	-	-	-	-	-	-	-	-
Veh in Median Storage, #	-	0	-	-	0	-	-	0	-	-	0	-
Grade, %	-	0	-	-	0	-	-	0	-	-	0	-
Peak Hour Factor	100	100	100	100	100	100	100	100	100	100	100	100
Heavy Vehicles, %	2	3	6	3	3	2	7	2	9	2	2	2
Mvmt Flow	1	476	35	39	425	1	23	1	52	1	0	0
Major/Minor	Major1	Major2	Minor1	Minor2								
Conflicting Flow All	429	0	0	512	0	0	1001	1004	497	1031	1021	429
Stage 1	-	-	-	-	-	497	497	-	507	507	-	-
Stage 2	-	-	-	-	-	504	507	-	524	514	-	-
Critical Hdwy	4.12	-	-	4.13	-	-	7.17	6.52	6.29	7.12	6.52	6.22
Critical Hdwy Stg 1	-	-	-	-	-	6.17	5.52	-	6.12	5.52	-	-
Critical Hdwy Stg 2	-	-	-	-	-	6.17	5.52	-	6.12	5.52	-	-
Follow-up Hdwy	2.218	-	-	2.227	-	-	3.563	4.018	3.381	3.518	4.018	3.318
Pot Cap-1 Maneuver	1130	-	-	1048	-	-	217	242	559	211	236	626
Stage 1	-	-	-	-	-	546	545	-	548	539	-	-
Stage 2	-	-	-	-	-	541	539	-	537	535	-	-
Platoon blocked, %	-	-	-	-	-	-	-	-	-	-	-	-
Mov Cap-1 Maneuver	1127	-	-	1047	-	-	209	229	558	183	223	625
Mov Cap-2 Maneuver	-	-	-	-	-	209	229	-	183	223	-	-
Stage 1	-	-	-	-	-	545	544	-	546	512	-	-
Stage 2	-	-	-	-	-	514	512	-	485	534	-	-
Approach	EB	WB	NB	SB								
HCM Control Delay, s	0	0.7	17.4	24.8								
HCM LOS			C	C								
Minor Lane/Major Mvmt	NBLn1	EBL	EBT	EBR	WBL	WBT	WBR	SBLn1				
Capacity (veh/h)	366	1127	-	-	1047	-	-	183				
HCM Lane V/C Ratio	0.208	0.001	-	-	0.037	-	-	0.005				
HCM Control Delay (s)	17.4	8.2	0	-	8.6	0	-	24.8				
HCM Lane LOS	C	A	A	-	A	A	-	C				
HCM 95th %tile Q(veh)	0.8	0	-	-	0.1	-	-	0				

Lanes, Volumes, Timings
1: St Laurent & Coventry/Ogilvie

2031 Future Total
PM Peak Hour

Lane Group	EBL	EBT	EBR	WBL	WBT	WBR	NBL	NBT	NBR	SBL	SBT	SBR
Lane Configurations	↔	↔	↔	↔	↔	↔	↔	↔	↔	↔	↔	↔
Traffic Volume (vph)	302	654	208	518	397	31	185	916	693	72	865	192
Future Volume (vph)	302	654	208	518	397	31	185	916	693	72	865	192
Satd. Flow (prot)	3216	3316	1483	3154	3075	1469	1566	3252	1483	1658	4764	1483
Fit Permitted	0.950			0.950			0.950			0.950		
Satd. Flow (perm)	2860	3316	1390	3089	3075	1285	1539	3252	1416	1642	4764	1385
Satd. Flow (RTOR)			210			210			379			211
Lane Group Flow (vph)	302	654	208	518	397	31	185	916	693	72	865	192
Turn Type	Prot	NA	Perm	Prot	NA	Perm	Prot	NA	Perm	Prot	NA	Perm
Protected Phases	7	4	4	3	8	8	5	2	2	1	6	6
Permitted Phases			4			8			2			6
Detector Phase	7	4	4	3	8	8	5	2	2	1	6	6
Switch Phase												
Minimum Initial (s)	5.0	10.0	10.0	5.0	10.0	10.0	5.0	10.0	10.0	5.0	10.0	10.0
Minimum Split (s)	11.9	37.5	37.5	11.9	37.5	37.5	11.4	35.4	35.4	11.4	35.4	35.4
Total Split (%)	23.5	37.5	37.5	23.5	37.5	37.5	23.6	44.0	44.0	15.0	35.4	35.4
Total Split (%)	19.6%	31.3%	31.3%	19.6%	31.3%	31.3%	19.7%	36.7%	36.7%	12.5%	29.5%	29.5%
Yellow Time (s)	3.7	3.7	3.7	3.7	3.7	3.7	3.7	3.7	3.7	3.7	3.7	3.7
All-Red Time (s)	3.2	2.8	2.8	3.2	2.8	2.8	2.7	2.7	2.7	2.7	2.7	2.7
Lost Time Adjust (s)	0.0	0.0	0.0	0.0	0.0	0.0	0.0	0.0	0.0	0.0	0.0	0.0
Total Lost Time (s)	6.9	6.5	6.5	6.9	6.5	6.5	6.4	6.4	6.4	6.4	6.4	6.4
Lead/Lag	Lag	Lead	Lead	Lag	Lead	Lead	Lag	Lag	Lag	Lag	Lag	Lag
Lead-Lag Optimize?	Yes	Yes	Yes	Yes	Yes	Yes	Yes	Yes	Yes	Yes	Yes	Yes
Recall Mode	None	None	None	None	None	None	None	C-Max	C-Max	None	C-Max	C-Max
Act Effct Green (s)	16.6	29.3	29.3	18.3	31.0	31.0	16.5	40.6	40.6	8.2	29.7	29.7
Actuated g/C Ratio	0.14	0.24	0.24	0.15	0.26	0.26	0.14	0.34	0.34	0.07	0.25	0.25
v/c Ratio	0.68	0.81	0.42	1.08	0.50	0.06	0.86	0.83	0.95	0.64	0.73	0.38
Control Delay	57.7	51.2	7.3	110.7	34.7	0.2	98.3	40.2	38.4	79.5	46.0	6.0
Queue Delay	0.0	0.0	0.0	0.0	0.0	0.0	0.0	0.0	0.0	0.0	0.0	0.0
Total Delay	57.7	51.2	7.3	110.7	34.7	0.2	98.3	40.2	38.4	79.5	46.0	6.0
LOS	E	D	A	F	C	A	F	D	D	E	D	A
Approach Delay	45.1				75.1		45.5			41.4		
Approach LOS	D				E		D			D		
Queue Length 50th (m)	35.3	75.1	0.0	-76.5	45.1	0.0	43.6	121.9	114.1	16.8	69.4	0.0
Queue Length 95th (m)	50.2	96.6	17.7	#111.1	57.2	m0.0	#81.9	#149.4	#104.3	#36.1	84.9	14.0
Internal Link Dist (m)		213.9			123.7		114.3			252.7		
Turn Bay Length (m)	100.0		64.0	75.0			47.5			40.0		45.0
Base Capacity (vph)	444	856	514	481	794	487	224	1099	729	118	1180	501
Starvation Cap Reductn	0	0	0	0	0	0	0	0	0	0	0	0
Spillback Cap Reductn	0	0	0	0	0	0	0	0	0	0	0	0
Storage Cap Reductn	0	0	0	0	0	0	0	0	0	0	0	0
Reduced v/c Ratio	0.68	0.76	0.40	1.08	0.50	0.06	0.83	0.83	0.95	0.61	0.73	0.38

Intersection Summary												
Cycle Length: 120												
Actuated Cycle Length: 120												
Offset: 0 (0%), Referenced to phase 2:NBT and 6:SBT, Start of Green												
Natural Cycle: 120												
Control Type: Actuated-Coordinated												

Lanes, Volumes, Timings
1: St Laurent & Coventry/Ogilvie

2031 Future Total
PM Peak Hour

Maximum v/c Ratio: 1.08	Intersection LOS: D
Intersection Signal Delay: 50.1	ICU Level of Service F
Intersection Capacity Utilization 96.7%	
Analysis Period (min) 15	
~ Volume exceeds capacity, queue is theoretically infinite.	
Queue shown is maximum after two cycles.	
# 95th percentile volume exceeds capacity, queue may be longer.	
Queue shown is maximum after two cycles.	
m Volume for 95th percentile queue is metered by upstream signal.	

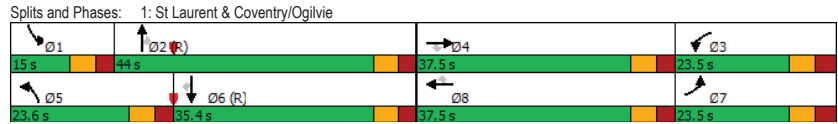

Lanes, Volumes, Timings
2: Lemieux & St Laurent

2031 Future Total
PM Peak Hour

Lane Group	WBL	WBR	NBT	NBR	SBL	SBT
Lane Configurations	↔↔	↔	↑↑↑	↔	↔	↑↑↑
Traffic Volume (vph)	520	161	1683	268	17	1957
Future Volume (vph)	520	161	1683	268	17	1957
Satd. Flow (prot)	2982	1414	4718	1483	1658	4672
Fit Permitted	0.950				0.108	
Satd. Flow (perm)	2982	1316	4718	1433	188	4672
Satd. Flow (RTOR)		30		268		
Lane Group Flow (vph)	520	161	1683	268	17	1957
Turn Type	Prot	Perm	NA	Perm	Perm	NA
Protected Phases	7		2			6
Permitted Phases		7		2	6	
Detector Phase	7	7	2	2	6	6
Switch Phase						
Minimum Initial (s)	5.0	5.0	10.0	10.0	10.0	10.0
Minimum Split (s)	36.1	36.1	43.5	43.5	16.0	16.0
Total Split (s)	38.0	38.0	82.0	82.0	82.0	82.0
Total Split (%)	31.7%	31.7%	68.3%	68.3%	68.3%	68.3%
Yellow Time (s)	3.3	3.3	3.7	3.7	3.7	3.7
All-Red Time (s)	2.8	2.8	1.8	1.8	1.8	1.8
Lost Time Adjust (s)	0.0	0.0	0.0	0.0	0.0	0.0
Total Lost Time (s)	6.1	6.1	5.5	5.5	5.5	5.5
Lead/Lag						
Lead-Lag Optimize?						
Recall Mode	None	None	C-Max	C-Max	C-Max	C-Max
Act Effct Green (s)	28.3	28.3	80.1	80.1	80.1	80.1
Actuated g/C Ratio	0.24	0.24	0.67	0.67	0.67	0.67
v/c Ratio	0.74	0.48	0.53	0.26	0.14	0.63
Control Delay	49.0	36.3	10.6	2.1	6.6	8.0
Queue Delay	0.0	0.0	0.3	0.0	0.0	0.2
Total Delay	49.0	36.3	10.9	2.1	6.6	8.3
LOS	D	D	B	A	A	A
Approach Delay	46.0		9.7			8.2
Approach LOS	D		A			A
Queue Length 50th (m)	57.5	26.1	94.5	8.8	0.9	73.0
Queue Length 95th (m)	74.7	46.1	76.5	7.9	m2.1	m76.4
Internal Link Dist (m)	75.1		117.1			60.0
Turn Bay Length (m)		51.5		53.5	115.0	
Base Capacity (vph)	792	371	3147	1045	125	3117
Starvation Cap Reductn	0	0	687	0	0	403
Spillback Cap Reductn	0	0	0	0	0	0
Storage Cap Reductn	0	0	0	0	0	0
Reduced v/c Ratio	0.66	0.43	0.68	0.26	0.14	0.72

Intersection Summary						
Cycle Length:	120					
Actuated Cycle Length:	120					
Offset:	99 (83%), Referenced to phase 2:NBT and 6:SBTL, Start of Green					
Natural Cycle:	80					
Control Type:	Actuated-Coordinated					

Lanes, Volumes, Timings
2: Lemieux & St Laurent

2031 Future Total
PM Peak Hour

Maximum v/c Ratio: 0.74	Intersection LOS: B
Intersection Signal Delay: 14.4	ICU Level of Service C
Intersection Capacity Utilization 72.8%	
Analysis Period (min) 15	

m Volume for 95th percentile queue is metered by upstream signal.

Splits and Phases: 2: Lemieux & St Laurent



Lanes, Volumes, Timings
3: St Laurent & Transitway

2031 Future Total
PM Peak Hour

Lane Group	WBL	WBR	NBT	NBR	SBL	SBT
Lane Configurations	↔	↔	↑↑↑	↔	↔	↑↑↑
Traffic Volume (vph)	40	20	2006	45	0	1338
Future Volume (vph)	40	20	2006	45	0	1338
Satd. Flow (prot)	914	0	4649	0	1745	4718
Fit Permitted	0.968					
Satd. Flow (perm)	914	0	4649	0	1745	4718
Satd. Flow (RTOR)	1		6			
Lane Group Flow (vph)	60	0	2051	0	0	1338
Turn Type	Prot		NA		Perm	NA
Protected Phases	8		2			6
Permitted Phases					6	
Detector Phase	8		2		6	6
Switch Phase						
Minimum Initial (s)	5.0		10.0		10.0	10.0
Minimum Split (s)	29.5		30.0		24.0	24.0
Total Split (s)	29.5		30.5		30.5	30.5
Total Split (%)	49.2%		50.8%		50.8%	50.8%
Yellow Time (s)	3.3		3.7		3.7	3.7
All-Red Time (s)	2.2		2.3		2.3	2.3
Lost Time Adjust (s)	0.0		0.0		0.0	0.0
Total Lost Time (s)	5.5		6.0		6.0	6.0
Lead/Lag						
Lead-Lag Optimize?						
Recall Mode	None		C-Max		C-Max	C-Max
Act Effct Green (s)	9.5		46.2		46.2	46.2
Actuated g/C Ratio	0.16		0.77		0.77	0.77
v/c Ratio	0.41		0.57		0.37	0.37
Control Delay	29.9		9.9		4.3	4.3
Queue Delay	0.0		0.0		0.0	0.0
Total Delay	29.9		9.9		4.3	4.3
LOS	C		A		A	A
Approach Delay	29.9		9.9		4.3	4.3
Approach LOS	C		A		A	A
Queue Length 50th (m)	6.0		76.4		29.7	29.7
Queue Length 95th (m)	14.1		125.4		44.9	44.9
Internal Link Dist (m)	43.2		196.1		117.1	117.1
Turn Bay Length (m)						
Base Capacity (vph)	366		3578		3630	3630
Starvation Cap Reductn	0		0		0	0
Spillback Cap Reductn	0		0		0	0
Storage Cap Reductn	0		0		0	0
Reduced v/c Ratio	0.16		0.57		0.37	0.37

Intersection Summary

Cycle Length: 60
Actuated Cycle Length: 60
Offset: 28 (47%), Referenced to phase 2:NBT and 6:SBTL, Start of Green
Natural Cycle: 65
Control Type: Actuated-Coordinated

Lanes, Volumes, Timings
3: St Laurent & Transitway

2031 Future Total
PM Peak Hour

Maximum v/c Ratio: 0.57	Intersection LOS: A
Intersection Signal Delay: 8.1	ICU Level of Service B
Intersection Capacity Utilization 55.7%	
Analysis Period (min) 15	

Splits and Phases: 3: St Laurent & Transitway

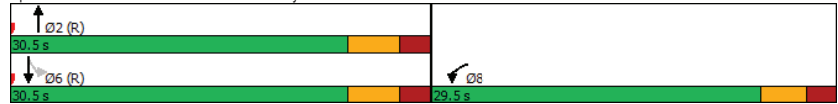

Lanes, Volumes, Timings
4: Hwy 417 EB Off-Ramp & St Laurent

2031 Future Total
PM Peak Hour

Lane Group	EBL	EBR	NBL	NBT	SBT	SBR
Lane Configurations	↔↔	↔		↑↑↑	↑↑↑	
Traffic Volume (vph)	787	263	0	1569	856	399
Future Volume (vph)	787	263	0	1569	856	399
Satd. Flow (prot)	3124	1414	0	4764	4265	0
Fit Permitted	0.950					
Satd. Flow (perm)	3124	1376	0	4764	4265	0
Satd. Flow (RTOR)		122			150	
Lane Group Flow (vph)	787	263	0	1569	1255	0
Turn Type	Prot	Perm		NA	NA	
Protected Phases	4			2	6	
Permitted Phases		4				
Detector Phase	4	4		2	6	
Switch Phase						
Minimum Initial (s)	5.0	5.0		10.0	10.0	
Minimum Split (s)	34.5	34.5		24.1	42.1	
Total Split (s)	50.0	50.0		70.0	70.0	
Total Split (%)	41.7%	41.7%		58.3%	58.3%	
Yellow Time (s)	3.3	3.3		3.7	3.7	
All-Red Time (s)	3.2	3.2		2.4	2.4	
Lost Time Adjust (s)	0.0	0.0		0.0	0.0	
Total Lost Time (s)	6.5	6.5		6.1	6.1	
Lead/Lag						
Lead-Lag Optimize?						
Recall Mode	None	None		C-Max	C-Max	
Act Effct Green (s)	36.4	36.4		71.0	71.0	
Actuated g/C Ratio	0.30	0.30		0.59	0.59	
v/c Ratio	0.83	0.52		0.56	0.49	
Control Delay	46.8	20.9		16.6	9.9	
Queue Delay	0.0	0.0		0.0	0.0	
Total Delay	46.8	20.9		16.6	9.9	
LOS	D	C		B	A	
Approach Delay	40.3			16.6	9.9	
Approach LOS	D			B	A	
Queue Length 50th (m)	88.6	26.6		78.2	53.4	
Queue Length 95th (m)	102.5	47.9		105.5	94.1	
Internal Link Dist (m)	73.5			158.0	196.1	
Turn Bay Length (m)						
Base Capacity (vph)	1132	576		2817	2584	
Starvation Cap Reductn	0	0		0	0	
Spillback Cap Reductn	0	0		0	0	
Storage Cap Reductn	0	0		0	0	
Reduced v/c Ratio	0.70	0.46		0.56	0.49	

Intersection Summary

Cycle Length: 120
Actuated Cycle Length: 120
Offset: 40 (33%), Referenced to phase 2:NBT and 6:SBT, Start of Green
Natural Cycle: 80
Control Type: Actuated-Coordinated

Lanes, Volumes, Timings
4: Hwy 417 EB Off-Ramp & St Laurent

2031 Future Total
PM Peak Hour

Maximum v/c Ratio: 0.83	Intersection LOS: C
Intersection Signal Delay: 20.9	ICU Level of Service C
Intersection Capacity Utilization 66.2%	
Analysis Period (min) 15	

Splits and Phases: 4: Hwy 417 EB Off-Ramp & St Laurent

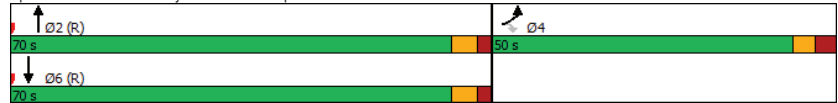

Lanes, Volumes, Timings
5: Cyrville & Ogilvie

2031 Future Total
PM Peak Hour

Lane Group	EBL	EBT	EBR	WBL	WBT	WBR	NBL	NBT	NBR	SBL	SBT	SBR
Lane Configurations		↑↑	↑	↑	↑↑	↑	↑	↑	↑	↑	↑	↑
Traffic Volume (vph)	0	1158	295	44	707	124	153	267	34	134	228	80
Future Volume (vph)	0	1158	295	44	707	124	153	267	34	134	228	80
Satd. Flow (prot)	0	3316	1469	1658	3316	1469	1580	1712	0	1642	1640	0
Fit Permitted			0.194				0.353			0.365		
Satd. Flow (perm)	0	3316	1362	337	3316	1327	585	1712	0	628	1640	0
Satd. Flow (RTOR)			295			124		6			16	
Lane Group Flow (vph)	0	1158	295	44	707	124	153	301	0	134	308	0
Turn Type		NA	Perm	Perm	NA	Perm	Perm	NA		Perm	NA	
Protected Phases		2			6		4		4		8	
Permitted Phases			2	6		6	4			8		
Detector Phase		2	2	6	6	6	4	4		8	8	
Switch Phase												
Minimum Initial (s)		10.0	10.0	10.0	10.0	10.0	10.0	10.0		10.0	10.0	
Minimum Split (s)		32.2	32.2	32.2	32.2	32.2	47.1	47.1		47.1	47.1	
Total Split (s)		70.0	70.0	70.0	70.0	70.0	50.0	50.0		50.0	50.0	
Total Split (%)		58.3%	58.3%	58.3%	58.3%	58.3%	41.7%	41.7%		41.7%	41.7%	
Yellow Time (s)		3.7	3.7	3.7	3.7	3.7	3.7	3.7		3.7	3.7	
All-Red Time (s)		2.5	2.5	2.5	2.5	2.5	3.4	3.4		3.4	3.4	
Lost Time Adjust (s)		0.0	0.0	0.0	0.0	0.0	0.0	0.0		0.0	0.0	
Total Lost Time (s)		6.2	6.2	6.2	6.2	6.2	7.1	7.1		7.1	7.1	
Lead/Lag												
Lead-Lag Optimize?												
Recall Mode		C-Max	C-Max	C-Max	C-Max	C-Max	None	None		None	None	
Act Effct Green (s)		76.8	76.8	76.8	76.8	76.8	29.9	29.9		29.9	29.9	
Actuated g/C Ratio		0.64	0.64	0.64	0.64	0.64	0.25	0.25		0.25	0.25	
v/c Ratio		0.55	0.30	0.20	0.33	0.14	1.06	0.70		0.86	0.73	
Control Delay		6.3	0.7	15.2	11.7	2.6	131.7	47.8		84.1	48.5	
Queue Delay		0.3	0.0	0.0	0.0	0.0	0.0	0.0		0.0	0.0	
Total Delay		6.6	0.7	15.2	11.7	2.6	131.7	47.8		84.1	48.5	
LOS		A	A	B	B	A	F	D		F	D	
Approach Delay		5.4			10.6			76.0			59.3	
Approach LOS		A			B			E			E	
Queue Length 50th (m)		33.4	0.0	4.0	37.0	0.0	~39.4	63.5		30.3	63.6	
Queue Length 95th (m)		m66.4	m1.5	13.7	63.3	8.7	#66.0	80.5		49.1	81.6	
Internal Link Dist (m)		123.7			139.9			44.2			76.2	
Turn Bay Length (m)				53.5		51.0	42.5			77.0		
Base Capacity (vph)		2122	977	215	2122	893	209	615		224	596	
Starvation Cap Reductn		345	0	0	0	0	0	0		0	0	
Spillback Cap Reductn		0	0	0	0	0	0	0		0	0	
Storage Cap Reductn		0	0	0	0	0	0	0		0	0	
Reduced v/c Ratio		0.65	0.30	0.20	0.33	0.14	0.73	0.49		0.60	0.52	

Intersection Summary												
Cycle Length: 120												
Actuated Cycle Length: 120												
Offset: 20 (17%), Referenced to phase 2:EBT and 6:WBTL, Start of Green												
Natural Cycle: 80												
Control Type: Actuated-Coordinated												

Lanes, Volumes, Timings
5: Cyrville & Ogilvie

2031 Future Total
PM Peak Hour

Maximum v/c Ratio: 1.06	Intersection LOS: C
Intersection Signal Delay: 24.1	ICU Level of Service E
Intersection Capacity Utilization 86.2%	
Analysis Period (min) 15	
~ Volume exceeds capacity, queue is theoretically infinite. Queue shown is maximum after two cycles.	
# 95th percentile volume exceeds capacity, queue may be longer. Queue shown is maximum after two cycles.	
m Volume for 95th percentile queue is metered by upstream signal.	

Splits and Phases: 5: Cyrville & Ogilvie

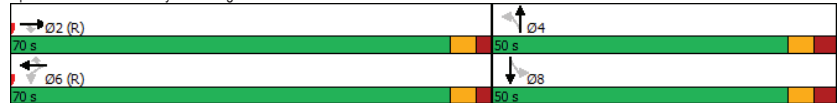

HCM 2010 TWSC
6: Labelle & Lemieux

2031 Future Total
PM Peak Hour

Intersection												
Int Delay, s/veh	5.2											
Movement	EBL	EBT	EBR	WBL	WBT	WBR	NBL	NBT	NBR	SBL	SBT	SBR
Lane Configurations	↔ ↕ ↕ ↕ ↕ ↕ ↕ ↕ ↕ ↕ ↕ ↕ ↕											
Traffic Vol, veh/h	131	0	0	0	0	162	112	320	27	0	0	176
Future Vol, veh/h	131	0	0	0	0	162	112	320	27	0	0	176
Conflicting Peds, #/hr	0	0	0	0	0	0	0	0	0	0	0	0
Sign Control	Stop	Stop	Stop	Stop	Stop	Stop	Free	Free	Free	Free	Free	Free
RT Channelized	-	-	None	-	-	None	-	-	Free	-	-	Yield
Storage Length	0	-	-	-	-	0	-	-	-	-	-	0
Veh in Median Storage, #	-	0	-	-	0	-	-	0	-	-	-	-
Grade, %	-	0	-	-	0	-	-	0	-	-	-	0
Peak Hour Factor	100	100	100	100	100	100	100	100	100	100	100	100
Heavy Vehicles, %	2	2	2	2	2	2	2	2	2	2	2	2
Mvmt Flow	131	0	0	0	0	162	112	320	27	0	0	176

Major/Minor	Minor2	Minor1	Major1
Conflicting Flow All	384	-	-
Stage 1	0	-	-
Stage 2	384	-	-
Critical Hdwy	7.54	-	-
Critical Hdwy Stg 1	-	-	-
Critical Hdwy Stg 2	6.54	-	-
Follow-up Hdwy	3.52	-	-
Pot Cap-1 Maneuver	549	0	0
Stage 1	-	0	0
Stage 2	611	0	0
Platoon blocked, %	-	-	-
Mov Cap-1 Maneuver	445	-	-
Mov Cap-2 Maneuver	445	-	-
Stage 1	-	-	-
Stage 2	496	-	-

Approach	EB	WB	NB
HCM Control Delay, s	16.4	10.2	
HCM LOS	C	B	

Minor Lane/Major Mvmt	NBL	NBT	EBLn1WBLn1
Capacity (veh/h)	-	-	445 857
HCM Lane V/C Ratio	-	-	0.294 0.189
HCM Control Delay (s)	-	-	16.4 10.2
HCM Lane LOS	-	-	C B
HCM 95th %tile Q(veh)	-	-	1.2 0.7

HCM 2010 TWSC
7: Access/Joseph Cyr & Lemieux

2031 Future Total
PM Peak Hour

Intersection												
Int Delay, s/veh	3.2											
Movement	EBL	EBT	EBR	WBL	WBT	WBR	NBL	NBT	NBR	SBL	SBT	SBR
Lane Configurations	↔		↔		↔		↔		↔		↔	
Traffic Vol, veh/h	112	159	14	2	562	38	12	4	0	17	6	101
Future Vol, veh/h	112	159	14	2	562	38	12	4	0	17	6	101
Conflicting Peds, #/hr	0	0	0	0	0	0	0	0	0	0	0	0
Sign Control	Free	Free	Free	Free	Free	Free	Stop	Stop	Stop	Stop	Stop	Stop
RT Channelized	-	-	None	-	-	None	-	-	None	-	-	None
Storage Length	22	-	-	-	-	-	-	-	-	-	-	-
Veh in Median Storage, #	-	0	-	-	0	-	-	0	-	-	0	-
Grade, %	-	0	-	-	0	-	-	0	-	-	0	-
Peak Hour Factor	100	100	100	100	100	100	100	100	100	100	100	100
Heavy Vehicles, %	2	2	2	2	4	3	2	2	2	2	2	3
Mvmt Flow	112	159	14	2	562	38	12	4	0	17	6	101

Major/Minor	Major1	Major2	Minor1	Minor2
Conflicting Flow All	600	0	0	173
Stage 1	-	-	-	-
Stage 2	-	-	-	-
Critical Hdwy	4.13	-	-	4.13
Critical Hdwy Stg 1	-	-	-	-
Critical Hdwy Stg 2	-	-	-	-
Follow-up Hdwy	2.219	-	-	2.219
Pot Cap-1 Maneuver	975	-	-	1402
Stage 1	-	-	-	-
Stage 2	-	-	-	-
Platoon blocked, %	-	-	-	-
Mov Cap-1 Maneuver	975	-	-	1402
Mov Cap-2 Maneuver	-	-	-	-
Stage 1	-	-	-	-
Stage 2	-	-	-	-

Approach	EB	WB	NB	SB
HCM Control Delay, s	3.6	0	20.3	15.2
HCM LOS			C	C

Minor Lane/Major Mvmt	NBLn1	EBL	EBT	EBR	WBL	WBT	WBR	SBLn1
Capacity (veh/h)	252	975	-	-	1402	-	-	477
HCM Lane V/C Ratio	0.063	0.115	-	-	0.001	-	-	0.26
HCM Control Delay (s)	20.3	9.2	-	-	7.6	0	-	15.2
HCM Lane LOS	C	A	-	-	A	A	-	C
HCM 95th %tile Q(veh)	0.2	0.4	-	-	0	-	-	1

HCM 2010 TWSC
8: Joseph Cyr & Cyrville

2031 Future Total
PM Peak Hour

Intersection												
Int Delay, s/veh	3											
Movement	EBL	EBT	EBR	WBL	WBT	WBR	NBL	NBT	NBR	SBL	SBT	SBR
Lane Configurations	↔		↔		↔		↔		↔		↔	
Traffic Vol, veh/h	0	492	58	53	409	1	43	5	82	1	1	1
Future Vol, veh/h	0	492	58	53	409	1	43	5	82	1	1	1
Conflicting Peds, #/hr	11	0	3	3	0	11	1	0	3	3	0	1
Sign Control	Free	Free	Free	Free	Free	Free	Stop	Stop	Stop	Stop	Stop	Stop
RT Channelized	-	-	None	-	-	None	-	-	None	-	-	None
Storage Length	-	-	-	-	-	-	-	-	-	-	-	-
Veh in Median Storage, #	-	0	-	-	0	-	-	0	-	-	0	-
Grade, %	-	0	-	-	0	-	-	0	-	-	0	-
Peak Hour Factor	100	100	100	100	100	100	100	100	100	100	100	100
Heavy Vehicles, %	2	3	2	4	2	2	2	2	2	2	2	2
Mvmt Flow	0	492	58	53	409	1	43	5	82	1	1	1

Major/Minor	Major1	Major2	Minor1	Minor2
Conflicting Flow All	421	0	0	553
Stage 1	-	-	-	-
Stage 2	-	-	-	-
Critical Hdwy	4.12	-	-	4.14
Critical Hdwy Stg 1	-	-	-	-
Critical Hdwy Stg 2	-	-	-	-
Follow-up Hdwy	2.218	-	-	2.236
Pot Cap-1 Maneuver	1138	-	-	1007
Stage 1	-	-	-	-
Stage 2	-	-	-	-
Platoon blocked, %	-	-	-	-
Mov Cap-1 Maneuver	1128	-	-	1005
Mov Cap-2 Maneuver	-	-	-	-
Stage 1	-	-	-	-
Stage 2	-	-	-	-

Approach	EB	WB	NB	SB
HCM Control Delay, s	0	1	22.7	21.1
HCM LOS			C	C

Minor Lane/Major Mvmt	NBLn1	EBL	EBT	EBR	WBL	WBT	WBR	SBLn1
Capacity (veh/h)	331	1128	-	-	1005	-	-	227
HCM Lane V/C Ratio	0.393	-	-	-	0.053	-	-	0.013
HCM Control Delay (s)	22.7	0	-	-	8.8	0	-	21.1
HCM Lane LOS	C	A	-	-	A	A	-	C
HCM 95th %tile Q(veh)	1.8	0	-	-	0.2	-	-	0

Appendix K

Turning Templates

HSU ENTERING SITE WITH STRAIGHT THROUGH MOVEMENT FROM JOSEPH CYR STREET.

Notes:

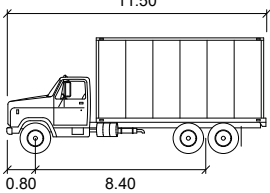

HSU

Width : 2.60 meters
Track : 2.60
Lock to Lock Time : 6.0
Steering Angle : 40.0

05	Updated Site Plan	BB	2022-12-05
04	Updated Site Plan	AN	2022-09-12
03	Updated Site Plan	BB	2022-09-01
02	Updated Site Plan	BB	2022-05-20
01	Issued for Review	BB	2022-04-21
REV:	DESCRIPTION:	BY:	DATE:
STATUS:			



CGH Transportation
6 Plaza Court
Ottawa, ON
K2H 7W1
(343) 999-9117

CLIENT: 1209 St. Laurent Partnership Inc.

ARCHITECT:

SITE: 1209 St. Laurent Blvd.

TITLE: Turning Movement Analysis
HSU Entrance Movement

SCALE AT A3:	DATE:	DRAWN:	CHECKED:
NTS	2022-12-05	BB	AL
PROJECT NO:	DRAWING NO:	REVISION:	
2022-026	001	05	

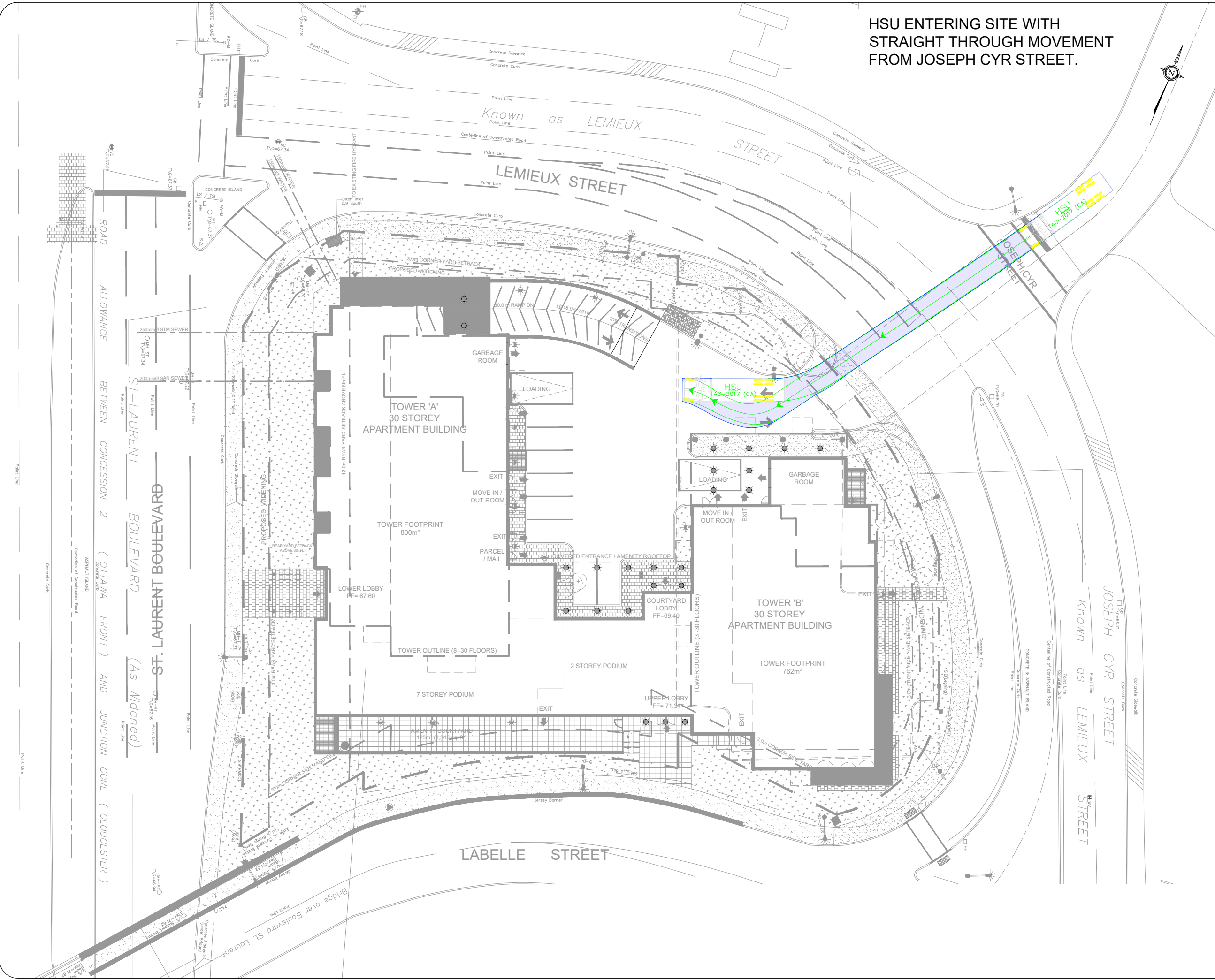

STEP 1: HSU TO TOWER 1 GARBAGE AFTER ENTERING SITE FROM JOSEPH CYR STREET.

Notes:

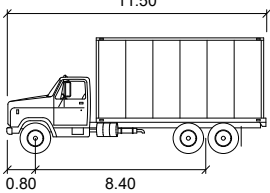

HSU

	units
Width	: 2.60
Track	: 2.60
Lock to Lock Time	: 6.0
Steering Angle	: 40.0

05	Updated Site Plan	BB	2022-12-05
04	Updated Site Plan	AN	2022-09-12
03	Updated Site Plan	BB	2022-09-01
02	Updated Site Plan	BB	2022-05-20
01	Issued for Review	BB	2022-04-21
REV:	DESCRIPTION:	BY:	DATE:
STATUS:			



CGH Transportation
 6 Plaza Court
 Ottawa, ON
 K2H 7W1
 (343) 999-9117

CLIENT: 1209 St. Laurent Partnership Inc.

ARCHITECT:

SITE: 1209 St. Laurent Blvd.

TITLE: Turning Movement Analysis
 HSU Movements (2)

SCALE AT A3:	DATE:	DRAWN:	CHECKED:
NTS	2022-12-05	BB	AL
PROJECT NO:	DRAWING NO:	REVISION:	
2022-026	002	05	

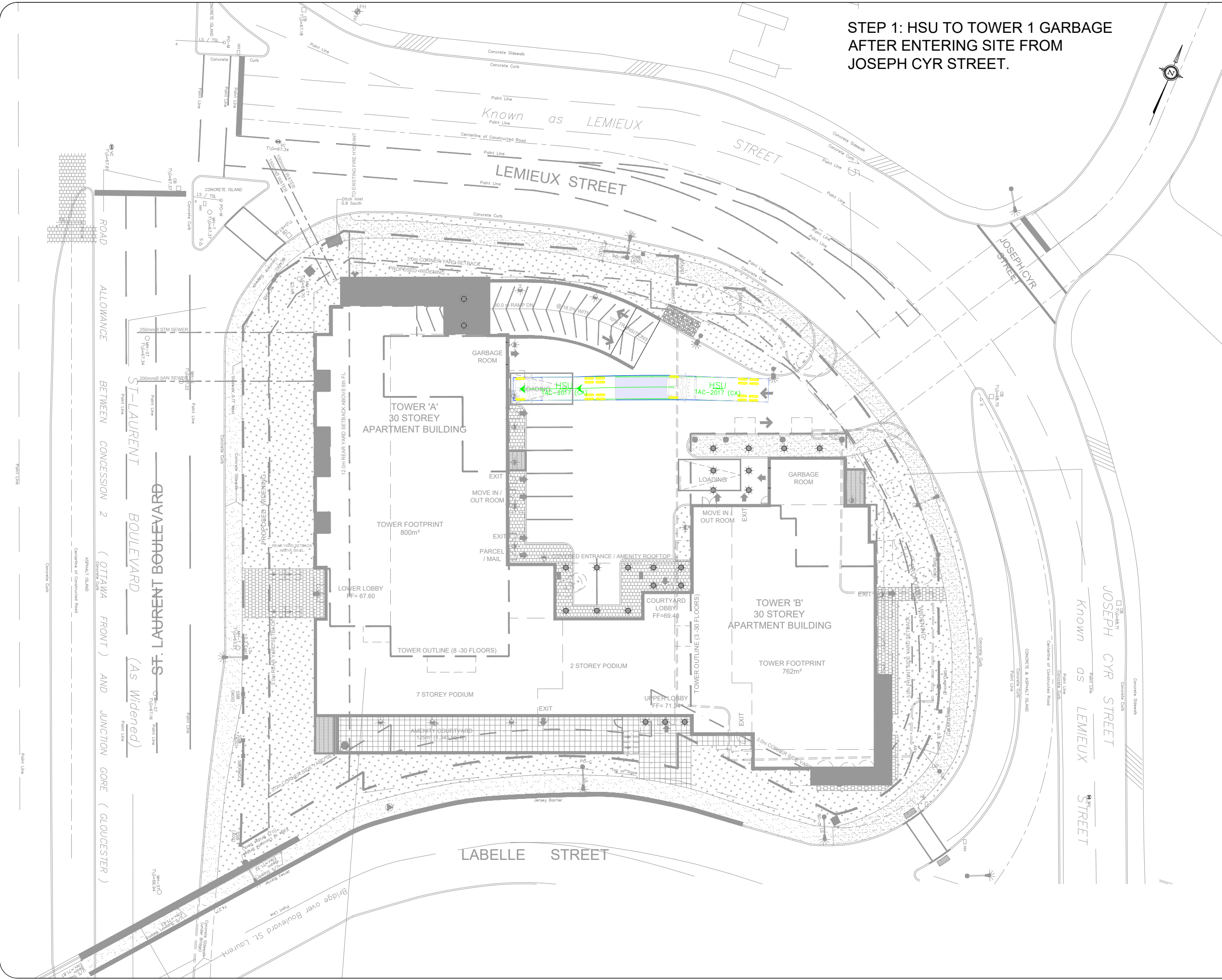

STEP 2: HSU GETTING TURNED AROUND AFTER COLLECTING GARBAGE TO EXIT (REVERSE, LEFT TURN).

Notes:

HSU

Width : 2.60 meters
Track : 2.60
Lock to Lock Time : 6.0
Steering Angle : 40.0

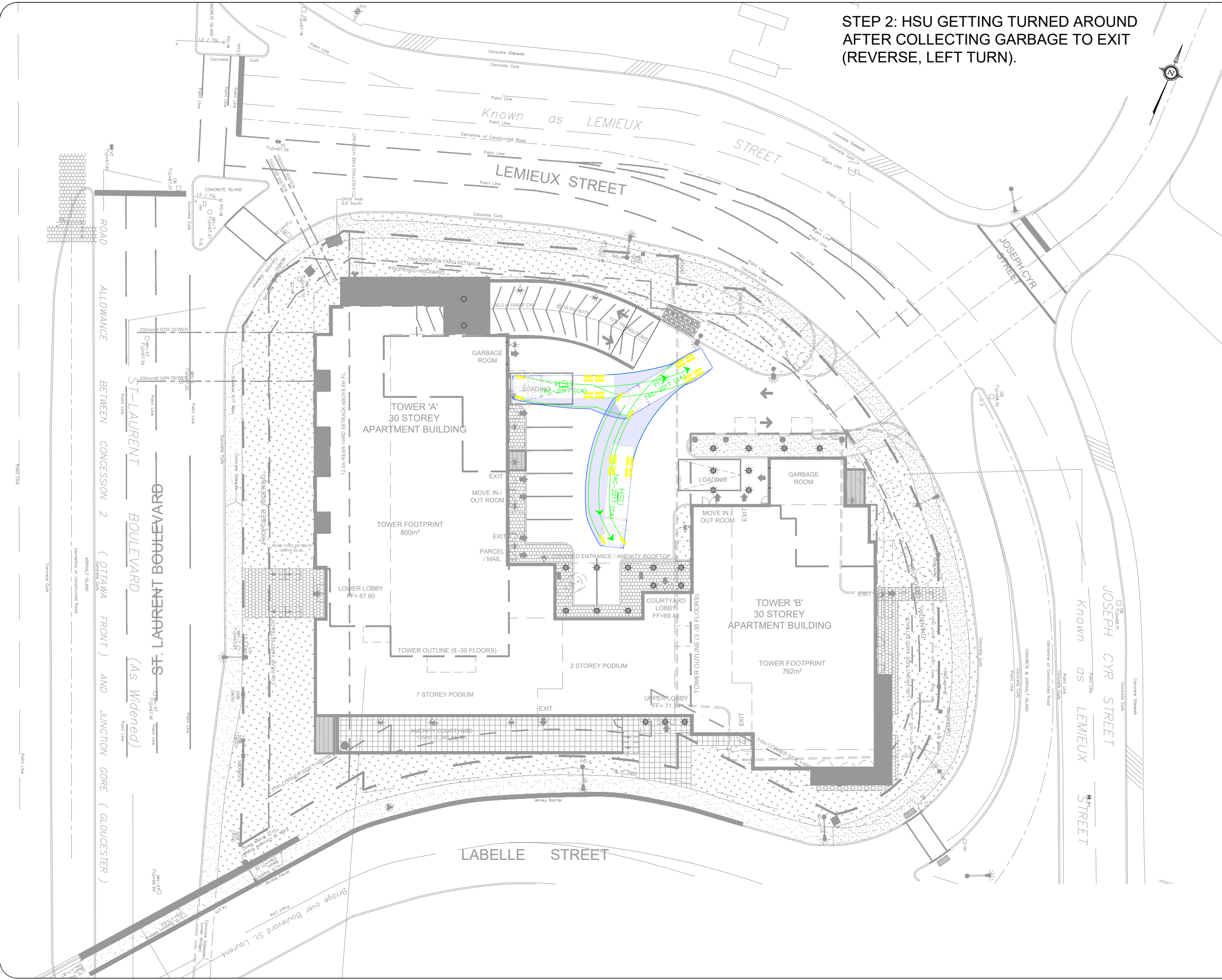

05	Updated Site Plan	BB	2022-12-05
04	Updated Site Plan	AN	2022-09-12
03	Updated Site Plan	BB	2022-09-01
02	Updated Site Plan	BB	2022-05-20
01	Issued for Review	BB	2022-04-21
REV:	DESCRIPTION:	BY:	DATE:
STATUS:			

CGH Transportation
6 Plaza Court
Ottawa, ON
K2H 7W1
(343) 999-9117

CLIENT: 1209 St. Laurent Partnership Inc.

ARCHITECT:

SITE: 1209 St. Laurent Blvd.

TITLE: Turning Movement Analysis
HSU Movements (3)

SCALE AT A3: NTS	DATE: 2022-12-05	DRAWN: BB	CHECKED: AL
PROJECT NO: 2022-026	DRAWING NO: 003	REVISION: 05	

Step 3: HSU COMPLETING TURN AROUND MOVEMENT AND EXITING THE SITE.

Notes:

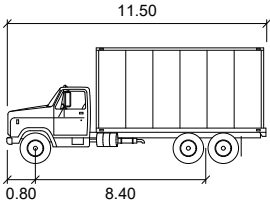

HSU

Width : 2.60 meters
 Track : 2.60
 Lock to Lock Time : 6.0
 Steering Angle : 40.0

05	Updated Site Plan	BB	2022-12-05
04	Updated Site Plan	AN	2022-09-12
03	Updated Site Plan	BB	2022-09-01
02	Updated Site Plan	BB	2022-05-20
01	Issued for Review	BB	2022-04-21
REV:	DESCRIPTION:	BY:	DATE:
STATUS:			

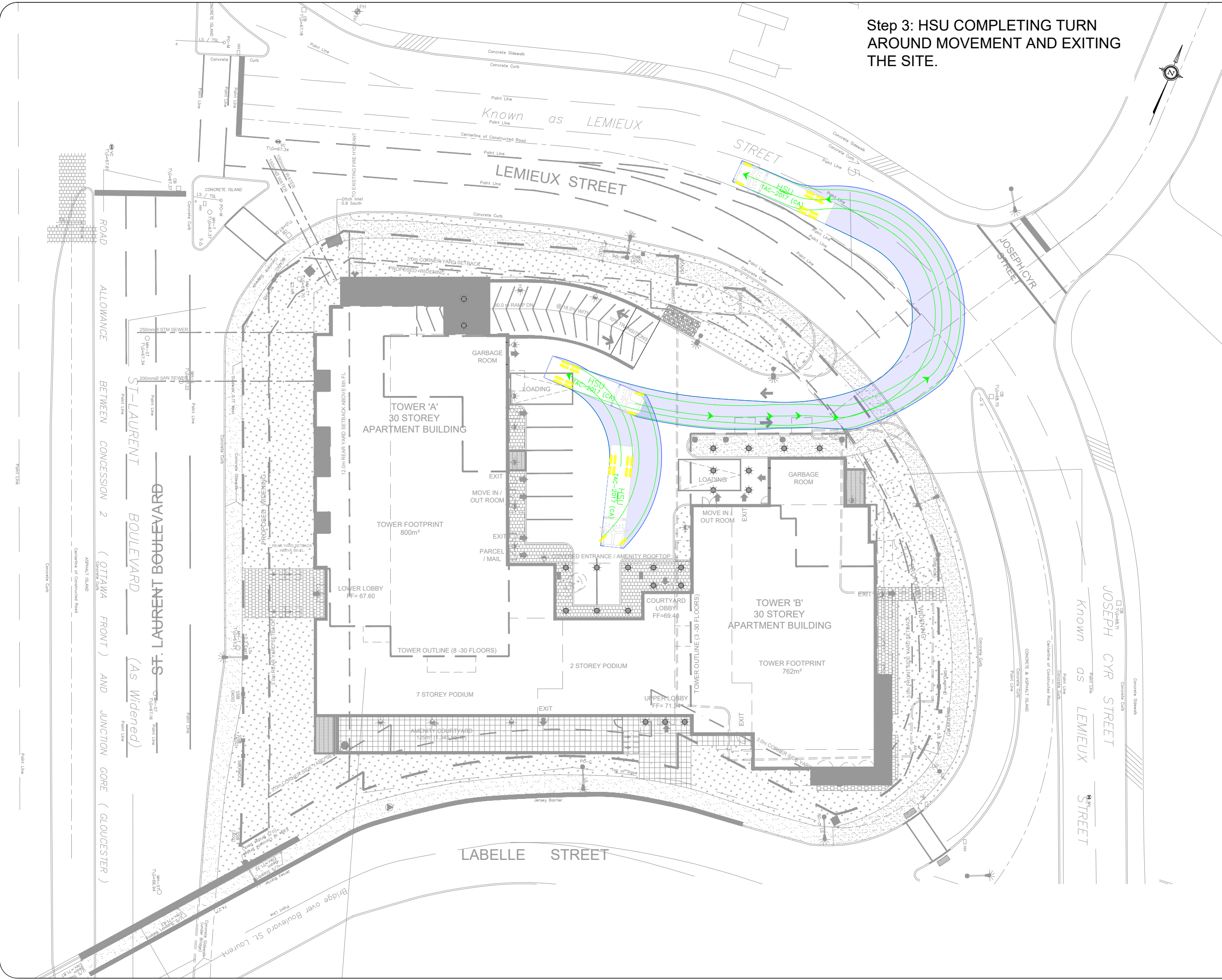

CGH Transportation
 6 Plaza Court
 Ottawa, ON
 K2H 7W1
 (343) 999-9117

CLIENT: 1209 St. Laurent Partnership Inc.

ARCHITECT:

SITE: 1209 St. Laurent Blvd.

TITLE: Turning Movement Analysis
 HSU Movements (5)

SCALE AT A3: NTS	DATE: 2022-12-05	DRAWN: BB	CHECKED: AL
PROJECT NO: 2022-026	DRAWING NO: 004	REVISION: 05	

MSU ENTERING SITE WITH
INBOUND RIGHT MOVEMENT.

Notes:

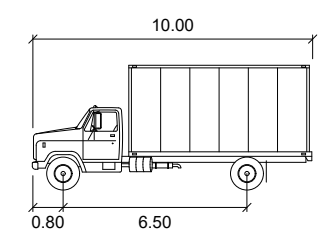

MSU
Width : 2.60
Track : 2.60
Lock to Lock Time : 6.0
Steering Angle : 40.2

05	Updated Site Plan	BB	2022-12-05
04	Updated Site Plan	AN	2022-09-12
03	Updated Site Plan	BB	2022-09-01
02	Updated Site Plan	BB	2022-05-20
01	Issued for Review	BB	2022-04-21
REV:	DESCRIPTION:	BY:	DATE:
STATUS:			

CGH Transportation
6 Plaza Court
Ottawa, ON
K2H 7W1
(343) 999-9117

CLIENT: 1209 St. Laurent Partnership Inc.
ARCHITECT:

SITE: 1209 St. Laurent Blvd.

TITLE: Turning Movement Analysis
MSU Entrance Movement

SCALE AT A3: NTS	DATE: 2022-12-05	DRAWN: BB	CHECKED: AL
PROJECT NO: 2022-026	DRAWING NO: 005	REVISION: 05	

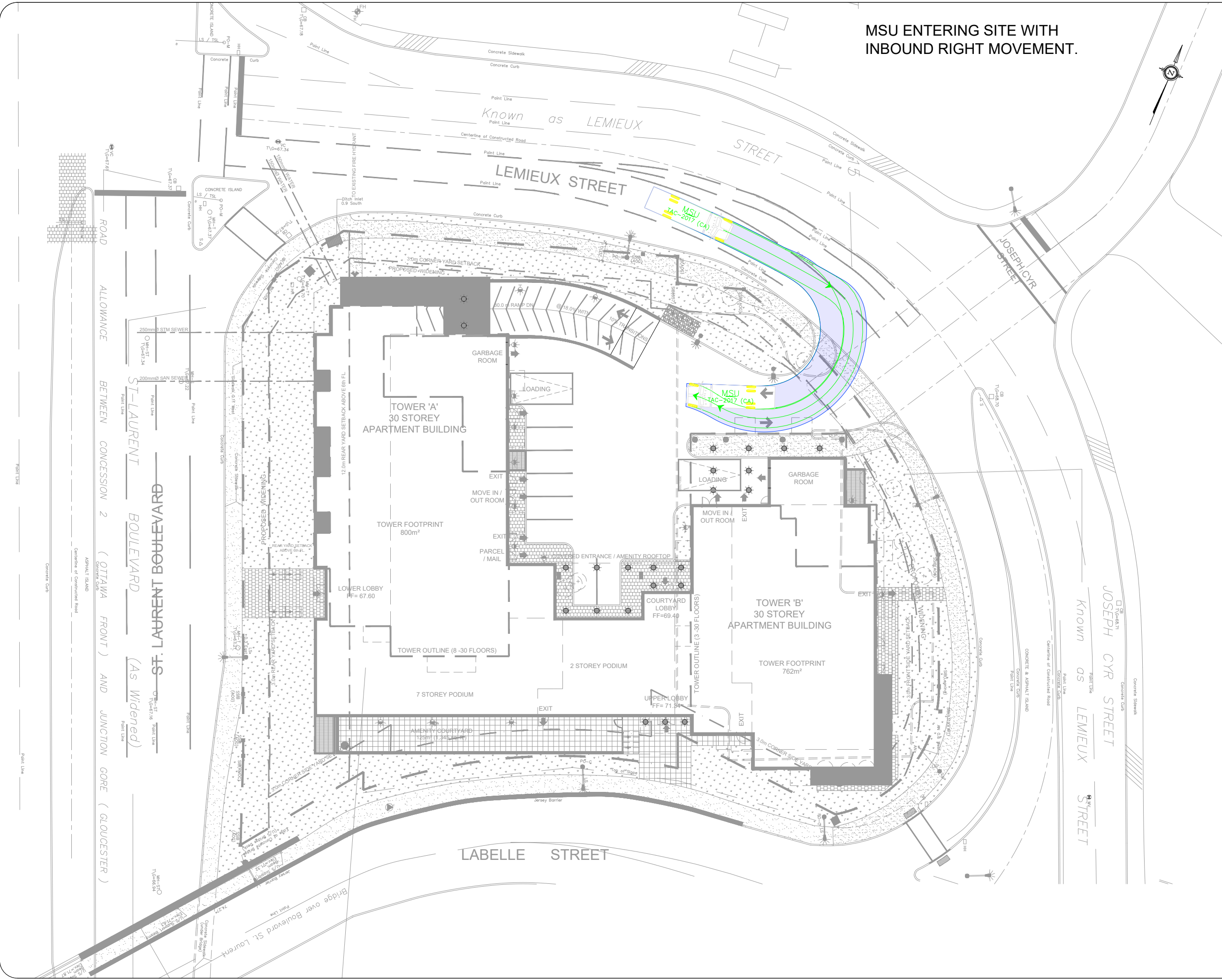

MSU TO TOWER 1 LOADING SPACE.

Notes:

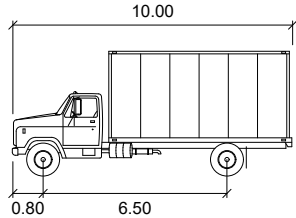

MSU

	units
Width	: 2.60
Track	: 2.60
Lock to Lock Time	: 6.0
Steering Angle	: 40.2

05	Updated Site Plan	BB	2022-12-05
04	Updated Site Plan	AN	2022-09-12
03	Updated Site Plan	BB	2022-09-01
02	Updated Site Plan	BB	2022-05-20
01	Issued for Review	BB	2022-04-21
REV:	DESCRIPTION:	BY:	DATE:
STATUS:			



CGH Transportation
 6 Plaza Court
 Ottawa, ON
 K2H 7W1
 (343) 999-9117

CLIENT: 1209 St. Laurent Partnership Inc.

ARCHITECT:

SITE:
 1209 St. Laurent Blvd.

TITLE: Turning Movement Analysis
 MSU Movements (2)

SCALE AT A3:	DATE:	DRAWN:	CHECKED:
NTS	2022-12-05	BB	AL
PROJECT NO:	DRAWING NO:	REVISION:	
2022-026	006	05	

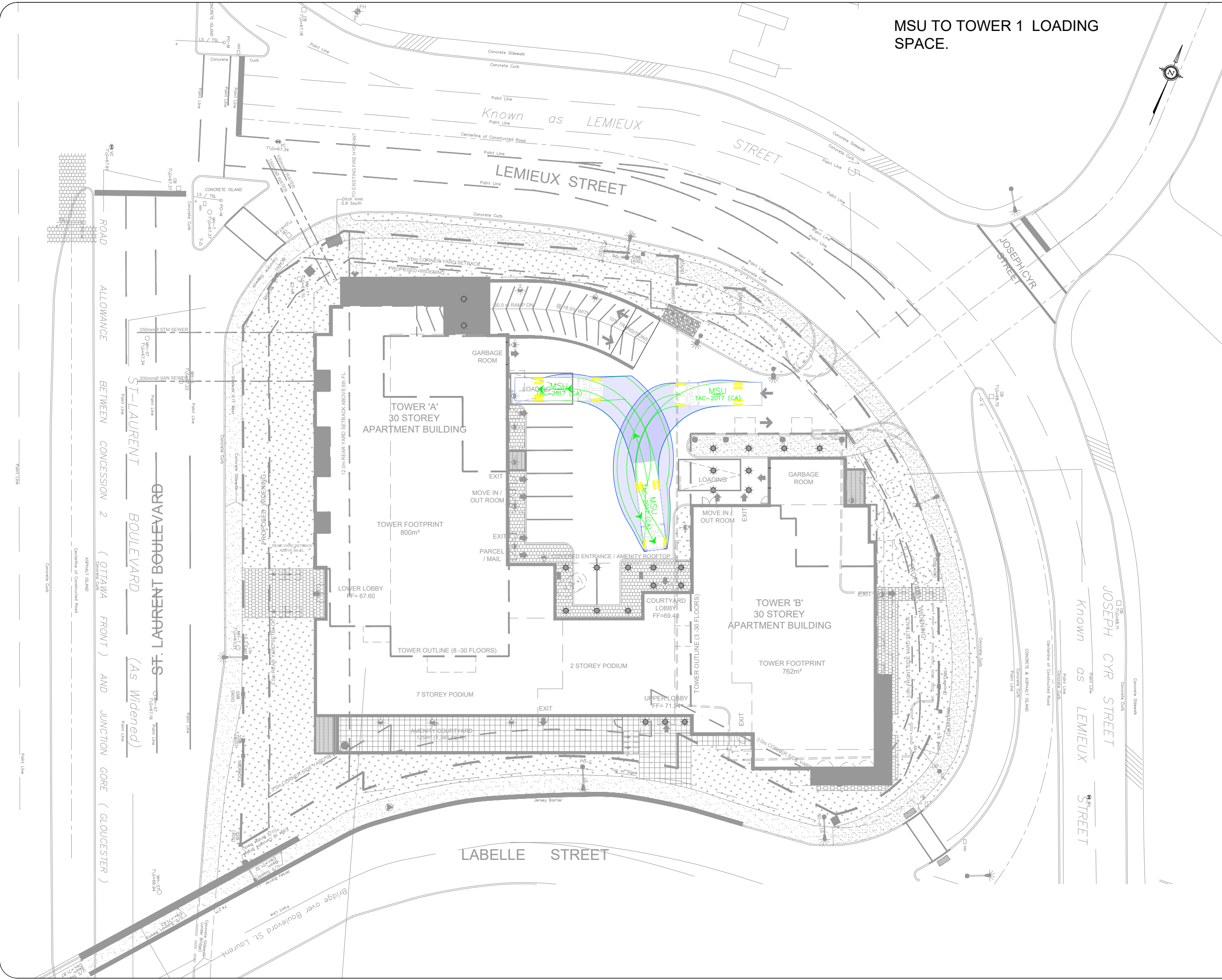

MSU TO TOWER 2 LOADING SPACE.

Notes:

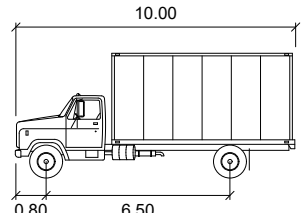

MSU

	meters
Width	: 2.60
Track	: 2.60
Lock to Lock Time	: 6.0
Steering Angle	: 40.2

05	Updated Site Plan	BB	2022-12-05
04	Updated Site Plan	AN	2022-09-12
03	Updated Site Plan	BB	2022-09-01
02	Updated Site Plan	BB	2022-05-20
01	Issued for Review	BB	2022-04-21
REV:	DESCRIPTION:	BY:	DATE:
STATUS:			

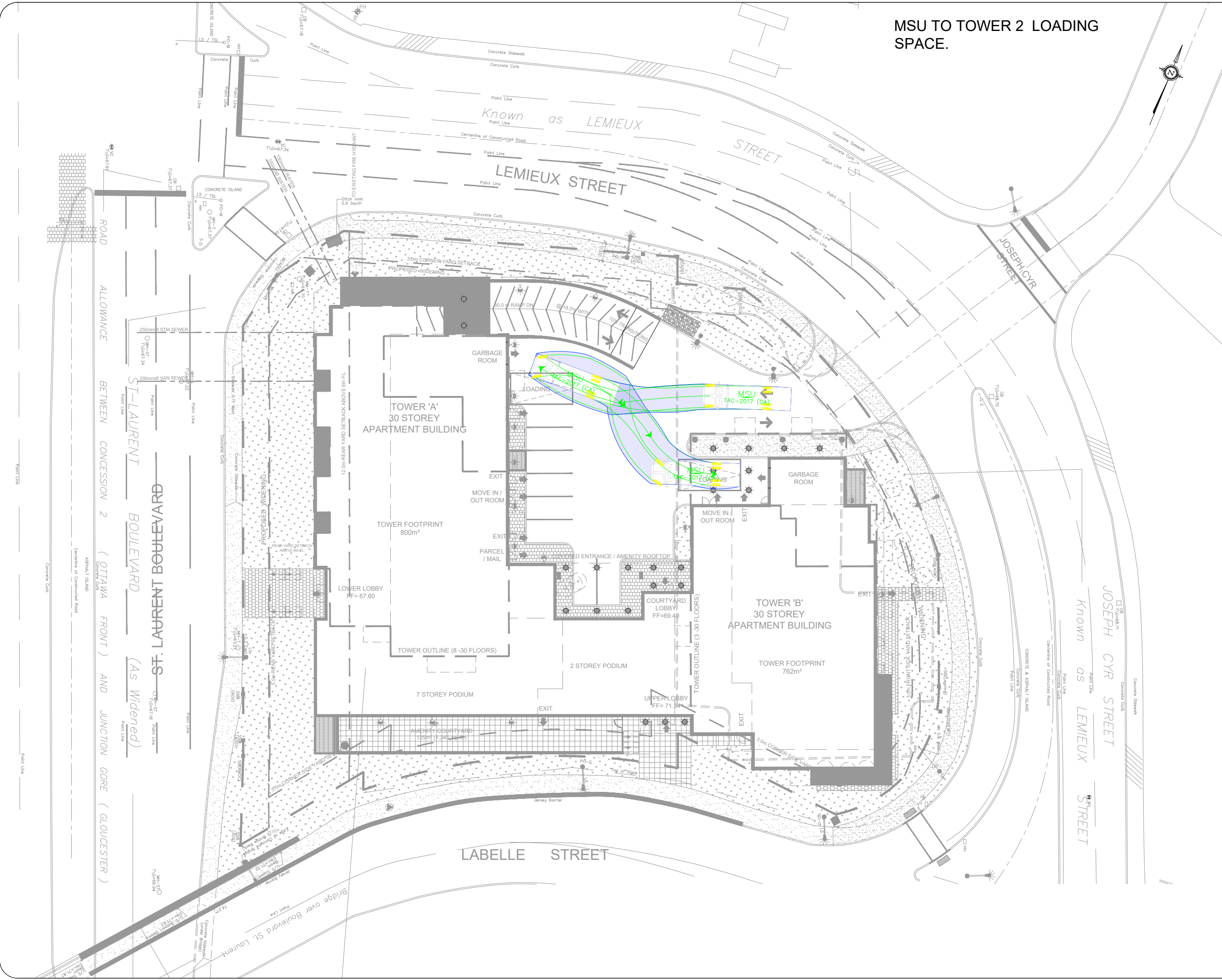

CGH Transportation
 6 Plaza Court
 Ottawa, ON
 K2H 7W1
 (343) 999-9117

CLIENT: 1209 St. Laurent Partnership Inc.

ARCHITECT:

SITE: 1209 St. Laurent Blvd.

TITLE: Turning Movement Analysis
 MSU Movements (4)

SCALE AT A3:	DATE:	DRAWN:	CHECKED:
NTS	2022-12-05	BB	AL
PROJECT NO:	DRAWING NO:	REVISION:	
2022-026	007	05	

**MSU EXITING TOWER 2
LOADING SPACE.**

Notes:

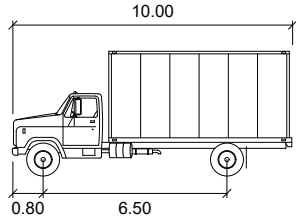

MSU

	meters
Width	: 2.60
Track	: 2.60
Lock to Lock Time	: 6.0
Steering Angle	: 40.2

05	Updated Site Plan	BB	2022-12-05
04	Updated Site Plan	AN	2022-09-12
03	Updated Site Plan	BB	2022-09-01
02	Updated Site Plan	BB	2022-05-20
01	Issued for Review	BB	2022-04-21
REV:	DESCRIPTION:	BY:	DATE:
STATUS:			

CGH Transportation
6 Plaza Court
Ottawa, ON
K2H 7W1
(343) 999-9117

CLIENT: 1209 St. Laurent Partnership Inc.

ARCHITECT:

SITE:
1209 St. Laurent Blvd.

TITLE:
**Turning Movement Analysis
MSU Movements (5)**

SCALE AT A3: NTS	DATE: 2022-12-05	DRAWN: BB	CHECKED: AL
PROJECT NO: 2022-026	DRAWING NO: 008	REVISION: 05	

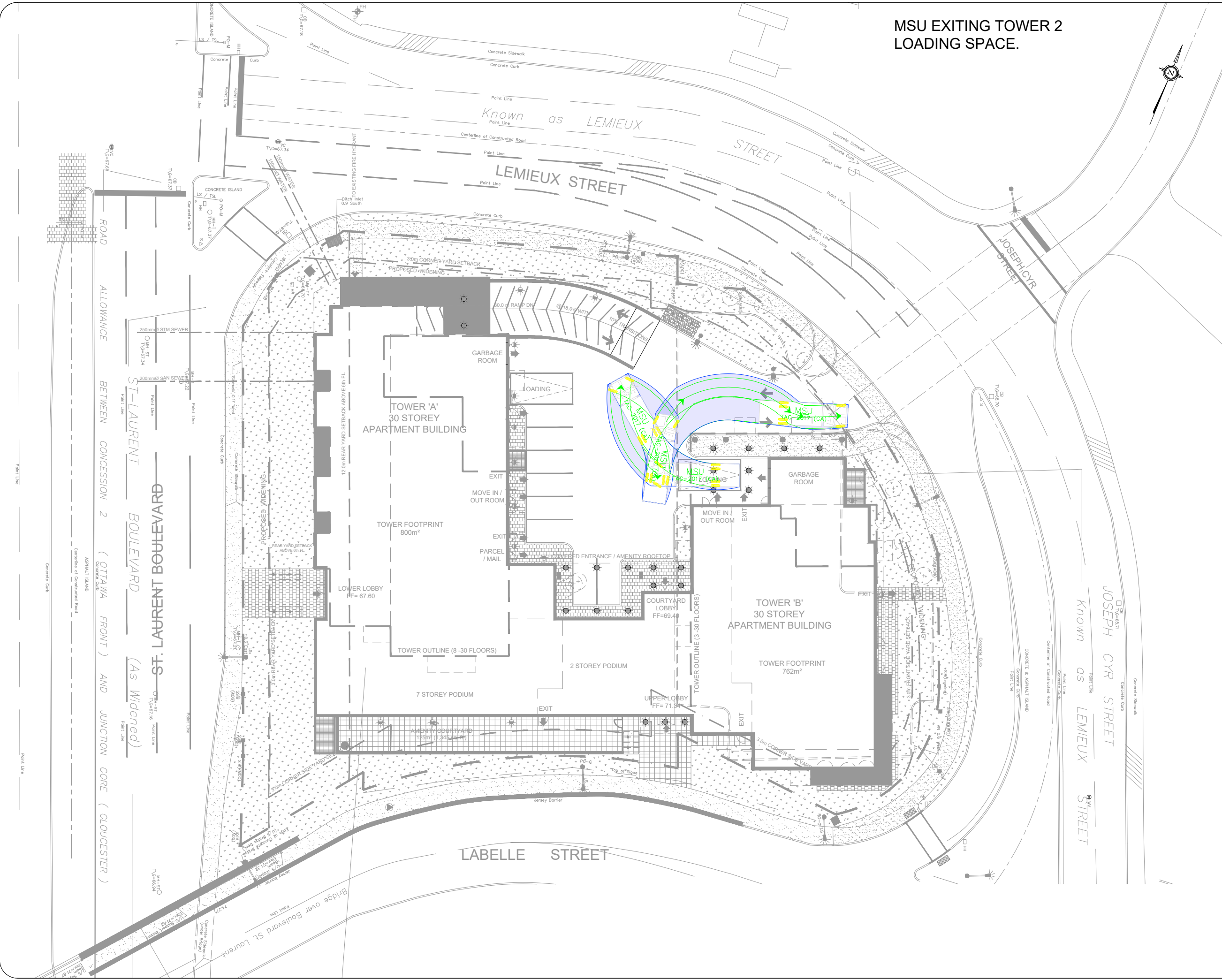

MSU EXITING SITE WITH LEFT TURN.

Notes:

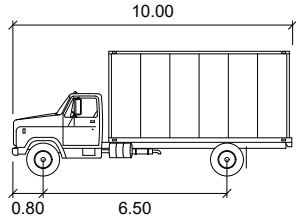

MSU

	units
Width	: 2.60
Track	: 2.60
Lock to Lock Time	: 6.0
Steering Angle	: 40.2

05	Updated Site Plan	BB	2022-12-05
04	Updated Site Plan	AN	2022-09-12
03	Updated Site Plan	BB	2022-09-01
02	Updated Site Plan	BB	2022-05-20
01	Issued for Review	BB	2022-04-21
REV:	DESCRIPTION:	BY:	DATE:
STATUS:			

CGH Transportation
 6 Plaza Court
 Ottawa, ON
 K2H 7W1
 (343) 999-9117

CLIENT: 1209 St. Laurent Partnership Inc.

ARCHITECT:

SITE: 1209 St. Laurent Blvd.

TITLE: Turning Movement Analysis
MSU Movements (6)

SCALE AT A3:	DATE:	DRAWN:	CHECKED:
NTS	2022-12-05	BB	AL
PROJECT NO:	DRAWING NO:	REVISION:	
2022-026	009	05	

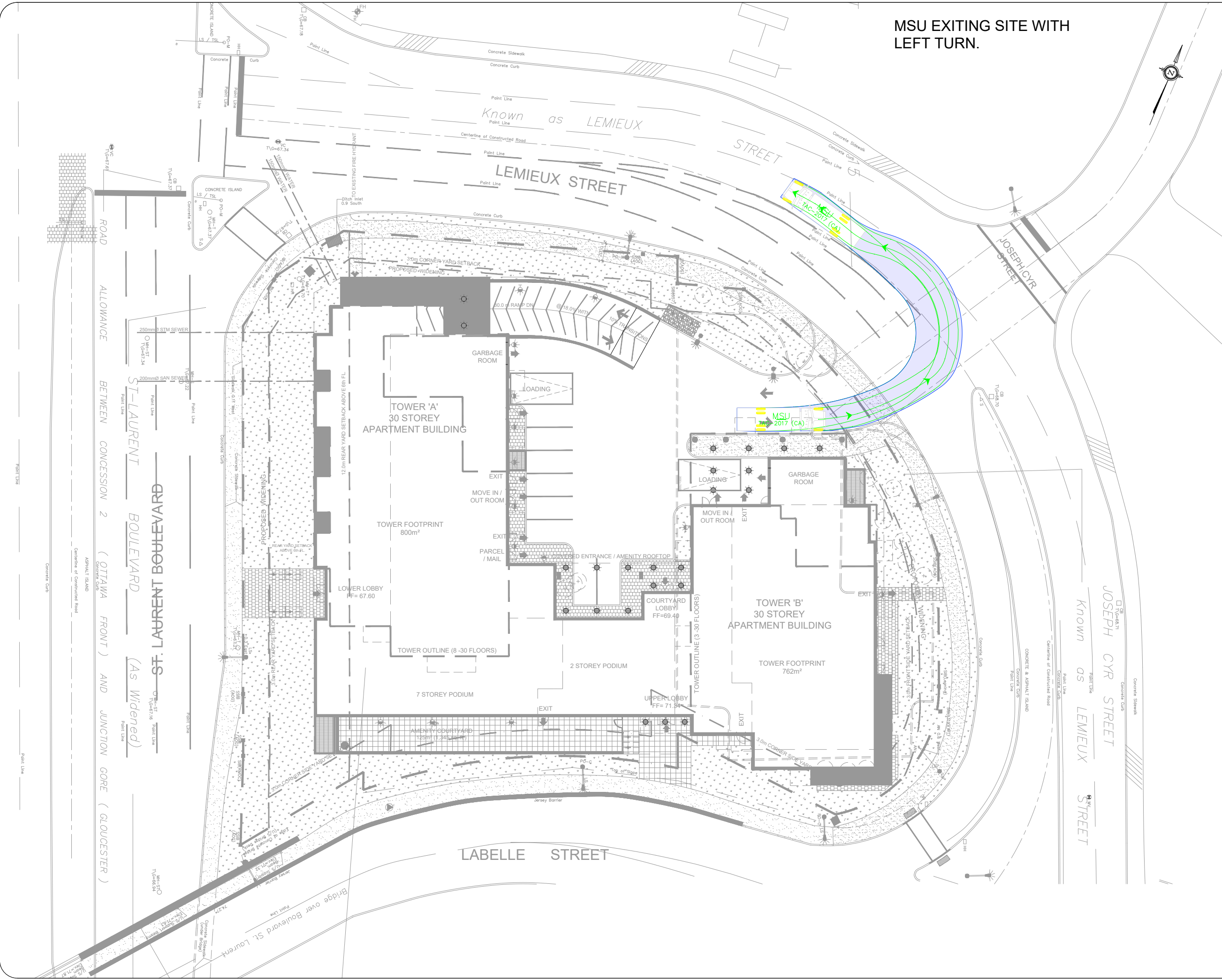

PARA TRANSPORT VEHICLE
PULLING UP TO LOBBY ENTRANCE
(OPTION 1).

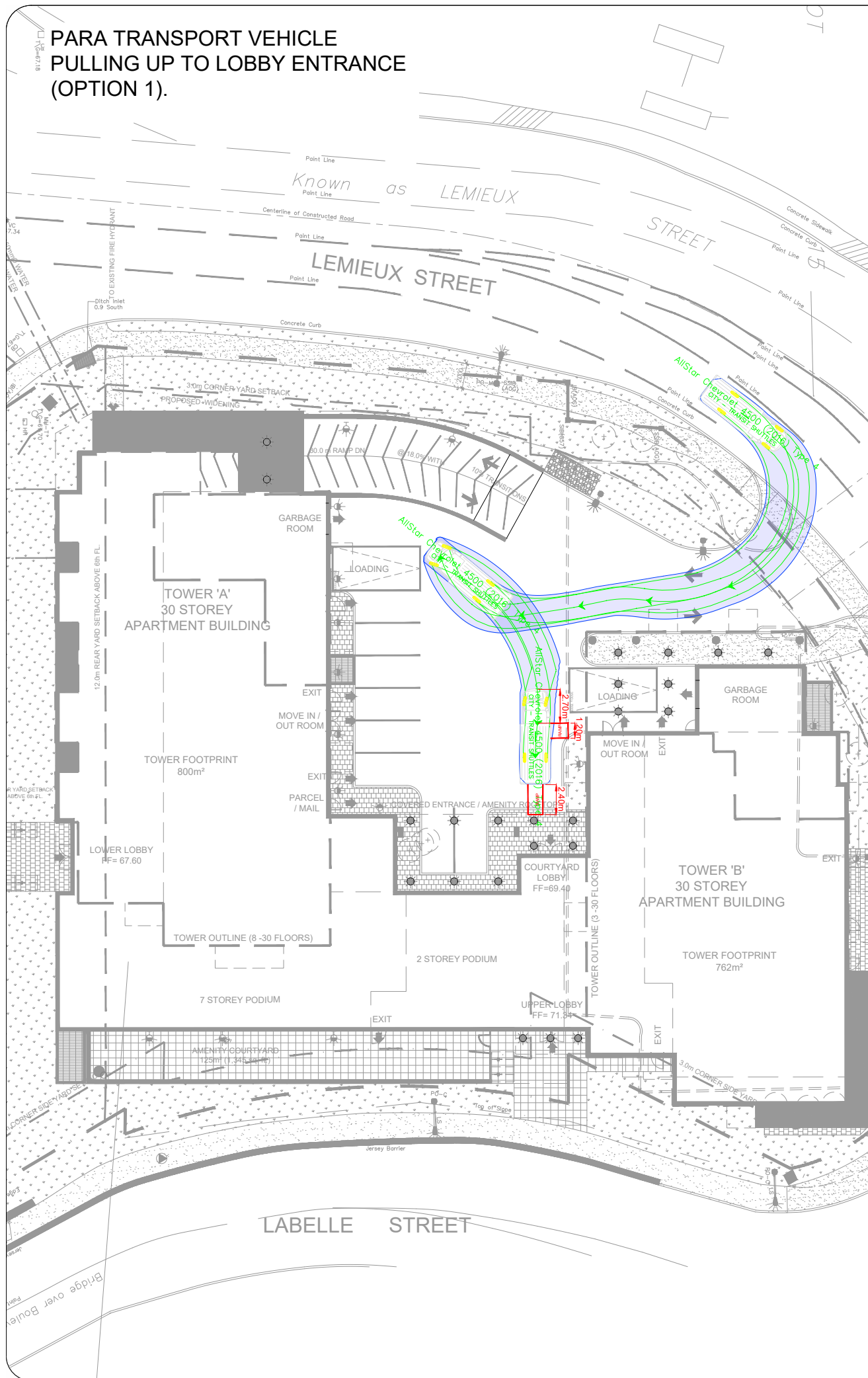

PARA TRANSPORT VEHICLE
PULLING UP TO LOBBY ENTRANCE
(OPTION 2).

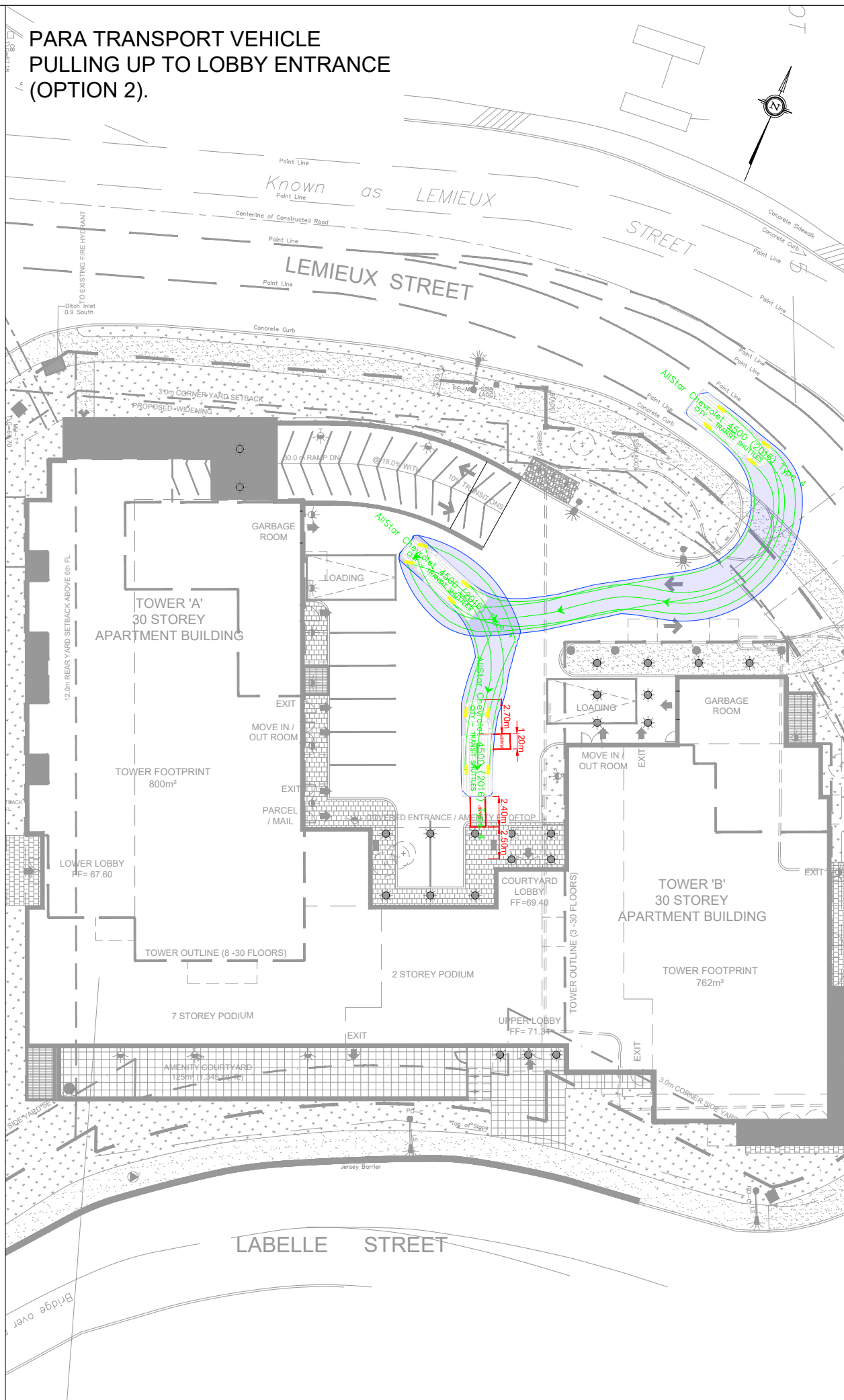

Notes:

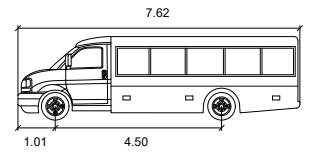

AllStar Chevrolet 4500 (2016) Type 4

Width	: 2.44	meters
Track	: 1.96	
Lock to Lock Time	: 6.0	
Steering Angle	: 34.2	

05	Updated Site Plan	BB	2022-12-05
04	Updated Site Plan	AN	2022-09-12
03	Updated Site Plan	BB	2022-09-01
02	Updated Site Plan	BB	2022-05-20
01	Issued for Review	BB	2022-04-21
REV:	DESCRIPTION:	BY:	DATE:
STATUS:			

CGH Transportation
6 Plaza Court
Ottawa, ON
K2H 7W1
(343) 999-9117

CLIENT: 1209 St. Laurent Partnership Inc.

ARCHITECT:

SITE:
1209 St. Laurent Blvd.

TITLE:
Turning Movement Analysis
Para Transport Entrance

SCALE AT A3:	DATE:	DRAWN:	CHECKED:
NTS	2022-12-05	BB	AL
PROJECT NO:	DRAWING NO:	REVISION:	
2022-026	010	05	

PARA TRANSPORT VEHICLE
EXITING SITE.

Notes:

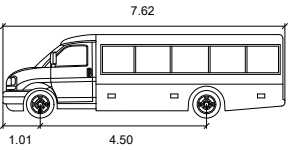

AllStar Chevrolet 4500 (2016) Type 4
 meters
 Width : 2.44
 Track : 1.96
 Lock to Lock Time : 6.0
 Steering Angle : 34.2

05	Updated Site Plan	BB	2022-12-05
04	Updated Site Plan	AN	2022-09-12
03	Updated Site Plan	BB	2022-09-01
02	Updated Site Plan	BB	2022-05-20
01	Issued for Review	BB	2022-04-21
REV:	DESCRIPTION:	BY:	DATE:
STATUS:			

CGH Transportation
 6 Plaza Court
 Ottawa, ON
 K2H 7W1
 (343) 999-9117

CLIENT: 1209 St. Laurent Partnership Inc.

ARCHITECT:

SITE: 1209 St. Laurent Blvd.

TITLE: Turning Movement Analysis
Para Transport Exit

SCALE AT A3: NTS	DATE: 2022-12-05	DRAWN: BB	CHECKED: AL
PROJECT NO: 2022-026	DRAWING NO: 011	REVISION: 05	

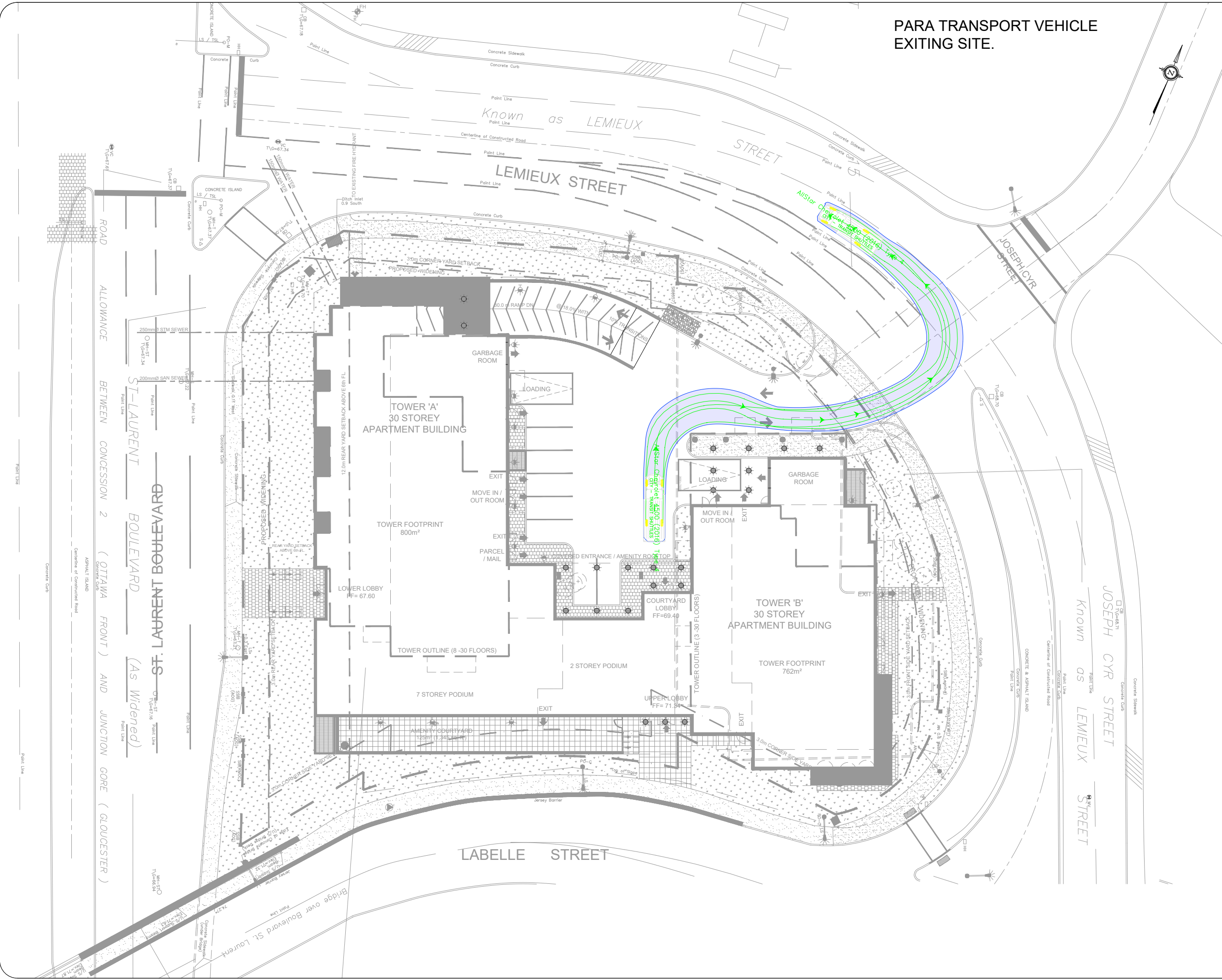

Appendix L

MMLOS Analysis

Multi-Modal Level of Service - Intersections Form

Consultant
Scenario
Comments

CGH Transportation Inc.	Project Date
Existing/Future	

1209 St Laurent Boulevard & 1200 Lemieux Street
12/7/2022

INTERSECTIONS		St Laurent Boulevard at Coventry Road/Ogilvie Road				St Laurent Boulevard at Lemieux Street				St Laurent Boulevard at Transitway Access				St Laurent Boulevard at Hwy 417 EB Off-Ramp				Cyrville Road at Ogilvie Road					
Crossing Side		NORTH	SOUTH	EAST	WEST	NORTH	SOUTH	EAST	WEST	NORTH	SOUTH	EAST	WEST	NORTH	SOUTH	EAST	WEST	NORTH	SOUTH	EAST	WEST		
Pedestrian	Lanes	8	8	7	7	8	4	7	4	8	7	8	4	5	6	10+	10+	5	6	10+	10+		
	Median	No Median - 2.4 m	No Median - 2.4 m	No Median - 2.4 m	No Median - 2.4 m	No Median - 2.4 m	No Median - 2.4 m	No Median - 2.4 m	No Median - 2.4 m	No Median - 2.4 m	No Median - 2.4 m	No Median - 2.4 m	No Median - 2.4 m	No Median - 2.4 m	No Median - 2.4 m	No Median - 2.4 m	No Median - 2.4 m	No Median - 2.4 m	No Median - 2.4 m	No Median - 2.4 m	No Median - 2.4 m	No Median - 2.4 m	
	Conflicting Left Turns	Protected	Protected	Protected	Protected	No left turn / Prohib.	Permissive	Permissive	Permissive	Permissive	No left turn / Prohib.	Permissive	Permissive	No left turn / Prohib.	Permissive	Permissive	Permissive	No left turn / Prohib.	Permissive	Permissive	Permissive	Permissive	
	Conflicting Right Turns	Permissive or yield control	Permissive or yield control	Permissive or yield control	Permissive or yield control	Permissive or yield control	Permissive or yield control	Permissive or yield control	Permissive or yield control	Permissive or yield control	No right turn	Permissive or yield control	Permissive or yield control	No right turn	Permissive or yield control	Permissive or yield control	Permissive or yield control	Permissive or yield control	Permissive or yield control	Permissive or yield control	Permissive or yield control	Permissive or yield control	
	Right Turns on Red (RTorR)?	RTOR allowed	RTOR allowed	RTOR allowed	RTOR allowed	RTOR allowed	RTOR allowed	RTOR allowed	RTOR allowed	RTOR allowed	RTOR prohibited	RTOR allowed	RTOR allowed	RTOR allowed	RTOR allowed	RTOR prohibited	RTOR allowed	RTOR allowed	RTOR allowed	RTOR allowed	RTOR allowed	RTOR allowed	
	Ped Signal Leading Interval?	No	No	No	No	No	No	No	No	No	No	No	No	No	No	No	No	No	No	No	No	No	No
	Right Turn Channel	Conv't without Receiving Lane	Conventional with Receiving Lane	Conventional with Receiving Lane	Conv't without Receiving Lane	Conv't without Receiving Lane	Conventional with Receiving Lane	Conventional with Receiving Lane	Conv't without Receiving Lane	Conv't without Receiving Lane	No Right Turn	Conv't without Receiving Lane	Conv't without Receiving Lane	No Right Turn	No Channel	No Channel	No Channel	Conventional with Receiving Lane	No Channel	No Channel	No Channel	Conventional with Receiving Lane	
	Corner Radius	15-25m	15-25m	15-25m	15-25m	15-25m	15-25m	15-25m	15-25m	15-25m	No Right Turn	>25m	>25m	No Right Turn	15-25m	>25m	5-10m	5-10m	15-25m	>25m	5-10m	5-10m	
	Crosswalk Type	Std transverse markings	Std transverse markings	Std transverse markings	Std transverse markings	Std transverse markings	Std transverse markings	Std transverse markings	Std transverse markings	Std transverse markings	Std transverse markings	Std transverse markings	Std transverse markings	Std transverse markings	Std transverse markings	Std transverse markings	Std transverse markings	Std transverse markings	Std transverse markings	Std transverse markings	Std transverse markings	Std transverse markings	
	PETSI Score	-2	-5	11	14	-5	52	14	5	14	5	17	79	43	17	44	43	43	17	44	43	43	
Ped. Exposure to Traffic LOS	F	F	F	F	F	-	D	-	-	F	F	-	-	F	-	B	E	F	#N/A	#N/A			
Cycle Length	120	120	120	120	130	130	130	65	65	130	130	130	130	130	130	130	130	130	130	130	130		
Effective Walk Time	7	7	7	7	66	21	12	7	60	3	10	10	57	57	57	57	57	57	57	57			
Average Pedestrian Delay	S3	S3	S3	S3	18	46	22	26	19	62	S5	S5	20	20	20	20	20	20	20	20			
Pedestrian Delay LOS	E	E	E	E	B	-	E	-	-	C	C	-	-	B	-	F	E	E	C	C			
Level of Service	F	F	F	F	F	-	E	-	-	F	F	-	-	F	-	F	E	F	#N/A	#N/A			
Approach From		NORTH	SOUTH	EAST	WEST	NORTH	SOUTH	EAST	WEST	NORTH	SOUTH	EAST	WEST	NORTH	SOUTH	EAST	WEST	NORTH	SOUTH	EAST	WEST		
Bicycle	Bicycle Lane Arrangement on Approach	Mixed Traffic	Mixed Traffic	Curb Bike Lane, Cycletrack or MUP	Curb Bike Lane, Cycletrack or MUP	Mixed Traffic	Mixed Traffic	Mixed Traffic	Mixed Traffic	Mixed Traffic	Mixed Traffic	Mixed Traffic	Mixed Traffic	Mixed Traffic	Mixed Traffic	Mixed Traffic	Mixed Traffic	Mixed Traffic	Curb Bike Lane, Cycletrack or MUP	Curb Bike Lane, Cycletrack or MUP	Curb Bike Lane, Cycletrack or MUP		
	Right Turn Lane Configuration	≤ 50 m	Not Applicable	Not Applicable	Not Applicable	> 50 m	≤ 50 m	Not Applicable	Not Applicable	Not Applicable	Not Applicable	Not Applicable	Not Applicable	Not Applicable	Not Applicable	Not Applicable	Not Applicable	Not Applicable	Not Applicable	Not Applicable	Not Applicable		
	Right Turning Speed	>25 km/h	Not Applicable	Not Applicable	Not Applicable	>25 km/h	>25 km/h	Not Applicable	Not Applicable	Not Applicable	Not Applicable	Not Applicable	Not Applicable	Not Applicable	Not Applicable	Not Applicable	Not Applicable	Not Applicable	Not Applicable	Not Applicable	Not Applicable		
	Cyclist relative to RT motorists	E	#N/A	Not Applicable	Not Applicable	#N/A	F	E	-	-	#N/A	#N/A	-	-	#N/A	#N/A	-	#N/A	#N/A	Not Applicable	Not Applicable	Not Applicable	
	Separated or Mixed Traffic	Mixed Traffic	Mixed Traffic	Separated	Separated	Mixed Traffic	Mixed Traffic	Mixed Traffic	Mixed Traffic	Mixed Traffic	Mixed Traffic	Mixed Traffic	Mixed Traffic	Mixed Traffic	Mixed Traffic	Mixed Traffic	Mixed Traffic	Mixed Traffic	Mixed Traffic	Separated	Separated	Separated	
	Left Turn Approach	≥ 2 lanes crossed	≥ 2 lanes crossed	≥ 2 lanes crossed	≥ 2 lanes crossed	≥ 2 lanes crossed	≥ 2 lanes crossed	≥ 2 lanes crossed	≥ 2 lanes crossed	≥ 2 lanes crossed	≥ 2 lanes crossed	≥ 2 lanes crossed	≥ 2 lanes crossed	≥ 2 lanes crossed	One lane crossed	1 lane crossed	1 lane crossed	≥ 2 lanes crossed	≥ 2 lanes crossed	≥ 2 lanes crossed	≥ 2 lanes crossed		
Operating Speed	≥ 60 km/h	≥ 60 km/h	≥ 60 km/h	≥ 60 km/h	≥ 60 km/h	> 50 to < 60 km/h	≥ 60 km/h	≥ 60 km/h	≥ 60 km/h	≥ 60 km/h	≥ 60 km/h	≥ 60 km/h	≥ 60 km/h	≥ 60 km/h	≥ 60 km/h	≥ 60 km/h	≥ 60 km/h	≥ 60 km/h	≥ 60 km/h	≥ 60 km/h	≥ 60 km/h		
Left Turning Cyclist	F	F	F	F	F	-	F	-	-	F	-	-	-	F	-	E	-	E	-	F			
Level of Service	F	#N/A	F	F	#N/A	-	F	-	-	#N/A	#N/A	-	-	#N/A	#N/A	-	#N/A	#N/A	E	-	F		
Average Signal Delay		> 40 sec	> 40 sec	> 40 sec	> 40 sec	≤ 20 sec	≤ 20 sec	≤ 20 sec	≤ 20 sec	≤ 10 sec	≤ 20 sec	≤ 20 sec	≤ 20 sec	≤ 20 sec	≤ 30 sec	≤ 30 sec	≤ 30 sec	≤ 30 sec	≤ 30 sec	≤ 30 sec	≤ 30 sec		
Level of Service	F	F	-	F	C	C	-	-	-	B	C	-	-	C	D	-	-	-	-	-			
Truck	Effective Corner Radius	10 - 15 m	> 15 m	> 15 m	> 15 m	> 15 m	> 15 m	> 15 m	> 15 m	> 15 m	10 - 15 m	> 15 m	> 15 m	> 15 m	10 - 15 m	10 - 15 m	> 15 m	> 15 m	> 15 m	> 15 m			
	Number of Receiving Lanes on Departure from Intersection	≥ 2	≥ 2	≥ 2	≥ 2	≥ 2	≥ 2	≥ 2	≥ 2	1	≥ 2	≥ 2	≥ 2	≥ 2	≥ 2	≥ 2	≥ 2	≥ 2	≥ 2	≥ 2			
	Level of Service	B	A	A	A	-	A	A	-	-	C	B	-	-	-	-	A	B	B	A	A		
Auto	Volume to Capacity Ratio	0.91 - 1.00				0.61 - 0.70				0.61 - 0.70				0.61 - 0.70				0.61 - 0.70					
	Level of Service	E				B				B				B				B					

Multi-Modal Level of Service - Segments Form

Consultant Scenario Comments	CGH Transportation Inc.	Project Date	1209 St Laurent Boulevard & 1200 Lemieux Street
	Existing/Future		12/7/2022

SEGMENTS		Lemieux Existing	Lemieux Future	St Laurent Existing/Future
Pedestrian	Sidewalk Width	no sidewalk	≥ 2 m	≥ 2 m
	Boulevard Width	n/a	0.5 - 2 m	< 0.5
	Avg Daily Curb Lane Traffic Volume	≤ 3000	≤ 3000	> 3000
	Operating Speed	> 50 to 60 km/h	> 50 to 60 km/h	> 60 km/h
	On-Street Parking	no	no	no
	Exposure to Traffic PLoS	F	A	F
	Effective Sidewalk Width			
Pedestrian Volume				
Crowding PLoS	-	-	-	
Level of Service	-	-	-	
Bicycle	Type of Cycling Facility	Mixed Traffic	Mixed Traffic	Mixed Traffic
	Number of Travel Lanes	4-5 lanes total	4-5 lanes total	≥ 6 lanes total
	Operating Speed	≥ 60 km/h	≥ 60 km/h	≥ 60 km/h
	# of Lanes & Operating Speed LoS	F	F	F
	Bike Lane (+ Parking Lane) Width			
	Bike Lane Width LoS	-	-	-
	Bike Lane Blockages			
	Blockage LoS	-	-	-
	Median Refuge Width (no median = < 1.8 m)	< 1.8 m refuge	< 1.8 m refuge	< 1.8 m refuge
	No. of Lanes at Unsignalized Crossing	≤ 3 lanes	≤ 3 lanes	≤ 3 lanes
Sidestreet Operating Speed	≤ 40 km/h	≤ 40 km/h	≤ 40 km/h	
Unsignalized Crossing - Lowest LoS	A	A	A	
Level of Service	F	F	F	
Transit	Facility Type			Mixed Traffic
	Friction or Ratio Transit:Posted Speed			Vt/Vp ≥ 0.8
	Level of Service	-	-	D
Truck	Truck Lane Width	> 3.7 m	> 3.7 m	> 3.7 m
	Travel Lanes per Direction	1	1	> 1
	Level of Service	B	B	A

Appendix M

Sight Line Review

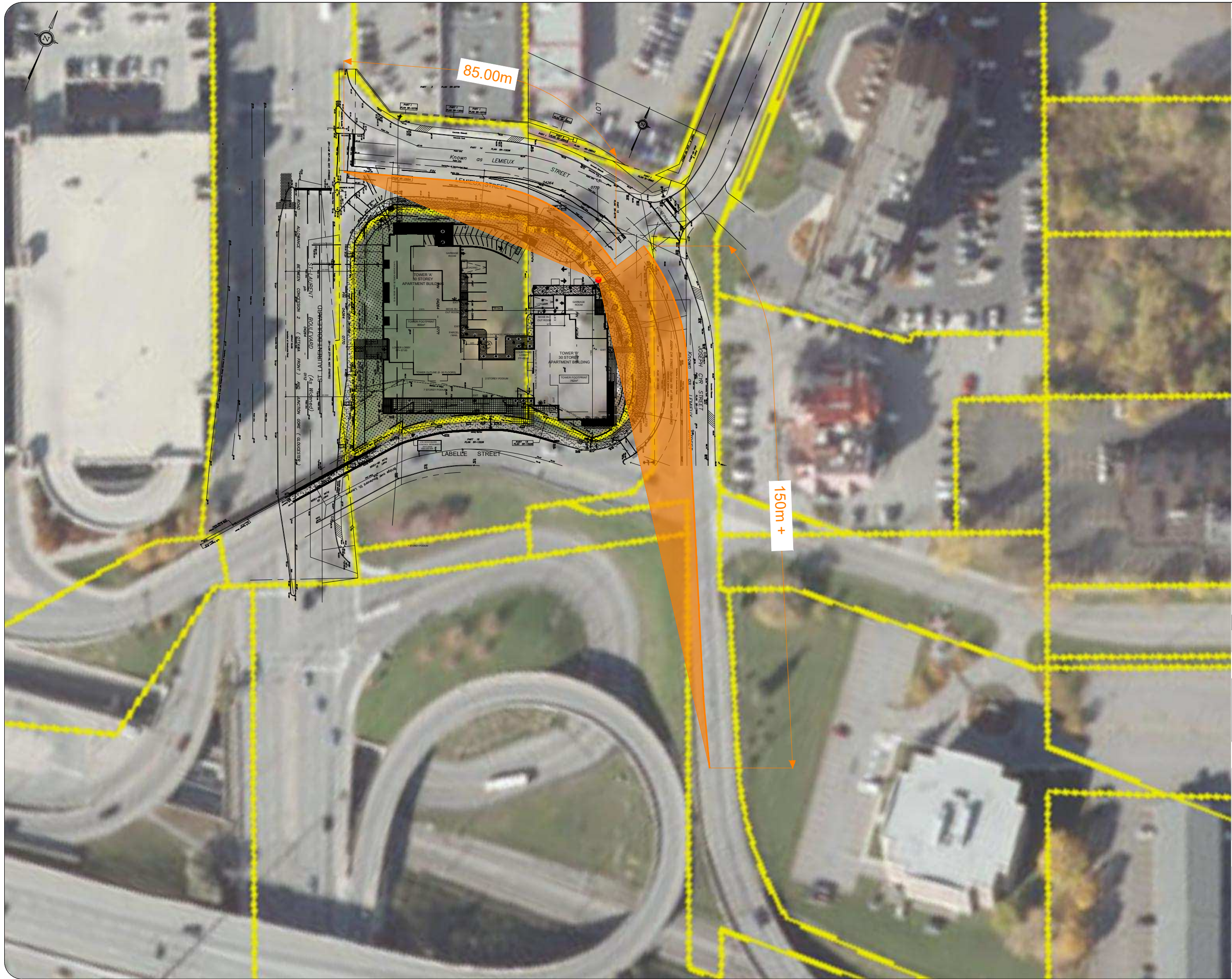

Notes:

LEGEND

- AVAILABLE SIGHT DISTANCE
- DECISION POINT

NOTES:
 HSU DRIVERS EYE HEIGHT AT APPROX.
 70.1m

BOTTOM OF SECOND FLOOR APPROX.
 72.6m

04	Issued for Review	BB	2022-12-05
03	Issued for Review	AN	2022-09-12
02	Issued for Review	BB	2022-09-01
01	Issued for Review	BB	2022-05-20
REV:	DESCRIPTION:	BY:	DATE:
STATUS:			

CGH Transportation
 6 Plaza Court
 Ottawa, ON
 K2H 7W1
 (343) 999-9117

CLIENT: 1209 St. Laurent Partnership Inc.

ARCHITECT:

SITE:
 1209 St. Laurent Blvd.

TITLE:
 Horizontal Sightline Analysis
 Available Sight Distance

SCALE AT A3: NTS	DATE: 2022-12-05	DRAWN: BB	CHECKED: AL
PROJECT NO: 2022-026	DRAWING NO: 001	REVISION: 04	

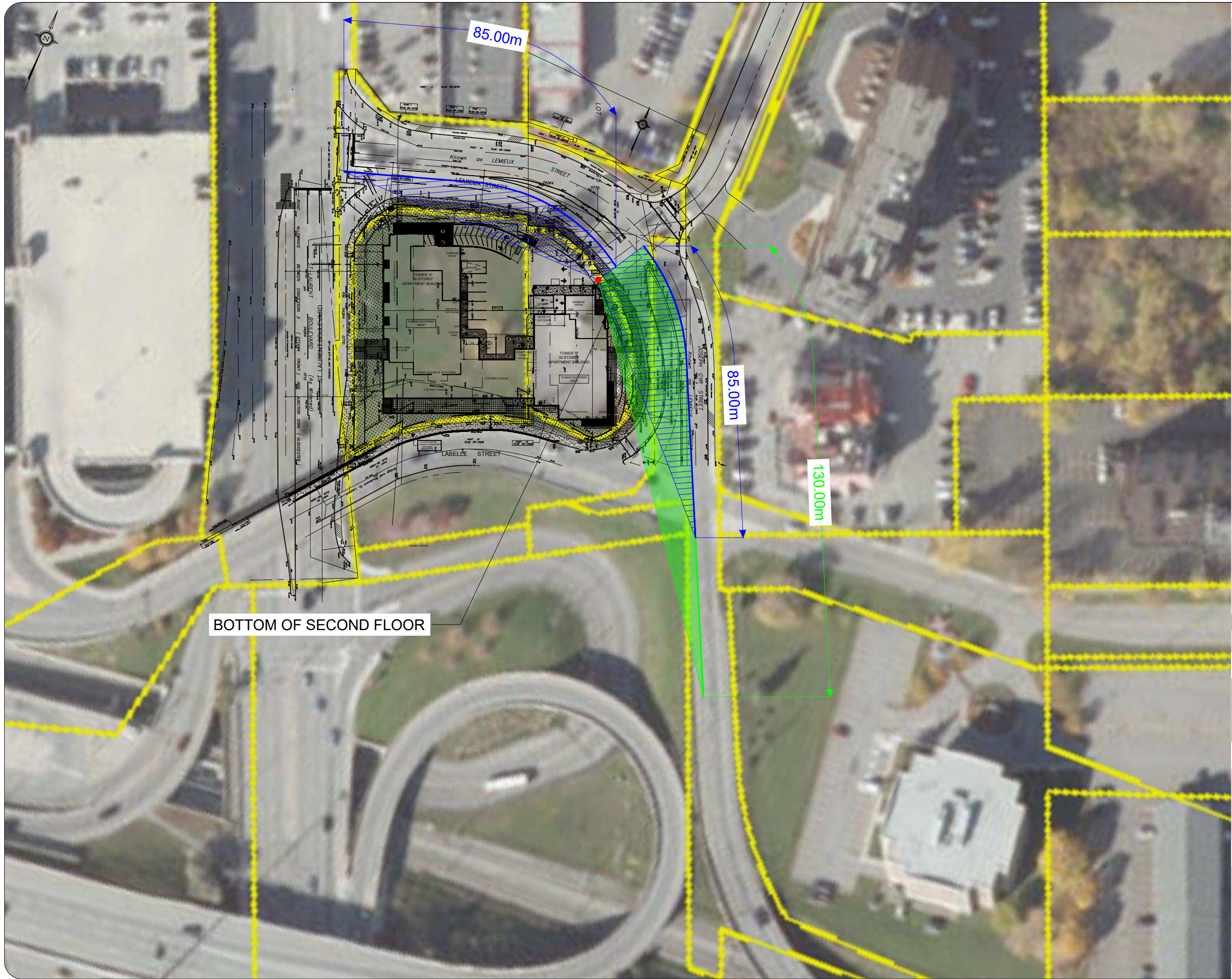

Notes:

LEGEND

- ▨ STOPPING SIGHT DISTANCE
- ▨ DEPARTURE SIGHT DISTANCE
- DECISION POINT

DESIGN SPEED = 60km/hr
 STOPPING SIGHT DISTANCE = 85m
 DEPARTURE SIGHT DISTANCE = 130m

NOTES:
 HSU DRIVERS EYE HEIGHT AT APPROX. 70.1m

BOTTOM OF SECOND FLOOR APPROX. 72.6m

04	Issued for Review	BB	2022-12-05
03	Issued for Review	AN	2022-09-12
02	Issued for Review	BB	2022-09-01
01	Issued for Review	BB	2022-05-20
REV:	DESCRIPTION:	BY:	DATE:
STATUS:			

CGH Transportation
 6 Plaza Court
 Ottawa, ON
 K2H 7W1
 (343) 999-9117

CLIENT: 1209 St. Laurent Partnership Inc.

ARCHITECT:

SITE: 1209 St. Laurent Blvd.

TITLE: Horizontal Sightline Analysis
 60km/hr Design Speed

SCALE AT A3:	DATE:	DRAWN:	CHECKED:
NTS	2022-12-05	BB	AL
PROJECT NO:	DRAWING NO:	REVISION:	
2022-026	002	04	

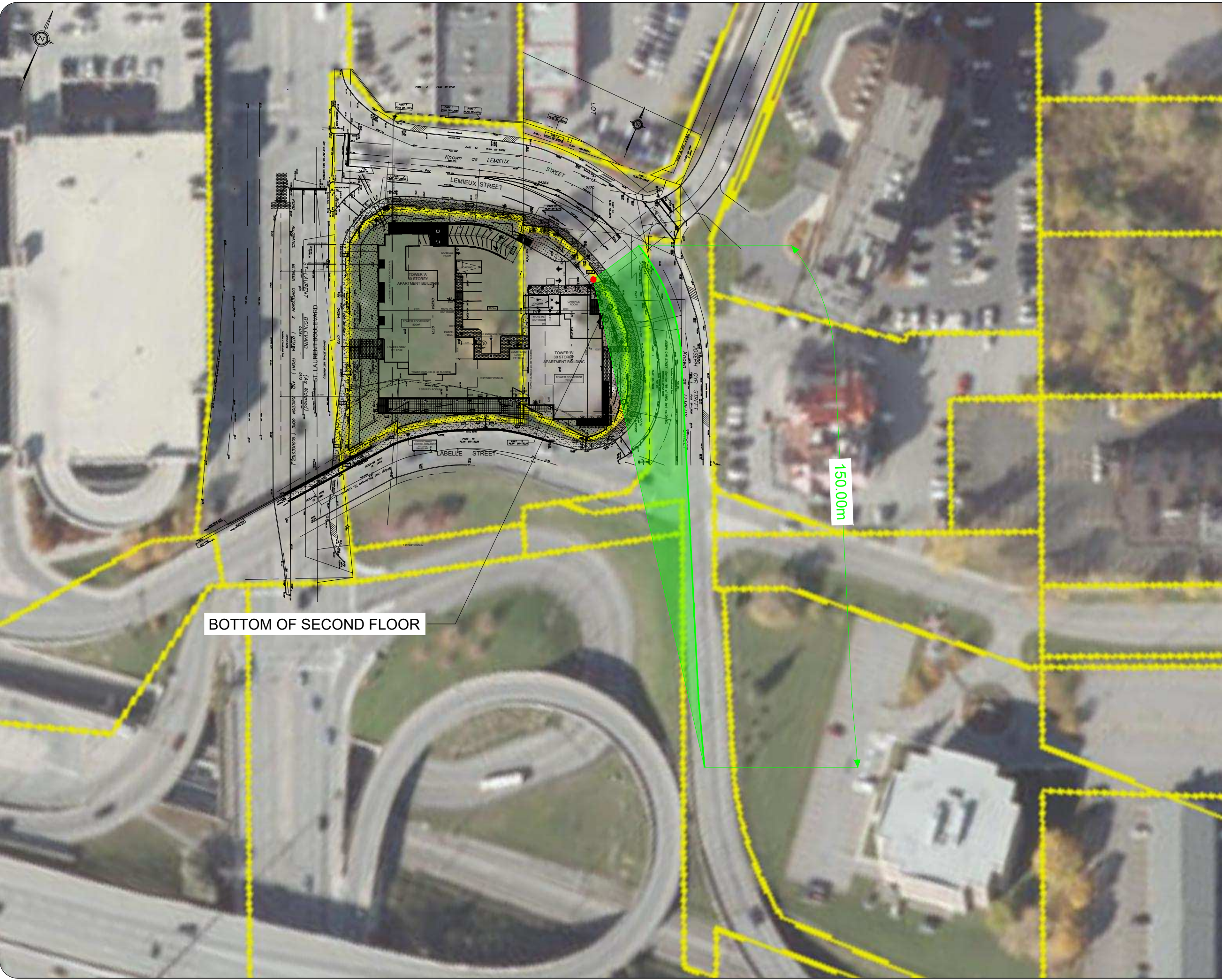

BOTTOM OF SECOND FLOOR

150.00m

Notes:

LEGEND

- █ DEPARTURE SIGHT DISTANCE
- DECISION POINT

DESIGN SPEED = 70km/hr
 DEPARTURE SIGHT DISTANCE = 150m

NOTES:
 HSU DRIVERS EYE HEIGHT AT APPROX. 70.1m

BOTTOM OF SECOND FLOOR APPROX. 72.6m

04	Issued for Review	BB	2022-12-05
03	Issued for Review	AN	2022-09-12
02	Issued for Review	BB	2022-09-01
01	Issued for Review	BB	2022-05-20
REV:	DESCRIPTION:	BY:	DATE:
STATUS:			

CGH Transportation
 6 Plaza Court
 Ottawa, ON
 K2H 7W1
 (343) 999-9117

CLIENT: 1209 St. Laurent Partnership Inc.

ARCHITECT:

SITE:
 1209 St. Laurent Blvd.

TITLE:
 Horizontal Sightline Analysis
 70km/hr Design Speed

SCALE AT A3: NTS	DATE: 2022-12-05	DRAWN: BB	CHECKED: AL
PROJECT NO: 2022-026	DRAWING NO: 003	REVISION: 04	

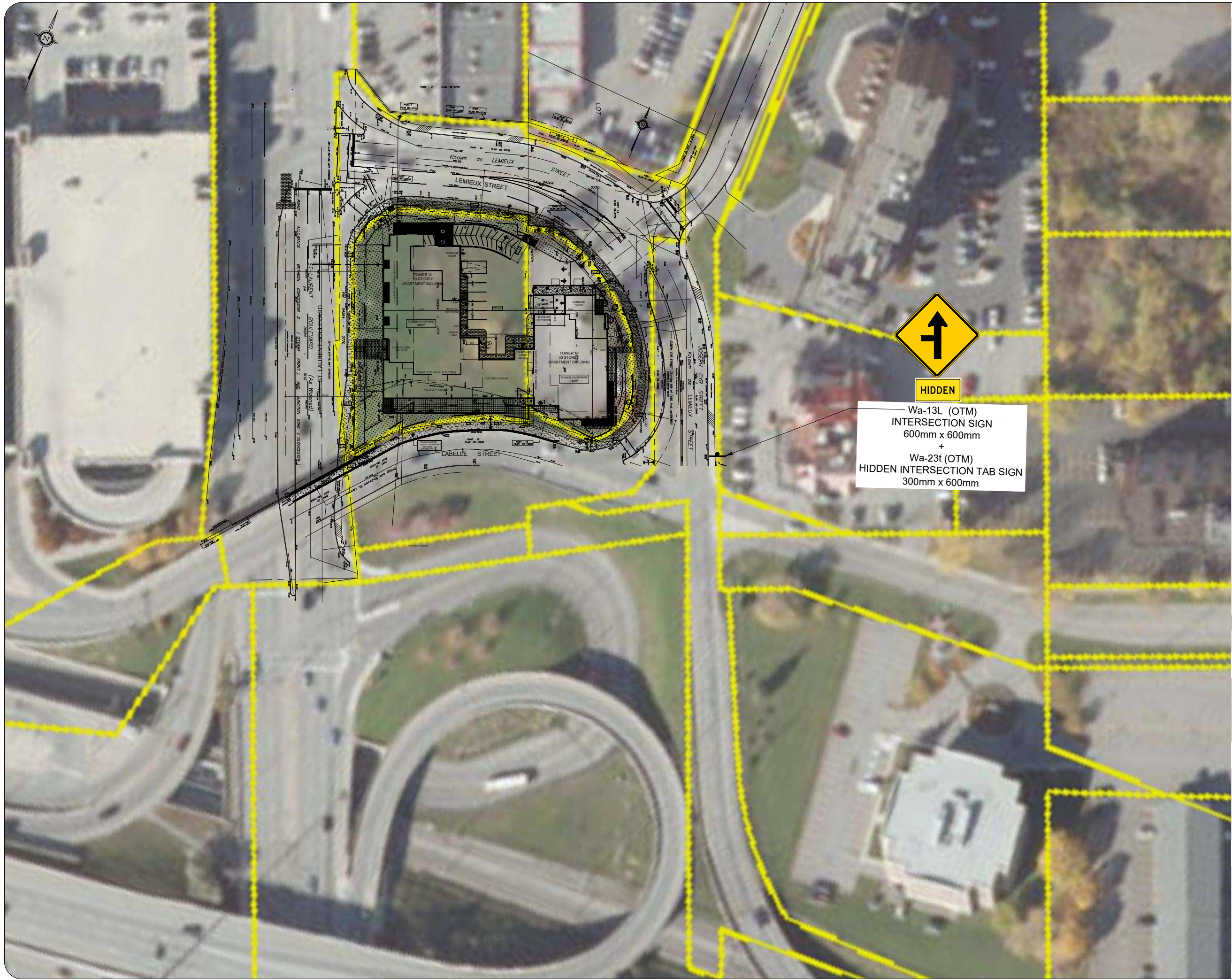

Notes:

04	Issued for Review	BB	2022-12-05
03	Issued for Review	AN	2022-09-12
02	Issued for Review	BB	2022-09-01
01	Issued for Review	BB	2022-05-20
REV:	DESCRIPTION:	BY:	DATE:
STATUS:			



CGH Transportation
 6 Plaza Court
 Ottawa, ON
 K2H 7W1
 (343) 999-9117

CLIENT: 1209 St. Laurent Partnership Inc.

ARCHITECT:

SITE: 1209 St. Laurent Blvd.

TITLE: Hidden Intersection Warning Signage

SCALE AT A3:	DATE:	DRAWN:	CHECKED:
NTS	2022-12-05	BB	AL
PROJECT NO:	DRAWING NO:	REVISION:	
2022-026	004	04	

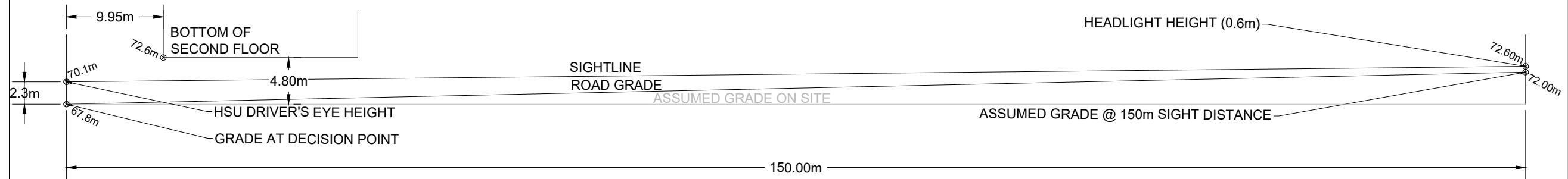

Notes:

04	Issued for Review	BB	2022-12-05
03	Issued for Review	AN	2022-09-12
02	Issued for Review	BB	2022-09-01
REV:	DESCRIPTION:	BY:	DATE:
STATUS:			

CGH Transportation
 6 Plaza Court
 Ottawa, ON
 K2H 7W1
 (343) 999-9117

CLIENT: 1209 St. Laurent Partnership Inc.

ARCHITECT:

SITE:
1209 St. Laurent Blvd.

TITLE: Vertical Sightline Analysis

SCALE AT A3: NTS	DATE: 2022-12-05	DRAWN: BB	CHECKED: AL
PROJECT NO: 2022-026	DRAWING NO: 005	REVISION: 04	

Appendix N

TDM Checklist

TDM Measures Checklist:
Residential Developments (multi-family, condominium or subdivision)

Legend	
BASIC	The measure is generally feasible and effective, and in most cases would benefit the development and its users
BETTER	The measure could maximize support for users of sustainable modes, and optimize development performance
★	The measure is one of the most dependably effective tools to encourage the use of sustainable modes

TDM measures: Residential developments		Check if proposed & add descriptions
1. TDM PROGRAM MANAGEMENT		
1.1 Program coordinator		
BASIC	★ 1.1.1 Designate an internal coordinator, or contract with an external coordinator	<input type="checkbox"/>
1.2 Travel surveys		
BETTER	1.2.1 Conduct periodic surveys to identify travel-related behaviours, attitudes, challenges and solutions, and to track progress	<input type="checkbox"/>
2. WALKING AND CYCLING		
2.1 Information on walking/cycling routes & destinations		
BASIC	2.1.1 Display local area maps with walking/cycling access routes and key destinations at major entrances (<i>multi-family, condominium</i>)	<input checked="" type="checkbox"/>
2.2 Bicycle skills training		
BETTER	2.2.1 Offer on-site cycling courses for residents, or subsidize off-site courses	<input type="checkbox"/>

TDM measures: <i>Residential developments</i>		Check if proposed & add descriptions
3. TRANSIT		
3.1 Transit information		
BASIC	3.1.1 Display relevant transit schedules and route maps at entrances (<i>multi-family, condominium</i>)	<input checked="" type="checkbox"/>
BETTER	3.1.2 Provide real-time arrival information display at entrances (<i>multi-family, condominium</i>)	<input type="checkbox"/>
3.2 Transit fare incentives		
BASIC ★	3.2.1 Offer PRESTO cards preloaded with one monthly transit pass on residence purchase/move-in, to encourage residents to use transit	<input type="checkbox"/>
BETTER	3.2.2 Offer at least one year of free monthly transit passes on residence purchase/move-in	<input checked="" type="checkbox"/>
3.3 Enhanced public transit service		
BETTER ★	3.3.1 Contract with OC Transpo to provide early transit services until regular services are warranted by occupancy levels (<i>subdivision</i>)	<input type="checkbox"/>
3.4 Private transit service		
BETTER	3.4.1 Provide shuttle service for seniors homes or lifestyle communities (e.g. scheduled mall or supermarket runs)	<input type="checkbox"/>
4. CARSHARING & BIKESHARING		
4.1 Bikeshare stations & memberships		
BETTER	4.1.1 Contract with provider to install on-site bikeshare station (<i>multi-family</i>)	<input checked="" type="checkbox"/>
BETTER	4.1.2 Provide residents with bikeshare memberships, either free or subsidized (<i>multi-family</i>)	<input type="checkbox"/>
4.2 Carshare vehicles & memberships		
BETTER	4.2.1 Contract with provider to install on-site carshare vehicles and promote their use by residents	<input checked="" type="checkbox"/>
BETTER	4.2.2 Provide residents with carshare memberships, either free or subsidized	<input type="checkbox"/>
5. PARKING		
5.1 Priced parking		
BASIC ★	5.1.1 Unbundle parking cost from purchase price (<i>condominium</i>)	<input checked="" type="checkbox"/>
BASIC ★	5.1.2 Unbundle parking cost from monthly rent (<i>multi-family</i>)	<input checked="" type="checkbox"/>

TDM measures: <i>Residential developments</i>		Check if proposed & add descriptions
6. TDM MARKETING & COMMUNICATIONS		
6.1 Multimodal travel information		
BASIC ★	6.1.1 Provide a multimodal travel option information package to new residents	<input checked="" type="checkbox"/>
6.2 Personalized trip planning		
BETTER ★	6.2.1 Offer personalized trip planning to new residents	<input type="checkbox"/>

TDM-Supportive Development Design and Infrastructure Checklist: *Residential Developments (multi-family or condominium)*

Legend	
REQUIRED	The Official Plan or Zoning By-law provides related guidance that must be followed
BASIC	The measure is generally feasible and effective, and in most cases would benefit the development and its users
BETTER	The measure could maximize support for users of sustainable modes, and optimize development performance

TDM-supportive design & infrastructure measures: <i>Residential developments</i>		Check if completed & add descriptions, explanations or plan/drawing references
1. WALKING & CYCLING: ROUTES		
1.1 Building location & access points		
BASIC	1.1.1 Locate building close to the street, and do not locate parking areas between the street and building entrances	<input checked="" type="checkbox"/>
BASIC	1.1.2 Locate building entrances in order to minimize walking distances to sidewalks and transit stops/stations	<input checked="" type="checkbox"/>
BASIC	1.1.3 Locate building doors and windows to ensure visibility of pedestrians from the building, for their security and comfort	<input checked="" type="checkbox"/>
1.2 Facilities for walking & cycling		
REQUIRED	1.2.1 Provide convenient, direct access to stations or major stops along rapid transit routes within 600 metres; minimize walking distances from buildings to rapid transit; provide pedestrian-friendly, weather-protected (where possible) environment between rapid transit accesses and building entrances; ensure quality linkages from sidewalks through building entrances to integrated stops/stations (<i>see Official Plan policy 4.3.3</i>)	<input checked="" type="checkbox"/>
REQUIRED	1.2.2 Provide safe, direct and attractive pedestrian access from public sidewalks to building entrances through such measures as: reducing distances between public sidewalks and major building entrances; providing walkways from public streets to major building entrances; within a site, providing walkways along the front of adjoining buildings, between adjacent buildings, and connecting areas where people may congregate, such as courtyards and transit stops; and providing weather protection through canopies, colonnades, and other design elements wherever possible (<i>see Official Plan policy 4.3.12</i>)	<input checked="" type="checkbox"/>

TDM-supportive design & infrastructure measures: <i>Residential developments</i>		Check if completed & add descriptions, explanations or plan/drawing references
REQUIRED	1.2.3 Provide sidewalks of smooth, well-drained walking surfaces of contrasting materials or treatments to differentiate pedestrian areas from vehicle areas, and provide marked pedestrian crosswalks at intersection sidewalks (<i>see Official Plan policy 4.3.10</i>)	<input checked="" type="checkbox"/>
REQUIRED	1.2.4 Make sidewalks and open space areas easily accessible through features such as gradual grade transition, depressed curbs at street corners and convenient access to extra-wide parking spaces and ramps (<i>see Official Plan policy 4.3.10</i>)	<input checked="" type="checkbox"/>
REQUIRED	1.2.5 Include adequately spaced inter-block/street cycling and pedestrian connections to facilitate travel by active transportation. Provide links to the existing or planned network of public sidewalks, multi-use pathways and on-road cycle routes. Where public sidewalks and multi-use pathways intersect with roads, consider providing traffic control devices to give priority to cyclists and pedestrians (<i>see Official Plan policy 4.3.11</i>)	<input checked="" type="checkbox"/>
BASIC	1.2.6 Provide safe, direct and attractive walking routes from building entrances to nearby transit stops	<input checked="" type="checkbox"/>
BASIC	1.2.7 Ensure that walking routes to transit stops are secure, visible, lighted, shaded and wind-protected wherever possible	<input checked="" type="checkbox"/>
BASIC	1.2.8 Design roads used for access or circulation by cyclists using a target operating speed of no more than 30 km/h, or provide a separated cycling facility	<input type="checkbox"/>
1.3 Amenities for walking & cycling		
BASIC	1.3.1 Provide lighting, landscaping and benches along walking and cycling routes between building entrances and streets, sidewalks and trails	<input type="checkbox"/>
BASIC	1.3.2 Provide wayfinding signage for site access (where required, e.g. when multiple buildings or entrances exist) and egress (where warranted, such as when directions to reach transit stops/stations, trails or other common destinations are not obvious)	<input type="checkbox"/>

TDM-supportive design & infrastructure measures: <i>Residential developments</i>		Check if completed & add descriptions, explanations or plan/drawing references
2. WALKING & CYCLING: END-OF-TRIP FACILITIES		
2.1 Bicycle parking		
REQUIRED	2.1.1 Provide bicycle parking in highly visible and lighted areas, sheltered from the weather wherever possible (see <i>Official Plan policy 4.3.6</i>)	<input checked="" type="checkbox"/>
REQUIRED	2.1.2 Provide the number of bicycle parking spaces specified for various land uses in different parts of Ottawa; provide convenient access to main entrances or well-used areas (see <i>Zoning By-law Section 111</i>)	<input checked="" type="checkbox"/>
REQUIRED	2.1.3 Ensure that bicycle parking spaces and access aisles meet minimum dimensions; that no more than 50% of spaces are vertical spaces; and that parking racks are securely anchored (see <i>Zoning By-law Section 111</i>)	<input checked="" type="checkbox"/>
BASIC	2.1.4 Provide bicycle parking spaces equivalent to the expected number of resident-owned bicycles, plus the expected peak number of visitor cyclists	<input type="checkbox"/>
2.2 Secure bicycle parking		
REQUIRED	2.2.1 Where more than 50 bicycle parking spaces are provided for a single residential building, locate at least 25% of spaces within a building/structure, a secure area (e.g. supervised parking lot or enclosure) or bicycle lockers (see <i>Zoning By-law Section 111</i>)	<input checked="" type="checkbox"/>
BETTER	2.2.2 Provide secure bicycle parking spaces equivalent to at least the number of units at condominiums or multi-family residential developments	<input checked="" type="checkbox"/>
2.3 Bicycle repair station		
BETTER	2.3.1 Provide a permanent bike repair station, with commonly used tools and an air pump, adjacent to the main bicycle parking area (or secure bicycle parking area, if provided)	<input checked="" type="checkbox"/>
3. TRANSIT		
3.1 Customer amenities		
BASIC	3.1.1 Provide shelters, lighting and benches at any on-site transit stops	<input type="checkbox"/>
BASIC	3.1.2 Where the site abuts an off-site transit stop and insufficient space exists for a transit shelter in the public right-of-way, protect land for a shelter and/or install a shelter	<input type="checkbox"/>
BETTER	3.1.3 Provide a secure and comfortable interior waiting area by integrating any on-site transit stops into the building	<input type="checkbox"/>

TDM-supportive design & infrastructure measures: <i>Residential developments</i>		Check if completed & add descriptions, explanations or plan/drawing references
4. RIDESHARING		
4.1 Pick-up & drop-off facilities		
BASIC	4.1.1 Provide a designated area for carpool drivers (plus taxis and ride-hailing services) to drop off or pick up passengers without using fire lanes or other no-stopping zones	<input type="checkbox"/>
5. CARSHARING & BIKESHARING		
5.1 Carshare parking spaces		
BETTER	5.1.1 Provide up to three carshare parking spaces in an R3, R4 or R5 Zone for specified residential uses (<i>see Zoning By-law Section 94</i>)	<input type="checkbox"/>
5.2 Bikeshare station location		
BETTER	5.2.1 Provide a designated bikeshare station area near a major building entrance, preferably lighted and sheltered with a direct walkway connection	<input checked="" type="checkbox"/>
6. PARKING		
6.1 Number of parking spaces		
REQUIRED	6.1.1 Do not provide more parking than permitted by zoning, nor less than required by zoning, unless a variance is being applied for	<input checked="" type="checkbox"/>
BASIC	6.1.2 Provide parking for long-term and short-term users that is consistent with mode share targets, considering the potential for visitors to use off-site public parking	<input type="checkbox"/>
BASIC	6.1.3 Where a site features more than one use, provide shared parking and reduce the cumulative number of parking spaces accordingly (<i>see Zoning By-law Section 104</i>)	<input type="checkbox"/>
BETTER	6.1.4 Reduce the minimum number of parking spaces required by zoning by one space for each 13 square metres of gross floor area provided as shower rooms, change rooms, locker rooms and other facilities for cyclists in conjunction with bicycle parking (<i>see Zoning By-law Section 111</i>)	<input type="checkbox"/>
6.2 Separate long-term & short-term parking areas		
BETTER	6.2.1 Provide separate areas for short-term and long-term parking (using signage or physical barriers) to permit access controls and simplify enforcement (i.e. to discourage residents from parking in visitor spaces, and vice versa)	<input type="checkbox"/>