

210 Clearview Avenue

Transportation Impact Assessment

Step 1 Screening Report

Step 2 Scoping Report

Step 3 Forecasting Report

Step 4 Strategy Report (Rev #1)

Prepared for:

Homestead Land Holdings Limited
80 Johnson Street
Kingston, ON, K7L 1X7

Prepared by:



6 Plaza Court
Ottawa, ON K2H 7W1

April 2023

PN: 2021-124

Table of Contents

1	Screening.....	1
2	Existing and Planned Conditions.....	1
2.1	Proposed Development.....	1
2.2	Existing Conditions.....	3
2.2.1	Area Road Network.....	3
2.2.2	Existing Intersections.....	3
2.2.3	Existing Driveways.....	4
2.2.4	Cycling and Pedestrian Facilities.....	5
2.2.5	Existing Transit.....	8
2.2.6	Existing Area Traffic Management Measures.....	9
2.2.7	Existing Peak Hour Travel Demand.....	9
2.2.8	Collision Analysis.....	12
2.3	Planned Conditions.....	13
2.3.1	Changes to the Area Transportation Network.....	13
2.3.2	Other Study Area Developments.....	14
3	Study Area and Time Periods.....	15
3.1	Study Area.....	15
3.2	Time Periods.....	15
3.3	Horizon Years.....	15
4	Exemption Review.....	15
5	Development-Generated Travel Demand.....	16
5.1	Mode Shares.....	16
5.2	Trip Generation.....	16
5.3	Trip Distribution.....	17
5.4	Trip Assignment.....	17
6	Background Network Travel Demands.....	19
6.1	Transportation Network Plans.....	19
6.2	Background Growth.....	19
6.3	Other Developments.....	20
7	Demand Rationalization.....	22
7.1	2027 Future Background Operations.....	22
7.2	2032 Future Background Operations.....	24
7.3	2027 Future Total Operations.....	26
7.4	2032 Future Total Operations.....	28
7.5	Modal Share Sensitivity and Demand Rationalization Conclusions.....	30
8	Transportation Demand Management.....	31
8.1	Context for TDM.....	31
8.2	Need and Opportunity.....	31
8.3	TDM Program.....	31
9	Neighbourhood Traffic Management.....	31
10	Transit.....	32
10.1	Route Capacity.....	32

10.2 Transit Priority 32

11 Network Intersection Design..... 32

11.1 Network Intersection Control..... 32

11.2 Network Intersection Design..... 32

11.2.1 2032 Future Total Network Intersection Operations 32

11.2.2 Network Intersection MMLoS..... 33

11.2.3 Recommended Design Elements..... 33

12 Summary of Improvements Indicated and Modifications Options..... 33

13 Conclusion 36

List of Figures

Figure 1: Area Context Plan1

Figure 2: Concept Plan.....2

Figure 3: Existing Driveways5

Figure 4: Study Area Pedestrian Facilities6

Figure 5: Study Area Cycling Facilities6

Figure 6: Existing Pedestrian Volumes7

Figure 7: Existing Cyclist Volumes7

Figure 8: Existing Study Area Transit Service.....8

Figure 9: Existing Study Area Transit Stops8

Figure 10: 2020 Existing Traffic Counts 10

Figure 11: Representation of Study Area Collision Records..... 13

Figure 12: New Site Generation Auto Volumes..... 19

Figure 13: 2027 Total Background Development Volumes..... 21

Figure 14: 2032 Total Background Development Volumes..... 22

Figure 15: 2027 Future Background Volumes 23

Figure 16: 2032 Future Background Volumes 25

Figure 17: 2027 Future Total Volumes 27

Figure 18: 2032 Future Total Volumes 29

Table of Tables

Table 1: Intersection Count Date.....9

Table 2: 2020 Existing Intersection Operations..... 11

Table 3: Study Area Collision Summary, 2016-2020 12

Table 4: Summary of Collision Locations, 2016-2020..... 13

Table 5: Exemption Review 15

Table 6: TRANS Trip Generation Manual Recommended Mode Shares – Ottawa West..... 16

Table 7: Proposed Development Mode Shares – Within 600 m of Rapid Transit..... 16

Table 8: Trip Generation Person Trip Rates by Peak Period..... 17

Table 9: Total Residential Person Trip Generation by Peak Period..... 17

Table 10: Residential Trip Generation by Mode..... 17

Table 11: OD Survey Distribution – Ottawa West 17

Table 12: Trip Assignment – AM Peak Hour 18

Table 13: Trip Assignment – PM Peak Hour 18

Table 14: TRANS Regional Model Projections – Study Area Growth Rates..... 20

Table 15: Recommended Area Growth Rates 20

Table 16: 2027 Future Background Intersection Operations 23

Table 17: 2032 Future Background Intersection Operations 25

Table 18: 2027 Future Total Intersection Operations 27

Table 19: 2032 Future Total Intersection Operations 29

Table 20: Trip Generation by Transit Mode 32

Table 21: Forecasted Site-Generated Transit Ridership..... 32

Table 22: Study Area Intersection MMLOS Analysis 33

List of Appendices

- Appendix A – TIA Screening Form and Certification Form
- Appendix B – Turning Movement Count Data
- Appendix C – Synchro Intersection Worksheets – Existing Conditions
- Appendix D – Collision Data
- Appendix E – Scott Street Bus Detour and Cycling Concept
- Appendix F – Scott Street – Preliminary Design
- Appendix G – TRANS Model Plots
- Appendix H – Background Development Volumes
- Appendix I – Synchro Intersection Worksheets – 2027 Future Background Conditions
- Appendix J – Synchro Intersection Worksheets – 2032 Future Background Conditions
- Appendix K – Synchro Intersection Worksheets – 2027 Future Total Conditions
- Appendix L – Synchro Intersection Worksheets – 2032 Future Total Conditions
- Appendix M – TDM Checklist
- Appendix N – MMLOS Analysis

1 Screening

This study has been prepared according to the City of Ottawa’s 2017 Transportation Impact Assessment (TIA) Guidelines. Accordingly, a Step 1 Screening Form has been prepared and is included as Appendix A, along with the Certification Form for the TIA Study PM. As shown in the Screening Form, a TIA is required including the Network Impact Component. This study has been prepared to support an official plan amendment and zoning by-law amendment application.

2 Existing and Planned Conditions

2.1 Proposed Development

The existing site, located at 200 Clearview Avenue, is planned to redevelop the existing surface parking lot. Approximately 90 existing surface parking spaces will be replaced with the two-level underground parking. The proposed development address will become 210 Clearview Avenue. The existing 26-storey apartment building will remain on the east side of the proposed development and the proposed building will consist of a four-storey podium and 25-storey tower with a total of 177 apartment units. A total of 213 underground vehicle parking spaces and 169 underground bike parking spaces are proposed. The existing surface parking lot accesses will be converted to an access to the underground parking from Clearview Avenue and access to the loading area from Lanark Avenue. An access is proposed to connect Lanark Avenue and Ellendale Crescent for the existing 26-storey apartment building on the east side of the proposed development. The site will also connect through the existing site to Ellendale Crescent. The front entrance will be located on Lanark Avenue. The anticipated full build-out and occupancy horizon is 2027 with construction occurring in a single phase. The site is zoned as Residential Fifth Density Zone (R5C H(28) S216). The site is located within Richmond Road/Westboro secondary plan and Richmond Road/Westboro community design plan areas. Figure 1 illustrates the study area context. Figure 2 illustrates the proposed concept plan.

Figure 1: Area Context Plan

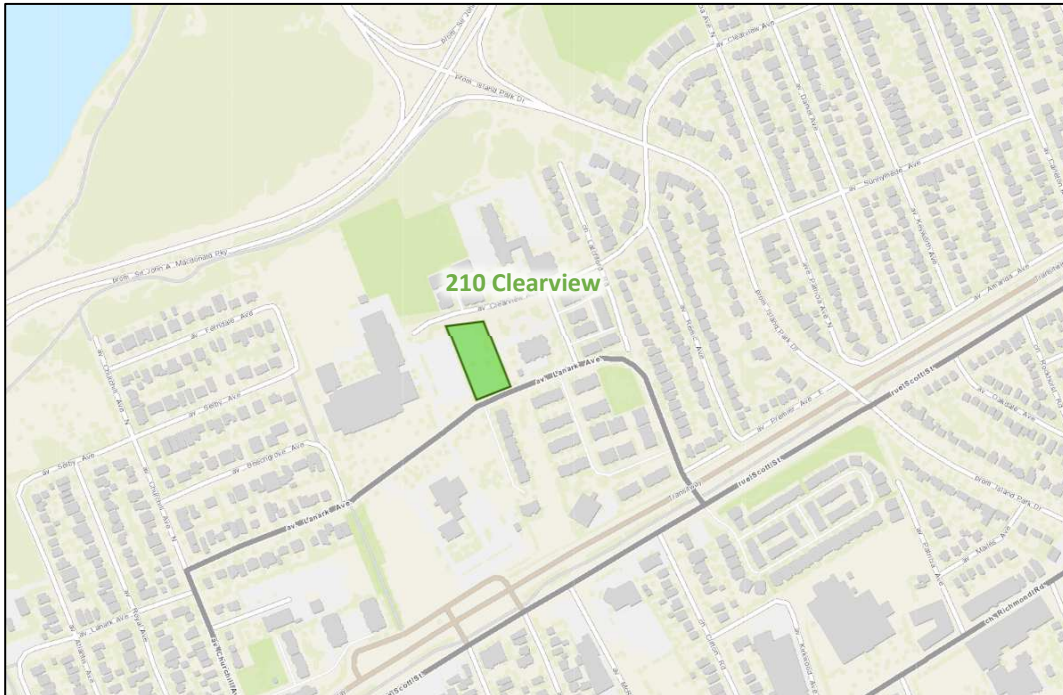

Source: <http://maps.ottawa.ca/geoOttawa/> Accessed: July 5, 2022

Figure 2: Concept Plan

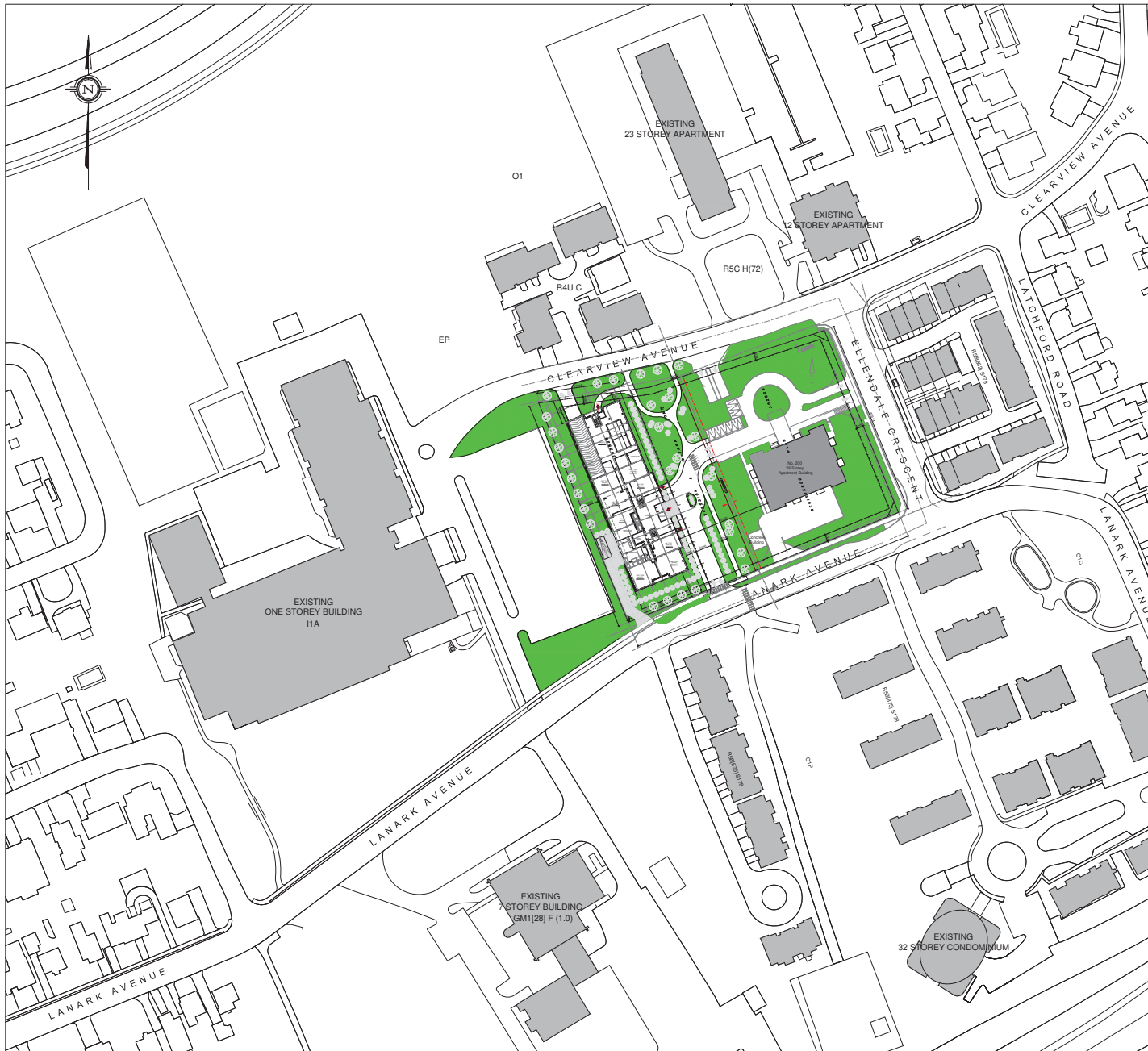

SITE INFO.

SITE AREA	10967.2 sq. m.
EXISTING ZONING	
AREA A	R5C H(28)
AREA B	O1 [313] S216
AREA C	O1 [313]
AREA D	R5C H(78)
GROSS FLOOR AREA (ZONING DEFINITION)	
EXISTING APARTMENT	~19300 SQ.M.
	224 units
	110 indoor parkings

PROJECT INFO.

BUILDING HEIGHT	25 STOREY
RESIDENTIAL UNITS	197
ONE BEDROOM	71
TWO BEDROOM	126
CAR PARKING REQUIRED	112 MIN.
MIN. RESIDENTIAL (0.5 after first 12)	93
MIN. VISITOR (0.1 after first 12)	19
MAX. VISITOR	30
MAX. RESIDENTIAL + VISITOR	345
BIKE PARKING REQUIRED	
RESIDENTIAL (0.5)	99
CAR PARKING PROVIDED	278
P1	129
P2	149
BIKE PARKING PROVIDED	169
P1	71
P2	98
AMENITY REQUIRED	1182 SQ.M.
(6 SQ.M. PER UNITS)	
MIN. COMMUNAL	591 SQ.M.
AMENITY PROVIDED	1934 SQ.M.
COMMUNAL (ROOF DECK AND INDOOR)	
GROUND FLOOR	412 SQ.M.
4TH FLOOR	1030 SQ.M.
25TH FLOOR	492 SQ.M.
PRIVATE BALCONY	1430 SQ.M.
LANDSCAPED AREA	47%

2.2 Existing Conditions

2.2.1 Area Road Network

Island Park Drive: Island Park Drive is a federally owned arterial road with a two-lane urban cross-section. Bike lanes and pathways are provided on both sides of the road. The posted speed limit is 40 km/h and the existing right of way within the study area is 30.5 metres.

Sir John A. Macdonald Parkway: Sir John A. Macdonald Parkway is a federally owned arterial road with a divided, four-lane urban cross-section. A pathway is provided on the south side of the roadway within the study area. The posted speed limit is 60km/h within the study area. The existing right of way throughout the study area varies along adjacent properties.

Churchill Avenue: Churchill Avenue is a City of Ottawa arterial road with a two-lane urban cross-section south of Scott Street, a collector road between Scott Street and Lanark Avenue, and a local road north of Lanark Avenue. Sidewalks are provided on both sides of the roadway south of Lanark Avenue. The unposted speed limit is assumed to be 50 km/h. Parking is permitted on both sides of the road north of Scott Street and for maximum of one hour on both sides of the road south of Scott Street from 7AM to 7PM. The existing right of way within the study area is 21.0 metres. Churchill Avenue south of Scott Street is a truck route.

Scott Street: Scott Street is a City of Ottawa arterial road with a two-lane urban cross-section. Bike lanes are presented on both sides of the road. An asphalt pathway is presented on the north side of the road and a sidewalk is presented on the south side of the road. The posted speed limit is 50 km/h and the City-protected right of way is 26.0 metres. Scott Street is a truck route.

Lanark Avenue: Lanark Avenue is a City of Ottawa collector road with a two-lane urban cross-section. Sidewalks are located on both sides of the roadway. The posted speed limit is 40km/h between 7:00 am to 9:00 am and 2:00 pm to 5:00 pm on school days. The existing right of way within the study area is 20.5 metres.

Clearview Avenue: Clearview Avenue is a City of Ottawa local road with a two-lane urban cross-section east of Ellendale Crescent, and a two-lane rural cross-section to the west. Sidewalks are present on both sides of the roadway between Ellendale Crescent and Latchford Road, on the north side of the road between Latchford Road and Island Park Drive, and on both sides east of Island Park Drive. The posted speed limit is 40 km/h, and parking is permitted on the south side of the road west of Ellendale Crescent. The existing right of way is 20.0 metres.

2.2.2 Existing Intersections

The key existing signalized area intersections within 400 metres of the site have been summarized below:

Island Park Drive at Sir John A. Macdonald Parkway The intersection of Island Park Drive at Sir John A. Macdonald Parkway is a signalized intersection. The northbound approach has a through lane, a bike lane, and an auxiliary channelized right-turn lane, and the southbound approach has an auxiliary left-turn lane, a left-turn lane, a through lane, a bike lane, and an auxiliary channelized right-turn lane. The eastbound and westbound approaches each consist of an auxiliary left-turn lane, two through lanes, and an auxiliary channelized right-turn lane. Northbound left turns are prohibited, and an additional westbound right-turn prohibition is included between the channelized right-turn and the intersection.

Island Park Drive at Clearview Avenue The intersection of Island Park Drive and Clearview Avenue is a stop-controlled intersection on the minor approaches of Clearview

Avenue. The northbound and southbound approaches each consists of a shared all-movement lane and a bike lane. The eastbound and westbound approaches each consists of a shared all-movement lane. The vehicles are prohibited from making westbound right-turn and eastbound left-turn movements during weekdays between 3:30 – 6:00 PM. Bicycles are permitted to make these movements, and authorized vehicles are permitted to make eastbound left-turn movement. Trucks are restricted from accessing the east leg.

Island Park Drive at Scott Street

The intersection of Island Park Drive at Scott Street is a signalized intersection. The northbound approach consists of a shared all-movement lane and a bike lane. The southbound and westbound approaches each consist of an auxiliary left-turn lane, a shared through/right-turn lane, and a bike lane. The eastbound approach consists of an auxiliary left-turn lane, a through lane, a bike lane, and an auxiliary right-turn lane. No turn restrictions were noted.

This intersection has been upgraded to a protected intersection with bike crossrides for all directions in June 2022, and this will be included in future horizons.

Lanark Avenue at Scott Street

The intersection of Lanark Avenue at Scott Street is a signalized intersection. The northbound and southbound approaches each consist of an auxiliary left-turn lane and a shared through/right-turn lane. The eastbound and westbound approaches each consist of an auxiliary left-turn lane, a shared through/right-turn lane, and a bike lane. No turn restrictions were noted.

This intersection has been upgraded to a protected intersection with bike crossrides for all directions in June 2022, and this will be included in future horizons.

Churchill Avenue and Lanark Avenue

The intersection of Churchill Avenue and Lanark Avenue is an all-way stop-controlled T-intersection. Each approach consists of a shared all-movement lane. No turn restrictions were noted.

2.2.3 Existing Driveways

Within 200 meters of the site accesses, one driveway to school, two to office, one to a high-rise building, and two to two dwelling units are located on Lanark Avenue. Six driveways to three high-rise buildings and three driveways to six townhouses are on Clearview Avenue. Two driveways to high-rise building are present on Ellendale Crescent Figure 3 illustrates the existing driveways.

Figure 3: Existing Driveways

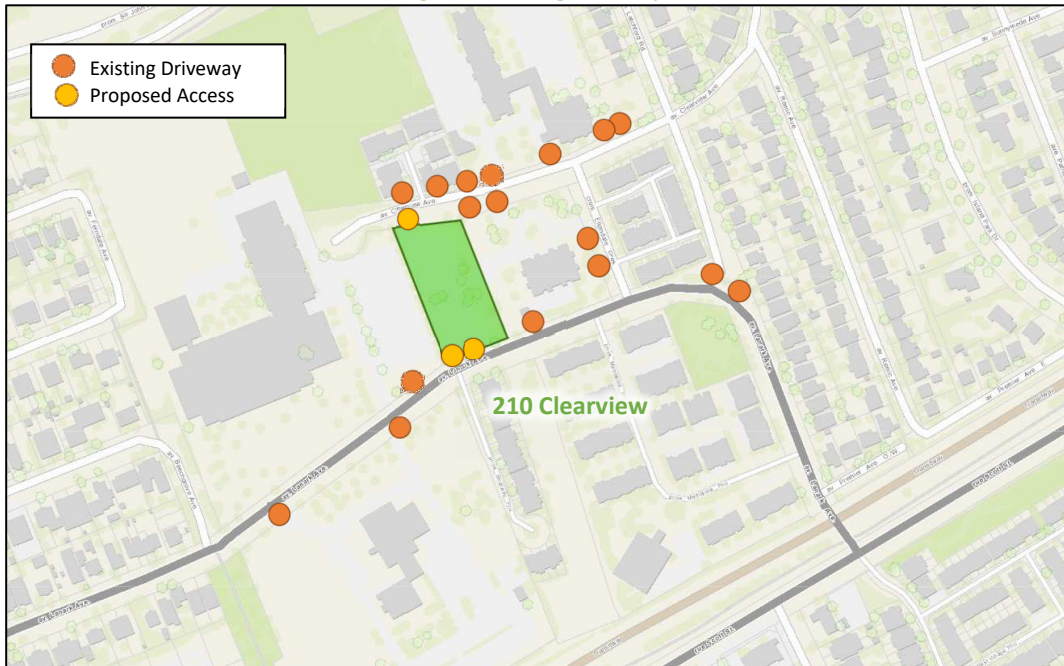

Source: <http://maps.ottawa.ca/geoOttawa/> Accessed: July 5, 2022

2.2.4 Cycling and Pedestrian Facilities

Figure 4 illustrates the pedestrian facilities in the study area and Figure 5 illustrates the cycling facilities.

Sidewalks are provided on both sides along Lanark Avenue, Churchill Avenue south of Lanark Avenue, and on the south side along Scott Street. Along Clearview Avenue, sidewalks are presented on both sides between Ellendale Crescent and Latchford Road, on the north side of the road between Latchford Road and Island Park Drive, and on both sides east of Island Park Drive.

Pedestrian crossovers are present at the intersections of Beechgrove Avenue at Lanark Avenue, Island Park Drive at Clearview Avenue, and on McRae Avenue.

Bike lanes are provided on both sides along Island Park Drive and Scott Street, and a MUP is provided on the north side along Scott Street. Upgrades along Scott Street have been completed in June 2022, including uni-directional cycle tracks on both sides of Scott Street and pedestrian pathway/sidewalk on the south side of the road, and these changes will be included in future horizons.

Island Park Drive and Scott Street are spine route, Churchill Avenue and Clifton Road north of Wilber Avenue are local route. Scott Street and Churchill Avenue south of Scott Street are cross-town bikeways. A major pathway is provided on the south side along Sir John A. Macdonald Parkway, and pathway links are provided along the north side of Scott Street and connect Scott Street, Lanark Avenue, and Sir John A. Macdonald Parkway.

Figure 4: Study Area Pedestrian Facilities

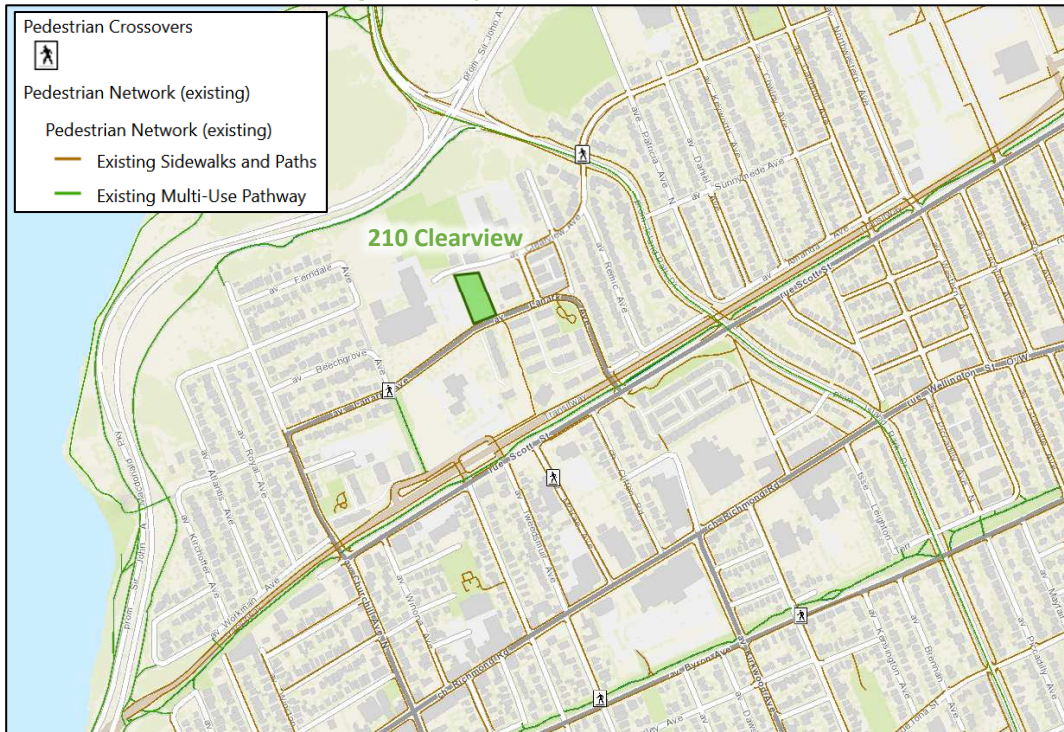

Source: <http://maps.ottawa.ca/geoOttawa/> Accessed: July 5, 2022

Figure 5: Study Area Cycling Facilities

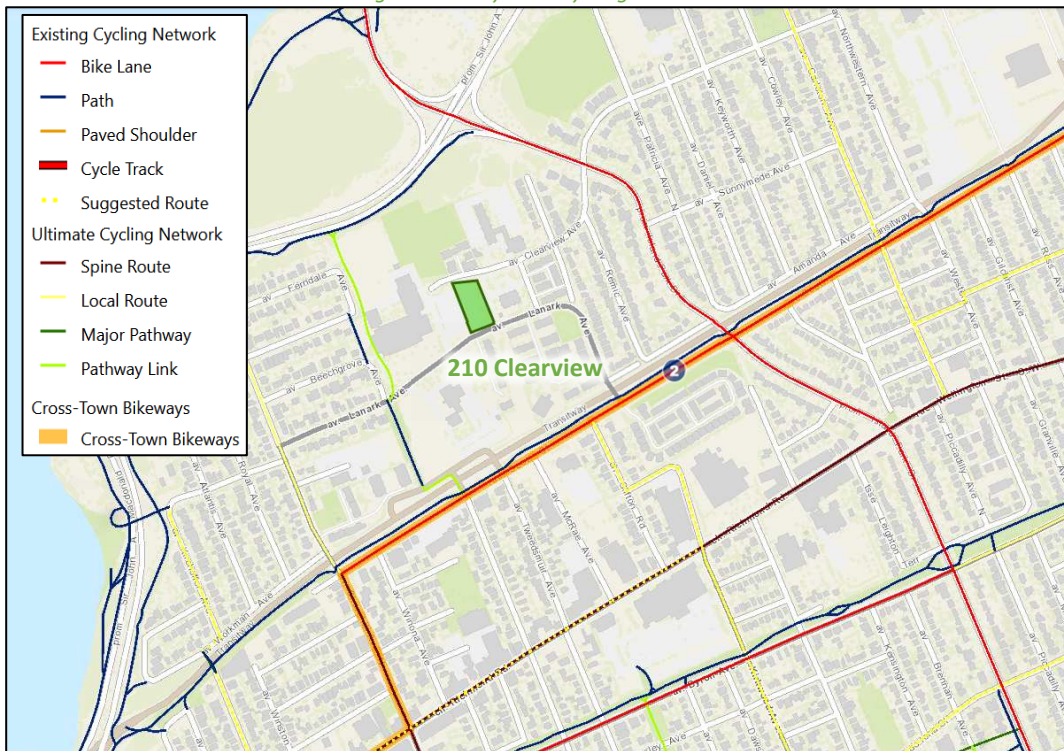

Source: <http://maps.ottawa.ca/geoOttawa/> Accessed: July 5, 2022

Pedestrian and cyclist volumes included in study area intersection counts, presented in Section 2.2.7, have been compiled and are illustrated in Figure 6 and Figure 7 respectively.

Figure 6: Existing Pedestrian Volumes

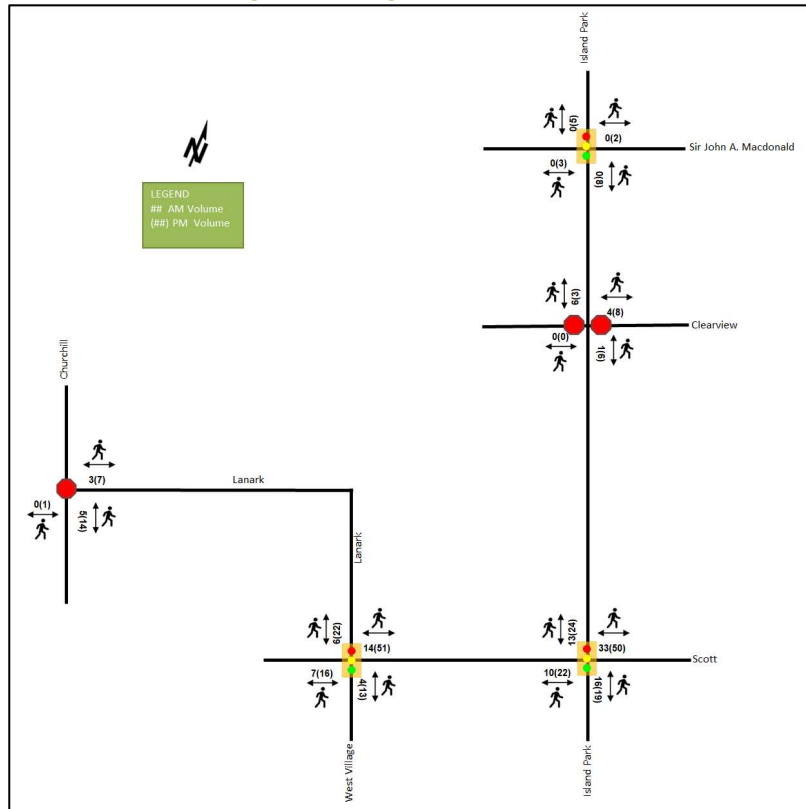
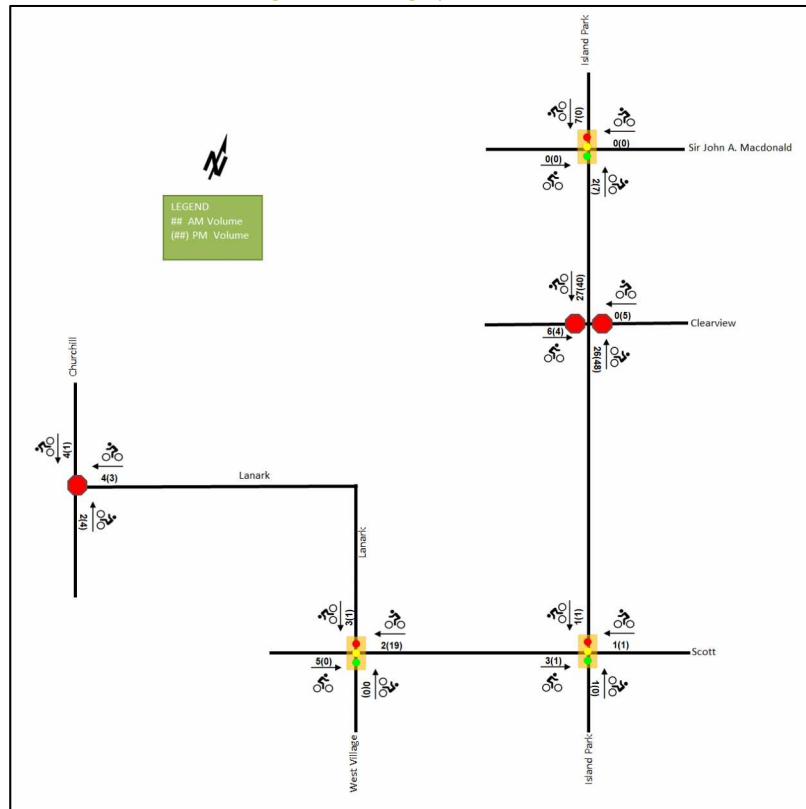

Figure 7: Existing Cyclist Volumes



2.2.5 Existing Transit

Within the study area, routes #16 and #153 travel along Lanark Avenue. Primary stop is located at the intersections of Lanark Avenue and Briarway Private and Lanark Avenue and Champlain. The frequency of these routes within proximity of the proposed site currently are:

- Route # 16 – 30-minute service all day
- Route # 153 – 2-hour service from 11:00 AM to 7:00 PM

Figure 8 illustrates the transit system map in the study area and Figure 9 illustrates nearby transit stops.

Figure 8: Existing Study Area Transit Service



Source: <http://www.octranspo.com/> Accessed: July 5, 2022

Figure 9: Existing Study Area Transit Stops

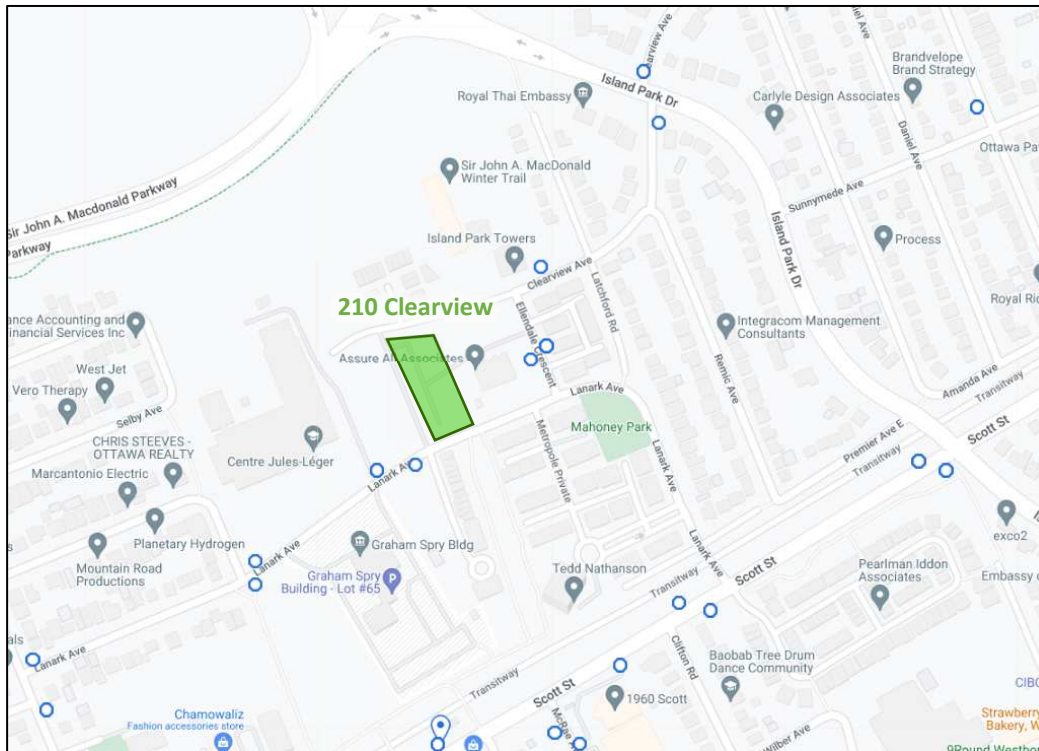

Source: <http://www.octranspo.com/> Accessed: July 5, 2022

2.2.6 Existing Area Traffic Management Measures

Bulb-outs are provided at the Lanark Avenue at Scott Street intersection, along Scott Street, along Lanark Avenue, and along Churchill Avenue south of Lanark Avenue. At the Island Park Drive and Clearview Avenue intersection, the vehicles are prohibited from making westbound right-turn and eastbound left-turn movements during weekdays between 3:30 – 6:00 PM. Bicycles are permitted to make these movements, and authorized vehicles are permitted to make eastbound left-turn movements.

2.2.7 Existing Peak Hour Travel Demand

Existing turning movement counts were acquired from the City of Ottawa for the existing study area intersection. Table 1 summarizes the intersection count dates.

Table 1: Intersection Count Date

Intersection	Count Date
Island Park Drive at Sir John A. Macdonald Parkway	Wednesday, January 29, 2020
Island Park Drive at Clearview Avenue	Thursday, July 18, 2019
Island Park Drive at Scott Street	Tuesday, March 28, 2017
Lanark Avenue at Scott Street	Tuesday, March 28, 2017
Churchill Avenue and Lanark Avenue	Thursday, October 24, 2019

Figure 10 illustrates the existing traffic counts and Table 2 summarizes the existing intersection operations. The level of service for signalized intersections is based on the v/c calculation for individual lane movements and HCM 2000 v/c calculations for the overall intersection, and HCM average delay for unsignalized intersections. Detailed turning movement count data is included in Appendix B and the Synchro worksheets are provided in Appendix C.

Figure 10: 2020 Existing Traffic Counts

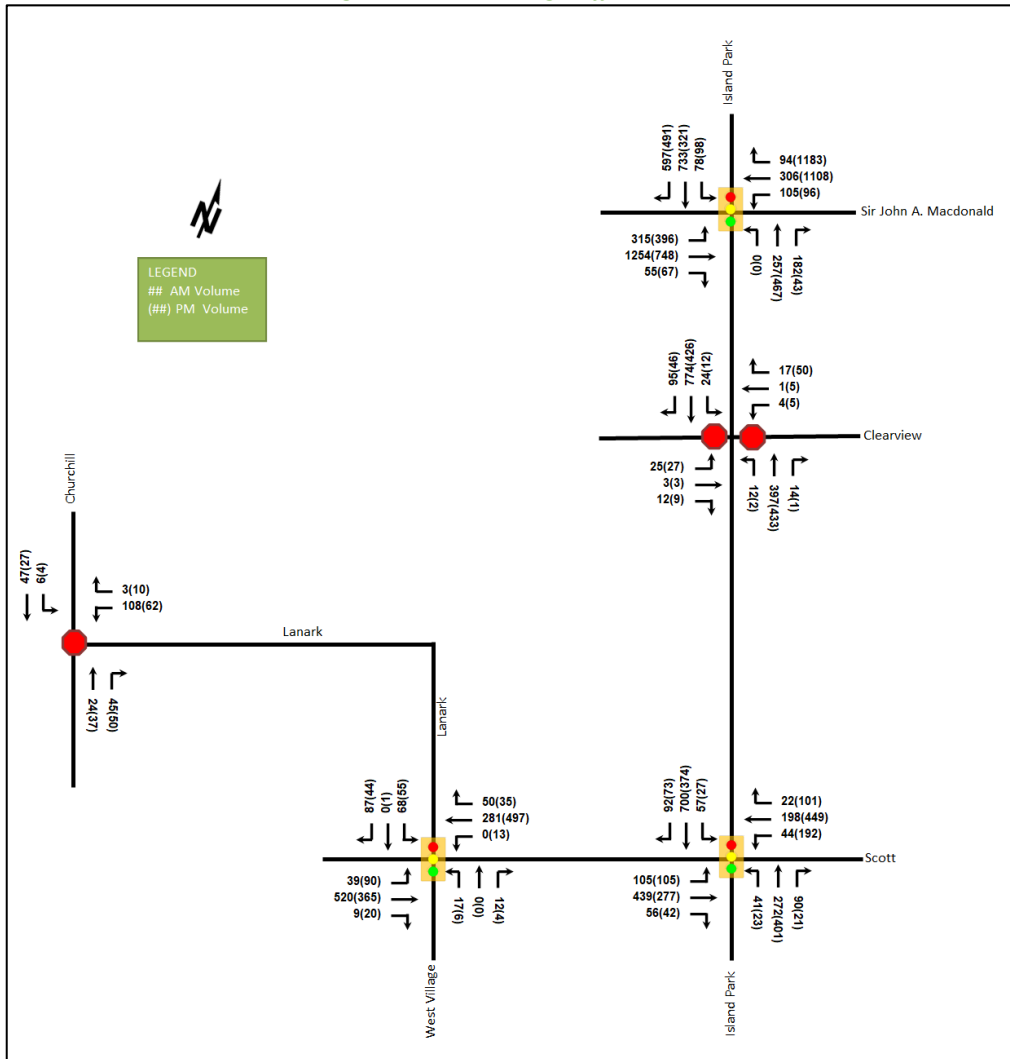

Table 2: 2020 Existing Intersection Operations

Intersection	Lane	AM Peak Hour				PM Peak Hour			
		LOS	V/C	Delay (s)	Q (95 th)	LOS	V/C	Delay (s)	Q (95 th)
Island Park Drive at Sir John A. Macdonald Parkway Signalized	EBL	D	0.89	73.7	#168.8	F	1.37	228.5	#252.8
	EBT	F	1.55	286.7	#363.3	F	1.11	119.1	#201.1
	EBR	A	0.13	1.9	2.5	A	0.18	4.5	6.6
	WBL	B	0.62	70.3	53.1	A	0.33	57.7	48.7
	WBT	B	0.69	61.3	66.0	F	1.65	336.1	#341.1
	WBR	A	0.35	12.5	16.6	F	2.38	649.1	#693.4
	NBT/R	D	0.82	49.7	167.0	E	0.94	72.6	#247.9
	SBL	A	0.40	65.6	21.8	A	0.51	77.8	27.4
	SBT/R	F	1.87	422.9	#730.1	F	1.17	126.5	#401.0
Overall	F	1.77	251.3	-	F	1.86	293.5	-	
Island Park Drive at Clearview Avenue Unsignalized	EB	F	0.36	50.0	11.3	D	0.21	26.5	6.0
	WB	C	0.09	20.2	2.3	B	0.15	14.8	3.8
	NB	B	0.02	10.2	0.8	A	0.00	8.5	0.0
	SB	A	0.02	8.3	0.8	A	0.01	8.5	0.0
	Overall	A	-	2.0	-	A	-	2.0	-
Island Park Drive at Scott Street Signalized	EBL	A	0.33	20.1	20.1	A	0.52	24.2	36.1
	EBT	C	0.74	28.8	88.4	A	0.36	13.9	38.5
	EBR	A	0.11	7.3	5.5	A	0.07	2.9	2.5
	WBL	A	0.28	25.8	15.7	A	0.48	21.0	46.7
	WBT/R	A	0.39	23.1	50.8	C	0.74	25.7	131.2
	NB	F	1.49	262.4	#118.7	E	0.92	54.8	#152.7
	SBL	A	0.16	15.0	13.9	A	0.13	22.7	10.4
	SBT/R	F	1.05	69.7	#247.5	C	0.78	36.9	#124.3
	Overall	F	1.17	86.6	-	D	0.81	31.8	-
Lanark Avenue at Scott Street Signalized	EBL	A	0.06	3.8	5.0	A	0.18	4.7	11.0
	EBT/R	A	0.43	5.5	60.7	A	0.31	4.4	38.2
	WBL	A	-	-	-	A	0.02	1.3	m0.3
	WBT/R	A	0.28	3.1	m18.8	A	0.43	1.8	m15.3
	NBL	A	0.13	37.5	9.2	A	0.05	37.2	5.1
	NBT/R	A	0.03	0.1	0.0	A	0.01	0.0	0.0
	SBL	A	0.47	47.6	25.8	A	0.39	46.8	22.7
	SBT/R	A	0.14	0.4	0.0	A	0.24	14.0	10.2
Overall	A	0.46	7.4	-	A	0.44	5.8	-	
Churchill Avenue and Lanark Avenue Unsignalized	WB	A	0.15	8.2	3.8	A	0.10	7.8	2.3
	NB	A	0.09	7.4	2.3	A	0.10	7.2	2.3
	SB	A	0.07	7.6	1.5	A	0.04	7.4	0.8
	Overall	A	-	7.8	-	A	-	7.5	-

Notes: Saturation flow rate of 1800 veh/h/lane
Queue is measured in metres
Peak Hour Factor = 0.90

m = metered queue
= volume for the 95th %ile cycle exceeds capacity

During both peak hours, the study area intersections are subject to queuing issues generally and capacity issues on various movements.

At the intersection of Island Park Drive at Sir John A. Macdonald Parkway, the eastbound through and southbound shared through/right-turn movements during the AM peak and eastbound left-turn, eastbound through, westbound through, westbound right-turn, and southbound shared through/right-turn movements during the PM peak are over theoretical capacity and may subject to high delays and extended queues. Extended queues may be

exhibited on the eastbound left-turn movement during the AM peak and northbound shared through/right-turn movements during the PM peak.

The eastbound movement during the AM peak at the intersection of Island Park Drive and Clearview Avenue is over theoretical capacity.

At the intersection of Island Park Drive and Scott Street, the northbound movements and southbound share through/right-turn movements during AM the peak are over theoretical capacity and may subject to high delays and extended queues. It may also be subject to extended queues on the northbound and southbound share through/right-turn movements during the PM peak. This intersection timings could be further optimized to improve the operations for the above noted capacity issues.

2.2.8 Collision Analysis

Collision data have been acquired from the City of Ottawa open data website (data.ottawa.ca) for five years prior to the commencement of this TIA for the surrounding study area road network. Table 3 summarizes the collisions types and conditions in the study area, Figure 11 illustrates the intersections and segments analyzed, and Table 4 summarizes the total collisions for each of these locations. Collision data are included in Appendix D.

Table 3: Study Area Collision Summary, 2016-2020

		Number	%
Total Collisions		5	100%
Classification	Fatality	0	0%
	Non-Fatal Injury	1	20%
	Property Damage Only	4	80%
Initial Impact Type	Sideswipe	1	20%
	SMV Unattended	2	40%
	SMV Other	2	40%
Road Surface Condition	Dry	3	60%
	Packed Snow	1	20%
	Ice	1	20%
Pedestrian Involved		0	0%
Cyclists Involved		0	0%

Figure 11: Representation of Study Area Collision Records

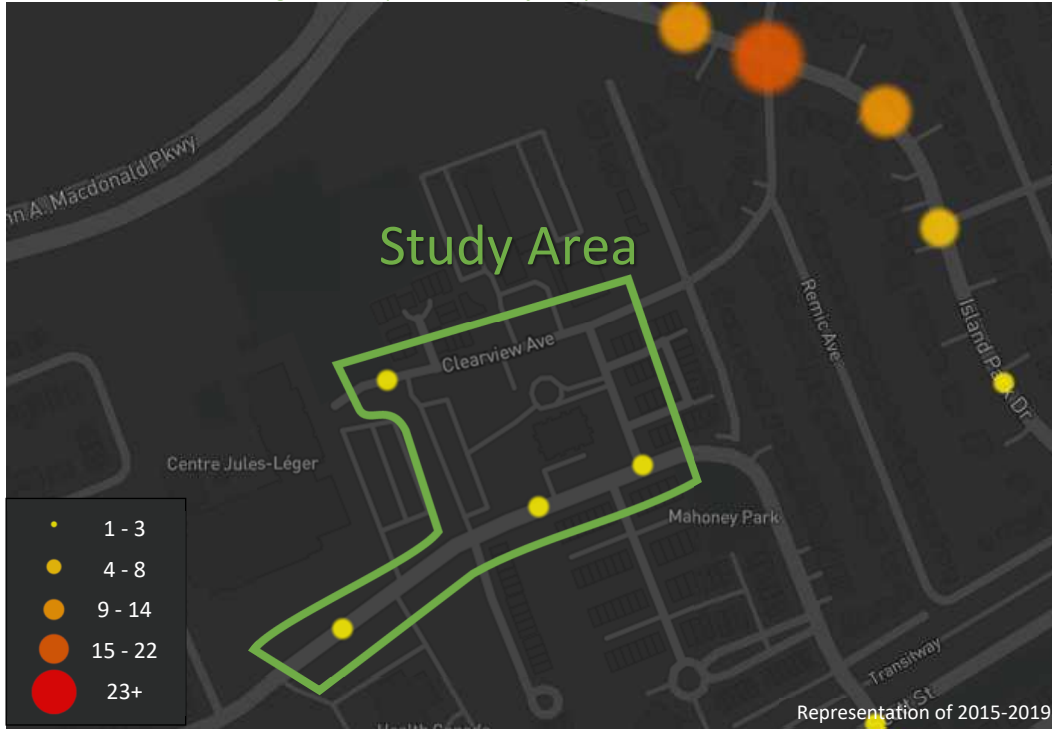

Table 4: Summary of Collision Locations, 2016-2020

Intersections / Segments	Number	%
	5	100%
Lanark Ave btwn Briarway Priv & Metropole Priv	2	40%
Ellendale Cres at Lanark Ave	1	20%
Lanark Ave btwn Beechgrove Ave & Briarway Priv	1	20%
Clearview Ave btwn Oak Park Priv & End	1	20%

Within the study area, the intersection and segments have a total of five collisions during 2016 to 2020 with four involving property damage only and the remaining one having non-fatal injuries. There are two collisions each by SMV Unattended and SMV Other and one collision each by sideswipe. Due to the low numbers of collision in the vicinity of the site, no further collision analysis is required within this study.

2.3 Planned Conditions

2.3.1 Changes to the Area Transportation Network

The subject development is within the Richmond Road/Westboro Community Design Plan (CDP) Area. The CDP illustrates green street, two-metre sidewalk and dedicated on-road cycle-lanes or signed cycle route on key local streets and informal pedestrian/cycling links connected to transitway station, local parks, community, and Ottawa River to be incorporated into the development as it redevelops or undergoes rehabilitation.

Westboro station is identified as one of the Confederation Line West extension new stations in the Stage 2 Light Rail Transit project and will be converted to accommodate LRT. Additional pedestrian connectivity, bicycle facilities, and a bus staging area will be provided. The anticipated build-out year of the project is 2027.

Additionally, as stated by the City of Ottawa, Scott Street between Churchill Avenue and Tunney’s Pasture has been used as a Transitway detour during the construction of the Stage 2 Confederation Line West extension. The bus only eastbound lane on Scott Street from Clifton Road to Island Park Drive, and the westbound right-turn

lane at Island Park Drive are part of detour plan. It is noted that the westbound right-turn lane at Island Park Drive is to alleviate westbound queues at the intersection. It is expected that the Transitway detour will be removed prior to 2027. The proposed detour plan can be found in Appendix E, and it is noted that the changes of the Cycling and pedestrian facilities along Scott Street will be included in the future horizons.

The City of Ottawa has also mentioned “long term plans” to upgrade Scott Street to a “complete street” following the removal of the Transitway detour. Scott Street between McRae Avenue and Churchill Avenue, cycle tracks are purposed to be provided on both sides of and sidewalk on the north side. The preliminary design of Scott Street between McRae Avenue and Churchill Avenue has been provided in Appendix F. As changes are not within the study area, no changes to the intersection will be made in future horizons.

2.3.2 Other Study Area Developments

234 Atlantis Avenue and 745 Sir John A. Macdonald Parkway

The proposed development includes a zoning by-law amendment, which consists of a parking lot, a lookout parking area, modifications to the SJAM Parkway at the Kitchissippi lookout, and an expansion of the existing Westboro Beach Café pavilion into new 14,000 m² Pavilion building facility. Due to the small change in the number of parking spots provided and decrease in the size of the proposed building, it is expected not to have any significant impact on the overall network. (exp Services Inc., 2020)

316-322 Clifton Road

The proposed development application includes a site plan for the construction of 31 dwelling units. The development is anticipated to be built out in 2025. The Screening Form did not identify the need for a full TIA.

70 Richmond Road

The proposed development includes an official plan amendment to facilitate the construction of a nine-storey mixed-use building, including 88 residential units and 2,290 ft² of ground floor retail. The development is anticipated to be built out in 2023 and the trip generation trigger does not meet. (CGH Transportation, 2022)

175 Richmond Road

The proposed development application includes a zoning by-law amendment consist of a six-storey mixed-use building with 104 residential units and 7,525 ft² of retail. The development is anticipated to be built out in 2025. Only TIA scoping report is available at this time. (Novatech, 2020)

295, 299, 301 Ashton Avenue and 2046, 2050 Scott Street

The proposed development application includes a site plan for the construction of a 30-storey mixed use residential tower with 353 units and 233 m² of ground commercial/office. The development built out year is assumed to be 2023, and it is anticipated to generate 35 new AM and 35 PM peak hour two-way auto trips. (Parsons, 2021)

315 Tweedsmuir Avenue and 320 Mcrae Avenue

The proposed development includes a zoning by-law amendment and site plan control application to construct a 26-storey mixed-use development containing 325 apartment units, 11 townhouse units, and 820 m² (8,826 ft²) of commercial space. The anticipated full build-out and occupancy horizon is 2022 and is anticipated to generate 34 new AM and 41 PM peak hour two-way auto trips. (CGH Transportation, 2020)

2070 Scott Street

The proposed development includes a zoning by-law amendment and site plan control application to construct a 25-storey mixed-use building with 264 residential units and 5,554 ft² of ground floor retail. The anticipated full build-out and occupancy horizon is 2022 and it is anticipated to generate 38 new AM and 35 PM peak hour two-way auto trips. (Stantec, 2019)

319-327 Richmond Road, 380 Winona Avenue, and 381 Churchill Avenue

The proposed development application includes a site plan for the construction of a nine-storey building with 184 apartment units, 18,685 sq. ft. of retail space. The anticipated full build-out and occupancy horizon is 2022, and it is anticipated to generate 21 new AM and 30 PM peak hour two-way auto trips. (CGH Transportation, 2020)

2006, 2020, and 2026 Scott Street, 314 and 318 Athlone Avenue

The proposed development application includes a zoning by-law amendment consist of two 40-storey towers with a total of approximately 813 dwelling units. The anticipated buildout of Phase One is 2026 and buildout of Phase Two is 2029, and the net additional auto trips are anticipated to be 17 AM and -9 PM peak hour two-way auto trips. (Novatech, 2022)

3 Study Area and Time Periods

3.1 Study Area

The study area will include the intersections of:

- Island Park Drive at:
 - Clearview Avenue
 - Sir John A. Macdonald Parkway
 - Scott Street
- Lanark Avenue:
 - Scott Street
 - Churchill Avenue

The boundary road will be Clearview Avenue and Lanark Avenue, and no screenlines are present within proximity to the site.

3.2 Time Periods

As the proposed development is composed entirely of residential units the AM and PM peak hours will be examined.

3.3 Horizon Years

The anticipated build-out year is 2027. As a result, the full build-out plus five years horizon year is 2032.

4 Exemption Review

Table 5 summarizes the exemptions for this TIA.

Table 5: Exemption Review

Module	Element	Explanation	Exempt/Required
Design Review Component			
4.1 Development Design	4.1.2 Circulation and Access	Only required for site plans	Required at Site Plan Application
	4.1.3 New Street Networks	Only required for plans of subdivision	Exempt
4.2 Parking	4.2.1 Parking Supply	Only required for site plans	Required at Site Plan Application
	4.2.2 Spillover Parking	Only required for site plans where parking supply is 15% below unconstrained demand	Exempt. May be required at Site Plan Application

Module	Element	Explanation	Exempt/Required
Network Impact Component			
4.5 Transportation Demand Management	All Elements	Not required for site plans expected to have fewer than 60 employees and/or students on location at any given time	Required
4.6 Neighbourhood Traffic Management	4.6.1 Adjacent Neighbourhoods	Only required when the development relies on local or collector streets for access and total volumes exceed ATM capacity thresholds	Required
4.8 Network Concept		Only required when proposed development generates more than 200 person-trips during the peak hour in excess of equivalent volume permitted by established zoning	Exempt

5 Development-Generated Travel Demand

5.1 Mode Shares

Examining the mode shares recommended in the TRANS Trip Generation Manual (2020) for the subject district, derived from the most recent National Capital Region Origin-Destination survey (OD Survey), the existing average district mode shares by land use for Ottawa West have been summarized in Table 6.

Table 6: TRANS Trip Generation Manual Recommended Mode Shares – Ottawa West

Travel Mode	Multi-Unit (High-Rise)	
	AM	PM
Auto Driver	28%	33%
Auto Passenger	11%	11%
Transit	41%	26%
Cycling	3%	7%
Walking	16%	23%
Total	100%	100%

Since Confederation Line West extension is planned to be completed by 2025, a higher transit mode is considered achievable at this location. A 5% shift to transit mode taken from the auto mode is proposed for both peak hours. The proposed modified mode share targets for the development and are summarized in Table 7.

Table 7: Proposed Development Mode Shares – Within 600 m of Rapid Transit

Travel Mode	Multi-Unit (High-Rise)	
	AM	PM
Auto Driver	23%	28%
Auto Passenger	11%	11%
Transit	46%	31%
Cycling	3%	7%
Walking	16%	23%
Total	100%	100%

5.2 Trip Generation

This TIA has been prepared using the vehicle and person trip rates for the residential dwellings using the TRANS Trip Generation Manual (2020). Table 8 summarizes the person trip rates for the proposed residential land use for peak period.

Table 8: Trip Generation Person Trip Rates by Peak Period

Land Use	Land Use Code	Peak Period	Person Trip Rates
Multi-Unit (High-Rise)	221 & 222 (TRANS)	AM	0.80
		PM	0.90

Using the above person trip rates, the total person trip generation has been estimated. Table 9 summarizes the total person trip generation for the residential land uses.

Table 9: Total Residential Person Trip Generation by Peak Period

Land Use	Units	AM Peak Period			PM Peak Period		
		In	Out	Total	In	Out	Total
Multi-Unit (High-Rise)	177	44	98	142	92	67	159

Using the above mode share targets for a LRT area and the person trip rates, the person trips by mode have been projected. Trip generation by peak hour has been forecasted using the prescribed peak period conversion factors presented in the TRANS Trip Generation Manual (2020) for the residential component. Table 10 summarizes the residential trip generation by mode and peak hour.

Table 10: Residential Trip Generation by Mode

Travel Mode		AM Peak Hour				PM Peak Hour			
		Mode Share	In	Out	Total	Mode Share	In	Out	Total
Multi-Unit (High-Rise)	Auto Driver	23%	5	11	16	28%	11	8	19
	Auto Passenger	11%	2	5	7	11%	4	3	7
	Transit	46%	11	25	36	31%	14	10	24
	Cycling	3%	1	2	3	7%	3	2	5
	Walking	16%	4	9	13	23%	11	8	19
Total		100%	23	52	75	100%	43	31	74

As shown above, a total of 16 AM new and 19 PM new peak hour two-way vehicle trips are projected as a result of the proposed development.

5.3 Trip Distribution

To understand the travel patterns of the subject development, the OD Survey has been reviewed to determine the travel for the residential component, and these patterns were applied based on the build-out of Ottawa West. Table 11 below summarizes the distributions.

Table 11: OD Survey Distribution – Ottawa West

To/From	Residential % of Trips
North	5%
South	50%
East	40%
West	5%
Total	100%

5.4 Trip Assignment

Using the distribution outlined above, turning movement splits, and access to major transportation infrastructure, the trips generated by the site have been assigned to the study area road network. Table 12 and Table 13 summarize the proportional assignment to the study area roadways during the AM peak hour and the PM peak hour, and Figure 12 illustrates the new site generated volumes.

Table 12: Trip Assignment – AM Peak Hour

To/From	Via
North	3% Sir John A. Macdonald Parkway (E) 2% Island Park Drive (N)
South	30% Island Park Drive (S) 20% Churchill Avenue (S)
East	20% Sir John A. Macdonald Parkway (E) 20% Scott Street (E)
West	2% Churchill Avenue (S) 2% Sir John A. Macdonald Parkway (W) 1% Island Park Drive (N)
Total	100%

Table 13: Trip Assignment – PM Peak Hour

To/From	Inbound Via	Outbound Via
North	3% Sir John A. Macdonald Parkway (E) 2% Island Park Drive (N)	3% Sir John A. Macdonald Parkway (E) 2% Island Park Drive (N)
South	30% Island Park Drive (S) 20% Churchill Avenue (S)	30% Island Park Drive (S) 20% Churchill Avenue (S)
East	20% Sir John A. Macdonald Parkway (E) 20% Scott Street (E)	40% Scott Street (E)
West	2% Churchill Avenue (S) 2% Sir John A. Macdonald Parkway (W) 1% Island Park Drive (N)	2% Churchill Avenue (S) 2% Sir John A. Macdonald Parkway (W) 1% Island Park Drive (N)
Total	100%	100%

Figure 12: New Site Generation Auto Volumes

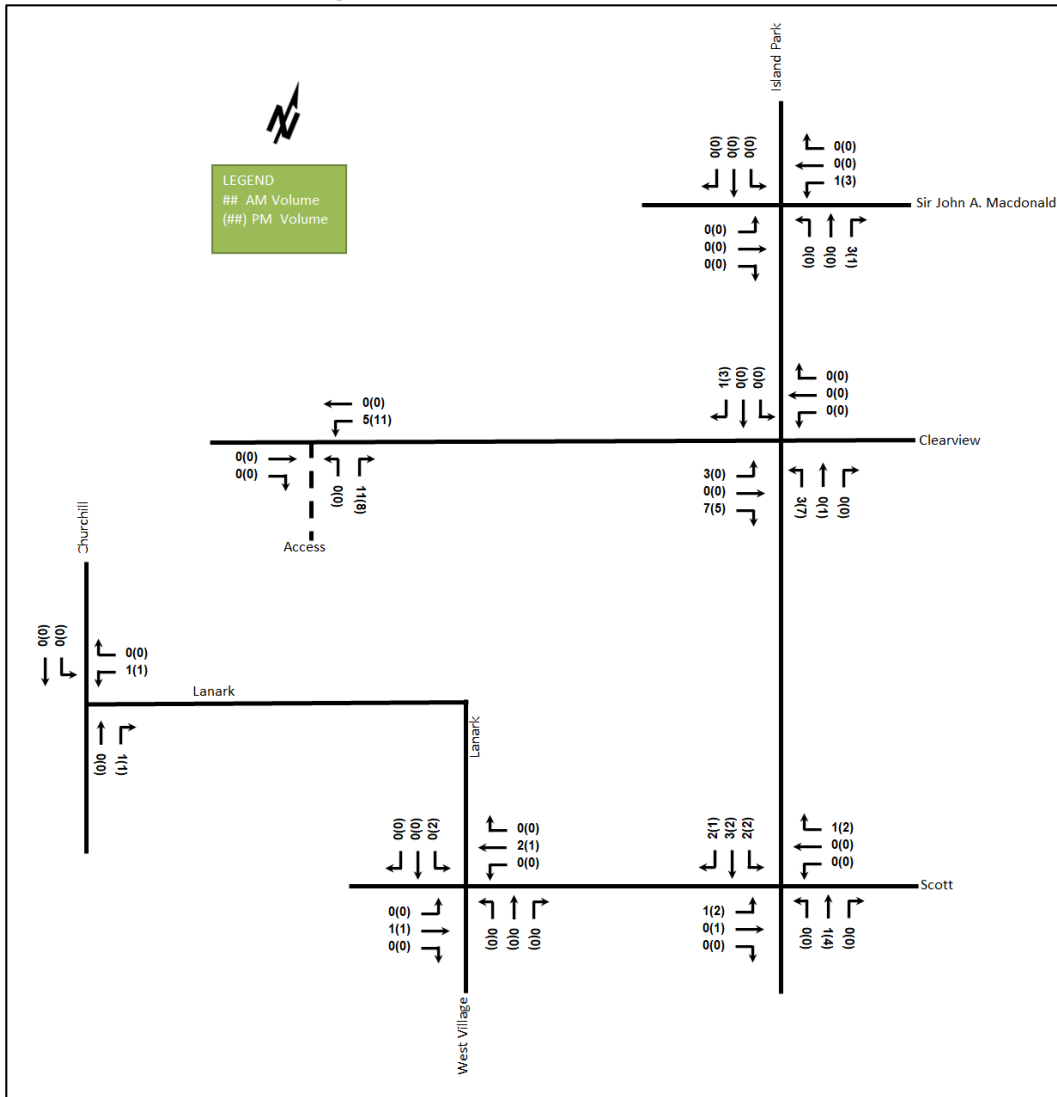

6 Background Network Travel Demands

6.1 Transportation Network Plans

The transportation network plans were discussed in Section 2.3 and have been incorporated into the road network analysis.

6.2 Background Growth

A review of the background projections from the City’s TRANS Regional Model for the 2011 and 2031 horizons was completed to determine the background growth for each of the study area roadways. The background TRANS model growth rates are summarized in Table 14 and the TRANS model plots are provided in Appendix G.

Table 14: TRANS Regional Model Projections – Study Area Growth Rates

Street	TRANS Rate		2011 to Existing		Existing to 2031	
	Eastbound	Westbound	Eastbound	Westbound	Eastbound	Westbound
Scott Street	-0.93%	1.83%	-1.54%	15.17%	-0.43%	-7.93%
Sir John A. Macdonald Parkway	0.46%	1.69%	-1.30%	1.74%	1.93%	1.65%
	Northbound	Southbound	Northbound	Southbound	Northbound	Southbound
Island Park Drive	1.62%	0.74%	3.48%	-2.92%	0.11%	3.84%
Churchill Avenue	-1.00%	0.34%	-6.05%	-2.85%	3.34%	3.02%
Lanark Avenue	-0.06%	0.33%	1.19%	-3.77%	-1.08%	3.82%

A comparison of the 2011 to Existing volumes and the Existing to 2031 volumes illustrates a situation that development has not progressed linearly. It is unlikely that the growth rates will decrease or increase as the Existing to 2031 summary outlines, therefore, growth rates derived from the TRANS Rate rounded to the nearest 0.25% will be peak-directionally applied to the appropriate roadway’s mainline volumes and to the appropriate major turning movements at the intersections. Table 15 summarizes the recommended growth rates to be considered within the study area.

Table 15: Recommended Area Growth Rates

Street	AM Peak Hour		PM Peak Hour	
	Eastbound	Westbound	Eastbound	Westbound
Scott Street	0%	1.75%	1.75%	0%
Sir John A. Macdonald Parkway	0.50%	1.75%	1.75%	0.50%
	Northbound	Southbound	Northbound	Southbound
Island Park Drive	1.50%	0.75%	0.75%	1.50%
Churchill Avenue	0%	0.25%	0.25%	0%
Lanark Avenue	0%	0.25%	0.25%	0%

6.3 Other Developments

The background developments explicitly considered in the background conditions (Section 6.2) include:

- 175 Richmond Road
- 295, 299, 301 Ashton Avenue and 2046, 2050 Scott Street
- 315 Tweedsmuir Avenue and 320 Mcrae Avenue
- 2070 Scott Street
- 319-327 Richmond Road, 380 Winona Avenue, and 381 Churchill Avenue
- 2006, 2020, and 2026 Scott Street, 314 and 318 Athlone Avenue

Figure 13 and Figure 14 illustrate the 2027 and 2032 total background development volumes, and each background development volumes within the study area have been provided in Appendix H.

Figure 13: 2027 Total Background Development Volumes

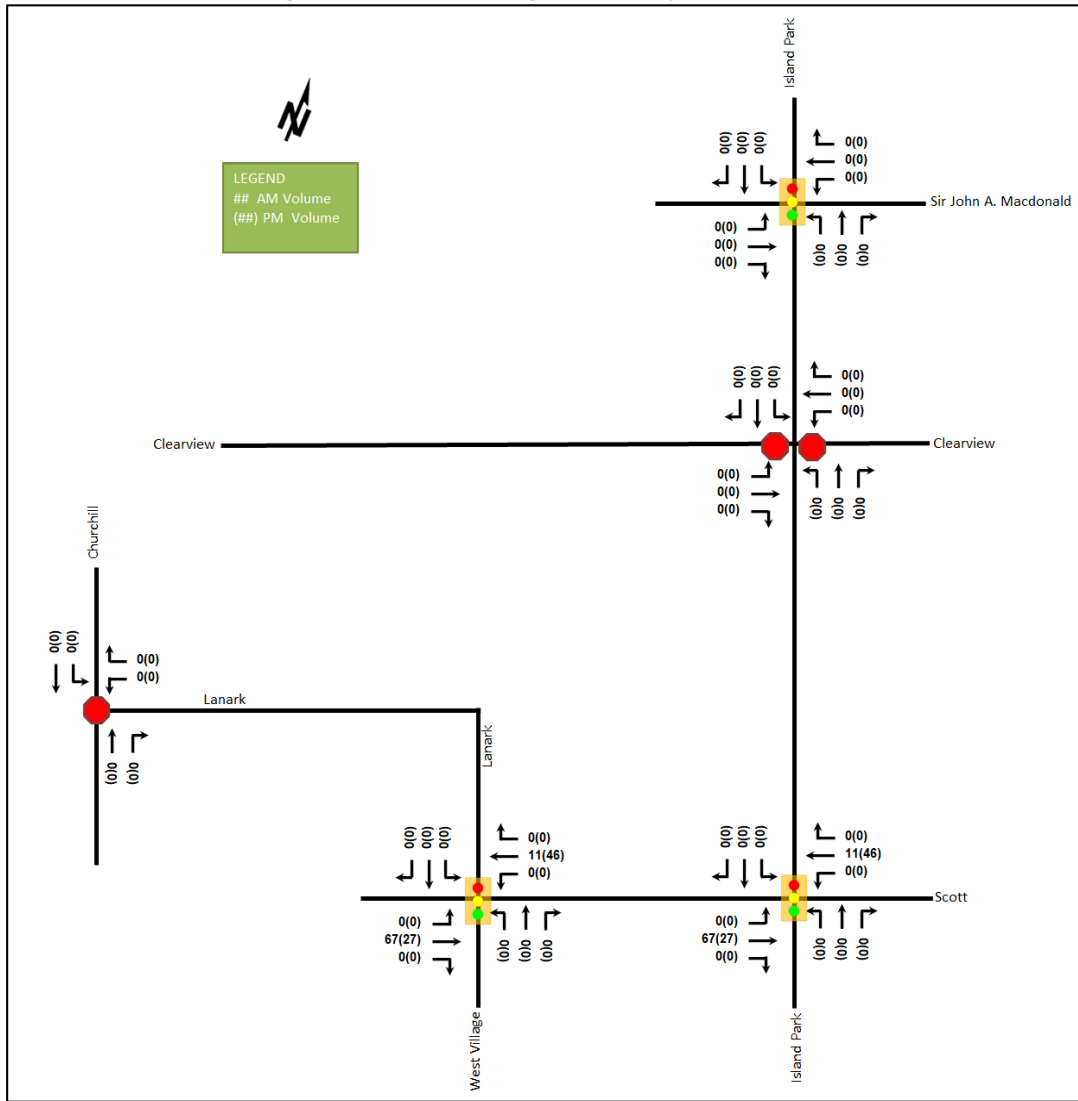
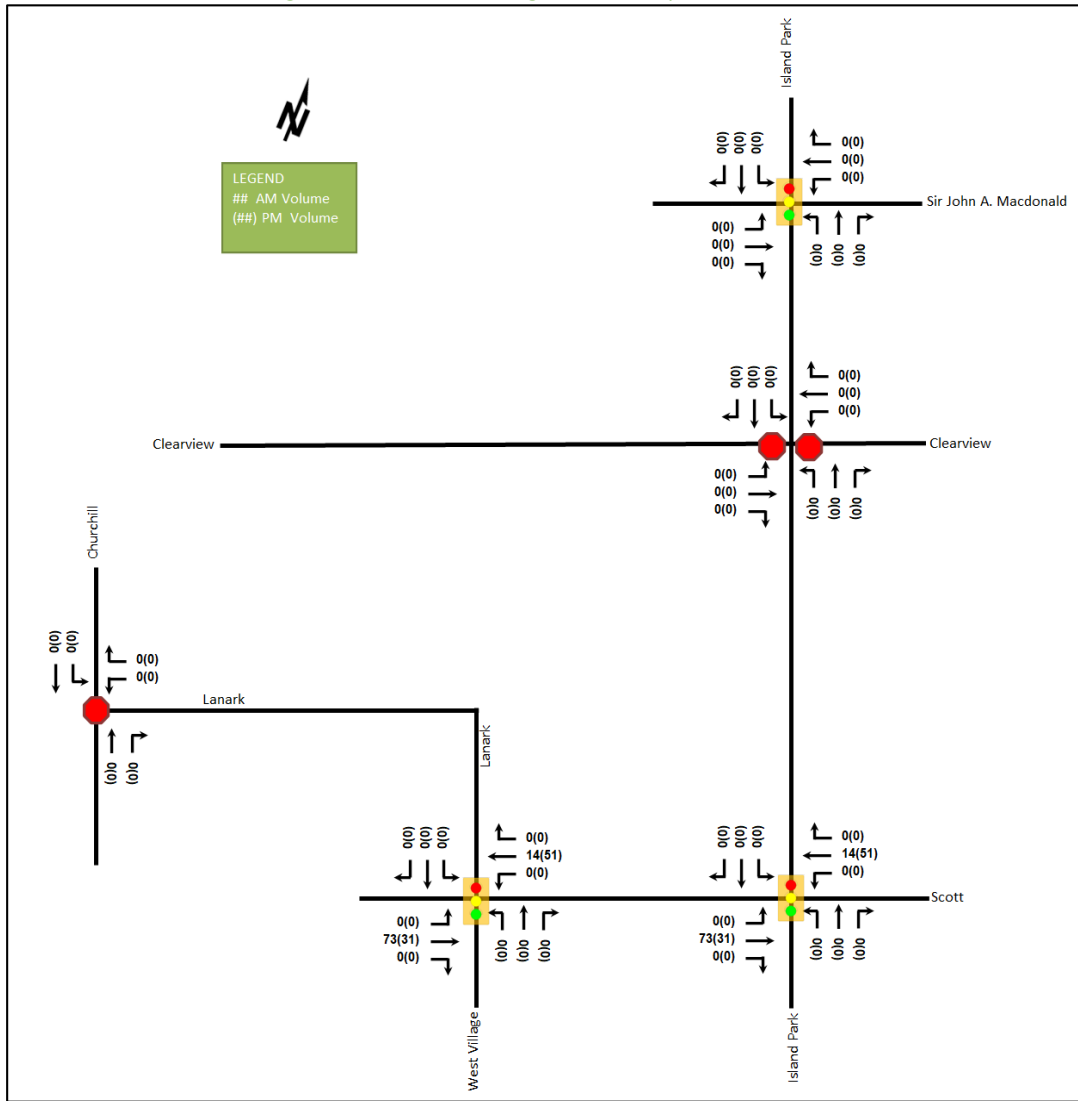

Figure 14: 2032 Total Background Development Volumes



7 Demand Rationalization

7.1 2027 Future Background Operations

Figure 15 illustrates the 2027 background volumes and Table 16 summarizes the 2027 background intersection operations. The level of service for signalized intersections is based on v/c calculations for individual lane movements and HCM 2000 v/c calculations for the overall intersection, and average delay for unsignalized intersections. The synchro worksheets for the 2027 future background horizon are provided in Appendix I.

Figure 15: 2027 Future Background Volumes

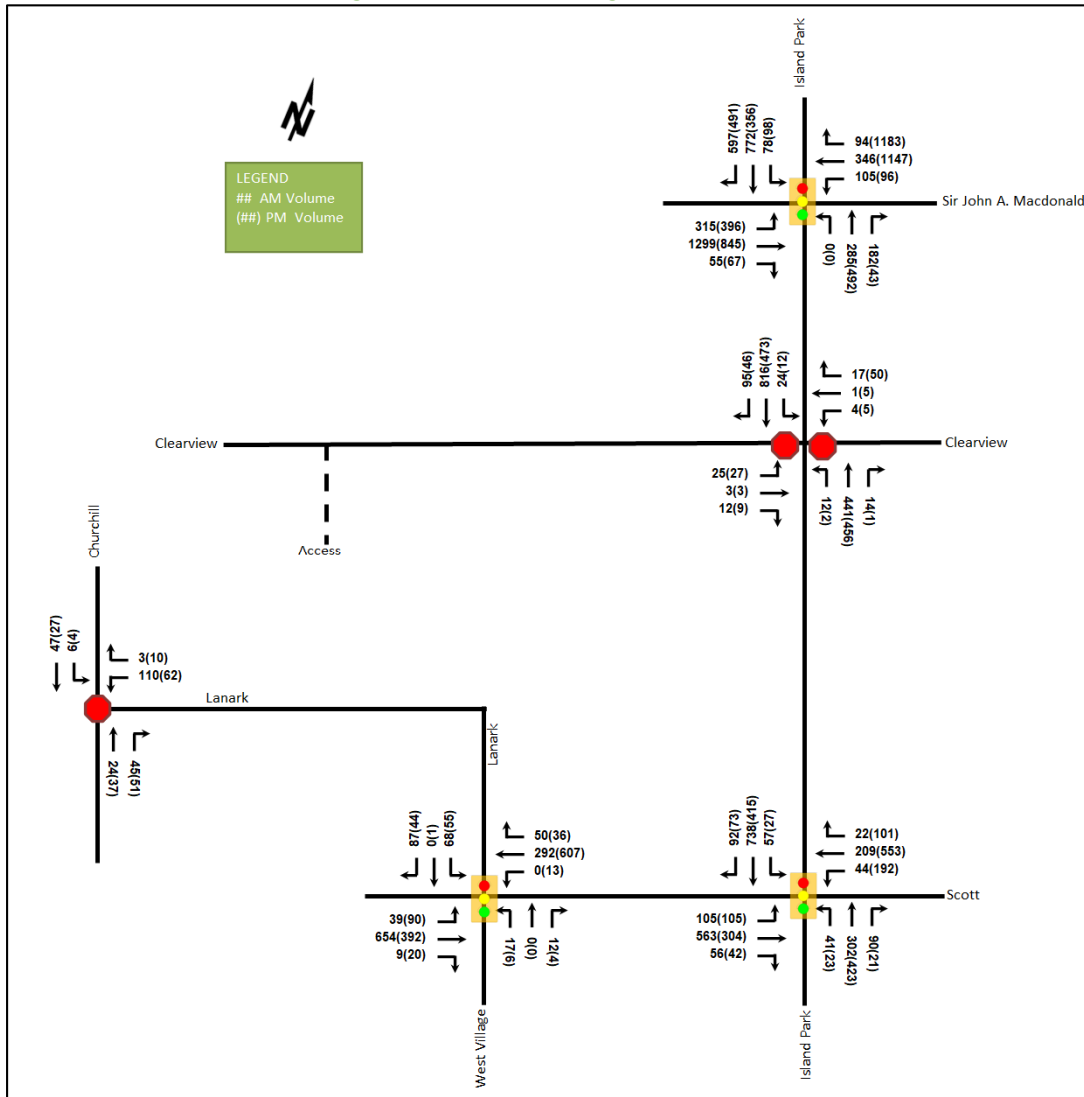

Table 16: 2027 Future Background Intersection Operations

Intersection	Lane	AM Peak Hour				PM Peak Hour			
		LOS	V/C	Delay (s)	Q (95 th)	LOS	V/C	Delay (s)	Q (95 th)
Island Park Drive at Sir John A. Macdonald Parkway Signalized	EBL	C	0.80	63.6	#146.7	F	1.20	164.9	#220.3
	EBT	F	1.42	229.9	#328.1	F	1.09	114.1	#204.3
	EBR	A	0.11	0.6	0.7	A	0.16	3.2	4.2
	WBL	A	0.57	67.3	48.0	A	0.29	55.8	44.2
	WBT	B	0.69	59.7	66.2	F	1.50	271.2	#310.1
	WBR	A	0.31	10.9	13.9	F	2.08	515.1	#596.9
	NBT/R	C	0.79	47.1	154.8	E	0.92	69.4	#223.0
	SBL	A	0.38	63.9	19.7	A	0.48	76.3	25.1
	SBT/R	F	1.75	368.0	#655.5	F	1.13	111.6	#363.6
	Overall	F	1.64	212.8	-	F	1.68	235.3	-

Intersection	Lane	AM Peak Hour				PM Peak Hour			
		LOS	V/C	Delay (s)	Q (95 th)	LOS	V/C	Delay (s)	Q (95 th)
Island Park Drive at Clearview Avenue <i>Unsignalized</i>	EB	E	0.30	42.5	9.0	C	0.18	24.5	4.5
	WB	C	0.08	18.9	2.3	B	0.13	14.3	3.8
	NB	A	0.02	9.9	0.0	A	0.00	8.5	0.0
	SB	A	0.02	8.3	0.8	A	0.01	8.4	0.0
	Overall	A	-	1.7	-	A	-	1.8	-
Island Park Drive at Scott Street <i>Signalized</i>	EBL	A	0.29	19.5	18.1	A	0.54	26.4	34.5
	EBT	D	0.85	36.2	#146.7	A	0.36	13.9	37.9
	EBR	A	0.10	6.7	m5.0	A	0.06	3.0	2.6
	WBL	A	0.35	31.0	16.0	A	0.43	19.7	41.1
	WBT/R	A	0.37	22.8	48.2	C	0.78	28.3	146.3
	NB	F	1.10	99.2	#146.5	D	0.83	42.4	#133.5
	SBL	A	0.15	14.7	12.7	A	0.11	22.2	9.4
	SBT/R	E	0.99	53.6	#227.3	C	0.76	36.1	119.1
Overall	E	0.99	50.8	-	C	0.80	29.6	-	
Lanark Avenue at Scott Street <i>Signalized</i>	EBL	A	0.05	3.7	4.7	A	0.17	4.7	10.2
	EBT/R	A	0.48	5.9	73.1	A	0.30	4.4	36.3
	WBL	-	-	-	-	A	0.02	1.4	m0.3
	WBT/R	A	0.25	2.9	m17.5	A	0.47	1.9	m17.4
	NBL	A	0.11	37.5	8.5	A	0.04	37.0	4.6
	NBT/R	A	0.03	0.1	0.0	A	0.01	0.0	0.0
	SBL	A	0.43	46.4	23.6	A	0.35	45.5	20.8
	SBT/R	A	0.12	0.4	0.0	A	0.22	14.4	9.6
Overall	A	0.50	7.3	-	A	0.47	5.4	-	
Churchill Avenue and Lanark Avenue <i>Unsignalized</i>	WB	A	0.15	8.1	3.8	A	0.09	7.8	2.3
	NB	A	0.08	7.3	1.5	A	0.10	7.2	2.3
	SB	A	0.06	7.6	1.5	A	0.04	7.4	0.8
	Overall	A	-	7.8	-	A	-	7.4	-

Notes: Saturation flow rate of 1800 veh/h/lane
Queue is measured in metres
Peak Hour Factor = 1.00

m = metered queue
= volume for the 95th %ile cycle exceeds capacity

Intersections within the study area will operate similarly to existing condition with improvement to the intersection operations due to the adjustment of the peak hour factor to 1.00 for forecasted conditions.

At the intersection of Island Park Drive and Scott Street, the northbound movement during AM peak hour is over theoretical capacity and may subject to high delays and extended queues. It may also be subject to extended queues on the eastbound through movement and the southbound share through/right-turn movements during AM peak hour and northbound movement during PM peak hour. Similar to the existing condition, this constraint could be addressed by signal timing adjustments.

7.2 2032 Future Background Operations

Figure 16 illustrates the 2032 background volumes and Table 17 summarizes the 2032 background intersection operations. The level of service for signalized intersections is based on the v/c calculation for individual lane movements and HCM 2000 v/c calculations for the overall intersection, and HCM average delay for unsignalized intersections. The synchro worksheets for the 2032 future background horizon are provided in Appendix J.

Figure 16: 2032 Future Background Volumes

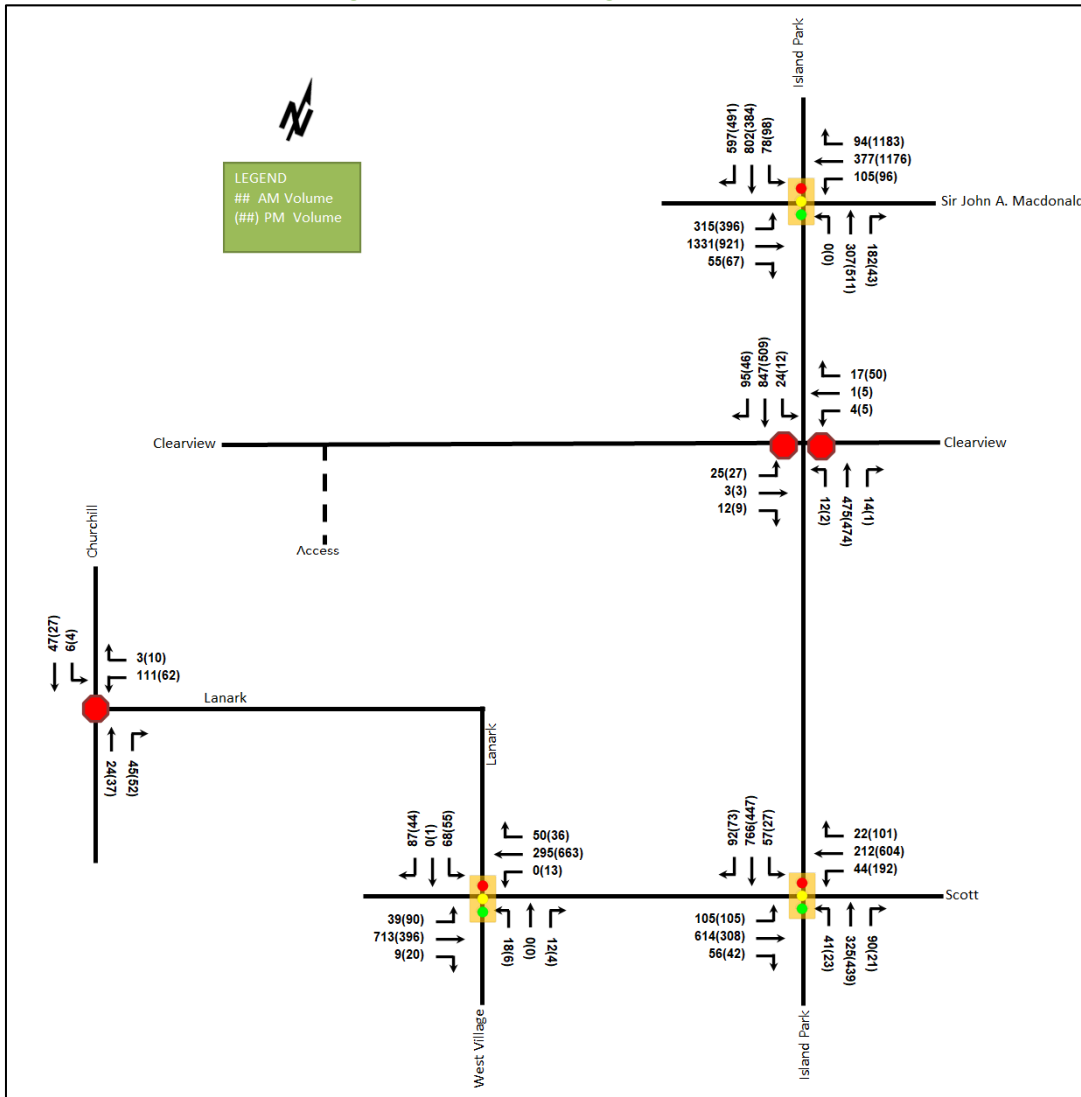

Table 17: 2032 Future Background Intersection Operations

Intersection	Lane	AM Peak Hour				PM Peak Hour			
		LOS	V/C	Delay (s)	Q (95 th)	LOS	V/C	Delay (s)	Q (95 th)
Island Park Drive at Sir John A. Macdonald Parkway Signalized	EBL	D	0.82	67.2	#149.3	F	1.21	170.8	#220.3
	EBT	F	1.49	259.5	#343.7	F	1.21	154.5	#231.0
	EBR	A	0.12	0.7	0.7	A	0.16	3.2	4.2
	WBL	A	0.53	65.5	47.7	A	0.29	56.3	44.2
	WBT	C	0.72	61.4	71.9	F	1.56	295.7	#320.0
	WBR	A	0.30	10.6	13.9	F	2.12	529.1	#600.0
	NBT/R	D	0.82	49.7	167.9	E	0.93	70.6	#235.9
	SBL	A	0.38	65.8	20.0	A	0.48	77.0	25.1
	SBT/R	F	1.78	382.6	#684.6	F	1.15	119.2	#382.5
	Overall	F	1.68	226.8	-	F	1.70	249.8	-

Intersection	Lane	AM Peak Hour				PM Peak Hour			
		LOS	V/C	Delay (s)	Q (95 th)	LOS	V/C	Delay (s)	Q (95 th)
Island Park Drive at Clearview Avenue <i>Unsignalized</i>	EB	E	0.33	47.8	9.8	D	0.19	26.6	5.3
	WB	C	0.09	20.3	2.3	B	0.14	14.8	3.8
	NB	B	0.02	10.1	0.8	A	0.00	8.6	0.0
	SB	A	0.02	8.4	0.8	A	0.01	8.5	0.0
	Overall	A	-	1.7	-	A	-	1.8	-
Island Park Drive at Scott Street <i>Signalized</i>	EBL	A	0.29	20.3	19.3	B	0.64	36.1	#42.1
	EBT	E	0.93	45.9	#169.3	A	0.36	13.9	38.1
	EBR	A	0.10	7.7	m5.3	A	0.06	3.0	2.5
	WBL	A	0.49	44.5	#21.1	A	0.43	19.8	41.3
	WBT/R	A	0.37	22.9	48.8	D	0.84	32.4	#181.9
	NB	F	1.28	169.6	#164.1	E	0.91	53.1	#148.3
	SBL	A	0.15	14.8	12.8	A	0.12	22.3	9.4
	Overall	F	1.13	69.8	-	D	0.87	34.3	-
Lanark Avenue at Scott Street <i>Signalized</i>	EBL	A	0.05	3.7	4.7	A	0.19	4.9	10.5
	EBT/R	A	0.52	6.5	84.8	A	0.30	4.4	36.9
	WBL	-	-	-	-	A	0.02	1.3	m0.3
	WBT/R	A	0.26	2.9	m17.1	A	0.51	1.9	m17.2
	NBL	A	0.12	37.6	8.9	A	0.04	37.0	4.6
	NBT/R	A	0.03	0.1	0.0	A	0.01	0.0	0.0
	SBL	A	0.43	46.4	23.6	A	0.35	45.5	20.8
	Overall	A	0.54	7.5	-	A	0.51	5.2	-
Churchill Avenue and Lanark Avenue <i>Unsignalized</i>	WB	A	0.14	8.1	3.8	A	0.09	7.7	2.3
	NB	A	0.08	7.3	1.5	A	0.09	7.2	2.3
	SB	A	0.06	7.6	1.5	A	0.04	7.4	0.8
	Overall	A	-	7.8	-	A	-	7.4	-

Notes: Saturation flow rate of 1800 veh/h/lane
 Queue is measured in metres
 Peak Hour Factor = 1.00

m = metered queue
 # = volume for the 95th %ile cycle exceeds capacity

The intersections at the 2032 future background condition are anticipated to operate similarly to the existing condition.

At the intersection of Island Park Drive and Scott Street, southbound share through/right-turn movements will return to being over capacity during AM peak hour and may subject to extended queues during PM peak hour. It is similar to the existing conditions and can be addressed by signal timing adjustments. The westbound left-turn movement during the AM peak and eastbound left-turn and westbound shared through/right-turn movements during the PM peak hour may start to subject to extended queues.

7.3 2027 Future Total Operations

Figure 17 illustrates the 2027 future total volumes and Table 18 summarizes the 2027 future total intersection operations. The level of service for signalized intersections is based on v/c calculations for individual lane movements and HCM 2000 v/c calculations for the overall intersection, and average delay for unsignalized intersections. The synchro worksheets for the 2027 future total horizon are provided in Appendix K.

Figure 17: 2027 Future Total Volumes

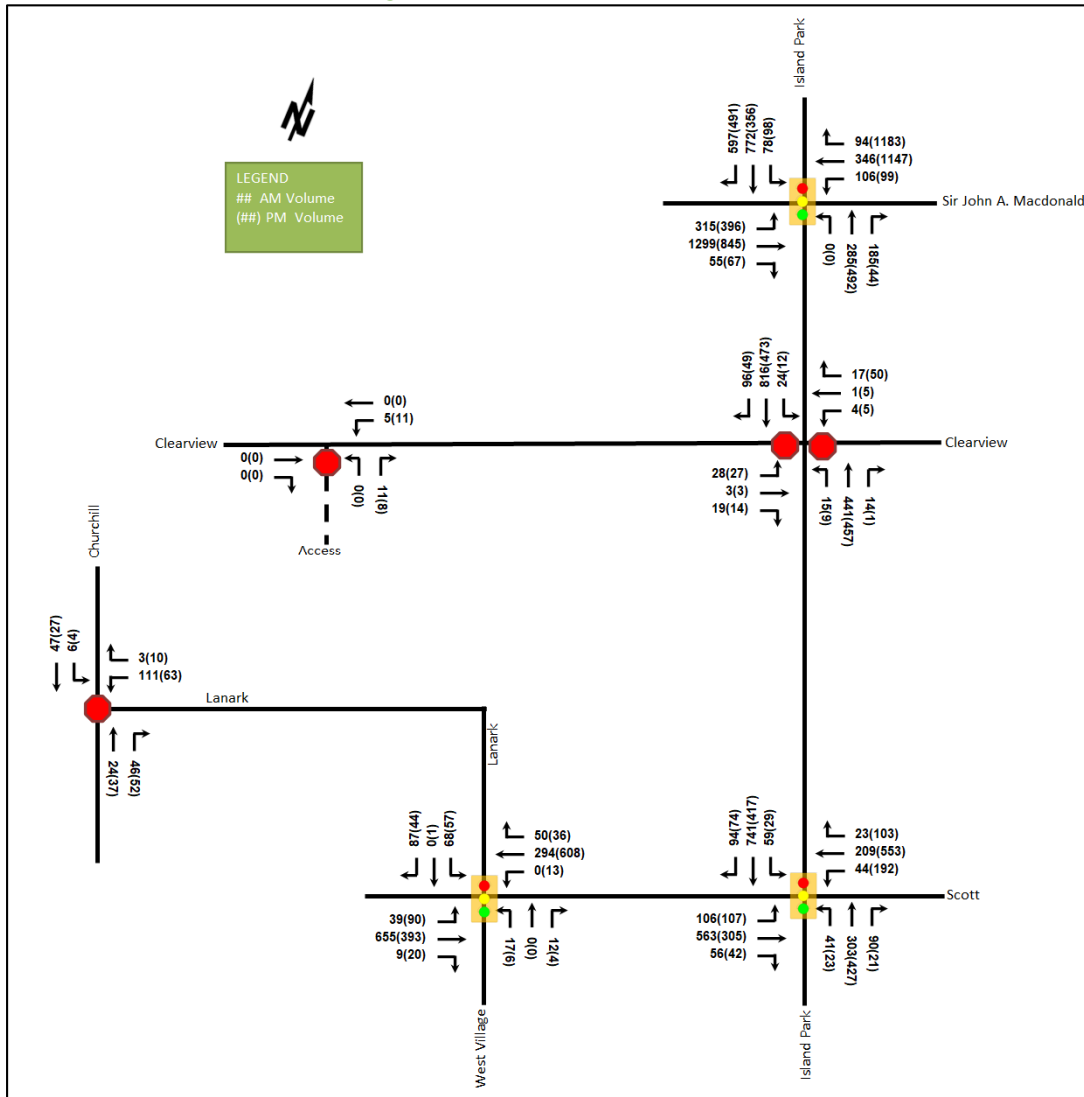

Table 18: 2027 Future Total Intersection Operations

Intersection	Lane	AM Peak Hour				PM Peak Hour			
		LOS	V/C	Delay (s)	Q (95 th)	LOS	V/C	Delay (s)	Q (95 th)
Island Park Drive at Sir John A. Macdonald Parkway Signalized	EBL	D	0.81	63.9	#146.7	F	1.20	164.9	#220.3
	EBT	F	1.42	230.8	#328.1	F	1.10	114.2	#204.3
	EBR	A	0.11	0.6	0.7	A	0.16	3.2	4.2
	WBL	A	0.58	67.7	48.3	A	0.30	56.0	45.2
	WBT	B	0.69	59.8	66.2	F	1.50	271.3	#310.1
	WBR	A	0.31	10.9	13.9	F	2.09	515.4	#596.9
	NBT/R	C	0.79	47.3	156.0	E	0.92	69.7	#223.6
	SBL	A	0.38	64.0	19.7	A	0.48	76.3	25.1
	SBT/R	F	1.75	367.2	#655.5	F	1.13	111.5	#363.6
	Overall	F	1.64	212.7	-	F	1.68	235.3	-

Intersection	Lane	AM Peak Hour				PM Peak Hour			
		LOS	V/C	Delay (s)	Q (95 th)	LOS	V/C	Delay (s)	Q (95 th)
Island Park Drive at Clearview Avenue <i>Unsignalized</i>	EB	E	0.35	42.7	10.5	C	0.19	24.0	5.3
	WB	C	0.08	19.3	2.3	B	0.14	14.4	3.8
	NB	A	0.02	10.0	0.8	A	0.01	8.5	0.0
	SB	A	0.02	8.3	0.8	A	0.01	8.4	0.0
	Overall	A	-	2.0	-	A	-	1.9	-
Island Park Drive at Scott Street <i>Signalized</i>	EBL	A	0.30	19.5	18.1	A	0.55	27.5	35.8
	EBT	D	0.85	36.2	#146.9	A	0.36	13.9	38.2
	EBR	A	0.10	6.7	m5.0	A	0.06	3.0	2.4
	WBL	A	0.35	31.0	16.0	A	0.43	19.7	41.2
	WBT/R	A	0.37	22.8	48.1	C	0.79	28.5	147.4
	NB	F	1.12	106.2	#148.1	D	0.84	43.5	#136.2
	SBL	A	0.15	14.8	13.1	A	0.12	22.4	10.0
	SBT/R	E	0.99	55.1	#229.3	C	0.77	36.4	120.6
	Overall	E	1.00	52.6	-	D	0.81	30.0	-
Lanark Avenue at Scott Street <i>Signalized</i>	EBL	A	0.05	3.7	4.7	A	0.17	4.7	10.2
	EBT/R	A	0.48	5.9	73.3	A	0.30	4.4	36.6
	WBL	-	-	-	-	A	0.02	1.4	m0.3
	WBT/R	A	0.26	3.0	m18.0	A	0.47	1.9	m17.5
	NBL	A	0.11	37.5	8.5	A	0.04	37.0	4.6
	NBT/R	A	0.03	0.1	0.0	A	0.01	0.0	0.0
	SBL	A	0.43	46.4	23.6	A	0.37	46.0	21.7
	SBT/R	A	0.12	0.4	0.0	A	0.22	14.4	9.6
	Overall	A	0.50	7.3	-	A	0.47	5.5	-
Churchill Avenue and Lanark Avenue <i>Unsignalized</i>	WB	A	0.14	8.1	3.8	A	0.09	7.8	2.3
	NB	A	0.08	7.3	1.5	A	0.09	7.2	2.3
	SB	A	0.06	7.6	1.5	A	0.04	7.4	0.8
	Overall	A	-	7.8	-	A	-	7.5	-

Notes: Saturation flow rate of 1800 veh/h/lane
 Queue is measured in metres
 Peak Hour Factor = 1.00

m = metered queue
 # = volume for the 95th %ile cycle exceeds capacity

The network intersection operations for the 2027 future total horizon operate similarly to the 2027 future background condition. No new capacity issues are noted.

7.4 2032 Future Total Operations

Figure 18 illustrates the 2032 future total volumes and Table 19 summarizes the 2032 future total intersection operations. The level of service for signalized intersections is based on the v/c calculation for individual lane movements and HCM 2000 v/c calculations for the overall intersection, and HCM average delay for unsignalized intersections. The synchro worksheets for the 2032 future total horizon are provided in Appendix L.

Figure 18: 2032 Future Total Volumes

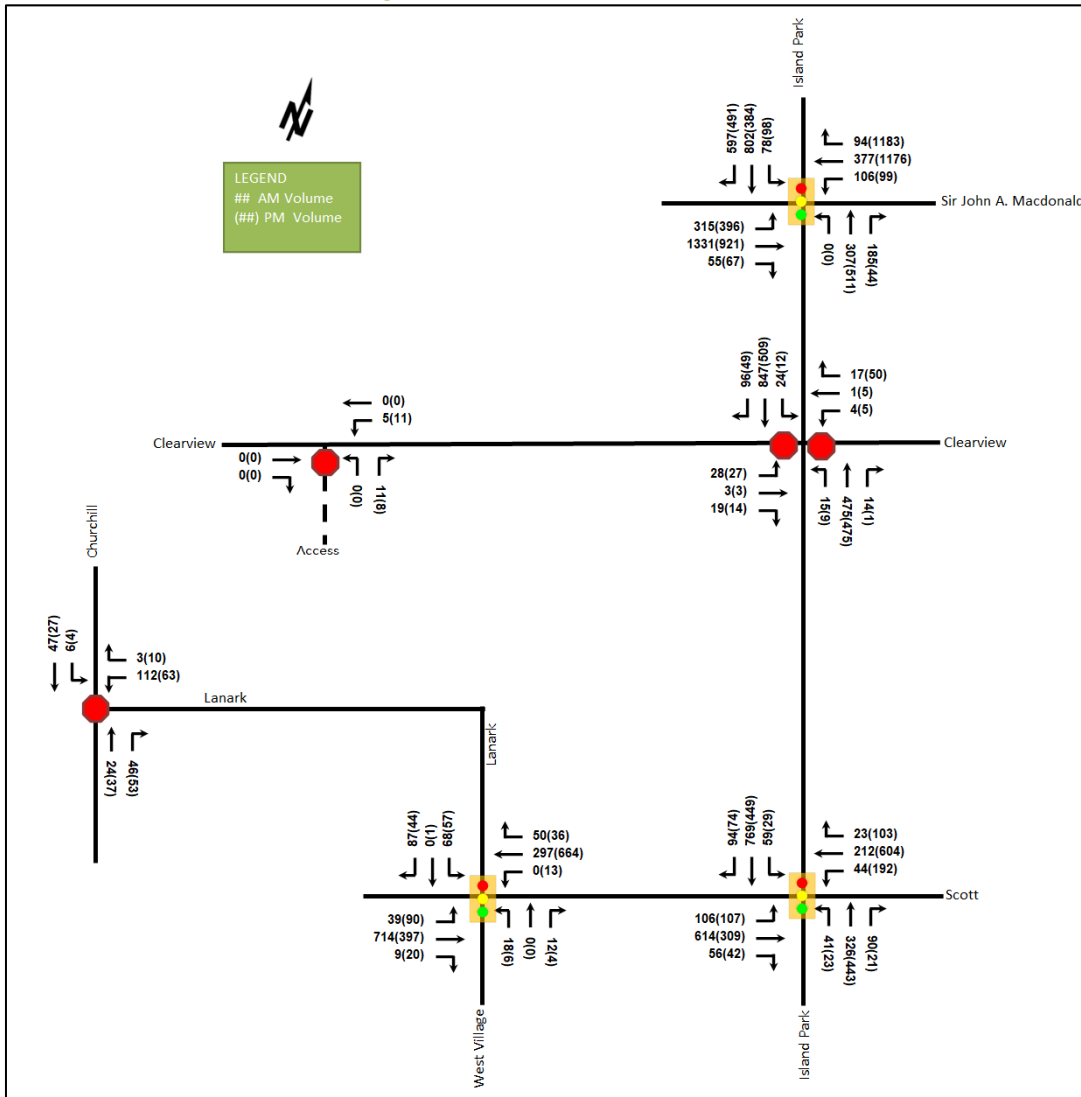

Table 19: 2032 Future Total Intersection Operations

Intersection	Lane	AM Peak Hour				PM Peak Hour			
		LOS	V/C	Delay (s)	Q (95 th)	LOS	V/C	Delay (s)	Q (95 th)
Island Park Drive at Sir John A. Macdonald Parkway Signalized	EBL	D	0.82	67.6	#149.3	F	1.21	171.4	#220.3
	EBT	F	1.49	260.6	#343.7	F	1.21	155.1	#231.0
	EBR	A	0.12	0.7	0.7	A	0.16	3.2	4.2
	WBL	A	0.54	65.9	48.0	A	0.30	56.6	45.2
	WBT	C	0.72	61.5	71.9	F	1.56	296.4	#320.0
	WBR	A	0.30	10.6	13.9	F	2.12	529.1	#600.0
	NBT/R	D	0.82	50.0	169.7	E	0.93	70.7	#236.8
	SBL	A	0.38	66.0	20.0	A	0.48	77.1	25.1
	SBT/R	F	1.78	381.2	#684.6	F	1.15	118.7	#382.5
	Overall	F	1.68	226.6	-	F	1.70	249.9	-

Intersection	Lane	AM Peak Hour				PM Peak Hour			
		LOS	V/C	Delay (s)	Q (95 th)	LOS	V/C	Delay (s)	Q (95 th)
Island Park Drive at Clearview Avenue <i>Unsignalized</i>	EB	E	0.39	49.0	12.0	D	0.21	26.0	5.3
	WB	C	0.09	20.6	2.3	B	0.14	14.9	3.8
	NB	B	0.02	10.1	0.8	A	0.01	8.6	0.0
	SB	A	0.02	8.4	0.8	A	0.01	8.5	0.0
	Overall	A	-	2.1	-	A	-	1.9	-
Island Park Drive at Scott Street <i>Signalized</i>	EBL	A	0.30	20.4	19.5	B	0.65	37.7	#43.6
	EBT	E	0.93	45.9	#169.2	A	0.36	13.9	38.6
	EBR	A	0.10	7.7	m5.3	A	0.06	3.0	2.4
	WBL	A	0.49	44.5	#21.1	A	0.43	19.8	41.3
	WBT/R	A	0.37	22.9	48.8	D	0.84	32.7	#182.9
	NB	F	1.31	183.0	#166.0	E	0.92	55.3	#151.0
	SBL	A	0.16	14.9	13.2	A	0.13	22.5	10.1
	SBT/R	F	1.03	63.4	#240.5	D	0.82	39.8	#142.6
Overall	F	1.15	72.9	-	D	0.88	35.0	-	
Lanark Avenue at Scott Street <i>Signalized</i>	EBL	A	0.05	3.7	4.7	A	0.19	4.9	10.5
	EBT/R	A	0.52	6.5	84.9	A	0.30	4.4	37.0
	WBL	-	-	-	-	A	0.02	1.3	m0.3
	WBT/R	A	0.26	2.9	m17.5	A	0.51	1.9	m17.3
	NBL	A	0.12	37.6	8.9	A	0.04	37.0	4.6
	NBT/R	A	0.03	0.1	0.0	A	0.01	0.0	0.0
	SBL	A	0.43	46.4	23.6	A	0.37	46.0	21.7
	SBT/R	A	0.12	0.4	0.0	A	0.22	14.4	9.6
Overall	A	0.54	7.5	-	A	0.51	5.3	-	
Churchill Avenue and Lanark Avenue <i>Unsignalized</i>	WB	A	0.14	8.1	3.8	A	0.09	7.8	2.3
	NB	A	0.08	7.3	1.5	A	0.09	7.2	2.3
	SB	A	0.06	7.6	1.5	A	0.04	7.4	0.8
	Overall	A	-	7.8	-	A	-	7.5	-

Notes: Saturation flow rate of 1800 veh/h/lane
Queue is measured in metres
Peak Hour Factor = 1.00

m = metered queue
= volume for the 95th %ile cycle exceeds capacity

The network intersection operations for the 2032 future total horizon operate similarly to the 2032 future background conditions. No new capacity issues are noted.

7.5 Modal Share Sensitivity and Demand Rationalization Conclusions

Capacity constraints have been noted at the Island Park Drive and Sir John A. Macdonald Parkway intersection at the existing condition. The site generation volumes are projected to be less than five on the northbound and westbound movement, and no volumes are generated on the southbound and eastbound movements. The impact due to site generation volumes is negligible at the Island Park Drive and Sir John A. Macdonald Parkway intersection.

At the intersection of Island Park Drive at Scott Street, the capacity constraint on the northbound movement during the AM peak hour has been noted at the existing condition, and impact due to site generation volumes is negligible at the intersection. Signal timing adjustments could address the constraint on the northbound movement.

The site volumes are projected to be less than 20 two-way vehicles during the peak hours and are not anticipated to be a contributing factor to the network constraints. No site demand rationalization is required for this development.

The background growth conditions in the area will continue to see increased volumes, longer queues and delays for the study area intersections. Typically, these conditions could be mitigated by changes in travel modes (e.g. auto to transit) or alternative routing to bypass the area. Unfortunately, the demands on the area road network are subject to the interprovincial crossing and have limited to no available to divert or change modes. Therefore, there is little potential for any regional/inter-provincial mitigation to be realized and this will continue to be experienced. The City's regional modelling software continues to project growth for the area despite the demands and no background reductions should be incorporated into this study.

8 Transportation Demand Management

8.1 Context for TDM

The mode shares used within the TIA represent a shift from auto modes to transit ridership with the future LRT station. Overall, the modal shares are likely to be achieved and supporting TDM measures should be provided.

The subject site is within Richmond Road/ Westboro Secondary Plan and Richmond Road/ Westboro community design plan areas. The total bedroom count within the development is subject to the final unit breakdown and layout selections by purchasers. No age restrictions are noted.

8.2 Need and Opportunity

The subject site has been assumed to rely predominantly on auto travel with an increase in transit ridership with the proximity to the future LRT station, and those assumptions have been carried through the analysis. The increase in transit ridership is achievable.

8.3 TDM Program

The "suite of post occupancy TDM measures" has been summarized in the TDM checklists for the residential land uses. The checklist is provided in Appendix M. The key TDM measures recommended to be considered in future site plan applications include:

- Display local area maps with walking and cycling routes, and transit route information and schedules at major entrances
- Provide a multimodal travel option information package to new residents
- Contract with providers to install on-site bikeshare (or other micromobility alternatives) and carshare spaces
- Unbundle parking cost from purchase or rental costs

9 Neighbourhood Traffic Management

The proposed development will connect to the arterial road network at Island Park Drive via Clearview Avenue (a local road). The TIA guidelines have outlined thresholds for two-way traffic on local roads and have been found to be too low for the purposes of this analysis. City Staff have noted that these thresholds are under review and will be updated in the future.

The existing volumes on Clearview Avenue are 148 two-way vehicles in the AM peak hour and 92 two-way vehicles in the PM peak hour. Overall, the site is anticipated to generate approximately 16 and 19 two-way vehicle trips during the AM and PM peak hours, resulting in 164 two-way vehicles in the AM peak hour and 111 two-way vehicles in the PM peak hour. No changes to the roadway classifications or proposed road network are proposed for the site.

10 Transit

10.1 Route Capacity

In Section 5.1 the trip generation by mode was estimated, including an estimate of the number of transit trips that will be generated by the proposed development. Table 20 summarizes the transit trip generation.

Table 20: Trip Generation by Transit Mode

Travel Mode	Mode Share	AM Peak Hour			PM Peak Hour		
		In	Out	Total	In	Out	Total
Transit	46% (31%)	11	25	36	14	10	24

The proposed development is anticipated to generate an additional 36 AM and 24 PM peak hour two-way transit trips. From the trip distribution found in section 5.3, these values can be further broken down. Table 21 summarizes forecasted site-generated transit ridership trips by direction and the equivalent bus loads.

Table 21: Forecasted Site-Generated Transit Ridership

Direction	AM Peak Hour		PM Peak Hour		Service Type	Approximate Equivalent Peak Hour/Direction Bus Loads
	In	Out	In	Out		
North	1	1	1	1	Bus	Negligible
South	6	13	7	5	Bus	One-quarter of a standard bus
East	3	10	5	3	Bus, LRT	One-quarter of a standard bus
West	1	1	1	1	Bus, LRT	Negligible

The Westboro LRT Station, scheduled to be completed by 2025, which provides 5–10-minute service during peak hours, is expected to provide adequate transit capacity to support the increase in travel demand by the proposed development to/from the east and the west. The existing transit routes within the study is expected to provide trips to/from the north and the south. Therefore, no service changes are anticipated as being required to accommodate site-generated transit trips.

10.2 Transit Priority

Examining the study area intersection delays, negligible impacts are noted on the transit movements at the study area intersections as a result of the development site traffic Road. Since the Westboro LRT station is scheduled to be completed by 2025, the delays on transit movements may be improved once the Westboro LRT station is completed.

11 Network Intersection Design

11.1 Network Intersection Control

No change to the existing intersection control is recommended for the network intersections.

11.2 Network Intersection Design

11.2.1 2032 Future Total Network Intersection Operations

The operations are noted in Section 7.4. Capacity constraints will be at the intersection of Island Park Drive at Sir John A. Macdonald Parkway during peak hours and on the northbound and southbound share through/right-turn movements at Innes Road at Island Park Drive at Scott Street during the AM peak.

Signal timing adjustments could address the constraint at Innes Road at Island Park Drive at Scott Street during the AM peak.

Since the site generated volumes are projected to be less than 20 two-way vehicles during peak hours, which are not anticipated to be a contributing factor to the network constraints, and constraints have been noted at the existing condition, no demand rationalization is required for this development.

11.2.2 Network Intersection MMLOS

Table 22 summarizes the MMLOS analysis for the network intersections of Island Park Drive at Sir John A. Macdonald Parkway, Island Park Drive at Scott Street, and Lanark Avenue at Scott Street. The existing and future conditions for both intersections will be the same and are considered in one row. The intersection analysis is based on “General Urban Area”. The MMLOS worksheets have been provided in Appendix N.

Table 22: Study Area Intersection MMLOS Analysis

Intersection		Pedestrian LOS		Bicycle LOS		Transit LOS		Truck LOS		Auto LOS	
		PLOS	Target	BLOS	Target	TLOS	Target	TrLOS	Target	ALOS	Target
Island Park Drive at Sir John A. Macdonald Parkway	Existing/Future	F	C	F	C	N/A	N/A	N/A	N/A	F	D
	Existing	F	C	D	C	N/A	N/A	N/A	N/A	F	D
Island Park Drive at Scott Street	Future	F	C	A	C	N/A	N/A	N/A	N/A	F	D
	Existing	E	C	D	B	F	B	N/A	N/A	A	D
Lanark Avenue at Scott Street	Future	E	C	A	B	F	B	N/A	N/A	A	D

The pedestrian LOS targets will not be met at the intersections throughout the study area. As typical for arterial roads, the crossing distance does not permit the targets to be met. To meet pedestrian LOS targets, the maximum crossing distance on all pedestrian crossings would need to be reduced to three lane-widths.

The bicycle LOS targets are not met at the existing intersections throughout the study area but will be met at the future intersections of Island Park Drive at Scott Street and Lanark Avenue at Scott Street. To meet bicycle LOS target at Island Park Drive at Sir John A. Macdonald Parkway intersection, protected facilities would be needed at the intersection.

Auto LOS will not be met at the intersection of Island Park Drive at Sir John A. Macdonald Parkway and Island Park Drive at Scott Street. The constraints have been noted at the existing condition, and the City will need to address the constraints.

11.2.3 Recommended Design Elements

No study area intersection design elements are proposed as part of this study.

12 Summary of Improvements Indicated and Modifications Options

The following summarizes the analysis and results presented in this TIA report:

Proposed Site and Screening

- The proposed site includes 177 apartment units
- Approximately 90 existing surface parking spaces will be replaced with the two-level underground parking
- The existing surface parking lot accesses will be converted to an access to the underground parking from Clearview Avenue and access to the loading area from Lanark Avenue
- An access is proposed to connect Lanark Avenue and Ellendale Crescent for the existing 26-storey apartment building on the east side of the proposed development

- The development is proposed to be completed as a single phase by 2027
- The trip generation and location triggers were met for the TIA Screening

Existing Conditions

- Island Park Drive and Sir John A. Macdonald Parkway are federally owned arterial road, and Churchill Avenue south of Scott Street and Scott Street are City of Ottawa arterial road in the study area
- Churchill Avenue between Scott Street and Lanark Avenue and Lanark Avenue are City of Ottawa collector road
- Sidewalks are provided on both sides along Lanark Avenue, Churchill Avenue south of Lanark Avenue, Clearview Avenue between Ellendale Crescent and Latchford Road, and east of Island Park Drive, on the north side of Clearview Avenue between Latchford Road and Island Park Drive, and on the south side of Scott Street
- Pedestrian crossovers are present at the intersections of Beechgrove Avenue at Lanark Avenue, Island Park Drive at Clearview Avenue, and on McRae Avenue
- Bike lanes are provided on both sides along Island Park Drive and Scott Street, and a MUP is provided on the north side along Scott Street
- Upgrades along Scott Street have been completed in June 2022, including uni-directional cycle tracks on the both sides of Scott Street and pedestrian pathway/sidewalk on the south side of Scott Street, and these changes were included in the future horizons.
- Island Park Drive and Scott Street are spine route, Churchill Avenue and Clifton Road north of Wilber Avenue are local route. Scott Street and Churchill Avenue south of Scott Street are cross-town bikeways. A major pathway is provided on the south side along Sir John A. Macdonald Parkway, and pathway links are provided along the north side of Scott Street and connect Scott Street, Lanark Avenue, and Sir John A. Macdonald Parkway
- Within the study area, the intersection and segments have a total of five collisions during 2016 to 2020 with four involving property damage only and the remaining one having non-fatal injuries
- Constraints have been noted at Island Park Drive at Sir John A. Macdonald Parkway intersection during both peak hours and at Island Park Drive at Scott Street Parkway intersection during the AM peak
- Constraints at the intersection of Island Park Drive and Scott Street could be addressed by signal timing adjustments

Development Generated Travel Demand

- The proposed development is forecasted to produce 75 AM and 74 PM two-way people trips
- Of the forecasted people trips, 16 AM and 19 PM two-way trips will be vehicle trips based on 23% and 28% modal share target
- Of the forecasted trips, 5% are anticipated to travel to the north and west, 50% to the south, and 40% to the east

Background Conditions

- The growth rates are applied along Scott Street, Sir John A. Macdonald Parkway, Island Park Drive, Churchill Avenue, and Lanark Avenue based on the existing volumes and two TRANS model plots
- Intersections within the study area will operate similarly to existing condition with improvement to the intersection operations due to the adjustment of the peak hour factor to 1.00 for forecasted condition

- The intersections at the 2032 future background condition are anticipated to operate similarly to the 2027 future background condition and the existing condition

TDM

- Supportive TDM measures to be included within the proposed development should include:
 - Display local area maps with walking and cycling routes, and transit route information and schedules at major entrances
 - Provide a multimodal travel option information package to new residents
 - Contract with providers to install on-site bikeshare (or other micromobility alternatives) and carshare spaces
 - Unbundle parking cost from purchase or rental costs

NTM

- The TIA guidelines have outlined thresholds for two-way traffic on local roads and have been found to be too low for the purposes of this analysis
- No changes to the roadway classifications or proposed road network are proposed for the site

Transit

- The proposed development is anticipated to generate 40 outbound AM trips and 26 inbound PM trips
- Peak hour increases in transit ridership resulting from the site equate to a quarter of a standard bus southerly and easterly of the site, and negligible impact northerly and westerly of the site
- The Westboro LRT Station is expected to provide adequate transit capacity to support the increase in travel demand by the proposed development
- The site traffic is not considered to have a significant impact on the transit movements

Network Intersection Design

- No change to the existing intersection control is recommended for the network intersections
- Generally, the network intersections in the future horizons will operate similarly to existing and future background conditions
- The pedestrian LOS targets will not be met at the existing or future intersections throughout the study area and requires crossings to be reduced to three lane-widths
- The bicycle LOS target will not be met at the intersection of Island Park Drive at Sir John A. Macdonald limited by the lack of dedicated facilities and improved left-turn configurations
- Future intersections of Island Park Drive at Scott Street and Lanark Avenue at Scott Street will meet bicycle LOS targets
- Auto LOS will not be met at the intersection of Island Park Drive at Sir John A. Macdonald Parkway and Island Park Drive at Scott Street and requires to be adjusted by the City

13 Conclusion

It is recommended that, from a transportation perspective, the proposed development applications proceed.

Prepared By:

Reviewed By:



Yu-Chu Chen, EIT
Transportation Engineering-Intern



Andrew Harte, P.Eng.
Senior Transportation Engineer

Appendix A

TIA Screening Form and PM Certification Form

City of Ottawa 2017 TIA Guidelines
Step 1 - Screening Form

Date: 19-Jul-22
Project Number: 2021-124
Project Reference: 210 Clearview Avenue

1.1 Description of Proposed Development	
Municipal Address	210 Clearview Avenue
Description of Location	Ward 15. Rectangular parcel fronting Clearview
Land Use Classification	Residential Fifth Density Zone (R5C H(28) S216)
Development Size	197 Residential Units
Accesses	One onto Clearview Avenue and one onto Lanark Avenue
Phase of Development	Single phase
Buildout Year	2027
TIA Requirement	Full TIA Required

1.2 Trip Generation Trigger	
Land Use Type	Townhomes or apartments
Development Size	197 Units
Trip Generation Trigger	Yes

1.3 Location Triggers	
Does the development propose a new driveway to a boundary street that is designated as part of the City's Transit Priority, Rapid Transit or Spine Bicycle Networks?	No
Is the development in a Design Priority Area (DPA) or Transit-oriented Development (TOD) zone?	No
Location Trigger	No

1.4. Safety Triggers	
Are posted speed limits on a boundary street 80 km/hr or greater?	No
Are there any horizontal/vertical curvatures on a boundary street limits sight lines at a proposed driveway?	No
Is the proposed driveway within the area of influence of an adjacent traffic signal or roundabout (i.e. within 300 m of intersection in rural conditions, or within 150 m of intersection in urban/ suburban conditions)?	No
Is the proposed driveway within auxiliary lanes of an intersection?	No
Does the proposed driveway make use of an existing median break that serves an existing site?	No
Is there is a documented history of traffic operations or safety concerns on the boundary streets within 500 m of the development?	No
Does the development include a drive-thru facility?	No
Safety Trigger	No



TIA Plan Reports

On 14 June 2017, the Council of the City of Ottawa adopted new Transportation Impact Assessment (TIA) Guidelines. In adopting the guidelines, Council established a requirement for those preparing and delivering transportation impact assessments and reports to sign a letter of certification.

Individuals submitting TIA reports will be responsible for all aspects of development-related transportation assessment and reporting, and undertaking such work, in accordance and compliance with the City of Ottawa's Official Plan, the Transportation Master Plan and the Transportation Impact Assessment (2017) Guidelines.

By submitting the attached TIA report (and any associated documents) and signing this document, the individual acknowledges that s/he meets the four criteria listed below.

CERTIFICATION

1. I have reviewed and have a sound understanding of the objectives, needs and requirements of the City of Ottawa's Official Plan, Transportation Master Plan and the Transportation Impact Assessment (2017) Guidelines;
2. I have a sound knowledge of industry standard practice with respect to the preparation of transportation impact assessment reports, including multi modal level of service review;
3. I have substantial experience (more than 5 years) in undertaking and delivering transportation impact studies (analysis, reporting and geometric design) with strong background knowledge in transportation planning, engineering or traffic operations; and
4. I am either a licensed¹ or registered² professional in good standing, whose field of expertise [check appropriate field(s)] is either transportation engineering or transportation planning .

1,2 License of registration body that oversees the profession is required to have a code of conduct and ethics guidelines that will ensure appropriate conduct and representation for transportation planning and/or transportation engineering works.

City Of Ottawa
Infrastructure Services and Community
Sustainability
Planning and Growth Management
110 Laurier Avenue West, 4th fl.
Ottawa, ON K1P 1J1
Tel. : 613-580-2424
Fax: 613-560-6006

Ville d'Ottawa
Services d'infrastructure et Viabilité des
collectivités
Urbanisme et Gestion de la croissance
110, avenue Laurier Ouest
Ottawa (Ontario) K1P 1J1
Tél. : 613-580-2424
Télécopieur: 613-560-6006

Dated at Ottawa this 20 day of September, 2018.
(City)

Name: Andrew Harte
(Please Print)

Professional Title: Professional Engineer

Signature of Individual certifier that s/he meets the above four criteria

Office Contact Information (Please Print)
Address: 6 Plaza Court
City / Postal Code: Ottawa / K2H 7W1
Telephone / Extension: (613) 697-3797
E-Mail Address: Andrew.Harte@CGHTransportation.com



Appendix B

Turning Movement Counts



Transportation Services - Traffic Services

Turning Movement Count - Study Results

OTTAWA RIVER PKWY @ ISLAND PARK DR

Survey Date: Wednesday, January 29, 2020

WO No: 39401

Start Time: 07:00

Device: Miovision

Full Study Diagram

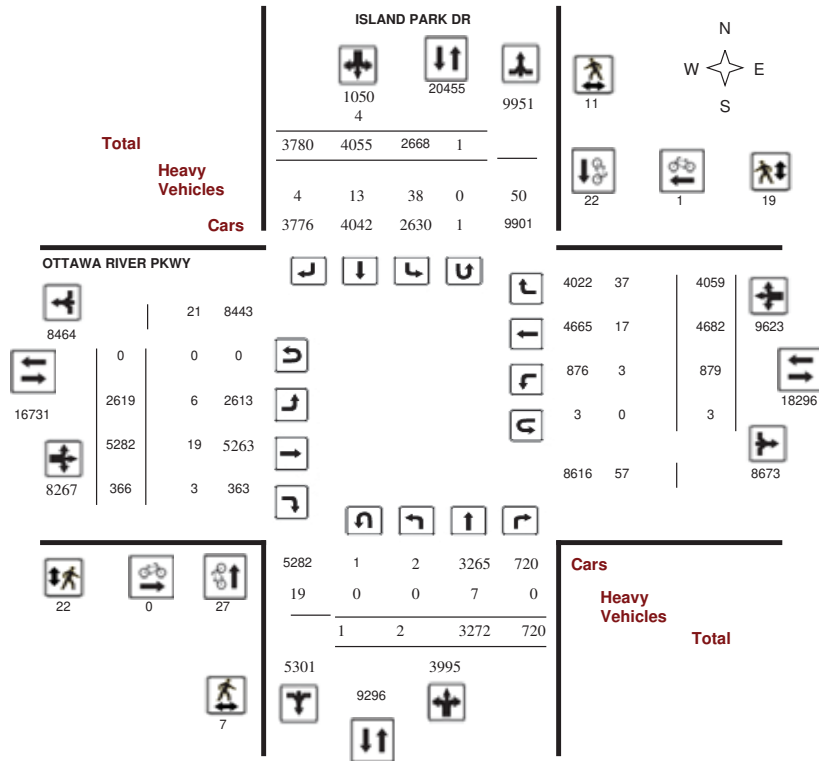

5473142 - WED JAN 29, 2020 - 8HRS - LORETTA



Transportation Services - Traffic Services

Turning Movement Count - Study Results

OTTAWA RIVER PKWY @ ISLAND PARK DR

Survey Date: Wednesday, January 29, 2020

WO No: 39401

Start Time: 07:00

Device: Miovision

Full Study Peak Hour Diagram

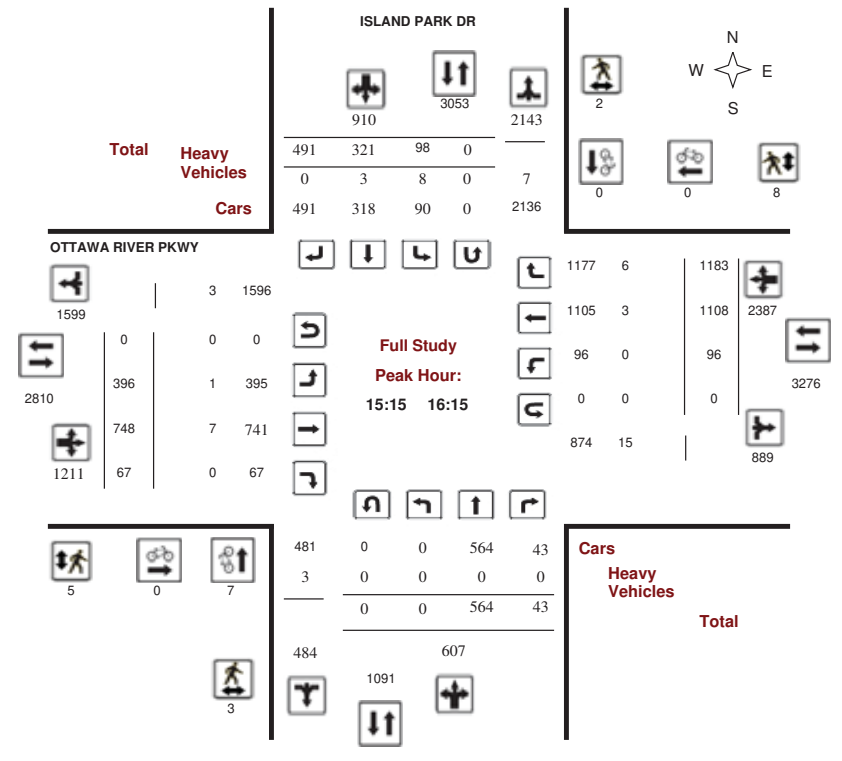

5473142 - WED JAN 29, 2020 - 8HRS - LORETTA



Transportation Services - Traffic Services

Turning Movement Count - Peak Hour Diagram

OTTAWA RIVER PKWY @ ISLAND PARK DR

Survey Date: Wednesday, January 29, 2020
Start Time: 07:00

WO No: 39401
Device: Miovision

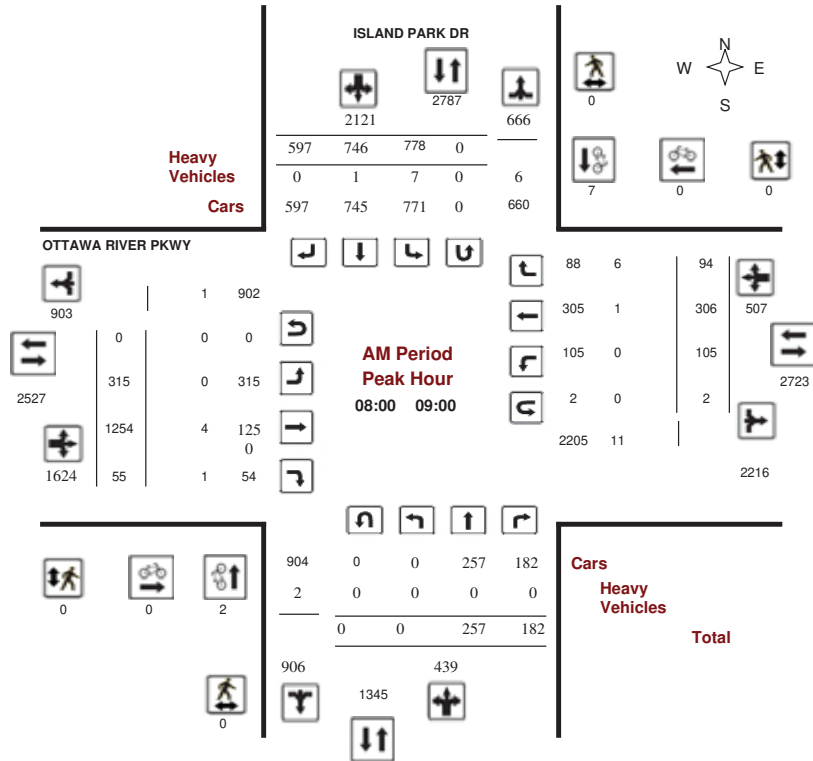

Comments 5473142 - WED JAN 29, 2020 - 8HRS - LORETTA



Transportation Services - Traffic Services

Turning Movement Count - Peak Hour Diagram

OTTAWA RIVER PKWY @ ISLAND PARK DR

Survey Date: Wednesday, January 29, 2020
Start Time: 07:00

WO No: 39401
Device: Miovision

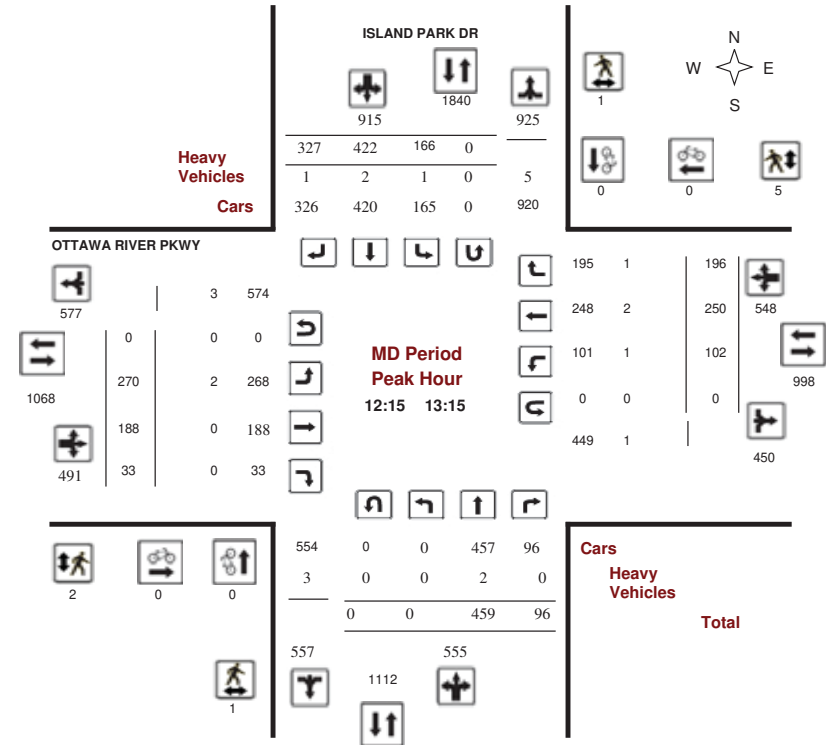

Comments 5473142 - WED JAN 29, 2020 - 8HRS - LORETTA



Transportation Services - Traffic Services

Turning Movement Count - Peak Hour Diagram

OTTAWA RIVER PKWY @ ISLAND PARK DR

Survey Date: Wednesday, January 29, 2020
Start Time: 07:00

WO No: 39401
Device: Miovision

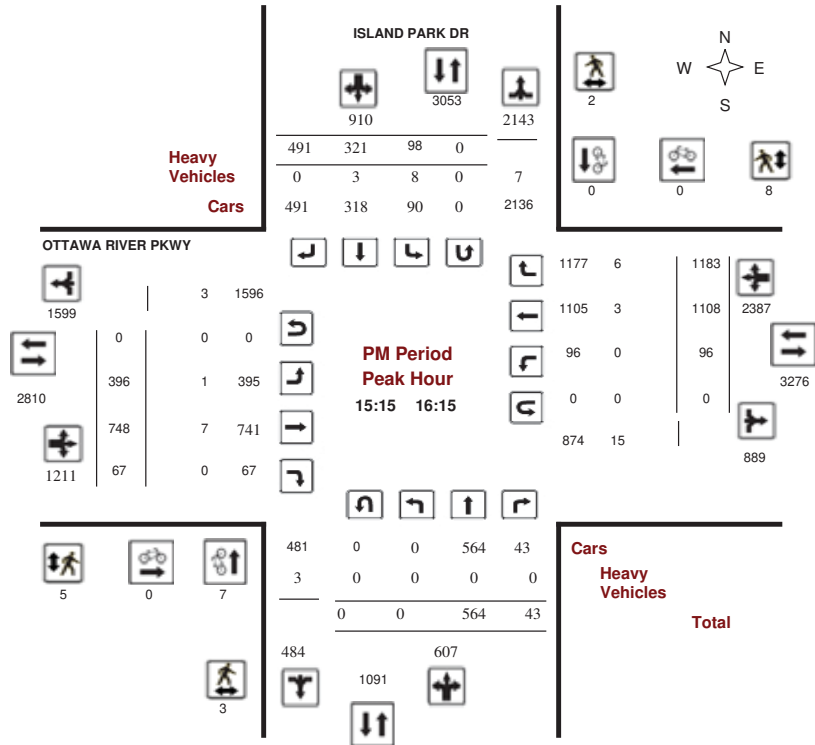

Comments 5473142 - WED JAN 29, 2020 - 8HRS - LORETTA



Transportation Services - Traffic Services

Turning Movement Count - Study Results

OTTAWA RIVER PKWY @ ISLAND PARK DR

Survey Date: Wednesday, January 29, 2020
Start Time: 07:00

WO No: 39401
Device: Miovision

Full Study Summary (8 HR Standard)

Survey Date: Wednesday, January 29, 2020

Total Observed U-Turns

Northbound: 1	Southbound: 1	AADT Factor
Eastbound: 0	Westbound: 3	1.00

Period	ISLAND PARK DR								OTTAWA RIVER PKWY								WB TOT	STR TOT	Grand Total
	Northbound				Southbound				Eastbound				Westbound						
	LT	ST	RT	TOT	LT	ST	RT	TOT	LT	ST	RT	TOT	LT	ST	RT	TOT			
07:00-08:00	0	212	103	315	813	795	707	2315	2630	308	1106	32	1446	121	275	91	487	1933	4563
08:00-09:00	0	257	182	439	778	746	597	2121	2560	315	1254	55	1624	105	306	94	505	2129	4689
09:00-10:00	0	243	149	392	398	693	488	1579	1971	318	740	60	1118	121	390	121	632	1750	3721
11:30-12:30	0	439	89	528	168	391	312	871	1399	257	181	30	468	126	242	179	547	1015	2414
12:30-13:30	0	453	88	541	163	413	292	868	1409	281	192	30	503	111	231	205	547	1050	2459
15:00-16:00	0	602	47	649	116	311	467	894	1543	381	688	56	1125	99	1038	1155	2292	3417	4960
16:00-17:00	1	541	35	577	104	329	480	913	1490	378	623	58	1059	65	1174	1144	2383	3442	4932
17:00-18:00	1	525	27	553	128	377	437	942	1495	381	498	45	924	131	1026	1070	2227	3151	4646
Sub Total	2	3272	720	3994	2668	4055	3780	10503	14497	2619	5282	366	8267	879	4682	4059	9620	17887	32384
U Turns	1			1	1			1	2	0		0	3				3	3	5
Total	3	3272	720	3995	2669	4055	3780	10504	14499	2619	5282	366	8267	882	4682	4059	9623	17890	32389
EQ 12hr	4	4548	1001	5553	3710	5636	5254	14600	20153	3640	7342	509	11491	1226	6508	5642	13376	24867	45020
AVG 12hr	4	4548	1001	5553	3710	5636	5254	14600	20153	3640	7342	509	11491	1226	6508	5642	13376	24867	45020
AVG 24hr	5	5958	1311	7274	4860	7383	6883	19126	26400	4768	9618	667	15053	1606	8525	7391	17522	32575	58975

Note: These values are calculated by multiplying the totals by the appropriate expansion factor. **1.39**

Note: These volumes are calculated by multiplying the Equivalent 12 hr. totals by the AADT factor. **1.00**

Note: These volumes are calculated by multiplying the Average Daily 12 hr. totals by 12 to 24 expansion factor. **1.31**

Note: U-Turns provided for approach totals. Refer to 'U-Turn' Report for specific breakdown.



Transportation Services - Traffic Services

Turning Movement Count - Study Results

OTTAWA RIVER PKWY @ ISLAND PARK DR

Survey Date: Wednesday, January 29, 2020

WO No: 39401

Start Time: 07:00

Device: Miovision

Full Study 15 Minute Increments

Table with columns for Time Period, Northbound, Southbound, Eastbound, Westbound, and Grand Total. Rows show 15-minute intervals from 07:00 to 18:00.

Note: U-Turns are included in Totals.



Transportation Services - Traffic Services

Turning Movement Count - Study Results

OTTAWA RIVER PKWY @ ISLAND PARK DR

Survey Date: Wednesday, January 29, 2020

WO No: 39401

Start Time: 07:00

Device: Miovision

Full Study Cyclist Volume

Table with columns for Time Period, Northbound, Southbound, Street Total, Eastbound, Westbound, Street Total, and Grand Total. Rows show 15-minute intervals from 07:00 to 18:00.



Transportation Services - Traffic Services

Turning Movement Count - Study Results

OTTAWA RIVER PKWY @ ISLAND PARK DR

Survey Date: Wednesday, January 29, 2020

WO No: 39401

Start Time: 07:00

Device: Miovision

Full Study Pedestrian Volume

ISLAND PARK DR OTTAWA RIVER PKWY

Table with 8 columns: Time Period, NB Approach, SB Approach, Total, EB Approach, WB Approach, Total, Grand Total. Rows show pedestrian counts for various time intervals from 07:00 to 17:45.

5473142 - WED JAN 29, 2020 - 8HRS - LORETTA



Transportation Services - Traffic Services

Turning Movement Count - Study Results

OTTAWA RIVER PKWY @ ISLAND PARK DR

Survey Date: Wednesday, January 29, 2020

WO No: 39401

Start Time: 07:00

Device: Miovision

Full Study Heavy Vehicles

ISLAND PARK DR OTTAWA RIVER PKWY

Table with 20 columns: Time Period, Northbound (LT, ST, RT, N TOT), Southbound (LT, ST, RT, S TOT, STR TOT), Eastbound (LT, ST, RT, E TOT), Westbound (LT, ST, RT, W TOT, STR TOT), Grand Total. Rows show heavy vehicle counts for various time intervals from 07:00 to 17:45.



Transportation Services - Traffic Services

Turning Movement Count - Study Results

OTTAWA RIVER PKWY @ ISLAND PARK DR

Survey Date: Wednesday, January 29, 2020

WO No: 39401

Start Time: 07:00

Device: Miovision

Full Study 15 Minute U-Turn Total

ISLAND PARK DR OTTAWA RIVER PKWY

Time Period	Northbound U-Turn Total	Southbound U-Turn Total	Eastbound U-Turn Total	Westbound U-Turn Total	Total
07:00 - 07:15	0	0	0	0	0
07:15 - 07:30	0	0	0	0	0
07:30 - 07:45	0	0	0	0	0
07:45 - 08:00	0	0	0	0	0
08:00 - 08:15	0	0	0	2	2
08:15 - 08:30	0	0	0	0	0
08:30 - 08:45	0	0	0	0	0
08:45 - 09:00	0	0	0	0	0
09:00 - 09:15	0	0	0	0	0
09:15 - 09:30	0	0	0	0	0
09:30 - 09:45	0	0	0	0	0
09:45 - 10:00	0	0	0	0	0
11:30 - 11:45	0	0	0	0	0
11:45 - 12:00	0	0	0	0	0
12:00 - 12:15	0	0	0	0	0
12:15 - 12:30	0	0	0	0	0
12:30 - 12:45	0	0	0	0	0
12:45 - 13:00	0	0	0	0	0
13:00 - 13:15	0	0	0	0	0
13:15 - 13:30	0	0	0	0	0
15:00 - 15:15	0	0	0	0	0
15:15 - 15:30	0	0	0	0	0
15:30 - 15:45	0	0	0	0	0
15:45 - 16:00	0	0	0	0	0
16:00 - 16:15	0	0	0	0	0
16:15 - 16:30	0	0	0	0	0
16:30 - 16:45	0	0	0	0	0
16:45 - 17:00	0	0	0	0	0
17:00 - 17:15	0	0	0	1	1
17:15 - 17:30	0	0	0	0	0
17:30 - 17:45	0	0	0	0	0
17:45 - 18:00	1	1	0	0	2
Total	1	1	0	3	5



Transportation Services - Traffic Services

Turning Movement Count - Study Results

CLEARVIEW AVE @ ISLAND PARK DR

Survey Date: Thursday, July 18, 2019

WO No: 38521

Start Time: 07:00

Device: Miovision

Full Study Diagram

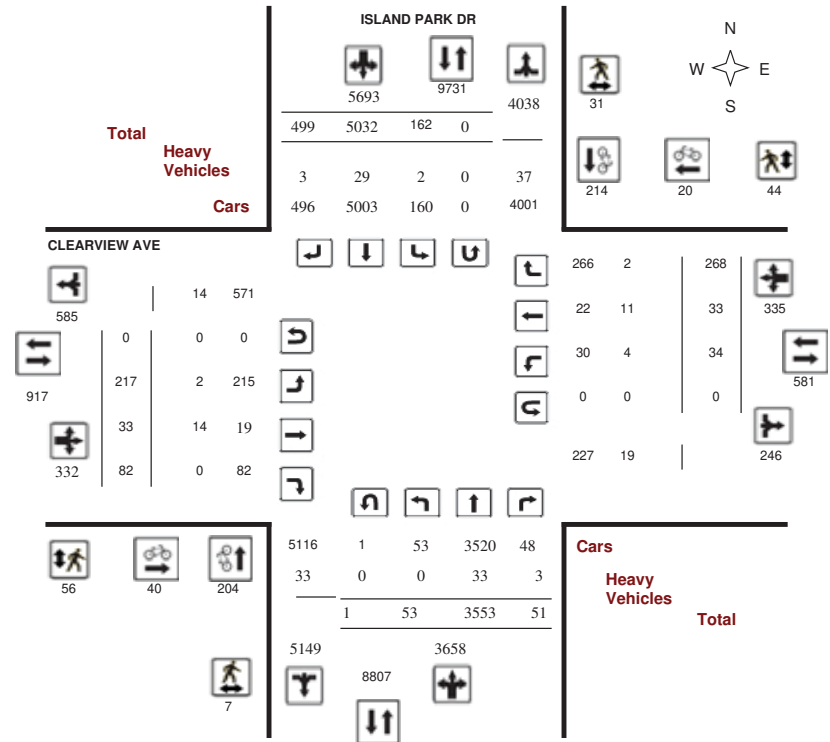



Transportation Services - Traffic Services

Turning Movement Count - Study Results

CLEARVIEW AVE @ ISLAND PARK DR

Survey Date: Thursday, July 18, 2019

WO No: 38521

Start Time: 07:00

Device: Miovision

Full Study Peak Hour Diagram

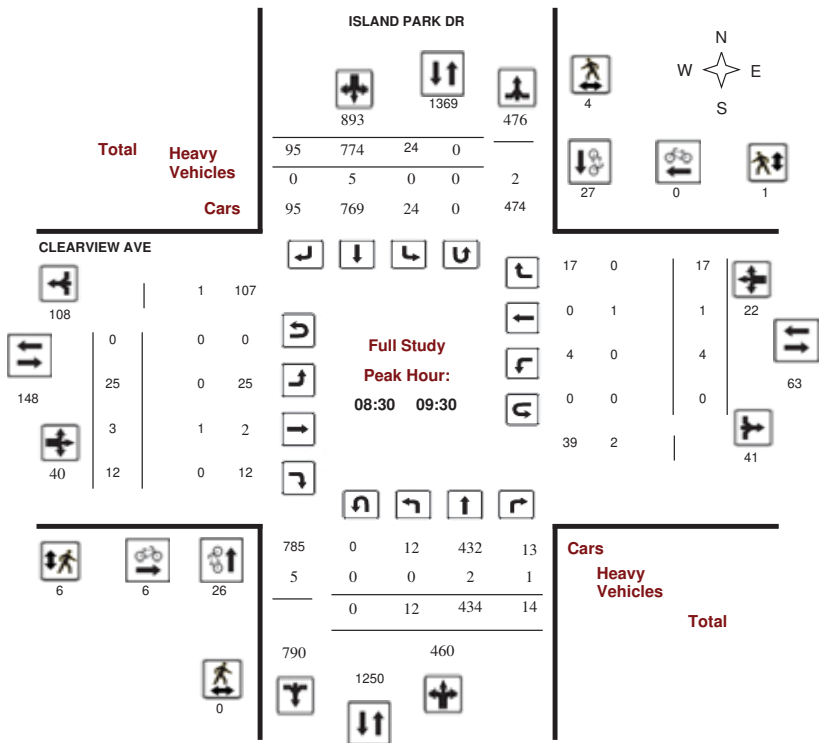

Transportation Services - Traffic Services

Turning Movement Count - Peak Hour Diagram

CLEARVIEW AVE @ ISLAND PARK DR

Survey Date: Thursday, July 18, 2019

WO No: 38521

Start Time: 07:00

Device: Miovision

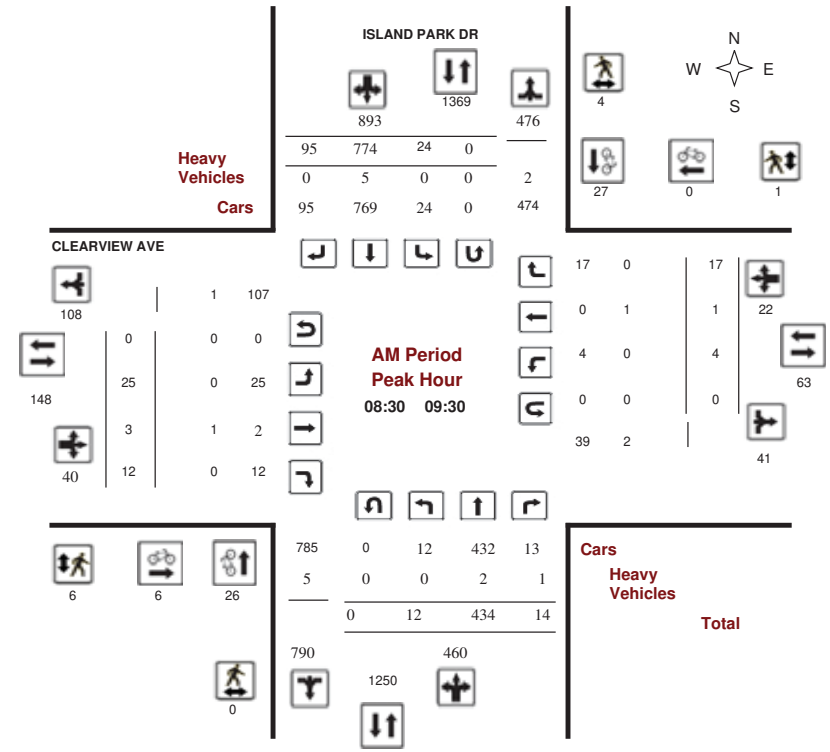

Comments



Transportation Services - Traffic Services

Turning Movement Count - Peak Hour Diagram

CLEARVIEW AVE @ ISLAND PARK DR

Survey Date: Thursday, July 18, 2019
Start Time: 07:00

WO No: 38521
Device: Miovision

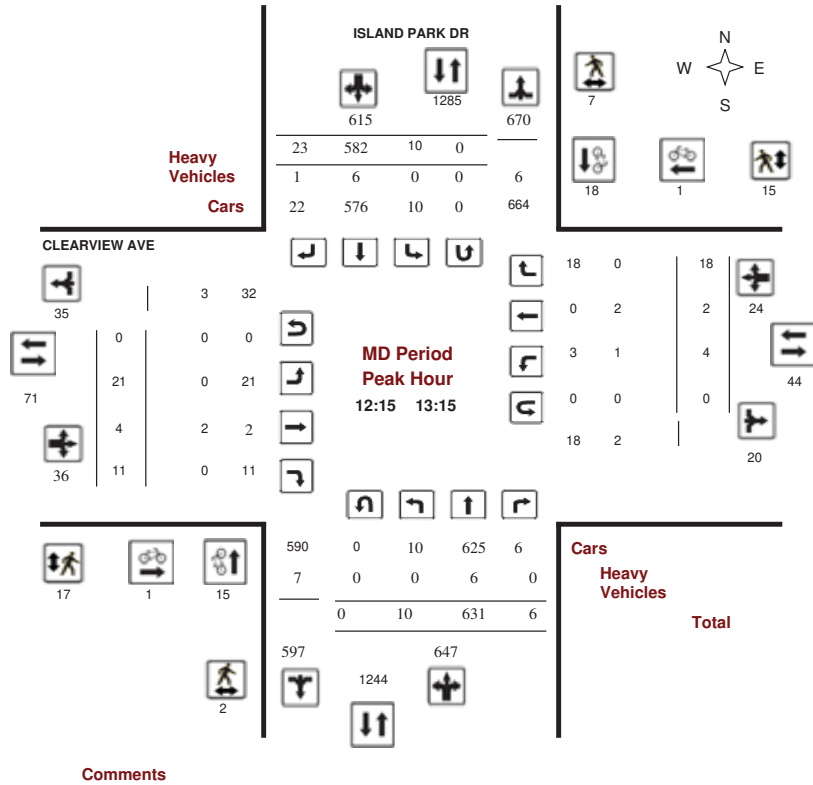

Transportation Services - Traffic Services

Turning Movement Count - Peak Hour Diagram

CLEARVIEW AVE @ ISLAND PARK DR

Survey Date: Thursday, July 18, 2019
Start Time: 07:00

WO No: 38521
Device: Miovision

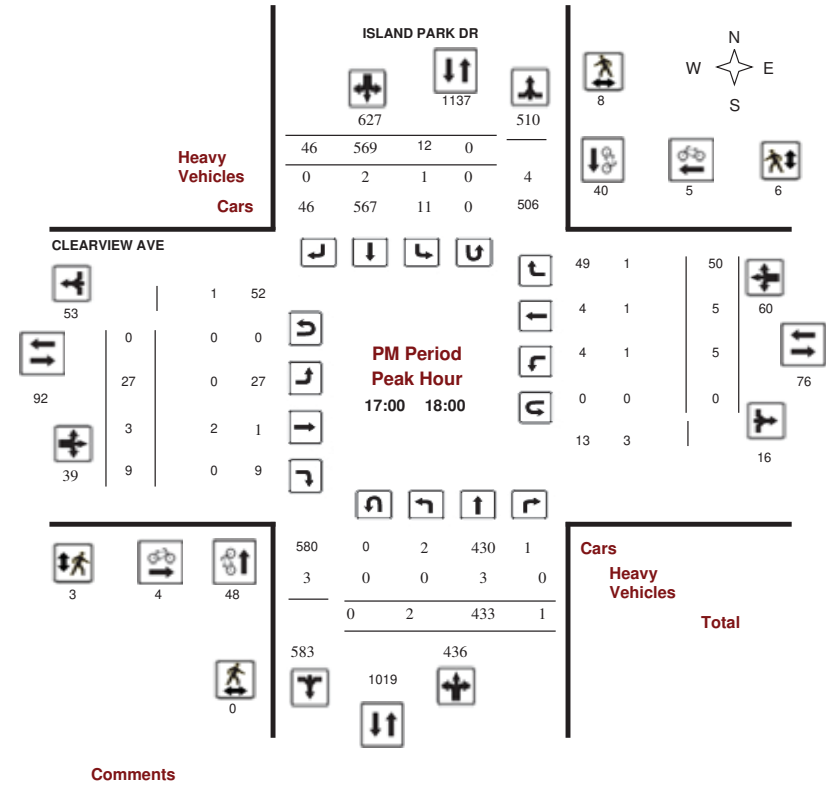



Transportation Services - Traffic Services

Turning Movement Count - Study Results

CLEARVIEW AVE @ ISLAND PARK DR

Survey Date: Thursday, July 18, 2019

WO No: 38521

Start Time: 07:00

Device: Miovision

Full Study Summary (8 HR Standard)

Survey Date: Thursday, July 18, 2019

Total Observed U-Turns

ADT Factor

Northbound: 1 Southbound: 0
Eastbound: 0 Westbound: 0

Period	ISLAND PARK DR								CLEARVIEW AVE								STR TOT	Grand Total	
	Northbound				Southbound				Eastbound				Westbound						
	LT	ST	RT	NB TOT	LT	ST	RT	SB TOT	LT	ST	RT	EB TOT	LT	ST	RT	WB TOT			
07:00 08:00	8	281	9	298	26	821	108	955	1253	15	6	7	28	5	2	9	16	44	1297
08:00 09:00	8	394	18	420	41	763	110	914	1334	27	3	5	35	5	4	17	26	61	1395
09:00 10:00	12	417	8	437	23	757	66	846	1283	23	5	13	41	3	2	13	18	59	1342
11:30 12:30	9	598	6	613	11	591	28	630	1243	19	5	12	36	4	5	10	19	55	1298
12:30 13:30	11	636	7	654	8	564	31	603	1257	21	2	10	33	4	2	17	23	56	1313
15:00 16:00	3	375	1	379	23	522	63	608	987	59	5	16	80	3	5	85	93	173	1160
16:00 17:00	0	419	1	420	18	445	47	510	930	26	4	10	40	5	8	67	80	120	1050
17:00 18:00	2	433	1	436	12	569	46	627	1063	27	3	9	39	5	5	50	60	99	1162
Sub Total	53	3553	51	3657	162	5032	499	5693	9350	217	33	82	332	34	33	268	335	667	10017
U Turns	1			1	0			0	1	0			0	0			0	0	1
Total	54	3553	51	3658	162	5032	499	5693	9351	217	33	82	332	34	33	268	335	667	10018
EQ 12hr	75	4939	71	5085	225	6994	694	7913	12998	302	46	114	462	47	46	373	466	928	13926
Note: These values are calculated by multiplying the totals by the appropriate expansion factor.																			1.39
AVG 12hr	68	4445	64	4577	202	6295	625	7122	11699	272	41	103	416	42	41	336	419	835	12534
Note: These volumes are calculated by multiplying the Equivalent 12 hr. totals by the ADT factor.																			.90
AVG 24hr	89	5823	84	5996	265	8246	819	9330	15326	356	54	135	545	55	54	440	549	1094	16420
Note: These volumes are calculated by multiplying the Average Daily 12 hr. totals by 12 to 24 expansion factor.																			1.31
Note: U-Turns provided for approach totals. Refer to 'U-Turn' Report for specific breakdown.																			



Transportation Services - Traffic Services

Turning Movement Count - Study Results

CLEARVIEW AVE @ ISLAND PARK DR

Survey Date: Thursday, July 18, 2019

WO No: 38521

Start Time: 07:00

Device: Miovision

Full Study 15 Minute Increments

Time Period	ISLAND PARK DR								CLEARVIEW AVE								STR TOT	Grand Total	
	Northbound				Southbound				Eastbound				Westbound						
	LT	ST	RT	N TOT	LT	ST	RT	S TOT	LT	ST	RT	E TOT	LT	ST	RT	W TOT			
07:00 07:15	1	54	1	56	3	227	20	250	306	1	3	0	4	0	0	2	2	6	312
07:15 07:30	2	78	3	83	8	198	22	228	311	6	2	2	10	2	1	1	4	14	325
07:30 07:45	2	87	2	91	5	218	21	244	335	2	0	2	4	1	1	3	5	9	344
07:45 08:00	3	62	3	68	10	178	45	233	301	6	1	3	10	2	0	3	5	15	316
08:00 08:15	3	86	7	96	11	193	21	225	321	5	0	1	6	2	2	1	5	11	332
08:15 08:30	0	74	3	77	14	203	29	246	323	8	2	1	11	1	2	4	7	18	341
08:30 08:45	1	121	7	129	12	180	33	225	354	5	0	1	6	1	0	9	10	16	370
08:45 09:00	4	113	1	118	4	187	27	218	336	9	1	2	12	1	0	3	4	16	352
09:00 09:15	4	100	4	108	4	186	17	207	315	5	0	4	9	2	0	2	4	13	328
09:15 09:30	3	100	2	105	4	221	18	243	348	6	2	5	13	0	1	3	4	17	365
09:30 09:45	2	105	1	108	6	173	18	197	305	5	2	3	10	1	1	3	5	15	320
09:45 10:00	3	112	1	116	9	177	13	199	315	7	1	1	9	0	0	5	5	14	329
11:30 11:45	3	143	2	148	2	159	8	169	317	8	1	1	10	1	1	2	4	14	331
11:45 12:00	3	151	1	155	0	146	6	152	307	5	1	4	10	1	2	0	3	13	320
12:00 12:15	2	142	2	146	5	130	7	142	288	2	1	4	7	1	1	4	6	13	301
12:15 12:30	1	162	1	164	4	156	7	167	331	4	2	3	9	1	1	4	6	15	346
12:30 12:45	1	150	2	153	2	122	7	131	284	7	1	3	11	0	0	4	4	15	299
12:45 13:00	4	170	1	175	1	163	6	170	345	6	1	3	10	2	1	7	10	20	365
13:00 13:15	4	149	2	155	3	141	3	147	302	4	0	2	6	1	0	3	4	10	312
13:15 13:30	2	167	2	171	2	138	15	155	326	4	0	2	6	1	1	3	5	11	337
15:00 15:15	1	103	1	105	4	138	10	152	257	21	0	7	28	1	0	20	21	49	306
15:15 15:30	1	103	0	104	1	146	16	163	267	15	3	5	23	1	2	30	33	56	323
15:30 15:45	1	79	0	80	7	118	18	143	223	12	1	0	13	0	1	17	18	31	254
15:45 16:00	0	90	0	90	11	120	19	150	240	11	1	4	16	1	2	18	21	37	277
16:00 16:15	0	114	0	114	3	109	13	125	239	8	3	6	17	0	2	18	20	37	276
16:15 16:30	0	126	1	127	6	117	12	135	262	5	1	2	8	1	2	16	19	27	289
16:30 16:45	0	94	0	94	6	113	9	128	222	7	0	1	8	3	2	19	24	32	254
16:45 17:00	1	85	0	86	3	106	13	122	208	6	0	1	7	1	2	14	17	24	232
17:00 17:15	1	92	0	93	4	130	13	147	240	6	1	4	11	2	3	9	14	25	265
17:15 17:30	0	95	0	95	1	146	12	159	254	6	2	1	9	0	2	15	17	26	280
17:30 17:45	0	120	0	120	6	148	9	163	283	7	0	1	8	2	0	17	19	27	310
17:45 18:00	1	126	1	128	1	145	12	158	286	8	0	3	11	1	0	9	10	21	307
Total:	54	3553	51	3658	162	5032	499	5693	9351	217	33	82	332	34	33	268	335	667	10,018

Note: U-Turns are included in Totals.



Transportation Services - Traffic Services

Turning Movement Count - Study Results

CLEARVIEW AVE @ ISLAND PARK DR

Survey Date: Thursday, July 18, 2019

WO No: 38521

Start Time: 07:00

Device: Miovision

Full Study Cyclist Volume

Time Period	ISLAND PARK DR			CLEARVIEW AVE			Grand Total
	Northbound	Southbound	Street Total	Eastbound	Westbound	Street Total	
07:00 07:15	0	12	12	4	0	4	16
07:15 07:30	4	9	13	3	0	3	16
07:30 07:45	2	9	11	1	1	2	13
07:45 08:00	3	18	21	1	1	2	23
08:00 08:15	3	10	13	1	0	1	14
08:15 08:30	6	11	17	6	0	6	23
08:30 08:45	3	9	12	4	0	4	16
08:45 09:00	5	7	12	2	0	2	14
09:00 09:15	8	4	12	0	0	0	12
09:15 09:30	10	7	17	0	0	0	17
09:30 09:45	3	7	10	1	2	3	13
09:45 10:00	6	4	10	0	0	0	10
11:30 11:45	7	4	11	0	0	0	11
11:45 12:00	0	2	2	0	0	0	2
12:00 12:15	6	3	9	0	0	0	9
12:15 12:30	3	5	8	0	0	0	8
12:30 12:45	1	4	5	0	0	0	5
12:45 13:00	4	7	11	0	0	0	11
13:00 13:15	7	2	9	1	1	2	11
13:15 13:30	4	4	8	0	1	1	9
15:00 15:15	3	1	4	2	0	2	6
15:15 15:30	4	4	8	0	0	0	8
15:30 15:45	5	5	10	2	0	2	12
15:45 16:00	7	5	12	0	0	0	12
16:00 16:15	11	3	14	3	0	3	17
16:15 16:30	16	8	24	5	3	8	32
16:30 16:45	11	7	18	0	2	2	20
16:45 17:00	14	3	17	0	4	4	21
17:00 17:15	16	11	27	2	0	2	29
17:15 17:30	13	7	20	1	2	3	23
17:30 17:45	9	14	23	0	1	1	24
17:45 18:00	10	8	18	1	2	3	21
Total	204	214	418	40	20	60	478



Transportation Services - Traffic Services

Turning Movement Count - Study Results

CLEARVIEW AVE @ ISLAND PARK DR

Survey Date: Thursday, July 18, 2019

WO No: 38521

Start Time: 07:00

Device: Miovision

Full Study Pedestrian Volume

Time Period	ISLAND PARK DR			CLEARVIEW AVE			Grand Total
	NB Approach (E or W Crossing)	SB Approach (E or W Crossing)	Total	EB Approach (N or S Crossing)	WB Approach (N or S Crossing)	Total	
07:00 07:15	0	0	0	0	1	1	1
07:15 07:30	0	2	2	4	2	6	8
07:30 07:45	1	1	2	1	1	2	4
07:45 08:00	0	3	3	3	2	5	8
08:00 08:15	0	0	0	2	0	2	2
08:15 08:30	0	0	0	2	1	3	3
08:30 08:45	0	1	1	0	0	0	1
08:45 09:00	0	3	3	1	1	2	5
09:00 09:15	0	0	0	2	0	2	2
09:15 09:30	0	0	0	3	0	3	3
09:30 09:45	0	0	0	4	4	8	8
09:45 10:00	1	0	1	0	0	0	1
11:30 11:45	0	2	2	0	0	0	2
11:45 12:00	0	0	0	0	1	1	1
12:00 12:15	0	0	0	5	0	5	5
12:15 12:30	2	2	4	5	4	9	13
12:30 12:45	0	2	2	9	5	14	16
12:45 13:00	0	3	3	2	4	6	9
13:00 13:15	0	0	0	1	2	3	3
13:15 13:30	0	0	0	0	0	0	0
15:00 15:15	1	0	1	0	3	3	4
15:15 15:30	2	1	3	1	1	2	5
15:30 15:45	0	0	0	3	3	6	6
15:45 16:00	0	0	0	0	0	0	0
16:00 16:15	0	0	0	2	0	2	2
16:15 16:30	0	1	1	1	0	1	2
16:30 16:45	0	1	1	1	2	3	4
16:45 17:00	0	1	1	1	1	2	3
17:00 17:15	0	1	1	0	0	0	1
17:15 17:30	0	6	6	1	2	3	9
17:30 17:45	0	1	1	1	0	1	2
17:45 18:00	0	0	0	1	4	5	5
Total	7	31	38	56	44	100	138



Transportation Services - Traffic Services

Turning Movement Count - Study Results

CLEARVIEW AVE @ ISLAND PARK DR

Survey Date: Thursday, July 18, 2019

WO No: 38521

Start Time: 07:00

Device: Miovision

Full Study Heavy Vehicles

Table with columns for Time Period, Northbound (LT, ST, RT, N TOT, STR TOT), Southbound (LT, ST, RT, S TOT, STR TOT), Eastbound (LT, ST, RT, E TOT), Westbound (LT, ST, RT, W TOT, STR TOT), and Grand Total. Rows show 15-minute intervals from 07:00 to 18:00.



Transportation Services - Traffic Services

Turning Movement Count - Study Results

CLEARVIEW AVE @ ISLAND PARK DR

Survey Date: Thursday, July 18, 2019

WO No: 38521

Start Time: 07:00

Device: Miovision

Full Study 15 Minute U-Turn Total

Table with columns for Time Period, Northbound U-Turn Total, Southbound U-Turn Total, Eastbound U-Turn Total, Westbound U-Turn Total, and Total. Rows show 15-minute intervals from 07:00 to 18:00.



Transportation Services - Traffic Services

Turning Movement Count - Study Results

ISLAND PARK DR @ SCOTT ST

Survey Date: Tuesday, March 28, 2017

WO No: 36808

Start Time: 07:00

Device: Miovision

Full Study Diagram

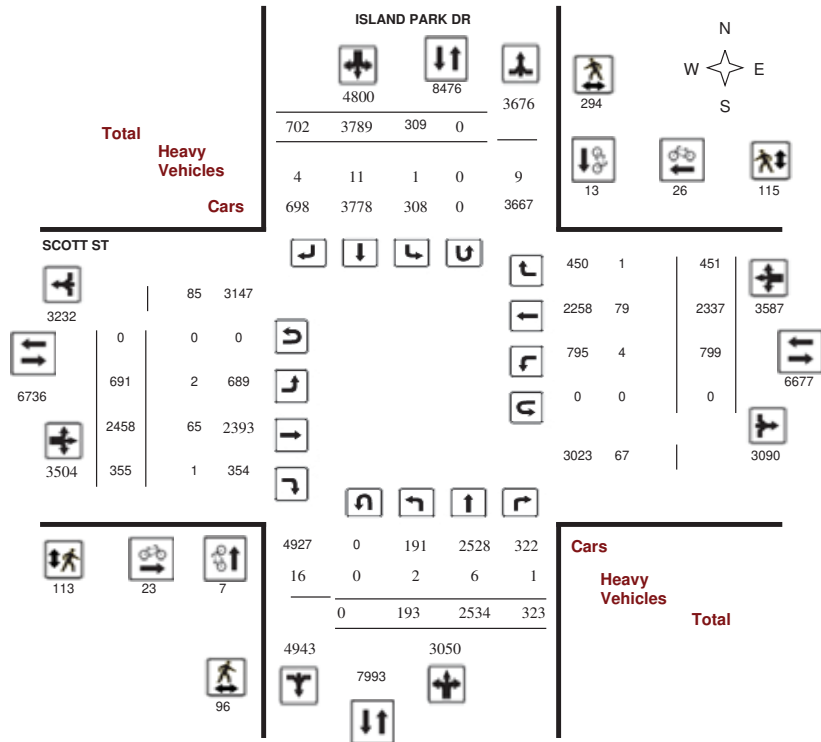

Transportation Services - Traffic Services

Turning Movement Count - Study Results

ISLAND PARK DR @ SCOTT ST

Survey Date: Tuesday, March 28, 2017

WO No: 36808

Start Time: 07:00

Device: Miovision

Full Study Peak Hour Diagram

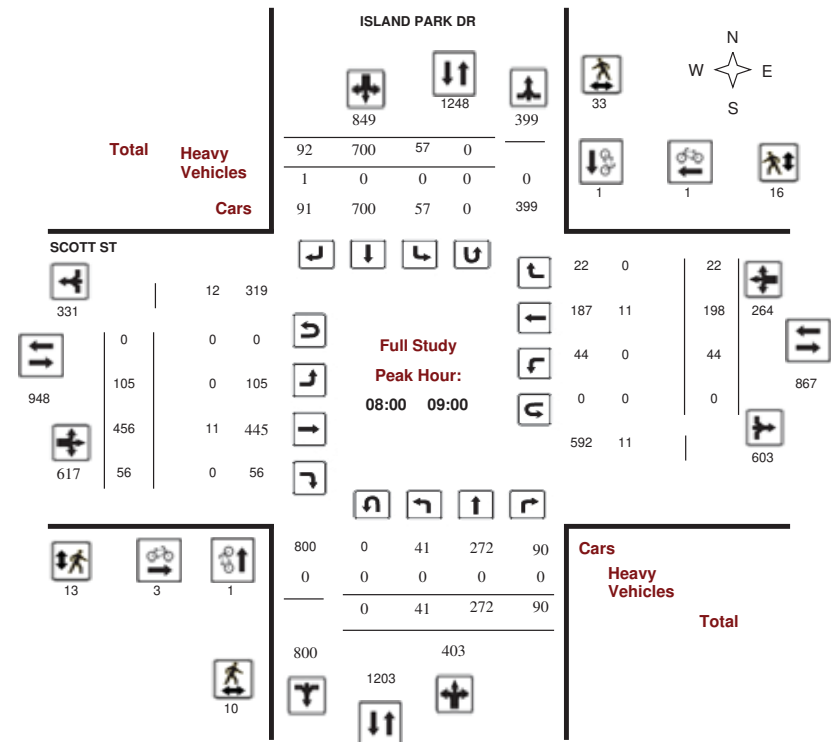



Transportation Services - Traffic Services

Turning Movement Count - Peak Hour Diagram

ISLAND PARK DR @ SCOTT ST

Survey Date: Tuesday, March 28, 2017
Start Time: 07:00

WO No: 36808
Device: Miovision

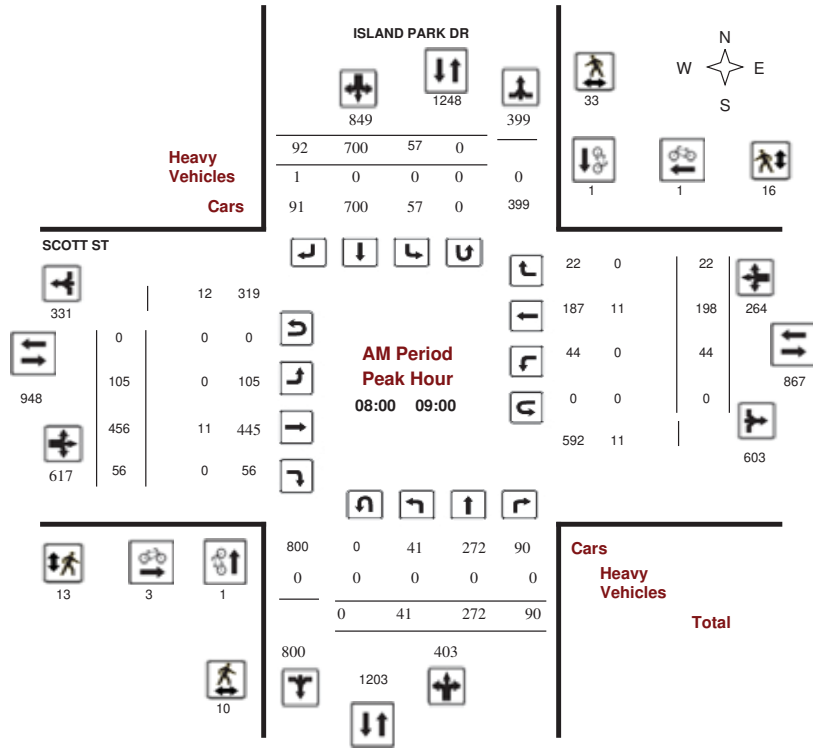

Comments



Transportation Services - Traffic Services

Turning Movement Count - Peak Hour Diagram

ISLAND PARK DR @ SCOTT ST

Survey Date: Tuesday, March 28, 2017
Start Time: 07:00

WO No: 36808
Device: Miovision

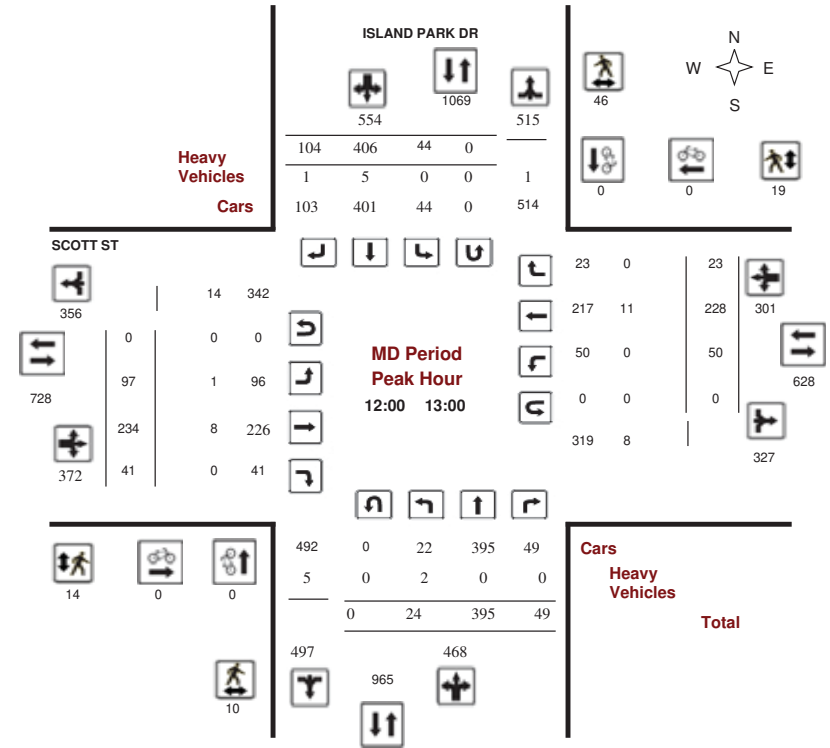

Comments



Transportation Services - Traffic Services

Turning Movement Count - Peak Hour Diagram

ISLAND PARK DR @ SCOTT ST

Survey Date: Tuesday, March 28, 2017
Start Time: 07:00

WO No: 36808
Device: Miovision

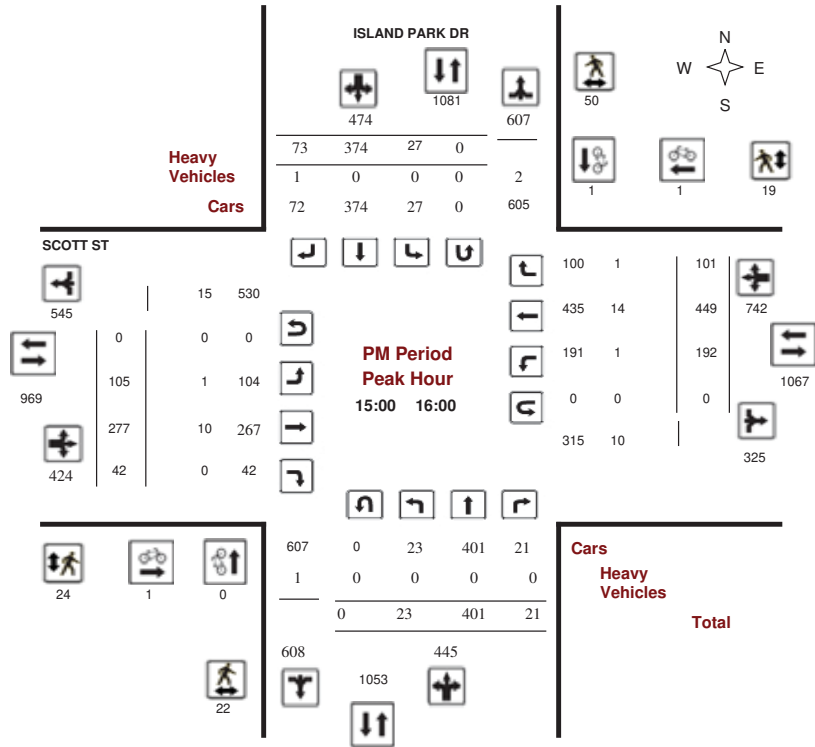

Comments



Transportation Services - Traffic Services

Turning Movement Count - Study Results

ISLAND PARK DR @ SCOTT ST

Survey Date: Tuesday, March 28, 2017
Start Time: 07:00

WO No: 36808
Device: Miovision

Full Study Summary (8 HR Standard)

Survey Date: Tuesday, March 28, 2017

Total Observed U-Turns
Northbound: 0 Southbound: 0
Eastbound: 0 Westbound: 0

AADT Factor
1.00

Period	ISLAND PARK DR								SCOTT ST								WB TOT	STR TOT	Grand Total
	Northbound				Southbound				Eastbound				Westbound						
	LT	ST	RT	NB TOT	LT	ST	RT	SB TOT	LT	ST	RT	EB TOT	LT	ST	RT	WB TOT			
07:00-08:00	20	242	79	341	32	696	66	794	1135	48	373	40	461	24	149	6	179	640	1775
08:00-09:00	41	272	90	403	57	700	92	849	1252	105	456	56	617	44	198	22	264	881	2133
09:00-10:00	37	313	34	384	42	542	107	691	1075	69	270	32	371	37	196	14	247	618	1693
11:30-12:30	24	378	36	438	27	397	100	524	962	81	223	46	350	54	238	22	314	664	1626
12:30-13:30	34	408	38	480	40	387	83	510	990	107	222	27	356	51	207	30	288	644	1634
15:00-16:00	23	401	21	445	27	374	73	474	919	105	277	42	424	192	449	101	742	1166	2085
16:00-17:00	5	204	9	218	38	330	84	452	670	80	309	56	445	244	449	150	843	1288	1958
17:00-18:00	9	316	16	341	46	363	97	506	847	96	328	56	480	153	451	106	710	1190	2037
Sub Total	193	2534	323	3050	309	3789	702	4800	7850	691	2458	355	3504	799	2337	451	3587	7091	14941
U Turns				0				0	0				0				0	0	0
Total	193	2534	323	3050	309	3789	702	4800	7850	691	2458	355	3504	799	2337	451	3587	7091	14941
EQ 12Hr	268	3522	449	4240	430	5267	976	6672	10912	960	3417	493	4871	1111	3248	627	4986	9856	20768
AVG 12Hr	253	3320	423	3996	405	4964	920	6288	10912	905	3220	465	4590	1047	3061	591	4699	9856	20768
AVG 24Hr	331	4349	554	5234	530	6502	1205	8237	13471	1186	4218	609	6013	1371	4011	774	6156	12169	25640

Note: These values are calculated by multiplying the totals by the appropriate expansion factor. **1.39**

Note: These volumes are calculated by multiplying the Equivalent 12 hr. totals by the AADT factor. **1**

Note: These volumes are calculated by multiplying the Average Daily 12 hr. totals by 12 to 24 expansion factor. **1.31**

Note: U-Turns provided for approach totals. Refer to 'U-Turn' Report for specific breakdown.



Transportation Services - Traffic Services

Turning Movement Count - Study Results

ISLAND PARK DR @ SCOTT ST

Survey Date: Tuesday, March 28, 2017

WO No: 36808

Start Time: 07:00

Device: Miovision

Full Study 15 Minute Increments

Table with columns for Time Period, Northbound, Southbound, Eastbound, Westbound, and Grand Total. Rows represent 15-minute intervals from 07:00 to 18:00.

Note: U-Turns are included in Totals.



Transportation Services - Traffic Services

Turning Movement Count - Study Results

ISLAND PARK DR @ SCOTT ST

Survey Date: Tuesday, March 28, 2017

WO No: 36808

Start Time: 07:00

Device: Miovision

Full Study Cyclist Volume

Table with columns for Time Period, Northbound, Southbound, Street Total, Eastbound, Westbound, Street Total, and Grand Total. Rows represent 15-minute intervals from 07:00 to 18:00.



Transportation Services - Traffic Services

Turning Movement Count - Study Results

ISLAND PARK DR @ SCOTT ST

Survey Date: Tuesday, March 28, 2017

WO No: 36808

Start Time: 07:00

Device: Miovision

Full Study Pedestrian Volume

ISLAND PARK DR SCOTT ST

Table with columns: Time Period, NB Approach (E or W Crossing), SB Approach (E or W Crossing), Total, EB Approach (N or S Crossing), WB Approach (N or S Crossing), Total, Grand Total. Rows show pedestrian counts for various time intervals from 07:00 to 18:00.



Transportation Services - Traffic Services

Turning Movement Count - Study Results

ISLAND PARK DR @ SCOTT ST

Survey Date: Tuesday, March 28, 2017

WO No: 36808

Start Time: 07:00

Device: Miovision

Full Study Heavy Vehicles

ISLAND PARK DR SCOTT ST

Table with columns: Time Period, Northbound (LT, ST, RT, N TOT), Southbound (LT, ST, RT, S TOT, STR TOT), Eastbound (LT, ST, RT, E TOT), Westbound (LT, ST, RT, W TOT, STR TOT), Grand Total. Rows show heavy vehicle counts for various time intervals from 07:00 to 18:00.



Transportation Services - Traffic Services

Turning Movement Count - Study Results

ISLAND PARK DR @ SCOTT ST

Survey Date: Tuesday, March 28, 2017

WO No: 36808

Start Time: 07:00

Device: Miovision

Full Study 15 Minute U-Turn Total

Time Period	ISLAND PARK DR		SCOTT ST		Total
	Northbound U-Turn Total	Southbound U-Turn Total	Eastbound U-Turn Total	Westbound U-Turn Total	
07:00 07:15	0	0	0	0	0
07:15 07:30	0	0	0	0	0
07:30 07:45	0	0	0	0	0
07:45 08:00	0	0	0	0	0
08:00 08:15	0	0	0	0	0
08:15 08:30	0	0	0	0	0
08:30 08:45	0	0	0	0	0
08:45 09:00	0	0	0	0	0
09:00 09:15	0	0	0	0	0
09:15 09:30	0	0	0	0	0
09:30 09:45	0	0	0	0	0
09:45 10:00	0	0	0	0	0
11:30 11:45	0	0	0	0	0
11:45 12:00	0	0	0	0	0
12:00 12:15	0	0	0	0	0
12:15 12:30	0	0	0	0	0
12:30 12:45	0	0	0	0	0
12:45 13:00	0	0	0	0	0
13:00 13:15	0	0	0	0	0
13:15 13:30	0	0	0	0	0
15:00 15:15	0	0	0	0	0
15:15 15:30	0	0	0	0	0
15:30 15:45	0	0	0	0	0
15:45 16:00	0	0	0	0	0
16:00 16:15	0	0	0	0	0
16:15 16:30	0	0	0	0	0
16:30 16:45	0	0	0	0	0
16:45 17:00	0	0	0	0	0
17:00 17:15	0	0	0	0	0
17:15 17:30	0	0	0	0	0
17:30 17:45	0	0	0	0	0
17:45 18:00	0	0	0	0	0
Total	0	0	0	0	0



Transportation Services - Traffic Services

Turning Movement Count - Full Study Summary Report

ISLAND PARK DR @ SCOTT ST

Work Order
36808

Survey Date: Tuesday, March 28, 2017

Total Observed U-Turns

AADT Factor

Northbound: 0 Southbound: 0
Eastbound: 0 Westbound: 0

1.00

Full Study

Period	ISLAND PARK DR								SCOTT ST								WB TOT	STR TOT	Grand Total
	Northbound				Southbound				Eastbound				Westbound						
	LT	ST	RT	NB TOT	LT	ST	RT	SB TOT	STR TOT	LT	ST	RT	EB TOT	LT	ST	RT			
07:00 08:00	20	242	79	341	32	696	66	794	1135	48	373	40	461	24	149	6	179	640	1775
08:00 09:00	41	272	90	403	57	700	92	849	1252	105	456	56	617	44	198	22	264	881	2133
09:00 10:00	37	313	34	384	42	542	107	691	1075	69	270	32	371	37	196	14	247	618	1693
11:30 12:30	24	378	36	438	27	397	100	524	962	81	223	46	350	54	238	22	314	664	1626
12:30 13:30	34	408	38	480	40	387	83	510	990	107	222	27	356	51	207	30	288	644	1634
15:00 16:00	23	401	21	445	27	374	73	474	919	105	277	42	424	192	449	101	742	1166	2085
16:00 17:00	5	204	9	218	38	330	84	452	670	80	309	56	445	244	449	150	843	1288	1958
17:00 18:00	9	316	16	341	46	363	97	506	847	96	328	56	480	153	451	106	710	1190	2037
Sub Total	193	2534	323	3050	309	3789	702	4800	7850	691	2458	355	3504	799	2337	451	3587	7091	14941
U Turns				0				0	0				0				0	0	0
Total	193	2534	323	3050	309	3789	702	4800	7850	691	2458	355	3504	799	2337	451	3587	7091	14941
EQ 12Hr	268	3522	449	4240	430	5267	976	6672	10912	960	3417	493	4871	1111	3248	627	4986	9857	20769
Note: These values are calculated by multiplying the totals by the appropriate expansion factor.													1.39						
AVG 12Hr	268	3522	449	4240	430	5267	976	6672	10912	960	3417	493	4871	1111	3248	627	4986	9857	20769
Note: These volumes are calculated by multiplying the Equivalent 12 hr. totals by the AADT factor.													1.00						
AVG 24Hr	351	4614	588	5554	563	6899	1278	8740	14294	1258	4476	646	6380	1455	4255	821	6532	12912	27206
Note: These volumes are calculated by multiplying the Average Daily 12 hr. totals by 12 to 24 expansion factor.													1.31						

Comments:

Note: U-Turns provided for approach totals. Refer to 'U-Turn' Report for specific breakdown.



Transportation Services - Traffic Services

Turning Movement Count - Peak Hour Diagram

LANARK AVE/WEST VILLAGE PRIV @ SCOTT ST

Survey Date: Tuesday, March 28, 2017
Start Time: 07:00

WO No: 36807
Device: Miovision

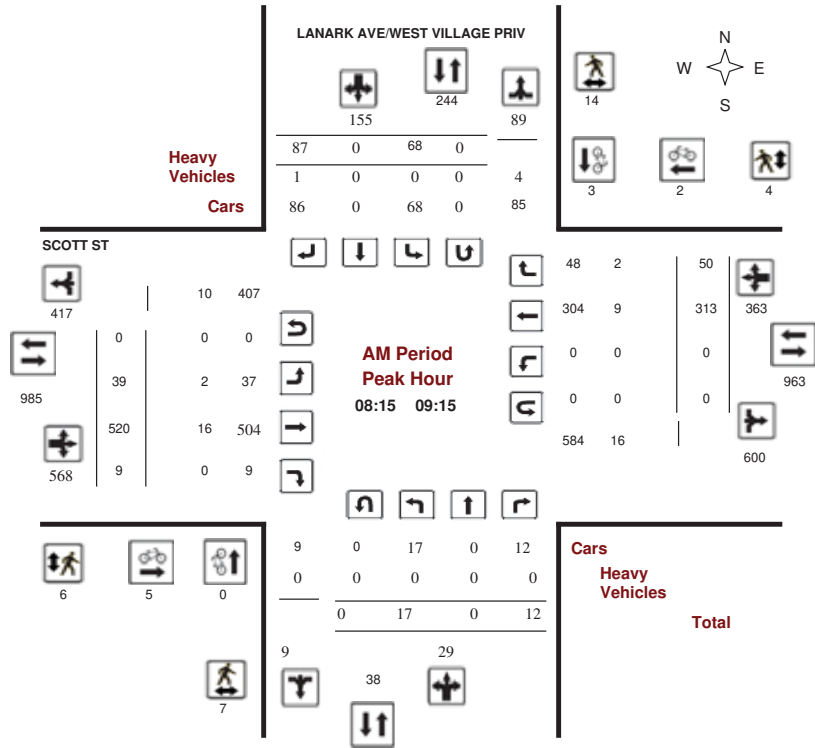

Comments



Transportation Services - Traffic Services

Turning Movement Count - Peak Hour Diagram

LANARK AVE/WEST VILLAGE PRIV @ SCOTT ST

Survey Date: Tuesday, March 28, 2017
Start Time: 07:00

WO No: 36807
Device: Miovision

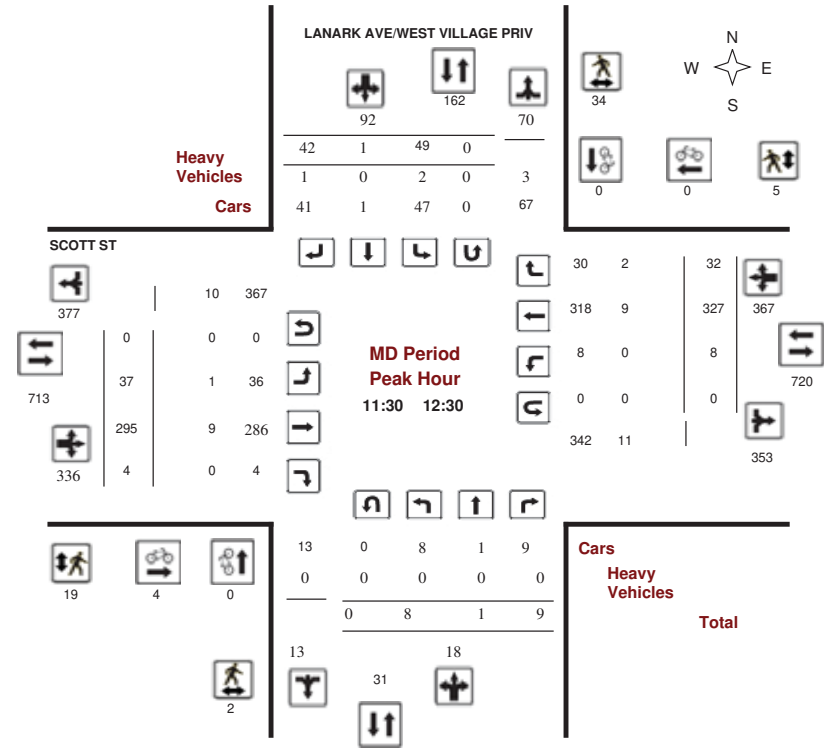

Comments



Transportation Services - Traffic Services

Turning Movement Count - Peak Hour Diagram

LANARK AVE/WEST VILLAGE PRIV @ SCOTT ST

Survey Date: Tuesday, March 28, 2017
Start Time: 07:00

WO No: 36807
Device: Miovision

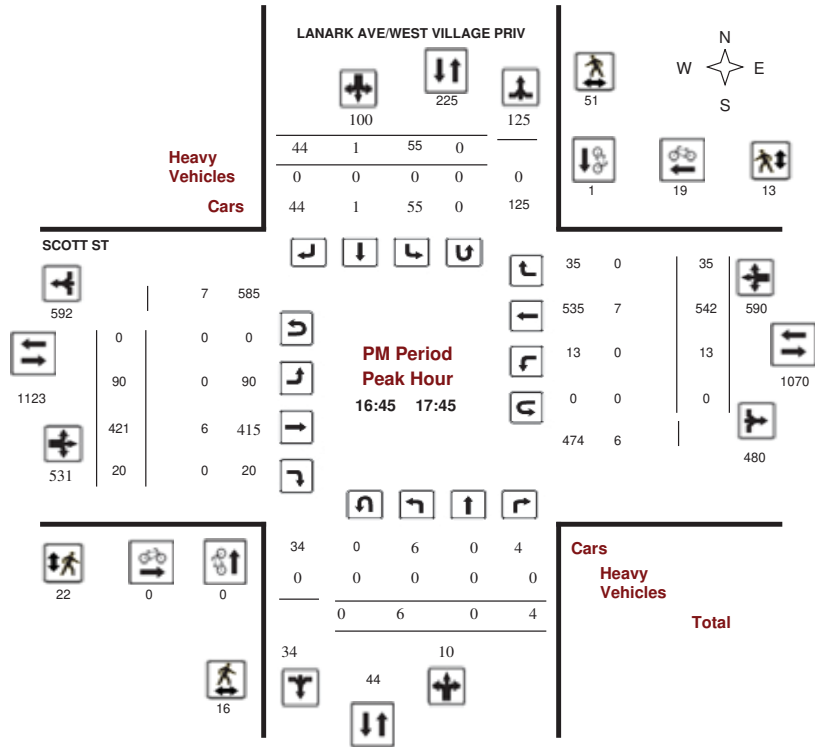

Transportation Services - Traffic Services

Turning Movement Count - Study Results

LANARK AVE/WEST VILLAGE PRIV @ SCOTT ST

Survey Date: Tuesday, March 28, 2017
Start Time: 07:00

WO No: 36807
Device: Miovision

Full Study Summary (8 HR Standard)

Survey Date: Tuesday, March 28, 2017

Total Observed U-Turns
Northbound: 0 Southbound: 0
Eastbound: 0 Westbound: 0

AADT Factor
1.00

Period	LANARK AVE/WEST VILLAGE PRIV										SCOTT ST						Grand Total			
	Northbound					Southbound					Eastbound			Westbound						
	LT	ST	RT	NB TOT	STR TOT	LT	ST	RT	SB TOT	STR TOT	LT	ST	RT	EB TOT	WB TOT	STR TOT				
07:00-08:00	6	0	18	24	125	48	0	53	101	125	23	380	3	406	0	219	27	246	652	777
08:00-09:00	14	0	13	27	199	72	0	100	172	199	38	534	7	579	0	283	43	326	905	1104
09:00-10:00	11	0	11	22	110	42	0	46	88	110	29	336	11	376	5	290	44	339	715	825
11:30-12:30	8	1	9	18	110	49	1	42	92	110	37	295	4	336	8	327	32	367	703	813
12:30-13:30	4	0	5	9	94	46	1	38	85	94	42	311	6	359	2	278	37	317	676	770
15:00-16:00	8	1	6	15	99	55	0	29	84	99	58	364	8	430	6	501	38	545	975	1074
16:00-17:00	7	0	4	11	111	63	0	37	100	111	71	373	11	455	6	515	38	559	1014	1125
17:00-18:00	7	0	7	14	118	56	1	47	104	118	102	425	21	548	13	506	37	556	1104	1222
Sub Total	65	2	73	140	966	431	3	392	826	966	400	3018	71	3489	40	2919	296	3255	6744	7710
U Turns	0	0	0	0	0	0	0	0	0	0	0	0	0	0	0	0	0	0	0	0
Total	65	2	73	140	966	431	3	392	826	966	400	3018	71	3489	40	2919	296	3255	6744	7710
EQ 12hr	90	3	101	194	1342	599	4	545	1148	1342	556	4195	99	4850	56	4057	411	4524	9374	10716
Note: These values are calculated by multiplying the totals by the appropriate expansion factor.																1.39				
AVG 12hr	90	3	101	194	1342	599	4	545	1148	1342	556	4195	99	4850	56	4057	411	4524	9374	10716
Note: These volumes are calculated by multiplying the Equivalent 12 hr. totals by the AADT factor.																1.00				
AVG 24hr	118	4	132	254	1758	785	5	714	1504	1758	728	5495	130	6353	73	5315	538	5926	12279	14037
Note: These volumes are calculated by multiplying the Average Daily 12 hr. totals by 12 to 24 expansion factor.																1.31				
Note: U-Turns provided for approach totals. Refer to 'U-Turn' Report for specific breakdown.																				



Transportation Services - Traffic Services

Turning Movement Count - Study Results

LANARK AVE/WEST VILLAGE PRIV @ SCOTT ST

Survey Date: Tuesday, March 28, 2017

WO No: 36807

Start Time: 07:00

Device: Miovision

Full Study 15 Minute Counts

LANARK AVE/WEST VILLAGE PRIV

SCOTT ST

Table with columns for Time Period, Northbound (LT, ST, RT, N TOT, STR TOT), Southbound (LT, ST, RT, S TOT, STR TOT), Eastbound (LT, ST, RT, E TOT, STR TOT), Westbound (LT, ST, RT, W TOT, STR TOT), and Grand Total. Rows represent 15-minute intervals from 07:00 to 18:00.

Note: U-Turns are included in Totals.



Transportation Services - Traffic Services

Turning Movement Count - Study Results

LANARK AVE/WEST VILLAGE PRIV @ SCOTT ST

Survey Date: Tuesday, March 28, 2017

WO No: 36807

Start Time: 07:00

Device: Miovision

Full Study Cyclist Volume

LANARK AVE/WEST VILLAGE PRIV

SCOTT ST

Table with columns for Time Period, Northbound, Southbound, Street Total, Eastbound, Westbound, Street Total, and Grand Total. Rows represent 15-minute intervals from 07:00 to 18:00.



Transportation Services - Traffic Services

Turning Movement Count - Study Results

LANARK AVE/WEST VILLAGE PRIV @ SCOTT ST

Survey Date: Tuesday, March 28, 2017

WO No: 36807

Start Time: 07:00

Device: Miovision

Full Study Pedestrian Volume

LANARK AVE/WEST VILLAGE PRIV SCOTT ST

Table with 8 columns: Time Period, NB Approach, SB Approach, Total, EB Approach, WB Approach, Total, Grand Total. Rows show pedestrian counts for various time intervals from 07:00 to 18:00.



Transportation Services - Traffic Services

Turning Movement Count - Study Results

LANARK AVE/WEST VILLAGE PRIV @ SCOTT ST

Survey Date: Tuesday, March 28, 2017

WO No: 36807

Start Time: 07:00

Device: Miovision

Full Study Heavy Vehicles

LANARK AVE/WEST VILLAGE PRIV SCOTT ST

Table with 20 columns: Time Period, Northbound (LT, ST, RT, N TOT), Southbound (LT, ST, RT, S TOT, STR TOT), Eastbound (LT, ST, RT, E TOT), Westbound (LT, ST, RT, W TOT, STR TOT), Grand Total. Rows show heavy vehicle counts for various time intervals from 07:00 to 18:00.



Transportation Services - Traffic Services

Turning Movement Count - Study Results

LANARK AVE/WEST VILLAGE PRIV @ SCOTT ST

Survey Date: Tuesday, March 28, 2017

WO No: 36807

Start Time: 07:00

Device: Miovision

Full Study 15 Minute U-Turn Total

LANARK AVE/WEST VILLAGE PRIV SCOTT ST

Time Period	Northbound U-Turn Total	Southbound U-Turn Total	Eastbound U-Turn Total	Westbound U-Turn Total	Total
07:00 - 07:15	0	0	0	0	0
07:15 - 07:30	0	0	0	0	0
07:30 - 07:45	0	0	0	0	0
07:45 - 08:00	0	0	0	0	0
08:00 - 08:15	0	0	0	0	0
08:15 - 08:30	0	0	0	0	0
08:30 - 08:45	0	0	0	0	0
08:45 - 09:00	0	0	0	0	0
09:00 - 09:15	0	0	0	0	0
09:15 - 09:30	0	0	0	0	0
09:30 - 09:45	0	0	0	0	0
09:45 - 10:00	0	0	0	0	0
11:30 - 11:45	0	0	0	0	0
11:45 - 12:00	0	0	0	0	0
12:00 - 12:15	0	0	0	0	0
12:15 - 12:30	0	0	0	0	0
12:30 - 12:45	0	0	0	0	0
12:45 - 13:00	0	0	0	0	0
13:00 - 13:15	0	0	0	0	0
13:15 - 13:30	0	0	0	0	0
15:00 - 15:15	0	0	0	0	0
15:15 - 15:30	0	0	0	0	0
15:30 - 15:45	0	0	0	0	0
15:45 - 16:00	0	0	0	0	0
16:00 - 16:15	0	0	0	0	0
16:15 - 16:30	0	0	0	0	0
16:30 - 16:45	0	0	0	0	0
16:45 - 17:00	0	0	0	0	0
17:00 - 17:15	0	0	0	0	0
17:15 - 17:30	0	0	0	0	0
17:30 - 17:45	0	0	0	0	0
17:45 - 18:00	0	0	0	0	0
Total	0	0	0	0	0



Transportation Services - Traffic Services

Turning Movement Count - Study Results

CHURCHILL AVE @ LANARK AVE

Survey Date: Thursday, October 24, 2019

WO No: 38900

Start Time: 07:00

Device: Miovision

Full Study Diagram

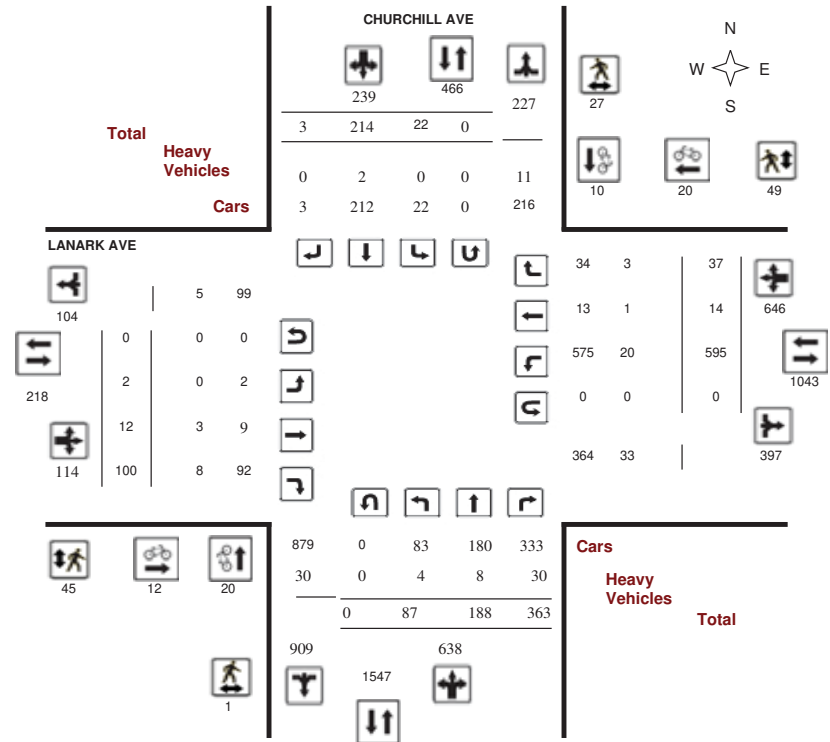



Transportation Services - Traffic Services

Turning Movement Count - Study Results

CHURCHILL AVE @ LANARK AVE

Survey Date: Thursday, October 24, 2019

WO No: 38900

Start Time: 07:00

Device: Miovision

Full Study Peak Hour Diagram

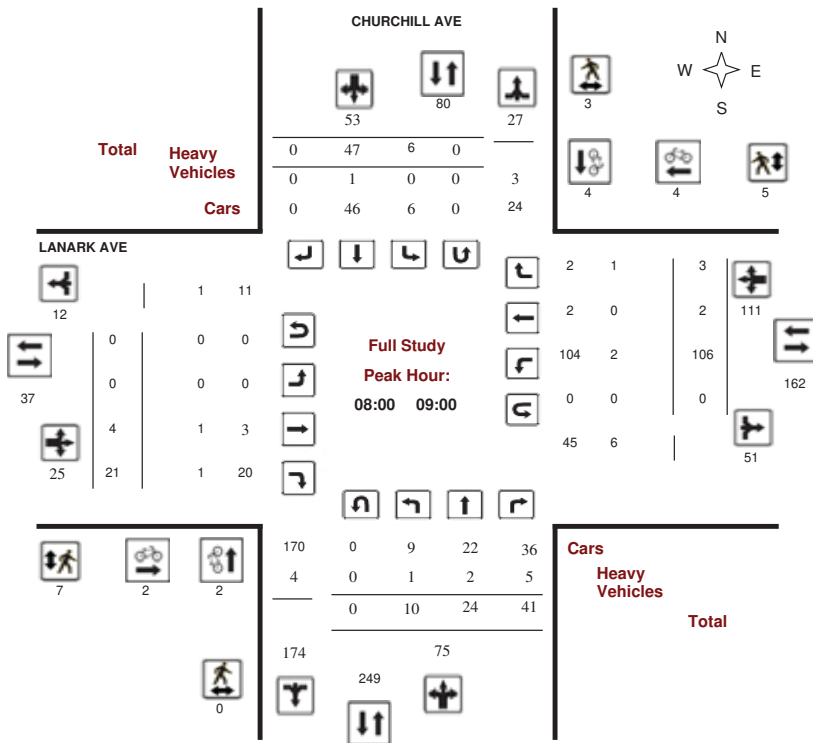

Transportation Services - Traffic Services

Turning Movement Count - Peak Hour Diagram

CHURCHILL AVE @ LANARK AVE

Survey Date: Thursday, October 24, 2019

WO No: 38900

Start Time: 07:00

Device: Miovision

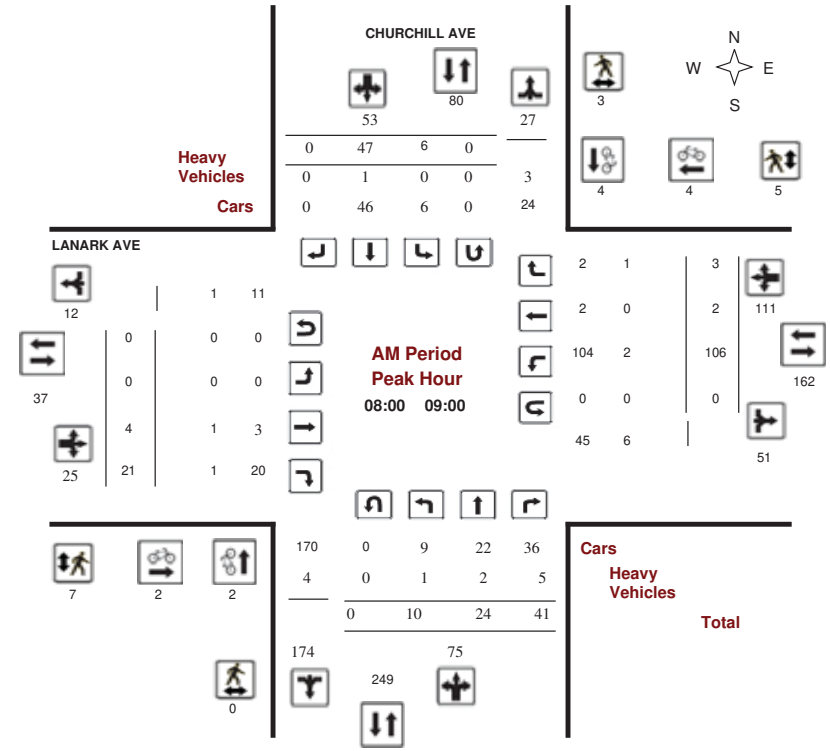

Comments



Transportation Services - Traffic Services

Turning Movement Count - Peak Hour Diagram

CHURCHILL AVE @ LANARK AVE

Survey Date: Thursday, October 24, 2019

Start Time: 07:00

WO No: 38900

Device: Miovision

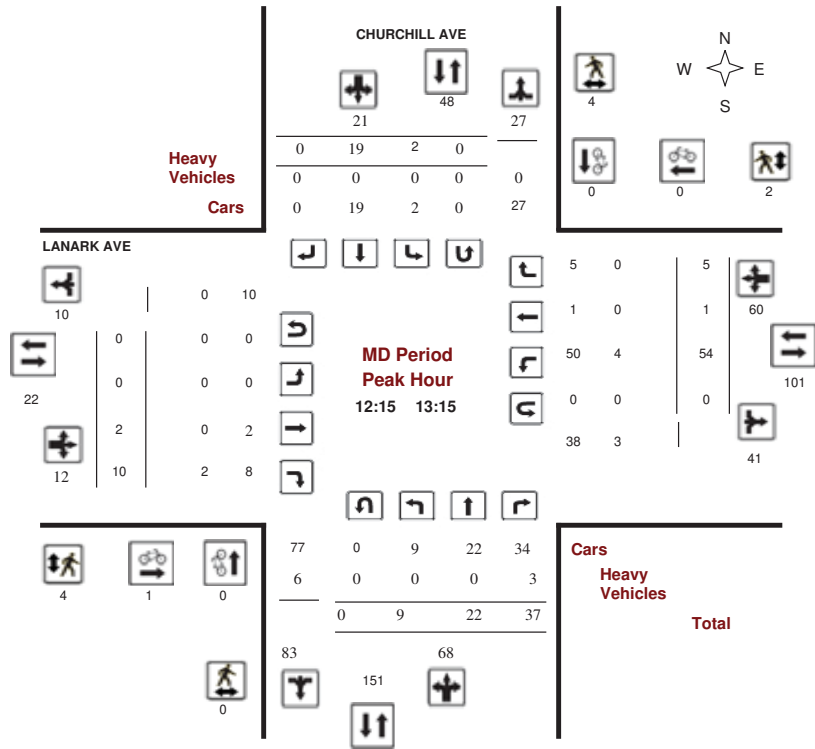

Comments



Transportation Services - Traffic Services

Turning Movement Count - Peak Hour Diagram

CHURCHILL AVE @ LANARK AVE

Survey Date: Thursday, October 24, 2019

Start Time: 07:00

WO No: 38900

Device: Miovision

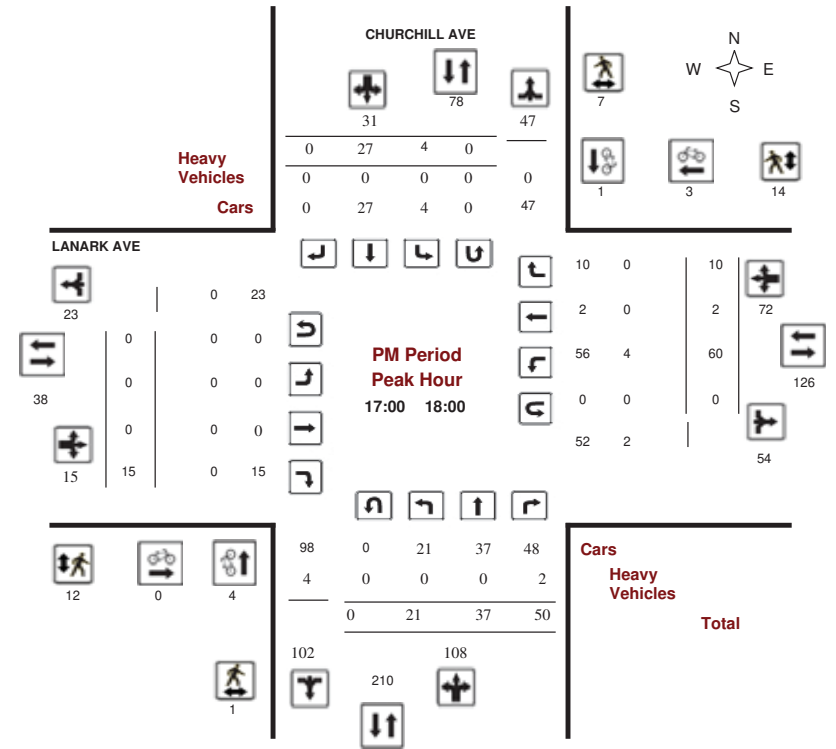

Comments



Transportation Services - Traffic Services

Turning Movement Count - Study Results

CHURCHILL AVE @ LANARK AVE

Survey Date: Thursday, October 24, 2019

WO No: 38900

Start Time: 07:00

Device: Miovision

Full Study Summary (8 HR Standard)

Survey Date: Thursday, October 24, 2019

Total Observed U-Turns **AADT Factor**

Northbound: 0 Southbound: 0 .90

Eastbound: 0 Westbound: 0

Period	CHURCHILL AVE										LANARK AVE										STR TOT	Grand Total
	Northbound					Southbound					Eastbound					Westbound						
	LT	ST	RT	NB TOT	STR TOT	LT	ST	RT	SB TOT	STR TOT	LT	ST	RT	EB TOT	STR TOT	LT	ST	RT	WB TOT	STR TOT		
07:00-08:00	6	16	42	64	28	3	24	1	28	92	0	2	10	12	111	0	2	113	125	217		
08:00-09:00	10	24	41	75	53	6	47	0	53	128	0	4	21	25	106	2	3	111	136	264		
09:00-10:00	7	21	44	72	27	4	22	1	27	99	1	1	12	14	100	0	2	102	116	215		
11:30-12:30	13	21	29	63	22	2	19	1	22	85	1	0	7	8	47	3	2	52	60	145		
12:30-13:30	6	22	37	65	16	1	15	0	16	81	0	2	12	14	54	1	7	62	76	157		
15:00-16:00	8	20	64	92	119	1	26	0	27	119	0	3	13	16	62	3	7	72	88	207		
16:00-17:00	16	27	56	99	134	1	34	0	35	134	0	0	10	10	55	3	4	62	72	206		
17:00-18:00	21	37	50	108	139	4	27	0	31	139	0	0	15	15	60	2	10	72	87	226		
Sub Total	87	188	363	638	877	22	214	3	239	877	2	12	100	114	595	14	37	646	760	1637		
U Turns	0	0	0	0	0	0	0	0	0	0	0	0	0	0	0	0	0	0	0	0		
Total	87	188	363	638	877	22	214	3	239	877	2	12	100	114	595	14	37	646	760	1637		

EQ 12hr 121 261 505 887 31 297 4 332 1219 3 17 139 159 827 19 51 897 1056 2275

Note: These values are calculated by multiplying the totals by the appropriate expansion factor. **1.39**

AVG 12hr 109 235 454 798 28 267 4 299 1097 3 15 125 143 744 17 46 807 950 2047

Note: These volumes are calculated by multiplying the Equivalent 12 hr. totals by the AADT factor. **.90**

AVG 24hr 143 308 595 1046 37 350 5 392 1438 4 20 164 188 975 22 60 1057 1245 2683

Note: These volumes are calculated by multiplying the Average Daily 12 hr. totals by 12 to 24 expansion factor. **1.31**

Note: U-Turns provided for approach totals. Refer to 'U-Turn' Report for specific breakdown.



Transportation Services - Traffic Services

Turning Movement Count - Study Results

CHURCHILL AVE @ LANARK AVE

Survey Date: Thursday, October 24, 2019

WO No: 38900

Start Time: 07:00

Device: Miovision

Full Study 15 Minute Increments

Time Period	CHURCHILL AVE										LANARK AVE										STR TOT	Grand Total
	Northbound					Southbound					Eastbound					Westbound						
	LT	ST	RT	N TOT	STR TOT	LT	ST	RT	S TOT	STR TOT	LT	ST	RT	E TOT	STR TOT	LT	ST	RT	W TOT	STR TOT		
07:00-07:15	3	2	6	11	15	1	3	0	4	15	0	0	1	1	22	0	0	22	23	38		
07:15-07:30	0	3	12	15	0	3	0	3	18	0	1	4	5	28	0	1	29	34	52			
07:30-07:45	2	6	12	20	1	12	0	13	33	0	0	2	2	18	0	1	19	21	54			
07:45-08:00	1	5	12	18	1	6	1	8	26	0	1	3	4	43	0	0	43	47	73			
08:00-08:15	5	4	11	20	2	12	0	14	34	0	2	9	11	18	0	1	19	30	64			
08:15-08:30	1	5	11	17	2	7	0	9	26	0	1	3	4	27	2	1	30	34	60			
08:30-08:45	1	8	9	18	2	13	0	15	33	0	0	3	3	23	0	1	24	27	60			
08:45-09:00	3	7	10	20	0	15	0	15	35	0	1	6	7	38	0	0	38	45	80			
09:00-09:15	1	8	12	21	1	7	1	9	30	0	1	2	3	26	0	0	26	29	59			
09:15-09:30	2	4	13	19	1	2	0	3	22	0	0	5	5	30	0	1	31	36	58			
09:30-09:45	3	7	10	20	1	8	0	9	29	1	0	3	4	24	0	1	25	29	58			
09:45-10:00	1	2	9	12	1	5	0	6	18	0	0	2	2	20	0	0	20	22	40			
11:30-11:45	3	6	9	18	1	2	1	4	22	0	0	2	2	7	1	0	8	10	32			
11:45-12:00	1	3	7	11	0	5	0	5	16	1	0	2	3	15	1	1	17	20	36			
12:00-12:15	4	3	4	11	0	4	0	4	15	0	0	3	3	12	1	1	14	17	32			
12:15-12:30	5	9	9	23	1	8	0	9	32	0	0	0	0	13	0	0	13	13	45			
12:30-12:45	1	4	7	12	0	3	0	3	15	0	0	2	2	15	0	1	16	18	33			
12:45-13:00	0	4	11	15	1	3	0	4	19	0	2	5	7	12	0	3	15	22	41			
13:00-13:15	3	5	10	18	0	5	0	5	23	0	0	3	3	14	1	1	16	19	42			
13:15-13:30	2	9	9	20	0	4	0	4	24	0	0	2	2	13	0	2	15	17	41			
15:00-15:15	4	6	18	28	1	4	0	5	33	0	3	5	8	9	1	0	10	18	51			
15:15-15:30	0	4	22	26	0	12	0	12	38	0	0	3	3	20	1	3	24	27	65			
15:30-15:45	2	3	14	19	0	6	0	6	25	0	0	2	2	18	1	1	20	22	47			
15:45-16:00	2	7	10	19	0	4	0	4	23	0	0	3	3	15	0	3	18	21	44			
16:00-16:15	4	9	12	25	0	9	0	9	34	0	0	3	3	9	2	2	13	16	50			
16:15-16:30	3	8	15	26	0	16	0	16	42	0	0	3	3	13	0	0	13	16	58			
16:30-16:45	4	5	15	24	0	8	0	8	32	0	0	2	2	21	1	1	23	25	57			
16:45-17:00	5	5	14	24	1	1	0	2	26	0	0	2	2	12	0	1	13	15	41			
17:00-17:15	5	5	12	22	0	3	0	3	25	0	0	1	1	14	0	1	15	16	41			
17:15-17:30	7	17	11	35	2	8	0	10	45	0	0	6	6	16	0	5	21	27	72			
17:30-17:45	3	7	15	25	0	11	0	11	36	0	0	4	4	12	0	3	15	19	55			
17:45-18:00	6	8	12	26	2	5	0	7	33	0	0	4	4	18	2	1	21	25	58			
Total	87	188	363	638	877	22	214	3	239	877	2	12	100	114	595	14	37	646	760	1,637		

Note: U-Turns are included in Totals.



Transportation Services - Traffic Services

Turning Movement Count - Study Results

CHURCHILL AVE @ LANARK AVE

Survey Date: Thursday, October 24, 2019

WO No: 38900

Start Time: 07:00

Device: Miovision

Full Study Cyclist Volume

Time Period	CHURCHILL AVE			LANARK AVE			Grand Total
	Northbound	Southbound	Street Total	Eastbound	Westbound	Street Total	
07:00 07:15	0	0	0	0	0	0	0
07:15 07:30	0	1	1	0	0	0	1
07:30 07:45	2	1	3	0	1	1	4
07:45 08:00	0	1	1	1	3	4	5
08:00 08:15	0	0	0	0	2	2	2
08:15 08:30	1	2	3	2	0	2	5
08:30 08:45	1	0	1	0	2	2	3
08:45 09:00	0	2	2	0	0	0	2
09:00 09:15	0	0	0	1	1	2	2
09:15 09:30	0	0	0	1	0	1	1
09:30 09:45	1	0	1	0	0	0	1
09:45 10:00	0	0	0	0	0	0	0
11:30 11:45	0	0	0	0	1	1	1
11:45 12:00	0	0	0	0	0	0	0
12:00 12:15	0	0	0	0	0	0	0
12:15 12:30	0	0	0	0	0	0	0
12:30 12:45	0	0	0	0	0	0	0
12:45 13:00	0	0	0	1	0	1	1
13:00 13:15	0	0	0	0	0	0	0
13:15 13:30	0	0	0	1	0	1	1
15:00 15:15	0	0	0	1	1	2	2
15:15 15:30	4	1	5	0	1	1	6
15:30 15:45	0	0	0	1	3	4	4
15:45 16:00	3	0	3	1	0	1	4
16:00 16:15	2	0	2	0	0	0	2
16:15 16:30	1	1	2	1	0	1	3
16:30 16:45	0	0	0	0	0	0	0
16:45 17:00	1	0	1	1	2	3	4
17:00 17:15	1	0	1	0	1	1	2
17:15 17:30	1	0	1	0	0	0	1
17:30 17:45	0	0	0	0	2	2	2
17:45 18:00	2	1	3	0	0	0	3
Total	20	10	30	12	20	32	62



Transportation Services - Traffic Services

Turning Movement Count - Study Results

CHURCHILL AVE @ LANARK AVE

Survey Date: Thursday, October 24, 2019

WO No: 38900

Start Time: 07:00

Device: Miovision

Full Study Pedestrian Volume

Time Period	CHURCHILL AVE			LANARK AVE			Grand Total
	NB Approach (E or W Crossing)	SB Approach (E or W Crossing)	Total	EB Approach (N or S Crossing)	WB Approach (N or S Crossing)	Total	
07:00 07:15	0	1	1	0	0	0	1
07:15 07:30	0	0	0	1	1	2	2
07:30 07:45	0	0	0	1	2	3	3
07:45 08:00	0	2	2	5	2	7	9
08:00 08:15	0	0	0	3	1	4	4
08:15 08:30	0	1	1	4	0	4	5
08:30 08:45	0	2	2	0	0	0	2
08:45 09:00	0	0	0	4	4	4	4
09:00 09:15	0	0	0	0	1	1	1
09:15 09:30	0	0	0	1	0	1	1
09:30 09:45	0	2	2	0	1	1	3
09:45 10:00	0	1	1	1	0	1	2
11:30 11:45	0	1	1	0	1	1	2
11:45 12:00	0	0	0	0	0	0	0
12:00 12:15	0	0	0	2	0	2	2
12:15 12:30	0	0	0	0	0	0	0
12:30 12:45	0	1	1	2	0	2	3
12:45 13:00	0	0	0	1	0	1	1
13:00 13:15	0	3	3	1	2	3	6
13:15 13:30	0	0	0	1	1	2	2
15:00 15:15	0	0	0	0	0	0	0
15:15 15:30	0	1	1	0	2	2	3
15:30 15:45	0	1	1	1	2	3	4
15:45 16:00	0	2	2	0	2	2	4
16:00 16:15	0	1	1	1	8	9	10
16:15 16:30	0	1	1	5	1	6	7
16:30 16:45	0	0	0	1	3	4	4
16:45 17:00	0	0	0	2	1	3	3
17:00 17:15	0	2	2	1	1	2	4
17:15 17:30	0	1	1	7	3	10	11
17:30 17:45	1	4	5	1	7	8	13
17:45 18:00	0	0	0	3	3	6	6
Total	1	27	28	45	49	94	122



Transportation Services - Traffic Services

Turning Movement Count - Study Results

CHURCHILL AVE @ LANARK AVE

Survey Date: Thursday, October 24, 2019

WO No: 38900

Start Time: 07:00

Device: Miovision

Full Study Heavy Vehicles

CHURCHILL AVE				LANARK AVE				CHURCHILL AVE				LANARK AVE				Grand Total				
Northbound		Southbound		Eastbound		Westbound		Northbound		Southbound		Eastbound		Westbound						
Time Period	LT	ST	RT	N TOT	LT	ST	RT	S TOT	STR TOT	LT	ST	RT	E TOT	LT	ST	RT	W TOT	STR TOT		
07:00	07:15	0	0	0	0	0	0	0	0	0	0	0	0	0	0	0	0	0	0	
07:15	07:30	0	1	2	3	0	0	0	0	3	0	1	0	1	1	0	1	2	3	
07:30	07:45	1	0	1	2	0	0	0	0	2	0	0	0	0	0	0	0	0	2	
07:45	08:00	0	0	2	2	0	0	0	0	2	0	0	0	0	1	0	0	1	1	
08:00	08:15	0	0	0	0	0	0	0	0	0	0	0	0	0	0	1	1	1	1	
08:15	08:30	1	0	2	3	0	1	0	1	4	0	0	0	0	1	0	0	1	1	
08:30	08:45	0	0	1	1	0	0	0	0	1	0	0	0	0	1	0	0	1	1	
08:45	09:00	0	2	2	4	0	0	0	0	4	0	1	1	2	0	0	0	2	6	
09:00	09:15	0	2	0	2	0	0	0	0	2	0	0	1	1	0	0	0	1	3	
09:15	09:30	0	0	2	2	0	0	0	0	2	0	0	0	0	1	0	0	1	3	
09:30	09:45	1	0	0	1	0	0	0	0	1	0	0	0	0	0	0	0	0	1	
09:45	10:00	0	0	1	1	0	0	0	0	1	0	0	0	1	0	0	1	1	2	
11:30	11:45	0	2	0	2	0	0	0	0	2	0	0	0	0	1	0	1	1	3	
11:45	12:00	0	0	2	2	0	0	0	0	2	0	0	0	1	0	0	1	1	3	
12:00	12:15	0	0	1	1	0	0	0	0	1	0	0	0	0	0	0	0	0	1	
12:15	12:30	0	0	1	1	0	0	0	0	1	0	0	0	2	0	0	2	2	3	
12:30	12:45	0	0	1	1	0	0	0	0	1	0	0	0	0	0	0	0	0	1	
12:45	13:00	0	0	1	1	0	0	0	0	1	0	0	1	1	2	0	0	2	4	
13:00	13:15	0	0	0	0	0	0	0	0	0	0	0	1	1	0	0	0	1	1	
13:15	13:30	0	0	1	1	0	0	0	0	1	0	0	0	0	1	0	0	1	2	
15:00	15:15	0	0	1	1	0	0	0	0	1	0	1	1	2	1	0	0	1	3	
15:15	15:30	0	0	1	1	0	1	0	1	2	0	0	0	1	0	0	1	1	3	
15:30	15:45	0	0	1	1	0	0	0	0	1	0	0	1	1	0	0	0	1	2	
15:45	16:00	0	0	0	0	0	0	0	0	0	0	0	1	1	1	0	1	2	3	
16:00	16:15	0	1	1	2	0	0	0	0	2	0	0	1	1	0	0	0	1	3	
16:15	16:30	1	0	2	3	0	0	0	0	3	0	0	0	0	0	0	0	0	3	
16:30	16:45	0	0	2	2	0	0	0	0	2	0	0	0	0	1	0	0	1	3	
16:45	17:00	0	0	0	0	0	0	0	0	0	0	0	0	0	0	0	0	0	0	
17:00	17:15	0	0	1	1	0	0	0	0	1	0	0	0	0	1	0	0	1	2	
17:15	17:30	0	0	0	0	0	0	0	0	0	0	0	0	2	0	0	2	2	2	
17:30	17:45	0	0	1	1	0	0	0	0	1	0	0	0	0	0	0	0	0	1	
17:45	18:00	0	0	0	0	0	0	0	0	0	0	0	0	0	1	0	0	1	1	
Total:	None	4	8	30	42	0	2	0	2	44	0	3	8	11	20	1	3	24	35	79



Transportation Services - Traffic Services

Turning Movement Count - Study Results

CHURCHILL AVE @ LANARK AVE

Survey Date: Thursday, October 24, 2019

WO No: 38900

Start Time: 07:00

Device: Miovision

Full Study 15 Minute U-Turn Total

CHURCHILL AVE		LANARK AVE		Total
Northbound U-Turn Total	Southbound U-Turn Total	Eastbound U-Turn Total	Westbound U-Turn Total	
Time Period				
07:00	07:15	0	0	0
07:15	07:30	0	0	0
07:30	07:45	0	0	0
07:45	08:00	0	0	0
08:00	08:15	0	0	0
08:15	08:30	0	0	0
08:30	08:45	0	0	0
08:45	09:00	0	0	0
09:00	09:15	0	0	0
09:15	09:30	0	0	0
09:30	09:45	0	0	0
09:45	10:00	0	0	0
10:00	10:15	0	0	0
10:15	10:30	0	0	0
10:30	10:45	0	0	0
10:45	11:00	0	0	0
11:00	11:15	0	0	0
11:15	11:30	0	0	0
11:30	11:45	0	0	0
11:45	12:00	0	0	0
12:00	12:15	0	0	0
12:15	12:30	0	0	0
12:30	12:45	0	0	0
12:45	13:00	0	0	0
13:00	13:15	0	0	0
13:15	13:30	0	0	0
13:30	13:45	0	0	0
13:45	14:00	0	0	0
14:00	14:15	0	0	0
14:15	14:30	0	0	0
14:30	14:45	0	0	0
14:45	15:00	0	0	0
15:00	15:15	0	0	0
15:15	15:30	0	0	0
15:30	15:45	0	0	0
15:45	16:00	0	0	0
16:00	16:15	0	0	0
16:15	16:30	0	0	0
16:30	16:45	0	0	0
16:45	17:00	0	0	0
17:00	17:15	0	0	0
17:15	17:30	0	0	0
17:30	17:45	0	0	0
17:45	18:00	0	0	0
Total		0	0	0

Appendix C

Synchro Intersection Worksheets – Existing Conditions

Lanes, Volumes, Timings
1: Island Park & Sir John A. Macdonald

Existing
AM Peak Hour

Lane Group	EBL	EBT	EBR	WBL	WBT	WBR	NBL	NBT	NBR	SBL	SBT	SBR
Lane Configurations	↔	↕	↔	↔	↕	↔	↔	↕	↔	↔	↕	↔
Traffic Volume (vph)	315	1254	55	105	306	94	0	257	182	78	733	597
Future Volume (vph)	315	1254	55	105	306	94	0	257	182	78	733	597
Satd. Flow (prot)	1658	3316	1483	1658	3316	1427	0	1638	0	3010	1617	0
Fit Permitted	0.950			0.950						0.950		
Satd. Flow (perm)	1658	3316	1483	1658	3316	1427	0	1638	0	3010	1617	0
Satd. Flow (RTOR)			101			104		23			35	
Lane Group Flow (vph)	350	1393	61	117	340	104	0	488	0	87	1477	0
Turn Type	Prot	NA	Perm	Prot	NA	Perm	NA	Prot	NA	Prot	NA	NA
Protected Phases	5	2		1	6			8		7	4	
Permitted Phases			2			6						
Detector Phase	5	2	2	1	6	6		8		7	4	
Switch Phase												
Minimum Initial (s)	5.0	15.0	15.0	5.0	15.0	15.0		10.0		5.0	10.0	
Minimum Split (s)	20.6	30.1	30.1	20.6	30.1	30.1		29.1		11.5	29.1	
Total Split (s)	35.6	41.1	41.1	35.6	41.1	41.1		61.1		26.5	61.1	
Total Split (%)	21.7%	25.0%	25.0%	21.7%	25.0%	25.0%		37.2%		16.1%	37.2%	
Yellow Time (s)	3.7	3.7	3.7	3.7	3.7	3.7		3.7		3.7	3.7	
All-Red Time (s)	1.9	2.4	2.4	1.9	2.4	2.4		2.4		2.8	2.4	
Lost Time Adjust (s)	0.0	0.0	0.0	0.0	0.0	0.0		0.0		0.0	0.0	
Total Lost Time (s)	5.6	6.1	6.1	5.6	6.1	6.1		6.1		6.5	6.1	
Lead/Lag	Lag	Lead	Lead	Lag	Lead	Lead		Lag		Lead		
Lead-Lag Optimize?	Yes	Yes	Yes	Yes	Yes	Yes		Yes		Yes		
Recall Mode	None	None	None	None	None	None		None		None	None	
Act Effct Green (s)	30.9	35.3	35.3	15.0	19.3	19.3		46.1		9.3	61.9	
Actuated g/C Ratio	0.24	0.27	0.27	0.12	0.15	0.15		0.35		0.07	0.48	
v/c Ratio	0.89	1.55	0.13	0.62	0.69	0.35		0.82		0.40	1.87	
Control Delay	73.7	286.7	1.9	70.3	61.3	12.5		49.7		65.6	422.9	
Queue Delay	0.0	0.0	0.0	0.0	0.0	0.0		0.0		0.0	0.0	
Total Delay	73.7	286.7	1.9	70.3	61.3	12.5		49.7		65.6	422.9	
LOS	E	F	A	E	E	B		D		E	F	
Approach Delay		235.7			54.1			49.7			403.0	
Approach LOS		F			D			D			F	
Queue Length 50th (m)	83.9	~254.1	0.0	28.1	42.6	0.0		108.0		10.8	~565.6	
Queue Length 95th (m)	#168.8	#363.3	2.5	53.1	66.0	16.6		167.0		21.8	#730.1	
Internal Link Dist (m)		762.8			208.9			249.0			166.2	
Turn Bay Length (m)	104.5		88.0	89.6						80.0		
Base Capacity (vph)	394	898	475	385	898	462		710		466	1033	
Starvation Cap Reductn	0	0	0	0	0	0		0		0	0	
Spillback Cap Reductn	0	0	0	0	0	0		0		0	0	
Storage Cap Reductn	0	0	0	0	0	0		0		0	0	
Reduced v/c Ratio	0.89	1.55	0.13	0.30	0.38	0.23		0.69		0.19	1.43	

Intersection Summary	
Cycle Length:	164.3
Actuated Cycle Length:	130.1
Natural Cycle:	145
Control Type:	Actuated-Uncoordinated
Maximum v/c Ratio:	1.87

Lanes, Volumes, Timings
1: Island Park & Sir John A. Macdonald

Existing
AM Peak Hour

Intersection Signal Delay: 251.3	Intersection LOS: F
Intersection Capacity Utilization 136.8%	ICU Level of Service H
Analysis Period (min) 15	
~ Volume exceeds capacity, queue is theoretically infinite.	
Queue shown is maximum after two cycles.	
# 95th percentile volume exceeds capacity, queue may be longer.	
Queue shown is maximum after two cycles.	

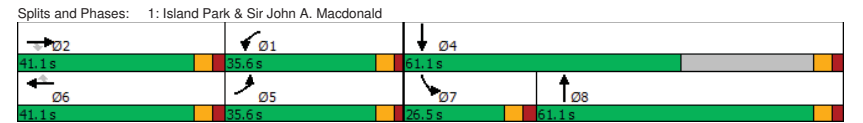

HCM 2010 TWSC
2: Island Park & Clearview

Existing
AM Peak Hour

Intersection													
Int Delay, s/veh	2												
Movement	EBL	EBT	EBR	WBL	WBT	WBR	NBL	NBT	NBR	SBL	SBT	SBR	
Lane Configurations	↔		↔		↔		↔		↔		↔		
Traffic Vol, veh/h	25	3	12	4	1	17	12	397	14	24	774	95	
Future Vol, veh/h	25	3	12	4	1	17	12	397	14	24	774	95	
Conflicting Peds, #/hr	4	0	0	0	0	4	6	0	1	1	0	6	
Sign Control	Stop	Stop	Stop	Stop	Stop	Free	Free	Free	Free	Free	Free	Free	
RT Channelized	-	-	None	-	-	None	-	-	None	-	-	None	
Storage Length	-	-	-	-	-	-	-	-	-	-	-	-	
Veh in Median Storage, #	-	0	-	-	0	-	-	0	-	-	0	-	
Grade, %	-	0	-	-	0	-	-	0	-	-	0	-	
Peak Hour Factor	90	90	90	90	90	90	90	90	90	90	90	90	
Heavy Vehicles, %	2	33	2	2	100	2	2	2	7	2	2	2	
Mvmt Flow	28	3	13	4	1	19	13	441	16	27	860	106	
Major/Minor	Minor2	Minor1		Major1		Major2							
Conflicting Flow All	1462	1457	919	1451	1502	454	972	0	0	458	0	0	
Stage 1	973	973	-	476	476	-	-	-	-	-	-	-	
Stage 2	489	484	-	975	1026	-	-	-	-	-	-	-	
Critical Hdwy	7.12	6.83	6.22	7.12	7.5	6.22	4.12	-	-	4.12	-	-	
Critical Hdwy Stg 1	6.12	5.83	-	6.12	6.5	-	-	-	-	-	-	-	
Critical Hdwy Stg 2	6.12	5.83	-	6.12	6.5	-	-	-	-	-	-	-	
Follow-up Hdwy	3.518	4.297	3.318	3.518	4.9	3.318	2.218	-	-	2.218	-	-	
Pot Cap-1 Maneuver	107	111	329	109	75	606	709	-	-	1103	-	-	
Stage 1	303	293	-	570	423	-	-	-	-	-	-	-	
Stage 2	561	504	-	303	214	-	-	-	-	-	-	-	
Platoon blocked, %	-	-	-	-	-	-	-	-	-	-	-	-	
Mov Cap-1 Maneuver	96	102	327	96	69	604	706	-	-	1102	-	-	
Mov Cap-2 Maneuver	96	102	-	96	69	-	-	-	-	-	-	-	
Stage 1	294	276	-	555	412	-	-	-	-	-	-	-	
Stage 2	527	491	-	272	201	-	-	-	-	-	-	-	
Approach	EB		WB		NB		SB						
HCM Control Delay, s	50		20.2		0.3		0.2						
HCM LOS	F		C										
Minor Lane/Major Mvmt	NBL	NBT	NBR	EBLn1	WBLn1	SBL	SBT	SBR					
Capacity (veh/h)	706	-	-	123	261	1102	-	-					
HCM Lane V/C Ratio	0.019	-	-	0.361	0.094	0.024	-	-					
HCM Control Delay (s)	10.2	0	-	50	20.2	8.3	0	-					
HCM Lane LOS	B	A	-	F	C	A	A	-					
HCM 95th %tile Q(veh)	0.1	-	-	1.5	0.3	0.1	-	-					

Lanes, Volumes, Timings
3: Island Park & Scott

Existing
AM Peak Hour

Lane Group	EBL	EBT	EBR	WBL	WBT	WBR	NBL	NBT	NBR	SBL	SBT	SBR
Lane Configurations	↔	↔	↔	↔	↔	↔	↔	↔	↔	↔	↔	↔
Traffic Volume (vph)	105	439	56	44	198	22	41	272	90	57	700	92
Future Volume (vph)	105	439	56	44	198	22	41	272	90	57	700	92
Satd. Flow (prot)	1658	1745	1483	1658	1646	0	0	1666	0	1658	1707	0
Fit Permitted	0.552			0.270				0.353		0.454		
Satd. Flow (perm)	922	1745	1423	468	1646	0	0	591	0	783	1707	0
Satd. Flow (RTOR)			40		7			21			10	
Lane Group Flow (vph)	117	488	62	49	244	0	0	448	0	63	880	0
Turn Type	Perm	NA	Perm	Perm	NA		Perm	NA		Perm	NA	
Protected Phases		4			8			2			6	
Permitted Phases	4		4	8				2			6	
Detector Phase	4	4	4	8	8		2	2		6	6	
Switch Phase												
Minimum Initial (s)	10.0	10.0	10.0	10.0	10.0		10.0	10.0		10.0	10.0	
Minimum Split (s)	34.8	34.8	34.8	34.8	34.8		34.5	34.5		34.5	34.5	
Total Split (s)	42.0	42.0	42.0	42.0	42.0		53.0	53.0		53.0	53.0	
Total Split (%)	44.2%	44.2%	44.2%	44.2%	44.2%		55.8%	55.8%		55.8%	55.8%	
Yellow Time (s)	3.3	3.3	3.3	3.3	3.3		3.0	3.0		3.0	3.0	
All-Red Time (s)	2.7	2.7	2.7	2.7	2.7		3.5	3.5		3.5	3.5	
Lost Time Adjust (s)	0.0	0.0	0.0	0.0	0.0		0.0	0.0		0.0	0.0	
Total Lost Time (s)	6.0	6.0	6.0	6.0	6.0		6.5	6.5		6.5	6.5	
Lead/Lag												
Lead-Lag Optimize?												
Recall Mode	Max	Max	Max	Max	Max		C-Max	C-Max		C-Max	C-Max	
Act Effct Green (s)	36.0	36.0	36.0	36.0	36.0		46.5	46.5		46.5	46.5	
Actuated g/C Ratio	0.38	0.38	0.38	0.38	0.38		0.49	0.49		0.49	0.49	
v/c Ratio	0.34	0.74	0.11	0.28	0.39		1.49	1.05		0.16	1.05	
Control Delay	20.1	28.8	7.3	25.8	23.1		262.4	15.0		69.7	69.7	
Queue Delay	0.0	0.0	0.0	0.0	0.0		0.0	0.0		0.0	0.0	
Total Delay	20.1	28.8	7.3	25.8	23.1		262.4	15.0		69.7	69.7	
LOS	C	C	A	C	C		F	B		E	E	
Approach Delay	25.3		23.6		262.4		66.1					
Approach LOS	C		C		F		E					
Queue Length 50th (m)	11.5	79.4	1.1	6.1	31.1		~113.7	6.2		~176.0	~176.0	
Queue Length 95th (m)	20.1	88.4	5.5	15.7	50.8		#118.7	13.9		#247.5	#247.5	
Internal Link Dist (m)	211.2		266.0		304.9		415.7					
Turn Bay Length (m)	58.7		29.5		250.0		36.5					
Base Capacity (vph)	349	661	564	177	628		300	383		840	840	
Starvation Cap Reductn	0	0	0	0	0		0	0		0	0	
Spillback Cap Reductn	0	0	0	0	0		0	0		0	0	
Storage Cap Reductn	0	0	0	0	0		0	0		0	0	
Reduced v/c Ratio	0.34	0.74	0.11	0.28	0.39		1.49	1.05		0.16	1.05	
Intersection Summary												
Cycle Length: 95												
Actuated Cycle Length: 95												
Offset: 38 (40%), Referenced to phase 2:NBT and 6:SBTL, Start of Green												
Natural Cycle: 90												
Control Type: Actuated-Coordinated												

Lanes, Volumes, Timings
3: Island Park & Scott

Existing
AM Peak Hour

Maximum v/c Ratio: 1.49	Intersection LOS: F
Intersection Signal Delay: 86.6	ICU Level of Service G
Intersection Capacity Utilization 106.7%	
Analysis Period (min) 15	
~ Volume exceeds capacity, queue is theoretically infinite.	
Queue shown is maximum after two cycles.	
# 95th percentile volume exceeds capacity, queue may be longer.	
Queue shown is maximum after two cycles.	

Splits and Phases: 3: Island Park & Scott



Lanes, Volumes, Timings
4: West Village/Lanark & Scott

Existing
AM Peak Hour

Lane Group	EBL	EBT	EBR	WBL	WBT	WBR	NBL	NBT	NBR	SBL	SBT	SBR
Lane Configurations	↔	↔	↔	↔	↔	↔	↔	↔	↔	↔	↔	↔
Traffic Volume (vph)	39	520	9	0	281	50	17	0	12	68	0	87
Future Volume (vph)	39	520	9	0	281	50	17	0	12	68	0	87
Satd. Flow (prot)	1610	1722	0	1745	1672	0	1658	1436	0	1658	1418	0
Fit Permitted	0.542						0.694			0.749		
Satd. Flow (perm)	901	1722	0	1745	1672	0	1192	1436	0	1292	1418	0
Satd. Flow (RTOR)		2			23			368			588	
Lane Group Flow (vph)	43	588	0	0	368	0	19	13	0	76	97	0
Turn Type	Perm	NA		Perm	NA		Perm	NA		Perm	NA	
Protected Phases		2			6			4			8	
Permitted Phases	2			6			4			8		
Detector Phase	2	2		6	6		4	4		8	8	
Switch Phase												
Minimum Initial (s)	10.0	10.0		10.0	10.0		10.0	10.0		10.0	10.0	
Minimum Split (s)	26.1	26.1		26.1	26.1		21.5	21.5		21.5	21.5	
Total Split (s)	73.0	73.0		73.0	73.0		22.0	22.0		22.0	22.0	
Total Split (%)	76.8%	76.8%		76.8%	76.8%		23.2%	23.2%		23.2%	23.2%	
Yellow Time (s)	3.3	3.3		3.3	3.3		3.3	3.3		3.3	3.3	
All-Red Time (s)	2.8	2.8		2.8	2.8		2.2	2.2		2.2	2.2	
Lost Time Adjust (s)	0.0	0.0		0.0	0.0		0.0	0.0		0.0	0.0	
Total Lost Time (s)	6.1	6.1		6.1	6.1		5.5	5.5		5.5	5.5	
Lead/Lag												
Lead-Lag Optimize?												
Recall Mode	C-Max	C-Max		C-Max	C-Max		None	None		None	None	
Act Effct Green (s)	75.8	75.8		75.8	75.8		12.0	12.0		12.0	12.0	
Actuated g/C Ratio	0.80	0.80		0.80	0.80		0.13	0.13		0.13	0.13	
v/c Ratio	0.06	0.43		0.28	0.13	0.03	0.47	0.14		0.47	0.14	
Control Delay	3.8	5.5		3.1	37.5	0.1	47.6	0.4		47.6	0.4	
Queue Delay	0.0	0.0		0.0	0.0	0.0	0.0	0.0		0.0	0.0	
Total Delay	3.8	5.5		3.1	37.5	0.1	47.6	0.4		47.6	0.4	
LOS	A	A		A	D	A	D	A		D	A	
Approach Delay		5.4			3.1		22.3			21.2		
Approach LOS		A			A		C			C		
Queue Length 50th (m)	1.6	31.0		11.8	3.2	0.0	13.3	0.0		25.8	0.0	
Queue Length 95th (m)	5.0	60.7		m18.8	9.2	0.0	82.5	0.0		82.5	0.0	
Internal Link Dist (m)		332.8			211.2			80.9			82.5	
Turn Bay Length (m)	36.5						18.0			18.0		
Base Capacity (vph)	718	1373		1338	207	553	224	732		224	732	
Starvation Cap Reductn	0	0		0	0	0	0	0		0	0	
Spillback Cap Reductn	0	0		0	0	0	0	0		0	0	
Storage Cap Reductn	0	0		0	0	0	0	0		0	0	
Reduced v/c Ratio	0.06	0.43		0.28	0.09	0.02	0.34	0.13		0.34	0.13	

Intersection Summary												
Cycle Length: 95												
Actuated Cycle Length: 95												
Offset: 83 (87%), Referenced to phase 2:EBTL and 6:WBTL, Start of Green												
Natural Cycle: 55												
Control Type: Actuated-Coordinated												

Lanes, Volumes, Timings
4: West Village/Lanark & Scott

Existing
AM Peak Hour

Maximum v/c Ratio: 0.47	Intersection LOS: A
Intersection Signal Delay: 7.4	ICU Level of Service B
Intersection Capacity Utilization 55.0%	
Analysis Period (min) 15	
m Volume for 95th percentile queue is metered by upstream signal.	

Splits and Phases: 4: West Village/Lanark & Scott



HCM 2010 AWSC
5: Churchill & Lanark

Existing
AM Peak Hour

Intersection	
Intersection Delay, s/veh	7.8
Intersection LOS	A

Movement	WBL	WBR	NBT	NBR	SBL	SBT
Lane Configurations	↔	↔	↔	↔	↔	↔
Traffic Vol, veh/h	108	3	24	45	6	47
Future Vol, veh/h	108	3	24	45	6	47
Peak Hour Factor	0.90	0.90	0.90	0.90	0.90	0.90
Heavy Vehicles, %	2	33	8	13	2	2
Mvmt Flow	120	3	27	50	7	52
Number of Lanes	1	0	1	0	0	1

Approach	WB	NB	SB
Opposing Approach		SB	NB
Opposing Lanes	0	1	1
Conflicting Approach Left	NB		WB
Conflicting Lanes Left	1	0	1
Conflicting Approach Right	SB	WB	
Conflicting Lanes Right	1	1	0
HCM Control Delay	8.2	7.4	7.6
HCM LOS	A	A	A

Lane	NBLn1	WBLn1	SBLn1
Vol Left, %	0%	97%	11%
Vol Thru, %	35%	0%	89%
Vol Right, %	65%	3%	0%
Sign Control	Stop	Stop	Stop
Traffic Vol by Lane	69	111	53
LT Vol	0	108	6
Through Vol	24	0	47
RT Vol	45	3	0
Lane Flow Rate	77	123	59
Geometry Grp	1	1	1
Degree of Util (X)	0.083	0.149	0.069
Departure Headway (Hd)	3.907	4.345	4.234
Convergence, Y/N	Yes	Yes	Yes
Cap	902	819	833
Service Time	1.999	2.406	2.325
HCM Lane V/C Ratio	0.085	0.15	0.071
HCM Control Delay	7.4	8.2	7.6
HCM Lane LOS	A	A	A
HCM 95th-tile Q	0.3	0.5	0.2

Lanes, Volumes, Timings
1: Island Park & Sir John A. Macdonald

Existing
PM Peak Hour

Lane Group	EBL	EBT	EBR	WBL	WBT	WBR	NBL	NBT	NBR	SBL	SBT	SBR
Lane Configurations	↔	↕	↔	↔	↕	↔	↔	↕	↔	↔	↕	↔
Traffic Volume (vph)	396	748	67	96	1108	1183	0	467	43	98	321	491
Future Volume (vph)	396	748	67	96	1108	1183	0	467	43	98	321	491
Satd. Flow (prot)	1658	3316	1483	1658	3283	1483	0	1721	0	3038	1586	0
Fit Permitted	0.950			0.950						0.950		
Satd. Flow (perm)	1656	3316	1439	1652	3283	1444	0	1721	0	2998	1586	0
Satd. Flow (RTOR)			101					289	3			66
Lane Group Flow (vph)	440	831	74	107	1231	1314	0	567	0	109	903	0
Turn Type	Prot	NA	Perm	Prot	NA	Perm	NA	Prot	NA	Prot	NA	NA
Protected Phases	5	2		1	6			8		7	4	
Permitted Phases			2			6						
Detector Phase	5	2	2	1	6	6		8		7	4	
Switch Phase												
Minimum Initial (s)	5.0	15.0	15.0	5.0	15.0	15.0		10.0		5.0	10.0	
Minimum Split (s)	20.6	30.1	30.1	20.6	30.1	30.1		29.1		11.5	29.1	
Total Split (s)	35.6	41.1	41.1	35.6	41.1	41.1		61.1		26.5	61.1	
Total Split (%)	21.7%	25.0%	25.0%	21.7%	25.0%	25.0%		37.2%		16.1%	37.2%	
Yellow Time (s)	3.7	3.7	3.7	3.7	3.7	3.7		3.7		3.7	3.7	
All-Red Time (s)	1.9	2.4	2.4	1.9	2.4	2.4		2.4		2.8	2.4	
Lost Time Adjust (s)	0.0	0.0	0.0	0.0	0.0	0.0		0.0		0.0	0.0	
Total Lost Time (s)	5.6	6.1	6.1	5.6	6.1	6.1		6.1		6.5	6.1	
Lead/Lag	Lag	Lead	Lead	Lag	Lead	Lead		Lag		Lead		
Lead-Lag Optimize?	Yes	Yes	Yes	Yes	Yes	Yes		Yes		Yes		
Recall Mode	None	None	None	None	None	None		None		None	None	
Act Effct Green (s)	30.0	35.0	35.0	30.0	35.0	35.0		54.0		10.9	71.5	
Actuated g/C Ratio	0.19	0.23	0.23	0.19	0.23	0.23		0.35		0.07	0.46	
v/c Ratio	1.37	1.11	0.18	0.33	1.65	2.38		0.94		0.51	1.17	
Control Delay	228.5	119.1	4.5	57.7	336.1	649.1		72.6		77.8	126.5	
Queue Delay	0.0	0.0	0.0	0.0	0.0	0.0		0.0		0.0	0.0	
Total Delay	228.5	119.1	4.5	57.7	336.1	649.1		72.6		77.8	126.5	
LOS	F	F	A	E	F	F		E		E	F	
Approach Delay		148.6			479.9			72.6			121.2	
Approach LOS		F			F			E			F	
Queue Length 50th (m)	~178.7	~153.6	0.0	28.8	~289.3	~596.7		167.3		17.0	~318.7	
Queue Length 95th (m)	#252.8	#201.1	6.6	48.7	#341.1	#693.4		#247.9		27.4	#401.0	
Internal Link Dist (m)		750.5			213.6			249.0			157.2	
Turn Bay Length (m)	104.5		88.0	89.6						80.0		
Base Capacity (vph)	322	752	404	322	745	551		615		393	869	
Starvation Cap Reductn	0	0	0	0	0	0		0		0	0	
Spillback Cap Reductn	0	0	0	0	0	0		0		0	0	
Storage Cap Reductn	0	0	0	0	0	0		0		0	0	
Reduced v/c Ratio	1.37	1.11	0.18	0.33	1.65	2.38		0.92		0.28	1.04	

Intersection Summary	
Cycle Length:	164.3
Actuated Cycle Length:	154.3
Natural Cycle:	145
Control Type:	Actuated-Uncoordinated
Maximum v/c Ratio:	2.38

Lanes, Volumes, Timings
1: Island Park & Sir John A. Macdonald

Existing
PM Peak Hour

Intersection Signal Delay: 293.5	Intersection LOS: F
Intersection Capacity Utilization 144.3%	ICU Level of Service H
Analysis Period (min) 15	
~ Volume exceeds capacity, queue is theoretically infinite.	
Queue shown is maximum after two cycles.	
# 95th percentile volume exceeds capacity, queue may be longer.	
Queue shown is maximum after two cycles.	

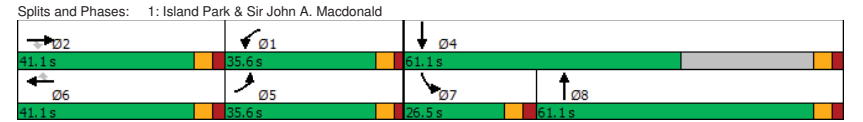

HCM 2010 TWSC
2: Island Park & Clearview

Existing
PM Peak Hour

Intersection												
Int Delay, s/veh	2											
Movement	EBL	EBT	EBR	WBL	WBT	WBR	NBL	NBT	NBR	SBL	SBT	SBR
Lane Configurations	↔		↔		↔		↔		↔		↔	
Traffic Vol, veh/h	27	3	9	5	5	50	2	433	1	12	426	46
Future Vol, veh/h	27	3	9	5	5	50	2	433	1	12	426	46
Conflicting Peds, #/hr	8	0	0	0	0	8	3	0	6	6	0	3
Sign Control	Stop	Stop	Stop	Stop	Stop	Free	Free	Free	Free	Free	Free	Free
RT Channelized	-	-	None	-	-	None	-	-	None	-	-	None
Storage Length	-	-	-	-	-	-	-	-	-	-	-	-
Veh in Median Storage, #	-	0	-	-	0	-	-	0	-	-	0	-
Grade, %	-	0	-	-	0	-	-	0	-	-	0	-
Peak Hour Factor	90	90	90	90	90	90	90	90	90	90	90	90
Heavy Vehicles, %	2	67	2	20	20	2	2	2	2	8	2	2
Mvmt Flow	30	3	10	6	6	56	2	481	1	13	473	51
Major/Minor	Minor2	Minor1	Major1	Major2								
Conflicting Flow All	1053	1020	502	1023	1045	496	527	0	0	488	0	0
Stage 1	528	528	-	492	492	-	-	-	-	-	-	-
Stage 2	525	492	-	531	553	-	-	-	-	-	-	-
Critical Hdwy	7.12	7.17	6.22	7.3	6.7	6.22	4.12	-	-	4.18	-	-
Critical Hdwy Stg 1	6.12	6.17	-	6.3	5.7	-	-	-	-	-	-	-
Critical Hdwy Stg 2	6.12	6.17	-	6.3	5.7	-	-	-	-	-	-	-
Follow-up Hdwy	3.518	4.603	3.318	3.68	4.18	3.318	2.218	-	-	2.272	-	-
Pot Cap-1 Maneuver	204	184	569	198	213	574	1040	-	-	1045	-	-
Stage 1	534	435	-	526	519	-	-	-	-	-	-	-
Stage 2	536	453	-	501	486	-	-	-	-	-	-	-
Platoon blocked, %	-	-	-	-	-	-	-	-	-	-	-	-
Mov Cap-1 Maneuver	176	179	568	188	207	568	1038	-	-	1040	-	-
Mov Cap-2 Maneuver	176	179	-	188	207	-	-	-	-	-	-	-
Stage 1	531	426	-	522	515	-	-	-	-	-	-	-
Stage 2	474	449	-	480	476	-	-	-	-	-	-	-
Approach	EB	WB	NB	SB								
HCM Control Delay, s	26.5	14.8	0	0.2								
HCM LOS	D	B										
Minor Lane/Major Mvmt	NBL	NBT	NBR	EBLn1	WBLn1	SBL	SBT	SBR				
Capacity (veh/h)	1038	-	-	210	432	1040	-	-				
HCM Lane V/C Ratio	0.002	-	-	0.206	0.154	0.013	-	-				
HCM Control Delay (s)	8.5	0	-	26.5	14.8	8.5	0	-				
HCM Lane LOS	A	A	-	D	B	A	A	-				
HCM 95th %tile Q(veh)	0	-	-	0.8	0.5	0	-	-				

Lanes, Volumes, Timings
3: Island Park & Scott

Existing
PM Peak Hour

Lane Group	EBL	EBT	EBR	WBL	WBT	WBR	NBL	NBT	NBR	SBL	SBT	SBR
Lane Configurations	↔	↔	↔	↔	↔	↔	↔	↔	↔	↔	↔	↔
Traffic Volume (vph)	105	277	42	192	449	101	23	401	21	27	374	73
Future Volume (vph)	105	277	42	192	449	101	23	401	21	27	374	73
Satd. Flow (prot)	1658	1712	1483	1658	1647	0	0	1725	0	1658	1686	0
Fit Permitted	0.263			0.523				0.826		0.345		
Satd. Flow (perm)	447	1712	1391	890	1647	0	0	1428	0	595	1686	0
Satd. Flow (RTOR)			47		16			3				11
Lane Group Flow (vph)	117	308	47	213	611	0	0	495	0	30	497	0
Turn Type	Perm	NA	Perm	Perm	NA		Perm	NA		Perm	NA	
Protected Phases			4		8			2				6
Permitted Phases	4		4	8			2					6
Detector Phase	4	4	4	8	8		2	2		6	6	
Switch Phase												
Minimum Initial (s)	10.0	10.0	10.0	10.0	10.0		10.0	10.0		10.0	10.0	
Minimum Split (s)	34.8	34.8	34.8	34.8	34.8		34.5	34.5		34.5	34.5	
Total Split (s)	56.0	56.0	56.0	56.0	56.0		44.0	44.0		44.0	44.0	
Total Split (%)	56.0%	56.0%	56.0%	56.0%	56.0%		44.0%	44.0%		44.0%	44.0%	
Yellow Time (s)	3.3	3.3	3.3	3.3	3.3		3.0	3.0		3.0	3.0	
All-Red Time (s)	2.7	2.7	2.7	2.7	2.7		3.5	3.5		3.5	3.5	
Lost Time Adjust (s)	0.0	0.0	0.0	0.0	0.0		0.0	0.0		0.0	0.0	
Total Lost Time (s)	6.0	6.0	6.0	6.0	6.0		6.5	6.5		6.5	6.5	
Lead/Lag												
Lead-Lag Optimize?												
Recall Mode	Max	Max	Max	Max	Max		C-Max	C-Max		C-Max	C-Max	
Act Effct Green (s)	50.0	50.0	50.0	50.0	50.0		37.5	37.5		37.5	37.5	
Actuated g/C Ratio	0.50	0.50	0.50	0.50	0.50		0.38	0.38		0.38	0.38	
v/c Ratio	0.52	0.36	0.07	0.48	0.74		0.92	0.13		0.78	0.78	
Control Delay	24.1	13.9	2.9	21.0	25.7		54.8	22.7		36.9	36.9	
Queue Delay	0.0	0.0	0.0	0.0	0.0		0.0	0.0		0.0	0.0	
Total Delay	24.1	13.9	2.9	21.0	25.7		54.8	22.7		36.9	36.9	
LOS	C	B	A	C	C		D	C		D	D	
Approach Delay	15.3				24.5		54.8				36.1	
Approach LOS	B				C		D				D	
Queue Length 50th (m)	11.9	27.6	0.0	26.0	87.6		89.9	3.8		82.0		
Queue Length 95th (m)	36.1	38.8	2.6	46.7	131.2		#152.7	10.4		#124.3		
Internal Link Dist (m)	217.8				273.2		304.9				417.3	
Turn Bay Length (m)	58.7		29.5		250.0						36.5	
Base Capacity (vph)	223	856	719	445	831		537	223		639		
Starvation Cap Reductn	0	0	0	0	0		0	0		0	0	
Spillback Cap Reductn	0	0	0	0	0		0	0		0	0	
Storage Cap Reductn	0	0	0	0	0		0	0		0	0	
Reduced v/c Ratio	0.52	0.36	0.07	0.48	0.74		0.92	0.13		0.78	0.78	
Intersection Summary												
Cycle Length: 100												
Actuated Cycle Length: 100												
Offset: 2 (2%), Referenced to phase 2:NBT and 6:SBL, Start of Green												
Natural Cycle: 70												
Control Type: Actuated-Coordinated												

Lanes, Volumes, Timings
3: Island Park & Scott

Existing
PM Peak Hour

Maximum v/c Ratio: 0.92	Intersection LOS: C
Intersection Signal Delay: 31.8	ICU Level of Service F
Intersection Capacity Utilization 99.6%	
Analysis Period (min) 15	
# 95th percentile volume exceeds capacity, queue may be longer.	
Queue shown is maximum after two cycles.	

Splits and Phases: 3: Island Park & Scott

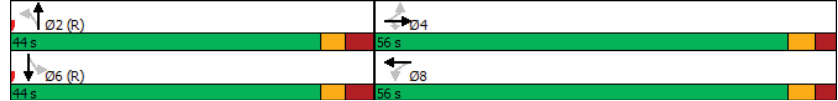

Lanes, Volumes, Timings
4: West Village/Lanark & Scott

Existing
PM Peak Hour

Lane Group	EBL	EBT	EBR	WBL	WBT	WBR	NBL	NBT	NBR	SBL	SBT	SBR
Lane Configurations	↔	↔	↔	↔	↔	↔	↔	↔	↔	↔	↔	↔
Traffic Volume (vph)	90	365	20	13	497	35	6	0	4	55	1	44
Future Volume (vph)	90	365	20	13	497	35	6	0	4	55	1	44
Satd. Flow (prot)	1658	1726	0	1658	1710	0	1658	1395	0	1658	1358	0
Fit Permitted	0.415			0.508			0.724			0.755		
Satd. Flow (perm)	691	1726	0	868	1710	0	1182	1395	0	1264	1358	0
Satd. Flow (RTOR)		7			9			499			49	
Lane Group Flow (vph)	100	428	0	14	591	0	7	4	0	61	50	0
Turn Type	Perm	NA		Perm	NA		Perm	NA		Perm	NA	
Protected Phases		2			6			4			8	
Permitted Phases	2			6			4			8		
Detector Phase	2	2		6	6		4	4		8	8	
Switch Phase												
Minimum Initial (s)	10.0	10.0		10.0	10.0		10.0	10.0		10.0	10.0	
Minimum Split (s)	26.1	26.1		26.1	26.1		21.5	21.5		21.5	21.5	
Total Split (s)	78.0	78.0		78.0	78.0		22.0	22.0		22.0	22.0	
Total Split (%)	78.0%	78.0%		78.0%	78.0%		22.0%	22.0%		22.0%	22.0%	
Yellow Time (s)	3.3	3.3		3.3	3.3		3.3	3.3		3.3	3.3	
All-Red Time (s)	2.8	2.8		2.8	2.8		2.2	2.2		2.2	2.2	
Lost Time Adjust (s)	0.0	0.0		0.0	0.0		0.0	0.0		0.0	0.0	
Total Lost Time (s)	6.1	6.1		6.1	6.1		5.5	5.5		5.5	5.5	
Lead/Lag												
Lead-Lag Optimize?												
Recall Mode	C-Max	C-Max		C-Max	C-Max		None	None		None	None	
Act Effct Green (s)	80.3	80.3		80.3	80.3		12.4	12.4		12.4	12.4	
Actuated g/C Ratio	0.80	0.80		0.80	0.80		0.12	0.12		0.12	0.12	
v/c Ratio	0.18	0.31		0.02	0.43		0.05	0.01		0.39	0.24	
Control Delay	4.7	4.4		1.4	1.9		37.2	0.0		46.8	14.0	
Queue Delay	0.0	0.0		0.0	0.0		0.0	0.0		0.0	0.0	
Total Delay	4.7	4.4		1.4	1.9		37.2	0.0		46.8	14.0	
LOS	A	A		A	A		D	A		D	B	
Approach Delay		4.5			1.9			23.7			32.0	
Approach LOS		A			A			C			C	
Queue Length 50th (m)	3.9	18.5		0.2	9.5		1.2	0.0		11.4	0.2	
Queue Length 95th (m)	11.0	38.2		m0.3	m15.7		5.1	0.0		22.7	10.2	
Internal Link Dist (m)		332.8			217.8			81.9			75.1	
Turn Bay Length (m)	36.5			42.0			18.0			18.0		
Base Capacity (vph)	555	1387		697	1374		195	646		208	264	
Starvation Cap Reductn	0	0		0	0		0	0		0	0	
Spillback Cap Reductn	0	0		0	0		0	0		0	0	
Storage Cap Reductn	0	0		0	0		0	0		0	0	
Reduced v/c Ratio	0.18	0.31		0.02	0.43		0.04	0.01		0.29	0.19	

Intersection Summary

Cycle Length: 100
Actuated Cycle Length: 100
Offset: 40 (40%), Referenced to phase 2:EBTL and 6:WBTL, Start of Green
Natural Cycle: 55
Control Type: Actuated-Coordinated

Lanes, Volumes, Timings
4: West Village/Lanark & Scott

Existing
PM Peak Hour

Maximum v/c Ratio: 0.43	Intersection LOS: A
Intersection Signal Delay: 5.8	ICU Level of Service C
Intersection Capacity Utilization 64.9%	
Analysis Period (min) 15	
m Volume for 95th percentile queue is metered by upstream signal.	

Splits and Phases: 4: West Village/Lanark & Scott



HCM 2010 AWSC
5: Churchill & Lanark

Existing
PM Peak Hour

Intersection	
Intersection Delay, s/veh	7.5
Intersection LOS	A

Movement	WBL	WBR	NBT	NBR	SBL	SBT
Lane Configurations	↔	↔	↔	↔	↔	↔
Traffic Vol, veh/h	62	10	37	50	4	27
Future Vol, veh/h	62	10	37	50	4	27
Peak Hour Factor	0.90	0.90	0.90	0.90	0.90	0.90
Heavy Vehicles, %	6	2	2	4	2	2
Mvmt Flow	69	11	41	56	4	30
Number of Lanes	1	0	1	0	0	1

Approach	WB	NB	SB
Opposing Approach		SB	NB
Opposing Lanes	0	1	1
Conflicting Approach Left	NB		WB
Conflicting Lanes Left	1	0	1
Conflicting Approach Right	SB	WB	
Conflicting Lanes Right	1	1	0
HCM Control Delay	7.8	7.2	7.4
HCM LOS	A	A	A

Lane	NBLn1	WBLn1	SBLn1
Vol Left, %	0%	86%	13%
Vol Thru, %	43%	0%	87%
Vol Right, %	57%	14%	0%
Sign Control	Stop	Stop	Stop
Traffic Vol by Lane	87	72	31
LT Vol	0	62	4
Through Vol	37	0	27
RT Vol	50	10	0
Lane Flow Rate	97	80	34
Geometry Grp	1	1	1
Degree of Util (X)	0.101	0.096	0.04
Departure Headway (Hd)	3.755	4.318	4.174
Convergence, Y/N	Yes	Yes	Yes
Cap	945	826	850
Service Time	1.813	2.364	2.238
HCM Lane V/C Ratio	0.103	0.097	0.04
HCM Control Delay	7.2	7.8	7.4
HCM Lane LOS	A	A	A
HCM 95th-tile Q	0.3	0.3	0.1

Appendix D

Collision Data

Accident Date	Accident Year	Accident Time	Location	Environment Condition	Light	Traffic Control	Traffic Control Condition	Classification Of Accident	Initial Impact Type	Road Surface Condition	# Vehicles	# Motorcycles	# Bicycles	# Pedestrians
1/7/2016	2016	7:26	ELLENDALE CRES @ LANARK AVE (0011274)	01 - Clear	03 - Dawn	02 - Stop sign	01 - Functioning	03 - P.D. only	07 - SMV other	06 - Ice	1	0	0	0
8/8/2016	2016	17:53	LANARK AVE btwn BRIARWAY PRIV & METROPOLE PRIV (_4TZ09Y)	01 - Clear	01 - Daylight	10 - No control	0	03 - P.D. only	04 - Sideswipe	01 - Dry	2	0	0	0
1/14/2019	2019	10:53	LANARK AVE btwn BEECHGROVE AVE & BRIARWAY PRIV (_4TZ067)	01 - Clear	01 - Daylight	10 - No control	0	03 - P.D. only	06 - SMV unattended vehicle	01 - Dry	1	0	0	0
7/28/2019	2019	19:11	LANARK AVE btwn BRIARWAY PRIV & METROPOLE PRIV (_4TZ09Y)	01 - Clear	01 - Daylight	10 - No control	0	02 - Non-fatal injury	06 - SMV unattended vehicle	01 - Dry	1	0	0	0
12/21/2017	2017	19:09	CLEARVIEW AVE btwn OAK PARK PRIV & END (_3ZAZHE)	01 - Clear	07 - Dark	10 - No control	0	03 - P.D. only	07 - SMV other	05 - Packed snow	1	0	0	0

Appendix E

Scott Street Bus Detour and Cycling Concept

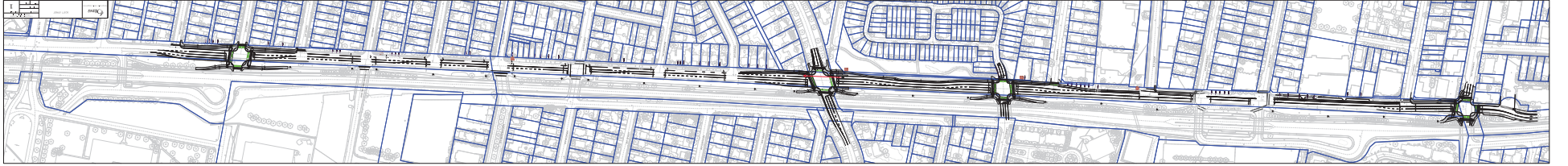

Appendix F

Scott Street – Preliminary Design



CONFEDERATION LINE EXTENSION

ROADWAYS SCOTT STREET

SEGMENT 2

RE-ISSUED FOR FINAL DESIGN DEVELOPMENT - CITY REVIEW

DECEMBER 22, 2020





WESTBORO STATION + EAST SIDE ST. 10/18

SECTION TO DRAINAGE
E:\PROJECTS\DRY-DWG-1003
MATCHLINE STA 1+860

SECTION TO DRAINAGE
E:\PROJECTS\DRY-DWG-1003
MATCHLINE STA 2+000

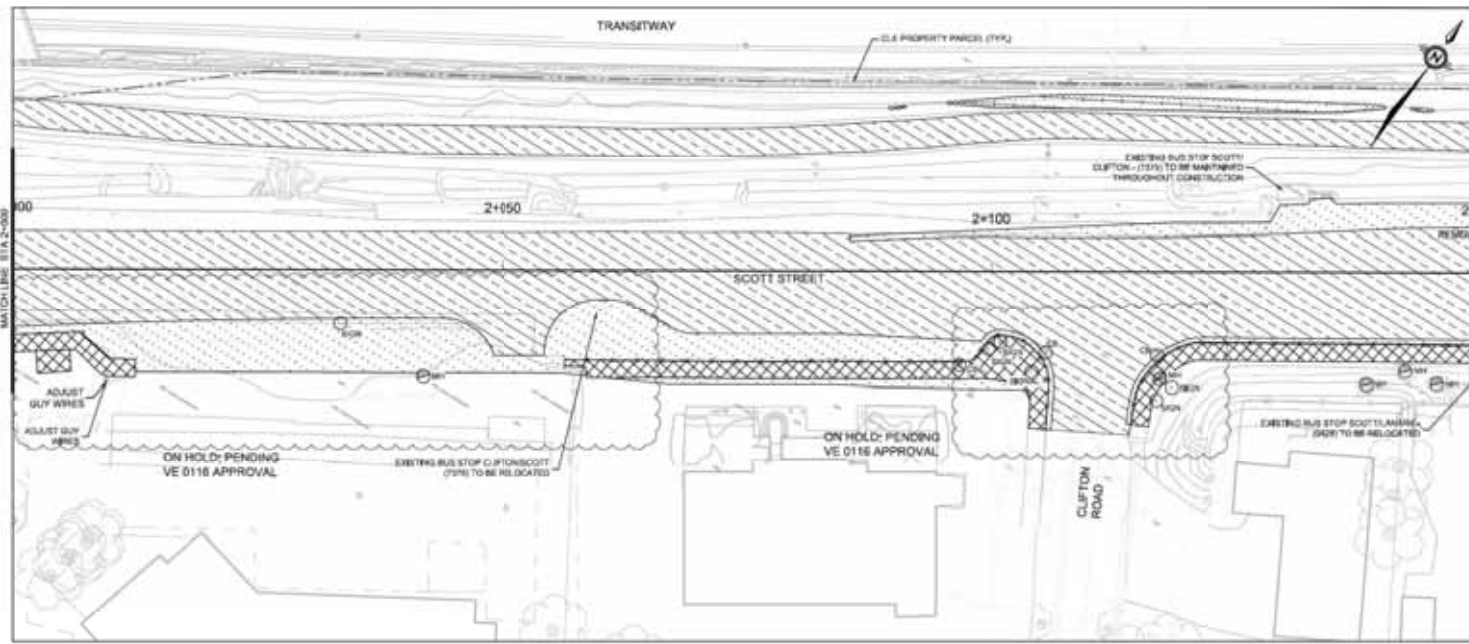
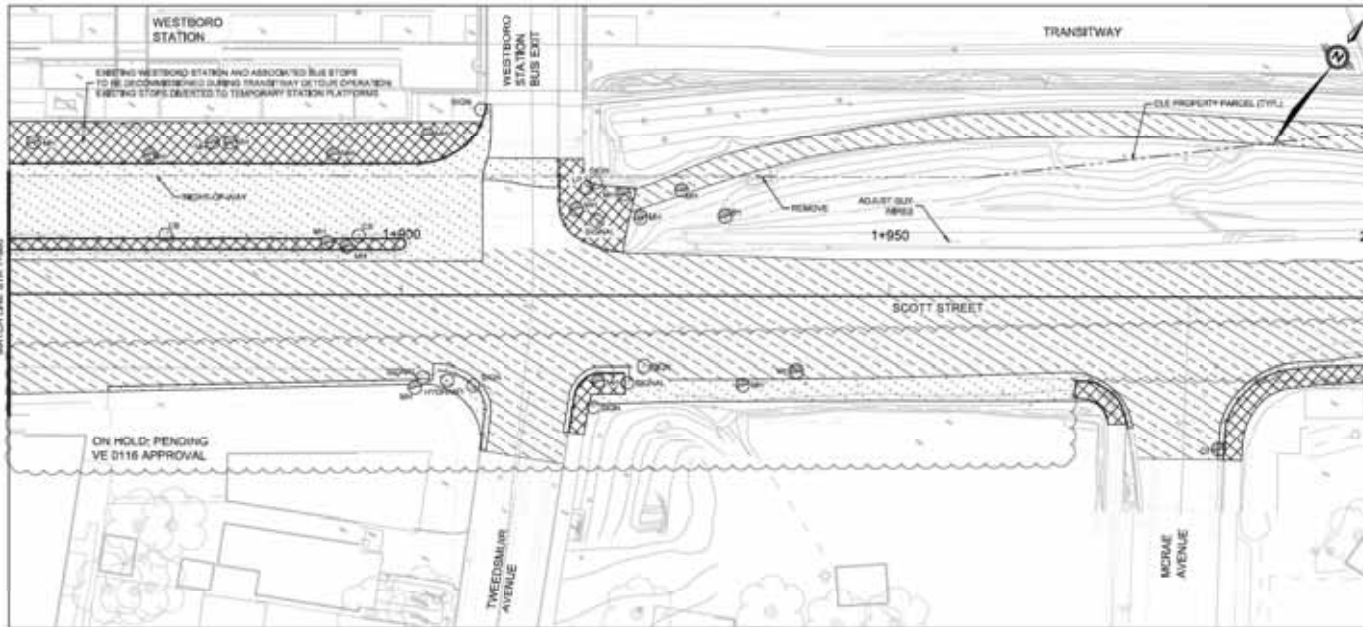

STAGE 2 Confederation + EAST
Confederation + WEST

Ottawa

DRAWING NAME: ROADWAY/DRAINAGE WEST - PACKAGE 2
SCOTT STREET
SEGMENT 2
REMOVALS
STA 1+860 TO STA 2+150

CONTRACT NO.: LRT19-1019

DATE: 11/20/19

DESIGNED BY: J. GILLESPIE
CHECKED BY: J. GILLESPIE
DRAWN BY: J. GILLESPIE
SCALE: AS SHOWN

PROJECT NO.: EJV-S2RDSC-RWY-DWG-1003

EWC DESIGNERS

SCALE: 1" = 20' HORIZONTAL, 1" = 4' VERTICAL

REV	DESCRIPTION	BY	DATE
A	ISSUED FOR PRELIMINARY DESIGN DEVELOPMENT - CITY REVIEW	JG	2019-04-01
B	ISSUED FOR PRELIMINARY DESIGN DEVELOPMENT - CIVIL REVIEW	JG	2019-04-02
C	ISSUED FOR PRELIMINARY DESIGN DEVELOPMENT - CITY REVIEW	JG	2019-04-04
D	ISSUED FOR PRELIMINARY DESIGN DEVELOPMENT - CIVIL REVIEW	JG	2019-04-04
E	ISSUED FOR PRELIMINARY DESIGN DEVELOPMENT - CITY REVIEW	JG	2019-04-04

KEY MAP - WEST
KEY MAP - EAST

AS PART OF THIS DOCUMENT MAY BE APPROVED, THIS DOCUMENT IS LIMITED TO THE PROJECT AND IS NOT TO BE REPRODUCED, COPIED, OR TRANSMITTED IN ANY FORM OR BY ANY MEANS, ELECTRONIC, MECHANICAL, PHOTOCOPYING, RECORDING, OR OTHERWISE, WITHOUT THE PRIOR WRITTEN PERMISSION.

LAYOUT INFORMATION BASED ON 3 DEGREE MTM ZONE 9 NAD 83 ORIGINAL COORDINATE SYSTEM, COMBINED SCALE FACTOR 0.9999

**PRELIMINARY
NOT FOR CONSTRUCTION**

LEGEND:

- ASPHALT - PARTIAL DEPTH
- ASPHALT - FULL DEPTH
- SIDEWALK
- CONCRETE REMOVAL
- AREA TO BE CLEARED AND GRUBBED
- ADJUST CATCH BASIN
- ADJUST MANHOLE VALVES
- REMOVE CATCH BASIN & SIGNS
- REMOVE CURB, GUTTER, UTILITY
- REMOVE TREES

ROW LINES ARE APPROXIMATE AND BASED ON CITY PROVIDED PROPERTY RECORDS PLANS (PPR). ANY PROPOSED CONSTRUCTION WITHIN THE OF A PROPERTY LINE REQUIRES THAT A LICENSED ONTARIO LAND SURVEYOR BE ENGAGED AS PER SCHEDULE 164 PART 1 ARTICLE 4.2.



2024-04-15 10:58 AM C:\Users\jdoyle\OneDrive\Documents\Projects\2024\2024-04-15 10:58 AM

2024-04-15 10:58 AM C:\Users\jdoyle\OneDrive\Documents\Projects\2024\2024-04-15 10:58 AM

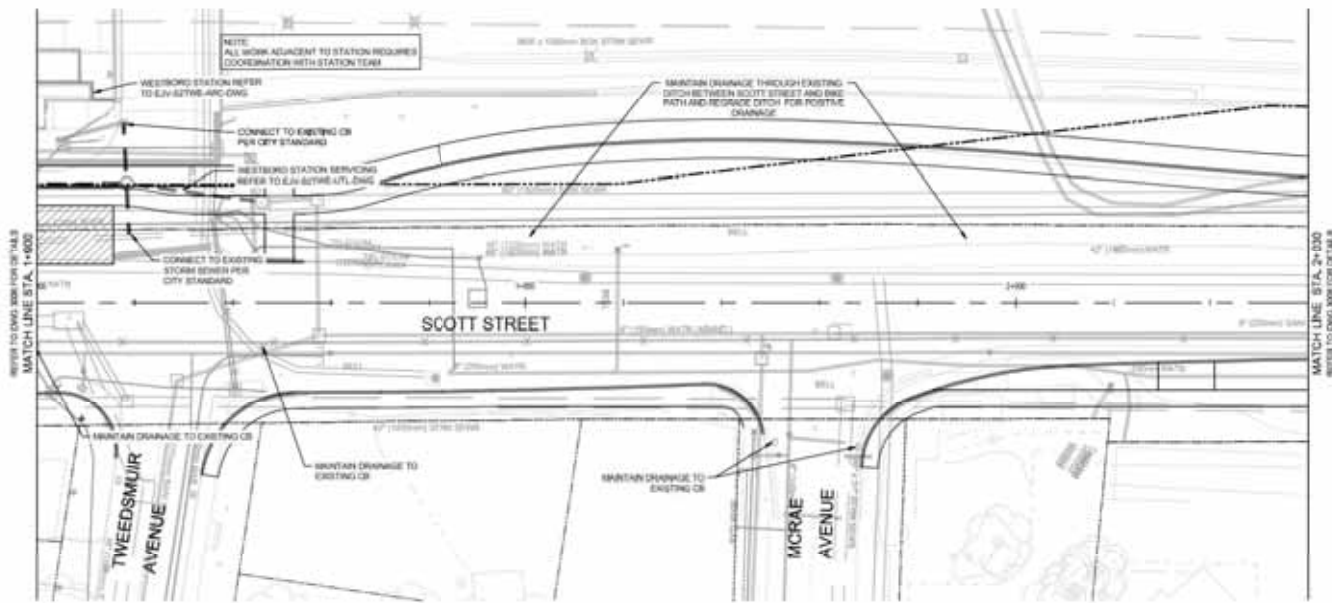

GRADE	50	55	60	65	70
STATION	1+00	1+200	1+400	1+600	1+800



STAGE 2

← STAGE 1 →

Confederation + EAST
Confederation + WEST

ROADWAY DRAINAGE WEST - PACKAGE 2
SCOTT STREET DETOUR
SEGMENT 2
GRADING AND DRAINAGE
STA 1+800 TO STA 2+000

PROJECT NO. LRT19-1019

DATE: 2024-04-15

DESIGNED BY: JDOYLE

CHECKED BY: JDOYLE

PROJECT TITLE: LRT19-1019

SCALE: 1" = 40' HORIZONTAL
1" = 4' VERTICAL

SHEET NO. 2 OF 2

REV.	DESCRIPTION	BY	DATE
1	ISSUED FOR PRELIMINARY DESIGN DEVELOPMENT - CITY REVIEW	JDOYLE	2024-04-15
2	ISSUED FOR PRELIMINARY DESIGN DEVELOPMENT - ONLY REVIEW	JDOYLE	2024-04-15
3	ISSUED FOR PRELIMINARY DESIGN DEVELOPMENT - CITY REVIEW	JDOYLE	2024-04-15
4	ISSUED FOR PRELIMINARY DESIGN DEVELOPMENT - ONLY REVIEW	JDOYLE	2024-04-15

REPART OF THIS DOCUMENT SHALL BE REPRODUCED, PUBLISHED, COPIED, OR STORED IN ANY DATA RETRIEVAL SYSTEM OR TRANSMITTED IN ANY FORM OR BY ANY MEANS, ELECTRONIC, MECHANICAL, PHOTOCOPYING, RECORDING, OR BY ANY INFORMATION STORAGE AND RETRIEVAL SYSTEM, WITHOUT THE WRITTEN PERMISSION OF THE PROJECT DESIGNER.

LAYOUT INFORMATION BASED ON 3 DEGREE MTM ZONE 9 NAD 83 ORIGINAL COORDINATE SYSTEM, COMBINED SCALE FACTOR 0.9999

PRELIMINARY
 NOT FOR CONSTRUCTION
 2024-04-15

GENERAL NOTE:
 EXISTING SUBDRAIN CONNECTIONS TO BE PRESERVED. EXISTING SUBDRAINS TO BREAK INTO AND CONNECT TO TO PROPOSED CATCH BASINS WHERE NECESSARY.

ROW LINES ARE APPROXIMATE AND BASED ON CITY PROVIDED PROPERTY RECORDS PLANS (PPR). ANY PROPOSED CONSTRUCTION WITHIN 10' OF A PROPERTY LIMIT REQUIRES THAT A LICENSED ONTARIO LAND SURVEYOR BE ENGAGED AS PER SCHEDULE 15-2 PART 1 ARTICLE 4.2



WESTBORD STATION

RELOCATED BUS WESTBORD TRANSITWAY PLATFORM

ON HOLD: PENDING VE 0116 APPROVAL

WESTBORD STATION

RELOCATED BUS STOP SCOTT STATION - (779) TO BE MAINTAINED THROUGHOUT CONSTRUCTION

ON HOLD: PENDING VE 0116 APPROVAL

EXISTING BUS STOP SCOTT STATION - (779) TO BE RELOCATED

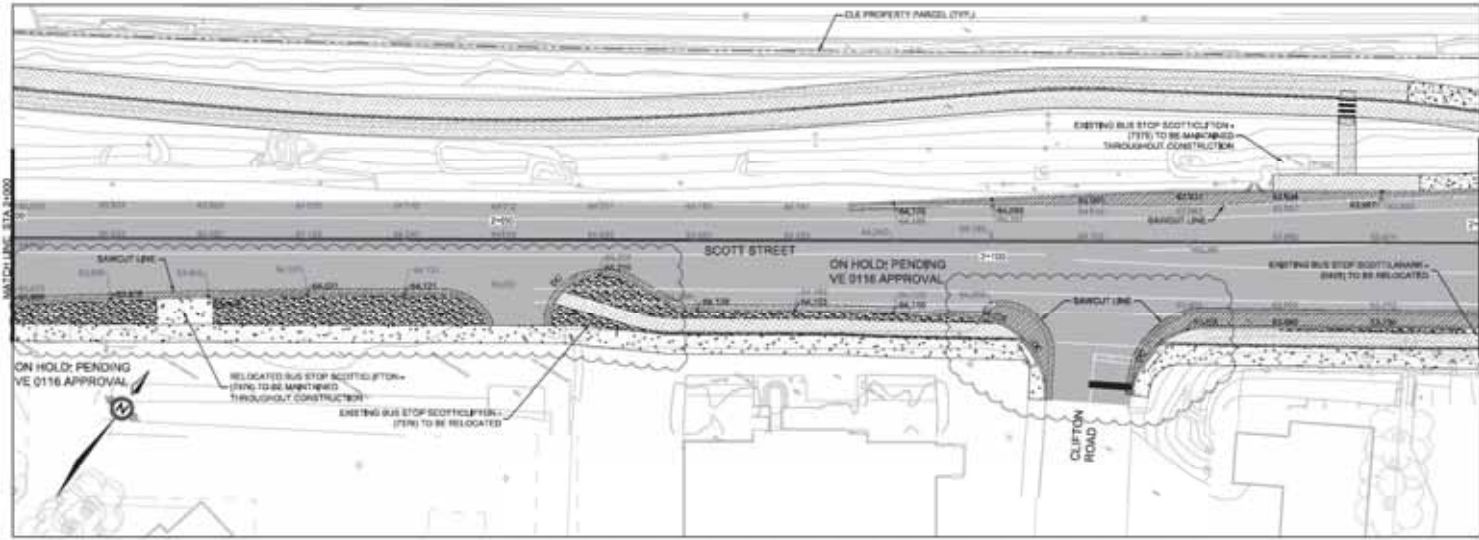
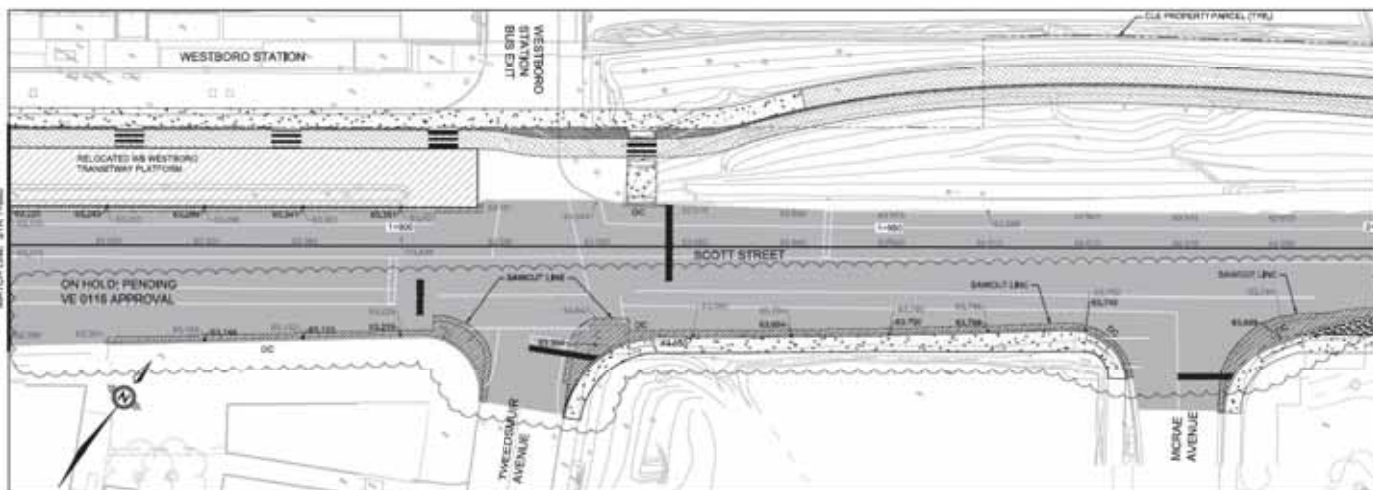

STAGE 2 **CONFIDENTIAL** + EAST
CONFIDENTIAL + WEST

OTTAWA

DRAWING NAME: ROADWAY/ DRAINAGE WEST - PACKAGE 2
SCOTT STREET SEGMENT 2
PAVEMENT ELEVATIONS
STA 1+860 TO STA 2+150

CONTRACT NO.: LRT19-1019

DATE: 2024-04-12

DESIGNED BY: EJC/ELN/AM

CHECKED BY: JLM/AM

DATE: 2024-04-12

PROJECT NO.: EJV-S2R05C-RWY-DWG-3103

DESIGNED BY: EJC/ELN/AM

CHECKED BY: JLM/AM

DATE: 2024-04-12

EWC DESIGNERS

SCALE: 1" = 40'

KEY:

REV	DESCRIPTION	BY	DATE
A	BUILD FOR FINAL DESIGN DEVELOPMENT - CITY REVIEW	JLM	2024-04-12
B	BUILD FOR FINAL DESIGN DEVELOPMENT - CITY REVIEW	JLM	2024-04-12
C	BUILD FOR FINAL DESIGN DEVELOPMENT - CITY REVIEW	JLM	2024-04-12
D	BUILD FOR FINAL DESIGN DEVELOPMENT - CITY REVIEW	JLM	2024-04-12
E	BUILD FOR FINAL DESIGN DEVELOPMENT - CITY REVIEW	JLM	2024-04-12

KEY MAP - WEST
KEY MAP - EAST

AS PART OF THIS DOCUMENT MAY BE REPRODUCED, COPIED, OR OTHERWISE USED IN ANY FORM OR BY ANY MEANS, WITHOUT THE WRITTEN PERMISSION OF THE PROJECT MANAGER.

LAYOUT INFORMATION BASED ON 3 DEGREE MTM ZONE 9 NAD 83 ORIGINAL COORDINATE SYSTEM, COMBINED SCALE FACTOR 0.9999

**PRELIMINARY
NOT FOR CONSTRUCTION**

LEGEND:

	ASPHALT ROADWAY (NEW)
	ASPHALT ROADWAY (REHAB)
	ASPHALT SIDEWALK
	CONCRETE SIDEWALK
	DELIMITATOR TILE WITH ALTERNATING DIRECTIONAL BARS
	TOPSOIL AND MULCH
	TOPSOIL AND SOD
	SAWCUT LINE
	NEW PAVEMENT ELEVATION
	REINSTATED PAVEMENT ELEVATION (AFTER ASPHALT RESURFACING)

ROW LINES ARE APPROXIMATE AND BASED ON CITY PROVIDED PROPERTY RECORDS PLANS (PNS) AND PROPOSED CONSTRUCTION SETBACK TO OF A PROPERTY LINE REQUIRES THAT A LICENSED ONTARIO LAND SURVEYOR BE ENGAGED AS PER SCHEDULE 162 PART 1 ARTICLE 4.2.



3/2/2018 10:11:11 AM

3/2/2018 10:11:11 AM

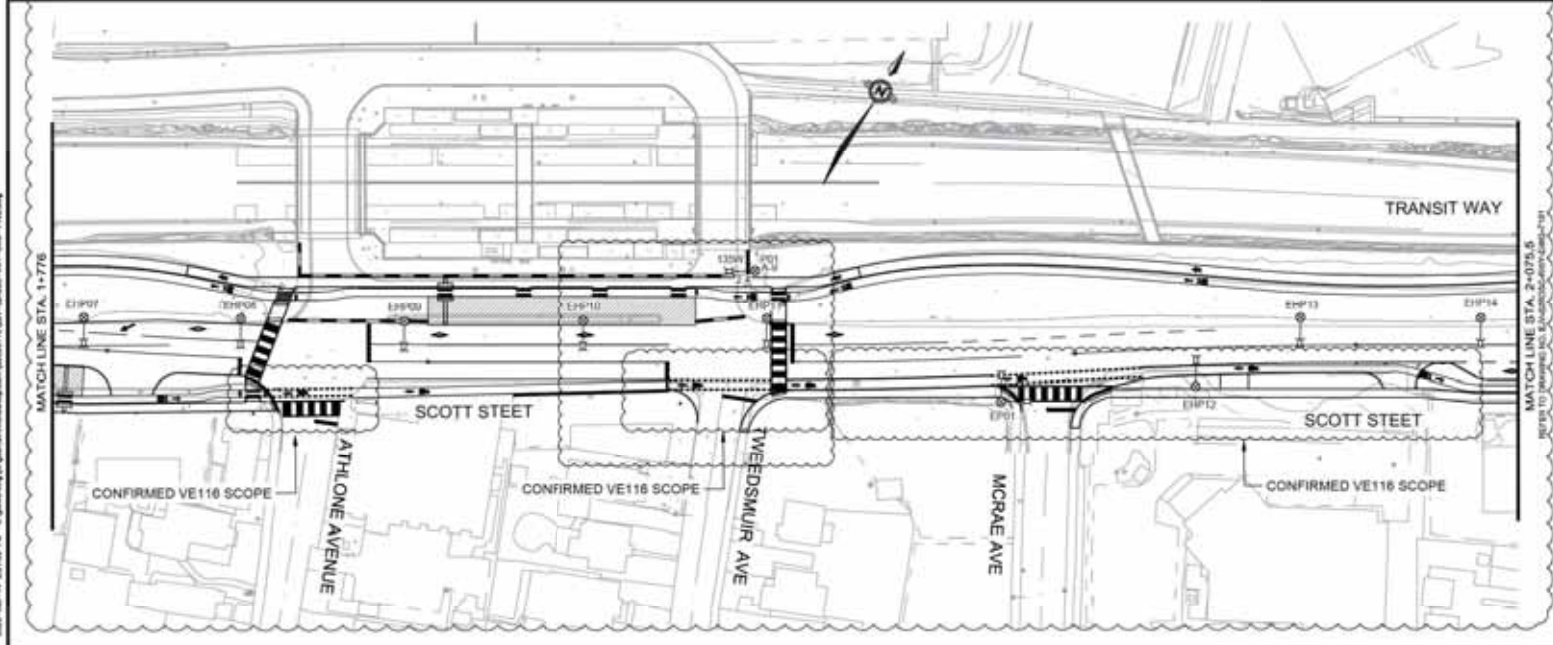
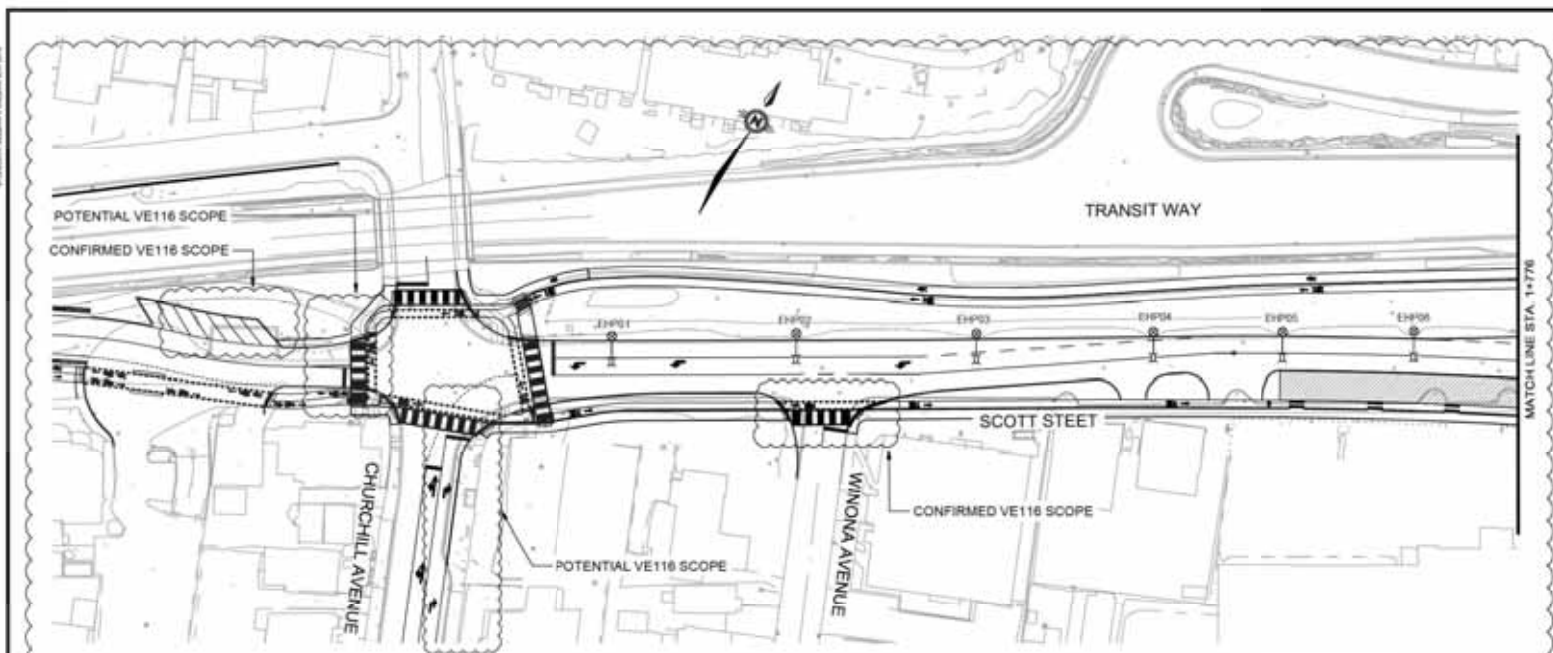

STAGE 2 Confederation + EAST
Confederation + WEST

Ottawa

CONTRACT NO. LRT19-1019

SCOTT STREET SEGMENT 2
TEMPORARY ELECTRICAL LAYOUT - I
STA 1+500 TO STA 2+075.5

PROJECT NO. EJV-S2RDSC-RWY-DWG-7100

EWC DESIGNERS

SCALE: 1" = 20'

NO.	DESCRIPTION	BY	DATE
1	ISSUED FOR FINAL DESIGN DEVELOPMENT - CITY REVIEW	C.P.	2018-04-24
2	ISSUED FOR FINAL DESIGN DEVELOPMENT - O&M REVIEW	C.P.	2018-04-24
3	ISSUED FOR FINAL DESIGN DEVELOPMENT - CITY REVIEW	C.P.	2018-04-24
4	ISSUED FOR FINAL DESIGN DEVELOPMENT - CITY REVIEW	C.P.	2018-04-24

KEY MAP - WEST
KEY MAP - EAST

LAYOUT INFORMATION BASED ON 3 DEGREE MTM ZONE 9 NAD 83 ORIGINAL COORDINATE SYSTEM. COMBINED SCALE FACTOR 0.9999

**PRELIMINARY
NOT FOR CONSTRUCTION**

GENERAL NOTES:

A. DESIGN PENDING D08 D17 APPROVAL.

NOTES:

- PENDING INTERSECTION LIGHTING DESIGN COORDINATION WITH THE CITY OF OTTAWA AND HYDRO OTTAWA REGARDING RELOCATED HYDRO POLES AND TRAFFIC SIGNALS SHOWN IN DRAWING.
- PENDING RFI RESPONSE REGARDING BICYCLE PATH LIGHTING.

ROW LINES ARE APPROXIMATE AND BASED ON CITY PROVIDED PROPERTY RECORD PLANS (PPR). ANY PROPOSED CONSTRUCTION WITHIN OR C.P. A PROPERTY LIMIT REQUIRES THAT A LICENSED ONTARIO LAND SURVEYOR BE ENGAGED AS PER SCHEDULE 15-2 PART 1 ARTICLE 4.2

Appendix G

TRANS Model Plots

TRANS Regional Model

Version 2.15 - Assigned June 16, 2020

AM Peak Hour Total Traffic Volume

Richmond Road Area Growth

2011 Model - Basecase

N/A

User Initials: TIMW
Plot Prepared: August 10, 2020
EMME Scenario: 21711



Legend

AM Peak Hour Total Traffic Volume

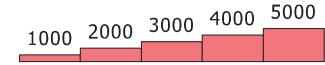

Distance (m)



The TRANS model is continuously refined & maintained, and all information is provided in good faith. However, model outputs are provided "as is", and no warranty or guarantee is provided as to the accuracy, reliability or reasonableness of the results. In using this data, you agree to accept any and all risks arising from any incorrect, incomplete, or misleading information.

Recipients are required to use caution and professional judgement in using and interpreting model outputs. In particular, caution should be used when focusing on a geographically limited area (such as a single road or intersection), as the model is primarily designed to simulate regional-scale phenomena and has been calibrated at a regional level.

As a general good practice, it is recommended that the user confirm the network coding within the area of interest, and compare base year forecasts against traffic count data to assess the extent to which the model may be over- or under-estimating the travel demand.



TRANS Regional Model

Version 2.15 - Assigned June 16, 2020

AM Peak Hour Total Traffic Volume Richmond Road Area Growth

2031 Model - Basecase

N/A

User Initials: TIMW
Plot Prepared: August 10, 2020
EMME Scenario: 21711



Legend

AM Peak Hour Total Traffic Volume

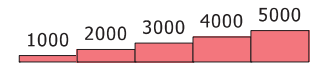

Distance (m)



The TRANS model is continuously refined & maintained, and all information is provided in good faith. However, model outputs are provided "as is", and no warranty or guarantee is provided as to the accuracy, reliability or reasonableness of the results. In using this data, you agree to accept any and all risks arising from any incorrect, incomplete, or misleading information.

Recipients are required to use caution and professional judgement in using and interpreting model outputs. In particular, caution should be used when focusing on a geographically limited area (such as a single road or intersection), as the model is primarily designed to simulate regional-scale phenomena and has been calibrated at a regional level.

As general good practice, it is recommended that the user confirm the network coding within the area of interest, and compare base year forecasts against traffic count data to assess the extent to which the model may be over- or under-estimating the travel demand.

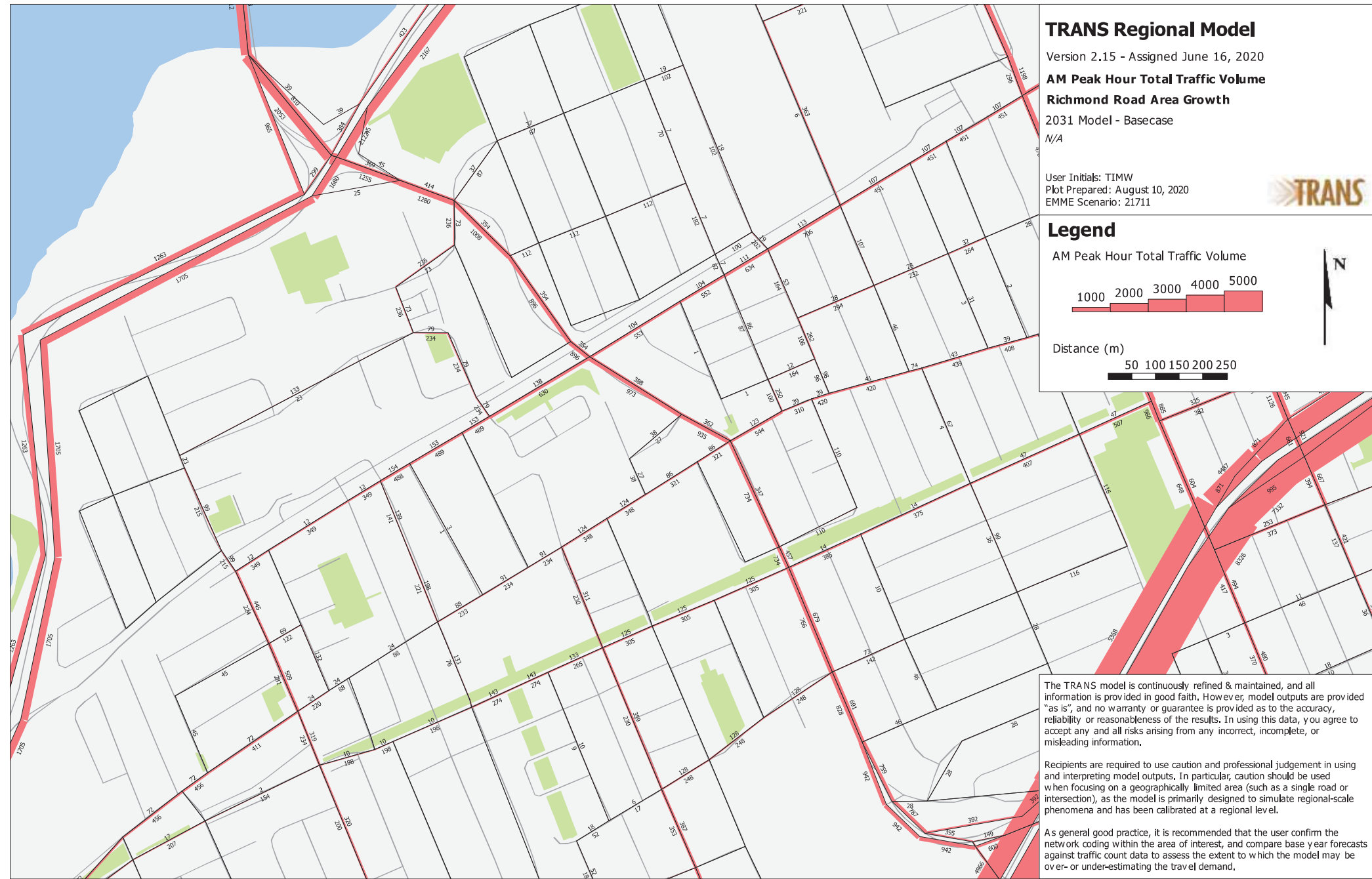

Appendix H

Background Development Volumes

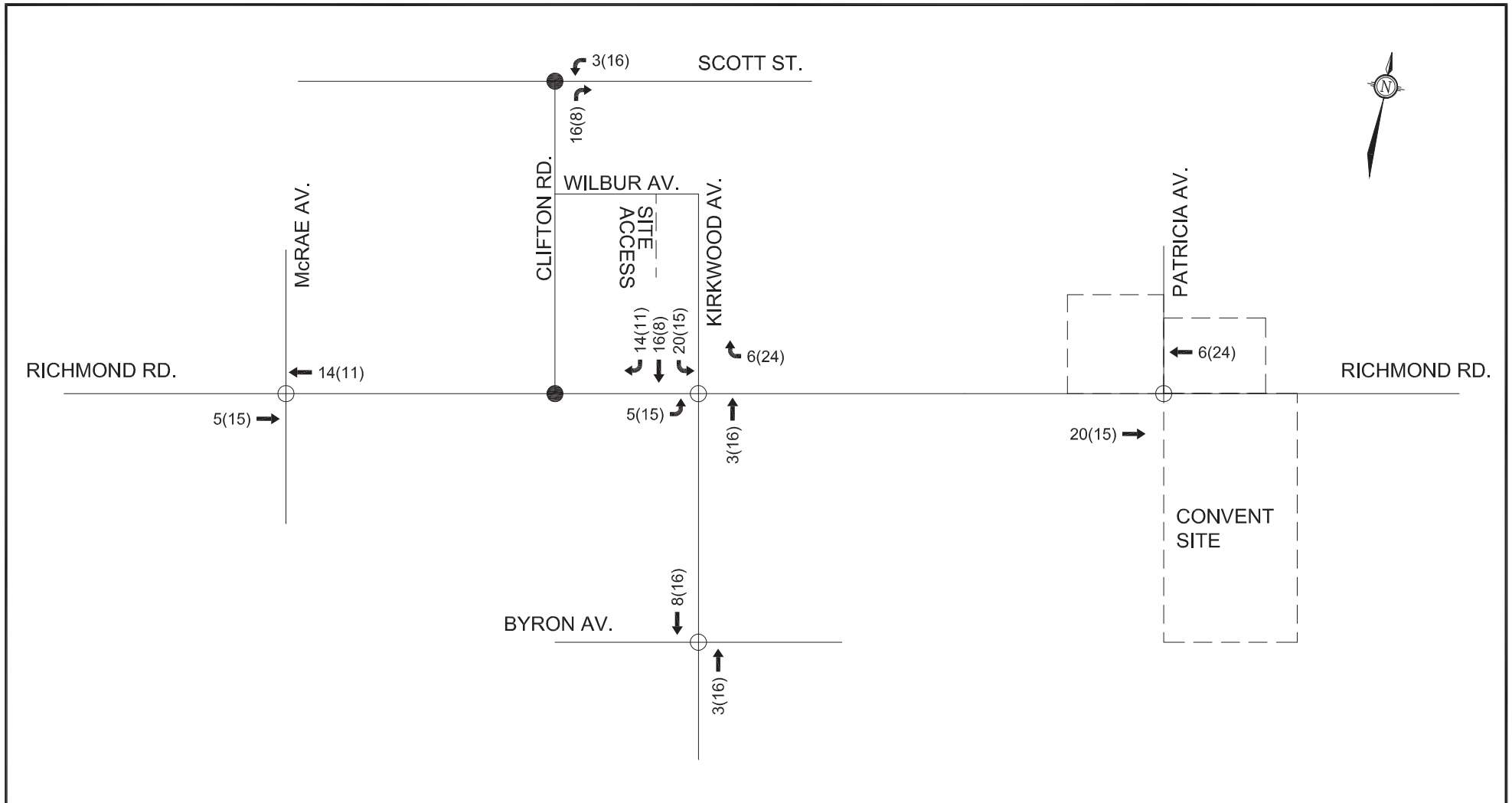

NOVATECH
ENGINEERING
CONSULTANTS LTD.

ENGINEERS & PLANNERS

Suite 200, 240 Michael Cowpland Drive
 Ottawa, Ontario, Canada
 K2M 1P6

Telephone (613) 254-9643
 Facsimile (613) 254-5867
 Email: novainfo@novatech-eng.com

LEGEND

- Unsignalized Intersection
- Signalized Intersection
- xx VPH AM Peak Hour
- (xx) VPH PM Peak Hour

175 RICHMOND ROAD

PROPOSED SITE TRAFFIC

SEP 2011

111130

FIGURE 9

Figure 9: 'New' Site-Generated Traffic

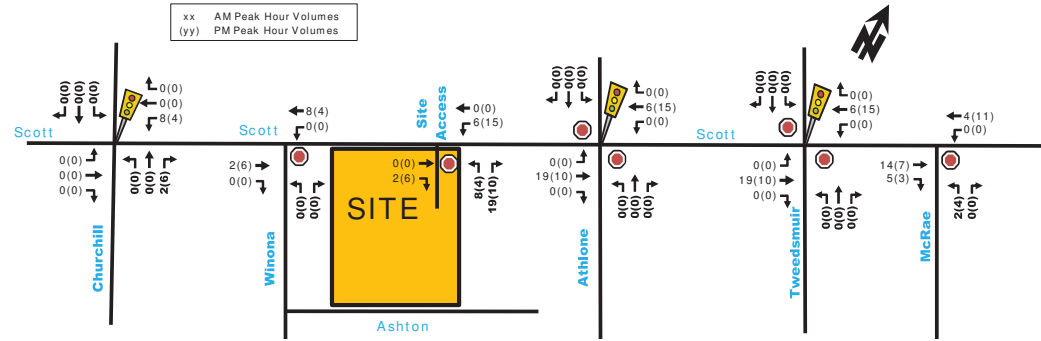

Figure 16: New 2022 Ste Generation Auto Volumes

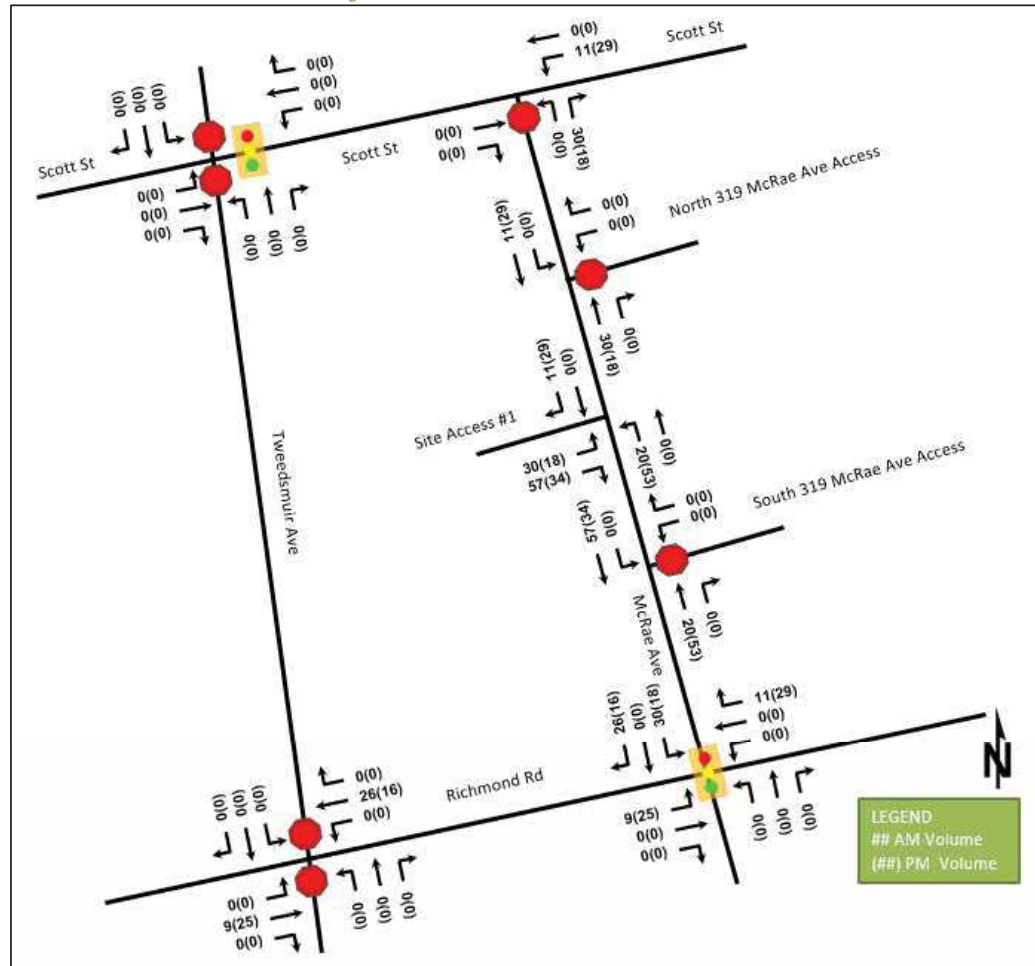

Figure 17: New 2027 Ste Generation Auto Volumes

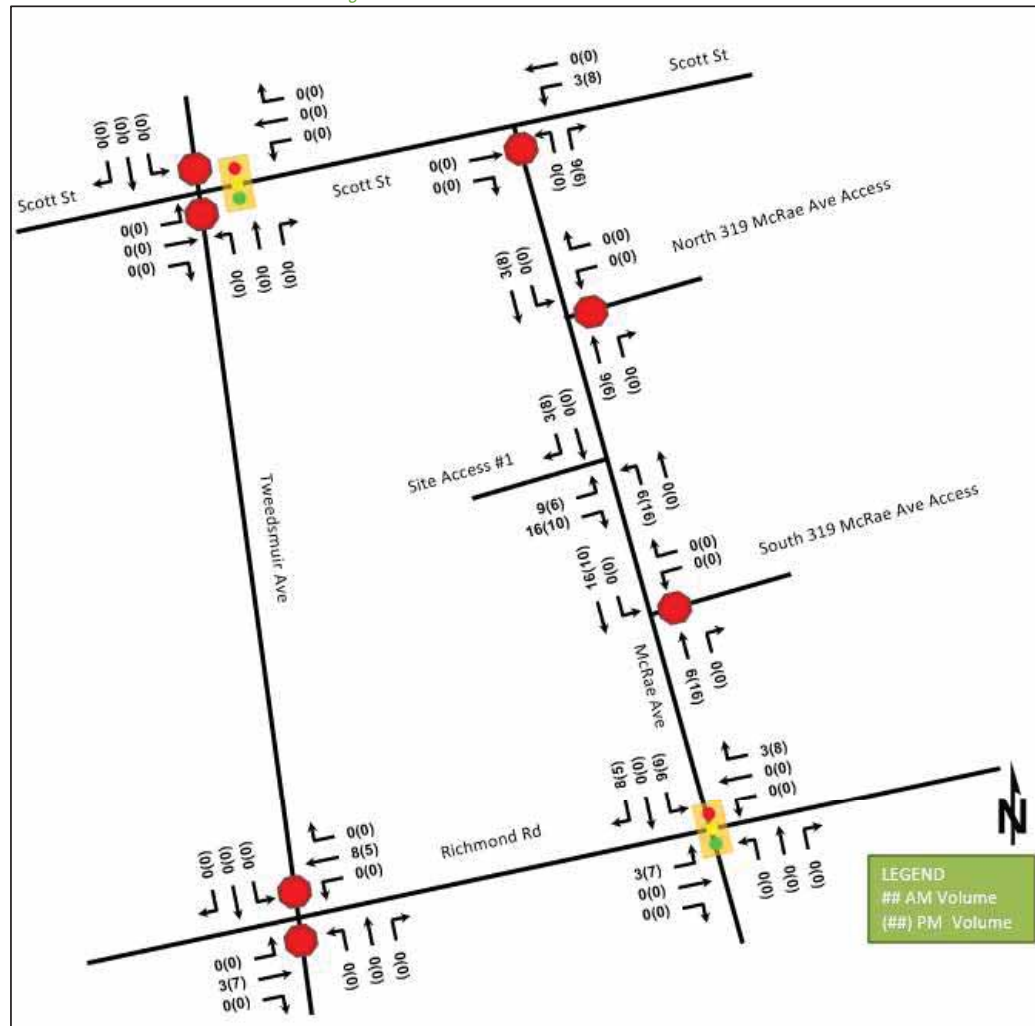

Figure 12 - Site Trips

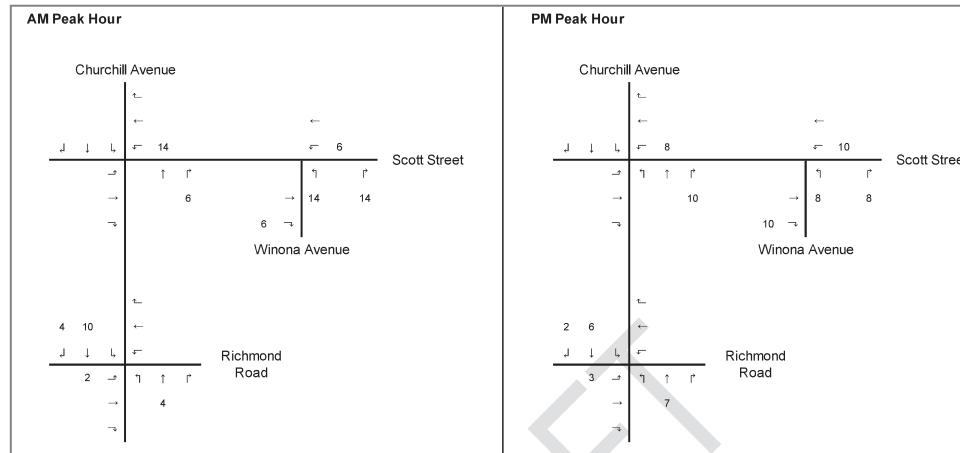

Figure 13: New Site Generation Auto Volumes

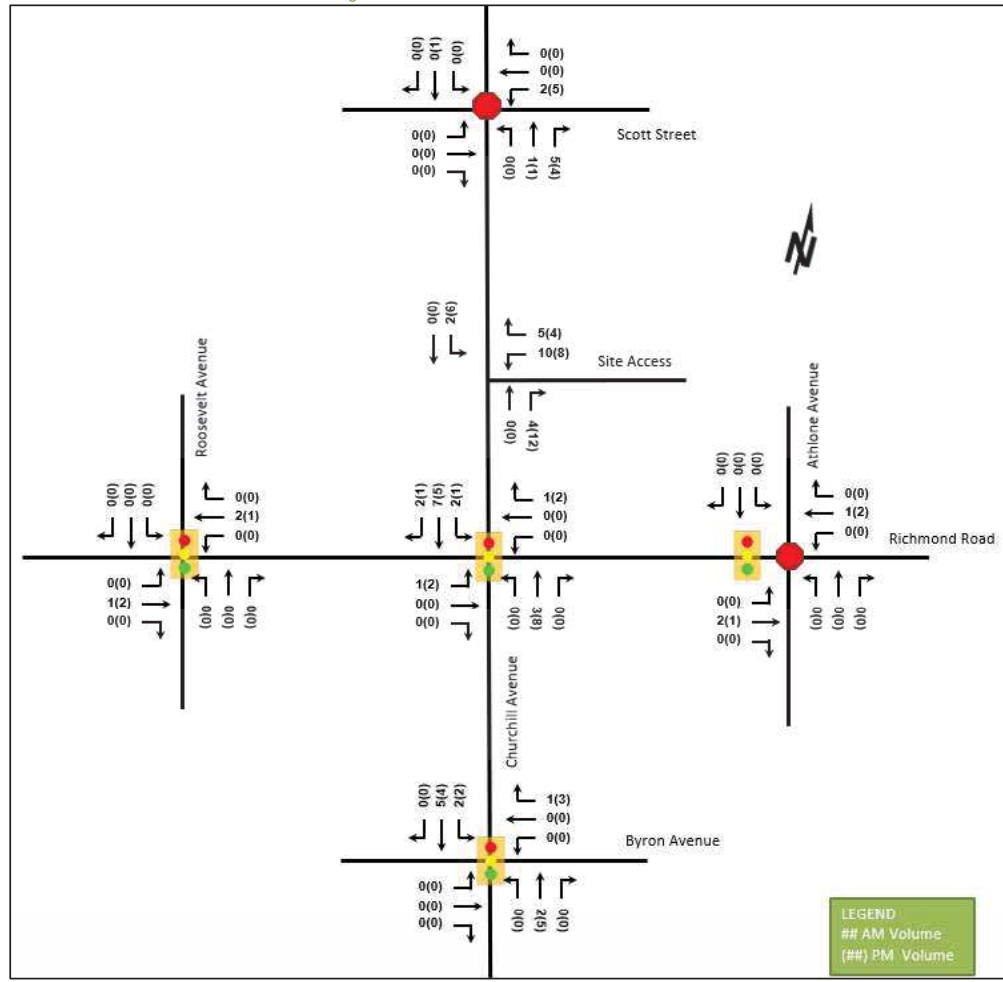

Figure 11: Net Site-Generated Traffic Volumes (2026)

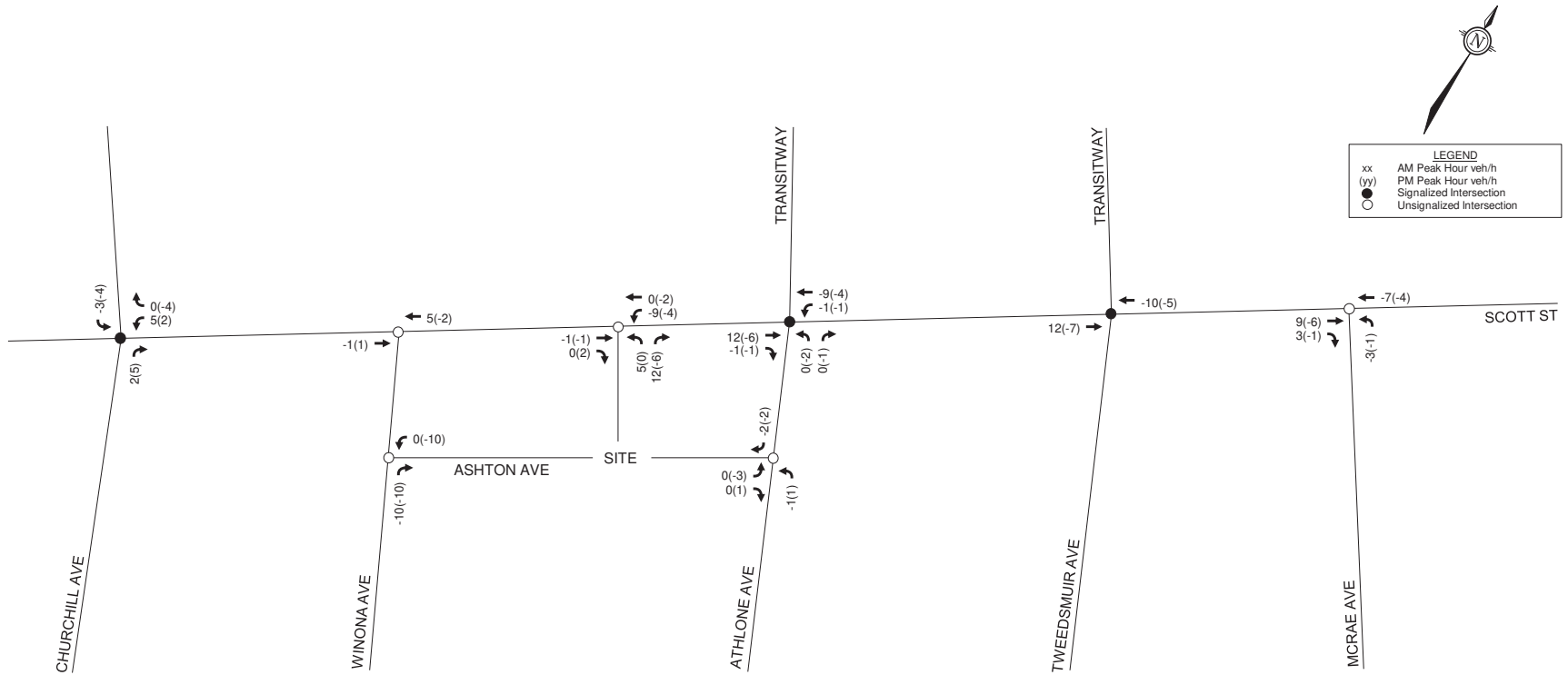
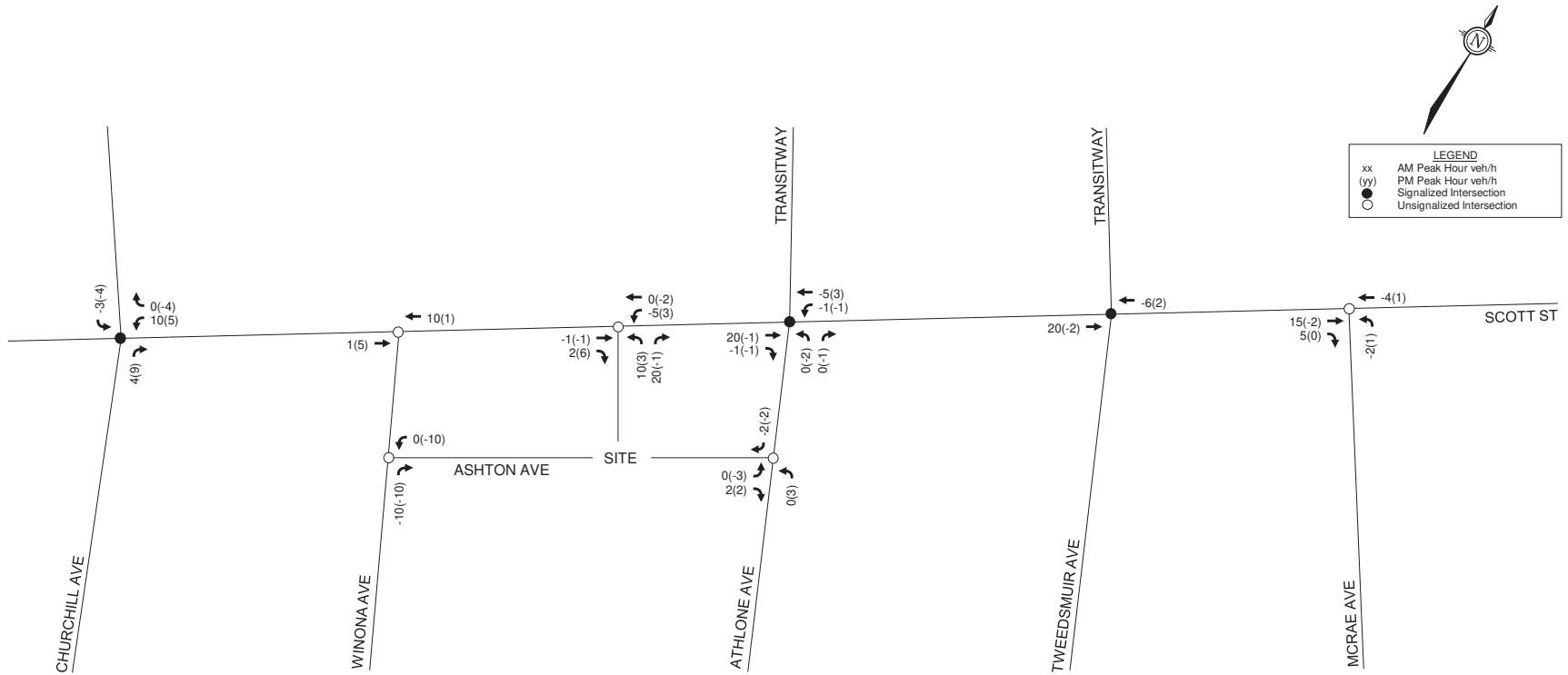

Figure 12: Net Site-Generated Traffic Volumes (2031)



Appendix I

Synchro Intersection Worksheets – 2027 Future Background Conditions

Lanes, Volumes, Timings

2027 Future Background

1: Island Park & Sir John A. Macdonald

AM Peak Hour



Lane Group	EBL	EBT	EBR	WBL	WBT	WBR	NBL	NBT	NBR	SBL	SBT	SBR
Lane Configurations	↔	↕	↔	↔	↕	↔	↔	↕	↔	↔	↕	↔
Traffic Volume (vph)	315	1299	55	105	346	94	0	285	182	78	772	597
Future Volume (vph)	315	1299	55	105	346	94	0	285	182	78	772	597
Satd. Flow (prot)	1658	3316	1483	1658	3316	1427	0	1644	0	3010	1621	0
Fit Permitted	0.950			0.950						0.950		
Satd. Flow (perm)	1658	3316	1483	1658	3316	1427	0	1644	0	3010	1621	0
Satd. Flow (RTOR)			101			101			21			34
Lane Group Flow (vph)	315	1299	55	105	346	94	0	467	0	78	1369	0
Turn Type	Prot	NA	Perm	Prot	NA	Perm	NA	NA	Prot	NA	NA	NA
Protected Phases	5	2		1	6			8		7	4	
Permitted Phases			2			6						
Detector Phase	5	2	2	1	6	6		8		7	4	
Switch Phase												
Minimum Initial (s)	5.0	15.0	15.0	5.0	15.0	15.0		10.0		5.0	10.0	
Minimum Split (s)	20.6	30.1	30.1	20.6	30.1	30.1		29.1		11.5	29.1	
Total Split (s)	35.6	41.1	41.1	35.6	41.1	41.1		61.1		26.5	61.1	
Total Split (%)	21.7%	25.0%	25.0%	21.7%	25.0%	25.0%		37.2%		16.1%	37.2%	
Yellow Time (s)	3.7	3.7	3.7	3.7	3.7	3.7		3.7		3.7	3.7	
All-Red Time (s)	1.9	2.4	2.4	1.9	2.4	2.4		2.4		2.8	2.4	
Lost Time Adjust (s)	0.0	0.0	0.0	0.0	0.0	0.0		0.0		0.0	0.0	
Total Lost Time (s)	5.6	6.1	6.1	5.6	6.1	6.1		6.1		6.5	6.1	
Lead/Lag	Lag	Lead	Lead	Lag	Lead	Lead		Lag		Lead		
Lead-Lag Optimize?	Yes	Yes	Yes	Yes	Yes	Yes		Yes		Yes		
Recall Mode	None	None	None	None	None	None		None		None	None	
Act Effct Green (s)	30.2	35.2	35.2	14.2	19.2	19.2		44.7		8.9	60.1	
Actuated g/C Ratio	0.24	0.28	0.28	0.11	0.15	0.15		0.35		0.07	0.47	
v/c Ratio	0.80	1.42	0.11	0.57	0.69	0.31		0.79		0.38	1.75	
Control Delay	63.6	229.9	0.6	67.3	59.7	10.9		47.1		63.9	368.0	
Queue Delay	0.0	0.0	0.0	0.0	0.0	0.0		0.0		0.0	0.0	
Total Delay	63.6	229.9	0.6	67.3	59.7	10.9		47.1		63.9	368.0	
LOS	E	F	A	E	E	B		D		E	F	
Approach Delay		191.0			52.8			47.1			351.6	
Approach LOS		F			D			D			F	
Queue Length 50th (m)	70.4	~215.1	0.0	24.1	41.5	0.0		99.6		9.3	~494.3	
Queue Length 95th (m)	#146.7	#328.1	0.7	48.0	66.2	13.9		154.8		19.7	#655.5	
Internal Link Dist (m)		762.8			208.9			249.0			160.1	
Turn Bay Length (m)	104.5		88.0	89.6						80.0		
Base Capacity (vph)	392	916	482	392	916	467		725		475	1054	
Starvation Cap Reductn	0	0	0	0	0	0		0		0	0	
Spillback Cap Reductn	0	0	0	0	0	0		0		0	0	
Storage Cap Reductn	0	0	0	0	0	0		0		0	0	
Reduced v/c Ratio	0.80	1.42	0.11	0.27	0.38	0.20		0.64		0.16	1.30	

Intersection Summary

Cycle Length: 164.3
Actuated Cycle Length: 127.5
Natural Cycle: 145
Control Type: Actuated-Uncoordinated
Maximum v/c Ratio: 1.75

Lanes, Volumes, Timings

2027 Future Background

1: Island Park & Sir John A. Macdonald

AM Peak Hour

Intersection Signal Delay: 212.8	Intersection LOS: F
Intersection Capacity Utilization 140.3%	ICU Level of Service H
Analysis Period (min) 15	
~ Volume exceeds capacity, queue is theoretically infinite.	
Queue shown is maximum after two cycles.	
# 95th percentile volume exceeds capacity, queue may be longer.	
Queue shown is maximum after two cycles.	

Splits and Phases: 1: Island Park & Sir John A. Macdonald

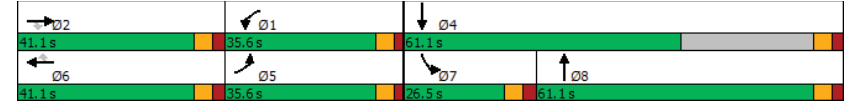

HCM 2010 TWSC
2: Island Park & Clearview

2027 Future Background
AM Peak Hour

Intersection													
Int Delay, s/veh	1.7												
Movement	EBL	EBT	EBR	WBL	WBT	WBR	NBL	NBT	NBR	SBL	SBT	SBR	
Lane Configurations	↔		↔		↔		↔		↔		↔		
Traffic Vol, veh/h	25	3	12	4	1	17	12	441	14	24	816	95	
Future Vol, veh/h	25	3	12	4	1	17	12	441	14	24	816	95	
Conflicting Peds, #/hr	4	0	0	0	0	4	6	0	1	1	0	6	
Sign Control	Stop	Stop	Stop	Stop	Stop	Stop	Free	Free	Free	Free	Free	Free	
RT Channelized	-	-	None	-	-	None	-	-	None	-	-	None	
Storage Length	-	-	-	-	-	-	-	-	-	-	-	-	
Veh in Median Storage, #	-	0	-	-	0	-	-	0	-	-	0	-	
Grade, %	-	0	-	-	0	-	-	0	-	-	0	-	
Peak Hour Factor	100	100	100	100	100	100	100	100	100	100	100	100	
Heavy Vehicles, %	2	33	2	2	100	2	2	2	7	2	2	2	
Mvmt Flow	25	3	12	4	1	17	12	441	14	24	816	95	
Major/Minor	Minor2	Minor1		Major1		Major2							
Conflicting Flow All	1403	1398	870	1392	1438	453	917	0	0	456	0	0	
Stage 1	918	918	-	473	473	-	-	-	-	-	-	-	
Stage 2	485	480	-	919	965	-	-	-	-	-	-	-	
Critical Hdwy	7.12	6.83	6.22	7.12	7.5	6.22	4.12	-	-	4.12	-	-	
Critical Hdwy Stg 1	6.12	5.83	-	6.12	6.5	-	-	-	-	-	-	-	
Critical Hdwy Stg 2	6.12	5.83	-	6.12	6.5	-	-	-	-	-	-	-	
Follow-up Hdwy	3.518	4.297	3.318	3.518	4.9	3.318	2.218	-	-	2.218	-	-	
Pot Cap-1 Maneuver	117	121	351	119	84	607	744	-	-	1105	-	-	
Stage 1	326	312	-	572	424	-	-	-	-	-	-	-	
Stage 2	563	506	-	325	231	-	-	-	-	-	-	-	
Platoon blocked, %	-	-	-	-	-	-	-	-	-	-	-	-	
Mov Cap-1 Maneuver	106	112	349	107	78	605	741	-	-	1104	-	-	
Mov Cap-2 Maneuver	106	112	-	107	78	-	-	-	-	-	-	-	
Stage 1	317	296	-	559	414	-	-	-	-	-	-	-	
Stage 2	532	494	-	297	219	-	-	-	-	-	-	-	
Approach	EB		WB		NB		SB						
HCM Control Delay, s	42.5		18.9		0.3		0.2						
HCM LOS	E		C										
Minor Lane/Major Mvmt	NBL	NBT	NBR	EBLn1	WBLn1	SBL	SBT	SBR					
Capacity (veh/h)	741	-	-	135	281	1104	-	-					
HCM Lane V/C Ratio	0.016	-	-	0.296	0.078	0.022	-	-					
HCM Control Delay (s)	9.9	0	-	42.5	18.9	8.3	0	-					
HCM Lane LOS	A	A	-	E	C	A	A	-					
HCM 95th %tile Q(veh)	0	-	-	1.2	0.3	0.1	-	-					

Lanes, Volumes, Timings
3: Island Park & Scott

2027 Future Background
AM Peak Hour

Lane Group	EBL	EBT	EBR	WBL	WBT	WBR	NBL	NBT	NBR	SBL	SBT	SBR
Lane Configurations	↔	↕	↔	↔	↕	↔	↔	↕	↔	↔	↕	↔
Traffic Volume (vph)	105	563	56	44	209	22	41	302	90	57	738	92
Future Volume (vph)	105	563	56	44	209	22	41	302	90	57	738	92
Satd. Flow (prot)	1658	1745	1483	1658	1648	0	0	1671	0	1658	1707	0
Fit Permitted	0.569		0.191				0.470		0.463			
Satd. Flow (perm)	949	1745	1423	332	1648	0	0	789	0	798	1707	0
Satd. Flow (RTOR)			40		6		19		9			
Lane Group Flow (vph)	105	563	56	44	231	0	0	433	0	57	830	0
Turn Type	Perm	NA	Perm	Perm	NA		Perm	NA		Perm	NA	
Protected Phases	4		8		8		2		6		6	
Permitted Phases	4		4		8		2		6		6	
Detector Phase	4		4		8		2		2		6	
Switch Phase												
Minimum Initial (s)	10.0	10.0	10.0	10.0	10.0		10.0	10.0		10.0	10.0	
Minimum Split (s)	34.8	34.8	34.8	34.8	34.8		34.5	34.5		34.5	34.5	
Total Split (s)	42.0	42.0	42.0	42.0	42.0		53.0	53.0		53.0	53.0	
Total Split (%)	44.2%	44.2%	44.2%	44.2%	44.2%		55.8%	55.8%		55.8%	55.8%	
Yellow Time (s)	3.3	3.3	3.3	3.3	3.3		3.0	3.0		3.0	3.0	
All-Red Time (s)	2.7	2.7	2.7	2.7	2.7		3.5	3.5		3.5	3.5	
Lost Time Adjust (s)	0.0	0.0	0.0	0.0	0.0		0.0	0.0		0.0	0.0	
Total Lost Time (s)	6.0	6.0	6.0	6.0	6.0		6.5	6.5		6.5	6.5	
Lead/Lag												
Lead-Lag Optimize?												
Recall Mode	Max	Max	Max	Max	Max		C-Max	C-Max		C-Max	C-Max	
Act Effct Green (s)	36.0	36.0	36.0	36.0	36.0		46.5	46.5		46.5	46.5	
Actuated g/C Ratio	0.38	0.38	0.38	0.38	0.38		0.49	0.49		0.49	0.49	
v/c Ratio	0.29	0.85	0.10	0.35	0.37		1.10	1.10		0.15	0.99	
Control Delay	19.5	36.2	6.7	31.0	22.8		99.2	99.2		14.7	53.6	
Queue Delay	0.0	0.0	0.0	0.0	0.0		0.0	0.0		0.0	0.0	
Total Delay	19.5	36.2	6.7	31.0	22.8		99.2	99.2		14.7	53.6	
LOS	B	D	A	C	C		F	F		B	D	
Approach Delay	31.5		24.1		99.2		51.1		51.1		51.1	
Approach LOS	C		C		F		D		D		D	
Queue Length 50th (m)	10.1	95.7	0.8	5.7	29.2		-88.7	-88.7		5.5	143.4	
Queue Length 95th (m)	18.1	#146.7	m5.0	16.0	48.2		#146.5	#146.5		12.7	#227.3	
Internal Link Dist (m)	211.2		266.0		304.9		415.7		415.7		415.7	
Turn Bay Length (m)	58.7		29.5		250.0		36.5		36.5		36.5	
Base Capacity (vph)	359	661	564	125	628		395	395		390	840	
Starvation Cap Reductn	0	0	0	0	0		0	0		0	0	
Spillback Cap Reductn	0	0	0	0	0		0	0		0	0	
Storage Cap Reductn	0	0	0	0	0		0	0		0	0	
Reduced v/c Ratio	0.29	0.85	0.10	0.35	0.37		1.10	1.10		0.15	0.99	
Intersection Summary												
Cycle Length: 95												
Actuated Cycle Length: 95												
Offset: 38 (40%), Referenced to phase 2:NBT and 6:SBTL, Start of Green												
Natural Cycle: 90												
Control Type: Actuated-Coordinated												

Lanes, Volumes, Timings
3: Island Park & Scott

2027 Future Background
AM Peak Hour

Maximum v/c Ratio: 1.10	Intersection LOS: D
Intersection Signal Delay: 50.8	ICU Level of Service H
Intersection Capacity Utilization 115.0%	
Analysis Period (min) 15	
~ Volume exceeds capacity, queue is theoretically infinite.	
Queue shown is maximum after two cycles.	
# 95th percentile volume exceeds capacity, queue may be longer.	
Queue shown is maximum after two cycles.	
m Volume for 95th percentile queue is metered by upstream signal.	

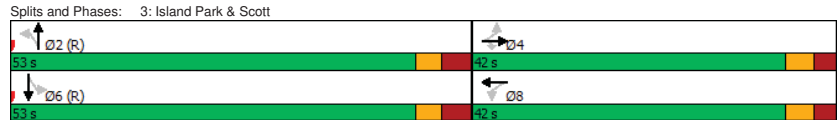

Lanes, Volumes, Timings
4: West Village/Lanark & Scott

2027 Future Background
AM Peak Hour

Lane Group	EBL	EBT	EBR	WBL	WBT	WBR	NBL	NBT	NBR	SBL	SBT	SBR
Lane Configurations	↔	↔	↔	↔	↔	↔	↔	↔	↔	↔	↔	↔
Traffic Volume (vph)	39	654	9	0	292	50	17	0	12	68	0	87
Future Volume (vph)	39	654	9	0	292	50	17	0	12	68	0	87
Satd. Flow (prot)	1610	1724	0	1745	1675	0	1658	1436	0	1658	1418	0
Fit Permitted	0.555						0.701			0.750		
Satd. Flow (perm)	922	1724	0	1745	1675	0	1204	1436	0	1294	1418	0
Satd. Flow (RTOR)		2			22			319				609
Lane Group Flow (vph)	39	663	0	0	342	0	17	12	0	68	87	0
Turn Type	Perm	NA		Perm	NA		Perm	NA		Perm	NA	
Protected Phases		2			6			4			8	
Permitted Phases	2			6			4			8		
Detector Phase	2	2		6	6		4	4		8	8	
Switch Phase												
Minimum Initial (s)	10.0	10.0		10.0	10.0		10.0	10.0		10.0	10.0	
Minimum Split (s)	26.1	26.1		26.1	26.1		21.5	21.5		21.5	21.5	
Total Split (s)	73.0	73.0		73.0	73.0		22.0	22.0		22.0	22.0	
Total Split (%)	76.8%	76.8%		76.8%	76.8%		23.2%	23.2%		23.2%	23.2%	
Yellow Time (s)	3.3	3.3		3.3	3.3		3.3	3.3		3.3	3.3	
All-Red Time (s)	2.8	2.8		2.8	2.8		2.2	2.2		2.2	2.2	
Lost Time Adjust (s)	0.0	0.0		0.0	0.0		0.0	0.0		0.0	0.0	
Total Lost Time (s)	6.1	6.1		6.1	6.1		5.5	5.5		5.5	5.5	
Lead/Lag												
Lead-Lag Optimize?												
Recall Mode	C-Max	C-Max		C-Max	C-Max		None	None		None	None	
Act Effct Green (s)	76.0	76.0		76.0	76.0		11.7	11.7		11.7	11.7	
Actuated g/C Ratio	0.80	0.80		0.80	0.80		0.12	0.12		0.12	0.12	
v/c Ratio	0.05	0.48		0.25	0.25		0.11	0.03		0.43	0.12	
Control Delay	3.7	5.9		2.9	2.9		37.5	0.1		46.4	0.4	
Queue Delay	0.0	0.0		0.0	0.0		0.0	0.0		0.0	0.0	
Total Delay	3.7	5.9		2.9	2.9		37.5	0.1		46.4	0.4	
LOS	A	A		A	A		D	A		D	A	
Approach Delay		5.8			2.9			22.0			20.6	
Approach LOS		A			A			C			C	
Queue Length 50th (m)	1.4	36.1		10.1	10.1		2.9	0.0		11.9	0.0	
Queue Length 95th (m)	4.7	73.1		m17.5	m17.5		8.5	0.0		23.6	0.0	
Internal Link Dist (m)		332.8			211.2			80.9			82.5	
Turn Bay Length (m)	36.5						18.0			18.0		
Base Capacity (vph)	738	1380		1344	1344		209	513		224	749	
Starvation Cap Reductn	0	0		0	0		0	0		0	0	
Spillback Cap Reductn	0	0		0	0		0	0		0	0	
Storage Cap Reductn	0	0		0	0		0	0		0	0	
Reduced v/c Ratio	0.05	0.48		0.25	0.25		0.08	0.02		0.30	0.12	

Intersection Summary												
Cycle Length: 95												
Actuated Cycle Length: 95												
Offset: 83 (87%), Referenced to phase 2:EBTL and 6:WBTL, Start of Green												
Natural Cycle: 60												
Control Type: Actuated-Coordinated												

Lanes, Volumes, Timings
4: West Village/Lanark & Scott

2027 Future Background
AM Peak Hour

Maximum v/c Ratio: 0.48	Intersection LOS: A
Intersection Signal Delay: 7.3	ICU Level of Service B
Intersection Capacity Utilization 57.7%	
Analysis Period (min) 15	

m Volume for 95th percentile queue is metered by upstream signal.

Splits and Phases: 4: West Village/Lanark & Scott



HCM 2010 AWSC
5: Churchill & Lanark

2027 Future Background
AM Peak Hour

Intersection	
Intersection Delay, s/veh	7.8
Intersection LOS	A

Movement	WBL	WBR	NBT	NBR	SBL	SBT
Lane Configurations	↔		↔		↔	↔
Traffic Vol, veh/h	110	3	24	45	6	47
Future Vol, veh/h	110	3	24	45	6	47
Peak Hour Factor	1.00	1.00	1.00	1.00	1.00	1.00
Heavy Vehicles, %	2	33	8	13	2	2
Mvmt Flow	110	3	24	45	6	47
Number of Lanes	1	0	1	0	0	1

Approach	WB	NB	SB
Opposing Approach		SB	NB
Opposing Lanes	0	1	1
Conflicting Approach Left	NB		WB
Conflicting Lanes Left	1	0	1
Conflicting Approach Right	SB	WB	
Conflicting Lanes Right	1	1	0
HCM Control Delay	8.1	7.3	7.6
HCM LOS	A	A	A

Lane	NBLn1	WBLn1	SBLn1
Vol Left, %	0%	97%	11%
Vol Thru, %	35%	0%	89%
Vol Right, %	65%	3%	0%
Sign Control	Stop	Stop	Stop
Traffic Vol by Lane	69	113	53
LT Vol	0	110	6
Through Vol	24	0	47
RT Vol	45	3	0
Lane Flow Rate	69	113	53
Geometry Grp	1	1	1
Degree of Util (X)	0.074	0.136	0.062
Departure Headway (Hd)	3.882	4.322	4.207
Convergence, Y/N	Yes	Yes	Yes
Cap	909	825	840
Service Time	1.967	2.376	2.291
HCM Lane V/C Ratio	0.076	0.137	0.063
HCM Control Delay	7.3	8.1	7.6
HCM Lane LOS	A	A	A
HCM 95th-tile Q	0.2	0.5	0.2

Lanes, Volumes, Timings

2027 Future Background

1: Island Park & Sir John A. Macdonald

PM Peak Hour



Lane Group	EBL	EBT	EBR	WBL	WBT	WBR	NBL	NBT	NBR	SBL	SBT	SBR
Lane Configurations	↔	↕	↔	↔	↕	↔		↕	↔	↔	↕	↔
Traffic Volume (vph)	396	845	67	96	1147	1183	0	492	43	98	356	491
Future Volume (vph)	396	845	67	96	1147	1183	0	492	43	98	356	491
Satd. Flow (prot)	1658	3316	1483	1658	3283	1483	0	1721	0	3038	1593	0
Fit Permitted	0.950			0.950						0.950		
Satd. Flow (perm)	1656	3316	1439	1653	3283	1460	0	1721	0	2996	1593	0
Satd. Flow (RTOR)			101			302		3			60	
Lane Group Flow (vph)	396	845	67	96	1147	1183	0	535	0	98	847	0
Turn Type	Prot	NA	Perm	Prot	NA	Perm	NA	Prot	NA	Prot	NA	NA
Protected Phases	5	2		1	6			8		7	4	
Permitted Phases			2			6						
Detector Phase	5	2	2	1	6	6		8		7	4	
Switch Phase												
Minimum Initial (s)	5.0	15.0	15.0	5.0	15.0	15.0		10.0		5.0	10.0	
Minimum Split (s)	20.6	30.1	30.1	20.6	30.1	30.1		29.1		11.5	29.1	
Total Split (s)	35.6	41.1	41.1	35.6	41.1	41.1		61.1		26.5	61.1	
Total Split (%)	21.7%	25.0%	25.0%	21.7%	25.0%	25.0%		37.2%		16.1%	37.2%	
Yellow Time (s)	3.7	3.7	3.7	3.7	3.7	3.7		3.7		3.7	3.7	
All-Red Time (s)	1.9	2.4	2.4	1.9	2.4	2.4		2.4		2.8	2.4	
Lost Time Adjust (s)	0.0	0.0	0.0	0.0	0.0	0.0		0.0		0.0	0.0	
Total Lost Time (s)	5.6	6.1	6.1	5.6	6.1	6.1		6.1		6.5	6.1	
Lead/Lag	Lag	Lead	Lead	Lag	Lead	Lead		Lag		Lead		
Lead-Lag Optimize?	Yes	Yes	Yes	Yes	Yes	Yes		Yes		Yes		
Recall Mode	None	None	None	None	None	None		None		None	None	
Act Effct Green (s)	30.1	35.1	35.1	30.1	35.1	35.1		50.9		10.2	67.7	
Actuated g/C Ratio	0.20	0.23	0.23	0.20	0.23	0.23		0.34		0.07	0.45	
v/c Ratio	1.20	1.09	0.16	0.29	1.50	2.07		0.92		0.48	1.13	
Control Delay	164.9	114.1	3.2	55.8	271.2	509.0		69.4		76.3	111.6	
Queue Delay	0.0	0.0	0.0	0.0	0.0	0.0		0.0		0.0	0.0	
Total Delay	164.9	114.1	3.2	55.8	271.2	509.0		69.4		76.3	111.6	
LOS	F	F	A	E	F	F		E		E	F	
Approach Delay		123.8			378.6			69.4			108.0	
Approach LOS		F			F			E			F	
Queue Length 50th (m)	~149.6	~157.2	0.0	25.5	~259.5	~502.0		152.5		15.2	~283.4	
Queue Length 95th (m)	#220.3	#204.3	4.2	44.2	#310.1	#595.7		#223.0		25.1	#363.6	
Internal Link Dist (m)		750.5			213.6			249.0			161.6	
Turn Bay Length (m)	104.5		88.0	89.6						80.0		
Base Capacity (vph)	330	772	412	330	764	571		631		404	891	
Starvation Cap Reductn	0	0	0	0	0	0		0		0	0	
Spillback Cap Reductn	0	0	0	0	0	0		0		0	0	
Storage Cap Reductn	0	0	0	0	0	0		0		0	0	
Reduced v/c Ratio	1.20	1.09	0.16	0.29	1.50	2.07		0.85		0.24	0.95	

Intersection Summary

Cycle Length: 164.3
Actuated Cycle Length: 150.7
Natural Cycle: 145
Control Type: Actuated-Uncoordinated
Maximum v/c Ratio: 2.07

Lanes, Volumes, Timings

2027 Future Background

1: Island Park & Sir John A. Macdonald

PM Peak Hour

Intersection Signal Delay: 233.9	Intersection LOS: F
Intersection Capacity Utilization 145.7%	ICU Level of Service H
Analysis Period (min) 15	
~ Volume exceeds capacity, queue is theoretically infinite.	
Queue shown is maximum after two cycles.	
# 95th percentile volume exceeds capacity, queue may be longer.	
Queue shown is maximum after two cycles.	

Splits and Phases: 1: Island Park & Sir John A. Macdonald

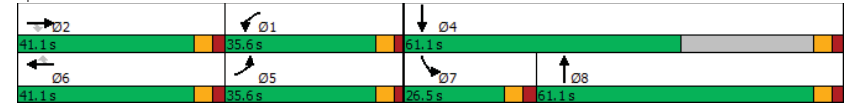

HCM 2010 TWSC
2: Island Park & Clearview

2027 Future Background
PM Peak Hour

Intersection												
Int Delay, s/veh	1.8											
Movement	EBL	EBT	EBR	WBL	WBT	WBR	NBL	NBT	NBR	SBL	SBT	SBR
Lane Configurations	↔		↔		↔		↔		↔		↔	
Traffic Vol, veh/h	27	3	9	5	5	50	2	456	1	12	473	46
Future Vol, veh/h	27	3	9	5	5	50	2	456	1	12	473	46
Conflicting Peds, #/hr	8	0	0	0	0	8	3	0	6	6	0	3
Sign Control	Stop	Stop	Stop	Stop	Stop	Free	Free	Free	Free	Free	Free	Free
RT Channelized	-	-	None	-	-	None	-	-	None	-	-	None
Storage Length	-	-	-	-	-	-	-	-	-	-	-	-
Veh in Median Storage, #	-	0	-	-	0	-	-	0	-	-	0	-
Grade, %	-	0	-	-	0	-	-	0	-	-	0	-
Peak Hour Factor	100	100	100	100	100	100	100	100	100	100	100	100
Heavy Vehicles, %	2	67	2	20	20	2	2	2	2	8	2	2
Mvmt Flow	27	3	9	5	5	50	2	456	1	12	473	46
Major/Minor	Minor2	Minor1	Major1	Major2								
Conflicting Flow All	1019	990	499	993	1013	471	522	0	0	463	0	0
Stage 1	523	523	-	467	467	-	-	-	-	-	-	-
Stage 2	496	467	-	526	546	-	-	-	-	-	-	-
Critical Hdwy	7.12	7.17	6.22	7.3	6.7	6.22	4.12	-	-	4.18	-	-
Critical Hdwy Stg 1	6.12	6.17	-	6.3	5.7	-	-	-	-	-	-	-
Critical Hdwy Stg 2	6.12	6.17	-	6.3	5.7	-	-	-	-	-	-	-
Follow-up Hdwy	3.518	4.603	3.318	3.68	4.18	3.318	2.218	-	-	2.272	-	-
Pot Cap-1 Maneuver	215	192	572	208	222	593	1044	-	-	1067	-	-
Stage 1	537	438	-	543	533	-	-	-	-	-	-	-
Stage 2	556	467	-	504	490	-	-	-	-	-	-	-
Platoon blocked, %	-	-	-	-	-	-	-	-	-	-	-	-
Mov Cap-1 Maneuver	189	187	571	198	216	587	1042	-	-	1062	-	-
Mov Cap-2 Maneuver	189	187	-	198	216	-	-	-	-	-	-	-
Stage 1	534	430	-	539	529	-	-	-	-	-	-	-
Stage 2	499	463	-	485	481	-	-	-	-	-	-	-
Approach	EB	WB	NB	SB								
HCM Control Delay, s	24.5	14.3	0	0.2								
HCM LOS	C	B										
Minor Lane/Major Mvmt	NBL	NBT	NBR	EBLn1	WBLn1	SBL	SBT	SBR				
Capacity (veh/h)	1042	-	-	223	449	1062	-	-				
HCM Lane V/C Ratio	0.002	-	-	0.175	0.134	0.011	-	-				
HCM Control Delay (s)	8.5	0	-	24.5	14.3	8.4	0	-				
HCM Lane LOS	A	A	-	C	B	A	A	-				
HCM 95th %tile Q(veh)	0	-	-	0.6	0.5	0	-	-				

Lanes, Volumes, Timings
3: Island Park & Scott

2027 Future Background
PM Peak Hour

Lane Group	EBL	EBT	EBR	WBL	WBT	WBR	NBL	NBT	NBR	SBL	SBT	SBR
Lane Configurations	↔	↔	↔	↔	↔	↔	↔	↔	↔	↔	↔	↔
Traffic Volume (vph)	105	304	42	192	553	101	23	423	21	27	415	73
Future Volume (vph)	105	304	42	192	553	101	23	423	21	27	415	73
Satd. Flow (prot)	1658	1712	1483	1658	1659	0	0	1727	0	1658	1691	0
Fit Permitted	0.229			0.527				0.870		0.364		
Satd. Flow (perm)	391	1712	1391	896	1659	0	0	1504	0	627	1691	0
Satd. Flow (RTOR)			42		13			3				10
Lane Group Flow (vph)	105	304	42	192	654	0	0	467	0	27	488	0
Turn Type	Perm	NA	Perm	Perm	NA		Perm	NA		Perm	NA	
Protected Phases					8			2				6
Permitted Phases	4		4	8			2				6	
Detector Phase	4	4	4	8	8		2	2		6	6	
Switch Phase												
Minimum Initial (s)	10.0	10.0	10.0	10.0	10.0		10.0	10.0		10.0	10.0	
Minimum Split (s)	34.8	34.8	34.8	34.8	34.8		34.5	34.5		34.5	34.5	
Total Split (s)	56.0	56.0	56.0	56.0	56.0		44.0	44.0		44.0	44.0	
Total Split (%)	56.0%	56.0%	56.0%	56.0%	56.0%		44.0%	44.0%		44.0%	44.0%	
Yellow Time (s)	3.3	3.3	3.3	3.3	3.3		3.0	3.0		3.0	3.0	
All-Red Time (s)	2.7	2.7	2.7	2.7	2.7		3.5	3.5		3.5	3.5	
Lost Time Adjust (s)	0.0	0.0	0.0	0.0	0.0		0.0	0.0		0.0	0.0	
Total Lost Time (s)	6.0	6.0	6.0	6.0	6.0		6.5	6.5		6.5	6.5	
Lead/Lag												
Lead-Lag Optimize?												
Recall Mode	Max	Max	Max	Max	Max		C-Max	C-Max		C-Max	C-Max	
Act Effct Green (s)	50.0	50.0	50.0	50.0	50.0		37.5	37.5		37.5	37.5	
Actuated g/C Ratio	0.50	0.50	0.50	0.50	0.50		0.38	0.38		0.38	0.38	
v/c Ratio	0.54	0.36	0.06	0.43	0.78		0.83	0.11		0.76	0.76	
Control Delay	26.4	13.9	3.0	19.7	28.3		42.4	22.2		36.1	36.1	
Queue Delay	0.0	0.0	0.0	0.0	0.0		0.0	0.0		0.0	0.0	
Total Delay	26.4	13.9	3.0	19.7	28.3		42.4	22.2		36.1	36.1	
LOS	C	B	A	B	C		D	C		D	D	
Approach Delay	15.8					26.3		42.4		35.3		
Approach LOS	B					C		D		D		
Queue Length 50th (m)	14.8	27.1	0.0	22.7	98.0		80.2	3.4		80.0		
Queue Length 95th (m)	34.5	37.9	2.6	41.1	146.3		#133.5	9.4		119.1		
Internal Link Dist (m)	217.8					273.2		304.9		417.3		
Turn Bay Length (m)	58.7		29.5		250.0				36.5			
Base Capacity (vph)	195	856	716	448	836		565	235		640		
Starvation Cap Reductn	0	0	0	0	0		0	0		0	0	
Spillback Cap Reductn	0	0	0	0	0		0	0		0	0	
Storage Cap Reductn	0	0	0	0	0		0	0		0	0	
Reduced v/c Ratio	0.54	0.36	0.06	0.43	0.78		0.83	0.11		0.76	0.76	
Intersection Summary												
Cycle Length: 100												
Actuated Cycle Length: 100												
Offset: 2 (2%), Referenced to phase 2:NBT and 6:SBTL, Start of Green												
Natural Cycle: 75												
Control Type: Actuated-Coordinated												

Lanes, Volumes, Timings
3: Island Park & Scott

2027 Future Background
PM Peak Hour

Maximum v/c Ratio: 0.83	Intersection LOS: C
Intersection Signal Delay: 29.6	ICU Level of Service G
Intersection Capacity Utilization 106.4%	
Analysis Period (min) 15	
# 95th percentile volume exceeds capacity, queue may be longer.	
Queue shown is maximum after two cycles.	

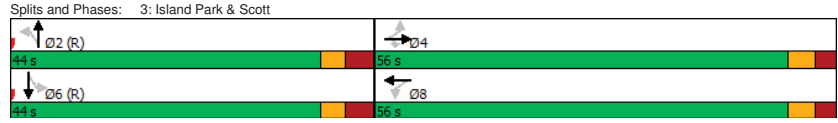

Lanes, Volumes, Timings
4: West Village/Lanark & Scott

2027 Future Background
PM Peak Hour

Lane Group	EBL	EBT	EBR	WBL	WBT	WBR	NBL	NBT	NBR	SBL	SBT	SBR
Lane Configurations	↖	↗		↖	↗		↖	↗		↖	↗	
Traffic Volume (vph)	90	392	20	13	607	36	6	0	4	55	1	44
Future Volume (vph)	90	392	20	13	607	36	6	0	4	55	1	44
Satd. Flow (prot)	1658	1728	0	1658	1716	0	1658	1395	0	1658	1358	0
Fit Permitted	0.388			0.518			0.728			0.755		
Satd. Flow (perm)	650	1728	0	885	1716	0	1188	1395	0	1264	1358	0
Satd. Flow (RTOR)		7			8			512			44	
Lane Group Flow (vph)	90	412	0	13	643	0	6	4	0	55	45	0
Turn Type	Perm	NA		Perm	NA		Perm	NA		Perm	NA	
Protected Phases		2			6			4			8	
Permitted Phases	2			6			4			8		
Detector Phase	2	2		6	6		4	4		8	8	
Switch Phase												
Minimum Initial (s)	10.0	10.0		10.0	10.0		10.0	10.0		10.0	10.0	
Minimum Split (s)	26.1	26.1		26.1	26.1		21.5	21.5		21.5	21.5	
Total Split (s)	78.0	78.0		78.0	78.0		22.0	22.0		22.0	22.0	
Total Split (%)	78.0%	78.0%		78.0%	78.0%		22.0%	22.0%		22.0%	22.0%	
Yellow Time (s)	3.3	3.3		3.3	3.3		3.3	3.3		3.3	3.3	
All-Red Time (s)	2.8	2.8		2.8	2.8		2.2	2.2		2.2	2.2	
Lost Time Adjust (s)	0.0	0.0		0.0	0.0		0.0	0.0		0.0	0.0	
Total Lost Time (s)	6.1	6.1		6.1	6.1		5.5	5.5		5.5	5.5	
Lead/Lag												
Lead-Lag Optimize?												
Recall Mode	C-Max	C-Max		C-Max	C-Max		None	None		None	None	
Act Effct Green (s)	80.3	80.3		80.3	80.3		12.4	12.4		12.4	12.4	
Actuated g/C Ratio	0.80	0.80		0.80	0.80		0.12	0.12		0.12	0.12	
v/c Ratio	0.17	0.30		0.02	0.47		0.04	0.01		0.35	0.22	
Control Delay	4.7	4.4		1.4	1.9		37.0	0.0		45.5	14.4	
Queue Delay	0.0	0.0		0.0	0.0		0.0	0.0		0.0	0.0	
Total Delay	4.7	4.4		1.4	1.9		37.0	0.0		45.5	14.4	
LOS	A	A		A	A		D	A		D	B	
Approach Delay		4.4			1.9			22.2			31.5	
Approach LOS		A			A			C			C	
Queue Length 50th (m)	3.5	17.5		0.1	9.4		1.1	0.0		10.2	0.2	
Queue Length 95th (m)	10.2	36.3		m0.3	m17.4		4.6	0.0		20.8	9.6	
Internal Link Dist (m)		332.8			217.8			81.9			75.1	
Turn Bay Length (m)	36.5			42.0			18.0			18.0		
Base Capacity (vph)	522	1389		710	1380		196	657		208	260	
Starvation Cap Reductn	0	0		0	0		0	0		0	0	
Spillback Cap Reductn	0	0		0	0		0	0		0	0	
Storage Cap Reductn	0	0		0	0		0	0		0	0	
Reduced v/c Ratio	0.17	0.30		0.02	0.47		0.03	0.01		0.26	0.17	

Intersection Summary												
Cycle Length: 100												
Actuated Cycle Length: 100												
Offset: 40 (40%), Referenced to phase 2:EBTL and 6:WBTL, Start of Green												
Natural Cycle: 60												
Control Type: Actuated-Coordinated												

Lanes, Volumes, Timings
4: West Village/Lanark & Scott

2027 Future Background
PM Peak Hour

Maximum v/c Ratio: 0.47	Intersection LOS: A
Intersection Signal Delay: 5.4	ICU Level of Service C
Intersection Capacity Utilization 71.0%	
Analysis Period (min) 15	
m Volume for 95th percentile queue is metered by upstream signal.	

Splits and Phases: 4: West Village/Lanark & Scott



HCM 2010 AWSC
5: Churchill & Lanark

2027 Future Background
PM Peak Hour

Intersection	
Intersection Delay, s/veh	7.4
Intersection LOS	A

Movement	WBL	WBR	NBT	NBR	SBL	SBT
Lane Configurations	↔	↔	↔	↔	↔	↔
Traffic Vol, veh/h	62	10	37	51	4	27
Future Vol, veh/h	62	10	37	51	4	27
Peak Hour Factor	1.00	1.00	1.00	1.00	1.00	1.00
Heavy Vehicles, %	6	2	2	4	2	2
Mvmt Flow	62	10	37	51	4	27
Number of Lanes	1	0	1	0	0	1

Approach	WB	NB	SB
Opposing Approach		SB	NB
Opposing Lanes	0	1	1
Conflicting Approach Left	NB		WB
Conflicting Lanes Left	1	0	1
Conflicting Approach Right	SB	WB	
Conflicting Lanes Right	1	1	0
HCM Control Delay	7.7	7.2	7.4
HCM LOS	A	A	A

Lane	NBLn1	WBLn1	SBLn1
Vol Left, %	0%	86%	13%
Vol Thru, %	42%	0%	87%
Vol Right, %	58%	14%	0%
Sign Control	Stop	Stop	Stop
Traffic Vol by Lane	88	72	31
LT Vol	0	62	4
Through Vol	37	0	27
RT Vol	51	10	0
Lane Flow Rate	88	72	31
Geometry Grp	1	1	1
Degree of Util (X)	0.091	0.086	0.036
Departure Headway (Hd)	3.736	4.297	4.153
Convergence, Y/N	Yes	Yes	Yes
Cap	952	831	856
Service Time	1.787	2.337	2.209
HCM Lane V/C Ratio	0.092	0.087	0.036
HCM Control Delay	7.2	7.7	7.4
HCM Lane LOS	A	A	A
HCM 95th-tile Q	0.3	0.3	0.1

Appendix J

Synchro Intersection Worksheets – 2032 Future Background Conditions

Lanes, Volumes, Timings

2032 Future Background

1: Island Park & Sir John A. Macdonald

AM Peak Hour



Lane Group	EBL	EBT	EBR	WBL	WBT	WBR	NBL	NBT	NBR	SBL	SBT	SBR
Lane Configurations	↔	↕	↔	↔	↕	↔	↔	↕	↔	↔	↕	↔
Traffic Volume (vph)	315	1331	55	105	377	94	0	307	182	78	802	597
Future Volume (vph)	315	1331	55	105	377	94	0	307	182	78	802	597
Satd. Flow (prot)	1658	3316	1483	1658	3316	1427	0	1650	0	3010	1623	0
Fit Permitted	0.950			0.950						0.950		
Satd. Flow (perm)	1658	3316	1483	1658	3316	1427	0	1650	0	3010	1623	0
Satd. Flow (RTOR)			101			101		20			32	
Lane Group Flow (vph)	315	1331	55	105	377	94	0	489	0	78	1399	0
Turn Type	Prot	NA	Perm	Prot	NA	Perm	NA	Prot	NA	Prot	NA	NA
Protected Phases	5	2		1	6			8		7	4	
Permitted Phases			2			6						
Detector Phase	5	2	2	1	6	6		8		7	4	
Switch Phase												
Minimum Initial (s)	5.0	15.0	15.0	5.0	15.0	15.0		10.0		5.0	10.0	
Minimum Split (s)	20.6	30.1	30.1	20.6	30.1	30.1		29.1		11.5	29.1	
Total Split (s)	35.6	41.1	41.1	35.6	41.1	41.1		61.1		26.5	61.1	
Total Split (%)	21.7%	25.0%	25.0%	21.7%	25.0%	25.0%		37.2%		16.1%	37.2%	
Yellow Time (s)	3.7	3.7	3.7	3.7	3.7	3.7		3.7		3.7	3.7	
All-Red Time (s)	1.9	2.4	2.4	1.9	2.4	2.4		2.4		2.8	2.4	
Lost Time Adjust (s)	0.0	0.0	0.0	0.0	0.0	0.0		0.0		0.0	0.0	
Total Lost Time (s)	5.6	6.1	6.1	5.6	6.1	6.1		6.1		6.5	6.1	
Lead/Lag	Lag	Lead	Lead	Lag	Lead	Lead		Lag		Lead		
Lead-Lag Optimize?	Yes	Yes	Yes	Yes	Yes	Yes		Yes		Yes		
Recall Mode	None	None	None	None	None	None		None		None	None	
Act Effct Green (s)	30.2	35.3	35.3	15.5	20.6	20.6		46.3		8.9	61.8	
Actuated g/C Ratio	0.23	0.27	0.27	0.12	0.16	0.16		0.35		0.07	0.47	
v/c Ratio	0.82	1.49	0.12	0.53	0.72	0.30		0.82		0.38	1.78	
Control Delay	67.2	259.5	0.7	65.5	61.4	10.6		49.7		65.8	382.6	
Queue Delay	0.0	0.0	0.0	0.0	0.0	0.0		0.0		0.0	0.0	
Total Delay	67.2	259.5	0.7	65.5	61.4	10.6		49.7		65.8	382.6	
LOS	E	F	A	E	E	B		D		E	F	
Approach Delay		215.5			53.9			49.7			365.9	
Approach LOS		F			D			D			F	
Queue Length 50th (m)	75.0	~239.8	0.0	25.0	47.5	0.0		109.4		9.7	~529.6	
Queue Length 95th (m)	#149.3	#343.7	0.7	47.7	71.9	13.9		167.9		20.0	#684.6	
Internal Link Dist (m)		762.8			208.9			249.0			153.3	
Turn Bay Length (m)	104.5		88.0	89.6						80.0		
Base Capacity (vph)	384	895	474	384	895	459		712		464	1032	
Starvation Cap Reductn	0	0	0	0	0	0		0		0	0	
Spillback Cap Reductn	0	0	0	0	0	0		0		0	0	
Storage Cap Reductn	0	0	0	0	0	0		0		0	0	
Reduced v/c Ratio	0.82	1.49	0.12	0.27	0.42	0.20		0.69		0.17	1.36	

Intersection Summary

Cycle Length: 164.3
Actuated Cycle Length: 130.5
Natural Cycle: 145
Control Type: Actuated-Uncoordinated
Maximum v/c Ratio: 1.78

Lanes, Volumes, Timings

2032 Future Background

1: Island Park & Sir John A. Macdonald

AM Peak Hour

Intersection Signal Delay: 226.8	Intersection LOS: F
Intersection Capacity Utilization 142.8%	ICU Level of Service H
Analysis Period (min) 15	
~ Volume exceeds capacity, queue is theoretically infinite.	
Queue shown is maximum after two cycles.	
# 95th percentile volume exceeds capacity, queue may be longer.	
Queue shown is maximum after two cycles.	

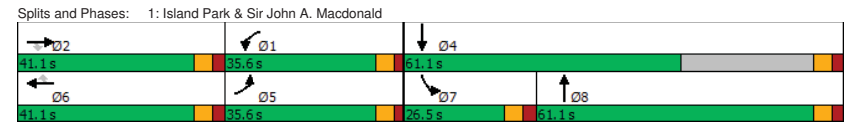

HCM 2010 TWSC
2: Island Park & Clearview

2032 Future Background
AM Peak Hour

Intersection													
Int Delay, s/veh	1.7												
Movement	EBL	EBT	EBR	WBL	WBT	WBR	NBL	NBT	NBR	SBL	SBT	SBR	
Lane Configurations	↔		↔		↔		↔		↔		↔		
Traffic Vol, veh/h	25	3	12	4	1	17	12	475	14	24	847	95	
Future Vol, veh/h	25	3	12	4	1	17	12	475	14	24	847	95	
Conflicting Peds, #/hr	4	0	0	0	0	4	6	0	1	1	0	6	
Sign Control	Stop	Stop	Stop	Stop	Stop	Stop	Free	Free	Free	Free	Free	Free	
RT Channelized	-	-	None	-	-	None	-	-	None	-	-	None	
Storage Length	-	-	-	-	-	-	-	-	-	-	-	-	
Veh in Median Storage, #	-	0	-	-	0	-	-	0	-	-	0	-	
Grade, %	-	0	-	-	0	-	-	0	-	-	0	-	
Peak Hour Factor	100	100	100	100	100	100	100	100	100	100	100	100	
Heavy Vehicles, %	2	33	2	2	100	2	2	2	7	2	2	2	
Mvmt Flow	25	3	12	4	1	17	12	475	14	24	847	95	
Major/Minor	Minor2	Minor1		Major1		Major2							
Conflicting Flow All	1468	1463	901	1457	1503	487	948	0	0	490	0	0	
Stage 1	949	949	-	507	507	-	-	-	-	-	-	-	
Stage 2	519	514	-	950	996	-	-	-	-	-	-	-	
Critical Hdwy	7.12	6.83	6.22	7.12	7.5	6.22	4.12	-	-	4.12	-	-	
Critical Hdwy Stg 1	6.12	5.83	-	6.12	6.5	-	-	-	-	-	-	-	
Critical Hdwy Stg 2	6.12	5.83	-	6.12	6.5	-	-	-	-	-	-	-	
Follow-up Hdwy	3.518	4.297	3.318	3.518	4.9	3.318	2.218	-	-	2.218	-	-	
Pot Cap-1 Maneuver	106	110	337	108	75	581	724	-	-	1073	-	-	
Stage 1	313	301	-	548	407	-	-	-	-	-	-	-	
Stage 2	540	488	-	312	222	-	-	-	-	-	-	-	
Platoon blocked, %	-	-	-	-	-	-	-	-	-	-	-	-	
Mov Cap-1 Maneuver	96	102	335	96	69	579	721	-	-	1072	-	-	
Mov Cap-2 Maneuver	96	102	-	96	69	-	-	-	-	-	-	-	
Stage 1	304	285	-	535	397	-	-	-	-	-	-	-	
Stage 2	509	476	-	283	210	-	-	-	-	-	-	-	
Approach	EB		WB		NB		SB						
HCM Control Delay, s	47.8		20.3		0.2		0.2						
HCM LOS	E		C										
Minor Lane/Major Mvmt	NBL	NBT	NBR	EBLn1	WBLn1	SBL	SBT	SBR					
Capacity (veh/h)	721	-	-	123	257	1072	-	-					
HCM Lane V/C Ratio	0.017	-	-	0.325	0.086	0.022	-	-					
HCM Control Delay (s)	10.1	0	-	47.8	20.3	8.4	0	-					
HCM Lane LOS	B	A	-	E	C	A	A	-					
HCM 95th %tile Q(veh)	0.1	-	-	1.3	0.3	0.1	-	-					

Lanes, Volumes, Timings
3: Island Park & Scott

2032 Future Background
AM Peak Hour

Lane Group	EBL	EBT	EBR	WBL	WBT	WBR	NBL	NBT	NBR	SBL	SBT	SBR
Lane Configurations	↔	↔	↔	↔	↔	↔	↔	↔	↔	↔	↔	↔
Traffic Volume (vph)	105	614	56	44	212	22	41	325	90	57	766	92
Future Volume (vph)	105	614	56	44	212	22	41	325	90	57	766	92
Satd. Flow (prot)	1658	1745	1483	1658	1648	0	0	1675	0	1658	1709	0
Fit Permitted	0.565		0.137				0.423		0.448			
Satd. Flow (perm)	942	1745	1423	238	1648	0	0	712	0	772	1709	0
Satd. Flow (RTOR)			40		6		18		9			
Lane Group Flow (vph)	105	614	56	44	234	0	0	456	0	57	858	0
Turn Type	Perm	NA	Perm	Perm	NA		Perm	NA		Perm	NA	
Protected Phases	4		8		8		2		6		6	
Permitted Phases	4		4		8		2		6		6	
Detector Phase	4		4		8		2		2		6	
Switch Phase												
Minimum Initial (s)	10.0	10.0	10.0	10.0	10.0		10.0	10.0		10.0	10.0	
Minimum Split (s)	34.8	34.8	34.8	34.8	34.8		34.5	34.5		34.5	34.5	
Total Split (s)	42.0	42.0	42.0	42.0	42.0		53.0	53.0		53.0	53.0	
Total Split (%)	44.2%	44.2%	44.2%	44.2%	44.2%		55.8%	55.8%		55.8%	55.8%	
Yellow Time (s)	3.3	3.3	3.3	3.3	3.3		3.0	3.0		3.0	3.0	
All-Red Time (s)	2.7	2.7	2.7	2.7	2.7		3.5	3.5		3.5	3.5	
Lost Time Adjust (s)	0.0	0.0	0.0	0.0	0.0		0.0	0.0		0.0	0.0	
Total Lost Time (s)	6.0	6.0	6.0	6.0	6.0		6.5	6.5		6.5	6.5	
Lead/Lag												
Lead-Lag Optimize?												
Recall Mode	Max	Max	Max	Max	Max		C-Max	C-Max		C-Max	C-Max	
Act Effct Green (s)	36.0	36.0	36.0	36.0	36.0		46.5	46.5		46.5	46.5	
Actuated g/C Ratio	0.38	0.38	0.38	0.38	0.38		0.49	0.49		0.49	0.49	
v/c Ratio	0.29	0.93	0.10	0.49	0.37		1.28	1.15		1.02	1.02	
Control Delay	20.3	45.9	7.7	44.5	22.9		169.6	14.8		61.8	61.8	
Queue Delay	0.0	0.0	0.0	0.0	0.0		0.0	0.0		0.0	0.0	
Total Delay	20.3	45.9	7.7	44.5	22.9		169.6	14.8		61.8	61.8	
LOS	C	D	A	D	C		F	B		E	E	
Approach Delay	39.6		26.3		169.6		58.9					
Approach LOS	D		C		F		E					
Queue Length 50th (m)	10.1	108.5	0.8	6.1	29.7		~105.5	5.5		~159.8	~159.8	
Queue Length 95th (m)	19.3	#169.3	m5.3	#21.1	48.8		#164.1	12.8		#238.9	#238.9	
Internal Link Dist (m)	211.2		266.0		304.9		415.7					
Turn Bay Length (m)	58.7		29.5		250.0		36.5					
Base Capacity (vph)	356	661	564	90	628		357	377		841	841	
Starvation Cap Reductn	0	0	0	0	0		0	0		0	0	
Spillback Cap Reductn	0	0	0	0	0		0	0		0	0	
Storage Cap Reductn	0	0	0	0	0		0	0		0	0	
Reduced v/c Ratio	0.29	0.93	0.10	0.49	0.37		1.28	1.15		1.02	1.02	
Intersection Summary												
Cycle Length: 95												
Actuated Cycle Length: 95												
Offset: 38 (40%), Referenced to phase 2:NBLT and 6:SBTL, Start of Green												
Natural Cycle: 100												
Control Type: Actuated-Coordinated												

Lanes, Volumes, Timings
3: Island Park & Scott

2032 Future Background
AM Peak Hour

Maximum v/c Ratio: 1.28	Intersection LOS: E
Intersection Signal Delay: 69.8	ICU Level of Service H
Intersection Capacity Utilization 119.0%	
Analysis Period (min) 15	
~ Volume exceeds capacity, queue is theoretically infinite.	
Queue shown is maximum after two cycles.	
# 95th percentile volume exceeds capacity, queue may be longer.	
Queue shown is maximum after two cycles.	
m Volume for 95th percentile queue is metered by upstream signal.	

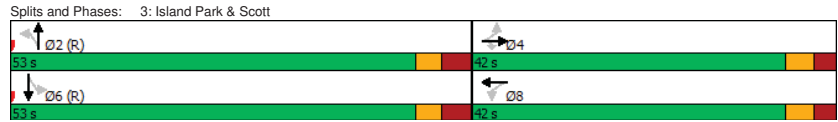

Lanes, Volumes, Timings
4: West Village/Lanark & Scott

2032 Future Background
AM Peak Hour

Lane Group	EBL	EBT	EBR	WBL	WBT	WBR	NBL	NBT	NBR	SBL	SBT	SBR
Lane Configurations	↔	↔	↔	↔	↔	↔	↔	↔	↔	↔	↔	↔
Traffic Volume (vph)	39	713	9	0	295	50	18	0	12	68	0	87
Future Volume (vph)	39	713	9	0	295	50	18	0	12	68	0	87
Satd. Flow (prot)	1610	1724	0	1745	1675	0	1658	1436	0	1658	1418	0
Fit Permitted	0.554						0.701			0.750		
Satd. Flow (perm)	920	1724	0	1745	1675	0	1204	1436	0	1294	1418	0
Satd. Flow (RTOR)		2			22			285				606
Lane Group Flow (vph)	39	722	0	0	345	0	18	12	0	68	87	0
Turn Type	Perm	NA		Perm	NA		Perm	NA		Perm	NA	
Protected Phases		2			6			4			8	
Permitted Phases	2			6			4			8		
Detector Phase	2	2		6	6		4	4		8	8	
Switch Phase												
Minimum Initial (s)	10.0	10.0		10.0	10.0		10.0	10.0		10.0	10.0	
Minimum Split (s)	26.1	26.1		26.1	26.1		21.5	21.5		21.5	21.5	
Total Split (s)	73.0	73.0		73.0	73.0		22.0	22.0		22.0	22.0	
Total Split (%)	76.8%	76.8%		76.8%	76.8%		23.2%	23.2%		23.2%	23.2%	
Yellow Time (s)	3.3	3.3		3.3	3.3		3.3	3.3		3.3	3.3	
All-Red Time (s)	2.8	2.8		2.8	2.8		2.2	2.2		2.2	2.2	
Lost Time Adjust (s)	0.0	0.0		0.0	0.0		0.0	0.0		0.0	0.0	
Total Lost Time (s)	6.1	6.1		6.1	6.1		5.5	5.5		5.5	5.5	
Lead/Lag												
Lead-Lag Optimize?												
Recall Mode	C-Max	C-Max		C-Max	C-Max		None	None		None	None	
Act Effct Green (s)	76.0	76.0		76.0	76.0		11.7	11.7		11.7	11.7	
Actuated g/C Ratio	0.80	0.80		0.80	0.80		0.12	0.12		0.12	0.12	
v/c Ratio	0.05	0.52		0.26	0.26		0.12	0.03		0.43	0.12	
Control Delay	3.7	6.5		2.9	2.9		37.6	0.1		46.4	0.4	
Queue Delay	0.0	0.0		0.0	0.0		0.0	0.0		0.0	0.0	
Total Delay	3.7	6.5		2.9	2.9		37.6	0.1		46.4	0.4	
LOS	A	A		A	A		D	A		D	A	
Approach Delay		6.3			2.9			22.6			20.6	
Approach LOS		A			A			C			C	
Queue Length 50th (m)	1.4	41.6			10.0		3.1	0.0		11.9	0.0	
Queue Length 95th (m)	4.7	84.8			m17.1		8.9	0.0		23.6	0.0	
Internal Link Dist (m)		332.8			211.2			80.9			82.5	
Turn Bay Length (m)	36.5							18.0			18.0	
Base Capacity (vph)	736	1380			1344		209	484		224	747	
Starvation Cap Reductn	0	0			0		0	0		0	0	
Spillback Cap Reductn	0	0			0		0	0		0	0	
Storage Cap Reductn	0	0			0		0	0		0	0	
Reduced v/c Ratio	0.05	0.52			0.26		0.09	0.02		0.30	0.12	

Intersection Summary												
Cycle Length: 95												
Actuated Cycle Length: 95												
Offset: 83 (87%), Referenced to phase 2:EBTL and 6:WBTL, Start of Green												
Natural Cycle: 60												
Control Type: Actuated-Coordinated												

Lanes, Volumes, Timings
4: West Village/Lanark & Scott

2032 Future Background
AM Peak Hour

Maximum v/c Ratio: 0.52	Intersection LOS: A
Intersection Signal Delay: 7.5	ICU Level of Service B
Intersection Capacity Utilization 61.0%	
Analysis Period (min) 15	
m Volume for 95th percentile queue is metered by upstream signal.	

Splits and Phases: 4: West Village/Lanark & Scott



HCM 2010 AWSC
5: Churchill & Lanark

2032 Future Background
AM Peak Hour

Intersection	
Intersection Delay, s/veh	7.8
Intersection LOS	A

Movement	WBL	WBR	NBT	NBR	SBL	SBT
Lane Configurations	↔	↔	↔	↔	↔	↔
Traffic Vol, veh/h	111	3	24	45	6	47
Future Vol, veh/h	111	3	24	45	6	47
Peak Hour Factor	1.00	1.00	1.00	1.00	1.00	1.00
Heavy Vehicles, %	2	33	8	13	2	2
Mvmt Flow	111	3	24	45	6	47
Number of Lanes	1	0	1	0	0	1

Approach	WB	NB	SB
Opposing Approach		SB	NB
Opposing Lanes	0	1	1
Conflicting Approach Left	NB		WB
Conflicting Lanes Left	1	0	1
Conflicting Approach Right	SB	WB	
Conflicting Lanes Right	1	1	0
HCM Control Delay	8.1	7.3	7.6
HCM LOS	A	A	A

Lane	NBLn1	WBLn1	SBLn1
Vol Left, %	0%	97%	11%
Vol Thru, %	35%	0%	89%
Vol Right, %	65%	3%	0%
Sign Control	Stop	Stop	Stop
Traffic Vol by Lane	69	114	53
LT Vol	0	111	6
Through Vol	24	0	47
RT Vol	45	3	0
Lane Flow Rate	69	114	53
Geometry Grp	1	1	1
Degree of Util (X)	0.074	0.137	0.062
Departure Headway (Hd)	3.884	4.322	4.209
Convergence, Y/N	Yes	Yes	Yes
Cap	908	824	840
Service Time	1.969	2.376	2.293
HCM Lane V/C Ratio	0.076	0.138	0.063
HCM Control Delay	7.3	8.1	7.6
HCM Lane LOS	A	A	A
HCM 95th-tile Q	0.2	0.5	0.2

Lanes, Volumes, Timings

2032 Future Background

1: Island Park & Sir John A. Macdonald

PM Peak Hour



Lane Group	EBL	EBT	EBR	WBL	WBT	WBR	NBL	NBT	NBR	SBL	SBT	SBR
Lane Configurations	↔	↕	↔	↔	↕	↔		↕	↔	↔	↕	↔
Traffic Volume (vph)	396	921	67	96	1176	1183	0	511	43	98	384	491
Future Volume (vph)	396	921	67	96	1176	1183	0	511	43	98	384	491
Satd. Flow (prot)	1658	3316	1483	1658	3283	1483	0	1723	0	3038	1599	0
Fit Permitted	0.950			0.950						0.950		
Satd. Flow (perm)	1656	3316	1439	1653	3283	1444	0	1723	0	2997	1599	0
Satd. Flow (RTOR)			101			296			3			56
Lane Group Flow (vph)	396	921	67	96	1176	1183	0	554	0	98	875	0
Turn Type	Prot	NA	Perm	Prot	NA	Perm	NA	NA	Prot	NA	NA	NA
Protected Phases	5	2		1	6			8		7	4	
Permitted Phases			2			6						
Detector Phase	5	2	2	1	6	6		8		7	4	
Switch Phase												
Minimum Initial (s)	5.0	15.0	15.0	5.0	15.0	15.0		10.0		5.0	10.0	
Minimum Split (s)	20.6	30.1	30.1	20.6	30.1	30.1		29.1		11.5	29.1	
Total Split (s)	35.6	41.1	41.1	35.6	41.1	41.1		61.1		26.5	61.1	
Total Split (%)	21.7%	25.0%	25.0%	21.7%	25.0%	25.0%		37.2%		16.1%	37.2%	
Yellow Time (s)	3.7	3.7	3.7	3.7	3.7	3.7		3.7		3.7	3.7	
All-Red Time (s)	1.9	2.4	2.4	1.9	2.4	2.4		2.4		2.8	2.4	
Lost Time Adjust (s)	0.0	0.0	0.0	0.0	0.0	0.0		0.0		0.0	0.0	
Total Lost Time (s)	5.6	6.1	6.1	5.6	6.1	6.1		6.1		6.5	6.1	
Lead/Lag	Lag	Lead	Lead	Lag	Lead	Lead		Lag		Lead		
Lead-Lag Optimize?	Yes	Yes	Yes	Yes	Yes	Yes		Yes		Yes		
Recall Mode	None	None	None	None	None	None		None		None	None	
Act Effct Green (s)	30.0	35.0	35.0	30.0	35.0	35.0		52.7		10.3	69.5	
Actuated g/C Ratio	0.20	0.23	0.23	0.20	0.23	0.23		0.35		0.07	0.46	
v/c Ratio	1.21	1.21	0.16	0.29	1.56	2.12		0.93		0.48	1.15	
Control Delay	170.8	154.5	3.2	56.3	295.7	529.1		70.6		77.0	119.2	
Queue Delay	0.0	0.0	0.0	0.0	0.0	0.0		0.0		0.0	0.0	
Total Delay	170.8	154.5	3.2	56.3	295.7	529.1		70.6		77.0	119.2	
LOS	F	F	A	E	F	F		E		E	F	
Approach Delay		151.9			398.8			70.6			114.9	
Approach LOS		F			F			E			F	
Queue Length 50th (m)	~149.6	~182.6	0.0	25.5	~269.3	~506.2		160.5		15.2	~301.9	
Queue Length 95th (m)	#220.3	#231.0	4.2	44.2	#320.0	#600.0		#235.9		25.1	#382.5	
Internal Link Dist (m)		750.5			213.6			249.0			157.7	
Turn Bay Length (m)	104.5		88.0	89.6						80.0		
Base Capacity (vph)	326	762	408	326	755	559		624		399	882	
Starvation Cap Reductn	0	0	0	0	0	0		0		0	0	
Spillback Cap Reductn	0	0	0	0	0	0		0		0	0	
Storage Cap Reductn	0	0	0	0	0	0		0		0	0	
Reduced v/c Ratio	1.21	1.21	0.16	0.29	1.56	2.12		0.89		0.25	0.99	

Intersection Summary

Cycle Length: 164.3
 Actuated Cycle Length: 152.4
 Natural Cycle: 145
 Control Type: Actuated-Uncoordinated
 Maximum v/c Ratio: 2.12

Lanes, Volumes, Timings

2032 Future Background

1: Island Park & Sir John A. Macdonald

PM Peak Hour

Intersection Signal Delay: 249.8
 Intersection LOS: F
 Intersection Capacity Utilization 146.7%
 ICU Level of Service H
 Analysis Period (min) 15
 ~ Volume exceeds capacity, queue is theoretically infinite.
 Queue shown is maximum after two cycles.
 # 95th percentile volume exceeds capacity, queue may be longer.
 Queue shown is maximum after two cycles.

Splits and Phases: 1: Island Park & Sir John A. Macdonald

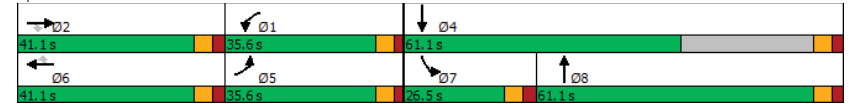

HCM 2010 TWSC
2: Island Park & Clearview

2032 Future Background
PM Peak Hour

Intersection												
Int Delay, s/veh	1.8											
Movement	EBL	EBT	EBR	WBL	WBT	WBR	NBL	NBT	NBR	SBL	SBT	SBR
Lane Configurations	↔		↔		↔		↔		↔		↔	
Traffic Vol, veh/h	27	3	9	5	5	50	2	474	1	12	509	46
Future Vol, veh/h	27	3	9	5	5	50	2	474	1	12	509	46
Conflicting Peds, #/hr	8	0	0	0	0	8	3	0	6	6	0	3
Sign Control	Stop	Stop	Stop	Stop	Stop	Free	Free	Free	Free	Free	Free	Free
RT Channelized	-	-	None	-	-	None	-	-	None	-	-	None
Storage Length	-	-	-	-	-	-	-	-	-	-	-	-
Veh in Median Storage, #	-	0	-	-	0	-	-	0	-	-	0	-
Grade, %	-	0	-	-	0	-	-	0	-	-	0	-
Peak Hour Factor	100	100	100	100	100	100	100	100	100	100	100	100
Heavy Vehicles, %	2	67	2	20	20	2	2	2	2	8	2	2
Mvmt Flow	27	3	9	5	5	50	2	474	1	12	509	46
Major/Minor	Minor2	Minor1	Major1	Major2								
Conflicting Flow All	1073	1044	535	1047	1067	489	558	0	0	481	0	0
Stage 1	559	559	-	485	485	-	-	-	-	-	-	-
Stage 2	514	485	-	562	582	-	-	-	-	-	-	-
Critical Hdwy	7.12	7.17	6.22	7.3	6.7	6.22	4.12	-	-	4.18	-	-
Critical Hdwy Stg 1	6.12	6.17	-	6.3	5.7	-	-	-	-	-	-	-
Critical Hdwy Stg 2	6.12	6.17	-	6.3	5.7	-	-	-	-	-	-	-
Follow-up Hdwy	3.518	4.603	3.318	3.68	4.18	3.318	2.218	-	-	2.272	-	-
Pot Cap-1 Maneuver	198	177	545	191	206	579	1013	-	-	1051	-	-
Stage 1	513	420	-	531	523	-	-	-	-	-	-	-
Stage 2	543	457	-	481	471	-	-	-	-	-	-	-
Platoon blocked, %	-	-	-	-	-	-	-	-	-	-	-	-
Mov Cap-1 Maneuver	173	172	544	182	200	573	1011	-	-	1046	-	-
Mov Cap-2 Maneuver	173	172	-	182	200	-	-	-	-	-	-	-
Stage 1	510	412	-	527	519	-	-	-	-	-	-	-
Stage 2	486	453	-	462	462	-	-	-	-	-	-	-
Approach	EB	WB	NB	SB								
HCM Control Delay, s	26.6	14.8	0	0.2								
HCM LOS	D	B										
Minor Lane/Major Mvmt	NBL	NBT	NBR	EBLn1	WBLn1	SBL	SBT	SBR				
Capacity (veh/h)	1011	-	-	205	429	1046	-	-				
HCM Lane V/C Ratio	0.002	-	-	0.19	0.14	0.011	-	-				
HCM Control Delay (s)	8.6	0	-	26.6	14.8	8.5	0	-				
HCM Lane LOS	A	A	-	D	B	A	A	-				
HCM 95th %tile Q(veh)	0	-	-	0.7	0.5	0	-	-				

Lanes, Volumes, Timings
3: Island Park & Scott

2032 Future Background
PM Peak Hour



Lane Group	EBL	EBT	EBR	WBL	WBT	WBR	NBL	NBT	NBR	SBL	SBT	SBR
Lane Configurations	↔	↔	↔	↔	↔	↔	↔	↔	↔	↔	↔	↔
Traffic Volume (vph)	105	308	42	192	604	101	23	439	21	27	447	73
Future Volume (vph)	105	308	42	192	604	101	23	439	21	27	447	73
Satd. Flow (prot)	1658	1712	1483	1658	1664	0	0	1727	0	1658	1693	0
Fit Permitted	0.189			0.523				0.816		0.352		
Satd. Flow (perm)	330	1712	1391	890	1664	0	0	1411	0	607	1693	0
Satd. Flow (RTOR)			42		12			3				9
Lane Group Flow (vph)	105	308	42	192	705	0	0	483	0	27	520	0
Turn Type	Perm	NA	Perm	Perm	NA		Perm	NA		Perm	NA	
Protected Phases			4		8			2			6	
Permitted Phases	4		4	8			2				6	
Detector Phase	4	4	4	8	8		2	2		6	6	
Switch Phase												
Minimum Initial (s)	10.0	10.0	10.0	10.0	10.0		10.0	10.0		10.0	10.0	
Minimum Split (s)	34.8	34.8	34.8	34.8	34.8		34.5	34.5		34.5	34.5	
Total Split (s)	56.0	56.0	56.0	56.0	56.0		44.0	44.0		44.0	44.0	
Total Split (%)	56.0%	56.0%	56.0%	56.0%	56.0%		44.0%	44.0%		44.0%	44.0%	
Yellow Time (s)	3.3	3.3	3.3	3.3	3.3		3.0	3.0		3.0	3.0	
All-Red Time (s)	2.7	2.7	2.7	2.7	2.7		3.5	3.5		3.5	3.5	
Lost Time Adjust (s)	0.0	0.0	0.0	0.0	0.0		0.0	0.0		0.0	0.0	
Total Lost Time (s)	6.0	6.0	6.0	6.0	6.0		6.5	6.5		6.5	6.5	
Lead/Lag												
Lead-Lag Optimize?												
Recall Mode	Max	Max	Max	Max	Max		C-Max	C-Max		C-Max	C-Max	
Act Effct Green (s)	50.0	50.0	50.0	50.0	50.0		37.5	37.5		37.5	37.5	
Actuated g/C Ratio	0.50	0.50	0.50	0.50	0.50		0.38	0.38		0.38	0.38	
v/c Ratio	0.64	0.36	0.06	0.43	0.84		0.91	0.12		0.81	0.12	
Control Delay	36.1	13.9	3.0	19.8	32.4		53.1	22.3		39.5	22.3	
Queue Delay	0.0	0.0	0.0	0.0	0.0		0.0	0.0		0.0	0.0	
Total Delay	36.1	13.9	3.0	19.8	32.4		53.1	22.3		39.5	22.3	
LOS	D	B	A	B	C		D	C		D	D	
Approach Delay	18.0				29.7		53.1				38.6	
Approach LOS	B				C		D				D	
Queue Length 50th (m)	15.7	27.4	0.0	22.8	111.5		87.0			3.4	87.9	
Queue Length 95th (m)	#42.1	38.1	2.5	41.3	#181.9		#148.3			9.4	#141.3	
Internal Link Dist (m)		217.8			273.2		304.9				417.3	
Turn Bay Length (m)	58.7			29.5	250.0					36.5		
Base Capacity (vph)	165	856	716	445	838		531			227	640	
Starvation Cap Reductn	0	0	0	0	0		0			0	0	
Spillback Cap Reductn	0	0	0	0	0		0			0	0	
Storage Cap Reductn	0	0	0	0	0		0			0	0	
Reduced v/c Ratio	0.64	0.36	0.06	0.43	0.84		0.91	0.12		0.81	0.12	

Intersection Summary												
Cycle Length: 100												
Actuated Cycle Length: 100												
Offset: 2 (2%), Referenced to phase 2:NBT and 6:SBL, Start of Green												
Natural Cycle: 80												
Control Type: Actuated-Coordinated												

Lanes, Volumes, Timings
3: Island Park & Scott

2032 Future Background
PM Peak Hour

Maximum v/c Ratio: 0.91	Intersection LOS: C
Intersection Signal Delay: 34.3	ICU Level of Service H
Intersection Capacity Utilization 110.1%	
Analysis Period (min) 15	
# 95th percentile volume exceeds capacity, queue may be longer.	
Queue shown is maximum after two cycles.	

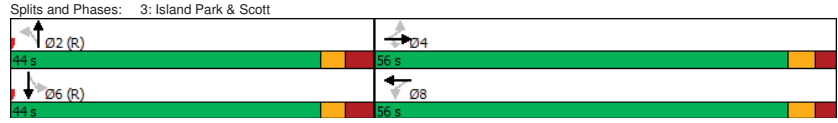

Lanes, Volumes, Timings
4: West Village/Lanark & Scott

2032 Future Background
PM Peak Hour

Lane Group	EBL	EBT	EBR	WBL	WBT	WBR	NBL	NBT	NBR	SBL	SBT	SBR
Lane Configurations	↖	↗		↖	↗		↖	↗		↖	↗	↖
Traffic Volume (vph)	90	396	20	13	663	36	6	0	4	55	1	44
Future Volume (vph)	90	396	20	13	663	36	6	0	4	55	1	44
Satd. Flow (prot)	1658	1728	0	1658	1717	0	1658	1395	0	1658	1358	0
Fit Permitted	0.359			0.515			0.728			0.755		
Satd. Flow (perm)	605	1728	0	880	1717	0	1188	1395	0	1264	1358	0
Satd. Flow (RTOR)		6		7			508			44		
Lane Group Flow (vph)	90	416	0	13	699	0	6	4	0	55	45	0
Turn Type	Perm	NA		Perm	NA		Perm	NA		Perm	NA	
Protected Phases		2		6			4			8		8
Permitted Phases	2			6			4			8		8
Detector Phase	2	2		6	6		4	4		8	8	
Switch Phase												
Minimum Initial (s)	10.0	10.0		10.0	10.0		10.0	10.0		10.0	10.0	
Minimum Split (s)	26.1	26.1		26.1	26.1		21.5	21.5		21.5	21.5	
Total Split (s)	78.0	78.0		78.0	78.0		22.0	22.0		22.0	22.0	
Total Split (%)	78.0%	78.0%		78.0%	78.0%		22.0%	22.0%		22.0%	22.0%	
Yellow Time (s)	3.3	3.3		3.3	3.3		3.3	3.3		3.3	3.3	
All-Red Time (s)	2.8	2.8		2.8	2.8		2.2	2.2		2.2	2.2	
Lost Time Adjust (s)	0.0	0.0		0.0	0.0		0.0	0.0		0.0	0.0	
Total Lost Time (s)	6.1	6.1		6.1	6.1		5.5	5.5		5.5	5.5	
Lead/Lag												
Lead-Lag Optimize?												
Recall Mode	C-Max	C-Max		C-Max	C-Max		None	None		None	None	
Act Effct Green (s)	80.3	80.3		80.3	80.3		12.4	12.4		12.4	12.4	
Actuated g/C Ratio	0.80	0.80		0.80	0.80		0.12	0.12		0.12	0.12	
v/c Ratio	0.19	0.30		0.02	0.51		0.04	0.01		0.35	0.22	
Control Delay	4.9	4.4		1.3	1.9		37.0	0.0		45.5	14.4	
Queue Delay	0.0	0.0		0.0	0.0		0.0	0.0		0.0	0.0	
Total Delay	4.9	4.4		1.3	1.9		37.0	0.0		45.5	14.4	
LOS	A	A		A	A		D	A		D	B	
Approach Delay		4.5			1.8			22.2			31.5	
Approach LOS		A			A			C			C	
Queue Length 50th (m)	3.5	17.7		0.2	9.2		1.1	0.0		10.2	0.2	
Queue Length 95th (m)	10.5	36.9		m0.3	m17.2		4.6	0.0		20.8	9.6	
Internal Link Dist (m)		332.8			217.8			81.9			75.1	
Turn Bay Length (m)	36.5			42.0			18.0			18.0		
Base Capacity (vph)	486	1389		706	1380		196	654		208	260	
Starvation Cap Reductn	0	0		0	0		0	0		0	0	
Spillback Cap Reductn	0	0		0	0		0	0		0	0	
Storage Cap Reductn	0	0		0	0		0	0		0	0	
Reduced v/c Ratio	0.19	0.30		0.02	0.51		0.03	0.01		0.26	0.17	

Intersection Summary												
Cycle Length: 100												
Actuated Cycle Length: 100												
Offset: 40 (40%), Referenced to phase 2:EBTL and 6:WBTL, Start of Green												
Natural Cycle: 60												
Control Type: Actuated-Coordinated												

Lanes, Volumes, Timings
4: West Village/Lanark & Scott

2032 Future Background
PM Peak Hour

Maximum v/c Ratio: 0.51	Intersection LOS: A
Intersection Signal Delay: 5.2	ICU Level of Service D
Intersection Capacity Utilization 74.1%	
Analysis Period (min) 15	

m Volume for 95th percentile queue is metered by upstream signal.

Splits and Phases: 4: West Village/Lanark & Scott



HCM 2010 AWSC
5: Churchill & Lanark

2032 Future Background
PM Peak Hour

Intersection	
Intersection Delay, s/veh	7.4
Intersection LOS	A

Movement	WBL	WBR	NBT	NBR	SBL	SBT
Lane Configurations	↔	↔	↔	↔	↔	↔
Traffic Vol, veh/h	62	10	37	52	4	27
Future Vol, veh/h	62	10	37	52	4	27
Peak Hour Factor	1.00	1.00	1.00	1.00	1.00	1.00
Heavy Vehicles, %	6	2	2	4	2	2
Mvmt Flow	62	10	37	52	4	27
Number of Lanes	1	0	1	0	0	1

Approach	WB	NB	SB
Opposing Approach		SB	NB
Opposing Lanes	0	1	1
Conflicting Approach Left	NB		WB
Conflicting Lanes Left	1	0	1
Conflicting Approach Right	SB	WB	
Conflicting Lanes Right	1	1	0
HCM Control Delay	7.7	7.2	7.4
HCM LOS	A	A	A

Lane	NBLn1	WBLn1	SBLn1
Vol Left, %	0%	86%	13%
Vol Thru, %	42%	0%	87%
Vol Right, %	58%	14%	0%
Sign Control	Stop	Stop	Stop
Traffic Vol by Lane	89	72	31
LT Vol	0	62	4
Through Vol	37	0	27
RT Vol	52	10	0
Lane Flow Rate	89	72	31
Geometry Grp	1	1	1
Degree of Util (X)	0.092	0.086	0.036
Departure Headway (Hd)	3.733	4.299	4.154
Convergence, Y/N	Yes	Yes	Yes
Cap	952	831	856
Service Time	1.784	2.339	2.21
HCM Lane V/C Ratio	0.093	0.087	0.036
HCM Control Delay	7.2	7.7	7.4
HCM Lane LOS	A	A	A
HCM 95th-tile Q	0.3	0.3	0.1

Appendix K

Synchro Intersection Worksheets – 2027 Future Total Conditions

Lanes, Volumes, Timings
1: Island Park & Sir John A. Macdonald

2027 Future Total
AM Peak Hour

Lane Group	EBL	EBT	EBR	WBL	WBT	WBR	NBL	NBT	NBR	SBL	SBT	SBR
Lane Configurations	↔	↕	↔	↔	↕	↔	↔	↕	↔	↔	↕	↔
Traffic Volume (vph)	315	1299	55	106	346	94	0	285	185	78	772	597
Future Volume (vph)	315	1299	55	106	346	94	0	285	185	78	772	597
Satd. Flow (prot)	1658	3316	1483	1658	3316	1427	0	1644	0	3010	1621	0
Fit Permitted	0.950			0.950						0.950		
Satd. Flow (perm)	1658	3316	1483	1658	3316	1427	0	1644	0	3010	1621	0
Satd. Flow (RTOR)			101			101		21			34	
Lane Group Flow (vph)	315	1299	55	106	346	94	0	470	0	78	1369	0
Turn Type	Prot	NA	Perm	Prot	NA	Perm	NA	NA	Prot	NA	NA	
Protected Phases	5	2		1	6			8		7	4	
Permitted Phases			2			6						
Detector Phase	5	2	2	1	6	6		8		7	4	
Switch Phase												
Minimum Initial (s)	5.0	15.0	15.0	5.0	15.0	15.0		10.0		5.0	10.0	
Minimum Split (s)	20.6	30.1	30.1	20.6	30.1	30.1		29.1		11.5	29.1	
Total Split (s)	35.6	41.1	41.1	35.6	41.1	41.1		61.1		26.5	61.1	
Total Split (%)	21.7%	25.0%	25.0%	21.7%	25.0%	25.0%		37.2%		16.1%	37.2%	
Yellow Time (s)	3.7	3.7	3.7	3.7	3.7	3.7		3.7		3.7	3.7	
All-Red Time (s)	1.9	2.4	2.4	1.9	2.4	2.4		2.4		2.8	2.4	
Lost Time Adjust (s)	0.0	0.0	0.0	0.0	0.0	0.0		0.0		0.0	0.0	
Total Lost Time (s)	5.6	6.1	6.1	5.6	6.1	6.1		6.1		6.5	6.1	
Lead/Lag	Lag	Lead	Lead	Lag	Lead	Lead		Lag		Lead		
Lead-Lag Optimize?	Yes	Yes	Yes	Yes	Yes	Yes		Yes		Yes		
Recall Mode	None	None	None	None	None	None		None		None	None	
Act Effct Green (s)	30.2	35.2	35.2	14.2	19.3	19.3		44.9		8.9	60.3	
Actuated g/C Ratio	0.24	0.28	0.28	0.11	0.15	0.15		0.35		0.07	0.47	
v/c Ratio	0.81	1.42	0.11	0.58	0.69	0.31		0.79		0.38	1.75	
Control Delay	63.9	230.8	0.6	67.7	59.8	10.9		47.3		64.0	367.2	
Queue Delay	0.0	0.0	0.0	0.0	0.0	0.0		0.0		0.0	0.0	
Total Delay	63.9	230.8	0.6	67.7	59.8	10.9		47.3		64.0	367.2	
LOS	E	F	A	E	E	B		D		E	F	
Approach Delay		191.7			52.9			47.3			350.9	
Approach LOS		F			D			D			F	
Queue Length 50th (m)	70.6	~216.0	0.0	24.4	41.6	0.0		100.5		9.3	~495.0	
Queue Length 95th (m)	#146.7	#328.1	0.7	48.3	66.2	13.9		156.0		19.7	#655.5	
Internal Link Dist (m)		762.8			208.9			249.0			151.1	
Turn Bay Length (m)	104.5		88.0	89.6						80.0		
Base Capacity (vph)	391	915	482	391	915	466		724		474	1053	
Starvation Cap Reductn	0	0	0	0	0	0		0		0	0	
Spillback Cap Reductn	0	0	0	0	0	0		0		0	0	
Storage Cap Reductn	0	0	0	0	0	0		0		0	0	
Reduced v/c Ratio	0.81	1.42	0.11	0.27	0.38	0.20		0.65		0.16	1.30	

Intersection Summary	
Cycle Length:	164.3
Actuated Cycle Length:	127.7
Natural Cycle:	145
Control Type:	Actuated-Uncoordinated
Maximum v/c Ratio:	1.75

Lanes, Volumes, Timings
1: Island Park & Sir John A. Macdonald

2027 Future Total
AM Peak Hour

Intersection Signal Delay: 212.7	Intersection LOS: F
Intersection Capacity Utilization 140.3%	ICU Level of Service H
Analysis Period (min) 15	
~ Volume exceeds capacity, queue is theoretically infinite.	
Queue shown is maximum after two cycles.	
# 95th percentile volume exceeds capacity, queue may be longer.	
Queue shown is maximum after two cycles.	

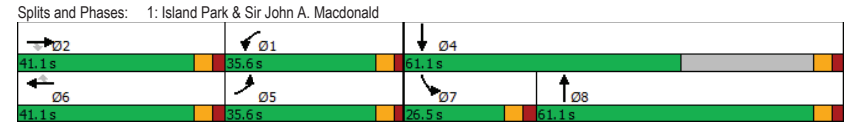

HCM 2010 TWSC
2: Island Park & Clearview

2027 Future Total
AM Peak Hour

Intersection												
Int Delay, s/veh	2											
Movement	EBL	EBT	EBR	WBL	WBT	WBR	NBL	NBT	NBR	SBL	SBT	SBR
Lane Configurations	↔		↔		↔		↔		↔		↔	
Traffic Vol, veh/h	28	3	19	4	1	17	15	441	14	24	816	96
Future Vol, veh/h	28	3	19	4	1	17	15	441	14	24	816	96
Conflicting Peds, #/hr	4	0	0	0	0	4	6	0	1	1	0	6
Sign Control	Stop	Stop	Stop	Stop	Stop	Stop	Free	Free	Free	Free	Free	Free
RT Channelized	-	-	None	-	-	None	-	-	None	-	-	None
Storage Length	-	-	-	-	-	-	-	-	-	-	-	-
Veh in Median Storage, #	-	0	-	-	0	-	-	0	-	-	0	-
Grade, %	-	0	-	-	0	-	-	0	-	-	0	-
Peak Hour Factor	100	100	100	100	100	100	100	100	100	100	100	100
Heavy Vehicles, %	2	33	2	2	100	2	2	2	7	2	2	2
Mvmt Flow	28	3	19	4	1	17	15	441	14	24	816	96
Major/Minor	Minor2	Minor1	Major1	Major2								
Conflicting Flow All	1409	1404	870	1402	1445	453	918	0	0	456	0	0
Stage 1	918	918	-	479	479	-	-	-	-	-	-	-
Stage 2	491	486	-	923	966	-	-	-	-	-	-	-
Critical Hdwy	7.12	6.83	6.22	7.12	7.5	6.22	4.12	-	-	4.12	-	-
Critical Hdwy Stg 1	6.12	5.83	-	6.12	6.5	-	-	-	-	-	-	-
Critical Hdwy Stg 2	6.12	5.83	-	6.12	6.5	-	-	-	-	-	-	-
Follow-up Hdwy	3.518	4.297	3.318	3.518	4.9	3.318	2.218	-	-	2.218	-	-
Pot Cap-1 Maneuver	116	120	351	117	83	607	743	-	-	1105	-	-
Stage 1	326	312	-	568	421	-	-	-	-	-	-	-
Stage 2	559	503	-	323	231	-	-	-	-	-	-	-
Platoon blocked, %	-	-	-	-	-	-	-	-	-	-	-	-
Mov Cap-1 Maneuver	105	111	349	102	77	605	740	-	-	1104	-	-
Mov Cap-2 Maneuver	105	111	-	102	77	-	-	-	-	-	-	-
Stage 1	316	296	-	552	409	-	-	-	-	-	-	-
Stage 2	526	489	-	289	219	-	-	-	-	-	-	-
Approach	EB	WB	NB	SB								
HCM Control Delay, s	42.7	19.3	0.3	0.2								
HCM LOS	E	C										
Minor Lane/Major Mvmt	NBL	NBT	NBR	EBLn1	WBLn1	SBL	SBT	SBR				
Capacity (veh/h)	740	-	-	144	274	1104	-	-				
HCM Lane V/C Ratio	0.02	-	-	0.347	0.08	0.022	-	-				
HCM Control Delay (s)	10	0	-	42.7	19.3	8.3	0	-				
HCM Lane LOS	A	A	-	E	C	A	A	-				
HCM 95th %tile Q(veh)	0.1	-	-	1.4	0.3	0.1	-	-				

Lanes, Volumes, Timings
3: Island Park & Scott

2027 Future Total
AM Peak Hour

Lane Group	EBL	EBT	EBR	WBL	WBT	WBR	NBL	NBT	NBR	SBL	SBT	SBR
Lane Configurations	↔	↔	↔	↔	↔	↔	↔	↔	↔	↔	↔	↔
Traffic Volume (vph)	106	563	56	44	209	23	41	303	90	59	741	94
Future Volume (vph)	106	563	56	44	209	23	41	303	90	59	741	94
Satd. Flow (prot)	1658	1745	1483	1658	1646	0	0	1671	0	1658	1707	0
Fit Permitted	0.567			0.191				0.462		0.462		
Satd. Flow (perm)	945	1745	1423	332	1646	0	0	776	0	796	1707	0
Satd. Flow (RTOR)			40		7			19				9
Lane Group Flow (vph)	106	563	56	44	232	0	0	434	0	59	835	0
Turn Type	Perm	NA	Perm	Perm	NA		Perm	NA		Perm	NA	
Protected Phases		4			8			2			6	
Permitted Phases	4		4	8			2				6	
Detector Phase	4	4	4	8	8		2	2		6	6	
Switch Phase												
Minimum Initial (s)	10.0	10.0	10.0	10.0	10.0		10.0	10.0		10.0	10.0	
Minimum Split (s)	34.8	34.8	34.8	34.8	34.8		34.5	34.5		34.5	34.5	
Total Split (s)	42.0	42.0	42.0	42.0	42.0		53.0	53.0		53.0	53.0	
Total Split (%)	44.2%	44.2%	44.2%	44.2%	44.2%		55.8%	55.8%		55.8%	55.8%	
Yellow Time (s)	3.3	3.3	3.3	3.3	3.3		3.0	3.0		3.0	3.0	
All-Red Time (s)	2.7	2.7	2.7	2.7	2.7		3.5	3.5		3.5	3.5	
Lost Time Adjust (s)	0.0	0.0	0.0	0.0	0.0		0.0	0.0		0.0	0.0	
Total Lost Time (s)	6.0	6.0	6.0	6.0	6.0		6.5	6.5		6.5	6.5	
Lead/Lag												
Lead-Lag Optimize?												
Recall Mode	Max	Max	Max	Max	Max		C-Max	C-Max		C-Max	C-Max	
Act Effct Green (s)	36.0	36.0	36.0	36.0	36.0		46.5	46.5		46.5	46.5	
Actuated g/C Ratio	0.38	0.38	0.38	0.38	0.38		0.49	0.49		0.49	0.49	
v/c Ratio	0.30	0.85	0.10	0.35	0.37		1.12	1.12		0.15	0.99	
Control Delay	19.5	36.2	6.7	31.0	22.8		106.2	106.2		14.8	55.1	
Queue Delay	0.0	0.0	0.0	0.0	0.0		0.0	0.0		0.0	0.0	
Total Delay	19.5	36.2	6.7	31.0	22.8		106.2	106.2		14.8	55.1	
LOS	B	D	A	C	C		F	F		B	E	
Approach Delay		31.5			24.1		106.2	106.2			52.4	
Approach LOS		C			C		F	F			D	
Queue Length 50th (m)	10.2	95.9	0.8	5.7	29.2		~90.4	~90.4		5.7	145.0	
Queue Length 95th (m)	18.1	#146.9	m5.0	16.0	48.1		#148.1	#148.1		13.1	#229.3	
Internal Link Dist (m)		211.2			266.0		304.9	304.9			415.7	
Turn Bay Length (m)	58.7		29.5	250.0						36.5		
Base Capacity (vph)	358	661	564	125	628		389	389		389	840	
Starvation Cap Reductn	0	0	0	0	0		0	0		0	0	
Spillback Cap Reductn	0	0	0	0	0		0	0		0	0	
Storage Cap Reductn	0	0	0	0	0		0	0		0	0	
Reduced v/c Ratio	0.30	0.85	0.10	0.35	0.37		1.12	1.12		0.15	0.99	

Intersection Summary												
Cycle Length: 95												
Actuated Cycle Length: 95												
Offset: 38 (40%), Referenced to phase 2:NBT and 6:SBTL, Start of Green												
Natural Cycle: 90												
Control Type: Actuated-Coordinated												

Lanes, Volumes, Timings
3: Island Park & Scott

2027 Future Total
AM Peak Hour

Maximum v/c Ratio: 1.12	Intersection LOS: D
Intersection Signal Delay: 52.6	ICU Level of Service H
Intersection Capacity Utilization 115.1%	
Analysis Period (min) 15	
~ Volume exceeds capacity, queue is theoretically infinite. Queue shown is maximum after two cycles.	
# 95th percentile volume exceeds capacity, queue may be longer. Queue shown is maximum after two cycles.	
m Volume for 95th percentile queue is metered by upstream signal.	

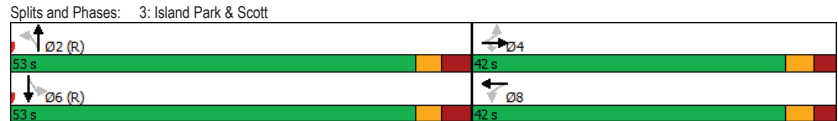

Lanes, Volumes, Timings
4: West Village/Lanark & Scott

2027 Future Total
AM Peak Hour

Lane Group	EBL	EBT	EBR	WBL	WBT	WBR	NBL	NBT	NBR	SBL	SBT	SBR
Lane Configurations	[Diagrammatic arrows for lane configurations]											
Traffic Volume (vph)	39	655	9	0	294	50	17	0	12	68	0	87
Future Volume (vph)	39	655	9	0	294	50	17	0	12	68	0	87
Satd. Flow (prot)	1610	1724	0	1745	1675	0	1658	1436	0	1658	1418	0
Fit Permitted	0.554						0.701				0.750	
Satd. Flow (perm)	920	1724	0	1745	1675	0	1204	1436	0	1294	1418	0
Satd. Flow (RTOR)	2				22		318				607	
Lane Group Flow (vph)	39	664	0	0	344	0	17	12	0	68	87	0
Turn Type	Perm	NA		Perm	NA		Perm	NA		Perm	NA	
Protected Phases	2				6		4				8	
Permitted Phases	2				6		4				8	
Detector Phase	2	2		6	6		4	4		8	8	
Switch Phase												
Minimum Initial (s)	10.0	10.0		10.0	10.0		10.0	10.0		10.0	10.0	
Minimum Split (s)	26.1	26.1		26.1	26.1		21.5	21.5		21.5	21.5	
Total Split (s)	73.0	73.0		73.0	73.0		22.0	22.0		22.0	22.0	
Total Split (%)	76.8%	76.8%		76.8%	76.8%		23.2%	23.2%		23.2%	23.2%	
Yellow Time (s)	3.3	3.3		3.3	3.3		3.3	3.3		3.3	3.3	
All-Red Time (s)	2.8	2.8		2.8	2.8		2.2	2.2		2.2	2.2	
Lost Time Adjust (s)	0.0	0.0		0.0	0.0		0.0	0.0		0.0	0.0	
Total Lost Time (s)	6.1	6.1		6.1	6.1		5.5	5.5		5.5	5.5	
Lead/Lag												
Lead-Lag Optimize?												
Recall Mode	C-Max	C-Max		C-Max	C-Max		None	None		None	None	
Act Effct Green (s)	76.0	76.0		76.0	76.0		11.7	11.7		11.7	11.7	
Actuated g/C Ratio	0.80	0.80		0.80	0.80		0.12	0.12		0.12	0.12	
v/c Ratio	0.05	0.48		0.26	0.26		0.11	0.03		0.43	0.12	
Control Delay	3.7	5.9		3.0	3.0		37.5	0.1		46.4	0.4	
Queue Delay	0.0	0.0		0.0	0.0		0.0	0.0		0.0	0.0	
Total Delay	3.7	5.9		3.0	3.0		37.5	0.1		46.4	0.4	
LOS	A	A		A	A		D	A		D	A	
Approach Delay	5.8				3.0		22.0				20.6	
Approach LOS	A				A		C				C	
Queue Length 50th (m)	1.4	36.2		10.3	10.3		2.9	0.0		11.9	0.0	
Queue Length 95th (m)	4.7	73.3		m18.0	m18.0		8.5	0.0		23.6	0.0	
Internal Link Dist (m)	332.8				211.2		80.9				82.5	
Turn Bay Length (m)	36.5						18.0				18.0	
Base Capacity (vph)	736	1380		1344	1344		209	512		224	747	
Starvation Cap Reductn	0	0		0	0		0	0		0	0	
Spillback Cap Reductn	0	0		0	0		0	0		0	0	
Storage Cap Reductn	0	0		0	0		0	0		0	0	
Reduced v/c Ratio	0.05	0.48		0.26	0.26		0.08	0.02		0.30	0.12	

Intersection Summary												
Cycle Length: 95												
Actuated Cycle Length: 95												
Offset: 83 (87%), Referenced to phase 2:EBTL and 6:WBTL, Start of Green												
Natural Cycle: 60												
Control Type: Actuated-Coordinated												

Lanes, Volumes, Timings
4: West Village/Lanark & Scott

2027 Future Total
AM Peak Hour

Maximum v/c Ratio: 0.48	Intersection LOS: A
Intersection Signal Delay: 7.3	ICU Level of Service B
Intersection Capacity Utilization 57.8%	
Analysis Period (min) 15	
m Volume for 95th percentile queue is metered by upstream signal.	

Splits and Phases: 4: West Village/Lanark & Scott



HCM 2010 AWSC
5: Churchill & Lanark

2027 Future Total
AM Peak Hour

Intersection	
Intersection Delay, s/veh	7.8
Intersection LOS	A

Movement	WBL	WBR	NBT	NBR	SBL	SBT
Lane Configurations	↔		↔			↔
Traffic Vol, veh/h	111	3	24	46	6	47
Future Vol, veh/h	111	3	24	46	6	47
Peak Hour Factor	1.00	1.00	1.00	1.00	1.00	1.00
Heavy Vehicles, %	2	33	8	13	2	2
Mvmt Flow	111	3	24	46	6	47
Number of Lanes	1	0	1	0	0	1

Approach	WB	NB	SB
Opposing Approach		SB	NB
Opposing Lanes	0	1	1
Conflicting Approach Left	NB		WB
Conflicting Lanes Left	1	0	1
Conflicting Approach Right	SB	WB	
Conflicting Lanes Right	1	1	0
HCM Control Delay	8.1	7.3	7.6
HCM LOS	A	A	A

Lane	NBLn1	WBLn1	SBLn1
Vol Left, %	0%	97%	11%
Vol Thru, %	34%	0%	89%
Vol Right, %	66%	3%	0%
Sign Control	Stop	Stop	Stop
Traffic Vol by Lane	70	114	53
LT Vol	0	111	6
Through Vol	24	0	47
RT Vol	46	3	0
Lane Flow Rate	70	114	53
Geometry Grp	1	1	1
Degree of Util (X)	0.075	0.137	0.062
Departure Headway (Hd)	3.881	4.324	4.21
Convergence, Y/N	Yes	Yes	Yes
Cap	909	824	839
Service Time	1.966	2.378	2.294
HCM Lane V/C Ratio	0.077	0.138	0.063
HCM Control Delay	7.3	8.1	7.6
HCM Lane LOS	A	A	A
HCM 95th-tile Q	0.2	0.5	0.2

Lanes, Volumes, Timings

1: Island Park & Sir John A. Macdonald

2027 Future Total

PM Peak Hour

Lane Group	EBL	EBT	EBR	WBL	WBT	WBR	NBL	NBT	NBR	SBL	SBT	SBR
Lane Configurations	[Diagrammatic arrows for lane configurations]											
Traffic Volume (vph)	396	845	67	99	1147	1183	0	492	44	98	356	491
Future Volume (vph)	396	845	67	99	1147	1183	0	492	44	98	356	491
Satd. Flow (prot)	1658	3316	1483	1658	3283	1483	0	1721	0	3038	1593	0
Fit Permitted	0.950			0.950						0.950		
Satd. Flow (perm)	1656	3316	1439	1653	3283	1444	0	1721	0	2996	1593	0
Satd. Flow (RTOR)	101			302			3			60		
Lane Group Flow (vph)	396	845	67	99	1147	1183	0	536	0	98	847	0
Turn Type	Prot	NA	Perm	Prot	NA	Perm	NA	Prot	NA	Prot	NA	
Protected Phases	5	2		1	6			8		7	4	
Permitted Phases	2			6						7		
Detector Phase	5	2	2	1	6	6		8		7	4	
Switch Phase												
Minimum Initial (s)	5.0	15.0	15.0	5.0	15.0	15.0		10.0		5.0	10.0	
Minimum Split (s)	20.6	30.1	30.1	20.6	30.1	30.1		29.1		11.5	29.1	
Total Split (s)	35.6	41.1	41.1	35.6	41.1	41.1		61.1		26.5	61.1	
Total Split (%)	21.7%	25.0%	25.0%	21.7%	25.0%	25.0%		37.2%		16.1%	37.2%	
Yellow Time (s)	3.7	3.7	3.7	3.7	3.7	3.7		3.7		3.7	3.7	
All-Red Time (s)	1.9	2.4	2.4	1.9	2.4	2.4		2.4		2.8	2.4	
Lost Time Adjust (s)	0.0	0.0	0.0	0.0	0.0	0.0		0.0		0.0	0.0	
Total Lost Time (s)	5.6	6.1	6.1	5.6	6.1	6.1		6.1		6.5	6.1	
Lead/Lag	Lag	Lead	Lead	Lag	Lead	Lead		Lag		Lead		
Lead-Lag Optimize?	Yes	Yes	Yes	Yes	Yes	Yes		Yes		Yes		
Recall Mode	None	None	None	None	None	None		None		None	None	
Act Effct Green (s)	30.1	35.1	35.1	30.1	35.1	35.1		50.9		10.2	67.7	
Actuated g/C Ratio	0.20	0.23	0.23	0.20	0.23	0.23		0.34		0.07	0.45	
v/c Ratio	1.20	1.10	0.16	0.30	1.50	2.09		0.92		0.48	1.13	
Control Delay	164.9	114.2	3.2	56.0	271.3	515.4		69.7		76.3	111.5	
Queue Delay	0.0	0.0	0.0	0.0	0.0	0.0		0.0		0.0	0.0	
Total Delay	164.9	114.2	3.2	56.0	271.3	515.4		69.7		76.3	111.5	
LOS	F	F	A	E	F	F		E		E	F	
Approach Delay	123.9			381.4			69.7			107.9		
Approach LOS	F			F			E			F		
Queue Length 50th (m)	~149.6	~157.2	0.0	26.4	~259.5	~503.2		152.9		15.2	~283.4	
Queue Length 95th (m)	#220.3	#204.3	4.2	45.2	#310.1	#596.9		#223.6		25.1	#363.6	
Internal Link Dist (m)	750.5		213.6		249.0				146.9			
Turn Bay Length (m)	104.5		88.0		89.6				80.0			
Base Capacity (vph)	330	771	412	330	764	567		631		404	891	
Starvation Cap Reductn	0	0	0	0	0	0		0		0	0	
Spillback Cap Reductn	0	0	0	0	0	0		0		0	0	
Storage Cap Reductn	0	0	0	0	0	0		0		0	0	
Reduced v/c Ratio	1.20	1.10	0.16	0.30	1.50	2.09		0.85		0.24	0.95	

Intersection Summary

Cycle Length: 164.3
 Actuated Cycle Length: 150.7
 Natural Cycle: 145
 Control Type: Actuated-Uncoordinated
 Maximum v/c Ratio: 2.09

Lanes, Volumes, Timings

1: Island Park & Sir John A. Macdonald

2027 Future Total

PM Peak Hour

Intersection Signal Delay: 235.3	Intersection LOS: F
Intersection Capacity Utilization 145.7%	ICU Level of Service H
Analysis Period (min) 15	
~ Volume exceeds capacity, queue is theoretically infinite.	
Queue shown is maximum after two cycles.	
# 95th percentile volume exceeds capacity, queue may be longer.	
Queue shown is maximum after two cycles.	

Splits and Phases: 1: Island Park & Sir John A. Macdonald

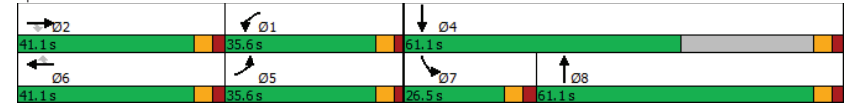

HCM 2010 TWSC
2: Island Park & Clearview

2027 Future Total
PM Peak Hour

Intersection												
Int Delay, s/veh	1.9											
Movement	EBL	EBT	EBR	WBL	WBT	WBR	NBL	NBT	NBR	SBL	SBT	SBR
Lane Configurations	↔		↔		↔		↔		↔		↔	
Traffic Vol, veh/h	27	3	14	5	5	50	9	457	1	12	473	49
Future Vol, veh/h	27	3	14	5	5	50	9	457	1	12	473	49
Conflicting Peds, #/hr	8	0	0	0	0	8	3	0	6	6	0	3
Sign Control	Stop	Stop	Stop	Stop	Stop	Stop	Free	Free	Free	Free	Free	Free
RT Channelized	-	-	None	-	-	None	-	-	None	-	-	None
Storage Length	-	-	-	-	-	-	-	-	-	-	-	-
Veh in Median Storage, #	-	0	-	-	0	-	-	0	-	-	0	-
Grade, %	-	0	-	-	0	-	-	0	-	-	0	-
Peak Hour Factor	100	100	100	100	100	100	100	100	100	100	100	100
Heavy Vehicles, %	2	67	2	20	20	2	2	2	2	8	2	2
Mvmt Flow	27	3	14	5	5	50	9	457	1	12	473	49
Major/Minor	Minor2	Minor1	Major1	Major2								
Conflicting Flow All	1036	1007	501	1012	1031	472	525	0	0	464	0	0
Stage 1	525	525	-	482	482	-	-	-	-	-	-	-
Stage 2	511	482	-	530	549	-	-	-	-	-	-	-
Critical Hdwy	7.12	7.17	6.22	7.3	6.7	6.22	4.12	-	-	4.18	-	-
Critical Hdwy Stg 1	6.12	6.17	-	6.3	5.7	-	-	-	-	-	-	-
Critical Hdwy Stg 2	6.12	6.17	-	6.3	5.7	-	-	-	-	-	-	-
Follow-up Hdwy	3.518	4.603	3.318	3.68	4.18	3.318	2.218	-	-	2.272	-	-
Pot Cap-1 Maneuver	210	187	570	202	217	592	1042	-	-	1066	-	-
Stage 1	536	437	-	533	524	-	-	-	-	-	-	-
Stage 2	545	459	-	501	488	-	-	-	-	-	-	-
Platoon blocked, %	-	-	-	-	-	-	-	-	-	-	-	-
Mov Cap-1 Maneuver	183	180	569	189	209	586	1040	-	-	1061	-	-
Mov Cap-2 Maneuver	183	180	-	189	209	-	-	-	-	-	-	-
Stage 1	528	429	-	524	515	-	-	-	-	-	-	-
Stage 2	485	451	-	477	479	-	-	-	-	-	-	-
Approach	EB	WB	NB	SB								
HCM Control Delay, s	24	14.4	0.2	0.2								
HCM LOS	C	B										
Minor Lane/Major Mvmt	NBL	NBT	NBR	EBLn1	WBLn1	SBL	SBT	SBR				
Capacity (veh/h)	1040	-	-	233	442	1061	-	-				
HCM Lane V/C Ratio	0.009	-	-	0.189	0.136	0.011	-	-				
HCM Control Delay (s)	8.5	0	-	24	14.4	8.4	0	-				
HCM Lane LOS	A	A	-	C	B	A	A	-				
HCM 95th %tile Q(veh)	0	-	-	0.7	0.5	0	-	-				

Lanes, Volumes, Timings
3: Island Park & Scott

2027 Future Total
PM Peak Hour



Lane Group	EBL	EBT	EBR	WBL	WBT	WBR	NBL	NBT	NBR	SBL	SBT	SBR
Lane Configurations	↔	↔	↔	↔	↔	↔	↔	↔	↔	↔	↔	↔
Traffic Volume (vph)	107	305	42	192	553	103	23	427	21	29	417	74
Future Volume (vph)	107	305	42	192	553	103	23	427	21	29	417	74
Satd. Flow (prot)	1658	1712	1483	1658	1657	0	0	1727	0	1658	1689	0
Fit Permitted	0.227			0.526				0.865		0.361		
Satd. Flow (perm)	387	1712	1391	895	1657	0	0	1496	0	622	1689	0
Satd. Flow (RTOR)			42		13			3				10
Lane Group Flow (vph)	107	305	42	192	656	0	0	471	0	29	491	0
Turn Type	Perm	NA	Perm	Perm	NA		Perm	NA		Perm	NA	
Protected Phases		4			8			2			6	
Permitted Phases	4		4	8			2				6	
Detector Phase	4	4	4	8	8		2	2			6	6
Switch Phase												
Minimum Initial (s)	10.0	10.0	10.0	10.0	10.0		10.0	10.0		10.0	10.0	
Minimum Split (s)	34.8	34.8	34.8	34.8	34.8		34.5	34.5		34.5	34.5	
Total Split (s)	56.0	56.0	56.0	56.0	56.0		44.0	44.0		44.0	44.0	
Total Split (%)	56.0%	56.0%	56.0%	56.0%	56.0%		44.0%	44.0%		44.0%	44.0%	
Yellow Time (s)	3.3	3.3	3.3	3.3	3.3		3.0	3.0		3.0	3.0	
All-Red Time (s)	2.7	2.7	2.7	2.7	2.7		3.5	3.5		3.5	3.5	
Lost Time Adjust (s)	0.0	0.0	0.0	0.0	0.0		0.0	0.0		0.0	0.0	
Total Lost Time (s)	6.0	6.0	6.0	6.0	6.0		6.5	6.5		6.5	6.5	
Lead/Lag												
Lead-Lag Optimize?												
Recall Mode	Max	Max	Max	Max	Max		C-Max	C-Max		C-Max	C-Max	
Act Effct Green (s)	50.0	50.0	50.0	50.0	50.0		37.5	37.5		37.5	37.5	
Actuated g/C Ratio	0.50	0.50	0.50	0.50	0.50		0.38	0.38		0.38	0.38	
v/c Ratio	0.55	0.36	0.06	0.43	0.79		0.84	0.12		0.77	0.12	
Control Delay	27.5	13.9	3.0	19.7	28.5		43.5	22.4		36.4	22.4	
Queue Delay	0.0	0.0	0.0	0.0	0.0		0.0	0.0		0.0	0.0	
Total Delay	27.5	13.9	3.0	19.7	28.5		43.5	22.4		36.4	22.4	
LOS	C	B	A	B	C		D	C		D	C	
Approach Delay	16.1				26.5		43.5				35.6	
Approach LOS	B				C		D				D	
Queue Length 50th (m)	15.3	27.3	0.0	22.7	98.7		81.5			3.6	80.7	
Queue Length 95th (m)	35.8	38.2	2.4	41.2	147.4		#136.2			10.0	120.6	
Internal Link Dist (m)		217.8			273.2		304.9				417.3	
Turn Bay Length (m)	58.7			29.5	250.0						36.5	
Base Capacity (vph)	193	856	716	447	835		562			233	639	
Starvation Cap Reductn	0	0	0	0	0		0			0	0	
Spillback Cap Reductn	0	0	0	0	0		0			0	0	
Storage Cap Reductn	0	0	0	0	0		0			0	0	
Reduced v/c Ratio	0.55	0.36	0.06	0.43	0.79		0.84	0.12		0.77	0.12	

Intersection Summary												
Cycle Length: 100												
Actuated Cycle Length: 100												
Offset: 2 (2%), Referenced to phase 2:NBTL and 6:SBTL, Start of Green												
Natural Cycle: 75												
Control Type: Actuated-Coordinated												

Lanes, Volumes, Timings
3: Island Park & Scott

2027 Future Total
PM Peak Hour

Maximum v/c Ratio: 0.84	Intersection LOS: C
Intersection Signal Delay: 30.0	ICU Level of Service G
Intersection Capacity Utilization 106.8%	
Analysis Period (min) 15	
# 95th percentile volume exceeds capacity, queue may be longer.	
Queue shown is maximum after two cycles.	

Splits and Phases: 3: Island Park & Scott

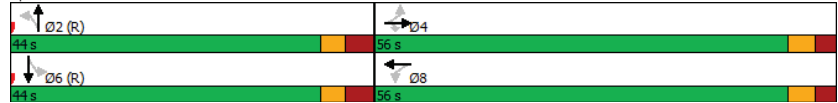

Lanes, Volumes, Timings
4: West Village/Lanark & Scott

2027 Future Total
PM Peak Hour

Lane Group	EBL	EBT	EBR	WBL	WBT	WBR	NBL	NBT	NBR	SBL	SBT	SBR
Lane Configurations	[Diagrammatic arrows for lane configurations]											
Traffic Volume (vph)	90	393	20	13	608	36	6	0	4	57	1	44
Future Volume (vph)	90	393	20	13	608	36	6	0	4	57	1	44
Satd. Flow (prot)	1658	1728	0	1658	1716	0	1658	1395	0	1658	1358	0
Fit Permitted	0.387			0.517			0.728			0.755		
Satd. Flow (perm)	649	1728	0	883	1716	0	1188	1395	0	1264	1358	0
Satd. Flow (RTOR)		7			8			511			44	
Lane Group Flow (vph)	90	413	0	13	644	0	6	4	0	57	45	0
Turn Type	Perm	NA		Perm	NA		Perm	NA		Perm	NA	
Protected Phases		2			6			4			8	
Permitted Phases	2			6			4			8		
Detector Phase	2	2		6	6		4	4		8	8	
Switch Phase												
Minimum Initial (s)	10.0	10.0		10.0	10.0		10.0	10.0		10.0	10.0	
Minimum Split (s)	26.1	26.1		26.1	26.1		21.5	21.5		21.5	21.5	
Total Split (s)	78.0	78.0		78.0	78.0		22.0	22.0		22.0	22.0	
Total Split (%)	78.0%	78.0%		78.0%	78.0%		22.0%	22.0%		22.0%	22.0%	
Yellow Time (s)	3.3	3.3		3.3	3.3		3.3	3.3		3.3	3.3	
All-Red Time (s)	2.8	2.8		2.8	2.8		2.2	2.2		2.2	2.2	
Lost Time Adjust (s)	0.0	0.0		0.0	0.0		0.0	0.0		0.0	0.0	
Total Lost Time (s)	6.1	6.1		6.1	6.1		5.5	5.5		5.5	5.5	
Lead/Lag												
Lead-Lag Optimize?												
Recall Mode	C-Max	C-Max		C-Max	C-Max		None	None		None	None	
Act Effct Green (s)	80.3	80.3		80.3	80.3		12.4	12.4		12.4	12.4	
Actuated g/C Ratio	0.80	0.80		0.80	0.80		0.12	0.12		0.12	0.12	
v/c Ratio	0.17	0.30		0.02	0.47		0.04	0.01		0.37	0.22	
Control Delay	4.7	4.4		1.4	1.9		37.0	0.0		46.0	14.4	
Queue Delay	0.0	0.0		0.0	0.0		0.0	0.0		0.0	0.0	
Total Delay	4.7	4.4		1.4	1.9		37.0	0.0		46.0	14.4	
LOS	A	A		A	A		D	A		D	B	
Approach Delay		4.4			1.9			22.2			32.0	
Approach LOS		A			A			C			C	
Queue Length 50th (m)	3.5	17.5		0.1	9.4		1.1	0.0		10.6	0.2	
Queue Length 95th (m)	10.2	36.6		m0.3	m17.5		4.6	0.0		21.7	9.6	
Internal Link Dist (m)		332.8			217.8			81.9			75.1	
Turn Bay Length (m)	36.5			42.0			18.0			18.0		
Base Capacity (vph)	521	1389		709	1380		196	656		208	260	
Starvation Cap Reductn	0	0		0	0		0	0		0	0	
Spillback Cap Reductn	0	0		0	0		0	0		0	0	
Storage Cap Reductn	0	0		0	0		0	0		0	0	
Reduced v/c Ratio	0.17	0.30		0.02	0.47		0.03	0.01		0.27	0.17	

Intersection Summary

Cycle Length: 100
Actuated Cycle Length: 100
Offset: 40 (40%), Referenced to phase 2:EBTL and 6:WBTL, Start of Green
Natural Cycle: 60
Control Type: Actuated-Coordinated

Lanes, Volumes, Timings
4: West Village/Lanark & Scott

2027 Future Total
PM Peak Hour

Maximum v/c Ratio: 0.47	Intersection LOS: A
Intersection Signal Delay: 5.5	ICU Level of Service C
Intersection Capacity Utilization 71.1%	
Analysis Period (min) 15	
m Volume for 95th percentile queue is metered by upstream signal.	

Splits and Phases: 4: West Village/Lanark & Scott



HCM 2010 AWSC
5: Churchill & Lanark

2027 Future Total
PM Peak Hour

Intersection	
Intersection Delay, s/veh	7.5
Intersection LOS	A

Movement	WBL	WBR	NBT	NBR	SBL	SBT
Lane Configurations	↔		↔			↔
Traffic Vol, veh/h	63	10	37	52	4	27
Future Vol, veh/h	63	10	37	52	4	27
Peak Hour Factor	1.00	1.00	1.00	1.00	1.00	1.00
Heavy Vehicles, %	6	2	2	4	2	2
Mvmt Flow	63	10	37	52	4	27
Number of Lanes	1	0	1	0	0	1

Approach	WB	NB	SB
Opposing Approach		SB	NB
Opposing Lanes	0	1	1
Conflicting Approach Left	NB		WB
Conflicting Lanes Left	1	0	1
Conflicting Approach Right	SB	WB	
Conflicting Lanes Right	1	1	0
HCM Control Delay	7.8	7.2	7.4
HCM LOS	A	A	A

Lane	NBLn1	WBLn1	SBLn1
Vol Left, %	0%	86%	13%
Vol Thru, %	42%	0%	87%
Vol Right, %	58%	14%	0%
Sign Control	Stop	Stop	Stop
Traffic Vol by Lane	89	73	31
LT Vol	0	63	4
Through Vol	37	0	27
RT Vol	52	10	0
Lane Flow Rate	89	73	31
Geometry Grp	1	1	1
Degree of Util (X)	0.092	0.087	0.036
Departure Headway (Hd)	3.735	4.3	4.156
Convergence, Y/N	Yes	Yes	Yes
Cap	952	831	855
Service Time	1.786	2.341	2.212
HCM Lane V/C Ratio	0.093	0.088	0.036
HCM Control Delay	7.2	7.8	7.4
HCM Lane LOS	A	A	A
HCM 95th-tile Q	0.3	0.3	0.1

Appendix L

Synchro Intersection Worksheets – 2032 Future Total Conditions

Lanes, Volumes, Timings
1: Island Park & Sir John A. Macdonald

2032 Future Total
AM Peak Hour

Lane Group	EBL	EBT	EBR	WBL	WBT	WBR	NBL	NBT	NBR	SBL	SBT	SBR
Lane Configurations	↔	↕	↔	↔	↕	↔	↔	↕	↔	↔	↕	↔
Traffic Volume (vph)	315	1331	55	106	377	94	0	307	185	78	802	597
Future Volume (vph)	315	1331	55	106	377	94	0	307	185	78	802	597
Satd. Flow (prot)	1658	3316	1483	1658	3316	1427	0	1648	0	3010	1623	0
Fit Permitted	0.950			0.950						0.950		
Satd. Flow (perm)	1658	3316	1483	1658	3316	1427	0	1648	0	3010	1623	0
Satd. Flow (RTOR)			101			101			20			32
Lane Group Flow (vph)	315	1331	55	106	377	94	0	492	0	78	1399	0
Turn Type	Prot	NA	Perm	Prot	NA	Perm	NA	NA	Prot	NA	NA	
Protected Phases	5	2		1	6			8		7	4	
Permitted Phases			2			6						
Detector Phase	5	2	2	1	6	6		8		7	4	
Switch Phase												
Minimum Initial (s)	5.0	15.0	15.0	5.0	15.0	15.0		10.0		5.0	10.0	
Minimum Split (s)	20.6	30.1	30.1	20.6	30.1	30.1		29.1		11.5	29.1	
Total Split (s)	35.6	41.1	41.1	35.6	41.1	41.1		61.1		26.5	61.1	
Total Split (%)	21.7%	25.0%	25.0%	21.7%	25.0%	25.0%		37.2%		16.1%	37.2%	
Yellow Time (s)	3.7	3.7	3.7	3.7	3.7	3.7		3.7		3.7	3.7	
All-Red Time (s)	1.9	2.4	2.4	1.9	2.4	2.4		2.4		2.8	2.4	
Lost Time Adjust (s)	0.0	0.0	0.0	0.0	0.0	0.0		0.0		0.0	0.0	
Total Lost Time (s)	5.6	6.1	6.1	5.6	6.1	6.1		6.1		6.5	6.1	
Lead/Lag	Lag	Lead	Lead	Lag	Lead	Lead		Lag		Lead		
Lead-Lag Optimize?	Yes	Yes	Yes	Yes	Yes	Yes		Yes		Yes		
Recall Mode	None	None	None	None	None	None		None		None	None	
Act Effct Green (s)	30.2	35.3	35.3	15.6	20.6	20.6		46.6		8.9	62.0	
Actuated g/C Ratio	0.23	0.27	0.27	0.12	0.16	0.16		0.36		0.07	0.47	
v/c Ratio	0.82	1.49	0.12	0.54	0.72	0.30		0.82		0.38	1.78	
Control Delay	67.6	260.6	0.7	65.9	61.5	10.6		50.0		66.0	381.2	
Queue Delay	0.0	0.0	0.0	0.0	0.0	0.0		0.0		0.0	0.0	
Total Delay	67.6	260.6	0.7	65.9	61.5	10.6		50.0		66.0	381.2	
LOS	E	F	A	E	E	B		D		E	F	
Approach Delay		216.5			54.0			50.0			364.6	
Approach LOS		F			D			D			F	
Queue Length 50th (m)	75.5	~241.6	0.0	25.4	47.7	0.0		110.7		9.8	~531.4	
Queue Length 95th (m)	#149.3	#343.7	0.7	48.0	71.9	13.9		169.7		20.0	#684.6	
Internal Link Dist (m)		762.8			208.9			249.0			152.7	
Turn Bay Length (m)	104.5		88.0	89.6						80.0		
Base Capacity (vph)	383	894	473	383	894	458		710		463	1030	
Starvation Cap Reductn	0	0	0	0	0	0		0		0	0	
Spillback Cap Reductn	0	0	0	0	0	0		0		0	0	
Storage Cap Reductn	0	0	0	0	0	0		0		0	0	
Reduced v/c Ratio	0.82	1.49	0.12	0.28	0.42	0.21		0.69		0.17	1.36	

Intersection Summary	
Cycle Length:	164.3
Actuated Cycle Length:	130.8
Natural Cycle:	145
Control Type:	Actuated-Uncoordinated
Maximum v/c Ratio:	1.78

Lanes, Volumes, Timings
1: Island Park & Sir John A. Macdonald

2032 Future Total
AM Peak Hour

Intersection Signal Delay: 226.6	Intersection LOS: F
Intersection Capacity Utilization 142.9%	ICU Level of Service H
Analysis Period (min) 15	
~ Volume exceeds capacity, queue is theoretically infinite.	
Queue shown is maximum after two cycles.	
# 95th percentile volume exceeds capacity, queue may be longer.	
Queue shown is maximum after two cycles.	

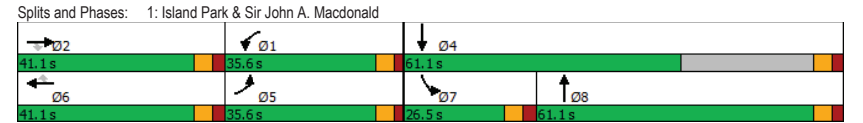

HCM 2010 TWSC
2: Island Park & Clearview

2032 Future Total
AM Peak Hour

Intersection												
Int Delay, s/veh	2.1											
Movement	EBL	EBT	EBR	WBL	WBT	WBR	NBL	NBT	NBR	SBL	SBT	SBR
Lane Configurations	↔		↔		↔		↔		↔		↔	
Traffic Vol, veh/h	28	3	19	4	1	17	15	475	14	24	847	96
Future Vol, veh/h	28	3	19	4	1	17	15	475	14	24	847	96
Conflicting Peds, #/hr	4	0	0	0	0	4	6	0	1	1	0	6
Sign Control	Stop	Stop	Stop	Stop	Stop	Stop	Free	Free	Free	Free	Free	Free
RT Channelized	-	-	None	-	-	None	-	-	None	-	-	None
Storage Length	-	-	-	-	-	-	-	-	-	-	-	-
Veh in Median Storage, #	-	0	-	-	0	-	-	0	-	-	0	-
Grade, %	-	0	-	-	0	-	-	0	-	-	0	-
Peak Hour Factor	100	100	100	100	100	100	100	100	100	100	100	100
Heavy Vehicles, %	2	33	2	2	100	2	2	2	7	2	2	2
Mvmt Flow	28	3	19	4	1	17	15	475	14	24	847	96
Major/Minor	Minor2	Minor1	Major1	Major2								
Conflicting Flow All	1474	1469	901	1467	1510	487	949	0	0	490	0	0
Stage 1	949	949	-	513	513	-	-	-	-	-	-	-
Stage 2	525	520	-	954	997	-	-	-	-	-	-	-
Critical Hdwy	7.12	6.83	6.22	7.12	7.5	6.22	4.12	-	-	4.12	-	-
Critical Hdwy Stg 1	6.12	5.83	-	6.12	6.5	-	-	-	-	-	-	-
Critical Hdwy Stg 2	6.12	5.83	-	6.12	6.5	-	-	-	-	-	-	-
Follow-up Hdwy	3.518	4.297	3.318	3.518	4.9	3.318	2.218	-	-	2.218	-	-
Pot Cap-1 Maneuver	105	109	337	106	75	581	724	-	-	1073	-	-
Stage 1	313	301	-	544	404	-	-	-	-	-	-	-
Stage 2	536	484	-	311	222	-	-	-	-	-	-	-
Platoon blocked, %	-	-	-	-	-	-	-	-	-	-	-	-
Mov Cap-1 Maneuver	94	100	335	92	69	579	721	-	-	1072	-	-
Mov Cap-2 Maneuver	94	100	-	92	69	-	-	-	-	-	-	-
Stage 1	302	285	-	528	392	-	-	-	-	-	-	-
Stage 2	502	469	-	276	210	-	-	-	-	-	-	-
Approach	EB	WB	NB	SB								
HCM Control Delay, s	49	20.6	0.3	0.2								
HCM LOS	E	C										
Minor Lane/Major Mvmt	NBL	NBT	NBR	EBLn1	WBLn1	SBL	SBT	SBR				
Capacity (veh/h)	721	-	-	130	252	1072	-	-				
HCM Lane V/C Ratio	0.021	-	-	0.385	0.087	0.022	-	-				
HCM Control Delay (s)	10.1	0	-	49	20.6	8.4	0	-				
HCM Lane LOS	B	A	-	E	C	A	A	-				
HCM 95th %tile Q(veh)	0.1	-	-	1.6	0.3	0.1	-	-				

Lanes, Volumes, Timings
3: Island Park & Scott

2032 Future Total
AM Peak Hour

Lane Group	EBL	EBT	EBR	WBL	WBT	WBR	NBL	NBT	NBR	SBL	SBT	SBR
Lane Configurations	↔	↔	↔	↔	↔	↔	↔	↔	↔	↔	↔	↔
Traffic Volume (vph)	106	614	56	44	212	23	41	326	90	59	769	94
Future Volume (vph)	106	614	56	44	212	23	41	326	90	59	769	94
Satd. Flow (prot)	1658	1745	1483	1658	1646	0	0	1675	0	1658	1709	0
Fit Permitted	0.564			0.137				0.414		0.447		
Satd. Flow (perm)	941	1745	1423	238	1646	0	0	696	0	771	1709	0
Satd. Flow (RTOR)			40		7			18				9
Lane Group Flow (vph)	106	614	56	44	235	0	0	457	0	59	863	0
Turn Type	Perm	NA	Perm	Perm	NA		Perm	NA		Perm	NA	
Protected Phases		4			8			2			6	
Permitted Phases	4		4	8			2				6	
Detector Phase	4	4	4	8	8		2	2		6	6	
Switch Phase												
Minimum Initial (s)	10.0	10.0	10.0	10.0	10.0		10.0	10.0		10.0	10.0	
Minimum Split (s)	34.8	34.8	34.8	34.8	34.8		34.5	34.5		34.5	34.5	
Total Split (s)	42.0	42.0	42.0	42.0	42.0		53.0	53.0		53.0	53.0	
Total Split (%)	44.2%	44.2%	44.2%	44.2%	44.2%		55.8%	55.8%		55.8%	55.8%	
Yellow Time (s)	3.3	3.3	3.3	3.3	3.3		3.0	3.0		3.0	3.0	
All-Red Time (s)	2.7	2.7	2.7	2.7	2.7		3.5	3.5		3.5	3.5	
Lost Time Adjust (s)	0.0	0.0	0.0	0.0	0.0		0.0	0.0		0.0	0.0	
Total Lost Time (s)	6.0	6.0	6.0	6.0	6.0		6.5	6.5		6.5	6.5	
Lead/Lag												
Lead-Lag Optimize?												
Recall Mode	Max	Max	Max	Max	Max		C-Max	C-Max		C-Max	C-Max	
Act Effct Green (s)	36.0	36.0	36.0	36.0	36.0		46.5	46.5		46.5	46.5	
Actuated g/C Ratio	0.38	0.38	0.38	0.38	0.38		0.49	0.49		0.49	0.49	
v/c Ratio	0.30	0.93	0.10	0.49	0.37		1.31	1.03		0.16	1.03	
Control Delay	20.4	45.9	7.7	44.5	22.9		183.0	14.9		63.4	63.4	
Queue Delay	0.0	0.0	0.0	0.0	0.0		0.0	0.0		0.0	0.0	
Total Delay	20.4	45.9	7.7	44.5	22.9		183.0	14.9		63.4	63.4	
LOS	C	D	A	D	C		F	B		E	E	
Approach Delay		39.6			26.3		183.0			60.3		
Approach LOS		D			C		F			E		
Queue Length 50th (m)	10.1	108.4	0.8	6.1	29.7		~107.5			5.7	~169.4	
Queue Length 95th (m)	19.5	#169.2	m5.3	#21.1	48.8		#166.0			13.2	#240.5	
Internal Link Dist (m)		211.2			266.0		304.9			415.7		
Turn Bay Length (m)	58.7		29.5	250.0						36.5		
Base Capacity (vph)	356	661	564	90	628		349	377		841	841	
Starvation Cap Reductn	0	0	0	0	0		0	0		0	0	
Spillback Cap Reductn	0	0	0	0	0		0	0		0	0	
Storage Cap Reductn	0	0	0	0	0		0	0		0	0	
Reduced v/c Ratio	0.30	0.93	0.10	0.49	0.37		1.31	1.03		0.16	1.03	

Intersection Summary												
Cycle Length: 95												
Actuated Cycle Length: 95												
Offset: 38 (40%), Referenced to phase 2:NBT and 6:SBTL, Start of Green												
Natural Cycle: 100												
Control Type: Actuated-Coordinated												

Lanes, Volumes, Timings
3: Island Park & Scott

2032 Future Total
AM Peak Hour

Maximum v/c Ratio: 1.31	Intersection LOS: E
Intersection Signal Delay: 72.9	ICU Level of Service H
Intersection Capacity Utilization 119.1%	
Analysis Period (min) 15	
~ Volume exceeds capacity, queue is theoretically infinite.	
Queue shown is maximum after two cycles.	
# 95th percentile volume exceeds capacity, queue may be longer.	
Queue shown is maximum after two cycles.	
m Volume for 95th percentile queue is metered by upstream signal.	

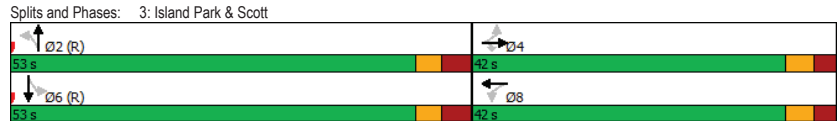

Lanes, Volumes, Timings
4: West Village/Lanark & Scott

2032 Future Total
AM Peak Hour

Lane Group	EBL	EBT	EBR	WBL	WBT	WBR	NBL	NBT	NBR	SBL	SBT	SBR
Lane Configurations	[Diagrammatic arrows for lane configurations]											
Traffic Volume (vph)	39	714	9	0	297	50	18	0	12	68	0	87
Future Volume (vph)	39	714	9	0	297	50	18	0	12	68	0	87
Satd. Flow (prot)	1610	1724	0	1745	1675	0	1658	1436	0	1658	1418	0
Fit Permitted	0.553						0.701		0.750			
Satd. Flow (perm)	919	1724	0	1745	1675	0	1204	1436	0	1294	1418	0
Satd. Flow (RTOR)	2		22		285		604					
Lane Group Flow (vph)	39	723	0	0	347	0	18	12	0	68	87	0
Turn Type	Perm	NA	Perm	NA	Perm	NA	Perm	NA	Perm	NA		
Protected Phases	2		6		4		8					
Permitted Phases	2		6		4		8					
Detector Phase	2	2	6	6	4	4	8	8				
Switch Phase												
Minimum Initial (s)	10.0	10.0	10.0	10.0	10.0	10.0	10.0	10.0	10.0	10.0	10.0	10.0
Minimum Split (s)	26.1	26.1	26.1	26.1	26.1	21.5	21.5	21.5	21.5	21.5	21.5	21.5
Total Split (s)	73.0	73.0	73.0	73.0	73.0	22.0	22.0	22.0	22.0	22.0	22.0	22.0
Total Split (%)	76.8%	76.8%	76.8%	76.8%	76.8%	23.2%	23.2%	23.2%	23.2%	23.2%	23.2%	23.2%
Yellow Time (s)	3.3	3.3	3.3	3.3	3.3	3.3	3.3	3.3	3.3	3.3	3.3	3.3
All-Red Time (s)	2.8	2.8	2.8	2.8	2.8	2.2	2.2	2.2	2.2	2.2	2.2	2.2
Lost Time Adjust (s)	0.0	0.0	0.0	0.0	0.0	0.0	0.0	0.0	0.0	0.0	0.0	0.0
Total Lost Time (s)	6.1	6.1	6.1	6.1	6.1	5.5	5.5	5.5	5.5	5.5	5.5	5.5
Lead/Lag												
Lead-Lag Optimize?												
Recall Mode	C-Max	C-Max	C-Max	C-Max	None	None	None	None	None	None	None	None
Act Effct Green (s)	76.0	76.0	76.0	76.0	11.7	11.7	11.7	11.7	11.7	11.7	11.7	11.7
Actuated g/C Ratio	0.80	0.80	0.80	0.80	0.12	0.12	0.12	0.12	0.12	0.12	0.12	0.12
v/c Ratio	0.05	0.52	0.05	0.05	0.26	0.12	0.03	0.43	0.12	0.43	0.12	0.12
Control Delay	3.7	6.5	3.7	3.7	2.9	37.6	0.1	46.4	0.4	46.4	0.4	0.4
Queue Delay	0.0	0.0	0.0	0.0	0.0	0.0	0.0	0.0	0.0	0.0	0.0	0.0
Total Delay	3.7	6.5	3.7	3.7	2.9	37.6	0.1	46.4	0.4	46.4	0.4	0.4
LOS	A	A	A	A	D	A	D	A	D	A	D	A
Approach Delay	6.3		2.9		22.6		20.6					
Approach LOS	A		A		C		C					
Queue Length 50th (m)	1.4	41.7	1.4	1.4	10.2	3.1	0.0	11.9	0.0	11.9	0.0	0.0
Queue Length 95th (m)	4.7	84.9	4.7	4.7	17.5	8.9	0.0	23.6	0.0	23.6	0.0	0.0
Internal Link Dist (m)	332.8		211.2		80.9		82.5					
Turn Bay Length (m)	36.5		18.0		18.0		18.0					
Base Capacity (vph)	735		1380		1344		209		484		224	
Starvation Cap Reductn	0		0		0		0		0		0	
Spillback Cap Reductn	0		0		0		0		0		0	
Storage Cap Reductn	0		0		0		0		0		0	
Reduced v/c Ratio	0.05	0.52	0.05	0.05	0.26	0.09	0.02	0.30	0.12	0.30	0.12	0.12

Intersection Summary												
Cycle Length: 95												
Actuated Cycle Length: 95												
Offset: 83 (87%), Referenced to phase 2:EBTL and 6:WBTL, Start of Green												
Natural Cycle: 60												
Control Type: Actuated-Coordinated												

Lanes, Volumes, Timings
4: West Village/Lanark & Scott

2032 Future Total
AM Peak Hour

Maximum v/c Ratio: 0.52

Intersection Signal Delay: 7.5 Intersection LOS: A

Intersection Capacity Utilization 61.0% ICU Level of Service B

Analysis Period (min) 15

m Volume for 95th percentile queue is metered by upstream signal.

Splits and Phases: 4: West Village/Lanark & Scott

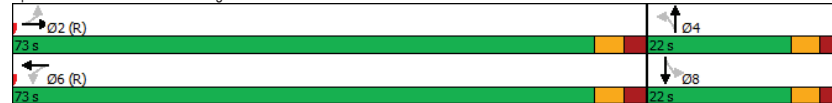

HCM 2010 AWSC
5: Churchill & Lanark

2032 Future Total
AM Peak Hour

Intersection	
Intersection Delay, s/veh	7.8
Intersection LOS	A

Movement	WBL	WBR	NBT	NBR	SBL	SBT
Lane Configurations	↔		↔		↔	↔
Traffic Vol, veh/h	112	3	24	46	6	47
Future Vol, veh/h	112	3	24	46	6	47
Peak Hour Factor	1.00	1.00	1.00	1.00	1.00	1.00
Heavy Vehicles, %	2	33	8	13	2	2
Mvmt Flow	112	3	24	46	6	47
Number of Lanes	1	0	1	0	0	1

Approach	WB	NB	SB
Opposing Approach		SB	NB
Opposing Lanes	0	1	1
Conflicting Approach Left	NB		WB
Conflicting Lanes Left	1	0	1
Conflicting Approach Right	SB	WB	
Conflicting Lanes Right	1	1	0
HCM Control Delay	8.1	7.3	7.6
HCM LOS	A	A	A

Lane	NBLn1	WBLn1	SBLn1
Vol Left, %	0%	97%	11%
Vol Thru, %	34%	0%	89%
Vol Right, %	66%	3%	0%
Sign Control	Stop	Stop	Stop
Traffic Vol by Lane	70	115	53
LT Vol	0	112	6
Through Vol	24	0	47
RT Vol	46	3	0
Lane Flow Rate	70	115	53
Geometry Grp	1	1	1
Degree of Util (X)	0.076	0.138	0.062
Departure Headway (Hd)	3.883	4.324	4.212
Convergence, Y/N	Yes	Yes	Yes
Cap	909	823	838
Service Time	1.968	2.38	2.297
HCM Lane V/C Ratio	0.077	0.14	0.063
HCM Control Delay	7.3	8.1	7.6
HCM Lane LOS	A	A	A
HCM 95th-tile Q	0.2	0.5	0.2

Lanes, Volumes, Timings
1: Island Park & Sir John A. Macdonald

2032 Future Total
PM Peak Hour

Lane Group	EBL	EBT	EBR	WBL	WBT	WBR	NBL	NBT	NBR	SBL	SBT	SBR
Lane Configurations	↔	↔	↔	↔	↔	↔		↔	↔	↔	↔	↔
Traffic Volume (vph)	396	921	67	99	1176	1183	0	511	44	98	384	491
Future Volume (vph)	396	921	67	99	1176	1183	0	511	44	98	384	491
Satd. Flow (prot)	1658	3316	1483	1658	3283	1483	0	1721	0	3038	1599	0
Fit Permitted	0.950			0.950						0.950		
Satd. Flow (perm)	1656	3316	1439	1653	3283	1444	0	1721	0	2997	1599	0
Satd. Flow (RTOR)			101			296		3			56	
Lane Group Flow (vph)	396	921	67	99	1176	1183	0	555	0	98	875	0
Turn Type	Prot	NA	Perm	Prot	NA	Perm	NA	Prot	NA	Prot	NA	
Protected Phases	5	2		1	6			8		7	4	
Permitted Phases			2			6						
Detector Phase	5	2	2	1	6	6		8		7	4	
Switch Phase												
Minimum Initial (s)	5.0	15.0	15.0	5.0	15.0	15.0		10.0		5.0	10.0	
Minimum Split (s)	20.6	30.1	30.1	20.6	30.1	30.1		29.1		11.5	29.1	
Total Split (s)	35.6	41.1	41.1	35.6	41.1	41.1		61.1		26.5	61.1	
Total Split (%)	21.7%	25.0%	25.0%	21.7%	25.0%	25.0%		37.2%		16.1%	37.2%	
Yellow Time (s)	3.7	3.7	3.7	3.7	3.7	3.7		3.7		3.7	3.7	
All-Red Time (s)	1.9	2.4	2.4	1.9	2.4	2.4		2.4		2.8	2.4	
Lost Time Adjust (s)	0.0	0.0	0.0	0.0	0.0	0.0		0.0		0.0	0.0	
Total Lost Time (s)	5.6	6.1	6.1	5.6	6.1	6.1		6.1		6.5	6.1	
Lead/Lag	Lag	Lead	Lead	Lag	Lead	Lead		Lag		Lead		
Lead-Lag Optimize?	Yes	Yes	Yes	Yes	Yes	Yes		Yes		Yes		
Recall Mode	None	None	None	None	None	None		None		None	None	
Act Effct Green (s)	30.0	35.1	35.1	30.0	35.1	35.1		52.9		10.3	69.7	
Actuated g/C Ratio	0.20	0.23	0.23	0.20	0.23	0.23		0.35		0.07	0.46	
v/c Ratio	1.21	1.21	0.16	0.30	1.56	2.12		0.93		0.48	1.15	
Control Delay	171.4	155.1	3.2	56.6	296.4	529.1		70.7		77.1	118.7	
Queue Delay	0.0	0.0	0.0	0.0	0.0	0.0		0.0		0.0	0.0	
Total Delay	171.4	155.1	3.2	56.6	296.4	529.1		70.7		77.1	118.7	
LOS	F	F	A	E	F	F		E		E	F	
Approach Delay		152.4			398.8			70.7			114.5	
Approach LOS		F			F			E			F	
Queue Length 50th (m)	~149.6	~182.6	0.0	26.4	~269.3	~506.2		161.0		15.2	~301.9	
Queue Length 95th (m)	#220.3	#231.0	4.2	45.2	#320.0	#600.0		#236.8		25.1	#382.5	
Internal Link Dist (m)		750.5			213.6			249.0			153.7	
Turn Bay Length (m)	104.5		88.0	89.6						80.0		
Base Capacity (vph)	326	761	408	326	754	559		623		398	881	
Starvation Cap Reductn	0	0	0	0	0	0		0		0	0	
Spillback Cap Reductn	0	0	0	0	0	0		0		0	0	
Storage Cap Reductn	0	0	0	0	0	0		0		0	0	
Reduced v/c Ratio	1.21	1.21	0.16	0.30	1.56	2.12		0.89		0.25	0.99	

Intersection Summary	
Cycle Length:	164.3
Actuated Cycle Length:	152.6
Natural Cycle:	145
Control Type:	Actuated-Uncoordinated
Maximum v/c Ratio:	2.12

Lanes, Volumes, Timings
1: Island Park & Sir John A. Macdonald

2032 Future Total
PM Peak Hour

Intersection Signal Delay: 249.9	Intersection LOS: F
Intersection Capacity Utilization 146.8%	ICU Level of Service H
Analysis Period (min) 15	
~ Volume exceeds capacity, queue is theoretically infinite.	
Queue shown is maximum after two cycles.	
# 95th percentile volume exceeds capacity, queue may be longer.	
Queue shown is maximum after two cycles.	

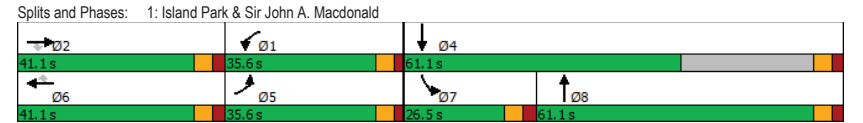

HCM 2010 TWSC
2: Island Park & Clearview

2032 Future Total
PM Peak Hour

Intersection												
Int Delay, s/veh	1.9											
Movement	EBL	EBT	EBR	WBL	WBT	WBR	NBL	NBT	NBR	SBL	SBT	SBR
Lane Configurations	↔		↔		↔		↔		↔		↔	
Traffic Vol, veh/h	27	3	14	5	5	50	9	475	1	12	509	49
Future Vol, veh/h	27	3	14	5	5	50	9	475	1	12	509	49
Conflicting Peds, #/hr	8	0	0	0	0	8	3	0	6	6	0	3
Sign Control	Stop	Stop	Stop	Stop	Stop	Stop	Free	Free	Free	Free	Free	Free
RT Channelized	-	-	None	-	-	None	-	-	None	-	-	None
Storage Length	-	-	-	-	-	-	-	-	-	-	-	-
Veh in Median Storage, #	-	0	-	-	0	-	-	0	-	-	0	-
Grade, %	-	0	-	-	0	-	-	0	-	-	0	-
Peak Hour Factor	100	100	100	100	100	100	100	100	100	100	100	100
Heavy Vehicles, %	2	67	2	20	20	2	2	2	2	8	2	2
Mvmt Flow	27	3	14	5	5	50	9	475	1	12	509	49
Major/Minor	Minor2	Minor1	Major1	Major2								
Conflicting Flow All	1090	1061	537	1066	1085	490	561	0	0	482	0	0
Stage 1	561	561	-	500	500	-	-	-	-	-	-	-
Stage 2	529	500	-	566	585	-	-	-	-	-	-	-
Critical Hdwy	7.12	7.17	6.22	7.3	6.7	6.22	4.12	-	-	4.18	-	-
Critical Hdwy Stg 1	6.12	6.17	-	6.3	5.7	-	-	-	-	-	-	-
Critical Hdwy Stg 2	6.12	6.17	-	6.3	5.7	-	-	-	-	-	-	-
Follow-up Hdwy	3.518	4.603	3.318	3.68	4.18	3.318	2.218	-	-	2.272	-	-
Pot Cap-1 Maneuver	193	173	544	185	201	578	1010	-	-	1050	-	-
Stage 1	512	419	-	521	514	-	-	-	-	-	-	-
Stage 2	533	449	-	478	470	-	-	-	-	-	-	-
Platoon blocked, %	-	-	-	-	-	-	-	-	-	-	-	-
Mov Cap-1 Maneuver	168	167	543	173	194	572	1008	-	-	1045	-	-
Mov Cap-2 Maneuver	168	167	-	173	194	-	-	-	-	-	-	-
Stage 1	505	411	-	512	505	-	-	-	-	-	-	-
Stage 2	473	441	-	454	461	-	-	-	-	-	-	-
Approach	EB	WB	NB	SB								
HCM Control Delay, s	26	14.9	0.2	0.2								
HCM LOS	D	B										
Minor Lane/Major Mvmt	NBL	NBT	NBR	EBLn1	WBLn1	SBL	SBT	SBR				
Capacity (veh/h)	1008	-	-	215	422	1045	-	-				
HCM Lane V/C Ratio	0.009	-	-	0.205	0.142	0.011	-	-				
HCM Control Delay (s)	8.6	0	-	26	14.9	8.5	0	-				
HCM Lane LOS	A	A	-	D	B	A	A	-				
HCM 95th %tile Q(veh)	0	-	-	0.7	0.5	0	-	-				

Lanes, Volumes, Timings
3: Island Park & Scott

2032 Future Total
PM Peak Hour

Lane Group	EBL	EBT	EBR	WBL	WBT	WBR	NBL	NBT	NBR	SBL	SBT	SBR
Lane Configurations	↔	↔	↔	↔	↔	↔	↔	↔	↔	↔	↔	↔
Traffic Volume (vph)	107	309	42	192	604	103	23	443	21	29	449	74
Future Volume (vph)	107	309	42	192	604	103	23	443	21	29	449	74
Satd. Flow (prot)	1658	1712	1483	1658	1662	0	0	1727	0	1658	1693	0
Fit Permitted	0.188			0.522				0.811		0.349		
Satd. Flow (perm)	328	1712	1391	888	1662	0	0	1403	0	601	1693	0
Satd. Flow (RTOR)			42		12			3				9
Lane Group Flow (vph)	107	309	42	192	707	0	0	487	0	29	523	0
Turn Type	Perm	NA	Perm	Perm	NA		Perm	NA		Perm	NA	
Protected Phases		4			8			2			6	
Permitted Phases	4		4	8			2				6	
Detector Phase	4	4	4	8	8		2	2		6	6	
Switch Phase												
Minimum Initial (s)	10.0	10.0	10.0	10.0	10.0		10.0	10.0		10.0	10.0	
Minimum Split (s)	34.8	34.8	34.8	34.8	34.8		34.5	34.5		34.5	34.5	
Total Split (s)	56.0	56.0	56.0	56.0	56.0		44.0	44.0		44.0	44.0	
Total Split (%)	56.0%	56.0%	56.0%	56.0%	56.0%		44.0%	44.0%		44.0%	44.0%	
Yellow Time (s)	3.3	3.3	3.3	3.3	3.3		3.0	3.0		3.0	3.0	
All-Red Time (s)	2.7	2.7	2.7	2.7	2.7		3.5	3.5		3.5	3.5	
Lost Time Adjust (s)	0.0	0.0	0.0	0.0	0.0		0.0	0.0		0.0	0.0	
Total Lost Time (s)	6.0	6.0	6.0	6.0	6.0		6.5	6.5		6.5	6.5	
Lead/Lag												
Lead-Lag Optimize?												
Recall Mode	Max	Max	Max	Max	Max		C-Max	C-Max		C-Max	C-Max	
Act Effct Green (s)	50.0	50.0	50.0	50.0	50.0		37.5	37.5		37.5	37.5	
Actuated g/C Ratio	0.50	0.50	0.50	0.50	0.50		0.38	0.38		0.38	0.38	
v/c Ratio	0.65	0.36	0.06	0.43	0.84		0.92	0.13		0.82	0.13	
Control Delay	37.7	13.9	3.0	19.8	32.7		55.3	22.5		39.8	22.5	
Queue Delay	0.0	0.0	0.0	0.0	0.0		0.0	0.0		0.0	0.0	
Total Delay	37.7	13.9	3.0	19.8	32.7		55.3	22.5		39.8	22.5	
LOS	D	B	A	B	C		E	C		D	C	
Approach Delay	18.5				29.9		55.3				38.9	
Approach LOS	B				C		E				D	
Queue Length 50th (m)	16.1	27.5	0.0	22.8	112.1		88.4			3.6	88.5	
Queue Length 95th (m)	#43.6	38.6	2.4	41.3	#182.9		#151.0			10.1	#142.6	
Internal Link Dist (m)		217.8			273.2		304.9				417.3	
Turn Bay Length (m)	58.7			29.5	250.0					36.5		
Base Capacity (vph)	164	856	716	444	837		528			225	640	
Starvation Cap Reductn	0	0	0	0	0		0			0	0	
Spillback Cap Reductn	0	0	0	0	0		0			0	0	
Storage Cap Reductn	0	0	0	0	0		0			0	0	
Reduced v/c Ratio	0.65	0.36	0.06	0.43	0.84		0.92			0.13	0.82	

Intersection Summary												
Cycle Length: 100												
Actuated Cycle Length: 100												
Offset: 2 (2%), Referenced to phase 2:NBT and 6:SBTL, Start of Green												
Natural Cycle: 80												
Control Type: Actuated-Coordinated												

Lanes, Volumes, Timings
3: Island Park & Scott

2032 Future Total
PM Peak Hour

Maximum v/c Ratio: 0.92	Intersection LOS: C
Intersection Signal Delay: 35.0	ICU Level of Service H
Intersection Capacity Utilization 110.4%	
Analysis Period (min) 15	
# 95th percentile volume exceeds capacity, queue may be longer.	
Queue shown is maximum after two cycles.	

Splits and Phases: 3: Island Park & Scott

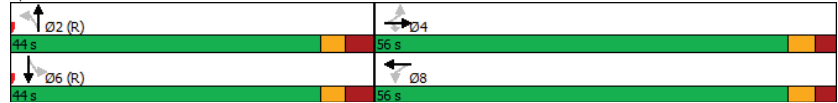

Lanes, Volumes, Timings
4: West Village/Lanark & Scott

2032 Future Total
PM Peak Hour

Lane Group	EBL	EBT	EBR	WBL	WBT	WBR	NBL	NBT	NBR	SBL	SBT	SBR
Lane Configurations	[Diagrammatic arrows for lane configurations]											
Traffic Volume (vph)	90	397	20	13	664	36	6	0	4	57	1	44
Future Volume (vph)	90	397	20	13	664	36	6	0	4	57	1	44
Satd. Flow (prot)	1658	1728	0	1658	1717	0	1658	1395	0	1658	1358	0
Fit Permitted	0.359			0.515			0.728			0.755		
Satd. Flow (perm)	605	1728	0	880	1717	0	1188	1395	0	1264	1358	0
Satd. Flow (RTOR)		6			7			507			44	
Lane Group Flow (vph)	90	417	0	13	700	0	6	4	0	57	45	0
Turn Type	Perm	NA		Perm	NA		Perm	NA		Perm	NA	
Protected Phases		2			6			4			8	
Permitted Phases	2			6			4			8		
Detector Phase	2	2		6	6		4	4		8	8	
Switch Phase												
Minimum Initial (s)	10.0	10.0		10.0	10.0		10.0	10.0		10.0	10.0	
Minimum Split (s)	26.1	26.1		26.1	26.1		21.5	21.5		21.5	21.5	
Total Split (s)	78.0	78.0		78.0	78.0		22.0	22.0		22.0	22.0	
Total Split (%)	78.0%	78.0%		78.0%	78.0%		22.0%	22.0%		22.0%	22.0%	
Yellow Time (s)	3.3	3.3		3.3	3.3		3.3	3.3		3.3	3.3	
All-Red Time (s)	2.8	2.8		2.8	2.8		2.2	2.2		2.2	2.2	
Lost Time Adjust (s)	0.0	0.0		0.0	0.0		0.0	0.0		0.0	0.0	
Total Lost Time (s)	6.1	6.1		6.1	6.1		5.5	5.5		5.5	5.5	
Lead/Lag												
Lead-Lag Optimize?												
Recall Mode	C-Max	C-Max		C-Max	C-Max		None	None		None	None	
Act Effct Green (s)	80.3	80.3		80.3	80.3		12.4	12.4		12.4	12.4	
Actuated g/C Ratio	0.80	0.80		0.80	0.80		0.12	0.12		0.12	0.12	
v/c Ratio	0.19	0.30		0.02	0.51		0.04	0.01		0.37	0.22	
Control Delay	4.9	4.4		1.3	1.9		37.0	0.0		46.0	14.4	
Queue Delay	0.0	0.0		0.0	0.0		0.0	0.0		0.0	0.0	
Total Delay	4.9	4.4		1.3	1.9		37.0	0.0		46.0	14.4	
LOS	A	A		A	A		D	A		D	B	
Approach Delay		4.5			1.8			22.2			32.0	
Approach LOS		A			A			C			C	
Queue Length 50th (m)	3.5	17.8		0.2	9.3		1.1	0.0		10.6	0.2	
Queue Length 95th (m)	10.5	37.0		m0.3	m17.3		4.6	0.0		21.7	9.6	
Internal Link Dist (m)		332.8			217.8			81.9			75.1	
Turn Bay Length (m)	36.5			42.0			18.0			18.0		
Base Capacity (vph)	486	1389		706	1380		196	653		208	260	
Starvation Cap Reductn	0	0		0	0		0	0		0	0	
Spillback Cap Reductn	0	0		0	0		0	0		0	0	
Storage Cap Reductn	0	0		0	0		0	0		0	0	
Reduced v/c Ratio	0.19	0.30		0.02	0.51		0.03	0.01		0.27	0.17	

Intersection Summary

Cycle Length: 100
Actuated Cycle Length: 100
Offset: 40 (40%), Referenced to phase 2:EBTL and 6:WBTL, Start of Green
Natural Cycle: 60
Control Type: Actuated-Coordinated

Lanes, Volumes, Timings
4: West Village/Lanark & Scott

2032 Future Total
PM Peak Hour

Maximum v/c Ratio: 0.51	Intersection LOS: A
Intersection Signal Delay: 5.3	ICU Level of Service D
Intersection Capacity Utilization 74.2%	
Analysis Period (min) 15	
m Volume for 95th percentile queue is metered by upstream signal.	

Splits and Phases: 4: West Village/Lanark & Scott



HCM 2010 AWSC
5: Churchill & Lanark

2032 Future Total
PM Peak Hour

Intersection	
Intersection Delay, s/veh	7.5
Intersection LOS	A

Movement	WBL	WBR	NBT	NBR	SBL	SBT
Lane Configurations	↔		↔			↔
Traffic Vol, veh/h	63	10	37	53	4	27
Future Vol, veh/h	63	10	37	53	4	27
Peak Hour Factor	1.00	1.00	1.00	1.00	1.00	1.00
Heavy Vehicles, %	6	2	2	4	2	2
Mvmt Flow	63	10	37	53	4	27
Number of Lanes	1	0	1	0	0	1

Approach	WB	NB	SB
Opposing Approach		SB	NB
Opposing Lanes	0	1	1
Conflicting Approach Left	NB		WB
Conflicting Lanes Left	1	0	1
Conflicting Approach Right	SB	WB	
Conflicting Lanes Right	1	1	0
HCM Control Delay	7.8	7.2	7.4
HCM LOS	A	A	A

Lane	NBLn1	WBLn1	SBLn1
Vol Left, %	0%	86%	13%
Vol Thru, %	41%	0%	87%
Vol Right, %	59%	14%	0%
Sign Control	Stop	Stop	Stop
Traffic Vol by Lane	90	73	31
LT Vol	0	63	4
Through Vol	37	0	27
RT Vol	53	10	0
Lane Flow Rate	90	73	31
Geometry Grp	1	1	1
Degree of Util (X)	0.093	0.087	0.036
Departure Headway (Hd)	3.732	4.302	4.157
Convergence, Y/N	Yes	Yes	Yes
Cap	953	830	855
Service Time	1.783	2.342	2.212
HCM Lane V/C Ratio	0.094	0.088	0.036
HCM Control Delay	7.2	7.8	7.4
HCM Lane LOS	A	A	A
HCM 95th-tile Q	0.3	0.3	0.1

Appendix M

TDM Checklist

TDM Measures Checklist:

Residential Developments (multi-family, condominium or subdivision)

Legend	
BASIC	The measure is generally feasible and effective, and in most cases would benefit the development and its users
BETTER	The measure could maximize support for users of sustainable modes, and optimize development performance
★	The measure is one of the most dependably effective tools to encourage the use of sustainable modes

TDM measures: Residential developments		Check if proposed & add descriptions
1. TDM PROGRAM MANAGEMENT		
1.1 Program coordinator		
BASIC ★	1.1.1 Designate an internal coordinator, or contract with an external coordinator	<input type="checkbox"/>
1.2 Travel surveys		
BETTER	1.2.1 Conduct periodic surveys to identify travel-related behaviours, attitudes, challenges and solutions, and to track progress	<input type="checkbox"/>
2. WALKING AND CYCLING		
2.1 Information on walking/cycling routes & destinations		
BASIC	2.1.1 Display local area maps with walking/cycling access routes and key destinations at major entrances (<i>multi-family, condominium</i>)	<input checked="" type="checkbox"/>
2.2 Bicycle skills training		
BETTER	2.2.1 Offer on-site cycling courses for residents, or subsidize off-site courses	<input type="checkbox"/>

TDM measures: Residential developments		Check if proposed & add descriptions
3. TRANSIT		
3.1 Transit information		
BASIC	3.1.1 Display relevant transit schedules and route maps at entrances (<i>multi-family, condominium</i>)	<input checked="" type="checkbox"/>
BETTER	3.1.2 Provide real-time arrival information display at entrances (<i>multi-family, condominium</i>)	<input type="checkbox"/>
3.2 Transit fare incentives		
BASIC ★	3.2.1 Offer PRESTO cards preloaded with one monthly transit pass on residence purchase/move-in, to encourage residents to use transit	<input type="checkbox"/>
BETTER	3.2.2 Offer at least one year of free monthly transit passes on residence purchase/move-in	<input type="checkbox"/>
3.3 Enhanced public transit service		
BETTER ★	3.3.1 Contract with OC Transpo to provide early transit services until regular services are warranted by occupancy levels (<i>subdivision</i>)	<input type="checkbox"/>
3.4 Private transit service		
BETTER	3.4.1 Provide shuttle service for seniors homes or lifestyle communities (e.g. scheduled mall or supermarket runs)	<input type="checkbox"/>
4. CARSHARING & BIKESHARING		
4.1 Bikeshare stations & memberships		
BETTER	4.1.1 Contract with provider to install on-site bikeshare station (<i>multi-family</i>)	<input checked="" type="checkbox"/>
BETTER	4.1.2 Provide residents with bikeshare memberships, either free or subsidized (<i>multi-family</i>)	<input type="checkbox"/>
4.2 Carshare vehicles & memberships		
BETTER	4.2.1 Contract with provider to install on-site carshare vehicles and promote their use by residents	<input checked="" type="checkbox"/>
BETTER	4.2.2 Provide residents with carshare memberships, either free or subsidized	<input type="checkbox"/>
5. PARKING		
5.1 Priced parking		
BASIC ★	5.1.1 Unbundle parking cost from purchase price (<i>condominium</i>)	<input checked="" type="checkbox"/>
BASIC ★	5.1.2 Unbundle parking cost from monthly rent (<i>multi-family</i>)	<input checked="" type="checkbox"/>

TDM measures: <i>Residential developments</i>		Check if proposed & add descriptions
6. TDM MARKETING & COMMUNICATIONS		
6.1 Multimodal travel information		
BASIC ★	6.1.1 Provide a multimodal travel option information package to new residents	<input checked="" type="checkbox"/>
6.2 Personalized trip planning		
BETTER ★	6.2.1 Offer personalized trip planning to new residents	<input type="checkbox"/>

Appendix N

MMLOS Analysis

Multi-Modal Level of Service - Intersections Form

Consultant Scenario Comments	CGH Transportation Inc. Existing/Future	Project Date	210 Clearview Ave 10/24/2022

INTERSECTIONS		Island Park Drive at Sir John A. Macdonald Parkway				Island Park Drive at Scott Street (Existing)				Island Park Drive at Scott Street (Future)				Lanark Avenue at Scott Street (Existing)				Lanark Avenue at Scott Street (Future)			
Crossing Side		NORTH	SOUTH	EAST	WEST	NORTH	SOUTH	EAST	WEST	NORTH	SOUTH	EAST	WEST	NORTH	SOUTH	EAST	WEST	NORTH	SOUTH	EAST	WEST
Pedestrian	Lanes	6	6	6	6	6	4	4	6	4	4	6	6	5	5	4	4	4	3	5	5
	Median	No Median - 2.4 m	No Median - 2.4 m	No Median - 2.4 m	No Median - 2.4 m	No Median - 2.4 m	No Median - 2.4 m	No Median - 2.4 m	No Median - 2.4 m	No Median - 2.4 m	No Median - 2.4 m	No Median - 2.4 m	No Median - 2.4 m	No Median - 2.4 m	No Median - 2.4 m	No Median - 2.4 m	No Median - 2.4 m	No Median - 2.4 m	No Median - 2.4 m	No Median - 2.4 m	No Median - 2.4 m
	Conflicting Left Turns	Protected	Protected	Protected	No left turn / Prohib.	Permissive	Permissive	Permissive	Permissive	Permissive	Permissive	Permissive	Permissive	Permissive	Permissive	Permissive	Permissive	Permissive	Permissive	Permissive	Permissive
	Conflicting Right Turns	Permissive or yield control	Permissive or yield control	Permissive or yield control	Permissive or yield control	Permissive or yield control	Permissive or yield control	Permissive or yield control	Permissive or yield control	Permissive or yield control	Permissive or yield control	Permissive or yield control	Permissive or yield control	Permissive or yield control	Permissive or yield control	Permissive or yield control	Permissive or yield control	Permissive or yield control	Permissive or yield control	Permissive or yield control	Permissive or yield control
	Right Turns on Red (RTorT) ?	RTOR allowed	RTOR allowed	RTOR allowed	RTOR allowed	RTOR allowed	RTOR allowed	RTOR allowed	RTOR allowed	RTOR allowed	RTOR allowed	RTOR allowed	RTOR allowed	RTOR allowed	RTOR allowed	RTOR allowed	RTOR allowed	RTOR allowed	RTOR allowed	RTOR allowed	RTOR allowed
	Ped Signal Leading Interval?	No	No	No	No	No	No	No	No	No	No	No	No	No	No	No	No	No	No	No	No
	Right Turn Channel	Conventional with Receiving Lane >25m	Conv'tl without Receiving Lane >25m	Conv'tl without Receiving Lane >25m	Conv'tl without Receiving Lane >25m	No Channel	No Channel	No Channel	No Channel	No Channel	No Channel	No Channel	No Channel	No Channel	No Channel	No Channel	No Channel	No Channel	No Channel	No Channel	No Channel
	Corner Radius	>25m	>25m	>25m	>25m	5-10m	5-10m	5-10m	5-10m	5-10m	3-5m	5-10m	3-5m	5-10m	5-10m	5-10m	5-10m	5-10m	5-10m	5-10m	5-10m
	Crosswalk Type	Zebra stripe hi-vis markings	Zebra stripe hi-vis markings	Zebra stripe hi-vis markings	Zebra stripe hi-vis markings	Zebra stripe hi-vis markings	Zebra stripe hi-vis markings	Zebra stripe hi-vis markings	Zebra stripe hi-vis markings	Zebra stripe hi-vis markings	Zebra stripe hi-vis markings	Zebra stripe hi-vis markings	Zebra stripe hi-vis markings	Std transverse markings	Std transverse markings	Std transverse markings	Std transverse markings	Std transverse markings	Std transverse markings	Std transverse markings	Std transverse markings
	PETSI Score	29	32	32	32	24	57	57	24	57	58	24	25	38	38	54	54	54	71	38	38
	Ped. Exposure to Traffic LoS	F	E	E	E	F	D	D	F	D	D	F	F	E	E	D	D	D	C	E	E
	Cycle Length	164	164	164	164	100	100	100	100	100	100	100	100	100	100	100	100	100	100	100	100
	Effective Walk Time	39	39	18	18	12	12	12	12	12	12	12	12	8	8	59	59	8	8	59	59
	Average Pedestrian Delay	48	48	65	65	39	39	39	39	39	39	39	39	42	42	8	8	42	42	8	8
Pedestrian Delay LoS	E	E	F	F	D	D	D	D	D	D	D	D	E	E	A	A	E	E	A	A	
Level of Service	F	E	F	F	F	D	D	F	D	D	F	F	E	E	D	D	E	E	E	E	
Approach From		NORTH	SOUTH	EAST	WEST	NORTH	SOUTH	EAST	WEST	NORTH	SOUTH	EAST	WEST	NORTH	SOUTH	EAST	WEST	NORTH	SOUTH	EAST	WEST
Bicycle	Bicycle Lane Arrangement on Approach	Pocket Bike Lane	Pocket Bike Lane	Mixed Traffic	Mixed Traffic	Pocket Bike Lane	Pocket Bike Lane	Pocket Bike Lane	Pocket Bike Lane	Curb Bike Lane, Cycletrack or MUP	Curb Bike Lane, Cycletrack or MUP	Curb Bike Lane, Cycletrack or MUP	Curb Bike Lane, Cycletrack or MUP	Mixed Traffic	Mixed Traffic	Pocket Bike Lane	Pocket Bike Lane	Curb Bike Lane, Cycletrack or MUP	Curb Bike Lane, Cycletrack or MUP	Curb Bike Lane, Cycletrack or MUP	Curb Bike Lane, Cycletrack or MUP
	Right Turn Lane Configuration	> 50 m Introduced right turn lane	> 50 m Introduced right turn lane	> 50 m	> 50 m	> 50 m Introduced right turn lane	> 50 m Introduced right turn lane	> 50 m	> 50 m	> 50 m Introduced right turn lane	> 50 m Introduced right turn lane	> 50 m Introduced right turn lane	> 50 m Introduced right turn lane	Not Applicable	Not Applicable	Not Applicable	Not Applicable	Not Applicable	Not Applicable	Not Applicable	Not Applicable
	Right Turning Speed	> 30 km/h	> 30 km/h	>25 km/h	>25 km/h	> 30 km/h	> 30 km/h	>25 km/h	>25 km/h	> 30 km/h	> 30 km/h	> 30 km/h	> 30 km/h	Not Applicable	Not Applicable	Not Applicable	Not Applicable	Not Applicable	Not Applicable	Not Applicable	Not Applicable
	Cyclist relative to RT motorists	F	F	F	F	#N/A	#N/A	#N/A	D	Not Applicable	Not Applicable	Not Applicable	Not Applicable	#N/A	#N/A	#N/A	#N/A	Not Applicable	Not Applicable	Not Applicable	Not Applicable
	Separated or Mixed Traffic	Separated	Separated	Mixed Traffic	Mixed Traffic	Separated	Separated	Separated	Separated	Separated	Separated	Separated	Separated	Mixed Traffic	Mixed Traffic	Separated	Separated	Mixed Traffic	Mixed Traffic	Separated	Separated
	Left Turn Approach	1 lane crossed	≥ 2 lanes crossed	≥ 2 lanes crossed	≥ 2 lanes crossed	1 lane crossed	No lane crossed	1 lane crossed	1 lane crossed	2-stage, LT box	2-stage, LT box	2-stage, LT box	2-stage, LT box	One lane crossed	One lane crossed	1 lane crossed	1 lane crossed	2-stage, LT box	2-stage, LT box	2-stage, LT box	2-stage, LT box
Operating Speed	> 50 to < 60 km/h	> 60 km/h	≥ 60 km/h	≥ 60 km/h	> 50 to < 60 km/h	> 50 to < 60 km/h	> 50 to < 60 km/h	> 50 to < 60 km/h	> 50 to < 60 km/h	> 50 to < 60 km/h	> 50 to < 60 km/h	> 50 to < 60 km/h	> 40 to < 50 km/h	≤ 40 km/h	> 50 to < 60 km/h	> 50 to < 60 km/h	> 40 to < 50 km/h	≤ 40 km/h	> 50 to < 60 km/h	> 50 to < 60 km/h	
Left Turning Cyclist	D	-	F	F	D	C	D	D	A	A	A	A	D	B	D	D	A	A	A	A	
Level of Service	F	-	F	F	#N/A	#N/A	#N/A	D	A	A	A	A	#N/A	#N/A	#N/A	#N/A	A	A	A	A	
Transit	Average Signal Delay	-	-	-	-	-	-	-	-	-	-	-	-	> 40 sec	≤ 10 sec	≤ 10 sec	≤ 10 sec	> 40 sec	-	≤ 10 sec	≤ 10 sec
	Level of Service	-	-	-	-	-	-	-	-	-	-	-	-	F	-	B	B	F	-	B	B
Truck	Effective Corner Radius	-	-	-	-	-	-	-	-	-	-	-	-	-	-	-	-	-	-	-	-
	Level of Service	-	-	-	-	-	-	-	-	-	-	-	-	-	-	-	-	-	-	-	-
Auto	Volume to Capacity Ratio	-	> 1.00	-	-	-	> 1.00	-	-	-	> 1.00	-	-	-	0.0 - 0.60	-	-	-	0.0 - 0.60	-	-
	Level of Service	-	F	-	-	-	F	-	-	-	F	-	-	-	A	-	-	-	A	-	-