

## Engineering

- Land/Site Development
- Municipal Infrastructure
- Environmental/Water Resources
- Traffic/Transportation
- Recreational

## Planning

- Land/Site Development
- Planning Application Management
- Municipal Planning
- Urban Design
- Expert Witness (LPAT)
- Wireless Industry

## Landscape Architecture

- Streetscapes & Public Amenities
- Open Space, Parks & Recreation
- Community & Residential
- Commercial & Institutional
- Environmental Restoration



## Proposed Mixed-Use Development 555, 591, 595, and 603 March Road, Ottawa Transportation Impact Assessment

**Proposed Mixed-Use Development  
555, 591, 595, and 603 March Road  
Transportation Impact Assessment**

Prepared For:

March & Main Developments Inc. and  
591-595 March Road Developments Inc.

Prepared By:

**NOVATECH**  
Suite 200, 240 Michael Cowpland Drive  
Ottawa, Ontario  
K2M 1P6

November 2022

Novatech File: 122125  
Ref: R-2022-145

November 10, 2022

City of Ottawa  
Planning and Growth Management Department  
110 Laurier Ave. W., 4<sup>th</sup> Floor,  
Ottawa, Ontario K1P 1J1

**Attention: Mr. Mike Giampa**  
**Senior Engineer, Infrastructure Applications**

Dear Mr. Giampa:

**Reference: 555, 591, 595, and 603 March Road**  
**Transportation Impact Assessment**  
**Novatech File No. 122125**

---

We are pleased to submit the following Transportation Impact Assessment (TIA) on behalf of March & Main Developments Inc. and 591-595 March Road Developments Inc., in support of a Zoning By-Law Amendment application at 555-603 March Road, for your review and signoff. The structure and format of this report is in accordance with the City of Ottawa's *Transportation Impact Assessment Guidelines* (June 2017).

If you have any questions or comments regarding this report, please feel free to contact Brad Byvelds, or the undersigned.

Yours truly,

**NOVATECH**



Joshua Audia, P.Eng.  
Project Engineer | Transportation



## **TIA Plan Reports**

On 14 June 2017, the Council of the City of Ottawa adopted new Transportation Impact Assessment (TIA) Guidelines. In adopting the guidelines, Council established a requirement for those preparing and delivering transportation impact assessments and reports to sign a letter of certification.

Individuals submitting TIA reports will be responsible for all aspects of development-related transportation assessment and reporting, and undertaking such work, in accordance and compliance with the City of Ottawa's Official Plan, the Transportation Master Plan and the Transportation Impact Assessment (2017) Guidelines.

By submitting the attached TIA report (and any associated documents) and signing this document, the individual acknowledges that s/he meets the four criteria listed below.

### **CERTIFICATION**

1. I have reviewed and have a sound understanding of the objectives, needs and requirements of the City of Ottawa's Official Plan, Transportation Master Plan and the Transportation Impact Assessment (2017) Guidelines;
2. I have a sound knowledge of industry standard practice with respect to the preparation of transportation impact assessment reports, including multi modal level of service review;
3. I have substantial experience (more than 5 years) in undertaking and delivering transportation impact studies (analysis, reporting and geometric design) with strong background knowledge in transportation planning, engineering or traffic operations; and
4. I am either a licensed<sup>1</sup> or registered<sup>2</sup> professional in good standing, whose field of expertise [check  appropriate field(s)] is either transportation engineering  or transportation planning .

**1,2 License of registration body that oversees the profession is required to have a code of conduct and ethics guidelines that will ensure appropriate conduct and representation for transportation planning and/or transportation engineering works.**

City Of Ottawa  
Infrastructure Services and Community  
Sustainability  
Planning and Growth Management  
110 Laurier Avenue West, 4th fl.  
Ottawa, ON K1P 1J1  
Tel. : 613-580-2424  
Fax: 613-560-6006

Ville d'Ottawa  
Services d'infrastructure et Viabilité des  
collectivités  
Urbanisme et Gestion de la croissance  
110, avenue Laurier Ouest  
Ottawa (Ontario) K1P 1J1  
Tél. : 613-580-2424  
Télécopieur: 613-560-6006

Dated at Ottawa this 10th day of November, 2022.  
(City)

Name: Brad Byvelds, P.Eng.  
(Please Print)

Professional Title: Project Coordinator, Transportation/Traffic

*B. Byvelds*

Signature of Individual certifier that s/he meets the above four criteria

<b>Office Contact Information (Please Print)</b>	
Address:	240 Michael Cowpland Drive, Suite 200
City / Postal Code:	Ottawa, ON, K2M 1P6
Telephone / Extension:	613-254-9643 x 286
E-Mail Address:	b.byvelds@novatech-eng.com

**TABLE OF CONTENTS**

**EXECUTIVE SUMMARY .....I**

**1.0 SCREENING.....1**

1.1 INTRODUCTION ..... 1

1.2 PROPOSED DEVELOPMENT..... 1

1.3 SCREENING FORM ..... 2

**2.0 SCOPING.....3**

2.1 EXISTING CONDITIONS ..... 3

2.1.1 Roadways.....3

2.1.2 Driveways.....4

2.1.3 Intersections .....5

2.1.4 Pedestrian and Cycling Facilities .....7

2.1.5 Transit .....7

2.1.6 Area Traffic Management .....10

2.1.7 Existing Traffic Volumes .....10

2.1.8 Collision Records.....12

2.2 PLANNED CONDITIONS ..... 15

2.2.1 Planned Transportation Projects.....15

2.2.2 Other Area Developments .....15

2.3 STUDY AREA AND TIME PERIODS ..... 18

2.4 EXEMPTIONS REVIEW..... 19

**3.0 FORECASTING .....20**

3.1 DEVELOPMENT-GENERATED TRAVEL DEMAND..... 20

3.1.1 Trip Generation.....20

3.1.2 Trip Distribution.....26

3.1.3 Trip Assignment.....27

3.2 BACKGROUND TRAFFIC ..... 28

3.2.1 Other Area Developments .....28

3.2.2 General Background Growth Rate .....30

3.2.3 March Road BRT Corridor .....30

3.3 VOLUME FIGURES ..... 31

3.4 DEMAND RATIONALIZATION..... 36

3.4.1 Existing Traffic Conditions .....37

3.4.2 2037 Background Traffic Conditions .....37

**4.0 ANALYSIS.....40**

4.1 TRANSPORTATION DEMAND MANAGEMENT ..... 40

4.1.1 Context for TDM .....40

4.1.2 Need and Opportunity.....40

4.1.3 TDM Program .....40

4.2 NEIGHBOURHOOD TRAFFIC MANAGEMENT..... 41

4.3 TRANSIT..... 41

4.4 NETWORK CONCEPT ..... 45

4.5 INTERSECTION DESIGN..... 45

4.5.1 Intersection MMLOS Review.....45

4.5.2 2037 Total Intersection Operations .....48

**5.0 CONCLUSIONS AND RECOMMENDATIONS .....49**

**Figures**

Figure 1: View of the Subject Site ..... 2  
 Figure 2: Roadway Network ..... 5  
 Figure 3: Pedestrian and Cycling Network ..... 8  
 Figure 4: OC Transpo Bus Stop Locations ..... 9  
 Figure 5: Existing Traffic Volumes ..... 11  
 Figure 6: Excerpt of the 2031 Affordable RTTP Network ..... 16  
 Figure 7: Excerpt of the 2031 RTTP Network Concept ..... 17  
 Figure 8: Existing Site-Generated Volumes ..... 31  
 Figure 9: Proposed Site-Generated Volumes ..... 32  
 Figure 10: Net Site-Generated Volumes ..... 33  
 Figure 11: Other Area Development-Generated Volumes ..... 34  
 Figure 12: 2037 Background Volumes ..... 35  
 Figure 13: 2037 Total Volumes ..... 36  
 Figure 14: Planned Modifications to March Road/Solandt Road ..... 38

**Tables**

Table 1: OC Transpo Transit Stops ..... 8  
 Table 2: OC Transpo Route Information ..... 10  
 Table 3: Reported Collisions ..... 12  
 Table 4: TIA Exemptions ..... 19  
 Table 5: Existing Development – Peak Hour Trip Generation ..... 20  
 Table 6: Surveyed Kanata/Stittsville Mode Shares – Existing Uses ..... 21  
 Table 7: Existing Development – Peak Hour Trips by Mode Share ..... 21  
 Table 8: Existing Strip Retail – Primary and Pass-by Trips ..... 22  
 Table 9: Surveyed Kanata/Stittsville Mode Shares – Proposed Uses ..... 22  
 Table 10: Proposed Residential – Peak Period Trip Generation ..... 23  
 Table 11: Proposed Residential – Peak Period Trips by Mode Share ..... 23  
 Table 12: Proposed Residential – Peak Hour Trips by Mode Share ..... 23  
 Table 13: Proposed Office/Retail – Peak Hour Trip Generation ..... 24  
 Table 14: Proposed Office/Retail – Peak Hour Trips by Mode Share ..... 24  
 Table 15: Proposed Development – Total Peak Hour Trips ..... 25  
 Table 16: Proposed Development – Internally Captured Trips ..... 25  
 Table 17: Proposed Retail – Primary and Pass-by Trips ..... 26  
 Table 18: Existing Office – Trip Assignment ..... 27  
 Table 19: Proposed Development – Trip Assignment ..... 28  
 Table 20: Existing Traffic Operations ..... 37  
 Table 21: 2037 Background Traffic Operations ..... 39  
 Table 22: 2037 Background – Critical Queues ..... 39  
 Table 23: Transit Utilization ..... 42  
 Table 24: Intersection MMLOS Summary ..... 45  
 Table 25: 2037 Total Traffic Operations ..... 48  
 Table 26: 2037 Total – Critical Queues ..... 48

**Appendices**

- Appendix A: Concept Plan
- Appendix B: TIA Screening Form
- Appendix C: OC Transpo Information
- Appendix D: Traffic Count Data
- Appendix E: Collision Records
- Appendix F: Internal Capture Worksheets
- Appendix G: Other Area Developments
- Appendix H: Strategic Long-Range Model Snapshots
- Appendix I: Future March Road Transitway Functional Design
- Appendix J: Signal Timing Plans
- Appendix K: Existing Synchro Analysis
- Appendix L: Background Synchro Analysis
- Appendix M: Transportation Demand Management
- Appendix N: MMLOS Analysis
- Appendix O: Total Synchro Analysis
- Appendix P: Left Turn Lane Warrants



## EXECUTIVE SUMMARY

This Transportation Impact Assessment (TIA) has been prepared on behalf of March & Main Developments Inc. and 591-595 March Road Developments Inc., in support of a Zoning By-Law Amendment application for the property located at 555, 591, 595, and 603 March Road ('Subject Site'). The Subject Site is approximately 13.6 acres in size, and currently includes a one-storey commercial use (recreational athletic facility) at 555 March Road, a one-storey retail plaza at 591 March Road, a vacant parcel at 595 March Road, and a two-storey office building at 603 March Road. The Subject Site is currently served by three right-in/right-out (RIRO) driveways to March Road and a full-movement driveway to Terry Fox Drive, which serve the separate parcels. Only the parcels at 555 and 591 March Road share access. The Subject Site is surrounded by the following:

- Terry Fox Drive, followed by low-rise single-detached residences to the north,
- Commercial/office uses to the south,
- March Road, followed by the 'Nokia' office use to the east, and
- Hines Road and commercial/office uses to the west.

March & Main is proposing a redevelopment of the Subject Site with eight residential and mixed-use buildings between six and 30 storeys, and two office buildings with seven or eight storeys. Ground-floor retail is proposed in select buildings. March & Main have prepared a concept plan in support of the Zoning By-Law Amendment application, to illustrate the potential redevelopment of the Subject Site in conformity with the policies in the new City of Ottawa Official Plan (particularly for the 'Activity Centre' outlined in Section 6.6.3.2 – Kanata North Economic District). In total, the proposed development will have the potential to include approximately 2,100 dwellings, 154,178 ft<sup>2</sup> gross floor area (GFA) of office space, and 31,482 ft<sup>2</sup> GFA of retail space. Access to the proposed development will be provided via new connections to March Road, Terry Fox Drive, and Hines Road. The development will be developed in phases through subsequent applications for Site Plan Approval and/or Draft Plan of Subdivision. It is anticipated to be fully completed by 2037.

The current zoning for the properties is a mixture of 'General Industrial' IG6 and 'Business Park Industrial Zone' IP6[1149] and IP6[1084]. The proposed residential uses are not permitted in these zones and therefore, a Zoning By-Law Amendment is required to permit them. Pursuant to the City of Ottawa's Official Plan (2021, Council Adopted), the Subject Site is located within the 'Kanata North Economic District,' 'Evolving Neighbourhood' overlay, and is designated as 'Corridor – Mainstreet' (March Road) and 'Corridor – Minor' (Terry Fox Drive) on Schedule B5.

The Council-adopted Official Plan includes proposed policies that will permit a higher density of development and greater degree of mixed uses, including residential within new 'activity centres' that are generally located within 600m of two planned transit stations in the Kanata North Economic District. The goal of the activity centres is to create a place to live, work, learn, play, and provide access to daily needs without the use of a car. The Subject Site is in the activity centre based around a planned transit station at the intersection of March Road/Terry Fox Drive, as part of a future Bus Rapid Transit (BRT) project.

The study area for this report includes the boundary roadways March Road, Terry Fox Drive, and Hines Road, as well as March Road/Morgan's Grant Way/Shirley's Brook Drive, March Road/Terry Fox Drive, March Road/Solandt Road, Terry Fox Drive/Flamborough Way/Innovation Drive, and Innovation Drive/Hines Road.

The selected time periods for the analysis are the weekday AM and PM peak hours, as they represent the 'worst case' combination of site generated traffic and adjacent street traffic. Analysis has been completed for the ultimate buildout year 2037.

### Forecasting

- The proposed development as a whole is estimated to generate 1,232 person trips during the AM peak hour (including 611 external vehicle trips) and 1,382 person trips during the PM peak hour (including 662 external vehicle trips).

### Transportation Demand Management

- While the final list of TDM measures to be implemented by the proposed development will be confirmed at the Site Plan Control application stage, the proponent has agreed to consider a suite of TDM measures for non-residential and residential developments at this time.

### Transit

- The proposed development is anticipated to generate the following number of external transit trips:
  - 287 transit trips during the AM peak hour (124 trips in, 163 trips out);
  - 279 transit trips during the PM peak hour (136 trips in, 143 trips out).
- The proposed development is not anticipated to necessitate more frequent service for OC Routes 63, 64, 110, and 166.

### Intersection MMLoS

- The results of the intersection MMLoS analysis can be summarized as follows:
  - No study area intersections meet the target pedestrian level of service (PLOS);
  - No study area intersections meet the target bicycle level of service (BLOS);
  - No study area intersections along March Road meet the target transit level of service (TLOS);
  - All study area intersections meet the target truck level of service (TkLOS), except for Terry Fox Drive/Flamborough Way/Innovation Drive.
- There is limited opportunity in improving the PLOS at any approach without reducing the number of travel lanes, restricting turning movements, or removing right turn channels. There is also limited opportunity in improving the delay score at any intersection to the target PLOS.
- The north, south, and east approaches of March Road/Morgan's Grant Way/Shirley's Brook Drive do not meet the target BLOS. The target BLOS can be achieved at the east approach by reducing the operating speed to 40 km/h (which is the current speed limit on Shirley's Brook Drive). For left turns from the north and south approaches, the implementation of two-stage left-turn bike boxes at all approaches would not require a right turns on red (RTOR) restriction. This would require the stop bars at all approaches to be shifted away from the intersection. These measures are identified for the City's consideration.

- All approaches of March Road/Terry Fox Drive do not meet the target BLOS. Given that all right turn movements are channelized at this intersection, the implementation of two-stage left turn-bike boxes at all approaches would not require a RTOR restriction. This would require the stop bars at all approaches to be shifted away from the intersection. This is identified for the City's consideration. The target BLOS can be met by shortening the right turn lanes to 50m or shorter. Given the high traffic volumes at this intersection, this is not recommended.
- The east and west approaches of March Road/Solandt Road does not meet the target BLOS. Two-stage left-turn bike boxes have recently been implemented for northbound and southbound cyclists. Implementing this improvement for eastbound and westbound cyclists as well is identified for the City's consideration. For cyclists interacting with right turning vehicles, the right turn lanes at the north and west approaches are greater than 50m, and the bike lane shifts to the left of the right turn lane at the south approach. The target BLOS can be met by shortening the right turn lanes to 50m or shorter. Given the high traffic volumes at this intersection, this is not recommended.
- All approaches of Terry Fox Drive/Flamborough Way/Innovation Drive do not meet the target BLOS. The target BLOS requires the implementation of two-stage left-turn bike boxes on all approaches, which would require RTOR restrictions. This is identified for the City's consideration. For cyclists interacting with right turning vehicles, the right turn lanes at the east and west approaches are greater than 50m. The target BLOS can be met by shortening the right turn lanes to 50m or shorter. Given the magnitude of right-turning traffic volumes at this intersection, this is not recommended.
- The City's RTTP Affordable Network includes at-grade median BRT on March Road south of Solandt Road, and transit signal priority and queue jump lanes north of Solandt Road. These initial measures are anticipated to improve the delays for transit vehicles to the target TLOS or better. Future conversion to median BRT along the entire March Road corridor is anticipated to further improve the delays for buses travelling along March Road.
- While the effective corner radii of each corner at Terry Fox Drive/Flamborough Way/Innovation Drive is greater than 15m, the target TkLOS can only be achieved by providing multiple receiving lanes. Since Flamborough Way and Innovation Drive are not classified as truck routes, no recommendations are identified.

#### Existing Traffic Operations

- All study area intersections operate at an acceptable level of service during the AM and PM peak hours.

#### Background Traffic Operations

- Critical movements at the study area intersections generally operate at an acceptable level of service, with the exception of the westbound left turn movement at March Road/Solandt Road during the PM peak hour. Per the functional design of the March Road BRT, one of the westbound left turn lanes will be removed. It is anticipated that this is the primary driver for the failing vehicular level of service of this movement. The westbound left turn movement would require a reduction of approximately 160 vehicles to achieve the target vehicular level of service (Auto LOS) E.

Total Traffic Operations

- Northbound through queues at March Road/Terry Fox Drive and southbound through queues at March Road/Nokia Access/Site Access do not extend into the opposite intersection. Based on the maximum northbound left turn queues at March Road/Terry Fox Drive, the existing northbound left turn storage length could be reduced to accommodate a longer southbound left turn lane at March Road/Nokia Access/Site Access. A functional design and Roadway Modification Approval (RMA) submission for this modification will be provided as part of a subsequent Site Plan Control application.
- It is anticipated that an auxiliary westbound left turn lane will be required at the proposed access to Terry Fox Drive. A review of the most relevant left turn lane storage graphs included in the Ministry of Transportation of Ontario (MTO)'s *Design Supplement to the Transportation Association of Canada (TAC)'s Geometric Design Guide for Canadian Roads* has been conducted to determine that a storage length of 30m is required. A functional design and RMA submission for this modification will be provided as part of a subsequent Site Plan Control application.
- Based on the foregoing, the proposed development is recommended from a transportation perspective.

## 1.0 SCREENING

### 1.1 Introduction

This Transportation Impact Assessment (TIA) has been prepared on behalf of March & Main Developments Inc. and 591-595 March Road Developments Inc., in support of a Zoning By-Law Amendment application for the property located at 555, 591, 595, and 603 March Road ('Subject Site'). The Subject Site is approximately 13.6 acres in size, and currently includes a one-storey commercial use (recreational athletic facility) at 555 March Road, a one-storey retail plaza at 591 March Road, a vacant parcel at 595 March Road, and a two-storey office building at 603 March Road. The Subject Site is currently served by three right-in/right-out (RIRO) driveways to March Road and a full-movement driveway to Terry Fox Drive, which serve the separate parcels. Only the parcels at 555 and 591 March Road share access. The Subject Site is surrounded by the following:

- Terry Fox Drive, followed by low-rise single-detached residences to the north,
- Commercial/office uses to the south,
- March Road, followed by the 'Nokia' office use to the east, and
- Hines Road and commercial/office uses to the west.

An aerial of the vicinity around the Subject Site is provided in **Figure 1**.

### 1.2 Proposed Development

March & Main is proposing a redevelopment of the Subject Site with eight residential and mixed-use buildings between six and 30 storeys, and two office buildings with seven or eight storeys. Ground-floor retail is proposed in select buildings. March & Main have prepared a concept plan in support of the Zoning By-Law Amendment application, to illustrate the potential redevelopment of the Subject Site in conformity with the policies in the new City of Ottawa Official Plan (particularly for the 'Activity Centre' outlined in Section 6.6.3.2 – Kanata North Economic District). In total, the proposed development will have the potential to include approximately 2,100 dwellings, 154,178 ft<sup>2</sup> gross floor area (GFA) of office space, and 31,482 ft<sup>2</sup> GFA of retail space. Access to the proposed development will be provided via new connections to March Road, Terry Fox Drive, and Hines Road. The development will be developed in phases through subsequent applications for Site Plan Approval and/or Draft Plan of Subdivision. It is anticipated to be fully completed by 2037. A copy of the concept plan is included in **Appendix A**.

The current zoning for the properties is a mixture of 'General Industrial' IG6 and 'Business Park Industrial Zone' IP6[1149] and IP6[1084]. The proposed residential uses are not permitted in these zones and therefore, a Zoning By-Law Amendment is required to permit them. Pursuant to the City of Ottawa's Official Plan (2021, Council Adopted), the Subject Site is located within the 'Kanata North Economic District,' 'Evolving Neighbourhood' overlay, and is designated as 'Corridor – Mainstreet' (March Road) and 'Corridor – Minor' (Terry Fox Drive) on Schedule B5.

The Council-adopted Official Plan includes proposed policies that will permit a higher density of development and greater degree of mixed uses, including residential within new 'activity centres' that are generally located within 600m of two planned transit stations in the Kanata North Economic District. The goal of the activity centres is to create a place to live, work, learn, play, and provide access to daily needs without the use of a car. The Subject Site is in the activity centre based around a planned transit station at the intersection of March Road/Terry Fox Drive, as part of a future Bus Rapid Transit (BRT) project.

Figure 1: View of the Subject Site



### 1.3 Screening Form

The City's 2017 TIA Guidelines identify three triggers for completing a TIA report, including trip generation, location, and safety. The criteria for each trigger are outlined in the City's TIA Screening Form, which is included in **Appendix B**. The trigger results are as follows:

- Trip Generation Trigger – The development is anticipated to generate over 60 peak hour person trips; further assessment is **required** based on this trigger.
- Location Triggers – The development proposes new connections to a designated Rapid Transit or Transit Priority (RTTP) corridor or Spine Cycling Route; further assessment is **required** based on this trigger.
- Safety Triggers – The development meets multiple safety triggers; further assessment is **required** based on this trigger.

## 2.0 SCOPING

### 2.1 Existing Conditions

#### 2.1.1 Roadways

All roadways within the study area fall under the jurisdiction of the City of Ottawa.

March Road is an arterial roadway that, for the purposes of this report, is considered to run on a north-south alignment within the study area, running between Dunrobin Road and Highway 417. West of Dunrobin Road, the roadway runs on an east-west alignment until Appleton Sideroad in the Town of Mississippi Mills, where it continues as Ottawa Street. South of Highway 417, the roadway continues on a north-south alignment as Eagleson Road. Within the study area, March Road has a four-lane divided urban cross-section, sidewalks on both sides of the roadway, on-street bike lanes, and a posted speed limit of 80 km/h. March Road is classified as a truck route, allowing full loads. Street parking is not permitted. The Official Plan reserves a 44.5m right-of-way (ROW) for March Road.

The *West Transitway Connection – Highway 417/Egleson Road to North of Maxwell Bridge Road* Environmental Project Report (EPR), prepared by Delcan in October 2013, identifies that further ROW widening within the vicinity of the intersection of March Road/Terry Fox Drive may be required. Per the approved functional design within the EPR, the ROW protection for March Road widens to approximately 51.5m along the Subject Site's frontage. A widening along some of the Subject Site's frontage may be required as part of a subsequent Draft Plan of Subdivision and/or Site Plan Control application.

Terry Fox Drive travels between Eagleson Road and Herzberg Road, and is classified as an arterial roadway west of March Road and major collector roadway east of March Road. Within the study area, Terry Fox Drive generally runs on an east-west alignment, has on-street bike lanes and a multi-use pathway west of the Subject Site, and a posted speed limit of 50 or 60 km/h. Terry Fox Drive generally has a four-lane divided rural cross-section west of March Road, transitioning to an urban cross-section within 50m of March Road, and a two-lane divided urban cross-section with a grass median east of March Road. Sidewalks or pathways are provided on the north side of Terry Fox Drive west of Flamborough Way, on the south side of Terry Fox Drive west of Acklam Terrace and east of McKinley Drive, and on both sides of Terry Fox Drive between Acklam Terrace and McKinley Drive. West of March Road, Terry Fox Drive is classified as a truck route, allowing full loads. Between March Road and Herzberg Road, Terry Fox Drive is not classified as a truck route. Street parking is not permitted. The Official Plan reserves a 44.5m ROW for Terry Fox Drive, and it appears that a widening will not be required as part of a subsequent Draft Plan of Subdivision and/or Site Plan Control application.

Morgan's Grant Way is a collector roadway that generally runs on an east-west alignment within the study area, running between Flamborough Way and March Road. East of March Road, the roadway continues as Shirley's Brook Drive. Within the study area, Morgan's Grant Way has a two-lane undivided urban cross-section, sidewalk on the south side of the roadway, and a posted speed limit of 40 km/h. Morgan's Grant Way is not classified as a truck route. Street parking is not permitted on either side of the roadway for the 60m immediately west of March Road, and is not permitted on the north side of the roadway for an additional 50m.

Shirley's Brook Drive is a collector roadway that generally runs on an east-west alignment within the study area, running between March Road and Helmsdale Drive. The roadway intersects with Helmsdale Drive in two locations, as it forms a loop east of Helmsdale Drive. West of March Road, the roadway continues as Morgan's Grant Way. Within the study area, Shirley's Brook Drive has a two-lane undivided urban cross-section, sidewalk on the south side of the roadway, and a posted speed limit of 40 km/h. Shirley's Brook Drive is not classified as a truck route. Street parking is permitted.

Solandt Road is a collector roadway that generally runs on an east-west alignment, starting at Hines Road and terminating approximately 450m east of Legget Drive. Within the study area, Solandt Road has a two-lane urban cross-section and an unposted regulatory speed limit of 50 km/h. Sidewalks are provided along the north side for the entire distance of Solandt Road, as well as the south side between March Road and Legget Drive. Solandt Road is not classified as a truck route. Street parking is permitted.

Flamborough Way is a collector roadway that generally runs on a north-south alignment, running between Halton Terrace and Terry Fox Drive. South of Terry Fox Drive, the roadway continues as Innovation Drive. Flamborough Way has a two-lane undivided urban cross-section, sidewalks on both sides of the roadway, and a posted speed limit of 40 km/h. Flamborough Way is not classified as a truck route. Street parking is permitted.

Innovation Drive is a curvilinear collector roadway, running between Terry Fox Drive and Hines Road. North of Terry Fox Drive, the roadway continues as Flamborough Way. Innovation Drive has a two-lane cross-section that is divided in the vicinity of Terry Fox Drive and undivided elsewhere, sidewalks or pathways on both sides of the roadway, and an unposted speed limit of 50 km/h. Innovation Drive is not classified as a truck route. Street parking is generally permitted.

Hines Road is a collector roadway that generally runs on a north-south alignment between Solandt Road and approximately 320m north of Innovation Drive. The roadway then turns 90-degrees and becomes an east-west roadway for approximately 140m to the west. Within the study area, Hines Road has a two-lane undivided cross-section, no sidewalks, and an unposted speed limit of 50 km/h. Hines Road is not classified as a truck route. Street parking is permitted.

The roadway network of the greater area surrounding the Subject Site is illustrated in **Figure 2**.

### 2.1.2 Driveways

A review of the existing adjacent driveways along the boundary roads are provided as follows:

#### **March Road, east side**

- One driveway to an office use at 600 March Road

#### **March Road, west side**

- One driveway to an office use at 525 March Road

#### **Terry Fox Drive, north side**

- No driveways within 200m of Subject Site

#### **Terry Fox Drive, south side**

- No driveways within 200m of Subject Site

#### **Hines Road, east side**

- Six driveways to commercial/office uses at 50, 70, 84, and 88 Hines Road

#### **Hines Road, west side**

- Five driveways to commercial/office uses at 93-99 Hines Road, 1000 Innovation Drive, and 385 Terry Fox Drive



Figure 2: Roadway Network

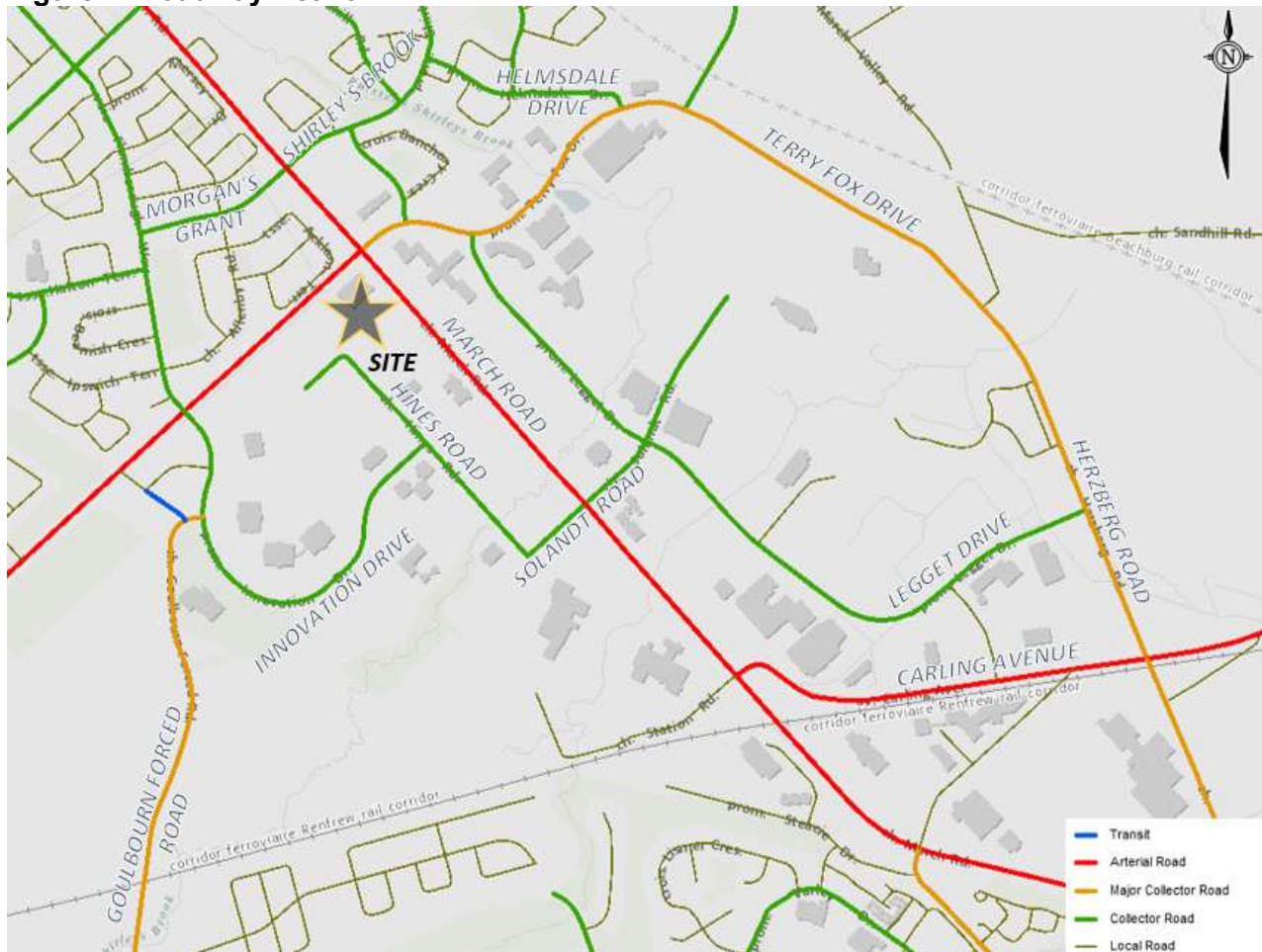

Source: GeoOttawa

### 2.1.3 Intersections

March Road/Morgan's Grant Way/  
Shirley's Brook Drive

- Signalized four-legged intersection
- North/South Approaches (March Road): one left turn lane, three through lanes, one bike lane, and one channelized right turn lane
- East Approach (Shirley's Brook Drive): one left turn lane, one through lane, and one channelized right turn lane
- West Approach (Morgan's Grant Way): one shared left turn/through lane and one channelized right turn lane
- Standard crosswalks on all approaches



March Road/Terry Fox Drive

- Signalized four-legged intersection
- North Approach (March Road): one left turn lane, three through lanes, one bike lane, and one channelized right turn lane
- South Approach (March Road): two left turn lanes, three through lanes, one bike lane, and one channelized right turn lane
- East/West Approaches (Terry Fox Drive): two left turn lanes, two through lanes, one bike lane, and one channelized right turn lane
- Standard crosswalks on all approaches



March Road/Solandt Road

- Signalized four-legged intersection
- North/South Approaches (March Road): one left turn lane, two through lanes, one bike lane, and one channelized right turn lane
- East Approach (Solandt Road): two left turn lanes, and one shared through/channelized right turn lane
- West Approach (Solandt Road): one left turn lane, one through lane, and one channelized right turn lane
- Standard crosswalks on all approaches
- Two-stage, left-turn bike boxes for northbound and southbound cyclists



Terry Fox Drive/Flamborough Way/  
Innovation Drive

- Signalized four-legged intersection
- North Approach (Flamborough Way): one left turn lane and one shared through/right turn lane
- South Approach (Innovation Drive): one left turn lane and one shared through/right turn lane
- East/West Approaches (Terry Fox Drive): one left turn lane, one through lane, one bike lane, and one right turn lane
- Standard crosswalks on all approaches



Innovation Drive/Hines Road

- Unsignalized four-legged intersection
- Stop-controlled on Innovation Drive and access to 70 Hines Road (Royal Canadian Legion)
- Multiple accesses across from west approach
- North Approach (Hines Road): one shared left turn/through/right turn lane
- South Approach (Hines Road): one shared left turn/through/right turn lane
- East Approach (access to 70 Hines Road): one shared left turn/through/right turn lane
- West Approach (Innovation Drive): one shared left turn/through/right turn lane
- Standard crosswalks on west approach (not shown in aerial)

**2.1.4 Pedestrian and Cycling Facilities**

As described in Section 2.1.1, sidewalks are provided on both sides of March Road, and on one or both sides of Terry Fox Drive, Morgan's Grant Way, Shirley's Brook Drive, Solandt Road, Flamborough Way, Innovation Drive, and Hines Road. Asphalt pathways with widths of 3.0m are provided on the south side of Terry Fox Drive west of the Subject Site, and on the outside of Innovation Drive.

In the City of Ottawa's primary cycling network, the Spine Routes within the study area include March Road and Terry Fox Drive, which is also designated as a Crosstown Bikeway west of March Road. The Local Routes within the study area include Shirley's Brook Drive west of Helmsdale Drive, Solandt Road west of Legget Drive, Flamborough Way south of Klondike Road, and the entire lengths of Morgan's Grant Way, Innovation Drive, and Hines Road. Bike lanes are provided along March Road and Terry Fox Drive within the study area.

The pedestrian and cycling network of the greater area surrounding the Subject Site is illustrated in **Figure 3**.

**2.1.5 Transit**

The locations of OC Transpo bus stops in the vicinity of the Subject Site are described in **Table 1**, and are shown in **Figure 4**. A summary of the various routes which serve the study area is included in **Table 2**. Detailed route information and an excerpt from the OC Transpo System Map are included in **Appendix C**.

Figure 3: Pedestrian and Cycling Network

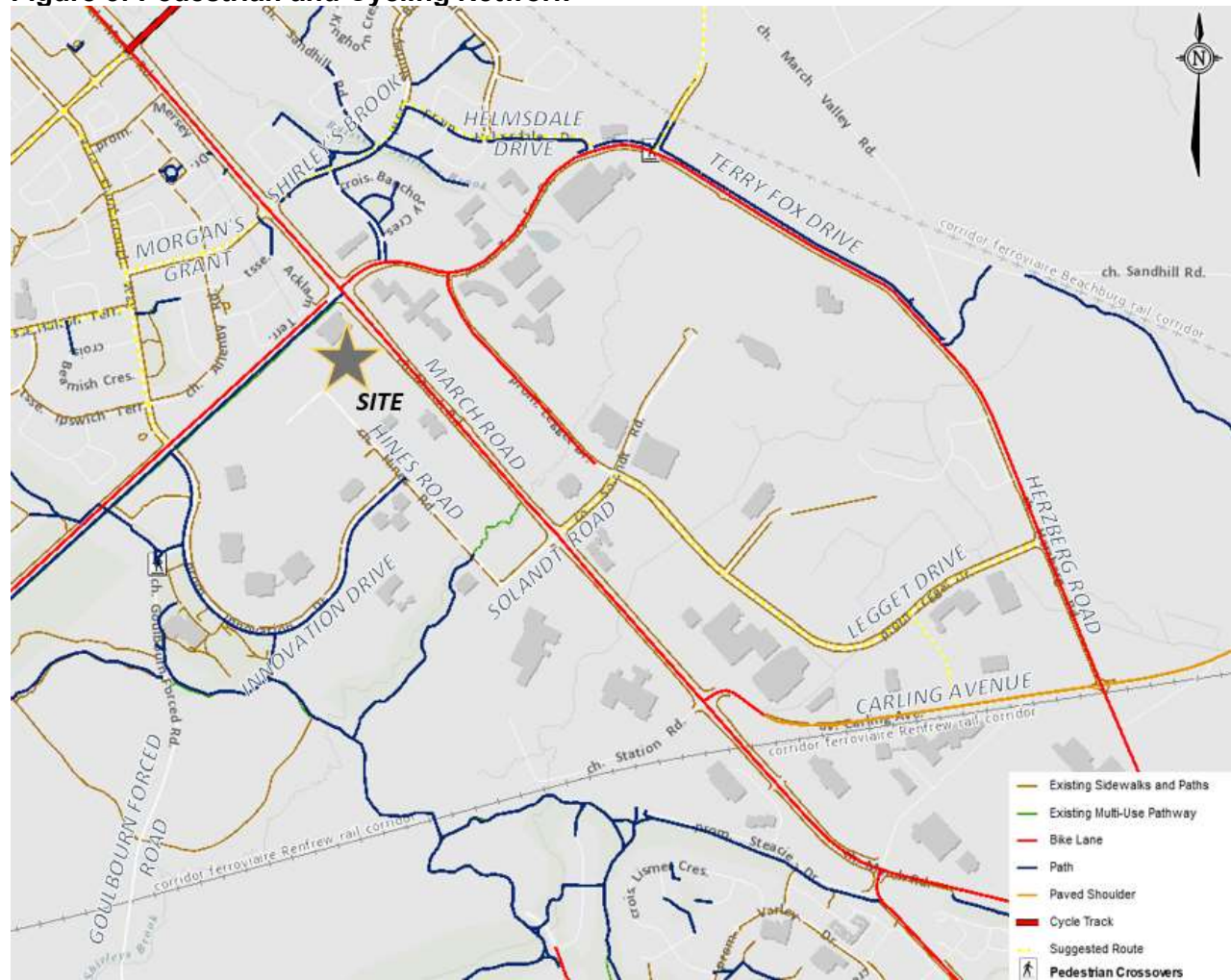

Source: GeoOttawa

Table 1: OC Transpo Transit Stops

Stop	Location	Routes Served
#1174	East side of Hines Road, south of Innovation Drive	64, 166
#1175	West side of Hines Road, south of Innovation Drive	64, 166
#1176	North side of Innovation Drive, west of Hines Road	64, 166
#1177	South side of Innovation Drive, west of Hines Road	64, 166
#1515	North side of Terry Fox Drive, east of Legget Drive	66, 166
#1536	East side of Innovation Drive, south of Terry Fox Drive	63, 165, 166
#1819	West side of Flamborough Way, south of Allenby Road	63, 64, 165
#1820	East side of March Road, between Terry Fox Drive and Solandt Road	63
#1821	North side of Shirley's Brook Drive, west of Inverary Drive	63, 165
#3057 (A/B)	Innovation Station, between Terry Fox Drive and Goulbourn Forced Road	63, 64, 110, 165, 166
#4875	North side of Terry Fox Drive, west of March Road	63, 110
#4972	West side of Legget Drive, south of Terry Fox Drive	63, 66, 110, 166
#6149	East side of Legget Drive, south of Terry Fox Drive	63, 66, 110, 166
#6152	North side of Morgan's Grant Way, west of March Road	63, 165



**Table 2: OC Transpo Route Information**

Route	From ↔ To	Frequency
63	Innovation / Briarbrook ↔ Tunney's Pasture / Gatineau	15- to 30-minute headways, seven days per week; all day service
64	Innovation / Morgan's Grant ↔ Tunney's Pasture	15- to 30-minute headways, Monday to Friday; all day service
66	Kanata ↔ Tunney's Pasture / Gatineau	15- to 30-minute headways, Monday to Friday; peak period service
110	Innovation ↔ Fallowfield	30-minute headways, Monday to Friday; no late evening service
165	Innovation ↔ Terry Fox	60-minute headways, Monday to Friday; selected time periods
166	Innovation ↔ Eagleson	Single bus per peak period, Monday to Friday; limited service

**2.1.6 Area Traffic Management**

There are no Area Traffic Management (ATM) studies within the study area that have been completed or are currently in progress. The following traffic calming measures have been implemented within the study area:

- Morgan's Grant Way: '40 KM/HR MAX' line painting and painted edge lines;
- Shirley's Brook Drive: '40 KM/HR MAX' line painting, centreline flex posts, and painted edge lines;
- Solandt Road: painted edge lines (west of March Road);
- Flamborough Way: '40 KM/HR MAX' line painting and centreline flex posts;
- Innovation Drive: 'SLOW' line painting.

**2.1.7 Existing Traffic Volumes**

Weekday traffic counts coordinated by Novatech were used to determine the existing pedestrian, cyclist, and vehicular traffic volumes at the study area intersections. These counts were completed on the following dates.

- March Road/Morgan's Grant Way/Shirley's Brook Drive August 4, 2022
- March Road/Terry Fox Drive August 4, 2022
- March Road/Solandt Road August 4, 2022
- Terry Fox Drive/Flamborough Way/Innovation Drive August 9, 2022
- Innovation Drive/Hines Road August 10, 2022

It is acknowledged that City traffic counts were conducted at the study area intersections between 2016 and 2018. City staff have concurred that these counts no longer reflect commuter patterns, with the increased prevalence of 'work from home' and 'hybrid work' arrangements arising from the COVID-19 pandemic, particularly among technology-based companies. Comparing pre-pandemic and post-pandemic data within the study area, traffic volumes are generally significantly lower in post-pandemic conditions.

Along the frontages to the Subject Site, the boundary streets March Road, Terry Fox Drive, and Hines Road approximately have the following average annual daily traffic (AADT) volumes, in vehicles per day (vpd):

- March Road: 21,580 vpd;
- Terry Fox Drive: 10,060 vpd;
- Hines Road: 950 vpd.

All traffic count data previously discussed are included in **Appendix D**. Traffic volumes within the study area are shown in **Figure 5**.

**Figure 5: Existing Traffic Volumes**

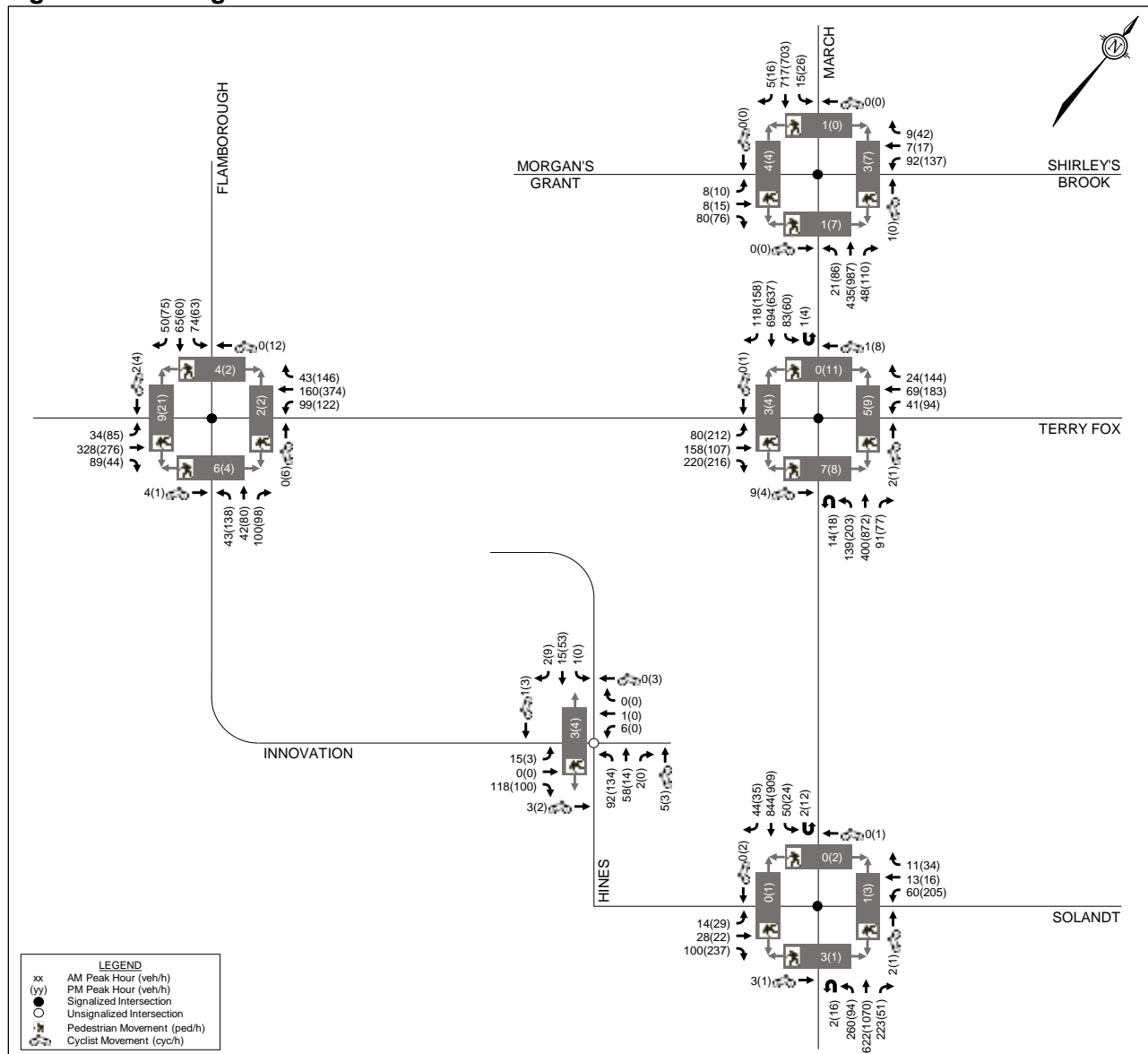

**2.1.8 Collision Records**

Historical collision data from the last five years was obtained from the City’s Public Works and Service Department for the study area intersections and midblock segments. Copies of the collision summary reports are included in **Appendix E**.

The collision data has been evaluated to determine if there are any identifiable collision patterns, which are defined in the *2017 TIA Guidelines* as ‘more than six collisions in five years’ for any one movement. The number of collisions at each intersection from January 1, 2016 to December 31, 2020 is summarized in **Table 3**.

**Table 3: Reported Collisions**

Intersection/ Street Segment	Impact Types						Total
	Approach	Angle	Rear End	Sideswipe	Turning Movement	SMV <sup>(1)</sup> / Other	
March Road/Morgan’s Grant Way/Shirley’s Brook Drive	-	4	12	4	17	1	<b>38</b>
March Road/Terry Fox Drive	1	2	28	7	2	7	<b>47</b>
March Road/Solandt Road	-	1	21	1	20	1	<b>44</b>
Terry Fox Drive/Flamborough Way/Innovation Drive	-	4	11	1	3	1	<b>20</b>
Innovation Drive/Hines Road	-	-	1	-	-	-	<b>1</b>
March Road btwn Morgan’s Grant Way and Terry Fox Drive	-	-	2	2	-	2	<b>6</b>
March Road btwn Terry Fox Drive and Solandt Road	-	1	7	2	-	6	<b>16</b>
Terry Fox Drive btwn March Road and Innovation Drive	-	-	3	-	1	1	<b>5</b>
Innovation Drive btwn Terry Fox Drive and Hines Road	-	3	-	-	-	2	<b>5</b>
Hines Road north of Innovation Drive	-	-	-	-	-	1	<b>1</b>

1. SMV = Single Motor Vehicle

**March Road/Morgan’s Grant Way/Shirley’s Brook Drive**

A total of 38 collisions were reported at this intersection over the last five years, of which there were four angle impacts, 12 rear-end impacts, four sideswipe impacts, 17 turning movement impacts, and one single vehicle/other impact. Eleven of the collisions caused injuries, but none caused fatalities. Eleven of the 38 collisions occurred in poor driving conditions. No collisions involved cyclists or pedestrians.

Of the 12 rear-end impacts, four involved northbound vehicles (one left turn incident and three through incidents), two involved southbound vehicles (two through incidents), two involved eastbound vehicles (one through incident and one right turn incident), and four involved westbound vehicles (two through incidents and two right turn incidents).

Of the 17 turning movement impacts, six involved left turns from the northbound approach, one involved a U-turn from the northbound approach, and ten involved left turns from the southbound approach. Turning movement impacts from the southbound approach exceeds the threshold to be considered a collision pattern.



Fully protected left turn phasing for the northbound and southbound left turn movements at March Road/Morgan's Grant Way/Shirley's Brook Drive have recently been implemented. This is anticipated to reduce the frequency of these collisions.

#### March Road/Terry Fox Drive

A total of 47 collisions were reported at this intersection over the last five years, of which there was one approaching impact, two angle impacts, 28 rear-end impacts, seven sideswipe impacts, two turning movement impacts, and seven single vehicle/other impacts. Ten of the collisions caused injuries, but none caused fatalities. Twenty-four of the 47 collisions occurred in poor driving conditions. No collisions involved cyclists or pedestrians.

Of the 28 rear-end impacts, 16 occurred at the northbound approach (including one left turn incident, 14 through incidents, and one right turn incident), seven occurred at the southbound approach (six through incidents and one right turn incident), three occurred at the eastbound approach (one through incident and two right turn incidents), and two occurred at the westbound approach (one through incident and one right turn incident). Through rear-end impacts at the northbound approach exceeds the threshold to be considered a collision pattern. High traffic volumes on March Road, as well as a posted speed limit of 80 km/h, may have been factors in these collisions. There does not appear to be any apparent geometric factors that would make rear-end impacts more likely at this intersection.

Of the seven sideswipe impacts, three occurred at the northbound approach, two occurred at the eastbound approach, and two occurred at the westbound approach.

Of the seven single vehicle/other impacts, two occurred at the northbound approach, two occurred at the southbound approach, two occurred at the eastbound approach, and one occurred at the westbound approach.

#### March Road/Solandt Road

A total of 44 collisions were reported at this intersection over the last five years, of which there was one angle impact, 21 rear-end impacts, one sideswipe impact, 20 turning movement impacts, and one single vehicle/other impact. Six collisions resulted in injuries, but none caused fatalities. Twenty of the 44 collisions occurred in poor driving conditions. None of the collisions involved pedestrians or cyclists.

Of the 21 rear-end impacts, six occurred at the northbound approach (one left turn incident, four through incidents, and one right turn incident), eight occurred at the southbound approach (six through incidents and two right turn incidents), four occurred at the eastbound approach (two through incidents and two right turn incidents), and three occurred at the westbound approach (one through incident and one right turn incidents). Similar to the discussion of the previous intersection, high traffic volumes and operating speeds on March Road may have been factors in these collisions.

Of the 20 turning movement impacts, ten involved a left turning vehicle at the northbound approach, four involved a left turning vehicle at the southbound approach, four involved a U-turning vehicle at the southbound approach, one involved a U-turning vehicle at the eastbound approach, and one involved a left turning vehicle at the westbound approach. Turning movement impacts at the northbound approach exceed the threshold to be considered a collision pattern.

Six of the ten northbound impacts occurred in poor driving conditions, suggesting that environmental conditions may have been a factor in these collisions. Other likely factors include the posted 80 km/h speed limit on March Road, and the significant left turn/opposing through volumes on March Road during the peak hours, which may result in drivers misjudging gaps in traffic or taking more risks when attempting a left turn.

Terry Fox Drive/Flamborough Way/Innovation Drive

A total of 20 collisions were reported at this intersection over the last five years, of which there was four angle impacts, 11 rear-end impacts, one sideswipe impact, three turning movement impacts, and one single vehicle/other impact. Six collisions resulted in injuries, but none caused fatalities. Ten of the 20 collisions occurred in poor driving conditions. One collision involved a pedestrian, and none involved cyclists.

Of the 11 rear-end impacts, three occurred at the southbound approach (three through incidents), two occurred at the eastbound approach (two through incidents), and six occurred at the westbound approach (one left turn incident and five through incidents).

Innovation Drive/Hines Road

One collision was reported at this intersection over the last five years, which was a rear-end impact at the eastbound approach. This collision did not result in injury, and did not involve any pedestrians or cyclists.

March Road between Morgan's Grant Way/Shirley's Brook Drive and Terry Fox Drive

A total of six collisions were reported along this segment over the last five years, of which there were two rear-end impacts, two sideswipe impacts, and two single vehicle/other impacts. Two collisions resulted in injuries, but none caused fatalities. All six collisions occurred in poor driving conditions. None of the collisions involved pedestrians or cyclists.

March Road between Terry Fox Drive and Solandt Road

A total of 16 collisions were reported along this segment over the last five years, of which there was one angle impact, seven rear-end impacts, two sideswipe impacts, and six single vehicle/other impacts. Six collisions resulted in injuries, but none caused fatalities. Nine of the 16 collisions occurred in poor driving conditions. None of the collisions involved pedestrians or cyclists.

Of the seven rear-end impacts, five involved northbound vehicles and two involved southbound vehicles. Of the six single vehicle/other impacts, one involved a northbound vehicle and five involved a southbound vehicle.

Terry Fox Drive between March Road and Innovation Drive

A total of five collisions were reported along this segment over the last five years, of which there were three rear-end impacts, one turning movement impact, and one single vehicle/other impact. One collision resulted in injuries, but none caused fatalities. Two of the five collisions occurred in poor driving conditions. None of the collisions involved pedestrians or cyclists.

Innovation Drive between Terry Fox Drive and Hines Road

A total of five collisions were reported along this segment over the last five years, of which there were three angle impacts and two single vehicle/other impacts. One collision resulted in injuries, but none caused fatalities. One of the five collisions occurred in poor driving conditions. None of the collisions involved pedestrians or cyclists.

### Hines Road north of Innovation Drive

One collision was reported along this segment over the last five years, which was a single vehicle/other impact involving a southbound vehicle. This collision did not result in injury, and did not involve any pedestrians or cyclists.

## **2.2 Planned Conditions**

### **2.2.1 Planned Transportation Projects**

The City's *2013 Transportation Master Plan (TMP)* does not identify any upcoming roadway projects within the study area in its 2031 Affordable Road Network.

The City's *2013 TMP* identifies transit improvements in its 2031 Affordable Network and 2031 Network Concept. In the Network Concept, at-grade bus rapid transit (BRT) will be provided on March Road between Highway 417 and the urban boundary. In the Affordable Network, at-grade BRT will be provided on March Road between Highway 417 and Solandt Road, and transit priority measures such as transit priority signals and queue jump lanes will be provided on March Road between Solandt Road and the urban boundary, which will allow for future conversion to BRT.

An excerpt of the Affordable Network and Network Concept maps from the City's *2013 TMP* are shown in **Figure 6** and **Figure 7**.

The City's *2013 Cycling Plan* identifies multiple Phase 2 (2020-2025) cycling infrastructure projects within the vicinity of the Kanata Research Park. Bike lanes will be implemented on Flamborough Way, Innovation Drive, Hines Road, Solandt Road, and Legget Drive, to improve connectivity between the residential and employment areas in northern Kanata. These projects are retained on the Active Transportation Project List in the City's Draft *2023 Transportation Master Plan*.

The City's *2013 Pedestrian Plan* does not identify any pedestrian infrastructure projects within the vicinity of the Kanata Research Park.

### **2.2.2 Other Area Developments**

In proximity of the proposed development, there are multiple other residential and mixed-use developments are under construction, approved, or in the approval process. Other developments in the area include the following.

#### 359 Terry Fox Drive and 525 Legget Drive

A TIA was prepared by Novatech in January 2022, in support of a development including a single 30-storey building with 253 apartment dwellings and a 3,877 ft<sup>2</sup> rooftop restaurant. The TIA identified a buildout year of 2024.

#### 570-600 March Road

A TIA was prepared by Stantec in July 2022, in support of a development including 1,900 residential dwellings, 46,000 m<sup>2</sup> of office space, and 11,350 m<sup>2</sup> of retail space. The TIA identified a buildout year of 2032.

#### 706-714 March Road

A TIA was prepared by CGH in December 2020, in support of a development including a 4,165 m<sup>2</sup> GFA supermarket, 350 m<sup>2</sup> GFA fast-food restaurant with drive-through, and 1,500 m<sup>2</sup> GFA of multi-unit commercial space. The TIA identified a buildout year of 2023.

Figure 6: Excerpt of the 2031 Affordable RTTP Network

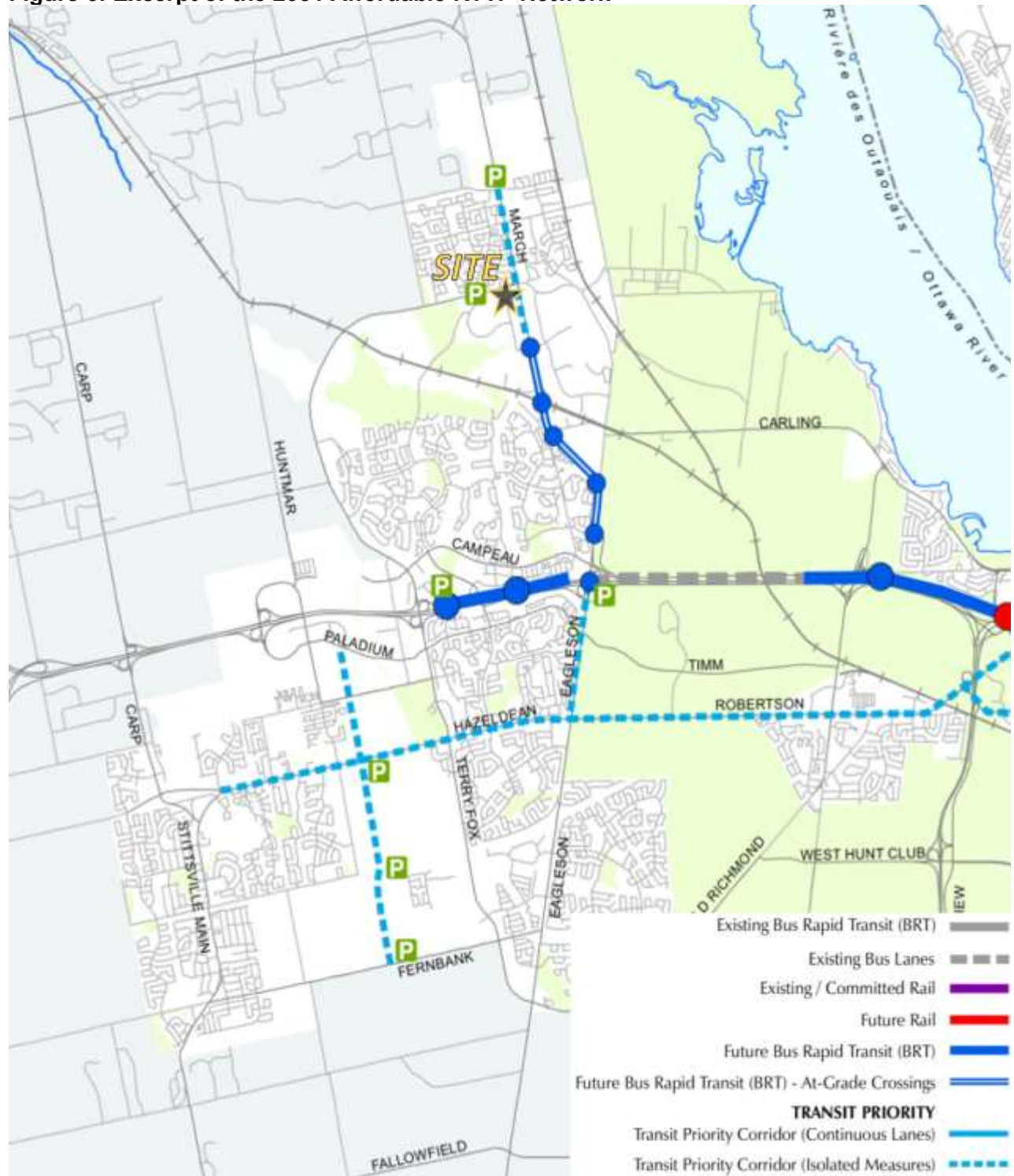

Source: City of Ottawa 2013 TMP

Figure 7: Excerpt of the 2031 RTP Network Concept



Source: City of Ottawa 2013 TMP

788 March Road

A TIA and three subsequent addenda were prepared by Parsons (originally submitted in August 2018, with the addenda submitted in October 2018, December 2018, and March 2020), in support of a development including 92 apartment dwellings. The TIA identified a buildout year of 2023.

910 March Road

A TIA was prepared by CGH in January 2021, in support of a development including a 1,835 m<sup>2</sup> hardware store, a 234 m<sup>2</sup> restaurant with drive-through, a 191 m<sup>2</sup> coffee shop with drive-through, a 416 m<sup>2</sup> retail store, and a 249 m<sup>2</sup> gas bar. The TIA identified a buildout year of 2022.

1104 Halton Terrace

A TIA was prepared by Novatech in October 2021, in support of a development including a four-storey building with 86 apartment dwellings. The TIA identified a buildout year of 2024.

2700 Solandt Road and 415 Legget Drive

A TIA was prepared by WSP in March 2022, in support of a development application to convert an existing two-storey office building into a warehouse and construct two new warehouses. In total, the development will result in approximately 32,930 m<sup>2</sup> of new warehouse space. The TIA identified a buildout year of 2023.

2707 Solandt Road

A TIA was prepared by Novatech in January 2020, in support of a development that includes an eight-storey, 198,615 ft<sup>2</sup> office building. The TIA identified a buildout year of 2021.

3026 Solandt Road

A TIA was prepared by CIMA+ in March 2020, in support of a development that includes a five-storey, 100,000 ft<sup>2</sup> office building. The TIA identified a buildout year of 2021.

Kanata North Urban Expansion Area (KNUEA)

The *KNUEA TMP* was prepared by Novatech in June 2016, and estimated that the development of the Kanata North lands has the potential to consist of 960 single-detached homes, 950 street townhomes, 1,040 multi-unit residential dwellings, 400,000 ft<sup>2</sup> GFA of commercial space, three elementary schools, one high school, and a 500-space park and ride. The TMP identified a buildout year of 2026.

## 2.3 Study Area and Time Periods

The study area for this report includes the boundary roadways March Road, Terry Fox Drive, and Hines Road, as well as the following intersections:

- March Road/Morgan's Grant Way/Shirley's Brook Drive;
- March Road/Terry Fox Drive;
- March Road/Solandt Road;
- Terry Fox Drive/Flamborough Way/Innovation Drive;
- Innovation Drive/Hines Road.

The selected time periods for the analysis are the weekday AM and PM peak hours, as they represent the ‘worst case’ combination of site generated traffic and adjacent street traffic. Analysis will be completed for the ultimate buildout year 2037. Due to the extended buildout period, a five-year horizon will not be completed. A further review of traffic operations will be provided as each phase proceeds to the Site Plan Control application stage.

## 2.4 Exemptions Review

This module reviews possible exemptions from the final Transportation Impact Assessment, as outlined in the 2017 TIA Guidelines. The applicable exemptions for this site are shown in **Table 4**.

**Table 4: TIA Exemptions**

Module	Element	Exemption Criteria	Status
<b>Design Review Component</b>			
4.1 Development Design	4.1.2 Circulation and Access	• Only required for site plans	Exempt
	4.1.3 New Street Networks	• Only required for plans of subdivision	Exempt
4.2 Parking	4.2.1 Parking Supply	• Only required for site plans	Exempt
	4.2.2 Spillover Parking	• Only required for site plans where parking supply is 15% below unconstrained demand	Exempt
<b>Network Impact Component</b>			
4.5 Transportation Demand Management	<i>All elements</i>	• Not required for non-residential site plans expected to have fewer than 60 employees and/or students on location at any given time	Not Exempt
4.6 Neighbourhood Traffic Management	4.6.1 Adjacent Neighbourhoods	• Only required when the development relies on local or collector streets for access and total volumes exceed ATM capacity thresholds	Not Exempt
4.8 Network Concept	<i>All elements</i>	• Only required when proposed development generates more than 200 person-trips during the peak hour in excess of the equivalent volume permitted by the established zoning	Exempt

As this TIA is in support of a Zoning By-Law Amendment application, the Design Review components (Modules 4.1 to 4.4) have been omitted from the analysis. Based on the foregoing, the following modules will be included in the TIA report:

### Network Impact Component

- Module 4.5: Transportation Demand Management
- Module 4.6: Neighbourhood Traffic Management
- Module 4.7: Transit
- Module 4.9: Intersection Design

### 3.0 FORECASTING

#### 3.1 Development-Generated Travel Demand

##### 3.1.1 Trip Generation

###### Existing Trip Generation

The area of the existing buildings at 555, 591, and 603 March Road have been estimated using aerial photography. The existing one-storey athletic facility is estimated to include 18,500 ft<sup>2</sup> of gym space, the existing two-storey office building is estimated to include 78,400 ft<sup>2</sup> GFA of office space, and the existing one-storey retail plaza is estimated to include 15,400 ft<sup>2</sup> GFA of retail space.

The number of trips generated by the existing uses has been estimated using the trip generation rates outlined in the *ITE Trip Generation Manual, 11<sup>th</sup> Edition*, corresponding to the Health/Fitness Club (code 492), General Office Building (code 710), or Strip Retail Plaza (code 822) land uses. Trips estimated using the *ITE Trip Generation Manual* have been converted to person trips using an adjustment factor of 1.28, consistent with the City’s *2017 TIA Guidelines*. To reflect the prevalence of ‘work from home’ or ‘hybrid work’ arrangements, the estimated vehicular volumes that are currently generated by the existing offices has been reduced by 40%. This assumption is based on the comparison of pre-pandemic and post-pandemic traffic counts on Solandt Road and Terry Fox Drive, which shows that 2022 volumes on these roadways have decreased by approximately 35% to 50%.

The estimated number of person trips generated by the existing land uses are shown in **Table 5**.

**Table 5: Existing Development – Peak Hour Trip Generation**

Land Use	ITE Code	GFA	AM Peak Hour (pph <sup>(1)</sup> )			PM Peak Hour (pph)		
			IN	OUT	TOT	IN	OUT	TOT
Health/Fitness Club	492	18,500 ft <sup>2</sup>	16	15	31	47	35	82
General Office Bldg	710	78,400 ft <sup>2</sup>	154	20	174	29	145	174
40% reduction			-61	-8	-69	-11	-58	-69
Strip Retail Plaza	822	15,400 ft <sup>2</sup>	29	20	49	68	68	136
<b>Total</b>			<b>138</b>	<b>47</b>	<b>185</b>	<b>133</b>	<b>190</b>	<b>323</b>

1. pph: Person Trips per Hour

From the previous table, the existing development is estimated to generate approximately 254 person trips during the AM peak hour and 323 person trips during the PM peak hour.

The *TRANS Trip Generation Manual Summary Report*, prepared in October 2020 by WSP, includes data to estimate the mode shares for employment trip generators and commercial trip generators, based on the district. The *TRANS Trip Generation Manual* identifies the Subject Site as being located within the Kanata/Stittsville district. The employment mode shares were only surveyed during the AM peak hour, as employees are assumed to use the same mode to arrive at and depart from work. All trips to/from the athletic facility are assumed to originate or terminate at other sites within Kanata/Stittsville. Therefore, the athletic facility mode shares have been estimated using the ‘Within District’ mode shares outlined in the *2011 TRANS O-D Survey Report*, for the Kanata/Stittsville district.

The surveyed peak hour mode shares for the existing land uses are summarized in **Table 6**.



**Table 6: Surveyed Kanata/Stittsville Mode Shares – Existing Uses**

Mode	Trips Within District		Employment		Commercial	
	AM	PM	AM	PM	AM	PM
Auto Driver	45%	57%	84%	-	81%	73%
Auto Passenger	17%	23%	4%	-	12%	22%
Transit	4%	2%	8%	-	5%	1%
Cyclist	1%	1%	1%	-	0%	0%
Pedestrian	19%	12%	3%	-	2%	4%
Other	15%	6%	-	-	-	-

For the purposes of this review, the employment mode shares have been applied directly to the trips generated by the existing office building. The commercial mode shares during the PM peak hour have been applied directly to the trips generated by the existing retail uses. The mode shares of the existing athletic facility are assumed to generally follow the surveyed mode shares within the Kanata/Stittsville district (i.e. 55% auto driver, 20% auto passenger, 5% transit, 5% cyclist, and 15% pedestrian). The estimated number of trips generated by the existing uses, broken down by mode share, are included in **Table 7**.

**Table 7: Existing Development – Peak Hour Trips by Mode Share**

Travel Mode	Mode Share		AM Peak Hour			PM Peak Hour		
	AM	PM	IN	OUT	TOT	IN	OUT	TOT
<b>Fitness Person Trips</b>			<b>16</b>	<b>15</b>	<b>31</b>	<b>47</b>	<b>35</b>	<b>82</b>
Auto Driver	55%		8	8	16	26	19	45
Auto Passenger	20%		3	3	6	10	7	17
Transit	5%		1	1	2	2	2	4
Cyclist	5%		1	1	2	2	2	4
Pedestrian	15%		3	2	5	7	5	12
<b>Office Person Trips</b>			<b>93</b>	<b>12</b>	<b>105</b>	<b>18</b>	<b>87</b>	<b>105</b>
Auto Driver	84%		78	10	88	15	73	88
Auto Passenger	4%		4	1	5	1	3	4
Transit	8%		7	1	8	2	7	9
Cyclist	1%		1	-	1	-	1	1
Pedestrian	3%		3	-	3	-	3	3
<b>Strip Retail Person Trips</b>			<b>29</b>	<b>20</b>	<b>49</b>	<b>68</b>	<b>68</b>	<b>136</b>
Auto Driver	81%	73%	24	16	40	50	50	100
Auto Passenger	12%	22%	3	2	5	15	15	30
Transit	5%	1%	1	1	2	1	-	1
Cyclist	0%	0%	-	-	-	-	-	-
Pedestrian	2%	4%	1	1	2	2	3	5
<b>Total Person Trips</b>			<b>138</b>	<b>47</b>	<b>185</b>	<b>133</b>	<b>190</b>	<b>323</b>
Auto Driver			110	34	144	91	142	233
Auto Passenger			10	6	16	26	25	51
Transit			9	3	12	5	9	14
Cyclist			2	1	3	2	3	5
Pedestrian			7	3	10	9	11	20

From the previous table, the existing development is anticipated to generate 144 vehicle trips during the AM peak hour and 233 vehicle trips during the PM peak hour.

The retail land uses is anticipated to generate two types of external peak hour trips: primary and pass-by trips. Primary trips are made for the specific purpose of visiting the site, while pass-by trips are made as intermediate stops on the way to another destination. Peak hour pass-by trips for the existing retail plaza are estimated to account for approximately 40% of all trips, based on the average rate identified in the *ITE Trip Generation Manual*.

The primary and pass-by trips generated by the existing retail plaza are summarized in **Table 8**.

**Table 8: Existing Strip Retail – Primary and Pass-by Trips**

Trip Type	AM Peak Hour (vph <sup>(1)</sup> )			PM Peak Hour (vph)		
	IN	OUT	TOT	IN	OUT	TOT
Existing Strip Retail Trips	24	16	40	50	50	100
Adjustment for Pass-by Trips (40%)	-8	-8	-16	-20	-20	-40
<b>Primary Trips (60%)</b>	<b>16</b>	<b>8</b>	<b>24</b>	<b>30</b>	<b>30</b>	<b>60</b>

1. vph: Vehicle Trips per Hour

It has been assumed that no existing trips generated by the Subject Site are internally captured, based on the general layout of the existing athletic facility, retail plaza, and office building. This assumption allows for a more conservative analysis.

Proposed Trip Generation

The proposed development is assumed to include 2,100 high-rise dwellings, 154,178 ft<sup>2</sup> GFA of office space, and 31,482 ft<sup>2</sup> GFA of retail space.

The *TRANS Trip Generation Manual Summary Report* includes data to estimate the mode shares for residential trip generators in the Kanata/Stittsville district, in addition to the employment and commercial trip generators described previously. The surveyed mode shares for the proposed land uses are included in **Table 9**.

**Table 9: Surveyed Kanata/Stittsville Mode Shares – Proposed Uses**

Mode	Residential		Employment		Commercial	
	AM	PM	AM	PM	AM	PM
Auto Driver	42%	55%	84%	-	81%	73%
Auto Passenger	26%	19%	4%	-	12%	22%
Transit	28%	21%	8%	-	5%	1%
Cyclist	0%	0%	1%	-	0%	0%
Pedestrian	4%	5%	3%	-	2%	4%

The assumed residential mode shares for the proposed residences have been developed by taking the average of the surveyed mode shares for residences in the Kanata/Stittsville district. Since the 2031 Affordable Transit Network will only include bus rapid transit along March Road between Solandt Road and Highway 417, and the surveyed transit share is already notably high at 21% to 28% during the peak hours, the transit share for the proposed residential development has not been increased. The assumed employment mode shares for the proposed offices have been adjusted by increasing the transit share to 20% from 8% and decreasing the driver share accordingly from 84% to 72%, to account for planned bus rapid transit to Solandt Road. The assumed commercial mode shares for the proposed retail uses have been adjusted by considering the PM peak hour only, increasing the transit share to 10% from 1%, and decreasing the driver share accordingly from 73% to 64%. This can be summarized as follows.

**Residential Mode Shares**

- Auto Driver: 49%
- Auto Passenger: 22%
- Transit: 25%
- Cyclist: 0%
- Pedestrian: 4%

**Employment Mode Shares**

- Auto Driver: 72%
- Auto Passenger: 4%
- Transit: 20%
- Cyclist: 1%
- Pedestrian: 3%

**Commercial Mode Shares**

- Auto Driver: 64%
- Auto Passenger: 22%
- Transit: 10%
- Cyclist: 0%
- Pedestrian: 4%

Proposed Residential Trip Generation

The *TRANS Trip Generation Manual Summary Report*, prepared in October 2020 by WSP, includes data to estimate the trip generation for residential uses, divided into single-family detached housing, low-rise multifamily housing (one or two storeys), and high-rise multifamily housing (three or more storeys). For the High-Rise Multifamily Housing land use, the process of converting the trip generation estimates from peak period to peak hour is shown in the following tables. The estimated number of person trips generated by the proposed dwellings for the AM and PM peak periods are shown in **Table 10**. A breakdown of these trips by mode share is shown in **Table 11**.

**Table 10: Proposed Residential – Peak Period Trip Generation**

Land Use	TRANS Rate	Units	AM Peak Period (ppp <sup>(1)</sup> )			PM Peak Period (ppp)		
			IN	OUT	TOT	IN	OUT	TOT
High-Rise Multifamily Housing	AM: 0.80 PM: 0.90	2,100	521	1,159	1,680	1,096	794	1,890

1. ppp: Person Trips per Peak Period

**Table 11: Proposed Residential – Peak Period Trips by Mode Share**

Travel Mode	Mode Share	AM Peak Period			PM Peak Period		
		IN	OUT	TOT	IN	OUT	TOT
<b>Residential Trips</b>		<b>521</b>	<b>1,159</b>	<b>1,680</b>	<b>1,096</b>	<b>794</b>	<b>1,890</b>
Auto Driver	49%	255	568	823	537	389	926
Auto Passenger	22%	115	255	370	241	175	416
Transit	25%	130	290	420	274	198	472
Cyclist	0%	-	-	-	-	-	-
Pedestrian	4%	21	46	67	44	32	76

Table 4 of the *TRANS Trip Generation Manual* includes adjustment factors to convert the estimated number of trips generated for each mode from peak period to peak hour. A breakdown of the peak hour trips by mode is shown in **Table 12**.

**Table 12: Proposed Residential – Peak Hour Trips by Mode Share**

Travel Mode	Adj. Factor		AM Peak Hour			PM Peak Hour		
	AM	PM	IN	OUT	TOT	IN	OUT	TOT
Auto Driver	0.48	0.44	123	273	396	236	171	407
Auto Passenger	0.48	0.44	55	122	177	106	76	182
Transit	0.55	0.47	71	160	231	129	94	223
Cyclist	0.58	0.48	-	-	-	-	-	-
Pedestrian	0.58	0.52	12	27	39	23	17	40
<b>Peak Hour Person Trips</b>			<b>261</b>	<b>582</b>	<b>843</b>	<b>494</b>	<b>358</b>	<b>852</b>

From the previous table, the proposed residential dwellings are estimated to generate 843 person trips during the AM peak hour (including 396 vehicle trips) and 852 person trips during the PM peak hour (including 407 vehicle trips).

Proposed Office and Retail Trip Generation

The number of trips generated by the proposed office and retail uses has been estimated using the trip generation rates outlined in the *ITE Trip Generation Manual, 11<sup>th</sup> Edition*, corresponding to the General Office Building (code 710) or Strip Retail Plaza (code 822) land uses. A 40% reduction has not been applied to the estimated number of office-generated trips, as this maintains a conservative analysis. The estimated number of person trips generated by the proposed office and retail uses are shown in **Table 13**, and are broken down by mode share in **Table 14**.

**Table 13: Proposed Office/Retail – Peak Hour Trip Generation**

Land Use	ITE Code	GFA	AM Peak Hour (pph)			PM Peak Hour (pph)		
			IN	OUT	TOT	IN	OUT	TOT
General Office Bldg	710	154,178 ft <sup>2</sup>	274	37	311	52	253	305
Strip Retail Plaza	822	31,482 ft <sup>2</sup>	47	31	78	113	112	225
<b>Total</b>			<b>321</b>	<b>68</b>	<b>389</b>	<b>165</b>	<b>365</b>	<b>530</b>

**Table 14: Proposed Office/Retail – Peak Hour Trips by Mode Share**

Travel Mode	Mode Share	AM Peak Hour			PM Peak Hour		
		IN	OUT	TOT	IN	OUT	TOT
<b>Office Person Trips</b>		<b>274</b>	<b>37</b>	<b>311</b>	<b>52</b>	<b>253</b>	<b>305</b>
Auto Driver	72%	197	27	224	37	182	219
Auto Passenger	4%	12	1	13	1	10	11
Transit	20%	55	7	62	11	51	62
Cyclist	1%	2	1	3	1	2	3
Pedestrian	3%	8	1	9	2	8	10
<b>Retail Person Trips</b>		<b>47</b>	<b>31</b>	<b>78</b>	<b>113</b>	<b>112</b>	<b>225</b>
Auto Driver	64%	30	20	50	72	72	144
Auto Passenger	22%	10	6	16	25	25	50
Transit	10%	5	4	9	12	11	23
Cyclist	0%	-	-	-	-	-	-
Pedestrian	4%	2	1	3	4	4	8
<b>Total Person Trips</b>		<b>321</b>	<b>68</b>	<b>389</b>	<b>165</b>	<b>365</b>	<b>530</b>
Auto Driver		227	47	274	109	254	363
Auto Passenger		22	7	29	26	35	61
Transit		60	11	71	23	62	85
Cyclist		2	1	3	1	2	3
Pedestrian		10	2	12	6	12	19

From the previous table, the proposed office and retail uses are estimated to generate 389 person trips during the AM peak hour (including 274 vehicle trips) and 530 person trips during the PM peak hour (including 363 vehicle trips).

The proposed development as a whole is estimated to generate 1,232 person trips during the AM peak hour (including 670 vehicle trips) and 1,382 person trips during the PM peak hour (including 770 vehicle trips). A detailed breakdown of the estimated trip generation by mode share is included in **Table 15**.

**Table 15: Proposed Development – Total Peak Hour Trips**

Travel Mode	AM Peak Hour			PM Peak Hour		
	IN	OUT	TOT	IN	OUT	TOT
<b>Total Person Trips</b>	<b>582</b>	<b>650</b>	<b>1,232</b>	<b>659</b>	<b>723</b>	<b>1,382</b>
Auto Driver	350	320	670	345	425	770
Auto Passenger	77	129	206	132	111	243
Transit	131	171	302	152	156	308
Cyclist	2	1	3	1	2	3
Pedestrian	22	29	51	29	29	58

Subtracting the existing site-generated volumes shown in **Table 7** from the proposed site-generated volumes shown in **Table 15**, the proposed development is estimated to generate a net additional 1,047 person trips (including 536 vehicle trips) during the AM peak hour, and a net additional 1,059 person trips (including 537 vehicle trips) during the PM peak hour.

Pass-by and Internally Captured Trips

Some trips are anticipated to be internally captured within the Subject Site, as people may both live and work within the Subject Site, and some resident/employee trips may involve travelling between home, work, and the proposed retail areas on-site. Additionally, the proposed retail uses are anticipated to generate both primary and pass-by trips. The results of adjusting for internally captured trips and pass-by trips is included below. Per the example included in the *TRANS Trip Generation Manual*, internally captured trips between the proposed land uses have been estimated using the methodology outlined in the *ITE Trip Generation Handbook* and the *NCHRP Report 684 Estimator* spreadsheet tool (developed by the Texas A&M Transportation Institute in 2010). The completed spreadsheets are included in **Appendix F**, and include internal trip adjustments for the driver, transit, and non-motorized modes.

A summary of the internally captured and external trips generated by the proposed development are included in **Table 16**.

**Table 16: Proposed Development – Internally Captured Trips**

Trip Type		AM Peak Hour			PM Peak Hour		
		IN	OUT	TOT	IN	OUT	TOT
Residential Trips	Vehicle	123	273	396	236	171	407
	Transit	71	160	231	129	94	223
	Non-Auto	12	27	39	23	17	40
Internal Adjustment	Vehicle	-3	-10	-13	-24	-17	-41
	Transit	-1	-4	-5	-9	-7	-16
	Non-Auto	-	-1	-1	-2	-1	-3
External Trips	Vehicle	120	263	383	212	154	366
	Transit	70	156	226	120	87	207
	Non-Auto	12	26	38	21	16	37
Office Trips	Vehicle	197	27	224	37	182	219
	Transit	55	7	62	11	51	62
	Non-Auto	10	2	12	3	10	13
Internal Adjustment	Vehicle	-13	-8	-21	-12	-11	-23
	Transit	-4	-2	-6	-4	-3	-7
	Non-Auto	-	-1	-1	-2	-	-2
External Trips	Vehicle	184	19	203	25	171	196
	Transit	51	5	56	7	48	55
	Non-Auto	10	1	11	1	10	11

Trip Type		AM Peak Hour			PM Peak Hour		
		IN	OUT	TOT	IN	OUT	TOT
Retail Trips	Vehicle	30	20	50	72	72	144
	Transit	5	4	9	12	11	23
	Non-Auto	2	1	3	4	4	8
Internal Adjustment	Vehicle	-14	-11	-25	-17	-27	-44
	Transit	-2	-2	-4	-3	-3	-6
	Non-Auto	-1	-	-1	-	-1	-1
External Trips	Vehicle	16	9	25	55	45	100
	Transit	3	2	5	9	8	17
	Non-Auto	1	1	2	4	3	7

Peak hour pass-by trips for the proposed retail areas are estimated to account for approximately 40% of all trips, matching the assumption for the existing strip retail uses. The primary and pass-by trips generated by the proposed retail uses are summarized in **Table 17**.

**Table 17: Proposed Retail – Primary and Pass-by Trips**

Trip Type	AM Peak Hour (vph)			PM Peak Hour (vph)		
	IN	OUT	TOT	IN	OUT	TOT
Retail External Vehicle Trips	16	9	25	55	45	100
Adjustment for Pass-by Trips (40%)	-5	-5	-10	-20	-20	-40
<b>Primary Trips (60%)</b>	<b>11</b>	<b>4</b>	<b>15</b>	<b>35</b>	<b>25</b>	<b>60</b>

### 3.1.2 Trip Distribution

The assumed distribution of trips generated by the proposed residential and existing/proposed office uses have been estimated by considering the typical commuter patterns (based on AM peak outbound volumes and PM peak inbound volumes for residential trips, and vice versa for office trips) and logical trip routing. Additional trips have been distributed to/from the north for the proposed offices, to account for the extensive KNUEA developments north of the study area. As a result, the assumed trip distribution for the residential and office uses is summarized as follows:

Proposed Residential

- 20% to/from the north via March Road;
- 45% to/from the south via March Road;
- 10% to/from the east via Terry Fox Drive;
- 10% to/from the east via Solandt Road;
- 10% to/from the west via Terry Fox Drive;
- 5% to/from the west via Innovation Drive.

Existing Office

- 25% to/from the north via March Road;
- 5% to/from the north via Flamborough Way;
- 40% to/from the south via March Road;
- 5% to/from the east via Terry Fox Drive;
- 5% to/from the east via Shirley’s Brook Drive;
- 15% to/from the west via Terry Fox Drive;
- 5% to/from the west via Morgan’s Grant Way.

Proposed Office

- 35% to/from the north via March Road;
- 5% to/from the north via Flamborough Way;
- 35% to/from the south via March Road;
- 5% to/from the east via Terry Fox Drive;
- 5% to/from the east via Shirley’s Brook Drive;
- 10% to/from the west via Terry Fox Drive;
- 5% to/from the west via Morgan’s Grant Way.

The assumed distribution of trips generated by the existing athletic facility and existing/proposed retail uses have been estimated based on the two-way midday peak hour volumes, as these uses are anticipated to have a more regional draw. As a result, the assumed trip distribution for the athletic facility and retail uses can be summarized as follows:

Existing or Proposed Retail and Existing Athletic Facility

- 25% to/from the north via March Road;
- 5% to/from the north via Flamborough Way;
- 30% to/from the south via March Road;
- 5% to/from the east via Terry Fox Drive;
- 5% to/from the east via Shirley’s Brook Drive;
- 5% to/from the east via Solandt Road;
- 10% to/from the west via Terry Fox Drive;
- 5% to/from the west via Morgan’s Grant Way;
- 10% to/from the west via Innovation Drive.

All pass-by trips for the existing or proposed retail uses are assumed to occur on March Road, as it carries the majority of traffic volumes throughout the study area and acts as the primary arterial roadway through northern Kanata.

**3.1.3 Trip Assignment**

Existing Land Uses

The existing office building are accessed via one full-movement access to Terry Fox Drive and one RIRO access to March Road. The assumed trip assignment for the office use is summarized in **Table 18**.

**Table 18: Existing Office – Trip Assignment**

Origin/Destination	March Road Access	Terry Fox Drive Access
to the north via March Road	-	100%
from the north via March Road	100%	-
to the south via March Road	100%	-
from the south via March Road	-	100%
to/from the north via Flamborough Way	-	100%
to/from the east via Terry Fox Drive	-	100%
to/from the west via Terry Fox Drive	-	100%

The existing retail plaza and athletic facility are accessed via the same two RIRO accesses to March Road. Based on the layout of these sites, all retail trips have been assigned to the northerly access (including all pass-by trips), and all athletic facility trips have been assigned to the southerly access. Based on the existing U-turn volumes at March Road/Terry Fox Drive and March Road/Solandt Road, it has been conservatively assumed that no trips travelling to/from the Subject Site perform a U-turn, and use other roadways within the Kanata Research Park. For example, inbound trips originating from the south via March Road or east via Solandt Road are assumed to travel on Legget Drive to Terry Fox Drive, and outbound trips destined to the north via Flamborough Way or west via Terry Fox Drive are assumed to travel on Solandt Road, Hines Road, and Innovation Drive.

Proposed Land Uses

The Subject Site is anticipated to include a full-movement access to March Road opposite the proposed signalized access to the Nokia development at 570-600 March Road (discussed further in Section 3.2.1), and full-movement accesses to Terry Fox Drive and Hines Road. In accordance with the previous section, all pass-by trips have been assigned to the proposed March Road access. All primary trips have been assigned to the proposed accesses as shown in **Table 19**.

**Table 19: Proposed Development – Trip Assignment**

Origin/Destination	March Road Access	Terry Fox Drive Access	Hines Road Access
to/from the north via March Road	50%	50%	-
to/from the north via Flamborough Way	-	100%	-
to/from the south via March Road	100%	-	-
to/from the east via Terry Fox Drive	-	100%	-
to/from the east via Shirley’s Brook Drive	50%	50%	-
to/from the east via Solandt Road	100%	-	-
to/from the west via Terry Fox Drive	-	100%	-
to/from the west via Morgan’s Grant Way	50%	50%	-
to/from the west via Innovation Drive	-	-	100%

**3.2 Background Traffic**

**3.2.1 Other Area Developments**

As first discussed in Section 2.2.2, there are multiple development applications for sites in proximity of the proposed development that are under construction, approved, or in the approval process. Traffic generated by these developments have been accounted for as background traffic. Relevant excerpts for the transportation studies in support of each development listed below are included in **Appendix G**.

359 Terry Fox Drive and 525 Legget Drive

The proposed development includes 253 apartment dwellings and 3,877 ft<sup>2</sup> GFA of restaurant space, and the associated TIA identified a buildout year of 2024. Therefore, volumes generated by this development have been added to the 2037 background volumes.

570-600 March Road

The proposed redevelopment of the Nokia campus includes 1,900 residential dwellings, 46,000 m<sup>2</sup> of office space, and 11,350 m<sup>2</sup> of retail space. The TIA identified a buildout year of 2032. Therefore, the net additional volumes generated by this development have been added to the 2037 background volumes. To reflect the prevalence of ‘work from home’ or ‘hybrid work’ arrangements, the estimated vehicular volumes that are currently generated by the existing offices has been reduced by 40%. This assumption is based on the comparison of pre-pandemic and post-pandemic traffic counts on Solandt Road and Terry Fox Drive, which shows that 2022 volumes on these roadways have decreased by approximately 35% to 50%.

The development includes a signalized, full-movement access to March Road. While the exact location of this signalized access has not been determined, it has been assumed that this signal will be located at the southern limit of the Subject Site, so that both the Nokia redevelopment and this proposed development can use this signal.



*706-714 March Road*

The proposed development includes a 4,165 m<sup>2</sup> GFA supermarket, 350 m<sup>2</sup> GFA fast-food restaurant with drive-through, and 1,500 m<sup>2</sup> GFA of multi-unit commercial space. The associated TIA identified a buildout year of 2023. Therefore, volumes generated by this development have been added to the 2037 background volumes.

*788 March Road*

The proposed development includes 92 apartment dwellings, and the associated TIA identified a buildout year of 2023. Therefore, volumes generated by this development have been added to the 2037 background volumes.

*910 March Road*

The proposed development includes a 1,835 m<sup>2</sup> hardware store, a 234 m<sup>2</sup> restaurant with drive-through, a 191 m<sup>2</sup> coffee shop with drive-through, a 416 m<sup>2</sup> retail store, and a 249 m<sup>2</sup> gas bar. The associated TIA identified a buildout year of 2022. Therefore, volumes generated by this development have been added to the 2037 background volumes.

*1104 Halton Terrace*

The proposed development includes 86 apartment dwellings. As this did not meet the trip generation trigger, the TIA did not include a distribution of development-generated traffic to its study area. Therefore, volumes generated by this development have not been added to the 2037 background volumes.

*2700 Solandt Road and 415 Legget Drive*

The proposed development includes approximately 32,930 m<sup>2</sup> of new warehouse space. The associated TIA identified a buildout year of 2022. Therefore, volumes generated by this development have been added to the 2037 background volumes.

*2707 Solandt Road*

The proposed development includes an eight-storey, 198,615 ft<sup>2</sup> office building. While the associated TIA identified a buildout year of 2021, this development has not been built out. Therefore, volumes generated by this development have been added to the 2037 background volumes.

*3026 Solandt Road*

The proposed development includes a five-storey, 100,000 ft<sup>2</sup> office building. While the associated TIA identified a buildout year of 2021, this development has not been built out. Therefore, volumes generated by this development have been added to the 2037 background volumes.

*Kanata North Urban Expansion Area (KNUEA)*

The KNUEA TMP was prepared by Novatech in June 2016, and estimated that the development of the Kanata North lands has the potential to consist of 960 single-detached homes, 950 street townhomes, 1,040 multi-unit residential dwellings, 400,000 ft<sup>2</sup> GFA of commercial space, three elementary schools, one high school, and a 500-space park and ride. The TMP originally identified a buildout year of 2026. Therefore, volumes generated by this development have been added to the 2037 background volumes.

### 3.2.2 General Background Growth Rate

A review of the City's *Strategic Long-Range Model* (comparing snapshots of 2011 and 2031 AM peak hour volumes) and *2013 TMP* has been conducted. The snapshots are included in **Appendix H**. A review of the long-range snapshots estimate negligible growth in traffic volumes on March Road, and the magnitude of traffic volumes modelled on Terry Fox Drive and Innovation Drive are generally not large enough to estimate a consistent growth rate. Since background volumes from all of the other area developments listed above have been added to the study area volumes, an annual background growth rate has not been applied.

### 3.2.3 March Road BRT Corridor

The assumed existing transit modal shares within the study area follow the modal shares outlined in the Existing Conditions report of the *KNUEA TMP*. The TMP included a Transportation Area of Interest (TAI) screenline located immediately south of Terry Fox Drive between Second Line Road and March Valley Road, where person trips for vehicle and non-auto modes were estimated using observed traffic, transit rider, cyclist, and pedestrian volumes. Passenger volumes were estimated using a private vehicle occupancy of 1.2. This analysis was performed because the *KNUEA* is located at the boundary between the Kanata/Stittsville and Rural West regions as shown in the *2011 TRANS O-D Survey Report*.

The results of this exercise indicated that, at the TAI screenline, the existing transit share is 7% and 5% in the weekday AM and PM peak hours, respectively. Existing mode shares at the TAI screenline were not found to be reflective of the mode shares presented for the Kanata/Stittsville district, since the rapid transit stations within Kanata/Stittsville are centralized along Highway 417, which is approximately 4.5km south of the screenline. Conversely, the existing shares are more aligned with those presented for the Rural West district. As the TAI screenline was located immediately south of Terry Fox Drive, and is therefore located within the study area, the existing transit shares of 7% in the AM peak hour and 5% in the PM peak hour have been assumed for this study.

Exhibit 2.13 of the City's *2013 TMP* identifies a transit share target of 21% within the Kanata/Stittsville district by 2031. Within the study area, it is anticipated that the 21% transit share target will be achieved through the implementation of the planned RTTP projects on March Road, as described in Section 2.2.1. Consistent with the *KNUEA TMP*, a reduction in the background vehicular volumes has been made in the buildout year 2037, to reflect the 21% transit share target and the planned implementation of transit priority measures on March Road.

A functional design of median BRT lanes on March Road was included as part of the *West Transitway Connection EPR*, prepared by Delcan in October 2013. The relevant pages of the functional design are included in **Appendix I**.

### 3.3 Volume Figures

The figures below present the following traffic conditions:

- Existing site-generated traffic volumes are shown in **Figure 8**;
- Proposed site-generated traffic volumes are shown in **Figure 9**;
- Net site-generated traffic volumes are shown in **Figure 10**;
- Other area development-generated traffic volumes in 2037 are shown in **Figure 11**;
- Background traffic volumes in 2037 are shown in **Figure 12**;
- Total traffic volumes in 2037 are shown in **Figure 13**.

**Figure 8: Existing Site-Generated Volumes**

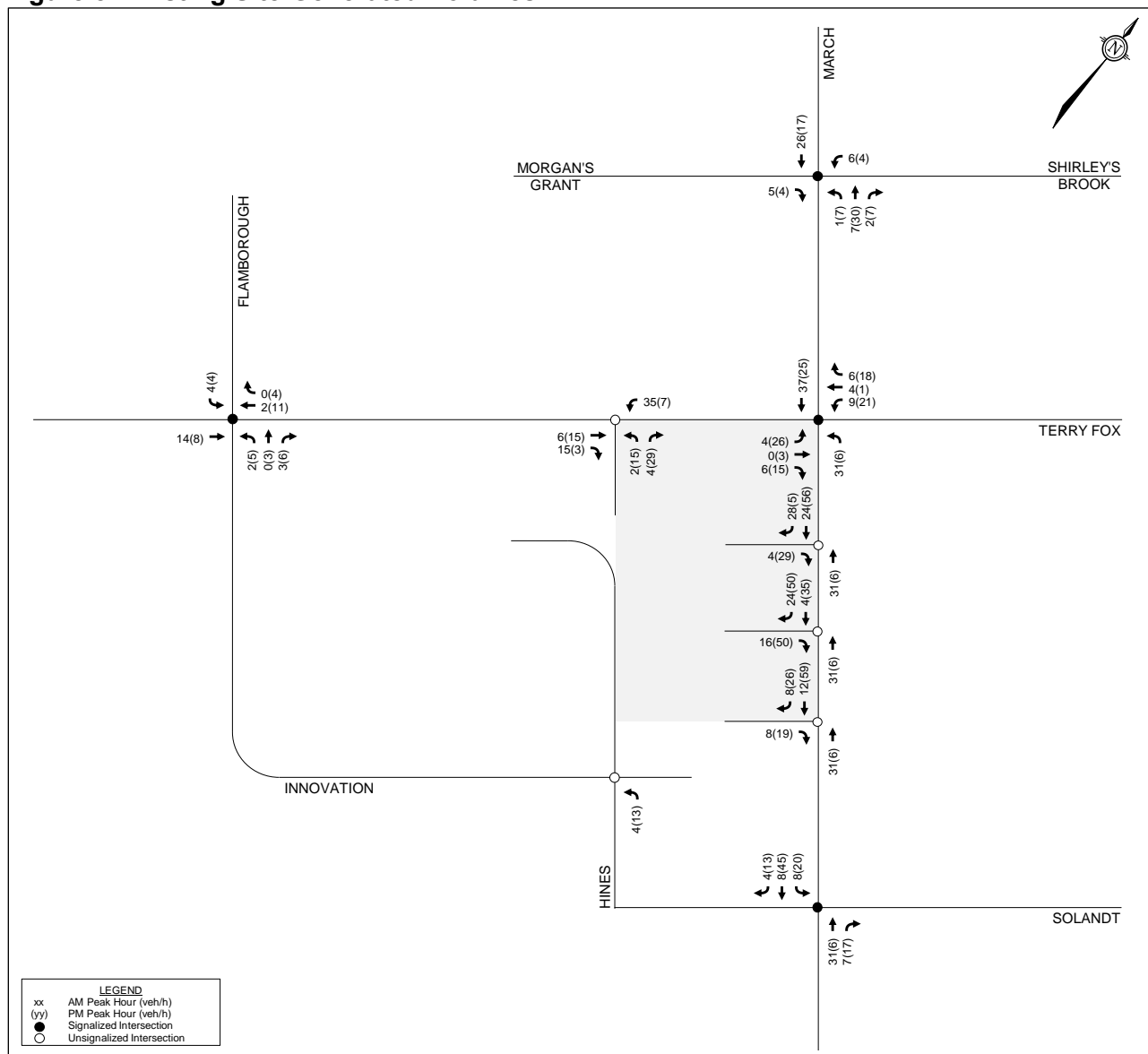

Figure 9: Proposed Site-Generated Volumes

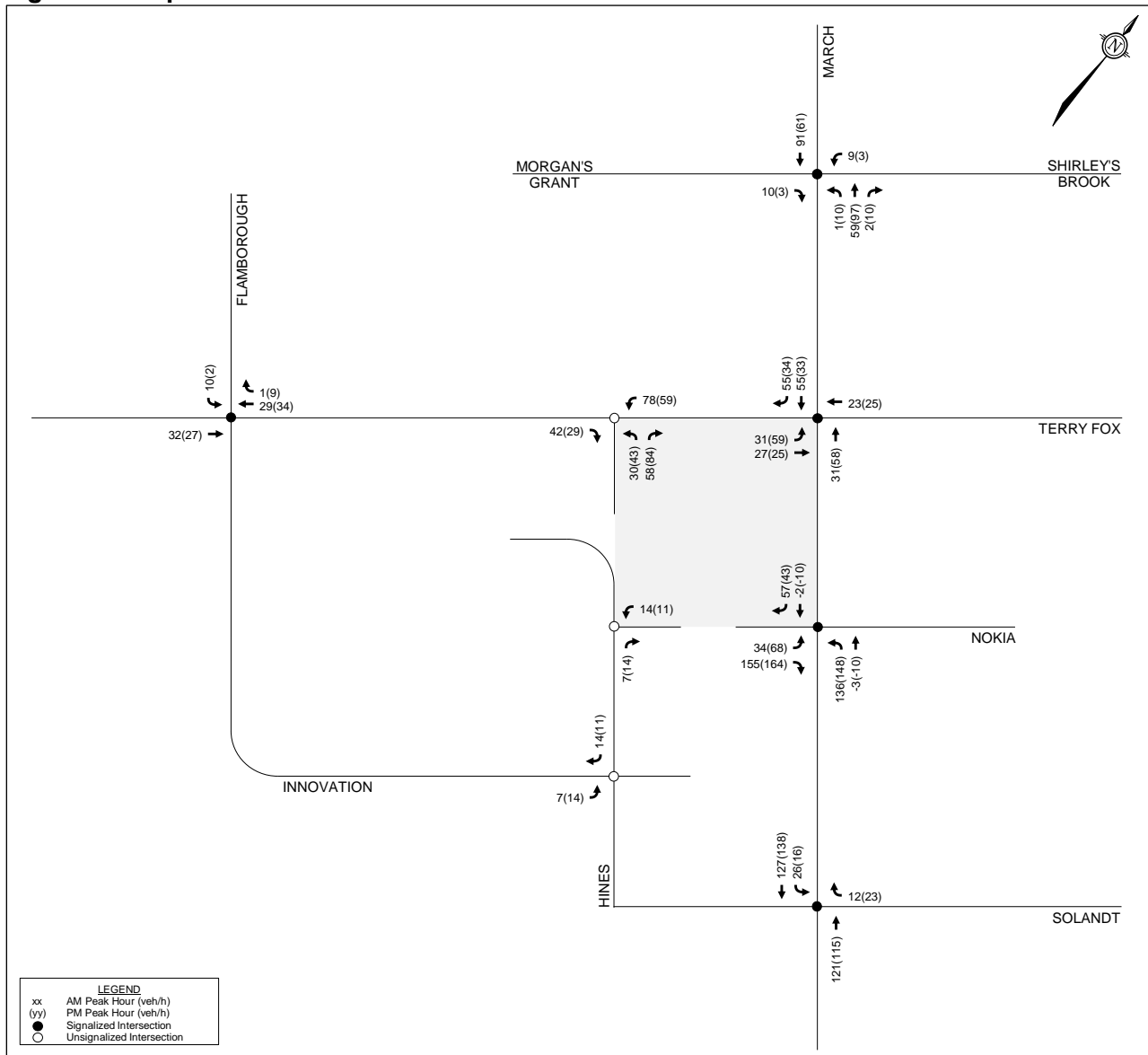

Figure 10: Net Site-Generated Volumes

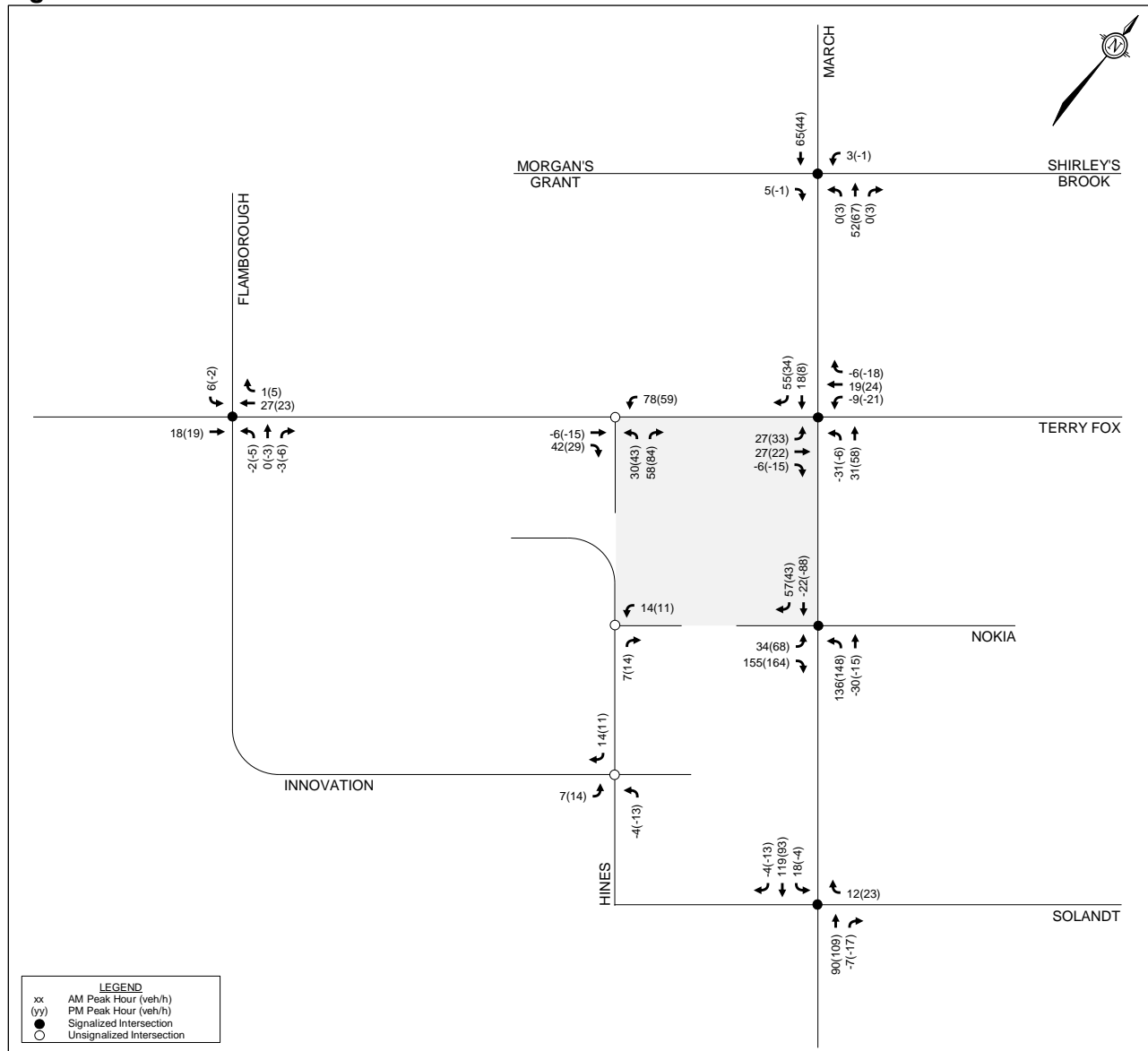

Figure 11: Other Area Development-Generated Volumes

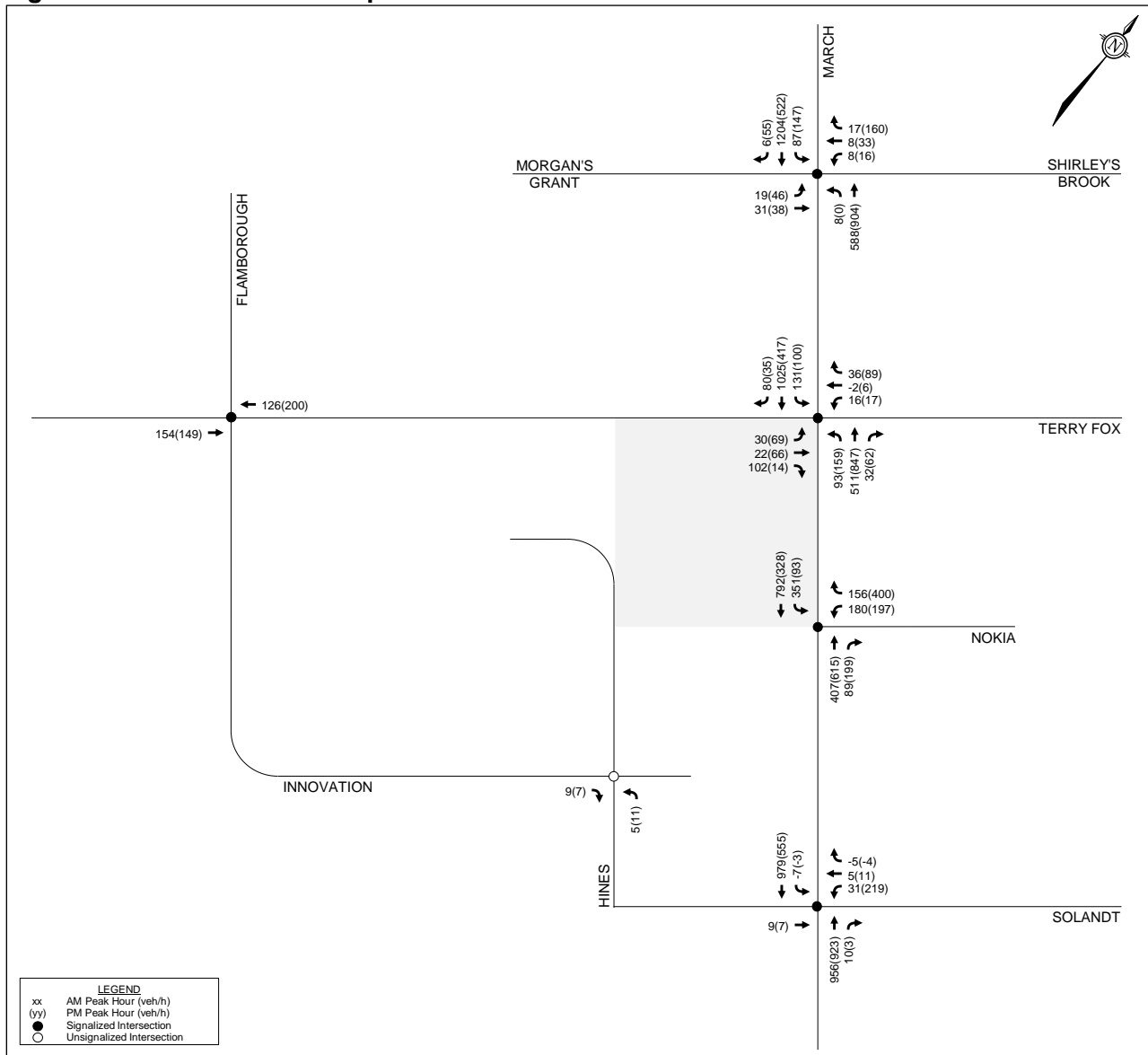
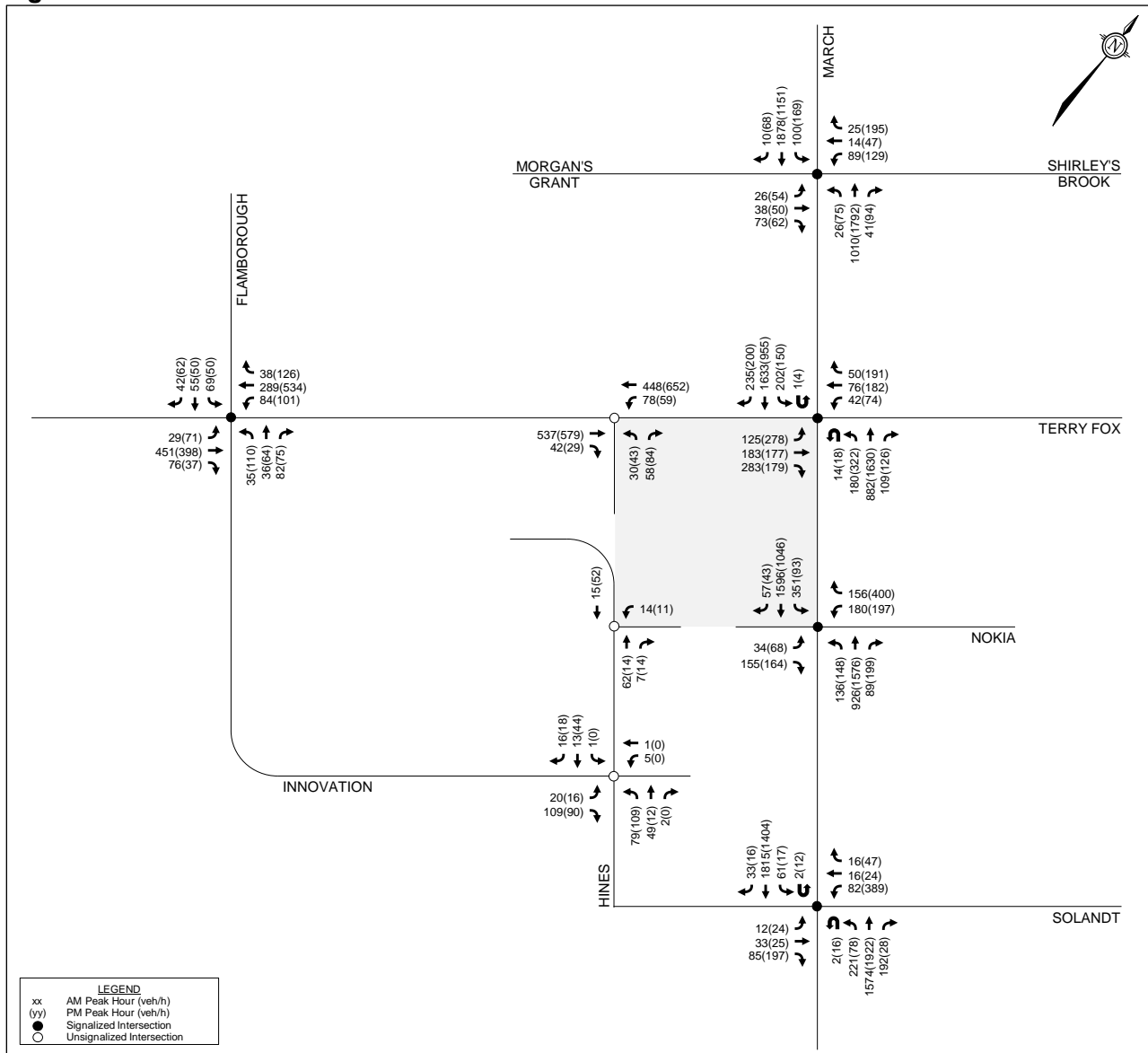



Figure 13: 2037 Total Volumes



### 3.4 Demand Rationalization

A review of the existing and background intersection operations has been conducted to determine where traffic volumes exceed capacity within the study area. The intersection parameters used in the analysis are consistent with the *2017 TIA Guidelines* (Saturated Flow Rate: 1,800 vphpl, Peak Hour Factor: 0.9 in existing conditions and 1.0 in future conditions). Per Exhibit 22 of the *Multi-Modal Level of Service (MMLOS) Guidelines*, the target vehicular level of service (Auto LOS) at all study area intersections is an Auto LOS D in existing conditions. This equates to a vehicle-to-capacity (v/c) ratio of 0.90 at signalized intersections, and a maximum delay of 35 seconds at unsignalized intersections. In future conditions, the *MMLOS Guidelines* identify a target Auto LOS E for March Road/Solandt Road and March Road/Nokia Access, as the 2031 Affordable Network identifies a future transit station within 600m of these intersections. Signal timing plans have been obtained from the City, and are included in **Appendix J**.



### 3.4.1 Existing Traffic Conditions

Intersection capacity analysis has been conducted for the existing traffic conditions. The results of the analysis are summarized in **Table 20** for the weekday AM and PM peak hours. Detailed reports are included in **Appendix K**.

**Table 20: Existing Traffic Operations**

Intersection	Period	Critical Movements			Intersection		
		Max v/c or Delay	LOS	Mvmt	v/c	Delay	LOS
March Road/Morgan’s Grant Way/Shirley’s Brook Drive <sup>(1)</sup>	AM	0.60	A	WBL	0.28	14 sec	A
	PM	0.73	C	WBL	0.31	16 sec	A
March Road/Terry Fox Drive <sup>(1)</sup>	AM	0.62	B	EBR	0.36	28 sec	A
	PM	0.69	B	NBL	0.48	32 sec	A
March Road/Solandt Road <sup>(1)</sup>	AM	0.64	B	NBL	0.56	14 sec	A
	PM	0.80	C	EBR	0.64	24 sec	B
Terry Fox Drive/Flamborough Way/Innovation Drive <sup>(1)</sup>	AM	0.73	C	SBL	0.40	21 sec	A
	PM	0.87	D	NBL	0.46	23 sec	A
Innovation Drive/Hines Road <sup>(2)</sup>	AM	13 sec	B	WB	-		
	PM	9 sec	A	EB			

- 1. Signalized intersection
- 2. Unsignalized intersection

From the previous table, all study area intersections operate at an acceptable level of service during the AM and PM peak hours.

### 3.4.2 2037 Background Traffic Conditions

Intersection capacity analysis has been conducted for the 2037 background traffic conditions. A reduction in the background vehicular volumes has been applied to reflect a higher transit modal share as a result of rapid transit and transit priority measures that will be implemented on March Road. Within the study area and the City’s Affordable Network, median bus lanes are anticipated on March Road at Solandt Road, and transit priority measures are anticipated on March Road north of Solandt Road. Therefore, the intersection geometry at March Road/Solandt Road and the signal timings at March Road/Morgan’s Grant Way/Shirley’s Brook Drive, March Road/Terry Fox Drive, and March Road/Solandt Road have been adjusted to reflect these measures. Other parameters have also been adjusted, consistent with the transportation assessments conducted by Delcan as part of the *West Transitway Connection* EPR. It should be noted that the transportation assessments evaluated the transitway alternatives based on person travel time rather than vehicular level of service.

Adjustments to the March Road/Morgan’s Grant Way/Shirley’s Brook Drive and March Road/Terry Fox Drive intersections are summarized as follows:

- Reduction of speed limit on March Road from 80 km/h to 60 km/h;
- Amber plus all-red timings adjusted to reflect increased clearance requirements and changes in the speed limit on March Road;
- Cycle length maintained at 130 seconds, but with splits and offsets optimized.

Adjustments to the March Road/Solandt Road intersection are summarized as follows:

- Adjustments to all right turn curb radii and turn lane lengths as required;
- Removal of the existing northbound right turn lane, southbound right turn lane, and one of the westbound left turn lanes;
- Addition of one auxiliary westbound right turn lane;
- Reduction of speed limit on March Road from 80 km/h to 60 km/h;
- Minimum pedestrian crossing times for eastbound/westbound pedestrians consistent with a two-stage crossing;
- Northbound/southbound left turn phases adjusted to become fully protected;
- Eastbound left turn phase adjusted to become permitted (no fully protected phase);
- Westbound left turn phase adjusted to become permitted during AM peak hour and protected plus permitted during PM peak hour (no fully protected phase);
- Amber plus all-red timings adjusted to reflect increased clearance requirements and changes in the speed limit on March Road;
- Cycle length maintained at 130 seconds, but with splits and offsets optimized.

A screenshot of the geometric changes to March Road/Solandt Road is included in **Figure 14**.

**Figure 14: Planned Modifications to March Road/Solandt Road**

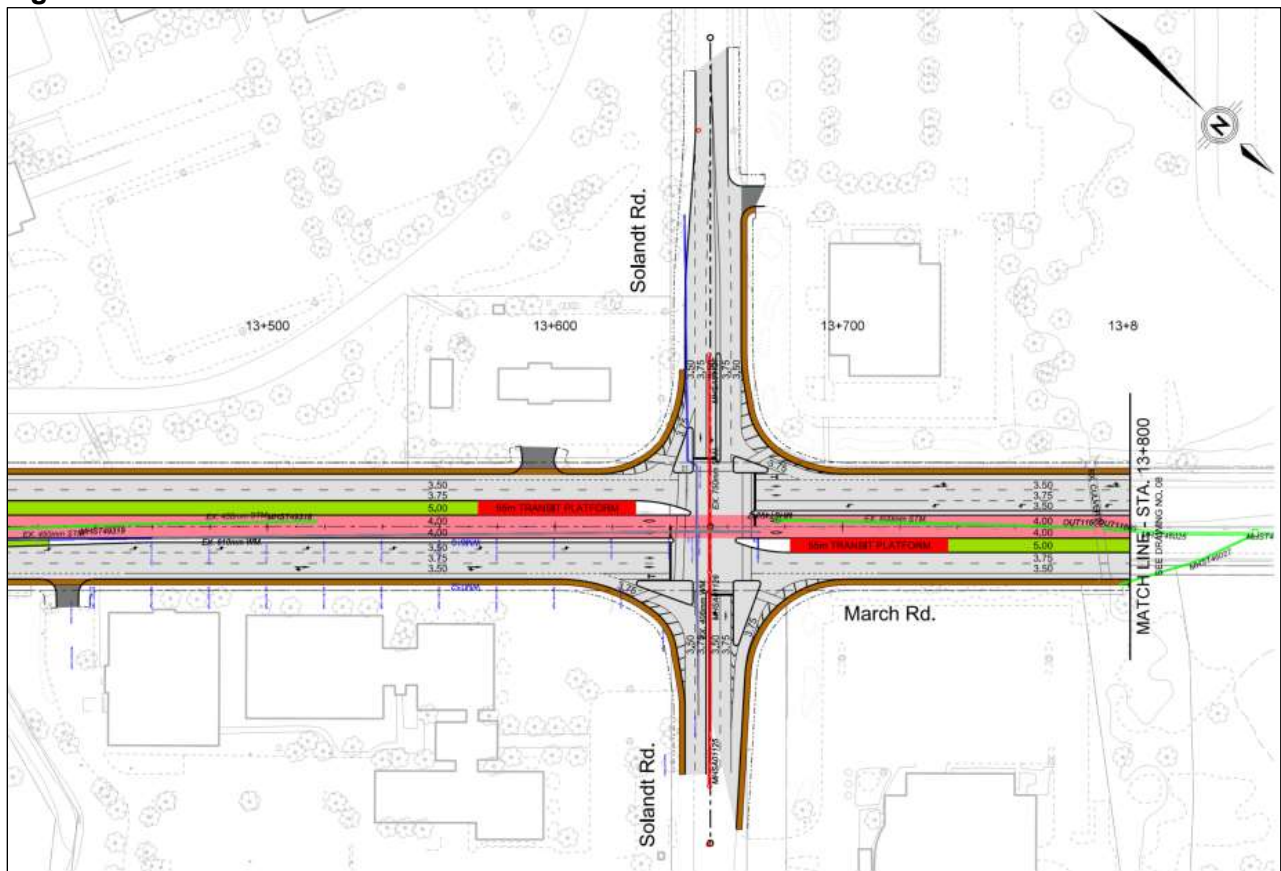

Analysis of the 2037 background volumes also includes the future signalized intersection at 570-600 March Road (referred to as March Road/Nokia Access). As the intersection is approximately located where three southbound lanes on March Road reduce to two, the location of this reduction has been shifted further south for the purposes of the Synchro analysis. This assumption is carried forward for the total traffic analysis as well (i.e. the southbound approach of this intersection will include one left turn lane into the Nokia development, two through lanes, and one shared through/right turn lane into the Subject Site).

The results of the analysis are summarized in **Table 21** and **Table 22** for the weekday AM and PM peak hours. Detailed reports are included in **Appendix L**.

**Table 21: 2037 Background Traffic Operations**

Intersection	Period	Critical Movements			Intersection		
		Max v/c or Delay	LOS	Mvmt	v/c	Delay	LOS
March Road/Morgan’s Grant Way/Shirley’s Brook Drive <sup>(1)</sup>	AM	0.60	A	SBL	0.38	14 sec	A
	PM	0.74	C	SBL	0.65	33 sec	B
March Road/Terry Fox Drive <sup>(1)</sup>	AM	0.78	C	SBL	0.64	35 sec	B
	PM	0.85	D	EBL	0.74	37 sec	C
March Road/Solandt Road <sup>(1)</sup>	AM	1.00	E	SBT/R	0.93	30 sec	E
	PM	<b>1.65</b>	<b>F</b>	<b>WBL</b>	<b>1.02</b>	<b>61 sec</b>	<b>F</b>
Terry Fox Drive/Flamborough Way/Innovation Drive <sup>(1)</sup>	AM	0.52	A	SBL	0.37	18 sec	A
	PM	0.72	C	NBL	0.44	24 sec	A
Innovation Drive/Hines Road <sup>(2)</sup>	AM	12 sec	B	WB	-		
	PM	9 sec	A	EB			
March Road/Nokia Access <sup>(1)</sup>	AM	0.72	C	WBL	0.61	14 sec	B
	PM	0.87	D	WBR	0.89	36 sec	D

- 1. Signalized intersection
- 2. Unsignalized intersection

**Table 22: 2037 Background – Critical Queues**

Intersection	Mvmt	Storage/ Spacing <sup>(1)</sup>	AM Peak			PM Peak		
			v/c [LOS]	50 <sup>th</sup> % Queue (m)	95 <sup>th</sup> % Queue (m)	v/c [LOS]	50 <sup>th</sup> % Queue (m)	95 <sup>th</sup> % Queue (m)
March Road/Solandt Road	NBL	165m	0.69 [B]	49	#105	0.59 [A]	21	#52
	NBT/R	200m	0.76 [C]	129	213	0.91 [E]	199	#316
	SBT/R	520m	1.00 [E]	222	#268	0.76 [C]	63	137
	WBL	135m	0.53 [A]	19	30	<b>1.65 [F]</b>	<b>~140</b>	<b>#164</b>
March Road/Nokia Access	SBL	TBC <sup>(2)</sup>	0.72 [B]	28	24	0.62 [B]	14	m#36
	WBL		0.69 [B]	41	57	0.47 [A]	39	56

- 1: Indicates the storage length for auxiliary lanes or the spacing to the nearest upstream intersection/access for through lanes
- 2. Storage requirements for SBL and WBL movements to be confirmed as part of future Site Plan Control applications
- #: Volume for the 95<sup>th</sup> percentile cycle exceeds capacity
- m: Queue is metered by an upstream signal
- ~: Approach is above capacity

From the previous tables, critical movements at the study area intersections generally operate at an acceptable level of service, with the exception of the westbound left turn movement at March Road/Solandt Road during the PM peak hour. Per the functional design of the March Road BRT, one of the westbound left turn lanes will be removed. It is anticipated that this is the primary driver for the failing vehicular level of service of this movement. The westbound left turn movement would require a reduction of approximately 160 vehicles to achieve the target Auto LOS E. Separate analysis with this reduction is included in **Appendix L**.

## 4.0 ANALYSIS

### 4.1 Transportation Demand Management

#### 4.1.1 Context for TDM

The exact number of proposed residential dwellings and GFAs for the proposed office and retail uses will be determined as part of subsequent Site Plan Control application(s). For the purposes of this TIA, the unit statistics outlined in the concept plan have been considered, which can be described as follows:

- 2,100 residential dwellings, which will include a mix of studio, one-bedroom, two-bedroom, and three-bedroom units;
- 154,178 ft<sup>2</sup> GFA of office space;
- 31,482 ft<sup>2</sup> GFA of retail space.

#### 4.1.2 Need and Opportunity

The Subject Site is located within the 'Kanata North Economic District,' 'Evolving Neighbourhood' overlay, and is designated as 'Corridor – Mainstreet' (March Road) and 'Corridor – Minor' (Terry Fox Drive) on Schedule B5 of the City of Ottawa's Official Plan (2021, Council Adopted). The implemented zoning for the properties are either 'General Industrial' IG6 and 'Business Park Industrial Zone' IP6[1149] and IP6[1084]. As first discussed in Section 3.1.1, the assumed mode shares for the proposed development are generally consistent with the surveyed residential, employment, and commercial mode shares of the Kanata/Stittsville district (as outlined in the *TRANS Trip Generation Manual*), with increased transit shares for the proposed office and retail uses.

The purpose of the proposed development is to become an 'activity centre,' designed for residents or employees to live, work, learn, play, and access daily needs without a car. Therefore, it is anticipated that the assumed driver share target will not be exceeded. Additionally, bus rapid transit along March Road is identified as a future improvement for commuters and residents of Kanata North.

#### 4.1.3 TDM Program

A review of the City's *TDM Measures Checklist* has been conducted by the proponent (included in **Appendix M**). While the final list of TDM measures to be implemented by the proposed development will be confirmed at the Site Plan Control application stage, the proponent has agreed to consider the following measures at this time:

##### Non-Residential

- 1.1.1 – Designate an internal coordinator, or contract with an external coordinator
- 2.1.1 – Display local area maps with walking/cycling access routes and key destinations at major entrances
- 3.1.1 – Display relevant transit schedules and route maps at entrances
- 3.1.2 – Provide online links to OC Transpo and STO information
- 4.1.1 – Provide a dedicated ridematching portal at OttawaRideMatch.com
- 5.1.1 – Contract with provider to install on-site bikeshare station for use by commuters and visitors

- 5.2.1 – Contact with provider to install on-site carshare vehicles and promote their use by tenants
- 6.1.1 – Charge for long-term parking (daily, weekly, monthly)
- 6.1.3 – Charge for short-term parking (hourly)
- 7.1.1 – Provide a multimodal travel option information package to new/relocating employees and students
- 8.2.1 – Encourage flex work hours
- 8.3.1 – Provide local business travel options that minimize the need for employees to bring a personal car to work
- 8.5.1 – Provide on-site amenities/services to minimize mid-day or mid-commute errands

### Residential

- 1.1.1 – Designate an internal coordinator, or contract with an external coordinator
- 2.1.1 – Display local area maps with walking/cycling access routes and key destinations at major entrances
- 3.1.1 – Display relevant transit schedules and route maps at entrances
- 4.1.1 – Contract with provider to install on-site bikeshare station
- 4.2.1 – Contract with provider to install on-site carshare vehicles and promote their use by residents
- 5.1.1 – Unbundle parking cost from purchase price
- 5.1.2 – Unbundle parking cost from monthly rent
- 6.1.1 – Provide a multimodal travel option information package to new residents

## **4.2 Neighbourhood Traffic Management**

The *2017 TIA Guidelines* identify two-way peak hour traffic volume thresholds for considering a Neighbourhood Traffic Management (NTM) plan should be developed, when the site relies on local or collector roadways for access. The NTM two-way volume thresholds are as follows:

- 120 vph for local roadways;
- 300 vph for collector roadways;
- 600 vph for major collector roadways.

While March Road and Terry Fox Drive are arterial roadways, the proposed development will also include an access to Hines Road (i.e. a collector roadway). Based on the two-way NTM thresholds for collector roadways and the 2037 total traffic peak hour volumes on Hines Road, peak hour traffic on Hines Road is not anticipated to exceed the City's NTM threshold.

## **4.3 Transit**

Based on the trip generation estimates presented in Section 3.1.1 and **Table 16**, the proposed development is anticipated to generate the following number of external transit trips:

- 287 transit trips during the AM peak hour (124 trips in, 163 trips out);
- 279 transit trips during the PM peak hour (136 trips in, 143 trips out).

Per discussions with City staff, all site-generated transit trips are anticipated to arrive or depart the study area via OC Routes 63, 64, 110, or 166, and all trips will utilize stops at Innovation Drive/Hines Road (stops #1174, #1175, #1176, and #1177), March Road/Terry Fox Drive (stops #4875 and #6155), and at 501 March Road (stop #7994).

Since nearly all site-generated transit trips are anticipated to be generated by the residential component of the development, the assumed transit trip distribution is similar to the residential distribution outlined in Section 3.1.2. The assumed distribution of transit trips to/from the proposed development can be summarized as follows:

- 25% to/from the north/west (i.e. Kanata North or Innovation) via OC Routes 63 and 64;
- 75% to/from the south/east (i.e. City of Ottawa) via OC Routes 63, 64, 110, and 166.

Transit utilization data from the Spring 2022 period (April 24 to June 25) has been obtained from OC Transpo, and is included in **Appendix C**. Average peak period (6:00am to 9:00am and 3:00pm to 6:00pm) boarding, alighting, and bus load at departure information was obtained for the stops previously listed in this section.

Existing and projected boarding and alighting information is summarized in **Table 23**. Any zero (0) values in the table indicate a measured average boarding and alighting value of zero, rather than an absence of data. Any dash (-) values in the table indicate that the route does not serve the stop in a given time period. Peak period boarding and alighting data have been converted to peak hour boardings and alightings, using factors of 0.55 for the AM peak hour and 0.47 for the PM peak hour (per the *TRANS Trip Generation Manual*).

**Table 23: Transit Utilization**

Stop	Location	Route	Dir	Boarding (tph) <sup>(1)</sup>			Alighting (tph) <sup>(1)</sup>		
				Existing	Site	Total	Existing	Site	Total
<b>AM Peak Hour</b>									
#1174	40 Hines	64	WB	1	0	1	3	25	28
		166	EB	0	0	0	0	19	19
#1175	Hines/Innovation	64	EB	0	41	41	0	0	0
		166	WB	-	-	-	-	-	-
#1176	Innovation/Hines	64	WB	0	21	21	4	0	4
		166	EB	0	0	0	0	0	0
#1177	Innovation/Hines	64	EB	0	0	0	0	16	16
		166	WB	-	-	-	-	-	-
#4875	Terry Fox/March	63	WB	0	20	22	1	25	26
		110	NB	0	0	0	1	0	1
#6155	Terry Fox/March	63	EB	2	20	22	0	7	7
		110	SB	1	41	42	0	25	25
#7994	March/Ad. 501	63	EB	0	20	20	0	7	7
<b>PM Peak Hour</b>									
#1174	40 Hines	64	WB	0	0	0	1	34	35
		166	EB	-	-	-	-	-	-
#1175	Hines/Innovation	64	EB	8	29	37	0	0	0
		166	WB	0	21	21	0	0	0
#1176	Innovation/Hines	64	WB	0	18	18	1	0	1
		166	EB	-	-	-	-	-	-
#1177	Innovation/Hines	64	EB	4	0	4	0	17	17
		166	WB	0	0	0	0	0	0
#4875	Terry Fox/March	63	WB	0	18	18	14	34	48
		110	NB	1	0	1	3	0	3
#6155	Terry Fox/March	63	EB	5	14	19	0	8	8
		110	SB	1	29	30	0	34	34
#7994	March/Ad. 501	63	EB	0	14	14	0	9	9

1. tph: transit trips per hour

A discussion of the site-generated impacts to OC Routes 63, 64, 110, and 166 during the weekday peak hours is included below.

Route 63 (eastbound, to Tunney's Pasture / Gatineau)

At stops #6155 and #7994, the proposed development is projected to generate an additional 20 AM boarding trips, seven AM alighting trips, 14 PM boarding trips, and eight PM alighting trips per stop. As route 63 runs on approximately 15-minute headways during the peak hours, this equates to approximately five AM boardings, two AM alightings, four PM boardings, and two PM alightings per bus at both stops.

The existing average bus loads at departure are five riders in the AM peak and three riders in the PM peak. Accounting for the above trips at both stops, the average bus loads when departing stop #7994 are anticipated to increase from five riders to 15 riders during the AM peak hour, and from three riders to 11 riders during the PM peak hour.

Route 63 (westbound, to Innovation / Briarbrook)

At stops #1820 and #4875, the proposed development is projected to generate an additional ten AM boarding trips, 13 AM alighting trips, nine PM boarding trips, and 17 PM alighting trips per stop. As route 63 runs on approximately 15-minute headways during the peak hours, this equates to approximately three AM boardings, four AM alightings, three PM boardings, and five PM alightings per bus at both stops.

The existing average bus loads at departure are one rider in the AM peak and six riders in the PM peak. Accounting for the above trips, the average bus loads when departing stop #4875 are anticipated to increase from one rider to six riders during the AM peak hour, and from six riders to 11 riders during the PM peak hour.

Route 64 (eastbound, to Tunney's Pasture)

At stop #1175, the proposed development is projected to generate an additional 41 AM boarding trips and 29 PM boarding trips. At stop #1177, the proposed development is projected to generate an additional 16 AM alighting trips and 17 PM alighting trips. As route 64 runs on approximately 15-minute headways during the peak hours, this equates to approximately 11 AM boardings, four AM alightings, eight PM boardings, and five PM alightings per bus at these stops.

The existing average bus loads at departure are five riders in the AM peak at both stops, two riders in the PM peak at stop #1177, and four riders in the PM peak at stop #1175. Accounting for the above trips, the average bus loads when departing stop #1175 are anticipated to increase from five riders to 16 riders during the AM peak hour, and from four riders to 12 riders during the PM peak hour. The average bus loads when arriving at stop #1177 are anticipated to increase from five riders to nine riders during the AM peak hour, and from two riders to seven riders during the PM peak hour.

Route 64 (westbound, to Innovation / Morgan's Grant)

At stop #1176, the proposed development is projected to generate an additional 21 AM boarding trips and 18 PM boarding trips. At stop #1174, the proposed development is projected to generate an additional 25 AM alighting trips and 34 PM alighting trips. As route 64 runs on approximately 15-minute headways during the peak hours, this equates to approximately five AM boardings, seven AM alightings, five PM boardings, and nine PM alightings per bus at these stops.

The existing average bus loads at departure are two riders in the AM peak at both stops, six riders in the PM peak at stop #1176, and seven riders in the PM peak at stop #1174. Accounting for the above trips, the average bus loads when departing stop #1176 are anticipated to increase from two riders to seven riders during the AM peak hour, and from six riders to 11 riders during the PM peak hour. The average bus loads when arriving at stop #1174 are anticipated to increase from two riders to nine riders during the AM peak hour, and from seven riders to 17 riders during the PM peak hour.

Route 110 (northbound, to Innovation)

The proposed development is not projected to generate any trips for this route and direction, as the route terminates at Innovation Station (i.e. within one kilometre of the Subject Site).

Route 110 (southbound, to Fallowfield)

At stop #6155, the proposed development is projected to generate an additional 41 AM boarding trips, 25 AM alighting trips, 29 PM boarding trips, and 34 PM alighting trips. As route 110 runs on approximately 30-minute headways during the peak hours, this equates to approximately 21 AM boardings, 13 AM alightings, 15 PM boardings, and 17 PM alightings per bus.

The existing average bus load at departure is one rider during both the AM and PM peaks. Accounting for the above trips, the average bus loads when departing stop #6155 are anticipated to increase from one rider to 22 riders during the AM peak hour, and from one rider to 16 riders during the PM peak hour.

Route 166 (northbound, to Innovation)

At stop #1174, the proposed development is projected to generate an additional 19 AM alighting trips. Route 166 runs once during the AM peak hour, in the northbound direction only.

The existing average bus load at departure is one rider during the AM peak. Accounting for the above trips, the average bus load when arriving at stop #1174 is anticipated to increase from one rider to 20 riders during the AM peak hour.

Route 166 (southbound, to Eagleson)

At stop #1175, the proposed development is projected to generate an additional 21 PM boarding trips. Route 166 runs once during the PM peak hour, in the southbound direction only.

The existing average bus load at departure is one rider during the PM peak. Accounting for the above trips, the average bus load when departing stop #1175 is anticipated to increase from one rider to 22 riders during the PM peak hour.

Based on the above, the proposed development is not anticipated to necessitate more frequent service for OC Routes 63, 64, 110, and 166.

As discussed in Section 2.2.1, the Affordable RTTP Network identifies at-grade BRT on March Road between Highway 417 and Solandt Road, along with transit priority signals and/or queue jump lanes on March Road between Solandt Road and the urban boundary. A future rapid transit station at Solandt Road will be located within 600m walking distance of the proposed development. These improvements to the transit service in the area is anticipated to increase the transit share of those travelling to/from the proposed development.



#### 4.4 Network Concept

The current zoning of the Subject Site permits a total GFA of approximately 1,415,000 ft<sup>2</sup>. From a traffic generation perspective, the ‘worst case’ would be constructing an office of this size. Based on the General Office Building land use rates included in the *ITE Trip Generation Manual, 11<sup>th</sup> Edition*, this would result in approximately 2,093 person trips during the AM peak hour and 1,917 person trips during the PM peak hour.

Per the *2017 TIA Guidelines*, the Network Concept module is only required when a proposed development generates more than 200 person trips during the peak hour in excess of the equivalent volume permitted by the established zoning. Since the proposed development will not generate more than the maximum development permitted by the established zoning, this module is exempt.

#### 4.5 Intersection Design

##### 4.5.1 Intersection MMLOS Review

This section provides a review of the signalized study area intersections using complete streets principles. All intersections within the study area have been evaluated for PLOS, BLOS, TLOS, and TkLOS. Since the *MMLOS Guidelines* refer to the land use designations outlined in the City’s previously adopted Official Plan, those designations have been considered for the purposes of this review.

The MMLOS targets associated with the ‘General Urban Area’ designation have been used to evaluate March Road/Morgan’s Grant Way/Shirley’s Brook Drive, and the targets associated with the ‘Employment Area’ designation have been used to evaluate March Road/Solandt Road. Since March Road/Terry Fox Drive and Terry Fox Drive/Flamborough Way/Innovation Drive are located in both land use designations, whichever target is stricter has been used in evaluation of these intersections. The full intersection MMLOS analysis is included in **Appendix N**. A summary of the results is shown in **Table 24**.

**Table 24: Intersection MMLOS Summary**

Intersection	PLOS		BLOS		TLOS		TkLOS	
	Actual	Target	Actual	Target	Actual	Target	Actual	Target
March Road/ Morgan’s Grant Way/Shirley’s Brook Drive	F	C	F	B	F	D	C	D
March Road/ Terry Fox Drive	F	C	F	B	F	D	A	B
March Road/ Solandt Road	F	C	F	C	F	B	A	B
Terry Fox Drive/ Flamborough Way/Innovation Drive	F	C	F	B	F	-	C	B

The results of the intersection MMLOS analysis can be summarized as follows:

- No study area intersections meet the target PLOS;
- No study area intersections meet the target BLOS;
- No study area intersections along March Road meet the target TLOS;
- All study area intersections meet the target TkLOS, except for Terry Fox Drive/Flamborough Way/Innovation Drive.

March Road/Morgan's Grant Way/Shirley's Brook Drive

This intersection does not meet the target PLOS C, BLOS B, or TLOS D.

All approaches have a divided cross-section with a width equivalent to ten lanes crossed or more (assuming a lane width equals 3.5m, per the *MMLOS Guidelines*). There is limited opportunity in improving the PLOS at each approach without reducing the number of travel lanes or restricting turning movements. No approaches meet the City's vehicle/pedestrian conflict threshold for zebra-striped crosswalks (greater than 400,000 vehicle/pedestrian conflicts over an eight-hour period). There is limited opportunity in improving the delay score for pedestrians without incurring major delays for vehicles.

The north, south, and east approaches do not meet the target BLOS based on left turn characteristics. Per Exhibit 12 of the *MMLOS Guidelines*, the target BLOS can be achieved at the east approach by reducing the operating speed to 40 km/h (which is the current speed limit on Shirley's Brook Drive). For left turns from the north and south approaches, cyclists are required to cross multiple lanes of traffic, on a roadway with a posted speed limit of 80 km/h. Given that all right turn movements are channelized at this intersection, the implementation of two-stage left-turn bike boxes at all approaches would not require a right turns on red (RTOR) restriction. This would require the stop bars at all approaches to be shifted away from the intersection. These measures are identified for the City's consideration.

The east approach does not meet the target TLOS. As Shirley's Brook Drive is not designated as a transit priority route, no modifications are not recommended for the east approach.

March Road/Terry Fox Drive

This intersection does not meet the target PLOS C, BLOS B, or TLOS D.

All approaches have a divided cross-section with a width equivalent to ten lanes crossed or more. There is limited opportunity in improving the PLOS at each approach without reducing the number of travel lanes or restricting turning movements. The north and south approaches meet the City's vehicle/pedestrian conflict threshold for zebra-striped crosswalks. There is limited opportunity in improving the delay score for pedestrians without incurring major delays for vehicles.

All approaches do not meet the target BLOS, based on both left and right turn characteristics. Given that all right turn movements are channelized at this intersection, the implementation of two-stage left turn-bike boxes at all approaches would not require a RTOR restriction. This would require the stop bars at all approaches to be shifted away from the intersection. This is identified for the City's consideration. Exhibit 12 of the *MMLOS Guidelines* identifies that the target BLOS can be met by shortening the right turn lanes to 50m or shorter. Given the high traffic volumes at this intersection, this is not recommended.

The east and west approaches do not have a target TLOS, but the approach delays of approximately 35 to 45 seconds during the peak hours are noted. The City's RTTP Affordable Network includes transit priority signals and queue jump lanes on March Road north of Solandt Road, and would be expected to improve the delays for northbound/southbound transit vehicles. Future conversion to median BRT is anticipated to further improve the delays for buses travelling along March Road.

March Road/Solandt Road

This intersection does not meet the target PLOS C, BLOS C, or TLOS B.

All approaches have a divided cross-section with a width equivalent to ten lanes crossed or more. There is limited opportunity in improving the PLOS at each approach without reducing the number of travel lanes or restricting turning movements. No approaches meet the City's vehicle/pedestrian conflict threshold for zebra-striped crosswalks. There is limited opportunity in improving the delay score for pedestrians without incurring major delays for vehicles.

The east approach does not meet the target BLOS based on left turn characteristics, and the west approach does not meet the target BLOS based on both left and right turn characteristics. For left turning cyclists on all approaches, they are required to cross at least one lane of traffic on roads with an operating speed of 50 km/h or greater. Two-stage left-turn bike boxes have recently been implemented for northbound and southbound cyclists. Implementing this improvement for eastbound and westbound cyclists as well is identified for the City's consideration.

For cyclists interacting with right turning vehicles, the right turn lanes at the north and west approaches are greater than 50m, and the bike lane shifts to the left of the right turn lane at the south approach. Exhibit 12 of the *MMLOS Guidelines* identifies that the target BLOS can be met by shortening the right turn lanes to 50m or shorter. Given the high traffic volumes at this intersection, this is not recommended.

The north and south approaches do not meet the target TLOS. The east and west approaches do not have a target TLOS, however delays are significant. The City's RTTP Affordable Network includes at-grade median BRT on March Road south of Solandt Road, and transit signal priority and queue jump lanes north of Solandt Road. These initial measures are anticipated to improve the delays for transit vehicles to the target TLOS or better. Future conversion to median BRT along the entire March Road corridor is anticipated to further improve the delays for buses travelling along March Road.

#### Terry Fox Drive/Flamborough Way/Innovation Drive

This intersection does not meet the target PLOS C, BLOS B, or TkLOS B.

All approaches have a divided cross-section with a width equivalent to five to eight lanes crossed. There is limited opportunity in improving the PLOS at each approach without reducing the number of travel lanes or restricting turning movements. The west approach meets the City's vehicle/pedestrian conflict threshold for zebra-striped crosswalks. There is limited opportunity in improving the delay score for pedestrians without incurring major delays for vehicles.

All approaches do not meet the target BLOS based on left turn characteristics, and additionally, the east and west approaches do not meet the target BLOS based on right turn characteristics. For left turning cyclists on all approaches, they are required to cross one lane of traffic on roads with an operating speed of 50 or 60 km/h. Exhibit 12 of the *MMLOS Guidelines* identifies that the target BLOS requires the implementation of two-stage left-turn bike boxes on all approaches, which would require RTOR restrictions. This is identified for the City's consideration.

For cyclists interacting with right turning vehicles, the right turn lanes at the east and west approaches are greater than 50m. Exhibit 12 of the *MMLOS Guidelines* identifies that the target BLOS can be met by shortening the right turn lanes to 50m or shorter. Given the magnitude of right-turning traffic volumes at this intersection, this is not recommended.

All approaches do not meet the target TkLOS. While the effective corner radii of each corner is greater than 15m (i.e. the best possible, per Exhibit 21 of the *MMLOS Guidelines*), the target TkLOS

can only be achieved by providing multiple receiving lanes. Since Flamborough Way and Innovation Drive are not classified as truck routes, no recommendations are identified.

#### 4.5.2 2037 Total Intersection Operations

Intersection capacity analysis has been conducted for the 2037 total traffic conditions. The results of the analysis are summarized in **Table 25** and **Table 26** for the weekday AM and PM peak hours. Detailed reports are included in **Appendix O**.

**Table 25: 2037 Total Traffic Operations**

Intersection	Period	Critical Movements			Intersection		
		Max v/c or Delay	LOS	Mvmt	v/c	Delay	LOS
March Road/Morgan's Grant Way/Shirley's Brook Drive <sup>(1)</sup>	AM	0.60	A	SBL	0.39	16 sec	A
	PM	0.75	C	SBL	0.68	18 sec	B
March Road/Terry Fox Drive <sup>(1)</sup>	AM	0.78	C	SBL	0.66	31 sec	B
	PM	<b>0.96</b>	<b>E</b>	<b>EBL</b>	0.78	35 sec	C
March Road/Solandt Road <sup>(1)</sup>	AM	<b>1.06</b>	<b>F</b>	<b>SBT/R</b>	0.99	42 sec	E
	PM	<b>1.56</b>	<b>F</b>	<b>WBL</b>	<b>1.04</b>	<b>62 sec</b>	<b>F</b>
Terry Fox Drive/Flamborough Way/Innovation Drive <sup>(1)</sup>	AM	0.54	A	SBL	0.38	17 sec	A
	PM	0.71	C	NBL	0.45	22 sec	A
Innovation Drive/Hines Road <sup>(2)</sup>	AM	12 sec	B	WB	-		
	PM	10 sec	A	EB			
March Road/Nokia Access/Site Access <sup>(1)</sup>	AM	0.87	D	WBL	0.60	27 sec	A
	PM	0.92	E	NBT	0.89	25 sec	D
Terry Fox Drive/Site Access <sup>(2)</sup>	AM	16 sec	C	NB	-		
	PM	18 sec	C	NB			
Hines Road/Site Access <sup>(2)</sup>	AM	9 sec	A	WB	-		
	PM	9 sec	A	WB			

- 1. Signalized intersection
- 2. Unsignalized intersection

**Table 26: 2037 Total – Critical Queues**

Intersection	Mvmt	Storage/ Spacing <sup>(1)</sup>	AM Peak			PM Peak		
			v/c [LOS]	50 <sup>th</sup> % Queue (m)	95 <sup>th</sup> % Queue (m)	v/c [LOS]	50 <sup>th</sup> % Queue (m)	95 <sup>th</sup> % Queue (m)
March Road/Terry Fox Drive	NBL	130m	0.67 [B]	24	33	0.76 [C]	43	m46
	NBT	280m	0.42 [A]	74	93	0.80 [C]	57	#171
March Road/Solandt Road	NBL	165m	0.69 [B]	49	#104	0.59 [A]	21	#54
	NBT/R	200m	0.84 [D]	155	#252	0.96 [E]	225	#341
	SBT/R	520m	<b>1.06 [F]</b>	<b>~253</b>	<b>#299</b>	0.81 [D]	169	#216
	WBL	135m	0.53 [A]	19	30	<b>1.56 [F]</b>	<b>~137</b>	<b>#161</b>
March Road/Nokia Access/Site Access	NBL	TBC <sup>(2)</sup>	0.61 [B]	18	m31	0.49 [A]	1	m1
	NBT	375m	0.59 [A]	70	102	0.92 [E]	171	m#221
	SBL	TBC <sup>(2)</sup>	0.75 [C]	57	42	0.65 [B]	14	m#41
	SBT	280m	0.61 [B]	137	157	0.47 [A]	26	71
	WBL	TBC <sup>(2)</sup>	0.87 [D]	41	62	0.78 [C]	37	54

- 1: Indicates the storage length for auxiliary lanes or the spacing to the nearest upstream intersection/access for through lanes
- 2: Storage requirements for SBL and WBL movements to be confirmed as part of future Site Plan Control applications
- #: Volume for the 95<sup>th</sup> percentile cycle exceeds capacity
- m: Queue is metered by an upstream signal
- ~: Approach is above capacity

From the previous tables, critical movements at the study area intersections generally operate at an acceptable level of service, with the exception of the southbound through/right turn movement at March Road/Solandt Road during the AM peak hour, the eastbound left turn movement at March Road/Terry Fox Drive during the PM peak hour, and the westbound left turn movement at March Road/Solandt Road during the PM peak hour.

In the AM peak hour, Synchro identifies that the southbound through/right turn movement at March Road/Solandt Road can be improved to the target Auto LOS E by adding ten seconds of green time to the southbound phase (subtracting from the northbound left turn phase).

In the PM peak hour, Synchro identifies that the eastbound left turn movement at March Road/Terry Fox Drive can be improved to the target Auto LOS D through minor adjustments in green time to each phase. A separate scenario with these changes are included in **Appendix O**.

Northbound through queues at March Road/Terry Fox Drive and southbound through queues at March Road/Nokia Access/Site Access do not extend into the opposite intersection. Based on the maximum northbound left turn queues at March Road/Terry Fox Drive, the existing northbound left turn storage length could be reduced to accommodate a longer southbound left turn lane at March Road/Nokia Access/Site Access. A functional design and Roadway Modification Approval (RMA) submission for this modification will be provided as part of a subsequent Site Plan Control application.

Based on the projected 2037 total traffic volumes, it is anticipated that an auxiliary westbound left turn lane will be required at the proposed access to Terry Fox Drive. A review of the most relevant left turn lane storage graphs included in the Ministry of Transportation of Ontario (MTO)'s *Design Supplement to the Transportation Association of Canada (TAC)'s Geometric Design Guide for Canadian Roads* has been conducted to determine the storage length required. In this scenario, the most relevant graphs are Exhibit 9A-10 and 9A-11, which are used for roadways with a design speed of 70km/h. During the AM peak hour, the westbound left-turning volume is approximately 15% of the total advancing volume (corresponding to Exhibit 9A-11). During the PM peak hour, the westbound left-turning volume is approximately 10% of the total advancing volume (corresponding to Exhibit 9A-10). In both exhibits, a storage length of 30m is required. These exhibits are included in **Appendix P**. A functional design and RMA submission for this modification will be provided as part of a subsequent Site Plan Control application.

## 5.0 CONCLUSIONS AND RECOMMENDATIONS

Based on the foregoing, the conclusions and recommendations of this TIA can be summarized as follows:

### Forecasting

- The proposed development as a whole is estimated to generate 1,232 person trips during the AM peak hour (including 611 external vehicle trips) and 1,382 person trips during the PM peak hour (including 662 external vehicle trips).

### Transportation Demand Management

- While the final list of TDM measures to be implemented by the proposed development will be confirmed at the Site Plan Control application stage, the proponent has agreed to consider a suite of TDM measures for non-residential and residential developments at this time.

### Transit

- The proposed development is anticipated to generate the following number of external transit trips:
  - 287 transit trips during the AM peak hour (124 trips in, 163 trips out);
  - 279 transit trips during the PM peak hour (136 trips in, 143 trips out).
- The proposed development is not anticipated to necessitate more frequent service for OC Routes 63, 64, 110, and 166.

### Intersection MMLOS

- The results of the intersection MMLOS analysis can be summarized as follows:
  - No study area intersections meet the target pedestrian level of service (PLOS);
  - No study area intersections meet the target bicycle level of service (BLOS);
  - No study area intersections along March Road meet the target transit level of service (TLOS);
  - All study area intersections meet the target truck level of service (TkLOS), except for Terry Fox Drive/Flamborough Way/Innovation Drive.
- There is limited opportunity in improving the PLOS at any approach without reducing the number of travel lanes, restricting turning movements, or removing right turn channels. There is also limited opportunity in improving the delay score at any intersection to the target PLOS.
- The north, south, and east approaches of March Road/Morgan's Grant Way/Shirley's Brook Drive do not meet the target BLOS. The target BLOS can be achieved at the east approach by reducing the operating speed to 40 km/h (which is the current speed limit on Shirley's Brook Drive). For left turns from the north and south approaches, the implementation of two-stage left-turn bike boxes at all approaches would not require a right turns on red (RTOR) restriction. This would require the stop bars at all approaches to be shifted away from the intersection. These measures are identified for the City's consideration.
- All approaches of March Road/Terry Fox Drive do not meet the target BLOS. Given that all right turn movements are channelized at this intersection, the implementation of two-stage left turn-bike boxes at all approaches would not require a RTOR restriction. This would require the stop bars at all approaches to be shifted away from the intersection. This is identified for the City's consideration. The target BLOS can be met by shortening the right turn lanes to 50m or shorter. Given the high traffic volumes at this intersection, this is not recommended.

- The east and west approaches of March Road/Solandt Road does not meet the target BLOS. Two-stage left-turn bike boxes have recently been implemented for northbound and southbound cyclists. Implementing this improvement for eastbound and westbound cyclists as well is identified for the City's consideration. For cyclists interacting with right turning vehicles, the right turn lanes at the north and west approaches are greater than 50m, and the bike lane shifts to the left of the right turn lane at the south approach. The target BLOS can be met by shortening the right turn lanes to 50m or shorter. Given the high traffic volumes at this intersection, this is not recommended.
- All approaches of Terry Fox Drive/Flamborough Way/Innovation Drive do not meet the target BLOS. The target BLOS requires the implementation of two-stage left-turn bike boxes on all approaches, which would require RTOR restrictions. This is identified for the City's consideration. For cyclists interacting with right turning vehicles, the right turn lanes at the east and west approaches are greater than 50m. The target BLOS can be met by shortening the right turn lanes to 50m or shorter. Given the magnitude of right-turning traffic volumes at this intersection, this is not recommended.
- The City's RTTP Affordable Network includes at-grade median bus rapid transit (BRT) on March Road south of Solandt Road, and transit signal priority and queue jump lanes north of Solandt Road. These initial measures are anticipated to improve the delays for transit vehicles to the target TLOS or better. Future conversion to median BRT along the entire March Road corridor is anticipated to further improve the delays for buses travelling along March Road.
- While the effective corner radii of each corner at Terry Fox Drive/Flamborough Way/Innovation Drive is greater than 15m, the target TkLOS can only be achieved by providing multiple receiving lanes. Since Flamborough Way and Innovation Drive are not classified as truck routes, no recommendations are identified.

#### Existing Traffic Operations

- All study area intersections operate at an acceptable level of service during the AM and PM peak hours.

#### Background Traffic Operations

- Critical movements at the study area intersections generally operate at an acceptable level of service, with the exception of the westbound left turn movement at March Road/Solandt Road during the PM peak hour. Per the functional design of the March Road BRT, one of the westbound left turn lanes will be removed. It is anticipated that this is the primary driver for the failing vehicular level of service of this movement. The westbound left turn movement would require a reduction of approximately 160 vehicles to achieve the target vehicular level of service (Auto LOS) E.

#### Total Traffic Operations

- Northbound through queues at March Road/Terry Fox Drive and southbound through queues at March Road/Nokia Access/Site Access do not extend into the opposite intersection. Based on the maximum northbound left turn queues at March Road/Terry Fox Drive, the existing northbound left turn storage length could be reduced to accommodate a longer southbound left turn lane at March Road/Nokia Access/Site Access. A functional design and Roadway Modification Approval (RMA) submission for this modification will be provided as part of a subsequent Site Plan Control application.

- It is anticipated that an auxiliary westbound left turn lane will be required at the proposed access to Terry Fox Drive. A review of the most relevant left turn lane storage graphs included in the Ministry of Transportation of Ontario (MTO)'s *Design Supplement to the Transportation Association of Canada (TAC)'s Geometric Design Guide for Canadian Roads* has been conducted to determine that a storage length of 30m is required. A functional design and RMA submission for this modification will be provided as part of a subsequent Site Plan Control application.

Based on the foregoing, the proposed development is recommended from a transportation perspective.

**NOVATECH**

Prepared by:



Joshua Audia, P.Eng.  
Project Engineer | Transportation

Reviewed by:



Brad Byvelds, P.Eng.  
Project Manager | Transportation



## **APPENDIX A**

---

Concept Plan

# Concept Plan

- Residential
- Amenity
- Office
- Retail
- Parking
- Bike Lane
- Loading/Parking
- Park
- Retail Edge
- Amenity Edge
- Parking/Loading Entrance
- Easement

Proposed GCA: **192,305m<sup>2</sup>** (2,069,971ft<sup>2</sup>)

Total # Units: **2,100**

Site Area: **55,511m<sup>2</sup>**



# Stats

## DEVELOPMENT TOTALS

	GCA		GFA <sup>1</sup>		%
	m <sup>2</sup>	ft <sup>2</sup>	m <sup>2</sup>	ft <sup>2</sup>	
Residential	172,949	1,861,624	147,007	1,582,380	89%
Office	15,915	171,309	14,324	154,178	9%
Retail	3,441	37,038	2,925	31,482	2%
<b>Total</b>	<b>192,305</b>	<b>2,069,971</b>	<b>164,255</b>	<b>1,768,041</b>	
<b>Total Projected # of Units</b>					2,100
<b>Predicted FSI</b>					3.0

Parking	# Parking Provided <sup>3</sup>	Parking Required <sup>2</sup>	Parking Rate
Block A	225	263	0.85
Block B	253	677	0.37
Block C	217	634	0.34
Block D	174	174	1.00
Block E	248	314	0.79
<b>Total</b>	<b>1116</b>	<b>2062</b>	<b>0.54</b>

### Notes:

1. GFA assumes efficiency of 85% for residential and retail. 90% efficiency assumed for Office program.
2. Parking required assumes a residential rate of 1 space/unit and an office rate of 1 space/100m<sup>2</sup> GFA (due to assumed proximity to future BRT stop)
3. Parking count provided based on assumption of 37m<sup>2</sup> GCA/space (400ft<sup>2</sup> GCA/space)
4. Projected unit count based on average unit size of 70m<sup>2</sup> GFA
5. Current parking counts do not account for visitor or retail parking. It is assumed that this parking will be accommodated at grade as on-street parking.

## Block C

Building	GCA		GFA <sup>1</sup>		# Units <sup>4</sup>	# Levels	Parking Required <sup>2</sup>
	m <sup>2</sup>	ft <sup>2</sup>	m <sup>2</sup>	ft <sup>2</sup>			
<b>C1</b>						27	
Residential	27,504	296,055	23,379	251,647	334		334
Office	-	-	-	-			-
Retail	-	-	-	-			-
<b>Subtotal</b>	<b>27,504</b>	<b>296,055</b>	<b>23,379</b>	<b>251,647</b>			<b>334</b>
<b>C2</b>						24	
Residential	24,670	265,550	20,970	225,717	300		300
Office	-	-	-	-			-
Retail	550	5,920	467	5,032			
<b>Subtotal</b>	<b>25,220</b>	<b>271,470</b>	<b>21,437</b>	<b>230,749</b>			<b>300</b>
<b>C3</b>							
Residential	-	-	-	-	-		-
Office	-	-	-	-	-		-
Retail	-	-	-	-	-		-
<b>Subtotal</b>	<b>-</b>	<b>-</b>	<b>-</b>	<b>-</b>	<b>-</b>		<b>-</b>
Residential	-	-	-	-	-		-
Office	-	-	-	-	-		-
Retail	-	-	-	-	-		-
<b>Subtotal</b>	<b>-</b>	<b>-</b>	<b>-</b>	<b>-</b>	<b>-</b>		<b>-</b>
<b>Block Total</b>	<b>52,724</b>	<b>567,525</b>	<b>44,816</b>	<b>482,396</b>	<b>634</b>		<b>634</b>

Parking	m <sup>2</sup>	ft <sup>2</sup>	# Spaces Provided <sup>3</sup>
Below Ground	6,108	65,750	1
Above Ground	1,916	20,621	1
<b>Total</b>	<b>8,024</b>	<b>86,371</b>	<b>217</b>

## Block A

Building	GCA		GFA <sup>1</sup>		# Units <sup>4</sup>	# Levels	Parking Required <sup>2</sup>
	m <sup>2</sup>	ft <sup>2</sup>	m <sup>2</sup>	ft <sup>2</sup>			
<b>A1</b>						8	
Residential	-	-	-	-	-		-
Office	9,017	97,054	8,115	87,348			81
Retail	796	8,567	676	7,282			
<b>Subtotal</b>	<b>9,812</b>	<b>105,621</b>	<b>8,791</b>	<b>94,630</b>			<b>81</b>
<b>A2</b>						6	
Residential	5,851	62,979	4,973	53,532	71		71
Office	-	-	-	-			-
Retail	572	6,157	486	5,233			
<b>Subtotal</b>	<b>6,423</b>	<b>69,136</b>	<b>5,459</b>	<b>58,766</b>			<b>71</b>
<b>A3</b>						8	
Residential	9,141	98,398	7,770	83,638	111		111
Office	-	-	-	-			-
Retail	-	-	-	-			-
<b>Subtotal</b>	<b>9,141</b>	<b>98,398</b>	<b>7,770</b>	<b>83,638</b>			<b>111</b>
Residential	-	-	-	-	-		-
Office	-	-	-	-	-		-
Retail	-	-	-	-	-		-
<b>Subtotal</b>	<b>-</b>	<b>-</b>	<b>-</b>	<b>-</b>	<b>-</b>		<b>-</b>
<b>Block Total</b>	<b>25,377</b>	<b>273,155</b>	<b>22,021</b>	<b>237,034</b>	<b>182</b>		<b>263</b>

Parking	m <sup>2</sup>	ft <sup>2</sup>	# Spaces Provided <sup>3</sup>
Below Ground	6,401	68,900	1
Above Ground	1,916	20,621	1
<b>Total</b>	<b>8,317</b>	<b>89,521</b>	<b>225</b>

## Block D

Building	GCA		GFA <sup>1</sup>		# Units <sup>4</sup>	# Levels	Parking Required <sup>2</sup>
	m <sup>2</sup>	ft <sup>2</sup>	m <sup>2</sup>	ft <sup>2</sup>			
<b>D1</b>						7	
Residential	-	-	-	-	-		-
Office	6,899	74,255	6,209	66,830			62.09
Retail	527	5,667	448	4,817			
<b>Subtotal</b>	<b>7,425</b>	<b>79,923</b>	<b>6,656</b>	<b>71,647</b>			<b>62</b>
<b>D2</b>						7	
Residential	4,916	52,920	4,179	44,982	60		60
Office	-	-	-	-			-
Retail	414	4,452	352	3,784			
<b>Subtotal</b>	<b>5,330</b>	<b>57,372</b>	<b>4,530</b>	<b>48,766</b>			<b>60</b>
<b>D2</b>						24	
Residential	19,225	206,942	16,342	175,901	233.45		233
Office	-	-	-	-			-
Retail	583	6,275	496	5,334			
<b>Subtotal</b>	<b>19,808</b>	<b>213,218</b>	<b>16,837</b>	<b>181,235</b>			<b>233</b>
Residential	-	-	-	-	-		-
Office	-	-	-	-	-		-
Retail	-	-	-	-	-		-
<b>Subtotal</b>	<b>-</b>	<b>-</b>	<b>-</b>	<b>-</b>	<b>-</b>		<b>-</b>
<b>Block Total</b>	<b>32,563</b>	<b>350,512</b>	<b>28,024</b>	<b>301,648</b>	<b>293</b>		<b>355</b>

Parking	m <sup>2</sup>	ft <sup>2</sup>	# Spaces Provided <sup>3</sup>
Below Ground	4,563	49,119	1
Above Ground	1,859	20,012	1
<b>Total</b>	<b>6,422</b>	<b>69,131</b>	<b>174</b>

## Block B

Building	GCA		GFA <sup>1</sup>		# Units <sup>4</sup>	# Levels	Parking Required <sup>2</sup>
	m <sup>2</sup>	ft <sup>2</sup>	m <sup>2</sup>	ft <sup>2</sup>			
<b>B1</b>						30	
Residential	29,810	320,872	25,338	272,741	362		362
Office	-	-	-	-			-
Retail	-	-	-	-			-
<b>Subtotal</b>	<b>29,810</b>	<b>320,872</b>	<b>25,338</b>	<b>272,741</b>			<b>362</b>
<b>B2</b>						25	
Residential	25,967	279,510	22,072	237,584	315		315
Office	-	-	-	-			-
Retail	-	-	-	-			-
<b>Subtotal</b>	<b>25,967</b>	<b>279,510</b>	<b>22,072</b>	<b>237,584</b>			<b>315</b>
Residential	-	-	-	-	-		-
Office	-	-	-	-	-		-
Retail	-	-	-	-	-		-
<b>Subtotal</b>	<b>-</b>	<b>-</b>	<b>-</b>	<b>-</b>	<b>-</b>		<b>-</b>
Residential	-	-	-	-	-		-
Office	-	-	-	-	-		-
Retail	-	-	-	-	-		-
<b>Subtotal</b>	<b>-</b>	<b>-</b>	<b>-</b>	<b>-</b>	<b>-</b>		<b>-</b>
<b>Block Total</b>	<b>55,777</b>	<b>600,382</b>	<b>47,410</b>	<b>510,325</b>	<b>677</b>		<b>677</b>

Parking	m <sup>2</sup>	ft <sup>2</sup>	# Spaces Provided <sup>3</sup>
Below Ground	6,109	65,757	1
Above Ground	3,245	34,927	1
<b>Total</b>	<b>9,354</b>	<b>100,684</b>	<b>253</b>

## Block E

Building	GCA		GFA <sup>1</sup>		# Units <sup>4</sup>	# Levels	Parking Required <sup>2</sup>
	m <sup>2</sup>	ft <sup>2</sup>	m <sup>2</sup>	ft <sup>2</sup>			
<b>E1</b>						8	
Residential	8,570	92,243	7,284	78,407	104		104
Office	-	-	-	-			-
Retail	-	-	-	-			-
<b>Subtotal</b>	<b>8,570</b>	<b>92,243</b>	<b>7,284</b>	<b>78,407</b>			<b>104</b>
<b>E2</b>						6	
Residential	8,647	93,077	7,350	79,115	105		105
Office	-	-	-	-			-
Retail	-	-	-	-			-
<b>Subtotal</b>	<b>8,647</b>	<b>93,077</b>	<b>7,350</b>	<b>79,115</b>			<b>105</b>
<b>E3</b>						8	
Residential	8,647	93,077	7,350	79,115	105		105
Office	-	-	-	-			-
Retail	-	-	-	-			-
<b>Subtotal</b>	<b>8,647</b>	<b>93,077</b>	<b>7,350</b>	<b>79,115</b>			<b>105</b>
Residential	-	-	-	-	-		-
Office	-	-	-	-	-		-
Retail	-	-	-	-	-		-
<b>Subtotal</b>	<b>-</b>	<b>-</b>	<b>-</b>	<b>-</b>	<b>-</b>		<b>-</b>
<b>Block Total</b>	<b>25,864</b>	<b>278,396</b>	<b>21,984</b>	<b>236,637</b>	<b>314</b>		<b>314</b>

Parking	m <sup>2</sup>	ft <sup>2</sup>	# Spaces Provided <sup>3</sup>
Below Ground	6,233	67,090	1
Above Ground	2,960	31,860	1
<b>Total</b>	<b>9,193</b>	<b>98,950</b>	<b>248</b>

## **APPENDIX B**

---

TIA Screening Form

## City of Ottawa 2017 TIA Guidelines Screening Form

### 1. Description of Proposed Development

Municipal Address	<b>555, 591, 595, and 603 March Road</b>
Description of Location	<b>Approx. 13.6 acres in area, located at the southwest corner of March Road/Terry Fox Drive</b>
Land Use Classification	<b>Residential, office, and retail</b>
Development Size (units)	<b>2,100 dwellings</b>
Development Size (m <sup>2</sup> )	<b>Approx. 154,178 ft<sup>2</sup> (14,324 m<sup>2</sup>) GFA of office space; Approx. 31,482 ft<sup>2</sup> (2,925 m<sup>2</sup>) GFA of commercial space</b>
Number of Accesses and Locations	<b>One access proposed to each of March Road, Terry Fox Drive, and Hines Road</b>
Phase of Development	<b>4</b>
Buildout Year	<b>2037</b>

If available, please attach a sketch of the development or site plan to this form.

### 2. Trip Generation Trigger

Considering the Development's Land Use type and Size (as filled out in the previous section), please refer to the Trip Generation Trigger checks below.

Land Use Type	Minimum Development Size
Single-family homes	40 units
<b><i>Townhomes or apartments</i></b>	<b><i>90 units</i></b>
<b><i>Office</i></b>	<b><i>3,500 m<sup>2</sup></i></b>
Industrial	5,000 m <sup>2</sup>
Fast-food restaurant or coffee shop	100 m <sup>2</sup>
<b><i>Destination retail</i></b>	<b><i>1,000 m<sup>2</sup></i></b>
Gas station or convenience market	75 m <sup>2</sup>

*\* If the development has a land use type other than what is presented in the table above, estimates of person-trip generation may be made based on average trip generation characteristics represented in the current edition of the Institute of Transportation Engineers (ITE) Trip Generation Manual.*

**If the proposed development size is greater than the sizes identified above, the Trip Generation Trigger is satisfied.**

### 3. Location Triggers

	Yes	No
Does the development propose a new driveway to a boundary street that is designated as part of the City's Transit Priority, Rapid Transit or Spine Bicycle Networks?	✓	
Is the development in a Design Priority Area (DPA) or Transit-oriented Development (TOD) zone?*		✓

\*DPA and TOD are identified in the City of Ottawa Official Plan (DPA in Section 2.5.1 and Schedules A and B; TOD in Annex 6). See Chapter 4 for a list of City of Ottawa Planning and Engineering documents that support the completion of TIA).

**If any of the above questions were answered with 'Yes,' the Location Trigger is satisfied.**

### 4. Safety Triggers

	Yes	No
Are posted speed limits on a boundary street are 80 km/hr or greater?	✓	
Are there any horizontal/vertical curvatures on a boundary street limiting sight lines at a proposed driveway?		✓
Is the proposed driveway within the area of influence of an adjacent traffic signal or roundabout (i.e. within 300 m of intersection in rural conditions, or within 150 m of intersection in urban/suburban conditions)?	✓	
Is the proposed driveway within auxiliary lanes of an intersection?	✓	
Does the proposed driveway make use of an existing median break that serves an existing site?	✓	
Is there is a documented history of traffic operations or safety concerns on the boundary streets within 500 m of the development?		✓
Does the development include a drive-thru facility?		✓

**If any of the above questions were answered with 'Yes,' the Safety Trigger is satisfied.**

### 5. Summary

	Yes	No
Does the development satisfy the Trip Generation Trigger?	✓	
Does the development satisfy the Location Trigger?	✓	
Does the development satisfy the Safety Trigger?	✓	

**If none of the triggers are satisfied, the TIA Study is complete. If one or more of the triggers is satisfied, the TIA Study must continue into the next stage (Screening and Scoping).**

## **APPENDIX C**

---

OC Transpo Information



**INNOVATION  
BRIARBROOK  
TUNNEY'S PASTURE  
GATINEAU**

**7 days a week / 7 jours par semaine**  
All day service  
Service toute la journée

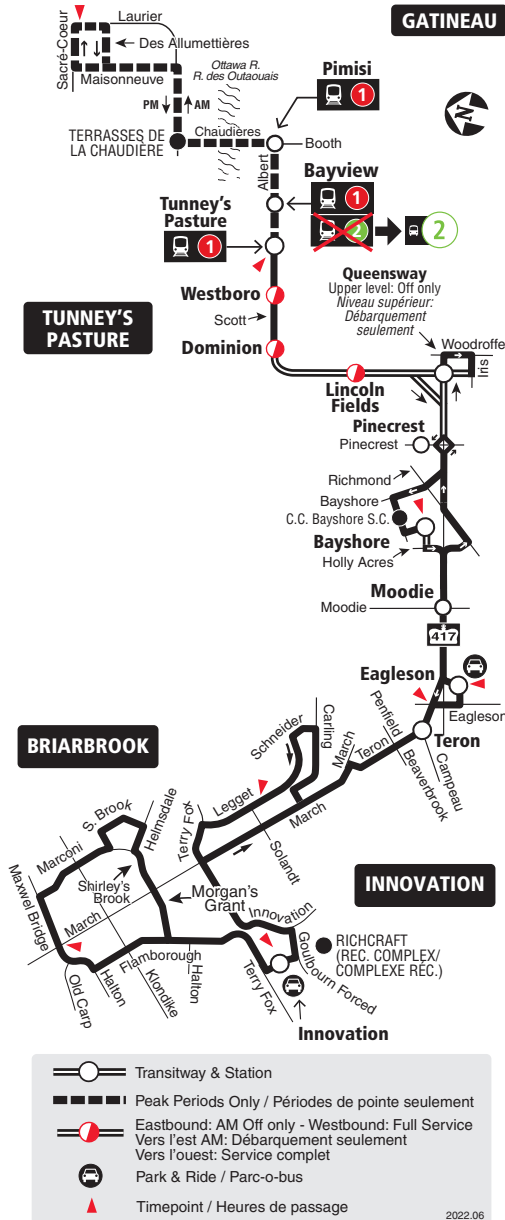

**Schedule / Horaire ..... 613-560-1000**  
**Text / Texto\* ..... 560560**  
plus your four digit bus stop number / plus votre numéro d'arrêt à quatre chiffres

Customer Service  
Service à la clientèle ..... **613-560-5000**  
Lost and Found / Objets perdus ..... **613-563-4011**  
Security / Sécurité ..... **613-741-2478**

**Effective June 26, 2022**  
**En vigueur 26 juin 2022**

**OC Transpo** INFO 613-560-5000  
octranspo.com





# 64

## MORGAN'S GRANT INNOVATION TUNNEY'S PASTURE

Local

Monday to Friday / Lundi au vendredi

All day service  
Service toute la journée

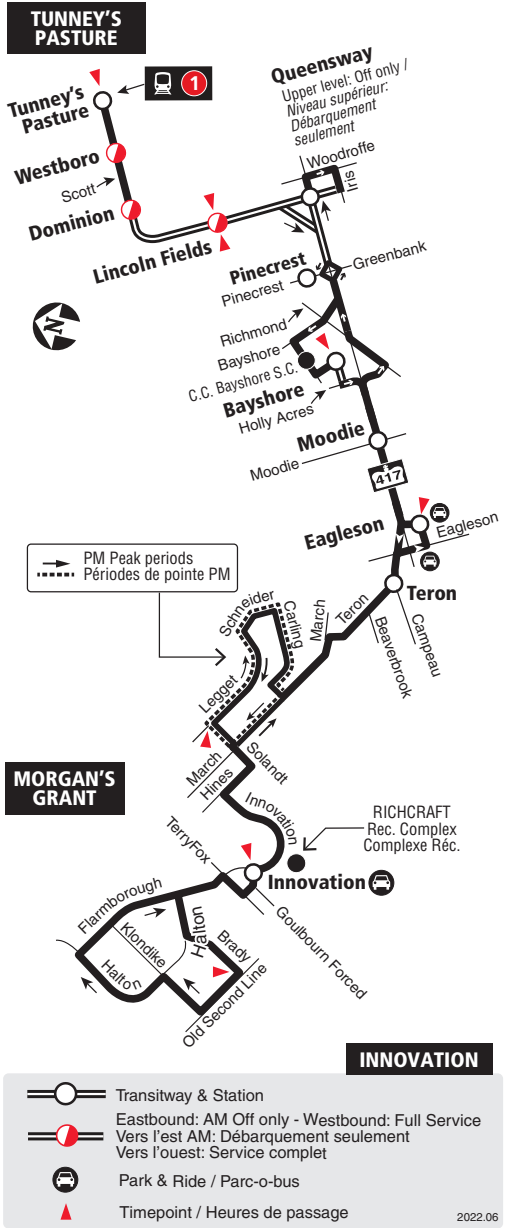

2022.06



Schedule / Horaire ..... 613-560-1000

Text / Texto\* ..... 560560

plus your four digit bus stop number / plus votre numéro d'arrêt à quatre chiffres

\*Standard message rates may apply / Les tarifs réguliers de messagerie texte peuvent s'appliquer

Customer Service  
Service à la clientèle ..... 613-560-5000

Lost and Found / Objets perdus ..... 613-563-4011

Security / Sécurité ..... 613-741-2478

Effective June 26, 2022

En vigueur 26 juin 2022



INFO 613-560-5000  
octranspo.com



# 66

## KANATA TUNNEY'S PASTURE GATINEAU

### Local

**Monday to Friday / Lundi au vendredi**

Peak periods only

Périodes de pointe seulement

**PM**  
↑  
**GATINEAU**

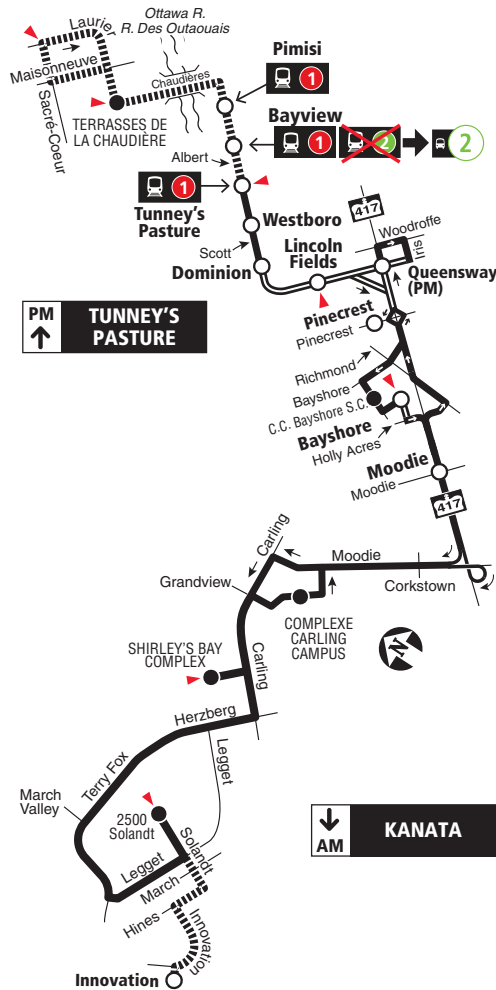

**PM**  
↑  
**TUNNEY'S PASTURE**

↓  
**AM**  
**KANATA**

- Transitway & Station
- Some trips / Quelques trajets
- Timepoint / Heures de passage

2022.06

2022.06

**Schedule / Horaire ..... 613-560-1000**  
**Text / Texto\* ..... 560560**  
*plus your four digit bus stop number / plus votre numéro d'arrêt à quatre chiffres*  
\*Standard message rates may apply / Les tarifs réguliers de messagerie texte peuvent s'appliquer

- Customer Service / Service à la clientèle ..... **613-560-5000**
- Lost and Found / Objets perdus ..... **613-563-4011**
- Security / Sécurité ..... **613-741-2478**

**Effective June 26, 2022**  
**En vigueur 26 juin 2022**



# 110

## FALLOWFIELD INNOVATION

Local

Monday to Friday / Lundi au vendredi

No late evening service

Aucun service en fin de soirée

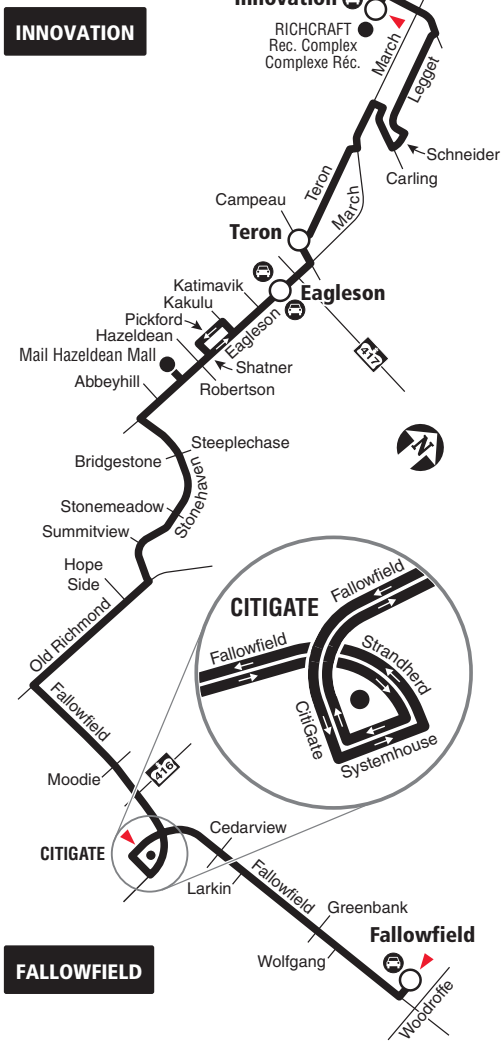

**INNOVATION**

**FALLOWFIELD**

- Stations
- Park & Ride / Parc-o-bus
- Timepoint / Heures de passage

2021.06

**Schedule / Horaire ..... 613-560-1000**  
**Text / Texto\* ..... 560560**  
*plus your four digit bus stop number / plus votre numéro d'arrêt à quatre chiffres*  
\*Standard message rates may apply / Les tarifs réguliers de messagerie texte peuvent s'appliquer

Customer Service  
 Service à la clientèle ..... **613-741-4390**  
 Lost and Found / Objets perdus ..... **613-563-4011**  
 Security / Sécurité ..... **613-741-2478**

**Effective June 20, 2021**  
**En vigueur 20 juin 2021**



# 165

## INNOVATION TERRY FOX

Local



Monday to Friday/ Lundi au vendredi

Selected time periods  
Périodes sélectionnées

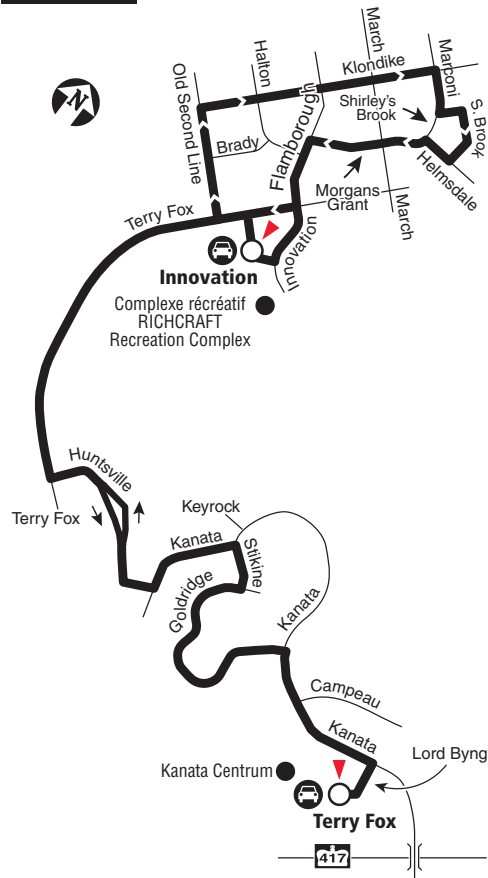
### INNOVATION



### TERRY FOX

-  Station
-  Park & Ride / Parc-o-bus
-  Timepoint / Heures de passage

2019.06



Schedule / Horaire.....613-560-1000  
Text / Texto .....560560

*plus your four digit bus stop number / plus votre numéro d'arrêt à quatre chiffres*

- Customer Service  
Service à la clientèle ..... 613-741-4390
- Lost and Found / Objets perdus..... 613-563-4011
- Security / Sécurité ..... 613-741-2478

Effective December 25, 2016  
En vigueur 25 décembre 2016



INFO 613-741-4390  
octranspo.com



# 166

## INNOVATION EAGLESON

Local

Monday to Friday/ Lundi au vendredi

Limited service / Service limité

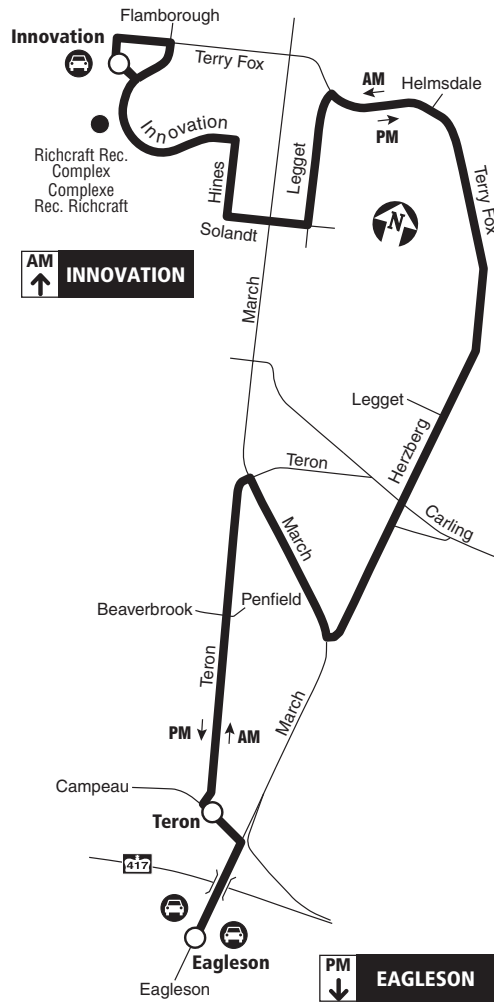

- Station
- Park & Ride / Parc-o-bus

2019.06

**Schedule / Horaire.....613-560-1000**  
**Text / Texto .....560560**  
*plus your four digit bus stop number / plus votre numéro d'arrêt à quatre chiffres*

Customer Service  
 Service à la clientèle ..... **613-741-4390**  
 Lost and Found / Objets perdus..... **613-563-4011**  
 Security / Sécurité ..... **613-741-2478**

**Effective December 25, 2016**  
**En vigueur 25 décembre 2016**

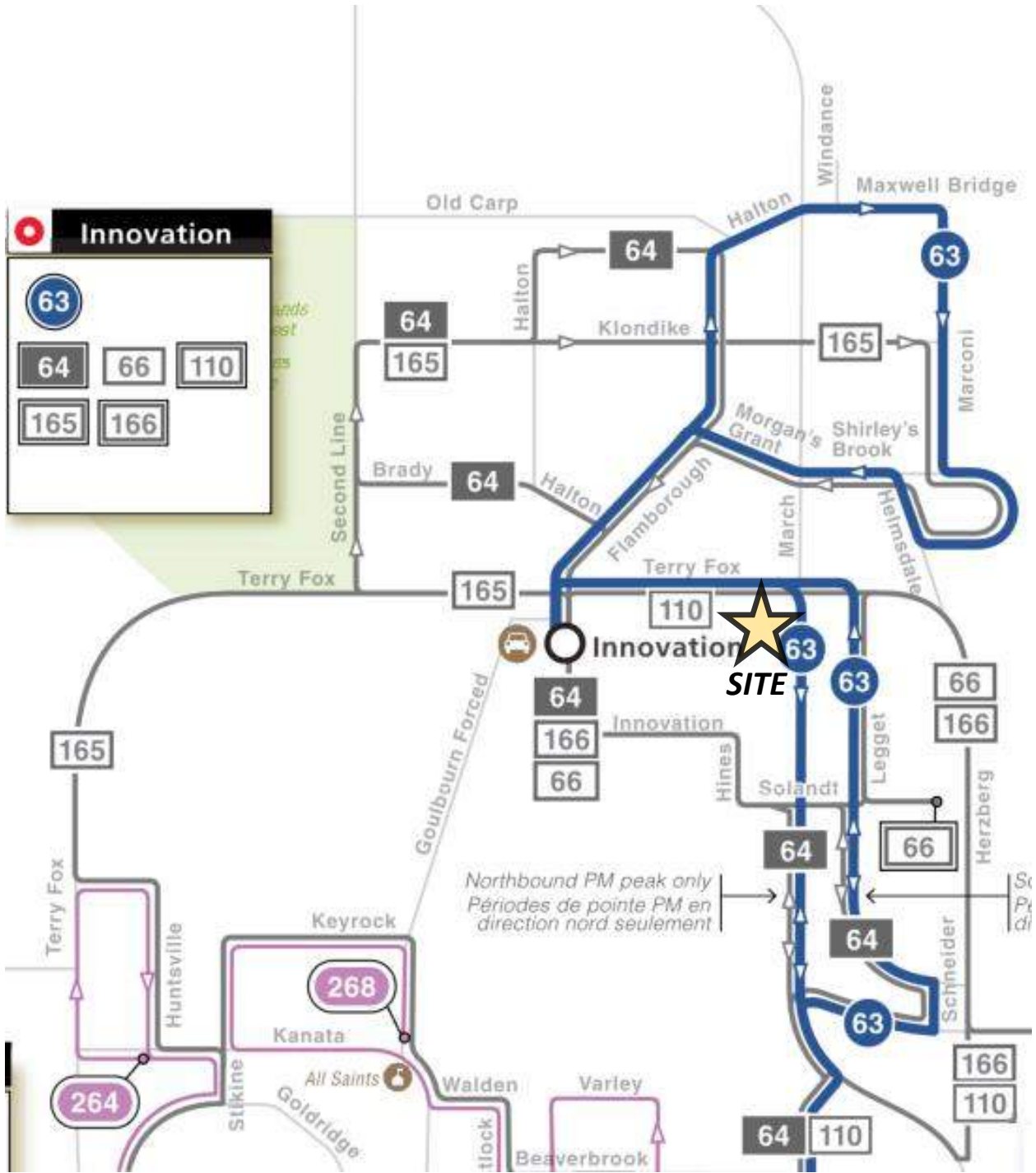

**Innovation**

- 63
- 64
- 66
- 110
- 165
- 166

Northbound PM peak only  
Périodes de pointe PM en direction nord seulement

## Joshua Audia

---

**From:** Rathwell, Graham <graham.rathwell@ottawa.ca>  
**Sent:** Tuesday, September 13, 2022 8:34 AM  
**To:** Joshua Audia <j.audia@novatech-eng.com>  
**Subject:** RE: Transit Data Request - March/Terry Fox area

Hi again Josh,

My apologies again for the delay, the requested data is provided in the table below. This list of stops should be a sufficient representative sample, covering those closest to the site in question and all of the routes/directions available within a short walk distance.

Data is provided for the Spring 2022 schedule period which ran from April 24 to June 25. System wide, conventional bus ridership for this period was at 51% of the ridership for same period in 2019, pre-pandemic. A reminder that zero (0) values indicate a measured average value of zero rather than an absence of data, based on available APC data. Dashes (-) indicate that the route does not serve the stop in question in the given time period. In this case this applies only to Route 166, which is a special limited peak-direction service.

Spring 2022 (April 24 - June 25)				AM (06:00-09:00)			PM (15:00-18:00)			24-hr		
Stop	Location	Route	Dir	Board	Alight	Avg Load Departure	Board	Alight	Avg Load Departure	Board	Alight	Avg Load Departure
1174	40 Hines	64	WB	1	6	2	0	1	7	1	10	3
		166	EB	0	0	1	-	-	-	0	0	1
1175	Hines/ Innovation	64	EB	0	0	5	17	0	4	17	0	3
		166	WB	-	-	-	0	0	1	0	0	1
1176	Innovation/ Hines	64	WB	0	8	2	0	1	6	0	13	3
		166	EB	0	0	1	-	-	-	0	0	1
1177	Innovation/ Hines	64	EB	0	0	5	9	0	2	10	0	2
		166	WB	-	-	-	0	0	1	0	0	1
4875	Terry Fox/ March	63	WB	0	1	1	0	29	6	1	51	3
		110	NB	0	1	0	1	6	1	1	11	1
6155	Terry Fox/ March	63	EB	3	0	5	11	0	3	29	0	3
		110	SB	2	0	1	2	0	1	5	0	1
7994	March/ AD. 501	63	EB	0	0	5	-	-	-	1	0	4

Please let me know if there are any questions, or if there is any additional data that you require.

Thank you,  
**Graham Rathwell**

Transit Planner, Network Service Design  
Service Planning Branch  
Transit Services Department  
OC Transpo | City of Ottawa

## **APPENDIX D**

---

### Traffic Count Data





# Turning Movement Count

## Summary Report Including Peak Hours, AADT and Expansion Factors

All Vehicles Except Bicycles



### March Road & Morgan's Grant Way/Shirley's Brook Drive

**Kanata, ON**

**Survey Date:** Thursday, August 04, 2022      **Start Time:** 0700      **AADT Factor:** 0.9  
**Weather AM:** Overcast 20° C      **Survey Duration:** 8 Hrs.      **Survey Hours:** 0700-1000, 1130-1330 & 1500-1800  
**Weather PM:** Mostly Cloudy 28° C      **Surveyor(s):** T. Carmody

#### Morgan's Grant Way

#### Shirley's Brook Dr.

#### March Rd.

#### March Rd.

Eastbound

Westbound

Northbound

Southbound

Time Period	LT	ST	RT	UT	E/B Tot	LT	ST	RT	UT	W/B Tot	Street Total	LT	ST	RT	UT	N/B Tot	LT	ST	RT	UT	S/B Tot	Street Total	Grand Total
0700-0800	4	8	82	0	94	74	7	9	0	90	184	20	267	26	1	314	5	594	4	1	604	918	1102
0800-0900	6	4	88	0	98	110	5	9	0	124	222	29	387	43	0	459	14	741	3	0	758	1217	1439
0900-1000	6	8	82	0	96	82	14	12	0	108	204	29	446	51	1	527	15	617	10	1	643	1170	1374
1130-1230	11	4	66	0	81	92	7	14	0	113	194	47	642	73	4	766	17	610	12	1	640	1406	1600
1230-1330	12	11	61	0	84	83	8	22	0	113	197	44	631	74	3	752	15	613	11	3	642	1394	1591
1500-1600	8	13	58	0	79	91	14	29	0	134	213	70	818	93	6	987	23	600	12	6	641	1628	1841
1600-1700	12	17	71	0	100	141	17	43	0	201	301	77	990	113	3	1183	31	668	13	2	714	1897	2198
1700-1800	9	14	79	0	102	98	17	26	0	141	243	77	992	115	1	1185	27	620	16	1	664	1849	2092
<b>Totals</b>	<b>68</b>	<b>79</b>	<b>587</b>	<b>0</b>	<b>734</b>	<b>771</b>	<b>89</b>	<b>164</b>	<b>0</b>	<b>1024</b>	<b>1758</b>	<b>393</b>	<b>5173</b>	<b>588</b>	<b>19</b>	<b>6173</b>	<b>147</b>	<b>5063</b>	<b>81</b>	<b>15</b>	<b>5306</b>	<b>11479</b>	<b>13237</b>

### Equivalent 12 & 24-hour Vehicle Volumes Including the Annual Average Daily Traffic (AADT) Factor

Applicable to the Day and Month of the Turning Movement Count

**Expansion factors are applied exclusively to standard weekday 8-hour turning movement counts conducted during the hours of 0700h - 1000h, 1130h - 1330h and 1500h - 1800h**

Equivalent 12-hour vehicle volumes. These volumes are calculated by multiplying the 8-hour totals by the 8 → 12 expansion factor of 1.39

Equ. 12 Hr	95	110	816	0	1020	1072	124	228	0	1423	2444	546	7190	817	26	8580	204	7038	113	21	7375	15956	18399
------------	----	-----	-----	---	------	------	-----	-----	---	------	------	-----	------	-----	----	------	-----	------	-----	----	------	-------	-------

Average daily 12-hour vehicle volumes. These volumes are calculated by multiplying the equivalent 12-hour totals by the AADT factor of: 0.9

AADT 12-hr	85	99	734	0	918	965	111	205	0	1281	2199	492	6471	736	24	7722	184	6334	101	19	6638	14360	16559
------------	----	----	-----	---	-----	-----	-----	-----	---	------	------	-----	------	-----	----	------	-----	------	-----	----	------	-------	-------

24-Hour AADT. These volumes are calculated by multiplying the average daily 12-hour vehicle volumes by the 12 → 24 expansion factor of 1.31

AADT 24 Hr	111	129	962	0	1203	1264	146	269	0	1678	2881	644	8478	964	31	10116	241	8297	133	25	8696	18812	21693
------------	-----	-----	-----	---	------	------	-----	-----	---	------	------	-----	------	-----	----	-------	-----	------	-----	----	------	-------	-------

### AADT and expansion factors provided by the City of Ottawa

AM Peak Hour Factor → 0.97						Highest Hourly Vehicle Volume Between 0700h & 1000h																	
AM Peak Hr	LT	ST	RT	UT	Total	LT	ST	RT	UT	Total	Str. Tot.	LT	ST	RT	UT	Total	LT	ST	RT	UT	Total	Str. Tot.	Gr. Tot.
0815-0915	8	8	80	0	96	92	7	9	0	108	204	21	435	48	0	504	15	717	5	0	737	1241	1445
OFF Peak Hour Factor → 0.98						Highest Hourly Vehicle Volume Between 1130h & 1330h																	
OFF Peak Hr	LT	ST	RT	UT	Total	LT	ST	RT	UT	Total	Str. Tot.	LT	ST	RT	UT	Total	LT	ST	RT	UT	Total	Str. Tot.	Gr. Tot.
1145-1245	12	9	64	0	85	86	8	17	0	111	196	42	676	78	3	799	17	629	12	1	659	1458	1654
PM Peak Hour Factor → 0.89						Highest Hourly Vehicle Volume Between 1500h & 1800h																	
PM Peak Hr	LT	ST	RT	UT	Total	LT	ST	RT	UT	Total	Str. Tot.	LT	ST	RT	UT	Total	LT	ST	RT	UT	Total	Str. Tot.	Gr. Tot.
1545-1645	10	15	76	0	101	137	17	42	0	196	297	82	987	110	4	1183	24	703	16	2	745	1928	2225

#### Comments:

OC Transpo and Para Transpo buses, together with a few school buses, comprise 10.19% of the heavy vehicle traffic. The bicycle totals include 2 E-Scooters (stand-up type). The pedestrian crossing totals include 1 with accessibility issues using an electric wheelchair.

#### Notes:

- Includes all vehicle types except bicycles, electric bicycles, and electric scooters.
- When expansion and AADT factors are applied, the results will differ slightly due to rounding.



# Turning Movement Count Summary, AM and PM Peak Hour Flow Diagrams



All Vehicles Except Bicycles

## March Road & Morgan's Grant Way/Shirley's Brook Drive Kanata, ON

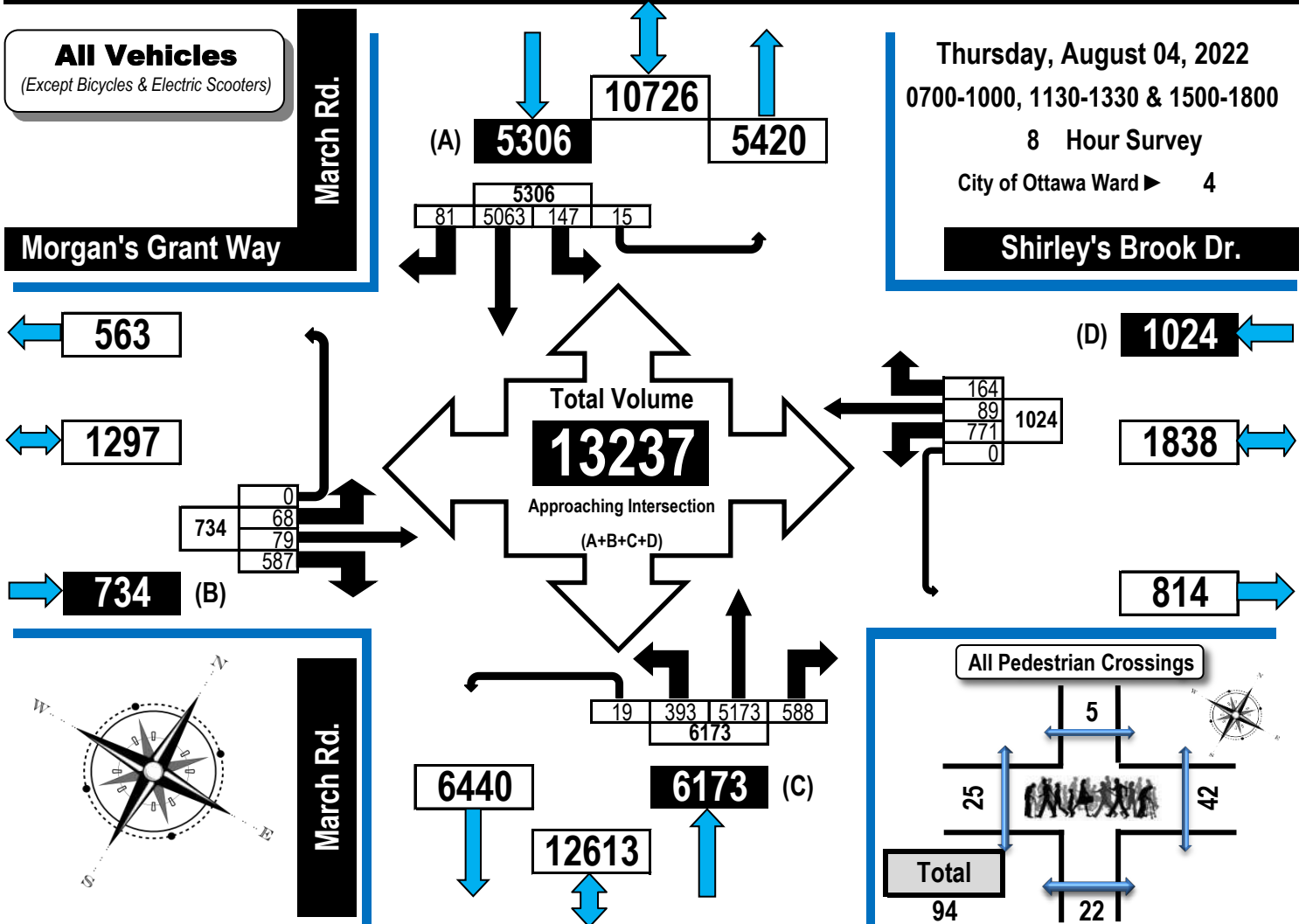

### AM Peak Hour Flow Diagram PM Peak Hour Flow Diagram

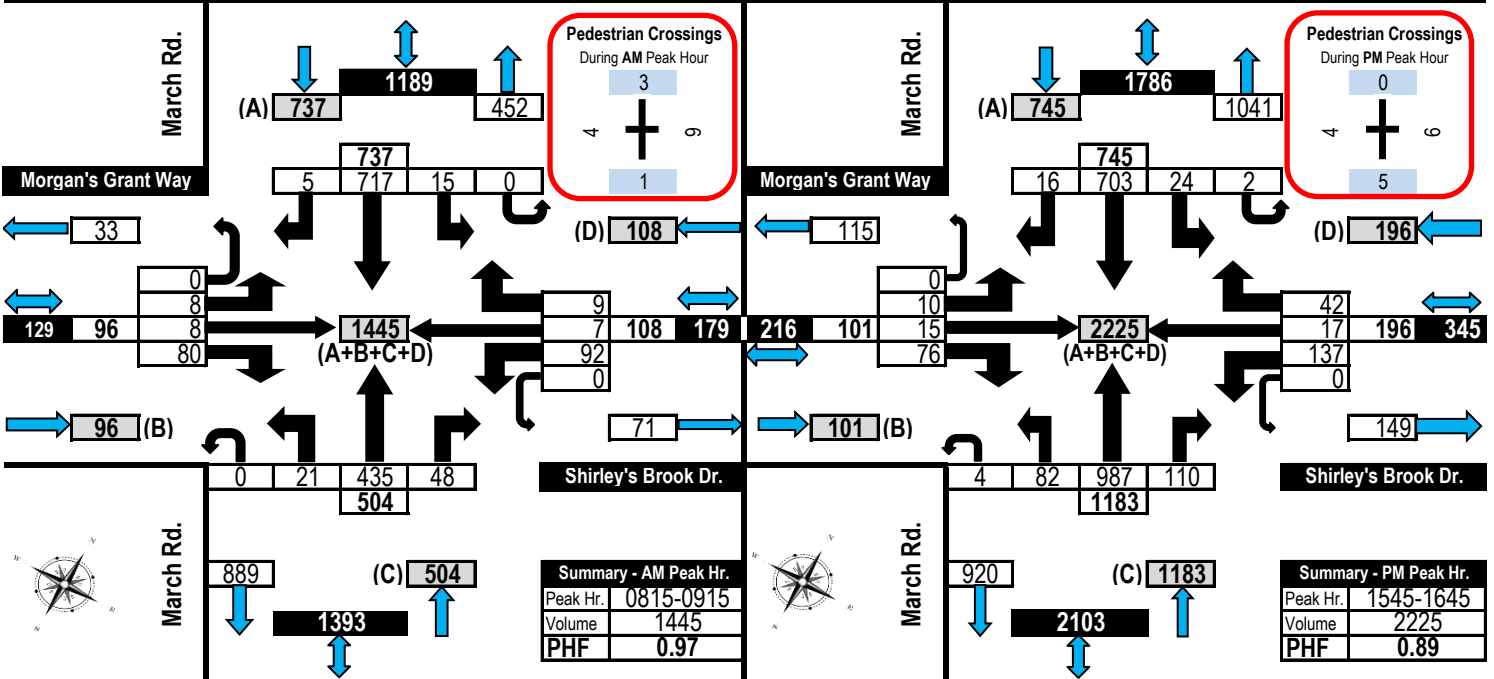



# Turning Movement Count

## Summary Report Including Peak Hours, AADT and Expansion Factors

All Vehicles Except Bicycles



### March Road & Terry Fox DriveKanata, ON

**Survey Date:** Thursday, August 04, 2022      **Start Time:** 0700      **AADT Factor:** 0.9  
**Weather AM:** Overcast 22° C      **Survey Duration:** 8 Hrs.      **Survey Hours:** 0700-1000, 1130-1330 & 1500-1800  
**Weather PM:** Mostly Cloudy 28° C      **Surveyor(s):** T. Carmody

Time Period	Terry Fox Dr. Eastbound					Terry Fox Dr. Westbound					March Rd. Northbound					March Rd. Southbound					Street Total	Grand Total	
	LT	ST	RT	UT	E/B Tot	LT	ST	RT	UT	W/B Tot	LT	ST	RT	UT	N/B Tot	LT	ST	RT	UT	S/B Tot			
0700-0800	35	87	151	0	273	32	37	11	0	80	353	71	267	52	10	400	50	630	59	1	740	1140	1493
0800-0900	67	130	194	0	391	29	50	19	1	99	490	127	369	96	14	606	85	743	111	0	939	1545	2035
0900-1000	87	158	157	0	402	45	74	36	0	155	557	131	418	78	16	643	71	589	113	2	775	1418	1975
1130-1230	129	104	146	0	379	75	111	82	0	268	647	125	550	82	14	771	85	583	112	0	780	1551	2198
1230-1330	141	100	130	0	371	76	84	70	1	231	602	125	530	76	18	749	75	554	121	3	753	1502	2104
1500-1600	146	89	167	0	402	81	118	93	0	292	694	128	752	54	21	955	63	567	127	2	759	1714	2408
1600-1700	214	119	207	0	540	87	194	137	0	418	958	213	819	78	20	1130	65	636	170	5	876	2006	2964
1700-1800	194	91	194	0	479	101	158	117	2	378	857	206	874	71	8	1159	60	582	137	4	783	1942	2799
<b>Totals</b>	<b>1013</b>	<b>878</b>	<b>1346</b>	<b>0</b>	<b>3237</b>	<b>526</b>	<b>826</b>	<b>565</b>	<b>4</b>	<b>1921</b>	<b>5158</b>	<b>1126</b>	<b>4579</b>	<b>587</b>	<b>121</b>	<b>6413</b>	<b>554</b>	<b>4884</b>	<b>950</b>	<b>17</b>	<b>6405</b>	<b>12818</b>	<b>17976</b>

**Equivalent 12 & 24-hour Vehicle Volumes Including the Annual Average Daily Traffic (AADT) Factor**  
**Applicable to the Day and Month of the Turning Movement Count**

**Expansion factors are applied exclusively to standard weekday 8-hour turning movement counts conducted during the hours of 0700h - 1000h, 1130h - 1330h and 1500h - 1800h**

Equivalent 12-hour vehicle volumes. These volumes are calculated by multiplying the 8-hour totals by the 8 → 12 expansion factor of 1.39

Equ. 12 Hr	1408	1220	1871	0	4499	731	1148	785	6	2670	7170	1565	6365	816	168	8914	770	6789	1321	24	8903	17817	24987
------------	------	------	------	---	------	-----	------	-----	---	------	------	------	------	-----	-----	------	-----	------	------	----	------	-------	-------

Average daily 12-hour vehicle volumes. These volumes are calculated by multiplying the equivalent 12-hour totals by the AADT factor of: 0.9

AADT 12-hr	1267	1098	1684	0	4049	658	1033	707	5	2403	6453	1409	5728	734	151	8023	693	6110	1188	21	8013	16035	22488
------------	------	------	------	---	------	-----	------	-----	---	------	------	------	------	-----	-----	------	-----	------	------	----	------	-------	-------

24-Hour AADT. These volumes are calculated by multiplying the average daily 12-hour vehicle volumes by the 12 → 24 expansion factor of 1.31

AADT 24 Hr	1660	1439	2206	0	5305	862	1354	926	7	3148	8453	1845	7504	962	198	10510	908	8004	1557	28	10497	21006	29459
------------	------	------	------	---	------	-----	------	-----	---	------	------	------	------	-----	-----	-------	-----	------	------	----	-------	-------	-------

**AADT and expansion factors provided by the City of Ottawa**

AM Peak Hour Factor → 0.94											Highest Hourly Vehicle Volume Between 0700h & 1000h												
AM Peak Hr	LT	ST	RT	UT	Total	LT	ST	RT	UT	Total	Str. Tot.	LT	ST	RT	UT	Total	LT	ST	RT	UT	Total	Str. Tot.	Gr. Tot.
0815-0915	80	158	220	0	458	40	69	24	1	134	592	139	400	91	14	644	83	694	118	1	896	1540	2132
OFF Peak Hour Factor → 0.97											Highest Hourly Vehicle Volume Between 1130h & 1330h												
OFF Peak Hr	LT	ST	RT	UT	Total	LT	ST	RT	UT	Total	Str. Tot.	LT	ST	RT	UT	Total	LT	ST	RT	UT	Total	Str. Tot.	Gr. Tot.
1145-1245	144	114	135	0	393	83	110	95	1	289	682	143	577	86	14	820	85	588	117	0	790	1610	2292
PM Peak Hour Factor → 0.92											Highest Hourly Vehicle Volume Between 1500h & 1800h												
PM Peak Hr	LT	ST	RT	UT	Total	LT	ST	RT	UT	Total	Str. Tot.	LT	ST	RT	UT	Total	LT	ST	RT	UT	Total	Str. Tot.	Gr. Tot.
1615-1715	212	107	216	0	535	93	183	144	1	421	956	203	872	77	18	1170	60	637	158	4	859	2029	2985

**Comments:**

OC Transpo and Para Transpo buses, together with a few school buses, comprise 18.97% of the heavy vehicle traffic. The bicycle totals include 3 E-Scooters (stand-up type). The pedestrian crossing totals include 1 with accessibility issues using an electric wheelchair.

**Notes:**

- Includes all vehicle types except bicycles, electric bicycles, and electric scooters.
- When expansion and AADT factors are applied, the results will differ slightly due to rounding.



# Turning Movement Count Summary, AM and PM Peak Hour Flow Diagrams

All Vehicles Except Bicycles



## March Road & Terry Fox Drive Kanata, ON

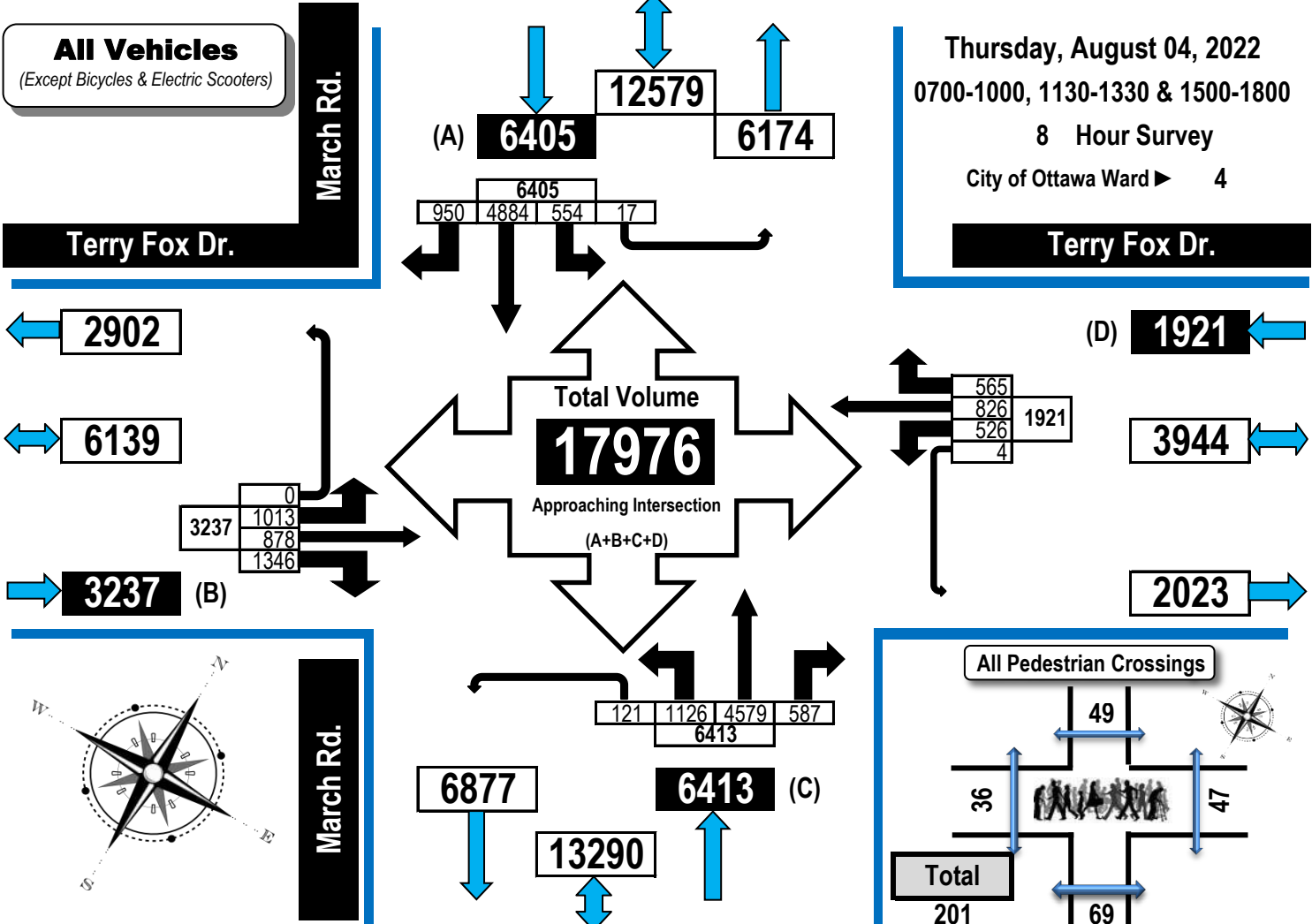

### AM Peak Hour Flow Diagram PM Peak Hour Flow Diagram

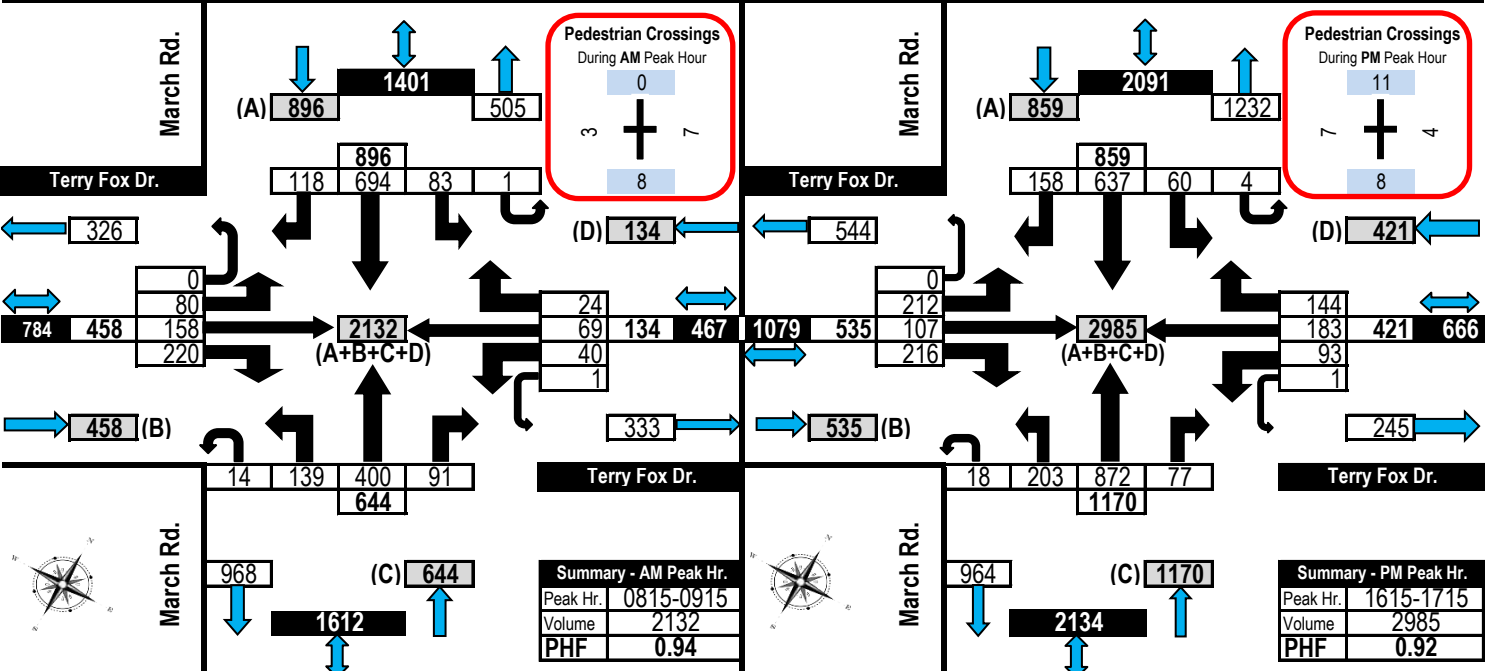



# Turning Movement Count

## Summary Report Including Peak Hours, AADT and Expansion Factors

All Vehicles Except Bicycles



### March Road & Solandt Road Kanata, ON

**Survey Date:** Thursday, August 04, 2022      **Start Time:** 0700      **AADT Factor:** 0.9  
**Weather AM:** Overcast 20° C      **Survey Duration:** 8 Hrs.      **Survey Hours:** 0700-1000, 1130-1330 & 1500-1800  
**Weather PM:** Mostly Cloudy 28° C      **Surveyor(s):** T. Carmody

Time Period	Solandt Rd. Eastbound					Solandt Rd. Westbound					March Rd. Northbound					March Rd. Southbound					Street Total	Grand Total	
	LT	ST	RT	UT	E/B Tot	LT	ST	RT	UT	W/B Tot	LT	ST	RT	UT	N/B Tot	LT	ST	RT	UT	S/B Tot			
0700-0800	4	15	37	0	56	18	8	4	0	30	86	175	389	118	1	683	25	753	34	0	812	1495	1581
0800-0900	17	25	80	0	122	50	13	10	0	73	195	248	567	202	2	1019	52	873	38	4	967	1986	2181
0900-1000	20	15	86	0	121	69	12	5	0	86	207	219	636	194	3	1052	35	742	47	0	824	1876	2083
1130-1230	42	12	110	0	164	90	12	18	0	120	284	96	703	66	11	876	36	726	41	3	806	1682	1966
1230-1330	22	18	106	0	146	80	13	10	0	103	249	106	692	85	8	891	24	705	46	12	787	1678	1927
1500-1600	20	12	119	0	151	146	16	15	0	177	328	71	912	67	3	1053	16	760	33	5	814	1867	2195
1600-1700	31	14	228	0	273	198	19	39	0	256	529	80	1050	59	7	1196	27	905	38	11	981	2177	2706
1700-1800	28	16	193	0	237	193	12	30	0	235	472	104	1078	40	22	1244	19	857	27	10	913	2157	2629
<b>Totals</b>	<b>184</b>	<b>127</b>	<b>959</b>	<b>0</b>	<b>1270</b>	<b>844</b>	<b>105</b>	<b>131</b>	<b>0</b>	<b>1080</b>	<b>2350</b>	<b>1099</b>	<b>6027</b>	<b>831</b>	<b>57</b>	<b>8014</b>	<b>234</b>	<b>6321</b>	<b>304</b>	<b>45</b>	<b>6904</b>	<b>14918</b>	<b>17268</b>

**Equivalent 12 & 24-hour Vehicle Volumes Including the Annual Average Daily Traffic (AADT) Factor**  
**Applicable to the Day and Month of the Turning Movement Count**

**Expansion factors are applied exclusively to standard weekday 8-hour turning movement counts conducted during the hours of 0700h - 1000h, 1130h - 1330h and 1500h - 1800h**

Equivalent 12-hour vehicle volumes. These volumes are calculated by multiplying the 8-hour totals by the 8 → 12 expansion factor of 1.39

Equ. 12 Hr	256	177	1333	0	1765	1173	146	182	0	1501	3267	1528	8378	1155	79	11139	325	8786	423	63	9597	20736	24003
------------	-----	-----	------	---	------	------	-----	-----	---	------	------	------	------	------	----	-------	-----	------	-----	----	------	-------	-------

Average daily 12-hour vehicle volumes. These volumes are calculated by multiplying the equivalent 12-hour totals by the AADT factor of: 0.9

AADT 12-hr	230	159	1200	0	1589	1056	131	164	0	1351	2940	1375	7540	1040	71	10026	293	7908	380	56	8637	18662	21602
------------	-----	-----	------	---	------	------	-----	-----	---	------	------	------	------	------	----	-------	-----	------	-----	----	------	-------	-------

24-Hour AADT. These volumes are calculated by multiplying the average daily 12-hour vehicle volumes by the 12 → 24 expansion factor of 1.31

AADT 24 Hr	302	208	1572	0	2081	1383	172	215	0	1770	3851	1801	9877	1362	93	13133	383	10359	498	74	11314	24448	28299
------------	-----	-----	------	---	------	------	-----	-----	---	------	------	------	------	------	----	-------	-----	-------	-----	----	-------	-------	-------

**AADT and expansion factors provided by the City of Ottawa**

AM Peak Hour Factor → 0.94						Highest Hourly Vehicle Volume Between 0700h & 1000h																	
AM Peak Hr	LT	ST	RT	UT	Total	LT	ST	RT	UT	Total	Str. Tot.	LT	ST	RT	UT	Total	LT	ST	RT	UT	Total	Str. Tot.	Gr. Tot.
0815-0915	14	28	100	0	142	60	13	11	0	84	226	260	622	223	2	1107	50	844	44	2	940	2047	2273
OFF Peak Hour Factor → 0.97						Highest Hourly Vehicle Volume Between 1130h & 1330h																	
OFF Peak Hr	LT	ST	RT	UT	Total	LT	ST	RT	UT	Total	Str. Tot.	LT	ST	RT	UT	Total	LT	ST	RT	UT	Total	Str. Tot.	Gr. Tot.
1145-1245	39	16	116	0	171	99	12	18	0	129	300	105	722	71	12	910	40	719	45	7	811	1721	2021
PM Peak Hour Factor → 0.97						Highest Hourly Vehicle Volume Between 1500h & 1800h																	
PM Peak Hr	LT	ST	RT	UT	Total	LT	ST	RT	UT	Total	Str. Tot.	LT	ST	RT	UT	Total	LT	ST	RT	UT	Total	Str. Tot.	Gr. Tot.
1630-1730	29	22	237	0	288	205	16	34	0	255	543	94	1070	51	16	1231	24	909	35	12	980	2211	2754

**Comments:**

OC Transpo and Para Transpo buses, together with a few school buses, comprise 18.11% of the heavy vehicle traffic. The bicycle totals include 1 E-Scooter (Vespa style). There was one serious conflict between a N/B left-turning & a S/B straight vehicle at 0916h.

**Notes:**

1. Includes all vehicle types except bicycles, electric bicycles, and electric scooters.
2. When expansion and AADT factors are applied, the results will differ slightly due to rounding.



# Turning Movement Count

## Summary, AM and PM Peak Hour

### Flow Diagrams

All Vehicles Except Bicycles



### March Road & Solandt Road Kanata, ON

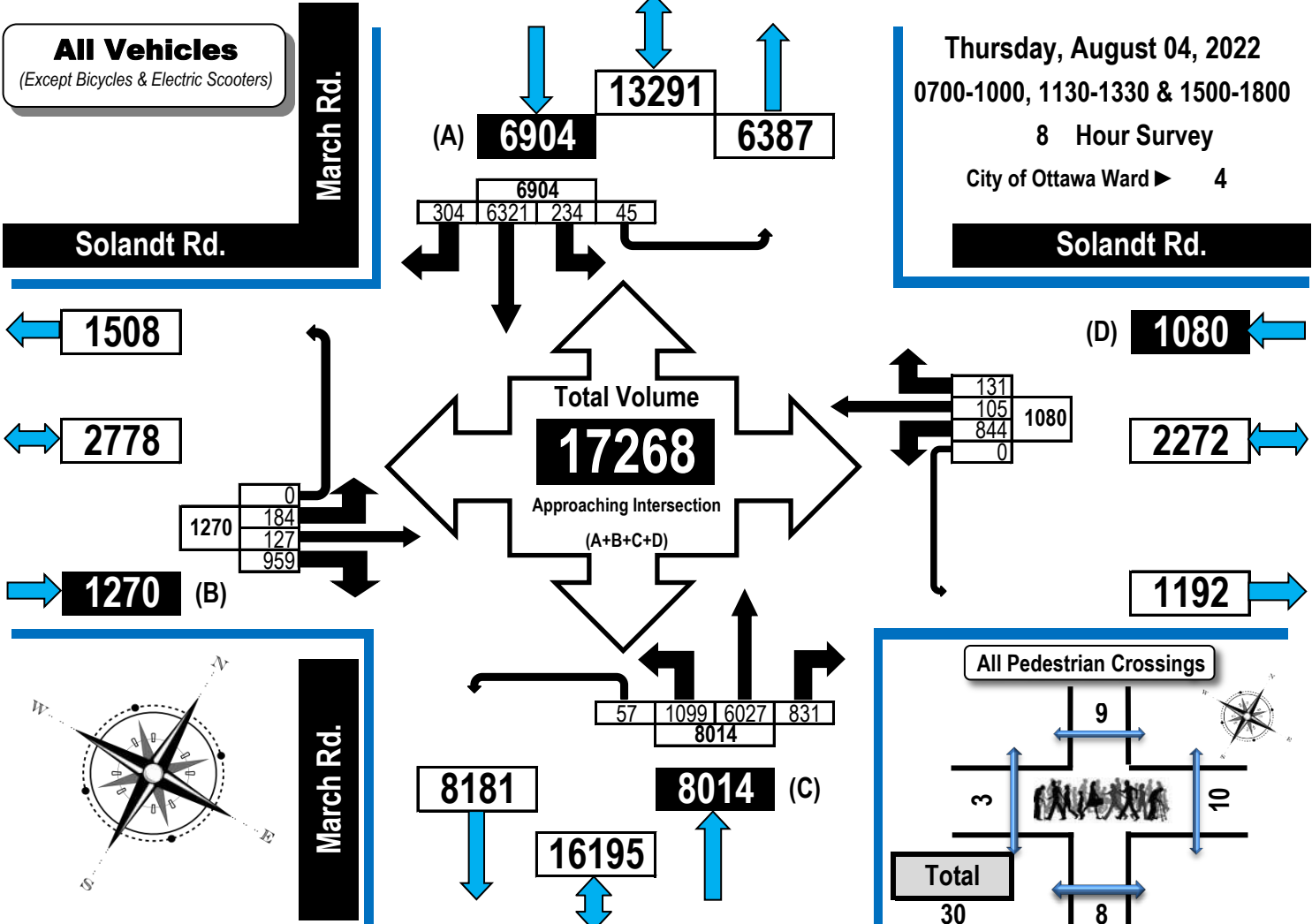

### AM Peak Hour Flow Diagram PM Peak Hour Flow Diagram

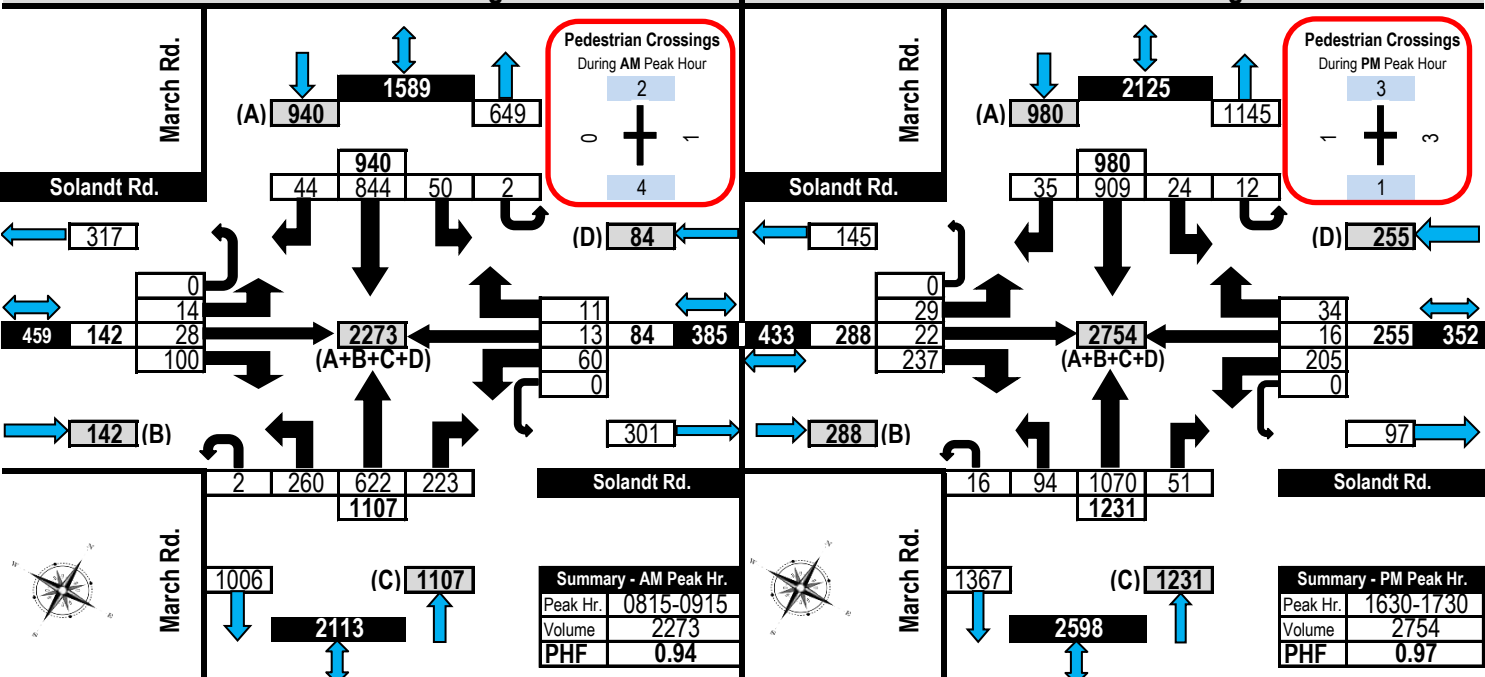



# Turning Movement Count

## Summary Report Including Peak Hours, AADT and Expansion Factors

All Vehicles Except Bicycles



### Flamborough Way/Innovation Drive & Terry Fox Drive Kanata, ON

**Survey Date:** Tuesday, August 09, 2022      **Start Time:** 0700      **AADT Factor:** 0.9  
**Weather AM:** Light Rain 15° C      **Survey Duration:** 8 Hrs.      **Survey Hours:** 0700-1000, 1130-1330 & 1500-1800  
**Weather PM:** Cloudy 19° C      **Surveyor(s):** J. Mousseau/S. Merrett

Time Period	Terry Fox Dr. Eastbound					Terry Fox Dr. Westbound					Innovation Dr. Northbound					Flamborough Way Southbound					Street Total	Grand Total	
	LT	ST	RT	UT	E/B Tot	LT	ST	RT	UT	W/B Tot	LT	ST	RT	UT	N/B Tot	LT	ST	RT	UT	S/B Tot			
0700-0800	21	165	55	0	241	35	96	26	0	157	398	25	12	40	0	77	73	40	32	0	145	222	620
0800-0900	40	269	96	0	405	75	140	41	0	256	661	31	40	85	0	156	98	64	49	0	211	367	1028
0900-1000	31	262	55	0	348	88	158	40	0	286	634	43	32	97	0	172	66	33	46	0	145	317	951
1130-1230	41	214	38	0	293	95	205	61	0	361	654	40	31	88	0	159	63	45	40	0	148	307	961
1230-1330	46	241	40	0	327	92	197	65	0	354	681	48	44	82	0	174	70	36	36	0	142	316	997
1500-1600	42	260	36	0	338	78	228	77	0	383	721	60	37	79	0	176	67	29	45	0	141	317	1038
1600-1700	85	276	44	0	405	122	374	146	0	642	1047	138	80	98	0	316	63	60	75	0	198	514	1561
1700-1800	85	253	47	0	385	119	321	113	0	553	938	89	52	97	0	238	76	40	66	0	182	420	1358
<b>Totals</b>	<b>391</b>	<b>1940</b>	<b>411</b>	<b>0</b>	<b>2742</b>	<b>704</b>	<b>1719</b>	<b>569</b>	<b>0</b>	<b>2992</b>	<b>5734</b>	<b>474</b>	<b>328</b>	<b>666</b>	<b>0</b>	<b>1468</b>	<b>576</b>	<b>347</b>	<b>389</b>	<b>0</b>	<b>1312</b>	<b>2780</b>	<b>8514</b>

**Equivalent 12 & 24-hour Vehicle Volumes Including the Annual Average Daily Traffic (AADT) Factor**  
**Applicable to the Day and Month of the Turning Movement Count**

**Expansion factors are applied exclusively to standard weekday 8-hour turning movement counts conducted during the hours of 0700h - 1000h, 1130h - 1330h and 1500h - 1800h**

Equivalent 12-hour vehicle volumes. These volumes are calculated by multiplying the 8-hour totals by the 8 → 12 expansion factor of 1.39

Equ. 12 Hr	543	2697	571	0	3811	979	2389	791	0	4159	7970	659	456	926	0	2041	801	482	541	0	1824	3864	11834
------------	-----	------	-----	---	------	-----	------	-----	---	------	------	-----	-----	-----	---	------	-----	-----	-----	---	------	------	-------

Average daily 12-hour vehicle volumes. These volumes are calculated by multiplying the equivalent 12-hour totals by the AADT factor of: 0.9

AADT 12-hr	489	2427	514	0	3430	881	2150	712	0	3743	7173	593	410	833	0	1836	721	434	487	0	1641	3478	10651
------------	-----	------	-----	---	------	-----	------	-----	---	------	------	-----	-----	-----	---	------	-----	-----	-----	---	------	------	-------

24-Hour AADT. These volumes are calculated by multiplying the average daily 12-hour vehicle volumes by the 12 → 24 expansion factor of 1.31

AADT 24 Hr	641	3179	674	0	4494	1154	2817	932	0	4903	9397	777	538	1091	0	2406	944	569	637	0	2150	4556	13953
------------	-----	------	-----	---	------	------	------	-----	---	------	------	-----	-----	------	---	------	-----	-----	-----	---	------	------	-------

**AADT and expansion factors provided by the City of Ottawa**

AM Peak Hour Factor → 0.88											Highest Hourly Vehicle Volume Between 0700h & 1000h												
AM Peak Hr	LT	ST	RT	UT	Total	LT	ST	RT	UT	Total	Str. Tot.	LT	ST	RT	UT	Total	LT	ST	RT	UT	Total	Str. Tot.	Gr. Tot.
0830-0930	34	328	89	0	451	99	160	43	0	302	753	43	42	100	0	185	74	65	50	0	189	374	1127
OFF Peak Hour Factor → 0.95											Highest Hourly Vehicle Volume Between 1130h & 1330h												
OFF Peak Hr	LT	ST	RT	UT	Total	LT	ST	RT	UT	Total	Str. Tot.	LT	ST	RT	UT	Total	LT	ST	RT	UT	Total	Str. Tot.	Gr. Tot.
1200-1300	43	258	43	0	344	117	205	68	0	390	734	45	34	81	0	160	71	51	40	0	162	322	1056
PM Peak Hour Factor → 0.92											Highest Hourly Vehicle Volume Between 1500h & 1800h												
PM Peak Hr	LT	ST	RT	UT	Total	LT	ST	RT	UT	Total	Str. Tot.	LT	ST	RT	UT	Total	LT	ST	RT	UT	Total	Str. Tot.	Gr. Tot.
1600-1700	85	276	44	0	405	122	374	146	0	642	1047	138	80	98	0	316	63	60	75	0	198	514	1561

**Comments:**

OC Transpo buses, together with a few school buses, comprise 55.36% of the heavy vehicle traffic.

**Notes:**

1. Includes all vehicle types except bicycles, electric bicycles, and electric scooters.
2. When expansion and AADT factors are applied, the results will differ slightly due to rounding.



# Turning Movement Count Summary, AM and PM Peak Hour Flow Diagrams



All Vehicles Except Bicycles

## Flamborough Way/Innovation Drive & Terry Fox Drive Kanata, ON

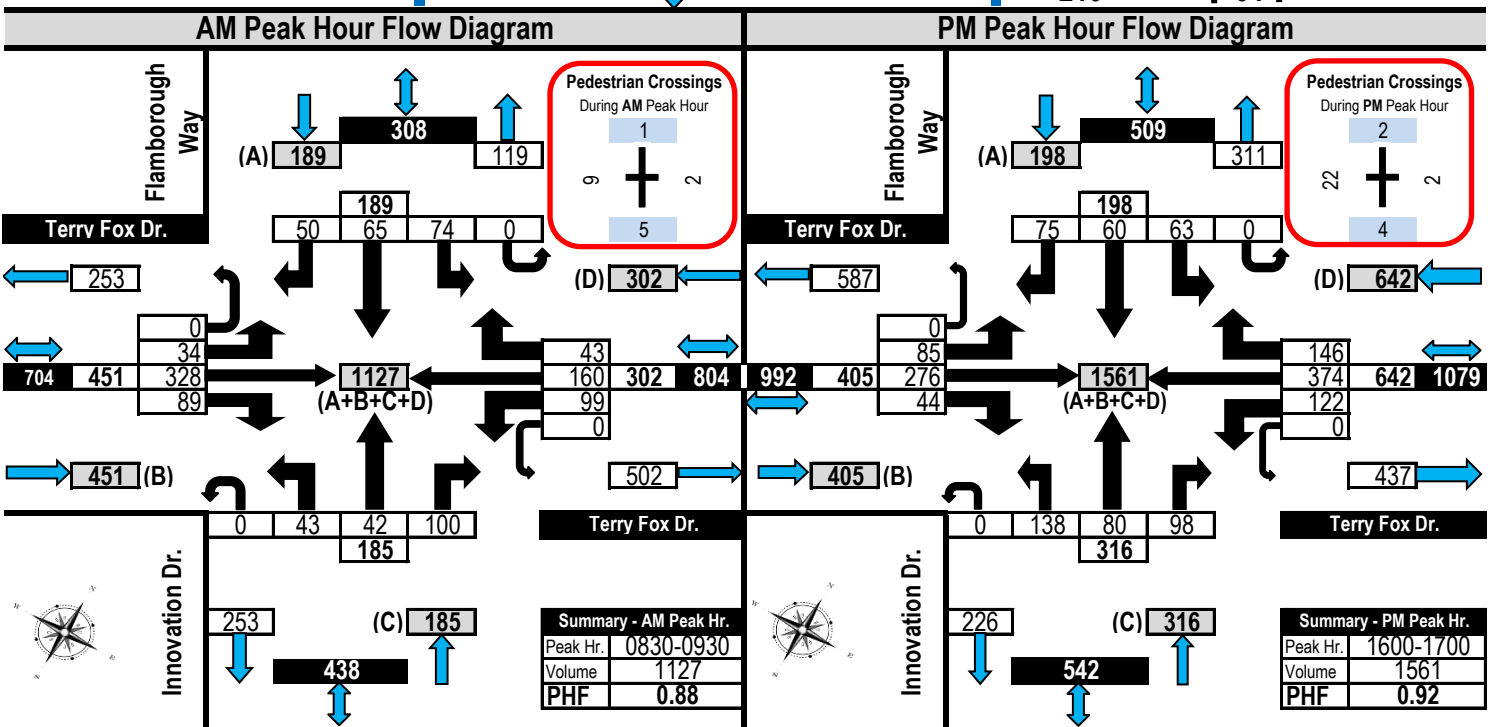
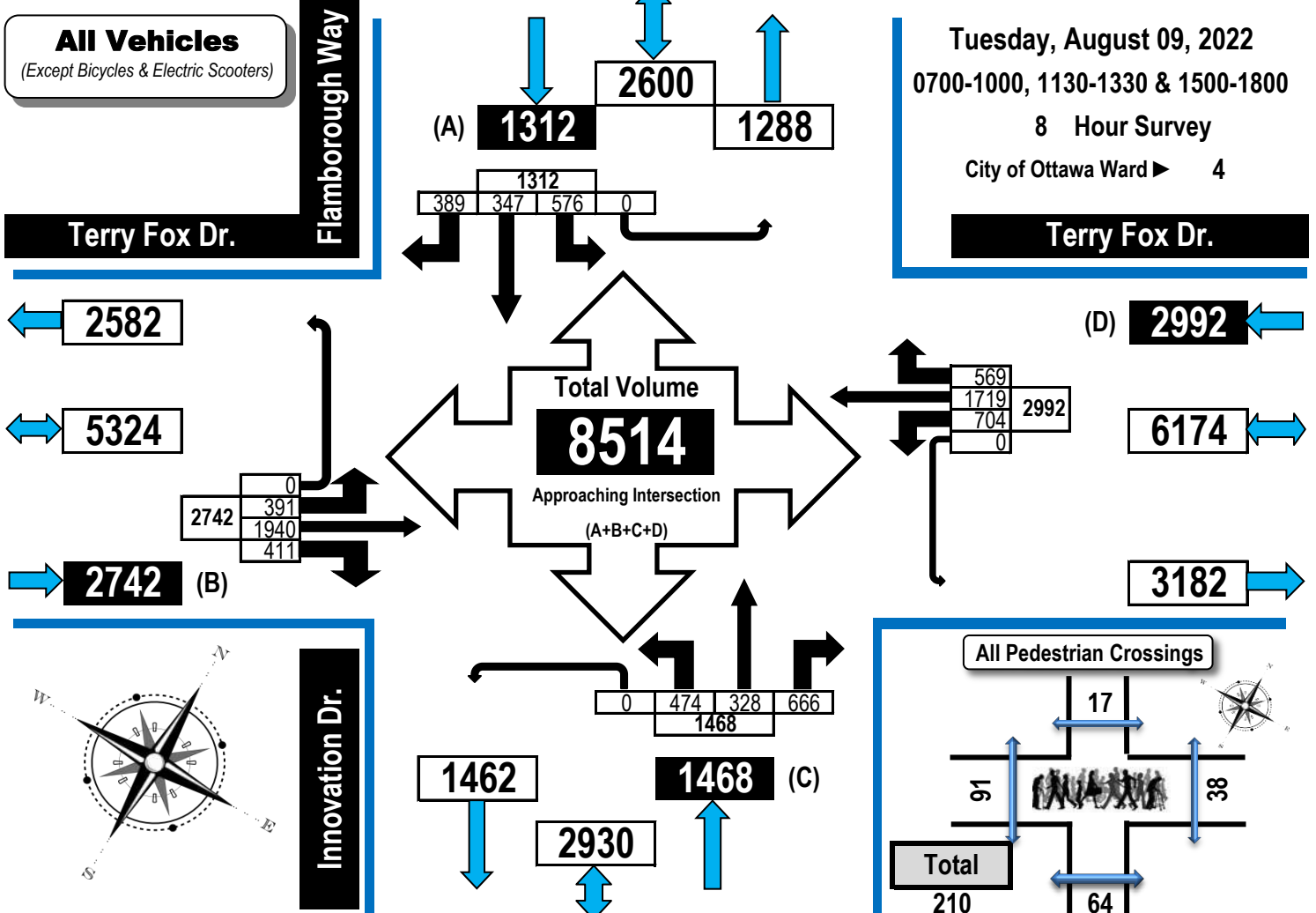





# Turning Movement Count

## Summary Report Including Peak Hours, AADT and Expansion Factors

All Vehicles Except Bicycles



### Hines Road & Innovation DriveKanata, ON

**Survey Date:** Wednesday, August 10, 2022      **Start Time:** 0700      **AADT Factor:** 0.9  
**Weather AM:** Clear & Sunny 12° C      **Survey Duration:** 8 Hrs.      **Survey Hours:** 0700-1000, 1130-1330 & 1500-1800  
**Weather PM:** Mostly Sunny 28° C      **Surveyor(s):** J. Mousseau, S. Merrett

Innovation Dr.					Royal Cdn. Legion					Hines Rd.					Hines Rd.				
Eastbound					Westbound					Northbound					Southbound				

Time Period	LT	ST	RT	UT	E/B Tot	LT	ST	RT	UT	W/B Tot	Street Total	LT	ST	RT	UT	N/B Tot	LT	ST	RT	UT	S/B Tot	Street Total	Grand Total
0700-0800	12	0	69	1	82	1	0	0	0	1	83	44	40	4	0	88	0	12	2	0	14	102	185
0800-0900	9	0	113	0	122	5	1	0	0	6	128	91	56	1	0	148	2	11	1	0	14	162	290
0900-1000	12	2	93	0	107	4	0	0	0	4	111	75	41	12	0	128	1	15	6	0	22	150	261
1130-1230	6	1	75	0	82	6	5	0	0	11	93	73	27	2	0	102	0	26	12	0	38	140	233
1230-1330	8	0	80	0	88	2	0	0	0	2	90	53	34	0	0	87	0	21	14	0	35	122	212
1500-1600	4	0	71	0	75	3	1	0	0	4	79	69	18	2	0	89	1	49	15	0	65	154	233
1600-1700	2	0	100	1	103	0	0	0	0	0	103	134	14	0	0	148	0	53	9	0	62	210	313
1700-1800	2	1	68	0	71	0	0	0	0	0	71	113	4	0	0	117	0	33	9	0	42	159	230
<b>Totals</b>	<b>55</b>	<b>4</b>	<b>669</b>	<b>2</b>	<b>730</b>	<b>21</b>	<b>7</b>	<b>0</b>	<b>0</b>	<b>28</b>	<b>758</b>	<b>652</b>	<b>234</b>	<b>21</b>	<b>0</b>	<b>907</b>	<b>4</b>	<b>220</b>	<b>68</b>	<b>0</b>	<b>292</b>	<b>1199</b>	<b>1957</b>

**Equivalent 12 & 24-hour Vehicle Volumes Including the Annual Average Daily Traffic (AADT) Factor**  
**Applicable to the Day and Month of the Turning Movement Count**

**Expansion factors are applied exclusively to standard weekday 8-hour turning movement counts conducted during the hours of 0700h - 1000h, 1130h - 1330h and 1500h - 1800h**

Equivalent 12-hour vehicle volumes. These volumes are calculated by multiplying the 8-hour totals by the 8 → 12 expansion factor of 1.39																							
Equ. 12 Hr	76	6	930	3	1015	29	10	0	0	39	1054	906	325	29	0	1261	6	306	95	0	406	1667	2720

Average daily 12-hour vehicle volumes. These volumes are calculated by multiplying the equivalent 12-hour totals by the AADT factor of: 0.9																							
AADT 12-hr	69	5	837	3	913	26	9	0	0	35	948	816	293	26	0	1135	5	275	85	0	365	1500	2448

24-Hour AADT. These volumes are calculated by multiplying the average daily 12-hour vehicle volumes by the 12 → 24 expansion factor of 1.31																							
AADT 24 Hr	90	7	1096	3	1196	34	11	0	0	46	1242	1069	383	34	0	1486	7	361	111	0	479	1965	3207

**AADT and expansion factors provided by the City of Ottawa**

<b>AM Peak Hour Factor → 0.93</b>											<b>Highest Hourly Vehicle Volume Between 0700h &amp; 1000h</b>												
<b>AM Peak Hr</b>	LT	ST	RT	UT	Total	LT	ST	RT	UT	Total	Str. Tot.	LT	ST	RT	UT	Total	LT	ST	RT	UT	Total	Str. Tot.	Gr. Tot.
0815-0915	15	0	118	0	133	6	1	0	0	7	140	92	58	2	0	152	1	15	2	0	18	170	310
<b>OFF Peak Hour Factor → 0.94</b>											<b>Highest Hourly Vehicle Volume Between 1130h &amp; 1330h</b>												
<b>OFF Peak Hr</b>	LT	ST	RT	UT	Total	LT	ST	RT	UT	Total	Str. Tot.	LT	ST	RT	UT	Total	LT	ST	RT	UT	Total	Str. Tot.	Gr. Tot.
1130-1230	6	1	75	0	82	6	5	0	0	11	93	73	27	2	0	102	0	26	12	0	38	140	233
<b>PM Peak Hour Factor → 0.89</b>											<b>Highest Hourly Vehicle Volume Between 1500h &amp; 1800h</b>												
<b>PM Peak Hr</b>	LT	ST	RT	UT	Total	LT	ST	RT	UT	Total	Str. Tot.	LT	ST	RT	UT	Total	LT	ST	RT	UT	Total	Str. Tot.	Gr. Tot.
1600-1700	2	0	100	1	103	0	0	0	0	0	103	134	14	0	0	148	0	53	9	0	62	210	313

**Comments:**

OC Transpo buses comprise 32.46% of the heavy vehicle traffic.

**Notes:**

1. Includes all vehicle types except bicycles, electric bicycles, and electric scooters.
2. When expansion and AADT factors are applied, the results will differ slightly due to rounding.



# Turning Movement Count

## Summary, AM and PM Peak Hour

### Flow Diagrams

All Vehicles Except Bicycles



## Hines Road & Innovation Drive Kanata, ON

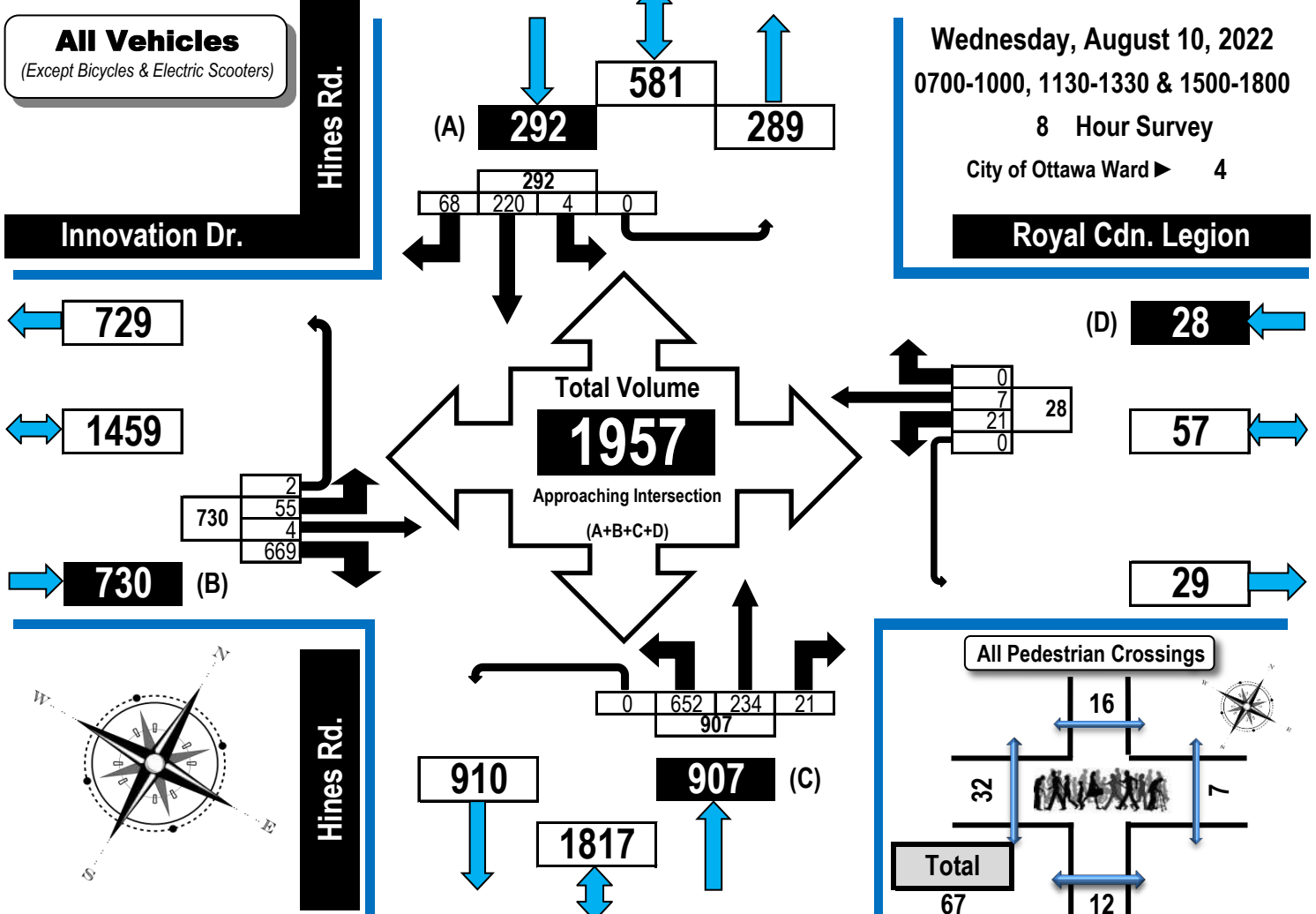

### AM Peak Hour Flow Diagram PM Peak Hour Flow Diagram

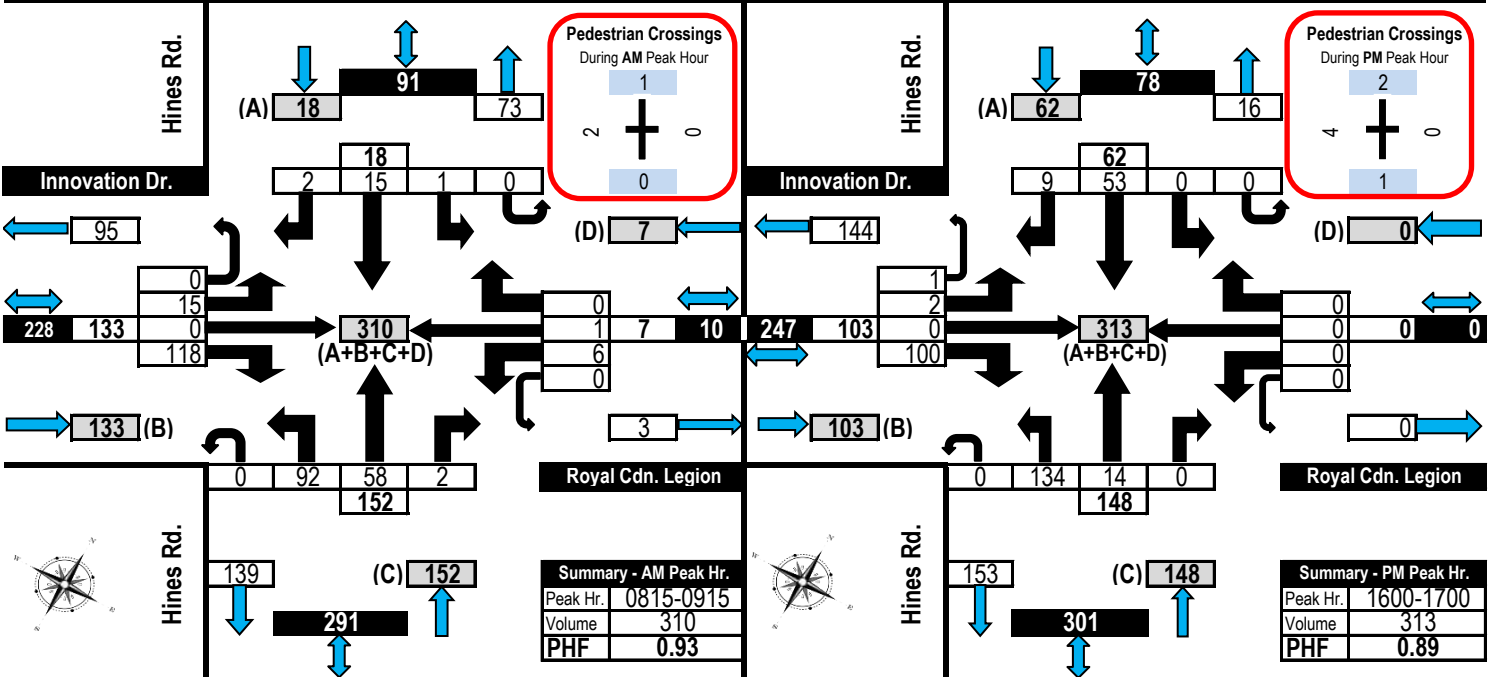

## **APPENDIX E**

---

### Collision Records



# Transportation Services - Traffic Services

## Collision Details Report - Public Version

From: January 1, 2016 To: December 31, 2020

**Location:** HINES RD @ INNOVATION DR

**Traffic Control:** Stop sign

**Total Collisions:** 1

Date/Day/Time	Environment	Impact Type	Classification	Surface Cond'n	Veh. Dir	Vehicle Manoeuvre	Vehicle type	First Event	No. Ped
2017-Mar-20, Mon,09:26	Clear	Rear end	P.D. only	Dry	East	Going ahead	Automobile, station wagon	Other motor vehicle	0
					East	Stopped	Unknown	Other motor vehicle	

**Location:** INNOVATION DR @ ProposedNULL NAME

**Traffic Control:** Traffic signal

**Total Collisions:** 1

Date/Day/Time	Environment	Impact Type	Classification	Surface Cond'n	Veh. Dir	Vehicle Manoeuvre	Vehicle type	First Event	No. Ped
2018-Sep-11, Tue,16:48	Clear	Angle	P.D. only	Dry	North	Going ahead	Automobile, station wagon	Other motor vehicle	0
					West	Going ahead	Automobile, station wagon	Other motor vehicle	

**Location:** INNOVATION DR btwn FLAMBOROUGH WAY & FLAMBOROUGH WAY

**Traffic Control:** No control

**Total Collisions:** 4

Date/Day/Time	Environment	Impact Type	Classification	Surface Cond'n	Veh. Dir	Vehicle Manoeuvre	Vehicle type	First Event	No. Ped
2016-Jun-20, Mon,13:10	Clear	SMV other	Non-fatal injury	Dry	North	Going ahead	Motorcycle	Other	0
2018-Apr-04, Wed,16:24	Clear	SMV other	P.D. only	Wet	South	Slowing or stopping	Automobile, station wagon	Debris on road	0
2018-Sep-12, Wed,18:26	Clear	Angle	P.D. only	Dry	East	Turning left	Automobile, station wagon	Other motor vehicle	0
					North	Going ahead	Automobile, station wagon	Other motor vehicle	
2020-Feb-27, Thu,07:00	Snow	Angle	P.D. only	Loose snow	South	Unknown	Truck - dump	Other motor vehicle	0
					East	Turning left	Automobile, station wagon	Other motor vehicle	

**Location:** MARCH RD @ MORGAN'S GRANT WAY/SHIRLEY'S BROOK

**Traffic Control:** Traffic signal

**Total Collisions:** 38

Date/Day/Time	Environment	Impact Type	Classification	Surface Cond'n	Veh. Dir	Vehicle Manoeuvre	Vehicle type	First Event	No. Ped
2016-Mar-06, Sun,12:03	Clear	Turning movement	Non-fatal injury	Dry	South	Going ahead	Pick-up truck	Other motor vehicle	0
					North	Turning left	Passenger van	Other motor vehicle	
2016-Jun-17, Fri,13:40	Clear	Rear end	P.D. only	Dry	North	Changing lanes	Automobile, station wagon	Other motor vehicle	0
					North	Going ahead	Pick-up truck	Other motor vehicle	



# Transportation Services - Traffic Services

## Collision Details Report - Public Version

From: January 1, 2016 To: December 31, 2020

**Location:** MARCH RD @ MORGAN'S GRANT WAY/SHIRLEY'S BROOK

**Traffic Control:** Traffic signal

**Total Collisions:** 38

Date/Day/Time	Environment	Impact Type	Classification	Surface Cond'n	Veh. Dir	Vehicle Manoeuver	Vehicle type	First Event	No. Ped
2016-Aug-04, Thu,09:12	Clear	Angle	P.D. only	Dry	South	Going ahead	Pick-up truck	Other motor vehicle	0
					West	Going ahead	Automobile, station wagon	Other motor vehicle	
2016-Nov-16, Wed,17:43	Clear	Turning movement	Non-fatal injury	Dry	North	Turning left	Delivery van	Other motor vehicle	0
					South	Going ahead	Automobile, station wagon	Other motor vehicle	
					East	Stopped	Automobile, station wagon	Debris falling off vehicle	
2017-Apr-18, Tue,09:31	Clear	Turning movement	P.D. only	Dry	South	Turning left	Passenger van	Other motor vehicle	0
					North	Going ahead	Automobile, station wagon	Other motor vehicle	
2017-Apr-27, Thu,12:53	Clear	Rear end	P.D. only	Dry	West	Turning right	Pick-up truck	Other motor vehicle	0
					West	Turning right	Automobile, station wagon	Other motor vehicle	
2017-May-17, Wed,16:47	Clear	Turning movement	P.D. only	Dry	South	Turning left	Pick-up truck	Other motor vehicle	0
					North	Going ahead	Pick-up truck	Other motor vehicle	
2017-Jun-09, Fri,22:27	Clear	Turning movement	P.D. only	Dry	South	Turning left	Automobile, station wagon	Other motor vehicle	0
					North	Going ahead	Automobile, station wagon	Other motor vehicle	
2017-Jun-28, Wed,13:14	Clear	Rear end	Non-fatal injury	Dry	North	Going ahead	Automobile, station wagon	Other motor vehicle	0
					North	Stopped	Automobile, station wagon	Other motor vehicle	
2017-Sep-21, Thu,17:33	Clear	Turning movement	Non-fatal injury	Dry	North	Turning left	Automobile, station wagon	Other motor vehicle	0
					South	Going ahead	Automobile, station wagon	Other motor vehicle	
2017-Sep-28, Thu,08:21	Clear	Sideswipe	P.D. only	Dry	South	Changing lanes	Passenger van	Other motor vehicle	0
					South	Going ahead	Automobile, station wagon	Other motor vehicle	
2017-Nov-28, Tue,17:07	Clear	Turning movement	P.D. only	Dry	North	Turning left	Truck and trailer	Other motor vehicle	0
					South	Going ahead	Pick-up truck	Other motor vehicle	
					East	Turning left	Automobile, station wagon	Other motor vehicle	
2017-Dec-26, Tue,14:33	Clear	Rear end	P.D. only	Dry	West	Stopped	Automobile, station wagon	Other motor vehicle	0
					West	Turning left	Delivery van	Other motor vehicle	



# Transportation Services - Traffic Services

## Collision Details Report - Public Version

From: January 1, 2016 To: December 31, 2020

**Location:** MARCH RD @ MORGAN'S GRANT WAY/SHIRLEY'S BROOK

**Traffic Control:** Traffic signal

**Total Collisions:** 38

Date/Day/Time	Environment	Impact Type	Classification	Surface Cond'n	Veh. Dir	Vehicle Manoeuvre	Vehicle type	First Event	No. Ped
2018-Jan-30, Tue,15:35	Clear	Rear end	P.D. only	Dry	South	Going ahead	Pick-up truck	Other motor vehicle	0
					South	Stopped	Unknown	Other motor vehicle	
2018-Feb-28, Wed,09:47	Clear	Rear end	P.D. only	Dry	East	Going ahead	Automobile, station wagon	Other motor vehicle	0
					East	Merging	Automobile, station wagon	Other motor vehicle	
2018-Apr-22, Sun,15:30	Clear	Rear end	Non-fatal injury	Dry	North	Slowing or stopping	Motorcycle	Skidding/sliding	0
					North	Stopped	Automobile, station wagon	Other motor vehicle	
2018-May-17, Thu,07:35	Clear	Turning movement	P.D. only	Dry	South	Turning left	Passenger van	Other motor vehicle	0
					South	Going ahead	Automobile, station wagon	Other motor vehicle	
2018-May-25, Fri,17:46	Rain	Sideswipe	P.D. only	Wet	North	Going ahead	Automobile, station wagon	Other motor vehicle	0
					North	Slowing or stopping	Automobile, station wagon	Other motor vehicle	
2018-Aug-15, Wed,22:13	Clear	Turning movement	Non-fatal injury	Dry	South	Turning left	Automobile, station wagon	Other motor vehicle	0
					North	Going ahead	Automobile, station wagon	Other motor vehicle	
2018-Sep-22, Sat,12:00	Clear	Rear end	P.D. only	Dry	West	Merging	Passenger van	Other motor vehicle	0
					West	Merging	Automobile, station wagon	Other motor vehicle	
2018-Nov-23, Fri,07:54	Clear	Rear end	P.D. only	Ice	South	Going ahead	Automobile, station wagon	Other motor vehicle	0
					South	Stopped	Pick-up truck	Other motor vehicle	
2018-Dec-06, Thu,06:21	Snow	Angle	P.D. only	Wet	South	Going ahead	Automobile, station wagon	Other motor vehicle	0
					West	Going ahead	Municipal transit bus	Other motor vehicle	
2018-Dec-20, Thu,09:55	Clear	Turning movement	P.D. only	Dry	South	Turning left	Automobile, station wagon	Other motor vehicle	0
					North	Going ahead	Unknown	Other motor vehicle	
2019-Jan-02, Wed,12:42	Clear	Turning movement	P.D. only	Dry	South	Turning left	Automobile, station wagon	Other motor vehicle	0
					North	Going ahead	Passenger van	Other motor vehicle	
2019-Jan-17, Thu,18:45	Clear	Angle	P.D. only	Dry	North	Going ahead	Automobile, station wagon	Other motor vehicle	0
					East	Going ahead	Automobile, station wagon	Other motor vehicle	



# Transportation Services - Traffic Services

## Collision Details Report - Public Version

From: January 1, 2016 To: December 31, 2020

**Location:** MARCH RD @ MORGAN'S GRANT WAY/SHIRLEY'S BROOK

**Traffic Control:** Traffic signal

**Total Collisions:** 38

Date/Day/Time	Environment	Impact Type	Classification	Surface Cond'n	Veh. Dir	Vehicle Manoeuver	Vehicle type	First Event	No. Ped
2019-Mar-06, Wed,15:45	Clear	Rear end	P.D. only	Dry	North	Turning left	Pick-up truck	Other motor vehicle	0
					North	Turning left	Automobile, station wagon	Other motor vehicle	
2019-May-01, Wed,18:11	Rain	Sideswipe	P.D. only	Wet	North	Unknown	Unknown	Other motor vehicle	0
					North	Going ahead	Automobile, station wagon	Other motor vehicle	
2019-Jul-30, Tue,17:36	Clear	Rear end	P.D. only	Dry	West	Turning right	Automobile, station wagon	Other motor vehicle	0
					West	Turning right	Automobile, station wagon	Other motor vehicle	
2019-Sep-28, Sat,19:33	Clear	Turning movement	Non-fatal injury	Dry	South	Turning left	Automobile, station wagon	Other motor vehicle	0
					North	Going ahead	Automobile, station wagon	Other motor vehicle	
2019-Dec-13, Fri,17:57	Clear	Turning movement	P.D. only	Dry	South	Turning left	Automobile, station wagon	Other motor vehicle	0
					North	Going ahead	Automobile, station wagon	Other motor vehicle	
2020-Jan-22, Wed,08:55	Clear	Rear end	P.D. only	Loose snow	East	Turning right	Automobile, station wagon	Other motor vehicle	0
					East	Turning right	Pick-up truck	Other motor vehicle	
2020-Feb-14, Fri,16:48	Clear	Turning movement	P.D. only	Dry	North	Turning left	Automobile, station wagon	Other motor vehicle	0
					South	Going ahead	Automobile, station wagon	Other motor vehicle	
2020-Apr-10, Fri,18:14	Clear	Turning movement	Non-fatal injury	Dry	North	Turning left	Pick-up truck	Other motor vehicle	0
					South	Going ahead	Automobile, station wagon	Other motor vehicle	
2020-May-23, Sat,12:21	Clear	Angle	P.D. only	Dry	North	Going ahead	Unknown	Other motor vehicle	0
					West	Going ahead	Pick-up truck	Other motor vehicle	
2020-Sep-26, Sat,15:23	Clear	Turning movement	Non-fatal injury	Dry	South	Turning left	Automobile, station wagon	Other motor vehicle	0
					North	Going ahead	Automobile, station wagon	Other motor vehicle	
2020-Oct-20, Tue,17:28	Clear	SMV other	Non-fatal injury	Dry	North	Going ahead	Automobile, station wagon	Ran off road	0
2020-Nov-10, Tue,06:40	Clear	Turning movement	Non-fatal injury	Dry	North	Making "U" turn	Automobile, station wagon	Other motor vehicle	0
					South	Going ahead	Automobile, station wagon	Other motor vehicle	



# Transportation Services - Traffic Services

## Collision Details Report - Public Version

From: January 1, 2016 To: December 31, 2020

**Location:** MARCH RD @ MORGAN'S GRANT WAY/SHIRLEY'S BROOK

**Traffic Control:** Traffic signal

**Total Collisions:** 38

Date/Day/Time	Environment	Impact Type	Classification	Surface Cond'n	Veh. Dir	Vehicle Manoeuvre	Vehicle type	First Event	No. Ped
2020-Dec-10, Thu,15:15	Clear	Sideswipe	P.D. only	Dry	North	Changing lanes	Automobile, station wagon	Other motor vehicle	0
					North	Going ahead	Automobile, station wagon	Other motor vehicle	

**Location:** MARCH RD @ SOLANDT RD

**Traffic Control:** Traffic signal

**Total Collisions:** 44

Date/Day/Time	Environment	Impact Type	Classification	Surface Cond'n	Veh. Dir	Vehicle Manoeuvre	Vehicle type	First Event	No. Ped
2016-Feb-16, Tue,11:02	Snow	Turning movement	P.D. only	Loose snow	West	Turning left	Passenger van	Other motor vehicle	0
					East	Going ahead	Pick-up truck	Other motor vehicle	
2016-Feb-23, Tue,15:50	Clear	Rear end	P.D. only	Dry	North	Slowing or stopping	Automobile, station wagon	Other motor vehicle	0
					North	Stopped	Pick-up truck	Other motor vehicle	
2016-Mar-02, Wed,19:35	Clear	Turning movement	P.D. only	Wet	North	Turning left	Automobile, station wagon	Other motor vehicle	0
					South	Going ahead	Passenger van	Other motor vehicle	
2016-Mar-14, Mon,10:46	Rain	Turning movement	P.D. only	Wet	North	Turning left	Automobile, station wagon	Other motor vehicle	0
					South	Going ahead	Automobile, station wagon	Other motor vehicle	
2016-May-03, Tue,16:55	Clear	Rear end	P.D. only	Dry	East	Turning right	Pick-up truck	Other motor vehicle	0
					East	Turning right	Automobile, station wagon	Other motor vehicle	
2016-Aug-17, Wed,10:51	Clear	Rear end	Non-fatal injury	Dry	North	Turning left	Automobile, station wagon	Other motor vehicle	0
					North	Turning left	Automobile, station wagon	Other motor vehicle	
2016-Sep-16, Fri,11:14	Clear	Rear end	P.D. only	Dry	South	Turning right	Automobile, station wagon	Other motor vehicle	0
					South	Going ahead	Automobile, station wagon	Other motor vehicle	
					South	Going ahead	Passenger van	Debris falling off vehicle	
2016-Oct-20, Thu,16:28	Rain	Rear end	P.D. only	Wet	South	Slowing or stopping	Automobile, station wagon	Other motor vehicle	0
					South	Stopped	Passenger van	Other motor vehicle	





# Transportation Services - Traffic Services

## Collision Details Report - Public Version

From: January 1, 2016 To: December 31, 2020

**Location:** MARCH RD @ SOLANDT RD

**Traffic Control:** Traffic signal

**Total Collisions:** 44

Date/Day/Time	Environment	Impact Type	Classification	Surface Cond'n	Veh. Dir	Vehicle Manoeuvre	Vehicle type	First Event	No. Ped
2016-Oct-31, Mon,08:05	Clear	Rear end	P.D. only	Dry	South	Turning right	Automobile, station wagon	Other motor vehicle	0
					South	Turning right	Automobile, station wagon	Other motor vehicle	
2016-Nov-20, Sun,20:27	Drifting Snow	SMV other	P.D. only	Ice	North	Turning left	Automobile, station wagon	Pole (utility, power)	0
2016-Nov-28, Mon,12:27	Clear	Turning movement	P.D. only	Dry	East	Making "U" turn	Automobile, station wagon	Other motor vehicle	0
					West	Going ahead	Automobile, station wagon	Other motor vehicle	
2017-Feb-16, Thu,19:15	Clear	Turning movement	P.D. only	Dry	North	Turning left	Automobile, station wagon	Other motor vehicle	0
					South	Going ahead	Pick-up truck	Other motor vehicle	
2017-Mar-22, Wed,09:35	Clear	Turning movement	Non-fatal injury	Dry	South	Going ahead	Pick-up truck	Other motor vehicle	0
					North	Turning left	Automobile, station wagon	Other motor vehicle	
2017-Apr-18, Tue,15:58	Clear	Rear end	Non-fatal injury	Dry	West	Turning right	Motorcycle	Other motor vehicle	0
					West	Turning right	Automobile, station wagon	Other motor vehicle	
2017-May-09, Tue,09:30	Clear	Rear end	P.D. only	Dry	North	Turning right	Automobile, station wagon	Other motor vehicle	0
					North	Turning right	Pick-up truck	Other motor vehicle	
2017-Jun-02, Fri,07:58	Clear	Turning movement	P.D. only	Dry	North	Going ahead	Automobile, station wagon	Other motor vehicle	0
					South	Turning left	Automobile, station wagon	Other motor vehicle	
2017-Jun-13, Tue,17:30	Clear	Turning movement	P.D. only	Dry	South	Making "U" turn	Automobile, station wagon	Other motor vehicle	0
					North	Going ahead	Pick-up truck	Other motor vehicle	
2017-Sep-12, Tue,07:13	Clear	Rear end	P.D. only	Dry	East	Going ahead	Passenger van	Other motor vehicle	0
					East	Stopped	Automobile, station wagon	Other motor vehicle	
2017-Oct-24, Tue,07:37	Rain	Turning movement	P.D. only	Wet	North	Turning left	Automobile, station wagon	Other motor vehicle	0
					South	Going ahead	Automobile, station wagon	Other motor vehicle	
2017-Oct-31, Tue,15:47	Clear	Turning movement	P.D. only	Dry	North	Turning left	Automobile, station wagon	Other motor vehicle	0
					South	Going ahead	Automobile, station wagon	Other motor vehicle	



# Transportation Services - Traffic Services

## Collision Details Report - Public Version

From: January 1, 2016 To: December 31, 2020

**Location:** MARCH RD @ SOLANDT RD

**Traffic Control:** Traffic signal

**Total Collisions:** 44

Date/Day/Time	Environment	Impact Type	Classification	Surface Cond'n	Veh. Dir	Vehicle Manoeuvre	Vehicle type	First Event	No. Ped
2017-Dec-20, Wed,15:51	Clear	Rear end	P.D. only	Dry	West	Going ahead	Automobile, station wagon	Other motor vehicle	0
					West	Turning left	Automobile, station wagon	Other motor vehicle	
2017-Dec-21, Thu,10:30	Clear	Angle	P.D. only	Dry	North	Going ahead	Automobile, station wagon	Other motor vehicle	0
					West	Turning left	Automobile, station wagon	Other motor vehicle	
2018-Jan-31, Wed,17:54	Snow	Rear end	P.D. only	Loose snow	South	Going ahead	Automobile, station wagon	Skidding/sliding	0
					South	Stopped	Automobile, station wagon	Other motor vehicle	
2018-Feb-26, Mon,19:50	Clear	Turning movement	P.D. only	Dry	South	Changing lanes	Automobile, station wagon	Other motor vehicle	0
					North	Turning left	Automobile, station wagon	Other motor vehicle	
2018-Mar-14, Wed,08:56	Snow	Turning movement	Non-fatal injury	Slush	North	Turning left	Automobile, station wagon	Other motor vehicle	0
					South	Going ahead	Automobile, station wagon	Other motor vehicle	
2018-Apr-06, Fri,16:40	Rain	Rear end	P.D. only	Wet	South	Slowing or stopping	Automobile, station wagon	Other motor vehicle	0
					South	Stopped	Automobile, station wagon	Other motor vehicle	
2018-May-28, Mon,20:50	Clear	Rear end	P.D. only	Dry	East	Turning right	Pick-up truck	Other motor vehicle	0
					East	Turning right	Automobile, station wagon	Other motor vehicle	
2018-Jun-06, Wed,20:24	Clear	Turning movement	P.D. only	Dry	South	Making "U" turn	Automobile, station wagon	Other motor vehicle	0
					North	Going ahead	Automobile, station wagon	Other motor vehicle	
2018-Aug-09, Thu,09:19	Clear	Turning movement	Non-fatal injury	Dry	South	Turning left	Automobile, station wagon	Other motor vehicle	0
					North	Going ahead	Automobile, station wagon	Other motor vehicle	
2018-Aug-24, Fri,15:53	Clear	Rear end	P.D. only	Dry	South	Slowing or stopping	Pick-up truck	Other motor vehicle	0
					South	Stopped	Automobile, station wagon	Other motor vehicle	
2018-Oct-09, Tue,06:53	Clear	Rear end	P.D. only	Wet	East	Unknown	Unknown	Other motor vehicle	0
					East	Stopped	Automobile, station wagon	Other motor vehicle	
2018-Oct-26, Fri,13:38	Clear	Rear end	P.D. only	Dry	South	Going ahead	Automobile, station wagon	Other motor vehicle	0
					South	Stopped	Automobile, station wagon	Other motor vehicle	



# Transportation Services - Traffic Services

## Collision Details Report - Public Version

From: January 1, 2016 To: December 31, 2020

**Location:** MARCH RD @ SOLANDT RD

**Traffic Control:** Traffic signal

**Total Collisions:** 44

Date/Day/Time	Environment	Impact Type	Classification	Surface Cond'n	Veh. Dir	Vehicle Manoeuvre	Vehicle type	First Event	No. Ped
2018-Oct-31, Wed,15:43	Rain	Rear end	P.D. only	Wet	North	Going ahead	Pick-up truck	Other motor vehicle	0
					North	Stopped	Automobile, station wagon	Other motor vehicle	
					North	Stopped	Passenger van	Other motor vehicle	
2019-Jan-11, Fri,07:27	Clear	Turning movement	P.D. only	Dry	South	Making "U" turn	Automobile, station wagon	Other motor vehicle	0
					North	Going ahead	Automobile, station wagon	Other motor vehicle	
2019-Jan-28, Mon,17:24	Clear	Turning movement	Non-fatal injury	Packed snow	South	Turning left	Automobile, station wagon	Other motor vehicle	0
					North	Going ahead	Automobile, station wagon	Other motor vehicle	
2019-Apr-01, Mon,12:40	Clear	Rear end	P.D. only	Dry	West	Turning right	Automobile, station wagon	Other motor vehicle	0
					West	Turning right	Automobile, station wagon	Other motor vehicle	
2019-Jun-08, Sat,10:11	Clear	Rear end	P.D. only	Dry	North	Slowing or stopping	Automobile, station wagon	Other motor vehicle	0
					North	Stopped	Automobile, station wagon	Other motor vehicle	
2019-Jul-10, Wed,10:24	Clear	Turning movement	P.D. only	Dry	North	Turning left	Truck and trailer	Other motor vehicle	0
					South	Going ahead	Automobile, station wagon	Other motor vehicle	
2019-Jul-27, Sat,21:52	Clear	Sideswipe	P.D. only	Dry	North	Changing lanes	Automobile, station wagon	Other motor vehicle	0
					North	Going ahead	Automobile, station wagon	Other motor vehicle	
2019-Sep-24, Tue,08:59	Clear	Turning movement	P.D. only	Dry	North	Turning left	Automobile, station wagon	Other motor vehicle	0
					South	Going ahead	Automobile, station wagon	Other motor vehicle	
2019-Dec-19, Thu,10:15	Clear	Rear end	P.D. only	Dry	South	Slowing or stopping	Automobile, station wagon	Other motor vehicle	0
					South	Stopped	Automobile, station wagon	Other motor vehicle	
2019-Dec-30, Mon,20:00	Freezing Rain	Rear end	P.D. only	Ice	North	Going ahead	Automobile, station wagon	Skidding/sliding	0
					North	Stopped	Automobile, station wagon	Other motor vehicle	
2020-Jan-05, Sun,10:55	Clear	Turning movement	P.D. only	Wet	South	Turning left	Automobile, station wagon	Other motor vehicle	0
					North	Going ahead	Automobile, station wagon	Other motor vehicle	



# Transportation Services - Traffic Services

## Collision Details Report - Public Version

From: January 1, 2016 To: December 31, 2020

**Location:** MARCH RD @ SOLANDT RD

**Traffic Control:** Traffic signal

**Total Collisions:** 44

Date/Day/Time	Environment	Impact Type	Classification	Surface Cond'n	Veh. Dir	Vehicle Manoeuver	Vehicle type	First Event	No. Ped
2020-Jan-21, Tue,18:06	Clear	Turning movement	P.D. only	Wet	South	Making "U" turn	Automobile, station wagon	Other motor vehicle	0
					North	Going ahead	Automobile, station wagon	Other motor vehicle	

**Location:** MARCH RD @ TERRY FOX DR

**Traffic Control:** Traffic signal

**Total Collisions:** 47

Date/Day/Time	Environment	Impact Type	Classification	Surface Cond'n	Veh. Dir	Vehicle Manoeuver	Vehicle type	First Event	No. Ped
2016-Jan-12, Tue,17:18	Clear	Rear end	P.D. only	Wet	North	Going ahead	Automobile, station wagon	Other motor vehicle	0
					North	Going ahead	Automobile, station wagon	Other motor vehicle	
2016-Apr-05, Tue,08:26	Clear	Rear end	P.D. only	Dry	East	Turning right	Pick-up truck	Other motor vehicle	0
					East	Turning right	Pick-up truck	Other motor vehicle	
2016-Apr-14, Thu,07:40	Clear	Rear end	Non-fatal injury	Dry	East	Turning right	Pick-up truck	Other motor vehicle	0
					East	Turning right	Pick-up truck	Other motor vehicle	
2016-Jul-26, Tue,16:23	Clear	Rear end	P.D. only	Dry	North	Going ahead	Automobile, station wagon	Other motor vehicle	0
					North	Stopped	Pick-up truck	Other motor vehicle	
2016-Oct-02, Sun,13:23	Rain	Sideswipe	P.D. only	Wet	West	Turning left	Pick-up truck	Other motor vehicle	0
					West	Turning left	Automobile, station wagon	Other motor vehicle	
2016-Dec-14, Wed,11:30	Clear	Angle	P.D. only	Dry	South	Turning left	Automobile, station wagon	Other motor vehicle	0
					East	Going ahead	Automobile, station wagon	Other motor vehicle	
2016-Dec-22, Thu,09:33	Snow	Sideswipe	P.D. only	Slush	North	Changing lanes	Automobile, station wagon	Skidding/sliding	0
					North	Going ahead	Automobile, station wagon	Other motor vehicle	
					North	Going ahead	Automobile, station wagon	Other motor vehicle	
2017-Jan-08, Sun,14:48	Clear	Rear end	P.D. only	Wet	South	Turning right	Automobile, station wagon	Other motor vehicle	0
					South	Turning right	Pick-up truck	Other motor vehicle	



# Transportation Services - Traffic Services

## Collision Details Report - Public Version

From: January 1, 2016 To: December 31, 2020

**Location:** MARCH RD @ TERRY FOX DR

**Traffic Control:** Traffic signal

**Total Collisions:** 47

Date/Day/Time	Environment	Impact Type	Classification	Surface Cond'n	Veh. Dir	Vehicle Manoeuver	Vehicle type	First Event	No. Ped
2017-Apr-24, Mon,14:47	Clear	Rear end	P.D. only	Dry	West	Going ahead	Automobile, station wagon	Other motor vehicle	0
					West	Stopped	Automobile, station wagon	Other motor vehicle	
2017-May-18, Thu,09:47	Clear	Rear end	P.D. only	Dry	North	Going ahead	Passenger van	Other motor vehicle	0
					North	Stopped	Truck and trailer	Other motor vehicle	
2017-Jun-13, Tue,20:15	Clear	Rear end	P.D. only	Dry	North	Changing lanes	Pick-up truck	Other motor vehicle	0
					North	Going ahead	Pick-up truck	Other motor vehicle	
2017-Jun-14, Wed,18:47	Clear	Rear end	Non-fatal injury	Dry	North	Slowing or stopping	Automobile, station wagon	Other motor vehicle	0
					North	Stopped	Pick-up truck	Other motor vehicle	
2017-Jun-29, Thu,11:53	Rain	Rear end	P.D. only	Wet	South	Going ahead	Automobile, station wagon	Other motor vehicle	0
					South	Stopped	Automobile, station wagon	Other motor vehicle	
2017-Jul-24, Mon,15:37	Rain	Rear end	P.D. only	Wet	South	Going ahead	Automobile, station wagon	Other motor vehicle	0
					South	Stopped	Passenger van	Other motor vehicle	
2017-Aug-24, Thu,17:49	Clear	Rear end	P.D. only	Dry	North	Going ahead	Automobile, station wagon	Other motor vehicle	0
					North	Stopped	Automobile, station wagon	Other motor vehicle	
2017-Sep-03, Sun,10:39	Rain	Sideswipe	Non-fatal injury	Wet	East	Going ahead	Automobile, station wagon	Other motor vehicle	0
					East	Turning left	Automobile, station wagon	Other motor vehicle	
2017-Sep-20, Wed,16:15	Clear	Rear end	P.D. only	Dry	North	Changing lanes	Automobile, station wagon	Other motor vehicle	0
					North	Going ahead	Automobile, station wagon	Other motor vehicle	
2017-Sep-27, Wed,14:43	Clear	Rear end	Non-fatal injury	Dry	North	Changing lanes	Automobile, station wagon	Other motor vehicle	0
					North	Stopped	Automobile, station wagon	Other motor vehicle	
2017-Oct-04, Wed,17:45	Clear	Sideswipe	P.D. only	Dry	West	Overtaking	Automobile, station wagon	Other motor vehicle	0
					West	Going ahead	Automobile, station wagon	Other motor vehicle	
2017-Oct-14, Sat,08:00	Rain	SMV other	P.D. only	Wet	North	Merging	Automobile, station wagon	Curb	0



# Transportation Services - Traffic Services

## Collision Details Report - Public Version

From: January 1, 2016 To: December 31, 2020

**Location:** MARCH RD @ TERRY FOX DR

**Traffic Control:** Traffic signal

**Total Collisions:** 47

Date/Day/Time	Environment	Impact Type	Classification	Surface Cond'n	Veh. Dir	Vehicle Manoeuvre	Vehicle type	First Event	No. Ped
2017-Oct-20, Fri,19:04	Clear	Other	P.D. only	Dry	West	Reversing	Automobile, station wagon	Other motor vehicle	0
					West	Stopped	Automobile, station wagon	Other motor vehicle	
2017-Dec-02, Sat,18:19	Clear	Sideswipe	P.D. only	Dry	North	Changing lanes	Passenger van	Other motor vehicle	0
					North	Turning left	Automobile, station wagon	Other motor vehicle	
2017-Dec-19, Tue,08:32	Clear	SMV other	P.D. only	Loose snow	North	Turning right	Automobile, station wagon	Snowbank/drift	0
2017-Dec-27, Wed,14:55	Clear	SMV other	P.D. only	Ice	South	Going ahead	Automobile, station wagon	Other	0
2018-Jan-14, Sun,12:37	Clear	Rear end	P.D. only	Ice	North	Going ahead	Automobile, station wagon	Other motor vehicle	0
					North	Stopped	Automobile, station wagon	Other motor vehicle	
2018-Jan-21, Sun,21:32	Clear	Angle	P.D. only	Dry	East	Reversing	Automobile, station wagon	Other motor vehicle	0
					South	Going ahead	Automobile, station wagon	Other motor vehicle	
2018-Feb-09, Fri,23:12	Snow	Turning movement	Non-fatal injury	Loose snow	South	Going ahead	Automobile, station wagon	Other motor vehicle	0
					North	Turning left	Automobile, station wagon	Other motor vehicle	
2018-Feb-11, Sun,18:56	Freezing Rain	SMV other	P.D. only	Ice	East	Turning right	Automobile, station wagon	Skidding/sliding	0
2018-Feb-22, Thu,17:20	Clear	Rear end	P.D. only	Wet	North	Slowing or stopping	Automobile, station wagon	Other motor vehicle	0
					North	Turning left	Automobile, station wagon	Other motor vehicle	
2018-Feb-28, Wed,13:53	Clear	Rear end	P.D. only	Dry	North	Slowing or stopping	Pick-up truck	Other motor vehicle	0
					North	Stopped	Automobile, station wagon	Other motor vehicle	
2018-Jun-06, Wed,17:35	Clear	Rear end	P.D. only	Dry	North	Unknown	Motorcycle	Other motor vehicle	0
					North	Stopped	Automobile, station wagon	Other motor vehicle	
2018-Jun-09, Sat,17:11	Clear	SMV other	P.D. only	Dry	South	Going ahead	Automobile, station wagon	Curb	0
2018-Jun-22, Fri,15:38	Clear	Rear end	P.D. only	Dry	North	Turning right	Pick-up truck	Other motor vehicle	0
					North	Turning right	Automobile, station wagon	Other motor vehicle	
2018-Jul-14, Sat,11:41	Clear	Rear end	P.D. only	Dry	West	Turning right	Automobile, station wagon	Other motor vehicle	0
					West	Stopped	Automobile, station wagon	Other motor vehicle	



# Transportation Services - Traffic Services

## Collision Details Report - Public Version

From: January 1, 2016 To: December 31, 2020

**Location:** MARCH RD @ TERRY FOX DR

**Traffic Control:** Traffic signal

**Total Collisions:** 47

Date/Day/Time	Environment	Impact Type	Classification	Surface Cond'n	Veh. Dir	Vehicle Manoeuvre	Vehicle type	First Event	No. Ped
2018-Jul-24, Tue,09:30	Rain	Rear end	P.D. only	Wet	East	Going ahead	Automobile, station wagon	Other motor vehicle	0
					East	Going ahead	Automobile, station wagon	Other motor vehicle	
2018-Nov-14, Wed,19:00	Clear	Rear end	Non-fatal injury	Dry	North	Going ahead	Automobile, station wagon	Other motor vehicle	0
					North	Stopped	Automobile, station wagon	Other motor vehicle	
2018-Dec-18, Tue,08:59	Clear	Rear end	Non-fatal injury	Dry	South	Going ahead	Automobile, station wagon	Other motor vehicle	0
					South	Slowing or stopping	Automobile, station wagon	Other motor vehicle	
2018-Dec-21, Fri,16:20	Rain	Rear end	Non-fatal injury	Wet	South	Going ahead	Automobile, station wagon	Other motor vehicle	0
					South	Stopped	Automobile, station wagon	Other motor vehicle	
2019-Feb-26, Tue,16:30	Snow	Sideswipe	P.D. only	Ice	North	Changing lanes	Automobile, station wagon	Other motor vehicle	0
					North	Going ahead	Automobile, station wagon	Other motor vehicle	
2019-Mar-10, Sun,14:45	Snow	Rear end	P.D. only	Slush	South	Slowing or stopping	Automobile, station wagon	Other motor vehicle	0
					South	Stopped	Automobile, station wagon	Other motor vehicle	
2019-Jun-26, Wed,09:46	Rain	Approaching	Non-fatal injury	Wet	South	Going ahead	Automobile, station wagon	Skidding/sliding	0
					North	Stopped	Automobile, station wagon	Other motor vehicle	
					North	Stopped	Automobile, station wagon	Other motor vehicle	
2019-Nov-05, Tue,18:17	Clear	Sideswipe	P.D. only	Dry	East	Turning right	Automobile, station wagon	Other motor vehicle	0
					East	Turning right	Truck and trailer	Other motor vehicle	
2019-Dec-24, Tue,22:58	Clear	Rear end	P.D. only	Dry	North	Going ahead	Automobile, station wagon	Other motor vehicle	0
					North	Stopped	Automobile, station wagon	Other motor vehicle	
2020-May-24, Sun,14:00	Clear	Rear end	P.D. only	Dry	North	Slowing or stopping	Automobile, station wagon	Other motor vehicle	0
					North	Going ahead	Automobile, station wagon	Other motor vehicle	
2020-Aug-13, Thu,14:30	Clear	Rear end	P.D. only	Dry	South	Unknown	Unknown	Other motor vehicle	0
					South	Stopped	Pick-up truck	Other motor vehicle	



# Transportation Services - Traffic Services

## Collision Details Report - Public Version

From: January 1, 2016 To: December 31, 2020

**Location:** MARCH RD @ TERRY FOX DR

**Traffic Control:** Traffic signal

**Total Collisions:** 47

Date/Day/Time	Environment	Impact Type	Classification	Surface Cond'n	Veh. Dir	Vehicle Manoeuvre	Vehicle type	First Event	No. Ped
2020-Oct-14, Wed,22:26	Clear	Turning movement	Non-fatal injury	Dry	South	Going ahead	Automobile, station wagon	Other motor vehicle	0
					North	Turning left	Automobile, station wagon	Other motor vehicle	
2020-Nov-22, Sun,17:45	Snow	SMV other	P.D. only	Loose snow	East	Slowing or stopping	Automobile, station wagon	Skidding/sliding	0

**Location:** MARCH RD btwn MORGAN'S GRANT WAY & TERRY FOX DR

**Traffic Control:** No control

**Total Collisions:** 6

Date/Day/Time	Environment	Impact Type	Classification	Surface Cond'n	Veh. Dir	Vehicle Manoeuvre	Vehicle type	First Event	No. Ped
2018-Feb-23, Fri,13:12	Freezing Rain	SMV other	Non-fatal injury	Ice	North	Going ahead	Automobile, station wagon	Ran off road	0
2018-Oct-29, Mon,07:27	Rain	Rear end	P.D. only	Wet	South	Going ahead	Automobile, station wagon	Other motor vehicle	0
					South	Stopped	Automobile, station wagon	Other motor vehicle	
					South	Going ahead	Delivery van	Other motor vehicle	
					South	Stopped	Automobile, station wagon	Other motor vehicle	
2019-May-14, Tue,20:48	Clear	Sideswipe	P.D. only	Dry	North	Going ahead	Automobile, station wagon	Other motor vehicle	0
					North	Going ahead	Delivery van	Other motor vehicle	
2019-May-28, Tue,10:39	Rain	SMV other	P.D. only	Wet	North	Going ahead	Automobile, station wagon	Curb	0
2019-Nov-05, Tue,06:41	Clear	Rear end	Non-fatal injury	Wet	South	Changing lanes	Automobile, station wagon	Other motor vehicle	0
					South	Going ahead	Automobile, station wagon	Other motor vehicle	
2020-Jan-04, Sat,19:54	Clear	Sideswipe	P.D. only	Wet	North	Changing lanes	Automobile, station wagon	Other motor vehicle	0
					North	Going ahead	Automobile, station wagon	Other motor vehicle	

**Location:** MARCH RD btwn SOLANDT RD & TERRY FOX DR

**Traffic Control:** No control

**Total Collisions:** 16

Date/Day/Time	Environment	Impact Type	Classification	Surface Cond'n	Veh. Dir	Vehicle Manoeuvre	Vehicle type	First Event	No. Ped
---------------	-------------	-------------	----------------	----------------	----------	-------------------	--------------	-------------	---------





# Transportation Services - Traffic Services

## Collision Details Report - Public Version

From: January 1, 2016 To: December 31, 2020

**Location:** MARCH RD btwn SOLANDT RD & TERRY FOX DR

**Traffic Control:** No control

**Total Collisions:** 16

Date/Day/Time	Environment	Impact Type	Classification	Surface Cond'n	Veh. Dir	Vehicle Manoeuver	Vehicle type	First Event	No. Ped
2016-Jan-15, Fri,17:54	Clear	Rear end	P.D. only	Dry	North	Slowing or stopping	Automobile, station wagon	Other motor vehicle	0
					North	Stopped	Automobile, station wagon	Other motor vehicle	
					North	Stopped	Automobile, station wagon	Other motor vehicle	
2016-Jun-17, Fri,06:36	Clear	SMV other	Non-fatal injury	Dry	South	Going ahead	Automobile, station wagon	Animal - wild	0
2016-Jun-30, Thu,16:46	Clear	Angle	Non-fatal injury	Dry	North	Going ahead	Bicycle	Other motor vehicle	0
					East	Turning right	Pick-up truck	Cyclist	
2016-Dec-19, Mon,23:58	Clear	Sideswipe	P.D. only	Loose snow	North	Changing lanes	Automobile, station wagon	Other motor vehicle	0
					North	Going ahead	Pick-up truck	Other motor vehicle	
2017-Feb-14, Tue,11:55	Snow	Rear end	Non-fatal injury	Wet	North	Merging	Automobile, station wagon	Other motor vehicle	0
					North	Stopped	Automobile, station wagon	Other motor vehicle	
2017-May-20, Sat,07:57	Clear	Sideswipe	P.D. only	Dry	South	Changing lanes	Automobile, station wagon	Other motor vehicle	0
					South	Going ahead	Automobile, station wagon	Other motor vehicle	
2017-Jun-05, Mon,08:55	Clear	Rear end	P.D. only	Dry	South	Changing lanes	Automobile, station wagon	Other motor vehicle	0
					South	Going ahead	Automobile, station wagon	Other motor vehicle	
					South	Going ahead	Truck and trailer	Other motor vehicle	
2018-Oct-30, Tue,17:12	Clear	Rear end	P.D. only	Dry	North	Going ahead	Automobile, station wagon	Other motor vehicle	0
					North	Slowing or stopping	Automobile, station wagon	Other motor vehicle	
					North	Stopped	Automobile, station wagon	Other motor vehicle	
					North	Stopped	Automobile, station wagon	Other motor vehicle	
2019-Apr-18, Thu,03:22	Clear	Rear end	Non-fatal injury	Dry	North	Going ahead	Automobile, station wagon	Other motor vehicle	0
					North	Going ahead	Pick-up truck	Other motor vehicle	
2019-May-23, Thu,16:30	Rain	Rear end	P.D. only	Wet	South	Unknown	Unknown	Other motor vehicle	0
					South	Stopped	Automobile, station wagon	Other motor vehicle	
2019-Aug-04, Sun,11:40	Clear	SMV other	Non-fatal injury	Dry	North	Going ahead	Motorcycle	Skidding/sliding	0



# Transportation Services - Traffic Services

## Collision Details Report - Public Version

From: January 1, 2016 To: December 31, 2020

**Location:** MARCH RD btwn SOLANDT RD & TERRY FOX DR

**Traffic Control:** No control

**Total Collisions:** 16

Date/Day/Time	Environment	Impact Type	Classification	Surface Cond'n	Veh. Dir	Vehicle Manoeuver	Vehicle type	First Event	No. Ped
2019-Nov-16, Sat,19:07	Clear	SMV other	P.D. only	Dry	South	Going ahead	Automobile, station wagon	Debris on road	0
2019-Nov-26, Tue,07:00	Clear	SMV other	P.D. only	Dry	South	Going ahead	Automobile, station wagon	Animal - wild	0
2019-Dec-31, Tue,07:57	Snow	Rear end	P.D. only	Slush	North	Going ahead	Pick-up truck	Other motor vehicle	0
					North	Stopped	Automobile, station wagon	Other motor vehicle	
2020-Apr-03, Fri,09:29	Rain	SMV other	Non-fatal injury	Wet	South	Going ahead	Automobile, station wagon	Pole (utility, power)	0
2020-Oct-29, Thu,07:10	Clear	SMV other	P.D. only	Dry	South	Going ahead	Passenger van	Animal - wild	0

**Location:** TERRY FOX DR btwn INNOVATION DR & MARCH RD

**Traffic Control:** No control

**Total Collisions:** 5

Date/Day/Time	Environment	Impact Type	Classification	Surface Cond'n	Veh. Dir	Vehicle Manoeuver	Vehicle type	First Event	No. Ped
2016-May-20, Fri,15:14	Clear	Rear end	Non-fatal injury	Dry	West	Going ahead	Automobile, station wagon	Other motor vehicle	0
					West	Slowing or stopping	Pick-up truck	Other motor vehicle	
2018-Apr-22, Sun,15:43	Clear	SMV other	P.D. only	Dry	West	Going ahead	Automobile, station wagon	Animal - wild	0
2018-Jun-14, Thu,17:32	Rain	Rear end	P.D. only	Wet	West	Slowing or stopping	Automobile, station wagon	Other motor vehicle	0
					West	Stopped	Automobile, station wagon	Other motor vehicle	
					West	Going ahead	Automobile, station wagon	Other motor vehicle	
2018-Oct-22, Mon,11:30	Clear	Turning movement	P.D. only	Dry	West	Turning right	Automobile, station wagon	Other motor vehicle	0
					West	Going ahead	Automobile, station wagon	Other motor vehicle	
2018-Nov-29, Thu,17:09	Clear	Rear end	P.D. only	Dry	West	Slowing or stopping	Automobile, station wagon	Other motor vehicle	0
					West	Stopped	Automobile, station wagon	Other motor vehicle	

**Location:** TERRY FOX DR N @ FLAMBOROUGH WAY/INNOVATION DR

**Traffic Control:** Traffic signal

**Total Collisions:** 20

Date/Day/Time	Environment	Impact Type	Classification	Surface Cond'n	Veh. Dir	Vehicle Manoeuver	Vehicle type	First Event	No. Ped
---------------	-------------	-------------	----------------	----------------	----------	-------------------	--------------	-------------	---------



# Transportation Services - Traffic Services

## Collision Details Report - Public Version

**From:** January 1, 2016    **To:** December 31, 2020

**Location:** TERRY FOX DR N @ FLAMBOROUGH WAY/INNOVATION DR

**Traffic Control:** Traffic signal

**Total Collisions:** 20

Date/Day/Time	Environment	Impact Type	Classification	Surface Cond'n	Veh. Dir	Vehicle Manoeuver	Vehicle type	First Event	No. Ped
2016-Feb-19, Fri,06:43	Clear	Angle	P.D. only	Ice	East	Going ahead	Pick-up truck	Other motor vehicle	0
					North	Turning left	Pick-up truck	Other motor vehicle	
2016-Jul-24, Sun,11:52	Clear	Rear end	P.D. only	Dry	East	Slowing or stopping	Passenger van	Other motor vehicle	0
					East	Stopped	Automobile, station wagon	Other motor vehicle	
2016-Jul-26, Tue,19:34	Clear	Rear end	P.D. only	Dry	West	Turning left	Pick-up truck	Other motor vehicle	0
					West	Turning left	Automobile, station wagon	Other motor vehicle	
2016-Sep-08, Thu,17:36	Clear	Rear end	P.D. only	Dry	West	Going ahead	Automobile, station wagon	Other motor vehicle	0
					West	Going ahead	Automobile, station wagon	Other motor vehicle	
2016-Oct-20, Thu,11:30	Rain	Sideswipe	P.D. only	Wet	North	Unknown	Pick-up truck	Other motor vehicle	0
					North	Going ahead	Pick-up truck	Other motor vehicle	
2017-Apr-04, Tue,09:11	Rain	Turning movement	Non-fatal injury	Wet	West	Turning left	Pick-up truck	Other motor vehicle	0
					East	Going ahead	Automobile, station wagon	Other motor vehicle	
					North	Stopped	Automobile, station wagon	Other motor vehicle	
					North	Stopped	Passenger van	Other motor vehicle	
					North	Stopped	Pick-up truck	Other motor vehicle	
2017-Jun-17, Sat,13:17	Clear	Angle	P.D. only	Dry	West	Slowing or stopping	Pick-up truck	Other motor vehicle	0
					South	Going ahead	Passenger van	Other motor vehicle	
2017-Aug-23, Wed,16:59	Clear	Rear end	Non-fatal injury	Dry	West	Going ahead	Delivery van	Other motor vehicle	0
					West	Stopped	Automobile, station wagon	Other motor vehicle	
					West	Slowing or stopping	Automobile, station wagon	Other motor vehicle	
					West	Stopped	Automobile, station wagon	Other motor vehicle	
2017-Dec-12, Tue,19:04	Snow	Rear end	P.D. only	Slush	South	Going ahead	Automobile, station wagon	Other motor vehicle	0
					South	Stopped	Pick-up truck	Other motor vehicle	



# Transportation Services - Traffic Services

## Collision Details Report - Public Version

From: January 1, 2016 To: December 31, 2020

**Location:** TERRY FOX DR N @ FLAMBOROUGH WAY/INNOVATION DR

**Traffic Control:** Traffic signal

**Total Collisions:** 20

Date/Day/Time	Environment	Impact Type	Classification	Surface Cond'n	Veh. Dir	Vehicle Manoeuver	Vehicle type	First Event	No. Ped
2018-Jan-13, Sat, 14:18	Clear	Turning movement	Non-fatal injury	Loose snow	West	Turning left	Automobile, station wagon	Other motor vehicle	0
					East	Going ahead	Automobile, station wagon	Other motor vehicle	
2018-Jan-16, Tue, 15:00	Clear	Rear end	P.D. only	Loose snow	West	Going ahead	Automobile, station wagon	Other motor vehicle	0
					West	Stopped	Automobile, station wagon	Other motor vehicle	
2018-Apr-05, Thu, 17:54	Clear	Turning movement	P.D. only	Dry	West	Making "U" turn	Automobile, station wagon	Other motor vehicle	0
					West	Going ahead	Automobile, station wagon	Other motor vehicle	
2018-May-24, Thu, 13:46	Clear	Rear end	P.D. only	Dry	South	Going ahead	Automobile, station wagon	Other motor vehicle	0
					South	Stopped	Automobile, station wagon	Other motor vehicle	
					South	Stopped	Automobile, station wagon	Other motor vehicle	
2018-Jun-04, Mon, 17:47	Rain	Rear end	P.D. only	Wet	West	Going ahead	Automobile, station wagon	Other motor vehicle	0
					West	Stopped	Automobile, station wagon	Other motor vehicle	
2018-Sep-12, Wed, 19:05	Clear	SMV other	P.D. only	Dry	North	Turning left	Unknown	Pedestrian	1
2019-Oct-01, Tue, 09:00	Rain	Rear end	Non-fatal injury	Wet	East	Going ahead	Pick-up truck	Other motor vehicle	0
					East	Slowing or stopping	Pick-up truck	Other motor vehicle	
2019-Oct-28, Mon, 17:48	Clear	Angle	Non-fatal injury	Dry	East	Going ahead	Passenger van	Other motor vehicle	0
					North	Going ahead	Automobile, station wagon	Other motor vehicle	
2019-Nov-14, Thu, 07:45	Snow	Rear end	P.D. only	Loose snow	South	Slowing or stopping	Automobile, station wagon	Other motor vehicle	0
					South	Stopped	Automobile, station wagon	Other motor vehicle	
2020-Feb-25, Tue, 17:20	Clear	Rear end	P.D. only	Wet	West	Going ahead	Automobile, station wagon	Other motor vehicle	0
					West	Stopped	Unknown	Other motor vehicle	
2020-Sep-21, Mon, 18:51	Clear	Angle	Non-fatal injury	Dry	North	Turning right	Automobile, station wagon	Cyclist	0
					East	Going ahead	Bicycle	Other motor vehicle	



# Transportation Services - Traffic Services

## Collision Details Report - Public Version

**From:** January 1, 2016 **To:** December 31, 2020

**Location:** HINES RD btwn END & INNOVATION DR

**Traffic Control:** No control

**Total Collisions:** 1

Date/Day/Time	Environment	Impact Type	Classification	Surface Cond'n	Veh. Dir	Vehicle Manoeuver	Vehicle type	First Event	No. Ped
2017-Dec-07, Thu,07:40	Snow	SMV other	P.D. only	Ice	South	Stopped	Automobile, station wagon	Ran off road	0

## **APPENDIX F**

---

Internal Capture Worksheets

NCHRP 684 Internal Trip Capture Estimation Tool			
Project Name:	555-603 March Road	Organization:	Novatech
Project Location:	Ottawa, ON	Performed By:	Josh Audia
Scenario Description:	Full Site Development	Date:	10/28/2022
Analysis Year:		Checked By:	
Analysis Period:	AM Street Peak Hour	Date:	

Table 1-A: Base Vehicle-Trip Generation Estimates (Single-Use Site Estimate)						
Land Use	Development Data (For Information Only)			Estimated Vehicle-Trips <sup>3</sup>		
	ITE LUCs <sup>1</sup>	Quantity	Units	Total	Entering	Exiting
Office				224	197	27
Retail				50	30	20
Restaurant				0		
Cinema/Entertainment				0		
Residential				396	123	273
Hotel				0		
All Other Land Uses <sup>2</sup>				0		
				670	350	320

Table 2-A: Mode Split and Vehicle Occupancy Estimates						
Land Use	Entering Trips			Exiting Trips		
	Veh. Occ. <sup>4</sup>	% Transit	% Non-Motorized	Veh. Occ. <sup>4</sup>	% Transit	% Non-Motorized
Office		20%	4%		20%	4%
Retail		10%	4%		10%	4%
Restaurant						
Cinema/Entertainment						
Residential		27%	5%		27%	5%
Hotel						
All Other Land Uses <sup>2</sup>						

Table 3-A: Average Land Use Interchange Distances (Feet Walking Distance)						
Origin (From)	Destination (To)					
	Office	Retail	Restaurant	Cinema/Entertainment	Residential	Hotel
Office						
Retail						
Restaurant						
Cinema/Entertainment						
Residential						
Hotel						

Table 4-A: Internal Person-Trip Origin-Destination Matrix*						
Origin (From)	Destination (To)					
	Office	Retail	Restaurant	Cinema/Entertainment	Residential	Hotel
Office		10	0	0	0	0
Retail	9		0	0	4	0
Restaurant	0	0		0	0	0
Cinema/Entertainment	0	0	0		0	0
Residential	8	6	0	0		0
Hotel	0	0	0	0	0	

Table 5-A: Computations Summary			
	Total	Entering	Exiting
All Person-Trips	1,232	582	650
Internal Capture Percentage	6%	6%	6%
External Vehicle-Trips <sup>5</sup>	611	320	291
External Transit-Trips <sup>6</sup>	287	124	163
External Non-Motorized Trips <sup>8</sup>	51	23	28

Table 6-A: Internal Trip Capture Percentages by Land Use		
Land Use	Entering Trips	Exiting Trips
Office	6%	27%
Retail	34%	42%
Restaurant	N/A	N/A
Cinema/Entertainment	N/A	N/A
Residential	2%	2%
Hotel	N/A	N/A

<sup>1</sup>Land Use Codes (LUCs) from *Trip Generation Manual*, published by the Institute of Transportation Engineers.

<sup>2</sup>Total estimate for all other land uses at mixed-use development site is not subject to internal trip capture computations in this estimator.

<sup>3</sup>Enter trips assuming no transit or non-motorized trips (as assumed in ITE *Trip Generation Manual*).

<sup>4</sup>Enter vehicle occupancy assumed in Table 1-A vehicle trips. If vehicle occupancy changes for proposed mixed-use project, manual adjustments must be made to Tables 5-A, 9-A (O and D). Enter transit, non-motorized percentages that will result with proposed mixed-use project complete.

<sup>5</sup>Vehicle-trips computed using the mode split and vehicle occupancy values provided in Table 2-A.

<sup>6</sup>Person-Trips

\*Indicates computation that has been rounded to the nearest whole number.

Estimation Tool Developed by the Texas A&M Transportation Institute - Version 2013.1

<b>Project Name:</b>	555-603 March Road
<b>Analysis Period:</b>	AM Street Peak Hour

Land Use	Table 7-A (D): Entering Trips		Table 7-A (O): Exiting Trips	
	Vehicle-Trips	Person-Trips*	Vehicle-Trips	Person-Trips*
Office	197	274	27	37
Retail	30	47	20	31
Restaurant	0	0	0	0
Cinema/Entertainment	0	0	0	0
Residential	123	261	273	582
Hotel	0	0	0	0

Origin (From)	Destination (To)					
	Office	Retail	Restaurant	Cinema/Entertainment	Residential	Hotel
Office		10	23	0	0	0
Retail	9		4	0	4	0
Restaurant	0	0		0	0	0
Cinema/Entertainment	0	0	0		0	0
Residential	12	6	116	0		0
Hotel	0	0	0	0	0	

Origin (From)	Destination (To)					
	Office	Retail	Restaurant	Cinema/Entertainment	Residential	Hotel
Office		15	0	0	0	0
Retail	11		0	0	5	0
Restaurant	38	4		0	13	0
Cinema/Entertainment	0	0	0		0	0
Residential	8	8	0	0		0
Hotel	8	2	0	0	0	

Destination Land Use	Person-Trip Estimates			External Trips by Mode*		
	Internal	External	Total	Vehicles <sup>1</sup>	Transit <sup>2</sup>	Non-Motorized <sup>2</sup>
Office	17	257	274	184	51	10
Retail	16	31	47	16	3	1
Restaurant	0	0	0	0	0	0
Cinema/Entertainment	0	0	0	0	0	0
Residential	4	257	261	120	70	12
Hotel	0	0	0	0	0	0
All Other Land Uses <sup>3</sup>	0	0	0	0	0	0

Origin Land Use	Person-Trip Estimates			External Trips by Mode*		
	Internal	External	Total	Vehicles <sup>1</sup>	Transit <sup>2</sup>	Non-Motorized <sup>2</sup>
Office	10	27	37	19	5	1
Retail	13	18	31	9	2	1
Restaurant	0	0	0	0	0	0
Cinema/Entertainment	0	0	0	0	0	0
Residential	14	568	582	263	156	26
Hotel	0	0	0	0	0	0
All Other Land Uses <sup>3</sup>	0	0	0	0	0	0

<sup>1</sup>Vehicle-trips computed using the mode split and vehicle occupancy values provided in Table 2-A  
<sup>2</sup>Person-Trips  
<sup>3</sup>Total estimate for all other land uses at mixed-use development site is not subject to internal trip capture computations in this estimator  
\*Indicates computation that has been rounded to the nearest whole number.



NCHRP 684 Internal Trip Capture Estimation Tool			
Project Name:	555-603 March Road	Organization:	Novatech
Project Location:	Ottawa, ON	Performed By:	Josh Audia
Scenario Description:	Full Site Development	Date:	10/28/2022
Analysis Year:		Checked By:	
Analysis Period:	PM Street Peak Hour	Date:	

Table 1-P: Base Vehicle-Trip Generation Estimates (Single-Use Site Estimate)						
Land Use	Development Data (For Information Only)			Estimated Vehicle-Trips <sup>3</sup>		
	ITE LUCs <sup>1</sup>	Quantity	Units	Total	Entering	Exiting
Office				219	37	182
Retail				144	72	72
Restaurant				0		
Cinema/Entertainment				0		
Residential				407	236	171
Hotel				0		
All Other Land Uses <sup>2</sup>				0		
				770	345	425

Table 2-P: Mode Split and Vehicle Occupancy Estimates						
Land Use	Entering Trips			Exiting Trips		
	Veh. Occ. <sup>4</sup>	% Transit	% Non-Motorized	Veh. Occ. <sup>4</sup>	% Transit	% Non-Motorized
Office		20%	4%		20%	4%
Retail		10%	4%		10%	4%
Restaurant						
Cinema/Entertainment						
Residential		26%	5%		26%	5%
Hotel						
All Other Land Uses <sup>2</sup>						

Table 3-P: Average Land Use Interchange Distances (Feet Walking Distance)						
Origin (From)	Destination (To)					
	Office	Retail	Restaurant	Cinema/Entertainment	Residential	Hotel
Office		328			328	
Retail					328	
Restaurant						
Cinema/Entertainment						
Residential		328				
Hotel						

Table 4-P: Internal Person-Trip Origin-Destination Matrix*						
Origin (From)	Destination (To)					
	Office	Retail	Restaurant	Cinema/Entertainment	Residential	Hotel
Office		9	0	0	5	0
Retail	2		0	0	29	0
Restaurant	0	0		0	0	0
Cinema/Entertainment	0	0	0		0	0
Residential	14	11	0	0		0
Hotel	0	0	0	0	0	

Table 5-P: Computations Summary			
	Total	Entering	Exiting
All Person-Trips	1,382	659	723
Internal Capture Percentage	10%	11%	10%
External Vehicle-Trips <sup>5</sup>	662	292	370
External Transit-Trips <sup>6</sup>	279	136	143
External Non-Motorized Trips <sup>6</sup>	55	26	29

Table 6-P: Internal Trip Capture Percentages by Land Use		
Land Use	Entering Trips	Exiting Trips
Office	31%	6%
Retail	18%	28%
Restaurant	N/A	N/A
Cinema/Entertainment	N/A	N/A
Residential	7%	7%
Hotel	N/A	N/A

<sup>1</sup>Land Use Codes (LUCs) from *Trip Generation Manual*, published by the Institute of Transportation Engineers.

<sup>2</sup>Total estimate for all other land uses at mixed-use development site is not subject to internal trip capture computations in this estimator.

<sup>3</sup>Enter trips assuming no transit or non-motorized trips (as assumed in *ITE Trip Generation Manual*).

<sup>4</sup>Enter vehicle occupancy assumed in Table 1-P vehicle trips. If vehicle occupancy changes for proposed mixed-use project, manual

<sup>5</sup>Vehicle-trips computed using the mode split and vehicle occupancy values provided in Table 2-P.

<sup>6</sup>Person-Trips

\*Indicates computation that has been rounded to the nearest whole number.

Estimation Tool Developed by the Texas A&M Transportation Institute - Version 2013.1

<b>Project Name:</b>	555-603 March Road
<b>Analysis Period:</b>	PM Street Peak Hour

Land Use	Table 7-P (D): Entering Trips		Table 7-P (O): Exiting Trips	
	Vehicle-Trips	Person-Trips*	Vehicle-Trips	Person-Trips*
Office	37	52	182	253
Retail	72	113	72	112
Restaurant	0	0	0	0
Cinema/Entertainment	0	0	0	0
Residential	236	494	171	358
Hotel	0	0	0	0

Origin (From)	Destination (To)					
	Office	Retail	Restaurant	Cinema/Entertainment	Residential	Hotel
Office		49	10	0	5	0
Retail	2		32	4	29	6
Restaurant	0	0		0	0	0
Cinema/Entertainment	0	0	0		0	0
Residential	14	145	75	0		11
Hotel	0	0	0	0	0	

Origin (From)	Destination (To)					
	Office	Retail	Restaurant	Cinema/Entertainment	Residential	Hotel
Office		9	0	0	20	0
Retail	16		0	0	227	0
Restaurant	16	57		0	79	0
Cinema/Entertainment	3	5	0		20	0
Residential	30	11	0	0		0
Hotel	0	2	0	0	0	

Destination Land Use	Person-Trip Estimates			External Trips by Mode*		
	Internal	External	Total	Vehicles <sup>1</sup>	Transit <sup>2</sup>	Non-Motorized <sup>2</sup>
Office	16	36	52	25	7	1
Retail	20	93	113	55	9	4
Restaurant	0	0	0	0	0	0
Cinema/Entertainment	0	0	0	0	0	0
Residential	34	460	494	212	120	21
Hotel	0	0	0	0	0	0
All Other Land Uses <sup>3</sup>	0	0	0	0	0	0

Origin Land Use	Person-Trip Estimates			External Trips by Mode*		
	Internal	External	Total	Vehicles <sup>1</sup>	Transit <sup>2</sup>	Non-Motorized <sup>2</sup>
Office	14	239	253	171	48	10
Retail	31	81	112	45	8	3
Restaurant	0	0	0	0	0	0
Cinema/Entertainment	0	0	0	0	0	0
Residential	25	333	358	154	87	16
Hotel	0	0	0	0	0	0
All Other Land Uses <sup>3</sup>	0	0	0	0	0	0

<sup>1</sup>Vehicle-trips computed using the mode split and vehicle occupancy values provided in Table 2-P  
<sup>2</sup>Person-Trips  
<sup>3</sup>Total estimate for all other land uses at mixed-use development site is not subject to internal trip capture computations in this estimator  
\*Indicates computation that has been rounded to the nearest whole number.

## **APPENDIX G**

---

Other Area Developments

## 1.0 SCREENING

### 1.1 Introduction

This Transportation Impact Assessment (TIA) has been prepared for a proposed development at 359 Terry Fox Drive and 525 Legget Drive on behalf of Wesley Clover International (Brookstreet Hotel), in support of Zoning By-Law Amendment and Site Plan Control applications. The Subject Site is a redevelopment of portions of 359 Terry Fox Drive and 525 Legget Drive (Brookstreet Hotel). A new parcel will be created through a severance process that will consist of the existing easterly access to 359 Terry Fox Drive and a portion of the area of 525 Legget Drive between an existing parking garage and the stormwater pond to the east.

The existing uses at 359 Terry Fox Drive include light industrial and office uses, and the existing uses at 525 Legget Drive include the Brookstreet Hotel, and accessory small commercial and office uses. Based on the location of the existing driveways, the subject site could be accessed via a driveway to 525 Legget Drive, two driveways to 555 Legget Drive, and two driveways to 359 Terry Fox Drive. The easterly access to 359 Terry Fox Drive, which will become part of the proposed parcel, is proposed to be the primary access to the development.

The subject site is surrounded by the following:

- Office uses, followed by Terry Fox Drive to the north,
- The Marshes Golf Club, followed by office uses and Solandt Road to the south,
- The Marshes Golf Club, followed by office uses and Terry Fox Drive to the east, and
- Legget Drive, followed by office uses and March Road to the west.

An aerial of the vicinity around the subject site is provided in **Figure 1**. A copy of the site plan is included in **Appendix A**.

### 1.2 Proposed Development

The subject site is designated as 'Urban Employment Area' on Schedule B of the City of Ottawa's Official Plan. The implemented zoning for the property is 'Business Park Industrial Zone (Kanata North Business Park)' (IP6). The subject site is not within any Community Design Plan or Secondary Plan areas. A Zoning By-Law Amendment is required to permit the proposed use. The draft City of Ottawa Official Plan includes proposed policies that will permit a higher density of development and greater degree of mixed uses, including residential within new 'activity centres' that are generally located within 600 metres of planned transit stations. The goal of the activity centres is to create a place to live, work, learn and play and provide access daily needs without a car. The City of Ottawa Official Plan includes a transit station at the intersection of March Road and Terry Fox as part of the future Bus Rapid Transit.

The proposed development consists of a single 30-storey high-rise residential building with 253 rental dwellings and approximately 3,877 ft<sup>2</sup> gross floor area (GFA) of rooftop restaurant space. The proposed development will provide a unique residential rental accommodation within the Kanata North Economic District, a technology park which employs over 20,000 people. The rental units will offer apartments within short walking or cycling distance of major employers, and will act as the catalyst for one of the City's proposed activity centres within the district. The residential tower will also be directly connected to the Brookstreet Hotel and will provide a unique experience for residents, as tenants will have access to amenities such as restaurants, fitness facilities, a spa, and recreational facilities.

Figure 1: View of the Subject Site



- Other area development-generated traffic volumes in 2029 are shown in **Figure 12**;
- Background traffic volumes in 2024 are shown in **Figure 13**;
- Background traffic volumes in 2029 are shown in **Figure 14**;
- Total traffic volumes in 2024 are shown in **Figure 15**;
- Total traffic volumes in 2029 are shown in **Figure 16**.

**Figure 8: Proposed Site-Generated Volumes**

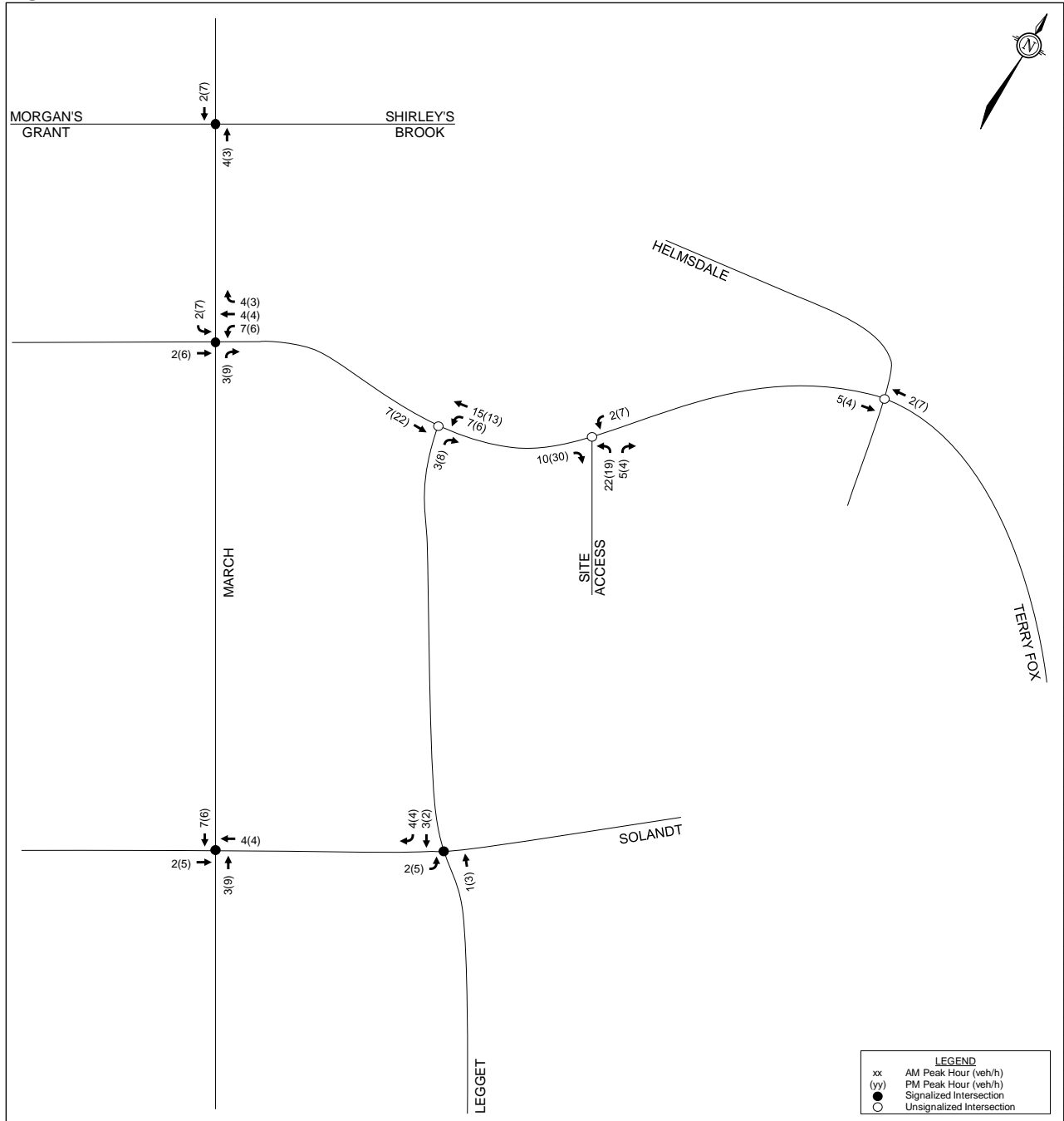

## 1.0 SCREENING

### 1.1 SUMMARY OF DEVELOPMENT

Municipal Address	600 March Road
Description of Location	Southeast quadrant of the March Road at Terry Fox Drive intersection
Land Use Classification	Mixed-Use Development (Residential High-Rise, Retail, Office)
Development Size (units)	Residential units = 1,900
Development Size (m <sup>2</sup> )	Office/Lab: 46,000 m <sup>2</sup> Retail: 11,350 m <sup>2</sup>
Number of Accesses and Locations	Four (4) accesses from March Road, One (1) access from Terry Fox Drive, Three (3) accesses from Legget Drive.
Phase of Development	Nokia Campus: 2026 Residential: 1 tower (250 units/year) after 2026
Buildout Year	2032 (10 year build out)

If available, please attach a sketch of the development or site plan to this form.

### 1.2 TRIP GENERATION TRIGGER

Considering the Development's Land Use type and Size (as filled out in the previous section), please refer to the Trip Generation Trigger checks below.

Land Use Type	Minimum Development Size	Triggered
Single-family homes	40 units	✘
Townhomes or apartments	90 units	✓
Office	3,500 m <sup>2</sup>	✓
Industrial	5,000 m <sup>2</sup>	✘
Fast-food restaurant or coffee shop	100 m <sup>2</sup>	✘
Destination retail	1,000 m <sup>2</sup>	✓
Gas station or convenience market	75 m <sup>2</sup>	✘

*\* If the development has a land use type other than what is presented in the table above, estimates of person-trip generation may be made based on average trip generation characteristics represented in the current edition of the Institute of Transportation Engineers (ITE) Trip Generation Manual.*

**If the proposed development size is greater than the sizes identified above, the Trip Generation Trigger is satisfied.**



Figure 1 - Site Location

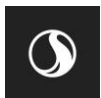



LUC	Land Use	Mode	%	Weekday AM Peak Hour			Weekday PM Peak Hour		
				In	Out	Total	In	Out	Total
710	General Office Building	Auto Driver	48%	694	94	788	107	523	631
		Auto Passenger	23%	209	28	238	32	158	190
		Transit	25%	10	1	11	1	7	9
		Cycling	0%	0	0	0	0	0	0
		Walking	5%	38	5	43	6	29	35

Comparing the vehicle trips associated with the existing Nokia campus, as outlined in **Table 9** above, to the existing traffic volumes along Legget Drive, it is clear that the volumes outlined in **Table 9** are an overestimation of the actual volumes the existing Nokia campus is generating. As the main entrances to the existing Nokia campus are on Legget Drive, the vehicle trips outlined in **Table 9** above are not realistic and thus were decreased to more accurately match the existing volumes along Legget Drive. This reduction was done in conjunction with assessing the existing volumes on Legget Drive along with the surrounding land uses. **Table 10** below outlines the existing Nokia volumes after the reductions were applied, which are more in line with the turning movement counts collected in the area.

**Table 10 – Adjusted Existing Trips**

LUC	Land Use	Trip Conversion	%	Weekday AM Peak Hour			Weekday PM Peak Hour		
				In	Out	Total	In	Out	Total
710	General Office Building	Reduction	30%	486	66	552	75	366	442

### 3.1.2 Future Trip Generation and Mode Shares

The *Institute of Transportation (ITE) Trip Generation Manual (11<sup>th</sup> Edition)* was used to forecast the auto trip generation for the retail and office land uses and the *Trans Trip Generation Study* was used to forecast the auto trip generation for the residential land use. Land use codes 222 – Multi-Unit High Rise Building, 821 – Shopping Plaza, and 710 – General Office Building were thought to be the most representative of the proposed land uses.

**Table 11** outlines the assumed land uses and the trip generation rates for each land use.

**Table 11 – Future Land Uses and Trip Generation Rates**

LUC	Land Use	Units/Employees/ GFA (1000's SF)	Weekday AM Peak Hour			Weekday PM Peak Hour		
			In	Out	Total	In	Out	Total
222	Multi - Unit (High-Rise)	1900 Units	31%	69%	0.80	58%	42%	0.90
710	General Office Building	2400	88%	12%	0.42	17%	83%	0.32
821	Shopping Plaza	122 GFA	62%	38%	1.73	48%	52%	5.19

It is noted that as per direction from Nokia, the office land use is anticipated to generate an additional 25 inbound and 25 outbound delivery trips during each of the AM and PM peak hours. Of the net 25 deliveries, 3 are anticipated to be tractor trailers (entering the site from Legget Drive), and 22 are anticipated to be box trucks / vans (entering the site from March Road). The delivery trips are not included in the trip generation tables and were accounted for as part of the total office land use trips shown in **Figure 12**.

**Table 12** outlines development-generated person trips for each land use.



**Table 12 – Future Person Trips Generated by Land Use**

LUC	Land Use	Trip Conversion	Weekday AM Peak Hour			Weekday PM Peak Hour		
			In	Out	Total	In	Out	Total
222	Multi - Unit (High-Rise)	Person Trips (Peak Period	471	1049	1520	992	718	1710
		Person Trips (Peak Hour) 0.50 for AM & 0.40 for PM	236	525	761	436	316	752
710	General Office	Auto Trips	880	120	1000	131	641	772
		Person Trip Factor	1.28					
		Person Trips	1126	154	1280	168	820	988
821	Shopping Plaza	Auto Trips	131	80	211	304	330	634
		Person Trip Factor	1.28					
		Person Trips	168	102	270	389	422	812
<b>Total Development</b>		<b>Total Person Trips</b>	<b>1530</b>	<b>781</b>	<b>2311</b>	<b>993</b>	<b>1558</b>	<b>2552</b>

To reflect local travel characteristics, the person trips were assigned to the four primary modal shares (i.e., auto, passenger, transit, and active moves). As per the City of Ottawa’s TMP, the March Road Bus Rapid Transit (BRT) is scheduled to be implemented by 2031, between Solandt Road and Highway 417. The subject development is planned to be built and occupied by 2032. The office portion of the subject development is anticipated to be within 400m of the planned BRT station at Solandt Road. Per direction from the City of Ottawa, the March Road BRT, north of Solandt Road, is scheduled to occur beyond the horizons of this subject study (i.e., post 2037). The residential / retail portion of the subject development (north half) are not anticipated to be within 400m of a rapid transit station during the study horizons. As such, the modal shares for the northern and southern portions of the subject development will differ as a direct result of the implementation plan of the March Road BRT.

**Residential Trips – Mode Shares**

Section 4.2 (Table 8) of the *TRANS Trip Generation Summary Report* was utilized to determine the residential mode share for high rise multi-family housing for the Kanata / Stittsville district. The average mode shares for the district include a 49% auto mode share and a 25% transit mode share. As the existing transit mode share is notably high for the general area, it is not anticipated to see increase as a result of the planned March Road BRT (between Highway 417 and Solandt Road) as the distance between the transit station and the residential component of the proposed development is anticipated to be greater than 400m.

**Office Trips – Mode Shares**

Section 6.2 (Table 12) of the *TRANS Trip Generation Summary Report* was utilized to determine the employment generator mode share by district. The report exclusively cites AM mode shares, however, it is expected that the PM mode shares would be identical as the commute from employment generators during the PM peak hour is very unlikely to differ from the commute to employment generators during the AM peak hour. For the Kanata / Stittsville district, the aforementioned report cites an 8% transit mode share and an 84% auto mode share.

**Commercial Trips – Mode Shares**

Section 6.3 (Table 13) of the *TRANS Trip Generation Summary Report* was utilized to determine the commercial generator mode share for the Kanata / Stittsville district. The report exclusively cites that the sample size for shopping trips during the AM peak tends to be low. As such, more emphasis was placed on the mode shares during the PM peak period to better represent the activity in the district. During the PM peak, the mode shares for the district include a 73%



auto mode share and a 1% transit mode share. To account for the enhanced overall transit service as a result of the planned March Road BRT (between Highway 417 and Solandt Road), the transit mode share for the commercial land use was increased from 1% to 10% (a 9% net increase) while subsequently reducing the 73% auto mode share by 9% for a total of 64%.

Table 13 outlines the modal shares that were used for the proposed development.

**Table 13 – Future Trip Generation by Travel Mode**

LUC	Land Use	Trip Conversion	Weekday AM Peak Hour			Weekday PM Peak Hour			
			In	Out	Total	In	Out	Total	
222	Multi - Unit (High-Rise)	Auto Driver	49%	116	257	373	214	155	369
		Auto Passenger	22%	52	116	168	96	70	166
		Transit	25%	58	129	187	107	77	184
		Cycling	0%	0	0	0	0	0	0
		Walking	4%	9	21	30	17	13	30
710	General Office Building	Auto Driver	84%	946	129	1075	141	689	832
		Auto Passenger	4%	45	6	51	7	33	39
		Transit	8%	90	12	102	13	66	79
		Cycling	1%	11	2	12	2	8	11
		Walking	3%	34	5	37	5	25	31
821	Shopping Plaza	Auto Driver	64%	108	65	173	249	270	51
		Auto Passenger	22%	37	22	59	86	93	179
		Transit	10%	17	10	27	39	42	81
		Cycling	0%	0	0	0	0	0	0
		Walking	4%	7	4	11	16	17	33
Total Development		<b>Auto Driver</b>		<b>1170</b>	<b>451</b>	<b>1621</b>	<b>604</b>	<b>1114</b>	<b>1719</b>
		<b>Auto Passenger</b>		<b>139</b>	<b>144</b>	<b>278</b>	<b>189</b>	<b>196</b>	<b>384</b>
		<b>Transit</b>		<b>165</b>	<b>151</b>	<b>316</b>	<b>159</b>	<b>185</b>	<b>344</b>
		<b>Cycling</b>		<b>11</b>	<b>2</b>	<b>12</b>	<b>2</b>	<b>8</b>	<b>11</b>
		<b>Walking</b>		<b>50</b>	<b>30</b>	<b>78</b>	<b>38</b>	<b>55</b>	<b>94</b>

### 3.1.3 Internal Capture and Pass-By

When predicting trips that are associated with different land use types the interaction between those land use types must be accounted for by applying the principals of internal capture adjustments. Internal capture trips are trips which are shared between two or more uses on the same site. A portion of the generated trips for each individual land use is therefore drawn from the adjacent land uses. Internal capture adjustments were made to account for vehicles that visit more than one land use within the subject development. Since these trips are contained within the subject site, accounting for each trip separately on the roadway network would result in “double-counting”. For this reason, land uses that may have associated internal capture trips between one another ultimately had their net new trips adjusted consistent with typical industry standards. In the subject development, the land uses that are subject to internal capture reductions are the retail and office land uses.

In addition, a portion of the auto trips generated by the proposed retail land uses will be ‘pass-by’ in nature. Pass-by trips are considered intermediate stops between an origin and a destination. They are site trips that are drawn from existing traffic volumes on the road network that are “passing-by” the site. While the total number of trips generated by a given development remains the same, the turning movements at study area intersections and site accesses require



adjustments to reflect pass-by traffic. The rate of pass-by traffic is based on the specific land use which was obtained from the *ITE Trip Generation Manual*. A pass-by rate of 34% was used for the retail land use.

**Table 14** outlines the pass-by, internal capture, and net new trips anticipated for the proposed development.

**Table 14 – Future Pass-By and Internal Capture Trips**

LUC	Land Use	Trip Conversion			Weekday AM Peak Hour			Weekday PM Peak Hour		
					In	Out	Total	In	Out	Total
710	General Office Building	Auto Trips			946	129	1075	141	690	831
		Internal Capture	AM	PM						
		Inbound	4%	10%	-38	-36	-74	-14	-34	-48
		Outbound	28%	5%						
		Net New Auto Trips			908	93	1001	127	655	783
821	Shopping Plaza	Auto Trips			108	65	173	249	270	519
		Internal Capture	AM	PM						
		Inbound	24%	16%	-26	-21	-47	-40	-76	-116
		Outbound	33%	28%						
		Net New Auto Trips			82	44	126	209	194	403
821 – Shopping Plaza	Auto Trips			82	44	126	209	194	403	
	Pass-By						71	66	137	
	Net Auto Trips			82	44	126	138	128	266	
<b>Net New Auto Trips</b>										
222 – Multi Unit (High Rise)				116	257	373	214	155	369	
710 – Office Building/ Lab				908	93	1001	127	655	783	
821 – Shopping Plaza				82	44	126	138	128	266	
<b>Total Development</b>										
Net New Auto Trips				1106	394	1500	479	938	1418	

### 3.1.4 Trip Distribution

The distribution of traffic to / from the proposed development was developed using the relative traffic flows and volumes at the study area inlets / outlets. To account for the significant Kanata North Urban Expansion Area (KNUEA) development north of the study area (anticipated to be fully built by the 2032 horizon year and is projected to add 800 vehicles to / from the north during the peak hours), the 2032 future background horizon volumes were utilized for this exercise.

Overall, for the office land use, the following trip distribution is anticipated:

- 35% to / from the North (via March Road)
- 50% to / from the South (via March Road)
- 15% to / from the West (via Terry Fox Drive)
- Note: Terry Fox Road (E) and Legget Drive (S) are anticipated to carry negligible development traffic due to the limited connectivity to the adjacent transportation network. Traffic to / from the south of the proposed development is projected to be predominantly on March Road due to the higher speeds and superior connectivity to Highway 417 and the district to the south.



Figure 15 - Site Generated Traffic Volumes - All Land Uses & Pass-by Trips

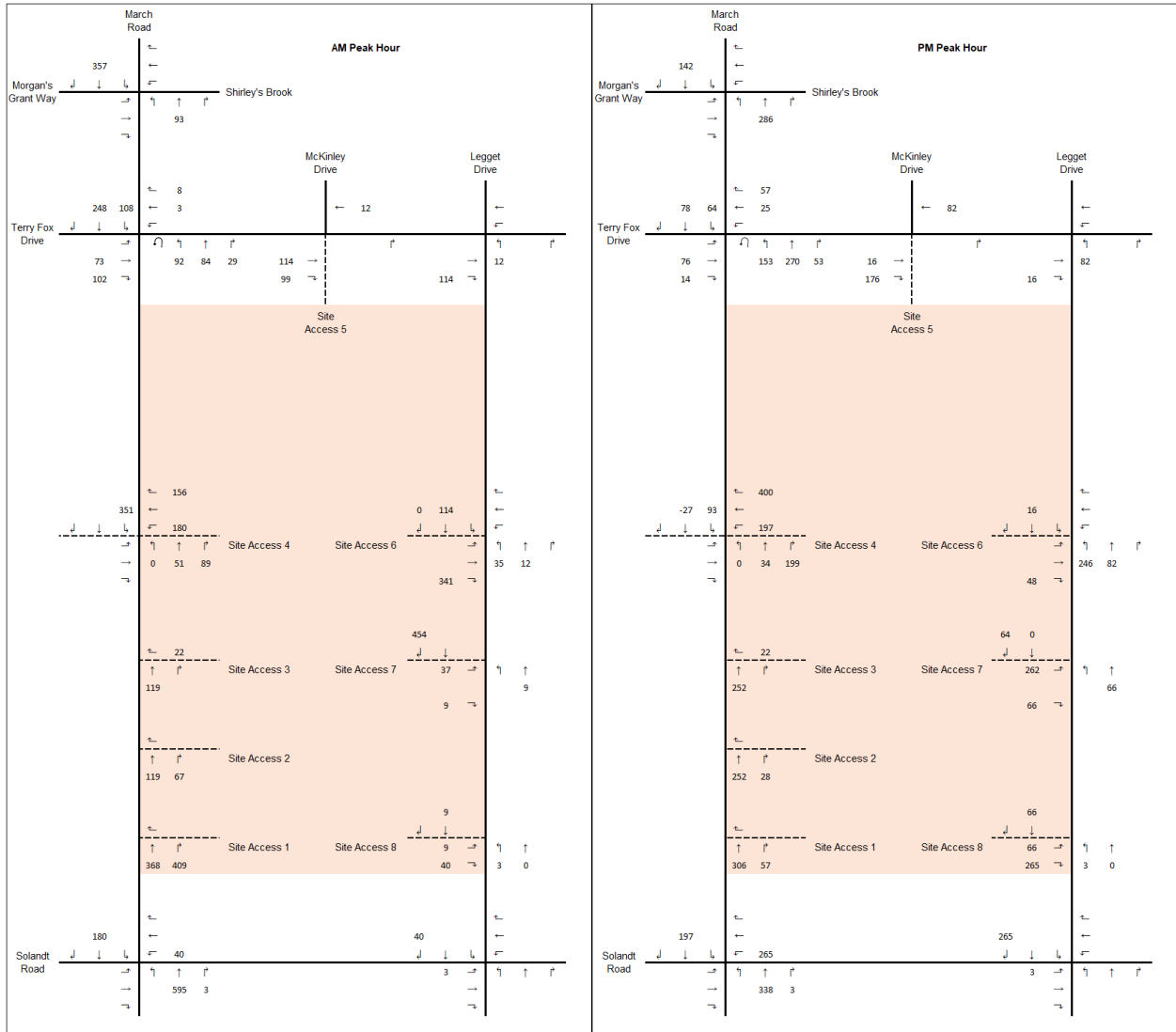

## 1 Screening

This study has been prepared according to the City of Ottawa’s 2017 Transportation Impact Assessment (TIA) Guidelines. Accordingly, a Step 1 Screening Form has been prepared and is included as Appendix A, along with the Certification Form for TIA Study PM. As shown in the Screening Form, a TIA is required including the Design Review Component and the Network Impact Component.

## 2 Existing and Planned Conditions

### 2.1 Proposed Development

The subject property, located at 706, 710, and 714 March Road, is currently zoned as General Mixed Use [GM] and Local Commercial [LC] and is currently undeveloped.

The proposed development consists of a 4,165 square metre supermarket, a 350 square-metre fast-food restaurant with a drive-through, and a large multi-unit commercial space that is 1,500 square metres. A total of 225 parking stalls are shown on the site plan.

Access to the site will be accommodated via March Road (190 metres north of Terry Fox Drive), McKinley Drive (235 and 210 metres north of Terry Fox Drive), and Shirley’s Brook Drive (100 metres east of March Road). As March road is divided by a median, this access would be restricted to a right in / right out only. The McKinley Drive access 235 metres north of Terry Fox Drive is anticipated to be a full movement access and will serve customers as well as small and medium trucks. Large heavy vehicles serving the supermarket loading docks will also exist the site via this access. The McKinley Drive Access 210 metres north of Terry Fox Drive will be a left-in only access and allow large trucks serving the supermarket to enter the site. The Shirley’s Brook Drive access will be east of the end of the left turn lane that is provided for the intersection with March Road, therefore, a full movement access can be considered at this access. For the purposes of this TIA the projected full build-out and occupancy horizon is 2023, and the plus five-year horizon is 2028. Figure 1 illustrates the Study Area Context. Figure 2 illustrates the proposed concept plan.

Figure 1: Area Context Plan

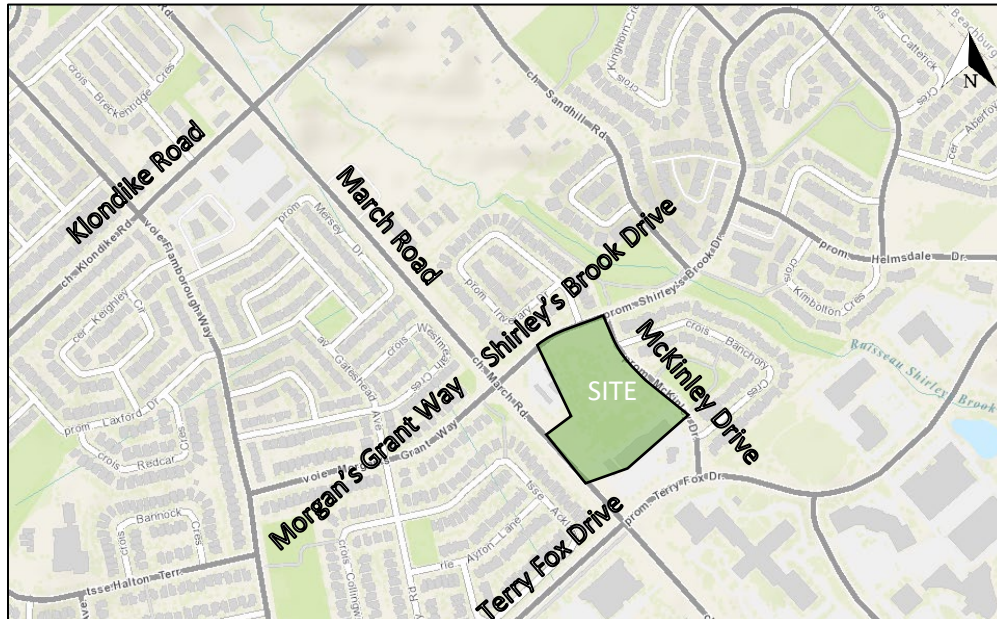

Source: <http://maps.ottawa.ca/geoOttawa/> Accessed: August 20, 2020

To assign the pass-by trips to the accesses, a ratio of southbound trips as a portion of all traffic on March Road, and northbound trips as a portion of all traffic on March Road was developed. It was determined that 75% of the total traffic is southbound and 25% is northbound in the 2023 AM peak period and 30% of the total traffic is southbound and 70% is northbound in both the 2023 PM and 2023 Saturday peak periods. It was also determined that 75% of the total traffic is southbound and 25% is northbound in the 2028 AM peak period and 30% of the total traffic is southbound and 70% is northbound in both the 2028 PM and 2028 Saturday peak periods. Using these percentages, the traffic volumes have been logically distributed to the access points. Figure 21 illustrates the site pass-by trip volumes.

Figure 22 illustrates the combined impact of the net new site trip generation and pass-by trips.

Figure 20: New Site Generation Auto Volumes

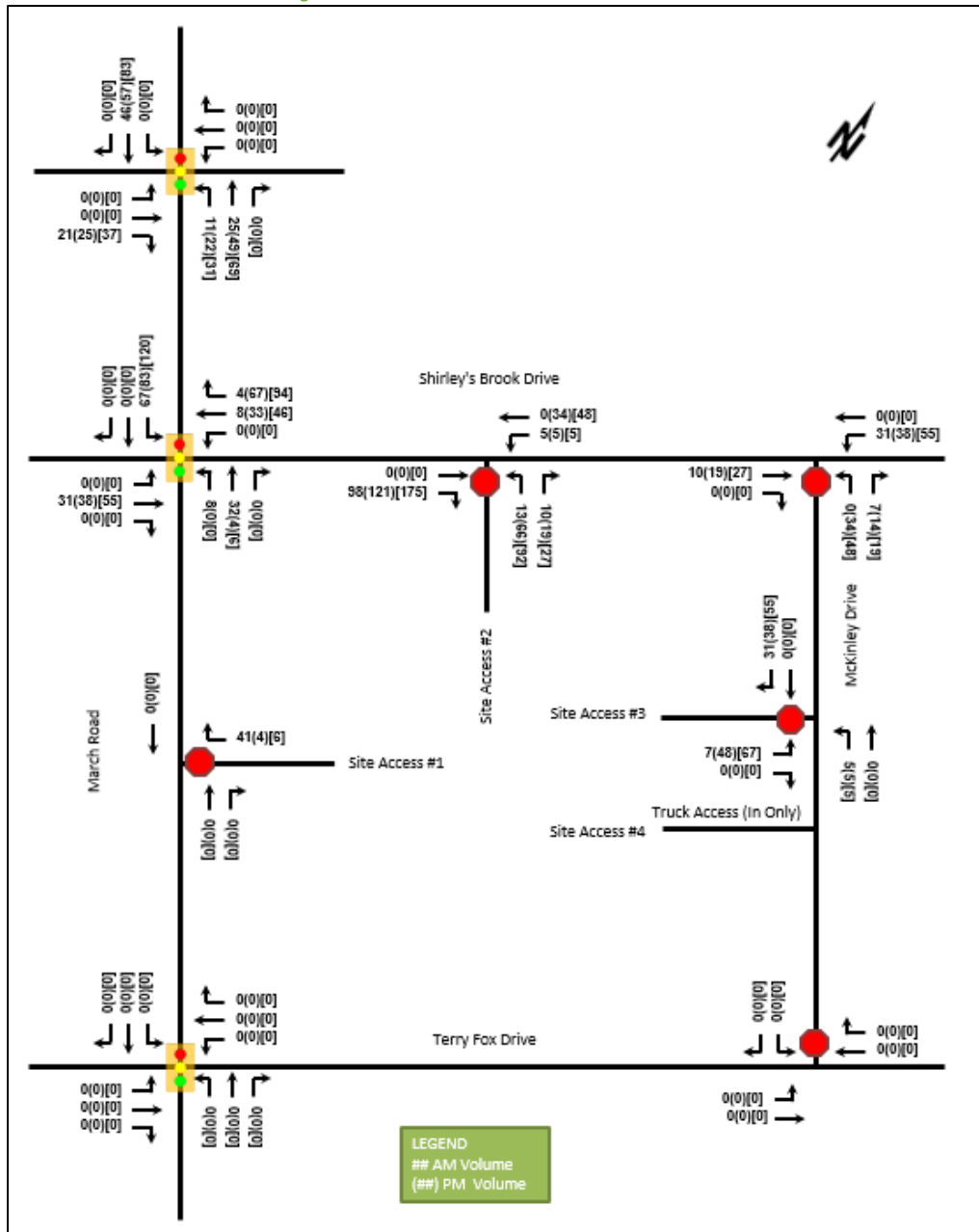
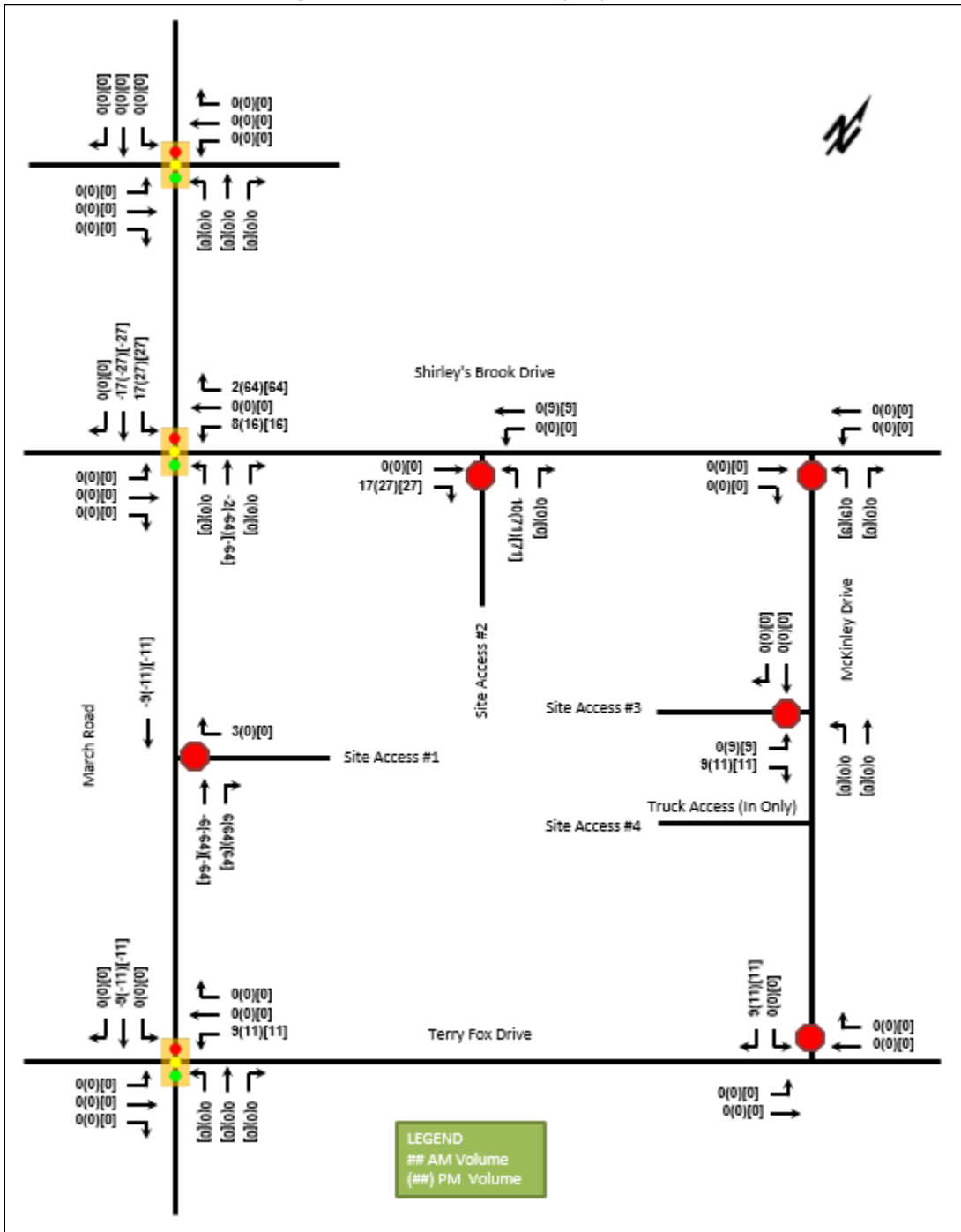

Figure 21: Forecasted Site Pass-by Trip Volumes







**March 19, 2020**

Ralph Esposito Jr.  
10731854 Canada Inc.  
555 Legget Drive, Suite 304, Tower A, Kanata, ON, K2K 2X3

**Subject: 788 March Road**

**Transportation Impact Assessment Study (October 2018) - Addendum 3**

## 1. Introduction

### 1.1. Context

Recent changes have been made to the original Site Plan (dated July 07, 2018) for this residential project that impact the proposed development’s peak hour traffic generation, and result in a different site configuration with respect to access location. This Addendum 3 represents an update to the original TIA and subsequent Addendum 1 to 2 with regard to these two items. The site is now anticipated to be developed in a single phase, and the updated Site Plan can be found in Appendix A.

## 2. Changes to Trip Generation

Site generated traffic is directly related to the number of proposed residential units. There is a proposed decrease in the number of units relative to the original study, and therefore the anticipated trips generated by the site is also expected to decrease. The following sections summarize the expected changes to the trip generation.

### 2.1. Trip Generation – Previous Study (2018)

The values shown in Table 1 below, were taken from the previous Site Plan for the Phase 2 (2023) horizon full buildout horizon where 196 residential units were proposed.

Table 1: Site Person Trip Generation Using OD-Survey Mode Share – Previous Study

Travel Mode	AM Mode Share	AM Peak (persons/h)			PM Peak (persons/h)		
		In	Out	Total	In	Out	Total
Auto Driver	50%	20	49	69	41	28	69
Auto Passenger	10%	3	11	14	8	6	14
Transit	25%	7	20	27	16	12	28
Non-motorized	15%	8	20	28	15	12	27
<b>Total People Trips</b>	<b>100%</b>	<b>38</b>	<b>100</b>	<b>138</b>	<b>80</b>	<b>58</b>	<b>138</b>
Total 'New' High-Rise Condominium (2023) Auto Trips		20	49	69	41	28	69

The total two-way anticipated site generated person trips are 138 for the AM and PM peak hours, and the total two-way vehicle generated trips are 69 trips for the AM and PM peak hours.

### 2.2. Trip Generation – 2020 Updated Site Plan

Using the updated Site Plan with the total of 92 proposed residential units and applying the same modal shares and directional splits, the new anticipated person trips are shown in Table 2 below.

Table 2: Site Person Trip Generation Using OD-Survey Mode Share – Updated

Travel Mode	AM Mode Share	AM Peak (persons/h)			PM Peak (persons/h)		
		In	Out	Total	In	Out	Total
Auto Driver	50%	9	23	32	19	13	32
Auto Passenger	10%	1	5	6	4	3	7
Transit	25%	4	13	17	9	7	16
Non-motorized	15%	3	7	10	5	5	10
<b>Total People Trips</b>	<b>100%</b>	<b>17</b>	<b>48</b>	<b>65</b>	<b>37</b>	<b>28</b>	<b>65</b>
Total 'New' High-Rise Condominium (2023) Auto Trips		9	23	32	19	13	32

The total two-way anticipated site generated person trips are 65 for the AM and PM peak hours, and the total two-way vehicle generated trips are 32 trips for the AM and PM peak hours. Figure 1, below shows the updated vehicle volumes assigned to the local roadways within the study area.

Figure 1: Updated Total Site Generated Vehicle Trips

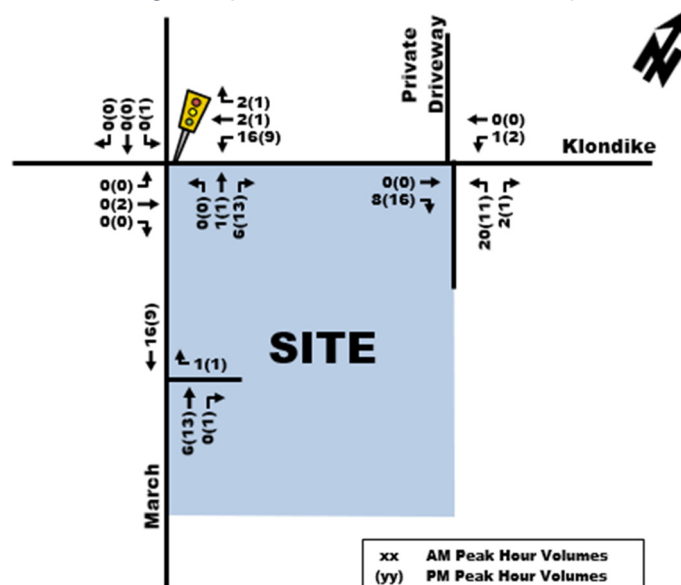

### 2.3. Difference in Forecasted Trips

To understand the difference between the previous Site Plan and the updated Site Plan with regard to trip generation, the forecasted volumes from the original TIA were compared to those associated with the updated Site Plan. Table 3 summarizes the difference (Table 2 - Table 1 values).

## 1 Screening

This study has been prepared according to the City of Ottawa's 2017 Transportation Impact Assessment (TIA) Guidelines. Accordingly, a Step 1 Screening Form has been prepared and is included as Appendix A, along with the Certification Form for TIA Study PM. As shown in the Screening Form, a TIA is required including the Design Review Component and the Network Impact Component.

As a result of the review process, additional comments and analysis have been produced for the City of Ottawa in the form of comment-response documents. The first round of responses to the City's comments have been included in Appendix B and the second round of responses to the City's comments have been included in Appendix C as supplements to the TIA.

Additionally, as the plan has evolved, the building areas have shifted slightly, however these changes are considered minor and have not been reflected in the analysis. Ambiguity surrounding the use of what is shown as Retail B in the most recent plan submitted with this report has required a conservative analysis approach to be adopted. It has been indicated that Retail B may in fact take the form of a restaurant. A previous version of the plan identified the building in question as a restaurant (Restaurant 2) instead of a retail building and as a result, the analysis sections of this TIA have considered this building to be a restaurant in order to produce a conservative analysis. The previous version of the plan is shown in Appendix D which shows the statistics used for Restaurant 2.

## 2 Existing and Planned Conditions

### 2.1 Proposed Development

The subject property, located at 910 March Road, is currently zoned as Rural [Ru] and Development Reserve [DR] and is undeveloped.

The proposed development consists of a 1,835 square metre hardware store, a 234 square metre restaurant with a drive through, a 416 square metre retail store, and a 249 square metre gas bar attached to a 191 square metre Tim Hortons with a drive-through. A total of 164 vehicle parking stalls and 16 bicycle parking spaces will be provided. The site is proposed to have two accesses. Both accesses are located along March Road; the first (Site Access #1) is a full-movement access located approximately 215 metres north of Maxwell Bridge Road, measured from intersection centreline to intersection centreline. Based on professional experience and the development design, signalization of this access is anticipated, however it will be confirmed within this report. The second (Site Access #2) is a right-in / right-out access located approximately 150 metres north of Maxwell Bridge Road, measured intersection centreline to intersection centreline. The anticipated full build-out and occupancy horizon is 2022. Figure 1 illustrates the Study Area Context. Figure 2 illustrates the proposed concept plan.

Figure 1: Area Context Plan

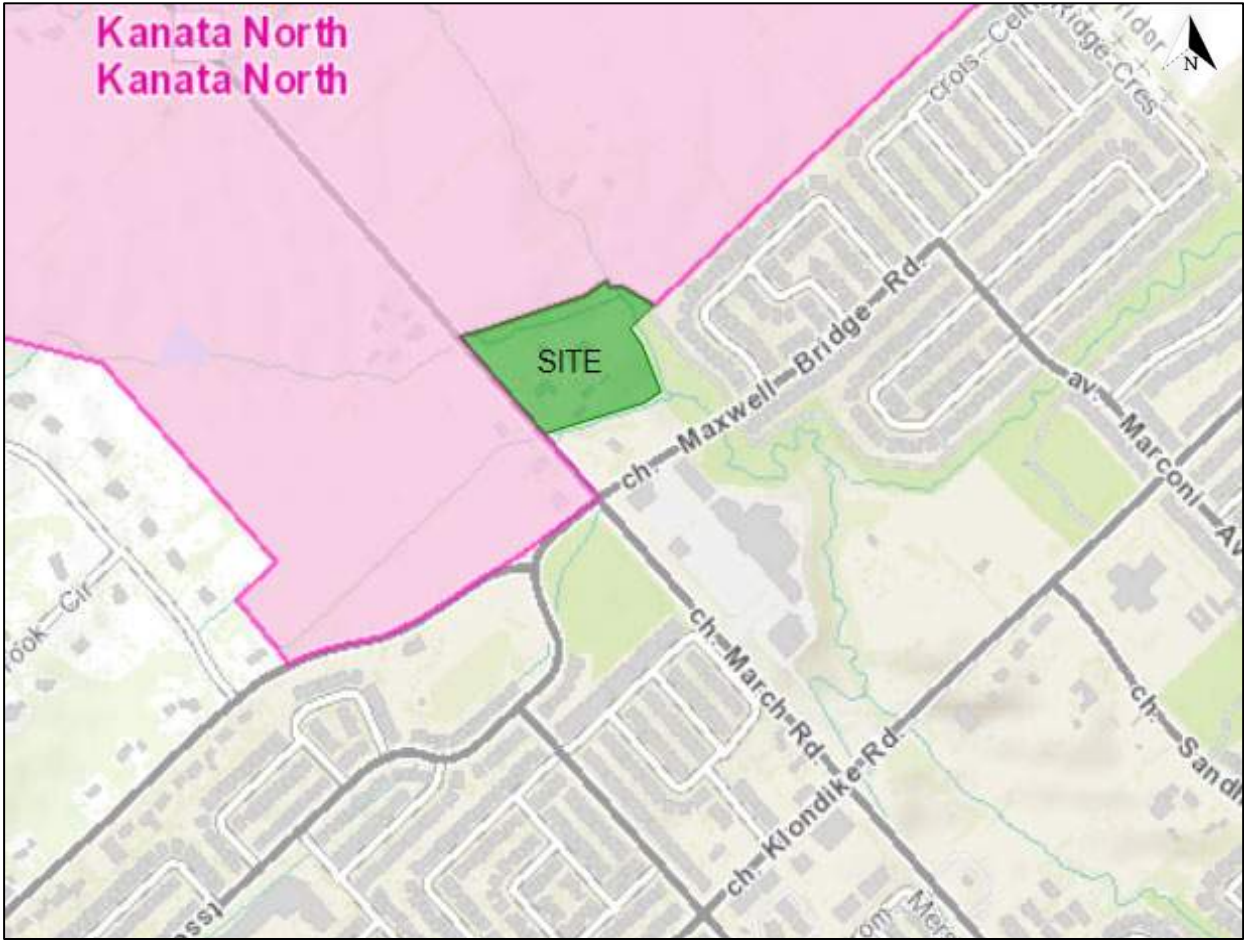
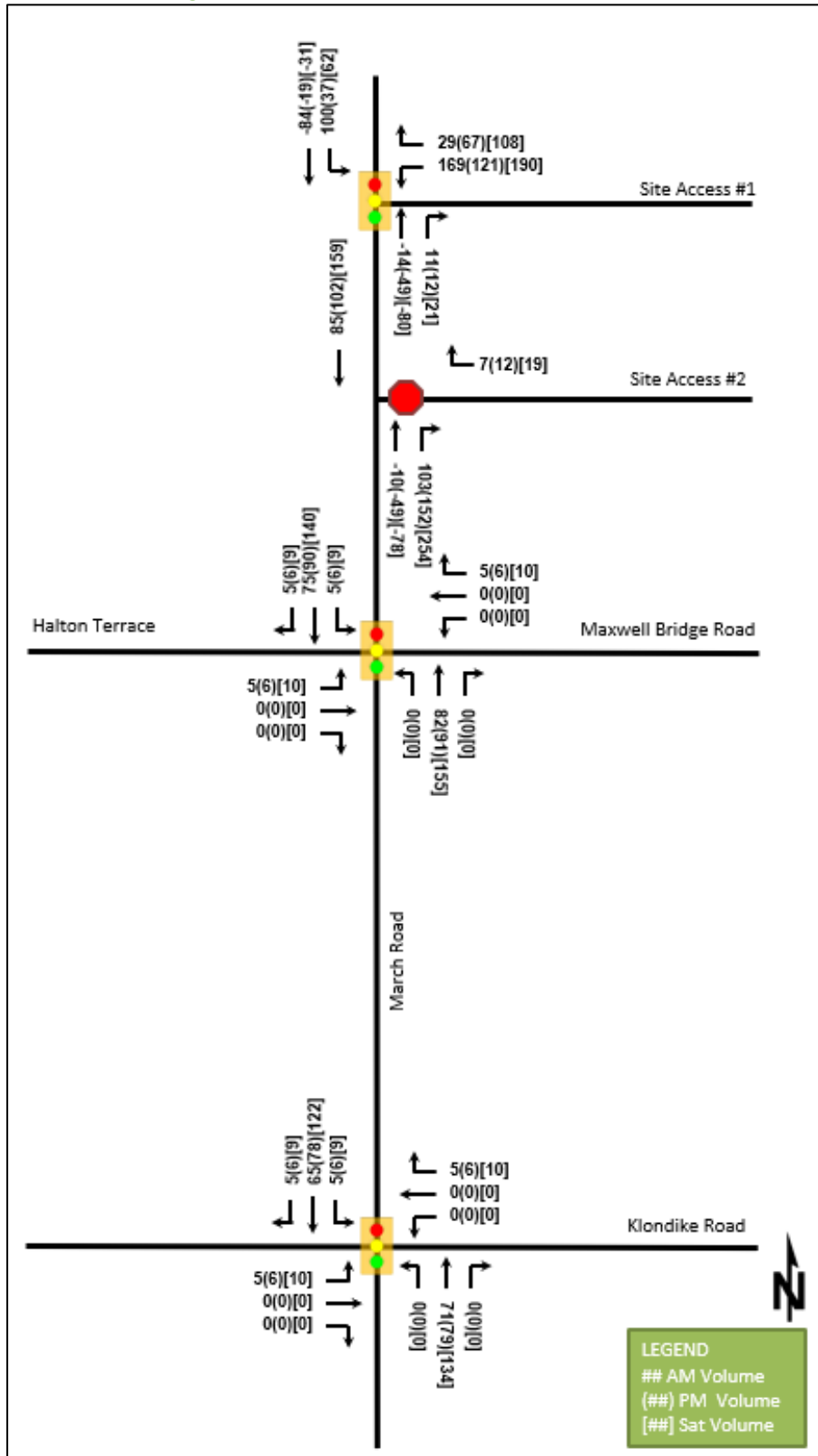

Figure 24: Net New Site Generation Auto Volumes 2022



## 1.0 INTRODUCTION

This TIA has been prepared in support of Site Plan Control and Zoning By-Law Amendment applications for the property located at 1104 Halton Terrace. The site is currently vacant and is surrounded by the following:

- Old Carp Road, followed by vacant land to the north;
- Halton Terrace, followed by a stormwater management pond to the east;
- Halton Terrace, followed by existing low-density residential development to the south; and
- Low-density residential development to the west.

A view of the subject site is provided in **Figure 1**.

**Figure 1: View of the Subject Site**



## 2.0 PROPOSED DEVELOPMENT

The proposed development is designated as 'General Urban Area' in Schedule B of the City of Ottawa's Official Plan. The implemented zoning for 1104 Halton Terrace is 'Residential Third Density' (R3).

The proposed development will feature 86 apartment dwellings. Five single detached dwellings with frontage on Halton Terrace are proposed at the southern limits of the site but are not part of the subject application. The proposed development will be accessed by two new driveways along Halton Terrace and Old Carp Road. The access along Halton Terrace will serve a surface parking lot containing 53 parking spaces. The access along Old Carp Road will serve an underground parking lot containing 68 parking spaces. The proposed development is expected to be constructed in a single phase, with full occupancy in 2024.

A copy of the proposed Site Plan is included in **Appendix A**.

## 3.0 SCREENING

### 3.1 Screening Form

The City's 2017 TIA Guidelines identify three triggers for completing a TIA report, including trip generation, location, and safety. The criteria for each trigger are outlined in the City's TIA Screening Form. The trigger results are as follows:

- Trip Generation Trigger – The development is not anticipated to generate over 60 peak hour person trips; further assessment is not required based on this trigger.
- Location Triggers – The development is not located within a Design Priority Area or Transit-Oriented Development zone, and does not propose a new driveway to a boundary street designated as part of the City's Rapid Transit, Transit Priority, or Spine Cycling networks; further assessment is not required based on this trigger.
- Safety Triggers – The horizontal curvature of Halton Terrace may limit sightlines at the proposed access to Halton Terrace; further assessment is required based on this trigger.

A copy of the TIA Screening Form is included in **Appendix B**.

## 4.0 SCOPING

### 4.1 Existing Conditions

#### 4.1.1 Roadways

All roadways within the study area fall under the jurisdiction of the City of Ottawa.

March Road is an arterial roadway that generally runs on a north-south alignment within the study area, running between Dunrobin Road and Highway 417. West of Dunrobin Road, the roadway runs on an east-west alignment until Appleton Sideroad in Almonte, where it continues as Ottawa Street. South of Highway 417, the roadway continues on a north-south alignment as Eagleson Road. Within



**Table 4: Proposed Residential – Peak Period Person Trips by Mode Share**

Travel Mode	Mode Share	AM Peak Period			PM Peak Period		
		IN	OUT	TOT	IN	OUT	TOT
<b>Peak Period Person Trips</b>		<b>21</b>	<b>48</b>	<b>69</b>	<b>45</b>	<b>32</b>	<b>77</b>
Auto Driver	50%	11	24	35	23	16	39
Auto Passenger	20%	4	10	14	9	6	15
Transit	25%	5	12	17	11	8	19
Cyclist	0%	0	0	0	0	0	0
Pedestrian	5%	1	2	3	2	2	4

Table 4 of the *TRANS Trip Generation Manual* includes adjustment factors to convert the estimated number of trips generated for each mode from peak period to peak hour. A breakdown of the peak hour person trips by mode is shown in the following table.

**Table 5: Proposed Residential – Peak Hour Person Trips by Mode Share**

Travel Mode	Adj. Factor		AM Peak Hour			PM Peak Hour		
	AM	PM	IN	OUT	TOT	IN	OUT	TOT
Auto Driver	0.48	0.44	5	12	17	10	7	17
Auto Passenger	0.48	0.44	2	5	7	4	3	7
Transit	0.55	0.47	3	6	9	5	4	9
Cyclist	0.58	0.48	0	0	0	0	0	0
Pedestrian	0.58	0.52	1	1	2	1	1	2
<b>Peak Hour Person Trips</b>			<b>11</b>	<b>24</b>	<b>35</b>	<b>20</b>	<b>15</b>	<b>35</b>

From the previous table, the development is estimated to generate 35 person trips (including 17 vehicle trips) during the AM and PM peak hours.

## 5.2 Background Traffic

### 5.2.1 Other Area Developments

The City of Ottawa Development Application Search Tool identifies the following other area developments in proximity of the subject site. Relevant excerpts from other area development traffic reports are included in **Appendix F**.

#### 706-714 March Road

Development of a 4,165 m<sup>2</sup> GFA supermarket, 350 m<sup>2</sup> GFA fast-food restaurant with drive-through, and 1,500 m<sup>2</sup> GFA of multi-unit commercial space. The TIA identified a buildout year of 2023. Traffic generated by this development has been added to the 2024 background traffic volumes.

#### 788 March Road

Development of a 92 apartment dwellings. The TIA identified a buildout year of 2023. Traffic generated by this development has been added to the 2024 background traffic volumes.

#### 910 March Road

Development of a 1,835 m<sup>2</sup> hardware store, a 234 m<sup>2</sup> restaurant with drive-through, a 191 m<sup>2</sup> coffee shop with drive-through, a 416 m<sup>2</sup> retail store, and a 249 m<sup>2</sup> gas bar. The TIA identified a buildout year of 2022. Traffic generated by this development has been added to the 2024 background traffic volumes.

## 2 SCOPING

### 2.1 SCREENING FORM

The completed Screening Form is provided in **Appendix B**.

### 2.2 DESCRIPTION OF PROPOSED DEVELOPMENT

This Transportation Impact Assessment (TIA) has been prepared in support of the Site Plan Control Application for the proposed development at 415 Legget Drive and 2700 Solandt Road. The site is currently occupied by a two-storey general office building (9,600 m<sup>2</sup>) with a large parking lot. The site area is 72,860 m<sup>2</sup> and is located at the northeast corner of the Legget Drive and Solandt Road intersection.

The redevelopment of the site is split into two (2) phases. Phase 1 includes the change of use from existing office and building to 2-storey warehousing occupancy. A partial removal of the second storey is proposed which will reduce the overall GFA of the building to approximately 14,350 m<sup>2</sup>.

The proposed development of Phase 2 will include the construction of two warehouse buildings. Proposed building 'A' and Proposed Building 'B' (combined GFA of 18,580 m<sup>2</sup>) will be constructed within the existing parking lot.

The property contains two access points along Legget Drive, and a third along Solandt Road about 150 m north of the intersection of Legget Drive and Solandt Road. All existing site accesses will remain as the access/egress points to the proposed development.

The property is currently zoned as a Business Park Industrial Zone Subzone 6 (IP-6). **Figure 2-1** illustrates the Study Area Context. The development information, as stated in the draft site plan attached as **Appendix C**, states that 152 surface level parking spaces will be provided.

The new warehouse buildings will be built with an estimated date of completion in 2022 and full occupancy in mid 2023.



**Figure 2-1. Area Context Plan**



Figure 3-1. Vehicle Trips Generated by Development

## 1.0 INTRODUCTION

This Transportation Impact Assessment has been prepared in support of Site Plan Control and Zoning By-Law Amendment applications for the property located at 2707 Solandt Road. The site is currently vacant.

The subject site is surrounded by the following:

- The Marshes Golf Club to the north and east;
- Solandt Road, followed by offices to the south;
- Offices, followed by Legget Drive to the west.

A view of the subject site is provided in **Figure 1**.

## 2.0 PROPOSED DEVELOPMENT

The proposed development will include an 8-storey, 198,615 ft<sup>2</sup> office building at 2707 Solandt Road, and will connect to the existing parking lot located at 2505 Solandt Road. As the parking lot at 2505 Solandt Road was previously approved in 2009 (SP D07-12-06-007), the Site Plan and re-zoning applications relate to the 2707 Solandt Road property only. A total of 587 parking spaces will be provided on the two sites combined. Access to the proposed development will be provided via two existing driveways to the parking lot at 2505 Solandt Road and two new driveways to 2707 Solandt Road. It is anticipated that the proposed development may be constructed in a single phase, with full occupancy in 2021.

The proposed development is designated as 'Urban Employment Area' in Schedule B of the City of Ottawa's Official Plan. The implemented zoning for the subject site is 'Business Park Industrial Zone (Kanata North Business Park)' (IP6). The proposed development is permitted under the implemented zoning, however a Zoning By-Law Amendment is required to seek relief of the current height limit of 22m.

A copy of the concept plan is included in **Appendix A**.

## 3.0 SCREENING

The City's 2017 TIA Guidelines identify three triggers for completing a TIA report, including trip generation, location, and safety. The criteria for each trigger are outlined in the City's TIA Screening Form. A copy of the TIA Screening Form is included in **Appendix B**. The trigger results are as follows:

- Trip Generation Trigger – The development is anticipated to generate over 60 peak hour person trips; further assessment is required based on this trigger.
- Location Triggers – The development is not located within a Design Priority Area or Transit-Oriented Development zone, and does not propose a new driveway to a boundary street designated as part of the City's Rapid Transit, Transit Priority, or Spine Cycling networks; further assessment is not required based on this trigger.
- Safety Triggers – No safety triggers outlined in the TIA Screening Form are met; further assessment is not required based on this trigger.

Figure 1: View of the Subject Site

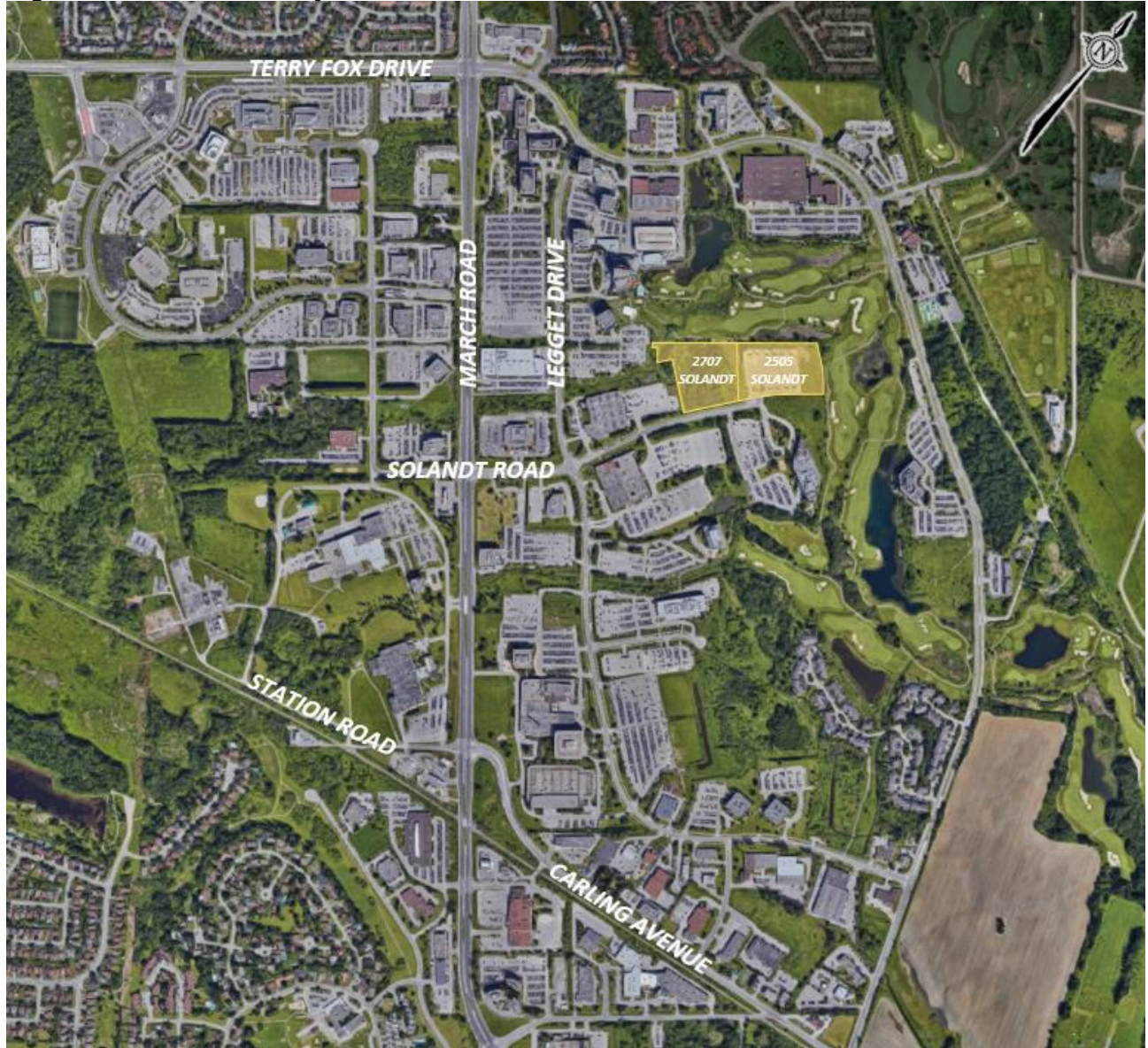
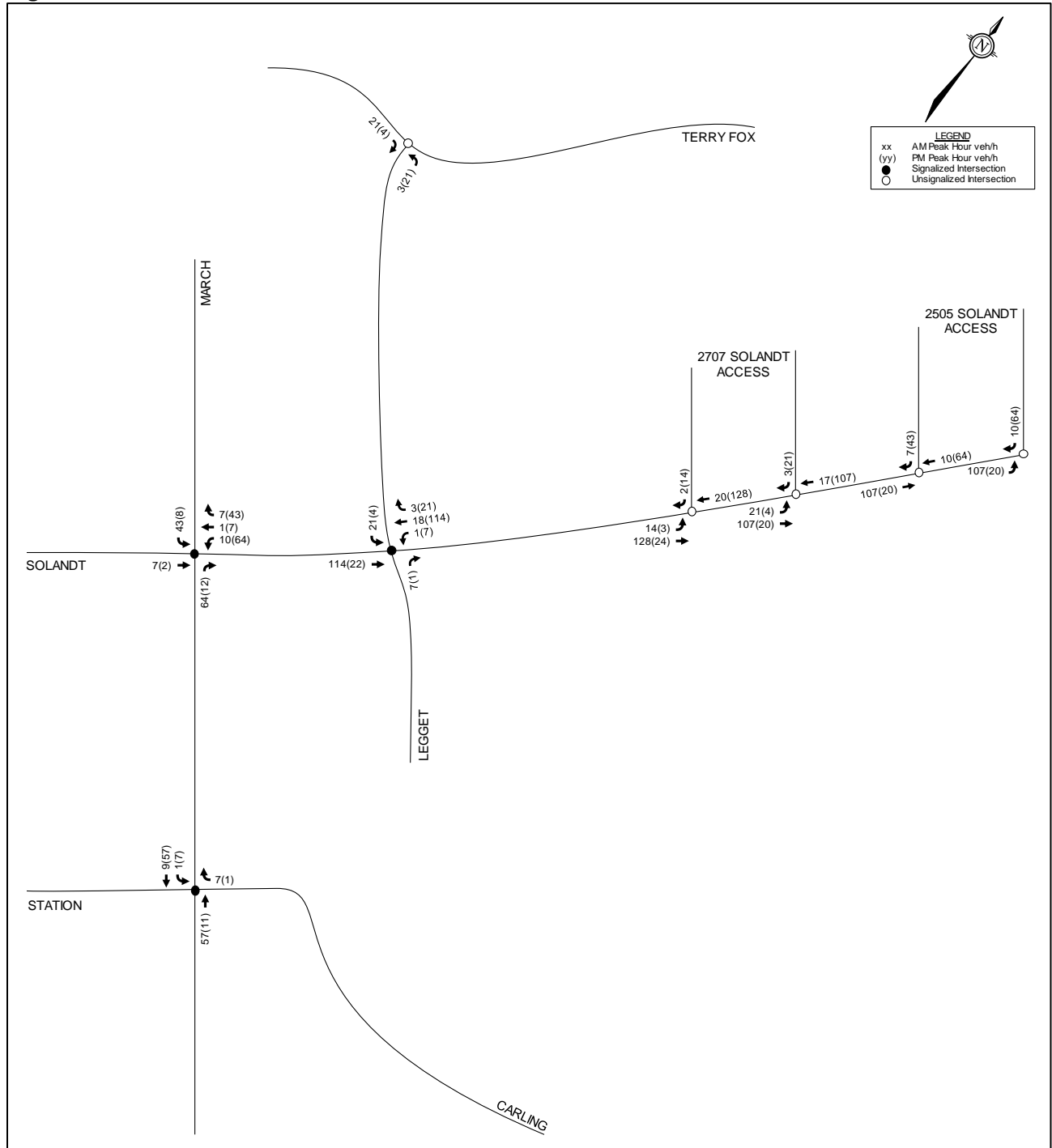

Figure 6: Site-Generated Traffic



## 1. Step 1 – Screening Form

With respect to the City of Ottawa's 2017 Transportation Impact Assessment (TIA) Guidelines, the proposed development (described below in Section 2.1) triggered the trip generation and the safety criteria outlined in the City's TIA Step 1 – Screening form. However, based on the location of the proposed development, the location trigger was not met. As only one of three triggers are required, a formal TIA (i.e. completed Steps 1-5) must accompany the subject development application.

## 2. Step 2 – Scoping

### 2.1 Description of Proposed Development

Based on the information provided, it is our understanding that the proponent is proposing a new office building located at 3026 Solandt Road, which is located on a vacant parcel of land that was previously occupied by a similar land use in 2014 (i.e. an office building existed on the subject parcel of land and has since been demolished). The new office building being proposed includes approximately 100,000 ft<sup>2</sup> of total floor area, accompanied by approximately 350 new parking spaces. The proposed development will be built in a single phase with an anticipated buildout year in 2021.

The latest Site Plan shows two direct vehicle driveway connections to Solandt Road, with inter-site connectivity between adjacent land uses to two other driveway connections (i.e. there will be a shared driveway connection to Legget Drive and March Road). All these driveways currently exist and are proposed to be maintained, with the exception of the west driveway connection to Solandt Road is proposed to be relocated towards the east and will function as one-way inbound only. It should be noted that the driveway connections to Solandt Road are currently barricaded.

In the event that inter-site connectivity between adjacent land uses is severed, it has been assumed that all site-generated traffic for the subject development will be assigned to the driveway connections to Solandt Road only. This is considered to be a conservative assumption as the available shared driveway connections to Legget Drive and March Road can provide additional capacity.

The local context of the subject site is provided as **Figure 1** and the proposed Concept Plan is provided as **Figure 2**.



Figure 1: Local Context



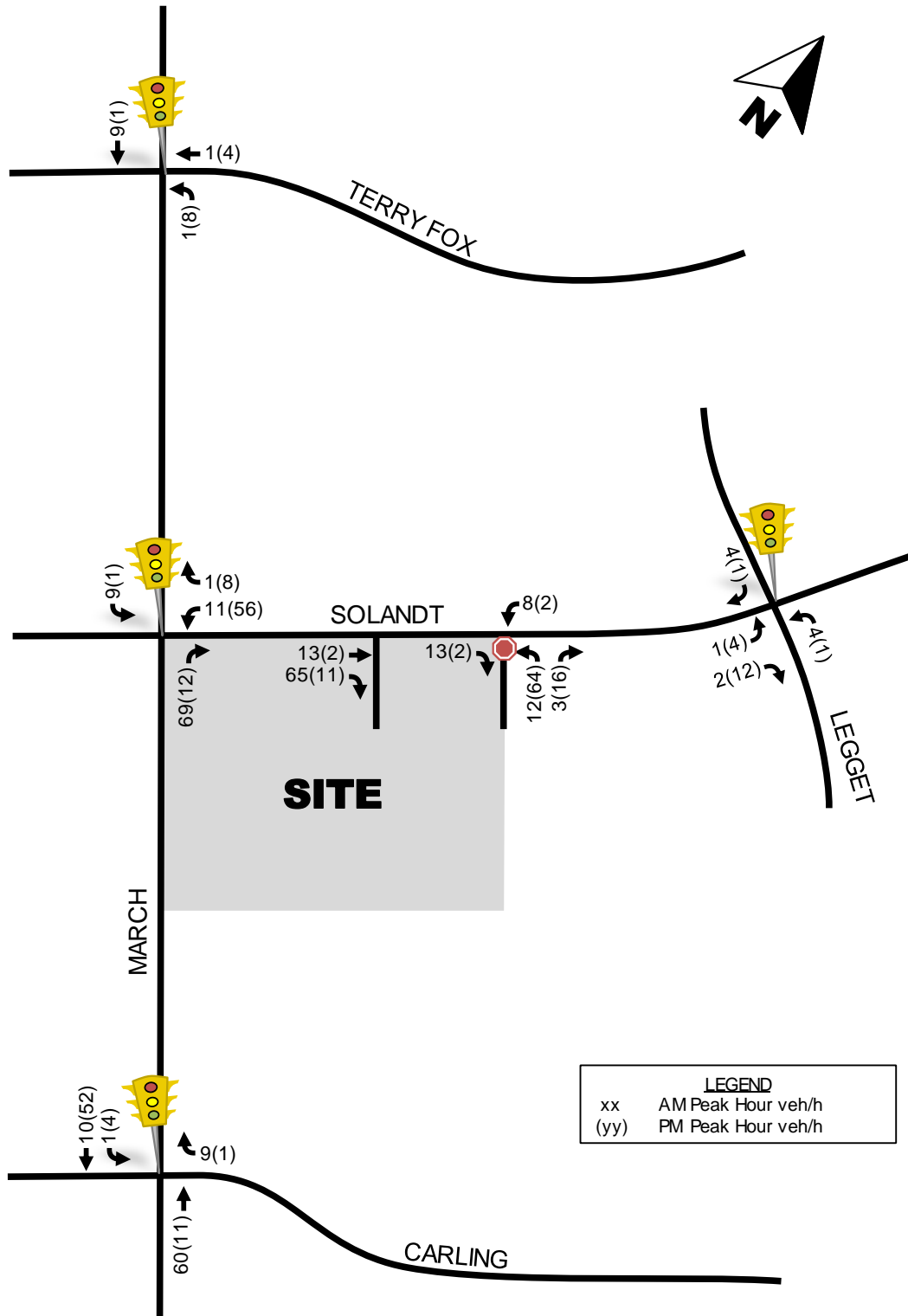
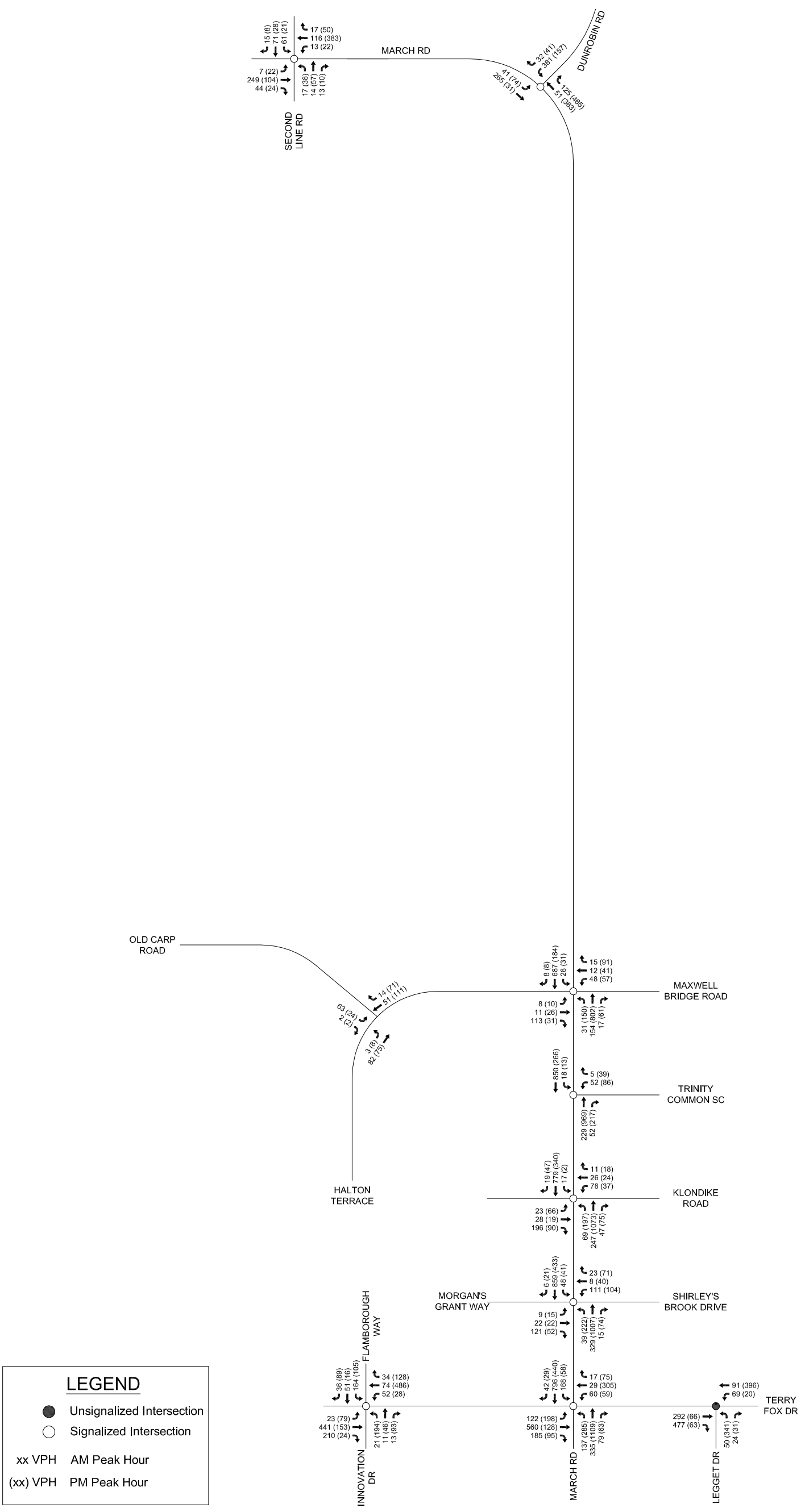

Figure 7: Projected Site-Generated Traffic

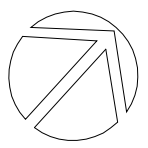

Figure 35 – Demonstration Plan

M:\2012\112117\CAD\Design\Figures\Traffic\FINAL\Traffic Figures.dwg, 2026 BACKGROUND, Mar 28, 2016 - 3:07pm, bbyvelids



**KANATA NORTH**  
COMMUNITY DESIGN PLAN



DATE JUN 2016 JOB 112117  
SCALE N.T.S.

**FIGURE NO. 11**  
2026 BACKGROUND  
TRAFFIC VOLUMES



Engineers, Planners & Landscape Architects

M:\2012\112117\CAD\Design\Figures\Traffic\FINAL\Traffic Figures.dwg, 2026 TOTAL, Mar 28, 2016 - 3:07pm, bbyvelds

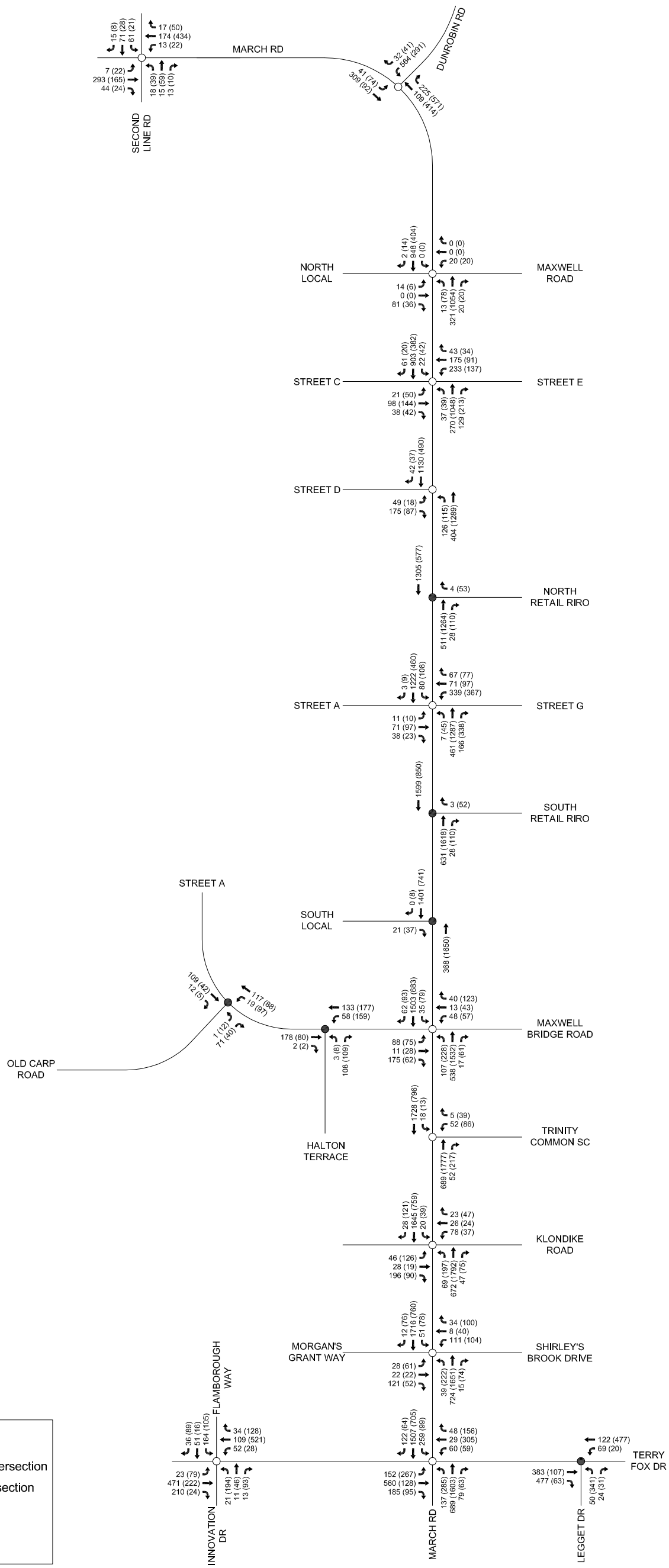

**KANATA NORTH**  
COMMUNITY DESIGN PLAN

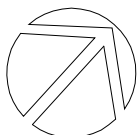

DATE JUN 2016 JOB 112117  
SCALE N.T.S.

**FIGURE NO. 36**  
2026 TOTAL TRAFFIC VOLUMES



Engineers, Planners & Landscape Architects

## **APPENDIX H**

---

### Strategic Long-Range Model Snapshots

# TRANS Regional Model

Version 2.15 - Assigned June 16, 2020

## AM Peak Hour Total Traffic Volume

### Shirley's Brook - Kanata

2011 Model - Basecase

N/A

User Initials: KN

Plot Prepared: Aug 5, 2022

EMME Scenario: 21713



## Legend

AM Peak Hour Total Traffic Volume

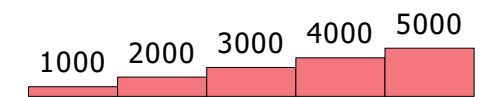

Distance (m)

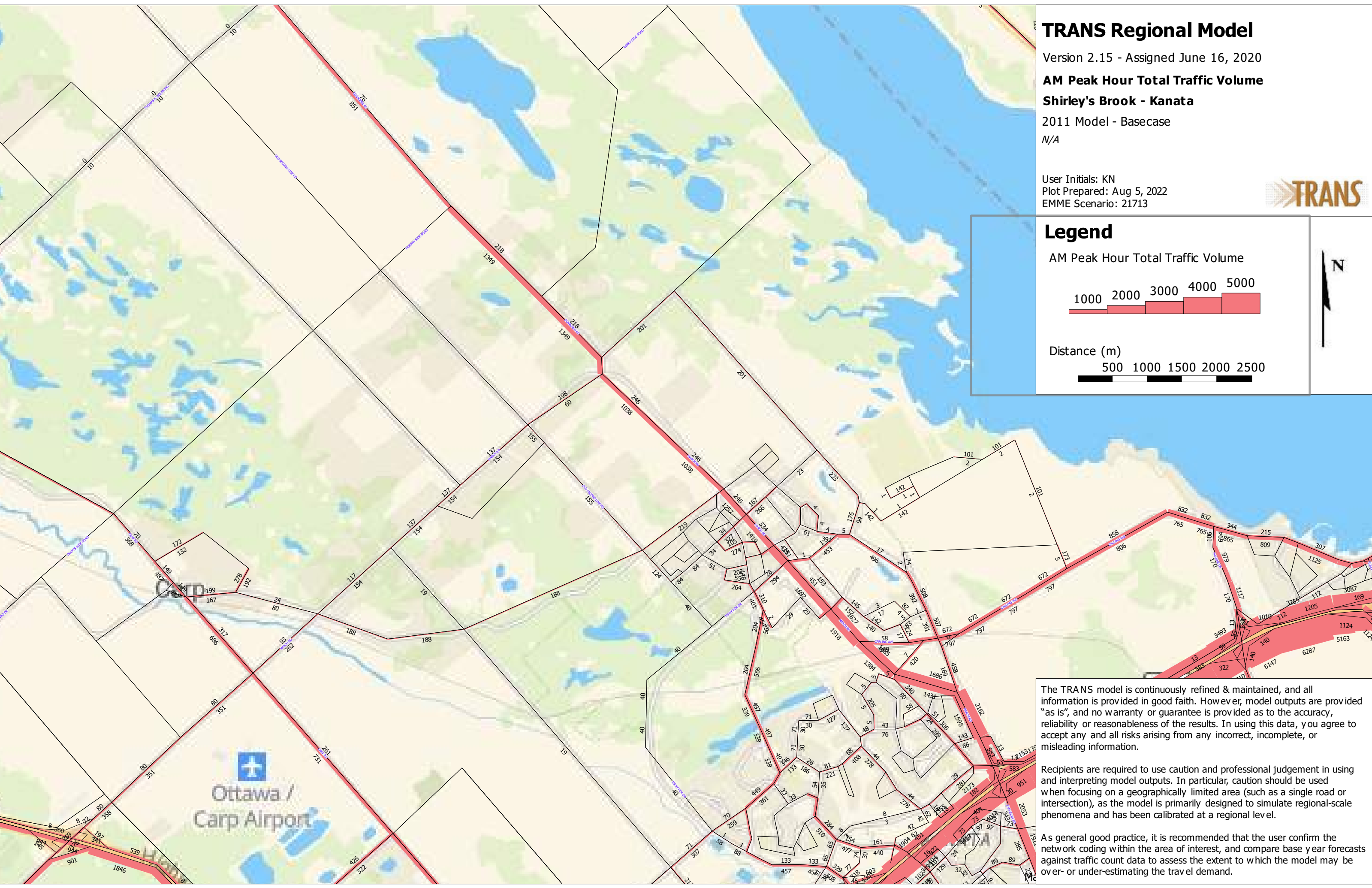
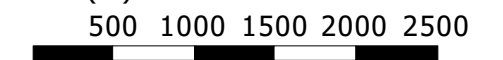

The TRANS model is continuously refined & maintained, and all information is provided in good faith. However, model outputs are provided "as is", and no warranty or guarantee is provided as to the accuracy, reliability or reasonableness of the results. In using this data, you agree to accept any and all risks arising from any incorrect, incomplete, or misleading information.

Recipients are required to use caution and professional judgement in using and interpreting model outputs. In particular, caution should be used when focusing on a geographically limited area (such as a single road or intersection), as the model is primarily designed to simulate regional-scale phenomena and has been calibrated at a regional level.

As general good practice, it is recommended that the user confirm the network coding within the area of interest, and compare base year forecasts against traffic count data to assess the extent to which the model may be over- or under-estimating the travel demand.

# TRANS Regional Model

Version 2.15 - Assigned June 16, 2020

## AM Peak Hour Total Traffic Volume

### Shirley's Brook - Kanata

2031 Model - Basecase

N/A

User Initials: KN

Plot Prepared: Aug 5, 2022

EMME Scenario: 21715



## Legend

AM Peak Hour Total Traffic Volume

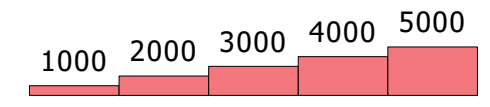

Distance (m)

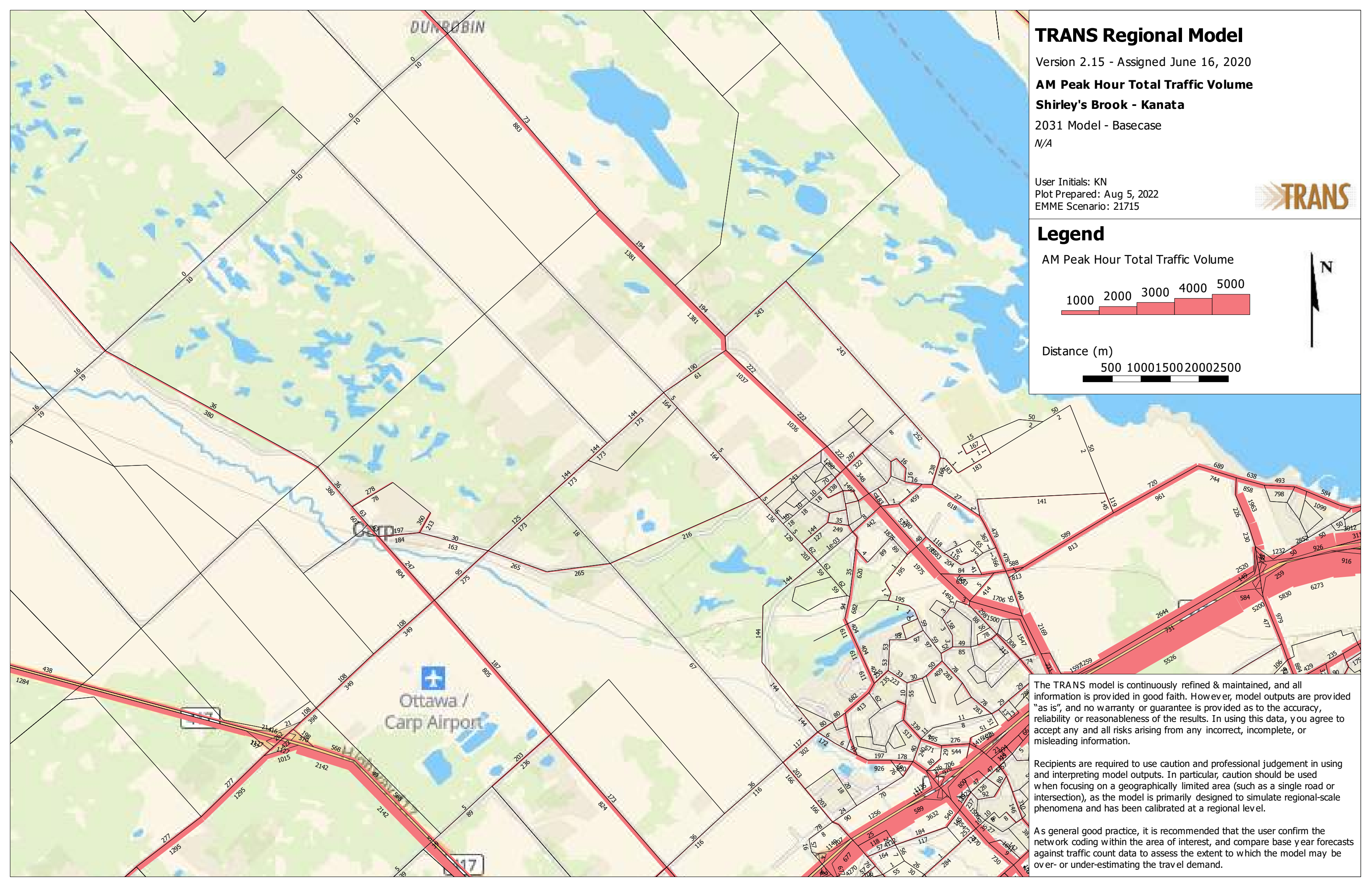
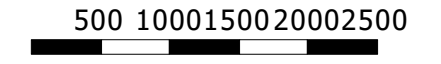

The TRANS model is continuously refined & maintained, and all information is provided in good faith. However, model outputs are provided "as is", and no warranty or guarantee is provided as to the accuracy, reliability or reasonableness of the results. In using this data, you agree to accept any and all risks arising from any incorrect, incomplete, or misleading information.

Recipients are required to use caution and professional judgement in using and interpreting model outputs. In particular, caution should be used when focusing on a geographically limited area (such as a single road or intersection), as the model is primarily designed to simulate regional-scale phenomena and has been calibrated at a regional level.

As general good practice, it is recommended that the user confirm the network coding within the area of interest, and compare base year forecasts against traffic count data to assess the extent to which the model may be over- or under-estimating the travel demand.

## **APPENDIX I**

---

### Future March Road Transitway Functional Design



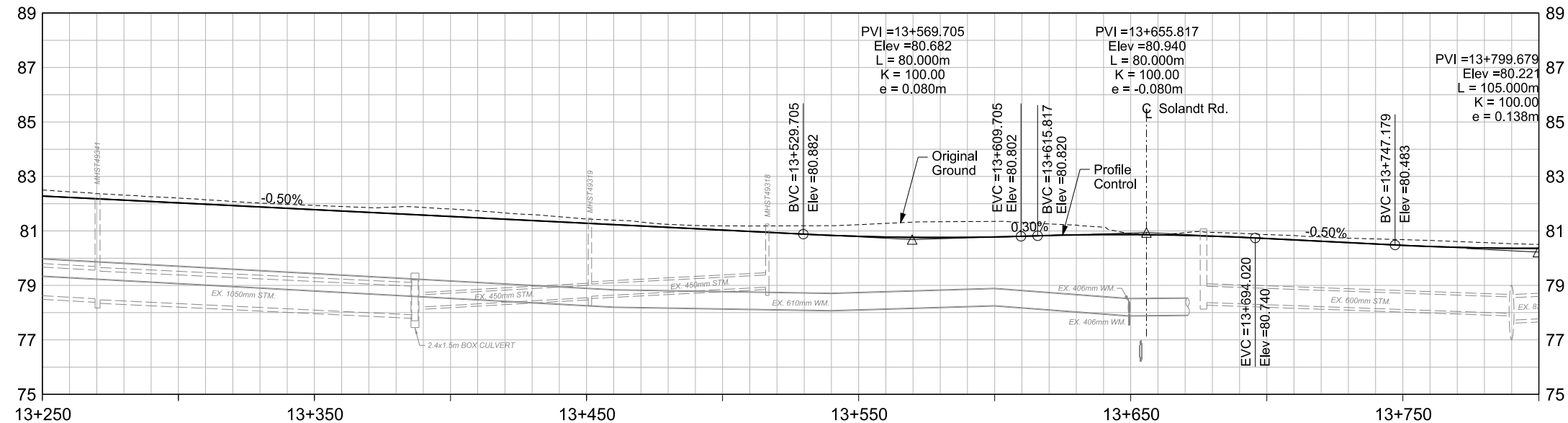
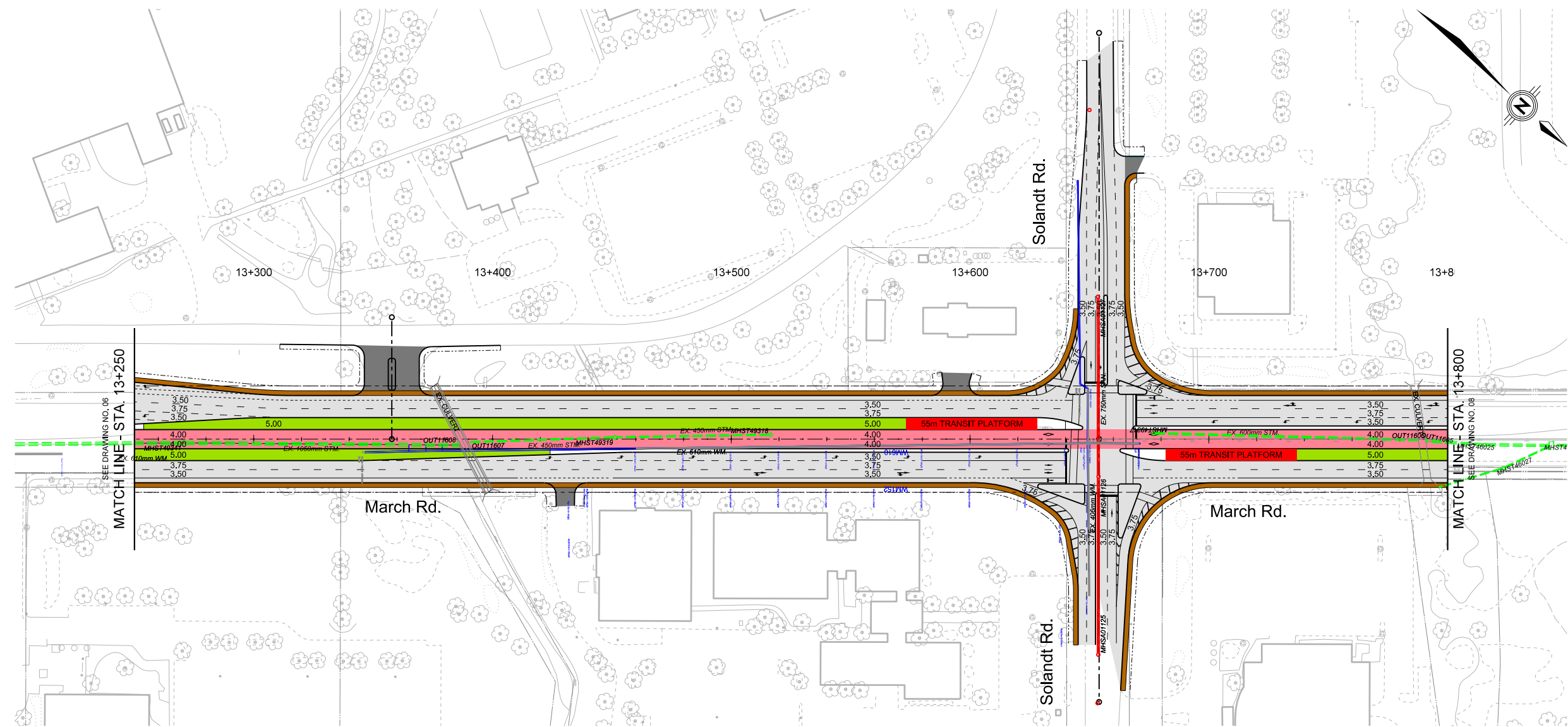

NOTES:  
 1. DURING DETAILED DESIGN STAGE SEGREGATED BICYCLE FACILITY WILL BE DESIGNED ALONG THE CORRIDOR AND THROUGH THE INTERSECTION.  
 2. METHODOLOGY FOR DETERMINING THE RIGHT OF WAY (ROW): MARCH ROAD - CORKSTOWN ROAD TO OLD CARP ROAD  
 -PROPERTY FOR THE TRANSITWAY FOR THE MOST PART IS INCLUDED WITHIN THE EXISTING MARCH ROAD ROW.  
 -PROPERTY ACQUISITION REQUIRED ON BOTH SIDES OF WIDENING.  
 -ROW SET TO FOOTPRINT OF TRANSITWAY PLUS 4.0m.  
 -THE EXACT OWNERSHIP WILL BE DETERMINED DURING DETAILED DESIGN.  
 SOUTH OF CORKSTOWN ROAD/MARCH ROAD STATION/WEST TRANSITWAY CONNECTION  
 -ROW SET TO FOOTPRINT OF TRANSITWAY PLUS 4.0m.  
 -THE EXACT OWNERSHIP WILL BE DETERMINED DURING DETAILED DESIGN.

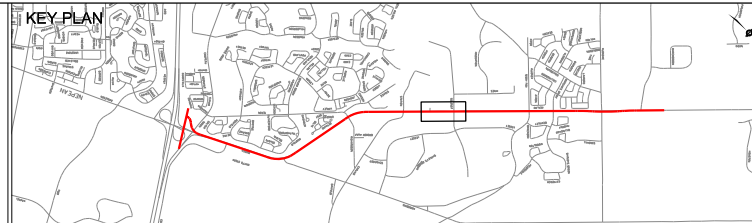

LEGEND:

	TRANSIT STATION		TRANSIT CENTRELINE
	TRANSIT LANES		PROPOSED RIGHT-OF-WAY
	TRAFFIC LANES		STRUCTURE OUTLINE
	SIDEWALK		PEDESTRIAN BRIDGE
	EDGE OF PAVEMENT		BRIDGE ACCESS POINT SEE SHEET 13

Date: SEPTEMBER 26 2012  
 Project Manager: DAH  
 Scale: 0m 10 20 40 60  
 HORIZONTAL  
 2 4 6  
 VERTICAL

**Kanata North Transitway**  
 (Hwy 417/Egleson-March Road to North of Maxwell Bridge Road)

Designed By: MDR / RRG	Drawn By: MB / RRG
Discipline Engineer: DAH	Checked By: RRG

CAD File Name: TO3065TOD-2.0-007.DGN  
 Plot Date: 30/09/2013  
 Drawings No.:  
 Revision: 01  
 Sheet No.: 07

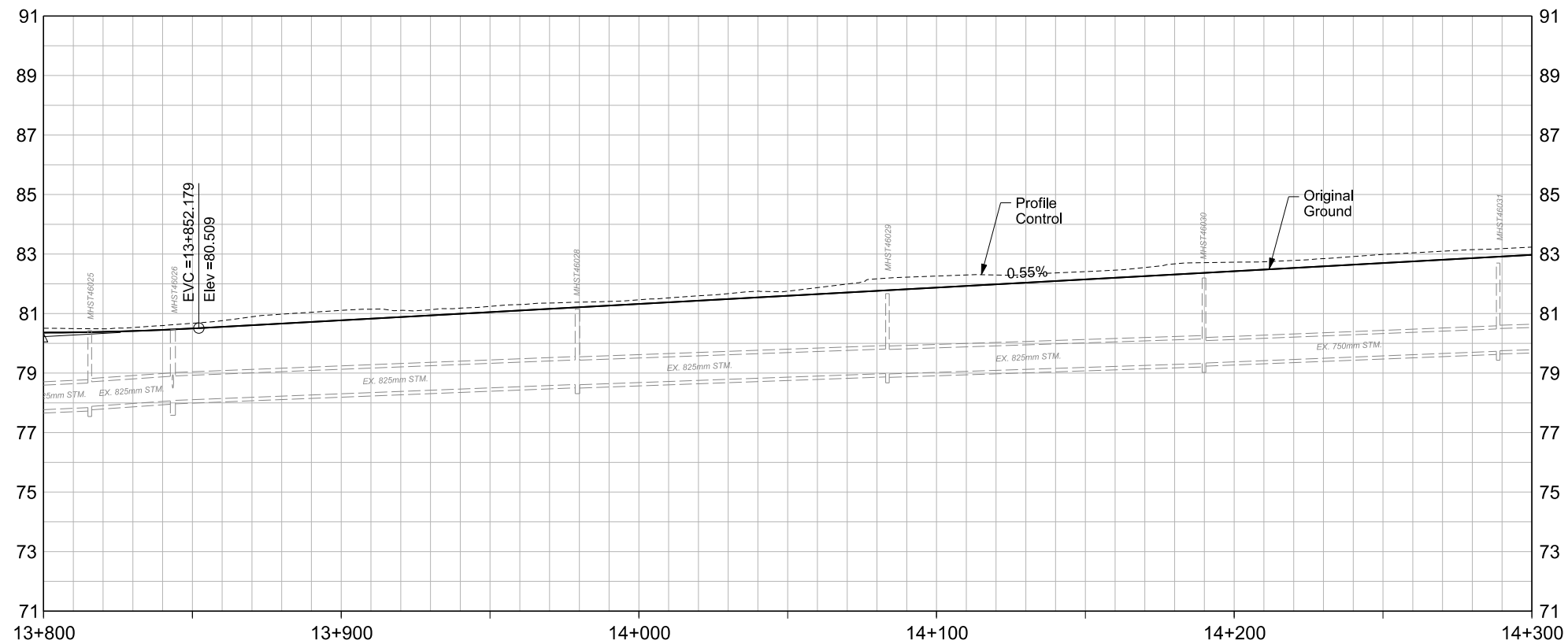
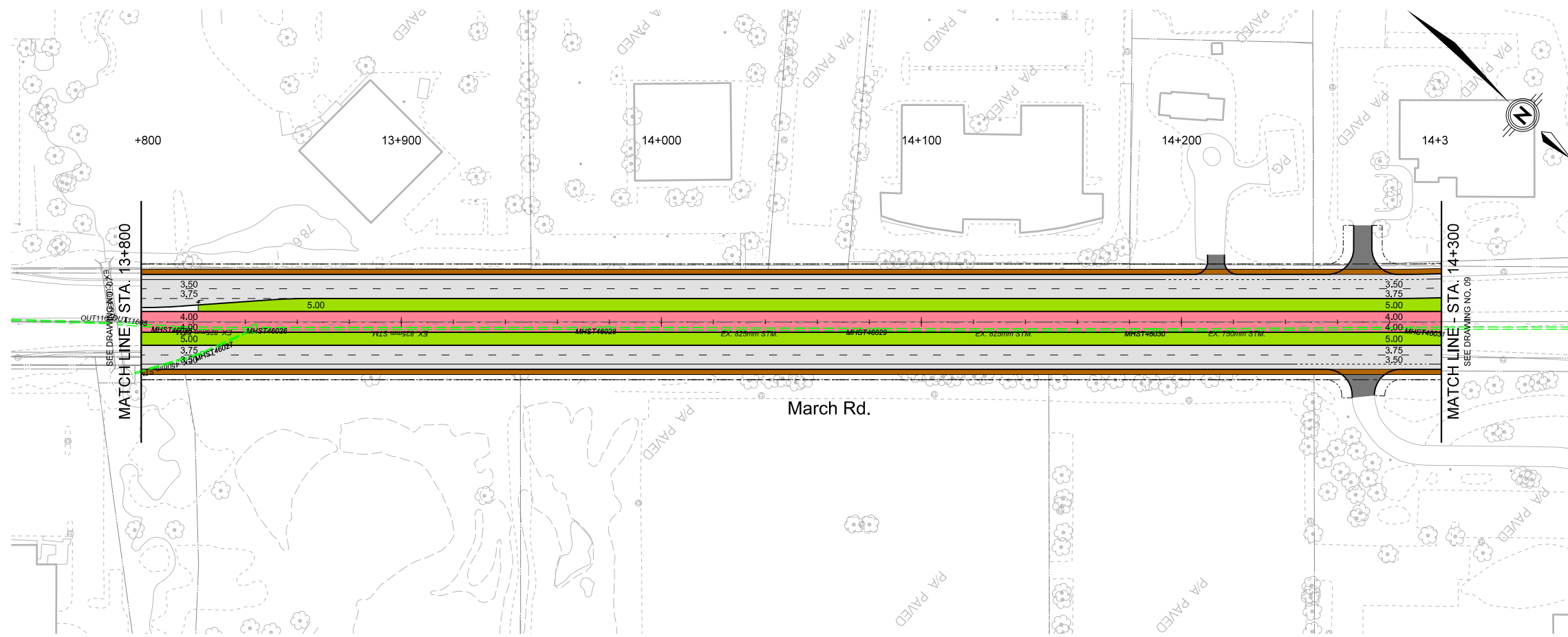

**NOTES:**  
 1. DURING DETAILED DESIGN STAGE SEGREGATED BICYCLE FACILITY WILL BE DESIGNED ALONG THE CORRIDOR AND THROUGH THE INTERSECTION.  
 2. METHODOLOGY FOR DETERMINING THE RIGHT OF WAY (ROW): MARCH ROAD - CORKSTOWN ROAD TO OLD CARP ROAD  
 -PROPERTY FOR THE TRANSITWAY FOR THE MOST PART IS INCLUDED WITHIN THE EXISTING MARCH ROAD ROW.  
 -PROPERTY ACQUISITION REQUIRED ON BOTH SIDES OF WIDENING.  
 -ROW SET TO FOOTPRINT OF TRANSITWAY PLUS 4.0m.  
 -THE EXACT OWNERSHIP WILL BE DETERMINED DURING DETAILED DESIGN.  
 SOUTH OF CORKSTOWN ROAD/MARCH ROAD STATION/WEST TRANSITWAY CONNECTION  
 -ROW SET TO FOOTPRINT OF TRANSITWAY PLUS 4.0m.  
 -THE EXACT OWNERSHIP WILL BE DETERMINED DURING DETAILED DESIGN.

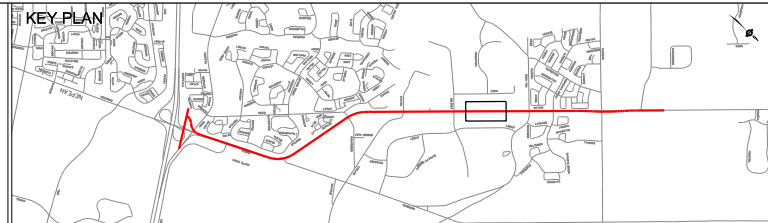

**LEGEND:**

	TRANSIT STATION		TRANSIT CENTRELINE
	TRANSIT LANES		PROPOSED RIGHT-OF-WAY
	TRAFFIC LANES		STRUCTURE OUTLINE
	SIDEWALK		PEDESTRIAN BRIDGE
	EDGE OF PAVEMENT		BRIDGE ACCESS POINT SEE SHEET 13

**Delcan**

Date: SEPTEMBER 26 2012	Designed By: MDR / RRG	Drawn By: MB / RRG
Project Manager: DAH	Discipline Engineer: DAH	Checked By: RRG

Scale:

CAD File Name: T03065TOD-2-0-008.DGN | Plot Date: 30/09/2013

**Ottawa**

**Kanata North Transitway**  
 (Hwy 417/Egleson-March Road to North of Maxwell Bridge Road)

Drawings No. 2 | Revision 01 | Sheet No. 08

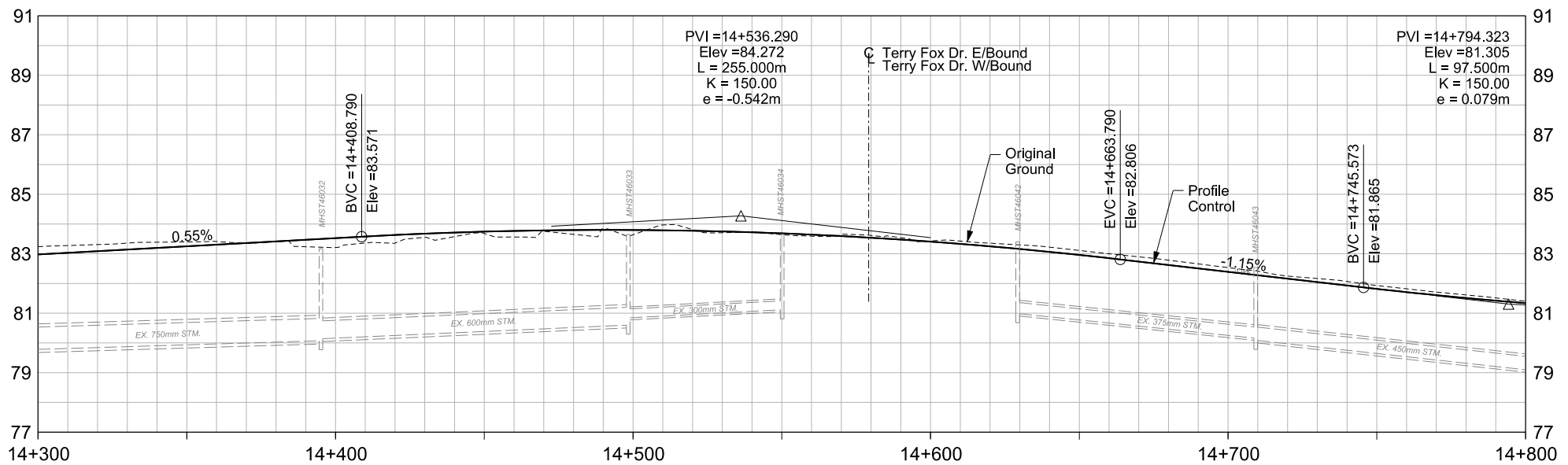
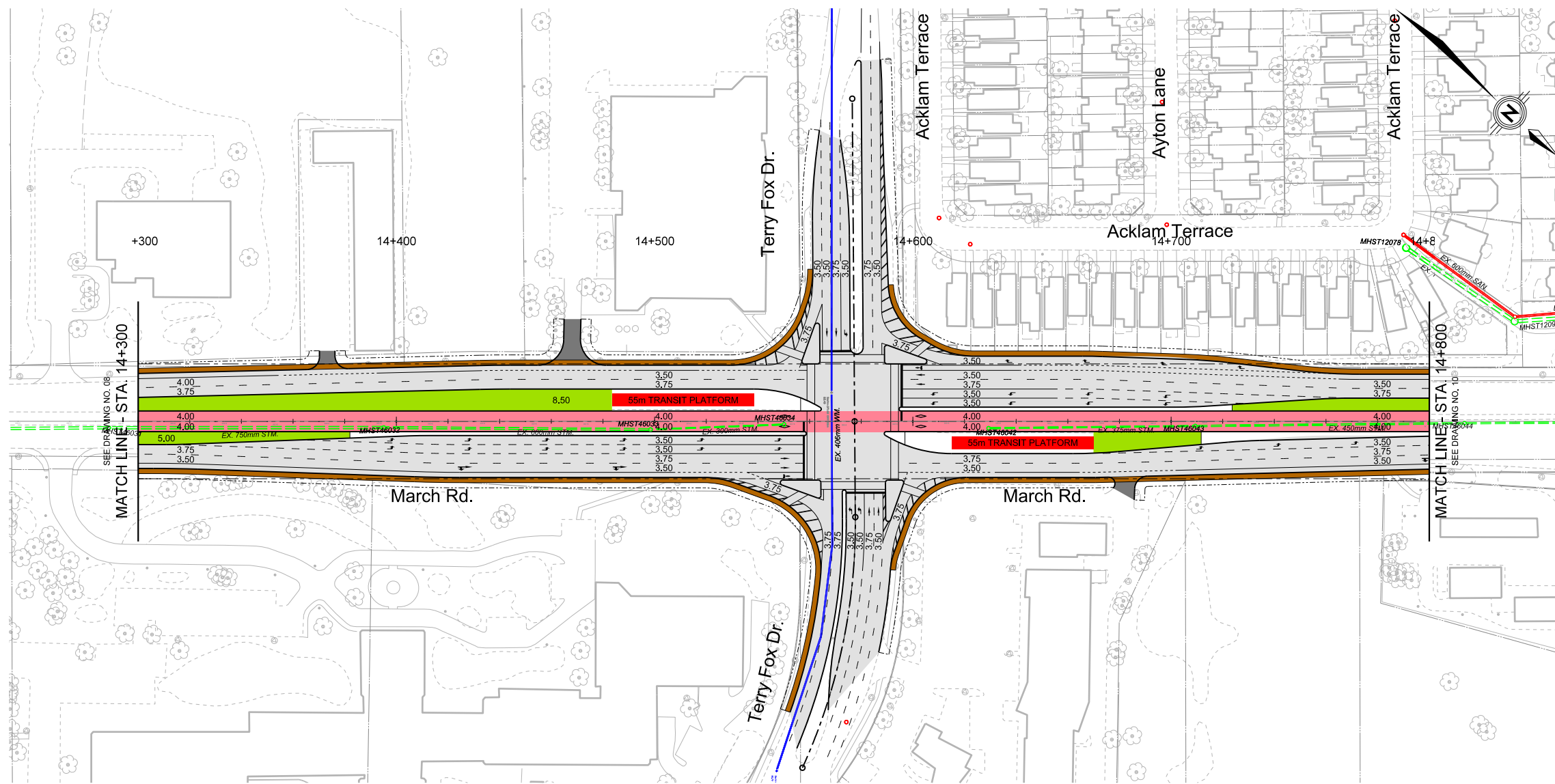

**NOTES:**  
 1. DURING DETAILED DESIGN STAGE SEGREGATED BICYCLE FACILITY WILL BE DESIGNED ALONG THE CORRIDOR AND THROUGH THE INTERSECTION.  
 2. METHODOLOGY FOR DETERMINING THE RIGHT OF WAY (ROW): MARCH ROAD - CORKSTOWN ROAD TO OLD CARP ROAD  
 -PROPERTY FOR THE TRANSITWAY FOR THE MOST PART IS INCLUDED WITHIN THE EXISTING MARCH ROAD ROW.  
 -PROPERTY ACQUISITION REQUIRED ON BOTH SIDES OF WIDENING.  
 -ROW SET TO FOOTPRINT OF TRANSITWAY PLUS 4.0m.  
 -THE EXACT OWNERSHIP WILL BE DETERMINED DURING DETAILED DESIGN.  
 SOUTH OF CORKSTOWN ROAD/MARCH ROAD STATION/WEST TRANSITWAY CONNECTION  
 -ROW SET TO FOOTPRINT OF TRANSITWAY PLUS 4.0m.  
 -THE EXACT OWNERSHIP WILL BE DETERMINED DURING DETAILED DESIGN.

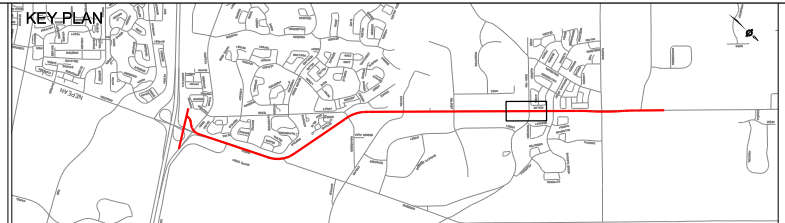

**LEGEND:**

	TRANSIT STATION		TRANSIT CENTRELINE
	TRANSIT LANES		PROPOSED RIGHT-OF-WAY
	TRAFFIC LANES		STRUCTURE OUTLINE
	SIDEWALK		PEDESTRIAN BRIDGE
	EDGE OF PAVEMENT		BRIDGE ACCESS POINT SEE SHEET 13

**Delcan**

Date: SEPTEMBER 26 2012	Designed By: MDR / RRG	Drawn By: MB / RRG
Project Manager: DAH	Discipline Engineer: DAH	Checked By: RRG

Scale: 0m 10 20 40 60  
 HORIZONTAL 1" = 40m  
 VERTICAL 1" = 4m

CAD File Name: TO3065TOD-2.0-009.DGN  
 Plot Date: 30/09/2013

**Ottawa**

**Kanata North Transitway**  
 (Hwy 417/Egleson-March Road to North of Maxwell Bridge Road)

Drawings No. 2  
 Revision 01  
 Sheet No. 09

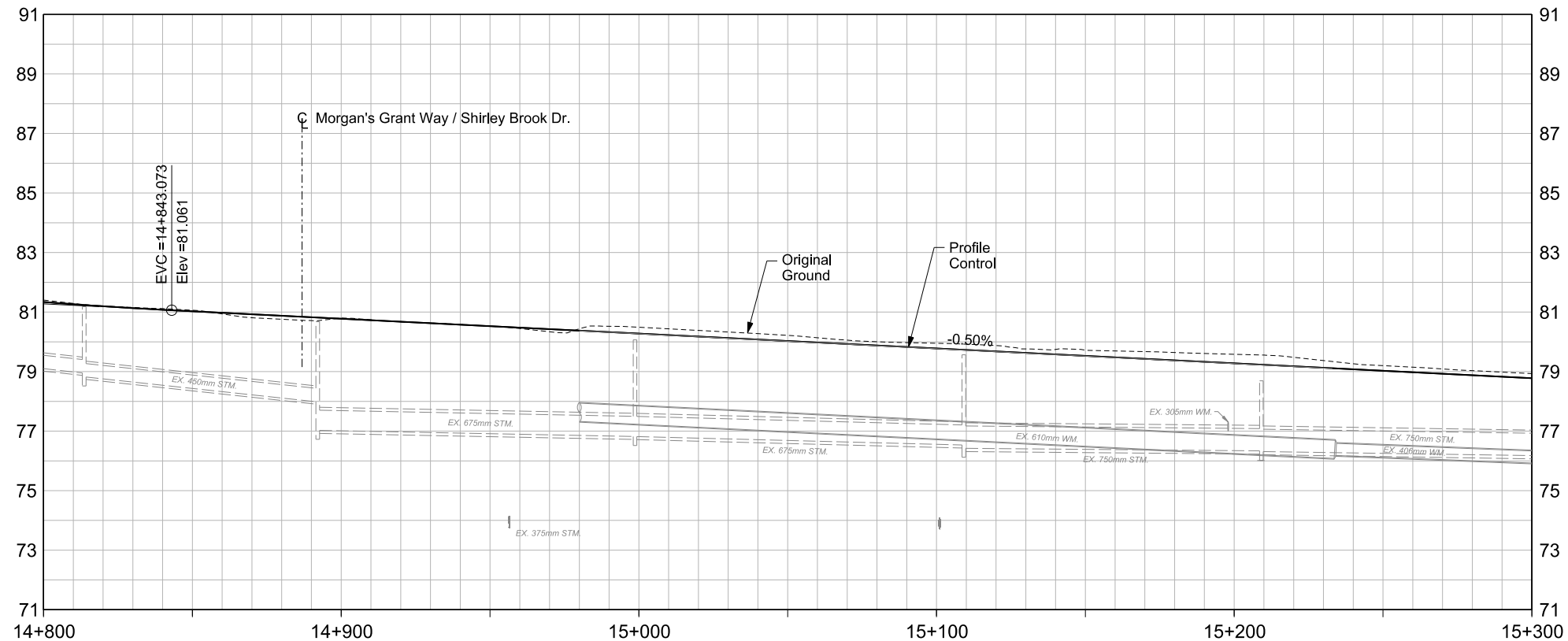
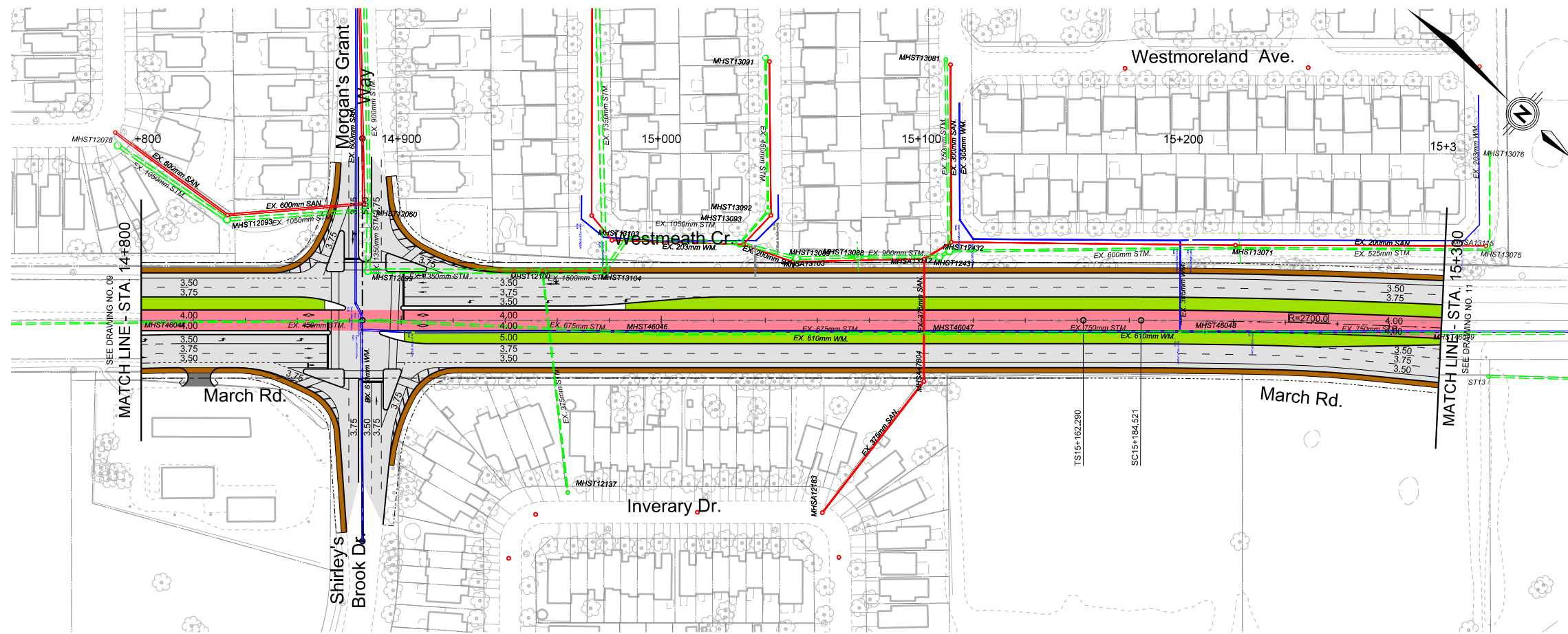

NOTES:  
 1. DURING DETAILED DESIGN STAGE SEGREGATED BICYCLE FACILITY WILL BE DESIGNED ALONG THE CORRIDOR AND THROUGH THE INTERSECTION.  
 2. METHODOLOGY FOR DETERMINING THE RIGHT OF WAY (ROW): MARCH ROAD - CORKSTOWN ROAD TO OLD CARP ROAD  
 -PROPERTY FOR THE TRANSITWAY FOR THE MOST PART IS INCLUDED WITHIN THE EXISTING MARCH ROAD ROW.  
 -PROPERTY ACQUISITION REQUIRED ON BOTH SIDES OF WIDENING.  
 -ROW SET TO FOOTPRINT OF TRANSITWAY PLUS 4.0m.  
 -THE EXACT OWNERSHIP WILL BE DETERMINED DURING DETAILED DESIGN.  
 SOUTH OF CORKSTOWN ROAD/MARCH ROAD STATION/WEST TRANSITWAY CONNECTION  
 -ROW SET TO FOOTPRINT OF TRANSITWAY PLUS 4.0m.  
 -THE EXACT OWNERSHIP WILL BE DETERMINED DURING DETAILED DESIGN.

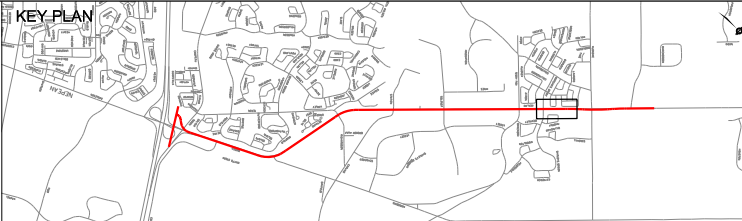

LEGEND:

	TRANSIT STATION		TRANSIT CENTRELINE
	TRANSIT LANES		PROPOSED RIGHT-OF-WAY
	TRAFFIC LANES		STRUCTURE OUTLINE
	SIDEWALK		PEDESTRIAN BRIDGE
	EDGE OF PAVEMENT		BRIDGE ACCESS POINT SEE SHEET 13

**Delcan**

Date: SEPTEMBER 26 2012	Designed By: MDR / RRG	Drawn By: MB / RRG
Project Manager: DAH	Discipline Engineer: DAH	Checked By: RRG

Scale:

CAD File Name: T03065TOD-2.0-010.DGN Plot Date: 30/09/2013

**Ottawa**

**Kanata North Transitway**  
 (Hwy 417/Egleson-March Road to North of Maxwell Bridge Road)

Drawings No. 2  
 Revision 01 Sheet No. 10

## **APPENDIX J**

---

### Signal Timing Plans

# Traffic Signal Timing

City of Ottawa, Public Works Department

Traffic Signal Operations Unit

<b>Intersection:</b>	<u>Main:</u> March	<u>Side:</u>	Morgans Grant / Shirleys Brook
<b>Controller:</b>	<u>ATC3</u>	<b>TSD:</b>	<u>5767</u>
<b>Author:</b>	<u>Matthew Anderson</u>	<b>Date:</b>	<u>28-Jul-2022</u>

## Existing Timing Plans<sup>†</sup>

	Plan					Ped Minimum Time		
	AM Peak 1	Off Peak 2	PM Peak 3	Night 4	PM Heavy 13	Walk	DW	A+R
<b>Cycle</b>	130	110	120	95	130			
<b>Offset</b>	95	90	89	X	105			
NB Thru	70	51	61	41	70	7	11	4.6+1.5
SB Thru	70	51	61	41	70	7	11	4.6+1.5
EB Thru	39	39	39	39	39	7	24	3.0+4.5
WB Thru	39	39	39	39	39	7	24	3.0+4.5
NB Left (fp)	21	20	20	15	21	-	-	4.6+1.8
SB Left (fp)	21	20	20	15	21	-	-	4.6+1.8

## Phasing Sequence<sup>‡</sup>

Plan: All

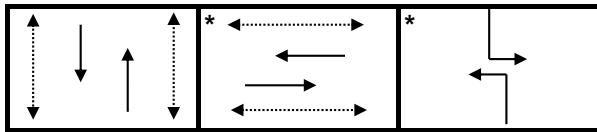

**Notes:** 1) If the EW pedestrian phase is not actuated, the EW phases will force off after 28s

## Schedule

### Weekday

Time	Plan
0:10	4
6:30	1
9:30	2
15:00	3
16:30	13
18:00	3
18:30	2
23:00	4

### Weekend

Time	Plan
0:10	4
8:00	2
22:00	4

### Sunday

Time	Plan
0:10	4
8:00	2
22:00	4

## Notes

†: Time for each direction includes amber and all red intervals  
 ‡: Start of first phase should be used as reference point for offset  
 Asterisk (\*) Indicates actuated phase  
 (fp): Fully Protected Left Turn  
 ◀.....▶ Pedestrian signal

Cost is \$61.16 (\$54.12 + HST)

# Traffic Signal Timing

City of Ottawa, Transportation Services Department

Traffic Signal Operations Unit

<b>Intersection:</b>	<i>Main:</i> March	<i>Side:</i> Terry Fox
<b>Controller:</b>	<b>MS 3200</b>	<b>TSD: 5920</b>
<b>Author:</b>	Matthew Anderson	<b>Date:</b> 27-Jul-2021

## Existing Timing Plans†

	Plan					Ped Minimum Time		
	AM Peak 1	Off Peak 2	PM Peak 3	Night 4	PM Heavy 13	Walk	DW	A+R
<b>Cycle</b>	130	110	120	105	130			
<b>Offset</b>	114	80	72	X	96			
NB Thru	47	38	38	38	41	7	19	4.6+2.1
SB Thru	47	38	38	38	41	7	19	4.6+2.1
EB Left (fp)	16	15	19	13	24	-	-	3.7+3.1
WB Left (fp)	16	15	19	13	24	-	-	3.7+3.1
EB Thru	42	42	42	42	42	7	28	3.7+3.3
WB Thru	42	42	42	42	42	7	28	3.7+3.3
NB Left (fp)	25	15	21	12	23	-	-	4.6+2.3
SB Left (fp)	25	15	21	12	23	-	-	4.6+2.3

## Phasing Sequence‡

Plan: All

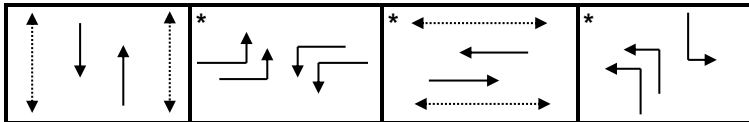

**Notes:** 1) If the EW Pedestrian phase is not actuated, the EW Thru phases will force off after 30s

## Schedule

### Weekday

Time	Plan
0:10	4
6:30	1
9:30	2
15:00	3
16:30	13
18:00	3
18:30	2
22:00	4

### Weekend

Time	Plan
0:10	4
8:00	2
22:00	4

## Notes

- †: Time for each direction includes amber and all red intervals
- ‡: Start of first phase should be used as reference point for offset
- Asterisk (\*) Indicates actuated phase
- (fp): Fully Protected Left Turn
- ◄.....► Pedestrian signal

Cost is \$59.96 (\$53.06 + HST)

# Traffic Signal Timing

City of Ottawa, Transportation Services Department

Traffic Signal Operations Unit

<b>Intersection:</b>	Main: March	<b>Side:</b>	Solandt
<b>Controller:</b>	MS-3200	<b>TSD:</b>	5359
<b>Author:</b>	Jean Nabolle	<b>Date:</b>	08-Jul-2019

## Existing Timing Plans†

	Plan					Ped Minimum Time		
	AM Peak 1	Off Peak 2	PM Peak 3	Night 4	PM Heavy 13	Walk	DW	A+R
<b>Cycle</b>	130	110	120	85	130			
<b>Offset</b>	15	16	21	X	30			
NB Thru	85	60	59	38	64	7	12	4.6 + 1.7
SB Thru	46	47	47	38	52	7	12	4.6 + 1.7
EB Left (fp)	13	18	29	16	34	-	-	3.3 + 2.6
WB Left (fp)	13	18	29	16	34	-	-	3.3 + 2.6
EB Thru	32	32	32	31	32	7	18	3.3 + 3.2
WB Thru	32	32	32	31	32	7	18	3.3 + 3.2
NB Left	39	13	12	-	12	-	-	4.6 + 1.7

## Phasing Sequence‡

Plan: 1, 2, 3, 13

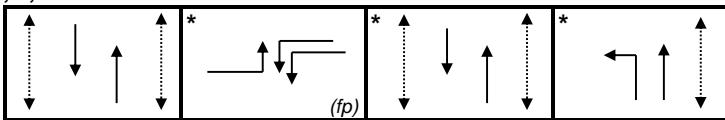

Plan: 4

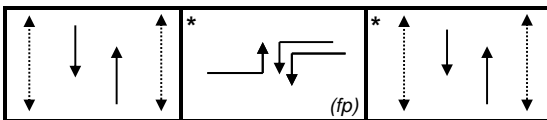

Notes: 1) For plan 1, if the pedestrian phase is not actuated then the EW thru movements will be forced off after 10 seconds green. In addition, all extra time for plan 1 will be added to the NS thru movements

### Weekday

Time	Plan
0:10	4
6:30	1
9:30	2
15:00	3
16:30	13
18:00	3
18:30	2
23:00	4

### Weekend

Time	Plan
0:10	4
8:00	2
22:30	4

## Notes

†: Time for each direction includes amber and all red intervals

‡: Start of first phase should be used as reference point for offset

Asterisk (\*) Indicates actuated phase

(fp): Fully Protected Left Turn

◄.....► Pedestrian signal

Cost is \$57.63 (\$51 + HST)



# Traffic Signal Timing

City of Ottawa, Public Works Department

Traffic Signal Operations Unit

<b>Intersection:</b>	<i>Main:</i> Terry Fox	<i>Side:</i> Innovation / Flamborough
<b>Controller:</b>	<b>ATC 3</b>	<b>TSD: 6768</b>
<b>Author:</b>	Matthew Anderson	<b>Date:</b> 28-Jul-2022

## Existing Timing Plans<sup>†</sup>

	Plan					Ped Minimum Time		
	AM Peak 1	Off Peak 2	PM Peak 3	Night 4	PM Heavy 13	Walk	DW	A+R
<b>Cycle</b>	130	110	120	80	130			
<b>Offset</b>	124	41	47	X	66			
EB Thru	70	57	63	42	66	7	15	3.7+2.2
WB Thru	70	57	63	42	66	7	15	3.7+2.2
NB Thru	42	40	45	38	52	7	23	3.3+3.0
SB Thru	42	40	45	38	52	7	23	3.3+3.0
EB Left	18	13	12	-	12	-	-	3.7+2.3
WB Left	18	13	12	-	12	-	-	3.7+2.3

## Phasing Sequence<sup>‡</sup>

Plan: 1,2,3,13

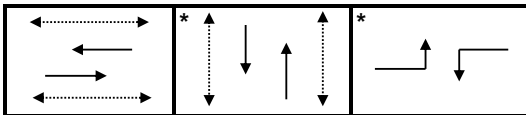

Plan: 4

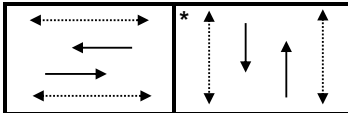

## Schedule

### Weekday

Time	Plan
0:15	4
6:30	1
9:30	2
15:00	3
16:30	13
18:00	3
18:30	2
22:00	4

### Weekend

Time	Plan
0:15	4
8:00	2
22:00	4

## Notes

- †: Time for each direction includes amber and all red intervals
- ‡: Start of first phase should be used as reference point for offset
- Asterisk (\*) Indicates actuated phase
- (fp): Fully Protected Left Turn
- ◄.....► Pedestrian signal

Cost is \$61.16 (\$54.12 + HST)

## **APPENDIX K**

---

Existing Synchro Analysis

1: March & Morgan's Grant/Shirley's Brook  
AM Peak Hour

555-603 March Road  
2022 Existing Traffic



Lane Group	EBL	EBT	EBR	WBL	WBT	WBR	NBL	NBT	NBR	SBL	SBT	SBR
Lane Configurations		↕	↗	↖	↕	↗	↖	↕↕↕	↗	↖	↕↕↕	↗
Traffic Volume (vph)	8	8	80	92	7	9	21	435	48	15	717	5
Future Volume (vph)	8	8	80	92	7	9	21	435	48	15	717	5
Ideal Flow (vphpl)	1800	1800	1800	1800	1800	1800	1800	1800	1800	1800	1800	1800
Storage Length (m)	0.0		20.0	45.0		35.0	130.0		30.0	65.0		25.0
Storage Lanes	0		1	1		1	1		1	1		1
Taper Length (m)	10.0			30.0			40.0			35.0		
Lane Util. Factor	1.00	1.00	1.00	1.00	1.00	1.00	1.00	0.91	1.00	1.00	0.91	1.00
Ped Bike Factor		1.00	0.99	1.00		0.99	1.00		0.97	0.99		0.97
Frt			0.850			0.850			0.850			0.850
Flt Protected		0.976		0.950			0.950			0.950		
Satd. Flow (prot)	0	1720	1498	1580	1271	1498	1674	4628	1427	1674	4718	1498
Flt Permitted		0.876		0.746			0.950			0.950		
Satd. Flow (perm)	0	1543	1478	1239	1271	1478	1666	4628	1383	1665	4718	1447
Right Turn on Red			Yes			Yes			Yes			Yes
Satd. Flow (RTOR)			89			80			91			91
Link Speed (k/h)		40			40			80			80	
Link Distance (m)		465.2			359.5			318.9			462.6	
Travel Time (s)		41.9			32.4			14.4			20.8	
Confl. Peds. (#/hr)	1		1	1		1	4		3	3		4
Confl. Bikes (#/hr)									1			
Peak Hour Factor	0.90	0.90	0.90	0.90	0.90	0.90	0.90	0.90	0.90	0.90	0.90	0.90
Heavy Vehicles (%)	1%	1%	1%	7%	40%	1%	1%	5%	6%	1%	3%	1%
Adj. Flow (vph)	9	9	89	102	8	10	23	483	53	17	797	6
Shared Lane Traffic (%)												
Lane Group Flow (vph)	0	18	89	102	8	10	23	483	53	17	797	6
Enter Blocked Intersection	No	No	No	No	No	No	No	No	No	No	No	No
Lane Alignment	L NA	Left	R NA	L NA	Left	R NA	L NA	Left	R NA	L NA	Left	R NA
Median Width(m)		3.5			5.0			9.0			9.0	
Link Offset(m)		0.0			0.0			0.0			0.0	
Crosswalk Width(m)		5.0			5.0			10.0			10.0	
Two way Left Turn Lane												
Headway Factor	1.09	1.09	1.09	1.09	1.09	1.09	1.09	1.09	1.09	1.09	1.09	1.09
Turning Speed (k/h)	24		14	24		14	24		14	24		14
Number of Detectors	1	2	1	1	2	1	1	2	1	1	2	1
Detector Template	Left	Thru	Right	Left	Thru	Right	Left	Thru	Right	Left	Thru	Right
Leading Detector (m)	2.0	10.0	2.0	2.0	10.0	2.0	2.0	10.0	2.0	2.0	10.0	2.0
Trailing Detector (m)	0.0	0.0	0.0	0.0	0.0	0.0	0.0	0.0	0.0	0.0	0.0	0.0
Detector 1 Position(m)	0.0	0.0	0.0	0.0	0.0	0.0	0.0	0.0	0.0	0.0	0.0	0.0
Detector 1 Size(m)	2.0	0.6	2.0	2.0	0.6	2.0	2.0	0.6	2.0	2.0	0.6	2.0
Detector 1 Type	Cl+Ex	Cl+Ex	Cl+Ex	Cl+Ex	Cl+Ex	Cl+Ex	Cl+Ex	Cl+Ex	Cl+Ex	Cl+Ex	Cl+Ex	Cl+Ex
Detector 1 Channel												
Detector 1 Extend (s)	0.0	0.0	0.0	0.0	0.0	0.0	0.0	0.0	0.0	0.0	0.0	0.0
Detector 1 Queue (s)	0.0	0.0	0.0	0.0	0.0	0.0	0.0	0.0	0.0	0.0	0.0	0.0
Detector 1 Delay (s)	0.0	0.0	0.0	0.0	0.0	0.0	0.0	0.0	0.0	0.0	0.0	0.0
Detector 2 Position(m)		9.4			9.4			9.4			9.4	
Detector 2 Size(m)		0.6			0.6			0.6			0.6	
Detector 2 Type		Cl+Ex			Cl+Ex			Cl+Ex			Cl+Ex	
Detector 2 Channel												
Detector 2 Extend (s)		0.0			0.0			0.0			0.0	
Turn Type	Perm	NA	Perm	Perm	NA	Perm	Prot	NA	Perm	Prot	NA	Perm
Protected Phases		4			8		5	2		1	6	
Permitted Phases	4		4	8		8			2			6
Detector Phase	4	4	4	8	8	8	5	2	2	1	6	6



Lane Group	EBL	EBT	EBR	WBL	WBT	WBR	NBL	NBT	NBR	SBL	SBT	SBR
Switch Phase												
Minimum Initial (s)	10.0	10.0	10.0	10.0	10.0	10.0	5.0	20.0	20.0	5.0	20.0	20.0
Minimum Split (s)	38.5	38.5	38.5	38.5	38.5	38.5	11.4	26.1	26.1	11.4	26.1	26.1
Total Split (s)	39.0	39.0	39.0	39.0	39.0	39.0	21.0	70.0	70.0	21.0	70.0	70.0
Total Split (%)	30.0%	30.0%	30.0%	30.0%	30.0%	30.0%	16.2%	53.8%	53.8%	16.2%	53.8%	53.8%
Maximum Green (s)	31.5	31.5	31.5	31.5	31.5	31.5	14.6	63.9	63.9	14.6	63.9	63.9
Yellow Time (s)	3.0	3.0	3.0	3.0	3.0	3.0	4.6	4.6	4.6	4.6	4.6	4.6
All-Red Time (s)	4.5	4.5	4.5	4.5	4.5	4.5	1.8	1.5	1.5	1.8	1.5	1.5
Lost Time Adjust (s)		0.0	0.0	0.0	0.0	0.0	0.0	0.0	0.0	0.0	0.0	0.0
Total Lost Time (s)		7.5	7.5	7.5	7.5	7.5	6.4	6.1	6.1	6.4	6.1	6.1
Lead/Lag							Lead	Lag	Lag	Lead	Lag	Lag
Lead-Lag Optimize?							Yes	Yes	Yes	Yes	Yes	Yes
Vehicle Extension (s)	3.0	3.0	3.0	3.0	3.0	3.0	3.0	3.0	3.0	3.0	3.0	3.0
Recall Mode	None	None	None	None	None	None	None	C-Max	C-Max	None	C-Max	C-Max
Walk Time (s)	7.0	7.0	7.0	7.0	7.0	7.0		7.0	7.0		7.0	7.0
Flash Dont Walk (s)	24.0	24.0	24.0	24.0	24.0	24.0		11.0	11.0		11.0	11.0
Pedestrian Calls (#/hr)	1	1	1	1	1	1		4	4		3	3
Act Effct Green (s)		17.8	17.8	17.8	17.8	17.8	7.3	92.7	92.7	6.9	89.7	89.7
Actuated g/C Ratio		0.14	0.14	0.14	0.14	0.14	0.06	0.71	0.71	0.05	0.69	0.69
v/c Ratio		0.09	0.32	0.60	0.05	0.04	0.24	0.15	0.05	0.19	0.24	0.01
Control Delay		45.4	11.5	65.7	43.9	0.2	64.3	7.9	2.4	63.2	9.6	0.0
Queue Delay		0.0	0.0	0.0	0.0	0.0	0.0	0.0	0.0	0.0	0.0	0.0
Total Delay		45.4	11.5	65.7	43.9	0.2	64.3	7.9	2.4	63.2	9.6	0.0
LOS		D	B	E	D	A	E	A	A	E	A	A
Approach Delay		17.2			58.8			9.7			10.6	
Approach LOS		B			E			A			B	
Queue Length 50th (m)		3.8	0.0	23.4	1.7	0.0	5.8	10.2	0.0	3.9	25.4	0.0
Queue Length 95th (m)		9.4	12.3	35.7	5.4	0.0	14.9	19.4	0.7	11.1	45.4	0.0
Internal Link Dist (m)		441.2			335.5			294.9			438.6	
Turn Bay Length (m)			20.0	45.0		35.0	130.0		30.0	65.0		25.0
Base Capacity (vph)		373	425	300	307	418	188	3300	1012	188	3256	1026
Starvation Cap Reductn		0	0	0	0	0	0	0	0	0	0	0
Spillback Cap Reductn		0	0	0	0	0	0	0	0	0	0	0
Storage Cap Reductn		0	0	0	0	0	0	0	0	0	0	0
Reduced v/c Ratio		0.05	0.21	0.34	0.03	0.02	0.12	0.15	0.05	0.09	0.24	0.01

**Intersection Summary**

Area Type: Other  
 Cycle Length: 130  
 Actuated Cycle Length: 130  
 Offset: 95 (73%), Referenced to phase 2:NBT and 6:SBT, Start of Green  
 Natural Cycle: 80  
 Control Type: Actuated-Coordinated  
 Maximum v/c Ratio: 0.60  
 Intersection Signal Delay: 14.3      Intersection LOS: B  
 Intersection Capacity Utilization 52.1%      ICU Level of Service A  
 Analysis Period (min) 15

Splits and Phases: 1: March & Morgan's Grant/Shirley's Brook



2: March & Terry Fox  
AM Peak Hour

555-603 March Road  
2022 Existing Traffic



Lane Group	EBL	EBT	EBR	WBL	WBT	WBR	NBU	NBL	NBT	NBR	SBU	SBL
Lane Configurations	↖↖	↕↕	↗	↖↖	↕↕	↗		↖↖	↕↕↕	↗		↖
Traffic Volume (vph)	80	158	220	41	69	24	14	139	400	91	1	83
Future Volume (vph)	80	158	220	41	69	24	14	139	400	91	1	83
Ideal Flow (vphpl)	1800	1800	1800	1800	1800	1800	1800	1800	1800	1800	1800	1800
Storage Length (m)	95.0		60.0	75.0		75.0		130.0		85.0		110.0
Storage Lanes	2		2	2		1		2		2		1
Taper Length (m)	40.0			20.0				90.0				40.0
Lane Util. Factor	0.97	0.95	1.00	0.97	0.95	1.00	0.91	0.97	0.91	1.00	0.91	1.00
Ped Bike Factor			0.97	0.99		0.99		1.00		0.98		1.00
Fr			0.850			0.850				0.850		
Flt Protected	0.950			0.950				0.950				0.950
Satd. Flow (prot)	3185	3316	1483	3248	3161	1498	0	3245	4628	1469	0	1674
Flt Permitted	0.950			0.950				0.950				0.950
Satd. Flow (perm)	3185	3316	1443	3228	3161	1479	0	3237	4628	1438	0	1667
Right Turn on Red			Yes			Yes				Yes		
Satd. Flow (RTOR)			244			146				149		
Link Speed (k/h)		60			60				80			
Link Distance (m)		165.4			149.1				308.9			
Travel Time (s)		9.9			8.9				13.9			
Confl. Peds. (#/hr)			7	7				3		5		5
Confl. Bikes (#/hr)			9			1				2		
Peak Hour Factor	0.90	0.90	0.90	0.90	0.90	0.90	0.90	0.90	0.90	0.90	0.90	0.90
Heavy Vehicles (%)	3%	2%	2%	1%	7%	1%	2%	1%	5%	3%	2%	1%
Adj. Flow (vph)	89	176	244	46	77	27	16	154	444	101	1	92
Shared Lane Traffic (%)												
Lane Group Flow (vph)	89	176	244	46	77	27	0	170	444	101	0	93
Enter Blocked Intersection	No	No	No	Yes	Yes	Yes	No	No	No	No	No	No
Lane Alignment	L NA	Left	R NA	L NA	Left	R NA	R NA	L NA	Left	R NA	R NA	L NA
Median Width(m)		10.5			10.5				10.5			
Link Offset(m)		0.0			0.0				0.0			
Crosswalk Width(m)		5.0			5.0				5.0			
Two way Left Turn Lane												
Headway Factor	1.09	1.09	1.09	1.09	1.09	1.09	1.09	1.09	1.09	1.09	1.09	1.09
Turning Speed (k/h)	24		14	24		14	14	24		14	14	24
Number of Detectors	1	2	1	1	2	1	1	1	2	1	1	1
Detector Template	Left	Thru	Right	Left	Thru	Right	Left	Left	Thru	Right	Left	Left
Leading Detector (m)	2.0	10.0	2.0	2.0	10.0	2.0	2.0	2.0	10.0	2.0	2.0	2.0
Trailing Detector (m)	0.0	0.0	0.0	0.0	0.0	0.0	0.0	0.0	0.0	0.0	0.0	0.0
Detector 1 Position(m)	0.0	0.0	0.0	0.0	0.0	0.0	0.0	0.0	0.0	0.0	0.0	0.0
Detector 1 Size(m)	2.0	0.6	2.0	2.0	0.6	2.0	2.0	2.0	0.6	2.0	2.0	2.0
Detector 1 Type	Cl+Ex	Cl+Ex	Cl+Ex	Cl+Ex	Cl+Ex	Cl+Ex	Cl+Ex	Cl+Ex	Cl+Ex	Cl+Ex	Cl+Ex	Cl+Ex
Detector 1 Channel												
Detector 1 Extend (s)	0.0	0.0	0.0	0.0	0.0	0.0	0.0	0.0	0.0	0.0	0.0	0.0
Detector 1 Queue (s)	0.0	0.0	0.0	0.0	0.0	0.0	0.0	0.0	0.0	0.0	0.0	0.0
Detector 1 Delay (s)	0.0	0.0	0.0	0.0	0.0	0.0	0.0	0.0	0.0	0.0	0.0	0.0
Detector 2 Position(m)		9.4			9.4				9.4			
Detector 2 Size(m)		0.6			0.6				0.6			
Detector 2 Type		Cl+Ex			Cl+Ex				Cl+Ex			
Detector 2 Channel												
Detector 2 Extend (s)		0.0			0.0				0.0			
Turn Type	Prot	NA	Perm	Prot	NA	Perm	Prot	Prot	NA	Perm	Prot	Prot
Protected Phases	7	4		3	8		5	5	2		1	1
Permitted Phases			4			8				2		
Detector Phase	7	4	4	3	8	8	5	5	2	2	1	1



Lane Group	SBT	SBR
Lane Configurations	↑↑↑	↑
Traffic Volume (vph)	694	118
Future Volume (vph)	694	118
Ideal Flow (vphpl)	1800	1800
Storage Length (m)		100.0
Storage Lanes		1
Taper Length (m)		
Lane Util. Factor	0.91	1.00
Ped Bike Factor		0.98
Frt		0.850
Flt Protected		
Satd. Flow (prot)	4718	1469
Flt Permitted		
Satd. Flow (perm)	4718	1445
Right Turn on Red		Yes
Satd. Flow (RTOR)		149
Link Speed (k/h)	80	
Link Distance (m)	318.9	
Travel Time (s)	14.4	
Confl. Peds. (#/hr)		3
Confl. Bikes (#/hr)		
Peak Hour Factor	0.90	0.90
Heavy Vehicles (%)	3%	3%
Adj. Flow (vph)	771	131
Shared Lane Traffic (%)		
Lane Group Flow (vph)	771	131
Enter Blocked Intersection	No	No
Lane Alignment	Left	R NA
Median Width(m)	7.0	
Link Offset(m)	0.0	
Crosswalk Width(m)	5.0	
Two way Left Turn Lane		
Headway Factor	1.09	1.09
Turning Speed (k/h)		14
Number of Detectors	2	1
Detector Template	Thru	Right
Leading Detector (m)	10.0	2.0
Trailing Detector (m)	0.0	0.0
Detector 1 Position(m)	0.0	0.0
Detector 1 Size(m)	0.6	2.0
Detector 1 Type	CI+Ex	CI+Ex
Detector 1 Channel		
Detector 1 Extend (s)	0.0	0.0
Detector 1 Queue (s)	0.0	0.0
Detector 1 Delay (s)	0.0	0.0
Detector 2 Position(m)	9.4	
Detector 2 Size(m)	0.6	
Detector 2 Type	CI+Ex	
Detector 2 Channel		
Detector 2 Extend (s)	0.0	
Turn Type	NA	Perm
Protected Phases	6	
Permitted Phases		6
Detector Phase	6	6



Lane Group	EBL	EBT	EBR	WBL	WBT	WBR	NBU	NBL	NBT	NBR	SBU	SBL
Switch Phase												
Minimum Initial (s)	5.0	10.0	10.0	5.0	10.0	10.0	5.0	5.0	20.0	20.0	5.0	5.0
Minimum Split (s)	11.8	42.0	42.0	11.8	42.0	42.0	11.9	11.9	32.7	32.7	11.9	11.9
Total Split (s)	16.0	42.0	42.0	16.0	42.0	42.0	25.0	25.0	47.0	47.0	25.0	25.0
Total Split (%)	12.3%	32.3%	32.3%	12.3%	32.3%	32.3%	19.2%	19.2%	36.2%	36.2%	19.2%	19.2%
Maximum Green (s)	9.2	35.0	35.0	9.2	35.0	35.0	18.1	18.1	40.3	40.3	18.1	18.1
Yellow Time (s)	3.7	3.7	3.7	3.7	3.7	3.7	4.6	4.6	4.6	4.6	4.6	4.6
All-Red Time (s)	3.1	3.3	3.3	3.1	3.3	3.3	2.3	2.3	2.1	2.1	2.3	2.3
Lost Time Adjust (s)	0.0	0.0	0.0	0.0	0.0	0.0		0.0	0.0	0.0		0.0
Total Lost Time (s)	6.8	7.0	7.0	6.8	7.0	7.0		6.9	6.7	6.7		6.9
Lead/Lag	Lead	Lag	Lag	Lead	Lag	Lag	Lead	Lead	Lag	Lag	Lead	Lead
Lead-Lag Optimize?	Yes	Yes	Yes	Yes	Yes	Yes	Yes	Yes	Yes	Yes	Yes	Yes
Vehicle Extension (s)	3.0	3.0	3.0	3.0	3.0	3.0	3.0	3.0	3.0	3.0	3.0	3.0
Recall Mode	None	None	None	None	None	None	None	None	C-Max	C-Max	None	None
Walk Time (s)		7.0	7.0		7.0	7.0		7.0	7.0			
Flash Dont Walk (s)		28.0	28.0		28.0	28.0		19.0	19.0			
Pedestrian Calls (#/hr)		7	7		1	1		5	5			
Act Effct Green (s)	9.1	16.5	16.5	7.3	15.6	15.6		12.1	68.8	68.8		12.5
Actuated g/C Ratio	0.07	0.13	0.13	0.06	0.12	0.12		0.09	0.53	0.53		0.10
v/c Ratio	0.40	0.42	0.62	0.25	0.20	0.09		0.56	0.18	0.12		0.58
Control Delay	60.0	50.9	15.2	61.7	50.0	0.6		58.9	23.7	7.1		85.8
Queue Delay	0.0	0.0	0.0	0.0	0.0	0.0		0.0	0.0	0.0		0.0
Total Delay	60.0	50.9	15.2	61.7	50.0	0.6		58.9	23.7	7.1		85.8
LOS	E	D	B	E	D	A		E	C	A		F
Approach Delay		35.4			44.7				29.7			
Approach LOS		D			D				C			
Queue Length 50th (m)	10.7	21.7	8.4	5.4	9.1	0.0		20.1	18.0	0.0		23.4
Queue Length 95th (m)	16.4	28.3	28.9	11.2	13.1	0.0		32.0	41.2	11.4		36.8
Internal Link Dist (m)		141.4			125.1				284.9			
Turn Bay Length (m)	95.0		60.0	75.0		75.0		130.0		85.0		110.0
Base Capacity (vph)	230	893	566	229	851	504		451	2447	830		233
Starvation Cap Reductn	0	0	0	0	0	0		0	0	0		0
Spillback Cap Reductn	0	0	0	0	0	0		0	0	0		0
Storage Cap Reductn	0	0	0	0	0	0		0	0	0		0
Reduced v/c Ratio	0.39	0.20	0.43	0.20	0.09	0.05		0.38	0.18	0.12		0.40

Intersection Summary

Area Type:	Other
Cycle Length:	130
Actuated Cycle Length:	130
Offset:	114 (88%), Referenced to phase 2:NBT and 6:SBT, Start of Green
Natural Cycle:	100
Control Type:	Actuated-Coordinated
Maximum v/c Ratio:	0.62
Intersection Signal Delay:	27.9
Intersection LOS:	C
Intersection Capacity Utilization:	71.3%
ICU Level of Service:	C
Analysis Period (min):	15

Splits and Phases: 2: March & Terry Fox

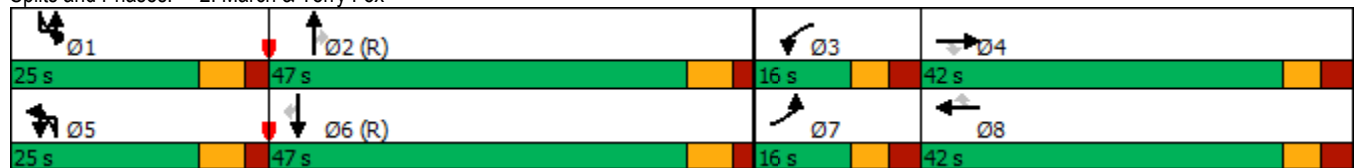



Lane Group	SBT	SBR
Switch Phase		
Minimum Initial (s)	20.0	20.0
Minimum Split (s)	32.7	32.7
Total Split (s)	47.0	47.0
Total Split (%)	36.2%	36.2%
Maximum Green (s)	40.3	40.3
Yellow Time (s)	4.6	4.6
All-Red Time (s)	2.1	2.1
Lost Time Adjust (s)	0.0	0.0
Total Lost Time (s)	6.7	6.7
Lead/Lag	Lag	Lag
Lead-Lag Optimize?	Yes	Yes
Vehicle Extension (s)	3.0	3.0
Recall Mode	C-Max	C-Max
Walk Time (s)	7.0	7.0
Flash Dont Walk (s)	19.0	19.0
Pedestrian Calls (#/hr)	3	3
Act Effct Green (s)	69.2	69.2
Actuated g/C Ratio	0.53	0.53
v/c Ratio	0.31	0.16
Control Delay	15.4	1.5
Queue Delay	0.0	0.0
Total Delay	15.4	1.5
LOS	B	A
Approach Delay	20.1	
Approach LOS	C	
Queue Length 50th (m)	18.8	0.3
Queue Length 95th (m)	68.3	3.9
Internal Link Dist (m)	294.9	
Turn Bay Length (m)		100.0
Base Capacity (vph)	2510	838
Starvation Cap Reductn	0	0
Spillback Cap Reductn	0	0
Storage Cap Reductn	0	0
Reduced v/c Ratio	0.31	0.16
<b>Intersection Summary</b>		



3: March & Solandt  
AM Peak Hour

555-603 March Road  
2022 Existing Traffic



Lane Group	EBL	EBT	EBR	WBL	WBT	WBR	NBU	NBL	NBT	NBR	SBU	SBL
Lane Configurations												
Traffic Volume (vph)	14	28	100	60	13	11	2	260	622	223	2	50
Future Volume (vph)	14	28	100	60	13	11	2	260	622	223	2	50
Ideal Flow (vphpl)	1800	1800	1800	1800	1800	1800	1800	1800	1800	1800	1800	1800
Storage Length (m)	35.0		60.0	85.0		0.0		165.0		0.0		155.0
Storage Lanes	1		1	2		0		1		1		1
Taper Length (m)	50.0			95.0				40.0				25.0
Lane Util. Factor	1.00	1.00	1.00	0.97	1.00	1.00	0.95	1.00	0.95	1.00	0.95	1.00
Ped Bike Factor			0.98	0.99						0.98		1.00
Fr <sub>t</sub>			0.850		0.931					0.850		
Fl <sub>t</sub> Protected	0.950			0.950				0.950				0.950
Satd. Flow (prot)	1537	1728	1414	3124	1421	0	0	1658	3283	1498	0	1674
Fl <sub>t</sub> Permitted	0.950			0.950				0.194				0.389
Satd. Flow (perm)	1537	1728	1386	3101	1421	0	0	339	3283	1461	0	684
Right Turn on Red			Yes			Yes				Yes		
Satd. Flow (RTOR)			130		12					248		
Link Speed (k/h)		50			50				80			
Link Distance (m)		212.6			241.6				610.9			
Travel Time (s)		15.3			17.4				27.5			
Confl. Peds. (#/hr)			3	3						1		1
Confl. Bikes (#/hr)			3							2		
Peak Hour Factor	0.90	0.90	0.90	0.90	0.90	0.90	0.90	0.90	0.90	0.90	0.90	0.90
Heavy Vehicles (%)	10%	3%	7%	5%	30%	1%	2%	2%	3%	1%	2%	1%
Adj. Flow (vph)	16	31	111	67	14	12	2	289	691	248	2	56
Shared Lane Traffic (%)												
Lane Group Flow (vph)	16	31	111	67	26	0	0	291	691	248	0	58
Enter Blocked Intersection	No	No	No	No	No	No	No	No	No	No	No	No
Lane Alignment	L NA	Left	R NA	L NA	Left	R NA	R NA	L NA	Left	R NA	R NA	L NA
Median Width(m)		7.0			10.5				3.5			
Link Offset(m)		0.0			0.0				0.0			
Crosswalk Width(m)		5.0			5.0				5.0			
Two way Left Turn Lane												
Headway Factor	1.09	1.09	1.09	1.09	1.09	1.09	1.09	1.09	1.09	1.09	1.09	1.09
Turning Speed (k/h)	24		14	24		14	14	24		14	14	24
Number of Detectors	1	2	1	1	2		1	1	2	1	1	1
Detector Template	Left	Thru	Right	Left	Thru		Left	Left	Thru	Right	Left	Left
Leading Detector (m)	2.0	10.0	2.0	2.0	10.0		2.0	2.0	10.0	2.0	2.0	2.0
Trailing Detector (m)	0.0	0.0	0.0	0.0	0.0		0.0	0.0	0.0	0.0	0.0	0.0
Detector 1 Position(m)	0.0	0.0	0.0	0.0	0.0		0.0	0.0	0.0	0.0	0.0	0.0
Detector 1 Size(m)	2.0	0.6	2.0	2.0	0.6		2.0	2.0	0.6	2.0	2.0	2.0
Detector 1 Type	Cl+Ex	Cl+Ex	Cl+Ex	Cl+Ex	Cl+Ex		Cl+Ex	Cl+Ex	Cl+Ex	Cl+Ex	Cl+Ex	Cl+Ex
Detector 1 Channel												
Detector 1 Extend (s)	0.0	0.0	0.0	0.0	0.0		0.0	0.0	0.0	0.0	0.0	0.0
Detector 1 Queue (s)	0.0	0.0	0.0	0.0	0.0		0.0	0.0	0.0	0.0	0.0	0.0
Detector 1 Delay (s)	0.0	0.0	0.0	0.0	0.0		0.0	0.0	0.0	0.0	0.0	0.0
Detector 2 Position(m)		9.4			9.4				9.4			
Detector 2 Size(m)		0.6			0.6				0.6			
Detector 2 Type		Cl+Ex			Cl+Ex				Cl+Ex			
Detector 2 Channel												
Detector 2 Extend (s)		0.0			0.0				0.0			
Turn Type	Prot	NA	Perm	Prot	NA		pm+pt	pm+pt	NA	Perm	Perm	Perm
Protected Phases	7	4		3	8		5	5	2			
Permitted Phases			4				2	2		2	6	6
Detector Phase	7	4	4	3	8		5	5	2	2	6	6

3: March & Solandt  
AM Peak Hour

555-603 March Road  
2022 Existing Traffic



Lane Group	SBT	SBR
Lane Configurations	↑↑	↑
Traffic Volume (vph)	844	44
Future Volume (vph)	844	44
Ideal Flow (vphpl)	1800	1800
Storage Length (m)		75.0
Storage Lanes		1
Taper Length (m)		
Lane Util. Factor	0.95	1.00
Ped Bike Factor		
Frt		0.850
Flt Protected		
Satd. Flow (prot)	3283	1498
Flt Permitted		
Satd. Flow (perm)	3283	1498
Right Turn on Red		Yes
Satd. Flow (RTOR)		132
Link Speed (k/h)	80	
Link Distance (m)	610.3	
Travel Time (s)	27.5	
Confl. Peds. (#/hr)		
Confl. Bikes (#/hr)		
Peak Hour Factor	0.90	0.90
Heavy Vehicles (%)	3%	1%
Adj. Flow (vph)	938	49
Shared Lane Traffic (%)		
Lane Group Flow (vph)	938	49
Enter Blocked Intersection	No	No
Lane Alignment	Left	R NA
Median Width(m)	3.5	
Link Offset(m)	0.0	
Crosswalk Width(m)	5.0	
Two way Left Turn Lane		
Headway Factor	1.09	1.09
Turning Speed (k/h)		14
Number of Detectors	2	1
Detector Template	Thru	Right
Leading Detector (m)	10.0	2.0
Trailing Detector (m)	0.0	0.0
Detector 1 Position(m)	0.0	0.0
Detector 1 Size(m)	0.6	2.0
Detector 1 Type	Cl+Ex	Cl+Ex
Detector 1 Channel		
Detector 1 Extend (s)	0.0	0.0
Detector 1 Queue (s)	0.0	0.0
Detector 1 Delay (s)	0.0	0.0
Detector 2 Position(m)	9.4	
Detector 2 Size(m)	0.6	
Detector 2 Type	Cl+Ex	
Detector 2 Channel		
Detector 2 Extend (s)	0.0	
Turn Type	NA	Perm
Protected Phases	6	
Permitted Phases		6
Detector Phase	6	6

3: March & Solandt  
AM Peak Hour

555-603 March Road  
2022 Existing Traffic



Lane Group	EBL	EBT	EBR	WBL	WBT	WBR	NBU	NBL	NBT	NBR	SBU	SBL
Switch Phase												
Minimum Initial (s)	5.0	10.0	10.0	5.0	10.0		5.0	5.0	20.0	20.0	20.0	20.0
Minimum Split (s)	10.9	31.5	31.5	10.9	31.5		11.3	11.3	26.3	26.3	26.3	26.3
Total Split (s)	13.0	32.0	32.0	13.0	32.0		39.0	39.0	85.0	85.0	46.0	46.0
Total Split (%)	10.0%	24.6%	24.6%	10.0%	24.6%		30.0%	30.0%	65.4%	65.4%	35.4%	35.4%
Maximum Green (s)	7.1	25.5	25.5	7.1	25.5		32.7	32.7	78.7	78.7	39.7	39.7
Yellow Time (s)	3.3	3.3	3.3	3.3	3.3		4.6	4.6	4.6	4.6	4.6	4.6
All-Red Time (s)	2.6	3.2	3.2	2.6	3.2		1.7	1.7	1.7	1.7	1.7	1.7
Lost Time Adjust (s)	0.0	0.0	0.0	0.0	0.0			0.0	0.0	0.0		0.0
Total Lost Time (s)	5.9	6.5	6.5	5.9	6.5			6.3	6.3	6.3		6.3
Lead/Lag	Lead	Lag	Lag	Lead	Lag		Lead	Lead			Lag	Lag
Lead-Lag Optimize?	Yes	Yes	Yes	Yes	Yes		Yes	Yes			Yes	Yes
Vehicle Extension (s)	3.0	3.0	3.0	3.0	3.0		3.0	3.0	3.0	3.0	3.0	3.0
Recall Mode	None	None	None	None	None		None	None	C-Max	C-Max	C-Max	C-Max
Walk Time (s)		7.0	7.0		7.0				7.0	7.0	7.0	7.0
Flash Dont Walk (s)		18.0	18.0		18.0				12.0	12.0	12.0	12.0
Pedestrian Calls (#/hr)		3	3		1				1	1	1	1
Act Effct Green (s)	6.5	13.0	13.0	6.9	18.2			93.8	93.8	93.8		66.6
Actuated g/C Ratio	0.05	0.10	0.10	0.05	0.14			0.72	0.72	0.72		0.51
v/c Ratio	0.21	0.18	0.44	0.41	0.12			0.64	0.29	0.22		0.17
Control Delay	65.6	53.5	10.5	67.2	32.5			15.7	7.8	1.6		13.5
Queue Delay	0.0	0.0	0.0	0.0	0.0			0.0	0.0	0.0		0.0
Total Delay	65.6	53.5	10.5	67.2	32.5			15.7	7.8	1.6		13.5
LOS	E	D	B	E	C			B	A	A		B
Approach Delay		24.5			57.5				8.4			
Approach LOS		C			E				A			
Queue Length 50th (m)	3.7	7.0	0.0	8.0	2.8			20.5	26.6	0.0		3.5
Queue Length 95th (m)	10.8	14.3	10.4	15.1	10.2			51.9	50.7	9.2		8.2
Internal Link Dist (m)		188.6			217.6				586.9			
Turn Bay Length (m)	35.0		60.0	85.0				165.0				155.0
Base Capacity (vph)	83	338	376	170	288			576	2368	1122		350
Starvation Cap Reductn	0	0	0	0	0			0	0	0		0
Spillback Cap Reductn	0	0	0	0	0			0	0	0		0
Storage Cap Reductn	0	0	0	0	0			0	0	0		0
Reduced v/c Ratio	0.19	0.09	0.30	0.39	0.09			0.51	0.29	0.22		0.17

Intersection Summary

Area Type: Other  
 Cycle Length: 130  
 Actuated Cycle Length: 130  
 Offset: 15 (12%), Referenced to phase 2:NBT and 6:SBTL, Start of Green  
 Natural Cycle: 90  
 Control Type: Actuated-Coordinated  
 Maximum v/c Ratio: 0.64  
 Intersection Signal Delay: 13.9 Intersection LOS: B  
 Intersection Capacity Utilization 74.5% ICU Level of Service D  
 Analysis Period (min) 15  
 # 95th percentile volume exceeds capacity, queue may be longer.  
 Queue shown is maximum after two cycles.

Splits and Phases: 3: March & Solandt





Lane Group	SBT	SBR
Switch Phase		
Minimum Initial (s)	20.0	20.0
Minimum Split (s)	26.3	26.3
Total Split (s)	46.0	46.0
Total Split (%)	35.4%	35.4%
Maximum Green (s)	39.7	39.7
Yellow Time (s)	4.6	4.6
All-Red Time (s)	1.7	1.7
Lost Time Adjust (s)	0.0	0.0
Total Lost Time (s)	6.3	6.3
Lead/Lag	Lag	Lag
Lead-Lag Optimize?	Yes	Yes
Vehicle Extension (s)	3.0	3.0
Recall Mode	C-Max	C-Max
Walk Time (s)	7.0	7.0
Flash Dont Walk (s)	12.0	12.0
Pedestrian Calls (#/hr)	1	1
Act Effct Green (s)	66.6	66.6
Actuated g/C Ratio	0.51	0.51
v/c Ratio	0.56	0.06
Control Delay	15.7	0.1
Queue Delay	0.0	0.0
Total Delay	15.7	0.1
LOS	B	A
Approach Delay	14.9	
Approach LOS	B	
Queue Length 50th (m)	86.7	0.1
Queue Length 95th (m)	#147.3	0.2
Internal Link Dist (m)	586.3	
Turn Bay Length (m)		75.0
Base Capacity (vph)	1681	831
Starvation Cap Reductn	0	0
Spillback Cap Reductn	0	0
Storage Cap Reductn	0	0
Reduced v/c Ratio	0.56	0.06
<b>Intersection Summary</b>		

4: Innovation/Flamborough & Terry Fox  
AM Peak Hour

555-603 March Road  
2022 Existing Traffic



Lane Group	EBL	EBT	EBR	WBL	WBT	WBR	NBL	NBT	NBR	SBL	SBT	SBR
Lane Configurations												
Traffic Volume (vph)	34	328	89	99	160	43	43	42	100	74	65	50
Future Volume (vph)	34	328	89	99	160	43	43	42	100	74	65	50
Ideal Flow (vphpl)	1800	1800	1800	1800	1800	1800	1800	1800	1800	1800	1800	1800
Storage Length (m)	75.0		120.0	110.0		130.0	220.0		0.0	30.0		0.0
Storage Lanes	1		1	1		1	1		0	1		0
Taper Length (m)	50.0			80.0			50.0			15.0		
Lane Util. Factor	1.00	1.00	1.00	1.00	1.00	1.00	1.00	1.00	1.00	1.00	1.00	1.00
Ped Bike Factor	0.99		0.96	0.99		0.97	0.98	0.98		1.00	0.98	
Fr <sub>t</sub>			0.850			0.850		0.895			0.934	
Flt Protected	0.950			0.950			0.950			0.950		
Satd. Flow (prot)	1470	1728	1469	1626	1728	1498	1658	1525	0	1674	1555	0
Flt Permitted	0.645			0.498			0.583			0.483		
Satd. Flow (perm)	989	1728	1410	845	1728	1451	1001	1525	0	848	1555	0
Right Turn on Red			Yes			Yes			Yes			Yes
Satd. Flow (RTOR)			99			78		90			30	
Link Speed (k/h)		60			60			50			50	
Link Distance (m)		508.2			485.8			547.1			313.7	
Travel Time (s)		30.5			29.1			39.4			22.6	
Confl. Peds. (#/hr)	4		6	6		4	9		2	2		9
Confl. Bikes (#/hr)			4									2
Peak Hour Factor	0.90	0.90	0.90	0.90	0.90	0.90	0.90	0.90	0.90	0.90	0.90	0.90
Heavy Vehicles (%)	15%	3%	3%	4%	3%	1%	2%	2%	3%	1%	1%	10%
Adj. Flow (vph)	38	364	99	110	178	48	48	47	111	82	72	56
Shared Lane Traffic (%)												
Lane Group Flow (vph)	38	364	99	110	178	48	48	158	0	82	128	0
Enter Blocked Intersection	No	No	No	No	No	No	No	No	No	No	No	No
Lane Alignment	L NA	Left	R NA	L NA	Left	R NA	L NA	Left	R NA	L NA	Left	R NA
Median Width(m)		3.5			3.5			3.5			3.5	
Link Offset(m)		0.0			0.0			0.0			0.0	
Crosswalk Width(m)		5.0			5.0			5.0			5.0	
Two way Left Turn Lane												
Headway Factor	1.09	1.09	1.09	1.09	1.09	1.09	1.09	1.09	1.09	1.09	1.09	1.09
Turning Speed (k/h)	24		14	24		14	24		14	24		14
Number of Detectors	1	2	1	1	2	1	1	2		1	2	
Detector Template	Left	Thru	Right	Left	Thru	Right	Left	Thru		Left	Thru	
Leading Detector (m)	2.0	10.0	2.0	2.0	10.0	2.0	2.0	10.0		2.0	10.0	
Trailing Detector (m)	0.0	0.0	0.0	0.0	0.0	0.0	0.0	0.0		0.0	0.0	
Detector 1 Position(m)	0.0	0.0	0.0	0.0	0.0	0.0	0.0	0.0		0.0	0.0	
Detector 1 Size(m)	2.0	0.6	2.0	2.0	0.6	2.0	2.0	0.6		2.0	0.6	
Detector 1 Type	Cl+Ex	Cl+Ex	Cl+Ex	Cl+Ex	Cl+Ex	Cl+Ex	Cl+Ex	Cl+Ex		Cl+Ex	Cl+Ex	
Detector 1 Channel												
Detector 1 Extend (s)	0.0	0.0	0.0	0.0	0.0	0.0	0.0	0.0		0.0	0.0	
Detector 1 Queue (s)	0.0	0.0	0.0	0.0	0.0	0.0	0.0	0.0		0.0	0.0	
Detector 1 Delay (s)	0.0	0.0	0.0	0.0	0.0	0.0	0.0	0.0		0.0	0.0	
Detector 2 Position(m)		9.4			9.4			9.4			9.4	
Detector 2 Size(m)		0.6			0.6			0.6			0.6	
Detector 2 Type		Cl+Ex			Cl+Ex			Cl+Ex			Cl+Ex	
Detector 2 Channel												
Detector 2 Extend (s)		0.0			0.0			0.0			0.0	
Turn Type	pm+pt	NA	Perm	pm+pt	NA	Perm	Perm	NA		Perm	NA	
Protected Phases	5	2		1	6			8			4	
Permitted Phases	2		2	6		6	8			4		
Detector Phase	5	2	2	1	6	6	8	8		4	4	

4: Innovation/Flamborough & Terry Fox  
AM Peak Hour

555-603 March Road  
2022 Existing Traffic



Lane Group	EBL	EBT	EBR	WBL	WBT	WBR	NBL	NBT	NBR	SBL	SBT	SBR
Switch Phase												
Minimum Initial (s)	5.0	10.0	10.0	5.0	10.0	10.0	10.0	10.0		10.0	10.0	
Minimum Split (s)	11.0	27.9	27.9	11.0	27.9	27.9	36.3	36.3		36.3	36.3	
Total Split (s)	18.0	70.0	70.0	18.0	70.0	70.0	42.0	42.0		42.0	42.0	
Total Split (%)	13.8%	53.8%	53.8%	13.8%	53.8%	53.8%	32.3%	32.3%		32.3%	32.3%	
Maximum Green (s)	12.0	64.1	64.1	12.0	64.1	64.1	35.7	35.7		35.7	35.7	
Yellow Time (s)	3.7	3.7	3.7	3.7	3.7	3.7	3.3	3.3		3.3	3.3	
All-Red Time (s)	2.3	2.2	2.2	2.3	2.2	2.2	3.0	3.0		3.0	3.0	
Lost Time Adjust (s)	0.0	0.0	0.0	0.0	0.0	0.0	0.0	0.0		0.0	0.0	
Total Lost Time (s)	6.0	5.9	5.9	6.0	5.9	5.9	6.3	6.3		6.3	6.3	
Lead/Lag	Lead	Lag	Lag	Lead	Lag	Lag						
Lead-Lag Optimize?	Yes	Yes	Yes	Yes	Yes	Yes						
Vehicle Extension (s)	3.0	3.0	3.0	3.0	3.0	3.0	3.0	3.0		3.0	3.0	
Recall Mode	None	C-Max	C-Max	None	C-Max	C-Max	None	None		None	None	
Walk Time (s)		7.0	7.0		7.0	7.0	7.0	7.0		7.0	7.0	
Flash Dont Walk (s)		15.0	15.0		15.0	15.0	23.0	23.0		23.0	23.0	
Pedestrian Calls (#/hr)		3	3		3	3	3	3		3	3	
Act Effct Green (s)	93.0	86.7	86.7	97.0	90.5	90.5	17.2	17.2		17.2	17.2	
Actuated g/C Ratio	0.72	0.67	0.67	0.75	0.70	0.70	0.13	0.13		0.13	0.13	
v/c Ratio	0.05	0.32	0.10	0.16	0.15	0.05	0.36	0.56		0.73	0.55	
Control Delay	5.3	11.5	2.5	2.9	6.0	2.2	56.2	29.9		86.7	47.6	
Queue Delay	0.0	0.0	0.0	0.0	0.0	0.0	0.0	0.0		0.0	0.0	
Total Delay	5.3	11.5	2.5	2.9	6.0	2.2	56.2	29.9		86.7	47.6	
LOS	A	B	A	A	A	A	E	C		F	D	
Approach Delay		9.3			4.4			36.0			62.8	
Approach LOS		A			A			D			E	
Queue Length 50th (m)	1.7	31.5	0.0	1.6	13.4	0.0	10.7	15.1		19.2	22.2	
Queue Length 95th (m)	6.1	67.5	7.4	11.6	21.0	0.0	19.7	31.3		31.7	35.9	
Internal Link Dist (m)		484.2			461.8			523.1			289.7	
Turn Bay Length (m)	75.0		120.0	110.0		130.0	220.0			30.0		
Base Capacity (vph)	794	1153	973	721	1202	1033	274	484		232	448	
Starvation Cap Reductn	0	0	0	0	0	0	0	0		0	0	
Spillback Cap Reductn	0	0	0	0	0	0	0	0		0	0	
Storage Cap Reductn	0	0	0	0	0	0	0	0		0	0	
Reduced v/c Ratio	0.05	0.32	0.10	0.15	0.15	0.05	0.18	0.33		0.35	0.29	

Intersection Summary

Area Type: Other  
 Cycle Length: 130  
 Actuated Cycle Length: 130  
 Offset: 124 (95%), Referenced to phase 2:EBTL and 6:WBTL, Start of Green  
 Natural Cycle: 80  
 Control Type: Actuated-Coordinated  
 Maximum v/c Ratio: 0.73  
 Intersection Signal Delay: 21.4      Intersection LOS: C  
 Intersection Capacity Utilization 65.5%      ICU Level of Service C  
 Analysis Period (min) 15

Splits and Phases: 4: Innovation/Flamborough & Terry Fox

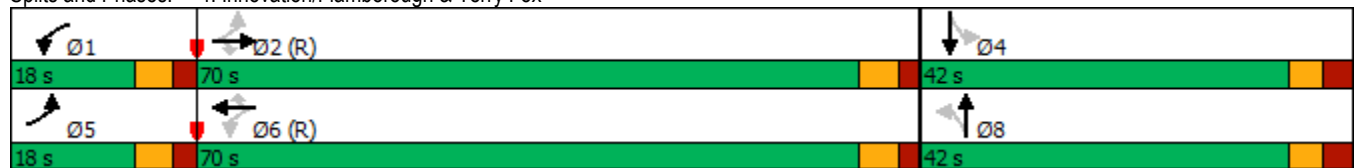

5: Hines & Innovation  
AM Peak Hour

555-603 March Road  
2022 Existing Traffic



Lane Group	EBL	EBT	EBR	WBL	WBT	WBR	NBL	NBT	NBR	SBL	SBT	SBR
Lane Configurations												
Traffic Volume (vph)	15	0	118	6	1	0	92	58	2	1	15	2
Future Volume (vph)	15	0	118	6	1	0	92	58	2	1	15	2
Ideal Flow (vphpl)	1800	1800	1800	1800	1800	1800	1800	1800	1800	1800	1800	1800
Lane Util. Factor	1.00	1.00	1.00	1.00	1.00	1.00	1.00	1.00	1.00	1.00	1.00	1.00
Ped Bike Factor												
Frt		0.881						0.998			0.986	
Flt Protected		0.994			0.958			0.971			0.998	
Satd. Flow (prot)	0	1479	0	0	1688	0	0	1633	0	0	1677	0
Flt Permitted		0.994			0.958			0.971			0.998	
Satd. Flow (perm)	0	1479	0	0	1688	0	0	1633	0	0	1677	0
Link Speed (k/h)		50			50			50			50	
Link Distance (m)		438.6			104.0			421.8			319.0	
Travel Time (s)		31.6			7.5			30.4			23.0	
Confl. Peds. (#/hr)	3					3	3					3
Confl. Bikes (#/hr)			3						5			1
Peak Hour Factor	0.90	0.90	0.90	0.90	0.90	0.90	0.90	0.90	0.90	0.90	0.90	0.90
Heavy Vehicles (%)	1%	2%	6%	1%	1%	1%	8%	2%	2%	2%	5%	1%
Adj. Flow (vph)	17	0	131	7	1	0	102	64	2	1	17	2
Shared Lane Traffic (%)												
Lane Group Flow (vph)	0	148	0	0	8	0	0	168	0	0	20	0
Enter Blocked Intersection	No	No	No	No	No	No	No	No	No	No	No	No
Lane Alignment	Left	Left	Right	Left	Left	Right	Left	Left	Right	Left	Left	Right
Median Width(m)		0.0			0.0			0.0			0.0	
Link Offset(m)		0.0			0.0			0.0			0.0	
Crosswalk Width(m)		5.0			5.0			5.0			5.0	
Two way Left Turn Lane												
Headway Factor	1.09	1.09	1.09	1.09	1.09	1.09	1.09	1.09	1.09	1.09	1.09	1.09
Turning Speed (k/h)	24		14	97		97	24		97	97		14
Sign Control		Stop			Stop			Free			Free	

Intersection Summary	
Area Type:	Other
Control Type:	Unsignalized
Intersection Capacity Utilization	30.3%
	ICU Level of Service A
Analysis Period (min)	15

1: March & Morgan's Grant/Shirley's Brook  
PM Peak Hour

555-603 March Road  
2022 Existing Traffic



Lane Group	EBL	EBT	EBR	WBL	WBT	WBR	NBL	NBT	NBR	SBL	SBT	SBR
Lane Configurations		↕	↗	↖	↕	↗	↖	↕↕↕	↗	↖	↕↕↕	↗
Traffic Volume (vph)	10	15	76	137	17	42	86	987	110	26	703	16
Future Volume (vph)	10	15	76	137	17	42	86	987	110	26	703	16
Ideal Flow (vphpl)	1800	1800	1800	1800	1800	1800	1800	1800	1800	1800	1800	1800
Storage Length (m)	0.0		20.0	45.0		35.0	130.0		30.0	65.0		25.0
Storage Lanes	0		1	1		1	1		1	1		1
Taper Length (m)	10.0			30.0			40.0			35.0		
Lane Util. Factor	1.00	1.00	1.00	1.00	1.00	1.00	1.00	0.91	1.00	1.00	0.91	1.00
Ped Bike Factor			0.98	0.99			1.00		0.95	0.99		0.97
Frt			0.850			0.850			0.850			0.850
Flt Protected		0.981		0.950			0.950			0.950		
Satd. Flow (prot)	0	1670	1498	1674	1548	1498	1674	4764	1498	1674	4718	1498
Flt Permitted		0.899		0.739			0.950			0.950		
Satd. Flow (perm)	0	1531	1467	1291	1548	1498	1666	4764	1428	1665	4718	1447
Right Turn on Red			Yes			Yes			Yes			Yes
Satd. Flow (RTOR)			84			80			91			91
Link Speed (k/h)		40			40			80			80	
Link Distance (m)		465.2			359.5			318.9			462.6	
Travel Time (s)		41.9			32.4			14.4			20.8	
Confl. Peds. (#/hr)			7	7			4		7	7		4
Confl. Bikes (#/hr)									3			
Peak Hour Factor	0.90	0.90	0.90	0.90	0.90	0.90	0.90	0.90	0.90	0.90	0.90	0.90
Heavy Vehicles (%)	10%	1%	1%	1%	15%	1%	1%	2%	1%	1%	3%	1%
Adj. Flow (vph)	11	17	84	152	19	47	96	1097	122	29	781	18
Shared Lane Traffic (%)												
Lane Group Flow (vph)	0	28	84	152	19	47	96	1097	122	29	781	18
Enter Blocked Intersection	No	No	No	No	No	No	No	No	No	No	No	No
Lane Alignment	L NA	Left	R NA	L NA	Left	R NA	L NA	Left	R NA	L NA	Left	R NA
Median Width(m)		3.5			5.0			9.0			9.0	
Link Offset(m)		0.0			0.0			0.0			0.0	
Crosswalk Width(m)		5.0			5.0			10.0			10.0	
Two way Left Turn Lane												
Headway Factor	1.09	1.09	1.09	1.09	1.09	1.09	1.09	1.09	1.09	1.09	1.09	1.09
Turning Speed (k/h)	24		14	24		14	24		14	24		14
Number of Detectors	1	2	1	1	2	1	1	2	1	1	2	1
Detector Template	Left	Thru	Right	Left	Thru	Right	Left	Thru	Right	Left	Thru	Right
Leading Detector (m)	2.0	10.0	2.0	2.0	10.0	2.0	2.0	10.0	2.0	2.0	10.0	2.0
Trailing Detector (m)	0.0	0.0	0.0	0.0	0.0	0.0	0.0	0.0	0.0	0.0	0.0	0.0
Detector 1 Position(m)	0.0	0.0	0.0	0.0	0.0	0.0	0.0	0.0	0.0	0.0	0.0	0.0
Detector 1 Size(m)	2.0	0.6	2.0	2.0	0.6	2.0	2.0	0.6	2.0	2.0	0.6	2.0
Detector 1 Type	Cl+Ex	Cl+Ex	Cl+Ex	Cl+Ex	Cl+Ex	Cl+Ex	Cl+Ex	Cl+Ex	Cl+Ex	Cl+Ex	Cl+Ex	Cl+Ex
Detector 1 Channel												
Detector 1 Extend (s)	0.0	0.0	0.0	0.0	0.0	0.0	0.0	0.0	0.0	0.0	0.0	0.0
Detector 1 Queue (s)	0.0	0.0	0.0	0.0	0.0	0.0	0.0	0.0	0.0	0.0	0.0	0.0
Detector 1 Delay (s)	0.0	0.0	0.0	0.0	0.0	0.0	0.0	0.0	0.0	0.0	0.0	0.0
Detector 2 Position(m)		9.4			9.4			9.4			9.4	
Detector 2 Size(m)		0.6			0.6			0.6			0.6	
Detector 2 Type		Cl+Ex			Cl+Ex			Cl+Ex			Cl+Ex	
Detector 2 Channel												
Detector 2 Extend (s)		0.0			0.0			0.0			0.0	
Turn Type	Perm	NA	Perm	Perm	NA	Perm	Prot	NA	Perm	Prot	NA	Perm
Protected Phases		4			8		5	2		1	6	
Permitted Phases	4		4	8		8			2			6
Detector Phase	4	4	4	8	8	8	5	2	2	1	6	6





Lane Group	EBL	EBT	EBR	WBL	WBT	WBR	NBL	NBT	NBR	SBL	SBT	SBR
Switch Phase												
Minimum Initial (s)	10.0	10.0	10.0	10.0	10.0	10.0	5.0	20.0	20.0	5.0	20.0	20.0
Minimum Split (s)	38.5	38.5	38.5	38.5	38.5	38.5	11.4	26.1	26.1	11.4	26.1	26.1
Total Split (s)	39.0	39.0	39.0	39.0	39.0	39.0	21.0	70.0	70.0	21.0	70.0	70.0
Total Split (%)	30.0%	30.0%	30.0%	30.0%	30.0%	30.0%	16.2%	53.8%	53.8%	16.2%	53.8%	53.8%
Maximum Green (s)	31.5	31.5	31.5	31.5	31.5	31.5	14.6	63.9	63.9	14.6	63.9	63.9
Yellow Time (s)	3.0	3.0	3.0	3.0	3.0	3.0	4.6	4.6	4.6	4.6	4.6	4.6
All-Red Time (s)	4.5	4.5	4.5	4.5	4.5	4.5	1.8	1.5	1.5	1.8	1.5	1.5
Lost Time Adjust (s)		0.0	0.0	0.0	0.0	0.0	0.0	0.0	0.0	0.0	0.0	0.0
Total Lost Time (s)		7.5	7.5	7.5	7.5	7.5	6.4	6.1	6.1	6.4	6.1	6.1
Lead/Lag							Lead	Lag	Lag	Lead	Lag	Lag
Lead-Lag Optimize?							Yes	Yes	Yes	Yes	Yes	Yes
Vehicle Extension (s)	3.0	3.0	3.0	3.0	3.0	3.0	3.0	3.0	3.0	3.0	3.0	3.0
Recall Mode	None	None	None	None	None	None	None	C-Max	C-Max	None	C-Max	C-Max
Walk Time (s)	7.0	7.0	7.0	7.0	7.0	7.0		7.0	7.0		7.0	7.0
Flash Dont Walk (s)	24.0	24.0	24.0	24.0	24.0	24.0		11.0	11.0		11.0	11.0
Pedestrian Calls (#/hr)	7	7	7	1	1	1		7	7		4	4
Act Effct Green (s)		21.0	21.0	21.0	21.0	21.0	12.2	86.2	86.2	7.8	76.8	76.8
Actuated g/C Ratio		0.16	0.16	0.16	0.16	0.16	0.09	0.66	0.66	0.06	0.59	0.59
v/c Ratio		0.11	0.27	0.73	0.08	0.15	0.61	0.35	0.12	0.29	0.28	0.02
Control Delay		44.0	10.6	70.6	43.1	3.1	93.2	3.0	0.5	65.1	14.6	0.1
Queue Delay		0.0	0.0	0.0	0.0	0.0	0.0	0.0	0.0	0.0	0.0	0.0
Total Delay		44.0	10.6	70.6	43.1	3.1	93.2	3.0	0.5	65.1	14.6	0.1
LOS		D	B	E	D	A	F	A	A	E	B	A
Approach Delay		19.0			53.6			9.3			16.1	
Approach LOS		B			D			A			B	
Queue Length 50th (m)		5.8	0.0	34.6	3.9	0.0	20.7	28.5	0.3	6.7	31.5	0.0
Queue Length 95th (m)		12.7	11.9	51.5	9.5	2.7	40.6	8.7	0.1	15.7	49.0	0.0
Internal Link Dist (m)		441.2			335.5			294.9			438.6	
Turn Bay Length (m)			20.0	45.0		35.0	130.0		30.0	65.0		25.0
Base Capacity (vph)		370	419	312	375	423	190	3157	977	188	2786	891
Starvation Cap Reductn		0	0	0	0	0	0	0	0	0	0	0
Spillback Cap Reductn		0	0	0	0	0	0	0	0	0	0	0
Storage Cap Reductn		0	0	0	0	0	0	0	0	0	0	0
Reduced v/c Ratio		0.08	0.20	0.49	0.05	0.11	0.51	0.35	0.12	0.15	0.28	0.02

Intersection Summary

Area Type:	Other
Cycle Length:	130
Actuated Cycle Length:	130
Offset:	105 (81%), Referenced to phase 2:NBT and 6:SBT, Start of Green
Natural Cycle:	80
Control Type:	Actuated-Coordinated
Maximum v/c Ratio:	0.73
Intersection Signal Delay:	15.9
Intersection LOS:	B
Intersection Capacity Utilization:	58.0%
ICU Level of Service:	B
Analysis Period (min):	15

Splits and Phases: 1: March & Morgan's Grant/Shirley's Brook

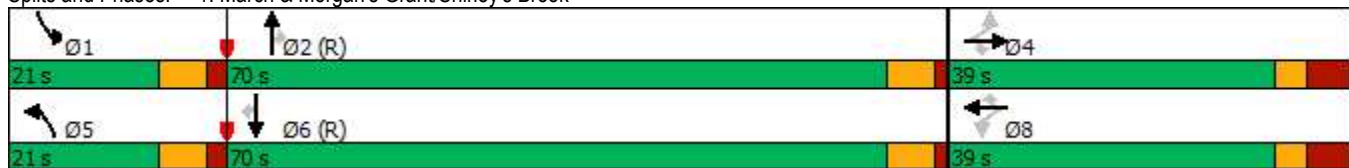

2: March & Terry Fox  
PM Peak Hour

555-603 March Road  
2022 Existing Traffic



Lane Group	EBL	EBT	EBR	WBL	WBT	WBR	NBU	NBL	NBT	NBR	SBU	SBL
Lane Configurations	↖↖	↗↗	↘	↖↖	↗↗	↘		↖↖	↗↗↗	↘		↘
Traffic Volume (vph)	212	107	216	94	183	144	18	203	872	77	4	60
Future Volume (vph)	212	107	216	94	183	144	18	203	872	77	4	60
Ideal Flow (vphpl)	1800	1800	1800	1800	1800	1800	1800	1800	1800	1800	1800	1800
Storage Length (m)	95.0		60.0	75.0		75.0		130.0		85.0		110.0
Storage Lanes	2		2	2		1		2		2		1
Taper Length (m)	40.0			20.0				90.0				40.0
Lane Util. Factor	0.97	0.95	1.00	0.97	0.95	1.00	0.91	0.97	0.91	1.00	0.91	1.00
Ped Bike Factor	0.99		0.98	0.99		0.97		1.00		0.97		1.00
Fr			0.850			0.850				0.850		
Flt Protected	0.950			0.950				0.950				0.950
Satd. Flow (prot)	3248	3221	1498	3248	3349	1498	0	3188	4764	1469	0	1673
Flt Permitted	0.950			0.950				0.950				0.950
Satd. Flow (perm)	3218	3221	1462	3224	3349	1452	0	3176	4764	1431	0	1667
Right Turn on Red			Yes			Yes				Yes		
Satd. Flow (RTOR)			240			160				149		
Link Speed (k/h)		60			60				80			
Link Distance (m)		165.4			149.1				308.9			
Travel Time (s)		9.9			8.9				13.9			
Confl. Peds. (#/hr)	11		8	8		11		4		9		9
Confl. Bikes (#/hr)			4			8				1		
Peak Hour Factor	0.90	0.90	0.90	0.90	0.90	0.90	0.90	0.90	0.90	0.90	0.90	0.90
Heavy Vehicles (%)	1%	5%	1%	1%	1%	1%	2%	3%	2%	3%	2%	1%
Adj. Flow (vph)	236	119	240	104	203	160	20	226	969	86	4	67
Shared Lane Traffic (%)												
Lane Group Flow (vph)	236	119	240	104	203	160	0	246	969	86	0	71
Enter Blocked Intersection	No	No	No	Yes	Yes	Yes	No	No	No	No	No	No
Lane Alignment	L NA	Left	R NA	L NA	Left	R NA	R NA	L NA	Left	R NA	R NA	L NA
Median Width(m)		10.5			10.5				10.5			
Link Offset(m)		0.0			0.0				0.0			
Crosswalk Width(m)		5.0			5.0				5.0			
Two way Left Turn Lane												
Headway Factor	1.09	1.09	1.09	1.09	1.09	1.09	1.09	1.09	1.09	1.09	1.09	1.09
Turning Speed (k/h)	24		14	24		14	14	24		14	14	24
Number of Detectors	1	2	1	1	2	1	1	1	2	1	1	1
Detector Template	Left	Thru	Right	Left	Thru	Right	Left	Left	Thru	Right	Left	Left
Leading Detector (m)	2.0	10.0	2.0	2.0	10.0	2.0	2.0	2.0	10.0	2.0	2.0	2.0
Trailing Detector (m)	0.0	0.0	0.0	0.0	0.0	0.0	0.0	0.0	0.0	0.0	0.0	0.0
Detector 1 Position(m)	0.0	0.0	0.0	0.0	0.0	0.0	0.0	0.0	0.0	0.0	0.0	0.0
Detector 1 Size(m)	2.0	0.6	2.0	2.0	0.6	2.0	2.0	2.0	0.6	2.0	2.0	2.0
Detector 1 Type	Cl+Ex	Cl+Ex	Cl+Ex	Cl+Ex	Cl+Ex	Cl+Ex	Cl+Ex	Cl+Ex	Cl+Ex	Cl+Ex	Cl+Ex	Cl+Ex
Detector 1 Channel												
Detector 1 Extend (s)	0.0	0.0	0.0	0.0	0.0	0.0	0.0	0.0	0.0	0.0	0.0	0.0
Detector 1 Queue (s)	0.0	0.0	0.0	0.0	0.0	0.0	0.0	0.0	0.0	0.0	0.0	0.0
Detector 1 Delay (s)	0.0	0.0	0.0	0.0	0.0	0.0	0.0	0.0	0.0	0.0	0.0	0.0
Detector 2 Position(m)		9.4			9.4				9.4			
Detector 2 Size(m)		0.6			0.6				0.6			
Detector 2 Type		Cl+Ex			Cl+Ex				Cl+Ex			
Detector 2 Channel												
Detector 2 Extend (s)		0.0			0.0				0.0			
Turn Type	Prot	NA	Perm	Prot	NA	Perm	Prot	Prot	NA	Perm	Prot	Prot
Protected Phases	7	4		3	8		5	5	2		1	1
Permitted Phases			4			8				2		
Detector Phase	7	4	4	3	8	8	5	5	2	2	1	1



Lane Group	SBT	SBR
Lane Configurations	↑↑↑	↗
Traffic Volume (vph)	637	158
Future Volume (vph)	637	158
Ideal Flow (vphpl)	1800	1800
Storage Length (m)		100.0
Storage Lanes		1
Taper Length (m)		
Lane Util. Factor	0.91	1.00
Ped Bike Factor		0.98
Fr <sub>t</sub>		0.850
Flt Protected		
Satd. Flow (prot)	4718	1483
Flt Permitted		
Satd. Flow (perm)	4718	1456
Right Turn on Red		Yes
Satd. Flow (RTOR)		176
Link Speed (k/h)	80	
Link Distance (m)	318.9	
Travel Time (s)	14.4	
Confl. Peds. (#/hr)		4
Confl. Bikes (#/hr)		1
Peak Hour Factor	0.90	0.90
Heavy Vehicles (%)	3%	2%
Adj. Flow (vph)	708	176
Shared Lane Traffic (%)		
Lane Group Flow (vph)	708	176
Enter Blocked Intersection	No	No
Lane Alignment	Left	R NA
Median Width(m)	7.0	
Link Offset(m)	0.0	
Crosswalk Width(m)	5.0	
Two way Left Turn Lane		
Headway Factor	1.09	1.09
Turning Speed (k/h)		14
Number of Detectors	2	1
Detector Template	Thru	Right
Leading Detector (m)	10.0	2.0
Trailing Detector (m)	0.0	0.0
Detector 1 Position(m)	0.0	0.0
Detector 1 Size(m)	0.6	2.0
Detector 1 Type	Cl+Ex	Cl+Ex
Detector 1 Channel		
Detector 1 Extend (s)	0.0	0.0
Detector 1 Queue (s)	0.0	0.0
Detector 1 Delay (s)	0.0	0.0
Detector 2 Position(m)	9.4	
Detector 2 Size(m)	0.6	
Detector 2 Type	Cl+Ex	
Detector 2 Channel		
Detector 2 Extend (s)	0.0	
Turn Type	NA	Perm
Protected Phases	6	
Permitted Phases		6
Detector Phase	6	6





Lane Group	SBT	SBR
Switch Phase		
Minimum Initial (s)	20.0	20.0
Minimum Split (s)	32.7	32.7
Total Split (s)	41.0	41.0
Total Split (%)	31.5%	31.5%
Maximum Green (s)	34.3	34.3
Yellow Time (s)	4.6	4.6
All-Red Time (s)	2.1	2.1
Lost Time Adjust (s)	0.0	0.0
Total Lost Time (s)	6.7	6.7
Lead/Lag	Lag	Lag
Lead-Lag Optimize?	Yes	Yes
Vehicle Extension (s)	3.0	3.0
Recall Mode	C-Max	C-Max
Walk Time (s)	7.0	7.0
Flash Dont Walk (s)	19.0	19.0
Pedestrian Calls (#/hr)	4	4
Act Effct Green (s)	52.7	52.7
Actuated g/C Ratio	0.41	0.41
v/c Ratio	0.37	0.25
Control Delay	27.7	6.7
Queue Delay	0.0	0.0
Total Delay	27.7	6.7
LOS	C	A
Approach Delay	27.1	
Approach LOS	C	
Queue Length 50th (m)	33.1	0.7
Queue Length 95th (m)	53.0	15.7
Internal Link Dist (m)	294.9	
Turn Bay Length (m)		100.0
Base Capacity (vph)	1910	694
Starvation Cap Reductn	0	0
Spillback Cap Reductn	0	0
Storage Cap Reductn	0	0
Reduced v/c Ratio	0.37	0.25
<b>Intersection Summary</b>		

3: March & Solandt  
PM Peak Hour

555-603 March Road  
2022 Existing Traffic

Lane Group	EBL	EBT	EBR	WBL	WBT	WBR	NBU	NBL	NBT	NBR	SBU	SBL
Lane Configurations												
Traffic Volume (vph)	29	22	237	205	16	34	16	94	1070	51	12	24
Future Volume (vph)	29	22	237	205	16	34	16	94	1070	51	12	24
Ideal Flow (vphpl)	1800	1800	1800	1800	1800	1800	1800	1800	1800	1800	1800	1800
Storage Length (m)	35.0		60.0	85.0		0.0		165.0		0.0		155.0
Storage Lanes	1		1	2		0		1		1		1
Taper Length (m)	50.0			95.0				40.0				25.0
Lane Util. Factor	1.00	1.00	1.00	0.97	1.00	1.00	0.95	1.00	0.95	1.00	0.95	1.00
Ped Bike Factor	1.00		0.99	1.00	0.99					0.97		
Fr			0.850		0.898					0.850		
Flt Protected	0.950			0.950				0.950				0.950
Satd. Flow (prot)	1674	1695	1483	3248	1463	0	0	1644	3316	1427	0	1647
Flt Permitted	0.950			0.950				0.159				0.225
Satd. Flow (perm)	1669	1695	1462	3240	1463	0	0	275	3316	1383	0	390
Right Turn on Red			Yes			Yes				Yes		
Satd. Flow (RTOR)			170		38					79		
Link Speed (k/h)		50			50				80			
Link Distance (m)		212.6			241.6				610.9			
Travel Time (s)		15.3			17.4				27.5			
Confl. Peds. (#/hr)	2		1	1		2		1		3		3
Confl. Bikes (#/hr)			1			1				1		
Peak Hour Factor	0.90	0.90	0.90	0.90	0.90	0.90	0.90	0.90	0.90	0.90	0.90	0.90
Heavy Vehicles (%)	1%	5%	2%	1%	6%	9%	2%	3%	2%	6%	2%	3%
Adj. Flow (vph)	32	24	263	228	18	38	18	104	1189	57	13	27
Shared Lane Traffic (%)												
Lane Group Flow (vph)	32	24	263	228	56	0	0	122	1189	57	0	40
Enter Blocked Intersection	No	No	No	No	No	No	No	No	No	No	No	No
Lane Alignment	L NA	Left	R NA	L NA	Left	R NA	R NA	L NA	Left	R NA	R NA	L NA
Median Width(m)		7.0			10.5				3.5			
Link Offset(m)		0.0			0.0				0.0			
Crosswalk Width(m)		5.0			5.0				5.0			
Two way Left Turn Lane												
Headway Factor	1.09	1.09	1.09	1.09	1.09	1.09	1.09	1.09	1.09	1.09	1.09	1.09
Turning Speed (k/h)	24		14	24		14	14	24		14	14	24
Number of Detectors	1	2	1	1	2		1	1	2	1	1	1
Detector Template	Left	Thru	Right	Left	Thru		Left	Left	Thru	Right	Left	Left
Leading Detector (m)	2.0	10.0	2.0	2.0	10.0		2.0	2.0	10.0	2.0	2.0	2.0
Trailing Detector (m)	0.0	0.0	0.0	0.0	0.0		0.0	0.0	0.0	0.0	0.0	0.0
Detector 1 Position(m)	0.0	0.0	0.0	0.0	0.0		0.0	0.0	0.0	0.0	0.0	0.0
Detector 1 Size(m)	2.0	0.6	2.0	2.0	0.6		2.0	2.0	0.6	2.0	2.0	2.0
Detector 1 Type	Cl+Ex	Cl+Ex	Cl+Ex	Cl+Ex	Cl+Ex		Cl+Ex	Cl+Ex	Cl+Ex	Cl+Ex	Cl+Ex	Cl+Ex
Detector 1 Channel												
Detector 1 Extend (s)	0.0	0.0	0.0	0.0	0.0		0.0	0.0	0.0	0.0	0.0	0.0
Detector 1 Queue (s)	0.0	0.0	0.0	0.0	0.0		0.0	0.0	0.0	0.0	0.0	0.0
Detector 1 Delay (s)	0.0	0.0	0.0	0.0	0.0		0.0	0.0	0.0	0.0	0.0	0.0
Detector 2 Position(m)		9.4			9.4				9.4			
Detector 2 Size(m)		0.6			0.6				0.6			
Detector 2 Type		Cl+Ex			Cl+Ex				Cl+Ex			
Detector 2 Channel												
Detector 2 Extend (s)		0.0			0.0				0.0			
Turn Type	Prot	NA	Perm	Prot	NA		pm+pt	pm+pt	NA	Perm	Perm	Perm
Protected Phases	7	4		3	8		5	5	2			
Permitted Phases			4				2	2		2	6	6
Detector Phase	7	4	4	3	8		5	5	2	2	6	6

3: March & Solandt  
PM Peak Hour

555-603 March Road  
2022 Existing Traffic



Lane Group	SBT	SBR
Lane Configurations	↑↑	↑
Traffic Volume (vph)	909	35
Future Volume (vph)	909	35
Ideal Flow (vphpl)	1800	1800
Storage Length (m)		75.0
Storage Lanes		1
Taper Length (m)		
Lane Util. Factor	0.95	1.00
Ped Bike Factor		0.97
Fr <sub>t</sub>		0.850
Flt Protected		
Satd. Flow (prot)	3316	1469
Flt Permitted		
Satd. Flow (perm)	3316	1432
Right Turn on Red		Yes
Satd. Flow (RTOR)		132
Link Speed (k/h)	80	
Link Distance (m)	610.3	
Travel Time (s)	27.5	
Confl. Peds. (#/hr)		1
Confl. Bikes (#/hr)		2
Peak Hour Factor	0.90	0.90
Heavy Vehicles (%)	2%	3%
Adj. Flow (vph)	1010	39
Shared Lane Traffic (%)		
Lane Group Flow (vph)	1010	39
Enter Blocked Intersection	No	No
Lane Alignment	Left	R NA
Median Width(m)	3.5	
Link Offset(m)	0.0	
Crosswalk Width(m)	5.0	
Two way Left Turn Lane		
Headway Factor	1.09	1.09
Turning Speed (k/h)		14
Number of Detectors	2	1
Detector Template	Thru	Right
Leading Detector (m)	10.0	2.0
Trailing Detector (m)	0.0	0.0
Detector 1 Position(m)	0.0	0.0
Detector 1 Size(m)	0.6	2.0
Detector 1 Type	Cl+Ex	Cl+Ex
Detector 1 Channel		
Detector 1 Extend (s)	0.0	0.0
Detector 1 Queue (s)	0.0	0.0
Detector 1 Delay (s)	0.0	0.0
Detector 2 Position(m)	9.4	
Detector 2 Size(m)	0.6	
Detector 2 Type	Cl+Ex	
Detector 2 Channel		
Detector 2 Extend (s)	0.0	
Turn Type	NA	Perm
Protected Phases	6	
Permitted Phases		6
Detector Phase	6	6

3: March & Solandt  
PM Peak Hour

555-603 March Road  
2022 Existing Traffic



Lane Group	EBL	EBT	EBR	WBL	WBT	WBR	NBU	NBL	NBT	NBR	SBU	SBL
Switch Phase												
Minimum Initial (s)	5.0	10.0	10.0	5.0	10.0		5.0	5.0	20.0	20.0	20.0	20.0
Minimum Split (s)	10.9	31.5	31.5	10.9	31.5		11.3	11.3	26.3	26.3	26.3	26.3
Total Split (s)	34.0	32.0	32.0	34.0	32.0		12.0	12.0	64.0	64.0	52.0	52.0
Total Split (%)	26.2%	24.6%	24.6%	26.2%	24.6%		9.2%	9.2%	49.2%	49.2%	40.0%	40.0%
Maximum Green (s)	28.1	25.5	25.5	28.1	25.5		5.7	5.7	57.7	57.7	45.7	45.7
Yellow Time (s)	3.3	3.3	3.3	3.3	3.3		4.6	4.6	4.6	4.6	4.6	4.6
All-Red Time (s)	2.6	3.2	3.2	2.6	3.2		1.7	1.7	1.7	1.7	1.7	1.7
Lost Time Adjust (s)	0.0	0.0	0.0	0.0	0.0			0.0	0.0	0.0		0.0
Total Lost Time (s)	5.9	6.5	6.5	5.9	6.5			6.3	6.3	6.3		6.3
Lead/Lag	Lead	Lag	Lag	Lead	Lag		Lead	Lead			Lag	Lag
Lead-Lag Optimize?	Yes	Yes	Yes	Yes	Yes		Yes	Yes			Yes	Yes
Vehicle Extension (s)	3.0	3.0	3.0	3.0	3.0		3.0	3.0	3.0	3.0	3.0	3.0
Recall Mode	None	None	None	None	None		None	None	C-Max	C-Max	C-Max	C-Max
Walk Time (s)		7.0	7.0		7.0				7.0	7.0	7.0	7.0
Flash Dont Walk (s)		18.0	18.0		18.0				12.0	12.0	12.0	12.0
Pedestrian Calls (#/hr)		3	3		1				1	1	1	1
Act Effct Green (s)	8.0	16.1	16.1	14.4	27.4			80.7	80.7	80.7		62.5
Actuated g/C Ratio	0.06	0.12	0.12	0.11	0.21			0.62	0.62	0.62		0.48
v/c Ratio	0.31	0.11	0.80	0.63	0.17			0.41	0.58	0.06		0.21
Control Delay	65.5	48.3	37.0	63.0	19.1			16.4	17.5	1.7		18.5
Queue Delay	0.0	0.0	0.0	0.0	0.0			0.0	0.0	0.0		0.0
Total Delay	65.5	48.3	37.0	63.0	19.1			16.4	17.5	1.7		18.5
LOS	E	D	D	E	B			B	B	A		B
Approach Delay		40.7			54.4				16.7			
Approach LOS		D			D				B			
Queue Length 50th (m)	7.4	5.2	21.7	26.9	3.6			10.8	79.8	0.0		4.8
Queue Length 95th (m)	16.8	11.7	46.6	37.9	13.2			24.6	130.4	3.5		m17.5
Internal Link Dist (m)		188.6			217.6				586.9			
Turn Bay Length (m)	35.0		60.0	85.0				165.0				155.0
Base Capacity (vph)	361	332	423	702	347			295	2059	888		187
Starvation Cap Reductn	0	0	0	0	0			0	0	0		0
Spillback Cap Reductn	0	0	0	0	0			0	0	0		0
Storage Cap Reductn	0	0	0	0	0			0	0	0		0
Reduced v/c Ratio	0.09	0.07	0.62	0.32	0.16			0.41	0.58	0.06		0.21

Intersection Summary

Area Type: Other  
 Cycle Length: 130  
 Actuated Cycle Length: 130  
 Offset: 30 (23%), Referenced to phase 2:NBT and 6:SBTL, Start of Green  
 Natural Cycle: 90  
 Control Type: Actuated-Coordinated  
 Maximum v/c Ratio: 0.80  
 Intersection Signal Delay: 25.0 Intersection LOS: C  
 Intersection Capacity Utilization 77.2% ICU Level of Service D  
 Analysis Period (min) 15  
 m Volume for 95th percentile queue is metered by upstream signal.

Splits and Phases: 3: March & Solandt

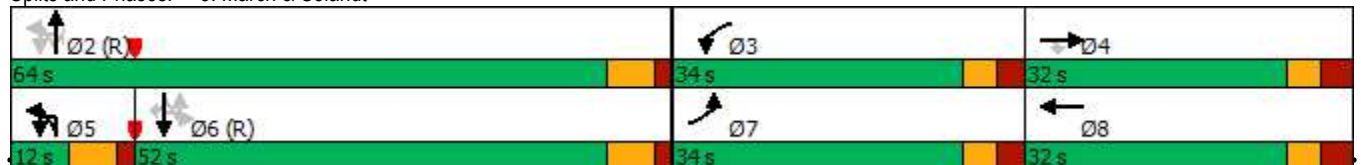





Lane Group	SBT	SBR
Switch Phase		
Minimum Initial (s)	20.0	20.0
Minimum Split (s)	26.3	26.3
Total Split (s)	52.0	52.0
Total Split (%)	40.0%	40.0%
Maximum Green (s)	45.7	45.7
Yellow Time (s)	4.6	4.6
All-Red Time (s)	1.7	1.7
Lost Time Adjust (s)	0.0	0.0
Total Lost Time (s)	6.3	6.3
Lead/Lag	Lag	Lag
Lead-Lag Optimize?	Yes	Yes
Vehicle Extension (s)	3.0	3.0
Recall Mode	C-Max	C-Max
Walk Time (s)	7.0	7.0
Flash Dont Walk (s)	12.0	12.0
Pedestrian Calls (#/hr)	1	1
Act Effct Green (s)	62.5	62.5
Actuated g/C Ratio	0.48	0.48
v/c Ratio	0.63	0.05
Control Delay	24.0	2.0
Queue Delay	0.0	0.0
Total Delay	24.0	2.0
LOS	C	A
Approach Delay	23.0	
Approach LOS	C	
Queue Length 50th (m)	108.7	0.4
Queue Length 95th (m)	144.4	m4.0
Internal Link Dist (m)	586.3	
Turn Bay Length (m)		75.0
Base Capacity (vph)	1595	757
Starvation Cap Reductn	0	0
Spillback Cap Reductn	0	0
Storage Cap Reductn	0	0
Reduced v/c Ratio	0.63	0.05
<b>Intersection Summary</b>		

4: Innovation/Flamborough & Terry Fox  
PM Peak Hour

555-603 March Road  
2022 Existing Traffic

Lane Group	EBL	EBT	EBR	WBL	WBT	WBR	NBL	NBT	NBR	SBL	SBT	SBR
Lane Configurations												
Traffic Volume (vph)	85	276	44	122	374	146	138	80	98	63	60	75
Future Volume (vph)	85	276	44	122	374	146	138	80	98	63	60	75
Ideal Flow (vphpl)	1800	1800	1800	1800	1800	1800	1800	1800	1800	1800	1800	1800
Storage Length (m)	75.0		120.0	110.0		130.0	220.0		0.0	30.0		0.0
Storage Lanes	1		1	1		1	1		0	1		0
Taper Length (m)	50.0			80.0			50.0			15.0		
Lane Util. Factor	1.00	1.00	1.00	1.00	1.00	1.00	1.00	1.00	1.00	1.00	1.00	1.00
Ped Bike Factor	1.00		0.97	0.99		0.96	0.96	0.98		1.00	0.96	
Frt			0.850			0.850		0.917			0.917	
Flt Protected	0.950			0.950			0.950			0.950		
Satd. Flow (prot)	1566	1745	1498	1642	1762	1498	1674	1548	0	1674	1497	0
Flt Permitted	0.465			0.533			0.568			0.452		
Satd. Flow (perm)	765	1745	1450	915	1762	1445	965	1548	0	794	1497	0
Right Turn on Red			Yes			Yes			Yes			Yes
Satd. Flow (RTOR)			78			162		52			53	
Link Speed (k/h)		60			60			50			50	
Link Distance (m)		508.2			485.8			547.1			313.7	
Travel Time (s)		30.5			29.1			39.4			22.6	
Confl. Peds. (#/hr)	2		4	4		2	21		2	2		21
Confl. Bikes (#/hr)			1			12			6			4
Peak Hour Factor	0.90	0.90	0.90	0.90	0.90	0.90	0.90	0.90	0.90	0.90	0.90	0.90
Heavy Vehicles (%)	8%	2%	1%	3%	1%	1%	1%	2%	5%	1%	1%	8%
Adj. Flow (vph)	94	307	49	136	416	162	153	89	109	70	67	83
Shared Lane Traffic (%)												
Lane Group Flow (vph)	94	307	49	136	416	162	153	198	0	70	150	0
Enter Blocked Intersection	No	No	No	No	No	No	No	No	No	No	No	No
Lane Alignment	L NA	Left	R NA	L NA	Left	R NA	L NA	Left	R NA	L NA	Left	R NA
Median Width(m)		3.5			3.5			3.5			3.5	
Link Offset(m)		0.0			0.0			0.0			0.0	
Crosswalk Width(m)		5.0			5.0			5.0			5.0	
Two way Left Turn Lane												
Headway Factor	1.09	1.09	1.09	1.09	1.09	1.09	1.09	1.09	1.09	1.09	1.09	1.09
Turning Speed (k/h)	24		14	24		14	24		14	24		14
Number of Detectors	1	2	1	1	2	1	1	2		1	2	
Detector Template	Left	Thru	Right	Left	Thru	Right	Left	Thru		Left	Thru	
Leading Detector (m)	2.0	10.0	2.0	2.0	10.0	2.0	2.0	10.0		2.0	10.0	
Trailing Detector (m)	0.0	0.0	0.0	0.0	0.0	0.0	0.0	0.0		0.0	0.0	
Detector 1 Position(m)	0.0	0.0	0.0	0.0	0.0	0.0	0.0	0.0		0.0	0.0	
Detector 1 Size(m)	2.0	0.6	2.0	2.0	0.6	2.0	2.0	0.6		2.0	0.6	
Detector 1 Type	Cl+Ex	Cl+Ex	Cl+Ex	Cl+Ex	Cl+Ex	Cl+Ex	Cl+Ex	Cl+Ex		Cl+Ex	Cl+Ex	
Detector 1 Channel												
Detector 1 Extend (s)	0.0	0.0	0.0	0.0	0.0	0.0	0.0	0.0		0.0	0.0	
Detector 1 Queue (s)	0.0	0.0	0.0	0.0	0.0	0.0	0.0	0.0		0.0	0.0	
Detector 1 Delay (s)	0.0	0.0	0.0	0.0	0.0	0.0	0.0	0.0		0.0	0.0	
Detector 2 Position(m)		9.4			9.4			9.4			9.4	
Detector 2 Size(m)		0.6			0.6			0.6			0.6	
Detector 2 Type		Cl+Ex			Cl+Ex			Cl+Ex			Cl+Ex	
Detector 2 Channel												
Detector 2 Extend (s)		0.0			0.0			0.0			0.0	
Turn Type	pm+pt	NA	Perm	pm+pt	NA	Perm	Perm	NA		Perm	NA	
Protected Phases	5	2		1	6			8			4	
Permitted Phases	2		2	6		6	8			4		
Detector Phase	5	2	2	1	6	6	8	8		4	4	

4: Innovation/Flamborough & Terry Fox  
PM Peak Hour

555-603 March Road  
2022 Existing Traffic



Lane Group	EBL	EBT	EBR	WBL	WBT	WBR	NBL	NBT	NBR	SBL	SBT	SBR
Switch Phase												
Minimum Initial (s)	5.0	10.0	10.0	5.0	10.0	10.0	10.0	10.0		10.0	10.0	
Minimum Split (s)	11.0	27.9	27.9	11.0	27.9	27.9	36.3	36.3		36.3	36.3	
Total Split (s)	12.0	66.0	66.0	12.0	66.0	66.0	52.0	52.0		52.0	52.0	
Total Split (%)	9.2%	50.8%	50.8%	9.2%	50.8%	50.8%	40.0%	40.0%		40.0%	40.0%	
Maximum Green (s)	6.0	60.1	60.1	6.0	60.1	60.1	45.7	45.7		45.7	45.7	
Yellow Time (s)	3.7	3.7	3.7	3.7	3.7	3.7	3.3	3.3		3.3	3.3	
All-Red Time (s)	2.3	2.2	2.2	2.3	2.2	2.2	3.0	3.0		3.0	3.0	
Lost Time Adjust (s)	0.0	0.0	0.0	0.0	0.0	0.0	0.0	0.0		0.0	0.0	
Total Lost Time (s)	6.0	5.9	5.9	6.0	5.9	5.9	6.3	6.3		6.3	6.3	
Lead/Lag	Lead	Lag	Lag	Lead	Lag	Lag						
Lead-Lag Optimize?	Yes	Yes	Yes	Yes	Yes	Yes						
Vehicle Extension (s)	3.0	3.0	3.0	3.0	3.0	3.0	3.0	3.0		3.0	3.0	
Recall Mode	None	C-Max	C-Max	None	C-Max	C-Max	None	None		None	None	
Walk Time (s)		7.0	7.0		7.0	7.0	7.0	7.0		7.0	7.0	
Flash Dont Walk (s)		15.0	15.0		15.0	15.0	23.0	23.0		23.0	23.0	
Pedestrian Calls (#/hr)		3	3		3	3	3	3		3	3	
Act Effct Green (s)	86.9	79.0	79.0	88.9	80.0	80.0	23.8	23.8		23.8	23.8	
Actuated g/C Ratio	0.67	0.61	0.61	0.68	0.62	0.62	0.18	0.18		0.18	0.18	
v/c Ratio	0.17	0.29	0.05	0.20	0.38	0.17	0.87	0.61		0.48	0.47	
Control Delay	7.5	14.8	1.3	3.7	7.3	0.7	90.4	42.3		56.6	33.5	
Queue Delay	0.0	0.0	0.0	0.0	0.0	0.0	0.0	0.0		0.0	0.0	
Total Delay	7.5	14.8	1.3	3.7	7.3	0.7	90.4	42.3		56.6	33.5	
LOS	A	B	A	A	A	A	F	D		E	C	
Approach Delay		11.8			5.1			63.3			40.9	
Approach LOS		B			A			E			D	
Queue Length 50th (m)	5.9	32.5	0.0	4.8	19.8	0.5	35.4	31.9		15.0	20.3	
Queue Length 95th (m)	13.9	61.4	2.4	10.9	34.7	1.1	54.3	50.2		26.8	36.0	
Internal Link Dist (m)		484.2			461.8			523.1			289.7	
Turn Bay Length (m)	75.0		120.0	110.0		130.0	220.0			30.0		
Base Capacity (vph)	560	1059	911	676	1083	951	339	577		279	560	
Starvation Cap Reductn	0	0	0	0	0	0	0	0		0	0	
Spillback Cap Reductn	0	0	0	0	0	0	0	0		0	0	
Storage Cap Reductn	0	0	0	0	0	0	0	0		0	0	
Reduced v/c Ratio	0.17	0.29	0.05	0.20	0.38	0.17	0.45	0.34		0.25	0.27	

Intersection Summary





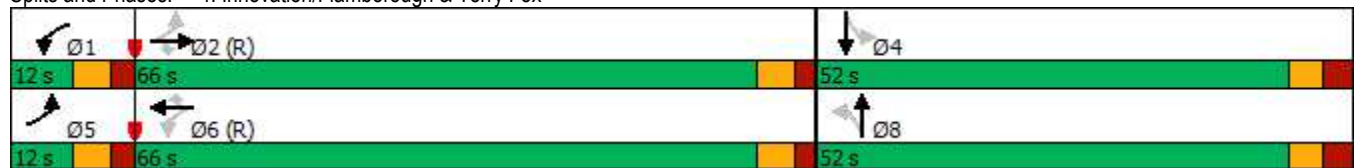











Area Type: Other  
 Cycle Length: 130  
 Actuated Cycle Length: 130  
 Offset: 66 (51%), Referenced to phase 2:EBTL and 6:WBTL, Start of Green  
 Natural Cycle: 80  
 Control Type: Actuated-Coordinated  
 Maximum v/c Ratio: 0.87  
 Intersection Signal Delay: 23.2  
 Intersection LOS: C  
 Intersection Capacity Utilization 71.7%  
 ICU Level of Service C  
 Analysis Period (min) 15

Splits and Phases: 4: Innovation/Flamborough & Terry Fox



5: Hines & Innovation  
PM Peak Hour

555-603 March Road  
2022 Existing Traffic

													
Lane Group	EBL	EBT	EBR	WBL	WBT	WBR	NBL	NBT	NBR	SBL	SBT	SBR	
Lane Configurations													
Traffic Volume (vph)	3	0	100	0	0	0	134	14	0	0	53	9	
Future Volume (vph)	3	0	100	0	0	0	134	14	0	0	53	9	
Ideal Flow (vphpl)	1800	1800	1800	1800	1800	1800	1800	1800	1800	1800	1800	1800	
Lane Util. Factor	1.00	1.00	1.00	1.00	1.00	1.00	1.00	1.00	1.00	1.00	1.00	1.00	
Ped Bike Factor													
Frt	0.869											0.980	
Flt Protected	0.999											0.957	
Satd. Flow (prot)	0	1515	0	0	1762	0	0	1649	0	0	1684	0	
Flt Permitted	0.999											0.957	
Satd. Flow (perm)	0	1515	0	0	1762	0	0	1649	0	0	1684	0	
Link Speed (k/h)	50											50	
Link Distance (m)	438.6											319.0	
Travel Time (s)	31.6											23.0	
Confl. Peds. (#/hr)	2												4
Confl. Bikes (#/hr)	2											3	
Peak Hour Factor	0.90	0.90	0.90	0.90	0.90	0.90	0.90	0.90	0.90	0.90	0.90	0.90	
Heavy Vehicles (%)	1%	1%	2%	1%	1%	1%	3%	6%	1%	1%	4%	1%	
Adj. Flow (vph)	3	0	111	0	0	0	149	16	0	0	59	10	
Shared Lane Traffic (%)													
Lane Group Flow (vph)	0	114	0	0	0	0	0	165	0	0	69	0	
Enter Blocked Intersection	No	No	No	No	No	No	No	No	No	No	No	No	
Lane Alignment	Left	Left	Right	Left	Left	Right	Left	Left	Right	Left	Left	Right	
Median Width(m)	0.0											0.0	
Link Offset(m)	0.0											0.0	
Crosswalk Width(m)	5.0											5.0	
Two way Left Turn Lane													
Headway Factor	1.09	1.09	1.09	1.09	1.09	1.09	1.09	1.09	1.09	1.09	1.09	1.09	
Turning Speed (k/h)	24	14		24	14		24	14		24	14		
Sign Control	Stop		Stop		Free		Free		Free		Free		
<b>Intersection Summary</b>													
Area Type:	Other												
Control Type:	Unsignalized												
Intersection Capacity Utilization 29.0%	ICU Level of Service A												
Analysis Period (min) 15													

## **APPENDIX L**

---

### Background Synchro Analysis

1: March & Morgan's Grant/Shirley's Brook  
AM Peak Hour

555-603 March Road  
2037 Background Traffic



Lane Group	EBL	EBT	EBR	WBL	WBT	WBR	NBL	NBT	NBR	SBL	SBT	SBR
Lane Configurations		↕	↗	↖	↕	↗	↖	↕↕↕	↗	↖	↕↕↕	↗
Traffic Volume (vph)	26	38	68	86	14	25	26	958	41	100	1813	10
Future Volume (vph)	26	38	68	86	14	25	26	958	41	100	1813	10
Ideal Flow (vphpl)	1800	1800	1800	1800	1800	1800	1800	1800	1800	1800	1800	1800
Storage Length (m)	0.0		20.0	45.0		35.0	130.0		30.0	65.0		25.0
Storage Lanes	0		1	1		1	1		1	1		1
Taper Length (m)	10.0			30.0			40.0			35.0		
Lane Util. Factor	1.00	1.00	1.00	1.00	1.00	1.00	1.00	0.91	1.00	1.00	0.91	1.00
Ped Bike Factor		1.00	0.98	0.99		0.98	1.00		0.96	1.00		0.96
Frt			0.850			0.850			0.850			0.850
Flt Protected		0.980		0.950			0.950			0.950		
Satd. Flow (prot)	0	1727	1498	1580	1271	1498	1674	4628	1427	1674	4718	1498
Flt Permitted		0.861		0.715			0.950			0.950		
Satd. Flow (perm)	0	1514	1464	1183	1271	1464	1672	4628	1368	1666	4718	1436
Right Turn on Red			Yes			Yes			Yes			Yes
Satd. Flow (RTOR)			136			136			145			91
Link Speed (k/h)		40			40			60			60	
Link Distance (m)		465.2			359.5			318.9			462.6	
Travel Time (s)		41.9			32.4			19.1			27.8	
Confl. Peds. (#/hr)	5		5	5		5	5		5	5		5
Confl. Bikes (#/hr)			5			5			5			5
Peak Hour Factor	1.00	1.00	1.00	1.00	1.00	1.00	1.00	1.00	1.00	1.00	1.00	1.00
Heavy Vehicles (%)	1%	1%	1%	7%	40%	1%	1%	5%	6%	1%	3%	1%
Adj. Flow (vph)	26	38	68	86	14	25	26	958	41	100	1813	10
Shared Lane Traffic (%)												
Lane Group Flow (vph)	0	64	68	86	14	25	26	958	41	100	1813	10
Enter Blocked Intersection	No	No	No	No	No	No	No	No	No	No	No	No
Lane Alignment	L NA	Left	R NA	L NA	Left	R NA	L NA	Left	R NA	L NA	Left	R NA
Median Width(m)		3.5			5.0			9.0			9.0	
Link Offset(m)		0.0			0.0			0.0			0.0	
Crosswalk Width(m)		5.0			5.0			10.0			10.0	
Two way Left Turn Lane												
Headway Factor	1.09	1.09	1.09	1.09	1.09	1.09	1.09	1.09	1.09	1.09	1.09	1.09
Turning Speed (k/h)	24		14	24		14	24		14	24		14
Number of Detectors	1	2	1	1	2	1	1	2	1	1	2	1
Detector Template	Left	Thru	Right	Left	Thru	Right	Left	Thru	Right	Left	Thru	Right
Leading Detector (m)	2.0	10.0	2.0	2.0	10.0	2.0	2.0	10.0	2.0	2.0	10.0	2.0
Trailing Detector (m)	0.0	0.0	0.0	0.0	0.0	0.0	0.0	0.0	0.0	0.0	0.0	0.0
Detector 1 Position(m)	0.0	0.0	0.0	0.0	0.0	0.0	0.0	0.0	0.0	0.0	0.0	0.0
Detector 1 Size(m)	2.0	0.6	2.0	2.0	0.6	2.0	2.0	0.6	2.0	2.0	0.6	2.0
Detector 1 Type	Cl+Ex	Cl+Ex	Cl+Ex	Cl+Ex	Cl+Ex	Cl+Ex	Cl+Ex	Cl+Ex	Cl+Ex	Cl+Ex	Cl+Ex	Cl+Ex
Detector 1 Channel												
Detector 1 Extend (s)	0.0	0.0	0.0	0.0	0.0	0.0	0.0	0.0	0.0	0.0	0.0	0.0
Detector 1 Queue (s)	0.0	0.0	0.0	0.0	0.0	0.0	0.0	0.0	0.0	0.0	0.0	0.0
Detector 1 Delay (s)	0.0	0.0	0.0	0.0	0.0	0.0	0.0	0.0	0.0	0.0	0.0	0.0
Detector 2 Position(m)		9.4			9.4			9.4			9.4	
Detector 2 Size(m)		0.6			0.6			0.6			0.6	
Detector 2 Type		Cl+Ex			Cl+Ex			Cl+Ex			Cl+Ex	
Detector 2 Channel												
Detector 2 Extend (s)		0.0			0.0			0.0			0.0	
Turn Type	Perm	NA	Perm	Perm	NA	Perm	Prot	NA	Perm	Prot	NA	Perm
Protected Phases		4			8		5	2		1	6	
Permitted Phases	4		4	8		8			2			6
Detector Phase	4	4	4	8	8	8	5	2	2	1	6	6

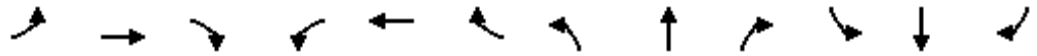

Lane Group	EBL	EBT	EBR	WBL	WBT	WBR	NBL	NBT	NBR	SBL	SBT	SBR
Switch Phase												
Minimum Initial (s)	10.0	10.0	10.0	10.0	10.0	10.0	5.0	10.0	10.0	5.0	10.0	10.0
Minimum Split (s)	38.5	38.5	38.5	38.5	38.5	38.5	11.4	24.4	24.4	11.4	24.4	24.4
Total Split (s)	40.0	40.0	40.0	40.0	40.0	40.0	14.0	65.0	65.0	25.0	76.0	76.0
Total Split (%)	30.8%	30.8%	30.8%	30.8%	30.8%	30.8%	10.8%	50.0%	50.0%	19.2%	58.5%	58.5%
Maximum Green (s)	32.5	32.5	32.5	32.5	32.5	32.5	7.6	58.6	58.6	18.6	69.6	69.6
Yellow Time (s)	3.0	3.0	3.0	3.0	3.0	3.0	3.7	3.7	3.7	3.7	3.7	3.7
All-Red Time (s)	4.5	4.5	4.5	4.5	4.5	4.5	2.7	2.7	2.7	2.7	2.7	2.7
Lost Time Adjust (s)		0.0	0.0	0.0	0.0	0.0	0.0	0.0	0.0	0.0	0.0	0.0
Total Lost Time (s)		7.5	7.5	7.5	7.5	7.5	6.4	6.4	6.4	6.4	6.4	6.4
Lead/Lag							Lead	Lag	Lag	Lead	Lag	Lag
Lead-Lag Optimize?												
Vehicle Extension (s)	3.0	3.0	3.0	3.0	3.0	3.0	3.0	3.0	3.0	3.0	3.0	3.0
Recall Mode	None	None	None	None	None	None	None	C-Max	C-Max	None	C-Max	C-Max
Walk Time (s)	7.0	7.0	7.0	7.0	7.0	7.0		7.0	7.0		7.0	7.0
Flash Dont Walk (s)	24.0	24.0	24.0	24.0	24.0	24.0		11.0	11.0		11.0	11.0
Pedestrian Calls (#/hr)	5	5	5	5	5	5		5	5		5	5
Act Effct Green (s)		17.1	17.1	17.1	17.1	17.1	7.4	79.6	79.6	13.1	90.2	90.2
Actuated g/C Ratio		0.13	0.13	0.13	0.13	0.13	0.06	0.61	0.61	0.10	0.69	0.69
v/c Ratio		0.32	0.22	0.55	0.08	0.08	0.27	0.34	0.05	0.60	0.55	0.01
Control Delay		52.8	1.6	64.3	45.9	0.5	86.8	2.0	0.1	69.8	13.1	0.0
Queue Delay		0.0	0.0	0.0	0.0	0.0	0.0	0.0	0.0	0.0	0.0	0.0
Total Delay		52.8	1.6	64.3	45.9	0.5	86.8	2.0	0.1	69.8	13.1	0.0
LOS		D	A	E	D	A	F	A	A	E	B	A
Approach Delay		26.4			49.5			4.1			16.0	
Approach LOS		C			D			A			B	
Queue Length 50th (m)		14.2	0.0	19.7	3.0	0.0	6.6	2.1	0.0	22.9	76.6	0.0
Queue Length 95th (m)		23.6	0.0	30.8	7.7	0.0	m15.0	3.7	m0.0	38.4	130.4	0.0
Internal Link Dist (m)		441.2			335.5			294.9			438.6	
Turn Bay Length (m)			20.0	45.0		35.0	130.0		30.0	65.0		25.0
Base Capacity (vph)		378	468	295	317	468	103	2832	893	239	3272	1024
Starvation Cap Reductn		0	0	0	0	0	0	0	0	0	0	0
Spillback Cap Reductn		0	0	0	0	0	0	0	0	0	0	0
Storage Cap Reductn		0	0	0	0	0	0	0	0	0	0	0
Reduced v/c Ratio		0.17	0.15	0.29	0.04	0.05	0.25	0.34	0.05	0.42	0.55	0.01

Intersection Summary

Area Type: Other  
 Cycle Length: 130  
 Actuated Cycle Length: 130  
 Offset: 94 (72%), Referenced to phase 2:NBT and 6:SBT, Start of Green  
 Natural Cycle: 90  
 Control Type: Actuated-Coordinated  
 Maximum v/c Ratio: 0.60  
 Intersection Signal Delay: 13.9 Intersection LOS: B  
 Intersection Capacity Utilization 76.8% ICU Level of Service D  
 Analysis Period (min) 15  
 m Volume for 95th percentile queue is metered by upstream signal.

Splits and Phases: 1: March & Morgan's Grant/Shirley's Brook

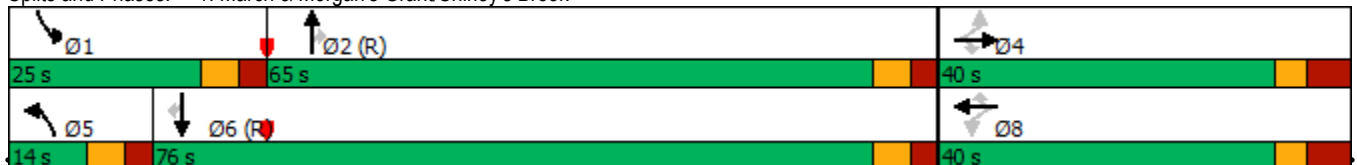

2: March & Terry Fox  
AM Peak Hour

555-603 March Road  
2037 Background Traffic

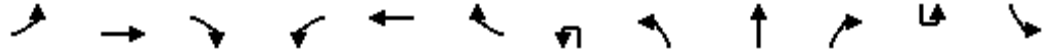

Lane Group	EBL	EBT	EBR	WBL	WBT	WBR	NBU	NBL	NBT	NBR	SBU	SBL
Lane Configurations	↗↗	↕↕	↗	↗↗	↕↕	↗		↗↗	↕↕↕	↗		↗
Traffic Volume (vph)	98	156	289	51	57	56	14	211	851	109	1	202
Future Volume (vph)	98	156	289	51	57	56	14	211	851	109	1	202
Ideal Flow (vphpl)	1800	1800	1800	1800	1800	1800	1800	1800	1800	1800	1800	1800
Storage Length (m)	95.0		60.0	75.0		75.0		130.0		85.0		110.0
Storage Lanes	2		2	2		1		2		2		1
Taper Length (m)	40.0			20.0				90.0				40.0
Lane Util. Factor	0.97	0.95	1.00	0.97	0.95	1.00	0.91	0.97	0.91	1.00	0.91	1.00
Ped Bike Factor	0.99		0.97	0.99		0.98		1.00		0.97		1.00
Fr			0.850			0.850				0.850		
Flt Protected	0.950			0.950				0.950				0.950
Satd. Flow (prot)	3185	3316	1483	3248	3161	1498	0	3246	4628	1469	0	1674
Flt Permitted	0.950			0.950				0.950				0.950
Satd. Flow (perm)	3169	3316	1438	3219	3161	1466	0	3242	4628	1424	0	1666
Right Turn on Red			Yes			Yes				Yes		
Satd. Flow (RTOR)			193			193				198		
Link Speed (k/h)		60			60				60			
Link Distance (m)		165.4			149.1				308.9			
Travel Time (s)		9.9			8.9				18.5			
Confl. Peds. (#/hr)	5		10	10		5		5		10		10
Confl. Bikes (#/hr)			10			5				5		
Peak Hour Factor	1.00	1.00	1.00	1.00	1.00	1.00	1.00	1.00	1.00	1.00	1.00	1.00
Heavy Vehicles (%)	3%	2%	2%	1%	7%	1%	2%	1%	5%	3%	2%	1%
Adj. Flow (vph)	98	156	289	51	57	56	14	211	851	109	1	202
Shared Lane Traffic (%)												
Lane Group Flow (vph)	98	156	289	51	57	56	0	225	851	109	0	203
Enter Blocked Intersection	No	No	No	Yes	Yes	Yes	No	No	No	No	No	No
Lane Alignment	L NA	Left	R NA	L NA	Left	R NA	R NA	L NA	Left	R NA	R NA	L NA
Median Width(m)		10.5			10.5				10.5			
Link Offset(m)		0.0			0.0				0.0			
Crosswalk Width(m)		5.0			5.0				5.0			
Two way Left Turn Lane												
Headway Factor	1.09	1.09	1.09	1.09	1.09	1.09	1.09	1.09	1.09	1.09	1.09	1.09
Turning Speed (k/h)	24		14	24		14	14	24		14	14	24
Number of Detectors	1	2	1	1	2	1	1	1	2	1	1	1
Detector Template	Left	Thru	Right	Left	Thru	Right	Left	Left	Thru	Right	Left	Left
Leading Detector (m)	2.0	10.0	2.0	2.0	10.0	2.0	2.0	2.0	10.0	2.0	2.0	2.0
Trailing Detector (m)	0.0	0.0	0.0	0.0	0.0	0.0	0.0	0.0	0.0	0.0	0.0	0.0
Detector 1 Position(m)	0.0	0.0	0.0	0.0	0.0	0.0	0.0	0.0	0.0	0.0	0.0	0.0
Detector 1 Size(m)	2.0	0.6	2.0	2.0	0.6	2.0	2.0	2.0	0.6	2.0	2.0	2.0
Detector 1 Type	Cl+Ex	Cl+Ex	Cl+Ex	Cl+Ex	Cl+Ex	Cl+Ex	Cl+Ex	Cl+Ex	Cl+Ex	Cl+Ex	Cl+Ex	Cl+Ex
Detector 1 Channel												
Detector 1 Extend (s)	0.0	0.0	0.0	0.0	0.0	0.0	0.0	0.0	0.0	0.0	0.0	0.0
Detector 1 Queue (s)	0.0	0.0	0.0	0.0	0.0	0.0	0.0	0.0	0.0	0.0	0.0	0.0
Detector 1 Delay (s)	0.0	0.0	0.0	0.0	0.0	0.0	0.0	0.0	0.0	0.0	0.0	0.0
Detector 2 Position(m)		9.4			9.4				9.4			
Detector 2 Size(m)		0.6			0.6				0.6			
Detector 2 Type		Cl+Ex			Cl+Ex				Cl+Ex			
Detector 2 Channel												
Detector 2 Extend (s)		0.0			0.0				0.0			
Turn Type	Prot	NA	Perm	Prot	NA	Perm	Prot	Prot	NA	Perm	Prot	Prot
Protected Phases	7	4		3	8		5	5	2		1	1
Permitted Phases			4			8				2		
Detector Phase	7	4	4	3	8	8	5	5	2	2	1	1





Lane Group	SBT	SBR
Lane Configurations	↑↑↑	↗
Traffic Volume (vph)	1615	180
Future Volume (vph)	1615	180
Ideal Flow (vphpl)	1800	1800
Storage Length (m)		100.0
Storage Lanes		1
Taper Length (m)		
Lane Util. Factor	0.91	1.00
Ped Bike Factor		0.98
Frt		0.850
Flt Protected		
Satd. Flow (prot)	4718	1469
Flt Permitted		
Satd. Flow (perm)	4718	1436
Right Turn on Red		Yes
Satd. Flow (RTOR)		180
Link Speed (k/h)	60	
Link Distance (m)	318.9	
Travel Time (s)	19.1	
Confl. Peds. (#/hr)		5
Confl. Bikes (#/hr)		5
Peak Hour Factor	1.00	1.00
Heavy Vehicles (%)	3%	3%
Adj. Flow (vph)	1615	180
Shared Lane Traffic (%)		
Lane Group Flow (vph)	1615	180
Enter Blocked Intersection	No	No
Lane Alignment	Left	R NA
Median Width(m)	7.0	
Link Offset(m)	0.0	
Crosswalk Width(m)	5.0	
Two way Left Turn Lane		
Headway Factor	1.09	1.09
Turning Speed (k/h)		14
Number of Detectors	2	1
Detector Template	Thru	Right
Leading Detector (m)	10.0	2.0
Trailing Detector (m)	0.0	0.0
Detector 1 Position(m)	0.0	0.0
Detector 1 Size(m)	0.6	2.0
Detector 1 Type	Cl+Ex	Cl+Ex
Detector 1 Channel		
Detector 1 Extend (s)	0.0	0.0
Detector 1 Queue (s)	0.0	0.0
Detector 1 Delay (s)	0.0	0.0
Detector 2 Position(m)	9.4	
Detector 2 Size(m)	0.6	
Detector 2 Type	Cl+Ex	
Detector 2 Channel		
Detector 2 Extend (s)	0.0	
Turn Type	NA	Perm
Protected Phases	6	
Permitted Phases		6
Detector Phase	6	6

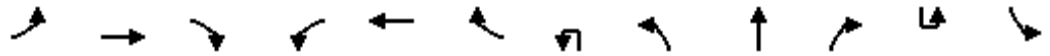

Lane Group	EBL	EBT	EBR	WBL	WBT	WBR	NBU	NBL	NBT	NBR	SBU	SBL
Switch Phase												
Minimum Initial (s)	5.0	10.0	10.0	5.0	10.0	10.0	5.0	5.0	10.0	10.0	5.0	5.0
Minimum Split (s)	11.8	42.0	42.0	11.8	42.0	42.0	11.4	11.4	32.4	32.4	11.4	11.4
Total Split (s)	13.0	43.0	43.0	12.0	42.0	42.0	18.0	18.0	44.0	44.0	31.0	31.0
Total Split (%)	10.0%	33.1%	33.1%	9.2%	32.3%	32.3%	13.8%	13.8%	33.8%	33.8%	23.8%	23.8%
Maximum Green (s)	6.2	36.0	36.0	5.2	35.0	35.0	11.6	11.6	37.6	37.6	24.6	24.6
Yellow Time (s)	3.7	3.7	3.7	3.7	3.7	3.7	3.7	3.7	3.7	3.7	3.7	3.7
All-Red Time (s)	3.1	3.3	3.3	3.1	3.3	3.3	2.7	2.7	2.7	2.7	2.7	2.7
Lost Time Adjust (s)	0.0	0.0	0.0	0.0	0.0	0.0		0.0	0.0	0.0		0.0
Total Lost Time (s)	6.8	7.0	7.0	6.8	7.0	7.0		6.4	6.4	6.4		6.4
Lead/Lag	Lead	Lag	Lag	Lead	Lag	Lag	Lead	Lead	Lag	Lag	Lead	Lead
Lead-Lag Optimize?												
Vehicle Extension (s)	3.0	3.0	3.0	3.0	3.0	3.0	3.0	3.0	3.0	3.0	3.0	3.0
Recall Mode	None	None	None	None	None	None	None	None	C-Max	C-Max	None	None
Walk Time (s)		7.0	7.0		7.0	7.0		7.0	7.0			
Flash Dont Walk (s)		28.0	28.0		28.0	28.0		19.0	19.0			
Pedestrian Calls (#/hr)		10	10		5	5		5	5			
Act Effect Green (s)	7.0	21.5	21.5	5.2	20.7	20.7		12.5	58.9	58.9		20.2
Actuated g/C Ratio	0.05	0.17	0.17	0.04	0.16	0.16		0.10	0.45	0.45		0.16
v/c Ratio	0.57	0.29	0.73	0.40	0.11	0.14		0.72	0.41	0.14		0.78
Control Delay	82.6	44.3	23.3	70.1	42.7	0.8		54.0	39.3	9.5		74.3
Queue Delay	0.0	0.0	0.0	0.0	0.0	0.0		0.0	0.0	0.0		0.0
Total Delay	82.6	44.3	23.3	70.1	42.7	0.8		54.0	39.3	9.5		74.3
LOS	F	D	C	E	D	A		D	D	A		E
Approach Delay		40.1			36.9				39.3			
Approach LOS		D			D				D			
Queue Length 50th (m)	12.7	14.1	13.4	6.1	6.5	0.0		24.2	73.4	1.1		49.3
Queue Length 95th (m)	#23.4	21.7	38.3	12.5	10.3	0.0		#42.8	90.1	20.1		74.1
Internal Link Dist (m)		141.4			125.1				284.9			
Turn Bay Length (m)	95.0		60.0	75.0		75.0		130.0		85.0		110.0
Base Capacity (vph)	171	918	537	129	851	535		316	2098	753		316
Starvation Cap Reductn	0	0	0	0	0	0		0	0	0		0
Spillback Cap Reductn	0	0	0	0	0	0		0	0	0		0
Storage Cap Reductn	0	0	0	0	0	0		0	0	0		0
Reduced v/c Ratio	0.57	0.17	0.54	0.40	0.07	0.10		0.71	0.41	0.14		0.64

Intersection Summary

Area Type: Other  
 Cycle Length: 130  
 Actuated Cycle Length: 130  
 Offset: 80 (62%), Referenced to phase 2:NBT and 6:SBT, Start of Green  
 Natural Cycle: 110  
 Control Type: Actuated-Coordinated  
 Maximum v/c Ratio: 0.78  
 Intersection Signal Delay: 35.0 Intersection LOS: D  
 Intersection Capacity Utilization 88.6% ICU Level of Service E  
 Analysis Period (min) 15  
 # 95th percentile volume exceeds capacity, queue may be longer.  
 Queue shown is maximum after two cycles.

Splits and Phases: 2: March & Terry Fox





Lane Group	SBT	SBR
Switch Phase		
Minimum Initial (s)	10.0	10.0
Minimum Split (s)	32.4	32.4
Total Split (s)	57.0	57.0
Total Split (%)	43.8%	43.8%
Maximum Green (s)	50.6	50.6
Yellow Time (s)	3.7	3.7
All-Red Time (s)	2.7	2.7
Lost Time Adjust (s)	0.0	0.0
Total Lost Time (s)	6.4	6.4
Lead/Lag	Lag	Lag
Lead-Lag Optimize?		
Vehicle Extension (s)	3.0	3.0
Recall Mode	C-Max	C-Max
Walk Time (s)	7.0	7.0
Flash Dont Walk (s)	19.0	19.0
Pedestrian Calls (#/hr)	5	5
Act Effct Green (s)	66.6	66.6
Actuated g/C Ratio	0.51	0.51
v/c Ratio	0.67	0.22
Control Delay	28.0	8.8
Queue Delay	0.0	0.0
Total Delay	28.0	8.8
LOS	C	A
Approach Delay	31.0	
Approach LOS	C	
Queue Length 50th (m)	67.2	0.0
Queue Length 95th (m)	122.4	27.0
Internal Link Dist (m)	294.9	
Turn Bay Length (m)		100.0
Base Capacity (vph)	2417	823
Starvation Cap Reductn	0	0
Spillback Cap Reductn	0	0
Storage Cap Reductn	0	0
Reduced v/c Ratio	0.67	0.22
<b>Intersection Summary</b>		

3: March & Solandt  
AM Peak Hour

555-603 March Road  
2037 Background Traffic



Lane Group	EBL	EBT	EBR	WBL	WBT	WBR	NBU	NBL	NBT	NBR	SBU	SBL
Lane Configurations												
Traffic Volume (vph)	12	33	85	82	16	4	2	221	1484	199	2	43
Future Volume (vph)	12	33	85	82	16	4	2	221	1484	199	2	43
Ideal Flow (vphpl)	1800	1800	1800	1800	1800	1800	1800	1800	1800	1800	1800	1800
Storage Length (m)	35.0		60.0	135.0		55.0		165.0		0.0		155.0
Storage Lanes	1		1	1		1		1		0		1
Taper Length (m)	50.0			50.0				40.0				25.0
Lane Util. Factor	1.00	1.00	1.00	1.00	1.00	1.00	0.95	1.00	0.95	0.95	0.95	1.00
Ped Bike Factor	0.99		0.98	0.99		0.98		1.00	1.00			1.00
Frt			0.850			0.850			0.982			
Flt Protected	0.950			0.950				0.950				0.950
Satd. Flow (prot)	1537	1728	1414	1610	1369	1498	0	1658	3223	0	0	1674
Flt Permitted	0.747			0.736				0.950				0.950
Satd. Flow (perm)	1201	1728	1381	1240	1369	1463	0	1656	3223	0	0	1672
Right Turn on Red			Yes			Yes				Yes		
Satd. Flow (RTOR)			141			141			19			
Link Speed (k/h)		50			50				60			
Link Distance (m)		212.6			241.6				610.9			
Travel Time (s)		15.3			17.4				36.7			
Confl. Peds. (#/hr)	5		5	5		5		5		5		5
Confl. Bikes (#/hr)			5			5				5		
Peak Hour Factor	1.00	1.00	1.00	1.00	1.00	1.00	1.00	1.00	1.00	1.00	1.00	1.00
Heavy Vehicles (%)	10%	3%	7%	5%	30%	1%	2%	2%	3%	1%	2%	1%
Adj. Flow (vph)	12	33	85	82	16	4	2	221	1484	199	2	43
Shared Lane Traffic (%)												
Lane Group Flow (vph)	12	33	85	82	16	4	0	223	1683	0	0	45
Enter Blocked Intersection	No	No	No	No	No	No	No	No	No	No	No	No
Lane Alignment	L NA	Left	R NA	L NA	Left	R NA	R NA	L NA	Left	R NA	R NA	L NA
Median Width(m)		3.5			10.5				17.5			
Link Offset(m)		0.0			0.0				0.0			
Crosswalk Width(m)		5.0			5.0				5.0			
Two way Left Turn Lane												
Headway Factor	1.09	1.09	1.09	1.09	1.09	1.09	1.09	1.09	1.09	1.09	1.09	1.09
Turning Speed (k/h)	24		14	24		14	14	24		14	14	24
Number of Detectors	1	2	1	1	2	1	1	1	2		1	1
Detector Template	Left	Thru	Right	Left	Thru	Right	Left	Left	Thru		Left	Left
Leading Detector (m)	2.0	10.0	2.0	2.0	10.0	2.0	2.0	2.0	10.0		2.0	2.0
Trailing Detector (m)	0.0	0.0	0.0	0.0	0.0	0.0	0.0	0.0	0.0		0.0	0.0
Detector 1 Position(m)	0.0	0.0	0.0	0.0	0.0	0.0	0.0	0.0	0.0		0.0	0.0
Detector 1 Size(m)	2.0	0.6	2.0	2.0	0.6	2.0	2.0	2.0	0.6		2.0	2.0
Detector 1 Type	Cl+Ex	Cl+Ex	Cl+Ex	Cl+Ex	Cl+Ex	Cl+Ex	Cl+Ex	Cl+Ex	Cl+Ex		Cl+Ex	Cl+Ex
Detector 1 Channel												
Detector 1 Extend (s)	0.0	0.0	0.0	0.0	0.0	0.0	0.0	0.0	0.0		0.0	0.0
Detector 1 Queue (s)	0.0	0.0	0.0	0.0	0.0	0.0	0.0	0.0	0.0		0.0	0.0
Detector 1 Delay (s)	0.0	0.0	0.0	0.0	0.0	0.0	0.0	0.0	0.0		0.0	0.0
Detector 2 Position(m)		9.4			9.4				9.4			
Detector 2 Size(m)		0.6			0.6				0.6			
Detector 2 Type		Cl+Ex			Cl+Ex				Cl+Ex			
Detector 2 Channel												
Detector 2 Extend (s)		0.0			0.0				0.0			
Turn Type	Perm	NA	Perm	Perm	NA	Perm	Prot	Prot	NA		Prot	Prot
Protected Phases		4			8		5	5	2		1	1
Permitted Phases	4		4	8		8						
Detector Phase	4	4	4	8	8	8	5	5	2		1	1

3: March & Solandt  
AM Peak Hour

555-603 March Road  
2037 Background Traffic



Lane Group	SBT	SBR
Lane Configurations	↑↑	
Traffic Volume (vph)	1696	37
Future Volume (vph)	1696	37
Ideal Flow (vphpl)	1800	1800
Storage Length (m)		0.0
Storage Lanes		0
Taper Length (m)		
Lane Util. Factor	0.95	0.95
Ped Bike Factor	1.00	
Frt	0.997	
Flt Protected		
Satd. Flow (prot)	3272	0
Flt Permitted		
Satd. Flow (perm)	3272	0
Right Turn on Red		Yes
Satd. Flow (RTOR)	2	
Link Speed (k/h)	60	
Link Distance (m)	411.0	
Travel Time (s)	24.7	
Confl. Peds. (#/hr)		5
Confl. Bikes (#/hr)		5
Peak Hour Factor	1.00	1.00
Heavy Vehicles (%)	3%	1%
Adj. Flow (vph)	1696	37
Shared Lane Traffic (%)		
Lane Group Flow (vph)	1733	0
Enter Blocked Intersection	No	No
Lane Alignment	Left	R NA
Median Width(m)	17.5	
Link Offset(m)	0.0	
Crosswalk Width(m)	5.0	
Two way Left Turn Lane		
Headway Factor	1.09	1.09
Turning Speed (k/h)		14
Number of Detectors	2	
Detector Template	Thru	
Leading Detector (m)	10.0	
Trailing Detector (m)	0.0	
Detector 1 Position(m)	0.0	
Detector 1 Size(m)	0.6	
Detector 1 Type	Cl+Ex	
Detector 1 Channel		
Detector 1 Extend (s)	0.0	
Detector 1 Queue (s)	0.0	
Detector 1 Delay (s)	0.0	
Detector 2 Position(m)	9.4	
Detector 2 Size(m)	0.6	
Detector 2 Type	Cl+Ex	
Detector 2 Channel		
Detector 2 Extend (s)	0.0	
Turn Type	NA	
Protected Phases	6	
Permitted Phases		
Detector Phase	6	

3: March & Solandt  
AM Peak Hour

555-603 March Road  
2037 Background Traffic



Lane Group	EBL	EBT	EBR	WBL	WBT	WBR	NBU	NBL	NBT	NBR	SBU	SBL
Switch Phase												
Minimum Initial (s)	10.0	10.0	10.0	10.0	10.0	10.0	5.0	5.0	10.0		5.0	5.0
Minimum Split (s)	36.5	36.5	36.5	36.5	36.5	36.5	12.0	12.0	26.8		12.0	12.0
Total Split (s)	36.6	36.6	36.6	36.6	36.6	36.6	23.0	23.0	80.4		13.0	13.0
Total Split (%)	28.2%	28.2%	28.2%	28.2%	28.2%	28.2%	17.7%	17.7%	61.8%		10.0%	10.0%
Maximum Green (s)	30.1	30.1	30.1	30.1	30.1	30.1	16.0	16.0	74.6		6.0	6.0
Yellow Time (s)	3.3	3.3	3.3	3.3	3.3	3.3	3.7	3.7	3.7		3.7	3.7
All-Red Time (s)	3.2	3.2	3.2	3.2	3.2	3.2	3.3	3.3	2.1		3.3	3.3
Lost Time Adjust (s)	0.0	0.0	0.0	0.0	0.0	0.0		0.0	0.0			0.0
Total Lost Time (s)	6.5	6.5	6.5	6.5	6.5	6.5		7.0	5.8			7.0
Lead/Lag							Lead	Lead	Lag		Lead	Lead
Lead-Lag Optimize?												
Vehicle Extension (s)	3.0	3.0	3.0	3.0	3.0	3.0	3.0	3.0	3.0		3.0	3.0
Recall Mode	None	None	None	None	None	None	None	None	C-Max		None	None
Walk Time (s)	7.0	7.0	7.0	7.0	7.0	7.0			7.0			
Flash Dont Walk (s)	23.0	23.0	23.0	23.0	23.0	23.0			14.0			
Pedestrian Calls (#/hr)	5	5	5	5	5	5			5			
Act Effct Green (s)	16.3	16.3	16.3	16.3	16.3	16.3		25.3	89.1			7.8
Actuated g/C Ratio	0.13	0.13	0.13	0.13	0.13	0.13		0.19	0.69			0.06
v/c Ratio	0.08	0.15	0.29	0.53	0.09	0.01		0.69	0.76			0.45
Control Delay	46.6	48.6	3.0	63.4	47.1	0.0		61.4	18.6			77.6
Queue Delay	0.0	0.0	0.0	0.0	0.0	0.0		0.0	0.0			0.0
Total Delay	46.6	48.6	3.0	63.4	47.1	0.0		61.4	18.6			77.6
LOS	D	D	A	E	D	A		E	B			E
Approach Delay		18.6			58.4				23.6			
Approach LOS		B			E				C			
Queue Length 50th (m)	2.6	7.2	0.0	18.8	3.5	0.0		48.6	129.3			11.2
Queue Length 95th (m)	7.2	14.3	1.5	29.8	8.7	0.0		#105.1	212.6			#26.7
Internal Link Dist (m)		188.6			217.6				586.9			
Turn Bay Length (m)	35.0		60.0	135.0		55.0		165.0				155.0
Base Capacity (vph)	278	400	428	287	316	447		322	2214			101
Starvation Cap Reductn	0	0	0	0	0	0		0	0			0
Spillback Cap Reductn	0	0	0	0	0	0		0	0			0
Storage Cap Reductn	0	0	0	0	0	0		0	0			0
Reduced v/c Ratio	0.04	0.08	0.20	0.29	0.05	0.01		0.69	0.76			0.45

Intersection Summary

Area Type: Other  
 Cycle Length: 130  
 Actuated Cycle Length: 130  
 Offset: 112 (86%), Referenced to phase 2:NBT and 6:SBT, Start of Green  
 Natural Cycle: 140  
 Control Type: Actuated-Coordinated  
 Maximum v/c Ratio: 1.00  
 Intersection Signal Delay: 30.1 Intersection LOS: C  
 Intersection Capacity Utilization 104.5% ICU Level of Service G  
 Analysis Period (min) 15  
 # 95th percentile volume exceeds capacity, queue may be longer.  
 Queue shown is maximum after two cycles.

Splits and Phases: 3: March & Solandt





Lane Group	SBT	SBR
Switch Phase		
Minimum Initial (s)	10.0	
Minimum Split (s)	26.8	
Total Split (s)	70.4	
Total Split (%)	54.2%	
Maximum Green (s)	64.6	
Yellow Time (s)	3.7	
All-Red Time (s)	2.1	
Lost Time Adjust (s)	0.0	
Total Lost Time (s)	5.8	
Lead/Lag	Lag	
Lead-Lag Optimize?		
Vehicle Extension (s)	3.0	
Recall Mode	C-Max	
Walk Time (s)	7.0	
Flash Dont Walk (s)	14.0	
Pedestrian Calls (#/hr)	5	
Act Effct Green (s)	69.1	
Actuated g/C Ratio	0.53	
v/c Ratio	1.00	
Control Delay	35.1	
Queue Delay	0.0	
Total Delay	35.1	
LOS	D	
Approach Delay	36.1	
Approach LOS	D	
Queue Length 50th (m)	221.8	
Queue Length 95th (m)	#267.8	
Internal Link Dist (m)	387.0	
Turn Bay Length (m)		
Base Capacity (vph)	1740	
Starvation Cap Reductn	0	
Spillback Cap Reductn	0	
Storage Cap Reductn	0	
Reduced v/c Ratio	1.00	
<b>Intersection Summary</b>		

4: Innovation/Flamborough & Terry Fox  
AM Peak Hour

555-603 March Road  
2037 Background Traffic



Lane Group	EBL	EBT	EBR	WBL	WBT	WBR	NBL	NBT	NBR	SBL	SBT	SBR
Lane Configurations												
Traffic Volume (vph)	29	433	76	84	262	37	37	36	85	63	55	42
Future Volume (vph)	29	433	76	84	262	37	37	36	85	63	55	42
Ideal Flow (vphpl)	1800	1800	1800	1800	1800	1800	1800	1800	1800	1800	1800	1800
Storage Length (m)	75.0		120.0	110.0		130.0	220.0		0.0	30.0		0.0
Storage Lanes	1		1	1		1	1		0	1		0
Taper Length (m)	50.0			80.0			50.0			15.0		
Lane Util. Factor	1.00	1.00	1.00	1.00	1.00	1.00	1.00	1.00	1.00	1.00	1.00	1.00
Ped Bike Factor	0.99		0.95	0.99		0.96	0.98	0.97		0.99	0.98	
Fr <sub>t</sub>			0.850			0.850		0.895			0.935	
Flt Protected	0.950			0.950			0.950			0.950		
Satd. Flow (prot)	1470	1728	1469	1626	1728	1498	1658	1511	0	1674	1554	0
Flt Permitted	0.597			0.454			0.684			0.593		
Satd. Flow (perm)	916	1728	1392	769	1728	1441	1171	1511	0	1036	1554	0
Right Turn on Red			Yes			Yes			Yes			Yes
Satd. Flow (RTOR)			78			78		85			29	
Link Speed (k/h)		60			60			50			50	
Link Distance (m)		508.2			485.8			547.1			313.7	
Travel Time (s)		30.5			29.1			39.4			22.6	
Confl. Peds. (#/hr)	5		10	10		5	10		5	5		10
Confl. Bikes (#/hr)			5			5			5			5
Peak Hour Factor	1.00	1.00	1.00	1.00	1.00	1.00	1.00	1.00	1.00	1.00	1.00	1.00
Heavy Vehicles (%)	15%	3%	3%	4%	3%	1%	2%	2%	3%	1%	1%	10%
Adj. Flow (vph)	29	433	76	84	262	37	37	36	85	63	55	42
Shared Lane Traffic (%)												
Lane Group Flow (vph)	29	433	76	84	262	37	37	121	0	63	97	0
Enter Blocked Intersection	No	No	No	No	No	No	No	No	No	No	No	No
Lane Alignment	L NA	Left	R NA	L NA	Left	R NA	L NA	Left	R NA	L NA	Left	R NA
Median Width(m)		3.5			3.5			3.5			3.5	
Link Offset(m)		0.0			0.0			0.0			0.0	
Crosswalk Width(m)		5.0			5.0			5.0			5.0	
Two way Left Turn Lane												
Headway Factor	1.09	1.09	1.09	1.09	1.09	1.09	1.09	1.09	1.09	1.09	1.09	1.09
Turning Speed (k/h)	24		14	24		14	24		14	24		14
Number of Detectors	1	2	1	1	2	1	1	2		1	2	
Detector Template	Left	Thru	Right	Left	Thru	Right	Left	Thru		Left	Thru	
Leading Detector (m)	2.0	10.0	2.0	2.0	10.0	2.0	2.0	10.0		2.0	10.0	
Trailing Detector (m)	0.0	0.0	0.0	0.0	0.0	0.0	0.0	0.0		0.0	0.0	
Detector 1 Position(m)	0.0	0.0	0.0	0.0	0.0	0.0	0.0	0.0		0.0	0.0	
Detector 1 Size(m)	2.0	0.6	2.0	2.0	0.6	2.0	2.0	0.6		2.0	0.6	
Detector 1 Type	Cl+Ex	Cl+Ex	Cl+Ex	Cl+Ex	Cl+Ex	Cl+Ex	Cl+Ex	Cl+Ex		Cl+Ex	Cl+Ex	
Detector 1 Channel												
Detector 1 Extend (s)	0.0	0.0	0.0	0.0	0.0	0.0	0.0	0.0		0.0	0.0	
Detector 1 Queue (s)	0.0	0.0	0.0	0.0	0.0	0.0	0.0	0.0		0.0	0.0	
Detector 1 Delay (s)	0.0	0.0	0.0	0.0	0.0	0.0	0.0	0.0		0.0	0.0	
Detector 2 Position(m)		9.4			9.4			9.4			9.4	
Detector 2 Size(m)		0.6			0.6			0.6			0.6	
Detector 2 Type		Cl+Ex			Cl+Ex			Cl+Ex			Cl+Ex	
Detector 2 Channel												
Detector 2 Extend (s)		0.0			0.0			0.0			0.0	
Turn Type	pm+pt	NA	Perm	pm+pt	NA	Perm	Perm	NA		Perm	NA	
Protected Phases	5	2		1	6			8			4	
Permitted Phases	2		2	6		6	8			4		
Detector Phase	5	2	2	1	6	6	8	8		4	4	



4: Innovation/Flamborough & Terry Fox  
AM Peak Hour

555-603 March Road  
2037 Background Traffic



Lane Group	EBL	EBT	EBR	WBL	WBT	WBR	NBL	NBT	NBR	SBL	SBT	SBR
Switch Phase												
Minimum Initial (s)	5.0	10.0	10.0	5.0	10.0	10.0	10.0	10.0		10.0	10.0	
Minimum Split (s)	11.0	27.9	27.9	11.0	27.9	27.9	36.3	36.3		36.3	36.3	
Total Split (s)	18.0	70.0	70.0	18.0	70.0	70.0	42.0	42.0		42.0	42.0	
Total Split (%)	13.8%	53.8%	53.8%	13.8%	53.8%	53.8%	32.3%	32.3%		32.3%	32.3%	
Maximum Green (s)	12.0	64.1	64.1	12.0	64.1	64.1	35.7	35.7		35.7	35.7	
Yellow Time (s)	3.7	3.7	3.7	3.7	3.7	3.7	3.3	3.3		3.3	3.3	
All-Red Time (s)	2.3	2.2	2.2	2.3	2.2	2.2	3.0	3.0		3.0	3.0	
Lost Time Adjust (s)	0.0	0.0	0.0	0.0	0.0	0.0	0.0	0.0		0.0	0.0	
Total Lost Time (s)	6.0	5.9	5.9	6.0	5.9	5.9	6.3	6.3		6.3	6.3	
Lead/Lag	Lead	Lag	Lag	Lead	Lag	Lag						
Lead-Lag Optimize?												
Vehicle Extension (s)	3.0	3.0	3.0	3.0	3.0	3.0	3.0	3.0		3.0	3.0	
Recall Mode	None	C-Max	C-Max	None	C-Max	C-Max	None	None		None	None	
Walk Time (s)		7.0	7.0		7.0	7.0	7.0	7.0		7.0	7.0	
Flash Dont Walk (s)		15.0	15.0		15.0	15.0	23.0	23.0		23.0	23.0	
Pedestrian Calls (#/hr)		5	5		5	5	5	5		5	5	
Act Effct Green (s)	95.2	89.2	89.2	99.5	94.8	94.8	15.4	15.4		15.4	15.4	
Actuated g/C Ratio	0.73	0.69	0.69	0.77	0.73	0.73	0.12	0.12		0.12	0.12	
v/c Ratio	0.04	0.37	0.08	0.13	0.21	0.03	0.27	0.48		0.52	0.46	
Control Delay	4.9	11.1	2.5	6.3	13.4	5.6	53.6	23.5		66.1	42.3	
Queue Delay	0.0	0.0	0.0	0.0	0.0	0.0	0.0	0.0		0.0	0.0	
Total Delay	4.9	11.1	2.5	6.3	13.4	5.6	53.6	23.5		66.1	42.3	
LOS	A	B	A	A	B	A	D	C		E	D	
Approach Delay		9.6			11.1			30.6			51.7	
Approach LOS		A			B			C			D	
Queue Length 50th (m)	1.1	35.3	0.0	11.3	37.2	0.9	8.3	8.0		14.6	15.4	
Queue Length 95th (m)	5.0	81.8	6.1	m19.7	66.8	m4.1	15.9	21.7		24.6	27.2	
Internal Link Dist (m)		484.2			461.8			523.1			289.7	
Turn Bay Length (m)	75.0		120.0	110.0		130.0	220.0			30.0		
Base Capacity (vph)	763	1185	979	682	1260	1072	321	476		284	447	
Starvation Cap Reductn	0	0	0	0	0	0	0	0		0	0	
Spillback Cap Reductn	0	0	0	0	0	0	0	0		0	0	
Storage Cap Reductn	0	0	0	0	0	0	0	0		0	0	
Reduced v/c Ratio	0.04	0.37	0.08	0.12	0.21	0.03	0.12	0.25		0.22	0.22	

Intersection Summary

Area Type: Other  
 Cycle Length: 130  
 Actuated Cycle Length: 130  
 Offset: 124 (95%), Referenced to phase 2:EBTL and 6:WBTL, Start of Green  
 Natural Cycle: 80  
 Control Type: Actuated-Coordinated  
 Maximum v/c Ratio: 0.52  
 Intersection Signal Delay: 18.1  
 Intersection LOS: B  
 Intersection Capacity Utilization 70.8%  
 ICU Level of Service C  
 Analysis Period (min) 15  
 m Volume for 95th percentile queue is metered by upstream signal.

Splits and Phases: 4: Innovation/Flamborough & Terry Fox

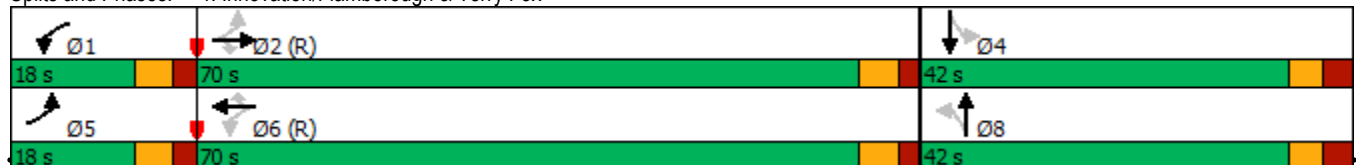

5: Hines & Innovation  
AM Peak Hour

555-603 March Road  
2037 Background Traffic



Lane Group	EBL	EBT	EBR	WBL	WBT	WBR	NBL	NBT	NBR	SBL	SBT	SBR
Lane Configurations												
Traffic Volume (vph)	15	0	118	6	1	0	92	58	2	1	15	2
Future Volume (vph)	15	0	118	6	1	0	92	58	2	1	15	2
Ideal Flow (vphpl)	1800	1800	1800	1800	1800	1800	1800	1800	1800	1800	1800	1800
Lane Util. Factor	1.00	1.00	1.00	1.00	1.00	1.00	1.00	1.00	1.00	1.00	1.00	1.00
Ped Bike Factor												
Frt		0.880						0.998			0.985	
Flt Protected		0.994			0.959			0.971			0.997	
Satd. Flow (prot)	0	1477	0	0	1690	0	0	1633	0	0	1675	0
Flt Permitted		0.994			0.959			0.971			0.997	
Satd. Flow (perm)	0	1477	0	0	1690	0	0	1633	0	0	1675	0
Link Speed (k/h)		50			50			50			50	
Link Distance (m)		438.6			104.0			421.8			319.0	
Travel Time (s)		31.6			7.5			30.4			23.0	
Confl. Peds. (#/hr)							5					5
Confl. Bikes (#/hr)			5			5			10			5
Peak Hour Factor	1.00	1.00	1.00	1.00	1.00	1.00	1.00	1.00	1.00	1.00	1.00	1.00
Heavy Vehicles (%)	1%	2%	6%	1%	1%	1%	8%	2%	2%	2%	5%	1%
Adj. Flow (vph)	15	0	118	6	1	0	92	58	2	1	15	2
Shared Lane Traffic (%)												
Lane Group Flow (vph)	0	133	0	0	7	0	0	152	0	0	18	0
Enter Blocked Intersection	No	No	No	No	No	No	No	No	No	No	No	No
Lane Alignment	Left	Left	Right	Left	Left	Right	Left	Left	Right	Left	Left	Right
Median Width(m)		0.0			0.0			0.0			0.0	
Link Offset(m)		0.0			0.0			0.0			0.0	
Crosswalk Width(m)		5.0			5.0			5.0			5.0	
Two way Left Turn Lane												
Headway Factor	1.09	1.09	1.09	1.09	1.09	1.09	1.09	1.09	1.09	1.09	1.09	1.09
Turning Speed (k/h)	24		14	97		97	24		97	97		14
Sign Control		Stop			Stop			Free			Free	















Intersection Summary

Area Type: Other

Control Type: Unsignalized

Intersection Capacity Utilization 30.3% ICU Level of Service A

Analysis Period (min) 15

						
Lane Group	WBL	WBR	NBT	NBR	SBL	SBT
Lane Configurations			 			  
Traffic Volume (vph)	180	156	956	89	351	1618
Future Volume (vph)	180	156	956	89	351	1618
Ideal Flow (vphpl)	1800	1800	1800	1800	1800	1800
Storage Length (m)	65.0	0.0		100.0	75.0	
Storage Lanes	1	1		1	1	
Taper Length (m)	25.0				50.0	
Lane Util. Factor	1.00	1.00	0.95	1.00	1.00	0.91
Ped Bike Factor	0.99	0.97		0.94		
Fr t		0.850		0.850		
Flt Protected	0.950				0.950	
Satd. Flow (prot)	1674	1498	3283	1498	1674	4718
Flt Permitted	0.950				0.202	
Satd. Flow (perm)	1654	1456	3283	1408	356	4718
Right Turn on Red		Yes		Yes		
Satd. Flow (RTOR)		156		89		
Link Speed (k/h)	50		60			60
Link Distance (m)	167.8		199.3			308.9
Travel Time (s)	12.1		12.0			18.5
Confl. Peds. (#/hr)	10	10		10	10	
Confl. Bikes (#/hr)		5		5		
Peak Hour Factor	1.00	1.00	1.00	1.00	1.00	1.00
Heavy Vehicles (%)	1%	1%	3%	1%	1%	3%
Adj. Flow (vph)	180	156	956	89	351	1618
Shared Lane Traffic (%)						
Lane Group Flow (vph)	180	156	956	89	351	1618
Enter Blocked Intersection	No	No	No	No	No	No
Lane Alignment	L NA	Right	Left	Right	L NA	Left
Median Width(m)	3.5		7.0			7.0
Link Offset(m)	0.0		0.0			0.0
Crosswalk Width(m)	5.0		5.0			5.0
Two way Left Turn Lane						
Headway Factor	1.09	1.09	1.09	1.09	1.09	1.09
Turning Speed (k/h)	24	14		14	24	
Number of Detectors	1	1	2	1	1	2
Detector Template	Left	Right	Thru	Right	Left	Thru
Leading Detector (m)	2.0	2.0	10.0	2.0	2.0	10.0
Trailing Detector (m)	0.0	0.0	0.0	0.0	0.0	0.0
Detector 1 Position(m)	0.0	0.0	0.0	0.0	0.0	0.0
Detector 1 Size(m)	2.0	2.0	0.6	2.0	2.0	0.6
Detector 1 Type	Cl+Ex	Cl+Ex	Cl+Ex	Cl+Ex	Cl+Ex	Cl+Ex
Detector 1 Channel						
Detector 1 Extend (s)	0.0	0.0	0.0	0.0	0.0	0.0
Detector 1 Queue (s)	0.0	0.0	0.0	0.0	0.0	0.0
Detector 1 Delay (s)	0.0	0.0	0.0	0.0	0.0	0.0
Detector 2 Position(m)			9.4			9.4
Detector 2 Size(m)			0.6			0.6
Detector 2 Type			Cl+Ex			Cl+Ex
Detector 2 Channel						
Detector 2 Extend (s)			0.0			0.0
Turn Type	Perm	Perm	NA	Perm	pm+pt	NA
Protected Phases			2		1	6
Permitted Phases	8	8		2	6	
Detector Phase	8	8	2	2	1	6



Lane Group	WBL	WBR	NBT	NBR	SBL	SBT
Switch Phase						
Minimum Initial (s)	10.0	10.0	10.0	10.0	5.0	10.0
Minimum Split (s)	38.5	38.5	23.8	23.8	11.4	23.8
Total Split (s)	42.0	42.0	55.0	55.0	33.0	88.0
Total Split (%)	32.3%	32.3%	42.3%	42.3%	25.4%	67.7%
Maximum Green (s)	35.5	35.5	49.2	49.2	26.6	82.2
Yellow Time (s)	3.3	3.3	3.7	3.7	3.7	3.7
All-Red Time (s)	3.2	3.2	2.1	2.1	2.7	2.1
Lost Time Adjust (s)	0.0	0.0	0.0	0.0	0.0	0.0
Total Lost Time (s)	6.5	6.5	5.8	5.8	6.4	5.8
Lead/Lag			Lag	Lag	Lead	
Lead-Lag Optimize?						
Vehicle Extension (s)	3.0	3.0	3.0	3.0	3.0	3.0
Recall Mode	None	None	C-Max	C-Max	None	C-Max
Walk Time (s)	7.0	7.0	7.0	7.0		7.0
Flash Dont Walk (s)	25.0	25.0	11.0	11.0		11.0
Pedestrian Calls (#/hr)	10	10	10	10		10
Act Effct Green (s)	20.6	20.6	68.5	68.5	96.5	97.1
Actuated g/C Ratio	0.16	0.16	0.53	0.53	0.74	0.75
v/c Ratio	0.69	0.43	0.55	0.11	0.72	0.46
Control Delay	64.2	10.0	19.7	6.1	15.8	6.1
Queue Delay	0.0	0.0	0.0	0.0	0.0	0.0
Total Delay	64.2	10.0	19.7	6.1	15.8	6.1
LOS	E	B	B	A	B	A
Approach Delay	39.0		18.6			7.9
Approach LOS	D		B			A
Queue Length 50th (m)	41.1	0.0	34.0	0.0	28.3	61.0
Queue Length 95th (m)	56.7	15.5	93.2	m6.8	23.8	72.5
Internal Link Dist (m)	143.8		175.3			284.9
Turn Bay Length (m)	65.0			100.0	75.0	
Base Capacity (vph)	451	511	1729	783	542	3524
Starvation Cap Reductn	0	0	0	0	0	0
Spillback Cap Reductn	0	0	0	0	0	0
Storage Cap Reductn	0	0	0	0	0	0
Reduced v/c Ratio	0.40	0.31	0.55	0.11	0.65	0.46

Intersection Summary

Area Type: Other  
 Cycle Length: 130  
 Actuated Cycle Length: 130  
 Offset: 0 (0%), Referenced to phase 2:NBT and 6:SBTL, Start of Green  
 Natural Cycle: 90  
 Control Type: Actuated-Coordinated  
 Maximum v/c Ratio: 0.72  
 Intersection Signal Delay: 14.3  
 Intersection LOS: B  
 Intersection Capacity Utilization 79.1%  
 ICU Level of Service D  
 Analysis Period (min) 15  
 m Volume for 95th percentile queue is metered by upstream signal.

Splits and Phases: 6: March & Nokia Access



1: March & Morgan's Grant/Shirley's Brook  
PM Peak Hour

555-603 March Road  
2037 Background Traffic



Lane Group	EBL	EBT	EBR	WBL	WBT	WBR	NBL	NBT	NBR	SBL	SBT	SBR
Lane Configurations		↕	↕	↕	↕	↕	↕	↕↕↕	↕	↕	↕↕↕	↕
Traffic Volume (vph)	54	50	63	130	47	195	72	1725	91	169	1107	68
Future Volume (vph)	54	50	63	130	47	195	72	1725	91	169	1107	68
Ideal Flow (vphpl)	1800	1800	1800	1800	1800	1800	1800	1800	1800	1800	1800	1800
Storage Length (m)	0.0		20.0	45.0		35.0	130.0		30.0	65.0		25.0
Storage Lanes	0		1	1		1	1		1	1		1
Taper Length (m)	10.0			30.0			40.0			35.0		
Lane Util. Factor	1.00	1.00	1.00	1.00	1.00	1.00	1.00	0.91	1.00	1.00	0.91	1.00
Ped Bike Factor		1.00	0.97	0.99		0.98	1.00		0.94	1.00		0.96
Frt			0.850			0.850			0.850			0.850
Flt Protected		0.975		0.950			0.950			0.950		
Satd. Flow (prot)	0	1642	1498	1674	1548	1498	1674	4764	1498	1674	4718	1498
Flt Permitted		0.812		0.690			0.950			0.950		
Satd. Flow (perm)	0	1364	1455	1203	1548	1464	1668	4764	1409	1669	4718	1436
Right Turn on Red			Yes			Yes			Yes			Yes
Satd. Flow (RTOR)			136			195			145			91
Link Speed (k/h)		40			40			60			60	
Link Distance (m)		465.2			359.5			318.9			462.6	
Travel Time (s)		41.9			32.4			19.1			27.8	
Confl. Peds. (#/hr)	5		10	10		5	5		10	10		5
Confl. Bikes (#/hr)			5			5			5			5
Peak Hour Factor	1.00	1.00	1.00	1.00	1.00	1.00	1.00	1.00	1.00	1.00	1.00	1.00
Heavy Vehicles (%)	10%	1%	1%	1%	15%	1%	1%	2%	1%	1%	3%	1%
Adj. Flow (vph)	54	50	63	130	47	195	72	1725	91	169	1107	68
Shared Lane Traffic (%)												
Lane Group Flow (vph)	0	104	63	130	47	195	72	1725	91	169	1107	68
Enter Blocked Intersection	No	No	No	No	No	No	No	No	No	No	No	No
Lane Alignment	L NA	Left	R NA	L NA	Left	R NA	L NA	Left	R NA	L NA	Left	R NA
Median Width(m)		3.5			5.0			9.0			9.0	
Link Offset(m)		0.0			0.0			0.0			0.0	
Crosswalk Width(m)		5.0			5.0			10.0			10.0	
Two way Left Turn Lane												
Headway Factor	1.09	1.09	1.09	1.09	1.09	1.09	1.09	1.09	1.09	1.09	1.09	1.09
Turning Speed (k/h)	24		14	24		14	24		14	24		14
Number of Detectors	1	2	1	1	2	1	1	2	1	1	2	1
Detector Template	Left	Thru	Right	Left	Thru	Right	Left	Thru	Right	Left	Thru	Right
Leading Detector (m)	2.0	10.0	2.0	2.0	10.0	2.0	2.0	10.0	2.0	2.0	10.0	2.0
Trailing Detector (m)	0.0	0.0	0.0	0.0	0.0	0.0	0.0	0.0	0.0	0.0	0.0	0.0
Detector 1 Position(m)	0.0	0.0	0.0	0.0	0.0	0.0	0.0	0.0	0.0	0.0	0.0	0.0
Detector 1 Size(m)	2.0	0.6	2.0	2.0	0.6	2.0	2.0	0.6	2.0	2.0	0.6	2.0
Detector 1 Type	Cl+Ex	Cl+Ex	Cl+Ex	Cl+Ex	Cl+Ex	Cl+Ex	Cl+Ex	Cl+Ex	Cl+Ex	Cl+Ex	Cl+Ex	Cl+Ex
Detector 1 Channel												
Detector 1 Extend (s)	0.0	0.0	0.0	0.0	0.0	0.0	0.0	0.0	0.0	0.0	0.0	0.0
Detector 1 Queue (s)	0.0	0.0	0.0	0.0	0.0	0.0	0.0	0.0	0.0	0.0	0.0	0.0
Detector 1 Delay (s)	0.0	0.0	0.0	0.0	0.0	0.0	0.0	0.0	0.0	0.0	0.0	0.0
Detector 2 Position(m)		9.4			9.4			9.4			9.4	
Detector 2 Size(m)		0.6			0.6			0.6			0.6	
Detector 2 Type		Cl+Ex			Cl+Ex			Cl+Ex			Cl+Ex	
Detector 2 Channel												
Detector 2 Extend (s)		0.0			0.0			0.0			0.0	
Turn Type	Perm	NA	Perm	Perm	NA	Perm	Prot	NA	Perm	Prot	NA	Perm
Protected Phases		4			8		5	2		1	6	
Permitted Phases	4		4	8		8			2			6
Detector Phase	4	4	4	8	8	8	5	2	2	1	6	6



Lane Group	EBL	EBT	EBR	WBL	WBT	WBR	NBL	NBT	NBR	SBL	SBT	SBR
Switch Phase												
Minimum Initial (s)	10.0	10.0	10.0	10.0	10.0	10.0	5.0	10.0	10.0	5.0	10.0	10.0
Minimum Split (s)	38.5	38.5	38.5	38.5	38.5	38.5	11.4	24.4	24.4	11.4	24.4	24.4
Total Split (s)	39.0	39.0	39.0	39.0	39.0	39.0	19.0	63.0	63.0	28.0	72.0	72.0
Total Split (%)	30.0%	30.0%	30.0%	30.0%	30.0%	30.0%	14.6%	48.5%	48.5%	21.5%	55.4%	55.4%
Maximum Green (s)	31.5	31.5	31.5	31.5	31.5	31.5	12.6	56.6	56.6	21.6	65.6	65.6
Yellow Time (s)	3.0	3.0	3.0	3.0	3.0	3.0	3.7	3.7	3.7	3.7	3.7	3.7
All-Red Time (s)	4.5	4.5	4.5	4.5	4.5	4.5	2.7	2.7	2.7	2.7	2.7	2.7
Lost Time Adjust (s)		0.0	0.0	0.0	0.0	0.0	0.0	0.0	0.0	0.0	0.0	0.0
Total Lost Time (s)		7.5	7.5	7.5	7.5	7.5	6.4	6.4	6.4	6.4	6.4	6.4
Lead/Lag							Lead	Lag	Lag	Lead	Lag	Lag
Lead-Lag Optimize?												
Vehicle Extension (s)	3.0	3.0	3.0	3.0	3.0	3.0	3.0	3.0	3.0	3.0	3.0	3.0
Recall Mode	None	None	None	None	None	None	None	C-Max	C-Max	None	C-Max	C-Max
Walk Time (s)	7.0	7.0	7.0	7.0	7.0	7.0		7.0	7.0		7.0	7.0
Flash Dont Walk (s)	24.0	24.0	24.0	24.0	24.0	24.0		11.0	11.0		11.0	11.0
Pedestrian Calls (#/hr)	10	10	10	5	5	5		10	10		5	5
Act Effct Green (s)		20.0	20.0	20.0	20.0	20.0	10.5	71.9	71.9	17.7	81.8	81.8
Actuated g/C Ratio		0.15	0.15	0.15	0.15	0.15	0.08	0.55	0.55	0.14	0.63	0.63
v/c Ratio		0.50	0.19	0.70	0.20	0.50	0.53	0.65	0.11	0.74	0.37	0.07
Control Delay		56.6	1.2	70.6	46.7	10.3	46.2	41.6	12.6	72.9	14.1	1.7
Queue Delay		0.0	0.0	0.0	0.0	0.0	0.0	0.0	0.0	0.0	0.0	0.0
Total Delay		56.6	1.2	70.6	46.7	10.3	46.2	41.6	12.6	72.9	14.1	1.7
LOS		E	A	E	D	B	D	D	B	E	B	A
Approach Delay		35.7			36.0			40.4			20.8	
Approach LOS		D			D			D			C	
Queue Length 50th (m)		22.9	0.0	29.6	9.9	0.0	15.8	111.1	0.1	38.6	46.0	0.0
Queue Length 95th (m)		35.8	0.0	45.0	18.3	17.2	m22.6	173.0	m11.5	59.3	71.1	4.0
Internal Link Dist (m)		441.2			335.5			294.9			438.6	
Turn Bay Length (m)			20.0	45.0		35.0	130.0		30.0	65.0		25.0
Base Capacity (vph)		330	455	291	375	502	163	2636	844	279	2967	936
Starvation Cap Reductn		0	0	0	0	0	0	0	0	0	0	0
Spillback Cap Reductn		0	0	0	0	0	0	0	0	0	0	0
Storage Cap Reductn		0	0	0	0	0	0	0	0	0	0	0
Reduced v/c Ratio		0.32	0.14	0.45	0.13	0.39	0.44	0.65	0.11	0.61	0.37	0.07

Intersection Summary

Area Type: Other  
 Cycle Length: 130  
 Actuated Cycle Length: 130  
 Offset: 83 (64%), Referenced to phase 2:NBT and 6:SBT, Start of Green  
 Natural Cycle: 90  
 Control Type: Actuated-Coordinated  
 Maximum v/c Ratio: 0.74  
 Intersection Signal Delay: 32.8  
 Intersection LOS: C  
 Intersection Capacity Utilization 81.5%  
 ICU Level of Service D  
 Analysis Period (min) 15  
 m Volume for 95th percentile queue is metered by upstream signal.

Splits and Phases: 1: March & Morgan's Grant/Shirley's Brook

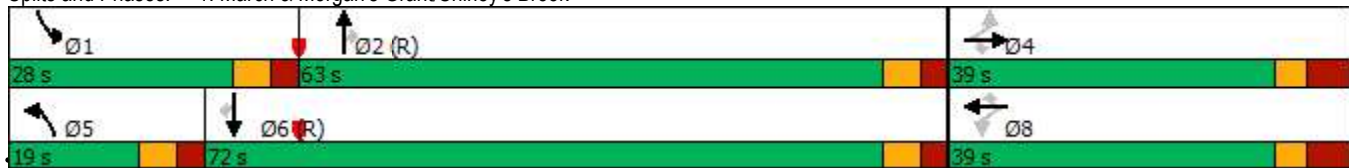

2: March & Terry Fox  
PM Peak Hour

555-603 March Road  
2037 Background Traffic



Lane Group	EBL	EBT	EBR	WBL	WBT	WBR	NBU	NBL	NBT	NBR	SBU	SBL
Lane Configurations	↖↖	↕↕	↗	↖↖	↕↕	↗		↖↖	↕↕↕	↗		↖
Traffic Volume (vph)	245	155	194	95	158	209	18	328	1572	126	4	150
Future Volume (vph)	245	155	194	95	158	209	18	328	1572	126	4	150
Ideal Flow (vphpl)	1800	1800	1800	1800	1800	1800	1800	1800	1800	1800	1800	1800
Storage Length (m)	95.0		60.0	75.0		75.0		130.0		85.0		110.0
Storage Lanes	2		2	2		1		2		2		1
Taper Length (m)	40.0			20.0				90.0				40.0
Lane Util. Factor	0.97	0.95	1.00	0.97	0.95	1.00	0.91	0.97	0.91	1.00	0.91	1.00
Ped Bike Factor	0.99		0.97	0.99		0.96		1.00		0.97		1.00
Fr			0.850			0.850				0.850		
Flt Protected	0.950			0.950				0.950				0.950
Satd. Flow (prot)	3248	3221	1498	3248	3349	1498	0	3187	4764	1469	0	1674
Flt Permitted	0.950			0.950				0.950				0.950
Satd. Flow (perm)	3204	3221	1458	3219	3349	1443	0	3176	4764	1425	0	1671
Right Turn on Red			Yes			Yes				Yes		
Satd. Flow (RTOR)			194			193				144		
Link Speed (k/h)		60			60				60			
Link Distance (m)		165.4			149.1				308.9			
Travel Time (s)		9.9			8.9				18.5			
Confl. Peds. (#/hr)	15		10	10		15		5		10		10
Confl. Bikes (#/hr)			5			10				5		
Peak Hour Factor	1.00	1.00	1.00	1.00	1.00	1.00	1.00	1.00	1.00	1.00	1.00	1.00
Heavy Vehicles (%)	1%	5%	1%	1%	1%	1%	2%	3%	2%	3%	2%	1%
Adj. Flow (vph)	245	155	194	95	158	209	18	328	1572	126	4	150
Shared Lane Traffic (%)												
Lane Group Flow (vph)	245	155	194	95	158	209	0	346	1572	126	0	154
Enter Blocked Intersection	No	No	No	Yes	Yes	Yes	No	No	No	No	No	No
Lane Alignment	L NA	Left	R NA	L NA	Left	R NA	R NA	L NA	Left	R NA	R NA	L NA
Median Width(m)		10.5			10.5				10.5			
Link Offset(m)		0.0			0.0				0.0			
Crosswalk Width(m)		5.0			5.0				5.0			
Two way Left Turn Lane												
Headway Factor	1.09	1.09	1.09	1.09	1.09	1.09	1.09	1.09	1.09	1.09	1.09	1.09
Turning Speed (k/h)	24		14	24		14	14	24		14	14	24
Number of Detectors	1	2	1	1	2	1	1	1	2	1	1	1
Detector Template	Left	Thru	Right	Left	Thru	Right	Left	Left	Thru	Right	Left	Left
Leading Detector (m)	2.0	10.0	2.0	2.0	10.0	2.0	2.0	2.0	10.0	2.0	2.0	2.0
Trailing Detector (m)	0.0	0.0	0.0	0.0	0.0	0.0	0.0	0.0	0.0	0.0	0.0	0.0
Detector 1 Position(m)	0.0	0.0	0.0	0.0	0.0	0.0	0.0	0.0	0.0	0.0	0.0	0.0
Detector 1 Size(m)	2.0	0.6	2.0	2.0	0.6	2.0	2.0	2.0	0.6	2.0	2.0	2.0
Detector 1 Type	Cl+Ex	Cl+Ex	Cl+Ex	Cl+Ex	Cl+Ex	Cl+Ex	Cl+Ex	Cl+Ex	Cl+Ex	Cl+Ex	Cl+Ex	Cl+Ex
Detector 1 Channel												
Detector 1 Extend (s)	0.0	0.0	0.0	0.0	0.0	0.0	0.0	0.0	0.0	0.0	0.0	0.0
Detector 1 Queue (s)	0.0	0.0	0.0	0.0	0.0	0.0	0.0	0.0	0.0	0.0	0.0	0.0
Detector 1 Delay (s)	0.0	0.0	0.0	0.0	0.0	0.0	0.0	0.0	0.0	0.0	0.0	0.0
Detector 2 Position(m)		9.4			9.4				9.4			
Detector 2 Size(m)		0.6			0.6				0.6			
Detector 2 Type		Cl+Ex			Cl+Ex				Cl+Ex			
Detector 2 Channel												
Detector 2 Extend (s)		0.0			0.0				0.0			
Turn Type	Prot	NA	Perm	Prot	NA	Perm	Prot	Prot	NA	Perm	Prot	Prot
Protected Phases	7	4		3	8		5	5	2		1	1
Permitted Phases			4			8				2		
Detector Phase	7	4	4	3	8	8	5	5	2	2	1	1



Lane Group	SBT	SBR
Lane Configurations	↑↑↑	↑
Traffic Volume (vph)	947	166
Future Volume (vph)	947	166
Ideal Flow (vphpl)	1800	1800
Storage Length (m)		100.0
Storage Lanes		1
Taper Length (m)		
Lane Util. Factor	0.91	1.00
Ped Bike Factor		0.98
Frt		0.850
Flt Protected		
Satd. Flow (prot)	4718	1483
Flt Permitted		
Satd. Flow (perm)	4718	1449
Right Turn on Red		Yes
Satd. Flow (RTOR)		198
Link Speed (k/h)	60	
Link Distance (m)	318.9	
Travel Time (s)	19.1	
Confl. Peds. (#/hr)		5
Confl. Bikes (#/hr)		5
Peak Hour Factor	1.00	1.00
Heavy Vehicles (%)	3%	2%
Adj. Flow (vph)	947	166
Shared Lane Traffic (%)		
Lane Group Flow (vph)	947	166
Enter Blocked Intersection	No	No
Lane Alignment	Left	R NA
Median Width(m)	7.0	
Link Offset(m)	0.0	
Crosswalk Width(m)	5.0	
Two way Left Turn Lane		
Headway Factor	1.09	1.09
Turning Speed (k/h)		14
Number of Detectors	2	1
Detector Template	Thru	Right
Leading Detector (m)	10.0	2.0
Trailing Detector (m)	0.0	0.0
Detector 1 Position(m)	0.0	0.0
Detector 1 Size(m)	0.6	2.0
Detector 1 Type	Cl+Ex	Cl+Ex
Detector 1 Channel		
Detector 1 Extend (s)	0.0	0.0
Detector 1 Queue (s)	0.0	0.0
Detector 1 Delay (s)	0.0	0.0
Detector 2 Position(m)	9.4	
Detector 2 Size(m)	0.6	
Detector 2 Type	Cl+Ex	
Detector 2 Channel		
Detector 2 Extend (s)	0.0	
Turn Type	NA	Perm
Protected Phases	6	
Permitted Phases		6
Detector Phase	6	6



2: March & Terry Fox  
PM Peak Hour

555-603 March Road  
2037 Background Traffic



Lane Group	EBL	EBT	EBR	WBL	WBT	WBR	NBU	NBL	NBT	NBR	SBU	SBL
Switch Phase												
Minimum Initial (s)	5.0	10.0	10.0	5.0	10.0	10.0	5.0	5.0	10.0	10.0	5.0	5.0
Minimum Split (s)	11.8	42.0	42.0	11.8	42.0	42.0	11.4	11.4	32.4	32.4	11.4	11.4
Total Split (s)	18.4	46.6	46.6	13.8	42.0	42.0	27.1	27.1	50.6	50.6	19.0	19.0
Total Split (%)	14.2%	35.8%	35.8%	10.6%	32.3%	32.3%	20.8%	20.8%	38.9%	38.9%	14.6%	14.6%
Maximum Green (s)	11.6	39.6	39.6	7.0	35.0	35.0	20.7	20.7	44.2	44.2	12.6	12.6
Yellow Time (s)	3.7	3.7	3.7	3.7	3.7	3.7	3.7	3.7	3.7	3.7	3.7	3.7
All-Red Time (s)	3.1	3.3	3.3	3.1	3.3	3.3	2.7	2.7	2.7	2.7	2.7	2.7
Lost Time Adjust (s)	0.0	0.0	0.0	0.0	0.0	0.0			0.0	0.0	0.0	0.0
Total Lost Time (s)	6.8	7.0	7.0	6.8	7.0	7.0			6.4	6.4	6.4	6.4
Lead/Lag	Lead	Lag	Lag	Lead	Lag	Lag	Lead	Lead	Lag	Lag	Lead	Lead
Lead-Lag Optimize?												
Vehicle Extension (s)	3.0	3.0	3.0	3.0	3.0	3.0	3.0	3.0	3.0	3.0	3.0	3.0
Recall Mode	None	None	None	None	None	None	None	None	C-Max	C-Max	None	None
Walk Time (s)		7.0	7.0		7.0	7.0			7.0	7.0		
Flash Dont Walk (s)		28.0	28.0		28.0	28.0			19.0	19.0		
Pedestrian Calls (#/hr)		15	15		15	15			10	10		
Act Effct Green (s)	11.6	25.0	25.0	6.9	20.3	20.3		18.4	55.9	55.9		15.6
Actuated g/C Ratio	0.09	0.19	0.19	0.05	0.16	0.16		0.14	0.43	0.43		0.12
v/c Ratio	0.85	0.25	0.44	0.55	0.30	0.54		0.77	0.77	0.18		0.77
Control Delay	79.9	52.9	16.8	72.6	47.5	12.2		70.5	31.6	4.6		69.7
Queue Delay	0.0	0.0	0.0	0.0	0.0	0.0		0.0	0.0	0.0		0.0
Total Delay	79.9	52.9	16.8	72.6	47.5	12.2		70.5	31.6	4.6		69.7
LOS	E	D	B	E	D	B		E	C	A		E
Approach Delay		52.3			36.7				36.6			
Approach LOS		D			D				D			
Queue Length 50th (m)	29.5	20.0	7.0	11.4	19.1	3.6		42.9	63.5	1.5		21.4
Queue Length 95th (m)	#49.2	28.2	31.1	19.8	23.5	20.8		m52.2	#161.5	m3.8		#72.1
Internal Link Dist (m)		141.4			125.1				284.9			
Turn Bay Length (m)	95.0		60.0	75.0		75.0		130.0		85.0		110.0
Base Capacity (vph)	289	981	579	174	901	529		507	2048	694		200
Starvation Cap Reductn	0	0	0	0	0	0		0	0	0		0
Spillback Cap Reductn	0	0	0	0	0	0		0	0	0		0
Storage Cap Reductn	0	0	0	0	0	0		0	0	0		0
Reduced v/c Ratio	0.85	0.16	0.34	0.55	0.18	0.40		0.68	0.77	0.18		0.77

Intersection Summary

Area Type: Other  
 Cycle Length: 130  
 Actuated Cycle Length: 130  
 Offset: 0 (0%), Referenced to phase 2:NBT and 6:SBT, Start of Green  
 Natural Cycle: 120  
 Control Type: Actuated-Coordinated  
 Maximum v/c Ratio: 0.85  
 Intersection Signal Delay: 37.5 Intersection LOS: D  
 Intersection Capacity Utilization 91.3% ICU Level of Service F  
 Analysis Period (min) 15  
 # 95th percentile volume exceeds capacity, queue may be longer.  
 Queue shown is maximum after two cycles.  
 m Volume for 95th percentile queue is metered by upstream signal.

Splits and Phases: 2: March & Terry Fox

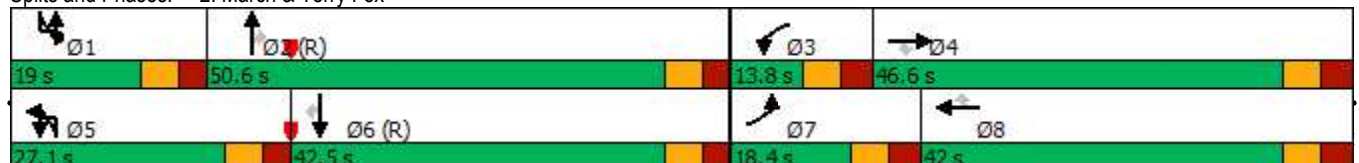



Lane Group	SBT	SBR
Switch Phase		
Minimum Initial (s)	10.0	10.0
Minimum Split (s)	32.4	32.4
Total Split (s)	42.5	42.5
Total Split (%)	32.7%	32.7%
Maximum Green (s)	36.1	36.1
Yellow Time (s)	3.7	3.7
All-Red Time (s)	2.7	2.7
Lost Time Adjust (s)	0.0	0.0
Total Lost Time (s)	6.4	6.4
Lead/Lag	Lag	Lag
Lead-Lag Optimize?		
Vehicle Extension (s)	3.0	3.0
Recall Mode	C-Max	C-Max
Walk Time (s)	7.0	7.0
Flash Dont Walk (s)	19.0	19.0
Pedestrian Calls (#/hr)	10	10
Act Effct Green (s)	53.0	53.0
Actuated g/C Ratio	0.41	0.41
v/c Ratio	0.49	0.23
Control Delay	30.2	10.2
Queue Delay	0.0	0.0
Total Delay	30.2	10.2
LOS	C	B
Approach Delay	32.4	
Approach LOS	C	
Queue Length 50th (m)	61.8	10.7
Queue Length 95th (m)	96.2	30.8
Internal Link Dist (m)	294.9	
Turn Bay Length (m)		100.0
Base Capacity (vph)	1924	708
Starvation Cap Reductn	0	0
Spillback Cap Reductn	0	0
Storage Cap Reductn	0	0
Reduced v/c Ratio	0.49	0.23
<b>Intersection Summary</b>		

3: March & Solandt  
PM Peak Hour

555-603 March Road  
2037 Background Traffic



Lane Group	EBL	EBT	EBR	WBL	WBT	WBR	NBU	NBL	NBT	NBR	SBU	SBL
Lane Configurations												
Traffic Volume (vph)	24	25	197	389	24	24	16	78	1813	45	12	21
Future Volume (vph)	24	25	197	389	24	24	16	78	1813	45	12	21
Ideal Flow (vphpl)	1800	1800	1800	1800	1800	1800	1800	1800	1800	1800	1800	1800
Storage Length (m)	35.0		60.0	135.0		55.0		165.0		0.0		155.0
Storage Lanes	1		1	1		1		1		0		1
Taper Length (m)	50.0			50.0				40.0				25.0
Lane Util. Factor	1.00	1.00	1.00	1.00	1.00	1.00	0.95	1.00	0.95	0.95	0.95	1.00
Ped Bike Factor	0.99		0.98	0.99		0.98		1.00	1.00			1.00
Frt			0.850			0.850			0.996			
Flt Protected	0.950			0.950				0.950				0.950
Satd. Flow (prot)	1674	1695	1483	1674	1679	1388	0	1644	3297	0	0	1648
Flt Permitted	0.742			0.520				0.950				0.950
Satd. Flow (perm)	1299	1695	1449	911	1679	1358	0	1641	3297	0	0	1646
Right Turn on Red			Yes			Yes				Yes		
Satd. Flow (RTOR)			137			82			3			
Link Speed (k/h)		50			50				60			
Link Distance (m)		212.6			241.6				610.9			
Travel Time (s)		15.3			17.4				36.7			
Confl. Peds. (#/hr)	5		5	5		5		5		5		5
Confl. Bikes (#/hr)			5			5				5		
Peak Hour Factor	1.00	1.00	1.00	1.00	1.00	1.00	1.00	1.00	1.00	1.00	1.00	1.00
Heavy Vehicles (%)	1%	5%	2%	1%	6%	9%	2%	3%	2%	6%	2%	3%
Adj. Flow (vph)	24	25	197	389	24	24	16	78	1813	45	12	21
Shared Lane Traffic (%)												
Lane Group Flow (vph)	24	25	197	389	24	24	0	94	1858	0	0	33
Enter Blocked Intersection	No	No	No	No	No	No	No	No	No	No	No	No
Lane Alignment	L NA	Left	R NA	L NA	Left	R NA	R NA	L NA	Left	R NA	R NA	L NA
Median Width(m)		3.5			10.5				17.5			
Link Offset(m)		0.0			0.0				0.0			
Crosswalk Width(m)		5.0			5.0				5.0			
Two way Left Turn Lane												
Headway Factor	1.09	1.09	1.09	1.09	1.09	1.09	1.09	1.09	1.09	1.09	1.09	1.09
Turning Speed (k/h)	24		14	24		14	14	24		14	14	24
Number of Detectors	1	2	1	1	2	1	1	1	2		1	1
Detector Template	Left	Thru	Right	Left	Thru	Right	Left	Left	Thru		Left	Left
Leading Detector (m)	2.0	10.0	2.0	2.0	10.0	2.0	2.0	2.0	10.0		2.0	2.0
Trailing Detector (m)	0.0	0.0	0.0	0.0	0.0	0.0	0.0	0.0	0.0		0.0	0.0
Detector 1 Position(m)	0.0	0.0	0.0	0.0	0.0	0.0	0.0	0.0	0.0		0.0	0.0
Detector 1 Size(m)	2.0	0.6	2.0	2.0	0.6	2.0	2.0	2.0	0.6		2.0	2.0
Detector 1 Type	Cl+Ex	Cl+Ex	Cl+Ex	Cl+Ex	Cl+Ex	Cl+Ex	Cl+Ex	Cl+Ex	Cl+Ex		Cl+Ex	Cl+Ex
Detector 1 Channel												
Detector 1 Extend (s)	0.0	0.0	0.0	0.0	0.0	0.0	0.0	0.0	0.0		0.0	0.0
Detector 1 Queue (s)	0.0	0.0	0.0	0.0	0.0	0.0	0.0	0.0	0.0		0.0	0.0
Detector 1 Delay (s)	0.0	0.0	0.0	0.0	0.0	0.0	0.0	0.0	0.0		0.0	0.0
Detector 2 Position(m)		9.4			9.4				9.4			
Detector 2 Size(m)		0.6			0.6				0.6			
Detector 2 Type		Cl+Ex			Cl+Ex				Cl+Ex			
Detector 2 Channel												
Detector 2 Extend (s)		0.0			0.0				0.0			
Turn Type	Perm	NA	Perm	pm+pt	NA	Perm	Prot	Prot	NA		Prot	Prot
Protected Phases		4		3	8		5	5	2		1	1
Permitted Phases	4		4	8		8						
Detector Phase	4	4	4	3	8	8	5	5	2		1	1

3: March & Solandt  
PM Peak Hour

555-603 March Road  
2037 Background Traffic



Lane Group	SBT	SBR
Lane Configurations	↑↑	
Traffic Volume (vph)	1311	29
Future Volume (vph)	1311	29
Ideal Flow (vphpl)	1800	1800
Storage Length (m)		0.0
Storage Lanes		0
Taper Length (m)		
Lane Util. Factor	0.95	0.95
Ped Bike Factor	1.00	
Frt	0.997	
Flt Protected		
Satd. Flow (prot)	3302	0
Flt Permitted		
Satd. Flow (perm)	3302	0
Right Turn on Red		Yes
Satd. Flow (RTOR)	2	
Link Speed (k/h)	60	
Link Distance (m)	411.0	
Travel Time (s)	24.7	
Confl. Peds. (#/hr)		5
Confl. Bikes (#/hr)		5
Peak Hour Factor	1.00	1.00
Heavy Vehicles (%)	2%	3%
Adj. Flow (vph)	1311	29
Shared Lane Traffic (%)		
Lane Group Flow (vph)	1340	0
Enter Blocked Intersection	No	No
Lane Alignment	Left	R NA
Median Width(m)	17.5	
Link Offset(m)	0.0	
Crosswalk Width(m)	5.0	
Two way Left Turn Lane		
Headway Factor	1.09	1.09
Turning Speed (k/h)		14
Number of Detectors	2	
Detector Template	Thru	
Leading Detector (m)	10.0	
Trailing Detector (m)	0.0	
Detector 1 Position(m)	0.0	
Detector 1 Size(m)	0.6	
Detector 1 Type	Cl+Ex	
Detector 1 Channel		
Detector 1 Extend (s)	0.0	
Detector 1 Queue (s)	0.0	
Detector 1 Delay (s)	0.0	
Detector 2 Position(m)	9.4	
Detector 2 Size(m)	0.6	
Detector 2 Type	Cl+Ex	
Detector 2 Channel		
Detector 2 Extend (s)	0.0	
Turn Type	NA	
Protected Phases	6	
Permitted Phases		
Detector Phase	6	



Lane Group	EBL	EBT	EBR	WBL	WBT	WBR	NBU	NBL	NBT	NBR	SBU	SBL
Switch Phase												
Minimum Initial (s)	10.0	10.0	10.0	5.0	10.0	10.0	5.0	5.0	10.0		5.0	5.0
Minimum Split (s)	36.5	36.5	36.5	11.5	36.5	36.5	12.0	12.0	26.8		12.0	12.0
Total Split (s)	37.0	37.0	37.0	13.0	50.0	50.0	15.0	15.0	68.0		12.0	12.0
Total Split (%)	28.5%	28.5%	28.5%	10.0%	38.5%	38.5%	11.5%	11.5%	52.3%		9.2%	9.2%
Maximum Green (s)	30.5	30.5	30.5	6.5	43.5	43.5	8.0	8.0	62.2		5.0	5.0
Yellow Time (s)	3.3	3.3	3.3	3.3	3.3	3.3	3.7	3.7	3.7		3.7	3.7
All-Red Time (s)	3.2	3.2	3.2	3.2	3.2	3.2	3.3	3.3	2.1		3.3	3.3
Lost Time Adjust (s)	0.0	0.0	0.0	0.0	0.0	0.0		0.0	0.0			0.0
Total Lost Time (s)	6.5	6.5	6.5	6.5	6.5	6.5		7.0	5.8			7.0
Lead/Lag	Lag	Lag	Lag	Lead			Lead	Lead	Lag		Lead	Lead
Lead-Lag Optimize?												
Vehicle Extension (s)	3.0	3.0	3.0	3.0	3.0	3.0	3.0	3.0	3.0		3.0	3.0
Recall Mode	None	None	None	None	None	None	None	None	C-Max		None	None
Walk Time (s)	7.0	7.0	7.0		7.0	7.0			7.0			
Flash Dont Walk (s)	23.0	23.0	23.0		23.0	23.0			14.0			
Pedestrian Calls (#/hr)	5	5	5		5	5			5			
Act Effct Green (s)	15.3	15.3	15.3	28.3	28.3	28.3		12.6	80.6			7.1
Actuated g/C Ratio	0.12	0.12	0.12	0.22	0.22	0.22		0.10	0.62			0.05
v/c Ratio	0.16	0.13	0.68	1.65	0.07	0.07		0.59	0.91			0.37
Control Delay	50.0	48.8	29.1	342.0	37.2	0.4		71.5	31.4			79.8
Queue Delay	0.0	0.0	0.0	0.0	0.0	0.0		0.0	0.0			0.0
Total Delay	50.0	48.8	29.1	342.0	37.2	0.4		71.5	31.4			79.8
LOS	D	D	C	F	D	A		E	C			E
Approach Delay		33.1			306.5				33.4			
Approach LOS		C			F				C			
Queue Length 50th (m)	5.4	5.6	13.7	~139.6	4.7	0.0		21.2	199.4			8.2
Queue Length 95th (m)	11.3	11.6	32.2	#163.9	9.6	0.0		#52.1	#315.8			#19.7
Internal Link Dist (m)		188.6			217.6				586.9			
Turn Bay Length (m)	35.0		60.0	135.0		55.0		165.0				155.0
Base Capacity (vph)	304	397	444	236	561	508		159	2045			90
Starvation Cap Reductn	0	0	0	0	0	0		0	0			0
Spillback Cap Reductn	0	0	0	0	0	0		0	0			0
Storage Cap Reductn	0	0	0	0	0	0		0	0			0
Reduced v/c Ratio	0.08	0.06	0.44	1.65	0.04	0.05		0.59	0.91			0.37

Intersection Summary

Area Type: Other  
 Cycle Length: 130  
 Actuated Cycle Length: 130  
 Offset: 16 (12%), Referenced to phase 2:NBT and 6:SBT, Start of Green  
 Natural Cycle: 150  
 Control Type: Actuated-Coordinated  
 Maximum v/c Ratio: 1.65  
 Intersection Signal Delay: 60.9  
 Intersection LOS: E  
 Intersection Capacity Utilization 104.2%  
 ICU Level of Service G  
 Analysis Period (min) 15  
 ~ Volume exceeds capacity, queue is theoretically infinite.  
 Queue shown is maximum after two cycles.  
 # 95th percentile volume exceeds capacity, queue may be longer.  
 Queue shown is maximum after two cycles.

Splits and Phases: 3: March & Solandt

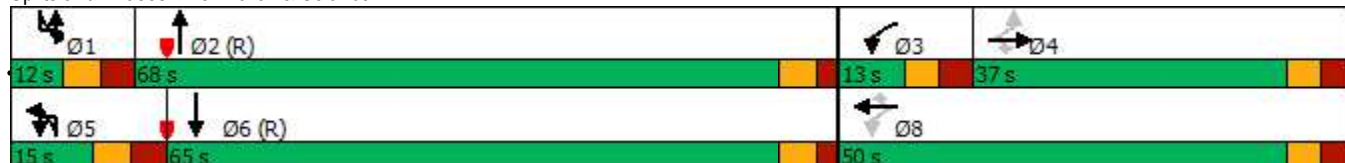



Lane Group	SBT	SBR
Switch Phase		
Minimum Initial (s)	10.0	
Minimum Split (s)	26.8	
Total Split (s)	65.0	
Total Split (%)	50.0%	
Maximum Green (s)	59.2	
Yellow Time (s)	3.7	
All-Red Time (s)	2.1	
Lost Time Adjust (s)	0.0	
Total Lost Time (s)	5.8	
Lead/Lag	Lag	
Lead-Lag Optimize?		
Vehicle Extension (s)	3.0	
Recall Mode	C-Max	
Walk Time (s)	7.0	
Flash Dont Walk (s)	14.0	
Pedestrian Calls (#/hr)	5	
Act Effct Green (s)	69.8	
Actuated g/C Ratio	0.54	
v/c Ratio	0.76	
Control Delay	25.6	
Queue Delay	0.0	
Total Delay	25.6	
LOS	C	
Approach Delay	26.9	
Approach LOS	C	
Queue Length 50th (m)	62.8	
Queue Length 95th (m)	137.3	
Internal Link Dist (m)	387.0	
Turn Bay Length (m)		
Base Capacity (vph)	1774	
Starvation Cap Reductn	0	
Spillback Cap Reductn	0	
Storage Cap Reductn	0	
Reduced v/c Ratio	0.76	
<b>Intersection Summary</b>		

4: Innovation/Flamborough & Terry Fox  
PM Peak Hour

555-603 March Road  
2037 Background Traffic

Lane Group	EBL	EBT	EBR	WBL	WBT	WBR	NBL	NBT	NBR	SBL	SBT	SBR
Lane Configurations												
Traffic Volume (vph)	71	379	37	101	511	121	115	67	81	52	50	62
Future Volume (vph)	71	379	37	101	511	121	115	67	81	52	50	62
Ideal Flow (vphpl)	1800	1800	1800	1800	1800	1800	1800	1800	1800	1800	1800	1800
Storage Length (m)	75.0		120.0	110.0		130.0	220.0		0.0	30.0		0.0
Storage Lanes	1		1	1		1	1		0	1		0
Taper Length (m)	50.0			80.0			50.0			15.0		
Lane Util. Factor	1.00	1.00	1.00	1.00	1.00	1.00	1.00	1.00	1.00	1.00	1.00	1.00
Ped Bike Factor	1.00		0.96	0.99		0.95	0.95	0.98		0.99	0.95	
Fr <sub>t</sub>			0.850			0.850		0.918			0.917	
Flt Protected	0.950			0.950			0.950			0.950		
Satd. Flow (prot)	1566	1745	1498	1642	1762	1498	1674	1541	0	1674	1485	0
Flt Permitted	0.422			0.488			0.647			0.537		
Satd. Flow (perm)	693	1745	1440	838	1762	1429	1087	1541	0	938	1485	0
Right Turn on Red			Yes			Yes			Yes			Yes
Satd. Flow (RTOR)			78			121		52			53	
Link Speed (k/h)		60			60			50			50	
Link Distance (m)		508.2			485.8			547.1			313.7	
Travel Time (s)		30.5			29.1			39.4			22.6	
Confl. Peds. (#/hr)	5		5	5		5	25		5	5		25
Confl. Bikes (#/hr)			5			15			10			10
Peak Hour Factor	1.00	1.00	1.00	1.00	1.00	1.00	1.00	1.00	1.00	1.00	1.00	1.00
Heavy Vehicles (%)	8%	2%	1%	3%	1%	1%	1%	2%	5%	1%	1%	8%
Adj. Flow (vph)	71	379	37	101	511	121	115	67	81	52	50	62
Shared Lane Traffic (%)												
Lane Group Flow (vph)	71	379	37	101	511	121	115	148	0	52	112	0
Enter Blocked Intersection	No	No	No	No	No	No	No	No	No	No	No	No
Lane Alignment	L NA	Left	R NA	L NA	Left	R NA	L NA	Left	R NA	L NA	Left	R NA
Median Width(m)		3.5			3.5			3.5			3.5	
Link Offset(m)		0.0			0.0			0.0			0.0	
Crosswalk Width(m)		5.0			5.0			5.0			5.0	
Two way Left Turn Lane												
Headway Factor	1.09	1.09	1.09	1.09	1.09	1.09	1.09	1.09	1.09	1.09	1.09	1.09
Turning Speed (k/h)	24		14	24		14	24		14	24		14
Number of Detectors	1	2	1	1	2	1	1	2		1	2	
Detector Template	Left	Thru	Right	Left	Thru	Right	Left	Thru		Left	Thru	
Leading Detector (m)	2.0	10.0	2.0	2.0	10.0	2.0	2.0	10.0		2.0	10.0	
Trailing Detector (m)	0.0	0.0	0.0	0.0	0.0	0.0	0.0	0.0		0.0	0.0	
Detector 1 Position(m)	0.0	0.0	0.0	0.0	0.0	0.0	0.0	0.0		0.0	0.0	
Detector 1 Size(m)	2.0	0.6	2.0	2.0	0.6	2.0	2.0	0.6		2.0	0.6	
Detector 1 Type	Cl+Ex	Cl+Ex	Cl+Ex	Cl+Ex	Cl+Ex	Cl+Ex	Cl+Ex	Cl+Ex		Cl+Ex	Cl+Ex	
Detector 1 Channel												
Detector 1 Extend (s)	0.0	0.0	0.0	0.0	0.0	0.0	0.0	0.0		0.0	0.0	
Detector 1 Queue (s)	0.0	0.0	0.0	0.0	0.0	0.0	0.0	0.0		0.0	0.0	
Detector 1 Delay (s)	0.0	0.0	0.0	0.0	0.0	0.0	0.0	0.0		0.0	0.0	
Detector 2 Position(m)		9.4			9.4			9.4			9.4	
Detector 2 Size(m)		0.6			0.6			0.6			0.6	
Detector 2 Type		Cl+Ex			Cl+Ex			Cl+Ex			Cl+Ex	
Detector 2 Channel												
Detector 2 Extend (s)		0.0			0.0			0.0			0.0	
Turn Type	pm+pt	NA	Perm	pm+pt	NA	Perm	Perm	NA		Perm	NA	
Protected Phases	5	2		1	6			8			4	
Permitted Phases	2		2	6		6	8			4		
Detector Phase	5	2	2	1	6	6	8	8		4	4	





5: Hines & Innovation  
PM Peak Hour

555-603 March Road  
2037 Background Traffic



Lane Group	EBL	EBT	EBR	WBL	WBT	WBR	NBL	NBT	NBR	SBL	SBT	SBR
Lane Configurations		↕			↕			↕			↕	
Traffic Volume (vph)	3	0	100	0	0	0	134	14	0	0	53	9
Future Volume (vph)	3	0	100	0	0	0	134	14	0	0	53	9
Ideal Flow (vphpl)	1800	1800	1800	1800	1800	1800	1800	1800	1800	1800	1800	1800
Lane Util. Factor	1.00	1.00	1.00	1.00	1.00	1.00	1.00	1.00	1.00	1.00	1.00	1.00
Ped Bike Factor												
Frt	0.869										0.980	
Flt Protected	0.999										0.957	
Satd. Flow (prot)	0	1515	0	0	1762	0	0	1649	0	0	1684	0
Flt Permitted	0.999										0.957	
Satd. Flow (perm)	0	1515	0	0	1762	0	0	1649	0	0	1684	0
Link Speed (k/h)	50				50				50			
Link Distance (m)	438.6				104.0				421.8			
Travel Time (s)	31.6				7.5				30.4			
Confl. Peds. (#/hr)							10					
Confl. Bikes (#/hr)	5			5			5			5		
Peak Hour Factor	1.00	1.00	1.00	1.00	1.00	1.00	1.00	1.00	1.00	1.00	1.00	1.00
Heavy Vehicles (%)	1%	1%	2%	1%	1%	1%	3%	6%	1%	1%	4%	1%
Adj. Flow (vph)	3	0	100	0	0	0	134	14	0	0	53	9
Shared Lane Traffic (%)												
Lane Group Flow (vph)	0	103	0	0	0	0	0	148	0	0	62	0
Enter Blocked Intersection	No	No	No	No	No	No	No	No	No	No	No	No
Lane Alignment	Left	Left	Right	Left	Left	Right	Left	Left	Right	Left	Left	Right
Median Width(m)	0.0				0.0				0.0			
Link Offset(m)	0.0				0.0				0.0			
Crosswalk Width(m)	5.0				5.0				5.0			
Two way Left Turn Lane												
Headway Factor	1.09	1.09	1.09	1.09	1.09	1.09	1.09	1.09	1.09	1.09	1.09	1.09
Turning Speed (k/h)	24		14	24		14	24		14	24		14
Sign Control	Stop			Stop			Free			Free		

Intersection Summary

Area Type: Other













Control Type: Unsignalized

Intersection Capacity Utilization 28.6% ICU Level of Service A

Analysis Period (min) 15

6: March & Nokia Access  
PM Peak Hour

555-603 March Road  
2037 Background Traffic

						
Lane Group	WBL	WBR	NBT	NBR	SBL	SBT
Lane Configurations						
Traffic Volume (vph)	197	400	1591	199	93	1134
Future Volume (vph)	197	400	1591	199	93	1134
Ideal Flow (vphpl)	1800	1800	1800	1800	1800	1800
Storage Length (m)	65.0	0.0		100.0	75.0	
Storage Lanes	1	1		1	1	
Taper Length (m)	25.0				50.0	
Lane Util. Factor	1.00	1.00	0.95	1.00	1.00	0.91
Ped Bike Factor	0.99	0.97		0.94		
Fr t		0.850		0.850		
Flt Protected	0.950				0.950	
Satd. Flow (prot)	1674	1498	3283	1498	1674	4718
Flt Permitted	0.950				0.052	
Satd. Flow (perm)	1654	1457	3283	1410	92	4718
Right Turn on Red		Yes		Yes		
Satd. Flow (RTOR)		99		199		
Link Speed (k/h)	50		60			60
Link Distance (m)	167.8		199.3			308.9
Travel Time (s)	12.1		12.0			18.5
Confl. Peds. (#/hr)	10	10		10	10	
Confl. Bikes (#/hr)		5		5		
Peak Hour Factor	1.00	1.00	1.00	1.00	1.00	1.00
Heavy Vehicles (%)	1%	1%	3%	1%	1%	3%
Adj. Flow (vph)	197	400	1591	199	93	1134
Shared Lane Traffic (%)						
Lane Group Flow (vph)	197	400	1591	199	93	1134
Enter Blocked Intersection	No	No	No	No	No	No
Lane Alignment	L NA	Right	Left	Right	L NA	Left
Median Width(m)	3.5		7.0			7.0
Link Offset(m)	0.0		0.0			0.0
Crosswalk Width(m)	5.0		5.0			5.0
Two way Left Turn Lane						
Headway Factor	1.09	1.09	1.09	1.09	1.09	1.09
Turning Speed (k/h)	97	97		97	97	
Number of Detectors	1	1	2	1	1	2
Detector Template	Left	Right	Thru	Right	Left	Thru
Leading Detector (m)	2.0	2.0	10.0	2.0	2.0	10.0
Trailing Detector (m)	0.0	0.0	0.0	0.0	0.0	0.0
Detector 1 Position(m)	0.0	0.0	0.0	0.0	0.0	0.0
Detector 1 Size(m)	2.0	2.0	0.6	2.0	2.0	0.6
Detector 1 Type	Cl+Ex	Cl+Ex	Cl+Ex	Cl+Ex	Cl+Ex	Cl+Ex
Detector 1 Channel						
Detector 1 Extend (s)	0.0	0.0	0.0	0.0	0.0	0.0
Detector 1 Queue (s)	0.0	0.0	0.0	0.0	0.0	0.0
Detector 1 Delay (s)	0.0	0.0	0.0	0.0	0.0	0.0
Detector 2 Position(m)			9.4			9.4
Detector 2 Size(m)			0.6			0.6
Detector 2 Type			Cl+Ex			Cl+Ex
Detector 2 Channel						
Detector 2 Extend (s)			0.0			0.0
Turn Type	Perm	Perm	NA	Perm	pm+pt	NA
Protected Phases			2		1	6
Permitted Phases	8	8		2	6	
Detector Phase	8	8	2	2	1	6



Lane Group	WBL	WBR	NBT	NBR	SBL	SBT
Switch Phase						
Minimum Initial (s)	10.0	10.0	10.0	10.0	5.0	10.0
Minimum Split (s)	38.5	38.5	23.8	23.8	11.4	23.8
Total Split (s)	48.0	48.0	70.0	70.0	12.0	82.0
Total Split (%)	36.9%	36.9%	53.8%	53.8%	9.2%	63.1%
Maximum Green (s)	41.5	41.5	64.2	64.2	5.6	76.2
Yellow Time (s)	3.3	3.3	3.7	3.7	3.7	3.7
All-Red Time (s)	3.2	3.2	2.1	2.1	2.7	2.1
Lost Time Adjust (s)	0.0	0.0	0.0	0.0	0.0	0.0
Total Lost Time (s)	6.5	6.5	5.8	5.8	6.4	5.8
Lead/Lag			Lag	Lag	Lead	
Lead-Lag Optimize?						
Vehicle Extension (s)	3.0	3.0	3.0	3.0	3.0	3.0
Recall Mode	None	None	C-Max	C-Max	None	C-Max
Walk Time (s)	7.0	7.0	7.0	7.0		7.0
Flash Dont Walk (s)	25.0	25.0	11.0	11.0		11.0
Pedestrian Calls (#/hr)	10	10	10	10		10
Act Effct Green (s)	33.1	33.1	70.7	70.7	84.0	84.6
Actuated g/C Ratio	0.25	0.25	0.54	0.54	0.65	0.65
v/c Ratio	0.47	0.90	0.89	0.23	0.62	0.37
Control Delay	43.3	58.1	48.5	13.6	58.8	9.0
Queue Delay	0.0	0.0	0.0	0.0	0.0	0.0
Total Delay	43.3	58.1	48.5	13.6	58.8	9.0
LOS	D	E	D	B	E	A
Approach Delay	53.2		44.6			12.8
Approach LOS	D		D			B
Queue Length 50th (m)	39.0	70.7	201.1	18.2	13.8	18.2
Queue Length 95th (m)	55.7	101.8	#247.4	m31.1	m#36.0	43.7
Internal Link Dist (m)	143.8		175.3			284.9
Turn Bay Length (m)	65.0			100.0	75.0	
Base Capacity (vph)	528	532	1786	858	150	3069
Starvation Cap Reductn	0	0	0	0	0	0
Spillback Cap Reductn	0	0	0	0	0	0
Storage Cap Reductn	0	0	0	0	0	0
Reduced v/c Ratio	0.37	0.75	0.89	0.23	0.62	0.37

Intersection Summary

Area Type: Other  
 Cycle Length: 130  
 Actuated Cycle Length: 130  
 Offset: 108 (83%), Referenced to phase 2:NBT and 6:SBTL, Start of Green  
 Natural Cycle: 100  
 Control Type: Actuated-Coordinated  
 Maximum v/c Ratio: 0.90  
 Intersection Signal Delay: 35.2 Intersection LOS: D  
 Intersection Capacity Utilization 83.9% ICU Level of Service E  
 Analysis Period (min) 15  
 # 95th percentile volume exceeds capacity, queue may be longer.  
 Queue shown is maximum after two cycles.  
 m Volume for 95th percentile queue is metered by upstream signal.

Splits and Phases: 6: March & Nokia Access

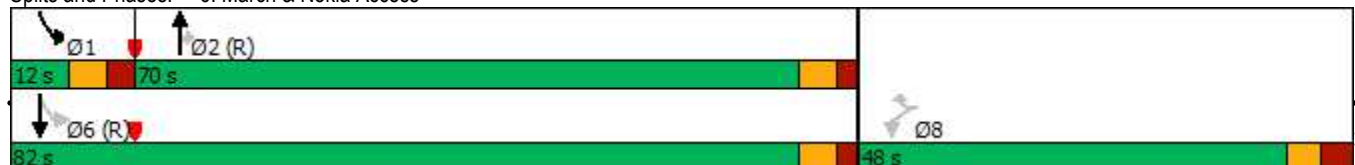

3: March & Solandt  
PM Peak Hour

555-603 March Road  
2037 Background Traffic (demand rationalized)



Lane Group	EBL	EBT	EBR	WBL	WBT	WBR	NBU	NBL	NBT	NBR	SBU	SBL
Lane Configurations												
Traffic Volume (vph)	24	25	197	229	24	24	16	78	1813	45	12	21
Future Volume (vph)	24	25	197	229	24	24	16	78	1813	45	12	21
Ideal Flow (vphpl)	1800	1800	1800	1800	1800	1800	1800	1800	1800	1800	1800	1800
Storage Length (m)	35.0		60.0	135.0		55.0		165.0		0.0		155.0
Storage Lanes	1		1	1		1		1		0		1
Taper Length (m)	50.0			50.0				40.0				25.0
Lane Util. Factor	1.00	1.00	1.00	1.00	1.00	1.00	0.95	1.00	0.95	0.95	0.95	1.00
Ped Bike Factor	0.99		0.98	0.99		0.98		1.00	1.00			1.00
Frt			0.850			0.850			0.996			
Flt Protected	0.950			0.950				0.950				0.950
Satd. Flow (prot)	1674	1695	1483	1674	1679	1388	0	1644	3297	0	0	1648
Flt Permitted	0.742			0.520				0.950				0.950
Satd. Flow (perm)	1299	1695	1449	911	1679	1358	0	1641	3297	0	0	1646
Right Turn on Red			Yes			Yes				Yes		
Satd. Flow (RTOR)			137			82			3			
Link Speed (k/h)		50			50				60			
Link Distance (m)		212.6			241.6				610.9			
Travel Time (s)		15.3			17.4				36.7			
Confl. Peds. (#/hr)	5		5	5		5		5		5		5
Confl. Bikes (#/hr)			5			5				5		
Peak Hour Factor	1.00	1.00	1.00	1.00	1.00	1.00	1.00	1.00	1.00	1.00	1.00	1.00
Heavy Vehicles (%)	1%	5%	2%	1%	6%	9%	2%	3%	2%	6%	2%	3%
Adj. Flow (vph)	24	25	197	229	24	24	16	78	1813	45	12	21
Shared Lane Traffic (%)												
Lane Group Flow (vph)	24	25	197	229	24	24	0	94	1858	0	0	33
Enter Blocked Intersection	No	No	No	No	No	No	No	No	No	No	No	No
Lane Alignment	L NA	Left	R NA	L NA	Left	R NA	R NA	L NA	Left	R NA	R NA	L NA
Median Width(m)		3.5			10.5				17.5			
Link Offset(m)		0.0			0.0				0.0			
Crosswalk Width(m)		5.0			5.0				5.0			
Two way Left Turn Lane												
Headway Factor	1.09	1.09	1.09	1.09	1.09	1.09	1.09	1.09	1.09	1.09	1.09	1.09
Turning Speed (k/h)	24		14	24		14	14	24		14	14	24
Number of Detectors	1	2	1	1	2	1	1	1	2		1	1
Detector Template	Left	Thru	Right	Left	Thru	Right	Left	Left	Thru		Left	Left
Leading Detector (m)	2.0	10.0	2.0	2.0	10.0	2.0	2.0	2.0	10.0		2.0	2.0
Trailing Detector (m)	0.0	0.0	0.0	0.0	0.0	0.0	0.0	0.0	0.0		0.0	0.0
Detector 1 Position(m)	0.0	0.0	0.0	0.0	0.0	0.0	0.0	0.0	0.0		0.0	0.0
Detector 1 Size(m)	2.0	0.6	2.0	2.0	0.6	2.0	2.0	2.0	0.6		2.0	2.0
Detector 1 Type	Cl+Ex	Cl+Ex	Cl+Ex	Cl+Ex	Cl+Ex	Cl+Ex	Cl+Ex	Cl+Ex	Cl+Ex		Cl+Ex	Cl+Ex
Detector 1 Channel												
Detector 1 Extend (s)	0.0	0.0	0.0	0.0	0.0	0.0	0.0	0.0	0.0		0.0	0.0
Detector 1 Queue (s)	0.0	0.0	0.0	0.0	0.0	0.0	0.0	0.0	0.0		0.0	0.0
Detector 1 Delay (s)	0.0	0.0	0.0	0.0	0.0	0.0	0.0	0.0	0.0		0.0	0.0
Detector 2 Position(m)		9.4			9.4				9.4			
Detector 2 Size(m)		0.6			0.6				0.6			
Detector 2 Type		Cl+Ex			Cl+Ex				Cl+Ex			
Detector 2 Channel												
Detector 2 Extend (s)		0.0			0.0				0.0			
Turn Type	Perm	NA	Perm	pm+pt	NA	Perm	Prot	Prot	NA		Prot	Prot
Protected Phases		4		3	8		5	5	2		1	1
Permitted Phases	4		4	8		8						
Detector Phase	4	4	4	3	8	8	5	5	2		1	1

3: March & Solandt  
PM Peak Hour

555-603 March Road  
2037 Background Traffic (demand rationalized)



Lane Group	SBT	SBR
Lane Configurations	↑↑	
Traffic Volume (vph)	1311	29
Future Volume (vph)	1311	29
Ideal Flow (vphpl)	1800	1800
Storage Length (m)		0.0
Storage Lanes		0
Taper Length (m)		
Lane Util. Factor	0.95	0.95
Ped Bike Factor	1.00	
Frt	0.997	
Flt Protected		
Satd. Flow (prot)	3302	0
Flt Permitted		
Satd. Flow (perm)	3302	0
Right Turn on Red		Yes
Satd. Flow (RTOR)	2	
Link Speed (k/h)	60	
Link Distance (m)	411.0	
Travel Time (s)	24.7	
Confl. Peds. (#/hr)		5
Confl. Bikes (#/hr)		5
Peak Hour Factor	1.00	1.00
Heavy Vehicles (%)	2%	3%
Adj. Flow (vph)	1311	29
Shared Lane Traffic (%)		
Lane Group Flow (vph)	1340	0
Enter Blocked Intersection	No	No
Lane Alignment	Left	R NA
Median Width(m)	17.5	
Link Offset(m)	0.0	
Crosswalk Width(m)	5.0	
Two way Left Turn Lane		
Headway Factor	1.09	1.09
Turning Speed (k/h)		14
Number of Detectors	2	
Detector Template	Thru	
Leading Detector (m)	10.0	
Trailing Detector (m)	0.0	
Detector 1 Position(m)	0.0	
Detector 1 Size(m)	0.6	
Detector 1 Type	Cl+Ex	
Detector 1 Channel		
Detector 1 Extend (s)	0.0	
Detector 1 Queue (s)	0.0	
Detector 1 Delay (s)	0.0	
Detector 2 Position(m)	9.4	
Detector 2 Size(m)	0.6	
Detector 2 Type	Cl+Ex	
Detector 2 Channel		
Detector 2 Extend (s)	0.0	
Turn Type	NA	
Protected Phases	6	
Permitted Phases		
Detector Phase	6	

3: March & Solandt  
PM Peak Hour

555-603 March Road  
2037 Background Traffic (demand rationalized)



Lane Group	EBL	EBT	EBR	WBL	WBT	WBR	NBU	NBL	NBT	NBR	SBU	SBL
Switch Phase												
Minimum Initial (s)	10.0	10.0	10.0	5.0	10.0	10.0	5.0	5.0	10.0		5.0	5.0
Minimum Split (s)	36.5	36.5	36.5	11.5	36.5	36.5	12.0	12.0	26.8		12.0	12.0
Total Split (s)	37.0	37.0	37.0	13.0	50.0	50.0	15.0	15.0	68.0		12.0	12.0
Total Split (%)	28.5%	28.5%	28.5%	10.0%	38.5%	38.5%	11.5%	11.5%	52.3%		9.2%	9.2%
Maximum Green (s)	30.5	30.5	30.5	6.5	43.5	43.5	8.0	8.0	62.2		5.0	5.0
Yellow Time (s)	3.3	3.3	3.3	3.3	3.3	3.3	3.7	3.7	3.7		3.7	3.7
All-Red Time (s)	3.2	3.2	3.2	3.2	3.2	3.2	3.3	3.3	2.1		3.3	3.3
Lost Time Adjust (s)	0.0	0.0	0.0	0.0	0.0	0.0		0.0	0.0			0.0
Total Lost Time (s)	6.5	6.5	6.5	6.5	6.5	6.5		7.0	5.8			7.0
Lead/Lag	Lag	Lag	Lag	Lead			Lead	Lead	Lag		Lead	Lead
Lead-Lag Optimize?												
Vehicle Extension (s)	3.0	3.0	3.0	3.0	3.0	3.0	3.0	3.0	3.0		3.0	3.0
Recall Mode	None	None	None	None	None	None	None	None	C-Max		None	None
Walk Time (s)	7.0	7.0	7.0		7.0	7.0			7.0			
Flash Dont Walk (s)	23.0	23.0	23.0		23.0	23.0			14.0			
Pedestrian Calls (#/hr)	5	5	5		5	5			5			
Act Effct Green (s)	15.3	15.3	15.3	28.3	28.3	28.3		12.6	80.6			7.1
Actuated g/C Ratio	0.12	0.12	0.12	0.22	0.22	0.22		0.10	0.62			0.05
v/c Ratio	0.16	0.13	0.68	0.97	0.07	0.07		0.59	0.91			0.37
Control Delay	50.0	48.8	29.1	99.3	37.2	0.4		71.5	31.4			79.8
Queue Delay	0.0	0.0	0.0	0.0	0.0	0.0		0.0	0.0			0.0
Total Delay	50.0	48.8	29.1	99.3	37.2	0.4		71.5	31.4			79.8
LOS	D	D	C	F	D	A		E	C			E
Approach Delay		33.1			85.3				33.4			
Approach LOS		C			F				C			
Queue Length 50th (m)	5.4	5.6	13.7	~57.2	4.7	0.0		21.2	199.4			8.2
Queue Length 95th (m)	11.3	11.6	32.2	63.3	9.6	0.0		#52.1	#315.8			#19.7
Internal Link Dist (m)		188.6			217.6				586.9			
Turn Bay Length (m)	35.0		60.0	135.0		55.0		165.0				155.0
Base Capacity (vph)	304	397	444	236	561	508		159	2045			90
Starvation Cap Reductn	0	0	0	0	0	0		0	0			0
Spillback Cap Reductn	0	0	0	0	0	0		0	0			0
Storage Cap Reductn	0	0	0	0	0	0		0	0			0
Reduced v/c Ratio	0.08	0.06	0.44	0.97	0.04	0.05		0.59	0.91			0.37

Intersection Summary

Area Type: Other  
 Cycle Length: 130  
 Actuated Cycle Length: 130  
 Offset: 16 (12%), Referenced to phase 2:NBT and 6:SBT, Start of Green  
 Natural Cycle: 150  
 Control Type: Actuated-Coordinated  
 Maximum v/c Ratio: 0.97  
 Intersection Signal Delay: 34.8      Intersection LOS: C  
 Intersection Capacity Utilization 99.3%      ICU Level of Service F  
 Analysis Period (min) 15  
 ~ Volume exceeds capacity, queue is theoretically infinite.  
 Queue shown is maximum after two cycles.  
 # 95th percentile volume exceeds capacity, queue may be longer.  
 Queue shown is maximum after two cycles.

Splits and Phases: 3: March & Solandt

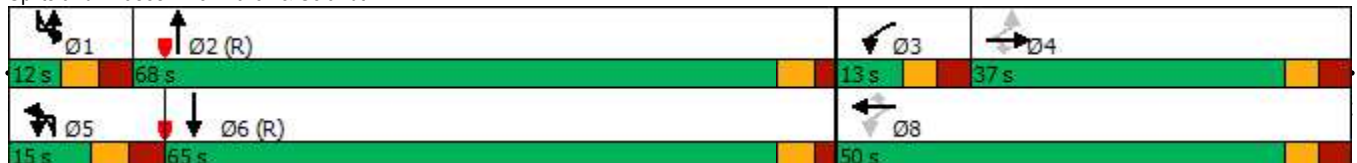



Lane Group	SBT	SBR
Switch Phase		
Minimum Initial (s)	10.0	
Minimum Split (s)	26.8	
Total Split (s)	65.0	
Total Split (%)	50.0%	
Maximum Green (s)	59.2	
Yellow Time (s)	3.7	
All-Red Time (s)	2.1	
Lost Time Adjust (s)	0.0	
Total Lost Time (s)	5.8	
Lead/Lag	Lag	
Lead-Lag Optimize?		
Vehicle Extension (s)	3.0	
Recall Mode	C-Max	
Walk Time (s)	7.0	
Flash Dont Walk (s)	14.0	
Pedestrian Calls (#/hr)	5	
Act Effct Green (s)	69.8	
Actuated g/C Ratio	0.54	
v/c Ratio	0.76	
Control Delay	25.6	
Queue Delay	0.0	
Total Delay	25.6	
LOS	C	
Approach Delay	26.9	
Approach LOS	C	
Queue Length 50th (m)	62.8	
Queue Length 95th (m)	137.3	
Internal Link Dist (m)	387.0	
Turn Bay Length (m)		
Base Capacity (vph)	1774	
Starvation Cap Reductn	0	
Spillback Cap Reductn	0	
Storage Cap Reductn	0	
Reduced v/c Ratio	0.76	
<b>Intersection Summary</b>		

## **APPENDIX M**

---

### Transportation Demand Management



**TDM Measures Checklist:**  
*Residential Developments (multi-family, condominium or subdivision)*

<b>Legend</b>	
<b>BASIC</b>	The measure is generally feasible and effective, and in most cases would benefit the development and its users
<b>BETTER</b>	The measure could maximize support for users of sustainable modes, and optimize development performance
★	The measure is one of the most dependably effective tools to encourage the use of sustainable modes

TDM measures: <i>Residential developments</i>		Check if proposed & add descriptions
<b>1. TDM PROGRAM MANAGEMENT</b>		
<b>1.1 Program coordinator</b>		
BASIC	★ 1.1.1 Designate an internal coordinator, or contract with an external coordinator	<input checked="" type="checkbox"/>
<b>1.2 Travel surveys</b>		
BETTER	1.2.1 Conduct periodic surveys to identify travel-related behaviours, attitudes, challenges and solutions, and to track progress	<input type="checkbox"/>
<b>2. WALKING AND CYCLING</b>		
<b>2.1 Information on walking/cycling routes &amp; destinations</b>		
BASIC	2.1.1 Display local area maps with walking/cycling access routes and key destinations at major entrances ( <i>multi-family, condominium</i> )	<input checked="" type="checkbox"/>
<b>2.2 Bicycle skills training</b>		
BETTER	2.2.1 Offer on-site cycling courses for residents, or subsidize off-site courses	<input type="checkbox"/>

TDM measures: <i>Residential developments</i>		Check if proposed & add descriptions
<b>3. TRANSIT</b>		
<b>3.1 Transit information</b>		
BASIC	3.1.1 Display relevant transit schedules and route maps at entrances ( <i>multi-family, condominium</i> )	<input checked="" type="checkbox"/>
BETTER	3.1.2 Provide real-time arrival information display at entrances ( <i>multi-family, condominium</i> )	<input type="checkbox"/>
<b>3.2 Transit fare incentives</b>		
BASIC ★	3.2.1 Offer PRESTO cards preloaded with one monthly transit pass on residence purchase/move-in, to encourage residents to use transit	<input type="checkbox"/>
BETTER	3.2.2 Offer at least one year of free monthly transit passes on residence purchase/move-in	<input type="checkbox"/>
<b>3.3 Enhanced public transit service</b>		
BETTER ★	3.3.1 Contract with OC Transpo to provide early transit services until regular services are warranted by occupancy levels ( <i>subdivision</i> )	<input type="checkbox"/>
<b>3.4 Private transit service</b>		
BETTER	3.4.1 Provide shuttle service for seniors homes or lifestyle communities (e.g. scheduled mall or supermarket runs)	<input type="checkbox"/>
<b>4. CARSHARING &amp; BIKESHARING</b>		
<b>4.1 Bikeshare stations &amp; memberships</b>		
BETTER	4.1.1 Contract with provider to install on-site bikeshare station ( <i>multi-family</i> )	<input checked="" type="checkbox"/>
BETTER	4.1.2 Provide residents with bikeshare memberships, either free or subsidized ( <i>multi-family</i> )	<input type="checkbox"/>
<b>4.2 Carshare vehicles &amp; memberships</b>		
BETTER	4.2.1 Contract with provider to install on-site carshare vehicles and promote their use by residents	<input checked="" type="checkbox"/>
BETTER	4.2.2 Provide residents with carshare memberships, either free or subsidized	<input type="checkbox"/>
<b>5. PARKING</b>		
<b>5.1 Priced parking</b>		
BASIC ★	5.1.1 Unbundle parking cost from purchase price ( <i>condominium</i> )	<input checked="" type="checkbox"/>
BASIC ★	5.1.2 Unbundle parking cost from monthly rent ( <i>multi-family</i> )	<input checked="" type="checkbox"/>

TDM measures: <i>Residential developments</i>		Check if proposed & add descriptions
<b>6. TDM MARKETING &amp; COMMUNICATIONS</b>		
<b>6.1 Multimodal travel information</b>		
<b>BASIC</b> ★	6.1.1 Provide a multimodal travel option information package to new residents	<input checked="" type="checkbox"/>
<b>6.2 Personalized trip planning</b>		
<b>BETTER</b> ★	6.2.1 Offer personalized trip planning to new residents	<input type="checkbox"/>

**TDM Measures Checklist:**  
*Non-Residential Developments (office, institutional, retail or industrial)*

<b>Legend</b>	
<b>BASIC</b>	The measure is generally feasible and effective, and in most cases would benefit the development and its users
<b>BETTER</b>	The measure could maximize support for users of sustainable modes, and optimize development performance
<b>★</b>	The measure is one of the most dependably effective tools to encourage the use of sustainable modes

<b>TDM measures: <i>Non-residential developments</i></b>		<b>Check if proposed &amp; add descriptions</b>
<b>1. TDM PROGRAM MANAGEMENT</b>		
<b>1.1 Program coordinator</b>		
<b>BASIC</b> ★	1.1.1 Designate an internal coordinator, or contract with an external coordinator	<input checked="" type="checkbox"/>
<b>1.2 Travel surveys</b>		
<b>BETTER</b>	1.2.1 Conduct periodic surveys to identify travel-related behaviours, attitudes, challenges and solutions, and to track progress	<input type="checkbox"/>
<b>2. WALKING AND CYCLING</b>		
<b>2.1 Information on walking/cycling routes &amp; destinations</b>		
<b>BASIC</b>	2.1.1 Display local area maps with walking/cycling access routes and key destinations at major entrances	<input checked="" type="checkbox"/>
<b>2.2 Bicycle skills training</b>		
<i>Commuter travel</i>		
<b>BETTER</b> ★	2.2.1 Offer on-site cycling courses for commuters, or subsidize off-site courses	<input type="checkbox"/>
<b>2.3 Valet bike parking</b>		
<i>Visitor travel</i>		
<b>BETTER</b>	2.3.1 Offer secure valet bike parking during public events when demand exceeds fixed supply (e.g. for festivals, concerts, games)	<input type="checkbox"/>

TDM measures: <i>Non-residential developments</i>		Check if proposed & add descriptions
<b>3. TRANSIT</b>		
<b>3.1 Transit information</b>		
BASIC	3.1.1 Display relevant transit schedules and route maps at entrances	<input checked="" type="checkbox"/>
BASIC	3.1.2 Provide online links to OC Transpo and STO information	<input checked="" type="checkbox"/>
BETTER	3.1.3 Provide real-time arrival information display at entrances	<input type="checkbox"/>
<b>3.2 Transit fare incentives</b>		
<i>Commuter travel</i>		
BETTER	3.2.1 Offer preloaded PRESTO cards to encourage commuters to use transit	<input type="checkbox"/>
BETTER ★	3.2.2 Subsidize or reimburse monthly transit pass purchases by employees	<input type="checkbox"/>
<i>Visitor travel</i>		
BETTER	3.2.3 Arrange inclusion of same-day transit fare in price of tickets (e.g. for festivals, concerts, games)	<input type="checkbox"/>
<b>3.3 Enhanced public transit service</b>		
<i>Commuter travel</i>		
BETTER	3.3.1 Contract with OC Transpo to provide enhanced transit services (e.g. for shift changes, weekends)	<input type="checkbox"/>
<i>Visitor travel</i>		
BETTER	3.3.2 Contract with OC Transpo to provide enhanced transit services (e.g. for festivals, concerts, games)	<input type="checkbox"/>
<b>3.4 Private transit service</b>		
<i>Commuter travel</i>		
BETTER	3.4.1 Provide shuttle service when OC Transpo cannot offer sufficient quality or capacity to serve demand (e.g. for shift changes, weekends)	<input type="checkbox"/>
<i>Visitor travel</i>		
BETTER	3.4.2 Provide shuttle service when OC Transpo cannot offer sufficient quality or capacity to serve demand (e.g. for festivals, concerts, games)	<input type="checkbox"/>

TDM measures: <i>Non-residential developments</i>		Check if proposed & add descriptions
<b>4. RIDESHARING</b>		
<b>4.1 Ridematching service</b>		
<i>Commuter travel</i>		
BASIC ★	4.1.1 Provide a dedicated ridematching portal at OttawaRideMatch.com	<input checked="" type="checkbox"/>
<b>4.2 Carpool parking price incentives</b>		
<i>Commuter travel</i>		
BETTER	4.2.1 Provide discounts on parking costs for registered carpools	<input type="checkbox"/>
<b>4.3 Vanpool service</b>		
<i>Commuter travel</i>		
BETTER	4.3.1 Provide a vanpooling service for long-distance commuters	<input type="checkbox"/>
<b>5. CARSHARING &amp; BIKESHARING</b>		
<b>5.1 Bikeshare stations &amp; memberships</b>		
BETTER	5.1.1 Contract with provider to install on-site bikeshare station for use by commuters and visitors	<input checked="" type="checkbox"/>
<i>Commuter travel</i>		
BETTER	5.1.2 Provide employees with bikeshare memberships for local business travel	<input type="checkbox"/>
<b>5.2 Carshare vehicles &amp; memberships</b>		
<i>Commuter travel</i>		
BETTER	5.2.1 Contract with provider to install on-site carshare vehicles and promote their use by tenants	<input checked="" type="checkbox"/>
BETTER	5.2.2 Provide employees with carshare memberships for local business travel	<input type="checkbox"/>
<b>6. PARKING</b>		
<b>6.1 Priced parking</b>		
<i>Commuter travel</i>		
BASIC ★	6.1.1 Charge for long-term parking (daily, weekly, monthly)	<input checked="" type="checkbox"/>
BASIC	6.1.2 Unbundle parking cost from lease rates at multi-tenant sites	<input type="checkbox"/>
<i>Visitor travel</i>		
BETTER	6.1.3 Charge for short-term parking (hourly)	<input checked="" type="checkbox"/>

TDM measures: <i>Non-residential developments</i>		Check if proposed & add descriptions
<b>7. TDM MARKETING &amp; COMMUNICATIONS</b>		
<b>7.1 Multimodal travel information</b>		
<i>Commuter travel</i>		
BASIC ★	7.1.1 Provide a multimodal travel option information package to new/relocating employees and students	<input checked="" type="checkbox"/>
<i>Visitor travel</i>		
BETTER ★	7.1.2 Include multimodal travel option information in invitations or advertising that attract visitors or customers (e.g. for festivals, concerts, games)	<input type="checkbox"/>
<b>7.2 Personalized trip planning</b>		
<i>Commuter travel</i>		
BETTER ★	7.2.1 Offer personalized trip planning to new/relocating employees	<input type="checkbox"/>
<b>7.3 Promotions</b>		
<i>Commuter travel</i>		
BETTER	7.3.1 Deliver promotions and incentives to maintain awareness, build understanding, and encourage trial of sustainable modes	<input type="checkbox"/>
<b>8. OTHER INCENTIVES &amp; AMENITIES</b>		
<b>8.1 Emergency ride home</b>		
<i>Commuter travel</i>		
BETTER ★	8.1.1 Provide emergency ride home service to non-driving commuters	<input type="checkbox"/>
<b>8.2 Alternative work arrangements</b>		
<i>Commuter travel</i>		
BASIC ★	8.2.1 Encourage flexible work hours	<input checked="" type="checkbox"/>
BETTER	8.2.2 Encourage compressed workweeks	<input type="checkbox"/>
BETTER ★	8.2.3 Encourage telework	<input type="checkbox"/>
<b>8.3 Local business travel options</b>		
<i>Commuter travel</i>		
BASIC ★	8.3.1 Provide local business travel options that minimize the need for employees to bring a personal car to work	<input checked="" type="checkbox"/>
<b>8.4 Commuter incentives</b>		
<i>Commuter travel</i>		
BETTER	8.4.1 Offer employees a taxable, mode-neutral commuting allowance	<input type="checkbox"/>
<b>8.5 On-site amenities</b>		
<i>Commuter travel</i>		
BETTER	8.5.1 Provide on-site amenities/services to minimize mid-day or mid-commute errands	<input checked="" type="checkbox"/>

## **APPENDIX N**

---

MMLOS Analysis



## Intersection MMLOS Analysis

The following is a review of the MMLOS of the signalized intersections within the study area, using complete streets principles. The MMLOS targets associated with the 'General Urban Area' designation have been used to evaluate March Road/Morgan's Grant Way/Shirley's Brook Drive, and the targets associated with the 'Employment Area' designation have been used to evaluate March Road/Solandt Road. Since March Road/Terry Fox Drive and Terry Fox Drive/Flamborough Way/Innovation Drive is located in both land use designations, whichever target is stricter has been used in evaluation of this intersection.

Exhibit 5 of the *Addendum to the MMLOS Guidelines* has been used to evaluate the existing PLOS at the intersections listed above. Exhibit 22 of the *MMLOS Guidelines* suggests a target PLOS C for all roadways within the General Urban or Employment Areas. The results of the intersection PLOS analysis are summarized in **Table 1** through **Table 4**.

Exhibit 12 of the *MMLOS Guidelines* has been used to evaluate the existing BLOS at the intersections listed above. Exhibit 22 of the *MMLOS Guidelines* suggests a target BLOS B for Local Routes in the General Urban Area (Morgan's Grant Way and Shirley's Brook Drive), and a target BLOS C for Spine Routes in the General Urban and Employment Areas (March Road and Terry Fox Drive) and Local Routes in the Employment Area (Solandt Road and Legget Drive). The results of the intersection BLOS analysis are summarized in **Table 5**.

Exhibit 16 of the *MMLOS Guidelines* has been used to evaluate the existing TLOS at the intersections listed above. Exhibit 22 of the *MMLOS Guidelines* identifies a target TLOS B for Rapid Transit Corridors (March Road south of Solandt Road), a target TLOS D for Transit Priority Corridors with Isolated Measures (March Road north of Solandt Road), and does not identify a target TLOS for roadways without a Rapid Transit or Transit Priority designation (Terry Fox Drive, Morgan's Grant Way/Shirley's Brook Drive, Solandt Road, Legget Drive). The TLOS has been evaluated for every approach that is currently used by transit. The results of the intersection TLOS analysis are summarized in **Table 6**.

Exhibit 21 of the *MMLOS Guidelines* has been used to evaluate the existing TkLOS at the intersections listed above. Exhibit 22 of the *MMLOS Guidelines* identifies a target TkLOS B for arterial truck routes in the Employment Area (March Road south of Terry Fox Drive, Terry Fox Drive west of March Road), and a target TkLOS D for arterial truck routes in the General Urban Area (March Road north of Terry Fox Drive) and collector roadways without a truck route designation in the Employment Area (Terry Fox Drive east of March Road, Legget Drive, and Solandt Road). No target is identified for collector roadways without a truck route designation in the General Urban Area (Morgan's Grant Way, Shirley's Brook Drive). The results of the intersection TkLOS analysis are summarized in **Table 7**.

**Table 1: PLOS Intersection Analysis – March Road/Morgan’s Grant Way/Shirley’s Brook Drive**

CRITERIA	North Approach		South Approach		East Approach		West Approach	
<b>PETSI SCORE</b>								
<i>CROSSING DISTANCE CONDITIONS</i>								
Median > 2.4m in Width	No	-10	No	-10	No	-10	No	-10
Lanes Crossed (3.5m Lane Width)	10 +		10 +		10 +		10 +	
<i>SIGNAL PHASING AND TIMING</i>								
Left Turn Conflict	Permissive	-8	Permissive	-8	Perm + Prot	-8	Perm + Prot	-8
Right Turn Conflict	Permissive or Yield	-5	Permissive or Yield	-5	Permissive or Yield	-5	Permissive or Yield	-5
Right Turn on Red	N/A	0	N/A	0	N/A	0	N/A	0
Leading Pedestrian Interval	No	-2	No	-2	No	-2	No	-2
<i>CORNER RADIUS</i>								
Parallel Radius	> 15m to 25m	-8	> 15m to 25m	-8	> 15m to 25m	-8	> 15m to 25m	-8
Parallel Right Turn Channel	Conventional without Receiving	0	Conventional without Receiving	0	Conventional without Receiving	0	Conventional without Receiving	0
Perpendicular Radius	> 15m to 25m	-8	> 15m to 25m	-8	> 15m to 25m	-8	> 15m to 25m	-8
Perpendicular Right Turn Channel	Conventional without Receiving	0	Conventional without Receiving	0	Conventional without Receiving	0	Conventional without Receiving	0
<i>CROSSING TREATMENT</i>								
Treatment	Standard	-7	Standard	-7	Standard	-7	Standard	-7
	<b>PETSI SCORE</b>	<b>-48</b>		<b>-48</b>		<b>-48</b>		<b>-48</b>
	<b>LOS</b>	<b>F</b>		<b>F</b>		<b>F</b>		<b>F</b>
<b>DELAY SCORE</b>								
Cycle Length		130		130		130		130
Pedestrian Walk Time		7.5		7.5		52.9		52.9
	<b>DELAY SCORE</b>	<b>57.7</b>		<b>57.7</b>		<b>22.9</b>		<b>22.9</b>
	<b>LOS</b>	<b>E</b>		<b>E</b>		<b>C</b>		<b>C</b>
<b>OVERALL</b>		<b>F</b>	<b>F</b>		<b>F</b>		<b>F</b>	

**Table 2: PLOS Intersection Analysis – March Road/Terry Fox Drive**

CRITERIA	North Approach		South Approach		East Approach		West Approach	
<b>PETSI SCORE</b>								
<i>CROSSING DISTANCE CONDITIONS</i>								
Median > 2.4m in Width	No	-10	No	-10	No	-10	No	-10
Lanes Crossed (3.5m Lane Width)	10 +		10 +		10 +		10 +	
<i>SIGNAL PHASING AND TIMING</i>								
Left Turn Conflict	Protected	0	Protected	0	Protected	0	Protected	0
Right Turn Conflict	Permissive or Yield	-5	Permissive or Yield	-5	Permissive or Yield	-5	Permissive or Yield	-5
Right Turn on Red	N/A	0	N/A	0	N/A	0	N/A	0
Leading Pedestrian Interval	No	-2	No	-2	No	-2	No	-2
<i>CORNER RADIUS</i>								
Parallel Radius	> 15m to 25m	-8	> 15m to 25m	-8	> 15m to 25m	-8	> 15m to 25m	-8
Parallel Right Turn Channel	Conventional without Receiving	0	Conventional without Receiving	0	Conventional without Receiving	0	Conventional without Receiving	0
Perpendicular Radius	> 15m to 25m	-8	> 15m to 25m	-8	> 15m to 25m	-8	> 15m to 25m	-8
Perpendicular Right Turn Channel	Conventional without Receiving	0	Conventional without Receiving	0	Conventional without Receiving	0	Conventional without Receiving	0
<i>CROSSING TREATMENT</i>								
Treatment	Standard	-7	Standard	-7	Standard	-7	Standard	-7
	<b>PETSI SCORE</b>	<b>-40</b>		<b>-40</b>		<b>-40</b>		<b>-40</b>
	<b>LOS</b>	<b>F</b>		<b>F</b>		<b>F</b>		<b>F</b>
<b>DELAY SCORE</b>								
Cycle Length		130		130		130		130
Pedestrian Walk Time		7.0		7.0		15.3		15.3
	<b>DELAY SCORE</b>	<b>58.2</b>		<b>58.2</b>		<b>50.6</b>		<b>50.6</b>
	<b>LOS</b>	<b>E</b>		<b>E</b>		<b>E</b>		<b>E</b>
<b>OVERALL</b>		<b>F</b>	<b>F</b>		<b>F</b>		<b>F</b>	

**Table 3: PLOS Intersection Analysis – March Road/Solandt Road**

CRITERIA	North Approach		South Approach		East Approach		West Approach	
<b>PETSI SCORE</b>								
<i>CROSSING DISTANCE CONDITIONS</i>								
Median > 2.4m in Width	No	-10	No	-10	No	-10	No	-10
Lanes Crossed (3.5m Lane Width)	10 +		10 +		10 +		10 +	
<i>SIGNAL PHASING AND TIMING</i>								
Left Turn Conflict	Protected	0	Protected	0	Permissive	-8	Perm + Prot	-8
Right Turn Conflict	Permissive or Yield	-5	Permissive or Yield	-5	Permissive or Yield	-5	Permissive or Yield	-5
Right Turn on Red	N/A	0	N/A	0	N/A	0	N/A	0
Leading Pedestrian Interval	No	-2	No	-2	No	-2	No	-2
<i>CORNER RADIUS</i>								
Parallel Radius	> 15m to 25m	-8	> 15m to 25m	-8	> 15m to 25m	-8	> 15m to 25m	-8
Parallel Right Turn Channel	Conventional without Receiving	0	Conventional without Receiving	0	Conventional without Receiving	0	Conventional without Receiving	0
Perpendicular Radius	> 15m to 25m	-8	> 15m to 25m	-8	> 15m to 25m	-8	> 15m to 25m	-8
Perpendicular Right Turn Channel	Conventional without Receiving	0	Conventional without Receiving	0	Conventional without Receiving	0	Conventional without Receiving	0
<i>CROSSING TREATMENT</i>								
Treatment	Standard	-7	Standard	-7	Standard	-7	Standard	-7
	<b>PETSI SCORE</b>	<b>-40</b>		<b>-40</b>		<b>-48</b>		<b>-48</b>
	<b>LOS</b>	<b>F</b>		<b>F</b>		<b>F</b>		<b>F</b>
<b>DELAY SCORE</b>								
Cycle Length		130		130		130		130
Pedestrian Walk Time		7.5		7.5		45.7		27.7
	<b>DELAY SCORE</b>	<b>57.7</b>		<b>57.7</b>		<b>27.3</b>		<b>40.3</b>
	<b>LOS</b>	<b>E</b>		<b>E</b>		<b>C</b>		<b>E</b>
<b>OVERALL</b>		<b>F</b>			<b>F</b>			<b>F</b>

**Table 4: PLOS Intersection Analysis – Terry Fox Drive/Flamborough Way/Innovation Drive**

CRITERIA	North Approach		South Approach		East Approach		West Approach	
<b>PETSI SCORE</b>								
<i>CROSSING DISTANCE CONDITIONS</i>								
Median > 2.4m in Width	No	72	No	72	No	23	No	39
Lanes Crossed (3.5m Lane Width)	5		5		8		7	
<i>SIGNAL PHASING AND TIMING</i>								
Left Turn Conflict	Perm + Prot	-8	Perm + Prot	-8	Permissive	-8	Perm + Prot	-8
Right Turn Conflict	Permissive or Yield	-5	Permissive or Yield	-5	Permissive or Yield	-5	Permissive or Yield	-5
Right Turn on Red	RTOR Allowed	-3	RTOR Allowed	-3	RTOR Allowed	-3	RTOR Allowed	-3
Leading Pedestrian Interval	No	-2	No	-2	No	-2	No	-2
<i>CORNER RADIUS</i>								
Parallel Radius	> 10m to 15m	-6	> 10m to 15m	-6	> 10m to 15m	-6	> 10m to 15m	-6
Parallel Right Turn Channel	No Right Turn Channel	-4	No Right Turn Channel	-4	No Right Turn Channel	-4	No Right Turn Channel	-4
Perpendicular Radius	N/A	0	N/A	0	N/A	0	N/A	0
Perpendicular Right Turn Channel	N/A	0	N/A	0	N/A	0	N/A	0
<i>CROSSING TREATMENT</i>								
Treatment	Standard	-7	Standard	-7	Standard	-7	Standard	-7
	<b>PETSI SCORE</b>	<b>37</b>		<b>37</b>		<b>-12</b>		<b>4</b>
	<b>LOS</b>	<b>E</b>		<b>E</b>		<b>F</b>		<b>F</b>
<b>DELAY SCORE</b>								
Cycle Length		130		130		130		130
Pedestrian Walk Time		45.1		45.1		12.7		12.7
	<b>DELAY SCORE</b>	<b>27.7</b>		<b>27.7</b>		<b>52.9</b>		<b>52.9</b>
	<b>LOS</b>	<b>C</b>		<b>C</b>		<b>E</b>		<b>E</b>
<b>OVERALL</b>		<b>E</b>			<b>E</b>			<b>F</b>

Table 5: BLOS Intersection Analysis

Approach	Facility Type	Criteria	Travel Lanes and/or Speed	BLOS
<b>March Road/Morgan's Grant Way/Shirley's Brook Drive</b>				
North Approach	Pocket Bike Lane	Right Turn Lane Characteristics	Right turn lane $\leq$ 50m and introduced to the right	<b>B</b>
		Left Turn Accommodation	Three lanes crossed, $\geq$ 60 km/h	<b>F</b>
South Approach	Pocket Bike Lane	Right Turn Lane Characteristics	Right turn lane $\leq$ 50m and introduced to the right	<b>B</b>
		Left Turn Accommodation	Three lanes crossed, $\geq$ 60 km/h	<b>F</b>
East Approach	Pocket Bike Lane	Right Turn Lane Characteristics	Right turn lane $\leq$ 50m and introduced to the right	<b>B</b>
		Left Turn Accommodation	One lane crossed, 50 km/h	<b>C</b>
West Approach	Curbside Bike Lane	Right Turn Lane Characteristics	No impact to level of traffic stress	<b>A</b>
		Left Turn Accommodation	No lanes crossed, $\leq$ 50 km/h	<b>B</b>
<b>March Road/Terry Fox Drive</b>				
North Approach	Pocket Bike Lane	Right Turn Lane Characteristics	Right turn lane $>$ 50m and introduced to the right	<b>D</b>
		Left Turn Accommodation	Three lanes crossed, $\geq$ 50 km/h	<b>F</b>
South Approach	Pocket Bike Lane	Right Turn Lane Characteristics	Right turn lane $>$ 50m and introduced to the right	<b>D</b>
		Left Turn Accommodation	Dual left turn lanes	<b>F</b>
East Approach	Pocket Bike Lane	Right Turn Lane Characteristics	Right turn lane $>$ 50m and introduced to the right	<b>D</b>
		Left Turn Accommodation	Dual left turn lanes	<b>F</b>
West Approach	Pocket Bike Lane	Right Turn Lane Characteristics	Right turn lane $>$ 50m and introduced to the right	<b>D</b>
		Left Turn Accommodation	Dual left turn lanes	<b>F</b>
<b>March Road/Solandt Road</b>				
North Approach	Pocket Bike Lane	Right Turn Lane Characteristics	Right turn lane $>$ 50m and introduced to the right	<b>D</b>
		Left Turn Accommodation	Two-stage left-turn bike box	<b>A</b>
South Approach	Pocket Bike Lane	Right Turn Lane Characteristics	Bike lane shifts to the left of the right turn lane	<b>D</b>
		Left Turn Accommodation	Two-stage left-turn bike box	<b>A</b>
East Approach	Mixed Traffic	Right Turn Lane Characteristics	Shared through/right turn lane	<b>A</b>
		Left Turn Accommodation	Dual left turn lanes	<b>F</b>
West Approach	Mixed Traffic	Right Turn Lane Characteristics	Right turn lane $>$ 50m	<b>F</b>
		Left Turn Accommodation	One lane crossed, $\geq$ 60 km/h	<b>F</b>

Approach	Facility Type	Criteria	Travel Lanes and/or Speed	BLOS
<b>Terry Fox Drive/Flamborough Way/Innovation Drive</b>				
North Approach	Mixed Traffic	Right Turn Lane Characteristics	Shared through/right turn lane	A
		Left Turn Accommodation	One lane crossed; 50 km/h	D
South Approach	Mixed Traffic	Right Turn Lane Characteristics	Shared through/right turn lane	A
		Left Turn Accommodation	One lane crossed; 50 km/h	F
East Approach	Pocket Bike Lane	Right Turn Lane Characteristics	Right turn lane > 50m and introduced to the right	D
		Left Turn Accommodation	One lane crossed; 50 km/h	E
West Approach	Pocket Bike Lane	Right Turn Lane Characteristics	Right turn lane > 50m and introduced to the right	D
		Left Turn Accommodation	One lane crossed; 50 km/h	E

**Table 6: TLOS Intersection Analysis**

Approach	Delay <sup>(1)</sup>		TLOS
	AM Peak	PM Peak	
<b>March Road/Morgan's Grant Way/Shirley's Brook Drive</b>			
North Approach	11 sec	16 sec	C
South Approach	10 sec	9 sec	B
East Approach	59 sec	54 sec	F
West Approach	17 sec	19 sec	C
<b>March Road/Terry Fox Drive</b>			
North Approach	20 sec	27 sec	D
South Approach	30 sec	28 sec	D
East Approach	45 sec	38 sec	F
West Approach	35 sec	41 sec	F
<b>March Road/Solandt Road</b>			
North Approach	15 sec	23 sec	D
South Approach	8 sec	17 sec	C
East Approach	58 sec	54 sec	F
West Approach	25 sec	41 sec	F
<b>Terry Fox Drive/Flamborough Way/Innovation Drive</b>			
North Approach	63 sec	41 sec	F
South Approach	36 sec	63 sec	F
East Approach	4 sec	5 sec	B
West Approach	9 sec	12 sec	C

1. Delay based on outputs from Synchro analysis of existing conditions

Table 7: TkLOS Intersection Analysis

Approach	Effective Corner Radius	Number of Receiving Lanes Departing Intersection	TkLOS
<b>March Road/Morgan's Grant Way/Shirley's Brook Drive</b>			
North Approach	> 15m	1	C
South Approach	> 15m	1	C
East Approach	> 15m	3	A
West Approach	> 15m	3	A
<b>March Road/Terry Fox Drive</b>			
North Approach	> 15m	2	A
South Approach	> 15m	2	A
East Approach	> 15m	3	A
West Approach	> 15m	3	A
<b>March Road/Solandt Road</b>			
North Approach	> 15m	2	A
South Approach	> 15m	2	A
East Approach	> 15m	3	A
West Approach	> 15m	3	A
<b>Terry Fox Drive/Flamborough Way/Innovation Drive</b>			
North Approach	> 15m	1	C
South Approach	> 15m	1	C
East Approach	> 15m	1	C
West Approach	> 15m	1	C

## **APPENDIX O**

---

Total Synchro Analysis

1: March & Morgan's Grant/Shirley's Brook  
AM Peak Hour

555-603 March Road  
2037 Total Traffic



Lane Group	EBL	EBT	EBR	WBL	WBT	WBR	NBL	NBT	NBR	SBL	SBT	SBR
Lane Configurations		↕	↗	↖	↕	↗	↖	↕↕↕	↗	↖	↕↕↕	↗
Traffic Volume (vph)	26	38	73	89	14	25	26	1010	41	100	1878	10
Future Volume (vph)	26	38	73	89	14	25	26	1010	41	100	1878	10
Ideal Flow (vphpl)	1800	1800	1800	1800	1800	1800	1800	1800	1800	1800	1800	1800
Storage Length (m)	0.0		20.0	45.0		35.0	130.0		30.0	65.0		25.0
Storage Lanes	0		1	1		1	1		1	1		1
Taper Length (m)	10.0			30.0			40.0			35.0		
Lane Util. Factor	1.00	1.00	1.00	1.00	1.00	1.00	1.00	0.91	1.00	1.00	0.91	1.00
Ped Bike Factor		1.00	0.98	0.99		0.98	1.00		0.96	1.00		0.96
Frt			0.850			0.850			0.850			0.850
Flt Protected		0.980		0.950			0.950			0.950		
Satd. Flow (prot)	0	1727	1498	1580	1271	1498	1674	4628	1427	1674	4718	1498
Flt Permitted		0.862		0.715			0.950			0.950		
Satd. Flow (perm)	0	1515	1464	1183	1271	1464	1672	4628	1368	1667	4718	1436
Right Turn on Red			Yes			Yes			Yes			Yes
Satd. Flow (RTOR)			136			136			145			91
Link Speed (k/h)		40			40			60			60	
Link Distance (m)		465.2			359.5			318.9			462.6	
Travel Time (s)		41.9			32.4			19.1			27.8	
Confl. Peds. (#/hr)	5		5	5		5	5		5	5		5
Confl. Bikes (#/hr)			5			5			5			5
Peak Hour Factor	1.00	1.00	1.00	1.00	1.00	1.00	1.00	1.00	1.00	1.00	1.00	1.00
Heavy Vehicles (%)	1%	1%	1%	7%	40%	1%	1%	5%	6%	1%	3%	1%
Adj. Flow (vph)	26	38	73	89	14	25	26	1010	41	100	1878	10
Shared Lane Traffic (%)												
Lane Group Flow (vph)	0	64	73	89	14	25	26	1010	41	100	1878	10
Enter Blocked Intersection	No	No	No	No	No	No	No	No	No	No	No	No
Lane Alignment	L NA	Left	R NA	L NA	Left	R NA	L NA	Left	R NA	L NA	Left	R NA
Median Width(m)		3.5			5.0			9.0			9.0	
Link Offset(m)		0.0			0.0			0.0			0.0	
Crosswalk Width(m)		5.0			5.0			10.0			10.0	
Two way Left Turn Lane												
Headway Factor	1.09	1.09	1.09	1.09	1.09	1.09	1.09	1.09	1.09	1.09	1.09	1.09
Turning Speed (k/h)	24		14	24		14	24		14	24		14
Number of Detectors	1	2	1	1	2	1	1	2	1	1	2	1
Detector Template	Left	Thru	Right	Left	Thru	Right	Left	Thru	Right	Left	Thru	Right
Leading Detector (m)	2.0	10.0	2.0	2.0	10.0	2.0	2.0	10.0	2.0	2.0	10.0	2.0
Trailing Detector (m)	0.0	0.0	0.0	0.0	0.0	0.0	0.0	0.0	0.0	0.0	0.0	0.0
Detector 1 Position(m)	0.0	0.0	0.0	0.0	0.0	0.0	0.0	0.0	0.0	0.0	0.0	0.0
Detector 1 Size(m)	2.0	0.6	2.0	2.0	0.6	2.0	2.0	0.6	2.0	2.0	0.6	2.0
Detector 1 Type	Cl+Ex	Cl+Ex	Cl+Ex	Cl+Ex	Cl+Ex	Cl+Ex	Cl+Ex	Cl+Ex	Cl+Ex	Cl+Ex	Cl+Ex	Cl+Ex
Detector 1 Channel												
Detector 1 Extend (s)	0.0	0.0	0.0	0.0	0.0	0.0	0.0	0.0	0.0	0.0	0.0	0.0
Detector 1 Queue (s)	0.0	0.0	0.0	0.0	0.0	0.0	0.0	0.0	0.0	0.0	0.0	0.0
Detector 1 Delay (s)	0.0	0.0	0.0	0.0	0.0	0.0	0.0	0.0	0.0	0.0	0.0	0.0
Detector 2 Position(m)		9.4			9.4			9.4			9.4	
Detector 2 Size(m)		0.6			0.6			0.6			0.6	
Detector 2 Type		Cl+Ex			Cl+Ex			Cl+Ex			Cl+Ex	
Detector 2 Channel												
Detector 2 Extend (s)		0.0			0.0			0.0			0.0	
Turn Type	Perm	NA	Perm	Perm	NA	Perm	Prot	NA	Perm	Prot	NA	Perm
Protected Phases		4			8		5	2		1	6	
Permitted Phases	4		4	8		8			2			6
Detector Phase	4	4	4	8	8	8	5	2	2	1	6	6





Lane Group	EBL	EBT	EBR	WBL	WBT	WBR	NBL	NBT	NBR	SBL	SBT	SBR
Switch Phase												
Minimum Initial (s)	10.0	10.0	10.0	10.0	10.0	10.0	5.0	10.0	10.0	5.0	10.0	10.0
Minimum Split (s)	38.5	38.5	38.5	38.5	38.5	38.5	11.4	24.4	24.4	11.4	24.4	24.4
Total Split (s)	40.0	40.0	40.0	40.0	40.0	40.0	14.0	65.0	65.0	25.0	76.0	76.0
Total Split (%)	30.8%	30.8%	30.8%	30.8%	30.8%	30.8%	10.8%	50.0%	50.0%	19.2%	58.5%	58.5%
Maximum Green (s)	32.5	32.5	32.5	32.5	32.5	32.5	7.6	58.6	58.6	18.6	69.6	69.6
Yellow Time (s)	3.0	3.0	3.0	3.0	3.0	3.0	3.7	3.7	3.7	3.7	3.7	3.7
All-Red Time (s)	4.5	4.5	4.5	4.5	4.5	4.5	2.7	2.7	2.7	2.7	2.7	2.7
Lost Time Adjust (s)		0.0	0.0	0.0	0.0	0.0	0.0	0.0	0.0	0.0	0.0	0.0
Total Lost Time (s)		7.5	7.5	7.5	7.5	7.5	6.4	6.4	6.4	6.4	6.4	6.4
Lead/Lag							Lead	Lag	Lag	Lead	Lag	Lag
Lead-Lag Optimize?												
Vehicle Extension (s)	3.0	3.0	3.0	3.0	3.0	3.0	3.0	3.0	3.0	3.0	3.0	3.0
Recall Mode	None	None	None	None	None	None	None	C-Max	C-Max	None	C-Max	C-Max
Walk Time (s)	7.0	7.0	7.0	7.0	7.0	7.0		7.0	7.0		7.0	7.0
Flash Dont Walk (s)	24.0	24.0	24.0	24.0	24.0	24.0		11.0	11.0		11.0	11.0
Pedestrian Calls (#/hr)	5	5	5	5	5	5		5	5		5	5
Act Effct Green (s)		17.3	17.3	17.3	17.3	17.3	7.4	79.4	79.4	13.1	90.0	90.0
Actuated g/C Ratio		0.13	0.13	0.13	0.13	0.13	0.06	0.61	0.61	0.10	0.69	0.69
v/c Ratio		0.32	0.23	0.57	0.08	0.08	0.27	0.36	0.05	0.60	0.58	0.01
Control Delay		52.5	1.8	64.9	45.8	0.5	56.9	9.9	0.5	69.8	13.5	0.0
Queue Delay		0.0	0.0	0.0	0.0	0.0	0.0	0.0	0.0	0.0	0.0	0.0
Total Delay		52.5	1.8	64.9	45.8	0.5	56.9	9.9	0.5	69.8	13.5	0.0
LOS		D	A	E	D	A	E	A	A	E	B	A
Approach Delay		25.4			50.2			10.7			16.3	
Approach LOS		C			D			B			B	
Queue Length 50th (m)		14.2	0.0	20.4	3.0	0.0	6.1	14.7	0.0	22.9	81.9	0.0
Queue Length 95th (m)		23.6	0.0	32.0	7.7	0.0	m14.9	39.1	m0.5	38.4	138.0	0.0
Internal Link Dist (m)		441.2			335.5			294.9			438.6	
Turn Bay Length (m)			20.0	45.0		35.0	130.0		30.0	65.0		25.0
Base Capacity (vph)		378	468	295	317	468	103	2825	891	239	3265	1021
Starvation Cap Reductn		0	0	0	0	0	0	0	0	0	0	0
Spillback Cap Reductn		0	0	0	0	0	0	0	0	0	0	0
Storage Cap Reductn		0	0	0	0	0	0	0	0	0	0	0
Reduced v/c Ratio		0.17	0.16	0.30	0.04	0.05	0.25	0.36	0.05	0.42	0.58	0.01

Intersection Summary

Area Type: Other  
 Cycle Length: 130  
 Actuated Cycle Length: 130  
 Offset: 63 (48%), Referenced to phase 2:NBT and 6:SBT, Start of Green  
 Natural Cycle: 90  
 Control Type: Actuated-Coordinated  
 Maximum v/c Ratio: 0.60  
 Intersection Signal Delay: 16.2 Intersection LOS: B  
 Intersection Capacity Utilization 78.2% ICU Level of Service D  
 Analysis Period (min) 15  
 m Volume for 95th percentile queue is metered by upstream signal.

Splits and Phases: 1: March & Morgan's Grant/Shirley's Brook

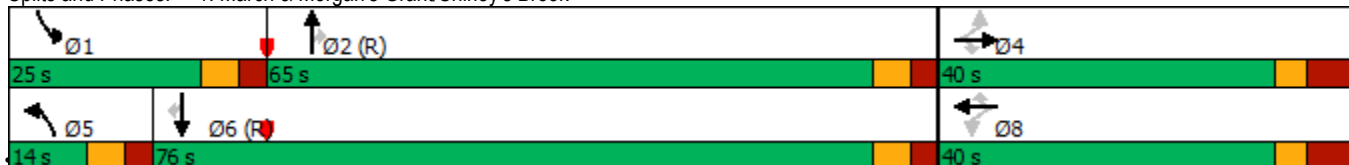

2: March & Terry Fox  
AM Peak Hour

555-603 March Road  
2037 Total Traffic



Lane Group	EBL	EBT	EBR	WBL	WBT	WBR	NBU	NBL	NBT	NBR	SBU	SBL
Lane Configurations	↔↔	↕↕	↗	↔↔	↕↕	↗		↔↔	↕↕↕	↗		↗
Traffic Volume (vph)	125	183	283	42	76	50	14	180	882	109	1	202
Future Volume (vph)	125	183	283	42	76	50	14	180	882	109	1	202
Ideal Flow (vphpl)	1800	1800	1800	1800	1800	1800	1800	1800	1800	1800	1800	1800
Storage Length (m)	95.0		60.0	75.0		75.0		130.0		85.0		110.0
Storage Lanes	2		2	2		1		2		2		1
Taper Length (m)	40.0			20.0				90.0				40.0
Lane Util. Factor	0.97	0.95	1.00	0.97	0.95	1.00	0.91	0.97	0.91	1.00	0.91	1.00
Ped Bike Factor	0.99		0.97	0.99		0.98		1.00		0.97		1.00
Fr			0.850			0.850				0.850		
Flt Protected	0.950			0.950				0.950				0.950
Satd. Flow (prot)	3185	3316	1483	3248	3161	1498	0	3246	4628	1469	0	1674
Flt Permitted	0.950			0.950				0.950				0.950
Satd. Flow (perm)	3169	3316	1438	3220	3161	1466	0	3242	4628	1424	0	1667
Right Turn on Red			Yes			Yes				Yes		
Satd. Flow (RTOR)			193			193				198		
Link Speed (k/h)		60			60				60			
Link Distance (m)		165.4			149.1				308.9			
Travel Time (s)		9.9			8.9				18.5			
Confl. Peds. (#/hr)	5		10	10		5		5		10		10
Confl. Bikes (#/hr)			10			5				5		
Peak Hour Factor	1.00	1.00	1.00	1.00	1.00	1.00	1.00	1.00	1.00	1.00	1.00	1.00
Heavy Vehicles (%)	3%	2%	2%	1%	7%	1%	2%	1%	5%	3%	2%	1%
Adj. Flow (vph)	125	183	283	42	76	50	14	180	882	109	1	202
Shared Lane Traffic (%)												
Lane Group Flow (vph)	125	183	283	42	76	50	0	194	882	109	0	203
Enter Blocked Intersection	No	No	No	Yes	Yes	Yes	No	No	No	No	No	No
Lane Alignment	L NA	Left	R NA	L NA	Left	R NA	R NA	L NA	Left	R NA	R NA	L NA
Median Width(m)		11.5			10.5				10.5			
Link Offset(m)		0.0			0.0				0.0			
Crosswalk Width(m)		5.0			5.0				5.0			
Two way Left Turn Lane												
Headway Factor	1.09	1.09	1.09	1.09	1.09	1.09	1.09	1.09	1.09	1.09	1.09	1.09
Turning Speed (k/h)	24		14	24		14	14	24		14	14	24
Number of Detectors	1	2	1	1	2	1	1	1	2	1	1	1
Detector Template	Left	Thru	Right	Left	Thru	Right	Left	Left	Thru	Right	Left	Left
Leading Detector (m)	2.0	10.0	2.0	2.0	10.0	2.0	2.0	2.0	10.0	2.0	2.0	2.0
Trailing Detector (m)	0.0	0.0	0.0	0.0	0.0	0.0	0.0	0.0	0.0	0.0	0.0	0.0
Detector 1 Position(m)	0.0	0.0	0.0	0.0	0.0	0.0	0.0	0.0	0.0	0.0	0.0	0.0
Detector 1 Size(m)	2.0	0.6	2.0	2.0	0.6	2.0	2.0	2.0	0.6	2.0	2.0	2.0
Detector 1 Type	Cl+Ex	Cl+Ex	Cl+Ex	Cl+Ex	Cl+Ex	Cl+Ex	Cl+Ex	Cl+Ex	Cl+Ex	Cl+Ex	Cl+Ex	Cl+Ex
Detector 1 Channel												
Detector 1 Extend (s)	0.0	0.0	0.0	0.0	0.0	0.0	0.0	0.0	0.0	0.0	0.0	0.0
Detector 1 Queue (s)	0.0	0.0	0.0	0.0	0.0	0.0	0.0	0.0	0.0	0.0	0.0	0.0
Detector 1 Delay (s)	0.0	0.0	0.0	0.0	0.0	0.0	0.0	0.0	0.0	0.0	0.0	0.0
Detector 2 Position(m)		9.4			9.4				9.4			
Detector 2 Size(m)		0.6			0.6				0.6			
Detector 2 Type		Cl+Ex			Cl+Ex				Cl+Ex			
Detector 2 Channel												
Detector 2 Extend (s)		0.0			0.0				0.0			
Turn Type	Prot	NA	Perm	Prot	NA	Perm	Prot	Prot	NA	Perm	Prot	Prot
Protected Phases	7	4		3	8		5	5	2		1	1
Permitted Phases			4			8				2		
Detector Phase	7	4	4	3	8	8	5	5	2	2	1	1



Lane Group	SBT	SBR
Lane Configurations	↑↑↑	↗
Traffic Volume (vph)	1633	235
Future Volume (vph)	1633	235
Ideal Flow (vphpl)	1800	1800
Storage Length (m)		100.0
Storage Lanes		1
Taper Length (m)		
Lane Util. Factor	0.91	1.00
Ped Bike Factor		0.98
Frt		0.850
Flt Protected		
Satd. Flow (prot)	4718	1469
Flt Permitted		
Satd. Flow (perm)	4718	1436
Right Turn on Red		Yes
Satd. Flow (RTOR)		235
Link Speed (k/h)	60	
Link Distance (m)	318.9	
Travel Time (s)	19.1	
Confl. Peds. (#/hr)		5
Confl. Bikes (#/hr)		5
Peak Hour Factor	1.00	1.00
Heavy Vehicles (%)	3%	3%
Adj. Flow (vph)	1633	235
Shared Lane Traffic (%)		
Lane Group Flow (vph)	1633	235
Enter Blocked Intersection	No	No
Lane Alignment	Left	R NA
Median Width(m)	7.0	
Link Offset(m)	0.0	
Crosswalk Width(m)	5.0	
Two way Left Turn Lane		
Headway Factor	1.09	1.09
Turning Speed (k/h)		14
Number of Detectors	2	1
Detector Template	Thru	Right
Leading Detector (m)	10.0	2.0
Trailing Detector (m)	0.0	0.0
Detector 1 Position(m)	0.0	0.0
Detector 1 Size(m)	0.6	2.0
Detector 1 Type	Cl+Ex	Cl+Ex
Detector 1 Channel		
Detector 1 Extend (s)	0.0	0.0
Detector 1 Queue (s)	0.0	0.0
Detector 1 Delay (s)	0.0	0.0
Detector 2 Position(m)	9.4	
Detector 2 Size(m)	0.6	
Detector 2 Type	Cl+Ex	
Detector 2 Channel		
Detector 2 Extend (s)	0.0	
Turn Type	NA	Perm
Protected Phases	6	
Permitted Phases		6
Detector Phase	6	6



Lane Group	EBL	EBT	EBR	WBL	WBT	WBR	NBU	NBL	NBT	NBR	SBU	SBL
Switch Phase												
Minimum Initial (s)	5.0	10.0	10.0	5.0	10.0	10.0	5.0	5.0	10.0	10.0	5.0	5.0
Minimum Split (s)	11.8	42.0	42.0	11.8	42.0	42.0	11.4	11.4	32.4	32.4	11.4	11.4
Total Split (s)	13.0	43.0	43.0	12.0	42.0	42.0	18.0	18.0	44.0	44.0	31.0	31.0
Total Split (%)	10.0%	33.1%	33.1%	9.2%	32.3%	32.3%	13.8%	13.8%	33.8%	33.8%	23.8%	23.8%
Maximum Green (s)	6.2	36.0	36.0	5.2	35.0	35.0	11.6	11.6	37.6	37.6	24.6	24.6
Yellow Time (s)	3.7	3.7	3.7	3.7	3.7	3.7	3.7	3.7	3.7	3.7	3.7	3.7
All-Red Time (s)	3.1	3.3	3.3	3.1	3.3	3.3	2.7	2.7	2.7	2.7	2.7	2.7
Lost Time Adjust (s)	0.0	0.0	0.0	0.0	0.0	0.0		0.0	0.0	0.0		0.0
Total Lost Time (s)	6.8	7.0	7.0	6.8	7.0	7.0		6.4	6.4	6.4		6.4
Lead/Lag	Lead	Lag	Lag	Lead	Lag	Lag	Lead	Lead	Lag	Lag	Lead	Lead
Lead-Lag Optimize?												
Vehicle Extension (s)	3.0	3.0	3.0	3.0	3.0	3.0	3.0	3.0	3.0	3.0	3.0	3.0
Recall Mode	None	None	None	None	None	None	None	None	C-Max	C-Max	None	None
Walk Time (s)		7.0	7.0		7.0	7.0			7.0	7.0		
Flash Dont Walk (s)		28.0	28.0		28.0	28.0			19.0	19.0		
Pedestrian Calls (#/hr)		10	10		5	5			5	5		
Act Effct Green (s)	7.0	21.4	21.4	5.2	20.6	20.6		11.6	59.1	59.1		20.2
Actuated g/C Ratio	0.05	0.16	0.16	0.04	0.16	0.16		0.09	0.45	0.45		0.16
v/c Ratio	0.73	0.34	0.71	0.33	0.15	0.13		0.67	0.42	0.14		0.78
Control Delay	92.1	45.7	22.6	67.6	44.0	0.7		55.2	37.3	10.7		88.1
Queue Delay	0.0	0.0	0.0	0.0	0.0	0.0		0.0	0.0	0.0		0.0
Total Delay	92.1	45.7	22.6	67.6	44.0	0.7		55.2	37.3	10.7		88.1
LOS	F	D	C	E	D	A		E	D	B		F
Approach Delay		44.5			37.0				37.8			
Approach LOS		D			D				D			
Queue Length 50th (m)	16.1	17.1	12.5	5.0	8.7	0.0		23.7	73.8	3.9		51.1
Queue Length 95th (m)	#32.5	25.1	37.8	10.7	12.9	0.0		32.7	92.7	19.7		70.9
Internal Link Dist (m)		141.4			125.1				284.9			
Turn Bay Length (m)	95.0		60.0	75.0		75.0		130.0		85.0		110.0
Base Capacity (vph)	171	918	537	129	851	535		301	2102	754		316
Starvation Cap Reductn	0	0	0	0	0	0		0	0	0		0
Spillback Cap Reductn	0	0	0	0	0	0		0	0	0		0
Storage Cap Reductn	0	0	0	0	0	0		0	0	0		0
Reduced v/c Ratio	0.73	0.20	0.53	0.33	0.09	0.09		0.64	0.42	0.14		0.64

Intersection Summary

Area Type: Other  
 Cycle Length: 130  
 Actuated Cycle Length: 130  
 Offset: 80 (62%), Referenced to phase 2:NBT and 6:SBT, Start of Green  
 Natural Cycle: 110  
 Control Type: Actuated-Coordinated  
 Maximum v/c Ratio: 0.78  
 Intersection Signal Delay: 31.3 Intersection LOS: C  
 Intersection Capacity Utilization 87.7% ICU Level of Service E  
 Analysis Period (min) 15  
 # 95th percentile volume exceeds capacity, queue may be longer.  
 Queue shown is maximum after two cycles.

Splits and Phases: 2: March & Terry Fox

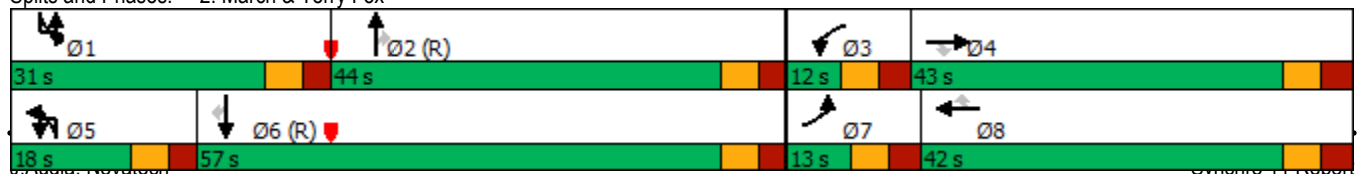



Lane Group	SBT	SBR
Switch Phase		
Minimum Initial (s)	10.0	10.0
Minimum Split (s)	32.4	32.4
Total Split (s)	57.0	57.0
Total Split (%)	43.8%	43.8%
Maximum Green (s)	50.6	50.6
Yellow Time (s)	3.7	3.7
All-Red Time (s)	2.7	2.7
Lost Time Adjust (s)	0.0	0.0
Total Lost Time (s)	6.4	6.4
Lead/Lag	Lag	Lag
Lead-Lag Optimize?		
Vehicle Extension (s)	3.0	3.0
Recall Mode	C-Max	C-Max
Walk Time (s)	7.0	7.0
Flash Dont Walk (s)	19.0	19.0
Pedestrian Calls (#/hr)	5	5
Act Effct Green (s)	67.6	67.6
Actuated g/C Ratio	0.52	0.52
v/c Ratio	0.67	0.27
Control Delay	18.4	1.6
Queue Delay	0.0	0.0
Total Delay	18.4	1.6
LOS	B	A
Approach Delay	23.3	
Approach LOS	C	
Queue Length 50th (m)	34.6	0.0
Queue Length 95th (m)	85.0	6.5
Internal Link Dist (m)	294.9	
Turn Bay Length (m)		100.0
Base Capacity (vph)	2453	859
Starvation Cap Reductn	0	0
Spillback Cap Reductn	0	0
Storage Cap Reductn	0	0
Reduced v/c Ratio	0.67	0.27
<b>Intersection Summary</b>		

3: March & Solandt  
AM Peak Hour

555-603 March Road  
2037 Total Traffic

Lane Group	EBL	EBT	EBR	WBL	WBT	WBR	NBU	NBL	NBT	NBR	SBU	SBL
Lane Configurations												
Traffic Volume (vph)	12	33	85	82	16	16	2	221	1574	192	2	61
Future Volume (vph)	12	33	85	82	16	16	2	221	1574	192	2	61
Ideal Flow (vphpl)	1800	1800	1800	1800	1800	1800	1800	1800	1800	1800	1800	1800
Storage Length (m)	35.0		60.0	135.0		55.0		165.0		0.0		155.0
Storage Lanes	1		1	1		1		1		0		1
Taper Length (m)	50.0			50.0				40.0				25.0
Lane Util. Factor	1.00	1.00	1.00	1.00	1.00	1.00	0.95	1.00	0.95	0.95	0.95	1.00
Ped Bike Factor	0.99		0.98	0.99		0.98		1.00	1.00			1.00
Frt			0.850			0.850			0.984			
Flt Protected	0.950			0.950				0.950				0.950
Satd. Flow (prot)	1537	1728	1414	1610	1369	1498	0	1658	3230	0	0	1674
Flt Permitted	0.747			0.736				0.950				0.950
Satd. Flow (perm)	1201	1728	1381	1240	1369	1463	0	1656	3230	0	0	1672
Right Turn on Red			Yes			Yes				Yes		
Satd. Flow (RTOR)			141			141			17			
Link Speed (k/h)		50			50				60			
Link Distance (m)		212.6			241.6				610.9			
Travel Time (s)		15.3			17.4				36.7			
Confl. Peds. (#/hr)	5		5	5		5		5		5		5
Confl. Bikes (#/hr)			5			5				5		
Peak Hour Factor	1.00	1.00	1.00	1.00	1.00	1.00	1.00	1.00	1.00	1.00	1.00	1.00
Heavy Vehicles (%)	10%	3%	7%	5%	30%	1%	2%	2%	3%	1%	2%	1%
Adj. Flow (vph)	12	33	85	82	16	16	2	221	1574	192	2	61
Shared Lane Traffic (%)												
Lane Group Flow (vph)	12	33	85	82	16	16	0	223	1766	0	0	63
Enter Blocked Intersection	No	No	No	No	No	No	No	No	No	No	No	No
Lane Alignment	L NA	Left	R NA	L NA	Left	R NA	R NA	L NA	Left	R NA	R NA	L NA
Median Width(m)		3.5			10.5				17.5			
Link Offset(m)		0.0			0.0				0.0			
Crosswalk Width(m)		5.0			5.0				5.0			
Two way Left Turn Lane												
Headway Factor	1.09	1.09	1.09	1.09	1.09	1.09	1.09	1.09	1.09	1.09	1.09	1.09
Turning Speed (k/h)	24		14	24		14	14	24		14	14	24
Number of Detectors	1	2	1	1	2	1	1	1	2		1	1
Detector Template	Left	Thru	Right	Left	Thru	Right	Left	Left	Thru		Left	Left
Leading Detector (m)	2.0	10.0	2.0	2.0	10.0	2.0	2.0	2.0	10.0		2.0	2.0
Trailing Detector (m)	0.0	0.0	0.0	0.0	0.0	0.0	0.0	0.0	0.0		0.0	0.0
Detector 1 Position(m)	0.0	0.0	0.0	0.0	0.0	0.0	0.0	0.0	0.0		0.0	0.0
Detector 1 Size(m)	2.0	0.6	2.0	2.0	0.6	2.0	2.0	2.0	0.6		2.0	2.0
Detector 1 Type	Cl+Ex	Cl+Ex	Cl+Ex	Cl+Ex	Cl+Ex	Cl+Ex	Cl+Ex	Cl+Ex	Cl+Ex		Cl+Ex	Cl+Ex
Detector 1 Channel												
Detector 1 Extend (s)	0.0	0.0	0.0	0.0	0.0	0.0	0.0	0.0	0.0		0.0	0.0
Detector 1 Queue (s)	0.0	0.0	0.0	0.0	0.0	0.0	0.0	0.0	0.0		0.0	0.0
Detector 1 Delay (s)	0.0	0.0	0.0	0.0	0.0	0.0	0.0	0.0	0.0		0.0	0.0
Detector 2 Position(m)		9.4			9.4				9.4			
Detector 2 Size(m)		0.6			0.6				0.6			
Detector 2 Type		Cl+Ex			Cl+Ex				Cl+Ex			
Detector 2 Channel												
Detector 2 Extend (s)		0.0			0.0				0.0			
Turn Type	Perm	NA	Perm	Perm	NA	Perm	Prot	Prot	NA		Prot	Prot
Protected Phases		4			8		5	5	2		1	1
Permitted Phases	4		4	8		8						
Detector Phase	4	4	4	8	8	8	5	5	2		1	1

3: March & Solandt  
AM Peak Hour

555-603 March Road  
2037 Total Traffic



Lane Group	SBT	SBR
Lane Configurations	↑↑	
Traffic Volume (vph)	1815	33
Future Volume (vph)	1815	33
Ideal Flow (vphpl)	1800	1800
Storage Length (m)		0.0
Storage Lanes		0
Taper Length (m)		
Lane Util. Factor	0.95	0.95
Ped Bike Factor	1.00	
Frt	0.997	
Flt Protected		
Satd. Flow (prot)	3273	0
Flt Permitted		
Satd. Flow (perm)	3273	0
Right Turn on Red		Yes
Satd. Flow (RTOR)	2	
Link Speed (k/h)	60	
Link Distance (m)	382.6	
Travel Time (s)	23.0	
Confl. Peds. (#/hr)		5
Confl. Bikes (#/hr)		5
Peak Hour Factor	1.00	1.00
Heavy Vehicles (%)	3%	1%
Adj. Flow (vph)	1815	33
Shared Lane Traffic (%)		
Lane Group Flow (vph)	1848	0
Enter Blocked Intersection	No	No
Lane Alignment	Left	R NA
Median Width(m)	17.5	
Link Offset(m)	0.0	
Crosswalk Width(m)	5.0	
Two way Left Turn Lane		
Headway Factor	1.09	1.09
Turning Speed (k/h)		14
Number of Detectors	2	
Detector Template	Thru	
Leading Detector (m)	10.0	
Trailing Detector (m)	0.0	
Detector 1 Position(m)	0.0	
Detector 1 Size(m)	0.6	
Detector 1 Type	CI+Ex	
Detector 1 Channel		
Detector 1 Extend (s)	0.0	
Detector 1 Queue (s)	0.0	
Detector 1 Delay (s)	0.0	
Detector 2 Position(m)	9.4	
Detector 2 Size(m)	0.6	
Detector 2 Type	CI+Ex	
Detector 2 Channel		
Detector 2 Extend (s)	0.0	
Turn Type	NA	
Protected Phases	6	
Permitted Phases		
Detector Phase	6	

3: March & Solandt  
AM Peak Hour

555-603 March Road  
2037 Total Traffic

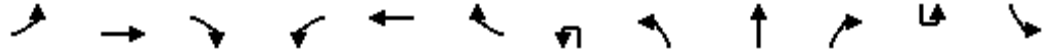

Lane Group	EBL	EBT	EBR	WBL	WBT	WBR	NBU	NBL	NBT	NBR	SBU	SBL
Switch Phase												
Minimum Initial (s)	10.0	10.0	10.0	10.0	10.0	10.0	5.0	5.0	10.0		5.0	5.0
Minimum Split (s)	36.5	36.5	36.5	36.5	36.5	36.5	12.0	12.0	26.8		12.0	12.0
Total Split (s)	37.0	37.0	37.0	37.0	37.0	37.0	23.0	23.0	81.0		12.0	12.0
Total Split (%)	28.5%	28.5%	28.5%	28.5%	28.5%	28.5%	17.7%	17.7%	62.3%		9.2%	9.2%
Maximum Green (s)	30.5	30.5	30.5	30.5	30.5	30.5	16.0	16.0	75.2		5.0	5.0
Yellow Time (s)	3.3	3.3	3.3	3.3	3.3	3.3	3.7	3.7	3.7		3.7	3.7
All-Red Time (s)	3.2	3.2	3.2	3.2	3.2	3.2	3.3	3.3	2.1		3.3	3.3
Lost Time Adjust (s)	0.0	0.0	0.0	0.0	0.0	0.0		0.0	0.0			0.0
Total Lost Time (s)	6.5	6.5	6.5	6.5	6.5	6.5		7.0	5.8			7.0
Lead/Lag							Lead	Lead	Lag		Lead	Lead
Lead-Lag Optimize?												
Vehicle Extension (s)	3.0	3.0	3.0	3.0	3.0	3.0	3.0	3.0	3.0		3.0	3.0
Recall Mode	None	None	None	None	None	None	None	None	C-Max		None	None
Walk Time (s)	7.0	7.0	7.0	7.0	7.0	7.0			7.0			
Flash Dont Walk (s)	23.0	23.0	23.0	23.0	23.0	23.0			14.0			
Pedestrian Calls (#/hr)	5	5	5	5	5	5			5			
Act Effct Green (s)	16.3	16.3	16.3	16.3	16.3	16.3		25.3	84.0			10.4
Actuated g/C Ratio	0.13	0.13	0.13	0.13	0.13	0.13		0.19	0.65			0.08
v/c Ratio	0.08	0.15	0.29	0.53	0.09	0.05		0.69	0.84			0.47
Control Delay	46.6	48.6	3.0	63.4	47.1	0.3		61.3	23.7			68.3
Queue Delay	0.0	0.0	0.0	0.0	0.0	0.0		0.0	0.0			0.0
Total Delay	46.6	48.6	3.0	63.4	47.1	0.3		61.3	23.7			68.3
LOS	D	D	A	E	D	A		E	C			E
Approach Delay		18.6			52.3				27.9			
Approach LOS		B			D				C			
Queue Length 50th (m)	2.6	7.2	0.0	18.8	3.5	0.0		48.6	155.1			14.9
Queue Length 95th (m)	7.2	14.3	1.5	29.8	8.7	0.0		#103.8	#251.8			m#34.5
Internal Link Dist (m)		188.6			217.6				586.9			
Turn Bay Length (m)	35.0		60.0	135.0		55.0		165.0				155.0
Base Capacity (vph)	281	405	431	290	321	451		323	2092			133
Starvation Cap Reductn	0	0	0	0	0	0		0	0			0
Spillback Cap Reductn	0	0	0	0	0	0		0	0			0
Storage Cap Reductn	0	0	0	0	0	0		0	0			0
Reduced v/c Ratio	0.04	0.08	0.20	0.28	0.05	0.04		0.69	0.84			0.47

Intersection Summary

Area Type: Other  
 Cycle Length: 130  
 Actuated Cycle Length: 130  
 Offset: 2 (2%), Referenced to phase 2:NBT and 6:SBT, Start of Green  
 Natural Cycle: 150  
 Control Type: Actuated-Coordinated  
 Maximum v/c Ratio: 1.06  
 Intersection Signal Delay: 42.4  
 Intersection LOS: D  
 Intersection Capacity Utilization 107.8%  
 ICU Level of Service G  
 Analysis Period (min) 15  
 ~ Volume exceeds capacity, queue is theoretically infinite.  
 Queue shown is maximum after two cycles.  
 # 95th percentile volume exceeds capacity, queue may be longer.  
 Queue shown is maximum after two cycles.  
 m Volume for 95th percentile queue is metered by upstream signal.

Splits and Phases: 3: March & Solandt

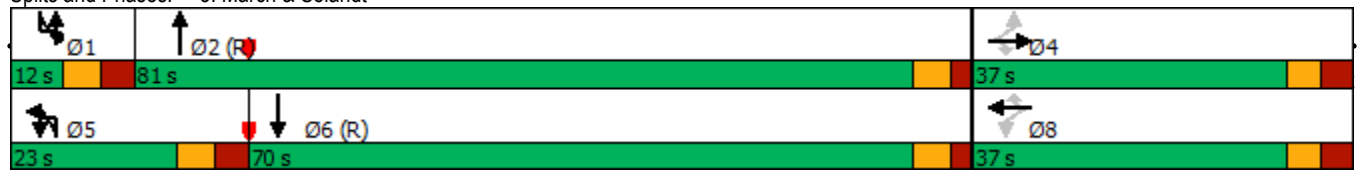





Lane Group	SBT	SBR
Switch Phase		
Minimum Initial (s)	10.0	
Minimum Split (s)	26.8	
Total Split (s)	70.0	
Total Split (%)	53.8%	
Maximum Green (s)	64.2	
Yellow Time (s)	3.7	
All-Red Time (s)	2.1	
Lost Time Adjust (s)	0.0	
Total Lost Time (s)	5.8	
Lead/Lag	Lag	
Lead-Lag Optimize?		
Vehicle Extension (s)	3.0	
Recall Mode	C-Max	
Walk Time (s)	7.0	
Flash Dont Walk (s)	14.0	
Pedestrian Calls (#/hr)	5	
Act Effct Green (s)	69.0	
Actuated g/C Ratio	0.53	
v/c Ratio	1.06	
Control Delay	58.2	
Queue Delay	0.0	
Total Delay	58.2	
LOS	E	
Approach Delay	58.5	
Approach LOS	E	
Queue Length 50th (m)	~252.8	
Queue Length 95th (m)	#299.4	
Internal Link Dist (m)	358.6	
Turn Bay Length (m)		
Base Capacity (vph)	1738	
Starvation Cap Reductn	0	
Spillback Cap Reductn	0	
Storage Cap Reductn	0	
Reduced v/c Ratio	1.06	
<b>Intersection Summary</b>		

4: Innovation/Flamborough & Terry Fox  
AM Peak Hour

555-603 March Road  
2037 Total Traffic

Lane Group	EBL	EBT	EBR	WBL	WBT	WBR	NBL	NBT	NBR	SBL	SBT	SBR
Lane Configurations												
Traffic Volume (vph)	29	451	76	84	289	38	35	36	82	69	55	42
Future Volume (vph)	29	451	76	84	289	38	35	36	82	69	55	42
Ideal Flow (vphpl)	1800	1800	1800	1800	1800	1800	1800	1800	1800	1800	1800	1800
Storage Length (m)	75.0		120.0	110.0		130.0	220.0		0.0	30.0		0.0
Storage Lanes	1		1	1		1	1		0	1		0
Taper Length (m)	50.0			80.0			50.0			15.0		
Lane Util. Factor	1.00	1.00	1.00	1.00	1.00	1.00	1.00	1.00	1.00	1.00	1.00	1.00
Ped Bike Factor	0.99		0.95	0.99		0.96	0.98	0.97		0.99	0.98	
Frt			0.850			0.850		0.896			0.935	
Flt Protected	0.950			0.950			0.950			0.950		
Satd. Flow (prot)	1470	1728	1469	1626	1728	1498	1658	1513	0	1674	1554	0
Flt Permitted	0.583			0.441			0.685			0.607		
Satd. Flow (perm)	895	1728	1392	747	1728	1441	1173	1513	0	1060	1554	0
Right Turn on Red			Yes			Yes			Yes			Yes
Satd. Flow (RTOR)			78			78		82			29	
Link Speed (k/h)		60			60			50			50	
Link Distance (m)		508.2			294.0			547.1			313.7	
Travel Time (s)		30.5			17.6			39.4			22.6	
Confl. Peds. (#/hr)	5		10	10		5	10		5	5		10
Confl. Bikes (#/hr)			5			5			5			5
Peak Hour Factor	1.00	1.00	1.00	1.00	1.00	1.00	1.00	1.00	1.00	1.00	1.00	1.00
Heavy Vehicles (%)	15%	3%	3%	4%	3%	1%	2%	2%	3%	1%	1%	10%
Adj. Flow (vph)	29	451	76	84	289	38	35	36	82	69	55	42
Shared Lane Traffic (%)												
Lane Group Flow (vph)	29	451	76	84	289	38	35	118	0	69	97	0
Enter Blocked Intersection	No	No	No	No	No	No	No	No	No	No	No	No
Lane Alignment	L NA	Left	R NA	L NA	Left	R NA	L NA	Left	R NA	L NA	Left	R NA
Median Width(m)		3.5			3.5			3.5			3.5	
Link Offset(m)		0.0			0.0			0.0			0.0	
Crosswalk Width(m)		5.0			5.0			5.0			5.0	
Two way Left Turn Lane												
Headway Factor	1.09	1.09	1.09	1.09	1.09	1.09	1.09	1.09	1.09	1.09	1.09	1.09
Turning Speed (k/h)	24		14	24		14	24		14	24		14
Number of Detectors	1	2	1	1	2	1	1	2		1	2	
Detector Template	Left	Thru	Right	Left	Thru	Right	Left	Thru		Left	Thru	
Leading Detector (m)	2.0	10.0	2.0	2.0	10.0	2.0	2.0	10.0		2.0	10.0	
Trailing Detector (m)	0.0	0.0	0.0	0.0	0.0	0.0	0.0	0.0		0.0	0.0	
Detector 1 Position(m)	0.0	0.0	0.0	0.0	0.0	0.0	0.0	0.0		0.0	0.0	
Detector 1 Size(m)	2.0	0.6	2.0	2.0	0.6	2.0	2.0	0.6		2.0	0.6	
Detector 1 Type	Cl+Ex	Cl+Ex	Cl+Ex	Cl+Ex	Cl+Ex	Cl+Ex	Cl+Ex	Cl+Ex		Cl+Ex	Cl+Ex	
Detector 1 Channel												
Detector 1 Extend (s)	0.0	0.0	0.0	0.0	0.0	0.0	0.0	0.0		0.0	0.0	
Detector 1 Queue (s)	0.0	0.0	0.0	0.0	0.0	0.0	0.0	0.0		0.0	0.0	
Detector 1 Delay (s)	0.0	0.0	0.0	0.0	0.0	0.0	0.0	0.0		0.0	0.0	
Detector 2 Position(m)		9.4			9.4			9.4			9.4	
Detector 2 Size(m)		0.6			0.6			0.6			0.6	
Detector 2 Type		Cl+Ex			Cl+Ex			Cl+Ex			Cl+Ex	
Detector 2 Channel												
Detector 2 Extend (s)		0.0			0.0			0.0			0.0	
Turn Type	pm+pt	NA	Perm	pm+pt	NA	Perm	Perm	NA		Perm	NA	
Protected Phases	5	2		1	6			8			4	
Permitted Phases	2		2	6		6	8			4		
Detector Phase	5	2	2	1	6	6	8	8		4	4	



Lane Group	EBL	EBT	EBR	WBL	WBT	WBR	NBL	NBT	NBR	SBL	SBT	SBR
Switch Phase												
Minimum Initial (s)	5.0	10.0	10.0	5.0	10.0	10.0	10.0	10.0		10.0	10.0	
Minimum Split (s)	11.0	27.9	27.9	11.0	27.9	27.9	36.3	36.3		36.3	36.3	
Total Split (s)	18.0	70.0	70.0	18.0	70.0	70.0	42.0	42.0		42.0	42.0	
Total Split (%)	13.8%	53.8%	53.8%	13.8%	53.8%	53.8%	32.3%	32.3%		32.3%	32.3%	
Maximum Green (s)	12.0	64.1	64.1	12.0	64.1	64.1	35.7	35.7		35.7	35.7	
Yellow Time (s)	3.7	3.7	3.7	3.7	3.7	3.7	3.3	3.3		3.3	3.3	
All-Red Time (s)	2.3	2.2	2.2	2.3	2.2	2.2	3.0	3.0		3.0	3.0	
Lost Time Adjust (s)	0.0	0.0	0.0	0.0	0.0	0.0	0.0	0.0		0.0	0.0	
Total Lost Time (s)	6.0	5.9	5.9	6.0	5.9	5.9	6.3	6.3		6.3	6.3	
Lead/Lag	Lead	Lag	Lag	Lead	Lag	Lag						
Lead-Lag Optimize?												
Vehicle Extension (s)	3.0	3.0	3.0	3.0	3.0	3.0	3.0	3.0		3.0	3.0	
Recall Mode	None	C-Max	C-Max	None	C-Max	C-Max	None	None		None	None	
Walk Time (s)		7.0	7.0		7.0	7.0	7.0	7.0		7.0	7.0	
Flash Dont Walk (s)		15.0	15.0		15.0	15.0	23.0	23.0		23.0	23.0	
Pedestrian Calls (#/hr)		5	5		5	5	5	5		5	5	
Act Effct Green (s)	94.9	88.8	88.8	99.1	94.5	94.5	15.8	15.8		15.8	15.8	
Actuated g/C Ratio	0.73	0.68	0.68	0.76	0.73	0.73	0.12	0.12		0.12	0.12	
v/c Ratio	0.04	0.38	0.08	0.14	0.23	0.04	0.25	0.46		0.54	0.45	
Control Delay	5.0	11.5	2.6	4.9	9.8	2.9	52.6	23.4		66.8	41.7	
Queue Delay	0.0	0.0	0.0	0.0	0.0	0.0	0.0	0.0		0.0	0.0	
Total Delay	5.0	11.5	2.6	4.9	9.8	2.9	52.6	23.4		66.8	41.7	
LOS	A	B	A	A	A	A	D	C		E	D	
Approach Delay		9.9			8.1			30.1			52.1	
Approach LOS		A			A			C			D	
Queue Length 50th (m)	1.1	38.0	0.0	7.7	31.3	0.4	7.8	8.0		15.9	15.4	
Queue Length 95th (m)	5.0	86.1	6.1	m14.9	53.7	m2.5	15.1	21.7		26.4	27.2	
Internal Link Dist (m)		484.2			270.0			523.1			289.7	
Turn Bay Length (m)	75.0		120.0	110.0		130.0	220.0			30.0		
Base Capacity (vph)	746	1180	975	664	1255	1068	322	474		291	447	
Starvation Cap Reductn	0	0	0	0	0	0	0	0		0	0	
Spillback Cap Reductn	0	0	0	0	0	0	0	0		0	0	
Storage Cap Reductn	0	0	0	0	0	0	0	0		0	0	
Reduced v/c Ratio	0.04	0.38	0.08	0.13	0.23	0.04	0.11	0.25		0.24	0.22	

Intersection Summary





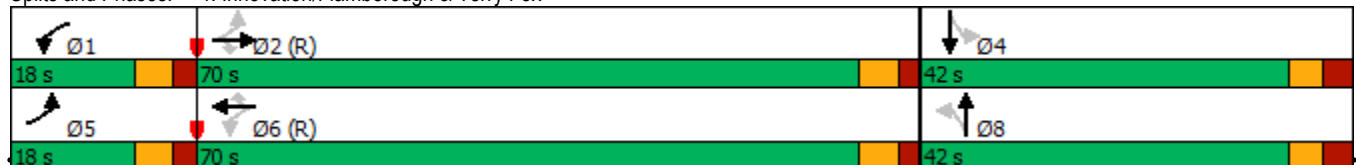











Area Type: Other  
 Cycle Length: 130  
 Actuated Cycle Length: 130  
 Offset: 124 (95%), Referenced to phase 2:EBTL and 6:WBTL, Start of Green  
 Natural Cycle: 80  
 Control Type: Actuated-Coordinated  
 Maximum v/c Ratio: 0.54  
 Intersection Signal Delay: 17.2 Intersection LOS: B  
 Intersection Capacity Utilization 59.9% ICU Level of Service B  
 Analysis Period (min) 15  
 m Volume for 95th percentile queue is metered by upstream signal.

Splits and Phases: 4: Innovation/Flamborough & Terry Fox



5: Hines & Innovation  
AM Peak Hour

555-603 March Road  
2037 Total Traffic

												
Lane Group	EBL	EBT	EBR	WBL	WBT	WBR	NBL	NBT	NBR	SBL	SBT	SBR
Lane Configurations												
Traffic Volume (vph)	20	0	109	5	1	0	79	49	2	1	13	16
Future Volume (vph)	20	0	109	5	1	0	79	49	2	1	13	16
Ideal Flow (vphpl)	1800	1800	1800	1800	1800	1800	1800	1800	1800	1800	1800	1800
Lane Util. Factor	1.00	1.00	1.00	1.00	1.00	1.00	1.00	1.00	1.00	1.00	1.00	1.00
Ped Bike Factor												
Frt		0.886						0.998			0.928	
Flt Protected		0.992			0.960			0.971			0.998	
Satd. Flow (prot)	0	1487	0	0	1692	0	0	1633	0	0	1604	0
Flt Permitted		0.992			0.960			0.971			0.998	
Satd. Flow (perm)	0	1487	0	0	1692	0	0	1633	0	0	1604	0
Link Speed (k/h)		50			50			50			50	
Link Distance (m)		438.6			104.0			421.8			190.7	
Travel Time (s)		31.6			7.5			30.4			13.7	
Confl. Peds. (#/hr)							5					5
Confl. Bikes (#/hr)			5			5			10			5
Peak Hour Factor	1.00	1.00	1.00	1.00	1.00	1.00	1.00	1.00	1.00	1.00	1.00	1.00
Heavy Vehicles (%)	1%	2%	6%	1%	1%	1%	8%	2%	2%	2%	5%	1%
Adj. Flow (vph)	20	0	109	5	1	0	79	49	2	1	13	16
Shared Lane Traffic (%)												
Lane Group Flow (vph)	0	129	0	0	6	0	0	130	0	0	30	0
Enter Blocked Intersection	No	No	No	No	No	No	No	No	No	No	No	No
Lane Alignment	Left	Left	Right	Left	Left	Right	Left	Left	Right	Left	Left	Right
Median Width(m)		0.0			0.0			0.0			0.0	
Link Offset(m)		0.0			0.0			0.0			0.0	
Crosswalk Width(m)		5.0			5.0			5.0			5.0	
Two way Left Turn Lane												
Headway Factor	1.09	1.09	1.09	1.09	1.09	1.09	1.09	1.09	1.09	1.09	1.09	1.09
Turning Speed (k/h)	24		14	97		97	24		97	97		14
Sign Control		Stop			Stop			Free			Free	
<b>Intersection Summary</b>												
Area Type:	Other											
Control Type:	Unsignalized											
Intersection Capacity Utilization 28.7%	ICU Level of Service A											
Analysis Period (min) 15												

6: March & Site Access/Nokia Access  
AM Peak Hour

555-603 March Road  
2037 Total Traffic

Lane Group	EBL	EBT	EBR	WBL	WBT	WBR	NBL	NBT	NBR	SBL	SBT	SBR
Lane Configurations												
Traffic Volume (vph)	34	0	155	180	0	156	136	926	89	351	1596	57
Future Volume (vph)	34	0	155	180	0	156	136	926	89	351	1596	57
Ideal Flow (vphpl)	1800	1800	1800	1800	1800	1800	1800	1800	1800	1800	1800	1800
Storage Length (m)	65.0		0.0	65.0		0.0	75.0		100.0	75.0		0.0
Storage Lanes	1		0	1		0	1		1	1		0
Taper Length (m)	20.0			25.0			50.0			50.0		
Lane Util. Factor	1.00	1.00	1.00	1.00	1.00	1.00	1.00	0.95	1.00	1.00	0.91	0.91
Ped Bike Factor				0.99	0.97				0.94			
Frt		0.850			0.850				0.850		0.995	
Flt Protected	0.950			0.950			0.950			0.950		
Satd. Flow (prot)	1658	1483	0	1674	1456	0	1658	3283	1498	1674	4696	0
Flt Permitted	0.576			0.578			0.116			0.193		
Satd. Flow (perm)	1005	1483	0	1009	1456	0	202	3283	1408	340	4696	0
Right Turn on Red			Yes			Yes			Yes			Yes
Satd. Flow (RTOR)		214			344				137			6
Link Speed (k/h)		50			50			60				60
Link Distance (m)		126.2			167.8			227.7				308.9
Travel Time (s)		9.1			12.1			13.7				18.5
Confl. Peds. (#/hr)				10		10			10	10		
Confl. Bikes (#/hr)						5			5			
Peak Hour Factor	1.00	1.00	1.00	1.00	1.00	1.00	1.00	1.00	1.00	1.00	1.00	1.00
Heavy Vehicles (%)	2%	2%	2%	1%	2%	1%	2%	3%	1%	1%	3%	2%
Adj. Flow (vph)	34	0	155	180	0	156	136	926	89	351	1596	57
Shared Lane Traffic (%)												
Lane Group Flow (vph)	34	155	0	180	156	0	136	926	89	351	1653	0
Enter Blocked Intersection	No	No	No	No	No	No	No	No	No	No	No	No
Lane Alignment	L NA	Left	R NA	L NA	Left	R NA	Left	Left	Right	Left	Left	Right
Median Width(m)		3.5			3.5			7.0			7.0	
Link Offset(m)		0.0			0.0			0.0			0.0	
Crosswalk Width(m)		5.0			5.0			5.0			5.0	
Two way Left Turn Lane												
Headway Factor	1.09	1.09	1.09	1.09	1.09	1.09	1.09	1.09	1.09	1.09	1.09	1.09
Turning Speed (k/h)	24		14	24		14	24		14	24		14
Number of Detectors	1	2		1	2		1	2	1	1		2
Detector Template	Left	Thru		Left	Thru		Left	Thru	Right	Left	Thru	
Leading Detector (m)	2.0	10.0		2.0	10.0		2.0	10.0	2.0	2.0	10.0	
Trailing Detector (m)	0.0	0.0		0.0	0.0		0.0	0.0	0.0	0.0	0.0	
Detector 1 Position(m)	0.0	0.0		0.0	0.0		0.0	0.0	0.0	0.0	0.0	
Detector 1 Size(m)	2.0	0.6		2.0	0.6		2.0	0.6	2.0	2.0	0.6	
Detector 1 Type	Cl+Ex	Cl+Ex		Cl+Ex	Cl+Ex		Cl+Ex	Cl+Ex	Cl+Ex	Cl+Ex	Cl+Ex	
Detector 1 Channel												
Detector 1 Extend (s)	0.0	0.0		0.0	0.0		0.0	0.0	0.0	0.0	0.0	
Detector 1 Queue (s)	0.0	0.0		0.0	0.0		0.0	0.0	0.0	0.0	0.0	
Detector 1 Delay (s)	0.0	0.0		0.0	0.0		0.0	0.0	0.0	0.0	0.0	
Detector 2 Position(m)		9.4			9.4			9.4			9.4	
Detector 2 Size(m)		0.6			0.6			0.6			0.6	
Detector 2 Type		Cl+Ex			Cl+Ex			Cl+Ex			Cl+Ex	
Detector 2 Channel												
Detector 2 Extend (s)		0.0			0.0			0.0			0.0	
Turn Type	Perm	NA		Perm	NA		pm+pt	NA	Perm	pm+pt	NA	
Protected Phases		4			8		5	2		1	6	
Permitted Phases	4			8			2		2	6		
Detector Phase	4	4		8	8		5	2	2	1	6	



Lane Group	EBL	EBT	EBR	WBL	WBT	WBR	NBL	NBT	NBR	SBL	SBT	SBR
Switch Phase												
Minimum Initial (s)	10.0	10.0		10.0	10.0		5.0	10.0	10.0	5.0	10.0	
Minimum Split (s)	38.5	38.5		38.5	38.5		11.4	23.8	23.8	11.4	23.8	
Total Split (s)	42.0	42.0		42.0	42.0		19.4	55.0	55.0	33.0	68.6	
Total Split (%)	32.3%	32.3%		32.3%	32.3%		14.9%	42.3%	42.3%	25.4%	52.8%	
Maximum Green (s)	35.5	35.5		35.5	35.5		13.0	49.2	49.2	26.6	62.8	
Yellow Time (s)	3.3	3.3		3.3	3.3		3.7	3.7	3.7	3.7	3.7	
All-Red Time (s)	3.2	3.2		3.2	3.2		2.7	2.1	2.1	2.7	2.1	
Lost Time Adjust (s)	0.0	0.0		0.0	0.0		0.0	0.0	0.0	0.0	0.0	
Total Lost Time (s)	6.5	6.5		6.5	6.5		6.4	5.8	5.8	6.4	5.8	
Lead/Lag							Lead	Lag	Lag	Lead	Lag	
Lead-Lag Optimize?												
Vehicle Extension (s)	3.0	3.0		3.0	3.0		3.0	3.0	3.0	3.0	3.0	
Recall Mode	None	None		None	None		None	C-Max	C-Max	None	C-Max	
Walk Time (s)	7.0	7.0		7.0	7.0		7.0	7.0	7.0	7.0	7.0	
Flash Dont Walk (s)	25.0	25.0		25.0	25.0		11.0	11.0	11.0	11.0	11.0	
Pedestrian Calls (#/hr)	10	10		10	10		10	10	10	10	10	
Act Effct Green (s)	26.6	26.6		26.6	26.6		71.6	62.2	62.2	90.5	74.7	
Actuated g/C Ratio	0.20	0.20		0.20	0.20		0.55	0.48	0.48	0.70	0.57	
v/c Ratio	0.17	0.33		0.87	0.27		0.61	0.59	0.12	0.75	0.61	
Control Delay	41.2	3.0		86.0	1.2		26.6	34.4	7.5	17.9	27.1	
Queue Delay	0.0	0.0		0.0	0.0		0.0	0.0	0.0	0.0	0.0	
Total Delay	41.2	3.0		86.0	1.2		26.6	34.4	7.5	17.9	27.1	
LOS	D	A		F	A		C	C	A	B	C	
Approach Delay		9.9			46.6			31.4			25.5	
Approach LOS		A			D			C			C	
Queue Length 50th (m)	6.6	0.0		41.3	0.0		18.3	69.5	0.9	57.4	137.1	
Queue Length 95th (m)	14.1	4.0		62.2	0.0		m31.1	102.1	m4.2	41.8	157.4	
Internal Link Dist (m)		102.2			143.8			203.7			284.9	
Turn Bay Length (m)	65.0			65.0			75.0		100.0	75.0		
Base Capacity (vph)	274	560		275	647		261	1571	745	512	2701	
Starvation Cap Reductn	0	0		0	0		0	0	0	0	0	
Spillback Cap Reductn	0	0		0	0		0	0	0	0	0	
Storage Cap Reductn	0	0		0	0		0	0	0	0	0	
Reduced v/c Ratio	0.12	0.28		0.65	0.24		0.52	0.59	0.12	0.69	0.61	

Intersection Summary

Area Type: Other  
 Cycle Length: 130  
 Actuated Cycle Length: 130  
 Offset: 0 (0%), Referenced to phase 2:NBT and 6:SBTL, Start of Green  
 Natural Cycle: 90  
 Control Type: Actuated-Coordinated  
 Maximum v/c Ratio: 0.87  
 Intersection Signal Delay: 28.5  
 Intersection LOS: C  
 Intersection Capacity Utilization 92.5%  
 ICU Level of Service F  
 Analysis Period (min) 15  
 m Volume for 95th percentile queue is metered by upstream signal.

Splits and Phases: 6: March & Site Access/Nokia Access

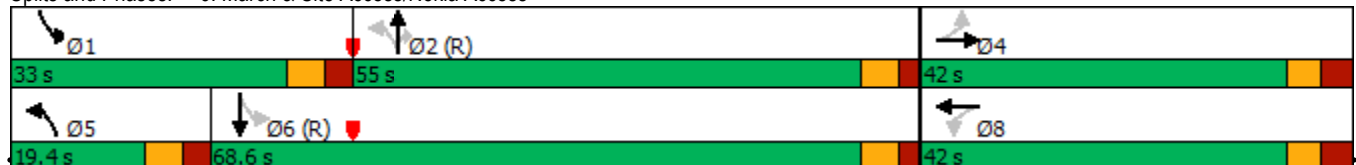



Lane Group	EBT	EBR	WBL	WBT	NBL	NBR
Lane Configurations						
Traffic Volume (vph)	537	42	78	448	30	58
Future Volume (vph)	537	42	78	448	30	58
Ideal Flow (vphpl)	1800	1800	1800	1800	1800	1800
Storage Length (m)		0.0	30.0		0.0	0.0
Storage Lanes		0	1		1	0
Taper Length (m)			40.0		10.0	
Lane Util. Factor	1.00	1.00	1.00	0.95	1.00	1.00
Ped Bike Factor						
Frt	0.990				0.911	
Flt Protected			0.950		0.983	
Satd. Flow (prot)	1713	0	1674	3283	1578	0
Flt Permitted			0.950		0.983	
Satd. Flow (perm)	1713	0	1674	3283	1578	0
Link Speed (k/h)	60			60	50	
Link Distance (m)	191.8			165.4	126.2	
Travel Time (s)	11.5			9.9	9.1	
Confl. Peds. (#/hr)		10	10			
Confl. Bikes (#/hr)		5				5
Peak Hour Factor	1.00	1.00	1.00	1.00	1.00	1.00
Heavy Vehicles (%)	3%	1%	1%	3%	1%	1%
Adj. Flow (vph)	537	42	78	448	30	58
Shared Lane Traffic (%)						
Lane Group Flow (vph)	579	0	78	448	88	0
Enter Blocked Intersection	No	No	No	No	No	No
Lane Alignment	Left	Right	Left	Left	L NA	R NA
Median Width(m)	7.0			9.0	3.5	
Link Offset(m)	0.0			0.0	0.0	
Crosswalk Width(m)	5.0			5.0	5.0	
Two way Left Turn Lane						
Headway Factor	1.09	1.09	1.09	1.09	1.09	1.09
Turning Speed (k/h)		14	24		24	14
Sign Control	Free			Free	Stop	

**Intersection Summary**

Area Type:	Other
Control Type:	Unsignalized
Intersection Capacity Utilization	52.7%
ICU Level of Service	A
Analysis Period (min)	15



Lane Group	WBL	WBR	NBT	NBR	SBL	SBT
Lane Configurations						
Traffic Volume (vph)	14	0	62	7	0	15
Future Volume (vph)	14	0	62	7	0	15
Ideal Flow (vphpl)	1800	1800	1800	1800	1800	1800
Lane Util. Factor	1.00	1.00	1.00	1.00	1.00	1.00
Ped Bike Factor						
Frt	0.986					
Flt Protected	0.950					
Satd. Flow (prot)	1674	0	1722	0	0	1745
Flt Permitted	0.950					
Satd. Flow (perm)	1674	0	1722	0	0	1745
Link Speed (k/h)	50	50		50		
Link Distance (m)	75.1	190.7		128.3		
Travel Time (s)	5.4	13.7		9.2		
Confl. Peds. (#/hr)				10	10	
Confl. Bikes (#/hr)	5		5			
Peak Hour Factor	1.00	1.00	1.00	1.00	1.00	1.00
Heavy Vehicles (%)	1%	1%	2%	1%	1%	2%
Adj. Flow (vph)	14	0	62	7	0	15
Shared Lane Traffic (%)						
Lane Group Flow (vph)	14	0	69	0	0	15
Enter Blocked Intersection	No	No	No	No	No	No
Lane Alignment	Left	Right	Left	Right	Left	Left
Median Width(m)	3.5	0.0		0.0		
Link Offset(m)	0.0	0.0		0.0		
Crosswalk Width(m)	5.0	5.0		5.0		
Two way Left Turn Lane						
Headway Factor	1.09	1.09	1.09	1.09	1.09	1.09
Turning Speed (k/h)	24	14	14		24	
Sign Control	Stop	Free		Free		

Intersection Summary	
Area Type:	Other
Control Type:	Unsignalized
Intersection Capacity Utilization	16.6%
	ICU Level of Service A
Analysis Period (min)	15



1: March & Morgan's Grant/Shirley's Brook  
PM Peak Hour

555-603 March Road  
2037 Total Traffic

Lane Group	EBL	EBT	EBR	WBL	WBT	WBR	NBL	NBT	NBR	SBL	SBT	SBR
Lane Configurations												
Traffic Volume (vph)	54	50	62	129	47	195	75	1792	94	169	1151	68
Future Volume (vph)	54	50	62	129	47	195	75	1792	94	169	1151	68
Ideal Flow (vphpl)	1800	1800	1800	1800	1800	1800	1800	1800	1800	1800	1800	1800
Storage Length (m)	0.0		20.0	45.0		35.0	130.0		30.0	65.0		25.0
Storage Lanes	0		1	1		1	1		1	1		1
Taper Length (m)	10.0			30.0			40.0			35.0		
Lane Util. Factor	1.00	1.00	1.00	1.00	1.00	1.00	1.00	0.91	1.00	1.00	0.91	1.00
Ped Bike Factor		1.00	0.97	0.99		0.98	1.00		0.94	1.00		0.96
Frt			0.850			0.850			0.850			0.850
Flt Protected		0.975		0.950			0.950			0.950		
Satd. Flow (prot)	0	1642	1498	1674	1548	1498	1674	4764	1498	1674	4718	1498
Flt Permitted		0.812		0.690			0.950			0.950		
Satd. Flow (perm)	0	1364	1455	1203	1548	1464	1668	4764	1409	1669	4718	1436
Right Turn on Red			Yes			Yes			Yes			Yes
Satd. Flow (RTOR)			136			195			145			91
Link Speed (k/h)		40			40			60				60
Link Distance (m)		465.2			359.5			318.9				462.6
Travel Time (s)		41.9			32.4			19.1				27.8
Confl. Peds. (#/hr)	5		10	10		5	5		10	10		5
Confl. Bikes (#/hr)			5			5			5			5
Peak Hour Factor	1.00	1.00	1.00	1.00	1.00	1.00	1.00	1.00	1.00	1.00	1.00	1.00
Heavy Vehicles (%)	10%	1%	1%	1%	15%	1%	1%	2%	1%	1%	3%	1%
Adj. Flow (vph)	54	50	62	129	47	195	75	1792	94	169	1151	68
Shared Lane Traffic (%)												
Lane Group Flow (vph)	0	104	62	129	47	195	75	1792	94	169	1151	68
Enter Blocked Intersection	No	No	No	No	No	No	No	No	No	No	No	No
Lane Alignment	L NA	Left	R NA	L NA	Left	R NA	L NA	Left	R NA	L NA	Left	R NA
Median Width(m)		3.5			5.0			9.0				9.0
Link Offset(m)		0.0			0.0			0.0				0.0
Crosswalk Width(m)		5.0			5.0			10.0				10.0
Two way Left Turn Lane												
Headway Factor	1.09	1.09	1.09	1.09	1.09	1.09	1.09	1.09	1.09	1.09	1.09	1.09
Turning Speed (k/h)	24		14	24		14	24		14	24		14
Number of Detectors	1	2	1	1	2	1	1	2	1	1	2	1
Detector Template	Left	Thru	Right	Left	Thru	Right	Left	Thru	Right	Left	Thru	Right
Leading Detector (m)	2.0	10.0	2.0	2.0	10.0	2.0	2.0	10.0	2.0	2.0	10.0	2.0
Trailing Detector (m)	0.0	0.0	0.0	0.0	0.0	0.0	0.0	0.0	0.0	0.0	0.0	0.0
Detector 1 Position(m)	0.0	0.0	0.0	0.0	0.0	0.0	0.0	0.0	0.0	0.0	0.0	0.0
Detector 1 Size(m)	2.0	0.6	2.0	2.0	0.6	2.0	2.0	0.6	2.0	2.0	0.6	2.0
Detector 1 Type	Cl+Ex	Cl+Ex	Cl+Ex	Cl+Ex	Cl+Ex	Cl+Ex	Cl+Ex	Cl+Ex	Cl+Ex	Cl+Ex	Cl+Ex	Cl+Ex
Detector 1 Channel												
Detector 1 Extend (s)	0.0	0.0	0.0	0.0	0.0	0.0	0.0	0.0	0.0	0.0	0.0	0.0
Detector 1 Queue (s)	0.0	0.0	0.0	0.0	0.0	0.0	0.0	0.0	0.0	0.0	0.0	0.0
Detector 1 Delay (s)	0.0	0.0	0.0	0.0	0.0	0.0	0.0	0.0	0.0	0.0	0.0	0.0
Detector 2 Position(m)		9.4			9.4			9.4				9.4
Detector 2 Size(m)		0.6			0.6			0.6				0.6
Detector 2 Type		Cl+Ex			Cl+Ex			Cl+Ex				Cl+Ex
Detector 2 Channel												
Detector 2 Extend (s)		0.0			0.0			0.0				0.0
Turn Type	Perm	NA	Perm	Perm	NA	Perm	Prot	NA	Perm	Prot	NA	Perm
Protected Phases		4			8		5	2		1		6
Permitted Phases	4		4	8		8			2			6
Detector Phase	4	4	4	8	8	8	5	2	2	1	6	6



Lane Group	EBL	EBT	EBR	WBL	WBT	WBR	NBL	NBT	NBR	SBL	SBT	SBR
Switch Phase												
Minimum Initial (s)	10.0	10.0	10.0	10.0	10.0	10.0	5.0	10.0	10.0	5.0	10.0	10.0
Minimum Split (s)	38.5	38.5	38.5	38.5	38.5	38.5	11.4	24.4	24.4	11.4	24.4	24.4
Total Split (s)	38.5	38.5	38.5	38.5	38.5	38.5	19.1	64.5	64.5	27.0	72.4	72.4
Total Split (%)	29.6%	29.6%	29.6%	29.6%	29.6%	29.6%	14.7%	49.6%	49.6%	20.8%	55.7%	55.7%
Maximum Green (s)	31.0	31.0	31.0	31.0	31.0	31.0	12.7	58.1	58.1	20.6	66.0	66.0
Yellow Time (s)	3.0	3.0	3.0	3.0	3.0	3.0	3.7	3.7	3.7	3.7	3.7	3.7
All-Red Time (s)	4.5	4.5	4.5	4.5	4.5	4.5	2.7	2.7	2.7	2.7	2.7	2.7
Lost Time Adjust (s)		0.0	0.0	0.0	0.0	0.0	0.0	0.0	0.0	0.0	0.0	0.0
Total Lost Time (s)		7.5	7.5	7.5	7.5	7.5	6.4	6.4	6.4	6.4	6.4	6.4
Lead/Lag							Lead	Lag	Lag	Lead	Lag	Lag
Lead-Lag Optimize?												
Vehicle Extension (s)	3.0	3.0	3.0	3.0	3.0	3.0	3.0	3.0	3.0	3.0	3.0	3.0
Recall Mode	None	None	None	None	None	None	None	C-Max	C-Max	None	C-Max	C-Max
Walk Time (s)	7.0	7.0	7.0	7.0	7.0	7.0		7.0	7.0		7.0	7.0
Flash Dont Walk (s)	24.0	24.0	24.0	24.0	24.0	24.0		11.0	11.0		11.0	11.0
Pedestrian Calls (#/hr)	10	10	10	5	5	5		10	10		5	5
Act Effct Green (s)		20.0	20.0	20.0	20.0	20.0	10.6	72.3	72.3	17.4	81.8	81.8
Actuated g/C Ratio		0.15	0.15	0.15	0.15	0.15	0.08	0.56	0.56	0.13	0.63	0.63
v/c Ratio		0.50	0.18	0.70	0.20	0.50	0.56	0.68	0.11	0.75	0.39	0.07
Control Delay		56.8	1.2	70.5	46.8	10.3	72.2	9.7	0.4	74.7	14.2	1.7
Queue Delay		0.0	0.0	0.0	0.0	0.0	0.0	0.0	0.0	0.0	0.0	0.0
Total Delay		56.8	1.2	70.5	46.8	10.3	72.2	9.7	0.4	74.7	14.2	1.7
LOS		E	A	E	D	B	E	A	A	E	B	A
Approach Delay		36.0			35.9			11.6			21.0	
Approach LOS		D			D			B			C	
Queue Length 50th (m)		22.9	0.0	29.4	9.9	0.0	18.8	29.1	0.2	38.6	48.4	0.0
Queue Length 95th (m)		35.8	0.0	44.5	18.3	17.2	m23.8	m35.6	m0.5	60.2	74.1	3.9
Internal Link Dist (m)		441.2			335.5			294.9			438.6	
Turn Bay Length (m)			20.0	45.0		35.0	130.0		30.0	65.0		25.0
Base Capacity (vph)		325	450	286	369	497	164	2650	848	266	2968	937
Starvation Cap Reductn		0	0	0	0	0	0	0	0	0	0	0
Spillback Cap Reductn		0	0	0	0	0	0	0	0	0	0	0
Storage Cap Reductn		0	0	0	0	0	0	0	0	0	0	0
Reduced v/c Ratio		0.32	0.14	0.45	0.13	0.39	0.46	0.68	0.11	0.64	0.39	0.07

Intersection Summary

Area Type: Other  
 Cycle Length: 130  
 Actuated Cycle Length: 130  
 Offset: 128 (98%), Referenced to phase 2:NBT and 6:SBT, Start of Green  
 Natural Cycle: 100  
 Control Type: Actuated-Coordinated  
 Maximum v/c Ratio: 0.75  
 Intersection Signal Delay: 18.3 Intersection LOS: B  
 Intersection Capacity Utilization 82.9% ICU Level of Service E  
 Analysis Period (min) 15  
 m Volume for 95th percentile queue is metered by upstream signal.

Splits and Phases: 1: March & Morgan's Grant/Shirley's Brook

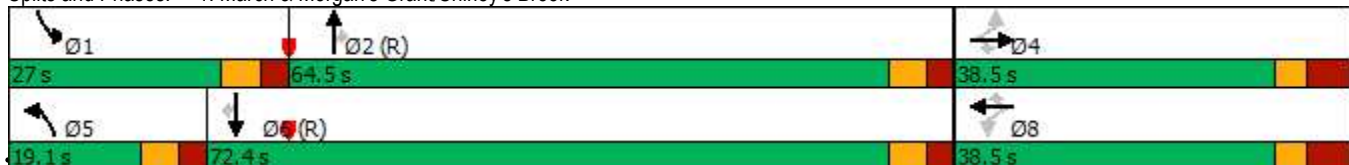

2: March & Terry Fox  
PM Peak Hour

555-603 March Road  
2037 Total Traffic

Lane Group	EBL	EBT	EBR	WBL	WBT	WBR	NBU	NBL	NBT	NBR	SBU	SBL
Lane Configurations												
Traffic Volume (vph)	278	177	179	74	182	191	18	322	1630	126	4	150
Future Volume (vph)	278	177	179	74	182	191	18	322	1630	126	4	150
Ideal Flow (vphpl)	1800	1800	1800	1800	1800	1800	1800	1800	1800	1800	1800	1800
Storage Length (m)	95.0		60.0	75.0		75.0		130.0		85.0		110.0
Storage Lanes	2		2	2		1		2		2		1
Taper Length (m)	40.0			20.0				90.0				40.0
Lane Util. Factor	0.97	0.95	1.00	0.97	0.95	1.00	0.91	0.97	0.91	1.00	0.91	1.00
Ped Bike Factor	0.99		0.97	0.99		0.96		1.00		0.97		1.00
Fr			0.850			0.850				0.850		
Flt Protected	0.950			0.950				0.950				0.950
Satd. Flow (prot)	3248	3221	1498	3248	3349	1498	0	3187	4764	1469	0	1674
Flt Permitted	0.950			0.950				0.950				0.950
Satd. Flow (perm)	3206	3221	1458	3220	3349	1443	0	3176	4764	1425	0	1671
Right Turn on Red			Yes			Yes				Yes		
Satd. Flow (RTOR)			193			193				144		
Link Speed (k/h)		60			60				60			
Link Distance (m)		165.4			149.1				308.9			
Travel Time (s)		9.9			8.9				18.5			
Confl. Peds. (#/hr)	15		10	10		15		5		10		10
Confl. Bikes (#/hr)			5			10				5		
Peak Hour Factor	1.00	1.00	1.00	1.00	1.00	1.00	1.00	1.00	1.00	1.00	1.00	1.00
Heavy Vehicles (%)	1%	5%	1%	1%	1%	1%	2%	3%	2%	3%	2%	1%
Adj. Flow (vph)	278	177	179	74	182	191	18	322	1630	126	4	150
Shared Lane Traffic (%)												
Lane Group Flow (vph)	278	177	179	74	182	191	0	340	1630	126	0	154
Enter Blocked Intersection	No	No	No	Yes	Yes	Yes	No	No	No	No	No	No
Lane Alignment	L NA	Left	R NA	L NA	Left	R NA	R NA	L NA	Left	R NA	R NA	L NA
Median Width(m)		11.5			10.5				10.5			
Link Offset(m)		0.0			0.0				0.0			
Crosswalk Width(m)		5.0			5.0				5.0			
Two way Left Turn Lane												
Headway Factor	1.09	1.09	1.09	1.09	1.09	1.09	1.09	1.09	1.09	1.09	1.09	1.09
Turning Speed (k/h)	24		14	24		14	14	24		14	14	24
Number of Detectors	1	2	1	1	2	1	1	1	2	1	1	1
Detector Template	Left	Thru	Right	Left	Thru	Right	Left	Left	Thru	Right	Left	Left
Leading Detector (m)	2.0	10.0	2.0	2.0	10.0	2.0	2.0	2.0	10.0	2.0	2.0	2.0
Trailing Detector (m)	0.0	0.0	0.0	0.0	0.0	0.0	0.0	0.0	0.0	0.0	0.0	0.0
Detector 1 Position(m)	0.0	0.0	0.0	0.0	0.0	0.0	0.0	0.0	0.0	0.0	0.0	0.0
Detector 1 Size(m)	2.0	0.6	2.0	2.0	0.6	2.0	2.0	2.0	0.6	2.0	2.0	2.0
Detector 1 Type	Cl+Ex	Cl+Ex	Cl+Ex	Cl+Ex	Cl+Ex	Cl+Ex	Cl+Ex	Cl+Ex	Cl+Ex	Cl+Ex	Cl+Ex	Cl+Ex
Detector 1 Channel												
Detector 1 Extend (s)	0.0	0.0	0.0	0.0	0.0	0.0	0.0	0.0	0.0	0.0	0.0	0.0
Detector 1 Queue (s)	0.0	0.0	0.0	0.0	0.0	0.0	0.0	0.0	0.0	0.0	0.0	0.0
Detector 1 Delay (s)	0.0	0.0	0.0	0.0	0.0	0.0	0.0	0.0	0.0	0.0	0.0	0.0
Detector 2 Position(m)		9.4			9.4				9.4			
Detector 2 Size(m)		0.6			0.6				0.6			
Detector 2 Type		Cl+Ex			Cl+Ex				Cl+Ex			
Detector 2 Channel												
Detector 2 Extend (s)		0.0			0.0				0.0			
Turn Type	Prot	NA	Perm	Prot	NA	Perm	Prot	Prot	NA	Perm	Prot	Prot
Protected Phases	7	4		3	8		5	5	2		1	1
Permitted Phases			4			8				2		
Detector Phase	7	4	4	3	8	8	5	5	2	2	1	1

2: March & Terry Fox  
PM Peak Hour

555-603 March Road  
2037 Total Traffic



Lane Group	SBT	SBR
Lane Configurations	↑↑↑	↑
Traffic Volume (vph)	955	200
Future Volume (vph)	955	200
Ideal Flow (vphpl)	1800	1800
Storage Length (m)		100.0
Storage Lanes		1
Taper Length (m)		
Lane Util. Factor	0.91	1.00
Ped Bike Factor		0.98
Frt		0.850
Flt Protected		
Satd. Flow (prot)	4718	1483
Flt Permitted		
Satd. Flow (perm)	4718	1449
Right Turn on Red		Yes
Satd. Flow (RTOR)		200
Link Speed (k/h)	60	
Link Distance (m)	318.9	
Travel Time (s)	19.1	
Confl. Peds. (#/hr)		5
Confl. Bikes (#/hr)		5
Peak Hour Factor	1.00	1.00
Heavy Vehicles (%)	3%	2%
Adj. Flow (vph)	955	200
Shared Lane Traffic (%)		
Lane Group Flow (vph)	955	200
Enter Blocked Intersection	No	No
Lane Alignment	Left	R NA
Median Width(m)	7.0	
Link Offset(m)	0.0	
Crosswalk Width(m)	5.0	
Two way Left Turn Lane		
Headway Factor	1.09	1.09
Turning Speed (k/h)		14
Number of Detectors	2	1
Detector Template	Thru	Right
Leading Detector (m)	10.0	2.0
Trailing Detector (m)	0.0	0.0
Detector 1 Position(m)	0.0	0.0
Detector 1 Size(m)	0.6	2.0
Detector 1 Type	Cl+Ex	Cl+Ex
Detector 1 Channel		
Detector 1 Extend (s)	0.0	0.0
Detector 1 Queue (s)	0.0	0.0
Detector 1 Delay (s)	0.0	0.0
Detector 2 Position(m)	9.4	
Detector 2 Size(m)	0.6	
Detector 2 Type	Cl+Ex	
Detector 2 Channel		
Detector 2 Extend (s)	0.0	
Turn Type	NA	Perm
Protected Phases	6	
Permitted Phases		6
Detector Phase	6	6



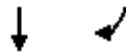

Lane Group	SBT	SBR
Switch Phase		
Minimum Initial (s)	10.0	10.0
Minimum Split (s)	32.4	32.4
Total Split (s)	42.5	42.5
Total Split (%)	32.7%	32.7%
Maximum Green (s)	36.1	36.1
Yellow Time (s)	3.7	3.7
All-Red Time (s)	2.7	2.7
Lost Time Adjust (s)	0.0	0.0
Total Lost Time (s)	6.4	6.4
Lead/Lag	Lag	Lag
Lead-Lag Optimize?		
Vehicle Extension (s)	3.0	3.0
Recall Mode	C-Max	C-Max
Walk Time (s)	7.0	7.0
Flash Dont Walk (s)	19.0	19.0
Pedestrian Calls (#/hr)	10	10
Act Effct Green (s)	52.8	52.8
Actuated g/C Ratio	0.41	0.41
v/c Ratio	0.50	0.28
Control Delay	23.0	1.8
Queue Delay	0.0	0.0
Total Delay	23.0	1.8
LOS	C	A
Approach Delay	27.3	
Approach LOS	C	
Queue Length 50th (m)	33.6	0.0
Queue Length 95th (m)	39.7	4.2
Internal Link Dist (m)	294.9	
Turn Bay Length (m)		100.0
Base Capacity (vph)	1917	707
Starvation Cap Reductn	0	0
Spillback Cap Reductn	0	0
Storage Cap Reductn	0	0
Reduced v/c Ratio	0.50	0.28
<b>Intersection Summary</b>		

3: March & Solandt  
PM Peak Hour

555-603 March Road  
2037 Total Traffic



Lane Group	EBL	EBT	EBR	WBL	WBT	WBR	NBU	NBL	NBT	NBR	SBU	SBL
Lane Configurations												
Traffic Volume (vph)	24	25	197	389	24	47	16	78	1922	28	12	17
Future Volume (vph)	24	25	197	389	24	47	16	78	1922	28	12	17
Ideal Flow (vphpl)	1800	1800	1800	1800	1800	1800	1800	1800	1800	1800	1800	1800
Storage Length (m)	35.0		60.0	135.0		55.0		165.0		0.0		155.0
Storage Lanes	1		1	1		1		1		0		1
Taper Length (m)	50.0			50.0				40.0				25.0
Lane Util. Factor	1.00	1.00	1.00	1.00	1.00	1.00	0.95	1.00	0.95	0.95	0.95	1.00
Ped Bike Factor	0.99		0.98	0.99		0.98		1.00	1.00			1.00
Frt			0.850			0.850			0.998			
Flt Protected	0.950			0.950				0.950				0.950
Satd. Flow (prot)	1674	1695	1483	1674	1679	1388	0	1644	3306	0	0	1648
Flt Permitted	0.742			0.520				0.950				0.950
Satd. Flow (perm)	1299	1695	1449	911	1679	1358	0	1641	3306	0	0	1647
Right Turn on Red			Yes			Yes				Yes		
Satd. Flow (RTOR)			137			82			1			
Link Speed (k/h)		50			50				60			
Link Distance (m)		212.6			241.6				610.9			
Travel Time (s)		15.3			17.4				36.7			
Confl. Peds. (#/hr)	5		5	5		5		5		5		5
Confl. Bikes (#/hr)			5			5				5		
Peak Hour Factor	1.00	1.00	1.00	1.00	1.00	1.00	1.00	1.00	1.00	1.00	1.00	1.00
Heavy Vehicles (%)	1%	5%	2%	1%	6%	9%	2%	3%	2%	6%	2%	3%
Adj. Flow (vph)	24	25	197	389	24	47	16	78	1922	28	12	17
Shared Lane Traffic (%)												
Lane Group Flow (vph)	24	25	197	389	24	47	0	94	1950	0	0	29
Enter Blocked Intersection	No	No	No	No	No	No	No	No	No	No	No	No
Lane Alignment	L NA	Left	R NA	L NA	Left	R NA	R NA	L NA	Left	R NA	R NA	L NA
Median Width(m)		3.5			10.5				17.5			
Link Offset(m)		0.0			0.0				0.0			
Crosswalk Width(m)		5.0			5.0				5.0			
Two way Left Turn Lane												
Headway Factor	1.09	1.09	1.09	1.09	1.09	1.09	1.09	1.09	1.09	1.09	1.09	1.09
Turning Speed (k/h)	24		14	24		14	14	24		14	14	24
Number of Detectors	1	2	1	1	2	1	1	1	2		1	1
Detector Template	Left	Thru	Right	Left	Thru	Right	Left	Left	Thru		Left	Left
Leading Detector (m)	2.0	10.0	2.0	2.0	10.0	2.0	2.0	2.0	10.0		2.0	2.0
Trailing Detector (m)	0.0	0.0	0.0	0.0	0.0	0.0	0.0	0.0	0.0		0.0	0.0
Detector 1 Position(m)	0.0	0.0	0.0	0.0	0.0	0.0	0.0	0.0	0.0		0.0	0.0
Detector 1 Size(m)	2.0	0.6	2.0	2.0	0.6	2.0	2.0	2.0	0.6		2.0	2.0
Detector 1 Type	Cl+Ex	Cl+Ex	Cl+Ex	Cl+Ex	Cl+Ex	Cl+Ex	Cl+Ex	Cl+Ex	Cl+Ex		Cl+Ex	Cl+Ex
Detector 1 Channel												
Detector 1 Extend (s)	0.0	0.0	0.0	0.0	0.0	0.0	0.0	0.0	0.0		0.0	0.0
Detector 1 Queue (s)	0.0	0.0	0.0	0.0	0.0	0.0	0.0	0.0	0.0		0.0	0.0
Detector 1 Delay (s)	0.0	0.0	0.0	0.0	0.0	0.0	0.0	0.0	0.0		0.0	0.0
Detector 2 Position(m)		9.4			9.4				9.4			
Detector 2 Size(m)		0.6			0.6				0.6			
Detector 2 Type		Cl+Ex			Cl+Ex				Cl+Ex			
Detector 2 Channel												
Detector 2 Extend (s)		0.0			0.0				0.0			
Turn Type	Perm	NA	Perm	pm+pt	NA	Perm	Prot	Prot	NA		Prot	Prot
Protected Phases		4		3	8		5	5	2		1	1
Permitted Phases	4		4	8		8						
Detector Phase	4	4	4	3	8	8	5	5	2		1	1

3: March & Solandt  
PM Peak Hour

555-603 March Road  
2037 Total Traffic



Lane Group	SBT	SBR
Lane Configurations	↑↑	
Traffic Volume (vph)	1404	16
Future Volume (vph)	1404	16
Ideal Flow (vphpl)	1800	1800
Storage Length (m)		0.0
Storage Lanes		0
Taper Length (m)		
Lane Util. Factor	0.95	0.95
Ped Bike Factor	1.00	
Frt	0.998	
Flt Protected		
Satd. Flow (prot)	3307	0
Flt Permitted		
Satd. Flow (perm)	3307	0
Right Turn on Red		Yes
Satd. Flow (RTOR)	1	
Link Speed (k/h)	60	
Link Distance (m)	382.6	
Travel Time (s)	23.0	
Confl. Peds. (#/hr)		5
Confl. Bikes (#/hr)		5
Peak Hour Factor	1.00	1.00
Heavy Vehicles (%)	2%	3%
Adj. Flow (vph)	1404	16
Shared Lane Traffic (%)		
Lane Group Flow (vph)	1420	0
Enter Blocked Intersection	No	No
Lane Alignment	Left	R NA
Median Width(m)	17.5	
Link Offset(m)	0.0	
Crosswalk Width(m)	5.0	
Two way Left Turn Lane		
Headway Factor	1.09	1.09
Turning Speed (k/h)		14
Number of Detectors	2	
Detector Template	Thru	
Leading Detector (m)	10.0	
Trailing Detector (m)	0.0	
Detector 1 Position(m)	0.0	
Detector 1 Size(m)	0.6	
Detector 1 Type	CI+Ex	
Detector 1 Channel		
Detector 1 Extend (s)	0.0	
Detector 1 Queue (s)	0.0	
Detector 1 Delay (s)	0.0	
Detector 2 Position(m)	9.4	
Detector 2 Size(m)	0.6	
Detector 2 Type	CI+Ex	
Detector 2 Channel		
Detector 2 Extend (s)	0.0	
Turn Type	NA	
Protected Phases	6	
Permitted Phases		
Detector Phase	6	



3: March & Solandt  
PM Peak Hour

555-603 March Road  
2037 Total Traffic



Lane Group	EBL	EBT	EBR	WBL	WBT	WBR	NBU	NBL	NBT	NBR	SBU	SBL
Switch Phase												
Minimum Initial (s)	10.0	10.0	10.0	5.0	10.0	10.0	5.0	5.0	10.0		5.0	5.0
Minimum Split (s)	36.5	36.5	36.5	11.5	36.5	36.5	12.0	12.0	26.8		12.0	12.0
Total Split (s)	36.5	36.5	36.5	14.0	50.5	50.5	15.0	15.0	67.5		12.0	12.0
Total Split (%)	28.1%	28.1%	28.1%	10.8%	38.8%	38.8%	11.5%	11.5%	51.9%		9.2%	9.2%
Maximum Green (s)	30.0	30.0	30.0	7.5	44.0	44.0	8.0	8.0	61.7		5.0	5.0
Yellow Time (s)	3.3	3.3	3.3	3.3	3.3	3.3	3.7	3.7	3.7		3.7	3.7
All-Red Time (s)	3.2	3.2	3.2	3.2	3.2	3.2	3.3	3.3	2.1		3.3	3.3
Lost Time Adjust (s)	0.0	0.0	0.0	0.0	0.0	0.0			0.0	0.0		0.0
Total Lost Time (s)	6.5	6.5	6.5	6.5	6.5	6.5			7.0	5.8		7.0
Lead/Lag	Lag	Lag	Lag	Lead			Lead	Lead	Lag		Lead	Lead
Lead-Lag Optimize?												
Vehicle Extension (s)	3.0	3.0	3.0	3.0	3.0	3.0	3.0	3.0	3.0		3.0	3.0
Recall Mode	None	None	None	None	None	None	None	None	C-Max		None	None
Walk Time (s)	7.0	7.0	7.0		7.0	7.0			7.0			
Flash Dont Walk (s)	23.0	23.0	23.0		23.0	23.0			14.0			
Pedestrian Calls (#/hr)	5	5	5		5	5			5			
Act Effct Green (s)	15.3	15.3	15.3	29.3	29.3	29.3		12.5	79.9			6.7
Actuated g/C Ratio	0.12	0.12	0.12	0.23	0.23	0.23		0.10	0.61			0.05
v/c Ratio	0.16	0.13	0.68	1.56	0.06	0.13		0.59	0.96			0.34
Control Delay	50.0	48.8	29.1	305.6	36.5	2.0		71.9	37.9			70.1
Queue Delay	0.0	0.0	0.0	0.0	0.0	0.0		0.0	0.0			0.0
Total Delay	50.0	48.8	29.1	305.6	36.5	2.0		71.9	37.9			70.1
LOS	D	D	C	F	D	A		E	D			E
Approach Delay		33.1			260.5				39.5			
Approach LOS		C			F				D			
Queue Length 50th (m)	5.4	5.6	13.7	~136.5	4.7	0.0		21.2	225.3			7.1
Queue Length 95th (m)	11.3	11.6	32.2	#160.7	9.5	2.0		#53.6	#341.1			m15.0
Internal Link Dist (m)		188.6			217.6				586.9			
Turn Bay Length (m)	35.0		60.0	135.0		55.0		165.0				155.0
Base Capacity (vph)	299	391	439	249	568	513		158	2032			85
Starvation Cap Reductn	0	0	0	0	0	0		0	0			0
Spillback Cap Reductn	0	0	0	0	0	0		0	0			0
Storage Cap Reductn	0	0	0	0	0	0		0	0			0
Reduced v/c Ratio	0.08	0.06	0.45	1.56	0.04	0.09		0.59	0.96			0.34

Intersection Summary

Area Type: Other  
 Cycle Length: 130  
 Actuated Cycle Length: 130  
 Offset: 60 (46%), Referenced to phase 2:NBT and 6:SBT, Start of Green  
 Natural Cycle: 150  
 Control Type: Actuated-Coordinated  
 Maximum v/c Ratio: 1.56  
 Intersection Signal Delay: 62.0 Intersection LOS: E  
 Intersection Capacity Utilization 106.7% ICU Level of Service G  
 Analysis Period (min) 15  
 ~ Volume exceeds capacity, queue is theoretically infinite.  
 Queue shown is maximum after two cycles.  
 # 95th percentile volume exceeds capacity, queue may be longer.  
 Queue shown is maximum after two cycles.  
 m Volume for 95th percentile queue is metered by upstream signal.

Splits and Phases: 3: March & Solandt

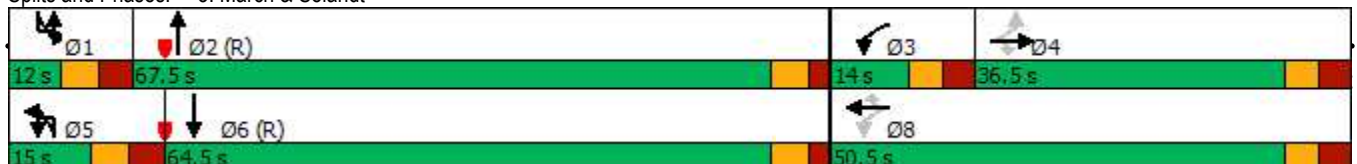



Lane Group	SBT	SBR
Switch Phase		
Minimum Initial (s)	10.0	
Minimum Split (s)	26.8	
Total Split (s)	64.5	
Total Split (%)	49.6%	
Maximum Green (s)	58.7	
Yellow Time (s)	3.7	
All-Red Time (s)	2.1	
Lost Time Adjust (s)	0.0	
Total Lost Time (s)	5.8	
Lead/Lag	Lag	
Lead-Lag Optimize?		
Vehicle Extension (s)	3.0	
Recall Mode	C-Max	
Walk Time (s)	7.0	
Flash Dont Walk (s)	14.0	
Pedestrian Calls (#/hr)	5	
Act Effct Green (s)	68.9	
Actuated g/C Ratio	0.53	
v/c Ratio	0.81	
Control Delay	34.9	
Queue Delay	0.0	
Total Delay	34.9	
LOS	C	
Approach Delay	35.6	
Approach LOS	D	
Queue Length 50th (m)	168.7	
Queue Length 95th (m)	#216.3	
Internal Link Dist (m)	358.6	
Turn Bay Length (m)		
Base Capacity (vph)	1753	
Starvation Cap Reductn	0	
Spillback Cap Reductn	0	
Storage Cap Reductn	0	
Reduced v/c Ratio	0.81	
<b>Intersection Summary</b>		

4: Innovation/Flamborough & Terry Fox  
PM Peak Hour

555-603 March Road  
2037 Total Traffic

Lane Group	EBL	EBT	EBR	WBL	WBT	WBR	NBL	NBT	NBR	SBL	SBT	SBR
Lane Configurations												
Traffic Volume (vph)	71	398	37	101	534	126	110	64	75	50	50	62
Future Volume (vph)	71	398	37	101	534	126	110	64	75	50	50	62
Ideal Flow (vphpl)	1800	1800	1800	1800	1800	1800	1800	1800	1800	1800	1800	1800
Storage Length (m)	75.0		120.0	110.0		130.0	220.0		0.0	30.0		0.0
Storage Lanes	1		1	1		1	1		0	1		0
Taper Length (m)	50.0			80.0			50.0			15.0		
Lane Util. Factor	1.00	1.00	1.00	1.00	1.00	1.00	1.00	1.00	1.00	1.00	1.00	1.00
Ped Bike Factor			0.96	0.99		0.95	0.95	0.98		0.99	0.95	
Fr <sub>t</sub>			0.850			0.850		0.919			0.917	
Flt Protected	0.950			0.950			0.950			0.950		
Satd. Flow (prot)	1566	1745	1498	1642	1762	1498	1674	1544	0	1674	1485	0
Flt Permitted	0.408			0.476			0.646			0.561		
Satd. Flow (perm)	672	1745	1440	818	1762	1429	1086	1544	0	980	1485	0
Right Turn on Red			Yes			Yes			Yes			Yes
Satd. Flow (RTOR)			78			126		50			53	
Link Speed (k/h)		60			60			50			50	
Link Distance (m)		508.2			294.0			547.1			313.7	
Travel Time (s)		30.5			17.6			39.4			22.6	
Confl. Peds. (#/hr)	5		5	5		5	25		5	5		25
Confl. Bikes (#/hr)			5			15			10			10
Peak Hour Factor	1.00	1.00	1.00	1.00	1.00	1.00	1.00	1.00	1.00	1.00	1.00	1.00
Heavy Vehicles (%)	8%	2%	1%	3%	1%	1%	1%	2%	5%	1%	1%	8%
Adj. Flow (vph)	71	398	37	101	534	126	110	64	75	50	50	62
Shared Lane Traffic (%)												
Lane Group Flow (vph)	71	398	37	101	534	126	110	139	0	50	112	0
Enter Blocked Intersection	No	No	No	No	No	No	No	No	No	No	No	No
Lane Alignment	L NA	Left	R NA	L NA	Left	R NA	L NA	Left	R NA	L NA	Left	R NA
Median Width(m)		3.5			3.5			3.5			3.5	
Link Offset(m)		0.0			0.0			0.0			0.0	
Crosswalk Width(m)		5.0			5.0			5.0			5.0	
Two way Left Turn Lane												
Headway Factor	1.09	1.09	1.09	1.09	1.09	1.09	1.09	1.09	1.09	1.09	1.09	1.09
Turning Speed (k/h)	24		14	24		14	24		14	24		14
Number of Detectors	1	2	1	1	2	1	1	2		1	2	
Detector Template	Left	Thru	Right	Left	Thru	Right	Left	Thru		Left	Thru	
Leading Detector (m)	2.0	10.0	2.0	2.0	10.0	2.0	2.0	10.0		2.0	10.0	
Trailing Detector (m)	0.0	0.0	0.0	0.0	0.0	0.0	0.0	0.0		0.0	0.0	
Detector 1 Position(m)	0.0	0.0	0.0	0.0	0.0	0.0	0.0	0.0		0.0	0.0	
Detector 1 Size(m)	2.0	0.6	2.0	2.0	0.6	2.0	2.0	0.6		2.0	0.6	
Detector 1 Type	Cl+Ex	Cl+Ex	Cl+Ex	Cl+Ex	Cl+Ex	Cl+Ex	Cl+Ex	Cl+Ex		Cl+Ex	Cl+Ex	
Detector 1 Channel												
Detector 1 Extend (s)	0.0	0.0	0.0	0.0	0.0	0.0	0.0	0.0		0.0	0.0	
Detector 1 Queue (s)	0.0	0.0	0.0	0.0	0.0	0.0	0.0	0.0		0.0	0.0	
Detector 1 Delay (s)	0.0	0.0	0.0	0.0	0.0	0.0	0.0	0.0		0.0	0.0	
Detector 2 Position(m)		9.4			9.4			9.4			9.4	
Detector 2 Size(m)		0.6			0.6			0.6			0.6	
Detector 2 Type		Cl+Ex			Cl+Ex			Cl+Ex			Cl+Ex	
Detector 2 Channel												
Detector 2 Extend (s)		0.0			0.0			0.0			0.0	
Turn Type	pm+pt	NA	Perm	pm+pt	NA	Perm	Perm	NA		Perm	NA	
Protected Phases	5	2		1	6			8			4	
Permitted Phases	2		2	6		6	8			4		
Detector Phase	5	2	2	1	6	6	8	8		4	4	



Lane Group	EBL	EBT	EBR	WBL	WBT	WBR	NBL	NBT	NBR	SBL	SBT	SBR
Switch Phase												
Minimum Initial (s)	5.0	10.0	10.0	5.0	10.0	10.0	10.0	10.0		10.0	10.0	
Minimum Split (s)	11.0	27.9	27.9	11.0	27.9	27.9	36.3	36.3		36.3	36.3	
Total Split (s)	12.0	66.0	66.0	12.0	66.0	66.0	52.0	52.0		52.0	52.0	
Total Split (%)	9.2%	50.8%	50.8%	9.2%	50.8%	50.8%	40.0%	40.0%		40.0%	40.0%	
Maximum Green (s)	6.0	60.1	60.1	6.0	60.1	60.1	45.7	45.7		45.7	45.7	
Yellow Time (s)	3.7	3.7	3.7	3.7	3.7	3.7	3.3	3.3		3.3	3.3	
All-Red Time (s)	2.3	2.2	2.2	2.3	2.2	2.2	3.0	3.0		3.0	3.0	
Lost Time Adjust (s)	0.0	0.0	0.0	0.0	0.0	0.0	0.0	0.0		0.0	0.0	
Total Lost Time (s)	6.0	5.9	5.9	6.0	5.9	5.9	6.3	6.3		6.3	6.3	
Lead/Lag	Lead	Lag	Lag	Lead	Lag	Lag						
Lead-Lag Optimize?												
Vehicle Extension (s)	3.0	3.0	3.0	3.0	3.0	3.0	3.0	3.0		3.0	3.0	
Recall Mode	None	C-Max	C-Max	None	C-Max	C-Max	None	None		None	None	
Walk Time (s)		7.0	7.0		7.0	7.0	7.0	7.0		7.0	7.0	
Flash Dont Walk (s)		15.0	15.0		15.0	15.0	23.0	23.0		23.0	23.0	
Pedestrian Calls (#/hr)		3	3		3	3	3	3		3	3	
Act Effct Green (s)	92.4	85.3	85.3	94.7	88.2	88.2	18.8	18.8		18.8	18.8	
Actuated g/C Ratio	0.71	0.66	0.66	0.73	0.68	0.68	0.14	0.14		0.14	0.14	
v/c Ratio	0.13	0.35	0.04	0.16	0.45	0.12	0.71	0.52		0.35	0.43	
Control Delay	5.8	12.5	0.1	8.0	18.6	6.3	74.8	38.1		54.3	30.7	
Queue Delay	0.0	0.0	0.0	0.0	0.0	0.0	0.0	0.0		0.0	0.0	
Total Delay	5.8	12.5	0.1	8.0	18.6	6.3	74.8	38.1		54.3	30.7	
LOS	A	B	A	A	B	A	E	D		D	C	
Approach Delay		10.6			15.1			54.3			38.0	
Approach LOS		B			B			D			D	
Queue Length 50th (m)	3.5	37.7	0.0	8.0	62.9	3.3	25.3	19.6		10.9	12.7	
Queue Length 95th (m)	10.0	74.4	0.3	m20.1	115.3	m15.7	39.7	34.8		20.4	26.6	
Internal Link Dist (m)		484.2			270.0			523.1			289.7	
Turn Bay Length (m)	75.0		120.0	110.0		130.0	220.0			30.0		
Base Capacity (vph)	527	1145	972	644	1196	1010	381	575		344	556	
Starvation Cap Reductn	0	0	0	0	0	0	0	0		0	0	
Spillback Cap Reductn	0	0	0	0	0	0	0	0		0	0	
Storage Cap Reductn	0	0	0	0	0	0	0	0		0	0	
Reduced v/c Ratio	0.13	0.35	0.04	0.16	0.45	0.12	0.29	0.24		0.15	0.20	

Intersection Summary





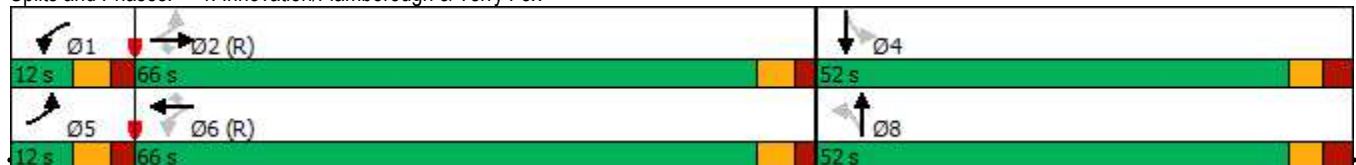











Area Type: Other  
 Cycle Length: 130  
 Actuated Cycle Length: 130  
 Offset: 66 (51%), Referenced to phase 2:EBTL and 6:WBTL, Start of Green  
 Natural Cycle: 80  
 Control Type: Actuated-Coordinated  
 Maximum v/c Ratio: 0.71  
 Intersection Signal Delay: 21.8 Intersection LOS: C  
 Intersection Capacity Utilization 80.3% ICU Level of Service D  
 Analysis Period (min) 15  
 m Volume for 95th percentile queue is metered by upstream signal.

Splits and Phases: 4: Innovation/Flamborough & Terry Fox



























5: Hines & Innovation  
PM Peak Hour

555-603 March Road  
2037 Total Traffic

													
Lane Group	EBL	EBT	EBR	WBL	WBT	WBR	NBL	NBT	NBR	SBL	SBT	SBR	
Lane Configurations													
Traffic Volume (vph)	16	0	90	0	0	0	109	12	0	0	44	18	
Future Volume (vph)	16	0	90	0	0	0	109	12	0	0	44	18	
Ideal Flow (vphpl)	1800	1800	1800	1800	1800	1800	1800	1800	1800	1800	1800	1800	
Lane Util. Factor	1.00	1.00	1.00	1.00	1.00	1.00	1.00	1.00	1.00	1.00	1.00	1.00	
Ped Bike Factor													
Frt	0.885										0.961		
Flt Protected	0.993								0.957				
Satd. Flow (prot)	0	1536	0	0	1762	0	0	1649	0	0	1659	0	
Flt Permitted	0.993								0.957				
Satd. Flow (perm)	0	1536	0	0	1762	0	0	1649	0	0	1659	0	
Link Speed (k/h)	50				50				50				
Link Distance (m)	438.6				104.0				421.8				
Travel Time (s)	31.6				7.5				30.4				
Confl. Peds. (#/hr)							10						
Confl. Bikes (#/hr)	5			5			5		5			5	
Peak Hour Factor	1.00	1.00	1.00	1.00	1.00	1.00	1.00	1.00	1.00	1.00	1.00	1.00	
Heavy Vehicles (%)	1%	1%	2%	1%	1%	1%	3%	6%	1%	1%	4%	1%	
Adj. Flow (vph)	16	0	90	0	0	0	109	12	0	0	44	18	
Shared Lane Traffic (%)													
Lane Group Flow (vph)	0	106	0	0	0	0	0	121	0	0	62	0	
Enter Blocked Intersection	No	No	No	No	No	No	No	No	No	No	No	No	
Lane Alignment	Left	Left	Right	Left	Left	Right	Left	Left	Right	Left	Left	Right	
Median Width(m)	0.0				0.0				0.0				
Link Offset(m)	0.0				0.0				0.0				
Crosswalk Width(m)	5.0				5.0				5.0				
Two way Left Turn Lane													
Headway Factor	1.09	1.09	1.09	1.09	1.09	1.09	1.09	1.09	1.09	1.09	1.09	1.09	
Turning Speed (k/h)	24		14	24		14	24		14	24		14	
Sign Control	Stop			Stop			Free			Free			
<b>Intersection Summary</b>													
Area Type:	Other												
Control Type:	Unsignalized												
Intersection Capacity Utilization 27.2%	ICU Level of Service A												
Analysis Period (min) 15													

6: March & Site Access/Nokia Access  
PM Peak Hour

555-603 March Road  
2037 Total Traffic

													
Lane Group	EBL	EBT	EBR	WBL	WBT	WBR	NBL	NBT	NBR	SBL	SBT	SBR	
Lane Configurations													
Traffic Volume (vph)	68	0	164	197	0	400	148	1576	199	93	1046	43	
Future Volume (vph)	68	0	164	197	0	400	148	1576	199	93	1046	43	
Ideal Flow (vphpl)	1800	1800	1800	1800	1800	1800	1800	1800	1800	1800	1800	1800	
Storage Length (m)	65.0		0.0	65.0		0.0	75.0		100.0	75.0		0.0	
Storage Lanes	1		0	1		0	1		1	1		0	
Taper Length (m)	20.0			25.0			50.0			50.0			
Lane Util. Factor	1.00	1.00	1.00	1.00	1.00	1.00	1.00	0.95	1.00	1.00	0.91	0.91	
Ped Bike Factor				0.99	0.97				0.94				
Frt		0.850			0.850				0.850		0.994		
Flt Protected	0.950			0.950			0.950			0.950			
Satd. Flow (prot)	1658	1483	0	1674	1456	0	1658	3283	1498	1674	4691	0	
Flt Permitted	0.153			0.535			0.187			0.063			
Satd. Flow (perm)	267	1483	0	934	1456	0	326	3283	1410	111	4691	0	
Right Turn on Red			Yes			Yes			Yes			Yes	
Satd. Flow (RTOR)		185			185				197			6	
Link Speed (k/h)		50			50			60				60	
Link Distance (m)		126.2			167.8			227.7				308.9	
Travel Time (s)		9.1			12.1			13.7				18.5	
Confl. Peds. (#/hr)				10		10			10	10			
Confl. Bikes (#/hr)						5			5				
Peak Hour Factor	1.00	1.00	1.00	1.00	1.00	1.00	1.00	1.00	1.00	1.00	1.00	1.00	
Heavy Vehicles (%)	2%	2%	2%	1%	2%	1%	2%	3%	1%	1%	3%	2%	
Adj. Flow (vph)	68	0	164	197	0	400	148	1576	199	93	1046	43	
Shared Lane Traffic (%)													
Lane Group Flow (vph)	68	164	0	197	400	0	148	1576	199	93	1089	0	
Enter Blocked Intersection	No	No	No	No	No	No	No	No	No	No	No	No	
Lane Alignment	L NA	Left	R NA	L NA	Left	R NA	Left	Left	Right	Left	Left	Right	
Median Width(m)		3.5			3.5			7.0				7.0	
Link Offset(m)		0.0			0.0			0.0				0.0	
Crosswalk Width(m)		5.0			5.0			5.0				5.0	
Two way Left Turn Lane													
Headway Factor	1.09	1.09	1.09	1.09	1.09	1.09	1.09	1.09	1.09	1.09	1.09	1.09	
Turning Speed (k/h)	97		97	97		97	97		97	97		97	
Number of Detectors	1	2		1	2		1	2	1	1		2	
Detector Template	Left	Thru		Left	Thru		Left	Thru	Right	Left		Thru	
Leading Detector (m)	2.0	10.0		2.0	10.0		2.0	10.0	2.0	2.0		10.0	
Trailing Detector (m)	0.0	0.0		0.0	0.0		0.0	0.0	0.0	0.0		0.0	
Detector 1 Position(m)	0.0	0.0		0.0	0.0		0.0	0.0	0.0	0.0		0.0	
Detector 1 Size(m)	2.0	0.6		2.0	0.6		2.0	0.6	2.0	2.0		0.6	
Detector 1 Type	Cl+Ex	Cl+Ex		Cl+Ex	Cl+Ex		Cl+Ex	Cl+Ex	Cl+Ex	Cl+Ex		Cl+Ex	
Detector 1 Channel													
Detector 1 Extend (s)	0.0	0.0		0.0	0.0		0.0	0.0	0.0	0.0		0.0	
Detector 1 Queue (s)	0.0	0.0		0.0	0.0		0.0	0.0	0.0	0.0		0.0	
Detector 1 Delay (s)	0.0	0.0		0.0	0.0		0.0	0.0	0.0	0.0		0.0	
Detector 2 Position(m)		9.4			9.4			9.4				9.4	
Detector 2 Size(m)		0.6			0.6			0.6				0.6	
Detector 2 Type		Cl+Ex			Cl+Ex			Cl+Ex				Cl+Ex	
Detector 2 Channel													
Detector 2 Extend (s)		0.0			0.0			0.0				0.0	
Turn Type	pm+pt	NA		pm+pt	NA		pm+pt	NA	Perm	pm+pt		NA	
Protected Phases	7	4		3	8		5	2		1		6	
Permitted Phases	4			8			2		2	6			
Detector Phase	7	4		3	8		5	2	2	1		6	





Lane Group	EBT	EBR	WBL	WBT	NBL	NBR
Lane Configurations						
Traffic Volume (vph)	579	29	59	652	43	84
Future Volume (vph)	579	29	59	652	43	84
Ideal Flow (vphpl)	1800	1800	1800	1800	1800	1800
Storage Length (m)		0.0	30.0		0.0	0.0
Storage Lanes		0	1		1	0
Taper Length (m)			40.0		10.0	
Lane Util. Factor	1.00	1.00	1.00	0.95	1.00	1.00
Ped Bike Factor						
Frt	0.994				0.911	
Flt Protected			0.950		0.983	
Satd. Flow (prot)	1735	0	1674	3316	1578	0
Flt Permitted			0.950		0.983	
Satd. Flow (perm)	1735	0	1674	3316	1578	0
Link Speed (k/h)	60			60	50	
Link Distance (m)	191.8			165.4	126.2	
Travel Time (s)	11.5			9.9	9.1	
Confl. Peds. (#/hr)		10	10			
Confl. Bikes (#/hr)		5				5
Peak Hour Factor	1.00	1.00	1.00	1.00	1.00	1.00
Heavy Vehicles (%)	2%	1%	1%	2%	1%	1%
Adj. Flow (vph)	579	29	59	652	43	84
Shared Lane Traffic (%)						
Lane Group Flow (vph)	608	0	59	652	127	0
Enter Blocked Intersection	No	No	No	No	No	No
Lane Alignment	Left	Right	Left	Left	L NA	R NA
Median Width(m)	7.0			9.0	3.5	
Link Offset(m)	0.0			0.0	0.0	
Crosswalk Width(m)	5.0			5.0	5.0	
Two way Left Turn Lane						
Headway Factor	1.09	1.09	1.09	1.09	1.09	1.09
Turning Speed (k/h)		97	97		97	97
Sign Control	Free			Free	Stop	

**Intersection Summary**

Area Type:	Other
Control Type:	Unsignalized
Intersection Capacity Utilization	55.5%
ICU Level of Service	B
Analysis Period (min)	15





Lane Group	WBL	WBR	NBT	NBR	SBL	SBT
Lane Configurations						
Traffic Volume (vph)	11	0	14	14	0	52
Future Volume (vph)	11	0	14	14	0	52
Ideal Flow (vphpl)	1800	1800	1800	1800	1800	1800
Lane Util. Factor	1.00	1.00	1.00	1.00	1.00	1.00
Ped Bike Factor						
Frt	0.932					
Flt Protected	0.950					
Satd. Flow (prot)	1674	0	1634	0	0	1745
Flt Permitted	0.950					
Satd. Flow (perm)	1674	0	1634	0	0	1745
Link Speed (k/h)	50	50		50		
Link Distance (m)	75.1	190.7		128.3		
Travel Time (s)	5.4	13.7		9.2		
Confl. Peds. (#/hr)				10	10	
Confl. Bikes (#/hr)	5		5			
Peak Hour Factor	1.00	1.00	1.00	1.00	1.00	1.00
Heavy Vehicles (%)	1%	1%	2%	1%	1%	2%
Adj. Flow (vph)	11	0	14	14	0	52
Shared Lane Traffic (%)						
Lane Group Flow (vph)	11	0	28	0	0	52
Enter Blocked Intersection	No	No	No	No	No	No
Lane Alignment	Left	Right	Left	Right	Left	Left
Median Width(m)	3.5	0.0		0.0		
Link Offset(m)	0.0	0.0		0.0		
Crosswalk Width(m)	5.0	5.0		5.0		
Two way Left Turn Lane						
Headway Factor	1.09	1.09	1.09	1.09	1.09	1.09
Turning Speed (k/h)	97	97	97		97	
Sign Control	Stop	Free		Free		

**Intersection Summary**

Area Type: Other

Control Type: Unsignalized























Intersection Capacity Utilization 16.2%

ICU Level of Service A

Analysis Period (min) 15

3: March & Solandt  
AM Peak Hour

555-603 March Road  
2037 Total Traffic (mitigated)

												
Lane Group	EBL	EBT	EBR	WBL	WBT	WBR	NBU	NBL	NBT	NBR	SBU	SBL
Lane Configurations												
Traffic Volume (vph)	12	33	85	82	16	16	2	221	1574	192	2	61
Future Volume (vph)	12	33	85	82	16	16	2	221	1574	192	2	61
Ideal Flow (vphpl)	1800	1800	1800	1800	1800	1800	1800	1800	1800	1800	1800	1800
Storage Length (m)	35.0		60.0	135.0		55.0		165.0		0.0		155.0
Storage Lanes	1		1	1		1		1		0		1
Taper Length (m)	50.0			50.0				40.0				25.0
Lane Util. Factor	1.00	1.00	1.00	1.00	1.00	1.00	0.95	1.00	0.95	0.95	0.95	1.00
Ped Bike Factor	0.99		0.98	0.99		0.98		1.00	1.00			1.00
Frt			0.850			0.850			0.984			
Flt Protected	0.950			0.950				0.950				0.950
Satd. Flow (prot)	1537	1728	1414	1610	1369	1498	0	1658	3230	0	0	1674
Flt Permitted	0.747			0.736				0.950				0.950
Satd. Flow (perm)	1201	1728	1381	1240	1369	1463	0	1656	3230	0	0	1672
Right Turn on Red			Yes			Yes				Yes		
Satd. Flow (RTOR)			82			82			17			
Link Speed (k/h)		50			50				60			
Link Distance (m)		212.6			241.6				610.9			
Travel Time (s)		15.3			17.4				36.7			
Confl. Peds. (#/hr)	5		5	5		5		5		5		5
Confl. Bikes (#/hr)			5			5				5		
Peak Hour Factor	1.00	1.00	1.00	1.00	1.00	1.00	1.00	1.00	1.00	1.00	1.00	1.00
Heavy Vehicles (%)	10%	3%	7%	5%	30%	1%	2%	2%	3%	1%	2%	1%
Adj. Flow (vph)	12	33	85	82	16	16	2	221	1574	192	2	61
Shared Lane Traffic (%)												
Lane Group Flow (vph)	12	33	85	82	16	16	0	223	1766	0	0	63
Enter Blocked Intersection	No	No	No	No	No	No	No	No	No	No	No	No
Lane Alignment	L NA	Left	R NA	L NA	Left	R NA	R NA	L NA	Left	R NA	R NA	L NA
Median Width(m)		3.5			10.5				17.5			
Link Offset(m)		0.0			0.0				0.0			
Crosswalk Width(m)		5.0			5.0				5.0			
Two way Left Turn Lane												
Headway Factor	1.09	1.09	1.09	1.09	1.09	1.09	1.09	1.09	1.09	1.09	1.09	1.09
Turning Speed (k/h)	24		14	24		14	14	24		14	14	24
Number of Detectors	1	2	1	1	2	1	1	1	2		1	1
Detector Template	Left	Thru	Right	Left	Thru	Right	Left	Left	Thru		Left	Left
Leading Detector (m)	2.0	10.0	2.0	2.0	10.0	2.0	2.0	2.0	10.0		2.0	2.0
Trailing Detector (m)	0.0	0.0	0.0	0.0	0.0	0.0	0.0	0.0	0.0		0.0	0.0
Detector 1 Position(m)	0.0	0.0	0.0	0.0	0.0	0.0	0.0	0.0	0.0		0.0	0.0
Detector 1 Size(m)	2.0	0.6	2.0	2.0	0.6	2.0	2.0	2.0	0.6		2.0	2.0
Detector 1 Type	Cl+Ex	Cl+Ex	Cl+Ex	Cl+Ex	Cl+Ex	Cl+Ex	Cl+Ex	Cl+Ex	Cl+Ex		Cl+Ex	Cl+Ex
Detector 1 Channel												
Detector 1 Extend (s)	0.0	0.0	0.0	0.0	0.0	0.0	0.0	0.0	0.0		0.0	0.0
Detector 1 Queue (s)	0.0	0.0	0.0	0.0	0.0	0.0	0.0	0.0	0.0		0.0	0.0
Detector 1 Delay (s)	0.0	0.0	0.0	0.0	0.0	0.0	0.0	0.0	0.0		0.0	0.0
Detector 2 Position(m)		9.4			9.4				9.4			
Detector 2 Size(m)		0.6			0.6				0.6			
Detector 2 Type		Cl+Ex			Cl+Ex				Cl+Ex			
Detector 2 Channel												
Detector 2 Extend (s)		0.0			0.0				0.0			
Turn Type	Perm	NA	Perm	Perm	NA	Perm	Prot	Prot	NA		Prot	Prot
Protected Phases		4			8		5	5	2		1	1
Permitted Phases	4		4	8		8						
Detector Phase	4	4	4	8	8	8	5	5	2		1	1

3: March & Solandt  
AM Peak Hour

555-603 March Road  
2037 Total Traffic (mitigated)



Lane Group	SBT	SBR
Lane Configurations	↑↑	
Traffic Volume (vph)	1815	33
Future Volume (vph)	1815	33
Ideal Flow (vphpl)	1800	1800
Storage Length (m)		0.0
Storage Lanes		0
Taper Length (m)		
Lane Util. Factor	0.95	0.95
Ped Bike Factor	1.00	
Frt	0.997	
Flt Protected		
Satd. Flow (prot)	3273	0
Flt Permitted		
Satd. Flow (perm)	3273	0
Right Turn on Red		Yes
Satd. Flow (RTOR)	2	
Link Speed (k/h)	60	
Link Distance (m)	382.6	
Travel Time (s)	23.0	
Confl. Peds. (#/hr)		5
Confl. Bikes (#/hr)		5
Peak Hour Factor	1.00	1.00
Heavy Vehicles (%)	3%	1%
Adj. Flow (vph)	1815	33
Shared Lane Traffic (%)		
Lane Group Flow (vph)	1848	0
Enter Blocked Intersection	No	No
Lane Alignment	Left	R NA
Median Width(m)	17.5	
Link Offset(m)	0.0	
Crosswalk Width(m)	5.0	
Two way Left Turn Lane		
Headway Factor	1.09	1.09
Turning Speed (k/h)		14
Number of Detectors	2	
Detector Template	Thru	
Leading Detector (m)	10.0	
Trailing Detector (m)	0.0	
Detector 1 Position(m)	0.0	
Detector 1 Size(m)	0.6	
Detector 1 Type	CI+Ex	
Detector 1 Channel		
Detector 1 Extend (s)	0.0	
Detector 1 Queue (s)	0.0	
Detector 1 Delay (s)	0.0	
Detector 2 Position(m)	9.4	
Detector 2 Size(m)	0.6	
Detector 2 Type	CI+Ex	
Detector 2 Channel		
Detector 2 Extend (s)	0.0	
Turn Type	NA	
Protected Phases	6	
Permitted Phases		
Detector Phase	6	

3: March & Solandt  
AM Peak Hour

555-603 March Road  
2037 Total Traffic (mitigated)



Lane Group	EBL	EBT	EBR	WBL	WBT	WBR	NBU	NBL	NBT	NBR	SBU	SBL
Switch Phase												
Minimum Initial (s)	10.0	10.0	10.0	10.0	10.0	10.0	5.0	5.0	10.0		5.0	5.0
Minimum Split (s)	36.5	36.5	36.5	36.5	36.5	36.5	12.0	12.0	26.8		12.0	12.0
Total Split (s)	37.0	37.0	37.0	37.0	37.0	37.0	13.0	13.0	81.0		12.0	12.0
Total Split (%)	28.5%	28.5%	28.5%	28.5%	28.5%	28.5%	10.0%	10.0%	62.3%		9.2%	9.2%
Maximum Green (s)	30.5	30.5	30.5	30.5	30.5	30.5	6.0	6.0	75.2		5.0	5.0
Yellow Time (s)	3.3	3.3	3.3	3.3	3.3	3.3	3.7	3.7	3.7		3.7	3.7
All-Red Time (s)	3.2	3.2	3.2	3.2	3.2	3.2	3.3	3.3	2.1		3.3	3.3
Lost Time Adjust (s)	0.0	0.0	0.0	0.0	0.0	0.0		0.0	0.0			0.0
Total Lost Time (s)	6.5	6.5	6.5	6.5	6.5	6.5		7.0	5.8			7.0
Lead/Lag							Lead	Lead	Lag		Lead	Lead
Lead-Lag Optimize?												
Vehicle Extension (s)	3.0	3.0	3.0	3.0	3.0	3.0	3.0	3.0	3.0		3.0	3.0
Recall Mode	None	None	None	None	None	None	None	None	C-Max		None	None
Walk Time (s)	7.0	7.0	7.0	7.0	7.0	7.0			7.0			
Flash Dont Walk (s)	23.0	23.0	23.0	23.0	23.0	23.0			14.0			
Pedestrian Calls (#/hr)	5	5	5	5	5	5			5			
Act Effct Green (s)	16.3	16.3	16.3	16.3	16.3	16.3		20.2	84.0			10.4
Actuated g/C Ratio	0.13	0.13	0.13	0.13	0.13	0.13		0.16	0.65			0.08
v/c Ratio	0.08	0.15	0.35	0.53	0.09	0.06		0.87	0.84			0.47
Control Delay	46.6	48.6	13.8	63.4	47.1	0.5		84.1	23.7			72.3
Queue Delay	0.0	0.0	0.0	0.0	0.0	0.0		0.0	0.0			0.0
Total Delay	46.6	48.6	13.8	63.4	47.1	0.5		84.1	23.7			72.3
LOS	D	D	B	E	D	A		F	C			E
Approach Delay		25.6			52.3				30.5			
Approach LOS		C			D				C			
Queue Length 50th (m)	2.6	7.2	0.7	18.8	3.5	0.0		50.8	155.1			14.9
Queue Length 95th (m)	7.2	14.3	12.9	29.8	8.7	0.0		#135.1	#251.8			m#34.5
Internal Link Dist (m)		188.6			217.6				586.9			
Turn Bay Length (m)	35.0		60.0	135.0		55.0		165.0				155.0
Base Capacity (vph)	281	405	386	290	321	406		257	2092			133
Starvation Cap Reductn	0	0	0	0	0	0		0	0			0
Spillback Cap Reductn	0	0	0	0	0	0		0	0			0
Storage Cap Reductn	0	0	0	0	0	0		0	0			0
Reduced v/c Ratio	0.04	0.08	0.22	0.28	0.05	0.04		0.87	0.84			0.47

Intersection Summary

Area Type: Other  
 Cycle Length: 130  
 Actuated Cycle Length: 130  
 Offset: 2 (2%), Referenced to phase 2:NBT and 6:SBT, Start of Green  
 Natural Cycle: 150  
 Control Type: Actuated-Coordinated  
 Maximum v/c Ratio: 0.99  
 Intersection Signal Delay: 33.8 Intersection LOS: C  
 Intersection Capacity Utilization 107.8% ICU Level of Service G  
 Analysis Period (min) 15  
 # 95th percentile volume exceeds capacity, queue may be longer.  
 Queue shown is maximum after two cycles.  
 m Volume for 95th percentile queue is metered by upstream signal.

Splits and Phases: 3: March & Solandt

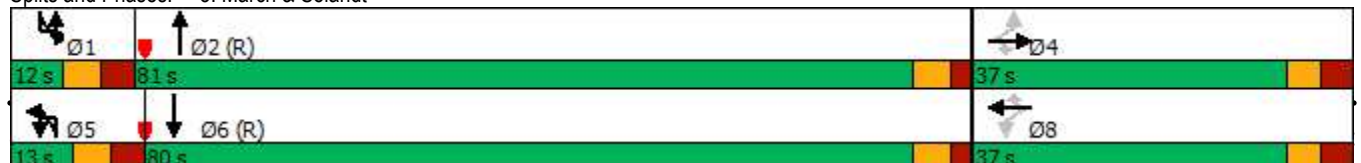



Lane Group	SBT	SBR
Switch Phase		
Minimum Initial (s)	10.0	
Minimum Split (s)	26.8	
Total Split (s)	80.0	
Total Split (%)	61.5%	
Maximum Green (s)	74.2	
Yellow Time (s)	3.7	
All-Red Time (s)	2.1	
Lost Time Adjust (s)	0.0	
Total Lost Time (s)	5.8	
Lead/Lag	Lag	
Lead-Lag Optimize?		
Vehicle Extension (s)	3.0	
Recall Mode	C-Max	
Walk Time (s)	7.0	
Flash Dont Walk (s)	14.0	
Pedestrian Calls (#/hr)	5	
Act Effct Green (s)	74.2	
Actuated g/C Ratio	0.57	
v/c Ratio	0.99	
Control Delay	35.5	
Queue Delay	0.0	
Total Delay	35.5	
LOS	D	
Approach Delay	36.7	
Approach LOS	D	
Queue Length 50th (m)	240.2	
Queue Length 95th (m)	#104.4	
Internal Link Dist (m)	358.6	
Turn Bay Length (m)		
Base Capacity (vph)	1868	
Starvation Cap Reductn	0	
Spillback Cap Reductn	0	
Storage Cap Reductn	0	
Reduced v/c Ratio	0.99	
<b>Intersection Summary</b>		

Lane Group	EBL	EBT	EBR	WBL	WBT	WBR	NBU	NBL	NBT	NBR	SBU	SBL
Lane Configurations												
Traffic Volume (vph)	278	177	179	74	182	191	18	322	1630	126	4	150
Future Volume (vph)	278	177	179	74	182	191	18	322	1630	126	4	150
Ideal Flow (vphpl)	1800	1800	1800	1800	1800	1800	1800	1800	1800	1800	1800	1800
Storage Length (m)	95.0		60.0	75.0		75.0		130.0		85.0		110.0
Storage Lanes	2		2	2		1		2		2		1
Taper Length (m)	40.0			20.0				90.0				40.0
Lane Util. Factor	0.97	0.95	1.00	0.97	0.95	1.00	0.91	0.97	0.91	1.00	0.91	1.00
Ped Bike Factor	0.99		0.97	0.99		0.96		1.00		0.97		1.00
Fr t			0.850			0.850				0.850		
Flt Protected	0.950			0.950				0.950				0.950
Satd. Flow (prot)	3248	3221	1498	3248	3349	1498	0	3187	4764	1469	0	1674
Flt Permitted	0.950			0.950				0.950				0.950
Satd. Flow (perm)	3206	3221	1459	3220	3349	1443	0	3176	4764	1425	0	1671
Right Turn on Red			Yes			Yes				Yes		
Satd. Flow (RTOR)			179			196				201		
Link Speed (k/h)		60			60				60			
Link Distance (m)		165.4			149.1				308.9			
Travel Time (s)		9.9			8.9				18.5			
Confl. Peds. (#/hr)	15		10	10		15		5		10		10
Confl. Bikes (#/hr)			5			10				5		
Peak Hour Factor	1.00	1.00	1.00	1.00	1.00	1.00	1.00	1.00	1.00	1.00	1.00	1.00
Heavy Vehicles (%)	1%	5%	1%	1%	1%	1%	2%	3%	2%	3%	2%	1%
Adj. Flow (vph)	278	177	179	74	182	191	18	322	1630	126	4	150
Shared Lane Traffic (%)												
Lane Group Flow (vph)	278	177	179	74	182	191	0	340	1630	126	0	154
Enter Blocked Intersection	No	No	No	Yes	Yes	Yes	No	No	No	No	No	No
Lane Alignment	L NA	Left	R NA	L NA	Left	R NA	R NA	L NA	Left	R NA	R NA	L NA
Median Width(m)		11.5			10.5				10.5			
Link Offset(m)		0.0			0.0				0.0			
Crosswalk Width(m)		5.0			5.0				5.0			
Two way Left Turn Lane												
Headway Factor	1.09	1.09	1.09	1.09	1.09	1.09	1.09	1.09	1.09	1.09	1.09	1.09
Turning Speed (k/h)	24		14	24		14	14	24		14	14	24
Number of Detectors	1	2	1	1	2	1	1	1	2	1	1	1
Detector Template	Left	Thru	Right	Left	Thru	Right	Left	Left	Thru	Right	Left	Left
Leading Detector (m)	2.0	10.0	2.0	2.0	10.0	2.0	2.0	2.0	10.0	2.0	2.0	2.0
Trailing Detector (m)	0.0	0.0	0.0	0.0	0.0	0.0	0.0	0.0	0.0	0.0	0.0	0.0
Detector 1 Position(m)	0.0	0.0	0.0	0.0	0.0	0.0	0.0	0.0	0.0	0.0	0.0	0.0
Detector 1 Size(m)	2.0	0.6	2.0	2.0	0.6	2.0	2.0	2.0	0.6	2.0	2.0	2.0
Detector 1 Type	Cl+Ex	Cl+Ex	Cl+Ex	Cl+Ex	Cl+Ex	Cl+Ex	Cl+Ex	Cl+Ex	Cl+Ex	Cl+Ex	Cl+Ex	Cl+Ex
Detector 1 Channel												
Detector 1 Extend (s)	0.0	0.0	0.0	0.0	0.0	0.0	0.0	0.0	0.0	0.0	0.0	0.0
Detector 1 Queue (s)	0.0	0.0	0.0	0.0	0.0	0.0	0.0	0.0	0.0	0.0	0.0	0.0
Detector 1 Delay (s)	0.0	0.0	0.0	0.0	0.0	0.0	0.0	0.0	0.0	0.0	0.0	0.0
Detector 2 Position(m)		9.4			9.4				9.4			
Detector 2 Size(m)		0.6			0.6				0.6			
Detector 2 Type		Cl+Ex			Cl+Ex				Cl+Ex			
Detector 2 Channel												
Detector 2 Extend (s)		0.0			0.0				0.0			
Turn Type	Prot	NA	Perm	Prot	NA	Perm	Prot	Prot	NA	Perm	Prot	Prot
Protected Phases	7	4		3	8		5	5	2		1	1
Permitted Phases			4			8				2		
Detector Phase	7	4	4	3	8	8	5	5	2	2	1	1



Lane Group	SBT	SBR
Lane Configurations	↑↑↑	↗
Traffic Volume (vph)	955	200
Future Volume (vph)	955	200
Ideal Flow (vphpl)	1800	1800
Storage Length (m)		100.0
Storage Lanes		1
Taper Length (m)		
Lane Util. Factor	0.91	1.00
Ped Bike Factor		0.98
Frt		0.850
Flt Protected		
Satd. Flow (prot)	4718	1483
Flt Permitted		
Satd. Flow (perm)	4718	1450
Right Turn on Red		Yes
Satd. Flow (RTOR)		201
Link Speed (k/h)	60	
Link Distance (m)	318.9	
Travel Time (s)	19.1	
Confl. Peds. (#/hr)		5
Confl. Bikes (#/hr)		5
Peak Hour Factor	1.00	1.00
Heavy Vehicles (%)	3%	2%
Adj. Flow (vph)	955	200
Shared Lane Traffic (%)		
Lane Group Flow (vph)	955	200
Enter Blocked Intersection	No	No
Lane Alignment	Left	R NA
Median Width(m)	7.0	
Link Offset(m)	0.0	
Crosswalk Width(m)	5.0	
Two way Left Turn Lane		
Headway Factor	1.09	1.09
Turning Speed (k/h)		14
Number of Detectors	2	1
Detector Template	Thru	Right
Leading Detector (m)	10.0	2.0
Trailing Detector (m)	0.0	0.0
Detector 1 Position(m)	0.0	0.0
Detector 1 Size(m)	0.6	2.0
Detector 1 Type	Cl+Ex	Cl+Ex
Detector 1 Channel		
Detector 1 Extend (s)	0.0	0.0
Detector 1 Queue (s)	0.0	0.0
Detector 1 Delay (s)	0.0	0.0
Detector 2 Position(m)	9.4	
Detector 2 Size(m)	0.6	
Detector 2 Type	Cl+Ex	
Detector 2 Channel		
Detector 2 Extend (s)	0.0	
Turn Type	NA	Perm
Protected Phases	6	
Permitted Phases		6
Detector Phase	6	6







Lane Group	SBT	SBR
Switch Phase		
Minimum Initial (s)	10.0	10.0
Minimum Split (s)	32.4	32.4
Total Split (s)	48.0	48.0
Total Split (%)	36.9%	36.9%
Maximum Green (s)	41.6	41.6
Yellow Time (s)	3.7	3.7
All-Red Time (s)	2.7	2.7
Lost Time Adjust (s)	0.0	0.0
Total Lost Time (s)	6.4	6.4
Lead/Lag	Lag	Lag
Lead-Lag Optimize?		
Vehicle Extension (s)	3.0	3.0
Recall Mode	C-Max	C-Max
Walk Time (s)	7.0	7.0
Flash Dont Walk (s)	19.0	19.0
Pedestrian Calls (#/hr)	10	10
Act Effct Green (s)	51.7	51.7
Actuated g/C Ratio	0.40	0.40
v/c Ratio	0.51	0.29
Control Delay	22.1	1.6
Queue Delay	0.0	0.0
Total Delay	22.1	1.6
LOS	C	A
Approach Delay	27.4	
Approach LOS	C	
Queue Length 50th (m)	30.5	0.0
Queue Length 95th (m)	35.8	3.4
Internal Link Dist (m)	294.9	
Turn Bay Length (m)		100.0
Base Capacity (vph)	1874	697
Starvation Cap Reductn	0	0
Spillback Cap Reductn	0	0
Storage Cap Reductn	0	0
Reduced v/c Ratio	0.51	0.29
<b>Intersection Summary</b>		

## **APPENDIX P**

---

Left Turn Lane Warrants

**Exhibit 9A-10**

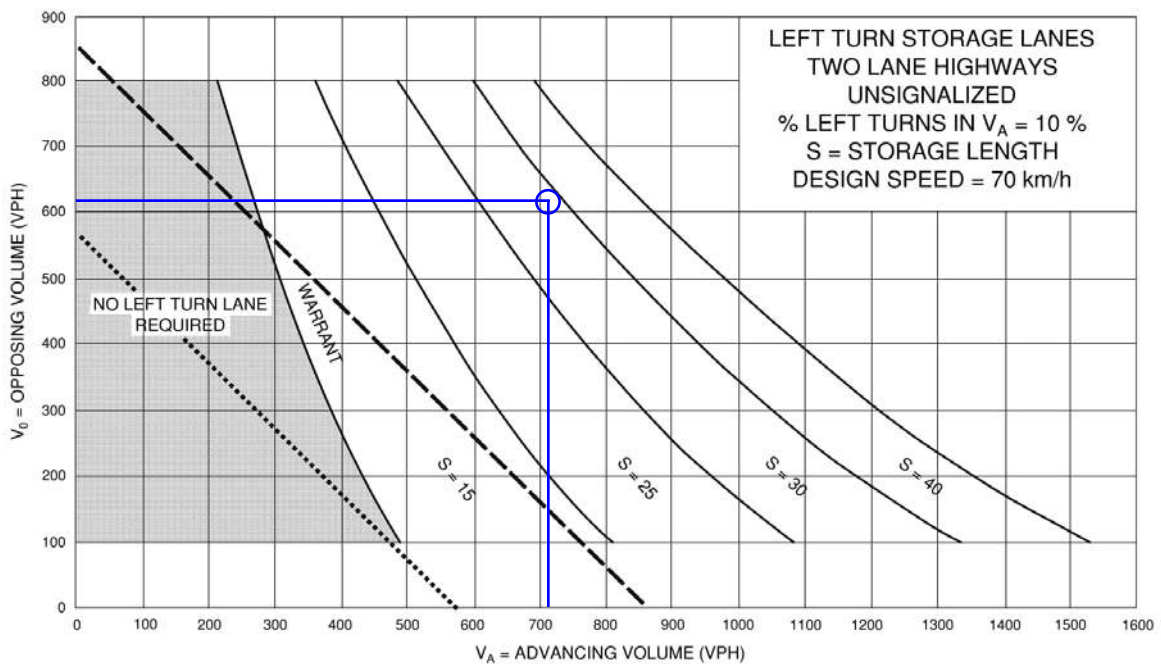
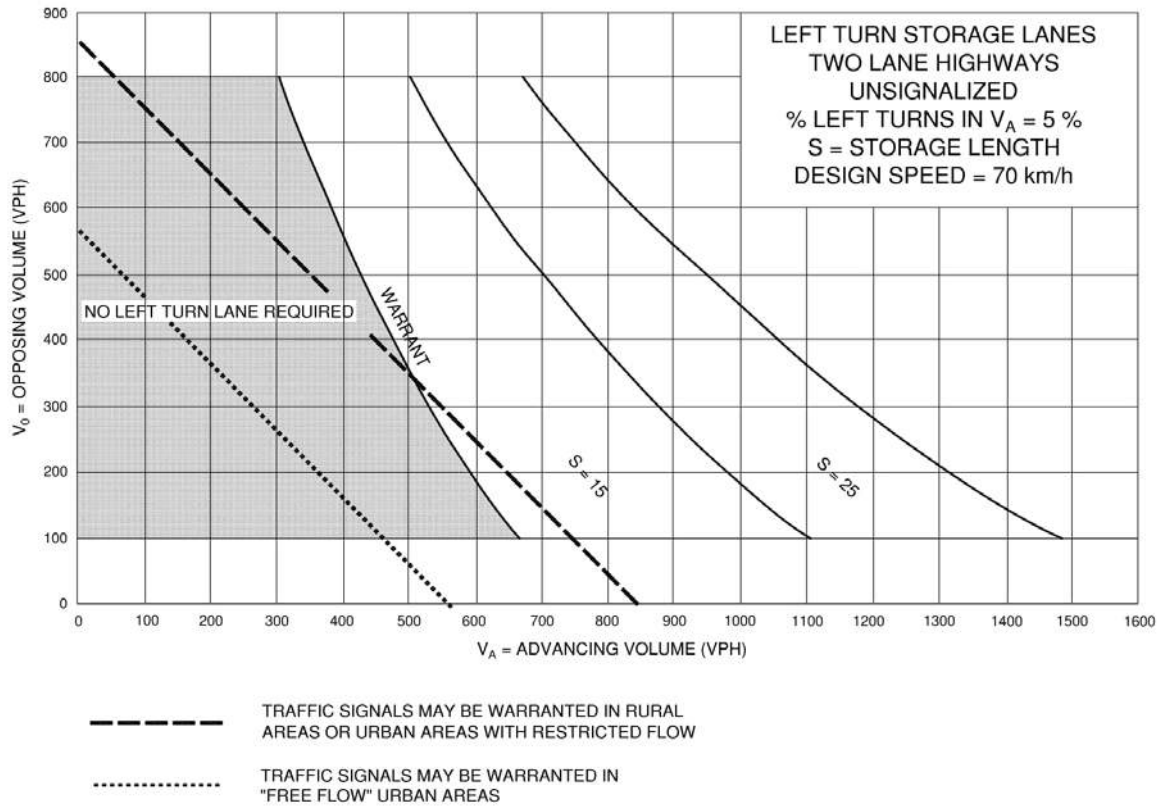

**Exhibit 9A-11**

