

# **Geotechnical Investigation**

## **Proposed Commercial Development**

444 Citigate Drive & 560 Dealership Drive  
Ottawa, Ontario

Prepared for Colonnade Bridgeport

Report PG6119-1 dated November 28, 2022

## Table of Contents

	<b>PAGE</b>
<b>1.0 Introduction .....</b>	<b>1</b>
<b>2.0 Proposed Development .....</b>	<b>1</b>
<b>3.0 Method of Investigation .....</b>	<b>2</b>
3.1 Field Investigation.....	2
3.2 Field Survey.....	3
3.3 Laboratory Review.....	3
3.4 Analytical Testing .....	4
<b>4.0 Observations .....</b>	<b>5</b>
4.1 Surface Conditions .....	5
4.2 Subsurface Profile .....	5
4.3 Groundwater.....	7
<b>5.0 Discussion .....</b>	<b>10</b>
5.1 Geotechnical Assessment.....	10
5.2 Site Grading and Preparation .....	10
5.3 Foundation Design .....	12
5.4 Design for Earthquakes .....	14
5.5 Slab-on-Grade Construction.....	14
5.6 Pavement Design .....	15
<b>6.0 Design and Construction Precautions .....</b>	<b>18</b>
6.1 Foundation Drainage and Backfill .....	18
6.2 Protection Against Frost Action .....	18
6.3 Excavation Side Slopes.....	19
6.4 Pipe Bedding and Backfill.....	20
6.5 Groundwater Control .....	20
6.6 Winter Construction .....	21
6.7 Corrosion Potential and Sulphate.....	22
6.8 Landscaping Considerations .....	22
<b>7.0 Recommendations .....</b>	<b>24</b>
<b>8.0 Statement of Limitations .....</b>	<b>25</b>

## **Appendices**

- Appendix 1**      Soil Profile and Test Data Sheets – 444 Citigate Drive  
                     Symbols and Terms  
                     Atterberg limits testing results  
                     Grain size analysis and hydrometer test results  
                     Analytical Testing Results – PG6119
- Appendix 2**      Figure 1 - Key Plan  
                     Drawing PG6119 -1 – Key Plan  
                     Drawing PG6119 -2 – Test Hole Location Plan – 444 Citigate Drive  
                     Drawing PG6119 -3 – Permissible Grade Raise Plan- 444 Citigate  
                     Drive  
                     Drawing PG6119 -4 – Tree Planting Setback Plan - 444 Citigate  
                     Drive
- Appendix 3**      Soil Profile and Test Data Sheets – 560 Dealership Drive  
                     Symbols and Terms  
                     Analytical Testing Results – 560 Dealership Drive
- Appendix 4**      Figure 1 – Exterior Apron Slab Details  
                     Drawing PG6119 -1 – Key Plan  
                     Drawing PG6119 -5 – Test Hole Location Plan – 560 Dealership  
                     Drive

## 1.0 Introduction

Paterson Group (Paterson) was commissioned by Colonnade Bridgeport to prepare a geotechnical investigation report for the proposed commercial developments to be located at 444 Citigate Drive & 560 Dealership Drive, Ottawa, Ontario (refer to Drawing -1 - Key Plan presented in Appendix 2).

The objective of the geotechnical investigation was to:

- ❑ determine the subsoil and groundwater conditions at the sites by means of test holes
- ❑ provide geotechnical recommendations for the design of the proposed developments including construction considerations which may affect its design.

The following report has been prepared specifically and solely for the aforementioned projects which are described herein. It contains our findings and includes geotechnical recommendations pertaining to the design and construction of the subject developments as they are understood at the time of writing this report.

## 2.0 Proposed Development

Based on the available conceptual drawings, it is understood that **four** commercial buildings are being proposed for the **444 Citigate Drive** and **three** commercial buildings for **560 Dealership Drive**. It is anticipated that the buildings will be one storey with slab on grade construction. Access lanes, driveways and parking garages, and landscaped areas are also anticipated as part of the proposed developments. It is further understood that the proposed commercial development will be municipally serviced.

## 3.0 Method of Investigation

### 3.1 Field Investigation

#### 444 Citigate Drive

The field program for the current investigation on 444 Citigate Drive was carried out between November 16, 2022, and November 25, 2022. At that time, a total of **twenty-five (25)** boreholes were advanced down to a maximum depth of 6m below existing ground surface. The test holes were placed in a manner to provide general coverage of the subject site taking into consideration site features and underground utilities. The test hole locations for the current investigation are presented on Drawing PG6119 - 1 - Test Hole Location Plan included in Appendix 2.

The boreholes were put down using a track-mounted auger drill rig operated by a two-person crew. All fieldwork was conducted under the full-time supervision of Paterson personnel under the direction of a senior engineer. The test hole procedures consisted of auguring to the required depths at the selected locations and sampling the overburden.

#### 560 Dealership Drive

The field program for the geotechnical investigation on 560 Dealership was carried out on December 2 and 3, 2020. At that time, **twelve (12)** test pits were advanced to a maximum depth of 5.5 m below the existing ground surface. A supplemental field investigation was carried out on December 16 and 17, 2020. At the time of the supplemental investigation, **two (2)** boreholes were advanced to a maximum depth of 10.4 m below the existing ground surface. The test hole locations were distributed in a manner to provide general coverage of the subject site. The approximate locations of the test holes are shown on Drawing PG6119 - 5 - Test Hole Location Plan included in Appendix 4.

The test pits were excavated using a hydraulic shovel at the selected locations across the site. All fieldwork was conducted under the full-time supervision of Paterson personnel under the direction of a senior engineer from the geotechnical division. The excavation procedure consisted of digging to the required depth at the selected locations, sampling and testing the overburden.

#### Sampling and In Situ Testing

Soil samples were recovered during drilling from the auger flights or a 50 mm diameter split-spoon sampler. The split-spoon samples were classified on site and placed in sealed plastic bags. All samples were transported to our laboratory for further examination and classification. The depths at which the samples were recovered from the test pits are shown as G and the split-spoon samples and auger grab-samples recovered from the boreholes are shown as SS and AU, respectively, on the Soil Profile and Test Data sheets presented in Appendix 1.

The Standard Penetration Test (SPT) was conducted in conjunction with the recovery of the split-spoon samples. The SPT results are recorded as “N” values on the Soil Profile and Test Data sheets. The “N” value is the number of blows required to drive the split-spoon sampler 300 mm into the soil after a 150 mm initial penetration using a 63.5 kg hammer falling from a height of 760 mm.

Undrained shear strength testing using a vane apparatus was carried out at regular depth intervals in cohesive soils.

The thickness of the overburden was evaluated during the course of the investigation by a dynamic cone penetration test (DCPT). The DCPT consists of driving a steel drill rod, equipped with a 50 mm diameter cone at its tip, using a 63.5 kg hammer falling from a height of 760 mm. The number of blows required to drive the cone into the soil is recorded for each 300 mm increment.

The subsurface conditions observed in the test holes were recorded in detail in the field. The soil profiles are presented on the Soil Profile and Test Data sheets in Appendix 1 of this report.

### **Groundwater**

Flexible polyethylene standpipes were installed in the boreholes to permit monitoring of the groundwater levels subsequent to the completion of the field investigations. Groundwater conditions were also observed and recorded in the field during the excavation of the test pits.

### **Sample Storage**

All samples will be stored in the laboratory for a period of one (1) month after the issuance of this report. They will then be discarded unless we are otherwise directed.

## **3.2 Field Survey**

The test hole locations were selected by Paterson to provide general coverage of the subject site. The test hole locations and ground surface elevation at each test hole location were surveyed by Paterson using a high-precision, handheld GPS and referenced to a geodetic datum. The location of the test holes is presented in Appendix 2 and 4.

## **3.3 Laboratory Review**

Soil samples were recovered from the subject sites and visually examined in our laboratory to review the results of the field logging. Six (6) samples were submitted for Atterberg Limits testing, one (1) sample for shrinkage limit testing, and five (5) sample for grain size distribution testing.

All test results are included in Appendix 1 and further discussed in Subsection 4.2 of the current report.

### **3.4 Analytical Testing**

One soil sample was submitted for analytical testing from each site, to assess the corrosion potential for exposed ferrous metals and the potential of sulphate attacks against subsurface concrete structures by others. The sample was submitted to determine the concentration of sulphate and chloride, the resistivity, and the pH of the samples. The results are presented in Appendix 1 and discussed further in Subsection 6.7.

## **4.0 Observations**

### **4.1 Surface Conditions**

#### **444 Citigate Drive**

The subject site on 444 Citigate Drive is currently vacant. The eastern portion of the site consists of relatively flat agricultural lands that are observed to be at grade with the neighboring road and properties. On the other hand, the western portion of the site is heavily treed and slopes upward from east to west from an approximate geodetic elevation of 96 to 104m.

The subject site is bordered by Systemhouse Street to the north, a creek followed by an agricultural field to the east, Highway 416 to the west, and a storm pond, a commercial development, and a vacant lot to the south.

#### **560 Dealership Drive**

The majority of the subject site is occupied by agricultural land. The site slopes gradually upwards from east to west from an approximate geodetic elevation of 94 to 108 m. An approximately 1.0 to 1.5 m deep ditch was noted along the eastern property boundary. A 3 to 4 m high slope runs along the west property boundary down to a drainage ditch running along the Highway 416 northbound lane.

The subject site is bordered by Dealership Drive to the northeast, Highway 416 to the west, vacant land to the north and south and commercial property to the east.

### **4.2 Subsurface Profile**

#### **Overburden - 444 Citigate Drive**

Generally, the subsurface profile observed at the test hole locations within 444 Citigate Drive site consists of topsoil followed by a silty clay deposit underlain by glacial till. The silty clay deposit was observed to be hard to stiff and brown at the top, and becoming firm grey with depth, at the location of most of the test holes. Practical refusal to augering and or DCPT was encountered at the location of BH 1-22, BH 3-22, BH 6-22, BH 7-22, BH 9-22, BH 10-22, BH 14-22, BH 15-22, BH 16-22, BH 19-22, BH 21-22, BH 23-22, BH 24-22 and BH 25-22 at depths ranging between 1.4 and 9.3m below existing ground surface.

Specific details of the soil profile at each test hole location are presented on the Soil Profile and Test Data sheets in Appendix 1.



## Overburden - 560 Dealership Drive

Generally, the subsurface profile at the test hole locations consisted of topsoil underlain by a layer of silty sand and/or fill throughout the western and portions of the subject site, respectively. The fill throughout the eastern portion of the site was observed to be underlain by a very stiff deposit of silty clay at TP 1, TP 3, and TP 5.

The silty clay deposit and the remainder of the test holes were observed to be underlain by a compact to very dense glacial till deposit. The fine matrix of the glacial till consisted of either a silty clay or silty sand throughout the east and west portions of the subject site, respectively. The glacial till was also observed to consist of gravel, cobbles and boulders. Boulders were noted frequently throughout the investigation and many were considered oversized (ie.-encountered boulders up to 3 m in diameter).

Specific details of the soil profile at each test hole location are presented on the Soil Profile and Test Data sheets in Appendix 3.

## Bedrock

Based on available geological mapping, the subject sites are located in an area where the bedrock consists of interbedded limestone and dolomite of the Gull River formation with an overburden drift thickness between 1 to 15 m.

## Grain Size Distribution and Hydrometer Test

Five sieve analyses were completed to classify selected soil samples according to the Unified Soil Classification System (USCS). The results are summarized in Table 1 and presented in Appendix 1.

<b>Table 1 - Grain Size Distribution and Hydrometer Testing</b>				
<b>Test Hole</b>	<b>Sample</b>	<b>Gravel (%)</b>	<b>Sand (%)</b>	<b>Silt and Clay (%)</b>
BH 2-22	SS3	0	0.6	99.4
BH 5-22	SS2	0	0.5	99.5
BH 6-22	SS2	0	1.9	98.1
BH 9-22	SS2	0	0.3	99.7
BH 10-22	SS3	0	0.6	99.4

## Atterberg Limit Tests

Six selected silty clay samples were submitted for Atterberg Limit testing. The test results indicate that both low and high plasticity silty clays are anticipated at the subject site. The results are summarized in Table 2 and presented in Appendix 1.

<b>Table 2 - Summary of Atterberg Limits Test Results</b>				
<b>Test Hole</b>	<b>Sample No.</b>	<b>Liquid Limit (%)</b>	<b>Plastic Limit (%)</b>	<b>Plasticity Index (%)</b>
BH 1-22	SS2	79	22	57
BH 5-22	SS3	84	22	62
BH 6-22	SS3	85	24	61
BH 8-22	SS3	81	22	59
BH 10-22	SS3	79	24	55
BH 11-22	SS3	83	22	61

### 4.3 Groundwater

Groundwater levels were measured in the installed piezometers during the current investigations. Furthermore, infiltration rates within the openholes were recording at the time of excavating the test pits. The measured groundwater level (GWL) readings and groundwater infiltration observations are presented in Tables 1 and 2 below and are shown on the Soil Profile and Test Data sheets in Appendix 1 and 3.

<b>Table 3 - Measured Groundwater Levels PG6119 – 444 Citigate Drive</b>				
<b>Test Hole Location</b>	<b>Ground Surface Elevation (m)</b>	<b>Groundwater Measurement</b>		<b>Date</b>
		<b>Depth (m)</b>	<b>Elevation (m)</b>	
<b>BH 1-22</b>	95.44	1.61	93.83	November 25, 2022
<b>BH 2-22</b>	96.00	dry	N/A	
<b>BH 3-22</b>	95.43	2.63	92.8	
<b>BH 4-22</b>	95.06	1.32	93.74	
<b>BH 5-22</b>	95.00	2.39	92.61	
<b>BH 6-22</b>	95.75	1.65	94.1	
<b>BH 7-22</b>	95.40	1.41	93.99	
<b>BH 8-22</b>	95.17	dry	N/A	
<b>BH 9-22</b>	94.90	1.12	93.78	
<b>BH 10-22</b>	94.56	3.08	91.48	
<b>BH 11-22</b>	94.54	1.23	93.31	
<b>BH 12-22</b>	94.89	2.43	92.46	
<b>BH 13-22</b>	95.37	1	94.37	
<b>BH 14-22</b>	98.13	0.99	97.14	
<b>BH 15-22</b>	103.19	dry	N/A	
<b>BH 16-22</b>	105.17	dry	N/A	
<b>BH 17-22</b>	107.67	dry	N/A	
<b>BH 18-22</b>	102.67	dry	N/A	
<b>BH 19-22</b>	106.78	dry	N/A	
<b>BH 20-22</b>	97.84	1.38	96.46	
<b>BH 21-22</b>	101.41	dry	dry	
<b>BH 22-22</b>	104.71	dry	dry	
<b>BH 23-22</b>	106.24	2	104.24	
<b>BH 24-22</b>	103.94	dry	Dry	
<b>BH 25-22</b>	100.22	dry	dry	

<b>Table 4 - Summary of Groundwater Level Readings PG5596 – 560 Dealership Drive</b>				
<b>Test Hole Number</b>	<b>Ground Surface Elevation (m)</b>	<b>Groundwater Depth (m)</b>	<b>Groundwater Elevation (m)</b>	<b>Date</b>
TP 1	95.67	2.55	93.12	December 2, 2020
TP 2	97.38	2.75	94.63	
TP 3	95.24	3.70	91.51	
TP 5	98.50	1.60	96.90	
TP 8	108.18	4.10	104.08	
BH 1	107.75	4.67	103.08	December 22, 2020
BH 2	107.56	Dry/Blocked	n/a	
<b>Note:</b> Ground surface elevations at all test hole locations were surveyed by Paterson and are referenced to a geodetic datum.				

Where encountered, groundwater infiltration was noted to be moderate to high along the test pit sidewalls at the above-noted depths and generally within the glacial till deposit.

The recorded groundwater levels are noted on the applicable Soil Profile and Test Data sheet presented in Appendix 1 and 3.

It should be noted that groundwater levels are subject to seasonal fluctuations. Therefore, the groundwater level could vary at the time of construction.

## **5.0 Discussion**

### **5.1 Geotechnical Assessment**

From a geotechnical perspective, the subject sites are suitable for the proposed developments. It is anticipated that the proposed buildings will be founded on conventional shallow footings bearing on an undisturbed, compact to very dense glacial till, stiff to very stiff brown silty clay bearing surface, or on approved engineered fill pad placed upon an approved undisturbed native overburden.

Due to the presence of silty clay within the eastern portion of both sites, a permissible grade raise restriction will be required where the buildings will be founded on the silty clay layer. Once the detailed grading plans are prepared for the subject sites, Paterson should complete a review of the proposed grades to ensure they are acceptable from a geotechnical perspective.

Recommendations are provided herein for the re-use of the site generated fill material in consideration of the cut and fill operation that will be required to accommodate the proposed grades.

The above and other considerations will be discussed further in the following sections.

### **5.2 Site Grading and Preparation**

#### **Stripping Depth**

Topsoil and any fill, containing significant amounts of deleterious or organic materials, should be stripped from under the proposed building, paved areas, pipe bedding and other settlement sensitive structures.

#### **Fill Placement**

It is anticipated that the site will require notable grade raises above the existing ground surface. Therefore, in-filling operations are anticipated to be completed using approved existing fill generated from the cut and fill operations. Re-assessment of the site-generated fill shall be done before construction.

Fill used for grading beneath the building footprints, unless otherwise specified, should consist of clean imported granular fill, such as Ontario Provincial Standard Specifications (OPSS) Granular A or Granular B Type II. Furthermore, suitable portions of the native glacial till material generated from the cut and fill operation on site can also be used for grading beneath the building footprint and pavement areas.

It is recommended to segregate wet and/or clay-dominant portions of the native glacial till fill throughout the lateral support zone of the proposed building footprints and as deemed appropriate by the geotechnical consultant at the time of construction.

Boulders larger than 300 mm in their longest dimensions should be removed from the glacial till prior to being reused. Imported fill should be tested and approved prior to delivery to the site. All fill used for grading below settlement sensitive areas should be placed in loose lifts no greater than 300 mm thick and compacted using suitable heavy sheepsfoot and smooth drum vibratory compaction equipment as deemed appropriate by Paterson at the time of construction. Fill placed beneath the building area should be compacted, **under dry conditions, and above freezing temperatures**, to at least 98% of the material's standard Proctor maximum dry density (SPMDD).

If site excavated cobbles and boulders are to be used as fill to build up the subgrade for roadways or the bearing mediums, it should be suitably fragmented to produce a well-graded material with a maximum particle size of 300 mm. Any crushed site-generated material greater than 300 mm in diameter should be segregated and hoe rammed into acceptable fragments. Where the fill is open-graded, a blinding layer of finer granular fill, such as OPSS Granular A, well-graded sand, crushed stone dust or a geotextile may be required to prevent adjacent finer materials from migrating into the voids, with associated loss of ground and settlements.

Non-specified existing fill along with site-excavated soil can be used as general landscaping fill where settlement of the ground surface is of minor concern. These materials should be spread in thin lifts and at least compacted by the tracks of the spreading equipment to minimize voids.

Placement of site-generated soil fill material during winter months increases the risk of placing frozen material which may result in poor performing areas that may require sub-excavation of the material and subsequent reinstatement. Non-specified existing fill and site-excavated soils are not suitable for use as backfill against foundation walls unless used in conjunction with a composite drainage blanket connected to a perimeter drainage system.

### **560 Dealership Drive - Building A Footprint Bearing Medium Preparation**

Consideration could be given to placing the proposed footings and floor slab for Building A over site-generated glacial till fill provided the placement of the fill is reviewed and approved by Paterson at the time of construction. The approved grade raise fill material should be proof-rolled using suitable compaction equipment **under dry conditions, above freezing temperatures, tested and approved by Paterson personnel**. A minimum 300 mm thick sub-footing granular pad, consisting of an OPSS Granular A crushed stone, compacted to 98% of its SPMDD is recommended to be placed at footing level over the approved

grade raise fill subgrade. A minimum 50 to 75 mm thick layer of lean-concrete (minimum 17 MPa 28-day compressive strength) may also be substituted for the sub-footing engineered fill layer. The sub-footing fill should be extended a minimum 300 mm horizontally beyond the footing face in all directions and throughout the lateral support zone of the footings.

Where the grade raise fill is deemed inadequate below the proposed footings, the fill should be sub-excavated below the design underside of footing and replaced with engineered fill, such as OPSS Granular A or OPSS Granular B Type II and compacted to a minimum 98% of the material's SPMDD.

### **5.3 Foundation Design**

#### **Bearing Resistance Values - 444 Citigate Drive**

Strip footings, up to 2 m wide, and pad footings, up to 5 m wide, placed on an undisturbed, very stiff to stiff brown silty clay bearing surface or on engineered fill pad over a very stiff to stiff brown silty clay can be designed using a bearing resistance value at serviceability limit states (SLS) of **150 kPa** and a factored bearing resistance value at ultimate limit states (ULS) of **225 kPa**.

Conventional spread footings placed on an undisturbed, compact glacial till bearing surface can be designed using bearing resistance values at serviceability limit states (SLS) of **250 kPa** and a factored bearing resistance value at ultimate limit states (ULS) of **400 kPa**.

A geotechnical resistance factor of 0.5 was applied to the above noted bearing resistance value at ULS.

#### **Bearing Resistance Values - 560 Dealership drive**

##### Building B and Building C - Bearing Resistance Values

Based on the proposed FFE's, Building B and Building C will be founded directly upon the in-situ, undisturbed, compact glacial till bearing medium. Conventional spread footings placed on an undisturbed, compact glacial till bearing surface can be designed using bearing resistance values at serviceability limit states (SLS) of **250 kPa** and a factored bearing resistance value at ultimate limit states (ULS) of **400 kPa**.

##### Building A - Bearing Resistance Values

Conventional spread footings placed on an approved sub-footing engineered fill or lean-concrete pad founded upon the approved site-generated grade-raise fill can be designed using bearing resistance values at serviceability limit states (SLS) of **200 kPa** and a factored bearing resistance value at ultimate limit states (ULS) of **350 kPa**.

An undisturbed soil bearing surface consists of one from which all topsoil and deleterious materials, such as loose, frozen or disturbed soil, whether in situ or not, have been removed, in the dry, prior to the placement of concrete for footings.

### **Lateral Support**

The bearing medium under footing-supported structures is required to be provided with adequate lateral support with respect to excavations and different foundation levels. Adequate lateral support is provided to the encountered overburden material above the groundwater table when a plane extending down and out from the bottom edge of the footing at a minimum of 1.5H:1V passes only through in situ soil of the same or higher capacity as the bearing medium soil. Near vertical (1H:6V) slopes can be used for unfractured bedrock bearing media; a 1H:1V slope can be used for fractured bedrock.

### **Permissible Grade Raise and Settlements – 444 Citigate Drive**

Due to the presence of the silty clay deposit, a permissible grade raise restriction is recommended where the proposed footings will be bearing on the silty clay deposit. The recommended grade raise restrictions for 444 Citigate are shown on Drawing PG6119-3 - Permissible Grade Raise Plan in Appendix 2. A post-development groundwater lowering of 0.5 m was considered in our permissible grade raise calculations.

Once the detailed grading plans are prepared for the subject sites, Paterson should complete a review of the proposed grades to ensure they are acceptable from a geotechnical perspective.

If higher than permissible grade raises are required, preloading with or without a surcharge, lightweight fill, and/or other measures should be investigated to reduce the risks of unacceptable long-term post construction total and differential settlements.

Footings bearing on an undisturbed soil bearing surface and designed using the bearing resistance values provided herein will be subjected to potential post-construction total and differential settlements of 25 and 20 mm, respectively.

### **Permissible Grade Raise and Settlements – 560 Dealership Drive**

The majority of the proposed development will be founded over the compact to dense glacial till deposit, which is not subject to permissible grade raise restrictions. The majority of the site east of Building B will be raised to accommodate the proposed grades. The footprint of Building A will be founded upon approved grade raise fill and located over a deposit of very stiff silty clay which is further underlain by the glacial till.



Based on this, only Building A will be subject to permissible grade raise restrictions as it is the only building located over a deposit of silty clay.

Based on the existing test hole coverage and undrained shear strength testing completed within the underlying cohesive soil, a permissible grade raise restriction of up to an elevation of **99.5 m** is recommended for grading surrounding Building A.

For the silty clay deposit areas, within the proposed parking lot areas in the eastern portion of the subject site, consideration should be given to preloading this portion of the site to consolidate the very stiff silty clay deposit. It is further recommended to delay paving over the grade-raise fill areas by a minimum of one freeze-thaw season (i.e.- place fill up to the end of fall and pave in the late spring/early summer).

#### **5.4 Design for Earthquakes**

The site class for seismic site response can be taken as **Class C** for foundations constructed at the subject site, according to Table 4.1.8.4.A of the 2012 Ontario Building Code (OBC 2012). The soils underlying the subject site are not susceptible to liquefaction. Reference should be made to the latest revision of the 2012 Ontario Building Code for a full discussion of the earthquake design requirements.

#### **5.5 Slab-on-Grade Construction**

With the removal of all topsoil and fill, containing deleterious or organic materials, within the footprint of the proposed building, the native soil and/or approved fill pad will be considered to be an acceptable subgrade surface on which to commence backfilling for the floor slab. The upper 300 mm of sub-slab fill should consist of an OPSS Granular A crushed stone. All backfill material within the footprint of the proposed building should be placed in maximum 300 mm thick loose lifts and compacted to at least 98% of its SPMDD.

Any soft areas should be removed and backfilled with appropriate backfill material. OPSS Granular A or Granular B Type II, with a maximum particle size of 50 mm, are recommended for backfilling below the floor slab.

## 5.6 Pavement Design

Car only parking areas, access lanes and heavy truck parking/loading areas are anticipated at these sites. The proposed flexible pavement structures are shown in Tables 5 and 6. The recommended rigid pavement structure for exterior concrete aprons is further presented in Table 7.

<b>Table 5 - Recommended Pavement Structure – Car Only Parking Areas</b>	
<b>Thickness (mm)</b>	<b>Material Description</b>
50	<b>Wear Course</b> - HL-3 or Superpave 12.5 Asphaltic Concrete
150	<b>BASE</b> - OPSS Granular A Crushed Stone
300	<b>SUBBASE</b> - OPSS Granular B Type II
<b>SUBGRADE</b> – Either fill, in situ soils or bedrock or OPSS Granular B Type I or II material placed over in situ soil, or fill	

<b>Table 6 - Recommended Pavement Structure/ Access Lanes and Heavy Truck Parking Areas</b>	
<b>Thickness (mm)</b>	<b>Material Description</b>
40	<b>Wear Course</b> - Superpave 12.5 Asphaltic Concrete
50	<b>Binder Course</b> - Superpave 19.0 Asphaltic Concrete
150	<b>BASE</b> - OPSS Granular A Crushed Stone
450	<b>SUBBASE</b> - OPSS Granular B Type II
<b>SUBGRADE</b> - Either fill, in situ soil, or OPSS Granular B Type I or II material placed over in situ soil or fill	

<b>Table 7 - Recommended Rigid Pavement Structure for Exterior Concrete Aprons</b>	
<b>Thickness (mm)</b>	<b>Material Description</b>
230	<b>Exposure Class C2 - 32 MPa Concrete</b> - (5 to 8% Air Entrainment)
150	<b>BASE</b> - OPSS Granular A Crushed Stone
450	<b>SUBBASE</b> - OPSS Granular B Type II
<b>SUBGRADE</b> - Either fill, in situ soil or OPSS Granular B Type I or II material placed over in situ soil or fill	

Minimum Performance Graded (PG) 58-34 asphalt cement should be used where a flexible pavement structure is to be used for this project. It is recommended that the exterior apron slabs should consist of a Category C2 Exposure Class concrete with a minimum 28-day compressive strength of 32 MPa.

It is recommended to provide a non-woven geotextile (such as Terrafix 270R or equivalent and approved other) separation layer between the pavement structure and the subgrade in areas where the subgrade layer consists of fill generated from the cut and fill operations.

### **Considerations for Pavement Structure - Subgrade Soft Spots**

If soft spots develop in the subgrade during compaction or due to construction traffic, the affected areas should be excavated and replaced with OPSS Granular B Type II material. The pavement granular base and subbase should be placed in maximum 300 mm thick lifts and compacted to a minimum of 98% of the material's SPMDD using suitable vibratory equipment.

### **Exterior Apron Slab Construction, Contraction and Isolation Joint Considerations**

To control cracking due to shrinking of the concrete apron slabs, it is recommended that strategically located saw cuts be used to create contraction joints within the concrete apron slab. The contraction joints should be saw-cut once the concrete has hardened sufficiently to prevent raveling or dislodging of aggregates. The control joints are generally recommended to be spaced at approximately 24 to 36 times the slab thickness (i.e.- a 203 mm thick slab should have control joints spaced between 4.8 and 7.3 m). The joints should be cut to a minimum depth of 1/5 of the apron slab thickness (i.e.- a minimum of 40 mm for a 203 mm thick apron slab) and be in-filled with a temporary backer-rod shortly after the initial cut.

All construction joints should be doweled at the vertical interface between the new and old concrete with ungreased round dowels embedded a minimum of 305 mm within each of the slabs at the vertical construction joint. These dowels should be cast into the first pour and carried-over into second pour. These dowels should be spaced along the length of the slab at a maximum centre-to-centre spacing of 610 mm.

Where construction and contraction joints were not initially provided a closed cell backer rod or the backer rod had been damaged and permitted sediment and fine material to enter the joint, the joints should be re-sawed to sufficiently clean the opening. All construction and contraction joints should be sealed by a joint sealer once the concrete has cured sufficiently and undergone the majority of its shrinkage. It is recommended to allow a minimum of 120 days (or as long as feasible as based on the project specific schedule) prior to sealing the construction and contraction joints.

All exterior apron slabs should be isolated from abutting to non-slab structures such as foundation walls, manholes, curbs and other non-slab structures. This can be accomplished by installing a non-absorbent and non-reactive material, such as an asphalt impregnated fiberboard, on the surface which the slab will be cast against. The isolation joint material should be sized vertically to extend the full width of the slab. Details pertaining to the above-noted recommendations can be referred to in Figure 2 -Exterior Apron Slab Details presented in Appendix 4.

### **Frost Tapers**

For utility trenches and other subgrade structures backfilled with non-frost susceptible granular material or at the interface between the concrete apron and flexible pavement structure, consideration should be given to installing a 1V:5H frost tapers in hard landscaped areas and below pavement structures to lessen the effects of differential frost heaving. Consideration could also be given to installing rigid insulation which requires tapering with various insulation thicknesses.

### **Pavement Structure Drainage**

The pavement structure performance is dependent on the moisture condition at the contact zone between the subgrade material and granular base. Failure to provide adequate drainage under conditions of heavy wheel loading could result in the subgrade fines pumped into the stone subbase voids, thereby reducing the load bearing capacity.

Due to the impervious nature of the subgrade and fill materials and transitions between various pavement structures, consideration should be provided to installing subdrains during the pavement construction. At transition zones between various pavement structures, subdrains should be installed longitudinally to drain any potential water trapped in the granular layers. The subdrains at catch basins should extend in four orthogonal directions and longitudinally when placed along a curb.

## **6.0 Design and Construction Precautions**

### **6.1 Foundation Drainage and Backfill**

#### **Foundation Drainage**

It is recommended that a perimeter foundation drainage system be provided for the proposed structures. The system should consist of a 150 mm diameter, geotextile-wrapped, perforated and corrugated plastic pipe surrounded on all sides by 150 mm of 19 mm clear crushed stone, placed at the footing level round the exterior perimeter of the structures. The pipe should have a positive outlet, such as a gravity connection to the storm sewer.

#### **Foundation Backfilling**

Backfill against the exterior sides of the foundation walls should consist of free-draining non frost susceptible granular materials. The greater part of the site excavated materials will be frost susceptible and, as such, are not recommended for re-use as backfill against the foundation walls, unless used in conjunction with a composite drainage system, such as Delta Drain 6000 or Miradrain G100N. Imported granular materials, such as clean sand or OPSS Granular B Type I granular material, should otherwise be used for this purpose.

Backfill material below sidewalk subgrade areas or other settlement sensitive structures should consist of free draining, non-frost susceptible material placed in maximum 300 mm thick loose lifts and compacted to at least 98% of its SPMDD under dry and above freezing conditions.

### **6.2 Protection Against Frost Action**

Perimeter footings of heated structures are required to be insulated against the deleterious effect of frost action. A minimum of 1.5 m thick soil cover (or equivalent) should be provided in this regard.

Exterior unheated footings, such as those for isolated exterior piers, footings located below loading docks and loading dock ramp wing-walls are more prone to deleterious movement associated with frost action than the exterior walls of the heated structure. These unheated structures require additional protection, such as soil cover of 2.1 m or an equivalent combination of soil cover and foundation insulation. It is recommended that Paterson review the proposed footing and/or insulation details for the above-noted items prior to construction to ensure the effects of frost action are mitigated appropriately.

### **6.3 Excavation Side Slopes**

The side slopes of excavations at the site should be either cut back at acceptable slopes or should be retained by shoring systems from the start of the excavation until the structure is backfilled. It is expected that sufficient room will be available for the excavation to be undertaken by open-cut methods.

The excavation side slopes above the groundwater level extending to a maximum depth of 3 m should be excavated at 1H:1V or shallower. The shallower slope is required for excavation below groundwater level (1.5H:1V). The subsoil at this site is considered to be mainly a Type 2 and 3 soil according to the Occupational Health and Safety Act and Regulations for Construction Projects.

Excavated soil should not be stockpiled directly at the top of excavations and heavy equipment should be kept away from the excavation sides.

Slopes in excess of 3 m in height should be periodically inspected by the geotechnical consultant in order to detect if the slopes are exhibiting signs of distress.

A trench box is recommended to protect personnel working in trenches with steep or vertical sides. Services are expected to be installed by “cut and cover” methods and excavations should not remain open for extended periods of time.

The landscaped side-slopes along the property boundaries are recommended to be cut back and left to remain at a slope of 1H:1V or flatter during the cut and fill operations to provide safe excavation side-slopes during construction.

#### **Retaining Wall At 560 Dealership Drive**

The proposed retaining walls should be checked for global stability and designed by a licensed professional engineer to maintain an adequate factor of safety in excess of the required 1.5 for static conditions and 1.1 for seismic loading conditions. The internal and external failure modes of the retaining wall sections should also be designed with the same factors of safety provided. The applicable seismic design should incorporate a Peak Ground Acceleration (PGA) of 0.32 for the Ottawa area, as per the Ontario Building Code (OBC 2012).

A geotechnical field review must be completed at the time of excavation, prior to placing the granular bedding layer, to assess the bearing medium under the proposed wall. Based on the current site plan grading, it is anticipated that the walls will be founded over an engineered fill pad or undisturbed, compact glacial till bearing surface.

## **6.4 Pipe Bedding and Backfill**

Bedding and backfill materials should be in accordance with the most recent Material Specifications and Standard Detail Drawings from the Department of Public Works and Services, Infrastructure Services Branch of the City of Ottawa.

A minimum of a 150 mm layer of OPSS Granular A crushed stone should be placed for pipe bedding for sewer and water pipes for a soil subgrade. The bedding should extend to the spring line of the pipe. Cover material, from the spring line to at least 300 mm above the obvert of the pipe, should consist of OPSS Granular A. The bedding and cover materials should be placed in maximum 300 mm thick lifts compacted to a minimum of 99% of the SPMDD.

It should generally be possible to re-use the site materials above the cover material if the operations are carried out in dry weather conditions. The site excavated material may be placed above cover material if the excavation operations are completed in dry weather conditions and the site excavated material is approved by the geotechnical consultant. All cobbles greater than 200 mm in the longest dimension should be removed prior to the site materials being reused.

Where hard surface areas are considered above the trench backfill, the trench backfill material within the frost zone (about 1.8 m below finished grade) and above the cover material should match the soils exposed at the trench walls to minimize differential frost heaving. The trench backfill should be placed in maximum 225 mm thick loose lifts and compacted to a minimum of 95% of the material standard Proctor maximum dry density.

## **6.5 Groundwater Control**

It is anticipated that groundwater infiltration into the excavations should be controllable using open sumps. Pumping from open sumps should be sufficient to control the groundwater influx through the sides of shallow excavations. The contractor should be prepared to direct water away from all bearing surfaces and subgrades, regardless of the source, to prevent disturbance to the founding medium.

A temporary Ministry of the Environment, Conservation and Parks (MECP) permit to take water (PTTW) Category 3 may be required for this project if more than 400,000 L/day of ground and/or surface water is to be pumped during the construction phase. A minimum of 4 to 5 months should be allowed for completion of the PTTW Category 3 application package and issuance of the permit by the MECP.

For typical ground or surface water volumes being pumped during the construction phase, between 50,000 to 400,000 L/day, it's required to register on the Environmental Activity and Sector Registry (EASR). A minimum of two to four weeks should be allotted for completion of the EASR registration and the Water Taking and Discharge Plan to be prepared by a Qualified Person as stipulated under O.Reg. 63/16. If a project qualifies for a PTTW based upon anticipated conditions, an EASR will not be allowed as a temporary dewatering measure while awaiting the MECP review of the PTTW application.

### **Impacts on Neighboring Properties**

It is understood that a notable cut of native material will be sub-excavated to accommodate the proposed buildings throughout the subject site. It is anticipated that the neighboring portion of Highway 416 and the commercial building located to the east of the site are founded within the dense glacial till and very stiff silty clay deposit, respectively. The glacial till deposit encountered was observed to be sufficiently dense and have a relatively high content of fine-grained soils such that the groundwater table will be lowered marginally within the vicinity of the subject site at the time of construction and as is typically experienced by temporary short-term dewatering for construction.

It should be noted that no issues are expected with respect to groundwater lowering that would long term damage to adjacent structures surrounding the proposed development.

## **6.6 Winter Construction**

Precautions must be taken if winter construction is considered for this project.

The subsoil conditions at this site mostly consist of frost susceptible materials. In the presence of water and freezing conditions, ice could form within the soil mass. Heaving and settlement upon thawing could occur.

In the event of construction during below zero temperatures, the founding stratum should be protected from freezing temperatures by the use of straw, propane heaters and tarpaulins or other suitable means. In this regard, the base of the excavations should be insulated from sub-zero temperatures immediately upon exposure and until such time as heat is adequately supplied to the building and the footings are protected with sufficient soil cover to prevent freezing at founding level.

Trench excavations and pavement construction are also difficult activities to complete during freezing conditions without introducing frost in the subgrade or in the excavation walls and bottoms. Precautions should be taken if such activities are to be carried out during freezing conditions.



## 6.7 Corrosion Potential and Sulphate

The results of analytical testing show that the sulphate content is less than 0.1%. This result is indicative that Type 10 Portland cement (normal cement) would be appropriate for this site. The chloride content and the pH of the sample indicate that they are not significant factors in creating a corrosive environment for exposed ferrous metals at this site, whereas the resistivity is indicative of a Moderate to slightly aggressive corrosive environment.

## 6.8 Landscaping Considerations

### Tree Planting Restrictions on 444 Citigate Drive

In accordance with the City of Ottawa Tree Planting in Sensitive Marine Clay Soils (2017 Guidelines), Paterson completed a soils review for samples taken from 444 Citigate Drive to determine applicable tree planting setbacks. Atterberg limits testing, grain size distribution and hydrometer testing were completed for recovered silty clay samples at selected locations throughout the subject site. The above noted soil samples were recovered from elevations below the anticipated design underside of footing elevation and 3.5 m depth below anticipated finished grade. The results of our testing are presented in Subsection 4.2 and in Appendix 1.

### High Sensitivity Area

Based on the results of our review, a high sensitivity clay soil was encountered as per City Guidelines at the areas outlined in Drawing PG6199-4 - Tree Planting Setback Recommendations in Appendix 2. Based on our Atterberg Limits test results, the plasticity index limit generally exceeds 40%. The following tree planting setbacks are recommended for these high sensitivity areas.

Large trees (mature height over 14 m) can be planted within this area provided a tree to foundation setback equal to the full mature height of the tree can be provided (e.g. in a park or other green space). Tree planting setback limits is **7.5 m** for small (mature tree height up to 7.5m) and medium size trees (mature tree height 7.5 m to 14 m) provided that the following conditions are met:

- The underside of footing (USF) is 2.1 m or greater below the lowest finished grade must be satisfied for footings within 10 m from the tree, as measured from the center of the tree trunk and verified by means of the Grading Plan as indicated procedural changes below. Based on our review of the silty clay crust at the founding elevation, this number can be lowered to 1.9 m due to the depth of the groundwater table and our assessment of the impacts of tree planting on the founding medium.

- A small tree must be provided with a minimum of 25 m<sup>3</sup> of available soil volume while a medium tree must be provided with a minimum of 30 m<sup>3</sup> of available soil volume, as determined by the Landscape Architect. The developer is to ensure that the soil is generally un-compacted when backfilling in street tree planting locations.
- The tree species must be small (mature tree height up to 7.5 m) to medium size (mature tree height 7.5 m to 14 m) as confirmed by the Landscape Architect.
- The foundation walls are to be reinforced at least nominally (minimum of two upper and two lower 15M bars in the foundation wall).
- Grading surround the tree must promote drainage to the tree root zone (in such a manner as not to be detrimental to the tree), as noted on the subdivision Grading Plan.

### **Tree Planting Restrictions on 560 Dealership Drive**

Based on our review, only Building A will be founded above a deposit of cohesive soil. In consideration of the inability for roots to penetrate the required very dense grade raise fill (approximately 1.0 to 3.0 m thick layer below the foundation) and engineered fill foundation pad (500 mm thick) layers, tree planting restrictions as based on the City of Ottawa Tree Planting in Sensitive Marine Clay Soils (2017 Guidelines) are not considered applicable for the subject site from a geotechnical perspective.

## 7.0 Recommendations

It is a requirement for the foundation design data provided herein to be applicable that the following material testing and observation program be performed by the geotechnical consultant.

- Review detailed grading plan from a geotechnical perspective.
- Observation of all bearing surfaces prior to the placement of concrete.
- Sampling and testing of the concrete and fill materials.
- Review and inspections of the cut and fill operations carried out to build up the subgrade.
- Periodic observation of the condition of unsupported excavation side slopes in excess of 3 m in height, if applicable.
- Observation of all subgrades prior to backfilling.
- Field density tests to ensure that the specified level of compaction has been achieved.
- Sampling and testing of the bituminous concrete including mix design reviews.

A report confirming that these works have been conducted in general accordance with our recommendations could be issued upon the completion of a satisfactory inspection program by the geotechnical consultant.

All excess soils, with the exception of engineered crushed stone fill, generated by construction activities that will be transported on-site or off-site should be handled as per *Ontario Regulation 406/19: On-Site and Excess Soil Management*.

## 8.0 Statement of Limitations

The recommendations provided are in accordance with the present understanding of the project. Paterson requests permission to review the recommendations when the drawings and specifications are completed.

A soils investigation is a limited sampling of a site. Should any conditions at the site be encountered which differ from those at the test locations, Paterson requests immediate notification to permit reassessment of our recommendations.

The recommendations provided herein should only be used by the design professionals associated with this project. They are not intended for contractors bidding on or undertaking the work. The latter should evaluate the factual information provided in this report and determine the suitability and completeness for their intended construction schedule and methods. Additional testing may be required for their purposes.

The present report applies only to the project described in this document. Use of this report for purposes other than those described herein or by person(s) other than Colonnade BridgePort or their agent(s) is not authorized without review by Paterson Group for the applicability of our recommendations to the altered use of the report.

**Paterson Group Inc.**



Maha K. Saleh, P.Eng.



David J. Gilbert, P.Eng.

### Report Distribution:

- Colonnade BridgePort (email copy)
- Paterson Group (1 copy)

# APPENDIX 1

SOIL PROFILE AND TEST DATA SHEETS – 444 CITIGATE DRIVE

SYMBOLS AND TERMS

ATTERBERG LIMITS TESTING RESULTS

GRAIN SIZE ANALYSIS AND HYDROMETER TEST RESULTS

ANALYTICAL TESTING RESULTS – 444 CITIGATE DRIVE

DATUM Geodetic

REMARKS

BORINGS BY CME-55 Low Clearance Drill

DATE November 16, 2022

FILE NO.  
**PG6119**

HOLE NO.  
**BH 1-22**

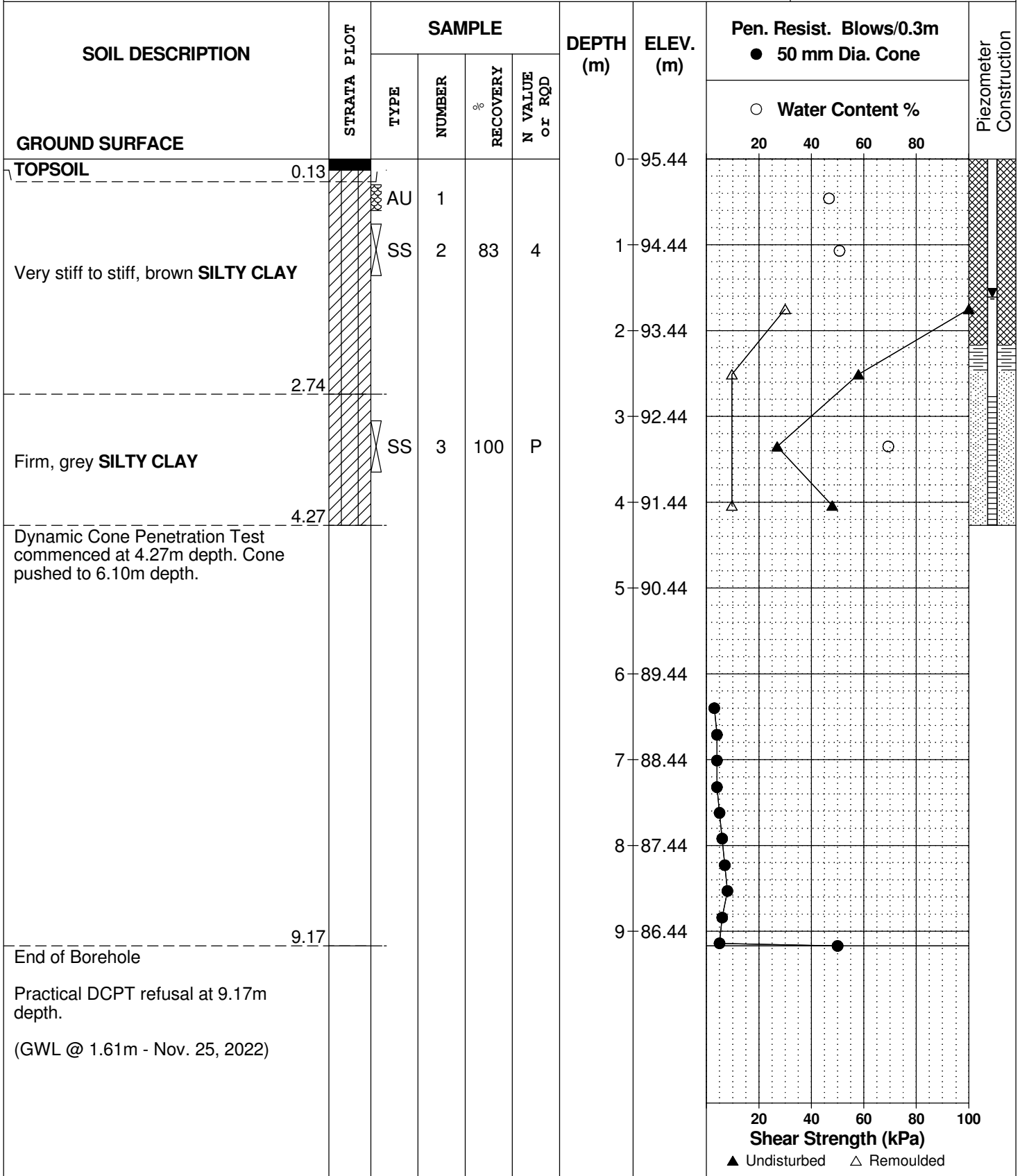

DATUM Geodetic

REMARKS

BORINGS BY CME-55 Low Clearance Drill

DATE November 16, 2022

FILE NO.  
**PG6119**

HOLE NO.  
**BH 2-22**

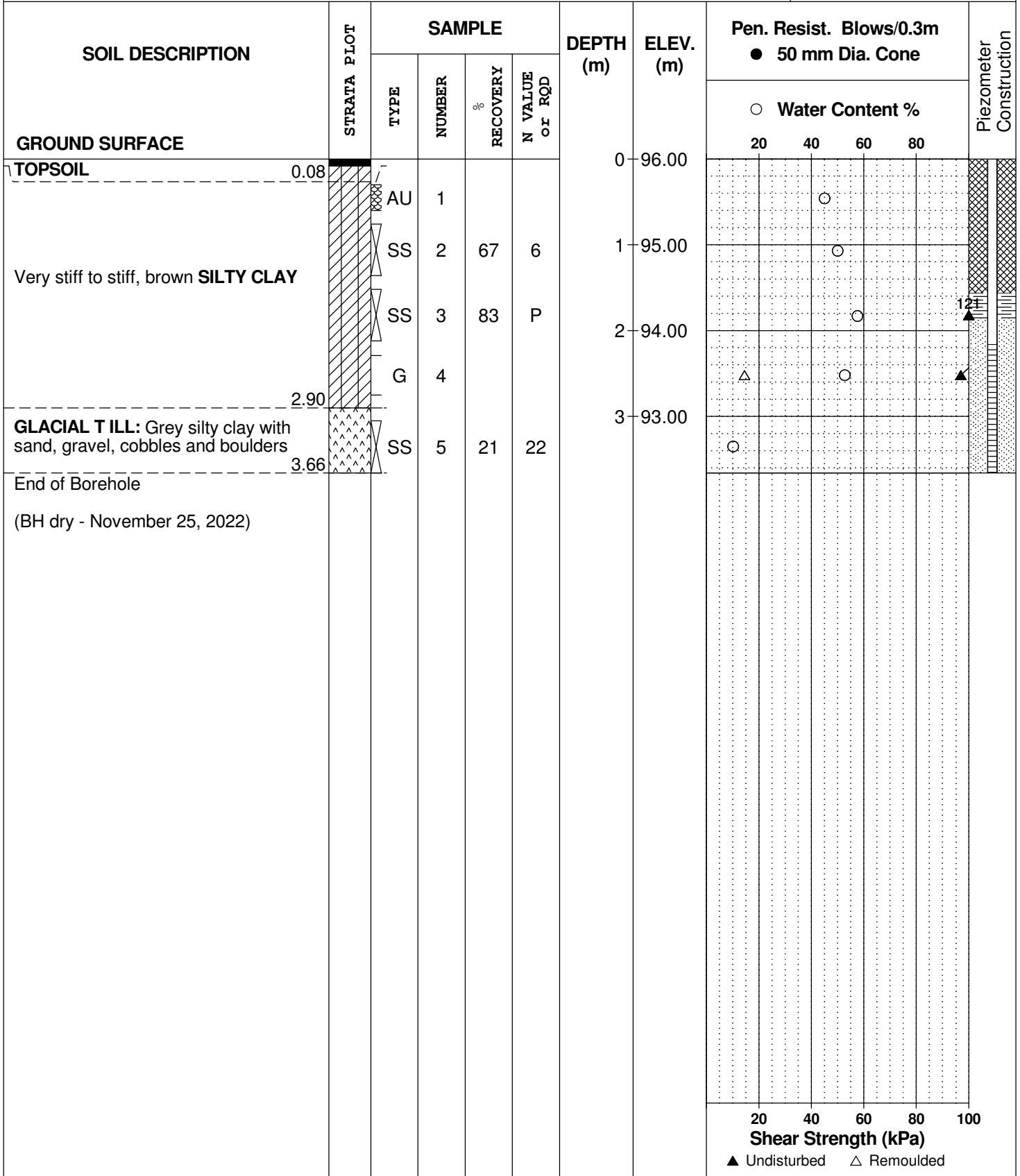

DATUM Geodetic

REMARKS

BORINGS BY CME-55 Low Clearance Drill

DATE November 16, 2022

FILE NO.  
**PG6119**

HOLE NO.  
**BH 3-22**

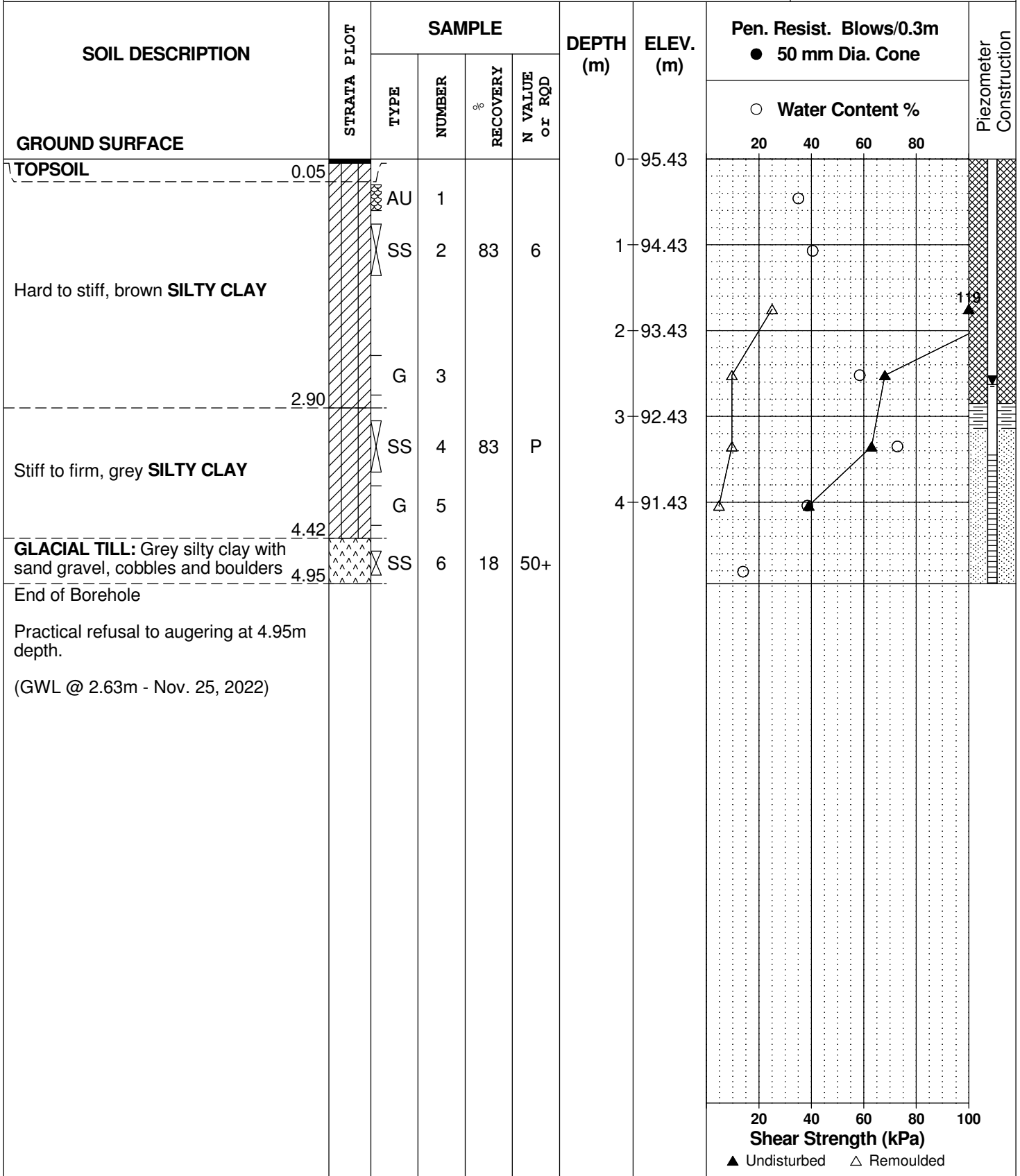



DATUM Geodetic

REMARKS

BORINGS BY CME-55 Low Clearance Drill

DATE November 16, 2022

FILE NO.  
**PG6119**

HOLE NO.  
**BH 4-22**

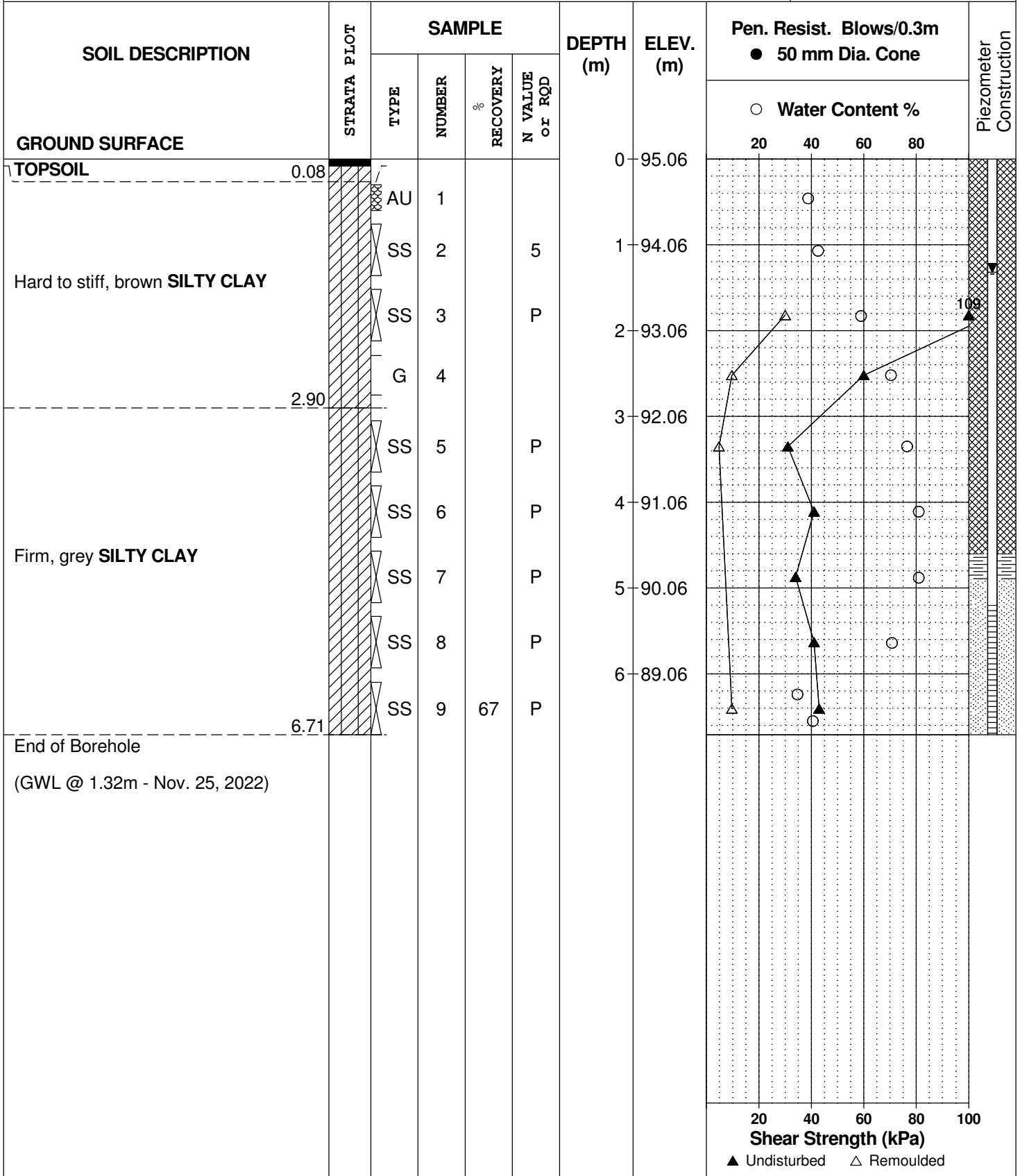

DATUM Geodetic

REMARKS

BORINGS BY CME-55 Low Clearance Drill

DATE November 17, 2022

FILE NO.  
**PG6119**

HOLE NO.  
**BH 5-22**

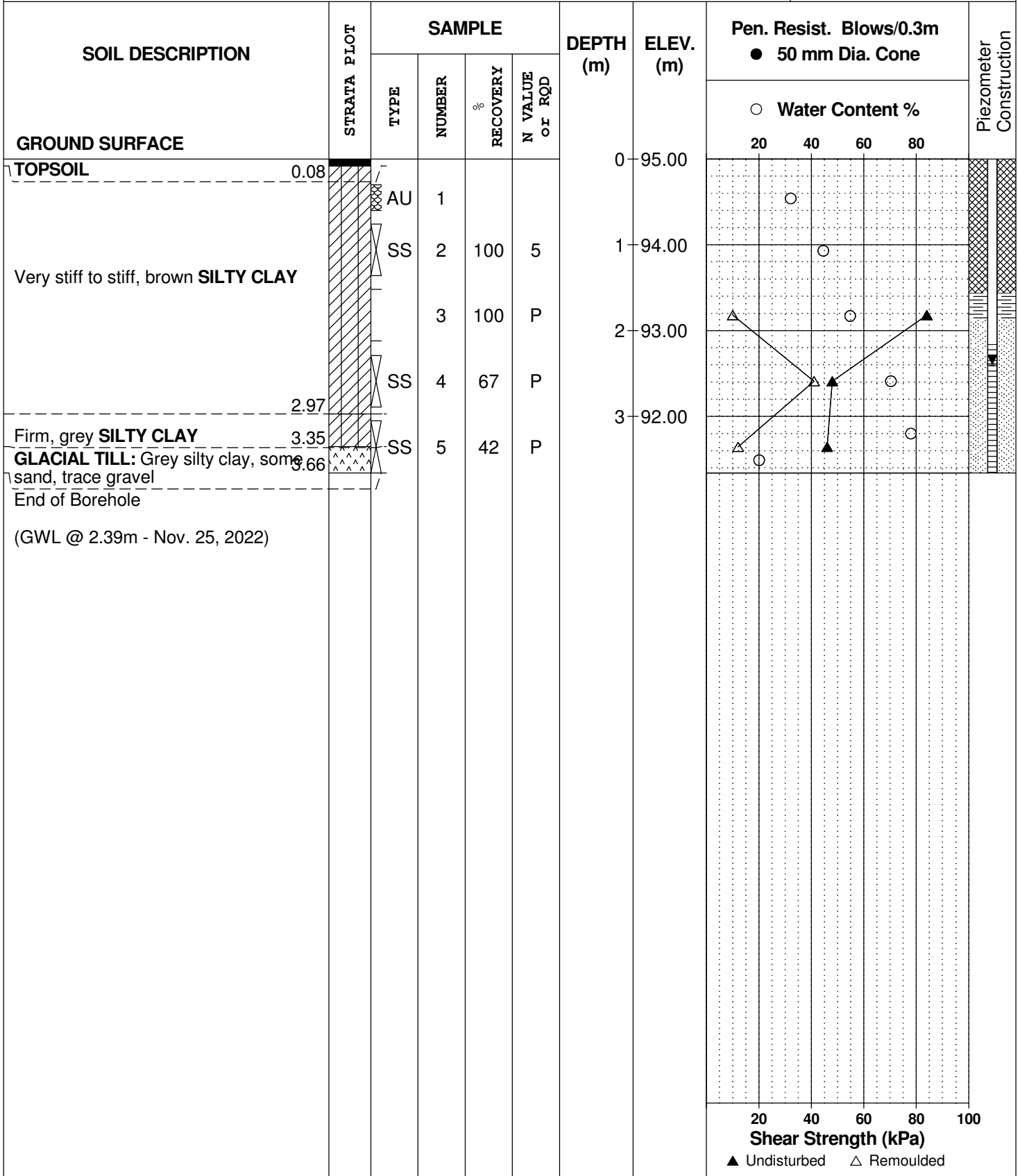

9 Auriga Drive, Ottawa, Ontario K2E 7T9

Geotechnical Investigation  
 Prop. Commercial Development - 444 Citigate Drive  
 Ottawa, Ontario

DATUM Geodetic

REMARKS

BORINGS BY CME-55 Low Clearance Drill

DATE November 17, 2022

FILE NO.  
**PG6119**

HOLE NO.  
**BH 6-22**

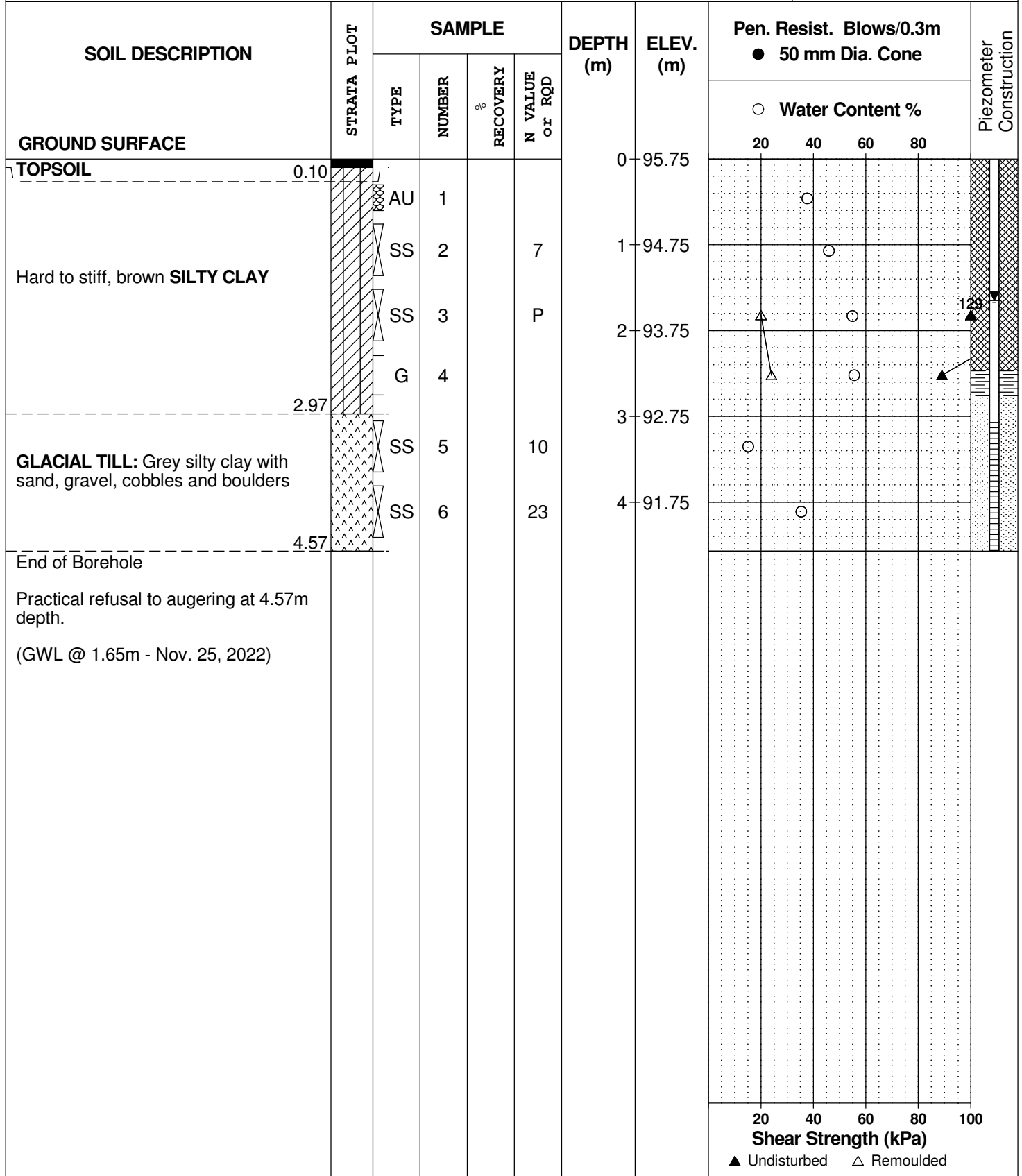

DATUM Geodetic

REMARKS

BORINGS BY CME-55 Low Clearance Drill

DATE November 17, 2022

FILE NO.  
**PG6119**

HOLE NO.  
**BH 7-22**

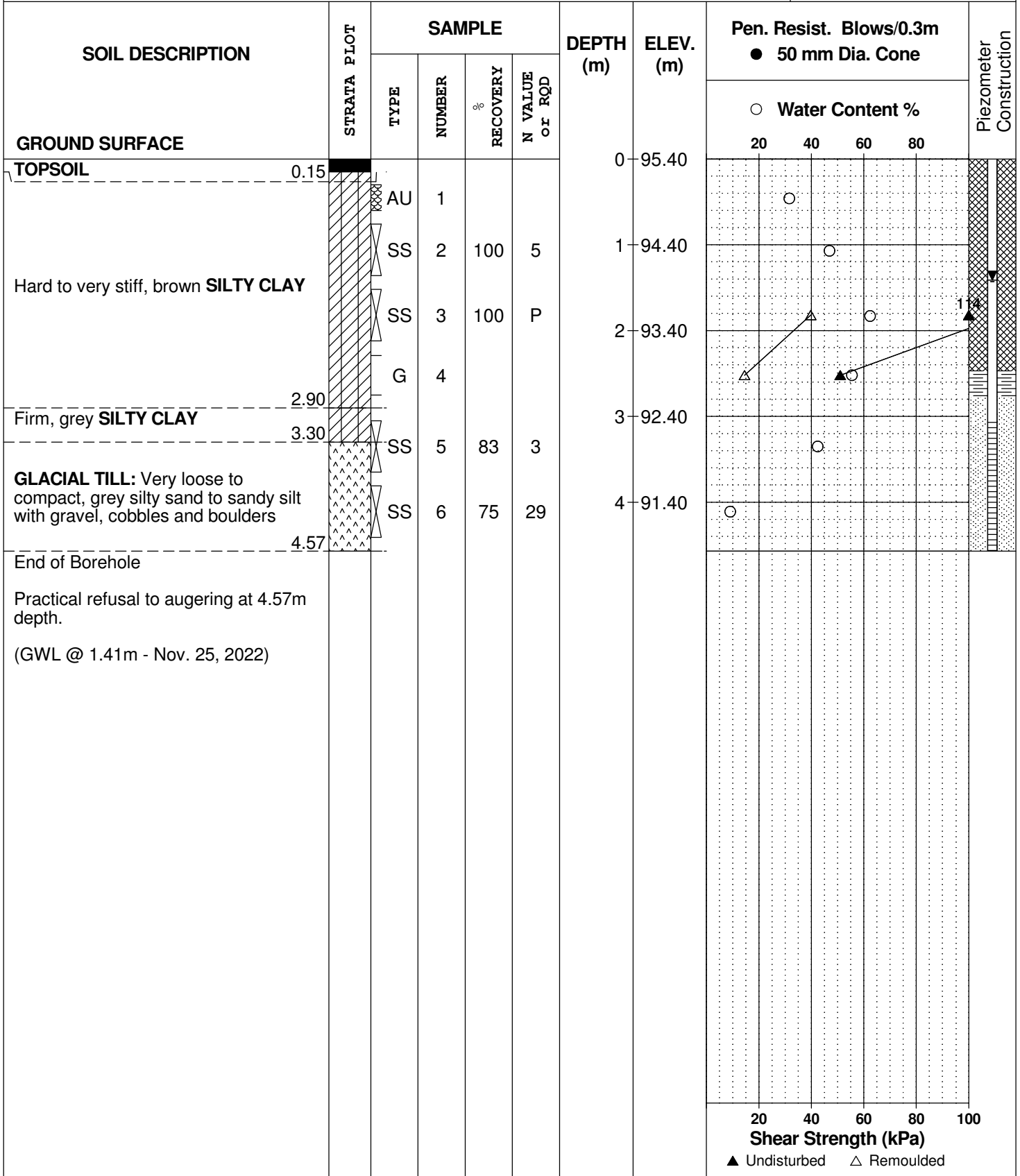

DATUM Geodetic

REMARKS

BORINGS BY CME-55 Low Clearance Drill

DATE November 17, 2022

FILE NO.  
**PG6119**

HOLE NO.  
**BH 8-22**

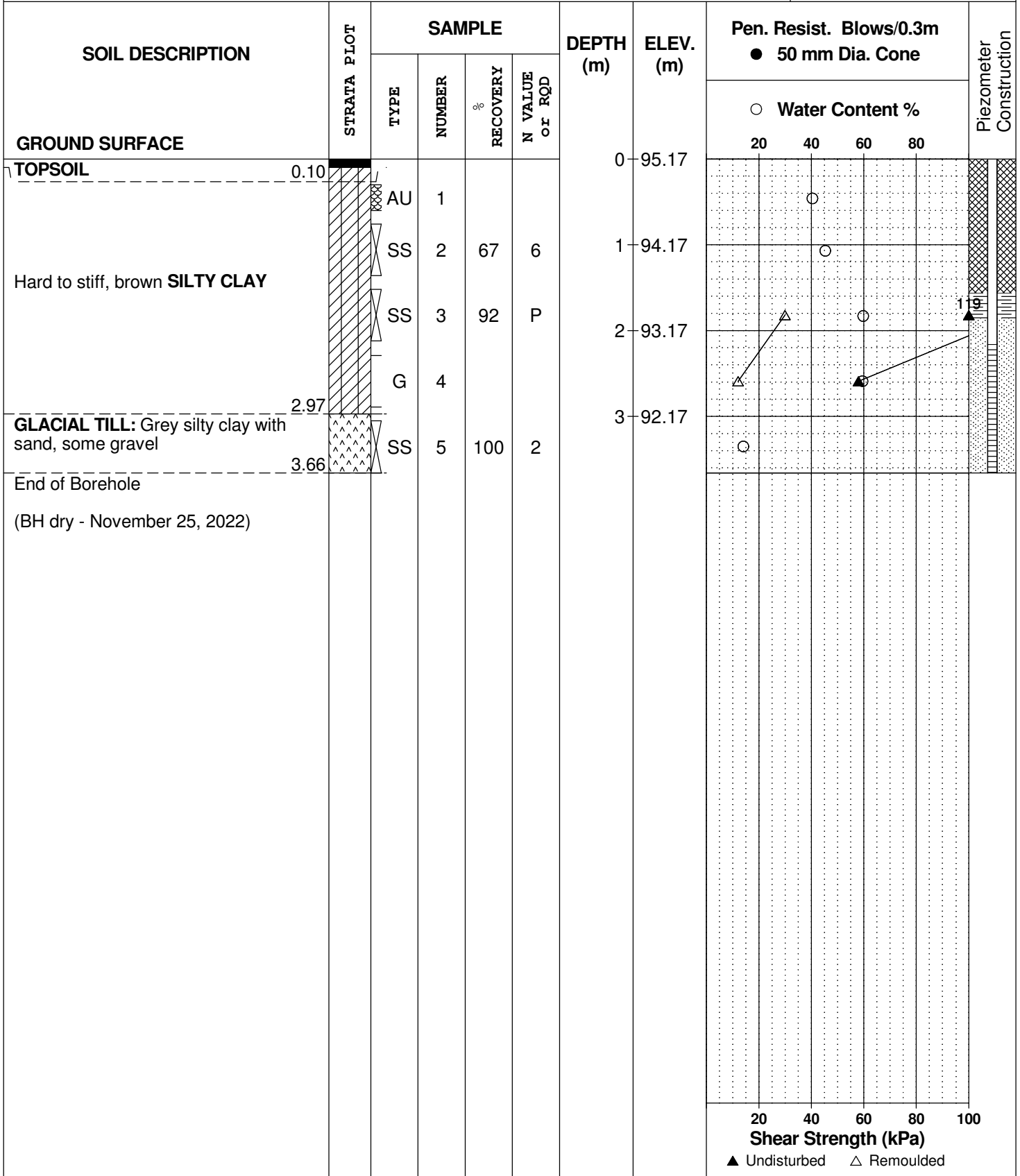

DATUM Geodetic

REMARKS

BORINGS BY CME-55 Low Clearance Drill

DATE November 17, 2022

FILE NO.  
**PG6119**

HOLE NO.  
**BH 9-22**

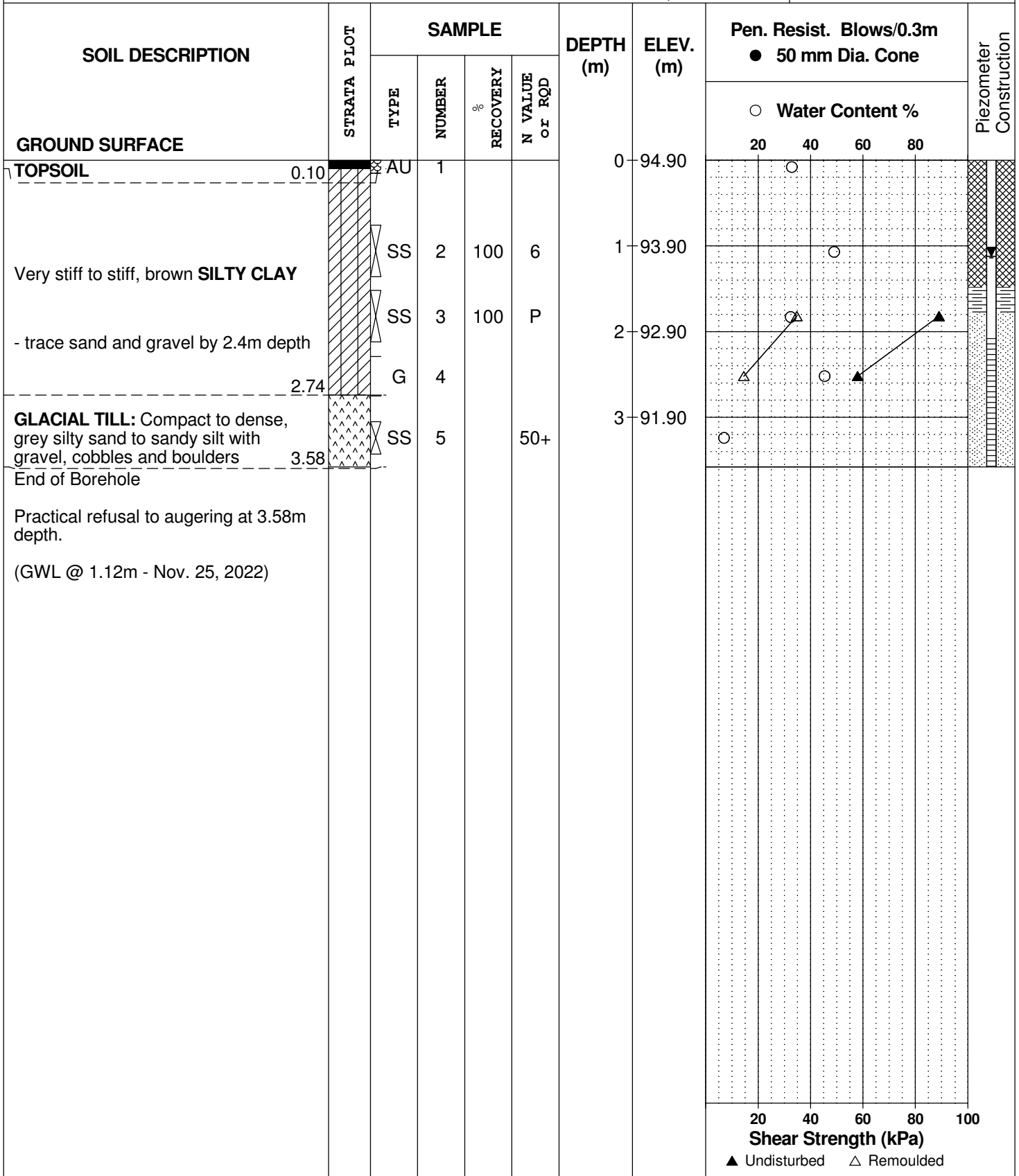

DATUM Geodetic

REMARKS

BORINGS BY CME-55 Low Clearance Drill

DATE November 17, 2022

FILE NO.  
**PG6119**

HOLE NO.  
**BH10-22**

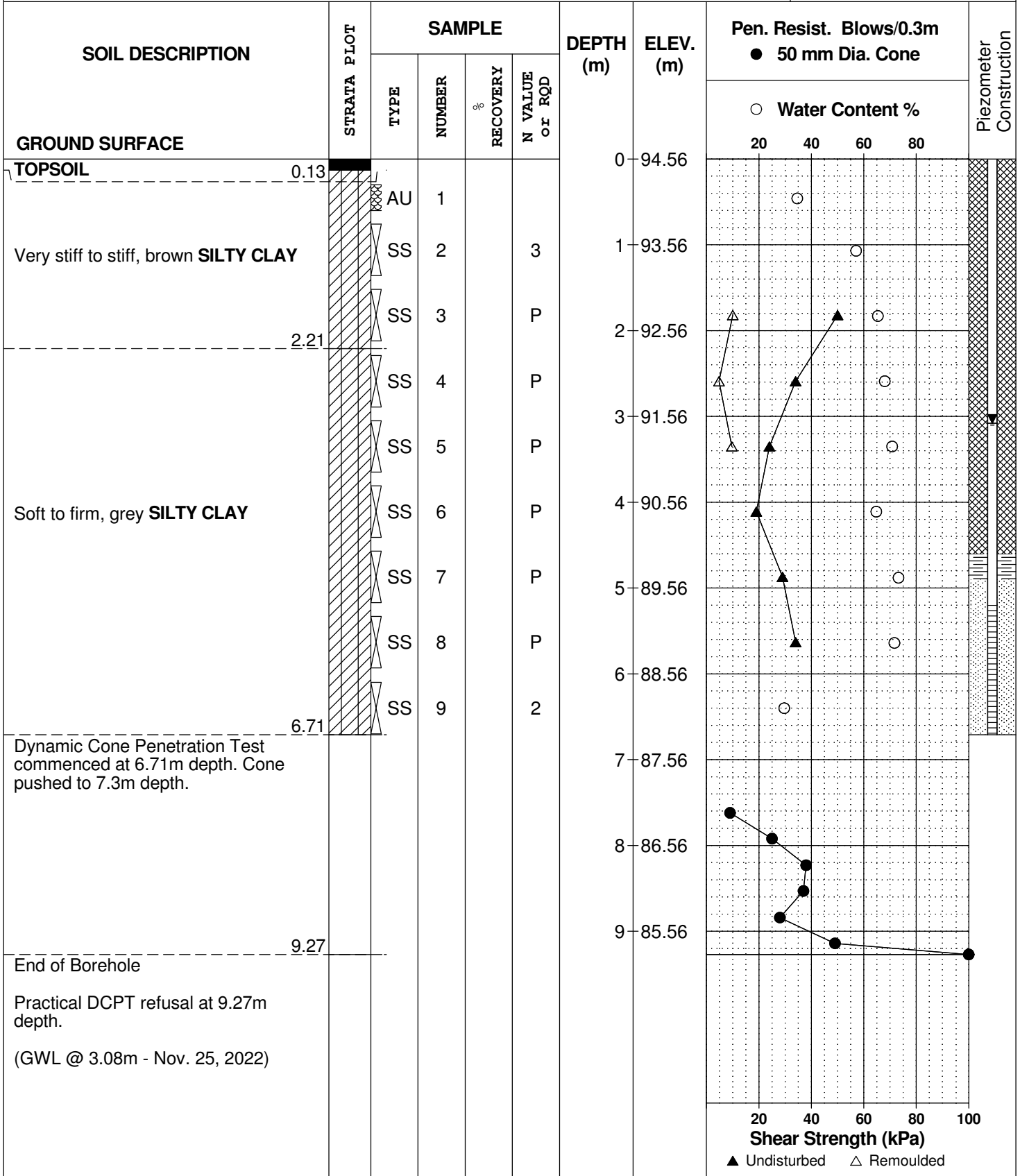

DATUM Geodetic

REMARKS

BORINGS BY CME-55 Low Clearance Drill

DATE November 18, 2022

FILE NO.  
**PG6119**

HOLE NO.  
**BH11-22**

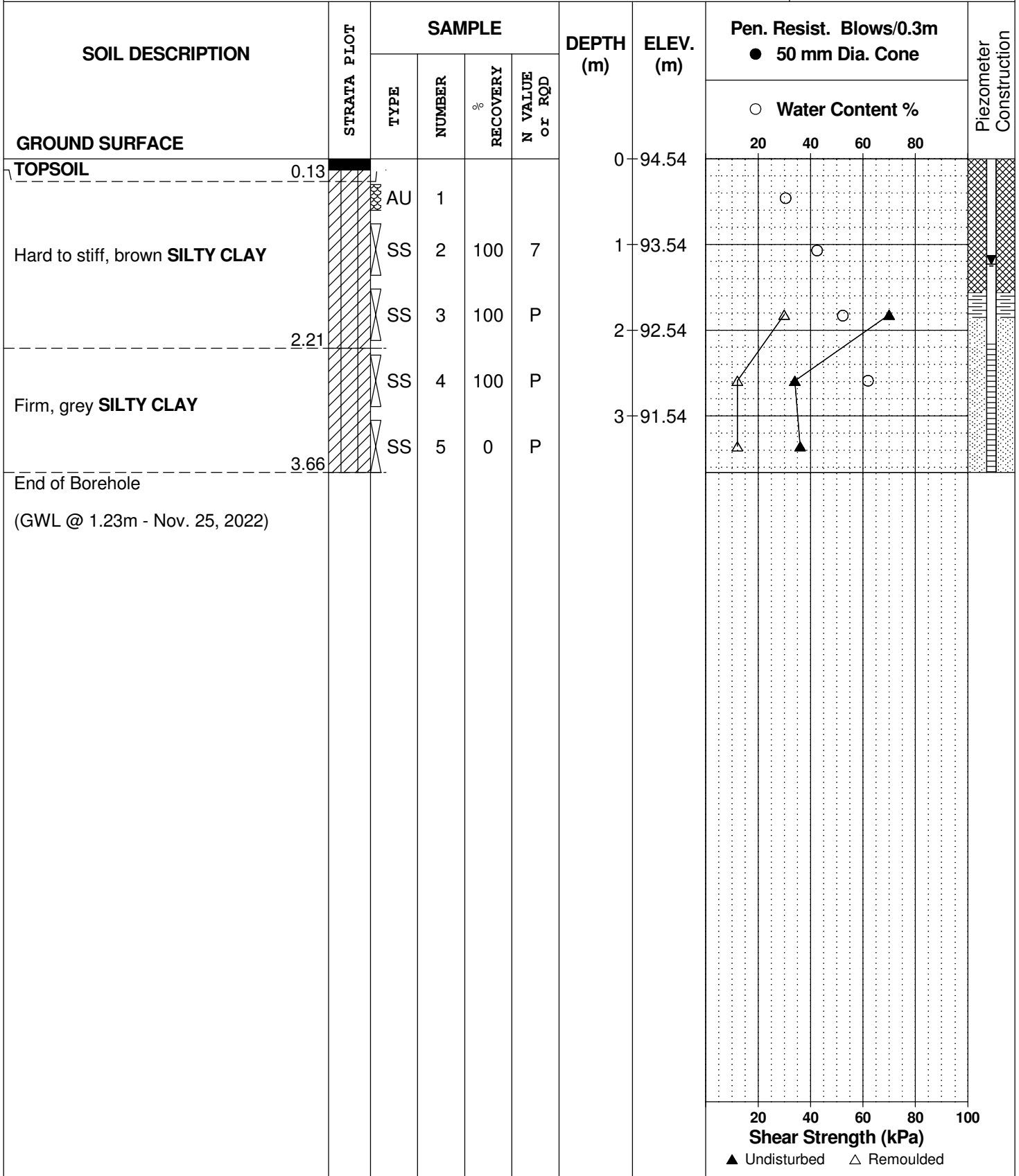



DATUM Geodetic

REMARKS

BORINGS BY CME-55 Low Clearance Drill

DATE November 18, 2022

FILE NO.  
**PG6119**

HOLE NO.  
**BH12-22**

SOIL DESCRIPTION	STRATA PLOT	SAMPLE				DEPTH (m)	ELEV. (m)	Pen. Resist. Blows/0.3m ● 50 mm Dia. Cone				Piezometer Construction
		TYPE	NUMBER	RECOVERY %	N VALUE or RQD			20	40	60	80	
<b>GROUND SURFACE</b>												
<b>TOPSOIL</b>	0.10					0	94.89					
Very stiff to stiff, brown <b>SILTY CLAY</b>		AU	1									
		SS	2		4	1	93.89					
	1.52											
<b>GLACIAL TILL:</b> Brown silty clay, some sand and gravel, occasional cobbles		SS	3		7	2	92.89					
- grey by 2.2m depth		SS	4		4							
		SS	5		11	3	91.89					
	3.66											
End of Borehole												
(GWL @ 2.43m - Nov. 25, 2022)												

20 40 60 80 100  
**Shear Strength (kPa)**  
▲ Undisturbed    △ Remoulded

DATUM Geodetic

REMARKS

BORINGS BY CME-55 Low Clearance Drill

DATE November 18, 2022

FILE NO.  
**PG6119**

HOLE NO.  
**BH13-22**

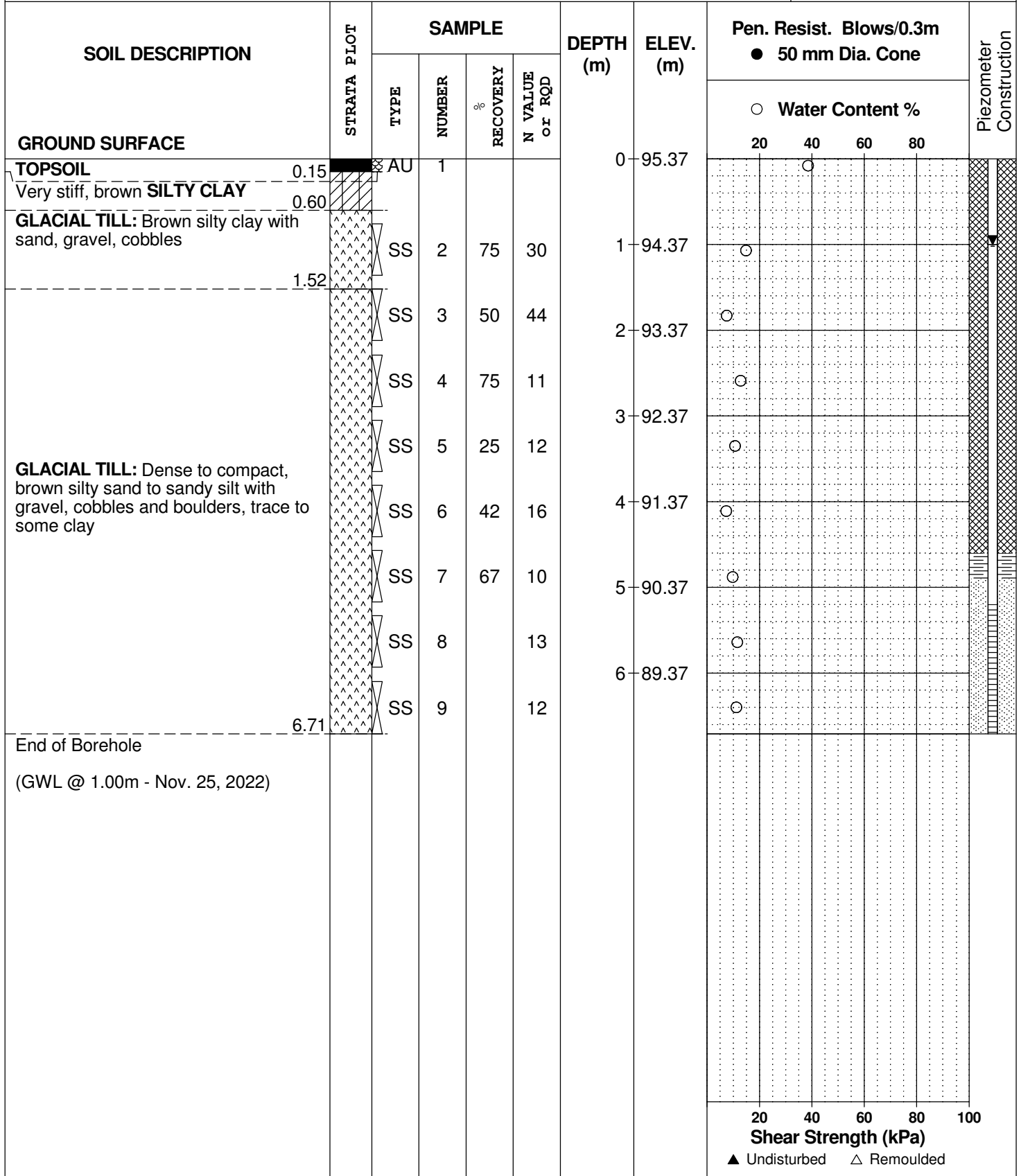

DATUM Geodetic

REMARKS

BORINGS BY CME-55 Low Clearance Drill

DATE November 22, 2022

FILE NO.  
**PG6119**

HOLE NO.  
**BH14-22**

SOIL DESCRIPTION	STRATA PLOT	SAMPLE				DEPTH (m)	ELEV. (m)	Pen. Resist. Blows/0.3m ● 50 mm Dia. Cone				Piezometer Construction	
		TYPE	NUMBER	RECOVERY %	N VALUE or RQD			○ Water Content %					
GROUND SURFACE								20	40	60	80		
<b>TOPSOIL</b> Loose to compact, brown <b>SILTY SAND</b> , some gravel, cobbles, trace clay	0.36 0.97	AU	1			0	98.13						
<b>GLACIAL TILL:</b> Compact to very dense, brown silty sand to sandy silt with gravel, cobbles and boulders  - loose to compact and grey by 3.0m depth		SS	2	25	15	1	97.13						
		SS	3	100	50+	2	96.13						
		SS	4	30	50+	3	95.13						
		SS	5		50+	4	94.13						
		SS	6		7	5	93.13						
		SS	7		37	6	92.13						
		SS	8		21								
		SS	9		50+								
	End of Borehole  Practical refusal to augering at 6.32m depth.  (GWL @ 0.99m - Nov. 25, 2022)	6.32											

20 40 60 80 100  
**Shear Strength (kPa)**  
 ▲ Undisturbed    △ Remoulded

## SOIL PROFILE AND TEST DATA

Geotechnical Investigation  
 Prop. Commercial Development - 444 Citigate Drive  
 Ottawa, Ontario

DATUM Geodetic

REMARKS

BORINGS BY CME-55 Low Clearance Drill

DATE November 22, 2022

FILE NO.  
**PG6119**

HOLE NO.  
**BH15-22**

SOIL DESCRIPTION	STRATA PLOT	SAMPLE				DEPTH (m)	ELEV. (m)	Pen. Resist. Blows/0.3m ● 50 mm Dia. Cone				Piezometer Construction	
		TYPE	NUMBER	RECOVERY	N VALUE or RQD			○ Water Content %					
GROUND SURFACE								20	40	60	80		
<b>TOPSOIL</b>						0	103.19						
Loose to compact, brown <b>SILTY SAND</b> , some gravel, cobbles	0.38 0.60	AU	1										
<b>GLACIAL TILL:</b> Compact to very dense, brown silty sand to sandy silt with gravel, cobbles and boulders		SS	2		26	1	102.19						
	2.03	SS	3		50+	2	101.19						
End of Borehole													
Practical refusal to augering at 2.03m depth.													
(BH dry - November 25, 2022)													

20 40 60 80 100  
**Shear Strength (kPa)**  
 ▲ Undisturbed    △ Remoulded

DATUM Geodetic

REMARKS

BORINGS BY CME-55 Low Clearance Drill

DATE November 22, 2022

FILE NO.  
**PG6119**

HOLE NO.  
**BH16-22**

SOIL DESCRIPTION	STRATA PLOT	SAMPLE			DEPTH (m)	ELEV. (m)	Pen. Resist. Blows/0.3m ● 50 mm Dia. Cone				Piezometer Construction	
		TYPE	NUMBER	RECOVERY %			N VALUE or RQD	○ Water Content %				
GROUND SURFACE							20	40	60	80		
<b>TOPSOIL</b>	0.38				0	105.17						
Dense, brown <b>SILTY SAND</b> , some gravel and cobbles	0.91	AU	1									
<b>GLACIAL TILL:</b> Very dense, brown silty and to sandy silt with gravel, cobbles and boulders		SS	2	58	36	1	104.17					
		SS	3	100	50+	2	103.17					
		SS	4	56	50+							
End of Borehole	3.05				3	102.17						
Practical refusal to augering at 3.05m depth. (BH dry - November 25, 2022)												
							20	40	60	80	100	
							<b>Shear Strength (kPa)</b>					
							▲ Undisturbed    △ Remoulded					

DATUM Geodetic

REMARKS

BORINGS BY CME-55 Low Clearance Drill

DATE November 23, 2022

FILE NO.  
**PG6119**

HOLE NO.  
**BH17-22**

SOIL DESCRIPTION	STRATA PLOT	SAMPLE				DEPTH (m)	ELEV. (m)	Pen. Resist. Blows/0.3m ● 50 mm Dia. Cone				Piezometer Construction	
		TYPE	NUMBER	RECOVERY %	N VALUE or RQD			20	40	60	80		
GROUND SURFACE						0	107.67						
TOPSOIL	0.23	AU	1										
GLACIAL TILL: Very dense, brown silty sand to sandy silt with gravel, cobbles and boulders		SS	2	58	50+	1	106.67						
		SS	3	67	50+	2	105.67						
		SS	4	100	50+								
		SS	5	67	50+	3	104.67						
		3.66											
End of Borehole (BH dry - November 25, 2022)													

20 40 60 80 100  
**Shear Strength (kPa)**  
 ▲ Undisturbed    △ Remoulded

DATUM Geodetic

REMARKS

BORINGS BY CME-55 Low Clearance Drill

DATE November 23, 2022

FILE NO.  
**PG6119**

HOLE NO.  
**BH18-22**

SOIL DESCRIPTION	STRATA PLOT	SAMPLE				DEPTH (m)	ELEV. (m)	Pen. Resist. Blows/0.3m ● 50 mm Dia. Cone				Piezometer Construction	
		TYPE	NUMBER	RECOVERY %	N VALUE or RQD			20	40	60	80		
GROUND SURFACE						0	102.67						
TOPSOIL	0.36	AU	1										
GLACIAL TILL: Compact to dense, brown silty sand to sandy silt with gravel, cobbles and boulders		SS	2	75	25	1	101.67						
		SS	3	83	39	2	100.67						
		SS	4	75	46								
		SS	5	83	43	3	99.67						
		3.66											
End of Borehole (BH dry - November 25, 2022)													

20 40 60 80 100  
**Shear Strength (kPa)**  
 ▲ Undisturbed    △ Remoulded

DATUM Geodetic

REMARKS

BORINGS BY CME-55 Low Clearance Drill

DATE November 23, 2022

FILE NO.  
**PG6119**

HOLE NO.  
**BH19-22**

SOIL DESCRIPTION	STRATA PLOT	SAMPLE				DEPTH (m)	ELEV. (m)	Pen. Resist. Blows/0.3m ● 50 mm Dia. Cone				Piezometer Construction	
		TYPE	NUMBER	RECOVERY %	N VALUE or RQD			20	40	60	80		
GROUND SURFACE						0	106.78						
TOPSOIL	0.43	AU	1										
GLACIAL TILL: Very dense, brown silty sand to sandy silt with gravel, cobbles and boulders		SS	2	83	50+	1	105.78						
		SS	3	93	50+	2	104.78						
		SS	4	33	50+								
End of Borehole	2.80												
Practical refusa to augering at 2.80m depth. (BH dry - November 25, 2022)													
								20	40	60	80	100	
								Shear Strength (kPa)					
								▲ Undisturbed    △ Remoulded					



DATUM Geodetic

REMARKS

BORINGS BY CME-55 Low Clearance Drill

DATE November 23, 2022

FILE NO.  
**PG6119**

HOLE NO.  
**BH20-22**

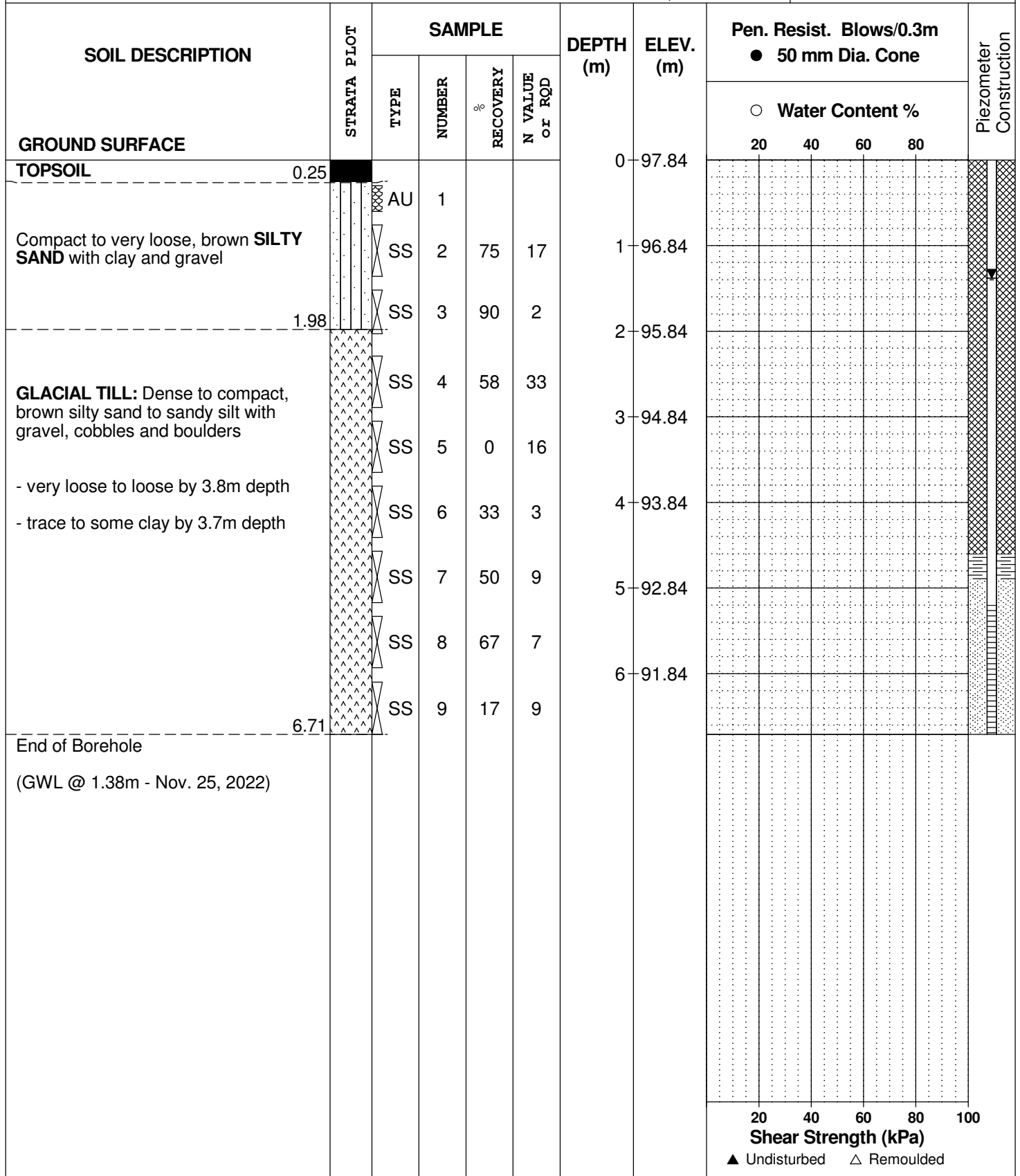

DATUM Geodetic

REMARKS

BORINGS BY Track-Mount Power Auger

DATE November 24, 2022

FILE NO.  
**PG6119**

HOLE NO.  
**BH21-22**

SOIL DESCRIPTION	STRATA PLOT	SAMPLE				DEPTH (m)	ELEV. (m)	Pen. Resist. Blows/0.3m ● 50 mm Dia. Cone				Piezometer Construction	
		TYPE	NUMBER	RECOVERY %	N VALUE or RQD			20	40	60	80		
GROUND SURFACE						0	101.41						
TOPSOIL	0.38	AU	1										
GLACIAL TILL: Compact to dense, brown silty sand to sandy silt with gravel, cobbles, boulders, rock fragments	1.42	SS	2		30	1	100.41						
End of Borehole													
Practical refusal to augering at 1.42m depth. (BH dry - November 25, 2022)													

20 40 60 80 100  
**Shear Strength (kPa)**  
 ▲ Undisturbed    △ Remoulded

## SOIL PROFILE AND TEST DATA

Geotechnical Investigation  
 Prop. Commercial Development - 444 Citigate Drive  
 Ottawa, Ontario

DATUM Geodetic

REMARKS

BORINGS BY Track-Mount Power Auger

DATE November 24, 2022

FILE NO.  
**PG6119**

HOLE NO.  
**BH22-22**

SOIL DESCRIPTION	STRATA PLOT	SAMPLE				DEPTH (m)	ELEV. (m)	Pen. Resist. Blows/0.3m ● 50 mm Dia. Cone				Piezometer Construction	
		TYPE	NUMBER	RECOVERY %	N VALUE or RQD			20	40	60	80		
<b>GROUND SURFACE</b>						0	104.71						
<b>TOPSOIL</b>	0.28												
Dense, brown <b>SILTY SAND</b> , some gravel		AU	1										
		SS	2	50	39	1	103.71						
	1.45												
<b>GLACIAL TILL:</b> Dense to compact, brown silty sand to sandy silt with gravel, cobbles and boulders  - some rock fragments by 3.5m depth		SS	3	67	50+	2	102.71						
		SS	4	75	33								
		SS	5	21	29	3	101.71						
End of Borehole	3.66												

20 40 60 80 100  
**Shear Strength (kPa)**

▲ Undisturbed    △ Remoulded

DATUM Geodetic

REMARKS

BORINGS BY Track-Mount Power Auger

DATE November 24, 2022

FILE NO.  
**PG6119**

HOLE NO.  
**BH23-22**

SOIL DESCRIPTION	STRATA PLOT	SAMPLE				DEPTH (m)	ELEV. (m)	Pen. Resist. Blows/0.3m ● 50 mm Dia. Cone				Piezometer Construction	
		TYPE	NUMBER	RECOVERY %	N VALUE or RQD			○ Water Content %					
GROUND SURFACE								20	40	60	80		
TOPSOIL	0.30					0	106.24						
Compact, brown <b>SILTY SAND</b> , some gravel and clay	0.69	AU	1										
<b>GLACIAL TILL:</b> Compact to dense, brown silty sand to sandy silt with gravel, cobbles and boulders  - silty clay layer from 1.7 to 1.85m depth  - some clay by 4.3m depth		SS	2	50	21	1	105.24						
		SS	3	100	19	2	104.24						
		SS	9	100	50+	3	103.24						
		SS	5	100	37	4	102.24						
		SS	6	58	16	5	101.24						
		SS	7	58	6	6							
		SS	8	78	50+	7							
		5.69											
End of Borehole  Practical refusal to augering at 5.69m depth.  (GWL @ 2.00m - Nov. 25, 2022)													

20 40 60 80 100  
**Shear Strength (kPa)**  
 ▲ Undisturbed    △ Remoulded

DATUM Geodetic

REMARKS

BORINGS BY Track-Mount Power Auger

DATE November 25, 2022

FILE NO.  
**PG6119**

HOLE NO.  
**BH24-22**

SOIL DESCRIPTION	STRATA PLOT	SAMPLE				DEPTH (m)	ELEV. (m)	Pen. Resist. Blows/0.3m ● 50 mm Dia. Cone				Piezometer Construction	
		TYPE	NUMBER	RECOVERY %	N VALUE or RQD			20	40	60	80		
GROUND SURFACE						0	103.94						
TOPSOIL	0.41	AU	1										
GLACIAL TILL: Dense to very dense, brown silty sand with gravel, cobbles and boulders		SS	2	58	32	1	102.94						
		SS	3	67	50+	2	101.94						
		SS	4	100	50+	3	100.94						
		SS	5	100	45	4	99.94						
		SS	6	67	38	5							
		SS	7	100	50+	6							
End of Borehole	4.78												
Practical refusal to augering at 4.78m depth.													

20 40 60 80 100  
**Shear Strength (kPa)**  
 ▲ Undisturbed    △ Remoulded

9 Auriga Drive, Ottawa, Ontario K2E 7T9

Geotechnical Investigation  
 Prop. Commercial Development - 444 Citigate Drive  
 Ottawa, Ontario

DATUM Geodetic

REMARKS

BORINGS BY Track-Mount Power Auger

DATE November 25, 2022

FILE NO.  
**PG6119**

HOLE NO.  
**BH25-22**

SOIL DESCRIPTION	STRATA PLOT	SAMPLE				DEPTH (m)	ELEV. (m)	Pen. Resist. Blows/0.3m ● 50 mm Dia. Cone				Piezometer Construction
		TYPE	NUMBER	RECOVERY %	N VALUE or RQD			○ Water Content %				
								20	40	60	80	
<b>GROUND SURFACE</b>						0	100.23					
<b>TOPSOIL</b>	0.25											
Compact, brown <b>SILTY SAND</b> , some gravel	0.69	AU	1									
Compact to very dense, brown silty sand with gravel, cobbles and boulders  - compact to loose and grey by 3.8m depth		SS	2	67	22	1	99.23					
		SS	3	100	50+	2	98.23					
		SS	4	75	50+	3	97.23					
		SS	5	75	50+	4	96.23					
		SS	6	50	12	5	95.23					
		SS	7	83	9							
	End of Borehole	5.23										

20 40 60 80 100  
**Shear Strength (kPa)**  
 ▲ Undisturbed    △ Remoulded

# SYMBOLS AND TERMS

## SOIL DESCRIPTION

Behavioural properties, such as structure and strength, take precedence over particle gradation in describing soils. Terminology describing soil structure are as follows:

Desiccated	-	having visible signs of weathering by oxidation of clay minerals, shrinkage cracks, etc.
Fissured	-	having cracks, and hence a blocky structure.
Varved	-	composed of regular alternating layers of silt and clay.
Stratified	-	composed of alternating layers of different soil types, e.g. silt and sand or silt and clay.
Well-Graded	-	Having wide range in grain sizes and substantial amounts of all intermediate particle sizes (see Grain Size Distribution).
Uniformly-Graded	-	Predominantly of one grain size (see Grain Size Distribution).

The standard terminology to describe the strength of cohesionless soils is the relative density, usually inferred from the results of the Standard Penetration Test (SPT) 'N' value. The SPT N value is the number of blows of a 63.5 kg hammer, falling 760 mm, required to drive a 51 mm O.D. split spoon sampler 300 mm into the soil after an initial penetration of 150 mm.

Relative Density	'N' Value	Relative Density %
Very Loose	<4	<15
Loose	4-10	15-35
Compact	10-30	35-65
Dense	30-50	65-85
Very Dense	>50	>85

The standard terminology to describe the strength of cohesive soils is the consistency, which is based on the undisturbed undrained shear strength as measured by the in situ or laboratory vane tests, penetrometer tests, unconfined compression tests, or occasionally by Standard Penetration Tests.

Consistency	Undrained Shear Strength (kPa)	'N' Value
Very Soft	<12	<2
Soft	12-25	2-4
Firm	25-50	4-8
Stiff	50-100	8-15
Very Stiff	100-200	15-30
Hard	>200	>30

## SYMBOLS AND TERMS (continued)

### SOIL DESCRIPTION (continued)

Cohesive soils can also be classified according to their "sensitivity". The sensitivity is the ratio between the undisturbed undrained shear strength and the remoulded undrained shear strength of the soil.

Terminology used for describing soil strata based upon texture, or the proportion of individual particle sizes present is provided on the Textural Soil Classification Chart at the end of this information package.

### ROCK DESCRIPTION

The structural description of the bedrock mass is based on the Rock Quality Designation (RQD).

The RQD classification is based on a modified core recovery percentage in which all pieces of sound core over 100 mm long are counted as recovery. The smaller pieces are considered to be a result of closely-spaced discontinuities (resulting from shearing, jointing, faulting, or weathering) in the rock mass and are not counted. RQD is ideally determined from NXL size core. However, it can be used on smaller core sizes, such as BX, if the bulk of the fractures caused by drilling stresses (called "mechanical breaks") are easily distinguishable from the normal in situ fractures.

<b>RQD %</b>	<b>ROCK QUALITY</b>
90-100	Excellent, intact, very sound
75-90	Good, massive, moderately jointed or sound
50-75	Fair, blocky and seamy, fractured
25-50	Poor, shattered and very seamy or blocky, severely fractured
0-25	Very poor, crushed, very severely fractured

### SAMPLE TYPES

SS	-	Split spoon sample (obtained in conjunction with the performing of the Standard Penetration Test (SPT))
TW	-	Thin wall tube or Shelby tube
PS	-	Piston sample
AU	-	Auger sample or bulk sample
WS	-	Wash sample
RC	-	Rock core sample (Core bit size AXT, BXL, etc.). Rock core samples are obtained with the use of standard diamond drilling bits.



## SYMBOLS AND TERMS (continued)

### GRAIN SIZE DISTRIBUTION

MC%	-	Natural moisture content or water content of sample, %
LL	-	Liquid Limit, % (water content above which soil behaves as a liquid)
PL	-	Plastic limit, % (water content above which soil behaves plastically)
PI	-	Plasticity index, % (difference between LL and PL)
Dxx	-	Grain size which xx% of the soil, by weight, is of finer grain sizes These grain size descriptions are not used below 0.075 mm grain size
D10	-	Grain size at which 10% of the soil is finer (effective grain size)
D60	-	Grain size at which 60% of the soil is finer
Cc	-	Concavity coefficient = $(D_{30})^2 / (D_{10} \times D_{60})$
Cu	-	Uniformity coefficient = $D_{60} / D_{10}$

Cc and Cu are used to assess the grading of sands and gravels:

Well-graded gravels have:  $1 < Cc < 3$  and  $Cu > 4$

Well-graded sands have:  $1 < Cc < 3$  and  $Cu > 6$

Sands and gravels not meeting the above requirements are poorly-graded or uniformly-graded.

Cc and Cu are not applicable for the description of soils with more than 10% silt and clay (more than 10% finer than 0.075 mm or the #200 sieve)

### CONSOLIDATION TEST

$p'_o$	-	Present effective overburden pressure at sample depth
$p'_c$	-	Preconsolidation pressure of (maximum past pressure on) sample
Ccr	-	Recompression index (in effect at pressures below $p'_c$ )
Cc	-	Compression index (in effect at pressures above $p'_c$ )
OC Ratio		Overconsolidation ratio = $p'_c / p'_o$
Void Ratio		Initial sample void ratio = volume of voids / volume of solids
Wo	-	Initial water content (at start of consolidation test)

### PERMEABILITY TEST

k	-	Coefficient of permeability or hydraulic conductivity is a measure of the ability of water to flow through the sample. The value of k is measured at a specified unit weight for (remoulded) cohesionless soil samples, because its value will vary with the unit weight or density of the sample during the test.
---	---	--

## SYMBOLS AND TERMS (continued)

### STRATA PLOT



Topsoil



Asphalt

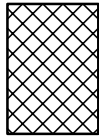

Fill



Peat

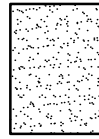

Sand

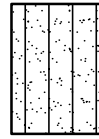

Silty Sand

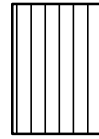

Silt

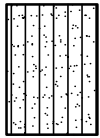

Sandy Silt

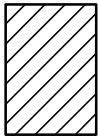

Clay

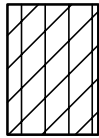

Silty Clay



Clayey Silty Sand



Glacial Till

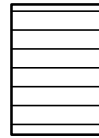

Shale

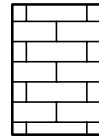

Bedrock

### MONITORING WELL AND PIEZOMETER CONSTRUCTION

#### MONITORING WELL CONSTRUCTION

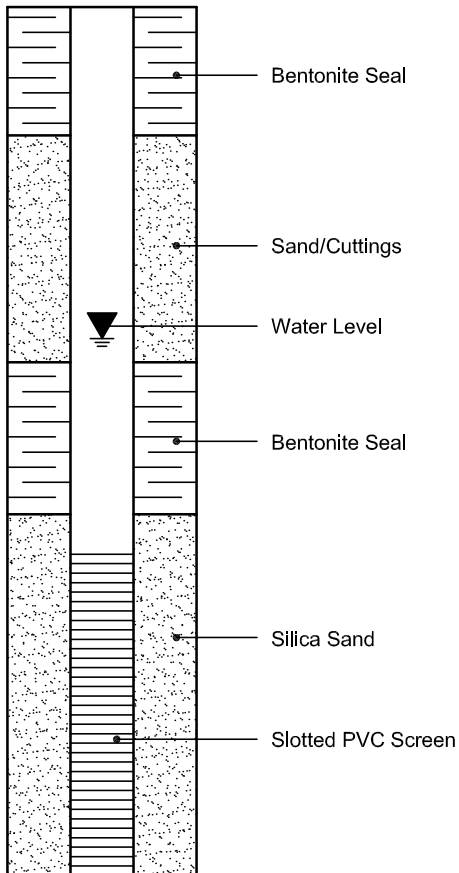

#### PIEZOMETER CONSTRUCTION

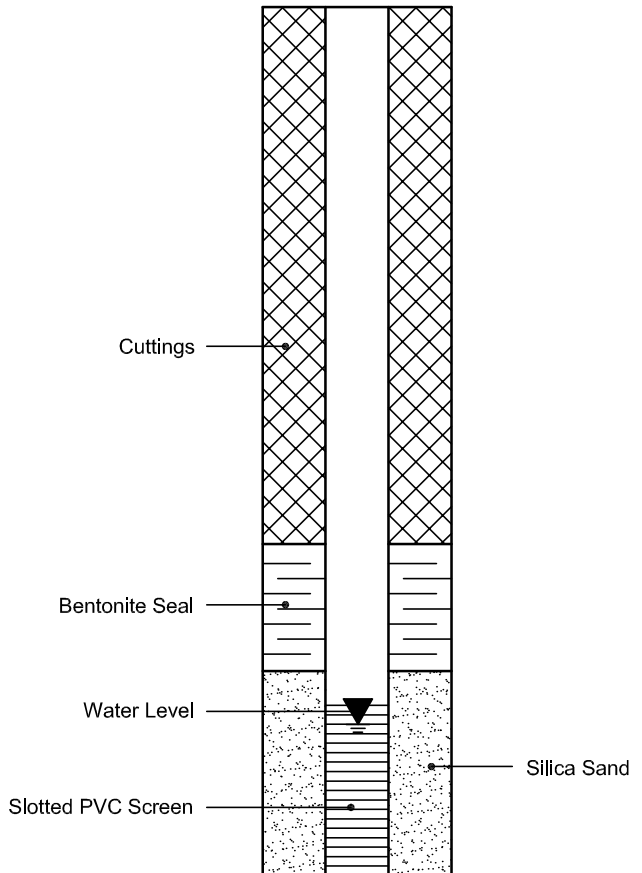

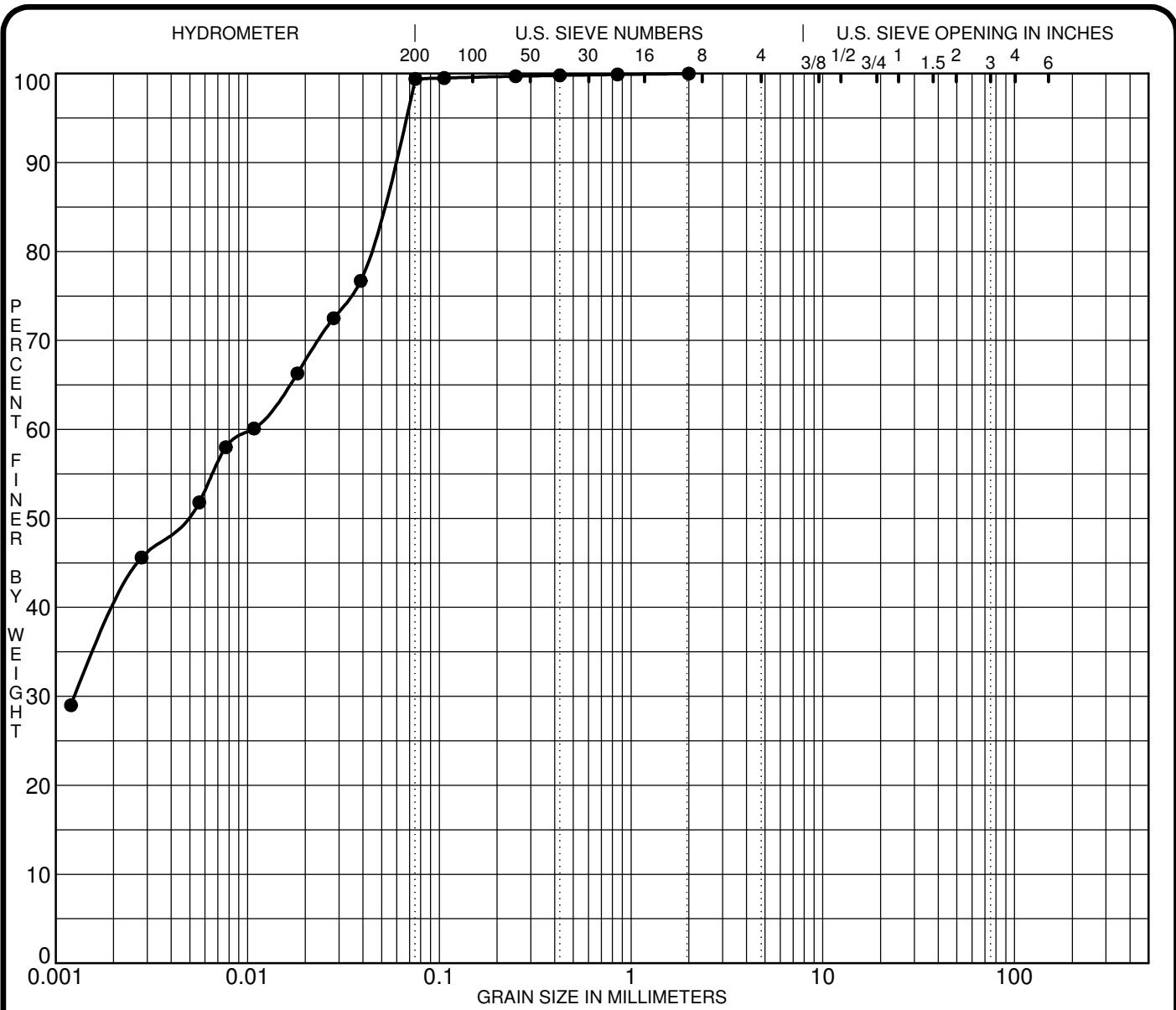

SILT OR CLAY	SAND			GRAVEL		COBBLES
	fine	medium	coarse	fine	coarse	

Specimen Identification	Classification				MC%	LL	PL	PI	Cc	Cu
● BH 2-22 SS3	Silty Clay									
☒										
▲										
★										
Specimen Identification	D100	D60	D30	D10	%Gravel	%Sand	%Silt	%Clay		
● BH 2-22 SS3	2.00	0.01	0.001		0.0	0.6	99.4			
☒										
▲										
★										

CLIENT Colonnade Bridgeport  
 PROJECT Geotechnical Investigation - Prop. Commercial  
Development - 444 Citigate Drive

FILE NO. PG6119  
 DATE 16 Nov 22

**paterosongroup** Consulting Engineers  
 9 Auriga Drive, Ottawa, Ontario K2E 7T9

**GRAIN SIZE DISTRIBUTION**

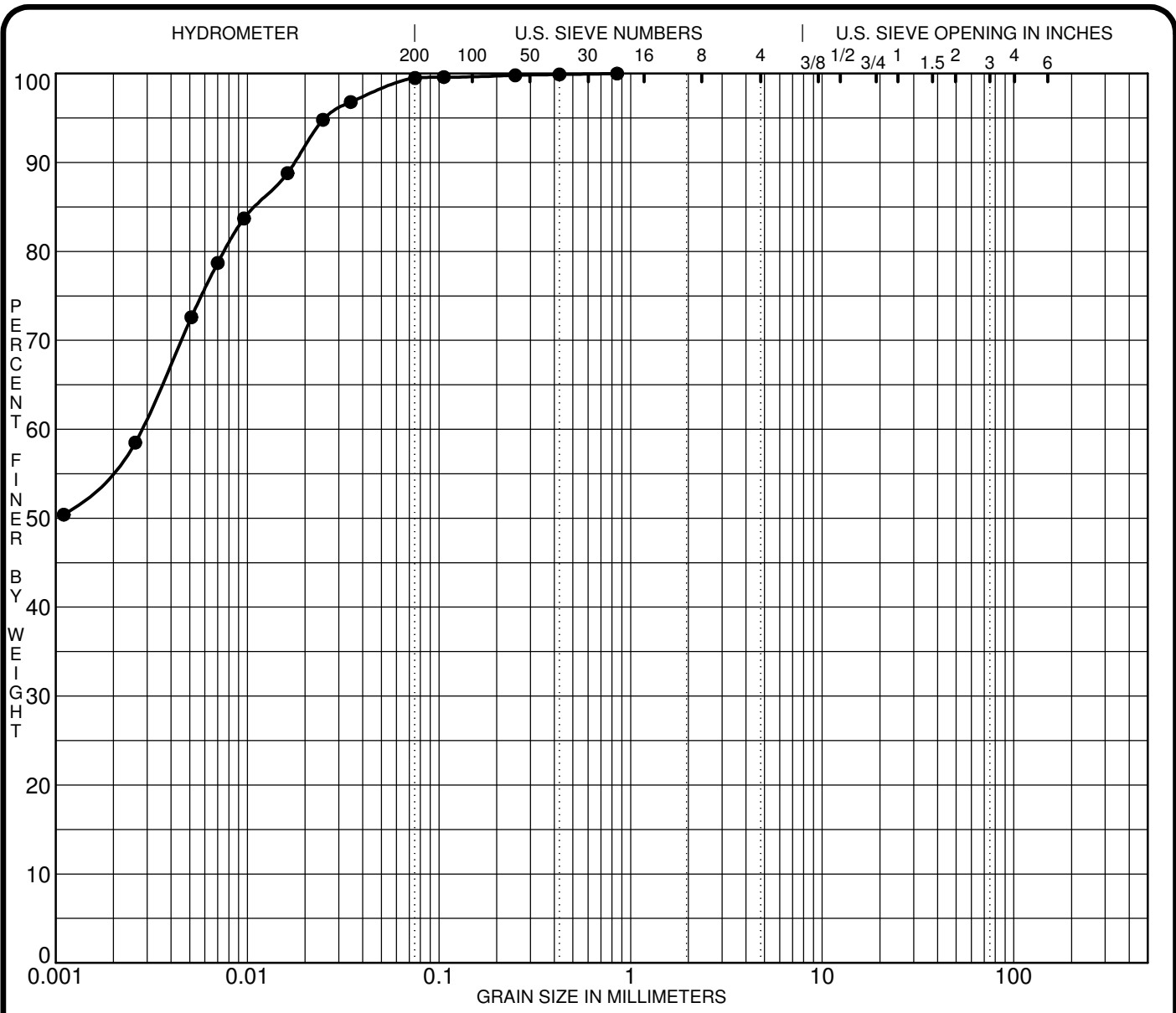

SILT OR CLAY	SAND			GRAVEL		COBBLES
	fine	medium	coarse	fine	coarse	

Specimen Identification	Classification					MC%	LL	PL	PI	Cc	Cu
● BH 5-22 SS2	Silty Clay										
☒											
▲											
★											
Specimen Identification	D100	D60	D30	D10	%Gravel	%Sand	%Silt	%Clay			
● BH 5-22 SS2	0.85	0.00			0.0	0.5	99.5				
☒											
▲											
★											

CLIENT Colonnade Bridgeport  
 PROJECT Geotechnical Investigation - Prop. Commercial  
Development - 444 Citigate Drive

FILE NO. PG6119  
 DATE 17 Nov 22

**paterosongroup** Consulting Engineers  
 9 Auriga Drive, Ottawa, Ontario K2E 7T9

**GRAIN SIZE DISTRIBUTION**

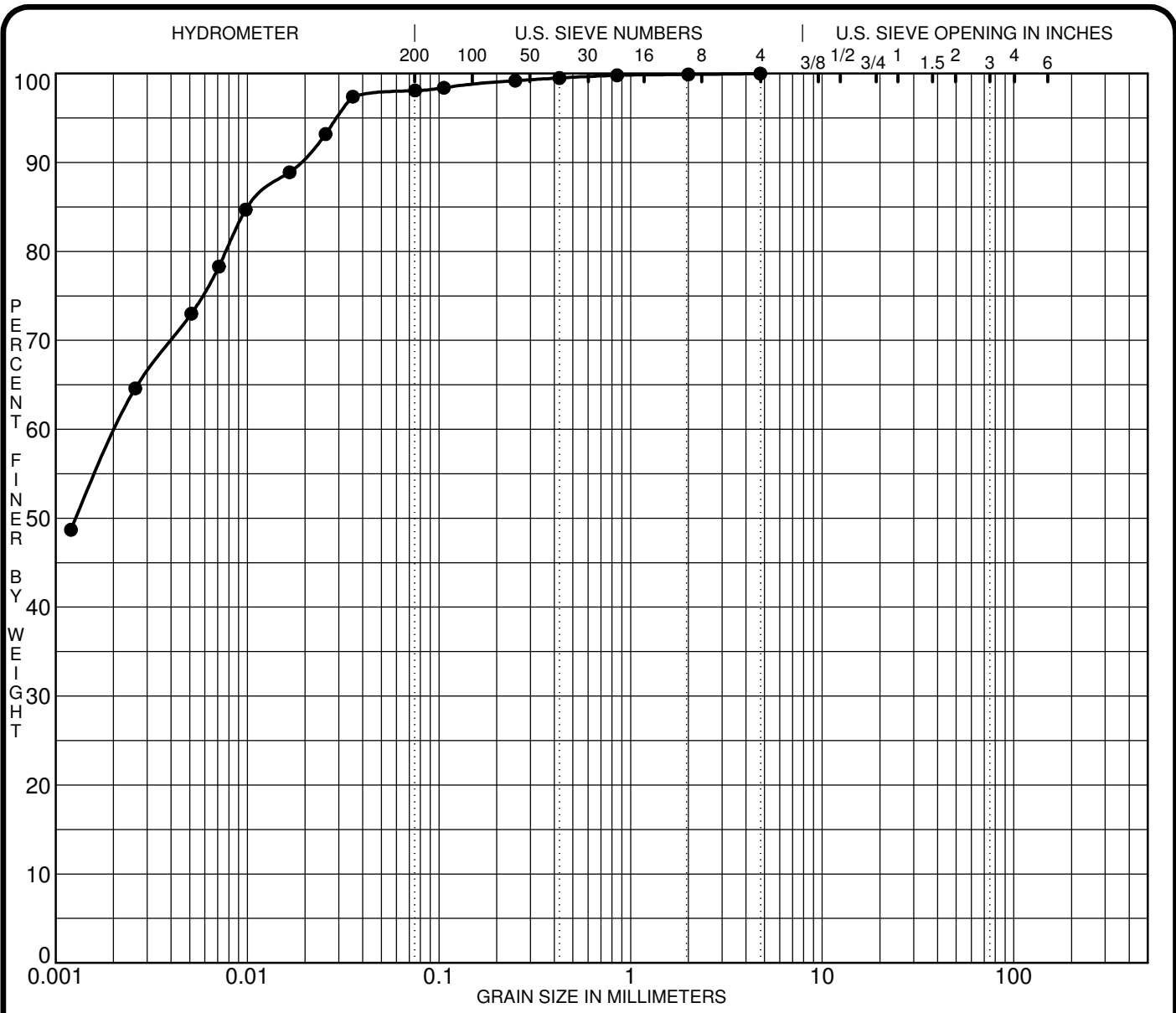

SILT OR CLAY	SAND			GRAVEL		COBBLES
	fine	medium	coarse	fine	coarse	

Specimen Identification	Classification					MC%	LL	PL	PI	Cc	Cu
● BH 6-22 SS3	Silty Clay						85	24	61		
☒											
▲											
★											
Specimen Identification	D100	D60	D30	D10	%Gravel	%Sand	%Silt	%Clay			
● BH 6-22 SS3	4.75	0.00			0.0	1.9	98.1				
☒											
▲											
★											

CLIENT Colonnade Bridgeport  
 PROJECT Geotechnical Investigation - Prop. Commercial  
Development - 444 Citigate Drive

FILE NO. PG6119  
 DATE 17 Nov 22

**paterongroup** Consulting Engineers  
 9 Auriga Drive, Ottawa, Ontario K2E 7T9

**GRAIN SIZE DISTRIBUTION**

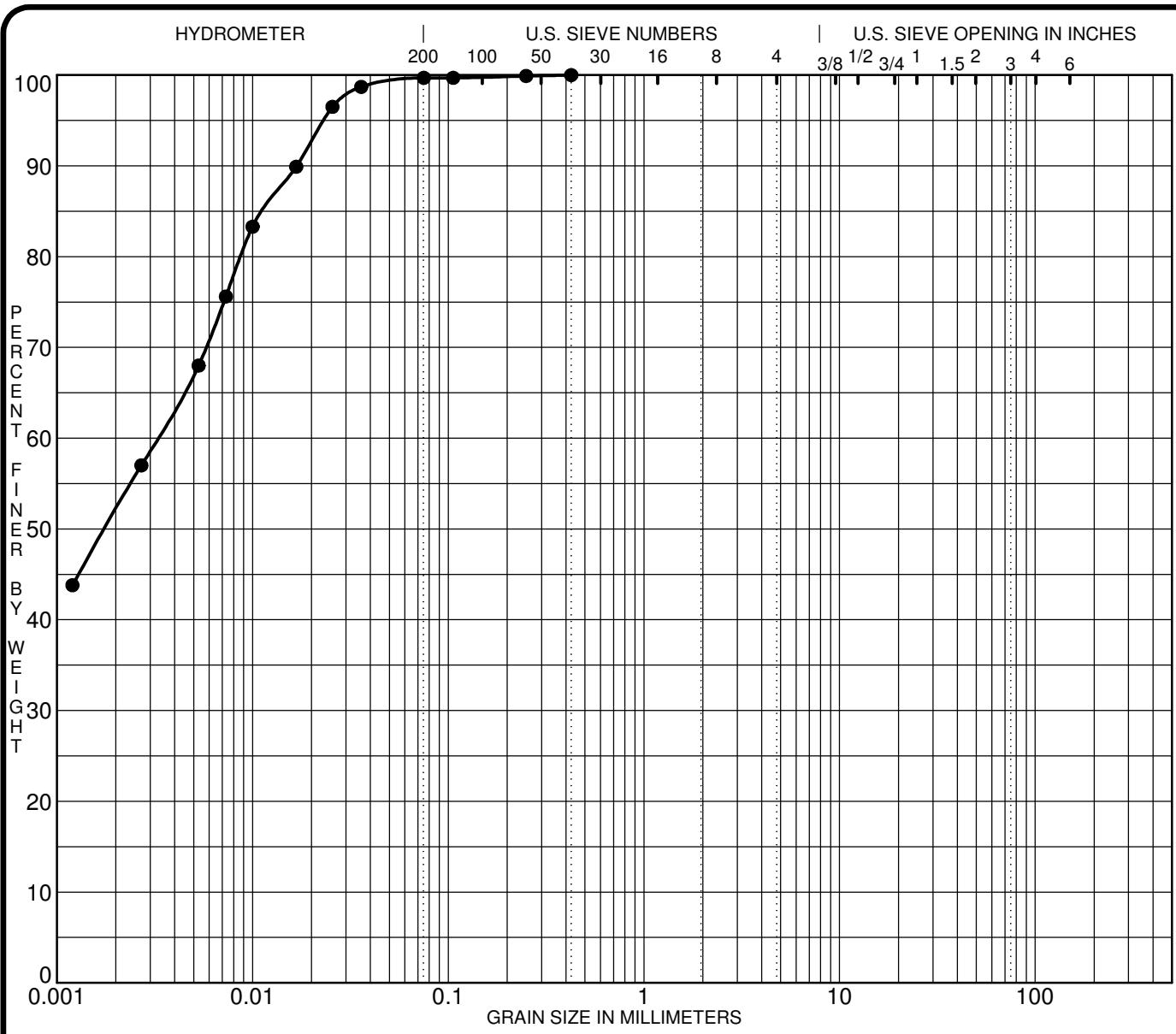

SILT OR CLAY	SAND			GRAVEL		COBBLES
	fine	medium	coarse	fine	coarse	

Specimen Identification	Classification	MC%	LL	PL	PI	Cc	Cu
● BH 9-22 SS2	Silty Clay						
☒							
▲							
★							

Specimen Identification	D100	D60	D30	D10	%Gravel	%Sand	%Silt	%Clay
● BH 9-22 SS2	0.43	0.00			0.0	0.3	99.7	
☒								
▲								
★								

CLIENT	<u>Colonnade Bridgeport</u>	FILE NO.	<u>PG6119</u>
PROJECT	<u>Geotechnical Investigation - Prop. Commercial Development - 444 Citigate Drive</u>	DATE	<u>17 Nov 22</u>

**pater-songgroup** Consulting Engineers  
 9 Auriga Drive, Ottawa, Ontario K2E 7T9

**GRAIN SIZE DISTRIBUTION**

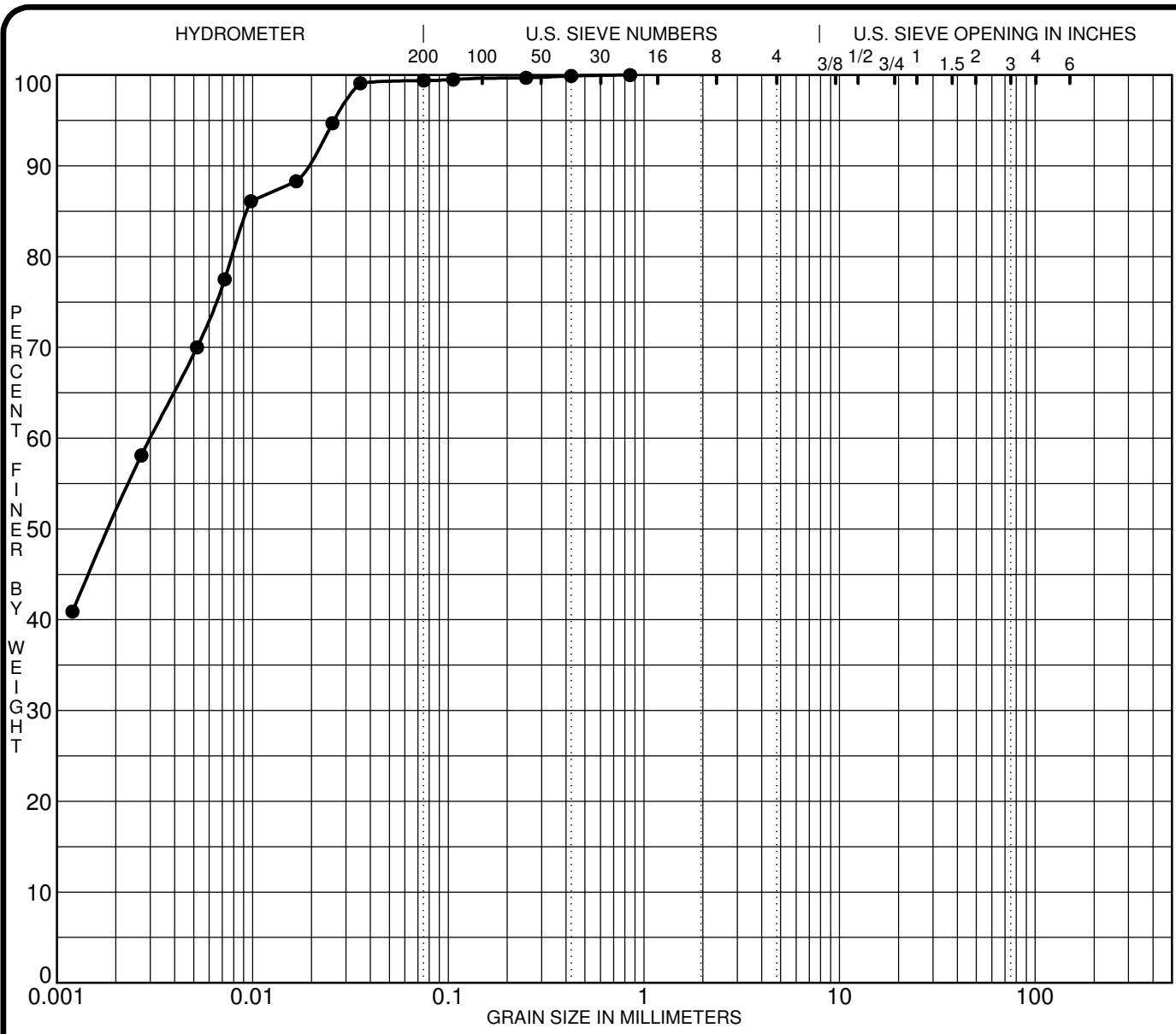

SILT OR CLAY	SAND			GRAVEL		COBBLES
	fine	medium	coarse	fine	coarse	

Specimen Identification	Classification	MC%	LL	PL	PI	Cc	Cu
● BH10-22 SS3	Silty Clay		79	24	55		
☒							
▲							
★							

Specimen Identification	D100	D60	D30	D10	%Gravel	%Sand	%Silt	%Clay
● BH10-22 SS3	0.85	0.00			0.0	0.6	99.4	
☒								
▲								
★								

CLIENT	<u>Colonnade Bridgeport</u>	FILE NO.	<u>PG6119</u>
PROJECT	<u>Geotechnical Investigation - Prop. Commercial Development - 444 Citigate Drive</u>	DATE	<u>17 Nov 22</u>

**paterosongroup** Consulting Engineers  
 9 Auriga Drive, Ottawa, Ontario K2E 7T9

**GRAIN SIZE DISTRIBUTION**

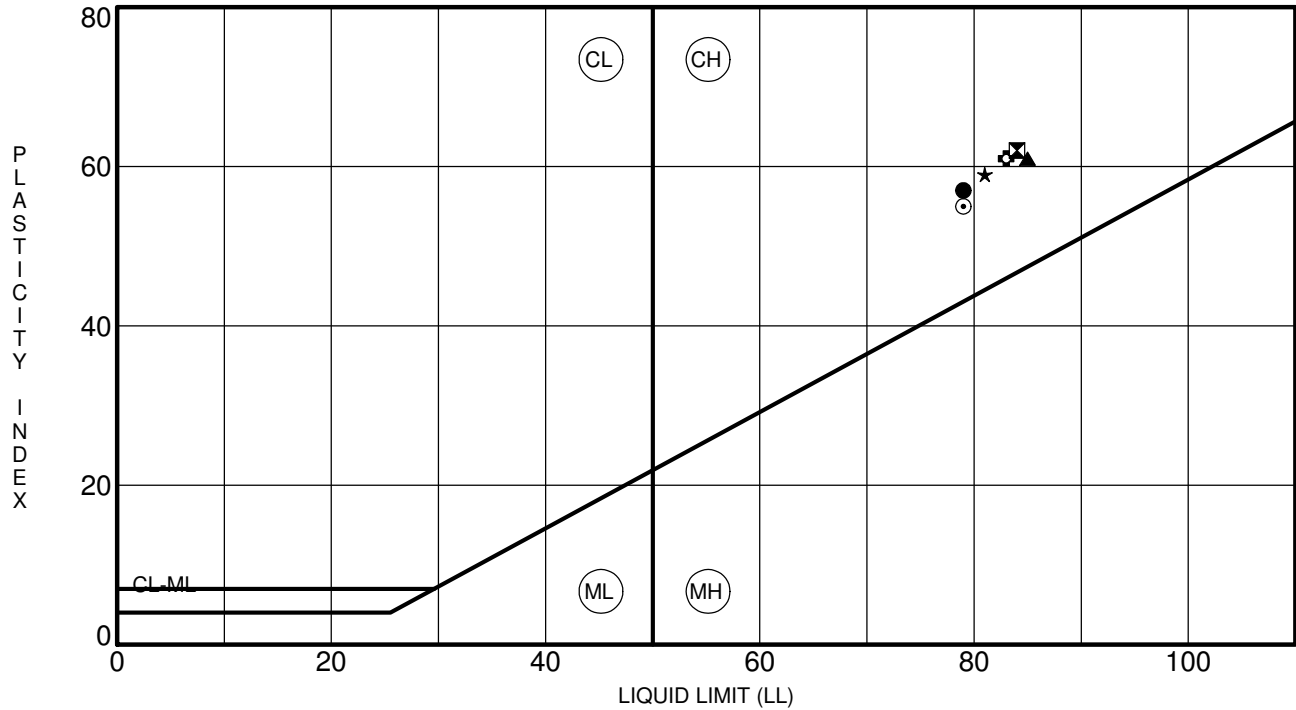

Specimen Identification	LL	PL	PI	Fines	Classification
● BH 1-22	SS2	79	22	57	CH - Inorganic clay of high plasticity
▣ BH 5-22	SS3	84	22	62	CH - Inorganic clay of high plasticity
▲ BH 6-22	SS3	85	24	61	CH - Inorganic clay of high plasticity
★ BH 8-22	SS2	81	22	59	CH - Inorganic clay of high plasticity
⊙ BH10-22	SS3	79	24	55	CH - Inorganic clay of high plasticity
⊕ BH11-22	SS3	83	22	61	CH - Inorganic clay of high plasticity

CLIENT Colonnade Bridgeport  
 PROJECT Geotechnical Investigation - Prop. Commercial  
 Development - 444 Citigate Drive

FILE NO. PG6119  
 DATE 18 Nov 22



Certificate of Analysis

Report Date: 24-Nov-2022

Client: Paterson Group Consulting Engineers

Order Date: 18-Nov-2022

Client PO: 56252

Project Description: PG6119

<b>Client ID:</b>	BH3-22-SS2	-	-	-	-
<b>Sample Date:</b>	16-Nov-22 09:00	-	-	-	-
<b>Sample ID:</b>	2248049-01	-	-	-	-
<b>Matrix:</b>	Soil	-	-	-	-
<b>MDL/Units</b>					

**Physical Characteristics**

% Solids	0.1 % by Wt.	69.3	-	-	-	-
----------	--------------	------	---	---	---	---

**General Inorganics**

pH	0.05 pH Units	7.24	-	-	-	-
Resistivity	0.1 Ohm.m	35.1	-	-	-	-

**Anions**

Chloride	5 ug/g	66	-	-	-	-
Sulphate	5 ug/g	79	-	-	-	-

# APPENDIX 2

FIGURE 1 – EXTERIOR APRON SLAB DETAILS

DRAWING PG6119 - 1 – KEY PLAN



DRAWING PG6119 -2 - TEST HOLE LOCATION PLAN - 444 CITIGATE DRIVE

DRAWING PG6119 -3 – PERMISSIBLE GRADE RAISE PLAN- 444 CITIGATE DRIVE

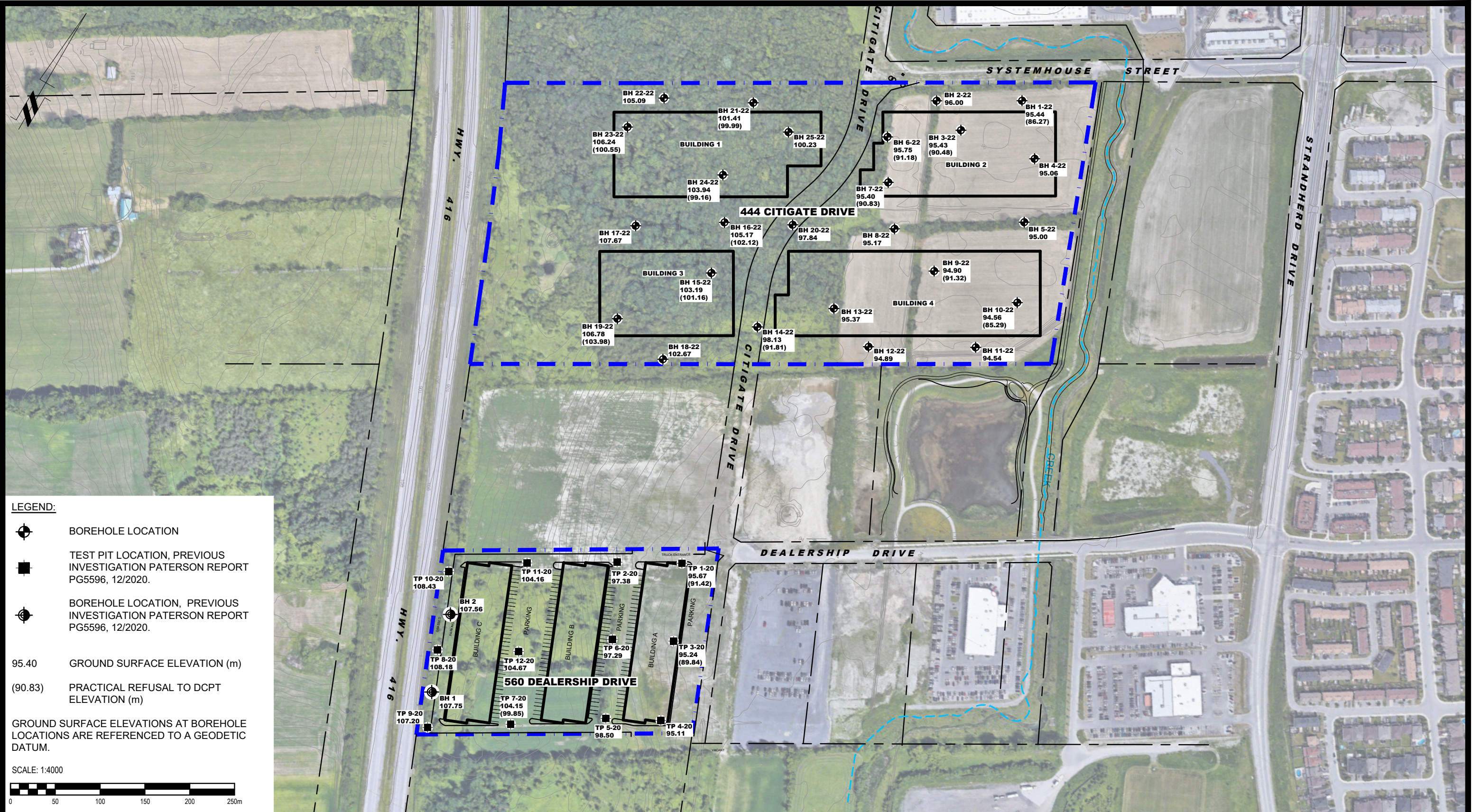
DRAWING PG6119 -4 – TREE PLANTING SETBACK PLAN - 444 CITIGATE DRIVE



**LEGEND:**

-  BOREHOLE LOCATION
-  TEST PIT LOCATION, PREVIOUS INVESTIGATION PATERSON REPORT PG5596, 12/2020.
-  BOREHOLE LOCATION, PREVIOUS INVESTIGATION PATERSON REPORT PG5596, 12/2020.
- 95.40 GROUND SURFACE ELEVATION (m)
- (90.83) PRACTICAL REFUSAL TO DCPT ELEVATION (m)

GROUND SURFACE ELEVATIONS AT BOREHOLE LOCATIONS ARE REFERENCED TO A GEODETIC DATUM.

SCALE: 1:4000



**PATERSON GROUP**  
 9 AURIGA DRIVE  
 OTTAWA, ON  
 K2E 7T9  
 TEL: (613) 226-7381

NO.	REVISIONS	DATE	INITIAL

**COLONNADE BRIDGEPORT**  
**GEOTECHNICAL INVESTIGATION**  
**PROPOSED COMMERCIAL DEVELOPMENT**  
**444 CITIGATE DRIVE & 560 DEALERSHIP DRIVE**

OTTAWA, ONTARIO

**KEY PLAN**

Scale:	1:4000	Date:	11/2022
Drawn by:	YA	Report No.:	PG6119-1
Checked by:	MS	Dwg. No.:	<b>PG6119-1</b>
Approved by:	DJG	Revision No.:	

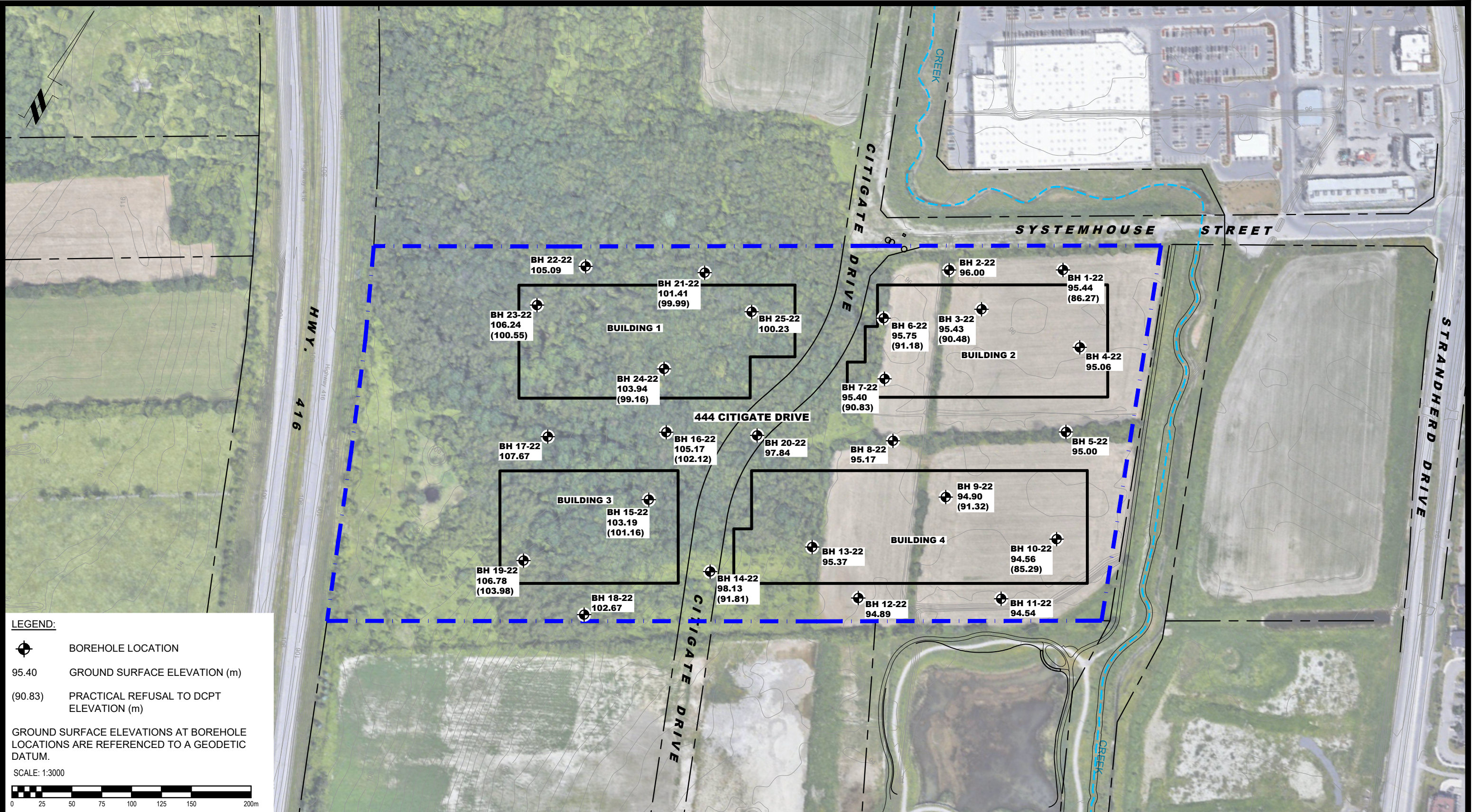

**LEGEND:**

-  BOREHOLE LOCATION
- 95.40 GROUND SURFACE ELEVATION (m)
- (90.83) PRACTICAL REFUSAL TO DCPT ELEVATION (m)

GROUND SURFACE ELEVATIONS AT BOREHOLE LOCATIONS ARE REFERENCED TO A GEODETIC DATUM.

SCALE: 1:3000

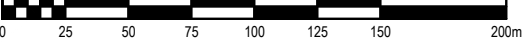

**PATERSON GROUP**  
 9 AURIGA DRIVE  
 OTTAWA, ON  
 K2E 7T9  
 TEL: (613) 226-7381

NO.	REVISIONS	DATE	INITIAL

**COLONNADE BRIDGEPORT**  
**GEOTECHNICAL INVESTIGATION**  
**PROPOSED COMMERCIAL DEVELOPMENT**  
**444 CITIGATE DRIVE**

OTTAWA, ONTARIO

**TEST HOLE LOCATION PLAN**

Scale:	1:3000	Date:	11/2022
Drawn by:	YA	Report No.:	PG6119-1
Checked by:	MS	Dwg. No.:	<b>PG6119-2</b>
Approved by:	DJG	Revision No.:	

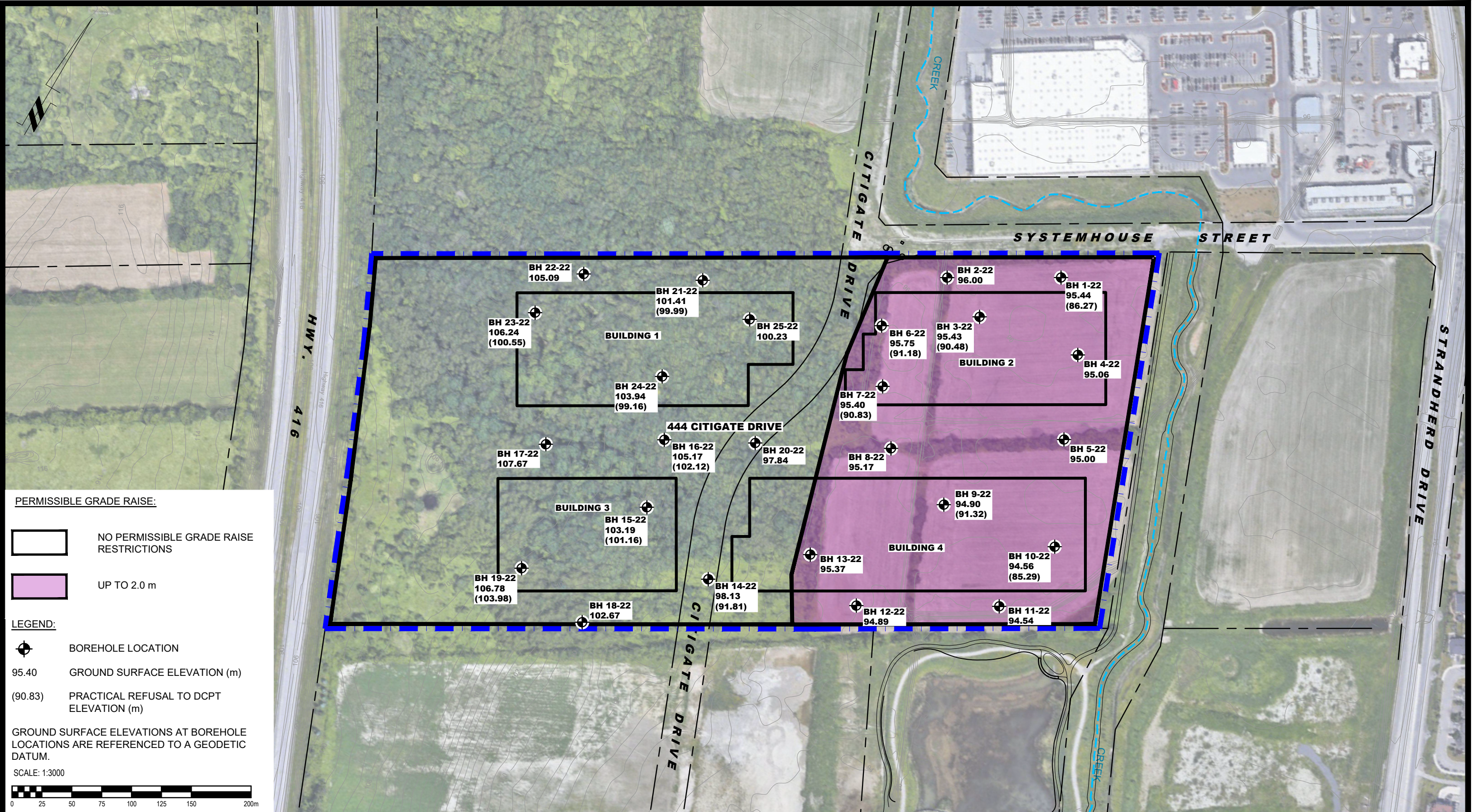

**PERMISSIBLE GRADE RAISE:**

- NO PERMISSIBLE GRADE RAISE RESTRICTIONS
- UP TO 2.0 m

**LEGEND:**

- +

 BOREHOLE LOCATION
- 95.40 GROUND SURFACE ELEVATION (m)
- (90.83) PRACTICAL REFUSAL TO DCPT ELEVATION (m)

GROUND SURFACE ELEVATIONS AT BOREHOLE LOCATIONS ARE REFERENCED TO A GEODETIC DATUM.

SCALE: 1:3000



9 AURIGA DRIVE  
OTTAWA, ON  
K2E 7T9  
TEL: (613) 226-7381

NO.	REVISIONS	DATE	INITIAL

**COLONNADE BRIDGEPORT**  
**GEOTECHNICAL INVESTIGATION**  
**PROPOSED COMMERCIAL DEVELOPMENT**  
**444 CITIGATE DRIVE**

OTTAWA, ONTARIO

**PERMISSIBLE GRADE RAISE PLAN**

Scale:	1:3000	Date:	11/2022
Drawn by:	YA	Report No.:	PG6119-1
Checked by:	MS	Dwg. No.:	<b>PG6119-3</b>
Approved by:	DJG	Revision No.:	

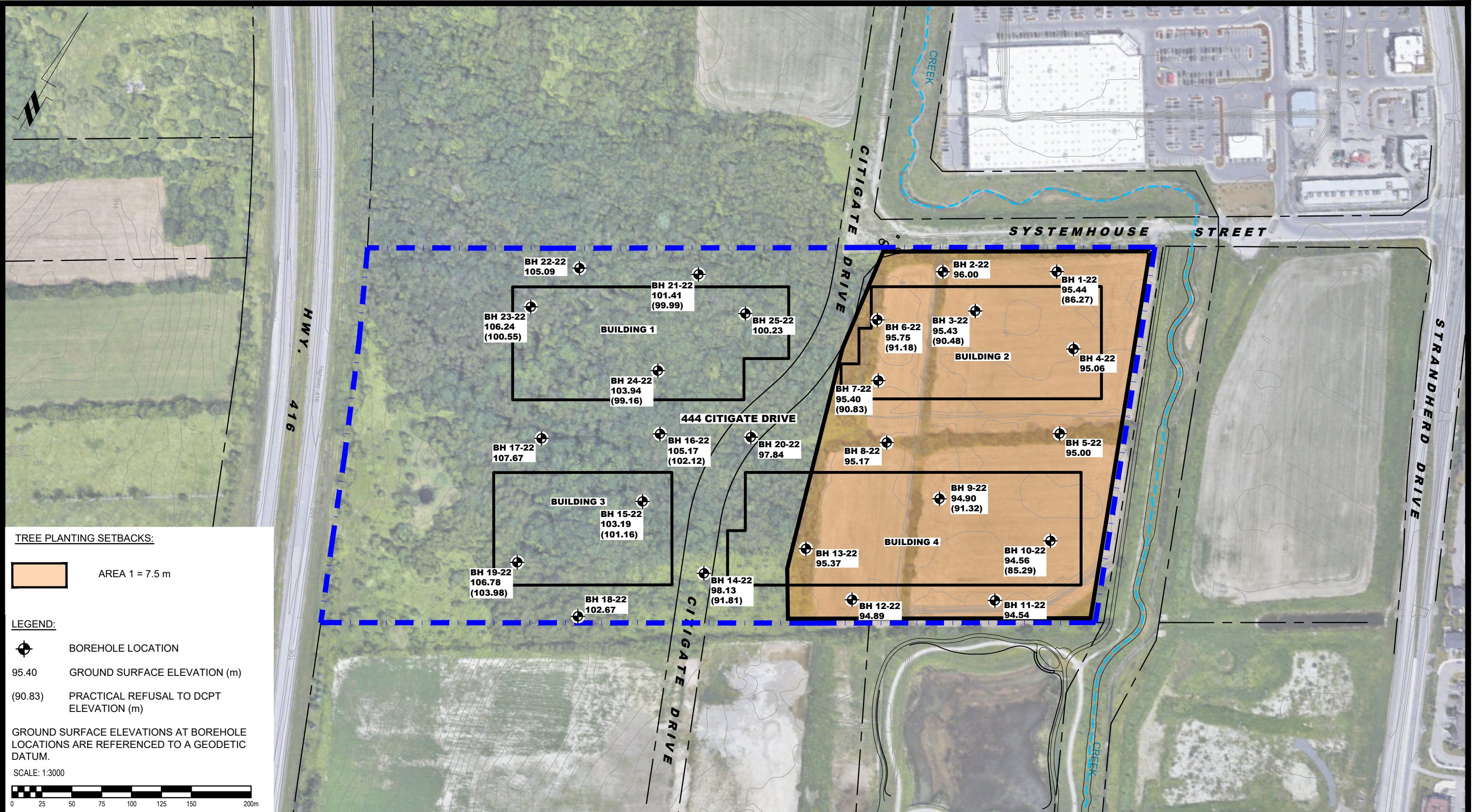

**TREE PLANTING SETBACKS:**

AREA 1 = 7.5 m

**LEGEND:**

-  BOREHOLE LOCATION
- 95.40 GROUND SURFACE ELEVATION (m)
- (90.83) PRACTICAL REFUSAL TO DCPT ELEVATION (m)

GROUND SURFACE ELEVATIONS AT BOREHOLE LOCATIONS ARE REFERENCED TO A GEODETIC DATUM.

SCALE: 1:3000



9 AURIGA DRIVE  
OTTAWA, ON  
K2E 7T9  
TEL: (613) 226-7381

NO.	REVISIONS	DATE	INITIAL

**COLONNADE BRIDGEPORT**  
**GEOTECHNICAL INVESTIGATION**  
**PROPOSED COMMERCIAL DEVELOPMENT**  
**444 CITIGATE DRIVE**

OTTAWA, ONTARIO

**TREE PLANTING SETBACKS**

Scale:	1:3000	Date:	11/2022
Drawn by:	YA	Report No.:	PG6119-1
Checked by:	MS	Dwg. No.:	<b>PG6119-4</b>
Approved by:	DJG	Revision No.:	

# APPENDIX 3

SOIL PROFILE AND TEST DATA SHEETS – 560 DEALERSHIP DRIVE

SYMBOLS AND TERMS

ANALYTICAL TESTING RESULTS – 560 DEALERSHIP DRIVE

DATUM Geodetic

REMARKS

BORINGS BY CME-55 Low Clearance Drill

DATE 2020 December 16

FILE NO. **PG5596**

HOLE NO. **BH 1**

SOIL DESCRIPTION	STRATA PLOT	SAMPLE				DEPTH (m)	ELEV. (m)	Pen. Resist. Blows/0.3m ● 50 mm Dia. Cone				Piezometer Construction
		TYPE	NUMBER	RECOVERY %	N VALUE or RQD			20	40	60	80	
<b>GROUND SURFACE</b>												
TOPSOIL	0.25	AU	1			0	107.75					
Reddish brown <b>SILTY SAND</b>	0.75	AU	2									
<b>GLACIAL TILL:</b> Compact to very dense brown silty sand with gravel, cobbles, oversized boulders, some clay  - Encountered seam of perched water at 3.8 and 5.2 m  - Cored through several boulders as of 6.8 m below ground surface						1	106.75					
						2	105.75					
						3	104.75					
						4	103.75					
						5	102.75					
			SS	3	46	66	6	101.75				
			SS	4	92	48	7	100.75				
			SS RC	5 1	0 34	50+	8	99.75				
			RC	2	30		9	98.75				
			RC	3	18		10	97.75				
End of Borehole	10.46											
(GWL @ 4.67 m - December 22, 2020)												

20 40 60 80 100  
**Shear Strength (kPa)**  
▲ Undisturbed    △ Remoulded



DATUM Geodetic

REMARKS

BORINGS BY CME-55 Low Clearance Drill

DATE 2020 December 16

FILE NO. **PG5596**

HOLE NO. **BH 2**

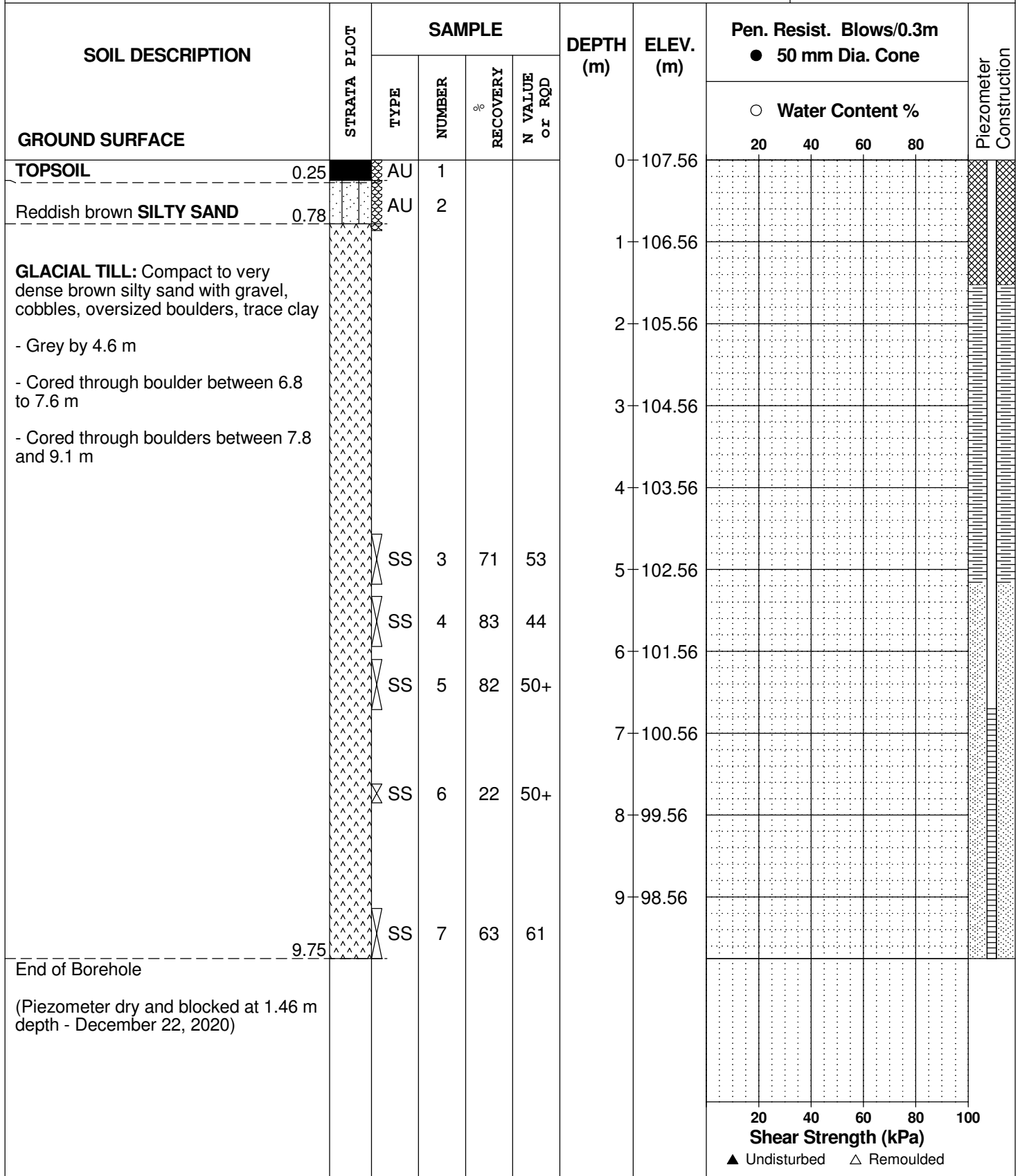

DATUM Geodetic

REMARKS

BORINGS BY Excavator

DATE December 2, 2020

FILE NO. PG5596

HOLE NO. TP 1

SOIL DESCRIPTION	STRATA PLOT	SAMPLE				DEPTH (m)	ELEV. (m)	Pen. Resist. Blows/0.3m ● 50 mm Dia. Cone				Piezometer Construction	
		TYPE	NUMBER	RECOVERY	N VALUE or RQD			○ Water Content %					
GROUND SURFACE								20	40	60	80		
TOPSOIL	0.22	G	1			0	95.67						
FILL: Brown silty sand, some gravel, trace cobbles and boulders		G	2			1	94.67						
Very stiff to stiff, brown SILTY CLAY	1.48	G	3			2	93.67					130	
GLACIAL TILL: Brown silty clay with sand, gravel, cobbles and oversized boulders	2.55	G	4			3	92.67					▽	
- grey by 3.2m depth		G	5			4	91.67						
End of Test Pit	4.25												
Practical refusal to excavation on inferred bedrock surface at 4.25m depth. (Sidewall infiltration noted at 2.55m depth) Unstable sidewalls due to noted groundwater infiltration.													
								20	40	60	80	100	
								Shear Strength (kPa)					
								▲ Undisturbed    △ Remoulded					

DATUM Geodetic

REMARKS

BORINGS BY Excavator

DATE December 2, 2020

FILE NO. PG5596

HOLE NO. TP 2

SOIL DESCRIPTION	STRATA PLOT	SAMPLE				DEPTH (m)	ELEV. (m)	Pen. Resist. Blows/0.3m ● 50 mm Dia. Cone				Piezometer Construction	
		TYPE	NUMBER	RECOVERY	N VALUE or RQD			○ Water Content %					
GROUND SURFACE								20	40	60	80		
TOPSOIL	0.27	G	1			0	97.38						
GLACIAL TILL: Brown silty clay, some sand, gravel, cobbles and boulders  - grey by 3.6m depth		G	2			1	96.38						
		G	3			2	95.38						
		G	4			3	94.38						
		G	4			4	93.38						
End of Test Pit	4.55												
TP terminated in glacial till at 4.55m depth (Groundwater infiltration at 2.75m depth) Unstable sidewalls due to noted groundwater infiltration.													
								20	40	60	80	100	
								Shear Strength (kPa)					
								▲ Undisturbed    △ Remoulded					

DATUM Geodetic

REMARKS

BORINGS BY Excavator

DATE December 2, 2020

FILE NO. **PG5596**

HOLE NO. **TP 3**

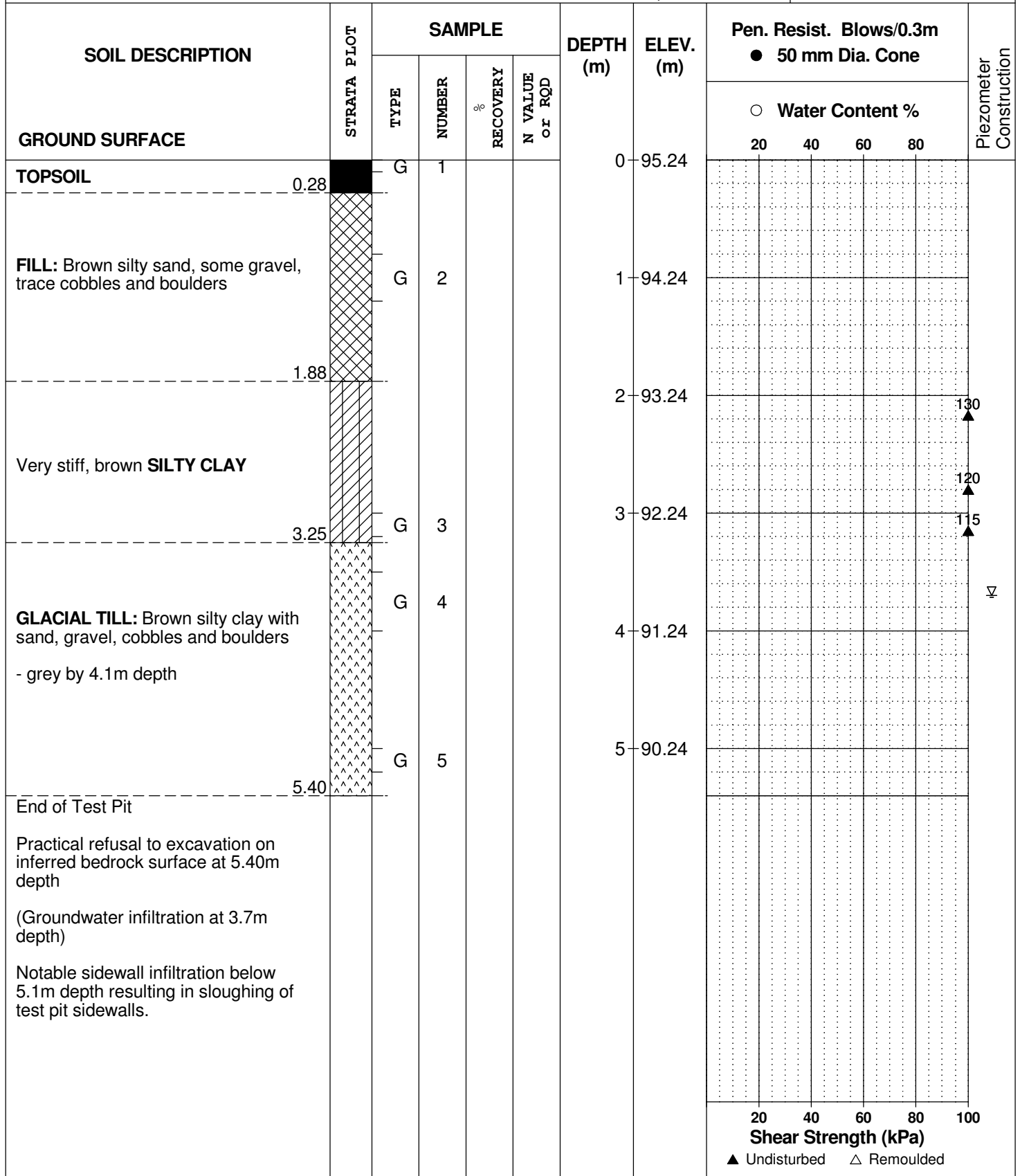

DATUM Geodetic

REMARKS

BORINGS BY Excavator

DATE December 2, 2020

FILE NO. PG5596

HOLE NO. TP 4

SOIL DESCRIPTION	STRATA PLOT	SAMPLE				DEPTH (m)	ELEV. (m)	Pen. Resist. Blows/0.3m ● 50 mm Dia. Cone				Piezometer Construction	
		TYPE	NUMBER	RECOVERY %	N VALUE or RQD			20	40	60	80		
GROUND SURFACE						0	95.11						
TOPSOIL	0.34	G	1										
FILL: Brown silty sand, some gravel, trace cobbles and clay	0.94	G	2										
		G	3			1	94.11						
GLACIAL TILL: Brown silty clay with sand, some gravel, cobbles and oversized boulders						2	93.11						
- grey by 2.6m depth		G	4			3	92.11						
		G	5			4	91.11						
End of Test Pit (TP dry upon completion)	4.88												

20 40 60 80 100  
Shear Strength (kPa)  
▲ Undisturbed    △ Remoulded

DATUM Geodetic

FILE NO. **PG5596**

REMARKS

HOLE NO. **TP 5**

BORINGS BY Excavator

DATE December 2, 2020

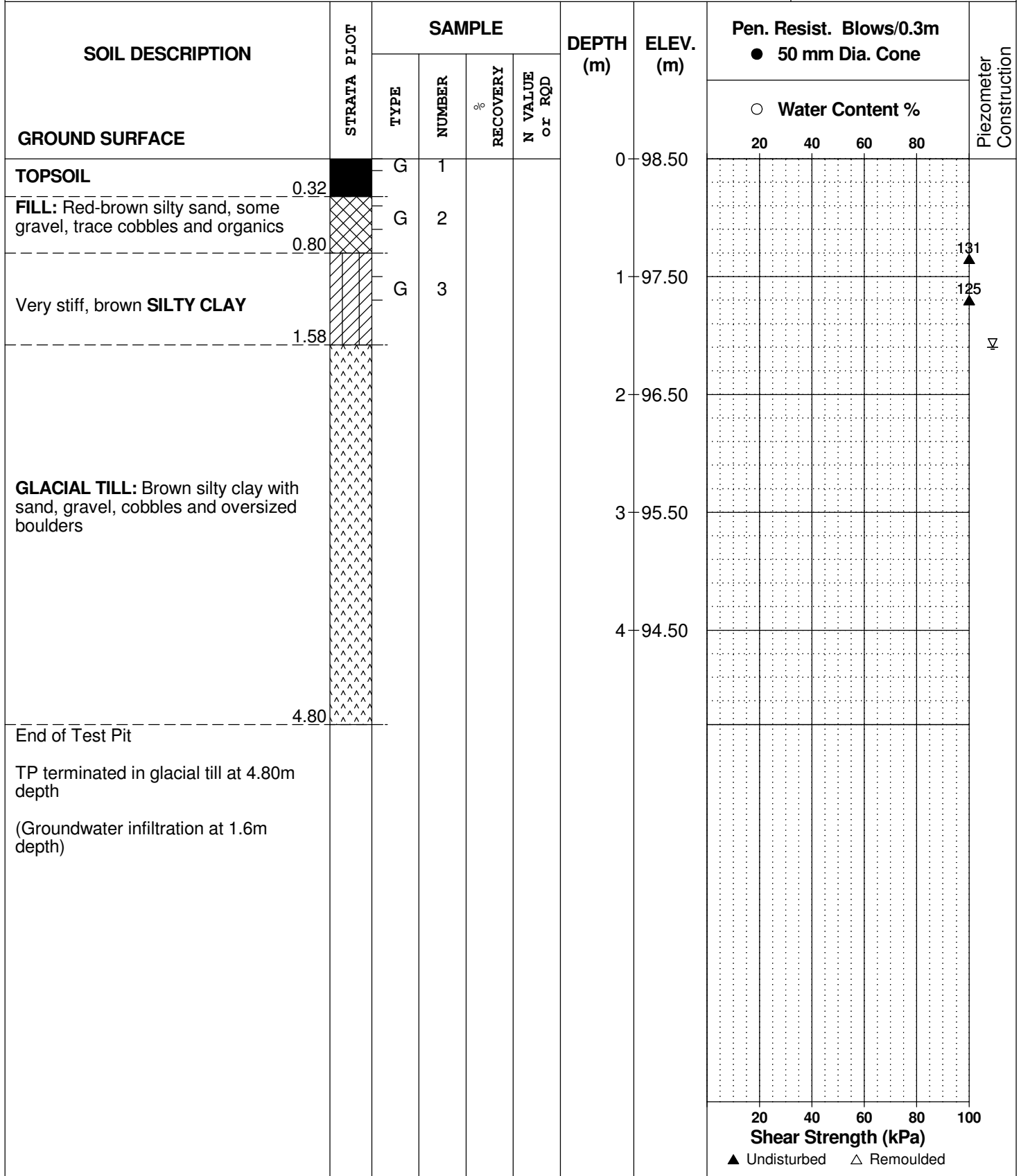

20 40 60 80 100  
Shear Strength (kPa)  
▲ Undisturbed    △ Remoulded

DATUM Geodetic

FILE NO. PG5596

REMARKS

HOLE NO. TP 6

BORINGS BY Excavator

DATE December 2, 2020

SOIL DESCRIPTION	STRATA PLOT	SAMPLE				DEPTH (m)	ELEV. (m)	Pen. Resist. Blows/0.3m ● 50 mm Dia. Cone				Piezometer Construction
		TYPE	NUMBER	RECOVERY %	N VALUE or RQD			20	40	60	80	
GROUND SURFACE												
TOPSOIL		G	1			0	97.29					
FILL: Brown silty sand with clay, some gravel, cobbles, trace organics	0.28 - 0.74	G	2									
		G	3			1	96.29					
GLACIAL TILL: Brown silty clay, some sand and gravel, trace cobbles and oversized boulders						2	95.29					
- grey by 3.1m depth						3	94.29					
		G	4			4	93.29					
End of Test Pit	4.84											
TP terminated in glacial till at 4.84m depth (TP dry upon completion)												

20 40 60 80 100  
Shear Strength (kPa)  
▲ Undisturbed    △ Remoulded

DATUM Geodetic

FILE NO. PG5596

REMARKS

HOLE NO. TP 7

BORINGS BY Excavator

DATE December 2, 2020

SOIL DESCRIPTION	STRATA PLOT	SAMPLE				DEPTH (m)	ELEV. (m)	Pen. Resist. Blows/0.3m ● 50 mm Dia. Cone				Piezometer Construction
		TYPE	NUMBER	RECOVERY %	N VALUE or RQD			○ Water Content %				
GROUND SURFACE								20	40	60	80	
TOPSOIL	0.26	G	1			0	104.15					
GLACIAL TILL: Brown silty sand with gravel, some cobbles and boulders		G	2			1	103.15					
						2	102.15					
						3	101.15					
End of Test Pit	4.30	G	3			4	100.15					
Practical refusal to excavation on boulders at 4.30m depth												
Test pit terminated in glacial till at 4.30m depth												
(TP dry upon completion)												

20 40 60 80 100  
Shear Strength (kPa)  
▲ Undisturbed    △ Remoulded



DATUM Geodetic

REMARKS

BORINGS BY Excavator

DATE December 2, 2020

FILE NO. PG5596

HOLE NO. TP 8

SOIL DESCRIPTION	STRATA PLOT	SAMPLE				DEPTH (m)	ELEV. (m)	Pen. Resist. Blows/0.3m ● 50 mm Dia. Cone				Piezometer Construction	
		TYPE	NUMBER	RECOVERY	N VALUE or RQD			○ Water Content %					
GROUND SURFACE								20	40	60	80		
TOPSOIL	0.24	G	1			0	108.18						
Compact, reddish brown <b>SILTY SAND</b> with rootlets, cobbles and boulders	0.40	G	2										
<b>GLACIAL TILL:</b> Brown silty sand, some gravel, cobbles and oversized boulders		G	3			1	107.18						
						2	106.18						
						3	105.18						
						4	104.18						∇
- grey by 4.4m depth						5	103.18						
End of Test Pit	5.33												
TP terminated in glacial till at 5.33m depth  (Groundwater infiltration at 4.1m depth)													
								20	40	60	80	100	
								<b>Shear Strength (kPa)</b>					
								▲ Undisturbed    △ Remoulded					

DATUM Geodetic

REMARKS

BORINGS BY Excavator

DATE December 3, 2020

FILE NO. **PG5596**

HOLE NO. **TP 9**

SOIL DESCRIPTION	STRATA PLOT	SAMPLE				DEPTH (m)	ELEV. (m)	Pen. Resist. Blows/0.3m ● 50 mm Dia. Cone				Piezometer Construction
		TYPE	NUMBER	RECOVERY %	N VALUE or RQD			20	40	60	80	
<b>GROUND SURFACE</b>												
<b>TOPSOIL</b>		G	1			0	107.12					
0.28 Compact, reddish brown <b>SILTY SAND</b> , some gravel, trace cobbles and boulders		G	2									
0.66		G	3			1	106.12					
		G	4			2	105.12					
		G	4			3	104.12					
<b>GLACIAL TILL:</b> Brown silty sand, some gravel, cobbles and boulders						4	103.12					
						5	102.12					
5.56 End of Test Pit												
TP terminated in glacial till at 5.56m depth. (TP dry upon completion)												

20 40 60 80 100  
**Shear Strength (kPa)**  
▲ Undisturbed    △ Remoulded

## SOIL PROFILE AND TEST DATA

Geotechnical Investigation  
Proposed Commercial Warehouse Development  
560 Dealership Dr., Ottawa, Ontario

DATUM Geodetic

REMARKS

BORINGS BY Excavator

DATE December 3, 2020

FILE NO. **PG5596**

HOLE NO. **TP10**

SOIL DESCRIPTION	STRATA PLOT	SAMPLE				DEPTH (m)	ELEV. (m)	Pen. Resist. Blows/0.3m ● 50 mm Dia. Cone				Piezometer Construction
		TYPE	NUMBER	RECOVERY %	N VALUE or RQD			20	40	60	80	
<b>GROUND SURFACE</b>												
<b>TOPSOIL</b>	0.27	G	1			0	108.43					
Compact, reddish brown <b>SILTY SAND</b> , some gravel, cobbles, trace boulders	0.88	G	2									
<b>GLACIAL TILL:</b> Brown silty sand, some gravel, cobbles and oversized boulders  - grey by 4.2m depth		G	3			1	107.43					
		G	4			2	106.43					
		G	5			3	105.43					
		G	5			4	104.43					
End of Test Pit TP terminated in glacial till at 4.85m depth	4.85											

○ Water Content %

20 40 60 80 100  
**Shear Strength (kPa)**  
▲ Undisturbed    △ Remoulded

DATUM Geodetic

REMARKS

BORINGS BY Excavator

DATE December 3, 2020

FILE NO. PG5596

HOLE NO. TP11

SOIL DESCRIPTION	STRATA PLOT	SAMPLE				DEPTH (m)	ELEV. (m)	Pen. Resist. Blows/0.3m ● 50 mm Dia. Cone				Piezometer Construction
		TYPE	NUMBER	RECOVERY	N VALUE or RQD			○ Water Content %				
GROUND SURFACE								20	40	60	80	
TOPSOIL	0.26	G	1			0	104.16					
Compact, reddish brown <b>SILTY SAND</b> , some gravel, cobbles and boulders	0.76	G	2									
<b>GLACIAL TILL:</b> Brown silty sand, some gravel, cobbles and boulders  - grey by 4.25m depth		G	3			1	103.16					
						2	102.16					
						3	101.16					
						4	100.16					
		G	4			5	99.16					
End of Test Pit	5.55											
TP terminated in glacial till at 5.55m depth  (TP dry upon completion)												

20 40 60 80 100  
**Shear Strength (kPa)**  
▲ Undisturbed    △ Remoulded

DATUM Geodetic

FILE NO. **PG5596**

REMARKS

HOLE NO. **TP12**

BORINGS BY Excavator

DATE December 3, 2020

SOIL DESCRIPTION	STRATA PLOT	SAMPLE				DEPTH (m)	ELEV. (m)	Pen. Resist. Blows/0.3m ● 50 mm Dia. Cone				Piezometer Construction
		TYPE	NUMBER	RECOVERY %	N VALUE or RQD			20	40	60	80	
<b>GROUND SURFACE</b>												
<b>TOPSOIL</b> 0.28 Compact, brown <b>SILTY SAND</b> , some gravel, trace cobbles and boulders		G	1			0	104.67					
0.84 <b>GLACIAL TILL:</b> Brown silty sand, some gravel, cobbles and boulders		G	2			1	103.67					
2 - grey by 3.7m depth						2	102.67					
3						3	101.67					
4						4	100.67					
4.91 End of Test Pit TP terminated in glacial till at 4.91m depth (TP dry upon completion)												

20 40 60 80 100  
**Shear Strength (kPa)**  
▲ Undisturbed    △ Remoulded

# SYMBOLS AND TERMS

## SOIL DESCRIPTION

Behavioural properties, such as structure and strength, take precedence over particle gradation in describing soils. Terminology describing soil structure are as follows:

Desiccated	-	having visible signs of weathering by oxidation of clay minerals, shrinkage cracks, etc.
Fissured	-	having cracks, and hence a blocky structure.
Varved	-	composed of regular alternating layers of silt and clay.
Stratified	-	composed of alternating layers of different soil types, e.g. silt and sand or silt and clay.
Well-Graded	-	Having wide range in grain sizes and substantial amounts of all intermediate particle sizes (see Grain Size Distribution).
Uniformly-Graded	-	Predominantly of one grain size (see Grain Size Distribution).

The standard terminology to describe the strength of cohesionless soils is the relative density, usually inferred from the results of the Standard Penetration Test (SPT) 'N' value. The SPT N value is the number of blows of a 63.5 kg hammer, falling 760 mm, required to drive a 51 mm O.D. split spoon sampler 300 mm into the soil after an initial penetration of 150 mm.

Relative Density	'N' Value	Relative Density %
Very Loose	<4	<15
Loose	4-10	15-35
Compact	10-30	35-65
Dense	30-50	65-85
Very Dense	>50	>85

The standard terminology to describe the strength of cohesive soils is the consistency, which is based on the undisturbed undrained shear strength as measured by the in situ or laboratory vane tests, penetrometer tests, unconfined compression tests, or occasionally by Standard Penetration Tests.

Consistency	Undrained Shear Strength (kPa)	'N' Value
Very Soft	<12	<2
Soft	12-25	2-4
Firm	25-50	4-8
Stiff	50-100	8-15
Very Stiff	100-200	15-30
Hard	>200	>30

## SYMBOLS AND TERMS (continued)

### SOIL DESCRIPTION (continued)

Cohesive soils can also be classified according to their "sensitivity". The sensitivity is the ratio between the undisturbed undrained shear strength and the remoulded undrained shear strength of the soil.

Terminology used for describing soil strata based upon texture, or the proportion of individual particle sizes present is provided on the Textural Soil Classification Chart at the end of this information package.

### ROCK DESCRIPTION

The structural description of the bedrock mass is based on the Rock Quality Designation (RQD).

The RQD classification is based on a modified core recovery percentage in which all pieces of sound core over 100 mm long are counted as recovery. The smaller pieces are considered to be a result of closely-spaced discontinuities (resulting from shearing, jointing, faulting, or weathering) in the rock mass and are not counted. RQD is ideally determined from NXL size core. However, it can be used on smaller core sizes, such as BX, if the bulk of the fractures caused by drilling stresses (called "mechanical breaks") are easily distinguishable from the normal in situ fractures.

RQD %	ROCK QUALITY
90-100	Excellent, intact, very sound
75-90	Good, massive, moderately jointed or sound
50-75	Fair, blocky and seamy, fractured
25-50	Poor, shattered and very seamy or blocky, severely fractured
0-25	Very poor, crushed, very severely fractured

### SAMPLE TYPES

SS	-	Split spoon sample (obtained in conjunction with the performing of the Standard Penetration Test (SPT))
TW	-	Thin wall tube or Shelby tube
PS	-	Piston sample
AU	-	Auger sample or bulk sample
WS	-	Wash sample
RC	-	Rock core sample (Core bit size AXT, BXL, etc.). Rock core samples are obtained with the use of standard diamond drilling bits.

## SYMBOLS AND TERMS (continued)

### GRAIN SIZE DISTRIBUTION

MC%	-	Natural moisture content or water content of sample, %
LL	-	Liquid Limit, % (water content above which soil behaves as a liquid)
PL	-	Plastic limit, % (water content above which soil behaves plastically)
PI	-	Plasticity index, % (difference between LL and PL)
Dxx	-	Grain size which xx% of the soil, by weight, is of finer grain sizes These grain size descriptions are not used below 0.075 mm grain size
D10	-	Grain size at which 10% of the soil is finer (effective grain size)
D60	-	Grain size at which 60% of the soil is finer
Cc	-	Concavity coefficient = $(D_{30})^2 / (D_{10} \times D_{60})$
Cu	-	Uniformity coefficient = $D_{60} / D_{10}$

Cc and Cu are used to assess the grading of sands and gravels:

Well-graded gravels have:  $1 < Cc < 3$  and  $Cu > 4$

Well-graded sands have:  $1 < Cc < 3$  and  $Cu > 6$

Sands and gravels not meeting the above requirements are poorly-graded or uniformly-graded.

Cc and Cu are not applicable for the description of soils with more than 10% silt and clay (more than 10% finer than 0.075 mm or the #200 sieve)

### CONSOLIDATION TEST

$p'_o$	-	Present effective overburden pressure at sample depth
$p'_c$	-	Preconsolidation pressure of (maximum past pressure on) sample
Ccr	-	Recompression index (in effect at pressures below $p'_c$ )
Cc	-	Compression index (in effect at pressures above $p'_c$ )
OC Ratio		Overconsolidation ratio = $p'_c / p'_o$
Void Ratio		Initial sample void ratio = volume of voids / volume of solids
Wo	-	Initial water content (at start of consolidation test)

### PERMEABILITY TEST

k	-	Coefficient of permeability or hydraulic conductivity is a measure of the ability of water to flow through the sample. The value of k is measured at a specified unit weight for (remoulded) cohesionless soil samples, because its value will vary with the unit weight or density of the sample during the test.
---	---	--



## SYMBOLS AND TERMS (continued)

### STRATA PLOT



Topsoil

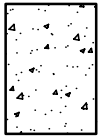

Asphalt

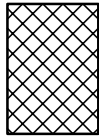

Fill



Peat

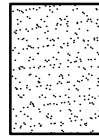

Sand

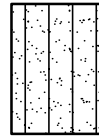

Silty Sand

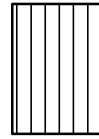

Silt

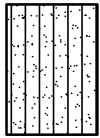

Sandy Silt

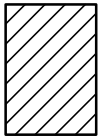

Clay

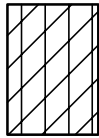

Silty Clay

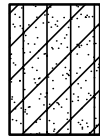

Clayey Silty Sand



Glacial Till

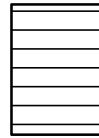

Shale

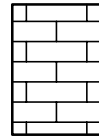

Bedrock

### MONITORING WELL AND PIEZOMETER CONSTRUCTION

#### MONITORING WELL CONSTRUCTION

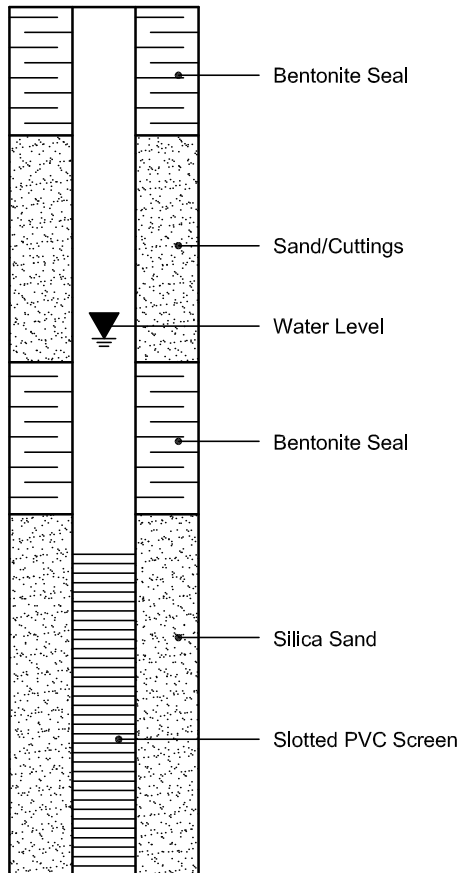

#### PIEZOMETER CONSTRUCTION

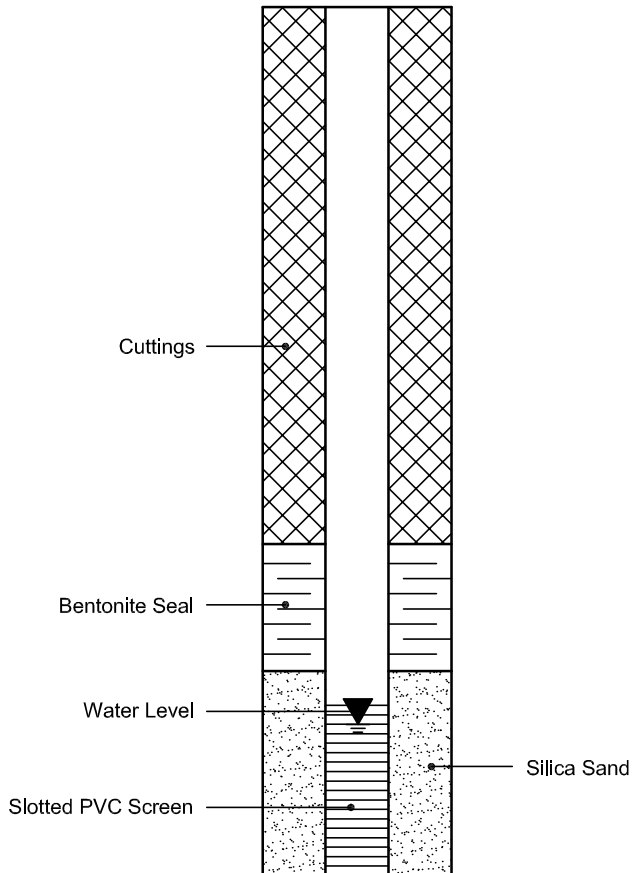

Certificate of Analysis

Report Date: 10-Dec-2020

Client: Paterson Group Consulting Engineers

Order Date: 4-Dec-2020

Client PO: 31257

Project Description: PG5596

<b>Client ID:</b>	TP9-G3	-	-	-
<b>Sample Date:</b>	03-Dec-20 09:00	-	-	-
<b>Sample ID:</b>	2049567-01	-	-	-
<b>MDL/Units</b>	Soil	-	-	-

**Physical Characteristics**

% Solids	0.1 % by Wt.	91.1	-	-	-
----------	--------------	------	---	---	---

**General Inorganics**

pH	0.05 pH Units	7.09	-	-	-
Resistivity	0.10 Ohm.m	108	-	-	-

**Anions**

Chloride	5 ug/g dry	<5	-	-	-
Sulphate	5 ug/g dry	<5	-	-	-



# APPENDIX 4

DRAWING PG6119 -1 - KEY PLAN

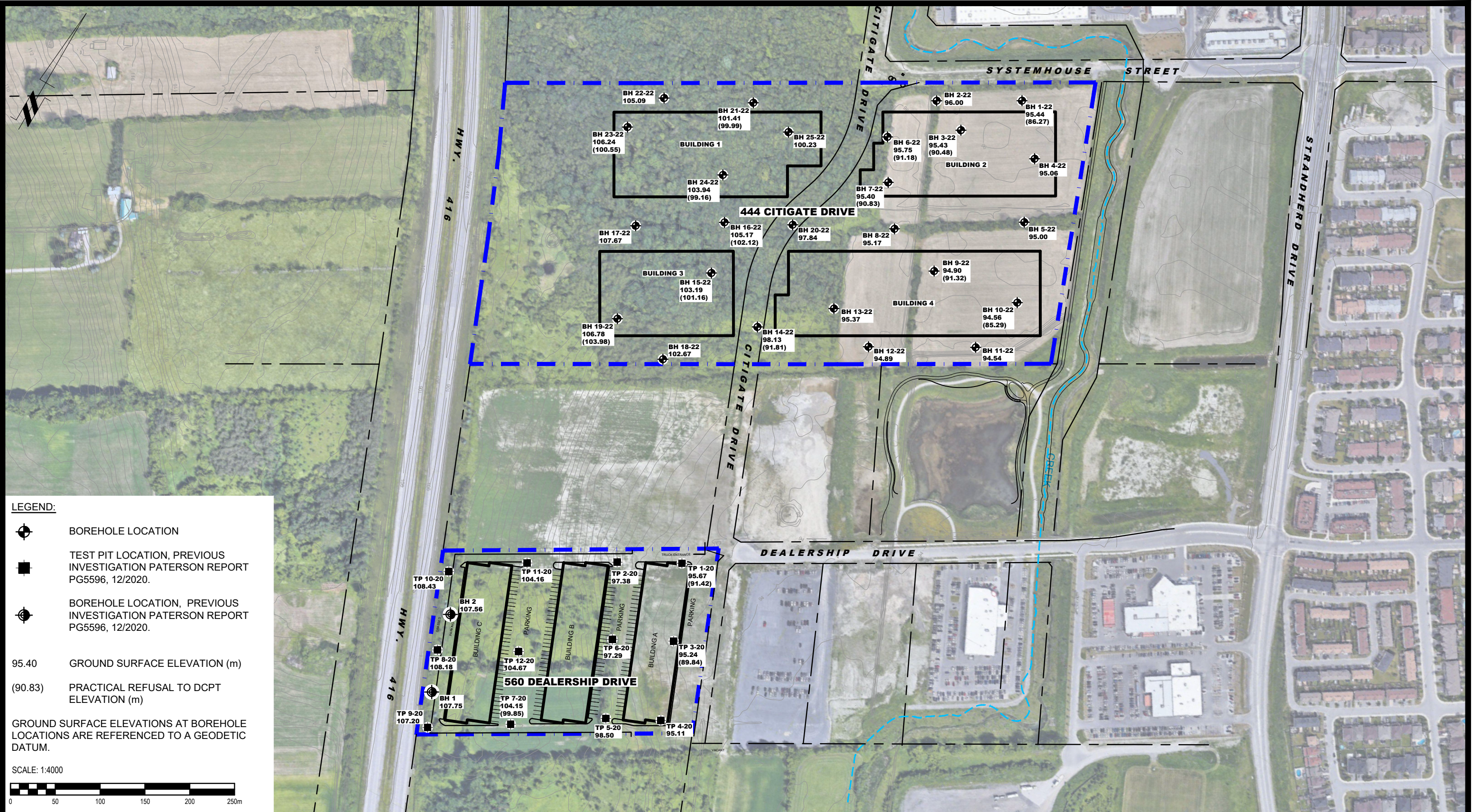
DRAWING PG6119 - 5 - TEST HOLE LOCATION PLAN - 560 DEALERSHIP DRIVE



**LEGEND:**

-  BOREHOLE LOCATION
-  TEST PIT LOCATION, PREVIOUS INVESTIGATION PATERSON REPORT PG5596, 12/2020.
-  BOREHOLE LOCATION, PREVIOUS INVESTIGATION PATERSON REPORT PG5596, 12/2020.
- 95.40 GROUND SURFACE ELEVATION (m)
- (90.83) PRACTICAL REFUSAL TO DCPT ELEVATION (m)

GROUND SURFACE ELEVATIONS AT BOREHOLE LOCATIONS ARE REFERENCED TO A GEODETIC DATUM.

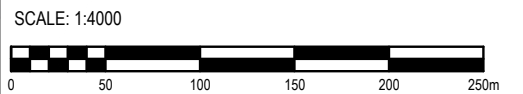

9 AURIGA DRIVE  
OTTAWA, ON  
K2E 7T9  
TEL: (613) 226-7381

NO.	REVISIONS	DATE	INITIAL

**COLONNADE BRIDGEPORT**  
**GEOTECHNICAL INVESTIGATION**  
**PROPOSED COMMERCIAL DEVELOPMENT**  
**444 CITIGATE DRIVE & 560 DEALERSHIP DRIVE**

OTTAWA, ONTARIO

**KEY PLAN**

Scale:	1:4000	Date:	11/2022
Drawn by:	YA	Report No.:	PG6119-1
Checked by:	MS	Dwg. No.:	<b>PG6119-1</b>
Approved by:	DJG	Revision No.:	



**LEGEND:**

■ TEST PIT LOCATION, PREVIOUS INVESTIGATION PATERSON REPORT PG5596, 12/2020.

⊙ BOREHOLE LOCATION, PREVIOUS INVESTIGATION PATERSON REPORT PG5596, 12/2020.

95.40 GROUND SURFACE ELEVATION (m)

(90.83) PRACTICAL REFUSAL TO DCPT ELEVATION (m)

GROUND SURFACE ELEVATIONS AT BOREHOLE LOCATIONS ARE REFERENCED TO A GEODETIC DATUM.

SCALE: 1:1500

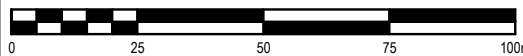

9 AURIGA DRIVE  
OTTAWA, ON  
K2E 7T9  
TEL: (613) 226-7381

NO.	REVISIONS	DATE	INITIAL

OTTAWA,  
Title:

COLONNADE BRIDGEPORT  
GEOTECHNICAL INVESTIGATION  
PROPOSED COMMERCIAL DEVELOPMENT  
560 DEALERSHIP DRIVE  
**TEST HOLE LOCATION PLAN**

ONTARIO

Scale: 1:1500

Date: 11/2022

Drawn by: YA

Report No.: PG6119-1

Checked by: MS

Dwg. No.: **PG6119-5**

Approved by: DJG

Revision No.:

### DETAIL 1 - SLAB CONSTRUCTION JOINT:

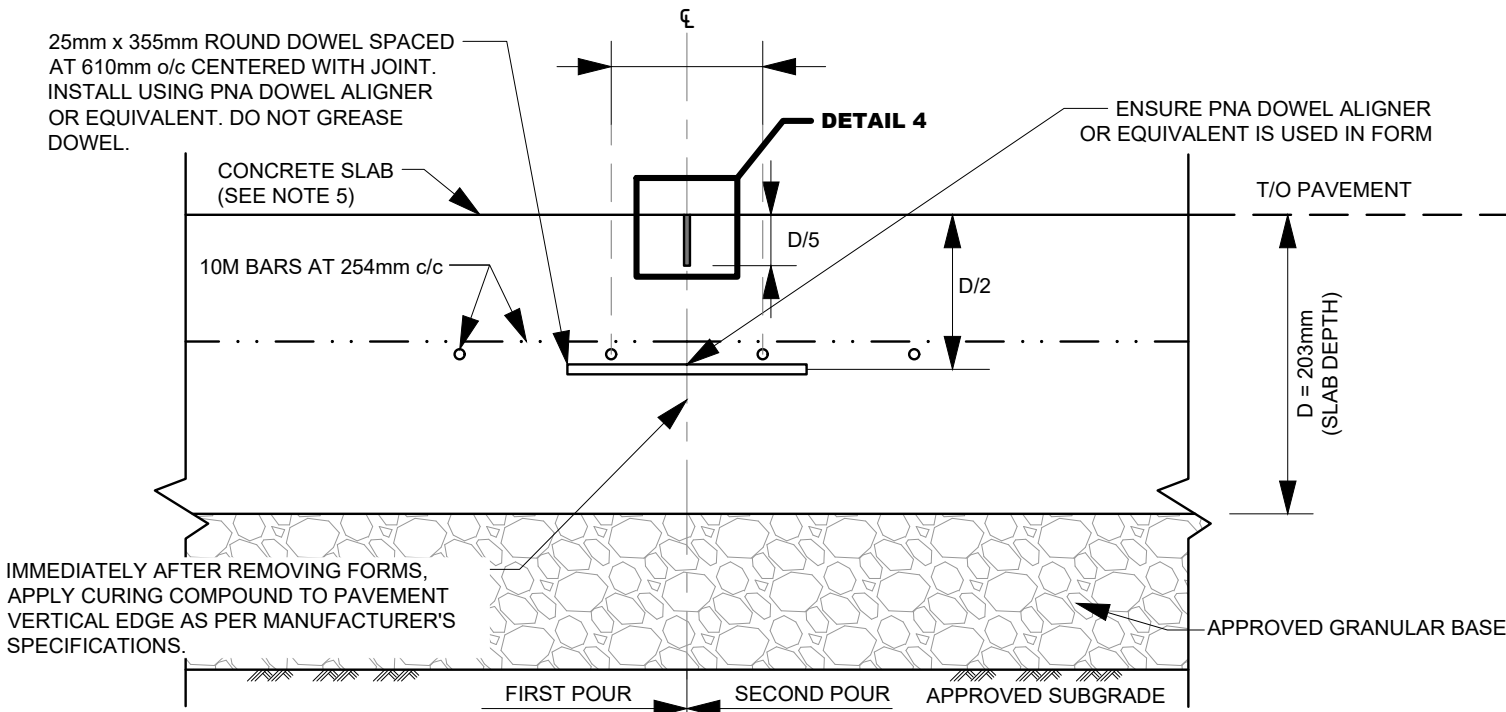

### DETAIL 2 - SLAB CONTRACTION JOINT:

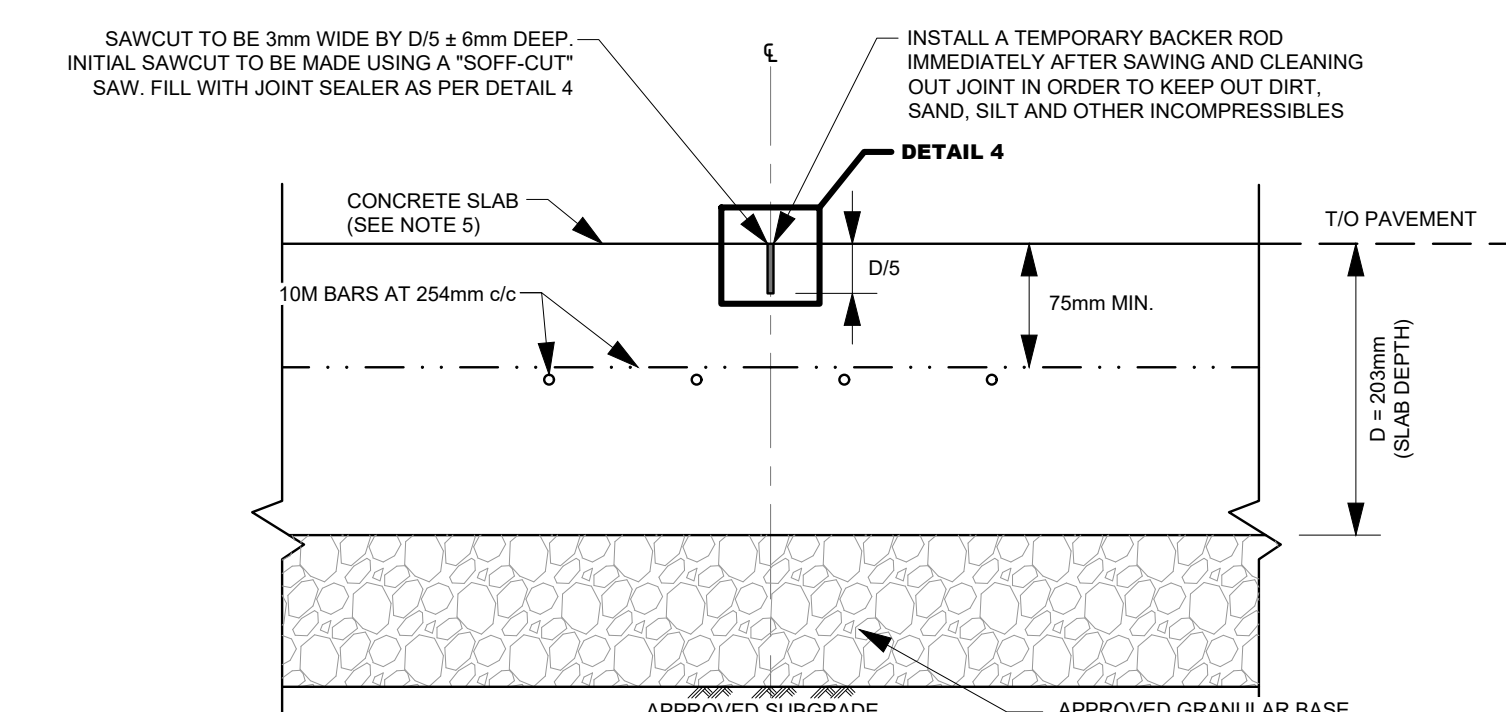

### DETAIL 3 - SLAB ISOLATION JOINT:

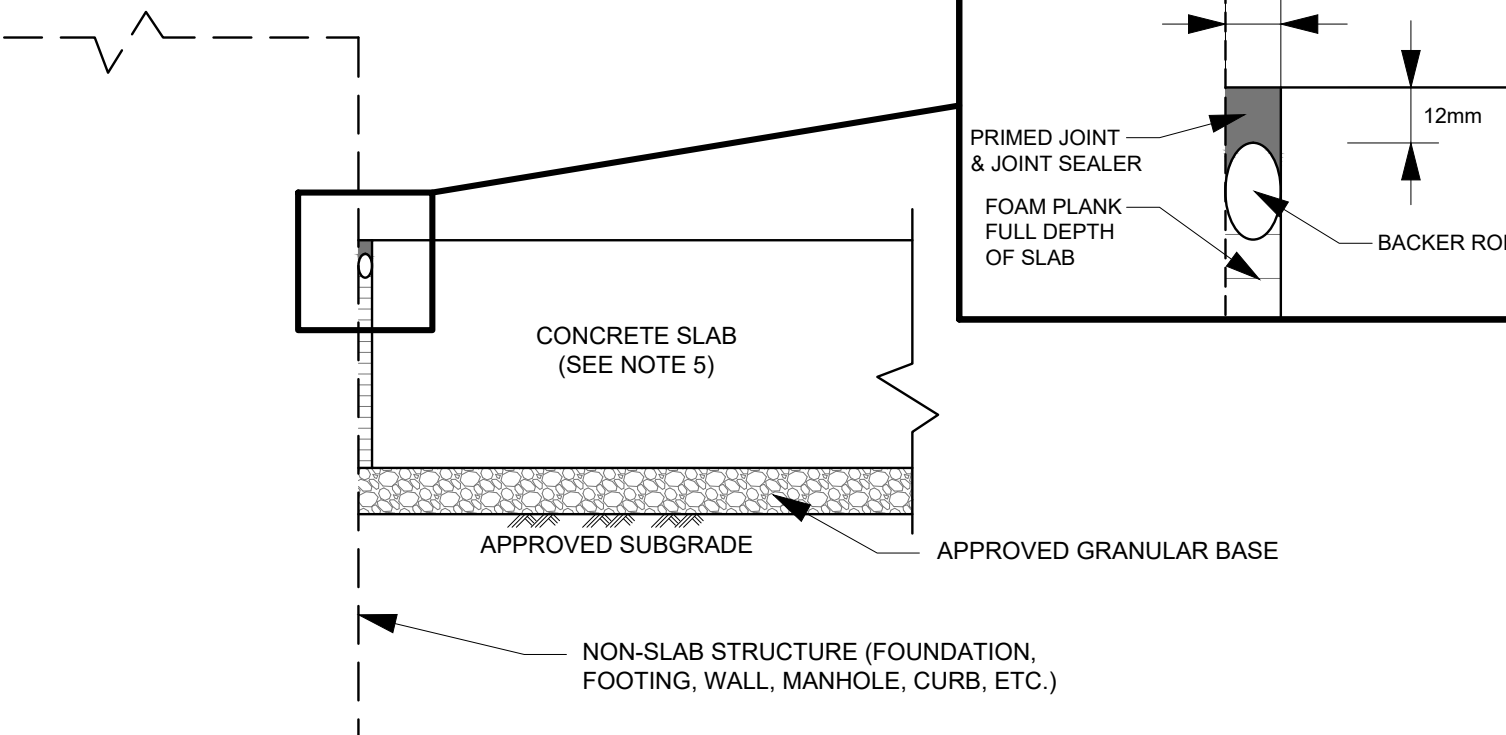

### ENLARGEMENT:

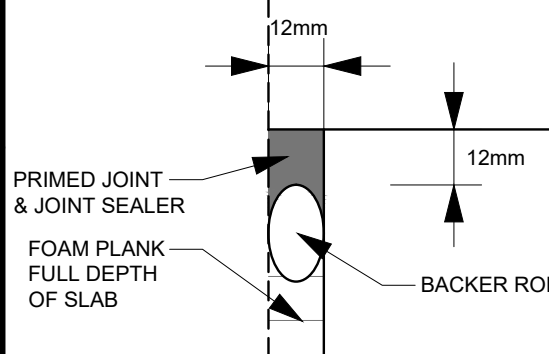

### DETAIL 4:

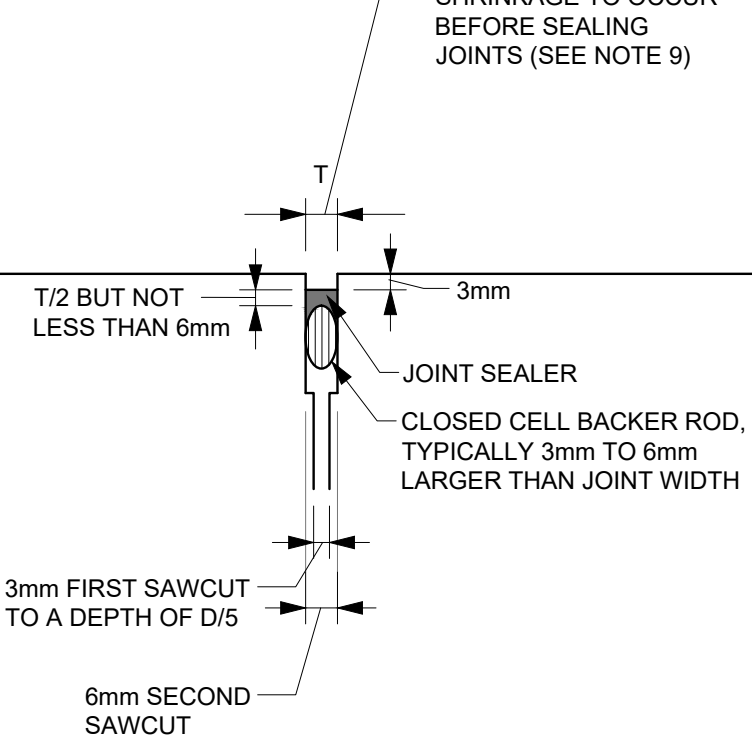

### NOTES:

- ENSURE JOINTS ARE CLEAN AND DRY PRIOR TO THE APPLICATION OF THE JOINT SEALER.
- INSTALL CLOSED CELL BACKER ROD AFTER JOINTS HAVE BEEN CLEANED AND DRIED IN ACCORDANCE WITH JOINT SEALER MANUFACTURER'S REQUIREMENTS.
- INSTALL CLOSED CELL BACKER ROD AT CONSISTENT AND UNIFORM DEPTH.
- JOINT SEALER (SUCH AS DOWSIL CCS OR APPROVED EQUIVALENT OTHER) APPLICATION SHALL BE IN STRICT COMPLIANCE WITH SEALANT MANUFACTURER'S REQUIREMENTS.
- CONCRETE SLAB SHOULD CONSIST OF MIN. 32 MPa CLASS C2 CONCRETE WITH 5-8% AIR ENTRAINMENT. DO NOT PLACE SLAB-ON-GRADE IN CONTINUOUS POURS IN LENGTHS EXCEEDING 30.0m IN EITHER DIRECTION.
- CONTRACTION JOINT SAW CUTS ARE TO BE CUT AT INTERVALS OF MIN. 24 TIMES SLAB THICKNESS c/c TO MAX. 36 TIMES SLAB THICKNESS c/c. PROPOSED SAW CUT LAYOUT TO BE SUBMITTED BY CONTRACTOR FOR REVIEW AND APPROVAL PRIOR TO COMMENCING WORK.
- CONSTRUCTION JOINTS SHOULD ONLY BE CUT ONCE SUFFICIENTLY CURED (24 HOURS) AND LOCATED CENTRALLY ALONG CENTERLINE OF ROUND DOWEL AS PER DETAIL 1.
- ISOLATION JOINTS PROVIDED WHERE SLABS ABUT FOUNDATIONS, FOOTINGS, WALLS, MANHOLES, CURBS, OR OTHER STRUCTURES THAT ARE NOT SUBJECT TO THE SAME MOVEMENT AS THE SLABS ARE TO BE IN-FILLED AS SHOWN IN DETAIL 3 ENLARGEMENT. FOAM PLANK TO CONSIST OF COMPRESSIBLE, NON-ABSORBENT AND NON-REACTIVE MATERIAL SUCH AS ASPHALT IMPREGNATED FIBREBOARD.
- ALLOW 120 DAYS FROM POUR DATE (OR AS LONG AS FEASIBLE BASED ON SITE PROJECT SPECIFIC SCHEDULE) FOR CONCRETE SHRINKAGE TO OCCUR PRIOR TO SEALING JOINTS. IF REQUIRED, RE-SAW JOINT IMMEDIATELY PRIOR TO INSTALLING SEALANT TO ACHIEVE A 6mm JOINT WIDTH. ENSURE JOINT IS CLEAN, DRY AND SIDES ARE PREPARED AS PER MANUFACTURER'S RECOMMENDATIONS.

9 AURIGA DRIVE  
OTTAWA, ON  
K2E 7T9  
TEL: (613) 226-7381

NO.	REVISIONS	DATE	INITIAL

COLONNADE BRIDGEPORT  
 GEOTECHNICAL INVESTIGATION  
 PROPOSED COMMERCIAL WAREHOUSE DEVELOPMENT  
 560 DEALERSHIP DRIVE  
 OTTAWA, ONTARIO

Title: **EXTERIOR APRON SLAB DETAILS**

Scale: N.T.S.  
 Date: 11/2022  
 Drawn by: YA  
 Report No.: PG6119-1  
 Checked by: MS  
 Dwg. No.: **FIGURE 1**  
 Approved by: DJG  
 Revision No.:

p:\autocad\drawings\geotechnical\pg6119\pg6119.dwg - figure 2 - exterior apron slab details.dwg