



Updated Geotechnical Investigation
Proposed Residential Development
178 Nepean Street, 219/223 Bank Street,
Ottawa, ON

Client:

Smart Living Properties

Type of Document:

FINAL

Project Number:

OTT-22018926-A0

City of Ottawa Application Numbers:

D02-02-22-0127 and D07-12-22- 0188

Prepared By:

Daniel Wall, M.Eng., P.Eng.

Reviewed By:

Ismail M. Taki, M.Eng., P.Eng.

EXP Services Inc.

100-2650 Queensview Drive

Ottawa, Ontario K2B 8H6

t: +1.613.688.1899

f: +1.613.225.7337

Date Submitted:

June 21, 2023 (superseded February 21, 2023 report)

Contents

Executive Summary	iii
1.0 Introduction.....	1
2.0 Site Description	2
3.0 Site Geology.....	3
4.0 Procedure	4
4.1 Fieldwork	4
4.2 Laboratory Testing Program.....	4
4.3 Seismic Shear Wave Velocity Sounding Survey	5
5.0 Subsurface Conditions and Groundwater Levels	6
5.1 Asphaltic Concrete.....	6
5.2 Concrete.....	6
5.3 Granular Fill.....	6
5.4 Fill	6
5.5 Silt and Clay.....	6
5.6 Glacial Till	7
5.7 Refusal and Shale Bedrock	8
5.8 Groundwater.....	8
6.0 Seismic Site Classification.....	10
7.0 Grade Raise Restrictions.....	11
8.0 Foundation Considerations	12
8.1 Shallow Foundations	12
8.2 Vibratory Control Modulus Columns	12
8.3 Micropiles	13
8.4 Piles	13
8.5 Relative benefits of each foundation option	14
9.0 Floor Slab and Drainage Requirements.....	17
10.0 Lateral Earth Pressures Against Subsurface Walls	18
11.0 Subsurface Concrete Requirements.....	19
12.0 Excavations.....	20
13.0 Backfilling Requirements and Suitability of On-site Soils for Backfilling Purposes	23
14.0 Impact of Construction on Adjacent Properties and Structures	24
15.0 General Comments.....	25

List of Tables

Table I: Summary of Laboratory Testing Program.....	5
Table II Summary of Results from Grain-Size Analysis and Atterberg Limit Determination – Silt and Clay Samples	7
Table III Summary of Results from Grain-Size Analysis – Glacial Till Samples.....	7
Table IV: Unit Weight and Unconfined Compressive Strength of Rock Cores	8
Table V: Summary of Groundwater Level Measurements	8
Table VI: Factored Geotechnical Resistance at Ultimate Limit State (ULS) for Steel Pipe and H-Piles	13
Table VII: Geotechnical Related Options for the Treatment of the Liquefiable Soils	14
Table VIII: Corrosion Test Results on a Selected Sample	19

List of Figures

Figure 1	–	Site Location Plan
Figure 2	–	Borehole Location Plan
Figure 3 to 6	–	Borehole Logs
Figures 7 to 10	–	Grain Size Analyses

List of Appendices

Appendix A:	Seismic Shear Wave Velocity Sounding Survey Report by GPR Rock Core Photographs
Appendix B:	Rock Core Photographs
Appendix C:	Liquification Analysis
Appendix D:	Ontario Provincial Standard Drawing (OPSD) 3001.100, Type II
Appendix E:	Laboratory Certificate of Analysis Report

Executive Summary

A geotechnical investigation was undertaken at the site of the proposed multi-use residential/commercial development to be located at 178 Nepean Street and 219/223 Bank Street, Ottawa, Ontario (Figure 1). Terms of reference for this project were provided in EXP proposal OTT-22018926-A0 dated July 21, 2022 and a subsequent agreement on January 26, 2023.

The proposed development will consist of a new nine (9) storey building with one basement level. The façade of the original buildings along Nepean Street, Bank Street and Lisgar Street will be preserved and incorporated into the design of the new building. The proposed building will include 245 residential units, 9 commercial retail units at the ground floor level and 6 commercial retail units at the basement level. There will be no underground parking. Based on the Annis, O’Sullivan and Vollebakk Ltd. Survey of 178 Nepean Street, the existing exterior grade ranges from Elevation 72.67 m to Elevation 72.82 m. Drawing A120 titled “Sections” by Woodman Architect and Associates, dated April 25, 2023, indicates that the proposed development will have a basement finished floor at 3.66 m below the existing grade. This corresponds to an approximate elevation of Elevation 69.1 m. A minimal grade raise (if any) is expected as part of the proposed development.

The borehole fieldwork for this geotechnical investigation was undertaken in two (2) stages. The first stage consisted of the drilling of three boreholes, Borehole No. 1, drilled in the basement of 223 Bank Street on December 5, 2022 and Borehole Nos. 2 and 3 drilled, exterior to the buildings, on November 23, 2022. The second stage consisted of an additional interior borehole (Borehole No. 4), drilled within 178 Nepean Street on February 3, 2023 and the completion of a multi-channel analysis of surface waves (MASW) study. The borehole fieldwork for both stages was supervised on a full-time basis by a representative from EXP

The geotechnical conditions at the site consist of 75 mm to 125 mm of concrete or asphaltic concrete underlain by fill extending to 0.2 m to 1.4 m depth (Elevation 71.0 m to 70.9 m). The fill is underlain by a deposit of clay in Borehole Nos. 1 to 3 which extends to depths of 2.1 to 4.0 m (Elevation 68.3 m to Elevation 68.1 m). Underlying the clay in Borehole Nos. 1 to 3 and the fill in Borehole No. 4 is a layer of glacial till with SPT N-values ranging from the weight of the SPT hammer to 65 blows indicating the glacial till is in a very loose to very dense state. Shale bedrock was confirmed in Borehole Nos. 1 and 4 at 7.9 m and 5.5 m depth, respectively (Elevation 62.5 m and 64.7 m). Groundwater was encountered at 6.1 to 7.0 m depths (Elevation 65.1 m to Elevation 64.3 m) and was found to be deeper than 7.1 m (Elevation 65.2 m) in Borehole No. 2 and deeper than 5.5 m (Elevation 64.7 m) in Borehole No. 4

In the preliminary geotechnical report, dated February 21, 2023, the presence of potentially liquifiable soils was noted in two of the three boreholes. The liquefaction analysis performed in the preliminary geotechnical report was updated using the data from the additional investigation and testing. The updated analysis indicates that the subsurface soils below 3.0 m in depth are not considered liquifiable in a seismic event. Excavations at the site are expected to extend to a maximum depth of 4.3 m below the existing street level (~Elevation 68.5 m)

The results of the MASW also indicate that the average seismic shear wave velocity below 3.0 m in depth was 966 m/s. Based on these results a **Class C** site class for seismic site response in accordance with Table 4.1.8.4.A of the 2012 Ontario Building Code (OBC), as amended May 2, 2019, can be used for pile caps or foundations where 3 metres (or more) of unconsolidated material lies between the bedrock surface and the bottom of the foundation or pile cap.

It is understood that the basement finished floor elevation will be at approximately 69.1 m elevation. Based on the basement floor elevation, shallow foundations would be expected to be at an approximate elevation of Elevation 68.5 m. Based on a review of the borehole information, footings at an elevation of Elevation 68.5 m would be founded on compact to dense glacial till in Borehole No. 4 and on stiff to hard native silty clay which is underlain by glacial till in Borehole Nos. 1 to 3. It is unlikely that the available Serviceability Limit State (SLS) bearing of the stiff to hard silty clay or the compact to dense glacial till are capable of supporting shallow foundation footings for the proposed nine (9) storey building. No design loading has been provided at the time of this report.

Based on the available data, the proposed nine storey building can be founded on shallow foundations supported on the shale bedrock (should the design of the building be changed), or supported on either Control Modulus Columns (CMCs), micropiles or by closed end steel pipe or steel H-piles.

The design of the basement floor slab will be dependant on which foundation option is selected. The lowest floor level of the proposed buildings will be located at an approximate 3.7 m depth below the existing street grade (~ Elevation 69.1 m). Based on the borehole information, a floor slab at Elevation 69.1 m will be founded on either very stiff to hard silty clay or on compact glacial till. Should the ground improvement option (CMCs) allow for a slab-on-grade floor slab then the slab-on-grade should be set on an engineered fill pad with a minimum thickness of 600 mm and constructed on top of the improved soil. The engineered fill pad should consist of OPSS Granular B Type II material compacted to 98 percent SPMDD. For the options where a slab-on-grade is not possible, the basement floor will have to be designed as a structural slab supported by CMCs, micropiles or conventional piles. Perimeter drainage systems should be provided. Underfloor is not required.

The fill excavated from site is not suitable for use as backfill and must be disposed of as per the requirements of the environmental report. Fill required for backfilling purposed would have to be imported and should conform to OPSS Granular A or B, Type II as specified in the report.

Excavations at the site are expected to extend to a maximum depth of 4.3 m below the existing street level (~Elevation 68.5 m). The excavation will extend through the concrete or asphaltic concrete, fill and terminate within the silt and clay or glacial layer. Further guidance can be provided if the excavations will extend to or below the bedrock surface. The excavations are anticipated to be above the groundwater level. Excavations may be undertaken by conventional heavy equipment capable of removing debris, cobbles and boulders present within the fill and cobbles and boulders within the native soils.

It is expected that side slopes noted above for the construction of the proposed building will not be able to be achieved due to space restrictions on site and consideration for the existing building façade. Excavation for the new building construction would have to be undertaken within the confines of an engineered support system (shoring system).

In order to ensure that no negative impacts will occur to adjacent structures or infrastructure, the engineered support system as well as adjacent settlement sensitive structures (buildings and the existing façade) and infrastructure should be monitored for movement (deflection) on a periodic basis during construction operations. Vibration monitoring should also be carried out on the adjacent structures and infrastructure and safe vibration limits need to be established prior to construction. It is recommended that the vibration monitoring is carried out with real-time alerts so that any activities which have potential to cause damage can be immediately halted.

The results of the resistivity tests indicate that shale bedrock is corrosive to moderately corrosive to bare steel as per the National Association of Corrosion Engineers (NACE). Appropriate measures should be taken to protect the buried bare steel from corrosion.

This executive summary is a brief synopsis of the report and should not be read in lieu of reading the report in its entirety.

1.0 Introduction

A geotechnical investigation was undertaken at the site of the proposed multi-use residential/commercial development to be located at 178 Nepean Street and 219/223 Bank Street, Ottawa, Ontario (Figure 1). Terms of reference for this project were provided in EXP proposal OTT-22018926-A0 dated July 21, 2022 and a subsequent agreement on January 26, 2023.

The proposed development will consist of a new nine (9) storey building with one basement level. The façade of the original buildings along Nepean Street, Bank Street and Lisgar Street will be preserved and incorporated into the design of the new building. The proposed building will include 245 residential units, 9 commercial retail units at the ground floor level and 6 commercial retail units at the basement level. There will be no underground parking. Based on the Annis, O’Sullivan and Vollebakk Ltd. Survey of 178 Nepean Street, the existing exterior grade ranges from Elevation 72.67 m to Elevation 72.82 m. Drawing A120 titled “Sections” by Woodman Architect and Associates, dated April 25, 2023, indicates that the proposed development will have a basement finished floor at 3.66 m below the existing grade. This corresponds to an approximate elevation of Elevation 69.1 m. A minimal grade raise (if any) is expected as part of the proposed development.

The geotechnical investigation was undertaken to:

- (a) Establish subsurface soil and groundwater conditions at four (4) borehole locations.,
- (b) Discuss feasibility of raising the grade at the site.,
- (c) Discuss foundation alternatives available including founding depth, Serviceability Limit State (SLS) bearing pressure, and factored geotechnical resistance at Ultimate Limit State (ULS) of the founding strata.,
- (d) Anticipated total and differential settlements for different foundation options.,
- (e) Classify the site for seismic site response in accordance with the requirements of the 2012 Ontario Building Code (as amended May 2, 2019) and assess the potential for liquefaction of the subsurface soils during a seismic event.,
- (f) Discuss slab-on-grade floor construction.,
- (g) Static and seismic earth forces on basement walls.,
- (h) Comment on excavation conditions anticipated and dewatering requirements during construction.,
- (i) Discuss backfilling requirements and the suitability of the on-site soil for backfilling purposes, and
- (j) Comment on subsurface concrete requirements.

The comments and recommendations given in this report are based on the assumption that the above-described design concept will proceed into construction. If changes are made either in the design phase or during construction, this office must be retained to review these modifications. The result of the review may be a modification of our recommendations, or it may require additional field and/or laboratory work to determine if the changes are acceptable from a geotechnical viewpoint.

2.0 Site Description

The site is approximately 0.5 acres in size with frontage along Nepean Street, Lisgar Street and Bank Street. The site is within a mature neighbourhood which includes retail shops, services, and multi-storey residential units. The existing property consists of multi-storey residential buildings with commercial retail space at street level and one basement level. The site is bounded to the east by residential buildings and a parking lot.

The ground surface elevations at the exterior borehole locations were Elevation 72.31 m and Elevation 72.11 m. The elevations of the basement boreholes have been estimated as Elevation 70.4 m and Elevation 70.2 m.

3.0 Site Geology

3.1 Surficial Geology Maps

The surficial geology was reviewed via the Google Earth applications published by the Ontario Ministry of Energy, Northern Development and Mines available via www.mndm.gov.on.ca/en/mines-and-minerals/applications/ogsearch/surficial-geology and was last modified on May 23, 2017. The map indicates the Site is underlain by fine-textured glaciomarine deposits consisting of silt and clay with minor sand and gravel overlying a stone-poor, sandy silt to silty sand-textured glacial till deposit. The surficial deposits are shown in Image 1 below.





-  Fine-textured glaciomarine deposits consisting of silt and clay with minor sand and gravel
-  Stone-poor, sandy silt to silty sand-textured till on Paleozoic terrain

Image 1 – Surficial Geology

3.2 Bedrock Geology Maps

The bedrock geology map (Ontario Geological Survey, Map P. 2611 – Geology and Mineral Deposits, Kingston Area, printed by the Government of Ontario, 1985) indicates the site is underlain by shale with minor limestone of the Billings formation. The shale of the Billings formation is an expansive type of shale. Close to the site is limestone of the Lindsay formation. The bedrock geology is shown in Image 2 below.





-  Billings Formation: Shale with minor limestone
-  Lindsay Formation: Limestone; nodular to black, laminated

Image 2 – Bedrock Geology

4.0 Procedure

4.1 Fieldwork

The borehole fieldwork for this geotechnical investigation was undertaken in two (2) stages. The first stage consisted of the drilling of three boreholes, Borehole No. 1, drilled in the basement of 223 Bank Street on December 5, 2022 and Borehole Nos. 2 and 3 drilled, exterior to the buildings, on November 23, 2022. The second stage consisted of an additional interior borehole (Borehole No. 4), drilled within 178 Nepean Street on February 3, 2023 and the completion of a multi-channel analysis of surface waves (MASW) study. The borehole fieldwork for both stages was supervised on a full-time basis by a representative from EXP.

The locations and the geodetic elevations for Boreholes Nos. 2 and 3 were established on site by EXP and are shown on the Borehole Location Plan, Figure 2. The geodetic elevation of Borehole Nos. 1 and 4 were estimated from the surveyed elevations exterior to the building and measurements taken within the existing buildings and therefore are considered to be approximate.

The borehole locations were cleared of private and public underground services, prior to the start of drilling by USL-1 Underground Service Locators acting as sub-contractor to exp.

Borehole Nos. 1 and 4 were drilled in the southwest and northwest corners of the basement in 223 Bank Street and 178 Nepean St, respectively, using hand portable drilling equipment advanced with a combination of continuous Standard Penetration Testing (SPT) using a third weight hammer and washboring. The latter was carried out by using NQ sized casing advanced using a Hilti drill. The boreholes extended to termination depths of 9.9 m and 8.5 m below the existing basement level in Borehole Nos. 1 and 4, respectively. The SPT “N” values from these boreholes have been corrected to N values using a standard weight hammer. The presence of bedrock was proven in both boreholes by rock coring. A field record was made of wash water return, colour of wash water and any sudden drops of the core barrel were kept during rock coring operations.

Boreholes Nos. 2 and 3 were drilled using a geoprobe track mounted drill rig equipped with soil sampling and SPT capabilities. SPT’s were performed at depth intervals of 0.75 m to 1.5 m with soil samples retrieved by the split-barrel sampler.

The undrained shear strength of the clayey soil was measured by conducting penetrometer tests on selected recovered soil samples and in-situ shear vane tests at selected depth intervals.

The subsurface soil conditions in each borehole were logged with each soil sample placed in a labelled plastic bag. The bedrock cores were also logged and stored in core boxes and identified.

Nineteen (19) mm diameter standpipes with slotted section were installed in all the boreholes for long-term monitoring of the groundwater levels. The standpipes were installed in accordance with EXP standard practice, and the installation configuration is documented on the respective borehole logs. The boreholes were backfilled upon completion of drilling.

4.2 Laboratory Testing Program

On completion of the fieldwork, the soil and rock samples were transported to the EXP laboratory in Ottawa. The soil and rock samples were visually examined in the laboratory by a senior geotechnical engineer and logs of boreholes prepared. All soil and rock samples were classified in accordance with the Unified Soil Classification System (USCS) and the modified Burmister Soil Classification System (2006 Fourth Edition of the Canadian Foundation Engineering Manual (CFEM)).

The geotechnical engineer also assigned the laboratory testing program which is summarized in Table I.

Table I: Summary of Laboratory Testing Program

Type of Test	Number of Tests Completed
Soil Samples	
Moisture Content Determination	32
Unit Weight Determination	5
Grain Size Analysis	4
Atterberg Limit Determination	4
Corrosion Analysis (pH, sulphate, chloride and resistivity)	1
Rock Samples	
Unconfined Compressive Strength	1
Unit Weight Determination	1

4.3 Seismic Shear Wave Velocity Sounding Survey

A seismic shear wave velocity sounding survey was conducted at the site on March 10, 2023 by Geophysics GPR International Inc. (GPR). The survey line is located along the east side of the site, as shown in Figure 2. The survey was undertaken using the multi-channel analysis of surface waves (MASW), spatial auto correlation (SPAC) and seismic refraction methods. The seismic shear wave velocity sounding survey report is shown in Appendix A.

5.0 Subsurface Conditions and Groundwater Levels

A detailed description of the subsurface conditions and groundwater levels from the boreholes are given on the attached Borehole Logs, Figure Nos. 3 to 6. The borehole logs and related information depict subsurface conditions only at the specific locations and times indicated. Subsurface conditions and water levels at other locations may differ from conditions at the locations where sampling was conducted. The passage of time also may result in changes in the conditions interpreted to exist at the locations where sampling was conducted.

Boreholes were drilled to provide representation of subsurface conditions as part of a geotechnical exploration program and are not intended to provide evidence of potential environmental conditions.

It should be noted that the soil and rock boundaries indicated on the borehole logs are inferred from non-continuous sampling and observations during drilling operations. These boundaries are intended to reflect approximate transition zones for the purpose of geotechnical design and should not be interpreted as exact planes of geological change. The “note on Sample Descriptions” preceding the borehole logs form an integral part of this report and should be read in conjunction with this report.

A review of the borehole logs indicates the following subsurface conditions with depth and groundwater level measurements.

5.1 Asphaltic Concrete

A 75 mm thick layer of asphaltic concrete was encountered at the surface of Borehole No. 3.

5.2 Concrete

A 75 mm to 125 mm thick concrete slab was encountered at the surface of Boreholes Nos. 1, 2 and 4.

5.3 Granular Fill

A 50 mm to 125 mm thick layer of granular fill was encountered underlying the asphaltic concrete or concrete in Borehole Nos. 1, 3 and 4.

5.4 Fill

The asphaltic concrete in Boreholes No. 2 and the granular fill in Borehole No. 3 are underlain by a fill consisting of a silty sand with gravel which extends to 1.1 m to 1.4 m depth (Elevation 71.0 m to Elevation 70.9 m). Based on the SPT N-values of 4 to 18 the fill is in a loose to compact state. The natural moisture content of the fill ranges from 4 percent to 17 percent. One unit weight of the fill was 23.7 kN/m³.

5.5 Silt and Clay

A silt and clay deposit was contacted below the fill or granular fill and extends to depths of 2.1 m to 4.0 m (Elevation 68.3 m to Elevation 68.1 m) in Borehole Nos. 1, 2 and 3. The undrained shear strength of the silt and clay ranges from 144 kPa to 200 kPa indicating a very stiff to hard consistency. The natural moisture content and unit weight of the silt and clay ranges from 34 percent to 77 percent and 17.3 kN/m³ to 18.7 kN/m³, respectively.

This layer was not encountered in Borehole No. 4.

The results from the grain-size analysis and Atterberg limits determination of two (2) samples of the silt and clay are summarized in Table II. The grain-size distribution curves are shown in Figures 7 and 8.

**Table II Summary of Results from Grain-Size Analysis and Atterberg Limit Determination –
 Silt and Clay Samples**

Borehole No. (BH) – Sample No. (SS)	Depth (m)	Grain-Size Analysis (%)				Atterberg Limits (%)				Soil Classification (USCS)	Soil Classification Burmister Soil Classification System
		Gravel	Sand	Silt	Clay	Moisture Content	Liquid Limit	Plastic Limit	Plasticity Index		
BH 1-SS3	0.8-1.4	0	3	41	56	47	26	57	31	Clay of High Plasticity (CH)	Silt and Clay, trace sand
BH3-SS3	4.6-5.2	0	8	39	53	40	29	63	34	Clay of High Plasticity (CH)	Silt and Clay, trace sand

Based on a review of the results of the grain-size analysis, the clay deposit at the site and may be classified as a clay of high plasticity (CH) in accordance with the USCS Soil Classification (USCS) and as a silt and clay, trace sand in accordance with the Burmister Soil Classification System.

5.6 Glacial Till

The clay in Borehole Nos. 1, 2 and 3 and the granular fill in Borehole No. 4 are underlain by a glacial till deposit contacted at 0.2 m to 4.0 m depths (Elevation 70.1 m to Elevation 68.1 m). The glacial till contains varying amounts of gravel, sand, silt and clay as well as cobbles and boulders. Based on SPT N-values of 9 to 65 the glacial till is generally in a loose to very dense state. High N-values for low sampler penetration, such as 50 for 50 mm of sampler penetration were recorded and may be a result of the sampler contacting cobbles or boulders within the glacial till deposit. In Borehole No. 2 low SPT N-values ranging from the weight of the SPT hammer to 2 blows were recorded indicating a very loose state.

In Borehole Nos. 1 and 4, refusal was encountered at 5.8 m and 5.6 m depth (Elevation 64.6 m and Elevation 65.0 m), respectively. Beyond the refusal depth the boreholes were advanced further using N size coring equipment and refusal was proven to be met on cobbles, boulders and shale fragments within the glacial till overburden, which extend to 7.9 m and 4.6 m depth (Elevation 62.5 m and Elevation 65.6 m) in Borehole Nos. 1 and 4, respectively. In Borehole No. 4 highly weathered (soil like) shale fragments were encountered at 4.6 m depth (Elevation 65.6) and extends to 5.5 m depth (Elevation 64.7 m). This layer may be weathered shale bedrock or glacial till with a high percentage of shale.

The natural moisture content of the glacial till ranges from 5 percent to 19 percent.

The results from the grain-size analysis conducted on two (2) samples of the glacial are summarized in Table III. The grain-size distribution curves are shown in Figures 9 and 10.

Table III Summary of Results from Grain-Size Analysis – Glacial Till Samples

Borehole No. (BH) – Sample No. (SS)	Depth (m)	Grain-Size Analysis (%)				Soil Classification (USCS)	Soil Classification Burmister Soil Classification System
		Gravel	Sand	Silt	Clay		
BH3 SS7	5.3 – 5.9	15	43	33	9	Silty sand with gravel (SM)	Silty sand, some gravel, trace clay
BH1 SS6	3.0 – 3.6	14	38	34	14	Silty Sand (SM)	Silty sand, some gravel and clay

Based on a review of the results of the grain-size analysis, the glacial till may be classified as a silty sand or silty sand with gravel (SM) in accordance with the USCS Soil Classification (USCS) and as a silty sand, some gravel, trace to some clay in accordance with the Burmister Soil Classification System. The glacial till contains cobbles, boulders and shale fragments.

5.7 Refusal and Shale Bedrock

Refusal was encountered in Borehole Nos. 2 and 3 at 7.0 m to 7.1 m depth (Elevation 65.2 m to 65.1 m) and likely met on cobbles and boulders within the glacial till layer.

In Borehole No. 4 highly weathered (soil like) shale fragments were encountered at 4.6 m depth (Elevation 65.6) and extends to 5.5 m depth (Elevation 64.7 m). This layer may be weathered shale bedrock or glacial till with a high percentage of shale. Shale bedrock was encountered in Boreholes Nos. 1 and 4 at 7.9 m and 5.5 m depth (Elevation 62.5 m and 64.7 m), respectively, and proven to 9.9 m and 8.5 m depth (Elevation 60.5 m and Elevation 61.7 m), respectively. The shale is grey to black in colour with a Total Core Recovery (TCR) of ranging from 62 percent to 100 percent and Rock Quality Designation (RQD) ranging from 0 percent to 65 percent. The RQD value indicates a very poor to fair quality shale bedrock. The results of a unit weight and unconfined compressive strength test undertaken on one (1) sample of the intact rock are given on Table IV. Photographs of the rock cores are shown in Appendix B.

Table IV: Unit Weight and Unconfined Compressive Strength of Rock Cores

Borehole #	Depth (m)	Unit Weight (kN/m ³)	Unconfined Compressive Strength (MPa)
1	9.4 – 9.5	25.3	32.1

On the basis of its unconfined compressive strength, the rock may be described as medium strong.

As previously mentioned, the shale bedrock at the site is of the Billings formation. This type of shale is prone to deterioration when exposed to the elements. It also heaves due to a complex mechanism caused in part from the bio-oxidation of the sulphides in the rock, which react with calcite seams to form expanding gypsum. This occurs when oxygen is permitted to enter the rock, usually by lowering of the water table and this process is accelerated by the presence of heat. Therefore, special treatment of the Billings shale bedrock will need to be incorporated into the design and construction of the proposed buildings if excavations extend to or beyond the bedrock surface.

5.8 Groundwater

A summary of the groundwater level measurements taken in the boreholes equipped with standpipes on December 7, 2022 and March 22, 2023 are shown in Table V. The standpipes in Borehole Nos. 1 to 3 were inaccessible on the March 22, 2023 site visit.

Table V: Summary of Groundwater Level Measurements

Borehole No. (BH)	Ground Surface Elevation (m)	December 7, 2022		March 22, 2023	
		Elapsed Time in Days from Date of Installation	Depth Below Ground Surface (Elevation), m	Elapsed Time in Days from Date of Installation	Depth Below Ground Surface (Elevation), m
BH-01	70.4	2 days	6.1 (64.3)	--	--
BH-02	72.31	14 days	Dry to 7.1 (65.2 m)	--	--
BH-03	72.11	14 days	7.0 (65.1)	--	--
BH-04	70.2	--	--	47 days	Dry to 5.5 (64.7 m)

The above table indicates the groundwater level to ranges from 6.1 m to 7.0 m depths (Elevation 65.1 m to Elevation 64.3 m) and was found to be deeper than 7.1 m (Elevation 65.2 m) in Borehole No. 2 and deeper than 5.5 m (Elevation 64.7 m) in Borehole No. 4.

The groundwater levels were determined in the boreholes at the time and under the condition stated in this report. Note that fluctuations in the level of groundwater may occur due to a seasonal variation such as precipitation,

snowmelt, rainfall activities, and other factors not evident at the time of measurement and therefore may be at a higher level during wet weather periods.

6.0 Seismic Site Classification

The geotechnical conditions at the site consist of 75 mm to 125 mm of concrete or asphaltic concrete underlain by fill extending to 0.2 m to 1.4 m depth (Elevation 71.0 m to 70.2 m). The fill is underlain by a deposit of silt and clay in Borehole Nos. 1 to 3 which extends to depths of 2.1 to 4.0 m (Elevation 68.3 m to Elevation 68.1 m). Underlying the silt and clay in Borehole Nos. 1 to 3 and the fill in Borehole No. 4 is a layer of glacial till with SPT N-values ranging from the weight of the SPT hammer to 65 blows indicating the glacial till is in a very loose to very dense state. Shale bedrock was confirmed in Borehole Nos. 1 and 4 at 7.9 m and 5.5 m depth (Elevation 62.5 m and 64.7 m), respectively.

In the preliminary geotechnical report, dated February 21, 2023, the presence of potentially liquifiable soils was noted in two of the three boreholes. In order to collect additional data on the presence (or absence) of potentially liquefiable soils an additional borehole was drilled in the in the basement of 178 Nepean Street (Borehole No 4) and a Multi-channel Analysis of Surface Waves (MASW) seismic shear wave velocity sounding survey was carried out. The results of the MASW, completed on March 10, 2023, are presented in Appendix A and the results of the additional borehole are presented in Figure No. 6.

The liquefaction analysis performed in the preliminary geotechnical report was updated using the data from the additional investigation and testing. The updated analysis indicates that the subsurface soils below 3.0 m in depth are not considered liquifiable in a seismic event. Excavations at the site are expected to extend to a maximum depth of 4.3 m below the existing street level (~Elevation 68.5 m). The liquification analysis calculations are included in Appendix C.

The results of the MASW also indicate that the average seismic shear wave velocity below 3.0 m in depth was 966 m/s. Based on these results a **Class C** site class for seismic site response in accordance with Table 4.1.8.4.A of the 2012 Ontario Building Code (OBC), as amended May 2, 2019, can be used for pile caps or foundations where 3 metres (or more) of unconsolidated material lies between the bedrock surface and the bottom of the foundation or pile cap.

7.0 Grade Raise Restrictions

Based on the Annis, O’Sullivan and Vollebakk Ltd. survey of 178 Nepean Street the existing floor elevation ranges from 72.67 m to 72.82 m. Assuming the existing floor elevations of 219/223 Bank Street are similar to 178 Nepean Street, a minimal grade (if any) raise is expected.

For preliminary design purposes the permissible maximum site grade raise for the proposed building may be taken as 0.5 m.

8.0 Foundation Considerations

It is understood that the basement finished floor elevation will be at approximately 69.1 m elevation. Based on the basement floor elevation, shallow foundations would be expected to be at an approximate elevation of Elevation 68.5 m. Based on a review of the borehole information, footings at an elevation of Elevation 68.5 m would be founded on compact to dense glacial till in Borehole No. 4 and on stiff to hard native silty clay which is underlain by glacial till in Borehole Nos. 1 to 3. It is unlikely that the available Serviceability Limit State (SLS) bearing of the stiff to hard silty clay or the compact to dense glacial till are capable of supporting shallow foundation footings for the proposed nine (9) storey building.

No design loading has been provided at the time of this report.

8.1 Shallow Foundations

If consideration is being given to adding additional basement levels, based on a review of the borehole information it is considered feasible to support the proposed building on spread and strip footings founded on shale bedrock, encountered in Boreholes Nos. 1 and 4 at 7.9 m and 5.5 m depth (Elevation 62.5 m and 64.7 m), respectively.

Spread and strip footings founded weathered shale bedrock may be designed for a bearing pressure at serviceability limit state (SLS) of 500 kPa and factored geotechnical resistance at ultimate limit state (ULS) of 750 kPa. The factored geotechnical resistance at ULS includes a resistance factor of 0.5. Settlements of footing designed for the above recommended factored geotechnical resistance at ULS and properly constructed are expected to be less than 10 mm.

All the footing beds should be thoroughly examined by a geotechnical engineer to ensure that the bedrock area is capable of supporting the design ULS value. Where fractured rock is encountered, sub-excavation may be undertaken to the underlying more competent bedrock. Alternatively, the footings may be redesigned to a reduced factored geotechnical resistance at ULS.

A minimum of 1.5 m of earth cover should be provided to exterior footings of heated structures to protect them from damage due to frost penetration. The frost cover should be increased to 2.1 m for unheated structures if snow will not be removed from the vicinity of the footing and 2.4 m of earth cover if snow will be removed from the vicinity of the footing. In areas where earth cover will be less than the required, rigid insulation may be used to protect the footings. Alternatively, a combination of earth cover and rigid insulation may also be used to protect the footings. For this project it is anticipated that the required earth cover for the footings of the proposed buildings will be satisfied, since the footings are anticipated to be at depths greater than 1.5 m below the final grade.

The shale bedrock at the site is from the Billings formation and is prone to swelling under certain conditions of heat and humidity. It is also prone to rapid deterioration especially for the portion of the shale bedrock below the groundwater table that is exposed to the elements. Should excavation be carried out to or below the bedrock surface, special design considerations and methods would be required.

If this option is being considered, further design recommendations can be provided.

8.2 Vibratory Control Modulus Columns

Consideration can be given the use of vibratory Control Modulus Columns (CMCs) to support the proposed building foundations. CMCs is a type of ground improvement technique used to strengthen weak or compressible soil deposits by concreted columns which are injected in a specific grid or pattern into the soil using a hydraulic displacement auger and via a load transfer platform, the structural loads spread to the reinforced soils. It is anticipated that the CMCs will terminate within the glacial till layer.

The CMCs would need to be designed and installed by a specialized and provincially recognized ground improvement contractor.

8.3 Micropiles

A micropile is a small diameter, 305 mm or less, friction pile that is installed by either boring or drilling and allow for the transfer of loading by a reinforcement bar cemented into either soil or bedrock. The installation of the micropiles can be carried out through cobbles, boulders or other obstructions and can be an angle to accommodate axial and lateral loads.

The micropiles are typically designed by a specialized design-build deep foundation construction company.

8.4 Piles

Based on the available data, the proposed nine storey building could be supported by closed end steel pipe or steel H-piles driven to practical refusal expected in the upper 1.0 m of the shale bedrock that was contacted in Boreholes Nos. 1 and 4 at 7.9 m and 5.5 m depth (Elevation 62.5 m and 64.7 m), respectively. Closed end pipe piles are typically used in the Ottawa area and can be more economical compared to H-piles. Further, H-piles tend to extend deeper into the shale bedrock to achieve practical refusal and required set compared with closed end pipe piles. Therefore, closed end pipe piles are recommended for this project.

The factored geotechnical resistance at ULS for various pile sections is shown in Table VI. The factored geotechnical resistance values at ULS are based on steel piles with a yield strength of 350 MPa and concrete compressive strength of 35 MPa and includes a geotechnical resistance factor of 0.4. Since the piles are expected to meet refusal within the shale bedrock, the factored geotechnical resistance at ULS will govern the design, since the bearing pressure at SLS for 25 mm of settlement will be greater than the factored geotechnical resistance at ULS.

Table VI: Factored Geotechnical Resistance at Ultimate Limit State (ULS) for Steel Pipe and H-Piles

Pile Section	Pile Section Size	Factored Geotechnical Resistance at ULS (kN)
Steel Pipe	245 mm O.D. by 10 mm wall thickness	1275
	245 mm O.D. by 12 mm wall thickness	1445
	324 mm O.D. by 12 mm wall thickness	2120
Steel H	HP 310 x 79	1260
	HP 310 x 110	1775
	HP 310 x 125	2000

Total settlement of piles designed for the above recommended factored geotechnical resistance at ULS are expected to be less than 10 mm.

To achieve the capacity given previously, the pile driving hammer must seat the pile into shale bedrock without overstressing the pile material. For guidance purposes, it is estimated that a hammer with rated energy of 54 kJ to 70 kJ (40,000 to 52,000 ft. lbs.) per blow would be required to drive the piles to practical refusal in the shale bedrock. Practical refusal is considered to have been achieved at a set of 5 blows for 6 mm or less of pile penetration. However, the driving criteria for a particular hammer-pile system must be established at the beginning of the project. This may be achieved with a Pile Driving Analyzer.

The glacial till is expected to contain cobbles and boulders. It is therefore recommended that the pile tips should be reinforced with a 25-mm thick steel plate and equipped with a driving shoe in accordance with Ontario Provincial Standard Drawing (OPSD) 3001.100, Type II, dated November 2017 and shown in Appendix D.

A number of test piles should be monitored with the Pile Driving Analyzer (PDA) during the initial driving and re-striking at the beginning of the project and 3 percent of the piles tested should be subjected to CAPWAP analysis. This monitoring will allow for the evaluation of transferred energy into the pile from the hammer, determination of driving criteria and an evaluation of the geotechnical resistance at ULS of the piles. Depending on the results of the pile driving analysis, the pile capacity may have to be proven by at least one pile load test for each pile type before production piling begins. If necessary, the pile load test should be performed in accordance with American Society for Testing and Materials (ASTM) D 1143.

Closed-end pipe piles tend to displace a relatively large volume of soil. When driven in a cluster or group, they may tend to jack up the adjacent piles in the group. Consequently, the elevation of the top of each pile in a group should be monitored immediately after driving and after all the piles in the group have been driven. This is to ensure that the piles are not heaving. Any piles found to heave more than 3 mm should be re-tapped.

Piles driven at the site may be subject to relaxation, i.e. loss of load carrying capacity with time. Therefore, it is recommended that the piles should be re-struck, minimum of 24 hours after initial driving to determine if the piles have relaxed. If relaxation is observed, this procedure should be repeated every 24 hours until it can be proven that relaxation is no longer a problem.

The installation of the piles at the site should be monitored on a full-time basis by a geotechnician working under the direction and supervision of a qualified geotechnical engineer to verify that the piles are driven in accordance with the project specifications.

The concrete grade beams and pile caps for heated structures should be protected from frost action by providing the beams and caps with 1.5 m of earth cover. For non-heated structures, the pile caps and beams should be provided with 2.4 m of earth cover in areas where the snow will be removed and 2.1 m of cover in areas where the snow will not be removed. Alternatively, frost protection may be provided by rigid insulation or a combination of earth cover and rigid insulation.

Consideration should be given to drill additional boreholes throughout the site once the buildings are demolished to provide additional data on the bedrock elevations to the contractors bidding on this project and to prevent/reduce potential of claims for extras.

8.5 Relative benefits of each foundation option

The geotechnical related advantages and disadvantages of the four foundation operations are presented in Table VII.

Table VII: Geotechnical Related Options for the Treatment of the Liquefiable Soils		
Option	Advantages	Disadvantages
Extending the excavation to the shale bedrock surface.	<ul style="list-style-type: none"> Shallow foundations can be used to support the building. Basement floor slab can be constructed as a slab on grade. 	<ul style="list-style-type: none"> A redesign of the subsurface levels would be required Bedrock depth is variable and will extend approximately 4.4 m to 6.6 m below the existing proposed underside of footing elevation The bedrock at the site is from the Billing formation and special considerations will have to be taken to keep the shale from being exposed to the air and humidity in order to keep the shale from deteriorating Increased depth of excavation and more extensive shoring requirements as compared to other methods Underpinning and support of the existing façade will be required during the excavation.

Table VII: Geotechnical Related Options for the Treatment of the Liquefiable Soils

Option	Advantages	Disadvantages
		<ul style="list-style-type: none"> • Excavations are anticipated to extend to a depth below the groundwater table and will require more extensive de-watering as compared with the other options. A ESAR or PTTW may be required. • Excavation will generate more excess soil that may require removal from the site compared with the other options.
Vibratory Control Modulus Columns	<ul style="list-style-type: none"> • Excavations are anticipated to be above the anticipated groundwater level and dewatering can be done by straightforward conventional sump pumping method. • The CMCs will transfer the loading from the proposed footing elevation to a more competent soil layer allowing for conventional strip and spread footings or a raft foundation founded on the improved soil can be used to support the building. • Reduced generation of excess soil when compared with the excavation to the bedrock surface. • Low vibration ground improvement methods can be used resulting in minimal impact on the existing building façade and surrounding structures. • Depending on the proposed loading requirements a slab-on-grade may be permissible. • CMC's can be used to support the existing façade during construction. 	<ul style="list-style-type: none"> • Specialized and provincially recognized ground improvement contractors will be required to design the soil improvement method and conduct the soil improvement. • A structural slab may be required
Micropiles	<ul style="list-style-type: none"> • Excavations are anticipated to be above the anticipated groundwater level and dewatering can be done by straightforward conventional sump pumping method. 	<ul style="list-style-type: none"> • Bedrock depth is variable • A structural slab may be required

Table VII: Geotechnical Related Options for the Treatment of the Liquefiable Soils

Option	Advantages	Disadvantages
	<ul style="list-style-type: none"> • Micropiles will transfer the loading from the proposed footing elevation to the bedrock and allowing for conventional strip and spread footings or a raft foundation founded on the improved soil can be used to support the building. • Reduced generation of excess soil when compared with the excavation to the bedrock surface. • Low vibration ground improvement methods can be used resulting in minimal impact on the existing building facade. • Micropiles can be used to support the existing façade. 	
Supporting the building addition on piles driven to bedrock	<ul style="list-style-type: none"> • Excavations are anticipated to be above the anticipated groundwater level and dewatering can be done by straightforward conventional sump pumping method. • Reduced excess soil generation as compared to excavation to the bedrock surface. • The design loads of the building addition can easily be supported by the pile foundation (i.e. pile capacity will exceed the anticipated design loads of the building). 	<ul style="list-style-type: none"> • Bedrock depth is variable • Structural slab will be required. • The method to install the piles will have to consider the existing façade and surrounding buildings. The generation of vibrations during the installation of the piles will have to be minimized so that the existing buildings and infrastructure within the construction zone of influence are not damaged.

9.0 Floor Slab and Drainage Requirements

The design of the basement floor slab will be dependant on which foundation option is selected. The lowest floor level of the proposed buildings will be located at an approximate 3.7 m depth below the existing street grade (~ Elevation 69.1 m). Based on the borehole information, a floor slab at Elevation 69.1 m will be founded on either very stiff to hard silty clay or on compact glacial till.

Should the ground improvement option (CMCs) allow for a slab-on-grade floor slab then the slab-on-grade should be set on an engineered fill pad with a minimum thickness of 600 mm and constructed on top of the improved soil. The engineered fill pad should consist of OPSS Granular B Type II material compacted to 98 percent SPMDD.

For the options where a slab-on-grade is not possible, the basement floor will have to be designed as a structural slab supported by CMCs, micropiles or conventional piles.

The slab-on-grade or structural slab may then be set on a bed of well compacted 19 mm clear stone, at least 200 mm thick, placed on the approved engineered fill pad for the ground improvement option and on the subgrade for the pile foundation option. The clear stone would minimize the capillary rise of moisture from the sub-soil to the floor slab. Alternatively, the clear stone may be replaced with a 200 mm thick bed of OPSS Granular A overlain by a vapour barrier. Adequate saw cuts should be provided in the floor slabs to control cracking.

Perimeter drainage systems should be provided. Underfloor is not required.

The ground floor of the proposed building should be set a minimum 150 mm above the surrounding final exterior grade. The finished exterior grade should be sloped away from the building to prevent ponding of surface water close to the exterior walls of the building.

10.0 Lateral Earth Pressures Against Subsurface Walls

The subsurface basement walls of the proposed new building should be backfilled with free draining material, such as OPSS Granular B Type II compacted to 95 percent SPMDD and equipped with a perimeter drainage system to prevent the buildup of hydrostatic pressure behind the walls. The walls will be subjected to lateral static and dynamic (seismic) earth forces. The expressions below assume free draining backfill material, a perimeter drainage system, level backfill surface behind the wall and vertical face on the back side of the wall.

For design purposes, the lateral static earth thrust against the subsurface walls may be computed from the following equation:

$$P = K_0 h \left(\frac{1}{2} \gamma h + q \right)$$

where P = lateral earth thrust acting on the subsurface wall, kN/m

K_0 = lateral earth pressure at rest coefficient, assumed to be 0.5 for Granular B Type II backfill material

γ = unit weight of free draining granular backfill; Granular B Type II = 22 kN/m³

h = depth of point of interest below top of backfill, m

q = surcharge load stress, kPa

The lateral dynamic thrust may be computed from the equation given below:

$$\Delta_{Pe} = \gamma H^2 \frac{a_h}{g} F_b$$

where Δ_{Pe} = dynamic thrust in kN/m of wall

H = height of wall, m

γ = unit weight of backfill material = 22 kN/m³

$\frac{a_h}{g}$ = earth pressure coefficient = 0.32 for Ottawa area

F_b = thrust factor = 1.0

The dynamic thrust does not take into account the surcharge load. The resultant force acts approximately at 0.63H above the base of the wall.

All subsurface walls should be properly waterproofed.

11.0 Subsurface Concrete Requirements

Chemical tests limited to pH, sulphate, chloride and resistivity were undertaken on one (1) soil sample. A summary of the results is shown in Table VIII. The laboratory certificate of analysis is shown in Appendix E.

Table VIII: Corrosion Test Results on a Selected Sample						
Borehole – Sample No.	Depth (m)	Soil Type	pH	Sulphate (%)	Chloride (%)	Resistivity (ohm-cm)
BH 1 SS3	2.3 – 2.4	Clay	8.37	0.026	0.082	1330

The results indicate the soils have a negligible sulphate attack on subsurface concrete. The concrete should be designed in accordance with CSA A.23.1-14.

The results of the resistivity tests indicate that is corrosive to moderately corrosive to bare steel as per the National Association of Corrosion Engineers (NACE). Appropriate measures should be taken to protect the buried bare steel from corrosion.

12.0 Excavations

12.1 Excess Soil Management

Ontario Regulation 406/19 specifies protocols that are required for the management and disposal of excess soils. As set forth in the regulation, specific analytical testing protocols need to be implemented and followed based on the volume of soil to be managed and the requirements of the receiving site. The testing protocols are specific as to whether the soils are stockpiled or in situ. In either scenario, the testing protocols are far more onerous than have been historically carried out as part of standard industry practices. These decisions should be factored in and accounted for prior to the initiation of the project-defined scope of work. EXP would be pleased to assist with the implementation of a soil management and testing program that would satisfy the requirements of Ontario Regulation 406/19.

12.2 Excavations

Excavations at the site are expected to extend to a maximum depth of 4.3 m below the existing street level (~Elevation 68.5 m). The excavation will extend through the concrete or asphaltic concrete, fill and terminate within the silt and clay or glacial layer. Further guidance can be provided if the excavations will extend to or below the bedrock surface. The excavations are anticipated to be above the groundwater level.

Excavations may be undertaken by conventional heavy equipment capable of removing debris, cobbles and boulders present within the fill and cobbles and boulders within the native soils.

The excavation within the subsurface soils should comply with the most recent Occupational Health and Safety Act (OHSA), Ontario Regulations 213/91 (August 1, 1991). Based on the definitions contained in OHSA, the subsurface soils at the site are classified as Type 3 soil and sidewalls of open cut excavations must be cut back at 1H:1V from the bottom of the excavation. Below the groundwater table, the excavation side slopes are expected to slough and will eventually stabilize at a slope of 2H:1V to 3H:1V.

It is expected that side slopes noted above for the construction of the proposed building will not be able to be achieved due to space restrictions on site and consideration for the existing building façade. Excavation for the new building construction would have to be undertaken within the confines of an engineered support system (shoring system).

The most appropriate type of shoring system and the design and installation of the shoring system should be determined by the contractors bidding on this project. The design of the shoring system should be undertaken by a professional engineer experienced in shoring design and the installation of the shoring system should be undertaken by a contractor experienced in the installation of shoring systems. The shoring system should be designed and installed in accordance with latest edition of Ontario Regulation 213/91 under the OHSA and the 2006 Fourth Edition of the Canadian Foundation Engineering Manual (CFEM). The shoring system as well as adjacent settlement sensitive structures (buildings) and infrastructure should be monitored for movement (deflection) on a periodic basis during construction operations.

In order to ensure that no negative impact will occur to adjacent structures, the engineered support system as well as adjacent settlement sensitive structures (buildings and the existing façade) and infrastructure should be monitored for movement (deflection) on a periodic basis during construction operations. Vibration monitoring should also be carried out on the adjacent structures and infrastructure, and safe vibration limits need to be established prior to construction. It is recommended that the vibration monitoring is carried out with real-time alerts so that any activities which have potential to cause damage can be immediately halted.

A pre-construction condition survey of buildings and infrastructure within the influence zone of the construction should be undertaken prior to start of construction activities.

Excavations that terminate within the native silt and clay or glacial till above the groundwater table are not expected to experience a base-heave type of failure. Open cut excavations which extend below the groundwater level within the glacial till may be susceptible to instability of the base of the excavation in the form of piping or heave. Should the excavations be expected to extend below the groundwater table, EXP should be contacted prior to the start of excavation to provide comments and recommendations to minimize instability of the excavation bases.

Many geologic materials deteriorate rapidly upon exposure to meteorological elements. Unless otherwise specifically indicated in this report, walls and floors of excavations must be protected from moisture, desiccation, and frost action throughout the course of construction.

Soldier Pile and Timber Lagging System

A conventional steel H soldier pile and timber lagging shoring system must be designed to support the lateral earth pressure given by the expression below:

$$P = k(\gamma h + q)$$

where

P = the pressure, at any depth, h , below the ground surface

k = applicable earth pressure coefficient; active lateral earth pressure coefficient = 0.33
'at rest' lateral earth pressure coefficient = 0.50

γ = unit weight of soil to be retained, estimated at 22 kN/m³

h = the depth, in metres, at which pressure, P , is being computed

q = the equivalent surcharge acting on the ground surface adjacent to the shoring system

The pressure distribution assumes that drainage is permitted between the lagging boards and that no build-up of hydrostatic pressure may occur.

As previously indicated, the shoring system as well as adjacent settlement sensitive structures and infrastructure should be monitored for movement (deflection) on a periodic basis during construction operations.

12.3 De-Watering Requirements

Seepage of the surface and subsurface water into the excavations is anticipated. However, it should be possible to remove any water entering the excavations by pumping from sumps. In areas of high infiltration or in areas where more permeable soil layers may exist, a higher seepage rate should be anticipated and will require high-capacity pumps to keep the excavation dry.

For construction dewatering, an Environmental Activity and Sector Registry (EASR) approval may be obtained for water takings greater than 50 m³ and less than 400 m³ per day. If more than 400 m³ per day of groundwater are generated for dewatering purposes, then a Category 3 Permit to Take Water (PTTW) must be obtained from the Ministry of the Environment, Conservation and Parks (MECP). A Category 3 PTTW would require a complete hydrogeological assessment and would take at least 90 days for the MECP to process once the application is submitted. A PPTW or a EASR are not expected for this site, based on the proposed excavation depth of 4.3 m.

Although this investigation has estimated the groundwater levels at the time of the fieldwork, and commented on dewatering and general construction problems, conditions may be present which are difficult to establish from standard boring and excavating techniques and which may affect the type and nature of dewatering procedures used by the contractor in practice. These conditions include local and seasonal fluctuations in the groundwater table, erratic changes in the soil profile, thin layers of soil with large or small permeabilities compared with the soil mass, etc. Only carefully controlled tests using pumped wells and observation wells will yield the quantitative data on groundwater volumes and pressures that are necessary to adequately engineer construction dewatering systems.

It is anticipated that the excavation for the foundations will be above the groundwater table and therefore there is no concern with impacting adjacent structures due to de-watering.

13.0 Backfilling Requirements and Suitability of On-site Soils for Backfilling Purposes

The materials that will be excavated include asphaltic concrete/concrete, fill, silt and clay and glacial till. These materials are not considered suitable for use as backfill at the site.

It is anticipated that the majority of the fill required would have to be imported and should conform to Ontario Provincial Standard Specifications (OPSS) for Granular A and Granular B Type II, depending on their use at the site.

14.0 Impact of Construction on Adjacent Properties and Structures

It is expected that the excavation at the site will extend to approximately 4.3 m below the existing grade at street level (~ Elevation 68.5). Based on the recorded groundwater levels which range from 6.1 m to 7.0 m depths (Elevation 65.1 m to Elevation 64.3 m) it is expected that excavations will be above the groundwater table.

It is expected that side slopes noted above for the construction of the proposed building will not be able to be achieved due to space restrictions on site and consideration for the existing building façade. Excavation for the new building construction would have to be undertaken within the confines of an engineered support system (shoring system). A pre-construction condition survey of buildings and infrastructure within the influence zone of the construction should be undertaken prior to start of construction activities. The existing façade will also have to be supported during any excavation activities.

In order to ensure that no negative impacts will occur to adjacent structures or infrastructure, the engineered support system as well as adjacent settlement sensitive structures (buildings and the existing façade) and infrastructure should be monitored for movement (deflection) on a periodic basis during construction operations. Vibration monitoring should also be carried out on the adjacent structures and infrastructure and safe vibration limits need to be established prior to construction. It is recommended that the vibration monitoring is carried out with real-time alerts so that any activities which have potential to cause damage can be immediately halted.

Based on the recorded groundwater levels, dewatering at the site is not expected and as such there is no concern for dewatering settlement of adjacent structures.

If the construction for the proposed development is carried out within a properly design shoring system, dewatering does not take place and monitoring of the deflection and vibrations of the adjacent structures and infrastructure is carried out, no negative impacts on adjacent properties or infrastructure is expected.

15.0 General Comments

The comments given in this report are intended only for the guidance of design engineers. The number of boreholes required to determine the localized underground conditions between boreholes required to determine the localized underground conditions between boreholes affecting construction cost, techniques, sequencing, equipment, scheduling, etc., would be much greater than has been carried out for the design purposes. Contractors bidding on or undertaking the works should, in this light, decide on their own investigations, as well as their own interpretations of the factual borehole results, so that they may draw their own conclusions as to how the subsurface conditions may affect them.



Daniel Wall, M.Eng., P.Eng.
Geotechnical Engineer
Geotechnical & Materials Engineering Services
Earth and Environment



Ismail M. Taki, M.Eng., P.Eng.
Senior Manager, Eastern Region
Geotechnical & Materials Engineering Services
Earth and Environment



EXP Services Inc.

Smart Living Properties

Updated Geotechnical Investigation – Proposed Residential Development

178 Nepean Street, 219/223 Bank Street, Ottawa, ON

OTT-22018926-A0

June 21, 2023

Figures

Filename: E:\OTT\OTT-22018926-A0_60_Execution\65 Drawings\22018926-A0_Geo.dwg
 Last Saved: Dec 21, 2022 9:57 AM
 Last Plotted: Dec 21, 2022 9:57 AM
 Plotted By: Severa



ORIGINAL SHEET SIZE = 11" x 8.5"

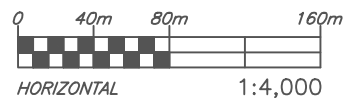

exp Services Inc.
 100-2650 Queensview Drive
 Ottawa, ON K2B 8H6
 www.exp.com



DESIGN	IT/MZ
DRAWN	AS
DATE	DECEMBER 2022
FILE NO	OTT-22018926-A0

GEOTECHNICAL INVESTIGATION	
178 NEPEAN STREET, 219/223 BANK STREET, OTTAWA, ON	
SITE LOCATION PLAN	

SCALE	1:4,000
SKETCH NO	FIG 1

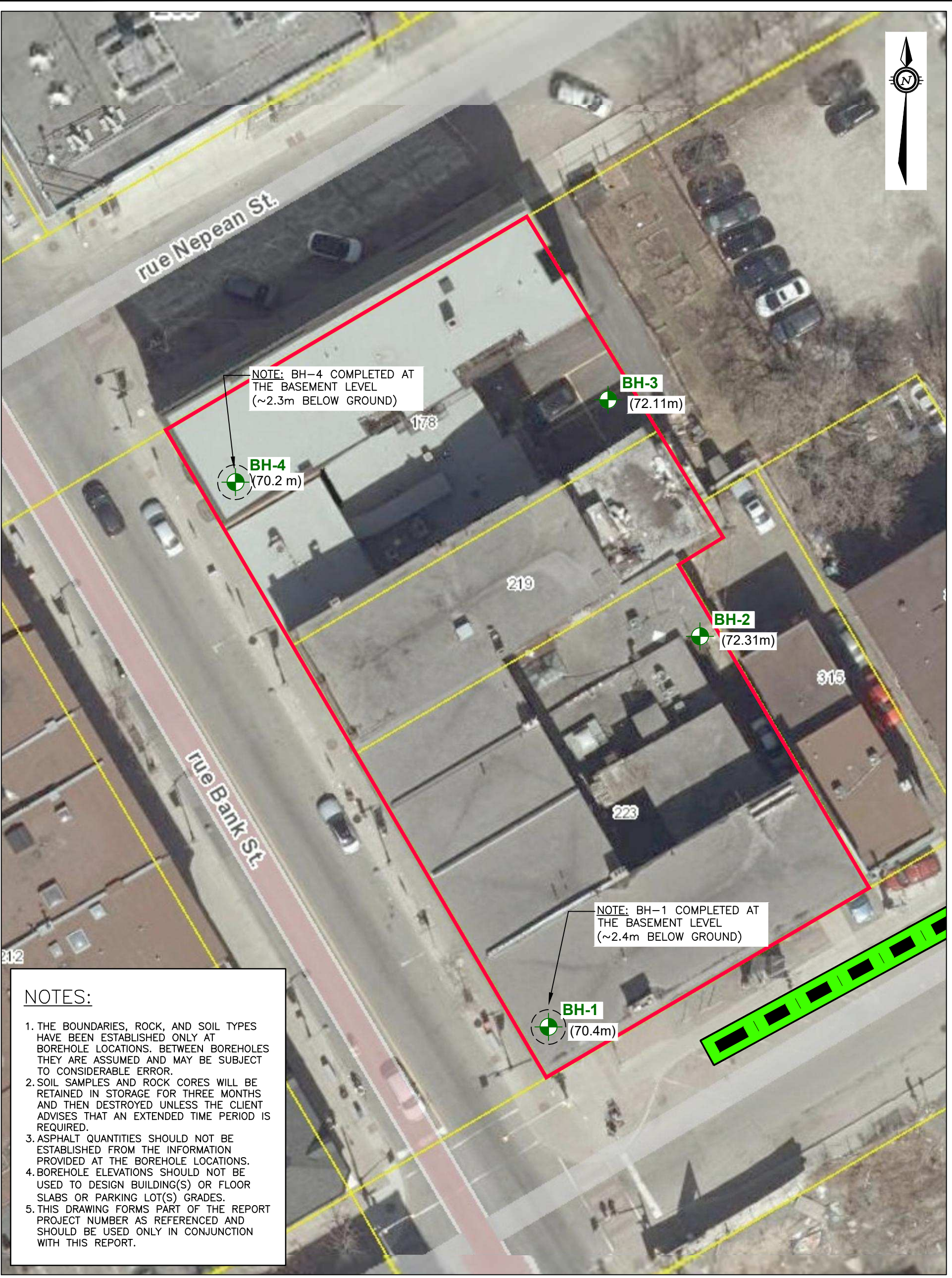

NOTE: BH-4 COMPLETED AT THE BASEMENT LEVEL (~2.3m BELOW GROUND)

BH-3 (72.11m)

BH-4 (70.2 m)

BH-2 (72.31m)

NOTE: BH-1 COMPLETED AT THE BASEMENT LEVEL (~2.4m BELOW GROUND)

BH-1 (70.4m)

NOTES:

1. THE BOUNDARIES, ROCK, AND SOIL TYPES HAVE BEEN ESTABLISHED ONLY AT BOREHOLE LOCATIONS. BETWEEN BOREHOLES THEY ARE ASSUMED AND MAY BE SUBJECT TO CONSIDERABLE ERROR.
2. SOIL SAMPLES AND ROCK CORES WILL BE RETAINED IN STORAGE FOR THREE MONTHS AND THEN DESTROYED UNLESS THE CLIENT ADVISES THAT AN EXTENDED TIME PERIOD IS REQUIRED.
3. ASPHALT QUANTITIES SHOULD NOT BE ESTABLISHED FROM THE INFORMATION PROVIDED AT THE BOREHOLE LOCATIONS.
4. BOREHOLE ELEVATIONS SHOULD NOT BE USED TO DESIGN BUILDING(S) OR FLOOR SLABS OR PARKING LOT(S) GRADES.
5. THIS DRAWING FORMS PART OF THE REPORT PROJECT NUMBER AS REFERENCED AND SHOULD BE USED ONLY IN CONJUNCTION WITH THIS REPORT.

LEGEND

- PROPERTY BOUNDARY
- BH-1 (70.4m) — BOREHOLE NO. & LOCATION (X.XX) – GROUND SURFACE ELEVATION (m)
- APPROXIMATE LOCATION OF SEISMIC SHEAR WAVE SURVEY LINE BY GPR

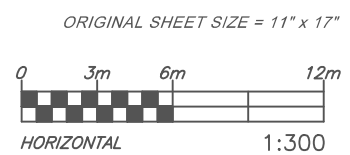

Filename: E:\OTT\22018926-A01_60_Execution\65 Drawings\22018926-A0_Geo.dwg
Last Saved: Mar 25, 2023 8:56 AM
Last Plotted: Mar 25, 2023 9:09 AM
Plotted by: Wallid

exp Services Inc. 100-2650 Queensview Drive Ottawa, ON K2B 8H6 www.exp.com		DESIGN IT/MZ	GEOTECHNICAL INVESTIGATION 178 NEPEAN STREET, 219/223 BANK STREET, OTTAWA, ON	SCALE 1:300
		DRAWN AS		SKETCH NO
		DATE DECEMBER 2022	BOREHOLE LOCATION PLAN	FIG 2
		FILE NO OTT-22018926-A0		

Notes On Sample Descriptions

1. All sample descriptions included in this report follow the Canadian Foundations Engineering Manual soil classification system. This system follows the standard proposed by the International Society for Soil Mechanics and Foundation Engineering. Laboratory grain size analyses provided by **exp** Services Inc. also follow the same system. Different classification systems may be used by others; one such system is the Unified Soil Classification. Please note that, with the exception of those samples where a grain size analysis has been made, all samples are classified visually. Visual classification is not sufficiently accurate to provide exact grain sizing or precise differentiation between size classification systems.

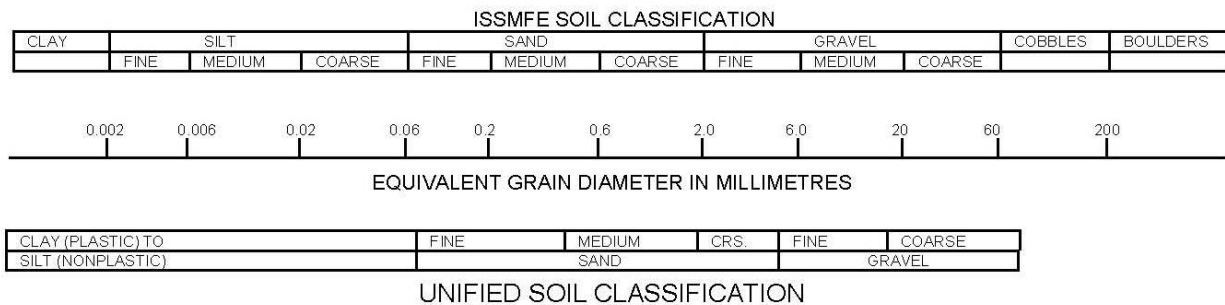

2. **Fill:** Where fill is designated on the borehole log it is defined as indicated by the sample recovered during the boring process. The reader is cautioned that fills are heterogeneous in nature and variable in density or degree of compaction. The borehole description may therefore not be applicable as a general description of site fill materials. All fills should be expected to contain obstruction such as wood, large concrete pieces or subsurface basements, floors, tanks, etc., none of these may have been encountered in the boreholes. Since boreholes cannot accurately define the contents of the fill, test pits are recommended to provide supplementary information. Despite the use of test pits, the heterogeneous nature of fill will leave some ambiguity as to the exact composition of the fill. Most fills contain pockets, seams, or layers of organically contaminated soil. This organic material can result in the generation of methane gas and/or significant ongoing and future settlements. Fill at this site may have been monitored for the presence of methane gas and, if so, the results are given on the borehole logs. The monitoring process does not indicate the volume of gas that can be potentially generated nor does it pinpoint the source of the gas. These readings are to advise of the presence of gas only, and a detailed study is recommended for sites where any explosive gas/methane is detected. Some fill material may be contaminated by toxic/hazardous waste that renders it unacceptable for deposition in any but designated land fill sites; unless specifically stated the fill on this site has not been tested for contaminants that may be considered toxic or hazardous. This testing and a potential hazard study can be undertaken if requested. In most residential/commercial areas undergoing reconstruction, buried oil tanks are common and are generally not detected in a conventional geotechnical site investigation.
3. **Till:** The term till on the borehole logs indicates that the material originates from a geological process associated with glaciation. Because of this geological process the till must be considered heterogeneous in composition and as such may contain pockets and/or seams of material such as sand, gravel, silt or clay. Till often contains cobbles (60 to 200 mm) or boulders (over 200 mm). Contractors may therefore encounter cobbles and boulders during excavation, even if they are not indicated by the borings. It should be appreciated that normal sampling equipment cannot differentiate the size or type of any obstruction. Because of the horizontal and vertical variability of till, the sample description may be applicable to a very limited zone; caution is therefore essential when dealing with sensitive excavations or dewatering programs in till materials.

Log of Borehole BH-1



Project No: OTT-22018926-A0
 Project: Proposed Residential Development
 Location: 178 Nepean Street and 219/223 Bank Street, Ottawa, ON
 Date Drilled: December 5th, 2022
 Drill Type: Hand Portable Drilling - Hilti Drill
 Datum: Approximate Geodetic Elevation
 Logged by: M.Z. Checked by: D.W.

Figure No. 3
 Page. 1 of 2

- | | | | |
|-----------------------------|-------------------------------------|---|-------------------------------------|
| Split Spoon Sample | <input checked="" type="checkbox"/> | Combustible Vapour Reading | <input type="checkbox"/> |
| Auger Sample | <input type="checkbox"/> | Natural Moisture Content | <input checked="" type="checkbox"/> |
| SPT (N) Value | <input type="checkbox"/> | Atterberg Limits | <input type="checkbox"/> |
| Dynamic Cone Test | <input type="checkbox"/> | Undrained Triaxial at % Strain at Failure | <input type="checkbox"/> |
| Shelby Tube | <input type="checkbox"/> | Shear Strength by Penetrometer Test | <input type="checkbox"/> |
| Shear Strength by Vane Test | <input type="checkbox"/> | | |

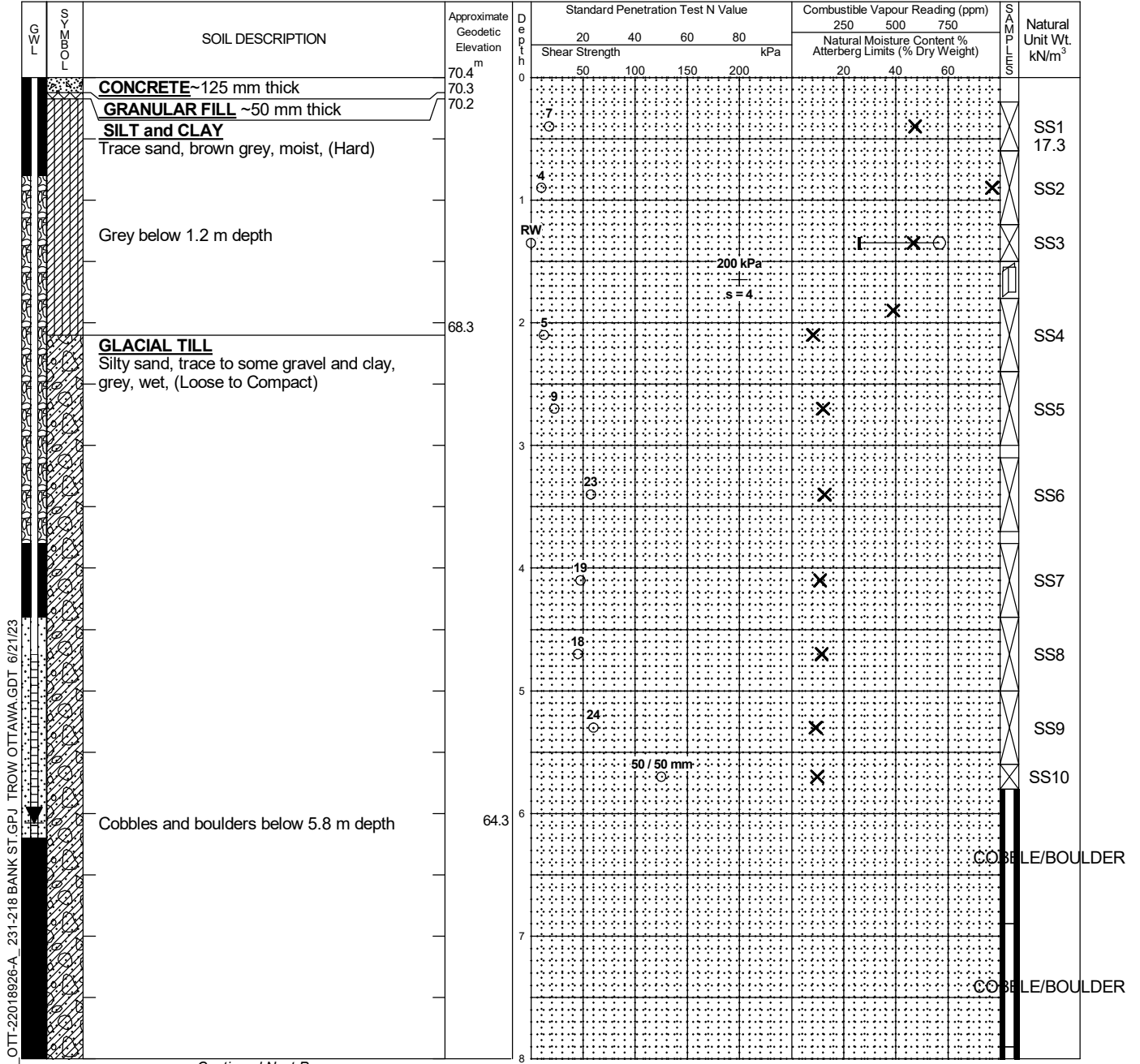

NOTES:

- Borehole data requires interpretation by EXP before use by others
- A 19 mm diameter standpipe was installed in the borehole upon completion.
- Field work was supervised by an EXP representative.
- See Notes on Sample Descriptions
- Log to be read with EXP Report OTT-22018926-A0

WATER LEVEL RECORDS		
Date	Water Level (m)	Hole Open To (m)
December 7, 2022	6.1	

CORE DRILLING RECORD			
Run No.	Depth (m)	% Rec.	RQD %
1	5.8 - 6.9	27	0
2	6.9 - 7.9	37	0
3	7.9 - 8.9	66	52
4	8.9 - 9.9	100	65

LOG OF BOREHOLE BH LOGS OTT-22018926-A - 231-218 BANK ST GPJ TROW OTTAWA.GDT 6/21/23

Continued Next Page

Log of Borehole BH-1



Project No: OTT-22018926-A0

Figure No. 3

Project: Proposed Residential Development

Page. 2 of 2

SOIL SYMBOL	SOIL DESCRIPTION	Approximate Geodetic Elevation (m)	Depth (m)	Standard Penetration Test N Value				Combustible Vapour Reading (ppm)			Natural Unit Wt. kN/m ³
				20	40	60	80	250	500	750	
				Shear Strength (kPa)				Natural Moisture Content % Atterberg Limits (% Dry Weight)			
		62.4	8	50	100	150	200	20	40	60	
	SHALE BEDROCK Black, slightly weathered, (fair quality)	62.1									RUN1
			9								
	Borehole Terminated at 9.9 m Depth	60.5									RUN2 25.3

LOG OF BOREHOLE BH LOGS OTT-22018926-A_ 231-218 BANK ST.GPJ TROW OTTAWA.GDT 6/21/23

- NOTES:**
- Borehole data requires interpretation by EXP before use by others
 - A 19 mm diameter standpipe was installed in the borehole upon completion.
 - Field work was supervised by an EXP representative.
 - See Notes on Sample Descriptions
 - Log to be read with EXP Report OTT-22018926-A0

WATER LEVEL RECORDS		
Date	Water Level (m)	Hole Open To (m)
December 7, 2022	6.1	

CORE DRILLING RECORD			
Run No.	Depth (m)	% Rec.	RQD %
1	5.8 - 6.9	27	0
2	6.9 - 7.9	37	0
3	7.9 - 8.9	66	52
4	8.9 - 9.9	100	65

Log of Borehole BH-2



Project No: OTT-22018926-A0

Figure No. 4

Project: Proposed Residential Development

Page. 1 of 1

Location: 178 Nepean Street and 219/223 Bank Street, Ottawa, ON

Date Drilled: November 23rd, 2022

Split Spoon Sample

Combustible Vapour Reading

Drill Type: Geoprobe Track-mounted Drill Rig

Auger Sample

Natural Moisture Content

SPT (N) Value

Atterberg Limits

Datum: Geodetic Elevation

Dynamic Cone Test

Undrained Triaxial at

Shelby Tube

% Strain at Failure

Logged by: M.Z. Checked by: D.W.

Shear Strength by Vane Test

Shear Strength by Penetrometer Test

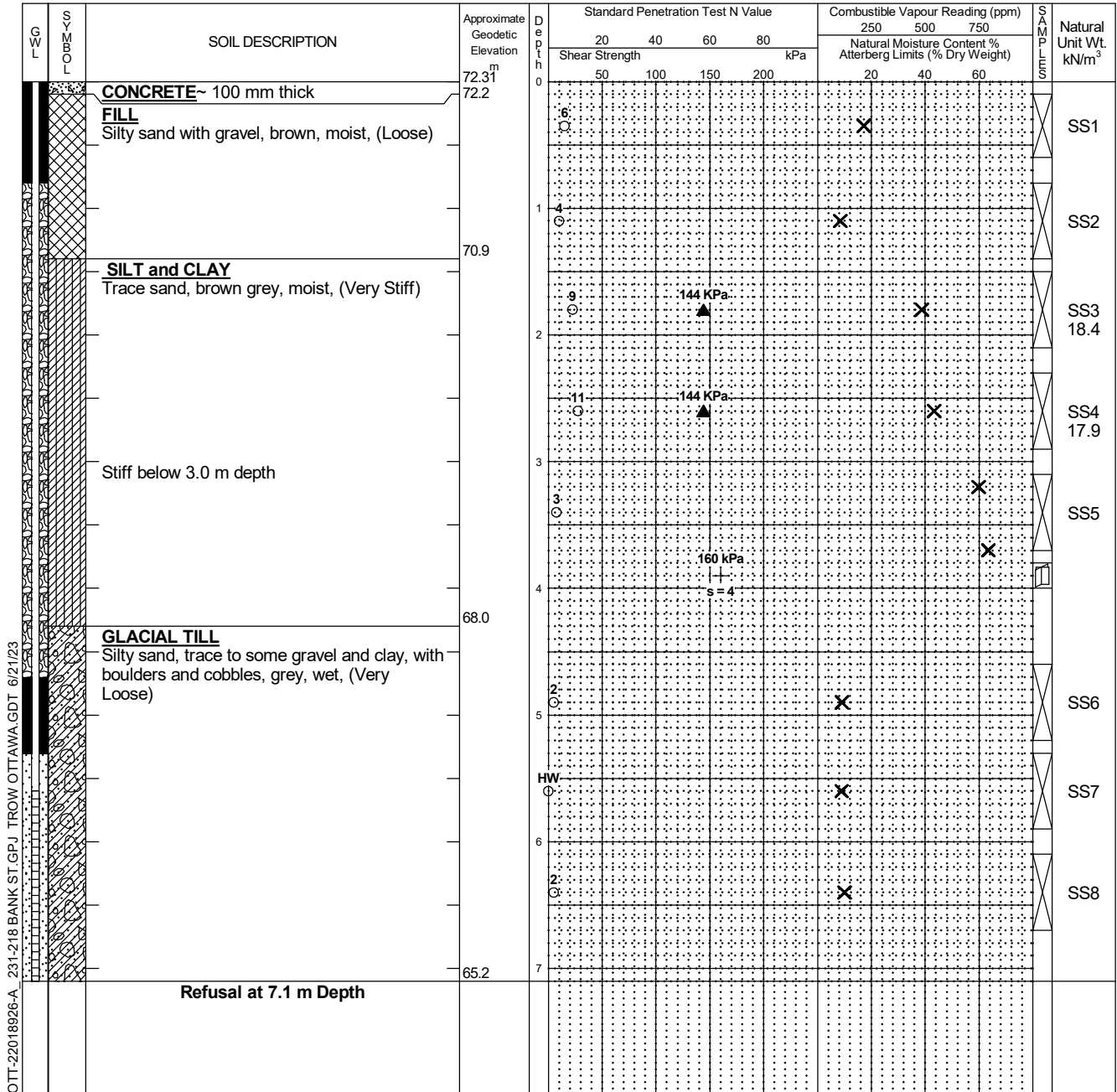

NOTES:

- Borehole data requires interpretation by EXP before use by others
- A 19 mm diameter standpipe was installed in the borehole upon completion.
- Field work was supervised by an EXP representative.
- See Notes on Sample Descriptions
- Log to be read with EXP Report OTT-22018926-A0

WATER LEVEL RECORDS		
Date	Water Level (m)	Hole Open To (m)
December 7, 2022	Dry to 7.1 m	

CORE DRILLING RECORD			
Run No.	Depth (m)	% Rec.	RQD %

LOG OF BOREHOLE BH LOGS OTT-22018926-A, 231-218 BANK ST GPJ TROW OTTAWA.GDT 6/21/23

Log of Borehole BH-3



Project No: OTT-22018926-A0
 Project: Proposed Residential Development
 Location: 178 Nepean Street and 219/223 Bank Street, Ottawa, ON
 Date Drilled: November 23rd, 2022
 Drill Type: Geoprobe Track-mounted Drill Rig
 Datum: Geodetic Elevation
 Logged by: M.Z. Checked by: D.W.

Figure No. 5
 Page. 1 of 1

- Split Spoon Sample
- Auger Sample
- SPT (N) Value
- Dynamic Cone Test
- Shebby Tube
- Shear Strength by Vane Test
- Combustible Vapour Reading
- Natural Moisture Content
- Atterberg Limits
- Undrained Triaxial at % Strain at Failure
- Shear Strength by Penetrometer Test

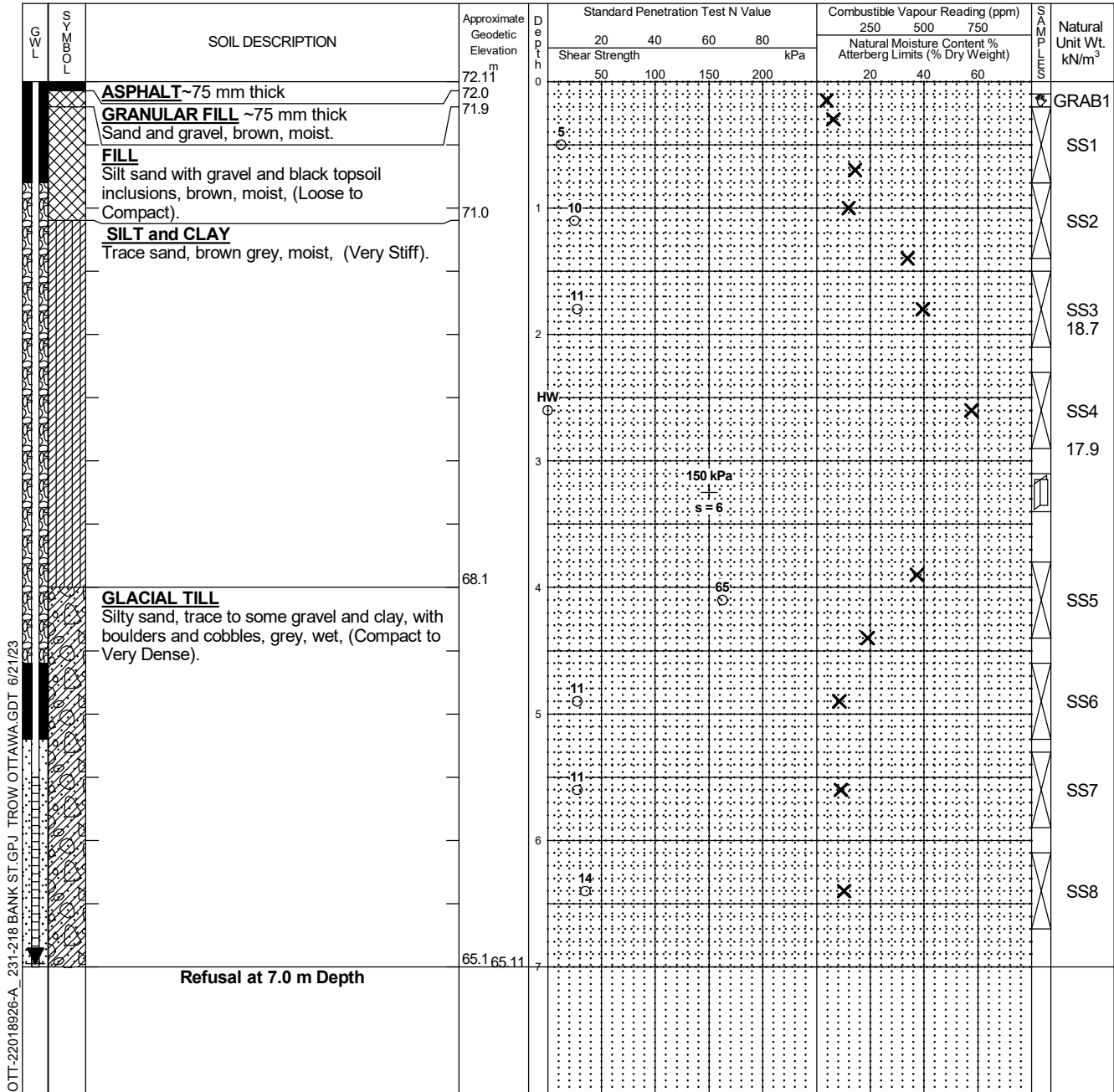

LOG OF BOREHOLE BH LOGS OTT-22018926-A, 231-218 BANK ST GPJ, TROW OTTAWA, GDT 6/21/23

- NOTES:
- Borehole data requires interpretation by EXP before use by others
 - A 19 mm diameter standpipe was installed in the borehole upon completion.
 - Field work was supervised by an EXP representative.
 - See Notes on Sample Descriptions
 - Log to be read with EXP Report OTT-22018926-A0

WATER LEVEL RECORDS		
Date	Water Level (m)	Hole Open To (m)
December 7, 2022	7.0	

CORE DRILLING RECORD			
Run No.	Depth (m)	% Rec.	RQD %

Log of Borehole BH-4



Project No: OTT-22018926-A0
 Project: Proposed Residential Development
 Location: 178 Nepean Street and 219/223 Bank Street, Ottawa, ON
 Date Drilled: February 3, 2023
 Drill Type: Hand Portable Drilling - Hilti Drill
 Datum: Approximate Geodetic Elevation
 Logged by: M.Z. Checked by: D.W.

Figure No. 6
 Page. 1 of 2

- Split Spoon Sample
- Auger Sample
- SPT (N) Value
- Dynamic Cone Test
- Shebly Tube
- Shear Strength by Vane Test
- Combustible Vapour Reading
- Natural Moisture Content
- Atterberg Limits
- Undrained Triaxial at % Strain at Failure
- Shear Strength by Penetrometer Test

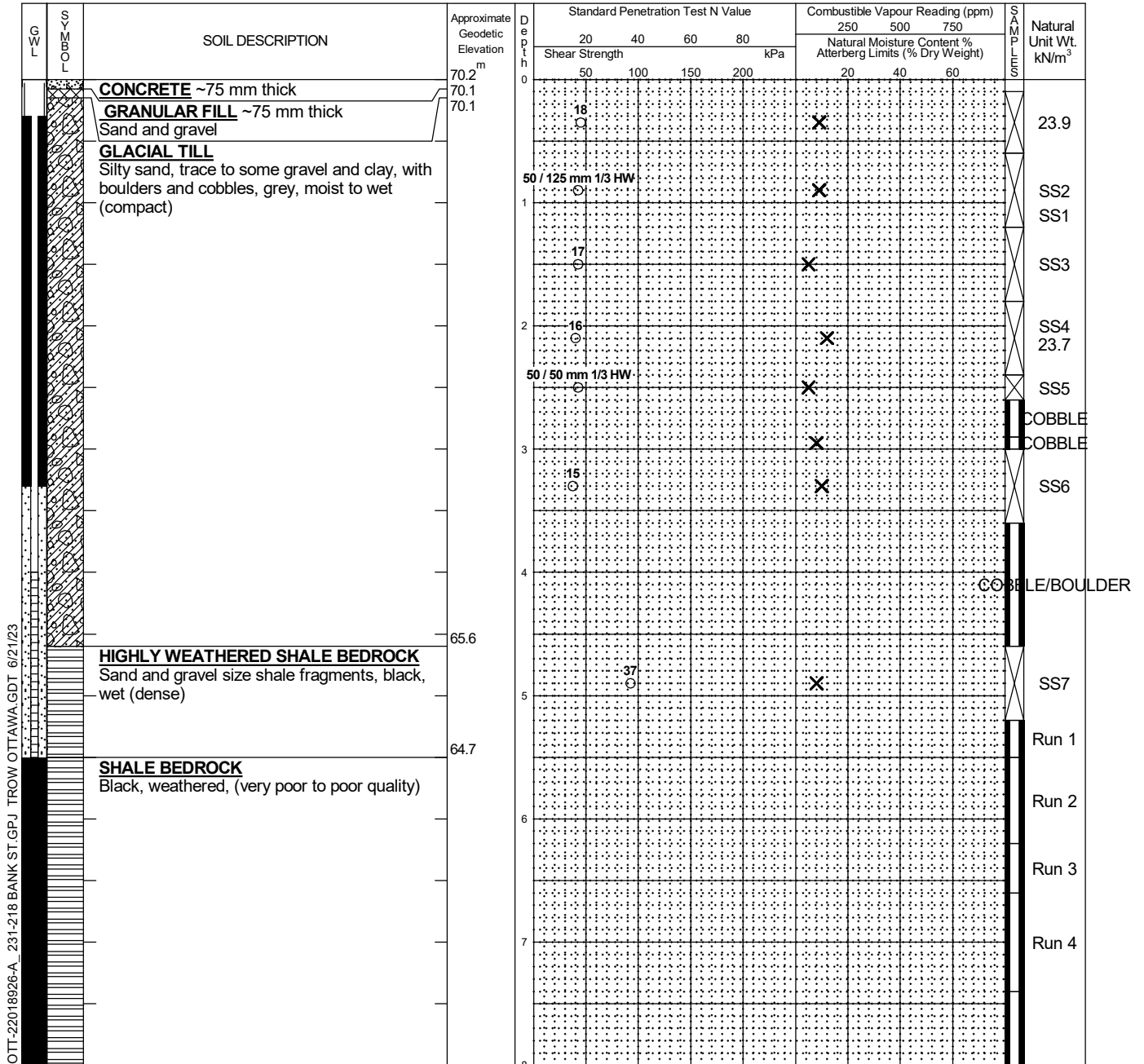

NOTES:
 1. Borehole data requires interpretation by EXP before use by others
 2. A 19 mm diameter standpipe was installed in the borehole upon completion.
 3. Field work was supervised by an EXP representative.
 4. See Notes on Sample Descriptions
 5. Log to be read with EXP Report OTT-22018926-A0

WATER LEVEL RECORDS		
Date	Water Level (m)	Hole Open To (m)
March 22, 2023	Dry to 5.5 m	

CORE DRILLING RECORD			
Run No.	Depth (m)	% Rec.	RQD %
1	5.2 - 5.5	100	0
2	5.5 - 6.2	62	0
3	6.2 - 6.6	100	0
4	6.6 - 7.4	79	0
5	7.4 - 8.5	95	37

LOG OF BOREHOLE BH LOGS OTT-22018926-A - 231-218 BANK ST GPJ TROW OTTAWA.GDT 6/21/23

Continued Next Page

Log of Borehole BH-4



Project No: OTT-22018926-A0

Figure No. 6

Project: Proposed Residential Development

Page. 2 of 2

G W L	S O B M Y L	SOIL DESCRIPTION	Approximate Geodetic Elevation m	D e p t h m	Standard Penetration Test N Value				Combustible Vapour Reading (ppm)			S O I L T E S T A S E	Natural Unit Wt. kN/m ³	
					20	40	60	80	250	500	750			
					Shear Strength kPa				Natural Moisture Content % Atterberg Limits (% Dry Weight)					
			62.2 ^m	8	50	100	150	200		20	40	60		Run 5
		SHALE BEDROCK Black, weathered, (very poor to poor quality) (continued)	61.7											
		Borehole Terminated at 8.5 m Depth												

LOG OF BOREHOLE BH LOGS OTT-22018926-A_ 231-218 BANK ST.GPJ TROW OTTAWA.GDT 6/21/23

- NOTES:
- Borehole data requires interpretation by EXP before use by others
 - A 19 mm diameter standpipe was installed in the borehole upon completion.
 - Field work was supervised by an EXP representative.
 - See Notes on Sample Descriptions
 - Log to be read with EXP Report OTT-22018926-A0

WATER LEVEL RECORDS		
Date	Water Level (m)	Hole Open To (m)
March 22, 2023	Dry to 5.5 m	

CORE DRILLING RECORD			
Run No.	Depth (m)	% Rec.	RQD %
1	5.2 - 5.5	100	0
2	5.5 - 6.2	62	0
3	6.2 - 6.6	100	0
4	6.6 - 7.4	79	0
5	7.4 - 8.5	95	37



Grain-Size Distribution Curve Method of Test For Particle Size Analysis of Soil ASTM C-136/ASTM D422

EXP Services Inc.
100-2650 Queensview Drive
Ottawa, ON K2B 8H6

Unified Soil Classification System

CLAY AND SILT	SAND			GRAVEL	
	Fine	Medium	Coarse	Fine	Coarse

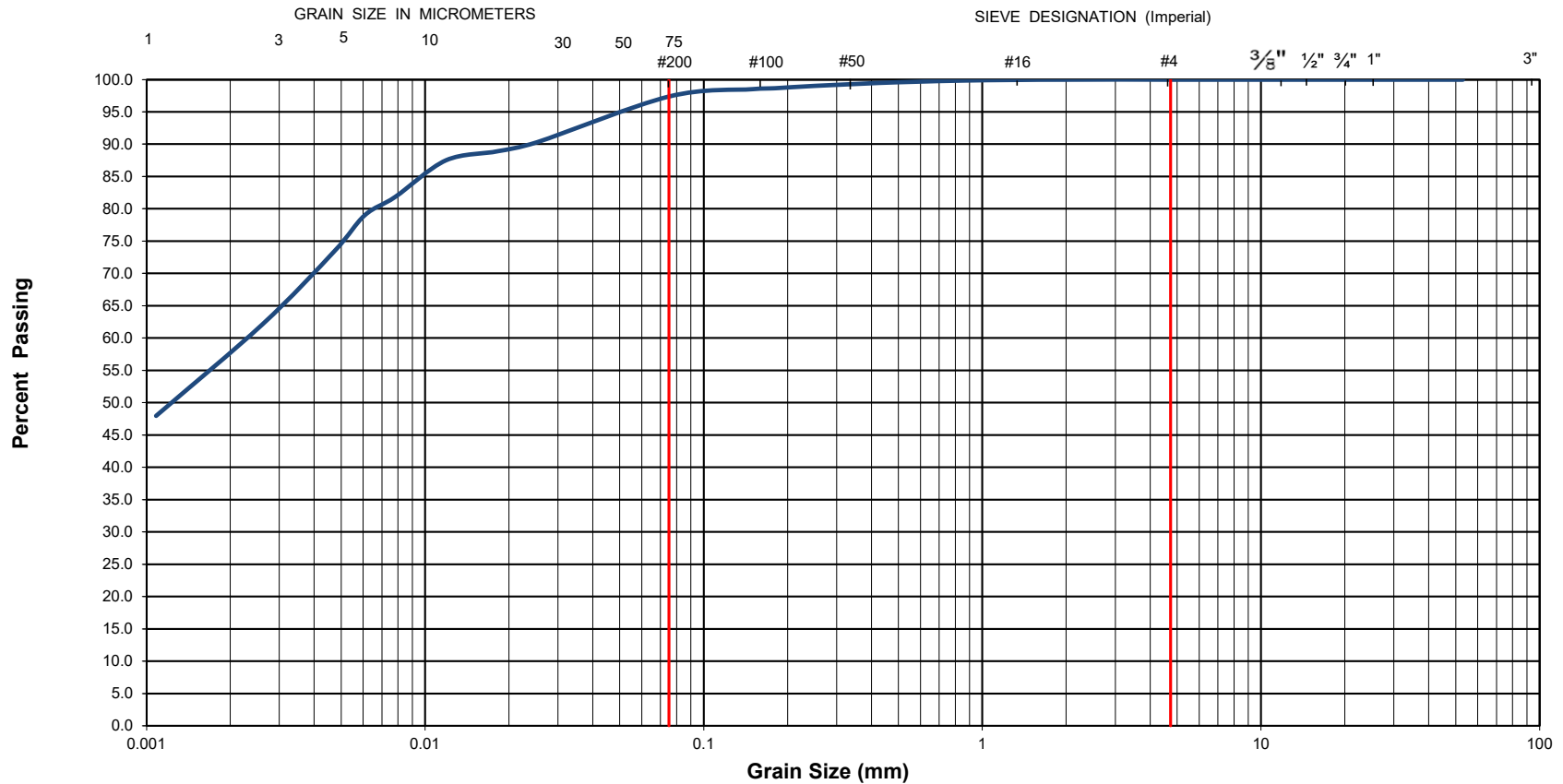

EXP Project No.:	OTT-22018926-A0	Project Name :	Proposed Residential Development		
Client :	Smart Living Properties	Project Location :	178 Nepean Street and 219/223 Bank Street, Ottawa, ON		
Date Sampled :	December 5, 2022	Borehole No:	BH1	Sample No.: SS3	
		Depth (m) :	1.2 - 1.5		
Sample Description :	% Silt and Clay	97	% Sand	3	
		% Gravel	0		
Sample Description :	Silt and Clay, Trace Sand; USCS - Clay of High Plasticity (CH)			Figure :	7



Grain-Size Distribution Curve Method of Test For Particle Size Analysis of Soil ASTM C-136/ASTM D422

EXP Services Inc.
100-2650 Queensview Drive
Ottawa, ON K2B 8H6

Unified Soil Classification System

CLAY AND SILT	SAND			GRAVEL	
	Fine	Medium	Coarse	Fine	Coarse

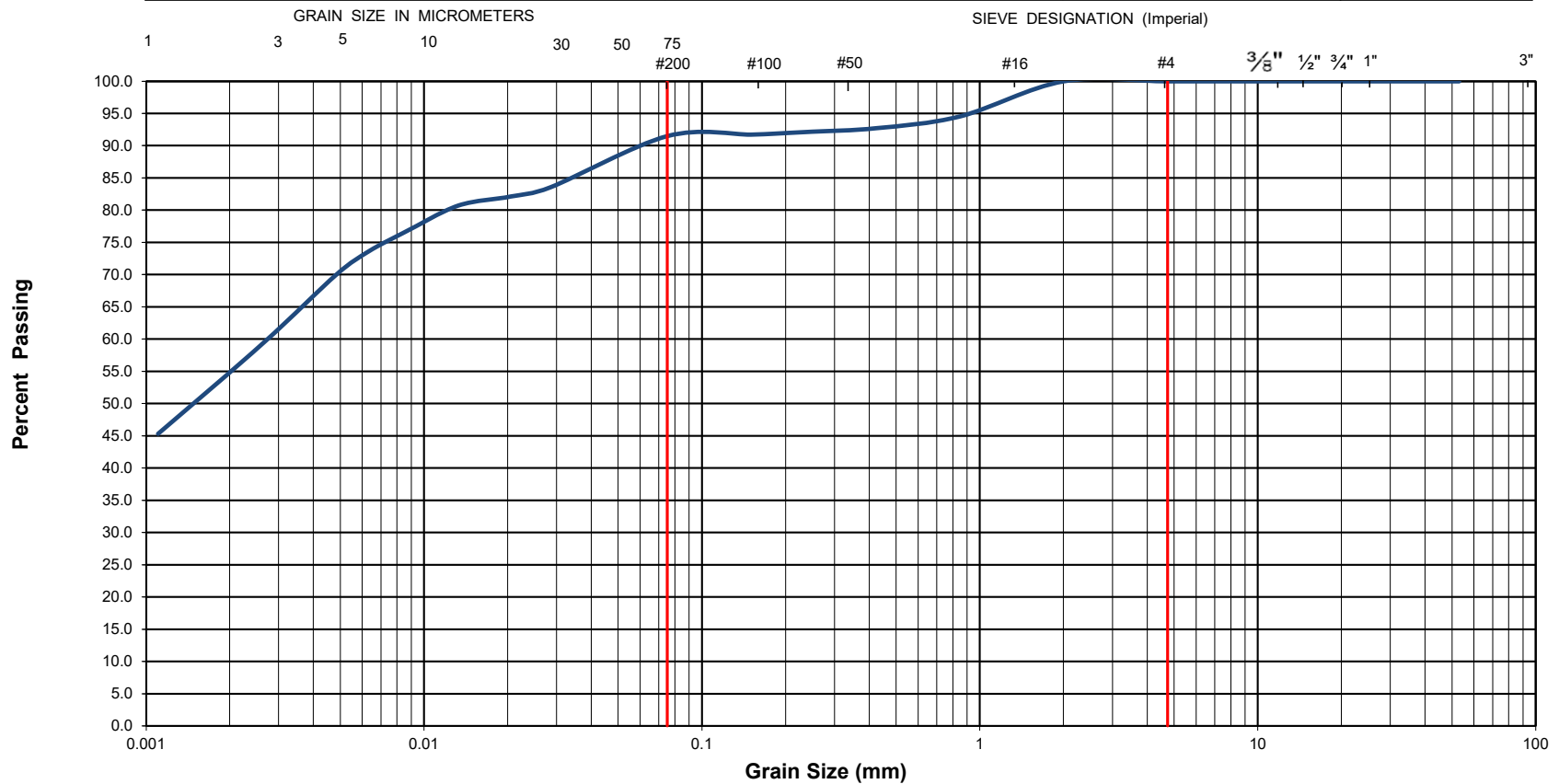

EXP Project No.:	OTT-22018926-A0	Project Name :	Proposed Residential Development		
Client :	Smart Living Properties	Project Location :	178 Nepean Street and 219/223 Bank Street, Ottawa, ON		
Date Sampled :	November 23, 2022	Borehole No:	BH3	Sample No.: SS3	
		Depth (m) :	1.5-2.1		
Sample Description :	% Silt and Clay	92	% Sand	8	
		% Gravel	0		
Sample Description :	Silt and Clay, Trace Sand; USCS - Clay of High Plasticity (CH)			Figure :	8



Grain-Size Distribution Curve Method of Test For Particle Size Analysis of Soil ASTM C-136/ASTM D422

EXP Services Inc.
100-2650 Queensview Drive
Ottawa, ON K2B 8H6

Unified Soil Classification System

CLAY AND SILT	SAND			GRAVEL	
	Fine	Medium	Coarse	Fine	Coarse

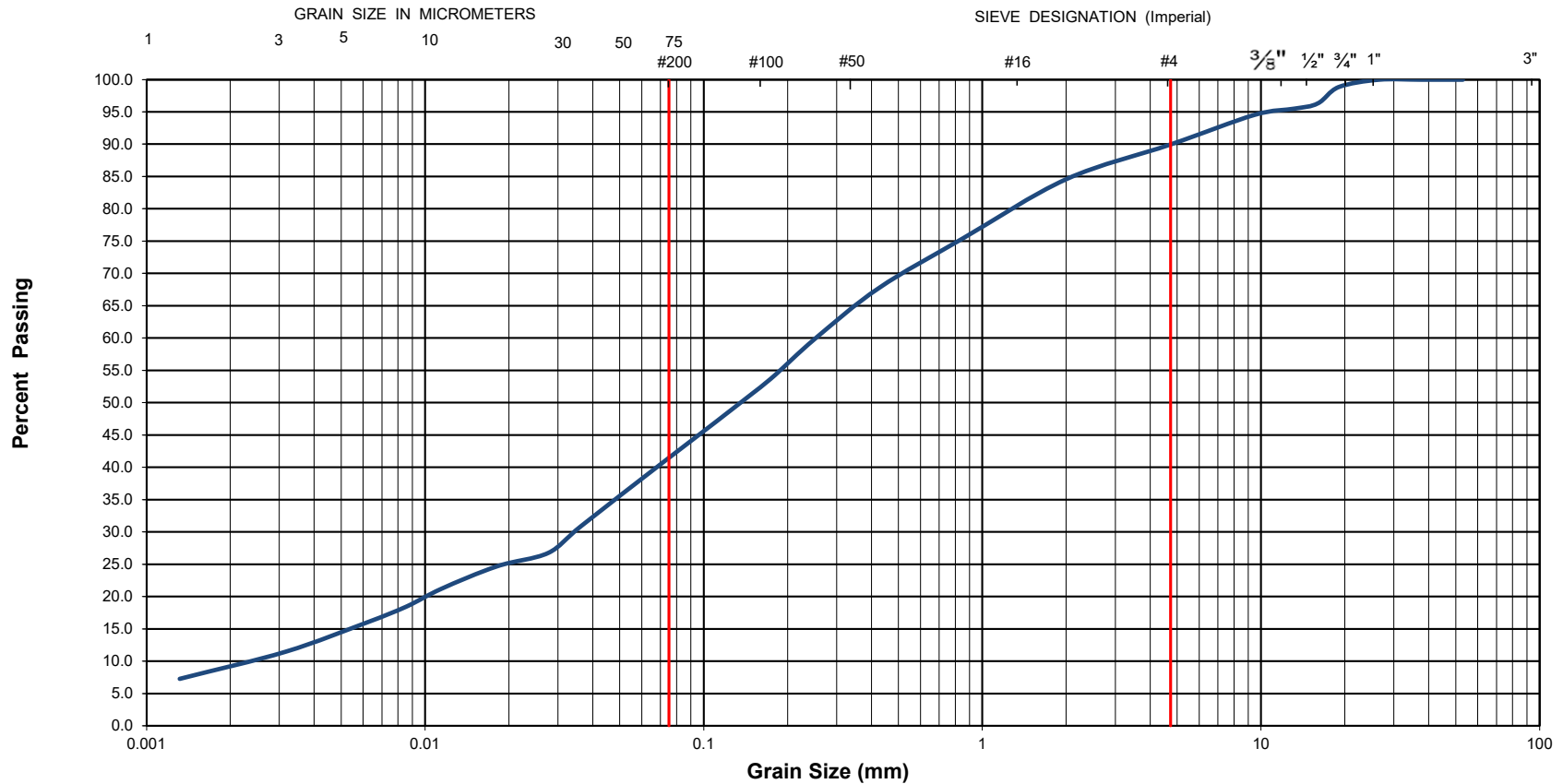

EXP Project No.:	OTT-22018926-A0	Project Name :	Proposed Residential Development		
Client :	Smart Living Properties	Project Location :	178 Nepean Street and 219/223 Bank Street, Ottawa, ON		
Date Sampled :	November 23, 2022	Borehole No:	BH3	Sample No.: SS7	
		Depth (m) :	5.3-5.9		
Sample Description :	% Silt and Clay	42	% Sand	43	
			% Gravel	15	
Sample Description :	GLACIAL TILL: Silty Sand, Some gravel, Trace clay; USCS - Silty Sand with gravel (SM)			Figure :	9



Grain-Size Distribution Curve Method of Test For Particle Size Analysis of Soil ASTM C-136/ASTM D422

EXP Services Inc.
100-2650 Queensview Drive
Ottawa, ON K2B 8H6

Unified Soil Classification System

CLAY AND SILT	SAND			GRAVEL	
	Fine	Medium	Coarse	Fine	Coarse

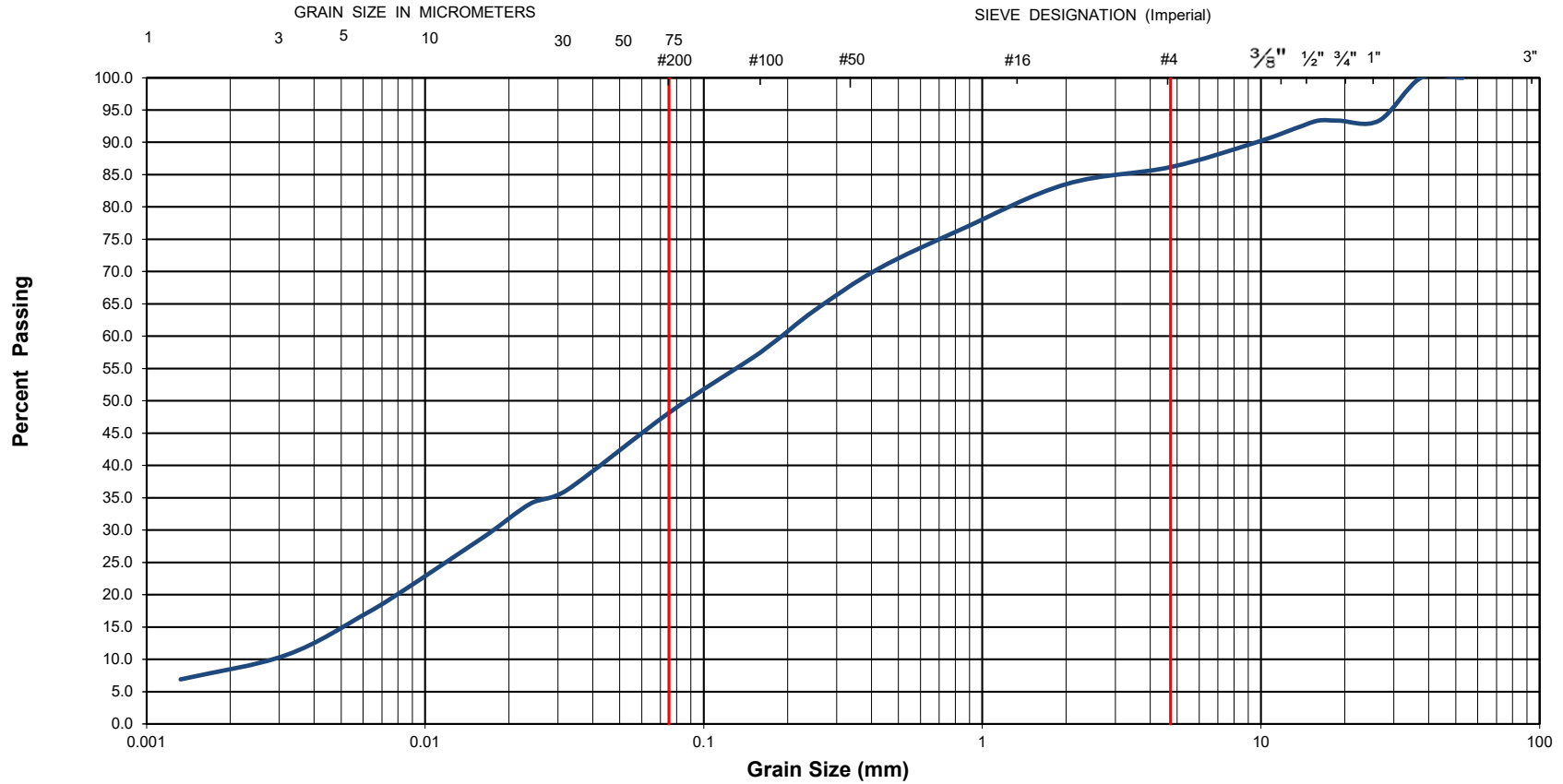

EXP Project No.:	OTT-22018926-A0	Project Name :	Proposed Residential Development		
Client :	Smart Living Properties	Project Location :	178 Nepean Street and 219/223 Bank Street, Ottawa, ON		
Date Sampled :	December 5, 2022	Borehole No:	BH1	Sample No.: SS6	
		Depth (m) :	3.0 - 3.6		
Sample Description :	% Silt and Clay	48	% Sand	38	
		% Gravel	14		
Sample Description :	GLACIAL TILL: Silty Sand, Some gravel and clay; USCS - Silty Sand (SM)			Figure :	10

EXP Services Inc.

Smart Living Properties

Updated Geotechnical Investigation – Proposed Residential Development

178 Nepean Street, 219/223 Bank Street, Ottawa, ON

OTT-22018926-A0

June 21, 2023

Appendix A: Seismic Shear Wave Velocity Sounding Survey Report by GPR Rock Core Photographs



March 20th, 2022

Transmitted by email: Ismail.Taki@exp.com
Our Ref.: GPR-23-04341

Mr. Ismail Taki, M.Eng., P.Eng.
Senior Manager, Earth & Environment, Eastern Region
exp Services inc.
100 – 2650 Queensview Drive
Ottawa ON K2B 8H6

Subject: Shear Wave Velocity Sounding for the Site Class Determination
219/223 Bank Street and 178 Nepean Street, Ottawa (ON)

[Project: OTT-22018926-A0]

Dear Sir,

Geophysics GPR International inc. has been mandated by **exp** Services inc. to carry out seismic shear wave surveys for the 219/223 Bank Street and 178 Nepean Street, in Ottawa (ON). The geophysical investigation used the Multi-channel Analysis of Surface Waves (MASW), the Spatial AutoCorrelation (SPAC), and the seismic refraction methods. From the subsequent results, the seismic shear wave velocity values were calculated for the soil and the rock, to determine the Site Class.

The surveys were carried out on March 10th, 2022, by Mr. Louis-Emmanuel Warnock, B.Sc. and Mr. Tobiah Markowitz, tech. Figure 1 shows the regional location of the site and Figure 2 illustrates the location of the seismic spreads. Both figures are presented in the Appendix.

The following paragraphs briefly describe the survey design, the principles of the testing methods, and the results presented in table and graph.

MASW PRINCIPLE

The *Multi-channel Analysis of Surface Waves* (MASW) and the *SPatial AutoCorrelation* (SPAC or MAM for *Microtremors Array Method*) are seismic methods used to evaluate the shear wave velocities of subsurface materials through the analysis of the dispersion properties of the Rayleigh surface wave. The MASW is considered an "active" method, as the seismic signal is induced at known location and time in the geophones' spread axis. Conversely, the SPAC is considered a "passive" method, using the low frequency "signals" produced far away. The method can also be used with "active" seismic source records. The SPAC method generally allows deeper V_s soundings. Its dispersion curve can then be merged with the one of higher frequency from the MASW to calculate a more complete inversion. The dispersion properties are expressed as a change of velocities with respect to frequencies. Surface wave energy will decay exponentially with depth. Lower frequency surface waves will travel deeper and thus be more influenced by deeper velocity layering than the shallow higher frequency waves. The inversion of the Rayleigh wave dispersion curve yields a shear wave (V_s) velocity depth profile (sounding).

Figure 3 schematically outlines the basic operating procedure for the MASW method. Figure 4 illustrates an example of one of the MASW/SPAC records, the corresponding spectrogram analysis and resulting 1D V_s model.

INTERPRETATION

The main processing sequence involved data inspection and edition when required; spectral analysis ("phase shift" for MASW, and "cross-correlation" for SPAC); picking the fundamental mode; and 1D inversion of the MASW and SPAC shot records using the SeisImagerSW™ software. The data inversions used a nonlinear least squares algorithm.

In theory, all the shot records for a given seismic spread should produce a similar shear-wave velocity profile. In practice, however, differences can arise due to energy dissipation, local surface seismic velocities variations, and/or dipping of overburden layers or rock. In general, the precision of the calculated seismic shear wave velocities (V_s) is around 15% or better.

More detailed descriptions of these methods are presented in *Shear Wave Velocity Measurement Guidelines for Canadian Seismic Site Characterization in Soil and Rock*, Hunter, J.A., Crow, H.L., et al., Geological Surveys of Canada, General Information Product 110, 2015.



SURVEY DESIGN

The seismic acquisition spreads were located north-east of the intersection of Bank Street and Lisgar Street, along Lisgar Street (Figure 2). The geophone spacing was 3.0 metres for the main spread, using 24 geophones. A shorter seismic spread, with geophone spacing of 1.0 metre, was dedicated to the near surface materials. The seismic records were produced with a seismograph Terraloc Pro 2 (from ABEM Instrument), and the geophones were 4.5 Hz. The seismic records counted 4096 data, sampled at 1000 μ s for the MASW surveys, and at 40 μ s for the seismic refraction. The records included a pre-triggered portion of 10 ms. An 8 kg sledgehammer was used as the energy source, with impacts being recorded off both ends of the seismic spreads. A stacking procedure was also used to improve the Signal / Noise ratio for the seismic records.

The shear wave depth sounding can be considered as the average of the bulk area within the geophone spread, especially for its central half-length.

RESULTS

The MASW calculated V_s results are illustrated at Figure 5. Some low seismic velocities were calculated from the surface up to 2 to 3 metres deep.

The \bar{V}_{S30} value results from the harmonic mean of the shear wave velocities, from the surface to 30 metres deep. It is calculated by dividing the total depth of interest (30 metres) by the sum of the time spent in each velocity layer from the surface down to 30 metres, as:

$$\bar{V}_{S30} = \frac{\sum_{i=1}^N H_i}{\sum_{i=1}^N \frac{H_i}{V_i}} \quad | \quad \sum_{i=1}^N H_i = 30 \text{ m}$$

(N: number of layers; H_i : thickness of layer "i" ; V_i : V_s of layer "i")

Thus, the \bar{V}_{S30} value represents the seismic shear wave velocity of an equivalent homogeneous single layer response, between the surface and 30 metres deep.

The calculated \bar{V}_{S30} value of the actual site is 635.8 m/s (Table 1), corresponding to the Site Class "C".

As the planned building is to be founded on piles, with caps at 3 metres below the actual ground surface, the \bar{V}_{S30}^* value would be 966.0 m/s, corresponding to the Site Class "B" (Table 2). However, the Site Classes A and B are not to be used if there are 3 metres or more of unconsolidated material between the rock and the bottom of the spread footing, pile cap or mat foundation. The geotechnical boreholes identified the rock between 7.4 and 8.3 metres deep. In such a case, the appropriate site designation is X_{760} .



CONCLUSION

Geophysical surveys were carried out to identify the Site Class for 219/223 Bank Street and 178 Nepean Street, in Ottawa (ON). The seismic surveys used the MASW and the SPAC analysis, and the seismic refraction to calculate the \bar{V}_{S30} value. Its calculation is presented at Table 1.

The \bar{V}_{S30} value of the actual site is 636 m/s, corresponding to the Site Class "C" ($360 < \bar{V}_{S30} \leq 760$ m/s), as determined through the MASW and SPAC methods, Table 4.1.8.4.-A of the NBC (2015), and the Building Code, O. Reg. 332/12.

The building currently planned is to be founded on piles, with caps at 3 metres below the actual ground surface. In such case the \bar{V}_{S30}^* value would be 966 m/s, corresponding to the Site Class "B" ($760 < \bar{V}_{S30} \leq 1500$ m/s). It must be noted that the Site Classes A and B are not to be used if there are 3 metres or more of unconsolidated material between the rock surface and the underside of the spread footing, pile cap or mat foundation. In such a case, the appropriate site designation is X_{760} (NBC 2020).

It must also be noted that other geotechnical information gleaned on site; including the presence of liquefiable soils, very soft clays, high moisture content etc. (cf. Table 4.1.8.4.-A of the NBC 2015) can supersede the Site classification provided in this report based on the \bar{V}_{S30} value.

The V_s values calculated are representative of the in situ materials and are not corrected for the total and effective stresses.

Hoping the whole to your satisfaction, we remain yours truly,



Jean-Luc Arsenault, M.A.Sc., P.Eng.
Senior Project Manager



2023-03-20



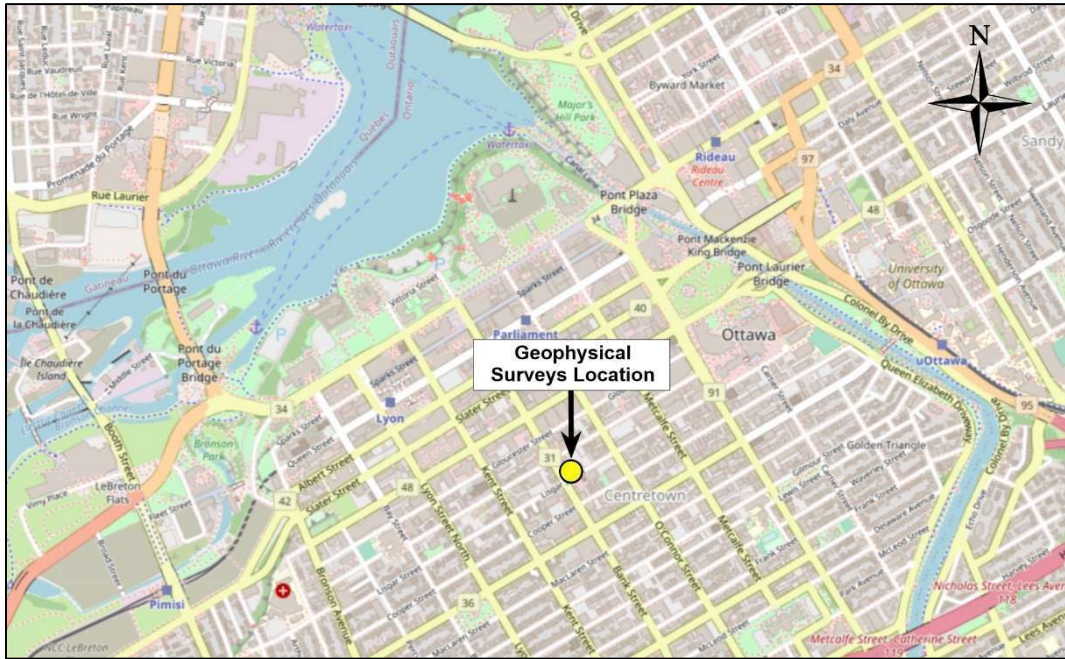

Figure 1: Regional location of the Site
 (source: *OpenStreetMap*©)



Figure 2: Location of the seismic spreads
 (source: *geoOttawa*)



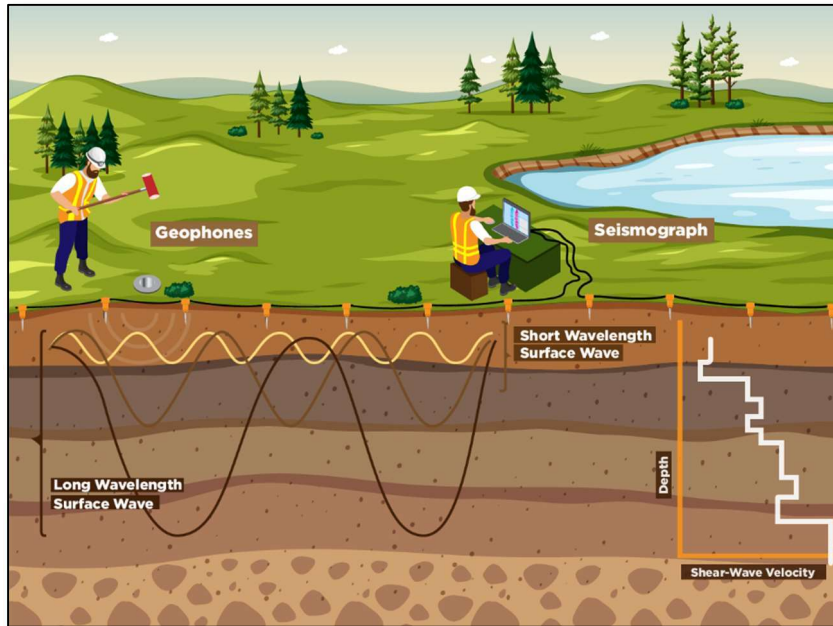

Figure 3: MASW Operating Principle

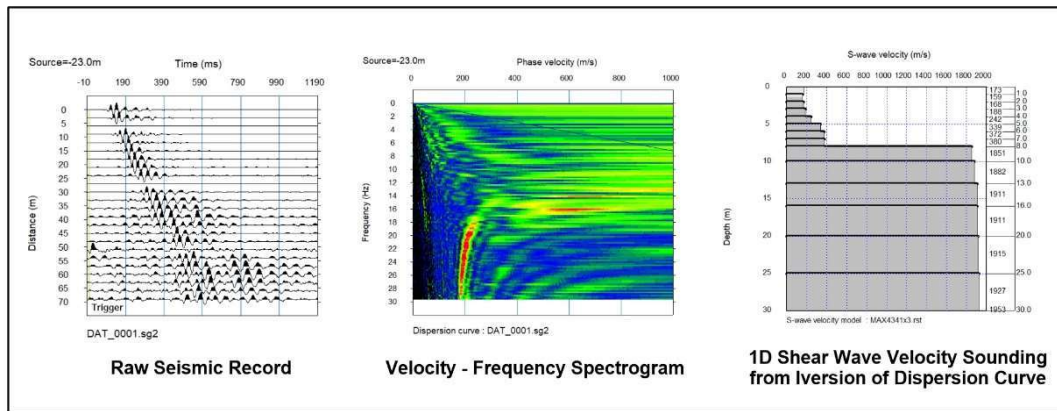

Figure 4: Example of a MASW/SPAC record, Phase Velocity - Frequency curve of the Rayleigh wave and resulting 1D Shear Wave Velocity Model



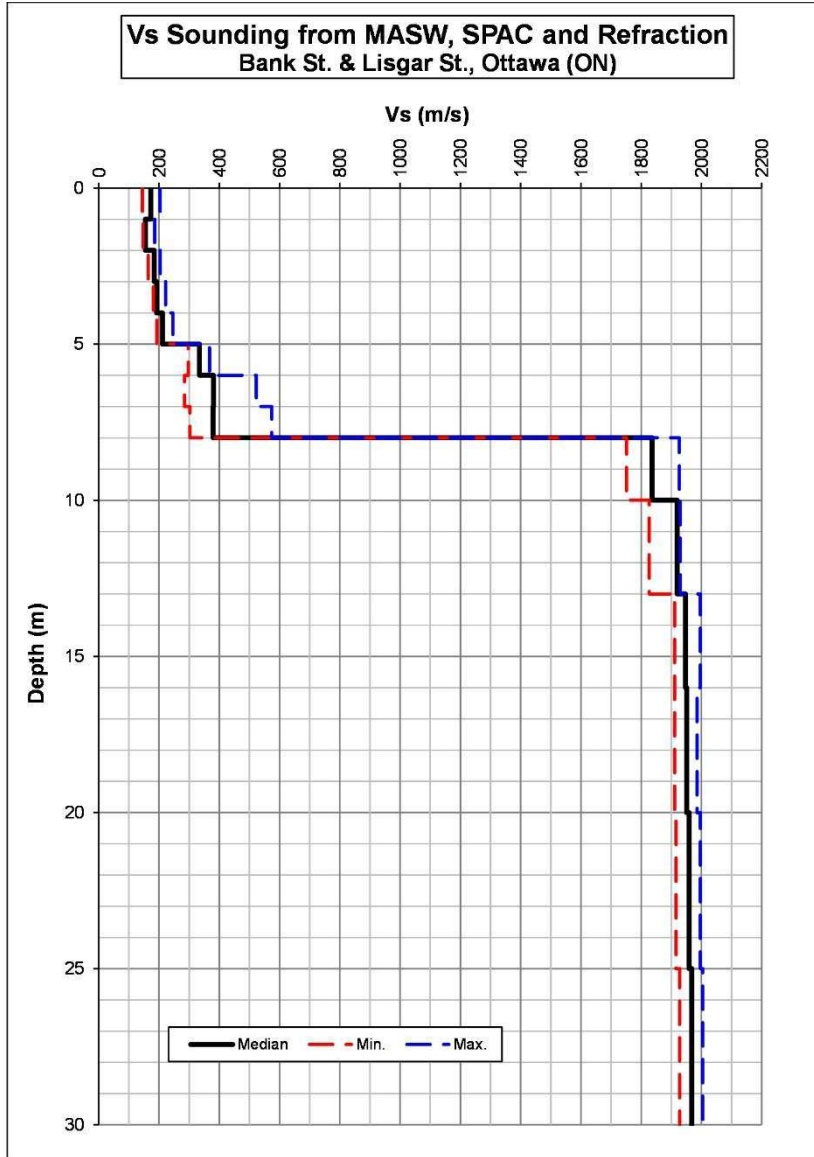

Figure 5: MASW Shear-Wave Velocity Sounding



TABLE 1
V_{S30} Calculation for the Site Class (actual site)

Depth	Vs			Thickness	Cumulative Thickness	Delay for med. Vs	Cumulative Delay	Vs at given Depth
	Min.	Median	Max.					
(m)	(m/s)	(m/s)	(m/s)	(m)	(m)	(s)	(s)	(m/s)
0	144.9	173.1	203.8	Grade Level (March 10, 2023)				
1.0	146.7	155.1	185.4	1.00	1.00	0.005777	0.005777	173.1
2.0	164.3	184.2	204.3	1.00	2.00	0.006449	0.012226	163.6
3.0	181.5	191.8	222.0	1.00	3.00	0.005429	0.017656	169.9
4.0	193.0	211.3	245.9	1.00	4.00	0.005214	0.022869	174.9
5.0	296.9	334.6	367.9	1.00	5.00	0.004733	0.027603	181.1
6.0	284.8	381.2	523.0	1.00	6.00	0.002988	0.030591	196.1
7.0	302.6	379.5	573.9	1.00	7.00	0.002623	0.033214	210.8
8.0	1751.2	1836.5	1926.4	1.00	8.00	0.002635	0.035849	223.2
10.0	1826.7	1919.5	1929.5	2.00	10.00	0.001089	0.036938	270.7
13.0	1911.2	1946.9	1996.3	3.00	13.00	0.001563	0.038501	337.7
16.0	1911.1	1950.8	1985.3	3.00	16.00	0.001541	0.040041	399.6
20.0	1915.4	1958.7	1995.8	4.00	20.00	0.002050	0.042092	475.2
25.0	1927.7	1967.7	2004.0	5.00	25.00	0.002553	0.044645	560.0
30				5.00	30.00	0.002541	0.047186	635.8

Vs30 (m/s)	635.8
Class	C

TABLE 2
V_{S30}* Calculation for the Site Class (foundation at 3 metres deep)

Depth	Vs			Thickness	Cumulative Thickness	Delay for med. Vs	Cumulative Delay	Vs at given Depth
	Min.	Median	Max.					
(m)	(m/s)	(m/s)	(m/s)	(m)	(m)	(s)	(s)	(m/s)
0	144.9	173.1	203.8	Considering the piles caps at 3 metres deep (5 metres of soils)				
1.0	146.7	155.1	185.4					
2.0	164.3	184.2	204.3					
3	181.5	191.8	222.0					
4.0	193.0	211.3	245.9	1.00	1.00	0.005214	0.005214	191.8
5.0	296.9	334.6	367.9	1.00	2.00	0.004733	0.009947	201.1
6.0	284.8	381.2	523.0	1.00	3.00	0.002988	0.012935	231.9
7.0	302.6	379.5	573.9	1.00	4.00	0.002623	0.015558	257.1
8.0	1751.2	1836.5	1926.4	1.00	5.00	0.002635	0.018193	274.8
10.0	1826.7	1919.5	1929.5	2.00	7.00	0.001089	0.019282	363.0
13.0	1911.2	1946.9	1996.3	3.00	10.00	0.001563	0.020845	479.7
16.0	1911.1	1950.8	1985.3	3.00	13.00	0.001541	0.022386	580.7
20.0	1915.4	1958.7	1995.8	4.00	17.00	0.002050	0.024436	695.7
25.0	1927.7	1967.7	2004.0	5.00	22.00	0.002553	0.026989	815.1
33				8.00	30.00	0.004066	0.031055	966.0

Vs30*	966.0
Class	B⁽¹⁾

(1) The Site Classes A and B are not to be used if there are 3 metres or more of unconsolidated materials between the rock surface and the bottom of the spread footing, pile cap or mat foundation.



Appendix B: Rock Core Photographs

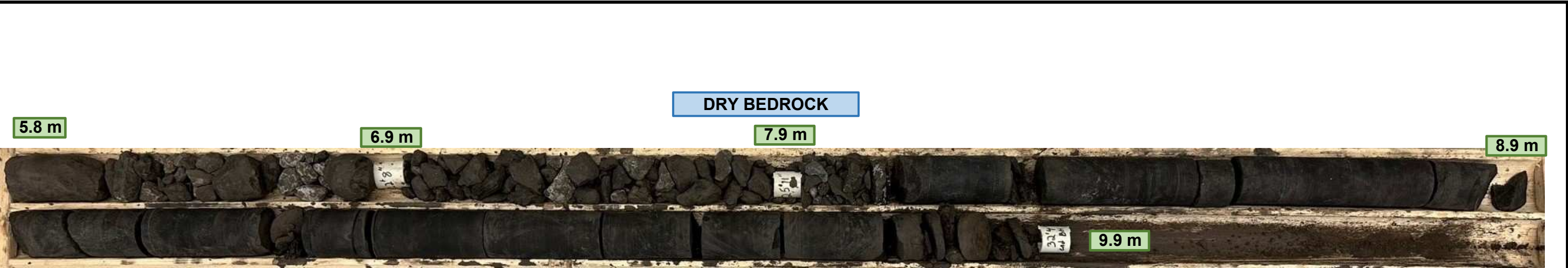

EXP Services Inc. www.exp.com
 t: +1.613.688.1899 | f: +1.613.225.7337
 2650 Queensview Drive, Suite 100
 Ottawa, ON K2B 8H6, Canada

borehole no. BH1	Depths: Run 1: 5.8 m - 6.9 m Run 2: 6.9 m - 7.9 m Run 3: 7.9 m - 8.9 m Run 4: 8.9 m - 9.9 m	project Geotechnical Investigation 178 Nepean Street and 219/223 Bank Street, Ottawa, ON	project no. OTT-22018926-A0
date cored Dec 06, 2022		Rock Core Photographs	FIG B-1

DRY BEDROCK CORES



WET BEDROCK CORES

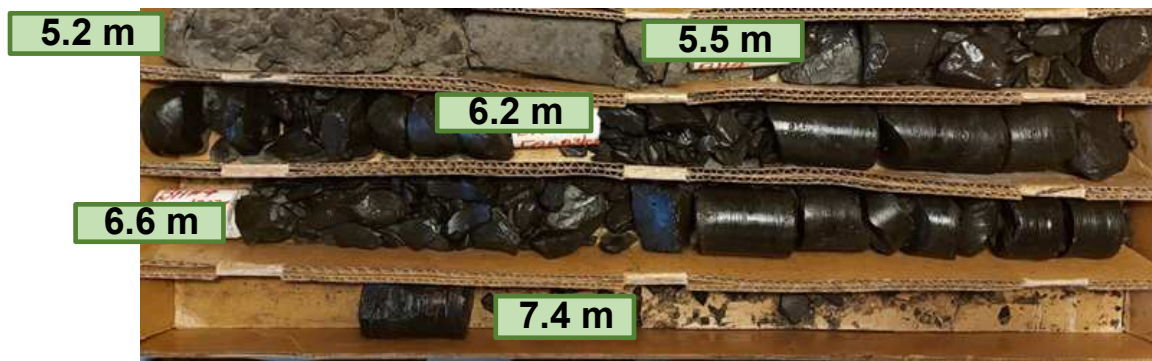

EXP Services Inc. www.exp.com
 t: +1.613.688.1899 | f: +1.613.225.7337
 2650 Queensview Drive, Suite 100
 Ottawa, ON K2B 8H6, Canada

borehole no. BH4	Depths: Run 1: 5.2 m - 5.5 m Run 2: 5.5 m - 6.2 m Run 3: 6.2 m - 6.6 m Run 4: 6.6 m - 7.4 m	project Geotechnical Investigation 178 Nepean Street and 219/223 Bank Street, Ottawa, ON	project no. OTT-22018926-A0
date cored Feb 03, 2023	Rock Core Photographs		FIG B-2

DRY BEDROCK CORES



WET BEDROCK CORES



EXP Services Inc. www.exp.com

t: +1.613.688.1899 | f: +1.613.225.7337

2650 Queensview Drive, Suite 100

Ottawa, ON K2B 8H6, Canada

borehole no. BH4	Depths: Run 5: 7.4 m - 8.5 m	project Geotechnical Investigation 178 Nepean Street and 219/223 Bank Street, Ottawa, ON	project no. OTT-22018926-A0
date cored Feb 03, 2023		Rock Core Photographs	FIG B-3

Appendix C: Liquefaction Analysis

LIQUEFACTION ANALYSIS
(Canadian Foundation Engineering Manual, 4E)

Project Name : 178 Nepean St, Ottawa

Reference Borehole : BH-1

Ground Surface Elev. = 70.4 m

Earthquake Magnitude, M = 7.0

Water Table Depth = 5.3 m

Depth z (m)	Soil Classification	γ (kN/m ³)	σ_v (kPa)	μ (kPa)	σ_v' (kPa)	N ₆₀	(N ₁) ₆₀	%Fine	CSR			Shear Wave Velocity		CRR	FS _L
									a _{max} /g	r _d	CSR	V _s (m/s)	V _{s1} (m/s)		
0.0	Concrete	24.0	0.0	0.0	0.0										
0.1	Fill	20.0	2.5	0.0	2.5										
0.2	Clay	18.2	3.9	0.0	3.9										
2.0	Sa & Si Till, compact	20.5	40.8	0.0	40.8	5	6	9	0.28	0.98	0.18	200	266	0.60	3.34
2.8	Sa & Si Till, compact	20.5	56.9	0.0	56.9	9	11	9	0.28	0.98	0.18	200	238	0.60	3.36
3.6	Sa & Si Till, compact	20.5	73.1	0.0	73.1	23	25	9	0.28	0.97	0.18	200	219	0.60	3.38
4.4	Sa & Si Till, compact	20.5	89.2	0.0	89.2	19	20	9	0.28	0.97	0.18	200	205	0.50	2.83
5.2	Sa & Si Till, compact	20.5	105.3	0.0	105.3	24	23	9	0.28	0.96	0.18	250	242	0.60	3.42
5.9	Sa & Si Till, v. dense	20.5	121.5	6.3	115.2										
6.7	Sa & Si Till, v. dense	20.5	137.6	14.0	123.6										
7.5	Sa & Si Till, v. dense	20.5	153.8	21.7	132.1										
8.3	Shale Bedrock	24.0	172.7	29.4	143.2										
9.9	Shale Bedrock	24.0	211.1	45.1	165.9										

Project No. : OTT-22018926-A0

Prepared By : HW

Date : June, 2023

Checked By : IT

LIQUEFACTION ANALYSIS
(Canadian Foundation Engineering Manual, 4E)

Project Name : 178 Nepean St, Ottawa

Reference Borehole : BH-2

Ground Surface Elev. = 72.3 m

Earthquake Magnitude, M = 7.0

Water Table Depth = 7.2 m

Depth z (m)	Soil Classification	γ (kN/m ³)	σ_v (kPa)	μ (kPa)	σ_v' (kPa)	N ₆₀	(N ₁) ₆₀	%Fine	CSR			Shear Wave Velocity		CRR	FS _L
									a _{max} /g	r _d	CSR	V _s (m/s)	V _{s1} (m/s)		
0.0	Concrete	24.0	0.0	0.0	0.0										
0.1	Fill	20.0	2.0	0.0	2.0										
1.5	Clay	18.2	27.7	0.0	27.7										
3.9	Sa & Si Till, v. loose	20.5	76.9	0.0	76.9	2	2	9	0.28	0.97	0.18	200	215	0.60	3.39
4.3	Sa & Si Till, v. loose	20.5	85.1	0.0	85.1	2	2	9	0.28	0.97	0.18	200	208	0.60	3.40
4.7	Sa & Si Till, v. loose	20.5	93.3	0.0	93.3	2	2	9	0.28	0.96	0.18	200	202	0.33	1.87
5.1	Sa & Si Till, v. loose	20.5	101.5	0.0	101.5	2	2	9	0.28	0.96	0.18	250	245	0.60	3.42
5.5	Sa & Si Till, v. loose	20.5	109.7	0.0	109.7	2	2	9	0.28	0.96	0.17	250	239	0.60	3.43
5.9	Sa & Si Till, v. loose	20.5	117.9	0.0	117.9	2	2	9	0.28	0.95	0.17	250	233	0.60	3.44
6.3	Sa & Si Till, v. loose	20.5	126.1	0.0	126.1	2	2	9	0.28	0.95	0.17	250	228	0.60	3.45
6.7	Sa & Si Till, v. loose	20.5	134.3	0.0	134.3	2	2	9	0.28	0.95	0.17	250	224	0.60	3.46
7.1	Refusal	24.0	143.9	0.0	143.9										
7.1	Refusal	24.0	143.9	0.0	143.9										

Project No. : OTT-22018926-A0

Prepared By : HW

Date : June, 2023

Checked By : IT

LIQUEFACTION ANALYSIS
(Canadian Foundation Engineering Manual, 4E)

Project Name : 178 Nepean St, Ottawa

Reference Borehole : BH-3

Ground Surface Elev. = 72.1 m

Earthquake Magnitude, M = 7.0

Water Table Depth = 7.0 m

Depth z (m)	Soil Classification	γ (kN/m ³)	σ_v (kPa)	μ (kPa)	σ_v' (kPa)	N_{60}	$(N_1)_{60}$	%Fine	CSR			Shear Wave Velocity		CRR	FS _L
									a_{max}/g	r_d	CSR	V_s (m/s)	V_{s1} (m/s)		
0.0	Asphalt	24.0	0.0	0.0	0.0										
0.1	Fill	20.0	1.5	0.0	1.5										
1.3	Clay	18.2	24.0	0.0	24.0										
4.0	Sa & Si Till, compact	20.5	79.3	0.0	79.3	11	12	9	0.28	0.97	0.18	200	213	0.60	3.39
4.4	Sa & Si Till, compact	20.5	87.0	0.0	87.0	11	11	9	0.28	0.97	0.18	200	207	0.60	3.40
4.8	Sa & Si Till, compact	20.5	94.7	0.0	94.7	11	11	9	0.28	0.96	0.18	200	201	0.33	1.88
5.1	Sa & Si Till, compact	20.5	102.4	0.0	102.4	11	11	9	0.28	0.96	0.18	250	245	0.60	3.42
5.5	Sa & Si Till, compact	20.5	110.1	0.0	110.1	11	11	9	0.28	0.96	0.17	250	239	0.60	3.43
5.9	Sa & Si Till, compact	20.5	117.8	0.0	117.8	11	10	9	0.28	0.95	0.17	250	234	0.60	3.44
6.3	Sa & Si Till, compact	20.5	125.5	0.0	125.5	14	13	9	0.28	0.95	0.17	250	229	0.60	3.45
6.6	Sa & Si Till, compact	20.5	133.1	0.0	133.1	14	12	9	0.28	0.95	0.17	250	224	0.60	3.46
7.0	Refusal	24.0	142.1	0.0	142.1										
11.6	Refusal	24.0	252.5	45.1	207.4										

Project No. : OTT-22018926-A0

Prepared By : HW

Date : June, 2023

Checked By : IT

Appendix D: Ontario Provincial Standard Drawing (OPSD) 3001.100, Type II

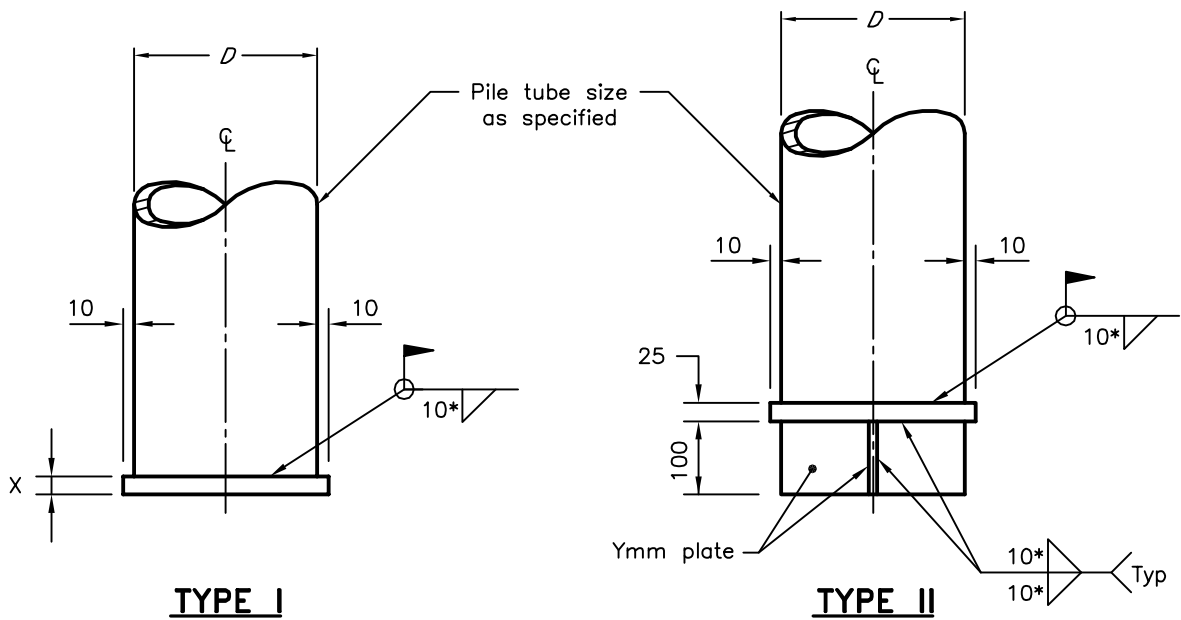

SHOE DETAILS

(*) or tube wall thickness whichever is smaller.

Pipe Diameter (mm)	Plate Thickness	
	X (mm)	Y (mm)
$D < 324$	25	12
$324 \leq D \leq 406$	40	15
$406 < D \leq 610$	50	25

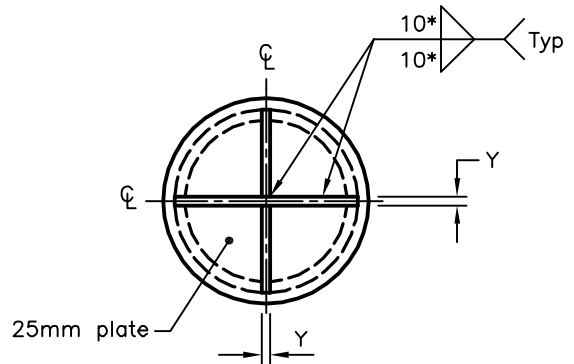

BOTTOM VIEW

NOTES:

- A Driving shoe Type I or II as specified.
- B Welding shall be according to CSA W59.
- C Steel plates shall be according to CSA G40.20/G40.21, Grade 300W/350W.
- D All dimensions are in millimeters unless otherwise shown.

ONTARIO PROVINCIAL STANDARD DRAWING	Nov 2017	Rev 2	
FOUNDATION PILES	-----		
STEEL TUBE PILE DRIVING SHOE	OPSD 3001.100		

EXP Services Inc.

Smart Living Properties

Updated Geotechnical Investigation – Proposed Residential Development

178 Nepean Street, 219/223 Bank Street, Ottawa, ON

OTT-22018926-A0

June 21, 2023

Appendix E: Laboratory Certificate of Analysis Report



CLIENT NAME: EXP SERVICES INC
2650 QUEENSVIEW DRIVE, UNIT 100
OTTAWA, ON K2B8H6
(613) 688-1899

ATTENTION TO: Matthew Zammit
PROJECT: OTT-22018926-AO

AGAT WORK ORDER: 22Z978681

SOIL ANALYSIS REVIEWED BY: Nivine Basily, Inorganics Report Writer

DATE REPORTED: Dec 15, 2022

PAGES (INCLUDING COVER): 5

VERSION*: 1

Should you require any information regarding this analysis please contact your client services representative at (905) 712-5100

***Notes**

Empty box for notes.

Disclaimer:

- All work conducted herein has been done using accepted standard protocols, and generally accepted practices and methods. AGAT test methods may incorporate modifications from the specified reference methods to improve performance.
- All samples will be disposed of within 30 days after receipt unless a Long Term Storage Agreement is signed and returned. Some specialty analysis may be exempt, please contact your Client Project Manager for details.
- AGAT's liability in connection with any delay, performance or non-performance of these services is only to the Client and does not extend to any other third party. Unless expressly agreed otherwise in writing, AGAT's liability is limited to the actual cost of the specific analysis or analyses included in the services.
- This Certificate shall not be reproduced except in full, without the written approval of the laboratory.
- The test results reported herewith relate only to the samples as received by the laboratory.
- Application of guidelines is provided "as is" without warranty of any kind, either expressed or implied, including, but not limited to, warranties of merchantability, fitness for a particular purpose, or non-infringement. AGAT assumes no responsibility for any errors or omissions in the guidelines contained in this document.
- All reportable information as specified by ISO/IEC 17025:2017 is available from AGAT Laboratories upon request.



Certificate of Analysis

AGAT WORK ORDER: 22Z978681

PROJECT: OTT-22018926-AO

5835 COOPERS AVENUE
MISSISSAUGA, ONTARIO
CANADA L4Z 1Y2
TEL (905)712-5100
FAX (905)712-5122
<http://www.agatlabs.com>

CLIENT NAME: EXP SERVICES INC

ATTENTION TO: Matthew Zammit

SAMPLING SITE:

SAMPLED BY: EXP

Inorganic Chemistry (Soil)

DATE RECEIVED: 2022-12-08

DATE REPORTED: 2022-12-15

		SAMPLE DESCRIPTION: BH#2 SS5	
		10'-12'	
		Soil	
		DATE SAMPLED: 2022-11-23	
Parameter	Unit	G / S	RDL
Chloride (2:1)	µg/g	2	82
Sulphate (2:1)	µg/g	2	262
pH (2:1)	pH Units	NA	8.37
Resistivity (2:1) (Calculated)	ohm.cm	1	1330

Comments: RDL - Reported Detection Limit; G / S - Guideline / Standard
4602231 Chloride and Sulphate were determined on the extract obtained from the 2:1 leaching procedure (2 parts DI water: 1 part soil).
 pH was determined on the 0.01M CaCl₂ extract obtained from 2:1 leaching procedure (2 parts extraction fluid:1 part wet soil).
 Resistivity is a calculated parameter.
 Analysis performed at AGAT Toronto (unless marked by *)

Certified By:



Matthew Zammit

Quality Assurance

CLIENT NAME: EXP SERVICES INC
PROJECT: OTT-22018926-AO
SAMPLING SITE:

AGAT WORK ORDER: 22Z978681
ATTENTION TO: Matthew Zammit
SAMPLED BY: EXP

Soil Analysis															
RPT Date: Dec 15, 2022			DUPLICATE				Method Blank	REFERENCE MATERIAL			METHOD BLANK SPIKE			MATRIX SPIKE	
PARAMETER	Batch	Sample Id	Dup #1	Dup #2	RPD	Measured Value		Acceptable Limits		Recovery	Acceptable Limits		Recovery	Acceptable Limits	
								Lower	Upper		Lower	Upper		Lower	Upper

Inorganic Chemistry (Soil)

Chloride (2:1)	4602231	4602231	82	78	5.0%	< 2	97%	70%	130%	100%	80%	120%	115%	70%	130%
Sulphate (2:1)	4602231	4602231	262	263	0.4%	< 2	104%	70%	130%	101%	80%	120%	NA	70%	130%
pH (2:1)	4602231	4602231	8.37	8.27	1.2%	NA	95%	80%	120%						

Comments: NA signifies Not Applicable.

Matrix spike NA: Spike level < native concentration. Matrix spike acceptance limits do not apply and are not calculated.

Certified By:



Nivine Basily



Method Summary

CLIENT NAME: EXP SERVICES INC

AGAT WORK ORDER: 22Z978681

PROJECT: OTT-22018926-AO

ATTENTION TO: Matthew Zammit

SAMPLING SITE:

SAMPLED BY:EXP

PARAMETER	AGAT S.O.P	LITERATURE REFERENCE	ANALYTICAL TECHNIQUE
Soil Analysis			
Chloride (2:1)	INOR-93-6004	modified from SM 4110 B	ION CHROMATOGRAPH
Sulphate (2:1)	INOR-93-6004	modified from SM 4110 B	ION CHROMATOGRAPH
pH (2:1)	INOR 93-6031	modified from EPA 9045D and MCKEAGUE 3.11	PH METER
Resistivity (2:1) (Calculated)	INOR-93-6036	McKeague 4.12, SM 2510 B,SSA #5 Part 3	CALCULATION

Laboratory Use Only

Work Order #: 222978681

Cooler Quantity: n/a - bag - no ice/packs

Arrival Temperatures: 21.1 | 21.0 | 21.1
LT 6.9 | 6.7

Custody Seal Intact: Yes No N/A

Notes: Begged ice

Chain of Custody Record

If this is a Drinking Water sample, please use Drinking Water Chain of Custody Form (potable water consumed by humans)

Report Information:

Company: EXP Services Inc- Ottawa
Contact: Matthew Zammit
Address: 2650 Queensview Dr. Unit 100
Ottawa, ON, K2B 8T6
Phone: 613-688-1891 Fax: _____
Reports to be sent to:
1. Email: matthew.zammit@exp.com
2. Email: _____

Regulatory Requirements:

(Please check all applicable boxes)

Regulation 153/04 Excess Soils R406 Sewer Use
 Sanitary Storm

Table _____ Indicate One _____
 Ind/Com Res/Park Agriculture

Regulation 558 CCME Other

Soil Texture (Check One) _____
 Coarse Fine

Region _____
Indicate One _____

Turnaround Time (TAT) Required:

Regular TAT 5 to 7 Business Days
Rush TAT (Rush Surcharges Apply)
 3 Business Days 2 Business Days Next Business Day
OR Date Required (Rush Surcharges May Apply): _____

Please provide prior notification for rush TAT
*TAT is exclusive of weekends and statutory holidays

For 'Same Day' analysis, please contact your AGAT CPM

Project Information:

Project: OTT-22018926-A0
Site Location: 178 Nepean St., Ottawa
Sampled By: EXP
AGAT Quote #: _____ PO: _____
Please note: If quotation number is not provided, client will be billed full price for analysis.

Invoice Information:

Bill To Same: Yes No
Company: _____
Contact: _____
Address: _____
Email: _____

Is this submission for a Record of Site Condition?

Yes No

Report Guideline on Certificate of Analysis

Yes No

Sample Matrix Legend

B Biota
GW Ground Water
O Oil
P Paint
S Soil
SD Sediment
SW Surface Water

Sample Identification	Date Sampled	Time Sampled	# of Containers	Sample Matrix	Comments/ Special Instructions	Y / N	Metals & Inorganics	Metals - <input type="checkbox"/> CVI, <input type="checkbox"/> Hg, <input type="checkbox"/> HWSB	BTEX, F1-F4 PHCs	Analyze F4G if required <input type="checkbox"/> Yes <input type="checkbox"/> No	PAHs	PCBs	VOC	Landfill Disposal Characterization TOLP: <input type="checkbox"/> M&I <input type="checkbox"/> VOCs <input type="checkbox"/> ABNs <input type="checkbox"/> B(a)P <input type="checkbox"/> PCBs	Excess Soils SPLP Rainwater Leach	SPLP: <input type="checkbox"/> Metals <input type="checkbox"/> VOCs <input type="checkbox"/> SVOCs	Excess Soils Characterization Package	pH, ICPMS Metals, BTEX, F1-F4	Salt - EC/SAR	Potentially Hazardous or High Concentration (Y/N)	
RH # 2 SSS 10-12'	Nov. 23	AM PM	1	S																	
		AM PM																			
		AM PM																			
		AM PM																			
		AM PM																			
		AM PM																			
		AM PM																			
		AM PM																			
		AM PM																			
		AM PM																			

Samples Relinquished By (Print Name and Sign): <u>Jeff MacMillan</u>	Date: <u>Dec 8/22</u>	Time: <u>1:38 PM</u>	Samples Received By (Print Name and Sign): <u>C. Anthea</u>	Date: <u>DEC 08 2022</u>	Time: <u>11:00</u>
Samples Relinquished By (Print Name and Sign): <u>C. To Puro</u>	Date: <u>DEC 08 2022</u>	Time: <u>11:00</u>	Samples Received By (Print Name and Sign): <u>Sarah Assayed</u>	Date: <u>DEC 08 2022</u>	Time: <u>8:35 AM</u>
Samples Relinquished By (Print Name and Sign):	Date:	Time:	Samples Received By (Print Name and Sign):	Date:	Time:

pH
sulphate
chlorides
resistivity

Legal Notification

This report was prepared by EXP Services for the account of Smart Living Properties.

Any use which a third party makes of this report, or any reliance on or decisions to be made based on it, are the responsibility of such third parties. EXP Services Inc. accepts no responsibility for damages, if any, suffered by any third party as a result of decisions made or actions based on this project.

List of Distribution

Report Distributed To:

Jules Lauzon jules@smartlivingproperties.ca

ahmadsa@smartlivingproperties.ca

corey@smartlivingproperties.ca