

381 Kent Street

Transportation Impact Assessment

Step 1 Screening Report

Step 2 Scoping Report

Step 3 Forecasting Report

Step 4 Strategy Report

Prepared for:

S.E.C. 381 Kent LP
69 rue Jean-Proulx, unité #301
Gatineau QC J8Z 1W2

Prepared by:



6 Plaza Court
Ottawa, ON K2H 7W1

February 2023

PN: 2021-108

Table of Contents

1	Screening.....	1
2	Existing and Planned Conditions.....	1
2.1	Proposed Development.....	1
2.2	Existing Conditions.....	3
2.2.1	Area Road Network.....	3
2.2.2	Existing Intersections.....	3
2.2.3	Existing Driveways.....	5
2.2.4	Cycling and Pedestrian Facilities.....	5
2.2.5	Existing Transit.....	8
2.2.6	Existing Area Traffic Management Measures.....	10
2.2.7	Existing Peak Hour Travel Demand.....	10
2.2.8	Collision Analysis.....	13
2.3	Planned Conditions.....	15
2.3.1	Changes to the Area Transportation Network.....	15
2.3.2	Other Study Area Developments.....	15
3	Study Area and Time Periods.....	16
3.1	Study Area.....	16
3.2	Time Periods.....	17
3.3	Horizon Years.....	17
4	Exemption Review.....	17
5	Development-Generated Travel Demand.....	17
5.1	Mode Shares.....	17
5.2	Trip Generation.....	18
5.3	Trip Distribution.....	19
5.4	Trip Assignment.....	19
6	Background Network Travel Demands.....	21
6.1	Transportation Network Plans.....	21
6.2	Background Growth.....	22
6.3	Other Developments.....	22
7	Demand Rationalization.....	22
7.1	2030 Future Background Operations.....	22
7.2	2035 Future Background Operations.....	25
7.3	2030 Future Total Operations.....	28
7.4	2035 Future Total Operations.....	30
7.5	Modal Share Sensitivity and Demand Rationalization Conclusions.....	33
8	Development Design.....	33
8.1	Design for Sustainable Modes.....	33
8.2	Circulation and Access.....	33
9	Parking.....	33
9.1	Parking Supply.....	33
10	Boundary Street Design.....	33
11	Access Intersections Design.....	34

11.1 Location and Design of Access..... 34

11.2 Intersection Control..... 35

11.3 Access Intersection Design 35

 11.3.1 Future Access Intersection Operations 35

 11.3.2 Access Intersection MMLOS 35

 11.3.3 Recommended Design Elements..... 35

12 Transportation Demand Management 35

 12.1 Context for TDM 35

 12.2 Need and Opportunity..... 35

 12.3 TDM Program 35

13 Neighbourhood Traffic Management..... 35

14 Transit..... 36

 14.1 Route Capacity..... 36

 14.2 Transit Priority 36

15 Network Intersection Design..... 36

 15.1 Network Intersection Control..... 36

 15.2 Network Intersection Design..... 36

 15.2.1 2030 and 2035 Future Total Network Intersection Operations 36

 15.2.2 Network Intersection MMLOS..... 36

 15.2.3 Recommended Design Elements..... 37

16 Summary of Improvements Indicated and Modifications Options..... 37

17 Conclusion 40

List of Figures

Figure 1: Area Context Plan1

Figure 2: Concept Plan.....2

Figure 3: Existing Driveways5

Figure 4: Study Area Pedestrian Facilities6

Figure 5: Study Area Cycling Facilities6

Figure 6: Existing Pedestrian Volumes7

Figure 7: Existing Cyclist Volumes8

Figure 8: Existing Study Area Transit Service.....9

Figure 9: Existing Study Area Transit Stops 10

Figure 10: Existing Traffic Counts 11

Figure 11: Study Area Collision Records..... 14

Figure 12: New Site Generation Volumes 20

Figure 13: Pass-By Auto Volumes 21

Figure 14: 2030 Future Background Volumes 23

Figure 15: 2035 Future Background Volumes 26

Figure 16: 2030 Future Total Volumes 28

Figure 17: 2035 Future Total Volumes 31

Figure 18: Proposed On-Street Parking..... 34

Table of Tables

Table 1: Intersection Count Date.....	10
Table 2: Existing Intersection Operations.....	12
Table 3: Study Area Collision Summary, 2016-2020	13
Table 4: Summary of Collision Locations, 2016-2020.....	14
Table 5: Kent Street and James Street Collision Summary.....	15
Table 6: Exemption Review	17
Table 7: TRANS Trip Generation Manual Recommended Mode Shares – Ottawa Inner Area	18
Table 8: Trip Generation Person Trip Rates.....	18
Table 9: Total Residential Person Trip Generation.....	18
Table 10: Internal Capture Rates.....	18
Table 11: Residential Trip Generation by Mode.....	19
Table 12: OD Survey Distribution – Ottawa Inner	19
Table 13: Trip Assignment	20
Table 14: TRANS Regional Model Projections – Study Area Growth Rates.....	22
Table 15: Recommended Area Growth Rates	22
Table 16: 2030 Future Background Intersection Operations	23
Table 17: 2035 Future Background Intersection Operations	26
Table 18: 2030 Future Total Intersection Operations	29
Table 19: 2035 Future Total Intersection Operations	31
Table 20: Boundary Street MMLOS Analysis	33
Table 21: Trip Generation by Transit Mode	36
Table 22: Forecasted Site-Generated Transit Ridership.....	36
Table 23: Study Area Intersection MMLOS Analysis	37

List of Appendices

Appendix A – TIA Screening Form and Certification Form
Appendix B – Turning Movement Count Data
Appendix C – Synchro Intersection Worksheets – Existing Conditions
Appendix D – Collision Data
Appendix E – TRANS Model Plots
Appendix F – Background Development Volumes
Appendix G – Synchro Intersection Worksheets – 2030 Future Background Conditions
Appendix H – Synchro Intersection Worksheets – 2035 Future Background Conditions
Appendix I – Synchro Intersection Worksheets – 2030 Future Total Conditions
Appendix J – Synchro Intersection Worksheets – 2035 Future Total Conditions
Appendix K – MMLOS Analysis
Appendix L – TDM Checklist

1 Screening

This study has been prepared according to the City of Ottawa's 2017 Transportation Impact Assessment (TIA) Guidelines. Accordingly, a Step 1 Screening Form has been prepared and is included as Appendix A, along with the Certification Form for the TIA Study PM. As shown in the Screening Form, a TIA is required including the Design Review component and the Network Impact Component. This study has been prepared to support a zoning bylaw amendment and site plan application.

2 Existing and Planned Conditions

2.1 Proposed Development

The existing site, located at 381 Kent Street, is zoned as Residential Fourth Density Zone (R4UD) and is occupied by a medical building and surface parking lot. The proposed development consists of two nine-storey mixed-use buildings with 218 apartment units, a park, 1,841 sq. ft of commercial space, 161 parking stalls, and 110 bicycle parking spaces. The proposed plan will remove the existing accesses on Gilmour Street and James Street and will replace them with a new access located on Gilmour Street. The anticipated full build-out and occupancy horizon is 2030. The site is located within the Centretown Secondary Plan and Community Design Plan areas, and the Downtown Ottawa Urban Design Strategy Design Priority Area. Figure 1 illustrates the study area context. Figure 2 illustrates the proposed concept plan.

Figure 1: Area Context Plan

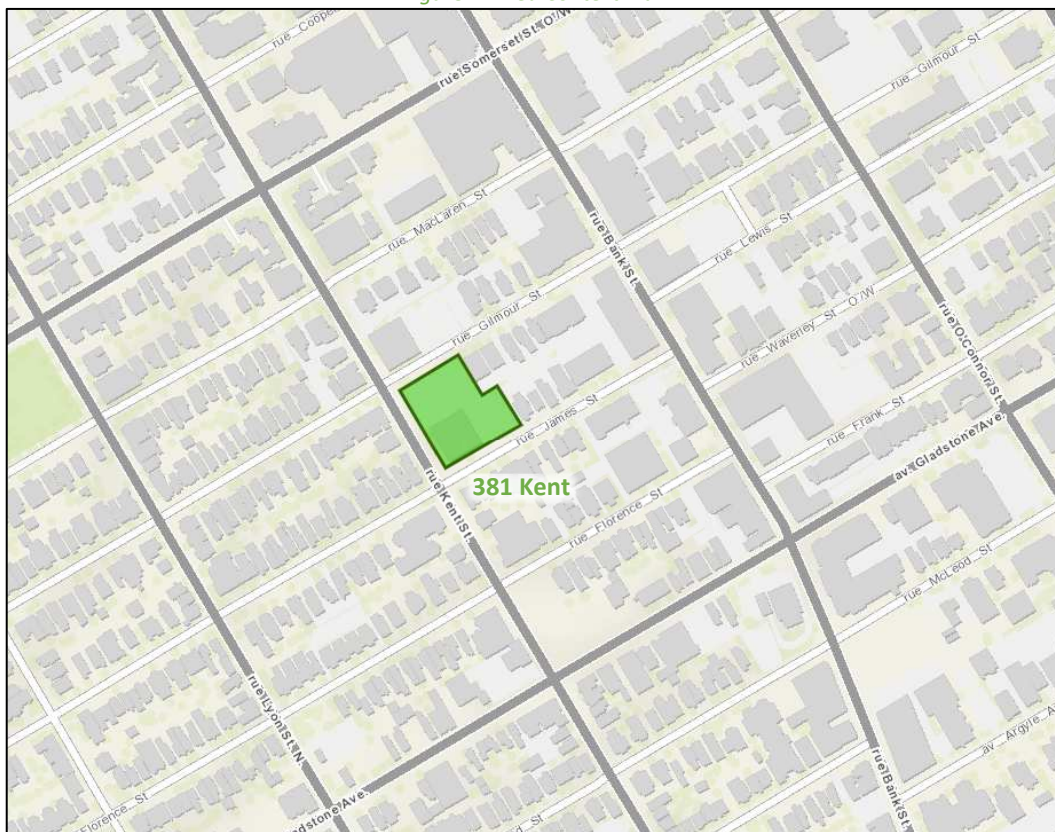

Source: <http://maps.ottawa.ca/geoOttawa/> Accessed: November 24, 2022

Figure 2: Concept Plan

LEGEND OF SYMBOLS		AREA SUMMARY		RESIDENTIAL UNITS SUMMARY		PARKING SUMMARY		LOCKERS SUMMARY	
	PROPOSED LINE	LOT AREA:	3,212.07'	TOTAL OF UNITS:		VEHICULAR PARKING:		BASEMENT LEVEL 2	
	SET BACK LINE	GROUND FLOOR AREA:	21,895.07'	LEVELS	QUANTITY	TOTAL		TYPE	TOTAL
	MAIN ENTRANCE	BUILDING FOOTPRINT:	27,895.07'	2nd FLOOR	18	BASEMENT LEVEL 1		TYPE	TOTAL
	VEHICULAR ENTRANCE	PARK (10%):	286.97'	3rd FLOOR	27	VEHICULAR SPACE 1993x220W STACKED	88	TYPE	TOTAL
	NEW CONSTRUCTION	P.O.P.S.:	286.97'	4th FLOOR	27	VEHICULAR SPACE 1993x220W STACKED	88	TYPE	TOTAL
				5th FLOOR	27	VEHICULAR SPACE 1993x220W STACKED	88	TYPE	TOTAL
				6th FLOOR	18	VEHICULAR SPACE 1993x220W STACKED	88	TYPE	TOTAL
				7th FLOOR	18	VEHICULAR SPACE 1993x220W STACKED	88	TYPE	TOTAL
				8th FLOOR	18	VEHICULAR SPACE 1993x220W STACKED	88	TYPE	TOTAL
				9th FLOOR	18	VEHICULAR SPACE 1993x220W STACKED	88	TYPE	TOTAL
				TOTAL QUANTITIES	181	VEHICULAR SPACE 1993x220W STACKED	88	TYPE	TOTAL
					253	VEHICULAR SPACE 1993x220W STACKED	88	TYPE	TOTAL
					253	VEHICULAR SPACE 1993x220W STACKED	88	TYPE	TOTAL

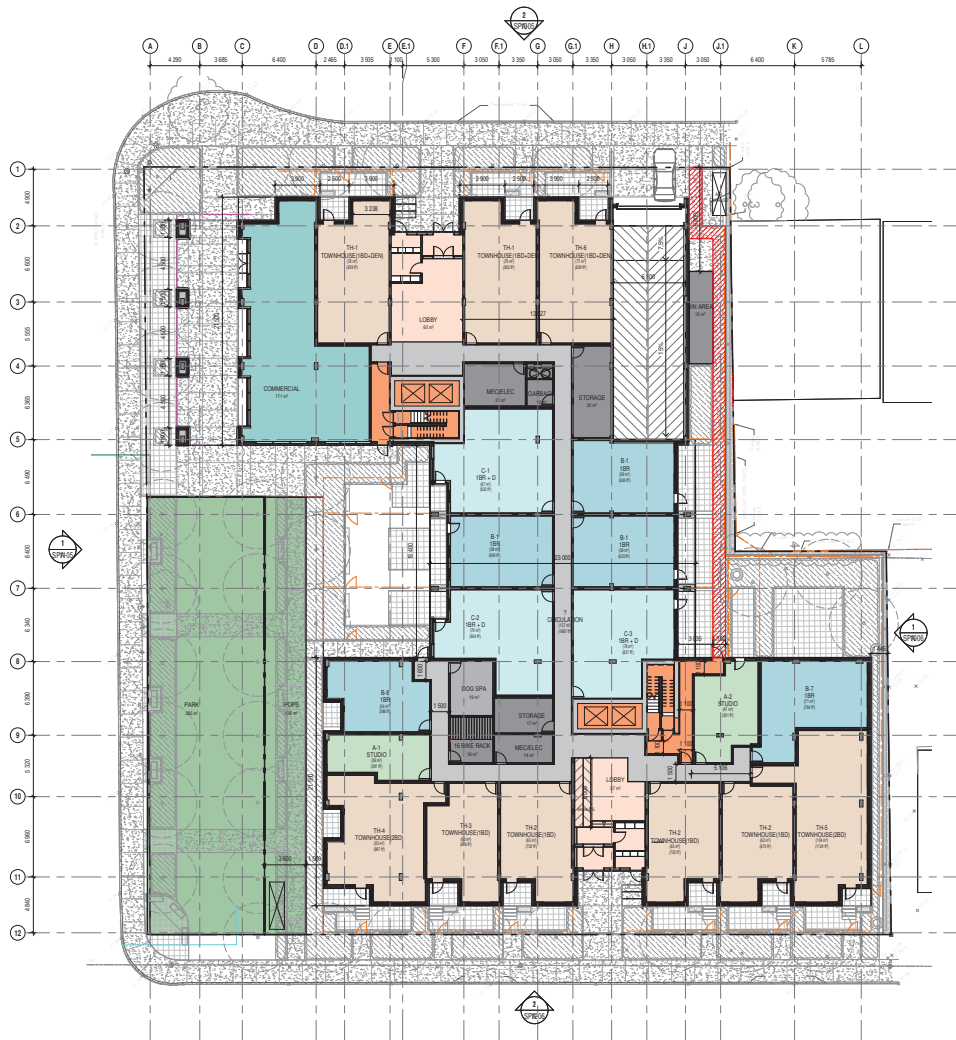

GROUND FLOOR
1:200

NOTES GÉNÉRALES - General Notes

1. Ces documents d'architecture sont le produit exclusif de NEUF architectes et de son équipe. Ils restent la propriété exclusive de NEUF architectes et ne peuvent être copiés, réimprimés ou autrement utilisés sans autorisation écrite préalable. Tous les droits réservés.
2. Les dimensions apparentées aux documents démontrent les unités de mesure utilisées et ne sont pas garanties. Les dimensions doivent être vérifiées sur le terrain.
3. L'ensemble des documents doit être lu et compris dans son ensemble.
4. Les dimensions sur ces documents doivent être lues et non mesurées.



ARCHITECTURE DE PAYSAGE - Landscape Architect
Nom de la firme
 Adresse de la firme
 Téléphone et adresse courriel

CLIENT - Client
Nom de la firme
 Adresse de la firme
 Téléphone et adresse courriel

ARCHITECTES ASSOCIÉS - ARCHITECTS ASSOCIATES
NEUF architecte(s) SENIOR
 650, boulevard Lavigne-O, 10e étage, Montréal, QC H3B 1S6
 T 514 441-1111 NEUFarchitectes.com

CGEAM / Seal



CLIENT - Client

CLIVAGE - Project
381 KENT STREET, OTTAWA
 EMPLACEMENT - Location
 NO PROJET - Project No. 12399

NO. REVISION	DATE (aa-mm-jj)

DESIGNÉ PAR - Drawn by: MM
 DATE (aa-mm-jj): 11/16/22
 ÉCHELLE - Scale: As Indicated
 TITRE DU DOSSIN - Drawing Title: SITE PLAN (GROUND LEVEL)

NO. REVISION - Revision
 NO. DESSIN - Drawing No. SPA-02

2.2 Existing Conditions

2.2.1 Area Road Network

Kent Street: Kent Street is a City of Ottawa one-way arterial road (northbound) with a three-lane urban cross-section, sidewalks on both sides of the road, and on-street parking permitted on both sides of the road (no stopping 7:00 AM-9:00 AM on the east side of the road). The unposted speed limit is 50 km/h and the City protected right-of-way is 20.0 metres. Kent Street is designated as a truck route.

Bank Street: Bank Street is a City of Ottawa arterial road with a two-lane urban cross-section, sidewalks on both sides of the road, and on-street parking permitted on the west side of the road (no stopping 7:00 AM-9:00 AM and 3:30 PM-5:30 PM). The posted speed limit is 50 km/h and the City protected right-of-way is 20.0 metres.

Lyon Street: Lyon Street is a City of Ottawa one-way arterial road (southbound) with a two-lane urban cross-section, sidewalks on both sides of the road. The bike lane is provided in the southbound direction. The unposted speed limit is 50 km/h and the City protected right-of-way is 20.0 metres.

Somerset Street: Somerset Street is a City of Ottawa arterial road with a two-lane urban cross-section, sidewalks on both sides of the road, and on-street parking permitted on both sides of the road. Parking on the north side is restricted during the AM peak and the south side is restricted during both peak hours. The unposted speed limit is 50 km/h and the City protected right-of-way is 20.0 metres. Somerset Street is designated as a truck route.

Gladstone Avenue: Gladstone Avenue is a City of Ottawa major collector road with a two-lane urban cross-section east of Bank Street and a four-lane cross-section to the west. On-street parking is permitted along both sides of the roadway, with the parking laybys to the east of Bank Street and parking within the curbside lane to the west of Bank Street (off-peak only). Sidewalks are provided on both sides of the road and the unposted speed limit is 50 km/h. The existing right-of-way is approximately 18.0 metres, although it varies slightly at different properties. Gladstone Avenue is designated as a truck route.

Gilmour Street: Gilmour Street is a City of Ottawa one-way local road (eastbound) with an urban cross-section, sidewalks on both sides of the road, and on-street parking permitted on the south side to the west of Bank Street and north side of the road to the east side of Bank Street. The unposted speed limit is 50 km/h and the existing right-of-way is 18.0 metres.

MacLaren Street: MacLaren Street is a City of Ottawa one-way local road (westbound) with an urban cross-section, sidewalks on both sides of the road, and on-street parking permitted on the north side to the west of Bank Street and both sides of the road to the east side of Bank Street. The unposted speed limit is 50 km/h and the existing right-of-way is 18.0 metres.

James Street: James Street is a City of Ottawa one-way local road (westbound) with an urban cross-section, sidewalks on both sides of the road, and on-street parking permitted on the south side and angled parking is located adjacent to Bank Street. The unposted speed limit is 50 km/h and the existing right-of-way is 18.0 metres.

2.2.2 Existing Intersections

The key existing signalized area intersections within 400 metres of the site have been summarized below:

Lyon Street & James Street

The intersection of Lyon Street and James Street is a signalized intersection. The southbound approach consists of a share left-turn/through lane and a shared through/right-turn lane, and the westbound approach consists of a shared left-turn/ through lane. No turn restrictions were noted.

Lyon Street & Gladstone Avenue

The intersection of Lyon Street and Gladstone Avenue is a signalized intersection. The southbound approach consists of a shared left-turn/through lane and a shared through/right-turn lane. The eastbound approach consists of a shared through/right-turn lane and the westbound approach consists of a shared left-turn/ through lane. No turn restrictions were noted.

Kent Street & Somerset Street

The intersection of Kent Street and Somerset Street is a signalized intersection. The northbound approach consists of a left-turn, two through lanes, and a shared through/right, the eastbound approach consists of a left-turn lane and shared through, and the westbound approach consists of a shared through/right-turn lane. Westbound right turns on red are prohibited.

Kent Street & Gilmour Street

The intersection of Kent Street and Gilmour Street is a signalized intersection. The northbound approach consists of two through lanes and a shared through/right, and the eastbound approach consists of a shared left-turn/through. No turn restrictions are noted.

Kent Street & Gladstone Avenue

The intersection of Kent Street and Gladstone Avenue is a signalized intersection. The northbound approach consists of an auxiliary left-turn, two through lanes, and a shared through/right, the eastbound approach consists of an auxiliary left-turn lane and a through lane, and the westbound approach consists of a shared through/right-turn lane. No turn restrictions are noted.

Bank Street & Somerset Street

The intersection of Bank Street and Somerset Street is a signalized intersection. The northbound approach consists of a shared all-movement lane, the southbound approach consists of a shared through/right-turn lane, the eastbound approach consists of a shared left-turn/through lane and a right-turn lane, and the westbound approach consists of an auxiliary left-turn lane and shared through/right-turn lane. All right turns on red are prohibited between 7:00 AM-7:00 PM. Southbound left-turns are restricted, bicycles are excepted, and the northbound left-turns are prohibited during peak hours, buses excepted.

Bank Street & MacLaren Street

The intersection of Bank Street and MacLaren Street is a signalized intersection. The northbound approach consists of a shared left-turn/through, the southbound approach consists of a shared through/right-turn lane, and the westbound approach consists of a shared all-movement lane. No turn restrictions are noted.

Bank Street & Gilmour Street

The intersection of Bank Street and Gilmour Street is a signalized intersection. The northbound approach consists of a shared through/right-turn lane, the southbound approach consists of a shared left-turn/through lane, and the eastbound approach consists of a shared all-movement lane. No turn restrictions are noted.

Bank Street & Gladstone Avenue

The intersection of Bank Street and Gladstone Avenue is a signalized intersection. The northbound approach consists of an auxiliary left-turn and a shared through/right, the southbound approach consists of a shared left-turn/through lane and a shared through/right-turn lane, the

eastbound approach consists of a shared left-turn/through lane and a shared through/right-lane, and the westbound approach consists of a shared all movement lane. All right turns on red are prohibited, and no left-turns are permitted in the southbound direction during the AM peak.

Kent Street & James Street

The intersection of Kent Street and James Street is an unsignalized intersection. The northbound approach consists of a shared left-turn/through lane and two through lanes, and the westbound approach consists of a shared through/right-turn lane. No turn restrictions are noted.

Bank Street & James Street

The intersection of Bank Street and James Street is an unsignalized intersection. The northbound and southbound approaches consist of single travel lanes, and the west leg of the intersection is inbound only. No turn restrictions are noted.

2.2.3 Existing Driveways

Within 200 metres of the proposed site, private accesses are located on both sides of James Street, Kent Street, and Gilmour Street. Figure 3 illustrates the existing driveways.

Figure 3: Existing Driveways



Source: <http://maps.ottawa.ca/geoOttawa/> Accessed: November 24, 2022

2.2.4 Cycling and Pedestrian Facilities

Figure 4 illustrates the pedestrian facilities in the study area and Figure 5 illustrates the cycling facilities. Sidewalks are provided along both sides of the road within the study area. Bike lanes are provided along Lyon Street, and Somerset Street, Bank Street, and Gladstone Avenue are suggested routes. Somerset Street, Lyon Street, and Gladstone Avenue are spine routes. Bank Street is a local route.

Figure 4: Study Area Pedestrian Facilities



Source: <http://maps.ottawa.ca/geoOttawa/> Accessed: November 24, 2022

Figure 5: Study Area Cycling Facilities



Source: <http://maps.ottawa.ca/geoOttawa/> Accessed: November 24, 2022

Pedestrian and cyclist volumes included in study area intersection counts, presented in Section 2.2.7, have been compiled and are illustrated in Figure 6 and Figure 7 respectively.

Figure 6: Existing Pedestrian Volumes

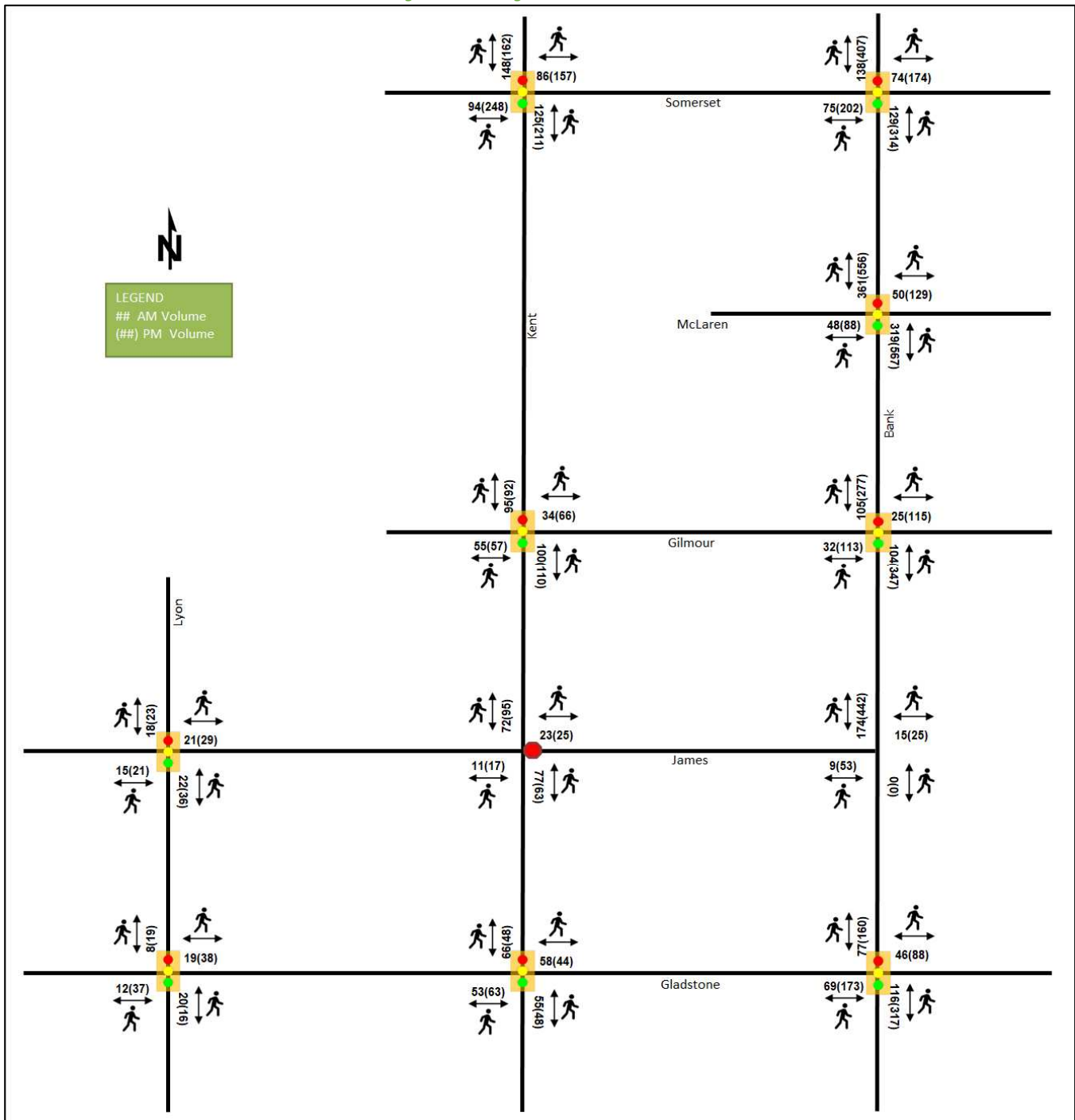
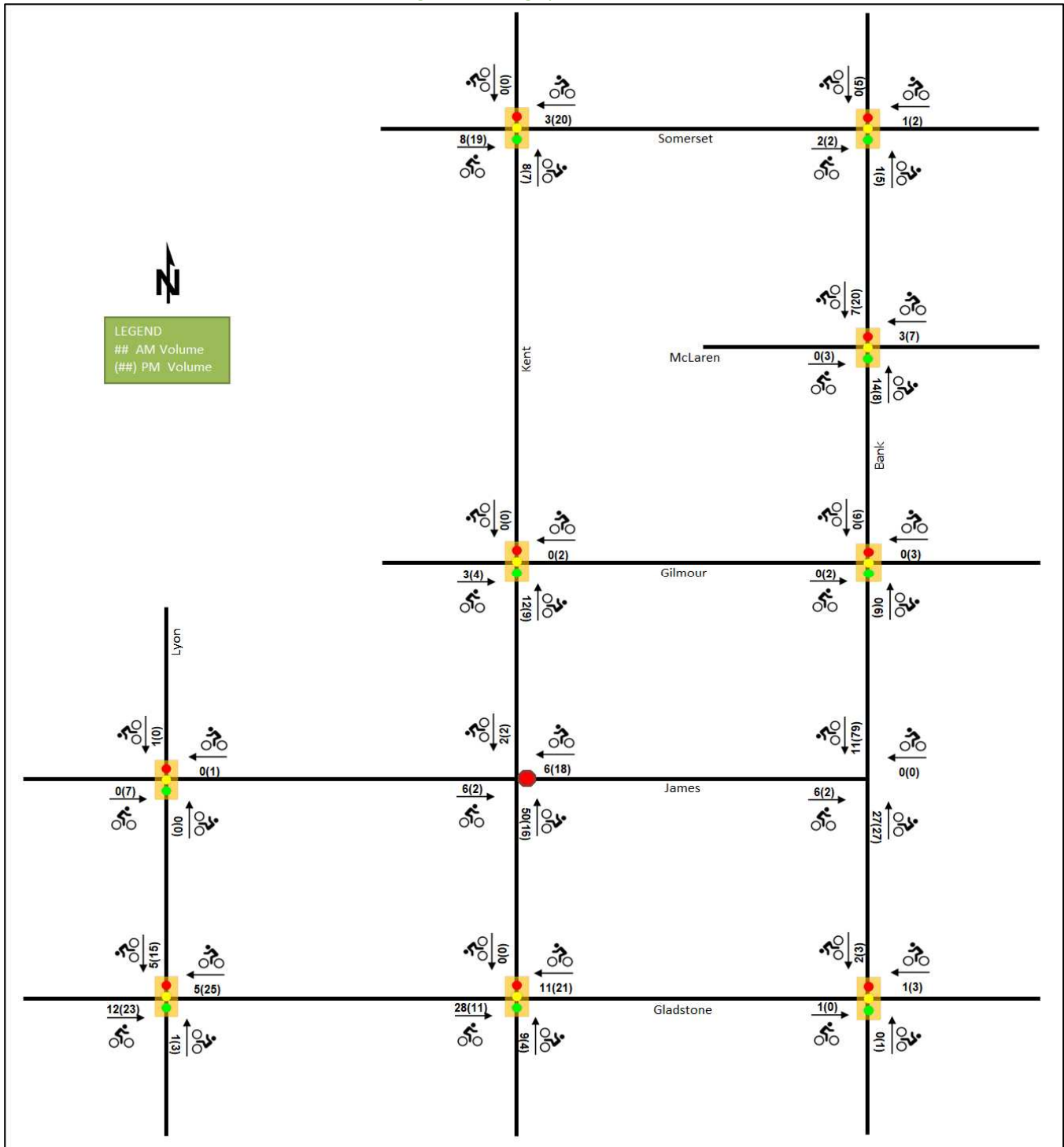

Figure 7: Existing Cyclist Volumes



2.2.5 Existing Transit

Figure 8 illustrates the transit system map in the study area and Figure 9 illustrates nearby transit stops. All transit information is from November 24, 2022 and is included for general information purposes and context to the surrounding area.

Within the study area, routes #6 and #7 travel along Bank Street, #11 travel along Somerset Street and north along Bank Street, and routes #14 and #114 travel along Gladstone Avenue. The frequency of these routes within proximity of the proposed site based on November 24, 2022 service levels are:

- Route # 6 – 10-15-minute service all day, 30-minute service during the evening
- Route # 7 – 10-15-minute service all day, 30-minute service during the evening
- Route # 11 – 15-20-minute service all day, 30-minute service after 10 PM
- Route # 14 – 10-15-minute service all day, 20-30 minutes service after 6 PM
- Route # 114 – two buses per peak direction/period daily

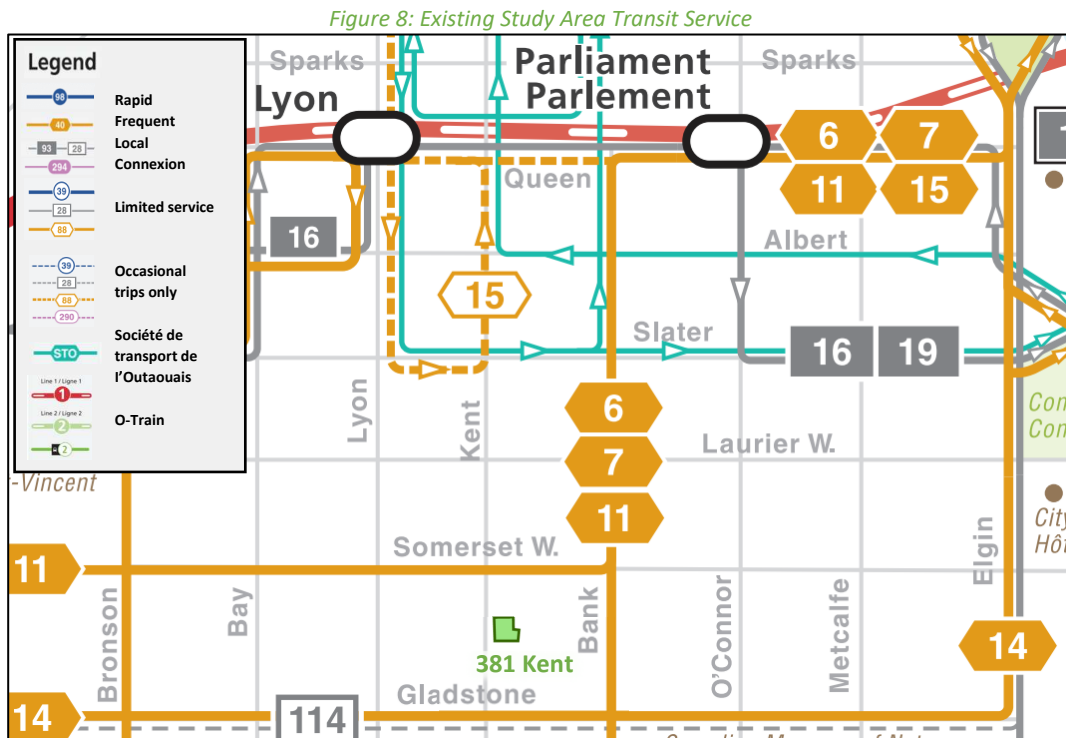

Source: <http://www.octranspo.com/> Accessed: November 24, 2022

Figure 9: Existing Study Area Transit Stops

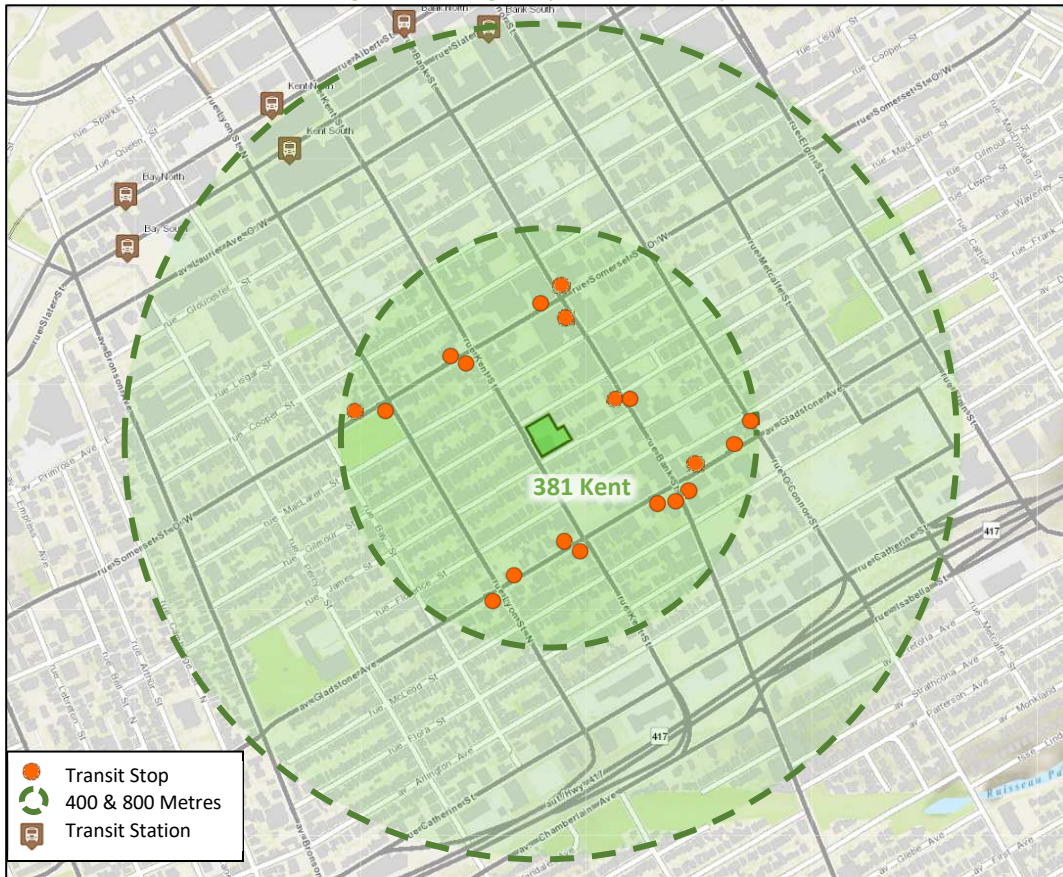

Source: <http://www.octranspo.com/> Accessed: November 24, 2022

2.2.6 Existing Area Traffic Management Measures

On-street parking and bulb-outs/planters are presented at the intersections of Lyon Street at James Street, Kent Street at Somerset Street, Kent Street at Gilmour Street, Kent Street at James Street, Kent Street at Gladstone Avenue, Bank Street at MaClaren Street, Bank Street at Gilmour Street, and Bank Street at James Street to provide to delineate the start and end of the parking areas. Speed humps are provided along Lyon Street, Gilmour Street, MaClaren Street, and James Street within the study area.

2.2.7 Existing Peak Hour Travel Demand

Existing turning movement counts were acquired from the City of Ottawa and The Traffic Specialist for the existing study area key intersections. The existing traffic counts were balanced along the roadways. Table 1 summarizes the intersection count dates and sources.

Table 1: Intersection Count Date

Intersection	Count Date	Source
Lyon Street & James Street	Tuesday, March 08, 2022	City of Ottawa
Lyon Street & Gladstone Avenue	Tuesday, March 08, 2022	City of Ottawa
Kent Street & Somerset Street	Wednesday, April 5, 2017	City of Ottawa
Kent Street & Gilmour Street	Wednesday, April 5, 2017	City of Ottawa
Kent Street & James Street	Tuesday, July 9, 2019	The Traffic Specialist
Kent Street & Gladstone Avenue	Tuesday, April 25, 2017	City of Ottawa
Bank Street & Somerset Street	Tuesday, March 08, 2022	City of Ottawa
Bank Street & MaClaren Street	Tuesday, April 16, 2019	City of Ottawa

Intersection	Count Date	Source
Bank Street & Gilmour Street	Tuesday, March 08, 2022	City of Ottawa
Bank Street & James Street	Tuesday, July 9, 2019	The Traffic Specialist
Bank Street & Gladstone Avenue	Tuesday, March 08, 2022	City of Ottawa

Figure 10 illustrates the existing traffic counts and Table 2 summarizes the existing intersection operations. The level of service for signalized intersections is based on the v/c calculation for individual lane movements and HCM 2000 v/c calculations for the overall intersection, and HCM average delay for unsignalized intersections. Detailed turning movement count data is included in Appendix B and the Synchro worksheets are provided in Appendix C.

Figure 10: Existing Traffic Counts

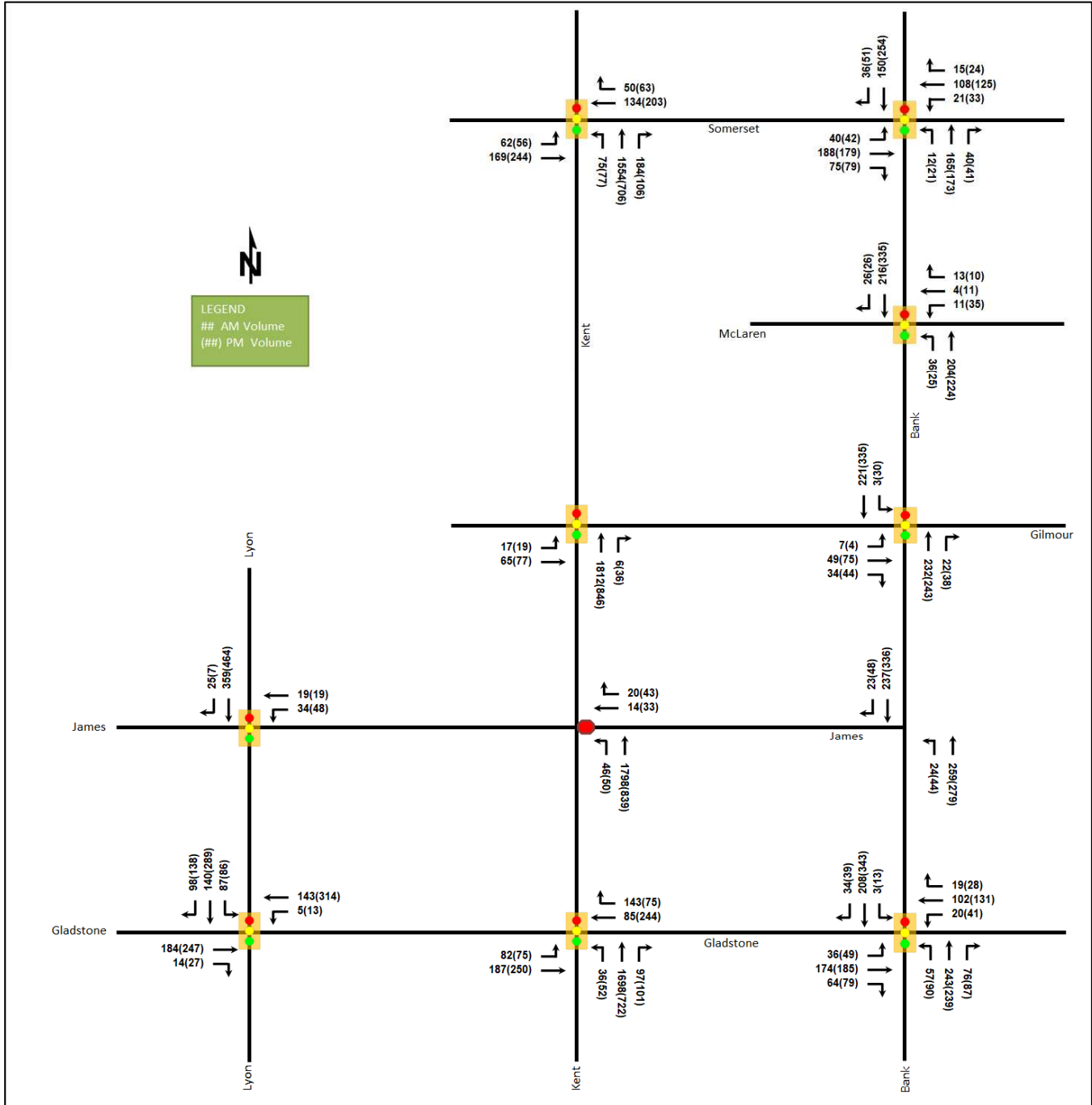

Table 2: Existing Intersection Operations

Intersection	Lane	AM Peak Hour				PM Peak Hour			
		LOS	V/C	Delay	Q (95 th)	LOS	V/C	Delay	Q (95 th)
Lyon Street & James Street Signalized	WBL/T	A	0.27	27.1	m11.6	A	0.32	29.1	22.2
	SB	A	0.16	2.4	12.9	A	0.20	3.3	16.4
	Overall	A	0.19	5.4	-	A	0.23	6.5	-
Lyon Street & Gladstone Avenue Signalized	EBT/R	A	0.30	14.6	34.8	A	0.39	15.2	47.1
	WBL/T	A	0.22	9.2	15.6	A	0.47	14.5	48.3
	SB	A	0.27	10.2	23.0	A	0.44	12.2	22.8
	Overall	A	0.27	11.2	-	A	0.44	13.6	-
Kent Street & Somerset Street Signalized	EBL	A	0.38	30.2	19.2	A	0.35	26.3	16.1
	EBT	A	0.51	30.5	40.8	A	0.57	27.7	50.1
	WBT/R	A	0.60	28.3	49.9	B	0.69	31.9	58.8
	NBL	A	0.12	9.3	m13.9	A	0.14	9.6	11.4
	NBT/R	B	0.66	10.1	75.0	A	0.36	10.3	25.7
	Overall	B	0.64	13.7	-	A	0.46	17.8	-
Kent Street & Gilmour Street Signalized	EB	A	0.32	29.8	23.7	A	0.35	29.4	27.2
	NB	A	0.57	13.6	129.4	A	0.29	3.5	15.8
	Overall	A	0.56	14.3	-	A	0.32	6.0	-
Kent Street & James Street Unsignalized	WB	D	0.19	27.7	5.3	B	0.19	14.9	5.3
	NBL/T	A	0.05	8.6	1.5	A	0.05	8.6	1.5
	NBT	A	-	0.0	-	A	-	0.3	-
	Overall	A	-	0.7	-	A	-	1.9	-
Kent Street & Gladstone Avenue Signalized	EBL	A	0.51	40.6	19.8	A	0.51	23.1	10.0
	EBT	A	0.52	37.0	36.4	A	0.57	18.5	24.9
	WBT/R	C	0.72	33.5	58.2	C	0.73	35.4	77.4
	NBL	A	0.05	7.5	7.1	A	0.07	9.6	11.0
	NBT/R	B	0.68	11.9	102.8	A	0.35	9.6	40.6
	Overall	B	0.69	17.0	-	A	0.47	17.1	-
Bank Street & Somerset Street Signalized	EBL/T	C	0.72	42.3	m58.6	B	0.68	28.8	49.3
	EBR	A	0.32	30.6	m18.6	A	0.49	26.8	22.6
	WBL	A	0.14	21.9	7.7	A	0.26	25.8	11.2
	WBT/R	A	0.35	24.7	28.2	A	0.43	26.3	33.9
	NB	A	0.27	3.5	7.0	A	0.31	3.9	9.2
	SB	A	0.24	8.5	28.9	A	0.39	10.2	50.1
	Overall	A	0.43	20.9	-	A	0.51	16.9	-
Bank Street & MacLaren Street Signalized	WB	A	0.10	15.7	8.1	A	0.19	20.5	15.4
	NB	A	0.23	1.7	2.3	A	0.26	5.1	10.0
	SB	A	0.23	7.8	25.8	A	0.36	10.9	28.4
	Overall	A	0.22	5.3	-	A	0.33	9.5	-
Bank Street & Gilmour Street Signalized	EB	A	0.33	13.8	m25.0	A	0.38	11.9	10.3
	NB	A	0.25	3.5	12.4	A	0.31	11.0	41.1
	SB	A	0.23	3.0	9.5	A	0.39	3.4	10.7
	Overall	A	0.26	4.9	-	A	0.38	7.5	-

Intersection	Lane	AM Peak Hour				PM Peak Hour			
		LOS	V/C	Delay	Q (95 th)	LOS	V/C	Delay	Q (95 th)
Bank Street & Gladstone Avenue Signalized	EB	A	0.59	39.8	m35.2	A	0.59	17.0	14.6
	WB	A	0.56	35.0	37.7	B	0.68	36.9	49.5
	NBL	A	0.15	11.9	11.9	A	0.36	19.6	22.7
	NBT/R	A	0.48	15.8	55.9	A	0.58	21.3	67.0
	SB	A	0.20	15.9	26.5	A	0.36	8.5	18.2
	Overall	A	0.44	24.6	-	A	0.51	18.7	-

Notes: Saturation flow rate of 1800 veh/h/lane
Queue is measured in metres
Peak Hour Factor = 0.90

Delay = average vehicle delay in seconds
m = metered queue
= volume for the 95th %ile cycle exceeds capacity

During both the AM and PM peak hours, the study area intersections operate well.

2.2.8 Collision Analysis

Collision data have been acquired from the City of Ottawa open data website (data.ottawa.ca) for five years prior to the commencement of this TIA for the surrounding study area road network. Table 3 summarizes the collision types and conditions in the study area, Figure 11 illustrates the intersections and segments analyzed, and Table 4 summarizes the total collisions for each of these locations. Collision data are included in Appendix D.

Table 3: Study Area Collision Summary, 2016-2020

		Number	%
Total Collisions		47	100%
Classification	Fatality	0	0%
	Non-Fatal Injury	8	17%
	Property Damage Only	39	83%
Initial Impact Type	Approaching	1	2%
	Angle	7	15%
	Rear end	9	19%
	Sideswipe	12	26%
	Turning Movement	5	11%
	SMV Unattended	9	19%
	SMV Other	2	4%
	Other	2	4%
Road Surface Condition	Dry	36	77%
	Wet	5	11%
	Loose Snow	3	6%
	Slush	2	4%
	Packed Snow	1	2%
Pedestrian Involved		1	2%
Cyclists Involved		1	2%

Figure 11: Study Area Collision Records



Table 4: Summary of Collision Locations, 2016-2020

Intersections / Segments	Number	%
Intersections / Segments	45	100%
Kent St @ James St	16	36%
Bank St @ Gilmour St	9	20%
Kent St @ Gilmour St	4	9%
Kent St Btwn Maclaren St & Gilmour St	5	11%
Kent St Btwn James St & Florence St	4	9%
Kent St Btwn Gilmour St & James St	3	7%
Gilmour St Btwn Lyon St & Kent St	3	7%
James St Btwn Lyon St & Kent St	1	2%

Within the study area, the intersection of Kent Street and James Street is noted to have experienced higher collisions than other locations. Table 5 summarizes the collision types and conditions for the intersection of Kent Street and James Street.

Table 5: Kent Street and James Street Collision Summary

		Number	%
Total Collisions		16	100%
Classification	Fatality	0	0%
	Non-Fatal Injury	2	13%
	Property Damage Only	14	88%
	Angle	7	44%
	Rear end	2	13%
	Sideswipe	4	25%
	Turning Movement	3	19%
Road Surface Condition	Dry	12	75%
	Wet	2	13%
	Loose Snow	1	6%
	Packed Snow	1	6%
Pedestrian Involved		0	0%
Cyclists Involved		0	0%

The Kent Street and James Street intersection had a total of 14 collisions during the 2016-2020 time period, with 12 involving property damage only and the remaining two having non-fatal injuries. The detailed collision records outline that angle collisions predominantly are the result of the westbound vehicles failed to yield and improper turns. The small set back of the existing houses, the overhang of the trees, and on-street parking restrict sight lines to/from the south on Kent Street and may contribute to these collisions. The City should review for right-of-way maintenance and the private landowners on the south side of James Street. Weather conditions do not affect collisions at this location. No further review of these collisions is required as part of this study and mitigation is subject to City review/action.

2.3 Planned Conditions

2.3.1 Changes to the Area Transportation Network

No roadway improvements are included within the Ottawa TMP for the study area road network. Isolated transit priority measures are identified as part of the Affordable Network along Bank Street, on Gladstone Avenue to support the LRT stations, and along Somerset Street between Woodroffe Avenue and Bank Street.

2.3.2 Other Study Area Developments

406 – 408 Bank Street

The proposed development includes a site plan for a five-storey mixed-use building, which includes 14 apartment units and ground-floor commercial. Recently reactivated, no TIA is available for this development.

390 – 394 Bank Street

The proposed development includes a site plan for a nine-storey mixed-use building, which includes 127 apartment units with approximately 6,750 sq. ft. of ground-floor retail space. The anticipated full build-out and occupancy horizon is 2024 and the development is predicted to generate 16 new AM two-way peak-hour auto trips and 19 new PM two-way peak-hour auto trips. (CGH, 2021)

267 O'Connor Street

The proposed development includes a zoning bylaw amendment to permit two 30-storey high-rise buildings. Both towers will include a total of 547 condo units. A park is included within the site. Phase one is anticipated to be built out by 2023 and to generate 59 new AM and 65 new PM peak hour two-way auto trips, and phase two is anticipated to be built out by 2025 and to generate 62 new AM and 69 new PM peak hour two-way auto trips.

The removal of the existing building on the site is additionally anticipated to reduce area network traffic by 29 AM and 30 PM peak hour two-way auto trips. (Parsons, 2020)

311 Somerset Street, 234 – 236 O’Connor Street

The proposed development includes a zoning bylaw amendment and site plan for the construction of a 16-storey, 140-unit apartment/mixed-use building with 2,645 sq. ft. of ground-floor commercial space. The development is anticipated to be built out in a single phase by 2024 and to generate 33 new AM and 37 new PM peak hour two-way auto trips. (CGH, 2021)

322 Waverley Street

The proposed development includes a zoning bylaw amendment for a six-storey residential building with a total of 27 dwelling units. The development satisfies the Location Trigger. No TIA is available at this time.

157 – 159 James Street

The proposed development includes a site plan to convert an existing seven-unit low-rise residential dwelling to a 12-unit dwelling. No TIA is required.

359 Kent Street, 436 & 444 MacLaren Street

The proposed development includes an official plan amendment and zoning bylaw amendment applications to permit a 35-storey residential tower, housing 405 apartment units, 21,388 ft² of office space, and 7,833 ft² of commercial space. The anticipated full build-out and occupancy horizon is 2024 and the development is predicted to generate 31 new AM two-way peak-hour auto trips and 32 new PM two-way peak-hour auto trips. (Parsons, 2021)

66 – 80 Flora Street and 17 – 19 Arlington Avenue

The proposed development includes 64 units. The anticipated full build-out and occupancy horizon is 2026 and not recommended to trigger a TIA. (CGH, 2022)

3 Study Area and Time Periods

3.1 Study Area

The study area will include the intersection will include:

- Lyon Street at:
 - Gladstone Avenue
 - James Street
- Kent Street at:
 - Somerset Street
 - Gilmour Street
 - James Street
 - Gladstone Avenue
- Bank Street at:
 - Somerset Street
 - McLaren Street
 - Gilmour Street
 - James Street
 - Gladstone Avenue

The boundary road will be James Street, Kent Street, and Gilmour Steet. No screenline is present within proximity to the site.

3.2 Time Periods

As the proposed development is a mixed-use development with residential units and commercial units, therefore, the AM and PM peak hours will be examined.

3.3 Horizon Years

The anticipated build-out year is 2030. As a result, the full build-out plus five years horizon year is 2035.

4 Exemption Review

Table 6 summarizes the exemptions for this TIA.

Table 6: Exemption Review

Module	Element	Explanation	Exempt/Required
Design Review Component			
4.1 Development Design	4.1.2 Circulation and Access	Only required for site plans	Required
	4.1.3 New Street Networks	Only required for plans of subdivision	Exempt
4.2 Parking	4.2.1 Parking Supply	Only required for site plans	Required
	4.2.2 Spillover Parking	Only required for site plans where parking supply is 15% below unconstrained demand	Exempt
Network Impact Component			
4.5 Transportation Demand Management	All Elements	Not required for site plans expected to have fewer than 60 employees and/or students on location at any given time	Required
4.6 Neighbourhood Traffic Management	4.6.1 Adjacent Neighbourhoods	Only required when the development relies on local or collector streets for access and total volumes exceed ATM capacity thresholds	Required
4.8 Network Concept		Only required when proposed development generates more than 200 person-trips during the peak hour in excess of equivalent volume permitted by established zoning	Exempt

5 Development-Generated Travel Demand

5.1 Mode Shares

Examining the mode shares recommended in the TRANS Trip Generation Manual (2020) for the subject district, derived from the most recent National Capital Region Origin-Destination survey (OD Survey), the existing average district mode shares by land use for Ottawa Inner Area have been summarized in Table 7.

Table 7: TRANS Trip Generation Manual Recommended Mode Shares – Ottawa Inner Area

Travel Mode	Multi-Unit (High-Rise)		Commercial Generator	
	AM	PM	AM	PM
Auto Driver	26%	25%	39%	22%
Auto Passenger	6%	8%	2%	4%
Transit	28%	21%	16%	12%
Cycling	5%	6%	3%	4%
Walking	34%	39%	40%	58%

5.2 Trip Generation

This TIA has been prepared using the vehicle and person trip rates for the residential dwellings using the TRANS Trip Generation Manual (2020) and the vehicle trip rates and derived person trip rates for commercial components from the ITE Trip Generation Manual 10th Edition (2017) using the City-prescribed conversion factor of 1.28. Table 8 summarizes the person trip rates for the proposed residential land uses for each peak period and the person trip rates for the non-residential land uses by peak hour.

Table 8: Trip Generation Person Trip Rates

Land Use	Land Use Code	Peak	Peak Period		Peak Hour	
			Vehicle Trip Rate	Person Trip Rates	Vehicle Trip Rate	Person Trip Rates
Multi-Unit (High-Rise)	221 & 222 (TRANS)	AM	-	0.80	-	-
		PM	-	0.90	-	-
Retail <40k sq. ft.	822 (ITE)	AM	-	-	2.36	3.02
		PM	-	-	6.59	8.44

Using the above person trip rates, the total person trip generation has been estimated. Table 9 summarizes the total person trip generation for the residential land uses and the non-residential land uses.

Table 9: Total Residential Person Trip Generation

Land Use	Units	AM Peak Period			PM Peak Period		
		In	Out	Total	In	Out	Total
Multi-Unit (High-Rise)	218	54	121	175	114	83	197
Land Use	Units / GFA	AM Peak Hour			PM Peak Hour		
		In	Out	Total	In	Out	Total
Shopping Centre	1841 sq. ft	4	2	6	8	8	16

Internal capture rates from the ITE Trip Generation Handbook 3rd Edition have been assigned to the development’s retail component for mixed-use developments. The rates summarized in Table 10 represent the percentage of trips to/from retail use based on the residential component.

Table 10: Internal Capture Rates

Land Use	AM		PM	
	In	Out	In	Out
Residential to/from Shopping Centre	17%	14%	10%	26%

Based on the low trip generation, pass-by reductions applied to the retail trip generation at a rate of 20% have been assumed.

Using the above mode share targets for the internal capture and pass-by rates, and the person trip rates, the person trips by mode have been projected. Table 11 summarizes the trip generation by mode and peak hour using the residential peak hour adjustment factor and the non-residential trip generation using the internal capture and pass-by reductions.

Table 11: Residential Trip Generation by Mode

Travel Mode		AM Peak Hour				PM Peak Hour			
		Mode Share	In	Out	Total	Mode Share	In	Out	Total
Multi-Unit (High-Rise)	Auto Driver	26%	7	15	22	25%	13	9	22
	Auto Passenger	6%	1	3	4	8%	4	3	7
	Transit	28%	8	19	27	21%	11	8	19
	Cycling	5%	2	3	5	6%	3	2	5
	Walking	34%	10	24	34	39%	23	17	40
	Total	100%	28	64	92	100%	54	39	93
Retail <40k sq. ft.	Auto Driver	39%	0	1	1	22%	0	0	0
	Auto Passenger	2%	0	0	0	4%	0	0	0
	Transit	16%	0	0	0	12%	1	1	2
	Cycling	3%	0	0	0	4%	0	0	0
	Walking	40%	1	1	2	58%	4	3	7
	Internal Capture	varies	-1	0	-1	varies	-1	-2	-3
	Pass-by	35%	-1	0	-1	35%	-2	-2	-4
	Total	100%	1	2	3	100%	5	4	9
Total	Auto Driver	-	7	16	23	-	13	9	22
	Auto Passenger	-	1	3	4	-	4	3	7
	Transit	-	8	19	27	-	12	9	21
	Cycling	-	2	3	5	-	3	2	5
	Walking	-	11	25	36	-	27	20	47
	Total	-	29	66	95	-	59	43	102

As shown above, a total of 23 AM and 22 PM new peak hour two-way vehicle trips are projected as a result of the proposed development.

5.3 Trip Distribution

To understand the travel patterns of the subject development, the OD Survey has been reviewed to determine the travel for the residential component, and these patterns were applied based on the build-out of Ottawa Inner. Table 12 below summarizes the distributions.

Table 12: OD Survey Distribution – Ottawa Inner

To/From	% of Trips
North	20%
South	35%
East	25%
West	20%
Total	100%

5.4 Trip Assignment

Using the distribution outlined above, turning movement splits, and access to major transportation infrastructure, the trips generated by the site have been assigned to the study area road network. Table 13 summarizes the proportional assignment to the study area roadways, and Figure 12 and Figure 13 illustrate the new site and pass-by generated volumes respectively.

Table 13: Trip Assignment

To/From	Inbound Via	Outbound Via
North	5% Bank Street (N), 15% Gilmour Street (W)	20% Bank Street(N)
South	35% Kent Street (S)	35% Bank Street (S)
East	25% Gladstone Avenue (E)	25 % Gilmour Street (E)
West	20% Gilmour Street (W)	10% Somerset Street (W), 10% Gladstone Avenue (W)
Total	100%	100%

Figure 12: New Site Generation Volumes

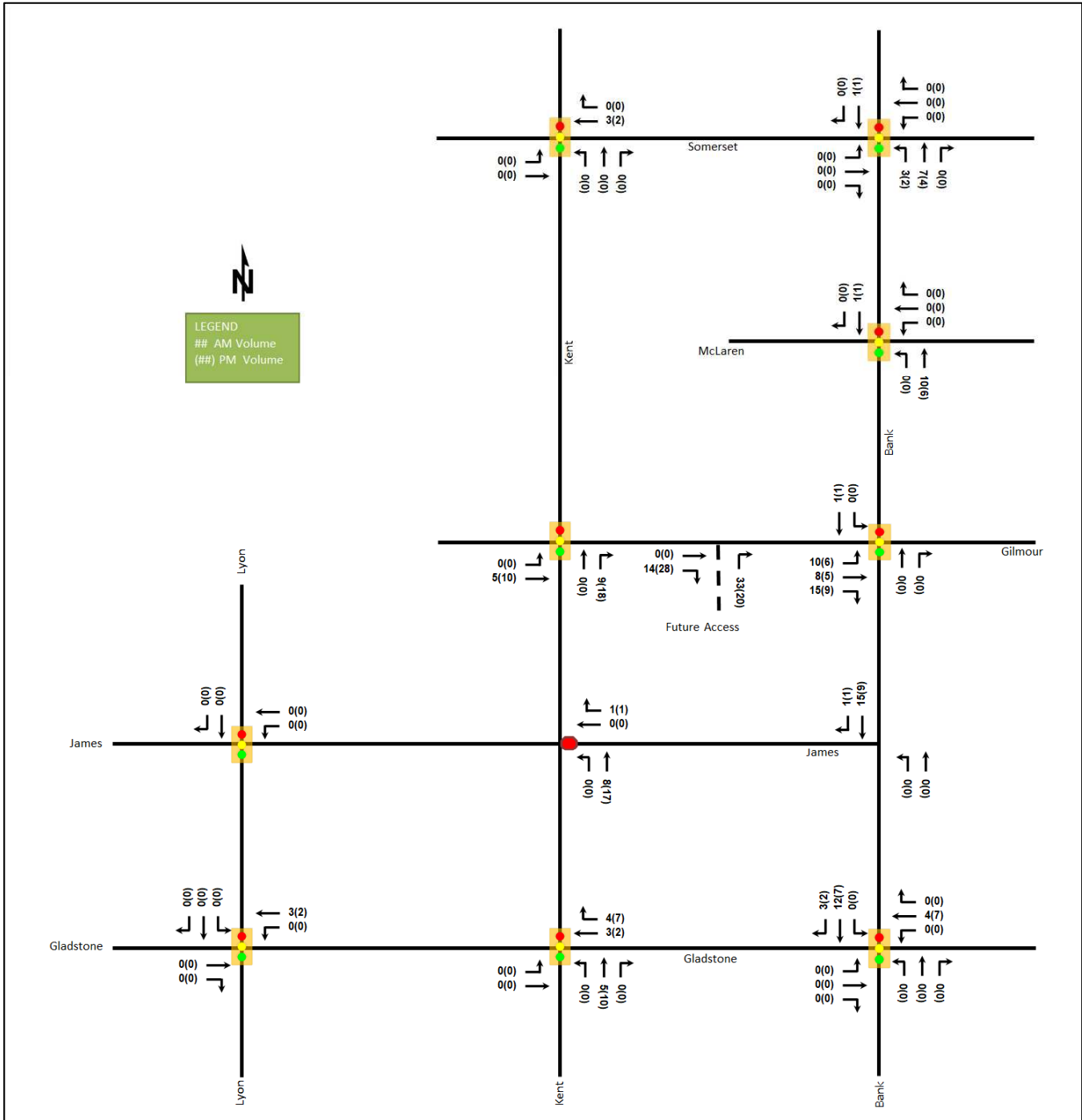
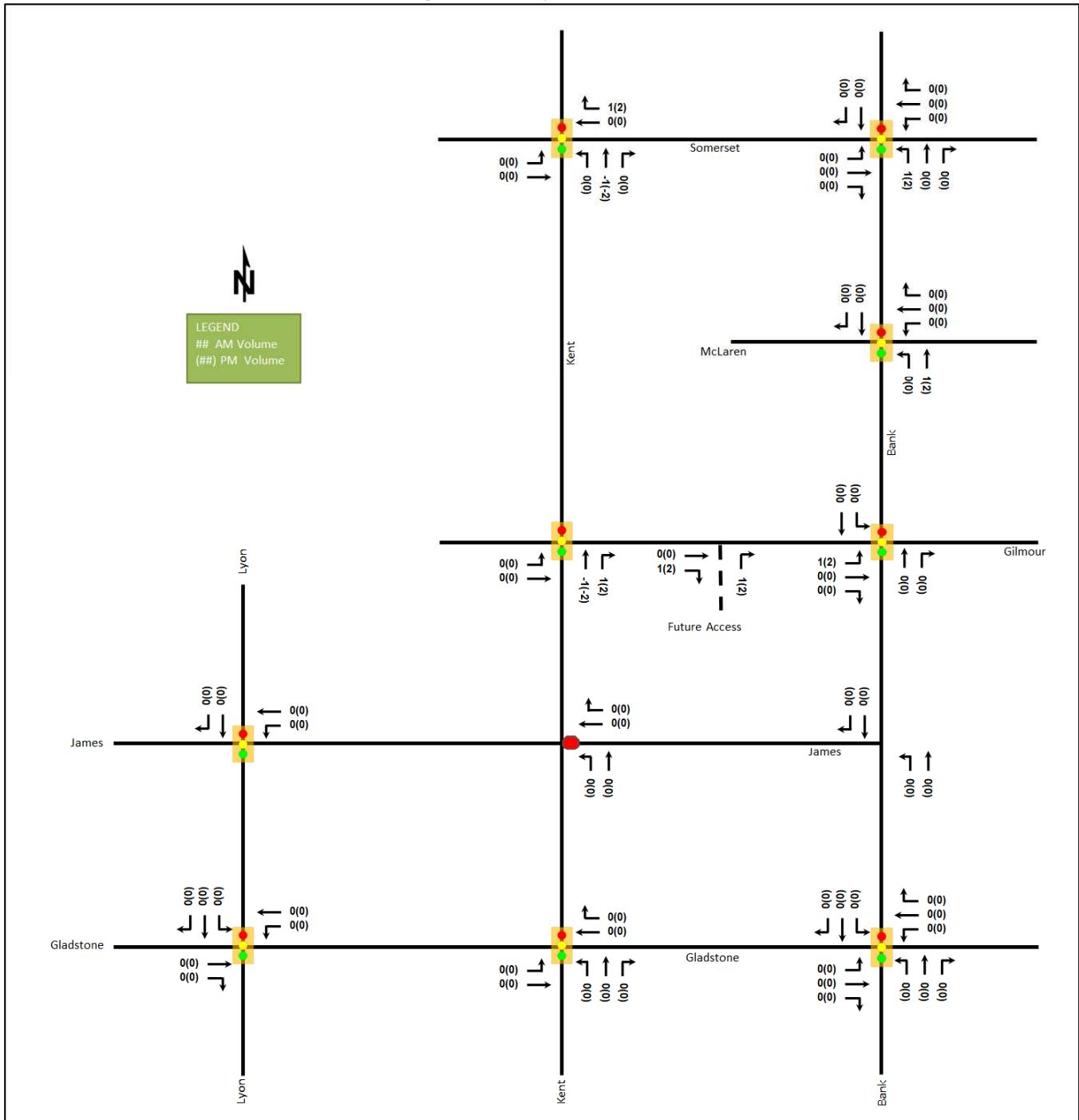

Figure 13: Pass-By Auto Volumes



6 Background Network Travel Demands

6.1 Transportation Network Plans

The transportation network plans were discussed in Section 2.3. and no impacts on the study area traffic volumes and travel patterns are anticipated from network changes.

6.2 Background Growth

A review of the background projections from the City's TRANS Regional Model for the 2011 and 2031 horizons was completed to determine the background growth for each of the study area roadways. The background TRANS model growth rates are summarized in Table 14 and the TRANS model plots are provided in Appendix E.

Table 14: TRANS Regional Model Projections – Study Area Growth Rates

Street	TRANS Rate		2011 to Existing		Existing to 2031	
	Eastbound	Westbound	Eastbound	Westbound	Eastbound	Westbound
Somerset St	-1.07%	-2.75%	-3.30%	1.25%	1.71%	-7.43%
Gladstone Ave	-0.54%	-3.29%	0.20%	1.71%	-1.43%	-9.07%
	Northbound	Southbound	Northbound	Southbound	Northbound	Southbound
Kent St	0.17%	n/a	3.16%	n/a	-3.35%	n/a
Bank St	0.07%	1.34%	-4.62%	4.66%	6.11%	-2.57%
Lyon St	n/a	4.15%	n/a	4.77%	n/a	3.65%

In general, the growth rates in the study area derived from the two TRANS model horizons are projected to be negative along Somerset Street and Gladstone Avenue and positive along all Kent Street, Bank Street, and Lyon Street. A comparison of 2011 to Existing volumes and Existing to 2031 volumes illustrates a situation that development has not progressed linearly. Table 15 summarizes the recommended growth rates to be considered within the study area.

Table 15: Recommended Area Growth Rates

Street	AM Peak Hour		PM Peak Hour	
	Eastbound	Westbound	Eastbound	Westbound
Somerset St	0%	0%	0%	0%
Gladstone Ave	0%	0%	0%	0%
	Northbound	Southbound	Northbound	Southbound
Kent St	0%	n/a	0%	n/a
Bank St	0%	1.00%	1.00%	0%
Lyon St	n/a	1.00%	n/a	1.00%

6.3 Other Developments

The background developments explicitly considered in the background conditions (Section 6.2) include:

- 390 – 394 Bank Street
- 267 O'Connor Street
- 311 Somerset Street, 234 – 236 O'Connor Street
- 359 Kent Street, 436 & 444 MacLaren Street

The background development volumes within the study area have been provided in Appendix F.

7 Demand Rationalization

7.1 2030 Future Background Operations

Figure 14 illustrates the 2030 background volumes and Table 16 summarizes the 2030 background intersection operations. The level of service for signalized intersections is based on the v/c calculation for individual lane movements and HCM 2000 v/c calculations for the overall intersection, and HCM average delay for unsignalized intersections. The synchro worksheets for the 2030 future background horizon are provided in Appendix G.

Figure 14: 2030 Future Background Volumes

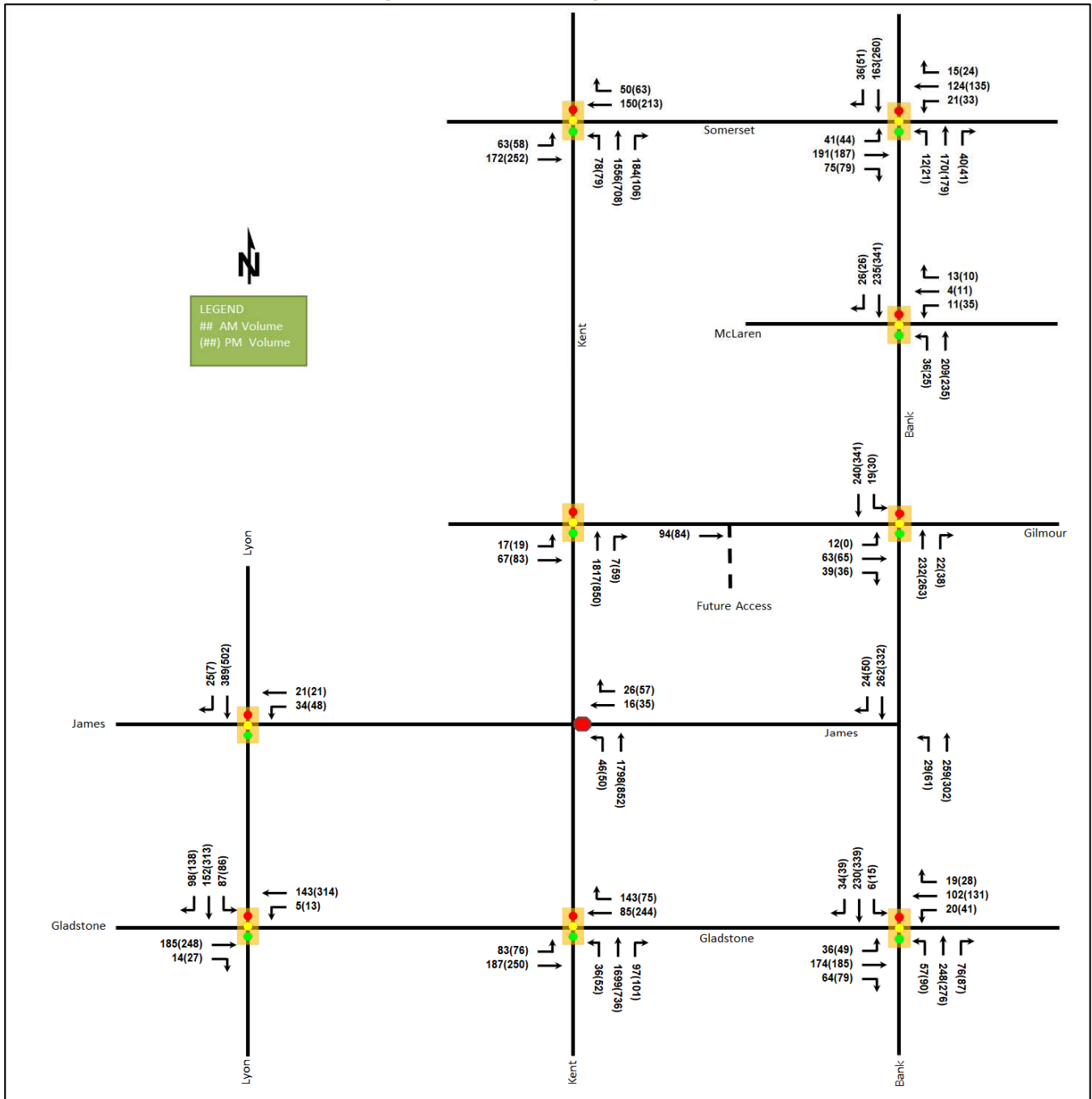

Table 16: 2030 Future Background Intersection Operations

Intersection	Lane	AM Peak Hour				PM Peak Hour			
		LOS	V/C	Delay	Q (95 th)	LOS	V/C	Delay	Q (95 th)
Lyon Street & James Street Signalized	WBL/T	A	0.25	26.1	m11.6	A	0.30	29.5	20.9
	SB	A	0.15	2.4	12.5	A	0.20	3.3	16.0
	Overall	A	0.19	5.2	-	A	0.23	6.4	-

Intersection	Lane	AM Peak Hour				PM Peak Hour			
		LOS	V/C	Delay	Q (95 th)	LOS	V/C	Delay	Q (95 th)
Lyon Street & Gladstone Avenue <i>Signalized</i>	EBT/R	A	0.27	14.3	31.7	A	0.36	14.6	42.1
	WBL/T	A	0.20	8.5	14.1	A	0.42	12.7	41.0
	SB	A	0.25	10.0	21.5	A	0.41	12.0	21.6
	Overall	A	0.24	10.9	-	A	0.41	12.8	-
Kent Street & Somerset Street <i>Signalized</i>	EBL	A	0.34	29.3	17.8	A	0.33	26.1	15.5
	EBT	A	0.47	29.7	37.7	A	0.55	28.0	47.9
	WBT/R	A	0.59	27.6	49.4	B	0.66	31.5	56.8
	NBL	A	0.11	8.5	m12.9	A	0.13	9.4	10.4
	NBT/R	A	0.59	9.1	63.1	A	0.32	9.7	24.9
	Overall	B	0.59	12.8	-	A	0.42	17.5	-
Kent Street & Gilmour Street <i>Signalized</i>	EB	A	0.30	29.3	22.1	A	0.33	29.0	26.0
	NB	A	0.51	12.0	112.6	A	0.27	3.5	14.6
	Overall	A	0.50	12.8	-	A	0.30	6.0	-
Kent Street & James Street <i>Unsignalized</i>	WB	C	0.18	24.2	5.3	B	0.19	14.4	5.3
	NBL	A	0.04	8.6	0.8	A	0.05	8.6	1.5
	NBT	A	-	2.7	-	A	-	0.2	-
	Overall	A	-	3.3	-	A	-	2.0	-
Kent Street & Gladstone Avenue <i>Signalized</i>	EBL	A	0.47	42.0	19.8	A	0.47	23.4	10.0
	EBT	A	0.51	39.4	36.0	A	0.56	20.0	24.3
	WBT/R	B	0.70	32.3	48.9	C	0.71	35.2	70.4
	NBL	A	0.04	6.8	6.3	A	0.06	8.5	9.4
	NBT/R	A	0.60	9.8	81.7	A	0.31	8.3	34.2
	Overall	B	0.62	15.5	-	A	0.42	16.5	-
Bank Street & Somerset Street <i>Signalized</i>	EBL/T	B	0.70	43.2	58.6	B	0.66	28.5	46.3
	EBR	A	0.30	32.0	m19.5	A	0.46	25.8	20.4
	WBL	A	0.12	22.5	7.4	A	0.23	25.8	10.5
	WBT/R	A	0.37	26.1	29.6	A	0.42	26.9	33.6
	NB	A	0.25	3.2	6.5	A	0.28	3.5	8.5
	SB	A	0.22	7.9	26.3	A	0.35	9.2	42.9
	Overall	A	0.39	21.1	-	A	0.47	16.5	-
Bank Street & MacLaren Street <i>Signalized</i>	WB	A	0.10	15.8	7.7	A	0.17	20.3	14.2
	NB	A	0.21	1.9	3.4	A	0.25	5.0	8.9
	SB	A	0.22	7.9	24.1	A	0.33	10.9	26.1
	Overall	A	0.21	5.5	-	A	0.30	9.4	-
Bank Street & Gilmour Street <i>Signalized</i>	EB	A	0.37	16.3	27.6	A	0.28	9.6	10.6
	NB	A	0.22	3.4	11.3	A	0.28	11.0	41.1
	SB	A	0.22	3.0	9.3	A	0.33	2.6	9.9
	Overall	A	0.25	5.6	-	A	0.32	6.8	-
Bank Street & Gladstone Avenue <i>Signalized</i>	EB	A	0.55	40.0	33.5	A	0.54	15.9	12.8
	WB	A	0.51	33.4	34.4	B	0.63	34.8	44.2
	NBL	A	0.14	11.7	11.0	A	0.31	18.3	20.0
	NBT/R	A	0.44	15.0	50.3	A	0.57	21.0	66.5
	SB	A	0.20	16.3	25.8	A	0.33	8.2	16.0
	Overall	A	0.40	24.0	-	A	0.48	18.0	-

Notes: Saturation flow rate of 1800 veh/h/lane
 Queue is measured in metres
 Peak Hour Factor = 1.00

Delay = average vehicle delay in seconds
 m = metered queue
 # = volume for the 95th %ile cycle exceeds capacity

The intersections at the 2030 future background condition are anticipated to operate similarly to the existing conditions. Nominal operational improvements are noted due to the change of the peak hour factor from 0.90 in the existing conditions to 1.00 for future forecasting.

7.2 2035 Future Background Operations

Figure 14 illustrates the 2035 background volumes and Table 17 summarizes the 2035 background intersection operations. The level of service for signalized intersections is based on the v/c calculation for individual lane movements and HCM 2000 v/c calculations for the overall intersection, and HCM average delay for unsignalized intersections. The synchro worksheets for the 2035 future background horizon are provided in Appendix H.

Figure 15: 2035 Future Background Volumes

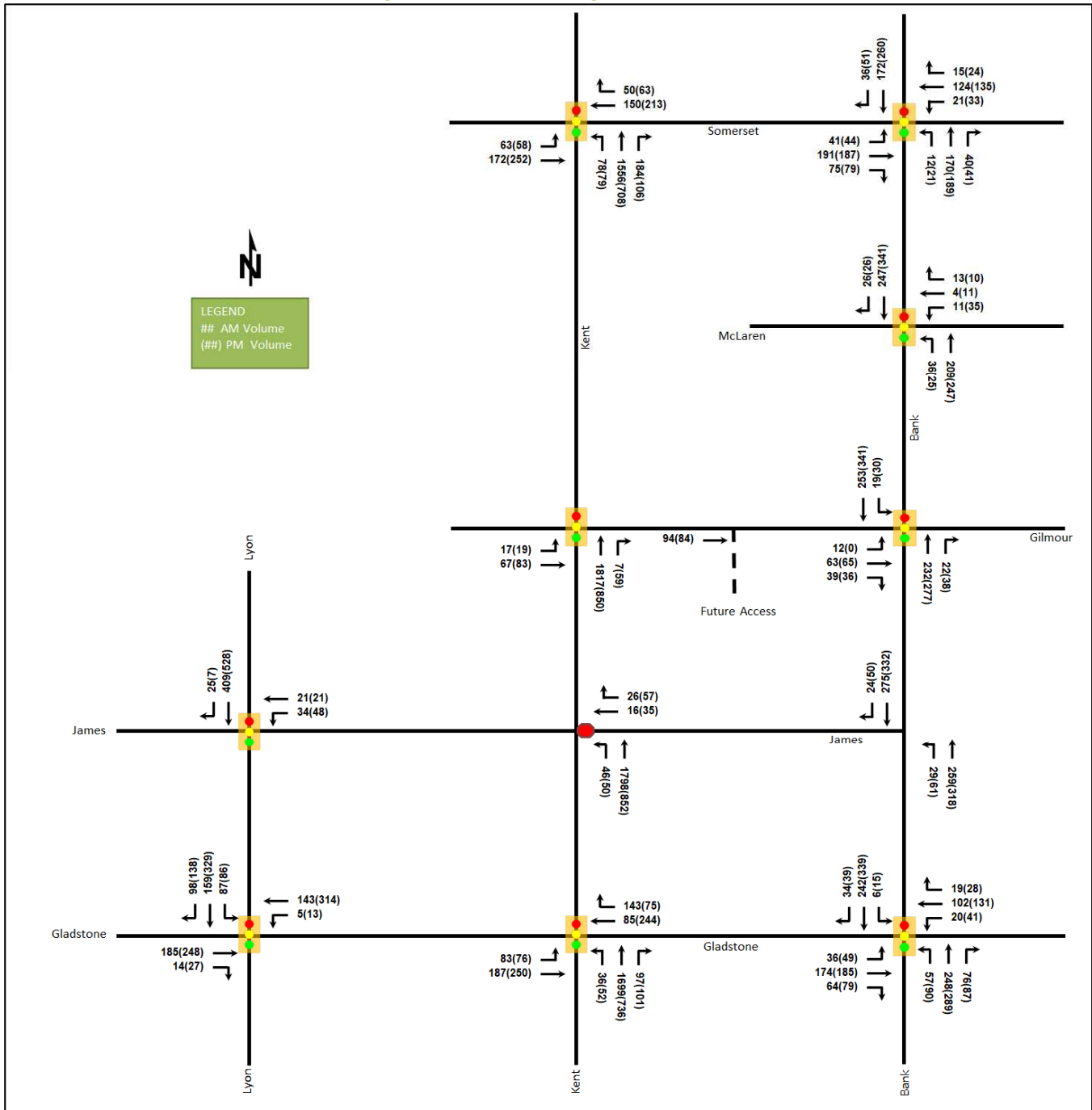

Table 17: 2035 Future Background Intersection Operations

Intersection	Lane	AM Peak Hour				PM Peak Hour			
		LOS	V/C	Delay	Q (95 th)	LOS	V/C	Delay	Q (95 th)
Lyon Street & James Street Signalized	WBL/T	A	0.25	26.1	m11.6	A	0.30	29.5	20.9
	SB	A	0.16	2.5	13.2	A	0.21	3.3	16.9
	Overall	A	0.19	5.1	-	A	0.23	6.3	-

Intersection	Lane	AM Peak Hour				PM Peak Hour			
		LOS	V/C	Delay	Q (95 th)	LOS	V/C	Delay	Q (95 th)
Lyon Street & Gladstone Avenue <i>Signalized</i>	EBT/R	A	0.27	14.3	31.7	A	0.36	14.6	42.1
	WBL/T	A	0.20	8.5	14.1	A	0.42	12.7	41.0
	SB	A	0.26	10.1	22.0	A	0.43	12.3	22.3
	Overall	A	0.25	10.9	-	A	0.42	13.0	-
Kent Street & Somerset Street <i>Signalized</i>	EBL	A	0.34	29.3	17.8	A	0.33	26.1	15.5
	EBT	A	0.47	29.7	37.7	A	0.55	28.0	47.9
	WBT/R	A	0.59	27.6	49.5	B	0.66	31.9	57.7
	NBL	A	0.11	8.5	m12.9	A	0.13	9.4	10.4
	NBT/R	A	0.59	9.1	63.0	A	0.32	9.7	24.9
	Overall	A	0.59	12.8	-	A	0.42	17.6	-
Kent Street & Gilmour Street <i>Signalized</i>	EB	A	0.30	29.3	22.1	A	0.33	29.0	26.0
	NB	A	0.51	12.0	112.6	A	0.27	3.5	14.6
	Overall	A	0.50	12.8	-	A	0.30	6.0	-
Kent Street & James Street <i>Unsignalized</i>	WB	C	0.18	24.2	5.3	B	0.19	14.4	5.3
	NBL	A	0.04	8.6	0.8	A	0.05	8.6	1.5
	NBT	A	-	2.7	-	A	-	0.2	-
	Overall	A	-	3.3	-	A	-	2.0	-
Kent Street & Gladstone Avenue <i>Signalized</i>	EBL	A	0.47	42.0	19.7	A	0.47	23.4	10.0
	EBT	A	0.51	39.4	36.0	A	0.56	19.9	24.4
	WBT/R	B	0.70	32.3	48.8	C	0.71	35.2	70.4
	NBL	A	0.04	6.8	6.3	A	0.06	8.5	9.4
	NBT/R	A	0.60	9.8	81.7	A	0.31	8.3	34.2
	Overall	B	0.62	15.5	-	A	0.42	16.5	-
Bank Street & Somerset Street <i>Signalized</i>	EBL/T	B	0.70	43.2	58.6	B	0.66	28.5	46.3
	EBR	A	0.30	32.0	m19.5	A	0.46	25.8	20.4
	WBL	A	0.12	22.5	7.4	A	0.23	25.8	10.5
	WBT/R	A	0.37	26.1	29.6	A	0.42	26.9	33.6
	NB	A	0.25	3.2	6.5	A	0.29	3.5	8.6
	SB	A	0.23	7.9	27.4	A	0.35	9.2	42.9
	Overall	A	0.39	21.0	-	A	0.47	16.4	-
Bank Street & MacLaren Street <i>Signalized</i>	WB	A	0.10	15.8	7.7	A	0.17	20.3	14.2
	NB	A	0.21	1.9	3.4	A	0.26	4.9	9.0
	SB	A	0.23	7.7	24.2	A	0.33	10.9	26.1
	Overall	A	0.22	5.5	-	A	0.30	9.3	-
Bank Street & Gilmour Street <i>Signalized</i>	EB	A	0.37	16.3	27.6	A	0.28	9.6	10.6
	NB	A	0.22	3.4	11.3	A	0.29	11.4	43.7
	SB	A	0.23	3.1	9.7	A	0.33	2.6	9.9
	Overall	A	0.26	5.6	-	A	0.32	7.0	-
Bank Street & Gladstone Avenue <i>Signalized</i>	EB	A	0.55	40.0	33.5	A	0.54	15.9	12.8
	WB	A	0.51	33.4	34.4	B	0.63	34.8	44.2
	NBL	A	0.14	11.7	11.0	A	0.31	18.3	20.0
	NBT/R	A	0.44	15.0	50.3	A	0.59	21.5	69.3
	SB	A	0.21	16.4	27.0	A	0.33	8.2	16.0
	Overall	B	0.40	24.0	-	A	0.49	18.1	-

Notes: Saturation flow rate of 1800 veh/h/lane
 Queue is measured in metres
 Peak Hour Factor = 1.00

Delay = average vehicle delay in seconds
 m = metered queue
 # = volume for the 95th %ile cycle exceeds capacity

The intersections at the 2035 future background condition are anticipated to operate similarly to the 2030 future background condition.

7.3 2030 Future Total Operations

Figure 16 illustrates the 2030 total volumes and Table 18 summarizes the 2030 total intersection operations. The level of service for signalized intersections is based on v/c calculations for individual lane movements and HCM 2000 v/c calculations for the overall intersection. The synchro worksheets for the 2030 total horizon are provided in Appendix I.

Figure 16: 2030 Future Total Volumes

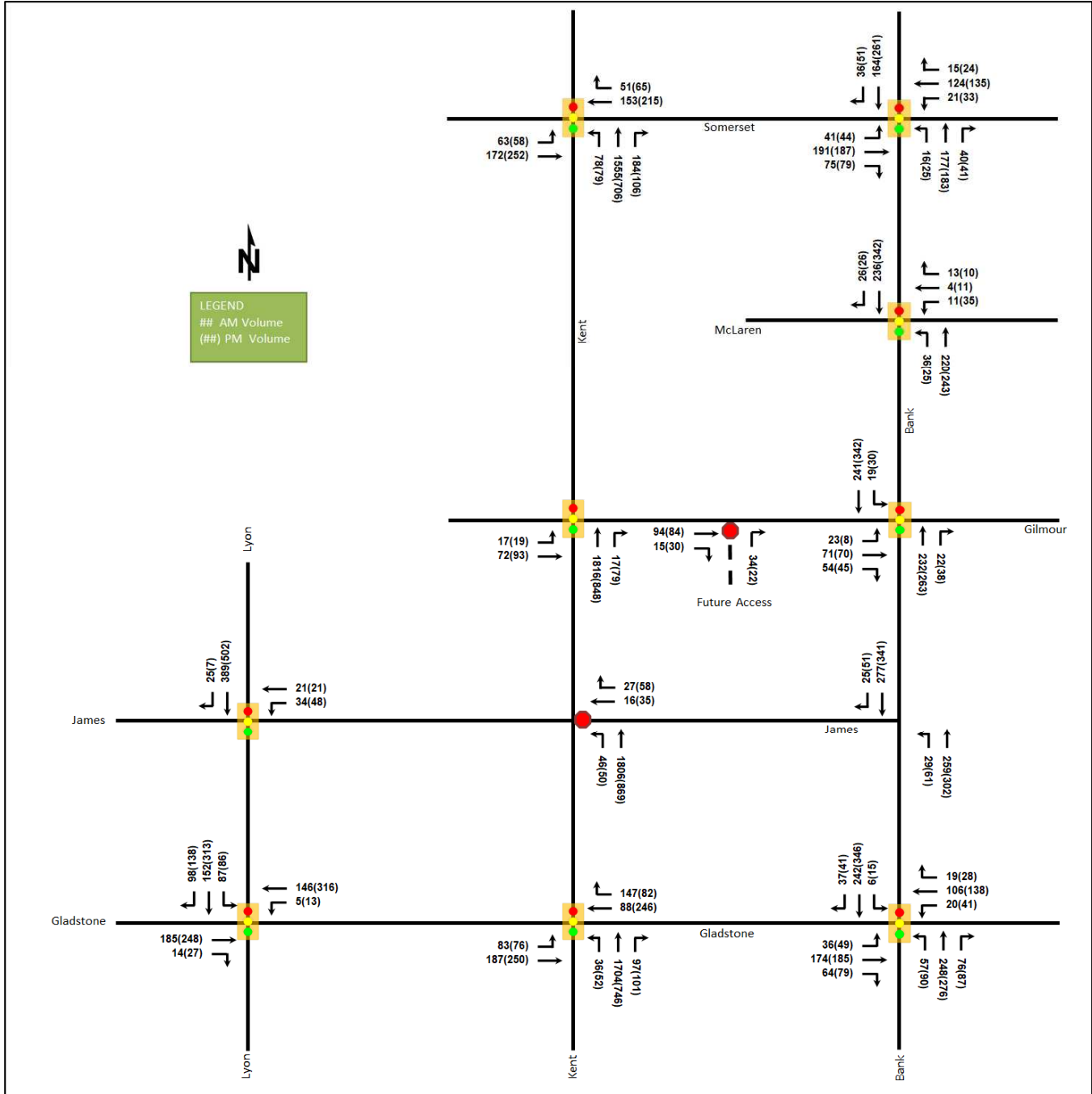

Table 18: 2030 Future Total Intersection Operations

Intersection	Lane	AM Peak Hour				PM Peak Hour			
		LOS	V/C	Delay	Q (95 th)	LOS	V/C	Delay	Q (95 th)
Lyon Street & James Street Signalized	WBL/T	A	0.25	26.2	m11.4	A	0.30	29.4	21.1
	SB	A	0.15	2.4	12.5	A	0.20	3.3	16.0
	Overall	A	0.19	5.2	-	A	0.23	6.4	-
Lyon Street & Gladstone Avenue Signalized	EBT/R	A	0.27	14.3	31.7	A	0.36	14.6	42.1
	WBL/T	A	0.20	8.4	14.1	A	0.43	13.1	41.9
	SB	A	0.25	10.0	21.5	A	0.41	12.0	21.6
	Overall	A	0.24	10.9	-	A	0.41	12.9	-
Kent Street & Somerset Street Signalized	EBL	A	0.34	29.2	17.7	A	0.33	26.1	15.4
	EBT	A	0.47	29.5	37.5	A	0.55	27.7	47.5
	WBT/R	A	0.60	28.1	49.7	B	0.67	32.1	57.7
	NBL	A	0.11	8.7	m13.1	A	0.13	9.3	10.4
	NBT/R	A	0.59	9.2	63.3	A	0.32	9.6	23.3
	Overall	A	0.59	13.0	-	A	0.42	17.6	-
Kent Street & Gilmour Street Signalized	EB	A	0.31	29.7	23.2	A	0.37	29.7	28.3
	NB	A	0.52	12.3	114.5	A	0.27	3.4	14.6
	Overall	A	0.51	13.1	-	A	0.31	6.2	-
Kent Street & James Street Unsignalized	WB	C	0.19	24.4	5.3	B	0.20	14.6	5.3
	NBL	A	0.04	8.6	0.8	A	0.05	8.6	1.5
	NBT	A	-	0.0	-	A	-	0.2	-
	Overall	A	-	0.7	-	A	-	2.0	-
Kent Street & Gladstone Avenue Signalized	EBL	A	0.47	41.2	19.2	A	0.47	23.1	9.8
	EBT	A	0.50	38.3	34.9	A	0.55	19.4	23.9
	WBT/R	B	0.70	32.4	51.3	C	0.72	35.3	72.2
	NBL	A	0.04	7.0	6.4	A	0.06	8.8	9.6
	NBT/R	A	0.60	10.1	83.4	A	0.31	8.6	35.3
	Overall	B	0.63	15.6	-	A	0.43	16.7	-
Bank Street & Somerset Street Signalized	EBL/T	B	0.70	43.2	58.6	B	0.66	28.6	46.3
	EBR	A	0.30	31.9	m19.4	A	0.46	25.9	20.5
	WBL	A	0.12	22.5	7.4	A	0.23	25.8	10.5
	WBT/R	A	0.37	26.1	29.6	A	0.42	26.9	33.6
	NB	A	0.26	3.2	6.5	A	0.29	3.5	8.5
	SB	A	0.22	7.9	26.4	A	0.35	9.2	43.1
	Overall	A	0.40	20.9	-	A	0.47	16.5	-
Bank Street & MacLaren Street Signalized	WB	A	0.10	15.8	7.7	A	0.17	20.3	14.2
	NB	A	0.22	2.6	6.0	A	0.25	5.3	10.6
	SB	A	0.22	7.8	24.1	A	0.33	10.9	26.1
	Overall	A	0.21	5.8	-	A	0.30	9.5	-
Bank Street & Gilmour Street Signalized	EB	A	0.48	25.0	29.4	A	0.35	19.8	24.3
	NB	A	0.24	3.8	11.3	A	0.30	11.3	41.1
	SB	A	0.24	3.5	9.2	A	0.36	3.1	9.9
	Overall	A	0.28	8.4	-	A	0.34	8.8	-

Intersection	Lane	AM Peak Hour				PM Peak Hour			
		LOS	V/C	Delay	Q (95 th)	LOS	V/C	Delay	Q (95 th)
Bank Street & Gladstone Avenue <i>Signalized</i>	EB	A	0.53	39.3	33.2	A	0.54	15.9	13.0
	WB	A	0.52	33.7	35.3	B	0.64	35.0	45.5
	NBL	A	0.14	11.7	11.0	A	0.31	18.3	20.0
	NBT/R	A	0.44	15.0	50.3	A	0.57	21.0	66.5
	SB	A	0.21	15.7	25.8	A	0.34	8.7	16.8
	Overall	A	0.40	23.7	-	A	0.49	18.2	-
Gilmour Street & Access <i>Unsignalized</i>	EB	A	0.12	7.4	3.0	A	0.12	7.3	3.0
	NB	A	0.03	6.7	0.8	A	0.02	6.7	0.8
	Overall	A	-	7.2	-	A	-	7.2	-

Notes: Saturation flow rate of 1800 veh/h/lane
 Queue is measured in metres
 Peak Hour Factor = 1.00

Delay = average vehicle delay in seconds
 m = metered queue
 # = volume for the 95th %ile cycle exceeds capacity

During both the AM and PM peak hours, the study area intersection operates well. No capacity issues are noted.

7.4 2035 Future Total Operations

Figure 16 illustrates the 2035 total volumes and Table 19 summarizes the 2035 total intersection operations. The level of service for signalized intersections is based on v/c calculations for individual lane movements and HCM 2000 v/c calculations for the overall intersection. The synchro worksheets for the 2035 total horizon are provided in Appendix J.

Figure 17: 2035 Future Total Volumes

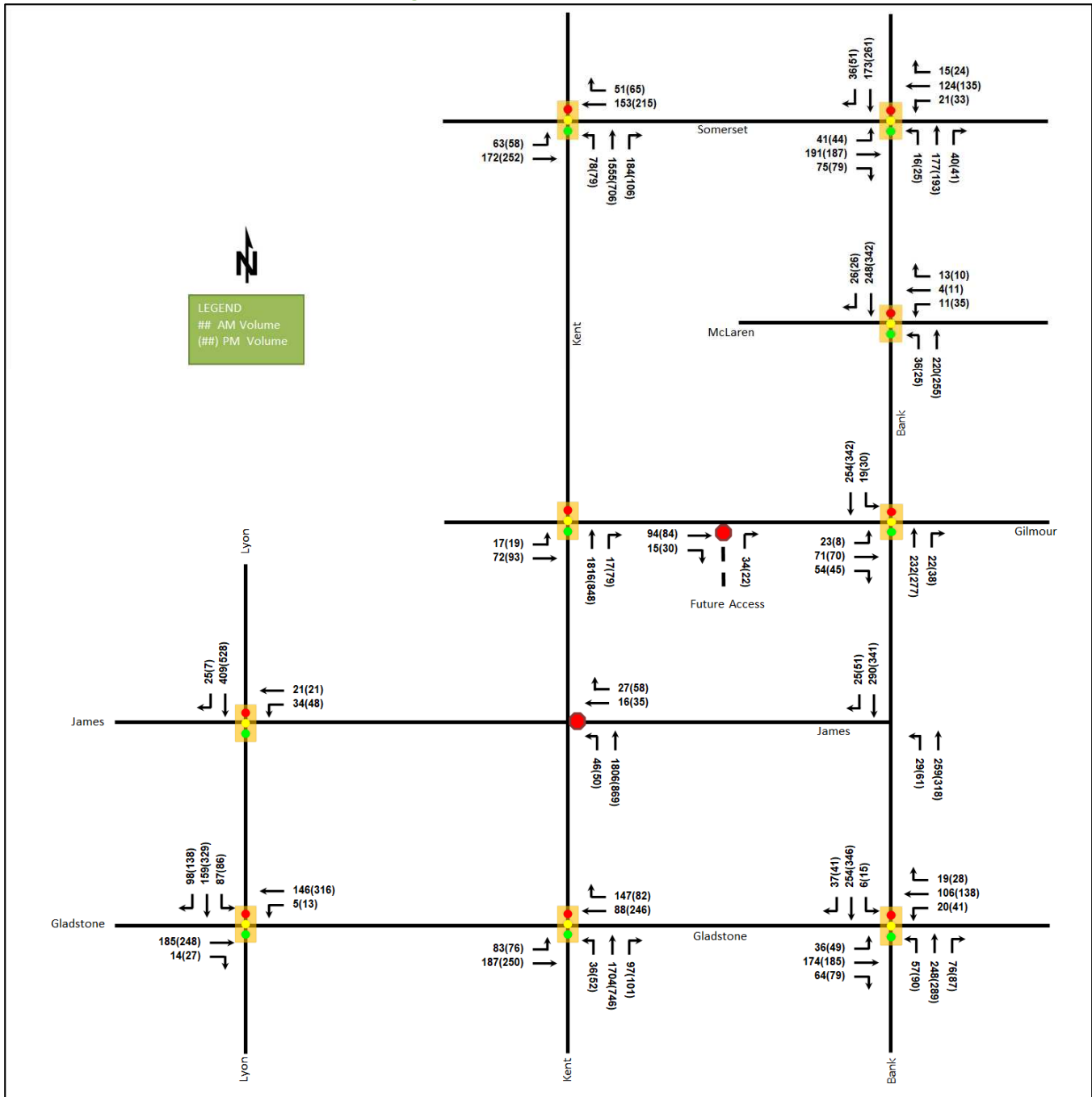

Table 19: 2035 Future Total Intersection Operations

Intersection	Lane	AM Peak Hour				PM Peak Hour			
		LOS	V/C	Delay	Q (95 th)	LOS	V/C	Delay	Q (95 th)
Lyon Street & James Street Signalized	WBL/T	A	0.25	26.2	m11.4	A	0.30	29.4	21.1
	SB	A	0.16	2.5	13.2	A	0.21	3.3	16.9
	Overall	A	0.19	5.1	-	A	0.23	6.3	-

Intersection	Lane	AM Peak Hour				PM Peak Hour			
		LOS	V/C	Delay	Q (95 th)	LOS	V/C	Delay	Q (95 th)
Lyon Street & Gladstone Avenue <i>Signalized</i>	EBT/R	A	0.27	14.3	31.7	A	0.36	14.6	42.1
	WBL/T	A	0.20	8.4	14.1	A	0.43	13.1	41.9
	SB	A	0.26	10.1	22.1	A	0.43	12.3	22.3
	Overall	A	0.25	10.9	-	A	0.42	13.1	-
Kent Street & Somerset Street <i>Signalized</i>	EBL	A	0.34	29.2	17.7	A	0.33	26.1	15.4
	EBT	A	0.47	29.5	37.5	A	0.55	27.7	47.5
	WBT/R	A	0.60	27.6	49.4	B	0.67	32.1	57.8
	NBL	A	0.11	8.7	m13.1	A	0.13	9.3	10.5
	NBT/R	A	0.59	9.2	63.3	A	0.32	9.6	23.3
	Overall	A	0.59	12.9	-	A	0.42	17.6	-
Kent Street & Gilmour Street <i>Signalized</i>	EB	A	0.31	29.7	23.2	A	0.37	29.7	28.3
	NB	A	0.52	12.3	114.5	A	0.27	3.4	14.6
	Overall	A	0.51	13.1	-	A	0.31	6.2	-
Kent Street & James Street <i>Unsignalized</i>	WB	C	0.19	24.4	5.3	B	0.20	14.6	5.3
	NBL	A	0.04	8.6	0.8	A	0.05	8.6	1.5
	NBT	A	-	0.0	-	A	-	0.2	-
	Overall	A	-	0.7	-	A	-	2.0	-
Kent Street & Gladstone Avenue <i>Signalized</i>	EBL	A	0.47	41.2	19.2	A	0.47	23.0	9.9
	EBT	A	0.50	38.3	35.0	A	0.55	19.3	24.0
	WBT/R	B	0.70	32.4	51.3	C	0.72	35.3	72.1
	NBL	A	0.04	7.0	6.4	A	0.06	8.8	9.6
	NBT/R	A	0.60	10.1	83.4	A	0.31	8.6	35.3
	Overall	B	0.63	15.6	-	A	0.43	16.7	-
Bank Street & Somerset Street <i>Signalized</i>	EBL/T	B	0.70	43.2	58.6	B	0.66	28.6	46.3
	EBR	A	0.30	31.9	m19.4	A	0.46	25.9	20.5
	WBL	A	0.12	22.5	7.4	A	0.23	25.8	10.5
	WBT/R	A	0.37	26.1	29.6	A	0.42	26.9	33.6
	NB	A	0.26	3.2	6.5	A	0.30	3.5	8.6
	SB	A	0.23	7.9	27.5	A	0.35	9.2	43.1
	Overall	A	0.40	20.8	-	A	0.47	16.3	-
Bank Street & MacLaren Street <i>Signalized</i>	WB	A	0.10	15.8	7.7	A	0.17	20.3	14.2
	NB	A	0.22	2.6	6.0	A	0.26	5.2	10.7
	SB	A	0.23	7.6	24.2	A	0.33	10.9	26.1
	Overall	A	0.22	5.7	-	A	0.30	9.4	-
Bank Street & Gilmour Street <i>Signalized</i>	EB	A	0.48	25.0	29.4	A	0.35	19.8	24.3
	NB	A	0.24	3.8	11.3	A	0.31	11.7	43.8
	SB	A	0.25	3.5	9.8	A	0.36	3.1	9.9
	Overall	A	0.29	8.3	-	A	0.34	9.0	-
Bank Street & Gladstone Avenue <i>Signalized</i>	EB	A	0.53	39.3	33.2	A	0.54	15.9	13.0
	WB	A	0.52	33.7	35.3	B	0.64	35.0	45.5
	NBL	A	0.14	11.8	11.0	A	0.31	18.3	20.0
	NBT/R	A	0.44	15.0	50.3	A	0.59	21.5	69.3
	SB	A	0.22	15.9	26.9	A	0.34	8.7	16.8
	Overall	A	0.40	23.6	-	A	0.50	18.3	-

Intersection	Lane	AM Peak Hour				PM Peak Hour			
		LOS	V/C	Delay	Q (95 th)	LOS	V/C	Delay	Q (95 th)
Gilmour Street & Access <i>Unsignalized</i>	EB	A	0.12	7.4	3.0	A	0.12	7.3	3.0
	NB	A	0.03	6.7	0.8	A	0.02	6.7	0.8
	Overall	A	-	7.2	-	A	-	7.2	-

Notes: Saturation flow rate of 1800 veh/h/lane
Queue is measured in metres
Peak Hour Factor = 1.00

Delay = average vehicle delay in seconds
m = metered queue
= volume for the 95th %ile cycle exceeds capacity

During both the AM and PM peak hours, the study area intersection operates well. No capacity issues are noted.

7.5 Modal Share Sensitivity and Demand Rationalization Conclusions

No capacity constraints are noted within the study area. As such, no rationalization of the modal share and network volumes is required.

8 Development Design

8.1 Design for Sustainable Modes

The proposed development is a residential building with parking provided on two underground levels. Bicycle storage rooms are accessed by the parking garage ramp, and bicycle racks are provided on ground level. Hard surface connections are provided between building entrances and the surrounding pedestrian facilities on Gilmour Street and James Street. Local bus stops are located within 400 metres of the site entrances and the LRT stations to the north are just beyond an 800-metre walking distance.

8.2 Circulation and Access

The site access is provided as a right-in-right-out driveway onto Gilmour Street and provides access to the internal parking. Garbage will be collected on Gilmour Street. The two-way access onto Gilmour Street is 6.5m wide.

9 Parking

9.1 Parking Supply

The site provides 161 underground parking spaces, 22 bicycle spaces on the ground floor, and 88 underground bicycle spaces. No parking is provided for the retail. The minimum vehicle parking provision is 110 spaces for the residential units and three spaces for the commercial spaces, the minimum visitor parking provision is 22, and the minimum bicycle parking provision is 110 spaces. The residential, visitor, and bicycle parking meet the minimum by-law requirements.

10 Boundary Street Design

Table 20 summarizes the MMLOS analysis for the boundary streets of James Street and Kent Street. The existing and future conditions for both streets will be the same and are considered in one row. The boundary street analysis is based on the “General Urban Area”. The MMLOS worksheets have been provided in Appendix K.

Table 20: Boundary Street MMLOS Analysis

Segment	Pedestrian LOS		Bicycle LOS		Transit LOS		Truck LOS	
	PLOS	Target	BLOS	Target	TLOS	Target	TrLOS	Target
James Street	F	C	D	D	N/A	N/A	N/A	N/A
Kent Street	D	C	E	D	N/A	N/A	B	D
Gilmour Street	F	C	D	D	N/A	N/A	N/A	N/A

The MMLOS targets for the pedestrian LOS do not be met on James Street and Gilmour Street. To meet the target, the City would need to reconstruct the roadway to provide a boulevard width of at least 0.5 metres.

The MMLOS targets for the bicycle LOS do not be met on Kent Street. To meet the target, the operating speed has to be lower than 50 km/h.

11 Access Intersections Design

11.1 Location and Design of Access

The existing access on Gilmour Street and James Street will be removed, and the site proposes a new on right-in-right-out access Gilmour Street. The proposed access is 6.1-metre wide, and it access to the parking garage ramp with 7.5% to 15% slope. The Gilmour frontage is approximately 44 metres, and it meets the maximum number of private approaches permitted. The distance between the access and nearest intersecting street line is approximately 35 metres, and it meets the requirement of 30 metres. Sidewalk and on-street parking will be provided along Gilmour Street, and the existing on-street parking will be adjusted. Figure 18 illustrates the proposed on-street parking along Gilmour Street.

Figure 18: Proposed On-Street Parking

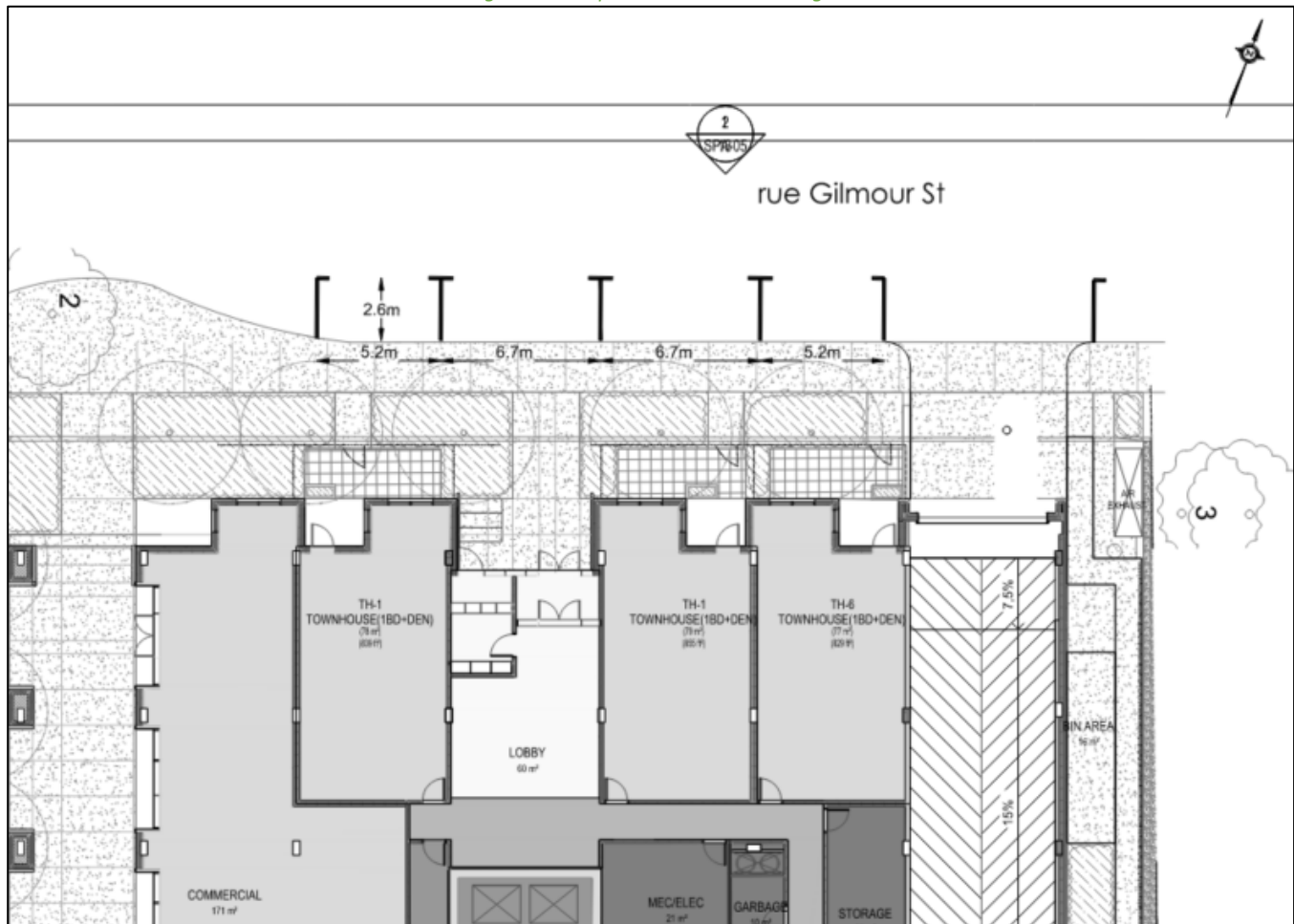

11.2 Intersection Control

The site access will have stop-control on the minor approach. No further traffic control is necessary for a private approach.

11.3 Access Intersection Design

11.3.1 Future Access Intersection Operations

The operations are noted in Section 7.4 and no mitigation of conditions is required for the subject site traffic.

11.3.2 Access Intersection MMLoS

The access intersection is unsignalized, and therefore no access intersection MMLoS analysis has been conducted.

11.3.3 Recommended Design Elements

The existing accesses on Gilmour Street and James Street will be removed, and a new right-in-right-out access on Gilmour Street is proposed.

12 Transportation Demand Management

12.1 Context for TDM

The mode shares used within the TIA represent the unmodified district mode shares. Overall, the modal shares are likely to be achieved, and supporting TDM measures should be provided to encourage shifts toward sustainable modes.

The subject site is within the Centretown Secondary Plan and Community Design Plan areas and the Downtown Ottawa Urban Design Strategy Design Priority Area. The total bedroom count within the development is 18 studios, 133 one-bedroom, 58 two-bedroom, and 10 three-bedroom.

12.2 Need and Opportunity

The subject site has been assumed to rely predominantly on auto travel and transit. The study area intersections are anticipated to have the residual capacity, and as the unmodified district mode shares have been applied, risks to other network users from failing to meet mode share targets are low.

12.3 TDM Program

The “suite of post occupancy TDM measures” has been summarized in the TDM checklists for the residential land uses. The checklist is provided in Appendix L. The key TDM measures recommended include:

- Display local area maps with walking and cycling routes, and transit route information and schedules at major entrances
- Contract with providers to install on-site bikeshare (or other micro-mobility, e.g. scooter share) and carshare spaces
- Inclusion of a 1-year Presto card for first time apartment rental, with a set time frame for this offer (e.g. 6-months) from the initial opening of the site
- Unbundle parking from rental costs
- Provide a multimodal travel option information package to new residents

13 Neighbourhood Traffic Management

The proposed development will connect to the arterial network via Gilmour Street (a local road). The TIA guidelines have outlined thresholds for two-way traffic on local and have been found to be too low for the

purposes of this analysis. City Staff have noted that these thresholds are under review and will be updated in the future. The existing volumes on Gilmour Street are between 71 and 123 vehicles during peak hours and are forecasted to be between 113 and 148 vehicles during peak hours. These volumes are consistent with local road usage and no changes to the roadway classification is required.

14 Transit

14.1 Route Capacity

In Section 5.1 the trip generation by mode was estimated, including an estimate of the number of transit trips that will be generated by the proposed development. Table 21 summarizes the transit trip generation.

Table 21: Trip Generation by Transit Mode

Travel Mode	Mode Share	AM Peak Hour			PM Peak Hour		
		In	Out	Total	In	Out	Total
Transit	Varies	8	19	27	12	9	21

The proposed development is anticipated to generate an additional 27 AM and 21 PM peak hour two-way transit trips. From the trip distribution found in section 5.3, these values can be further broken down. Table 22 summarizes forecasted site-generated transit ridership trips by direction and the equivalent bus loads.

Table 22: Forecasted Site-Generated Transit Ridership

Direction	AM Peak Hour		PM Peak Hour		Service Type	Approximate Equivalent Peak Hour/Direction Bus Loads
	In	Out	In	Out		
North	2	4	2	2	Bus	Negligible
South	2	6	5	3	LRT, Bus	Negligible
East	2	5	3	2	LRT, Bus	Negligible
West	2	4	2	2	LRT, Bus	Negligible

14.2 Transit Priority

Examining the study area intersection delays, negligible impacts are noted on the transit movements at the study area intersections.

15 Network Intersection Design

15.1 Network Intersection Control

No change to any existing signalized intersection control is recommended for the network intersections.

15.2 Network Intersection Design

15.2.1 2030 and 2035 Future Total Network Intersection Operations

The operations are noted in Section 7.4 and no mitigation of conditions is required for the subject site traffic.

15.2.2 Network Intersection MMLoS

Table 23 summarizes the MMLoS analysis for the network intersections in the study area. The existing and future conditions will be the same and are considered in one row. The analysis is based on “Traditional Main Street” for Somerset Street, Bank Street, and Gladstone Avenue at Bank Street to the west, and the remaining intersections are based on the “General Urban Area”. The effective walk time does not used to evaluate the Pedestrian LOS. The MMLoS worksheets have been provided in Appendix K.

Table 23: Study Area Intersection MMLoS Analysis

Intersection	Pedestrian LOS		Bicycle LOS		Transit LOS		Truck LOS		Auto LOS	
	PLOS	Target	BLOS	Target	TLOS	Target	TrLOS	Target	ALOS	Target
Kent Street & Somerset Street	C	B	E	C	E	D	E	D	A	D
Kent Street & Gilmour Street	B	C	B	C	N/A	N/A	N/A	N/A	A	D
Kent Street & Gladstone Avenue	C	B	E	C	E	D	D	D	B	D
Bank Street & Somerset Street	D	B	D	C	D	D	N/A	N/A	A	D
Bank Street & MacLaren Street	B	B	B	C	B	D	N/A	N/A	A	D
Bank Street & Gilmour Street	B	B	B	C	C	D	N/A	N/A	A	D
Bank Street & Gladstone Avenue	D	B	D	C	E	D	N/A	N/A	A	D
Lyon Street & James Street	A	C	B	C	N/A	N/A	N/A	N/A	A	D
Lyon Street & Gladstone Avenue	B	B	B	C	N/A	N/A	N/A	N/A	A	D

The pedestrian LOS will not be met at the intersections of Kent Street and Somerset Street, Kent Street and Gladstone Avenue, Bank Street and Somerset Street, and Bank Street and Gladstone Avenue. To meet pedestrian LOS at all intersections, the maximum crossing distance on all pedestrian crossings would need to be reduced to three lane-widths.

The bicycle LOS will not be met at the intersections of Kent Street and Somerset Street, Kent Street and Gladstone Avenue, Bank Street and Somerset Street, and Bank Street and Gladstone Avenue. To meet bicycle LOS at all intersections, the left-turn configurations would need to be two-stage or include turn boxes, and dedicated facilities would be required along the roadways.

The transit LOS will not be met at the intersections of Kent Street and Somerset Street, Kent Street and Gladstone Avenue, and Bank Street and Gladstone Avenue. To meet transit LOS, the delay would need to be reduced to below 30 seconds on all transit movements.

The truck LOS will not be met at the existing or future intersections of Kent Street and Somerset Street. To meet truck LOS, the effective corner radius needs to increase to at least 15 metres.

Pedestrian delay LOS is not considered in the PLOS calculation as it is not a suitable metric for the assessment of pedestrian LOS as formulated. This exclusion is consistent with City direction since 2015, and no alternative methodology has been provided for its assessment. If mitigation is to be provided by the City, it will be incumbent on internal City discussions to revise the signal timings to be a balanced phasing and be reduce to a cycle length approximately 60-70 seconds.

15.2.3 Recommended Design Elements

No study area intersection design elements are proposed as part of this study.

16 Summary of Improvements Indicated and Modifications Options

The following summarizes the analysis and results presented in this TIA report:

Proposed Site and Screening

- The proposed site includes 218 apartment units, a park, and 1841 sq. ft of commercial space
- The existing accesses on Gilmour Street and James Street will be removed and will be replaced with a new access located on Gilmour Street
- A total of 161 parking stalls and 110 bicycle parking spaces are proposed
- The development is proposed to be completed as a single phase by 2030
- The trip generation, location and safety triggers were met for the TIA Screening

Existing Conditions

- Kent Street, Bank Street, Lyon Street, and Somerset Street are arterial roads, and Gladstone Avenue is a major collector road in the study area
- Sidewalks are provided along both sides of the road within the study area
- Bike lanes are provided along Lyon Street, and Somerset Street, Bank Street, and Gladstone Avenue are suggested routes
- Somerset Street, Lyon Street, and Gladstone Avenue are spine routes, and Bank Street is a local route
- Within the study area, the intersection of Kent Street and James Street is noted to have experienced higher collisions than other locations
- The detailed collision records outline that angle collisions predominantly are the result of the westbound vehicle failing to yield and improper turns
- No further review of these collisions is required as part of this study and mitigation is subject to City review/action

Development Generated Travel Demand

- The proposed development is forecasted to produce 95 two-way people trips during the AM peak hour and 102 two-way people trips during the PM peak hour
- Of the forecasted people trips, 23 two-way trips will be vehicle trips during the AM peak hour and 22 two-way trips will be vehicle trips during the PM peak hour
- Of the forecasted trips, 20% are anticipated to travel the north and the west, 35% to the south, and 25% to both the east

Background Conditions

- The background developments were explicitly included in the background conditions, along with a total background growth of 1.00% per annum along the mainline volumes and direction of Bank Street and Lyon Street
- The study area intersections will operate similarly to the existing conditions

Development Design

- The proposed development is a residential building with the parking provided on two underground levels
- Bicycle storage rooms are accessed by the parking garage ramp, and bicycle racks are provided on the ground level
- Hard surface connections are provided between building entrances and the surrounding pedestrian facilities on James Street and Gilmour Street
- Garbage will be collected on Gilmour Street frontage
- Emergency services are proposed as accessing the site via the Gilmour Street frontage

Parking

- The site provides 161 underground parking spaces, 22 bicycle racks on the ground floor, and 88 underground bicycle spaces
- The minimum residential, visitor, and bicycle parking the minimum by-law requirements

Boundary Street Design

- James Street and Gilmour Steet do not meet the pedestrian LOS target, and boulevard width has to be widened to at least 0.5 metres to meet the target
- Kent Street does not meet the pedestrian LOS target, and the operating speed has to be lower than 50 km/h

Access Intersections Design

- The existing accesses on Gilmour Street and James Street will be removed, and a new right-in-right-out access on Gilmour Steet is proposed
- Sidewalk and on-street parking will be provided along Gilmour Street, and the existing on-street parking will be adjusted
- The site will access Gilmour Steet via a right-in-right-out access, and the access width is 6.1 metres
- The Gilmour frontage meets the maximum number of private approaches permitted
- The distance between the access and nearest intersecting street line meets the requirement
- The site access will have stop-control on the minor approach

TDM

- Supportive TDM measures to be included within the proposed development should include:
 - Display local area maps with walking and cycling routes, and transit route information and schedules at major entrances
 - Contract with providers to install on-site bikeshare (or other micro-mobility, e.g. scooter share) and carshare spaces
 - Inclusion of a 1-year Presto card for first time apartment rental, with a set time frame for this offer (e.g.6-months) from the initial opening of the site
 - Unbundle parking from rental costs
 - Provide a multimodal travel option information package to new residents

Neighbourhood Traffic Management

- The existing volumes on Gilmour Street is between 71 and 123 vehicles during the peak hours and is forecasted to be between 113 and 148 vehicles during the peak hours
- No changes to the roadway classifications

Transit

- The proposed development is anticipated to generate an additional 27 AM and 21 PM peak hour two-way transit trips
- Peak hour increases in transit ridership have negligible impacts
- Negligible impacts are noted on the transit movements at the study area intersections

Network Intersection Design

- Generally, the network intersections will operate well

- The pedestrian LOS targets will not be met at the intersections of Kent Street and Somerset Street, Kent Street and Gladstone Avenue, Bank Street and Somerset Street, and Bank Street and Gladstone Avenue, and the maximum crossing distance on all pedestrian crossings are required to be reduced to three lane-widths
- The bicycle LOS targets will not be met at the intersections of Kent Street and Somerset Street, Kent Street and Gladstone Avenue, Bank Street and Somerset Street, and Bank Street and Gladstone Avenue, and the left-turn configurations are required to be two-stage or include turn boxes
- The transit LOS will not be met at the intersections of Kent Street and Somerset Street, Kent Street and Gladstone Avenue, and Bank Street and Gladstone Avenue, and the delay is required to be below 30 seconds
- The truck LOS will not be met at the existing or future intersections of Kent Street and Somerset Street and the effective corner radius needs to increase to at least 15 metres

17 Conclusion

It is recommended that, from a transportation perspective, the proposed development applications proceed.

Prepared By:



Yu-Chu Chen, EIT
Transportation Engineering-Intern

Reviewed By:



Andrew Harte, P.Eng.
Senior Transportation Engineer

Appendix A

TIA Screening Form and PM Certification Form

DRAFT

City of Ottawa 2017 TIA Guidelines
Step 1 - Screening Form

Date: 17-Feb-23
Project Number: 2021-108
Project Reference: 381 Kent Street

1.1 Description of Proposed Development	
Municipal Address	381 Kent Street
Description of Location	Ward 14, Northeast corner of the James Street and Kent Street
Land Use Classification	Residential Fourth Density Zone (R4UD)
Development Size	218 apartment units and 1,841 sq. ft of commercial space
Accesses	One access onto Gilmour Street
Phase of Development	Single
Buildout Year	2030
TIA Requirement	Full TIA Required

1.2 Trip Generation Trigger	
Land Use Type	Townhomes or apartments
Development Size	218 Units
Trip Generation Trigger	Yes

1.3 Location Triggers	
Does the development propose a new driveway to a boundary street that is designated as part of the City's Transit Priority, Rapid Transit or Spine Bicycle Networks?	No
Is the development in a Design Priority Area (DPA) or Transit-oriented Development (TOD) zone?	Yes Design Strategy Design Priority Area
Location Trigger	Yes

1.4. Safety Triggers	
Are posted speed limits on a boundary street 80 km/hr or greater?	No
Are there any horizontal/vertical curvatures on a boundary street limits sight lines at a proposed driveway?	No
Is the proposed driveway within the area of influence of an adjacent traffic signal or roundabout (i.e. within 300 m of intersection in rural conditions, or within 150 m of intersection in urban/ suburban conditions)?	Yes Kent Street at Gilmour Street is within 150m
Is the proposed driveway within auxiliary lanes of an intersection?	No
Does the proposed driveway make use of an existing median break that serves an existing site?	No
Is there is a documented history of traffic operations or safety concerns on the boundary streets within 500 m of the development?	No
Does the development include a drive-thru facility?	No
Safety Trigger	Yes

Appendix B

Turning Movement Counts

DRAFT



Transportation Services - Traffic Services

Turning Movement Count - Study Results

JAMES ST @ LYON ST

Survey Date: Tuesday, March 08, 2022

WO No: 40221

Start Time: 07:00

Device: Miovision

Full Study Diagram

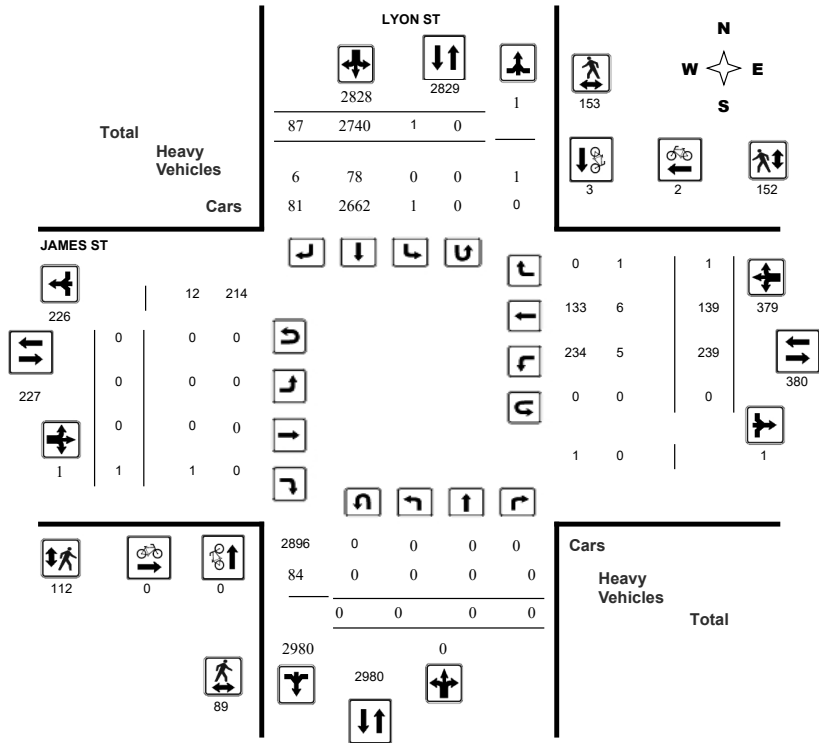

Transportation Services - Traffic Services

Turning Movement Count - Study Results

JAMES ST @ LYON ST

Survey Date: Tuesday, March 08, 2022

WO No: 40221

Start Time: 07:00

Device: Miovision

Full Study Peak Hour Diagram

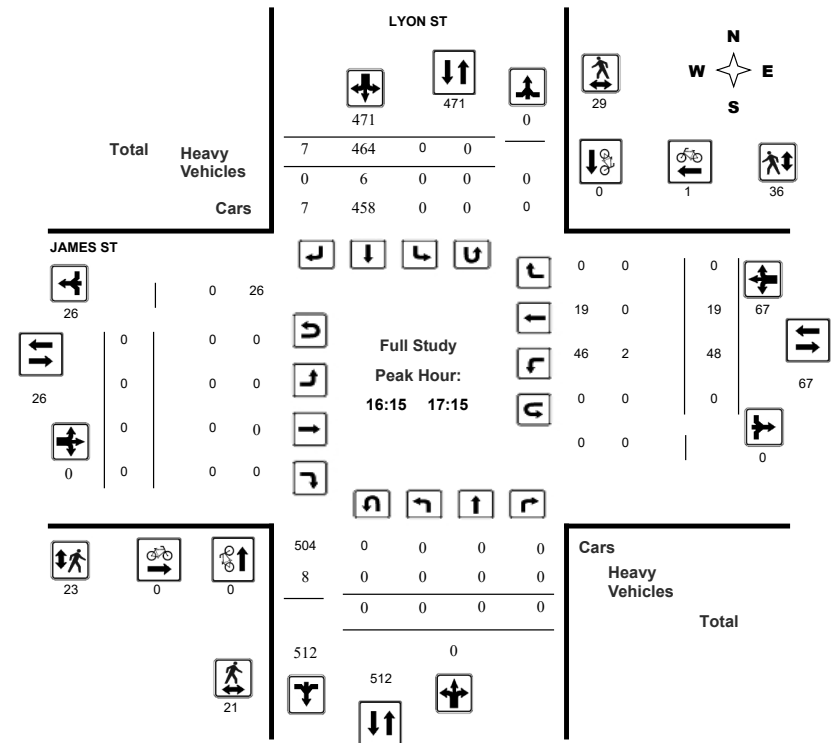



Transportation Services - Traffic Services

Turning Movement Count - Peak Hour Diagram

JAMES ST @ LYON ST

Survey Date: Tuesday, March 08, 2022

Start Time: 07:00

WO No: 40221

Device: Miovision

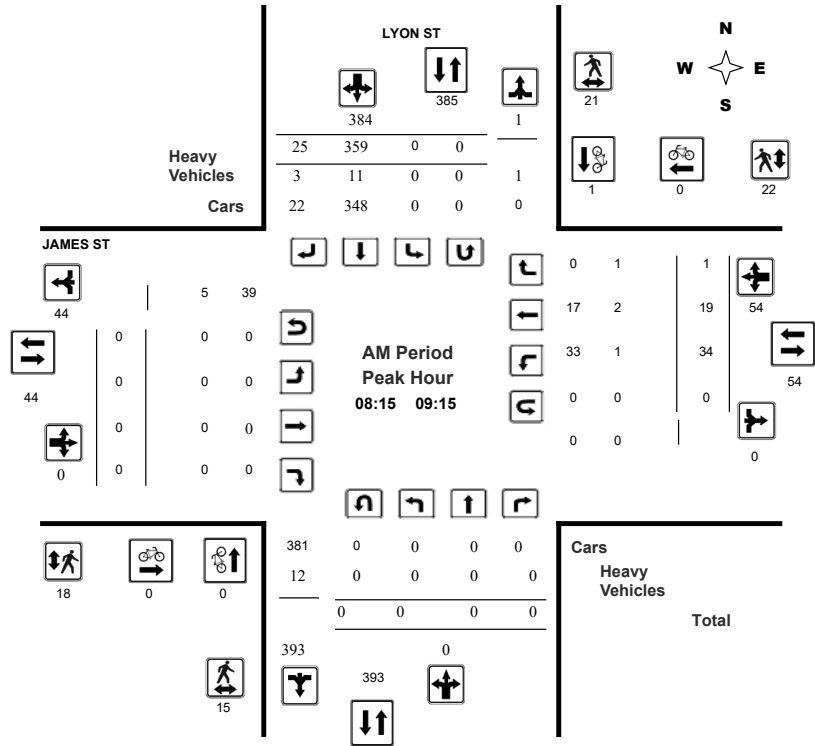

Comments



Transportation Services - Traffic Services

Turning Movement Count - Peak Hour Diagram

JAMES ST @ LYON ST

Survey Date: Tuesday, March 08, 2022

Start Time: 07:00

WO No: 40221

Device: Miovision

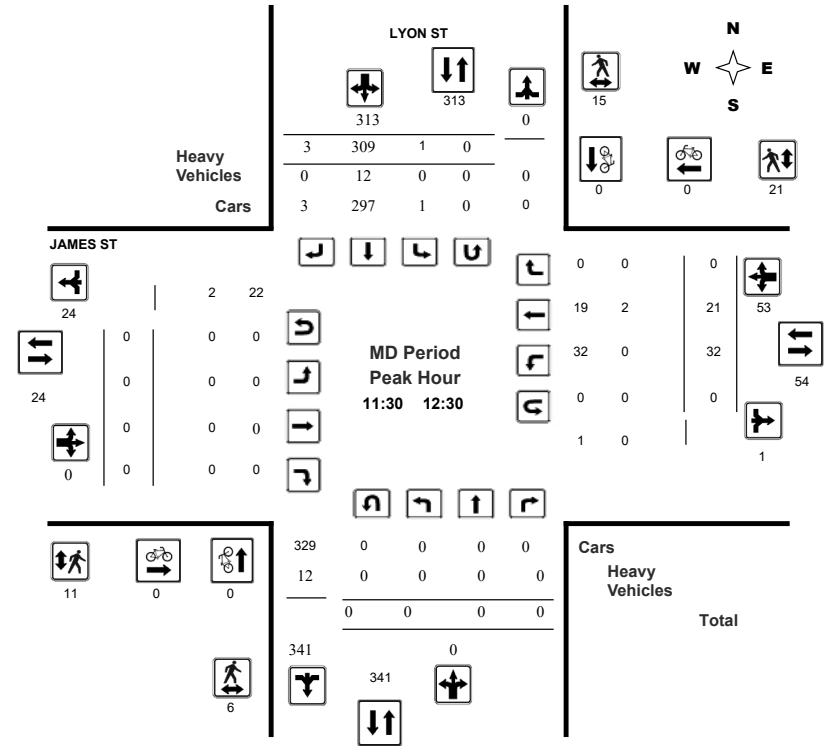

Comments



Transportation Services - Traffic Services
Turning Movement Count - Peak Hour Diagram
JAMES ST @ LYON ST

Survey Date: Tuesday, March 08, 2022
 Start Time: 07:00

WO No: 40221
 Device: Miovision

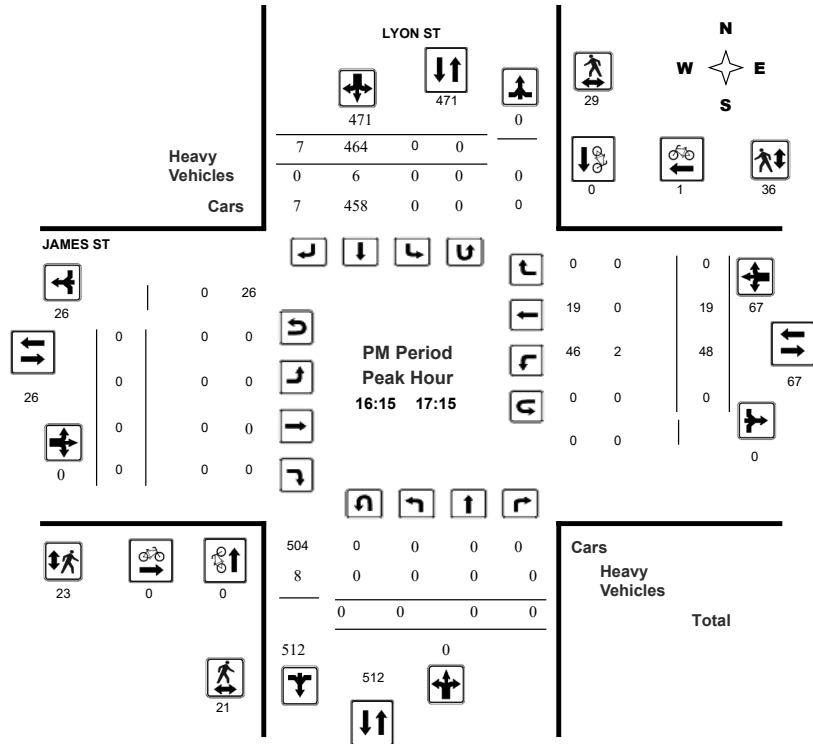

Comments



Transportation Services - Traffic Services
Turning Movement Count - Study Results
JAMES ST @ LYON ST

Survey Date: Tuesday, March 08, 2022
 Start Time: 07:00

WO No: 40221
 Device: Miovision

Full Study Summary (8 HR Standard)

Survey Date: Tuesday, March 08, 2022

Total Observed U-Turns
 Northbound: 0 Southbound: 0
 Eastbound: 0 Westbound: 0

AADT Factor
 1.00

Period	LYON ST				JAMES ST				WB TOT	STR TOT	Grand Total								
	Northbound		Southbound		Eastbound		Westbound												
	LT	ST	RT	NB TOT	LT	ST	RT	SB TOT	STR TOT	LT	ST	RT	EB TOT	LT	ST	RT	WB TOT	STR TOT	Grand Total
07:00 08:00	0	0	0	0	0	238	8	246	246	0	0	1	1	14	2	0	16	17	263
08:00 09:00	0	0	0	0	0	366	22	388	388	0	0	0	0	34	14	0	48	48	436
09:00 10:00	0	0	0	0	0	259	15	274	274	0	0	0	0	22	24	1	47	47	321
11:30 12:30	0	0	0	0	1	309	3	313	313	0	0	0	0	32	21	0	53	53	366
12:30 13:30	0	0	0	0	0	289	8	297	297	0	0	0	0	22	17	0	39	39	336
15:00 16:00	0	0	0	0	0	438	11	449	449	0	0	0	0	32	19	0	51	51	500
16:00 17:00	0	0	0	0	0	445	7	452	452	0	0	0	0	43	13	0	56	56	508
17:00 18:00	0	0	0	0	0	396	13	409	409	0	0	0	0	40	29	0	69	69	478
Sub Total	0	0	0	0	1	2740	87	2828	2828	0	0	1	1	239	139	1	379	380	3208
U Turns	0	0	0	0	0	0	0	0	0	0	0	0	0	0	0	0	0	0	0
Total	0	0	0	0	1	2740	87	2828	2828	0	0	1	1	239	139	1	379	380	3208
EQ 12Hr	0	0	0	0	1	3809	121	3931	3931	0	0	1	1	332	193	1	527	528	4459
Note: These values are calculated by multiplying the totals by the appropriate expansion factor.													1.39						
AVG 12Hr	0	0	0	0	1	4989	158	3931	3931	0	0	1	1	332	193	1	527	528	4459
Note: These volumes are calculated by multiplying the Equivalent 12 hr. totals by the AADT factor.													1.00						
AVG 24Hr	0	0	0	0	1	6536	207	5150	5150	0	0	1	1	435	253	1	690	692	5841
Note: These volumes are calculated by multiplying the Average Daily 12 hr. totals by 12 to 24 expansion factor.													1.31						
Note: U-Turns provided for approach totals. Refer to 'U-Turn' Report for specific breakdown.																			



Transportation Services - Traffic Services

Turning Movement Count - Study Results

JAMES ST @ LYON ST

Survey Date: Tuesday, March 08, 2022

WO No: 40221

Start Time: 07:00

Device: Miovision

Full Study 15 Minute Increments

Table with columns for Time Period, Northbound, Southbound, Eastbound, Westbound, and Grand Total. Rows show 15-minute intervals from 07:00 to 17:45.

Note: U-Turns are included in Totals.



Transportation Services - Traffic Services

Turning Movement Count - Study Results

JAMES ST @ LYON ST

Survey Date: Tuesday, March 08, 2022

WO No: 40221

Start Time: 07:00

Device: Miovision

Full Study Cyclist Volume

Table with columns for Time Period, Northbound, Southbound, Street Total, Eastbound, Westbound, Street Total, and Grand Total. Rows show 15-minute intervals from 07:00 to 17:45.



Transportation Services - Traffic Services

Turning Movement Count - Study Results

JAMES ST @ LYON ST

Survey Date: Tuesday, March 08, 2022

WO No: 40221

Start Time: 07:00

Device: Miovision

Full Study Pedestrian Volume

LYON ST

JAMES ST

Table with 8 columns: Time Period, NB Approach (E or W Crossing), SB Approach (E or W Crossing), Total, EB Approach (N or S Crossing), WB Approach (N or S Crossing), Total, Grand Total. Rows show pedestrian counts for various time intervals from 07:00 to 17:45, with a total of 242 pedestrians.



Transportation Services - Traffic Services

Turning Movement Count - Study Results

JAMES ST @ LYON ST

Survey Date: Tuesday, March 08, 2022

WO No: 40221

Start Time: 07:00

Device: Miovision

Full Study Heavy Vehicles

LYON ST

JAMES ST

Table with 20 columns: Time Period, Northbound (LT, ST, RT, N TOT), Southbound (LT, ST, RT, S TOT, STR TOT), Eastbound (LT, ST, RT, E TOT), Westbound (LT, ST, RT, W TOT, STR TOT), Grand Total. Rows show heavy vehicle counts for various time intervals from 07:00 to 17:45, with a total of 84 heavy vehicles.



Transportation Services - Traffic Services

Turning Movement Count - Study Results

JAMES ST @ LYON ST

Survey Date: Tuesday, March 08, 2022

WO No: 40221

Start Time: 07:00

Device: Miovision

Full Study 15 Minute U-Turn Total

LYON ST JAMES ST

Time Period	Northbound U-Turn Total	Southbound U-Turn Total	Eastbound U-Turn Total	Westbound U-Turn Total	Total
07:00 - 07:15	0	0	0	0	0
07:15 - 07:30	0	0	0	0	0
07:30 - 07:45	0	0	0	0	0
07:45 - 08:00	0	0	0	0	0
08:00 - 08:15	0	0	0	0	0
08:15 - 08:30	0	0	0	0	0
08:30 - 08:45	0	0	0	0	0
08:45 - 09:00	0	0	0	0	0
09:00 - 09:15	0	0	0	0	0
09:15 - 09:30	0	0	0	0	0
09:30 - 09:45	0	0	0	0	0
09:45 - 10:00	0	0	0	0	0
11:30 - 11:45	0	0	0	0	0
11:45 - 12:00	0	0	0	0	0
12:00 - 12:15	0	0	0	0	0
12:15 - 12:30	0	0	0	0	0
12:30 - 12:45	0	0	0	0	0
12:45 - 13:00	0	0	0	0	0
13:00 - 13:15	0	0	0	0	0
13:15 - 13:30	0	0	0	0	0
15:00 - 15:15	0	0	0	0	0
15:15 - 15:30	0	0	0	0	0
15:30 - 15:45	0	0	0	0	0
15:45 - 16:00	0	0	0	0	0
16:00 - 16:15	0	0	0	0	0
16:15 - 16:30	0	0	0	0	0
16:30 - 16:45	0	0	0	0	0
16:45 - 17:00	0	0	0	0	0
17:00 - 17:15	0	0	0	0	0
17:15 - 17:30	0	0	0	0	0
17:30 - 17:45	0	0	0	0	0
17:45 - 18:00	0	0	0	0	0
Total	0	0	0	0	0



Transportation Services - Traffic Services

Turning Movement Count - Study Results

GLADSTONE AVE @ LYON ST

Survey Date: Wednesday, August 24, 2022

WO No: 40574

Start Time: 07:00

Device: Miovision

Full Study Diagram

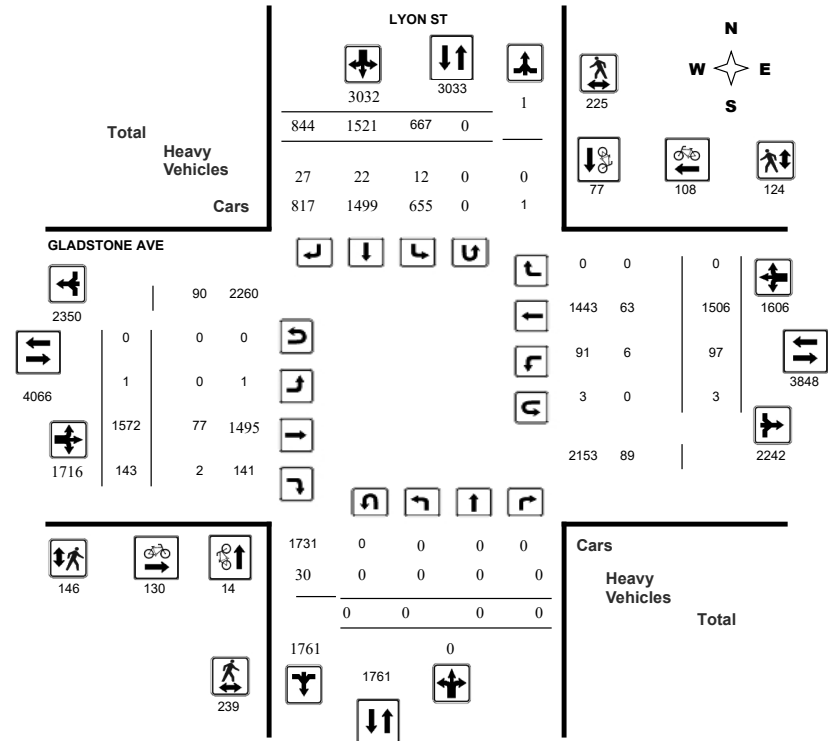



Transportation Services - Traffic Services

Turning Movement Count - Study Results

GLADSTONE AVE @ LYON ST

Survey Date: Wednesday, August 24, 2022

WO No: 40574

Start Time: 07:00

Device: Miovision

Full Study Peak Hour Diagram

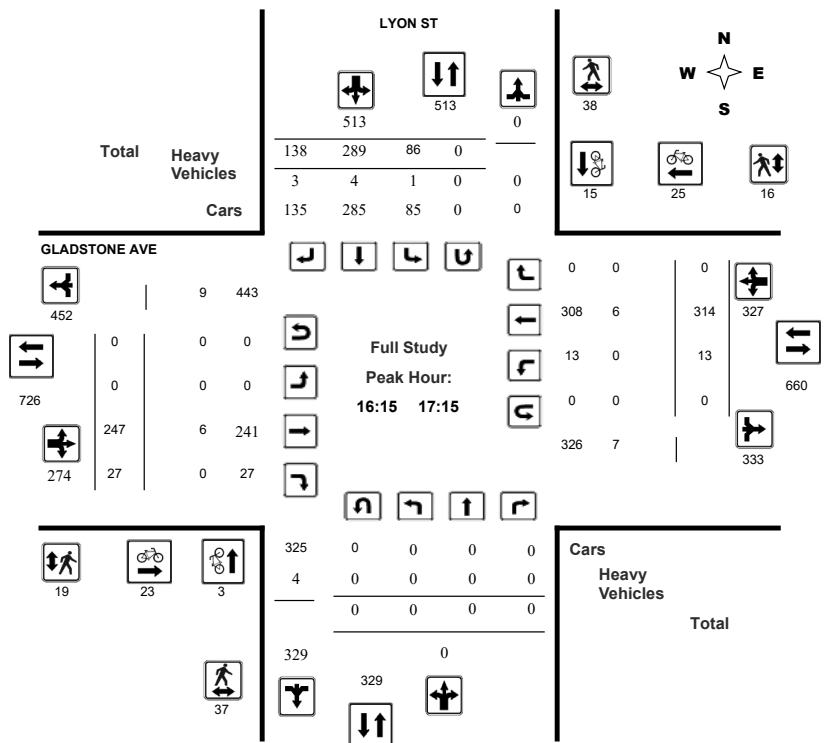

Transportation Services - Traffic Services

Turning Movement Count - Peak Hour Diagram

GLADSTONE AVE @ LYON ST

Survey Date: Wednesday, August 24, 2022

WO No: 40574

Start Time: 07:00

Device: Miovision

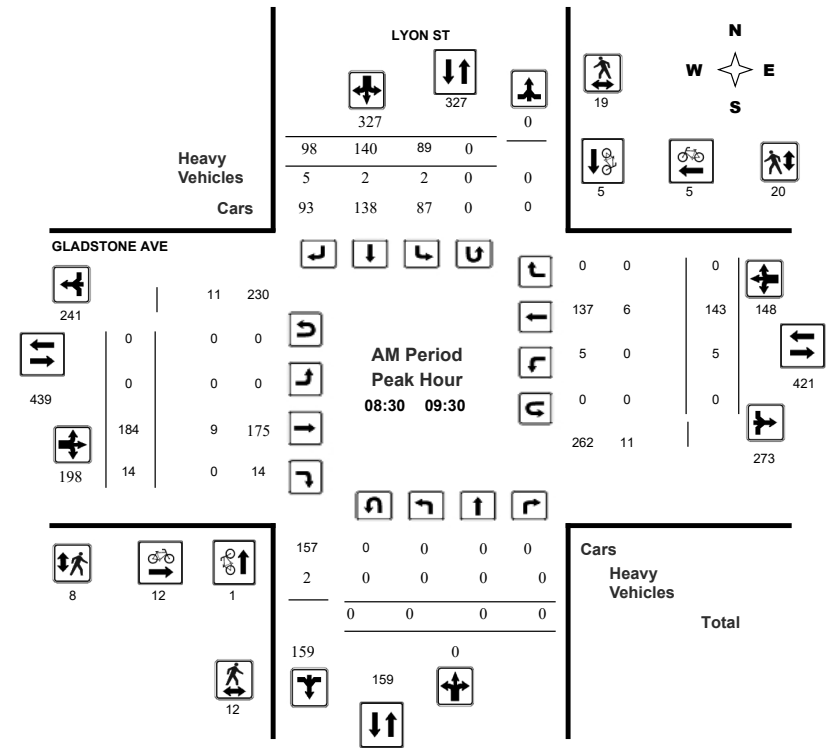



Transportation Services - Traffic Services

Turning Movement Count - Peak Hour Diagram

GLADSTONE AVE @ LYON ST

Survey Date: Wednesday, August 24, 2022
Start Time: 07:00

WO No: 40574
Device: Miovision

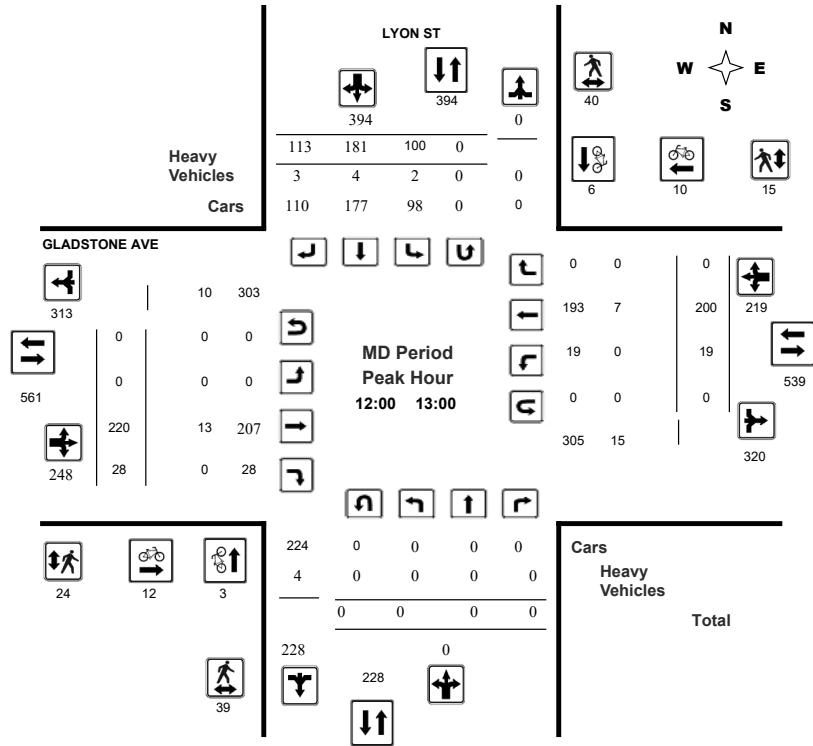

Comments



Transportation Services - Traffic Services

Turning Movement Count - Peak Hour Diagram

GLADSTONE AVE @ LYON ST

Survey Date: Wednesday, August 24, 2022
Start Time: 07:00

WO No: 40574
Device: Miovision

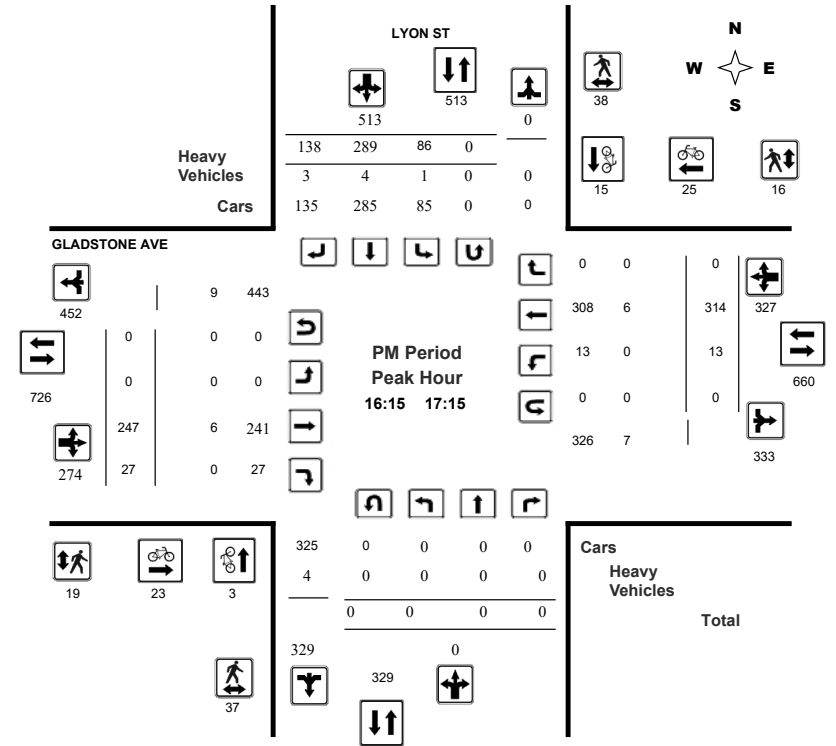

Comments



Transportation Services - Traffic Services

Turning Movement Count - Study Results

GLADSTONE AVE @ LYON ST

Survey Date: Wednesday, August 24, 2022
Start Time: 07:00

WO No: 40574
Device: Miovision

Full Study Summary (8 HR Standard)

Survey Date: Wednesday, August 24, 2022

Total Observed U-Turns AADT Factor
Northbound: 0 Southbound: 0 .90
Eastbound: 0 Westbound: 3

Period	LYON ST				GLADSTONE AVE												WB TOT	STR TOT	Grand Total
	Northbound		Southbound		Eastbound				Westbound										
	LT	ST	RT	NB TOT	LT	ST	RT	SB TOT	STR TOT	LT	ST	RT	EB TOT	LT	ST	RT			
07:00 08:00	0	0	0	0	60	133	66	259	259	0	125	6	131	7	88	0	95	226	485
08:00 09:00	0	0	0	0	92	149	98	339	339	0	155	9	164	9	104	0	113	277	616
09:00 10:00	0	0	0	0	60	143	82	285	285	0	184	18	202	2	137	0	139	341	626
11:30 12:30	0	0	0	0	89	176	113	378	378	0	217	22	239	20	197	0	217	456	834
12:30 13:30	0	0	0	0	91	172	103	366	366	1	227	20	248	17	204	0	221	469	835
15:00 16:00	0	0	0	0	96	212	122	430	430	0	198	18	216	14	216	0	230	446	876
16:00 17:00	0	0	0	0	85	273	143	501	501	0	229	25	254	12	315	0	327	581	1082
17:00 18:00	0	0	0	0	94	263	117	474	474	0	237	25	262	16	245	0	261	523	997
Sub Total	0	0	0	0	667	1521	844	3032	3032	1	1572	143	1716	97	1506	0	1603	3319	6351
U Turns	0				0				0				3				3	3	
Total	0	0	0	0	667	1521	844	3032	3032	1	1572	143	1716	97	1506	0	1606	3322	6354
EQ 12Hr	0	0	0	0	927	2114	1173	4214	4214	1	2185	199	2385	135	2093	0	2232	4618	8832
Note: These values are calculated by multiplying the totals by the appropriate expansion factor. 1.39																			
AVG 12Hr	0	0	0	0	834	2493	1383	3793	3793	1	1966	179	2146	122	1884	0	2009	4156	7949
Note: These volumes are calculated by multiplying the Equivalent 12 hr. totals by the AADT factor. .90																			
AVG 24Hr	0	0	0	0	1093	3266	1812	4969	4969	1	2575	234	2811	160	2468	0	2632	5444	10413
Note: These volumes are calculated by multiplying the Average Daily 12 hr. totals by 12 to 24 expansion factor. 1.31																			
Note: U-Turns provided for approach totals. Refer to 'U-Turn' Report for specific breakdown.																			



Transportation Services - Traffic Services

Turning Movement Count - Study Results

GLADSTONE AVE @ LYON ST

Survey Date: Wednesday, August 24, 2022
Start Time: 07:00

WO No: 40574
Device: Miovision

Full Study 15 Minute Increments

Time Period	LYON ST								GLADSTONE AVE								W TOT	STR TOT	Grand Total
	Northbound				Southbound				Eastbound				Westbound						
	LT	ST	RT	N TOT	LT	ST	RT	S TOT	STR TOT	LT	ST	RT	E TOT	LT	ST	RT			
07:00 07:15	0	0	0	0	10	23	13	46	46	0	20	3	23	0	12	0	12	35	81
07:15 07:30	0	0	0	0	17	29	14	60	60	0	29	0	29	1	23	0	24	53	113
07:30 07:45	0	0	0	0	18	31	15	64	64	0	43	2	45	3	28	0	31	76	140
07:45 08:00	0	0	0	0	15	50	24	89	89	0	33	1	34	3	25	0	28	62	151
08:00 08:15	0	0	0	0	20	37	20	77	77	0	36	3	39	1	23	0	25	64	141
08:15 08:30	0	0	0	0	21	40	22	83	83	0	31	1	32	3	17	0	20	52	135
08:30 08:45	0	0	0	0	31	34	24	89	89	0	44	3	47	5	30	0	35	82	171
08:45 09:00	0	0	0	0	20	38	32	90	90	0	44	2	46	0	34	0	34	80	170
09:00 09:15	0	0	0	0	16	34	17	67	67	0	54	4	58	0	47	0	47	105	172
09:15 09:30	0	0	0	0	22	34	25	81	81	0	42	5	47	0	32	0	32	79	160
09:30 09:45	0	0	0	0	10	47	19	76	76	0	39	5	44	1	26	0	27	71	147
09:45 10:00	0	0	0	0	12	28	21	61	61	0	49	4	53	1	32	0	33	86	147
11:30 11:45	0	0	0	0	11	51	31	93	93	0	56	7	63	5	48	0	54	117	210
11:45 12:00	0	0	0	0	30	36	23	89	89	0	58	2	60	4	52	0	56	116	205
12:00 12:15	0	0	0	0	29	52	27	108	108	0	56	3	59	6	43	0	49	108	216
12:15 12:30	0	0	0	0	19	37	32	88	88	0	47	10	57	5	54	0	59	116	204
12:30 12:45	0	0	0	0	27	43	27	97	97	0	66	4	70	4	47	0	51	121	218
12:45 13:00	0	0	0	0	25	49	27	101	101	0	51	11	62	4	56	0	60	122	223
13:00 13:15	0	0	0	0	23	48	22	93	93	1	54	4	59	4	52	0	56	115	208
13:15 13:30	0	0	0	0	16	32	27	75	75	0	56	1	57	5	49	0	54	111	186
15:00 15:15	0	0	0	0	19	48	29	96	96	0	56	5	61	2	56	0	58	119	215
15:15 15:30	0	0	0	0	26	57	36	119	119	0	50	3	53	4	50	0	55	108	227
15:30 15:45	0	0	0	0	29	52	27	108	108	0	40	4	44	5	54	0	59	103	211
15:45 16:00	0	0	0	0	22	55	30	107	107	0	52	6	58	3	56	0	59	117	224
16:00 16:15	0	0	0	0	21	55	27	103	103	0	50	5	55	2	67	0	69	124	227
16:15 16:30	0	0	0	0	27	79	39	145	145	0	64	8	72	4	79	0	83	155	300
16:30 16:45	0	0	0	0	18	76	44	138	138	0	49	6	55	1	85	0	86	141	279
16:45 17:00	0	0	0	0	19	63	33	115	115	0	66	6	72	5	84	0	89	161	276
17:00 17:15	0	0	0	0	22	71	22	115	115	0	68	7	75	3	66	0	69	144	259
17:15 17:30	0	0	0	0	31	77	27	135	135	0	66	11	77	6	58	0	64	141	276
17:30 17:45	0	0	0	0	21	60	31	112	112	0	59	3	62	4	69	0	73	135	247
17:45 18:00	0	0	0	0	20	55	37	112	112	0	44	4	48	3	52	0	55	103	215
Total:	0	0	0	0	667	1521	844	3032	3032	1	1572	143	1716	97	1506	0	1606	3322	6,354

Note: U-Turns are included in Totals.



Transportation Services - Traffic Services

Turning Movement Count - Study Results

GLADSTONE AVE @ LYON ST

Survey Date: Wednesday, August 24, 2022

WO No: 40574

Start Time: 07:00

Device: Miovision

Full Study Cyclist Volume

Time Period	LYON ST			GLADSTONE AVE			Grand Total
	Northbound	Southbound	Street Total	Eastbound	Westbound	Street Total	
07:00 07:15	0	2	2	3	4	7	9
07:15 07:30	0	0	0	2	1	3	3
07:30 07:45	0	0	0	4	2	6	6
07:45 08:00	1	1	2	7	1	8	10
08:00 08:15	0	4	4	4	3	7	11
08:15 08:30	1	0	1	3	0	3	4
08:30 08:45	1	0	1	2	1	3	4
08:45 09:00	0	3	3	3	1	4	7
09:00 09:15	0	2	2	2	1	3	5
09:15 09:30	0	0	0	5	2	7	7
09:30 09:45	0	1	1	2	2	4	5
09:45 10:00	0	1	1	2	1	3	4
11:30 11:45	0	3	3	2	2	4	7
11:45 12:00	0	3	3	6	4	10	13
12:00 12:15	0	2	2	4	1	5	7
12:15 12:30	2	1	3	4	3	7	10
12:30 12:45	0	0	0	2	3	5	5
12:45 13:00	1	3	4	2	3	5	9
13:00 13:15	0	3	3	5	1	6	9
13:15 13:30	0	7	7	2	1	3	10
15:00 15:15	0	2	2	7	4	11	13
15:15 15:30	0	0	0	9	7	16	16
15:30 15:45	0	2	2	2	2	4	6
15:45 16:00	1	1	2	1	4	5	7
16:00 16:15	4	3	7	10	8	18	25
16:15 16:30	1	4	5	8	5	13	18
16:30 16:45	1	2	3	5	5	10	13
16:45 17:00	1	5	6	4	10	14	20
17:00 17:15	0	4	4	6	5	11	15
17:15 17:30	0	10	10	3	7	10	20
17:30 17:45	0	6	6	2	7	9	15
17:45 18:00	0	2	2	7	7	14	16
Total	14	77	91	130	108	238	329



Transportation Services - Traffic Services

Turning Movement Count - Study Results

GLADSTONE AVE @ LYON ST

Survey Date: Wednesday, August 24, 2022

WO No: 40574

Start Time: 07:00

Device: Miovision

Full Study Pedestrian Volume

Time Period	LYON ST			GLADSTONE AVE			Grand Total
	NB Approach (E or W Crossing)	SB Approach (E or W Crossing)	Total	EB Approach (N or S Crossing)	WB Approach (N or S Crossing)	Total	
07:00 07:15	1	0	1	0	0	0	1
07:15 07:30	1	0	1	1	2	3	4
07:30 07:45	1	3	4	1	0	1	5
07:45 08:00	11	6	17	1	9	10	27
08:00 08:15	5	3	7	2	3	5	12
08:15 08:30	2	3	5	4	4	8	13
08:30 08:45	3	5	8	0	4	4	12
08:45 09:00	6	7	11	4	8	12	23
09:00 09:15	1	1	2	3	3	6	8
09:15 09:30	2	8	10	1	5	6	16
09:30 09:45	5	6	11	6	3	9	20
09:45 10:00	11	3	14	3	3	6	20
11:30 11:45	4	7	11	5	2	7	18
11:45 12:00	16	5	21	0	4	4	25
12:00 12:15	6	9	15	5	3	8	23
12:15 12:30	15	12	27	8	3	11	38
12:30 12:45	10	8	18	5	3	8	26
12:45 13:00	8	11	19	6	6	12	31
13:00 13:15	13	5	18	8	4	12	30
13:15 13:30	8	2	10	7	6	13	23
15:00 15:15	4	10	14	5	1	6	20
15:15 15:30	12	15	27	6	2	8	35
15:30 15:45	11	5	16	5	7	12	28
15:45 16:00	5	12	17	6	4	10	27
16:00 16:15	7	5	12	11	1	12	24
16:15 16:30	11	8	19	5	4	9	28
16:30 16:45	9	9	18	4	8	12	30
16:45 17:00	5	10	15	5	3	8	23
17:00 17:15	12	11	23	5	1	6	29
17:15 17:30	19	18	37	17	3	20	57
17:30 17:45	6	10	16	3	7	10	26
17:45 18:00	9	11	20	4	8	12	32
Total	239	225	464	146	124	270	734



Transportation Services - Traffic Services

Turning Movement Count - Study Results

GLADSTONE AVE @ LYON ST

Survey Date: Wednesday, August 24, 2022

WO No: 40574

Start Time: 07:00

Device: Miovision

Full Study Heavy Vehicles

LYON ST				GLADSTONE AVE																
		Northbound		Southbound		Eastbound		Westbound												
Time Period	LT	ST	RT	N TOT	LT	ST	RT	S TOT	STR TOT	LT	ST	RT	E TOT	LT	ST	RT	W TOT	STR TOT	Grand Total	
07:00	07:15	0	0	0	1	0	1	1	2	3	0	2	0	5	0	2	0	4	9	6
07:15	07:30	0	0	0	1	1	0	1	2	3	0	0	0	2	1	1	0	3	5	4
07:30	07:45	0	0	0	2	0	0	0	2	0	0	0	10	2	5	0	12	22	12	
07:45	08:00	0	0	0	0	0	2	2	2	2	0	2	0	6	0	2	0	4	10	6
08:00	08:15	0	0	0	1	1	1	1	3	4	0	2	0	6	0	3	0	6	12	8
08:15	08:30	0	0	0	1	0	1	1	2	3	0	2	0	5	0	2	0	4	9	6
08:30	08:45	0	0	0	1	1	1	1	3	4	0	1	0	3	0	1	0	3	6	5
08:45	09:00	0	0	0	0	0	1	1	1	1	0	1	0	4	0	2	0	3	7	4
09:00	09:15	0	0	0	0	1	0	2	3	3	0	4	0	8	0	2	0	7	15	9
09:15	09:30	0	0	0	1	0	1	1	2	3	0	3	0	5	0	1	0	4	9	6
09:30	09:45	0	0	0	3	0	2	0	2	5	0	1	1	2	0	0	0	1	3	4
09:45	10:00	0	0	0	1	1	0	0	1	2	0	3	1	7	0	3	0	7	14	8
11:30	11:45	0	0	0	1	0	0	3	3	4	0	4	0	9	1	2	0	7	16	10
11:45	12:00	0	0	0	2	0	2	1	3	5	0	2	0	5	0	2	0	4	9	7
12:00	12:15	0	0	0	1	0	1	1	2	3	0	2	0	5	0	2	0	4	9	6
12:15	12:30	0	0	0	0	0	0	0	0	0	0	4	0	6	0	2	0	6	12	6
12:30	12:45	0	0	0	2	1	2	2	5	7	0	2	0	6	0	2	0	5	11	9
12:45	13:00	0	0	0	1	1	1	0	2	3	0	5	0	6	0	1	0	7	13	8
13:00	13:15	0	0	0	0	1	0	2	3	3	0	3	0	9	0	4	0	8	17	10
13:15	13:30	0	0	0	2	0	1	2	3	5	0	1	0	6	1	3	0	5	11	8
15:00	15:15	0	0	0	2	0	2	0	2	4	0	4	0	7	0	3	0	7	14	9
15:15	15:30	0	0	0	0	1	0	1	2	2	0	1	0	3	0	1	0	3	6	4
15:30	15:45	0	0	0	0	2	0	0	2	2	0	6	0	10	0	4	0	12	22	12
15:45	16:00	0	0	0	1	0	1	0	1	2	0	2	0	4	0	2	0	4	8	5
16:00	16:15	0	0	0	1	0	1	1	2	3	0	4	0	7	0	2	0	6	13	8
16:15	16:30	0	0	0	0	1	0	0	1	1	0	1	0	3	0	2	0	4	7	4
16:30	16:45	0	0	0	2	0	2	2	4	6	0	2	0	5	0	1	0	3	8	7
16:45	17:00	0	0	0	0	0	0	0	0	0	0	1	0	3	0	2	0	3	6	3
17:00	17:15	0	0	0	2	0	2	1	3	5	0	2	0	4	0	1	0	3	7	6
17:15	17:30	0	0	0	1	0	0	0	0	1	0	2	0	4	1	2	0	5	9	5
17:30	17:45	0	0	0	0	0	0	0	0	0	0	0	0	1	0	1	0	1	2	1
17:45	18:00	0	0	0	0	0	0	0	0	0	0	3	0	3	0	0	0	3	6	3
Total:	None	0	0	0	30	12	22	27	61	91	0	77	2	169	6	63	0	158	327	209



Transportation Services - Traffic Services

Turning Movement Count - Study Results

GLADSTONE AVE @ LYON ST

Survey Date: Wednesday, August 24, 2022

WO No: 40574

Start Time: 07:00

Device: Miovision

Full Study 15 Minute U-Turn Total

		LYON ST		GLADSTONE AVE			
Time Period		Northbound U-Turn Total	Southbound U-Turn Total	Eastbound U-Turn Total	Westbound U-Turn Total	Total	
07:00	07:15	0	0	0	0	0	0
07:15	07:30	0	0	0	0	0	0
07:30	07:45	0	0	0	0	0	0
07:45	08:00	0	0	0	0	0	0
08:00	08:15	0	0	0	1	1	1
08:15	08:30	0	0	0	0	0	0
08:30	08:45	0	0	0	0	0	0
08:45	09:00	0	0	0	0	0	0
09:00	09:15	0	0	0	0	0	0
09:15	09:30	0	0	0	0	0	0
09:30	09:45	0	0	0	0	0	0
09:45	10:00	0	0	0	0	0	0
11:30	11:45	0	0	0	1	1	1
11:45	12:00	0	0	0	0	0	0
12:00	12:15	0	0	0	0	0	0
12:15	12:30	0	0	0	0	0	0
12:30	12:45	0	0	0	0	0	0
12:45	13:00	0	0	0	0	0	0
13:00	13:15	0	0	0	0	0	0
13:15	13:30	0	0	0	0	0	0
15:00	15:15	0	0	0	0	0	0
15:15	15:30	0	0	0	1	1	1
15:30	15:45	0	0	0	0	0	0
15:45	16:00	0	0	0	0	0	0
16:00	16:15	0	0	0	0	0	0
16:15	16:30	0	0	0	0	0	0
16:30	16:45	0	0	0	0	0	0
16:45	17:00	0	0	0	0	0	0
17:00	17:15	0	0	0	0	0	0
17:15	17:30	0	0	0	0	0	0
17:30	17:45	0	0	0	0	0	0
17:45	18:00	0	0	0	0	0	0
Total		0	0	0	3	3	3



Transportation Services - Traffic Services

Turning Movement Count - Full Study Peak Hour Diagram

KENT ST @ SOMERSET ST

Survey Date: Wednesday, April 05, 2017
Start Time: 07:00

WO No: 36850
Device: Miovision

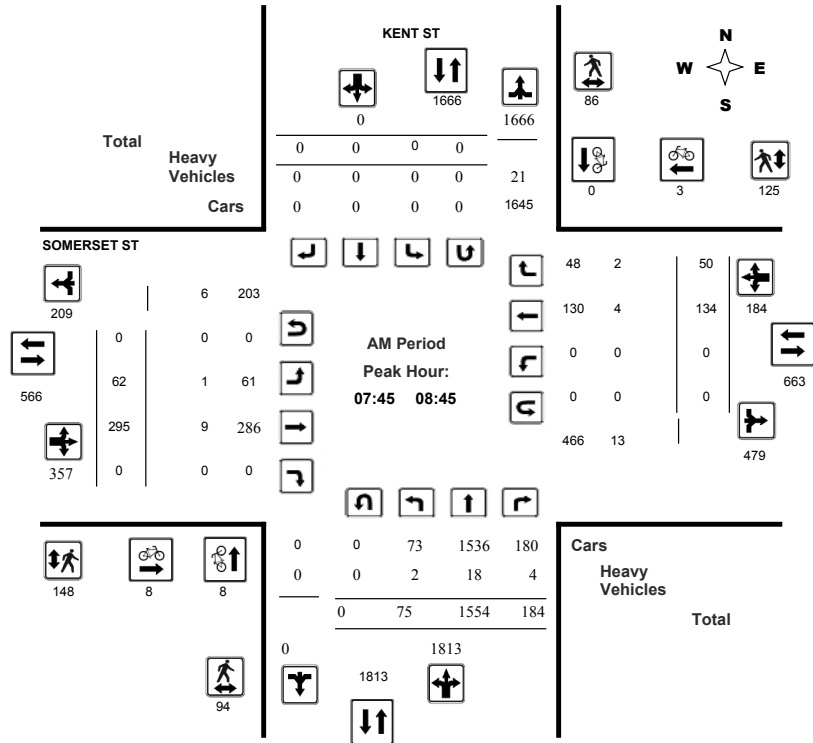

Comments



Transportation Services - Traffic Services

Turning Movement Count - Full Study Peak Hour Diagram

KENT ST @ SOMERSET ST

Survey Date: Wednesday, April 05, 2017
Start Time: 07:00

WO No: 36850
Device: Miovision

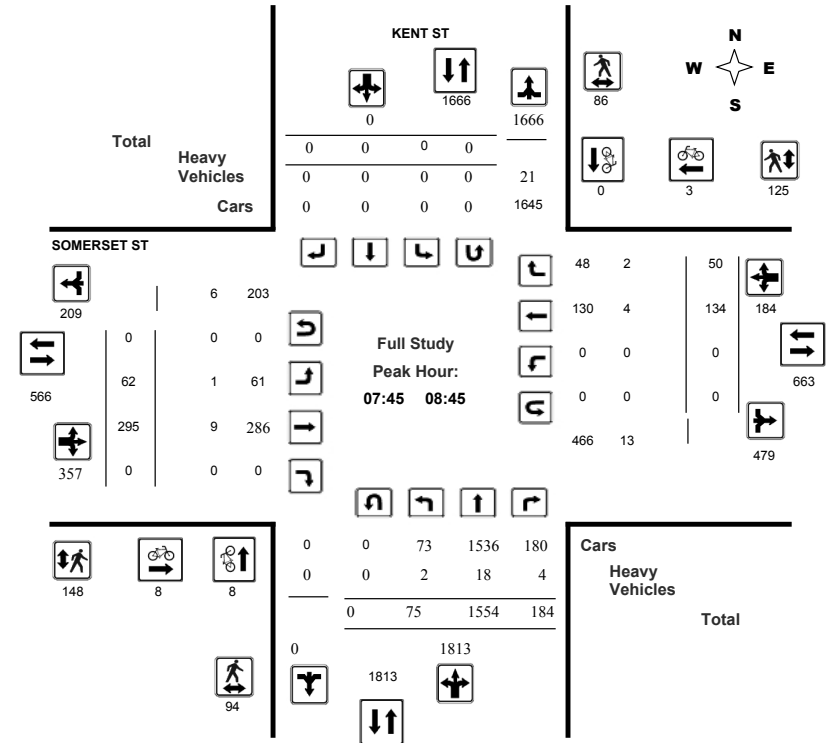

Comments



Transportation Services - Traffic Services

Turning Movement Count - Full Study Peak Hour Diagram

KENT ST @ SOMERSET ST

Survey Date: Wednesday, April 05, 2017
Start Time: 07:00

WO No: 36850
Device: Miovision

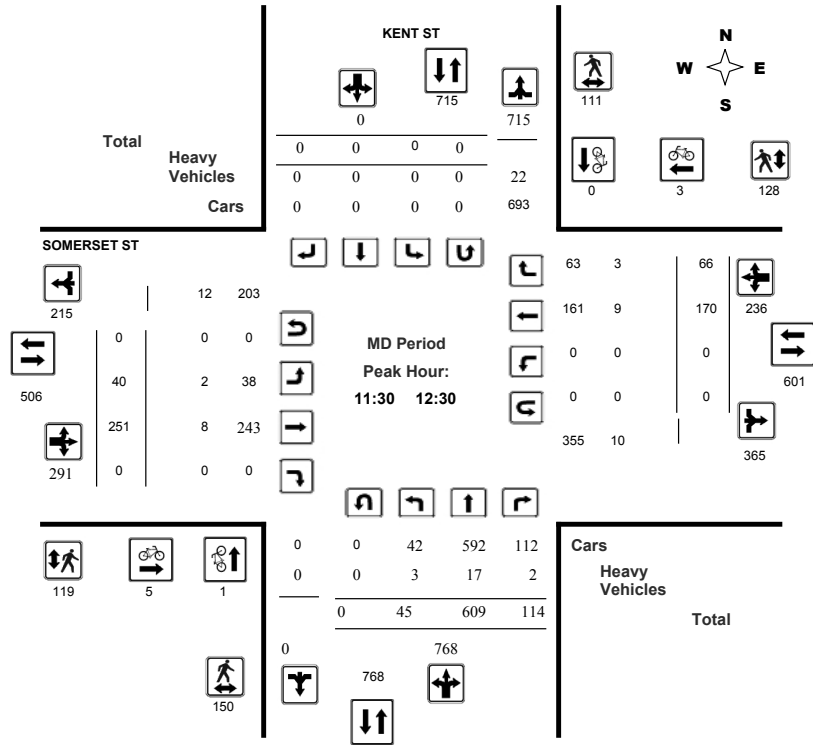

Comments



Transportation Services - Traffic Services

Turning Movement Count - Full Study Peak Hour Diagram

KENT ST @ SOMERSET ST

Survey Date: Wednesday, April 05, 2017
Start Time: 07:00

WO No: 36850
Device: Miovision

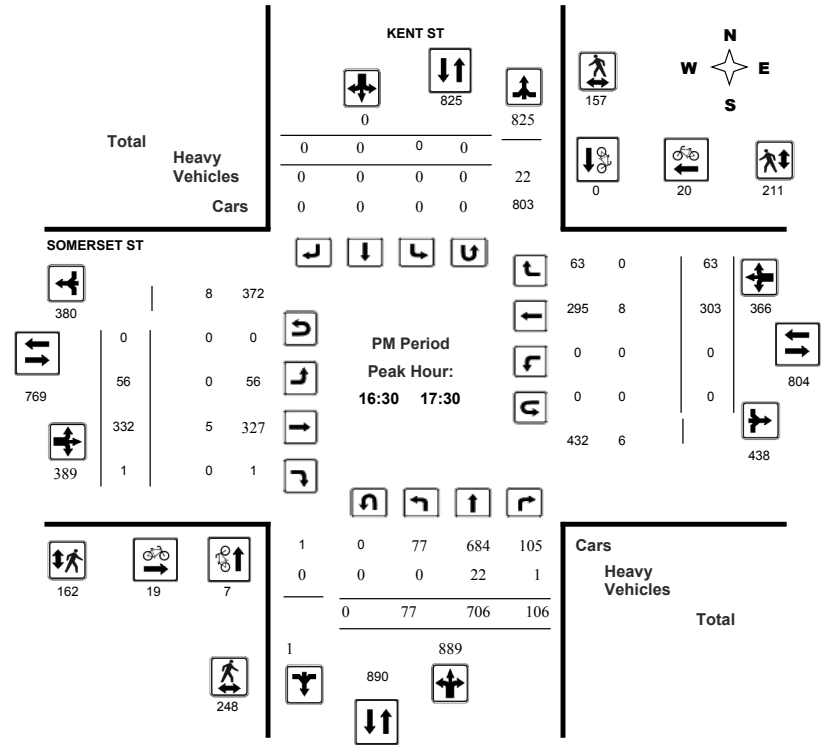

Comments



Transportation Services - Traffic Services
Turning Movement Count - Full Study Diagram

KENT ST @ SOMERSET ST

Survey Date: Wednesday, April 05, 2017

WO#: 36850
Device: Miovision

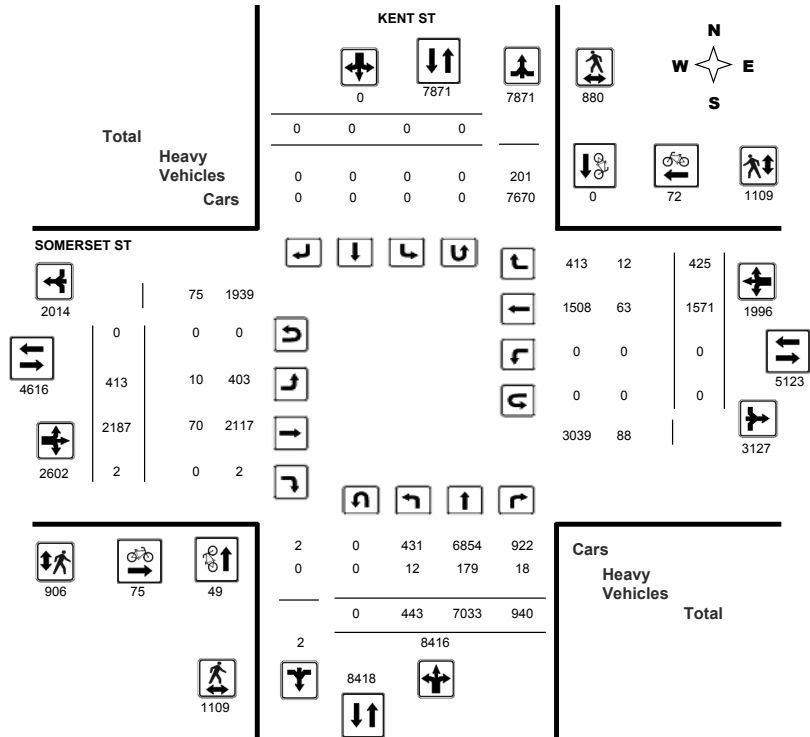

Comments



Transportation Services - Traffic Services

Work Order
36850

Turning Movement Count - Full Study Summary Report

KENT ST @ SOMERSET ST

Survey Date: Wednesday, April 05, 2017

Total Observed U-Turns
Northbound: 0 Southbound: 0
Eastbound: 0 Westbound: 0
AADT Factor: .90

Full Study

Period	KENT ST				SOMERSET ST				Grand Total											
	Northbound		Southbound		Eastbound		Westbound													
	LT	ST	RT	NB TOT	LT	ST	RT	SB TOT	STR TOT	LT	ST	RT	EB TOT	LT	ST	RT	WB TOT	STR TOT		
07:00 08:00	53	1393	126	1572	0	0	0	0	1572	46	245	0	291	0	93	44	137	428	2000	
08:00 09:00	69	1516	190	1775	0	0	0	0	1775	68	301	0	369	0	152	48	200	569	2344	
09:00 10:00	48	944	106	1098	0	0	0	0	1098	56	233	0	289	0	166	40	206	495	1593	
11:30 12:30	45	609	114	768	0	0	0	0	768	40	251	0	291	0	170	66	236	527	1295	
12:30 13:30	42	530	90	662	0	0	0	0	662	45	242	1	288	0	161	41	202	490	1152	
15:00 16:00	56	651	113	820	0	0	0	0	820	35	305	0	340	0	251	56	307	647	1467	
16:00 17:00	64	682	96	842	0	0	0	0	842	61	330	1	392	0	318	66	384	776	1618	
17:00 18:00	66	708	105	879	0	0	0	0	879	62	280	0	342	0	260	64	324	666	1545	
Sub Total	443	7033	940	8416	0	0	0	0	8416	413	2187	2	2602	0	1571	425	1996	4598	13014	
U Turns	0	0	0	0	0	0	0	0	0	0	0	0	0	0	0	0	0	0	0	
Total	443	7033	940	8416	0	0	0	0	8416	413	2187	2	2602	0	1571	425	1996	4598	13014	
EQ 12Hr	616	9776	1307	11698	0	0	0	0	11698	574	3040	3	3617	0	2184	591	2774	6391	18089	
Note: These values are calculated by multiplying the totals by the appropriate expansion factor.													1.39							
AVG 12Hr	554	8798	1176	10528	0	0	0	0	10528	517	2736	3	3255	0	1965	532	2497	5752	16280	
Note: These volumes are calculated by multiplying the Equivalent 12 hr. totals by the AADT factor.													.90							
AVG 24Hr	726	11526	1540	13792	0	0	0	0	13792	677	3584	3	4264	0	2575	696	3271	7535	21327	
Note: These volumes are calculated by multiplying the Average Daily 12 hr. totals by 12 to 24 expansion factor.													1.31							

Comments:

Note: U-Turns provided for approach totals. Refer to 'U-Turn' Report for specific breakdown.



Transportation Services - Traffic Services W.O. 36850
Turning Movement Count - 15 Minute Summary Report

KENT ST @ SOMERSET ST

Survey Date: Wednesday, April 05, 2017

Total Observed U-Turns
 Northbound: 0 Southbound: 0
 Eastbound: 0 Westbound: 0

KENT ST				SOMERSET ST				Grand Total											
Northbound		Southbound		Eastbound		Westbound													
Time Period	LT	ST	RT	N TOT	LT	ST	RT	S TOT	STR TOT	LT	ST	RT	E TOT	LT	ST	RT	W TOT	STR TOT	
07:00 07:15	8	312	26	346	0	0	0	0	346	6	61	0	67	0	14	12	26	93	439
07:15 07:30	8	335	33	376	0	0	0	0	376	7	46	0	53	0	22	9	31	84	460
07:30 07:45	12	348	30	390	0	0	0	0	390	16	65	0	81	0	35	11	46	127	517
07:45 08:00	25	398	37	460	0	0	0	0	460	17	73	0	90	0	22	12	34	124	584
08:00 08:15	17	373	39	429	0	0	0	0	429	14	68	0	82	0	29	12	41	123	552
08:15 08:30	18	416	46	480	0	0	0	0	480	12	67	0	79	0	41	15	56	135	615
08:30 08:45	15	367	62	444	0	0	0	0	444	19	87	0	106	0	42	11	53	159	603
08:45 09:00	19	360	43	422	0	0	0	0	422	23	79	0	102	0	40	10	50	152	574
09:00 09:15	9	306	34	349	0	0	0	0	349	14	59	0	73	0	42	11	53	126	475
09:15 09:30	16	250	20	286	0	0	0	0	286	13	60	0	73	0	42	9	51	124	410
09:30 09:45	10	202	27	239	0	0	0	0	239	13	55	0	68	0	38	13	51	119	358
09:45 10:00	13	186	25	224	0	0	0	0	224	16	59	0	75	0	44	7	51	126	350
11:30 11:45	12	145	31	188	0	0	0	0	188	10	61	0	71	0	40	22	62	133	321
11:45 12:00	9	197	28	234	0	0	0	0	234	12	63	0	75	0	49	12	61	136	370
12:00 12:15	15	125	27	167	0	0	0	0	167	9	66	0	75	0	47	17	64	139	306
12:15 12:30	9	142	28	179	0	0	0	0	179	9	61	0	70	0	34	15	49	119	298
12:30 12:45	9	139	23	171	0	0	0	0	171	13	56	0	69	0	48	9	57	126	297
12:45 13:00	14	121	24	159	0	0	0	0	159	8	64	0	72	0	37	9	46	118	277
13:00 13:15	8	141	21	170	0	0	0	0	170	8	68	0	76	0	44	19	63	139	309
13:15 13:30	11	129	22	162	0	0	0	0	162	16	54	1	71	0	32	4	36	107	269
15:00 15:15	11	144	30	185	0	0	0	0	185	3	80	0	83	0	53	20	73	156	341
15:15 15:30	16	183	26	225	0	0	0	0	225	13	78	0	91	0	60	8	68	159	384
15:30 15:45	15	175	17	207	0	0	0	0	207	9	72	0	81	0	70	13	83	164	371
15:45 16:00	14	149	40	203	0	0	0	0	203	10	75	0	85	0	68	15	83	168	371
16:00 16:15	18	158	21	197	0	0	0	0	197	18	88	0	106	0	73	16	89	195	392
16:15 16:30	13	172	17	202	0	0	0	0	202	15	64	0	79	0	85	22	107	186	388
16:30 16:45	14	181	26	221	0	0	0	0	221	12	85	0	97	0	82	11	93	190	411
16:45 17:00	19	171	32	222	0	0	0	0	222	16	93	1	110	0	78	17	95	205	427
17:00 17:15	24	167	29	220	0	0	0	0	220	9	76	0	85	0	76	12	88	173	393
17:15 17:30	20	187	19	226	0	0	0	0	226	19	78	0	97	0	67	23	90	187	413
17:30 17:45	7	193	24	224	0	0	0	0	224	16	69	0	85	0	68	18	86	171	395
17:45 18:00	15	161	33	209	0	0	0	0	209	18	57	0	75	0	49	11	60	135	344
TOTAL:	443	7033	940	8416	0	0	0	0	8416	413	2187	2	2602	0	1571	425	1996	4598	13014

Note: U-Turns are included in Totals.

Comment:



Transportation Services - Traffic Services
Turning Movement Count - Cyclist Volume Report

Work Order
36850

KENT ST @ SOMERSET ST

Count Date: Wednesday, April 05, 2017

Start Time: 07:00

Time Period	KENT ST			SOMERSET ST			Grand Total
	Northbound	Southbound	Street Total	Eastbound	Westbound	Street Total	
07:00 08:00	8	0	8	12	4	16	24
08:00 09:00	10	0	10	8	5	13	23
09:00 10:00	7	0	7	7	6	13	20
11:30 12:30	1	0	1	5	3	8	9
12:30 13:30	4	0	4	11	8	19	23
15:00 16:00	4	0	4	8	10	18	22
16:00 17:00	8	0	8	18	20	38	46
17:00 18:00	7	0	7	6	16	22	29
Total	49	0	49	75	72	147	196

Comment:

Note: These volumes consists of bicycles only (no mopeds or motorcycles) and ARE NOT included in the Turning Movement Count Summary.



Transportation Services - Traffic Services

W.O.
36850

Turning Movement Count - Heavy Vehicle Report

KENT ST @ SOMERSET ST

Survey Date: Wednesday, April 05, 2017

Time Period	KENT ST								SOMERSET ST								Grand Total		
	Northbound				Southbound				Eastbound				Westbound						
	LT	ST	RT	N TOT	LT	ST	RT	S TOT	STR TOT	LT	ST	RT	E TOT	LT	ST	RT		W TOT	STR TOT
07:00 08:00	2	18	1	21	0	0	0	0	21	2	10	0	12	0	7	2	9	21	42
08:00 09:00	3	20	5	28	0	0	0	0	28	2	13	0	15	0	6	2	8	23	51
09:00 10:00	2	30	3	35	0	0	0	0	35	1	15	0	16	0	13	1	14	30	65
11:30 12:30	3	17	2	22	0	0	0	0	22	2	8	0	10	0	9	3	12	22	44
12:30 13:30	1	14	0	15	0	0	0	0	15	2	5	0	7	0	6	2	8	15	30
15:00 16:00	0	34	5	39	0	0	0	0	39	0	7	0	7	0	8	0	8	15	54
16:00 17:00	1	27	1	29	0	0	0	0	29	1	7	0	8	0	7	1	8	16	45
17:00 18:00	0	19	1	20	0	0	0	0	20	0	5	0	5	0	7	1	8	13	33
Sub Total	12	179	18	209	0	0	0	0	209	10	70	0	80	0	63	12	75	155	364
U-Turns (Heavy Vehicles)	0	0	0	0	0	0	0	0	0	0	0	0	0	0	0	0	0	0	0
Total	12	179	18	209	0	0	0	0	209	10	70	0	80	0	63	12	75	155	364

Heavy Vehicles include Buses, Single-Unit Trucks and Articulated Trucks. Further, they ARE included in the Turning Movement Count Summary.



Transportation Services - Traffic Services

Work Order
36850

Turning Movement Count - Pedestrian Volume Report

KENT ST @ SOMERSET ST

Count Date: Wednesday, April 05, 2017

Start Time: 07:00

Time Period	NB Approach (E or W Crossing)	SB Approach (E or W Crossing)	Total	EB Approach (N or S Crossing)	WB Approach (N or S Crossing)	Total	Grand Total
07:00 07:15	2	7	9	3	12	15	24
07:15 07:30	11	13	24	14	14	28	52
07:30 07:45	5	15	20	10	24	34	54
07:45 08:00	23	21	44	36	27	63	107
07:00 08:00	41	56	97	63	77	140	237
08:00 08:15	22	18	40	27	27	54	94
08:15 08:30	17	22	39	32	38	70	109
08:30 08:45	32	25	57	53	33	86	143
08:45 09:00	26	22	48	35	29	64	112
08:00 09:00	97	87	184	147	127	274	458
09:00 09:15	30	17	47	33	22	55	102
09:15 09:30	22	16	38	30	30	60	98
09:30 09:45	20	16	36	19	14	33	69
09:45 10:00	23	16	39	18	25	43	82
09:00 10:00	95	65	160	100	91	191	351
11:30 11:45	36	17	53	12	22	34	87
11:45 12:00	42	24	66	36	32	68	134
12:00 12:15	35	33	68	43	39	82	150
12:15 12:30	37	37	74	28	35	63	137
11:30 12:30	150	111	261	119	128	247	508
12:30 12:45	27	38	65	28	35	63	128
12:45 13:00	40	33	73	33	36	69	142
13:00 13:15	32	29	61	29	37	66	127
13:15 13:30	23	29	52	12	32	44	96
12:30 13:30	122	129	251	102	140	242	493
15:00 15:15	28	32	60	30	31	61	121
15:15 15:30	19	30	49	29	27	56	105
15:30 15:45	55	27	82	32	45	77	159
15:45 16:00	30	40	70	18	39	57	127
15:00 16:00	132	129	261	109	142	251	512
16:00 16:15	49	29	78	19	56	75	153
16:15 16:30	60	38	98	38	53	91	189
16:30 16:45	66	45	111	51	70	121	232
16:45 17:00	55	32	87	46	54	100	187
16:00 17:00	230	144	374	154	233	387	761
17:00 17:15	71	40	111	33	45	78	189
17:15 17:30	56	40	96	32	42	74	170
17:30 17:45	50	27	77	16	44	60	137
17:45 18:00	65	52	117	31	40	71	188
17:00 18:00	242	159	401	112	171	283	684
Total	1109	880	1989	906	1109	2015	4004

Comment:



Transportation Services - Traffic Services

Work Order 36850

Turning Movement Count - 15 Min U-Turn Total Report

KENT ST @ SOMERSET ST

Survey Date: Wednesday, April 05, 2017

Table with columns: Time Period, Northbound U-Turn Total, Southbound U-Turn Total, Eastbound U-Turn Total, Westbound U-Turn Total, Total. Rows show 15-minute intervals from 07:00 to 18:00, with all counts being 0.



Transportation Services - Traffic Services

Turning Movement Count - Full Study Peak Hour Diagram

GILMOUR ST @ KENT ST

Survey Date: Wednesday, April 05, 2017

WO No: 36849

Start Time: 07:00

Device: Miovision

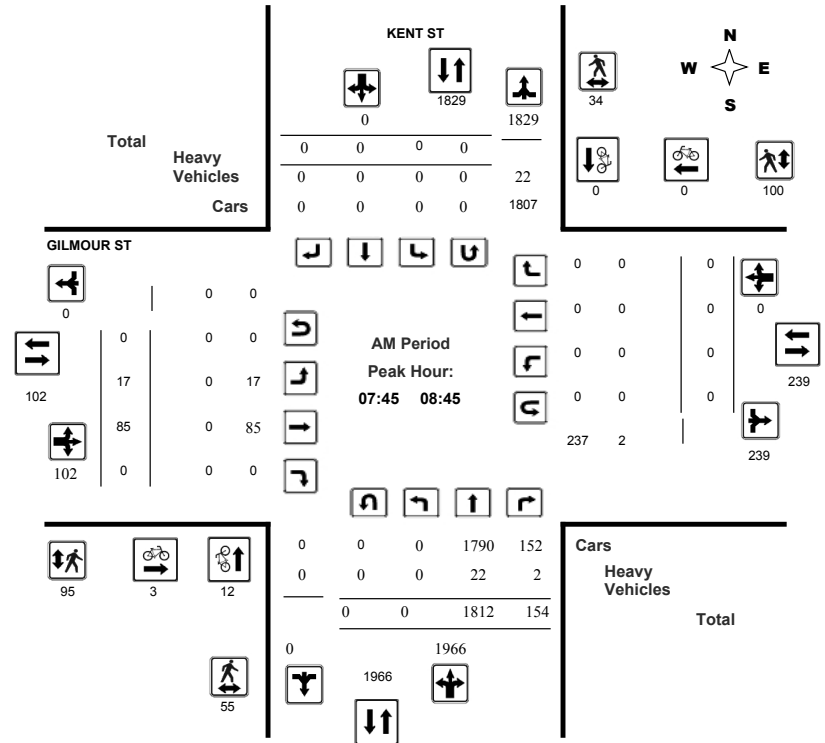

Comments



Transportation Services - Traffic Services

Turning Movement Count - Full Study Peak Hour Diagram

GILMOUR ST @ KENT ST

Survey Date: Wednesday, April 05, 2017
Start Time: 07:00

WO No: 36849
Device: Miovision

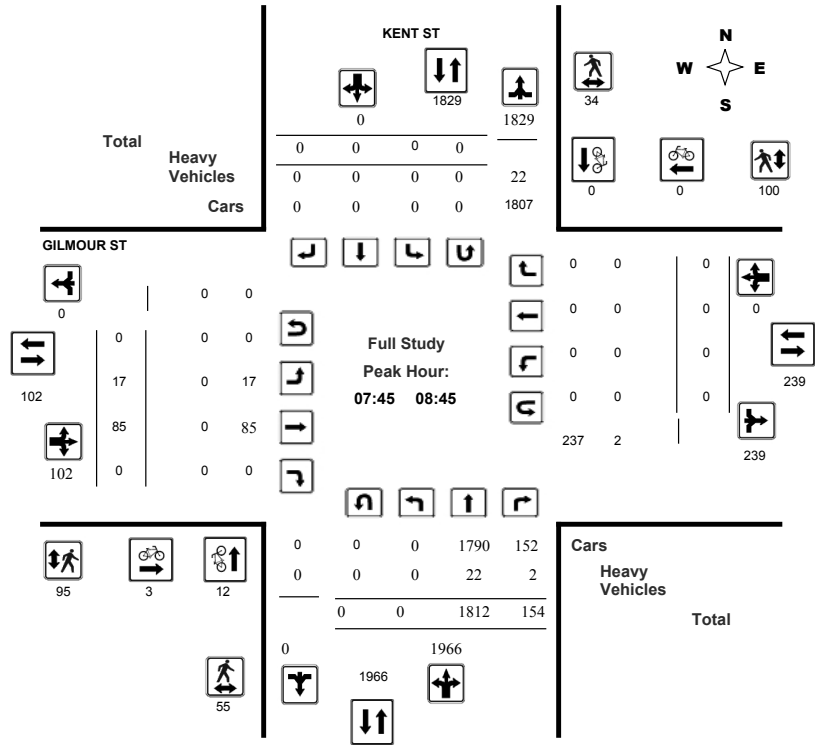

Comments



Transportation Services - Traffic Services

Turning Movement Count - Full Study Peak Hour Diagram

GILMOUR ST @ KENT ST

Survey Date: Wednesday, April 05, 2017
Start Time: 07:00

WO No: 36849
Device: Miovision

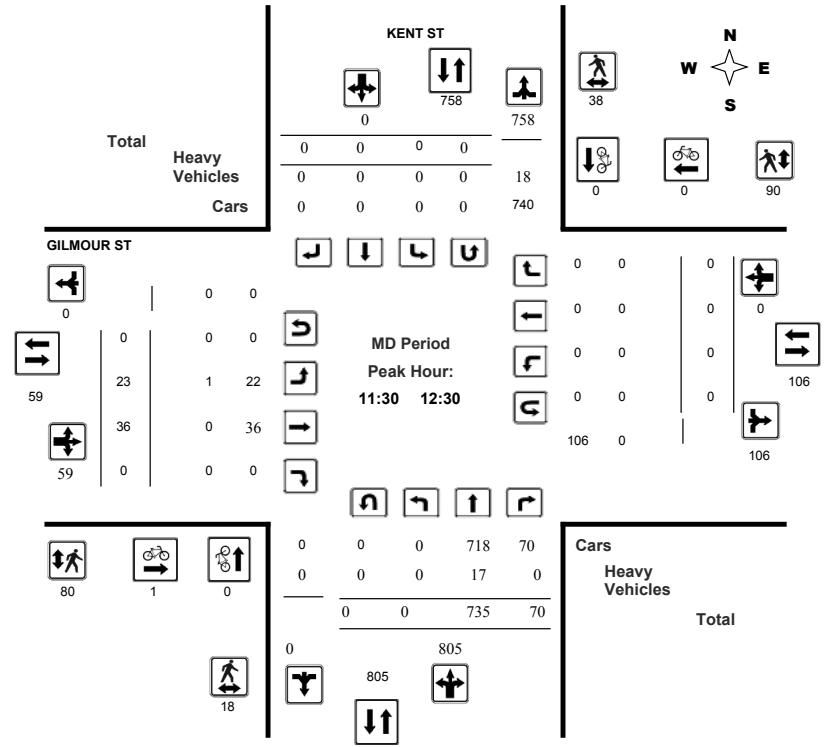

Comments



Transportation Services - Traffic Services

Turning Movement Count - Full Study Peak Hour Diagram

GILMOUR ST @ KENT ST

Survey Date: Wednesday, April 05, 2017
Start Time: 07:00

WO No: 36849
Device: Miovision

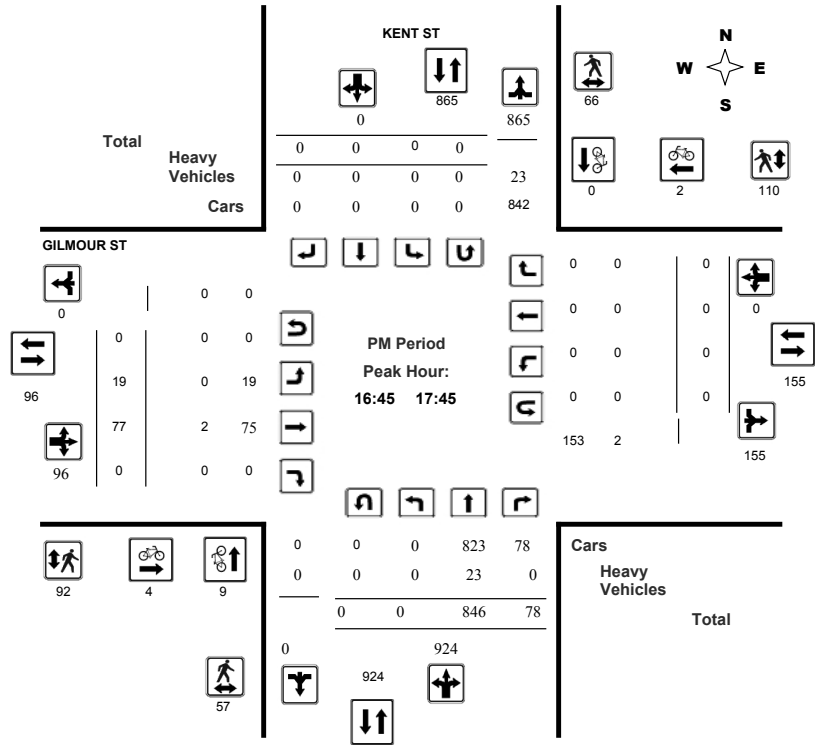

Comments



Transportation Services - Traffic Services

Turning Movement Count - Full Study Diagram

GILMOUR ST @ KENT ST

Survey Date: Wednesday, April 05, 2017

WO#: 36849
Device: Miovision

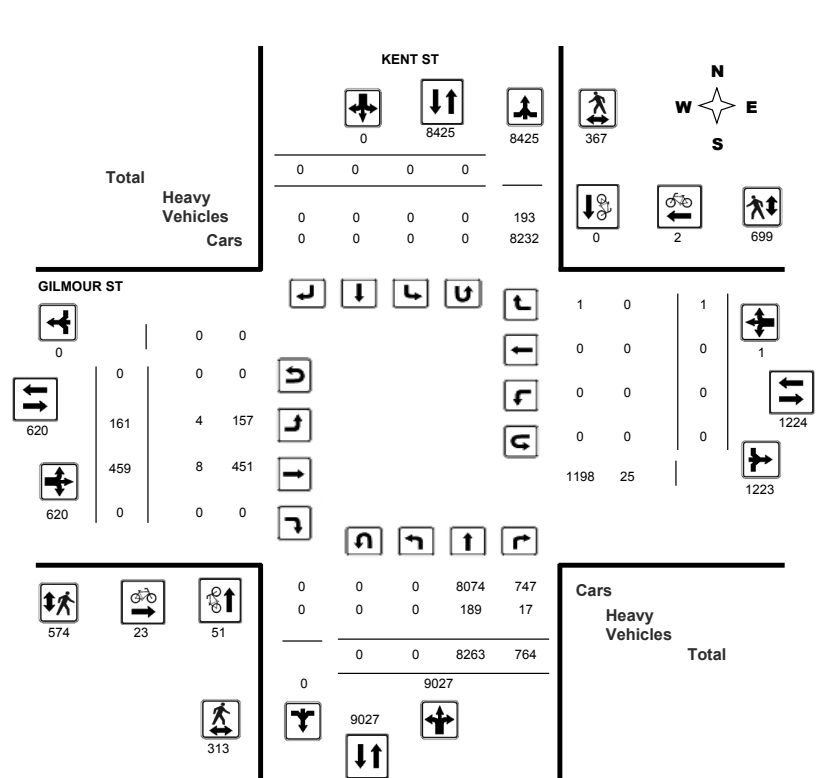

Comments



Transportation Services - Traffic Services

Work Order
36849

Turning Movement Count - Full Study Summary Report

GILMOUR ST @ KENT ST

Survey Date: Wednesday, April 05, 2017

Total Observed U-Turns		AADT Factor
Northbound: 0	Southbound: 0	.90
Eastbound: 0	Westbound: 0	

Full Study

Period	KENT ST				GILMOUR ST								WB TOT	STR TOT	Grand Total				
	Northbound		Southbound		Eastbound				Westbound										
	LT	ST	RT	NB TOT	LT	ST	RT	SB TOT	STR TOT	LT	ST	RT				EB TOT	LT	ST	RT
07:00 08:00	0	1629	91	1720	0	0	0	0	1720	14	41	0	55	0	0	0	0	55	1775
08:00 09:00	0	1767	156	1923	0	0	0	0	1923	19	98	0	117	0	0	0	0	117	2040
09:00 10:00	0	1075	123	1198	0	0	0	0	1198	30	46	0	76	0	0	1	1	77	1275
11:30 12:30	0	735	70	805	0	0	0	0	805	23	36	0	59	0	0	0	0	59	864
12:30 13:30	0	638	86	724	0	0	0	0	724	18	60	0	78	0	0	0	0	78	802
15:00 16:00	0	777	83	860	0	0	0	0	860	24	45	0	69	0	0	0	0	69	929
16:00 17:00	0	792	86	878	0	0	0	0	878	15	60	0	75	0	0	0	0	75	953
17:00 18:00	0	850	69	919	0	0	0	0	919	18	73	0	91	0	0	0	0	91	1010
Sub Total	0	8263	764	9027	0	0	0	0	9027	161	459	0	620	0	0	1	1	621	9648
U Turns				0				0					0					0	0
Total	0	8263	764	9027	0	0	0	0	9027	161	459	0	620	0	0	1	1	621	9648
EQ 12Hr	0	11486	1062	12548	0	0	0	0	12548	224	638	0	862	0	0	1	1	863	13411
Note: These values are calculated by multiplying the totals by the appropriate expansion factor.																			
1.39																			
AVG 12Hr	0	10337	956	11293	0	0	0	0	11293	201	574	0	776	0	0	1	1	777	12070
Note: These volumes are calculated by multiplying the Equivalent 12 hr. totals by the AADT factor.																			
.90																			
AVG 24Hr	0	13541	1252	14794	0	0	0	0	14794	264	752	0	1016	0	0	2	2	1018	15812
Note: These volumes are calculated by multiplying the Average Daily 12 hr. totals by 12 to 24 expansion factor.																			
1.31																			

Comments:

Note: U-Turns provided for approach totals. Refer to 'U-Turn' Report for specific breakdown.



Transportation Services - Traffic Services

W.O. 36849

Turning Movement Count - 15 Minute Summary Report

GILMOUR ST @ KENT ST

Survey Date: Wednesday, April 05, 2017

Total Observed U-Turns

Northbound: 0	Southbound: 0
Eastbound: 0	Westbound: 0

KENT ST

GILMOUR ST

Time Period	Northbound			Southbound			Eastbound			Westbound			W TOT	STR TOT	Grand Total				
	LT	ST	RT	N TOT	LT	ST	RT	S TOT	STR TOT	LT	ST	RT				E TOT	LT	ST	RT
07:00 07:15	0	361	16	377	0	0	0	0	377	2	8	0	10	0	0	0	0	10	387
07:15 07:30	0	394	21	415	0	0	0	0	415	3	10	0	13	0	0	0	0	13	428
07:30 07:45	0	409	23	432	0	0	0	0	432	3	10	0	13	0	0	0	0	13	445
07:45 08:00	0	465	31	496	0	0	0	0	496	6	13	0	19	0	0	0	0	19	515
08:00 08:15	0	430	43	473	0	0	0	0	473	7	30	0	37	0	0	0	0	37	510
08:15 08:30	0	480	43	523	0	0	0	0	523	3	19	0	22	0	0	0	0	22	545
08:30 08:45	0	437	37	474	0	0	0	0	474	1	23	0	24	0	0	0	0	24	498
08:45 09:00	0	420	33	453	0	0	0	0	453	8	26	0	34	0	0	0	0	34	487
09:00 09:15	0	351	26	377	0	0	0	0	377	7	17	0	24	0	0	0	0	24	401
09:15 09:30	0	276	30	306	0	0	0	0	306	8	12	0	20	0	0	0	0	20	326
09:30 09:45	0	248	30	278	0	0	0	0	278	8	12	0	20	0	0	1	1	21	299
09:45 10:00	0	200	37	237	0	0	0	0	237	7	5	0	12	0	0	0	0	12	249
11:30 11:45	0	179	23	202	0	0	0	0	202	4	5	0	9	0	0	0	0	9	211
11:45 12:00	0	220	21	241	0	0	0	0	241	6	14	0	20	0	0	0	0	20	261
12:00 12:15	0	165	16	181	0	0	0	0	181	5	9	0	14	0	0	0	0	14	195
12:15 12:30	0	171	10	181	0	0	0	0	181	8	8	0	16	0	0	0	0	16	197
12:30 12:45	0	169	12	181	0	0	0	0	181	4	13	0	17	0	0	0	0	17	198
12:45 13:00	0	154	26	180	0	0	0	0	180	4	12	0	16	0	0	0	0	16	196
13:00 13:15	0	161	25	186	0	0	0	0	186	6	14	0	20	0	0	0	0	20	206
13:15 13:30	0	154	23	177	0	0	0	0	177	4	21	0	25	0	0	0	0	25	202
15:00 15:15	0	178	17	195	0	0	0	0	195	7	13	0	20	0	0	0	0	20	215
15:15 15:30	0	205	23	228	0	0	0	0	228	5	10	0	15	0	0	0	0	15	243
15:30 15:45	0	206	22	228	0	0	0	0	228	4	13	0	17	0	0	0	0	17	245
15:45 16:00	0	188	21	209	0	0	0	0	209	8	9	0	17	0	0	0	0	17	226
16:00 16:15	0	179	24	203	0	0	0	0	203	5	13	0	18	0	0	0	0	18	221
16:15 16:30	0	191	18	209	0	0	0	0	209	4	17	0	21	0	0	0	0	21	230
16:30 16:45	0	215	19	234	0	0	0	0	234	2	14	0	16	0	0	0	0	16	250
16:45 17:00	0	207	25	232	0	0	0	0	232	4	16	0	20	0	0	0	0	20	252
17:00 17:15	0	200	13	213	0	0	0	0	213	6	21	0	27	0	0	0	0	27	240
17:15 17:30	0	226	26	252	0	0	0	0	252	7	18	0	25	0	0	0	0	25	277
17:30 17:45	0	213	14	227	0	0	0	0	227	2	22	0	24	0	0	0	0	24	251
17:45 18:00	0	211	16	227	0	0	0	0	227	3	12	0	15	0	0	0	0	15	242
TOTAL:	0	8263	764	9027	0	0	0	0	9027	161	459	0	620	0	0	1	1	621	9648

Note: U-Turns are included in Totals.

Comment:



Transportation Services - Traffic Services
Turning Movement Count - Cyclist Volume Report

Work Order
36849

GILMOUR ST @ KENT ST

Count Date: Wednesday, April 05, 2017

Start Time: 07:00

Time Period	KENT ST			GILMOUR ST			Grand Total
	Northbound	Southbound	Street Total	Eastbound	Westbound	Street Total	
07:00 08:00	7	0	7	3	0	3	10
08:00 09:00	13	0	13	2	0	2	15
09:00 10:00	3	0	3	5	0	5	8
11:30 12:30	0	0	0	1	0	1	1
12:30 13:30	3	0	3	3	0	3	6
15:00 16:00	5	0	5	4	0	4	9
16:00 17:00	9	0	9	1	0	1	10
17:00 18:00	11	0	11	4	2	6	17
Total	51	0	51	23	2	25	76

Comment:

Note: These volumes consists of bicycles only (no mopeds or motorcycles) and ARE NOT included in the Turning Movement Count Summary.



Transportation Services - Traffic Services
Turning Movement Count - Heavy Vehicle Report

W.O.
36849

GILMOUR ST @ KENT ST

Survey Date: Wednesday, April 05, 2017

Time Period	KENT ST								GILMOUR ST								W TOT	STR TOT	Grand Total
	Northbound				Southbound				Eastbound				Westbound						
	LT	ST	RT	N TOT	LT	ST	RT	S TOT	LT	ST	RT	E TOT	LT	ST	RT	W TOT			
07:00 08:00	0	22	2	24	0	0	0	0	24	0	0	0	0	0	0	0	0	24	
08:00 09:00	0	24	2	26	0	0	0	0	26	0	1	0	1	0	0	0	0	27	
09:00 10:00	0	28	5	33	0	0	0	0	33	1	0	0	1	0	0	0	1	34	
11:30 12:30	0	17	0	17	0	0	0	0	17	1	0	0	1	0	0	0	1	18	
12:30 13:30	0	17	1	18	0	0	0	0	18	0	1	0	1	0	0	0	1	19	
15:00 16:00	0	33	4	37	0	0	0	0	37	2	3	0	5	0	0	0	5	42	
16:00 17:00	0	30	3	33	0	0	0	0	33	0	1	0	1	0	0	0	1	34	
17:00 18:00	0	18	0	18	0	0	0	0	18	0	2	0	2	0	0	0	2	20	
Sub Total	0	189	17	206	0	0	0	0	206	4	8	0	12	0	0	0	12	218	
U-Turns (Heavy Vehicles)	0	0	0	0	0	0	0	0	0	0	0	0	0	0	0	0	0	0	
Total	0	189	17	206	0	0	0	0	206	4	8	0	12	0	0	0	12	218	

Heavy Vehicles include Buses, Single-Unit Trucks and Articulated Trucks. Further, they ARE included in the Turning Movement Count Summary.



Transportation Services - Traffic Services
Turning Movement Count - Pedestrian Volume Report

Work Order
36849

GILMOUR ST @ KENT ST

Count Date: Wednesday, April 05, 2017		Start Time: 07:00					
Time Period	NB Approach (E or W Crossing)	SB Approach (E or W Crossing)	Total	EB Approach (N or S Crossing)	WB Approach (N or S Crossing)	Total	Grand Total
07:00 07:15	3	9	12	3	13	16	28
07:15 07:30	5	7	12	9	6	15	27
07:30 07:45	1	5	6	5	18	23	29
07:45 08:00	12	8	20	14	22	36	56
07:00 08:00	21	29	50	31	59	90	140
08:00 08:15	10	8	18	21	22	43	61
08:15 08:30	15	7	22	32	24	56	78
08:30 08:45	18	11	29	28	32	60	89
08:45 09:00	18	9	27	17	21	38	65
08:00 09:00	61	35	96	98	99	197	293
09:00 09:15	11	6	17	19	17	36	53
09:15 09:30	15	10	25	14	11	25	50
09:30 09:45	9	7	16	17	19	36	52
09:45 10:00	8	13	21	14	20	34	55
09:00 10:00	43	36	79	64	67	131	210
11:30 11:45	3	9	12	12	17	29	41
11:45 12:00	4	10	14	22	30	52	66
12:00 12:15	4	9	13	19	23	42	55
12:15 12:30	7	10	17	27	20	47	64
11:30 12:30	18	38	56	80	90	170	226
12:30 12:45	11	14	25	27	30	57	82
12:45 13:00	8	13	21	16	23	39	60
13:00 13:15	9	15	24	12	16	28	52
13:15 13:30	9	12	21	8	17	25	46
12:30 13:30	37	54	91	63	86	149	240
15:00 15:15	8	9	17	16	20	36	53
15:15 15:30	13	20	33	18	18	36	69
15:30 15:45	13	13	26	25	24	49	75
15:45 16:00	9	17	26	13	31	44	70
15:00 16:00	43	59	102	72	93	165	267
16:00 16:15	6	11	17	14	22	36	53
16:15 16:30	8	16	24	17	28	45	69
16:30 16:45	11	17	28	28	31	59	87
16:45 17:00	15	21	36	23	45	68	104
16:00 17:00	40	65	105	82	126	208	313
17:00 17:15	15	17	32	18	29	47	79
17:15 17:30	20	11	31	28	19	47	78
17:30 17:45	7	17	24	23	17	40	64
17:45 18:00	8	6	14	15	14	29	43
17:00 18:00	50	51	101	84	79	163	264
Total	313	367	680	574	699	1273	1953

Comment:



Transportation Services - Traffic Services
Turning Movement Count - 15 Min U-Turn Total Report
GILMOUR ST @ KENT ST

Work Order
36849

Survey Date: Wednesday, April 05, 2017

Time Period	Northbound U-Turn Total	Southbound U-Turn Total	Eastbound U-Turn Total	Westbound U-Turn Total	Total
07:00 07:15	0	0	0	0	0
07:15 07:30	0	0	0	0	0
07:30 07:45	0	0	0	0	0
07:45 08:00	0	0	0	0	0
08:00 08:15	0	0	0	0	0
08:15 08:30	0	0	0	0	0
08:30 08:45	0	0	0	0	0
08:45 09:00	0	0	0	0	0
09:00 09:15	0	0	0	0	0
09:15 09:30	0	0	0	0	0
09:30 09:45	0	0	0	0	0
09:45 10:00	0	0	0	0	0
11:30 11:45	0	0	0	0	0
11:45 12:00	0	0	0	0	0
12:00 12:15	0	0	0	0	0
12:15 12:30	0	0	0	0	0
12:30 12:45	0	0	0	0	0
12:45 13:00	0	0	0	0	0
13:00 13:15	0	0	0	0	0
13:15 13:30	0	0	0	0	0
15:00 15:15	0	0	0	0	0
15:15 15:30	0	0	0	0	0
15:30 15:45	0	0	0	0	0
15:45 16:00	0	0	0	0	0
16:00 16:15	0	0	0	0	0
16:15 16:30	0	0	0	0	0
16:30 16:45	0	0	0	0	0
16:45 17:00	0	0	0	0	0
17:00 17:15	0	0	0	0	0
17:15 17:30	0	0	0	0	0
17:30 17:45	0	0	0	0	0
17:45 18:00	0	0	0	0	0
Total	0	0	0	0	0



Turning Movement Count Bicycle Summary Flow Diagram

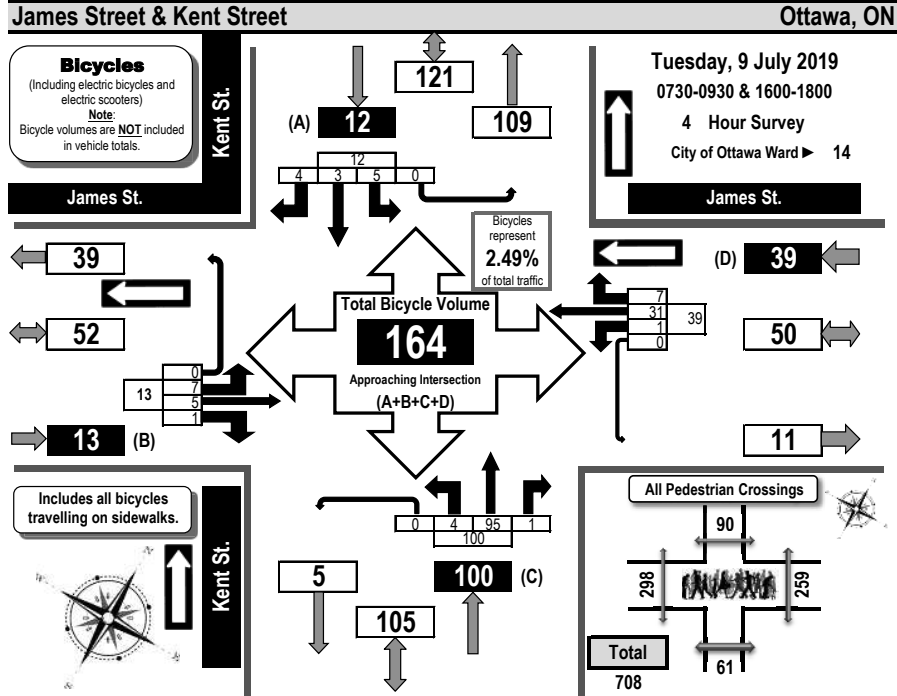

Time Period	James St. Eastbound				James St. Westbound				Kent St. Northbound				Kent St. Southbound				G.Tot.					
	LT	ST	RT	UT	LT	ST	RT	UT	LT	ST	RT	UT	LT	ST	RT	UT						
0730-0800	0	0	1	0	1	0	1	2	0	3	1	11	0	0	0	12	1	0	0	0	1	17
0800-0900	5	1	0	0	6	0	4	2	0	6	2	48	0	0	0	50	2	0	0	0	2	64
0900-0930	2	0	0	0	2	0	0	0	0	0	0	9	0	0	0	9	1	0	0	0	1	12
1600-1700	0	2	0	0	2	1	10	1	0	12	0	13	0	0	0	13	1	1	4	0	6	33
1700-1800	0	2	0	0	2	0	16	2	0	18	1	14	1	0	0	16	0	2	0	0	2	38
Totals	7	5	1	0	13	1	31	7	0	39	4	95	1	0	100	5	3	4	0	12	164	

Comments:
Bronson Avenue, northbound, is closed due to construction between Catherine Street and Chamberlain Avenue. Kent Street is one way northbound and James Street is one way westbound. Bicycle volumes were counted on all approaches.



Turning Movement Count Summary, AM and PM Peak Hour Flow Diagrams

Automobiles, Taxis, Light Trucks, Vans, SUV's, Motorcycles, Heavy Trucks, Buses, and School Buses

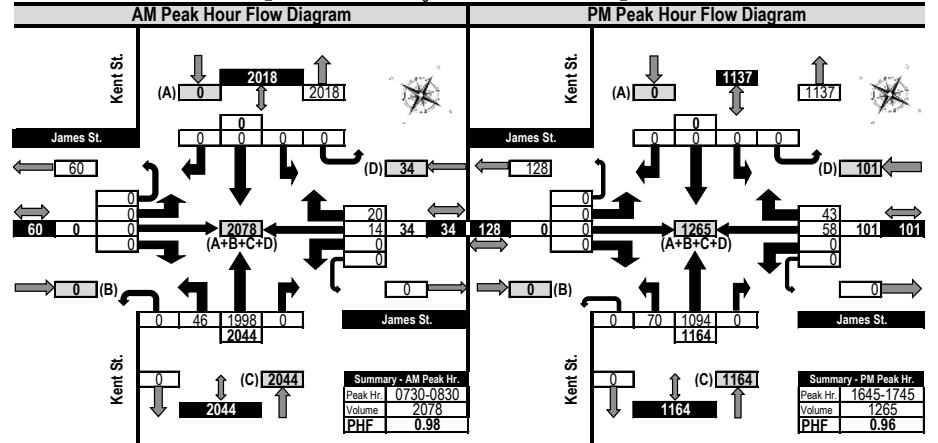
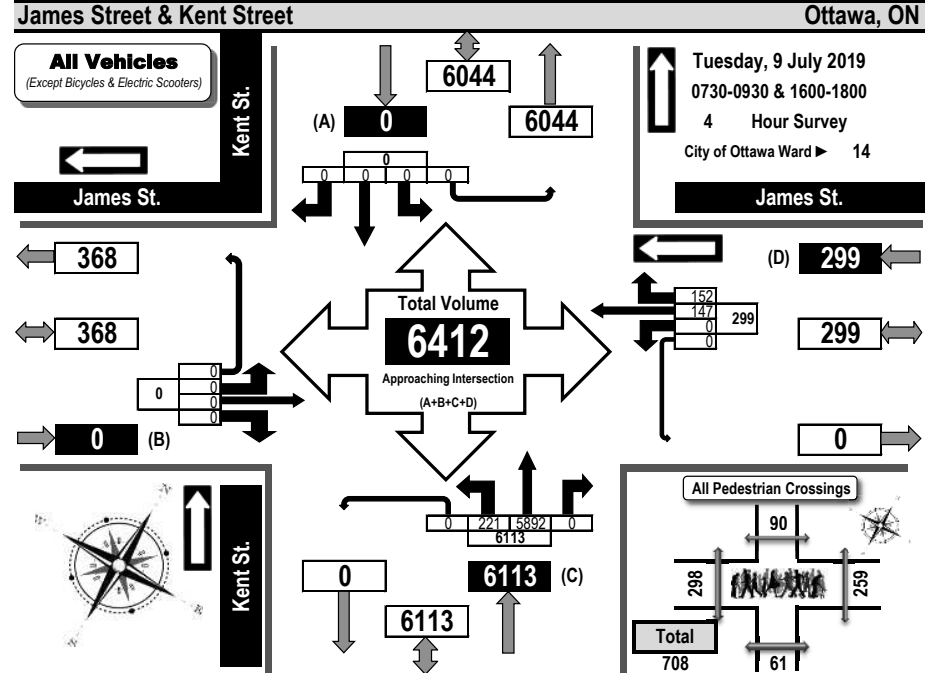



Turning Movement Count Heavy Vehicle Summary Flow Diagram

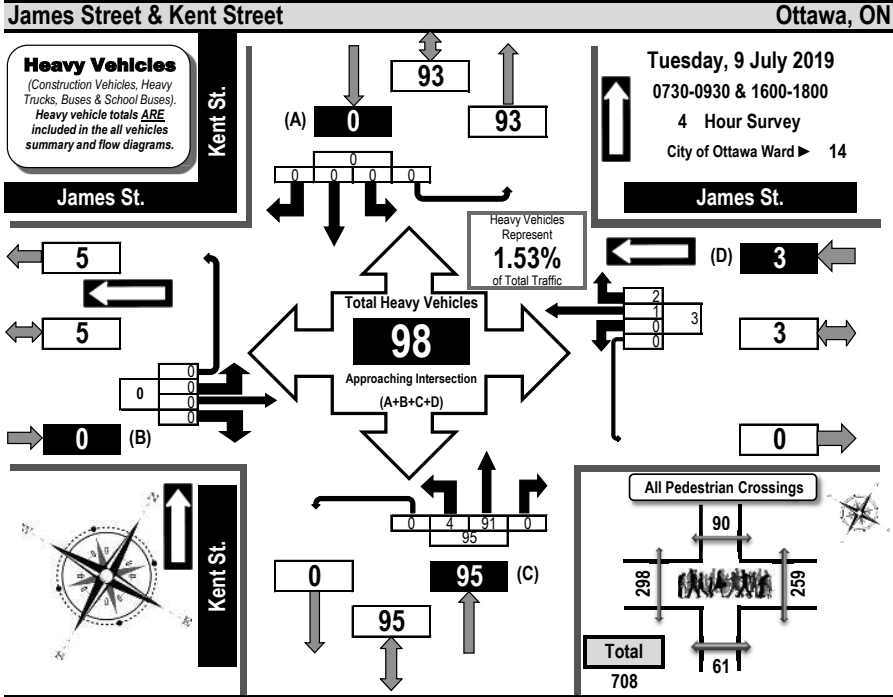

Time Period	James St. Eastbound					James St. Westbound					Kent St. Northbound					Kent St. Southbound					S. Tot.	G. Tot.
	LT	ST	RT	UT	S. Tot.	LT	ST	RT	UT	S. Tot.	LT	ST	RT	UT	S. Tot.	LT	ST	RT	UT	S. Tot.		
	0730-0800	0	0	0	0	0	0	0	0	0	0	0	0	10	0	10	0	0	0	0		
0800-0900	0	0	0	0	0	0	0	1	1	2	3	33	0	0	36	0	0	0	0	0	0	36
0900-0930	0	0	0	0	0	0	0	0	0	0	0	15	0	0	15	0	0	0	0	0	0	15
1600-1700	0	0	0	0	0	0	0	0	0	0	1	24	0	0	25	0	0	0	0	0	0	25
1700-1800	0	0	0	0	0	0	0	0	1	1	0	9	0	0	9	0	0	0	0	0	0	10
Totals	0	0	0	0	0	0	0	1	2	3	4	91	0	0	95	0	0	0	0	0	0	98

Comments:
Bronson Avenue, northbound, is closed due to construction between Catherine Street and Chamberlain Avenue. Kent Street is one way northbound and James Street is one way westbound. Bicycle volumes were counted on all approaches.



Turning Movement Count Pedestrian Crossings Summary and Flow Diagram

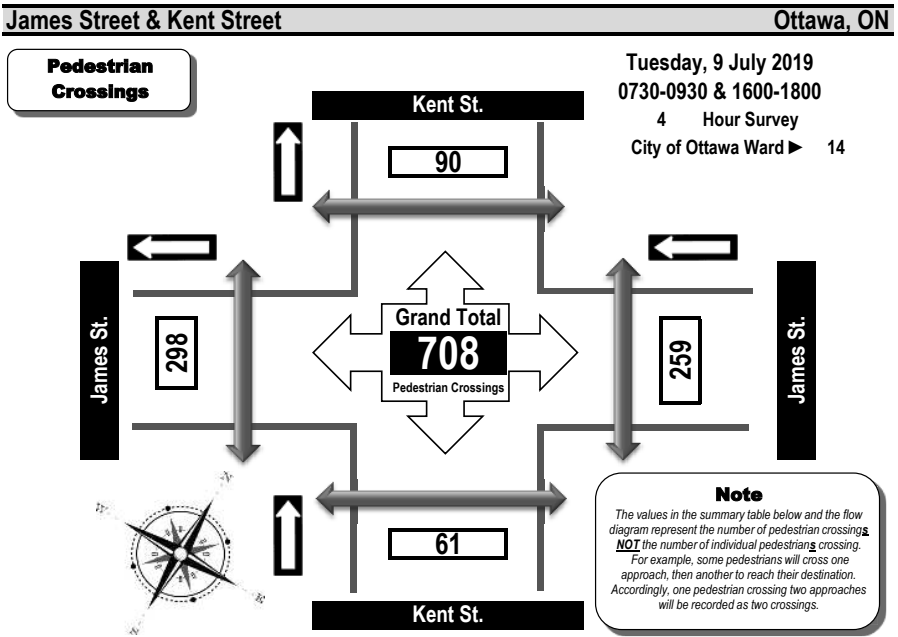

Time Period	West Side Crossing James St.		Street Total	South Side Crossing Kent St.		North Side Crossing Kent St.		Street Total	Grand Total
	James St.	James St.		Kent St.	Kent St.				
0730-0800	26	28	54	1	10	11	65		
0800-0900	72	77	149	11	23	34	183		
0900-0930	21	38	59	11	8	19	78		
1600-1700	95	63	158	17	25	42	200		
1700-1800	84	53	137	21	24	45	182		
Totals	298	259	557	61	90	151	708		

Comments:
Bronson Avenue, northbound, is closed due to construction between Catherine Street and Chamberlain Avenue. Kent Street is one way northbound and James Street is one way westbound. Bicycle volumes were counted on all approaches.



Turning Movement Count Summary Report AADT and Expansion Factors

Automobiles, Taxis,
Light Trucks, Vans,
SUV's, Motorcycles,
Heavy Trucks, Buses,
and School Buses

James Street & Kent Street Ottawa, ON

Survey Date: Tuesday, 9 July 2019 Start Time: 0730 AADT Factor: 0.9
 Weather AM: Clear + 16°C Survey Duration: 4 Hrs. Survey Hours: 0730-0930 & 1600-1800
 Weather PM: Partly Cloudy +30°C Surveyor(s): Carmody

Time Period	James St. Eastbound					James St. Westbound					Kent St. Northbound					Kent St. Southbound					Street Total	Grand Total	
	LT	ST	RT	UT	E/B Tot	LT	ST	RT	UT	W/B Tot	LT	ST	RT	UT	N/B Tot	LT	ST	RT	UT	S/B Tot			
0730-0800	0	0	0	0	0	0	0	7	8	0	15	15	17	1024	0	0	1041	0	0	0	0	1041	1056
0800-0900	0	0	0	0	0	0	0	18	33	0	51	51	49	1904	0	0	1953	0	0	0	0	1953	2004
0900-0930	0	0	0	0	0	0	0	11	17	0	28	28	29	826	0	0	855	0	0	0	0	855	883
1600-1700	0	0	0	0	0	0	0	61	53	0	114	114	56	1045	0	0	1101	0	0	0	0	1101	1215
1700-1800	0	0	0	0	0	0	0	50	41	0	91	91	70	1093	0	0	1163	0	0	0	0	1163	1254
Totals	0	0	0	0	0	0	0	147	152	0	299	299	221	5892	0	0	6113	0	0	0	0	6113	6412

Equivalent 12 & 24-hour Vehicle Volumes Including the Annual Average Daily Traffic (AADT) Factor Applicable to the Day and Month of the Turning Movement Count

Expansion factors are applied exclusively to standard weekday 8-hour turning movement counts conducted during the hours of 0700h - 1000h, 1130h - 1330h and 1500h - 1800h

Equivalent 12-hour vehicle volumes. These volumes are calculated by multiplying the 8-hour totals by the 8 → 12 expansion factor of 1.39

Equ. 12 Hr	n/a	n/a	n/a	n/a	n/a	n/a	n/a	n/a	n/a	n/a	n/a	n/a	n/a	n/a	n/a	n/a	n/a	n/a	n/a	n/a	n/a	n/a	n/a	n/a
------------	-----	-----	-----	-----	-----	-----	-----	-----	-----	-----	-----	-----	-----	-----	-----	-----	-----	-----	-----	-----	-----	-----	-----	-----

Average daily 12-hour vehicle volumes. These volumes are calculated by multiplying the equivalent 12-hour totals by the AADT factor of: 0.9

AADT 12-hr	n/a	n/a	n/a	n/a	n/a	n/a	n/a	n/a	n/a	n/a	n/a	n/a	n/a	n/a	n/a	n/a	n/a	n/a	n/a	n/a	n/a	n/a	n/a	n/a
------------	-----	-----	-----	-----	-----	-----	-----	-----	-----	-----	-----	-----	-----	-----	-----	-----	-----	-----	-----	-----	-----	-----	-----	-----

24-Hour AADT. These volumes are calculated by multiplying the average daily 12-hour vehicle volumes by the 12 → 24 expansion factor of 1.31

AADT 24 Hr	n/a	n/a	n/a	n/a	n/a	n/a	n/a	n/a	n/a	n/a	n/a	n/a	n/a	n/a	n/a	n/a	n/a	n/a	n/a	n/a	n/a	n/a	n/a	n/a
------------	-----	-----	-----	-----	-----	-----	-----	-----	-----	-----	-----	-----	-----	-----	-----	-----	-----	-----	-----	-----	-----	-----	-----	-----

AADT and expansion factors provided by the City of Ottawa

AM Peak Hour Factor	Highest Hourly Vehicle Volume Between 0700h & 1000h																								
AM Peak Hr	LT	ST	RT	UT	TOT	LT	ST	RT	UT	TOT	LT	ST	RT	UT	TOT	LT	ST	RT	UT	TOT	LT	ST	RT	UT	TOT
0730-0830	0	0	0	0	0	0	0	14	20	0	34	34	46	1998	0	0	2044	0	0	0	0	0	2044	2078	

PM Peak Hour Factor	Highest Hourly Vehicle Volume Between 1500h & 1800h																								
PM Peak Hr	LT	ST	RT	UT	TOT	LT	ST	RT	UT	TOT	LT	ST	RT	UT	TOT	LT	ST	RT	UT	TOT	LT	ST	RT	UT	TOT
1645-1745	0	0	0	0	0	0	0	58	43	0	101	101	70	1094	0	0	1164	0	0	0	0	0	1164	1265	

Comments:
Bronson Avenue, northbound, is closed due to construction between Catherine Street and Chamberlain Avenue. Kent Street is one way northbound and James Street is one way westbound. Bicycle volumes were counted on all approaches.

- Notes:**
- Includes all vehicle types except bicycles, electric bicycles, and electric scooters.
 - When expansion and AADT factors are applied, the results will differ slightly due to rounding.



Transportation Services - Traffic Services Turning Movement Count - Full Study Peak Hour Diagram GLADSTONE AVE @ KENT ST

Survey Date: Tuesday, April 25, 2017 WO No: 36848
 Start Time: 07:00 Device: Miovision

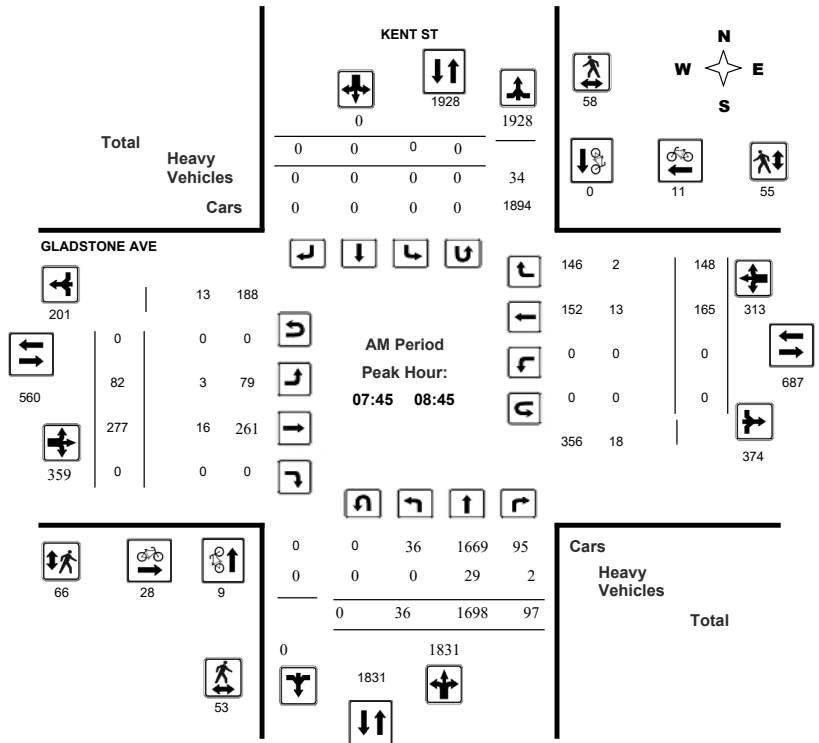



Transportation Services - Traffic Services

Turning Movement Count - Full Study Peak Hour Diagram

GLADSTONE AVE @ KENT ST

Survey Date: Tuesday, April 25, 2017
Start Time: 07:00

WO No: 36848
Device: Miovision

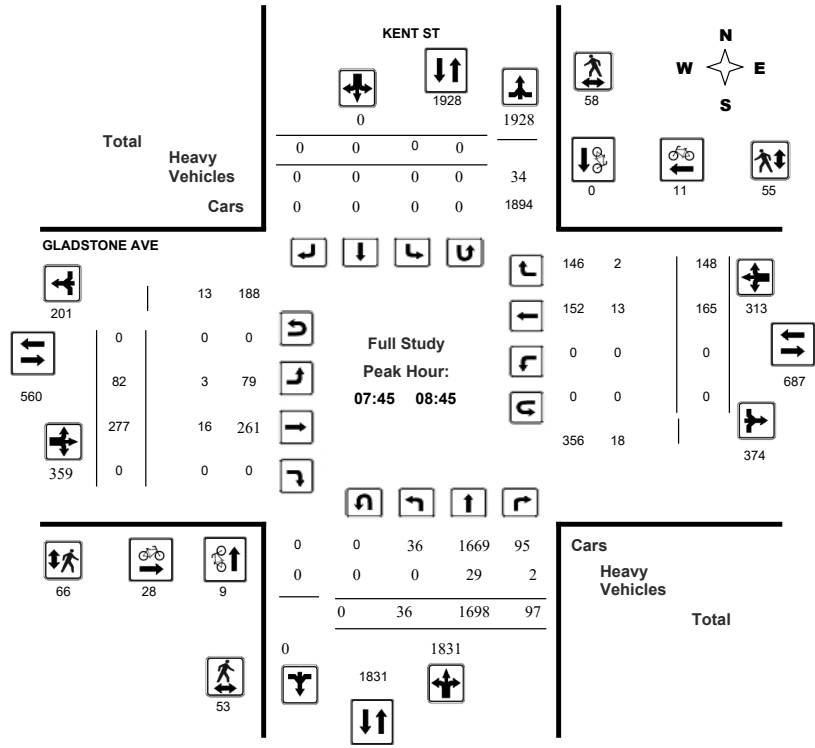

Comments



Transportation Services - Traffic Services

Turning Movement Count - Full Study Peak Hour Diagram

GLADSTONE AVE @ KENT ST

Survey Date: Tuesday, April 25, 2017
Start Time: 07:00

WO No: 36848
Device: Miovision

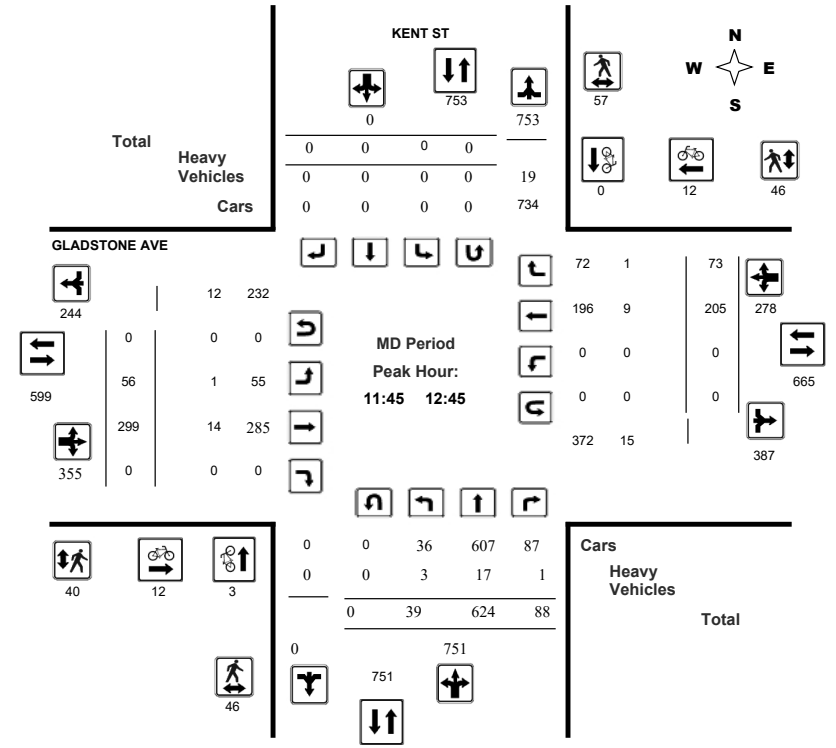

Comments



Transportation Services - Traffic Services

Turning Movement Count - Full Study Peak Hour Diagram

GLADSTONE AVE @ KENT ST

Survey Date: Tuesday, April 25, 2017
Start Time: 07:00

WO No: 36848
Device: Miovision

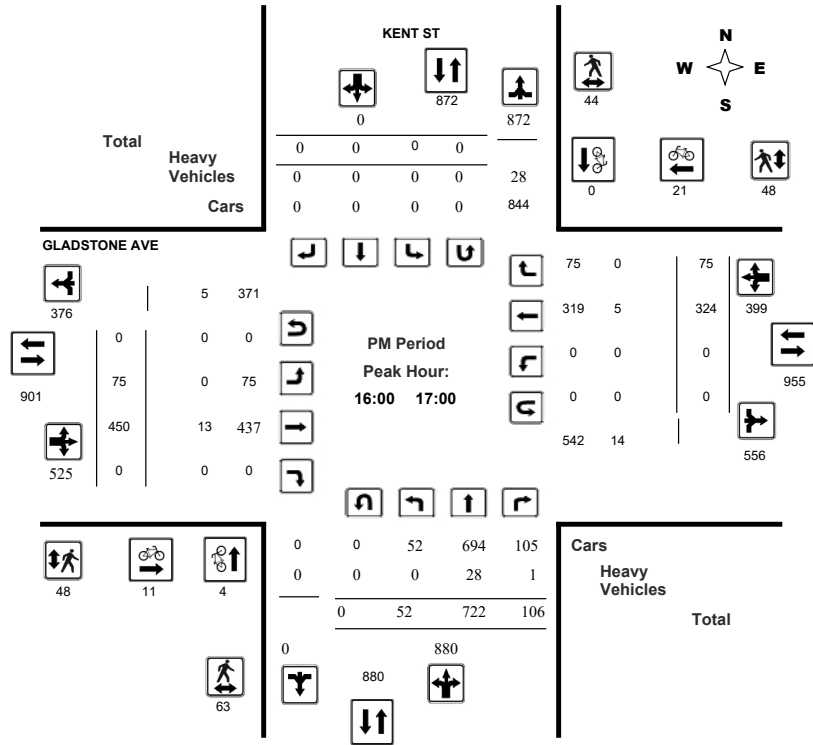

Comments



Transportation Services - Traffic Services

Turning Movement Count - Full Study Diagram

GLADSTONE AVE @ KENT ST

Survey Date: Tuesday, April 25, 2017

WO#: 36848
Device: Miovision

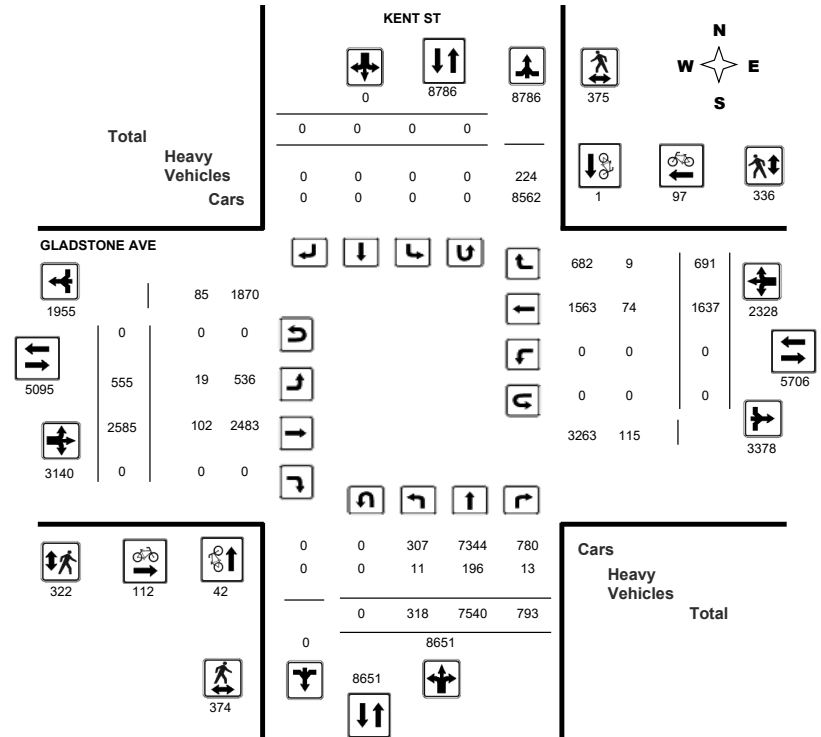

Comments



Transportation Services - Traffic Services

Work Order 36848

Turning Movement Count - Full Study Summary Report

GLADSTONE AVE @ KENT ST

Survey Date: Tuesday, April 25, 2017

Total Observed U-Turns: Northbound: 0, Southbound: 0, Eastbound: 0, Westbound: 0. AADT Factor: .90

Table with columns for Period, KENT ST (Northbound, Southbound), GLADSTONE AVE (Eastbound, Westbound), and Grand Total. Includes sub-totals for U Turns and expansion factors for EQ 12Hr, AVG 12Hr, and AVG 24Hr.

Comments: Note: U-Turns provided for approach totals. Refer to 'U-Turn' Report for specific breakdown.



Transportation Services - Traffic Services

W.O. 36848

Turning Movement Count - 15 Minute Summary Report

GLADSTONE AVE @ KENT ST

Survey Date: Tuesday, April 25, 2017

Total Observed U-Turns: Northbound: 0, Southbound: 0, Eastbound: 0, Westbound: 0

Table with columns for Time Period, KENT ST (Northbound, Southbound), GLADSTONE AVE (Eastbound, Westbound), and Grand Total. Shows 15-minute intervals from 07:00 to 17:45.

Note: U-Turns are included in Totals.

Comment:



Transportation Services - Traffic Services
Turning Movement Count - Cyclist Volume Report

Work Order
36848

GLADSTONE AVE @ KENT ST

Count Date: Tuesday, April 25, 2017

Start Time: 07:00

Time Period	KENT ST			GLADSTONE AVE			Grand Total
	Northbound	Southbound	Street Total	Eastbound	Westbound	Street Total	
07:00 08:00	5	0	5	15	12	27	32
08:00 09:00	13	0	13	29	13	42	55
09:00 10:00	8	0	8	13	6	19	27
11:30 12:30	2	0	2	12	11	23	25
12:30 13:30	8	0	8	8	13	21	29
15:00 16:00	0	1	1	8	5	13	14
16:00 17:00	4	0	4	11	21	32	36
17:00 18:00	2	0	2	16	16	32	34
Total	42	1	43	112	97	209	252

Comment:

Note: These volumes consists of bicycles only (no mopeds or motorcycles) and ARE NOT included in the Turning Movement Count Summary.



Transportation Services - Traffic Services
Turning Movement Count - Heavy Vehicle Report

W.O.
36848

GLADSTONE AVE @ KENT ST

Survey Date: Tuesday, April 25, 2017

Time Period	KENT ST									GLADSTONE AVE									Grand Total
	Northbound				Southbound					Eastbound				Westbound					
	LT	ST	RT	N TOT	LT	ST	RT	S TOT	STR TOT	LT	ST	RT	E TOT	LT	ST	RT	W TOT	STR TOT	
07:00 08:00	2	17	2	21	0	0	0	0	21	5	12	0	17	0	11	1	12	29	50
08:00 09:00	2	31	1	34	0	0	0	0	34	5	16	0	21	0	10	2	12	33	67
09:00 10:00	2	24	5	31	0	0	0	0	31	2	12	0	14	0	15	2	17	31	62
11:30 12:30	2	20	1	23	0	0	0	0	23	2	12	0	14	0	8	1	9	23	46
12:30 13:30	2	12	0	14	0	0	0	0	14	2	16	0	18	0	8	0	8	26	40
15:00 16:00	0	45	3	48	0	0	0	0	48	2	13	0	15	0	12	3	15	30	78
16:00 17:00	0	28	1	29	0	0	0	0	29	0	13	0	13	0	5	0	5	18	47
17:00 18:00	1	19	0	20	0	0	0	0	20	1	8	0	9	0	5	0	5	14	34
Sub Total	11	196	13	220	0	0	0	0	220	19	102	0	121	0	74	9	83	204	424
U-Turns (Heavy Vehicles)	0	0	0	0	0	0	0	0	0	0	0	0	0	0	0	0	0	0	0
Total	11	196	13	0	0	0	0	0	220	19	102	0	121	0	74	9	83	204	424

Heavy Vehicles include Buses, Single-Unit Trucks and Articulated Trucks. Further, they ARE included in the Turning Movement Count Summary.



Transportation Services - Traffic Services
Turning Movement Count - Pedestrian Volume Report

Work Order
36848

GLADSTONE AVE @ KENT ST

Count Date: Tuesday, April 25, 2017		Start Time: 07:00					
Time Period	NB Approach (E or W Crossing)	SB Approach (E or W Crossing)	Total	EB Approach (N or S Crossing)	WB Approach (N or S Crossing)	Total	Grand Total
07:00 07:15	2	4	6	3	4	7	13
07:15 07:30	3	9	12	9	5	14	26
07:30 07:45	8	5	13	16	5	21	34
07:45 08:00	9	8	17	13	8	21	38
07:00 08:00	22	26	48	41	22	63	111
08:00 08:15	10	11	21	18	12	30	51
08:15 08:30	17	24	41	21	17	38	79
08:30 08:45	17	15	32	14	18	32	64
08:45 09:00	12	10	22	13	10	23	45
08:00 09:00	56	60	116	66	57	123	239
09:00 09:15	6	11	17	7	14	21	38
09:15 09:30	6	6	12	8	6	14	26
09:30 09:45	6	13	19	4	4	8	27
09:45 10:00	6	15	21	8	7	15	36
09:00 10:00	24	45	69	27	31	58	127
11:30 11:45	9	6	15	11	5	16	31
11:45 12:00	5	13	18	4	8	12	30
12:00 12:15	13	16	29	8	12	20	49
12:15 12:30	12	13	25	14	17	31	56
11:30 12:30	39	48	87	37	42	79	166
12:30 12:45	16	15	31	14	9	23	54
12:45 13:00	14	10	24	3	9	12	36
13:00 13:15	15	16	31	4	13	17	48
13:15 13:30	12	16	28	6	8	14	42
12:30 13:30	57	57	114	27	39	66	180
15:00 15:15	10	14	24	5	12	17	41
15:15 15:30	12	6	18	17	15	32	50
15:30 15:45	13	11	24	2	16	18	42
15:45 16:00	12	9	21	5	11	16	37
15:00 16:00	47	40	87	29	54	83	170
16:00 16:15	12	11	23	9	10	19	42
16:15 16:30	17	12	29	17	14	31	60
16:30 16:45	18	10	28	9	12	21	49
16:45 17:00	16	11	27	13	12	25	52
16:00 17:00	63	44	107	48	48	96	203
17:00 17:15	23	13	36	13	13	26	62
17:15 17:30	8	17	25	13	14	27	52
17:30 17:45	20	12	32	9	10	19	51
17:45 18:00	15	13	28	12	6	18	46
17:00 18:00	66	55	121	47	43	90	211
Total	374	375	749	322	336	658	1407

Comment:



Transportation Services - Traffic Services
Turning Movement Count - 15 Min U-Turn Total Report
GLADSTONE AVE @ KENT ST

Work Order
36848

Survey Date: Tuesday, April 25, 2017

Time Period	Northbound U-Turn Total	Southbound U-Turn Total	Eastbound U-Turn Total	Westbound U-Turn Total	Total
07:00 07:15	0	0	0	0	0
07:15 07:30	0	0	0	0	0
07:30 07:45	0	0	0	0	0
07:45 08:00	0	0	0	0	0
08:00 08:15	0	0	0	0	0
08:15 08:30	0	0	0	0	0
08:30 08:45	0	0	0	0	0
08:45 09:00	0	0	0	0	0
09:00 09:15	0	0	0	0	0
09:15 09:30	0	0	0	0	0
09:30 09:45	0	0	0	0	0
09:45 10:00	0	0	0	0	0
11:30 11:45	0	0	0	0	0
11:45 12:00	0	0	0	0	0
12:00 12:15	0	0	0	0	0
12:15 12:30	0	0	0	0	0
12:30 12:45	0	0	0	0	0
12:45 13:00	0	0	0	0	0
13:00 13:15	0	0	0	0	0
13:15 13:30	0	0	0	0	0
15:00 15:15	0	0	0	0	0
15:15 15:30	0	0	0	0	0
15:30 15:45	0	0	0	0	0
15:45 16:00	0	0	0	0	0
16:00 16:15	0	0	0	0	0
16:15 16:30	0	0	0	0	0
16:30 16:45	0	0	0	0	0
16:45 17:00	0	0	0	0	0
17:00 17:15	0	0	0	0	0
17:15 17:30	0	0	0	0	0
17:30 17:45	0	0	0	0	0
17:45 18:00	0	0	0	0	0
Total	0	0	0	0	0



Transportation Services - Traffic Services

Turning Movement Count - Study Results

BANK ST @ SOMERSET ST

Survey Date: Tuesday, March 08, 2022
Start Time: 07:00

WO No: 40216
Device: Miovision

Full Study Diagram

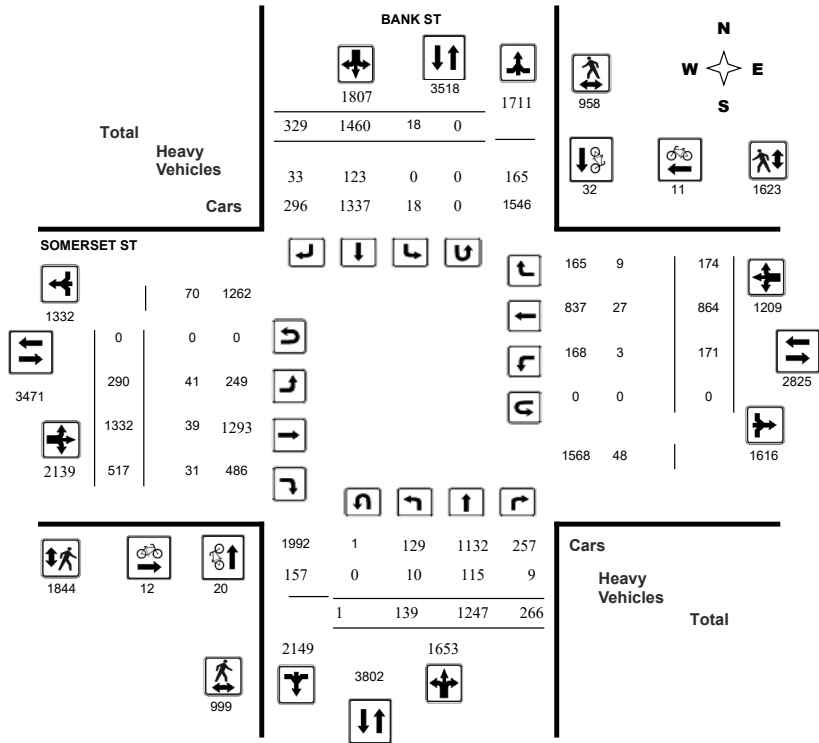

Transportation Services - Traffic Services

Turning Movement Count - Study Results

BANK ST @ SOMERSET ST

Survey Date: Tuesday, March 08, 2022
Start Time: 07:00

WO No: 40216
Device: Miovision

Full Study Peak Hour Diagram

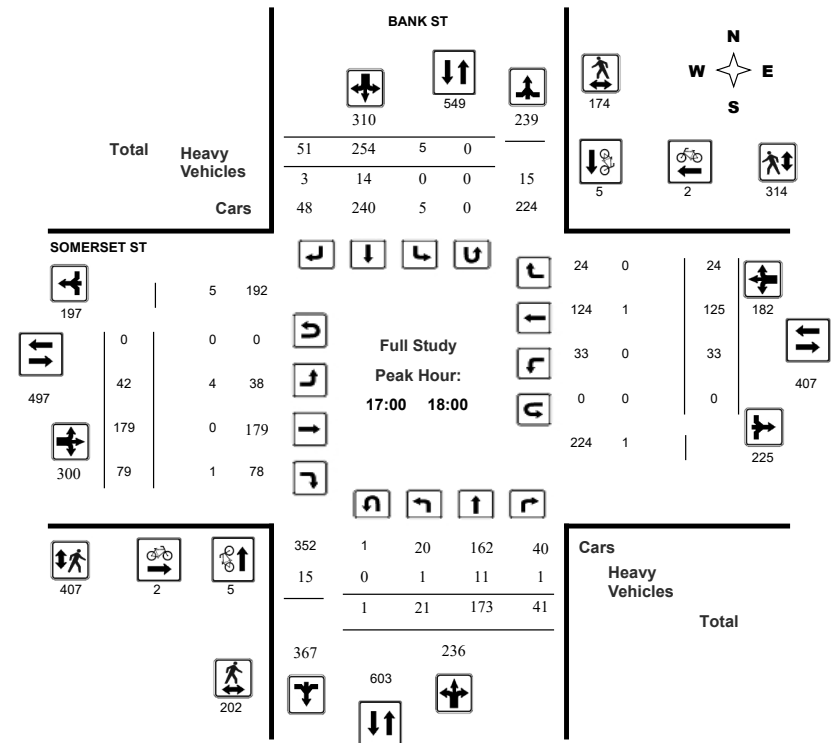



Transportation Services - Traffic Services

Turning Movement Count - Peak Hour Diagram

BANK ST @ SOMERSET ST

Survey Date: Tuesday, March 08, 2022
Start Time: 07:00

WO No: 40216
Device: Miovision

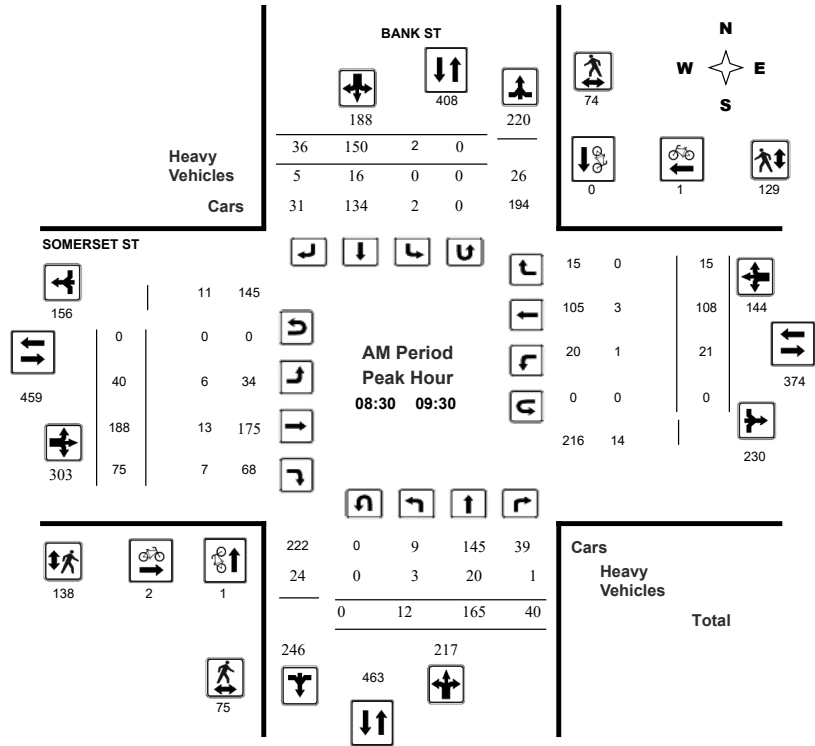

Transportation Services - Traffic Services

Turning Movement Count - Peak Hour Diagram

BANK ST @ SOMERSET ST

Survey Date: Tuesday, March 08, 2022
Start Time: 07:00

WO No: 40216
Device: Miovision

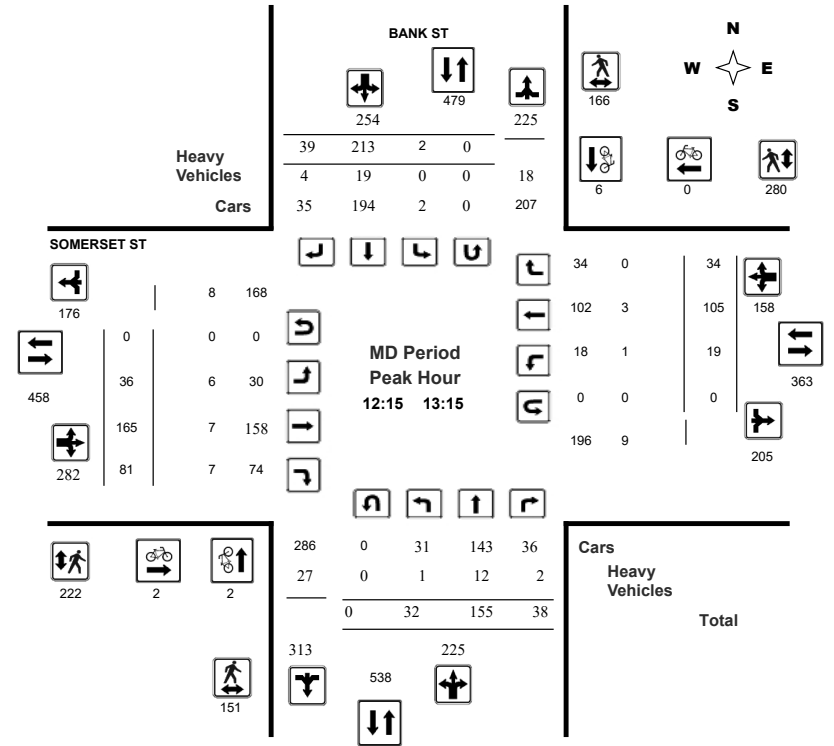



Transportation Services - Traffic Services

Turning Movement Count - Peak Hour Diagram

BANK ST @ SOMERSET ST

Survey Date: Tuesday, March 08, 2022
Start Time: 07:00

WO No: 40216
Device: Miovision

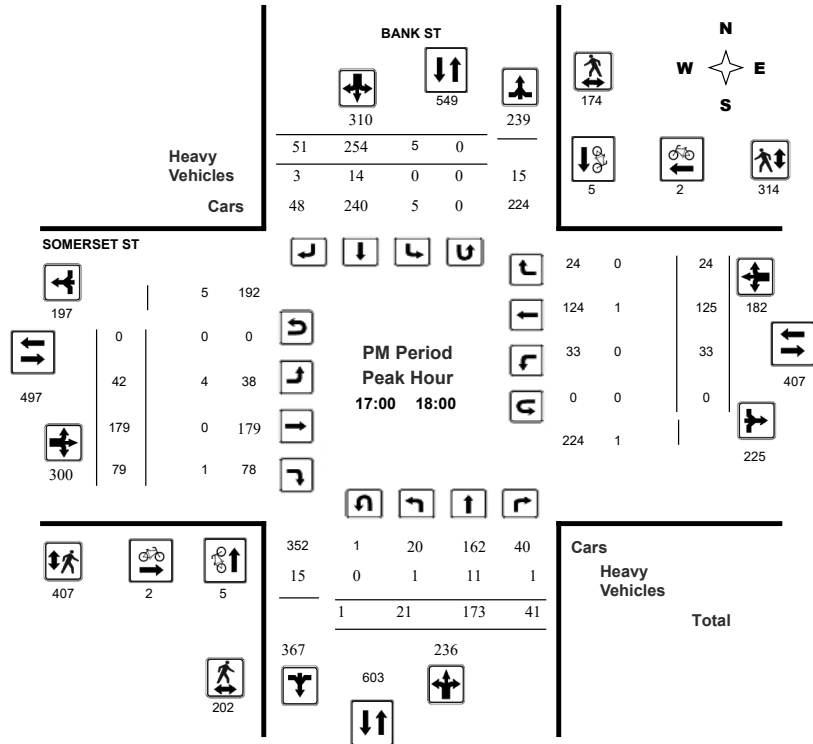

Comments



Transportation Services - Traffic Services

Turning Movement Count - Study Results

BANK ST @ SOMERSET ST

Survey Date: Tuesday, March 08, 2022
Start Time: 07:00

WO No: 40216
Device: Miovision

Full Study Summary (8 HR Standard)

Survey Date: Tuesday, March 08, 2022

Total Observed U-Turns

Northbound:	1	Southbound:	0
Eastbound:	0	Westbound:	0

AADT Factor: 1.00

Period	BANK ST				SOMERSET ST								WB TOT	STR TOT	Grand Total				
	Northbound		Southbound		Eastbound			Westbound											
	LT	ST	RT	SB TOT	STR TOT	LT	ST	RT	EB TOT	LT	ST	RT							
07:00 08:00	6	116	30	152	1	88	17	106	258	35	128	30	193	4	61	11	76	269	527
08:00 09:00	5	169	29	203	2	140	36	178	381	43	192	57	292	18	117	20	155	447	828
09:00 10:00	17	156	29	202	1	148	35	184	386	36	162	69	267	25	86	14	125	392	778
11:30 12:30	30	171	39	240	5	187	43	235	475	21	151	58	230	19	107	23	149	379	854
12:30 13:30	27	154	34	215	0	211	36	247	462	44	168	83	295	24	98	38	160	455	917
15:00 16:00	18	142	22	182	4	206	51	261	443	37	184	70	291	22	119	22	163	454	897
16:00 17:00	15	166	42	223	0	226	60	286	509	32	168	71	271	26	151	22	199	470	979
17:00 18:00	21	173	41	235	5	254	51	310	545	42	179	79	300	33	125	24	182	482	1027
Sub Total	139	1247	266	1652	18	1460	329	1807	3459	290	1332	517	2139	171	864	174	1209	3348	6807
U Turns				1				0	1				0				0	0	1
Total	139	1247	266	1653	18	1460	329	1807	3460	290	1332	517	2139	171	864	174	1209	3348	6808
EQ 12Hr	193	1733	370	2298	25	2029	457	2512	4809	403	1851	719	2973	238	1201	242	1681	4654	9463
Note: These values are calculated by multiplying the totals by the appropriate expansion factor.																			1.39
AVG 12Hr	193	1733	370	2298	25	2659	599	2512	4809	403	1851	719	2973	238	1201	242	1681	4654	9463
Note: These volumes are calculated by multiplying the Equivalent 12 hr. totals by the AADT factor.																			1.00
AVG 24Hr	253	2270	485	3010	33	3483	785	3291	6300	528	2425	942	3895	312	1573	317	2202	6097	12397
Note: These volumes are calculated by multiplying the Average Daily 12 hr. totals by 12 to 24 expansion factor.																			1.31
Note: U-Turns provided for approach totals. Refer to 'U-Turn' Report for specific breakdown.																			



Transportation Services - Traffic Services

Turning Movement Count - Study Results

BANK ST @ SOMERSET ST

Survey Date: Tuesday, March 08, 2022

WO No: 40216

Start Time: 07:00

Device: Miovision

Full Study 15 Minute Increments

Table with columns for Time Period, Northbound (LT, ST, RT, N TOT, STR TOT), Southbound (LT, ST, RT, S TOT, STR TOT), Eastbound (LT, ST, RT, E TOT), Westbound (LT, ST, RT, W TOT, STR TOT), and Grand Total. Rows represent 15-minute intervals from 07:00 to 17:45.

Note: U-Turns are included in Totals.



Transportation Services - Traffic Services

Turning Movement Count - Study Results

BANK ST @ SOMERSET ST

Survey Date: Tuesday, March 08, 2022

WO No: 40216

Start Time: 07:00

Device: Miovision

Full Study Cyclist Volume

Table with columns for Time Period, Northbound, Southbound, Street Total, Eastbound, Westbound, Street Total, and Grand Total. Rows represent 15-minute intervals from 07:00 to 17:45.



Transportation Services - Traffic Services

Turning Movement Count - Study Results

BANK ST @ SOMERSET ST

Survey Date: Tuesday, March 08, 2022

WO No: 40216

Start Time: 07:00

Device: Miovision

Full Study Pedestrian Volume

Table with columns: Time Period, NB Approach, SB Approach, Total, EB Approach, WB Approach, Grand Total. Rows show pedestrian volume data from 07:00 to 17:45.



Transportation Services - Traffic Services

Turning Movement Count - Study Results

BANK ST @ SOMERSET ST

Survey Date: Tuesday, March 08, 2022

WO No: 40216

Start Time: 07:00

Device: Miovision

Full Study Heavy Vehicles

Table with columns: Time Period, Northbound, Southbound, Eastbound, Westbound, Grand Total. Rows show heavy vehicle volume data from 07:00 to 17:45.



Transportation Services - Traffic Services

Turning Movement Count - Study Results

BANK ST @ SOMERSET ST

Survey Date: Tuesday, March 08, 2022

WO No: 40216

Start Time: 07:00

Device: Miovision

Full Study 15 Minute U-Turn Total

BANK ST SOMERSET ST

Time Period	Northbound U-Turn Total	Southbound U-Turn Total	Eastbound U-Turn Total	Westbound U-Turn Total	Total
07:00 - 07:15	0	0	0	0	0
07:15 - 07:30	0	0	0	0	0
07:30 - 07:45	0	0	0	0	0
07:45 - 08:00	0	0	0	0	0
08:00 - 08:15	0	0	0	0	0
08:15 - 08:30	0	0	0	0	0
08:30 - 08:45	0	0	0	0	0
08:45 - 09:00	0	0	0	0	0
09:00 - 09:15	0	0	0	0	0
09:15 - 09:30	0	0	0	0	0
09:30 - 09:45	0	0	0	0	0
09:45 - 10:00	0	0	0	0	0
11:30 - 11:45	0	0	0	0	0
11:45 - 12:00	0	0	0	0	0
12:00 - 12:15	0	0	0	0	0
12:15 - 12:30	0	0	0	0	0
12:30 - 12:45	0	0	0	0	0
12:45 - 13:00	0	0	0	0	0
13:00 - 13:15	0	0	0	0	0
13:15 - 13:30	0	0	0	0	0
15:00 - 15:15	0	0	0	0	0
15:15 - 15:30	0	0	0	0	0
15:30 - 15:45	0	0	0	0	0
15:45 - 16:00	0	0	0	0	0
16:00 - 16:15	0	0	0	0	0
16:15 - 16:30	0	0	0	0	0
16:30 - 16:45	0	0	0	0	0
16:45 - 17:00	0	0	0	0	0
17:00 - 17:15	0	0	0	0	0
17:15 - 17:30	0	0	0	0	0
17:30 - 17:45	0	0	0	0	0
17:45 - 18:00	1	0	0	0	1
Total	1	0	0	0	1



Transportation Services - Traffic Services

Turning Movement Count - Full Study Peak Hour Diagram

BANK ST @ MACLAREN ST

Survey Date: Tuesday, April 16, 2019

WO No: 38538

Start Time: 07:00

Device: Miovision

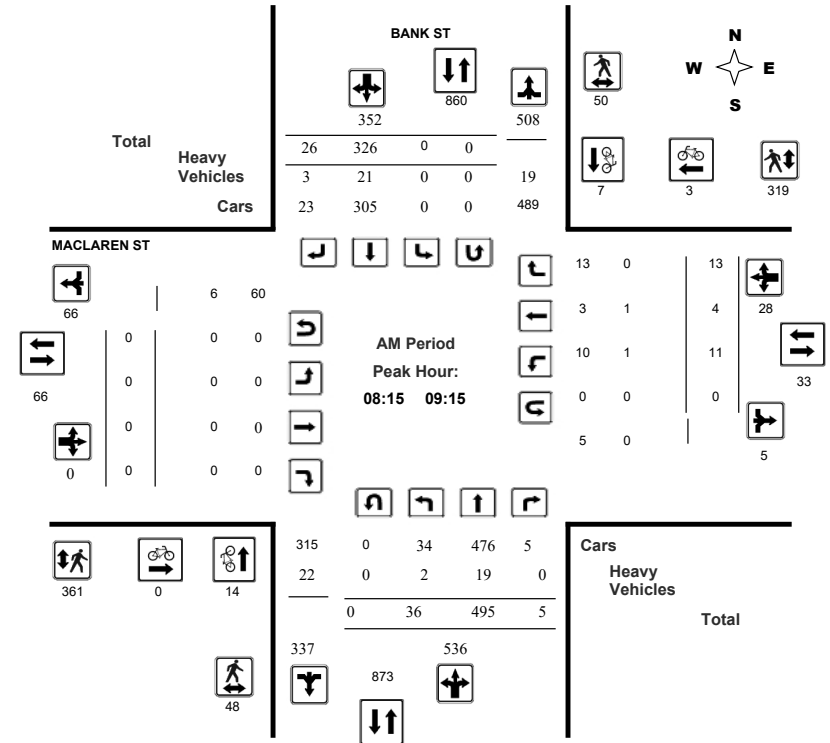



Transportation Services - Traffic Services

Turning Movement Count - Full Study Peak Hour Diagram

BANK ST @ MACLAREN ST

Survey Date: Tuesday, April 16, 2019
Start Time: 07:00

WO No: 38538
Device: Miovision

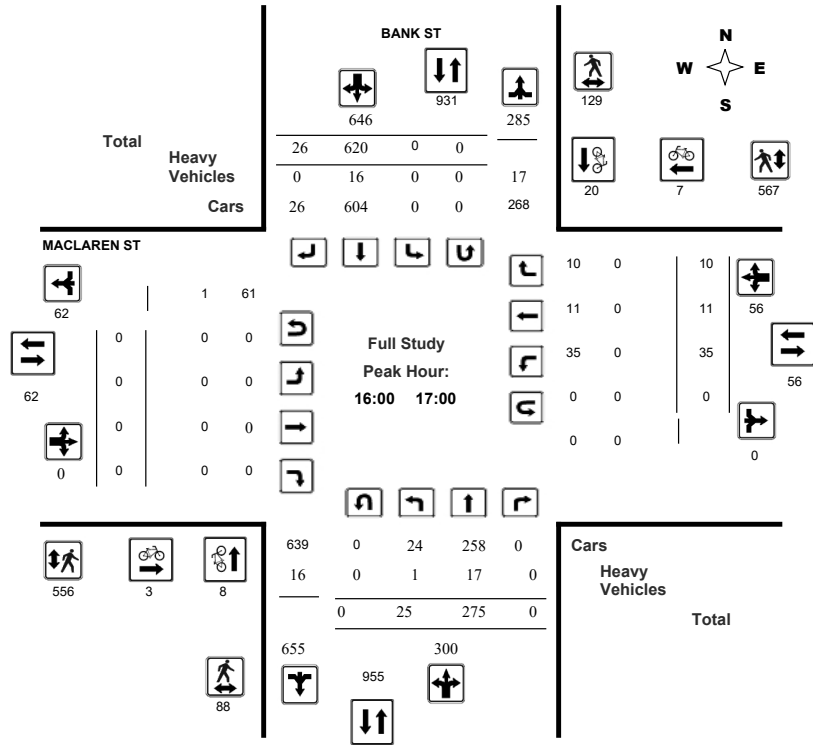

Comments



Transportation Services - Traffic Services

Turning Movement Count - Full Study Peak Hour Diagram

BANK ST @ MACLAREN ST

Survey Date: Tuesday, April 16, 2019
Start Time: 07:00

WO No: 38538
Device: Miovision

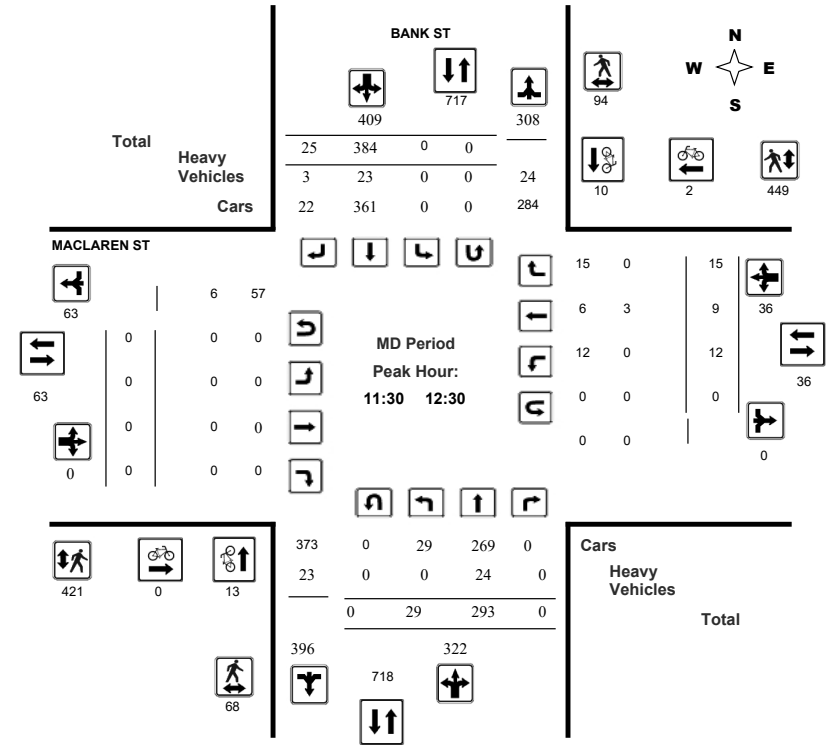

Comments



Transportation Services - Traffic Services

Turning Movement Count - Full Study Peak Hour Diagram

BANK ST @ MACLAREN ST

Survey Date: Tuesday, April 16, 2019
Start Time: 07:00

WO No: 38538
Device: Miovision

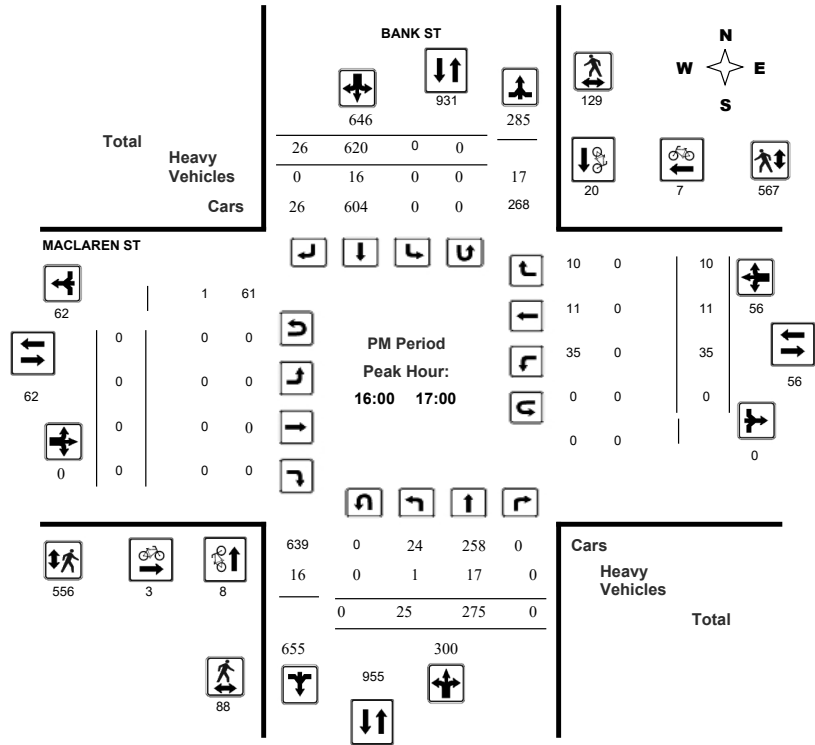

Comments



Transportation Services - Traffic Services

Turning Movement Count - Full Study Diagram

BANK ST @ MACLAREN ST

Survey Date: Tuesday, April 16, 2019

WO#: 38538
Device: Miovision

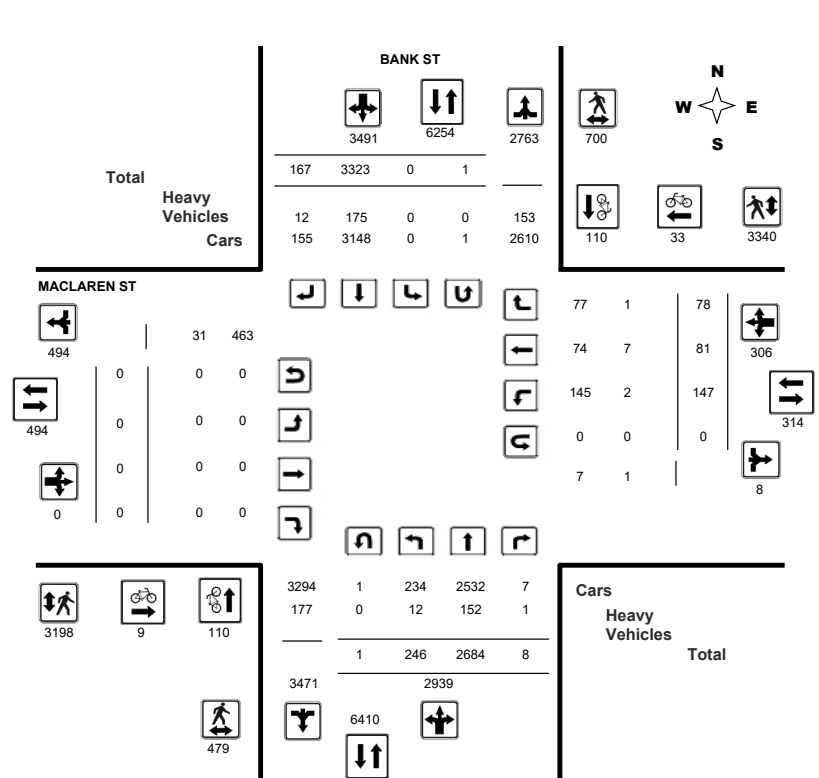

Comments



Transportation Services - Traffic Services

Work Order 38538

Turning Movement Count - Full Study Summary Report

BANK ST @ MACLAREN ST

Survey Date: Tuesday, April 16, 2019

Total Observed U-Turns: Northbound: 1, Southbound: 1, Eastbound: 0, Westbound: 0. AADT Factor: .90

Full Study

Table with columns for Period, Bank St (Northbound, Southbound, Eastbound, Westbound), and MacLaren St (Eastbound, Westbound). Includes sub-totals for U-Turns, EQ 12Hr, AVG 12Hr, and AVG 24Hr.

Comments: Note: U-Turns provided for approach totals. Refer to 'U-Turn' Report for specific breakdown.



Transportation Services - Traffic Services

W.O. 38538

Turning Movement Count - 15 Minute Summary Report

BANK ST @ MACLAREN ST

Survey Date: Tuesday, April 16, 2019

Total Observed U-Turns: Northbound: 1, Southbound: 1, Eastbound: 0, Westbound: 0

BANK ST

MACLAREN ST

Table with columns for Time Period, Bank St (Northbound, Southbound), and MacLaren St (Eastbound, Westbound). Includes Grand Total column.

TOTAL: 246 2684 8 2939 0 3323 167 3491 6430 0 0 0 0 147 81 78 306 306 6736

Comment: Note: U-Turns are included in Totals.



Transportation Services - Traffic Services
Turning Movement Count - Cyclist Volume Report

Work Order
38538

BANK ST @ MACLAREN ST

Count Date: Tuesday, April 16, 2019

Start Time: 07:00

Time Period	BANK ST			MACLAREN ST			Grand Total
	Northbound	Southbound	Street Total	Eastbound	Westbound	Street Total	
07:00 08:00	14	1	15	0	2	2	17
08:00 09:00	20	4	24	0	3	3	27
09:00 10:00	11	7	18	0	3	3	21
11:30 12:30	13	10	23	0	2	2	25
12:30 13:30	15	18	33	1	2	3	36
15:00 16:00	12	14	26	3	5	8	34
16:00 17:00	8	20	28	3	7	10	38
17:00 18:00	17	36	53	2	9	11	64
Total	110	110	220	9	33	42	262

Comment:

Note: These volumes consists of bicycles only (no mopeds or motorcycles) and ARE NOT included in the Turning Movement Count Summary.



Transportation Services - Traffic Services
Turning Movement Count - Heavy Vehicle Report

W.O.
38538

BANK ST @ MACLAREN ST

Survey Date: Tuesday, April 16, 2019

Time Period	BANK ST									MACLAREN ST									Grand Total	
	Northbound			Southbound			Eastbound			Westbound			W TOT	STR TOT						
	LT	ST	RT	N TOT	LT	ST	RT	S TOT	STR TOT	LT	ST	RT			E TOT	LT	ST	RT		
07:00 08:00	2	21	0	23	0	22	0	22	45	0	0	0	0	0	0	0	0	0	0	45
08:00 09:00	2	18	0	20	0	21	3	24	44	0	0	0	0	1	1	0	2	2	2	46
09:00 10:00	3	22	1	26	0	23	3	26	52	0	0	0	0	0	0	0	0	0	0	52
11:30 12:30	0	24	0	24	0	23	3	26	50	0	0	0	0	0	3	0	3	3	3	53
12:30 13:30	3	19	0	22	0	28	2	30	52	0	0	0	0	0	2	1	3	3	3	55
15:00 16:00	1	15	0	16	0	23	1	24	40	0	0	0	0	1	1	0	2	2	2	42
16:00 17:00	1	17	0	18	0	16	0	16	34	0	0	0	0	0	0	0	0	0	0	34
17:00 18:00	0	16	0	16	0	19	0	19	35	0	0	0	0	0	0	0	0	0	0	35
Sub Total	12	152	1	165	0	175	12	187	352	0	0	0	0	2	7	1	10	10	10	362
U-Turns (Heavy Vehicles)				0				0	0				0				0	0	0	0
Total	12	152	1	0	0	175	12	187	352	0	0	0	0	2	7	1	10	10	10	362

Heavy Vehicles include Buses, Single-Unit Trucks and Articulated Trucks. Further, they ARE included in the Turning Movement Count Summary.



Transportation Services - Traffic Services
Turning Movement Count - Pedestrian Volume Report

Work Order
38538

BANK ST @ MACLAREN ST

Count Date: Tuesday, April 16, 2019		Start Time: 07:00					
Time Period	NB Approach (E or W Crossing)	SB Approach (E or W Crossing)	Total	EB Approach (N or S Crossing)	WB Approach (N or S Crossing)	Total	Grand Total
07:00 07:15	3	4	7	26	35	61	68
07:15 07:30	5	5	10	35	34	69	79
07:30 07:45	6	7	13	56	49	105	118
07:45 08:00	14	8	22	65	68	133	155
07:00 08:00	28	24	52	182	186	368	420
08:00 08:15	12	9	21	78	72	150	171
08:15 08:30	13	10	23	89	87	176	199
08:30 08:45	12	14	26	87	77	164	190
08:45 09:00	15	11	26	106	99	205	231
08:00 09:00	52	44	96	360	335	695	791
09:00 09:15	8	15	23	79	56	135	158
09:15 09:30	12	18	30	61	48	109	139
09:30 09:45	6	9	15	60	45	105	120
09:45 10:00	7	13	20	61	34	95	115
09:00 10:00	33	55	88	261	183	444	532
11:30 11:45	8	25	33	76	78	154	187
11:45 12:00	21	25	46	104	99	203	249
12:00 12:15	20	22	42	131	121	252	294
12:15 12:30	19	22	41	110	151	261	302
11:30 12:30	68	94	162	421	449	870	1032
12:30 12:45	9	22	31	96	138	234	265
12:45 13:00	20	27	47	97	142	239	286
13:00 13:15	24	21	45	92	110	202	247
13:15 13:30	10	41	51	88	113	201	252
12:30 13:30	63	111	174	373	503	876	1050
15:00 15:15	15	15	30	105	84	189	219
15:15 15:30	8	23	31	87	106	193	224
15:30 15:45	17	36	53	90	142	232	285
15:45 16:00	16	23	39	96	124	220	259
15:00 16:00	56	97	153	378	456	834	987
16:00 16:15	16	17	33	138	112	250	283
16:15 16:30	17	43	60	120	169	289	349
16:30 16:45	36	37	73	157	122	279	352
16:45 17:00	19	32	51	141	164	305	356
16:00 17:00	88	129	217	556	567	1123	1340
17:00 17:15	28	37	65	184	155	339	404
17:15 17:30	20	46	66	170	214	384	450
17:30 17:45	16	30	46	144	159	303	349
17:45 18:00	27	33	60	169	133	302	362
17:00 18:00	91	146	237	667	1328	1995	2565
Total	479	700	1179	3198	3340	6538	7717

Comment:



Transportation Services - Traffic Services

Work Order
38538

Turning Movement Count - 15 Min U-Turn Total Report

BANK ST @ MACLAREN ST

Survey Date: Tuesday, April 16, 2019

Time Period	Northbound U-Turn Total	Southbound U-Turn Total	Eastbound U-Turn Total	Westbound U-Turn Total	Total
07:00 07:15	0	0	0	0	0
07:15 07:30	0	0	0	0	0
07:30 07:45	0	0	0	0	0
07:45 08:00	0	0	0	0	0
08:00 08:15	0	0	0	0	0
08:15 08:30	0	0	0	0	0
08:30 08:45	0	0	0	0	0
08:45 09:00	0	0	0	0	0
09:00 09:15	0	0	0	0	0
09:15 09:30	0	0	0	0	0
09:30 09:45	0	0	0	0	0
09:45 10:00	0	0	0	0	0
11:30 11:45	0	0	0	0	0
11:45 12:00	0	0	0	0	0
12:00 12:15	0	0	0	0	0
12:15 12:30	0	0	0	0	0
12:30 12:45	0	0	0	0	0
12:45 13:00	0	0	0	0	0
13:00 13:15	1	0	0	0	1
13:15 13:30	0	1	0	0	1
15:00 15:15	0	0	0	0	0
15:15 15:30	0	0	0	0	0
15:30 15:45	0	0	0	0	0
15:45 16:00	0	0	0	0	0
16:00 16:15	0	0	0	0	0
16:15 16:30	0	0	0	0	0
16:30 16:45	0	0	0	0	0
16:45 17:00	0	0	0	0	0
17:00 17:15	0	0	0	0	0
17:15 17:30	0	0	0	0	0
17:30 17:45	0	0	0	0	0
17:45 18:00	0	0	0	0	0
Total	1	1	0	0	2



Transportation Services - Traffic Services

Turning Movement Count - Study Results

BANK ST @ GILMOUR ST

Survey Date: Tuesday, March 08, 2022

WO No: 40217

Start Time: 07:00

Device: Miovision

Full Study Diagram

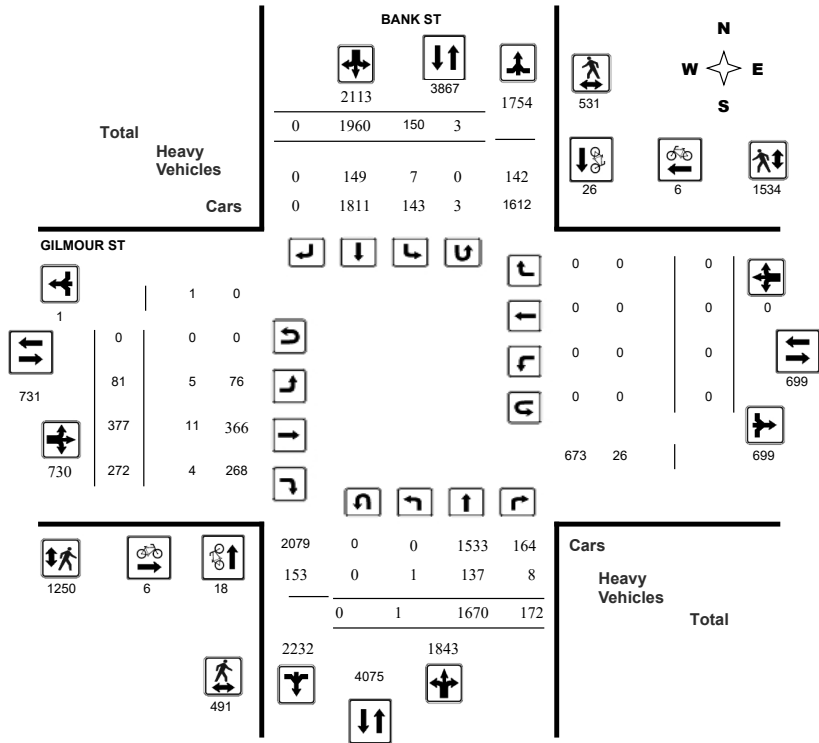

Transportation Services - Traffic Services

Turning Movement Count - Study Results

BANK ST @ GILMOUR ST

Survey Date: Tuesday, March 08, 2022

WO No: 40217

Start Time: 07:00

Device: Miovision

Full Study Peak Hour Diagram

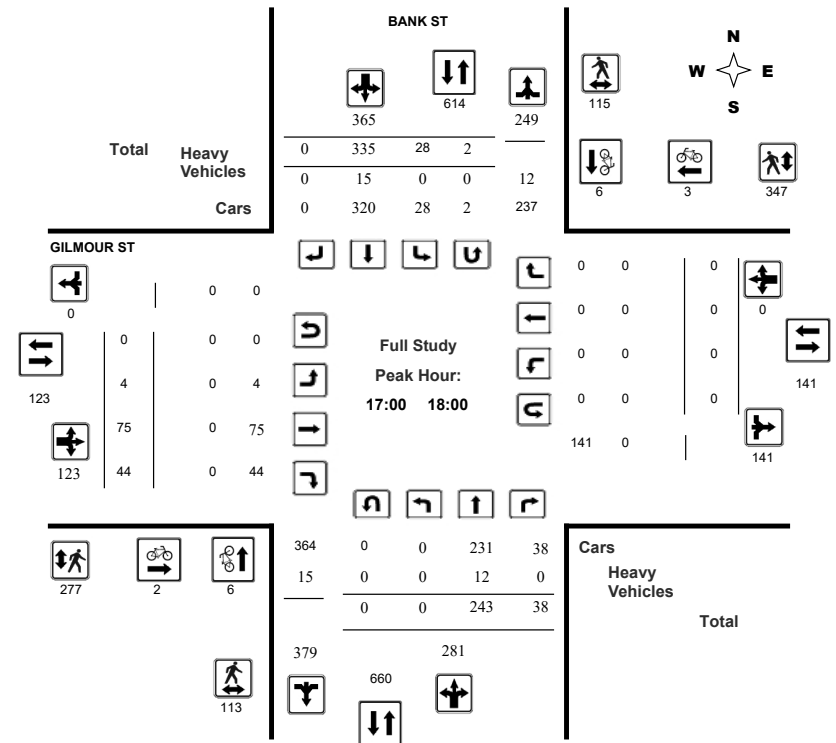



Transportation Services - Traffic Services

Turning Movement Count - Peak Hour Diagram

BANK ST @ GILMOUR ST

Survey Date: Tuesday, March 08, 2022
Start Time: 07:00

WO No: 40217
Device: Miovision

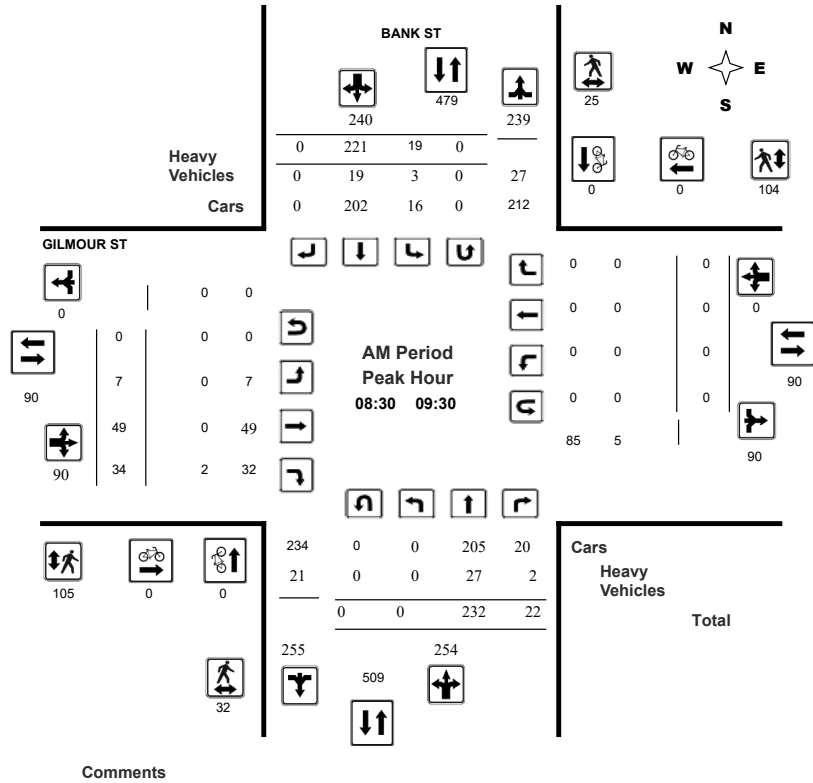

Comments



Transportation Services - Traffic Services

Turning Movement Count - Peak Hour Diagram

BANK ST @ GILMOUR ST

Survey Date: Tuesday, March 08, 2022
Start Time: 07:00

WO No: 40217
Device: Miovision

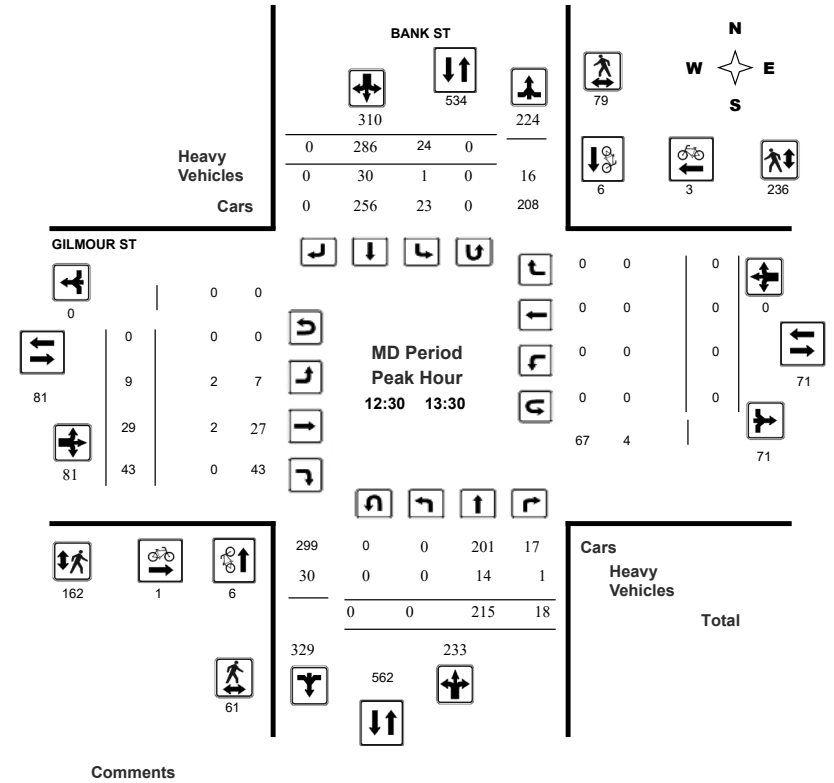

Comments



Transportation Services - Traffic Services
Turning Movement Count - Peak Hour Diagram
BANK ST @ GILMOUR ST

Survey Date: Tuesday, March 08, 2022
 Start Time: 07:00

WO No: 40217
 Device: Miovision

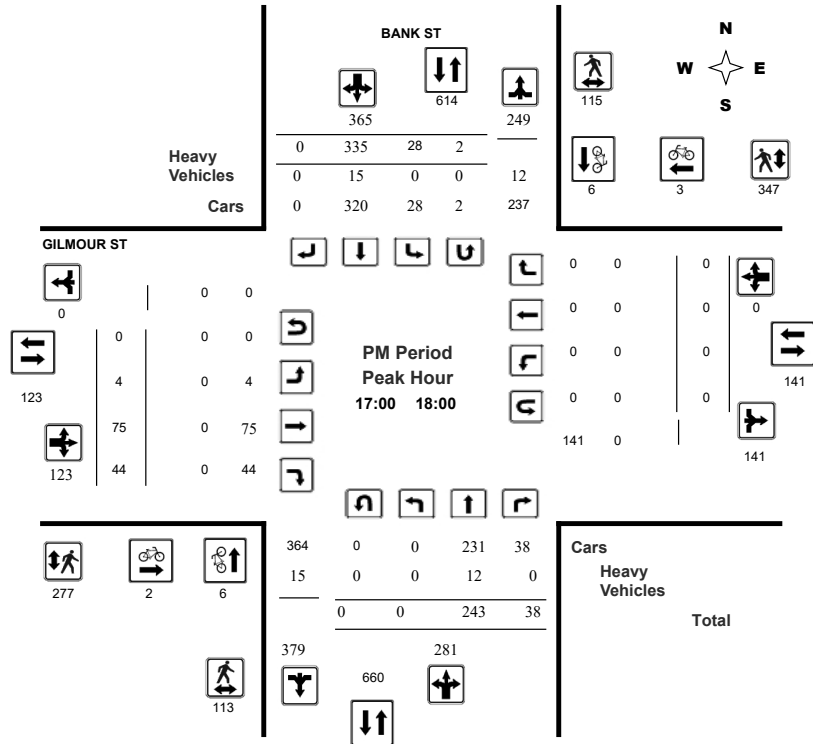

Comments



Transportation Services - Traffic Services
Turning Movement Count - Study Results
BANK ST @ GILMOUR ST

Survey Date: Tuesday, March 08, 2022
 Start Time: 07:00

WO No: 40217
 Device: Miovision

Full Study Summary (8 HR Standard)

Survey Date: Tuesday, March 08, 2022

Total Observed U-Turns
 Northbound: 0 Southbound: 3
 Eastbound: 0 Westbound: 0

AADT Factor
 1.00

Period	BANK ST					GILMOUR ST					WB TOT	STR TOT	Grand Total						
	Northbound			Southbound		Eastbound			Westbound										
	LT	ST	RT	NB TOT	LT	ST	RT	SB TOT	STR TOT	LT				ST	RT	EB TOT	WB TOT	STR TOT	
07:00 08:00	1	159	17	177	7	115	0	122	299	6	25	16	47	0	0	0	0	47	346
08:00 09:00	0	208	15	223	9	204	0	213	436	11	54	30	95	0	0	0	0	95	531
09:00 10:00	0	214	22	236	26	204	0	230	466	7	38	36	81	0	0	0	0	81	547
11:30 12:30	0	229	17	246	11	250	0	261	507	16	50	33	99	0	0	0	0	99	606
12:30 13:30	0	215	18	233	24	286	0	310	543	9	29	43	81	0	0	0	0	81	624
15:00 16:00	0	174	22	196	17	269	0	286	482	14	52	33	99	0	0	0	0	99	581
16:00 17:00	0	228	23	251	28	297	0	325	576	14	54	37	105	0	0	0	0	105	681
17:00 18:00	0	243	38	281	28	335	0	363	644	4	75	44	123	0	0	0	0	123	767
Sub Total	1	1670	172	1843	150	1960	0	2110	3953	81	377	272	730	0	0	0	0	730	4683
U Turns				0				3	3				0				0	0	3
Total	1	1670	172	1843	150	1960	0	2113	3956	81	377	272	730	0	0	0	0	730	4686
EQ 12Hr	1	2321	239	2562	208	2724	0	2937	5499	113	524	378	1015	0	0	0	0	1015	6514

Note: These values are calculated by multiplying the totals by the appropriate expansion factor.

1.39

AVG 12Hr 1 2321 239 2562 208 2724 0 2937 5499 113 524 378 1015 0 0 0 0 0 1015 6514

Note: These volumes are calculated by multiplying the Equivalent 12 hr. totals by the AADT factor.

1.00

AVG 24Hr 1 3041 313 3356 272 4675 0 3847 7204 148 686 495 1330 0 0 0 0 0 1330 8533

Note: These volumes are calculated by multiplying the Average Daily 12 hr. totals by 12 to 24 expansion factor.

1.31

Note: U-Turns provided for approach totals. Refer to 'U-Turn' Report for specific breakdown.



Transportation Services - Traffic Services

Turning Movement Count - Study Results

BANK ST @ GILMOUR ST

Survey Date: Tuesday, March 08, 2022

WO No: 40217

Start Time: 07:00

Device: Miovision

Full Study 15 Minute Increments

Table with columns for Time Period, Northbound, Southbound, Eastbound, Westbound, and Grand Total. Rows show 15-minute increments from 07:00 to 18:00.

Note: U-Turns are included in Totals.



Transportation Services - Traffic Services

Turning Movement Count - Study Results

BANK ST @ GILMOUR ST

Survey Date: Tuesday, March 08, 2022

WO No: 40217

Start Time: 07:00

Device: Miovision

Full Study Cyclist Volume

Table with columns for Time Period, Northbound, Southbound, Street Total, Eastbound, Westbound, Street Total, and Grand Total. Rows show 15-minute increments from 07:00 to 18:00.



Transportation Services - Traffic Services

Turning Movement Count - Study Results

BANK ST @ GILMOUR ST

Survey Date: Tuesday, March 08, 2022

WO No: 40217

Start Time: 07:00

Device: Miovision

Full Study Pedestrian Volume

Time Period	BANK ST		Total	GILMOUR ST		Total	Grand Total
	NB Approach (E or W Crossing)	SB Approach (E or W Crossing)		EB Approach (N or S Crossing)	WB Approach (N or S Crossing)		
07:00 07:15	3	6	9	7	6	13	22
07:15 07:30	6	5	11	18	11	29	40
07:30 07:45	6	12	18	20	24	44	62
07:45 08:00	16	16	32	21	17	38	70
08:00 08:15	16	11	27	13	16	29	56
08:15 08:30	10	8	18	31	19	50	68
08:30 08:45	14	4	18	24	40	64	82
08:45 09:00	6	6	12	33	18	51	63
09:00 09:15	8	9	17	28	21	49	66
09:15 09:30	4	6	10	20	25	45	55
09:30 09:45	12	11	23	27	21	48	71
09:45 10:00	7	5	12	22	13	35	47
11:30 11:45	13	18	31	22	55	77	108
11:45 12:00	20	14	34	32	52	84	118
12:00 12:15	10	19	29	36	49	85	114
12:15 12:30	11	23	34	54	69	123	157
12:30 12:45	10	15	25	38	54	92	117
12:45 13:00	17	12	29	47	58	105	134
13:00 13:15	14	24	38	41	59	100	138
13:15 13:30	20	28	48	36	65	101	149
15:00 15:15	14	21	35	29	59	88	123
15:15 15:30	12	23	35	50	46	96	131
15:30 15:45	24	21	45	58	50	108	153
15:45 16:00	20	13	33	46	56	102	135
16:00 16:15	18	21	39	49	72	121	160
16:15 16:30	24	20	44	50	59	109	153
16:30 16:45	21	20	41	52	86	138	179
16:45 17:00	22	25	47	69	67	136	183
17:00 17:15	21	34	55	55	84	139	194
17:15 17:30	26	22	48	82	91	173	221
17:30 17:45	35	22	57	68	78	146	203
17:45 18:00	31	37	68	72	94	166	234
Total	491	531	1022	1250	1534	2784	3806



Transportation Services - Traffic Services

Turning Movement Count - Study Results

BANK ST @ GILMOUR ST

Survey Date: Tuesday, March 08, 2022

WO No: 40217

Start Time: 07:00

Device: Miovision

Full Study Heavy Vehicles

Time Period	BANK ST						GILMOUR ST						Grand Total						
	Northbound			Southbound			Eastbound			Westbound									
	LT	ST	RT	N TOT	LT	ST	RT	S TOT	STR TOT	LT	ST	RT		E TOT	LT	ST	RT	W TOT	STR TOT
07:00 07:15	0	4	0	7	0	3	0	7	14	0	0	0	0	0	0	0	0	0	7
07:15 07:30	0	3	0	7	1	4	0	8	15	0	0	0	0	0	0	0	1	1	8
07:30 07:45	0	4	0	7	0	3	0	7	14	0	0	0	0	0	0	0	0	0	7
07:45 08:00	1	5	0	9	0	3	0	8	17	0	1	0	2	0	0	0	1	3	10
08:00 08:15	0	4	0	9	0	5	0	9	18	0	1	0	1	0	0	0	1	2	10
08:15 08:30	0	7	2	15	0	6	0	13	28	0	0	0	0	0	0	2	2	15	
08:30 08:45	0	8	0	12	0	4	0	12	24	0	0	0	0	0	0	0	0	12	
08:45 09:00	0	7	0	14	0	6	0	13	27	0	0	1	1	0	0	0	1	14	
09:00 09:15	0	8	1	15	1	5	0	14	29	0	0	1	1	0	0	2	3	16	
09:15 09:30	0	4	1	9	2	4	0	10	19	0	0	0	0	0	0	3	3	11	
09:30 09:45	0	5	0	10	0	4	0	9	19	0	0	1	1	0	0	0	1	10	
09:45 10:00	0	11	1	19	1	7	0	19	38	0	0	0	0	0	0	2	2	20	
11:30 11:45	0	6	0	14	0	8	0	14	28	0	0	0	0	0	0	0	0	14	
11:45 12:00	0	5	0	8	0	3	0	8	16	0	2	0	2	0	0	2	4	10	
12:00 12:15	0	6	2	13	0	4	0	10	23	0	0	1	1	0	0	2	3	13	
12:15 12:30	0	5	0	10	0	5	0	11	21	1	0	0	1	0	0	0	1	11	
12:30 12:45	0	5	0	12	0	7	0	13	25	1	0	0	1	0	0	0	1	13	
12:45 13:00	0	3	0	10	0	7	0	10	20	0	2	0	2	0	0	2	4	12	
13:00 13:15	0	2	0	9	0	7	0	10	19	1	0	0	1	0	0	0	1	10	
13:15 13:30	0	4	1	14	1	9	0	14	28	0	0	0	0	0	0	2	2	15	
15:00 15:15	0	3	0	10	0	7	0	10	20	0	2	0	2	0	0	2	4	12	
15:15 15:30	0	3	0	6	0	3	0	7	13	1	1	0	2	0	0	1	3	8	
15:30 15:45	0	3	0	5	0	2	0	5	10	0	1	0	1	0	0	1	2	6	
15:45 16:00	0	2	0	5	0	3	0	6	11	1	1	0	2	0	0	1	3	7	
16:00 16:15	0	3	0	6	0	3	0	6	12	0	0	0	0	0	0	0	0	6	
16:15 16:30	0	2	0	6	1	4	0	7	13	0	0	0	0	0	0	1	1	7	
16:30 16:45	0	1	0	5	0	4	0	5	10	0	0	0	0	0	0	0	0	5	
16:45 17:00	0	2	0	6	0	4	0	6	12	0	0	0	0	0	0	0	0	6	
17:00 17:15	0	4	0	7	0	3	0	7	14	0	0	0	0	0	0	0	0	7	
17:15 17:30	0	0	0	4	0	4	0	4	8	0	0	0	0	0	0	0	0	4	
17:30 17:45	0	4	0	9	0	5	0	9	18	0	0	0	0	0	0	0	0	9	
17:45 18:00	0	4	0	7	0	3	0	7	14	0	0	0	0	0	0	0	0	7	
Total: None	1	137	8	299	7	149	0	298	597	5	11	4	21	0	0	0	26	47	322



Transportation Services - Traffic Services

Turning Movement Count - Study Results

BANK ST @ GILMOUR ST

Survey Date: Tuesday, March 08, 2022

WO No: 40217

Start Time: 07:00

Device: Miovision

Full Study 15 Minute U-Turn Total

Time Period		Northbound U-Turn Total	Southbound U-Turn Total	Eastbound U-Turn Total	Westbound U-Turn Total	Total
07:00	07:15	0	0	0	0	0
07:15	07:30	0	0	0	0	0
07:30	07:45	0	0	0	0	0
07:45	08:00	0	0	0	0	0
08:00	08:15	0	0	0	0	0
08:15	08:30	0	0	0	0	0
08:30	08:45	0	0	0	0	0
08:45	09:00	0	0	0	0	0
09:00	09:15	0	0	0	0	0
09:15	09:30	0	0	0	0	0
09:30	09:45	0	0	0	0	0
09:45	10:00	0	0	0	0	0
11:30	11:45	0	0	0	0	0
11:45	12:00	0	0	0	0	0
12:00	12:15	0	0	0	0	0
12:15	12:30	0	1	0	0	1
12:30	12:45	0	0	0	0	0
12:45	13:00	0	0	0	0	0
13:00	13:15	0	0	0	0	0
13:15	13:30	0	0	0	0	0
15:00	15:15	0	0	0	0	0
15:15	15:30	0	0	0	0	0
15:30	15:45	0	0	0	0	0
15:45	16:00	0	0	0	0	0
16:00	16:15	0	0	0	0	0
16:15	16:30	0	0	0	0	0
16:30	16:45	0	0	0	0	0
16:45	17:00	0	0	0	0	0
17:00	17:15	0	1	0	0	1
17:15	17:30	0	0	0	0	0
17:30	17:45	0	1	0	0	1
17:45	18:00	0	0	0	0	0
Total		0	3	0	0	3



Turning Movement Count Bicycle Summary Flow Diagram



Bank Street & James Street Ottawa, ON

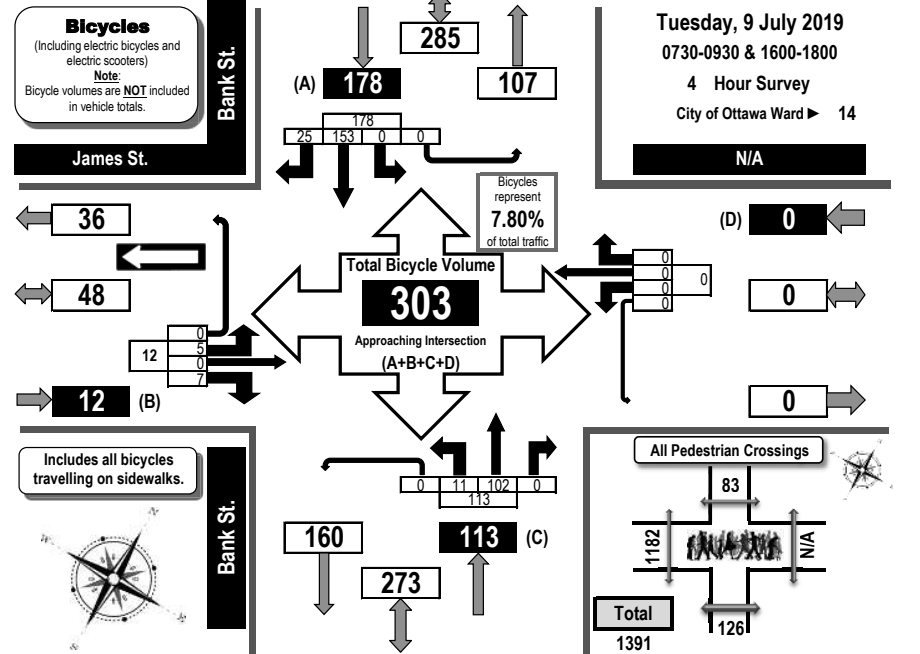

Time Period	James St. Eastbound					N/A Westbound					Bank St. Northbound					Bank St. Southbound					G.Tot.
	LT	ST	RT	UT	S.Tot.	LT	ST	RT	UT	S.Tot.	LT	ST	RT	UT	S.Tot.	LT	ST	RT	UT	S.Tot.	
0730-0800	0	0	1	0	1	0	0	0	0	0	2	16	0	0	18	0	6	4	0	10	29
0800-0900	3	0	3	0	6	0	0	0	0	0	2	25	0	0	27	0	9	2	0	11	44
0900-0930	0	0	1	0	1	0	0	0	0	0	0	12	0	0	12	0	7	0	0	7	20
1600-1700	1	0	1	0	2	0	0	0	0	0	4	25	0	0	29	0	63	8	0	71	102
1700-1800	1	0	1	0	2	0	0	0	0	0	3	24	0	0	27	0	68	11	0	79	108
Totals	5	0	7	0	12	0	0	0	0	0	11	102	0	0	113	0	153	25	0	178	303

Comments:

Bronson Avenue, northbound, is closed due to construction between Catherine Street and Chamberlain Avenue. James Street is one way westbound. Bicycles were counted on all approaches. Pedestrians using the sidewalk on the east side of Bank Street were not counted; however, all bicycles driving on it were and are included in the bicycle summary. There were two eastbound vehicles from James Street but they are not included in the summary. The majority of heavy vehicle traffic consists of OC Transpo buses.



Turning Movement Count Summary, AM and PM Peak Hour Flow Diagrams

Automobiles, Taxis, Light Trucks, Vans, SUV's, Motorcycles, Heavy Trucks, Buses, and School Buses

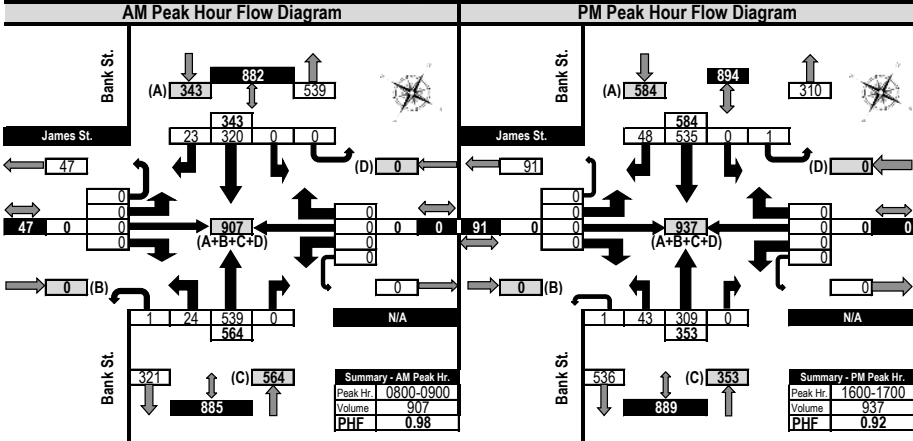
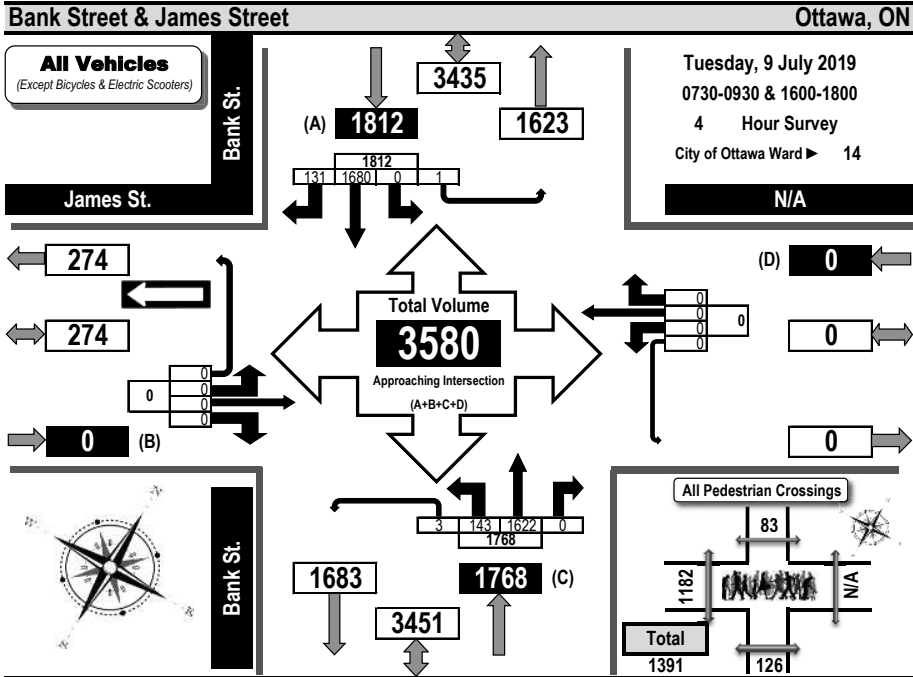

Turning Movement Count Heavy Vehicle Summary Flow Diagram

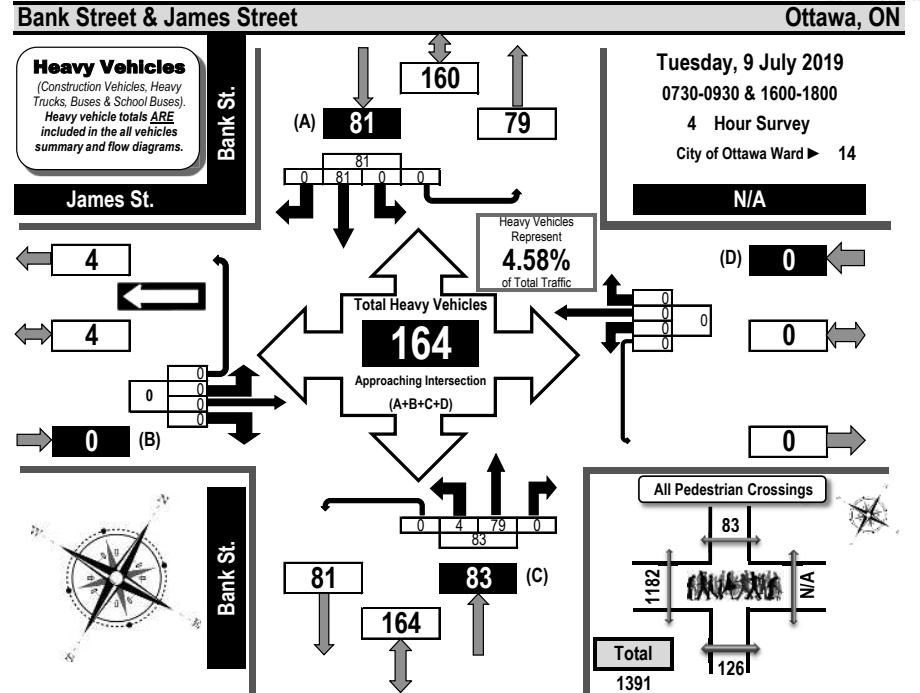

Time Period	James St. Eastbound					N/A Westbound					Bank St. Northbound					Bank St. Southbound					S. Tot.	G. Tot.
	LT	ST	RT	UT	S. Tot.	LT	ST	RT	UT	S. Tot.	LT	ST	RT	UT	S. Tot.	LT	ST	RT	UT	S. Tot.		
0730-0800	0	0	0	0	0	0	0	0	0	0	0	0	13	0	13	0	13	0	0	13	26	
0800-0900	0	0	0	0	0	0	0	0	0	0	0	2	26	0	28	0	25	0	0	25	53	
0900-0930	0	0	0	0	0	0	0	0	0	0	0	0	15	0	15	0	12	0	0	12	27	
1600-1700	0	0	0	0	0	0	0	0	0	0	0	1	13	0	14	0	10	0	0	10	24	
1700-1800	0	0	0	0	0	0	0	0	0	0	0	1	12	0	13	0	21	0	0	21	34	
Totals	0	0	0	0	0	0	0	0	0	0	0	4	79	0	83	0	81	0	0	81	164	

Comments:
Bronson Avenue, northbound, is closed due to construction between Catherine Street and Chamberlain Avenue. James Street is one way westbound. Bicycles were counted on all approaches. Pedestrians using the sidewalk on the east side of Bank Street were not counted; however, all bicycles driving on it were and are included in the bicycle summary. There were two eastbound vehicles from James Street but they are not included in the summary. The majority of heavy vehicle traffic consists of OC Transpo buses.



Turning Movement Count Pedestrian Crossings Summary and Flow Diagram



Bank Street & James Street Ottawa, ON

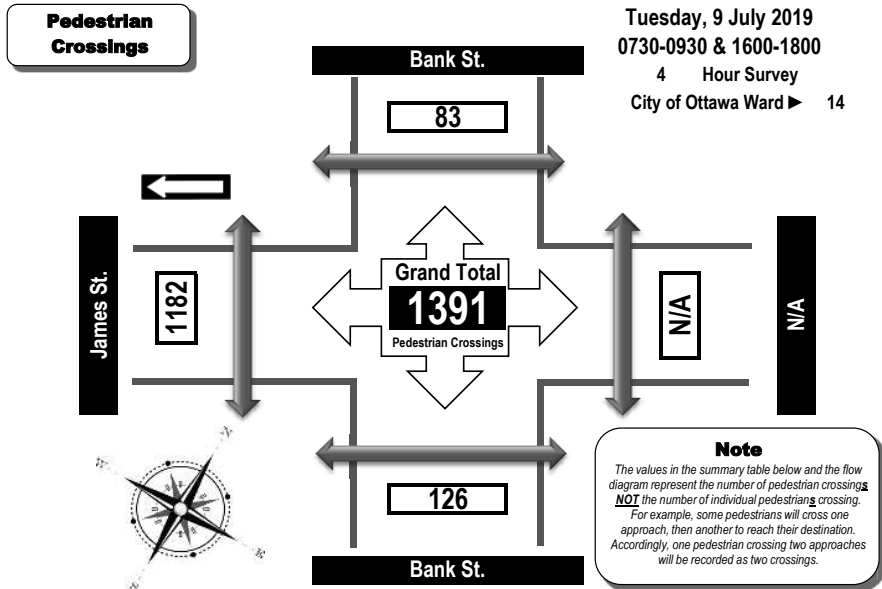

Tuesday, 9 July 2019
0730-0930 & 1600-1800
4 Hour Survey
City of Ottawa Ward ► 14

Time Period	West Side Crossing James St.	East Side Crossing N/A	Street Total	South Side Crossing Bank St.	North Side Crossing Bank St.	Street Total	Grand Total
0730-0800	78	0	78	4	4	8	86
0800-0900	174	0	174	9	15	24	198
0900-0930	49	0	49	17	9	26	75
1600-1700	439	0	439	43	30	73	512
1700-1800	442	0	442	53	25	78	520
Totals	1182	0	1182	126	83	209	1391

Comments:

Bronson Avenue, northbound, is closed due to construction between Catherine Street and Chamberlain Avenue. James Street is one way westbound. Bicycles were counted on all approaches. Pedestrians using the sidewalk on the east side of Bank Street were not counted; however, all bicycles driving on it were and are included in the bicycle summary. There were two eastbound vehicles from James Street but they are not included in the summary. The majority of heavy vehicle traffic consists of OC Transpo buses.



Turning Movement Count Summary Report AADT and Expansion Factors

Automobiles, Taxis,
Light Trucks, Vans,
SUV's, Motorcycles,
Heavy Trucks, Buses,
and School Buses

Bank Street & James Street Ottawa, ON

Survey Date: Tuesday, 9 July 2019 Start Time: 0730 AADT Factor: 0.9
Weather AM: Clear +16°C Survey Duration: 4 Hrs. Survey Hours: 0730-0930 & 1600-1800
Weather PM: Partly Cloudy +30°C Surveyor(s): Carmody

Time Period	James St.					N/A					Bank St.					Bank St.					Street Total	Grand Total	
	Eastbound					Westbound					Northbound					Southbound							
	LT	ST	RT	UT	W/B Tot	LT	ST	RT	UT	W/B Tot	LT	ST	RT	UT	N/B Tot	LT	ST	RT	UT	S/B Tot			
0730-0800	0	0	0	0	0	0	0	0	0	0	0	12	261	0	0	273	0	161	6	0	167	440	440
0800-0900	0	0	0	0	0	0	0	0	0	0	0	24	539	0	1	564	0	320	23	0	343	907	907
0900-0930	0	0	0	0	0	0	0	0	0	0	0	16	194	0	0	210	0	150	15	0	165	375	375
1600-1700	0	0	0	0	0	0	0	0	0	0	0	43	309	0	1	353	0	535	48	1	584	937	937
1700-1800	0	0	0	0	0	0	0	0	0	0	0	48	319	0	1	368	0	514	39	0	553	921	921
Totals	0	0	0	0	0	0	0	0	0	0	0	143	1622	0	3	1768	0	1680	131	1	1812	3580	3580

**Equivalent 12 & 24-hour Vehicle Volumes Including the Annual Average Daily Traffic (AADT) Factor
Applicable to the Day and Month of the Turning Movement Count**

Expansion factors are applied exclusively to standard weekday 8-hour turning movement counts conducted during the hours of 0700h - 1000h, 1130h - 1330h and 1500h - 1800h

Equivalent 12-hour vehicle volumes. These volumes are calculated by multiplying the 8-hour totals by the 8 → 12 expansion factor of 1.39																
Equ. 12 Hr	n/a	n/a	n/a	n/a	n/a	n/a	n/a	n/a	n/a	n/a	n/a	n/a	n/a	n/a	n/a	n/a
Average daily 12-hour vehicle volumes. These volumes are calculated by multiplying the equivalent 12-hour totals by the AADT factor of: 0.9																
AADT 12-hr	n/a	n/a	n/a	n/a	n/a	n/a	n/a	n/a	n/a	n/a	n/a	n/a	n/a	n/a	n/a	n/a
24-Hour AADT. These volumes are calculated by multiplying the average daily 12-hour vehicle volumes by the 12 → 24 expansion factor of 1.31																
AADT 24 Hr	n/a	n/a	n/a	n/a	n/a	n/a	n/a	n/a	n/a	n/a	n/a	n/a	n/a	n/a	n/a	n/a

AADT and expansion factors provided by the City of Ottawa

AM Peak Hour Factor → 0.98											Highest Hourly Vehicle Volume Between 0700h & 1000h												
AM Peak Hr	LT	ST	RT	UT	TOT	LT	ST	RT	UT	TOT	LT	ST	RT	UT	TOT	LT	ST	RT	UT	TOT	S.TOT	G.TOT	
0800-0900	0	0	0	0	0	0	0	0	0	0	0	24	539	0	1	564	0	320	23	0	343	907	907

PM Peak Hour Factor → 0.92											Highest Hourly Vehicle Volume Between 1500h & 1800h												
PM Peak Hr	LT	ST	RT	UT	TOT	LT	ST	RT	UT	TOT	LT	ST	RT	UT	TOT	LT	ST	RT	UT	TOT	S.TOT	G.TOT	
1600-1700	0	0	0	0	0	0	0	0	0	0	0	43	309	0	1	353	0	535	48	1	584	937	937

Comments:

Bronson Avenue, northbound, is closed due to construction between Catherine Street and Chamberlain Avenue. James Street is one way westbound. Bicycles were counted on all approaches. Pedestrians using the sidewalk on the east side of Bank Street were not counted; however, all bicycles driving on it were and are included in the bicycle summary. There were two eastbound vehicles from James Street but they are not included in the summary. The majority of heavy vehicle traffic consists of OC Transpo buses.

Notes:

1. Includes all vehicle types except bicycles, electric bicycles, and electric scooters.
2. When expansion and AADT factors are applied, the results will differ slightly due to rounding.



Transportation Services - Traffic Services

Turning Movement Count - Study Results

BANK ST @ GLADSTONE AVE

Survey Date: Tuesday, March 08, 2022

WO No: 40220

Start Time: 07:00

Device: Miovision

Full Study Diagram

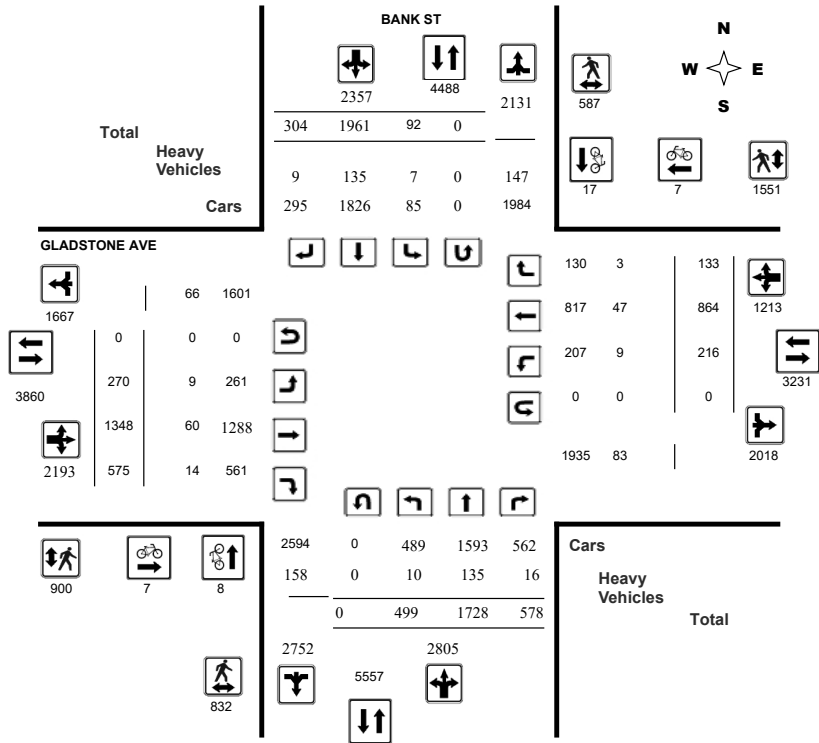

Transportation Services - Traffic Services

Turning Movement Count - Study Results

BANK ST @ GLADSTONE AVE

Survey Date: Tuesday, March 08, 2022

WO No: 40220

Start Time: 07:00

Device: Miovision

Full Study Peak Hour Diagram

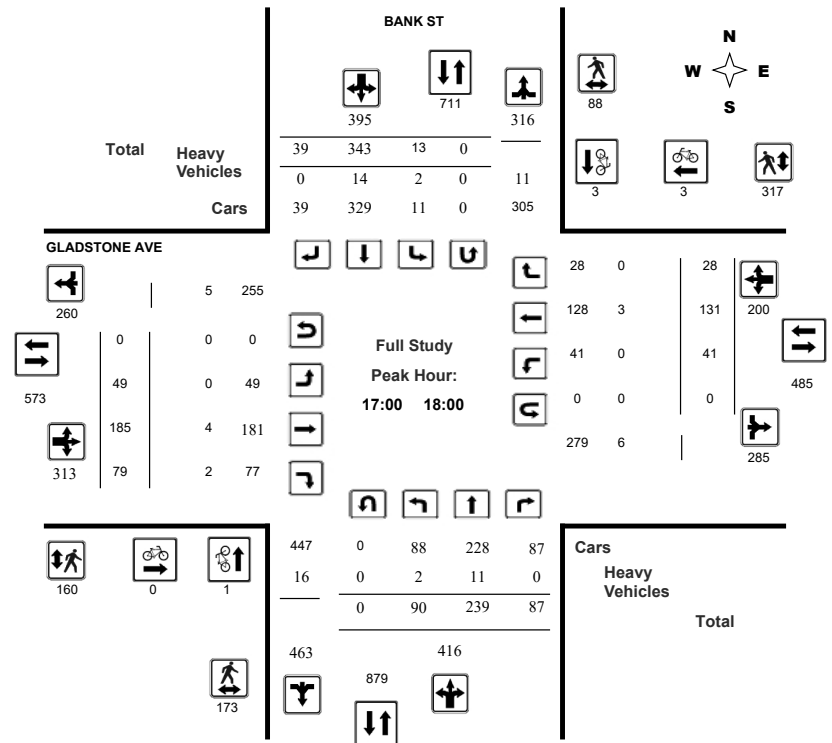



Transportation Services - Traffic Services

Turning Movement Count - Peak Hour Diagram

BANK ST @ GLADSTONE AVE

Survey Date: Tuesday, March 08, 2022
Start Time: 07:00

WO No: 40220
Device: Miovision

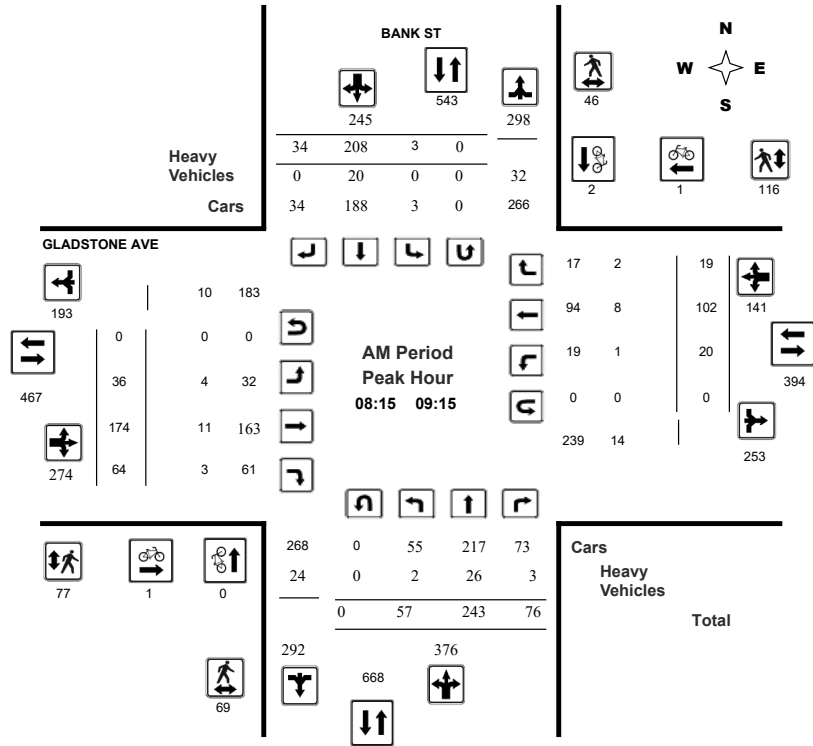

Comments



Transportation Services - Traffic Services

Turning Movement Count - Peak Hour Diagram

BANK ST @ GLADSTONE AVE

Survey Date: Tuesday, March 08, 2022
Start Time: 07:00

WO No: 40220
Device: Miovision

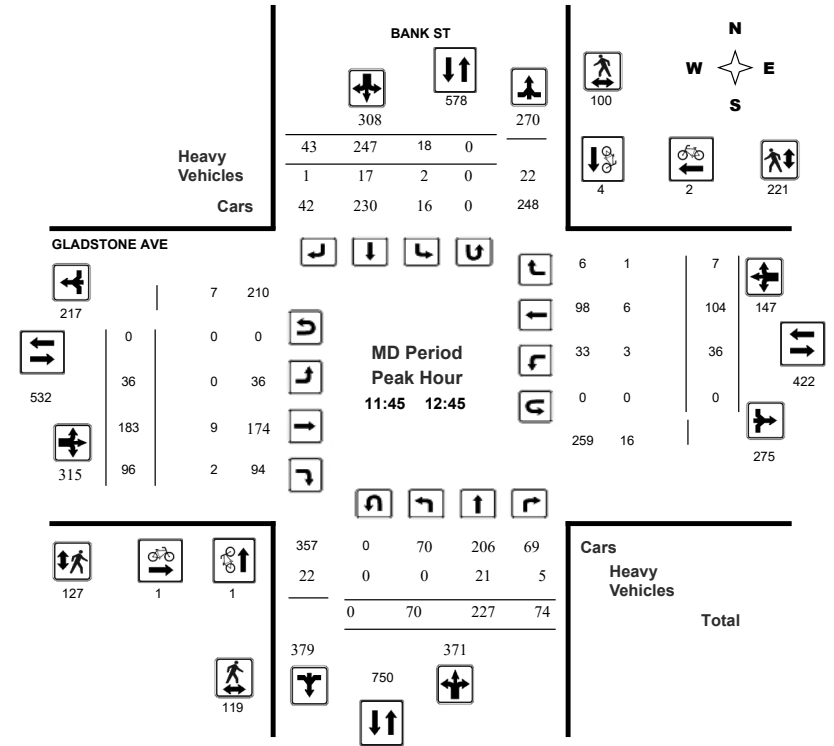

Comments



Transportation Services - Traffic Services

Turning Movement Count - Peak Hour Diagram

BANK ST @ GLADSTONE AVE

Survey Date: Tuesday, March 08, 2022
Start Time: 07:00

WO No: 40220
Device: Miovision

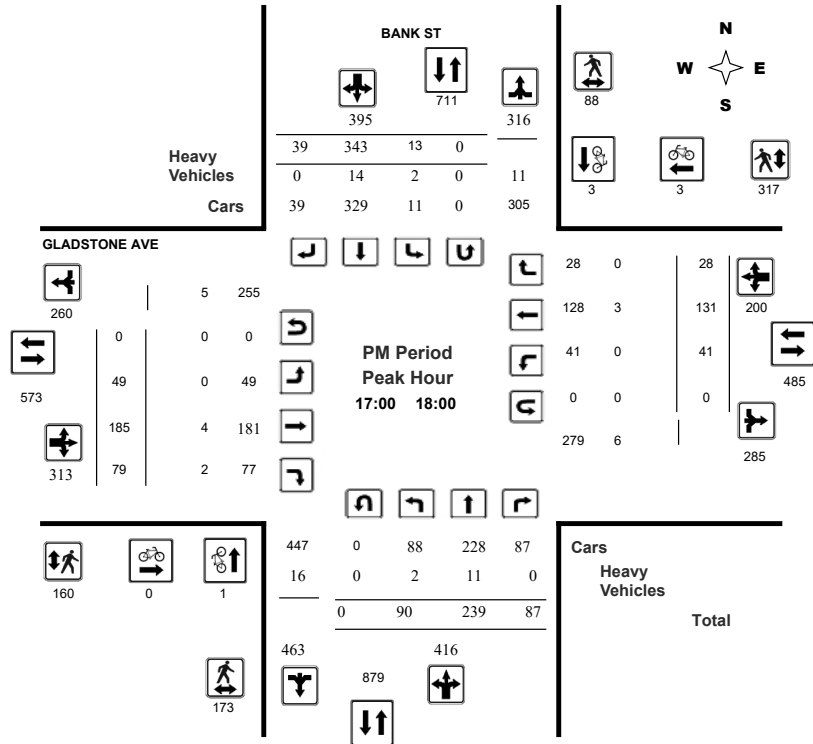

Comments



Transportation Services - Traffic Services

Turning Movement Count - Study Results

BANK ST @ GLADSTONE AVE

Survey Date: Tuesday, March 08, 2022
Start Time: 07:00

WO No: 40220
Device: Miovision

Full Study Summary (8 HR Standard)

Survey Date: Tuesday, March 08, 2022

Total Observed U-Turns
 Northbound: 0 Southbound: 0
 Eastbound: 0 Westbound: 0

AADT Factor
1.00

Period	BANK ST				GLADSTONE AVE								WB TOT	STR TOT	Grand Total								
	Northbound		Southbound		Eastbound			Westbound															
	LT	ST	RT	SB TOT	STR TOT	LT	ST	RT	EB TOT	LT	ST	RT											
07:00 08:00	47	181	73	301	0	133	13	146	447	21	132	38	191	13	53	8	74	265	712				
08:00 09:00	59	223	79	361	1	198	33	232	593	29	185	62	276	24	95	18	137	413	1006				
09:00 10:00	42	229	59	330	11	189	41	241	571	30	155	51	236	12	99	11	122	358	929				
11:30 12:30	71	227	69	367	11	232	46	289	656	38	176	95	309	35	106	13	154	463	1119				
12:30 13:30	67	216	81	364	20	272	44	336	700	30	175	77	282	23	106	10	139	421	1121				
15:00 16:00	62	184	62	308	19	279	48	346	654	32	172	89	293	26	129	21	176	469	1123				
16:00 17:00	61	229	68	358	17	315	40	372	730	41	168	84	293	42	145	24	211	504	1234				
17:00 18:00	90	239	87	416	13	343	39	395	811	49	185	79	313	41	131	28	200	513	1324				
Sub Total	499	1728	578	2805	92	1961	304	2357	5162	270	1348	575	2193	216	864	133	1213	3406	8568				
U Turns				0				0	0				0				0	0	0				
Total	499	1728	578	2805	92	1961	304	2357	5162	270	1348	575	2193	216	864	133	1213	3406	8568				
EQ 12Hr	694	2402	803	3899	128	2726	423	3276	7175	375	1874	799	3048	300	1201	185	1686	4734	11910				
Note: These values are calculated by multiplying the totals by the appropriate expansion factor.													1.39										
AVG 12Hr	694	2402	803	3899	128	3571	554	3276	7175	375	1874	799	3048	300	1201	185	1686	4734	11910				
Note: These volumes are calculated by multiplying the Equivalent 12 hr. totals by the AADT factor.													1.00										
AVG 24Hr	909	3147	1052	5108	168	4678	726	4292	9399	491	2455	1047	3993	393	1573	242	2209	6202	15602				
Note: These volumes are calculated by multiplying the Average Daily 12 hr. totals by 12 to 24 expansion factor.													1.31										
Note: U-Turns provided for approach totals. Refer to 'U-Turn' Report for specific breakdown.																							



Transportation Services - Traffic Services

Turning Movement Count - Study Results

BANK ST @ GLADSTONE AVE

Survey Date: Tuesday, March 08, 2022

WO No: 40220

Start Time: 07:00

Device: Miovision

Full Study 15 Minute Increments

BANK ST GLADSTONE AVE

Table with columns for Time Period, Northbound (LT, ST, RT, N TOT, STR TOT), Southbound (LT, ST, RT, S TOT, STR TOT), Eastbound (LT, ST, RT, E TOT), Westbound (LT, ST, RT, W TOT, STR TOT), and Grand Total. Rows represent 15-minute intervals from 07:00 to 17:45.

Note: U-Turns are included in Totals.



Transportation Services - Traffic Services

Turning Movement Count - Study Results

BANK ST @ GLADSTONE AVE

Survey Date: Tuesday, March 08, 2022

WO No: 40220

Start Time: 07:00

Device: Miovision

Full Study Cyclist Volume

BANK ST GLADSTONE AVE

Table with columns for Time Period, Northbound, Southbound, Street Total, Eastbound, Westbound, Street Total, and Grand Total. Rows represent 15-minute intervals from 07:00 to 17:45.



Transportation Services - Traffic Services

Turning Movement Count - Study Results

BANK ST @ GLADSTONE AVE

Survey Date: Tuesday, March 08, 2022

WO No: 40220

Start Time: 07:00

Device: Miovision

Full Study Pedestrian Volume

Time Period	BANK ST		Total	GLADSTONE AVE		Total	Grand Total
	NB Approach (E or W Crossing)	SB Approach (E or W Crossing)		EB Approach (N or S Crossing)	WB Approach (N or S Crossing)		
07:00 07:15	9	6	15	6	10	16	31
07:15 07:30	4	5	9	10	10	20	29
07:30 07:45	10	1	11	11	20	31	42
07:45 08:00	20	11	31	11	23	34	65
08:00 08:15	22	19	41	11	27	38	79
08:15 08:30	24	11	35	16	31	47	82
08:30 08:45	22	8	30	20	36	56	86
08:45 09:00	10	10	20	19	27	46	66
09:00 09:15	13	17	30	22	22	44	74
09:15 09:30	15	7	22	11	24	35	57
09:30 09:45	13	9	22	22	17	39	61
09:45 10:00	15	10	25	19	16	35	60
11:30 11:45	16	25	41	28	40	68	109
11:45 12:00	30	21	51	23	54	77	128
12:00 12:15	23	27	50	43	40	83	133
12:15 12:30	36	25	61	32	64	96	157
12:30 12:45	30	27	57	29	63	92	149
12:45 13:00	27	33	60	29	73	102	162
13:00 13:15	24	27	51	35	75	110	161
13:15 13:30	25	32	57	37	54	91	148
15:00 15:15	34	18	52	24	49	73	125
15:15 15:30	25	17	42	35	38	73	115
15:30 15:45	22	26	48	37	48	85	133
15:45 16:00	34	19	53	37	63	100	153
16:00 16:15	42	14	56	45	81	126	182
16:15 16:30	35	30	65	47	71	118	183
16:30 16:45	41	16	57	39	79	118	175
16:45 17:00	38	28	66	42	79	121	187
17:00 17:15	50	22	72	31	80	111	183
17:15 17:30	45	22	67	49	79	128	195
17:30 17:45	36	23	59	47	74	121	180
17:45 18:00	42	21	63	33	84	117	180
Total	832	587	1419	900	1551	2451	3870



Transportation Services - Traffic Services

Turning Movement Count - Study Results

BANK ST @ GLADSTONE AVE

Survey Date: Tuesday, March 08, 2022

WO No: 40220

Start Time: 07:00

Device: Miovision

Full Study Heavy Vehicles

Time Period	BANK ST				GLADSTONE AVE				Grand Total										
	Northbound		Southbound		Eastbound		Westbound												
	LT	ST	RT	N TOT	LT	ST	RT	S TOT		STR TOT	LT	ST	RT	E TOT	LT	ST	RT	W TOT	STR TOT
07:00 07:15	2	4	0	9	0	3	0	7	16	0	2	0	5	0	1	0	3	8	12
07:15 07:30	0	3	0	7	0	4	0	7	14	0	3	0	4	0	1	0	4	8	11
07:30 07:45	0	4	1	10	0	3	0	7	17	0	2	1	3	1	0	0	4	7	12
07:45 08:00	0	5	1	8	0	2	0	7	15	0	0	0	3	0	3	0	4	7	11
08:00 08:15	0	8	0	11	0	3	0	11	22	0	1	0	3	0	2	0	3	6	14
08:15 08:30	0	5	2	16	0	6	0	12	28	0	3	2	9	1	4	1	11	20	24
08:30 08:45	1	7	1	12	0	3	0	12	24	2	3	0	7	0	1	0	5	12	18
08:45 09:00	1	7	0	15	0	6	0	14	29	0	2	1	5	0	1	1	4	9	19
09:00 09:15	0	7	0	12	0	5	0	14	26	2	3	0	7	0	2	0	5	12	19
09:15 09:30	1	4	0	10	0	5	1	10	20	0	2	0	5	0	1	0	3	8	14
09:30 09:45	1	5	1	13	0	6	0	11	24	0	3	0	6	0	2	0	6	12	18
09:45 10:00	0	9	1	16	0	6	1	19	35	3	5	0	13	0	4	0	10	23	29
11:30 11:45	0	4	0	10	0	4	2	10	20	0	1	0	4	2	1	0	4	8	14
11:45 12:00	0	6	3	12	1	2	0	9	21	0	2	1	5	0	2	0	8	13	17
12:00 12:15	0	5	0	11	0	5	1	12	23	0	4	1	6	0	0	1	5	11	17
12:15 12:30	0	7	1	13	0	3	0	10	23	0	2	0	5	2	3	0	8	13	18
12:30 12:45	0	3	1	12	1	7	0	11	23	0	1	0	2	1	1	0	5	7	15
12:45 13:00	0	3	1	9	1	4	1	9	18	0	2	1	4	0	0	0	4	8	13
13:00 13:15	1	2	1	13	0	7	0	9	22	0	3	2	8	0	2	0	6	14	18
13:15 13:30	0	5	0	14	1	9	1	16	30	0	3	0	6	0	2	0	6	12	21
15:00 15:15	1	4	0	13	0	8	0	12	25	0	2	0	5	0	2	0	4	9	17
15:15 15:30	0	2	0	4	1	2	0	7	11	2	1	0	4	0	1	0	3	7	9
15:30 15:45	0	4	0	6	0	2	0	6	12	0	0	0	1	0	1	0	1	2	7
15:45 16:00	0	1	1	6	0	3	0	4	10	0	0	1	3	0	2	0	3	6	8
16:00 16:15	0	4	0	7	0	3	1	8	15	0	2	0	4	0	1	0	3	7	11
16:15 16:30	0	2	0	8	0	4	1	7	15	0	2	1	6	1	2	0	5	11	13
16:30 16:45	0	1	1	6	0	3	0	4	10	0	1	1	3	0	1	0	3	6	8
16:45 17:00	0	3	0	7	0	3	0	6	13	0	1	0	2	1	1	0	3	5	9
17:00 17:15	2	3	0	9	1	3	0	7	16	0	1	1	4	0	0	0	2	6	11
17:15 17:30	0	1	0	5	0	4	0	5	10	0	0	0	1	0	1	0	1	2	6
17:30 17:45	0	3	0	7	1	4	0	8	15	0	1	0	2	0	1	0	3	5	10
17:45 18:00	0	4	0	8	0	3	0	7	15	0	2	1	4	0	1	0	3	7	11
Total: None	10	135	16	319	7	135	9	298	617	9	60	14	149	9	47	3	142	291	454



Transportation Services - Traffic Services

Turning Movement Count - Study Results

BANK ST @ GLADSTONE AVE

Survey Date: Tuesday, March 08, 2022

WO No: 40220

Start Time: 07:00

Device: Miovision

Full Study 15 Minute U-Turn Total

BANK ST

GLADSTONE AVE

Time Period	Northbound U-Turn Total	Southbound U-Turn Total	Eastbound U-Turn Total	Westbound U-Turn Total	Total
07:00 07:15	0	0	0	0	0
07:15 07:30	0	0	0	0	0
07:30 07:45	0	0	0	0	0
07:45 08:00	0	0	0	0	0
08:00 08:15	0	0	0	0	0
08:15 08:30	0	0	0	0	0
08:30 08:45	0	0	0	0	0
08:45 09:00	0	0	0	0	0
09:00 09:15	0	0	0	0	0
09:15 09:30	0	0	0	0	0
09:30 09:45	0	0	0	0	0
09:45 10:00	0	0	0	0	0
11:30 11:45	0	0	0	0	0
11:45 12:00	0	0	0	0	0
12:00 12:15	0	0	0	0	0
12:15 12:30	0	0	0	0	0
12:30 12:45	0	0	0	0	0
12:45 13:00	0	0	0	0	0
13:00 13:15	0	0	0	0	0
13:15 13:30	0	0	0	0	0
15:00 15:15	0	0	0	0	0
15:15 15:30	0	0	0	0	0
15:30 15:45	0	0	0	0	0
15:45 16:00	0	0	0	0	0
16:00 16:15	0	0	0	0	0
16:15 16:30	0	0	0	0	0
16:30 16:45	0	0	0	0	0
16:45 17:00	0	0	0	0	0
17:00 17:15	0	0	0	0	0
17:15 17:30	0	0	0	0	0
17:30 17:45	0	0	0	0	0
17:45 18:00	0	0	0	0	0
Total	0	0	0	0	0

Appendix C

Synchro Intersection Worksheets – Existing Conditions

DRAFT

Lanes, Volumes, Timings
1: Lyon & James

Existing AM Peak Hour
11/08/2021

Lane Group	EBL	EBT	EBR	WBL	WBT	WBR	NBL	NBT	NBR	SBL	SBT	SBR
Lane Configurations					↕						↕↕	
Traffic Volume (vph)	0	0	0	56	23	0	0	0	0	0	423	11
Future Volume (vph)	0	0	0	56	23	0	0	0	0	0	423	11
Satd. Flow (prot)	0	0	0	0	1652	0	0	0	0	0	3297	0
Fit Permitted					0.966							
Satd. Flow (perm)	0	0	0	0	1644	0	0	0	0	0	3297	0
Satd. Flow (RTOR)											8	
Lane Group Flow (vph)	0	0	0	0	88	0	0	0	0	0	482	0
Turn Type				Perm	NA						NA	
Protected Phases					8						6	
Permitted Phases				8						6		
Detector Phase				8	8					6	6	
Switch Phase												
Minimum Initial (s)				10.0	10.0					10.0	10.0	
Minimum Split (s)				17.1	17.1					29.7	29.7	
Total Split (s)				17.1	17.1					57.9	57.9	
Total Split (%)				22.8%	22.8%					77.2%	77.2%	
Yellow Time (s)				3.3	3.3					3.3	3.3	
All-Red Time (s)				1.8	1.8					1.4	1.4	
Lost Time Adjust (s)					0.0						0.0	
Total Lost Time (s)					5.1						4.7	
Lead/Lag												
Lead-Lag Optimize?												
Recall Mode				None	None					C-Max	C-Max	
Act Effct Green (s)					10.8						58.4	
Actuated g/C Ratio					0.14						0.78	
v/c Ratio					0.37						0.19	
Control Delay					29.8						3.2	
Queue Delay					0.0						0.0	
Total Delay					29.8						3.2	
LOS					C						A	
Approach Delay					29.8						3.2	
Approach LOS					C						A	
Queue Length 50th (m)					10.7						8.9	
Queue Length 95th (m)					18.3						14.9	
Internal Link Dist (m)		102.5			161.6			141.5			55.1	
Turn Bay Length (m)												
Base Capacity (vph)					263						2567	
Starvation Cap Reductn					0						0	
Spillback Cap Reductn					0						0	
Storage Cap Reductn					0						0	
Reduced v/c Ratio					0.33						0.19	
Intersection Summary												
Cycle Length: 75												
Actuated Cycle Length: 75												
Offset: 16 (21%), Referenced to phase 2: and 6:SBTL, Start of Green												
Natural Cycle: 50												
Control Type: Actuated-Coordinated												

Lanes, Volumes, Timings
1: Lyon & James

Existing AM Peak Hour
11/08/2021

Maximum v/c Ratio: 0.37	Intersection LOS: A
Intersection Signal Delay: 7.3	ICU Level of Service A
Intersection Capacity Utilization 40.2%	
Analysis Period (min) 15	
m Volume for 95th percentile queue is metered by upstream signal.	

Splits and Phases: 1: Lyon & James



Lanes, Volumes, Timings
2: Lyon & Gladstone

Existing AM Peak Hour
11/08/2021

Lane Group	EBL	EBT	EBR	WBL	WBT	WBR	NBL	NBT	NBR	SBL	SBT	SBR
Lane Configurations		↔		↔	↔					↔	↔	
Traffic Volume (vph)	0	304	68	32	166	0	0	0	0	67	340	57
Future Volume (vph)	0	304	68	32	166	0	0	0	0	67	340	57
Satd. Flow (prot)	0	1675	0	0	1687	0	0	0	0	0	3233	0
Fit Permitted					0.897						0.993	
Satd. Flow (perm)	0	1675	0	0	1525	0	0	0	0	0	3233	0
Satd. Flow (RTOR)		19									25	
Lane Group Flow (vph)	0	414	0	0	220	0	0	0	0	0	515	0
Turn Type		NA		Perm	NA					Perm	NA	
Protected Phases		2			6						8	
Permitted Phases				6						8		
Detector Phase		2		6	6					8	8	
Switch Phase												
Minimum Initial (s)		10.0		10.0	10.0					10.0	10.0	
Minimum Split (s)		17.2		17.2	17.2					22.6	22.6	
Total Split (s)		38.0		38.0	38.0					37.0	37.0	
Total Split (%)		50.7%		50.7%	50.7%					49.3%	49.3%	
Yellow Time (s)		3.3		3.3	3.3					3.3	3.3	
All-Red Time (s)		1.9		1.9	1.9					2.3	2.3	
Lost Time Adjust (s)		0.0		0.0	0.0					0.0	0.0	
Total Lost Time (s)		5.2		5.2	5.2					5.6	5.6	
Lead/Lag												
Lead-Lag Optimize?												
Recall Mode		C-Max		C-Max	C-Max					Max	Max	
Act Effct Green (s)		32.8		32.8	32.8						31.4	
Actuated g/C Ratio		0.44		0.44	0.44						0.42	
v/c Ratio		0.56		0.33	0.33						0.38	
Control Delay		18.5		6.7	6.7						15.5	
Queue Delay		0.0		0.0	0.0						0.0	
Total Delay		18.5		6.7	6.7						15.5	
LOS		B		A	A						B	
Approach Delay		18.5		6.7	6.7						15.5	
Approach LOS		B		A	A						B	
Queue Length 50th (m)		42.0		6.3	6.3						27.9	
Queue Length 95th (m)		68.8		12.1	12.1						40.6	
Internal Link Dist (m)		110.8		164.9	164.9			56.5			141.5	
Turn Bay Length (m)												
Base Capacity (vph)		743		666	666						1368	
Starvation Cap Reductn		0		0	0						0	
Spillback Cap Reductn		0		0	0						0	
Storage Cap Reductn		0		0	0						0	
Reduced v/c Ratio		0.56		0.33	0.33						0.38	

Intersection Summary	
Cycle Length:	75
Actuated Cycle Length:	75
Offset:	10 (13%), Referenced to phase 2:EBT and 6:WBTL, Start of Green
Natural Cycle:	45
Control Type:	Actuated-Coordinated

Lanes, Volumes, Timings
2: Lyon & Gladstone

Existing AM Peak Hour
11/08/2021

Maximum v/c Ratio: 0.56	Intersection LOS: B
Intersection Signal Delay: 14.9	ICU Level of Service B
Intersection Capacity Utilization 59.6%	
Analysis Period (min) 15	
m Volume for 95th percentile queue is metered by upstream signal.	

Splits and Phases: 2: Lyon & Gladstone

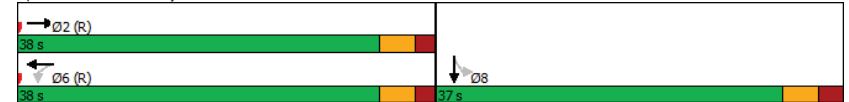

Lanes, Volumes, Timings
3: Kent & Somerset

Existing AM Peak Hour
11/08/2021

Lane Group	EBL	EBT	EBR	WBL	WBT	WBR	NBL	NBT	NBR	SBL	SBT	SBR
Lane Configurations	↖	↗			↖	↗	↖	↗	↖	↗	↖	↗
Traffic Volume (vph)	62	265	0	0	134	50	75	1554	164	0	0	0
Future Volume (vph)	62	265	0	0	134	50	75	1554	164	0	0	0
Satd. Flow (prot)	1658	1728	0	0	1600	0	1642	4558	0	0	0	0
Fit Permitted	0.560						0.950					
Satd. Flow (perm)	892	1728	0	0	1600	0	1072	4558	0	0	0	0
Satd. Flow (RTOR)							39					
Lane Group Flow (vph)	69	294	0	0	205	0	83	1909	0	0	0	0
Turn Type	Perm	NA			NA		Perm	NA				
Protected Phases		4			8			2				
Permitted Phases	4						2					
Detector Phase	4	4			8		2	2				
Switch Phase												
Minimum Initial (s)	10.0	10.0			10.0		10.0	10.0				
Minimum Split (s)	21.5	21.5			21.5		21.4	21.4				
Total Split (s)	27.0	27.0			27.0		48.0	48.0				
Total Split (%)	36.0%	36.0%			36.0%		64.0%	64.0%				
Yellow Time (s)	3.3	3.3			3.3		3.3	3.3				
All-Red Time (s)	2.2	2.2			2.2		2.1	2.1				
Lost Time Adjust (s)	0.0	0.0			0.0		0.0	0.0				
Total Lost Time (s)	5.5	5.5			5.5		5.4	5.4				
Lead/Lag												
Lead-Lag Optimize?												
Recall Mode	None	None			None		C-Max	C-Max				
Act Effct Green (s)	17.4	17.4			17.4		46.7	46.7				
Actuated g/C Ratio	0.23	0.23			0.23		0.62	0.62				
v/c Ratio	0.33	0.73			0.55		0.12	0.67				
Control Delay	27.2	37.4			21.5		11.0	11.6				
Queue Delay	0.0	0.0			0.0		0.0	0.0				
Total Delay	27.2	37.4			21.5		11.0	11.6				
LOS	C	D			C		B	B				
Approach Delay		35.5			21.5			11.6				
Approach LOS		D			C			B				
Queue Length 50th (m)	8.5	40.3			30.1		3.9	39.3				
Queue Length 95th (m)	18.7	62.4			m51.2		m13.5	77.9				
Internal Link Dist (m)		61.7			174.8			152.2			110.1	
Turn Bay Length (m)	25.0						40.0					
Base Capacity (vph)	255	495			458		666	2850				
Starvation Cap Reductn	0	0			0		0	0				
Spillback Cap Reductn	0	0			0		0	0				
Storage Cap Reductn	0	0			0		0	0				
Reduced v/c Ratio	0.27	0.59			0.45		0.12	0.67				

Intersection Summary	
Cycle Length:	75
Actuated Cycle Length:	75
Offset:	66 (88%), Referenced to phase 2:NBL and 6:; Start of Green
Natural Cycle:	60
Control Type:	Actuated-Coordinated

Lanes, Volumes, Timings
3: Kent & Somerset

Existing AM Peak Hour
11/08/2021

Maximum v/c Ratio: 0.73	Intersection LOS: B
Intersection Signal Delay: 15.8	ICU Level of Service C
Intersection Capacity Utilization 71.4%	
Analysis Period (min) 15	
m Volume for 95th percentile queue is metered by upstream signal.	

Splits and Phases: 3: Kent & Somerset

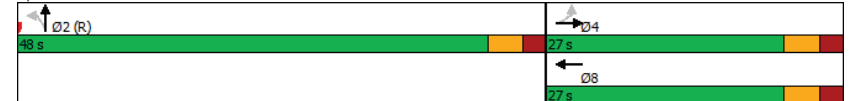

Lanes, Volumes, Timings
4: Kent & Gilmour

Existing AM Peak Hour
11/08/2021

Lane Group	EBL	EBT	EBR	WBL	WBT	WBR	NBL	NBT	NBR	SBL	SBT	SBR
Lane Configurations		↕						↕↕↕				
Traffic Volume (vph)	17	75	0	0	0	0	0	1812	114	0	0	0
Future Volume (vph)	17	75	0	0	0	0	0	1812	114	0	0	0
Satd. Flow (prot)	0	1729	0	0	0	0	0	4680	0	0	0	0
Fit Permitted		0.991										
Satd. Flow (perm)	0	1714	0	0	0	0	0	4680	0	0	0	0
Satd. Flow (RTOR)		31						26				
Lane Group Flow (vph)	0	102	0	0	0	0	0	2140	0	0	0	0
Turn Type	Perm	NA						NA				
Protected Phases		4						2				
Permitted Phases	4											
Detector Phase	4	4						2				
Switch Phase												
Minimum Initial (s)	10.0	10.0						10.0				
Minimum Split (s)	21.5	21.5						35.1				
Total Split (s)	22.0	22.0						53.0				
Total Split (%)	29.3%	29.3%						70.7%				
Yellow Time (s)	3.3	3.3						3.3				
All-Red Time (s)	2.2	2.2						1.8				
Lost Time Adjust (s)		0.0						0.0				
Total Lost Time (s)		5.5						5.1				
Lead/Lag												
Lead-Lag Optimize?												
Recall Mode	None	None						C-Max				
Act Effct Green (s)		12.4						56.1				
Actuated g/C Ratio		0.17						0.75				
v/c Ratio		0.33						0.61				
Control Delay		22.2						15.2				
Queue Delay		0.0						0.0				
Total Delay		22.2						15.2				
LOS		C						B				
Approach Delay		22.2						15.2				
Approach LOS		C						B				
Queue Length 50th (m)		9.7						104.3				
Queue Length 95th (m)		21.3						134.2				
Internal Link Dist (m)		69.3			174.3			57.8			152.2	
Turn Bay Length (m)												
Base Capacity (vph)		401						3508				
Starvation Cap Reductn		0						0				
Spillback Cap Reductn		0						0				
Storage Cap Reductn		0						0				
Reduced v/c Ratio		0.25						0.61				
Intersection Summary												
Cycle Length: 75												
Actuated Cycle Length: 75												
Offset: 5 (7%), Referenced to phase 2:NBT and 6.: Start of Green												
Natural Cycle: 60												
Control Type: Actuated-Coordinated												

Lanes, Volumes, Timings
4: Kent & Gilmour

Existing AM Peak Hour
11/08/2021

Maximum v/c Ratio: 0.61	Intersection LOS: B
Intersection Signal Delay: 15.6	ICU Level of Service B
Intersection Capacity Utilization 61.9%	
Analysis Period (min) 15	

Splits and Phases: 4: Kent & Gilmour



HCM 2010 TWSC
5: Kent & James

Existing AM Peak Hour
11/08/2021

Intersection													
Int Delay, s/veh	0.7												
Movement	EBL	EBT	EBR	WBL	WBT	WBR	NBL	NBT	NBR	SBL	SBT	SBR	
Lane Configurations					↔			↔↔↔					
Traffic Vol, veh/h	0	0	0	0	14	20	46	1798	0	0	0	0	
Future Vol, veh/h	0	0	0	0	14	20	46	1798	0	0	0	0	
Conflicting Peds, #/hr	23	0	11	11	0	23	72	0	77	77	0	72	
Sign Control	Free	Free	Free	Stop	Stop	Stop	Free	Free	Free	Free	Free	Free	
RT Channelized	-	-	None	-	-	None	-	-	None	-	-	None	
Storage Length	-	-	-	-	-	-	-	-	-	-	-	-	
Veh in Median Storage, #	-917504	-	-	-	0	-	-	0	-	-	-	-	
Grade, %	-	0	-	-	0	-	-	0	-	-	0	-	
Peak Hour Factor	90	90	90	90	90	90	90	90	90	90	90	90	
Heavy Vehicles, %	2	2	2	2	7	5	7	2	2	2	2	2	
Mvmt Flow	0	0	0	0	16	22	51	1998	0	0	0	0	
Major/Minor		Minor1			Major1								
Conflicting Flow All	-	2172	1022	72	0	-	-	-	-	-	-	-	
Stage 1	-	2100	-	-	-	-	-	-	-	-	-	-	
Stage 2	-	72	-	-	-	-	-	-	-	-	-	-	
Critical Hdwy	-	6.64	7.2	5.44	-	-	-	-	-	-	-	-	
Critical Hdwy Stg 1	-	5.64	-	-	-	-	-	-	-	-	-	-	
Critical Hdwy Stg 2	-	-	-	-	-	-	-	-	-	-	-	-	
Follow-up Hdwy	-	4.07	3.95	3.17	-	-	-	-	-	-	-	-	
Pot Cap-1 Maneuver	0	43	196	1051	-	0	-	-	-	-	-	-	
Stage 1	0	86	-	-	-	0	-	-	-	-	-	-	
Stage 2	0	-	-	-	-	0	-	-	-	-	-	-	
Platoon blocked, %	-	-	-	-	-	-	-	-	-	-	-	-	
Mov Cap-1 Maneuver	-	0	196	1051	-	-	-	-	-	-	-	-	
Mov Cap-2 Maneuver	-	0	-	-	-	-	-	-	-	-	-	-	
Stage 1	-	0	-	-	-	-	-	-	-	-	-	-	
Stage 2	-	0	-	-	-	-	-	-	-	-	-	-	
Approach		WB			NB								
HCM Control Delay, s	-	-	27.7	-	-	-	0.2	-	-	-	-	-	
HCM LOS	-	-	D	-	-	-		-	-	-	-	-	
Minor Lane/Major Mvmt		NBL			NBTWBLn1								
Capacity (veh/h)	1051	-	196	-	-	-	-	-	-	-	-	-	
HCM Lane V/C Ratio	0.049	-	0.193	-	-	-	-	-	-	-	-	-	
HCM Control Delay (s)	8.6	0	27.7	-	-	-	-	-	-	-	-	-	
HCM Lane LOS	A	A	D	-	-	-	-	-	-	-	-	-	
HCM 95th %tile Q(veh)	0.2	-	0.7	-	-	-	-	-	-	-	-	-	

Lanes, Volumes, Timings
6: Kent & Gladstone

Existing AM Peak Hour
11/08/2021

Lanes, Volumes, Timings												
Lane Group	EBL	EBT	EBR	WBL	WBT	WBR	NBL	NBT	NBR	SBL	SBT	SBR
Lane Configurations	↔	↔	↔	↔	↔	↔	↔↔↔	↔↔↔	↔	↔	↔	↔
Traffic Volume (vph)	82	277	0	0	160	143	36	1698	97	0	0	0
Future Volume (vph)	82	277	0	0	160	143	36	1698	97	0	0	0
Satd. Flow (prot)	1626	1679	0	0	1507	0	1658	4703	0	0	0	0
Fit Permitted	0.365	-	-	-	-	-	0.950	-	-	-	-	-
Satd. Flow (perm)	598	1679	0	0	1507	0	1401	4703	0	0	0	0
Satd. Flow (RTOR)	-	-	-	-	6	-	-	18	-	-	-	-
Lane Group Flow (vph)	91	308	0	0	337	0	40	1995	0	0	0	0
Turn Type	Perm	NA	-	-	NA	-	Perm	NA	-	-	-	-
Protected Phases	-	4	-	-	-	8	-	-	2	-	-	-
Permitted Phases	4	-	-	-	-	-	-	2	-	-	-	-
Detector Phase	4	4	-	-	8	-	-	2	2	-	-	-
Switch Phase	-	-	-	-	-	-	-	-	-	-	-	-
Minimum Initial (s)	10.0	10.0	-	-	10.0	-	10.0	10.0	-	-	-	-
Minimum Split (s)	21.4	21.4	-	-	20.4	-	21.4	21.4	-	-	-	-
Total Split (s)	30.0	30.0	-	-	30.0	-	45.0	45.0	-	-	-	-
Total Split (%)	40.0%	40.0%	-	-	40.0%	-	60.0%	60.0%	-	-	-	-
Yellow Time (s)	3.3	3.3	-	-	3.3	-	3.3	3.3	-	-	-	-
All-Red Time (s)	2.1	2.1	-	-	2.1	-	2.1	2.1	-	-	-	-
Lost Time Adjust (s)	0.0	0.0	-	-	0.0	-	0.0	0.0	-	-	-	-
Total Lost Time (s)	5.4	5.4	-	-	5.4	-	5.4	5.4	-	-	-	-
Lead/Lag	-	-	-	-	-	-	-	-	-	-	-	-
Lead-Lag Optimize?	-	-	-	-	-	-	-	-	-	-	-	-
Recall Mode	None	None	-	-	None	-	C-Max	C-Max	-	-	-	-
Act Effct Green (s)	20.6	20.6	-	-	20.6	-	43.6	43.6	-	-	-	-
Actuated g/C Ratio	0.27	0.27	-	-	0.27	-	0.58	0.58	-	-	-	-
v/c Ratio	0.55	0.67	-	-	0.81	-	0.05	0.73	-	-	-	-
Control Delay	44.0	41.0	-	-	40.7	-	8.4	14.1	-	-	-	-
Queue Delay	0.0	0.0	-	-	0.0	-	0.0	0.0	-	-	-	-
Total Delay	44.0	41.0	-	-	40.7	-	8.4	14.1	-	-	-	-
LOS	D	D	-	-	D	-	A	B	-	-	-	-
Approach Delay	-	41.7	-	-	40.7	-	-	14.0	-	-	-	-
Approach LOS	-	D	-	-	D	-	-	B	-	-	-	-
Queue Length 50th (m)	12.1	41.2	-	-	51.8	-	2.4	73.6	-	-	-	-
Queue Length 95th (m)	m21.5	59.2	-	-	80.2	-	7.1	102.8	-	-	-	-
Internal Link Dist (m)	-	164.9	-	-	173.9	-	-	90.5	-	-	-	139.7
Turn Bay Length (m)	30.0	-	-	-	-	-	40.0	-	-	-	-	-
Base Capacity (vph)	196	550	-	-	498	-	814	2742	-	-	-	-
Starvation Cap Reductn	0	0	-	-	0	-	0	0	-	-	-	-
Spillback Cap Reductn	0	0	-	-	0	-	0	0	-	-	-	-
Storage Cap Reductn	0	0	-	-	0	-	0	0	-	-	-	-
Reduced v/c Ratio	0.46	0.56	-	-	0.68	-	0.05	0.73	-	-	-	-
Intersection Summary												
Cycle Length: 75												
Actuated Cycle Length: 75												
Offset: 36 (48%), Referenced to phase 2:NBT and 6: Start of Green												
Natural Cycle: 55												
Control Type: Actuated-Coordinated												

Lanes, Volumes, Timings
6: Kent & Gladstone

Existing AM Peak Hour
11/08/2021

Maximum v/c Ratio: 0.81	Intersection LOS: C
Intersection Signal Delay: 21.2	ICU Level of Service D
Intersection Capacity Utilization 79.2%	
Analysis Period (min) 15	

m Volume for 95th percentile queue is metered by upstream signal.

Splits and Phases: 6: Kent & Gladstone

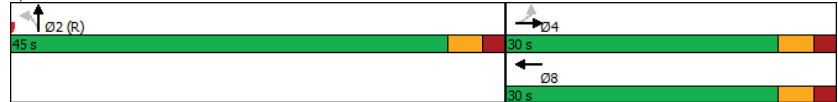

Lanes, Volumes, Timings
7: Bank & Somerset

Existing AM Peak Hour
11/08/2021

Lane Group	EBL	EBT	EBR	WBL	WBT	WBR	NBL	NBT	NBR	SBL	SBT	SBR
Lane Configurations	↔	↔		↔	↔		↕	↕		↕	↕	↕
Traffic Volume (vph)	52	253	75	14	153	11	8	469	67	0	152	8
Future Volume (vph)	52	253	75	14	153	11	8	469	67	0	152	8
Satd. Flow (prot)	1537	1511	0	1658	1690	0	0	1525	0	0	1601	0
Fit Permitted	0.633			0.362				0.996				
Satd. Flow (perm)	780	1511	0	534	1690	0	0	1510	0	0	1601	0
Satd. Flow (RTOR)												
Lane Group Flow (vph)	58	364	0	16	182	0	0	604	0	0	178	0
Turn Type	Perm	NA		Perm	NA		Perm	NA			NA	
Protected Phases		4			8			2			6	
Permitted Phases	4			8			2				6	
Detector Phase	4	4		8	8		2	2			6	6
Switch Phase												
Minimum Initial (s)	10.0	10.0		10.0	10.0		10.0	10.0			10.0	10.0
Minimum Split (s)	20.5	20.5		20.5	20.5		20.5	20.5			20.5	20.5
Total Split (s)	25.0	25.0		25.0	25.0		40.0	40.0			40.0	40.0
Total Split (%)	33.3%	33.3%		33.3%	33.3%		53.3%	53.3%			53.3%	53.3%
Yellow Time (s)	3.3	3.3		3.3	3.3		3.3	3.3			3.3	3.3
All-Red Time (s)	2.2	2.2		2.2	2.2		2.2	2.2			2.2	2.2
Lost Time Adjust (s)	0.0	0.0		0.0	0.0		0.0	0.0			0.0	0.0
Total Lost Time (s)	5.5	5.5		5.5	5.5		5.5	5.5			5.5	5.5
Lead/Lag	Lag	Lag		Lag	Lag		Lag	Lag			Lag	Lag
Lead-Lag Optimize?	Yes	Yes		Yes	Yes		Yes	Yes			Yes	Yes
Recall Mode	None	None		None	None		C-Max	C-Max			C-Max	C-Max
Act Effct Green (s)	23.0	23.0		23.0	23.0		41.0	41.0			41.0	41.0
Actuated g/C Ratio	0.31	0.31		0.31	0.31		0.55	0.55			0.55	0.55
v/c Ratio	0.24	0.78		0.10	0.35		0.73	0.73			0.20	0.20
Control Delay	26.6	40.6		19.6	21.9		10.1	10.1			10.0	10.0
Queue Delay	0.0	0.0		0.0	0.0		0.0	0.0			0.0	0.0
Total Delay	26.6	40.6		19.6	21.9		10.1	10.1			10.0	10.0
LOS	C	D		B	C		B	B			A	A
Approach Delay		38.7			21.7			10.1				10.0
Approach LOS		D			C			B				A
Queue Length 50th (m)	8.3	54.0		1.6	20.2			9.2				13.2
Queue Length 95th (m)	m12.6	#89.0		6.2	36.4			#28.7				23.9
Internal Link Dist (m)		174.8			68.0			65.6				106.3
Turn Bay Length (m)	25.0			15.0								
Base Capacity (vph)	241	467		165	523		824	824			874	874
Starvation Cap Reductn	0	0		0	0		1	1			0	0
Spillback Cap Reductn	0	0		0	0		0	0			0	0
Storage Cap Reductn	0	0		0	0		0	0			0	0
Reduced v/c Ratio	0.24	0.78		0.10	0.35		0.73	0.73			0.20	0.20

Intersection Summary	
Cycle Length: 75	
Actuated Cycle Length: 75	
Offset: 46 (61%), Referenced to phase 2:NBT and 6:SBTL, Start of Green	
Natural Cycle: 75	
Control Type: Actuated-Coordinated	

Lanes, Volumes, Timings
7: Bank & Somerset

Existing AM Peak Hour
11/08/2021

Lane Group	Ø1	Ø3	Ø5	Ø7
Lane Configurations				
Traffic Volume (vph)				
Future Volume (vph)				
Satd. Flow (prot)				
Fit Permitted				
Satd. Flow (perm)				
Satd. Flow (RTOR)				
Lane Group Flow (vph)				
Turn Type				
Protected Phases	1	3	5	7
Permitted Phases				
Detector Phase				
Switch Phase				
Minimum Initial (s)	1.0	1.0	1.0	1.0
Minimum Split (s)	3.0	3.0	3.0	3.0
Total Split (s)	5.0	5.0	5.0	5.0
Total Split (%)	7%	7%	7%	7%
Yellow Time (s)	2.0	2.0	2.0	2.0
All-Red Time (s)	0.0	0.0	0.0	0.0
Lost Time Adjust (s)				
Total Lost Time (s)				
Lead/Lag	Lead	Lead	Lead	Lead
Lead-Lag Optimize?	Yes	Yes	Yes	Yes
Recall Mode	None	None	None	None
Act Effct Green (s)				
Actuated g/C Ratio				
v/c Ratio				
Control Delay				
Queue Delay				
Total Delay				
LOS				
Approach Delay				
Approach LOS				
Queue Length 50th (m)				
Queue Length 95th (m)				
Internal Link Dist (m)				
Turn Bay Length (m)				
Base Capacity (vph)				
Starvation Cap Reductn				
Spillback Cap Reductn				
Storage Cap Reductn				
Reduced v/c Ratio				
Intersection Summary				

Lanes, Volumes, Timings
7: Bank & Somerset

Existing AM Peak Hour
11/08/2021

Maximum v/c Ratio: 0.78
 Intersection Signal Delay: 20.3
 Intersection Capacity Utilization 80.7%
 Analysis Period (min) 15
 Intersection LOS: C
 ICU Level of Service D
 # 95th percentile volume exceeds capacity, queue may be longer.
 Queue shown is maximum after two cycles.
 m Volume for 95th percentile queue is metered by upstream signal.

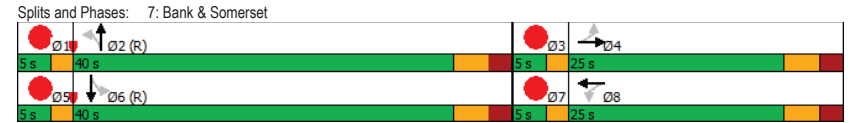

Lanes, Volumes, Timings
8: Bank & MacLaren

Existing AM Peak Hour
11/08/2021

Lane Group	EBL	EBT	EBR	WBL	WBT	WBR	NBL	NBT	NBR	SBL	SBT	SBR
Lane Configurations												
Traffic Volume (vph)	0	0	0	11	4	13	36	535	0	0	221	26
Future Volume (vph)	0	0	0	11	4	13	36	535	0	0	221	26
Satd. Flow (prot)	0	0	0	0	1430	0	0	1704	0	0	1539	0
Fit Permitted					0.980			0.969				
Satd. Flow (perm)	0	0	0	0	1376	0	0	1614	0	0	1539	0
Satd. Flow (RTOR)					14						15	
Lane Group Flow (vph)	0	0	0	0	30	0	0	634	0	0	275	0
Turn Type				Perm	NA		Perm	NA			NA	
Protected Phases					8			2			6	
Permitted Phases					8			2				
Detector Phase					8	8		2	2			6
Switch Phase												
Minimum Initial (s)				10.0	10.0		10.0	10.0			10.0	
Minimum Split (s)				24.2	24.2		18.0	18.0			18.0	
Total Split (s)				24.2	24.2		50.8	50.8			50.8	
Total Split (%)				32.3%	32.3%		67.7%	67.7%			67.7%	
Yellow Time (s)				3.3	3.3		3.3	3.3			3.3	
All-Red Time (s)				1.9	1.9		1.7	1.7			1.7	
Lost Time Adjust (s)					0.0			0.0			0.0	
Total Lost Time (s)					5.2			5.0			5.0	
Lead/Lag												
Lead-Lag Optimize?												
Recall Mode				None	None		C-Max	C-Max			C-Max	
Act Effct Green (s)					15.4			57.5			57.5	
Actuated g/C Ratio					0.21			0.77			0.77	
v/c Ratio					0.10			0.51			0.23	
Control Delay					15.7			3.6			5.3	
Queue Delay					0.0			0.0			0.2	
Total Delay					15.7			3.7			5.5	
LOS					B			A			A	
Approach Delay					15.7			3.7			5.5	
Approach LOS					B			A			A	
Queue Length 50th (m)					1.8			23.5			16.0	
Queue Length 95th (m)					8.1			7.7			m23.8	
Internal Link Dist (m)		130.7			122.8			60.9			65.6	
Turn Bay Length (m)												
Base Capacity (vph)					359			1237			1183	
Starvation Cap Reductn					0			17			334	
Spillback Cap Reductn					0			9			0	
Storage Cap Reductn					0			0			0	
Reduced v/c Ratio					0.08			0.52			0.32	

Intersection Summary												
Cycle Length: 75												
Actuated Cycle Length: 75												
Offset: 42 (56%), Referenced to phase 2:NBTL and 6:SBT, Start of Green												
Natural Cycle: 60												
Control Type: Actuated-Coordinated												

Lanes, Volumes, Timings
8: Bank & MacLaren

Existing AM Peak Hour
11/08/2021

Maximum v/c Ratio: 0.51	Intersection Signal Delay: 4.6	Intersection LOS: A
Intersection Capacity Utilization 74.2%	ICU Level of Service D	
Analysis Period (min) 15		
m Volume for 95th percentile queue is metered by upstream signal.		

Splits and Phases: 8: Bank & MacLaren

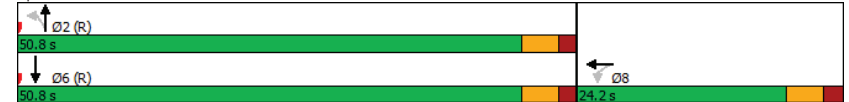

Lanes, Volumes, Timings
9: Bank & Gilmour

Existing AM Peak Hour
11/08/2021

Lane Group	EBL	EBT	EBR	WBL	WBT	WBR	NBL	NBT	NBR	SBL	SBT	SBR
Lane Configurations		↔						↔				↔
Traffic Volume (vph)	32	48	31	0	0	0	0	540	34	15	214	0
Future Volume (vph)	32	48	31	0	0	0	0	540	34	15	214	0
Satd. Flow (prot)	0	1602	0	0	0	0	0	1669	0	0	1576	0
Fit Permitted		0.986									0.955	
Satd. Flow (perm)	0	1545	0	0	0	0	0	1669	0	0	1502	0
Satd. Flow (RTOR)		25						8				
Lane Group Flow (vph)	0	123	0	0	0	0	0	638	0	0	255	0
Turn Type	Perm	NA						NA	Perm	NA		
Protected Phases		4						2			6	
Permitted Phases	4									6		
Detector Phase	4	4						2		6	6	
Switch Phase												
Minimum Initial (s)	10.0	10.0						10.0	10.0	10.0		
Minimum Split (s)	23.2	23.2						20.1	20.1	20.1		
Total Split (s)	25.0	25.0						50.0	50.0	50.0		
Total Split (%)	33.3%	33.3%						66.7%	66.7%	66.7%		
Yellow Time (s)	3.3	3.3						3.3	3.3	3.3		
All-Red Time (s)	1.9	1.9						1.8	1.8	1.8		
Lost Time Adjust (s)		0.0						0.0	0.0	0.0		
Total Lost Time (s)		5.2						5.1	5.1	5.1		
Lead/Lag												
Lead-Lag Optimize?												
Recall Mode	None	None						C-Max	C-Max	C-Max		
Act Effct Green (s)		13.2						55.5	55.5	55.5		
Actuated g/C Ratio		0.18						0.74	0.74	0.74		
v/c Ratio		0.42						0.52	0.52	0.23		
Control Delay		26.4						4.3	4.3	2.6		
Queue Delay		0.0						0.1	0.1	0.2		
Total Delay		26.4						4.4	4.4	2.8		
LOS		C						A	A	A		
Approach Delay		26.4						4.4	4.4	2.8		
Approach LOS		C						A	A	A		
Queue Length 50th (m)		13.2						17.9	17.9	4.2		
Queue Length 95th (m)		m25.7						m23.8	m23.8	8.7		
Internal Link Dist (m)		174.3			69.2			57.1	57.1	60.9		
Turn Bay Length (m)												
Base Capacity (vph)		426						1238	1238	1112		
Starvation Cap Reductn		0						0	0	359		
Spillback Cap Reductn		0						48	48	0		
Storage Cap Reductn		0						0	0	0		
Reduced v/c Ratio		0.29						0.54	0.54	0.34		

Intersection Summary
 Cycle Length: 75
 Actuated Cycle Length: 75
 Offset: 37 (49%), Referenced to phase 2:NBT and 6:SRTL, Start of Green
 Natural Cycle: 60
 Control Type: Actuated-Coordinated

Lanes, Volumes, Timings
9: Bank & Gilmour

Existing AM Peak Hour
11/08/2021

Maximum v/c Ratio: 0.52
 Intersection Signal Delay: 6.6
 Intersection Capacity Utilization 55.7%
 Analysis Period (min) 15
 Intersection LOS: A
 ICU Level of Service B
 m Volume for 95th percentile queue is metered by upstream signal.

Splits and Phases: 9: Bank & Gilmour

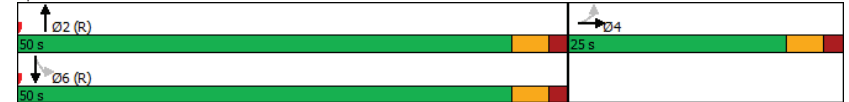

Lanes, Volumes, Timings
11: Bank & Gladstone

Existing AM Peak Hour
11/08/2021

Lane Group	EBL	EBT	EBR	WBL	WBT	WBR	NBL	NBT	NBR	SBL	SBT	SBR
Lane Configurations		↔			↔		↔	↔			↔	
Traffic Volume (vph)	63	218	116	28	110	27	112	459	86	5	229	29
Future Volume (vph)	63	218	116	28	110	27	112	459	86	5	229	29
Satd. Flow (prot)	0	2867	0	0	1610	0	1642	1540	0	0	2939	0
Fit Permitted		0.834			0.862		0.573				0.945	
Satd. Flow (perm)	0	2370	0	0	1380	0	777	1540	0	0	2776	0
Satd. Flow (RTOR)												
Lane Group Flow (vph)	0	441	0	0	183	0	124	606	0	0	292	0
Turn Type	Perm	NA		Perm	NA		Perm	NA		Perm	NA	
Protected Phases		4			8			2			6	
Permitted Phases	4			8			2			6		
Detector Phase	4	4		8	8		2	2		6	6	
Switch Phase												
Minimum Initial (s)	10.0	10.0		10.0	10.0		10.0	10.0		10.0	10.0	
Minimum Split (s)	20.5	20.5		20.5	20.5		20.5	20.5		20.5	20.5	
Total Split (s)	23.0	23.0		23.0	23.0		42.0	42.0		42.0	42.0	
Total Split (%)	30.7%	30.7%		30.7%	30.7%		56.0%	56.0%		56.0%	56.0%	
Yellow Time (s)	3.3	3.3		3.3	3.3		3.3	3.3		3.3	3.3	
All-Red Time (s)	2.2	2.2		2.2	2.2		2.2	2.2		2.2	2.2	
Lost Time Adjust (s)		0.0			0.0			0.0			0.0	
Total Lost Time (s)		5.5			5.5			5.5			5.5	
Lead/Lag	Lag	Lag		Lag	Lag		Lag	Lag		Lag	Lag	
Lead-Lag Optimize?	Yes	Yes		Yes	Yes		Yes	Yes		Yes	Yes	
Recall Mode	None	None		None	None		C-Max	C-Max		C-Max	C-Max	
Act Effct Green (s)		16.7			16.7			36.5			36.5	
Actuated g/C Ratio		0.22			0.22			0.49			0.49	
v/c Ratio		0.84			0.60			0.33			0.81	
Control Delay		50.4			34.9			14.9			27.1	
Queue Delay		0.0			0.0			0.0			0.0	
Total Delay		50.4			34.9			14.9			27.1	
LOS		D			C			B			C	
Approach Delay		50.4			34.9			25.0			15.8	
Approach LOS		D			C			C			B	
Queue Length 50th (m)		37.1			24.1			10.7			72.1	
Queue Length 95th (m)		m#57.1			44.4			23.0			#133.7	
Internal Link Dist (m)		173.9			70.9			108.7			139.2	
Turn Bay Length (m)								38.0				
Base Capacity (vph)		553			322			378			749	
Starvation Cap Reductn		0			0			0			0	
Spillback Cap Reductn		0			0			0			0	
Storage Cap Reductn		0			0			0			0	
Reduced v/c Ratio		0.80			0.57			0.33			0.81	

Intersection Summary
 Cycle Length: 75
 Actuated Cycle Length: 75
 Offset: 20 (27%), Referenced to phase 2:NBL and 6:SBTL, Start of Green
 Natural Cycle: 60
 Control Type: Actuated-Coordinated

Lanes, Volumes, Timings
11: Bank & Gladstone

Existing AM Peak Hour
11/08/2021

Lane Group	Ø1	Ø3	Ø5	Ø7
Lane Configurations				
Traffic Volume (vph)				
Future Volume (vph)				
Satd. Flow (prot)				
Fit Permitted				
Satd. Flow (perm)				
Satd. Flow (RTOR)				
Lane Group Flow (vph)				
Turn Type				
Protected Phases	1	3	5	7
Permitted Phases				
Detector Phase				
Switch Phase				
Minimum Initial (s)	1.0	1.0	1.0	1.0
Minimum Split (s)	3.0	3.0	3.0	3.0
Total Split (s)	5.0	5.0	5.0	5.0
Total Split (%)	7%	7%	7%	7%
Yellow Time (s)	2.0	2.0	2.0	2.0
All-Red Time (s)	0.0	0.0	0.0	0.0
Lost Time Adjust (s)				
Total Lost Time (s)				
Lead/Lag	Lead	Lead	Lead	Lead
Lead-Lag Optimize?	Yes	Yes	Yes	Yes
Recall Mode	Max	Max	Max	Max
Act Effct Green (s)				
Actuated g/C Ratio				
v/c Ratio				
Control Delay				
Queue Delay				
Total Delay				
LOS				
Approach Delay				
Approach LOS				
Queue Length 50th (m)				
Queue Length 95th (m)				
Internal Link Dist (m)				
Turn Bay Length (m)				
Base Capacity (vph)				
Starvation Cap Reductn				
Spillback Cap Reductn				
Storage Cap Reductn				
Reduced v/c Ratio				

Intersection Summary

Lanes, Volumes, Timings
11: Bank & Gladstone

Existing AM Peak Hour
11/08/2021

Maximum v/c Ratio: 0.84
 Intersection Signal Delay: 31.3 Intersection LOS: C
 Intersection Capacity Utilization 89.5% ICU Level of Service E
 Analysis Period (min) 15
 # 95th percentile volume exceeds capacity, queue may be longer.
 Queue shown is maximum after two cycles.
 m Volume for 95th percentile queue is metered by upstream signal.

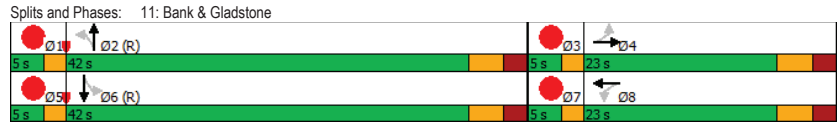

Lanes, Volumes, Timings
1: Lyon & James

Existing PM Peak Hour

Lane Group	EBL	EBT	EBR	WBL	WBT	WBR	NBL	NBT	NBR	SBL	SBT	SBR
Lane Configurations					↕						↕↕	
Traffic Volume (vph)	0	0	0	70	30	0	0	0	0	0	893	22
Future Volume (vph)	0	0	0	70	30	0	0	0	0	0	893	22
Satd. Flow (prot)	0	0	0	0	1681	0	0	0	0	0	3294	0
Fit Permitted					0.966							
Satd. Flow (perm)	0	0	0	0	1612	0	0	0	0	0	3294	0
Satd. Flow (RTOR)											8	
Lane Group Flow (vph)	0	0	0	0	111	0	0	0	0	0	1016	0
Turn Type					Perm	NA					NA	
Protected Phases						8						6
Permitted Phases					8						6	
Detector Phase					8	8					6	6
Switch Phase												
Minimum Initial (s)					10.0	10.0					10.0	10.0
Minimum Split (s)					17.1	17.1					29.7	29.7
Total Split (s)					17.1	17.1					57.9	57.9
Total Split (%)					22.8%	22.8%					77.2%	77.2%
Yellow Time (s)					3.3	3.3					3.3	3.3
All-Red Time (s)					1.8	1.8					1.4	1.4
Lost Time Adjust (s)						0.0						0.0
Total Lost Time (s)						5.1						4.7
Lead/Lag												
Lead-Lag Optimize?												
Recall Mode					None	None					C-Max	C-Max
Act Effct Green (s)						10.9						58.3
Actuated g/C Ratio						0.15						0.78
v/c Ratio						0.48						0.40
Control Delay						32.1						4.3
Queue Delay						0.0						0.0
Total Delay						32.1						4.3
LOS						C						A
Approach Delay						32.1						4.3
Approach LOS						C						A
Queue Length 50th (m)						15.8						24.2
Queue Length 95th (m)						31.0						36.4
Internal Link Dist (m)							110.6			164.0	139.6	62.1
Turn Bay Length (m)												
Base Capacity (vph)						257						2561
Starvation Cap Reductn						0						0
Spillback Cap Reductn						0						0
Storage Cap Reductn						0						0
Reduced v/c Ratio						0.43						0.40

Intersection Summary
 Cycle Length: 75
 Actuated Cycle Length: 75
 Offset: 0 (0%), Referenced to phase 2: and 6:SBTL, Start of Green
 Natural Cycle: 50
 Control Type: Actuated-Coordinated

Lanes, Volumes, Timings

1: Lyon & James

Existing PM Peak Hour

Maximum v/c Ratio: 0.48	Intersection LOS: A
Intersection Signal Delay: 7.0	ICU Level of Service A
Intersection Capacity Utilization 47.5%	
Analysis Period (min) 15	

Splits and Phases: 1: Lyon & James

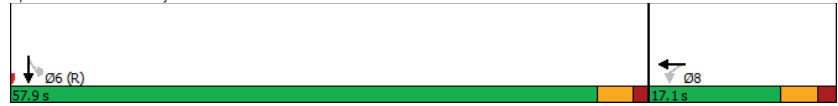

Lanes, Volumes, Timings

2: Gladstone & Lyon

Existing PM Peak Hour

Lane Group	EBL	EBT	EBR	WBL	WBT	WBR	NBL	NBT	NBR	SBL	SBT	SBR
Lane Configurations		↔			↔						↔	↔
Traffic Volume (vph)	0	360	38	26	289	0	0	0	0	132	748	63
Future Volume (vph)	0	360	38	26	289	0	0	0	0	132	748	63
Satd. Flow (prot)	0	1690	0	0	1738	0	0	0	0	0	3246	0
Fit Permitted					0.945						0.993	
Satd. Flow (perm)	0	1690	0	0	1646	0	0	0	0	0	3228	0
Satd. Flow (RTOR)		9									12	
Lane Group Flow (vph)	0	442	0	0	350	0	0	0	0	0	1048	0
Turn Type		NA		Perm	NA					Perm	NA	
Protected Phases		2			6						8	
Permitted Phases				6						8		
Detector Phase		2		6	6					8	8	
Switch Phase												
Minimum Initial (s)		10.0		10.0	10.0					10.0	10.0	
Minimum Split (s)		23.2		23.6	23.6					23.6	23.6	
Total Split (s)		39.0		39.0	39.0					36.0	36.0	
Total Split (%)		52.0%		52.0%	52.0%					48.0%	48.0%	
Yellow Time (s)		3.3		3.3	3.3					3.3	3.3	
All-Red Time (s)		1.9		1.9	1.9					2.3	2.3	
Lost Time Adjust (s)		0.0		0.0	0.0					0.0	0.0	
Total Lost Time (s)		5.2		5.2	5.2					5.6	5.6	
Lead/Lag												
Lead-Lag Optimize?												
Recall Mode		C-Max		Max	Max					Max	Max	
Act Effct Green (s)		33.8			33.8						30.4	
Actuated g/C Ratio		0.45			0.45						0.41	
v/c Ratio		0.58			0.47						0.80	
Control Delay		18.7			15.1						21.5	
Queue Delay		0.0			0.0						0.0	
Total Delay		18.7			15.1						21.5	
LOS		B			B						C	
Approach Delay		18.7			15.1						21.5	
Approach LOS		B			B						C	
Queue Length 50th (m)		45.7			21.3						35.5	
Queue Length 95th (m)		74.2			48.4						64.0	
Internal Link Dist (m)		109.1			166.3			55.5			139.6	
Turn Bay Length (m)												
Base Capacity (vph)		766			741						1315	
Starvation Cap Reductn		0			0						0	
Spillback Cap Reductn		0			0						0	
Storage Cap Reductn		0			0						0	
Reduced v/c Ratio		0.58			0.47						0.80	

Intersection Summary	
Cycle Length:	75
Actuated Cycle Length:	75
Offset:	45 (60%), Referenced to phase 2:EBT, Start of Green
Natural Cycle:	50
Control Type:	Actuated-Coordinated

Lanes, Volumes, Timings
2: Gladstone & Lyon

Existing PM Peak Hour

Maximum v/c Ratio: 0.80	Intersection LOS: B
Intersection Signal Delay: 19.6	ICU Level of Service D
Intersection Capacity Utilization 79.2%	
Analysis Period (min) 15	

Splits and Phases: 2: Gladstone & Lyon

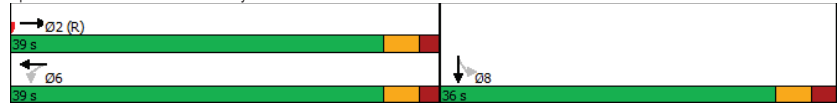

Lanes, Volumes, Timings
3: Kent & Somerset

Existing PM Peak Hour

Lane Group	EBL	EBT	EBR	WBL	WBT	WBR	NBL	NBT	NBR	SBL	SBT	SBR
Lane Configurations	↔	↕			↔	↕	↔	↕				
Traffic Volume (vph)	56	332	0	0	303	63	77	706	106	0	0	0
Future Volume (vph)	56	332	0	0	303	63	77	706	106	0	0	0
Satd. Flow (prot)	1658	1745	0	0	1623	0	1658	4322	0	0	0	0
Fit Permitted	0.327						0.950					
Satd. Flow (perm)	513	1745	0	0	1623	0	1028	4322	0	0	0	0
Satd. Flow (RTOR)							43					
Lane Group Flow (vph)	62	369	0	0	407	0	86	902	0	0	0	0
Turn Type	Perm	NA			NA		Perm	NA				
Protected Phases		4			8			2				
Permitted Phases	4						2					
Detector Phase	4	4			8		2	2				
Switch Phase												
Minimum Initial (s)	10.0	10.0			10.0		10.0	10.0				
Minimum Split (s)	21.5	21.5			21.5		21.4	21.4				
Total Split (s)	41.0	41.0			41.0		34.0	34.0				
Total Split (%)	54.7%	54.7%			54.7%		45.3%	45.3%				
Yellow Time (s)	3.3	3.3			3.3		3.3	3.3				
All-Red Time (s)	2.2	2.2			2.2		2.1	2.1				
Lost Time Adjust (s)	0.0	0.0			0.0		0.0	0.0				
Total Lost Time (s)	5.5	5.5			5.5		5.4	5.4				
Lead/Lag												
Lead-Lag Optimize?												
Recall Mode	None	None			None		C-Max	C-Max				
Act Effct Green (s)	24.6	24.6			24.6		39.5	39.5				
Actuated g/C Ratio	0.33	0.33			0.33		0.53	0.53				
v/c Ratio	0.37	0.64			0.76		0.16	0.39				
Control Delay	23.7	26.0			32.4		13.4	13.2				
Queue Delay	0.0	0.0			0.0		0.0	0.0				
Total Delay	23.7	26.0			32.4		13.4	13.2				
LOS	C	C			C		B	B				
Approach Delay		25.6			32.4			13.2				
Approach LOS		C			C			B				
Queue Length 50th (m)	6.9	45.9			62.1		5.7	21.2				
Queue Length 95th (m)	15.1	61.3			87.4		15.4	55.2				
Internal Link Dist (m)		61.7			174.8			152.2			110.1	
Turn Bay Length (m)	25.0						40.0					
Base Capacity (vph)	242	825			768		540	2294				
Starvation Cap Reductn	0	0			0		0	0				
Spillback Cap Reductn	0	0			0		0	0				
Storage Cap Reductn	0	0			0		0	0				
Reduced v/c Ratio	0.26	0.45			0.53		0.16	0.39				

Intersection Summary

Cycle Length: 75
Actuated Cycle Length: 75
Offset: 50 (67%), Referenced to phase 2:NBTL and 6:, Start of Green
Natural Cycle: 45
Control Type: Actuated-Coordinated

Lanes, Volumes, Timings
3: Kent & Somerset

Existing PM Peak Hour

Maximum v/c Ratio: 0.76	Intersection LOS: C
Intersection Signal Delay: 20.4	ICU Level of Service B
Intersection Capacity Utilization 62.0%	
Analysis Period (min) 15	

Splits and Phases: 3: Kent & Somerset

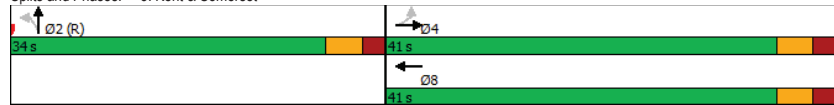

Lanes, Volumes, Timings
4: Kent & Gilmour

Existing PM Peak Hour

Lane Group	EBL	EBT	EBR	WBL	WBT	WBR	NBL	NBT	NBR	SBL	SBT	SBR
Lane Configurations		↕						↕↕↕				
Traffic Volume (vph)	19	77	0	0	0	0	0	846	78	0	0	0
Future Volume (vph)	19	77	0	0	0	0	0	846	78	0	0	0
Satd. Flow (prot)	0	1714	0	0	0	0	0	4598	0	0	0	0
Fit Permitted		0.990										
Satd. Flow (perm)	0	1683	0	0	0	0	0	4598	0	0	0	0
Satd. Flow (RTOR)		31						40				
Lane Group Flow (vph)	0	107	0	0	0	0	0	1027	0	0	0	0
Turn Type	Perm	NA						NA				
Protected Phases		4						2				
Permitted Phases	4											
Detector Phase	4	4						2				
Switch Phase												
Minimum Initial (s)	10.0	10.0						10.0				
Minimum Split (s)	21.5	21.5						35.1				
Total Split (s)	22.0	22.0						53.0				
Total Split (%)	29.3%	29.3%						70.7%				
Yellow Time (s)	3.3	3.3						3.3				
All-Red Time (s)	2.2	2.2						1.8				
Lost Time Adjust (s)		0.0						0.0				
Total Lost Time (s)		5.5						5.1				
Lead/Lag												
Lead-Lag Optimize?												
Recall Mode	None	None						C-Max				
Act Effct Green (s)		13.6						54.9				
Actuated g/C Ratio		0.18						0.73				
v/c Ratio		0.32						0.30				
Control Delay		21.5						4.4				
Queue Delay		0.0						0.0				
Total Delay		21.5						4.4				
LOS		C						A				
Approach Delay		21.5						4.4				
Approach LOS		C						A				
Queue Length 50th (m)		9.4						13.6				
Queue Length 95th (m)		22.6						26.5				
Internal Link Dist (m)		69.3				174.3		57.8			152.2	
Turn Bay Length (m)												
Base Capacity (vph)		394						3377				
Starvation Cap Reductn		0						0				
Spillback Cap Reductn		0						0				
Storage Cap Reductn		0						0				
Reduced v/c Ratio		0.27						0.30				
Intersection Summary												
Cycle Length: 75												
Actuated Cycle Length: 75												
Offset: 0 (0%), Referenced to phase 2:NBT and 6:, Start of Green												
Natural Cycle: 60												
Control Type: Actuated-Coordinated												

Lanes, Volumes, Timings
4: Kent & Gilmour

Existing PM Peak Hour

Maximum v/c Ratio: 0.32	
Intersection Signal Delay: 6.0	Intersection LOS: A
Intersection Capacity Utilization 47.0%	ICU Level of Service A
Analysis Period (min) 15	

Splits and Phases: 4: Kent & Gilmour



HCM 2010 TWSC
5: Kent & James

Existing PM Peak Hour

Intersection												
Int Delay, s/veh		2.5										
Movement	EBL	EBT	EBR	WBL	WBT	WBR	NBL	NBT	NBR	SBL	SBT	SBR
Lane Configurations												
Traffic Vol, veh/h	0	0	0	0	58	43	70	819	0	0	0	0
Future Vol, veh/h	0	0	0	0	58	43	70	819	0	0	0	0
Conflicting Peds, #/hr	25	0	17	17	0	25	95	0	63	63	0	95
Sign Control	Free	Free	Free	Stop	Stop	Stop	Free	Free	Free	Free	Free	Free
RT Channelized	-	-	None	-	-	None	-	-	None	-	-	None
Storage Length	-	-	-	-	-	-	-	-	-	-	-	-
Veh in Median Storage, #	-	-	-	-	0	-	-	0	-	-	-	-
Grade, %	-	0	-	-	0	-	-	0	-	-	0	-
Peak Hour Factor	90	90	90	90	90	90	90	90	90	90	90	90
Heavy Vehicles, %	2	2	2	2	2	2	2	2	2	2	2	2
Mvmt Flow	0	0	0	0	64	48	78	910	0	0	0	0

Major/Minor	Minor1	Major1
Conflicting Flow All	- 1161	480 95 0 -
Stage 1	- 1066	- - - -
Stage 2	- 95	- - - -
Critical Hdwy	- 6.54	7.14 5.34 - -
Critical Hdwy Stg 1	- 5.54	- - - -
Critical Hdwy Stg 2	- -	- - - -
Follow-up Hdwy	- 4.02	3.92 3.12 - -
Pot Cap-1 Maneuver	0 194	455 1044 - 0
Stage 1	0 297	- - - - 0
Stage 2	0 -	- - - - 0
Platoon blocked, %	-	-
Mov Cap-1 Maneuver	- 0	455 1044 - -
Mov Cap-2 Maneuver	- 0	- - - -
Stage 1	- 0	- - - -
Stage 2	- 0	- - - -

Approach	WB	NB
HCM Control Delay, s	15.5	1
HCM LOS	C	

Minor Lane/Major Mvmt	NBL	NBTWBLn1
Capacity (veh/h)	1044	- 455
HCM Lane V/C Ratio	0.074	- 0.247
HCM Control Delay (s)	8.7	0.3 15.5
HCM Lane LOS	A	A C
HCM 95th %tile Q(veh)	0.2	- 1

Lanes, Volumes, Timings
6: Kent & Gladstone

Existing PM Peak Hour

Lane Group	EBL	EBT	EBR	WBL	WBT	WBR	NBL	NBT	NBR	SBL	SBT	SBR
Lane Configurations	↖	↗	↘	↙	↖	↗	↘	↙	↘	↙	↘	↙
Traffic Volume (vph)	75	405	0	0	274	75	52	722	101	0	0	0
Future Volume (vph)	75	405	0	0	274	75	52	722	101	0	0	0
Satd. Flow (prot)	1658	1728	0	0	1664	0	1658	4554	0	0	0	0
Fit Permitted	0.370						0.950					
Satd. Flow (perm)	624	1728	0	0	1664	0	1471	4554	0	0	0	0
Satd. Flow (RTOR)					27			36				
Lane Group Flow (vph)	83	450	0	0	387	0	58	914	0	0	0	0
Turn Type	Perm	NA			NA		Perm	NA				
Protected Phases		4			8			2				
Permitted Phases	4							2				
Detector Phase	4	4			8			2	2			
Switch Phase												
Minimum Initial (s)	10.0	10.0			10.0		10.0	10.0				
Minimum Split (s)	21.4	21.4			20.4		21.4	21.4				
Total Split (s)	45.0	45.0			45.0		30.0	30.0				
Total Split (%)	60.0%	60.0%			60.0%		40.0%	40.0%				
Yellow Time (s)	3.3	3.3			3.3		3.3	3.3				
All-Red Time (s)	2.1	2.1			2.1		2.1	2.1				
Lost Time Adjust (s)	0.0	0.0			0.0		0.0	0.0				
Total Lost Time (s)	5.4	5.4			5.4		5.4	5.4				
Lead/Lag												
Lead-Lag Optimize?												
Recall Mode	None	None			None		C-Max	C-Max				
Act Effct Green (s)	26.1	26.1			26.1		38.1	38.1				
Actuated g/C Ratio	0.35	0.35			0.35		0.51	0.51				
v/c Ratio	0.38	0.75			0.65		0.08	0.39				
Control Delay	13.2	18.0			28.8		12.6	12.7				
Queue Delay	0.0	0.0			0.0		0.0	0.0				
Total Delay	13.2	18.0			28.8		12.6	12.7				
LOS	B	B			C		B	B				
Approach Delay		17.3			28.8			12.7				
Approach LOS		B			C			B				
Queue Length 50th (m)	5.5	30.5			56.9		4.2	27.4				
Queue Length 95th (m)	m6.7	m32.0			m64.4		12.8	47.2				
Internal Link Dist (m)		166.3			173.9			90.5			139.7	
Turn Bay Length (m)	30.0						40.0					
Base Capacity (vph)	329	912			891		747	2331				
Starvation Cap Reductn	0	0			0		0	0				
Spillback Cap Reductn	0	0			0		0	0				
Storage Cap Reductn	0	0			0		0	0				
Reduced v/c Ratio	0.25	0.49			0.43		0.08	0.39				

Intersection Summary	
Cycle Length:	75
Actuated Cycle Length:	75
Offset:	23 (31%), Referenced to phase 2:NBL and 6:; Start of Green
Natural Cycle:	45
Control Type:	Actuated-Coordinated

Lanes, Volumes, Timings
6: Kent & Gladstone

Existing PM Peak Hour

Maximum v/c Ratio: 0.75	Intersection LOS: B
Intersection Signal Delay: 17.3	ICU Level of Service B
Intersection Capacity Utilization 60.2%	
Analysis Period (min) 15	
m Volume for 95th percentile queue is metered by upstream signal.	

Splits and Phases: 6: Kent & Gladstone

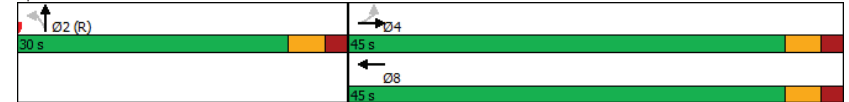

Lanes, Volumes, Timings

7: Bank & Somerset

Existing PM Peak Hour

Lane Group	EBL	EBT	EBR	WBL	WBT	WBR	NBL	NBT	NBR	SBL	SBT	SBR
Lane Configurations	↔	↔		↔	↔			↔			↔	
Traffic Volume (vph)	34	278	99	59	254	4	9	260	35	0	331	32
Future Volume (vph)	34	278	99	59	254	4	9	260	35	0	331	32
Satd. Flow (prot)	1433	1560	0	1658	1729	0	0	1535	0	0	1591	0
Fit Permitted	0.488			0.310				0.987				
Satd. Flow (perm)	529	1560	0	505	1729	0	0	1503	0	0	1591	0
Satd. Flow (RTOR)												
Lane Group Flow (vph)	38	419	0	66	286	0	0	338	0	0	404	0
Turn Type	Perm	NA		Perm	NA		Perm	NA			NA	
Protected Phases		4			8			2				6
Permitted Phases	4			8			2			6		
Detector Phase	4	4		8	8		2	2		6	6	
Switch Phase												
Minimum Initial (s)	10.0	10.0		10.0	10.0		10.0	10.0		10.0	10.0	
Minimum Split (s)	20.5	20.5		20.5	20.5		20.5	20.5		20.5	20.5	
Total Split (s)	25.0	25.0		25.0	25.0		40.0	40.0		40.0	40.0	
Total Split (%)	33.3%	33.3%		33.3%	33.3%		53.3%	53.3%		53.3%	53.3%	
Yellow Time (s)	3.3	3.3		3.3	3.3		3.3	3.3		3.3	3.3	
All-Red Time (s)	2.2	2.2		2.2	2.2		2.2	2.2		2.2	2.2	
Lost Time Adjust (s)	0.0	0.0		0.0	0.0		0.0	0.0		0.0	0.0	
Total Lost Time (s)	5.5	5.5		5.5	5.5		5.5	5.5		5.5	5.5	
Lead/Lag	Lag	Lag		Lag	Lag		Lag	Lag		Lag	Lag	
Lead-Lag Optimize?	Yes	Yes		Yes	Yes		Yes	Yes		Yes	Yes	
Recall Mode	None	None		None	None		C-Max	C-Max		C-Max	C-Max	
Act Effct Green (s)	24.5	24.5		24.5	24.5		39.5	39.5		39.5	39.5	
Actuated g/C Ratio	0.33	0.33		0.33	0.33		0.53	0.53		0.53	0.53	
v/c Ratio	0.22	0.82		0.40	0.51		0.43	0.48		0.48	0.48	
Control Delay	19.4	35.8		28.6	24.2		5.6	13.7		13.7	13.7	
Queue Delay	0.0	0.0		0.0	0.0		0.3	0.1		0.1	0.1	
Total Delay	19.4	35.8		28.6	24.2		5.9	13.8		13.8	13.8	
LOS	B	D		C	C		A	B		B	B	
Approach Delay		34.4			25.0		5.9	13.8		13.8		
Approach LOS		C			C		A	B		B		
Queue Length 50th (m)	4.7	59.3		7.5	33.9		8.9	35.5		35.5	35.5	
Queue Length 95th (m)	m12.1	#106.1		19.8	56.8		12.2	58.3		58.3	58.3	
Internal Link Dist (m)		174.8			68.0		65.6	106.3		106.3	106.3	
Turn Bay Length (m)	25.0			15.0								
Base Capacity (vph)	172	509		164	564		791	837		837	837	
Starvation Cap Reductn	0	0		0	0		114	0		0	0	
Spillback Cap Reductn	0	0		0	0		0	28		28	28	
Storage Cap Reductn	0	0		0	0		0	0		0	0	
Reduced v/c Ratio	0.22	0.82		0.40	0.51		0.50	0.50		0.50	0.50	

Intersection Summary

Cycle Length: 75

Actuated Cycle Length: 75

Offset: 7 (9%), Referenced to phase 2:NBL and 6:SBTL, Start of Green

Natural Cycle: 60

Control Type: Actuated-Coordinated

Lanes, Volumes, Timings

7: Bank & Somerset

Existing PM Peak Hour

Lane Group	Ø1	Ø3	Ø5	Ø7
Lane Configurations				
Traffic Volume (vph)				
Future Volume (vph)				
Satd. Flow (prot)				
Fit Permitted				
Satd. Flow (perm)				
Satd. Flow (RTOR)				
Lane Group Flow (vph)				
Turn Type				
Protected Phases	1	3	5	7
Permitted Phases				
Detector Phase				
Switch Phase				
Minimum Initial (s)	1.0	1.0	1.0	1.0
Minimum Split (s)	3.0	3.0	3.0	3.0
Total Split (s)	5.0	5.0	5.0	5.0
Total Split (%)	7%	7%	7%	7%
Yellow Time (s)	2.0	2.0	2.0	2.0
All-Red Time (s)	0.0	0.0	0.0	0.0
Lost Time Adjust (s)				
Total Lost Time (s)				
Lead/Lag	Lead	Lead	Lead	Lead
Lead-Lag Optimize?	Yes	Yes	Yes	Yes
Recall Mode	None	None	None	None
Act Effct Green (s)				
Actuated g/C Ratio				
v/c Ratio				
Control Delay				
Queue Delay				
Total Delay				
LOS				
Approach Delay				
Approach LOS				
Queue Length 50th (m)				
Queue Length 95th (m)				
Internal Link Dist (m)				
Turn Bay Length (m)				
Base Capacity (vph)				
Starvation Cap Reductn				
Spillback Cap Reductn				
Storage Cap Reductn				
Reduced v/c Ratio				

Intersection Summary

Lanes, Volumes, Timings

7: Bank & Somerset

Existing PM Peak Hour

Maximum v/c Ratio: 0.82	Intersection LOS: C
Intersection Signal Delay: 20.7	ICU Level of Service C
Intersection Capacity Utilization 70.7%	
Analysis Period (min) 15	
# 95th percentile volume exceeds capacity, queue may be longer.	
Queue shown is maximum after two cycles.	
m Volume for 95th percentile queue is metered by upstream signal.	

Splits and Phases: 7: Bank & Somerset

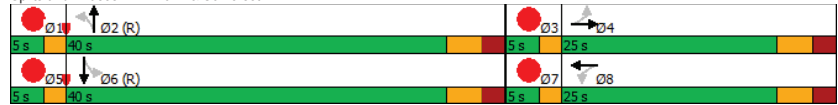

Lanes, Volumes, Timings

8: Bank & MacLaren

Existing PM Peak Hour

Lane Group	EBL	EBT	EBR	WBL	WBT	WBR	NBL	NBT	NBR	SBL	SBT	SBR
Lane Configurations					↔			↔				↔
Traffic Volume (vph)	0	0	0	35	11	10	25	310	0	0	445	26
Future Volume (vph)	0	0	0	35	11	10	25	310	0	0	445	26
Satd. Flow (prot)	0	0	0	0	1571	0	0	1675	0	0	1648	0
Fit Permitted					0.970			0.948				
Satd. Flow (perm)	0	0	0	0	1399	0	0	1564	0	0	1648	0
Satd. Flow (RTOR)					11			7				
Lane Group Flow (vph)	0	0	0	0	62	0	0	372	0	0	523	0
Turn Type				Perm	NA		Perm	NA			NA	
Protected Phases					8			2			6	
Permitted Phases					8			2				
Detector Phase					8	8		2	2			6
Switch Phase												
Minimum Initial (s)				10.0	10.0		10.0	10.0			10.0	
Minimum Split (s)				24.2	24.2		18.0	18.0			18.0	
Total Split (s)				24.2	24.2		50.8	50.8			50.8	
Total Split (%)				32.3%	32.3%		67.7%	67.7%			67.7%	
Yellow Time (s)				3.3	3.3		3.3	3.3			3.3	
All-Red Time (s)				1.9	1.9		1.7	1.7			1.7	
Lost Time Adjust (s)					0.0			0.0			0.0	
Total Lost Time (s)					5.2			5.0			5.0	
Lead/Lag												
Lead-Lag Optimize?												
Recall Mode				None	None		C-Max	C-Max			C-Max	
Act Effct Green (s)					17.2			51.6			51.6	
Actuated g/C Ratio					0.23			0.69			0.69	
v/c Ratio					0.19			0.35			0.46	
Control Delay					20.5			4.5			10.1	
Queue Delay					0.0			0.1			0.3	
Total Delay					20.5			4.6			10.5	
LOS					C			A			B	
Approach Delay					20.5			4.6			10.5	
Approach LOS					C			A			B	
Queue Length 50th (m)					5.9			10.9			27.9	
Queue Length 95th (m)					15.4			12.5			m37.0	
Internal Link Dist (m)					130.7			60.9			65.6	
Turn Bay Length (m)												
Base Capacity (vph)					362			1077			1137	
Starvation Cap Reductn					0			158			206	
Spillback Cap Reductn					0			0			0	
Storage Cap Reductn					0			0			0	
Reduced v/c Ratio					0.17			0.40			0.56	

Intersection Summary

Cycle Length: 75
Actuated Cycle Length: 75
Offset: 7 (9%), Referenced to phase 2:NBT and 6:SBT, Start of Green
Natural Cycle: 55
Control Type: Actuated-Coordinated

Lanes, Volumes, Timings
8: Bank & MacLaren

Existing PM Peak Hour

Maximum v/c Ratio: 0.46	Intersection LOS: A
Intersection Signal Delay: 8.9	ICU Level of Service B
Intersection Capacity Utilization 63.3%	
Analysis Period (min) 15	

m Volume for 95th percentile queue is metered by upstream signal.

Splits and Phases: 8: Bank & MacLaren



Lanes, Volumes, Timings
9: Bank & Gilmour

Existing PM Peak Hour

Lane Group	EBL	EBT	EBR	WBL	WBT	WBR	NBL	NBT	NBR	SBL	SBT	SBR
Lane Configurations		↕						↕				↕
Traffic Volume (vph)	14	116	61	0	0	0	0	335	28	19	443	0
Future Volume (vph)	14	116	61	0	0	0	0	335	28	19	443	0
Satd. Flow (prot)	0	1595	0	0	0	0	0	1664	0	0	1692	0
Fit Permitted		0.996									0.978	
Satd. Flow (perm)	0	1557	0	0	0	0	0	1664	0	0	1646	0
Satd. Flow (RTOR)		31						10				
Lane Group Flow (vph)	0	213	0	0	0	0	0	403	0	0	513	0
Turn Type	Perm	NA						NA		Perm	NA	
Protected Phases		4						2			6	
Permitted Phases	4									6		
Detector Phase	4	4						2		6	6	
Switch Phase												
Minimum Initial (s)	10.0	10.0						10.0		10.0	10.0	
Minimum Split (s)	23.2	23.2						20.1		20.1	20.1	
Total Split (s)	25.0	25.0						50.0		50.0	50.0	
Total Split (%)	33.3%	33.3%						66.7%		66.7%	66.7%	
Yellow Time (s)	3.3	3.3						3.3		3.3	3.3	
All-Red Time (s)	1.9	1.9						1.8		1.8	1.8	
Lost Time Adjust (s)		0.0						0.0		0.0	0.0	
Total Lost Time (s)		5.2						5.1		5.1	5.1	
Lead/Lag												
Lead-Lag Optimize?												
Recall Mode	None	None						C-Max		C-Max	C-Max	
Act Effct Green (s)		18.4						46.3			46.3	
Actuated g/C Ratio		0.25						0.62			0.62	
v/c Ratio		0.53						0.39			0.50	
Control Delay		19.7						13.9			3.7	
Queue Delay		0.0						0.0			0.1	
Total Delay		19.7						13.9			3.8	
LOS		B						B			A	
Approach Delay		19.7						13.9			3.8	
Approach LOS		B						B			A	
Queue Length 50th (m)		18.8						36.0			7.5	
Queue Length 95th (m)		28.8						m60.1			10.9	
Internal Link Dist (m)		174.3				69.2		57.1			60.9	
Turn Bay Length (m)												
Base Capacity (vph)		433						1031			1016	
Starvation Cap Reductn		0						0			59	
Spillback Cap Reductn		0						0			0	
Storage Cap Reductn		0						0			0	
Reduced v/c Ratio		0.49						0.39			0.54	

Intersection Summary		
Cycle Length:	75	
Actuated Cycle Length:	75	
Offset:	6 (8%), Referenced to phase 2:NBT and 6:SBTL, Start of Green	
Natural Cycle:	55	
Control Type:	Actuated-Coordinated	

Lanes, Volumes, Timings

9: Bank & Gilmour

Existing PM Peak Hour

Maximum v/c Ratio: 0.53	Intersection LOS: B
Intersection Signal Delay: 10.4	ICU Level of Service C
Intersection Capacity Utilization 68.5%	
Analysis Period (min) 15	

m Volume for 95th percentile queue is metered by upstream signal.

Splits and Phases: 9: Bank & Gilmour

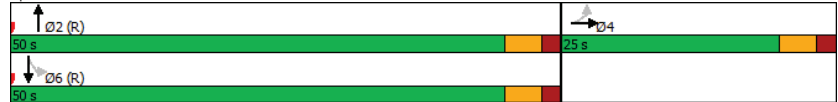

Lanes, Volumes, Timings

11: Bank & Gladstone

Existing PM Peak Hour

Lane Group	EBL	EBT	EBR	WBL	WBT	WBR	NBL	NBT	NBR	SBL	SBT	SBR
Lane Configurations		↕↕			↕↕		↕↕	↕↕			↕↕	
Traffic Volume (vph)	43	252	165	56	166	23	95	321	93	24	475	47
Future Volume (vph)	43	252	165	56	166	23	95	321	93	24	475	47
Satd. Flow (prot)	0	2796	0	0	1613	0	1658	1500	0	0	3112	0
Fit Permitted		0.882			0.699		0.370				0.922	
Satd. Flow (perm)	0	2440	0	0	1112	0	520	1500	0	0	2860	0
Satd. Flow (RTOR)												
Lane Group Flow (vph)	0	511	0	0	272	0	106	460	0	0	607	0
Turn Type	Perm	NA		Perm	NA		Perm	NA		Perm	NA	
Protected Phases		4			8			2			6	
Permitted Phases	4			8			2			6		
Detector Phase	4	4		8	8		2	2		6	6	
Switch Phase												
Minimum Initial (s)	10.0	10.0		10.0	10.0		10.0	10.0		10.0	10.0	
Minimum Split (s)	20.5	20.5		20.5	20.5		20.5	20.5		20.5	20.5	
Total Split (s)	28.0	28.0		28.0	28.0		37.0	37.0		37.0	37.0	
Total Split (%)	37.3%	37.3%		37.3%	37.3%		49.3%	49.3%		49.3%	49.3%	
Yellow Time (s)	3.3	3.3		3.3	3.3		3.3	3.3		3.3	3.3	
All-Red Time (s)	2.2	2.2		2.2	2.2		2.2	2.2		2.2	2.2	
Lost Time Adjust (s)		0.0			0.0		0.0	0.0		0.0	0.0	
Total Lost Time (s)		5.5			5.5		5.5	5.5		5.5	5.5	
Lead/Lag	Lag	Lag		Lag	Lag		Lag	Lag		Lag	Lag	
Lead-Lag Optimize?	Yes	Yes		Yes	Yes		Yes	Yes		Yes	Yes	
Recall Mode	None	None		None	None		C-Max	C-Max		C-Max	C-Max	
Act Effct Green (s)		20.3			20.3		31.5	31.5		31.5	31.5	
Actuated g/C Ratio		0.27			0.27		0.42	0.42		0.42	0.42	
v/c Ratio		0.77			0.90		0.49	0.73		0.51	0.51	
Control Delay		19.5			60.1		25.2	26.6		10.0	10.0	
Queue Delay		0.0			0.0		0.0	0.0		0.0	0.0	
Total Delay		19.5			60.1		25.2	26.6		10.0	10.0	
LOS		B			E		C	C		B	B	
Approach Delay		19.5			60.1		26.4	26.6		10.0	10.0	
Approach LOS		B			E		C	C		B	B	
Queue Length 50th (m)		9.8			37.3		11.1	55.4		17.4	17.4	
Queue Length 95th (m)		35.5			#78.1		27.4	#92.7		26.3	26.3	
Internal Link Dist (m)		173.9			70.9		108.7	108.7		139.2	139.2	
Turn Bay Length (m)							38.0					
Base Capacity (vph)		732			333		218	630		1201	1201	
Starvation Cap Reductn		0			0		0	0		0	0	
Spillback Cap Reductn		0			0		0	0		0	0	
Storage Cap Reductn		0			0		0	0		0	0	
Reduced v/c Ratio		0.70			0.82		0.49	0.73		0.51	0.51	

Intersection Summary	
Cycle Length: 75	
Actuated Cycle Length: 75	
Offset: 26 (35%), Referenced to phase 2:NBT and 6:SBTL, Start of Green	
Natural Cycle: 60	
Control Type: Actuated-Coordinated	

Lanes, Volumes, Timings
11: Bank & Gladstone

Existing PM Peak Hour

Lane Group	Ø1	Ø3	Ø5	Ø7
Lane Configurations				
Traffic Volume (vph)				
Future Volume (vph)				
Satd. Flow (prot)				
Fit Permitted				
Satd. Flow (perm)				
Satd. Flow (RTOR)				
Lane Group Flow (vph)				
Turn Type				
Protected Phases	1	3	5	7
Permitted Phases				
Detector Phase				
Switch Phase				
Minimum Initial (s)	1.0	1.0	1.0	1.0
Minimum Split (s)	3.0	3.0	3.0	3.0
Total Split (s)	5.0	5.0	5.0	5.0
Total Split (%)	7%	7%	7%	7%
Yellow Time (s)	2.0	2.0	2.0	2.0
All-Red Time (s)	0.0	0.0	0.0	0.0
Lost Time Adjust (s)				
Total Lost Time (s)				
Lead/Lag	Lead	Lead	Lead	Lead
Lead-Lag Optimize?	Yes	Yes	Yes	Yes
Recall Mode	Max	Max	Max	Max
Act Effct Green (s)				
Actuated g/C Ratio				
v/c Ratio				
Control Delay				
Queue Delay				
Total Delay				
LOS				
Approach Delay				
Approach LOS				
Queue Length 50th (m)				
Queue Length 95th (m)				
Internal Link Dist (m)				
Turn Bay Length (m)				
Base Capacity (vph)				
Starvation Cap Reductn				
Spillback Cap Reductn				
Storage Cap Reductn				
Reduced v/c Ratio				
Intersection Summary				

Lanes, Volumes, Timings
11: Bank & Gladstone

Existing PM Peak Hour

Maximum v/c Ratio: 0.90
Intersection Signal Delay: 24.2
Intersection Capacity Utilization 92.4%
Analysis Period (min) 15
95th percentile volume exceeds capacity, queue may be longer.
Queue shown is maximum after two cycles.

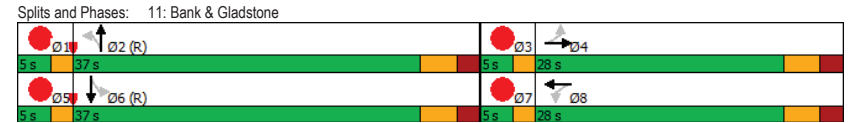

Appendix D

Collision Data

DRAFT

Accident Date	Accident Year	Accident Time	Location	Environment Condition	Light	Traffic Control	Traffic Control Condition	Classification Of Accident	Initial Impact Type	Road Surface Condition	# Vehicles	# Motorcycles	# Bicycles	# Pedestrians
6/3/2016	2016	18:00	BANK ST @ GILMOUR ST (0007270)	01 - Clear	01 - Daylight	01 - Traffic signal	01 - Functioning	02 - Non-fatal injury	05 - Turning movement	01 - Dry	2	0	1	0
10/10/2018	2018	20:37	BANK ST @ GILMOUR ST (0007270)	01 - Clear	07 - Dark	01 - Traffic signal	01 - Functioning	03 - P.D. only	03 - Rear end	02 - Wet	3	0	0	0
1/29/2018	2018	13:54	BANK ST @ GILMOUR ST (0007270)	01 - Clear	01 - Daylight	01 - Traffic signal	01 - Functioning	03 - P.D. only	04 - Sideswipe	02 - Wet	2	0	0	0
6/8/2018	2018	15:16	BANK ST @ GILMOUR ST (0007270)	01 - Clear	01 - Daylight	01 - Traffic signal	01 - Functioning	02 - Non-fatal injury	05 - Turning movement	01 - Dry	2	1	0	0
7/13/2018	2018	20:47	BANK ST @ GILMOUR ST (0007270)	01 - Clear	05 - Dusk	01 - Traffic signal	01 - Functioning	03 - P.D. only	03 - Rear end	01 - Dry	2	0	0	0
9/5/2018	2018	23:16	BANK ST @ GILMOUR ST (0007270)	01 - Clear	07 - Dark	01 - Traffic signal	02 - Not functioning	03 - P.D. only	03 - Rear end	01 - Dry	2	0	0	0
3/24/2019	2019	20:24	BANK ST @ GILMOUR ST (0007270)	01 - Clear	07 - Dark	01 - Traffic signal	01 - Functioning	03 - P.D. only	99 - Other	01 - Dry	2	0	0	0
6/26/2019	2019	16:40	BANK ST @ GILMOUR ST (0007270)	01 - Clear	01 - Daylight	01 - Traffic signal	00 - Unknown	03 - P.D. only	04 - Sideswipe	01 - Dry	2	0	0	0
3/6/2020	2020	14:43	BANK ST @ GILMOUR ST (0007270)	01 - Clear	01 - Daylight	01 - Traffic signal	01 - Functioning	03 - P.D. only	03 - Rear end	01 - Dry	2	0	0	0
8/21/2016	2016	16:33	GILMOUR ST @ KENT ST (0007283)	02 - Rain	01 - Daylight	01 - Traffic signal	01 - Functioning	02 - Non-fatal injury	07 - SMV other	02 - Wet	1	0	0	1
9/8/2018	2018	16:03	GILMOUR ST @ KENT ST (0007283)	01 - Clear	01 - Daylight	01 - Traffic signal	01 - Functioning	03 - P.D. only	01 - Dry	01 - Dry	2	0	0	0
11/17/2019	2019	9:07	GILMOUR ST @ KENT ST (0007283)	01 - Clear	01 - Daylight	01 - Traffic signal	01 - Functioning	03 - P.D. only	04 - Sideswipe	01 - Dry	2	0	0	0
9/27/2020	2020	18:44	GILMOUR ST @ KENT ST (0007283)	01 - Clear	05 - Dusk	01 - Traffic signal	01 - Functioning	03 - P.D. only	02 - Angle	01 - Dry	2	0	0	0
12/31/2016	2016	14:12	JAMES ST @ KENT ST (0007277)	03 - Snow	01 - Daylight	02 - Stop sign	01 - Functioning	03 - P.D. only	04 - Sideswipe	03 - Loose snow	2	0	0	0
8/29/2017	2017	13:44	JAMES ST @ KENT ST (0007277)	01 - Clear	01 - Daylight	02 - Stop sign	01 - Functioning	02 - Non-fatal injury	02 - Angle	05 - Packed snow	2	0	0	0
5/7/2016	2016	13:52	JAMES ST @ KENT ST (0007277)	01 - Clear	01 - Daylight	02 - Stop sign	01 - Functioning	03 - P.D. only	04 - Sideswipe	01 - Dry	2	0	0	0
6/26/2016	2016	11:00	JAMES ST @ KENT ST (0007277)	01 - Clear	01 - Daylight	02 - Stop sign	01 - Functioning	03 - P.D. only	05 - Turning movement	01 - Dry	2	0	0	0
5/29/2017	2017	10:20	JAMES ST @ KENT ST (0007277)	02 - Rain	01 - Daylight	02 - Stop sign	01 - Functioning	03 - P.D. only	02 - Angle	02 - Wet	2	0	0	0
8/29/2017	2017	13:44	JAMES ST @ KENT ST (0007277)	01 - Clear	01 - Daylight	02 - Stop sign	01 - Functioning	03 - P.D. only	05 - Turning movement	01 - Dry	2	0	0	0
6/6/2018	2018	1:43	JAMES ST @ KENT ST (0007277)	01 - Clear	07 - Dark	02 - Stop sign	01 - Functioning	02 - Non-fatal injury	02 - Angle	01 - Dry	2	0	0	0
6/3/2018	2018	16:58	JAMES ST @ KENT ST (0007277)	01 - Clear	01 - Daylight	02 - Stop sign	01 - Functioning	03 - P.D. only	02 - Angle	01 - Dry	2	0	0	0
9/17/2019	2019	8:25	JAMES ST @ KENT ST (0007277)	01 - Clear	01 - Daylight	02 - Stop sign	01 - Functioning	03 - P.D. only	03 - Rear end	01 - Dry	2	0	0	0
10/15/2019	2019	15:35	JAMES ST @ KENT ST (0007277)	01 - Clear	01 - Daylight	02 - Stop sign	01 - Functioning	03 - P.D. only	02 - Angle	01 - Dry	2	0	0	0
10/23/2019	2019	12:23	JAMES ST @ KENT ST (0007277)	01 - Clear	01 - Daylight	02 - Stop sign	01 - Functioning	03 - P.D. only	02 - Angle	01 - Dry	2	0	0	0
5/10/2019	2019	21:00	JAMES ST @ KENT ST (0007277)	01 - Clear	07 - Dark	02 - Stop sign	00 - Unknown	03 - P.D. only	04 - Sideswipe	01 - Dry	2	0	0	0
1/24/2020	2020	18:35	JAMES ST @ KENT ST (0007277)	01 - Clear	07 - Dark	02 - Stop sign	00 - Unknown	03 - P.D. only	04 - Sideswipe	01 - Dry	2	0	0	0
1/1/2020	2020	20:20	JAMES ST @ KENT ST (0007277)	01 - Clear	07 - Dark	02 - Stop sign	02 - Not functioning	03 - P.D. only	02 - Angle	01 - Dry	2	0	0	0
2/8/2020	2020	22:10	JAMES ST @ KENT ST (0007277)	01 - Clear	07 - Dark	02 - Stop sign	00 - Unknown	03 - P.D. only	05 - Turning movement	02 - Wet	2	0	0	0
3/19/2020	2020	16:15	JAMES ST @ KENT ST (0007277)	01 - Clear	01 - Daylight	02 - Stop sign	01 - Functioning	03 - P.D. only	01 - Dry	01 - Dry	2	0	0	0
6/17/2016	2016	14:04	KENT ST btwn MACLAREN ST & GILMOUR ST (_32BOE1)	01 - Clear	01 - Daylight	10 - No control	0	03 - P.D. only	03 - Rear end	01 - Dry	2	0	0	0
12/2/2017	2017	14:01	KENT ST btwn MACLAREN ST & GILMOUR ST (_32BOE1)	01 - Clear	01 - Daylight	10 - No control	0	03 - P.D. only	06 - SMV unattended vehicle	01 - Dry	1	0	0	0
5/31/2017	2017	21:12	KENT ST btwn MACLAREN ST & GILMOUR ST (_32BOE1)	01 - Clear	07 - Dark	10 - No control	0	03 - P.D. only	04 - Sideswipe	01 - Dry	2	0	0	0
11/1/2019	2019	6:55	KENT ST btwn MACLAREN ST & GILMOUR ST (_32BOE1)	02 - Rain	03 - Dawn	10 - No control	0	03 - P.D. only	03 - Rear end	02 - Wet	2	0	0	0
7/26/2019	2019	16:17	KENT ST btwn MACLAREN ST & GILMOUR ST (_32BOE1)	01 - Clear	01 - Daylight	10 - No control	0	03 - P.D. only	01 - Approaching	01 - Dry	2	0	0	0
3/24/2017	2017	16:55	KENT ST btwn GILMOUR ST & JAMES ST (_32A3QT)	01 - Clear	01 - Daylight	10 - No control	0	03 - P.D. only	07 - SMV other	03 - Loose snow	1	0	0	0
12/20/2019	2019	12:30	KENT ST btwn GILMOUR ST & JAMES ST (_32A3QT)	01 - Clear	01 - Daylight	10 - No control	0	03 - P.D. only	04 - Sideswipe	01 - Dry	2	0	0	0
12/17/2020	2020	17:59	KENT ST btwn GILMOUR ST & JAMES ST (_32A3QT)	01 - Clear	07 - Dark	10 - No control	0	03 - P.D. only	03 - Rear end	01 - Dry	2	0	0	0
7/13/2016	2016	16:42	KENT ST btwn JAMES ST & FLORENCE ST (_32A3QI)	01 - Clear	01 - Daylight	10 - No control	0	02 - Non-fatal injury	03 - Rear end	01 - Dry	3	0	0	0
10/28/2017	2017	5:03	KENT ST btwn JAMES ST & FLORENCE ST (_32A3QI)	01 - Clear	07 - Dark	10 - No control	0	03 - P.D. only	04 - Sideswipe	01 - Dry	2	0	0	0
6/14/2017	2017	Unknown	KENT ST btwn JAMES ST & FLORENCE ST (_32A3QI)	01 - Clear	00 - Unknown	10 - No control	0	03 - P.D. only	06 - SMV unattended vehicle	01 - Dry	1	0	0	0
6/30/2018	2018	Unknown	KENT ST btwn JAMES ST & FLORENCE ST (_32A3QI)	01 - Clear	00 - Unknown	10 - No control	0	03 - P.D. only	06 - SMV unattended vehicle	01 - Dry	1	0	0	0
12/22/2016	2016	9:07	GILMOUR ST btwn LYON ST N & KENT ST (_32BORF)	03 - Snow	01 - Daylight	10 - No control	0	03 - P.D. only	06 - SMV unattended vehicle	04 - Slush	1	0	0	0
1/14/2016	2016	9:30	GILMOUR ST btwn LYON ST N & KENT ST (_32BORF)	03 - Snow	01 - Daylight	10 - No control	0	03 - P.D. only	06 - SMV unattended vehicle	04 - Slush	1	0	0	0
8/4/2016	2016	13:56	GILMOUR ST btwn LYON ST N & KENT ST (_32BORF)	01 - Clear	01 - Daylight	10 - No control	0	03 - P.D. only	06 - SMV unattended vehicle	01 - Dry	1	0	0	0
6/17/2018	2018	Unknown	JAMES ST btwn LYON ST N & KENT ST (_32BORG)	01 - Clear	00 - Unknown	10 - No control	0	03 - P.D. only	06 - SMV unattended vehicle	01 - Dry	1	0	0	0



Transportation Services - Traffic Services

Collision Details Report - Public Version

From: January 1, 2015 **To:** December 31, 2019

Location: JAMES ST @ KENT ST

Traffic Control: Stop sign

Total Collisions: 14

Date/Day/Time	Environment	Impact Type	Classification	Surface Cond'n	Veh. Dir	Vehicle Manoeuver	Vehicle type	First Event	No. Ped
2015-Jan-29, Thu,19:32	Snow	Angle	P.D. only	Loose snow	West	Turning right	Automobile, station wagon	Other motor vehicle	0
					North	Going ahead	Automobile, station wagon	Other motor vehicle	
2015-Feb-27, Fri,18:30	Clear	Sideswipe	P.D. only	Dry	North	Changing lanes	Automobile, station wagon	Other motor vehicle	0
					North	Going ahead	Automobile, station wagon	Other motor vehicle	



Transportation Services - Traffic Services

Collision Details Report - Public Version

From: January 1, 2015 To: December 31, 2019

Location: JAMES ST @ KENT ST

Traffic Control: Stop sign

Total Collisions: 14

Date/Day/Time	Environment	Impact Type	Classification	Surface Cond'n	Veh. Dir	Vehicle Manoeuvre	Vehicle type	First Event	No. Ped
2016-Mar-03, Thu,17:12	Clear	Angle	Non-fatal injury	Packed snow	West	Going ahead	Automobile, station wagon	Other motor vehicle	0
					North	Going ahead	Automobile, station wagon	Other motor vehicle	
2016-May-02, Mon,13:52	Clear	Sideswipe	P.D. only	Dry	North	Changing lanes	Automobile, station wagon	Other motor vehicle	0
					North	Turning left	Automobile, station wagon	Other motor vehicle	
2016-Jun-26, Sun,11:00	Clear	Turning movement	P.D. only	Dry	North	Turning left	Pick-up truck	Other motor vehicle	0
					North	Going ahead	Automobile, station wagon	Other motor vehicle	
2016-Dec-31, Sat,14:12	Snow	Sideswipe	P.D. only	Loose snow	North	Changing lanes	Pick-up truck	Other motor vehicle	0
					North	Going ahead	Automobile, station wagon	Other motor vehicle	
2017-May-29, Mon,10:20	Rain	Angle	P.D. only	Wet	West	Turning left	Automobile, station wagon	Other motor vehicle	0
					North	Going ahead	Automobile, station wagon	Other motor vehicle	
2017-Aug-29, Tue,13:44	Clear	Turning movement	P.D. only	Dry	North	Turning left	Automobile, station wagon	Other motor vehicle	0
					North	Going ahead	Automobile, station wagon	Other motor vehicle	
2018-Jun-03, Sun,16:58	Clear	Angle	P.D. only	Dry	West	Turning right	Automobile, station wagon	Other motor vehicle	0
					North	Going ahead	Automobile, station wagon	Other motor vehicle	
2018-Jun-06, Wed,01:43	Clear	Angle	Non-fatal injury	Dry	West	Turning right	Automobile, station wagon	Other motor vehicle	0
					North	Going ahead	Automobile, station wagon	Other motor vehicle	
2019-May-10, Fri,21:00	Clear	Sideswipe	P.D. only	Dry	North	Changing lanes	Automobile, station wagon	Other motor vehicle	0
					North	Going ahead	Automobile, station wagon	Other motor vehicle	
2019-Sep-17, Tue,08:25	Clear	Rear end	P.D. only	Dry	North	Going ahead	Automobile, station wagon	Other motor vehicle	0
					North	Stopped	Automobile, station wagon	Other motor vehicle	
2019-Oct-15, Tue,15:35	Clear	Angle	P.D. only	Dry	North	Going ahead	Automobile, station wagon	Other motor vehicle	0
					West	Turning right	Automobile, station wagon	Other motor vehicle	



Transportation Services - Traffic Services

Collision Details Report - Public Version

From: January 1, 2015 To: December 31, 2019

Location: JAMES ST @ KENT ST

Traffic Control: Stop sign

Total Collisions: 14

Date/Day/Time	Environment	Impact Type	Classification	Surface Cond'n	Veh. Dir	Vehicle Manoeuver	Vehicle type	First Event	No. Ped
2019-Oct-23, Wed,12:23	Clear	Angle	P.D. only	Dry	West	Turning right	Automobile, station wagon	Other motor vehicle	0
					North	Going ahead	Automobile, station wagon	Other motor vehicle	

Appendix E

TRANS Model Plots

DRAFT

TRANS Regional Model

Version 2.15 - Assigned June 16, 2020

AM Peak Hour Total Traffic Volume

Somerset Street W Growth Rate

2011 Model - Basecase

N/A

User Initials: TIMW

Plot Prepared: September 17, 2020

EMME Scenario: 21711



Legend

AM Peak Hour Total Traffic Volume

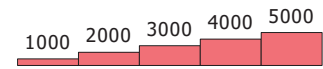

Distance (m)



The TRANS model is continuously refined & maintained, and all information is provided in good faith. However, model outputs are provided "as is", and no warranty or guarantee is provided as to the accuracy, reliability or reasonableness of the results. In using this data, you agree to accept any and all risks arising from any incorrect, incomplete, or misleading information.

Recipients are required to use caution and professional judgement in using and interpreting model outputs. In particular, caution should be used when focusing on a geographically limited area (such as a single road or intersection), as the model is primarily designed to simulate regional-scale phenomena and has been calibrated at a regional level.

As general good practice, it is recommended that the user confirm the network coding within the area of interest, and compare base year forecasts against traffic count data to assess the extent to which the model may be over- or under-estimating the travel demand.

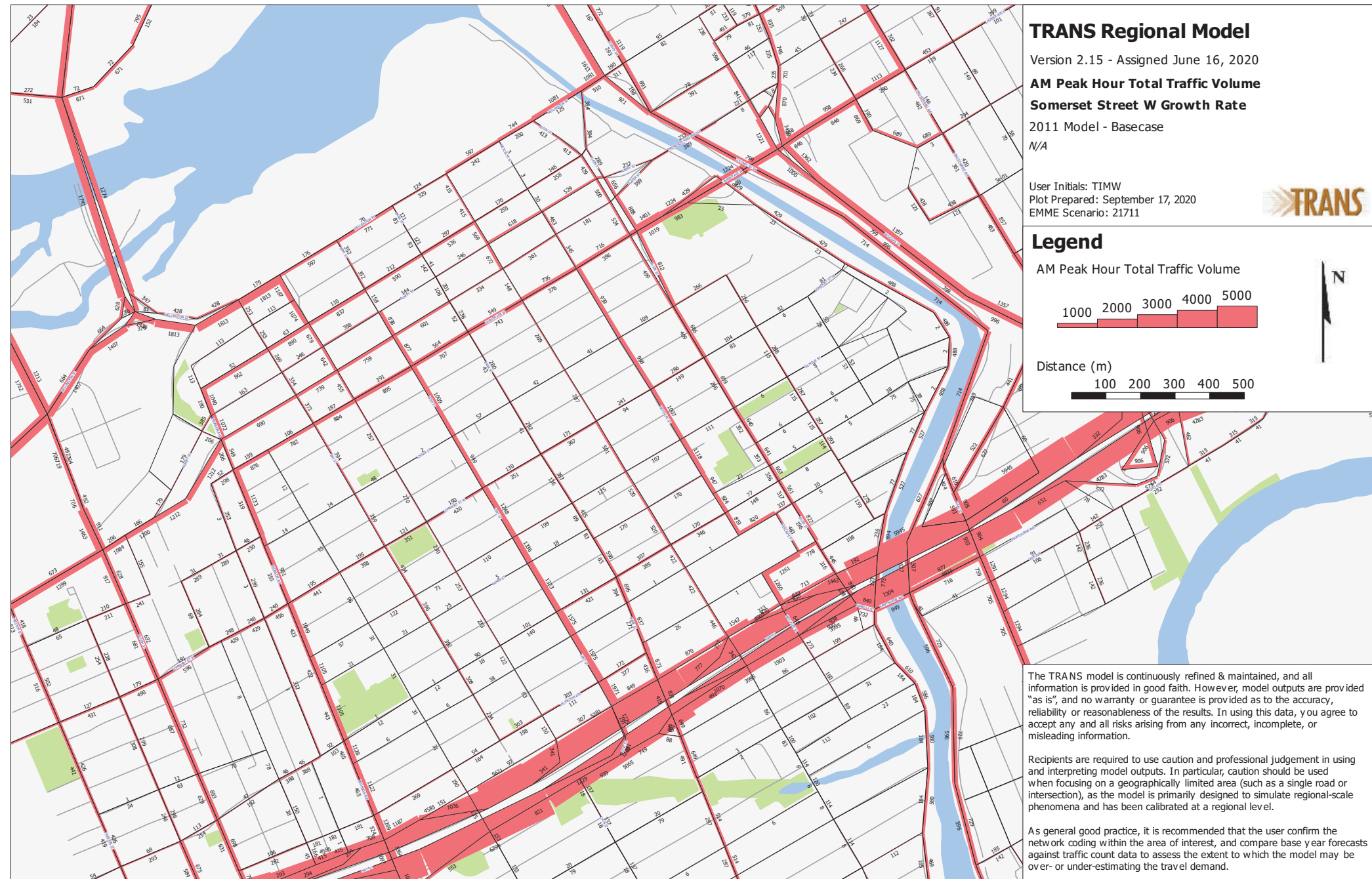

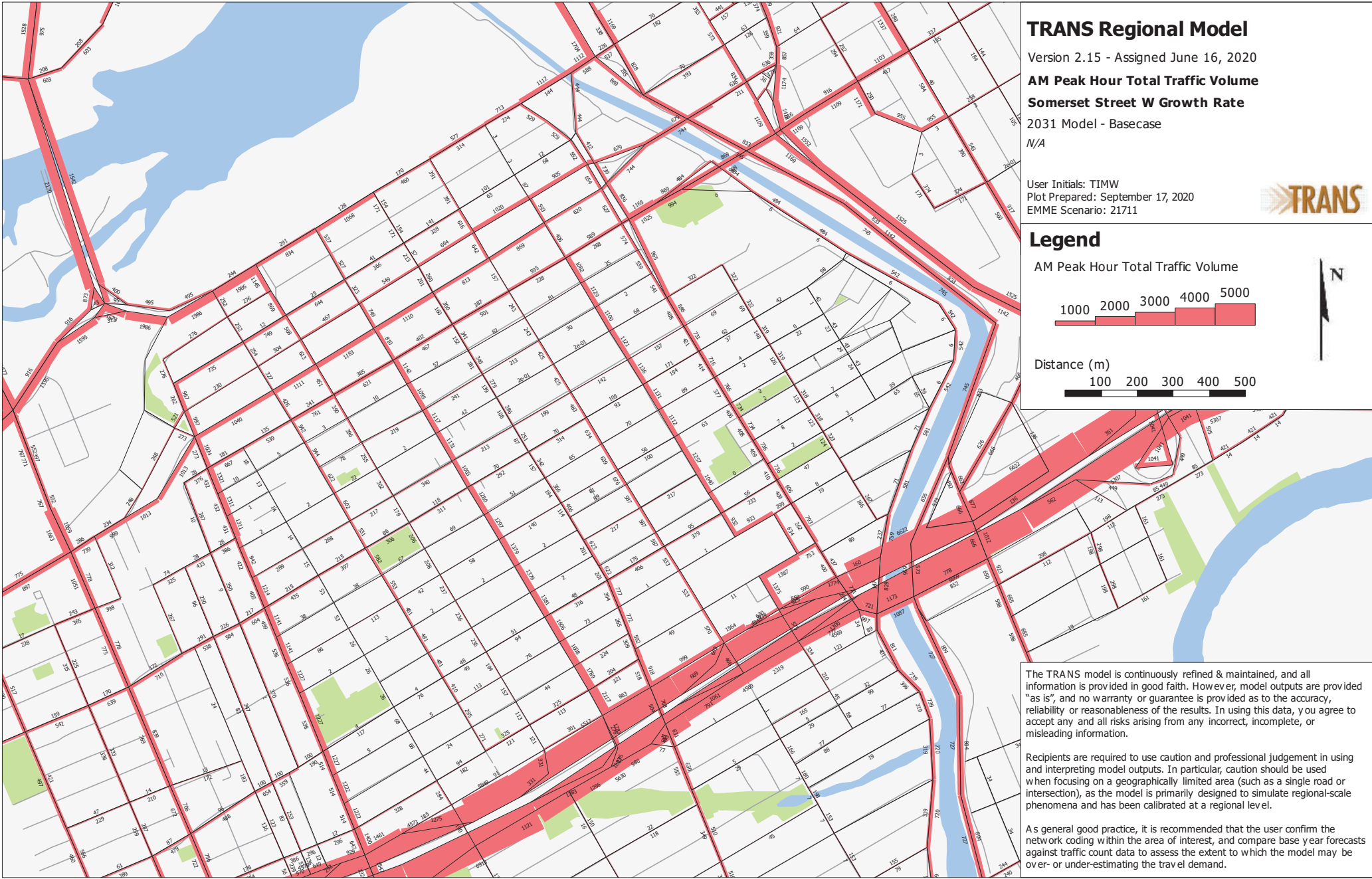

TRANS Regional Model

Version 2.15 - Assigned June 16, 2020
AM Peak Hour Total Traffic Volume
Somerset Street W Growth Rate
 2031 Model - Basecase
 N/A

User Initials: TIMW
 Plot Prepared: September 17, 2020
 EMME Scenario: 21711



Legend

AM Peak Hour Total Traffic Volume

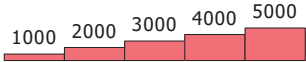

The TRANS model is continuously refined & maintained, and all information is provided in good faith. However, model outputs are provided "as is", and no warranty or guarantee is provided as to the accuracy, reliability or reasonableness of the results. In using this data, you agree to accept any and all risks arising from any incorrect, incomplete, or misleading information.

Recipients are required to use caution and professional judgement in using and interpreting model outputs. In particular, caution should be used when focusing on a geographically limited area (such as a single road or intersection), as the model is primarily designed to simulate regional-scale phenomena and has been calibrated at a regional level.

As a general good practice, it is recommended that the user confirm the network coding within the area of interest, and compare base year forecasts against traffic count data to assess the extent to which the model may be over- or under-estimating the travel demand.

Appendix F

Background Development Volumes

DRAFT

Figure 11: New Site Generation Auto Volumes

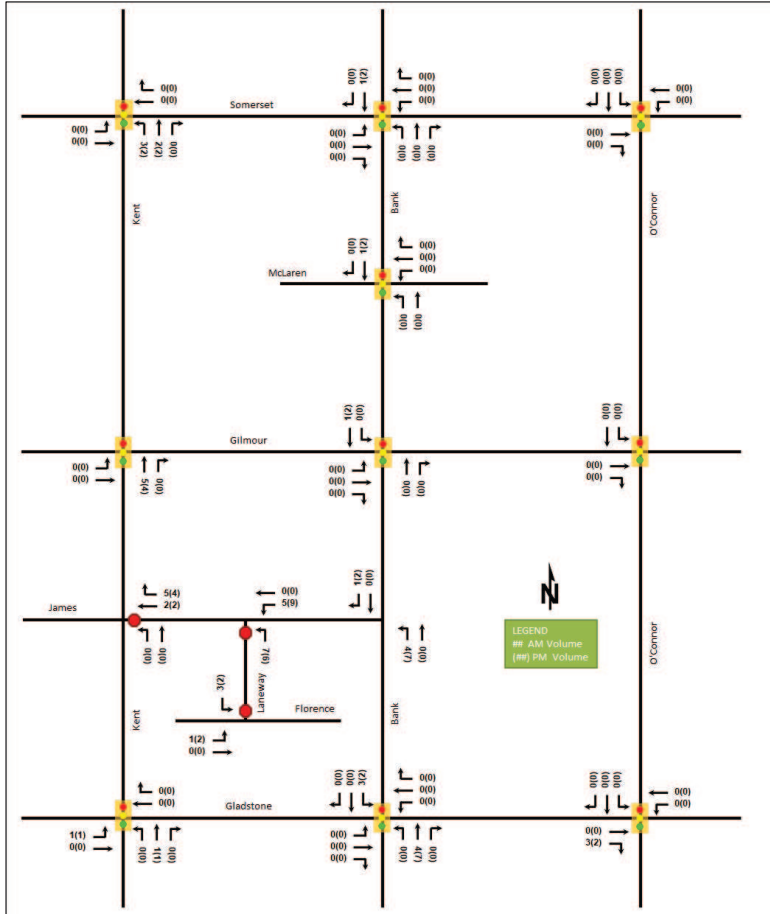

Figure 7: Phase I 'New' Site Generated Traffic

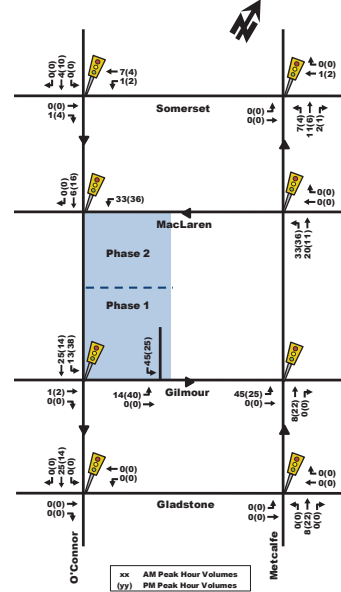

Figure 8: Phase II 'New' Site Generated Traffic

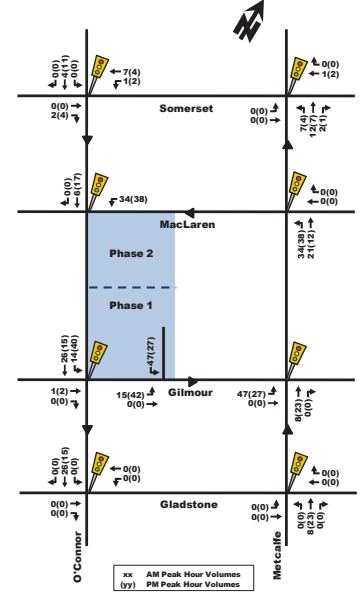

Figure 9: Total Phase I & II 'New' Site Generated Traffic

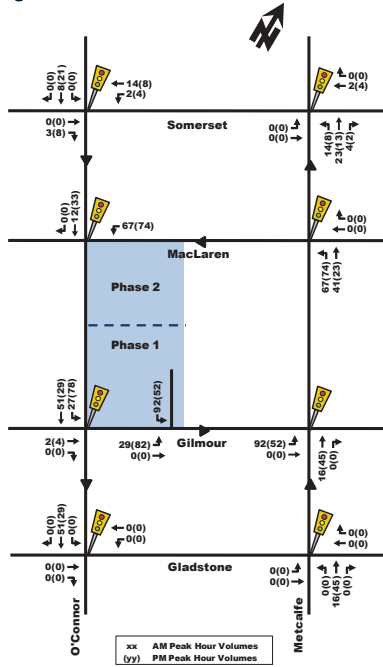

Figure 9: New Site Generation Auto Volumes

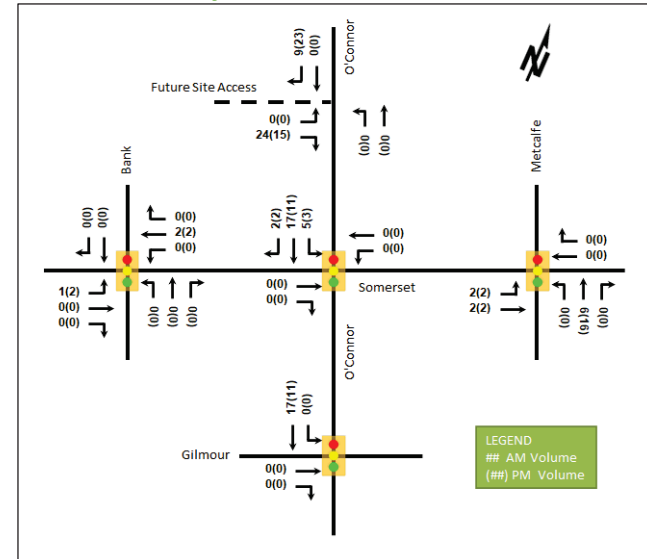
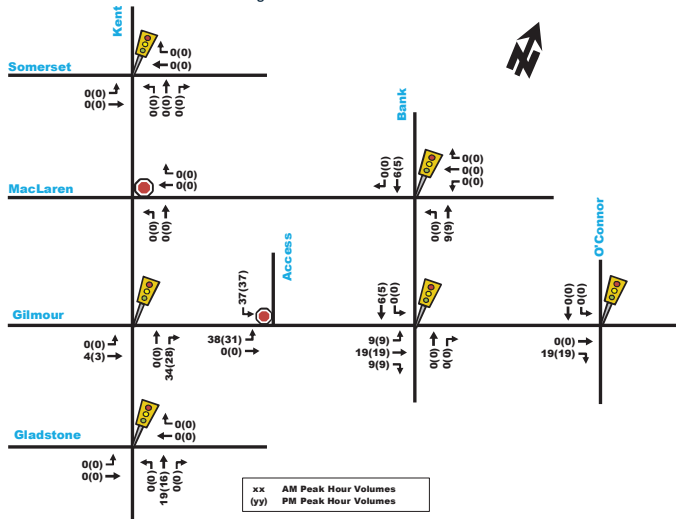

Figure 14: 2024 Site-Generated Traffic



Appendix G

Synchro Intersection Worksheets – 2030 Future Background Conditions

DRAFT

Lanes, Volumes, Timings
1: Lyon & James

2030 Future Background
AM Peak Hour

Lane Group	EBL	EBT	EBR	WBL	WBT	WBR	NBL	NBT	NBR	SBL	SBT	SBR
Lane Configurations					↕						↕↕	
Traffic Volume (vph)	0	0	0	34	21	0	0	0	0	0	389	25
Future Volume (vph)	0	0	0	34	21	0	0	0	0	0	389	25
Satd. Flow (prot)	0	0	0	0	1628	0	0	0	0	0	3228	0
Fit Permitted					0.970							
Satd. Flow (perm)	0	0	0	0	1600	0	0	0	0	0	3228	0
Satd. Flow (RTOR)					21							
Lane Group Flow (vph)	0	0	0	0	55	0	0	0	0	0	414	0
Turn Type				Perm	NA						NA	
Protected Phases					8							6
Permitted Phases					8						6	
Detector Phase					8	8					6	6
Switch Phase												
Minimum Initial (s)				10.0	10.0					10.0	10.0	
Minimum Split (s)				17.1	17.1					29.7	29.7	
Total Split (s)				17.1	17.1					57.9	57.9	
Total Split (%)				22.8%	22.8%					77.2%	77.2%	
Yellow Time (s)				3.3	3.3					3.3	3.3	
All-Red Time (s)				1.8	1.8					1.4	1.4	
Lost Time Adjust (s)					0.0						0.0	
Total Lost Time (s)					5.1						4.7	
Lead/Lag												
Lead-Lag Optimize?												
Recall Mode				None	None					C-Max	C-Max	
Act Effct Green (s)					10.4						62.7	
Actuated g/C Ratio					0.14						0.84	
v/c Ratio					0.25						0.15	
Control Delay					26.1						2.4	
Queue Delay					0.0						0.0	
Total Delay					26.1						2.4	
LOS					C						A	
Approach Delay					26.1						2.4	
Approach LOS					C						A	
Queue Length 50th (m)					7.5						7.2	
Queue Length 95th (m)					m11.6						12.5	
Internal Link Dist (m)		102.5			161.6			141.5			55.1	
Turn Bay Length (m)												
Base Capacity (vph)					256						2703	
Starvation Cap Reductn					0						0	
Spillback Cap Reductn					0						0	
Storage Cap Reductn					0						0	
Reduced v/c Ratio					0.21						0.15	
Intersection Summary												
Cycle Length: 75												
Actuated Cycle Length: 75												
Offset: 16 (21%), Referenced to phase 2: and 6:SBTL, Start of Green												
Natural Cycle: 50												
Control Type: Actuated-Coordinated												

Lanes, Volumes, Timings
1: Lyon & James

2030 Future Background
AM Peak Hour

Maximum v/c Ratio: 0.25	Intersection LOS: A
Intersection Signal Delay: 5.2	ICU Level of Service A
Intersection Capacity Utilization 38.9%	
Analysis Period (min) 15	
m Volume for 95th percentile queue is metered by upstream signal.	

Splits and Phases: 1: Lyon & James



Lanes, Volumes, Timings
2: Lyon & Gladstone

2030 Future Background
AM Peak Hour

Lane Group	EBL	EBT	EBR	WBL	WBT	WBR	NBL	NBT	NBR	SBL	SBT	SBR
Lane Configurations		↔		↔	↔						↔↔	
Traffic Volume (vph)	0	185	14	5	143	0	0	0	0	87	152	98
Future Volume (vph)	0	185	14	5	143	0	0	0	0	87	152	98
Satd. Flow (prot)	0	1679	0	0	1709	0	0	0	0	0	3064	0
Fit Permitted					0.992						0.987	
Satd. Flow (perm)	0	1679	0	0	1698	0	0	0	0	0	3030	0
Satd. Flow (RTOR)		6									98	
Lane Group Flow (vph)	0	199	0	0	148	0	0	0	0	0	337	0
Turn Type		NA		Perm	NA					Perm	NA	
Protected Phases		2			6						8	
Permitted Phases				6						8		
Detector Phase		2		6	6					8	8	
Switch Phase												
Minimum Initial (s)		10.0		10.0	10.0					10.0	10.0	
Minimum Split (s)		17.2		17.2	17.2					22.6	22.6	
Total Split (s)		38.0		38.0	38.0					37.0	37.0	
Total Split (%)		50.7%		50.7%	50.7%					49.3%	49.3%	
Yellow Time (s)		3.3		3.3	3.3					3.3	3.3	
All-Red Time (s)		1.9		1.9	1.9					2.3	2.3	
Lost Time Adjust (s)		0.0		0.0	0.0					0.0	0.0	
Total Lost Time (s)		5.2		5.2	5.2					5.6	5.6	
Lead/Lag												
Lead-Lag Optimize?												
Recall Mode		C-Max		C-Max	C-Max					Max	Max	
Act Effct Green (s)		32.8		32.8	32.8						31.4	
Actuated g/C Ratio		0.44		0.44	0.44						0.42	
v/c Ratio		0.27		0.20	0.20						0.25	
Control Delay		14.3		8.5	8.5						10.0	
Queue Delay		0.0		0.0	0.0						0.0	
Total Delay		14.3		8.5	8.5						10.0	
LOS		B		A	A						A	
Approach Delay		14.3		8.5	8.5						10.0	
Approach LOS		B		A	A						A	
Queue Length 50th (m)		17.6		5.7	5.7						12.5	
Queue Length 95th (m)		31.7		14.1	14.1						21.5	
Internal Link Dist (m)		110.8		164.9	164.9		56.5				141.5	
Turn Bay Length (m)												
Base Capacity (vph)		737		742	742						1325	
Starvation Cap Reductn		0		0	0						0	
Spillback Cap Reductn		0		0	0						0	
Storage Cap Reductn		0		0	0						0	
Reduced v/c Ratio		0.27		0.20	0.20						0.25	

Intersection Summary	
Cycle Length:	75
Actuated Cycle Length:	75
Offset:	10 (13%), Referenced to phase 2:EBT and 6:WBTL, Start of Green
Natural Cycle:	40
Control Type:	Actuated-Coordinated

Lanes, Volumes, Timings
2: Lyon & Gladstone

2030 Future Background
AM Peak Hour

Maximum v/c Ratio: 0.27	Intersection LOS: B
Intersection Signal Delay: 10.9	ICU Level of Service A
Intersection Capacity Utilization 35.4%	
Analysis Period (min) 15	

Splits and Phases: 2: Lyon & Gladstone

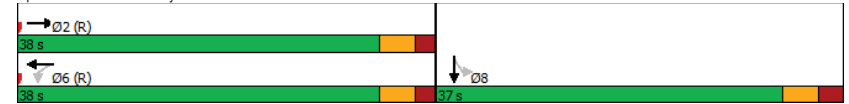

Lanes, Volumes, Timings
3: Kent & Somerset

2030 Future Background
AM Peak Hour

Lane Group	EBL	EBT	EBR	WBL	WBT	WBR	NBL	NBT	NBR	SBL	SBT	SBR
Lane Configurations	↔	↗	↘	↔	↗	↘	↔	↗	↘	↔	↗	↘
Traffic Volume (vph)	63	172	0	0	150	50	78	1556	184	0	0	0
Future Volume (vph)	63	172	0	0	150	50	78	1556	184	0	0	0
Satd. Flow (prot)	1658	1728	0	0	1610	0	1642	4534	0	0	0	0
Fit Permitted	0.556						0.950					
Satd. Flow (perm)	885	1728	0	0	1610	0	1072	4534	0	0	0	0
Satd. Flow (RTOR)							45					
Lane Group Flow (vph)	63	172	0	0	200	0	78	1740	0	0	0	0
Turn Type	Perm	NA			NA		Perm	NA				
Protected Phases		4			8			2				
Permitted Phases	4							2				
Detector Phase	4	4			8			2	2			
Switch Phase												
Minimum Initial (s)	10.0	10.0			10.0		10.0	10.0				
Minimum Split (s)	21.5	21.5			21.5		21.4	21.4				
Total Split (s)	27.0	27.0			27.0		48.0	48.0				
Total Split (%)	36.0%	36.0%			36.0%		64.0%	64.0%				
Yellow Time (s)	3.3	3.3			3.3		3.3	3.3				
All-Red Time (s)	2.2	2.2			2.2		2.1	2.1				
Lost Time Adjust (s)	0.0	0.0			0.0		0.0	0.0				
Total Lost Time (s)	5.5	5.5			5.5		5.4	5.4				
Lead/Lag												
Lead-Lag Optimize?												
Recall Mode	None	None			None		C-Max	C-Max				
Act Effct Green (s)	15.8	15.8			15.8		48.3	48.3				
Actuated g/C Ratio	0.21	0.21			0.21		0.64	0.64				
v/c Ratio	0.34	0.47			0.59		0.11	0.59				
Control Delay	29.3	29.7			27.0		8.5	9.1				
Queue Delay	0.0	0.0			0.0		0.0	0.0				
Total Delay	29.3	29.7			27.0		8.5	9.1				
LOS	C	C			C		A	A				
Approach Delay		29.6			27.0			9.0				
Approach LOS		C			C			A				
Queue Length 50th (m)	8.0	22.5			29.2		1.6	12.2				
Queue Length 95th (m)	17.8	37.7			49.2		m12.9	63.1				
Internal Link Dist (m)		61.7			174.8			152.2			110.1	
Turn Bay Length (m)	25.0						40.0					
Base Capacity (vph)	253	495			461		690	2937				
Starvation Cap Reductn	0	0			0		0	0				
Spillback Cap Reductn	0	0			0		0	0				
Storage Cap Reductn	0	0			0		0	0				
Reduced v/c Ratio	0.25	0.35			0.43		0.11	0.59				

Intersection Summary	
Cycle Length:	75
Actuated Cycle Length:	75
Offset:	66 (88%), Referenced to phase 2:NBTL and 6:, Start of Green
Natural Cycle:	50
Control Type:	Actuated-Coordinated

Lanes, Volumes, Timings
3: Kent & Somerset

2030 Future Background
AM Peak Hour

Maximum v/c Ratio: 0.59	Intersection LOS: B
Intersection Signal Delay: 12.8	ICU Level of Service C
Intersection Capacity Utilization 72.1%	
Analysis Period (min) 15	
m Volume for 95th percentile queue is metered by upstream signal.	

Splits and Phases: 3: Kent & Somerset

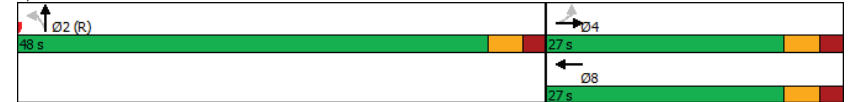

Lanes, Volumes, Timings
4: Kent & Gilmour

2030 Future Background
AM Peak Hour

Lane Group	EBL	EBT	EBR	WBL	WBT	WBR	NBL	NBT	NBR	SBL	SBT	SBR
Lane Configurations		↕						↕↕↕				
Traffic Volume (vph)	17	67	0	0	0	0	0	1817	7	0	0	0
Future Volume (vph)	17	67	0	0	0	0	0	1817	7	0	0	0
Satd. Flow (prot)	0	1728	0	0	0	0	0	4757	0	0	0	0
Fit Permitted		0.990										
Satd. Flow (perm)	0	1711	0	0	0	0	0	4757	0	0	0	0
Satd. Flow (RTOR)								1				
Lane Group Flow (vph)	0	84	0	0	0	0	0	1824	0	0	0	0
Turn Type	Perm	NA						NA				
Protected Phases		4						2				
Permitted Phases	4											
Detector Phase	4	4						2				
Switch Phase												
Minimum Initial (s)	10.0	10.0						10.0				
Minimum Split (s)	21.5	21.5						35.1				
Total Split (s)	22.0	22.0						53.0				
Total Split (%)	29.3%	29.3%						70.7%				
Yellow Time (s)	3.3	3.3						3.3				
All-Red Time (s)	2.2	2.2						1.8				
Lost Time Adjust (s)		0.0						0.0				
Total Lost Time (s)		5.5						5.1				
Lead/Lag												
Lead-Lag Optimize?												
Recall Mode	None	None						C-Max				
Act Effct Green (s)		12.4						56.1				
Actuated g/C Ratio		0.17						0.75				
v/c Ratio		0.30						0.51				
Control Delay		29.3						12.0				
Queue Delay		0.0						0.0				
Total Delay		29.3						12.0				
LOS		C						B				
Approach Delay		29.3						12.0				
Approach LOS		C						B				
Queue Length 50th (m)		11.6						57.8				
Queue Length 95th (m)		22.1						112.6				
Internal Link Dist (m)		69.3			174.3			57.8			152.2	
Turn Bay Length (m)												
Base Capacity (vph)		376						3559				
Starvation Cap Reductn		0						0				
Spillback Cap Reductn		0						0				
Storage Cap Reductn		0						0				
Reduced v/c Ratio		0.22						0.51				
Intersection Summary												
Cycle Length: 75												
Actuated Cycle Length: 75												
Offset: 5 (7%), Referenced to phase 2:NBT and 6:, Start of Green												
Natural Cycle: 60												
Control Type: Actuated-Coordinated												

Lanes, Volumes, Timings
4: Kent & Gilmour

2030 Future Background
AM Peak Hour

Maximum v/c Ratio: 0.51	Intersection LOS: B
Intersection Signal Delay: 12.8	ICU Level of Service B
Intersection Capacity Utilization 59.1%	
Analysis Period (min) 15	

Splits and Phases: 4: Kent & Gilmour



HCM 2010 TWSC
5: Kent & James

2030 Future Background
AM Peak Hour

Intersection													
Int Delay, s/veh	3.3												
Movement	EBL	EBT	EBR	WBL	WBT	WBR	NBL	NBT	NBR	SBL	SBT	SBR	
Lane Configurations					↔			↔↔↔					
Traffic Vol, veh/h	0	0	0	0	16	26	46	1798	0	0	0	0	
Future Vol, veh/h	0	0	0	0	16	26	46	1798	0	0	0	0	
Conflicting Peds, #/hr	23	0	11	11	0	23	72	0	77	77	0	72	
Sign Control	Free	Free	Free	Stop	Stop	Stop	Free	Free	Free	Free	Free	Free	
RT Channelized	-	-	None	-	-	None	-	-	None	-	-	None	
Storage Length	-	-	-	-	-	-	-	-	-	-	-	-	
Veh in Median Storage, #	1048576	-	-	-	0	-	-	0	-	-	-	-	
Grade, %	-	0	-	-	0	-	-	0	-	-	0	-	
Peak Hour Factor	100	100	100	100	100	100	100	100	100	100	100	100	
Heavy Vehicles, %	2	2	2	2	7	5	7	2	2	2	2	2	
Mvmt Flow	0	0	0	0	16	26	46	1798	0	0	0	0	
Major/Minor		Minor1			Major1								
Conflicting Flow All	-	1962	922	72	0	-	-	-	-	-	-	-	
Stage 1	-	1890	-	-	-	-	-	-	-	-	-	-	
Stage 2	-	72	-	-	-	-	-	-	-	-	-	-	
Critical Hdwy	-	6.64	7.2	5.44	-	-	-	-	-	-	-	-	
Critical Hdwy Stg 1	-	5.64	-	-	-	-	-	-	-	-	-	-	
Critical Hdwy Stg 2	-	-	-	-	-	-	-	-	-	-	-	-	
Follow-up Hdwy	-	4.07	3.95	3.17	-	-	-	-	-	-	-	-	
Pot Cap-1 Maneuver	0	59	229	1051	-	0	-	-	-	-	-	-	
Stage 1	0	111	-	-	-	0	-	-	-	-	-	-	
Stage 2	0	-	-	-	-	0	-	-	-	-	-	-	
Platoon blocked, %	-	-	-	-	-	-	-	-	-	-	-	-	
Mov Cap-1 Maneuver	-	0	229	1051	-	-	-	-	-	-	-	-	
Mov Cap-2 Maneuver	-	0	-	-	-	-	-	-	-	-	-	-	
Stage 1	-	0	-	-	-	-	-	-	-	-	-	-	
Stage 2	-	0	-	-	-	-	-	-	-	-	-	-	
Approach		WB			NB								
HCM Control Delay, s	24.2			2.8									
HCM LOS	C												
Minor Lane/Major Mvmt		NBL			NBTWBLn1								
Capacity (veh/h)	1051			- 229									
HCM Lane V/C Ratio	0.044			- 0.183									
HCM Control Delay (s)	8.6			2.7 24.2									
HCM Lane LOS	A			A C									
HCM 95th %tile Q(veh)	0.1			- 0.7									

Lanes, Volumes, Timings
6: Kent & Gladstone

2030 Future Background
AM Peak Hour

Lane Group	EBL	EBT	EBR	WBL	WBT	WBR	NBL	NBT	NBR	SBL	SBT	SBR
Lane Configurations	↔	↔			↔		↔↔↔	↔↔↔				
Traffic Volume (vph)	83	187	0	0	85	143	36	1699	97	0	0	0
Future Volume (vph)	83	187	0	0	85	143	36	1699	97	0	0	0
Satd. Flow (prot)	1626	1679	0	0	1461	0	1658	4703	0	0	0	0
Fit Permitted	0.501						0.950					
Satd. Flow (perm)	807	1679	0	0	1461	0	1401	4703	0	0	0	0
Satd. Flow (RTOR)					10			18				
Lane Group Flow (vph)	83	187	0	0	228	0	36	1796	0	0	0	0
Turn Type	Perm	NA			NA		Perm	NA				
Protected Phases		4			8			2				
Permitted Phases	4							2				
Detector Phase	4	4			8			2	2			
Switch Phase												
Minimum Initial (s)	10.0	10.0			10.0		10.0	10.0				
Minimum Split (s)	21.4	21.4			20.4		21.4	21.4				
Total Split (s)	30.0	30.0			30.0		45.0	45.0				
Total Split (%)	40.0%	40.0%			40.0%		60.0%	60.0%				
Yellow Time (s)	3.3	3.3			3.3		3.3	3.3				
All-Red Time (s)	2.1	2.1			2.1		2.1	2.1				
Lost Time Adjust (s)	0.0	0.0			0.0		0.0	0.0				
Total Lost Time (s)	5.4	5.4			5.4		5.4	5.4				
Lead/Lag												
Lead-Lag Optimize?												
Recall Mode	None	None			None		C-Max	C-Max				
Act Effct Green (s)	16.5	16.5			16.5		47.7	47.7				
Actuated g/C Ratio	0.22	0.22			0.22		0.64	0.64				
v/c Ratio	0.47	0.51			0.70		0.04	0.60				
Control Delay	42.0	39.4			32.3		6.8	9.8				
Queue Delay	0.0	0.0			0.0		0.0	0.0				
Total Delay	42.0	39.4			32.3		6.8	9.8				
LOS	D	D			C		A	A				
Approach Delay		40.2			32.3			9.7				
Approach LOS		D			C			A				
Queue Length 50th (m)	13.2	29.8			18.6		1.7	49.3				
Queue Length 95th (m)	19.8	36.0			48.9		6.3	81.7				
Internal Link Dist (m)		164.9			173.9			90.5			139.7	
Turn Bay Length (m)	30.0						40.0					
Base Capacity (vph)	264	550			485		891	2998				
Starvation Cap Reductn	0	0			0		0	0				
Spillback Cap Reductn	0	0			0		0	0				
Storage Cap Reductn	0	0			0		0	0				
Reduced v/c Ratio	0.31	0.34			0.47		0.04	0.60				

Intersection Summary												
Cycle Length: 75												
Actuated Cycle Length: 75												
Offset: 36 (48%), Referenced to phase 2:NBTL and 6., Start of Green												
Natural Cycle: 50												
Control Type: Actuated-Coordinated												

Lanes, Volumes, Timings
6: Kent & Gladstone

2030 Future Background
AM Peak Hour

Maximum v/c Ratio: 0.70	Intersection LOS: B
Intersection Signal Delay: 15.5	ICU Level of Service D
Intersection Capacity Utilization 75.7%	
Analysis Period (min) 15	

Splits and Phases: 6: Kent & Gladstone



Lanes, Volumes, Timings
7: Bank & Somerset

2030 Future Background
AM Peak Hour

Lane Group	EBL	EBT	EBR	WBL	WBT	WBR	NBL	NBT	NBR	SBL	SBT	SBR
Lane Configurations		↕	↕	↕	↕			↕			↕	
Traffic Volume (vph)	41	191	75	21	124	15	12	170	40	2	163	36
Future Volume (vph)	41	191	75	21	124	15	12	170	40	2	163	36
Satd. Flow (prot)	0	1627	1388	1610	1665	0	0	1465	0	0	1459	0
Fit Permitted		0.918		0.502				0.985			0.998	
Satd. Flow (perm)	0	1467	1102	746	1665	0	0	1428	0	0	1453	0
Satd. Flow (RTOR)												
Lane Group Flow (vph)	0	232	75	21	139	0	0	222	0	0	201	0
Turn Type	Perm	NA	Perm	Perm	NA		Perm	NA		Perm	NA	
Protected Phases		4			8			2			6	
Permitted Phases	4		4	8			2			6		
Detector Phase	4	4	4	8	8		2	2		6	6	
Switch Phase												
Minimum Initial (s)	10.0	10.0	10.0	10.0	10.0		10.0	10.0		10.0	10.0	
Minimum Split (s)	20.5	20.5	20.5	20.5	20.5		20.5	20.5		20.5	20.5	
Total Split (s)	25.0	25.0	25.0	25.0	25.0		40.0	40.0		40.0	40.0	
Total Split (%)	33.3%	33.3%	33.3%	33.3%	33.3%		53.3%	53.3%		53.3%	53.3%	
Yellow Time (s)	3.3	3.3	3.3	3.3	3.3		3.3	3.3		3.3	3.3	
All-Red Time (s)	2.2	2.2	2.2	2.2	2.2		2.2	2.2		2.2	2.2	
Lost Time Adjust (s)		0.0	0.0	0.0	0.0			0.0			0.0	
Total Lost Time (s)		5.5	5.5	5.5	5.5			5.5			5.5	
Lead/Lag	Lag	Lag	Lag	Lag	Lag		Lag	Lag		Lag	Lag	
Lead-Lag Optimize?	Yes	Yes	Yes	Yes	Yes		Yes	Yes		Yes	Yes	
Recall Mode	None	None	None	None	None		C-Max	C-Max		C-Max	C-Max	
Act Effct Green (s)		16.9	16.9	16.9	16.9			47.1			47.1	
Actuated g/C Ratio		0.23	0.23	0.23	0.23			0.63			0.63	
v/c Ratio		0.70	0.30	0.12	0.37			0.25			0.22	
Control Delay		43.2	32.0	22.5	26.1			3.0			7.9	
Queue Delay		0.0	0.0	0.0	0.0			0.2			0.0	
Total Delay		43.2	32.0	22.5	26.1			3.2			7.9	
LOS		D	C	C	C			A			A	
Approach Delay		40.5			25.6			3.2			7.9	
Approach LOS		D			C			A			A	
Queue Length 50th (m)		37.1	11.9	2.5	17.6			3.6			11.4	
Queue Length 95th (m)		58.6	19.5	7.4	29.6			6.5			26.3	
Internal Link Dist (m)		174.8			68.0			65.6			106.3	
Turn Bay Length (m)			28.0	15.0								
Base Capacity (vph)		395	296	200	448			896			912	
Starvation Cap Reductn		0	0	0	0			245			0	
Spillback Cap Reductn		0	0	0	0			0			0	
Storage Cap Reductn		0	0	0	0			0			0	
Reduced v/c Ratio		0.59	0.25	0.10	0.31			0.34			0.22	

Intersection Summary

Cycle Length: 75
Actuated Cycle Length: 75
Offset: 46 (61%), Referenced to phase 2:NBTL and 6:SBTL, Start of Green
Natural Cycle: 50
Control Type: Actuated-Coordinated

Lanes, Volumes, Timings
7: Bank & Somerset

2030 Future Background
AM Peak Hour

Lane Group	Ø1	Ø3	Ø5	Ø7
Lane Configurations				
Traffic Volume (vph)				
Future Volume (vph)				
Satd. Flow (prot)				
Fit Permitted				
Satd. Flow (perm)				
Satd. Flow (RTOR)				
Lane Group Flow (vph)				
Turn Type				
Protected Phases	1	3	5	7
Permitted Phases				
Detector Phase				
Switch Phase				
Minimum Initial (s)	1.0	1.0	1.0	1.0
Minimum Split (s)	3.0	3.0	3.0	3.0
Total Split (s)	5.0	5.0	5.0	5.0
Total Split (%)	7%	7%	7%	7%
Yellow Time (s)	2.0	2.0	2.0	2.0
All-Red Time (s)	0.0	0.0	0.0	0.0
Lost Time Adjust (s)				
Total Lost Time (s)				
Lead/Lag	Lead	Lead	Lead	Lead
Lead-Lag Optimize?	Yes	Yes	Yes	Yes
Recall Mode	None	None	None	None
Act Effct Green (s)				
Actuated g/C Ratio				
v/c Ratio				
Control Delay				
Queue Delay				
Total Delay				
LOS				
Approach Delay				
Approach LOS				
Queue Length 50th (m)				
Queue Length 95th (m)				
Internal Link Dist (m)				
Turn Bay Length (m)				
Base Capacity (vph)				
Starvation Cap Reductn				
Spillback Cap Reductn				
Storage Cap Reductn				
Reduced v/c Ratio				
Intersection Summary				

Lanes, Volumes, Timings
7: Bank & Somerset

2030 Future Background
AM Peak Hour

Maximum v/c Ratio: 0.70	
Intersection Signal Delay: 21.1	Intersection LOS: C
Intersection Capacity Utilization 60.4%	ICU Level of Service B
Analysis Period (min) 15	
m Volume for 95th percentile queue is metered by upstream signal.	

Splits and Phases: 7: Bank & Somerset



Lanes, Volumes, Timings
8: Bank & MacLaren

2030 Future Background
AM Peak Hour

Lane Group	EBL	EBT	EBR	WBL	WBT	WBR	NBL	NBT	NBR	SBL	SBT	SBR
Lane Configurations												
Traffic Volume (vph)	0	0	0	11	4	13	36	209	0	0	235	26
Future Volume (vph)	0	0	0	11	4	13	36	209	0	0	235	26
Satd. Flow (prot)	0	0	0	0	1430	0	0	1695	0	0	1547	0
Fit Permitted					0.981			0.936				
Satd. Flow (perm)	0	0	0	0	1376	0	0	1498	0	0	1547	0
Satd. Flow (RTOR)					13			14				
Lane Group Flow (vph)	0	0	0	0	28	0	0	245	0	0	261	0
Turn Type				Perm	NA		Perm	NA			NA	
Protected Phases					8			2			6	
Permitted Phases					8			2				
Detector Phase					8	8		2	2		6	
Switch Phase												
Minimum Initial (s)				10.0	10.0		10.0	10.0			10.0	
Minimum Split (s)				24.2	24.2		18.0	18.0			18.0	
Total Split (s)				24.2	24.2		50.8	50.8			50.8	
Total Split (%)				32.3%	32.3%		67.7%	67.7%			67.7%	
Yellow Time (s)				3.3	3.3		3.3	3.3			3.3	
All-Red Time (s)				1.9	1.9		1.7	1.7			1.7	
Lost Time Adjust (s)					0.0			0.0			0.0	
Total Lost Time (s)					5.2			5.0			5.0	
Lead/Lag												
Lead-Lag Optimize?												
Recall Mode				None	None		C-Max	C-Max			C-Max	
Act Effct Green (s)					15.4			57.5			57.5	
Actuated g/C Ratio					0.21			0.77			0.77	
v/c Ratio					0.10			0.21			0.22	
Control Delay					15.8			1.8			7.7	
Queue Delay					0.0			0.1			0.2	
Total Delay					15.8			1.9			7.9	
LOS					B			A			A	
Approach Delay					15.8			1.9			7.9	
Approach LOS					B			A			A	
Queue Length 50th (m)					1.7			8.6			22.3	
Queue Length 95th (m)					7.7			3.4			24.1	
Internal Link Dist (m)		130.7			122.8			60.9			65.6	
Turn Bay Length (m)												
Base Capacity (vph)					358			1148			1189	
Starvation Cap Reductn					0			317			373	
Spillback Cap Reductn					0			0			0	
Storage Cap Reductn					0			0			0	
Reduced v/c Ratio					0.08			0.29			0.32	

Intersection Summary												
Cycle Length: 75												
Actuated Cycle Length: 75												
Offset: 42 (56%), Referenced to phase 2:NBTL and 6:SBT, Start of Green												
Natural Cycle: 45												
Control Type: Actuated-Coordinated												

Lanes, Volumes, Timings
8: Bank & MacLaren

2030 Future Background
AM Peak Hour

Maximum v/c Ratio: 0.22	Intersection LOS: A
Intersection Signal Delay: 5.5	ICU Level of Service B
Intersection Capacity Utilization 56.8%	
Analysis Period (min) 15	

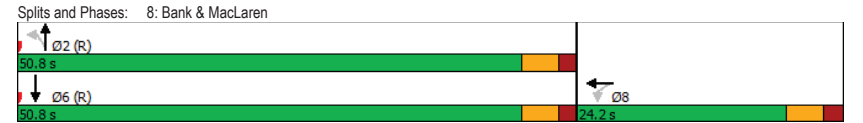

Lanes, Volumes, Timings
9: Bank & Gilmour

2030 Future Background
AM Peak Hour

Lane Group	EBL	EBT	EBR	WBL	WBT	WBR	NBL	NBT	NBR	SBL	SBT	SBR
Lane Configurations		↔						↔				↔
Traffic Volume (vph)	12	63	39	0	0	0	0	232	22	19	240	0
Future Volume (vph)	12	63	39	0	0	0	0	232	22	19	240	0
Satd. Flow (prot)	0	1587	0	0	0	0	0	1536	0	0	1619	0
Fit Permitted		0.995									0.974	
Satd. Flow (perm)	0	1578	0	0	0	0	0	1536	0	0	1562	0
Satd. Flow (RTOR)		34						11				
Lane Group Flow (vph)	0	114	0	0	0	0	0	254	0	0	259	0
Turn Type	Perm	NA						NA		Perm	NA	
Protected Phases		4						2			6	
Permitted Phases	4									6		
Detector Phase	4	4						2		6	6	
Switch Phase												
Minimum Initial (s)	10.0	10.0						10.0		10.0	10.0	
Minimum Split (s)	23.2	23.2						20.1		20.1	20.1	
Total Split (s)	25.0	25.0						50.0		50.0	50.0	
Total Split (%)	33.3%	33.3%						66.7%		66.7%	66.7%	
Yellow Time (s)	3.3	3.3						3.3		3.3	3.3	
All-Red Time (s)	1.9	1.9						1.8		1.8	1.8	
Lost Time Adjust (s)		0.0						0.0		0.0	0.0	
Total Lost Time (s)		5.2						5.1		5.1	5.1	
Lead/Lag												
Lead-Lag Optimize?												
Recall Mode	None	None						C-Max		C-Max	C-Max	
Act Effct Green (s)		13.2						55.6		55.6	55.6	
Actuated g/C Ratio		0.18						0.74		0.74	0.74	
v/c Ratio		0.37						0.22		0.22	0.22	
Control Delay		16.3						3.4		2.8	2.8	
Queue Delay		0.0						0.0		0.2	0.2	
Total Delay		16.3						3.4		3.0	3.0	
LOS		B						A		A	A	
Approach Delay		16.3						3.4		3.0	3.0	
Approach LOS		B						A		A	A	
Queue Length 50th (m)		12.9						7.2		4.4	4.4	
Queue Length 95th (m)		27.6						11.3		9.3	9.3	
Internal Link Dist (m)		174.3			69.2			57.1		60.9	60.9	
Turn Bay Length (m)												
Base Capacity (vph)		441						1140		1157	1157	
Starvation Cap Reductn		0						0		406	406	
Spillback Cap Reductn		0						0		0	0	
Storage Cap Reductn		0						0		0	0	
Reduced v/c Ratio		0.26						0.22		0.34	0.34	

Intersection Summary	
Cycle Length:	75
Actuated Cycle Length:	75
Offset:	37 (49%), Referenced to phase 2:NBT and 6:SBLT, Start of Green
Natural Cycle:	45
Control Type:	Actuated-Coordinated

Lanes, Volumes, Timings
9: Bank & Gilmour

2030 Future Background
AM Peak Hour

Maximum v/c Ratio: 0.37	Intersection LOS: A
Intersection Signal Delay: 5.6	ICU Level of Service A
Intersection Capacity Utilization 53.2%	
Analysis Period (min) 15	

Splits and Phases: 9: Bank & Gilmour

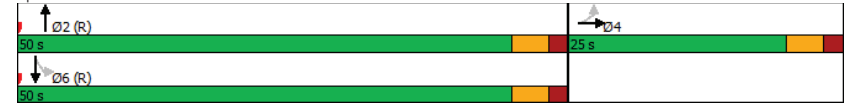

Lanes, Volumes, Timings
10: Bank & James

2030 Future Background
AM Peak Hour

Lane Group	EBL	EBR	NBL	NBT	SBT	SBR
Lane Configurations				↕	↕	
Traffic Volume (vph)	0	0	29	259	262	24
Future Volume (vph)	0	0	29	259	262	24
Satd. Flow (prot)	0	0	0	1682	1638	0
Fit Permitted				0.995		
Satd. Flow (perm)	0	0	0	1682	1638	0
Lane Group Flow (vph)	0	0	0	288	286	0
Sign Control	Stop		Free		Free	
Intersection Summary						
Control Type: Unsignalized						
Intersection Capacity Utilization 48.7%						
ICU Level of Service A						
Analysis Period (min) 15						

Lanes, Volumes, Timings
11: Bank & Gladstone

2030 Future Background
AM Peak Hour

Lane Group	EBL	EBT	EBR	WBL	WBT	WBR	NBL	NBT	NBR	SBL	SBT	SBR
Lane Configurations		↕			↕		↕	↕			↕	
Traffic Volume (vph)	36	174	64	20	102	19	57	248	76	6	230	34
Future Volume (vph)	36	174	64	20	102	19	57	248	76	6	230	34
Satd. Flow (prot)	0	2964	0	0	1578	0	1626	1503	0	0	2965	0
Fit Permitted		0.872			0.910		0.585				0.948	
Satd. Flow (perm)	0	2574	0	0	1432	0	869	1503	0	0	2808	0
Satd. Flow (RTOR)												
Lane Group Flow (vph)	0	274	0	0	141	0	57	324	0	0	270	0
Turn Type	Perm	NA		Perm	NA		Perm	NA		Perm	NA	
Protected Phases	4		8		2		6		6		6	
Permitted Phases	4		8		2		6		6		6	
Detector Phase	4		8		2		6		6		6	
Switch Phase												
Minimum Initial (s)	10.0	10.0		10.0	10.0		10.0	10.0		10.0	10.0	
Minimum Split (s)	20.5	20.5		20.5	20.5		20.5	20.5		20.5	20.5	
Total Split (s)	23.0	23.0		23.0	23.0		42.0	42.0		42.0	42.0	
Total Split (%)	30.7%	30.7%		30.7%	30.7%		56.0%	56.0%		56.0%	56.0%	
Yellow Time (s)	3.3	3.3		3.3	3.3		3.3	3.3		3.3	3.3	
All-Red Time (s)	2.2	2.2		2.2	2.2		2.2	2.2		2.2	2.2	
Lost Time Adjust (s)	0.0		0.0		0.0		0.0		0.0		0.0	
Total Lost Time (s)	5.5		5.5		5.5		5.5		5.5		5.5	
Lead/Lag	Lag	Lag		Lag	Lag		Lag	Lag		Lag	Lag	
Lead-Lag Optimize?	Yes	Yes		Yes	Yes		Yes	Yes		Yes	Yes	
Recall Mode	None	None		None	None		C-Max	C-Max		C-Max	C-Max	
Act Effct Green (s)	14.5		14.5		36.5		36.5		36.5		36.5	
Actuated g/C Ratio	0.19		0.19		0.49		0.49		0.49		0.49	
v/c Ratio	0.55		0.51		0.14		0.44		0.20		0.20	
Control Delay	40.0		33.4		11.7		15.0		16.3		16.3	
Queue Delay	0.0		0.0		0.0		0.0		0.0		0.0	
Total Delay	40.0		33.4		11.7		15.0		16.3		16.3	
LOS	D		C		B		B		B		B	
Approach Delay	40.0		33.4		14.5		16.3		16.3		16.3	
Approach LOS	D		C		B		B		B		B	
Queue Length 50th (m)	22.6		18.8		4.4		29.9		16.6		16.6	
Queue Length 95th (m)	33.5		34.4		11.0		50.3		25.8		25.8	
Internal Link Dist (m)	173.9		70.9		108.7		139.2		139.2		139.2	
Turn Bay Length (m)	38.0											
Base Capacity (vph)	600		334		422		731		1366		1366	
Starvation Cap Reductn	0		0		0		0		0		0	
Spillback Cap Reductn	0		0		0		0		0		0	
Storage Cap Reductn	0		0		0		0		0		0	
Reduced v/c Ratio	0.46		0.42		0.14		0.44		0.20		0.20	
Intersection Summary												
Cycle Length: 75												
Actuated Cycle Length: 75												
Offset: 20 (27%), Referenced to phase 2:NBTL and 6:SBTL, Start of Green												
Natural Cycle: 50												
Control Type: Actuated-Coordinated												

Lanes, Volumes, Timings
11: Bank & Gladstone

2030 Future Background
AM Peak Hour

Lane Group	Ø1	Ø3	Ø5	Ø7
Lane Configurations				
Traffic Volume (vph)				
Future Volume (vph)				
Satd. Flow (prot)				
Fit Permitted				
Satd. Flow (perm)				
Satd. Flow (RTOR)				
Lane Group Flow (vph)				
Turn Type				
Protected Phases	1	3	5	7
Permitted Phases				
Detector Phase				
Switch Phase				
Minimum Initial (s)	1.0	1.0	1.0	1.0
Minimum Split (s)	3.0	3.0	3.0	3.0
Total Split (s)	5.0	5.0	5.0	5.0
Total Split (%)	7%	7%	7%	7%
Yellow Time (s)	2.0	2.0	2.0	2.0
All-Red Time (s)	0.0	0.0	0.0	0.0
Lost Time Adjust (s)				
Total Lost Time (s)				
Lead/Lag	Lead	Lead	Lead	Lead
Lead-Lag Optimize?	Yes	Yes	Yes	Yes
Recall Mode	Max	Max	Max	Max
Act Effct Green (s)				
Actuated g/C Ratio				
v/c Ratio				
Control Delay				
Queue Delay				
Total Delay				
LOS				
Approach Delay				
Approach LOS				
Queue Length 50th (m)				
Queue Length 95th (m)				
Internal Link Dist (m)				
Turn Bay Length (m)				
Base Capacity (vph)				
Starvation Cap Reductn				
Spillback Cap Reductn				
Storage Cap Reductn				
Reduced v/c Ratio				
Intersection Summary				

Lanes, Volumes, Timings
11: Bank & Gladstone

2030 Future Background
AM Peak Hour

Maximum v/c Ratio: 0.55	
Intersection Signal Delay: 24.0	Intersection LOS: C
Intersection Capacity Utilization 72.1%	ICU Level of Service C
Analysis Period (min) 15	

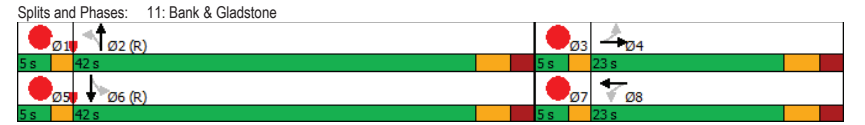

Lanes, Volumes, Timings
1: Lyon & James

2030 Future Background
PM Peak Hour

Lane Group	EBL	EBT	EBR	WBL	WBT	WBR	NBL	NBT	NBR	SBL	SBT	SBR
Lane Configurations					↕						↕↕	
Traffic Volume (vph)	0	0	0	48	21	0	0	0	0	0	502	7
Future Volume (vph)	0	0	0	48	21	0	0	0	0	0	502	7
Satd. Flow (prot)	0	0	0	0	1663	0	0	0	0	0	3307	0
Fit Permitted					0.966							
Satd. Flow (perm)	0	0	0	0	1618	0	0	0	0	0	3307	0
Satd. Flow (RTOR)											4	
Lane Group Flow (vph)	0	0	0	0	69	0	0	0	0	0	509	0
Turn Type				Perm	NA						NA	
Protected Phases					8							6
Permitted Phases				8						6		
Detector Phase				8	8					6	6	
Switch Phase												
Minimum Initial (s)				10.0	10.0					10.0	10.0	
Minimum Split (s)				17.1	17.1					29.7	29.7	
Total Split (s)				17.1	17.1					57.9	57.9	
Total Split (%)				22.8%	22.8%					77.2%	77.2%	
Yellow Time (s)				3.3	3.3					3.3	3.3	
All-Red Time (s)				1.8	1.8					1.4	1.4	
Lost Time Adjust (s)					0.0						0.0	
Total Lost Time (s)					5.1						4.7	
Lead/Lag												
Lead-Lag Optimize?												
Recall Mode				None	None					C-Max	C-Max	
Act Effct Green (s)					10.8						58.4	
Actuated g/C Ratio					0.14						0.78	
v/c Ratio					0.30						0.20	
Control Delay					29.5						3.3	
Queue Delay					0.0						0.0	
Total Delay					29.5						3.3	
LOS					C						A	
Approach Delay					29.5						3.3	
Approach LOS					C						A	
Queue Length 50th (m)					9.6						9.5	
Queue Length 95th (m)					20.9						16.0	
Internal Link Dist (m)		110.6			164.0			139.6			62.1	
Turn Bay Length (m)												
Base Capacity (vph)					258						2574	
Starvation Cap Reductn					0						0	
Spillback Cap Reductn					0						0	
Storage Cap Reductn					0						0	
Reduced v/c Ratio					0.27						0.20	
Intersection Summary												
Cycle Length: 75												
Actuated Cycle Length: 75												
Offset: 0 (0%), Referenced to phase 2: and 6:SBTL, Start of Green												
Natural Cycle: 50												
Control Type: Actuated-Coordinated												

Lanes, Volumes, Timings
1: Lyon & James

2030 Future Background
PM Peak Hour

Maximum v/c Ratio: 0.30	Intersection Signal Delay: 6.4	Intersection LOS: A
Intersection Capacity Utilization 39.6%	ICU Level of Service A	
Analysis Period (min) 15		

Splits and Phases: 1: Lyon & James



Lanes, Volumes, Timings
2: Gladstone & Lyon

2030 Future Background
PM Peak Hour

Lane Group	EBL	EBT	EBR	WBL	WBT	WBR	NBL	NBT	NBR	SBL	SBT	SBR
Lane Configurations		↔		↔	↔						↔↔	
Traffic Volume (vph)	0	248	27	13	314	0	0	0	0	86	313	138
Future Volume (vph)	0	248	27	13	314	0	0	0	0	86	313	138
Satd. Flow (prot)	0	1707	0	0	1742	0	0	0	0	0	3101	0
Fit Permitted					0.985						0.992	
Satd. Flow (perm)	0	1707	0	0	1716	0	0	0	0	0	3083	0
Satd. Flow (RTOR)		10									77	
Lane Group Flow (vph)	0	275	0	0	327	0	0	0	0	0	537	0
Turn Type		NA		Perm	NA					Perm	NA	
Protected Phases		2			6						8	
Permitted Phases				6						8		
Detector Phase		2		6	6					8	8	
Switch Phase												
Minimum Initial (s)		10.0		10.0	10.0					10.0	10.0	
Minimum Split (s)		23.2		23.6	23.6					23.6	23.6	
Total Split (s)		39.0		39.0	39.0					36.0	36.0	
Total Split (%)		52.0%		52.0%	52.0%					48.0%	48.0%	
Yellow Time (s)		3.3		3.3	3.3					3.3	3.3	
All-Red Time (s)		1.9		1.9	1.9					2.3	2.3	
Lost Time Adjust (s)		0.0		0.0	0.0					0.0	0.0	
Total Lost Time (s)		5.2		5.2	5.2					5.6	5.6	
Lead/Lag												
Lead-Lag Optimize?												
Recall Mode		C-Max		Max	Max					Max	Max	
Act Effct Green (s)		33.8			33.8						30.4	
Actuated g/C Ratio		0.45			0.45						0.41	
v/c Ratio		0.36			0.42						0.41	
Control Delay		14.6			12.7						12.0	
Queue Delay		0.0			0.0						0.0	
Total Delay		14.6			12.7						12.0	
LOS		B			B						B	
Approach Delay		14.6			12.7						12.0	
Approach LOS		B			B						B	
Queue Length 50th (m)		24.6			14.5						11.0	
Queue Length 95th (m)		42.1			41.0						21.6	
Internal Link Dist (m)		109.1			166.3			55.5			139.6	
Turn Bay Length (m)												
Base Capacity (vph)		774			773						1295	
Starvation Cap Reductn		0			0						0	
Spillback Cap Reductn		0			0						0	
Storage Cap Reductn		0			0						0	
Reduced v/c Ratio		0.36			0.42						0.41	

Intersection Summary	
Cycle Length:	75
Actuated Cycle Length:	75
Offset:	45 (60%), Referenced to phase 2:EBT, Start of Green
Natural Cycle:	50
Control Type:	Actuated-Coordinated

Lanes, Volumes, Timings
2: Gladstone & Lyon

2030 Future Background
PM Peak Hour

Maximum v/c Ratio: 0.42	Intersection LOS: B
Intersection Signal Delay: 12.8	ICU Level of Service B
Intersection Capacity Utilization 57.8%	
Analysis Period (min) 15	

Splits and Phases: 2: Gladstone & Lyon

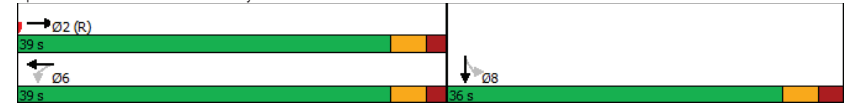

Lanes, Volumes, Timings
3: Kent & Somerset

2030 Future Background
PM Peak Hour

Lane Group	EBL	EBT	EBR	WBL	WBT	WBR	NBL	NBT	NBR	SBL	SBT	SBR
Lane Configurations	↔	↕			↕		↔	↕	↕			
Traffic Volume (vph)	58	252	0	0	213	63	79	708	106	0	0	0
Future Volume (vph)	58	252	0	0	213	63	79	708	106	0	0	0
Satd. Flow (prot)	1658	1745	0	0	1589	0	1658	4323	0	0	0	0
Fit Permitted	0.455						0.950					
Satd. Flow (perm)	681	1745	0	0	1589	0	1028	4323	0	0	0	0
Satd. Flow (RTOR)							43					
Lane Group Flow (vph)	58	252	0	0	276	0	79	814	0	0	0	0
Turn Type	Perm	NA			NA		Perm	NA				
Protected Phases		4			8			2				
Permitted Phases	4						2					
Detector Phase	4	4			8		2	2				
Switch Phase												
Minimum Initial (s)	10.0	10.0			10.0		10.0	10.0				
Minimum Split (s)	21.5	21.5			21.5		21.4	21.4				
Total Split (s)	41.0	41.0			41.0		34.0	34.0				
Total Split (%)	54.7%	54.7%			54.7%		45.3%	45.3%				
Yellow Time (s)	3.3	3.3			3.3		3.3	3.3				
All-Red Time (s)	2.2	2.2			2.2		2.1	2.1				
Lost Time Adjust (s)	0.0	0.0			0.0		0.0	0.0				
Total Lost Time (s)	5.5	5.5			5.5		5.4	5.4				
Lead/Lag												
Lead-Lag Optimize?												
Recall Mode	None	None			None		C-Max	C-Max				
Act Effct Green (s)	19.7	19.7			19.7		44.4	44.4				
Actuated g/C Ratio	0.26	0.26			0.26		0.59	0.59				
v/c Ratio	0.33	0.55			0.66		0.13	0.32				
Control Delay	26.1	28.0			31.9		9.4	9.7				
Queue Delay	0.0	0.0			0.0		0.0	0.0				
Total Delay	26.1	28.0			31.9		9.4	9.7				
LOS	C	C			C		A	A				
Approach Delay		27.6			31.9			9.7				
Approach LOS		C			C			A				
Queue Length 50th (m)	7.1	33.1			42.3		4.9	17.7				
Queue Length 95th (m)	15.5	47.9			57.6		10.4	24.9				
Internal Link Dist (m)		61.7			174.8			152.2			110.1	
Turn Bay Length (m)	25.0						40.0					
Base Capacity (vph)	322	825			752		609	2578				
Starvation Cap Reductn	0	0			0		0	0				
Spillback Cap Reductn	0	0			0		0	0				
Storage Cap Reductn	0	0			0		0	0				
Reduced v/c Ratio	0.18	0.31			0.37		0.13	0.32				

Intersection Summary	
Cycle Length:	75
Actuated Cycle Length:	75
Offset:	50 (67%), Referenced to phase 2:NBTL and 6:, Start of Green
Natural Cycle:	45
Control Type:	Actuated-Coordinated

Lanes, Volumes, Timings
3: Kent & Somerset

2030 Future Background
PM Peak Hour

Maximum v/c Ratio: 0.66	Intersection LOS: B
Intersection Signal Delay: 17.6	ICU Level of Service B
Intersection Capacity Utilization 57.5%	
Analysis Period (min) 15	

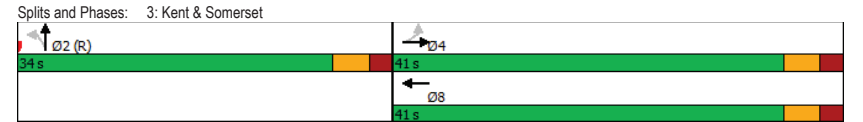

Lanes, Volumes, Timings
4: Kent & Gilmour

2030 Future Background
PM Peak Hour

Lane Group	EBL	EBT	EBR	WBL	WBT	WBR	NBL	NBT	NBR	SBL	SBT	SBR
Lane Configurations		↕						↕↕↕				
Traffic Volume (vph)	19	83	0	0	0	0	0	850	59	0	0	0
Future Volume (vph)	19	83	0	0	0	0	0	850	59	0	0	0
Satd. Flow (prot)	0	1716	0	0	0	0	0	4626	0	0	0	0
Fit Permitted		0.991										
Satd. Flow (perm)	0	1686	0	0	0	0	0	4626	0	0	0	0
Satd. Flow (RTOR)								29				
Lane Group Flow (vph)	0	102	0	0	0	0	0	909	0	0	0	0
Turn Type	Perm	NA						NA				
Protected Phases		4						2				
Permitted Phases	4											
Detector Phase	4	4						2				
Switch Phase												
Minimum Initial (s)	10.0	10.0						10.0				
Minimum Split (s)	21.5	21.5						35.1				
Total Split (s)	22.0	22.0						53.0				
Total Split (%)	29.3%	29.3%						70.7%				
Yellow Time (s)	3.3	3.3						3.3				
All-Red Time (s)	2.2	2.2						1.8				
Lost Time Adjust (s)		0.0						0.0				
Total Lost Time (s)		5.5						5.1				
Lead/Lag												
Lead-Lag Optimize?												
Recall Mode	None	None						C-Max				
Act Effct Green (s)		13.6						54.9				
Actuated g/C Ratio		0.18						0.73				
v/c Ratio		0.33						0.27				
Control Delay		29.0						3.5				
Queue Delay		0.0						0.0				
Total Delay		29.0						3.5				
LOS		C						A				
Approach Delay		29.0						3.5				
Approach LOS		C						A				
Queue Length 50th (m)		12.8						11.7				
Queue Length 95th (m)		26.0						14.6				
Internal Link Dist (m)		69.3			174.3			57.8			152.2	
Turn Bay Length (m)												
Base Capacity (vph)		370						3395				
Starvation Cap Reductn		0						0				
Spillback Cap Reductn		0						0				
Storage Cap Reductn		0						0				
Reduced v/c Ratio		0.28						0.27				
Intersection Summary												
Cycle Length: 75												
Actuated Cycle Length: 75												
Offset: 0 (0%), Referenced to phase 2:NBT and 6:, Start of Green												
Natural Cycle: 60												
Control Type: Actuated-Coordinated												

Lanes, Volumes, Timings
4: Kent & Gilmour

2030 Future Background
PM Peak Hour

Maximum v/c Ratio: 0.33	Intersection LOS: A
Intersection Signal Delay: 6.0	ICU Level of Service A
Intersection Capacity Utilization 47.0%	
Analysis Period (min) 15	

Splits and Phases: 4: Kent & Gilmour



HCM 2010 TWSC
5: Kent & James

2030 Future Background
PM Peak Hour

Intersection													
Int Delay, s/veh	2												
Movement	EBL	EBT	EBR	WBL	WBT	WBR	NBL	NBT	NBR	SBL	SBT	SBR	
Lane Configurations					↔			↔↔↔					
Traffic Vol, veh/h	0	0	0	0	35	57	50	852	0	0	0	0	
Future Vol, veh/h	0	0	0	0	35	57	50	852	0	0	0	0	
Conflicting Peds, #/hr	25	0	17	17	0	25	95	0	63	63	0	95	
Sign Control	Free	Free	Free	Stop	Stop	Stop	Free	Free	Free	Free	Free	Free	
RT Channelized	-	-	None	-	None	-	-	None	-	-	-	None	
Storage Length	-	-	-	-	-	-	-	-	-	-	-	-	
Veh in Median Storage, #	2293760												
Grade, %	-	0	-	-	0	-	-	0	-	-	0	-	
Peak Hour Factor	100	100	100	100	100	100	100	100	100	100	100	100	
Heavy Vehicles, %	2	2	2	2	2	2	2	2	2	2	2	2	
Mvmt Flow	0	0	0	0	35	57	50	852	0	0	0	0	
Major/Minor		Minor1			Major1								
Conflicting Flow All	-	1047	451	95	0	-	-	-	-	-	-	-	
Stage 1	-	952	-	-	-	-	-	-	-	-	-	-	
Stage 2	-	95	-	-	-	-	-	-	-	-	-	-	
Critical Hdwy	-	6.54	7.14	5.34	-	-	-	-	-	-	-	-	
Critical Hdwy Stg 1	-	5.54	-	-	-	-	-	-	-	-	-	-	
Critical Hdwy Stg 2	-	-	-	-	-	-	-	-	-	-	-	-	
Follow-up Hdwy	-	4.02	3.92	3.12	-	-	-	-	-	-	-	-	
Pot Cap-1 Maneuver	0	227	475	1044	-	0	-	-	-	-	-	-	
Stage 1	0	336	-	-	-	0	-	-	-	-	-	-	
Stage 2	0	-	-	-	-	0	-	-	-	-	-	-	
Platoon blocked, %	-												
Mov Cap-1 Maneuver	-	0	475	1044	-	-	-	-	-	-	-	-	
Mov Cap-2 Maneuver	-	0	-	-	-	-	-	-	-	-	-	-	
Stage 1	-	0	-	-	-	-	-	-	-	-	-	-	
Stage 2	-	0	-	-	-	-	-	-	-	-	-	-	
Approach		WB			NB								
HCM Control Delay, s	14.4			0.7									
HCM LOS	B												
Minor Lane/Major Mvmt		NBL			NBTWBLn1								
Capacity (veh/h)	1044			- 475									
HCM Lane V/C Ratio	0.048			- 0.194									
HCM Control Delay (s)	8.6			0.2 14.4									
HCM Lane LOS	A			A B									
HCM 95th %tile Q(veh)	0.2			- 0.7									

Lanes, Volumes, Timings
6: Kent & Gladstone

2030 Future Background
PM Peak Hour

Lane Group	EBL	EBT	EBR	WBL	WBT	WBR	NBL	NBT	NBR	SBL	SBT	SBR
Lane Configurations	↔	↔	0	0	↔	↔	↔↔↔	↔↔↔	101	0	0	0
Traffic Volume (vph)	76	250	0	0	244	75	52	736	101	0	0	0
Future Volume (vph)	76	250	0	0	244	75	52	736	101	0	0	0
Satd. Flow (prot)	1658	1728	0	0	1656	0	1658	4554	0	0	0	0
Fit Permitted	0.372						0.950					
Satd. Flow (perm)	624	1728	0	0	1656	0	1471	4554	0	0	0	0
Satd. Flow (RTOR)					31		35					
Lane Group Flow (vph)	76	250	0	0	319	0	52	837	0	0	0	0
Turn Type	Perm	NA			NA		Perm	NA				
Protected Phases	4				8		2					
Permitted Phases	4						2					
Detector Phase	4		4		8		2		2			
Switch Phase												
Minimum Initial (s)	10.0	10.0			10.0		10.0	10.0				
Minimum Split (s)	21.4	21.4			20.4		21.4	21.4				
Total Split (s)	45.0	45.0			45.0		30.0	30.0				
Total Split (%)	60.0%	60.0%			60.0%		40.0%	40.0%				
Yellow Time (s)	3.3	3.3			3.3		3.3	3.3				
All-Red Time (s)	2.1	2.1			2.1		2.1	2.1				
Lost Time Adjust (s)	0.0	0.0			0.0		0.0	0.0				
Total Lost Time (s)	5.4	5.4			5.4		5.4	5.4				
Lead/Lag												
Lead-Lag Optimize?												
Recall Mode	None	None			None		C-Max	C-Max				
Act Effct Green (s)	19.2	19.2			19.2		45.0	45.0				
Actuated g/C Ratio	0.26	0.26			0.26		0.60	0.60				
v/c Ratio	0.47	0.56			0.71		0.06	0.31				
Control Delay	23.4	20.0			35.2		8.5	8.3				
Queue Delay	0.0	0.0			0.0		0.0	0.0				
Total Delay	23.4	20.0			35.2		8.5	8.3				
LOS	C	B			D		A	A				
Approach Delay	20.8				35.2		8.3					
Approach LOS	C				D		A					
Queue Length 50th (m)	5.8	19.1			44.4		2.9	19.0				
Queue Length 95th (m)	10.0	24.3			70.4		9.4	34.2				
Internal Link Dist (m)	166.3				173.9		90.5				139.7	
Turn Bay Length (m)	30.0						40.0					
Base Capacity (vph)	329		912		889		881		2744			
Starvation Cap Reductn	0		0		0		0		0			
Spillback Cap Reductn	0		0		0		0		0			
Storage Cap Reductn	0		0		0		0		0			
Reduced v/c Ratio	0.23	0.27			0.36		0.06	0.31				
Intersection Summary												
Cycle Length: 75												
Actuated Cycle Length: 75												
Offset: 23 (31%), Referenced to phase 2:NBTL and 6., Start of Green												
Natural Cycle: 45												
Control Type: Actuated-Coordinated												

Lanes, Volumes, Timings
6: Kent & Gladstone

2030 Future Background
PM Peak Hour

Maximum v/c Ratio: 0.71	Intersection LOS: B
Intersection Signal Delay: 16.5	ICU Level of Service B
Intersection Capacity Utilization 58.9%	
Analysis Period (min) 15	

Splits and Phases: 6: Kent & Gladstone

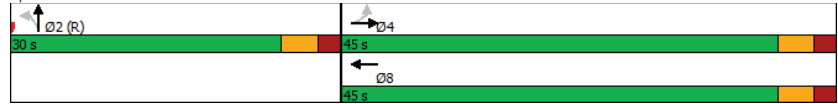

Lanes, Volumes, Timings
7: Bank & Somerset

2030 Future Background
PM Peak Hour

Lane Group	EBL	EBT	EBR	WBL	WBT	WBR	NBL	NBT	NBR	SBL	SBT	SBR
Lane Configurations		↕	↕	↕	↕			↕			↕	↕
Traffic Volume (vph)	44	187	79	33	135	24	21	179	41	5	260	51
Future Volume (vph)	44	187	79	33	135	24	21	179	41	5	260	51
Satd. Flow (prot)	0	1704	1483	1658	1590	0	0	1487	0	0	1479	0
Fit Permitted		0.908		0.515				0.962			0.996	
Satd. Flow (perm)	0	1457	723	601	1590	0	0	1396	0	0	1466	0
Satd. Flow (RTOR)												
Lane Group Flow (vph)	0	231	79	33	159	0	0	241	0	0	316	0
Turn Type	Perm	NA	Perm	Perm	NA		Perm	NA		Perm	NA	
Protected Phases		4			8			2			6	
Permitted Phases	4		4	8			2			6		
Detector Phase	4	4	4	8	8		2	2		6	6	
Switch Phase												
Minimum Initial (s)	10.0	10.0	10.0	10.0	10.0		10.0	10.0		10.0	10.0	
Minimum Split (s)	20.5	20.5	20.5	20.5	20.5		20.5	20.5		20.5	20.5	
Total Split (s)	25.0	25.0	25.0	25.0	25.0		40.0	40.0		40.0	40.0	
Total Split (%)	33.3%	33.3%	33.3%	33.3%	33.3%		53.3%	53.3%		53.3%	53.3%	
Yellow Time (s)	3.3	3.3	3.3	3.3	3.3		3.3	3.3		3.3	3.3	
All-Red Time (s)	2.2	2.2	2.2	2.2	2.2		2.2	2.2		2.2	2.2	
Lost Time Adjust (s)		0.0	0.0	0.0	0.0		0.0	0.0		0.0	0.0	
Total Lost Time (s)		5.5	5.5	5.5	5.5		5.5	5.5		5.5	5.5	
Lead/Lag	Lag	Lag	Lag	Lag	Lag		Lag	Lag		Lag	Lag	
Lead-Lag Optimize?	Yes	Yes	Yes	Yes	Yes		Yes	Yes		Yes	Yes	
Recall Mode	None	None	None	None	None		C-Max	C-Max		C-Max	C-Max	
Act Effct Green (s)		17.9	17.9	17.9	17.9		46.1	46.1		46.1	46.1	
Actuated g/C Ratio		0.24	0.24	0.24	0.24		0.61	0.61		0.61	0.61	
v/c Ratio		0.66	0.46	0.23	0.42		0.28	0.35		0.35	0.35	
Control Delay		28.5	25.8	25.8	26.9		3.2	9.2		9.2	9.2	
Queue Delay		0.0	0.0	0.0	0.0		0.2	0.0		0.0	0.0	
Total Delay		28.5	25.8	25.8	26.9		3.5	9.2		9.2	9.2	
LOS		C	C	C	C		A	A		A	A	
Approach Delay		27.8			26.7		3.5	9.2		9.2	9.2	
Approach LOS		C			C		A	A		A	A	
Queue Length 50th (m)		32.4	10.0	4.1	20.5		6.0	19.6		19.6	19.6	
Queue Length 95th (m)		46.3	20.4	10.5	33.6		8.5	42.9		42.9	42.9	
Internal Link Dist (m)		174.8			68.0		65.6	106.3		106.3	106.3	
Turn Bay Length (m)			28.0	15.0								
Base Capacity (vph)		392	194	162	429		857	900		900	900	
Starvation Cap Reductn		0	0	0	0		206	0		0	0	
Spillback Cap Reductn		0	0	0	0		0	0		0	0	
Storage Cap Reductn		0	0	0	0		0	0		0	0	
Reduced v/c Ratio		0.59	0.41	0.20	0.37		0.37	0.35		0.35	0.35	

Intersection Summary

Cycle Length: 75
Actuated Cycle Length: 75
Offset: 7 (9%), Referenced to phase 2:NBTL and 6:SBTL, Start of Green
Natural Cycle: 50
Control Type: Actuated-Coordinated

Lanes, Volumes, Timings
7: Bank & Somerset

2030 Future Background
PM Peak Hour

Lane Group	Ø1	Ø3	Ø5	Ø7
Lane Configurations				
Traffic Volume (vph)				
Future Volume (vph)				
Satd. Flow (prot)				
Fit Permitted				
Satd. Flow (perm)				
Satd. Flow (RTOR)				
Lane Group Flow (vph)				
Turn Type				
Protected Phases	1	3	5	7
Permitted Phases				
Detector Phase				
Switch Phase				
Minimum Initial (s)	1.0	1.0	1.0	1.0
Minimum Split (s)	3.0	3.0	3.0	3.0
Total Split (s)	5.0	5.0	5.0	5.0
Total Split (%)	7%	7%	7%	7%
Yellow Time (s)	2.0	2.0	2.0	2.0
All-Red Time (s)	0.0	0.0	0.0	0.0
Lost Time Adjust (s)				
Total Lost Time (s)				
Lead/Lag	Lead	Lead	Lead	Lead
Lead-Lag Optimize?	Yes	Yes	Yes	Yes
Recall Mode	None	None	None	None
Act Effct Green (s)				
Actuated g/C Ratio				
v/c Ratio				
Control Delay				
Queue Delay				
Total Delay				
LOS				
Approach Delay				
Approach LOS				
Queue Length 50th (m)				
Queue Length 95th (m)				
Internal Link Dist (m)				
Turn Bay Length (m)				
Base Capacity (vph)				
Starvation Cap Reductn				
Spillback Cap Reductn				
Storage Cap Reductn				
Reduced v/c Ratio				
Intersection Summary				

Lanes, Volumes, Timings
7: Bank & Somerset

2030 Future Background
PM Peak Hour

Maximum v/c Ratio: 0.66	
Intersection Signal Delay: 16.5	Intersection LOS: B
Intersection Capacity Utilization 66.4%	ICU Level of Service C
Analysis Period (min) 15	

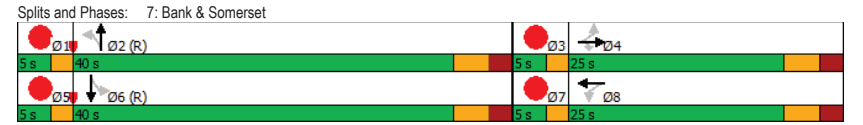

Lanes, Volumes, Timings
8: Bank & MacLaren

2030 Future Background
PM Peak Hour

Lane Group	EBL	EBT	EBR	WBL	WBT	WBR	NBL	NBT	NBR	SBL	SBT	SBR
Lane Configurations												
Traffic Volume (vph)	0	0	0	35	11	10	25	235	0	0	341	26
Future Volume (vph)	0	0	0	35	11	10	25	235	0	0	341	26
Satd. Flow (prot)	0	0	0	0	1570	0	0	1674	0	0	1624	0
Fit Permitted					0.970			0.952				
Satd. Flow (perm)	0	0	0	0	1400	0	0	1541	0	0	1624	0
Satd. Flow (RTOR)					10			9				
Lane Group Flow (vph)	0	0	0	0	56	0	0	260	0	0	367	0
Turn Type				Perm	NA		Perm	NA			NA	
Protected Phases					8			2			6	
Permitted Phases					8			2				
Detector Phase					8	8		2	2		6	
Switch Phase												
Minimum Initial (s)				10.0	10.0		10.0	10.0			10.0	
Minimum Split (s)				24.2	24.2		18.0	18.0			18.0	
Total Split (s)				24.2	24.2		50.8	50.8			50.8	
Total Split (%)				32.3%	32.3%		67.7%	67.7%			67.7%	
Yellow Time (s)				3.3	3.3		3.3	3.3			3.3	
All-Red Time (s)				1.9	1.9		1.7	1.7			1.7	
Lost Time Adjust (s)					0.0			0.0			0.0	
Total Lost Time (s)					5.2			5.0			5.0	
Lead/Lag												
Lead-Lag Optimize?												
Recall Mode				None	None		C-Max	C-Max			C-Max	
Act Effct Green (s)					17.2			51.6			51.6	
Actuated g/C Ratio					0.23			0.69			0.69	
v/c Ratio					0.17			0.25			0.33	
Control Delay					20.3			4.9			10.5	
Queue Delay					0.0			0.2			0.4	
Total Delay					20.3			5.0			10.9	
LOS					C			A			B	
Approach Delay					20.3			5.0			10.9	
Approach LOS					C			A			B	
Queue Length 50th (m)					5.3			8.5			40.4	
Queue Length 95th (m)					14.2			8.9			26.1	
Internal Link Dist (m)		130.7			122.8			60.9			65.6	
Turn Bay Length (m)												
Base Capacity (vph)					362			1061			1121	
Starvation Cap Reductn					0			276			344	
Spillback Cap Reductn					0			0			0	
Storage Cap Reductn					0			0			0	
Reduced v/c Ratio					0.15			0.33			0.47	

Intersection Summary												
Cycle Length: 75												
Actuated Cycle Length: 75												
Offset: 7 (9%), Referenced to phase 2:NBTL and 6:SBT, Start of Green												
Natural Cycle: 45												
Control Type: Actuated-Coordinated												

Lanes, Volumes, Timings
8: Bank & MacLaren

2030 Future Background
PM Peak Hour

Maximum v/c Ratio: 0.33	Intersection Signal Delay: 9.4	Intersection LOS: A
Intersection Capacity Utilization 59.3%	ICU Level of Service B	
Analysis Period (min) 15		

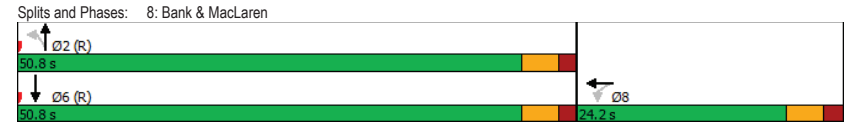

Lanes, Volumes, Timings
9: Bank & Gilmour

2030 Future Background
PM Peak Hour

Lane Group	EBL	EBT	EBR	WBL	WBT	WBR	NBL	NBT	NBR	SBL	SBT	SBR
Lane Configurations		↔						↔			↔	
Traffic Volume (vph)	0	65	36	0	0	0	0	263	38	30	341	0
Future Volume (vph)	0	65	36	0	0	0	0	263	38	30	341	0
Satd. Flow (prot)	0	1512	0	0	0	0	0	1549	0	0	1707	0
Fit Permitted											0.962	
Satd. Flow (perm)	0	1512	0	0	0	0	0	1549	0	0	1600	0
Satd. Flow (RTOR)		36						17				
Lane Group Flow (vph)	0	101	0	0	0	0	0	301	0	0	371	0
Turn Type		NA						NA	Perm	NA		
Protected Phases		4						2			6	
Permitted Phases		4								6		
Detector Phase		4	4					2		6	6	
Switch Phase												
Minimum Initial (s)	10.0	10.0						10.0	10.0	10.0		
Minimum Split (s)	23.2	23.2						20.1	20.1	20.1		
Total Split (s)	25.0	25.0						50.0	50.0	50.0		
Total Split (%)	33.3%	33.3%						66.7%	66.7%	66.7%		
Yellow Time (s)	3.3	3.3						3.3	3.3	3.3		
All-Red Time (s)	1.9	1.9						1.8	1.8	1.8		
Lost Time Adjust (s)		0.0						0.0	0.0	0.0		
Total Lost Time (s)		5.2						5.1	5.1	5.1		
Lead/Lag												
Lead-Lag Optimize?												
Recall Mode	None	None						C-Max	C-Max	C-Max		
Act Effct Green (s)		16.4						52.4	52.4	52.4		
Actuated g/C Ratio		0.22						0.70	0.70	0.70		
v/c Ratio		0.28						0.28	0.33	0.33		
Control Delay		9.6						11.0	2.5	2.5		
Queue Delay		0.0						0.0	0.2	0.2		
Total Delay		9.6						11.0	2.6	2.6		
LOS		A						B	A	A		
Approach Delay		9.6						11.0	2.6	2.6		
Approach LOS		A						B	A	A		
Queue Length 50th (m)		3.2						22.2	6.6	6.6		
Queue Length 95th (m)		10.6						41.1	9.9	9.9		
Internal Link Dist (m)		174.3			69.2			57.1	60.9	60.9		
Turn Bay Length (m)												
Base Capacity (vph)		425						1086	1117	1117		
Starvation Cap Reductn		0						0	206	206		
Spillback Cap Reductn		0						0	0	0		
Storage Cap Reductn		0						0	0	0		
Reduced v/c Ratio		0.24						0.28	0.41	0.41		

Intersection Summary	
Cycle Length:	75
Actuated Cycle Length:	75
Offset:	6 (8%), Referenced to phase 2:NBT and 6:SBTL, Start of Green
Natural Cycle:	45
Control Type:	Actuated-Coordinated

Lanes, Volumes, Timings
9: Bank & Gilmour

2030 Future Background
PM Peak Hour

Maximum v/c Ratio: 0.33	Intersection LOS: A
Intersection Signal Delay: 6.8	ICU Level of Service C
Intersection Capacity Utilization 66.6%	
Analysis Period (min) 15	

Splits and Phases: 9: Bank & Gilmour



Lanes, Volumes, Timings
10: Bank & James

2030 Future Background
PM Peak Hour

Lane Group	EBL	EBR	NBL	NBT	SBT	SBR
Lane Configurations				↕	↕	
Traffic Volume (vph)	0	0	61	302	332	50
Future Volume (vph)	0	0	61	302	332	50
Satd. Flow (prot)	0	0	0	1703	1685	0
Fit Permitted				0.992		
Satd. Flow (perm)	0	0	0	1703	1685	0
Lane Group Flow (vph)	0	0	0	363	382	0
Sign Control	Stop		Free		Free	
Intersection Summary						
Control Type: Unsignalized						
Intersection Capacity Utilization 64.9%						
ICU Level of Service C						
Analysis Period (min) 15						

Lanes, Volumes, Timings
11: Bank & Gladstone

2030 Future Background
PM Peak Hour

Lane Group	EBL	EBT	EBR	WBL	WBT	WBR	NBL	NBT	NBR	SBL	SBT	SBR
Lane Configurations		↕			↕		↕	↕			↕	
Traffic Volume (vph)	49	185	79	41	131	28	90	276	87	15	339	39
Future Volume (vph)	49	185	79	41	131	28	90	276	87	15	339	39
Satd. Flow (prot)	0	2944	0	0	1638	0	1658	1511	0	0	3059	0
Fit Permitted		0.860			0.862		0.517				0.936	
Satd. Flow (perm)	0	2496	0	0	1377	0	694	1511	0	0	2851	0
Satd. Flow (RTOR)												
Lane Group Flow (vph)	0	313	0	0	200	0	90	363	0	0	393	0
Turn Type	Perm	NA		Perm	NA		Perm	NA		Perm	NA	
Protected Phases		4			8			2			6	
Permitted Phases	4			8			2			6		
Detector Phase	4	4		8	8		2	2		6	6	
Switch Phase												
Minimum Initial (s)	10.0	10.0		10.0	10.0		10.0	10.0		10.0	10.0	
Minimum Split (s)	20.5	20.5		20.5	20.5		20.5	20.5		20.5	20.5	
Total Split (s)	28.0	28.0		28.0	28.0		37.0	37.0		37.0	37.0	
Total Split (%)	37.3%	37.3%		37.3%	37.3%		49.3%	49.3%		49.3%	49.3%	
Yellow Time (s)	3.3	3.3		3.3	3.3		3.3	3.3		3.3	3.3	
All-Red Time (s)	2.2	2.2		2.2	2.2		2.2	2.2		2.2	2.2	
Lost Time Adjust (s)		0.0			0.0			0.0			0.0	
Total Lost Time (s)		5.5			5.5			5.5			5.5	
Lead/Lag	Lag	Lag		Lag	Lag		Lag	Lag		Lag	Lag	
Lead-Lag Optimize?	Yes	Yes		Yes	Yes		Yes	Yes		Yes	Yes	
Recall Mode	None	None		None	None		C-Max	C-Max		C-Max	C-Max	
Act Effct Green (s)		17.4			17.4		31.5	31.5			31.5	
Actuated g/C Ratio		0.23			0.23		0.42	0.42			0.42	
v/c Ratio		0.54			0.63		0.31	0.57			0.33	
Control Delay		15.9			34.8		18.3	21.0			8.2	
Queue Delay		0.0			0.0		0.0	0.0			0.0	
Total Delay		15.9			34.8		18.3	21.0			8.2	
LOS		B			C		B	C			A	
Approach Delay		15.9			34.8			20.5			8.2	
Approach LOS		B			C			C			A	
Queue Length 50th (m)		8.3			27.6		8.6	39.8			9.4	
Queue Length 95th (m)		12.8			44.2		20.0	66.5			16.0	
Internal Link Dist (m)		173.9			70.9			108.7			139.2	
Turn Bay Length (m)								38.0				
Base Capacity (vph)		748			413		291	634			1197	
Starvation Cap Reductn		0			0		0	0			0	
Spillback Cap Reductn		0			0		0	0			0	
Storage Cap Reductn		0			0		0	0			0	
Reduced v/c Ratio		0.42			0.48		0.31	0.57			0.33	

Intersection Summary												
Cycle Length: 75												
Actuated Cycle Length: 75												
Offset: 26 (35%), Referenced to phase 2:NBT and 6:SBTL, Start of Green												
Natural Cycle: 55												
Control Type: Actuated-Coordinated												

Lanes, Volumes, Timings
11: Bank & Gladstone

2030 Future Background
PM Peak Hour

Lane Group	Ø1	Ø3	Ø5	Ø7
Lane Configurations				
Traffic Volume (vph)				
Future Volume (vph)				
Satd. Flow (prot)				
Fit Permitted				
Satd. Flow (perm)				
Satd. Flow (RTOR)				
Lane Group Flow (vph)				
Turn Type				
Protected Phases	1	3	5	7
Permitted Phases				
Detector Phase				
Switch Phase				
Minimum Initial (s)	1.0	1.0	1.0	1.0
Minimum Split (s)	3.0	3.0	3.0	3.0
Total Split (s)	5.0	5.0	5.0	5.0
Total Split (%)	7%	7%	7%	7%
Yellow Time (s)	2.0	2.0	2.0	2.0
All-Red Time (s)	0.0	0.0	0.0	0.0
Lost Time Adjust (s)				
Total Lost Time (s)				
Lead/Lag	Lead	Lead	Lead	Lead
Lead-Lag Optimize?	Yes	Yes	Yes	Yes
Recall Mode	Max	Max	Max	Max
Act Effct Green (s)				
Actuated g/C Ratio				
v/c Ratio				
Control Delay				
Queue Delay				
Total Delay				
LOS				
Approach Delay				
Approach LOS				
Queue Length 50th (m)				
Queue Length 95th (m)				
Internal Link Dist (m)				
Turn Bay Length (m)				
Base Capacity (vph)				
Starvation Cap Reductn				
Spillback Cap Reductn				
Storage Cap Reductn				
Reduced v/c Ratio				
Intersection Summary				

Lanes, Volumes, Timings
11: Bank & Gladstone

2030 Future Background
PM Peak Hour

Maximum v/c Ratio: 0.63
Intersection Signal Delay: 18.0
Intersection Capacity Utilization 78.8%
Analysis Period (min) 15
Intersection LOS: B
ICU Level of Service D

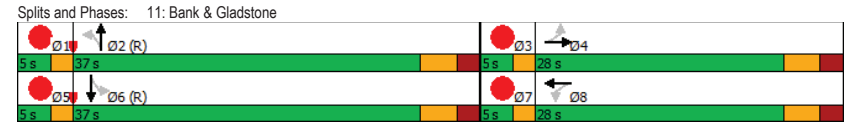

Appendix H

Synchro Intersection Worksheets – 2035 Future Background Conditions

DRAFT

Lanes, Volumes, Timings
1: Lyon & James

2035 Future Background
AM Peak Hour

Lane Group	EBL	EBT	EBR	WBL	WBT	WBR	NBL	NBT	NBR	SBL	SBT	SBR
Lane Configurations					↕						↕↔	
Traffic Volume (vph)	0	0	0	34	21	0	0	0	0	0	409	25
Future Volume (vph)	0	0	0	34	21	0	0	0	0	0	409	25
Satd. Flow (prot)	0	0	0	0	1628	0	0	0	0	0	3229	0
Fit Permitted					0.970							
Satd. Flow (perm)	0	0	0	0	1600	0	0	0	0	0	3229	0
Satd. Flow (RTOR)					20							
Lane Group Flow (vph)	0	0	0	0	55	0	0	0	0	0	434	0
Turn Type				Perm	NA						NA	
Protected Phases					8						6	
Permitted Phases					8						6	
Detector Phase					8	8					6	6
Switch Phase												
Minimum Initial (s)				10.0	10.0					10.0	10.0	
Minimum Split (s)				17.1	17.1					29.7	29.7	
Total Split (s)				17.1	17.1					57.9	57.9	
Total Split (%)				22.8%	22.8%					77.2%	77.2%	
Yellow Time (s)				3.3	3.3					3.3	3.3	
All-Red Time (s)				1.8	1.8					1.4	1.4	
Lost Time Adjust (s)					0.0						0.0	
Total Lost Time (s)					5.1						4.7	
Lead/Lag												
Lead-Lag Optimize?												
Recall Mode				None	None					C-Max	C-Max	
Act Effct Green (s)					10.4						62.7	
Actuated g/C Ratio					0.14						0.84	
v/c Ratio					0.25						0.16	
Control Delay					26.1						2.5	
Queue Delay					0.0						0.0	
Total Delay					26.1						2.5	
LOS					C						A	
Approach Delay					26.1						2.5	
Approach LOS					C						A	
Queue Length 50th (m)					7.5						7.6	
Queue Length 95th (m)					m11.6						13.2	
Internal Link Dist (m)		102.5			161.6			141.5			55.1	
Turn Bay Length (m)												
Base Capacity (vph)					256						2703	
Starvation Cap Reductn					0						0	
Spillback Cap Reductn					0						0	
Storage Cap Reductn					0						0	
Reduced v/c Ratio					0.21						0.16	
Intersection Summary												
Cycle Length: 75												
Actuated Cycle Length: 75												
Offset: 16 (21%), Referenced to phase 2: and 6:SBTL, Start of Green												
Natural Cycle: 50												
Control Type: Actuated-Coordinated												

Lanes, Volumes, Timings
1: Lyon & James

2035 Future Background
AM Peak Hour

Maximum v/c Ratio: 0.25	Intersection Signal Delay: 5.1	Intersection LOS: A
Intersection Capacity Utilization 38.9%	ICU Level of Service A	
Analysis Period (min) 15		
m Volume for 95th percentile queue is metered by upstream signal.		

Splits and Phases: 1: Lyon & James



Lanes, Volumes, Timings
2: Lyon & Gladstone

2035 Future Background
AM Peak Hour

Lane Group	EBL	EBT	EBR	WBL	WBT	WBR	NBL	NBT	NBR	SBL	SBT	SBR
Lane Configurations		↔		↔	↔						↔↔	
Traffic Volume (vph)	0	185	14	5	143	0	0	0	0	87	159	98
Future Volume (vph)	0	185	14	5	143	0	0	0	0	87	159	98
Satd. Flow (prot)	0	1679	0	0	1709	0	0	0	0	0	3072	0
Fit Permitted					0.992						0.988	
Satd. Flow (perm)	0	1679	0	0	1698	0	0	0	0	0	3038	0
Satd. Flow (RTOR)		6									97	
Lane Group Flow (vph)	0	199	0	0	148	0	0	0	0	0	344	0
Turn Type		NA		Perm	NA					Perm	NA	
Protected Phases		2			6						8	
Permitted Phases				6						8		
Detector Phase		2		6	6					8	8	
Switch Phase												
Minimum Initial (s)		10.0		10.0	10.0					10.0	10.0	
Minimum Split (s)		17.2		17.2	17.2					22.6	22.6	
Total Split (s)		38.0		38.0	38.0					37.0	37.0	
Total Split (%)		50.7%		50.7%	50.7%					49.3%	49.3%	
Yellow Time (s)		3.3		3.3	3.3					3.3	3.3	
All-Red Time (s)		1.9		1.9	1.9					2.3	2.3	
Lost Time Adjust (s)		0.0		0.0	0.0					0.0	0.0	
Total Lost Time (s)		5.2		5.2	5.2					5.6	5.6	
Lead/Lag												
Lead-Lag Optimize?												
Recall Mode		C-Max		C-Max	C-Max					Max	Max	
Act Effct Green (s)		32.8		32.8	32.8						31.4	
Actuated g/C Ratio		0.44		0.44	0.44						0.42	
v/c Ratio		0.27		0.20	0.20						0.26	
Control Delay		14.3		8.5	8.5						10.1	
Queue Delay		0.0		0.0	0.0						0.0	
Total Delay		14.3		8.5	8.5						10.1	
LOS		B		A	A						B	
Approach Delay		14.3		8.5	8.5						10.1	
Approach LOS		B		A	A						B	
Queue Length 50th (m)		17.6		5.7	5.7						12.9	
Queue Length 95th (m)		31.7		14.1	14.1						22.0	
Internal Link Dist (m)		110.8		164.9	164.9		56.5				141.5	
Turn Bay Length (m)												
Base Capacity (vph)		737		742	742						1328	
Starvation Cap Reductn		0		0	0						0	
Spillback Cap Reductn		0		0	0						0	
Storage Cap Reductn		0		0	0						0	
Reduced v/c Ratio		0.27		0.20	0.20						0.26	

Intersection Summary	
Cycle Length:	75
Actuated Cycle Length:	75
Offset:	10 (13%), Referenced to phase 2:EBT and 6:WBTL, Start of Green
Natural Cycle:	40
Control Type:	Actuated-Coordinated

Lanes, Volumes, Timings
2: Lyon & Gladstone

2035 Future Background
AM Peak Hour

Maximum v/c Ratio: 0.27	Intersection LOS: B
Intersection Signal Delay: 10.9	ICU Level of Service A
Intersection Capacity Utilization 35.4%	
Analysis Period (min) 15	

Splits and Phases: 2: Lyon & Gladstone

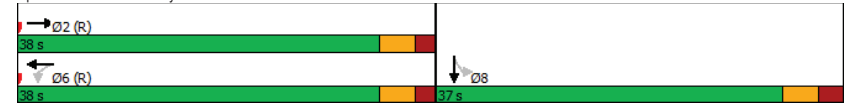

Lanes, Volumes, Timings
3: Kent & Somerset

2035 Future Background
AM Peak Hour

Lane Group	EBL	EBT	EBR	WBL	WBT	WBR	NBL	NBT	NBR	SBL	SBT	SBR
Lane Configurations	↖	↗		↖	↗		↖	↗	↖	↗	↖	↗
Traffic Volume (vph)	63	172	0	0	150	50	78	1556	184	0	0	0
Future Volume (vph)	63	172	0	0	150	50	78	1556	184	0	0	0
Satd. Flow (prot)	1658	1728	0	0	1610	0	1642	4534	0	0	0	0
Fit Permitted	0.556						0.950					
Satd. Flow (perm)	885	1728	0	0	1610	0	1072	4534	0	0	0	0
Satd. Flow (RTOR)							45					
Lane Group Flow (vph)	63	172	0	0	200	0	78	1740	0	0	0	0
Turn Type	Perm	NA			NA		Perm	NA				
Protected Phases		4			8			2				
Permitted Phases	4						2					
Detector Phase	4	4			8		2	2				
Switch Phase												
Minimum Initial (s)	10.0	10.0			10.0		10.0	10.0				
Minimum Split (s)	21.5	21.5			21.5		21.4	21.4				
Total Split (s)	27.0	27.0			27.0		48.0	48.0				
Total Split (%)	36.0%	36.0%			36.0%		64.0%	64.0%				
Yellow Time (s)	3.3	3.3			3.3		3.3	3.3				
All-Red Time (s)	2.2	2.2			2.2		2.1	2.1				
Lost Time Adjust (s)	0.0	0.0			0.0		0.0	0.0				
Total Lost Time (s)	5.5	5.5			5.5		5.4	5.4				
Lead/Lag												
Lead-Lag Optimize?												
Recall Mode	None	None			None		C-Max	C-Max				
Act Effct Green (s)	15.8	15.8			15.8		48.3	48.3				
Actuated g/C Ratio	0.21	0.21			0.21		0.64	0.64				
v/c Ratio	0.34	0.47			0.59		0.11	0.59				
Control Delay	29.3	29.7			27.1		8.5	9.1				
Queue Delay	0.0	0.0			0.0		0.0	0.0				
Total Delay	29.3	29.7			27.1		8.5	9.1				
LOS	C	C			C		A	A				
Approach Delay		29.6			27.1		9.0					
Approach LOS		C			C		A					
Queue Length 50th (m)	8.0	22.5			29.2		1.6	12.2				
Queue Length 95th (m)	17.8	37.7			49.3		m12.9	63.0				
Internal Link Dist (m)		61.7			174.8		152.2			110.1		
Turn Bay Length (m)	25.0						40.0					
Base Capacity (vph)	253	495			461		690	2937				
Starvation Cap Reductn	0	0			0		0	0				
Spillback Cap Reductn	0	0			0		0	0				
Storage Cap Reductn	0	0			0		0	0				
Reduced v/c Ratio	0.25	0.35			0.43		0.11	0.59				

Intersection Summary	
Cycle Length:	75
Actuated Cycle Length:	75
Offset:	66 (88%), Referenced to phase 2:NBTL and 6:, Start of Green
Natural Cycle:	50
Control Type:	Actuated-Coordinated

Lanes, Volumes, Timings
3: Kent & Somerset

2035 Future Background
AM Peak Hour

Maximum v/c Ratio: 0.59	Intersection LOS: B
Intersection Signal Delay: 12.8	ICU Level of Service C
Intersection Capacity Utilization 72.1%	
Analysis Period (min) 15	
m Volume for 95th percentile queue is metered by upstream signal.	

Splits and Phases: 3: Kent & Somerset

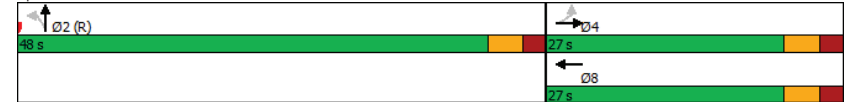

Lanes, Volumes, Timings
4: Kent & Gilmour

2035 Future Background
AM Peak Hour

Lane Group	EBL	EBT	EBR	WBL	WBT	WBR	NBL	NBT	NBR	SBL	SBT	SBR
Lane Configurations		↕						↕↕↕				
Traffic Volume (vph)	17	67	0	0	0	0	0	1817	7	0	0	0
Future Volume (vph)	17	67	0	0	0	0	0	1817	7	0	0	0
Satd. Flow (prot)	0	1728	0	0	0	0	0	4757	0	0	0	0
Fit Permitted		0.990										
Satd. Flow (perm)	0	1711	0	0	0	0	0	4757	0	0	0	0
Satd. Flow (RTOR)								1				
Lane Group Flow (vph)	0	84	0	0	0	0	0	1824	0	0	0	0
Turn Type	Perm	NA						NA				
Protected Phases		4						2				
Permitted Phases	4											
Detector Phase	4	4						2				
Switch Phase												
Minimum Initial (s)	10.0	10.0						10.0				
Minimum Split (s)	21.5	21.5						35.1				
Total Split (s)	22.0	22.0						53.0				
Total Split (%)	29.3%	29.3%						70.7%				
Yellow Time (s)	3.3	3.3						3.3				
All-Red Time (s)	2.2	2.2						1.8				
Lost Time Adjust (s)		0.0						0.0				
Total Lost Time (s)		5.5						5.1				
Lead/Lag												
Lead-Lag Optimize?												
Recall Mode	None	None						C-Max				
Act Effct Green (s)		12.4						56.1				
Actuated g/C Ratio		0.17						0.75				
v/c Ratio		0.30						0.51				
Control Delay		29.3						12.0				
Queue Delay		0.0						0.0				
Total Delay		29.3						12.0				
LOS		C						B				
Approach Delay		29.3						12.0				
Approach LOS		C						B				
Queue Length 50th (m)		11.6						57.8				
Queue Length 95th (m)		22.1						112.6				
Internal Link Dist (m)		69.3			174.3			57.8			152.2	
Turn Bay Length (m)												
Base Capacity (vph)		376						3559				
Starvation Cap Reductn		0						0				
Spillback Cap Reductn		0						0				
Storage Cap Reductn		0						0				
Reduced v/c Ratio		0.22						0.51				
Intersection Summary												
Cycle Length: 75												
Actuated Cycle Length: 75												
Offset: 5 (7%), Referenced to phase 2:NBT and 6:, Start of Green												
Natural Cycle: 60												
Control Type: Actuated-Coordinated												

Lanes, Volumes, Timings
4: Kent & Gilmour

2035 Future Background
AM Peak Hour

Maximum v/c Ratio: 0.51	Intersection LOS: B
Intersection Signal Delay: 12.8	ICU Level of Service B
Intersection Capacity Utilization 59.1%	
Analysis Period (min) 15	

Splits and Phases: 4: Kent & Gilmour



HCM 2010 TWSC
5: Kent & James

2035 Future Background
AM Peak Hour

Intersection												
Int Delay, s/veh	3.3											
Movement	EBL	EBT	EBR	WBL	WBT	WBR	NBL	NBT	NBR	SBL	SBT	SBR
Lane Configurations												
Traffic Vol, veh/h	0	0	0	0	16	26	46	1798	0	0	0	0
Future Vol, veh/h	0	0	0	0	16	26	46	1798	0	0	0	0
Conflicting Peds, #/hr	23	0	11	11	0	23	72	0	77	77	0	72
Sign Control	Free	Free	Free	Stop	Stop	Stop	Free	Free	Free	Free	Free	Free
RT Channelized	-	-	None	-	-	None	-	-	None	-	-	None
Storage Length	-	-	-	-	-	-	-	-	-	-	-	-
Veh in Median Storage, #	1048576	-	-	-	0	-	-	0	-	-	-	-
Grade, %	-	0	-	-	0	-	-	0	-	-	0	-
Peak Hour Factor	100	100	100	100	100	100	100	100	100	100	100	100
Heavy Vehicles, %	2	2	2	2	7	5	7	2	2	2	2	2
Mvmt Flow	0	0	0	0	16	26	46	1798	0	0	0	0
Major/Minor												
	Minor1			Major1								
Conflicting Flow All	-	1962	922	72	0	-						
Stage 1	-	1890	-	-	-	-						
Stage 2	-	72	-	-	-	-						
Critical Hdwy	-	6.64	7.2	5.44	-	-						
Critical Hdwy Stg 1	-	5.64	-	-	-	-						
Critical Hdwy Stg 2	-	-	-	-	-	-						
Follow-up Hdwy	-	4.07	3.95	3.17	-	-						
Pot Cap-1 Maneuver	0	59	229	1051	-	0						
Stage 1	0	111	-	-	-	0						
Stage 2	0	-	-	-	-	0						
Platoon blocked, %	-	-	-	-	-	-						
Mov Cap-1 Maneuver	-	0	229	1051	-	-						
Mov Cap-2 Maneuver	-	0	-	-	-	-						
Stage 1	-	0	-	-	-	-						
Stage 2	-	0	-	-	-	-						
Approach												
	WB			NB								
HCM Control Delay, s	24.2			2.8								
HCM LOS	C											
Minor Lane/Major Mvmt												
	NBL	NBT	WBLn1									
Capacity (veh/h)	1051	-	229									
HCM Lane V/C Ratio	0.044	-	0.183									
HCM Control Delay (s)	8.6	2.7	24.2									
HCM Lane LOS	A	A	C									
HCM 95th %tile Q(veh)	0.1	-	0.7									

Lanes, Volumes, Timings
6: Kent & Gladstone

2035 Future Background
AM Peak Hour

Lane Group	EBL	EBT	EBR	WBL	WBT	WBR	NBL	NBT	NBR	SBL	SBT	SBR
Lane Configurations												
Traffic Volume (vph)	83	187	0	0	85	143	36	1699	97	0	0	0
Future Volume (vph)	83	187	0	0	85	143	36	1699	97	0	0	0
Satd. Flow (prot)	1626	1679	0	0	1461	0	1658	4703	0	0	0	0
Fit Permitted	0.501						0.950					
Satd. Flow (perm)	807	1679	0	0	1461	0	1401	4703	0	0	0	0
Satd. Flow (RTOR)					10			18				
Lane Group Flow (vph)	83	187	0	0	228	0	36	1796	0	0	0	0
Turn Type	Perm	NA			NA		Perm	NA				
Protected Phases		4			8			2				
Permitted Phases	4							2				
Detector Phase	4	4			8			2	2			
Switch Phase												
Minimum Initial (s)	10.0	10.0			10.0		10.0	10.0				
Minimum Split (s)	21.4	21.4			20.4		21.4	21.4				
Total Split (s)	30.0	30.0			30.0		45.0	45.0				
Total Split (%)	40.0%	40.0%			40.0%		60.0%	60.0%				
Yellow Time (s)	3.3	3.3			3.3		3.3	3.3				
All-Red Time (s)	2.1	2.1			2.1		2.1	2.1				
Lost Time Adjust (s)	0.0	0.0			0.0		0.0	0.0				
Total Lost Time (s)	5.4	5.4			5.4		5.4	5.4				
Lead/Lag												
Lead-Lag Optimize?												
Recall Mode	None	None			None		C-Max	C-Max				
Act Effct Green (s)	16.5	16.5			16.5		47.7	47.7				
Actuated g/C Ratio	0.22	0.22			0.22		0.64	0.64				
v/c Ratio	0.47	0.51			0.70		0.04	0.60				
Control Delay	42.0	39.4			32.3		6.8	9.8				
Queue Delay	0.0	0.0			0.0		0.0	0.0				
Total Delay	42.0	39.4			32.3		6.8	9.8				
LOS	D	D			C		A	A				
Approach Delay		40.2			32.3			9.7				
Approach LOS		D			C			A				
Queue Length 50th (m)	13.3	29.8			18.6		1.7	49.3				
Queue Length 95th (m)	19.7	36.0			48.8		6.3	81.7				
Internal Link Dist (m)		164.9			173.9			90.5			139.7	
Turn Bay Length (m)	30.0						40.0					
Base Capacity (vph)	264	550			485		891	2998				
Starvation Cap Reductn	0	0			0		0	0				
Spillback Cap Reductn	0	0			0		0	0				
Storage Cap Reductn	0	0			0		0	0				
Reduced v/c Ratio	0.31	0.34			0.47		0.04	0.60				

Intersection Summary	
Cycle Length: 75	
Actuated Cycle Length: 75	
Offset: 36 (48%), Referenced to phase 2:NBTL and 6., Start of Green	
Natural Cycle: 50	
Control Type: Actuated-Coordinated	

Lanes, Volumes, Timings
6: Kent & Gladstone

2035 Future Background
AM Peak Hour

Maximum v/c Ratio: 0.70	Intersection LOS: B
Intersection Signal Delay: 15.5	ICU Level of Service D
Intersection Capacity Utilization 75.7%	
Analysis Period (min) 15	

Splits and Phases: 6: Kent & Gladstone



Lanes, Volumes, Timings
7: Bank & Somerset

2035 Future Background
AM Peak Hour

Lane Group	EBL	EBT	EBR	WBL	WBT	WBR	NBL	NBT	NBR	SBL	SBT	SBR
Lane Configurations		↕	↕	↕	↕			↕			↕	
Traffic Volume (vph)	41	191	75	21	124	15	12	170	40	2	172	36
Future Volume (vph)	41	191	75	21	124	15	12	170	40	2	172	36
Satd. Flow (prot)	0	1627	1388	1610	1665	0	0	1465	0	0	1465	0
Fit Permitted		0.918		0.502				0.984			0.998	
Satd. Flow (perm)	0	1467	1102	746	1665	0	0	1427	0	0	1459	0
Satd. Flow (RTOR)												
Lane Group Flow (vph)	0	232	75	21	139	0	0	222	0	0	210	0
Turn Type	Perm	NA	Perm	Perm	NA		Perm	NA		Perm	NA	
Protected Phases		4			8			2			6	
Permitted Phases	4		4	8			2			6		
Detector Phase	4	4	4	8	8		2	2		6	6	
Switch Phase												
Minimum Initial (s)	10.0	10.0	10.0	10.0	10.0		10.0	10.0		10.0	10.0	
Minimum Split (s)	20.5	20.5	20.5	20.5	20.5		20.5	20.5		20.5	20.5	
Total Split (s)	25.0	25.0	25.0	25.0	25.0		40.0	40.0		40.0	40.0	
Total Split (%)	33.3%	33.3%	33.3%	33.3%	33.3%		53.3%	53.3%		53.3%	53.3%	
Yellow Time (s)	3.3	3.3	3.3	3.3	3.3		3.3	3.3		3.3	3.3	
All-Red Time (s)	2.2	2.2	2.2	2.2	2.2		2.2	2.2		2.2	2.2	
Lost Time Adjust (s)		0.0	0.0	0.0	0.0			0.0			0.0	
Total Lost Time (s)		5.5	5.5	5.5	5.5			5.5			5.5	
Lead/Lag	Lag	Lag	Lag	Lag	Lag		Lag	Lag		Lag	Lag	
Lead-Lag Optimize?	Yes	Yes	Yes	Yes	Yes		Yes	Yes		Yes	Yes	
Recall Mode	None	None	None	None	None		C-Max	C-Max		C-Max	C-Max	
Act Effct Green (s)		16.9	16.9	16.9	16.9			47.1			47.1	
Actuated g/C Ratio		0.23	0.23	0.23	0.23			0.63			0.63	
v/c Ratio		0.70	0.30	0.12	0.37			0.25			0.23	
Control Delay		43.2	32.0	22.5	26.1			3.0			7.9	
Queue Delay		0.0	0.0	0.0	0.0			0.2			0.0	
Total Delay		43.2	32.0	22.5	26.1			3.2			7.9	
LOS		D	C	C	C			A			A	
Approach Delay		40.5			25.6			3.2			7.9	
Approach LOS		D			C			A			A	
Queue Length 50th (m)		37.1	11.9	2.5	17.6			3.6			11.9	
Queue Length 95th (m)		58.6	19.5	7.4	29.6			6.5			27.4	
Internal Link Dist (m)		174.8			68.0			65.6			106.3	
Turn Bay Length (m)			28.0	15.0								
Base Capacity (vph)		395	296	200	448			895			915	
Starvation Cap Reductn		0	0	0	0			244			0	
Spillback Cap Reductn		0	0	0	0			0			0	
Storage Cap Reductn		0	0	0	0			0			0	
Reduced v/c Ratio		0.59	0.25	0.10	0.31			0.34			0.23	

Intersection Summary

Cycle Length: 75
Actuated Cycle Length: 75
Offset: 46 (61%), Referenced to phase 2:NBTL and 6:SBTL, Start of Green
Natural Cycle: 50
Control Type: Actuated-Coordinated

Lanes, Volumes, Timings
7: Bank & Somerset

2035 Future Background
AM Peak Hour

Lane Group	Ø1	Ø3	Ø5	Ø7
Lane Configurations				
Traffic Volume (vph)				
Future Volume (vph)				
Satd. Flow (prot)				
Fit Permitted				
Satd. Flow (perm)				
Satd. Flow (RTOR)				
Lane Group Flow (vph)				
Turn Type				
Protected Phases	1	3	5	7
Permitted Phases				
Detector Phase				
Switch Phase				
Minimum Initial (s)	1.0	1.0	1.0	1.0
Minimum Split (s)	3.0	3.0	3.0	3.0
Total Split (s)	5.0	5.0	5.0	5.0
Total Split (%)	7%	7%	7%	7%
Yellow Time (s)	2.0	2.0	2.0	2.0
All-Red Time (s)	0.0	0.0	0.0	0.0
Lost Time Adjust (s)				
Total Lost Time (s)				
Lead/Lag	Lead	Lead	Lead	Lead
Lead-Lag Optimize?	Yes	Yes	Yes	Yes
Recall Mode	None	None	None	None
Act Effct Green (s)				
Actuated g/C Ratio				
v/c Ratio				
Control Delay				
Queue Delay				
Total Delay				
LOS				
Approach Delay				
Approach LOS				
Queue Length 50th (m)				
Queue Length 95th (m)				
Internal Link Dist (m)				
Turn Bay Length (m)				
Base Capacity (vph)				
Starvation Cap Reductn				
Spillback Cap Reductn				
Storage Cap Reductn				
Reduced v/c Ratio				
Intersection Summary				

Lanes, Volumes, Timings
7: Bank & Somerset

2035 Future Background
AM Peak Hour

Maximum v/c Ratio: 0.70	
Intersection Signal Delay: 21.0	Intersection LOS: C
Intersection Capacity Utilization 60.5%	ICU Level of Service B
Analysis Period (min) 15	
m Volume for 95th percentile queue is metered by upstream signal.	

Splits and Phases: 7: Bank & Somerset

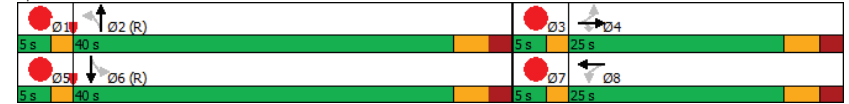

Lanes, Volumes, Timings
8: Bank & MacLaren

2035 Future Background
AM Peak Hour

Lane Group	EBL	EBT	EBR	WBL	WBT	WBR	NBL	NBT	NBR	SBL	SBT	SBR
Lane Configurations												
Traffic Volume (vph)	0	0	0	11	4	13	36	209	0	0	247	26
Future Volume (vph)	0	0	0	11	4	13	36	209	0	0	247	26
Satd. Flow (prot)	0	0	0	0	1430	0	0	1695	0	0	1552	0
Fit Permitted					0.981			0.934				
Satd. Flow (perm)	0	0	0	0	1376	0	0	1497	0	0	1552	0
Satd. Flow (RTOR)					13						13	
Lane Group Flow (vph)	0	0	0	0	28	0	0	245	0	0	273	0
Turn Type				Perm	NA		Perm	NA			NA	
Protected Phases					8			2			6	
Permitted Phases				8			2					
Detector Phase				8	8		2	2			6	
Switch Phase												
Minimum Initial (s)				10.0	10.0		10.0	10.0			10.0	
Minimum Split (s)				24.2	24.2		18.0	18.0			18.0	
Total Split (s)				24.2	24.2		50.8	50.8			50.8	
Total Split (%)				32.3%	32.3%		67.7%	67.7%			67.7%	
Yellow Time (s)				3.3	3.3		3.3	3.3			3.3	
All-Red Time (s)				1.9	1.9		1.7	1.7			1.7	
Lost Time Adjust (s)					0.0			0.0			0.0	
Total Lost Time (s)					5.2			5.0			5.0	
Lead/Lag												
Lead-Lag Optimize?												
Recall Mode				None	None		C-Max	C-Max			C-Max	
Act Effct Green (s)					15.4			57.5			57.5	
Actuated g/C Ratio					0.21			0.77			0.77	
v/c Ratio					0.10			0.21			0.23	
Control Delay					15.8			1.8			7.5	
Queue Delay					0.0			0.1			0.2	
Total Delay					15.8			1.9			7.7	
LOS					B			A			A	
Approach Delay					15.8			1.9			7.7	
Approach LOS					B			A			A	
Queue Length 50th (m)					1.7			8.6			23.7	
Queue Length 95th (m)					7.7			3.4			24.2	
Internal Link Dist (m)		130.7			122.8			60.9			65.6	
Turn Bay Length (m)												
Base Capacity (vph)					358			1147			1192	
Starvation Cap Reductn					0			316			362	
Spillback Cap Reductn					0			0			0	
Storage Cap Reductn					0			0			0	
Reduced v/c Ratio					0.08			0.29			0.33	

Intersection Summary	
Cycle Length:	75
Actuated Cycle Length:	75
Offset:	42 (56%), Referenced to phase 2:NBTL and 6:SBT, Start of Green
Natural Cycle:	45
Control Type:	Actuated-Coordinated

Lanes, Volumes, Timings
8: Bank & MacLaren

2035 Future Background
AM Peak Hour

Maximum v/c Ratio: 0.23	Intersection LOS: A
Intersection Signal Delay: 5.5	ICU Level of Service B
Intersection Capacity Utilization 57.4%	
Analysis Period (min) 15	

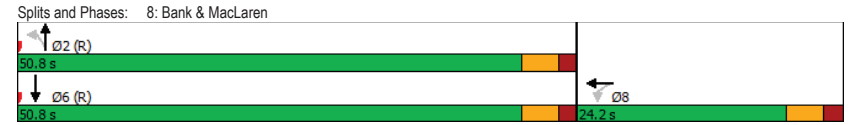

Lanes, Volumes, Timings
9: Bank & Gilmour

2035 Future Background
AM Peak Hour

Lane Group	EBL	EBT	EBR	WBL	WBT	WBR	NBL	NBT	NBR	SBL	SBT	SBR
Lane Configurations		↔						↔			↔	
Traffic Volume (vph)	12	63	39	0	0	0	0	232	22	19	253	0
Future Volume (vph)	12	63	39	0	0	0	0	232	22	19	253	0
Satd. Flow (prot)	0	1587	0	0	0	0	0	1536	0	0	1621	0
Fit Permitted		0.995									0.975	
Satd. Flow (perm)	0	1578	0	0	0	0	0	1536	0	0	1565	0
Satd. Flow (RTOR)		34						11				
Lane Group Flow (vph)	0	114	0	0	0	0	0	254	0	0	272	0
Turn Type	Perm	NA						NA		Perm	NA	
Protected Phases		4						2			6	
Permitted Phases	4									6		
Detector Phase	4	4						2		6	6	
Switch Phase												
Minimum Initial (s)	10.0	10.0						10.0		10.0	10.0	
Minimum Split (s)	23.2	23.2						20.1		20.1	20.1	
Total Split (s)	25.0	25.0						50.0		50.0	50.0	
Total Split (%)	33.3%	33.3%						66.7%		66.7%	66.7%	
Yellow Time (s)	3.3	3.3						3.3		3.3	3.3	
All-Red Time (s)	1.9	1.9						1.8		1.8	1.8	
Lost Time Adjust (s)		0.0						0.0		0.0	0.0	
Total Lost Time (s)		5.2						5.1		5.1	5.1	
Lead/Lag												
Lead-Lag Optimize?												
Recall Mode	None	None						C-Max		C-Max	C-Max	
Act Effct Green (s)		13.2						55.6		55.6	55.6	
Actuated g/C Ratio		0.18						0.74		0.74	0.74	
v/c Ratio		0.37						0.22		0.23	0.23	
Control Delay		16.3						3.4		2.8	2.8	
Queue Delay		0.0						0.0		0.2	0.2	
Total Delay		16.3						3.4		3.1	3.1	
LOS		B						A		A	A	
Approach Delay		16.3						3.4		3.1	3.1	
Approach LOS		B						A		A	A	
Queue Length 50th (m)		12.9						7.2		4.8	4.8	
Queue Length 95th (m)		27.6						11.3		9.7	9.7	
Internal Link Dist (m)		174.3			69.2			57.1		60.9	60.9	
Turn Bay Length (m)												
Base Capacity (vph)		441						1140		1159	1159	
Starvation Cap Reductn		0						0		390	390	
Spillback Cap Reductn		0						0		0	0	
Storage Cap Reductn		0						0		0	0	
Reduced v/c Ratio		0.26						0.22		0.35	0.35	

Intersection Summary		
Cycle Length:	75	
Actuated Cycle Length:	75	
Offset:	37 (49%), Referenced to phase 2:NBT and 6:SBL, Start of Green	
Natural Cycle:	45	
Control Type:	Actuated-Coordinated	

Lanes, Volumes, Timings
9: Bank & Gilmour

2035 Future Background
AM Peak Hour

Maximum v/c Ratio: 0.37	Intersection LOS: A
Intersection Signal Delay: 5.6	ICU Level of Service A
Intersection Capacity Utilization 53.9%	
Analysis Period (min) 15	

Splits and Phases: 9: Bank & Gilmour

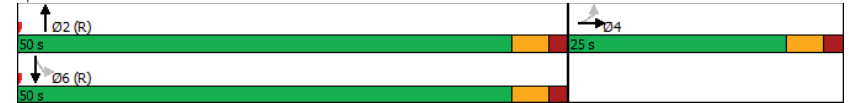

Lanes, Volumes, Timings
10: Bank & James

2035 Future Background
AM Peak Hour

Lane Group	EBL	EBR	NBL	NBT	SBT	SBR
Lane Configurations				↕	↕	
Traffic Volume (vph)	0	0	29	259	275	24
Future Volume (vph)	0	0	29	259	275	24
Satd. Flow (prot)	0	0	0	1682	1637	0
Fit Permitted				0.995		
Satd. Flow (perm)	0	0	0	1682	1637	0
Lane Group Flow (vph)	0	0	0	288	299	0
Sign Control	Stop		Free		Free	
Intersection Summary						
Control Type: Unsignalized						
Intersection Capacity Utilization 49.4%						
ICU Level of Service A						
Analysis Period (min) 15						

Lanes, Volumes, Timings
11: Bank & Gladstone

2035 Future Background
AM Peak Hour

Lane Group	EBL	EBT	EBR	WBL	WBT	WBR	NBL	NBT	NBR	SBL	SBT	SBR
Lane Configurations		↕			↕		↕	↕			↕	
Traffic Volume (vph)	36	174	64	20	102	19	57	248	76	6	242	34
Future Volume (vph)	36	174	64	20	102	19	57	248	76	6	242	34
Satd. Flow (prot)	0	2964	0	0	1578	0	1626	1503	0	0	2971	0
Fit Permitted		0.872			0.910		0.579				0.948	
Satd. Flow (perm)	0	2574	0	0	1432	0	862	1503	0	0	2813	0
Satd. Flow (RTOR)												
Lane Group Flow (vph)	0	274	0	0	141	0	57	324	0	0	282	0
Turn Type	Perm	NA		Perm	NA		Perm	NA		Perm	NA	
Protected Phases	4		8		2		6		6		6	
Permitted Phases	4		8		2		6		6		6	
Detector Phase	4		8		2		6		6		6	
Switch Phase												
Minimum Initial (s)	10.0	10.0		10.0	10.0		10.0	10.0		10.0	10.0	
Minimum Split (s)	20.5	20.5		20.5	20.5		20.5	20.5		20.5	20.5	
Total Split (s)	23.0	23.0		23.0	23.0		42.0	42.0		42.0	42.0	
Total Split (%)	30.7%	30.7%		30.7%	30.7%		56.0%	56.0%		56.0%	56.0%	
Yellow Time (s)	3.3	3.3		3.3	3.3		3.3	3.3		3.3	3.3	
All-Red Time (s)	2.2	2.2		2.2	2.2		2.2	2.2		2.2	2.2	
Lost Time Adjust (s)	0.0		0.0		0.0		0.0		0.0		0.0	
Total Lost Time (s)	5.5		5.5		5.5		5.5		5.5		5.5	
Lead/Lag	Lag	Lag		Lag	Lag		Lag	Lag		Lag	Lag	
Lead-Lag Optimize?	Yes	Yes		Yes	Yes		Yes	Yes		Yes	Yes	
Recall Mode	None	None		None	None		C-Max	C-Max		C-Max	C-Max	
Act Effct Green (s)	14.5		14.5		36.5		36.5		36.5		36.5	
Actuated g/C Ratio	0.19		0.19		0.49		0.49		0.49		0.49	
v/c Ratio	0.55		0.51		0.14		0.44		0.21		0.21	
Control Delay	40.0		33.4		11.7		15.0		16.4		16.4	
Queue Delay	0.0		0.0		0.0		0.0		0.0		0.0	
Total Delay	40.0		33.4		11.7		15.0		16.4		16.4	
LOS	D		C		B		B		B		B	
Approach Delay	40.0		33.4		14.5		16.4		16.4		16.4	
Approach LOS	D		C		B		B		B		B	
Queue Length 50th (m)	22.6		18.8		4.4		29.9		17.5		17.5	
Queue Length 95th (m)	33.5		34.4		11.0		50.3		27.0		27.0	
Internal Link Dist (m)	173.9		70.9		108.7		139.2		139.2		139.2	
Turn Bay Length (m)	38.0											
Base Capacity (vph)	600		334		419		731		1368		1368	
Starvation Cap Reductn	0		0		0		0		0		0	
Spillback Cap Reductn	0		0		0		0		0		0	
Storage Cap Reductn	0		0		0		0		0		0	
Reduced v/c Ratio	0.46		0.42		0.14		0.44		0.21		0.21	
Intersection Summary												
Cycle Length: 75												
Actuated Cycle Length: 75												
Offset: 20 (27%), Referenced to phase 2:NBTL and 6:SBTL, Start of Green												
Natural Cycle: 50												
Control Type: Actuated-Coordinated												

Lanes, Volumes, Timings
11: Bank & Gladstone

2035 Future Background
AM Peak Hour

Lane Group	Ø1	Ø3	Ø5	Ø7
Lane Configurations				
Traffic Volume (vph)				
Future Volume (vph)				
Satd. Flow (prot)				
Fit Permitted				
Satd. Flow (perm)				
Satd. Flow (RTOR)				
Lane Group Flow (vph)				
Turn Type				
Protected Phases	1	3	5	7
Permitted Phases				
Detector Phase				
Switch Phase				
Minimum Initial (s)	1.0	1.0	1.0	1.0
Minimum Split (s)	3.0	3.0	3.0	3.0
Total Split (s)	5.0	5.0	5.0	5.0
Total Split (%)	7%	7%	7%	7%
Yellow Time (s)	2.0	2.0	2.0	2.0
All-Red Time (s)	0.0	0.0	0.0	0.0
Lost Time Adjust (s)				
Total Lost Time (s)				
Lead/Lag	Lead	Lead	Lead	Lead
Lead-Lag Optimize?	Yes	Yes	Yes	Yes
Recall Mode	Max	Max	Max	Max
Act Effct Green (s)				
Actuated g/C Ratio				
v/c Ratio				
Control Delay				
Queue Delay				
Total Delay				
LOS				
Approach Delay				
Approach LOS				
Queue Length 50th (m)				
Queue Length 95th (m)				
Internal Link Dist (m)				
Turn Bay Length (m)				
Base Capacity (vph)				
Starvation Cap Reductn				
Spillback Cap Reductn				
Storage Cap Reductn				
Reduced v/c Ratio				
Intersection Summary				

Lanes, Volumes, Timings
11: Bank & Gladstone

2035 Future Background
AM Peak Hour

Maximum v/c Ratio: 0.55
Intersection Signal Delay: 24.0
Intersection Capacity Utilization 72.1%
Analysis Period (min) 15
Intersection LOS: C
ICU Level of Service C

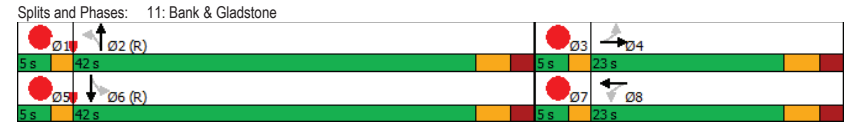

Lanes, Volumes, Timings
1: Lyon & James

2035 Future Background
PM Peak Hour

Lane Group	EBL	EBT	EBR	WBL	WBT	WBR	NBL	NBT	NBR	SBL	SBT	SBR
Lane Configurations					↕						↕↕	
Traffic Volume (vph)	0	0	0	48	21	0	0	0	0	0	528	7
Future Volume (vph)	0	0	0	48	21	0	0	0	0	0	528	7
Satd. Flow (prot)	0	0	0	0	1663	0	0	0	0	0	3307	0
Fit Permitted					0.966							
Satd. Flow (perm)	0	0	0	0	1618	0	0	0	0	0	3307	0
Satd. Flow (RTOR)											4	
Lane Group Flow (vph)	0	0	0	0	69	0	0	0	0	0	535	0
Turn Type				Perm	NA						NA	
Protected Phases					8							6
Permitted Phases				8						6		
Detector Phase				8	8					6	6	
Switch Phase												
Minimum Initial (s)				10.0	10.0					10.0	10.0	
Minimum Split (s)				17.1	17.1					29.7	29.7	
Total Split (s)				17.1	17.1					57.9	57.9	
Total Split (%)				22.8%	22.8%					77.2%	77.2%	
Yellow Time (s)				3.3	3.3					3.3	3.3	
All-Red Time (s)				1.8	1.8					1.4	1.4	
Lost Time Adjust (s)					0.0						0.0	
Total Lost Time (s)					5.1						4.7	
Lead/Lag												
Lead-Lag Optimize?												
Recall Mode				None	None					C-Max	C-Max	
Act Effct Green (s)					10.8						58.4	
Actuated g/C Ratio					0.14						0.78	
v/c Ratio					0.30						0.21	
Control Delay					29.5						3.3	
Queue Delay					0.0						0.0	
Total Delay					29.5						3.3	
LOS					C						A	
Approach Delay					29.5						3.3	
Approach LOS					C						A	
Queue Length 50th (m)					9.6						10.2	
Queue Length 95th (m)					20.9						16.9	
Internal Link Dist (m)		110.6			164.0			139.6			62.1	
Turn Bay Length (m)												
Base Capacity (vph)					258						2574	
Starvation Cap Reductn					0						0	
Spillback Cap Reductn					0						0	
Storage Cap Reductn					0						0	
Reduced v/c Ratio					0.27						0.21	
Intersection Summary												
Cycle Length: 75												
Actuated Cycle Length: 75												
Offset: 0 (0%), Referenced to phase 2: and 6:SBTL, Start of Green												
Natural Cycle: 50												
Control Type: Actuated-Coordinated												

Lanes, Volumes, Timings
1: Lyon & James

2035 Future Background
PM Peak Hour

Maximum v/c Ratio: 0.30	Intersection LOS: A
Intersection Signal Delay: 6.3	ICU Level of Service A
Intersection Capacity Utilization 39.6%	
Analysis Period (min) 15	

Splits and Phases: 1: Lyon & James



Lanes, Volumes, Timings
2: Gladstone & Lyon

2035 Future Background
PM Peak Hour

Lane Group	EBL	EBT	EBR	WBL	WBT	WBR	NBL	NBT	NBR	SBL	SBT	SBR
Lane Configurations		↔		↔	↔						↔↔	
Traffic Volume (vph)	0	248	27	13	314	0	0	0	0	86	329	138
Future Volume (vph)	0	248	27	13	314	0	0	0	0	86	329	138
Satd. Flow (prot)	0	1707	0	0	1742	0	0	0	0	0	3109	0
Fit Permitted					0.985						0.992	
Satd. Flow (perm)	0	1707	0	0	1716	0	0	0	0	0	3092	0
Satd. Flow (RTOR)		10									73	
Lane Group Flow (vph)	0	275	0	0	327	0	0	0	0	0	553	0
Turn Type		NA		Perm	NA					Perm	NA	
Protected Phases		2			6						8	
Permitted Phases				6						8		
Detector Phase		2		6	6					8	8	
Switch Phase												
Minimum Initial (s)		10.0		10.0	10.0					10.0	10.0	
Minimum Split (s)		23.2		23.6	23.6					23.6	23.6	
Total Split (s)		39.0		39.0	39.0					36.0	36.0	
Total Split (%)		52.0%		52.0%	52.0%					48.0%	48.0%	
Yellow Time (s)		3.3		3.3	3.3					3.3	3.3	
All-Red Time (s)		1.9		1.9	1.9					2.3	2.3	
Lost Time Adjust (s)		0.0		0.0	0.0					0.0	0.0	
Total Lost Time (s)		5.2		5.2	5.2					5.6	5.6	
Lead/Lag												
Lead-Lag Optimize?												
Recall Mode		C-Max		Max	Max					Max	Max	
Act Effct Green (s)		33.8			33.8						30.4	
Actuated g/C Ratio		0.45			0.45						0.41	
v/c Ratio		0.36			0.42						0.43	
Control Delay		14.6			12.7						12.3	
Queue Delay		0.0			0.0						0.0	
Total Delay		14.6			12.7						12.3	
LOS		B			B						B	
Approach Delay		14.6			12.7						12.3	
Approach LOS		B			B						B	
Queue Length 50th (m)		24.6			14.5						11.7	
Queue Length 95th (m)		42.1			41.0						22.3	
Internal Link Dist (m)		109.1			166.3			55.5			139.6	
Turn Bay Length (m)												
Base Capacity (vph)		774			773						1296	
Starvation Cap Reductn		0			0						0	
Spillback Cap Reductn		0			0						0	
Storage Cap Reductn		0			0						0	
Reduced v/c Ratio		0.36			0.42						0.43	

Intersection Summary	
Cycle Length:	75
Actuated Cycle Length:	75
Offset:	45 (60%), Referenced to phase 2:EBT, Start of Green
Natural Cycle:	50
Control Type:	Actuated-Coordinated

Lanes, Volumes, Timings
2: Gladstone & Lyon

2035 Future Background
PM Peak Hour

Maximum v/c Ratio: 0.43	Intersection LOS: B
Intersection Signal Delay: 13.0	ICU Level of Service B
Intersection Capacity Utilization 58.3%	
Analysis Period (min) 15	

Splits and Phases: 2: Gladstone & Lyon

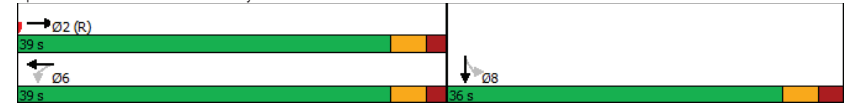

Lanes, Volumes, Timings
3: Kent & Somerset

2035 Future Background
PM Peak Hour

Lane Group	EBL	EBT	EBR	WBL	WBT	WBR	NBL	NBT	NBR	SBL	SBT	SBR
Lane Configurations	↔	↗	↘	↔	↗	↘	↔	↗	↘	↔	↗	↘
Traffic Volume (vph)	58	252	0	0	213	63	79	708	106	0	0	0
Future Volume (vph)	58	252	0	0	213	63	79	708	106	0	0	0
Satd. Flow (prot)	1658	1745	0	0	1589	0	1658	4323	0	0	0	0
Fit Permitted	0.455						0.950					
Satd. Flow (perm)	681	1745	0	0	1589	0	1028	4323	0	0	0	0
Satd. Flow (RTOR)							43					
Lane Group Flow (vph)	58	252	0	0	276	0	79	814	0	0	0	0
Turn Type	Perm	NA			NA		Perm	NA				
Protected Phases		4			8			2				
Permitted Phases	4						2					
Detector Phase	4	4			8		2	2				
Switch Phase												
Minimum Initial (s)	10.0	10.0			10.0		10.0	10.0				
Minimum Split (s)	21.5	21.5			21.5		21.4	21.4				
Total Split (s)	41.0	41.0			41.0		34.0	34.0				
Total Split (%)	54.7%	54.7%			54.7%		45.3%	45.3%				
Yellow Time (s)	3.3	3.3			3.3		3.3	3.3				
All-Red Time (s)	2.2	2.2			2.2		2.1	2.1				
Lost Time Adjust (s)	0.0	0.0			0.0		0.0	0.0				
Total Lost Time (s)	5.5	5.5			5.5		5.4	5.4				
Lead/Lag												
Lead-Lag Optimize?												
Recall Mode	None	None			None		C-Max	C-Max				
Act Effct Green (s)	19.7	19.7			19.7		44.4	44.4				
Actuated g/C Ratio	0.26	0.26			0.26		0.59	0.59				
v/c Ratio	0.33	0.55			0.66		0.13	0.32				
Control Delay	26.1	28.0			31.9		9.4	9.7				
Queue Delay	0.0	0.0			0.0		0.0	0.0				
Total Delay	26.1	28.0			31.9		9.4	9.7				
LOS	C	C			C		A	A				
Approach Delay		27.6			31.9			9.7				
Approach LOS		C			C			A				
Queue Length 50th (m)	7.1	33.1			42.3		4.9	17.7				
Queue Length 95th (m)	15.5	47.9			57.7		10.4	24.9				
Internal Link Dist (m)		61.7			174.8			152.2			110.1	
Turn Bay Length (m)	25.0						40.0					
Base Capacity (vph)	322	825			752		609	2578				
Starvation Cap Reductn	0	0			0		0	0				
Spillback Cap Reductn	0	0			0		0	0				
Storage Cap Reductn	0	0			0		0	0				
Reduced v/c Ratio	0.18	0.31			0.37		0.13	0.32				

Intersection Summary	
Cycle Length:	75
Actuated Cycle Length:	75
Offset:	50 (67%), Referenced to phase 2:NBTL and 6:, Start of Green
Natural Cycle:	45
Control Type:	Actuated-Coordinated

Lanes, Volumes, Timings
3: Kent & Somerset

2035 Future Background
PM Peak Hour

Maximum v/c Ratio: 0.66	Intersection LOS: B
Intersection Signal Delay: 17.6	ICU Level of Service B
Intersection Capacity Utilization 57.5%	
Analysis Period (min) 15	

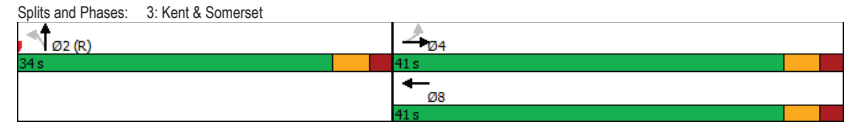

Lanes, Volumes, Timings
4: Kent & Gilmour

2035 Future Background
PM Peak Hour

Lane Group	EBL	EBT	EBR	WBL	WBT	WBR	NBL	NBT	NBR	SBL	SBT	SBR
Lane Configurations		↕						↕↕↕				
Traffic Volume (vph)	19	83	0	0	0	0	0	850	59	0	0	0
Future Volume (vph)	19	83	0	0	0	0	0	850	59	0	0	0
Satd. Flow (prot)	0	1716	0	0	0	0	0	4626	0	0	0	0
Fit Permitted		0.991										
Satd. Flow (perm)	0	1686	0	0	0	0	0	4626	0	0	0	0
Satd. Flow (RTOR)								29				
Lane Group Flow (vph)	0	102	0	0	0	0	0	909	0	0	0	0
Turn Type	Perm	NA						NA				
Protected Phases		4						2				
Permitted Phases	4											
Detector Phase	4	4						2				
Switch Phase												
Minimum Initial (s)	10.0	10.0						10.0				
Minimum Split (s)	21.5	21.5						35.1				
Total Split (s)	22.0	22.0						53.0				
Total Split (%)	29.3%	29.3%						70.7%				
Yellow Time (s)	3.3	3.3						3.3				
All-Red Time (s)	2.2	2.2						1.8				
Lost Time Adjust (s)		0.0						0.0				
Total Lost Time (s)		5.5						5.1				
Lead/Lag												
Lead-Lag Optimize?												
Recall Mode	None	None						C-Max				
Act Effct Green (s)		13.6						54.9				
Actuated g/C Ratio		0.18						0.73				
v/c Ratio		0.33						0.27				
Control Delay		29.0						3.5				
Queue Delay		0.0						0.0				
Total Delay		29.0						3.5				
LOS		C						A				
Approach Delay		29.0						3.5				
Approach LOS		C						A				
Queue Length 50th (m)		12.8						11.7				
Queue Length 95th (m)		26.0						14.6				
Internal Link Dist (m)		69.3			174.3			57.8			152.2	
Turn Bay Length (m)												
Base Capacity (vph)		370						3395				
Starvation Cap Reductn		0						0				
Spillback Cap Reductn		0						0				
Storage Cap Reductn		0						0				
Reduced v/c Ratio		0.28						0.27				
Intersection Summary												
Cycle Length: 75												
Actuated Cycle Length: 75												
Offset: 0 (0%), Referenced to phase 2:NBT and 6:, Start of Green												
Natural Cycle: 60												
Control Type: Actuated-Coordinated												

Lanes, Volumes, Timings
4: Kent & Gilmour

2035 Future Background
PM Peak Hour

Maximum v/c Ratio: 0.33	Intersection LOS: A
Intersection Signal Delay: 6.0	ICU Level of Service A
Intersection Capacity Utilization 47.0%	
Analysis Period (min) 15	

Splits and Phases: 4: Kent & Gilmour



HCM 2010 TWSC
5: Kent & James

2035 Future Background
PM Peak Hour

Intersection												
Int Delay, s/veh	2											
Movement	EBL	EBT	EBR	WBL	WBT	WBR	NBL	NBT	NBR	SBL	SBT	SBR
Lane Configurations					↔			↔↔↔				
Traffic Vol, veh/h	0	0	0	0	35	57	50	852	0	0	0	0
Future Vol, veh/h	0	0	0	0	35	57	50	852	0	0	0	0
Conflicting Peds, #/hr	25	0	17	17	0	25	95	0	63	63	0	95
Sign Control	Free	Free	Free	Stop	Stop	Stop	Free	Free	Free	Free	Free	Free
RT Channelized	-	-	None	-	None	-	-	None	-	-	-	None
Storage Length	-	-	-	-	-	-	-	-	-	-	-	-
Veh in Median Storage, #	2293760											
Grade, %	-	0	-	-	0	-	-	0	-	-	0	-
Peak Hour Factor	100	100	100	100	100	100	100	100	100	100	100	100
Heavy Vehicles, %	2	2	2	2	2	2	2	2	2	2	2	2
Mvmt Flow	0	0	0	0	35	57	50	852	0	0	0	0
Major/Minor												
	Minor1				Major1							
Conflicting Flow All	-	1047	451	95	0	-	-	-	-	-	-	-
Stage 1	-	952	-	-	-	-	-	-	-	-	-	-
Stage 2	-	95	-	-	-	-	-	-	-	-	-	-
Critical Hdwy	-	6.54	7.14	5.34	-	-	-	-	-	-	-	-
Critical Hdwy Stg 1	-	5.54	-	-	-	-	-	-	-	-	-	-
Critical Hdwy Stg 2	-	-	-	-	-	-	-	-	-	-	-	-
Follow-up Hdwy	-	4.02	3.92	3.12	-	-	-	-	-	-	-	-
Pot Cap-1 Maneuver	0	227	475	1044	-	0	-	-	-	-	-	-
Stage 1	0	336	-	-	-	0	-	-	-	-	-	-
Stage 2	0	-	-	-	-	0	-	-	-	-	-	-
Platoon blocked, %	-											
Mov Cap-1 Maneuver	-	0	475	1044	-	-	-	-	-	-	-	-
Mov Cap-2 Maneuver	-	0	-	-	-	-	-	-	-	-	-	-
Stage 1	-	0	-	-	-	-	-	-	-	-	-	-
Stage 2	-	0	-	-	-	-	-	-	-	-	-	-
Approach												
	WB				NB							
HCM Control Delay, s	14.4				0.7							
HCM LOS	B											
Minor Lane/Major Mvmt												
	NBL		NBTWBLn1									
Capacity (veh/h)	1044		- 475									
HCM Lane V/C Ratio	0.048		- 0.194									
HCM Control Delay (s)	8.6		0.2 14.4									
HCM Lane LOS	A		A B									
HCM 95th %tile Q(veh)	0.2		- 0.7									

Lanes, Volumes, Timings
6: Kent & Gladstone

2035 Future Background
PM Peak Hour

Lane Group	EBL	EBT	EBR	WBL	WBT	WBR	NBL	NBT	NBR	SBL	SBT	SBR
Lane Configurations	↔	↔			↔		↔↔↔	↔↔↔				
Traffic Volume (vph)	76	250	0	0	244	75	52	736	101	0	0	0
Future Volume (vph)	76	250	0	0	244	75	52	736	101	0	0	0
Satd. Flow (prot)	1658	1728	0	0	1656	0	1658	4554	0	0	0	0
Fit Permitted	0.372						0.950					
Satd. Flow (perm)	624	1728	0	0	1656	0	1471	4554	0	0	0	0
Satd. Flow (RTOR)					31		35					
Lane Group Flow (vph)	76	250	0	0	319	0	52	837	0	0	0	0
Turn Type	Perm	NA			NA		Perm	NA				
Protected Phases	4				8		2					
Permitted Phases	4						2					
Detector Phase	4		4		8		2		2			
Switch Phase												
Minimum Initial (s)	10.0	10.0			10.0		10.0	10.0				
Minimum Split (s)	21.4	21.4			20.4		21.4	21.4				
Total Split (s)	45.0	45.0			45.0		30.0	30.0				
Total Split (%)	60.0%	60.0%			60.0%		40.0%	40.0%				
Yellow Time (s)	3.3	3.3			3.3		3.3	3.3				
All-Red Time (s)	2.1	2.1			2.1		2.1	2.1				
Lost Time Adjust (s)	0.0	0.0			0.0		0.0	0.0				
Total Lost Time (s)	5.4	5.4			5.4		5.4	5.4				
Lead/Lag												
Lead-Lag Optimize?												
Recall Mode	None	None			None		C-Max	C-Max				
Act Effct Green (s)	19.2	19.2			19.2		45.0	45.0				
Actuated g/C Ratio	0.26	0.26			0.26		0.60	0.60				
v/c Ratio	0.47	0.56			0.71		0.06	0.31				
Control Delay	23.4	19.9			35.2		8.5	8.3				
Queue Delay	0.0	0.0			0.0		0.0	0.0				
Total Delay	23.4	19.9			35.2		8.5	8.3				
LOS	C	B			D		A	A				
Approach Delay	20.7				35.2		8.3					
Approach LOS	C				D		A					
Queue Length 50th (m)	5.8	19.1			44.4		2.9	19.0				
Queue Length 95th (m)	10.0	24.4			70.4		9.4	34.2				
Internal Link Dist (m)	166.3				173.9		90.5					139.7
Turn Bay Length (m)	30.0						40.0					
Base Capacity (vph)	329		912		889		881		2744			
Starvation Cap Reductn	0	0			0		0	0				
Spillback Cap Reductn	0	0			0		0	0				
Storage Cap Reductn	0	0			0		0	0				
Reduced v/c Ratio	0.23	0.27			0.36		0.06	0.31				

Intersection Summary												
Cycle Length: 75												
Actuated Cycle Length: 75												
Offset: 23 (31%), Referenced to phase 2:NBTL and 6., Start of Green												
Natural Cycle: 45												
Control Type: Actuated-Coordinated												

Lanes, Volumes, Timings
6: Kent & Gladstone

2035 Future Background
PM Peak Hour

Maximum v/c Ratio: 0.71	Intersection LOS: B
Intersection Signal Delay: 16.5	ICU Level of Service B
Intersection Capacity Utilization 58.9%	
Analysis Period (min) 15	

Splits and Phases: 6: Kent & Gladstone

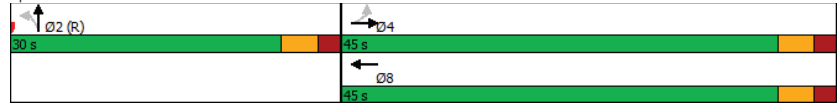

Lanes, Volumes, Timings
7: Bank & Somerset

2035 Future Background
PM Peak Hour

Lane Group	EBL	EBT	EBR	WBL	WBT	WBR	NBL	NBT	NBR	SBL	SBT	SBR
Lane Configurations		↕	↕	↕	↕			↕			↕	↕
Traffic Volume (vph)	44	187	79	33	135	24	21	189	41	5	260	51
Future Volume (vph)	44	187	79	33	135	24	21	189	41	5	260	51
Satd. Flow (prot)	0	1704	1483	1658	1590	0	0	1494	0	0	1479	0
Fit Permitted		0.908		0.515				0.963			0.996	
Satd. Flow (perm)	0	1457	723	601	1590	0	0	1406	0	0	1467	0
Satd. Flow (RTOR)												
Lane Group Flow (vph)	0	231	79	33	159	0	0	251	0	0	316	0
Turn Type	Perm	NA	Perm	Perm	NA		Perm	NA		Perm	NA	
Protected Phases		4			8			2			6	
Permitted Phases	4		4	8			2				6	
Detector Phase	4	4	4	8	8		2	2			6	6
Switch Phase												
Minimum Initial (s)	10.0	10.0	10.0	10.0	10.0		10.0	10.0		10.0	10.0	
Minimum Split (s)	20.5	20.5	20.5	20.5	20.5		20.5	20.5		20.5	20.5	
Total Split (s)	25.0	25.0	25.0	25.0	25.0		40.0	40.0		40.0	40.0	
Total Split (%)	33.3%	33.3%	33.3%	33.3%	33.3%		53.3%	53.3%		53.3%	53.3%	
Yellow Time (s)	3.3	3.3	3.3	3.3	3.3		3.3	3.3		3.3	3.3	
All-Red Time (s)	2.2	2.2	2.2	2.2	2.2		2.2	2.2		2.2	2.2	
Lost Time Adjust (s)		0.0	0.0	0.0	0.0			0.0			0.0	
Total Lost Time (s)		5.5	5.5	5.5	5.5			5.5			5.5	
Lead/Lag	Lag	Lag	Lag	Lag	Lag		Lag	Lag		Lag	Lag	
Lead-Lag Optimize?	Yes	Yes	Yes	Yes	Yes		Yes	Yes		Yes	Yes	
Recall Mode	None	None	None	None	None		C-Max	C-Max		C-Max	C-Max	
Act Effct Green (s)		17.9	17.9	17.9	17.9			46.1			46.1	
Actuated g/C Ratio		0.24	0.24	0.24	0.24			0.61			0.61	
v/c Ratio		0.66	0.46	0.23	0.42			0.29			0.35	
Control Delay		28.5	25.8	25.8	26.9			3.2			9.2	
Queue Delay		0.0	0.0	0.0	0.0			0.2			0.0	
Total Delay		28.5	25.8	25.8	26.9			3.5			9.2	
LOS		C	C	C	C			A			A	
Approach Delay		27.8			26.7			3.5			9.2	
Approach LOS		C			C			A			A	
Queue Length 50th (m)		32.4	10.0	4.1	20.5			6.2			19.6	
Queue Length 95th (m)		46.3	20.4	10.5	33.6			8.6			42.9	
Internal Link Dist (m)		174.8			68.0			65.6			106.3	
Turn Bay Length (m)			28.0	15.0								
Base Capacity (vph)		392	194	162	429			863			901	
Starvation Cap Reductn		0	0	0	0			199			0	
Spillback Cap Reductn		0	0	0	0			0			0	
Storage Cap Reductn		0	0	0	0			0			0	
Reduced v/c Ratio		0.59	0.41	0.20	0.37			0.38			0.35	

Intersection Summary

Cycle Length: 75
Actuated Cycle Length: 75
Offset: 7 (9%), Referenced to phase 2:NBTL and 6:SBTL, Start of Green
Natural Cycle: 55
Control Type: Actuated-Coordinated

Lanes, Volumes, Timings
7: Bank & Somerset

2035 Future Background
PM Peak Hour

Lane Group	Ø1	Ø3	Ø5	Ø7
Lane Configurations				
Traffic Volume (vph)				
Future Volume (vph)				
Satd. Flow (prot)				
Fit Permitted				
Satd. Flow (perm)				
Satd. Flow (RTOR)				
Lane Group Flow (vph)				
Turn Type				
Protected Phases	1	3	5	7
Permitted Phases				
Detector Phase				
Switch Phase				
Minimum Initial (s)	1.0	1.0	1.0	1.0
Minimum Split (s)	3.0	3.0	3.0	3.0
Total Split (s)	5.0	5.0	5.0	5.0
Total Split (%)	7%	7%	7%	7%
Yellow Time (s)	2.0	2.0	2.0	2.0
All-Red Time (s)	0.0	0.0	0.0	0.0
Lost Time Adjust (s)				
Total Lost Time (s)				
Lead/Lag	Lead	Lead	Lead	Lead
Lead-Lag Optimize?	Yes	Yes	Yes	Yes
Recall Mode	None	None	None	None
Act Effct Green (s)				
Actuated g/C Ratio				
v/c Ratio				
Control Delay				
Queue Delay				
Total Delay				
LOS				
Approach Delay				
Approach LOS				
Queue Length 50th (m)				
Queue Length 95th (m)				
Internal Link Dist (m)				
Turn Bay Length (m)				
Base Capacity (vph)				
Starvation Cap Reductn				
Spillback Cap Reductn				
Storage Cap Reductn				
Reduced v/c Ratio				
Intersection Summary				

Lanes, Volumes, Timings
7: Bank & Somerset

2035 Future Background
PM Peak Hour

Maximum v/c Ratio: 0.66	
Intersection Signal Delay: 16.4	Intersection LOS: B
Intersection Capacity Utilization 66.8%	ICU Level of Service C
Analysis Period (min) 15	

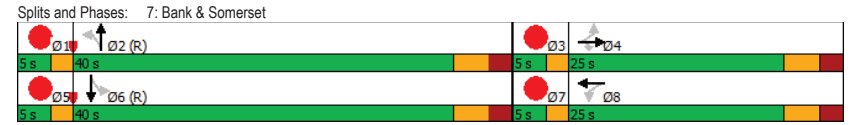

Lanes, Volumes, Timings
8: Bank & MacLaren

2035 Future Background
PM Peak Hour

Lane Group	EBL	EBT	EBR	WBL	WBT	WBR	NBL	NBT	NBR	SBL	SBT	SBR
Lane Configurations												
Traffic Volume (vph)	0	0	0	35	11	10	25	247	0	0	341	26
Future Volume (vph)	0	0	0	35	11	10	25	247	0	0	341	26
Satd. Flow (prot)	0	0	0	0	1570	0	0	1674	0	0	1624	0
Fit Permitted					0.970			0.954				
Satd. Flow (perm)	0	0	0	0	1400	0	0	1547	0	0	1624	0
Satd. Flow (RTOR)					10			9				
Lane Group Flow (vph)	0	0	0	0	56	0	0	272	0	0	367	0
Turn Type				Perm	NA		Perm	NA			NA	
Protected Phases					8			2			6	
Permitted Phases					8			2				
Detector Phase					8	8		2	2		6	
Switch Phase												
Minimum Initial (s)				10.0	10.0		10.0	10.0			10.0	
Minimum Split (s)				24.2	24.2		18.0	18.0			18.0	
Total Split (s)				24.2	24.2		50.8	50.8			50.8	
Total Split (%)				32.3%	32.3%		67.7%	67.7%			67.7%	
Yellow Time (s)				3.3	3.3		3.3	3.3			3.3	
All-Red Time (s)				1.9	1.9		1.7	1.7			1.7	
Lost Time Adjust (s)					0.0			0.0			0.0	
Total Lost Time (s)					5.2			5.0			5.0	
Lead/Lag												
Lead-Lag Optimize?												
Recall Mode				None	None		C-Max	C-Max			C-Max	
Act Effct Green (s)					17.2			51.6			51.6	
Actuated g/C Ratio					0.23			0.69			0.69	
v/c Ratio					0.17			0.26			0.33	
Control Delay					20.3			4.8			10.5	
Queue Delay					0.0			0.2			0.4	
Total Delay					20.3			4.9			10.9	
LOS					C			A			B	
Approach Delay					20.3			4.9			10.9	
Approach LOS					C			A			B	
Queue Length 50th (m)					5.3			8.6			40.4	
Queue Length 95th (m)					14.2			9.0			26.1	
Internal Link Dist (m)			130.7		122.8			60.9			65.6	
Turn Bay Length (m)												
Base Capacity (vph)					362			1065			1121	
Starvation Cap Reductn					0			264			344	
Spillback Cap Reductn					0			0			0	
Storage Cap Reductn					0			0			0	
Reduced v/c Ratio					0.15			0.34			0.47	

Intersection Summary												
Cycle Length: 75												
Actuated Cycle Length: 75												
Offset: 7 (9%), Referenced to phase 2:NBTL and 6:SBT, Start of Green												
Natural Cycle: 45												
Control Type: Actuated-Coordinated												

Lanes, Volumes, Timings
8: Bank & MacLaren

2035 Future Background
PM Peak Hour

Maximum v/c Ratio: 0.33	Intersection LOS: A
Intersection Signal Delay: 9.3	ICU Level of Service B
Intersection Capacity Utilization 59.9%	
Analysis Period (min) 15	

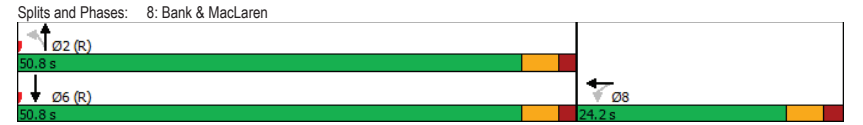

Lanes, Volumes, Timings
9: Bank & Gilmour

2035 Future Background
PM Peak Hour

Lane Group	EBL	EBT	EBR	WBL	WBT	WBR	NBL	NBT	NBR	SBL	SBT	SBR
Lane Configurations		↔						↔			↔	
Traffic Volume (vph)	0	65	36	0	0	0	0	277	38	30	341	0
Future Volume (vph)	0	65	36	0	0	0	0	277	38	30	341	0
Satd. Flow (prot)	0	1512	0	0	0	0	0	1556	0	0	1707	0
Fit Permitted											0.961	
Satd. Flow (perm)	0	1512	0	0	0	0	0	1556	0	0	1600	0
Satd. Flow (RTOR)		36						16				
Lane Group Flow (vph)	0	101	0	0	0	0	0	315	0	0	371	0
Turn Type		NA						NA	Perm	NA		
Protected Phases		4						2			6	
Permitted Phases	4									6		
Detector Phase	4	4						2		6	6	
Switch Phase												
Minimum Initial (s)	10.0	10.0						10.0	10.0	10.0		
Minimum Split (s)	23.2	23.2						20.1	20.1	20.1		
Total Split (s)	25.0	25.0						50.0	50.0	50.0		
Total Split (%)	33.3%	33.3%						66.7%	66.7%	66.7%		
Yellow Time (s)	3.3	3.3						3.3	3.3	3.3		
All-Red Time (s)	1.9	1.9						1.8	1.8	1.8		
Lost Time Adjust (s)		0.0						0.0	0.0	0.0		
Total Lost Time (s)		5.2						5.1	5.1	5.1		
Lead/Lag												
Lead-Lag Optimize?												
Recall Mode	None	None						C-Max	C-Max	C-Max		
Act Effct Green (s)		16.4						52.4	52.4	52.4		
Actuated g/C Ratio		0.22						0.70	0.70	0.70		
v/c Ratio		0.28						0.29	0.33	0.33		
Control Delay		9.6						11.4	2.5	2.5		
Queue Delay		0.0						0.0	0.2	0.2		
Total Delay		9.6						11.4	2.6	2.6		
LOS		A						B	A	A		
Approach Delay		9.6						11.4	2.6	2.6		
Approach LOS		A						B	A	A		
Queue Length 50th (m)		3.2						24.1	6.6	6.6		
Queue Length 95th (m)		10.6						43.7	9.9	9.9		
Internal Link Dist (m)		174.3			69.2			57.1	60.9	60.9		
Turn Bay Length (m)												
Base Capacity (vph)		425						1090	1117	1117		
Starvation Cap Reductn		0						0	206	206		
Spillback Cap Reductn		0						0	0	0		
Storage Cap Reductn		0						0	0	0		
Reduced v/c Ratio		0.24						0.29	0.41	0.41		

Intersection Summary	
Cycle Length:	75
Actuated Cycle Length:	75
Offset:	6 (8%), Referenced to phase 2:NBT and 6:SBTL, Start of Green
Natural Cycle:	45
Control Type:	Actuated-Coordinated

Lanes, Volumes, Timings
9: Bank & Gilmour

2035 Future Background
PM Peak Hour

Maximum v/c Ratio: 0.33	Intersection LOS: A
Intersection Signal Delay: 7.0	ICU Level of Service C
Intersection Capacity Utilization 67.3%	
Analysis Period (min) 15	

Splits and Phases: 9: Bank & Gilmour

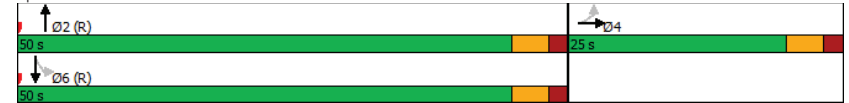

Lanes, Volumes, Timings
10: Bank & James

2035 Future Background
PM Peak Hour

Lane Group	EBL	EBR	NBL	NBT	SBT	SBR
Lane Configurations				↕	↕	
Traffic Volume (vph)	0	0	61	318	332	50
Future Volume (vph)	0	0	61	318	332	50
Satd. Flow (prot)	0	0	0	1703	1685	0
Fit Permitted				0.992		
Satd. Flow (perm)	0	0	0	1703	1685	0
Lane Group Flow (vph)	0	0	0	379	382	0
Sign Control	Stop		Free		Free	
Intersection Summary						
Control Type: Unsignalized						
Intersection Capacity Utilization 65.7%						
ICU Level of Service C						
Analysis Period (min) 15						

Lanes, Volumes, Timings
11: Bank & Gladstone

2035 Future Background
PM Peak Hour

Lane Group	EBL	EBT	EBR	WBL	WBT	WBR	NBL	NBT	NBR	SBL	SBT	SBR
Lane Configurations		↕			↕		↕	↕			↕	
Traffic Volume (vph)	49	185	79	41	131	28	90	289	87	15	339	39
Future Volume (vph)	49	185	79	41	131	28	90	289	87	15	339	39
Satd. Flow (prot)	0	2944	0	0	1638	0	1658	1517	0	0	3059	0
Fit Permitted		0.860			0.862		0.517				0.936	
Satd. Flow (perm)	0	2496	0	0	1377	0	694	1517	0	0	2852	0
Satd. Flow (RTOR)												
Lane Group Flow (vph)	0	313	0	0	200	0	90	376	0	0	393	0
Turn Type	Perm	NA		Perm	NA		Perm	NA		Perm	NA	
Protected Phases		4			8			2			6	
Permitted Phases	4			8			2			6		
Detector Phase	4	4		8	8		2	2		6	6	
Switch Phase												
Minimum Initial (s)	10.0	10.0		10.0	10.0		10.0	10.0		10.0	10.0	
Minimum Split (s)	20.5	20.5		20.5	20.5		20.5	20.5		20.5	20.5	
Total Split (s)	28.0	28.0		28.0	28.0		37.0	37.0		37.0	37.0	
Total Split (%)	37.3%	37.3%		37.3%	37.3%		49.3%	49.3%		49.3%	49.3%	
Yellow Time (s)	3.3	3.3		3.3	3.3		3.3	3.3		3.3	3.3	
All-Red Time (s)	2.2	2.2		2.2	2.2		2.2	2.2		2.2	2.2	
Lost Time Adjust (s)		0.0			0.0		0.0	0.0		0.0	0.0	
Total Lost Time (s)		5.5			5.5		5.5	5.5		5.5	5.5	
Lead/Lag	Lag	Lag		Lag	Lag		Lag	Lag		Lag	Lag	
Lead-Lag Optimize?	Yes	Yes		Yes	Yes		Yes	Yes		Yes	Yes	
Recall Mode	None	None		None	None		C-Max	C-Max		C-Max	C-Max	
Act Effct Green (s)		17.4			17.4		31.5	31.5		31.5	31.5	
Actuated g/C Ratio		0.23			0.23		0.42	0.42		0.42	0.42	
v/c Ratio		0.54			0.63		0.31	0.59		0.33	0.33	
Control Delay		15.9			34.8		18.3	21.5		8.2	8.2	
Queue Delay		0.0			0.0		0.0	0.0		0.0	0.0	
Total Delay		15.9			34.8		18.3	21.5		8.2	8.2	
LOS		B			C		B	C		A	A	
Approach Delay		15.9			34.8		20.9			8.2		
Approach LOS		B			C		C			A		
Queue Length 50th (m)		8.3			27.6		8.6	41.7		9.4		
Queue Length 95th (m)		12.8			44.2		20.0	69.3		16.0		
Internal Link Dist (m)		173.9			70.9		108.7			139.2		
Turn Bay Length (m)							38.0					
Base Capacity (vph)		748			413		291	637		1197		
Starvation Cap Reductn		0			0		0	0		0		
Spillback Cap Reductn		0			0		0	0		0		
Storage Cap Reductn		0			0		0	0		0		
Reduced v/c Ratio		0.42			0.48		0.31	0.59		0.33		
Intersection Summary												
Cycle Length: 75												
Actuated Cycle Length: 75												
Offset: 26 (35%), Referenced to phase 2:NBT and 6:SBTL, Start of Green												
Natural Cycle: 55												
Control Type: Actuated-Coordinated												

Lanes, Volumes, Timings
11: Bank & Gladstone

2035 Future Background
PM Peak Hour

Lane Group	Ø1	Ø3	Ø5	Ø7
Lane Configurations				
Traffic Volume (vph)				
Future Volume (vph)				
Satd. Flow (prot)				
Fit Permitted				
Satd. Flow (perm)				
Satd. Flow (RTOR)				
Lane Group Flow (vph)				
Turn Type				
Protected Phases	1	3	5	7
Permitted Phases				
Detector Phase				
Switch Phase				
Minimum Initial (s)	1.0	1.0	1.0	1.0
Minimum Split (s)	3.0	3.0	3.0	3.0
Total Split (s)	5.0	5.0	5.0	5.0
Total Split (%)	7%	7%	7%	7%
Yellow Time (s)	2.0	2.0	2.0	2.0
All-Red Time (s)	0.0	0.0	0.0	0.0
Lost Time Adjust (s)				
Total Lost Time (s)				
Lead/Lag	Lead	Lead	Lead	Lead
Lead-Lag Optimize?	Yes	Yes	Yes	Yes
Recall Mode	Max	Max	Max	Max
Act Effct Green (s)				
Actuated g/C Ratio				
v/c Ratio				
Control Delay				
Queue Delay				
Total Delay				
LOS				
Approach Delay				
Approach LOS				
Queue Length 50th (m)				
Queue Length 95th (m)				
Internal Link Dist (m)				
Turn Bay Length (m)				
Base Capacity (vph)				
Starvation Cap Reductn				
Spillback Cap Reductn				
Storage Cap Reductn				
Reduced v/c Ratio				
Intersection Summary				

Lanes, Volumes, Timings
11: Bank & Gladstone

2035 Future Background
PM Peak Hour

Maximum v/c Ratio: 0.63
Intersection Signal Delay: 18.1
Intersection Capacity Utilization 79.5%
Analysis Period (min) 15
Intersection LOS: B
ICU Level of Service D

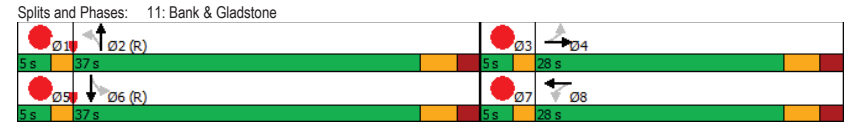

Appendix I

Synchro Intersection Worksheets – 2030 Future Total Conditions

DRAFT

Lanes, Volumes, Timings
1: Lyon & James

2030 Future Total
AM Peak Hour

Lane Group	EBL	EBT	EBR	WBL	WBT	WBR	NBL	NBT	NBR	SBL	SBT	SBR
Lane Configurations					↕						↕↔	
Traffic Volume (vph)	0	0	0	34	21	0	0	0	0	0	389	25
Future Volume (vph)	0	0	0	34	21	0	0	0	0	0	389	25
Satd. Flow (prot)	0	0	0	0	1628	0	0	0	0	0	3228	0
Fit Permitted					0.970							
Satd. Flow (perm)	0	0	0	0	1600	0	0	0	0	0	3228	0
Satd. Flow (RTOR)					21							
Lane Group Flow (vph)	0	0	0	0	55	0	0	0	0	0	414	0
Turn Type				Perm	NA						NA	
Protected Phases					8							6
Permitted Phases					8						6	
Detector Phase					8	8					6	6
Switch Phase												
Minimum Initial (s)				10.0	10.0					10.0	10.0	
Minimum Split (s)				17.1	17.1					29.7	29.7	
Total Split (s)				17.1	17.1					57.9	57.9	
Total Split (%)				22.8%	22.8%					77.2%	77.2%	
Yellow Time (s)				3.3	3.3					3.3	3.3	
All-Red Time (s)				1.8	1.8					1.4	1.4	
Lost Time Adjust (s)					0.0						0.0	
Total Lost Time (s)					5.1						4.7	
Lead/Lag												
Lead-Lag Optimize?												
Recall Mode				None	None					C-Max	C-Max	
Act Effct Green (s)					10.4						62.7	
Actuated g/C Ratio					0.14						0.84	
v/c Ratio					0.25						0.15	
Control Delay					26.2						2.4	
Queue Delay					0.0						0.0	
Total Delay					26.2						2.4	
LOS					C						A	
Approach Delay					26.2						2.4	
Approach LOS					C						A	
Queue Length 50th (m)					7.5						7.2	
Queue Length 95th (m)					m11.4						12.5	
Internal Link Dist (m)		102.5			161.6			141.5			55.1	
Turn Bay Length (m)												
Base Capacity (vph)					256						2703	
Starvation Cap Reductn					0						0	
Spillback Cap Reductn					0						0	
Storage Cap Reductn					0						0	
Reduced v/c Ratio					0.21						0.15	
Intersection Summary												
Cycle Length: 75												
Actuated Cycle Length: 75												
Offset: 16 (21%), Referenced to phase 2: and 6:SBTL, Start of Green												
Natural Cycle: 50												
Control Type: Actuated-Coordinated												

Lanes, Volumes, Timings
1: Lyon & James

2030 Future Total
AM Peak Hour

Maximum v/c Ratio: 0.25	Intersection LOS: A
Intersection Signal Delay: 5.2	ICU Level of Service A
Intersection Capacity Utilization 38.9%	
Analysis Period (min) 15	
m Volume for 95th percentile queue is metered by upstream signal.	

Splits and Phases: 1: Lyon & James



Lanes, Volumes, Timings
2: Lyon & Gladstone

2030 Future Total
AM Peak Hour

Lane Group	EBL	EBT	EBR	WBL	WBT	WBR	NBL	NBT	NBR	SBL	SBT	SBR
Lane Configurations		↔		↔	↔						↔↔	
Traffic Volume (vph)	0	185	14	5	146	0	0	0	0	87	152	98
Future Volume (vph)	0	185	14	5	146	0	0	0	0	87	152	98
Satd. Flow (prot)	0	1679	0	0	1709	0	0	0	0	0	3064	0
Fit Permitted					0.992						0.987	
Satd. Flow (perm)	0	1679	0	0	1698	0	0	0	0	0	3030	0
Satd. Flow (RTOR)		6									98	
Lane Group Flow (vph)	0	199	0	0	151	0	0	0	0	0	337	0
Turn Type		NA		Perm	NA					Perm	NA	
Protected Phases		2			6						8	
Permitted Phases				6						8		
Detector Phase		2		6	6					8	8	
Switch Phase												
Minimum Initial (s)		10.0		10.0	10.0					10.0	10.0	
Minimum Split (s)		17.2		17.2	17.2					22.6	22.6	
Total Split (s)		38.0		38.0	38.0					37.0	37.0	
Total Split (%)		50.7%		50.7%	50.7%					49.3%	49.3%	
Yellow Time (s)		3.3		3.3	3.3					3.3	3.3	
All-Red Time (s)		1.9		1.9	1.9					2.3	2.3	
Lost Time Adjust (s)		0.0		0.0	0.0					0.0	0.0	
Total Lost Time (s)		5.2		5.2	5.2					5.6	5.6	
Lead/Lag												
Lead-Lag Optimize?												
Recall Mode		C-Max		C-Max	C-Max					Max	Max	
Act Effct Green (s)		32.8		32.8	32.8						31.4	
Actuated g/C Ratio		0.44		0.44	0.44						0.42	
v/c Ratio		0.27		0.20	0.20						0.25	
Control Delay		14.3		8.4	8.4						10.0	
Queue Delay		0.0		0.0	0.0						0.0	
Total Delay		14.3		8.4	8.4						10.0	
LOS		B		A	A						B	
Approach Delay		14.3		8.4	8.4						10.0	
Approach LOS		B		A	A						B	
Queue Length 50th (m)		17.6		5.7	5.7						12.5	
Queue Length 95th (m)		31.7		14.1	14.1						21.5	
Internal Link Dist (m)		110.8		164.9	164.9		56.5				141.5	
Turn Bay Length (m)												
Base Capacity (vph)		737		742	742						1325	
Starvation Cap Reductn		0		0	0						0	
Spillback Cap Reductn		0		0	0						0	
Storage Cap Reductn		0		0	0						0	
Reduced v/c Ratio		0.27		0.20	0.20						0.25	

Intersection Summary	
Cycle Length:	75
Actuated Cycle Length:	75
Offset:	10 (13%), Referenced to phase 2:EBT and 6:WBTL, Start of Green
Natural Cycle:	40
Control Type:	Actuated-Coordinated

Lanes, Volumes, Timings
2: Lyon & Gladstone

2030 Future Total
AM Peak Hour

Maximum v/c Ratio: 0.27	Intersection LOS: B
Intersection Signal Delay: 10.9	ICU Level of Service A
Intersection Capacity Utilization 35.5%	
Analysis Period (min) 15	

Splits and Phases: 2: Lyon & Gladstone

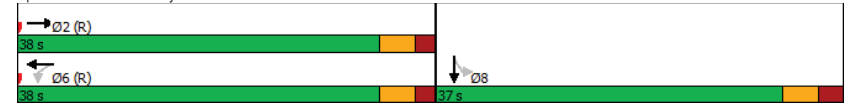

Lanes, Volumes, Timings
3: Kent & Somerset

2030 Future Total
AM Peak Hour

Lane Group	EBL	EBT	EBR	WBL	WBT	WBR	NBL	NBT	NBR	SBL	SBT	SBR
Lane Configurations	↔	↑			↔		↔	↑↑				
Traffic Volume (vph)	63	172	0	0	153	51	78	1555	184	0	0	0
Future Volume (vph)	63	172	0	0	153	51	78	1555	184	0	0	0
Satd. Flow (prot)	1658	1728	0	0	1610	0	1642	4534	0	0	0	0
Fit Permitted	0.549						0.950					
Satd. Flow (perm)	874	1728	0	0	1610	0	1072	4534	0	0	0	0
Satd. Flow (RTOR)							45					
Lane Group Flow (vph)	63	172	0	0	204	0	78	1739	0	0	0	0
Turn Type	Perm	NA			NA		Perm	NA				
Protected Phases		4			8			2				
Permitted Phases	4							2				
Detector Phase	4	4			8			2	2			
Switch Phase												
Minimum Initial (s)	10.0	10.0			10.0		10.0	10.0				
Minimum Split (s)	21.5	21.5			21.5		21.4	21.4				
Total Split (s)	27.0	27.0			27.0		48.0	48.0				
Total Split (%)	36.0%	36.0%			36.0%		64.0%	64.0%				
Yellow Time (s)	3.3	3.3			3.3		3.3	3.3				
All-Red Time (s)	2.2	2.2			2.2		2.1	2.1				
Lost Time Adjust (s)	0.0	0.0			0.0		0.0	0.0				
Total Lost Time (s)	5.5	5.5			5.5		5.4	5.4				
Lead/Lag												
Lead-Lag Optimize?												
Recall Mode	None	None			None		C-Max	C-Max				
Act Effct Green (s)	15.9	15.9			15.9		48.2	48.2				
Actuated g/C Ratio	0.21	0.21			0.21		0.64	0.64				
v/c Ratio	0.34	0.47			0.60		0.11	0.59				
Control Delay	29.2	29.5			27.5		8.7	9.2				
Queue Delay	0.0	0.0			0.0		0.0	0.0				
Total Delay	29.2	29.5			27.5		8.7	9.2				
LOS	C	C			C		A	A				
Approach Delay		29.4			27.5			9.1				
Approach LOS		C			C			A				
Queue Length 50th (m)	8.0	22.5			29.8		1.6	12.3				
Queue Length 95th (m)	17.7	37.5			49.3		m13.1	63.3				
Internal Link Dist (m)		61.7			174.8			152.2			110.1	
Turn Bay Length (m)	25.0						40.0					
Base Capacity (vph)	250	495			461		688	2929				
Starvation Cap Reductn	0	0			0		0	0				
Spillback Cap Reductn	0	0			0		0	0				
Storage Cap Reductn	0	0			0		0	0				
Reduced v/c Ratio	0.25	0.35			0.44		0.11	0.59				

Intersection Summary	
Cycle Length:	75
Actuated Cycle Length:	75
Offset:	66 (88%), Referenced to phase 2:NBTL and 6:, Start of Green
Natural Cycle:	50
Control Type:	Actuated-Coordinated

Lanes, Volumes, Timings
3: Kent & Somerset

2030 Future Total
AM Peak Hour

Maximum v/c Ratio:	0.60
Intersection Signal Delay:	12.9
Intersection Capacity Utilization:	72.1%
Analysis Period (min):	15
Volume for 95th percentile queue is metered by upstream signal.	
Intersection LOS:	B
ICU Level of Service:	C

Splits and Phases: 3: Kent & Somerset

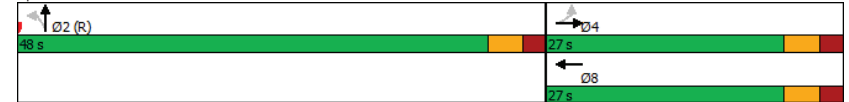

Lanes, Volumes, Timings
4: Kent & Gilmour

2030 Future Total
AM Peak Hour

Lane Group	EBL	EBT	EBR	WBL	WBT	WBR	NBL	NBT	NBR	SBL	SBT	SBR
Lane Configurations		↕						↕↕↕				
Traffic Volume (vph)	17	72	0	0	0	0	0	1816	17	0	0	0
Future Volume (vph)	17	72	0	0	0	0	0	1816	17	0	0	0
Satd. Flow (prot)	0	1729	0	0	0	0	0	4753	0	0	0	0
Fit Permitted		0.991										
Satd. Flow (perm)	0	1714	0	0	0	0	0	4753	0	0	0	0
Satd. Flow (RTOR)								3				
Lane Group Flow (vph)	0	89	0	0	0	0	0	1833	0	0	0	0
Turn Type	Perm	NA						NA				
Protected Phases		4						2				
Permitted Phases	4											
Detector Phase	4	4						2				
Switch Phase												
Minimum Initial (s)	10.0	10.0						10.0				
Minimum Split (s)	21.5	21.5						35.1				
Total Split (s)	22.0	22.0						53.0				
Total Split (%)	29.3%	29.3%						70.7%				
Yellow Time (s)	3.3	3.3						3.3				
All-Red Time (s)	2.2	2.2						1.8				
Lost Time Adjust (s)		0.0						0.0				
Total Lost Time (s)		5.5						5.1				
Lead/Lag												
Lead-Lag Optimize?												
Recall Mode	None	None						C-Max				
Act Effct Green (s)		12.4						56.1				
Actuated g/C Ratio		0.17						0.75				
v/c Ratio		0.31						0.52				
Control Delay		29.7						12.3				
Queue Delay		0.0						0.0				
Total Delay		29.7						12.3				
LOS		C						B				
Approach Delay		29.7						12.3				
Approach LOS		C						B				
Queue Length 50th (m)		12.3						60.1				
Queue Length 95th (m)		23.2						114.5				
Internal Link Dist (m)		69.3			25.1			57.8			152.2	
Turn Bay Length (m)												
Base Capacity (vph)		377						3557				
Starvation Cap Reductn		0						0				
Spillback Cap Reductn		0						0				
Storage Cap Reductn		0						0				
Reduced v/c Ratio		0.24						0.52				
Intersection Summary												
Cycle Length: 75												
Actuated Cycle Length: 75												
Offset: 5 (7%), Referenced to phase 2:NBT and 6:, Start of Green												
Natural Cycle: 60												
Control Type: Actuated-Coordinated												

Lanes, Volumes, Timings
4: Kent & Gilmour

2030 Future Total
AM Peak Hour

Maximum v/c Ratio: 0.52	Intersection LOS: B
Intersection Signal Delay: 13.1	ICU Level of Service B
Intersection Capacity Utilization 59.4%	
Analysis Period (min) 15	

Splits and Phases: 4: Kent & Gilmour



HCM 2010 TWSC
5: Kent & James

2030 Future Total
AM Peak Hour

Intersection													
Int Delay, s/veh	0.7												
Movement	EBL	EBT	EBR	WBL	WBT	WBR	NBL	NBT	NBR	SBL	SBT	SBR	
Lane Configurations					↔			↔↔↔					
Traffic Vol, veh/h	0	0	0	0	16	27	46	1806	0	0	0	0	
Future Vol, veh/h	0	0	0	0	16	27	46	1806	0	0	0	0	
Conflicting Peds, #/hr	23	0	11	11	0	23	72	0	77	77	0	72	
Sign Control	Free	Free	Free	Stop	Stop	Stop	Free	Free	Free	Free	Free	Free	
RT Channelized	-	-	None	-	-	None	-	-	None	-	-	None	
Storage Length	-	-	-	-	-	-	-	-	-	-	-	-	
Veh in Median Storage, #	1048576	-	-	0	-	-	0	-	-	-	-	-	
Grade, %	-	0	-	-	0	-	-	0	-	-	0	-	
Peak Hour Factor	100	100	100	100	100	100	100	100	100	100	100	100	
Heavy Vehicles, %	2	2	2	2	7	5	7	2	2	2	2	2	
Mvmt Flow	0	0	0	0	16	27	46	1806	0	0	0	0	
Major/Minor													
	Minor1			Major1									
Conflicting Flow All	-	1970	926	72	0	-							
Stage 1	-	1898	-	-	-	-							
Stage 2	-	72	-	-	-	-							
Critical Hdwy	-	6.64	7.2	5.44	-	-							
Critical Hdwy Stg 1	-	5.64	-	-	-	-							
Critical Hdwy Stg 2	-	-	-	-	-	-							
Follow-up Hdwy	-	4.07	3.95	3.17	-	-							
Pot Cap-1 Maneuver	0	58	228	1051	-	0							
Stage 1	0	110	-	-	-	0							
Stage 2	0	-	-	-	-	0							
Platoon blocked, %	-	-	-	-	-	-							
Mov Cap-1 Maneuver	-	0	228	1051	-	-							
Mov Cap-2 Maneuver	-	0	-	-	-	-							
Stage 1	-	0	-	-	-	-							
Stage 2	-	0	-	-	-	-							
Approach													
	WB			NB									
HCM Control Delay, s	24.4			0.2									
HCM LOS	C												
Minor Lane/Major Mvmt													
	NBL	NBTWBLn1											
Capacity (veh/h)	1051	-	228										
HCM Lane V/C Ratio	0.044	-	0.189										
HCM Control Delay (s)	8.6	0	24.4										
HCM Lane LOS	A	A	C										
HCM 95th %tile Q(veh)	0.1	-	0.7										

Lanes, Volumes, Timings
6: Kent & Gladstone

2030 Future Total
AM Peak Hour

Lanes, Volumes, Timings												
Lane Group	EBL	EBT	EBR	WBL	WBT	WBR	NBL	NBT	NBR	SBL	SBT	SBR
Lane Configurations	↔	↕			↕		↕↕↕	↕↕↕				
Traffic Volume (vph)	83	187	0	0	88	147	36	1704	97	0	0	0
Future Volume (vph)	83	187	0	0	88	147	36	1704	97	0	0	0
Satd. Flow (prot)	1626	1679	0	0	1463	0	1658	4703	0	0	0	0
Fit Permitted	0.491						0.950					
Satd. Flow (perm)	791	1679	0	0	1463	0	1401	4703	0	0	0	0
Satd. Flow (RTOR)					10			18				
Lane Group Flow (vph)	83	187	0	0	235	0	36	1801	0	0	0	0
Turn Type	Perm	NA			NA		Perm	NA				
Protected Phases		4			8			2				
Permitted Phases	4						2					
Detector Phase	4	4			8		2	2				
Switch Phase												
Minimum Initial (s)	10.0	10.0			10.0		10.0	10.0				
Minimum Split (s)	21.4	21.4			20.4		21.4	21.4				
Total Split (s)	30.0	30.0			30.0		45.0	45.0				
Total Split (%)	40.0%	40.0%			40.0%		60.0%	60.0%				
Yellow Time (s)	3.3	3.3			3.3		3.3	3.3				
All-Red Time (s)	2.1	2.1			2.1		2.1	2.1				
Lost Time Adjust (s)	0.0	0.0			0.0		0.0	0.0				
Total Lost Time (s)	5.4	5.4			5.4		5.4	5.4				
Lead/Lag												
Lead-Lag Optimize?												
Recall Mode	None	None			None		C-Max	C-Max				
Act Effct Green (s)	16.8	16.8			16.8		47.4	47.4				
Actuated g/C Ratio	0.22	0.22			0.22		0.63	0.63				
v/c Ratio	0.47	0.50			0.70		0.04	0.60				
Control Delay	41.2	38.3			32.4		7.0	10.1				
Queue Delay	0.0	0.0			0.0		0.0	0.0				
Total Delay	41.2	38.3			32.4		7.0	10.1				
LOS	D	D			C		A	B				
Approach Delay		39.2			32.4			10.0				
Approach LOS		D			C			B				
Queue Length 50th (m)	13.2	29.7			19.0		1.8	50.5				
Queue Length 95th (m)	19.2	34.9			51.3		6.4	83.4				
Internal Link Dist (m)		164.9			173.9			90.5				139.7
Turn Bay Length (m)	30.0						40.0					
Base Capacity (vph)	259	550			486		885	2980				
Starvation Cap Reductn	0	0			0		0	0				
Spillback Cap Reductn	0	0			0		0	0				
Storage Cap Reductn	0	0			0		0	0				
Reduced v/c Ratio	0.32	0.34			0.48		0.04	0.60				
Intersection Summary												
Cycle Length: 75												
Actuated Cycle Length: 75												
Offset: 36 (48%), Referenced to phase 2:NBTL and 6., Start of Green												
Natural Cycle: 55												
Control Type: Actuated-Coordinated												

Lanes, Volumes, Timings
6: Kent & Gladstone

2030 Future Total
AM Peak Hour

Maximum v/c Ratio: 0.70	Intersection LOS: B
Intersection Signal Delay: 15.6	ICU Level of Service D
Intersection Capacity Utilization 76.2%	
Analysis Period (min) 15	

Splits and Phases: 6: Kent & Gladstone



Lanes, Volumes, Timings
7: Bank & Somerset

2030 Future Total
AM Peak Hour

Lane Group	EBL	EBT	EBR	WBL	WBT	WBR	NBL	NBT	NBR	SBL	SBT	SBR
Lane Configurations		↕	↕	↕	↕			↕			↕	
Traffic Volume (vph)	41	191	75	21	124	15	16	177	40	2	164	36
Future Volume (vph)	41	191	75	21	124	15	16	177	40	2	164	36
Satd. Flow (prot)	0	1627	1388	1610	1665	0	0	1467	0	0	1459	0
Fit Permitted		0.918		0.502				0.979			0.998	
Satd. Flow (perm)	0	1467	1102	746	1665	0	0	1417	0	0	1453	0
Satd. Flow (RTOR)												
Lane Group Flow (vph)	0	232	75	21	139	0	0	233	0	0	202	0
Turn Type	Perm	NA	Perm	Perm	NA		Perm	NA		Perm	NA	
Protected Phases		4			8			2			6	
Permitted Phases	4		4	8			2			6		
Detector Phase	4	4	4	8	8		2	2		6	6	
Switch Phase												
Minimum Initial (s)	10.0	10.0	10.0	10.0	10.0		10.0	10.0		10.0	10.0	
Minimum Split (s)	20.5	20.5	20.5	20.5	20.5		20.5	20.5		20.5	20.5	
Total Split (s)	25.0	25.0	25.0	25.0	25.0		40.0	40.0		40.0	40.0	
Total Split (%)	33.3%	33.3%	33.3%	33.3%	33.3%		53.3%	53.3%		53.3%	53.3%	
Yellow Time (s)	3.3	3.3	3.3	3.3	3.3		3.3	3.3		3.3	3.3	
All-Red Time (s)	2.2	2.2	2.2	2.2	2.2		2.2	2.2		2.2	2.2	
Lost Time Adjust (s)		0.0	0.0	0.0	0.0			0.0			0.0	
Total Lost Time (s)		5.5	5.5	5.5	5.5			5.5			5.5	
Lead/Lag	Lag	Lag	Lag	Lag	Lag		Lag	Lag		Lag	Lag	
Lead-Lag Optimize?	Yes	Yes	Yes	Yes	Yes		Yes	Yes		Yes	Yes	
Recall Mode	None	None	None	None	None		C-Max	C-Max		C-Max	C-Max	
Act Effct Green (s)		16.9	16.9	16.9	16.9			47.1			47.1	
Actuated g/C Ratio		0.23	0.23	0.23	0.23			0.63			0.63	
v/c Ratio		0.70	0.30	0.12	0.37			0.26			0.22	
Control Delay		43.2	31.9	22.5	26.1			2.9			7.9	
Queue Delay		0.0	0.0	0.0	0.0			0.2			0.0	
Total Delay		43.2	31.9	22.5	26.1			3.2			7.9	
LOS		D	C	C	C			A			A	
Approach Delay		40.4			25.6			3.2			7.9	
Approach LOS		D			C			A			A	
Queue Length 50th (m)		37.0	11.9	2.5	17.6			3.7			11.4	
Queue Length 95th (m)		58.6	19.4	7.4	29.6			6.5			26.4	
Internal Link Dist (m)		174.8			68.0			65.6			106.3	
Turn Bay Length (m)			28.0	15.0								
Base Capacity (vph)		395	296	200	448			889			912	
Starvation Cap Reductn		0	0	0	0			229			0	
Spillback Cap Reductn		0	0	0	0			0			0	
Storage Cap Reductn		0	0	0	0			0			0	
Reduced v/c Ratio		0.59	0.25	0.10	0.31			0.35			0.22	

Intersection Summary

Cycle Length: 75
Actuated Cycle Length: 75
Offset: 46 (61%), Referenced to phase 2:NBTL and 6:SBTL, Start of Green
Natural Cycle: 50
Control Type: Actuated-Coordinated

Lanes, Volumes, Timings
7: Bank & Somerset

2030 Future Total
AM Peak Hour

Lane Group	Ø1	Ø3	Ø5	Ø7
Lane Configurations				
Traffic Volume (vph)				
Future Volume (vph)				
Satd. Flow (prot)				
Fit Permitted				
Satd. Flow (perm)				
Satd. Flow (RTOR)				
Lane Group Flow (vph)				
Turn Type				
Protected Phases	1	3	5	7
Permitted Phases				
Detector Phase				
Switch Phase				
Minimum Initial (s)	1.0	1.0	1.0	1.0
Minimum Split (s)	3.0	3.0	3.0	3.0
Total Split (s)	5.0	5.0	5.0	5.0
Total Split (%)	7%	7%	7%	7%
Yellow Time (s)	2.0	2.0	2.0	2.0
All-Red Time (s)	0.0	0.0	0.0	0.0
Lost Time Adjust (s)				
Total Lost Time (s)				
Lead/Lag	Lead	Lead	Lead	Lead
Lead-Lag Optimize?	Yes	Yes	Yes	Yes
Recall Mode	None	None	None	None
Act Effct Green (s)				
Actuated g/C Ratio				
v/c Ratio				
Control Delay				
Queue Delay				
Total Delay				
LOS				
Approach Delay				
Approach LOS				
Queue Length 50th (m)				
Queue Length 95th (m)				
Internal Link Dist (m)				
Turn Bay Length (m)				
Base Capacity (vph)				
Starvation Cap Reductn				
Spillback Cap Reductn				
Storage Cap Reductn				
Reduced v/c Ratio				
Intersection Summary				

Lanes, Volumes, Timings
7: Bank & Somerset

2030 Future Total
AM Peak Hour

Maximum v/c Ratio: 0.70	
Intersection Signal Delay: 20.9	Intersection LOS: C
Intersection Capacity Utilization 63.6%	ICU Level of Service B
Analysis Period (min) 15	
m Volume for 95th percentile queue is metered by upstream signal.	

Splits and Phases: 7: Bank & Somerset

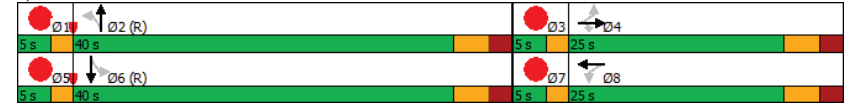

Lanes, Volumes, Timings
8: Bank & MacLaren

2030 Future Total
AM Peak Hour

Lane Group	EBL	EBT	EBR	WBL	WBT	WBR	NBL	NBT	NBR	SBL	SBT	SBR
Lane Configurations												
Traffic Volume (vph)	0	0	0	11	4	13	36	220	0	0	236	26
Future Volume (vph)	0	0	0	11	4	13	36	220	0	0	236	26
Satd. Flow (prot)	0	0	0	0	1430	0	0	1695	0	0	1547	0
Fit Permitted					0.981			0.938				
Satd. Flow (perm)	0	0	0	0	1376	0	0	1506	0	0	1547	0
Satd. Flow (RTOR)					13						14	
Lane Group Flow (vph)	0	0	0	0	28	0	0	256	0	0	262	0
Turn Type				Perm	NA		Perm	NA			NA	
Protected Phases					8			2			6	
Permitted Phases					8			2				
Detector Phase					8	8		2	2		6	
Switch Phase												
Minimum Initial (s)				10.0	10.0		10.0	10.0			10.0	
Minimum Split (s)				24.2	24.2		18.0	18.0			18.0	
Total Split (s)				24.2	24.2		50.8	50.8			50.8	
Total Split (%)				32.3%	32.3%		67.7%	67.7%			67.7%	
Yellow Time (s)				3.3	3.3		3.3	3.3			3.3	
All-Red Time (s)				1.9	1.9		1.7	1.7			1.7	
Lost Time Adjust (s)					0.0			0.0			0.0	
Total Lost Time (s)					5.2			5.0			5.0	
Lead/Lag												
Lead-Lag Optimize?												
Recall Mode				None	None		C-Max	C-Max			C-Max	
Act Effct Green (s)					15.4			57.5			57.5	
Actuated g/C Ratio					0.21			0.77			0.77	
v/c Ratio					0.10			0.22			0.22	
Control Delay					15.8			2.4			7.7	
Queue Delay					0.0			0.2			0.2	
Total Delay					15.8			2.6			7.8	
LOS					B			A			A	
Approach Delay					15.8			2.6			7.8	
Approach LOS					B			A			A	
Queue Length 50th (m)					1.7			10.3			23.0	
Queue Length 95th (m)					7.7			6.0			24.1	
Internal Link Dist (m)		130.7			122.8			60.9			65.6	
Turn Bay Length (m)												
Base Capacity (vph)					358			1154			1189	
Starvation Cap Reductn					0			319			371	
Spillback Cap Reductn					0			0			0	
Storage Cap Reductn					0			0			0	
Reduced v/c Ratio					0.08			0.31			0.32	

Intersection Summary	
Cycle Length:	75
Actuated Cycle Length:	75
Offset:	42 (56%), Referenced to phase 2:NBTL and 6:SBT, Start of Green
Natural Cycle:	45
Control Type:	Actuated-Coordinated

Lanes, Volumes, Timings
8: Bank & MacLaren

2030 Future Total
AM Peak Hour

Maximum v/c Ratio: 0.22	Intersection LOS: A
Intersection Signal Delay: 5.8	ICU Level of Service B
Intersection Capacity Utilization 57.4%	
Analysis Period (min) 15	

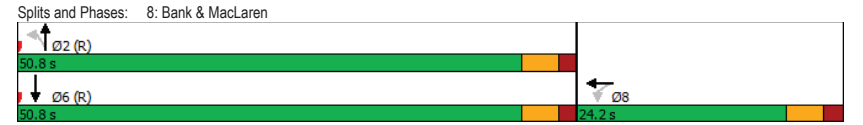

Lanes, Volumes, Timings
9: Bank & Gilmour

2030 Future Total
AM Peak Hour

Lane Group	EBL	EBT	EBR	WBL	WBT	WBR	NBL	NBT	NBR	SBL	SBT	SBR
Lane Configurations		↔						↔			↔	
Traffic Volume (vph)	23	71	54	0	0	0	0	232	22	19	241	0
Future Volume (vph)	23	71	54	0	0	0	0	232	22	19	241	0
Satd. Flow (prot)	0	1573	0	0	0	0	0	1536	0	0	1619	0
Fit Permitted		0.992									0.974	
Satd. Flow (perm)	0	1560	0	0	0	0	0	1536	0	0	1562	0
Satd. Flow (RTOR)		37						11				
Lane Group Flow (vph)	0	148	0	0	0	0	0	254	0	0	260	0
Turn Type	Perm	NA						NA		Perm	NA	
Protected Phases		4						2			6	
Permitted Phases	4									6		
Detector Phase	4	4						2		6	6	
Switch Phase												
Minimum Initial (s)	10.0	10.0						10.0		10.0	10.0	
Minimum Split (s)	23.2	23.2						20.1		20.1	20.1	
Total Split (s)	25.0	25.0						50.0		50.0	50.0	
Total Split (%)	33.3%	33.3%						66.7%		66.7%	66.7%	
Yellow Time (s)	3.3	3.3						3.3		3.3	3.3	
All-Red Time (s)	1.9	1.9						1.8		1.8	1.8	
Lost Time Adjust (s)		0.0						0.0		0.0	0.0	
Total Lost Time (s)		5.2						5.1		5.1	5.1	
Lead/Lag												
Lead-Lag Optimize?												
Recall Mode	None	None						C-Max		C-Max	C-Max	
Act Effct Green (s)		13.4						51.3		51.3	51.3	
Actuated g/C Ratio		0.18						0.68		0.68	0.68	
v/c Ratio		0.48						0.24		0.24	0.24	
Control Delay		25.0						3.8		3.1	3.1	
Queue Delay		0.0						0.0		0.3	0.3	
Total Delay		25.0						3.8		3.5	3.5	
LOS		C						A		A	A	
Approach Delay		25.0						3.8		3.5	3.5	
Approach LOS		C						A		A	A	
Queue Length 50th (m)		15.5						7.2		4.4	4.4	
Queue Length 95th (m)		29.4						11.3		9.2	9.2	
Internal Link Dist (m)		125.3			69.2			57.1		60.9	60.9	
Turn Bay Length (m)												
Base Capacity (vph)		439						1054		1069	1069	
Starvation Cap Reductn		0						0		394	394	
Spillback Cap Reductn		0						0		0	0	
Storage Cap Reductn		0						0		0	0	
Reduced v/c Ratio		0.34						0.24		0.39	0.39	

Intersection Summary	
Cycle Length:	75
Actuated Cycle Length:	75
Offset:	37 (49%), Referenced to phase 2:NBT and 6:SBTL, Start of Green
Natural Cycle:	45
Control Type:	Actuated-Coordinated

Lanes, Volumes, Timings
9: Bank & Gilmour

2030 Future Total
AM Peak Hour

Maximum v/c Ratio: 0.48	Intersection LOS: A
Intersection Signal Delay: 8.4	ICU Level of Service A
Intersection Capacity Utilization 55.0%	
Analysis Period (min) 15	

Splits and Phases: 9: Bank & Gilmour

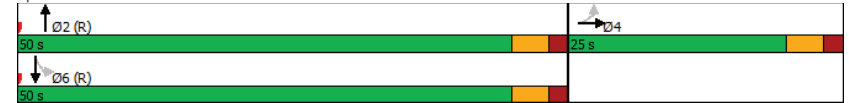

Lanes, Volumes, Timings
10: Bank & James

2030 Future Total
AM Peak Hour

Lane Group	EBL	EBR	NBL	NBT	SBT	SBR
Lane Configurations				↕	↕	
Traffic Volume (vph)	0	0	29	259	277	25
Future Volume (vph)	0	0	29	259	277	25
Satd. Flow (prot)	0	0	0	1682	1638	0
Fit Permitted				0.995		
Satd. Flow (perm)	0	0	0	1682	1638	0
Lane Group Flow (vph)	0	0	0	288	302	0
Sign Control	Stop		Free		Free	
Intersection Summary						
Control Type: Unsignalized						
Intersection Capacity Utilization 49.6%						
ICU Level of Service A						
Analysis Period (min) 15						

Lanes, Volumes, Timings
11: Bank & Gladstone

2030 Future Total
AM Peak Hour

Lane Group	EBL	EBT	EBR	WBL	WBT	WBR	NBL	NBT	NBR	SBL	SBT	SBR
Lane Configurations		↕			↕		↕	↕			↕	
Traffic Volume (vph)	36	174	64	20	106	19	57	248	76	6	242	37
Future Volume (vph)	36	174	64	20	106	19	57	248	76	6	242	37
Satd. Flow (prot)	0	2964	0	0	1579	0	1626	1503	0	0	2964	0
Fit Permitted		0.900			0.918		0.577				0.949	
Satd. Flow (perm)	0	2657	0	0	1446	0	860	1503	0	0	2809	0
Satd. Flow (RTOR)												
Lane Group Flow (vph)	0	274	0	0	145	0	57	324	0	0	285	0
Turn Type	Perm	NA		Perm	NA		Perm	NA		Perm	NA	
Protected Phases	4		8		2		6		6		6	
Permitted Phases	4		8		2		6		6		6	
Detector Phase	4		8		2		6		6		6	
Switch Phase												
Minimum Initial (s)	10.0	10.0		10.0	10.0		10.0	10.0		10.0	10.0	
Minimum Split (s)	20.5	20.5		20.5	20.5		20.5	20.5		20.5	20.5	
Total Split (s)	23.0	23.0		23.0	23.0		42.0	42.0		42.0	42.0	
Total Split (%)	30.7%	30.7%		30.7%	30.7%		56.0%	56.0%		56.0%	56.0%	
Yellow Time (s)	3.3	3.3		3.3	3.3		3.3	3.3		3.3	3.3	
All-Red Time (s)	2.2	2.2		2.2	2.2		2.2	2.2		2.2	2.2	
Lost Time Adjust (s)	0.0		0.0		0.0		0.0		0.0		0.0	
Total Lost Time (s)	5.5		5.5		5.5		5.5		5.5		5.5	
Lead/Lag	Lag	Lag		Lag	Lag		Lag	Lag		Lag	Lag	
Lead-Lag Optimize?	Yes	Yes		Yes	Yes		Yes	Yes		Yes	Yes	
Recall Mode	None	None		None	None		C-Max	C-Max		C-Max	C-Max	
Act Effct Green (s)	14.5		14.5		36.5		36.5		36.5		36.5	
Actuated g/C Ratio	0.19		0.19		0.49		0.49		0.49		0.49	
v/c Ratio	0.53		0.52		0.14		0.44		0.21		0.21	
Control Delay	39.3		33.7		11.7		15.0		15.7		15.7	
Queue Delay	0.0		0.0		0.0		0.0		0.0		0.0	
Total Delay	39.3		33.7		11.7		15.0		15.7		15.7	
LOS	D		C		B		B		B		B	
Approach Delay	39.3		33.7		14.5		15.7		15.7		15.7	
Approach LOS	D		C		B		B		B		B	
Queue Length 50th (m)	22.6		19.4		4.4		29.9		16.8		16.8	
Queue Length 95th (m)	33.2		35.3		11.0		50.3		25.8		25.8	
Internal Link Dist (m)	173.9		70.9		108.7		139.2		139.2		139.2	
Turn Bay Length (m)					38.0							
Base Capacity (vph)	619		337		418		731		1367		1367	
Starvation Cap Reductn	0		0		0		0		0		0	
Spillback Cap Reductn	0		0		0		0		0		0	
Storage Cap Reductn	0		0		0		0		0		0	
Reduced v/c Ratio	0.44		0.43		0.14		0.44		0.21		0.21	
Intersection Summary												
Cycle Length: 75												
Actuated Cycle Length: 75												
Offset: 20 (27%), Referenced to phase 2:NBTL and 6:SBTL, Start of Green												
Natural Cycle: 50												
Control Type: Actuated-Coordinated												

Lanes, Volumes, Timings
11: Bank & Gladstone

2030 Future Total
AM Peak Hour

Lane Group	Ø1	Ø3	Ø5	Ø7
Lane Configurations				
Traffic Volume (vph)				
Future Volume (vph)				
Satd. Flow (prot)				
Fit Permitted				
Satd. Flow (perm)				
Satd. Flow (RTOR)				
Lane Group Flow (vph)				
Turn Type				
Protected Phases	1	3	5	7
Permitted Phases				
Detector Phase				
Switch Phase				
Minimum Initial (s)	1.0	1.0	1.0	1.0
Minimum Split (s)	3.0	3.0	3.0	3.0
Total Split (s)	5.0	5.0	5.0	5.0
Total Split (%)	7%	7%	7%	7%
Yellow Time (s)	2.0	2.0	2.0	2.0
All-Red Time (s)	0.0	0.0	0.0	0.0
Lost Time Adjust (s)				
Total Lost Time (s)				
Lead/Lag	Lead	Lead	Lead	Lead
Lead-Lag Optimize?	Yes	Yes	Yes	Yes
Recall Mode	Max	Max	Max	Max
Act Effct Green (s)				
Actuated g/C Ratio				
v/c Ratio				
Control Delay				
Queue Delay				
Total Delay				
LOS				
Approach Delay				
Approach LOS				
Queue Length 50th (m)				
Queue Length 95th (m)				
Internal Link Dist (m)				
Turn Bay Length (m)				
Base Capacity (vph)				
Starvation Cap Reductn				
Spillback Cap Reductn				
Storage Cap Reductn				
Reduced v/c Ratio				
Intersection Summary				

Lanes, Volumes, Timings
11: Bank & Gladstone

2030 Future Total
AM Peak Hour

Maximum v/c Ratio: 0.53	
Intersection Signal Delay: 23.7	Intersection LOS: C
Intersection Capacity Utilization 72.2%	ICU Level of Service C
Analysis Period (min) 15	

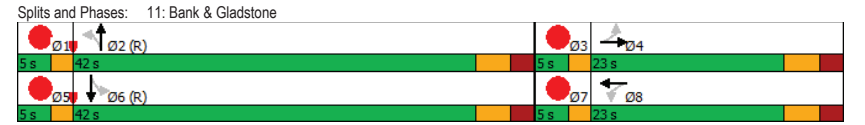

HCM 2010 AWSC
12: Access & Gilmour

2030 Future Total
AM Peak Hour

Intersection						
Intersection Delay, s/veh	7.2					
Intersection LOS	A					

Movement	EBT	EBR	WBL	WBT	NBL	NBR
Lane Configurations	↔					↔
Traffic Vol, veh/h	94	15	0	0	0	34
Future Vol, veh/h	94	15	0	0	0	34
Peak Hour Factor	1.00	1.00	1.00	1.00	1.00	1.00
Heavy Vehicles, %	2	2	2	2	2	2
Mvmt Flow	94	15	0	0	0	34
Number of Lanes	1	0	0	0	0	1

Approach	EB	NB
Opposing Approach		
Opposing Lanes	0	0
Conflicting Approach Left		EB
Conflicting Lanes Left	0	1
Conflicting Approach Right	NB	
Conflicting Lanes Right	1	0
HCM Control Delay	7.4	6.7
HCM LOS	A	A

Lane	NBLn1	EBLn1
Vol Left, %	0%	0%
Vol Thru, %	0%	86%
Vol Right, %	100%	14%
Sign Control	Stop	Stop
Traffic Vol by Lane	34	109
LT Vol	0	0
Through Vol	0	94
RT Vol	34	15
Lane Flow Rate	34	109
Geometry Grp	1	1
Degree of Util (X)	0.033	0.118
Departure Headway (Hd)	3.524	3.91
Convergence, Y/N	Yes	Yes
Cap	1010	921
Service Time	1.565	1.916
HCM Lane V/C Ratio	0.034	0.118
HCM Control Delay	6.7	7.4
HCM Lane LOS	A	A
HCM 95th-tile Q	0.1	0.4

Lanes, Volumes, Timings
1: Lyon & James

2030 Future Total
PM Peak Hour



Lane Group	EBL	EBT	EBR	WBL	WBT	WBR	NBL	NBT	NBR	SBL	SBT	SBR
Lane Configurations					↔						↔	↔
Traffic Volume (vph)	0	0	0	48	21	0	0	0	0	0	0	502
Future Volume (vph)	0	0	0	48	21	0	0	0	0	0	0	502
Satd. Flow (prot)	0	0	0	0	1663	0	0	0	0	0	0	3307
Fit Permitted					0.966							
Satd. Flow (perm)	0	0	0	0	1618	0	0	0	0	0	0	3307
Satd. Flow (RTOR)												4
Lane Group Flow (vph)	0	0	0	0	69	0	0	0	0	0	0	509
Turn Type				Perm	NA							NA
Protected Phases					8							6
Permitted Phases					8							6
Detector Phase					8	8						6
Switch Phase												6
Minimum Initial (s)					10.0	10.0						10.0
Minimum Split (s)					17.1	17.1						29.7
Total Split (s)					17.1	17.1						57.9
Total Split (%)					22.8%	22.8%						77.2%
Yellow Time (s)					3.3	3.3						3.3
All-Red Time (s)					1.8	1.8						1.4
Lost Time Adjust (s)						0.0						0.0
Total Lost Time (s)						5.1						4.7
Lead/Lag												
Lead-Lag Optimize?												
Recall Mode					None	None					C-Max	C-Max
Act Effct Green (s)						10.8						58.4
Actuated g/C Ratio						0.14						0.78
v/c Ratio						0.30						0.20
Control Delay						29.4						3.3
Queue Delay						0.0						0.0
Total Delay						29.4						3.3
LOS						C						A
Approach Delay						29.4						3.3
Approach LOS						C						A
Queue Length 50th (m)						9.6						9.5
Queue Length 95th (m)						21.1						16.0
Internal Link Dist (m)						110.6			139.6			62.1
Turn Bay Length (m)												
Base Capacity (vph)						258						2574
Starvation Cap Reductn						0						0
Spillback Cap Reductn						0						0
Storage Cap Reductn						0						0
Reduced v/c Ratio						0.27						0.20

Intersection Summary		
Cycle Length:	75	
Actuated Cycle Length:	75	
Offset:	0 (0%), Referenced to phase 2: and 6:SBTL, Start of Green	
Natural Cycle:	50	
Control Type:	Actuated-Coordinated	

Lanes, Volumes, Timings
1: Lyon & James

2030 Future Total
PM Peak Hour

Maximum v/c Ratio: 0.30	Intersection LOS: A
Intersection Signal Delay: 6.4	ICU Level of Service A
Intersection Capacity Utilization 39.6%	
Analysis Period (min) 15	

Splits and Phases: 1: Lyon & James

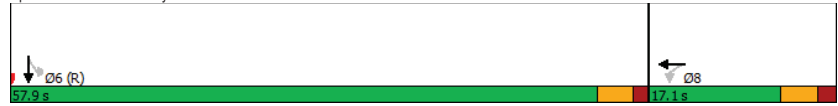

Lanes, Volumes, Timings
2: Gladstone & Lyon

2030 Future Total
PM Peak Hour

Lane Group	EBL	EBT	EBR	WBL	WBT	WBR	NBL	NBT	NBR	SBL	SBT	SBR
Lane Configurations		↔			↔						↔↔	
Traffic Volume (vph)	0	248	27	13	316	0	0	0	0	86	313	138
Future Volume (vph)	0	248	27	13	316	0	0	0	0	86	313	138
Satd. Flow (prot)	0	1707	0	0	1742	0	0	0	0	0	3101	0
Fit Permitted					0.985						0.992	
Satd. Flow (perm)	0	1707	0	0	1716	0	0	0	0	0	3083	0
Satd. Flow (RTOR)		10									77	
Lane Group Flow (vph)	0	275	0	0	329	0	0	0	0	0	537	0
Turn Type		NA		Perm	NA					Perm	NA	
Protected Phases		2			6						8	
Permitted Phases				6						8		
Detector Phase		2		6	6					8	8	
Switch Phase												
Minimum Initial (s)		10.0		10.0	10.0					10.0	10.0	
Minimum Split (s)		23.2		23.6	23.6					23.6	23.6	
Total Split (s)		39.0		39.0	39.0					36.0	36.0	
Total Split (%)		52.0%		52.0%	52.0%					48.0%	48.0%	
Yellow Time (s)		3.3		3.3	3.3					3.3	3.3	
All-Red Time (s)		1.9		1.9	1.9					2.3	2.3	
Lost Time Adjust (s)		0.0		0.0	0.0					0.0	0.0	
Total Lost Time (s)		5.2		5.2	5.2					5.6	5.6	
Lead/Lag												
Lead-Lag Optimize?												
Recall Mode		C-Max		Max	Max					Max	Max	
Act Effct Green (s)		33.8			33.8						30.4	
Actuated g/C Ratio		0.45			0.45						0.41	
v/c Ratio		0.36			0.43						0.41	
Control Delay		14.6			13.1						12.0	
Queue Delay		0.0			0.0						0.0	
Total Delay		14.6			13.1						12.0	
LOS		B			B						B	
Approach Delay		14.6			13.1						12.0	
Approach LOS		B			B						B	
Queue Length 50th (m)		24.6			15.8						11.0	
Queue Length 95th (m)		42.1			41.9						21.6	
Internal Link Dist (m)		109.1			166.3			55.5			139.6	
Turn Bay Length (m)												
Base Capacity (vph)		774			773						1295	
Starvation Cap Reductn		0			0						0	
Spillback Cap Reductn		0			0						0	
Storage Cap Reductn		0			0						0	
Reduced v/c Ratio		0.36			0.43						0.41	

Intersection Summary	
Cycle Length:	75
Actuated Cycle Length:	75
Offset:	45 (60%), Referenced to phase 2:EBT, Start of Green
Natural Cycle:	50
Control Type:	Actuated-Coordinated

Lanes, Volumes, Timings
2: Gladstone & Lyon

2030 Future Total
PM Peak Hour

Maximum v/c Ratio: 0.43	Intersection LOS: B
Intersection Signal Delay: 12.9	ICU Level of Service B
Intersection Capacity Utilization 57.9%	
Analysis Period (min) 15	

Splits and Phases: 2: Gladstone & Lyon

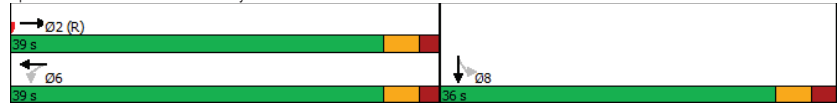

Lanes, Volumes, Timings
3: Kent & Somerset

2030 Future Total
PM Peak Hour

Lane Group	EBL	EBT	EBR	WBL	WBT	WBR	NBL	NBT	NBR	SBL	SBT	SBR
Lane Configurations	↔	↕			↔		↔	↕	↔			
Traffic Volume (vph)	58	252	0	0	215	65	79	706	106	0	0	0
Future Volume (vph)	58	252	0	0	215	65	79	706	106	0	0	0
Satd. Flow (prot)	1658	1745	0	0	1587	0	1658	4322	0	0	0	0
Fit Permitted	0.449						0.950					
Satd. Flow (perm)	673	1745	0	0	1587	0	1028	4322	0	0	0	0
Satd. Flow (RTOR)							43					
Lane Group Flow (vph)	58	252	0	0	280	0	79	812	0	0	0	0
Turn Type	Perm	NA			NA		Perm	NA				
Protected Phases		4			8			2				
Permitted Phases	4						2					
Detector Phase	4	4			8		2	2				
Switch Phase												
Minimum Initial (s)	10.0	10.0			10.0		10.0	10.0				
Minimum Split (s)	21.5	21.5			21.5		21.4	21.4				
Total Split (s)	41.0	41.0			41.0		34.0	34.0				
Total Split (%)	54.7%	54.7%			54.7%		45.3%	45.3%				
Yellow Time (s)	3.3	3.3			3.3		3.3	3.3				
All-Red Time (s)	2.2	2.2			2.2		2.1	2.1				
Lost Time Adjust (s)	0.0	0.0			0.0		0.0	0.0				
Total Lost Time (s)	5.5	5.5			5.5		5.4	5.4				
Lead/Lag												
Lead-Lag Optimize?												
Recall Mode	None	None			None		C-Max	C-Max				
Act Effct Green (s)	19.8	19.8			19.8		44.3	44.3				
Actuated g/C Ratio	0.26	0.26			0.26		0.59	0.59				
v/c Ratio	0.33	0.55			0.67		0.13	0.32				
Control Delay	26.1	27.7			32.1		9.3	9.6				
Queue Delay	0.0	0.0			0.0		0.0	0.0				
Total Delay	26.1	27.7			32.1		9.3	9.6				
LOS	C	C			C		A	A				
Approach Delay		27.4			32.1			9.6				
Approach LOS		C			C			A				
Queue Length 50th (m)	7.1	33.0			43.0		4.8	17.5				
Queue Length 95th (m)	15.4	47.5			57.7		10.4	23.3				
Internal Link Dist (m)		61.7			174.8			152.2			110.1	
Turn Bay Length (m)	25.0						40.0					
Base Capacity (vph)	318	825			751		607	2570				
Starvation Cap Reductn	0	0			0		0	0				
Spillback Cap Reductn	0	0			0		0	0				
Storage Cap Reductn	0	0			0		0	0				
Reduced v/c Ratio	0.18	0.31			0.37		0.13	0.32				

Intersection Summary												
Cycle Length: 75												
Actuated Cycle Length: 75												
Offset: 50 (67%), Referenced to phase 2:NBTL and 6., Start of Green												
Natural Cycle: 45												
Control Type: Actuated-Coordinated												

Lanes, Volumes, Timings
3: Kent & Somerset

2030 Future Total
PM Peak Hour

Maximum v/c Ratio: 0.67	Intersection LOS: B
Intersection Signal Delay: 17.6	ICU Level of Service B
Intersection Capacity Utilization 57.7%	
Analysis Period (min) 15	

Splits and Phases: 3: Kent & Somerset

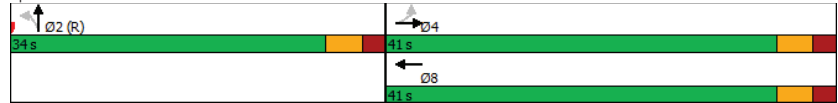

Lanes, Volumes, Timings
4: Kent & Gilmour

2030 Future Total
PM Peak Hour

Lane Group	EBL	EBT	EBR	WBL	WBT	WBR	NBL	NBT	NBR	SBL	SBT	SBR
Lane Configurations		↕						↕↕↕				
Traffic Volume (vph)	19	93	0	0	0	0	0	848	79	0	0	0
Future Volume (vph)	19	93	0	0	0	0	0	848	79	0	0	0
Satd. Flow (prot)	0	1717	0	0	0	0	0	4598	0	0	0	0
Fit Permitted		0.992										
Satd. Flow (perm)	0	1690	0	0	0	0	0	4598	0	0	0	0
Satd. Flow (RTOR)								40				
Lane Group Flow (vph)	0	112	0	0	0	0	0	927	0	0	0	0
Turn Type	Perm	NA						NA				
Protected Phases		4						2				
Permitted Phases	4											
Detector Phase	4	4						2				
Switch Phase												
Minimum Initial (s)	10.0	10.0						10.0				
Minimum Split (s)	21.5	21.5						35.1				
Total Split (s)	22.0	22.0						53.0				
Total Split (%)	29.3%	29.3%						70.7%				
Yellow Time (s)	3.3	3.3						3.3				
All-Red Time (s)	2.2	2.2						1.8				
Lost Time Adjust (s)		0.0						0.0				
Total Lost Time (s)		5.5						5.1				
Lead/Lag												
Lead-Lag Optimize?												
Recall Mode	None	None						C-Max				
Act Effct Green (s)		13.6						54.9				
Actuated g/C Ratio		0.18						0.73				
v/c Ratio		0.37						0.27				
Control Delay		29.7						3.4				
Queue Delay		0.0						0.0				
Total Delay		29.7						3.4				
LOS		C						A				
Approach Delay		29.7						3.4				
Approach LOS		C						A				
Queue Length 50th (m)		14.1						11.6				
Queue Length 95th (m)		28.3						14.6				
Internal Link Dist (m)		69.3				21.3		57.8			152.2	
Turn Bay Length (m)												
Base Capacity (vph)		371						3377				
Starvation Cap Reductn		0						0				
Spillback Cap Reductn		0						0				
Storage Cap Reductn		0						0				
Reduced v/c Ratio		0.30						0.27				

Intersection Summary

Cycle Length: 75
Actuated Cycle Length: 75
Offset: 0 (0%), Referenced to phase 2:NBT and 6:, Start of Green
Natural Cycle: 60
Control Type: Actuated-Coordinated

Lanes, Volumes, Timings
4: Kent & Gilmour

2030 Future Total
PM Peak Hour

Maximum v/c Ratio: 0.37	Intersection LOS: A
Intersection Signal Delay: 6.2	ICU Level of Service A
Intersection Capacity Utilization 47.1%	
Analysis Period (min) 15	

Splits and Phases: 4: Kent & Gilmour



HCM 2010 TWSC
5: Kent & James

2030 Future Total
PM Peak Hour

Intersection												
Int Delay, s/veh 2												
Movement	EBL	EBT	EBR	WBL	WBT	WBR	NBL	NBT	NBR	SBL	SBT	SBR
Lane Configurations												
Traffic Vol, veh/h	0	0	0	0	35	58	50	869	0	0	0	0
Future Vol, veh/h	0	0	0	0	35	58	50	869	0	0	0	0
Conflicting Peds, #/hr	25	0	17	17	0	25	95	0	63	63	0	95
Sign Control	Free	Free	Free	Stop	Stop	Stop	Free	Free	Free	Free	Free	Free
RT Channelized	-	-	None	-	-	None	-	-	None	-	-	None
Storage Length	-	-	-	-	-	-	-	-	-	-	-	-
Veh in Median Storage, #	2293760	-	-	-	0	-	-	0	-	-	-	-
Grade, %	-	0	-	-	0	-	-	0	-	-	0	-
Peak Hour Factor	100	100	100	100	100	100	100	100	100	100	100	100
Heavy Vehicles, %	2	2	2	2	2	2	2	2	2	2	2	2
Mvmt Flow	0	0	0	0	35	58	50	869	0	0	0	0

Major/Minor	Minor1	Major1
Conflicting Flow All	- 1064	460 95 0 -
Stage 1	- 969	- - - -
Stage 2	- 95	- - - -
Critical Hdwy	- 6.54	7.14 5.34 - -
Critical Hdwy Stg 1	- 5.54	- - - -
Critical Hdwy Stg 2	- -	- - - -
Follow-up Hdwy	- 4.02	3.92 3.12 - -
Pot Cap-1 Maneuver	0 221	469 1044 - 0
Stage 1	0 330	- - - 0
Stage 2	0 -	- - - 0
Platoon blocked, %	-	-
Mov Cap-1 Maneuver	- 0	469 1044 - -
Mov Cap-2 Maneuver	- 0	- - - -
Stage 1	- 0	- - - -
Stage 2	- 0	- - - -

Approach	WB	NB
HCM Control Delay, s	14.6	0.7
HCM LOS	B	

Minor Lane/Major Mvmt	NBL	NBTWBLn1
Capacity (veh/h)	1044	- 469
HCM Lane V/C Ratio	0.048	- 0.198
HCM Control Delay (s)	8.6	0.2 14.6
HCM Lane LOS	A	A B
HCM 95th %tile Q(veh)	0.2	- 0.7

Lanes, Volumes, Timings
6: Kent & Gladstone

2030 Future Total
PM Peak Hour

Lane Group	EBL	EBT	EBR	WBL	WBT	WBR	NBL	NBT	NBR	SBL	SBT	SBR
Lane Configurations	↖	↗	↘	↙	↖	↗	↘	↙	↘	↙	↘	↙
Traffic Volume (vph)	76	250	0	0	246	82	52	746	101	0	0	0
Future Volume (vph)	76	250	0	0	246	82	52	746	101	0	0	0
Satd. Flow (prot)	1658	1728	0	0	1650	0	1658	4555	0	0	0	0
Fit Permitted	0.365						0.950					
Satd. Flow (perm)	613	1728	0	0	1650	0	1471	4555	0	0	0	0
Satd. Flow (RTOR)					34		35					
Lane Group Flow (vph)	76	250	0	0	328	0	52	847	0	0	0	0
Turn Type	Perm	NA			NA		Perm	NA				
Protected Phases	4				8		2					
Permitted Phases	4						2					
Detector Phase	4	4			8		2	2				
Switch Phase												
Minimum Initial (s)	10.0	10.0			10.0		10.0	10.0				
Minimum Split (s)	21.4	21.4			20.4		21.4	21.4				
Total Split (s)	45.0	45.0			45.0		30.0	30.0				
Total Split (%)	60.0%	60.0%			60.0%		40.0%	40.0%				
Yellow Time (s)	3.3	3.3			3.3		3.3	3.3				
All-Red Time (s)	2.1	2.1			2.1		2.1	2.1				
Lost Time Adjust (s)	0.0	0.0			0.0		0.0	0.0				
Total Lost Time (s)	5.4	5.4			5.4		5.4	5.4				
Lead/Lag												
Lead-Lag Optimize?												
Recall Mode	None	None			None		C-Max	C-Max				
Act Effct Green (s)	19.7	19.7			19.7		44.5	44.5				
Actuated g/C Ratio	0.26	0.26			0.26		0.59	0.59				
v/c Ratio	0.47	0.55			0.72		0.06	0.31				
Control Delay	23.1	19.4			35.3		8.8	8.6				
Queue Delay	0.0	0.0			0.0		0.0	0.0				
Total Delay	23.1	19.4			35.3		8.8	8.6				
LOS	C	B			D		A	A				
Approach Delay	20.2				35.3		8.6					
Approach LOS	C				D		A					
Queue Length 50th (m)	5.8	18.9			45.8		2.9	19.6				
Queue Length 95th (m)	9.8	23.9			72.2		9.6	35.3				
Internal Link Dist (m)	166.3				173.9		90.5				139.7	
Turn Bay Length (m)	30.0						40.0					
Base Capacity (vph)	323		912		887		873		2719			
Starvation Cap Reductn	0	0			0		0	0				
Spillback Cap Reductn	0	0			0		0	0				
Storage Cap Reductn	0	0			0		0	0				
Reduced v/c Ratio	0.24	0.27			0.37		0.06	0.31				

Intersection Summary												
Cycle Length: 75												
Actuated Cycle Length: 75												
Offset: 23 (31%), Referenced to phase 2:NBTL and 6:, Start of Green												
Natural Cycle: 45												
Control Type: Actuated-Coordinated												

Lanes, Volumes, Timings
6: Kent & Gladstone

2030 Future Total
PM Peak Hour

Maximum v/c Ratio: 0.72	Intersection LOS: B
Intersection Signal Delay: 16.7	ICU Level of Service B
Intersection Capacity Utilization 59.7%	
Analysis Period (min) 15	

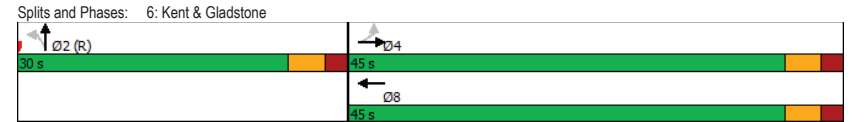

Lanes, Volumes, Timings
7: Bank & Somerset

2030 Future Total
PM Peak Hour

Lane Group	EBL	EBT	EBR	WBL	WBT	WBR	NBL	NBT	NBR	SBL	SBT	SBR
Lane Configurations		↕	↕	↕	↕			↕			↕	
Traffic Volume (vph)	44	187	79	33	135	24	25	183	41	5	261	51
Future Volume (vph)	44	187	79	33	135	24	25	183	41	5	261	51
Satd. Flow (prot)	0	1704	1483	1658	1590	0	0	1492	0	0	1480	0
Fit Permitted		0.908		0.515				0.953			0.996	
Satd. Flow (perm)	0	1457	723	601	1590	0	0	1383	0	0	1467	0
Satd. Flow (RTOR)												
Lane Group Flow (vph)	0	231	79	33	159	0	0	249	0	0	317	0
Turn Type	Perm	NA	Perm	Perm	NA		Perm	NA		Perm	NA	
Protected Phases		4			8			2			6	
Permitted Phases	4		4	8			2			6		
Detector Phase	4	4	4	8	8		2	2		6	6	
Switch Phase												
Minimum Initial (s)	10.0	10.0	10.0	10.0	10.0		10.0	10.0		10.0	10.0	
Minimum Split (s)	20.5	20.5	20.5	20.5	20.5		20.5	20.5		20.5	20.5	
Total Split (s)	25.0	25.0	25.0	25.0	25.0		40.0	40.0		40.0	40.0	
Total Split (%)	33.3%	33.3%	33.3%	33.3%	33.3%		53.3%	53.3%		53.3%	53.3%	
Yellow Time (s)	3.3	3.3	3.3	3.3	3.3		3.3	3.3		3.3	3.3	
All-Red Time (s)	2.2	2.2	2.2	2.2	2.2		2.2	2.2		2.2	2.2	
Lost Time Adjust (s)		0.0	0.0	0.0	0.0			0.0			0.0	
Total Lost Time (s)		5.5	5.5	5.5	5.5			5.5			5.5	
Lead/Lag	Lag	Lag	Lag	Lag	Lag		Lag	Lag		Lag	Lag	
Lead-Lag Optimize?	Yes	Yes	Yes	Yes	Yes		Yes	Yes		Yes	Yes	
Recall Mode	None	None	None	None	None		C-Max	C-Max		C-Max	C-Max	
Act Effct Green (s)		17.9	17.9	17.9	17.9			46.1			46.1	
Actuated g/C Ratio		0.24	0.24	0.24	0.24			0.61			0.61	
v/c Ratio		0.66	0.46	0.23	0.42			0.29			0.35	
Control Delay		28.6	25.9	25.8	26.9			3.3			9.2	
Queue Delay		0.0	0.0	0.0	0.0			0.2			0.0	
Total Delay		28.6	25.9	25.8	26.9			3.5			9.2	
LOS		C	C	C	C			A			A	
Approach Delay		27.9			26.7			3.5			9.2	
Approach LOS		C			C			A			A	
Queue Length 50th (m)		32.1	10.0	4.1	20.5			6.1			19.7	
Queue Length 95th (m)		46.3	20.5	10.5	33.6			8.5			43.1	
Internal Link Dist (m)		174.8			68.0			65.6			106.3	
Turn Bay Length (m)			28.0	15.0								
Base Capacity (vph)		392	194	162	429			849			901	
Starvation Cap Reductn		0	0	0	0			191			0	
Spillback Cap Reductn		0	0	0	0			0			0	
Storage Cap Reductn		0	0	0	0			0			0	
Reduced v/c Ratio		0.59	0.41	0.20	0.37			0.38			0.35	

Intersection Summary
 Cycle Length: 75
 Actuated Cycle Length: 75
 Offset: 7 (9%), Referenced to phase 2:NBTL and 6:SBLT, Start of Green
 Natural Cycle: 55
 Control Type: Actuated-Coordinated

Lanes, Volumes, Timings
7: Bank & Somerset

2030 Future Total
PM Peak Hour

Lane Group	Ø1	Ø3	Ø5	Ø7
Lane Configurations				
Traffic Volume (vph)				
Future Volume (vph)				
Satd. Flow (prot)				
Fit Permitted				
Satd. Flow (perm)				
Satd. Flow (RTOR)				
Lane Group Flow (vph)				
Turn Type				
Protected Phases	1	3	5	7
Permitted Phases				
Detector Phase				
Switch Phase				
Minimum Initial (s)	1.0	1.0	1.0	1.0
Minimum Split (s)	3.0	3.0	3.0	3.0
Total Split (s)	5.0	5.0	5.0	5.0
Total Split (%)	7%	7%	7%	7%
Yellow Time (s)	2.0	2.0	2.0	2.0
All-Red Time (s)	0.0	0.0	0.0	0.0
Lost Time Adjust (s)				
Total Lost Time (s)				
Lead/Lag	Lead	Lead	Lead	Lead
Lead-Lag Optimize?	Yes	Yes	Yes	Yes
Recall Mode	None	None	None	None
Act Effct Green (s)				
Actuated g/C Ratio				
v/c Ratio				
Control Delay				
Queue Delay				
Total Delay				
LOS				
Approach Delay				
Approach LOS				
Queue Length 50th (m)				
Queue Length 95th (m)				
Internal Link Dist (m)				
Turn Bay Length (m)				
Base Capacity (vph)				
Starvation Cap Reductn				
Spillback Cap Reductn				
Storage Cap Reductn				
Reduced v/c Ratio				

Intersection Summary

Lanes, Volumes, Timings
7: Bank & Somerset

2030 Future Total
PM Peak Hour

Maximum v/c Ratio: 0.66	Intersection LOS: B
Intersection Signal Delay: 16.5	ICU Level of Service C
Intersection Capacity Utilization 69.2%	
Analysis Period (min) 15	

Splits and Phases: 7: Bank & Somerset

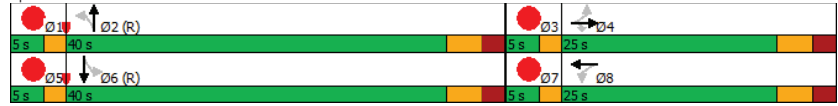

Lanes, Volumes, Timings
8: Bank & MacLaren

2030 Future Total
PM Peak Hour

Lane Group	EBL	EBT	EBR	WBL	WBT	WBR	NBL	NBT	NBR	SBL	SBT	SBR
Lane Configurations					↔			↔				↔
Traffic Volume (vph)	0	0	0	35	11	10	25	243	0	0	342	26
Future Volume (vph)	0	0	0	35	11	10	25	243	0	0	342	26
Satd. Flow (prot)	0	0	0	0	1570	0	0	1674	0	0	1624	0
Fit Permitted					0.970			0.954				
Satd. Flow (perm)	0	0	0	0	1400	0	0	1546	0	0	1624	0
Satd. Flow (RTOR)					10						9	
Lane Group Flow (vph)	0	0	0	0	56	0	0	268	0	0	368	0
Turn Type				Perm	NA		Perm	NA			NA	
Protected Phases					8			2			6	
Permitted Phases					8			2				
Detector Phase					8	8		2	2			6
Switch Phase												
Minimum Initial (s)				10.0	10.0		10.0	10.0			10.0	
Minimum Split (s)				24.2	24.2		18.0	18.0			18.0	
Total Split (s)				24.2	24.2		50.8	50.8			50.8	
Total Split (%)				32.3%	32.3%		67.7%	67.7%			67.7%	
Yellow Time (s)				3.3	3.3		3.3	3.3			3.3	
All-Red Time (s)				1.9	1.9		1.7	1.7			1.7	
Lost Time Adjust (s)					0.0			0.0			0.0	
Total Lost Time (s)					5.2			5.0			5.0	
Lead/Lag												
Lead-Lag Optimize?												
Recall Mode				None	None		C-Max	C-Max			C-Max	
Act Effct Green (s)					17.2			51.6			51.6	
Actuated g/C Ratio					0.23			0.69			0.69	
v/c Ratio					0.17			0.25			0.33	
Control Delay					20.3			5.2			10.5	
Queue Delay					0.0			0.2			0.4	
Total Delay					20.3			5.3			10.9	
LOS					C			A			B	
Approach Delay					20.3			5.3			10.9	
Approach LOS					C			A			B	
Queue Length 50th (m)					5.3			9.6			40.5	
Queue Length 95th (m)					14.2			10.6			26.1	
Internal Link Dist (m)					130.7			60.9			65.6	
Turn Bay Length (m)												
Base Capacity (vph)					362			1064			1121	
Starvation Cap Reductn					0			279			343	
Spillback Cap Reductn					0			0			0	
Storage Cap Reductn					0			0			0	
Reduced v/c Ratio					0.15			0.34			0.47	

Intersection Summary												
Cycle Length: 75												
Actuated Cycle Length: 75												
Offset: 7 (9%), Referenced to phase 2:NBTL and 6:SBT, Start of Green												
Natural Cycle: 45												
Control Type: Actuated-Coordinated												

Lanes, Volumes, Timings
8: Bank & MacLaren

2030 Future Total
PM Peak Hour

Maximum v/c Ratio: 0.33	Intersection LOS: A
Intersection Signal Delay: 9.5	ICU Level of Service B
Intersection Capacity Utilization 59.7%	
Analysis Period (min) 15	

Splits and Phases: 8: Bank & MacLaren

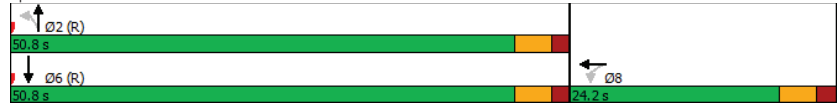

Lanes, Volumes, Timings
9: Bank & Gilmour

2030 Future Total
PM Peak Hour

Lane Group	EBL	EBT	EBR	WBL	WBT	WBR	NBL	NBT	NBR	SBL	SBT	SBR
Lane Configurations		↕						↕				↕
Traffic Volume (vph)	8	70	45	0	0	0	0	263	38	30	342	0
Future Volume (vph)	8	70	45	0	0	0	0	263	38	30	342	0
Satd. Flow (prot)	0	1502	0	0	0	0	0	1549	0	0	1707	0
Fit Permitted		0.997									0.962	
Satd. Flow (perm)	0	1478	0	0	0	0	0	1549	0	0	1600	0
Satd. Flow (RTOR)		38						17				
Lane Group Flow (vph)	0	123	0	0	0	0	0	301	0	0	372	0
Turn Type	Perm	NA						NA	Perm	NA		
Protected Phases		4						2			6	
Permitted Phases	4									6		
Detector Phase	4	4						2		6	6	
Switch Phase												
Minimum Initial (s)	10.0	10.0						10.0		10.0	10.0	
Minimum Split (s)	23.2	23.2						20.1		20.1	20.1	
Total Split (s)	25.0	25.0						50.0		50.0	50.0	
Total Split (%)	33.3%	33.3%						66.7%		66.7%	66.7%	
Yellow Time (s)	3.3	3.3						3.3		3.3	3.3	
All-Red Time (s)	1.9	1.9						1.8		1.8	1.8	
Lost Time Adjust (s)		0.0						0.0		0.0	0.0	
Total Lost Time (s)		5.2						5.1		5.1	5.1	
Lead/Lag												
Lead-Lag Optimize?												
Recall Mode	None	None						C-Max		C-Max	C-Max	
Act Effct Green (s)		16.4						48.3			48.3	
Actuated g/C Ratio		0.22						0.64			0.64	
v/c Ratio		0.35						0.30			0.36	
Control Delay		19.8						11.3			2.8	
Queue Delay		0.0						0.0			0.2	
Total Delay		19.8						11.3			3.1	
LOS		B						B			A	
Approach Delay		19.8						11.3			3.1	
Approach LOS		B						B			A	
Queue Length 50th (m)		10.2						22.2			6.6	
Queue Length 95th (m)		24.3						41.1			9.9	
Internal Link Dist (m)		129.1				69.2		57.1			60.9	
Turn Bay Length (m)												
Base Capacity (vph)		418						1003			1030	
Starvation Cap Reductn		0						0			205	
Spillback Cap Reductn		0						0			0	
Storage Cap Reductn		0						0			0	
Reduced v/c Ratio		0.29						0.30			0.45	

Intersection Summary		
Cycle Length:	75	
Actuated Cycle Length:	75	
Offset:	6 (8%), Referenced to phase 2:NBT and 6:SBTL, Start of Green	
Natural Cycle:	45	
Control Type:	Actuated-Coordinated	

Lanes, Volumes, Timings
9: Bank & Gilmour

2030 Future Total
PM Peak Hour

Maximum v/c Ratio: 0.36	Intersection LOS: A
Intersection Signal Delay: 8.8	ICU Level of Service C
Intersection Capacity Utilization 68.0%	
Analysis Period (min) 15	

Splits and Phases: 9: Bank & Gilmour



Lanes, Volumes, Timings
10: Bank & James

2030 Future Total
PM Peak Hour

Lane Group	EBL	EBR	NBL	NBT	SBT	SBR
Lane Configurations				↕	↕	
Traffic Volume (vph)	0	0	61	302	341	51
Future Volume (vph)	0	0	61	302	341	51
Satd. Flow (prot)	0	0	0	1703	1685	0
Fit Permitted				0.992		
Satd. Flow (perm)	0	0	0	1703	1685	0
Lane Group Flow (vph)	0	0	0	363	392	0
Sign Control	Stop			Free	Free	

Intersection Summary						
Control Type: Unsignalized						
Intersection Capacity Utilization 65.4%				ICU Level of Service C		
Analysis Period (min) 15						

Lanes, Volumes, Timings
11: Bank & Gladstone

2030 Future Total
PM Peak Hour

Lane Group	EBL	EBT	EBR	WBL	WBT	WBR	NBL	NBT	NBR	SBL	SBT	SBR
Lane Configurations	↔		↔		↔		↔		↔		↔	
Traffic Volume (vph)	49	185	79	41	138	28	90	276	87	15	346	41
Future Volume (vph)	49	185	79	41	138	28	90	276	87	15	346	41
Satd. Flow (prot)	0	2944	0	0	1642	0	1658	1511	0	0	3056	0
Fit Permitted	0.856		0.866		0.511		0.937					
Satd. Flow (perm)	0	2485	0	0	1388	0	690	1511	0	0	2851	0
Satd. Flow (RTOR)												
Lane Group Flow (vph)	0	313	0	0	207	0	90	363	0	0	402	0
Turn Type	Perm	NA	Perm	NA	Perm	NA	Perm	NA	Perm	NA	Perm	NA
Protected Phases	4		8		2		6		6		6	
Permitted Phases	4		8		2		6		6		6	
Detector Phase	4		8		2		6		6		6	
Switch Phase												
Minimum Initial (s)	10.0	10.0	10.0	10.0	10.0	10.0	10.0	10.0	10.0	10.0	10.0	10.0
Minimum Split (s)	20.5	20.5	20.5	20.5	20.5	20.5	20.5	20.5	20.5	20.5	20.5	20.5
Total Split (s)	28.0	28.0	28.0	28.0	37.0	37.0	37.0	37.0	37.0	37.0	37.0	37.0
Total Split (%)	37.3%	37.3%	37.3%	37.3%	49.3%	49.3%	49.3%	49.3%	49.3%	49.3%	49.3%	49.3%
Yellow Time (s)	3.3	3.3	3.3	3.3	3.3	3.3	3.3	3.3	3.3	3.3	3.3	3.3
All-Red Time (s)	2.2	2.2	2.2	2.2	2.2	2.2	2.2	2.2	2.2	2.2	2.2	2.2
Lost Time Adjust (s)	0.0		0.0		0.0		0.0		0.0		0.0	
Total Lost Time (s)	5.5		5.5		5.5		5.5		5.5		5.5	
Lead/Lag	Lag	Lag	Lag	Lag	Lag	Lag	Lag	Lag	Lag	Lag	Lag	Lag
Lead-Lag Optimize?	Yes	Yes	Yes	Yes	Yes	Yes	Yes	Yes	Yes	Yes	Yes	Yes
Recall Mode	None	None	None	None	C-Max	C-Max	C-Max	C-Max	C-Max	C-Max	C-Max	C-Max
Act Effct Green (s)	17.5		17.5		31.5		31.5		31.5		31.5	
Actuated g/C Ratio	0.23		0.23		0.42		0.42		0.42		0.42	
v/c Ratio	0.54		0.64		0.31		0.57		0.34		0.34	
Control Delay	15.9		35.0		18.3		21.0		8.7		8.7	
Queue Delay	0.0		0.0		0.0		0.0		0.0		0.0	
Total Delay	15.9		35.0		18.3		21.0		8.7		8.7	
LOS	B		D		B		C		A		A	
Approach Delay	15.9		35.0		20.5		8.7		8.7		8.7	
Approach LOS	B		D		C		A		A		A	
Queue Length 50th (m)	8.3		28.6		8.6		39.8		10.5		10.5	
Queue Length 95th (m)	13.0		45.5		20.0		66.5		16.8		16.8	
Internal Link Dist (m)	173.9		70.9		108.7		139.2		139.2		139.2	
Turn Bay Length (m)												
Base Capacity (vph)	745		416		289		634		1197		1197	
Starvation Cap Reductn	0		0		0		0		0		0	
Spillback Cap Reductn	0		0		0		0		0		0	
Storage Cap Reductn	0		0		0		0		0		0	
Reduced v/c Ratio	0.42		0.50		0.31		0.57		0.34		0.34	

Intersection Summary
 Cycle Length: 75
 Actuated Cycle Length: 75
 Offset: 26 (35%), Referenced to phase 2:NBTL and 6:SBTL, Start of Green
 Natural Cycle: 55
 Control Type: Actuated-Coordinated

Lanes, Volumes, Timings
11: Bank & Gladstone

2030 Future Total
PM Peak Hour

Lane Group	Ø1	Ø3	Ø5	Ø7
Lane Configurations				
Traffic Volume (vph)				
Future Volume (vph)				
Satd. Flow (prot)				
Fit Permitted				
Satd. Flow (perm)				
Satd. Flow (RTOR)				
Lane Group Flow (vph)				
Turn Type				
Protected Phases	1	3	5	7
Permitted Phases				
Detector Phase				
Switch Phase				
Minimum Initial (s)	1.0	1.0	1.0	1.0
Minimum Split (s)	3.0	3.0	3.0	3.0
Total Split (s)	5.0	5.0	5.0	5.0
Total Split (%)	7%	7%	7%	7%
Yellow Time (s)	2.0	2.0	2.0	2.0
All-Red Time (s)	0.0	0.0	0.0	0.0
Lost Time Adjust (s)				
Total Lost Time (s)				
Lead/Lag	Lead	Lead	Lead	Lead
Lead-Lag Optimize?	Yes	Yes	Yes	Yes
Recall Mode	Max	Max	Max	Max
Act Effct Green (s)				
Actuated g/C Ratio				
v/c Ratio				
Control Delay				
Queue Delay				
Total Delay				
LOS				
Approach Delay				
Approach LOS				
Queue Length 50th (m)				
Queue Length 95th (m)				
Internal Link Dist (m)				
Turn Bay Length (m)				
Base Capacity (vph)				
Starvation Cap Reductn				
Spillback Cap Reductn				
Storage Cap Reductn				
Reduced v/c Ratio				

Intersection Summary

Lanes, Volumes, Timings
11: Bank & Gladstone

2030 Future Total
PM Peak Hour

Maximum v/c Ratio: 0.64	Intersection LOS: B
Intersection Signal Delay: 18.2	ICU Level of Service D
Intersection Capacity Utilization 79.1%	
Analysis Period (min) 15	

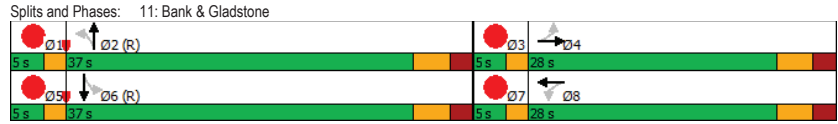

HCM 2010 AWSC
12: Access & Gilmour

2030 Future Total
PM Peak Hour

Intersection	
Intersection Delay, s/veh	7.2
Intersection LOS	A

Movement	EBT	EBR	WBL	WBT	NBL	NBR
Lane Configurations	↔					↔
Traffic Vol, veh/h	84	30	0	0	0	22
Future Vol, veh/h	84	30	0	0	0	22
Peak Hour Factor	1.00	1.00	1.00	1.00	1.00	1.00
Heavy Vehicles, %	2	2	2	2	2	2
Mvmt Flow	84	30	0	0	0	22
Number of Lanes	1	0	0	0	0	1

Approach	EB	NB
Opposing Approach		
Opposing Lanes	0	0
Conflicting Approach Left		EB
Conflicting Lanes Left	0	1
Conflicting Approach Right	NB	
Conflicting Lanes Right	1	0
HCM Control Delay	7.3	6.7
HCM LOS	A	A

Lane	NBLn1	EBLn1
Vol Left, %	0%	0%
Vol Thru, %	0%	74%
Vol Right, %	100%	26%
Sign Control	Stop	Stop
Traffic Vol by Lane	22	114
LT Vol	0	0
Through Vol	0	84
RT Vol	22	30
Lane Flow Rate	22	114
Geometry Grp	1	1
Degree of Util (X)	0.022	0.121
Departure Headway (Hd)	3.532	3.815
Convergence, Y/N	Yes	Yes
Cap	1008	944
Service Time	1.571	1.819
HCM Lane V/C Ratio	0.022	0.121
HCM Control Delay	6.7	7.3
HCM Lane LOS	A	A
HCM 95th-tile Q	0.1	0.4

Appendix J

Synchro Intersection Worksheets – 2035 Future Total Conditions

DRAFT

Lanes, Volumes, Timings
1: Lyon & James

2035 Future Total
AM Peak Hour

Lane Group	EBL	EBT	EBR	WBL	WBT	WBR	NBL	NBT	NBR	SBL	SBT	SBR
Lane Configurations					↕						↕↕	
Traffic Volume (vph)	0	0	0	34	21	0	0	0	0	0	409	25
Future Volume (vph)	0	0	0	34	21	0	0	0	0	0	409	25
Satd. Flow (prot)	0	0	0	0	1628	0	0	0	0	0	3229	0
Fit Permitted					0.970							
Satd. Flow (perm)	0	0	0	0	1600	0	0	0	0	0	3229	0
Satd. Flow (RTOR)											20	
Lane Group Flow (vph)	0	0	0	0	55	0	0	0	0	0	434	0
Turn Type				Perm	NA						NA	
Protected Phases					8						6	
Permitted Phases					8						6	
Detector Phase					8	8					6	6
Switch Phase												
Minimum Initial (s)				10.0	10.0					10.0	10.0	
Minimum Split (s)				17.1	17.1					29.7	29.7	
Total Split (s)				17.1	17.1					57.9	57.9	
Total Split (%)				22.8%	22.8%					77.2%	77.2%	
Yellow Time (s)				3.3	3.3					3.3	3.3	
All-Red Time (s)				1.8	1.8					1.4	1.4	
Lost Time Adjust (s)					0.0						0.0	
Total Lost Time (s)					5.1						4.7	
Lead/Lag												
Lead-Lag Optimize?												
Recall Mode				None	None					C-Max	C-Max	
Act Effct Green (s)					10.4						62.7	
Actuated g/C Ratio					0.14						0.84	
v/c Ratio					0.25						0.16	
Control Delay					26.2						2.5	
Queue Delay					0.0						0.0	
Total Delay					26.2						2.5	
LOS					C						A	
Approach Delay					26.2						2.5	
Approach LOS					C						A	
Queue Length 50th (m)					7.5						7.6	
Queue Length 95th (m)					m11.4						13.2	
Internal Link Dist (m)		102.5			161.6				141.5		55.1	
Turn Bay Length (m)												
Base Capacity (vph)					256						2703	
Starvation Cap Reductn					0						0	
Spillback Cap Reductn					0						0	
Storage Cap Reductn					0						0	
Reduced v/c Ratio					0.21						0.16	
Intersection Summary												
Cycle Length: 75												
Actuated Cycle Length: 75												
Offset: 16 (21%), Referenced to phase 2: and 6:SBTL, Start of Green												
Natural Cycle: 50												
Control Type: Actuated-Coordinated												

Lanes, Volumes, Timings
1: Lyon & James

2035 Future Total
AM Peak Hour

Maximum v/c Ratio: 0.25	Intersection Signal Delay: 5.1	Intersection LOS: A
Intersection Capacity Utilization 38.9%	ICU Level of Service A	
Analysis Period (min) 15		
m Volume for 95th percentile queue is metered by upstream signal.		

Splits and Phases: 1: Lyon & James



Lanes, Volumes, Timings
2: Lyon & Gladstone

2035 Future Total
AM Peak Hour

Lane Group	EBL	EBT	EBR	WBL	WBT	WBR	NBL	NBT	NBR	SBL	SBT	SBR
Lane Configurations		↔		↔	↔						↔↔	
Traffic Volume (vph)	0	185	14	5	146	0	0	0	0	87	159	98
Future Volume (vph)	0	185	14	5	146	0	0	0	0	87	159	98
Satd. Flow (prot)	0	1679	0	0	1709	0	0	0	0	0	3072	0
Fit Permitted					0.992						0.988	
Satd. Flow (perm)	0	1679	0	0	1698	0	0	0	0	0	3038	0
Satd. Flow (RTOR)		6									97	
Lane Group Flow (vph)	0	199	0	0	151	0	0	0	0	0	344	0
Turn Type		NA		Perm	NA					Perm	NA	
Protected Phases		2			6						8	
Permitted Phases				6						8		
Detector Phase		2		6	6					8	8	
Switch Phase												
Minimum Initial (s)		10.0		10.0	10.0					10.0	10.0	
Minimum Split (s)		17.2		17.2	17.2					22.6	22.6	
Total Split (s)		38.0		38.0	38.0					37.0	37.0	
Total Split (%)		50.7%		50.7%	50.7%					49.3%	49.3%	
Yellow Time (s)		3.3		3.3	3.3					3.3	3.3	
All-Red Time (s)		1.9		1.9	1.9					2.3	2.3	
Lost Time Adjust (s)		0.0		0.0	0.0					0.0	0.0	
Total Lost Time (s)		5.2		5.2	5.2					5.6	5.6	
Lead/Lag												
Lead-Lag Optimize?												
Recall Mode		C-Max		C-Max	C-Max					Max	Max	
Act Effct Green (s)		32.8		32.8	32.8						31.4	
Actuated g/C Ratio		0.44		0.44	0.44						0.42	
v/c Ratio		0.27		0.20	0.20						0.26	
Control Delay		14.3		8.4	8.4						10.1	
Queue Delay		0.0		0.0	0.0						0.0	
Total Delay		14.3		8.4	8.4						10.1	
LOS		B		A	A						B	
Approach Delay		14.3		8.4	8.4						10.1	
Approach LOS		B		A	A						B	
Queue Length 50th (m)		17.6		5.7	5.7						12.9	
Queue Length 95th (m)		31.7		14.1	14.1						22.1	
Internal Link Dist (m)		110.8		164.9	164.9		56.5				141.5	
Turn Bay Length (m)												
Base Capacity (vph)		737		742	742						1328	
Starvation Cap Reductn		0		0	0						0	
Spillback Cap Reductn		0		0	0						0	
Storage Cap Reductn		0		0	0						0	
Reduced v/c Ratio		0.27		0.20	0.20						0.26	

Intersection Summary	
Cycle Length:	75
Actuated Cycle Length:	75
Offset:	10 (13%), Referenced to phase 2:EBT and 6:WBTL, Start of Green
Natural Cycle:	40
Control Type:	Actuated-Coordinated

Lanes, Volumes, Timings
2: Lyon & Gladstone

2035 Future Total
AM Peak Hour

Maximum v/c Ratio: 0.27	Intersection LOS: B
Intersection Signal Delay: 10.9	ICU Level of Service A
Intersection Capacity Utilization 35.6%	
Analysis Period (min) 15	

Splits and Phases: 2: Lyon & Gladstone

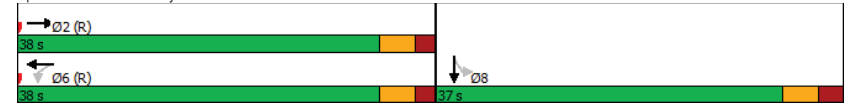

Lanes, Volumes, Timings
3: Kent & Somerset

2035 Future Total
AM Peak Hour

Lane Group	EBL	EBT	EBR	WBL	WBT	WBR	NBL	NBT	NBR	SBL	SBT	SBR
Lane Configurations	↔	↗	↘	↔	↗	↘	↔	↗	↘	↔	↗	↘
Traffic Volume (vph)	63	172	0	0	153	51	78	1555	184	0	0	0
Future Volume (vph)	63	172	0	0	153	51	78	1555	184	0	0	0
Satd. Flow (prot)	1658	1728	0	0	1610	0	1642	4534	0	0	0	0
Fit Permitted	0.549						0.950					
Satd. Flow (perm)	874	1728	0	0	1610	0	1072	4534	0	0	0	0
Satd. Flow (RTOR)							45					
Lane Group Flow (vph)	63	172	0	0	204	0	78	1739	0	0	0	0
Turn Type	Perm	NA			NA		Perm	NA				
Protected Phases		4			8			2				
Permitted Phases	4							2				
Detector Phase	4	4			8			2	2			
Switch Phase												
Minimum Initial (s)	10.0	10.0			10.0		10.0	10.0				
Minimum Split (s)	21.5	21.5			21.5		21.4	21.4				
Total Split (s)	27.0	27.0			27.0		48.0	48.0				
Total Split (%)	36.0%	36.0%			36.0%		64.0%	64.0%				
Yellow Time (s)	3.3	3.3			3.3		3.3	3.3				
All-Red Time (s)	2.2	2.2			2.2		2.1	2.1				
Lost Time Adjust (s)	0.0	0.0			0.0		0.0	0.0				
Total Lost Time (s)	5.5	5.5			5.5		5.4	5.4				
Lead/Lag												
Lead-Lag Optimize?												
Recall Mode	None	None			None		C-Max	C-Max				
Act Effct Green (s)	15.9	15.9			15.9		48.2	48.2				
Actuated g/C Ratio	0.21	0.21			0.21		0.64	0.64				
v/c Ratio	0.34	0.47			0.60		0.11	0.59				
Control Delay	29.2	29.5			27.6		8.7	9.2				
Queue Delay	0.0	0.0			0.0		0.0	0.0				
Total Delay	29.2	29.5			27.6		8.7	9.2				
LOS	C	C			C		A	A				
Approach Delay		29.4			27.6			9.1				
Approach LOS		C			C			A				
Queue Length 50th (m)	8.0	22.5			29.8		1.6	12.3				
Queue Length 95th (m)	17.7	37.5			49.4		m13.1	63.3				
Internal Link Dist (m)		61.7			174.8			152.2			110.1	
Turn Bay Length (m)	25.0						40.0					
Base Capacity (vph)	250	495			461		688	2929				
Starvation Cap Reductn	0	0			0		0	0				
Spillback Cap Reductn	0	0			0		0	0				
Storage Cap Reductn	0	0			0		0	0				
Reduced v/c Ratio	0.25	0.35			0.44		0.11	0.59				

Intersection Summary	
Cycle Length:	75
Actuated Cycle Length:	75
Offset:	66 (88%), Referenced to phase 2:NBTL and 6:, Start of Green
Natural Cycle:	50
Control Type:	Actuated-Coordinated

Lanes, Volumes, Timings
3: Kent & Somerset

2035 Future Total
AM Peak Hour

Maximum v/c Ratio:	0.60
Intersection Signal Delay:	12.9
Intersection Capacity Utilization:	72.1%
Analysis Period (min):	15
Intersection LOS:	B
ICU Level of Service:	C
m Volume for 95th percentile queue is metered by upstream signal.	

Splits and Phases: 3: Kent & Somerset

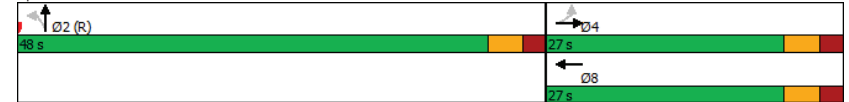

Lanes, Volumes, Timings
4: Kent & Gilmour

2035 Future Total
AM Peak Hour

Lane Group	EBL	EBT	EBR	WBL	WBT	WBR	NBL	NBT	NBR	SBL	SBT	SBR
Lane Configurations		↕						↕↕↕				
Traffic Volume (vph)	17	72	0	0	0	0	0	1816	17	0	0	0
Future Volume (vph)	17	72	0	0	0	0	0	1816	17	0	0	0
Satd. Flow (prot)	0	1729	0	0	0	0	0	4753	0	0	0	0
Fit Permitted		0.991										
Satd. Flow (perm)	0	1714	0	0	0	0	0	4753	0	0	0	0
Satd. Flow (RTOR)								3				
Lane Group Flow (vph)	0	89	0	0	0	0	0	1833	0	0	0	0
Turn Type	Perm	NA						NA				
Protected Phases		4						2				
Permitted Phases	4											
Detector Phase	4	4						2				
Switch Phase												
Minimum Initial (s)	10.0	10.0						10.0				
Minimum Split (s)	21.5	21.5						35.1				
Total Split (s)	22.0	22.0						53.0				
Total Split (%)	29.3%	29.3%						70.7%				
Yellow Time (s)	3.3	3.3						3.3				
All-Red Time (s)	2.2	2.2						1.8				
Lost Time Adjust (s)		0.0						0.0				
Total Lost Time (s)		5.5						5.1				
Lead/Lag												
Lead-Lag Optimize?												
Recall Mode	None	None						C-Max				
Act Effct Green (s)		12.4						56.1				
Actuated g/C Ratio		0.17						0.75				
v/c Ratio		0.31						0.52				
Control Delay		29.7						12.3				
Queue Delay		0.0						0.0				
Total Delay		29.7						12.3				
LOS		C						B				
Approach Delay		29.7						12.3				
Approach LOS		C						B				
Queue Length 50th (m)		12.3						60.1				
Queue Length 95th (m)		23.2						114.5				
Internal Link Dist (m)		69.3			25.1			57.8			152.2	
Turn Bay Length (m)												
Base Capacity (vph)		377						3557				
Starvation Cap Reductn		0						0				
Spillback Cap Reductn		0						0				
Storage Cap Reductn		0						0				
Reduced v/c Ratio		0.24						0.52				
Intersection Summary												
Cycle Length: 75												
Actuated Cycle Length: 75												
Offset: 5 (7%), Referenced to phase 2:NBT and 6:, Start of Green												
Natural Cycle: 60												
Control Type: Actuated-Coordinated												

Lanes, Volumes, Timings
4: Kent & Gilmour

2035 Future Total
AM Peak Hour

Maximum v/c Ratio: 0.52	Intersection LOS: B
Intersection Signal Delay: 13.1	ICU Level of Service B
Intersection Capacity Utilization 59.4%	
Analysis Period (min) 15	

Splits and Phases: 4: Kent & Gilmour



HCM 2010 TWSC
5: Kent & James

2035 Future Total
AM Peak Hour

Intersection													
Int Delay, s/veh	0.7												
Movement	EBL	EBT	EBR	WBL	WBT	WBR	NBL	NBT	NBR	SBL	SBT	SBR	
Lane Configurations					↔			↔↔↔					
Traffic Vol, veh/h	0	0	0	0	16	27	46	1806	0	0	0	0	
Future Vol, veh/h	0	0	0	0	16	27	46	1806	0	0	0	0	
Conflicting Peds, #/hr	23	0	11	11	0	23	72	0	77	77	0	72	
Sign Control	Free	Free	Free	Stop	Stop	Stop	Free	Free	Free	Free	Free	Free	
RT Channelized	-	-	None	-	-	None	-	-	None	-	-	None	
Storage Length	-	-	-	-	-	-	-	-	-	-	-	-	
Veh in Median Storage, #	1048576	-	-	-	0	-	-	0	-	-	-	-	
Grade, %	-	0	-	-	0	-	-	0	-	-	0	-	
Peak Hour Factor	100	100	100	100	100	100	100	100	100	100	100	100	
Heavy Vehicles, %	2	2	2	2	7	5	7	2	2	2	2	2	
Mvmt Flow	0	0	0	0	16	27	46	1806	0	0	0	0	
Major/Minor		Minor1			Major1								
Conflicting Flow All		-	1970	926	72	0	-						
Stage 1		-	1898	-	-	-	-						
Stage 2		-	72	-	-	-	-						
Critical Hdwy		-	6.64	7.2	5.44	-	-						
Critical Hdwy Stg 1		-	5.64	-	-	-	-						
Critical Hdwy Stg 2		-	-	-	-	-	-						
Follow-up Hdwy		-	4.07	3.95	3.17	-	-						
Pot Cap-1 Maneuver		0	58	228	1051	-	0						
Stage 1		0	110	-	-	-	0						
Stage 2		0	-	-	-	-	0						
Platoon blocked, %		-	-	-	-	-	-						
Mov Cap-1 Maneuver		-	0	228	1051	-	-						
Mov Cap-2 Maneuver		-	0	-	-	-	-						
Stage 1		-	0	-	-	-	-						
Stage 2		-	0	-	-	-	-						
Approach		WB			NB								
HCM Control Delay, s		24.4			0.2								
HCM LOS		C											
Minor Lane/Major Mvmt		NBL			NBTWBLn1								
Capacity (veh/h)		1051			- 228								
HCM Lane V/C Ratio		0.044			- 0.189								
HCM Control Delay (s)		8.6			0 24.4								
HCM Lane LOS		A			A C								
HCM 95th %tile Q(veh)		0.1			- 0.7								

Lanes, Volumes, Timings
6: Kent & Gladstone

2035 Future Total
AM Peak Hour

Lanes, Volumes, Timings												
Lane Group	EBL	EBT	EBR	WBL	WBT	WBR	NBL	NBT	NBR	SBL	SBT	SBR
Lane Configurations	↔	↔			↔		↔↔↔	↔↔↔				
Traffic Volume (vph)	83	187	0	0	88	147	36	1704	97	0	0	0
Future Volume (vph)	83	187	0	0	88	147	36	1704	97	0	0	0
Satd. Flow (prot)	1626	1679	0	0	1463	0	1658	4703	0	0	0	0
Fit Permitted	0.491						0.950					
Satd. Flow (perm)	791	1679	0	0	1463	0	1401	4703	0	0	0	0
Satd. Flow (RTOR)					10			18				
Lane Group Flow (vph)	83	187	0	0	235	0	36	1801	0	0	0	0
Turn Type	Perm	NA			NA		Perm	NA				
Protected Phases		4			8			2				
Permitted Phases	4						2					
Detector Phase	4	4			8		2	2				
Switch Phase												
Minimum Initial (s)	10.0	10.0			10.0		10.0	10.0				
Minimum Split (s)	21.4	21.4			20.4		21.4	21.4				
Total Split (s)	30.0	30.0			30.0		45.0	45.0				
Total Split (%)	40.0%	40.0%			40.0%		60.0%	60.0%				
Yellow Time (s)	3.3	3.3			3.3		3.3	3.3				
All-Red Time (s)	2.1	2.1			2.1		2.1	2.1				
Lost Time Adjust (s)	0.0	0.0			0.0		0.0	0.0				
Total Lost Time (s)	5.4	5.4			5.4		5.4	5.4				
Lead/Lag												
Lead-Lag Optimize?												
Recall Mode	None	None			None		C-Max	C-Max				
Act Effct Green (s)	16.8	16.8			16.8		47.4	47.4				
Actuated g/C Ratio	0.22	0.22			0.22		0.63	0.63				
v/c Ratio	0.47	0.50			0.70		0.04	0.60				
Control Delay	41.2	38.3			32.4		7.0	10.1				
Queue Delay	0.0	0.0			0.0		0.0	0.0				
Total Delay	41.2	38.3			32.4		7.0	10.1				
LOS	D	D			C		A	B				
Approach Delay		39.2			32.4			10.0				
Approach LOS		D			C			B				
Queue Length 50th (m)	13.3	29.8			19.0		1.8	50.5				
Queue Length 95th (m)	19.2	35.0			51.3		6.4	83.4				
Internal Link Dist (m)		164.9			173.9			90.5				139.7
Turn Bay Length (m)	30.0						40.0					
Base Capacity (vph)	259	550			486		885	2980				
Starvation Cap Reductn	0	0			0		0	0				
Spillback Cap Reductn	0	0			0		0	0				
Storage Cap Reductn	0	0			0		0	0				
Reduced v/c Ratio	0.32	0.34			0.48		0.04	0.60				
Intersection Summary												
Cycle Length: 75												
Actuated Cycle Length: 75												
Offset: 36 (48%), Referenced to phase 2:NBTL and 6., Start of Green												
Natural Cycle: 55												
Control Type: Actuated-Coordinated												

Lanes, Volumes, Timings
6: Kent & Gladstone

2035 Future Total
AM Peak Hour

Maximum v/c Ratio: 0.70	Intersection LOS: B
Intersection Signal Delay: 15.6	ICU Level of Service D
Intersection Capacity Utilization 76.2%	
Analysis Period (min) 15	

Splits and Phases: 6: Kent & Gladstone



Lanes, Volumes, Timings
7: Bank & Somerset

2035 Future Total
AM Peak Hour

Lane Group	EBL	EBT	EBR	WBL	WBT	WBR	NBL	NBT	NBR	SBL	SBT	SBR
Lane Configurations		↕	↕	↕	↕			↕			↕	
Traffic Volume (vph)	41	191	75	21	124	15	16	177	40	2	173	36
Future Volume (vph)	41	191	75	21	124	15	16	177	40	2	173	36
Satd. Flow (prot)	0	1627	1388	1610	1665	0	0	1467	0	0	1465	0
Fit Permitted		0.918		0.502				0.978			0.998	
Satd. Flow (perm)	0	1467	1102	746	1665	0	0	1416	0	0	1460	0
Satd. Flow (RTOR)												
Lane Group Flow (vph)	0	232	75	21	139	0	0	233	0	0	211	0
Turn Type	Perm	NA	Perm	Perm	NA		Perm	NA		Perm	NA	
Protected Phases		4			8			2			6	
Permitted Phases	4		4	8			2			6		
Detector Phase	4	4	4	8	8		2	2		6	6	
Switch Phase												
Minimum Initial (s)	10.0	10.0	10.0	10.0	10.0		10.0	10.0		10.0	10.0	
Minimum Split (s)	20.5	20.5	20.5	20.5	20.5		20.5	20.5		20.5	20.5	
Total Split (s)	25.0	25.0	25.0	25.0	25.0		40.0	40.0		40.0	40.0	
Total Split (%)	33.3%	33.3%	33.3%	33.3%	33.3%		53.3%	53.3%		53.3%	53.3%	
Yellow Time (s)	3.3	3.3	3.3	3.3	3.3		3.3	3.3		3.3	3.3	
All-Red Time (s)	2.2	2.2	2.2	2.2	2.2		2.2	2.2		2.2	2.2	
Lost Time Adjust (s)		0.0	0.0	0.0	0.0			0.0			0.0	
Total Lost Time (s)		5.5	5.5	5.5	5.5			5.5			5.5	
Lead/Lag	Lag	Lag	Lag	Lag	Lag		Lag	Lag		Lag	Lag	
Lead-Lag Optimize?	Yes	Yes	Yes	Yes	Yes		Yes	Yes		Yes	Yes	
Recall Mode	None	None	None	None	None		C-Max	C-Max		C-Max	C-Max	
Act Effct Green (s)		16.9	16.9	16.9	16.9			47.1			47.1	
Actuated g/C Ratio		0.23	0.23	0.23	0.23			0.63			0.63	
v/c Ratio		0.70	0.30	0.12	0.37			0.26			0.23	
Control Delay		43.2	31.9	22.5	26.1			2.9			7.9	
Queue Delay		0.0	0.0	0.0	0.0			0.2			0.0	
Total Delay		43.2	31.9	22.5	26.1			3.2			7.9	
LOS		D	C	C	C			A			A	
Approach Delay		40.4			25.6			3.2			7.9	
Approach LOS		D			C			A			A	
Queue Length 50th (m)		37.0	11.9	2.5	17.6			3.7			12.0	
Queue Length 95th (m)		58.6	19.4	7.4	29.6			6.5			27.5	
Internal Link Dist (m)		174.8			68.0			65.6			106.3	
Turn Bay Length (m)			28.0	15.0								
Base Capacity (vph)		395	296	200	448			889			916	
Starvation Cap Reductn		0	0	0	0			228			0	
Spillback Cap Reductn		0	0	0	0			0			0	
Storage Cap Reductn		0	0	0	0			0			0	
Reduced v/c Ratio		0.59	0.25	0.10	0.31			0.35			0.23	

Intersection Summary

Cycle Length: 75
Actuated Cycle Length: 75
Offset: 46 (61%), Referenced to phase 2:NBTL and 6:SBTL, Start of Green
Natural Cycle: 50
Control Type: Actuated-Coordinated

Lanes, Volumes, Timings
7: Bank & Somerset

2035 Future Total
AM Peak Hour

Lane Group	Ø1	Ø3	Ø5	Ø7
Lane Configurations				
Traffic Volume (vph)				
Future Volume (vph)				
Satd. Flow (prot)				
Fit Permitted				
Satd. Flow (perm)				
Satd. Flow (RTOR)				
Lane Group Flow (vph)				
Turn Type				
Protected Phases	1	3	5	7
Permitted Phases				
Detector Phase				
Switch Phase				
Minimum Initial (s)	1.0	1.0	1.0	1.0
Minimum Split (s)	3.0	3.0	3.0	3.0
Total Split (s)	5.0	5.0	5.0	5.0
Total Split (%)	7%	7%	7%	7%
Yellow Time (s)	2.0	2.0	2.0	2.0
All-Red Time (s)	0.0	0.0	0.0	0.0
Lost Time Adjust (s)				
Total Lost Time (s)				
Lead/Lag	Lead	Lead	Lead	Lead
Lead-Lag Optimize?	Yes	Yes	Yes	Yes
Recall Mode	None	None	None	None
Act Effct Green (s)				
Actuated g/C Ratio				
v/c Ratio				
Control Delay				
Queue Delay				
Total Delay				
LOS				
Approach Delay				
Approach LOS				
Queue Length 50th (m)				
Queue Length 95th (m)				
Internal Link Dist (m)				
Turn Bay Length (m)				
Base Capacity (vph)				
Starvation Cap Reductn				
Spillback Cap Reductn				
Storage Cap Reductn				
Reduced v/c Ratio				
Intersection Summary				

Lanes, Volumes, Timings
7: Bank & Somerset

2035 Future Total
AM Peak Hour

Maximum v/c Ratio: 0.70	
Intersection Signal Delay: 20.8	Intersection LOS: C
Intersection Capacity Utilization 63.7%	ICU Level of Service B
Analysis Period (min) 15	
m Volume for 95th percentile queue is metered by upstream signal.	

Splits and Phases: 7: Bank & Somerset

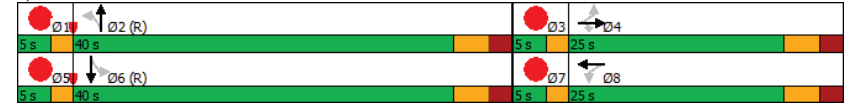

Lanes, Volumes, Timings
8: Bank & MacLaren

2035 Future Total
AM Peak Hour

Lane Group	EBL	EBT	EBR	WBL	WBT	WBR	NBL	NBT	NBR	SBL	SBT	SBR
Lane Configurations												
Traffic Volume (vph)	0	0	0	11	4	13	36	220	0	0	248	26
Future Volume (vph)	0	0	0	11	4	13	36	220	0	0	248	26
Satd. Flow (prot)	0	0	0	0	1430	0	0	1695	0	0	1552	0
Fit Permitted					0.981			0.937				
Satd. Flow (perm)	0	0	0	0	1376	0	0	1507	0	0	1552	0
Satd. Flow (RTOR)					13						13	
Lane Group Flow (vph)	0	0	0	0	28	0	0	256	0	0	274	0
Turn Type				Perm	NA		Perm	NA			NA	
Protected Phases					8			2			6	
Permitted Phases				8			2					
Detector Phase				8	8		2	2			6	
Switch Phase												
Minimum Initial (s)				10.0	10.0		10.0	10.0			10.0	
Minimum Split (s)				24.2	24.2		18.0	18.0			18.0	
Total Split (s)				24.2	24.2		50.8	50.8			50.8	
Total Split (%)				32.3%	32.3%		67.7%	67.7%			67.7%	
Yellow Time (s)				3.3	3.3		3.3	3.3			3.3	
All-Red Time (s)				1.9	1.9		1.7	1.7			1.7	
Lost Time Adjust (s)					0.0			0.0			0.0	
Total Lost Time (s)					5.2			5.0			5.0	
Lead/Lag												
Lead-Lag Optimize?												
Recall Mode				None	None		C-Max	C-Max			C-Max	
Act Effct Green (s)					15.4			57.5			57.5	
Actuated g/C Ratio					0.21			0.77			0.77	
v/c Ratio					0.10			0.22			0.23	
Control Delay					15.8			2.4			7.4	
Queue Delay					0.0			0.2			0.2	
Total Delay					15.8			2.6			7.6	
LOS					B			A			A	
Approach Delay					15.8			2.6			7.6	
Approach LOS					B			A			A	
Queue Length 50th (m)					1.7			10.3			24.2	
Queue Length 95th (m)					7.7			6.0			24.2	
Internal Link Dist (m)		130.7			122.8			60.9			65.6	
Turn Bay Length (m)												
Base Capacity (vph)					358			1155			1192	
Starvation Cap Reductn					0			319			360	
Spillback Cap Reductn					0			0			0	
Storage Cap Reductn					0			0			0	
Reduced v/c Ratio					0.08			0.31			0.33	

Intersection Summary	
Cycle Length:	75
Actuated Cycle Length:	75
Offset:	42 (56%), Referenced to phase 2:NBTL and 6:SBT, Start of Green
Natural Cycle:	45
Control Type:	Actuated-Coordinated

Lanes, Volumes, Timings
8: Bank & MacLaren

2035 Future Total
AM Peak Hour

Maximum v/c Ratio: 0.23	Intersection LOS: A
Intersection Signal Delay: 5.7	ICU Level of Service B
Intersection Capacity Utilization 58.1%	
Analysis Period (min) 15	

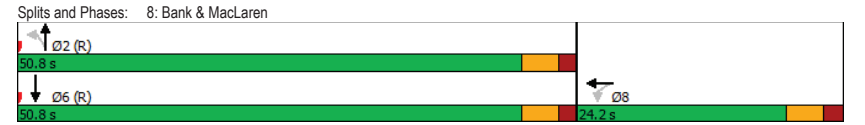

Lanes, Volumes, Timings
9: Bank & Gilmour

2035 Future Total
AM Peak Hour

Lane Group	EBL	EBT	EBR	WBL	WBT	WBR	NBL	NBT	NBR	SBL	SBT	SBR
Lane Configurations		↔						↔			↔	
Traffic Volume (vph)	23	71	54	0	0	0	0	232	22	19	254	0
Future Volume (vph)	23	71	54	0	0	0	0	232	22	19	254	0
Satd. Flow (prot)	0	1573	0	0	0	0	0	1536	0	0	1621	0
Fit Permitted		0.992									0.975	
Satd. Flow (perm)	0	1560	0	0	0	0	0	1536	0	0	1565	0
Satd. Flow (RTOR)		37						11				
Lane Group Flow (vph)	0	148	0	0	0	0	0	254	0	0	273	0
Turn Type	Perm	NA						NA		Perm	NA	
Protected Phases		4						2			6	
Permitted Phases	4									6		
Detector Phase	4	4						2		6	6	
Switch Phase												
Minimum Initial (s)	10.0	10.0						10.0		10.0	10.0	
Minimum Split (s)	23.2	23.2						20.1		20.1	20.1	
Total Split (s)	25.0	25.0						50.0		50.0	50.0	
Total Split (%)	33.3%	33.3%						66.7%		66.7%	66.7%	
Yellow Time (s)	3.3	3.3						3.3		3.3	3.3	
All-Red Time (s)	1.9	1.9						1.8		1.8	1.8	
Lost Time Adjust (s)		0.0						0.0		0.0	0.0	
Total Lost Time (s)		5.2						5.1		5.1	5.1	
Lead/Lag												
Lead-Lag Optimize?												
Recall Mode	None	None						C-Max		C-Max	C-Max	
Act Effct Green (s)		13.4						51.3		51.3	51.3	
Actuated g/C Ratio		0.18						0.68		0.68	0.68	
v/c Ratio		0.48						0.24		0.25	0.25	
Control Delay		25.0						3.8		3.2	3.2	
Queue Delay		0.0						0.0		0.3	0.3	
Total Delay		25.0						3.8		3.5	3.5	
LOS		C						A		A	A	
Approach Delay		25.0						3.8		3.5	3.5	
Approach LOS		C						A		A	A	
Queue Length 50th (m)		15.5						7.2		4.8	4.8	
Queue Length 95th (m)		29.4						11.3		9.8	9.8	
Internal Link Dist (m)		125.3			69.2			57.1		60.9	60.9	
Turn Bay Length (m)												
Base Capacity (vph)		439						1054		1071	1071	
Starvation Cap Reductn		0						0		377	377	
Spillback Cap Reductn		0						0		0	0	
Storage Cap Reductn		0						0		0	0	
Reduced v/c Ratio		0.34						0.24		0.39	0.39	

Intersection Summary		
Cycle Length:	75	
Actuated Cycle Length:	75	
Offset:	37 (49%), Referenced to phase 2:NBT and 6:SBTL, Start of Green	
Natural Cycle:	45	
Control Type:	Actuated-Coordinated	

Lanes, Volumes, Timings
9: Bank & Gilmour

2035 Future Total
AM Peak Hour

Maximum v/c Ratio: 0.48	Intersection LOS: A
Intersection Signal Delay: 8.3	ICU Level of Service B
Intersection Capacity Utilization 55.7%	
Analysis Period (min) 15	

Splits and Phases: 9: Bank & Gilmour

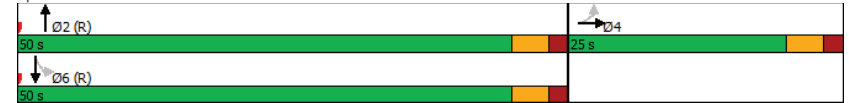

Lanes, Volumes, Timings
10: Bank & James

2035 Future Total
AM Peak Hour

Lane Group	EBL	EBR	NBL	NBT	SBT	SBR
Lane Configurations				↕	↕	
Traffic Volume (vph)	0	0	29	259	290	25
Future Volume (vph)	0	0	29	259	290	25
Satd. Flow (prot)	0	0	0	1682	1637	0
Fit Permitted				0.995		
Satd. Flow (perm)	0	0	0	1682	1637	0
Lane Group Flow (vph)	0	0	0	288	315	0
Sign Control	Stop		Free		Free	
Intersection Summary						
Control Type: Unsignalized						
Intersection Capacity Utilization 50.3%						
ICU Level of Service A						
Analysis Period (min) 15						

Lanes, Volumes, Timings
11: Bank & Gladstone

2035 Future Total
AM Peak Hour

Lane Group	EBL	EBT	EBR	WBL	WBT	WBR	NBL	NBT	NBR	SBL	SBT	SBR
Lane Configurations		↕			↕		↕	↕			↕	
Traffic Volume (vph)	36	174	64	20	106	19	57	248	76	6	254	37
Future Volume (vph)	36	174	64	20	106	19	57	248	76	6	254	37
Satd. Flow (prot)	0	2964	0	0	1579	0	1626	1503	0	0	2966	0
Fit Permitted		0.900			0.918		0.570				0.949	
Satd. Flow (perm)	0	2657	0	0	1446	0	851	1503	0	0	2811	0
Satd. Flow (RTOR)												
Lane Group Flow (vph)	0	274	0	0	145	0	57	324	0	0	297	0
Turn Type	Perm	NA		Perm	NA		Perm	NA		Perm	NA	
Protected Phases	4		8		2		6		6		6	
Permitted Phases	4		8		2		6		6		6	
Detector Phase	4		8		2		6		6		6	
Switch Phase												
Minimum Initial (s)	10.0	10.0		10.0	10.0		10.0	10.0		10.0	10.0	
Minimum Split (s)	20.5	20.5		20.5	20.5		20.5	20.5		20.5	20.5	
Total Split (s)	23.0	23.0		23.0	23.0		42.0	42.0		42.0	42.0	
Total Split (%)	30.7%	30.7%		30.7%	30.7%		56.0%	56.0%		56.0%	56.0%	
Yellow Time (s)	3.3	3.3		3.3	3.3		3.3	3.3		3.3	3.3	
All-Red Time (s)	2.2	2.2		2.2	2.2		2.2	2.2		2.2	2.2	
Lost Time Adjust (s)	0.0		0.0		0.0		0.0		0.0		0.0	
Total Lost Time (s)	5.5		5.5		5.5		5.5		5.5		5.5	
Lead/Lag	Lag	Lag		Lag	Lag		Lag	Lag		Lag	Lag	
Lead-Lag Optimize?	Yes	Yes		Yes	Yes		Yes	Yes		Yes	Yes	
Recall Mode	None	None		None	None		C-Max	C-Max		C-Max	C-Max	
Act Effct Green (s)	14.5		14.5		36.5		36.5		36.5		36.5	
Actuated g/C Ratio	0.19		0.19		0.49		0.49		0.49		0.49	
v/c Ratio	0.53		0.52		0.14		0.44		0.22		0.22	
Control Delay	39.3		33.7		11.8		15.0		15.9		15.9	
Queue Delay	0.0		0.0		0.0		0.0		0.0		0.0	
Total Delay	39.3		33.7		11.8		15.0		15.9		15.9	
LOS	D		C		B		B		B		B	
Approach Delay	39.3		33.7		14.5		15.9		15.9		15.9	
Approach LOS	D		C		B		B		B		B	
Queue Length 50th (m)	22.6		19.4		4.4		29.9		17.7		17.7	
Queue Length 95th (m)	33.2		35.3		11.0		50.3		26.9		26.9	
Internal Link Dist (m)	173.9		70.9		108.7		139.2		139.2		139.2	
Turn Bay Length (m)					38.0							
Base Capacity (vph)	619		337		414		731		1368		1368	
Starvation Cap Reductn	0		0		0		0		0		0	
Spillback Cap Reductn	0		0		0		0		0		0	
Storage Cap Reductn	0		0		0		0		0		0	
Reduced v/c Ratio	0.44		0.43		0.14		0.44		0.22		0.22	
Intersection Summary												
Cycle Length: 75												
Actuated Cycle Length: 75												
Offset: 20 (27%), Referenced to phase 2:NBTL and 6:SBTL, Start of Green												
Natural Cycle: 50												
Control Type: Actuated-Coordinated												

Lanes, Volumes, Timings
11: Bank & Gladstone

2035 Future Total
AM Peak Hour

Lane Group	Ø1	Ø3	Ø5	Ø7
Lane Configurations				
Traffic Volume (vph)				
Future Volume (vph)				
Satd. Flow (prot)				
Fit Permitted				
Satd. Flow (perm)				
Satd. Flow (RTOR)				
Lane Group Flow (vph)				
Turn Type				
Protected Phases	1	3	5	7
Permitted Phases				
Detector Phase				
Switch Phase				
Minimum Initial (s)	1.0	1.0	1.0	1.0
Minimum Split (s)	3.0	3.0	3.0	3.0
Total Split (s)	5.0	5.0	5.0	5.0
Total Split (%)	7%	7%	7%	7%
Yellow Time (s)	2.0	2.0	2.0	2.0
All-Red Time (s)	0.0	0.0	0.0	0.0
Lost Time Adjust (s)				
Total Lost Time (s)				
Lead/Lag	Lead	Lead	Lead	Lead
Lead-Lag Optimize?	Yes	Yes	Yes	Yes
Recall Mode	Max	Max	Max	Max
Act Effct Green (s)				
Actuated g/C Ratio				
v/c Ratio				
Control Delay				
Queue Delay				
Total Delay				
LOS				
Approach Delay				
Approach LOS				
Queue Length 50th (m)				
Queue Length 95th (m)				
Internal Link Dist (m)				
Turn Bay Length (m)				
Base Capacity (vph)				
Starvation Cap Reductn				
Spillback Cap Reductn				
Storage Cap Reductn				
Reduced v/c Ratio				
Intersection Summary				

Lanes, Volumes, Timings
11: Bank & Gladstone

2035 Future Total
AM Peak Hour

Maximum v/c Ratio: 0.53	
Intersection Signal Delay: 23.6	Intersection LOS: C
Intersection Capacity Utilization 72.2%	ICU Level of Service C
Analysis Period (min) 15	

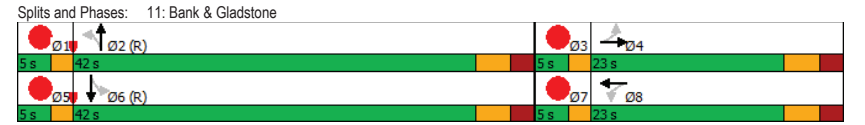

HCM 2010 AWSC
12: Access & Gilmour

2035 Future Total
AM Peak Hour

Intersection	
Intersection Delay, s/veh	7.2
Intersection LOS	A

Movement	EBT	EBR	WBL	WBT	NBL	NBR
Lane Configurations	↔					↔
Traffic Vol, veh/h	94	15	0	0	0	34
Future Vol, veh/h	94	15	0	0	0	34
Peak Hour Factor	1.00	1.00	1.00	1.00	1.00	1.00
Heavy Vehicles, %	2	2	2	2	2	2
Mvmt Flow	94	15	0	0	0	34
Number of Lanes	1	0	0	0	0	1

Approach	EB	NB
Opposing Approach		
Opposing Lanes	0	0
Conflicting Approach Left		EB
Conflicting Lanes Left	0	1
Conflicting Approach Right	NB	
Conflicting Lanes Right	1	0
HCM Control Delay	7.4	6.7
HCM LOS	A	A

Lane	NBLn1	EBLn1
Vol Left, %	0%	0%
Vol Thru, %	0%	86%
Vol Right, %	100%	14%
Sign Control	Stop	Stop
Traffic Vol by Lane	34	109
LT Vol	0	0
Through Vol	0	94
RT Vol	34	15
Lane Flow Rate	34	109
Geometry Grp	1	1
Degree of Util (X)	0.033	0.118
Departure Headway (Hd)	3.524	3.91
Convergence, Y/N	Yes	Yes
Cap	1010	921
Service Time	1.565	1.916
HCM Lane V/C Ratio	0.034	0.118
HCM Control Delay	6.7	7.4
HCM Lane LOS	A	A
HCM 95th-tile Q	0.1	0.4

Lanes, Volumes, Timings
1: Lyon & James

2035 Future Total
PM Peak Hour



Lane Group	EBL	EBT	EBR	WBL	WBT	WBR	NBL	NBT	NBR	SBL	SBT	SBR
Lane Configurations					↔						↔	
Traffic Volume (vph)	0	0	0	48	21	0	0	0	0	0	528	7
Future Volume (vph)	0	0	0	48	21	0	0	0	0	0	528	7
Satd. Flow (prot)	0	0	0	0	1663	0	0	0	0	0	3307	0
Fit Permitted					0.966							
Satd. Flow (perm)	0	0	0	0	1618	0	0	0	0	0	3307	0
Satd. Flow (RTOR)											4	
Lane Group Flow (vph)	0	0	0	0	69	0	0	0	0	0	535	0
Turn Type				Perm	NA						NA	
Protected Phases						8						6
Permitted Phases					8						6	
Detector Phase					8	8					6	6
Switch Phase												
Minimum Initial (s)					10.0	10.0					10.0	10.0
Minimum Split (s)					17.1	17.1					29.7	29.7
Total Split (s)					17.1	17.1					57.9	57.9
Total Split (%)					22.8%	22.8%					77.2%	77.2%
Yellow Time (s)					3.3	3.3					3.3	3.3
All-Red Time (s)					1.8	1.8					1.4	1.4
Lost Time Adjust (s)						0.0					0.0	0.0
Total Lost Time (s)						5.1					4.7	4.7
Lead/Lag												
Lead-Lag Optimize?												
Recall Mode					None	None					C-Max	C-Max
Act Effct Green (s)						10.8						58.4
Actuated g/C Ratio						0.14						0.78
v/c Ratio						0.30						0.21
Control Delay						29.4						3.3
Queue Delay						0.0						0.0
Total Delay						29.4						3.3
LOS						C						A
Approach Delay						29.4						3.3
Approach LOS						C						A
Queue Length 50th (m)						9.6						10.2
Queue Length 95th (m)						21.1						16.9
Internal Link Dist (m)							110.6			139.6		62.1
Turn Bay Length (m)												
Base Capacity (vph)						258						2574
Starvation Cap Reductn						0						0
Spillback Cap Reductn						0						0
Storage Cap Reductn						0						0
Reduced v/c Ratio						0.27						0.21

Intersection Summary	
Cycle Length: 75	
Actuated Cycle Length: 75	
Offset: 0 (0%), Referenced to phase 2: and 6:SBTL, Start of Green	
Natural Cycle: 50	
Control Type: Actuated-Coordinated	

Lanes, Volumes, Timings
1: Lyon & James

2035 Future Total
PM Peak Hour

Maximum v/c Ratio: 0.30	Intersection LOS: A
Intersection Signal Delay: 6.3	ICU Level of Service A
Intersection Capacity Utilization 39.6%	
Analysis Period (min) 15	

Splits and Phases: 1: Lyon & James

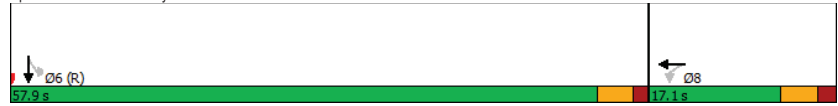

Lanes, Volumes, Timings
2: Gladstone & Lyon

2035 Future Total
PM Peak Hour

Lane Group	EBL	EBT	EBR	WBL	WBT	WBR	NBL	NBT	NBR	SBL	SBT	SBR
Lane Configurations		↔			↔						↔↔	
Traffic Volume (vph)	0	248	27	13	316	0	0	0	0	86	329	138
Future Volume (vph)	0	248	27	13	316	0	0	0	0	86	329	138
Satd. Flow (prot)	0	1707	0	0	1742	0	0	0	0	0	3109	0
Fit Permitted					0.985						0.992	
Satd. Flow (perm)	0	1707	0	0	1716	0	0	0	0	0	3092	0
Satd. Flow (RTOR)		10									73	
Lane Group Flow (vph)	0	275	0	0	329	0	0	0	0	0	553	0
Turn Type		NA		Perm	NA					Perm	NA	
Protected Phases		2			6						8	
Permitted Phases				6						8		
Detector Phase		2		6	6					8	8	
Switch Phase												
Minimum Initial (s)		10.0		10.0	10.0					10.0	10.0	
Minimum Split (s)		23.2		23.6	23.6					23.6	23.6	
Total Split (s)		39.0		39.0	39.0					36.0	36.0	
Total Split (%)		52.0%		52.0%	52.0%					48.0%	48.0%	
Yellow Time (s)		3.3		3.3	3.3					3.3	3.3	
All-Red Time (s)		1.9		1.9	1.9					2.3	2.3	
Lost Time Adjust (s)		0.0		0.0	0.0					0.0	0.0	
Total Lost Time (s)		5.2		5.2	5.2					5.6	5.6	
Lead/Lag												
Lead-Lag Optimize?												
Recall Mode		C-Max		Max	Max					Max	Max	
Act Effct Green (s)		33.8			33.8						30.4	
Actuated g/C Ratio		0.45			0.45						0.41	
v/c Ratio		0.36			0.43						0.43	
Control Delay		14.6			13.1						12.3	
Queue Delay		0.0			0.0						0.0	
Total Delay		14.6			13.1						12.3	
LOS		B			B						B	
Approach Delay		14.6			13.1						12.3	
Approach LOS		B			B						B	
Queue Length 50th (m)		24.6			15.8						11.7	
Queue Length 95th (m)		42.1			41.9						22.3	
Internal Link Dist (m)		109.1			166.3			55.5			139.6	
Turn Bay Length (m)												
Base Capacity (vph)		774			773						1296	
Starvation Cap Reductn		0			0						0	
Spillback Cap Reductn		0			0						0	
Storage Cap Reductn		0			0						0	
Reduced v/c Ratio		0.36			0.43						0.43	

Intersection Summary	
Cycle Length: 75	
Actuated Cycle Length: 75	
Offset: 45 (60%), Referenced to phase 2:EBT, Start of Green	
Natural Cycle: 50	
Control Type: Actuated-Coordinated	

Lanes, Volumes, Timings
2: Gladstone & Lyon

2035 Future Total
PM Peak Hour

Maximum v/c Ratio: 0.43	Intersection LOS: B
Intersection Signal Delay: 13.1	ICU Level of Service B
Intersection Capacity Utilization 58.4%	
Analysis Period (min) 15	

Splits and Phases: 2: Gladstone & Lyon

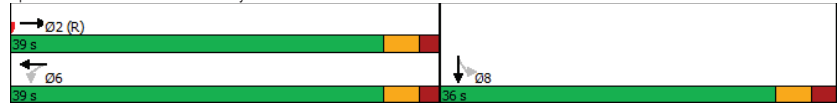

Lanes, Volumes, Timings
3: Kent & Somerset

2035 Future Total
PM Peak Hour

Lane Group	EBL	EBT	EBR	WBL	WBT	WBR	NBL	NBT	NBR	SBL	SBT	SBR
Lane Configurations	↔	↕			↔		↔	↕	↔			
Traffic Volume (vph)	58	252	0	0	215	65	79	706	106	0	0	0
Future Volume (vph)	58	252	0	0	215	65	79	706	106	0	0	0
Satd. Flow (prot)	1658	1745	0	0	1587	0	1658	4322	0	0	0	0
Fit Permitted	0.449						0.950					
Satd. Flow (perm)	673	1745	0	0	1587	0	1028	4322	0	0	0	0
Satd. Flow (RTOR)							43					
Lane Group Flow (vph)	58	252	0	0	280	0	79	812	0	0	0	0
Turn Type	Perm	NA			NA		Perm	NA				
Protected Phases		4			8			2				
Permitted Phases	4						2					
Detector Phase	4	4			8		2	2				
Switch Phase												
Minimum Initial (s)	10.0	10.0			10.0		10.0	10.0				
Minimum Split (s)	21.5	21.5			21.5		21.4	21.4				
Total Split (s)	41.0	41.0			41.0		34.0	34.0				
Total Split (%)	54.7%	54.7%			54.7%		45.3%	45.3%				
Yellow Time (s)	3.3	3.3			3.3		3.3	3.3				
All-Red Time (s)	2.2	2.2			2.2		2.1	2.1				
Lost Time Adjust (s)	0.0	0.0			0.0		0.0	0.0				
Total Lost Time (s)	5.5	5.5			5.5		5.4	5.4				
Lead/Lag												
Lead-Lag Optimize?												
Recall Mode	None	None			None		C-Max	C-Max				
Act Effct Green (s)	19.8	19.8			19.8		44.3	44.3				
Actuated g/C Ratio	0.26	0.26			0.26		0.59	0.59				
v/c Ratio	0.33	0.55			0.67		0.13	0.32				
Control Delay	26.1	27.7			32.1		9.3	9.6				
Queue Delay	0.0	0.0			0.0		0.0	0.0				
Total Delay	26.1	27.7			32.1		9.3	9.6				
LOS	C	C			C		A	A				
Approach Delay		27.4			32.1			9.6				
Approach LOS		C			C			A				
Queue Length 50th (m)	7.1	33.0			43.0		4.8	17.5				
Queue Length 95th (m)	15.4	47.5			57.8		10.5	23.3				
Internal Link Dist (m)		61.7			174.8			152.2			110.1	
Turn Bay Length (m)	25.0						40.0					
Base Capacity (vph)	318	825			751		607	2570				
Starvation Cap Reductn	0	0			0		0	0				
Spillback Cap Reductn	0	0			0		0	0				
Storage Cap Reductn	0	0			0		0	0				
Reduced v/c Ratio	0.18	0.31			0.37		0.13	0.32				

Intersection Summary												
Cycle Length: 75												
Actuated Cycle Length: 75												
Offset: 50 (67%), Referenced to phase 2:NBTL and 6., Start of Green												
Natural Cycle: 45												
Control Type: Actuated-Coordinated												

Lanes, Volumes, Timings
3: Kent & Somerset

2035 Future Total
PM Peak Hour

Maximum v/c Ratio: 0.67	Intersection LOS: B
Intersection Signal Delay: 17.6	ICU Level of Service B
Intersection Capacity Utilization 57.7%	
Analysis Period (min) 15	

Splits and Phases: 3: Kent & Somerset

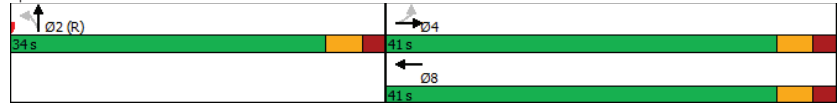

Lanes, Volumes, Timings
4: Kent & Gilmour

2035 Future Total
PM Peak Hour

Lane Group	EBL	EBT	EBR	WBL	WBT	WBR	NBL	NBT	NBR	SBL	SBT	SBR
Lane Configurations		↕						↕↕↕				
Traffic Volume (vph)	19	93	0	0	0	0	0	848	79	0	0	0
Future Volume (vph)	19	93	0	0	0	0	0	848	79	0	0	0
Satd. Flow (prot)	0	1717	0	0	0	0	0	4598	0	0	0	0
Fit Permitted		0.992										
Satd. Flow (perm)	0	1690	0	0	0	0	0	4598	0	0	0	0
Satd. Flow (RTOR)								40				
Lane Group Flow (vph)	0	112	0	0	0	0	0	927	0	0	0	0
Turn Type	Perm	NA						NA				
Protected Phases		4						2				
Permitted Phases	4											
Detector Phase	4	4						2				
Switch Phase												
Minimum Initial (s)	10.0	10.0						10.0				
Minimum Split (s)	21.5	21.5						35.1				
Total Split (s)	22.0	22.0						53.0				
Total Split (%)	29.3%	29.3%						70.7%				
Yellow Time (s)	3.3	3.3						3.3				
All-Red Time (s)	2.2	2.2						1.8				
Lost Time Adjust (s)		0.0						0.0				
Total Lost Time (s)		5.5						5.1				
Lead/Lag												
Lead-Lag Optimize?												
Recall Mode	None	None						C-Max				
Act Effct Green (s)		13.6						54.9				
Actuated g/C Ratio		0.18						0.73				
v/c Ratio		0.37						0.27				
Control Delay		29.7						3.4				
Queue Delay		0.0						0.0				
Total Delay		29.7						3.4				
LOS		C						A				
Approach Delay		29.7						3.4				
Approach LOS		C						A				
Queue Length 50th (m)		14.1						11.6				
Queue Length 95th (m)		28.3						14.6				
Internal Link Dist (m)		69.3				21.3		57.8			152.2	
Turn Bay Length (m)												
Base Capacity (vph)		371						3377				
Starvation Cap Reductn		0						0				
Spillback Cap Reductn		0						0				
Storage Cap Reductn		0						0				
Reduced v/c Ratio		0.30						0.27				

Intersection Summary

Cycle Length: 75
Actuated Cycle Length: 75
Offset: 0 (0%), Referenced to phase 2:NBT and 6:, Start of Green
Natural Cycle: 60
Control Type: Actuated-Coordinated

Lanes, Volumes, Timings
4: Kent & Gilmour

2035 Future Total
PM Peak Hour

Maximum v/c Ratio: 0.37	Intersection LOS: A
Intersection Signal Delay: 6.2	ICU Level of Service A
Intersection Capacity Utilization 47.1%	
Analysis Period (min) 15	

Splits and Phases: 4: Kent & Gilmour



HCM 2010 TWSC
5: Kent & James

2035 Future Total
PM Peak Hour

Intersection												
Int Delay, s/veh												
2												
Movement	EBL	EBT	EBR	WBL	WBT	WBR	NBL	NBT	NBR	SBL	SBT	SBR
Lane Configurations												
Traffic Vol, veh/h	0	0	0	0	35	58	50	869	0	0	0	0
Future Vol, veh/h	0	0	0	0	35	58	50	869	0	0	0	0
Conflicting Peds, #/hr	25	0	17	17	0	25	95	0	63	63	0	95
Sign Control	Free	Free	Free	Stop	Stop	Stop	Free	Free	Free	Free	Free	Free
RT Channelized	-	-	None	-	-	None	-	-	None	-	-	None
Storage Length	-	-	-	-	-	-	-	-	-	-	-	-
Veh in Median Storage, #	2293760	-	-	-	0	-	-	0	-	-	-	-
Grade, %	-	0	-	-	0	-	-	0	-	-	0	-
Peak Hour Factor	100	100	100	100	100	100	100	100	100	100	100	100
Heavy Vehicles, %	2	2	2	2	2	2	2	2	2	2	2	2
Mvmt Flow	0	0	0	0	35	58	50	869	0	0	0	0

Major/Minor	Minor1	Major1
Conflicting Flow All	- 1064	460 95 0 -
Stage 1	- 969	- - - -
Stage 2	- 95	- - - -
Critical Hdwy	- 6.54	7.14 5.34 - -
Critical Hdwy Stg 1	- 5.54	- - - -
Critical Hdwy Stg 2	- -	- - - -
Follow-up Hdwy	- 4.02	3.92 3.12 - -
Pot Cap-1 Maneuver	0 221	469 1044 - 0
Stage 1	0 330	- - - 0
Stage 2	0 -	- - - 0
Platoon blocked, %	-	-
Mov Cap-1 Maneuver	- 0	469 1044 - -
Mov Cap-2 Maneuver	- 0	- - - -
Stage 1	- 0	- - - -
Stage 2	- 0	- - - -

Approach	WB	NB
HCM Control Delay, s	14.6	0.7
HCM LOS	B	

Minor Lane/Major Mvmt	NBL	NBTWBLn1
Capacity (veh/h)	1044	- 469
HCM Lane V/C Ratio	0.048	- 0.198
HCM Control Delay (s)	8.6	0.2 14.6
HCM Lane LOS	A	A B
HCM 95th %tile Q(veh)	0.2	- 0.7

Lanes, Volumes, Timings
6: Kent & Gladstone

2035 Future Total
PM Peak Hour

Lane Group	EBL	EBT	EBR	WBL	WBT	WBR	NBL	NBT	NBR	SBL	SBT	SBR
Lane Configurations	↖	↗	↘	↙	↖	↗	↘	↙	↘	↙	↘	↙
Traffic Volume (vph)	76	250	0	0	246	82	52	746	101	0	0	0
Future Volume (vph)	76	250	0	0	246	82	52	746	101	0	0	0
Satd. Flow (prot)	1658	1728	0	0	1650	0	1658	4555	0	0	0	0
Fit Permitted	0.365						0.950					
Satd. Flow (perm)	613	1728	0	0	1650	0	1471	4555	0	0	0	0
Satd. Flow (RTOR)					34			35				
Lane Group Flow (vph)	76	250	0	0	328	0	52	847	0	0	0	0
Turn Type	Perm	NA			NA		Perm	NA				
Protected Phases		4			8			2				
Permitted Phases	4							2				
Detector Phase	4	4			8			2	2			
Switch Phase												
Minimum Initial (s)	10.0	10.0			10.0		10.0	10.0				
Minimum Split (s)	21.4	21.4			20.4		21.4	21.4				
Total Split (s)	45.0	45.0			45.0		30.0	30.0				
Total Split (%)	60.0%	60.0%			60.0%		40.0%	40.0%				
Yellow Time (s)	3.3	3.3			3.3		3.3	3.3				
All-Red Time (s)	2.1	2.1			2.1		2.1	2.1				
Lost Time Adjust (s)	0.0	0.0			0.0		0.0	0.0				
Total Lost Time (s)	5.4	5.4			5.4		5.4	5.4				
Lead/Lag												
Lead-Lag Optimize?												
Recall Mode	None	None			None		C-Max	C-Max				
Act Effct Green (s)	19.7	19.7			19.7		44.5	44.5				
Actuated g/C Ratio	0.26	0.26			0.26		0.59	0.59				
v/c Ratio	0.47	0.55			0.72		0.06	0.31				
Control Delay	23.0	19.3			35.3		8.8	8.6				
Queue Delay	0.0	0.0			0.0		0.0	0.0				
Total Delay	23.0	19.3			35.3		8.8	8.6				
LOS	C	B			D		A	A				
Approach Delay		20.2			35.3			8.6				
Approach LOS		C			D			A				
Queue Length 50th (m)	5.8	18.9			45.8		2.9	19.6				
Queue Length 95th (m)	9.9	24.0			72.1		9.6	35.3				
Internal Link Dist (m)		166.3			173.9			90.5				139.7
Turn Bay Length (m)	30.0						40.0					
Base Capacity (vph)	323	912			887		873	2719				
Starvation Cap Reductn	0	0			0		0	0				
Spillback Cap Reductn	0	0			0		0	0				
Storage Cap Reductn	0	0			0		0	0				
Reduced v/c Ratio	0.24	0.27			0.37		0.06	0.31				

Intersection Summary	
Cycle Length:	75
Actuated Cycle Length:	75
Offset:	23 (31%), Referenced to phase 2:NBTL and 6:, Start of Green
Natural Cycle:	45
Control Type:	Actuated-Coordinated

Lanes, Volumes, Timings
6: Kent & Gladstone

2035 Future Total
PM Peak Hour

Maximum v/c Ratio: 0.72	Intersection LOS: B
Intersection Signal Delay: 16.7	ICU Level of Service B
Intersection Capacity Utilization 59.7%	
Analysis Period (min) 15	

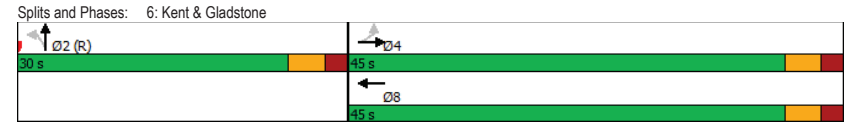

Lanes, Volumes, Timings
7: Bank & Somerset

2035 Future Total
PM Peak Hour

Lane Group	EBL	EBT	EBR	WBL	WBT	WBR	NBL	NBT	NBR	SBL	SBT	SBR
Lane Configurations		↕	↕	↕	↕			↕			↕	
Traffic Volume (vph)	44	187	79	33	135	24	25	193	41	5	261	51
Future Volume (vph)	44	187	79	33	135	24	25	193	41	5	261	51
Satd. Flow (prot)	0	1704	1483	1658	1590	0	0	1499	0	0	1480	0
Fit Permitted		0.908		0.515				0.955			0.996	
Satd. Flow (perm)	0	1457	723	601	1590	0	0	1394	0	0	1467	0
Satd. Flow (RTOR)												
Lane Group Flow (vph)	0	231	79	33	159	0	0	259	0	0	317	0
Turn Type	Perm	NA	Perm	Perm	NA		Perm	NA		Perm	NA	
Protected Phases		4			8			2			6	
Permitted Phases	4		4	8			2			6		
Detector Phase	4	4	4	8	8		2	2		6	6	
Switch Phase												
Minimum Initial (s)	10.0	10.0	10.0	10.0	10.0		10.0	10.0		10.0	10.0	
Minimum Split (s)	20.5	20.5	20.5	20.5	20.5		20.5	20.5		20.5	20.5	
Total Split (s)	25.0	25.0	25.0	25.0	25.0		40.0	40.0		40.0	40.0	
Total Split (%)	33.3%	33.3%	33.3%	33.3%	33.3%		53.3%	53.3%		53.3%	53.3%	
Yellow Time (s)	3.3	3.3	3.3	3.3	3.3		3.3	3.3		3.3	3.3	
All-Red Time (s)	2.2	2.2	2.2	2.2	2.2		2.2	2.2		2.2	2.2	
Lost Time Adjust (s)		0.0	0.0	0.0	0.0			0.0			0.0	
Total Lost Time (s)		5.5	5.5	5.5	5.5			5.5			5.5	
Lead/Lag	Lag	Lag	Lag	Lag	Lag		Lag	Lag		Lag	Lag	
Lead-Lag Optimize?	Yes	Yes	Yes	Yes	Yes		Yes	Yes		Yes	Yes	
Recall Mode	None	None	None	None	None		C-Max	C-Max		C-Max	C-Max	
Act Effct Green (s)		17.9	17.9	17.9	17.9			46.1			46.1	
Actuated g/C Ratio		0.24	0.24	0.24	0.24			0.61			0.61	
v/c Ratio		0.66	0.46	0.23	0.42			0.30			0.35	
Control Delay		28.6	25.9	25.8	26.9			3.3			9.2	
Queue Delay		0.0	0.0	0.0	0.0			0.2			0.0	
Total Delay		28.6	25.9	25.8	26.9			3.5			9.2	
LOS		C	C	C	C			A			A	
Approach Delay		27.9			26.7			3.5			9.2	
Approach LOS		C			C			A			A	
Queue Length 50th (m)		32.1	10.0	4.1	20.5			6.4			19.7	
Queue Length 95th (m)		46.3	20.5	10.5	33.6			8.6			43.1	
Internal Link Dist (m)		174.8			68.0			65.6			106.3	
Turn Bay Length (m)			28.0	15.0								
Base Capacity (vph)		392	194	162	429			856			901	
Starvation Cap Reductn		0	0	0	0			186			0	
Spillback Cap Reductn		0	0	0	0			0			0	
Storage Cap Reductn		0	0	0	0			0			0	
Reduced v/c Ratio		0.59	0.41	0.20	0.37			0.39			0.35	

Intersection Summary
 Cycle Length: 75
 Actuated Cycle Length: 75
 Offset: 7 (9%), Referenced to phase 2:NBTL and 6:SBLT, Start of Green
 Natural Cycle: 55
 Control Type: Actuated-Coordinated

Lanes, Volumes, Timings
7: Bank & Somerset

2035 Future Total
PM Peak Hour

Lane Group	Ø1	Ø3	Ø5	Ø7
Lane Configurations				
Traffic Volume (vph)				
Future Volume (vph)				
Satd. Flow (prot)				
Fit Permitted				
Satd. Flow (perm)				
Satd. Flow (RTOR)				
Lane Group Flow (vph)				
Turn Type				
Protected Phases	1	3	5	7
Permitted Phases				
Detector Phase				
Switch Phase				
Minimum Initial (s)	1.0	1.0	1.0	1.0
Minimum Split (s)	3.0	3.0	3.0	3.0
Total Split (s)	5.0	5.0	5.0	5.0
Total Split (%)	7%	7%	7%	7%
Yellow Time (s)	2.0	2.0	2.0	2.0
All-Red Time (s)	0.0	0.0	0.0	0.0
Lost Time Adjust (s)				
Total Lost Time (s)				
Lead/Lag	Lead	Lead	Lead	Lead
Lead-Lag Optimize?	Yes	Yes	Yes	Yes
Recall Mode	None	None	None	None
Act Effct Green (s)				
Actuated g/C Ratio				
v/c Ratio				
Control Delay				
Queue Delay				
Total Delay				
LOS				
Approach Delay				
Approach LOS				
Queue Length 50th (m)				
Queue Length 95th (m)				
Internal Link Dist (m)				
Turn Bay Length (m)				
Base Capacity (vph)				
Starvation Cap Reductn				
Spillback Cap Reductn				
Storage Cap Reductn				
Reduced v/c Ratio				

Intersection Summary

Lanes, Volumes, Timings
7: Bank & Somerset

2035 Future Total
PM Peak Hour

Maximum v/c Ratio: 0.66	Intersection LOS: B
Intersection Signal Delay: 16.3	ICU Level of Service C
Intersection Capacity Utilization 69.7%	
Analysis Period (min) 15	

Splits and Phases: 7: Bank & Somerset

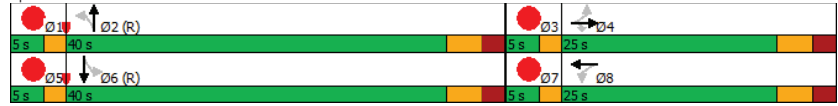

Lanes, Volumes, Timings
8: Bank & MacLaren

2035 Future Total
PM Peak Hour

Lane Group	EBL	EBT	EBR	WBL	WBT	WBR	NBL	NBT	NBR	SBL	SBT	SBR
Lane Configurations												
Traffic Volume (vph)	0	0	0	35	11	10	25	255	0	0	342	26
Future Volume (vph)	0	0	0	35	11	10	25	255	0	0	342	26
Satd. Flow (prot)	0	0	0	0	1570	0	0	1675	0	0	1624	0
Fit Permitted					0.970			0.955				
Satd. Flow (perm)	0	0	0	0	1400	0	0	1550	0	0	1624	0
Satd. Flow (RTOR)					10						9	
Lane Group Flow (vph)	0	0	0	0	56	0	0	280	0	0	368	0
Turn Type				Perm	NA		Perm	NA			NA	
Protected Phases					8			2			6	
Permitted Phases				8			2					
Detector Phase				8	8		2	2			6	
Switch Phase												
Minimum Initial (s)				10.0	10.0		10.0	10.0			10.0	
Minimum Split (s)				24.2	24.2		18.0	18.0			18.0	
Total Split (s)				24.2	24.2		50.8	50.8			50.8	
Total Split (%)				32.3%	32.3%		67.7%	67.7%			67.7%	
Yellow Time (s)				3.3	3.3		3.3	3.3			3.3	
All-Red Time (s)				1.9	1.9		1.7	1.7			1.7	
Lost Time Adjust (s)					0.0			0.0			0.0	
Total Lost Time (s)					5.2			5.0			5.0	
Lead/Lag												
Lead-Lag Optimize?												
Recall Mode				None	None		C-Max	C-Max			C-Max	
Act Effct Green (s)					17.2			51.6			51.6	
Actuated g/C Ratio					0.23			0.69			0.69	
v/c Ratio					0.17			0.26			0.33	
Control Delay					20.3			5.1			10.5	
Queue Delay					0.0			0.2			0.4	
Total Delay					20.3			5.2			10.9	
LOS					C			A			B	
Approach Delay					20.3			5.2			10.9	
Approach LOS					C			A			B	
Queue Length 50th (m)					5.3			9.7			40.5	
Queue Length 95th (m)					14.2			10.7			26.1	
Internal Link Dist (m)					130.7			60.9			65.6	
Turn Bay Length (m)												
Base Capacity (vph)					362			1067			1121	
Starvation Cap Reductn					0			264			343	
Spillback Cap Reductn					0			0			0	
Storage Cap Reductn					0			0			0	
Reduced v/c Ratio					0.15			0.35			0.47	

Intersection Summary

Cycle Length: 75
Actuated Cycle Length: 75
Offset: 7 (9%), Referenced to phase 2:NBTL and 6:SBT, Start of Green
Natural Cycle: 45
Control Type: Actuated-Coordinated

Lanes, Volumes, Timings
8: Bank & MacLaren

2035 Future Total
PM Peak Hour

Maximum v/c Ratio: 0.33	Intersection LOS: A
Intersection Signal Delay: 9.4	ICU Level of Service B
Intersection Capacity Utilization 60.4%	
Analysis Period (min) 15	

Splits and Phases: 8: Bank & MacLaren

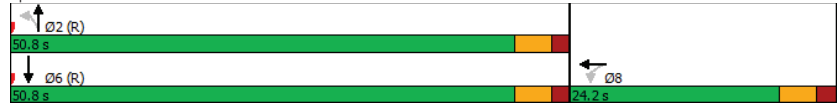

Lanes, Volumes, Timings
9: Bank & Gilmour

2035 Future Total
PM Peak Hour

Lane Group	EBL	EBT	EBR	WBL	WBT	WBR	NBL	NBT	NBR	SBL	SBT	SBR
Lane Configurations		↕						↕				↕
Traffic Volume (vph)	8	70	45	0	0	0	0	277	38	30	342	0
Future Volume (vph)	8	70	45	0	0	0	0	277	38	30	342	0
Satd. Flow (prot)	0	1502	0	0	0	0	0	1556	0	0	1707	0
Fit Permitted		0.997									0.960	
Satd. Flow (perm)	0	1478	0	0	0	0	0	1556	0	0	1599	0
Satd. Flow (RTOR)		38						16				
Lane Group Flow (vph)	0	123	0	0	0	0	0	315	0	0	372	0
Turn Type	Perm	NA						NA		Perm	NA	
Protected Phases		4						2			6	
Permitted Phases	4									6		
Detector Phase	4	4						2		6	6	
Switch Phase												
Minimum Initial (s)	10.0	10.0						10.0		10.0	10.0	
Minimum Split (s)	23.2	23.2						20.1		20.1	20.1	
Total Split (s)	25.0	25.0						50.0		50.0	50.0	
Total Split (%)	33.3%	33.3%						66.7%		66.7%	66.7%	
Yellow Time (s)	3.3	3.3						3.3		3.3	3.3	
All-Red Time (s)	1.9	1.9						1.8		1.8	1.8	
Lost Time Adjust (s)		0.0						0.0		0.0	0.0	
Total Lost Time (s)		5.2						5.1		5.1	5.1	
Lead/Lag												
Lead-Lag Optimize?												
Recall Mode	None	None						C-Max		C-Max	C-Max	
Act Effct Green (s)		16.4						48.3			48.3	
Actuated g/C Ratio		0.22						0.64			0.64	
v/c Ratio		0.35						0.31			0.36	
Control Delay		19.8						11.7			2.8	
Queue Delay		0.0						0.0			0.2	
Total Delay		19.8						11.7			3.1	
LOS		B						B			A	
Approach Delay		19.8						11.7			3.1	
Approach LOS		B						B			A	
Queue Length 50th (m)		10.2						24.1			6.6	
Queue Length 95th (m)		24.3						43.8			9.9	
Internal Link Dist (m)		129.1				69.2		57.1			60.9	
Turn Bay Length (m)												
Base Capacity (vph)		418						1007			1029	
Starvation Cap Reductn		0						0			204	
Spillback Cap Reductn		0						0			0	
Storage Cap Reductn		0						0			0	
Reduced v/c Ratio		0.29						0.31			0.45	

Intersection Summary		
Cycle Length:	75	
Actuated Cycle Length:	75	
Offset:	6 (8%), Referenced to phase 2:NBT and 6:SBTL, Start of Green	
Natural Cycle:	45	
Control Type:	Actuated-Coordinated	

Lanes, Volumes, Timings
9: Bank & Gilmour

2035 Future Total
PM Peak Hour

Maximum v/c Ratio: 0.36	Intersection LOS: A
Intersection Signal Delay: 9.0	ICU Level of Service C
Intersection Capacity Utilization 68.7%	
Analysis Period (min) 15	

Splits and Phases: 9: Bank & Gilmour

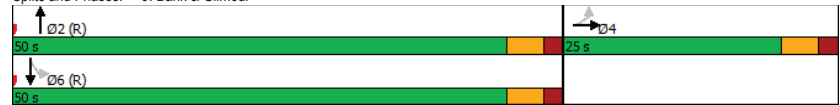

Lanes, Volumes, Timings
10: Bank & James

2035 Future Total
PM Peak Hour

Lane Group	EBL	EBR	NBL	NBT	SBT	SBR
Lane Configurations				↕	↕	
Traffic Volume (vph)	0	0	61	318	341	51
Future Volume (vph)	0	0	61	318	341	51
Satd. Flow (prot)	0	0	0	1703	1685	0
Fit Permitted				0.992		
Satd. Flow (perm)	0	0	0	1703	1685	0
Lane Group Flow (vph)	0	0	0	379	392	0
Sign Control	Stop			Free	Free	

Intersection Summary						
Control Type: Unsignalized						
Intersection Capacity Utilization 66.3%				ICU Level of Service C		
Analysis Period (min) 15						

Lanes, Volumes, Timings
11: Bank & Gladstone

2035 Future Total
PM Peak Hour

Lane Group	EBL	EBT	EBR	WBL	WBT	WBR	NBL	NBT	NBR	SBL	SBT	SBR
Lane Configurations	↔		↔		↔		↔		↔		↔	
Traffic Volume (vph)	49	185	79	41	138	28	90	289	87	15	346	41
Future Volume (vph)	49	185	79	41	138	28	90	289	87	15	346	41
Satd. Flow (prot)	0	2944	0	0	1642	0	1658	1517	0	0	3056	0
Fit Permitted	0.856		0.866		0.511		0.936					
Satd. Flow (perm)	0	2485	0	0	1388	0	690	1517	0	0	2849	0
Satd. Flow (RTOR)												
Lane Group Flow (vph)	0	313	0	0	207	0	90	376	0	0	402	0
Turn Type	Perm	NA	Perm	NA	Perm	NA	Perm	NA	Perm	NA	Perm	NA
Protected Phases	4		8		8		2		6		6	
Permitted Phases	4		8		2		6		6		6	
Detector Phase	4		4		8		8		2		2	
Switch Phase												
Minimum Initial (s)	10.0	10.0	10.0	10.0	10.0	10.0	10.0	10.0	10.0	10.0	10.0	10.0
Minimum Split (s)	20.5	20.5	20.5	20.5	20.5	20.5	20.5	20.5	20.5	20.5	20.5	20.5
Total Split (s)	28.0	28.0	28.0	28.0	37.0	37.0	37.0	37.0	37.0	37.0	37.0	37.0
Total Split (%)	37.3%	37.3%	37.3%	37.3%	49.3%	49.3%	49.3%	49.3%	49.3%	49.3%	49.3%	49.3%
Yellow Time (s)	3.3	3.3	3.3	3.3	3.3	3.3	3.3	3.3	3.3	3.3	3.3	3.3
All-Red Time (s)	2.2	2.2	2.2	2.2	2.2	2.2	2.2	2.2	2.2	2.2	2.2	2.2
Lost Time Adjust (s)	0.0		0.0		0.0		0.0		0.0		0.0	
Total Lost Time (s)	5.5		5.5		5.5		5.5		5.5		5.5	
Lead/Lag	Lag	Lag	Lag	Lag	Lag	Lag	Lag	Lag	Lag	Lag	Lag	Lag
Lead-Lag Optimize?	Yes	Yes	Yes	Yes	Yes	Yes	Yes	Yes	Yes	Yes	Yes	Yes
Recall Mode	None	None	None	None	C-Max	C-Max	C-Max	C-Max	C-Max	C-Max	C-Max	C-Max
Act Effct Green (s)	17.5		17.5		31.5		31.5		31.5		31.5	
Actuated g/C Ratio	0.23		0.23		0.42		0.42		0.42		0.42	
v/c Ratio	0.54		0.64		0.31		0.59		0.34		0.34	
Control Delay	15.9		35.0		18.3		21.5		8.7		8.7	
Queue Delay	0.0		0.0		0.0		0.0		0.0		0.0	
Total Delay	15.9		35.0		18.3		21.5		8.7		8.7	
LOS	B		D		B		C		A		A	
Approach Delay	15.9		35.0		20.9		8.7		8.7		8.7	
Approach LOS	B		D		C		A		A		A	
Queue Length 50th (m)	8.3		28.6		8.6		41.7		10.5		10.5	
Queue Length 95th (m)	13.0		45.5		20.0		69.3		16.8		16.8	
Internal Link Dist (m)	173.9		70.9		108.7		139.2		139.2		139.2	
Turn Bay Length (m)												
Base Capacity (vph)	745		416		289		637		1196		1196	
Starvation Cap Reductn	0		0		0		0		0		0	
Spillback Cap Reductn	0		0		0		0		0		0	
Storage Cap Reductn	0		0		0		0		0		0	
Reduced v/c Ratio	0.42		0.50		0.31		0.59		0.34		0.34	

Intersection Summary
 Cycle Length: 75
 Actuated Cycle Length: 75
 Offset: 26 (35%), Referenced to phase 2:NBTL and 6:SBTL, Start of Green
 Natural Cycle: 55
 Control Type: Actuated-Coordinated

Lanes, Volumes, Timings
11: Bank & Gladstone

2035 Future Total
PM Peak Hour

Lane Group	Ø1	Ø3	Ø5	Ø7
Lane Configurations				
Traffic Volume (vph)				
Future Volume (vph)				
Satd. Flow (prot)				
Fit Permitted				
Satd. Flow (perm)				
Satd. Flow (RTOR)				
Lane Group Flow (vph)				
Turn Type				
Protected Phases	1	3	5	7
Permitted Phases				
Detector Phase				
Switch Phase				
Minimum Initial (s)	1.0	1.0	1.0	1.0
Minimum Split (s)	3.0	3.0	3.0	3.0
Total Split (s)	5.0	5.0	5.0	5.0
Total Split (%)	7%	7%	7%	7%
Yellow Time (s)	2.0	2.0	2.0	2.0
All-Red Time (s)	0.0	0.0	0.0	0.0
Lost Time Adjust (s)				
Total Lost Time (s)				
Lead/Lag	Lead	Lead	Lead	Lead
Lead-Lag Optimize?	Yes	Yes	Yes	Yes
Recall Mode	Max	Max	Max	Max
Act Effct Green (s)				
Actuated g/C Ratio				
v/c Ratio				
Control Delay				
Queue Delay				
Total Delay				
LOS				
Approach Delay				
Approach LOS				
Queue Length 50th (m)				
Queue Length 95th (m)				
Internal Link Dist (m)				
Turn Bay Length (m)				
Base Capacity (vph)				
Starvation Cap Reductn				
Spillback Cap Reductn				
Storage Cap Reductn				
Reduced v/c Ratio				

Intersection Summary

Lanes, Volumes, Timings
11: Bank & Gladstone

2035 Future Total
PM Peak Hour

Maximum v/c Ratio: 0.64	Intersection LOS: B
Intersection Signal Delay: 18.3	ICU Level of Service D
Intersection Capacity Utilization 79.8%	
Analysis Period (min) 15	

Splits and Phases: 11: Bank & Gladstone



HCM 2010 AWSC
12: Access & Gilmour

2035 Future Total
PM Peak Hour

Intersection	
Intersection Delay, s/veh	7.2
Intersection LOS	A

Movement	EBT	EBR	WBL	WBT	NBL	NBR
Lane Configurations	↔					↔
Traffic Vol, veh/h	84	30	0	0	0	22
Future Vol, veh/h	84	30	0	0	0	22
Peak Hour Factor	1.00	1.00	1.00	1.00	1.00	1.00
Heavy Vehicles, %	2	2	2	2	2	2
Mvmt Flow	84	30	0	0	0	22
Number of Lanes	1	0	0	0	0	1

Approach	EB	NB
Opposing Approach		
Opposing Lanes	0	0
Conflicting Approach Left		EB
Conflicting Lanes Left	0	1
Conflicting Approach Right	NB	
Conflicting Lanes Right	1	0
HCM Control Delay	7.3	6.7
HCM LOS	A	A

Lane	NBLn1	EBLn1
Vol Left, %	0%	0%
Vol Thru, %	0%	74%
Vol Right, %	100%	26%
Sign Control	Stop	Stop
Traffic Vol by Lane	22	114
LT Vol	0	0
Through Vol	0	84
RT Vol	22	30
Lane Flow Rate	22	114
Geometry Grp	1	1
Degree of Util (X)	0.022	0.121
Departure Headway (Hd)	3.532	3.815
Convergence, Y/N	Yes	Yes
Cap	1008	944
Service Time	1.571	1.819
HCM Lane V/C Ratio	0.022	0.121
HCM Control Delay	6.7	7.3
HCM Lane LOS	A	A
HCM 95th-tile Q	0.1	0.4

Appendix K

MMLOS Analysis

DRAFT

Multi-Modal Level of Service - Intersections Form

Consultant	CGH Transportation Inc.	Project	381 Kent Street
Scenario	Existing/Future	Date	2/16/2023
Comments			

INTERSECTIONS		Kent & Somerset				Kent & Gilmour				Kent & Gladstone			
Crossing Side		NORTH	SOUTH	EAST	WEST	NORTH	SOUTH	EAST	WEST	NORTH	SOUTH	EAST	WEST
Pedestrian	Lanes	3	4	4	3	3	3	0-2	0-2	3	4	4	4
	Median	No Median - 2.4 m	No Median - 2.4 m	No Median - 2.4 m	No Median - 2.4 m	No Median - 2.4 m	No Median - 2.4 m	No Median - 2.4 m	No Median - 2.4 m	No Median - 2.4 m	No Median - 2.4 m	No Median - 2.4 m	No Median - 2.4 m
	Conflicting Left Turns	Permissive	No left turn / Prohib.	No left turn / Prohib.	Permissive	Permissive	No left turn / Prohib.	No left turn / Prohib.	No left turn / Prohib.	Permissive	No left turn / Prohib.	No left turn / Prohib.	Permissive
	Conflicting Right Turns	Permissive or yield control	No right turn	Permissive or yield control	No right turn	No right turn	Permissive or yield control	No right turn	No right turn	Permissive or yield control	No right turn	Permissive or yield control	No right turn
	Right Turns on Red (RTOR) ?	RTOR prohibited	RTOR allowed	RTOR allowed	RTOR prohibited	RTOR prohibited	RTOR allowed	RTOR prohibited	RTOR prohibited	RTOR prohibited	RTOR allowed	RTOR allowed	RTOR prohibited
	Ped Signal Leading Interval?	No	No	No	No	No	No	No	No	No	No	No	No
	Right Turn Channel	No Channel	No Right Turn	No Channel	No Right Turn	No Right Turn	No Right Turn	No Channel	No Right Turn	No Channel	No Right Turn	No Channel	No Right Turn
	Corner Radius	3-5m	No Right Turn	3-5m	No Right Turn	No Right Turn	No Right Turn	5-10m	No Right Turn	3-5m	No Right Turn	3-5m	No Right Turn
	Crosswalk Type	Std transverse markings	Std transverse markings	Textured/coloured pavement	Textured/coloured pavement	Std transverse markings	Std transverse markings	Textured/coloured pavement	Textured/coloured pavement	Std transverse markings	Std transverse markings	Textured/coloured pavement	Textured/coloured pavement
	PETS I Score	75	76	66	91	88	88	105	114	75	76	66	74
	Ped. Exposure to Traffic LoS	B	B	C	A	B	B	A	A	B	B	C	C
	Cycle Length		75	75	75		75	75	75	75	75	75	75
Effective Walk Time		20	13	13		43	8	8	27	27	12	12	
Average Pedestrian Delay		20	26	26		7	30	30	15	15	26	26	
Pedestrian Delay LoS		-	C	C	C	-	A	-	D	B	B	C	C
Level of Service		B	C	C	C	B	B	A	D	B	B	C	C
Approach From		C				D				C			
Bicycle	Bicycle Lane Arrangement on Approach		Mixed Traffic	Mixed Traffic			Mixed Traffic				Mixed Traffic	Mixed Traffic	
	Right Turn Lane Configuration												
	Right Turning Speed												
	Cyclist relative to RT motorists	-	#N/A	#N/A	-	-	#N/A	-	-	-	#N/A	#N/A	-
	Separated or Mixed Traffic	-	Mixed Traffic	Mixed Traffic	-	-	Mixed Traffic	-	-	-	Mixed Traffic	Mixed Traffic	-
	Left Turn Approach		≥ 2 lanes crossed	One lane crossed				No lane crossed			≥ 2 lanes crossed	One lane crossed	
	Operating Speed		> 50 to < 60 km/h	> 50 to < 60 km/h	> 50 to < 60 km/h			≤ 40 km/h			> 40 to ≤ 50 km/h	> 40 to ≤ 50 km/h	> 40 to ≤ 50 km/h
Left Turning Cyclist	-	F	-	E	-	-	-	B	-	E	-	D	
Level of Service	-	#N/A	#N/A	-	-	#N/A	-	-	-	#N/A	#N/A	-	
Average Signal Delay				≤ 40 sec	≤ 30 sec							≤ 40 sec	≤ 40 sec
Level of Service				E	D							E	E
Truck	Effective Corner Radius		10 - 15 m	< 10 m							< 10 m	< 10 m	
	Number of Receiving Lanes on Departure from Intersection		1	≥ 2							≥ 2	≥ 2	
	Level of Service		E	D	-						D	D	-
Auto	Volume to Capacity Ratio		0.0 - 0.60				0.0 - 0.60				0.61 - 0.70		
	Level of Service		A				A				B		

Multi-Modal Level of Service - Segments Form

Consultant	CGH Transportation Inc.	Project	381 Kent Street
Scenario	Existing/Future	Date	2/16/2023
Comments			

SEGMENTS		James St	Kent St	Gilmour St
		1	2	3
Pedestrian	Sidewalk Width	1.5 m	1.8 m	1.5 m
	Boulevard Width	< 0.5 m	< 0.5 m	< 0.5 m
	Avg Daily Curb Lane Traffic Volume	≤ 3000	> 3000	≤ 3000
	Operating Speed	> 50 to 60 km/h	> 50 to 60 km/h	> 50 to 60 km/h
	On-Street Parking	yes	yes	yes
	Exposure to Traffic PLoS	F	D	F
	Effective Sidewalk Width			
Pedestrian Volume				
Crowding PLoS	-	-	-	
Level of Service	-	-	-	
Bicycle	Type of Cycling Facility	Mixed Traffic	Mixed Traffic	Mixed Traffic
	Number of Travel Lanes	≤ 2 (no centreline)	2-3 lanes total	≤ 2 (no centreline)
	Operating Speed	≥ 50 to 60 km/h	≥ 50 to 60 km/h	≥ 50 to 60 km/h
	# of Lanes & Operating Speed LoS	D	E	D
	Bike Lane (+ Parking Lane) Width			
	Bike Lane Width LoS	-	-	-
	Bike Lane Blockages			
	Blockage LoS	-	-	-
	Median Refuge Width (no median = < 1.8 m)	< 1.8 m refuge	< 1.8 m refuge	< 1.8 m refuge
	No. of Lanes at Unsignalized Crossing	≤ 3 lanes	≤ 3 lanes	≤ 3 lanes
Sidestreet Operating Speed	≤ 40 km/h	≤ 40 km/h	≤ 40 km/h	
Unsignalized Crossing - Lowest LoS	A	A	A	
Level of Service	D	E	D	
Transit	Facility Type			
	Friction or Ratio Transit:Posted Speed			
	Level of Service	-	-	-
Truck	Truck Lane Width		≤ 3.5 m	
	Travel Lanes per Direction		> 1	
	Level of Service	-	A	-

Appendix L

TDM Checklist

DRAFT

TDM Measures Checklist:
Non-Residential Developments (office, institutional, retail or industrial)

Legend	
BASIC	The measure is generally feasible and effective, and in most cases would benefit the development and its users
BETTER	The measure could maximize support for users of sustainable modes, and optimize development performance
★	The measure is one of the most dependably effective tools to encourage the use of sustainable modes

TDM measures: <i>Non-residential developments</i>		Check if proposed & add descriptions
1. TDM PROGRAM MANAGEMENT		
1.1 Program coordinator		
BASIC	★ 1.1.1 Designate an internal coordinator, or contract with an external coordinator	<input type="checkbox"/>
1.2 Travel surveys		
BETTER	1.2.1 Conduct periodic surveys to identify travel-related behaviours, attitudes, challenges and solutions, and to track progress	<input type="checkbox"/>
2. WALKING AND CYCLING		
2.1 Information on walking/cycling routes & destinations		
BASIC	2.1.1 Display local area maps with walking/cycling access routes and key destinations at major entrances	<input checked="" type="checkbox"/>
2.2 Bicycle skills training		
<i>Commuter travel</i>		
BETTER	★ 2.2.1 Offer on-site cycling courses for commuters, or subsidize off-site courses	<input type="checkbox"/>
2.3 Valet bike parking		
<i>Visitor travel</i>		
BETTER	2.3.1 Offer secure valet bike parking during public events when demand exceeds fixed supply (e.g. for festivals, concerts, games)	<input type="checkbox"/>

TDM measures: <i>Non-residential developments</i>		Check if proposed & add descriptions
3. TRANSIT		
3.1 Transit information		
BASIC	3.1.1 Display relevant transit schedules and route maps at entrances	<input checked="" type="checkbox"/>
BASIC	3.1.2 Provide online links to OC Transpo and STO information	<input type="checkbox"/>
BETTER	3.1.3 Provide real-time arrival information display at entrances	<input type="checkbox"/>
3.2 Transit fare incentives		
<i>Commuter travel</i>		
BETTER	3.2.1 Offer preloaded PRESTO cards to encourage commuters to use transit	<input type="checkbox"/>
BETTER	★ 3.2.2 Subsidize or reimburse monthly transit pass purchases by employees	<input type="checkbox"/>
<i>Visitor travel</i>		
BETTER	3.2.3 Arrange inclusion of same-day transit fare in price of tickets (e.g. for festivals, concerts, games)	<input type="checkbox"/>
3.3 Enhanced public transit service		
<i>Commuter travel</i>		
BETTER	3.3.1 Contract with OC Transpo to provide enhanced transit services (e.g. for shift changes, weekends)	<input type="checkbox"/>
<i>Visitor travel</i>		
BETTER	3.3.2 Contract with OC Transpo to provide enhanced transit services (e.g. for festivals, concerts, games)	<input type="checkbox"/>
3.4 Private transit service		
<i>Commuter travel</i>		
BETTER	3.4.1 Provide shuttle service when OC Transpo cannot offer sufficient quality or capacity to serve demand (e.g. for shift changes, weekends)	<input type="checkbox"/>
<i>Visitor travel</i>		
BETTER	3.4.2 Provide shuttle service when OC Transpo cannot offer sufficient quality or capacity to serve demand (e.g. for festivals, concerts, games)	<input type="checkbox"/>

TDM measures: <i>Non-residential developments</i>		Check if proposed & add descriptions
4. RIDESHARING		
4.1 Ridematching service		
<i>Commuter travel</i>		
BASIC ★	4.1.1 Provide a dedicated ridematching portal at OttawaRideMatch.com	<input type="checkbox"/>
4.2 Carpool parking price incentives		
<i>Commuter travel</i>		
BETTER	4.2.1 Provide discounts on parking costs for registered carpools	<input type="checkbox"/>
4.3 Vanpool service		
<i>Commuter travel</i>		
BETTER	4.3.1 Provide a vanpooling service for long-distance commuters	<input type="checkbox"/>
5. CARSHARING & BIKESHARING		
5.1 Bikeshare stations & memberships		
BETTER	5.1.1 Contract with provider to install on-site bikeshare station for use by commuters and visitors	<input type="checkbox"/>
<i>Commuter travel</i>		
BETTER	5.1.2 Provide employees with bikeshare memberships for local business travel	<input type="checkbox"/>
5.2 Carshare vehicles & memberships		
<i>Commuter travel</i>		
BETTER	5.2.1 Contract with provider to install on-site carshare vehicles and promote their use by tenants	<input type="checkbox"/>
BETTER	5.2.2 Provide employees with carshare memberships for local business travel	<input type="checkbox"/>
6. PARKING		
6.1 Priced parking		
<i>Commuter travel</i>		
BASIC ★	6.1.1 Charge for long-term parking (daily, weekly, monthly)	<input checked="" type="checkbox"/>
BASIC	6.1.2 Unbundle parking cost from lease rates at multi-tenant sites	<input checked="" type="checkbox"/>
<i>Visitor travel</i>		
BETTER	6.1.3 Charge for short-term parking (hourly)	<input type="checkbox"/>

TDM measures: <i>Non-residential developments</i>		Check if proposed & add descriptions
7. TDM MARKETING & COMMUNICATIONS		
7.1 Multimodal travel information		
<i>Commuter travel</i>		
BASIC ★	7.1.1 Provide a multimodal travel option information package to new/relocating employees and students	<input checked="" type="checkbox"/>
<i>Visitor travel</i>		
BETTER ★	7.1.2 Include multimodal travel option information in invitations or advertising that attract visitors or customers (e.g. for festivals, concerts, games)	<input type="checkbox"/>
7.2 Personalized trip planning		
<i>Commuter travel</i>		
BETTER ★	7.2.1 Offer personalized trip planning to new/relocating employees	<input type="checkbox"/>
7.3 Promotions		
<i>Commuter travel</i>		
BETTER	7.3.1 Deliver promotions and incentives to maintain awareness, build understanding, and encourage trial of sustainable modes	<input type="checkbox"/>
8. OTHER INCENTIVES & AMENITIES		
8.1 Emergency ride home		
<i>Commuter travel</i>		
BETTER ★	8.1.1 Provide emergency ride home service to non-driving commuters	<input type="checkbox"/>
8.2 Alternative work arrangements		
<i>Commuter travel</i>		
BASIC ★	8.2.1 Encourage flexible work hours	<input type="checkbox"/>
BETTER	8.2.2 Encourage compressed workweeks	<input type="checkbox"/>
BETTER ★	8.2.3 Encourage telework	<input type="checkbox"/>
8.3 Local business travel options		
<i>Commuter travel</i>		
BASIC ★	8.3.1 Provide local business travel options that minimize the need for employees to bring a personal car to work	<input type="checkbox"/>
8.4 Commuter incentives		
<i>Commuter travel</i>		
BETTER	8.4.1 Offer employees a taxable, mode-neutral commuting allowance	<input type="checkbox"/>
8.5 On-site amenities		
<i>Commuter travel</i>		
BETTER	8.5.1 Provide on-site amenities/services to minimize mid-day or mid-commute errands	<input type="checkbox"/>

TDM Measures Checklist:
Residential Developments (multi-family, condominium or subdivision)

Legend	
BASIC	The measure is generally feasible and effective, and in most cases would benefit the development and its users
BETTER	The measure could maximize support for users of sustainable modes, and optimize development performance
★	The measure is one of the most dependably effective tools to encourage the use of sustainable modes

TDM measures: Residential developments		Check if proposed & add descriptions
1. TDM PROGRAM MANAGEMENT		
1.1 Program coordinator		
BASIC ★	1.1.1 Designate an internal coordinator, or contract with an external coordinator	<input type="checkbox"/>
1.2 Travel surveys		
BETTER	1.2.1 Conduct periodic surveys to identify travel-related behaviours, attitudes, challenges and solutions, and to track progress	<input type="checkbox"/>
2. WALKING AND CYCLING		
2.1 Information on walking/cycling routes & destinations		
BASIC	2.1.1 Display local area maps with walking/cycling access routes and key destinations at major entrances (<i>multi-family, condominium</i>)	<input checked="" type="checkbox"/>
2.2 Bicycle skills training		
BETTER	2.2.1 Offer on-site cycling courses for residents, or subsidize off-site courses	<input type="checkbox"/>

TDM measures: Residential developments		Check if proposed & add descriptions
3. TRANSIT		
3.1 Transit information		
BASIC	3.1.1 Display relevant transit schedules and route maps at entrances (<i>multi-family, condominium</i>)	<input checked="" type="checkbox"/>
BETTER	3.1.2 Provide real-time arrival information display at entrances (<i>multi-family, condominium</i>)	<input type="checkbox"/>
3.2 Transit fare incentives		
BASIC ★	3.2.1 Offer PRESTO cards preloaded with one monthly transit pass on residence purchase/move-in, to encourage residents to use transit	<input checked="" type="checkbox"/>
BETTER	3.2.2 Offer at least one year of free monthly transit passes on residence purchase/move-in	<input checked="" type="checkbox"/>
3.3 Enhanced public transit service		
BETTER ★	3.3.1 Contract with OC Transpo to provide early transit services until regular services are warranted by occupancy levels (<i>subdivision</i>)	<input type="checkbox"/>
3.4 Private transit service		
BETTER	3.4.1 Provide shuttle service for seniors homes or lifestyle communities (e.g. scheduled mall or supermarket runs)	<input type="checkbox"/>
4. CARSHARING & BIKESHARING		
4.1 Bikeshare stations & memberships		
BETTER	4.1.1 Contract with provider to install on-site bikeshare station (<i>multi-family</i>)	<input checked="" type="checkbox"/>
BETTER	4.1.2 Provide residents with bikeshare memberships, either free or subsidized (<i>multi-family</i>)	<input type="checkbox"/>
4.2 Carshare vehicles & memberships		
BETTER	4.2.1 Contract with provider to install on-site carshare vehicles and promote their use by residents	<input checked="" type="checkbox"/>
BETTER	4.2.2 Provide residents with carshare memberships, either free or subsidized	<input type="checkbox"/>
5. PARKING		
5.1 Priced parking		
BASIC ★	5.1.1 Unbundle parking cost from purchase price (<i>condominium</i>)	<input type="checkbox"/>
BASIC ★	5.1.2 Unbundle parking cost from monthly rent (<i>multi-family</i>)	<input checked="" type="checkbox"/>

TDM measures: Residential developments		Check if proposed & add descriptions
6. TDM MARKETING & COMMUNICATIONS		
6.1 Multimodal travel information		
BASIC ★	6.1.1 Provide a multimodal travel option information package to new residents	<input checked="" type="checkbox"/>
6.2 Personalized trip planning		
BETTER ★	6.2.1 Offer personalized trip planning to new residents	<input type="checkbox"/>

TDM-Supportive Development Design and Infrastructure Checklist:
Residential Developments (multi-family or condominium)

Legend	
REQUIRED	The Official Plan or Zoning By-law provides related guidance that must be followed
BASIC	The measure is generally feasible and effective, and in most cases would benefit the development and its users
BETTER	The measure could maximize support for users of sustainable modes, and optimize development performance

TDM-supportive design & infrastructure measures: Residential developments		Check if completed & add descriptions, explanations or plan/drawing references
1. WALKING & CYCLING: ROUTES		
1.1 Building location & access points		
BASIC	1.1.1 Locate building close to the street, and do not locate parking areas between the street and building entrances	<input checked="" type="checkbox"/>
BASIC	1.1.2 Locate building entrances in order to minimize walking distances to sidewalks and transit stops/stations	<input checked="" type="checkbox"/>
BASIC	1.1.3 Locate building doors and windows to ensure visibility of pedestrians from the building, for their security and comfort	<input checked="" type="checkbox"/>
1.2 Facilities for walking & cycling		
REQUIRED	1.2.1 Provide convenient, direct access to stations or major stops along rapid transit routes within 600 metres; minimize walking distances from buildings to rapid transit; provide pedestrian-friendly, weather-protected (where possible) environment between rapid transit accesses and building entrances; ensure quality linkages from sidewalks through building entrances to integrated stops/stations (see Official Plan policy 4.3.3)	<input checked="" type="checkbox"/>
REQUIRED	1.2.2 Provide safe, direct and attractive pedestrian access from public sidewalks to building entrances through such measures as: reducing distances between public sidewalks and major building entrances; providing walkways from public streets to major building entrances; within a site, providing walkways along the front of adjoining buildings, between adjacent buildings, and connecting areas where people may congregate, such as courtyards and transit stops; and providing weather protection through canopies, colonnades, and other design elements wherever possible (see Official Plan policy 4.3.12)	<input checked="" type="checkbox"/>

TDM-supportive design & infrastructure measures: <i>Residential developments</i>		Check if completed & add descriptions, explanations or plan/drawing references
REQUIRED	1.2.3 Provide sidewalks of smooth, well-drained walking surfaces of contrasting materials or treatments to differentiate pedestrian areas from vehicle areas, and provide marked pedestrian crosswalks at intersection sidewalks (see <i>Official Plan policy 4.3.10</i>)	<input checked="" type="checkbox"/>
REQUIRED	1.2.4 Make sidewalks and open space areas easily accessible through features such as gradual grade transition, depressed curbs at street corners and convenient access to extra-wide parking spaces and ramps (see <i>Official Plan policy 4.3.10</i>)	<input checked="" type="checkbox"/>
REQUIRED	1.2.5 Include adequately spaced inter-block/street cycling and pedestrian connections to facilitate travel by active transportation. Provide links to the existing or planned network of public sidewalks, multi-use pathways and on-road cycle routes. Where public sidewalks and multi-use pathways intersect with roads, consider providing traffic control devices to give priority to cyclists and pedestrians (see <i>Official Plan policy 4.3.11</i>)	<input checked="" type="checkbox"/>
BASIC	1.2.6 Provide safe, direct and attractive walking routes from building entrances to nearby transit stops	<input checked="" type="checkbox"/>
BASIC	1.2.7 Ensure that walking routes to transit stops are secure, visible, lighted, shaded and wind-protected wherever possible	<input type="checkbox"/>
BASIC	1.2.8 Design roads used for access or circulation by cyclists using a target operating speed of no more than 30 km/h, or provide a separated cycling facility	<input type="checkbox"/>
1.3 Amenities for walking & cycling		
BASIC	1.3.1 Provide lighting, landscaping and benches along walking and cycling routes between building entrances and streets, sidewalks and trails	<input type="checkbox"/>
BASIC	1.3.2 Provide wayfinding signage for site access (where required, e.g. when multiple buildings or entrances exist) and egress (where warranted, such as when directions to reach transit stops/stations, trails or other common destinations are not obvious)	<input type="checkbox"/>

TDM-supportive design & infrastructure measures: <i>Residential developments</i>		Check if completed & add descriptions, explanations or plan/drawing references
2. WALKING & CYCLING: END-OF-TRIP FACILITIES		
2.1 Bicycle parking		
REQUIRED	2.1.1 Provide bicycle parking in highly visible and lighted areas, sheltered from the weather wherever possible (see <i>Official Plan policy 4.3.6</i>)	<input checked="" type="checkbox"/>
REQUIRED	2.1.2 Provide the number of bicycle parking spaces specified for various land uses in different parts of Ottawa; provide convenient access to main entrances or well-used areas (see <i>Zoning By-law Section 111</i>)	<input checked="" type="checkbox"/>
REQUIRED	2.1.3 Ensure that bicycle parking spaces and access aisles meet minimum dimensions; that no more than 50% of spaces are vertical spaces; and that parking racks are securely anchored (see <i>Zoning By-law Section 111</i>)	<input checked="" type="checkbox"/>
BASIC	2.1.4 Provide bicycle parking spaces equivalent to the expected number of resident-owned bicycles, plus the expected peak number of visitor cyclists	<input type="checkbox"/>
2.2 Secure bicycle parking		
REQUIRED	2.2.1 Where more than 50 bicycle parking spaces are provided for a single residential building, locate at least 25% of spaces within a building/structure, a secure area (e.g. supervised parking lot or enclosure) or bicycle lockers (see <i>Zoning By-law Section 111</i>)	<input checked="" type="checkbox"/>
BETTER	2.2.2 Provide secure bicycle parking spaces equivalent to at least the number of units at condominiums or multi-family residential developments	<input checked="" type="checkbox"/>
2.3 Bicycle repair station		
BETTER	2.3.1 Provide a permanent bike repair station, with commonly used tools and an air pump, adjacent to the main bicycle parking area (or secure bicycle parking area, if provided)	<input checked="" type="checkbox"/>
3. TRANSIT		
3.1 Customer amenities		
BASIC	3.1.1 Provide shelters, lighting and benches at any on-site transit stops	<input type="checkbox"/>
BASIC	3.1.2 Where the site abuts an off-site transit stop and insufficient space exists for a transit shelter in the public right-of-way, protect land for a shelter and/or install a shelter	<input type="checkbox"/>
BETTER	3.1.3 Provide a secure and comfortable interior waiting area by integrating any on-site transit stops into the building	<input type="checkbox"/>

TDM-supportive design & infrastructure measures: <i>Residential developments</i>		Check if completed & add descriptions, explanations or plan/drawing references
4. RIDESHARING		
4.1 Pick-up & drop-off facilities		
BASIC	4.1.1 Provide a designated area for carpool drivers (plus taxis and ride-hailing services) to drop off or pick up passengers without using fire lanes or other no-stopping zones	<input type="checkbox"/>
5. CARSHARING & BIKESHARING		
5.1 Carshare parking spaces		
BETTER	5.1.1 Provide up to three carshare parking spaces in an R3, R4 or R5 Zone for specified residential uses (see <i>Zoning By-law Section 94</i>)	<input checked="" type="checkbox"/>
5.2 Bikeshare station location		
BETTER	5.2.1 Provide a designated bikeshare station area near a major building entrance, preferably lighted and sheltered with a direct walkway connection	<input checked="" type="checkbox"/>
6. PARKING		
6.1 Number of parking spaces		
REQUIRED	6.1.1 Do not provide more parking than permitted by zoning, nor less than required by zoning, unless a variance is being applied for	<input checked="" type="checkbox"/>
BASIC	6.1.2 Provide parking for long-term and short-term users that is consistent with mode share targets, considering the potential for visitors to use off-site public parking	<input type="checkbox"/>
BASIC	6.1.3 Where a site features more than one use, provide shared parking and reduce the cumulative number of parking spaces accordingly (see <i>Zoning By-law Section 104</i>)	<input type="checkbox"/>
BETTER	6.1.4 Reduce the minimum number of parking spaces required by zoning by one space for each 13 square metres of gross floor area provided as shower rooms, change rooms, locker rooms and other facilities for cyclists in conjunction with bicycle parking (see <i>Zoning By-law Section 111</i>)	<input type="checkbox"/>
6.2 Separate long-term & short-term parking areas		
BETTER	6.2.1 Provide separate areas for short-term and long-term parking (using signage or physical barriers) to permit access controls and simplify enforcement (i.e. to discourage residents from parking in visitor spaces, and vice versa)	<input type="checkbox"/>