



# 265 Catherine Street

Transportation Impact Assessment (TIA) Report

**FINAL**

May 2024



## **TIA Plan Reports**

On 14 June 2017, the Council of the City of Ottawa adopted new Transportation Impact Assessment (TIA) Guidelines. In adopting the guidelines, Council established a requirement for those preparing and delivering transportation impact assessments and reports to sign a letter of certification.

Individuals submitting TIA reports will be responsible for all aspects of development-related transportation assessment and reporting, and undertaking such work, in accordance and compliance with the City of Ottawa's Official Plan, the Transportation Master Plan and the Transportation Impact Assessment (2017) Guidelines.

By submitting the attached TIA report (and any associated documents) and signing this document, the individual acknowledges that s/he meets the four criteria listed below.

### **CERTIFICATION**

1. I have reviewed and have a sound understanding of the objectives, needs and requirements of the City of Ottawa's Official Plan, Transportation Master Plan and the Transportation Impact Assessment (2017) Guidelines;
2. I have a sound knowledge of industry standard practice with respect to the preparation of transportation impact assessment reports, including multi modal level of service review;
3. I have substantial experience (more than 5 years) in undertaking and delivering transportation impact studies (analysis, reporting and geometric design) with strong background knowledge in transportation planning, engineering or traffic operations; and
4. I am either a licensed<sup>1</sup> or registered<sup>2</sup> professional in good standing, whose field of expertise [check  appropriate field(s)] is either transportation engineering  or transportation planning .

**1,2 License of registration body that oversees the profession is required to have a code of conduct and ethics guidelines that will ensure appropriate conduct and representation for transportation planning and/or transportation engineering works.**

City Of Ottawa  
Infrastructure Services and Community  
Sustainability  
Planning and Growth Management  
110 Laurier Avenue West, 4th fl.  
Ottawa, ON K1P 1J1  
Tel. : 613-580-2424  
Fax: 613-560-6006

Ville d'Ottawa  
Services d'infrastructure et Viabilité des  
collectivités  
Urbanisme et Gestion de la croissance  
110, avenue Laurier Ouest  
Ottawa (Ontario) K1P 1J1  
Tél. : 613-580-2424  
Télécopieur: 613-560-6006

Dated at Ottawa this 22 day of May, 2024  
(City)

Name: Austin Shih, P.Eng.  
(Please Print)

Professional Title: Senior Project Manager



Signature of Individual certifier that s/he meets the above four criteria

<b>Office Contact Information (Please Print)</b>
Address: 1223 Michael Street North, Suite 100
City / Postal Code: Ottawa, Ontario, K1J 7T2
Telephone / Extension: 613-738-4160
E-Mail Address: austin.shih@parsons.com

# 265 Catherine Street

## Transportation Impact Assessment (TIA) Report

prepared for:  
Brigil Construction Inc.  
98 Lois Street  
Gatineau, QC  
J8Y 3R7

prepared by:  
 **PARSONS**  
1223 Michael Street North  
Suite 100  
Ottawa, ON K1J 7T2

May 23, 2024

478038-01000

---

## DOCUMENT CONTROL PAGE

<b>CLIENT:</b>	Brigil Construction
<b>PROJECT NAME:</b>	265 Catherine Street
<b>REPORT TITLE:</b>	Transportation Impact Assessment (TIA) Report
<b>PARSONS PROJECT NO:</b>	478038 - 01000
<b>APPLICATION TYPE:</b>	Zoning By-Law Amendment (ZBLA) and Site Plan Control (SPC) Application
<b>VERSION:</b>	Final
<b>DIGITAL MASTER:</b>	\\xcca57fs01\data\ISO\478038\1000\DOCS\STEP5-TIA Submission #2\265 Catherine St - TIA Report May 2024.docx
<b>ORIGINATOR</b>	Basel Ansari P.Eng.
<b>REVIEWER:</b>	Austin Shih, M.A.Sc., P.Eng.
<b>AUTHORIZATION:</b>	
<b>CIRCULATION LIST:</b>	Wally Dubyk, C.E.T.
<b>HISTORY:</b>	<ul style="list-style-type: none"> <li>- TIA Step 1 Screening Form - June 14, 2022</li> <li>- TIA Step 2 Scoping Report - June 14, 2022</li> <li>- TIA Step 3 Forecasting Report - March 13, 2023</li> <li>- TIA Step 4 Strategy Report - May 19, 2023</li> <li>- TIA Report - March 08, 2024</li> <li>- TIA Report Submission #2 - May 23, 2024</li> </ul>

# TABLE OF CONTENTS

1.0	SCREENING FORM .....	1
2.0	SCOPING REPORT .....	1
2.1.	EXISTING AND PLANNED CONDITIONS .....	1
2.1.1.	PROPOSED DEVELOPMENT .....	1
2.1.2.	EXISTING CONDITIONS.....	4
2.1.3.	PLANNED CONDITIONS .....	14
2.1.3.2	Future Transportation Network Changes .....	14
2.1.3.3	Other Area Developments .....	17
2.2.	STUDY AREA AND TIME PERIODS .....	17
2.3.	EXEMPTION REVIEW .....	18
3.0	FORECASTING .....	18
3.1.	DEVELOPMENT GENERATED TRAVEL DEMAND .....	18
3.1.1.	TRIP GENERATION AND MODE SHARES .....	18
3.1.2.	TRIP DISTRIBUTION AND ASSIGNMENT .....	25
3.2.	BACKGROUND NETWORK TRAFFIC .....	26
3.2.1.	TRANSPORTATION NETWORK PLANS .....	26
3.2.2.	BACKGROUND GROWTH.....	26
3.2.3.	OTHER DEVELOPMENTS.....	28
3.3.	DEMAND RATIONALIZATION.....	28
4.0	ANALYSIS.....	31
4.1.	DEVELOPMENT DESIGN.....	31
4.1.1.	DESIGN FOR SUSTAINABLE MODES .....	31
4.1.2.	CIRCULATION AND ACCESS .....	32
4.1.3.	NEW STREET NETWORK .....	33
4.2.	PARKING .....	33
4.2.1.	PARKING SUPPLY .....	33
4.2.2.	PARKING VARIANCE IMPLICATIONS .....	35
4.3.	BOUNDARY STREET DESIGN.....	35
4.4.	ACCESS INTERSECTION DESIGN .....	37
4.5.	TRANSPORTATION DEMAND MANAGEMENT .....	38
4.5.1.	CONTEXT FOR TDM .....	38
4.5.2.	NEED AND OPPORTUNITY.....	38
4.5.3.	TDM PROGRAM .....	39
4.6.	NEIGHBOURHOOD TRAFFIC MANAGEMENT.....	40
4.7.	TRANSIT.....	41
4.8.	REVIEW OF NETWORK CONCEPT.....	42
4.9.	INTERSECTION DESIGN.....	42
4.9.1.	INTERSECTION CONTROL .....	42
4.9.2.	INTERSECTION DESIGN .....	42
5.0	FINDINGS, CONCLUSIONS AND RECOMMENDATIONS .....	48

**LIST OF FIGURES**

FIGURE 1: LOCAL CONTEXT ..... 1

FIGURE 2: EXISTING SITE ACCESSES AND CIRCULATION ..... 2

FIGURE 3: PROPOSED FULL SITE CONCEPT PLAN..... 3

FIGURE 4: ADJACENT DRIVEWAYS WITHIN 200M OF SITE ACCESS ..... 9

FIGURE 5: STUDY AREA ACTIVE TRANSPORTATION FACILITIES ..... 10

FIGURE 6: AREA TRANSIT NETWORK..... 11

FIGURE 7: BUS STOP LOCATIONS ..... 11

FIGURE 8: EXISTING PEAK HOUR TRAFFIC VOLUMES ..... 12

FIGURE 9: EXISTING PEDESTRIAN AND CYCLISTS PEAK HOUR VOLUMES ..... 13

FIGURE 10: CENTRETOWN CDP STUDY AREA..... 16

FIGURE 11: STUDY AREA..... 18

FIGURE 12: PHASE 1 SITE-GENERATED TRAFFIC ..... 25

FIGURE 13: FULL BUILDOUT PHASE 1 + PHASE 2 SITE-GENERATED TRAFFIC ..... 26

FIGURE 14: FUTURE BACKGROUND 2026 TRAFFIC VOLUMES ..... 27

FIGURE 15: FUTURE BACKGROUND 2031 TRAFFIC VOLUMES ..... 27

FIGURE 16: FUTURE BACKGROUND 2036 TRAFFIC VOLUMES ..... 28

FIGURE 17: TOTAL PROJECTED 2026 TRAFFIC VOLUMES..... 29

FIGURE 18: TOTAL PROJECTED 2031 TRAFFIC VOLUMES..... 30

FIGURE 19: TOTAL PROJECTED 2036 TRAFFIC VOLUMES..... 30

FIGURE 20: PROPOSED BUS STOP REALIGNMENT AND ENHANCEMENT ..... 31

FIGURE 21: TRANSIT RIDERSHIP DATA BUS STOP LOCATIONS ..... 41

**LIST OF TABLES**

TABLE 1: PROPOSED DEVELOPMENT SITE STATISTICS ..... 2

TABLE 2: EXEMPTIONS REVIEW SUMMARY ..... 18

TABLE 3: PROPOSED DEVELOPMENT TRIP RATES ..... 18

TABLE 4: RESIDENTIAL UNITS PEAK PERIOD PERSON TRIP GENERATION ..... 19

TABLE 5: HIGH-RISE APARTMENTS PEAK PERIOD TRIPS MODE SHARES BREAKDOWN ..... 19

TABLE 6: TOWNHOMES PEAK PERIOD TRIPS MODE SHARES BREAKDOWN..... 19

TABLE 7: PEAK PERIOD TO PEAK HOUR CONVERSION FACTORS (2020 TRANS MANUAL) ..... 20

TABLE 8: HIGH-RISE APARTMENTS PEAK HOUR TRIPS MODE SHARE BREAKDOWN ..... 20

TABLE 9: TOWNHOMES PEAK HOUR TRIPS MODE SHARE BREAKDOWN ..... 20

TABLE 10: HIGH-RISE APARTMENTS PEAK HOUR TRIPS MODE SHARE BREAKDOWN ..... 21

TABLE 11: TOWNHOMES PEAK HOUR TRIPS MODE SHARE BREAKDOWN..... 21

TABLE 12: HIGH-RISE APARTMENTS MODE SHARES BREAKDOWN (2020 TRANS REPORT)..... 21

TABLE 13: TOWNHOMES MODE SHARES BREAKDOWN (2020 TRANS REPORT) ..... 21

TABLE 14: TOTAL RESIDENTIAL TRIP GENERATION ..... 22

TABLE 15: RETAIL UNITS PEAK HOUR PERSON TRIPS ..... 22

TABLE 16: TRANS 2020 MODE SHARES FOR COMMERCIAL USE AND PROPOSED MODE SHARES ..... 23

TABLE 17: RETAIL PEAK HOUR TRIPS MODE SHARE BREAKDOWN ..... 23

TABLE 18: TOTAL NONRESIDENTIAL TRIP GENERATION..... 24

TABLE 19: RESIDENTIAL PEAK HOUR TRIPS WITH INTERNAL REDUCTIONS ..... 24

TABLE 20: TOTAL TRIPS GENERATED..... 24

TABLE 21: REQUIRED AND PROPOSED VEHICLE PARKING SPACES ..... 34

TABLE 22: REQUIRED AND PROPOSED BICYCLE PARKING SPACES ..... 34

TABLE 23: MMLOS ANALYSIS, BOUNDARY ROAD SEGMENTS ..... 37

TABLE 24: ARLINGTON AVE EXISTING AND FUTURE TWO-WAY VOLUMES..... 40

TABLE 25: TRANSIT RIDERSHIP DATA (JAN 5, 2020 - MAR 16, 2020) .....	41
TABLE 26: EXISTING CONDITIONS INTERSECTION PERFORMANCE .....	43
TABLE 27: FUTURE BACKGROUND 2036 CONDITIONS INTERSECTION PERFORMANCE .....	44
TABLE 28: TOTAL PROJECTED 2026 CONDITIONS INTERSECTION PERFORMANCE – PHASE 1 .....	44
TABLE 29: FUTURE PROJECTED 2031 INTERSECTION PERFORMANCE – PHASE 1 & 2 .....	45
TABLE 30: FUTURE PROJECTED 2036 INTERSECTION PERFORMANCE – PHASE 1 & 2 .....	46
TABLE 31: QUEUEING ANALYSIS FOR SENSITIVE INTERSECTION MOVEMENTS (2036 PROJECTED).....	46
TABLE 32: MMLOS ANALYSIS, SIGNALIZED INTERSECTION .....	47

## **LIST OF APPENDICES**

APPENDIX A: SCREENING FORM & CITY COMMENT REPOSSES
APPENDIX B: TRANSIT ROUTE MAPS
APPENDIX C: TRAFFIC DATA
APPENDIX D: COLLISION DATA
APPENDIX E: INTERNAL REDUCTION CALCULATIONS
APPENDIX F: TDM CHECKLIST
APPENDIX G: PASSENGER CAR AND TRUCK TURNING TEMPLATES
APPENDIX H: MMLOS ANALYSIS: ROAD SEGMENTS
APPENDIX I: SYNCHRO ANALYSIS SUMMARY REPORTS
APPENDIX J: SIMTRAFFIC SUMMARY REPORTS
APPENDIX K: MMLOS ANALYSIS: INTERSECTIONS



# TRANSPORTATION IMPACT ASSESSMENT REPORT

Parsons has been retained by Brigil Construction to prepare a TIA in support of Zoning By-Law Amendment (ZBLA) and Site Plan Control (SPC) Application for a three-tower residential development. This document follows the TIA process as outlined in the City Transportation Impact Assessment (TIA) Guidelines (2017). The following report represents Step 5 – TIA Report. The Screening Form and responses to City Comments have been provided in **Appendix A**.

## 1.0 SCREENING FORM

The Screening Form confirmed the need for a TIA Report based on the Trip Generation and Safety triggers. The Trip Generation trigger was met as the development is anticipated to generate more than 60 person trips during peak hours. The Safety trigger was met following a review of collisions history in the study area.

## 2.0 SCOPING REPORT

### 2.1. Existing and Planned Conditions

#### 2.1.1. Proposed Development

The proposed development will be located at the municipal address of 265 Catherine St, replacing the existing Greyhound Bus Station that is no longer active. The local context of the site is illustrated in **Figure 1**.

Figure 1: Local Context

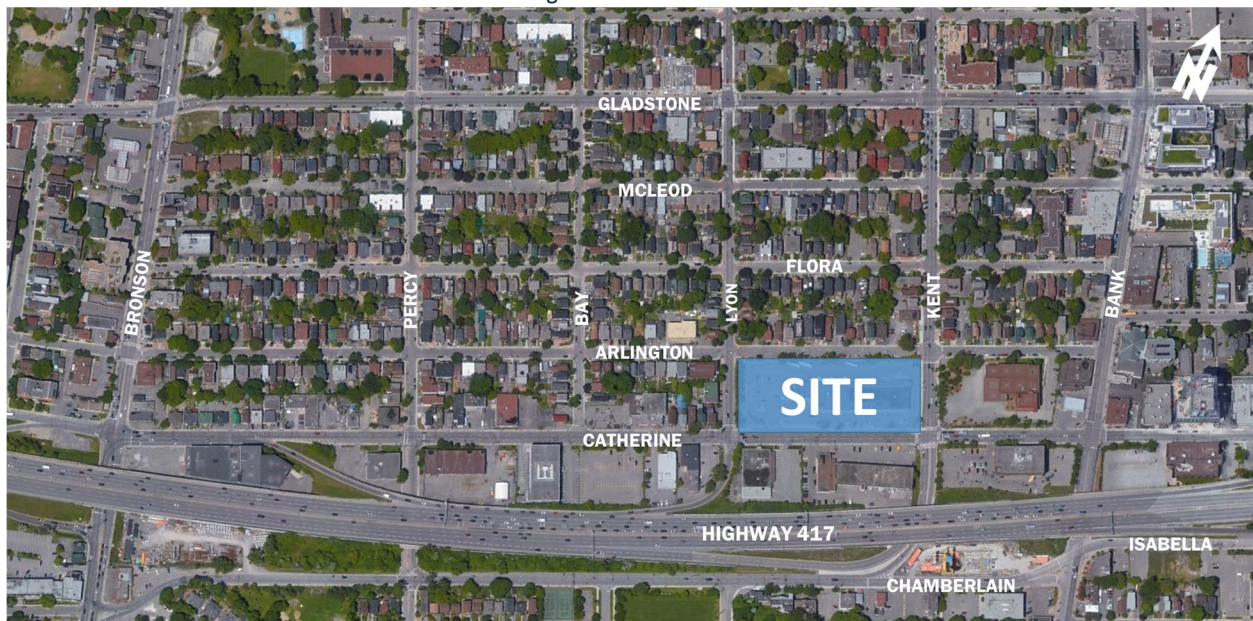

The subject site currently provides accesses onto Catherine St only as shown in **Figure 2**. The site is currently zoned as a General Mixed-Use Zone and is located within the Ontario Ministry of Transportation (MTO) permit control zone.

Figure 2: Existing Site Accesses and Circulation

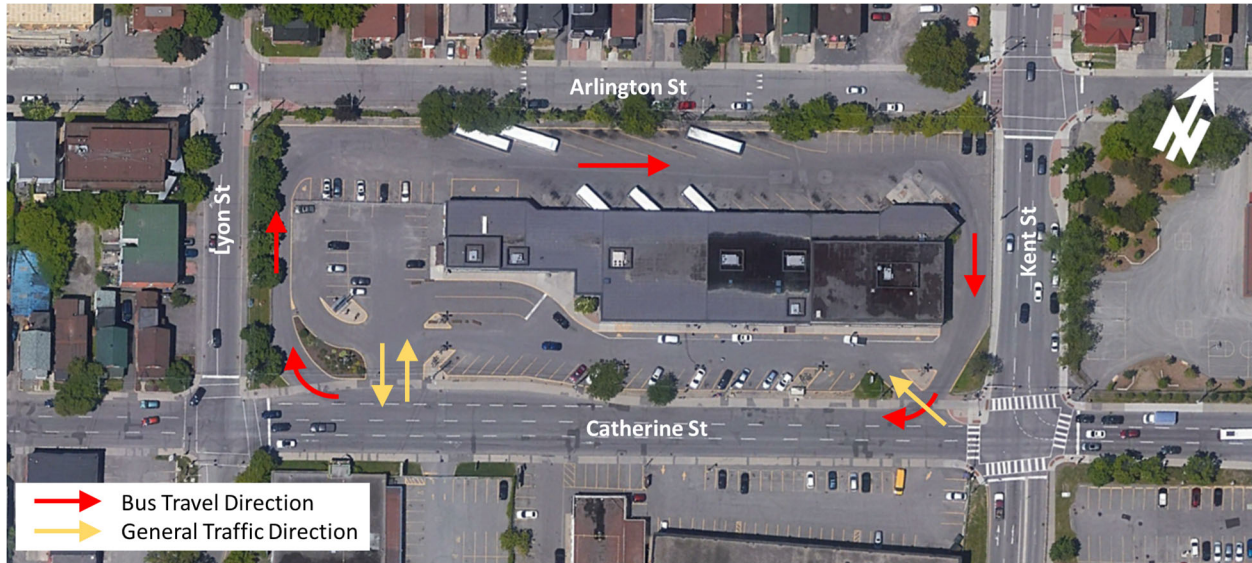

The proposed development will consist of residential and commercial uses constructed as a two phased development. The site statistics have been summarized in **Table 1**. The full buildout concept plan is illustrated in **Figure 3** (high quality plan provided in **Appendix A**).

Table 1: Proposed Development Site Statistics

Land Use	Storeys	Residential (Units)	Commercial (m <sup>2</sup> )	Vehicle Parking	Bike Parking
<b>Phase 1</b>					
Building A (Tower 1)	32	400	1,299	144	410
<b>Phase 1 Total</b>		<b>400</b>	<b>1,299</b>	<b>143</b>	<b>410</b>
<b>Phase 2</b>					
Building B (Towers 2, 3)	34 to 36	727	1,124	216	739
Building C (Townhomes)	3	7	0	-	-
<b>Phase 2 Total</b>		<b>734</b>	<b>1,124</b>	<b>214</b>	<b>739</b>
<b>Full Buildout Total</b>		<b>1,134</b>	<b>2,423</b>	<b>357</b>	<b>1,149</b>

All vehicle parking will be provided in a two-level underground parking garage accessed by new two-way ramps on Catherine St and Arlington St. Almost all bicycle parking spaces will be provided within the underground parking garage as well, which will be accessed through main elevator cores or through the parking ramps. A one-way southbound woonerf connecting Arlington St to Catherine St is proposed which will primarily serve as an extension of the expansive pedestrian realm onsite but has been designed to also accommodate loading operations, garbage truck operations and short-term deliveries. Phase 1, including the woonerf is assumed to be completed by 2026 and Phase 2 is assumed to be completed by 2031.

Further detail for onsite circulation can be found in **Section 4.1**, for vehicle and bike parking in **Section 4.2**, and for site access/driveways in **Section 4.4**.

Figure 3: Proposed Full Site Concept Plan

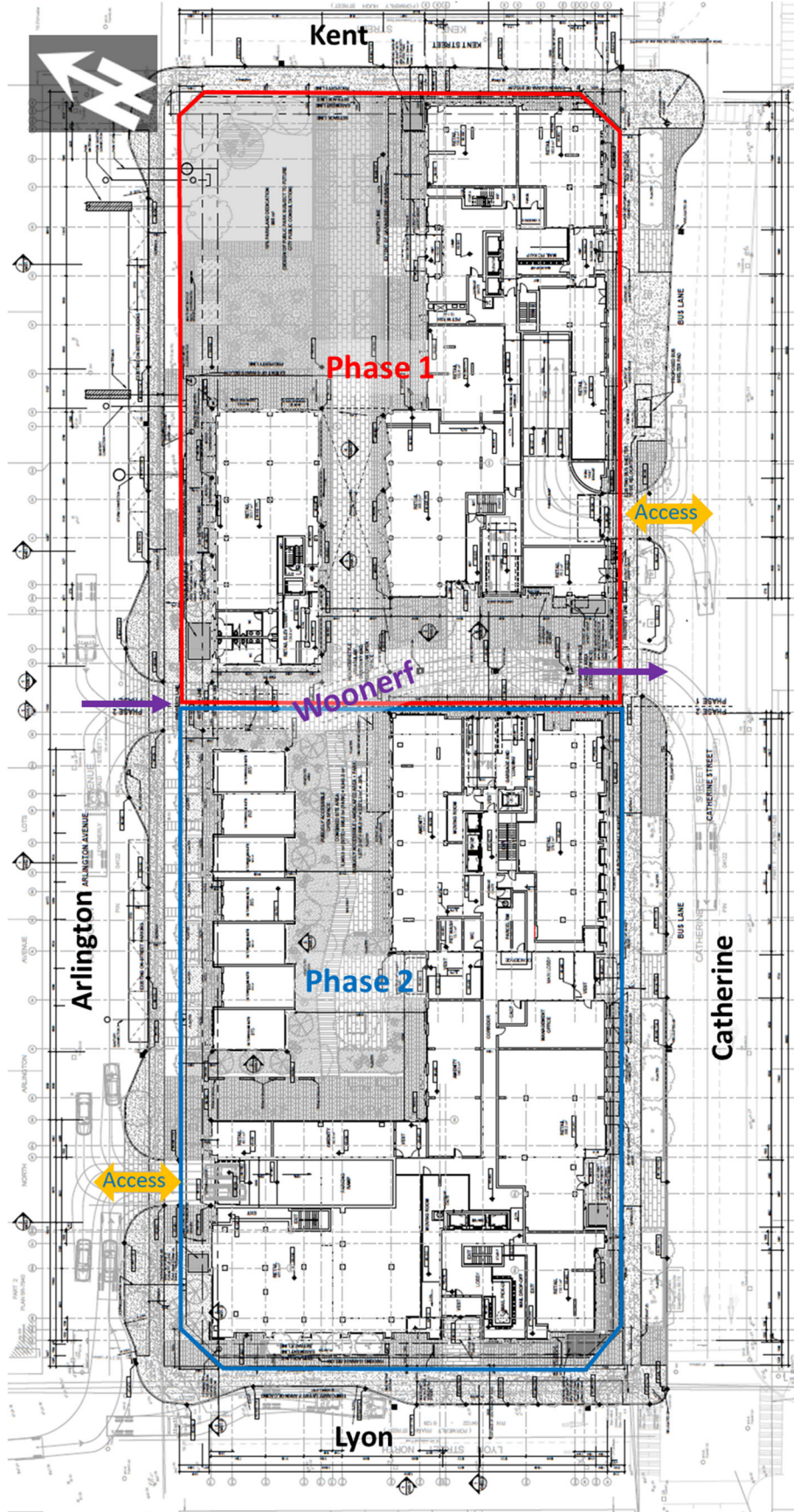

## 2.1.2. Existing Conditions

### Area Road Network

The following roads were included in the TIA. Description for each road within the study area has been provided below.

**Kent Street** is a north-south municipal arterial road that extends from Wellington St in the north to Chamberlain Ave in the south forming the east boundary road to the site. The roadway operates as a one-way northbound road with a three-lane cross-section and on-street parking. The posted speed limit is 50km/h.

**Lyon Street N** is a north-south municipal arterial road that extends from Wellington St in the north to Catherine St in the south that forms the western site boundary. The roadway operates as a one-way southbound road with a two-lane cross-section. The speed limit is assumed to be 50km/h.

**Catherine Street** is an east-west municipal arterial road bordering the site to the south that extends from Queen Elizabeth Dr in the east to Bronson Ave in the west, where it continues as Raymond St. The roadway currently operates as a one-way westbound road with a three-lane cross-section and an assumed speed limit of 50km/h.

**Arlington Avenue** is an east-west municipal local road that extends from Bank St in the east to Booth St in the west, forming the northern site boundary. The roadway consists of a two-way two-lane cross-section, with a posted speed limit of 30km/h.

**Bank Street** is a north-south municipal arterial road that extends from Wellington St in the north to past the City of Ottawa's limits in the south. Within the study area, the roadway consists of a two-way two-lane cross-section with a posted speed limit of 50km/h north of Catherine St and 40km/h south of thereof. Additionally, Bank St is designated as a traditional mainstreet in the City of Ottawa Official Plan.

**Percy Street** is a north-south municipal local road that extends from Laurier Ave W in the north to Fifth Ave in the south. Notably, the southbound through movement is not permitted on Percy St at the Chamberlain Ave intersection. Within the study area, the road consists of a two-way two-lane cross-section with on-street parking, a posted speed limit of 30km/h north of Catherine St and an assumed speed limit of 40km/h south of thereof.

**Gladstone Avenue** is an east-west municipal major collector road that extends from Parkdale Ave in the west to Cartier St in the east. The roadway consists of a two-lane cross-section along the majority of its length, with a four-lane cross-section between Bank St and Kent St. The speed limit is assumed to be 50km/h in the study area.

**Bronson Avenue** is a north-south municipal arterial road that extends from Sparks St in the north to Heron St on/off ramps in the south, where it continues as the Airport Parkway. The road consists of a four-lane cross-section, with posted speed limits of 50km/h.

**Chamberlain Avenue/Isabella Street** are east-west municipal arterial roads that extend from Bronson Ave in the west as Chamberlain Ave to Bank St, where it continues east as Isabella St to Queen Elizabeth Dr in the east. The roadway is one-way eastbound only with a two-lane cross-section and a 50km/h speed limit within the study area.

## Existing Study Area Intersections

### Lyon/Catherine

The Lyon/Catherine intersection is a four-legged signalized intersection of southbound and westbound one-way streets. The westbound approach consists of two through lanes and a shared through/left-turn lane. The southbound approach consists of a through lane and a right-turn lane. Only westbound and southbound operations are permitted at this intersection. The southbound egress serves the Hwy 417 westbound on-ramp

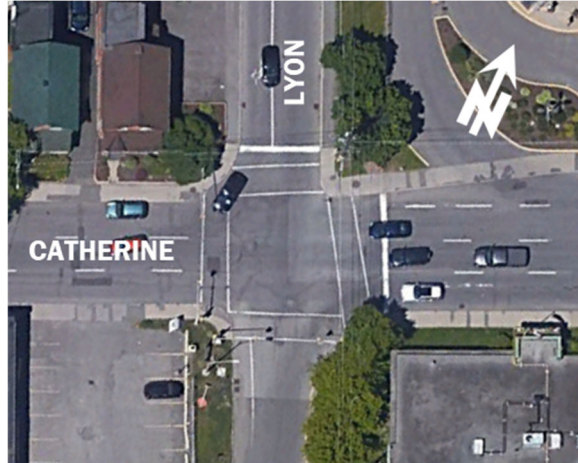

### Kent/Catherine

The Kent/Catherine intersection is a four-legged signalized intersection of northbound and westbound one-way streets. The westbound approach consists of one through lane, one through/right-turn lane and one right-turn lane. The northbound approach consists of two through lanes and a through/left-turn lane. One northbound through lane is separated by a median on the approach. Only westbound and northbound operations are permitted at this intersection and westbound right-turns are not permitted on a red light.



### Bank/Catherine

The Bank/Catherine intersection is a signalized four-legged intersection, where Catherine St is westbound only. The northbound approach consists of a through lane and a through/left-turn lane. The southbound approach consists of a through lane and a through/right-turn lane. The westbound approach consists of two through lanes and a through/right-turn lane. There are no eastbound operations at this intersection.

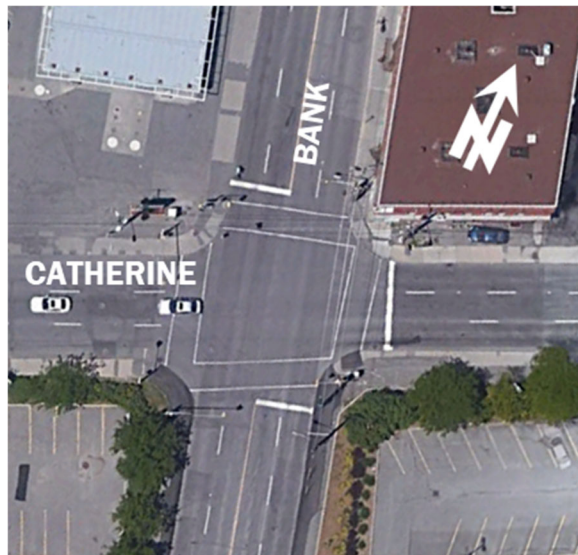

### Percy/Catherine

The Percy/Catherine intersection is a four-legged signalized intersection of southbound and westbound one-way streets. The westbound approach consists of two through lanes and a shared through/left-turn lane. The southbound approach consists of a through lane and a right-turn lane. A north-south bidirectional bike crossing with a bike signal is provided on the west leg of the intersection. Only westbound and southbound operations are permitted at this intersection for vehicles. The southbound right-turn on red is prohibited.



### Lyon/Arlington

The Lyon/Arlington intersection is an unsignalized four-legged intersection, with Stop control on Arlington Ave. Lyon St operates as one-way southbound. The westbound approach consists of a through/left-turn lane and the eastbound approach consists of a through/right-turn lane. Lyon St consists of a through/left-turn and through/right-turn lanes. There are no northbound operations at this intersection.



### Kent/Arlington

The Kent/Arlington intersection is a signalized four-legged intersection, where Kent St is northbound only. The northbound approach consists of a through lane, a through/left-turn lane and a through/right-turn lane. The eastbound approach consists of a through/left-turn lane and the westbound approach consists of a through/right-turn lane. There are no southbound operations at this intersection.



### Bank/Arlington

The Bank/Arlington intersection is an unsignalized three-legged “T” intersection, with Stop control on Arlington Ave. The northbound approach consists of a through lane and a shared through/left-turn lane. The southbound approach consists of a through lane and a shared through/right-turn lane. Arlington St consists of a single all-movement lane. There are no restricted movements at this intersection.



### Kent/Gladstone

The Kent/Gladstone intersection is a signalized four-legged intersection, where Kent St is northbound only. The northbound approach consists two through lanes, a shared through/right-turn lane and a left-turn lane. The eastbound approach consists of a through lane and a left-turn lane, while the westbound approach consists of a shared through/right-turn lane. There are no southbound operations at the intersection.



### Lyon/Gladstone

The Lyon/Gladstone intersection is a signalized four-legged intersection, where Lyon St is southbound only. The southbound approach consists of a shared through/right-turn lane and a shared through-left-turn lane. The eastbound approach consists of a through lane and an unmarked short right-turn lane. The westbound approach consists of a through lane and an unmarked short left-turn lane. There are no northbound operations at this intersection.



### Bank/Chamberlain/Isabella

The Bank/Chamberlain/Isabella intersection is a signalized four-legged intersection, where Chamberlain Ave/Isabella St is eastbound only. The northbound approach consists of a through lane and a shared through/right-turn lane. The southbound approach consists of a through lane and a shared through/left-turn lane. The eastbound approach consist of a through lane, a shared through/left-turn lane and a stop-controlled right-turn lane. There are no westbound operations at this intersection.

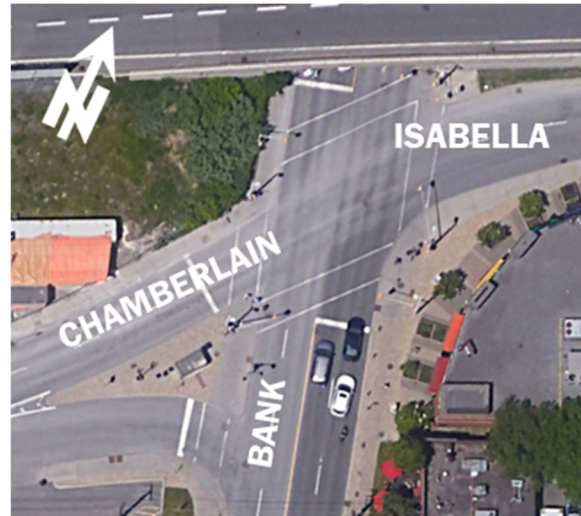

### Bronson/Catherine

The Bronson/Catherine intersection is a signalized four-legged intersection, where Catherine St is westbound only. The northbound approach consists of two through lanes and a left-turn lane. The southbound approach consists of a through lane and a shared through/right-turn lane. The westbound approach consists of a through lane, a shared through/left-turn lane, a left-turn lane and a right-turn lane. There are no eastbound operations at this intersection.

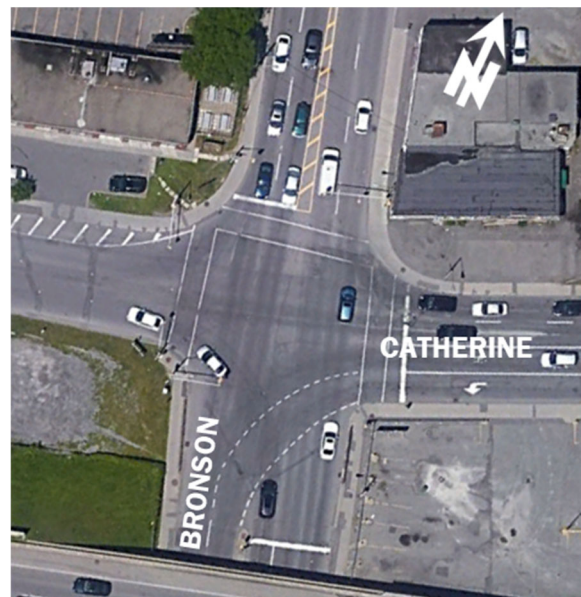

### Existing Driveways to Adjacent Developments

Within 200m of the proposed site accesses along Catherine St and Arlington St, there is a total of 37 adjacent driveways as shown in **Figure 4**. Along Arlington St, there are 24 adjacent accesses (21 north side, 3 south side). Nearly all Arlington St accesses are used by individual residential units, with the exception of the access nearest to the northwest corner of the Kent/Arlington intersection, which is used to give access to the parking lot of a small restaurant.

Along Catherine St, there are 13 adjacent accesses (5 north side, 8 south side). On the north side of Catherine St, the four accesses west of Lyon St are for individual residential units, some of which are being used as office/business, while the accesses east of Kent St is for a gas station. All south side accesses are used for office buildings, business, and commercial units of different sizes.



Figure 4: Adjacent Driveways within 200m of Site Access



### Existing Area Traffic Management Measures

Various area traffic management measures are currently provided within the study area, including the following:

- Advance pedestrian walk phases at the intersections of Kent/Catherine and Bank/Catherine,
- Bike signal and crossing phase at the intersection of Percy/Catherine,
- Zebra crosswalks on all legs at the intersection of Kent/Catherine, Lyon/Gladstone, Bank/Catherine, and Bronson/Catherine,
- Textured brick crosswalks on the east leg of the intersection of Lyon/Arlington, west leg of Kent/Arlington and west leg of Bank/Arlington,
- Curb extensions on the south side of Arlington Ave at the intersections of Lyon St and Kent St, as well as north side at the intersection of Kent St,
- Curb extension on the east side of Kent St at the intersection of Arlington Ave,
- On-street parking permitted along sections of Arlington Ave (including south side site frontage), Kent St (including east side site frontage), Lyon St, Percy St, Catherine St, and Gladstone Ave,
- Speed humps at different locations along Percy St, Lyon St, and Arlington Ave (including two at site frontage),
- Reduced 30km/h speeds along Percy St north of Catherine St and Arlington Ave,
- Southbound through restriction along Percy St at Chamberlain Ave intersection, where only bikes are permitted, and
- Modal filter along Bay St, 20m north of Catherine St, which prevent vehicles from passing and permits pedestrians and cyclists.
- Eastbound traffic restriction on Arlington Ave, approximately 50m east of Bronson Ave.

In addition to the above, the City of Ottawa has provided a list of Temporary Traffic Calming (TTC) measures within or near the study area, which includes:

- A “SLOW” pavement marking on Arlington Ave, west of Kent St.
- A speed display board on Kent St, north of Arlington Ave.
- Delineators on Lyon St, north of Gladstone Ave.
- Delineators, painted bulb-out, “SLOW” pavement marking and speed display boards on different locations of Percy St, north of Catherine St.

## Pedestrian/Cycling Network

The active transportation network facilities for pedestrians and cyclists are illustrated in **Figure 5** (map obtained from GeoOttawa). As shown, sidewalk facilities are provided throughout the study area, including both sides of all roadways. Southbound bike lanes are provided on Lyon St, north of Arlington Ave, and a bi-directional cycle track is provided along Percy St. Northbound bike lanes are also provided along Bay St, 30m north of Catherine St. Although not identified in the map shown, it is noted that a contraflow (eastbound) bike lane is provided on McLeod St, between Percy St and Lyon St.

Additionally, the City of Ottawa Transportation Master Plan (TMP) designates Chamberlain Ave/Isabella St as part of a Crosstown Bikeway route. Bank St and Gladstone Ave are suggested cycling routes, along with a small portion of Arlington Ave, between Percy St and Lyon St.

Figure 5: Study Area Active Transportation Facilities



## Transit Network

The following description of OC Transpo routes within the study area reflect the current bus operations:

- **Route #6 (Greenboro <-> Rockcliffe):** identified by OC Transpo as a “Frequent Route”, this route operates all day, 7 days a week and at an average rate of every 15 minutes or less from 6am to 6pm. The nearest bus stops to the site are at the intersections of Bank/Arlington and Bank/Catherine.
- **Route #7 (Carleton <-> St. Laurent):** identified by OC Transpo as a “Frequent Route”, this route operates all day, 7 days a week and at an average rate of every 15 minutes or less from 6am to 6pm. The nearest bus stops to the site are at the intersections of Bank/Arlington and Bank/Catherine.

- **Route #14 (St-Laurent <-> Tunney's Pasture):** identified by OC Transpo as a "Frequent Route", this route operates all day, 7 days a week and at an average rate of every 15 minutes or less from 6am to 6pm. The nearest bus stops to the site are at the intersections of Lyon/Gladstone and Kent/Gladstone.
- **Route #55 (Westgate <-> Elmvale):** identified by OC Transpo as a "Local Route", this route operates throughout the day during the week. The nearest bus stop to the site is along Catherine St, at the frontage of the site.
- **Route #114 (Rideau <-> Carlington):** identified by OC Transpo as a "Local Route", this route operates from Monday to Friday on a selected trip only basis. The nearest bus stops to the site are at the intersections of Lyon/Gladstone and Kent/Gladstone.

The transit network for the study area is illustrated in **Figure 6** and the transit route maps are provided in **Appendix B**. **Figure 7** illustrates the bus stop locations.

Figure 6: Area Transit Network



Figure 7: Bus Stop Locations



### Peak Hour Travel Demands

The existing peak hour traffic volumes at the signalized intersections within the study area were obtained from the City of Ottawa for the following intersections:

- Kent/Catherine – Conducted Wednesday, April 18, 2018
- Lyon/Catherine – Conducted Wednesday, April 18, 2018
- Bank/Catherine – Conducted Thursday, April 19, 2018
- Percy/Catherine – Conducted Thursday, April 19, 2018
- Lyon/Gladstone – Conducted Wednesday, August 24, 2022
- Kent/Gladstone – Conducted Tuesday, April 25, 2017
- Bank/Isabella/Chamberlain – Conducted Wednesday, April 18, 2018
- Catherine/Bronson - Conducted Thursday, April 19, 2018

In addition to the City of Ottawa counts, new traffic counts were obtained separately for the following intersection:

- Kent/Arlington – Conducted Tuesday, April 11, 2023
- Lyon/Arlington – Conducted Tuesday, April 11, 2023
- Bank/Arlington (mainly in/out volumes on Arlington Ave were collected) – Conducted Tuesday, April 18, 2023

The traffic volumes at study area intersections are illustrated in **Figure 8**, While existing active transportations (pedestrian and cyclist) volumes at study area intersections has been provided in **Figure 9**. Raw traffic count data provided in **Appendix C**.

It is important to note that Greyhound shut down their operations in Canada during the COVID-19 pandemic. While some of the traffic counts collected predate the closure, there is no way to verify peak hour traffic activity when the station was still active. The expectation is the weekday morning and afternoon activity was not significant. Therefore, existing traffic counts were not adjusted to remove the bus station traffic from pre-COVID-19 traffic data.

Traffic volumes at study area intersections were balanced conservatively to account for notable differences between adjacent intersections. No additional traffic growth adjustment was applied to the traffic volumes up to the existing horizon year (2023).

However, two developments that have been constructed in recent years, which includes 203 Catherine St and 488-500 Bank St, have been accounted for by adding their estimated vehicle trips to the existing traffic volumes. Note that the transportation memo for 488-500 Bank St was obtained from the City, but City staff have indicated that the TIA brief for 203 Catherine St is outdated (2011) and unavailable. Using the number of units for the 203 Catherine St development (200 units based on developer website), the number of site-generated trips were calculated. Travel mode and trip distribution assumptions followed the same assumptions of 265 Catherine St, as provided in **Section 3.0**.

Figure 8: Existing Peak Hour Traffic Volumes

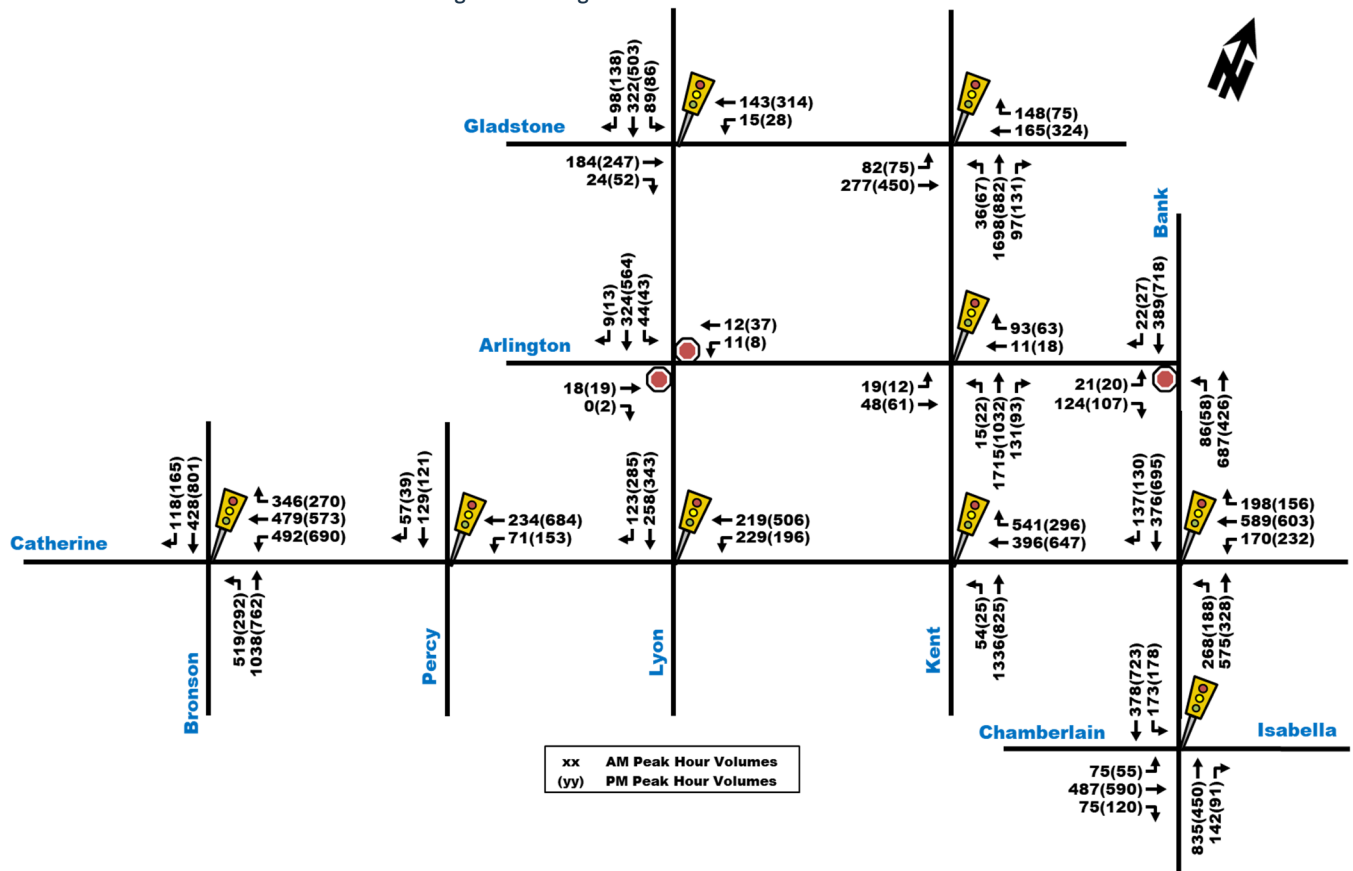
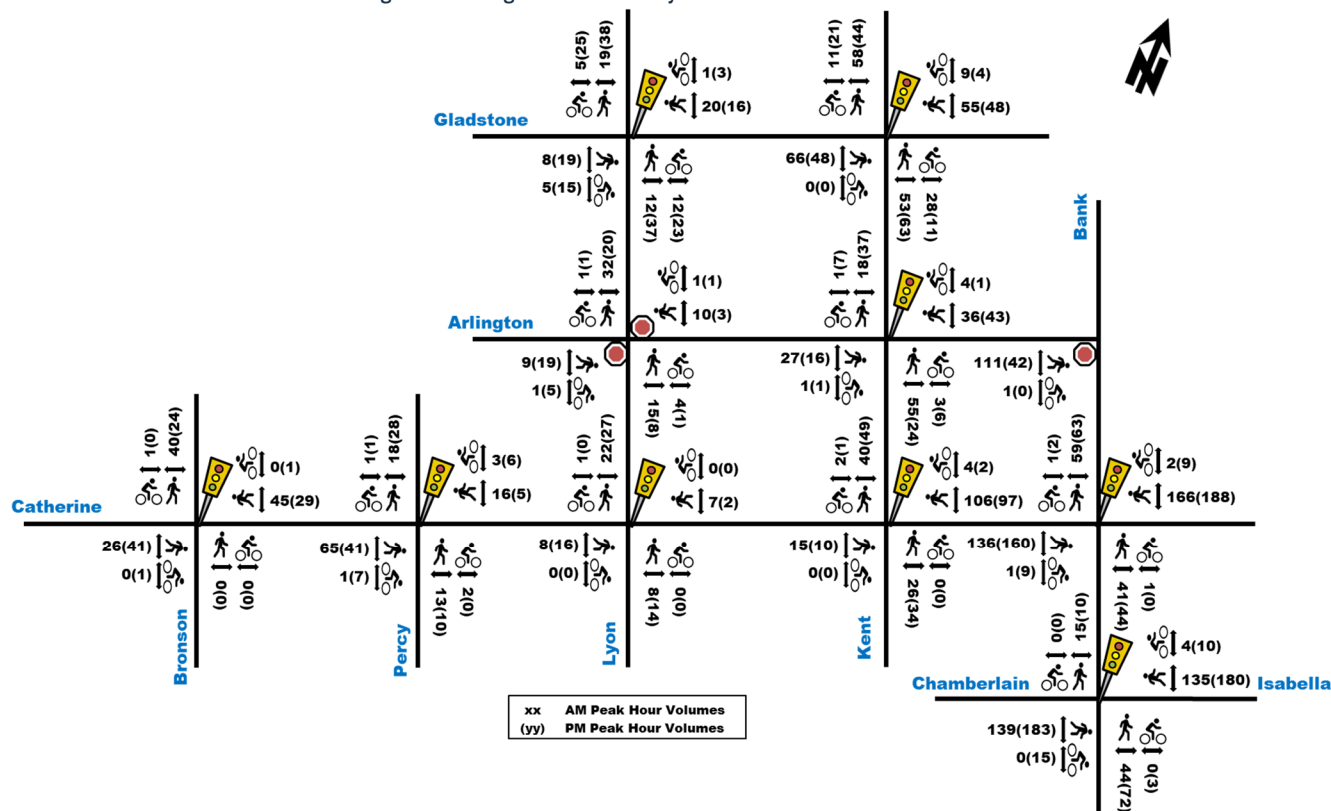

Figure 9: Existing Pedestrian and Cyclists Peak Hour Volumes



**Existing Road Safety Conditions**

A five-year collision history data (2017-2021, inclusive) was obtained from the City of Ottawa open data source for the 11 study area intersections and segments between intersections. Upon analyzing the collision data, the total number of collisions observed within the broader study area was 427 collisions within the past five-years. The majority of the collisions 359 (84%) resulted in property damage only, and 68 (16%) resulted in non-fatal injury. There were no fatal collisions recorded. Overall, the collisions type frequencies were mainly split in three distinct groups, 117 (27%) were sideswipe, 110 (26%) angle, 98 (23%) turning movement. Rear end collisions accounted for 62 (15%) and the rest less than 25 (<5%) collisions each type.

Within the study area, the quantity of collisions and collisions per million entering vehicles (MEV) at each location has occurred at a rate of:

- Bronson/Catherine: 91, MEV 1.27
- Percy/Catherine: 6, MEV 0.42
- Lyon/Catherine: 17, MEV 0.80
- Kent/Catherine: 96, MEV 2.64
- Bank/Catherine: 61, MEV 1.44
- Gladstone/Lyon: 8, MEV 0.42
- Arlington/Lyon: 2, MEV 0.12
- Gladstone/Kent: 25, MEV 0.59
- Arlington/Kent: 23, MEV 0.82
- Arlington/Bank: 10, MEV 0.41
- Bank/Chamberlain: 41, MEV 0.93
- Mid-block on Catherine (Bronson to Bank): 16 (915m)
- Mid-block on Arlington (Lyon to Bank): 8 (350m)
- Mid-block on Gladstone (Lyon to Kent): 8 (190m)
- Mid-block on Lyon (Gladstone to Catherine): 4 (315m)
- Mid-block on Kent (Gladstone to Catherine): 7 (315m)
- Mid-block on Bank (Arlington to Chamberlain): 4 (185m)
- Collisions with Pedestrians: 13 (3%)
- Collisions with Cyclists: 10 (2%)

Kent/Catherine showed to have a higher-than-average MEV or likeliness of collision than other intersections. The leading types of collisions at this intersection involved turning movements 46 (48%), sideswipe 23 (24%) and angle 20 (21%), accounting for up to 93% of all collision types. All these types of collisions involve a vehicle

changing directions, switching lanes, or turning. The City has implemented no right or left turns for the heavier northbound movement and have added a no-right-on-red for the westbound movement, effectively eliminating potential turning conflicts with opposing movements. Still, turning movements account for the highest collision type, a possible side effect of non-compliance. A red-light camera has been added to the westbound movement as of 2020, which can help mitigate some collisions from the westbound approach. The shared westbound through/right-turn lane may be resulting in unpredictable movements or lane changes by drivers which causes confusion and leads to increased conflict potential. Although there are many collisions at this location, it is believed that they occur at low speeds given that only 7% of all collisions caused non-fatal injuries.

Other intersections with MEV greater than one was all intersections where two arterials meet. The higher quantity of collisions at these intersections are indicative of the high volumes of vehicles, congestion and increased decision-making tasks required by drivers.

The intersection of Bank/Catherine experienced collisions with 6 cyclists and 8 pedestrians, accounting for 61% of all study area active transportation collisions. Bank Street, an arterial mainstreet with plenty of commercial opportunities attracts large crowds of pedestrians, cyclists, and vehicles alike. It is highly recommended that this intersection be redesigned to comply with the recent introduction of the Protected Intersection Design measures to priority the safety of the more vulnerable active transportation users. However, this task of retrofitting this intersection should not be a responsibility of the developer.

It is important to note that there are long-term plans to redesign a section of the Catherine St corridor that includes some of the intersections noted above, with the intention of enhancing safety and transit priority that benefits all road users. Further discussion on this design is provided in **Section 2.1.3**.

No other major trends were identified. The source collision data as provided by the City of Ottawa and related analysis is provided as **Appendix D**.

### **2.1.3. Planned Conditions**

#### **2.1.3.2 Future Transportation Network Changes**

##### **Transportation Master Plan (TMP)**

The City of Ottawa's TMP (2031 affordable Rapid Transit and Transit Priority Network) illustrates Bank St as a transit priority corridor with isolated measures between Albert St in the north and Riverside Dr in the south, along with Gladstone Ave between Elgin St in the east and Preston St in the west.

##### **Catherine St Functional Design Study**

A functional design study was completed by the City for Chamberlain Ave, Catherine St, and Isabella St. Within the study area frontage, modifications include:

- A proposed transit priority lane on Catherine St, west of Kent St, which converts the north general-purpose lane to a dedicated transit lane. Based on input from City staff, the western half of the bus lane would permit 1 hour parking during off-peak hours from 9am to 3:30pm. The development proposed modifications along Catherine St are not expected to impact the proposed design of the transit lane.
- A double westbound right-turn lane at the intersection of Catherine/Kent, which allows for separate pedestrian and right-turn traffic signal phases and significantly reduces collision potential at the westbound approach of the intersection.
- No right-turn-on-red for the westbound movement at the intersection of Catherine/Kent.
- A two-way 3.0m wide multi-use pathways on the south side of Chamberlain Ave and Isabella St.

These plans have received formal approval based on traffic study and public consultation. However, the detailed design and subsequent construction are not anticipated to begin until the ongoing MTO bridge rehabilitation

work on Highway 417 is completed. City staff confirmed it would be reasonable to assume implementation of the Catherine St design by 2031.

### **Centretown Community Design Plan (CDP) and Secondary Plan**

The CDP and Secondary Plan were completed in 2013 with the purpose of creating a comprehensive design plan to guide and manage future growth in the Centretown area of Ottawa. The purpose of the Secondary Plan is to translate many key aspects of the CDP into statutory policy. Note that the secondary plan was consolidated into the Central and East Downtown Core Secondary Plan as part of the new city Official Plan. As illustrated in **Figure 10**, the CDP spans a wide area from Rideau Canal to Bronson Ave and from the Queensway to Gloucester St. However, the core study area of the CDP is an area bounded by Elgin St to the east, Kent St to the west, Highway 417 to the south and Gloucester St to the north. Nonetheless, recommendations were made in the CDP for the Centretown area as a whole.

Based on the CDP, the Centretown area is divided into four different character areas, which include the Northern Character Area, the Central Character Area, the Southern Character Area, and the Residential Character Area. The proposed 265 Catherine St development is located in the Southern Character Area, which acts as a “buffer” between the busy Highway 417 and the Central and Residential zones. The Southern Area currently consists of mostly low to mid-rise buildings, with few high-rise buildings and primarily retail and employment land uses. The vision for the Southern area anticipates high-rise buildings with at-grade commercial uses in addition to residential uses and “gateway buildings and architecture” on corner sites fronting arterials (such as Catherine St), along with improved streetscape and public park opportunities along all routes, including Catherine St.



The relevant recommendations below were provided in the CDP.

- **Pedestrian Network:** Catherine St intersections at Lyon St, Kent St and Bank St have been identified as potential locations for improved pedestrian crossing. It should be noted that some measures were already in place or may have already taken effect since the CDP and Secondary Plans were introduced in 2013. Some of the measures included providing curb extensions and removing on-street parking, providing zebra crosswalks, prohibiting right-turns on red, and providing pedestrian push buttons and countdown signals.
- **Transit Network:** general suggested strategies include provision of transit priority measures during future roadway reconstruction such as transit lanes, bulbouts and additional shelters, as well as providing enhanced waiting facilities at bus stops. The City has completed a functional design study for Chamberlain, Catherine, and Isabella, which includes the conversion of a general-purpose lane to a new transit priority lane.
- **Cycling Network:** a suggested general strategy included provision of cycling infrastructure as part of new proposed developments, expanding the cycling network and implementing other cycling improvements guided by the Ottawa Cycling Plan and Centretown CDP. The City functional design study also includes new cycling infrastructure and treatments.
- **Transportation Demand Management:** suggested TDM Measures which could be incorporated as part of new developments include the provision of enhanced bicycle and pedestrian access (weather-protected facilities, safe and secure bicycle parking, streetscape improvements), improvements to transit access (provision of shelters and other amenities, service planning changes), and provision of car-sharing facilities. TDM measures were incorporated into the development proposal.

- **Right of Way (ROW) Protection:** the City identifies target widths for ROW protection to be 23m for Catherine St and 20m for Kent St and Lyon St (with a perspective to address the needs of pedestrians and increase streetscape opportunities). For Kent St and Lyon St, the maximum land requirement from property abutting the existing ROW is 0.90m. Additionally, the two roads are subject to a widening/easement policy (discussed in more detail in **Section 4.3**). These ROW protection limits were accounted for in the development proposal.
- **Parking Supply:** the CDP suggests encouraging the provision of off-street public parking in new development where appropriate. The amount of available on-street parking is expected to decrease overtime due to providing additional space for pedestrians, cyclists, and public transit.
- **Two-Way Conversion of Roads:** one major recommendation of the CDP involves converting each of Kent St and Lyon St to two-way roads. This would improve the street environment for all users, slow down traffic, create a greater choice of routes and improve wayfinding. The timeline for this modification is unknown and no studies assessing the effects of this modification have been produced yet. It has been assumed this recommendation will not be implemented within the established future horizons for this TIA.
- **Streetscapes:** the Catherine St and Kent St corridors are both illustrated as locations for priority streetscape improvements in the CDP and Secondary Plan, with Catherine St and Lyon St both enlisted in the Secondary Plan as key streets to undertake streetscape improvements as part of the capital budget for any road and infrastructure renewal program. For Catherine St, streetscape design strategies include a vision for a tree-lined street, and a generous sidewalk and landscape setbacks between the development and the sidewalk. For Kent St and Lyon St, streetscape design strategies include streetscape environment improvement through conversion of both roads to two-way, planting trees where space permits and rebuilding the asphalt sidewalk along Lyon St to City standards.

Figure 10: Centretown CDP Study Area

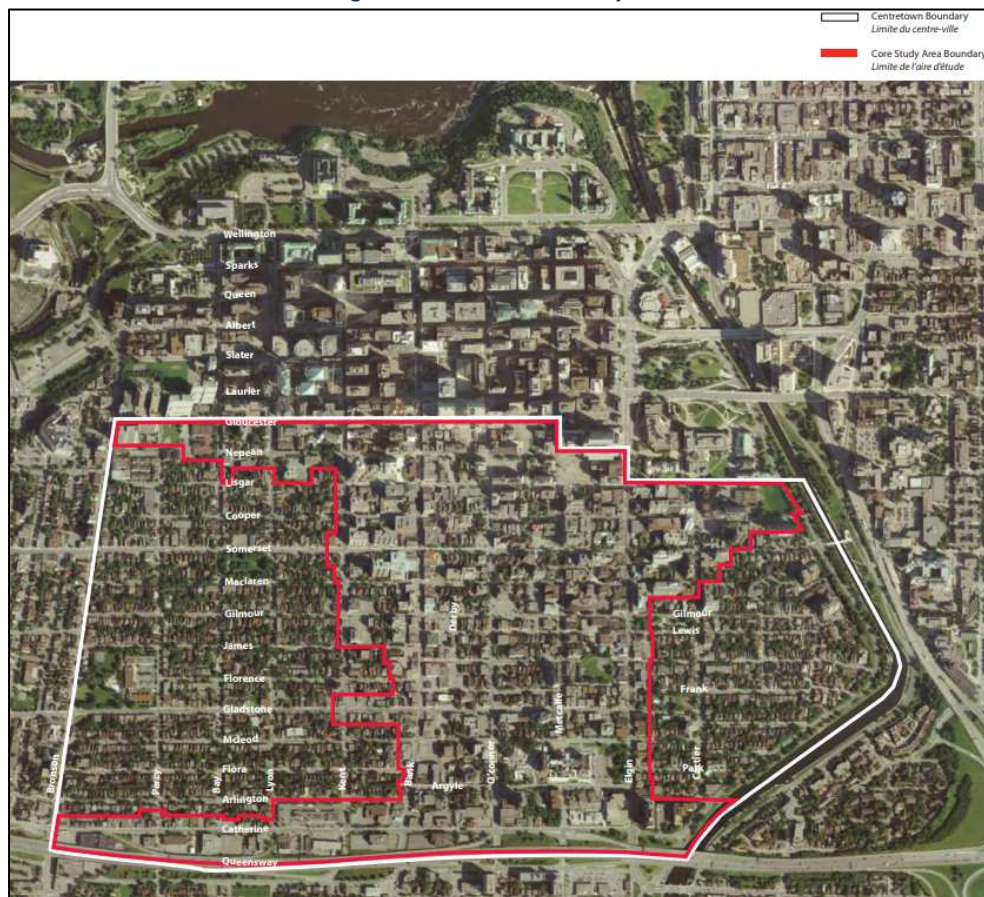



### 2.1.3.3 Other Area Developments

This section outlines adjacent developments within the study area. Based on the City of Ottawa's Development Applications search tool, several applications have been initiated near the proposed development site. However, the majority of these applications are either for low-rise apartment buildings with minimal traffic generation or for renovating/adding new units to existing low-rise units. Any traffic generated by the minor adjacent future developments will be captured in the background growth rate in traffic forecasting. Only one development has been identified given its relatively larger size:

- **30-48 Chamberlain Avenue:** a TIA report was prepared by CGH in October 2020 in support of a 16-storey apartment building containing 150 apartment units. The development is anticipated to be constructed in a single phase by 2024 and is expected to generate a minimal number of vehicles in the study area with up to 42 total two-way traffic volumes during peak hours. Given the low number of traffic volumes, this development has been captured in the background growth rate in traffic forecasting.

## 2.2. Study Area and Time Periods

For the purposes of this report, Phase 1 of the proposed development is assumed to be constructed by 2026, while the full buildout is assumed to be completed by 2031. As such, horizon years 2026 and 2031 will be analyzed using the weekday morning and afternoon peak hour time period traffic volumes. Analysis of horizon year 2036 (five-years after full buildout) will also be included as per the requirements of the TIA Guidelines. However, it should be noted that the City of Ottawa TMP, including the affordable networks only provide plans for future City transportation infrastructure up to year 2031.

A meeting was held with City staff on Tuesday, April 25, 2023, to discuss the TIA Step 3 comments received on March 30, 2023. City staff confirmed in a meeting they do not have major concerns with excluding three select intersections: Chamberlain/Percy, Gladston/Bank and Flora/Bank.

We have discounted the Chamberlain/Percy intersection because Percy St is a one-way street section, it only permits the southbound left-turn at Chamberlain, and it is signalized with no opposing traffic. We do not anticipate any concerns with operations at this location with the low amount of site generated traffic anticipated.

The two Bank St intersections were also excluded because we do not anticipate significant site generated traffic at either of the Gladstone/Bank or Flora/Bank intersections; they will be few in comparison to existing traffic volumes on Bank St. Kent St is expected to be the primary outbound route northbound. Inbound traffic from the north will be split between Lyon St and Bank Street, and the likely access street from Bank St will be either Arlington Ave (which we have added) or Catherine St (that was already captured). We expect site generated traffic will have negligible long-term impacts on these intersections.

Proposed study area intersections, agreed to by City staff, are listed below and illustrated in **Figure 11**.

- Lyon/Catherine
- Kent/Catherine
- Bank/Catherine
- Bronson/Catherine
- Percy/Catherine
- Kent/Gladstone
- Lyon/Gladstone
- Lyon/Arlington
- Kent/Arlington
- Bank/Arlington
- Bank/Chamberlain/Isabella

Figure 11: Study Area

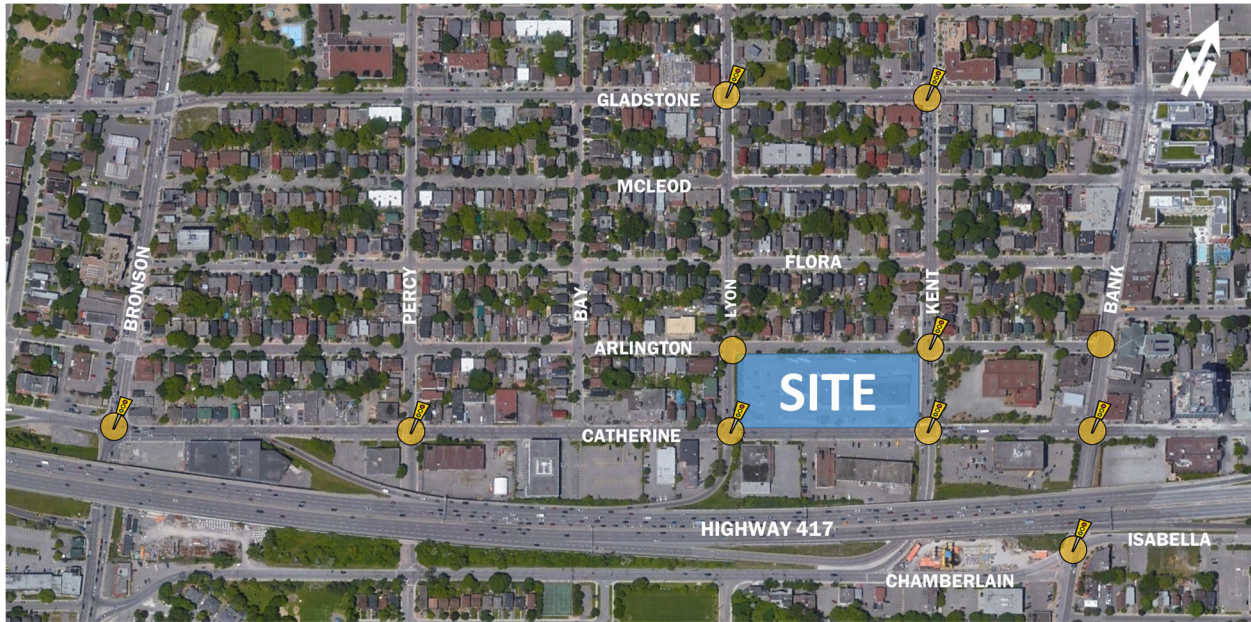

### 2.3. Exemption Review

The modules/elements of the TIA process in **Table 2** are recommended to be exempt based on the City’s TIA guidelines, the current ZBLA/SPC process and the current site plan arrangement.

Table 2: Exemptions Review Summary

Module	Element	Exemption Consideration
4.1 Development Design	4.1.3 New Street Networks	Only required for plans of subdivision.

## 3.0 FORECASTING

### 3.1. Development Generated Travel Demand

#### 3.1.1. Trip Generation and Mode Shares

##### Trip Generation Rates

The proposed development will consist of 7 townhome units, 1,127 apartment units and 2,423m<sup>2</sup> (26,081ft<sup>2</sup>) of ground floor retail space. The trip rates for the land uses are summarized in **Table 3** below.

The appropriate trip generation rates for townhomes and high-rise apartment units were obtained from the 2020 TRANS Trip Generation Manual. The Manual provides person-trip rates during the peak AM and PM periods (i.e. 7am-9:30am and 3:30pm-6pm). The peak hour trip generation rates for the non-residential land uses were obtained from the ITE Trip Generation Manual (11<sup>th</sup> edition), assuming the “Retail Strip Plaza (less than 40,000 ft<sup>2</sup> GFA)” land use for the total retail area.

Table 3: Proposed Development Trip Rates

Land Use	ITE/TRANS Designation	Data Source	Trip Rates	
			AM Peak	PM Peak
Residential	“High-Rise Apartments”	TRANS	T = 0.8(du);	T = 0.9(du);
	“Townhomes (Low-Rise Units)”	TRANS	T = 1.35(du);	T = 1.58(du);
Commercial	“Retail Strip Plaza”	ITE 822	T = 0.66Ln(x) + 1.84	T = 0.71Ln(x) + 2.72

Notes:  
 T = Average Vehicle Trip Ends  
 du = Dwelling unit  
 x = Gross Floor Area (1,000 ft<sup>2</sup>)

## Residential Trip Generation

Using the respective residential trip rates in **Table 3**, the total number of vehicles per hour generated by the proposed residential land uses of the development are calculated for the morning and afternoon peak periods, as shown in **Table 4**.

Table 4: Residential Units Peak Period Person Trip Generation

Phase	Land Use	Dwelling Units	AM Peak Period Person Trips	PM Peak Period Person Trips
Phase 1	High-Rise Apartments	400	320	360
Phase 2	High-Rise Apartments	727	582	654
	Townhomes (Low-Rise Units)	7	9	11
<b>Total</b>		<b>1,134</b>	<b>911</b>	<b>1,025</b>

The proposed development's residential land use is anticipated to generate a total of approximately 911 and 1,025 person trips during the morning and afternoon peak periods, respectively. The total peak period person trips in **Table 4** for each land use are then divided into different travel modes using mode share percentages obtained from the 2020 TRANS Manual for the "Ottawa Inner Area" district. **Table 5** and **Table 6** provide the travel mode breakdown for the proposed high-rise apartments and townhomes, respectively.

Table 5: High-Rise Apartments Peak Period Trips Mode Shares Breakdown

Travel Mode	Mode Share	AM Peak Period Person Trip	Mode Share	PM Peak Period Person Trips
<b>Phase 1</b>				
Auto Driver	26%	84	25%	91
Auto Passenger	6%	19	8%	29
Transit	28%	89	21%	77
Cycling	5%	18	6%	21
Walking	34%	110	39%	141
<b>Total Person Trips</b>	<b>100%</b>	<b>320</b>	<b>100%</b>	<b>360</b>
<b>Phase 2</b>				
Auto Driver	26%	152	25%	166
Auto Passenger	6%	35	8%	53
Transit	28%	162	21%	140
Cycling	5%	32	6%	38
Walking	34%	200	39%	257
<b>Total Person Trips</b>	<b>100%</b>	<b>582</b>	<b>100%</b>	<b>654</b>

Table 6: Townhomes Peak Period Trips Mode Shares Breakdown

Travel Mode	Mode Share	AM Peak Period Person Trip	Mode Share	PM Peak Period Person Trips
<b>Phase 2</b>				
Auto Driver	27%	3	31%	3
Auto Passenger	8%	1	9%	1
Transit	26%	2	20%	2
Cycling	9%	1	9%	1
Walking	30%	3	31%	3
<b>Total Person Trips</b>	<b>100%</b>	<b>9</b>	<b>100%</b>	<b>11</b>

Standard traffic analysis is usually conducted using the morning and afternoon peak hour trips as they represent a worst-case scenario. The 2020 TRANS Manual provides conversions rates from peak period to peak hours for different mode shares, as shown in **Table 7** below.

Table 7: Peak Period to Peak Hour Conversion Factors (2020 TRANS Manual)

Travel Mode	Peak Period to Peak Hour Conversion Factors	
	AM	PM
Auto Driver and Passenger	0.48	0.44
Transit	0.55	0.47
Bike	0.58	0.48
Walk	0.58	0.52

Using the conversion rates in **Table 7** and the peak period person trips for different travel modes in **Table 5** and **Table 6**, the peak hour trips for different travel modes can be calculated as shown in **Table 8** and **Table 9**.

Table 8: High-Rise Apartments Peak Hour Trips Mode Share Breakdown

Travel Mode	AM Peak Hour Trips	PM Peak Hour Trips
<b>Phase 1</b>		
Auto Driver	40	40
Auto Passenger	9	13
Transit	49	36
Cycling	10	10
Walking	64	74
<b>Total Person Trips</b>	<b>173</b>	<b>173</b>
<b>Phase 2</b>		
Auto Driver	73	73
Auto Passenger	17	24
Transit	89	66
Cycling	18	18
Walking	116	134
<b>Total Person Trips</b>	<b>314</b>	<b>314</b>

Table 9: Townhomes Peak Hour Trips Mode Share Breakdown

Travel Mode	AM Peak Hour Trips	PM Peak Hour Trips
<b>Phase 2</b>		
Auto Driver	1	2
Auto Passenger	0	0
Transit	1	1
Cycling	1	0
Walking	2	2
<b>Total Person Trips</b>	<b>5</b>	<b>5</b>

As shown above, the residential land use of the proposed development is anticipated to generate a total of up to 492 total person trips, which includes up to 115 vehicle trips, 26 to 37 passenger trips, 103 to 139 transit trips and 211 to 238 active transportation (walking and cycling) trips during peak hours.

Considering the location and context surrounding the proposed development, such as proximity to the Highway 417, and the notable distance from LRT or a rapid transit corridor, it was assumed that a higher auto driver mode share would be more appropriate relative to the district average, which accounts for the Confederation line and several LRT stations. The increase in auto-driver mode share comes at the expense of transit, walking and cycling. The adjusted mode share percentages are shown in **Table 10** and **Table 11** for the high-rise apartments and townhomes, respectively. Note that the same mode share percentages are applied to both the AM and PM peak hours.

Table 10: High-Rise Apartments Peak Hour Trips Mode Share Breakdown

Travel Mode	Mode Share	AM Peak Hour Trips	PM Peak Hour Trips
<b>Phase 1</b>			
Auto Driver	40%	69	69
Auto Passenger	10%	17	17
Transit	20%	35	35
Cycling	5%	9	9
Walking	25%	43	43
<b>Total Person Trips</b>	<b>100%</b>	<b>173</b>	<b>173</b>
<b>Phase 2</b>			
Auto Driver	40%	125	126
Auto Passenger	10%	31	31
Transit	20%	63	63
Cycling	5%	16	16
Walking	25%	78	79
<b>Total Person Trips</b>	<b>100%</b>	<b>314</b>	<b>314</b>

Table 11: Townhomes Peak Hour Trips Mode Share Breakdown

Travel Mode	Mode Share	AM Peak Hour Trips	PM Peak Hour Trips
<b>Phase 2</b>			
Auto Driver	40%	2	2
Auto Passenger	10%	1	1
Transit	20%	1	1
Cycling	5%	0	0
Walking	25%	1	1
<b>Total Person Trips</b>	<b>100%</b>	<b>5</b>	<b>5</b>

Using the modified mode shares above, the breakdown of inbound and outbound trips for the high-rise apartments and townhomes are provided in **Table 12** and **Table 13** respectively. The inbound and outbound percentages were obtained from the 2020 TRANS Manual.

Table 12: High-Rise Apartments Mode Shares Breakdown (2020 TRANS Report)

Travel Mode	AM Peak (Person Trips/h)			PM Peak (Person Trips/h)		
	In (31%)	Out (69%)	Total	In (58%)	Out (42%)	Total
<b>Phase 1</b>						
Auto Driver	21	48	69	40	29	69
Auto Passenger	5	12	17	10	7	17
Transit	11	24	35	20	15	35
Cycling	3	6	9	5	4	9
Walking	13	30	43	25	18	43
<b>Total Person Trips</b>	<b>54</b>	<b>119</b>	<b>173</b>	<b>100</b>	<b>73</b>	<b>173</b>
<b>Phase 2</b>						
Auto Driver	39	86	125	73	53	126
Auto Passenger	10	21	31	18	13	31
Transit	20	43	63	37	26	63
Cycling	5	11	16	9	7	16
Walking	24	54	78	46	33	79
<b>Total Person Trips</b>	<b>97</b>	<b>217</b>	<b>314</b>	<b>182</b>	<b>132</b>	<b>314</b>

Table 13: Townhomes Mode Shares Breakdown (2020 TRANS Report)

Travel Mode	AM Peak (Person Trips/h)			PM Peak (Person Trips/h)		
	In (30%)	Out (70%)	Total	In (56%)	Out (44%)	Total
<b>Phase 2</b>						
Auto Driver	1	1	2	1	1	2
Auto Passenger	0	1	1	1	0	1
Transit	0	1	1	1	0	1
Cycling	0	0	0	0	0	0
Walking	0	1	1	1	0	1
<b>Total Person Trips</b>	<b>2</b>	<b>4</b>	<b>5</b>	<b>3</b>	<b>2</b>	<b>5</b>

Using the tables above, the projected number of trips anticipated to be generated by the residential land uses of the proposed development are provided in **Table 14**.

Table 14: Total Residential Trip Generation

Travel Mode	AM Peak (Person Trips/h)			PM Peak (Person Trips/h)		
	In	Out	Total	In	Out	Total
<b>Phase 1</b>						
Auto Driver	21	48	69	40	29	69
Auto Passenger	5	12	17	10	7	17
Transit	11	24	35	20	15	35
Cycling	3	6	9	5	4	9
Walking	13	30	43	25	18	43
<b>Total Person Trips</b>	<b>54</b>	<b>119</b>	<b>173</b>	<b>100</b>	<b>73</b>	<b>173</b>
<b>Phase 2</b>						
Auto Driver	40	87	127	74	54	128
Auto Passenger	10	22	32	19	13	32
Transit	20	44	64	38	26	64
Cycling	5	11	16	9	7	16
Walking	24	55	79	47	33	80
<b>Total Person Trips</b>	<b>99</b>	<b>221</b>	<b>319</b>	<b>185</b>	<b>134</b>	<b>319</b>
<b>Total</b>						
Auto Driver	61	135	196	114	83	197
Auto Passenger	15	34	49	29	20	49
Transit	31	68	99	58	41	99
Cycling	8	17	25	14	11	25
Walking	37	85	122	72	51	123
<b>Total Person Trips</b>	<b>153</b>	<b>340</b>	<b>492</b>	<b>285</b>	<b>207</b>	<b>492</b>

As shown in **Table 14**, the total number of vehicle trips anticipated to be generated by the residential land uses are 197 vehicles per hour during both the morning and afternoon peak hours.

### Retail Units Trip Generation

The proposed non-residential land uses of the site consist of retail units, where the exact occupants of the retail units have not been confirmed as of yet. It is important to note that the development is not located in any retail node and the Catherine St corridor is not utilized for any many retail uses, as opposed to a traditional mainstreet such as Bank St. Therefore, the majority of patrons using the retail units are expected to be either internal site residents or local walking trips from adjacent developments, which would generate a very minimal number of new vehicle trips.

Using the trip rates provided in **Table 3**, the total number of person trips per hour generated by the proposed retail units are multiplied by a factor of 1.28, as per TIA standards, to account for typical North American auto occupancy values of approximately 1.15 and combined transit and non-motorized modal shares of less than 10%. The resulting total person trips per hour are summarized in **Table 15**.

Table 15: Retail Units Peak Hour Person Trips

Land Use	GFA (ft <sup>2</sup> )	AM Peak (Person Trips/h)			PM Peak (Person Trips/h)		
		In (60%)	Out (40%)	Total	In (50%)	Out (50%)	Total
<b>Phase 1</b>							
Strip Retail Plaza	13,984	27	19	46	63	63	126
<b>Phase 2</b>							
Strip Retail Plaza	12,096	25	17	42	57	57	114
<b>Total</b>		<b>52</b>	<b>36</b>	<b>88</b>	<b>120</b>	<b>120</b>	<b>240</b>

The commercial elements of the proposed development are intended primarily to serve local residents and nearby communities (the population will increase as future developments and intensification plans continue to progress in the downtown).

Given the mixture of land uses proposed onsite, an internal reduction rate was applied based on mixed-use parameters described in Section 6.5 of the ITE Trip Generation Manual 3<sup>rd</sup> Edition, to account for multi-purpose peak hour trips such as a local resident shopping, getting a haircut, stopping at a drycleaner, or any other minor

retail tenant that may occupy a retail space. These trips may be reduced to reflect double counted trips, which has been incorporated in the trip generation tables that follow. The base calculation for determining the quantity of internal reductions has been provided in **Appendix E**.

Pass-by trips were also considered for commercial uses. Pass-by trips are intermediate trips along the original route between the primary origin and destination, such as a trip to a retail use while travelling between home and another destination. These are not considered ‘new’ trips, but existing trips already on the network. Appendix E of the ITE Trip Generation Manual 3<sup>rd</sup> edition was used to determine pass-by rates. Pass-by trips were calculated after the internal reduction factor was applied.

The proposed mode shares for commercial uses have been summarized in **Table 16**.

Table 16: TRANS 2020 Mode Shares for Commercial Use and Proposed Mode Shares

Travel Mode	TRANS Mode Shares		Proposed Mode Share (AM & PM)	Proposed Modal Share Rationale
	AM	PM		
Auto Driver	39%	22%	15%	A reduction in driver mode share from TRANS is justifiable given the small scale of commercial uses proposed. Nearby high-density residential, commercial and office settings, plus low parking availability promote walking and cycling to access the commercial uses on site. Transit anticipated to be similar to existing mode shares. The majority of trips are anticipated to be generated locally and will most likely attract nearby pedestrians, cyclists, and residents of the same development.
Auto Passenger	2%	4%	5%	
Transit	16%	12%	15%	
Cycling	3%	4%	5%	
Walking	40%	58%	60%	

The trip generation rates for commercial land uses from **Table 15** were used along with the proposed sizes for each phase of development and the proposed mode shares from **Table 16** to provide the retail peak hour trips breakdown shown in **Table 17**. Residential and commercial vehicle trips are both inputted into the internal reductions sheets in **Appendix E** to determine the internal trips. Note that the internal reductions for Phase 2 use combined vehicle trips of both Phases 1 and 2 to internal trips at full buildout.

Table 17: Retail Peak Hour Trips Mode Share Breakdown

Travel Mode	Mode Share	AM Peak (Person Trips/h)			PM Peak (Person Trips/h)		
		In (60%)	Out (40%)	Total	In (50%)	Out (50%)	Total
<b>Phase 1</b>							
Auto Driver	15%	5	3	8	9	7	16
<i>Pre-Internal Reduction Vehicles Reduced</i>		5	3	8	10	10	20
		0	0	0	-1	-3	-4
Auto Passenger	5%	1	1	2	4	4	8
Transit	15%	4	3	7	9	9	18
Cycling	5%	1	1	2	3	3	6
Walking	60%	16	11	27	37	37	74
<b>Total Person Trips</b>	<b>100%</b>	<b>27</b>	<b>19</b>	<b>46</b>	<b>62</b>	<b>60</b>	<b>122</b>
Pass-By	0%(35%)	0	0	0	-3	-3	-6
<b>Total 'New' Vehicle Trips</b>	-	<b>5</b>	<b>3</b>	<b>8</b>	<b>6</b>	<b>4</b>	<b>10</b>
<b>Phase 2</b>							
Auto Driver	15%	3	2	5	8	7	15
<i>Pre-Internal Reduction Vehicles Reduced</i>		4	3	7	9	9	18
		-1	-1	-2	-1	-2	-3
Auto Passenger	5%	2	1	3	3	3	6
Transit	15%	3	2	5	8	8	16
Cycling	5%	1	1	2	3	3	6
Walking	60%	15	10	25	34	34	68
<b>Total Person Trips</b>	<b>100%</b>	<b>24</b>	<b>16</b>	<b>40</b>	<b>55</b>	<b>52</b>	<b>107</b>
Pass-By	0%(35%)	0	0	0	-3	-3	-6
<b>Total 'New' Vehicle Trips</b>		<b>3</b>	<b>2</b>	<b>5</b>	<b>5</b>	<b>4</b>	<b>9</b>

As shown in **Table 17**, the retail land uses are expected to generate 46 to 122 person trips during peak hours of Phase 1, as well as 40 to 107 persons trips during the peak hours of Phase 2. In total, the nonresidential land uses are expected to generate trips as shown in **Table 18** below.

Table 18: Total Nonresidential Trip Generation

Travel Mode	AM Peak (Person Trips/h)			PM Peak (Person Trips/h)		
	In	Out	Total	In	Out	Total
Auto Driver	8	5	13	17	14	31
<i>Pre-Internal Reduction</i>	9	6	15	19	19	38
<i>Vehicles Reduced</i>	-1	-1	-2	-2	-5	-7
Auto Passenger	3	2	5	7	7	14
Transit	7	5	12	17	17	34
Cycling	2	2	4	6	6	12
Walking	31	21	52	71	71	142
<b>Total Person Trips</b>	<b>51</b>	<b>35</b>	<b>86</b>	<b>118</b>	<b>115</b>	<b>233</b>
Pass-By	0	0	0	-6	-6	-12
<b>Total 'New' Vehicle Trips</b>	<b>8</b>	<b>5</b>	<b>13</b>	<b>11</b>	<b>8</b>	<b>19</b>

**Total Trips Generated**

Similar to commercial, an internal reduction to residential trips is applicable, as shown in Table 19.

Table 19: Residential Peak Hour Trips with Internal Reductions

Travel Mode	Mode Share	AM Peak (Person Trips/h)			PM Peak (Person Trips/h)		
		In	Out	Total	In	Out	Total
<b>Phase 1</b>							
Auto Driver		21	48	69	37	28	65
<i>Pre-Internal Reduction</i>		21	48	69	40	29	69
<i>Vehicles Reduced</i>		0	0	0	-3	-1	-4
<b>Total 'New' Vehicle Trips</b>		<b>21</b>	<b>48</b>	<b>69</b>	<b>37</b>	<b>28</b>	<b>65</b>
<b>Phase 1 &amp; 2 Combined</b>							
Auto Driver		60	134	194	109	81	190
<i>Pre-Internal Reduction</i>		61	135	196	114	83	197
<i>Vehicles Reduced</i>		-1	-1	-2	-5	-2	-7
<b>Total 'New' Vehicle Trips</b>		<b>60</b>	<b>134</b>	<b>194</b>	<b>109</b>	<b>81</b>	<b>190</b>

The total person trips anticipated to be generated by the residential and non-residential land uses of the proposed future development are provided in Table 20, which includes all travel mode shares of the residential units plus the auto driver mode of the nonresidential uses.

Table 20: Total Trips Generated

Travel Mode	AM Peak (Person Trips/h)			PM Peak (Person Trips/h)		
	In	Out	Total	In	Out	Total
<b>Phase 1</b>						
Auto Driver	26	51	77	46	35	81
<i>Pre-Internal Reduction</i>	26	51	77	50	39	89
<i>Vehicles Reduced</i>	0	0	0	-4	-4	-8
Auto Passenger	6	13	19	14	11	25
Transit	15	27	42	29	24	53
Cycling	4	7	11	8	7	15
Walking	29	41	70	62	55	117
<b>Total Person Trips</b>	<b>80</b>	<b>139</b>	<b>219</b>	<b>159</b>	<b>132</b>	<b>291</b>
Pass-By	0	0	0	-3	-3	-6
<b>Total 'New' Vehicle Trips</b>	<b>26</b>	<b>51</b>	<b>77</b>	<b>43</b>	<b>32</b>	<b>75</b>
<b>Phase 1 &amp; 2 Combined</b>						
Auto Driver	68	139	207	126	95	221
<i>Pre-Internal Reduction</i>	70	141	211	133	102	235
<i>Vehicles Reduced</i>	-2	-2	-4	-7	-7	-14
Auto Passenger	18	36	54	36	27	63
Transit	38	73	111	75	58	133
Cycling	10	19	29	20	17	37
Walking	68	106	174	143	122	265
<b>Total Person Trips</b>	<b>202</b>	<b>373</b>	<b>575</b>	<b>400</b>	<b>319</b>	<b>719</b>
Pass-By	0	0	0	-6	-6	-12
<b>Total 'New' Vehicle Trips</b>	<b>68</b>	<b>139</b>	<b>207</b>	<b>120</b>	<b>89</b>	<b>209</b>



Based on the results provided in **Table 20**, the proposed future development is anticipated to generate a total of approximately 575 and 720 person trips during the morning and afternoon peak hours respectively, including roughly 210 'new' vehicle trips in both peak hour periods.

### 3.1.2. Trip Distribution and Assignment

Based on the 2011 OD Survey (Ottawa Inner Area district) and the location of adjacent arterial roadways and neighbourhoods, the distribution of site-generated traffic volumes was estimated as follows:

- 20% to/from the east via HWY-417;
- 30% to/from the west HWY-417;
- 25% to/from the north via Bronson Ave/Bank St/Lyon St/Kent St; and,
- 25% to/from the south via Bronson Ave/Bank St.

The anticipated 'new' auto trips for the proposed development from **Table 20** were then assigned to the road network as shown in **Figure 12** for Phase 1 and **Figure 13** for total site-generated traffic at full buildout. At Phase 1, the Catherine St garage access and the woonerf are expected to be constructed. The Arlington Ave access is expected to be constructed at Phase 2. Note that no vehicles were modelled using the woonerf as truck traffic using this access will be infrequent and generally occur during off-peak hours.

Figure 12: Phase 1 Site-Generated Traffic

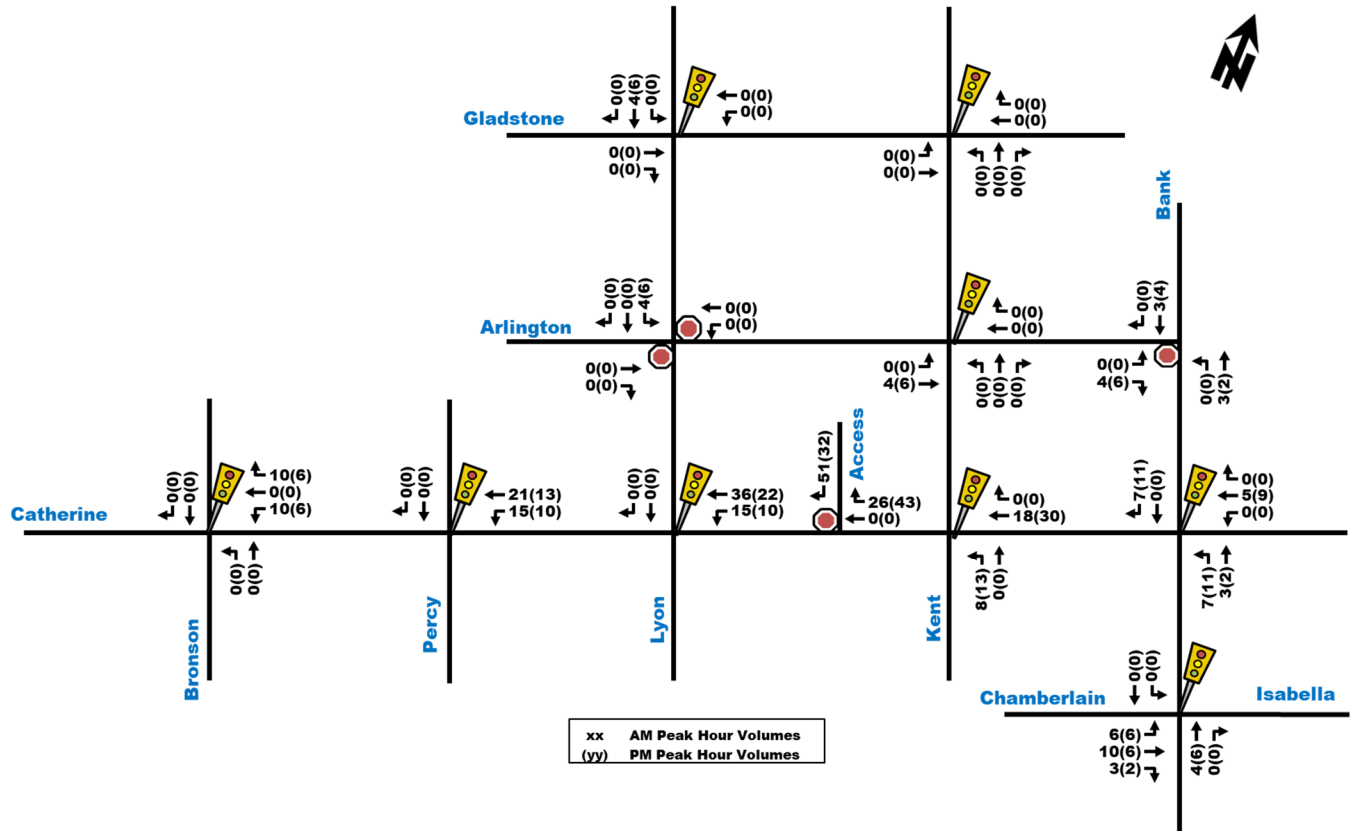
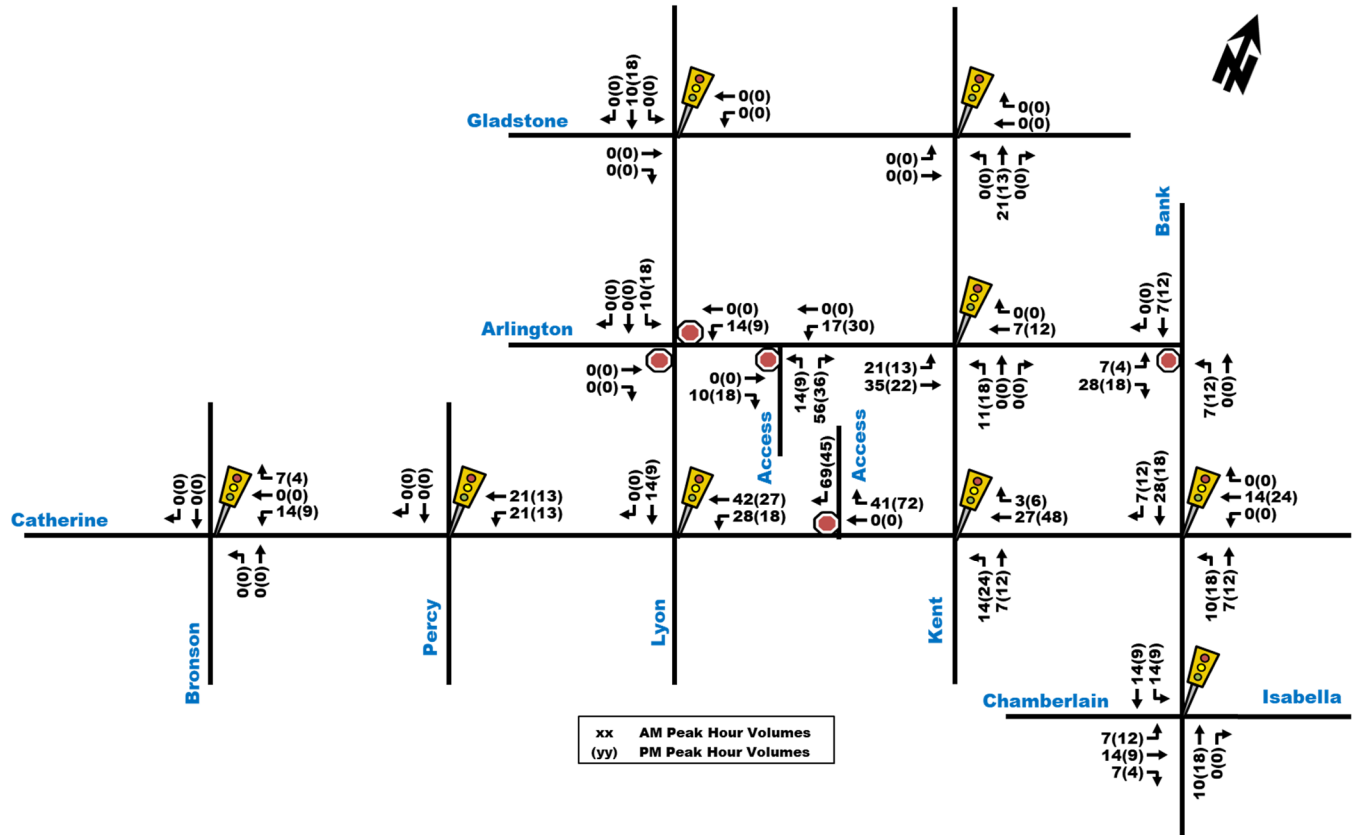

Figure 13: Full Buildout Phase 1 + Phase 2 Site-Generated Traffic



### 3.2. Background Network Traffic

#### 3.2.1. Transportation network plans

Refer to Section 2.1.3: Planned Conditions.

#### 3.2.2. Background Growth

The development is located in the Downtown Core Transect (as designated within the Official Plan), where policies are aimed towards augmenting and prioritizing the movement of pedestrians, cyclists, and transit users. Traffic flow and parking requirements are secondary priorities, which suggest traffic volumes along study area roadways may not increase as rapidly in the future and may even experience a decline. However, based on the vision of the Centretown CDP and Secondary Plan, more development intensification is planned along Catherine St, which will increase population within the study area. As such, a conservative 0.5% background growth rate was applied to arterial roads within the study area that provide connectivity to and from Highway 417, including Catherine St, Kent St, Lyon St, and Chamberlain Ave. The future background 2026, 2031 and 2036 traffic volumes are illustrated in Figure 14, Figure 15 and Figure 16, respectively.

Figure 14: Future Background 2026 Traffic Volumes

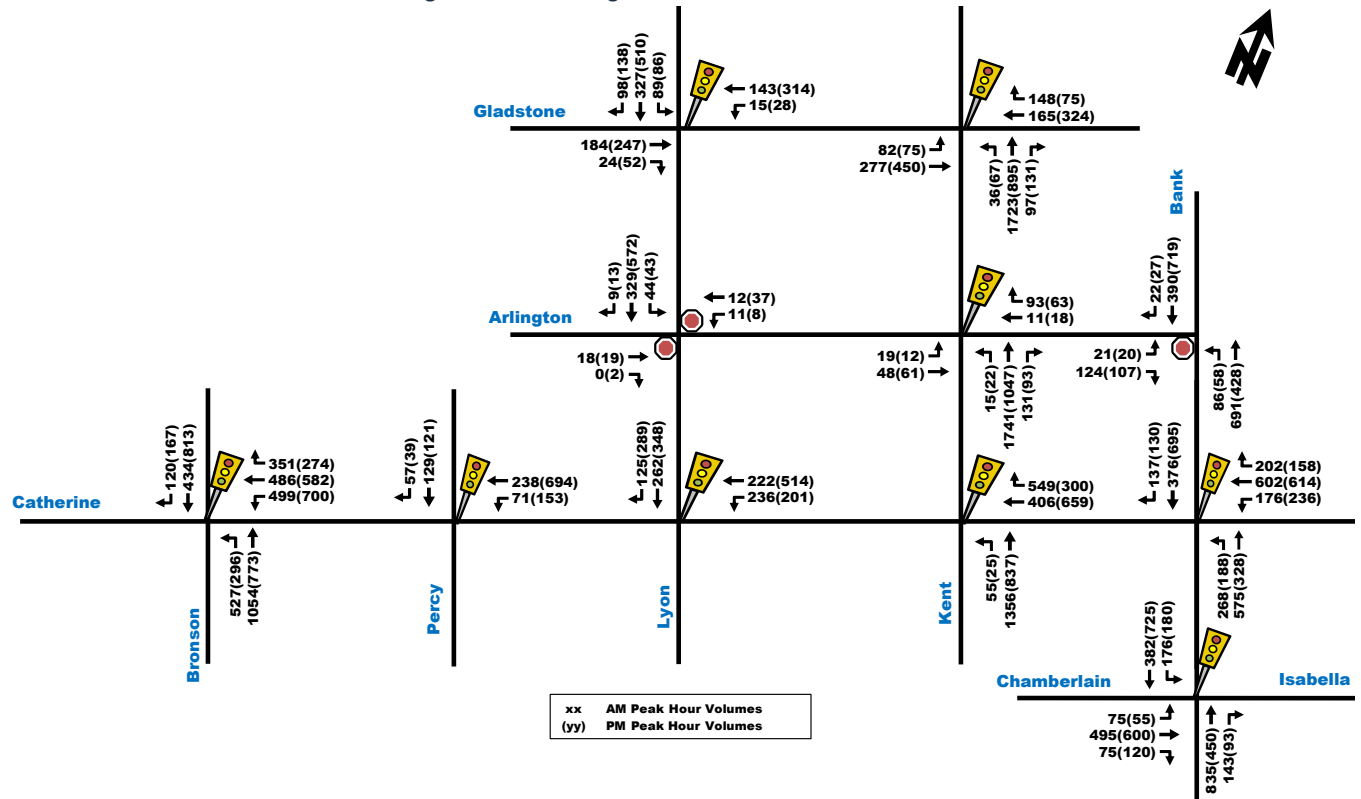

Figure 15: Future Background 2031 Traffic Volumes

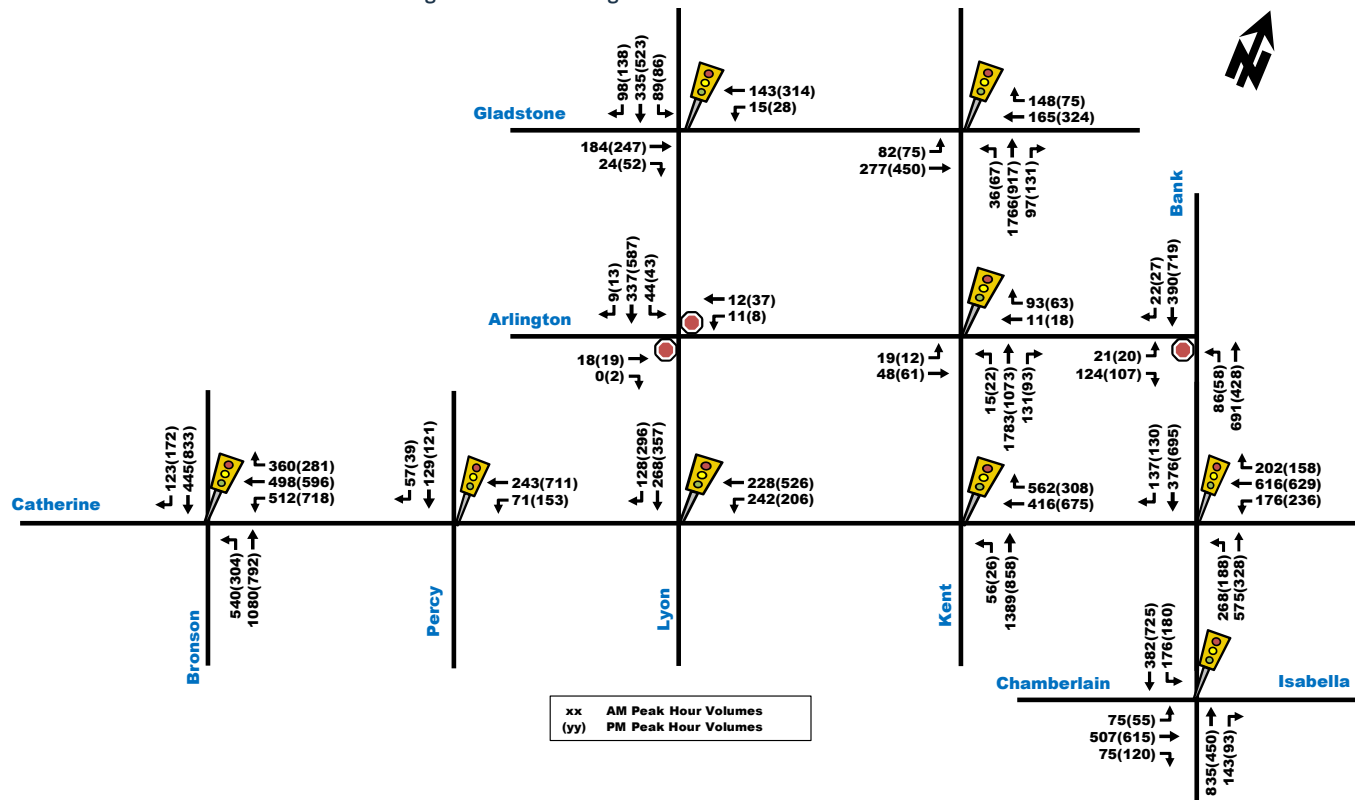
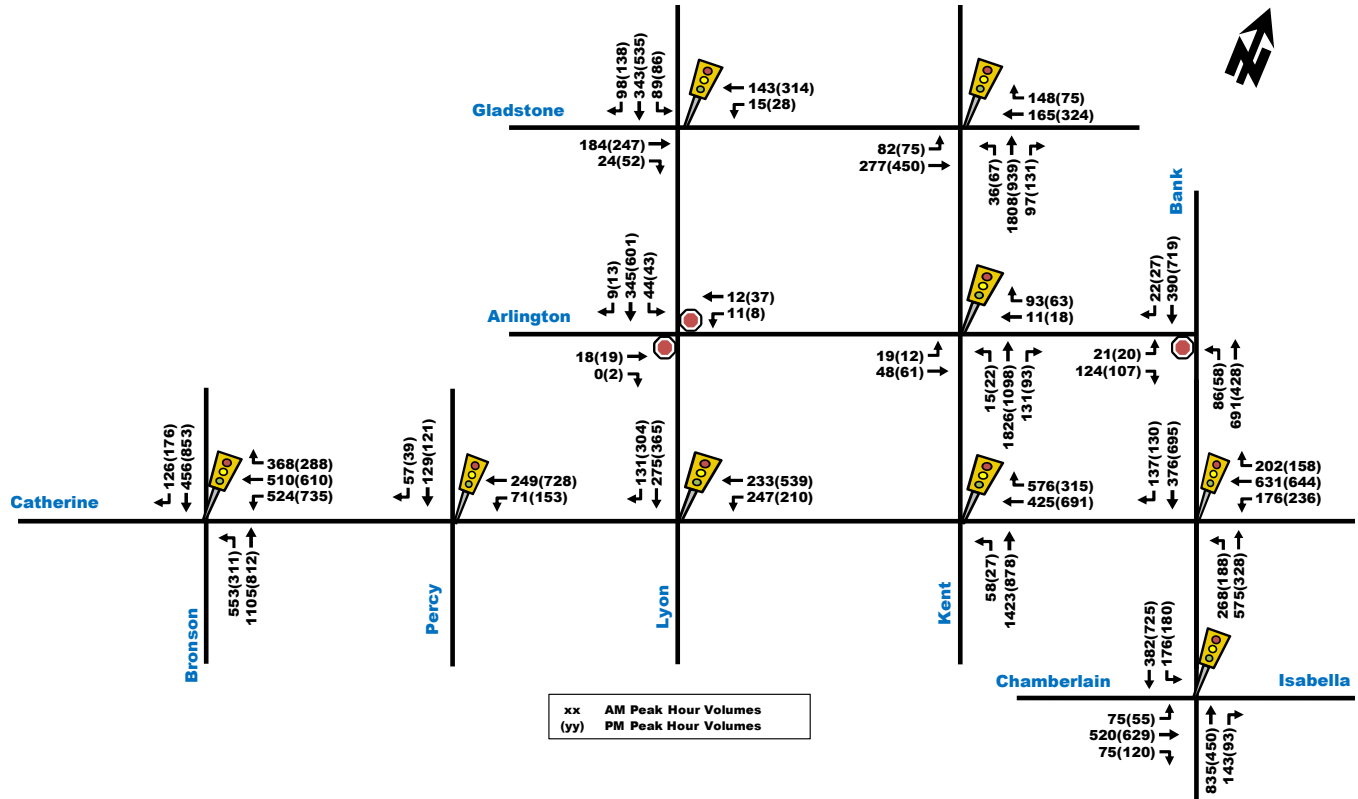

Figure 16: Future Background 2036 Traffic Volumes



### 3.2.3. Other Developments

Refer to Section 2.1.3.3 - Other Area Developments, no other area development included in future conditions.

### 3.3. Demand Rationalization

The following section indicates factors that may be used to rationalize the future travel demands in the study area and determine if there are potential capacity limitations and how they may be addressed.

The total projected 2026, 2031 and 2036 traffic volumes can be calculated by superimposing the site-generated traffic in Figure 12 and Figure 13, onto the future background traffic in Figure 14, Figure 15 and Figure 16. The total projected 2026, 2031 and 2036 traffic volumes are illustrated in Figure 17, Figure 18 and Figure 19, respectively.

It is important to note that the ongoing evolution of travel behaviour post-COVID-19, combined with long-term transportation network changes of the Centretown area and broader City of Ottawa investments in transit and active transportation (as discussed in Section 2.1.3), are expected to gradually discourage auto use in the Downtown Transect (as designated in the City Official Plan). Further discussion on elements is provided below.

#### TDM Measures

The Centretown CDP suggests implementing aggressive TDM Measure as part of new developments in the Southern Area of the Centretown district, where the proposed development is located. These measures include providing enhanced pedestrian, cycling, and transit facilities where possible, as part of new developments. The purpose of such measures is to reduce reliance on vehicle travel modes and encourage alternative travel behaviors. Depending on the size and density of future developments, implementing appropriate TDM measures may help reduce future traffic volumes in the Centretown area. For the future development at 265 Catherine St,

aggressive measures may be implemented to incentivize residents to rely on transit and active transportation modes such as walking and cycling. These measures are identified in **Section 4.5**.

**LRT**

The City of Ottawa LRT construction is underway, where Stage 1 has already been constructed and in use as of 2019, while Stage 2 is under construction and includes further expansions of the LRT corridor in different directions. Lyon Station and Parliament Station are located along Queen St in the Centretown area, where the Lyon Station is located approximately 1.4km north of the proposed development site.

The LRT is expected to have resulted in significant reductions in background traffic volumes, influencing the Centretown area as a whole. Most traffic volumes used for the purpose of this TIA Report were mostly conducted in 2018, prior to the opening of the LRT Stage 1. As such, they may not reflect any changes in travel patterns as a result of the LRT. As the LRT continues to expand and the travel behaviors of background trips adjust, it is expected that transit usage would increase, while background traffic decreases.

**COVID-19 Changes to Travel Behavior**

The COVID-19 pandemic resulted in significant implications to travel behaviors across the country. A considerable percentage of the workforce have shifted to a work-from-home only or hybrid home/office work schedule, with such effects expected to have long lasting impacts. This change resulted in a noticeable reduction of traffic volumes during peak hours – anecdotally, interprovincial bridge crossings are currently 75% below pre-covid levels (based on ongoing work for the Wellington Street Closure Assessment by the City of Ottawa).

As businesses continue to adjust to new and more widely desirable work schedules, it is uncertain how persistent the reduction in traffic volumes will remain. Therefore, it is important to acknowledge that any growth applied to background traffic volumes from pre-COVID levels should be considered a conservative assumption.

In this TIA, a 0.5% background traffic growth rate was assumed from pre-COVID traffic volumes (discussed in **Section 3.2.2**) without applying any further reductions to the study area traffic volumes, representing as a worst-case scenario. The impact of the proposed development’s site-generated traffic volumes on the study area intersections and roadways will be determined in the subsequent sections of the TIA report.

Figure 17: Total Projected 2026 Traffic Volumes

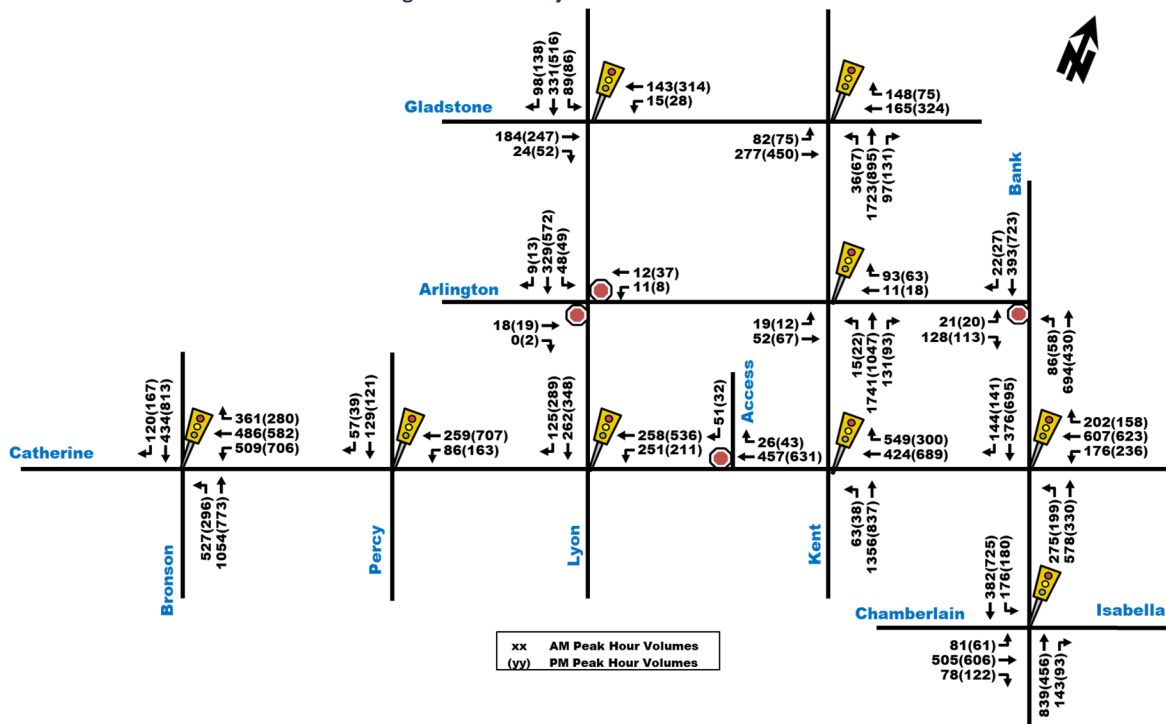

Figure 18: Total Projected 2031 Traffic Volumes

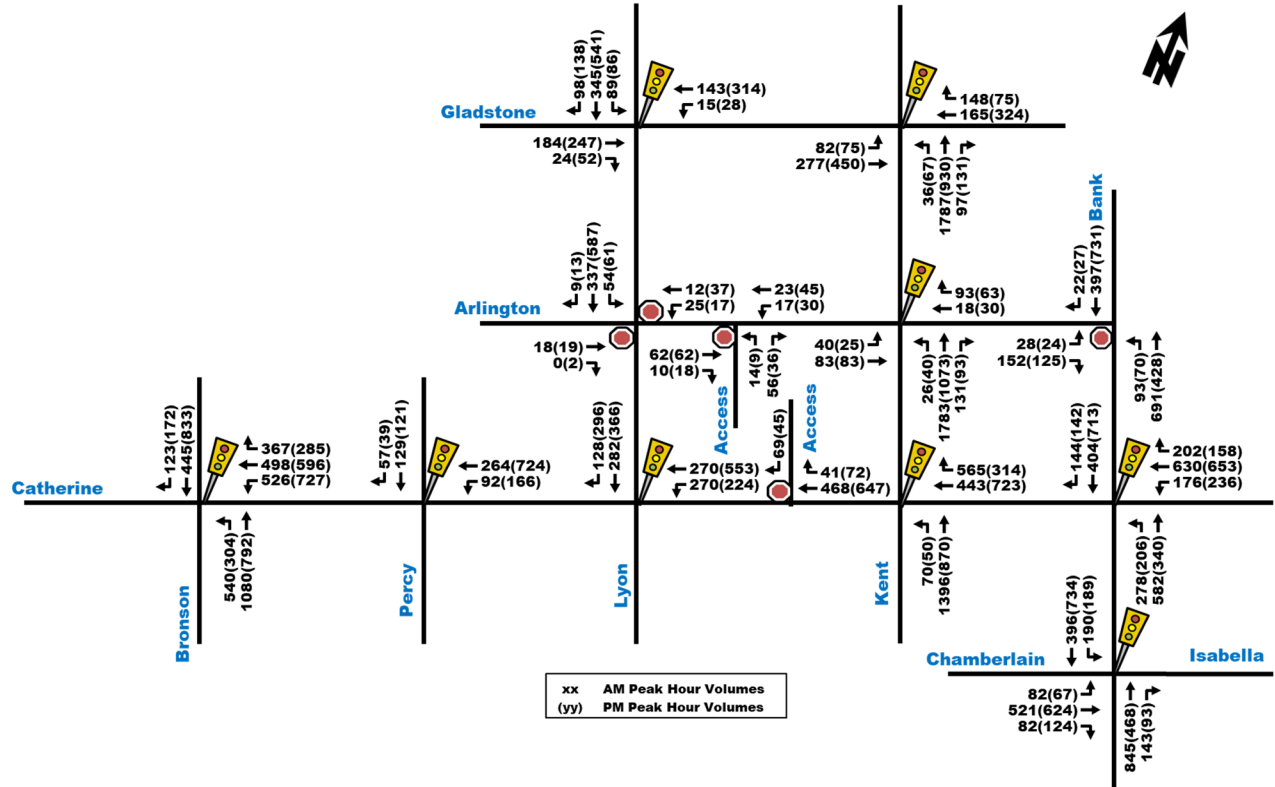
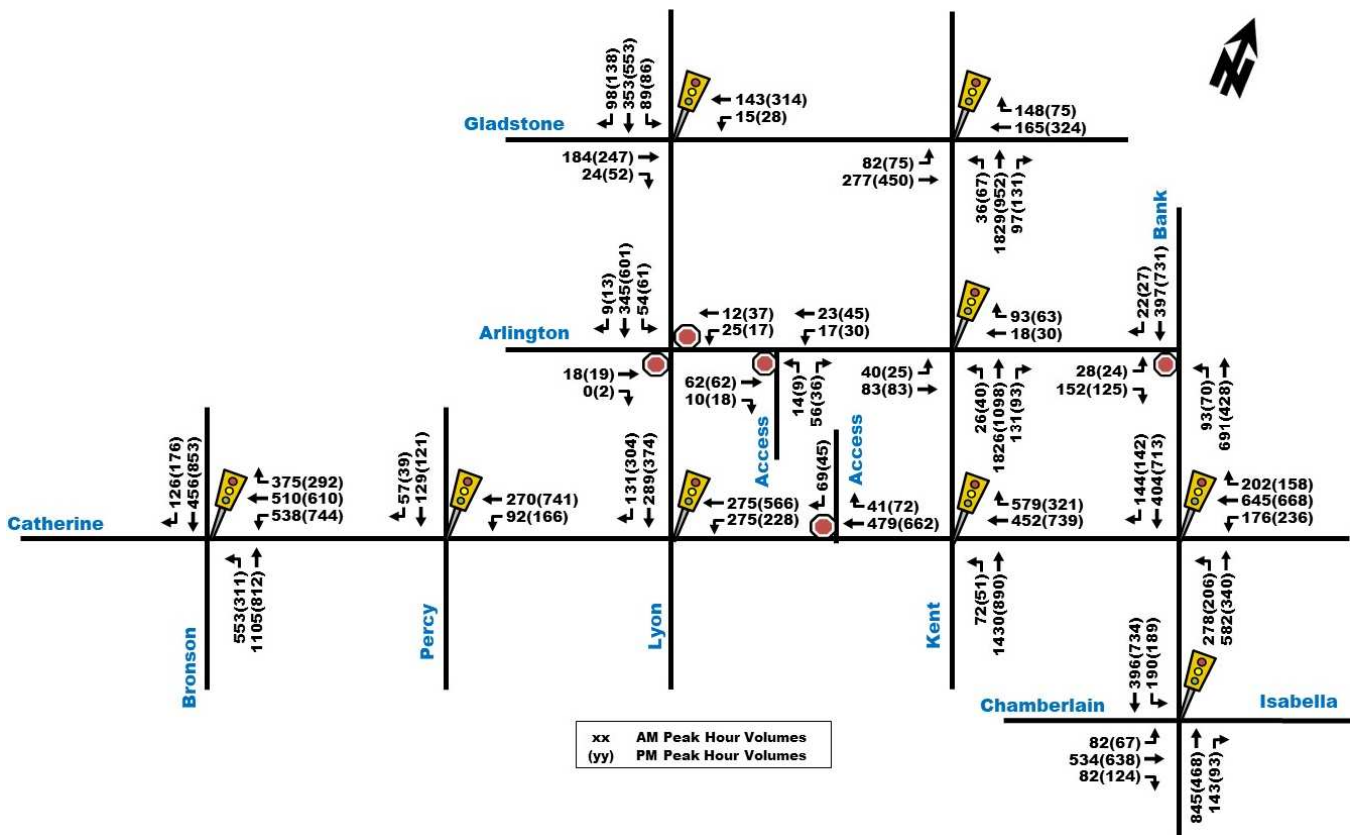

Figure 19: Total Projected 2036 Traffic Volumes



## 4.0 ANALYSIS

### 4.1. Development Design

A description of the available and proposed transportation network elements for different travel modes is provided in the sections below.

#### 4.1.1. Design for Sustainable Modes

A woonerf is proposed that bisects the site north-south connecting Catherine St and Arlington Ave. It has been carefully designed as an enhanced pedestrian amenity area that also permits infrequent vehicle access for trucks/loading vehicles (see Section 4.1.2 for further discussion on vehicle access). The woonerf ties into the publicly accessible open spaces within the site, and feature unique pavers, an offset alignment and various landscaping accents that provides strong visual cues to any drivers that this is a calm pedestrian environment. The woonerf provides excellent pedestrian and cycling permeability through the block that ties into the existing municipal active transportation network.

Sidewalk facilities will be provided on all site frontages and will be at least 2.0m wide at all locations. Given the location of the development, pedestrian facilities within the Centretown area are well established and help to provide optimal access to transit stop locations.

Along Catherine St, the existing bus stop at the site frontage (approximately 45m west of Kent St) will be maintained at the same approximate location but realigned slightly to the new proposed curb location. **Figure 20** illustrates the proposed future bus facilities. The bus stop provided will be in accordance with City specification SC12, which includes a bus shelter and a 15m bus landing pad. The design of the bus stop prevents the bus shelter from interrupting the pedestrian realm, providing a better experience for active users.

The city intends to convert the north curbside general purpose travel lane on Catherine St to a transit priority lane between the Kent St and Bronson Ave, as per the Catherine Street Functional Design Study. The proposed bus lane design will not be impacted by the proposed development at 265 Catherine St.

In order to reduce potential weaving conflicts between the site parking garage access and the bus lane, the west curb radius was reduced to 3m, which helps direct traffic exiting the site onto the general traffic lane. Additionally, to prevent right turns from Catherine St onto the woonerf, a slight bumpout was added to the east curb of the woonerf access, which reinforces the one-way southbound only operations of the woonerf.

Figure 20: Proposed Bus Stop Realignment and Enhancement

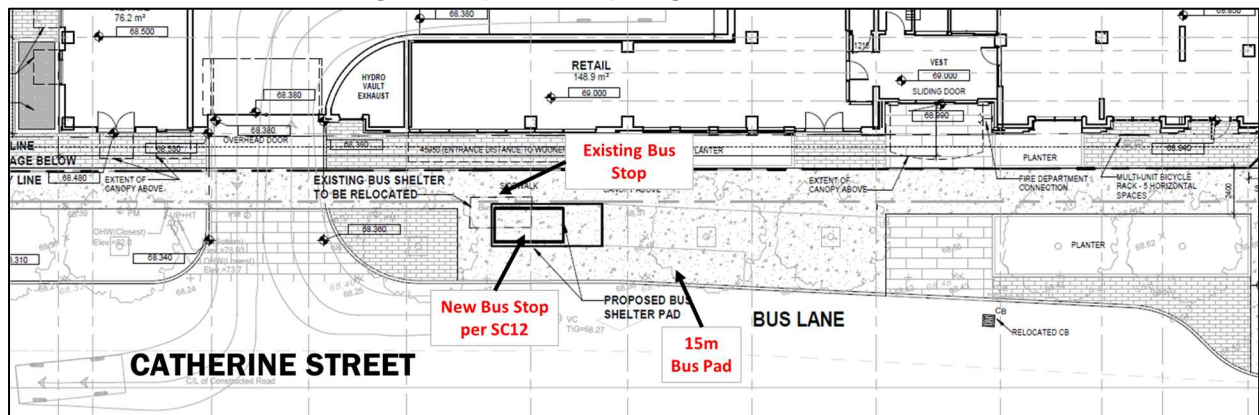

Other bus stops in the study area include existing bus stops on Gladstone Ave at both Lyon St and Kent St that are approximately 250m walking distance from the site. While outside of typical walking distance, it is noted that the LRT operates north of the site at approximately 1.4km walking distance.

Note that the City of Ottawa's TDM-Supportive Development Design and Infrastructure has been provided in **Appendix F** and discussed in more detail in **Section 4.5**.

#### 4.1.2. Circulation and Access

Truck and passenger vehicle turning maneuvers at all site accesses and laybys have been reviewed in significant detail and several iterations and adjustments were made to ensure their ability to accommodate the expected design vehicles. All vehicle turning templates have been provided in **Appendix G**.

##### Circulation and Access

The proposed development will provide two accesses to the underground parking garage:

1. Catherine St, approximately 60m west of Kent St, and
2. Arlington Ave, approximately 25m east of Lyon St.

There will be 2-levels of underground parking, where visitor and retail parking spaces will be provided on the first level and will be separated from resident parking spaces through the use of restricted gate access that only residents can enter.

The proposed woonerf, connecting Arlington Ave to Catherine St, was developed after early discussions with City staff. Current City policies (in the New Official Plan and Centretown CDP) encourage loading activities in the downtown districts to be off-street/internalized rather than on-street. Although the primary function of the woonerf is to provide an enhanced pedestrian environment and meeting place for the local community, its secondary function is to enable garbage pickup for all buildings, and moving/loading operations for Buildings A and B. The woonerf will also permit other infrequent activities such as deliveries and provide an accessible passenger loading zone for paratransit and other accessible vehicles.

General traffic is not permitted within the woonerf, only designated truck traffic (garbage, emergency and moving trucks). This restriction will be reinforced with signage, but is also supported by its various unique design elements, such as:

- One-way southbound – vehicle travel on Arlington Ave is far less intense than Catherine St, which reduces the risk of short-cutting or infiltration of general traffic on the woonerf. Furthermore, the one-way restrictions on the main fronting streets (Catherine St, Kent St, and Lyon St) make shortcutting less prominent or attractive for drivers.
- Materials and landscaping – the aesthetic provides strong visual cues to drivers that the woonerf is not a road. To reinforce this messaging, the vehicular unit paving on the woonerf is also provided between the sidewalk and the curb at each of Catherine St and Arlington Ave.
- Furniture and fixtures – the placement of street furniture and fixtures also offer visual cues as well as added friction to further reinforce the woonerf is not a road.
- A slight bulbout at the east curb of the woonerf access along Catherine St to prevent traffic from turning right into the woonerf.

If the proposed design is shown to be insufficient to maintain compliance, property management may always consider a physical gate in the future.

Given the proposed curb extensions along Arlington Ave and at the Lyon/Arlington intersection resulting in a narrower road for Arlington Ave, City staff requested a truck turn check be completed for southbound left-turns from Lyon St to Arlington Ave. The truck turn templates are provided in **Appendix G**, which show that HSU trucks would be able to complete their turns from the left lane on Lyon St, without conflict with curbs or any vehicles in the oncoming lane of Arlington Ave. Given the one-way travel direction of Lyon St, completing a truck turn from the right turn without any conflicts would be difficult for both existing and proposed conditions. Trucks completing the turn from the left lane are expected to take reasonable precautions to ensure the right lane is clear of vehicles before completing the turn.



## Lyon St Layby

The layby on Lyon Street serves as a drop-off space for move-ins and is located near a secured service corridor that leads to the elevator core in Tower 3. Due to the configuration of Building B with the two towers, it is not possible to provide internal access to both tower cores from the loading bay located under Tower 2 adjacent to the internal lane. Since the City will not permit loading vehicles to reverse onto a public street, the internal lane (or woonerf) functions to allow loading vehicles to access the site and leave in a forward motion during scheduled times. Since the core of Tower 3 is not near the internal lane, vehicles are not be able to access this tower from the internal part of the site without either reversing onto Arlington Avenue from an exterior loading space located between Buildings B and C (townhouse), or an internal loading bay located adjacent to the parking garage ramp along Arlington Avenue, or driving through the entire site to reach the internal lane to be able to leave in a forward motion.

The Central and East Downtown Core Secondary Plan indicates in Section 3.3.2.17 that loading and other vehicle access infrastructure should be located where it would not compromise sustainable modes and prohibits its provision on Corridors where possible. It is noted that the landscaped open space throughout the site has been designed to minimize vehicles and to favor pedestrians. Additionally, the buildings have been designed to minimize blank façades or 'back-of-house' type functions such as loading bays, garbage rooms etc., and instead have been designed to favor the pedestrian realm by providing as much animation and visibility around the entire site. From a transportation perspective, the layby proposal is considered acceptable for the following reasons as well:

- Lyon St is one-way southbound, which eliminates vehicle conflicts from on-coming vehicles.
- Lyon St is a traffic calmed road, there is a speed hump and on-street parking on the east side of the road just north of Arlington Ave.
- The layby is located as far north as possible along the frontage, ensuring there is as much separation from the Catherine St intersection as possible.
- Lyon St has a wide pavement width (nearly 9m for two travel lanes), which provides ample space for vehicles in the adjacent lane to pass comfortably if a truck is in the layby.
- The proposed design includes a 2.0m continuous sidewalk along the frontage, thus the layby does not impinge on the pedestrian realm.
- Loading operations with large trucks are expected to be infrequent (coinciding with move-ins), and rarely occur during the weekday morning/afternoon peak hour periods.

The Lyon St layby should be signed as a loading zone with time restrictions, which limits use to 15-minutes or less for loading/ unloading operations.

### 4.1.3. New Street Network

Exempt, refer to **Table 2**.

## 4.2. Parking

---

### 4.2.1. Parking Supply

Based on City of Ottawa Parking Provisions, Schedule 1A, the proposed development is located in "Area X". As such, the required number of parking spaces will be calculated based on the rates set out for this area. The proposed development will locate all vehicle and bicycle parking spaces in the two-level underground parking garage. **Table 21** provides a summary of the required and the proposed parking rates for vehicles and **Table 22** for bicycles.

Table 21: Required and Proposed Vehicle Parking Spaces

Land Use	Size	Zoning By-Law Parking Rates		Required Spaces			Proposed Spaces		
		Base	Visitor/Retail	Base	Visitor/Retail	Total	Base	Visitor/Retail	Total
<b>Phase 1</b>									
High-Rise Residential	400 Units	0.5 per unit, excluding first 12 units	0.1 per unit, excluding first 12 units, 30 spaces max per building	194	30	224	93	50 <i>Shared with retail</i>	143
Retail*	625 m <sup>2</sup>	-	1.25 per 100 m <sup>2</sup>	-	8	8	<i>Shared with Residential visitor parking</i>		-
<b>Phase 1 Total</b>				<b>194</b>	<b>38</b>	<b>232</b>	<b>93</b>	<b>50</b>	<b>143</b>
<b>Phase 2</b>									
High-Rise Residential	727 Units	0.5 per unit, excluding first 12 units per building	0.1 per unit, excluding first 12 units, 30 spaces max per building	352	60	412	152	62 <i>Shared with retail</i>	214
Townhomes	7 units	0.75 per unit	0.1 per unit, excluding first 12 units, 30 spaces max per building	6	1	7			
Retail*	1,047 m <sup>2</sup>	-	1.25 per 100 m <sup>2</sup>	-	13	13	<i>Shared with Residential visitor parking</i>		-
<b>Phase 2 Total</b>				<b>358</b>	<b>74</b>	<b>432</b>	<b>152</b>	<b>62</b>	<b>214</b>
<b>Full Buildout Total</b>				<b>552</b>	<b>112</b>	<b>664</b>	<b>245</b>	<b>112</b>	<b>357</b>

\*Retail units with an area less than 200 m<sup>2</sup> do not require off-street vehicle parking to be provided, as per the Parking Provisions.

As shown in **Table 21**, the development intends to provide fewer vehicle parking spaces than the minimum requirements by approximately 300 residential parking spaces. As such, a parking variance is needed as part of the development application.

The potential implications for residential vehicle parking demand are provided in the following section. However, it is noted that the minimum requirements for both visitors and retail use are being maintained. Additionally, it is worth noting that 1 carshare space will be provided as part of Phase 1 and 2 carshare spaces will be provided as part of Phase 2, for a total of 3 carshare space.

Although visitor and retail parking requirements are being met, additional opportunities for parking are provided at on-street locations around the site, which can help enable quick drop-off/pick-up activities as needed. On-street parking will continue to be permitted on the east side of Kent St and the south side of Arlington Ave in the future. Additionally, off-peak 1-hour parking will be permitted along the transit lane on the west half of the block.

Table 22: Required and Proposed Bicycle Parking Spaces

Land Use	Size	Zoning By-Law Parking Rates	Required Spaces	Proposed Spaces
		Bicycle	Bicycle	Bicycle
<b>Phase 1</b>				
High-Rise Residential	400 Units	0.5 per unit	200	400
Retail	1,299 m <sup>2</sup>	1.0 per 250 m <sup>2</sup>	6	10
<b>Phase 1 Total</b>			<b>206</b>	<b>410</b>
<b>Phase 2</b>				
High-Rise Residential	727 Units	0.5 per unit	364	729
Townhomes	7 units	-	-	-
Retail	1,124 m <sup>2</sup>	1.0 per 250 m <sup>2</sup>	5	10
<b>Phase 2 Total</b>			<b>369</b>	<b>739</b>
<b>Full Buildout Total</b>			<b>575</b>	<b>1,149</b>

The proposed number of bicycle parking spaces exceed the required minimum, providing at least a 1:1 ratio for the number of units to promote cycling use. The majority of bicycle parking is proposed to be provided in the two-level underground parking garage, with easy access through building elevators and the garage ramps. Some bike parking is also proposed outdoor near amenity areas. At least 50% of bicycle spaces are horizontal as per City requirements.

### 4.2.2. Parking Variance Implications

The development proposal provides approximately 300 fewer vehicle parking spaces than the By-Law requirement. To offset the reliance on vehicles and vehicle parking requirements, the site is providing excess bike parking spaces (at least a 1:1 ratio with units) that is supported by high quality pedestrian and cycling facilities in the vicinity, and a mix of different land uses that promotes a walkable neighbourhood. The City's long-term plan for Catherine St includes a new transit priority lane with a bus stop along the development frontage, as well as augmented pedestrian and cycling accommodations at study area intersections. A strong TDM program is proposed to encourage alternate modes of transportation that will leverage the existing and planned infrastructure provided by the city (further details provided in Section 4.5), which reduces the need for excess vehicle parking. During the public consultation with the local community, the reduction in parking supply was supported. Lastly, the reduction in parking is supported by policies in the New Official Plan to maximize the priority of movement for sustainable modes in the Downtown Core Transect and limiting on-site parking where possible.<sup>1</sup>

In the unlikely event that parking spillover is observed, the Centretown Local Area Parking Study (LAPS) from 2016 suggests there is available on-street parking supply within the Centretown neighbourhood to accommodate potential demand. The LAPS table 22 documented between 50-57% on-street parking utilization during all time periods, meaning that there is almost half of remaining on-street parking unoccupied and available. During paid periods, an increase in public off-street parking up to a maximum of 80% occupancy was documented. During weekends, the off-street parking utilization is normally less than 10%, providing a large availability of parking<sup>2</sup>. City By-Law is also equipped to respond with greater enforcement if there is an observed increase in parking infractions.

### 4.3. Boundary Street Design

#### Rights-of-Way and Corner Triangles

The City of Ottawa Official Plan Schedule C16 identifies Right-of-Way (ROW) protection requirements, including widening/easement needs and corner triangles at intersections. For the boundary streets surrounding the development site, the ROW requirements at the site frontage are as follows:

- Catherine St: the Official Plan indicates the ROW protection requirement to be 23m. The existing ROW is approximately 18m. The development meets the ROW protection needs along Catherine St.
- Kent St and Lyon St: the Official Plan indicates the ROW protection requirement to be 20m, with a stipulation that the maximum land requirements needed from the property abutting the existing ROW being 0.9m. Additionally, both frontages are subject to a widening/easement policy, whereby a 1.5m wide and 4.5m high unobstructed surface easement for the use of pedestrians along the street frontage is required. The development meets both the ROW protection needs and widening/easement policy needs along Kent St and Lyon St.

In addition to the ROW protection at frontages, corner triangles at intersections are required as dedications of land for road ROW. As shown in the Site Plan, a 5mx5m corner triangle, as per minimum requirement, is provided on all corners of the property, with the exception of the Arlington/Kent intersection, where a 3mx3m sight triangle was proposed. This corner of the property will be city owned for the future public park. City staff confirmed in a meeting held on April 25, 2023, that there are no concerns with the reduced sight triangle at the Arlington/Kent intersection corner.

#### MMLOS Analysis for Boundary Streets

Using discrete quantitative methods, the Multi-Modal Level of Service (MMLOS) analysis describes the level of convenience and comfort experienced by pedestrians, cyclists, transit, and trucks. MMLOS analysis was

<sup>1</sup> City of Ottawa Official Plan (2021), City of Ottawa, Section 5.1, Pg 133-137.

<sup>2</sup> <https://pub-ottawa.escribemeetings.com/filestream.ashx?documentid=41676>

conducted at the boundary roads of the proposed development, which includes Catherine St, Kent St, Lyon St, and Arlington Ave. The geometry and features along the of boundary streets are anticipated to differ between the existing and future horizon year conditions as a result of both the future Catherine St Functional Design Plan and the proposed development's Site Plan. Below is a description of the proposed development's existing boundary streets and future modifications at the site's frontage:

#### **Catherine St (arterial road classification)**

- *Existing*
  - 2.0m wide sidewalk and no boulevard,
  - 3 lanes total (WB only),
  - 3.7m or wider lanes,
  - Operating speed of 50 to 60km/h,
  - Less than 3000 average daily curb lane traffic volume,
  - No on-street parking, cycling facilities or transit facilities, and
  - A designated truck route.
- *Future*
  - New curbside bus lane
  - Greater than 2.0m wide boulevard, and
  - 3.5m wide lanes.

#### **Kent St (arterial road classification)**

- *Existing*
  - 1.8m wide sidewalk and no boulevard,
  - 3 lanes total (NB only),
  - 3.7m or wider lanes,
  - Operating speed of 50 to 60km/h,
  - More than 3000 average daily curb lane traffic volume,
  - No on-street parking on the west side (only on east side), cycling facilities or bus routes, and
  - A designated truck route.
- *Future*
  - 2.0m wide sidewalks and no boulevard.

#### **Lyon St (arterial road classification)**

- *Existing*
  - 1.5m wide sidewalk and no boulevard,
  - 2 lanes total (SB only),
  - 3.7m or wider lanes,
  - Operating speed of 50 to 60km/h,
  - More than 3000 average daily curb lane traffic volume,
  - No on-street parking, cycling facilities or bus routes, and
  - Not a designated truck route.
- *Future*
  - A greater than 2.0m wide sidewalk and no boulevard with loading layby (assumed as on-street parking in analysis) on the north half of the block.
  - A 2.0m wide sidewalk and 3m wide boulevard on the south half of the block.
  - *Note that the north half design will be used for analysis to assess a more "critical" condition.*

#### **Arlington Ave (local road classification)**

- *Existing*
  - 1.5m wide sidewalk and no boulevard,

- 2 lanes total (1 WB and 1 EB),
- Operating speed of 30 to 50km/h,
- Less than 3000 average daily curb lane traffic volume,
- Permitted on-street parking,
- No cycling facilities or bus routes, and
- Not a designated truck route.
- *Future*
  - 2.0m wide sidewalks and greater than 2.0m wide boulevard.

Detailed analysis sheets have been provided in **Appendix H. Table 23** below provides a summary of the results, along with the minimum desirable targets obtained from the MMLoS Guidelines, for each respective travel mode. The targets are based on the proposed development site’s location in a “within 300m of a school” (i.e. Glashan Elementary School) Policy Area for both existing and future conditions.

Table 23: MMLoS Analysis, Boundary Road Segments

Road Segment	Level of Service							
	Pedestrian (PLOS)		Bicycle (BLOS)		Transit (TLOS)		Truck (TkLOS)	
	PLOS	Target	BLOS	Target	TLOS	Target	TkLOS	Target
Catherine St	C, B*	A	E	D	D, B*	C	A, A*	D
Kent St	F, E*	A	E	D	N/A	N/A	A, A*	D
Lyon St	F, D*	A	D	D	N/A	N/A	A, A*	E
Arlington Ave	E, B*	A	A	B	N/A	N/A	N/A	No Target

\*Result based on future street design at site frontage.

Red font in the table above indicates that the respective desirable target has not been met. As shown in **Table 23**, the minimum desirable pedestrian LOS targets are not met at any of the road segments in both existing and future conditions. This is due to a combination of factors, which includes high curbside lane traffic volumes, high operating speeds given the arterial designation of three of the boundary roads and limited opportunity for boulevard width. It should be noted that in future conditions, a boulevard wider than 2.0m will be provided along both Catherine St and Arlington Ave, which reflects significant improvements in the PLOS results.

The minimum desirable bicycle LOS targets are not met on Catherine St and Kent St primarily due to the number of travel lanes (three on-way lanes), which reduces cyclist comfort. The minimum desirable transit LOS target is not met on Catherine St in existing conditions but is expected to be met in the future as a result of the proposed transit lane.

It should be noted that there are no applicable TLOS results or targets for Kent St, Lyon St, or Arlington Ave as there are no active transit routes along these roads. Similarly, there are no minimum desirable truck LOS target along Arlington St given its local road designation with limited truck usage.

#### 4.4. Access Intersection Design

As was described in **Section 4.1.2**, access to the underground parking garage will be provided via two accesses, one along Catherine St that will be constructed as part of Phase 1, and the other access along Arlington Ave to be constructed as part of Phase 2. Both accesses will provide 6m wide ramps. The Catherine St access will be located approximately 60m west of Kent St, while the Arlington Ave access will be located approximately 25m east of Lyon St. The Arlington Ave access design includes bulb-outs on both sides according to City specifications, which also act as a traffic calming measures along the frontage street (by reducing the effective pavement width). At the Catherine St access, the west curb radius was reduced to 3m rather than the typical 5m to help direct exiting traffic more onto the general traffic lane and less onto the future transit lane. Continuous depressed sidewalks are provided across all site accesses.

The two garage access points ensure a balanced spread of traffic (thereby reducing traffic loading to any one access point) and provides more direct access for residents. One of the drawbacks of one-way streets on three

frontages is it forces inefficient vehicle routing if access points to the site are limited. A single access off Catherine St would encourage traffic infiltration on surrounding streets (particularly vehicles coming from the northwest), increasing the number of turns and create more pedestrian and cyclist conflicts on the adjacent road network than having a secondary access of Arlington St.

The proposed access design would also reduce traffic loading on any one street. Both Arlington Ave and Catherine St are sensitive corridors for different reasons. Catherine St is a future transit priority corridor and a “feeder” street to Highway 417, which would benefit from fewer vehicle trips turning in and out of the site during peak hour periods. Arlington Ave is a traffic calmed local street with direct residential frontage, which requires more consideration of traffic implications to local residents. Splitting the traffic distribution at two different access points reduces long-term operational risks.

The design considerations for the proposed woonerf were previously described in **Section 4.1.2**. It will be constructed as part of Phase 1. The south access point will be located approximately 15m west of the proposed garage access off Catherine St, which does not adhere to the Private Approach By-law (PABL). However, Catherine St is a one-way only street with westbound travel and the woonerf is one-way only southbound. At Catherine St, the woonerf would only permit outbound vehicles from the site and reinforces it with a slight bulbout at the east curb, resulting in very low conflict potential between the woonerf access and the underground parking garage access. Therefore, the proposed separation distance was considered acceptable. The north woonerf access will be located approximately 60m east of the Arlington Ave access, which adheres to the PABL and is similarly designed based on City specifications.

Providing additional access points from the woonerf was a strategic choice to prioritize off-street loading operations within the woonerf, as well as separate residential traffic from truck traffic, which ultimately balances onsite and adjacent corridor operations.

In order to not impede sightlines for vehicles and pedestrians at the different access points of the site, trees proposed to be planted near accesses are expected to be large canopy trees where sightlines will be protected below the canopies. Landscaping choices were made to avoid any potential impediment of sightlines.

## 4.5. Transportation Demand Management

---

### 4.5.1. Context for TDM

Based on the 2021 City of Ottawa Official Plan, the proposed development’s boundary roads Catherine St, Kent St and Lyon St are all designated as minor corridors within Design Priority Areas, along with Gladstone Ave. Bank St and Bronson Ave are both designated as mainstreet corridors within Design Priority Areas.

Given the proposed land-use of the development as a residential building, it is assumed that most trips generated will be from residents leaving the site in the AM peak to go to work and returning to the site in the PM peak. **Sections 3.1.1** and **3.1.2** describe how many trips are anticipated per travel mode and anticipates the likely locations that they will travel to and from based on the OD-Survey 2011 for Ottawa.

The development is proposing to provide 1,127 apartment units within 3 towers up to 36-storeys high, along with 7 townhome units and approximately 2,423m<sup>2</sup> of retail space. A breakdown of the unit types on the Site Plan indicates that the apartment units provided will consist of 167 bachelor units, 260 one-bedroom units, 258 one-bedroom and den units, 370 two-bedroom units, 30 two-bedroom and den units and 49 three-bedroom units. The property is owned and will be managed by the property developer, Brigil.

### 4.5.2. Need and Opportunity

The proposed development is located in a well-developed core area of the City of Ottawa, where transit and active transportation facilities are well-maintained and developed, which naturally results in an increased transit and active transportation usage and decreased auto trips. However, given the development’s location relative

to Highway 417, as well as near the southern limit of the Centretown area, it is reasonable to expect that auto driver mode shares will be higher relative to the typical Centretown mode share splits.

In order to ensure that personal vehicle use remains reasonable given the size of the proposed development, aggressive Transportation Demand Management (TDM) measures will need to be utilized. The proposed development TDM measures are described in detail in **Section 4.5.3** below. Additionally, **Section 4.2** details the rationale for providing a reduced number of parking spaces compared to minimum zoning bylaw requirements.

#### **4.5.3. TDM Program**

The TDM Infrastructure and TDM Measures Checklists have been provided in **Appendix F**. The proposed measures in each respective checklists are identified below.

##### **Proposed measures identified in the TDM-supportive Development Design and Infrastructure Checklist are:**

- Ten (10) out of the ten (10) “Required” measures have been satisfied.
- Twelve (12) out of fourteen (14) “Basic” measures related to Walking and Cycling and Parking have been satisfied, namely:
  - Locating building close to the street.
  - Locating building entrances to minimize walk distance to sidewalks and transit.
  - Locating building doors and windows to ensure visibility of pedestrians.
  - Providing safe, direct and attractive walking routes to transit.
  - Ensuring walking routes are secure, visible, and lighted.
  - Designing roads for cyclist circulation.
  - Providing lighting, landscaping and benches along walking and cycling routes.
  - Providing wayfinding signage for site access.
  - Providing bicycle parking equivalent to expected number of resident-owned and visitor cyclists.
  - Providing off-site transit shelter at a new location with shelter.
  - Providing a designated area to drop off or pick up passengers.
  - Providing shared parking for different uses (i.e. visitors, commercial, etc.)
- Four (4) out of seven (7) “Better” measures related to Walking and Cycling and Carsharing have been satisfied, namely:
  - Providing secure bike parking spaces equivalent to at least the number of units.
  - Providing a permanent bike repair station adjacent to bicycle parking area.
  - Providing up to three carshare parking spaces.
  - Providing separate areas for short-term and long-term parking with access controls.

##### **Proposed measures identified in the TDM Measures Checklist are:**

- Five (5) out of seven (7) “Basic” measures related to Walking and Cycling, Transit, Parking and TDM Marketing have been satisfied. Three (3) of those, which have been designated by an asterisk (\*), are considered by the TDM Measures to be some of the most dependably effective tools to encourage sustainable travel modes. This includes:
  - Display walking and cycling information at major entrances.
  - Display transit information at major entrances.
  - \*Offer preloaded PRESTO card to residents one monthly transit pass.
  - \* Unbundle parking costs from monthly rent.
  - \* Provide multi-modal travel information package to new residents.
- Three (3) out of eleven (11) “Better” measures related to Walking and Cycling, Transit, Carsharing, Parking and TDM Marketing have been satisfied. One (1) of those, which has been designated by an asterisk (\*), is considered by the TDM Measures to be some of the most dependably effective tools to encourage sustainable travel modes. This includes:
  - Offer on-site cycling courses for residents or subsidize off-site courses.
  - Provide on-site carshare vehicles for residents.

- \*Offer personalized trip planning to new residents.

#### 4.6. Neighbourhood Traffic Management

This module compares the maximum one-way traffic of a local road during morning and afternoon peak hours, to the respective threshold provided by the City of Ottawa TIA Guidelines.

Site-generated traffic of the proposed development is expected to use local road Arlington Ave as part of their access route to/from the proposed development. The thresholds provided in the TIA Guidelines indicate a maximum ideal one-way traffic of 120 veh/h for local roads during peak hours. Using the total projected 2036 traffic volumes in **Figure 19**, future traffic volumes along Arlington Ave were compared to existing volumes and the ideal local road threshold as shown in **Table 24**. Arlington Ave was divided into three sections to gain full understanding of traffic activity.

Table 24: Arlington Ave Existing and Future Two-Way Volumes

Roadway	Classification	Ideal Daily Threshold (veh/day)	Ideal Peak Hour Threshold (veh/h)	Section	Peak Hour Two-Way Volumes AM (PM)	
					Existing	Projected
Arlington Ave	Local	1,000	120	West of Lyon St	39 (71)	39 (71)
				Between Lyon St and Kent St	93 (113)	167 (178)
				Between Kent St and Bank St	283 (235)	325 (269)

As shown in **Table 24**, note the following:

- West of Lyon St: traffic volumes along this section of Arlington Ave are well below the ideal threshold of a local road in both existing and future conditions. This indicates the majority of this traffic is local traffic and there is very limited cut-through traffic activity occurring on Arlington Ave between Bronson Ave and Lyon St. The low volumes are also attributed to the eastbound traffic restriction on Arlington Ave, approximately 50m east of Bronson Ave.
- Between Lyon St and Kent St: traffic volumes along this section of Arlington Ave are near the ideal threshold of a local road in existing conditions but are expected to exceed the threshold by up to approximately 58 veh/h in future projected conditions.
  - It should be noted that some traffic increase along Arlington Ave would have occurred regardless of whether an access is provided along Arlington Ave. This is due to the one-way nature of the surrounding roads that would have forced southbound traffic on Lyon St to take a circuitous route along Arlington Ave and Bank St to use the access along Catherine St.
  - Traffic volumes exceeding the ideal threshold of a local road is not an automatic indication of traffic operational problems on Arlington Ave. Traffic analysis will identify if there will be any intersection operational concerns at adjacent intersections and any safety concerns can be mitigated through the use of traffic calming measures and speed reduction. It is noted that this section of Arlington Ave has a reduced posted speed of 30km/h, along with intersection curb extensions and two speed humps. The future development is expected to add additional mid-block curb extensions at site accesses that will further narrow the road and help further calm the street.
- Between Kent St and Bank St: traffic volumes along this section of Arlington Ave are well above the ideal threshold of a local road in both existing and projected conditions and are approaching the 300veh/h threshold of a collector road. The high traffic volumes are like caused by a combination of the following:
  - The drop-off/pick-up activity that would occur during peak hours (especially in the AM) at Glashan Elementary School on the south side of Bank St. Since the school acts as a traffic generator during peak hours, there would be limited opportunity to mitigate these traffic volumes.



- Cut-through traffic may be using Arlington Ave as a quicker route to travel between Kent St and Bank St – more specifically, eastbound traffic exiting Highway 417 at Kent St are likely using Arlington Ave in order to access Bank St. Similarly, traffic travelling northbound on Bank St can use Arlington Ave instead of Catherine St to travel northbound on Kent St. There are few opportunities to limit this traffic infiltration besides road closures, which requires further study by the City and Council approval.

While site generated traffic is expected to contribute to this section, it will be to a much smaller proportion compared to existing/background traffic. The city Neighbourhood Traffic Calming Branch may consider investigating this section of Arlington Ave if future concerns are raised and validated through the established city process.

It is important to reiterate that the Arlington St corridor is already traffic calmed, including speed humps. That said, the development proposal introduces four new bulb-outs at the two proposed access points that will narrow the road from existing 10m to 7m, which reinforces the traffic calmed environment.

### 4.7. Transit

As shown in **Table 20**, the proposed development is anticipated to generate up to 133 transit trips during peak hour periods. These trips will have access to existing bus routes within the study area, which includes OC Transpo bus routes #6, #7, #14, #55 and #114.

Existing transit ridership data (pre-COVID to reflect ‘typical’ ridership before pandemic impacts) was obtained from OC Transpo for six bus stops near the proposed development site, as shown in **Figure 21**. The data, as provided in **Table 25**, is a summary of average bus boarding, alighting and occupancy information for bus routes at each of the respective stop numbers, during morning and afternoon peak hours.

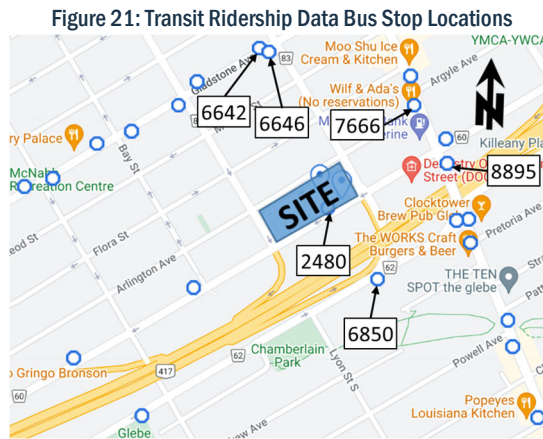

Table 25: Transit Ridership Data (Jan 5, 2020 - Mar 16, 2020)

Stop No.	Location	Route	Direction	AM			PM		
				Boarding	Alighting	Avg. Load at Depart.	Boarding	Alighting	Avg. Load at Depart.
2480	Catherine/ Kent	55	WB	11	5	21	11	8	16
6642	Gladstone/ Kent	14	WB	5	6	20	7	12	28
		114	WB	-	-	-	-	-	-
6646	Gladstone/ Kent	14	EB	6	13	19	12	17	16
		114	EB	-	-	-	-	-	-
6850	Chamberlain/ Kent	55	EB	16	8	17	15	17	15
7666	Bank/ Arlington	6	SB	22	34	23	58	54	38
		7	WB	24	26	24	20	38	28
8895	Bank/ Catherine	6	NB	14	28	33	12	16	30
		7	EB	11	5	23	20	19	31

As shown in **Table 25**, the average load of each bus route at its respective bus stop ranges from about 15 to 38 persons during the peak hours. It should be noted that these bus routes serve their respective stops several times during peak hours. Bus route #6, #7 and #14 in particular are “frequent routes” that arrive every 15 minutes or less during peak hours.

Based on information obtained from the OC Transpo website, the person capacity of OC Transpo vehicles, which includes the number of seats on the bus plus the standing capacity, ranges from approximately 57 occupants in its smallest vehicles to approximately 110 occupants in its largest vehicles. Some of these routes connect to the Confederation Line LRT approximately 1.4km north of the development site, which has a significantly higher frequency and ample capacity of 336 occupants.

Therefore, based on the current average bus loads and the future implementation of the Catherine St transit priority lane, the estimated 133 site generated transit trips during the peak hour periods are expected to be adequately accommodated by transit service at full buildout.

The existing bus stop located along Catherine St at the site frontage will be redesigned as a bus shelter at the new curb location that will adhere to the City bus stop specification SC12. No modifications are anticipated to the proposed future transit lane design as a result of the development. At the south end of the woonerf, an accessible passenger loading zone will be provided, which can accommodate paratransit vehicles.

#### 4.8. Review of Network Concept

---

There are no identifiable planning screenlines within or in close proximity of the study area. A strong TDM program in combination with planned City sustainable infrastructure limits the anticipated number of vehicle and transit trips. Therefore, no major modifications are needed for the network to continue to perform acceptably. Transit trips were discussed in **Section 4.7** and is expected to be accommodated by the existing bus operations in the study area. Vehicle trips are also expected to be accommodated along study area roads, where any intersection operational concerns will be confirmed as part of **Section 4.9.2**.

#### 4.9. Intersection Design

---

##### 4.9.1. Intersection Control

Stop or Yield control may be considered for traffic exiting the underground parking garage ramps and the woonerf, to be confirmed during the detailed design. All other off-site intersection controls in the study area will continue to operate as per existing conditions, with the exceptions of recommended signal timing adjustments at the intersections of Catherine/Kent and Bank/Chamberlain/Isabella, as part of the future Catherine St Functional Design Plan Modifications, which is assumed to be completed in the 2031 and 2036 horizon years.

Additionally, the WBR movement at Catherine/Kent, will be fully protected with no-right-turn-on-red restriction and time separated pedestrian phase. At Bank/Chamberlain/Isabella, the NBR will not permit right-turn-on-red due to the proposed bidirectional crossing on the south leg of the intersection.

##### 4.9.2. Intersection Design

Synchro 11 Trafficware was used to analyze intersection performance of intersections within the study area. Critical movements at each of the intersections were assessed based on either the movement with the highest volume-to-capacity ratio (for signalized intersections), or the movement experiencing the highest average delay (for unsignalized intersections). It should be noted that, as per the TIA Guidelines, the Peak Hour Factor (PHF) used for analysis was 0.90 in existing conditions and 1.0 in all future scenario conditions. All Synchro report outputs for existing and future conditions have been provided in **Appendix I**.

## Existing Conditions Intersection Performance

**Table 26** below summarizes the intersection performance of study area intersections, based on existing conditions traffic volumes illustrated in **Figure 8**.

Table 26: Existing Conditions Intersection Performance

Intersection	Weekday AM Peak (PM Peak)					
	Critical Movement			Intersection 'As a Whole'		
	LOS	max. v/c or avg. delay (s)	Movement	Delay (s)	LOS	v/c
Catherine/Lyon (S)	A(A)	0.41(0.51)	SBT(WBT)	11.4(16.5)	A(A)	0.29(0.47)
Catherine/Kent (S)	C(A)	0.72(0.56)	NBT(WBR)	24.7(17.4)	C(A)	0.72(0.55)
Bank/Catherine (S)	D(E)	0.89(0.99)	WBT(SBT)	29.1(50.8)	D(D)	0.89(0.88)
Catherine/Percy (S)	A(A)	0.28(0.52)	SBT(WBT)	7.5(10.6)	A(A)	0.26(0.48)
Arlington/Kent (S)	C(A)	0.77(0.47)	NBT(NBT)	16.1(8.1)	C(A)	0.72(0.43)
Gladstone/Lyon (S)	A(A)	0.41(0.60)	SBT(SBT)	16.3(15.5)	A(A)	0.37(0.55)
Gladstone/Kent (S)	C(B)	0.79(0.61)	NBT(EBT)	9.7(13.5)	C(B)	0.76(0.61)
Bank/Isabella/Chamberlain (S)	E(C)	0.91(0.79)	SBT(SBT)	16.7(17.7)	D(C)	0.82(0.76)
Catherine/Bronson (S)	<b>F(F)</b>	1.03(1.11)	WBL(WBL)	45.2(55.8)	E(E)	0.91(0.98)
Arlington/Lyon (U)	B(C)	13(18)	EB(WB)	2(2)	A(A)	-
Arlington/Bank (U)	C(C)	20(20)	EB(EB)	3(3)	A(A)	-

Note: Analysis of signalized intersections assumes a PHF of 0.9 and a saturation flow rate of 1800 veh/h/lane.  
(S) - Signalized intersection, movement with highest v/c ratio identified as critical movement.  
(U) - Unsignalized intersection, movement with highest average delay identified as critical movement.

As shown in **Table 26**, the signalized intersections 'as a whole' operate at a LOS 'E' or better during the morning and afternoon peak hours.

The Catherine/Bronson intersection had a critical westbound left-turn above capacity for both the AM and PM peak hour. Bronson Ave is a major north-south arterial road in the city, which moves large volumes of commuters from the downtown and from the east end who exit Highway 417 and proceed southbound on Bronson Ave. The resulting performance for the WBL movement was expected. That said, the WB approach queue was shown to be acceptable (further detail provided in **Section 4.9.3**). Considering the Catherine/Bronson intersection was only recently modified as part of the MTO bridge rehabilitation project, only signal timing optimizations should be completed - no further mitigation is recommended at this location.

## Future Background 2036 Intersection Performance

The most critical of all background conditions between background 2026, 2031 and 2036 was chosen for analysis. The 2036 background accounts for a 0.5% annual growth rate and includes all adjacent developments plus the transit priority lane conversion along Catherine Street resulting in a reduction from three general travel lanes to two general travel lanes as part of the Catherine St Functional Design Plan.

The results from this scenario were compared with intersection performance results within the study area after the proposed development is added, in order to quantify the adjacent road network implications of the proposed development. **Table 27** below summarizes the intersection operational performance at study area intersections using Synchro analysis software for this scenario.

Table 27: Future Background 2036 Conditions Intersection Performance

Intersection	Weekday AM Peak (PM Peak)					
	Critical Movement			Intersection 'As a Whole'		
	LOS	max. v/c or avg. delay (s)	Movement	Delay (s)	LOS	v/c
Catherine/Lyon (S)	A(A)	0.34(0.50)	SBT(WBT)	14.6(17.9)	A(A)	0.33(0.49)
Catherine/Kent (S)	D(B)	0.83(0.61)	NBT(NBT)	55.9(25.4)	C(A)	0.75(0.55)
Bank/Catherine (S)	D(D)	0.89(0.89)	WBT(WBT)	26.6(29.1)	D(C)	0.85(0.78)
Catherine/Percy (S)	A(B)	0.42(0.69)	WBT(WBT)	9.7(14.6)	A(B)	0.34(0.62)
Arlington/Kent (S)	C(A)	0.73(0.49)	NBT(NBT)	60.7(55.5)	B(A)	0.69(0.45)
Gladstone/Lyon (S)	A(A)	0.36(0.53)	SBT(SBT)	12.5(14.9)	A(A)	0.33(0.50)
Gladstone/Kent (S)	C(B)	0.79(0.64)	NBT(NBT)	13.4(13.3)	C(A)	0.74(0.60)
Bank/Isabella/Chamberlain (S)	C(C)	0.76(0.79)	EBT(EBT)	17.3(18.2)	B(C)	0.65(0.72)
Catherine/Bronson (S)	E(E)	0.91(0.92)	SBT(WBL)	38.1(39.4)	D(E)	0.90(0.92)
Arlington/Lyon (U)	B(C)	13(17)	EB(WB)	2(2)	A(A)	-
Arlington/Bank (U)	C(C)	18(17)	EB(EB)	3(2)	A(A)	-

Note: Analysis of signalized intersections assumes a PHF of 1.0 and a saturation flow rate of 1800 veh/h/lane.  
 (S) - Signalized intersection, movement with highest v/c ratio identified as critical movement.  
 (U) - Unsignalized intersection, movement with highest average delay identified as critical movement.

As shown in **Table 27** intersections are projected to operate similarly to existing conditions. In general, intersections with roads connecting to Highway 417 and which received a 0.5% annual growth rate experienced a slight worsening in intersection performance, while other intersections a slight improvement due to increasing the PHF to 1.00 compared to existing PHF of 0.90 as per TIA Guidelines.

**Total Projected 2026 Intersection Performance**

Within this scenario, a new right-in-right-out (RIRO) access to the site has been added to Catherine Street approximately 60m west of Kent St. The Woonerf was not modelled as traffic volumes are expected to be very minimal and generally off-peak hours.

**Table 28** below summarizes the intersection operational performance at study area intersections using Synchro analysis software for this scenario, based on total projected 2026 volumes in **Figure 17**.

Table 28: Total Projected 2026 Conditions Intersection Performance - Phase 1

Intersection	Weekday AM Peak (PM Peak)					
	Critical Movement			Intersection 'As a Whole'		
	LOS	max. v/c or avg. delay (s)	Movement	Delay (s)	LOS	v/c
Catherine/Lyon (S)	A(A)	0.32(0.42)	SBT(SBT)	8.7(14.1)	A(A)	0.28(0.39)
Catherine/Kent (S)	C(A)	0.75(0.59)	NBT(NBT)	22.9(15.2)	B(A)	0.70(0.54)
Bank/Catherine (S)	D(D)	0.84(0.86)	WBT(WBT)	25.6(28.5)	D(C)	0.84(0.78)
Catherine/Percy (S)	A(A)	0.25(0.52)	WBT(WBT)	7.4(10.5)	A(A)	0.25(0.47)
Arlington/Kent (S)	C(A)	0.71(0.46)	NBT(NBT)	15.6(7.3)	B(A)	0.67(0.42)
Gladstone/Lyon (S)	A(A)	0.35(0.52)	SBT(SBT)	12.4(14.6)	A(A)	0.32(0.49)
Gladstone/Kent (S)	C(B)	0.77(0.62)	NBT(NBT)	13.1(11.2)	C(A)	0.72(0.59)
Bank/Isabella/Chamberlain (S)	C(C)	0.75(0.73)	EBT(EBT)	17.0(16.9)	B(B)	0.64(0.70)
Catherine/Bronson (S)	D(D)	0.87(0.89)	WBL(WBL)	34.4(36.4)	D(D)	0.85(0.88)
Arlington/Lyon (U)	B(C)	13(16)	EB(WB)	2(2)	A(A)	-
Catherine/Site Access (U)	A(A)	10(10)	SB(SB)	1(0)	A(A)	-
Arlington/Bank (U)	C(C)	15(17)	EB(EB)	2(2)	A(A)	-

Note: Analysis of signalized intersections assumes a PHF of 1.0 and a saturation flow rate of 1800 veh/h/lane. Catherine/Bronson was optimized while keeping the same cycle length.  
 (S) - Signalized intersection, movement with highest v/c ratio identified as critical movement.  
 (U) - Unsignalized intersection, movement with highest average delay identified as critical movement.

As shown in **Table 28**, the intersections will continue to operate similar to, or in some instances better than, existing conditions. The site access intersection to Catherine St operates well.

### Total Projected 2031 Intersection Performance

Within this scenario, a new full movement site access to Arlington St approximately 25m east of Lyon St has been added. Additionally, a general-purpose travel lane on Catherine St has been removed to a total of two general travel lanes to account for the Catherine St Functional Design Plan. As requested by city staff, a time separated east-west pedestrian phase was modelled. The crossing distance was measured at approximately 13m, and as such, a 13s pedestrian phase was modelled assuming 1m/s approach.

**Table 29** below summarizes the intersection operational performance at study area intersections using Synchro analysis software for this scenario, based on total projected 2031 traffic volumes in **Figure 18**.

Table 29: Future Projected 2031 Intersection Performance - Phase 1 & 2

Intersection	Weekday AM Peak (PM Peak)					
	Critical Movement			Intersection 'As a Whole'		
	LOS	max. v/c or avg. delay (s)	Movement	Delay (s)	LOS	v/c
Catherine/Lyon (S)	A(A)	0.37(0.52)	WBT(WBT)	13.6(17.5)	A(A)	0.36(0.51)
Catherine/Kent (S)	D(B)	0.83(0.65)	NBT(NBT)	55.5(25.8)	C(A)	0.75(0.57)
Bank/Catherine (S)	E(E)	0.94(0.92)	WBT(WBT)	29.2(30.6)	D(D)	0.88(0.81)
Catherine/Percy (S)	A(B)	0.35(0.64)	WBT(WBT)	8.0(12.0)	A(A)	0.32(0.58)
Arlington/Kent (S)	C(A)	0.73(0.48)	NBT(NBT)	59.6(53.7)	B(A)	0.70(0.46)
Gladstone/Lyon (S)	A(A)	0.36(0.54)	SBT(SBT)	12.5(14.9)	A(A)	0.33(0.51)
Gladstone/Kent (S)	C(B)	0.78(0.64)	NBT(NBT)	13.3(13.5)	C(A)	0.73(0.60)
Bank/Isabella/Chamberlain (S)	C(C)	0.76(0.76)	EBT(EBT)	17.3(17.8)	B(C)	0.66(0.73)
Catherine/Bronson (S)	D(E)	0.88(0.91)	WBL(WBL)	35.9(37.9)	D(D)	0.87(0.90)
Arlington/Lyon (U)	B(C)	13(16)	EB(WB)	2(2)	A(A)	-
Catherine/Site Access (U)	A(A)	9(9)	SB(SB)	1(0)	A(A)	-
Arlington/Site Access (U)	A(A)	9(9)	NB(NB)	4(3)	A(A)	-
Arlington/Bank (U)	C(C)	17(19)	EB(EB)	3(3)	A(A)	-
Note: Analysis of signalized intersections assumes a PHF of 1.0 and a saturation flow rate of 1800 veh/h/lane. Catherine/Bronson was optimized while keeping the same cycle length.						
(S) - Signalized intersection, movement with highest v/c ratio identified as critical movement.						
(U) - Unsignalized intersection, movement with highest average delay identified as critical movement.						

As shown in **Table 29**, the study area intersections will continue to operate similar to, or in some instances better than, existing conditions. All the site accesses operate well.

### Total Projected 2036 Intersection Performance

Total projected 2036 model assumes the same road geometries as total projected 2031 scenario. The main difference in this scenario is that a 0.5% annual growth rate has been applied to background traffic volumes for an additional 5 years, which represents a conservative scenario (as previously discussed in **Section 3.3**).

**Table 30** below summarizes the intersection operational performance at study area intersections using Synchro analysis software for this scenario, based on total projected 2036 traffic volumes in **Figure 19**.

Table 30: Future Projected 2036 Intersection Performance - Phase 1 & 2

Intersection	Weekday AM Peak (PM Peak)					
	Critical Movement			Intersection 'As a Whole'		
	LOS	max. v/c or avg. delay (s)	Movement	Delay (s)	LOS	v/c
Catherine/Lyon (S)	A(A)	0.38(0.53)	WBT(WBT)	19.4(17.8)	A(A)	0.37(0.52)
Catherine/Kent (S)	C(B)	0.80(0.66)	NBT(NBT)	22.0(27.2)	C(A)	0.74(0.58)
Bank/Catherine (S)	D(E)	0.90(0.93)	WBT(WBT)	28.1(31.2)	D(D)	0.87(0.81)
Catherine/Percy (S)	A(B)	0.36(0.65)	WBT(WBT)	8.0(12.1)	A(A)	0.32(0.59)
Arlington/Kent (S)	C(A)	0.73(0.49)	NBT(NBT)	25.3(53.9)	B(A)	0.70(0.47)
Gladstone/Lyon (S)	A(A)	0.37(0.54)	SBT(SBT)	12.5(15.1)	A(A)	0.34(0.51)
Gladstone/Kent (S)	C(B)	0.79(0.63)	NBT(NBT)	17.2(13.8)	C(A)	0.74(0.60)
Bank/Isabella/Chamberlain (S)	C(C)	0.78(0.75)	EBT(EBT)	17.7(17.6)	B(C)	0.68(0.73)
Catherine/Bronson (S)	D(E)	0.82(0.93)	SBT(WBL)	31.8(39.8)	C(E)	0.80(0.92)
Arlington/Lyon (U)	B(C)	13(16)	EB(WB)	2(2)	A(A)	-
Catherine/Site Access (U)	A(A)	9(9)	SB(SB)	1(0)	A(A)	-
Arlington/Site Access (U)	A(A)	9(9)	NB(NB)	4(3)	A(A)	-
Arlington/Bank (U)	C(C)	16(19)	EB(EB)	3(3)	A(A)	-

Note: Analysis of signalized intersections assumes a PHF of 1.0 and a saturation flow rate of 1800 veh/h/lane. Catherine/Bronson was optimized while keeping the same cycle length.  
 (S) - Signalized intersection, movement with highest v/c ratio identified as critical movement.  
 (U) - Unsignalized intersection, movement with highest average delay identified as critical movement.

Even with 5 years of additional background growth, the full buildout volumes plus 2036 background volumes continue to operate well. All intersections as a whole and associated critical movements operate within City of Ottawa standards with a v/c below 1.00.

**Queueing Implications on Catherine Street**

SimTraffic and Synchro softwares were used to determine queueing and the risk of spillback on study area intersections. Within the simulation parameters, the westbound right-turn at the Bank/Catherine intersection was treated as a defacto turn-lane to model a more realistic flow in the SimTraffic model. **Table 31** summarizes sensitive locations for queueing, predominantly on Catherine St which is proposed to have future exclusive transit lanes. Detailed SimTraffic output results have been provided in **Appendix J**.

Table 31: Queueing Analysis for Sensitive Intersection Movements (2036 Projected)

Intersection - Movement	Available Storage (m)	Synchro Forecasted Queues AM (PM) (m)		SimTraffic Forecasted Queues AM (PM) (m)	
		50th Percentile	95th Percentile	50th Percentile	95th Percentile
Bank/Catherine - WB <sup>1</sup>	210m	48(52)	#72(#77)	91(104)	141(185)
Kent/Catherine - WBR	130m	44(24)	m54(m28)	42(24)	62(39)
Kent/Catherine - WBT		32(55)	m39(m64)	32(43)	47(58)
Lyon/Catherine - WBL	160m	30(55)	m43(73)	48(35)	70(63)
Lyon/Catherine - WBT				30(24)	49(45)
Percy/Catherine - WB <sup>1</sup>	275m	6(25)	12(39)	19(41)	35(66)
Bronson/Catherine - WB <sup>1</sup>	120, 250m*	75(91)	#125(#157)	72(73)	110(100)

# - 95th percentile volume exceeds capacity; queue may be longer; m - volume for 95th percentile queue is metered by upstream signal. \* - 120m to terminus of 417 off-ramp and 250m to Percy St. 1. The longest westbound movement queue was used.

As shown in **Table 31**, all forecasted vehicle queues within the Catherine St corridor are contained to their respective road segments without spilling back to the upstream signalized intersection.

The Catherine St Functional Design Study proposes converting a general-purpose travel lane to a transit priority lane along Catherine St between Kent St and Bronson St. The proposed development is not anticipated to impact the design of the future transit lane.

As shown in **Table 31**, vehicle queues on Lyon/Catherine westbound do not exceed 70m in the WBL lane and 50m in the WBT lane, which suggests the risk of buses being blocked from entering the transit priority lane in the future is low. Furthermore, the signal timing plans between Kent St and Lyon St may be optimized to ensure the vehicle queue is “flushed” out prior to the arrival of oncoming vehicles if needed.

The corridor performance along Catherine St in the 2036 horizon (provided in **Table 30**) does not suggest there will be any notable operational implications to transit operations and travel times with the development proposal. The transit priority lane is expected to ensure buses can move efficiently through the corridor unencumbered.

### MMLOS Analysis for Signalized Intersections

As per requirements of the TIA Guidelines, MMLOS analysis was conducted for signalized intersections within the study area. Since the Catherine St Functional Design Plan will result in future modifications at study area intersections, analysis was conducted for each of existing and future conditions.

Similar to boundary street MMLOS analysis, the signalized intersection MMLOS analysis is conducted for four different travel modes, including pedestrian, cyclist, transit, and trucks. For each travel mode, the minimum desirable LOS target is obtained from the City of Ottawa TIA Guidelines. A summary of the analysis results and respective minimum desirable LOS targets are provided in **Table 32**, with the detailed analysis provided in **Appendix K**.

Table 32: MMLOS Analysis, Signalized Intersection

Intersection	Level of Service							
	Pedestrian (PLOS)		Bicycle (BLOS)		Transit (TLOS)		Truck (TkLOS)	
	PLOS	Target	BLOS	Target	TLOS <sub>1</sub>	Target	TkLOS	Target
Catherine/Kent	C, C*	A	F	D	D	- (D)	D	D
Catherine/Lyon	C, C*	A	F	C	C	- (D)	D	D
Arlington/Kent	D	A	E	D, (C)	-	-	-	-
Bank/Catherine	C, C*	A	E	D, (B)	F	D	B	D
Gladstone/Lyon	C	C	A	C	C	D	F	-
Gladstone/Kent	C	A	F	D, (C)	D	D	D	D
Catherine/Percy	D, D*	C	E, F*	C	C	- (D)	D	D
Catherine/Bronson	E, E*	C	E	D	F	- (D)	D	D
Bank/Isabella/Chamberlain	D, D*	A	E, D*	D, (B)	E	D	D, B*	D

\*Result based on Catherine St Functional Design Plan; (xx) = future target when it differs from existing target 1. TLOS was evaluated based on 2036 full buildout operations only.

Red font in the table above indicates that the desirable target LOS is not achieved.

- With regards to pedestrian LOS, the results are largely based on the number of lanes that pedestrians have to cross, followed by the degree of comfort and safety that pedestrians feel while crossing. This includes factors such as the amount of interference with crossing pedestrians due to permissible vehicle left-turns and right-turns.
- With regards to bicycle LOS, the target LOS was only met at Gladstone/Lyon and future Bank/Isabella intersections. Other intersections failed to meet the bicycle LOS target due to the lack of cycling facilities at the intersection or turning movement facilities at the approaches such as two-stage left-turn boxes.
- With regards to transit LOS, the target LOS is achieved at most intersections with the exception of Bank/Catherine, Bank/Isabella, and Catherine/Bronson due to the bus movement approaches exceeding 30 second delays. Buses operate in mixed traffic at various locations, so they experience the same level of delay as general traffic at the intersection. Adjusting the signal timing and phasing of the intersections to provide more dedicated green time to the approaches used by busses may help reduce the traffic delays.
- With regards to truck LOS, all locations with a target goal were met.

## 5.0 FINDINGS, CONCLUSIONS AND RECOMMENDATIONS

Based on the results summarized herein, the following transportation related conclusions are offered:

### Existing Conditions

- The site is located at the former Greyhound Bus Station (currently not in operation).
- Nearby Bank St and Gladstone Ave are designated transit priority corridors with isolated measures within the 2031 Affordable Network in the TMP.
- Overall, there were 427 collisions recorded in five years within the study area. Kent/Catherine showed to have higher than average likeliness of collisions, but most resulted in property damage only. Bank/Catherine intersection broadcasted a disproportionate number of collisions with pedestrians and cyclists compared to other study intersections. Bank St being an arterial mainstreet which attracts active users is recommended to be retrofitted to include Protected Intersection Design Guide measures to priority the safety of vulnerable users.
- The site is currently accessed by three right-in right-out driveways to/from Catherine St.
- Existing intersections operate at acceptable overall LoS 'E' or better. The intersection of Catherine/Bronson has critical movements at capacity during the weekday peak hours for the westbound left-turn.

### Proposed Development

- A two phased development is proposed, with the first phase of development occurring on the east half of the site.
- The proposed development will comprise of approximately 1,134 residential units and 26,081 ft<sup>2</sup> of ground floor commercial/retail, within three towers and podiums ranging from 32 to 36-storeys high and 7 townhomes.
- The proposed development is projected to generate approximately 111 to 133 'new' transit trips during the AM and PM peak hour periods, which can be accommodated by various routes operating near to the site. Local route 50 operates on Catherine St adjacent to the site. Frequent routes 6 and 7 operate on Bank St and frequent route 14 operates on Gladstone Ave. An ongoing study is determining the feasibility of adding exclusive transit lanes on Catherine St.
- A total of 357 parking spaces are proposed which is lower than the city's minimum parking requirements for this location, triggering a parking variance. The development has proposed strong TDM measures and excess bike parking spaces to promote alternate modes of transportation and reduce the reliance on vehicles for this site. In the event of spillover, on-street parking is available, which would help promote slower driving speeds as a traffic calming measure. The minimum requirements for visitor and commercial parking were met.
- The developer proposes 1,149 bike parking spaces, the majority located in the underground parking garage. A few bike parking spaces are proposed outdoor near the commercial uses. The proposed number of bike parking are provided at a ratio of at least 1:1 per residential unit.
- An extensive list of TDM measures have been proposed for this development to support a parking variance to provide fewer spaces than the By-Law requirement, as well as support the Official Plan policies to encourage sustainable modes of transportation in the Downtown Transect. Refer to **Section 4.5** or **Appendix F** for further details.
- The proposed development is projected to generate 'new' vehicle volumes of approximately 210 veh/h two-way total during the weekday morning and afternoon peak hours.



- Access to the underground parking lot will be provided via two accesses, where one access will be located along Catherine St and will be constructed as part of Phase 1, and the other access will be located along Arlington Ave and constructed at full buildout. Two access points to the parking garage ensure efficient access for residents and spread of vehicle traffic to the site. This prevents excess traffic infiltration on adjacent streets (increasing pedestrian and cycling conflicts at intersections) with only one access point, due to the one-way operation of the three frontage streets to the subject site.
- A one-way southbound woonerf is proposed connecting Arlington St and Catherine St. This woonerf was added to allow garbage pick-up and delivery drop off internal to the site as dictated in various policies for the City of Ottawa. The risk of short-cutting by general traffic is expected to be very low due to lower traffic volumes on Arlington St and limited route options with Catherine St being one-way westbound. Materials, landscaping, furniture and fixtures were carefully chosen to dissuade drivers as well as promote an enhanced environment for pedestrians. The woonerf will allow delivery activities such as mail drop off and other short-term stay activities, as well as provide an accessible passenger loading zone for paratransit vehicles near the south end.
- The separation distance between the woonerf access and the adjacent parking garage access off Catherine St does not adhere to the Private Approach By-law. However, considering the very low anticipated volume, predominantly off-peak, combined with the one-way operations of Catherine St, the proposed separation distance was deemed appropriate given the context.
- Due to difficulties in providing an internal loading bay for Tower 3, a loading layby has been proposed on Lyon St for any commercial uses relating to Phase 2. Given that Lyon St is a one-way traffic calmed street with wide pavement width and loading operations expected to be infrequent and during off-peak hours, the layby was considered acceptable.
- On-street parking availability around the site provide opportunity for pick-up and drop-off activities to the site. Parking is available along the east side of Kent St and will be provided along the south side of Arlington Ave as part of the proposed development. The future transit lane along Catherine St will also permit short-term parking on the west half of the site during off-peak hours.

### Future Conditions

- Other nearby developments applied a 0.5% annual growth rate to existing volumes on arterials connecting to Highway 417 to estimate future background conditions. The furthest horizon, 2036 background conditions showed overall intersection performance of all study area intersections was LoS 'E' or better and with critical movement of 'E' or better which is similar to existing.
- The MMLOS road segment analysis shows that existing and future conditions on boundary streets do not meet MMLOS area targets for pedestrians due the pedestrian infrastructure and high vehicular volumes, coupled with aggressive targets due to the proximity to a school. However, there are notable improvements proposed to the pedestrian realm as part of the development, such as wide boulevards and sidewalks. The bike targets were only met at Lyon St and Arlington Ave due to the number of travel lanes. There is only a transit route on Catherine St. Transit goals are not met for existing conditions due to mixed traffic but meet the target in future conditions if a segregated bus lane is built. Truck targets were all met.
- The MMLOS intersection analysis shows that truck target goals are met at all intersections. Given the higher-operating speeds and number of travel lanes, or high target rate due to proximity to a school, it is not possible to meet pedestrian target goals with the exception of Gladstone/Lyon. The bicycle target goals were also not met at most locations given the lack of cycling facilities on all approaches, the quantity of lanes required to be crossed and the higher operating speeds. Only Gladstone/Lyon met the bike targets and future Bank/Isabella. The transit TLoS was met at most intersections with the exception of Bank/Catherine, Bank/Isabella, and Catherine/Bronson due to delays greater than 30 seconds.

- Future phase 1 conditions with the addition of pedestrians, cyclists, transit users and site vehicle traffic performed at acceptable levels of service with respect to v/c and delay resulting in overall LoS 'D' or better and with critical movement of 'D' or better.
- Future full buildout conditions with the addition of pedestrians, cyclists, transit users and site vehicle traffic performed at acceptable levels of service with respect to v/c and delay resulting in overall LoS 'D' or better and with critical movement of 'E' or better.
- The section of Arlington Ave between Kent St and Bank St experiences higher levels of vehicle traffic than the city local road threshold, which is likely triggered by short-cut traffic to/from Kent St (predominantly the Hwy 417 off-ramp) and Bank St. While site generated traffic is expected to contribute to this section, it will be to a much smaller proportion compared to existing/background traffic. It is also important to reiterate that the Arlington St corridor is already traffic calmed, including speed humps. That said, the development proposal introduces four new bulb-outs at the two proposed access points that will narrow the road from existing 10m to 7m, which reinforces the traffic calmed environment. The city Neighbourhood Traffic Calming Branch may consider investigating this section of Arlington Ave if future concerns are raised and validated through the established city process.
- The City of Ottawa has completed a study to convert a general-purpose travel lane to a peak hour transit priority lane on Catherine St, starting at Kent St and extending west to Bronson Ave. The proposed development is not anticipated to impact the design of the future transit lane. Synchro and SimTraffic simulation determined that WB queue lengths on Catherine St would not block buses from entering the bus lane. If needed, the city can also consider optimizing signal timing plans of the Lyon St and Kent St intersections on Catherine St to ensure vehicles are "flushed" out prior to the arrival of oncoming vehicles.
- The corridor performance along Catherine St in the 2036 horizon does not suggest there will be any notable operational implications to transit operations and travel times with the development proposal. The transit priority lane is expected to ensure buses can move efficiently through the corridor unencumbered.

Based on the foregoing findings, the proposed development located at 265 Catherine St is recommended from a transportation perspective.

Prepared By:



Basel Ansari, P. Eng.  
Transportation Engineers

Reviewed By:



Austin Shih, M.A.Sc., P.Eng.  
Senior Transportation Engineer

# Appendix A:

Screening Form & City Comment Responses

City of Ottawa 2017 TIA Guidelines

Date

23-May-24

**TIA Screening Form**

Project

265 Catherine TIA

Project Number

478038-01000

Results of Screening	Yes/No
Development Satisfies the Trip Generation Trigger	Yes
Development Satisfies the Location Trigger	No
Development Satisfies the Safety Trigger	Yes

Module 1.1 - Description of Proposed Development	
Municipal Address	265 Catherine St
Description of location	At Greyhound Station, borders Kent, Catherine, Lyon, Arlington
Land Use	Residential apartment building
Development Size	1127 units, two towers, townhomes
Number of Accesses and Locations	Two on Catherine, two on Arlington
Development Phasing	Two phases
Buildout Year	Assumed 2031
Sketch Plan / Site Plan	See attached

Module 1.2 - Trip Generation Trigger		
Land Use Type	Townhomes or Apartments	
Development Size	1127	Units
Trip Generation Trigger Met?	Yes	

Module 1.3 - Location Triggers	
Development Proposes a new driveway to a boundary street that is designated as part of the City's Transit Priority, Rapid Transit, or Spine Bicycle Networks (See Sheet 3)	No
Development is in a Design Priority Area (DPA) or Transit-oriented Development (TOD) zone. (See Sheet 3)	No
Location Trigger Met?	No

Module 1.4 - Safety Triggers		
Posted Speed Limit on any boundary road	<80	km/h
Horizontal / Vertical Curvature on a boundary street limits sight lines at a proposed driveway	No	
A proposed driveway is within the area of influence of an adjacent traffic signal or roundabout (i.e. within 300 m of intersection in rural conditions, or within 150 m of intersection in urban/ suburban conditions) or within auxiliary lanes of an intersection;	Yes	
A proposed driveway makes use of an existing median break that serves an existing site	No	
There is a documented history of traffic operations or safety concerns on the boundary streets within 500 m of the development	Yes	
The development includes a drive-thru facility	No	
Safety Trigger Met?	Yes	



Date	No.	Description
2024-03-15	Zoning By-Law Amendment & Site Plan Approval (Resubmission)	
2023-05-15	Zoning By-Law Amendment & Site Plan Approval	

ISSUE RECORD

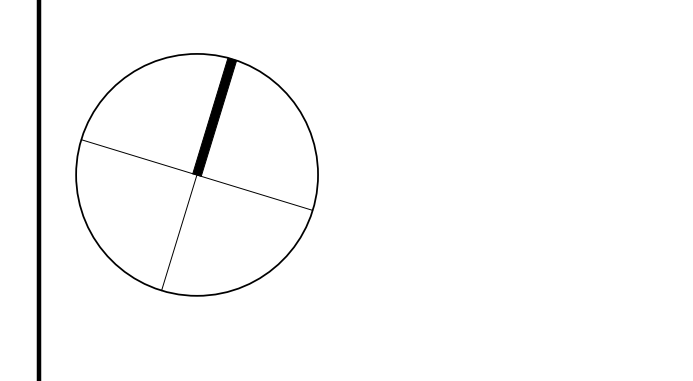

## BDP. Quadrangle

Quadrangle Architects Limited  
 1410 Spadina Avenue, Suite 2100, Toronto, ON M5S 2E8  
 416-598-1200 www.bdpquadrangle.com

265 Catherine Street, Ottawa  
 for  
 Brigid  
 DWG190911 - 001-13-23-0017 SPC / 002-02-23-0042 ZBA / 201-01-23-0008 OMA

21007 1:150 GZ R/L  
 PROJECT SCALE DRAWN REVIEWED

Ground Floor Plan

# A200.S

23 May 2024

City of Ottawa  
Development Review Services  
110 Laurier Avenue West  
Ottawa, ON K1P 1J1

**Attention: Wally Dubyk**

Dear Wally:

**Re: 265 Catherine Street TIA**  
**Step 5 Submission #2 – Response to City Comments**

The following response has been prepared in response to City of Ottawa TIA Report comments received on April 18, 2024. City comments are presented in black with the corresponding responses from Parsons in **Green**.

**Transportation PM Comments**

*The following comments refer to comment numbers found within the ‘Second Round of Comments Matrix – Updated 2024-03-18’ document.*

1. Section 3.1.1 Trip Generation and Mode Shares:

There appears to be an error in Table 17, as the Phase 1 trip totals are equivalent to the number of trips at full build-out (as shown in Table 18). Please review.

**Table 17 has been updated. The update results in a slight reduction of 6 to 10 two-way vehicle trips (in Phase 1 trips only) compared to the previous estimates.**

Right of Way Comments:

2. Comment #60 – The site plan and landscape plan show two planters adjacent to Building A encroaching into the Catherine Street ROW. Please reduce the width of these planters to be entirely within private property (like the similar planter adjacent to Building B).

**Comment addressed by project’s landscape architect. Updates were made to the Site Plan.**

3. Comment #61 – Per Policy 2.1.1 (d) of Schedule C16 of the Official Plan, the 1.5m surface easement must be unobstructed. A planter on Lyon Street obstructs the 1.5m pedestrian easement. Please revise planter.

**Comment addressed by project’s landscape architect. Updates were made to the Site Plan.**

4. Comment #62 – The site plan and landscape plan show a proposed planter encroaching into the Lyon Street and Arlington Avenue corner triangle. Reduce or eliminate this encroachment.

**Comment addressed by project’s landscape architect. Updates were made to the Site Plan.**

5. Ensure paving materials used on City right of way are durable and appropriate to the harsh urban and climatic conditions of Ottawa. Use materials that can be sourced when needed to be replaced. Contact David Atkinson for additional information on paver selection. A maintenance and liability agreement may be required for these pavers placed in City ROW.

**Comment referred to project's landscape architect.**

**Lyon Street Frontage:**

6. Comment #64 – Note that Section 3.3.2.17 of the Central and East Downtown Core Secondary Plan requires that loading and other vehicle access infrastructure is located to not compromise sustainable modes and prohibits this infrastructure on Corridors where possible. Acknowledge this policy when discussing rationale for the proposed layby.

**Policy has been acknowledged in the TIA Report.**

7. Comment #65 and Comment #66 – If the segment MMLoS evaluation for Lyon Street is considering the north half of the block adjacent to the loading layby, then the MMLoS spreadsheet in Appendix H should indicate “yes” for on-street parking on Lyon Street (future). Revise Appendix H, as well as the pedestrian LOS results/discussion in Section 4.3 of the TIA.

**Segment MMLoS analysis has been updated in both Section 4.3 and Appendix H.**

**Catherine Street Frontage:**

8. Comment 68 – The site plan provided in Appendix A still shows the relocated bus shelter near Lyon Street (in front of Tower 3). Please revise the Appendix A site plan to remove the depiction of the relocated bus shelter near Lyon Street.

**Relocated bus shelter in front of Tower 3 has been removed from latest Site Plan.**

9. Comment 69 – The proposed narrowing of Catherine Street on the east half of the block and the associated two-car lay-by is not accepted. Refer to the following additional comments from the Chamberlain, Catherine, and Isabella Functional Design study's project manager (Vanessa Black):
  - a. Note that Section 3.3.2.17 of the Central and East Downtown Core Secondary Plan requires that loading and other vehicle access infrastructure is located to not compromise sustainable modes and prohibits this infrastructure on Corridors, where possible.
  - b. The back of the lay-by is approximately 7m from the west crosswalk of the Catherine Street and Kent Street intersection. Section 7 (1) (a) prohibits parking within 9m of an intersection. Therefore, the proposed lay-by can legally accommodate a single vehicle only.
  - c. The location of the proposed layby on Catherine Street is very close to the bus stop (to the west) and to the Kent Street intersection (to the east). This, in combination with the proximity of the access to the bus stop, creates too much parking/driveway friction within a short segment of street. The proposed layby near Kent Street should be removed and following alternative(s) explored:
    - d. A loading zone near the east end of Arlington; and/or
    - e. A short duration permissive parking zone be implemented just west of the woonerf access, during off-peak times when the bus lane is not in operation.
  - f. It is recommended that the peak period transit lane approved as part of the Catherine, Chamberlain, and Isabella Functional Design Study, that extends the entire block, be maintained. Catherine Street is an emergency detour route, paramedic route, and fire route, and includes multiple highway access points. Locating the bus stop in the travel lane as opposed to the transit lane may negatively impact traffic operations. The Catherine, Chamberlain and Isabella Functional Design Study did traffic analysis on various road design scenarios at the Catherine Street/Kent Street and Catherine Street/Bank Street intersections, which were sensitive to certain scenarios with reduced capacity, resulting in the recommended design to ensure vehicular levels of service are acceptable within the network. In addition, studies which may further impact traffic capacity are commencing/underway on Kent Street and on Bank Street, adjacent to and near the site.
  - g. The 95th percentile queues in the TIA are close to the length of the shortened transit lane. Retaining the approved full block transit lane prevents potential queue spillbacks from blocking transit access to the lane.
  - h. Consult with the project manager of the Catherine, Chamberlain, and Isabella Functional Design Study on any potential changes to the approved plan for Catherine Street.

- i. Ensure that proposed tree locations and landscape design do not impede sightlines to/from the proposed site access.

Following a meeting held with City staff on May 03, 2024, to discuss comments provided and consult with the project manager of the Catherine, Chamberlain, and Isabella Functional Design Study, the proposed Catherine St layby was removed, and the peak period transit lane was reinstated as per the approved study's design. The design of landscape and tree locations have been addressed to the project's landscape architect and are expected to not impede sightlines at any proposed site accesses.

- 10. New Comment – the grading plan shows a relocated catch basin on the northeast corner of the Lyon Street and Catherine Street intersection that appears to be designed as a curb inlet catch basin. However, this catch basin is on a section of depressed curb, so it cannot be a curb inlet catch basin. In addition, the catch basin should not be relocated to within the east crosswalk of the intersection.

Comment referred to Stantec. Updates were made to the Site Plan.

Arlington Avenue Frontage:

- 11. Comment 74 – Include the future Arlington Avenue segment in the MMLOS spreadsheet (Appendix H).

Future Arlington Avenue segment has been added to MMLOS spreadsheet in Appendix H.

Section 4.1.2 Circulation and Access:

- 12. Comment 78 – Section 4.1.2 of the TIA Report suggests that general traffic will be discouraged from using the woonerf because the proposed materials and landscaping “provides strong visual cues to drivers that the woonerf is not a road”. To reinforce this messaging, recommend utilizing the woonerf’s vehicular unit paving on the woonerf accesses in-between the sidewalk and the curb.

Comment addressed by project’s landscape architect. Updates were made to the Site Plan. Comment added to TIA Report Section 4.1.2.

Section 4.2.1 Parking Supply:

- 13. Comment 80 – The first paragraph of Section 4.2.1 still indicates that indoor bike parking is proposed on the mezzanine rather than the underground parking levels. Revise to describe the currently proposed indoor bike parking location.

Paragraph has been updated to indicate all bicycle parking now being located in the underground parking garage.

Section 4.4 Access Design:

- 14. Comment 83 – The woonerf access at Catherine Street does not correctly show a depressed curb across the access per SC7.1 on the site plan, landscape plan, or architectural package. In addition, the woonerf access at Catherine Street includes 5m radii on both the west and east side of the driveway. Because the woonerf is intended to be southbound only, there should be no corner radius on the east side of the access. Please revise. Refer to markup below:

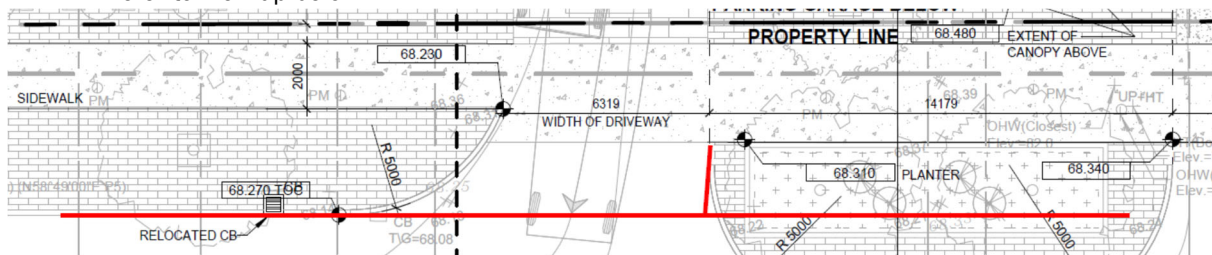



The woonerf access at Catherine St has been updated to include SC7.1 elements. The east side curb has also been revised as per latest Site Plan.

#### Section 4.5.3 TDM program:

15. Comment 86 – It is now indicated that a permanent bike repair station will be provided. However, this bike repair station can no longer be located on the architectural floor plans. Please identify where this repair station is proposed. In addition, the TDM Measures Checklist for Residential Developments Item 4.1.1 indicates that a bikeshare station will be provided on site. Describe in the TIA report where the bikeshare station will be located and how bikeshare will be provided without an established bikeshare system currently operating in the City of Ottawa.

The bike repair station was confirmed by the architect as being located along the Lyon St building frontage. The bikeshare station was removed due to its unconfirmed status at this time.

### Traffic Engineering

16. Traffic Engineering comments 92, 93, 94 and 95 of the Comments Matrix are not addressed and are still standing.

A meeting was held with City staff on May 3, 2024, to further discuss City comments and the potential changes along the Catherine St frontage. Based on the discussion, the full-length transit lane on Catherine St was reinstated as per original functional design plan and the proposed Catherine St layby was removed.

17. Comment 92. – The city project manager for Catherine Street design (Vanessa Black) was not consulted as suggested. Item #69 is a different issue than what was asked in 92, which was the removal of the proposed transit lane for private use.

Refer to comment response above. Vanessa Black was also included in the meeting mentioned.

18. Comments 93, 94, and 95 – We do not agree with the explanation provided to justify the proposed short distance between the woonerf access and the parking garage access, as well as the proximity of the layby to the signalized intersection at Kent Street.

The layby along Catherine St is no longer being proposed and the original bus lane design was reinstated as per the Catherine St functional design plan. In regards to the distance between the parking garage access and the woonerf on Catherine St, it is important to acknowledge that the woonerf is not a typical road, nor will it be used as such. The purpose of the woonerf is to provide an alternate route for move-in and waste collection trucks, both of which will be infrequent, and the majority will be outside of peak hours. The woonerf allows only one-way southbound operations from Arlington Ave to Catherine St and prevents any potential northbound vehicles with the proposed east curb design at Catherine St. Additionally, the west curb radii of the parking garage access has been reduced to 3m in order to help direct traffic exiting the garage onto the general traffic lane instead of the transit lane. The proposed operations of the woonerf and the design modifications at the accesses will help to significantly mitigate any potential conflicts.

### Streetlighting

19. No comments with the TIA for this circulation. Street lighting reserves the right to make future comments based on subsequent submissions.

Noted.

20. Future considerations are as follows:

If there are any proposed changes to the existing roadway geometry, the City of Ottawa Street Light Asset Management Group is required to provide a full street light design. Upon completion of proposed roadway geometry design changes, please submit digital Micro Station drawings with proposed roadway geometry changes to the Street Lighting Department, so that we may proceed with the detailed street light design and coordination with the Street Light maintenance provider and all necessary parties. Be advised that the applicant will be 100% responsible for all costs associated with any Street Light design as a result of the roadway geometry change.

Alterations and /or repairs are required where the existing street light plant is directly, indirectly or adversely affected by the scope of work under this circulation, due to the proposed road reconstruction process. All street light plant alterations and/or repairs must be performed by the City of Ottawa’s Street Light maintenance provider.

Noted.

### Transit Services

21. Ensure that the height and landscape design of the planter between the Building A parking garage access on Catherine Street and the Woonerf does not obstruct the sightlines between vehicles exiting the Woonerf southbound and buses traveling westbound.

Noted. The project’s landscape architect has acknowledged this comment and will address as needed.

22. Identify accessible passenger loading zones within 30m of an accessible entrance for each building per City of Ottawa Accessibility Design Standards Section 3.2.

The comment provided was discussed with the transit services staff on May 6, 2024. As per discussion conclusion, the woonerf’s south end near Catherine St was identified as an acceptable location to allow paratransit vehicles to operate and an accessible passenger loading zone to be implemented.

The woonerf serves a primary function of providing an enhanced pedestrian environment and provides a wide area with different types of unit pavers to distinctly separate a vehicle’s travel path, while still maintaining pedestrian priority. Since all different unit paver segments along the woonerf are at level surface (i.e. no grade differences), this enables the passenger loading zone design shown in Figure 28 of the Ottawa Accessibility Design Standards to be implemented without the need for a curb ramp or having to alter curbs at other locations on site to provide the “no parking” area.

The general location of the passenger loading zone has been highlighted in the figure below. It should be recognized that this location is somewhat outside of the recommended 30m distance from an accessible entrance as it is located less than 55m from the Building A main entrance and less than 40m from the Building B main entrance. That said, distance between the identified location and main entrances of the adjacent retail stores at the building corners is significantly shorter (less than 15m).

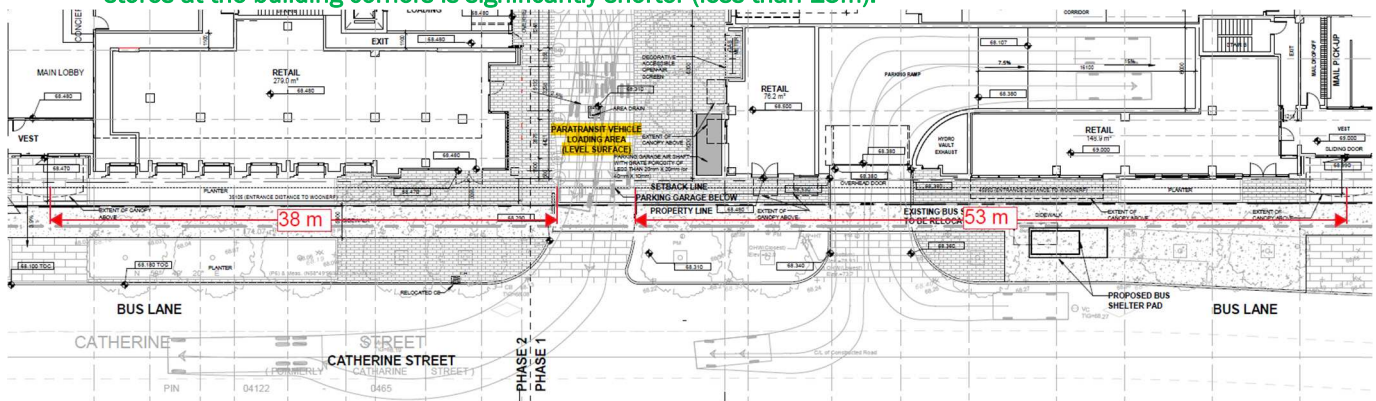

# Appendix B:

Transit Route Maps



# 6

## ROCKCLIFFE GREENBORO

### Fréquent

#### 7 days a week / 7 jours par semaine

All day service

Service toute la journée

**ROCKCLIFFE**

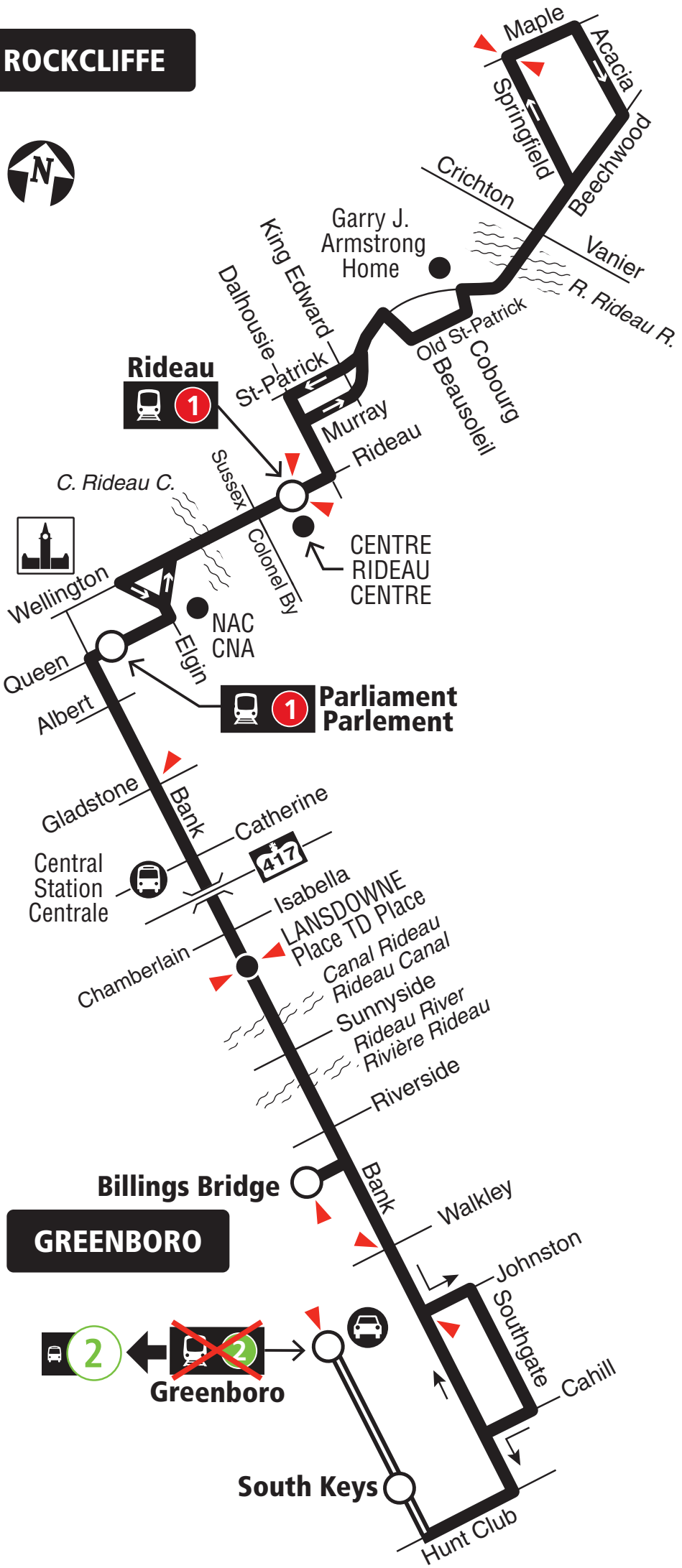

Transitway & Station



Park & Ride / Parc-o-Bus



Timepoint / Heures de passage

2023/09

2023.09



**Schedule / Horaire ..... 613-560-1000**

**Text / Texto\* ..... 560560**

plus your four digit bus stop number / plus votre numéro d'arrêt à quatre chiffres

\*Standard message rates may apply / Les tarifs réguliers de messagerie texte peuvent s'appliquer

Customer Service

Service à la clientèle ..... **613-560-5000**

Lost and Found / Objets perdus ..... **613-563-4011**

Security / Sécurité ..... **613-741-2478**

**Effective Fall 2020**

**En vigueur automne 2020**



**INFO 613-560-5000**  
**octranspo.com**



# 7

## CARLETON ST-LAURENT

### Fréquent

#### 7 days a week / 7 jours par semaine

All day service

Service toute la journée

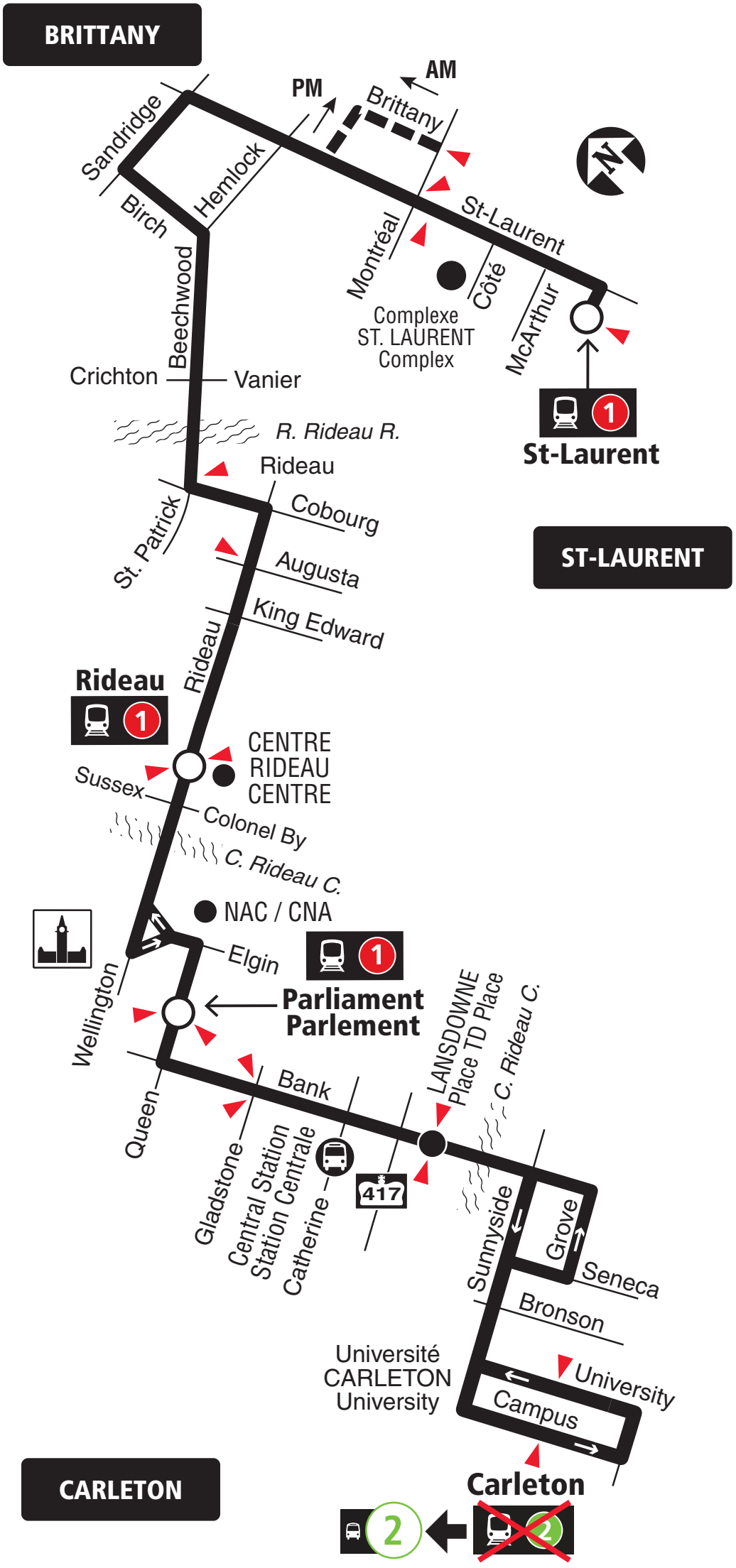

- Station
- Peak periods only / Périodes de pointe seulement
- Timepoint / Heures de passage

2020.08



**Schedule / Horaire ..... 613-560-1000**

**Text / Texto\* ..... 560560**

*plus your four digit bus stop number / plus votre numéro d'arrêt à quatre chiffres*

\*Standard message rates may apply / Les tarifs réguliers de messagerie texte peuvent s'appliquer

Customer Service  
Service à la clientèle ..... **613-560-5000**

Lost and Found / Objets perdus ..... **613-563-4011**

Security / Sécurité ..... **613-741-2478**

**Effective Fall 2020**

**En vigueur automne 2020**



**INFO 613-560-5000**  
**octranspo.com**



# 14

## ST-LAURENT TUNNEY'S PASTURE

### Fréquent

7 days a week / 7 jours par semaine

All day service

Service toute la journée

#### ST-LAURENT

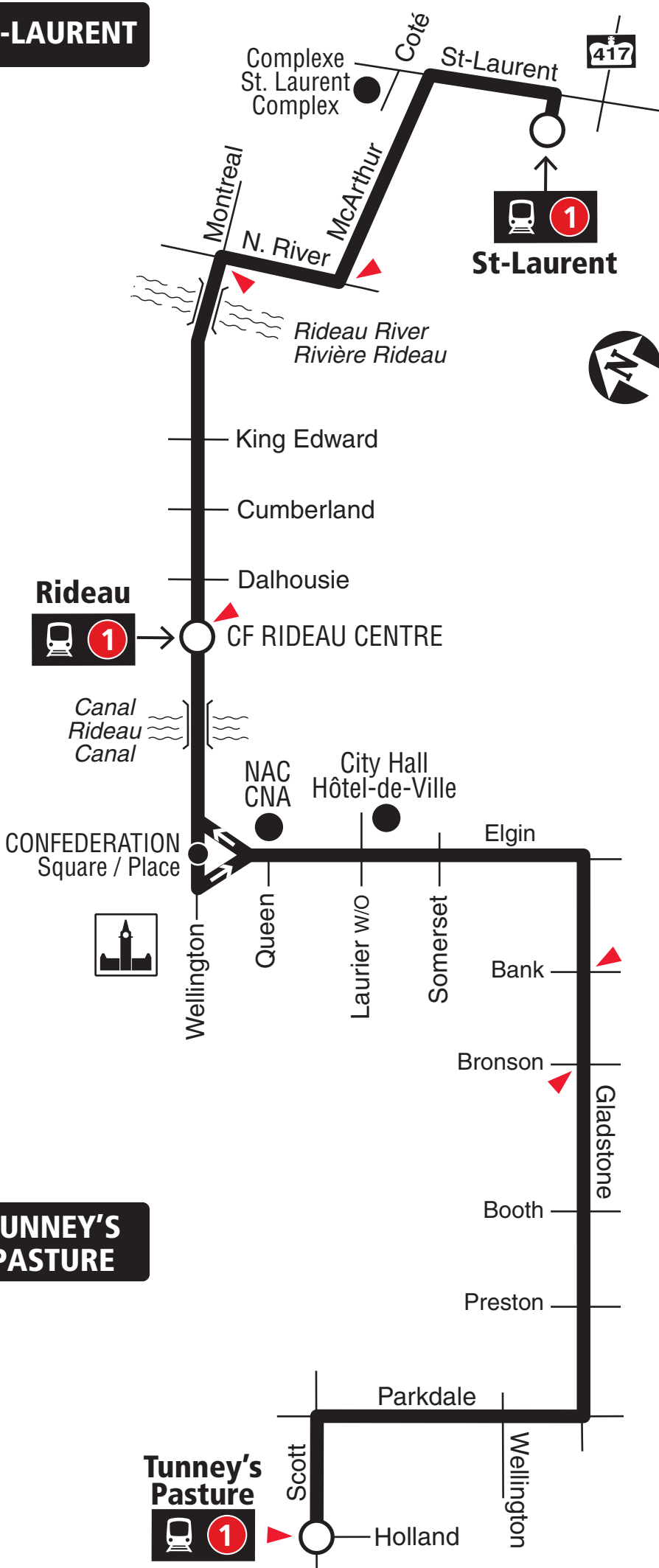

#### TUNNEY'S PASTURE



Station



Timepoint / Heures de passage

2020.09



**Schedule / Horaire.....613-560-1000**

**Text / Texto .....560560**

*plus your four digit bus stop number / plus votre numéro d'arrêt à quatre chiffres*

Customer Service

Service à la clientèle ..... **613-741-4390**

Lost and Found / Objets perdus..... **613-563-4011**

Security / Sécurité ..... **613-741-2478**

**Fall 2020**

**Automne 2020**



**INFO 613-741-4390**  
**octranspo.com**



# 55

## ELMVALE WESTGATE

### Local

7 days a week / 7 jours par semaine

#### ELMVALE

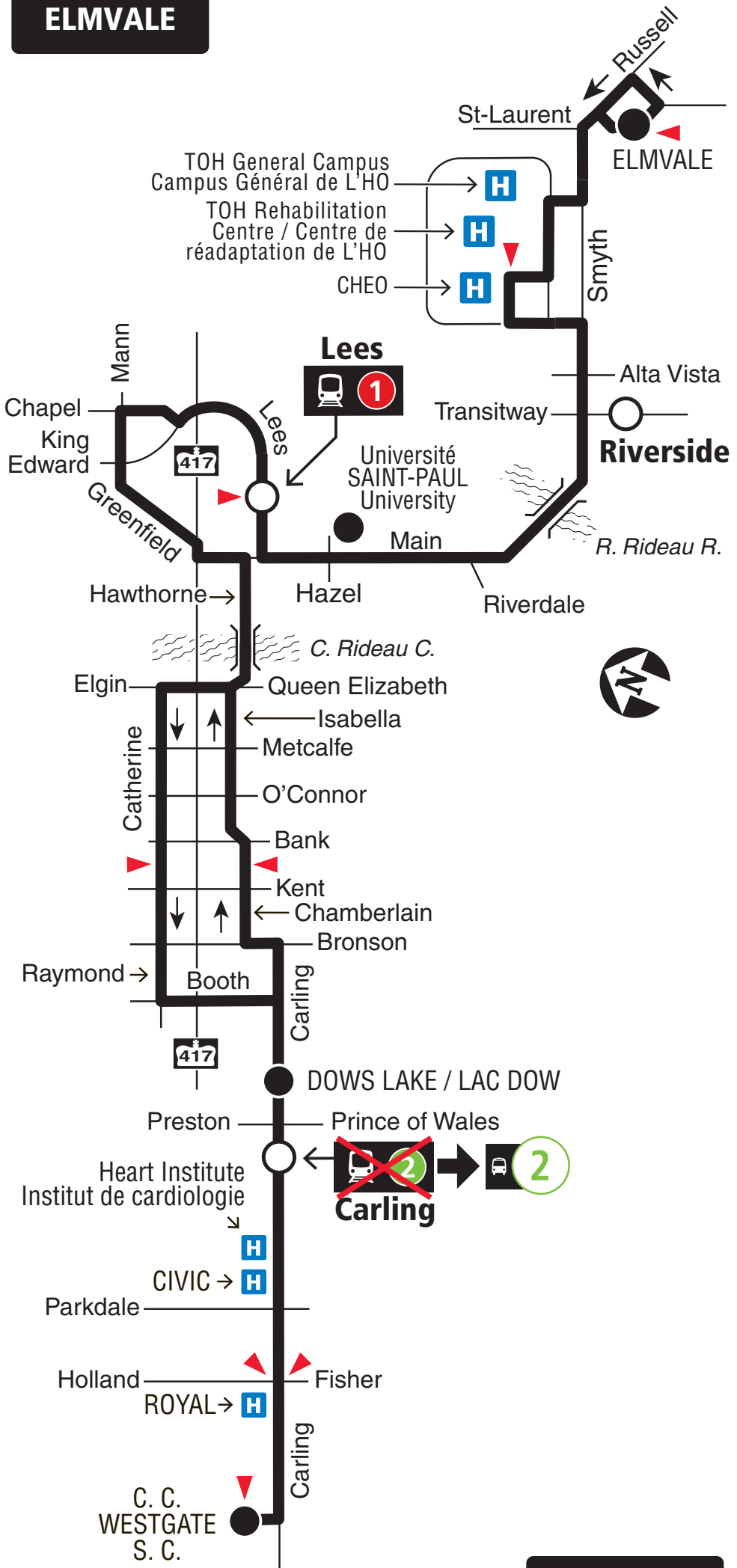

2021.06



**Schedule / Horaire ..... 613-560-1000**

**Text / Texto\* ..... 560560**

plus your four digit bus stop number / plus votre numéro d'arrêt à quatre chiffres

\*Standard message rates may apply / Les tarifs réguliers de messagerie texte peuvent s'appliquer

Customer Service

Service à la clientèle ..... **613-741-4390**

Lost and Found / Objets perdus..... **613-563-4011**

Security / Sécurité ..... **613-741-2478**

**Effective June 20, 2021**

**En vigueur 20 juin 2021**



INFO 613-741-4390  
octranspo.com



# 114

## CARLINGTON RIDEAU

### Local

### Monday to Friday / Lundi au vendredi

Selected trips only

Trajets sélectionnés seulement

**RIDEAU**

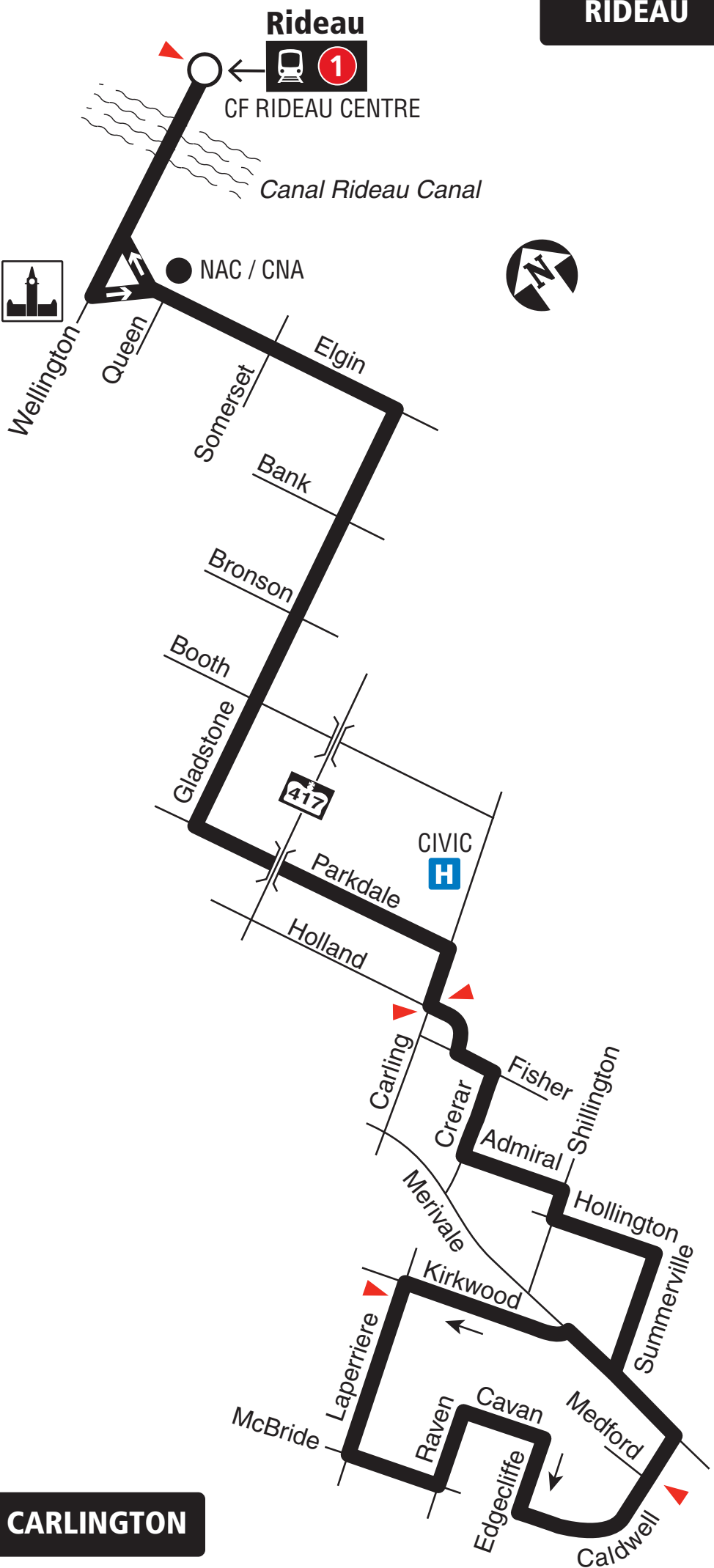

**CARLINGTON**



Station



Timepoint / Heures de passage

2020.08



**Schedule / Horaire.....613-560-1000**

**Text / Texto .....560560**

plus your four digit bus stop number / plus votre numéro d'arrêt à quatre chiffres

Customer Service

Service à la clientèle ..... **613-560-5000**

Lost and Found / Objets perdus..... **613-563-4011**

Security / Sécurité ..... **613-741-2478**

**Effective Fall 2020**

**En vigueur automne 2020**



**INFO 613-560-5000**  
**octranspo.com**



# Appendix C:

Traffic Data



# Turning Movement Count

## Summary Report Including Peak Hours, AADT and Expansion Factors

All Vehicles Except Bicycles



### Arlington Street & Kent Street Ottawa, ON

**Survey Date:** Tuesday, April 11, 2023      **Start Time:** 0700      **AADT Factor:** 0.7  
**Weather AM:** Cloudy 7° C      **Survey Duration:** 8 Hrs.      **Survey Hours:** 0700-1000, 1130-1330 & 1500-1800  
**Weather PM:** Mostly Sunny 17° C      **Surveyor(s):** T. Carmody

Time Period	Arlington St. Eastbound					Arlington St. Westbound					Kent St. Northbound					Kent St. Southbound					Street Total	Grand Total	
	LT	ST	RT	UT	E/B Tot	LT	ST	RT	UT	W/B Tot	LT	ST	RT	UT	N/B Tot	LT	ST	RT	UT	S/B Tot			
0700-0800	4	27	0	0	31	0	7	53	0	60	91	9	1524	60	0	1593	0	0	0	0	0	1593	1684
0800-0900	19	48	0	0	67	0	11	93	0	104	171	15	1618	121	0	1754	0	0	0	0	0	1754	1925
0900-1000	7	41	0	0	48	0	9	49	0	58	106	18	1225	103	0	1346	0	0	0	0	0	1346	1452
1130-1230	5	32	0	0	37	0	3	52	0	55	92	19	775	117	0	911	0	0	0	0	0	911	1003
1230-1330	7	31	0	0	38	0	14	40	0	54	92	17	711	114	0	842	0	0	0	0	0	842	934
1500-1600	18	51	0	0	69	0	21	53	0	74	143	17	914	84	0	1015	0	0	0	0	0	1015	1158
1600-1700	7	53	0	0	60	0	14	44	0	58	118	25	923	74	0	1022	0	0	0	0	0	1022	1140
1700-1800	12	61	0	0	73	0	18	63	1	82	155	22	1021	93	0	1136	0	0	0	0	0	1136	1291
<b>Totals</b>	<b>79</b>	<b>344</b>	<b>0</b>	<b>0</b>	<b>423</b>	<b>0</b>	<b>97</b>	<b>447</b>	<b>1</b>	<b>545</b>	<b>968</b>	<b>142</b>	<b>8711</b>	<b>766</b>	<b>0</b>	<b>9619</b>	<b>0</b>	<b>0</b>	<b>0</b>	<b>0</b>	<b>0</b>	<b>9619</b>	<b>10587</b>

**Equivalent 12 & 24-hour Vehicle Volumes Including the Annual Average Daily Traffic (AADT) Factor**  
**Applicable to the Day and Month of the Turning Movement Count**

**Expansion factors are applied exclusively to standard weekday 8-hour turning movement counts conducted during the hours of 0700h - 1000h, 1130h - 1330h and 1500h - 1800h**

Equivalent 12-hour vehicle volumes. These volumes are calculated by multiplying the 8-hour totals by the 8 → 12 expansion factor of 1.39

Equ. 12 Hr	110	478	0	0	588	0	135	621	1	758	1346	197	12108	1065	0	13370	0	0	0	0	0	13370	14716
------------	-----	-----	---	---	-----	---	-----	-----	---	-----	------	-----	-------	------	---	-------	---	---	---	---	---	-------	-------

Average daily 12-hour vehicle volumes. These volumes are calculated by multiplying the equivalent 12-hour totals by the AADT factor of: 0.7

AADT 12-hr	77	335	0	0	412	0	94	435	1	530	942	138	8476	745	0	9359	0	0	0	0	0	9359	10301
------------	----	-----	---	---	-----	---	----	-----	---	-----	-----	-----	------	-----	---	------	---	---	---	---	---	------	-------

24-Hour AADT. These volumes are calculated by multiplying the average daily 12-hour vehicle volumes by the 12 → 24 expansion factor of 1.31

AADT 24 Hr	101	438	0	0	539	0	124	570	1	695	1234	181	11103	976	0	12261	0	0	0	0	0	12261	13495
------------	-----	-----	---	---	-----	---	-----	-----	---	-----	------	-----	-------	-----	---	-------	---	---	---	---	---	-------	-------

**AADT and expansion factors provided by the City of Ottawa**

AM Peak Hour Factor → 0.95											Highest Hourly Vehicle Volume Between 0700h & 1000h												
AM Peak Hr	LT	ST	RT	UT	Total	LT	ST	RT	UT	Total	Str. Tot.	LT	ST	RT	UT	Total	LT	ST	RT	UT	Total	Str. Tot.	Gr. Tot.
0800-0900	19	48	0	0	67	0	11	93	0	104	171	15	1618	121	0	1754	0	0	0	0	0	1754	1925
OFF Peak Hour Factor → 0.90											Highest Hourly Vehicle Volume Between 1130h & 1330h												
OFF Peak Hr	LT	ST	RT	UT	Total	LT	ST	RT	UT	Total	Str. Tot.	LT	ST	RT	UT	Total	LT	ST	RT	UT	Total	Str. Tot.	Gr. Tot.
1130-1230	5	32	0	0	37	0	3	52	0	55	92	19	775	117	0	911	0	0	0	0	0	911	1003
PM Peak Hour Factor → 0.89											Highest Hourly Vehicle Volume Between 1500h & 1800h												
PM Peak Hr	LT	ST	RT	UT	Total	LT	ST	RT	UT	Total	Str. Tot.	LT	ST	RT	UT	Total	LT	ST	RT	UT	Total	Str. Tot.	Gr. Tot.
1700-1800	12	61	0	0	73	0	18	63	1	82	155	22	1021	93	0	1136	0	0	0	0	0	1136	1291

**Comments:**

OC Transpo and Para Transpo buses, private buses and school buses comprise 20.00% of the heavy vehicle traffic. The bicycle totals include 7 varieties of electric personal transportation types. Many vehicles on Kent Street turn left or right to Arlington Street from the centre lane.

**Notes:**

1. Includes all vehicle types except bicycles, electric bicycles, and electric scooters.
2. When expansion and AADT factors are applied, the results will differ slightly due to rounding.



# Turning Movement Count

## Summary, AM and PM Peak Hour

### Flow Diagrams

All Vehicles Except Bicycles



#### Arlington Street & Kent Street Ottawa, ON

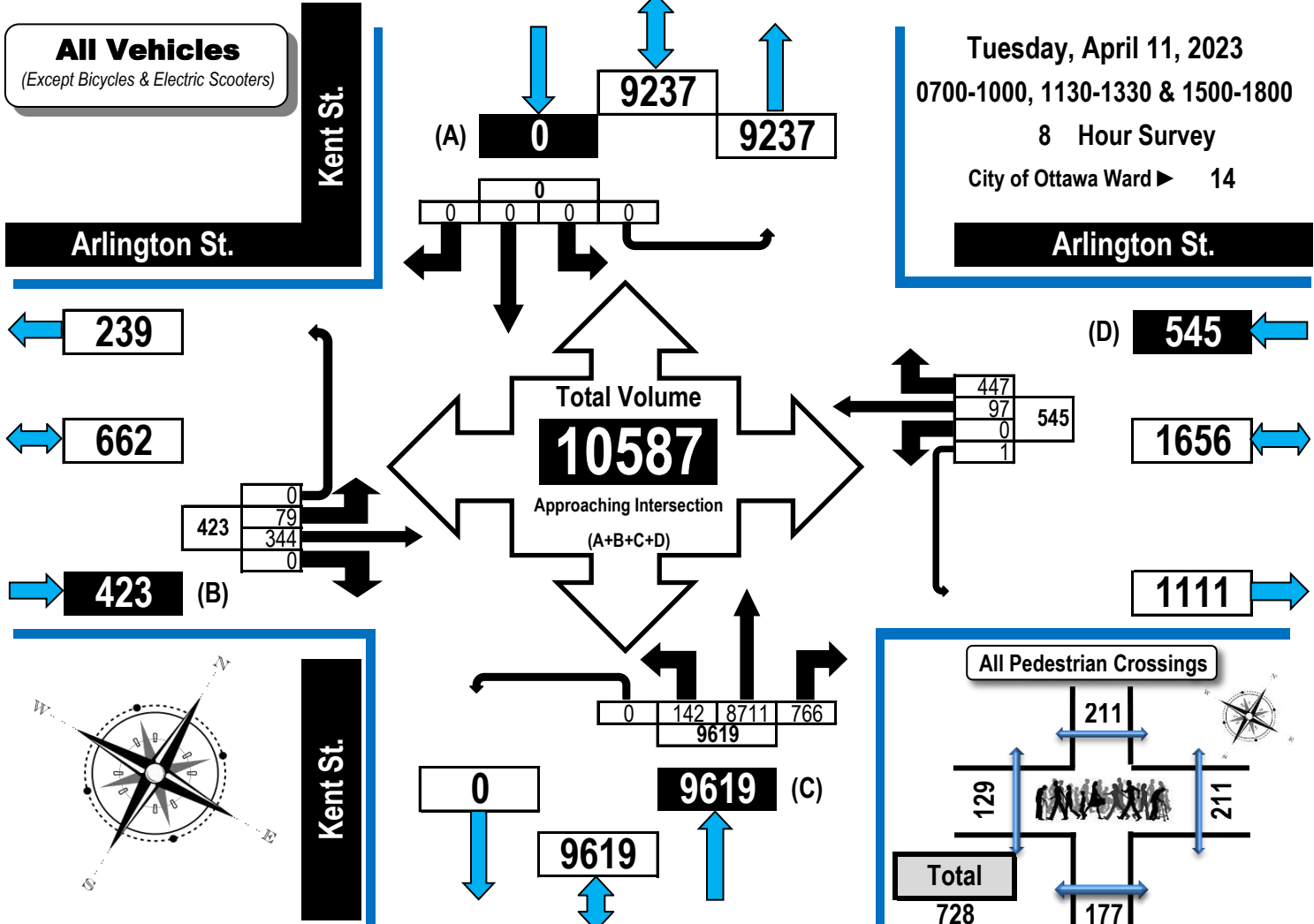

#### AM Peak Hour Flow Diagram PM Peak Hour Flow Diagram

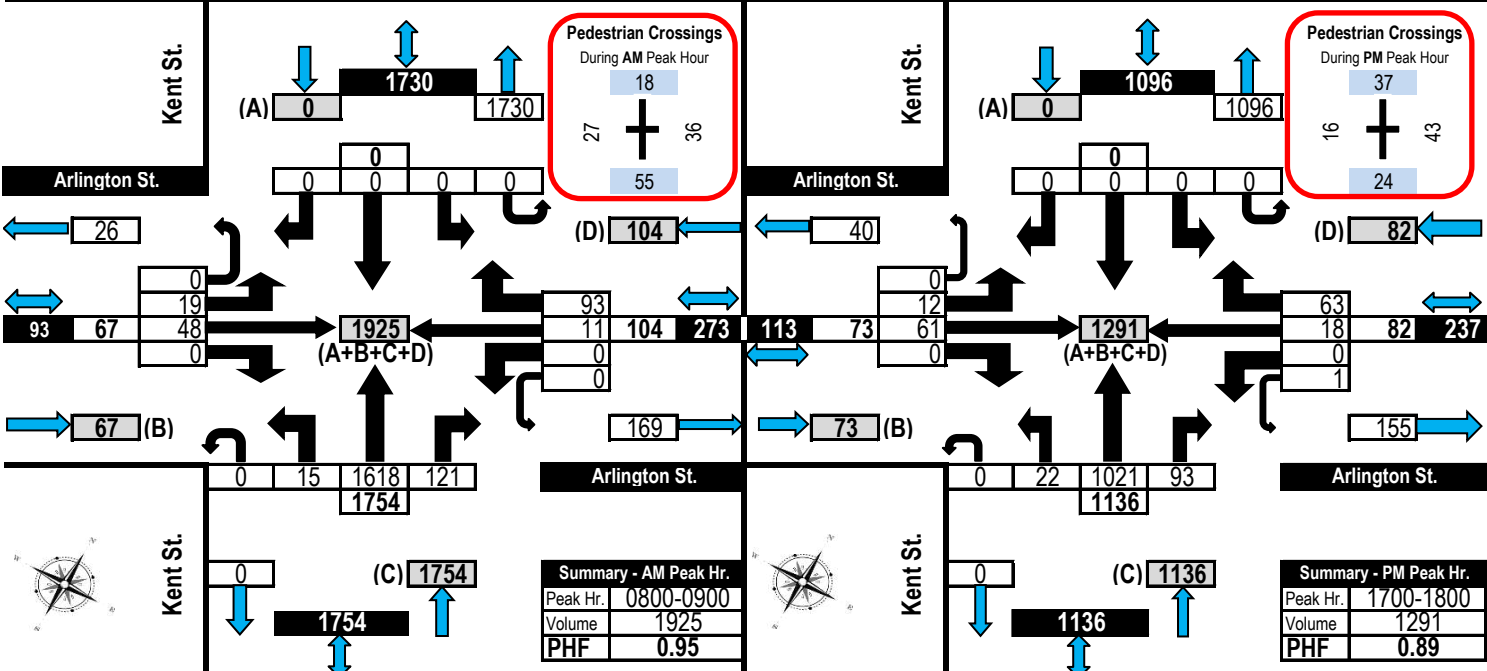



# Turning Movement Count

## Summary, OFF and EVENING Peak Hour

### Flow Diagrams

All Vehicles Except Bicycles



### Arlington Street & Kent Street

### Ottawa, ON

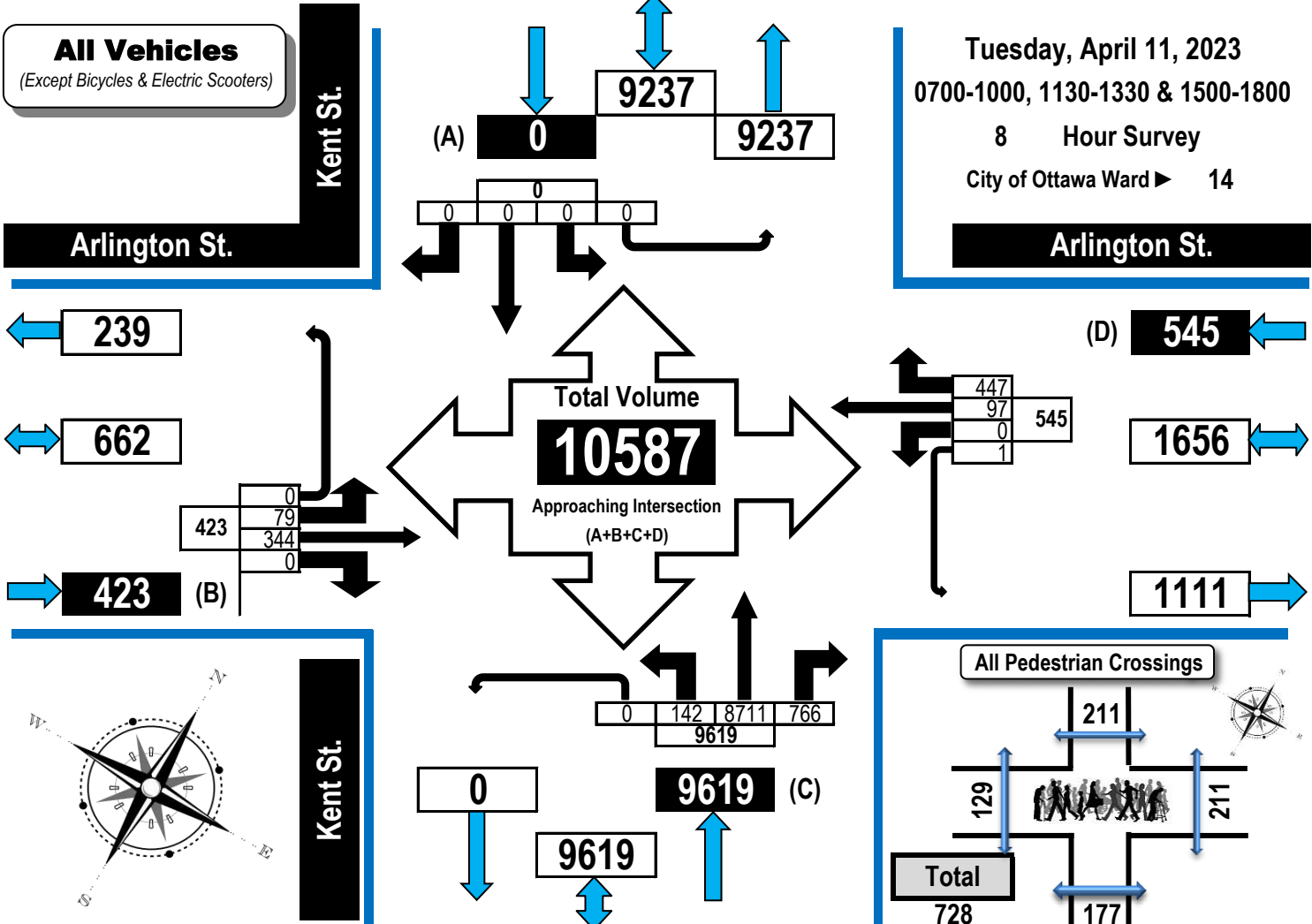

#### Off Peak Hour Flow Diagram

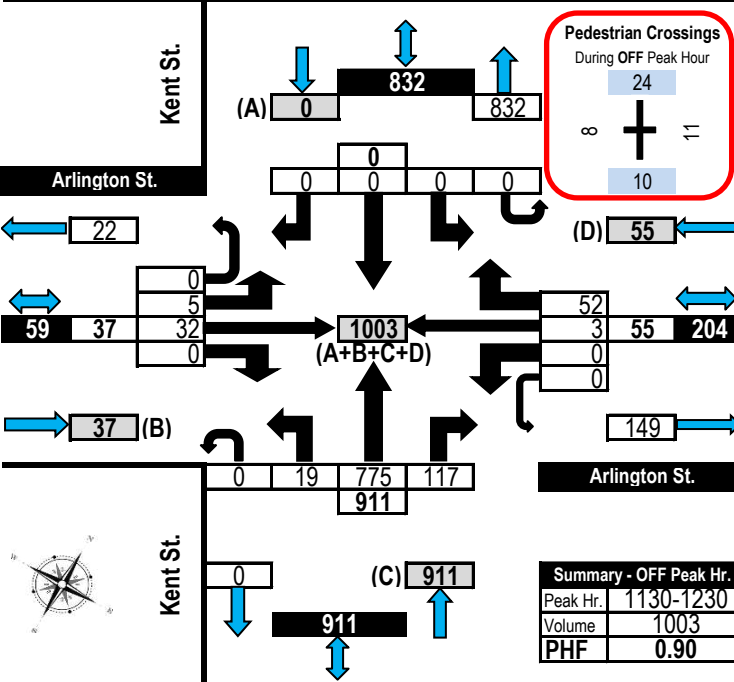

#### Evening Peak Hour Flow Diagram

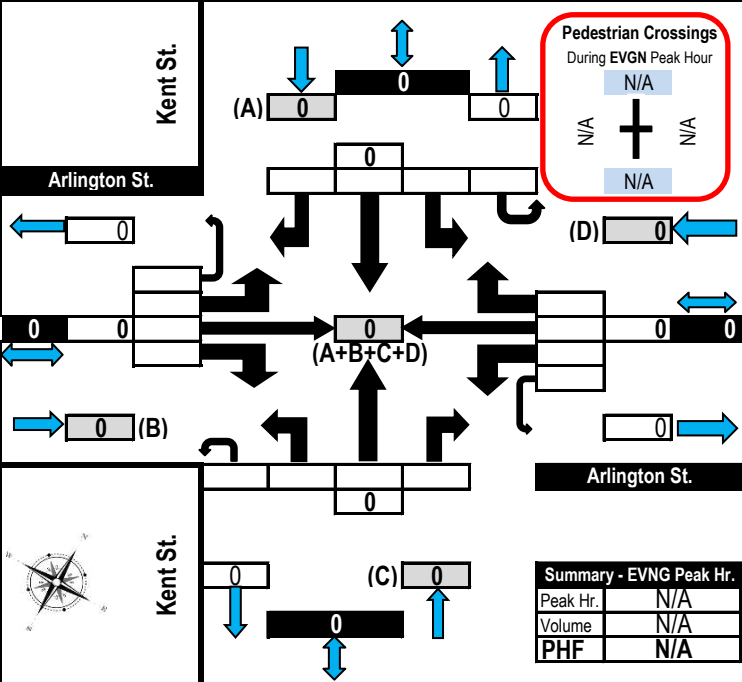



# Turning Movement Count Heavy Vehicle Summary (FHWA Class 4-13) Flow Diagram



**Arlington Street & Kent Street**

**Ottawa, ON**

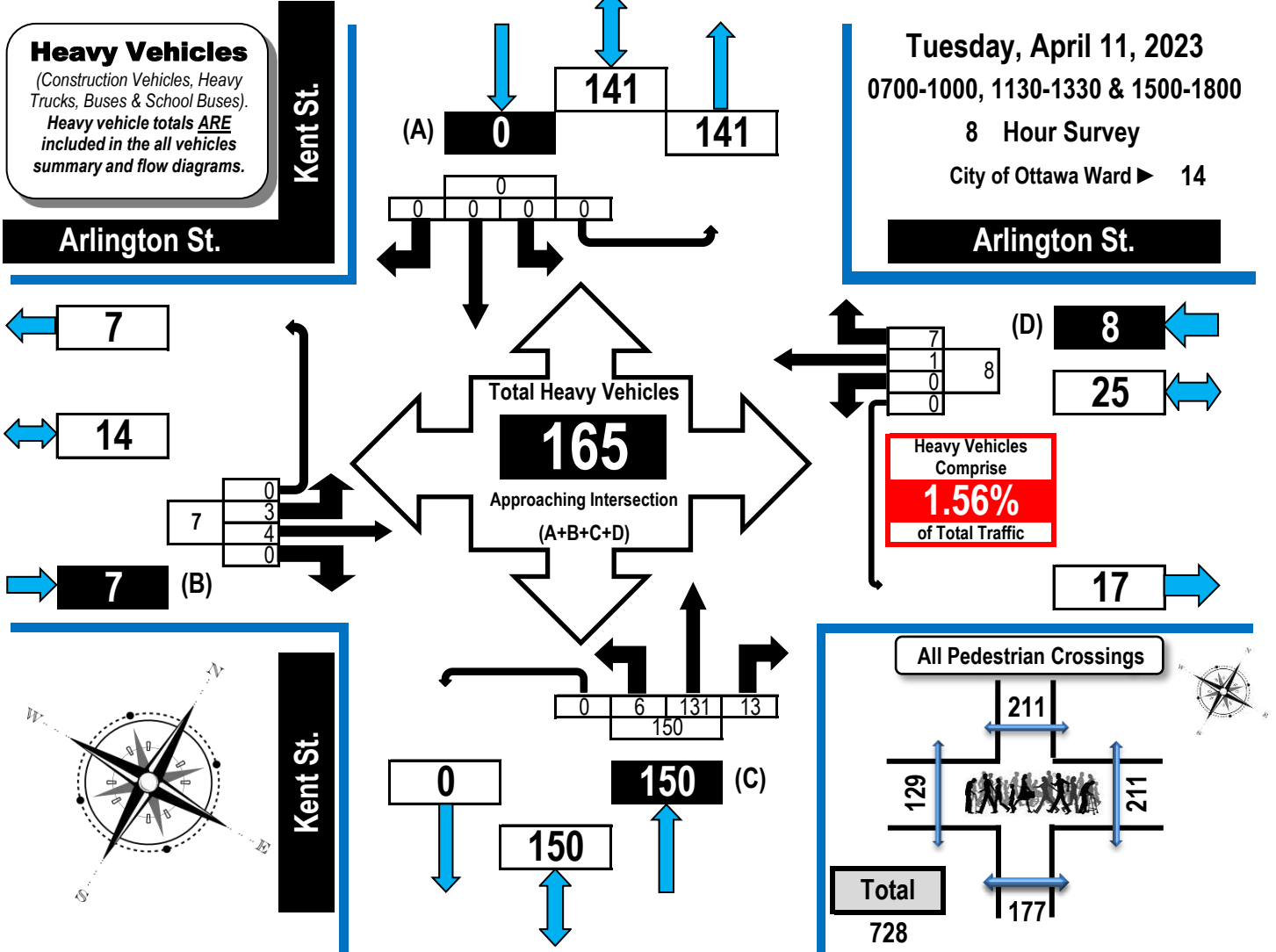

Arlington St.					Arlington St.					Kent St.					Kent St.				
Eastbound					Westbound					Northbound					Southbound				

Time Period	LT	ST	RT	UT	EB Tot	LT	ST	RT	UT	WB Tot	LT	ST	RT	UT	NB Tot	LT	ST	RT	UT	SB Tot	GR Tot
0700-0800	0	0	0	0	0	0	1	2	0	3	1	17	1	0	19	0	0	0	0	0	22
0800-0900	0	2	0	0	2	0	0	1	0	1	1	27	3	0	31	0	0	0	0	0	34
0900-1000	3	1	0	0	4	0	0	2	0	2	2	29	2	0	33	0	0	0	0	0	39
1130-1230	0	0	0	0	0	0	0	2	0	2	0	12	4	0	16	0	0	0	0	0	18
1230-1330	0	0	0	0	0	0	0	0	0	0	0	20	0	0	20	0	0	0	0	0	20
1500-1600	0	0	0	0	0	0	0	0	0	0	0	9	0	0	9	0	0	0	0	0	9
1600-1700	0	1	0	0	1	0	0	0	0	0	2	10	2	0	14	0	0	0	0	0	15
1700-1800	0	0	0	0	0	0	0	0	0	0	0	7	1	0	8	0	0	0	0	0	8
<b>Totals</b>	<b>3</b>	<b>4</b>	<b>0</b>	<b>0</b>	<b>7</b>	<b>0</b>	<b>1</b>	<b>7</b>	<b>0</b>	<b>8</b>	<b>6</b>	<b>131</b>	<b>13</b>	<b>0</b>	<b>150</b>	<b>0</b>	<b>0</b>	<b>0</b>	<b>0</b>	<b>0</b>	<b>165</b>

**Comments:**

OC Transpo and Para Transpo buses, private buses and school buses comprise 20.00% of the heavy vehicle traffic. The bicycle totals include 7 varieties of electric personal transportation types. Many vehicles on Kent Street turn left or right to Arlington Street from the centre lane.



# Turning Movement Count

## All Buses Summary (FHWA Class 4 ONLY)

### Flow Diagram



## Arlington Street & Kent Street Ottawa, ON

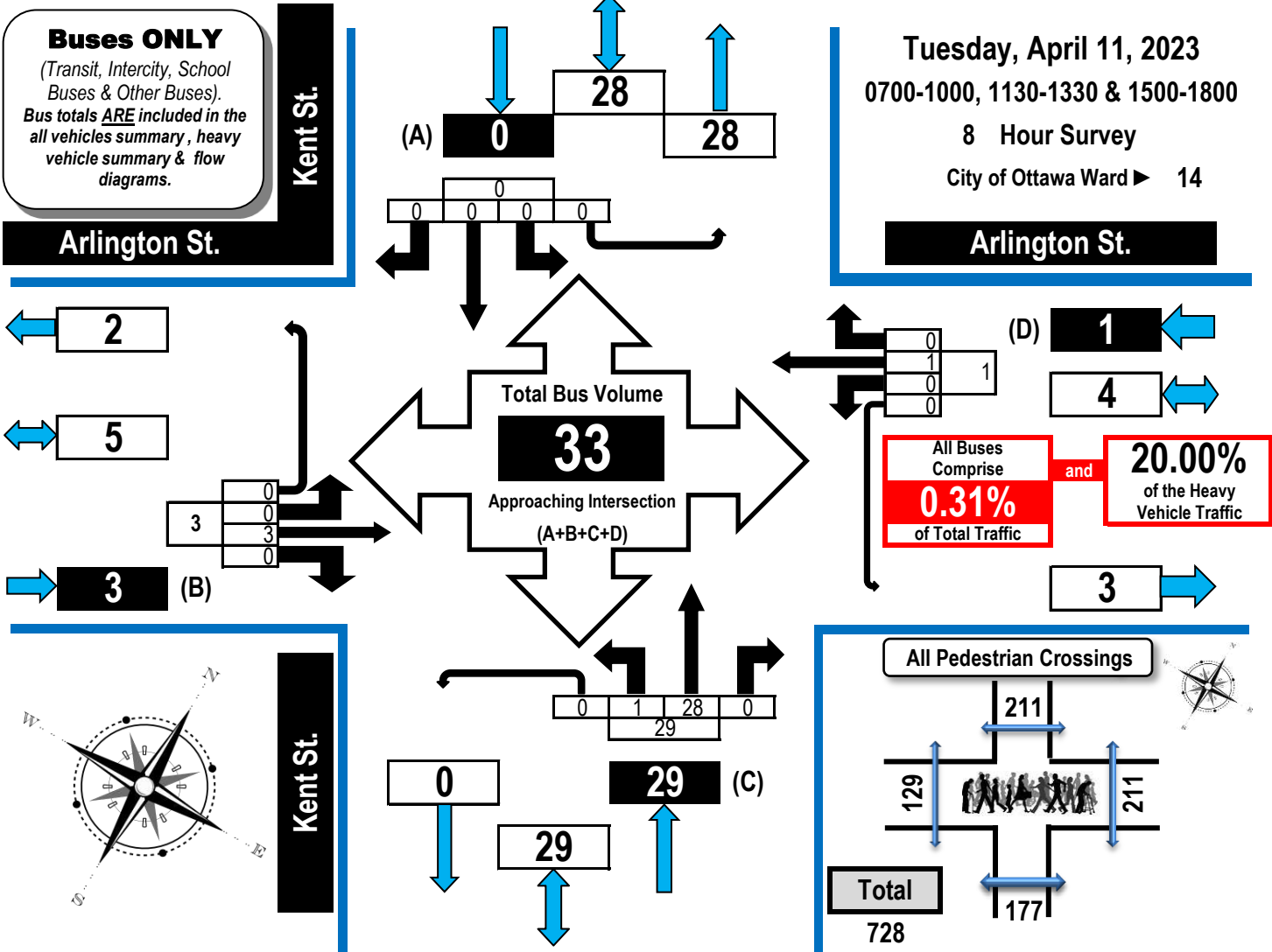

Time Period	Arlington St. Eastbound					Arlington St. Westbound					Kent St. Northbound					Kent St. Southbound					
	LT	ST	RT	UT	EB Tot	LT	ST	RT	UT	WB Tot	LT	ST	RT	UT	NB Tot	LT	ST	RT	UT	SB Tot	GR Tot
0700-0800	0	0	0	0	0	0	1	0	0	1	0	2	0	0	2	0	0	0	0	0	3
0800-0900	0	1	0	0	1	0	0	0	0	0	0	2	0	0	2	0	0	0	0	0	3
0900-1000	0	1	0	0	1	0	0	0	0	0	0	4	0	0	4	0	0	0	0	0	5
1130-1230	0	0	0	0	0	0	0	0	0	0	0	2	0	0	2	0	0	0	0	0	2
1230-1330	0	0	0	0	0	0	0	0	0	0	0	2	0	0	2	0	0	0	0	0	2
1500-1600	0	0	0	0	0	0	0	0	0	0	0	3	0	0	3	0	0	0	0	0	3
1600-1700	0	1	0	0	1	0	0	0	0	0	1	8	0	0	9	0	0	0	0	0	10
1700-1800	0	0	0	0	0	0	0	0	0	0	0	5	0	0	5	0	0	0	0	0	5
Totals	0	3	0	0	3	0	1	0	0	1	1	28	0	0	29	0	0	0	0	0	33

**Comments:**  
 OC Transpo and Para Transpo buses, private buses and school buses comprise 20.00% of the heavy vehicle traffic. The bicycle totals include 7 varieties of electric personal transportation types. Many vehicles on Kent Street turn left or right to Arlington Street from the centre lane.



# Turning Movement Count Bicycle Summary Flow Diagram



**Arlington Street & Kent Street**

**Ottawa, ON**

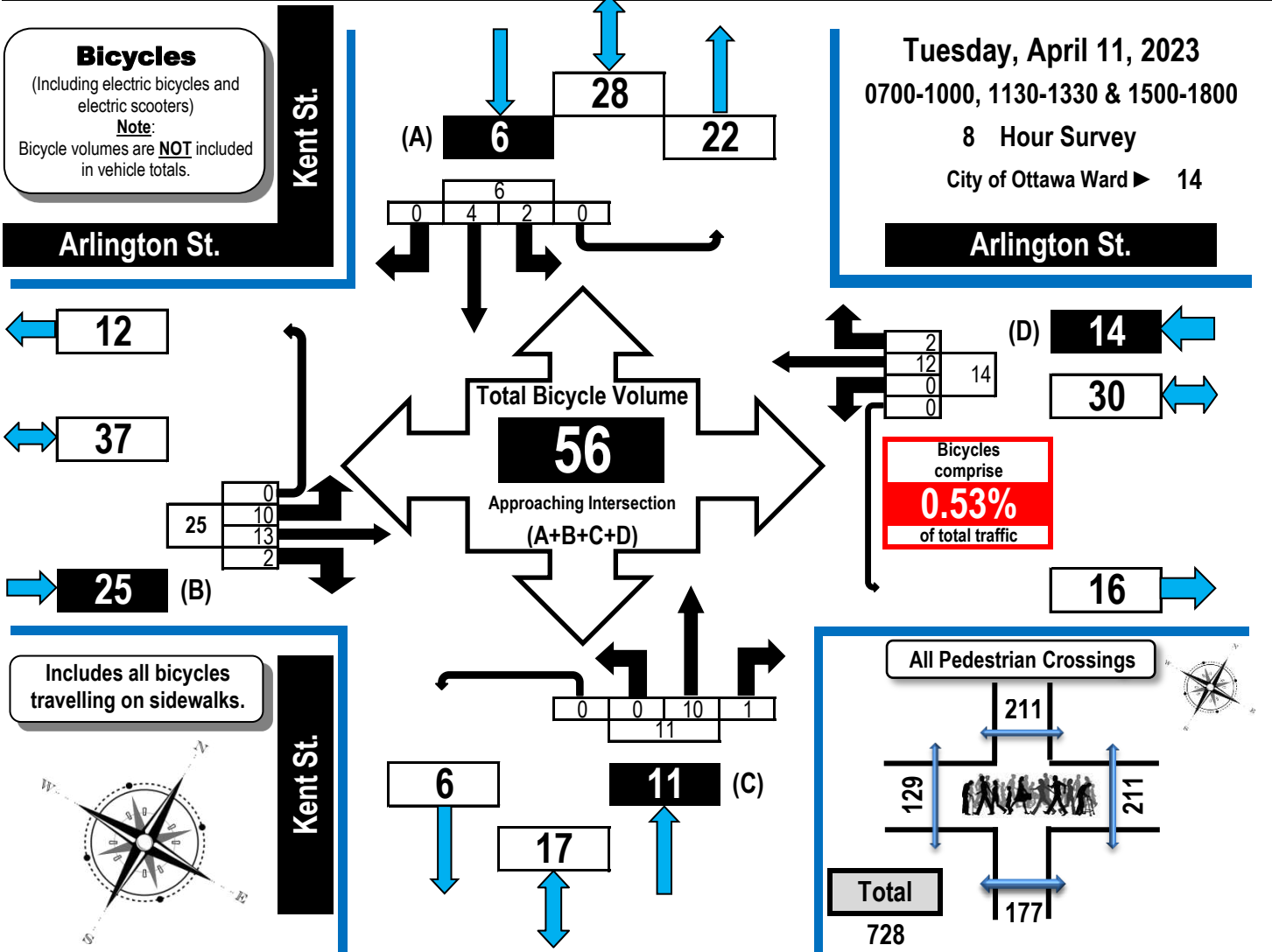

Time Period	Arlington St. Eastbound					Arlington St. Westbound					Kent St. Northbound					Kent St. Southbound					GR Tot
	LT	ST	RT	UT	EB Tot	LT	ST	RT	UT	WB Tot	LT	ST	RT	UT	NB Tot	LT	ST	RT	UT	SB Tot	
0700-0800	1	1	0	0	2	0	0	0	0	0	0	1	0	0	1	0	0	0	0	0	3
0800-0900	3	0	0	0	3	0	1	0	0	1	0	1	0	0	1	0	4	0	0	4	9
0900-1000	1	2	0	0	3	0	0	1	0	1	0	0	1	0	1	0	0	0	0	0	5
1130-1230	1	4	0	0	5	0	0	0	0	0	0	0	0	0	0	0	0	0	0	0	5
1230-1330	1	2	0	0	3	0	1	1	0	2	0	1	0	0	1	1	0	0	0	1	7
1500-1600	0	1	0	0	1	0	1	0	0	1	0	3	0	0	3	0	0	0	0	0	5
1600-1700	1	0	1	0	2	0	2	0	0	2	0	3	0	0	3	0	0	0	0	0	7
1700-1800	2	3	1	0	6	0	7	0	0	7	0	1	0	0	1	1	0	0	0	1	15
<b>Totals</b>	<b>10</b>	<b>13</b>	<b>2</b>	<b>0</b>	<b>25</b>	<b>0</b>	<b>12</b>	<b>2</b>	<b>0</b>	<b>14</b>	<b>0</b>	<b>10</b>	<b>1</b>	<b>0</b>	<b>11</b>	<b>2</b>	<b>4</b>	<b>0</b>	<b>0</b>	<b>6</b>	<b>56</b>

**Comments:**

OC Transpo and Para Transpo buses, private buses and school buses comprise 20.00% of the heavy vehicle traffic. The bicycle totals include 7 varieties of electric personal transportation types. Many vehicles on Kent Street turn left or right to Arlington Street from the centre lane.



# Turning Movement Count Pedestrian Crossings Summary and Flow Diagram



**Arlington Street & Kent Street** **Ottawa, ON**

**Pedestrian  
Crossings**

**Tuesday, April 11, 2023**  
 0700-1000, 1130-1330 & 1500-1800  
 8 Hour Survey  
 City of Ottawa Ward ► 14

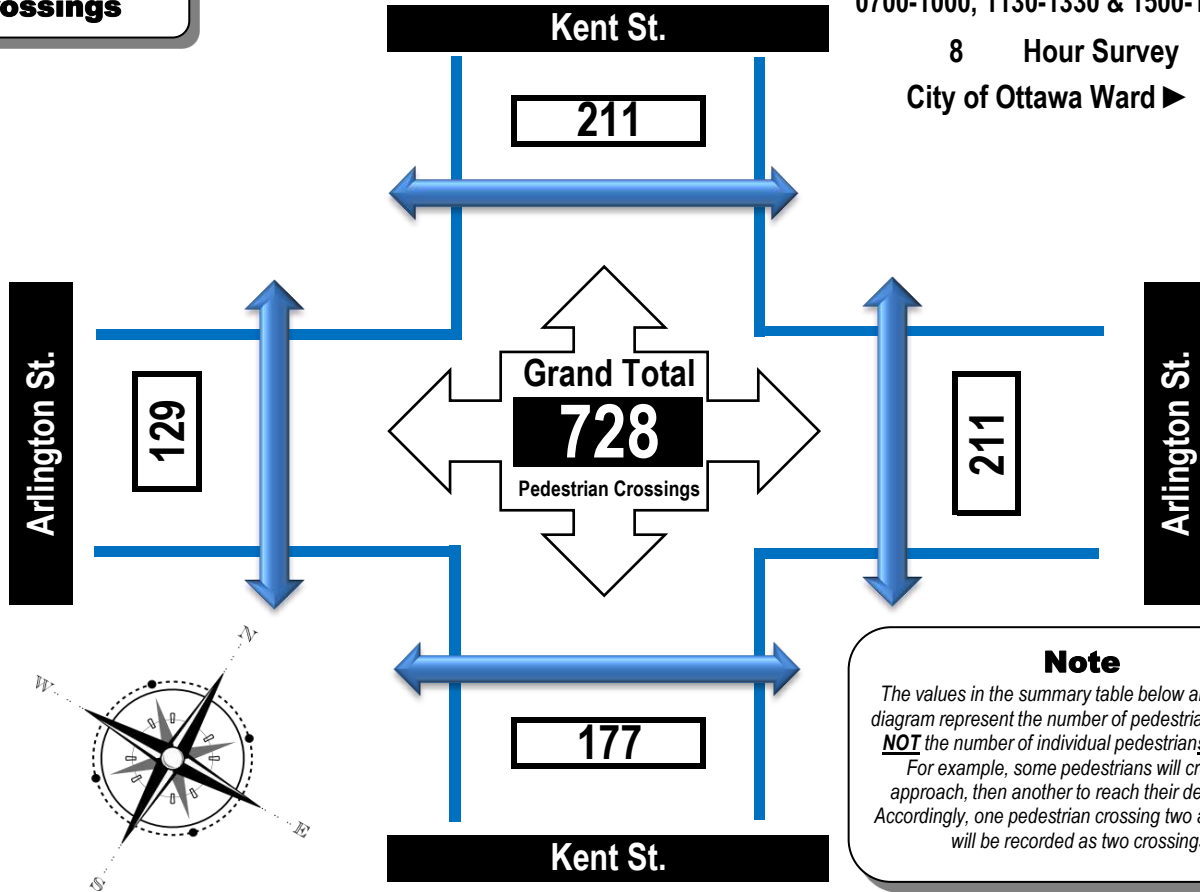

**Note**

*The values in the summary table below and the flow diagram represent the number of pedestrian crossings **NOT** the number of individual pedestrians crossing. For example, some pedestrians will cross one approach, then another to reach their destination. Accordingly, one pedestrian crossing two approaches will be recorded as two crossings.*

Time Period	West Side Crossing Arlington St.	East Side Crossing Arlington St.	Street Total	South Side Crossing Kent St.	North Side Crossing Kent St.	Street Total	Grand Total
0700-0800	10	16	26	4	21	25	51
0800-0900	27	36	63	55	18	73	136
0900-1000	15	18	33	12	20	32	65
1130-1230	8	11	19	10	24	34	53
1230-1330	9	18	27	3	23	26	53
1500-1600	17	42	59	46	44	90	149
1600-1700	27	27	54	23	24	47	101
1700-1800	16	43	59	24	37	61	120
<b>Totals</b>	<b>129</b>	<b>211</b>	<b>340</b>	<b>177</b>	<b>211</b>	<b>388</b>	<b>728</b>

**Comments:**

OC Transpo and Para Transpo buses, private buses and school buses comprise 20.00% of the heavy vehicle traffic. The bicycle totals include 7 varieties of electric personal transportation types. Many vehicles on Kent Street turn left or right to Arlington Street from the centre lane.



# Diagrams, Maps and Photographs

## Arlington Street & Lyon Street

Tuesday, April 11, 2023



S/B left turn to Arlington Street forced to turn into W/B lane as W/B driver was turning left from the E/B lane.

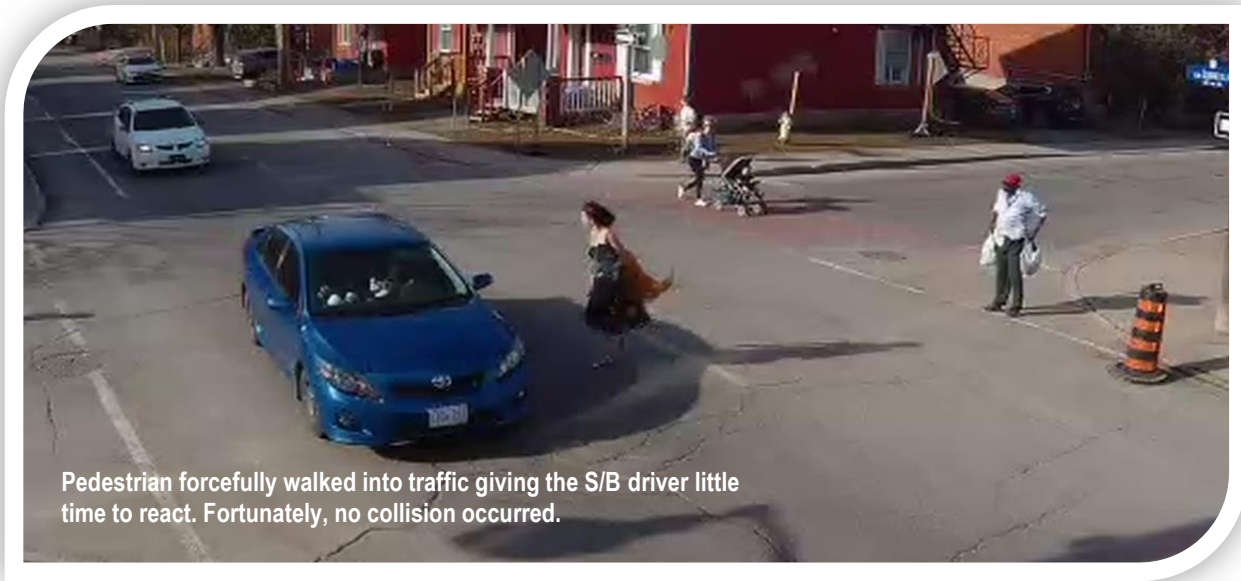

Pedestrian forcefully walked into traffic giving the S/B driver little time to react. Fortunately, no collision occurred.



S/B left turn to Arlington Street from west curb lane. This manoeuvre occurred throughout the day.



# Turning Movement Count

## Summary Report Including Peak Hours, AADT and Expansion Factors

All Vehicles Except Bicycles



### Arlington Street & Lyon Street Ottawa, ON

**Survey Date:** Tuesday, April 11, 2023      **Start Time:** 0700      **AADT Factor:** 0.7  
**Weather AM:** Cloudy 7° C      **Survey Duration:** 8 Hrs.      **Survey Hours:** 0700-1000, 1130-1330 & 1500-1800  
**Weather PM:** Mostly Sunny 17° C      **Surveyor(s):** J. Mousseau

Time Period	Arlington St. Eastbound					Arlington St. Westbound					Kent St. Northbound					Kent St. Southbound					Street Total	Grand Total	
	LT	ST	RT	UT	E/B Tot	LT	ST	RT	UT	W/B Tot	LT	ST	RT	UT	N/B Tot	LT	ST	RT	UT	S/B Tot			
0700-0800	0	10	0	1	11	5	7	0	0	12	23	0	0	0	0	0	19	113	2	0	134	134	157
0800-0900	0	19	0	0	19	11	13	0	0	24	43	0	0	0	0	0	44	166	7	0	217	217	260
0900-1000	0	11	4	0	15	7	16	0	0	23	38	0	0	0	0	0	39	161	9	0	209	209	247
1130-1230	0	10	3	0	13	7	13	0	0	20	33	0	0	0	0	0	27	150	13	0	190	190	223
1230-1330	0	5	2	0	7	8	20	0	0	28	35	0	0	0	0	0	35	160	9	0	204	204	239
1500-1600	0	21	4	0	25	12	25	0	1	38	63	0	0	0	0	0	39	344	6	0	389	389	452
1600-1700	0	19	1	0	20	7	33	0	0	40	60	0	0	0	0	0	46	336	12	0	394	394	454
1700-1800	0	17	2	0	19	13	23	0	2	38	57	0	0	0	0	0	42	278	18	0	338	338	395
<b>Totals</b>	<b>0</b>	<b>112</b>	<b>16</b>	<b>1</b>	<b>129</b>	<b>70</b>	<b>150</b>	<b>0</b>	<b>3</b>	<b>223</b>	<b>352</b>	<b>0</b>	<b>0</b>	<b>0</b>	<b>0</b>	<b>0</b>	<b>291</b>	<b>1708</b>	<b>76</b>	<b>0</b>	<b>2075</b>	<b>2075</b>	<b>2427</b>

**Equivalent 12 & 24-hour Vehicle Volumes Including the Annual Average Daily Traffic (AADT) Factor**  
**Applicable to the Day and Month of the Turning Movement Count**

**Expansion factors are applied exclusively to standard weekday 8-hour turning movement counts conducted during the hours of 0700h - 1000h, 1130h - 1330h and 1500h - 1800h**

Equivalent 12-hour vehicle volumes. These volumes are calculated by multiplying the 8-hour totals by the 8 → 12 expansion factor of 1.39

Equ. 12 Hr	0	156	22	1	179	97	209	0	4	310	489	0	0	0	0	0	404	2374	106	0	2884	2884	3374
------------	---	-----	----	---	-----	----	-----	---	---	-----	-----	---	---	---	---	---	-----	------	-----	---	------	------	------

Average daily 12-hour vehicle volumes. These volumes are calculated by multiplying the equivalent 12-hour totals by the AADT factor of: 0.7

AADT 12-hr	0	109	16	1	126	68	146	0	3	217	342	0	0	0	0	0	283	1662	74	0	2019	2019	2361
------------	---	-----	----	---	-----	----	-----	---	---	-----	-----	---	---	---	---	---	-----	------	----	---	------	------	------

24-Hour AADT. These volumes are calculated by multiplying the average daily 12-hour vehicle volumes by the 12 → 24 expansion factor of 1.31

AADT 24 Hr	0	143	20	1	164	89	191	0	4	284	449	0	0	0	0	0	371	2177	97	0	2645	2645	3094
------------	---	-----	----	---	-----	----	-----	---	---	-----	-----	---	---	---	---	---	-----	------	----	---	------	------	------

**AADT and expansion factors provided by the City of Ottawa**

AM Peak Hour Factor → 0.89											Highest Hourly Vehicle Volume Between 0700h & 1000h												
AM Peak Hr	LT	ST	RT	UT	Total	LT	ST	RT	UT	Total	Str. Tot.	LT	ST	RT	UT	Total	LT	ST	RT	UT	Total	Str. Tot.	Gr. Tot.
0815-0915	0	18	0	0	18	11	12	0	0	23	41	0	0	0	0	0	44	174	9	0	227	227	268
OFF Peak Hour Factor → 0.95											Highest Hourly Vehicle Volume Between 1130h & 1330h												
OFF Peak Hr	LT	ST	RT	UT	Total	LT	ST	RT	UT	Total	Str. Tot.	LT	ST	RT	UT	Total	LT	ST	RT	UT	Total	Str. Tot.	Gr. Tot.
1230-1330	0	5	2	0	7	8	20	0	0	28	35	0	0	0	0	0	35	160	9	0	204	204	239
PM Peak Hour Factor → 0.93											Highest Hourly Vehicle Volume Between 1500h & 1800h												
PM Peak Hr	LT	ST	RT	UT	Total	LT	ST	RT	UT	Total	Str. Tot.	LT	ST	RT	UT	Total	LT	ST	RT	UT	Total	Str. Tot.	Gr. Tot.
1545-1645	0	19	2	0	21	8	37	0	0	45	66	0	0	0	0	0	43	364	13	0	420	420	486

**Comments:**

Transit buses and school buses comprise 30.23% of the heavy vehicle traffic. Lyon Street ramp to Highway 417 westbound closed due to construction. Southbound traffic south of Arlington Street is open to right turns to Catherine Street. Many S/B left turning vehicles to Arlington Street E/B do so from the west through lane.

**Notes:**

1. Includes all vehicle types except bicycles, electric bicycles, and electric scooters.
2. When expansion and AADT factors are applied, the results will differ slightly due to rounding.



# Turning Movement Count

## Summary, AM and PM Peak Hour

### Flow Diagrams

All Vehicles Except Bicycles



## Arlington Street & Lyon Street

## Ottawa, ON

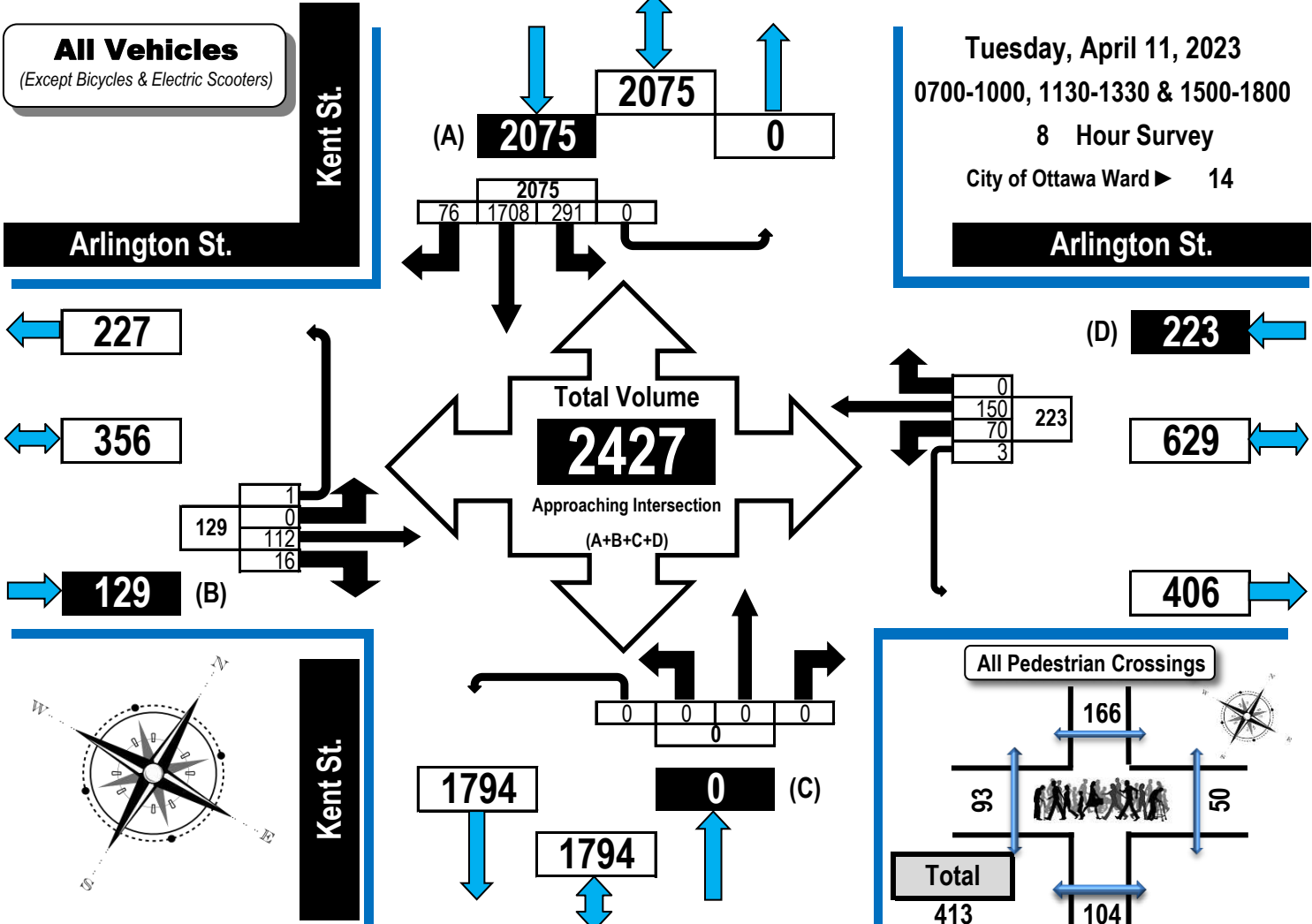

### AM Peak Hour Flow Diagram

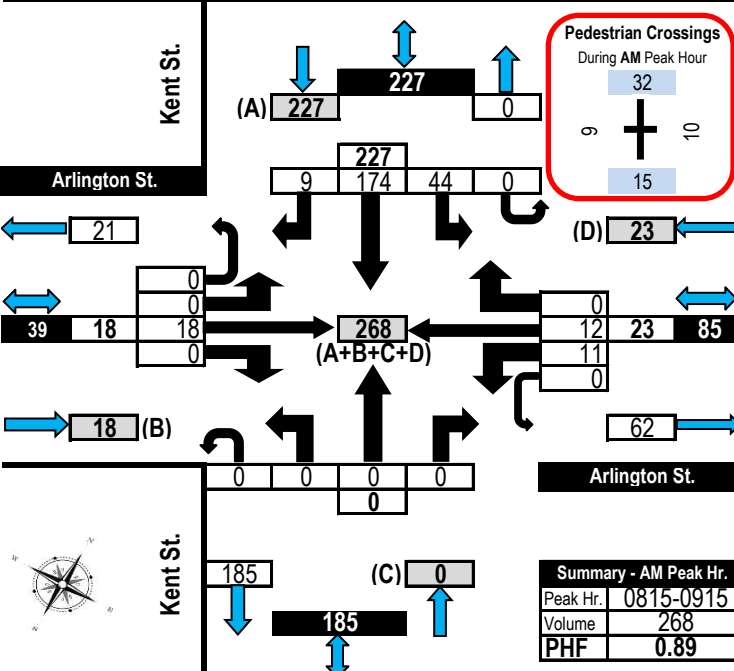

### PM Peak Hour Flow Diagram

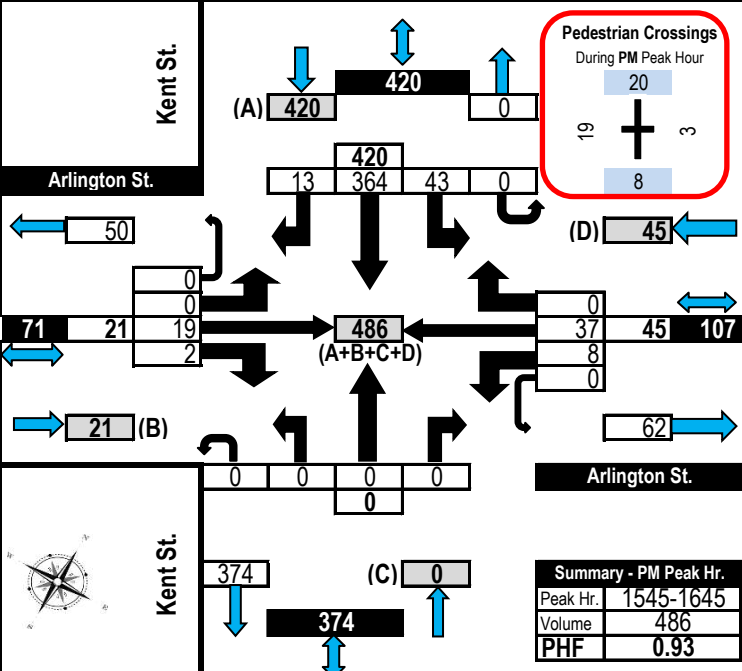



# Turning Movement Count

## Summary, OFF and EVENING Peak Hour

### Flow Diagrams

All Vehicles Except Bicycles



## Arlington Street & Lyon Street Ottawa, ON

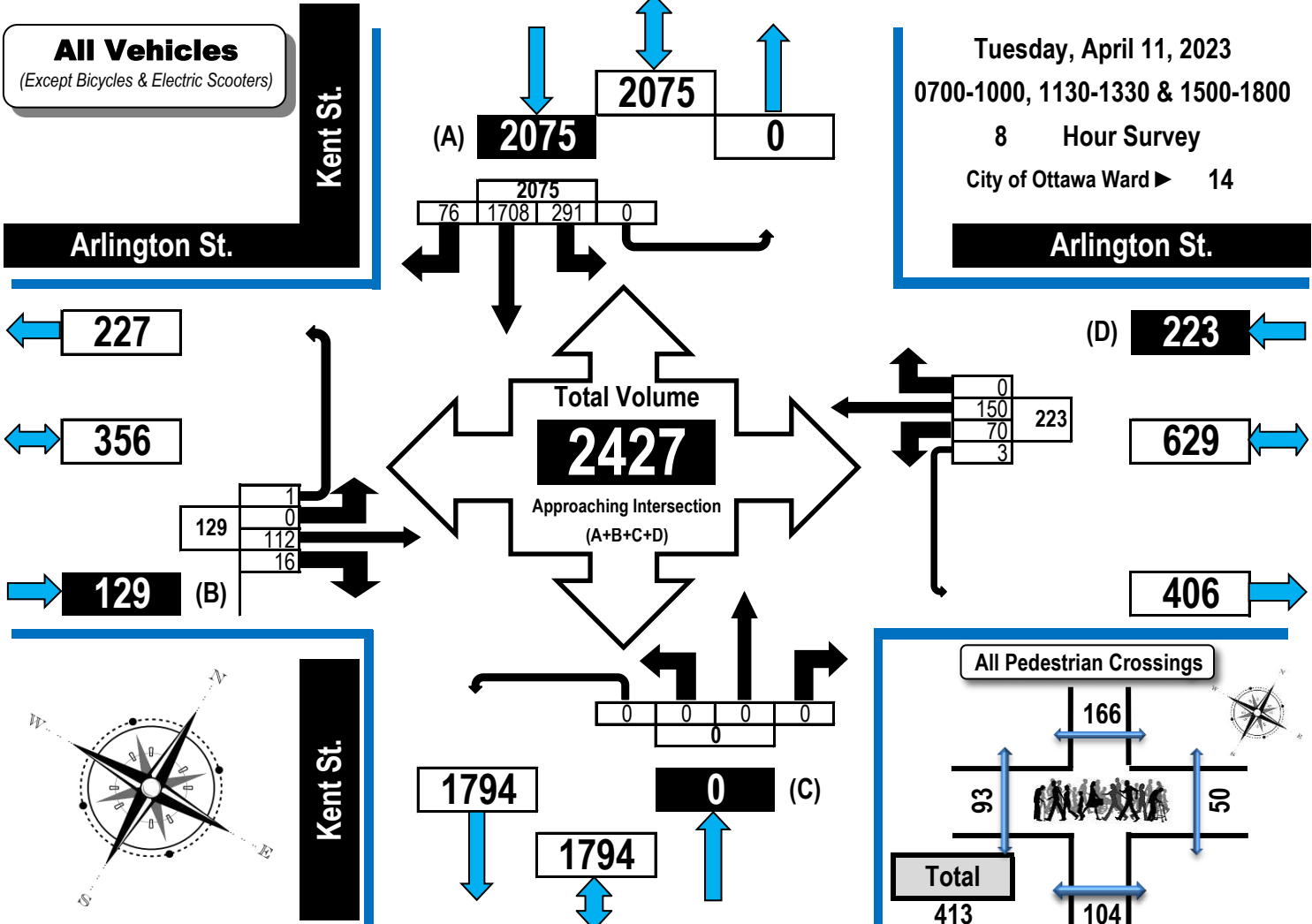

### Off Peak Hour Flow Diagram Evening Peak Hour Flow Diagram

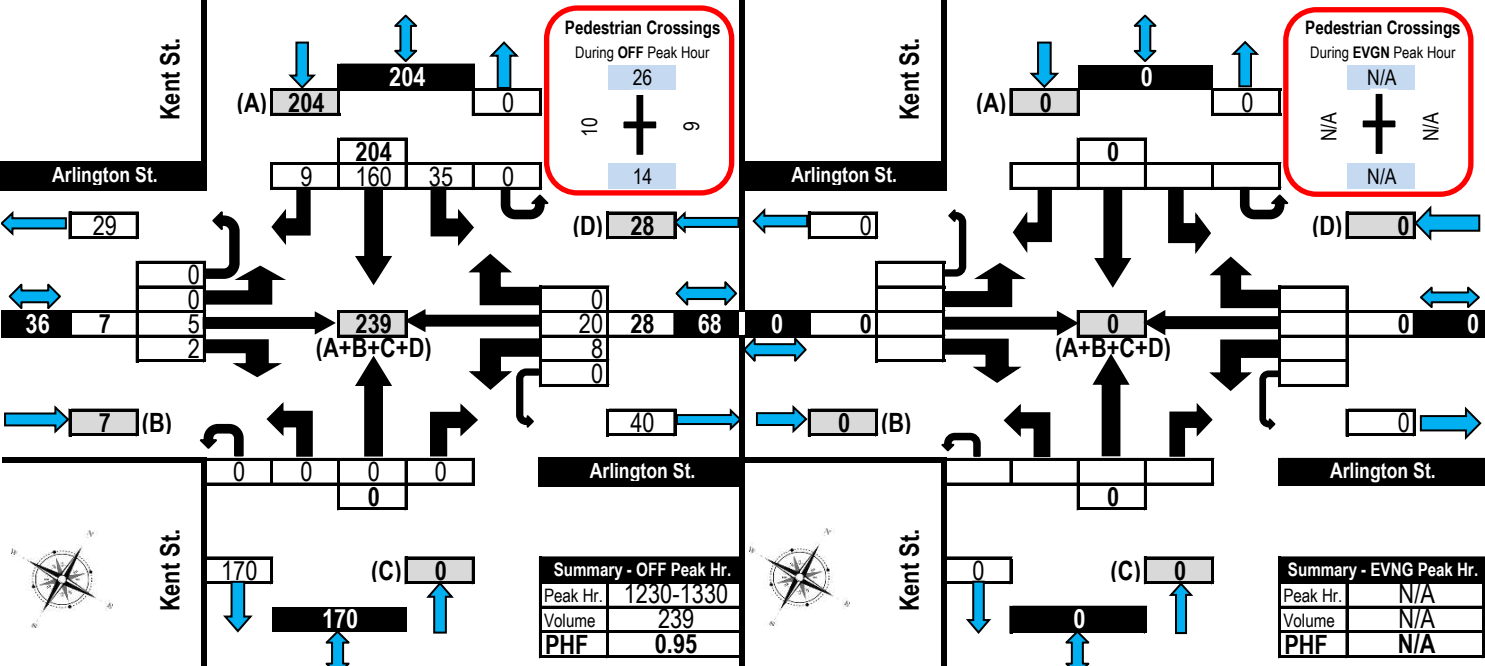



# Turning Movement Count Heavy Vehicle Summary (FHWA Class 4-13) Flow Diagram



**Arlington Street & Lyon Street**

**Ottawa, ON**

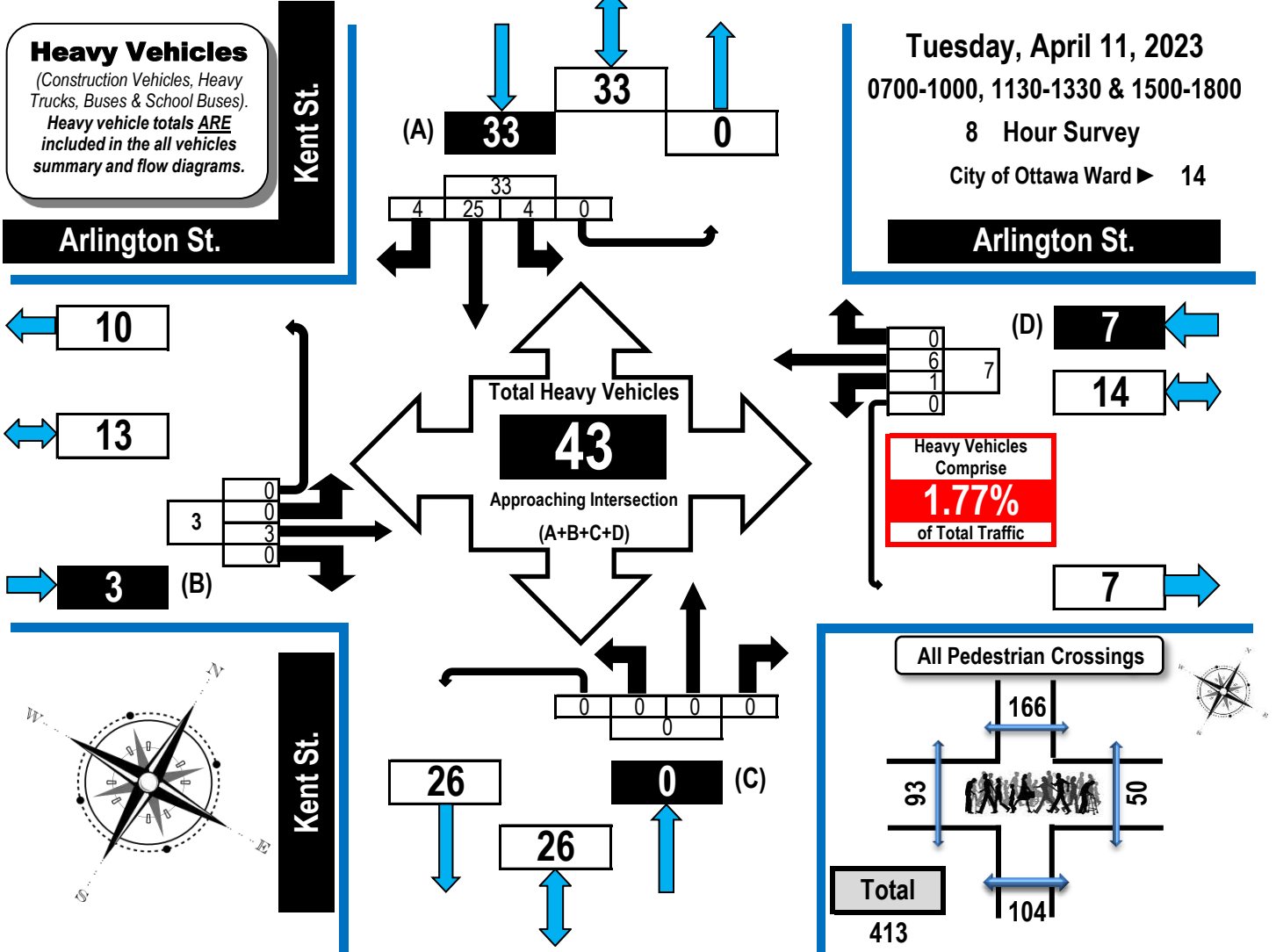

Arlington St.					Arlington St.					Kent St.					Kent St.				
Eastbound					Westbound					Northbound					Southbound				

Time Period	LT	ST	RT	UT	EB Tot	LT	ST	RT	UT	WB Tot	LT	ST	RT	UT	NB Tot	LT	ST	RT	UT	SB Tot	GR Tot	
0700-0800	0	0	0	0	0	0	2	0	0	2	0	0	0	0	0	0	0	1	0	0	1	3
0800-0900	0	1	0	0	1	1	0	0	0	1	0	0	0	0	0	0	2	2	1	0	5	7
0900-1000	0	1	0	0	1	0	2	0	0	2	0	0	0	0	0	0	2	6	2	0	10	13
1130-1230	0	0	0	0	0	0	0	0	0	0	0	0	0	0	0	0	0	7	1	0	8	8
1230-1330	0	0	0	0	0	0	0	0	0	0	0	0	0	0	0	0	0	2	0	0	2	2
1500-1600	0	0	0	0	0	0	0	0	0	0	0	0	0	0	0	0	0	3	0	0	3	3
1600-1700	0	1	0	0	1	0	2	0	0	2	0	0	0	0	0	0	0	1	0	0	1	4
1700-1800	0	0	0	0	0	0	0	0	0	0	0	0	0	0	0	0	0	3	0	0	3	3
<b>Totals</b>	0	3	0	0	3	1	6	0	0	7	0	0	0	0	0	0	4	25	4	0	33	43

**Comments:**

Transit buses and school buses comprise 30.23% of the heavy vehicle traffic. Lyon Street ramp to Highway 417 westbound closed due to construction. Southbound traffic south of Arlington Street is open to right turns to Catherine Street. Many S/B left turning vehicles to Arlington Street E/B do so from the west through lane.



# Turning Movement Count

## All Buses Summary (FHWA Class 4 ONLY)

### Flow Diagram



## Arlington Street & Lyon Street Ottawa, ON

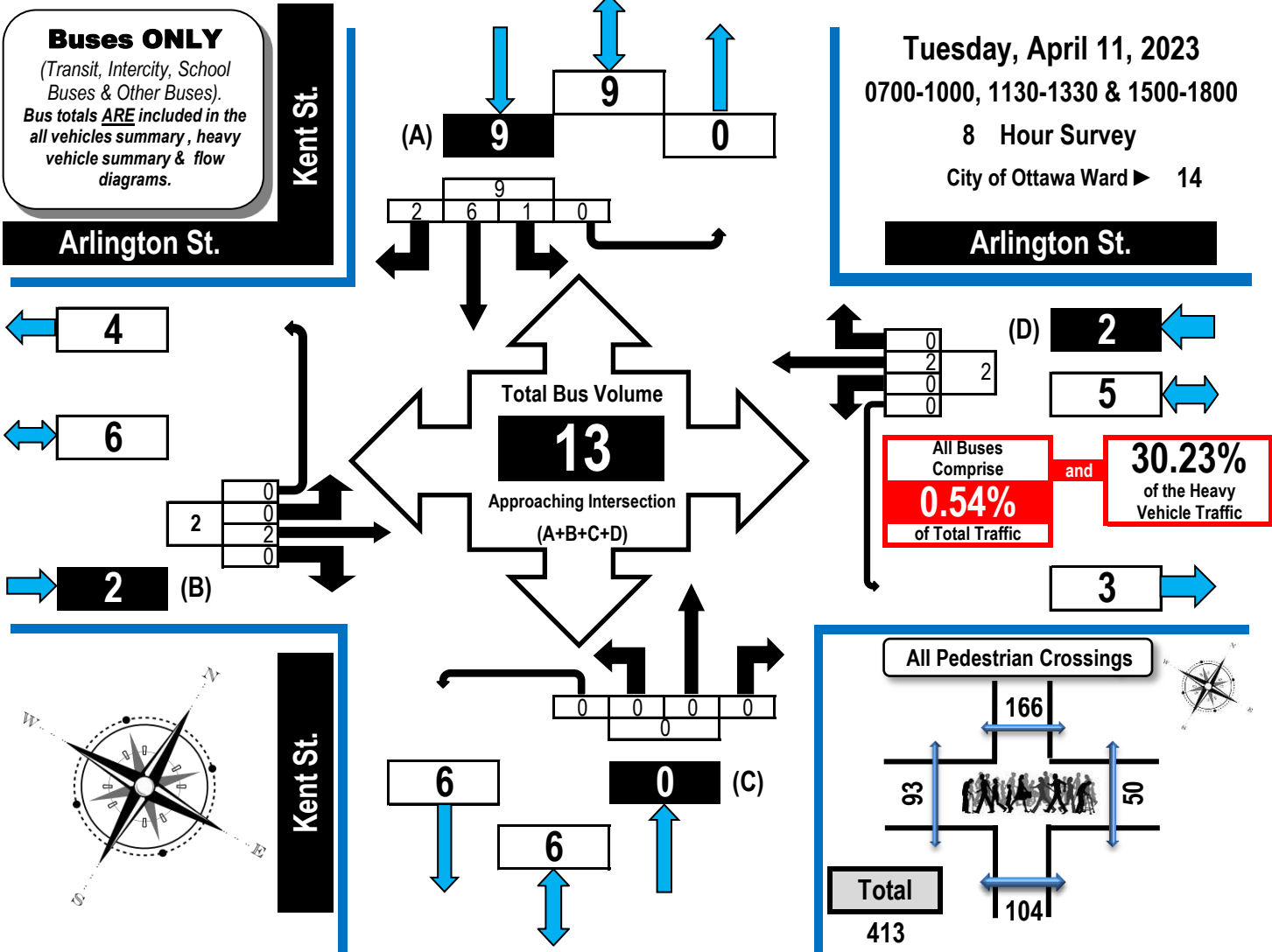

Arlington St. Eastbound	Arlington St. Westbound	Kent St. Northbound	Kent St. Southbound
----------------------------	----------------------------	------------------------	------------------------

Time Period	LT	ST	RT	UT	EB Tot	LT	ST	RT	UT	WB Tot	LT	ST	RT	UT	NB Tot	LT	ST	RT	UT	SB Tot	GR Tot
0700-0800	0	0	0	0	0	0	1	0	0	1	0	0	0	0	0	0	1	0	0	1	2
0800-0900	0	1	0	0	1	0	0	0	0	0	0	0	0	0	0	1	0	0	0	1	2
0900-1000	0	0	0	0	0	0	0	0	0	0	0	0	0	0	0	0	2	1	0	3	3
1130-1230	0	0	0	0	0	0	0	0	0	0	0	0	0	0	0	0	0	1	0	1	1
1230-1330	0	0	0	0	0	0	0	0	0	0	0	0	0	0	0	0	1	0	0	1	1
1500-1600	0	0	0	0	0	0	0	0	0	0	0	0	0	0	0	0	2	0	0	2	2
1600-1700	0	1	0	0	1	0	1	0	0	1	0	0	0	0	0	0	0	0	0	0	2
1700-1800	0	0	0	0	0	0	0	0	0	0	0	0	0	0	0	0	0	0	0	0	0
<b>Totals</b>	<b>0</b>	<b>2</b>	<b>0</b>	<b>0</b>	<b>2</b>	<b>0</b>	<b>2</b>	<b>0</b>	<b>0</b>	<b>2</b>	<b>0</b>	<b>0</b>	<b>0</b>	<b>0</b>	<b>0</b>	<b>1</b>	<b>6</b>	<b>2</b>	<b>0</b>	<b>9</b>	<b>13</b>

**Comments:**  
Transit buses and school buses comprise 30.23% of the heavy vehicle traffic. Lyon Street ramp to Highway 417 westbound closed due to construction. Southbound traffic south of Arlington Street is open to right turns to Catherine Street. Many S/B left turning vehicles to Arlington Street E/B do so from the west through lane.



# Turning Movement Count Bicycle Summary Flow Diagram



**Arlington Street & Lyon Street** **Ottawa, ON**

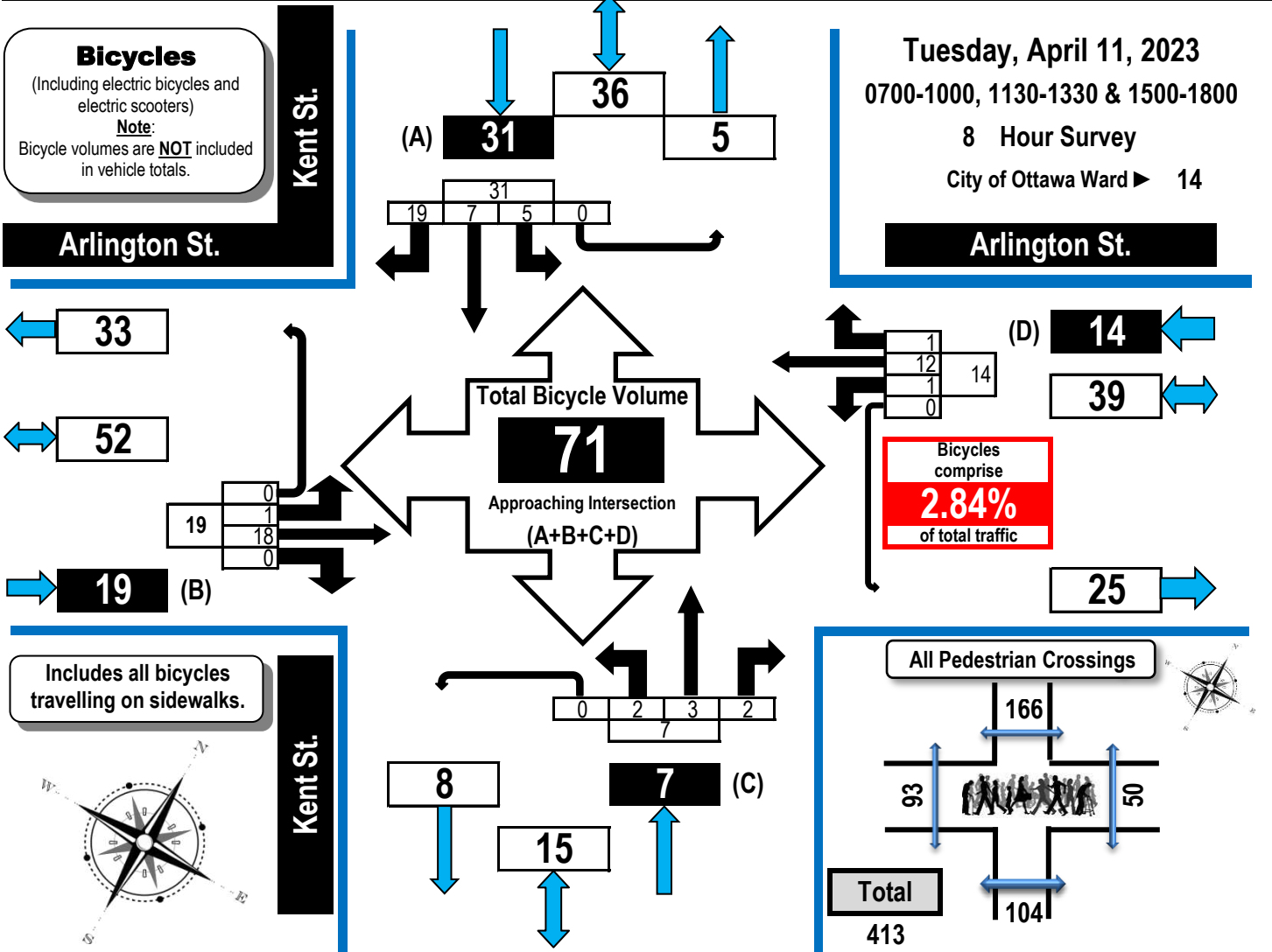

Time Period	Arlington St. Eastbound					Arlington St. Westbound					Kent St. Northbound					Kent St. Southbound					GR Tot
	LT	ST	RT	UT	EB Tot	LT	ST	RT	UT	WB Tot	LT	ST	RT	UT	NB Tot	LT	ST	RT	UT	SB Tot	
0700-0800	0	1	0	0	1	0	0	0	0	0	2	0	0	0	2	0	2	0	0	2	5
0800-0900	0	4	0	0	4	0	1	0	0	1	0	1	0	0	1	0	1	0	0	1	7
0900-1000	0	1	0	0	1	0	2	0	0	2	0	1	0	0	1	1	0	1	0	2	6
1130-1230	0	3	0	0	3	0	0	0	0	0	0	0	1	0	1	1	2	1	0	4	8
1230-1330	0	1	0	0	1	0	1	0	0	1	0	1	0	0	1	1	0	0	0	1	4
1500-1600	0	1	0	0	1	0	1	0	0	1	0	0	0	0	0	0	5	0	0	5	7
1600-1700	1	0	0	0	1	0	1	0	0	1	0	1	0	0	1	1	4	0	0	5	8
1700-1800	0	7	0	0	7	1	6	1	0	8	0	0	0	0	0	1	8	0	0	11	26
<b>Totals</b>	<b>1</b>	<b>18</b>	<b>0</b>	<b>0</b>	<b>19</b>	<b>1</b>	<b>12</b>	<b>1</b>	<b>0</b>	<b>14</b>	<b>2</b>	<b>3</b>	<b>2</b>	<b>0</b>	<b>7</b>	<b>5</b>	<b>7</b>	<b>19</b>	<b>0</b>	<b>31</b>	<b>71</b>

**Comments:**  
Transit buses and school buses comprise 30.23% of the heavy vehicle traffic. Lyon Street ramp to Highway 417 westbound closed due to construction. Southbound traffic south of Arlington Street is open to right turns to Catherine Street. Many S/B left turning vehicles to Arlington Street E/B do so from the west through lane.



# Turning Movement Count Pedestrian Crossings Summary and Flow Diagram



**Arlington Street & Lyon Street** **Ottawa, ON**

**Pedestrian Crossings**

**Tuesday, April 11, 2023**  
 0700-1000, 1130-1330 & 1500-1800  
 8 Hour Survey  
 City of Ottawa Ward ► 14

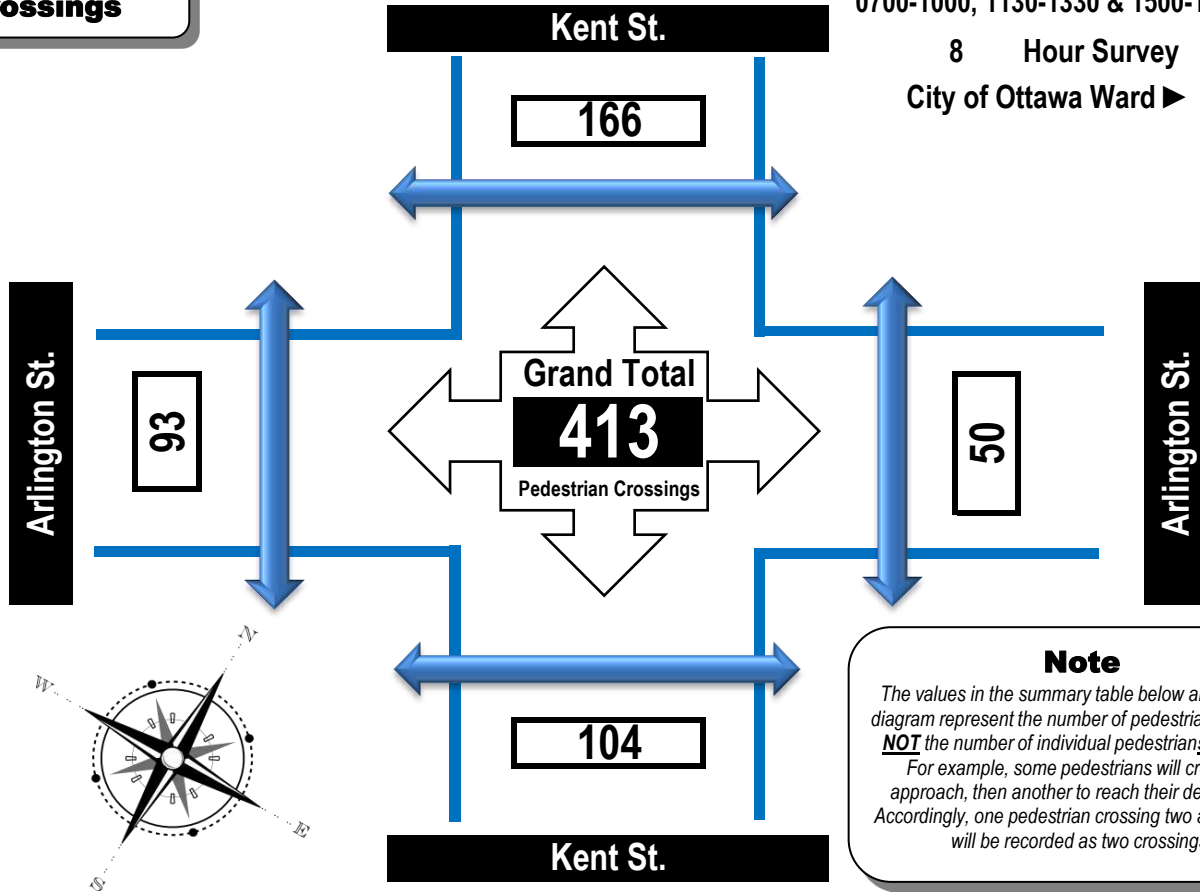

**Note**  
 The values in the summary table below and the flow diagram represent the number of pedestrian crossings **NOT** the number of individual pedestrians crossing. For example, some pedestrians will cross one approach, then another to reach their destination. Accordingly, one pedestrian crossing two approaches will be recorded as two crossings.

Time Period	West Side Crossing Arlington St.	East Side Crossing Arlington St.	Street Total	South Side Crossing Kent St.	North Side Crossing Kent St.	Street Total	Grand Total
0700-0800	7	4	11	5	15	20	31
0800-0900	11	11	22	16	31	47	69
0900-1000	3	5	8	4	7	11	19
1130-1230	12	6	18	21	10	31	49
1230-1330	10	9	19	14	26	40	59
1500-1600	16	5	21	23	35	58	79
1600-1700	18	4	22	11	17	28	50
1700-1800	16	6	22	10	25	35	57
<b>Totals</b>	<b>93</b>	<b>50</b>	<b>143</b>	<b>104</b>	<b>166</b>	<b>270</b>	<b>413</b>

**Comments:**

Transit buses and school buses comprise 30.23% of the heavy vehicle traffic. Lyon Street ramp to Highway 417 westbound closed due to construction. Southbound traffic south of Arlington Street is open to right turns to Catherine Street. Many S/B left turning vehicles to Arlington Street E/B do so from the west through lane.



# DIRECTIONAL TRAFFIC FLOW

Intersection: Arlington Avenue at Bank Street

DATE: Day: 18 Month: Apr. Year: 2023 Day of Week: Tuesday

Observer: Jordan Terada Weather: Overcast

Chkd by: \_\_\_\_\_ Date: \_\_\_\_\_

TIME PERIOD: From: 7 : 35 To: 8 : 35

N



Pedestrians

<div style="border: 1px solid black; width: 20px; height: 10px; margin: 0 auto; position: relative;"> <span style="position: absolute; left: -5px; top: 5px;">←</span> <span style="position: absolute; right: -5px; top: 5px;">→</span> </div> <div style="border: 1px solid black; width: 20px; height: 10px; margin: 0 auto; position: relative;"> <span style="position: absolute; left: -5px; top: -5px;">↑</span> <span style="position: absolute; right: -5px; top: -5px;">↓</span> </div>	0
111	
Street Name: <b>Arlington Avenue</b>	

1	0	0	HV Bikes
1	0	0	
21	0	0	Pass. Vehicles

Street Name: <b>Bank Street</b>
------------------------------------

1	0	21
0	0	0

0	0	0
---	---	---

1	4	120
---	---	-----

Street Name: <b>Bank Street</b>
------------------------------------

84	0	0	HV Bikes
2	0	0	
0	0	0	Pass. Vehicles

0	0	
---	---	--

0	0	0
---	---	---

0	0	0
---	---	---

Street Name:		
--------------	--	--

Pedestrians

<div style="border: 1px solid black; width: 20px; height: 10px; margin: 0 auto; position: relative;"> <span style="position: absolute; left: -5px; top: 5px;">←</span> <span style="position: absolute; right: -5px; top: 5px;">→</span> </div> <div style="border: 1px solid black; width: 20px; height: 10px; margin: 0 auto; position: relative;"> <span style="position: absolute; left: -5px; top: -5px;">↑</span> <span style="position: absolute; right: -5px; top: -5px;">↓</span> </div>	0
0	

# DIRECTIONAL TRAFFIC FLOW

Intersection: Arlington Avenue at Bank Street

DATE: Day: 18 Month: Apr. Year: 2023 Day of Week: Tuesday

Observer: Jordan Terada Weather: Rain

Chkd by: \_\_\_\_\_ Date: \_\_\_\_\_

TIME PERIOD: From: 4 : 15 To: 5 : 15

N



Pedestrians

↔	0
↕	42

Street Name:  
**Arlington Avenue**

0	0	0
0	0	0
27		

HV Bikes  
Pass. Vehicles

Street Name:  
**Bank Street**

Bikes HV Pass. Vehicles

0	0	20
---	---	----

R  
L

0	0	0
---	---	---

S

1	1	106
---	---	-----

Street Name:  
**Bank Street**

Pass. Vehicles  
Bikes HV

58	0	0
0	0	0
3	0	0

	0	
--	---	--

	0	0
--	---	---

S

	0	0
--	---	---

Pass. Vehicles HV Bikes

Street Name:

Pedestrians

↔	0
↕	0

**Survey Date:** Thursday, April 19, 2018

**WO No:** 39991

**Start Time:** 07:00

**Device:** Miovision

### Full Study Diagram

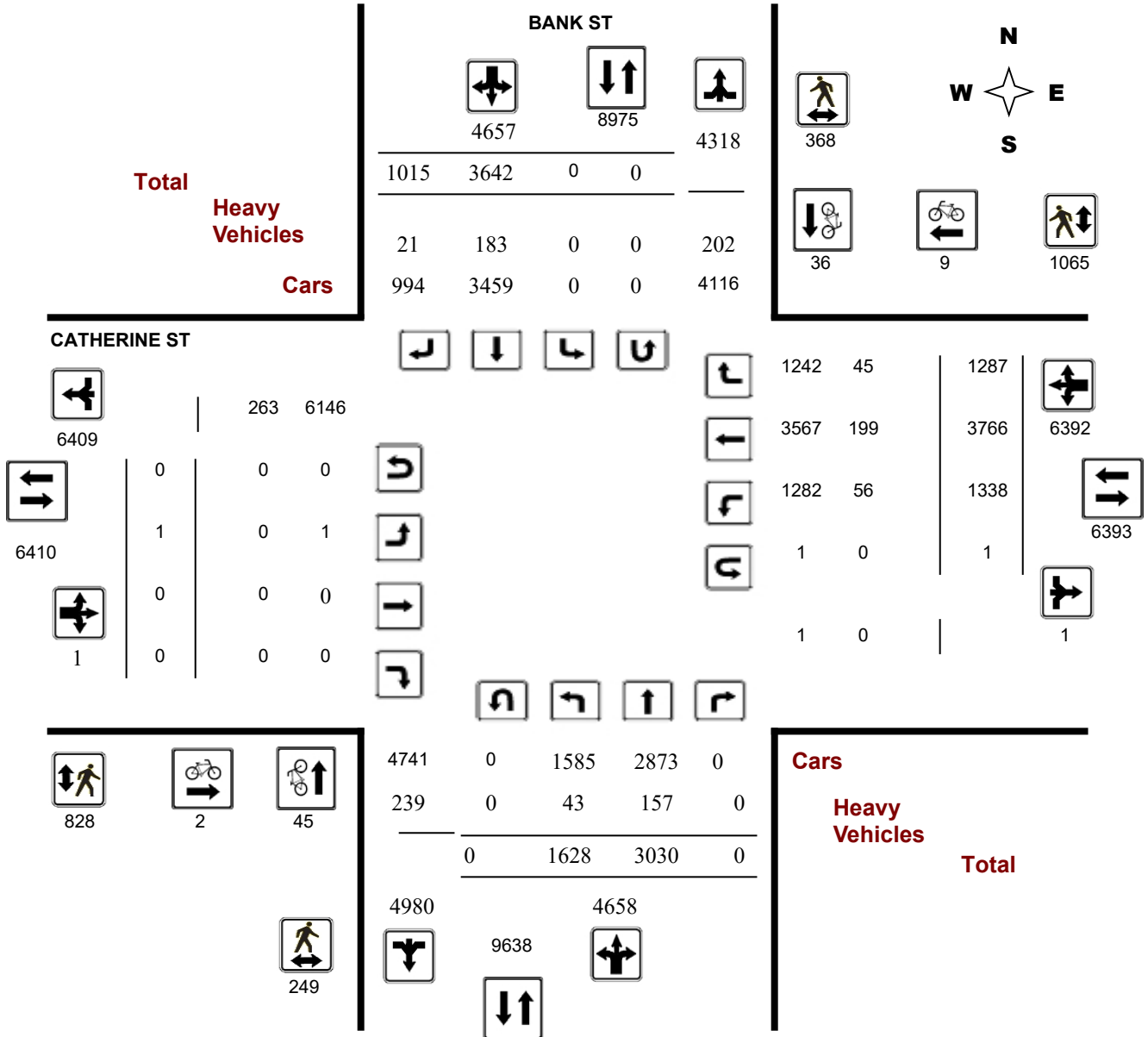

## Turning Movement Count - Study Results

### BANK ST @ CATHERINE ST

**Survey Date:** Thursday, April 19, 2018

**WO No:** 39991

**Start Time:** 07:00

**Device:** Miovision

### Full Study Peak Hour Diagram

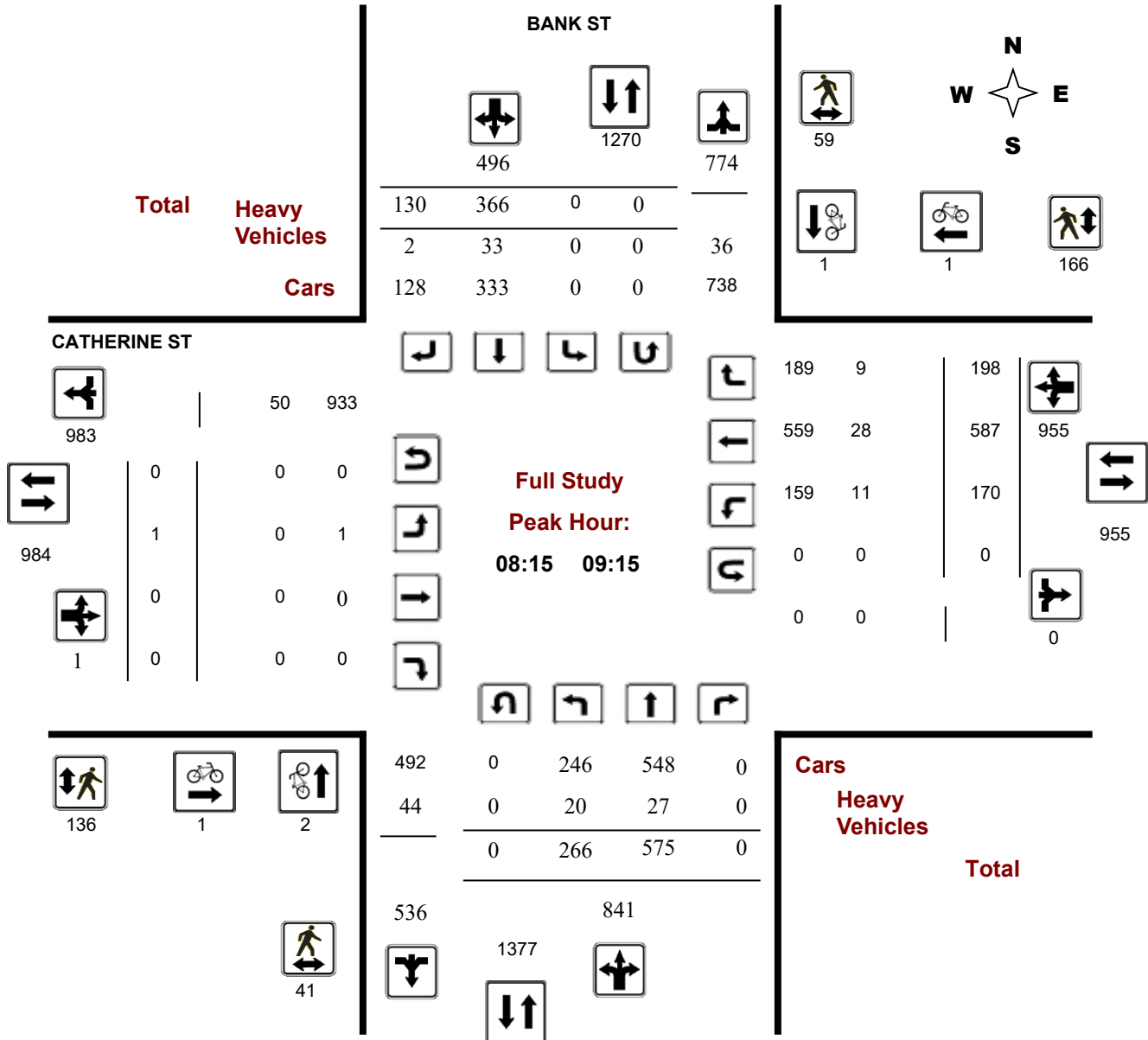

## Turning Movement Count - Peak Hour Diagram

### BANK ST @ CATHERINE ST

**Survey Date:** Thursday, April 19, 2018

**Start Time:** 07:00

**WO No:** 39991

**Device:** Miovision

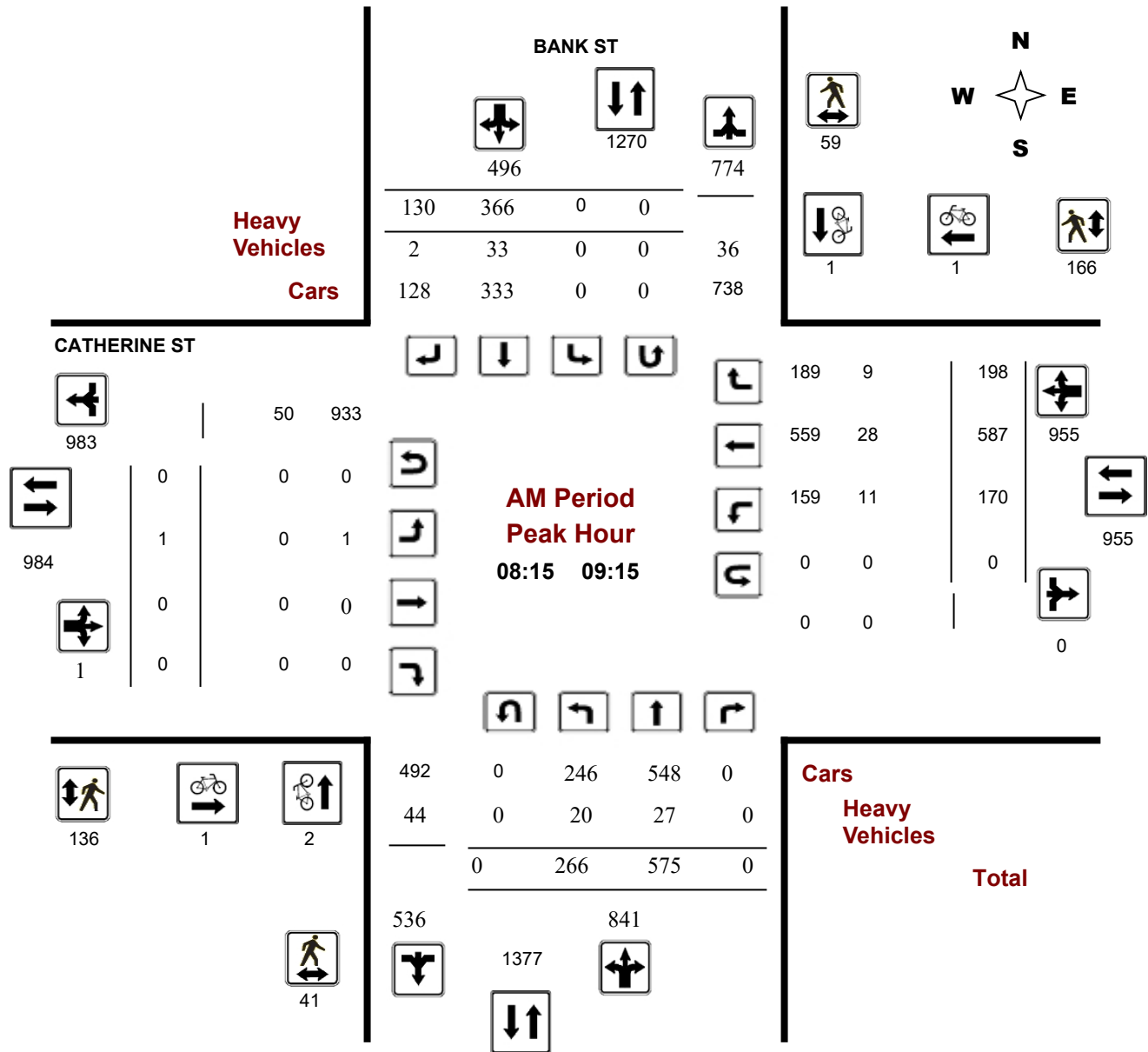

## Turning Movement Count - Peak Hour Diagram

### BANK ST @ CATHERINE ST

**Survey Date:** Thursday, April 19, 2018

**Start Time:** 07:00

**WO No:** 39991

**Device:** Miovision

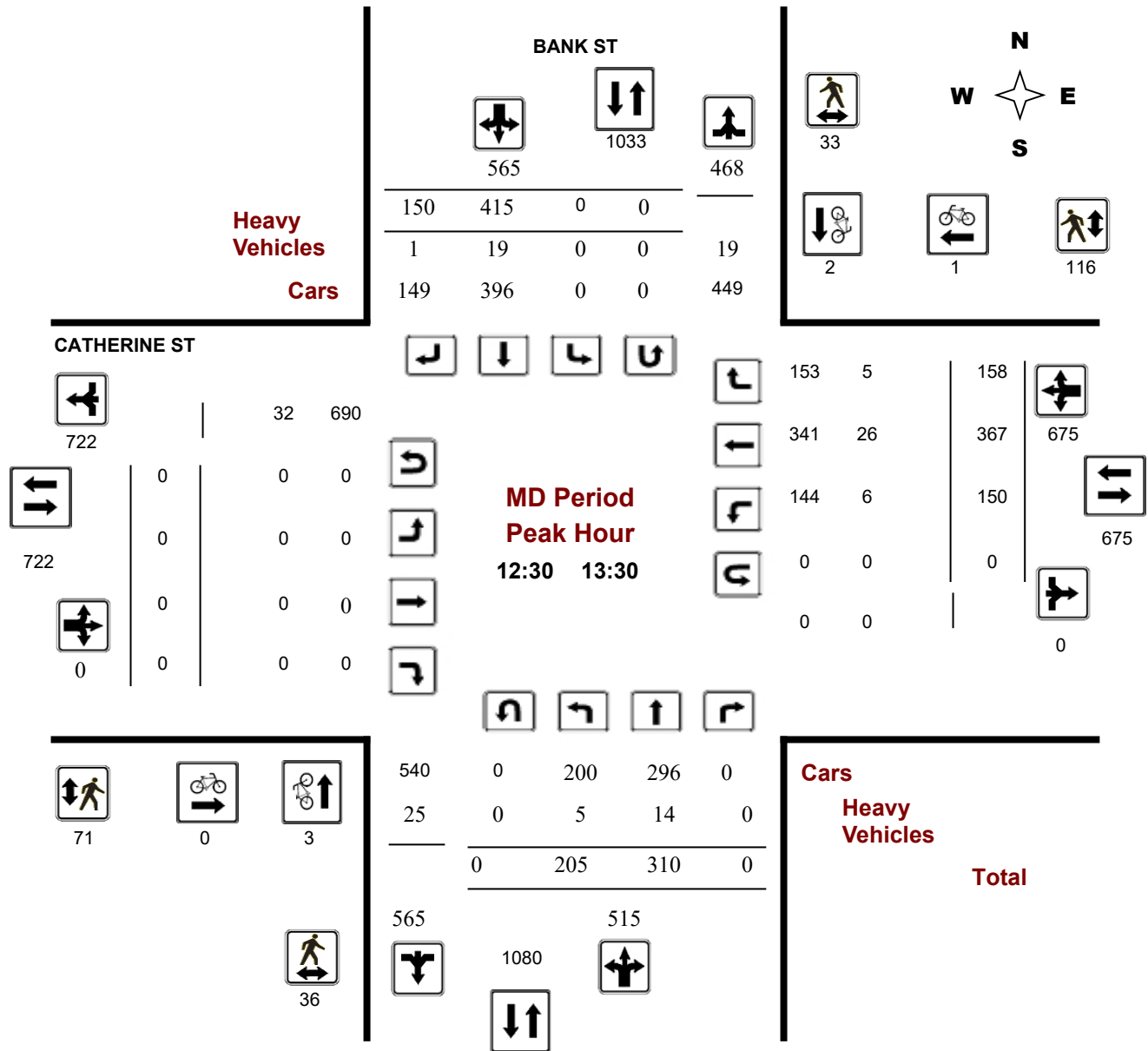

## Turning Movement Count - Peak Hour Diagram

### BANK ST @ CATHERINE ST

**Survey Date:** Thursday, April 19, 2018

**Start Time:** 07:00

**WO No:** 39991

**Device:** Miovision

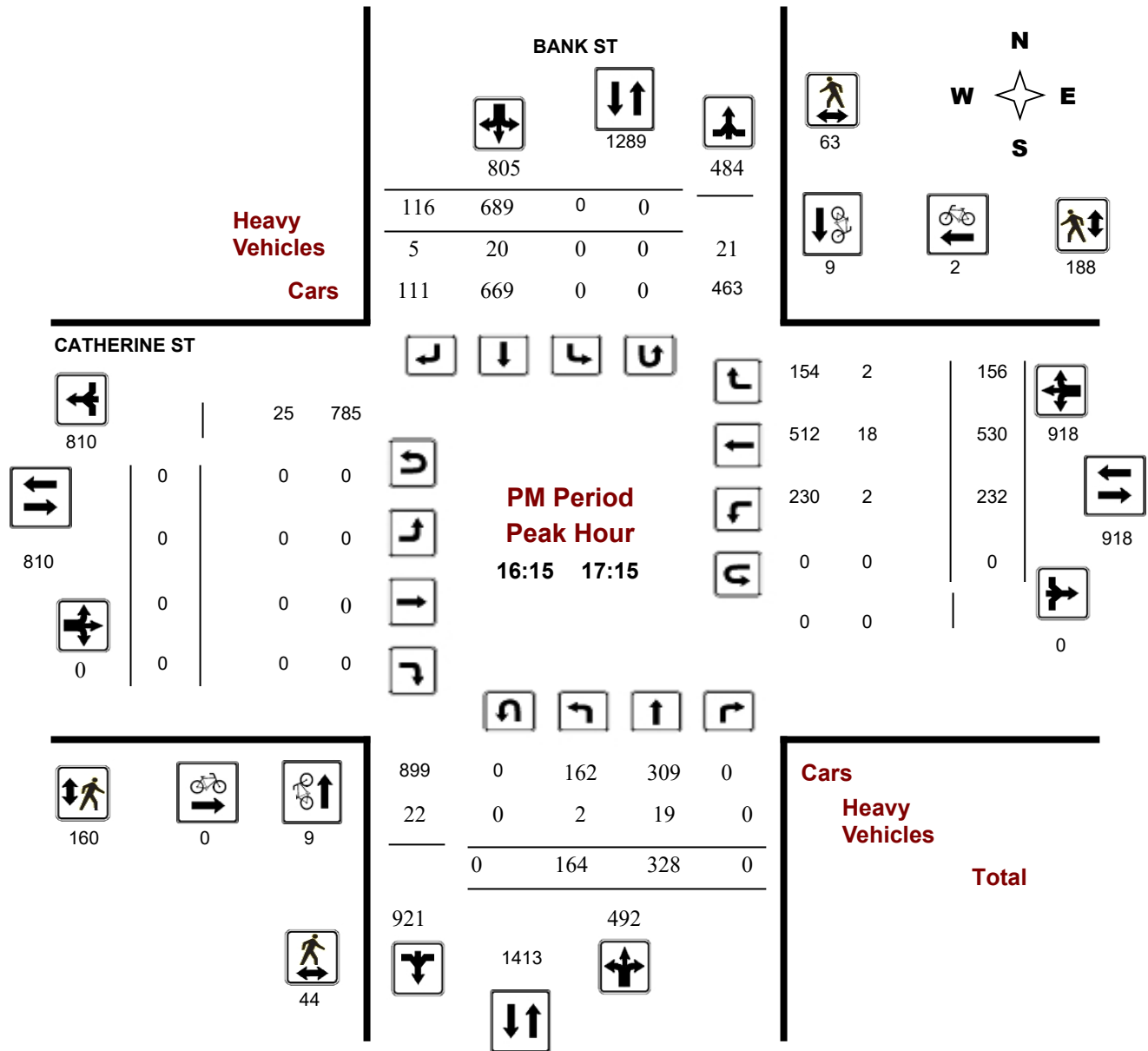



# Transportation Services - Traffic Services

## Turning Movement Count - Study Results

### BANK ST @ CATHERINE ST

**Survey Date:** Thursday, April 19, 2018

**WO No:** 39991

**Start Time:** 07:00

**Device:** Miovision

### Full Study Summary (8 HR Standard)

**Survey Date:** Thursday, April 19, 2018

**Total Observed U-Turns**

**AADT Factor**

Northbound: 0      Southbound: 0  
 Eastbound: 0      Westbound: 1  
 .90

Period	BANK ST										CATHERINE ST										Grand Total
	Northbound					Southbound					Eastbound					Westbound					
	LT	ST	RT	NB TOT	STR TOT	LT	ST	RT	SB TOT	STR TOT	LT	ST	RT	EB TOT	STR TOT	LT	ST	RT	WB TOT	STR TOT	
07:00 08:00	212	493	0	705	1065	0	268	92	360	1065	0	0	0	0	0	100	566	165	831	831	1896
08:00 09:00	271	602	0	873	1342	0	356	113	469	1342	0	0	0	0	0	167	580	196	943	943	2285
09:00 10:00	211	392	0	603	1088	0	350	135	485	1088	1	0	0	1	1	153	436	172	761	762	1850
11:30 12:30	195	288	0	483	1005	0	380	142	522	1005	0	0	0	0	0	154	349	132	635	635	1640
12:30 13:30	205	310	0	515	1080	0	415	150	565	1080	0	0	0	0	0	150	367	158	675	675	1755
15:00 16:00	194	268	0	462	1176	0	566	148	714	1176	0	0	0	0	0	177	538	161	876	876	2052
16:00 17:00	164	325	0	489	1274	0	663	122	785	1274	0	0	0	0	0	219	559	153	931	931	2205
17:00 18:00	176	352	0	528	1285	0	644	113	757	1285	0	0	0	0	0	218	371	150	739	739	2024
<b>Sub Total</b>	1628	3030	0	4658	9315	0	3642	1015	4657	9315	1	0	0	1	1	1338	3766	1287	6391	6392	15707
<b>U Turns</b>				0	0				0	0				0	0				1	1	1
<b>Total</b>	1628	3030	0	4658	9315	0	3642	1015	4657	9315	1	0	0	1	1	1338	3766	1287	6392	6393	15708
<b>EQ 12Hr</b>	2263	4212	0	6475	12948	0	5062	1411	6473	12948	1	0	0	1	1	1860	5235	1789	8885	8886	21834
Note: These values are calculated by multiplying the totals by the appropriate expansion factor.														<b>1.39</b>							
<b>AVG 12Hr</b>	2037	3791	0	5828	11653	0	5969	1663	5826	11653	1	0	0	1	1	1674	4712	1610	7996	7997	19651
Note: These volumes are calculated by multiplying the Equivalent 12 hr. totals by the AADT factor.														<b>.90</b>							
<b>AVG 24Hr</b>	2668	4966	0	7635	15265	0	7819	2179	7632	15265	1	0	0	1	1	2193	6173	2109	10475	10476	25743
Note: These volumes are calculated by multiplying the Average Daily 12 hr. totals by 12 to 24 expansion factor.														<b>1.31</b>							
Note: U-Turns provided for approach totals. Refer to 'U-Turn' Report for specific breakdown.																					





# Transportation Services - Traffic Services

## Turning Movement Count - Study Results

### BANK ST @ CATHERINE ST

**Survey Date:** Thursday, April 19, 2018

**WO No:** 39991

**Start Time:** 07:00

**Device:** Miovision

### Full Study 15 Minute Increments

#### BANK ST

#### CATHERINE ST

Northbound

Southbound

Eastbound

Westbound

Time Period	LT	ST	RT	N TOT	LT	ST	RT	S TOT	STR TOT	LT	ST	RT	E TOT	LT	ST	RT	W TOT	STR TOT	Grand Total
07:00 07:15	37	86	0	123	0	50	26	76	199	0	0	0	0	19	128	44	191	191	390
07:15 07:30	49	111	0	160	0	66	21	87	247	0	0	0	0	24	128	47	199	199	446
07:30 07:45	58	136	0	194	0	71	22	93	287	0	0	0	0	17	160	37	214	214	501
07:45 08:00	68	160	0	228	0	81	23	104	332	0	0	0	0	40	150	37	227	227	559
08:00 08:15	68	143	0	211	0	82	18	100	311	0	0	0	0	36	141	51	228	228	539
08:15 08:30	65	154	0	219	0	99	36	135	354	0	0	0	0	46	150	46	242	242	596
08:30 08:45	70	159	0	229	0	104	33	137	366	0	0	0	0	37	142	52	231	231	597
08:45 09:00	68	146	0	214	0	71	26	97	311	0	0	0	0	48	147	47	242	242	553
09:00 09:15	63	116	0	179	0	92	35	127	306	1	0	0	1	39	148	53	240	241	547
09:15 09:30	60	73	0	133	0	81	28	109	242	0	0	0	0	45	109	53	207	207	449
09:30 09:45	56	101	0	157	0	90	27	117	274	0	0	0	0	42	91	35	168	168	442
09:45 10:00	32	102	0	134	0	87	45	132	266	0	0	0	0	27	88	31	147	147	413
11:30 11:45	45	67	0	112	0	96	33	129	241	0	0	0	0	43	83	37	163	163	404
11:45 12:00	54	76	0	130	0	93	32	125	255	0	0	0	0	46	94	42	182	182	437
12:00 12:15	54	79	0	133	0	88	38	126	259	0	0	0	0	37	98	25	160	160	419
12:15 12:30	42	66	0	108	0	103	39	142	250	0	0	0	0	28	74	28	130	130	380
12:30 12:45	46	79	0	125	0	96	44	140	265	0	0	0	0	45	90	38	173	173	438
12:45 13:00	42	76	0	118	0	110	39	149	267	0	0	0	0	32	91	41	164	164	431
13:00 13:15	66	79	0	145	0	100	29	129	274	0	0	0	0	30	88	31	149	149	423
13:15 13:30	51	76	0	127	0	109	38	147	274	0	0	0	0	43	98	48	189	189	463
15:00 15:15	54	66	0	120	0	134	48	182	302	0	0	0	0	41	93	40	174	174	476
15:15 15:30	50	70	0	120	0	144	36	180	300	0	0	0	0	35	130	52	217	217	517
15:30 15:45	51	63	0	114	0	144	38	182	296	0	0	0	0	51	139	33	223	223	519
15:45 16:00	39	69	0	108	0	144	26	170	278	0	0	0	0	50	176	36	262	262	540
16:00 16:15	45	86	0	131	0	160	38	198	329	0	0	0	0	45	140	36	221	221	550
17:15 17:30	48	85	0	133	0	161	28	189	322	0	0	0	0	57	101	43	201	201	523
17:30 17:45	39	80	0	119	0	154	20	174	293	0	0	0	0	53	83	33	169	169	462
17:45 18:00	44	98	0	142	0	143	33	176	318	0	0	0	0	50	76	35	161	161	479
16:15 16:30	42	70	0	112	0	169	29	198	310	0	0	0	0	64	184	34	282	282	592
16:30 16:45	41	86	0	127	0	151	29	180	307	0	0	0	0	57	123	43	223	223	530
16:45 17:00	36	83	0	119	0	183	26	209	328	0	0	0	0	53	112	40	205	205	533
17:00 17:15	45	89	0	134	0	186	32	218	352	0	0	0	0	58	111	39	208	208	560
<b>Total:</b>	<b>1628</b>	<b>3030</b>	<b>0</b>	<b>4658</b>	<b>0</b>	<b>3642</b>	<b>1015</b>	<b>4657</b>	<b>9315</b>	<b>1</b>	<b>0</b>	<b>0</b>	<b>1</b>	<b>1338</b>	<b>3766</b>	<b>1287</b>	<b>6392</b>	<b>6393</b>	<b>15,708</b>

Note: U-Turns are included in Totals.



# Transportation Services - Traffic Services

## Turning Movement Count - Study Results

### BANK ST @ CATHERINE ST

**Survey Date:** Thursday, April 19, 2018

**WO No:** 39991

**Start Time:** 07:00

**Device:** Miovision

### Full Study Cyclist Volume

Time Period	BANK ST			CATHERINE ST			Grand Total
	Northbound	Southbound	Street Total	Eastbound	Westbound	Street Total	
07:00 07:15	1	1	2	0	0	0	2
07:15 07:30	1	0	1	0	0	0	1
07:30 07:45	1	0	1	0	0	0	1
07:45 08:00	3	0	3	0	0	0	3
08:00 08:15	3	0	3	0	0	0	3
08:15 08:30	1	1	2	0	1	1	3
08:30 08:45	1	0	1	0	0	0	1
08:45 09:00	0	0	0	0	0	0	0
09:00 09:15	0	0	0	1	0	1	1
09:15 09:30	1	1	2	0	0	0	2
09:30 09:45	2	0	2	0	0	0	2
09:45 10:00	2	0	2	0	0	0	2
11:30 11:45	0	1	1	0	1	1	2
11:45 12:00	1	2	3	0	0	0	3
12:00 12:15	1	1	2	0	0	0	2
12:15 12:30	0	4	4	0	0	0	4
12:30 12:45	2	1	3	0	0	0	3
12:45 13:00	0	0	0	0	1	1	1
13:00 13:15	0	0	0	0	0	0	0
13:15 13:30	1	1	2	0	0	0	2
15:00 15:15	1	2	3	0	2	2	5
15:15 15:30	2	2	4	1	0	1	5
15:30 15:45	3	2	5	0	0	0	5
15:45 16:00	4	1	5	0	1	1	6
16:00 16:15	0	1	1	0	1	1	2
17:15 17:30	1	2	3	0	0	0	3
17:30 17:45	0	1	1	0	0	0	1
17:45 18:00	4	3	7	0	0	0	7
16:15 16:30	2	2	4	0	1	1	5
16:30 16:45	4	2	6	0	1	1	7
16:45 17:00	3	1	4	0	0	0	4
17:00 17:15	0	4	4	0	0	0	4
<b>Total</b>	<b>45</b>	<b>36</b>	<b>81</b>	<b>2</b>	<b>9</b>	<b>11</b>	<b>92</b>



# Transportation Services - Traffic Services

## Turning Movement Count - Study Results

### BANK ST @ CATHERINE ST

**Survey Date:** Thursday, April 19, 2018

**WO No:** 39991

**Start Time:** 07:00

**Device:** Miovision

### Full Study Pedestrian Volume

#### BANK ST

#### CATHERINE ST

Time Period	NB Approach (E or W Crossing)	SB Approach (E or W Crossing)	Total	EB Approach (N or S Crossing)	WB Approach (N or S Crossing)	Total	Grand Total
07:00 07:15	2	5	7	8	9	17	24
07:15 07:30	4	5	9	18	10	28	37
07:30 07:45	2	5	7	18	18	36	43
07:45 08:00	2	6	8	12	16	28	36
08:00 08:15	10	5	15	18	42	60	75
08:15 08:30	13	17	30	28	46	74	104
08:30 08:45	11	19	30	74	50	124	154
08:45 09:00	9	15	24	19	34	53	77
09:00 09:15	8	8	16	15	36	51	67
09:15 09:30	4	14	18	9	25	34	52
09:30 09:45	4	19	23	2	23	25	48
09:45 10:00	5	3	8	4	23	27	35
11:30 11:45	7	11	18	15	25	40	58
11:45 12:00	5	11	16	21	28	49	65
12:00 12:15	7	24	31	18	28	46	77
12:15 12:30	6	14	20	21	37	58	78
12:30 12:45	4	12	16	28	14	42	58
12:45 13:00	15	10	25	16	42	58	83
13:00 13:15	8	6	14	12	30	42	56
13:15 13:30	9	5	14	15	30	45	59
15:00 15:15	9	14	23	22	23	45	68
15:15 15:30	10	22	32	69	42	111	143
15:30 15:45	9	13	22	25	34	59	81
15:45 16:00	11	4	15	37	33	70	85
16:00 16:15	6	9	15	32	27	59	74
17:15 17:30	8	8	16	43	61	104	120
17:30 17:45	10	6	16	38	41	79	95
17:45 18:00	7	15	22	31	50	81	103
16:15 16:30	13	15	28	48	41	89	117
16:30 16:45	6	11	17	33	49	82	99
16:45 17:00	12	22	34	43	45	88	122
17:00 17:15	13	15	28	36	53	89	117
<b>Total .....</b>	<b>249</b>	<b>368</b>	<b>617</b>	<b>828</b>	<b>1065</b>	<b>1893</b>	<b>2510</b>



# Transportation Services - Traffic Services

## Turning Movement Count - Study Results

### BANK ST @ CATHERINE ST

**Survey Date:** Thursday, April 19, 2018

**WO No:** 39991

**Start Time:** 07:00

**Device:** Miovision

### Full Study Heavy Vehicles

#### BANK ST

#### CATHERINE ST

Northbound

Southbound

Eastbound

Westbound

Time Period	Northbound			N TOT	Southbound			S TOT	STR TOT	Eastbound			E TOT	Westbound			W TOT	STR TOT	Grand Total
	LT	ST	RT		LT	ST	RT			LT	ST	RT		LT	ST	RT			
07:00 07:15	2	4	0	13	0	5	1	11	24	0	0	0	9	2	6	1	9	18	21
07:15 07:30	0	3	0	10	0	5	2	17	27	0	0	0	5	2	3	7	12	17	22
07:30 07:45	2	4	0	12	0	3	1	9	21	0	0	0	10	3	7	1	11	21	21
07:45 08:00	1	6	0	16	0	8	0	16	32	0	0	0	7	1	6	2	9	16	24
08:00 08:15	0	5	0	11	0	2	1	11	22	0	0	0	9	4	8	3	15	24	23
08:15 08:30	2	7	0	22	0	10	0	18	40	0	0	0	10	3	8	1	12	22	31
08:30 08:45	3	3	0	18	0	8	1	12	30	0	0	0	13	4	9	0	13	26	28
08:45 09:00	3	11	0	23	0	7	1	24	47	0	0	0	10	2	6	5	13	23	35
09:00 09:15	12	6	0	28	0	8	0	17	45	0	0	0	17	2	5	3	10	27	36
09:15 09:30	0	4	0	17	0	11	0	17	34	0	0	0	5	2	5	2	9	14	24
09:30 09:45	4	4	0	18	0	7	0	14	32	0	0	0	6	3	2	3	8	14	23
09:45 10:00	1	2	0	15	0	10	1	16	31	0	0	0	14	2	12	3	17	31	31
11:30 11:45	3	3	0	17	0	8	0	14	31	0	0	0	6	3	3	3	9	15	23
11:45 12:00	0	10	0	14	0	2	0	13	27	0	0	0	3	2	3	1	6	9	18
12:00 12:15	1	6	0	16	0	4	0	10	26	0	0	0	11	5	10	0	15	26	26
12:15 12:30	2	6	0	11	0	3	2	12	23	0	0	0	6	0	2	1	3	9	16
12:30 12:45	2	0	0	7	0	4	0	5	12	0	0	0	8	1	6	1	8	16	14
12:45 13:00	1	7	0	17	0	6	1	15	32	0	0	0	8	3	6	1	10	18	25
13:00 13:15	1	3	0	8	0	4	0	7	15	0	0	0	6	0	5	0	5	11	13
13:15 13:30	1	4	0	12	0	5	0	12	24	0	0	0	10	2	9	3	14	24	24
15:00 15:15	0	5	0	15	0	7	3	15	30	0	0	0	13	3	10	0	13	26	28
15:15 15:30	0	3	0	13	0	8	1	12	25	0	0	0	13	2	12	0	14	27	26
15:30 15:45	0	7	0	12	0	4	0	12	24	0	0	0	13	1	13	1	15	28	26
15:45 16:00	0	6	0	8	0	2	0	8	16	0	0	0	8	0	8	0	8	16	16
16:00 16:15	0	5	0	8	0	3	1	9	17	0	0	0	10	0	9	0	9	19	18
17:15 17:30	0	1	0	12	0	10	0	11	23	0	0	0	2	1	2	0	3	5	14
17:30 17:45	0	6	0	10	0	3	0	9	19	0	0	0	4	1	4	0	5	9	14
17:45 18:00	0	7	0	13	0	6	0	14	27	0	0	0	2	0	2	1	3	5	16
16:15 16:30	0	3	0	6	0	2	2	7	13	0	0	0	10	1	8	0	9	19	16
16:30 16:45	0	5	0	11	0	6	1	12	23	0	0	0	5	0	4	0	4	9	16
16:45 17:00	1	7	0	16	0	7	1	17	33	0	0	0	3	1	1	2	4	7	20
17:00 17:15	1	4	0	10	0	5	1	10	20	0	0	0	7	0	5	0	5	12	16
Total: None	43	157	0	439	0	183	21	406	845	0	0	0	263	56	199	45	300	563	704



# Transportation Services - Traffic Services

## Turning Movement Count - Study Results

### BANK ST @ CATHERINE ST

**Survey Date:** Thursday, April 19, 2018

**WO No:** 39991

**Start Time:** 07:00

**Device:** Miovision

### Full Study 15 Minute U-Turn Total

#### BANK ST

#### CATHERINE ST

Time Period		Northbound U-Turn Total	Southbound U-Turn Total	Eastbound U-Turn Total	Westbound U-Turn Total	Total
07:00	07:15	0	0	0	0	0
07:15	07:30	0	0	0	0	0
07:30	07:45	0	0	0	0	0
07:45	08:00	0	0	0	0	0
08:00	08:15	0	0	0	0	0
08:15	08:30	0	0	0	0	0
08:30	08:45	0	0	0	0	0
08:45	09:00	0	0	0	0	0
09:00	09:15	0	0	0	0	0
09:15	09:30	0	0	0	0	0
09:30	09:45	0	0	0	0	0
09:45	10:00	0	0	0	1	1
11:30	11:45	0	0	0	0	0
11:45	12:00	0	0	0	0	0
12:00	12:15	0	0	0	0	0
12:15	12:30	0	0	0	0	0
12:30	12:45	0	0	0	0	0
12:45	13:00	0	0	0	0	0
13:00	13:15	0	0	0	0	0
13:15	13:30	0	0	0	0	0
15:00	15:15	0	0	0	0	0
15:15	15:30	0	0	0	0	0
15:30	15:45	0	0	0	0	0
15:45	16:00	0	0	0	0	0
16:00	16:15	0	0	0	0	0
17:15	17:30	0	0	0	0	0
17:30	17:45	0	0	0	0	0
17:45	18:00	0	0	0	0	0
16:15	16:30	0	0	0	0	0
16:30	16:45	0	0	0	0	0
16:45	17:00	0	0	0	0	0
17:00	17:15	0	0	0	0	0
Total		0	0	0	1	1

**Survey Date:** Wednesday, April 18, 2018

**WO No:** 39632

**Start Time:** 07:00

**Device:** Miovision

### Full Study Diagram

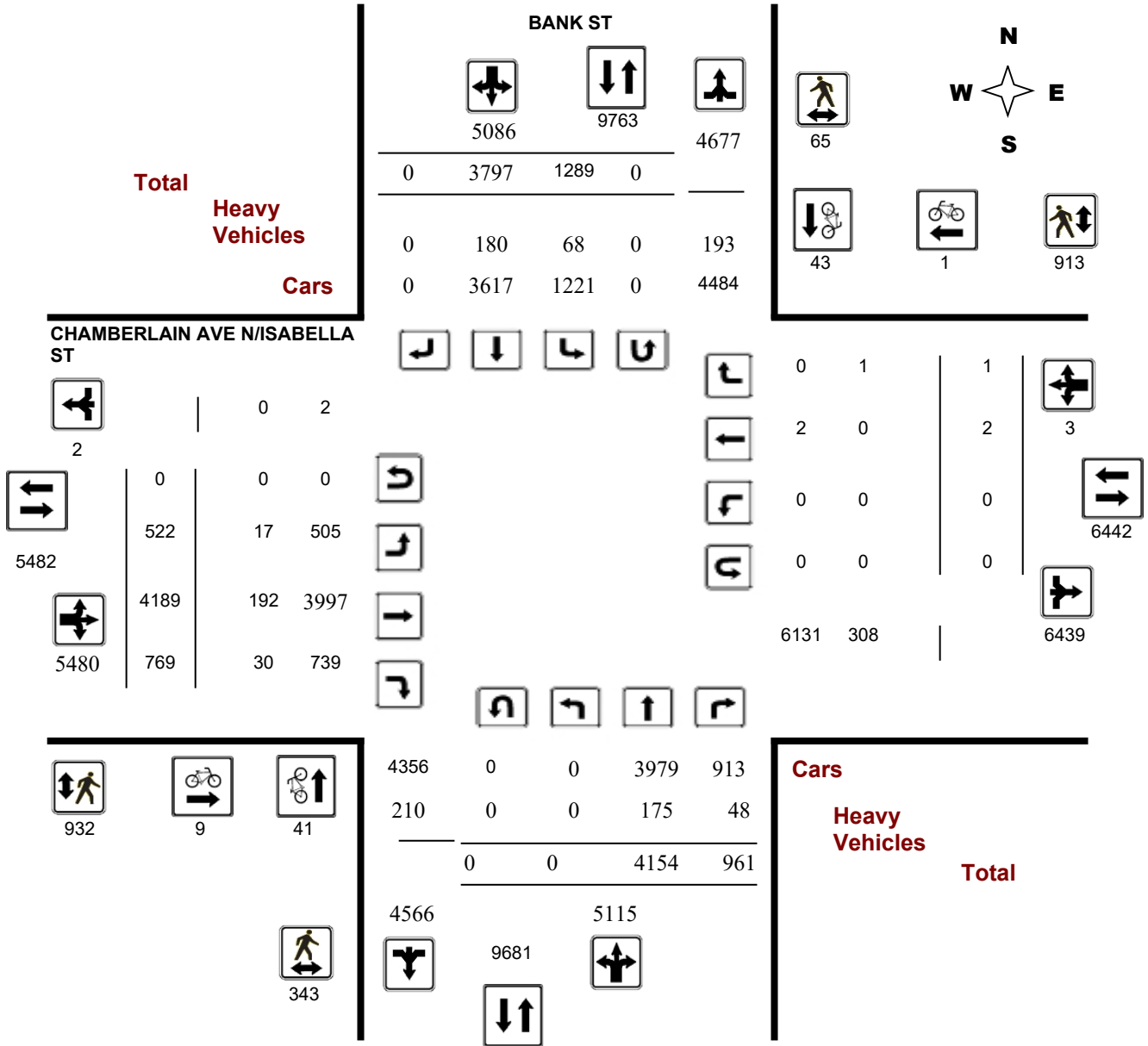

W.O. 5365004 - WED APR 18TH - CONSULTANT - (8HR REIMPORT)

## Turning Movement Count - Study Results

### BANK ST @ CHAMBERLAIN AVE N/ISABELLA ST

**Survey Date:** Wednesday, April 18, 2018

**WO No:** 39632

**Start Time:** 07:00

**Device:** Miovision

### Full Study Peak Hour Diagram

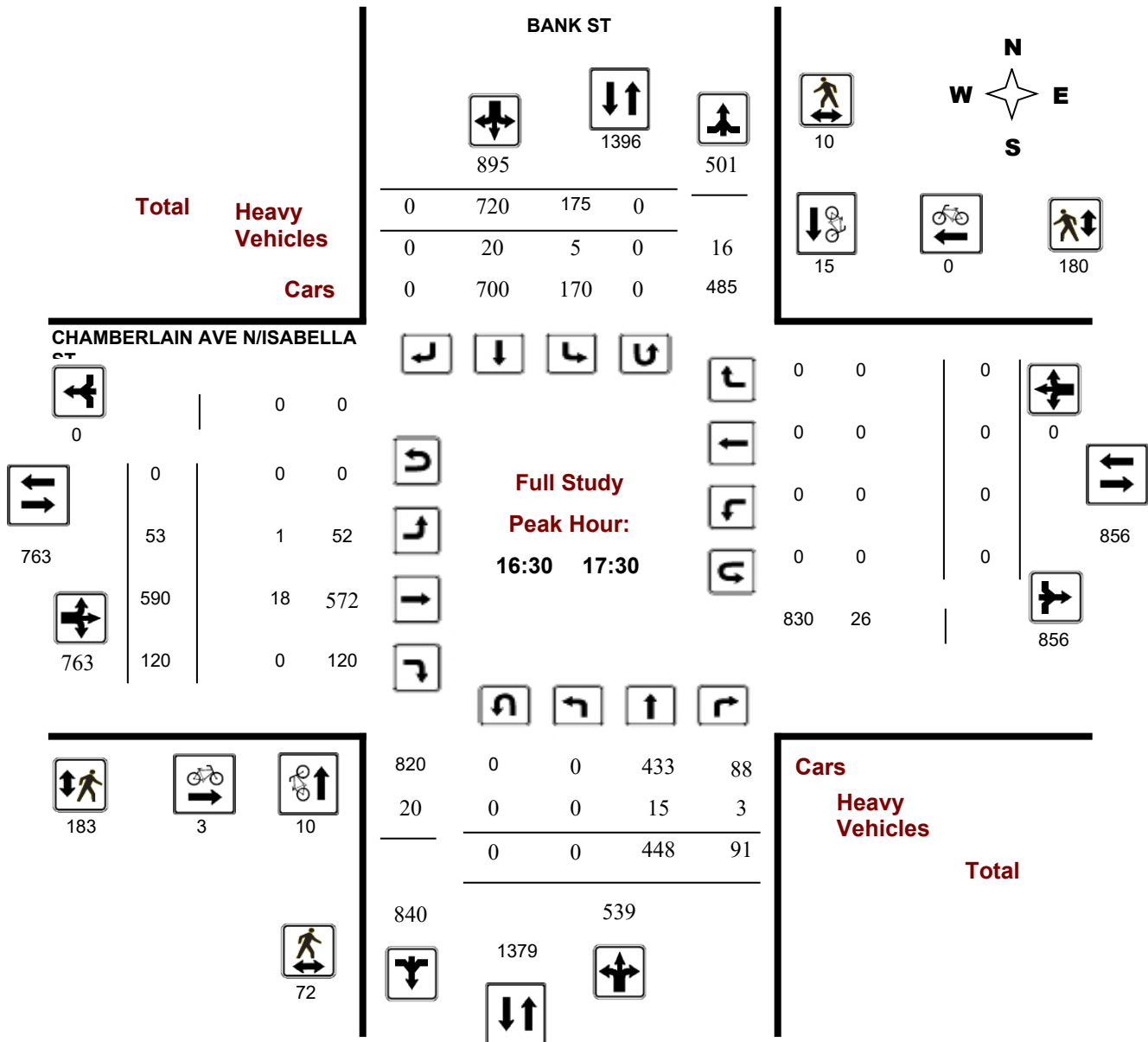

W.O. 5365004 - WED APR 18TH - CONSULTANT - (8HR REIMPORT)

## Turning Movement Count - Peak Hour Diagram

### BANK ST @ CHAMBERLAIN AVE N/ISABELLA ST

**Survey Date:** Wednesday, April 18, 2018

**Start Time:** 07:00

**WO No:** 39632

**Device:** Miovision

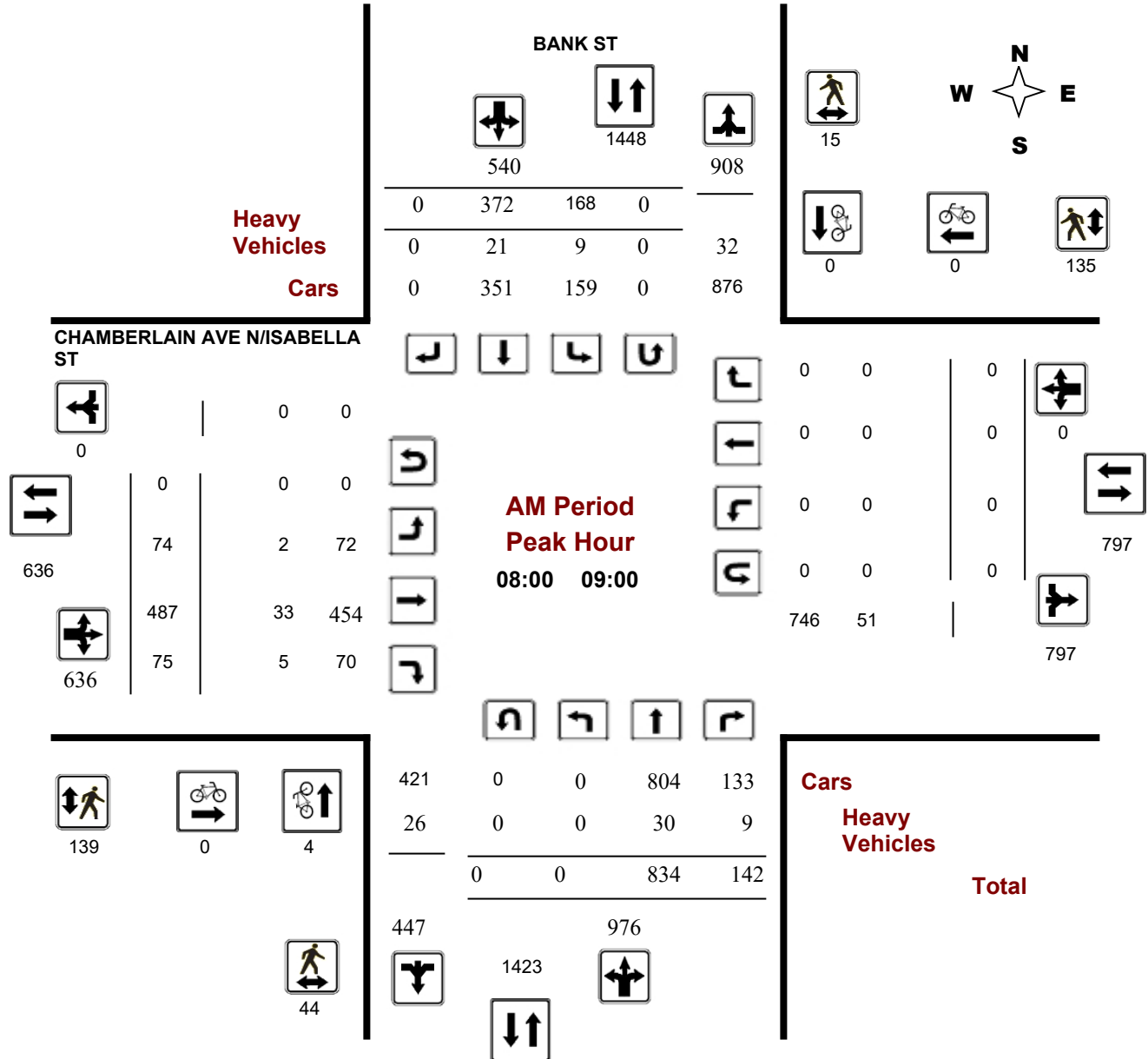

**Comments** W.O. 5365004 - WED APR 18TH - CONSULTANT - (8HR REIMPORT)



## Turning Movement Count - Peak Hour Diagram

### BANK ST @ CHAMBERLAIN AVE N/ISABELLA ST

**Survey Date:** Wednesday, April 18, 2018

**Start Time:** 07:00

**WO No:** 39632

**Device:** Miovision

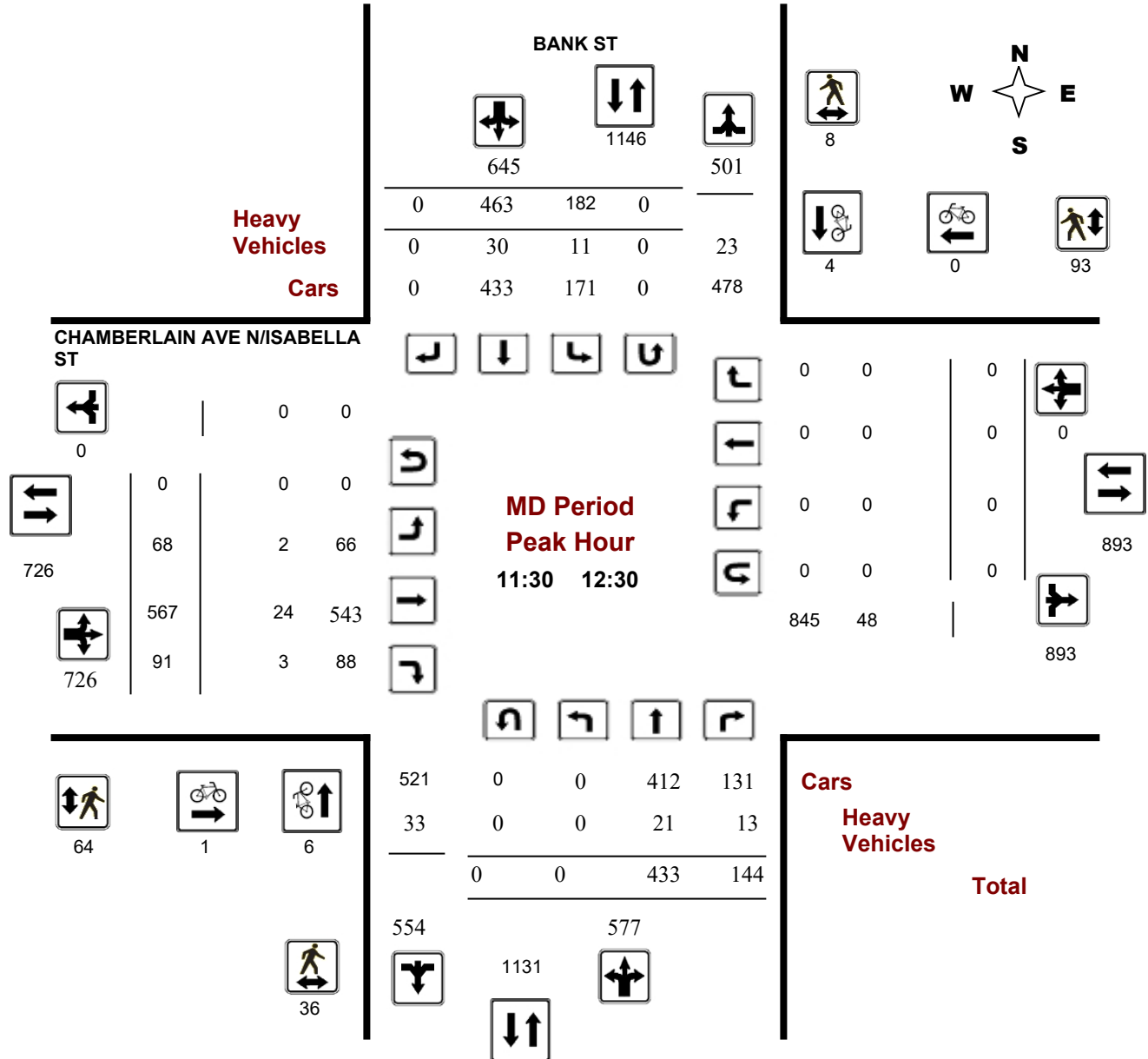

**Comments** W.O. 5365004 - WED APR 18TH - CONSULTANT - (8HR REIMPORT)

## Turning Movement Count - Peak Hour Diagram

### BANK ST @ CHAMBERLAIN AVE N/ISABELLA ST

**Survey Date:** Wednesday, April 18, 2018

**Start Time:** 07:00

**WO No:** 39632

**Device:** Miovision

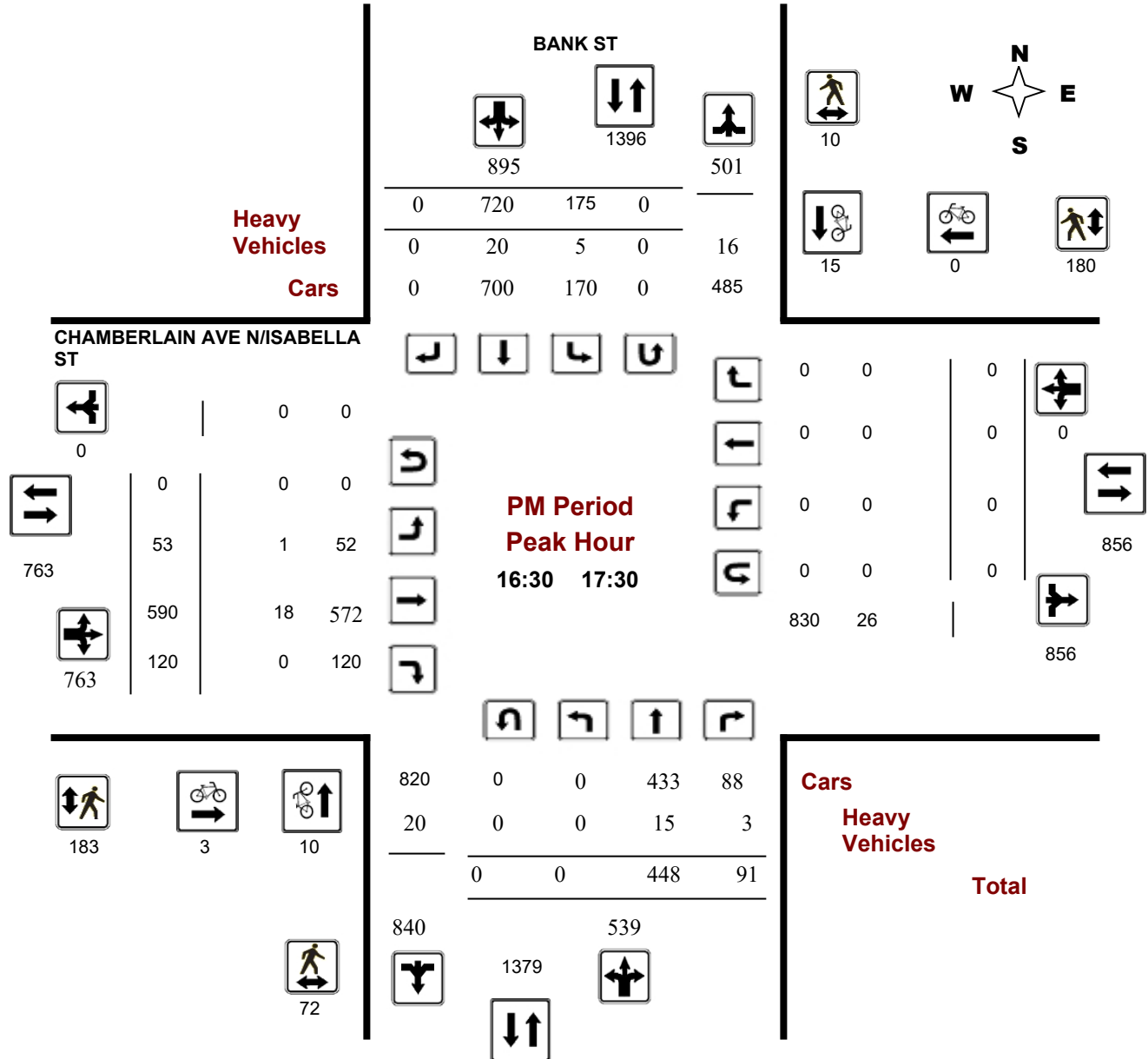

**Comments** W.O. 5365004 - WED APR 18TH - CONSULTANT - (8HR REIMPORT)



# Transportation Services - Traffic Services

## Turning Movement Count - Study Results

### BANK ST @ CHAMBERLAIN AVE N/ISABELLA ST

**Survey Date:** Wednesday, April 18, 2018

**WO No:** 39632

**Start Time:** 07:00

**Device:** Miovision

### Full Study Summary (8 HR Standard)

**Survey Date:** Wednesday, April 18, 2018

**Total Observed U-Turns**  
 Northbound: 0      Southbound: 0  
 Eastbound: 0      Westbound: 0

**AADT Factor**  
 .90

Period	BANK ST									CHAMBERLAIN AVE N/ISABELLA ST									Grand Total
	Northbound			NB TOT	Southbound			SB TOT	STR TOT	Eastbound			EB TOT	Westbound			WB TOT	STR TOT	
	LT	ST	RT		LT	ST	RT			LT	ST	RT		LT	ST	RT			
07:00 08:00	0	655	83	738	105	264	0	369	1107	58	391	56	505	0	2	0	2	507	1614
08:00 09:00	0	834	142	976	168	372	0	540	1516	74	487	75	636	0	0	0	0	636	2152
09:00 10:00	0	471	111	582	158	380	0	538	1120	84	499	68	651	0	0	1	1	652	1772
11:30 12:30	0	433	144	577	182	463	0	645	1222	68	567	91	726	0	0	0	0	726	1948
12:30 13:30	0	429	139	568	135	432	0	567	1135	67	518	115	700	0	0	0	0	700	1835
15:00 16:00	0	441	139	580	185	523	0	708	1288	63	582	126	771	0	0	0	0	771	2059
16:00 17:00	0	442	102	544	174	686	0	860	1404	54	565	99	718	0	0	0	0	718	2122
17:00 18:00	0	449	101	550	182	677	0	859	1409	54	580	139	773	0	0	0	0	773	2182
<b>Sub Total</b>	0	4154	961	5115	1289	3797	0	5086	10201	522	4189	769	5480	0	2	1	3	5483	15684
<b>U Turns</b>				0				0	0				0				0	0	0
<b>Total</b>	0	4154	961	5115	1289	3797	0	5086	10201	522	4189	769	5480	0	2	1	3	5483	15684
<b>EQ 12Hr</b>	0	5774	1336	7110	1792	5278	0	7070	14179	726	5823	1069	7617	0	3	1	4	7621	21801
Note: These values are calculated by multiplying the totals by the appropriate expansion factor.																	<b>1.39</b>		
<b>AVG 12Hr</b>	0	4898	1133	6031	1520	4477	0	5996	12761	615	4939	907	6461	0	2	1	4	6859	19621
Note: These volumes are calculated by multiplying the Equivalent 12 hr. totals by the AADT factor.																	<b>0.9</b>		
<b>AVG 24Hr</b>	0	6416	1484	7900	1991	5864	0	7855	15755	806	6470	1188	8464	0	3	2	5	8469	24224
Note: These volumes are calculated by multiplying the Average Daily 12 hr. totals by 12 to 24 expansion factor.																	<b>1.31</b>		

Note: U-Turns provided for approach totals. Refer to 'U-Turn' Report for specific breakdown.



# Transportation Services - Traffic Services

## Turning Movement Count - Study Results

### BANK ST @ CHAMBERLAIN AVE N/ISABELLA ST

**Survey Date:** Wednesday, April 18, 2018

**WO No:** 39632

**Start Time:** 07:00

**Device:** Miovision

### Full Study 15 Minute Increments

Time Period	BANK ST					CHAMBERLAIN AVE N/ISABELLA S															Grand Total
	Northbound			Southbound		Eastbound					Westbound										
	LT	ST	RT	N TOT	LT	ST	RT	S TOT	STR TOT	LT	ST	RT	E TOT	LT	ST	RT	W TOT	STR TOT			
07:00 07:15	0	118	15	133	24	54	0	78	16	10	74	16	100	0	2	0	2	16	313		
07:15 07:30	0	128	15	143	26	54	0	80	18	15	94	22	131	0	0	0	0	18	354		
07:30 07:45	0	196	21	217	25	78	0	103	11	20	102	10	132	0	0	0	0	11	452		
07:45 08:00	0	213	32	245	30	78	0	108	15	13	121	8	142	0	0	0	0	15	495		
08:00 08:15	0	215	37	252	43	81	0	124	18	21	102	20	143	0	0	0	0	18	519		
08:15 08:30	0	210	31	241	41	83	0	124	16	23	121	15	159	0	0	0	0	16	524		
08:30 08:45	0	214	37	251	41	95	0	136	15	13	118	18	149	0	0	0	0	15	536		
08:45 09:00	0	195	37	232	43	113	0	156	20	17	146	22	185	0	0	0	0	20	573		
09:00 09:15	0	143	45	188	34	87	0	121	22	21	142	16	179	0	0	0	0	22	488		
09:15 09:30	0	113	27	140	37	98	0	135	20	23	141	11	175	0	0	1	1	20	451		
09:30 09:45	0	109	14	123	59	94	0	153	22	15	109	19	143	0	0	0	0	22	419		
09:45 10:00	0	106	25	131	28	101	0	129	20	25	107	22	154	0	0	0	0	20	414		
11:30 11:45	0	110	30	140	36	124	0	160	19	21	137	18	176	0	0	0	0	19	476		
11:45 12:00	0	117	27	144	50	106	0	156	16	12	144	28	184	0	0	0	0	16	484		
12:00 12:15	0	111	38	149	50	104	0	154	19	20	151	21	192	0	0	0	0	19	495		
12:15 12:30	0	95	49	144	46	129	0	175	21	15	135	24	174	0	0	0	0	21	493		
12:30 12:45	0	100	31	131	39	109	0	148	12	18	139	20	177	0	0	0	0	12	456		
12:45 13:00	0	117	37	154	28	105	0	133	14	17	120	30	167	0	0	0	0	14	454		
13:00 13:15	0	98	40	138	34	112	0	146	12	21	141	22	184	0	0	0	0	12	468		
13:15 13:30	0	114	31	145	34	106	0	140	15	11	118	43	172	0	0	0	0	15	457		
15:00 15:15	0	120	38	158	45	114	0	159	12	16	148	28	192	0	0	0	0	12	509		
15:15 15:30	0	114	33	147	51	120	0	171	14	17	141	32	190	0	0	0	0	14	508		
15:30 15:45	0	98	38	136	40	131	0	171	6	13	137	41	191	0	0	0	0	6	498		
15:45 16:00	0	109	30	139	49	158	0	207	13	17	156	25	198	0	0	0	0	13	544		
16:00 16:15	0	132	27	159	35	163	0	198	10	13	133	34	180	0	0	0	0	10	537		
16:15 16:30	0	102	28	130	50	165	0	215	12	14	137	22	173	0	0	0	0	12	518		
16:30 16:45	0	98	25	123	46	179	0	225	15	17	153	26	196	0	0	0	0	15	544		
16:45 17:00	0	110	22	132	43	179	0	222	9	10	142	17	169	0	0	0	0	9	523		
17:00 17:15	0	117	24	141	43	174	0	217	10	12	156	35	203	0	0	0	0	10	561		
17:15 17:30	0	123	20	143	43	188	0	231	9	14	139	42	195	0	0	0	0	9	569		
17:30 17:45	0	100	24	124	50	148	0	198	12	18	141	40	199	0	0	0	0	12	521		
17:45 18:00	0	109	33	142	46	167	0	213	8	10	144	22	176	0	0	0	0	8	531		
<b>Total:</b>	<b>0</b>	<b>4154</b>	<b>961</b>	<b>5115</b>	<b>1289</b>	<b>3797</b>	<b>0</b>	<b>5086</b>	<b>471</b>	<b>522</b>	<b>4189</b>	<b>769</b>	<b>5480</b>	<b>0</b>	<b>2</b>	<b>1</b>	<b>3</b>	<b>471</b>	<b>15,684</b>		

Note: U-Turns are included in Totals.



# Transportation Services - Traffic Services

## Turning Movement Count - Study Results

### BANK ST @ CHAMBERLAIN AVE N/ISABELLA ST

**Survey Date:** Wednesday, April 18, 2018

**WO No:** 39632

**Start Time:** 07:00

**Device:** Miovision

### Full Study Cyclist Volume

Time Period	BANK ST			CHAMBERLAIN AVE N/ISABELLA ST			Grand Total
	Northbound	Southbound	Street Total	Eastbound	Westbound	Street Total	
07:00 07:15	0	1	1	0	0	0	1
07:15 07:30	0	0	0	0	0	0	0
07:30 07:45	2	0	2	0	0	0	2
07:45 08:00	0	1	1	0	0	0	1
08:00 08:15	1	0	1	0	0	0	1
08:15 08:30	0	0	0	0	0	0	0
08:30 08:45	0	0	0	0	0	0	0
08:45 09:00	3	0	3	0	0	0	3
09:00 09:15	1	0	1	0	0	0	1
09:15 09:30	0	2	2	1	0	1	3
09:30 09:45	1	0	1	0	1	1	2
09:45 10:00	0	0	0	0	0	0	0
11:30 11:45	2	1	3	0	0	0	3
11:45 12:00	1	1	2	1	0	1	3
12:00 12:15	2	0	2	0	0	0	2
12:15 12:30	1	2	3	0	0	0	3
12:30 12:45	0	1	1	0	0	0	1
12:45 13:00	2	0	2	0	0	0	2
13:00 13:15	0	0	0	0	0	0	0
13:15 13:30	1	1	2	0	0	0	2
15:00 15:15	2	2	4	2	0	2	6
15:15 15:30	2	3	5	0	0	0	5
15:30 15:45	3	1	4	0	0	0	4
15:45 16:00	0	2	2	0	0	0	2
16:00 16:15	3	5	8	0	0	0	8
16:15 16:30	0	1	1	0	0	0	1
16:30 16:45	3	4	7	2	0	2	9
16:45 17:00	4	4	8	0	0	0	8
17:00 17:15	1	2	3	1	0	1	4
17:15 17:30	2	5	7	0	0	0	7
17:30 17:45	2	1	3	1	0	1	4
17:45 18:00	2	3	5	1	0	1	6
<b>Total</b>	<b>41</b>	<b>43</b>	<b>84</b>	<b>9</b>	<b>1</b>	<b>10</b>	<b>94</b>



# Transportation Services - Traffic Services

## Turning Movement Count - Study Results

### BANK ST @ CHAMBERLAIN AVE N/ISABELLA ST

**Survey Date:** Wednesday, April 18, 2018

**WO No:** 39632

**Start Time:** 07:00

**Device:** Miovision

### Full Study Pedestrian Volume

#### BANK ST

#### CHAMBERLAIN AVE N/ISABELLA S

Time Period	NB Approach (E or W Crossing)	SB Approach (E or W Crossing)	Total	EB Approach (N or S Crossing)	WB Approach (N or S Crossing)	Total	Grand Total
07:00 07:15	6	1	7	11	7	18	25
07:15 07:30	5	2	7	8	14	22	29
07:30 07:45	5	0	5	18	15	33	38
07:45 08:00	4	2	6	19	17	36	42
08:00 08:15	5	2	7	17	32	49	56
08:15 08:30	18	3	21	29	28	57	78
08:30 08:45	12	5	17	60	43	103	120
08:45 09:00	9	5	14	33	32	65	79
09:00 09:15	7	1	8	19	23	42	50
09:15 09:30	7	5	12	13	24	37	49
09:30 09:45	0	1	1	16	12	28	29
09:45 10:00	23	0	23	31	16	47	70
11:30 11:45	8	1	9	13	19	32	41
11:45 12:00	5	2	7	15	25	40	47
12:00 12:15	17	2	19	15	30	45	64
12:15 12:30	6	3	9	21	19	40	49
12:30 12:45	8	2	10	16	29	45	55
12:45 13:00	9	1	10	18	20	38	48
13:00 13:15	3	1	4	22	21	43	47
13:15 13:30	6	0	6	20	31	51	57
15:00 15:15	12	1	13	24	24	48	61
15:15 15:30	21	0	21	95	28	123	144
15:30 15:45	7	1	8	26	31	57	65
15:45 16:00	10	2	12	27	32	59	71
16:00 16:15	15	1	16	23	29	52	68
16:15 16:30	13	5	18	49	41	90	108
16:30 16:45	16	2	18	39	49	88	106
16:45 17:00	19	2	21	46	34	80	101
17:00 17:15	21	3	24	43	43	86	110
17:15 17:30	16	3	19	55	54	109	128
17:30 17:45	19	5	24	50	50	100	124
17:45 18:00	11	1	12	41	41	82	94
<b>Total .....</b>	<b>343</b>	<b>65</b>	<b>408</b>	<b>932</b>	<b>913</b>	<b>1845</b>	<b>2253</b>

W.O. 5365004 - WED APR 18TH - CONSULTANT - (8HR REIMPORT)



# Transportation Services - Traffic Services

## Turning Movement Count - Study Results

### BANK ST @ CHAMBERLAIN AVE N/ISABELLA ST

**Survey Date:** Wednesday, April 18, 2018

**WO No:** 39632

**Start Time:** 07:00

**Device:** Miovision

### Full Study Heavy Vehicles

#### BANK ST

#### CHAMBERLAIN AVE N/ISABELLA S

Northbound

Southbound

Eastbound

Westbound

Time Period	Northbound			N TOT	Southbound			S TOT	STR TOT	Eastbound			E TOT	Westbound			W TOT	STR TOT	Grand Total
	LT	ST	RT		LT	ST	RT			LT	ST	RT		LT	ST	RT			
07:00 07:15	0	7	0	7	0	9	0	9	16	0	5	1	6	0	0	0	0	6	22
07:15 07:30	0	9	1	10	1	7	0	8	18	0	6	1	7	0	0	0	0	7	25
07:30 07:45	0	6	0	6	1	4	0	5	11	1	4	1	6	0	0	0	0	6	17
07:45 08:00	0	6	3	9	3	3	0	6	15	0	2	0	2	0	0	0	0	2	17
08:00 08:15	0	8	1	9	4	5	0	9	18	0	8	1	9	0	0	0	0	9	27
08:15 08:30	0	6	3	9	0	7	0	7	16	0	4	0	4	0	0	0	0	4	20
08:30 08:45	0	6	1	7	4	4	0	8	15	1	8	3	12	0	0	0	0	12	27
08:45 09:00	0	10	4	14	1	5	0	6	20	1	13	1	15	0	0	0	0	15	35
09:00 09:15	0	5	6	11	5	6	0	11	22	2	7	1	10	0	0	0	0	10	32
09:15 09:30	0	8	3	11	1	8	0	9	20	3	11	0	14	0	0	1	1	15	35
09:30 09:45	0	6	1	7	6	9	0	15	22	1	7	3	11	0	0	0	0	11	33
09:45 10:00	0	4	1	5	5	10	0	15	20	0	3	3	6	0	0	0	0	6	26
11:30 11:45	0	2	6	8	1	10	0	11	19	1	7	1	9	0	0	0	0	9	28
11:45 12:00	0	6	2	8	1	7	0	8	16	0	5	0	5	0	0	0	0	5	21
12:00 12:15	0	9	1	10	4	5	0	9	19	0	4	0	4	0	0	0	0	4	23
12:15 12:30	0	4	4	8	5	8	0	13	21	1	8	2	11	0	0	0	0	11	32
12:30 12:45	0	3	2	5	1	6	0	7	12	0	4	1	5	0	0	0	0	5	17
12:45 13:00	0	6	1	7	2	5	0	7	14	0	5	3	8	0	0	0	0	8	22
13:00 13:15	0	4	1	5	3	4	0	7	12	1	9	0	10	0	0	0	0	10	22
13:15 13:30	0	7	1	8	2	5	0	7	15	0	7	2	9	0	0	0	0	9	24
15:00 15:15	0	6	0	6	0	6	0	6	12	0	8	0	8	0	0	0	0	8	20
15:15 15:30	0	3	1	4	1	9	0	10	14	1	4	1	6	0	0	0	0	6	20
15:30 15:45	0	3	0	3	2	1	0	3	6	0	4	1	5	0	0	0	0	5	11
15:45 16:00	0	6	0	6	3	4	0	7	13	1	4	1	6	0	0	0	0	6	19
16:00 16:15	0	5	1	6	0	4	0	4	10	1	8	2	11	0	0	0	0	11	21
16:15 16:30	0	5	0	5	5	2	0	7	12	1	6	0	7	0	0	0	0	7	19
16:30 16:45	0	6	1	7	2	6	0	8	15	1	1	0	2	0	0	0	0	2	17
16:45 17:00	0	4	1	5	2	2	0	4	9	0	5	0	5	0	0	0	0	5	14
17:00 17:15	0	4	0	4	0	6	0	6	10	0	6	0	6	0	0	0	0	6	16
17:15 17:30	0	1	1	2	1	6	0	7	9	0	6	0	6	0	0	0	0	6	15
17:30 17:45	0	5	1	6	1	5	0	6	12	0	6	1	7	0	0	0	0	7	19
17:45 18:00	0	5	0	5	1	2	0	3	8	0	7	0	7	0	0	0	0	7	15
Total: None	0	175	48	223	68	180	0	248	471	17	192	30	239	0	0	1	1	240	711



# Transportation Services - Traffic Services

## Turning Movement Count - Study Results

### BANK ST @ CHAMBERLAIN AVE N/ISABELLA ST

**Survey Date:** Wednesday, April 18, 2018

**WO No:** 39632

**Start Time:** 07:00

**Device:** Miovision

### Full Study 15 Minute U-Turn Total

**BANK ST**

**CHAMBERLAIN AVE N/ISABELLA S**

Time Period		Northbound U-Turn Total	Southbound U-Turn Total	Eastbound U-Turn Total	Westbound U-Turn Total	Total
07:00	07:15	0	0	0	0	0
07:15	07:30	0	0	0	0	0
07:30	07:45	0	0	0	0	0
07:45	08:00	0	0	0	0	0
08:00	08:15	0	0	0	0	0
08:15	08:30	0	0	0	0	0
08:30	08:45	0	0	0	0	0
08:45	09:00	0	0	0	0	0
09:00	09:15	0	0	0	0	0
09:15	09:30	0	0	0	0	0
09:30	09:45	0	0	0	0	0
09:45	10:00	0	0	0	0	0
11:30	11:45	0	0	0	0	0
11:45	12:00	0	0	0	0	0
12:00	12:15	0	0	0	0	0
12:15	12:30	0	0	0	0	0
12:30	12:45	0	0	0	0	0
12:45	13:00	0	0	0	0	0
13:00	13:15	0	0	0	0	0
13:15	13:30	0	0	0	0	0
15:00	15:15	0	0	0	0	0
15:15	15:30	0	0	0	0	0
15:30	15:45	0	0	0	0	0
15:45	16:00	0	0	0	0	0
16:00	16:15	0	0	0	0	0
16:15	16:30	0	0	0	0	0
16:30	16:45	0	0	0	0	0
16:45	17:00	0	0	0	0	0
17:00	17:15	0	0	0	0	0
17:15	17:30	0	0	0	0	0
17:30	17:45	0	0	0	0	0
17:45	18:00	0	0	0	0	0
Total		0	0	0	0	0





## Turning Movement Count - Study Results

### BRONSON AVE @ CATHERINE ST/RAYMOND ST

**Survey Date:** Thursday, April 19, 2018

**WO No:** 39598

**Start Time:** 07:00

**Device:** Miovision

### Full Study Peak Hour Diagram

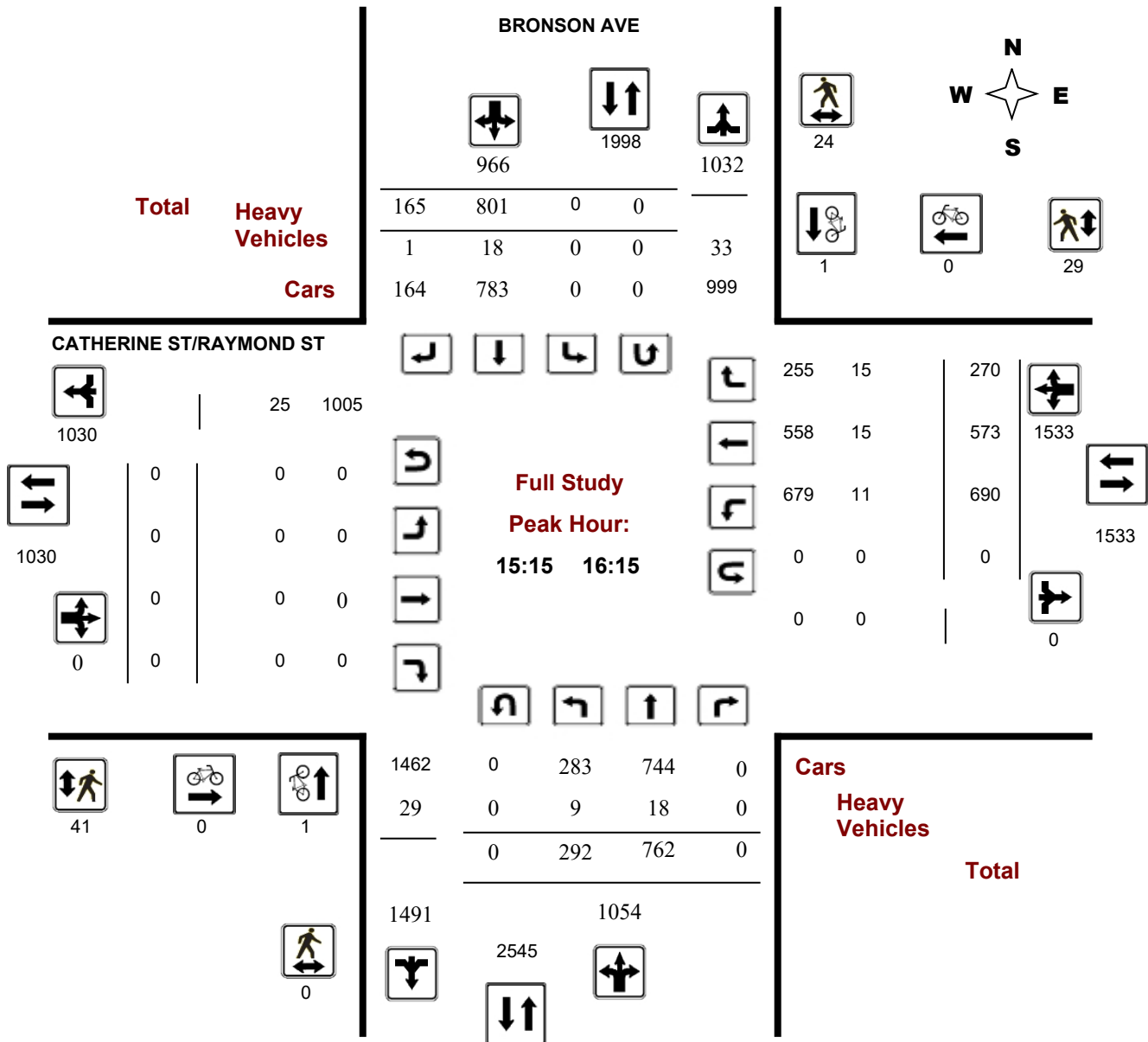

W.O. 5365004 - THURS APR 19TH - CONSULTANT - 48 HRS (REIMPORT - 8HR STANDARD)

## Turning Movement Count - Peak Hour Diagram

### BRONSON AVE @ CATHERINE ST/RAYMOND ST

**Survey Date:** Thursday, April 19, 2018

**Start Time:** 07:00

**WO No:** 39598

**Device:** Miovision

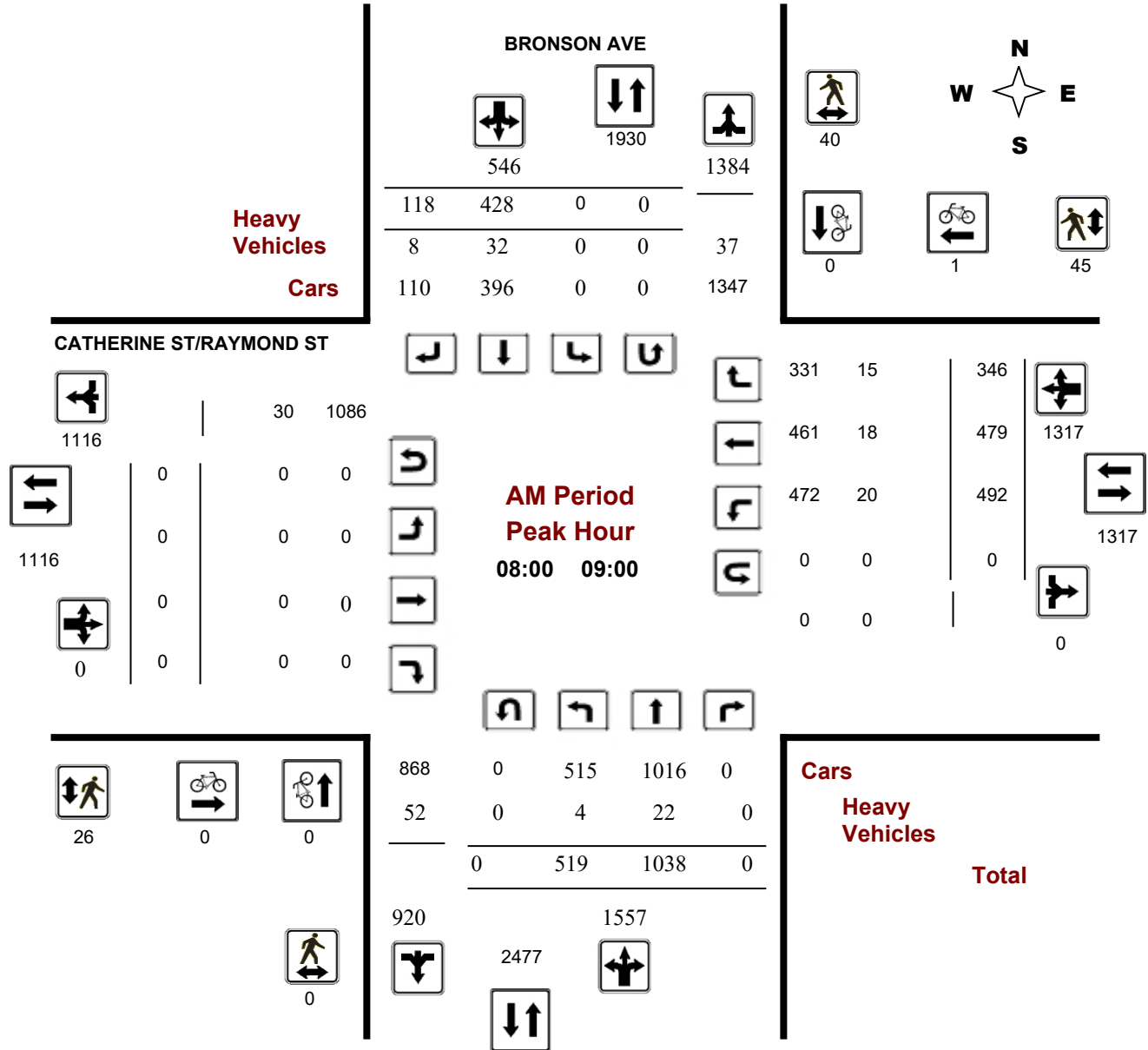

**Comments** W.O. 5365004 - THURS APR 19TH - CONSULTANT - 48 HRS (REIMPORT - 8HR STANDAR

## Turning Movement Count - Peak Hour Diagram

### BRONSON AVE @ CATHERINE ST/RAYMOND ST

**Survey Date:** Thursday, April 19, 2018

**Start Time:** 07:00

**WO No:** 39598

**Device:** Miovision

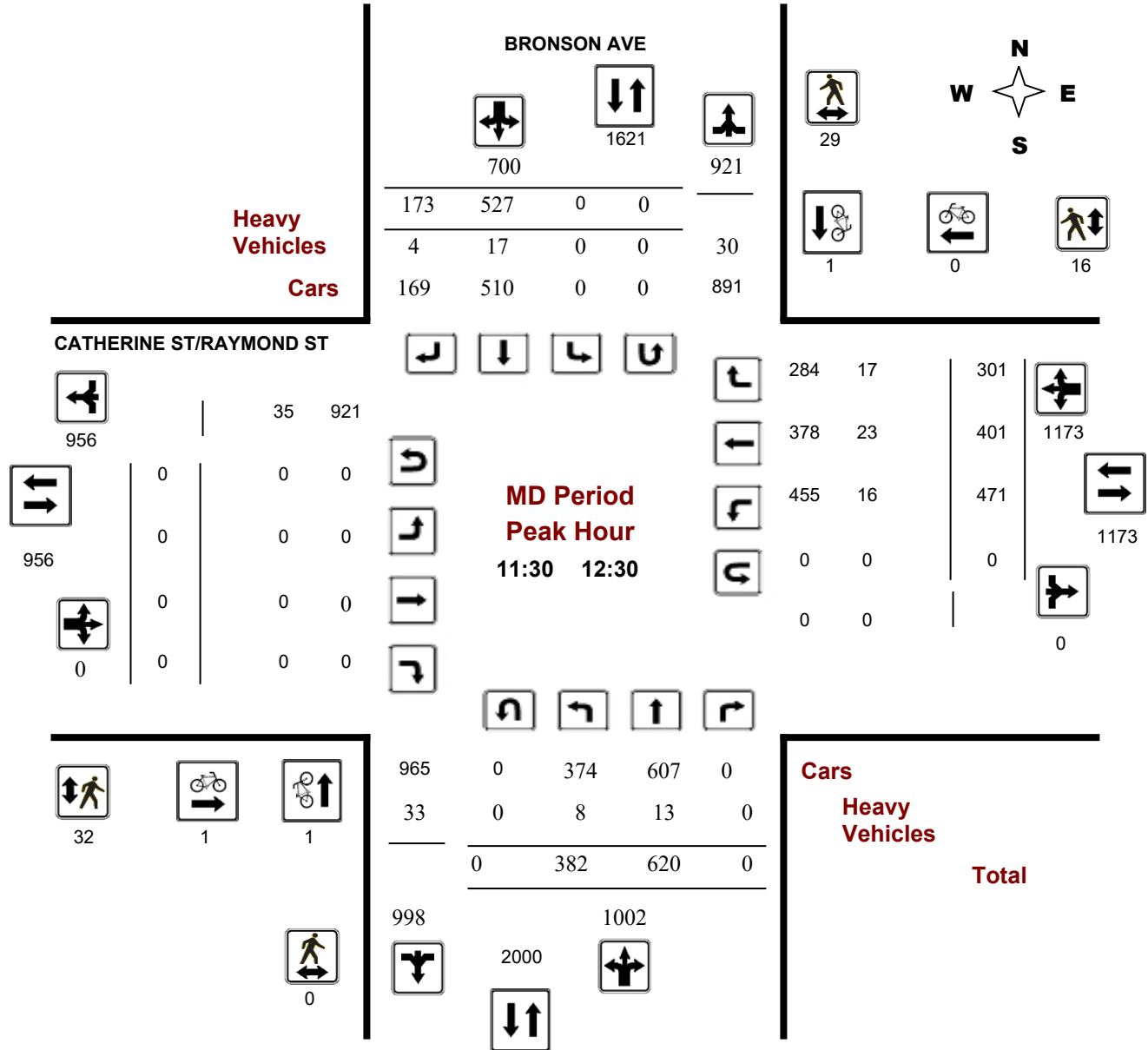

**Comments** W.O. 5365004 - THURS APR 19TH - CONSULTANT - 48 HRS (REIMPORT - 8HR STANDAR

## Turning Movement Count - Peak Hour Diagram

### BRONSON AVE @ CATHERINE ST/RAYMOND ST

**Survey Date:** Thursday, April 19, 2018

**Start Time:** 07:00

**WO No:** 39598

**Device:** Miovision

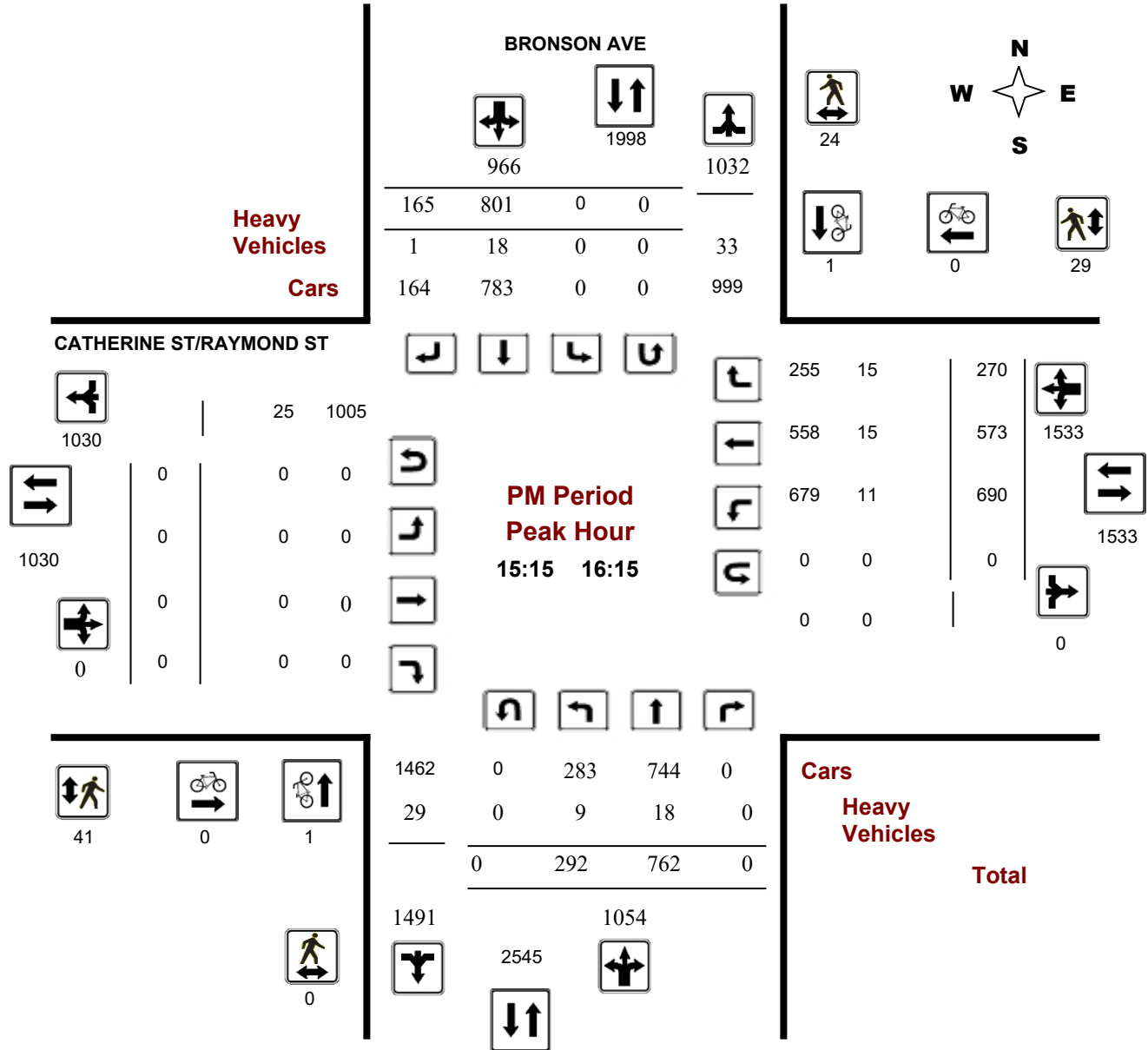

**Comments** W.O. 5365004 - THURS APR 19TH - CONSULTANT - 48 HRS (REIMPORT - 8HR STANDAR



# Transportation Services - Traffic Services

## Turning Movement Count - Study Results

### BRONSON AVE @ CATHERINE ST/RAYMOND ST

**Survey Date:** Thursday, April 19, 2018

**WO No:** 39598

**Start Time:** 07:00

**Device:** Miovision

### Full Study Summary (8 HR Standard)

**Survey Date:** Thursday, April 19, 2018

**Total Observed U-Turns**

**AADT Factor**

Northbound: 0      Southbound: 0

.90

Eastbound: 0      Westbound: 0

#### BRONSON AVE

#### CATHERINE ST/RAYMOND ST

Period	Northbound					Southbound					Eastbound					Westbound					Grand Total
	LT	ST	RT	NB TOT	LT	ST	RT	SB TOT	STR TOT	LT	ST	RT	EB TOT	LT	ST	RT	WB TOT	STR TOT			
07:00 08:00	478	846	0	1324	0	428	140	568	1892	0	0	0	0	465	446	345	1256	1256	3148		
08:00 09:00	519	1038	0	1557	0	428	118	546	2103	0	0	0	0	492	479	346	1317	1317	3420		
09:00 10:00	387	699	0	1086	0	406	133	539	1625	0	0	0	0	480	403	329	1212	1212	2837		
11:30 12:30	382	620	0	1002	0	527	173	700	1702	0	0	0	0	471	401	301	1173	1173	2875		
12:30 13:30	349	568	0	917	0	560	167	727	1644	0	0	0	0	484	321	310	1115	1115	2759		
15:00 16:00	299	747	0	1046	0	783	177	960	2006	0	0	0	0	697	517	299	1513	1513	3519		
16:00 17:00	265	813	0	1078	0	733	130	863	1941	0	0	0	0	677	638	248	1563	1563	3504		
17:00 18:00	281	725	0	1006	0	727	147	874	1880	0	0	0	0	662	438	310	1410	1410	3290		
<b>Sub Total</b>	2960	6056	0	9016	0	4592	1185	5777	14793	0	0	0	0	4428	3643	2488	10559	10559	25352		
<b>U Turns</b>				0				0	0				0				0	0	0		
<b>Total</b>	2960	6056	0	9016	0	4592	1185	5777	14793	0	0	0	0	4428	3643	2488	10559	10559	25352		
<b>EQ 12Hr</b>	4114	8418	0	12532	0	6383	1647	8030	20562	0	0	0	0	6155	5064	3458	14677	14677	35239		
Note: These values are calculated by multiplying the totals by the appropriate expansion factor.													<b>1.39</b>								
<b>AVG 12Hr</b>	3490	7140	0	10630	0	5414	1397	6811	18506	0	0	0	0	5221	4295	2933	12449	13209	31715		
Note: These volumes are calculated by multiplying the Equivalent 12 hr. totals by the AADT factor.													<b>0.9</b>								
<b>AVG 24Hr</b>	4572	9353	0	13925	0	7092	1830	8923	22848	0	0	0	0	6839	5627	3843	16308	16308	39156		

Note: These volumes are calculated by multiplying the Average Daily 12 hr. totals by 12 to 24 expansion factor. **1.31**

Note: U-Turns provided for approach totals. Refer to 'U-Turn' Report for specific breakdown.



# Transportation Services - Traffic Services

## Turning Movement Count - Study Results

### BRONSON AVE @ CATHERINE ST/RAYMOND ST

**Survey Date:** Thursday, April 19, 2018

**WO No:** 39598

**Start Time:** 07:00

**Device:** Miovision

### Full Study 15 Minute Increments

#### BRONSON AVE

#### CATHERINE ST/RAYMOND ST

Northbound

Southbound

Eastbound

Westbound

Time Period	LT	ST	RT	N TOT	LT	ST	RT	S TOT	STR TOT	LT	ST	RT	E TOT	LT	ST	RT	W TOT	STR TOT	Grand Total
07:00 07:15	92	184	0	276	0	99	31	130	883	0	0	0	0	103	112	91	306	883	712
07:15 07:30	120	223	0	343	0	115	38	153	1036	0	0	0	0	113	99	89	301	1036	797
07:30 07:45	143	228	0	371	0	107	41	148	1061	0	0	0	0	118	115	89	322	1061	841
07:45 08:00	123	211	0	334	0	107	30	137	996	0	0	0	0	131	120	76	327	996	798
08:00 08:15	129	244	0	373	0	106	31	137	1064	0	0	0	0	131	122	73	326	1064	836
08:15 08:30	124	267	0	391	0	104	31	135	1119	0	0	0	0	132	125	90	347	1119	873
08:30 08:45	125	262	0	387	0	109	23	132	1118	0	0	0	0	136	128	92	356	1118	875
08:45 09:00	141	265	0	406	0	109	33	142	1106	0	0	0	0	93	104	91	288	1106	836
09:00 09:15	129	207	0	336	0	87	25	112	967	0	0	0	0	120	128	105	353	967	801
09:15 09:30	88	179	0	267	0	124	37	161	942	0	0	0	0	132	107	79	318	942	746
09:30 09:45	81	164	0	245	0	107	39	146	838	0	0	0	0	106	90	70	266	838	657
09:45 10:00	89	149	0	238	0	88	32	120	792	0	0	0	0	122	78	75	275	792	633
11:30 11:45	97	165	0	262	0	104	40	144	874	0	0	0	0	117	107	82	306	874	712
11:45 12:00	93	134	0	227	0	109	48	157	829	0	0	0	0	117	108	85	310	829	694
12:00 12:15	99	143	0	242	0	167	42	209	934	0	0	0	0	104	98	69	271	934	722
12:15 12:30	93	178	0	271	0	147	43	190	984	0	0	0	0	133	88	65	286	984	747
12:30 12:45	90	140	0	230	0	139	33	172	895	0	0	0	0	124	87	90	301	895	703
12:45 13:00	84	139	0	223	0	103	45	148	806	0	0	0	0	126	78	67	271	806	642
13:00 13:15	84	148	0	232	0	168	46	214	957	0	0	0	0	118	71	77	266	957	712
13:15 13:30	91	141	0	232	0	150	43	193	908	0	0	0	0	116	85	76	277	908	702
15:00 15:15	73	192	0	265	0	174	47	221	1117	0	0	0	0	184	104	81	369	1117	855
15:15 15:30	77	183	0	260	0	195	41	236	1124	0	0	0	0	169	136	81	386	1124	882
15:30 15:45	69	175	0	244	0	214	48	262	1156	0	0	0	0	191	139	70	400	1156	906
15:45 16:00	80	197	0	277	0	200	41	241	1135	0	0	0	0	153	138	67	358	1135	876
16:00 16:15	66	207	0	273	0	192	35	227	1128	0	0	0	0	177	160	52	389	1128	889
16:15 16:30	78	190	0	268	0	184	28	212	1084	0	0	0	0	183	170	47	400	1084	880
16:30 16:45	63	203	0	266	0	191	40	231	1122	0	0	0	0	157	162	74	393	1122	890
16:45 17:00	58	213	0	271	0	166	27	193	1078	0	0	0	0	160	146	75	381	1078	845
17:00 17:15	51	179	0	230	0	185	30	215	1066	0	0	0	0	174	138	83	395	1066	840
17:15 17:30	73	199	0	272	0	178	36	214	1121	0	0	0	0	173	119	85	377	1121	863
17:30 17:45	76	174	0	250	0	208	39	247	1103	0	0	0	0	150	89	74	313	1103	810
17:45 18:00	81	173	0	254	0	156	42	198	1014	0	0	0	0	165	92	68	325	1014	777
<b>Total:</b>	<b>2960</b>	<b>6056</b>	<b>0</b>	<b>9016</b>	<b>0</b>	<b>4592</b>	<b>1185</b>	<b>5777</b>	<b>32357</b>	<b>0</b>	<b>0</b>	<b>0</b>	<b>0</b>	<b>4428</b>	<b>3643</b>	<b>2488</b>	<b>10559</b>	<b>32357</b>	<b>25,352</b>

Note: U-Turns are included in Totals.



# Transportation Services - Traffic Services

## Turning Movement Count - Study Results

### BRONSON AVE @ CATHERINE ST/RAYMOND ST

**Survey Date:** Thursday, April 19, 2018

**WO No:** 39598

**Start Time:** 07:00

**Device:** Miovision

### Full Study Cyclist Volume

Time Period	BRONSON AVE			CATHERINE ST/RAYMOND ST			Grand Total
	Northbound	Southbound	Street Total	Eastbound	Westbound	Street Total	
07:00 07:15	1	0	1	0	0	0	1
07:15 07:30	1	0	1	0	0	0	1
07:30 07:45	0	0	0	0	0	0	0
07:45 08:00	0	0	0	0	1	1	1
08:00 08:15	0	0	0	0	1	1	1
08:15 08:30	0	0	0	0	0	0	0
08:30 08:45	0	0	0	0	0	0	0
08:45 09:00	0	0	0	0	0	0	0
09:00 09:15	1	0	1	0	0	0	1
09:15 09:30	0	0	0	0	0	0	0
09:30 09:45	0	0	0	0	0	0	0
09:45 10:00	0	0	0	0	0	0	0
11:30 11:45	0	0	0	1	0	1	1
11:45 12:00	0	0	0	0	0	0	0
12:00 12:15	1	1	2	0	0	0	2
12:15 12:30	0	0	0	0	0	0	0
12:30 12:45	2	1	3	0	0	0	3
12:45 13:00	0	0	0	0	2	2	2
13:00 13:15	0	0	0	0	0	0	0
13:15 13:30	0	0	0	0	0	0	0
15:00 15:15	0	0	0	0	0	0	0
15:15 15:30	0	0	0	0	0	0	0
15:30 15:45	0	0	0	0	0	0	0
15:45 16:00	0	0	0	0	0	0	0
16:00 16:15	1	1	2	0	0	0	2
16:15 16:30	1	1	2	0	0	0	2
16:30 16:45	1	0	1	0	0	0	1
16:45 17:00	0	2	2	0	0	0	2
17:00 17:15	0	0	0	0	0	0	0
17:15 17:30	1	1	2	0	1	1	3
17:30 17:45	0	0	0	0	0	0	0
17:45 18:00	0	0	0	0	1	1	1
<b>Total</b>	<b>10</b>	<b>7</b>	<b>17</b>	<b>1</b>	<b>6</b>	<b>7</b>	<b>24</b>





# Transportation Services - Traffic Services

## Turning Movement Count - Study Results

### BRONSON AVE @ CATHERINE ST/RAYMOND ST

**Survey Date:** Thursday, April 19, 2018

**WO No:** 39598

**Start Time:** 07:00

**Device:** Miovision

### Full Study Pedestrian Volume

#### BRONSON AVE

#### CATHERINE ST/RAYMOND ST

Time Period	NB Approach (E or W Crossing)	SB Approach (E or W Crossing)	Total	EB Approach (N or S Crossing)	WB Approach (N or S Crossing)	Total	Grand Total
07:00 07:15	0	2	2	3	6	9	11
07:15 07:30	0	6	6	5	6	11	17
07:30 07:45	0	6	6	4	5	9	15
07:45 08:00	0	2	2	4	9	13	15
08:00 08:15	0	6	6	7	7	14	20
08:15 08:30	0	11	11	8	15	23	34
08:30 08:45	0	12	12	4	8	12	24
08:45 09:00	0	11	11	7	15	22	33
09:00 09:15	0	8	8	9	11	20	28
09:15 09:30	0	4	4	4	1	5	9
09:30 09:45	0	6	6	8	1	9	15
09:45 10:00	0	4	4	10	2	12	16
11:30 11:45	0	5	5	9	6	15	20
11:45 12:00	0	11	11	7	3	10	21
12:00 12:15	0	12	12	6	5	11	23
12:15 12:30	0	1	1	10	2	12	13
12:30 12:45	0	9	9	13	8	21	30
12:45 13:00	0	5	5	10	2	12	17
13:00 13:15	0	7	7	8	8	16	23
13:15 13:30	0	2	2	5	4	9	11
15:00 15:15	0	8	8	20	12	32	40
15:15 15:30	0	14	14	11	18	29	43
15:30 15:45	0	4	4	12	3	15	19
15:45 16:00	0	1	1	8	3	11	12
16:00 16:15	0	5	5	10	5	15	20
16:15 16:30	0	7	7	7	10	17	24
16:30 16:45	0	7	7	6	4	10	17
16:45 17:00	0	4	4	8	8	16	20
17:00 17:15	0	12	12	14	8	22	34
17:15 17:30	0	5	5	11	3	14	19
17:30 17:45	1	5	6	18	5	23	29
17:45 18:00	0	6	6	13	4	17	23
<b>Total</b>	<b>1</b>	<b>208</b>	<b>209</b>	<b>279</b>	<b>207</b>	<b>486</b>	<b>695</b>

W.O. 5365004 - THURS APR 19TH - CONSULTANT - 48 HRS (REIMPORT - 8HR STANDARD)



# Transportation Services - Traffic Services

## Turning Movement Count - Study Results

### BRONSON AVE @ CATHERINE ST/RAYMOND ST

**Survey Date:** Thursday, April 19, 2018

**WO No:** 39598

**Start Time:** 07:00

**Device:** Miovision

### Full Study Heavy Vehicles

#### BRONSON AVE

#### CATHERINE ST/RAYMOND ST

Northbound

Southbound

Eastbound

Westbound

Time Period	Northbound				Southbound				Eastbound				Westbound				Grand Total			
	LT	ST	RT	N TOT	LT	ST	RT	S TOT	STR TOT	LT	ST	RT	E TOT	LT	ST	RT		W TOT	STR TOT	
07:00 07:15	1	1	0	10	0	6	8	18	28	0	0	0	17	2	8	3	13	30	29	
07:15 07:30	2	3	0	14	0	7	4	18	32	0	0	0	11	2	5	4	11	22	27	
07:30 07:45	2	5	0	13	0	4	5	16	29	0	0	0	11	2	4	2	8	19	24	
07:45 08:00	4	2	0	15	0	6	6	18	33	0	0	0	15	3	5	4	12	27	30	
08:00 08:15	2	2	0	13	0	5	2	13	26	0	0	0	12	4	8	4	16	28	27	
08:15 08:30	1	9	0	21	0	7	1	18	39	0	0	0	4	4	2	1	7	11	25	
08:30 08:45	1	8	0	23	0	9	2	23	46	0	0	0	7	5	4	4	13	20	33	
08:45 09:00	0	3	0	21	0	11	3	23	44	0	0	0	7	7	4	6	17	24	34	
09:00 09:15	8	6	0	25	0	7	2	26	51	0	0	0	17	4	7	11	22	39	45	
09:15 09:30	1	7	0	23	0	10	1	26	49	0	0	0	11	5	9	8	22	33	41	
09:30 09:45	2	5	0	15	0	4	2	14	29	0	0	0	9	4	5	3	12	21	25	
09:45 10:00	3	5	0	22	0	5	0	21	43	0	0	0	9	9	6	11	26	35	39	
11:30 11:45	2	3	0	13	0	2	0	10	23	0	0	0	8	6	6	5	17	25	24	
11:45 12:00	3	4	0	17	0	6	4	20	37	0	0	0	14	4	7	6	17	31	34	
12:00 12:15	2	3	0	12	0	6	0	13	25	0	0	0	7	1	5	4	10	17	21	
12:15 12:30	1	3	0	12	0	3	0	8	20	0	0	0	6	5	5	2	12	18	19	
12:30 12:45	2	6	0	15	0	6	1	18	33	0	0	0	9	1	6	5	12	21	27	
12:45 13:00	0	3	0	10	0	3	1	10	20	0	0	0	3	4	2	3	9	12	16	
13:00 13:15	1	5	0	15	0	6	0	15	30	0	0	0	8	3	7	4	14	22	26	
13:15 13:30	4	4	0	15	0	4	0	11	26	0	0	0	10	3	6	3	12	22	24	
15:00 15:15	0	6	0	18	0	9	2	21	39	0	0	0	4	3	2	4	9	13	26	
15:15 15:30	2	8	0	15	0	2	0	13	28	0	0	0	5	3	3	3	9	14	21	
15:30 15:45	2	4	0	13	0	5	1	16	29	0	0	0	6	2	3	6	11	17	23	
15:45 16:00	4	3	0	14	0	5	0	10	24	0	0	0	7	2	3	2	7	14	19	
16:00 16:15	1	3	0	14	0	6	0	13	27	0	0	0	7	4	6	4	14	21	24	
16:15 16:30	1	4	0	14	0	7	1	13	27	0	0	0	3	2	1	1	4	7	17	
16:30 16:45	1	1	0	9	0	6	0	11	20	0	0	0	4	1	3	4	8	12	16	
16:45 17:00	0	4	0	11	0	4	0	9	20	0	0	0	4	3	4	1	8	12	16	
17:00 17:15	0	3	0	11	0	5	0	9	20	0	0	0	2	3	2	1	6	8	14	
17:15 17:30	0	2	0	6	0	2	0	4	10	0	0	0	1	2	1	0	3	4	7	
17:30 17:45	2	5	0	10	0	2	2	9	19	0	0	0	6	1	2	0	3	9	14	
17:45 18:00	1	3	0	9	0	4	0	7	16	0	0	0	3	1	2	0	3	6	11	
<b>Total:</b>	None	56	133	0	468	0	174	48	474	942	0	0	0	247	105	143	119	367	614	778



# Transportation Services - Traffic Services

## Turning Movement Count - Study Results

### BRONSON AVE @ CATHERINE ST/RAYMOND ST

**Survey Date:** Thursday, April 19, 2018

**WO No:** 39598

**Start Time:** 07:00

**Device:** Miovision

### Full Study 15 Minute U-Turn Total

BRONSON AVE                      CATHERINE ST/RAYMOND ST

Time Period		Northbound U-Turn Total	Southbound U-Turn Total	Eastbound U-Turn Total	Westbound U-Turn Total	Total
07:00	07:15	0	0	0	0	0
07:15	07:30	0	0	0	0	0
07:30	07:45	0	0	0	0	0
07:45	08:00	0	0	0	0	0
08:00	08:15	0	0	0	0	0
08:15	08:30	0	0	0	0	0
08:30	08:45	0	0	0	0	0
08:45	09:00	0	0	0	0	0
09:00	09:15	0	0	0	0	0
09:15	09:30	0	0	0	0	0
09:30	09:45	0	0	0	0	0
09:45	10:00	0	0	0	0	0
11:30	11:45	0	0	0	0	0
11:45	12:00	0	0	0	0	0
12:00	12:15	0	0	0	0	0
12:15	12:30	0	0	0	0	0
12:30	12:45	0	0	0	0	0
12:45	13:00	0	0	0	0	0
13:00	13:15	0	0	0	0	0
13:15	13:30	0	0	0	0	0
15:00	15:15	0	0	0	0	0
15:15	15:30	0	0	0	0	0
15:30	15:45	0	0	0	0	0
15:45	16:00	0	0	0	0	0
16:00	16:15	0	0	0	0	0
16:15	16:30	0	0	0	0	0
16:30	16:45	0	0	0	0	0
16:45	17:00	0	0	0	0	0
17:00	17:15	0	0	0	0	0
17:15	17:30	0	0	0	0	0
17:30	17:45	0	0	0	0	0
17:45	18:00	0	0	0	0	0
Total		0	0	0	0	0

**Survey Date:** Wednesday, April 18, 2018

**WO No:** 40741

**Start Time:** 07:00

**Device:** Miovision

### Full Study Diagram

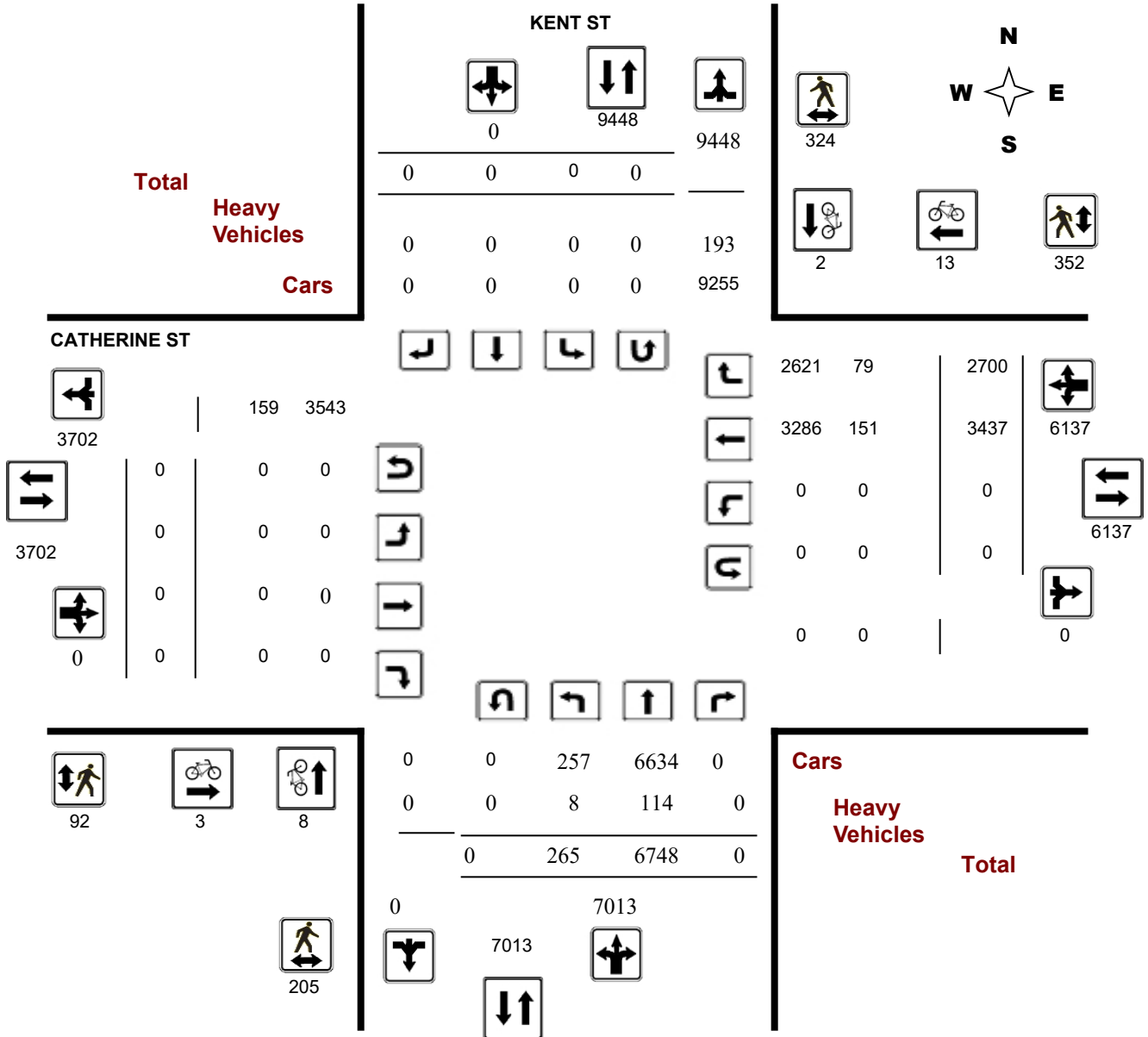





## Turning Movement Count - Peak Hour Diagram

### CATHERINE ST @ KENT ST

**Survey Date:** Wednesday, April 18, 2018

**Start Time:** 07:00

**WO No:** 40741

**Device:** Miovision

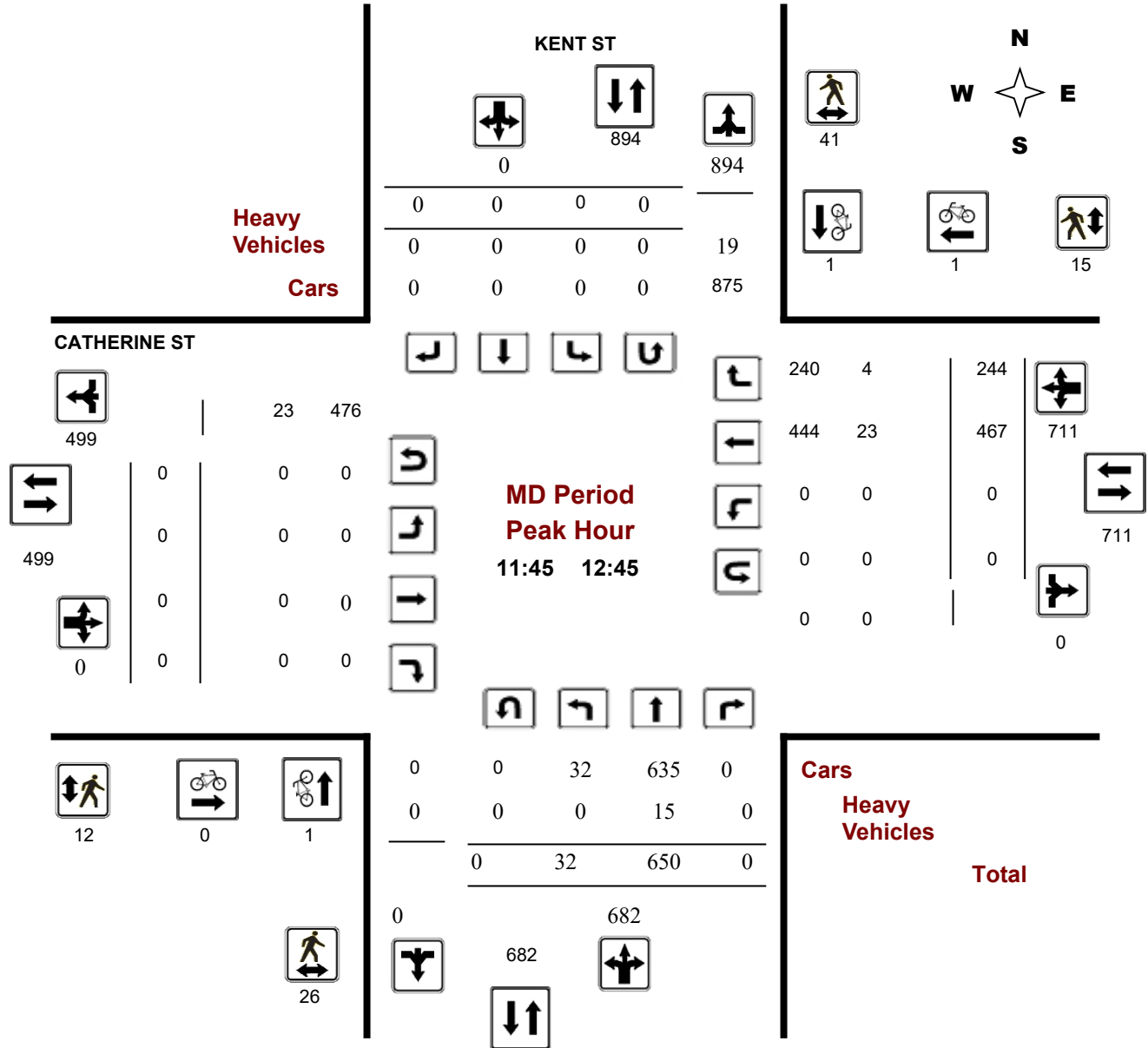

**Comments**

## Turning Movement Count - Peak Hour Diagram

### CATHERINE ST @ KENT ST

**Survey Date:** Wednesday, April 18, 2018

**Start Time:** 07:00

**WO No:** 40741

**Device:** Miovision

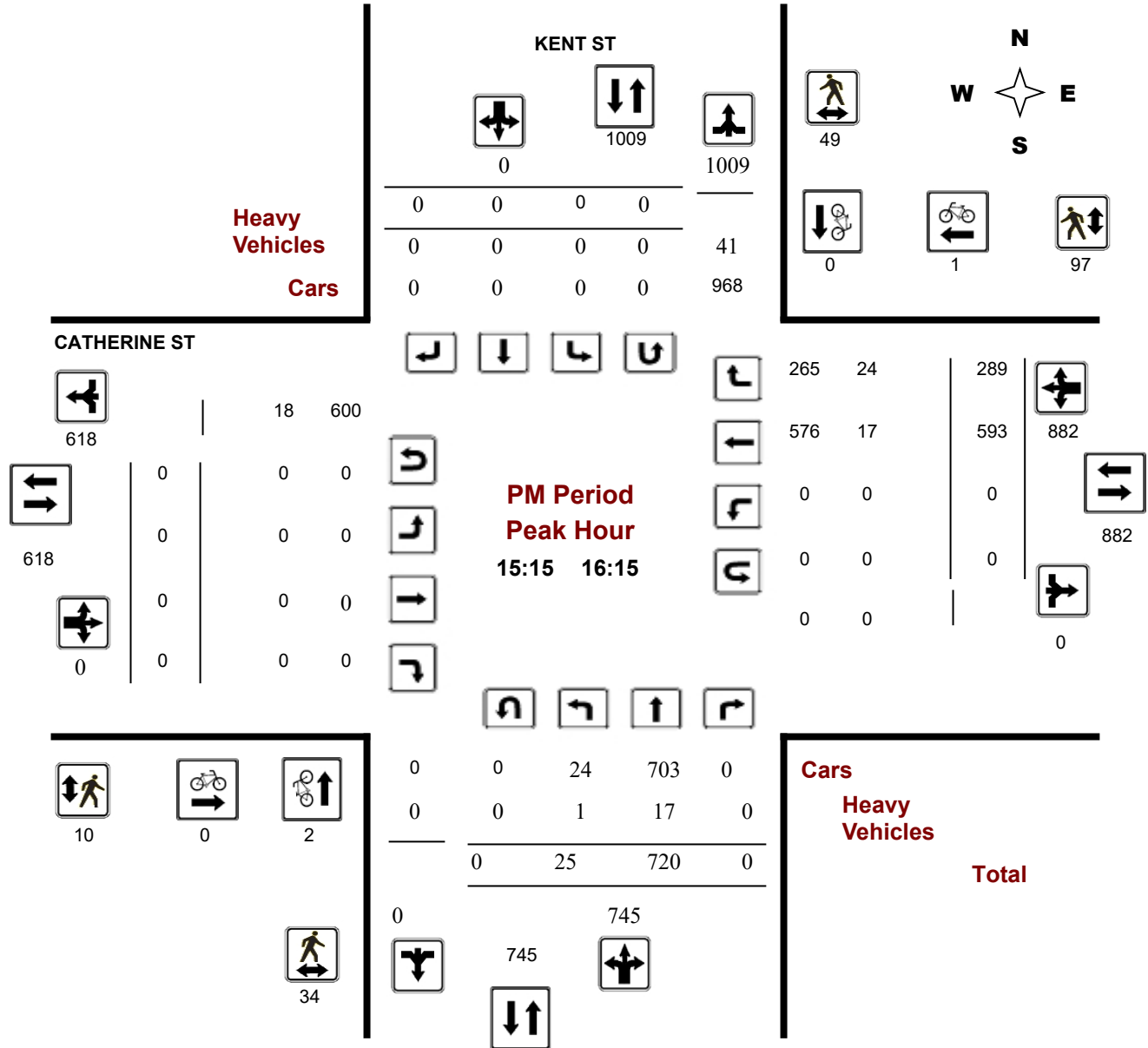

**Comments**





# Transportation Services - Traffic Services

## Turning Movement Count - Study Results

### CATHERINE ST @ KENT ST

**Survey Date:** Wednesday, April 18, 2018

**WO No:** 40741

**Start Time:** 07:00

**Device:** Miovision

### Full Study Summary (8 HR Standard)

**Survey Date:** Wednesday, April 18, 2018

**Total Observed U-Turns**

**AADT Factor**

Northbound: 0      Southbound: 0

.90

Eastbound: 0      Westbound: 0

Period	KENT ST									CATHERINE ST									Grand Total
	Northbound			NB TOT	Southbound			SB TOT	STR TOT	Eastbound			EB TOT	Westbound			WB TOT	STR TOT	
	LT	ST	RT		LT	ST	RT			LT	ST	RT		LT	ST	RT			
07:00 08:00	36	1225	0	1261	0	0	0	0	1261	0	0	0	0	0	304	504	808	808	2069
08:00 09:00	54	1326	0	1380	0	0	0	0	1380	0	0	0	0	0	392	530	922	922	2302
09:00 10:00	41	968	0	1009	0	0	0	0	1009	0	0	0	0	0	411	342	753	753	1762
11:30 12:30	36	626	0	662	0	0	0	0	662	0	0	0	0	0	452	231	683	683	1345
12:30 13:30	40	631	0	671	0	0	0	0	671	0	0	0	0	0	477	174	651	651	1322
15:00 16:00	29	652	0	681	0	0	0	0	681	0	0	0	0	0	556	302	858	858	1539
16:00 17:00	18	590	0	608	0	0	0	0	608	0	0	0	0	0	479	311	790	790	1398
17:00 18:00	11	730	0	741	0	0	0	0	741	0	0	0	0	0	366	306	672	672	1413
<b>Sub Total</b>	265	6748	0	7013	0	0	0	0	7013	0	0	0	0	0	3437	2700	6137	6137	13150
<b>U Turns</b>				0					0								0	0	0
<b>Total</b>	265	6748	0	7013	0	0	0	0	7013	0	0	0	0	0	3437	2700	6137	6137	13150

**EQ 12Hr** 368 9380 0 9748 0 0 0 0 9748 0 0 0 0 0 4777 3753 8530 8530 18278

Note: These values are calculated by multiplying the totals by the appropriate expansion factor. **1.39**

**AVG 12Hr** 331 8442 0 8773 0 0 0 0 8773 0 0 0 0 0 4299 3378 7677 7677 16450

Note: These volumes are calculated by multiplying the Equivalent 12 hr. totals by the AADT factor. **.90**

**AVG 24Hr** 434 11059 0 11493 0 0 0 0 11493 0 0 0 0 0 5632 4425 10057 10057 21550

Note: These volumes are calculated by multiplying the Average Daily 12 hr. totals by 12 to 24 expansion factor. **1.31**

Note: U-Turns provided for approach totals. Refer to 'U-Turn' Report for specific breakdown.



# Transportation Services - Traffic Services

## Turning Movement Count - Study Results

### CATHERINE ST @ KENT ST

**Survey Date:** Wednesday, April 18, 2018

**WO No:** 40741

**Start Time:** 07:00

**Device:** Miovision

### Full Study 15 Minute Increments

#### KENT ST

#### CATHERINE ST

Northbound

Southbound

Eastbound

Westbound

Time Period	LT	ST	RT	N TOT	LT	ST	RT	S TOT	STR TOT	LT	ST	RT	E TOT	LT	ST	RT	W TOT	STR TOT	Grand Total
07:00 07:15	7	277	0	284	0	0	0	0	284	0	0	0	0	0	72	116	188	188	472
07:15 07:30	8	293	0	301	0	0	0	0	301	0	0	0	0	0	58	123	181	181	482
07:30 07:45	9	312	0	321	0	0	0	0	321	0	0	0	0	0	90	117	207	207	528
07:45 08:00	12	343	0	355	0	0	0	0	355	0	0	0	0	0	84	148	232	232	587
08:00 08:15	12	314	0	326	0	0	0	0	326	0	0	0	0	0	100	134	234	234	560
08:15 08:30	13	347	0	360	0	0	0	0	360	0	0	0	0	0	98	127	225	225	585
08:30 08:45	17	329	0	346	0	0	0	0	346	0	0	0	0	0	107	128	235	235	581
08:45 09:00	12	336	0	348	0	0	0	0	348	0	0	0	0	0	87	141	228	228	576
09:00 09:15	8	293	0	301	0	0	0	0	301	0	0	0	0	0	95	97	192	192	493
09:15 09:30	12	229	0	241	0	0	0	0	241	0	0	0	0	0	104	91	195	195	436
09:30 09:45	8	225	0	233	0	0	0	0	233	0	0	0	0	0	112	76	188	188	421
09:45 10:00	13	221	0	234	0	0	0	0	234	0	0	0	0	0	100	78	178	178	412
11:30 11:45	13	169	0	182	0	0	0	0	182	0	0	0	0	0	105	52	157	157	339
11:45 12:00	7	150	0	157	0	0	0	0	157	0	0	0	0	0	105	68	173	173	330
12:00 12:15	6	133	0	139	0	0	0	0	139	0	0	0	0	0	125	50	175	175	314
12:15 12:30	10	174	0	184	0	0	0	0	184	0	0	0	0	0	117	61	178	178	362
12:30 12:45	9	193	0	202	0	0	0	0	202	0	0	0	0	0	120	65	185	185	387
12:45 13:00	9	160	0	169	0	0	0	0	169	0	0	0	0	0	125	31	156	156	325
13:00 13:15	8	134	0	142	0	0	0	0	142	0	0	0	0	0	108	34	142	142	284
13:15 13:30	14	144	0	158	0	0	0	0	158	0	0	0	0	0	124	44	168	168	326
15:00 15:15	8	151	0	159	0	0	0	0	159	0	0	0	0	0	120	90	210	210	369
15:15 15:30	10	148	0	158	0	0	0	0	158	0	0	0	0	0	154	67	221	221	379
15:30 15:45	3	180	0	183	0	0	0	0	183	0	0	0	0	0	156	69	225	225	408
15:45 16:00	8	173	0	181	0	0	0	0	181	0	0	0	0	0	126	76	202	202	383
16:00 16:15	4	219	0	223	0	0	0	0	223	0	0	0	0	0	157	77	234	234	457
16:15 16:30	0	102	0	102	0	0	0	0	102	0	0	0	0	0	144	92	236	236	338
16:30 16:45	5	113	0	118	0	0	0	0	118	0	0	0	0	0	100	79	179	179	297
16:45 17:00	9	156	0	165	0	0	0	0	165	0	0	0	0	0	78	63	141	141	306
17:00 17:15	4	193	0	197	0	0	0	0	197	0	0	0	0	0	100	70	170	170	367
17:15 17:30	1	193	0	194	0	0	0	0	194	0	0	0	0	0	95	88	183	183	377
17:30 17:45	4	158	0	162	0	0	0	0	162	0	0	0	0	0	86	90	176	176	338
17:45 18:00	2	186	0	188	0	0	0	0	188	0	0	0	0	0	85	58	143	143	331
<b>Total:</b>	<b>265</b>	<b>6748</b>	<b>0</b>	<b>7013</b>	<b>0</b>	<b>0</b>	<b>0</b>	<b>0</b>	<b>7013</b>	<b>0</b>	<b>0</b>	<b>0</b>	<b>0</b>	<b>0</b>	<b>3437</b>	<b>2700</b>	<b>6137</b>	<b>6137</b>	<b>13,150</b>

Note: U-Turns are included in Totals.



# Transportation Services - Traffic Services

## Turning Movement Count - Study Results

### CATHERINE ST @ KENT ST

**Survey Date:** Wednesday, April 18, 2018

**WO No:** 40741

**Start Time:** 07:00

**Device:** Miovision

### Full Study Cyclist Volume

Time Period	KENT ST			CATHERINE ST			Grand Total
	Northbound	Southbound	Street Total	Eastbound	Westbound	Street Total	
07:00 07:15	0	0	0	0	0	0	0
07:15 07:30	0	0	0	0	0	0	0
07:30 07:45	0	0	0	0	0	0	0
07:45 08:00	1	0	1	0	0	0	1
08:00 08:15	1	0	1	0	0	0	1
08:15 08:30	1	0	1	0	2	2	3
08:30 08:45	1	0	1	0	0	0	1
08:45 09:00	0	0	0	0	0	0	0
09:00 09:15	0	0	0	0	2	2	2
09:15 09:30	0	0	0	0	0	0	0
09:30 09:45	0	0	0	0	0	0	0
09:45 10:00	0	0	0	0	0	0	0
11:30 11:45	0	0	0	0	0	0	0
11:45 12:00	0	0	0	0	0	0	0
12:00 12:15	0	0	0	0	1	1	1
12:15 12:30	0	1	1	0	0	0	1
12:30 12:45	1	0	1	0	0	0	1
12:45 13:00	0	0	0	0	0	0	0
13:00 13:15	0	0	0	0	0	0	0
13:15 13:30	0	0	0	1	0	1	1
15:00 15:15	0	0	0	0	1	1	1
15:15 15:30	0	0	0	0	0	0	0
15:30 15:45	0	0	0	0	0	0	0
15:45 16:00	0	0	0	0	1	1	1
16:00 16:15	2	0	2	0	0	0	2
16:15 16:30	0	0	0	0	3	3	3
16:30 16:45	0	0	0	0	1	1	1
16:45 17:00	0	1	1	1	0	1	2
17:00 17:15	0	0	0	0	1	1	1
17:15 17:30	0	0	0	1	0	1	1
17:30 17:45	0	0	0	0	0	0	0
17:45 18:00	1	0	1	0	1	1	2
<b>Total</b>	<b>8</b>	<b>2</b>	<b>10</b>	<b>3</b>	<b>13</b>	<b>16</b>	<b>26</b>



# Transportation Services - Traffic Services

## Turning Movement Count - Study Results

### CATHERINE ST @ KENT ST

**Survey Date:** Wednesday, April 18, 2018

**WO No:** 40741

**Start Time:** 07:00

**Device:** Miovision

### Full Study Pedestrian Volume

#### KENT ST

#### CATHERINE ST

Time Period	NB Approach (E or W Crossing)	SB Approach (E or W Crossing)	Total	EB Approach (N or S Crossing)	WB Approach (N or S Crossing)	Total	Grand Total
07:00 07:15	2	9	11	3	0	3	14
07:15 07:30	0	4	4	0	3	3	7
07:30 07:45	4	9	13	5	9	14	27
07:45 08:00	7	8	15	4	6	10	25
08:00 08:15	8	12	20	5	8	13	33
08:15 08:30	8	9	17	6	20	26	43
08:30 08:45	3	11	14	0	72	72	86
08:45 09:00	10	10	20	3	15	18	38
09:00 09:15	8	6	14	2	5	7	21
09:15 09:30	4	7	11	4	5	9	20
09:30 09:45	8	15	23	2	2	4	27
09:45 10:00	6	8	14	8	2	10	24
11:30 11:45	8	10	18	2	6	8	26
11:45 12:00	4	12	16	2	6	8	24
12:00 12:15	12	12	24	5	3	8	32
12:15 12:30	5	11	16	3	6	9	25
12:30 12:45	5	6	11	2	0	2	13
12:45 13:00	9	15	24	9	2	11	35
13:00 13:15	7	8	15	0	3	3	18
13:15 13:30	6	11	17	0	7	7	24
15:00 15:15	5	13	18	3	9	12	30
15:15 15:30	8	15	23	4	77	81	104
15:30 15:45	10	12	22	2	2	4	26
15:45 16:00	8	8	16	3	9	12	28
16:00 16:15	8	14	22	1	9	10	32
16:15 16:30	10	12	22	5	11	16	38
16:30 16:45	8	4	12	1	2	3	15
16:45 17:00	4	15	19	0	12	12	31
17:00 17:15	8	10	18	3	13	16	34
17:15 17:30	7	9	16	3	12	15	31
17:30 17:45	4	14	18	2	8	10	28
17:45 18:00	1	5	6	0	8	8	14
<b>Total .....</b>	<b>205</b>	<b>324</b>	<b>529</b>	<b>92</b>	<b>352</b>	<b>444</b>	<b>973</b>



# Transportation Services - Traffic Services

## Turning Movement Count - Study Results

### CATHERINE ST @ KENT ST

**Survey Date:** Wednesday, April 18, 2018

**WO No:** 40741

**Start Time:** 07:00

**Device:** Miovision

### Full Study Heavy Vehicles

KENT ST										CATHERINE ST										Grand Total
Northbound					Southbound					Eastbound					Westbound					
Time Period	LT	ST	RT	N TOT	LT	ST	RT	S TOT	STR TOT	LT	ST	RT	E TOT	LT	ST	RT	W TOT	STR TOT		
07:00	07:15	0	1	0	1	0	0	0	2	3	0	0	0	11	0	11	1	12	23	13
07:15	07:30	0	2	0	2	0	0	0	4	6	0	0	0	5	0	5	2	7	12	9
07:30	07:45	1	1	0	2	0	0	0	6	8	0	0	0	6	0	5	5	10	16	12
07:45	08:00	0	4	0	4	0	0	0	7	11	0	0	0	4	0	4	3	7	11	11
08:00	08:15	0	3	0	3	0	0	0	5	8	0	0	0	10	0	10	2	12	22	15
08:15	08:30	0	3	0	3	0	0	0	4	7	0	0	0	4	0	4	1	5	9	8
08:30	08:45	0	7	0	7	0	0	0	7	14	0	0	0	7	0	7	0	7	14	14
08:45	09:00	0	5	0	5	0	0	0	7	12	0	0	0	4	0	4	2	6	10	11
09:00	09:15	0	6	0	6	0	0	0	8	14	0	0	0	4	0	4	2	6	10	12
09:15	09:30	0	4	0	4	0	0	0	6	10	0	0	0	10	0	10	2	12	22	16
09:30	09:45	0	4	0	4	0	0	0	5	9	0	0	0	7	0	7	1	8	15	12
09:45	10:00	0	7	0	7	0	0	0	12	19	0	0	0	4	0	4	5	9	13	16
11:30	11:45	1	4	0	5	0	0	0	6	11	0	0	0	2	0	1	2	3	5	8
11:45	12:00	0	2	0	2	0	0	0	2	4	0	0	0	5	0	5	0	5	10	7
12:00	12:15	0	3	0	3	0	0	0	3	6	0	0	0	3	0	3	0	3	6	6
12:15	12:30	0	6	0	6	0	0	0	10	16	0	0	0	8	0	8	4	12	20	18
12:30	12:45	0	4	0	4	0	0	0	4	8	0	0	0	7	0	7	0	7	14	11
12:45	13:00	0	4	0	4	0	0	0	5	9	0	0	0	2	0	2	1	3	5	7
13:00	13:15	0	4	0	4	0	0	0	6	10	0	0	0	5	0	5	2	7	12	11
13:15	13:30	2	1	0	3	0	0	0	3	6	0	0	0	5	0	3	2	5	10	8
15:00	15:15	1	1	0	2	0	0	0	10	12	0	0	0	8	0	7	9	16	24	18
15:15	15:30	0	2	0	2	0	0	0	10	12	0	0	0	4	0	4	8	12	16	14
15:30	15:45	0	4	0	4	0	0	0	12	16	0	0	0	7	0	7	8	15	22	19
15:45	16:00	0	5	0	5	0	0	0	6	11	0	0	0	5	0	5	1	6	11	11
16:00	16:15	1	6	0	7	0	0	0	13	20	0	0	0	2	0	1	7	8	10	15
16:15	16:30	0	2	0	2	0	0	0	3	5	0	0	0	7	0	7	1	8	15	10
16:30	16:45	0	2	0	2	0	0	0	5	7	0	0	0	3	0	3	3	6	9	8
16:45	17:00	2	3	0	5	0	0	0	3	8	0	0	0	4	0	2	0	2	6	7
17:00	17:15	0	4	0	4	0	0	0	7	11	0	0	0	1	0	1	3	4	5	8
17:15	17:30	0	4	0	4	0	0	0	4	8	0	0	0	2	0	2	0	2	4	6
17:30	17:45	0	3	0	3	0	0	0	4	7	0	0	0	2	0	2	1	3	5	6
17:45	18:00	0	3	0	3	0	0	0	4	7	0	0	0	1	0	1	1	2	3	5
Total:	None	8	114	0	122	0	0	0	193	315	0	0	0	159	0	151	79	230	389	352



# Transportation Services - Traffic Services

## Turning Movement Count - Study Results

### CATHERINE ST @ KENT ST

**Survey Date:** Wednesday, April 18, 2018

**WO No:** 40741

**Start Time:** 07:00

**Device:** Miovision

### Full Study 15 Minute U-Turn Total

KENT ST

CATHERINE ST

Time Period		Northbound U-Turn Total	Southbound U-Turn Total	Eastbound U-Turn Total	Westbound U-Turn Total	Total
07:00	07:15	0	0	0	0	0
07:15	07:30	0	0	0	0	0
07:30	07:45	0	0	0	0	0
07:45	08:00	0	0	0	0	0
08:00	08:15	0	0	0	0	0
08:15	08:30	0	0	0	0	0
08:30	08:45	0	0	0	0	0
08:45	09:00	0	0	0	0	0
09:00	09:15	0	0	0	0	0
09:15	09:30	0	0	0	0	0
09:30	09:45	0	0	0	0	0
09:45	10:00	0	0	0	0	0
11:30	11:45	0	0	0	0	0
11:45	12:00	0	0	0	0	0
12:00	12:15	0	0	0	0	0
12:15	12:30	0	0	0	0	0
12:30	12:45	0	0	0	0	0
12:45	13:00	0	0	0	0	0
13:00	13:15	0	0	0	0	0
13:15	13:30	0	0	0	0	0
15:00	15:15	0	0	0	0	0
15:15	15:30	0	0	0	0	0
15:30	15:45	0	0	0	0	0
15:45	16:00	0	0	0	0	0
16:00	16:15	0	0	0	0	0
16:15	16:30	0	0	0	0	0
16:30	16:45	0	0	0	0	0
16:45	17:00	0	0	0	0	0
17:00	17:15	0	0	0	0	0
17:15	17:30	0	0	0	0	0
17:30	17:45	0	0	0	0	0
17:45	18:00	0	0	0	0	0
Total		0	0	0	0	0

**Survey Date:** Wednesday, April 18, 2018

**WO No:** 40740

**Start Time:** 07:00

**Device:** Miovision

### Full Study Diagram

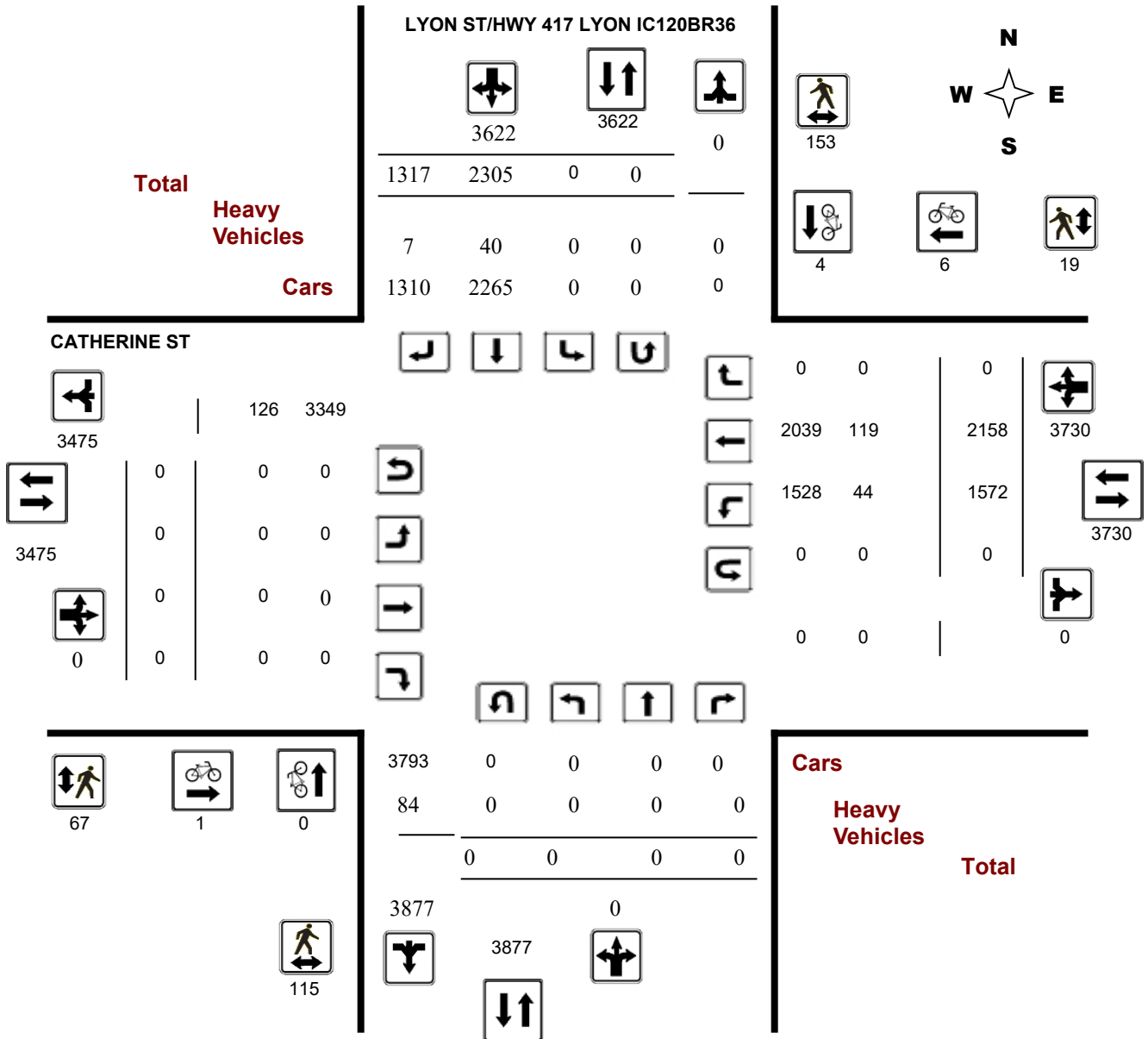





## Turning Movement Count - Peak Hour Diagram

### CATHERINE ST @ LYON ST/HWY 417 LYON IC120BR36

**Survey Date:** Wednesday, April 18, 2018

**Start Time:** 07:00

**WO No:** 40740

**Device:** Miovision

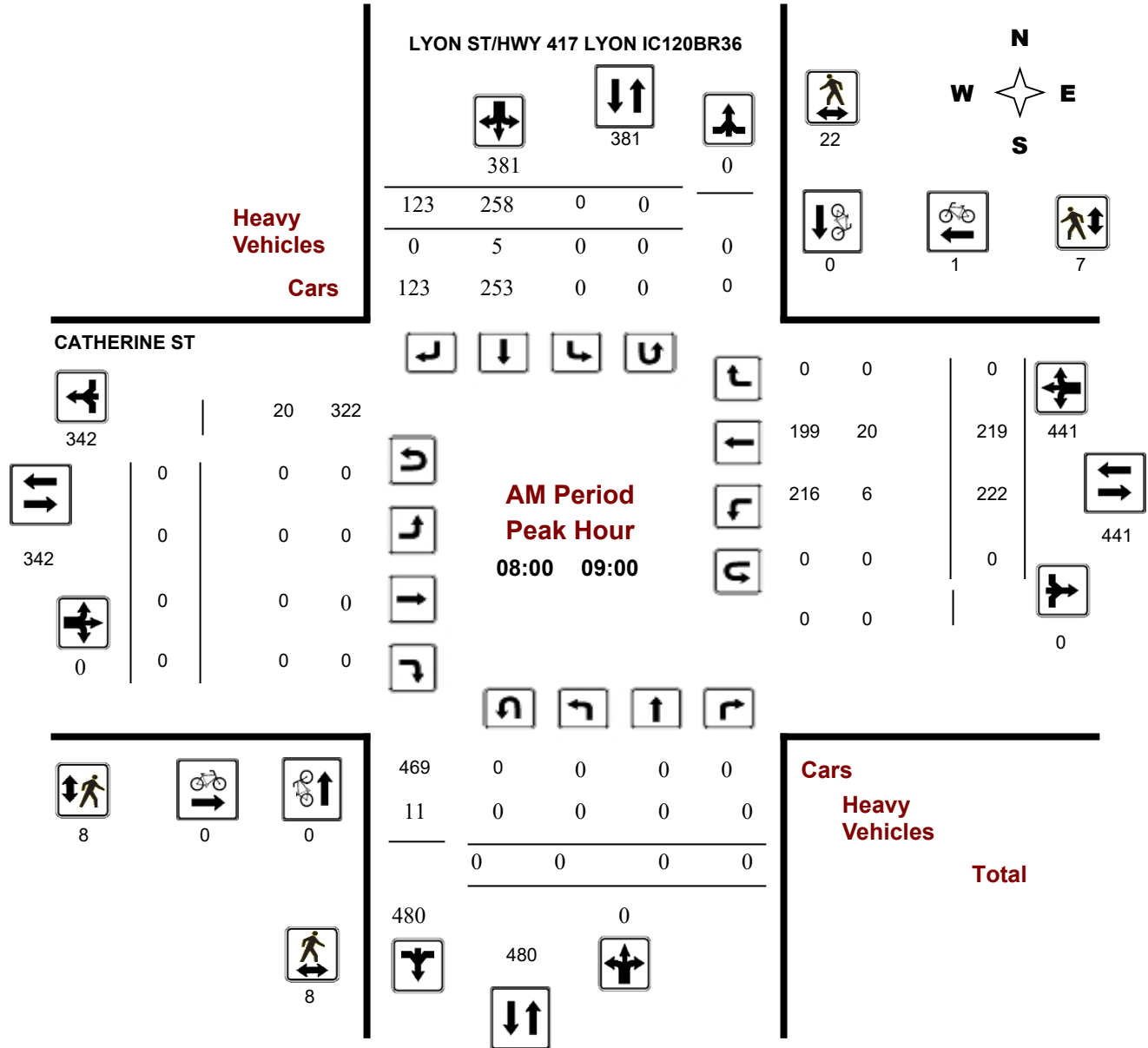

**Comments**

## Turning Movement Count - Peak Hour Diagram

### CATHERINE ST @ LYON ST/HWY 417 LYON IC120BR36

**Survey Date:** Wednesday, April 18, 2018

**Start Time:** 07:00

**WO No:** 40740

**Device:** Miovision

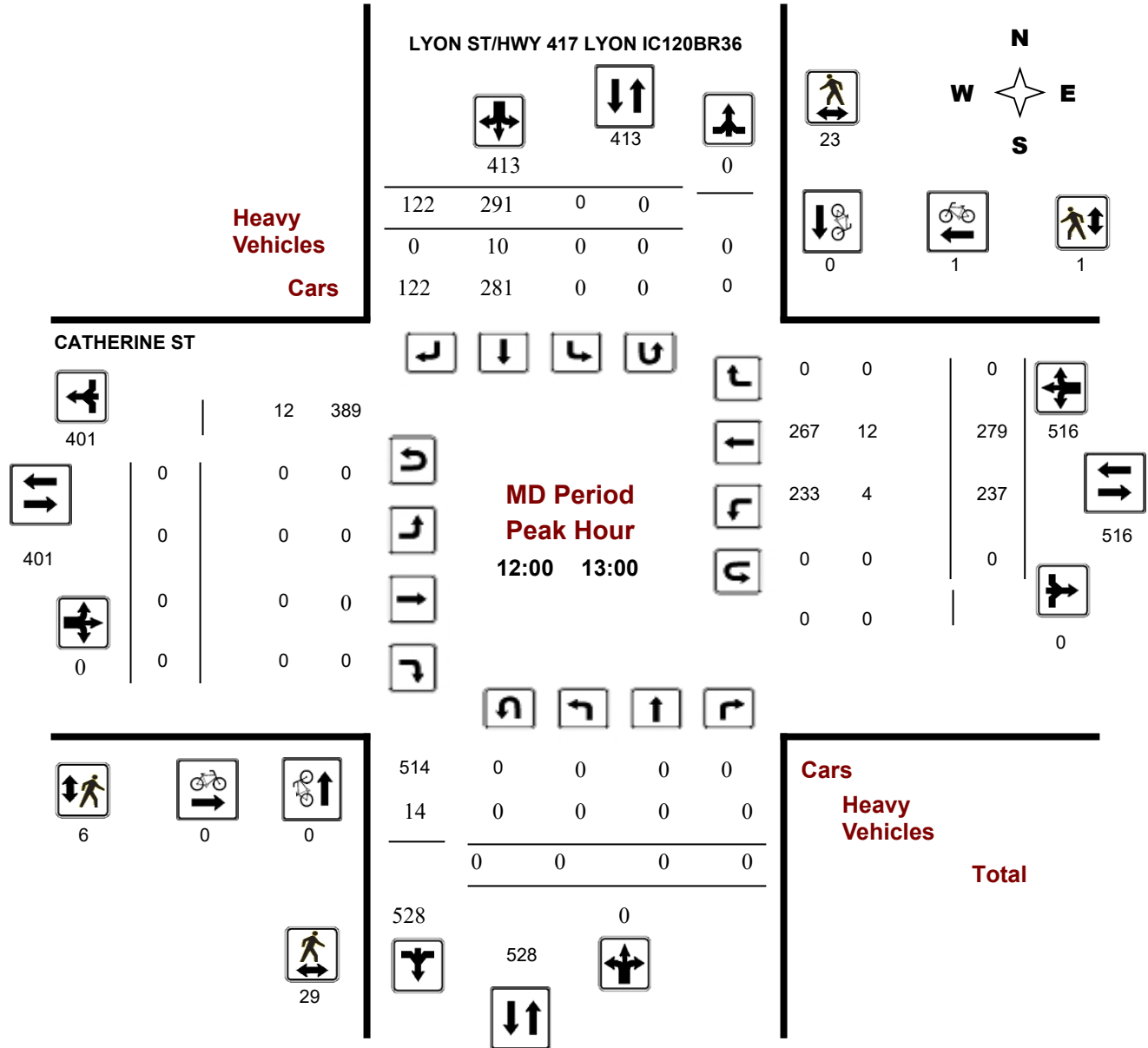

**Comments**

## Turning Movement Count - Peak Hour Diagram

### CATHERINE ST @ LYON ST/HWY 417 LYON IC120BR36

**Survey Date:** Wednesday, April 18, 2018

**Start Time:** 07:00

**WO No:** 40740

**Device:** Miovision

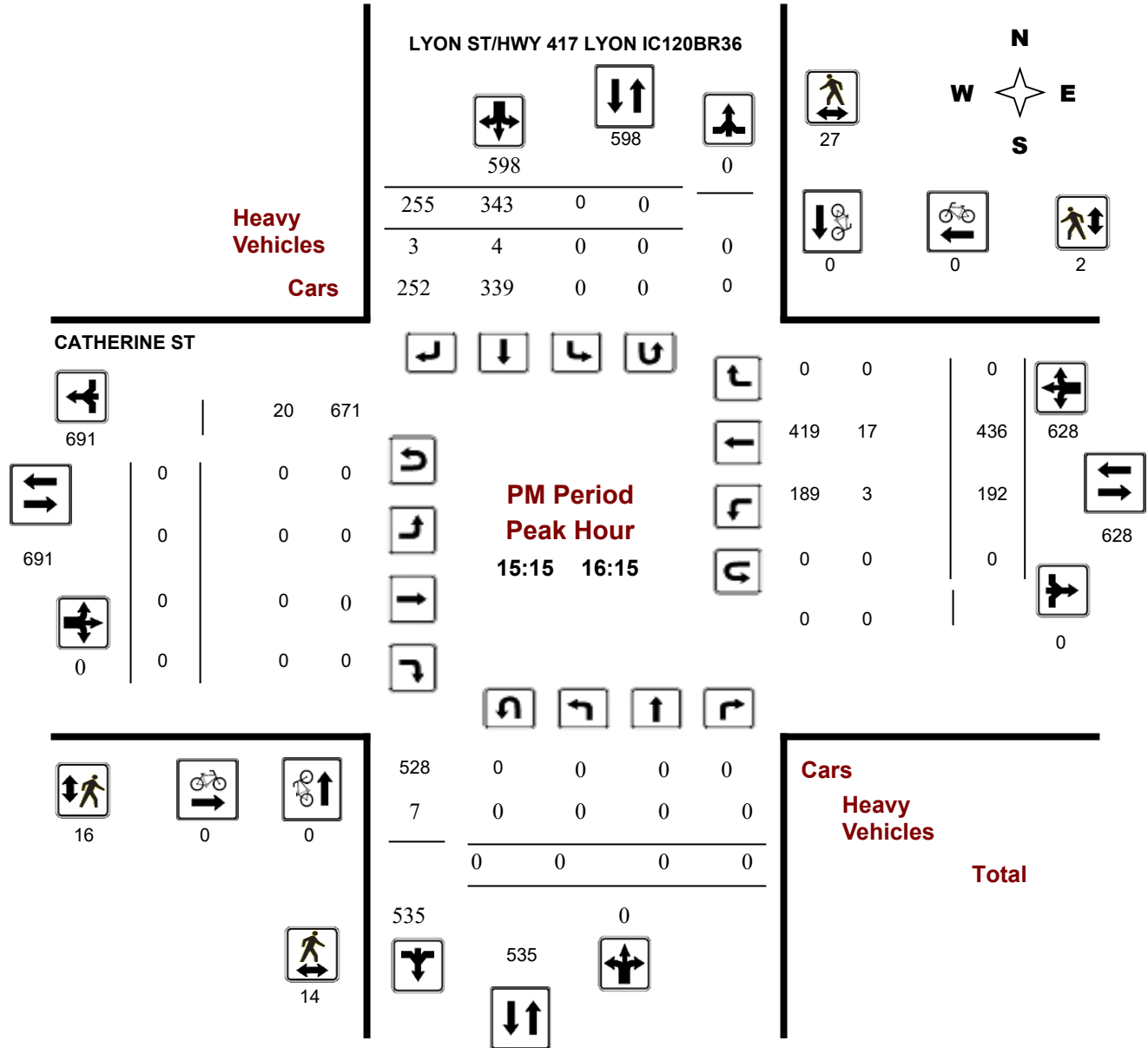

**Comments**



# Transportation Services - Traffic Services

## Turning Movement Count - Study Results

### CATHERINE ST @ LYON ST/HWY 417 LYON IC120BR36

**Survey Date:** Wednesday, April 18, 2018

**WO No:** 40740

**Start Time:** 07:00

**Device:** Miovision

### Full Study Summary (8 HR Standard)

**Survey Date:** Wednesday, April 18, 2018

**Total Observed U-Turns**

**AADT Factor**

Northbound: 0      Southbound: 0

.90

Eastbound: 0      Westbound: 0

#### LYON ST/HWY 417 LYON IC120BR36

#### CATHERINE ST

Period	Northbound					Southbound					Eastbound				Westbound				STR TOT	Grand Total
	LT	ST	RT	NB TOT	STR TOT	LT	ST	RT	SB TOT	STR TOT	LT	ST	RT	EB TOT	LT	ST	RT	WB TOT		
07:00 08:00	0	0	0	0	0	0	223	94	317	317	0	0	0	0	150	192	0	342	342	659
08:00 09:00	0	0	0	0	0	0	258	123	381	381	0	0	0	0	222	219	0	441	441	822
09:00 10:00	0	0	0	0	0	0	213	108	321	321	0	0	0	0	183	244	0	427	427	748
11:30 12:30	0	0	0	0	0	0	279	122	401	401	0	0	0	0	236	265	0	501	501	902
12:30 13:30	0	0	0	0	0	0	267	110	377	377	0	0	0	0	241	269	0	510	510	887
15:00 16:00	0	0	0	0	0	0	402	213	615	615	0	0	0	0	200	407	0	607	607	1222
16:00 17:00	0	0	0	0	0	0	297	301	598	598	0	0	0	0	169	344	0	513	513	1111
17:00 18:00	0	0	0	0	0	0	366	246	612	612	0	0	0	0	171	218	0	389	389	1001
<b>Sub Total</b>	0	0	0	0	0	0	2305	1317	3622	3622	0	0	0	0	1572	2158	0	3730	3730	7352
<b>U Turns</b>				0					0	0								0	0	0
<b>Total</b>	0	0	0	0	0	0	2305	1317	3622	3622	0	0	0	0	1572	2158	0	3730	3730	7352

**EQ 12Hr**      0      0      0      0      0      3204      1831      5035      5035      0      0      0      0      2185      3000      0      5185      5185      10219

Note: These values are calculated by multiplying the totals by the appropriate expansion factor.

**1.39**

**AVG 12Hr**      0      0      0      0      0      3777      2158      4532      4532      0      0      0      0      1966      2700      0      4666      4666      9197

Note: These volumes are calculated by multiplying the Equivalent 12 hr. totals by the AADT factor.

**.90**

**AVG 24Hr**      0      0      0      0      0      4948      2827      5937      5937      0      0      0      0      2575      3537      0      6112      6112      12048

Note: These volumes are calculated by multiplying the Average Daily 12 hr. totals by 12 to 24 expansion factor.

**1.31**

Note: U-Turns provided for approach totals. Refer to 'U-Turn' Report for specific breakdown.



# Transportation Services - Traffic Services

## Turning Movement Count - Study Results

### CATHERINE ST @ LYON ST/HWY 417 LYON IC120BR36

**Survey Date:** Wednesday, April 18, 2018

**WO No:** 40740

**Start Time:** 07:00

**Device:** Miovision

### Full Study 15 Minute Increments

LYON ST/HWY 417 LYON  
IC120BR36

CATHERINE ST

Northbound

Southbound

Eastbound

Westbound

Time Period	Northbound				Southbound				Eastbound				Westbound				Grand Total		
	LT	ST	RT	N TOT	LT	ST	RT	S TOT	STR TOT	LT	ST	RT	E TOT	LT	ST	RT		W TOT	STR TOT
07:00 07:15	0	0	0	0	0	44	20	64	64	0	0	0	0	37	51	0	88	88	152
07:15 07:30	0	0	0	0	0	58	19	77	77	0	0	0	0	24	38	0	62	62	139
07:30 07:45	0	0	0	0	0	64	30	94	94	0	0	0	0	45	50	0	95	95	189
07:45 08:00	0	0	0	0	0	57	25	82	82	0	0	0	0	44	53	0	97	97	179
08:00 08:15	0	0	0	0	0	62	27	89	89	0	0	0	0	57	57	0	114	114	203
08:15 08:30	0	0	0	0	0	66	29	95	95	0	0	0	0	59	53	0	112	112	207
08:30 08:45	0	0	0	0	0	74	38	112	112	0	0	0	0	56	57	0	113	113	225
08:45 09:00	0	0	0	0	0	56	29	85	85	0	0	0	0	50	52	0	102	102	187
09:00 09:15	0	0	0	0	0	57	34	91	91	0	0	0	0	46	56	0	102	102	193
09:15 09:30	0	0	0	0	0	61	28	89	89	0	0	0	0	53	56	0	109	109	198
09:30 09:45	0	0	0	0	0	64	26	90	90	0	0	0	0	50	61	0	111	111	201
09:45 10:00	0	0	0	0	0	31	20	51	51	0	0	0	0	34	71	0	105	105	156
11:30 11:45	0	0	0	0	0	56	31	87	87	0	0	0	0	62	74	0	136	136	223
11:45 12:00	0	0	0	0	0	68	28	96	96	0	0	0	0	53	58	0	111	111	207
12:00 12:15	0	0	0	0	0	73	31	104	104	0	0	0	0	53	72	0	125	125	229
12:15 12:30	0	0	0	0	0	82	32	114	114	0	0	0	0	68	61	0	129	129	243
12:30 12:45	0	0	0	0	0	65	29	94	94	0	0	0	0	54	72	0	126	126	220
12:45 13:00	0	0	0	0	0	71	30	101	101	0	0	0	0	62	74	0	136	136	237
13:00 13:15	0	0	0	0	0	80	25	105	105	0	0	0	0	62	51	0	113	113	218
13:15 13:30	0	0	0	0	0	51	26	77	77	0	0	0	0	63	72	0	135	135	212
15:00 15:15	0	0	0	0	0	132	47	179	179	0	0	0	0	61	72	0	133	133	312
15:15 15:30	0	0	0	0	0	100	62	162	162	0	0	0	0	50	114	0	164	164	326
15:30 15:45	0	0	0	0	0	92	52	144	144	0	0	0	0	43	131	0	174	174	318
15:45 16:00	0	0	0	0	0	78	52	130	130	0	0	0	0	46	90	0	136	136	266
16:00 16:15	0	0	0	0	0	73	89	162	162	0	0	0	0	53	101	0	154	154	316
16:15 16:30	0	0	0	0	0	88	76	164	164	0	0	0	0	46	115	0	161	161	325
16:30 16:45	0	0	0	0	0	69	62	131	131	0	0	0	0	36	63	0	99	99	230
16:45 17:00	0	0	0	0	0	67	74	141	141	0	0	0	0	34	65	0	99	99	240
17:00 17:15	0	0	0	0	0	93	77	170	170	0	0	0	0	48	57	0	105	105	275
17:15 17:30	0	0	0	0	0	110	60	170	170	0	0	0	0	50	61	0	111	111	281
17:30 17:45	0	0	0	0	0	84	68	152	152	0	0	0	0	35	52	0	87	87	239
17:45 18:00	0	0	0	0	0	79	41	120	120	0	0	0	0	38	48	0	86	86	206
Total:	0	0	0	0	0	2305	1317	3622	3622	0	0	0	0	1572	2158	0	3730	3730	7,352

Note: U-Turns are included in Totals.



# Transportation Services - Traffic Services

## Turning Movement Count - Study Results

### CATHERINE ST @ LYON ST/HWY 417 LYON IC120BR36

**Survey Date:** Wednesday, April 18, 2018

**WO No:** 40740

**Start Time:** 07:00

**Device:** Miovision

### Full Study Cyclist Volume

#### LYON ST/HWY 417 LYON IC120BR36

#### CATHERINE ST

Time Period	Northbound	Southbound	Street Total	Eastbound	Westbound	Street Total	Grand Total
07:00 07:15	0	0	0	0	0	0	0
07:15 07:30	0	0	0	0	0	0	0
07:30 07:45	0	0	0	0	0	0	0
07:45 08:00	0	0	0	0	0	0	0
08:00 08:15	0	0	0	0	0	0	0
08:15 08:30	0	0	0	0	1	1	1
08:30 08:45	0	0	0	0	0	0	0
08:45 09:00	0	0	0	0	0	0	0
09:00 09:15	0	0	0	0	0	0	0
09:15 09:30	0	0	0	0	1	1	1
09:30 09:45	0	0	0	0	0	0	0
09:45 10:00	0	0	0	0	0	0	0
11:30 11:45	0	1	1	0	0	0	1
11:45 12:00	0	1	1	0	0	0	1
12:00 12:15	0	0	0	0	0	0	0
12:15 12:30	0	0	0	0	1	1	1
12:30 12:45	0	0	0	0	0	0	0
12:45 13:00	0	0	0	0	0	0	0
13:00 13:15	0	0	0	0	0	0	0
13:15 13:30	0	0	0	0	0	0	0
15:00 15:15	0	0	0	0	0	0	0
15:15 15:30	0	0	0	0	0	0	0
15:30 15:45	0	0	0	0	0	0	0
15:45 16:00	0	0	0	0	0	0	0
16:00 16:15	0	0	0	0	0	0	0
16:15 16:30	0	0	0	0	2	2	2
16:30 16:45	0	0	0	0	1	1	1
16:45 17:00	0	0	0	1	0	1	1
17:00 17:15	0	0	0	0	0	0	0
17:15 17:30	0	0	0	0	0	0	0
17:30 17:45	0	1	1	0	0	0	1
17:45 18:00	0	1	1	0	0	0	1
<b>Total</b>	<b>0</b>	<b>4</b>	<b>4</b>	<b>1</b>	<b>6</b>	<b>7</b>	<b>11</b>



# Transportation Services - Traffic Services

## Turning Movement Count - Study Results

### CATHERINE ST @ LYON ST/HWY 417 LYON IC120BR36

**Survey Date:** Wednesday, April 18, 2018

**WO No:** 40740

**Start Time:** 07:00

**Device:** Miovision

### Full Study Pedestrian Volume

LYON ST/HWY 417 LYON  
IC120BR36

CATHERINE ST

Time Period	NB Approach (E or W Crossing)	SB Approach (E or W Crossing)	Total	EB Approach (N or S Crossing)	WB Approach (N or S Crossing)	Total	Grand Total
07:00 07:15	1	4	5	0	0	0	5
07:15 07:30	0	0	0	1	0	1	1
07:30 07:45	1	3	4	0	0	0	4
07:45 08:00	1	3	4	0	0	0	4
08:00 08:15	1	8	9	0	3	3	12
08:15 08:30	2	5	7	3	1	4	11
08:30 08:45	4	2	6	4	1	5	11
08:45 09:00	1	7	8	1	2	3	11
09:00 09:15	3	6	9	1	1	2	11
09:15 09:30	1	1	2	0	0	0	2
09:30 09:45	7	2	9	5	0	5	14
09:45 10:00	8	2	10	2	0	2	12
11:30 11:45	6	2	8	0	2	2	10
11:45 12:00	5	7	12	0	1	1	13
12:00 12:15	14	7	21	3	0	3	24
12:15 12:30	5	6	11	1	1	2	13
12:30 12:45	7	5	12	1	0	1	13
12:45 13:00	3	5	8	1	0	1	9
13:00 13:15	1	4	5	4	1	5	10
13:15 13:30	7	7	14	3	2	5	19
15:00 15:15	9	11	20	6	0	6	26
15:15 15:30	4	6	10	5	1	6	16
15:30 15:45	0	11	11	6	1	7	18
15:45 16:00	7	5	12	3	0	3	15
16:00 16:15	3	5	8	2	0	2	10
16:15 16:30	4	6	10	5	2	7	17
16:30 16:45	1	1	2	1	0	1	3
16:45 17:00	3	3	6	3	0	3	9
17:00 17:15	3	9	12	4	0	4	16
17:15 17:30	1	7	8	2	0	2	10
17:30 17:45	1	2	3	0	0	0	3
17:45 18:00	1	1	2	0	0	0	2
<b>Total .....</b>	<b>115</b>	<b>153</b>	<b>268</b>	<b>67</b>	<b>19</b>	<b>86</b>	<b>354</b>



# Transportation Services - Traffic Services

## Turning Movement Count - Study Results

### CATHERINE ST @ LYON ST/HWY 417 LYON IC120BR36

**Survey Date:** Wednesday, April 18, 2018

**WO No:** 40740

**Start Time:** 07:00

**Device:** Miovision

### Full Study Heavy Vehicles

LYON ST/HWY 417 LYON  
IC120BR36

CATHERINE ST

Northbound Southbound Eastbound Westbound

Time Period	Northbound			N TOT	Southbound			S TOT	STR TOT	Eastbound			E TOT	Westbound			W TOT	STR TOT	Grand Total
	LT	ST	RT		LT	ST	RT			LT	ST	RT		LT	ST	RT			
07:00 07:15	0	0	0	8	0	4	0	4	12	0	0	0	9	4	9	0	13	22	17
07:15 07:30	0	0	0	7	0	5	0	5	12	0	0	0	3	2	3	0	5	8	10
07:30 07:45	0	0	0	3	0	2	0	2	5	0	0	0	3	1	3	0	4	7	6
07:45 08:00	0	0	0	0	0	0	0	0	0	0	0	0	5	0	5	0	5	10	5
08:00 08:15	0	0	0	4	0	0	0	0	4	0	0	0	7	4	7	0	11	18	11
08:15 08:30	0	0	0	2	0	1	0	1	3	0	0	0	5	1	5	0	6	11	7
08:30 08:45	0	0	0	3	0	2	0	2	5	0	0	0	4	1	4	0	5	9	7
08:45 09:00	0	0	0	2	0	2	0	2	4	0	0	0	4	0	4	0	4	8	6
09:00 09:15	0	0	0	1	0	0	0	0	1	0	0	0	3	1	3	0	4	7	4
09:15 09:30	0	0	0	5	0	0	0	0	5	0	0	0	4	5	4	0	9	13	9
09:30 09:45	0	0	0	5	0	3	0	3	8	0	0	0	2	2	2	0	4	6	7
09:45 10:00	0	0	0	1	0	1	0	1	2	0	0	0	6	0	6	0	6	12	7
11:30 11:45	0	0	0	1	0	0	2	2	3	0	0	0	4	1	2	0	3	7	5
11:45 12:00	0	0	0	6	0	3	1	4	10	0	0	0	6	3	5	0	8	14	12
12:00 12:15	0	0	0	2	0	2	0	2	4	0	0	0	4	0	4	0	4	8	6
12:15 12:30	0	0	0	5	0	4	0	4	9	0	0	0	4	1	4	0	5	9	9
12:30 12:45	0	0	0	3	0	1	0	1	4	0	0	0	4	2	4	0	6	10	7
12:45 13:00	0	0	0	4	0	3	0	3	7	0	0	0	0	1	0	0	1	1	4
13:00 13:15	0	0	0	3	0	1	0	1	4	0	0	0	3	2	3	0	5	8	6
13:15 13:30	0	0	0	1	0	0	1	1	2	0	0	0	3	1	2	0	3	6	4
15:00 15:15	0	0	0	5	0	1	0	1	6	0	0	0	6	4	6	0	10	16	11
15:15 15:30	0	0	0	2	0	1	0	1	3	0	0	0	2	1	2	0	3	5	4
15:30 15:45	0	0	0	3	0	1	1	2	5	0	0	0	6	2	5	0	7	13	9
15:45 16:00	0	0	0	0	0	0	0	0	0	0	0	0	4	0	4	0	4	8	4
16:00 16:15	0	0	0	2	0	2	2	4	6	0	0	0	8	0	6	0	6	14	10
16:15 16:30	0	0	0	2	0	0	0	0	2	0	0	0	6	2	6	0	8	14	8
16:30 16:45	0	0	0	1	0	0	0	0	1	0	0	0	2	1	2	0	3	5	3
16:45 17:00	0	0	0	1	0	1	0	1	2	0	0	0	4	0	4	0	4	8	5
17:00 17:15	0	0	0	0	0	0	0	0	0	0	0	0	2	0	2	0	2	4	2
17:15 17:30	0	0	0	0	0	0	0	0	0	0	0	0	1	0	1	0	1	2	1
17:30 17:45	0	0	0	2	0	0	0	0	2	0	0	0	2	2	2	0	4	6	4
17:45 18:00	0	0	0	0	0	0	0	0	0	0	0	0	0	0	0	0	0	0	0
Total: None	0	0	0	84	0	40	7	47	131	0	0	0	126	44	119	0	163	289	210





# Transportation Services - Traffic Services

## Turning Movement Count - Study Results

### CATHERINE ST @ LYON ST/HWY 417 LYON IC120BR36

**Survey Date:** Wednesday, April 18, 2018

**WO No:** 40740

**Start Time:** 07:00

**Device:** Miovision

### Full Study 15 Minute U-Turn Total

LYON ST/HWY 417 LYON CATHERINE ST

IC120BR36

Time Period		Northbound U-Turn Total	Southbound U-Turn Total	Eastbound U-Turn Total	Westbound U-Turn Total	Total
07:00	07:15	0	0	0	0	0
07:15	07:30	0	0	0	0	0
07:30	07:45	0	0	0	0	0
07:45	08:00	0	0	0	0	0
08:00	08:15	0	0	0	0	0
08:15	08:30	0	0	0	0	0
08:30	08:45	0	0	0	0	0
08:45	09:00	0	0	0	0	0
09:00	09:15	0	0	0	0	0
09:15	09:30	0	0	0	0	0
09:30	09:45	0	0	0	0	0
09:45	10:00	0	0	0	0	0
11:30	11:45	0	0	0	0	0
11:45	12:00	0	0	0	0	0
12:00	12:15	0	0	0	0	0
12:15	12:30	0	0	0	0	0
12:30	12:45	0	0	0	0	0
12:45	13:00	0	0	0	0	0
13:00	13:15	0	0	0	0	0
13:15	13:30	0	0	0	0	0
15:00	15:15	0	0	0	0	0
15:15	15:30	0	0	0	0	0
15:30	15:45	0	0	0	0	0
15:45	16:00	0	0	0	0	0
16:00	16:15	0	0	0	0	0
16:15	16:30	0	0	0	0	0
16:30	16:45	0	0	0	0	0
16:45	17:00	0	0	0	0	0
17:00	17:15	0	0	0	0	0
17:15	17:30	0	0	0	0	0
17:30	17:45	0	0	0	0	0
17:45	18:00	0	0	0	0	0
Total		0	0	0	0	0

**Survey Date:** Thursday, April 19, 2018

**WO No:** 40917

**Start Time:** 07:00

**Device:** Miovision

### Full Study Diagram

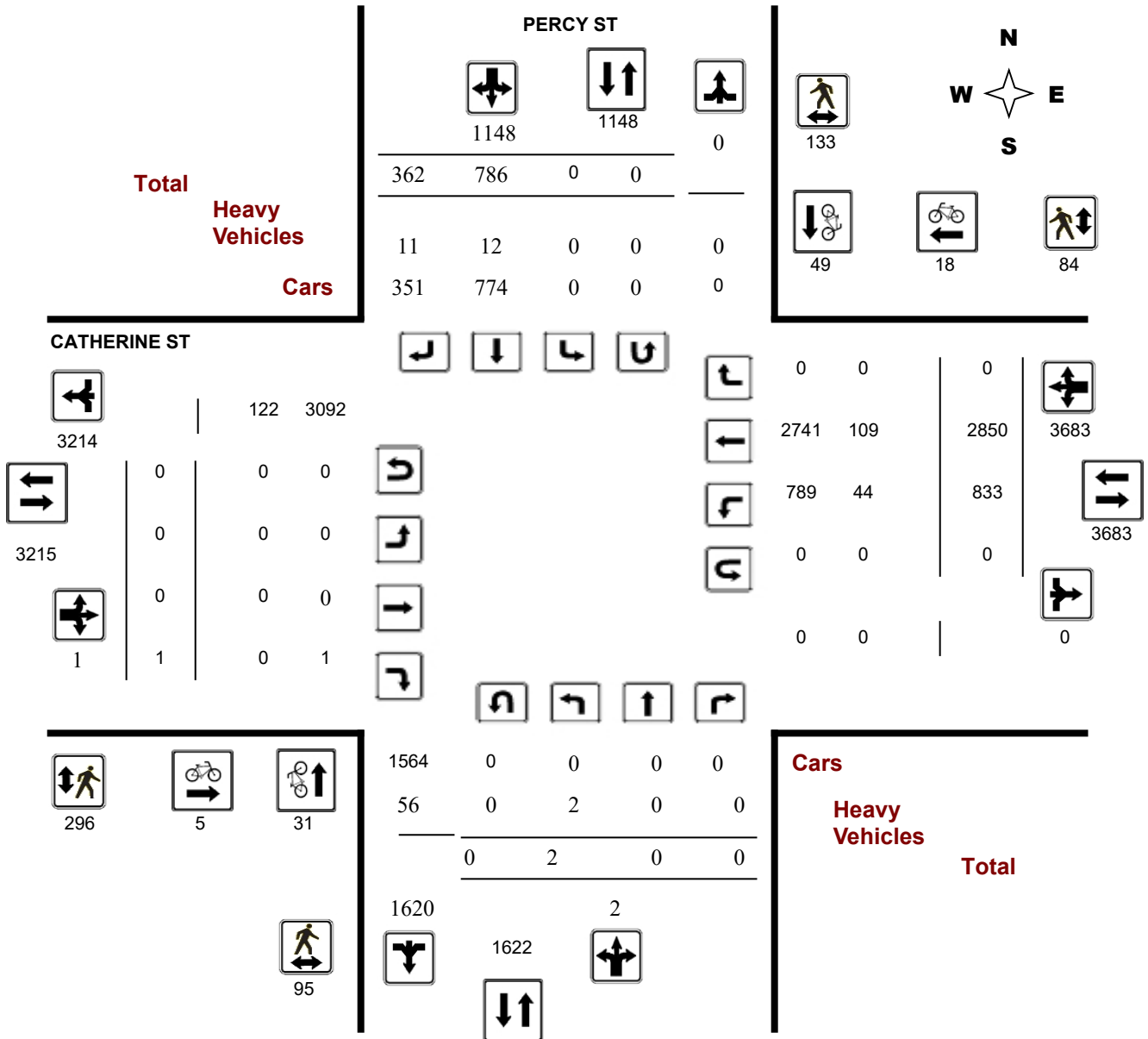

## Turning Movement Count - Study Results

### CATHERINE ST @ PERCY ST

**Survey Date:** Thursday, April 19, 2018

**WO No:** 40917

**Start Time:** 07:00

**Device:** Miovision

### Full Study Peak Hour Diagram

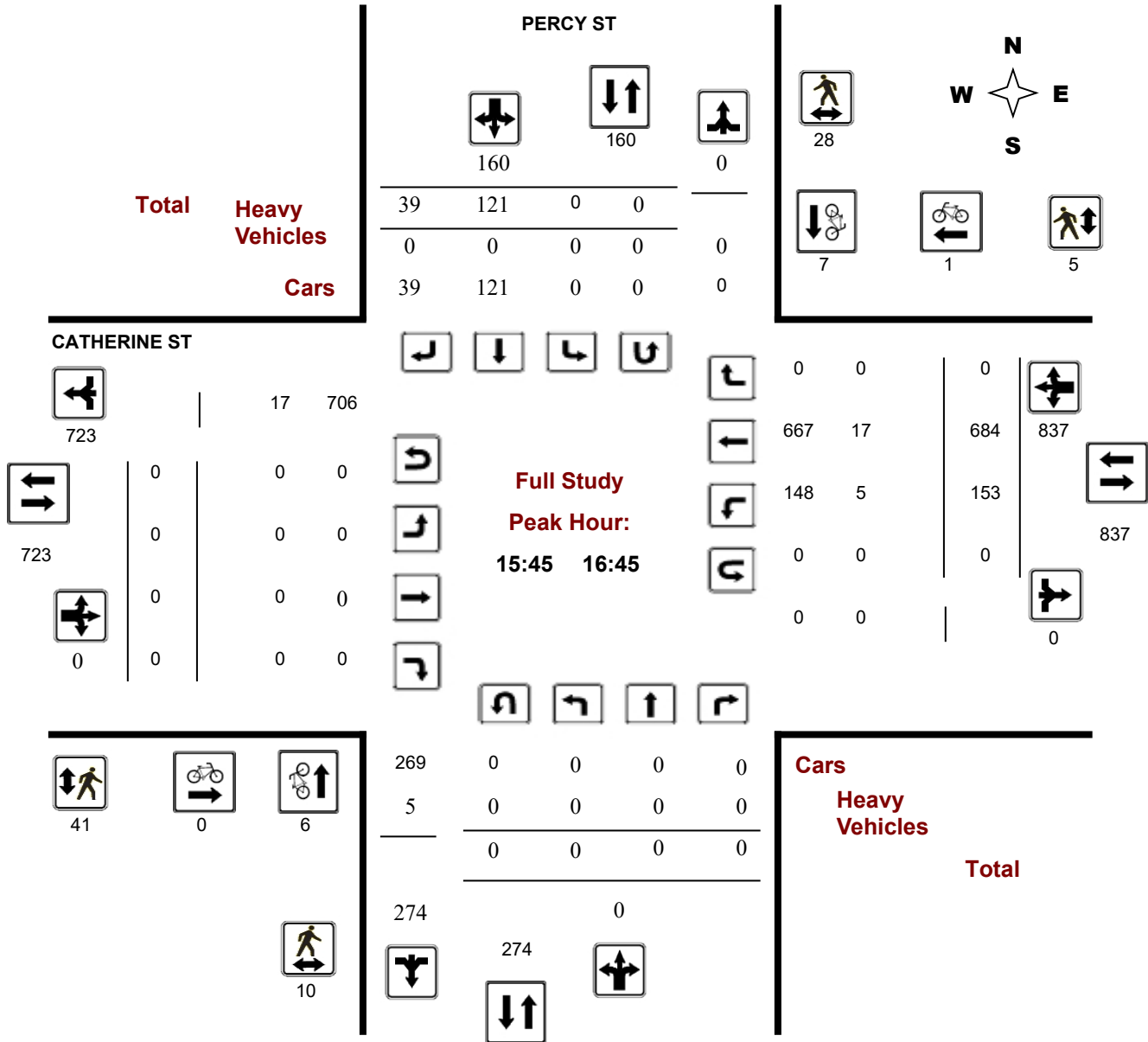

## Turning Movement Count - Peak Hour Diagram

### CATHERINE ST @ PERCY ST

**Survey Date:** Thursday, April 19, 2018

**Start Time:** 07:00

**WO No:** 40917

**Device:** Miovision

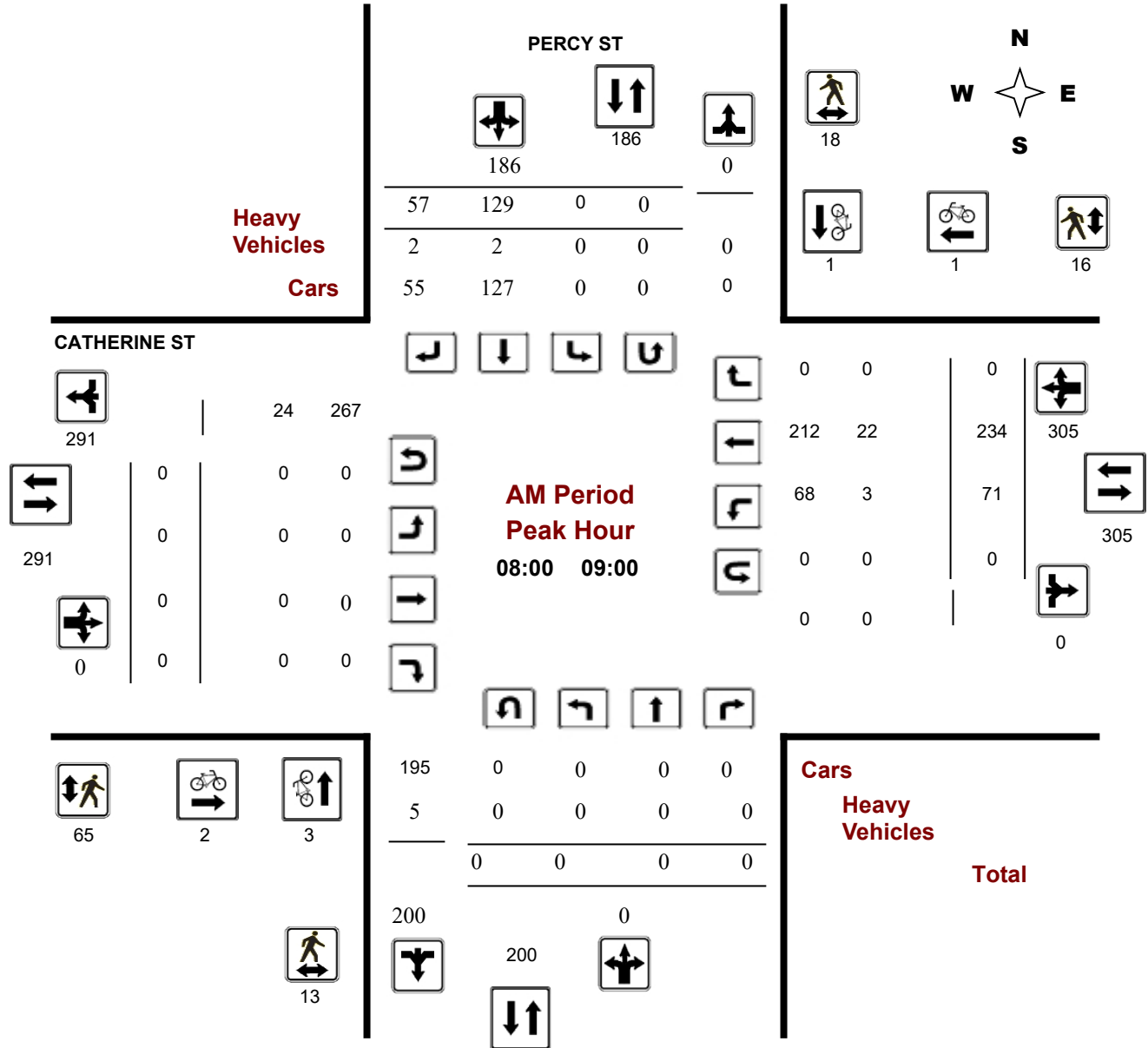

**Comments**

## Turning Movement Count - Peak Hour Diagram

### CATHERINE ST @ PERCY ST

**Survey Date:** Thursday, April 19, 2018

**Start Time:** 07:00

**WO No:** 40917

**Device:** Miovision

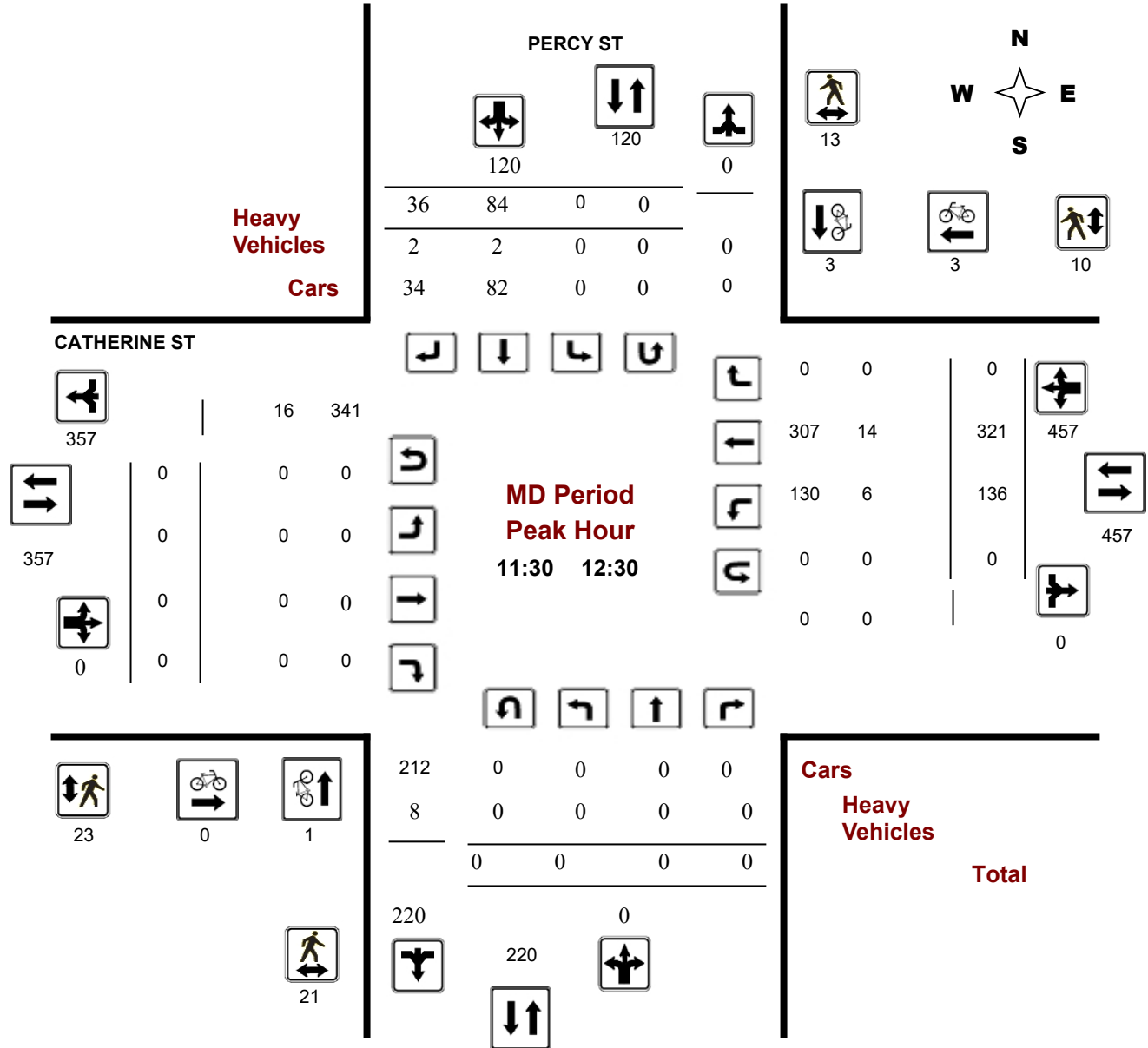

## Turning Movement Count - Peak Hour Diagram

### CATHERINE ST @ PERCY ST

**Survey Date:** Thursday, April 19, 2018

**Start Time:** 07:00

**WO No:** 40917

**Device:** Miovision

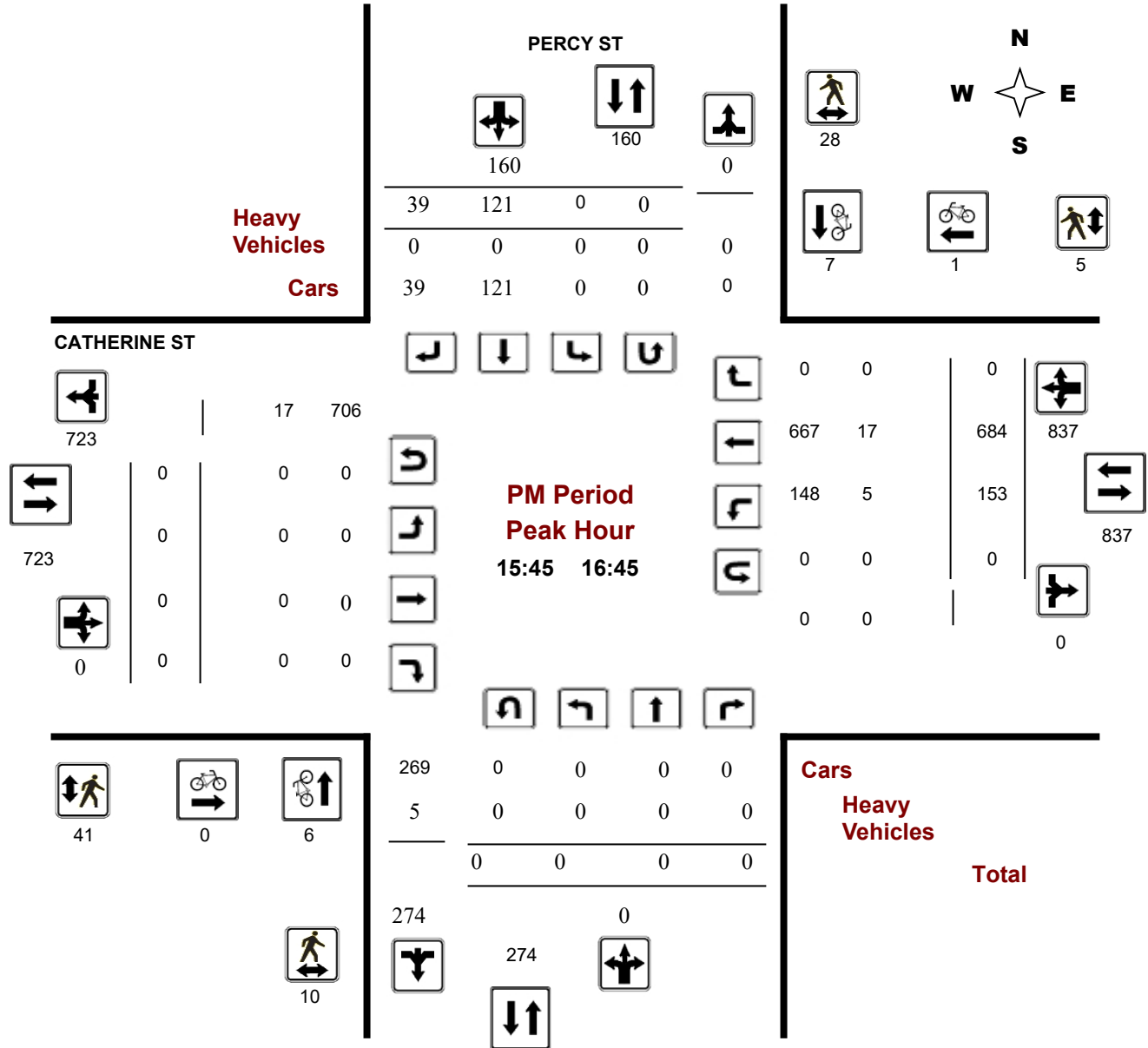

**Comments**



# Transportation Services - Traffic Services

## Turning Movement Count - Study Results

### CATHERINE ST @ PERCY ST

**Survey Date:** Thursday, April 19, 2018

**WO No:** 40917

**Start Time:** 07:00

**Device:** Miovision

### Full Study Summary (8 HR Standard)

**Survey Date:** Thursday, April 19, 2018

**Total Observed U-Turns**

**AADT Factor**

Northbound: 0      Southbound: 0

.90

Eastbound: 0      Westbound: 0

Period	PERCY ST									CATHERINE ST									Grand Total
	Northbound			NB TOT	Southbound			SB TOT	STR TOT	Eastbound			EB TOT	Westbound			WB TOT	STR TOT	
	LT	ST	RT		LT	ST	RT			LT	ST	RT		LT	ST	RT			
07:00 08:00	0	0	0	0	0	83	39	122	122	0	0	0	0	45	161	0	206	206	328
08:00 09:00	0	0	0	0	0	129	57	186	186	0	0	0	0	71	234	0	305	305	491
09:00 10:00	0	0	0	0	0	79	33	112	112	0	0	0	0	84	216	0	300	300	412
11:30 12:30	0	0	0	0	0	84	36	120	120	0	0	0	0	136	321	0	457	457	577
12:30 13:30	2	0	0	2	0	64	33	97	99	0	0	0	0	89	279	0	368	368	467
15:00 16:00	0	0	0	0	0	103	58	161	161	0	0	0	0	126	553	0	679	679	840
16:00 17:00	0	0	0	0	0	119	43	162	162	0	0	0	0	162	644	0	806	806	968
17:00 18:00	0	0	0	0	0	125	63	188	188	0	0	1	1	120	442	0	562	563	751
<b>Sub Total</b>	<b>2</b>	<b>0</b>	<b>0</b>	<b>2</b>	<b>0</b>	<b>786</b>	<b>362</b>	<b>1148</b>	<b>1150</b>	<b>0</b>	<b>0</b>	<b>1</b>	<b>1</b>	<b>833</b>	<b>2850</b>	<b>0</b>	<b>3683</b>	<b>3684</b>	<b>4834</b>
<b>U Turns</b>				<b>0</b>				<b>0</b>	<b>0</b>				<b>0</b>				<b>0</b>	<b>0</b>	<b>0</b>
<b>Total</b>	<b>2</b>	<b>0</b>	<b>0</b>	<b>2</b>	<b>0</b>	<b>786</b>	<b>362</b>	<b>1148</b>	<b>1150</b>	<b>0</b>	<b>0</b>	<b>1</b>	<b>1</b>	<b>833</b>	<b>2850</b>	<b>0</b>	<b>3683</b>	<b>3684</b>	<b>4834</b>
<b>EQ 12Hr</b>	<b>3</b>	<b>0</b>	<b>0</b>	<b>3</b>	<b>0</b>	<b>1093</b>	<b>503</b>	<b>1596</b>	<b>1598</b>	<b>0</b>	<b>0</b>	<b>1</b>	<b>1</b>	<b>1158</b>	<b>3961</b>	<b>0</b>	<b>5119</b>	<b>5121</b>	<b>6719</b>
Note: These values are calculated by multiplying the totals by the appropriate expansion factor.													<b>1.39</b>						
<b>AVG 12Hr</b>	<b>3</b>	<b>0</b>	<b>0</b>	<b>3</b>	<b>0</b>	<b>1288</b>	<b>593</b>	<b>1436</b>	<b>1438</b>	<b>0</b>	<b>0</b>	<b>1</b>	<b>1</b>	<b>1042</b>	<b>3565</b>	<b>0</b>	<b>4607</b>	<b>4609</b>	<b>6047</b>
Note: These volumes are calculated by multiplying the Equivalent 12 hr. totals by the AADT factor.													<b>.90</b>						
<b>AVG 24Hr</b>	<b>4</b>	<b>0</b>	<b>0</b>	<b>4</b>	<b>0</b>	<b>1687</b>	<b>777</b>	<b>1881</b>	<b>1884</b>	<b>0</b>	<b>0</b>	<b>1</b>	<b>1</b>	<b>1365</b>	<b>4670</b>	<b>0</b>	<b>6035</b>	<b>6038</b>	<b>7922</b>
Note: These volumes are calculated by multiplying the Average Daily 12 hr. totals by 12 to 24 expansion factor.													<b>1.31</b>						
Note: U-Turns provided for approach totals. Refer to 'U-Turn' Report for specific breakdown.																			



# Transportation Services - Traffic Services

## Turning Movement Count - Study Results

### CATHERINE ST @ PERCY ST

**Survey Date:** Thursday, April 19, 2018

**WO No:** 40917

**Start Time:** 07:00

**Device:** Miovision

### Full Study 15 Minute Increments

#### PERCY ST

#### CATHERINE ST

Northbound

Southbound

Eastbound

Westbound

Time Period	LT	ST	RT	N TOT	LT	ST	RT	S TOT	STR TOT	LT	ST	RT	E TOT	LT	ST	RT	W TOT	STR TOT	Grand Total
07:00 07:15	0	0	0	0	0	9	9	18	18	0	0	0	0	9	36	0	45	45	63
07:15 07:30	0	0	0	0	0	20	7	27	27	0	0	0	0	9	36	0	45	45	72
07:30 07:45	0	0	0	0	0	23	5	28	28	0	0	0	0	14	48	0	62	62	90
07:45 08:00	0	0	0	0	0	31	18	49	49	0	0	0	0	13	41	0	54	54	103
08:00 08:15	0	0	0	0	0	32	16	48	48	0	0	0	0	14	54	0	68	68	116
08:15 08:30	0	0	0	0	0	32	14	46	46	0	0	0	0	17	59	0	76	76	122
08:30 08:45	0	0	0	0	0	30	18	48	48	0	0	0	0	17	67	0	84	84	132
08:45 09:00	0	0	0	0	0	35	9	44	44	0	0	0	0	23	54	0	77	77	121
09:00 09:15	0	0	0	0	0	19	4	23	23	0	0	0	0	27	63	0	90	90	113
09:15 09:30	0	0	0	0	0	26	12	38	38	0	0	0	0	19	52	0	71	71	109
09:30 09:45	0	0	0	0	0	12	13	25	25	0	0	0	0	17	50	0	67	67	92
09:45 10:00	0	0	0	0	0	22	4	26	26	0	0	0	0	21	51	0	72	72	98
11:30 11:45	0	0	0	0	0	22	8	30	30	0	0	0	0	29	77	0	106	106	136
11:45 12:00	0	0	0	0	0	20	13	33	33	0	0	0	0	29	78	0	107	107	140
12:00 12:15	0	0	0	0	0	21	8	29	29	0	0	0	0	37	76	0	113	113	142
12:15 12:30	0	0	0	0	0	21	7	28	28	0	0	0	0	41	90	0	131	131	159
12:30 12:45	2	0	0	2	0	19	9	28	30	0	0	0	0	23	67	0	90	90	120
12:45 13:00	0	0	0	0	0	19	8	27	27	0	0	0	0	23	59	0	82	82	109
13:00 13:15	0	0	0	0	0	12	6	18	18	0	0	0	0	21	79	0	100	100	118
13:15 13:30	0	0	0	0	0	14	10	24	24	0	0	0	0	22	74	0	96	96	120
15:00 15:15	0	0	0	0	0	21	15	36	36	0	0	0	0	25	83	0	108	108	144
15:15 15:30	0	0	0	0	0	24	16	40	40	0	0	0	0	42	147	0	189	189	229
15:30 15:45	0	0	0	0	0	34	18	52	52	0	0	0	0	25	172	0	197	197	249
15:45 16:00	0	0	0	0	0	24	9	33	33	0	0	0	0	34	151	0	185	185	218
16:00 16:15	0	0	0	0	0	30	11	41	41	0	0	0	0	26	165	0	191	191	232
16:15 16:30	0	0	0	0	0	31	11	42	42	0	0	0	0	34	202	0	236	236	278
16:30 16:45	0	0	0	0	0	36	8	44	44	0	0	0	0	59	166	0	225	225	269
16:45 17:00	0	0	0	0	0	22	13	35	35	0	0	0	0	43	111	0	154	154	189
17:00 17:15	0	0	0	0	0	43	15	58	58	0	0	0	0	43	120	0	163	163	221
17:15 17:30	0	0	0	0	0	26	11	37	37	0	0	1	1	30	131	0	161	162	199
17:30 17:45	0	0	0	0	0	36	21	57	57	0	0	0	0	21	85	0	106	106	163
17:45 18:00	0	0	0	0	0	20	16	36	36	0	0	0	0	26	106	0	132	132	168
<b>Total:</b>	<b>2</b>	<b>0</b>	<b>0</b>	<b>2</b>	<b>0</b>	<b>786</b>	<b>362</b>	<b>1148</b>	<b>1150</b>	<b>0</b>	<b>0</b>	<b>1</b>	<b>1</b>	<b>833</b>	<b>2850</b>	<b>0</b>	<b>3683</b>	<b>3684</b>	<b>4,834</b>

Note: U-Turns are included in Totals.





# Transportation Services - Traffic Services

## Turning Movement Count - Study Results

### CATHERINE ST @ PERCY ST

**Survey Date:** Thursday, April 19, 2018

**WO No:** 40917

**Start Time:** 07:00

**Device:** Miovision

### Full Study Cyclist Volume

Time Period	PERCY ST			CATHERINE ST			Grand Total
	Northbound	Southbound	Street Total	Eastbound	Westbound	Street Total	
07:00 07:15	1	0	1	0	0	0	1
07:15 07:30	0	1	1	0	0	0	1
07:30 07:45	0	0	0	0	0	0	0
07:45 08:00	0	0	0	0	0	0	0
08:00 08:15	2	1	3	0	0	0	3
08:15 08:30	0	0	0	0	0	0	0
08:30 08:45	0	0	0	0	1	1	1
08:45 09:00	1	0	1	2	0	2	3
09:00 09:15	2	0	2	0	0	0	2
09:15 09:30	4	0	4	0	0	0	4
09:30 09:45	2	0	2	1	0	1	3
09:45 10:00	4	0	4	0	0	0	4
11:30 11:45	1	1	2	0	3	3	5
11:45 12:00	0	1	1	0	0	0	1
12:00 12:15	0	0	0	0	0	0	0
12:15 12:30	0	1	1	0	0	0	1
12:30 12:45	0	3	3	0	0	0	3
12:45 13:00	0	1	1	0	2	2	3
13:00 13:15	0	0	0	0	0	0	0
13:15 13:30	3	2	5	1	1	2	7
15:00 15:15	1	1	2	0	1	1	3
15:15 15:30	2	0	2	0	3	3	5
15:30 15:45	1	3	4	1	1	2	6
15:45 16:00	0	1	1	0	0	0	1
16:00 16:15	2	1	3	0	1	1	4
16:15 16:30	1	4	5	0	0	0	5
16:30 16:45	3	1	4	0	0	0	4
16:45 17:00	0	3	3	0	1	1	4
17:00 17:15	1	4	5	0	0	0	5
17:15 17:30	0	10	10	0	1	1	11
17:30 17:45	0	4	4	0	2	2	6
17:45 18:00	0	6	6	0	1	1	7
<b>Total</b>	<b>31</b>	<b>49</b>	<b>80</b>	<b>5</b>	<b>18</b>	<b>23</b>	<b>103</b>



# Transportation Services - Traffic Services

## Turning Movement Count - Study Results

### CATHERINE ST @ PERCY ST

**Survey Date:** Thursday, April 19, 2018

**WO No:** 40917

**Start Time:** 07:00

**Device:** Miovision

### Full Study Pedestrian Volume

#### PERCY ST

#### CATHERINE ST

Time Period	NB Approach (E or W Crossing)	SB Approach (E or W Crossing)	Total	EB Approach (N or S Crossing)	WB Approach (N or S Crossing)	Total	Grand Total
07:00 07:15	1	1	2	3	3	6	8
07:15 07:30	1	3	4	8	3	11	15
07:30 07:45	2	0	2	12	1	13	15
07:45 08:00	2	1	3	10	2	12	15
08:00 08:15	2	2	4	15	3	18	22
08:15 08:30	2	7	9	13	4	17	26
08:30 08:45	6	5	11	23	5	28	39
08:45 09:00	3	4	7	14	4	18	25
09:00 09:15	3	2	5	9	5	14	19
09:15 09:30	0	1	1	1	2	3	4
09:30 09:45	0	2	2	4	1	5	7
09:45 10:00	0	3	3	6	0	6	9
11:30 11:45	2	0	2	3	3	6	8
11:45 12:00	7	2	9	10	1	11	20
12:00 12:15	9	4	13	6	4	10	23
12:15 12:30	3	7	10	4	2	6	16
12:30 12:45	3	3	6	4	0	4	10
12:45 13:00	4	5	9	3	0	3	12
13:00 13:15	4	3	7	4	7	11	18
13:15 13:30	3	2	5	2	1	3	8
15:00 15:15	8	2	10	17	6	23	33
15:15 15:30	2	12	14	7	5	12	26
15:30 15:45	5	5	10	8	1	9	19
15:45 16:00	0	5	5	5	1	6	11
16:00 16:15	8	5	13	13	1	14	27
16:15 16:30	2	6	8	9	0	9	17
16:30 16:45	0	12	12	14	3	17	29
16:45 17:00	6	10	16	14	6	20	36
17:00 17:15	0	9	9	16	2	18	27
17:15 17:30	5	4	9	17	2	19	28
17:30 17:45	1	4	5	13	3	16	21
17:45 18:00	1	2	3	9	3	12	15
<b>Total .....</b>	<b>95</b>	<b>133</b>	<b>228</b>	<b>296</b>	<b>84</b>	<b>380</b>	<b>608</b>



# Transportation Services - Traffic Services

## Turning Movement Count - Study Results

### CATHERINE ST @ PERCY ST

**Survey Date:** Thursday, April 19, 2018

**WO No:** 40917

**Start Time:** 07:00

**Device:** Miovision

### Full Study Heavy Vehicles

#### PERCY ST

#### CATHERINE ST

Northbound

Southbound

Eastbound

Westbound

Time Period	PERCY ST Northbound			N TOT	PERCY ST Southbound			S TOT	STR TOT	CATHERINE ST Eastbound			E TOT	CATHERINE ST Westbound			W TOT	STR TOT	Grand Total	
	LT	ST	RT		LT	ST	RT			LT	ST	RT		LT	ST	RT				
07:00 07:15	0	0	0	2	0	0	1	1	3	0	0	0	5	2	4	0	6	11	7	
07:15 07:30	0	0	0	1	0	0	1	1	2	0	0	0	4	1	3	0	4	8	5	
07:30 07:45	0	0	0	0	0	0	0	0	0	0	0	0	2	0	2	0	2	4	2	
07:45 08:00	0	0	0	2	0	0	1	1	3	0	0	0	5	2	4	0	6	11	7	
08:00 08:15	0	0	0	1	0	0	0	0	1	0	0	0	10	1	10	0	11	21	11	
08:15 08:30	0	0	0	1	0	1	1	2	3	0	0	0	3	0	2	0	2	5	4	
08:30 08:45	0	0	0	2	0	1	1	2	4	0	0	0	8	1	7	0	8	16	10	
08:45 09:00	0	0	0	1	0	0	0	0	1	0	0	0	3	1	3	0	4	7	4	
09:00 09:15	0	0	0	7	0	1	0	1	8	0	0	0	7	6	7	0	13	20	14	
09:15 09:30	0	0	0	1	0	0	0	0	1	0	0	0	3	1	3	0	4	7	4	
09:30 09:45	0	0	0	0	0	0	0	0	0	0	0	0	1	0	1	0	1	2	1	
09:45 10:00	0	0	0	6	0	2	1	3	9	0	0	0	4	4	3	0	7	11	10	
11:30 11:45	0	0	0	2	0	1	0	1	3	0	0	0	6	1	6	0	7	13	8	
11:45 12:00	0	0	0	2	0	1	2	3	5	0	0	0	2	1	0	0	1	3	4	
12:00 12:15	0	0	0	1	0	0	0	0	1	0	0	0	4	1	4	0	5	9	5	
12:15 12:30	0	0	0	3	0	0	0	0	3	0	0	0	4	3	4	0	7	11	7	
12:30 12:45	2	0	0	4	0	0	0	0	4	0	0	0	4	2	2	0	4	8	6	
12:45 13:00	0	0	0	1	0	0	0	0	1	0	0	0	1	1	1	0	2	3	2	
13:00 13:15	0	0	0	2	0	0	0	0	2	0	0	0	4	2	4	0	6	10	6	
13:15 13:30	0	0	0	2	0	0	0	0	2	0	0	0	3	2	3	0	5	8	5	
15:00 15:15	0	0	0	3	0	1	1	2	5	0	0	0	3	2	2	0	4	7	6	
15:15 15:30	0	0	0	2	0	0	1	1	3	0	0	0	4	2	3	0	5	9	6	
15:30 15:45	0	0	0	1	0	0	1	1	2	0	0	0	4	1	3	0	4	8	5	
15:45 16:00	0	0	0	1	0	0	0	0	1	0	0	0	3	1	3	0	4	7	4	
16:00 16:15	0	0	0	3	0	0	0	0	3	0	0	0	8	3	8	0	11	19	11	
16:15 16:30	0	0	0	1	0	0	0	0	1	0	0	0	5	1	5	0	6	11	6	
16:30 16:45	0	0	0	0	0	0	0	0	0	0	0	0	1	0	1	0	1	2	1	
16:45 17:00	0	0	0	1	0	1	0	1	2	0	0	0	4	0	4	0	4	8	5	
17:00 17:15	0	0	0	4	0	2	0	2	6	0	0	0	1	2	1	0	3	4	5	
17:15 17:30	0	0	0	0	0	0	0	0	0	0	0	0	3	0	3	0	3	6	3	
17:30 17:45	0	0	0	1	0	1	0	1	2	0	0	0	1	0	1	0	1	2	2	
17:45 18:00	0	0	0	0	0	0	0	0	0	0	0	0	2	0	2	0	2	4	2	
<b>Total:</b>	<b>None</b>	<b>2</b>	<b>0</b>	<b>0</b>	<b>58</b>	<b>0</b>	<b>12</b>	<b>11</b>	<b>23</b>	<b>81</b>	<b>0</b>	<b>0</b>	<b>0</b>	<b>122</b>	<b>44</b>	<b>109</b>	<b>0</b>	<b>153</b>	<b>275</b>	<b>178</b>



# Transportation Services - Traffic Services

## Turning Movement Count - Study Results

### CATHERINE ST @ PERCY ST

**Survey Date:** Thursday, April 19, 2018

**WO No:** 40917

**Start Time:** 07:00

**Device:** Miovision

### Full Study 15 Minute U-Turn Total

PERCY ST

CATHERINE ST

Time Period		Northbound U-Turn Total	Southbound U-Turn Total	Eastbound U-Turn Total	Westbound U-Turn Total	Total
07:00	07:15	0	0	0	0	0
07:15	07:30	0	0	0	0	0
07:30	07:45	0	0	0	0	0
07:45	08:00	0	0	0	0	0
08:00	08:15	0	0	0	0	0
08:15	08:30	0	0	0	0	0
08:30	08:45	0	0	0	0	0
08:45	09:00	0	0	0	0	0
09:00	09:15	0	0	0	0	0
09:15	09:30	0	0	0	0	0
09:30	09:45	0	0	0	0	0
09:45	10:00	0	0	0	0	0
11:30	11:45	0	0	0	0	0
11:45	12:00	0	0	0	0	0
12:00	12:15	0	0	0	0	0
12:15	12:30	0	0	0	0	0
12:30	12:45	0	0	0	0	0
12:45	13:00	0	0	0	0	0
13:00	13:15	0	0	0	0	0
13:15	13:30	0	0	0	0	0
15:00	15:15	0	0	0	0	0
15:15	15:30	0	0	0	0	0
15:30	15:45	0	0	0	0	0
15:45	16:00	0	0	0	0	0
16:00	16:15	0	0	0	0	0
16:15	16:30	0	0	0	0	0
16:30	16:45	0	0	0	0	0
16:45	17:00	0	0	0	0	0
17:00	17:15	0	0	0	0	0
17:15	17:30	0	0	0	0	0
17:30	17:45	0	0	0	0	0
17:45	18:00	0	0	0	0	0
Total		0	0	0	0	0

## Turning Movement Count - Study Results

### GLADSTONE AVE @ KENT ST

**Survey Date:** Tuesday, April 25, 2017

**WO No:** 36848

**Start Time:** 07:00

**Device:** Miovision

### Full Study Diagram

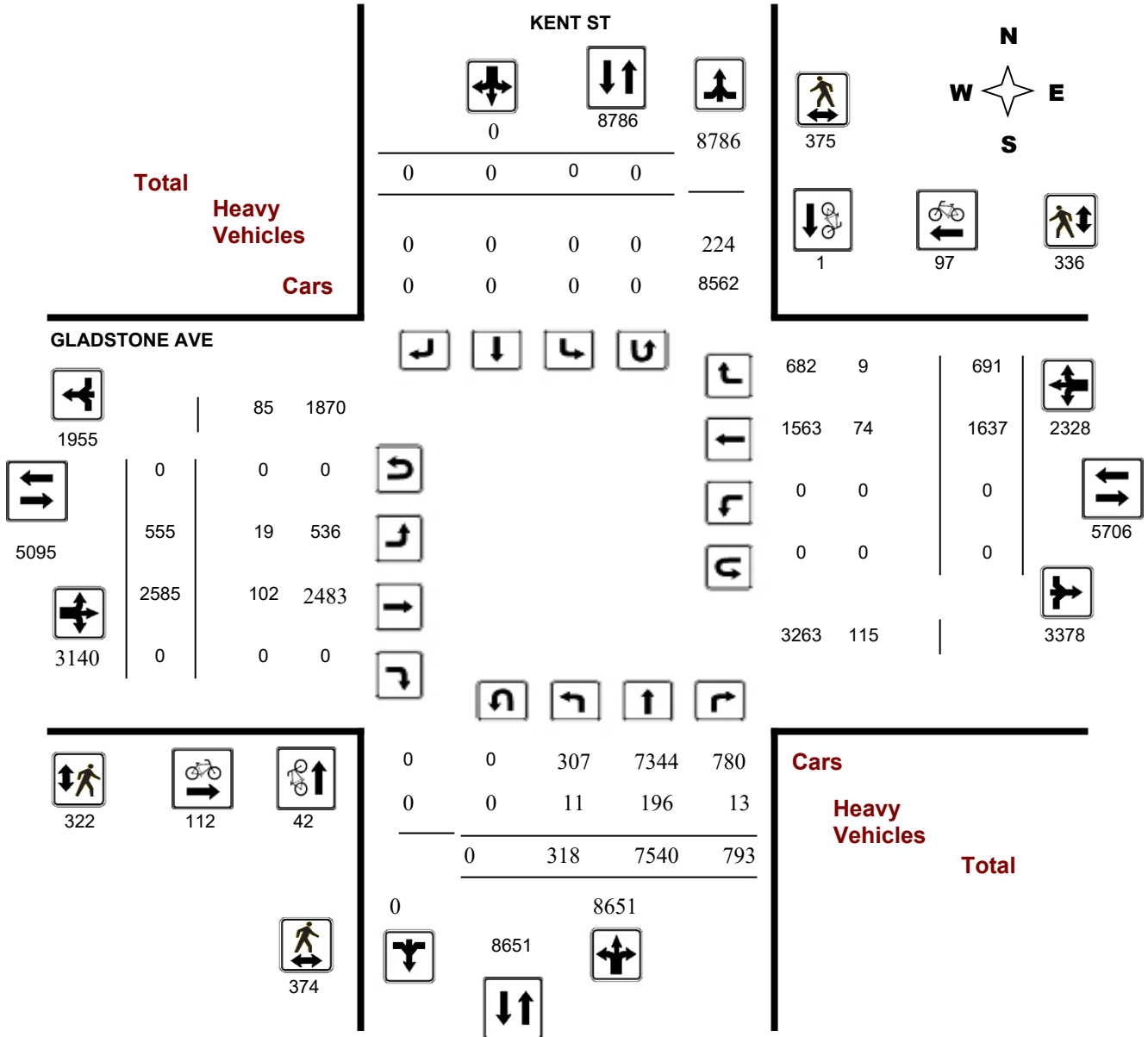

## Turning Movement Count - Study Results

### GLADSTONE AVE @ KENT ST

**Survey Date:** Tuesday, April 25, 2017

**WO No:** 36848

**Start Time:** 07:00

**Device:** Miovision

### Full Study Peak Hour Diagram

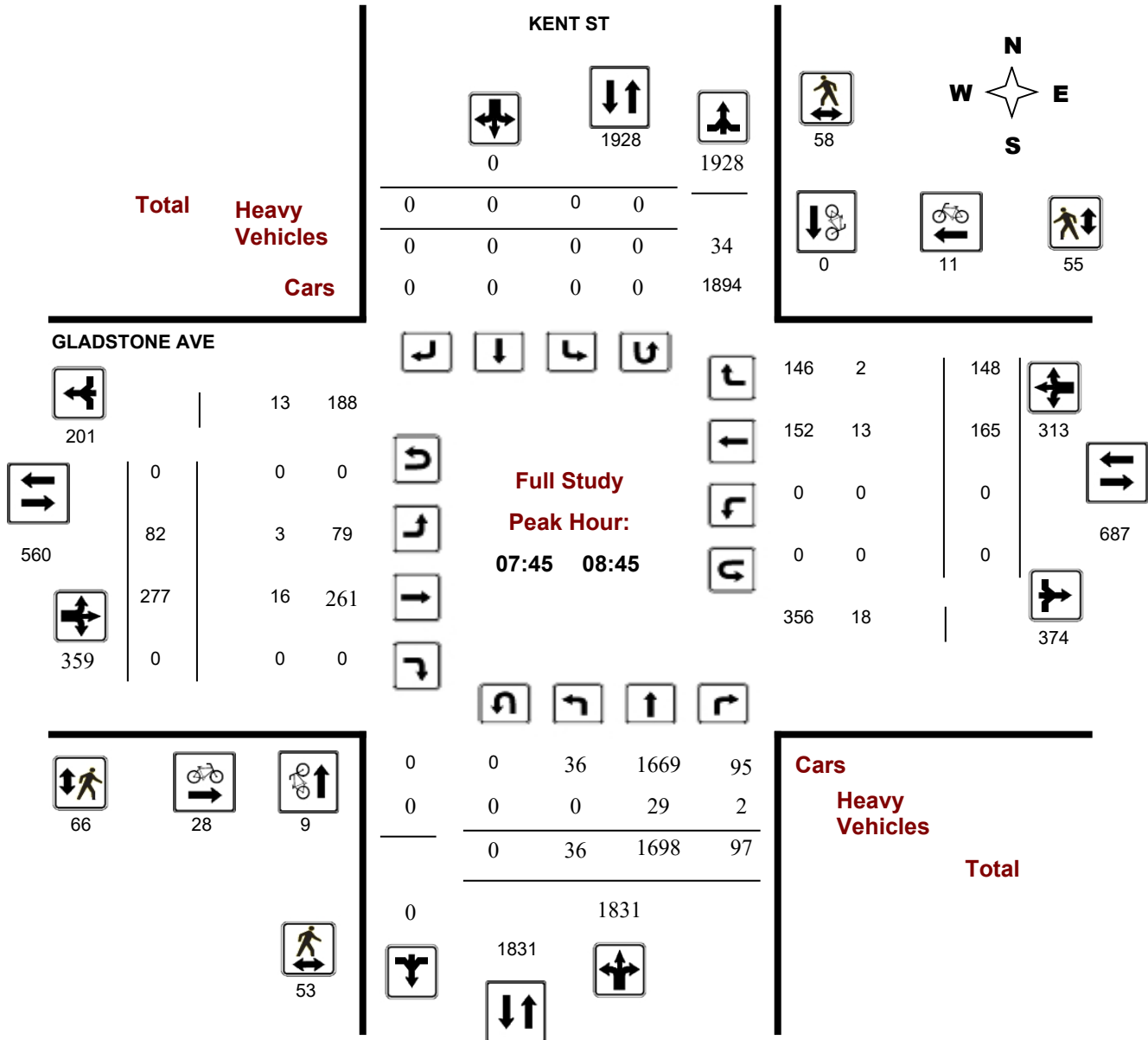

## Turning Movement Count - Peak Hour Diagram

### GLADSTONE AVE @ KENT ST

**Survey Date:** Tuesday, April 25, 2017

**Start Time:** 07:00

**WO No:** 36848

**Device:** Miovision

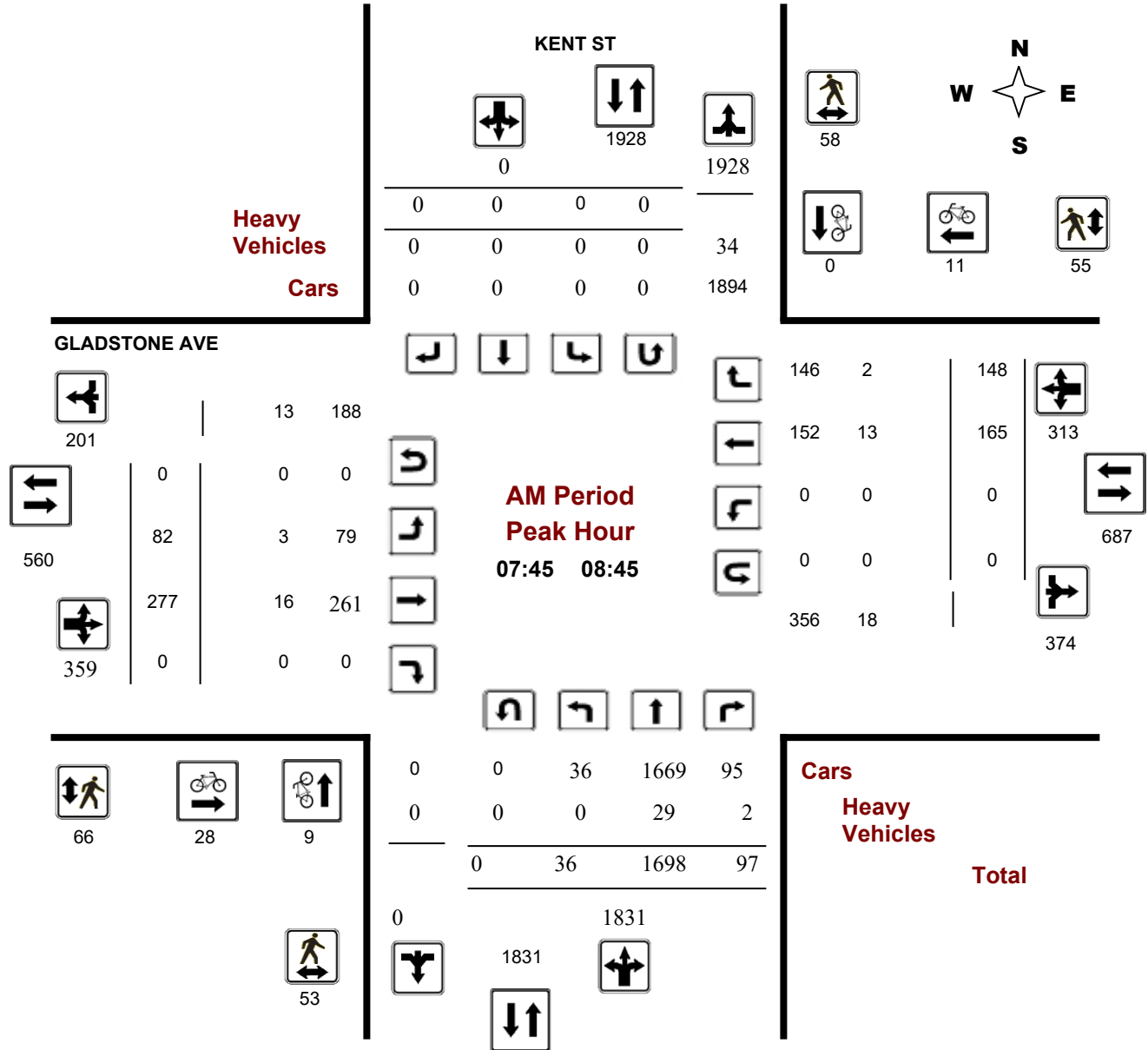

## Turning Movement Count - Peak Hour Diagram

### GLADSTONE AVE @ KENT ST

**Survey Date:** Tuesday, April 25, 2017

**Start Time:** 07:00

**WO No:** 36848

**Device:** Miovision

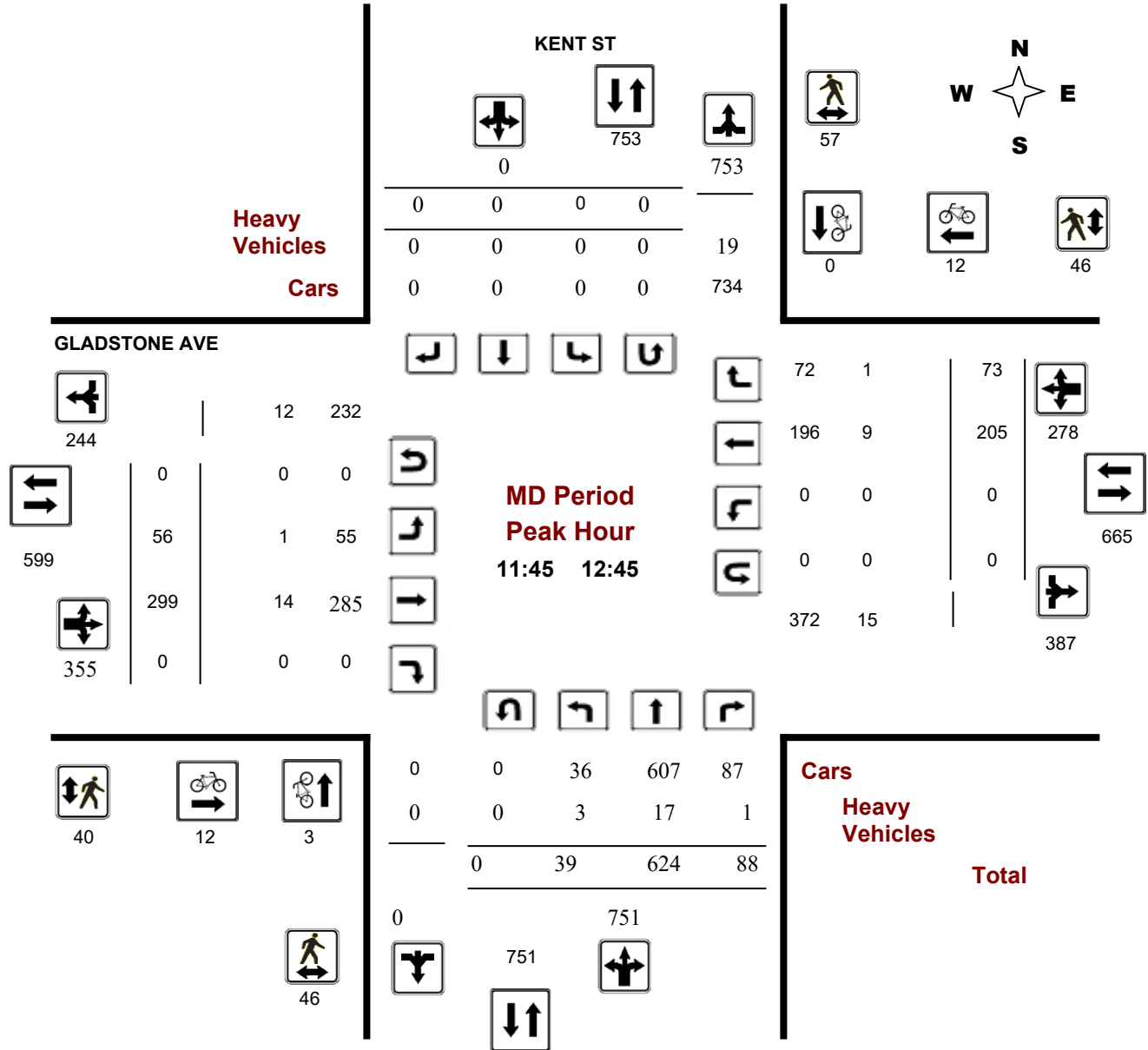



## Turning Movement Count - Peak Hour Diagram

### GLADSTONE AVE @ KENT ST

**Survey Date:** Tuesday, April 25, 2017

**Start Time:** 07:00

**WO No:** 36848

**Device:** Miovision

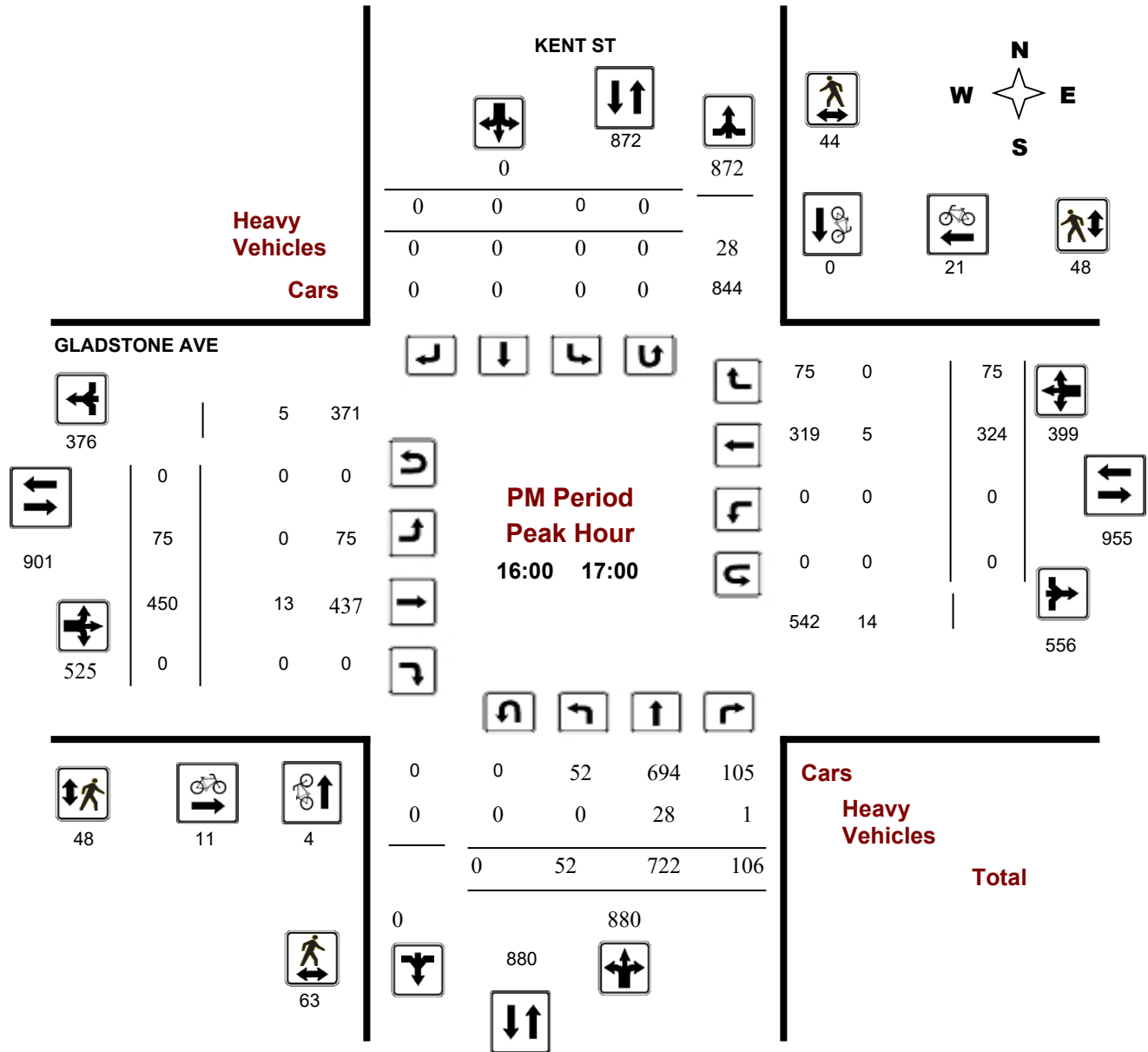

**Comments**



# Transportation Services - Traffic Services

## Turning Movement Count - Study Results

### GLADSTONE AVE @ KENT ST

**Survey Date:** Tuesday, April 25, 2017

**WO No:** 36848

**Start Time:** 07:00

**Device:** Miovision

### Full Study Summary (8 HR Standard)

**Survey Date:** Tuesday, April 25, 2017

**Total Observed U-Turns**  
 Northbound: 0      Southbound: 0  
 Eastbound: 0      Westbound: 0

**AADT Factor**  
 .90

Period	KENT ST									GLADSTONE AVE									Grand Total
	Northbound				Southbound					Eastbound				Westbound					
	LT	ST	RT	NB TOT	LT	ST	RT	SB TOT	STR TOT	LT	ST	RT	EB TOT	LT	ST	RT	WB TOT	STR TOT	
07:00 08:00	14	1536	96	1646	0	0	0	0	1646	61	214	0	275	0	100	104	204	479	2125
08:00 09:00	42	1679	98	1819	0	0	0	0	1819	82	291	0	373	0	172	130	302	675	2494
09:00 10:00	34	943	107	1084	0	0	0	0	1084	76	256	0	332	0	173	76	249	581	1665
11:30 12:30	36	633	80	749	0	0	0	0	749	55	288	0	343	0	182	77	259	602	1351
12:30 13:30	33	569	97	699	0	0	0	0	699	54	321	0	375	0	201	74	275	650	1349
15:00 16:00	47	667	108	822	0	0	0	0	822	66	394	0	460	0	237	72	309	769	1591
16:00 17:00	52	722	106	880	0	0	0	0	880	75	450	0	525	0	324	75	399	924	1804
17:00 18:00	60	791	101	952	0	0	0	0	952	86	371	0	457	0	248	83	331	788	1740
<b>Sub Total</b>	318	7540	793	8651	0	0	0	0	8651	555	2585	0	3140	0	1637	691	2328	5468	14119
<b>U Turns</b>	0			0	0			0	0	0			0	0			0	0	0
<b>Total</b>	318	7540	793	8651	0	0	0	0	8651	555	2585	0	3140	0	1637	691	2328	5468	14119
<b>EQ 12Hr</b>	442	10481	1102	12025	0	0	0	0	12025	771	3593	0	4364	0	2275	960	3235	7599	19624
Note: These values are calculated by multiplying the totals by the appropriate expansion factor.																	<b>1.39</b>		
<b>AVG 12Hr</b>	398	9433	992	10823	0	0	0	0	10823	694	3234	0	3928	0	2048	864	2912	6840	17663
Note: These volumes are calculated by multiplying the Equivalent 12 hr. totals by the AADT factor.																	<b>.90</b>		
<b>AVG 24Hr</b>	521	12357	1300	14178	0	0	0	0	14178	909	4237	0	5146	0	2683	1132	3815	8961	23139
Note: These volumes are calculated by multiplying the Average Daily 12 hr. totals by 12 to 24 expansion factor.																	<b>1.31</b>		

Note: U-Turns provided for approach totals. Refer to 'U-Turn' Report for specific breakdown.



# Transportation Services - Traffic Services

## Turning Movement Count - Study Results

### GLADSTONE AVE @ KENT ST

**Survey Date:** Tuesday, April 25, 2017

**WO No:** 36848

**Start Time:** 07:00

**Device:** Miovision

### Full Study 15 Minute Increments

#### KENT ST

#### GLADSTONE AVE

Northbound

Southbound

Eastbound

Westbound

Time Period	LT	ST	RT	N TOT	LT	ST	RT	S TOT	STR TOT	LT	ST	RT	E TOT	LT	ST	RT	W TOT	STR TOT	Grand Total
07:00 07:15	1	319	24	344	0	0	0	0	344	17	51	0	68	0	20	10	30	98	442
07:15 07:30	2	382	24	408	0	0	0	0	408	13	40	0	53	0	18	21	39	92	500
07:30 07:45	6	402	25	433	0	0	0	0	433	15	64	0	79	0	22	31	53	132	565
07:45 08:00	5	433	23	461	0	0	0	0	461	16	59	0	75	0	40	42	82	157	618
08:00 08:15	8	428	33	469	0	0	0	0	469	22	79	0	101	0	31	42	73	174	643
08:15 08:30	7	435	19	461	0	0	0	0	461	22	70	0	92	0	50	28	78	170	631
08:30 08:45	16	402	22	440	0	0	0	0	440	22	69	0	91	0	44	36	80	171	611
08:45 09:00	11	414	24	449	0	0	0	0	449	16	73	0	89	0	47	24	71	160	609
09:00 09:15	6	319	28	353	0	0	0	0	353	17	66	0	83	0	51	31	82	165	518
09:15 09:30	14	243	26	283	0	0	0	0	283	27	66	0	93	0	33	17	50	143	426
09:30 09:45	4	177	29	210	0	0	0	0	210	15	61	0	76	0	41	15	56	132	342
09:45 10:00	10	204	24	238	0	0	0	0	238	17	63	0	80	0	48	13	61	141	379
11:30 11:45	6	158	12	176	0	0	0	0	176	14	67	0	81	0	33	18	51	132	308
11:45 12:00	8	167	28	203	0	0	0	0	203	17	82	0	99	0	55	25	80	179	382
12:00 12:15	14	153	25	192	0	0	0	0	192	13	65	0	78	0	44	19	63	141	333
12:15 12:30	8	155	15	178	0	0	0	0	178	11	74	0	85	0	50	15	65	150	328
12:30 12:45	9	149	20	178	0	0	0	0	178	15	78	0	93	0	56	14	70	163	341
12:45 13:00	6	153	19	178	0	0	0	0	178	12	66	0	78	0	47	22	69	147	325
13:00 13:15	15	141	32	188	0	0	0	0	188	16	96	0	112	0	48	19	67	179	367
13:15 13:30	3	126	26	155	0	0	0	0	155	11	81	0	92	0	50	19	69	161	316
15:00 15:15	11	154	15	180	0	0	0	0	180	20	85	0	105	0	59	19	78	183	363
15:15 15:30	14	157	28	199	0	0	0	0	199	18	102	0	120	0	56	21	77	197	396
15:30 15:45	9	167	21	197	0	0	0	0	197	16	107	0	123	0	65	14	79	202	399
15:45 16:00	13	189	44	246	0	0	0	0	246	12	100	0	112	0	57	18	75	187	433
16:00 16:15	14	172	23	209	0	0	0	0	209	14	118	0	132	0	86	25	111	243	452
16:15 16:30	9	195	28	232	0	0	0	0	232	24	111	0	135	0	71	19	90	225	457
16:30 16:45	16	167	18	201	0	0	0	0	201	19	116	0	135	0	89	18	107	242	443
16:45 17:00	13	188	37	238	0	0	0	0	238	18	105	0	123	0	78	13	91	214	452
17:00 17:15	19	176	29	224	0	0	0	0	224	20	99	0	119	0	69	17	86	205	429
17:15 17:30	14	201	27	242	0	0	0	0	242	26	109	0	135	0	53	25	78	213	455
17:30 17:45	15	215	26	256	0	0	0	0	256	25	93	0	118	0	69	21	90	208	464
17:45 18:00	12	199	19	230	0	0	0	0	230	15	70	0	85	0	57	20	77	162	392
<b>Total:</b>	<b>318</b>	<b>7540</b>	<b>793</b>	<b>8651</b>	<b>0</b>	<b>0</b>	<b>0</b>	<b>0</b>	<b>8651</b>	<b>555</b>	<b>2585</b>	<b>0</b>	<b>3140</b>	<b>0</b>	<b>1637</b>	<b>691</b>	<b>2328</b>	<b>8651</b>	<b>14,119</b>

Note: U-Turns are included in Totals.



# Transportation Services - Traffic Services

## Turning Movement Count - Study Results

### GLADSTONE AVE @ KENT ST

**Survey Date:** Tuesday, April 25, 2017

**WO No:** 36848

**Start Time:** 07:00

**Device:** Miovision

### Full Study Cyclist Volume

Time Period	KENT ST			GLADSTONE AVE			Grand Total
	Northbound	Southbound	Street Total	Eastbound	Westbound	Street Total	
07:00 07:15	1	0	1	2	3	5	6
07:15 07:30	1	0	1	3	2	5	6
07:30 07:45	0	0	0	4	5	9	9
07:45 08:00	3	0	3	6	2	8	11
08:00 08:15	2	0	2	9	3	12	14
08:15 08:30	4	0	4	6	1	7	11
08:30 08:45	0	0	0	7	5	12	12
08:45 09:00	7	0	7	7	4	11	18
09:00 09:15	0	0	0	7	1	8	8
09:15 09:30	7	0	7	1	2	3	10
09:30 09:45	1	0	1	2	1	3	4
09:45 10:00	0	0	0	3	2	5	5
11:30 11:45	0	0	0	3	3	6	6
11:45 12:00	1	0	1	1	4	5	6
12:00 12:15	0	0	0	6	2	8	8
12:15 12:30	1	0	1	2	2	4	5
12:30 12:45	1	0	1	3	4	7	8
12:45 13:00	3	0	3	2	7	9	12
13:00 13:15	1	0	1	3	1	4	5
13:15 13:30	3	0	3	0	1	1	4
15:00 15:15	0	0	0	4	1	5	5
15:15 15:30	0	1	1	1	0	1	2
15:30 15:45	0	0	0	3	2	5	5
15:45 16:00	0	0	0	0	2	2	2
16:00 16:15	0	0	0	4	2	6	6
16:15 16:30	3	0	3	1	7	8	11
16:30 16:45	0	0	0	2	7	9	9
16:45 17:00	1	0	1	4	5	9	10
17:00 17:15	0	0	0	6	5	11	11
17:15 17:30	1	0	1	4	7	11	12
17:30 17:45	0	0	0	3	3	6	6
17:45 18:00	1	0	1	3	1	4	5
<b>Total</b>	<b>42</b>	<b>1</b>	<b>43</b>	<b>112</b>	<b>97</b>	<b>209</b>	<b>252</b>



# Transportation Services - Traffic Services

## Turning Movement Count - Study Results

### GLADSTONE AVE @ KENT ST

**Survey Date:** Tuesday, April 25, 2017

**WO No:** 36848

**Start Time:** 07:00

**Device:** Miovision

### Full Study Pedestrian Volume

#### KENT ST

#### GLADSTONE AVE

Time Period	NB Approach (E or W Crossing)	SB Approach (E or W Crossing)	Total	EB Approach (N or S Crossing)	WB Approach (N or S Crossing)	Total	Grand Total
07:00 07:15	2	4	6	3	4	7	13
07:15 07:30	3	9	12	9	5	14	26
07:30 07:45	8	5	13	16	5	21	34
07:45 08:00	9	8	17	13	8	21	38
08:00 08:15	10	11	21	18	12	30	51
08:15 08:30	17	24	41	21	17	38	79
08:30 08:45	17	15	32	14	18	32	64
08:45 09:00	12	10	22	13	10	23	45
09:00 09:15	6	11	17	7	14	21	38
09:15 09:30	6	6	12	8	6	14	26
09:30 09:45	6	13	19	4	4	8	27
09:45 10:00	6	15	21	8	7	15	36
11:30 11:45	9	6	15	11	5	16	31
11:45 12:00	5	13	18	4	8	12	30
12:00 12:15	13	16	29	8	12	20	49
12:15 12:30	12	13	25	14	17	31	56
12:30 12:45	16	15	31	14	9	23	54
12:45 13:00	14	10	24	3	9	12	36
13:00 13:15	15	16	31	4	13	17	48
13:15 13:30	12	16	28	6	8	14	42
15:00 15:15	10	14	24	5	12	17	41
15:15 15:30	12	6	18	17	15	32	50
15:30 15:45	13	11	24	2	16	18	42
15:45 16:00	12	9	21	5	11	16	37
16:00 16:15	12	11	23	9	10	19	42
16:15 16:30	17	12	29	17	14	31	60
16:30 16:45	18	10	28	9	12	21	49
16:45 17:00	16	11	27	13	12	25	52
17:00 17:15	23	13	36	13	13	26	62
17:15 17:30	8	17	25	13	14	27	52
17:30 17:45	20	12	32	9	10	19	51
17:45 18:00	15	13	28	12	6	18	46
<b>Total</b> .....	<b>374</b>	<b>375</b>	<b>749</b>	<b>322</b>	<b>336</b>	<b>658</b>	<b>1407</b>



# Transportation Services - Traffic Services

## Turning Movement Count - Study Results

### GLADSTONE AVE @ KENT ST

**Survey Date:** Tuesday, April 25, 2017

**WO No:** 36848

**Start Time:** 07:00

**Device:** Miovision

### Full Study Heavy Vehicles

KENT ST					GLADSTONE AVE															Grand Total
Time Period	Northbound			N TOT	Southbound			S TOT	STR TOT	Eastbound			E TOT	Westbound			W TOT	STR TOT		
	LT	ST	RT		LT	ST	RT			LT	ST	RT		LT	ST	RT			LT	
07:00	07:15	0	5	0	5	0	0	0	0	5	3	2	0	5	0	2	0	2	7	12
07:15	07:30	1	3	1	5	0	0	0	0	5	1	2	0	3	0	1	1	2	5	10
07:30	07:45	1	4	0	5	0	0	0	0	5	1	5	0	6	0	5	0	5	11	16
07:45	08:00	0	5	1	6	0	0	0	0	6	0	3	0	3	0	3	0	3	6	12
08:00	08:15	0	7	1	8	0	0	0	0	8	3	4	0	7	0	2	2	4	11	19
08:15	08:30	0	10	0	10	0	0	0	0	10	0	3	0	3	0	4	0	4	7	17
08:30	08:45	0	7	0	7	0	0	0	0	7	0	6	0	6	0	4	0	4	10	17
08:45	09:00	2	7	0	9	0	0	0	0	9	2	3	0	5	0	0	0	0	5	14
09:00	09:15	2	5	3	10	0	0	0	0	10	0	5	0	5	0	3	2	5	10	20
09:15	09:30	0	4	1	5	0	0	0	0	5	0	2	0	2	0	3	0	3	5	10
09:30	09:45	0	9	1	10	0	0	0	0	10	1	2	0	3	0	2	0	2	5	15
09:45	10:00	0	6	0	6	0	0	0	0	6	1	3	0	4	0	7	0	7	11	17
11:30	11:45	0	5	0	5	0	0	0	0	5	1	2	0	3	0	2	0	2	5	10
11:45	12:00	1	7	1	9	0	0	0	0	9	0	2	0	2	0	3	0	3	5	14
12:00	12:15	0	4	0	4	0	0	0	0	4	0	4	0	4	0	2	1	3	7	11
12:15	12:30	1	4	0	5	0	0	0	0	5	1	4	0	5	0	1	0	1	6	11
12:30	12:45	1	2	0	3	0	0	0	0	3	0	4	0	4	0	3	0	3	7	10
12:45	13:00	0	3	0	3	0	0	0	0	3	1	3	0	4	0	0	0	0	4	7
13:00	13:15	0	3	0	3	0	0	0	0	3	0	2	0	2	0	3	0	3	5	8
13:15	13:30	1	4	0	5	0	0	0	0	5	1	7	0	8	0	2	0	2	10	15
15:00	15:15	0	13	1	14	0	0	0	0	14	1	4	0	5	0	5	1	6	11	25
15:15	15:30	0	11	2	13	0	0	0	0	13	0	1	0	1	0	1	1	2	3	16
15:30	15:45	0	12	0	12	0	0	0	0	12	0	6	0	6	0	3	0	3	9	21
15:45	16:00	0	9	0	9	0	0	0	0	9	1	2	0	3	0	3	1	4	7	16
16:00	16:15	0	8	0	8	0	0	0	0	8	0	4	0	4	0	2	0	2	6	14
16:15	16:30	0	9	0	9	0	0	0	0	9	0	5	0	5	0	1	0	1	6	15
16:30	16:45	0	7	1	8	0	0	0	0	8	0	1	0	1	0	1	0	1	2	10
16:45	17:00	0	4	0	4	0	0	0	0	4	0	3	0	3	0	1	0	1	4	8
17:00	17:15	1	6	0	7	0	0	0	0	7	1	4	0	5	0	1	0	1	6	13
17:15	17:30	0	7	0	7	0	0	0	0	7	0	0	0	0	0	0	0	0	0	7
17:30	17:45	0	4	0	4	0	0	0	0	4	0	4	0	4	0	1	0	1	5	9
17:45	18:00	0	2	0	2	0	0	0	0	2	0	0	0	0	0	3	0	3	3	5
Total:	None	11	196	13	220	0	0	0	0	220	19	102	0	121	0	74	9	83	204	424



# Transportation Services - Traffic Services

## Turning Movement Count - Study Results

### GLADSTONE AVE @ KENT ST

**Survey Date:** Tuesday, April 25, 2017

**WO No:** 36848

**Start Time:** 07:00

**Device:** Miovision

### Full Study 15 Minute U-Turn Total

KENT ST

GLADSTONE AVE

Time Period		Northbound U-Turn Total	Southbound U-Turn Total	Eastbound U-Turn Total	Westbound U-Turn Total	Total
07:00	07:15	0	0	0	0	0
07:15	07:30	0	0	0	0	0
07:30	07:45	0	0	0	0	0
07:45	08:00	0	0	0	0	0
08:00	08:15	0	0	0	0	0
08:15	08:30	0	0	0	0	0
08:30	08:45	0	0	0	0	0
08:45	09:00	0	0	0	0	0
09:00	09:15	0	0	0	0	0
09:15	09:30	0	0	0	0	0
09:30	09:45	0	0	0	0	0
09:45	10:00	0	0	0	0	0
11:30	11:45	0	0	0	0	0
11:45	12:00	0	0	0	0	0
12:00	12:15	0	0	0	0	0
12:15	12:30	0	0	0	0	0
12:30	12:45	0	0	0	0	0
12:45	13:00	0	0	0	0	0
13:00	13:15	0	0	0	0	0
13:15	13:30	0	0	0	0	0
15:00	15:15	0	0	0	0	0
15:15	15:30	0	0	0	0	0
15:30	15:45	0	0	0	0	0
15:45	16:00	0	0	0	0	0
16:00	16:15	0	0	0	0	0
16:15	16:30	0	0	0	0	0
16:30	16:45	0	0	0	0	0
16:45	17:00	0	0	0	0	0
17:00	17:15	0	0	0	0	0
17:15	17:30	0	0	0	0	0
17:30	17:45	0	0	0	0	0
17:45	18:00	0	0	0	0	0
Total		0	0	0	0	0

## Turning Movement Count - Study Results

### GLADSTONE AVE @ LYON ST

**Survey Date:** Wednesday, August 24, 2022

**WO No:** 40574

**Start Time:** 07:00

**Device:** Miovision

### Full Study Diagram

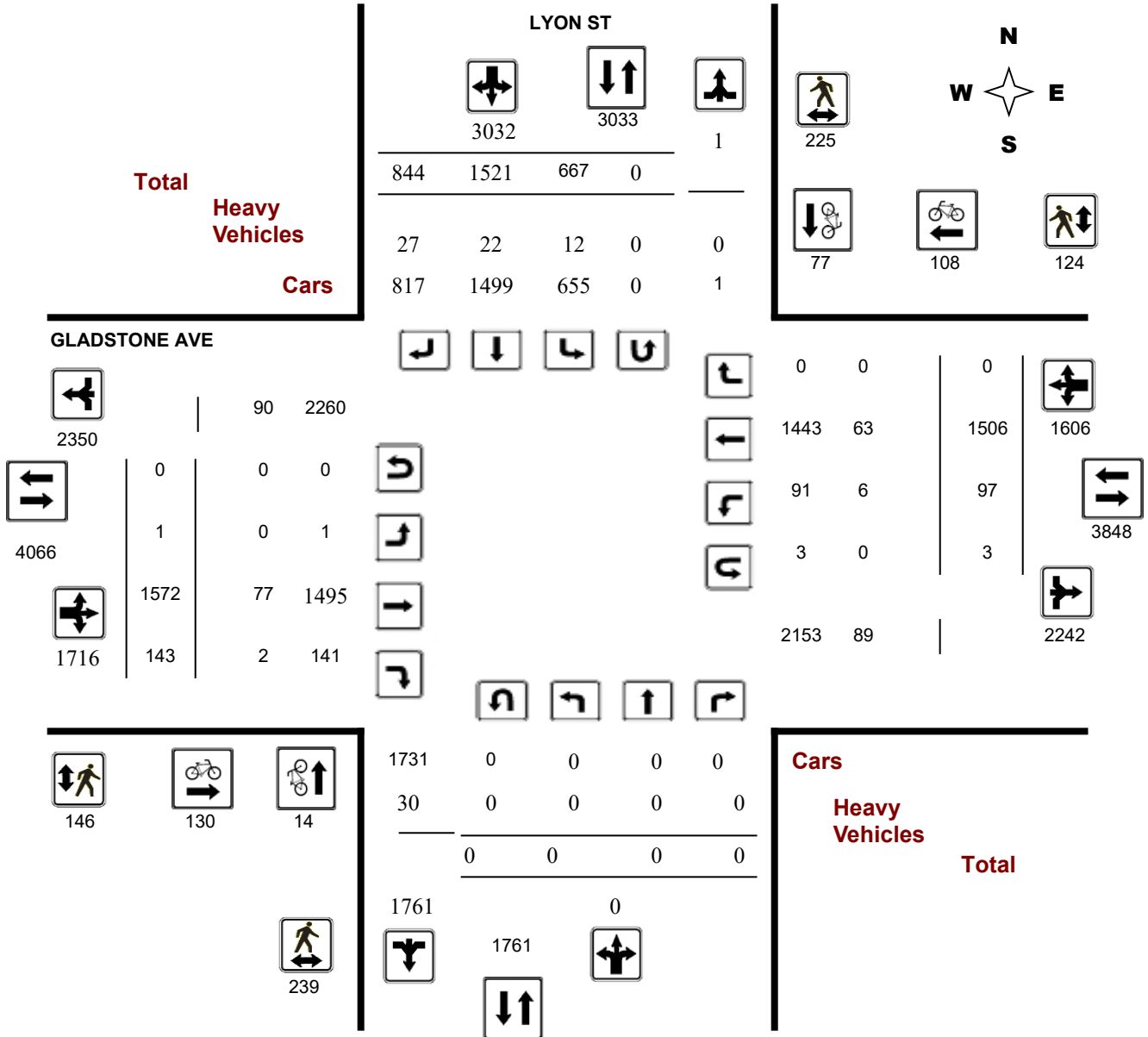



## Turning Movement Count - Study Results

### GLADSTONE AVE @ LYON ST

**Survey Date:** Wednesday, August 24, 2022

**WO No:** 40574

**Start Time:** 07:00

**Device:** Miovision

### Full Study Peak Hour Diagram

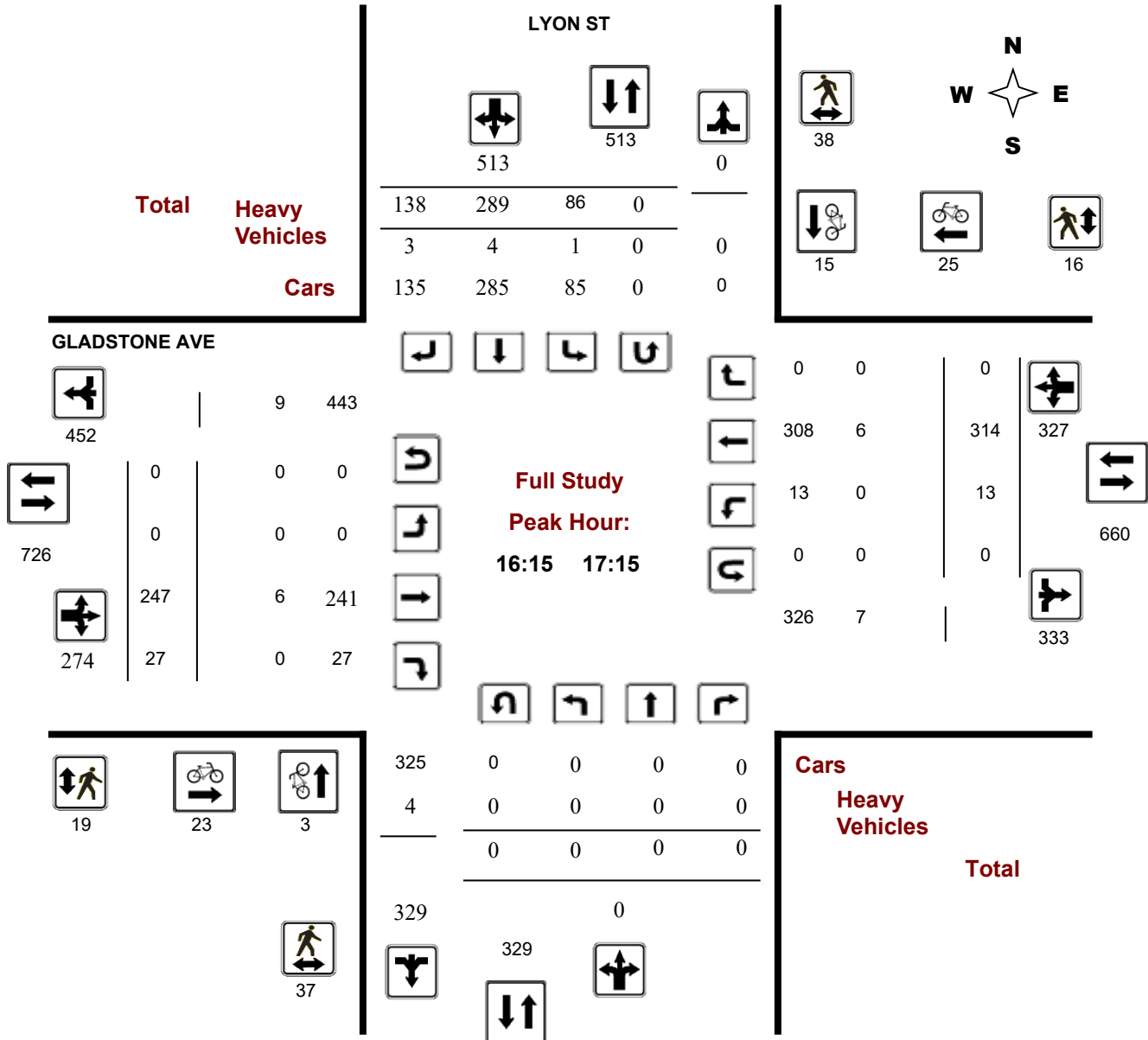

## Turning Movement Count - Peak Hour Diagram

### GLADSTONE AVE @ LYON ST

**Survey Date:** Wednesday, August 24, 2022

**Start Time:** 07:00

**WO No:** 40574

**Device:** Miovision

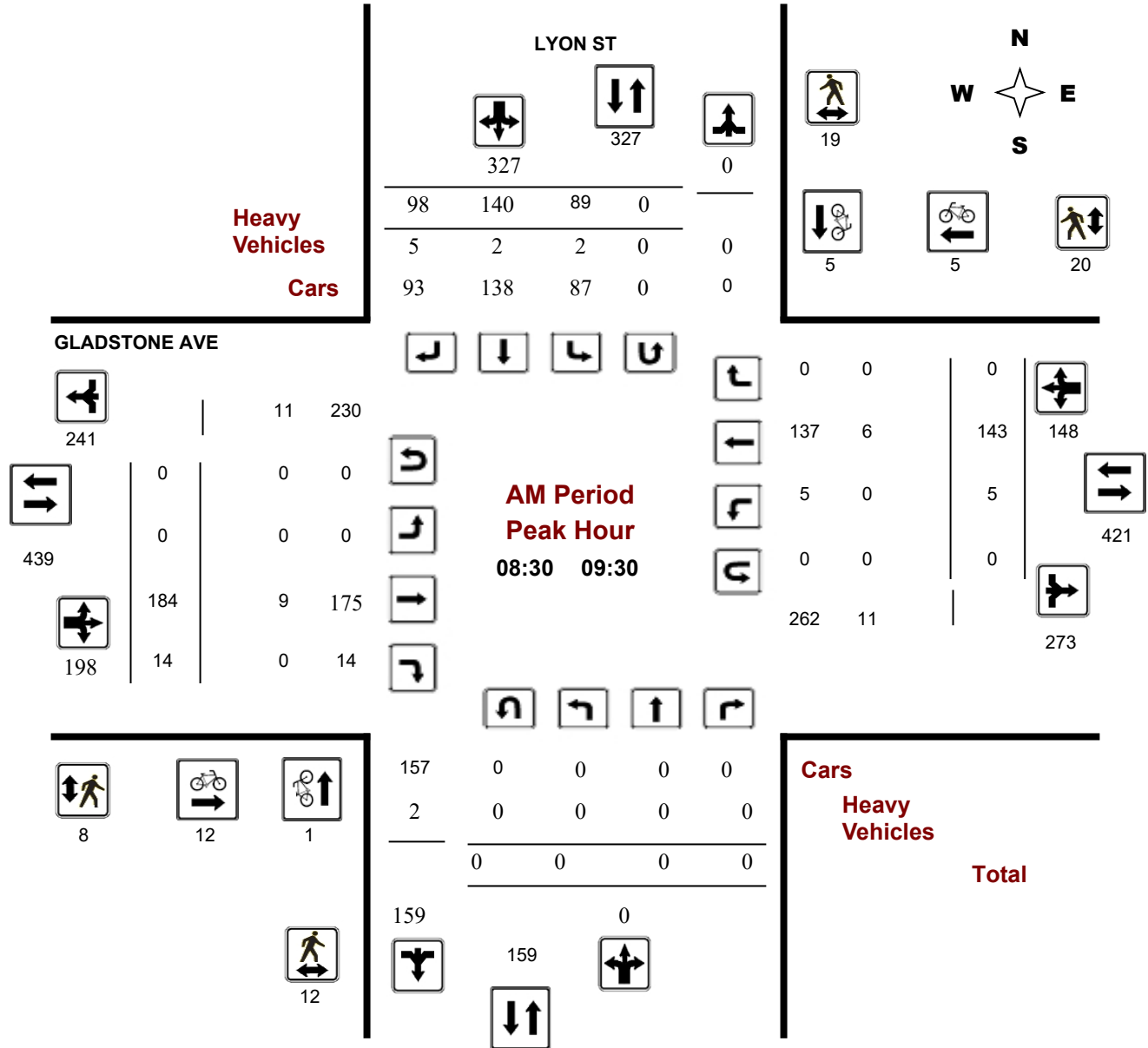

## Turning Movement Count - Peak Hour Diagram

### GLADSTONE AVE @ LYON ST

**Survey Date:** Wednesday, August 24, 2022

**Start Time:** 07:00

**WO No:** 40574

**Device:** Miovision

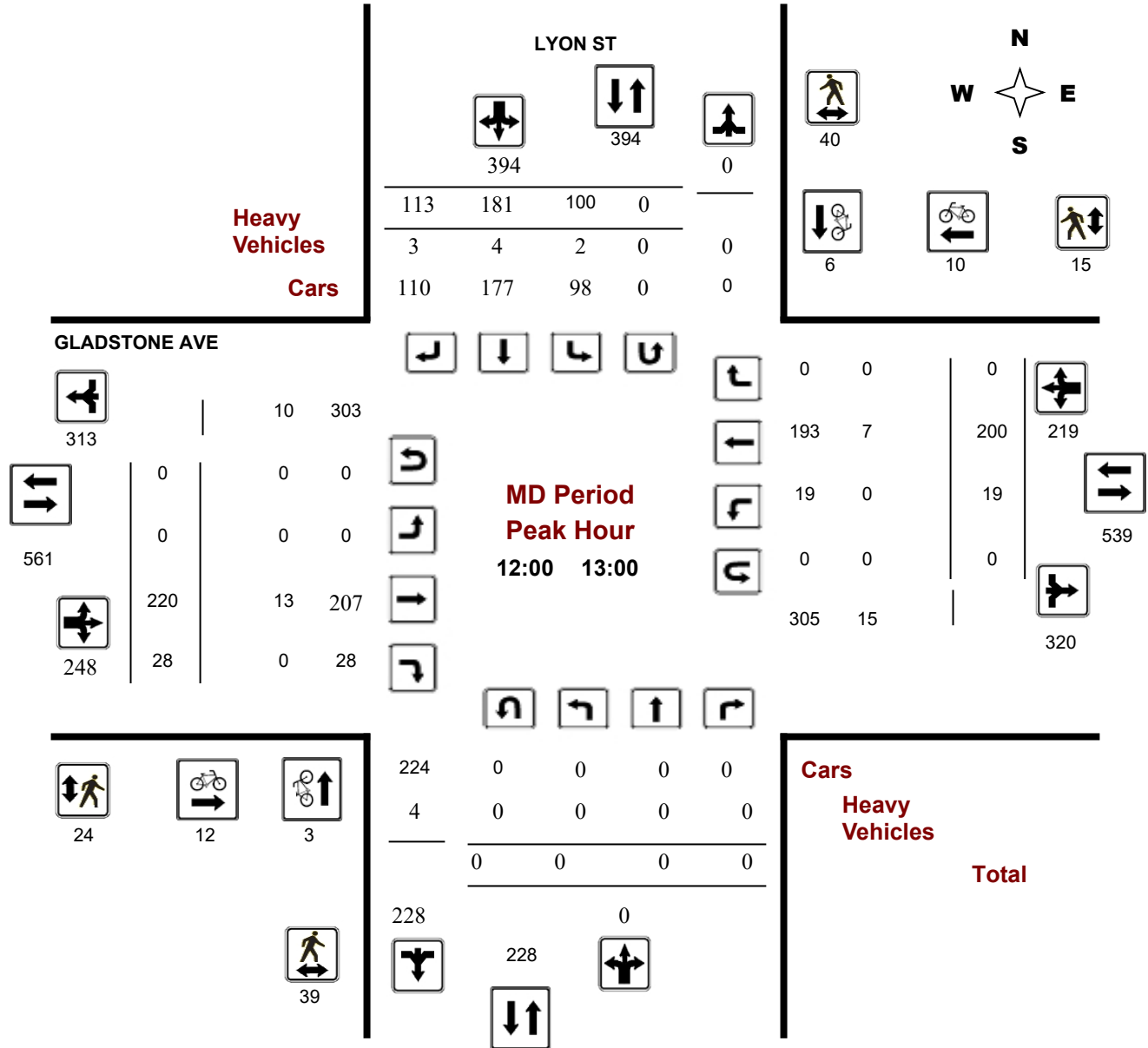

**Comments**

## Turning Movement Count - Peak Hour Diagram

### GLADSTONE AVE @ LYON ST

**Survey Date:** Wednesday, August 24, 2022

**Start Time:** 07:00

**WO No:** 40574

**Device:** Miovision

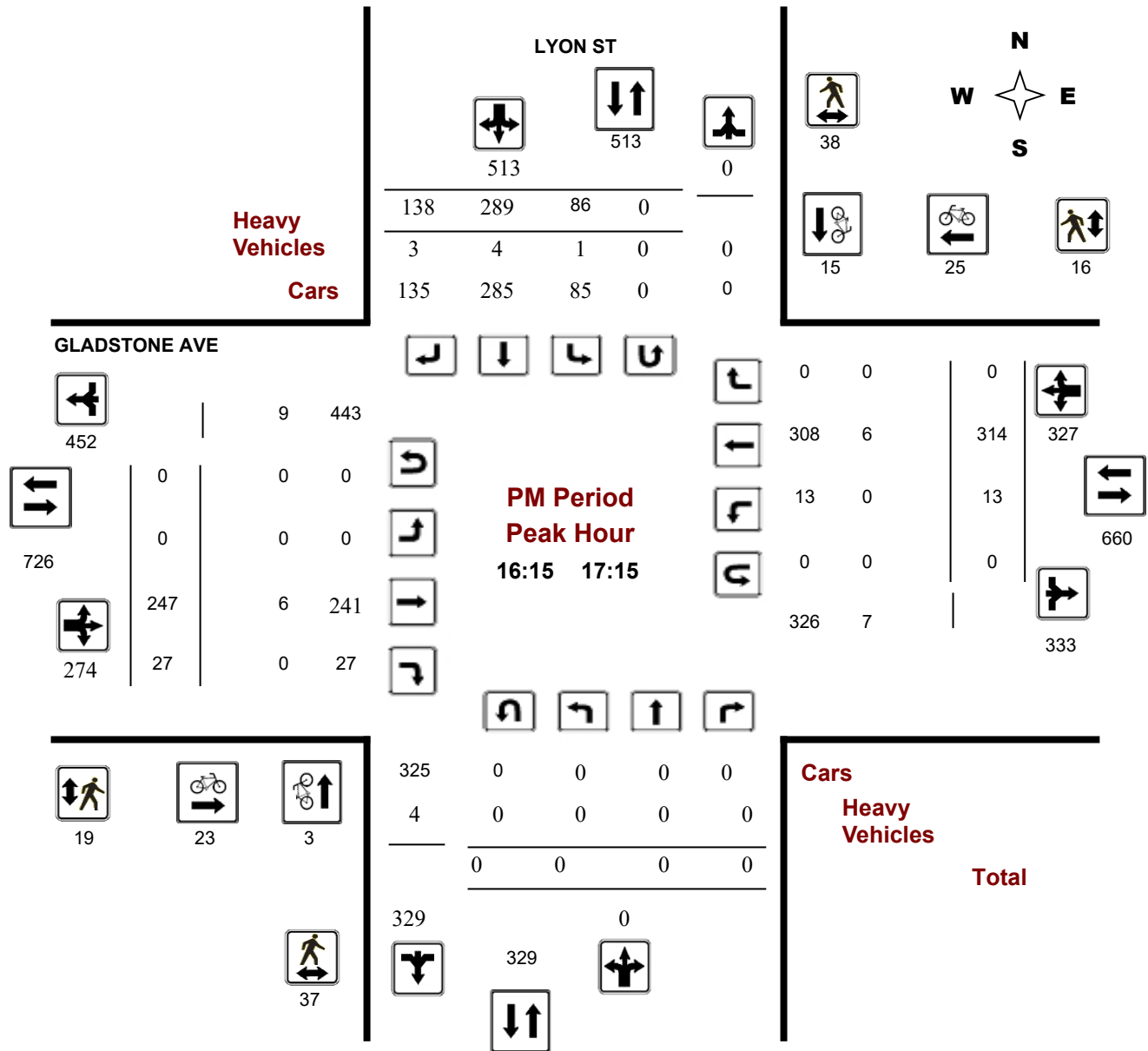



# Transportation Services - Traffic Services

## Turning Movement Count - Study Results

### GLADSTONE AVE @ LYON ST

**Survey Date:** Wednesday, August 24, 2022

**WO No:** 40574

**Start Time:** 07:00

**Device:** Miovision

### Full Study Summary (8 HR Standard)

**Survey Date:** Wednesday, August 24, 2022

**Total Observed U-Turns**

**AADT Factor**

Northbound: 0      Southbound: 0

.90

Eastbound: 0      Westbound: 3

Period	LYON ST										GLADSTONE AVE										Grand Total
	Northbound					Southbound					Eastbound					Westbound					
	LT	ST	RT	NB TOT	STR TOT	LT	ST	RT	SB TOT	STR TOT	LT	ST	RT	EB TOT	STR TOT	LT	ST	RT	WB TOT	STR TOT	
07:00 08:00	0	0	0	0	259	60	133	66	259	259	0	125	6	131	226	7	88	0	95	226	485
08:00 09:00	0	0	0	0	339	92	149	98	339	339	0	155	9	164	277	9	104	0	113	277	616
09:00 10:00	0	0	0	0	285	60	143	82	285	285	0	184	18	202	341	2	137	0	139	341	626
11:30 12:30	0	0	0	0	378	89	176	113	378	378	0	217	22	239	456	20	197	0	217	456	834
12:30 13:30	0	0	0	0	366	91	172	103	366	366	1	227	20	248	469	17	204	0	221	469	835
15:00 16:00	0	0	0	0	430	96	212	122	430	430	0	198	18	216	446	14	216	0	230	446	876
16:00 17:00	0	0	0	0	501	85	273	143	501	501	0	229	25	254	581	12	315	0	327	581	1082
17:00 18:00	0	0	0	0	474	94	263	117	474	474	0	237	25	262	523	16	245	0	261	523	997
<b>Sub Total</b>	0	0	0	0	3032	667	1521	844	3032	3032	1	1572	143	1716	3319	97	1506	0	1603	3319	6351
<b>U Turns</b>				0	0				0	0				0	3				3	3	3
<b>Total</b>	0	0	0	0	3032	667	1521	844	3032	3032	1	1572	143	1716	3322	97	1506	0	1606	3322	6354
<b>EQ 12Hr</b>	0	0	0	0	4214	927	2114	1173	4214	4214	1	2185	199	2385	4618	135	2093	0	2232	4618	8832
Note: These values are calculated by multiplying the totals by the appropriate expansion factor.													<b>1.39</b>								
<b>AVG 12Hr</b>	0	0	0	0	3793	834	2493	1383	3793	3793	1	1966	179	2146	4156	122	1884	0	2009	4156	7949
Note: These volumes are calculated by multiplying the Equivalent 12 hr. totals by the AADT factor.													<b>.90</b>								
<b>AVG 24Hr</b>	0	0	0	0	4969	1093	3266	1812	4969	4969	1	2575	234	2811	5444	160	2468	0	2632	5444	10413
Note: These volumes are calculated by multiplying the Average Daily 12 hr. totals by 12 to 24 expansion factor.													<b>1.31</b>								
Note: U-Turns provided for approach totals. Refer to 'U-Turn' Report for specific breakdown.																					



# Transportation Services - Traffic Services

## Turning Movement Count - Study Results

### GLADSTONE AVE @ LYON ST

**Survey Date:** Wednesday, August 24, 2022

**WO No:** 40574

**Start Time:** 07:00

**Device:** Miovision

### Full Study 15 Minute Increments

#### LYON ST

#### GLADSTONE AVE

Northbound

Southbound

Eastbound

Westbound

Time Period	LT	ST	RT	N TOT	LT	ST	RT	S TOT	STR TOT	LT	ST	RT	E TOT	LT	ST	RT	W TOT	STR TOT	Grand Total
07:00 07:15	0	0	0	0	10	23	13	46	46	0	20	3	23	0	12	0	12	35	81
07:15 07:30	0	0	0	0	17	29	14	60	60	0	29	0	29	1	23	0	24	53	113
07:30 07:45	0	0	0	0	18	31	15	64	64	0	43	2	45	3	28	0	31	76	140
07:45 08:00	0	0	0	0	15	50	24	89	89	0	33	1	34	3	25	0	28	62	151
08:00 08:15	0	0	0	0	20	37	20	77	77	0	36	3	39	1	23	0	25	64	141
08:15 08:30	0	0	0	0	21	40	22	83	83	0	31	1	32	3	17	0	20	52	135
08:30 08:45	0	0	0	0	31	34	24	89	89	0	44	3	47	5	30	0	35	82	171
08:45 09:00	0	0	0	0	20	38	32	90	90	0	44	2	46	0	34	0	34	80	170
09:00 09:15	0	0	0	0	16	34	17	67	67	0	54	4	58	0	47	0	47	105	172
09:15 09:30	0	0	0	0	22	34	25	81	81	0	42	5	47	0	32	0	32	79	160
09:30 09:45	0	0	0	0	10	47	19	76	76	0	39	5	44	1	26	0	27	71	147
09:45 10:00	0	0	0	0	12	28	21	61	61	0	49	4	53	1	32	0	33	86	147
11:30 11:45	0	0	0	0	11	51	31	93	93	0	56	7	63	5	48	0	54	117	210
11:45 12:00	0	0	0	0	30	36	23	89	89	0	58	2	60	4	52	0	56	116	205
12:00 12:15	0	0	0	0	29	52	27	108	108	0	56	3	59	6	43	0	49	108	216
12:15 12:30	0	0	0	0	19	37	32	88	88	0	47	10	57	5	54	0	59	116	204
12:30 12:45	0	0	0	0	27	43	27	97	97	0	66	4	70	4	47	0	51	121	218
12:45 13:00	0	0	0	0	25	49	27	101	101	0	51	11	62	4	56	0	60	122	223
13:00 13:15	0	0	0	0	23	48	22	93	93	1	54	4	59	4	52	0	56	115	208
13:15 13:30	0	0	0	0	16	32	27	75	75	0	56	1	57	5	49	0	54	111	186
15:00 15:15	0	0	0	0	19	48	29	96	96	0	56	5	61	2	56	0	58	119	215
15:15 15:30	0	0	0	0	26	57	36	119	119	0	50	3	53	4	50	0	55	108	227
15:30 15:45	0	0	0	0	29	52	27	108	108	0	40	4	44	5	54	0	59	103	211
15:45 16:00	0	0	0	0	22	55	30	107	107	0	52	6	58	3	56	0	59	117	224
16:00 16:15	0	0	0	0	21	55	27	103	103	0	50	5	55	2	67	0	69	124	227
16:15 16:30	0	0	0	0	27	79	39	145	145	0	64	8	72	4	79	0	83	155	300
16:30 16:45	0	0	0	0	18	76	44	138	138	0	49	6	55	1	85	0	86	141	279
16:45 17:00	0	0	0	0	19	63	33	115	115	0	66	6	72	5	84	0	89	161	276
17:00 17:15	0	0	0	0	22	71	22	115	115	0	68	7	75	3	66	0	69	144	259
17:15 17:30	0	0	0	0	31	77	27	135	135	0	66	11	77	6	58	0	64	141	276
17:30 17:45	0	0	0	0	21	60	31	112	112	0	59	3	62	4	69	0	73	135	247
17:45 18:00	0	0	0	0	20	55	37	112	112	0	44	4	48	3	52	0	55	103	215
<b>Total:</b>	<b>0</b>	<b>0</b>	<b>0</b>	<b>0</b>	<b>667</b>	<b>1521</b>	<b>844</b>	<b>3032</b>	<b>3032</b>	<b>1</b>	<b>1572</b>	<b>143</b>	<b>1716</b>	<b>97</b>	<b>1506</b>	<b>0</b>	<b>1606</b>	<b>3322</b>	<b>6,354</b>

Note: U-Turns are included in Totals.



# Transportation Services - Traffic Services

## Turning Movement Count - Study Results

### GLADSTONE AVE @ LYON ST

**Survey Date:** Wednesday, August 24, 2022

**WO No:** 40574

**Start Time:** 07:00

**Device:** Miovision

### Full Study Cyclist Volume

Time Period	LYON ST			GLADSTONE AVE			Grand Total
	Northbound	Southbound	Street Total	Eastbound	Westbound	Street Total	
07:00-07:15	0	2	2	3	4	7	9
07:15-07:30	0	0	0	2	1	3	3
07:30-07:45	0	0	0	4	2	6	6
07:45-08:00	1	1	2	7	1	8	10
08:00-08:15	0	4	4	4	3	7	11
08:15-08:30	1	0	1	3	0	3	4
08:30-08:45	1	0	1	2	1	3	4
08:45-09:00	0	3	3	3	1	4	7
09:00-09:15	0	2	2	2	1	3	5
09:15-09:30	0	0	0	5	2	7	7
09:30-09:45	0	1	1	2	2	4	5
09:45-10:00	0	1	1	2	1	3	4
11:30-11:45	0	3	3	2	2	4	7
11:45-12:00	0	3	3	6	4	10	13
12:00-12:15	0	2	2	4	1	5	7
12:15-12:30	2	1	3	4	3	7	10
12:30-12:45	0	0	0	2	3	5	5
12:45-13:00	1	3	4	2	3	5	9
13:00-13:15	0	3	3	5	1	6	9
13:15-13:30	0	7	7	2	1	3	10
15:00-15:15	0	2	2	7	4	11	13
15:15-15:30	0	0	0	9	7	16	16
15:30-15:45	0	2	2	2	2	4	6
15:45-16:00	1	1	2	1	4	5	7
16:00-16:15	4	3	7	10	8	18	25
16:15-16:30	1	4	5	8	5	13	18
16:30-16:45	1	2	3	5	5	10	13
16:45-17:00	1	5	6	4	10	14	20
17:00-17:15	0	4	4	6	5	11	15
17:15-17:30	0	10	10	3	7	10	20
17:30-17:45	0	6	6	2	7	9	15
17:45-18:00	0	2	2	7	7	14	16
<b>Total</b>	<b>14</b>	<b>77</b>	<b>91</b>	<b>130</b>	<b>108</b>	<b>238</b>	<b>329</b>



# Transportation Services - Traffic Services

## Turning Movement Count - Study Results

### GLADSTONE AVE @ LYON ST

**Survey Date:** Wednesday, August 24, 2022

**WO No:** 40574

**Start Time:** 07:00

**Device:** Miovision

### Full Study Pedestrian Volume

#### LYON ST

#### GLADSTONE AVE

Time Period	NB Approach (E or W Crossing)	SB Approach (E or W Crossing)	Total	EB Approach (N or S Crossing)	WB Approach (N or S Crossing)	Total	Grand Total
07:00 07:15	1	0	1	0	0	0	1
07:15 07:30	1	0	1	1	2	3	4
07:30 07:45	1	3	4	1	0	1	5
07:45 08:00	11	6	17	1	9	10	27
08:00 08:15	5	2	7	2	3	5	12
08:15 08:30	2	3	5	4	4	8	13
08:30 08:45	3	5	8	0	4	4	12
08:45 09:00	6	5	11	4	8	12	23
09:00 09:15	1	1	2	3	3	6	8
09:15 09:30	2	8	10	1	5	6	16
09:30 09:45	5	6	11	6	3	9	20
09:45 10:00	11	3	14	3	3	6	20
11:30 11:45	4	7	11	5	2	7	18
11:45 12:00	16	5	21	0	4	4	25
12:00 12:15	6	9	15	5	3	8	23
12:15 12:30	15	12	27	8	3	11	38
12:30 12:45	10	8	18	5	3	8	26
12:45 13:00	8	11	19	6	6	12	31
13:00 13:15	13	5	18	8	4	12	30
13:15 13:30	8	2	10	7	6	13	23
15:00 15:15	4	10	14	5	1	6	20
15:15 15:30	12	15	27	6	2	8	35
15:30 15:45	11	5	16	5	7	12	28
15:45 16:00	5	12	17	6	4	10	27
16:00 16:15	7	5	12	11	1	12	24
16:15 16:30	11	8	19	5	4	9	28
16:30 16:45	9	9	18	4	8	12	30
16:45 17:00	5	10	15	5	3	8	23
17:00 17:15	12	11	23	5	1	6	29
17:15 17:30	19	18	37	17	3	20	57
17:30 17:45	6	10	16	3	7	10	26
17:45 18:00	9	11	20	4	8	12	32
<b>Total .....</b>	<b>239</b>	<b>225</b>	<b>464</b>	<b>146</b>	<b>124</b>	<b>270</b>	<b>734</b>





# Transportation Services - Traffic Services

## Turning Movement Count - Study Results

### GLADSTONE AVE @ LYON ST

**Survey Date:** Wednesday, August 24, 2022

**WO No:** 40574

**Start Time:** 07:00

**Device:** Miovision

### Full Study Heavy Vehicles

#### LYON ST

#### GLADSTONE AVE

Northbound

Southbound

Eastbound

Westbound

Time Period	Northbound			N TOT	Southbound			S TOT	STR TOT	Eastbound			E TOT	Westbound			W TOT	STR TOT	Grand Total
	LT	ST	RT		LT	ST	RT			LT	ST	RT		LT	ST	RT			
07:00 07:15	0	0	0	1	0	1	1	2	3	0	2	0	5	0	2	0	4	9	6
07:15 07:30	0	0	0	1	1	0	1	2	3	0	0	0	2	1	1	0	3	5	4
07:30 07:45	0	0	0	2	0	0	0	0	2	0	5	0	10	2	5	0	12	22	12
07:45 08:00	0	0	0	0	0	0	2	2	2	0	2	0	6	0	2	0	4	10	6
08:00 08:15	0	0	0	1	1	1	1	3	4	0	2	0	6	0	3	0	6	12	8
08:15 08:30	0	0	0	1	0	1	1	2	3	0	2	0	5	0	2	0	4	9	6
08:30 08:45	0	0	0	1	1	1	1	3	4	0	1	0	3	0	1	0	3	6	5
08:45 09:00	0	0	0	0	0	0	1	1	1	0	1	0	4	0	2	0	3	7	4
09:00 09:15	0	0	0	0	1	0	2	3	3	0	4	0	8	0	2	0	7	15	9
09:15 09:30	0	0	0	1	0	1	1	2	3	0	3	0	5	0	1	0	4	9	6
09:30 09:45	0	0	0	3	0	2	0	2	5	0	1	1	2	0	0	0	1	3	4
09:45 10:00	0	0	0	1	1	0	0	1	2	0	3	1	7	0	3	0	7	14	8
11:30 11:45	0	0	0	1	0	0	3	3	4	0	4	0	9	1	2	0	7	16	10
11:45 12:00	0	0	0	2	0	2	1	3	5	0	2	0	5	0	2	0	4	9	7
12:00 12:15	0	0	0	1	0	1	1	2	3	0	2	0	5	0	2	0	4	9	6
12:15 12:30	0	0	0	0	0	0	0	0	0	0	4	0	6	0	2	0	6	12	6
12:30 12:45	0	0	0	2	1	2	2	5	7	0	2	0	6	0	2	0	5	11	9
12:45 13:00	0	0	0	1	1	1	0	2	3	0	5	0	6	0	1	0	7	13	8
13:00 13:15	0	0	0	0	1	0	2	3	3	0	3	0	9	0	4	0	8	17	10
13:15 13:30	0	0	0	2	0	1	2	3	5	0	1	0	6	1	3	0	5	11	8
15:00 15:15	0	0	0	2	0	2	0	2	4	0	4	0	7	0	3	0	7	14	9
15:15 15:30	0	0	0	0	1	0	1	2	2	0	1	0	3	0	1	0	3	6	4
15:30 15:45	0	0	0	0	2	0	0	2	2	0	6	0	10	0	4	0	12	22	12
15:45 16:00	0	0	0	1	0	1	0	1	2	0	2	0	4	0	2	0	4	8	5
16:00 16:15	0	0	0	1	0	1	1	2	3	0	4	0	7	0	2	0	6	13	8
16:15 16:30	0	0	0	0	1	0	0	1	1	0	1	0	3	0	2	0	4	7	4
16:30 16:45	0	0	0	2	0	2	2	4	6	0	2	0	5	0	1	0	3	8	7
16:45 17:00	0	0	0	0	0	0	0	0	0	0	1	0	3	0	2	0	3	6	3
17:00 17:15	0	0	0	2	0	2	1	3	5	0	2	0	4	0	1	0	3	7	6
17:15 17:30	0	0	0	1	0	0	0	0	1	0	2	0	4	1	2	0	5	9	5
17:30 17:45	0	0	0	0	0	0	0	0	0	0	0	0	1	0	1	0	1	2	1
17:45 18:00	0	0	0	0	0	0	0	0	0	0	3	0	3	0	0	0	3	6	3
Total: None	0	0	0	30	12	22	27	61	91	0	77	2	169	6	63	0	158	327	209



# Transportation Services - Traffic Services

## Turning Movement Count - Study Results

### GLADSTONE AVE @ LYON ST

**Survey Date:** Wednesday, August 24, 2022

**WO No:** 40574

**Start Time:** 07:00

**Device:** Miovision

### Full Study 15 Minute U-Turn Total

LYON ST

GLADSTONE AVE

Time Period		Northbound U-Turn Total	Southbound U-Turn Total	Eastbound U-Turn Total	Westbound U-Turn Total	Total
07:00	07:15	0	0	0	0	0
07:15	07:30	0	0	0	0	0
07:30	07:45	0	0	0	0	0
07:45	08:00	0	0	0	0	0
08:00	08:15	0	0	0	1	1
08:15	08:30	0	0	0	0	0
08:30	08:45	0	0	0	0	0
08:45	09:00	0	0	0	0	0
09:00	09:15	0	0	0	0	0
09:15	09:30	0	0	0	0	0
09:30	09:45	0	0	0	0	0
09:45	10:00	0	0	0	0	0
11:30	11:45	0	0	0	1	1
11:45	12:00	0	0	0	0	0
12:00	12:15	0	0	0	0	0
12:15	12:30	0	0	0	0	0
12:30	12:45	0	0	0	0	0
12:45	13:00	0	0	0	0	0
13:00	13:15	0	0	0	0	0
13:15	13:30	0	0	0	0	0
15:00	15:15	0	0	0	0	0
15:15	15:30	0	0	0	1	1
15:30	15:45	0	0	0	0	0
15:45	16:00	0	0	0	0	0
16:00	16:15	0	0	0	0	0
16:15	16:30	0	0	0	0	0
16:30	16:45	0	0	0	0	0
16:45	17:00	0	0	0	0	0
17:00	17:15	0	0	0	0	0
17:15	17:30	0	0	0	0	0
17:30	17:45	0	0	0	0	0
17:45	18:00	0	0	0	0	0
Total		0	0	0	3	3

# Appendix D:

Collision Data

**Total Area**

Classification of Accident	Rear End	Turning Movement	Sideswipe	Angle	Approaching	SMV other	SMV unattended vehicle	Other	Total
P.D. only	55	85	112	81	1	8	12	5	359
Non-fatal injury	7	13	5	29	0	13	1	0	68
Non-reportable	0	0	0	0	0	0	0	0	0
<b>Total</b>	<b>62</b>	<b>98</b>	<b>117</b>	<b>110</b>	<b>1</b>	<b>21</b>	<b>13</b>	<b>5</b>	<b>427</b>
	#4 or 15%	#3 or 23%	#1 or 27%	#2 or 26%	#8 or 0%	#5 or 5%	#6 or 3%	#7 or 1%	

84%  
16%  
0%  
100%

**BRN SON AVE/CATHERINE ST/RAYMOND ST**

Years	Total # Collisions	24 Hr AADT Veh Volume	Days	Collisions/MEV
2017-2021	91	39,156	1825	<b>1.27</b>

Peds	Cyclists
<b>2</b>	<b>1</b>

Classification of Accident	Rear End	Turning Movement	Sideswipe	Angle	Approaching	SMV other	SMV unattended vehicle	Other	Total
P.D. only	16	14	25	16	0	1	0	1	73
Non-fatal injury	1	5	1	9	0	2	0	0	18
Non-reportable	0	0	0	0	0	0	0	0	0
<b>Total</b>	<b>17</b>	<b>19</b>	<b>26</b>	<b>25</b>	<b>0</b>	<b>3</b>	<b>0</b>	<b>1</b>	<b>91</b>
	19%	21%	29%	27%	0%	3%	0%	1%	

80%  
20%  
0%  
100%

**CATHERINE ST/PERCY ST**

Years	Total # Collisions	24 Hr AADT Veh Volume	Days	Collisions/MEV
2017-2021	6	7,922	1825	<b>0.42</b>

Peds	Cyclists
<b>0</b>	<b>0</b>

Classification of Accident	Rear End	Turning Movement	Sideswipe	Angle	Approaching	SMV other	SMV unattended vehicle	Other	Total
P.D. only	1	2	0	1	0	0	0	1	5
Non-fatal injury	0	0	0	1	0	0	0	0	1
Non-reportable	0	0	0	0	0	0	0	0	0
<b>Total</b>	<b>1</b>	<b>2</b>	<b>0</b>	<b>2</b>	<b>0</b>	<b>0</b>	<b>0</b>	<b>1</b>	<b>6</b>
	17%	33%	0%	33%	0%	0%	0%	17%	

83%  
17%  
0%  
100%

**CATHERINE ST/LYON ST/HWY 417 LYON IC120BR36**

Years	Total # Collisions	24 Hr AADT Veh Volume	Days	Collisions/MEV
2017-2021	17	11,711	1825	<b>0.80</b>

Peds	Cyclists
<b>0</b>	<b>0</b>

Classification of Accident	Rear End	Turning Movement	Sideswipe	Angle	Approaching	SMV other	SMV unattended vehicle	Other	Total
P.D. only	2	0	1	10	0	1	0	0	14
Non-fatal injury	1	0	0	2	0	0	0	0	3
Non-reportable	0	0	0	0	0	0	0	0	0
<b>Total</b>	<b>3</b>	<b>0</b>	<b>1</b>	<b>12</b>	<b>0</b>	<b>1</b>	<b>0</b>	<b>0</b>	<b>17</b>
	18%	0%	6%	71%	0%	6%	0%	0%	

82%  
18%  
0%  
100%

**CATHERINE ST/KENT ST**

Years	Total # Collisions	24 Hr AADT Veh Volume	Days	Collisions/MEV
2017-2021	96	19,918	1825	<b>2.64</b>

Peds	Cyclists
<b>0</b>	<b>0</b>

Classification of Accident	Rear End	Turning Movement	Sideswipe	Angle	Approaching	SMV other	SMV unattended vehicle	Other	Total
P.D. only	5	42	22	18	0	0	0	2	89
Non-fatal injury	0	4	1	2	0	0	0	0	7
Non-reportable	0	0	0	0	0	0	0	0	0
<b>Total</b>	<b>5</b>	<b>46</b>	<b>23</b>	<b>20</b>	<b>0</b>	<b>0</b>	<b>0</b>	<b>2</b>	<b>96</b>
	5%	48%	24%	21%	0%	0%	0%	2%	

93%  
7%  
0%  
100%

**BANK ST/CATHERINE ST**

Years	Total # Collisions	24 Hr AADT Veh Volume	Days	Collisions/MEV
2017-2021	61	23,164	1825	<b>1.44</b>

Peds	Cyclists
<b>8</b>	<b>6</b>

Classification of Accident	Rear End	Turning Movement	Sideswipe	Angle	Approaching	SMV other	SMV unattended vehicle	Other	Total
P.D. only	11	3	15	7	1	2	0	0	39
Non-fatal injury	3	3	1	7	0	8	0	0	22
Non-reportable	0	0	0	0	0	0	0	0	0
<b>Total</b>	<b>14</b>	<b>6</b>	<b>16</b>	<b>14</b>	<b>1</b>	<b>10</b>	<b>0</b>	<b>0</b>	<b>61</b>
	23%	10%	26%	23%	2%	16%	0%	0%	

64%  
36%  
0%  
100%

**GLADSTONE AVE/LYON ST**

Years	Total # Collisions	24 Hr AADT Veh Volume	Days	Collisions/MEV
2017-2021	8	10,413	1825	<b>0.42</b>

Peds	Cyclists
<b>1</b>	<b>1</b>

Classification of Accident	Rear End	Turning Movement	Sideswipe	Angle	Approaching	SMV other	SMV unattended vehicle	Other	Total
P.D. only	2	1	0	3	0	0	0	0	6
Non-fatal injury	0	0	0	1	0	1	0	0	2
Non-reportable	0	0	0	0	0	0	0	0	0
<b>Total</b>	<b>2</b>	<b>1</b>	<b>0</b>	<b>4</b>	<b>0</b>	<b>1</b>	<b>0</b>	<b>0</b>	<b>8</b>
	25%	13%	0%	50%	0%	13%	0%	0%	

75%  
25%  
0%  
100%

**ARLINGTON AVE/LYON ST**

Years	Total # Collisions	24 Hr AADT Veh Volume	Days	Collisions/MEV
2017-2021	2	8,854	1825	<b>0.12</b>

Peds	Cyclists
<b>0</b>	<b>0</b>

Classification of Accident	Rear End	Turning Movement	Sideswipe	Angle	Approaching	SMV other	SMV unattended vehicle	Other	Total
P.D. only	0	0	1	1	0	0	0	0	2
Non-fatal injury	0	0	0	0	0	0	0	0	0
Non-reportable	0	0	0	0	0	0	0	0	0
<b>Total</b>	<b>0</b>	<b>0</b>	<b>1</b>	<b>1</b>	<b>0</b>	<b>0</b>	<b>0</b>	<b>0</b>	<b>2</b>
	0%	0%	50%	50%	0%	0%	0%	0%	

100%  
0%  
0%  
100%

**GLADSTONE AVE/KENT ST**

Years	Total # Collisions	24 Hr AADT Veh Volume	Days	Collisions/MEV
2017-2021	25	23,139	1825	<b>0.59</b>

Peds	Cyclists
<b>1</b>	<b>0</b>

Classification of Accident	Rear End	Turning Movement	Sideswipe	Angle	Approaching	SMV other	SMV unattended vehicle	Other	Total
P.D. only	5	4	5	10	0	0	0	0	24
Non-fatal injury	0	0	0	0	0	1	0	0	1
Non-reportable	0	0	0	0	0	0	0	0	0
<b>Total</b>	<b>5</b>	<b>4</b>	<b>5</b>	<b>10</b>	<b>0</b>	<b>1</b>	<b>0</b>	<b>0</b>	<b>25</b>
	20%	16%	20%	40%	0%	4%	0%	0%	

96%  
4%  
0%  
100%

**ARLINGTON AVE/KENT ST**

Years	Total # Collisions	24 Hr AADT Veh Volume	Days	Collisions/MEV
2017-2021	23	15,280	1825	<b>0.82</b>

Peds	Cyclists
<b>0</b>	<b>0</b>

Classification of Accident	Rear End	Turning Movement	Sideswipe	Angle	Approaching	SMV other	SMV unattended vehicle	Other	Total
P.D. only	1	6	12	3	0	0	0	0	22
Non-fatal injury	0	0	0	1	0	0	0	0	1
Non-reportable	0	0	0	0	0	0	0	0	0
<b>Total</b>	<b>1</b>	<b>6</b>	<b>12</b>	<b>4</b>	<b>0</b>	<b>0</b>	<b>0</b>	<b>0</b>	<b>23</b>
	4%	26%	52%	17%	0%	0%	0%	0%	

96%  
4%  
0%  
100%

**ARLINGTON AVE/BANK ST**

Years	Total # Collisions	24 Hr AADT Veh Volume	Days	Collisions/MEV
2017-2021	10	13,240	1825	<b>0.41</b>

Peds	Cyclists
<b>1</b>	<b>1</b>

Classification of Accident	Rear End	Turning Movement	Sideswipe	Angle	Approaching	SMV other	SMV unattended vehicle	Other	Total
----------------------------	----------	------------------	-----------	-------	-------------	-----------	------------------------	-------	-------

P.D. only	1	2	1	3	0	0	0	1	8	80%
Non-fatal injury	0	0	0	1	0	1	0	0	2	20%
Non-reportable	0	0	0	0	0	0	0	0	0	0%
<b>Total</b>	<b>1</b>	<b>2</b>	<b>1</b>	<b>4</b>	<b>0</b>	<b>1</b>	<b>0</b>	<b>1</b>	<b>10</b>	100%
	10%	20%	10%	40%	0%	10%	0%	10%		

**BANK ST/CHAMBERLAIN AVE N/ISABELLA ST**

Years	Total # Collisions	24 Hr AADT Veh Volume	Days	Collisions/MEV
2017-2021	41	24,224	1825	<b>0.93</b>

Peds	Cyclists
<b>0</b>	<b>0</b>

Classification of Accident	Rear End	Turning Movement	Sideswipe	Angle	Approaching	SMV other	SMV unattended vehicle	Other	Total	
P.D. only	8	8	11	5	0	2	0	0	34	83%
Non-fatal injury	2	0	0	5	0	0	0	0	7	17%
Non-reportable	0	0	0	0	0	0	0	0	0	0%
<b>Total</b>	<b>10</b>	<b>8</b>	<b>11</b>	<b>10</b>	<b>0</b>	<b>2</b>	<b>0</b>	<b>0</b>	<b>41</b>	100%
	24%	20%	27%	24%	0%	5%	0%	0%		

**ROAD SEGMENTS**

**CATHERINE ST, BRONSON AVE to PERCY ST**

Years	Total # Collisions	24 Hr AADT Veh Volume	Days	Collisions/MEV
2017-2021	5	n/a	1825	<b>n/a</b>

Peds	Cyclists
<b>0</b>	<b>0</b>

Classification of Accident	Rear End	Turning Movement	Sideswipe	Angle	Approaching	SMV other	SMV unattended vehicle	Other	Total	
P.D. only	1	0	3	1	0	0	0	0	5	100%
Non-fatal injury	0	0	0	0	0	0	0	0	0	0%
Non-reportable	0	0	0	0	0	0	0	0	0	0%
<b>Total</b>	<b>1</b>	<b>0</b>	<b>3</b>	<b>1</b>	<b>0</b>	<b>0</b>	<b>0</b>	<b>0</b>	<b>5</b>	100%
	20%	0%	60%	20%	0%	0%	0%	0%		

**CATHERINE ST, BAY ST to PERCY ST**

Years	Total # Collisions	24 Hr AADT Veh Volume	Days	Collisions/MEV
2017-2021	2	n/a	1825	<b>n/a</b>

Peds	Cyclists
<b>0</b>	<b>0</b>

Classification of Accident	Rear End	Turning Movement	Sideswipe	Angle	Approaching	SMV other	SMV unattended vehicle	Other	Total	
P.D. only	0	1	0	1	0	0	0	0	2	100%
Non-fatal injury	0	0	0	0	0	0	0	0	0	0%
Non-reportable	0	0	0	0	0	0	0	0	0	0%
<b>Total</b>	<b>0</b>	<b>1</b>	<b>0</b>	<b>1</b>	<b>0</b>	<b>0</b>	<b>0</b>	<b>0</b>	<b>2</b>	100%
	0%	50%	0%	50%	0%	0%	0%	0%		

**CATHERINE ST, LYON to KENT ST**

Years	Total # Collisions	24 Hr AADT Veh Volume	Days	Collisions/MEV
2017-2021	5	n/a	1825	<b>n/a</b>

Peds	Cyclists
<b>0</b>	<b>0</b>

Classification of Accident	Rear End	Turning Movement	Sideswipe	Angle	Approaching	SMV other	SMV unattended vehicle	Other	Total	
P.D. only	0	1	3	0	0	1	0	0	5	100%
Non-fatal injury	0	0	0	0	0	0	0	0	0	0%
Non-reportable	0	0	0	0	0	0	0	0	0	0%
<b>Total</b>	<b>0</b>	<b>1</b>	<b>3</b>	<b>0</b>	<b>0</b>	<b>1</b>	<b>0</b>	<b>0</b>	<b>5</b>	100%
	0%	20%	60%	0%	0%	20%	0%	0%		

**CATHERINE ST, BANK ST to KENT ST**

Years	Total # Collisions	24 Hr AADT Veh Volume	Days	Collisions/MEV
2017-2021	4	n/a	1825	<b>n/a</b>

Peds	Cyclists
<b>0</b>	<b>0</b>

Classification of Accident	Rear End	Turning Movement	Sideswipe	Angle	Approaching	SMV other	SMV unattended vehicle	Other	Total
P.D. only	0	0	2	2	0	0	0	0	4
Non-fatal injury	0	0	0	0	0	0	0	0	0
Non-reportable	0	0	0	0	0	0	0	0	0
<b>Total</b>	<b>0</b>	<b>0</b>	<b>2</b>	<b>2</b>	<b>0</b>	<b>0</b>	<b>0</b>	<b>0</b>	<b>4</b>
	0%	0%	50%	50%	0%	0%	0%	0%	

100%  
0%  
0%  
100%

**LYON ST N, GLADSTONE AVE to CATHERINE ST**

Years	Total # Collisions	24 Hr AADT Veh Volume	Days	Collisions/MEV
2017-2021	4	n/a	1825	n/a

Peds	Cyclists
0	0

Classification of Accident	Rear End	Turning Movement	Sideswipe	Angle	Approaching	SMV other	SMV unattended vehicle	Other	Total
P.D. only	0	0	1	0	0	1	2	0	4
Non-fatal injury	0	0	0	0	0	0	0	0	0
Non-reportable	0	0	0	0	0	0	0	0	0
<b>Total</b>	<b>0</b>	<b>0</b>	<b>1</b>	<b>0</b>	<b>0</b>	<b>1</b>	<b>2</b>	<b>0</b>	<b>4</b>
	0%	0%	25%	0%	0%	25%	50%	0%	

100%  
0%  
0%  
100%

**GLADSTONE AVE, KENT ST to LYON ST N**

Years	Total # Collisions	24 Hr AADT Veh Volume	Days	Collisions/MEV
2017-2021	8	n/a	1825	n/a

Peds	Cyclists
0	0

Classification of Accident	Rear End	Turning Movement	Sideswipe	Angle	Approaching	SMV other	SMV unattended vehicle	Other	Total
P.D. only	1	0	1	0	0	0	4	0	6
Non-fatal injury	0	0	1	0	0	0	1	0	2
Non-reportable	0	0	0	0	0	0	0	0	0
<b>Total</b>	<b>1</b>	<b>0</b>	<b>2</b>	<b>0</b>	<b>0</b>	<b>0</b>	<b>5</b>	<b>0</b>	<b>8</b>
	13%	0%	25%	0%	0%	0%	63%	0%	

75%  
25%  
0%  
100%

**KENT ST, FLORA ST to MCLEOD ST**

Years	Total # Collisions	24 Hr AADT Veh Volume	Days	Collisions/MEV
2017-2021	2	n/a	1825	n/a

Peds	Cyclists
0	0

Classification of Accident	Rear End	Turning Movement	Sideswipe	Angle	Approaching	SMV other	SMV unattended vehicle	Other	Total
P.D. only	0	0	2	0	0	0	0	0	2
Non-fatal injury	0	0	0	0	0	0	0	0	0
Non-reportable	0	0	0	0	0	0	0	0	0
<b>Total</b>	<b>0</b>	<b>0</b>	<b>2</b>	<b>0</b>	<b>0</b>	<b>0</b>	<b>0</b>	<b>0</b>	<b>2</b>
	0%	0%	100%	0%	0%	0%	0%	0%	

100%  
0%  
0%  
100%

**KENT ST, ARLINGTON AVE to CATHERINE ST**

Years	Total # Collisions	24 Hr AADT Veh Volume	Days	Collisions/MEV
2017-2021	5	n/a	1825	n/a

Peds	Cyclists
0	0

Classification of Accident	Rear End	Turning Movement	Sideswipe	Angle	Approaching	SMV other	SMV unattended vehicle	Other	Total
P.D. only	0	0	4	0	0	0	0	0	4
Non-fatal injury	0	0	1	0	0	0	0	0	1
Non-reportable	0	0	0	0	0	0	0	0	0
<b>Total</b>	<b>0</b>	<b>0</b>	<b>5</b>	<b>0</b>	<b>0</b>	<b>0</b>	<b>0</b>	<b>0</b>	<b>5</b>
	0%	0%	100%	0%	0%	0%	0%	0%	

80%  
20%  
0%  
100%

**ARLINGTON AVE, KENT ST to LYON ST N**

Years	Total # Collisions	24 Hr AADT Veh Volume	Days	Collisions/MEV
2017-2021	2	n/a	1825	n/a

Peds	Cyclists
0	0

Classification of Accident	Rear End	Turning Movement	Sideswipe	Angle	Approaching	SMV other	SMV unattended vehicle	Other	Total
----------------------------	----------	------------------	-----------	-------	-------------	-----------	------------------------	-------	-------

P.D. only	0	0	0	0	0	0	2	0	2	100%
Non-fatal injury	0	0	0	0	0	0	0	0	0	0%
Non-reportable	0	0	0	0	0	0	0	0	0	0%
<b>Total</b>	<b>0</b>	<b>0</b>	<b>0</b>	<b>0</b>	<b>0</b>	<b>0</b>	<b>2</b>	<b>0</b>	<b>2</b>	100%
	0%	0%	0%	0%	0%	0%	100%	0%		

**ARLINGTON AVE, BANK ST to KENT ST**

Years	Total # Collisions	24 Hr AADT Veh Volume	Days	Collisions/MEV
2017-2021	6	n/a	1825	<b>n/a</b>

Peds	Cyclists
<b>0</b>	<b>0</b>

Classification of Accident	Rear End	Turning Movement	Sideswipe	Angle	Approaching	SMV other	SMV unattended vehicle	Other	Total	
P.D. only	0	1	1	0	0	0	4	0	6	100%
Non-fatal injury	0	0	0	0	0	0	0	0	0	0%
Non-reportable	0	0	0	0	0	0	0	0	0	0%
<b>Total</b>	<b>0</b>	<b>1</b>	<b>1</b>	<b>0</b>	<b>0</b>	<b>0</b>	<b>4</b>	<b>0</b>	<b>6</b>	100%
	0%	17%	17%	0%	0%	0%	67%	0%		

**BANK ST, ARLINGTON AVE to CATHERINE ST**

Years	Total # Collisions	24 Hr AADT Veh Volume	Days	Collisions/MEV
2017-2021	4	n/a	1825	<b>n/a</b>

Peds	Cyclists
<b>0</b>	<b>1</b>

Classification of Accident	Rear End	Turning Movement	Sideswipe	Angle	Approaching	SMV other	SMV unattended vehicle	Other	Total	
P.D. only	1	0	2	0	0	0	0	0	3	75%
Non-fatal injury	0	1	0	0	0	0	0	0	1	25%
Non-reportable	0	0	0	0	0	0	0	0	0	0%
<b>Total</b>	<b>1</b>	<b>1</b>	<b>2</b>	<b>0</b>	<b>0</b>	<b>0</b>	<b>0</b>	<b>0</b>	<b>4</b>	100%
	25%	25%	50%	0%	0%	0%	0%	0%		



# Appendix E:

Internal Reduction Calculations

NCHRP 684 Internal Trip Capture Estimation Tool			
Project Name:	265 Catherine Phase 1	Organization:	Parsons
Project Location:		Performed By:	
Scenario Description:	AM Internal Reduction	Date:	2/27/2024
Analysis Year:		Checked By:	
Analysis Period:	AM Street Peak Hour	Date:	

Table 1-A: Base Vehicle-Trip Generation Estimates (Single-Use Site Estimate)						
Land Use	Development Data (For Information Only)			Estimated Vehicle-Trips <sup>3</sup>		
	ITE LUCs <sup>1</sup>	Quantity	Units	Total	Entering	Exiting
Office				0		
Retail				8	5	3
Restaurant				0		
Cinema/Entertainment				0		
Residential				69	21	48
Hotel				0		
All Other Land Uses <sup>2</sup>				0		
				77	26	51

Table 2-A: Mode Split and Vehicle Occupancy Estimates						
Land Use	Entering Trips			Exiting Trips		
	Veh. Occ. <sup>4</sup>	% Transit	% Non-Motorized	Veh. Occ. <sup>4</sup>	% Transit	% Non-Motorized
Office						
Retail						
Restaurant						
Cinema/Entertainment						
Residential						
Hotel						
All Other Land Uses <sup>2</sup>						

Table 3-A: Average Land Use Interchange Distances (Feet Walking Distance)						
Origin (From)	Destination (To)					
	Office	Retail	Restaurant	Cinema/Entertainment	Residential	Hotel
Office						
Retail						
Restaurant						
Cinema/Entertainment						
Residential						
Hotel						

Table 4-A: Internal Person-Trip Origin-Destination Matrix*						
Origin (From)	Destination (To)					
	Office	Retail	Restaurant	Cinema/Entertainment	Residential	Hotel
Office						
Retail	0		0	0	0	0
Restaurant	0	0		0	0	0
Cinema/Entertainment	0	0	0		0	0
Residential	0	0	0	0		0
Hotel	0	0	0	0	0	

Table 5-A: Computations Summary			
	Total	Entering	Exiting
All Person-Trips	77	26	51
Internal Capture Percentage	0%	0%	0%
External Vehicle-Trips <sup>5</sup>	77	26	51
External Transit-Trips <sup>6</sup>	0	0	0
External Non-Motorized Trips <sup>6</sup>	0	0	0

Table 6-A: Internal Trip Capture Percentages by Land Use		
Land Use	Entering Trips	Exiting Trips
Office	N/A	N/A
Retail	0%	0%
Restaurant	N/A	N/A
Cinema/Entertainment	N/A	N/A
Residential	0%	0%
Hotel	N/A	N/A

<sup>1</sup>Land Use Codes (LUCs) from *Trip Generation Manual*, published by the Institute of Transportation Engineers.

<sup>2</sup>Total estimate for all other land uses at mixed-use development site is not subject to internal trip capture computations in this estimator.

<sup>3</sup>Enter trips assuming no transit or non-motorized trips (as assumed in ITE *Trip Generation Manual*).

<sup>4</sup>Enter vehicle occupancy assumed in Table 1-A vehicle trips. If vehicle occupancy changes for proposed mixed-use project, manual adjustments must be made to Tables 5-A, 9-A (O and D). Enter transit, non-motorized percentages that will result with proposed mixed-use project complete.

<sup>5</sup>Vehicle-trips computed using the mode split and vehicle occupancy values provided in Table 2-A.

<sup>6</sup>Person-Trips

\*Indicates computation that has been rounded to the nearest whole number.

Estimation Tool Developed by the Texas A&M Transportation Institute - Version 2013.1

<b>Project Name:</b>	265 Catherine Phase 1
<b>Analysis Period:</b>	AM Street Peak Hour

Table 7-A: Conversion of Vehicle-Trip Ends to Person-Trip Ends						
Land Use	Table 7-A (D): Entering Trips			Table 7-A (O): Exiting Trips		
	Veh. Occ.	Vehicle-Trips	Person-Trips*	Veh. Occ.	Vehicle-Trips	Person-Trips*
Office	1.00	0	0	1.00	0	0
Retail	1.00	5	5	1.00	3	3
Restaurant	1.00	0	0	1.00	0	0
Cinema/Entertainment	1.00	0	0	1.00	0	0
Residential	1.00	21	21	1.00	48	48
Hotel	1.00	0	0	1.00	0	0

Table 8-A (O): Internal Person-Trip Origin-Destination Matrix (Computed at Origin)						
Origin (From)	Destination (To)					
	Office	Retail	Restaurant	Cinema/Entertainment	Residential	Hotel
Office		0	0	0	0	0
Retail	1		0	0	0	0
Restaurant	0	0		0	0	0
Cinema/Entertainment	0	0	0		0	0
Residential	1	0	10	0		0
Hotel	0	0	0	0	0	

Table 8-A (D): Internal Person-Trip Origin-Destination Matrix (Computed at Destination)						
Origin (From)	Destination (To)					
	Office	Retail	Restaurant	Cinema/Entertainment	Residential	Hotel
Office		2	0	0	0	0
Retail	0		0	0	0	0
Restaurant	0	0		0	1	0
Cinema/Entertainment	0	0	0		0	0
Residential	0	1	0	0		0
Hotel	0	0	0	0	0	

Table 9-A (D): Internal and External Trips Summary (Entering Trips)						
Destination Land Use	Person-Trip Estimates			External Trips by Mode*		
	Internal	External	Total	Vehicles <sup>1</sup>	Transit <sup>2</sup>	Non-Motorized <sup>2</sup>
Office	0	0	0	0	0	0
Retail	0	5	5	5	0	0
Restaurant	0	0	0	0	0	0
Cinema/Entertainment	0	0	0	0	0	0
Residential	0	21	21	21	0	0
Hotel	0	0	0	0	0	0
All Other Land Uses <sup>3</sup>	0	0	0	0	0	0

Table 9-A (O): Internal and External Trips Summary (Exiting Trips)						
Origin Land Use	Person-Trip Estimates			External Trips by Mode*		
	Internal	External	Total	Vehicles <sup>1</sup>	Transit <sup>2</sup>	Non-Motorized <sup>2</sup>
Office	0	0	0	0	0	0
Retail	0	3	3	3	0	0
Restaurant	0	0	0	0	0	0
Cinema/Entertainment	0	0	0	0	0	0
Residential	0	48	48	48	0	0
Hotel	0	0	0	0	0	0
All Other Land Uses <sup>3</sup>	0	0	0	0	0	0

<sup>1</sup>Vehicle-trips computed using the mode split and vehicle occupancy values provided in Table 2-A  
<sup>2</sup>Person-Trips  
<sup>3</sup>Total estimate for all other land uses at mixed-use development site is not subject to internal trip capture computations in this estimator  
\*Indicates computation that has been rounded to the nearest whole number.

NCHRP 684 Internal Trip Capture Estimation Tool			
Project Name:	265 Catherine Phase 1	Organization:	Parsons
Project Location:		Performed By:	
Scenario Description:	PM Internal Reduction	Date:	2/27/2024
Analysis Year:		Checked By:	
Analysis Period:	PM Street Peak Hour	Date:	

Table 1-P: Base Vehicle-Trip Generation Estimates (Single-Use Site Estimate)						
Land Use	Development Data (For Information Only)			Estimated Vehicle-Trips <sup>3</sup>		
	ITE LUCs <sup>1</sup>	Quantity	Units	Total	Entering	Exiting
Office				0		
Retail				20	10	10
Restaurant				0		
Cinema/Entertainment				0		
Residential				69	40	29
Hotel				0		
All Other Land Uses <sup>2</sup>				0		
				89	50	39

Table 2-P: Mode Split and Vehicle Occupancy Estimates						
Land Use	Entering Trips			Exiting Trips		
	Veh. Occ. <sup>4</sup>	% Transit	% Non-Motorized	Veh. Occ. <sup>4</sup>	% Transit	% Non-Motorized
Office						
Retail						
Restaurant						
Cinema/Entertainment						
Residential						
Hotel						
All Other Land Uses <sup>2</sup>						

Table 3-P: Average Land Use Interchange Distances (Feet Walking Distance)						
Origin (From)	Destination (To)					
	Office	Retail	Restaurant	Cinema/Entertainment	Residential	Hotel
Office						
Retail					150	
Restaurant						
Cinema/Entertainment						
Residential		150				
Hotel						

Table 4-P: Internal Person-Trip Origin-Destination Matrix*						
Origin (From)	Destination (To)					
	Office	Retail	Restaurant	Cinema/Entertainment	Residential	Hotel
Office		0	0	0	0	0
Retail	0		0	0	3	0
Restaurant	0	0		0	0	0
Cinema/Entertainment	0	0	0		0	0
Residential	0	1	0	0		0
Hotel	0	0	0	0	0	

Table 5-P: Computations Summary			
	Total	Entering	Exiting
All Person-Trips	89	50	39
Internal Capture Percentage	9%	8%	10%
External Vehicle-Trips <sup>5</sup>	81	46	35
External Transit-Trips <sup>6</sup>	0	0	0
External Non-Motorized Trips <sup>6</sup>	0	0	0

Table 6-P: Internal Trip Capture Percentages by Land Use		
Land Use	Entering Trips	Exiting Trips
Office	N/A	N/A
Retail	10%	30%
Restaurant	N/A	N/A
Cinema/Entertainment	N/A	N/A
Residential	8%	3%
Hotel	N/A	N/A

<sup>1</sup>Land Use Codes (LUCs) from *Trip Generation Manual*, published by the Institute of Transportation Engineers.

<sup>2</sup>Total estimate for all other land uses at mixed-use development site is not subject to internal trip capture computations in this estimator.

<sup>3</sup>Enter trips assuming no transit or non-motorized trips (as assumed in ITE *Trip Generation Manual*).

<sup>4</sup>Enter vehicle occupancy assumed in Table 1-P vehicle trips. If vehicle occupancy changes for proposed mixed-use project, manual adjustments must be made.

<sup>5</sup>Vehicle-trips computed using the mode split and vehicle occupancy values provided in Table 2-P.

<sup>6</sup>Person-Trips

\*Indicates computation that has been rounded to the nearest whole number.

Estimation Tool Developed by the Texas A&M Transportation Institute - Version 2013.1

<b>Project Name:</b>	265 Catherine Phase 1
<b>Analysis Period:</b>	PM Street Peak Hour

Table 7-P: Conversion of Vehicle-Trip Ends to Person-Trip Ends						
Land Use	Table 7-P (D): Entering Trips			Table 7-P (O): Exiting Trips		
	Veh. Occ.	Vehicle-Trips	Person-Trips*	Veh. Occ.	Vehicle-Trips	Person-Trips*
Office	1.00	0	0	1.00	0	0
Retail	1.00	10	10	1.00	10	10
Restaurant	1.00	0	0	1.00	0	0
Cinema/Entertainment	1.00	0	0	1.00	0	0
Residential	1.00	40	40	1.00	29	29
Hotel	1.00	0	0	1.00	0	0

Table 8-P (O): Internal Person-Trip Origin-Destination Matrix (Computed at Origin)						
Origin (From)	Destination (To)					
	Office	Retail	Restaurant	Cinema/Entertainment	Residential	Hotel
Office		0	0	0	0	0
Retail	0		3	0	3	1
Restaurant	0	0		0	0	0
Cinema/Entertainment	0	0	0		0	0
Residential	1	12	6	0		1
Hotel	0	0	0	0	0	

Table 8-P (D): Internal Person-Trip Origin-Destination Matrix (Computed at Destination)						
Origin (From)	Destination (To)					
	Office	Retail	Restaurant	Cinema/Entertainment	Residential	Hotel
Office		1	0	0	2	0
Retail	0		0	0	18	0
Restaurant	0	5		0	6	0
Cinema/Entertainment	0	0	0		2	0
Residential	0	1	0	0		0
Hotel	0	0	0	0	0	

Table 9-P (D): Internal and External Trips Summary (Entering Trips)						
Destination Land Use	Person-Trip Estimates			External Trips by Mode*		
	Internal	External	Total	Vehicles <sup>1</sup>	Transit <sup>2</sup>	Non-Motorized <sup>2</sup>
Office	0	0	0	0	0	0
Retail	1	9	10	9	0	0
Restaurant	0	0	0	0	0	0
Cinema/Entertainment	0	0	0	0	0	0
Residential	3	37	40	37	0	0
Hotel	0	0	0	0	0	0
All Other Land Uses <sup>3</sup>	0	0	0	0	0	0

Table 9-P (O): Internal and External Trips Summary (Exiting Trips)						
Origin Land Use	Person-Trip Estimates			External Trips by Mode*		
	Internal	External	Total	Vehicles <sup>1</sup>	Transit <sup>2</sup>	Non-Motorized <sup>2</sup>
Office	0	0	0	0	0	0
Retail	3	7	10	7	0	0
Restaurant	0	0	0	0	0	0
Cinema/Entertainment	0	0	0	0	0	0
Residential	1	28	29	28	0	0
Hotel	0	0	0	0	0	0
All Other Land Uses <sup>3</sup>	0	0	0	0	0	0

<sup>1</sup>Vehicle-trips computed using the mode split and vehicle occupancy values provided in Table 2-P

<sup>2</sup>Person-Trips

<sup>3</sup>Total estimate for all other land uses at mixed-use development site is not subject to internal trip capture computations in this estimator

\*Indicates computation that has been rounded to the nearest whole number.

NCHRP 684 Internal Trip Capture Estimation Tool					
Project Name:	Full Buildout 265 Catherine			Organization:	Parsons
Project Location:				Performed By:	
Scenario Description:	AM Internal Reduction			Date:	2/27/2024
Analysis Year:				Checked By:	
Analysis Period:	AM Street Peak Hour			Date:	

Table 1-A: Base Vehicle-Trip Generation Estimates (Single-Use Site Estimate)						
Land Use	Development Data (For Information Only)			Estimated Vehicle-Trips <sup>3</sup>		
	ITE LUCs <sup>1</sup>	Quantity	Units	Total	Entering	Exiting
Office				0		
Retail				14	8	6
Restaurant				0		
Cinema/Entertainment				0		
Residential				196	61	135
Hotel				0		
All Other Land Uses <sup>2</sup>				0		
				210	69	141

Table 2-A: Mode Split and Vehicle Occupancy Estimates						
Land Use	Entering Trips			Exiting Trips		
	Veh. Occ. <sup>4</sup>	% Transit	% Non-Motorized	Veh. Occ. <sup>4</sup>	% Transit	% Non-Motorized
Office						
Retail						
Restaurant						
Cinema/Entertainment						
Residential						
Hotel						
All Other Land Uses <sup>2</sup>						

Table 3-A: Average Land Use Interchange Distances (Feet Walking Distance)						
Origin (From)	Destination (To)					
	Office	Retail	Restaurant	Cinema/Entertainment	Residential	Hotel
Office						
Retail						
Restaurant						
Cinema/Entertainment						
Residential						
Hotel						

Table 4-A: Internal Person-Trip Origin-Destination Matrix*						
Origin (From)	Destination (To)					
	Office	Retail	Restaurant	Cinema/Entertainment	Residential	Hotel
Office		0	0	0	0	0
Retail	0		0	0	1	0
Restaurant	0	0		0	0	0
Cinema/Entertainment	0	0	0		0	0
Residential	0	1	0	0		0
Hotel	0	0	0	0	0	

Table 5-A: Computations Summary			
	Total	Entering	Exiting
All Person-Trips	210	69	141
Internal Capture Percentage	2%	3%	1%
External Vehicle-Trips <sup>5</sup>	206	67	139
External Transit-Trips <sup>6</sup>	0	0	0
External Non-Motorized Trips <sup>6</sup>	0	0	0

Table 6-A: Internal Trip Capture Percentages by Land Use		
Land Use	Entering Trips	Exiting Trips
Office	N/A	N/A
Retail	13%	17%
Restaurant	N/A	N/A
Cinema/Entertainment	N/A	N/A
Residential	2%	1%
Hotel	N/A	N/A

<sup>1</sup>Land Use Codes (LUCs) from *Trip Generation Manual*, published by the Institute of Transportation Engineers.

<sup>2</sup>Total estimate for all other land uses at mixed-use development site is not subject to internal trip capture computations in this estimator.

<sup>3</sup>Enter trips assuming no transit or non-motorized trips (as assumed in ITE *Trip Generation Manual*).

<sup>4</sup>Enter vehicle occupancy assumed in Table 1-A vehicle trips. If vehicle occupancy changes for proposed mixed-use project, manual adjustments must be made to Tables 5-A, 9-A (O and D). Enter transit, non-motorized percentages that will result with proposed mixed-use project complete.

<sup>5</sup>Vehicle-trips computed using the mode split and vehicle occupancy values provided in Table 2-A.

<sup>6</sup>Person-Trips

\*Indicates computation that has been rounded to the nearest whole number.

Estimation Tool Developed by the Texas A&M Transportation Institute - Version 2013.1

<b>Project Name:</b>	Full Buildout 265 Catherine
<b>Analysis Period:</b>	AM Street Peak Hour

Table 7-A: Conversion of Vehicle-Trip Ends to Person-Trip Ends						
Land Use	Table 7-A (D): Entering Trips			Table 7-A (O): Exiting Trips		
	Veh. Occ.	Vehicle-Trips	Person-Trips*	Veh. Occ.	Vehicle-Trips	Person-Trips*
Office	1.00	0	0	1.00	0	0
Retail	1.00	8	8	1.00	6	6
Restaurant	1.00	0	0	1.00	0	0
Cinema/Entertainment	1.00	0	0	1.00	0	0
Residential	1.00	61	61	1.00	135	135
Hotel	1.00	0	0	1.00	0	0

Table 8-A (O): Internal Person-Trip Origin-Destination Matrix (Computed at Origin)						
Origin (From)	Destination (To)					
	Office	Retail	Restaurant	Cinema/Entertainment	Residential	Hotel
Office		0	0	0	0	0
Retail	2		1	0	1	0
Restaurant	0	0		0	0	0
Cinema/Entertainment	0	0	0		0	0
Residential	3	1	27	0		0
Hotel	0	0	0	0	0	

Table 8-A (D): Internal Person-Trip Origin-Destination Matrix (Computed at Destination)						
Origin (From)	Destination (To)					
	Office	Retail	Restaurant	Cinema/Entertainment	Residential	Hotel
Office		3	0	0	0	0
Retail	0		0	0	1	0
Restaurant	0	1		0	3	0
Cinema/Entertainment	0	0	0		0	0
Residential	0	1	0	0		0
Hotel	0	0	0	0	0	

Table 9-A (D): Internal and External Trips Summary (Entering Trips)						
Destination Land Use	Person-Trip Estimates			External Trips by Mode*		
	Internal	External	Total	Vehicles <sup>1</sup>	Transit <sup>2</sup>	Non-Motorized <sup>2</sup>
Office	0	0	0	0	0	0
Retail	1	7	8	7	0	0
Restaurant	0	0	0	0	0	0
Cinema/Entertainment	0	0	0	0	0	0
Residential	1	60	61	60	0	0
Hotel	0	0	0	0	0	0
All Other Land Uses <sup>3</sup>	0	0	0	0	0	0

Table 9-A (O): Internal and External Trips Summary (Exiting Trips)						
Origin Land Use	Person-Trip Estimates			External Trips by Mode*		
	Internal	External	Total	Vehicles <sup>1</sup>	Transit <sup>2</sup>	Non-Motorized <sup>2</sup>
Office	0	0	0	0	0	0
Retail	1	5	6	5	0	0
Restaurant	0	0	0	0	0	0
Cinema/Entertainment	0	0	0	0	0	0
Residential	1	134	135	134	0	0
Hotel	0	0	0	0	0	0
All Other Land Uses <sup>3</sup>	0	0	0	0	0	0

<sup>1</sup>Vehicle-trips computed using the mode split and vehicle occupancy values provided in Table 2-A  
<sup>2</sup>Person-Trips  
<sup>3</sup>Total estimate for all other land uses at mixed-use development site is not subject to internal trip capture computations in this estimator  
\*Indicates computation that has been rounded to the nearest whole number.

NCHRP 684 Internal Trip Capture Estimation Tool			
Project Name:	Full Buildout 265 Catherine	Organization:	Parsons
Project Location:		Performed By:	
Scenario Description:	PM Internal Reduction	Date:	2/27/2024
Analysis Year:		Checked By:	
Analysis Period:	PM Street Peak Hour	Date:	

Table 1-P: Base Vehicle-Trip Generation Estimates (Single-Use Site Estimate)						
Land Use	Development Data (For Information Only)			Estimated Vehicle-Trips <sup>3</sup>		
	ITE LUCs <sup>1</sup>	Quantity	Units	Total	Entering	Exiting
Office				0		
Retail				36	18	18
Restaurant				0		
Cinema/Entertainment				0		
Residential				197	114	83
Hotel				0		
All Other Land Uses <sup>2</sup>				0		
				233	132	101

Table 2-P: Mode Split and Vehicle Occupancy Estimates						
Land Use	Entering Trips			Exiting Trips		
	Veh. Occ. <sup>4</sup>	% Transit	% Non-Motorized	Veh. Occ. <sup>4</sup>	% Transit	% Non-Motorized
Office						
Retail						
Restaurant						
Cinema/Entertainment						
Residential						
Hotel						
All Other Land Uses <sup>2</sup>						

Table 3-P: Average Land Use Interchange Distances (Feet Walking Distance)						
Origin (From)	Destination (To)					
	Office	Retail	Restaurant	Cinema/Entertainment	Residential	Hotel
Office						
Retail					150	
Restaurant						
Cinema/Entertainment						
Residential		150				
Hotel						

Table 4-P: Internal Person-Trip Origin-Destination Matrix*						
Origin (From)	Destination (To)					
	Office	Retail	Restaurant	Cinema/Entertainment	Residential	Hotel
Office		0	0	0	0	0
Retail	0		0	0	5	0
Restaurant	0	0		0	0	0
Cinema/Entertainment	0	0	0		0	0
Residential	0	2	0	0		0
Hotel	0	0	0	0	0	

Table 5-P: Computations Summary			
	Total	Entering	Exiting
All Person-Trips	233	132	101
Internal Capture Percentage	6%	5%	7%
External Vehicle-Trips <sup>5</sup>	219	125	94
External Transit-Trips <sup>6</sup>	0	0	0
External Non-Motorized Trips <sup>6</sup>	0	0	0

Table 6-P: Internal Trip Capture Percentages by Land Use		
Land Use	Entering Trips	Exiting Trips
Office	N/A	N/A
Retail	11%	28%
Restaurant	N/A	N/A
Cinema/Entertainment	N/A	N/A
Residential	4%	2%
Hotel	N/A	N/A

<sup>1</sup>Land Use Codes (LUCs) from *Trip Generation Manual*, published by the Institute of Transportation Engineers.

<sup>2</sup>Total estimate for all other land uses at mixed-use development site is not subject to internal trip capture computations in this estimator.

<sup>3</sup>Enter trips assuming no transit or non-motorized trips (as assumed in ITE *Trip Generation Manual*).

<sup>4</sup>Enter vehicle occupancy assumed in Table 1-P vehicle trips. If vehicle occupancy changes for proposed mixed-use project, manual adjustments must be made.

<sup>5</sup>Vehicle-trips computed using the mode split and vehicle occupancy values provided in Table 2-P.

<sup>6</sup>Person-Trips

\*Indicates computation that has been rounded to the nearest whole number.

Estimation Tool Developed by the Texas A&M Transportation Institute - Version 2013.1



<b>Project Name:</b>	Full Buildout 265 Catherine
<b>Analysis Period:</b>	PM Street Peak Hour

Table 7-P: Conversion of Vehicle-Trip Ends to Person-Trip Ends						
Land Use	Table 7-P (D): Entering Trips			Table 7-P (O): Exiting Trips		
	Veh. Occ.	Vehicle-Trips	Person-Trips*	Veh. Occ.	Vehicle-Trips	Person-Trips*
Office	1.00	0	0	1.00	0	0
Retail	1.00	18	18	1.00	18	18
Restaurant	1.00	0	0	1.00	0	0
Cinema/Entertainment	1.00	0	0	1.00	0	0
Residential	1.00	114	114	1.00	83	83
Hotel	1.00	0	0	1.00	0	0

Table 8-P (O): Internal Person-Trip Origin-Destination Matrix (Computed at Origin)						
Origin (From)	Destination (To)					
	Office	Retail	Restaurant	Cinema/Entertainment	Residential	Hotel
Office		0	0	0	0	0
Retail	0		5	1	5	1
Restaurant	0	0		0	0	0
Cinema/Entertainment	0	0	0		0	0
Residential	3	35	17	0		2
Hotel	0	0	0	0	0	

Table 8-P (D): Internal Person-Trip Origin-Destination Matrix (Computed at Destination)						
Origin (From)	Destination (To)					
	Office	Retail	Restaurant	Cinema/Entertainment	Residential	Hotel
Office		1	0	0	5	0
Retail	0		0	0	52	0
Restaurant	0	9		0	18	0
Cinema/Entertainment	0	1	0		5	0
Residential	0	2	0	0		0
Hotel	0	0	0	0	0	

Table 9-P (D): Internal and External Trips Summary (Entering Trips)						
Destination Land Use	Person-Trip Estimates			External Trips by Mode*		
	Internal	External	Total	Vehicles <sup>1</sup>	Transit <sup>2</sup>	Non-Motorized <sup>2</sup>
Office	0	0	0	0	0	0
Retail	2	16	18	16	0	0
Restaurant	0	0	0	0	0	0
Cinema/Entertainment	0	0	0	0	0	0
Residential	5	109	114	109	0	0
Hotel	0	0	0	0	0	0
All Other Land Uses <sup>3</sup>	0	0	0	0	0	0

Table 9-P (O): Internal and External Trips Summary (Exiting Trips)						
Origin Land Use	Person-Trip Estimates			External Trips by Mode*		
	Internal	External	Total	Vehicles <sup>1</sup>	Transit <sup>2</sup>	Non-Motorized <sup>2</sup>
Office	0	0	0	0	0	0
Retail	5	13	18	13	0	0
Restaurant	0	0	0	0	0	0
Cinema/Entertainment	0	0	0	0	0	0
Residential	2	81	83	81	0	0
Hotel	0	0	0	0	0	0
All Other Land Uses <sup>3</sup>	0	0	0	0	0	0

<sup>1</sup>Vehicle-trips computed using the mode split and vehicle occupancy values provided in Table 2-P

<sup>2</sup>Person-Trips

<sup>3</sup>Total estimate for all other land uses at mixed-use development site is not subject to internal trip capture computations in this estimator

\*Indicates computation that has been rounded to the nearest whole number.

# Appendix F:

TDM Checklist

## TDM-Supportive Development Design and Infrastructure Checklist: *Residential Developments (multi-family or condominium)*

<b>Legend</b>	
<b>REQUIRED</b>	The Official Plan or Zoning By-law provides related guidance that must be followed
<b>BASIC</b>	The measure is generally feasible and effective, and in most cases would benefit the development and its users
<b>BETTER</b>	The measure could maximize support for users of sustainable modes, and optimize development performance

TDM-supportive design & infrastructure measures: <i>Residential developments</i>		Check if completed & add descriptions, explanations or plan/drawing references
<b>1. WALKING &amp; CYCLING: ROUTES</b>		
<b>1.1 Building location &amp; access points</b>		
BASIC	1.1.1 Locate building close to the street, and do not locate parking areas between the street and building entrances	<input checked="" type="checkbox"/>
BASIC	1.1.2 Locate building entrances in order to minimize walking distances to sidewalks and transit stops/stations	<input checked="" type="checkbox"/>
BASIC	1.1.3 Locate building doors and windows to ensure visibility of pedestrians from the building, for their security and comfort	<input checked="" type="checkbox"/>
<b>1.2 Facilities for walking &amp; cycling</b>		
REQUIRED	1.2.1 Provide convenient, direct access to stations or major stops along rapid transit routes within 600 metres; minimize walking distances from buildings to rapid transit; provide pedestrian-friendly, weather-protected (where possible) environment between rapid transit accesses and building entrances; ensure quality linkages from sidewalks through building entrances to integrated stops/stations ( <i>see Official Plan policy 4.3.3</i> )	<input checked="" type="checkbox"/>
REQUIRED	1.2.2 Provide safe, direct and attractive pedestrian access from public sidewalks to building entrances through such measures as: reducing distances between public sidewalks and major building entrances; providing walkways from public streets to major building entrances; within a site, providing walkways along the front of adjoining buildings, between adjacent buildings, and connecting areas where people may congregate, such as courtyards and transit stops; and providing weather protection through canopies, colonnades, and other design elements wherever possible ( <i>see Official Plan policy 4.3.12</i> )	<input checked="" type="checkbox"/>

TDM-supportive design & infrastructure measures: <i>Residential developments</i>		Check if completed & add descriptions, explanations or plan/drawing references
REQUIRED	1.2.3 Provide sidewalks of smooth, well-drained walking surfaces of contrasting materials or treatments to differentiate pedestrian areas from vehicle areas, and provide marked pedestrian crosswalks at intersection sidewalks ( <i>see Official Plan policy 4.3.10</i> )	<input checked="" type="checkbox"/>
REQUIRED	1.2.4 Make sidewalks and open space areas easily accessible through features such as gradual grade transition, depressed curbs at street corners and convenient access to extra-wide parking spaces and ramps ( <i>see Official Plan policy 4.3.10</i> )	<input checked="" type="checkbox"/>
REQUIRED	1.2.5 Include adequately spaced inter-block/street cycling and pedestrian connections to facilitate travel by active transportation. Provide links to the existing or planned network of public sidewalks, multi-use pathways and on-road cycle routes. Where public sidewalks and multi-use pathways intersect with roads, consider providing traffic control devices to give priority to cyclists and pedestrians ( <i>see Official Plan policy 4.3.11</i> )	<input checked="" type="checkbox"/>
BASIC	1.2.6 Provide safe, direct and attractive walking routes from building entrances to nearby transit stops	<input checked="" type="checkbox"/>
BASIC	1.2.7 Ensure that walking routes to transit stops are secure, visible, lighted, shaded and wind-protected wherever possible	<input checked="" type="checkbox"/>
BASIC	1.2.8 Design roads used for access or circulation by cyclists using a target operating speed of no more than 30 km/h, or provide a separated cycling facility	<input checked="" type="checkbox"/>
<b>1.3 Amenities for walking &amp; cycling</b>		
BASIC	1.3.1 Provide lighting, landscaping and benches along walking and cycling routes between building entrances and streets, sidewalks and trails	<input checked="" type="checkbox"/>
BASIC	1.3.2 Provide wayfinding signage for site access (where required, e.g. when multiple buildings or entrances exist) and egress (where warranted, such as when directions to reach transit stops/stations, trails or other common destinations are not obvious)	<input checked="" type="checkbox"/>

TDM-supportive design & infrastructure measures: <i>Residential developments</i>		Check if completed & add descriptions, explanations or plan/drawing references
<b>2. WALKING &amp; CYCLING: END-OF-TRIP FACILITIES</b>		
<b>2.1 Bicycle parking</b>		
REQUIRED	2.1.1 Provide bicycle parking in highly visible and lighted areas, sheltered from the weather wherever possible (see <i>Official Plan policy 4.3.6</i> )	<input checked="" type="checkbox"/>
REQUIRED	2.1.2 Provide the number of bicycle parking spaces specified for various land uses in different parts of Ottawa; provide convenient access to main entrances or well-used areas (see <i>Zoning By-law Section 111</i> )	<input checked="" type="checkbox"/>
REQUIRED	2.1.3 Ensure that bicycle parking spaces and access aisles meet minimum dimensions; that no more than 50% of spaces are vertical spaces; and that parking racks are securely anchored (see <i>Zoning By-law Section 111</i> )	<input checked="" type="checkbox"/>
BASIC	2.1.4 Provide bicycle parking spaces equivalent to the expected number of resident-owned bicycles, plus the expected peak number of visitor cyclists	<input checked="" type="checkbox"/>
<b>2.2 Secure bicycle parking</b>		
REQUIRED	2.2.1 Where more than 50 bicycle parking spaces are provided for a single residential building, locate at least 25% of spaces within a building/structure, a secure area (e.g. supervised parking lot or enclosure) or bicycle lockers (see <i>Zoning By-law Section 111</i> )	<input checked="" type="checkbox"/>
BETTER	2.2.2 Provide secure bicycle parking spaces equivalent to at least the number of units at condominiums or multi-family residential developments	<input checked="" type="checkbox"/>
<b>2.3 Bicycle repair station</b>		
BETTER	2.3.1 Provide a permanent bike repair station, with commonly used tools and an air pump, adjacent to the main bicycle parking area (or secure bicycle parking area, if provided)	<input checked="" type="checkbox"/>
<b>3. TRANSIT</b>		
<b>3.1 Customer amenities</b>		
BASIC	3.1.1 Provide shelters, lighting and benches at any on-site transit stops	<input type="checkbox"/>
BASIC	3.1.2 Where the site abuts an off-site transit stop and insufficient space exists for a transit shelter in the public right-of-way, protect land for a shelter and/or install a shelter	<input checked="" type="checkbox"/>
BETTER	3.1.3 Provide a secure and comfortable interior waiting area by integrating any on-site transit stops into the building	<input type="checkbox"/>

TDM-supportive design & infrastructure measures: <i>Residential developments</i>		Check if completed & add descriptions, explanations or plan/drawing references
<b>4. RIDESHARING</b>		
<b>4.1 Pick-up &amp; drop-off facilities</b>		
BASIC	4.1.1 Provide a designated area for carpool drivers (plus taxis and ride-hailing services) to drop off or pick up passengers without using fire lanes or other no-stopping zones	<input checked="" type="checkbox"/>
<b>5. CARSHARING &amp; BIKESHARING</b>		
<b>5.1 Carshare parking spaces</b>		
BETTER	5.1.1 Provide up to three carshare parking spaces in an R3, R4 or R5 Zone for specified residential uses (see <i>Zoning By-law Section 94</i> )	<input checked="" type="checkbox"/>
<b>5.2 Bikeshare station location</b>		
BETTER	5.2.1 Provide a designated bikeshare station area near a major building entrance, preferably lighted and sheltered with a direct walkway connection	<input type="checkbox"/>
<b>6. PARKING</b>		
<b>6.1 Number of parking spaces</b>		
REQUIRED	6.1.1 Do not provide more parking than permitted by zoning, nor less than required by zoning, unless a variance is being applied for	<input checked="" type="checkbox"/>
BASIC	6.1.2 Provide parking for long-term and short-term users that is consistent with mode share targets, considering the potential for visitors to use off-site public parking	<input type="checkbox"/>
BASIC	6.1.3 Where a site features more than one use, provide shared parking and reduce the cumulative number of parking spaces accordingly (see <i>Zoning By-law Section 104</i> )	<input checked="" type="checkbox"/>
BETTER	6.1.4 Reduce the minimum number of parking spaces required by zoning by one space for each 13 square metres of gross floor area provided as shower rooms, change rooms, locker rooms and other facilities for cyclists in conjunction with bicycle parking (see <i>Zoning By-law Section 111</i> )	<input type="checkbox"/>
<b>6.2 Separate long-term &amp; short-term parking areas</b>		
BETTER	6.2.1 Provide separate areas for short-term and long-term parking (using signage or physical barriers) to permit access controls and simplify enforcement (i.e. to discourage residents from parking in visitor spaces, and vice versa)	<input checked="" type="checkbox"/>

**TDM Measures Checklist:**  
*Residential Developments (multi-family, condominium or subdivision)*

<b>Legend</b>	
<b>BASIC</b>	The measure is generally feasible and effective, and in most cases would benefit the development and its users
<b>BETTER</b>	The measure could maximize support for users of sustainable modes, and optimize development performance
★	The measure is one of the most dependably effective tools to encourage the use of sustainable modes

TDM measures: <i>Residential developments</i>		Check if proposed & add descriptions
<b>1. TDM PROGRAM MANAGEMENT</b>		
<b>1.1 Program coordinator</b>		
<b>BASIC</b>	★ 1.1.1 Designate an internal coordinator, or contract with an external coordinator	<input type="checkbox"/>
<b>1.2 Travel surveys</b>		
<b>BETTER</b>	1.2.1 Conduct periodic surveys to identify travel-related behaviours, attitudes, challenges and solutions, and to track progress	<input type="checkbox"/>
<b>2. WALKING AND CYCLING</b>		
<b>2.1 Information on walking/cycling routes &amp; destinations</b>		
<b>BASIC</b>	2.1.1 Display local area maps with walking/cycling access routes and key destinations at major entrances ( <i>multi-family, condominium</i> )	<input checked="" type="checkbox"/>
<b>2.2 Bicycle skills training</b>		
<b>BETTER</b>	2.2.1 Offer on-site cycling courses for residents, or subsidize off-site courses	<input checked="" type="checkbox"/>

TDM measures: <i>Residential developments</i>		Check if proposed & add descriptions
<b>3. TRANSIT</b>		
<b>3.1 Transit information</b>		
BASIC	3.1.1 Display relevant transit schedules and route maps at entrances ( <i>multi-family, condominium</i> )	<input checked="" type="checkbox"/>
BETTER	3.1.2 Provide real-time arrival information display at entrances ( <i>multi-family, condominium</i> )	<input type="checkbox"/>
<b>3.2 Transit fare incentives</b>		
BASIC ★	3.2.1 Offer PRESTO cards preloaded with one monthly transit pass on residence purchase/move-in, to encourage residents to use transit	<input checked="" type="checkbox"/>
BETTER	3.2.2 Offer at least one year of free monthly transit passes on residence purchase/move-in	<input type="checkbox"/>
<b>3.3 Enhanced public transit service</b>		
BETTER ★	3.3.1 Contract with OC Transpo to provide early transit services until regular services are warranted by occupancy levels ( <i>subdivision</i> )	<input type="checkbox"/>
<b>3.4 Private transit service</b>		
BETTER	3.4.1 Provide shuttle service for seniors homes or lifestyle communities (e.g. scheduled mall or supermarket runs)	<input type="checkbox"/>
<b>4. CARSHARING &amp; BIKESHARING</b>		
<b>4.1 Bikeshare stations &amp; memberships</b>		
BETTER	4.1.1 Contract with provider to install on-site bikeshare station ( <i>multi-family</i> )	<input type="checkbox"/>
BETTER	4.1.2 Provide residents with bikeshare memberships, either free or subsidized ( <i>multi-family</i> )	<input type="checkbox"/>
<b>4.2 Carshare vehicles &amp; memberships</b>		
BETTER	4.2.1 Contract with provider to install on-site carshare vehicles and promote their use by residents	<input checked="" type="checkbox"/>
BETTER	4.2.2 Provide residents with carshare memberships, either free or subsidized	<input type="checkbox"/>
<b>5. PARKING</b>		
<b>5.1 Priced parking</b>		
BASIC ★	5.1.1 Unbundle parking cost from purchase price ( <i>condominium</i> )	<input type="checkbox"/>
BASIC ★	5.1.2 Unbundle parking cost from monthly rent ( <i>multi-family</i> )	<input checked="" type="checkbox"/>



TDM measures: <i>Residential developments</i>		Check if proposed & add descriptions
<b>6. TDM MARKETING &amp; COMMUNICATIONS</b>		
<b>6.1 Multimodal travel information</b>		
<b>BASIC</b>	★ 6.1.1 Provide a multimodal travel option information package to new residents	<input checked="" type="checkbox"/>
<b>6.2 Personalized trip planning</b>		
<b>BETTER</b>	★ 6.2.1 Offer personalized trip planning to new residents	<input checked="" type="checkbox"/>

# Appendix G:

Passenger Car and Truck Turning Templates

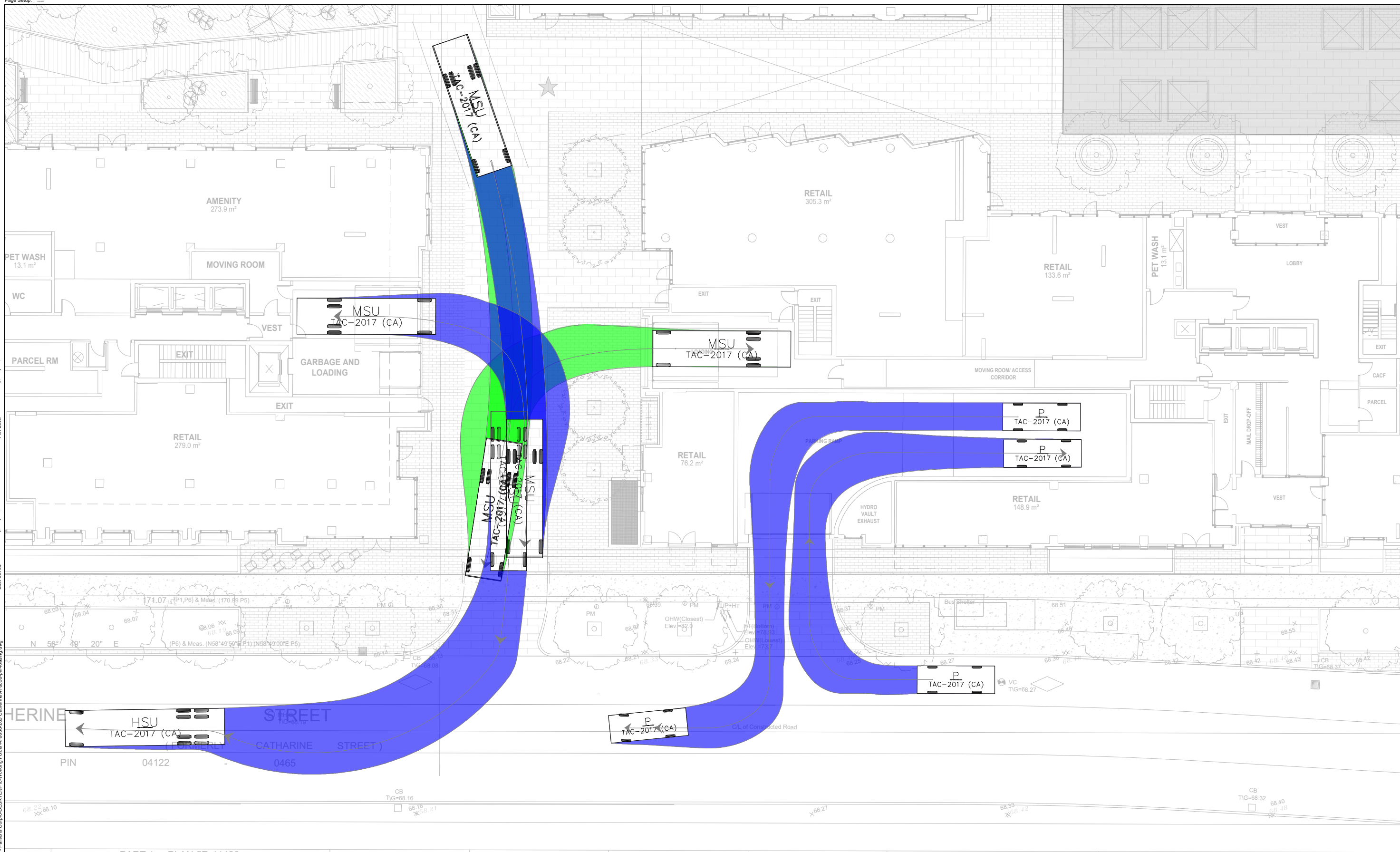

PART 1 PLAN 5R-11428



Legend

	P	Width : 2.00 Track : 2.00 Lock to Lock Time : 6.0 Steering Angle : 35.9
	MSU	Width : 2.60 Track : 2.60 Lock to Lock Time : 6.0 Steering Angle : 42.2
	HSU	Width : 2.80 Track : 2.80 Lock to Lock Time : 6.0 Steering Angle : 40.0

Not to Scale

Drawing Description		Catherine St	
Client	Date	May 22, 2024	Figure Number
Project Number	478038	Project Description	265 Catherine St

NOTE: The location of utilities is approximate only, the exact location should be determined by consulting the municipal authorities and utility companies concerned. The contractor shall prove the location of utilities and shall be responsible for adequate protection from damage.

PART 2  
PLAN 5R-7940

NORTH

ARLINGTON

AVENUE

LOTS

ARLINGTON

AVENUE  
(FORMERLY ARCHIBALD STREET)

Plot Date: Wednesday, May 22, 2024 4:19:11 PM

Last Saved: Wednesday, May 22, 2024 4:17:08 PM

Informant: C:\Users\04978\OneDrive - Parsons Corp\0-DESKTEMP\Working Folder\478038-265 Catherine St\478038-ph-loading.dwg

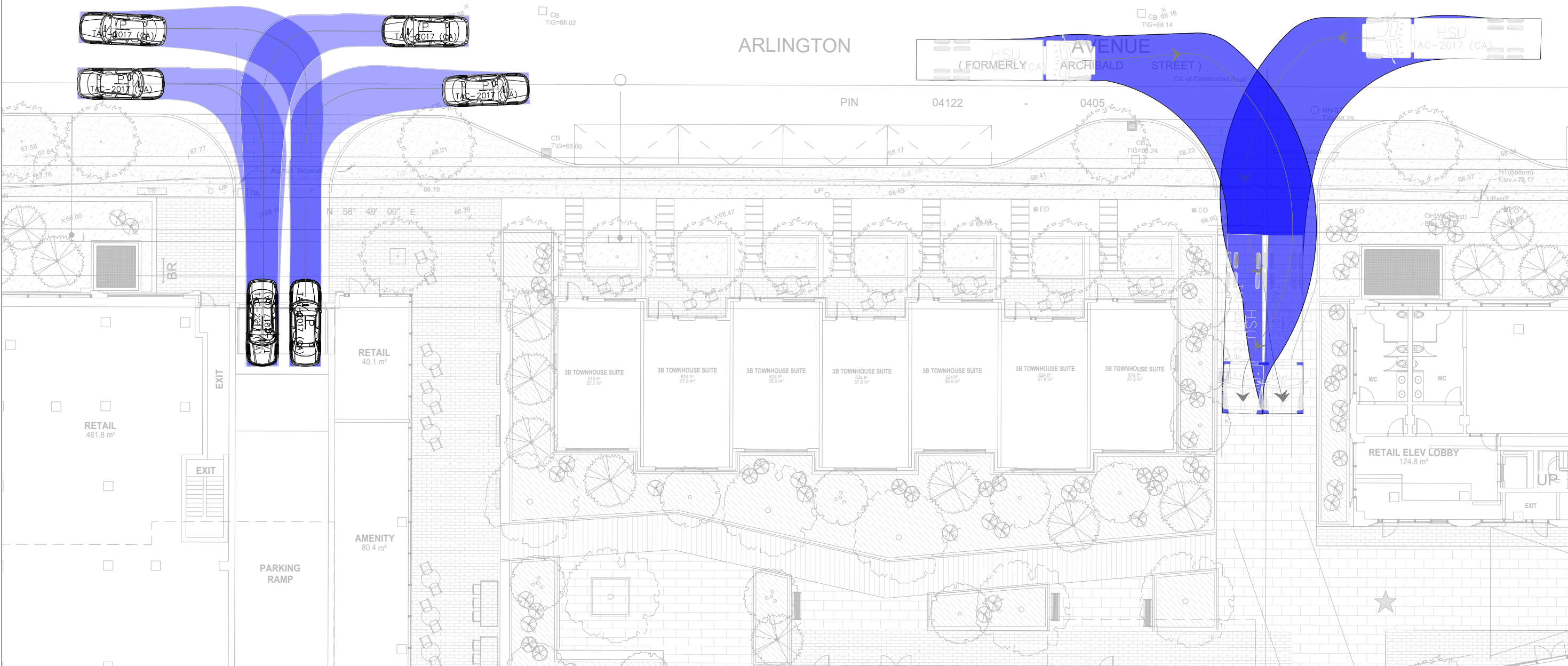

**Legend**

Width : 2.00 Track : 2.00 Lock to Lock Time : 4.0 Steering Angle : 35.9	Width : 2.60 Track : 2.60 Lock to Lock Time : 6.0 Steering Angle : 42.2	Width : 2.80 Track : 2.80 Lock to Lock Time : 6.0 Steering Angle : 40.0

Not to Scale

Drawing Description <b>Arlington Ave</b>	
Client	Date May 22, 2024
Project Number <b>478038</b>	Figure Number 002
Project Description <b>265 Catherine St</b>	

NOTE: The location of utilities is approximate only, the exact location should be determined by consulting the municipal authorities and utility companies concerned. The contractor shall prove the location of utilities and shall be responsible for adequate protection from damage.

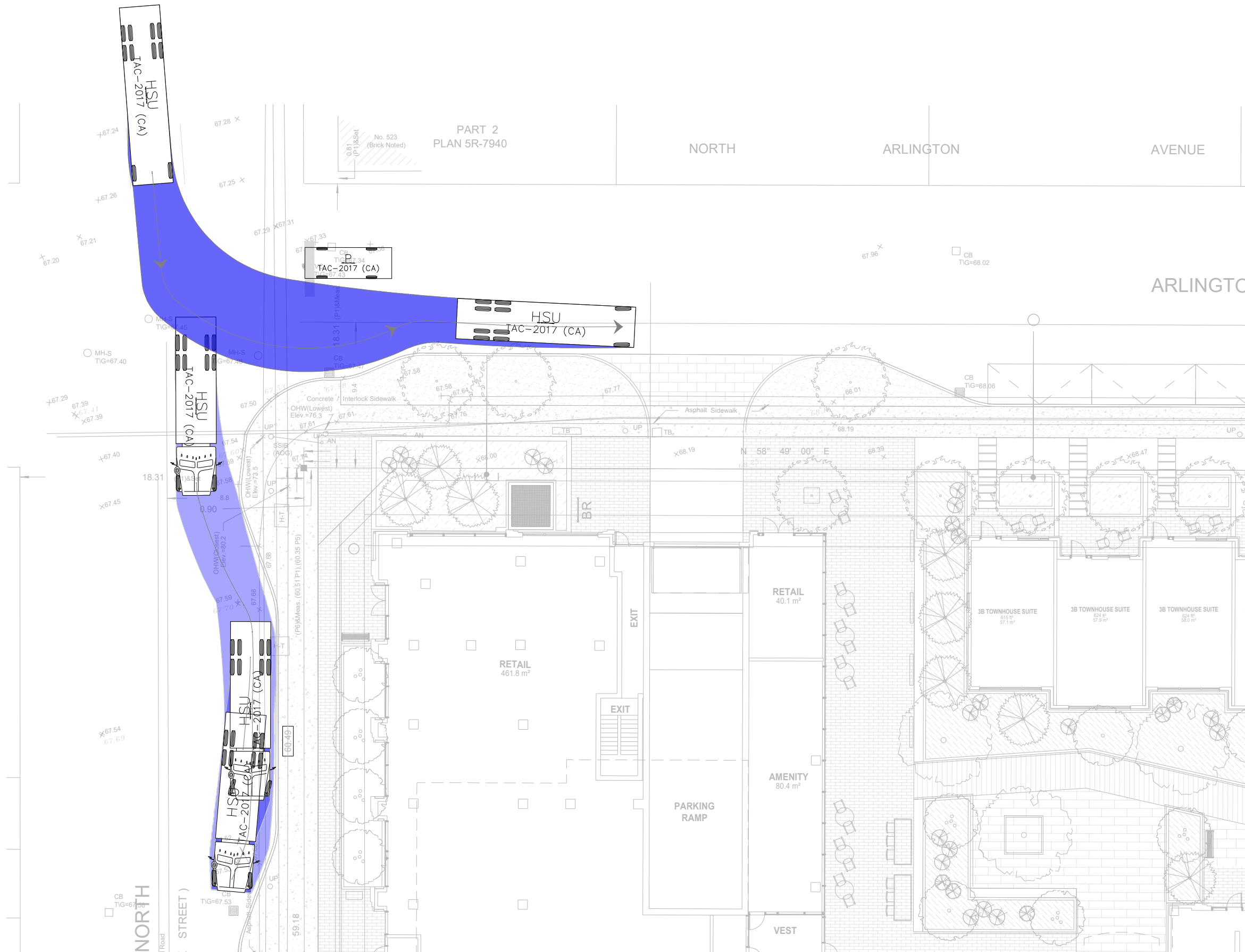

**Legend**

Vehicle Type	Dimensions (meters)
P (Passenger Car)	Width: 1.80, Track: 2.00, Lock to Lock Time: 6.9, Steering Angle: 35.9
MSU (Medium Size Unit)	Width: 2.60, Track: 2.60, Lock to Lock Time: 8.0, Steering Angle: 42.2
HSU (Heavy Size Unit)	Width: 2.80, Track: 2.80, Lock to Lock Time: 8.0, Steering Angle: 40.0

Not to Scale

Drawing Description		Lyon St	
Client	Date	May 22, 2024	Figure Number
Project Number	Project Description	478038	265 Catherine St
			003

NOTE: The location of utilities is approximate only, the exact location should be determined by consulting the municipal authorities and utility companies concerned. The contractor shall prove the location of utilities and shall be responsible for adequate protection from damage.

# Appendix H:

MMLOS Analysis: Road Segments

## Multi-Modal Level of Service - Segments Form

Consultant	<b>Parsons</b>
Scenario	<b>Existing and Future</b>
Comments	

Project	<b>478038-01000</b>
Date	<b>14-May-24</b>

SEGMENTS		Street A	Catherine St 1	Kent St 2	Lyon St 3	Arlington Ave 4	Catherine (future) 5	Kent (future) 6	Lyon (future) 7	Arlington (future) 8	
<b>Pedestrian</b>	Sidewalk Width	<b>F</b>	≥ 2 m	1.8 m	1.5 m	1.5 m	≥ 2 m	≥ 2 m	≥ 2 m	≥ 2 m	
	Boulevard Width		< 0.5	< 0.5 m	< 0.5 m	< 0.5 m	> 2 m	< 0.5	< 0.5	< 0.5	
	Avg Daily Curb Lane Traffic Volume		≤ 3000	> 3000	> 3000	≤ 3000	≤ 3000	> 3000	> 3000	≤ 3000	
	Operating Speed		> 50 to 60 km/h	> 50 to 60 km/h	> 50 to 60 km/h	> 30 to 50 km/h	> 50 to 60 km/h	> 50 to 60 km/h	> 50 to 60 km/h	> 50 to 60 km/h	> 30 to 50 km/h
	On-Street Parking		no	no	no	yes	no	no	yes	yes	
	<b>Exposure to Traffic PLoS</b>		<b>C</b>	<b>F</b>	<b>F</b>	<b>E</b>	<b>A</b>	<b>E</b>	<b>D</b>	<b>B</b>	
	Effective Sidewalk Width		2.0 m	1.5 m	1.5 m	1.5 m	2.5 m	2.0 m	2.0 m	2.0 m	
	Pedestrian Volume		250 ped/hr	250 ped/hr	250 ped/hr	250 ped/hr	250 ped/hr	250 ped/hr	250 ped/hr	250 ped/hr	
<b>Crowding PLoS</b>	<b>B</b>	<b>B</b>	<b>B</b>	<b>B</b>	<b>B</b>	<b>B</b>	<b>B</b>	<b>B</b>			
<b>Level of Service</b>	<b>C</b>	<b>F</b>	<b>F</b>	<b>E</b>	<b>B</b>	<b>E</b>	<b>D</b>	<b>B</b>			
<b>Bicycle</b>	Type of Cycling Facility	<b>E</b>	Mixed Traffic	Mixed Traffic	Mixed Traffic	Mixed Traffic					
	Number of Travel Lanes		2-3 lanes total	2-3 lanes total	≤ 2 (no centreline)	≤ 2 (no centreline)					
	Operating Speed		≥ 50 to 60 km/h	≥ 50 to 60 km/h	≥ 50 to 60 km/h	≤ 40 km/h					
	<b># of Lanes &amp; Operating Speed LoS</b>		<b>E</b>	<b>E</b>	<b>D</b>	<b>A</b>	-	-	-	-	
	Bike Lane (+ Parking Lane) Width										
	<b>Bike Lane Width LoS</b>		-	-	-	-	-	-	-	-	
	Bike Lane Blockages										
	<b>Blockage LoS</b>		-	-	-	-	-	-	-	-	
	Median Refuge Width (no median = < 1.8 m)		< 1.8 m refuge	< 1.8 m refuge	< 1.8 m refuge	< 1.8 m refuge					
	No. of Lanes at Unsignalized Crossing		≤ 3 lanes	≤ 3 lanes	≤ 3 lanes	≤ 3 lanes					
Sidestreet Operating Speed	≤ 40 km/h	≤ 40 km/h	≤ 40 km/h	≤ 40 km/h							
<b>Unsignalized Crossing - Lowest LoS</b>	<b>A</b>	<b>A</b>	<b>A</b>	<b>A</b>	-	-	-	-			
<b>Level of Service</b>	<b>E</b>	<b>E</b>	<b>D</b>	<b>A</b>	-	-	-	-			
<b>Transit</b>	Facility Type	<b>D</b>	Mixed Traffic				Bus lane				
	Friction or Ratio Transit:Posted Speed		Vt/Vp ≥ 0.8				Cf ≤ 60				
<b>Level of Service</b>	<b>D</b>	-	-	-	<b>B</b>	-	-	-			
<b>Truck</b>	Truck Lane Width	<b>A</b>	> 3.7 m	> 3.7 m	> 3.7 m		≤ 3.5 m				
	Travel Lanes per Direction		> 1	> 1	> 1		> 1				
	<b>Level of Service</b>		<b>A</b>	<b>A</b>	<b>A</b>	-	<b>A</b>	-	-		

# Appendix I:

Synchro Analysis Summary Reports



## **Existing Conditions**

Lanes, Volumes, Timings

1: Hwy 417 WB On Ramp/Lyon St N & Catherine St

05/04/2023



Lane Group	EBL	EBT	EBR	WBL	WBT	WBR	NBL	NBT	NBR	SBL	SBT	SBR
Lane Configurations					↕↕↕						↕	↕
Traffic Volume (vph)	0	0	0	222	219	0	0	0	0	0	258	123
Future Volume (vph)	0	0	0	222	219	0	0	0	0	0	258	123
Satd. Flow (prot)	0	0	0	0	4571	0	0	0	0	0	1784	1547
Fit Permitted					0.975							
Satd. Flow (perm)	0	0	0	0	4538	0	0	0	0	0	1784	1517
Satd. Flow (RTOR)					247							137
Lane Group Flow (vph)	0	0	0	0	490	0	0	0	0	0	287	137
Turn Type				Perm	NA						NA	Perm
Protected Phases					8						6	
Permitted Phases				8								6
Minimum Split (s)				26.2	26.2						28.3	28.3
Total Split (s)				40.0	40.0						35.0	35.0
Total Split (%)				53.3%	53.3%						46.7%	46.7%
Yellow Time (s)				3.3	3.3						3.3	3.3
All-Red Time (s)				1.9	1.9						2.0	2.0
Lost Time Adjust (s)					0.0						0.0	0.0
Total Lost Time (s)					5.2						5.3	5.3
Lead/Lag												
Lead-Lag Optimize?												
Act Effct Green (s)					34.8						29.7	29.7
Actuated g/C Ratio					0.46						0.40	0.40
v/c Ratio					0.22						0.41	0.20
Control Delay					9.9						16.3	6.2
Queue Delay					0.0						0.0	0.0
Total Delay					9.9						16.3	6.2
LOS					A						B	A
Approach Delay					9.9						13.1	
Approach LOS					A						B	
Queue Length 50th (m)					19.9						34.8	3.5
Queue Length 95th (m)					25.4						57.2	18.3
Internal Link Dist (m)		271.6			163.9			117.8			52.8	
Turn Bay Length (m)												
Base Capacity (vph)					2238						706	683
Starvation Cap Reductn					0						0	0
Spillback Cap Reductn					0						0	0
Storage Cap Reductn					0						0	0
Reduced v/c Ratio					0.22						0.41	0.20

Intersection Summary

Cycle Length: 75	
Actuated Cycle Length: 75	
Offset: 48 (64%), Referenced to phase 8:WBTL, Start of Green	
Natural Cycle: 55	
Control Type: Pretimed	
Maximum v/c Ratio: 0.41	
Intersection Signal Delay: 11.4	Intersection LOS: B
Intersection Capacity Utilization 47.6%	ICU Level of Service A
Analysis Period (min) 15	

Splits and Phases: 1: Hwy 417 WB On Ramp/Lyon St N & Catherine St

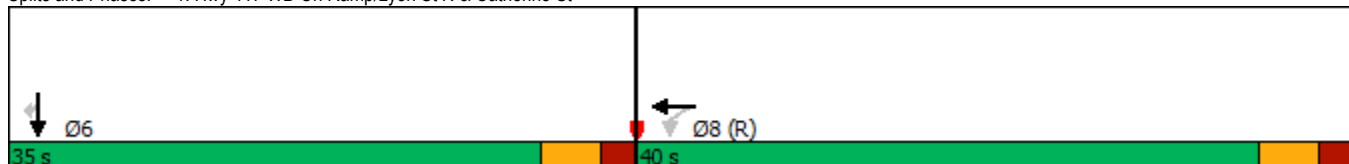

Lanes, Volumes, Timings

2: Hwy 417 EB Off Ramp/Chamberlain Ave/Kent St & Catherine St

05/04/2023



Lane Group	EBL	EBT	EBR	WBL	WBT	WBR	NBL	NBT	NBR	SBL	SBT	SBR
Lane Configurations					↕↕	↗		↕↕↕				
Traffic Volume (vph)	0	0	0	0	389	537	54	1333	0	0	0	0
Future Volume (vph)	0	0	0	0	389	537	54	1333	0	0	0	0
Satd. Flow (prot)	0	0	0	0	2923	1394	0	4911	0	0	0	0
Fit Permitted								0.998				
Satd. Flow (perm)	0	0	0	0	2923	1303	0	4906	0	0	0	0
Satd. Flow (RTOR)								70				
Lane Group Flow (vph)	0	0	0	0	707	322	0	1541	0	0	0	0
Turn Type					NA	Perm	Perm	NA				
Protected Phases					8			2				
Permitted Phases						8		2				
Minimum Split (s)					22.8	22.8		22.5				
Total Split (s)					32.0	32.0		38.0				
Total Split (%)					42.7%	42.7%		50.7%				
Yellow Time (s)					3.3	3.3		3.3				
All-Red Time (s)					2.5	2.5		2.5				
Lost Time Adjust (s)					0.0	0.0		0.0				
Total Lost Time (s)					5.8	5.8		5.8				
Lead/Lag												
Lead-Lag Optimize?												
Act Effct Green (s)					26.2	26.2		32.2				
Actuated g/C Ratio					0.35	0.35		0.43				
v/c Ratio					0.69	0.71		0.72				
Control Delay					26.7	30.2		19.1				
Queue Delay					0.0	0.0		3.4				
Total Delay					26.7	30.2		22.6				
LOS					C	C		C				
Approach Delay					27.8			22.6				
Approach LOS					C			C				
Queue Length 50th (m)					52.0	47.5		60.6				
Queue Length 95th (m)					m60.6	m56.4		76.6				
Internal Link Dist (m)		163.9			131.7			67.4			53.0	
Turn Bay Length (m)												
Base Capacity (vph)					1021	455		2146				
Starvation Cap Reductn					0	0		0				
Spillback Cap Reductn					0	0		496				
Storage Cap Reductn					0	0		0				
Reduced v/c Ratio					0.69	0.71		0.93				

Intersection Summary

Cycle Length: 75	
Actuated Cycle Length: 75	
Offset: 15 (20%), Referenced to phase 8:WBT, Start of Green	
Natural Cycle: 55	
Control Type: Pretimed	
Maximum v/c Ratio: 0.72	
Intersection Signal Delay: 24.7	Intersection LOS: C
Intersection Capacity Utilization 64.8%	ICU Level of Service C
Analysis Period (min) 15	
m Volume for 95th percentile queue is metered by upstream signal.	

Splits and Phases: 2: Hwy 417 EB Off Ramp/Chamberlain Ave/Kent St & Catherine St

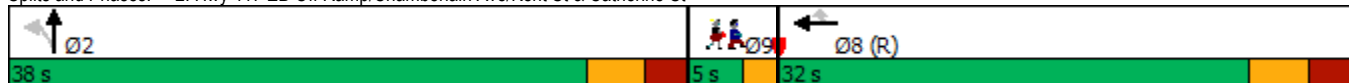

Lanes, Volumes, Timings

2: Hwy 417 EB Off Ramp/Chamberlain Ave/Kent St & Catherine St

05/04/2023

Lane Group	Ø9
Lane Configurations	
Traffic Volume (vph)	
Future Volume (vph)	
Satd. Flow (prot)	
Fit Permitted	
Satd. Flow (perm)	
Satd. Flow (RTOR)	
Lane Group Flow (vph)	
Turn Type	
Protected Phases	9
Permitted Phases	
Minimum Split (s)	5.0
Total Split (s)	5.0
Total Split (%)	7%
Yellow Time (s)	2.0
All-Red Time (s)	0.0
Lost Time Adjust (s)	
Total Lost Time (s)	
Lead/Lag	
Lead-Lag Optimize?	
Act Effct Green (s)	
Actuated g/C Ratio	
v/c Ratio	
Control Delay	
Queue Delay	
Total Delay	
LOS	
Approach Delay	
Approach LOS	
Queue Length 50th (m)	
Queue Length 95th (m)	
Internal Link Dist (m)	
Turn Bay Length (m)	
Base Capacity (vph)	
Starvation Cap Reductn	
Spillback Cap Reductn	
Storage Cap Reductn	
Reduced v/c Ratio	
Intersection Summary	

Lanes, Volumes, Timings  
3: Bank St & Catherine St

05/04/2023



Lane Group	EBL	EBT	EBR	WBL	WBT	WBR	NBL	NBT	NBR	SBL	SBT	SBR
Lane Configurations					↕↕↕			↕↕			↕↕	
Traffic Volume (vph)	0	0	0	170	587	198	266	575	0	0	366	130
Future Volume (vph)	0	0	0	170	587	198	266	575	0	0	366	130
Satd. Flow (prot)	0	0	0	0	4430	0	0	3212	0	0	2870	0
Fit Permitted					0.991			0.617				
Satd. Flow (perm)	0	0	0	0	4374	0	0	1951	0	0	2870	0
Satd. Flow (RTOR)					84						64	
Lane Group Flow (vph)	0	0	0	0	1061	0	0	935	0	0	551	0
Turn Type				Perm	NA		pm+pt	NA			NA	
Protected Phases					8		9	2			6	
Permitted Phases					8		2					
Minimum Split (s)				18.6	18.6		10.4	16.4			16.4	
Total Split (s)				25.0	25.0		15.0	40.0			25.0	
Total Split (%)				33.3%	33.3%		20.0%	53.3%			33.3%	
Yellow Time (s)				3.3	3.3		3.3	3.3			3.3	
All-Red Time (s)				2.3	2.3		2.1	2.1			2.1	
Lost Time Adjust (s)					0.0			0.0			0.0	
Total Lost Time (s)					5.6			5.4			5.4	
Lead/Lag				Lag	Lag			Lag			Lag	
Lead-Lag Optimize?				Yes	Yes			Yes			Yes	
Act Effct Green (s)					19.4			34.6			19.6	
Actuated g/C Ratio					0.26			0.46			0.26	
v/c Ratio					0.89			0.88			0.69	
Control Delay					35.6			22.7			27.2	
Queue Delay					0.0			0.0			0.0	
Total Delay					35.6			22.7			27.2	
LOS					D			C			C	
Approach Delay					35.6			22.7			27.2	
Approach LOS					D			C			C	
Queue Length 50th (m)					48.9			25.0			32.5	
Queue Length 95th (m)					#72.7			#48.9			49.1	
Internal Link Dist (m)		131.7			201.7			90.2			52.9	
Turn Bay Length (m)												
Base Capacity (vph)					1193			1061			797	
Starvation Cap Reductn					0			0			0	
Spillback Cap Reductn					0			0			0	
Storage Cap Reductn					0			0			0	
Reduced v/c Ratio					0.89			0.88			0.69	

Intersection Summary

Cycle Length: 75  
 Actuated Cycle Length: 75  
 Offset: 70 (93%), Referenced to phase 2:NBT and 6:SBT, Start of Green  
 Natural Cycle: 90  
 Control Type: Pretimed  
 Maximum v/c Ratio: 0.89  
 Intersection Signal Delay: 29.1  
 Intersection Capacity Utilization 78.9%  
 Analysis Period (min) 15  
 # 95th percentile volume exceeds capacity, queue may be longer.  
 Queue shown is maximum after two cycles.

Splits and Phases: 3: Bank St & Catherine St

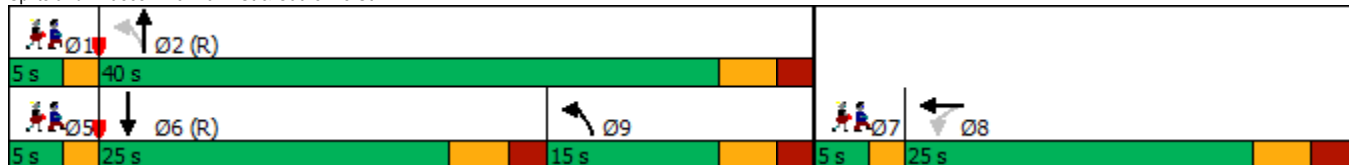

Lanes, Volumes, Timings  
 3: Bank St & Catherine St

05/04/2023

Lane Group	Ø1	Ø5	Ø7
Lane Configurations			
Traffic Volume (vph)			
Future Volume (vph)			
Satd. Flow (prot)			
Fit Permitted			
Satd. Flow (perm)			
Satd. Flow (RTOR)			
Lane Group Flow (vph)			
Turn Type			
Protected Phases	1	5	7
Permitted Phases			
Minimum Split (s)	5.0	5.0	5.0
Total Split (s)	5.0	5.0	5.0
Total Split (%)	7%	7%	7%
Yellow Time (s)	2.0	2.0	2.0
All-Red Time (s)	0.0	0.0	0.0
Lost Time Adjust (s)			
Total Lost Time (s)			
Lead/Lag	Lead	Lead	Lead
Lead-Lag Optimize?	Yes	Yes	Yes
Act Effct Green (s)			
Actuated g/C Ratio			
v/c Ratio			
Control Delay			
Queue Delay			
Total Delay			
LOS			
Approach Delay			
Approach LOS			
Queue Length 50th (m)			
Queue Length 95th (m)			
Internal Link Dist (m)			
Turn Bay Length (m)			
Base Capacity (vph)			
Starvation Cap Reductn			
Spillback Cap Reductn			
Storage Cap Reductn			
Reduced v/c Ratio			
Intersection Summary			

Lanes, Volumes, Timings  
4: Percy St & Catherine St

05/04/2023



Lane Group	EBL	EBT	EBR	WBL	WBT	WBR	NBL	NBT	NBR	SBL	SBT	SBR
Lane Configurations					↑↑↑						↓	
Traffic Volume (vph)	0	0	0	71	234	0	0	0	0	0	129	57
Future Volume (vph)	0	0	0	71	234	0	0	0	0	0	129	57
Satd. Flow (prot)	0	0	0	0	4552	0	0	0	0	0	1645	0
Fit Permitted					0.988							
Satd. Flow (perm)	0	0	0	0	4523	0	0	0	0	0	1645	0
Satd. Flow (RTOR)					160							
Lane Group Flow (vph)	0	0	0	0	339	0	0	0	0	0	206	0
Turn Type				Perm	NA							NA
Protected Phases					8							6
Permitted Phases				8								
Detector Phase				8	8							6
Switch Phase												
Minimum Initial (s)				10.0	10.0							10.0
Minimum Split (s)				26.5	26.5							23.4
Total Split (s)				34.0	34.0							24.0
Total Split (%)				37.8%	37.8%							26.7%
Yellow Time (s)				3.3	3.3							3.3
All-Red Time (s)				2.2	2.2							2.1
Lost Time Adjust (s)					0.0							0.0
Total Lost Time (s)					5.5							5.4
Lead/Lag				Lag	Lag							
Lead-Lag Optimize?				Yes	Yes							
Recall Mode				None	None							Max
Act Effct Green (s)					11.9							18.8
Actuated g/C Ratio					0.29							0.45
v/c Ratio					0.24							0.28
Control Delay					6.3							9.6
Queue Delay					0.0							0.0
Total Delay					6.3							9.6
LOS					A							A
Approach Delay					6.3							9.6
Approach LOS					A							A
Queue Length 50th (m)					3.4							7.4
Queue Length 95th (m)					7.4							25.6
Internal Link Dist (m)		71.6			271.6			106.7				288.0
Turn Bay Length (m)												
Base Capacity (vph)					3170							740
Starvation Cap Reductn					0							0
Spillback Cap Reductn					0							0
Storage Cap Reductn					0							0
Reduced v/c Ratio					0.11							0.28

Intersection Summary

Cycle Length: 90  
 Actuated Cycle Length: 41.7  
 Natural Cycle: 65  
 Control Type: Semi Act-Uncoord  
 Maximum v/c Ratio: 0.28  
 Intersection Signal Delay: 7.5  
 Intersection Capacity Utilization 37.9%  
 Analysis Period (min) 15

Intersection LOS: A  
 ICU Level of Service A

Splits and Phases: 4: Percy St & Catherine St

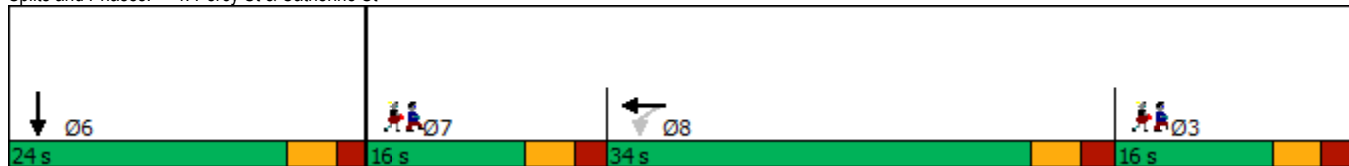

Lanes, Volumes, Timings  
 4: Percy St & Catherine St

05/04/2023

Lane Group	Ø3	Ø7
Lane Configurations		
Traffic Volume (vph)		
Future Volume (vph)		
Satd. Flow (prot)		
Fit Permitted		
Satd. Flow (perm)		
Satd. Flow (RTOR)		
Lane Group Flow (vph)		
Turn Type		
Protected Phases	3	7
Permitted Phases		
Detector Phase		
Switch Phase		
Minimum Initial (s)	1.0	1.0
Minimum Split (s)	6.4	6.4
Total Split (s)	16.0	16.0
Total Split (%)	18%	18%
Yellow Time (s)	3.3	3.3
All-Red Time (s)	2.1	2.1
Lost Time Adjust (s)		
Total Lost Time (s)		
Lead/Lag		Lead
Lead-Lag Optimize?		Yes
Recall Mode	None	None
Act Effct Green (s)		
Actuated g/C Ratio		
v/c Ratio		
Control Delay		
Queue Delay		
Total Delay		
LOS		
Approach Delay		
Approach LOS		
Queue Length 50th (m)		
Queue Length 95th (m)		
Internal Link Dist (m)		
Turn Bay Length (m)		
Base Capacity (vph)		
Starvation Cap Reductn		
Spillback Cap Reductn		
Storage Cap Reductn		
Reduced v/c Ratio		
Intersection Summary		



Lanes, Volumes, Timings  
6: Kent St & Arlington Ave

05/04/2023



Lane Group	EBL	EBT	EBR	WBL	WBT	WBR	NBL	NBT	NBR	SBL	SBT	SBR
Lane Configurations		↕			↕			↕↕↕				
Traffic Volume (vph)	19	48	0	0	11	93	15	1708	131	0	0	0
Future Volume (vph)	19	48	0	0	11	93	15	1708	131	0	0	0
Satd. Flow (prot)	0	1745	0	0	1542	0	0	4790	0	0	0	0
Fit Permitted		0.914										
Satd. Flow (perm)	0	1610	0	0	1542	0	0	4788	0	0	0	0
Satd. Flow (RTOR)					8			26				
Lane Group Flow (vph)	0	74	0	0	115	0	0	2061	0	0	0	0
Turn Type	Perm	NA			NA		Perm	NA				
Protected Phases		4			8			2				
Permitted Phases	4						2					
Minimum Split (s)	27.3	27.3			27.3		32.3	32.3				
Total Split (s)	28.0	28.0			28.0		47.0	47.0				
Total Split (%)	37.3%	37.3%			37.3%		62.7%	62.7%				
Yellow Time (s)	3.3	3.3			3.3		3.3	3.3				
All-Red Time (s)	2.0	2.0			2.0		2.0	2.0				
Lost Time Adjust (s)		0.0			0.0			0.0				
Total Lost Time (s)		5.3			5.3			5.3				
Lead/Lag												
Lead-Lag Optimize?												
Act Effct Green (s)		22.7			22.7			41.7				
Actuated g/C Ratio		0.30			0.30			0.56				
v/c Ratio		0.15			0.24			0.77				
Control Delay		13.3			19.4			13.2				
Queue Delay		0.0			0.0			2.8				
Total Delay		13.3			19.4			16.0				
LOS		B			B			B				
Approach Delay		13.3			19.4			16.0				
Approach LOS		B			B			B				
Queue Length 50th (m)		6.3			9.0			104.4				
Queue Length 95th (m)		13.4			m12.7			113.9				
Internal Link Dist (m)		164.0			143.1			53.0			216.0	
Turn Bay Length (m)												
Base Capacity (vph)		487			472			2673				
Starvation Cap Reductn		0			0			483				
Spillback Cap Reductn		0			0			0				
Storage Cap Reductn		0			0			0				
Reduced v/c Ratio		0.15			0.24			0.94				

**Intersection Summary**  
 Cycle Length: 75  
 Actuated Cycle Length: 75  
 Offset: 50 (67%), Referenced to phase 2:NBT, Start of Green  
 Natural Cycle: 60  
 Control Type: Pretimed  
 Maximum v/c Ratio: 0.77  
 Intersection Signal Delay: 16.1  
 Intersection Capacity Utilization 67.8%  
 Analysis Period (min) 15  
 m Volume for 95th percentile queue is metered by upstream signal.

Splits and Phases: 6: Kent St & Arlington Ave

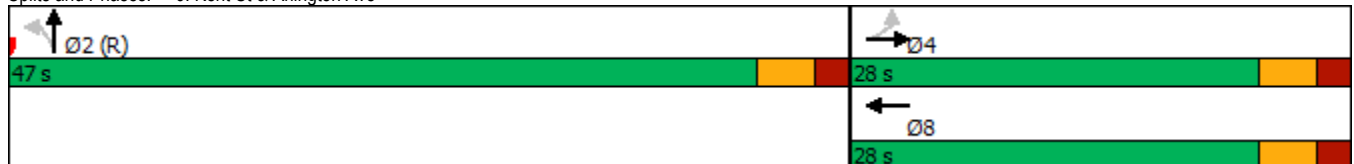

Lanes, Volumes, Timings  
7: Lyon St N & Gladstone Ave

05/04/2023



Lane Group	EBL	EBT	EBR	WBL	WBT	WBR	NBL	NBT	NBR	SBL	SBT	SBR
Lane Configurations		↑	↗	↖	↑						↕	↕
Traffic Volume (vph)	0	184	24	15	143	0	0	0	0	89	320	98
Future Volume (vph)	0	184	24	15	143	0	0	0	0	89	320	98
Satd. Flow (prot)	0	1733	1547	1729	1750	0	0	0	0	0	3240	0
Fit Permitted				0.626							0.991	
Satd. Flow (perm)	0	1733	1485	1120	1750	0	0	0	0	0	3215	0
Satd. Flow (RTOR)			38								48	
Lane Group Flow (vph)	0	204	27	17	159	0	0	0	0	0	564	0
Turn Type		NA	Perm	Perm	NA					Perm	NA	
Protected Phases		4			8							6
Permitted Phases			4	8						6		
Minimum Split (s)		17.2	17.2	17.2	17.2					22.6	22.6	
Total Split (s)		38.0	38.0	38.0	38.0					37.0	37.0	
Total Split (%)		50.7%	50.7%	50.7%	50.7%					49.3%	49.3%	
Yellow Time (s)		3.3	3.3	3.3	3.3					3.3	3.3	
All-Red Time (s)		1.9	1.9	1.9	1.9					2.3	2.3	
Lost Time Adjust (s)		0.0	0.0	0.0	0.0						0.0	
Total Lost Time (s)		5.2	5.2	5.2	5.2						5.6	
Lead/Lag												
Lead-Lag Optimize?												
Act Effct Green (s)		32.8	32.8	32.8	32.8						31.4	
Actuated g/C Ratio		0.44	0.44	0.44	0.44						0.42	
v/c Ratio		0.27	0.04	0.03	0.21						0.41	
Control Delay		14.7	3.5	21.7	24.7						15.0	
Queue Delay		0.0	0.0	0.0	0.0						0.0	
Total Delay		14.7	3.5	21.7	24.7						15.0	
LOS		B	A	C	C						B	
Approach Delay		13.4			24.4						15.0	
Approach LOS		B			C						B	
Queue Length 50th (m)		17.7	0.0	2.2	21.3						25.7	
Queue Length 95th (m)		31.2	3.1	m4.1	m33.2						38.0	
Internal Link Dist (m)		254.8			165.0			215.6			214.3	
Turn Bay Length (m)				25.0								
Base Capacity (vph)		757	670	489	765						1373	
Starvation Cap Reductn		0	0	0	0						0	
Spillback Cap Reductn		0	0	0	0						0	
Storage Cap Reductn		0	0	0	0						0	
Reduced v/c Ratio		0.27	0.04	0.03	0.21						0.41	

**Intersection Summary**  
 Cycle Length: 75  
 Actuated Cycle Length: 75  
 Offset: 10 (13%), Referenced to phase 4:EBT and 8:WBTL, Start of Green  
 Natural Cycle: 40  
 Control Type: Pretimed  
 Maximum v/c Ratio: 0.41  
 Intersection Signal Delay: 16.3  
 Intersection Capacity Utilization 79.8%  
 Analysis Period (min) 15  
 Intersection LOS: B  
 ICU Level of Service D  
 m Volume for 95th percentile queue is metered by upstream signal.

Splits and Phases: 7: Lyon St N & Gladstone Ave

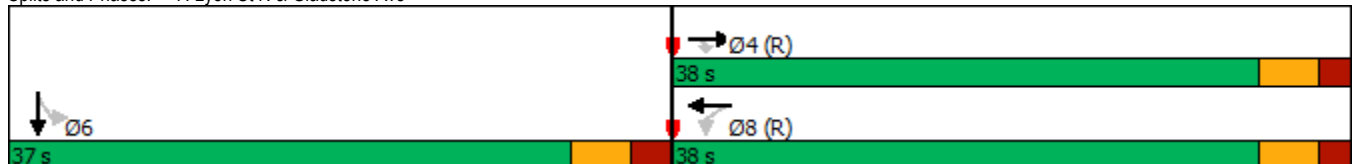

Lanes, Volumes, Timings  
8: Kent St & Gladstone Ave

05/04/2023



Lane Group	EBL	EBT	EBR	WBL	WBT	WBR	NBL	NBT	NBR	SBL	SBT	SBR
Lane Configurations												
Traffic Volume (vph)	82	277	0	0	165	148	36	1698	97	0	0	0
Future Volume (vph)	82	277	0	0	165	148	36	1698	97	0	0	0
Satd. Flow (prot)	1662	1717	0	0	1552	0	1729	4790	0	0	0	0
Fit Permitted	0.404						0.950					
Satd. Flow (perm)	679	1717	0	0	1552	0	1444	4790	0	0	0	0
Satd. Flow (RTOR)					6			18				
Lane Group Flow (vph)	91	308	0	0	347	0	40	1995	0	0	0	0
Turn Type	Perm	NA			NA		Perm	NA				
Protected Phases		4			8			2				
Permitted Phases	4						2					
Minimum Split (s)	21.4	21.4			21.4		20.4	20.4				
Total Split (s)	30.0	30.0			30.0		45.0	45.0				
Total Split (%)	40.0%	40.0%			40.0%		60.0%	60.0%				
Yellow Time (s)	3.3	3.3			3.3		3.3	3.3				
All-Red Time (s)	2.1	2.1			2.1		2.1	2.1				
Lost Time Adjust (s)	0.0	0.0			0.0		0.0	0.0				
Total Lost Time (s)	5.4	5.4			5.4		5.4	5.4				
Lead/Lag												
Lead-Lag Optimize?												
Act Effct Green (s)	24.6	24.6			24.6		39.6	39.6				
Actuated g/C Ratio	0.33	0.33			0.33		0.53	0.53				
v/c Ratio	0.41	0.55			0.68		0.05	0.79				
Control Delay	27.1	25.9			29.2		1.5	3.1				
Queue Delay	0.0	0.0			0.0		0.0	0.0				
Total Delay	27.1	25.9			29.2		1.5	3.1				
LOS	C	C			C		A	A				
Approach Delay		26.1			29.2			3.1				
Approach LOS		C			C			A				
Queue Length 50th (m)	11.5	40.4			41.1		0.4	7.3				
Queue Length 95th (m)	25.7	65.2			68.8		m0.6	8.3				
Internal Link Dist (m)		165.0			168.8			216.0			203.6	
Turn Bay Length (m)	30.0						40.0					
Base Capacity (vph)	222	563			513		762	2537				
Starvation Cap Reductn	0	0			0		0	0				
Spillback Cap Reductn	0	0			0		0	0				
Storage Cap Reductn	0	0			0		0	0				
Reduced v/c Ratio	0.41	0.55			0.68		0.05	0.79				

Intersection Summary

Cycle Length: 75  
 Actuated Cycle Length: 75  
 Offset: 36 (48%), Referenced to phase 4:EBTL and 8:WBT, Start of Green  
 Natural Cycle: 55  
 Control Type: Pretimed  
 Maximum v/c Ratio: 0.79  
 Intersection Signal Delay: 9.7  
 Intersection LOS: A  
 Intersection Capacity Utilization 79.8%  
 ICU Level of Service D  
 Analysis Period (min) 15  
 m Volume for 95th percentile queue is metered by upstream signal.

Splits and Phases: 8: Kent St & Gladstone Ave



Lanes, Volumes, Timings  
 9: Bank St & Chamberlain Ave/Isabella St

05/04/2023



Lane Group	EBL	EBT	EBR	WBL	WBT	WBR	NBL	NBT	NBR	SBL	SBT	SBR
Lane Configurations		↕↕	↗					↕↕			↕↕	
Traffic Volume (vph)	74	487	75	0	0	0	0	834	142	168	372	0
Future Volume (vph)	74	487	75	0	0	0	0	834	142	168	372	0
Satd. Flow (prot)	0	3225	1446	0	0	0	0	3154	0	0	3223	0
Fit Permitted		0.993									0.526	
Satd. Flow (perm)	0	3218	1358	0	0	0	0	3154	0	0	1721	0
Satd. Flow (RTOR)			134					27				
Lane Group Flow (vph)	0	623	83	0	0	0	0	1085	0	0	600	0
Turn Type	Perm	NA	Perm					NA		pm+pt	NA	
Protected Phases		4						2		5	6	
Permitted Phases	4		4							6		
Detector Phase	4	4	4					2		5	6	
Switch Phase												
Minimum Initial (s)	10.0	10.0	10.0					10.0		5.0	10.0	
Minimum Split (s)	26.2	26.2	26.2					23.1		11.1	23.1	
Total Split (s)	29.0	29.0	29.0					31.0		15.0	46.0	
Total Split (%)	38.7%	38.7%	38.7%					41.3%		20.0%	61.3%	
Yellow Time (s)	3.3	3.3	3.3					3.0		3.0	3.0	
All-Red Time (s)	2.9	2.9	2.9					3.1		3.1	3.1	
Lost Time Adjust (s)		0.0	0.0					0.0			0.0	
Total Lost Time (s)		6.2	6.2					6.1			6.1	
Lead/Lag												
Lead-Lag Optimize?												
Recall Mode	None	None	None					C-Max		None	C-Max	
Act Effct Green (s)		19.9	19.9					42.8			42.8	
Actuated g/C Ratio		0.27	0.27					0.57			0.57	
v/c Ratio		0.73	0.18					0.60			0.91dl	
Control Delay		30.2	2.2					12.6			12.2	
Queue Delay		0.0	0.0					0.0			0.0	
Total Delay		30.2	2.2					12.6			12.2	
LOS		C	A					B			B	
Approach Delay		26.9						12.6			12.2	
Approach LOS		C						B			B	
Queue Length 50th (m)		41.1	0.0					48.8			17.2	
Queue Length 95th (m)		56.1	3.4					71.1			m62.0	
Internal Link Dist (m)		296.0			233.4			215.6			90.2	
Turn Bay Length (m)			40.0									
Base Capacity (vph)		978	506					1809			981	
Starvation Cap Reductn		0	0					0			0	
Spillback Cap Reductn		0	0					0			0	
Storage Cap Reductn		0	0					0			0	
Reduced v/c Ratio		0.64	0.16					0.60			0.61	

**Intersection Summary**

Cycle Length: 75  
 Actuated Cycle Length: 75  
 Offset: 1 (1%), Referenced to phase 2:NBT and 6:SBTL, Start of Green  
 Natural Cycle: 70  
 Control Type: Actuated-Coordinated  
 Maximum v/c Ratio: 0.73  
 Intersection Signal Delay: 16.7  
 Intersection Capacity Utilization 81.2%  
 Analysis Period (min) 15  
 Intersection LOS: B  
 ICU Level of Service D

m Volume for 95th percentile queue is metered by upstream signal.  
 dl Defacto Left Lane. Recode with 1 though lane as a left lane.

Splits and Phases: 9: Bank St & Chamberlain Ave/Isabella St

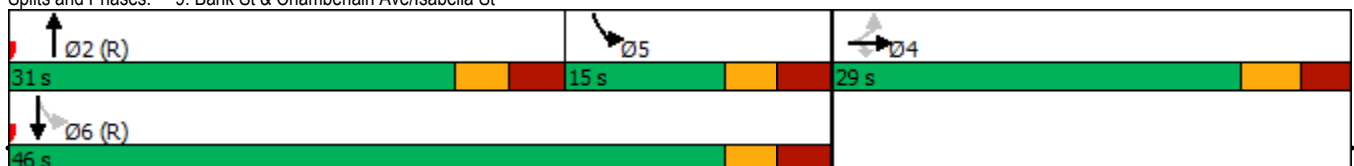

Existing AM

Synchro 11 Report

Lanes, Volumes, Timings  
13: Bronson Ave & Catherine St

05/04/2023



Lane Group	EBL	EBT	EBR	WBL	WBT	WBR	NBL	NBT	NBR	SBL	SBT	SBR
Lane Configurations				↖ ↗	↖ ↗		↖ ↗	↖ ↗			↖ ↗	
Traffic Volume (vph)	0	0	0	492	479	346	519	1038	0	0	428	118
Future Volume (vph)	0	0	0	492	479	346	519	1038	0	0	428	118
Satd. Flow (prot)	0	0	0	1430	4136	0	1712	3390	0	0	3087	0
Fit Permitted				0.950	0.992		0.234					
Satd. Flow (perm)	0	0	0	1430	4136	0	422	3390	0	0	3087	0
Satd. Flow (RTOR)					78						30	
Lane Group Flow (vph)	0	0	0	372	1091	0	577	1153	0	0	607	0
Turn Type				Perm	NA		pm+pt	NA			NA	
Protected Phases					8		5	7			2	6
Permitted Phases				8			2					
Minimum Split (s)				28.3	28.3			23.8			23.8	
Total Split (s)				34.0	34.0			76.0			33.0	
Total Split (%)				30.9%	30.9%			69.1%			30.0%	
Yellow Time (s)				3.3	3.3			3.3			3.3	
All-Red Time (s)				3.0	3.0			3.5			3.5	
Lost Time Adjust (s)				0.0	0.0			0.0			0.0	
Total Lost Time (s)				6.3	6.3			6.8			6.8	
Lead/Lag												Lag
Lead-Lag Optimize?												Yes
Act Effct Green (s)				27.7	27.7		69.8	69.2			26.2	
Actuated g/C Ratio				0.25	0.25		0.63	0.63			0.24	
v/c Ratio				1.03	0.99		0.92	0.54			0.80	
Control Delay				97.6	64.1		39.1	12.6			46.6	
Queue Delay				0.0	0.0		0.0	0.0			0.0	
Total Delay				97.6	64.1		39.1	12.6			46.6	
LOS				F	E		D	B			D	
Approach Delay					72.6			21.5			46.6	
Approach LOS					E			C			D	
Queue Length 50th (m)				~100.0	85.3		62.9	67.5			61.7	
Queue Length 95th (m)				#166.0	#118.8		#123.4	84.3			82.7	
Internal Link Dist (m)		141.5			120.8			240.1			287.4	
Turn Bay Length (m)				80.0			45.0					
Base Capacity (vph)				360	1099		626	2132			758	
Starvation Cap Reductn				0	0		0	0			0	
Spillback Cap Reductn				0	0		0	0			0	
Storage Cap Reductn				0	0		0	0			0	
Reduced v/c Ratio				1.03	0.99		0.92	0.54			0.80	

**Intersection Summary**  
 Cycle Length: 110  
 Actuated Cycle Length: 110  
 Offset: 38 (35%), Referenced to phase 2:NBT and 6:SBT, Start of Green  
 Natural Cycle: 100  
 Control Type: Pretimed  
 Maximum v/c Ratio: 1.03  
 Intersection Signal Delay: 45.2      Intersection LOS: D  
 Intersection Capacity Utilization 85.7%      ICU Level of Service E  
 Analysis Period (min) 15  
 ~ Volume exceeds capacity, queue is theoretically infinite.  
 Queue shown is maximum after two cycles.  
 # 95th percentile volume exceeds capacity, queue may be longer.  
 Queue shown is maximum after two cycles.

Splits and Phases: 13: Bronson Ave & Catherine St

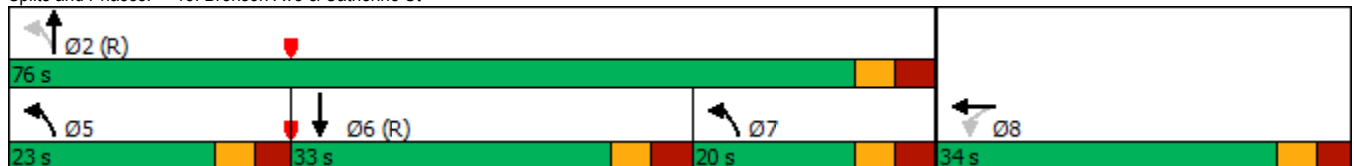

Lanes, Volumes, Timings  
 13: Bronson Ave & Catherine St

05/04/2023

Lane Group	Ø5	Ø7
Lane Configurations		
Traffic Volume (vph)		
Future Volume (vph)		
Satd. Flow (prot)		
Fit Permitted		
Satd. Flow (perm)		
Satd. Flow (RTOR)		
Lane Group Flow (vph)		
Turn Type		
Protected Phases	5	7
Permitted Phases		
Minimum Split (s)	11.2	11.8
Total Split (s)	23.0	20.0
Total Split (%)	21%	18%
Yellow Time (s)	3.3	3.3
All-Red Time (s)	2.9	3.5
Lost Time Adjust (s)		
Total Lost Time (s)		
Lead/Lag	Lead	
Lead-Lag Optimize?	Yes	
Act Effct Green (s)		
Actuated g/C Ratio		
v/c Ratio		
Control Delay		
Queue Delay		
Total Delay		
LOS		
Approach Delay		
Approach LOS		
Queue Length 50th (m)		
Queue Length 95th (m)		
Internal Link Dist (m)		
Turn Bay Length (m)		
Base Capacity (vph)		
Starvation Cap Reductn		
Spillback Cap Reductn		
Storage Cap Reductn		
Reduced v/c Ratio		
Intersection Summary		

Intersection												
Int Delay, s/veh	2.1											
Movement	EBL	EBT	EBR	WBL	WBT	WBR	NBL	NBT	NBR	SBL	SBT	SBR
Lane Configurations		↕			↕						↕↔	
Traffic Vol, veh/h	0	18	0	11	12	0	0	0	0	44	324	9
Future Vol, veh/h	0	18	0	11	12	0	0	0	0	44	324	9
Conflicting Peds, #/hr	32	0	15	15	0	32	9	0	10	10	0	9
Sign Control	Stop	Stop	Stop	Stop	Stop	Stop	Free	Free	Free	Free	Free	Free
RT Channelized	-	-	None	-	-	None	-	-	None	-	-	None
Storage Length	-	-	-	-	-	-	-	-	-	-	-	-
Veh in Median Storage, #	-	0	-	-	0	-	-	-	-	-	0	-
Grade, %	-	0	-	-	0	-	-	0	-	-	0	-
Peak Hour Factor	90	90	90	90	90	90	90	90	90	90	90	90
Heavy Vehicles, %	0	6	0	9	0	0	0	0	0	5	1	11
Mvmt Flow	0	20	0	12	13	0	0	0	0	49	360	10
Major/Minor	Minor2		Minor1			Major2						
Conflicting Flow All	-	482	209	313	487	-	-	10	0	0	-	-
Stage 1	-	472	-	10	10	-	-	-	-	-	-	-
Stage 2	-	10	-	303	477	-	-	-	-	-	-	-
Critical Hdwy	-	6.62	6.9	7.68	6.5	-	-	4.2	-	-	-	-
Critical Hdwy Stg 1	-	5.62	-	-	-	-	-	-	-	-	-	-
Critical Hdwy Stg 2	-	-	-	6.68	5.5	-	-	-	-	-	-	-
Follow-up Hdwy	-	4.06	3.3	3.59	4	-	-	2.25	-	-	-	-
Pot Cap-1 Maneuver	0	474	803	599	484	0	-	1586	-	-	-	-
Stage 1	0	547	-	-	-	0	-	-	-	-	-	-
Stage 2	0	-	-	662	559	0	-	-	-	-	-	-
Platoon blocked, %	-	-	-	-	-	-	-	-	-	-	-	-
Mov Cap-1 Maneuver	-	448	796	556	457	-	-	1571	-	-	-	-
Mov Cap-2 Maneuver	-	448	-	556	457	-	-	-	-	-	-	-
Stage 1	-	521	-	-	-	-	-	-	-	-	-	-
Stage 2	-	-	-	612	533	-	-	-	-	-	-	-
Approach	EB		WB			SB						
HCM Control Delay, s	13.4		12.6			0.9						
HCM LOS	B		B									
Minor Lane/Major Mvmt	EBLn1	WBLn1	SBL	SBT	SBR							
Capacity (veh/h)	448	500	1571	-	-							
HCM Lane V/C Ratio	0.045	0.051	0.031	-	-							
HCM Control Delay (s)	13.4	12.6	7.4	0.1	-							
HCM Lane LOS	B	B	A	A	-							
HCM 95th %tile Q(veh)	0.1	0.2	0.1	-	-							

Intersection						
Int Delay, s/veh	3.2					
Movement	EBL	EBR	NBL	NBT	SBT	SBR
Lane Configurations	↔			↕	↕	
Traffic Vol, veh/h	21	124	86	687	372	22
Future Vol, veh/h	21	124	86	687	372	22
Conflicting Peds, #/hr	0	0	111	0	0	111
Sign Control	Stop	Stop	Free	Free	Free	Free
RT Channelized	-	None	-	None	-	None
Storage Length	0	-	-	-	-	-
Veh in Median Storage, #	0	-	-	0	0	-
Grade, %	0	-	-	0	0	-
Peak Hour Factor	90	90	90	90	90	90
Heavy Vehicles, %	0	3	2	5	8	5
Mvmt Flow	23	138	96	763	413	24

Major/Minor	Minor2	Major1	Major2			
Conflicting Flow All	1110	330	548	0	-	0
Stage 1	536	-	-	-	-	-
Stage 2	574	-	-	-	-	-
Critical Hdwy	6.8	6.96	4.14	-	-	-
Critical Hdwy Stg 1	5.8	-	-	-	-	-
Critical Hdwy Stg 2	5.8	-	-	-	-	-
Follow-up Hdwy	3.5	3.33	2.22	-	-	-
Pot Cap-1 Maneuver	207	663	1018	-	-	-
Stage 1	556	-	-	-	-	-
Stage 2	532	-	-	-	-	-
Platoon blocked, %				-	-	-
Mov Cap-1 Maneuver	136	595	914	-	-	-
Mov Cap-2 Maneuver	136	-	-	-	-	-
Stage 1	408	-	-	-	-	-
Stage 2	477	-	-	-	-	-

Approach	EB	NB	SB
HCM Control Delay, s	19.9	1.7	0
HCM LOS	C		

Minor Lane/Major Mvmt	NBL	NBT	EBLn1	SBT	SBR
Capacity (veh/h)	914	-	400	-	-
HCM Lane V/C Ratio	0.105	-	0.403	-	-
HCM Control Delay (s)	9.4	0.7	19.9	-	-
HCM Lane LOS	A	A	C	-	-
HCM 95th %tile Q(veh)	0.3	-	1.9	-	-



Lanes, Volumes, Timings

1: Hwy 417 WB On Ramp/Lyon St N & Catherine St

05/04/2023



Lane Group	EBL	EBT	EBR	WBL	WBT	WBR	NBL	NBT	NBR	SBL	SBT	SBR
Lane Configurations					↕↕↕						↕	↕
Traffic Volume (vph)	0	0	0	192	506	0	0	0	0	0	343	285
Future Volume (vph)	0	0	0	192	506	0	0	0	0	0	343	285
Satd. Flow (prot)	0	0	0	0	4736	0	0	0	0	0	1802	1532
Fit Permitted					0.986							
Satd. Flow (perm)	0	0	0	0	4703	0	0	0	0	0	1802	1490
Satd. Flow (RTOR)					131							73
Lane Group Flow (vph)	0	0	0	0	775	0	0	0	0	0	381	317
Turn Type				Perm	NA						NA	Perm
Protected Phases					8						6	
Permitted Phases				8							6	
Minimum Split (s)				26.2	26.2						28.3	28.3
Total Split (s)				28.0	28.0						47.0	47.0
Total Split (%)				37.3%	37.3%						62.7%	62.7%
Yellow Time (s)				3.3	3.3						3.3	3.3
All-Red Time (s)				1.9	1.9						2.0	2.0
Lost Time Adjust (s)					0.0						0.0	0.0
Total Lost Time (s)					5.2						5.3	5.3
Lead/Lag												
Lead-Lag Optimize?												
Act Effct Green (s)					22.8						41.7	41.7
Actuated g/C Ratio					0.30						0.56	0.56
v/c Ratio					0.51						0.38	0.37
Control Delay					18.6						15.5	12.8
Queue Delay					0.0						0.0	0.0
Total Delay					18.6						15.5	12.8
LOS					B						B	B
Approach Delay					18.6						14.3	
Approach LOS					B						B	
Queue Length 50th (m)					11.4						48.3	33.7
Queue Length 95th (m)					17.8						72.0	56.8
Internal Link Dist (m)		271.6			163.9			117.8			52.8	
Turn Bay Length (m)												
Base Capacity (vph)					1520						1001	860
Starvation Cap Reductn					0						0	0
Spillback Cap Reductn					0						0	0
Storage Cap Reductn					0						0	0
Reduced v/c Ratio					0.51						0.38	0.37

Intersection Summary

Cycle Length: 75	
Actuated Cycle Length: 75	
Offset: 24 (32%), Referenced to phase 8:WBTL, Start of Green	
Natural Cycle: 55	
Control Type: Pretimed	
Maximum v/c Ratio: 0.51	
Intersection Signal Delay: 16.5	Intersection LOS: B
Intersection Capacity Utilization 46.5%	ICU Level of Service A
Analysis Period (min) 15	

Splits and Phases: 1: Hwy 417 WB On Ramp/Lyon St N & Catherine St



Lanes, Volumes, Timings

2: Hwy 417 EB Off Ramp/Chamberlain Ave/Kent St & Catherine St

05/04/2023



Lane Group	EBL	EBT	EBR	WBL	WBT	WBR	NBL	NBT	NBR	SBL	SBT	SBR
Lane Configurations					↕↕	↗		↕↕↕				
Traffic Volume (vph)	0	0	0	0	643	289	25	820	0	0	0	0
Future Volume (vph)	0	0	0	0	643	289	25	820	0	0	0	0
Satd. Flow (prot)	0	0	0	0	3180	1303	0	4863	0	0	0	0
Fit Permitted								0.999				
Satd. Flow (perm)	0	0	0	0	3180	1204	0	4861	0	0	0	0
Satd. Flow (RTOR)								70				
Lane Group Flow (vph)	0	0	0	0	746	289	0	939	0	0	0	0
Turn Type					NA	Perm	Perm	NA				
Protected Phases					8			2				
Permitted Phases						8		2				
Minimum Split (s)					22.8	22.8	22.5	22.5				
Total Split (s)					38.0	38.0	32.0	32.0				
Total Split (%)					50.7%	50.7%	42.7%	42.7%				
Yellow Time (s)					3.3	3.3	3.3	3.3				
All-Red Time (s)					2.5	2.5	2.5	2.5				
Lost Time Adjust (s)					0.0	0.0		0.0				
Total Lost Time (s)					5.8	5.8		5.8				
Lead/Lag												
Lead-Lag Optimize?												
Act Effct Green (s)					32.2	32.2		26.2				
Actuated g/C Ratio					0.43	0.43		0.35				
v/c Ratio					0.55	0.56		0.54				
Control Delay					15.1	17.1		19.4				
Queue Delay					0.0	0.0		0.0				
Total Delay					15.1	17.1		19.4				
LOS					B	B		B				
Approach Delay					15.7			19.4				
Approach LOS					B			B				
Queue Length 50th (m)					35.2	27.3		35.3				
Queue Length 95th (m)					m38.3	m31.7		46.9				
Internal Link Dist (m)		163.9			131.7			67.4			53.0	
Turn Bay Length (m)												
Base Capacity (vph)					1365	516		1743				
Starvation Cap Reductn					0	0		0				
Spillback Cap Reductn					0	0		21				
Storage Cap Reductn					0	0		0				
Reduced v/c Ratio					0.55	0.56		0.55				

Intersection Summary

Cycle Length: 75  
 Actuated Cycle Length: 75  
 Offset: 12 (16%), Referenced to phase 8:WBT, Start of Green  
 Natural Cycle: 55  
 Control Type: Pretimed  
 Maximum v/c Ratio: 0.56  
 Intersection Signal Delay: 17.4      Intersection LOS: B  
 Intersection Capacity Utilization 51.7%      ICU Level of Service A  
 Analysis Period (min) 15  
 m Volume for 95th percentile queue is metered by upstream signal.

Splits and Phases: 2: Hwy 417 EB Off Ramp/Chamberlain Ave/Kent St & Catherine St

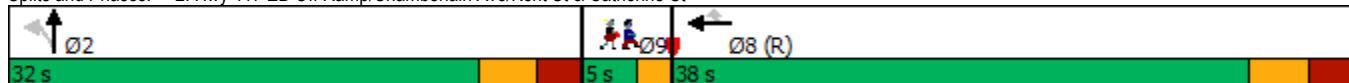

Lanes, Volumes, Timings

2: Hwy 417 EB Off Ramp/Chamberlain Ave/Kent St & Catherine St

05/04/2023

Lane Group	Ø9
Lane Configurations	
Traffic Volume (vph)	
Future Volume (vph)	
Satd. Flow (prot)	
Fit Permitted	
Satd. Flow (perm)	
Satd. Flow (RTOR)	
Lane Group Flow (vph)	
Turn Type	
Protected Phases	9
Permitted Phases	
Minimum Split (s)	5.0
Total Split (s)	5.0
Total Split (%)	7%
Yellow Time (s)	2.0
All-Red Time (s)	0.0
Lost Time Adjust (s)	
Total Lost Time (s)	
Lead/Lag	
Lead-Lag Optimize?	
Act Effct Green (s)	
Actuated g/C Ratio	
v/c Ratio	
Control Delay	
Queue Delay	
Total Delay	
LOS	
Approach Delay	
Approach LOS	
Queue Length 50th (m)	
Queue Length 95th (m)	
Internal Link Dist (m)	
Turn Bay Length (m)	
Base Capacity (vph)	
Starvation Cap Reductn	
Spillback Cap Reductn	
Storage Cap Reductn	
Reduced v/c Ratio	
Intersection Summary	

Lanes, Volumes, Timings  
3: Bank St & Catherine St

05/04/2023



Lane Group	EBL	EBT	EBR	WBL	WBT	WBR	NBL	NBT	NBR	SBL	SBT	SBR
Lane Configurations					↕↕↕			↕↕			↕↕	
Traffic Volume (vph)	0	0	0	232	600	156	184	328	0	0	689	126
Future Volume (vph)	0	0	0	232	600	156	184	328	0	0	689	126
Satd. Flow (prot)	0	0	0	0	4598	0	0	3259	0	0	3116	0
Fit Permitted					0.988			0.551				
Satd. Flow (perm)	0	0	0	0	4516	0	0	1828	0	0	3116	0
Satd. Flow (RTOR)					48			28			28	
Lane Group Flow (vph)	0	0	0	0	1098	0	0	568	0	0	906	0
Turn Type				Perm	NA		pm+pt	NA			NA	
Protected Phases					8		9	2			6	
Permitted Phases				8			2					
Minimum Split (s)				18.6	18.6		10.4	16.4			16.4	
Total Split (s)				24.0	24.0		14.0	41.0			27.0	
Total Split (%)				32.0%	32.0%		18.7%	54.7%			36.0%	
Yellow Time (s)				3.3	3.3		3.3	3.3			3.3	
All-Red Time (s)				2.3	2.3		2.1	2.1			2.1	
Lost Time Adjust (s)					0.0			0.0			0.0	
Total Lost Time (s)					5.6			5.4			5.4	
Lead/Lag				Lag	Lag		Lag	Lag			Lag	
Lead-Lag Optimize?				Yes	Yes		Yes	Yes			Yes	
Act Effct Green (s)					18.4			35.6			21.6	
Actuated g/C Ratio					0.25			0.47			0.29	
v/c Ratio					0.96			0.55			0.99	
Control Delay					46.8			12.3			54.8	
Queue Delay					0.1			0.0			25.0	
Total Delay					46.9			12.3			79.7	
LOS					D			B			E	
Approach Delay					46.9			12.3			79.7	
Approach LOS					D			B			E	
Queue Length 50th (m)					53.9			15.8			65.0	
Queue Length 95th (m)					#81.5			20.1			#104.3	
Internal Link Dist (m)		131.7			201.7			90.2			52.9	
Turn Bay Length (m)												
Base Capacity (vph)					1144			1031			917	
Starvation Cap Reductn					0			0			0	
Spillback Cap Reductn					1			0			69	
Storage Cap Reductn					0			0			0	
Reduced v/c Ratio					0.96			0.55			1.07	

**Intersection Summary**  
 Cycle Length: 75  
 Actuated Cycle Length: 75  
 Offset: 50 (67%), Referenced to phase 2:NBT and 6:SBT, Start of Green  
 Natural Cycle: 80  
 Control Type: Pretimed  
 Maximum v/c Ratio: 0.99  
 Intersection Signal Delay: 50.8  
 Intersection Capacity Utilization 78.2%  
 Analysis Period (min) 15  
 # 95th percentile volume exceeds capacity, queue may be longer.  
 Queue shown is maximum after two cycles.

Splits and Phases: 3: Bank St & Catherine St

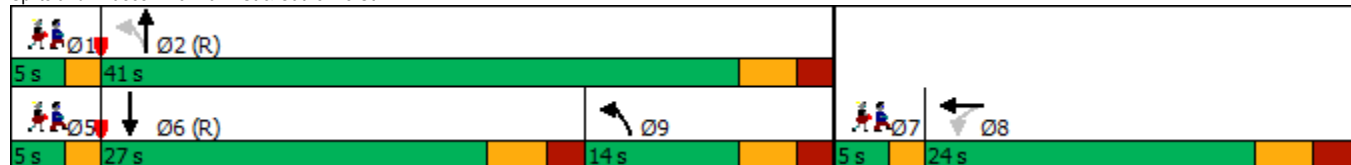

Lanes, Volumes, Timings  
 3: Bank St & Catherine St

05/04/2023

Lane Group	Ø1	Ø5	Ø7
Lane Configurations			
Traffic Volume (vph)			
Future Volume (vph)			
Satd. Flow (prot)			
Fit Permitted			
Satd. Flow (perm)			
Satd. Flow (RTOR)			
Lane Group Flow (vph)			
Turn Type			
Protected Phases	1	5	7
Permitted Phases			
Minimum Split (s)	5.0	5.0	5.0
Total Split (s)	5.0	5.0	5.0
Total Split (%)	7%	7%	7%
Yellow Time (s)	2.0	2.0	2.0
All-Red Time (s)	0.0	0.0	0.0
Lost Time Adjust (s)			
Total Lost Time (s)			
Lead/Lag	Lead	Lead	Lead
Lead-Lag Optimize?	Yes	Yes	Yes
Act Effct Green (s)			
Actuated g/C Ratio			
v/c Ratio			
Control Delay			
Queue Delay			
Total Delay			
LOS			
Approach Delay			
Approach LOS			
Queue Length 50th (m)			
Queue Length 95th (m)			
Internal Link Dist (m)			
Turn Bay Length (m)			
Base Capacity (vph)			
Starvation Cap Reductn			
Spillback Cap Reductn			
Storage Cap Reductn			
Reduced v/c Ratio			
Intersection Summary			

Lanes, Volumes, Timings  
4: Percy St & Catherine St

05/04/2023



Lane Group	EBL	EBT	EBR	WBL	WBT	WBR	NBL	NBT	NBR	SBL	SBT	SBR
Lane Configurations					↑↑↑						↓	
Traffic Volume (vph)	0	0	0	153	684	0	0	0	0	0	121	39
Future Volume (vph)	0	0	0	153	684	0	0	0	0	0	121	39
Satd. Flow (prot)	0	0	0	0	4819	0	0	0	0	0	1726	0
Fit Permitted					0.991							
Satd. Flow (perm)	0	0	0	0	4800	0	0	0	0	0	1726	0
Satd. Flow (RTOR)					160							
Lane Group Flow (vph)	0	0	0	0	930	0	0	0	0	0	177	0
Turn Type				Perm	NA						NA	
Protected Phases					8						6	
Permitted Phases				8								
Detector Phase				8	8						6	
Switch Phase												
Minimum Initial (s)				10.0	10.0						10.0	
Minimum Split (s)				26.5	26.5						23.4	
Total Split (s)				34.0	34.0						24.0	
Total Split (%)				37.8%	37.8%						26.7%	
Yellow Time (s)				3.3	3.3						3.3	
All-Red Time (s)				2.2	2.2						2.1	
Lost Time Adjust (s)					0.0						0.0	
Total Lost Time (s)					5.5						5.4	
Lead/Lag				Lag	Lag							
Lead-Lag Optimize?				Yes	Yes							
Recall Mode				None	None						Max	
Act Effct Green (s)					15.8						18.7	
Actuated g/C Ratio					0.35						0.41	
v/c Ratio					0.52						0.25	
Control Delay					10.6						11.1	
Queue Delay					0.0						0.0	
Total Delay					10.6						11.1	
LOS					B						B	
Approach Delay					10.6						11.1	
Approach LOS					B						B	
Queue Length 50th (m)					16.6						8.6	
Queue Length 95th (m)					24.8						22.0	
Internal Link Dist (m)		71.6			271.6			106.7			288.0	
Turn Bay Length (m)												
Base Capacity (vph)					3082						709	
Starvation Cap Reductn					0						0	
Spillback Cap Reductn					0						0	
Storage Cap Reductn					0						0	
Reduced v/c Ratio					0.30						0.25	

**Intersection Summary**  
 Cycle Length: 90  
 Actuated Cycle Length: 45.5  
 Natural Cycle: 65  
 Control Type: Semi Act-Uncoord  
 Maximum v/c Ratio: 0.52  
 Intersection Signal Delay: 10.6  
 Intersection Capacity Utilization 43.5%  
 Analysis Period (min) 15  
 Intersection LOS: B  
 ICU Level of Service A

Splits and Phases: 4: Percy St & Catherine St

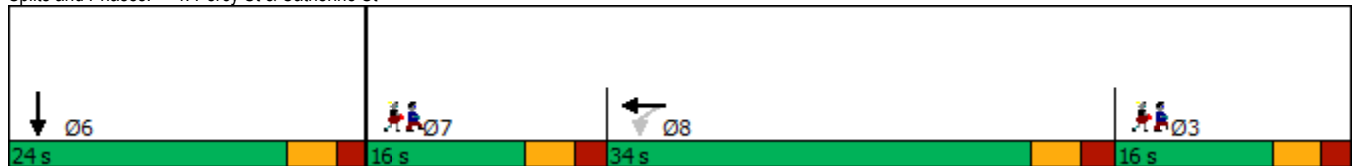

Lanes, Volumes, Timings  
 4: Percy St & Catherine St

05/04/2023

Lane Group	Ø3	Ø7
Lane Configurations		
Traffic Volume (vph)		
Future Volume (vph)		
Satd. Flow (prot)		
Fit Permitted		
Satd. Flow (perm)		
Satd. Flow (RTOR)		
Lane Group Flow (vph)		
Turn Type		
Protected Phases	3	7
Permitted Phases		
Detector Phase		
Switch Phase		
Minimum Initial (s)	1.0	1.0
Minimum Split (s)	6.4	6.4
Total Split (s)	16.0	16.0
Total Split (%)	18%	18%
Yellow Time (s)	3.3	3.3
All-Red Time (s)	2.1	2.1
Lost Time Adjust (s)		
Total Lost Time (s)		
Lead/Lag		Lead
Lead-Lag Optimize?		Yes
Recall Mode	None	None
Act Effct Green (s)		
Actuated g/C Ratio		
v/c Ratio		
Control Delay		
Queue Delay		
Total Delay		
LOS		
Approach Delay		
Approach LOS		
Queue Length 50th (m)		
Queue Length 95th (m)		
Internal Link Dist (m)		
Turn Bay Length (m)		
Base Capacity (vph)		
Starvation Cap Reductn		
Spillback Cap Reductn		
Storage Cap Reductn		
Reduced v/c Ratio		
Intersection Summary		

Lanes, Volumes, Timings  
6: Kent St & Arlington Ave

05/04/2023



Lane Group	EBL	EBT	EBR	WBL	WBT	WBR	NBL	NBT	NBR	SBL	SBT	SBR
Lane Configurations		↕			↕			↕↕↕				
Traffic Volume (vph)	12	61	0	0	18	63	22	1021	93	0	0	0
Future Volume (vph)	12	61	0	0	18	63	22	1021	93	0	0	0
Satd. Flow (prot)	0	1805	0	0	1561	0	0	4823	0	0	0	0
Fit Permitted		0.958						0.999				
Satd. Flow (perm)	0	1734	0	0	1561	0	0	4821	0	0	0	0
Satd. Flow (RTOR)					58			31				
Lane Group Flow (vph)	0	81	0	0	90	0	0	1261	0	0	0	0
Turn Type	Perm	NA			NA		Perm	NA				
Protected Phases		4			8			2				
Permitted Phases	4						2					
Minimum Split (s)	27.3	27.3			27.3		32.3	32.3				
Total Split (s)	28.0	28.0			28.0		47.0	47.0				
Total Split (%)	37.3%	37.3%			37.3%		62.7%	62.7%				
Yellow Time (s)	3.3	3.3			3.3		3.3	3.3				
All-Red Time (s)	2.0	2.0			2.0		2.0	2.0				
Lost Time Adjust (s)		0.0			0.0			0.0				
Total Lost Time (s)		5.3			5.3			5.3				
Lead/Lag												
Lead-Lag Optimize?												
Act Effct Green (s)		22.7			22.7			41.7				
Actuated g/C Ratio		0.30			0.30			0.56				
v/c Ratio		0.15			0.18			0.47				
Control Delay		28.8			9.8			6.4				
Queue Delay		0.0			0.0			0.3				
Total Delay		28.8			9.8			6.6				
LOS		C			A			A				
Approach Delay		28.8			9.8			6.6				
Approach LOS		C			A			A				
Queue Length 50th (m)		10.4			1.3			20.1				
Queue Length 95th (m)		m19.9			m5.6			23.9				
Internal Link Dist (m)		164.0			143.1			53.0			216.0	
Turn Bay Length (m)												
Base Capacity (vph)		524			512			2694				
Starvation Cap Reductn		0			0			659				
Spillback Cap Reductn		0			0			0				
Storage Cap Reductn		0			0			0				
Reduced v/c Ratio		0.15			0.18			0.62				

**Intersection Summary**  
 Cycle Length: 75  
 Actuated Cycle Length: 75  
 Offset: 50 (67%), Referenced to phase 2:NBT, Start of Green  
 Natural Cycle: 60  
 Control Type: Pretimed  
 Maximum v/c Ratio: 0.47  
 Intersection Signal Delay: 8.1  
 Intersection LOS: A  
 Intersection Capacity Utilization 53.2%  
 ICU Level of Service A  
 Analysis Period (min) 15  
 m Volume for 95th percentile queue is metered by upstream signal.

Splits and Phases: 6: Kent St & Arlington Ave

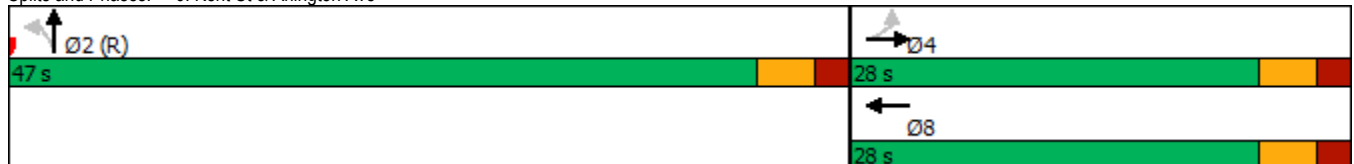



Lanes, Volumes, Timings  
7: Lyon St N & Gladstone Ave

05/04/2023



Lane Group	EBL	EBT	EBR	WBL	WBT	WBR	NBL	NBT	NBR	SBL	SBT	SBR
Lane Configurations		↑	↗	↖	↑						↕	↘
Traffic Volume (vph)	0	247	52	28	314	0	0	0	0	86	499	138
Future Volume (vph)	0	247	52	28	314	0	0	0	0	86	499	138
Satd. Flow (prot)	0	1784	1547	1729	1784	0	0	0	0	0	3252	0
Fit Permitted				0.552							0.994	
Satd. Flow (perm)	0	1784	1408	961	1784	0	0	0	0	0	3238	0
Satd. Flow (RTOR)			58								46	
Lane Group Flow (vph)	0	274	58	31	349	0	0	0	0	0	803	0
Turn Type		NA	Perm	Perm	NA					Perm	NA	
Protected Phases		4			8							6
Permitted Phases			4	8						6		
Minimum Split (s)		17.2	17.2	17.2	17.2					22.6	22.6	
Total Split (s)		39.0	39.0	39.0	39.0					36.0	36.0	
Total Split (%)		52.0%	52.0%	52.0%	52.0%					48.0%	48.0%	
Yellow Time (s)		3.3	3.3	3.3	3.3					3.3	3.3	
All-Red Time (s)		1.9	1.9	1.9	1.9					2.3	2.3	
Lost Time Adjust (s)		0.0	0.0	0.0	0.0						0.0	
Total Lost Time (s)		5.2	5.2	5.2	5.2						5.6	
Lead/Lag												
Lead-Lag Optimize?												
Act Effct Green (s)		33.8	33.8	33.8	33.8						30.4	
Actuated g/C Ratio		0.45	0.45	0.45	0.45						0.41	
v/c Ratio		0.34	0.09	0.07	0.43						0.60	
Control Delay		14.9	4.0	6.7	11.3						18.7	
Queue Delay		0.0	0.0	0.0	0.0						0.0	
Total Delay		14.9	4.0	6.7	11.3						18.7	
LOS		B	A	A	B						B	
Approach Delay		13.0			10.9						18.7	
Approach LOS		B			B						B	
Queue Length 50th (m)		24.0	0.0	1.4	39.4						42.7	
Queue Length 95th (m)		40.5	5.7	m2.7	52.4						59.8	
Internal Link Dist (m)		254.8			165.0			215.6			214.3	
Turn Bay Length (m)				25.0								
Base Capacity (vph)		803	666	433	803						1339	
Starvation Cap Reductn		0	0	0	0						0	
Spillback Cap Reductn		0	0	0	0						0	
Storage Cap Reductn		0	0	0	0						0	
Reduced v/c Ratio		0.34	0.09	0.07	0.43						0.60	

**Intersection Summary**  
 Cycle Length: 75  
 Actuated Cycle Length: 75  
 Offset: 45 (60%), Referenced to phase 4:EBT and 8:WBTL, Start of Green  
 Natural Cycle: 40  
 Control Type: Pretimed  
 Maximum v/c Ratio: 0.60  
 Intersection Signal Delay: 15.5  
 Intersection LOS: B  
 Intersection Capacity Utilization 66.9%  
 ICU Level of Service C  
 Analysis Period (min) 15  
 m Volume for 95th percentile queue is metered by upstream signal.

Splits and Phases: 7: Lyon St N & Gladstone Ave

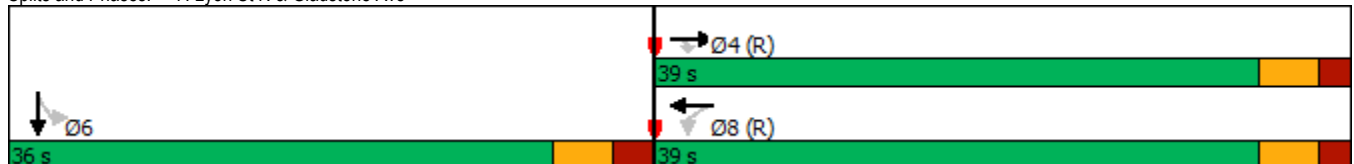

Lanes, Volumes, Timings  
8: Kent St & Gladstone Ave

05/04/2023



Lane Group	EBL	EBT	EBR	WBL	WBT	WBR	NBL	NBT	NBR	SBL	SBT	SBR
Lane Configurations												
Traffic Volume (vph)	75	450	0	0	324	75	67	882	131	0	0	0
Future Volume (vph)	75	450	0	0	324	75	67	882	131	0	0	0
Satd. Flow (prot)	1729	1767	0	0	1719	0	1729	4618	0	0	0	0
Fit Permitted	0.392						0.950					
Satd. Flow (perm)	695	1767	0	0	1719	0	1522	4618	0	0	0	0
Satd. Flow (RTOR)					21			44				
Lane Group Flow (vph)	83	500	0	0	443	0	74	1126	0	0	0	0
Turn Type	Perm	NA			NA		Perm	NA				
Protected Phases		4			8			2				
Permitted Phases	4						2					
Minimum Split (s)	21.4	21.4			21.4		20.4	20.4				
Total Split (s)	40.0	40.0			40.0		35.0	35.0				
Total Split (%)	53.3%	53.3%			53.3%		46.7%	46.7%				
Yellow Time (s)	3.3	3.3			3.3		3.3	3.3				
All-Red Time (s)	2.1	2.1			2.1		2.1	2.1				
Lost Time Adjust (s)	0.0	0.0			0.0		0.0	0.0				
Total Lost Time (s)	5.4	5.4			5.4		5.4	5.4				
Lead/Lag												
Lead-Lag Optimize?												
Act Effct Green (s)	34.6	34.6			34.6		29.6	29.6				
Actuated g/C Ratio	0.46	0.46			0.46		0.39	0.39				
v/c Ratio	0.26	0.61			0.55		0.12	0.61				
Control Delay	23.4	28.7			17.1		4.6	5.2				
Queue Delay	0.0	0.0			0.0		0.0	0.0				
Total Delay	23.4	28.7			17.1		4.6	5.2				
LOS	C	C			B		A	A				
Approach Delay		27.9			17.1			5.1				
Approach LOS		C			B			A				
Queue Length 50th (m)	8.9	66.5			40.9		1.5	7.0				
Queue Length 95th (m)	m19.7	97.8			66.8		3.3	9.0				
Internal Link Dist (m)		165.0			168.8			216.0			203.6	
Turn Bay Length (m)	30.0						40.0					
Base Capacity (vph)	320	815			804		600	1849				
Starvation Cap Reductn	0	0			0		0	0				
Spillback Cap Reductn	0	0			0		0	0				
Storage Cap Reductn	0	0			0		0	0				
Reduced v/c Ratio	0.26	0.61			0.55		0.12	0.61				

**Intersection Summary**  
 Cycle Length: 75  
 Actuated Cycle Length: 75  
 Offset: 23 (31%), Referenced to phase 4:EBTL and 8:WBT, Start of Green  
 Natural Cycle: 45  
 Control Type: Pretimed  
 Maximum v/c Ratio: 0.61  
 Intersection Signal Delay: 13.5  
 Intersection LOS: B  
 Intersection Capacity Utilization 66.9%  
 ICU Level of Service C  
 Analysis Period (min) 15  
 m Volume for 95th percentile queue is metered by upstream signal.

Splits and Phases: 8: Kent St & Gladstone Ave

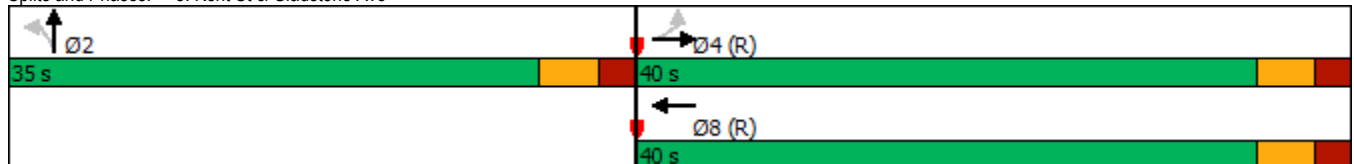

Lanes, Volumes, Timings  
 9: Bank St & Chamberlain Ave/Isabella St

05/04/2023



Lane Group	EBL	EBT	EBR	WBL	WBT	WBR	NBL	NBT	NBR	SBL	SBT	SBR
Lane Configurations		↕↕	↗					↕↕			↕↕	
Traffic Volume (vph)	53	590	120	0	0	0	0	448	91	175	720	0
Future Volume (vph)	53	590	120	0	0	0	0	448	91	175	720	0
Satd. Flow (prot)	0	3347	1547	0	0	0	0	3136	0	0	3324	0
Fit Permitted		0.996									0.700	
Satd. Flow (perm)	0	3343	1403	0	0	0	0	3136	0	0	2309	0
Satd. Flow (RTOR)			134					33				
Lane Group Flow (vph)	0	715	133	0	0	0	0	599	0	0	994	0
Turn Type	Perm	NA	Perm					NA		pm+pt	NA	
Protected Phases		4						2		5	6	
Permitted Phases	4		4							6		
Detector Phase	4	4	4					2		5	6	
Switch Phase												
Minimum Initial (s)	10.0	10.0	10.0					10.0		5.0	10.0	
Minimum Split (s)	26.2	26.2	26.2					23.1		11.1	23.1	
Total Split (s)	31.0	31.0	31.0					30.0		14.0	44.0	
Total Split (%)	41.3%	41.3%	41.3%					40.0%		18.7%	58.7%	
Yellow Time (s)	3.3	3.3	3.3					3.0		3.0	3.0	
All-Red Time (s)	2.9	2.9	2.9					3.1		3.1	3.1	
Lost Time Adjust (s)		0.0	0.0					0.0			0.0	
Total Lost Time (s)		6.2	6.2					6.1			6.1	
Lead/Lag												
Lead-Lag Optimize?												
Recall Mode	None	None	None					C-Max		None	C-Max	
Act Effct Green (s)		22.1	22.1					40.6			40.6	
Actuated g/C Ratio		0.29	0.29					0.54			0.54	
v/c Ratio		0.73	0.26					0.35			0.79	
Control Delay		28.2	5.1					10.4			14.1	
Queue Delay		0.0	0.0					0.0			2.1	
Total Delay		28.2	5.1					10.4			16.3	
LOS		C	A					B			B	
Approach Delay		24.6						10.4			16.3	
Approach LOS		C						B			B	
Queue Length 50th (m)		46.2	0.0					22.7			82.3	
Queue Length 95th (m)		62.2	10.5					34.6			m84.1	
Internal Link Dist (m)		296.0			233.4			215.6			90.2	
Turn Bay Length (m)			40.0									
Base Capacity (vph)		1105	553					1714			1251	
Starvation Cap Reductn		0	0					0			139	
Spillback Cap Reductn		0	0					0			0	
Storage Cap Reductn		0	0					0			0	
Reduced v/c Ratio		0.65	0.24					0.35			0.89	

Intersection Summary

Cycle Length: 75  
 Actuated Cycle Length: 75  
 Offset: 60 (80%), Referenced to phase 2:NBT and 6:SBTL, Start of Green  
 Natural Cycle: 65  
 Control Type: Actuated-Coordinated  
 Maximum v/c Ratio: 0.79  
 Intersection Signal Delay: 17.7  
 Intersection Capacity Utilization 81.3%  
 Analysis Period (min) 15  
 Intersection LOS: B  
 ICU Level of Service D  
 m Volume for 95th percentile queue is metered by upstream signal.

Splits and Phases: 9: Bank St & Chamberlain Ave/Isabella St

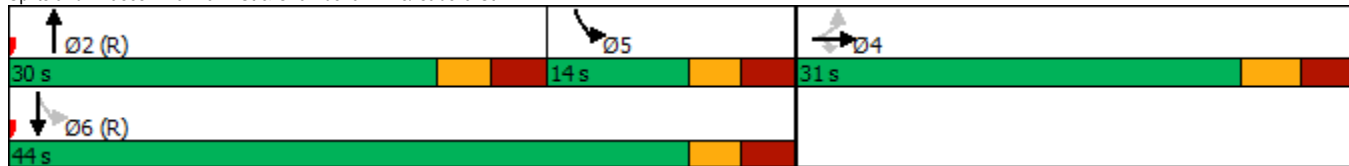

Lanes, Volumes, Timings  
13: Bronson Ave & Catherine St

05/04/2023



Lane Group	EBL	EBT	EBR	WBL	WBT	WBR	NBL	NBT	NBR	SBL	SBT	SBR
Lane Configurations				↔↔↔	↔↔↔		↔↔	↔↔			↔↔	
Traffic Volume (vph)	0	0	0	690	573	270	292	762	0	0	801	165
Future Volume (vph)	0	0	0	690	573	270	292	762	0	0	801	165
Satd. Flow (prot)	0	0	0	1458	4279	0	1679	3390	0	0	3261	0
Fit Permitted				0.950	0.987		0.097					
Satd. Flow (perm)	0	0	0	1458	4279	0	171	3390	0	0	3261	0
Satd. Flow (RTOR)					76						27	
Lane Group Flow (vph)	0	0	0	430	1274	0	324	847	0	0	1073	0
Turn Type				Perm	NA		pm+pt	NA			NA	
Protected Phases					8		5	2				6
Permitted Phases				8			2					
Minimum Split (s)				28.3	28.3		11.2	23.8			23.8	
Total Split (s)				33.0	33.0		25.0	67.0			42.0	
Total Split (%)				33.0%	33.0%		25.0%	67.0%			42.0%	
Yellow Time (s)				3.3	3.3		3.3	3.3			3.3	
All-Red Time (s)				3.0	3.0		2.9	3.5			3.5	
Lost Time Adjust (s)				0.0	0.0		0.0	0.0			0.0	
Total Lost Time (s)				6.3	6.3		6.2	6.8			6.8	
Lead/Lag							Lead				Lag	
Lead-Lag Optimize?							Yes				Yes	
Act Effct Green (s)				26.7	26.7		60.8	60.2			35.2	
Actuated g/C Ratio				0.27	0.27		0.61	0.60			0.35	
v/c Ratio				1.11	1.06		0.84	0.42			0.92	
Control Delay				113.2	78.8		44.0	11.3			44.2	
Queue Delay				0.0	0.0		0.0	0.0			0.0	
Total Delay				113.2	78.8		44.0	11.3			44.2	
LOS				F	E		D	B			D	
Approach Delay					87.5			20.4			44.2	
Approach LOS					F			C			D	
Queue Length 50th (m)				~111.0	~101.7		45.0	42.4			101.6	
Queue Length 95th (m)				#177.9	#132.0		#90.1	54.9			#142.1	
Internal Link Dist (m)		141.5			120.8			240.1			287.4	
Turn Bay Length (m)				80.0			45.0					
Base Capacity (vph)				389	1198		387	2040			1165	
Starvation Cap Reductn				0	0		0	0			0	
Spillback Cap Reductn				0	0		0	0			0	
Storage Cap Reductn				0	0		0	0			0	
Reduced v/c Ratio				1.11	1.06		0.84	0.42			0.92	

**Intersection Summary**  
 Cycle Length: 100  
 Actuated Cycle Length: 100  
 Offset: 60 (60%), Referenced to phase 2:NBTL and 6:SBT, Start of Green  
 Natural Cycle: 90  
 Control Type: Pretimed  
 Maximum v/c Ratio: 1.11  
 Intersection Signal Delay: 55.8      Intersection LOS: E  
 Intersection Capacity Utilization 87.7%      ICU Level of Service E  
 Analysis Period (min) 15  
 ~ Volume exceeds capacity, queue is theoretically infinite.  
 Queue shown is maximum after two cycles.  
 # 95th percentile volume exceeds capacity, queue may be longer.  
 Queue shown is maximum after two cycles.

Splits and Phases: 13: Bronson Ave & Catherine St

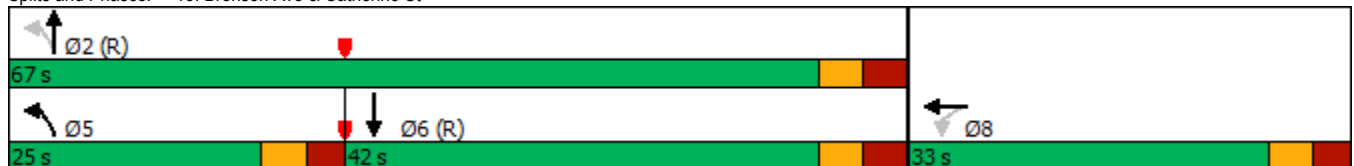

Intersection												
Int Delay, s/veh	2.2											
Movement	EBL	EBT	EBR	WBL	WBT	WBR	NBL	NBT	NBR	SBL	SBT	SBR
Lane Configurations		↔			↔						↔↔	
Traffic Vol, veh/h	0	19	2	8	37	0	0	0	0	43	564	13
Future Vol, veh/h	0	19	2	8	37	0	0	0	0	43	564	13
Conflicting Peds, #/hr	20	0	8	8	0	20	19	0	3	3	0	19
Sign Control	Stop	Stop	Stop	Stop	Stop	Stop	Free	Free	Free	Free	Free	Free
RT Channelized	-	-	None	-	-	None	-	-	None	-	-	None
Storage Length	-	-	-	-	-	-	-	-	-	-	-	-
Veh in Median Storage, #	-	0	-	-	0	-	-	-	-	-	0	-
Grade, %	-	0	-	-	0	-	-	0	-	-	0	-
Peak Hour Factor	90	90	90	90	90	90	90	90	90	90	90	90
Heavy Vehicles, %	0	5	0	0	5	0	0	0	0	0	0	0
Mvmt Flow	0	21	2	9	41	0	0	0	0	48	627	14
Major/Minor	Minor2		Minor1				Major2					
Conflicting Flow All	-	752	348	431	759	-	-	-	3	0	0	
Stage 1	-	749	-	3	3	-	-	-	-	-	-	
Stage 2	-	3	-	428	756	-	-	-	-	-	-	
Critical Hdwy	-	6.6	6.9	7.5	6.6	-	-	-	4.1	-	-	
Critical Hdwy Stg 1	-	5.6	-	-	-	-	-	-	-	-	-	
Critical Hdwy Stg 2	-	-	-	6.5	5.6	-	-	-	-	-	-	
Follow-up Hdwy	-	4.05	3.3	3.5	4.05	-	-	-	2.2	-	-	
Pot Cap-1 Maneuver	0	332	654	513	329	0	-	-	1632	-	-	
Stage 1	0	410	-	-	-	0	-	-	-	-	-	
Stage 2	0	-	-	581	407	0	-	-	-	-	-	
Platoon blocked, %	-	-	-	-	-	-	-	-	-	-	-	
Mov Cap-1 Maneuver	-	310	643	466	307	-	-	-	1627	-	-	
Mov Cap-2 Maneuver	-	310	-	466	307	-	-	-	-	-	-	
Stage 1	-	384	-	-	-	-	-	-	-	-	-	
Stage 2	-	-	-	522	381	-	-	-	-	-	-	
Approach	EB		WB				SB					
HCM Control Delay, s	16.9		18				0.6					
HCM LOS	C		C									
Minor Lane/Major Mvmt	EBLn1	WBLn1	SBL	SBT	SBR							
Capacity (veh/h)	326	327	1627	-	-							
HCM Lane V/C Ratio	0.072	0.153	0.029	-	-							
HCM Control Delay (s)	16.9	18	7.3	0.1	-							
HCM Lane LOS	C	C	A	A	-							
HCM 95th %tile Q(veh)	0.2	0.5	0.1	-	-							

Intersection						
Int Delay, s/veh	2.5					
Movement	EBL	EBR	NBL	NBT	SBT	SBR
Lane Configurations	↔			↕↕	↕↕	
Traffic Vol, veh/h	20	107	58	426	708	27
Future Vol, veh/h	20	107	58	426	708	27
Conflicting Peds, #/hr	0	0	42	0	0	42
Sign Control	Stop	Stop	Free	Free	Free	Free
RT Channelized	-	None	-	None	-	None
Storage Length	0	-	-	-	-	-
Veh in Median Storage, #	0	-	-	0	0	-
Grade, %	0	-	-	0	0	-
Peak Hour Factor	90	90	90	90	90	90
Heavy Vehicles, %	0	1	0	5	3	0
Mvmt Flow	22	119	64	473	787	30

Major/Minor	Minor2	Major1	Major2			
Conflicting Flow All	1209	451	859	0	-	0
Stage 1	844	-	-	-	-	-
Stage 2	365	-	-	-	-	-
Critical Hdwy	6.8	6.92	4.1	-	-	-
Critical Hdwy Stg 1	5.8	-	-	-	-	-
Critical Hdwy Stg 2	5.8	-	-	-	-	-
Follow-up Hdwy	3.5	3.31	2.2	-	-	-
Pot Cap-1 Maneuver	178	558	791	-	-	-
Stage 1	387	-	-	-	-	-
Stage 2	679	-	-	-	-	-
Platoon blocked, %				-	-	-
Mov Cap-1 Maneuver	146	536	760	-	-	-
Mov Cap-2 Maneuver	146	-	-	-	-	-
Stage 1	329	-	-	-	-	-
Stage 2	653	-	-	-	-	-

Approach	EB	NB	SB
HCM Control Delay, s	20.2	1.7	0
HCM LOS	C		

Minor Lane/Major Mvmt	NBL	NBT	EBLn1	SBT	SBR
Capacity (veh/h)	760	-	377	-	-
HCM Lane V/C Ratio	0.085	-	0.374	-	-
HCM Control Delay (s)	10.2	0.5	20.2	-	-
HCM Lane LOS	B	A	C	-	-
HCM 95th %tile Q(veh)	0.3	-	1.7	-	-

## **Future Background 2036**

Lanes, Volumes, Timings

1: Hwy 417 WB On Ramp/Lyon St N & Catherine St

05/18/2023



Lane Group	EBL	EBT	EBR	WBL	WBT	WBR	NBL	NBT	NBR	SBL	SBT	SBR
Lane Configurations					↕↕						↕	↕
Traffic Volume (vph)	0	0	0	247	233	0	0	0	0	0	275	131
Future Volume (vph)	0	0	0	247	233	0	0	0	0	0	275	131
Satd. Flow (prot)	0	0	0	0	3183	0	0	0	0	0	1784	1547
Fit Permitted					0.975							
Satd. Flow (perm)	0	0	0	0	3160	0	0	0	0	0	1784	1517
Satd. Flow (RTOR)					247							131
Lane Group Flow (vph)	0	0	0	0	480	0	0	0	0	0	275	131
Turn Type				Perm	NA						NA	Perm
Protected Phases					8						6	
Permitted Phases				8								6
Minimum Split (s)				26.2	26.2						28.3	28.3
Total Split (s)				36.0	36.0						39.0	39.0
Total Split (%)				48.0%	48.0%						52.0%	52.0%
Yellow Time (s)				3.3	3.3						3.3	3.3
All-Red Time (s)				1.9	1.9						2.0	2.0
Lost Time Adjust (s)					0.0						0.0	0.0
Total Lost Time (s)					5.2						5.3	5.3
Lead/Lag												
Lead-Lag Optimize?												
Act Effct Green (s)					30.8						33.7	33.7
Actuated g/C Ratio					0.41						0.45	0.45
v/c Ratio					0.33						0.34	0.17
Control Delay					10.2						23.8	11.9
Queue Delay					0.0						0.0	0.0
Total Delay					10.2						23.8	11.9
LOS					B						C	B
Approach Delay					10.2						19.9	
Approach LOS					B						B	
Queue Length 50th (m)					29.0						36.9	2.1
Queue Length 95th (m)					m41.7						59.0	20.4
Internal Link Dist (m)		271.6			163.9			117.8			52.8	
Turn Bay Length (m)												
Base Capacity (vph)					1443						801	753
Starvation Cap Reductn					0						0	0
Spillback Cap Reductn					0						0	0
Storage Cap Reductn					0						0	0
Reduced v/c Ratio					0.33						0.34	0.17

Intersection Summary

Cycle Length: 75  
 Actuated Cycle Length: 75  
 Offset: 24 (32%), Referenced to phase 8:WBTL, Start of Green  
 Natural Cycle: 55  
 Control Type: Pretimed  
 Maximum v/c Ratio: 0.34  
 Intersection Signal Delay: 14.6      Intersection LOS: B  
 Intersection Capacity Utilization 49.0%      ICU Level of Service A  
 Analysis Period (min) 15  
 m Volume for 95th percentile queue is metered by upstream signal.

Splits and Phases: 1: Hwy 417 WB On Ramp/Lyon St N & Catherine St

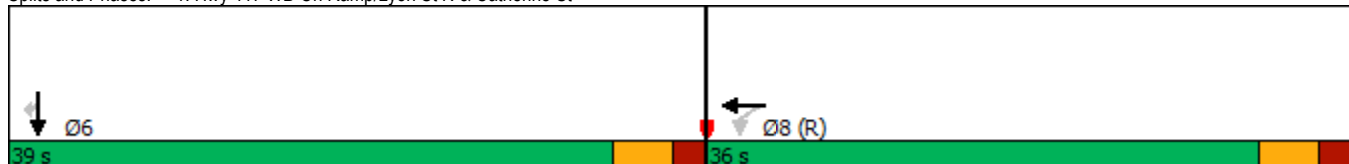



Lanes, Volumes, Timings

2: Hwy 417 EB Off Ramp/Chamberlain Ave/Kent St & Catherine St

05/18/2023

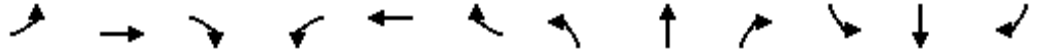

Lane Group	EBL	EBT	EBR	WBL	WBT	WBR	NBL	NBT	NBR	SBL	SBT	SBR
Lane Configurations					↑↑	↑↑		↑↑↑				
Traffic Volume (vph)	0	0	0	0	425	576	58	1423	0	0	0	0
Future Volume (vph)	0	0	0	0	425	576	58	1423	0	0	0	0
Satd. Flow (prot)	0	0	0	0	3262	2696	0	4911	0	0	0	0
Fit Permitted								0.998				
Satd. Flow (perm)	0	0	0	0	3262	2696	0	4906	0	0	0	0
Satd. Flow (RTOR)								70				
Lane Group Flow (vph)	0	0	0	0	425	576	0	1481	0	0	0	0
Turn Type					NA	Prot	Perm	NA				
Protected Phases					8	8		2				
Permitted Phases								2				
Detector Phase					8	8		2	2			
Switch Phase												
Minimum Initial (s)					10.0	10.0	10.0	10.0				
Minimum Split (s)					15.8	15.8	22.5	22.5				
Total Split (s)					29.6	29.6	32.4	32.4				
Total Split (%)					39.5%	39.5%	43.2%	43.2%				
Yellow Time (s)					3.3	3.3	3.3	3.3				
All-Red Time (s)					2.5	2.5	2.5	2.5				
Lost Time Adjust (s)					0.0	0.0		0.0				
Total Lost Time (s)					5.8	5.8		5.8				
Lead/Lag												
Lead-Lag Optimize?												
Recall Mode					C-Max	C-Max	Max	Max				
Act Effct Green (s)					29.0	29.0		26.6				
Actuated g/C Ratio					0.39	0.39		0.35				
v/c Ratio					0.34	0.55		0.83				
Control Delay					23.3	26.5		26.1				
Queue Delay					0.0	0.0		50.5				
Total Delay					23.3	26.5		76.6				
LOS					C	C		E				
Approach Delay					25.2			76.6				
Approach LOS					C			E				
Queue Length 50th (m)					28.7	44.2		65.8				
Queue Length 95th (m)					m35.2	m55.1		83.5				
Internal Link Dist (m)		163.9			131.7			67.4			53.0	
Turn Bay Length (m)						60.0						
Base Capacity (vph)					1261	1042		1785				
Starvation Cap Reductn					0	0		0				
Spillback Cap Reductn					0	0		1050				
Storage Cap Reductn					0	0		0				
Reduced v/c Ratio					0.34	0.55		2.01				

Intersection Summary

Cycle Length: 75  
 Actuated Cycle Length: 75  
 Offset: 0 (0%), Referenced to phase 8:WBT, Start of Green  
 Natural Cycle: 60  
 Control Type: Actuated-Coordinated  
 Maximum v/c Ratio: 0.83  
 Intersection Signal Delay: 55.9  
 Intersection LOS: E  
 Intersection Capacity Utilization 64.6%  
 ICU Level of Service C  
 Analysis Period (min) 15  
 m Volume for 95th percentile queue is metered by upstream signal.

Splits and Phases: 2: Hwy 417 EB Off Ramp/Chamberlain Ave/Kent St & Catherine St

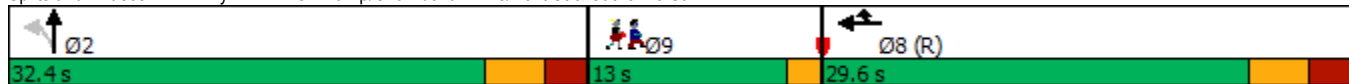

Lanes, Volumes, Timings

2: Hwy 417 EB Off Ramp/Chamberlain Ave/Kent St & Catherine St

05/18/2023

Lane Group	Ø9
Lane Configurations	
Traffic Volume (vph)	
Future Volume (vph)	
Satd. Flow (prot)	
Fit Permitted	
Satd. Flow (perm)	
Satd. Flow (RTOR)	
Lane Group Flow (vph)	
Turn Type	
Protected Phases	9
Permitted Phases	
Detector Phase	
Switch Phase	
Minimum Initial (s)	3.0
Minimum Split (s)	13.0
Total Split (s)	13.0
Total Split (%)	17%
Yellow Time (s)	2.0
All-Red Time (s)	0.0
Lost Time Adjust (s)	
Total Lost Time (s)	
Lead/Lag	
Lead-Lag Optimize?	
Recall Mode	None
Act Effct Green (s)	
Actuated g/C Ratio	
v/c Ratio	
Control Delay	
Queue Delay	
Total Delay	
LOS	
Approach Delay	
Approach LOS	
Queue Length 50th (m)	
Queue Length 95th (m)	
Internal Link Dist (m)	
Turn Bay Length (m)	
Base Capacity (vph)	
Starvation Cap Reductn	
Spillback Cap Reductn	
Storage Cap Reductn	
Reduced v/c Ratio	
Intersection Summary	

Lanes, Volumes, Timings  
3: Bank St & Catherine St

05/18/2023



Lane Group	EBL	EBT	EBR	WBL	WBT	WBR	NBL	NBT	NBR	SBL	SBT	SBR
Lane Configurations					↕↕↕			↕↕			↕↕	
Traffic Volume (vph)	0	0	0	176	631	202	268	575	0	0	376	137
Future Volume (vph)	0	0	0	176	631	202	268	575	0	0	376	137
Satd. Flow (prot)	0	0	0	0	4439	0	0	3211	0	0	2863	0
Fit Permitted					0.991			0.648				
Satd. Flow (perm)	0	0	0	0	4384	0	0	2049	0	0	2863	0
Satd. Flow (RTOR)					76						74	
Lane Group Flow (vph)	0	0	0	0	1009	0	0	843	0	0	513	0
Turn Type				Perm	NA		pm+pt	NA			NA	
Protected Phases					8		9	2			6	
Permitted Phases				8			2					
Minimum Split (s)				18.6	18.6		10.4	16.4			16.4	
Total Split (s)				24.0	24.0		10.4	41.0			30.6	
Total Split (%)				32.0%	32.0%		13.9%	54.7%			40.8%	
Yellow Time (s)				3.3	3.3		3.3	3.3			3.3	
All-Red Time (s)				2.3	2.3		2.1	2.1			2.1	
Lost Time Adjust (s)					0.0			0.0			0.0	
Total Lost Time (s)					5.6			5.4			5.4	
Lead/Lag				Lag	Lag		Lag	Lag			Lag	
Lead-Lag Optimize?				Yes	Yes		Yes	Yes			Yes	
Act Effct Green (s)					18.4			35.6			25.2	
Actuated g/C Ratio					0.25			0.47			0.34	
v/c Ratio					0.89			0.80			0.51	
Control Delay					36.9			19.0			19.0	
Queue Delay					0.0			0.0			0.0	
Total Delay					36.9			19.0			19.0	
LOS					D			B			B	
Approach Delay					36.9			19.0			19.0	
Approach LOS					D			B			B	
Queue Length 50th (m)					46.9			25.6			25.4	
Queue Length 95th (m)					#70.3			#39.3			39.2	
Internal Link Dist (m)		131.7			201.7			90.2			52.9	
Turn Bay Length (m)												
Base Capacity (vph)					1132			1050			1011	
Starvation Cap Reductn					0			0			0	
Spillback Cap Reductn					0			0			0	
Storage Cap Reductn					0			0			0	
Reduced v/c Ratio					0.89			0.80			0.51	

**Intersection Summary**  
 Cycle Length: 75  
 Actuated Cycle Length: 75  
 Offset: 50 (67%), Referenced to phase 2:NBT and 6:SBT, Start of Green  
 Natural Cycle: 65  
 Control Type: Pretimed  
 Maximum v/c Ratio: 0.89  
 Intersection Signal Delay: 26.6  
 Intersection LOS: C  
 Intersection Capacity Utilization 80.6%  
 ICU Level of Service D  
 Analysis Period (min) 15  
 # 95th percentile volume exceeds capacity, queue may be longer.  
 Queue shown is maximum after two cycles.

Splits and Phases: 3: Bank St & Catherine St

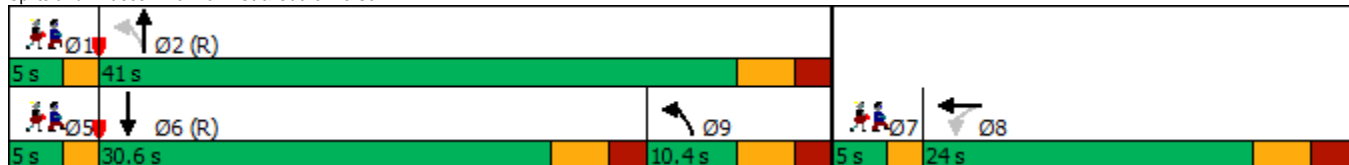

Lanes, Volumes, Timings  
 3: Bank St & Catherine St

05/18/2023

Lane Group	Ø1	Ø5	Ø7
Lane Configurations			
Traffic Volume (vph)			
Future Volume (vph)			
Satd. Flow (prot)			
Fit Permitted			
Satd. Flow (perm)			
Satd. Flow (RTOR)			
Lane Group Flow (vph)			
Turn Type			
Protected Phases	1	5	7
Permitted Phases			
Minimum Split (s)	5.0	5.0	5.0
Total Split (s)	5.0	5.0	5.0
Total Split (%)	7%	7%	7%
Yellow Time (s)	2.0	2.0	2.0
All-Red Time (s)	0.0	0.0	0.0
Lost Time Adjust (s)			
Total Lost Time (s)			
Lead/Lag	Lead	Lead	Lead
Lead-Lag Optimize?	Yes	Yes	Yes
Act Effct Green (s)			
Actuated g/C Ratio			
v/c Ratio			
Control Delay			
Queue Delay			
Total Delay			
LOS			
Approach Delay			
Approach LOS			
Queue Length 50th (m)			
Queue Length 95th (m)			
Internal Link Dist (m)			
Turn Bay Length (m)			
Base Capacity (vph)			
Starvation Cap Reductn			
Spillback Cap Reductn			
Storage Cap Reductn			
Reduced v/c Ratio			
Intersection Summary			

Lanes, Volumes, Timings  
4: Percy St & Catherine St

05/18/2023



Lane Group	EBL	EBT	EBR	WBL	WBT	WBR	NBL	NBT	NBR	SBL	SBT	SBR
Lane Configurations					↕↕						↕	
Traffic Volume (vph)	0	0	0	71	249	0	0	0	0	0	129	57
Future Volume (vph)	0	0	0	71	249	0	0	0	0	0	129	57
Satd. Flow (prot)	0	0	0	0	3170	0	0	0	0	0	1645	0
Fit Permitted					0.989							
Satd. Flow (perm)	0	0	0	0	3150	0	0	0	0	0	1645	0
Satd. Flow (RTOR)					160							
Lane Group Flow (vph)	0	0	0	0	320	0	0	0	0	0	186	0
Turn Type				Perm	NA						NA	
Protected Phases					8						6	
Permitted Phases				8								
Detector Phase				8	8						6	
Switch Phase												
Minimum Initial (s)				10.0	10.0						10.0	
Minimum Split (s)				26.5	26.5						23.4	
Total Split (s)				36.0	36.0						41.2	
Total Split (%)				40.0%	40.0%						45.8%	
Yellow Time (s)				3.3	3.3						3.3	
All-Red Time (s)				2.2	2.2						2.1	
Lost Time Adjust (s)					0.0						0.0	
Total Lost Time (s)					5.5						5.4	
Lead/Lag				Lag	Lag							
Lead-Lag Optimize?				Yes	Yes							
Recall Mode				None	None						Max	
Act Effct Green (s)					12.0						36.0	
Actuated g/C Ratio					0.20						0.61	
v/c Ratio					0.42						0.19	
Control Delay					11.6						6.4	
Queue Delay					0.0						0.0	
Total Delay					11.6						6.4	
LOS					B						A	
Approach Delay					11.6						6.4	
Approach LOS					B						A	
Queue Length 50th (m)					7.6						6.6	
Queue Length 95th (m)					16.2						21.3	
Internal Link Dist (m)		106.8			271.6			106.7			288.0	
Turn Bay Length (m)												
Base Capacity (vph)					1716						1004	
Starvation Cap Reductn					0						0	
Spillback Cap Reductn					0						0	
Storage Cap Reductn					0						0	
Reduced v/c Ratio					0.19						0.19	

**Intersection Summary**  
 Cycle Length: 90  
 Actuated Cycle Length: 58.9  
 Natural Cycle: 65  
 Control Type: Semi Act-Uncoord  
 Maximum v/c Ratio: 0.42  
 Intersection Signal Delay: 9.7  
 Intersection LOS: A  
 Intersection Capacity Utilization 39.0%  
 ICU Level of Service A  
 Analysis Period (min) 15

Splits and Phases: 4: Percy St & Catherine St

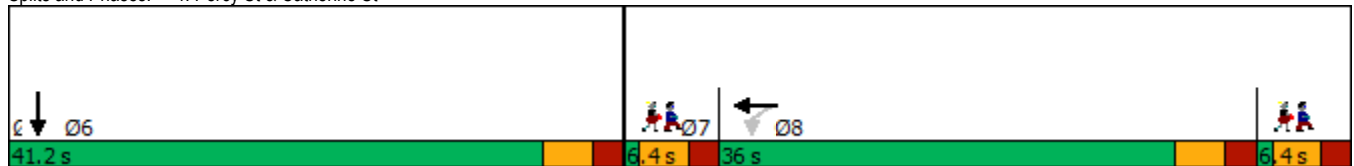

Lanes, Volumes, Timings  
 4: Percy St & Catherine St

05/18/2023

Lane Group	Ø3	Ø7
Lane Configurations		
Traffic Volume (vph)		
Future Volume (vph)		
Satd. Flow (prot)		
Fit Permitted		
Satd. Flow (perm)		
Satd. Flow (RTOR)		
Lane Group Flow (vph)		
Turn Type		
Protected Phases	3	7
Permitted Phases		
Detector Phase		
Switch Phase		
Minimum Initial (s)	1.0	1.0
Minimum Split (s)	6.4	6.4
Total Split (s)	6.4	6.4
Total Split (%)	7%	7%
Yellow Time (s)	3.3	3.3
All-Red Time (s)	2.1	2.1
Lost Time Adjust (s)		
Total Lost Time (s)		
Lead/Lag		Lead
Lead-Lag Optimize?		Yes
Recall Mode	None	None
Act Effct Green (s)		
Actuated g/C Ratio		
v/c Ratio		
Control Delay		
Queue Delay		
Total Delay		
LOS		
Approach Delay		
Approach LOS		
Queue Length 50th (m)		
Queue Length 95th (m)		
Internal Link Dist (m)		
Turn Bay Length (m)		
Base Capacity (vph)		
Starvation Cap Reductn		
Spillback Cap Reductn		
Storage Cap Reductn		
Reduced v/c Ratio		
Intersection Summary		

Lanes, Volumes, Timings  
6: Kent St & Arlington Ave

05/18/2023



Lane Group	EBL	EBT	EBR	WBL	WBT	WBR	NBL	NBT	NBR	SBL	SBT	SBR
Lane Configurations		↕			↕			↕↕↕				
Traffic Volume (vph)	19	48	0	0	11	93	15	1826	131	0	0	0
Future Volume (vph)	19	48	0	0	11	93	15	1826	131	0	0	0
Satd. Flow (prot)	0	1745	0	0	1542	0	0	4797	0	0	0	0
Fit Permitted		0.918										
Satd. Flow (perm)	0	1617	0	0	1542	0	0	4795	0	0	0	0
Satd. Flow (RTOR)					11			24				
Lane Group Flow (vph)	0	67	0	0	104	0	0	1972	0	0	0	0
Turn Type	Perm	NA			NA		Perm	NA				
Protected Phases		4			8			2				
Permitted Phases	4						2					
Minimum Split (s)	27.3	27.3			27.3		32.3	32.3				
Total Split (s)	27.4	27.4			27.4		47.6	47.6				
Total Split (%)	36.5%	36.5%			36.5%		63.5%	63.5%				
Yellow Time (s)	3.3	3.3			3.3		3.3	3.3				
All-Red Time (s)	2.0	2.0			2.0		2.0	2.0				
Lost Time Adjust (s)		0.0			0.0			0.0				
Total Lost Time (s)		5.3			5.3			5.3				
Lead/Lag												
Lead-Lag Optimize?												
Act Effct Green (s)		22.1			22.1			42.3				
Actuated g/C Ratio		0.29			0.29			0.56				
v/c Ratio		0.14			0.23			0.73				
Control Delay		33.0			16.6			15.3				
Queue Delay		0.0			0.0			48.7				
Total Delay		33.0			16.6			64.0				
LOS		C			B			E				
Approach Delay		33.0			16.6			64.0				
Approach LOS		C			B			E				
Queue Length 50th (m)		9.0			8.3			88.2				
Queue Length 95th (m)		19.9			m13.3			107.7				
Internal Link Dist (m)		164.0			143.1			53.0			216.0	
Turn Bay Length (m)												
Base Capacity (vph)		476			462			2714				
Starvation Cap Reductn		0			0			1414				
Spillback Cap Reductn		0			0			0				
Storage Cap Reductn		0			0			0				
Reduced v/c Ratio		0.14			0.23			1.52				

**Intersection Summary**  
 Cycle Length: 75  
 Actuated Cycle Length: 75  
 Offset: 50 (67%), Referenced to phase 2:NBT, Start of Green  
 Natural Cycle: 60  
 Control Type: Pretimed  
 Maximum v/c Ratio: 0.73  
 Intersection Signal Delay: 60.7  
 Intersection Capacity Utilization 70.2%  
 Analysis Period (min) 15  
 m Volume for 95th percentile queue is metered by upstream signal.

Splits and Phases: 6: Kent St & Arlington Ave

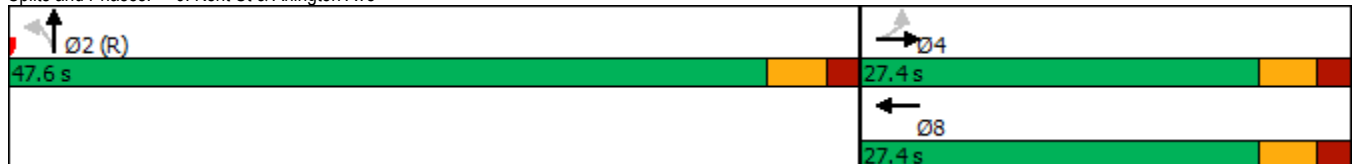

Lanes, Volumes, Timings  
7: Lyon St N & Gladstone Ave

05/18/2023



Lane Group	EBL	EBT	EBR	WBL	WBT	WBR	NBL	NBT	NBR	SBL	SBT	SBR
Lane Configurations		↑	↗	↖	↑						↕	↕
Traffic Volume (vph)	0	184	24	15	143	0	0	0	0	89	343	98
Future Volume (vph)	0	184	24	15	143	0	0	0	0	89	343	98
Satd. Flow (prot)	0	1733	1547	1729	1750	0	0	0	0	0	3249	0
Fit Permitted				0.641							0.992	
Satd. Flow (perm)	0	1733	1485	1146	1750	0	0	0	0	0	3225	0
Satd. Flow (RTOR)			38								47	
Lane Group Flow (vph)	0	184	24	15	143	0	0	0	0	0	530	0
Turn Type		NA	Perm	Perm	NA					Perm	NA	
Protected Phases		4			8							6
Permitted Phases			4	8						6		
Minimum Split (s)		17.2	17.2	17.2	17.2					22.6	22.6	
Total Split (s)		36.0	36.0	36.0	36.0					39.0	39.0	
Total Split (%)		48.0%	48.0%	48.0%	48.0%					52.0%	52.0%	
Yellow Time (s)		3.3	3.3	3.3	3.3					3.3	3.3	
All-Red Time (s)		1.9	1.9	1.9	1.9					2.3	2.3	
Lost Time Adjust (s)		0.0	0.0	0.0	0.0						0.0	
Total Lost Time (s)		5.2	5.2	5.2	5.2						5.6	
Lead/Lag												
Lead-Lag Optimize?												
Act Effct Green (s)		30.8	30.8	30.8	30.8						33.4	
Actuated g/C Ratio		0.41	0.41	0.41	0.41						0.45	
v/c Ratio		0.26	0.04	0.03	0.20						0.36	
Control Delay		15.8	3.3	5.4	7.4						13.3	
Queue Delay		0.0	0.0	0.0	0.0						0.0	
Total Delay		15.8	3.3	5.4	7.4						13.3	
LOS		B	A	A	A						B	
Approach Delay		14.4			7.3						13.3	
Approach LOS		B			A						B	
Queue Length 50th (m)		16.6	0.0	0.7	9.4						22.4	
Queue Length 95th (m)		29.8	2.8	m1.1	13.7						33.4	
Internal Link Dist (m)		254.8			165.0			215.6			214.3	
Turn Bay Length (m)				25.0								
Base Capacity (vph)		711	632	470	718						1462	
Starvation Cap Reductn		0	0	0	0						0	
Spillback Cap Reductn		0	0	0	0						0	
Storage Cap Reductn		0	0	0	0						0	
Reduced v/c Ratio		0.26	0.04	0.03	0.20						0.36	

Intersection Summary

Cycle Length: 75  
 Actuated Cycle Length: 75  
 Offset: 45 (60%), Referenced to phase 4:EBT and 8:WBTL, Start of Green  
 Natural Cycle: 40  
 Control Type: Pretimed  
 Maximum v/c Ratio: 0.36  
 Intersection Signal Delay: 12.5  
 Intersection Capacity Utilization 82.0%  
 Analysis Period (min) 15  
 Intersection LOS: B  
 ICU Level of Service D  
 m Volume for 95th percentile queue is metered by upstream signal.

Splits and Phases: 7: Lyon St N & Gladstone Ave

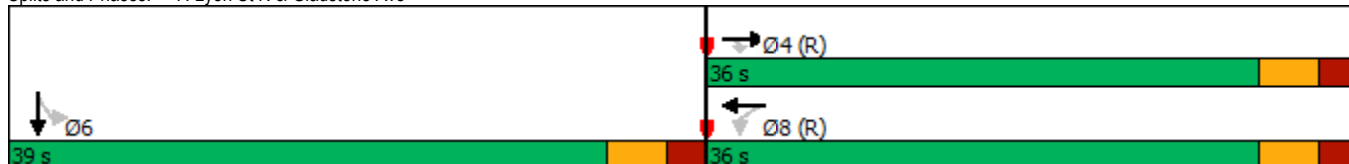



Lanes, Volumes, Timings  
8: Kent St & Gladstone Ave

05/18/2023



Lane Group	EBL	EBT	EBR	WBL	WBT	WBR	NBL	NBT	NBR	SBL	SBT	SBR
Lane Configurations												
Traffic Volume (vph)	82	277	0	0	165	148	36	1808	97	0	0	0
Future Volume (vph)	82	277	0	0	165	148	36	1808	97	0	0	0
Satd. Flow (prot)	1662	1717	0	0	1552	0	1729	4793	0	0	0	0
Fit Permitted	0.468						0.950					
Satd. Flow (perm)	786	1717	0	0	1552	0	1444	4793	0	0	0	0
Satd. Flow (RTOR)					5			16				
Lane Group Flow (vph)	82	277	0	0	313	0	36	1905	0	0	0	0
Turn Type	Perm	NA			NA		Perm	NA				
Protected Phases		4			8			2				
Permitted Phases	4						2					
Minimum Split (s)	21.4	21.4			21.4		20.4	20.4				
Total Split (s)	32.0	32.0			32.0		43.0	43.0				
Total Split (%)	42.7%	42.7%			42.7%		57.3%	57.3%				
Yellow Time (s)	3.3	3.3			3.3		3.3	3.3				
All-Red Time (s)	2.1	2.1			2.1		2.1	2.1				
Lost Time Adjust (s)	0.0	0.0			0.0		0.0	0.0				
Total Lost Time (s)	5.4	5.4			5.4		5.4	5.4				
Lead/Lag												
Lead-Lag Optimize?												
Act Effct Green (s)	26.6	26.6			26.6		37.6	37.6				
Actuated g/C Ratio	0.35	0.35			0.35		0.50	0.50				
v/c Ratio	0.29	0.46			0.57		0.05	0.79				
Control Delay	27.3	28.1			24.1		8.1	9.1				
Queue Delay	0.0	0.0			0.0		0.0	0.0				
Total Delay	27.3	28.1			24.1		8.1	9.1				
LOS	C	C			C		A	A				
Approach Delay		27.9			24.1			9.0				
Approach LOS		C			C			A				
Queue Length 50th (m)	9.9	37.6			34.5		1.4	28.4				
Queue Length 95th (m)	23.4	59.7			58.6		m2.9	43.3				
Internal Link Dist (m)		165.0			168.8			216.0			203.6	
Turn Bay Length (m)	30.0						40.0					
Base Capacity (vph)	278	608			553		723	2410				
Starvation Cap Reductn	0	0			0		0	0				
Spillback Cap Reductn	0	0			0		0	0				
Storage Cap Reductn	0	0			0		0	0				
Reduced v/c Ratio	0.29	0.46			0.57		0.05	0.79				

Intersection Summary

Cycle Length: 75  
 Actuated Cycle Length: 75  
 Offset: 23 (31%), Referenced to phase 4:EBTL and 8:WBT, Start of Green  
 Natural Cycle: 55  
 Control Type: Pretimed  
 Maximum v/c Ratio: 0.79  
 Intersection Signal Delay: 13.4  
 Intersection Capacity Utilization 82.0%  
 Analysis Period (min) 15  
 m Volume for 95th percentile queue is metered by upstream signal.

Intersection LOS: B  
 ICU Level of Service D

Splits and Phases: 8: Kent St & Gladstone Ave

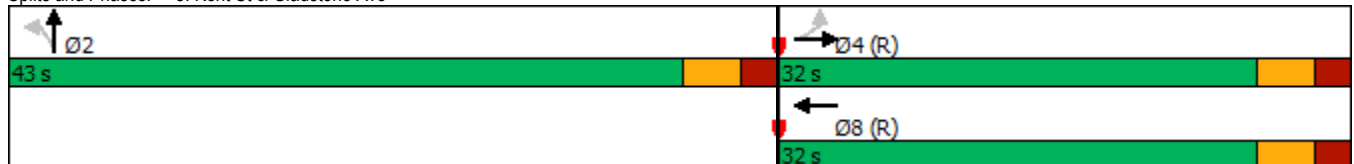

Lanes, Volumes, Timings  
 9: Bank St & Chamberlain Ave/Isabella St

05/18/2023



Lane Group	EBL	EBT	EBR	WBL	WBT	WBR	NBL	NBT	NBR	SBL	SBT	SBR
Lane Configurations		↕↕	↗					↕↕			↕↕	
Traffic Volume (vph)	75	520	75	0	0	0	0	835	143	176	382	0
Future Volume (vph)	75	520	75	0	0	0	0	835	143	176	382	0
Satd. Flow (prot)	0	3228	1446	0	0	0	0	3153	0	0	3220	0
Fit Permitted		0.994									0.547	
Satd. Flow (perm)	0	3221	1358	0	0	0	0	3153	0	0	1772	0
Satd. Flow (RTOR)			134									
Lane Group Flow (vph)	0	595	75	0	0	0	0	978	0	0	558	0
Turn Type	Perm	NA	Perm					NA		pm+pt	NA	
Protected Phases		4						2		5	6	
Permitted Phases	4		4							6		
Detector Phase	4	4	4					2		5	6	
Switch Phase												
Minimum Initial (s)	10.0	10.0	10.0					10.0		5.0	10.0	
Minimum Split (s)	26.2	26.2	26.2					23.1		11.1	23.1	
Total Split (s)	26.2	26.2	26.2					37.7		11.1	48.8	
Total Split (%)	34.9%	34.9%	34.9%					50.3%		14.8%	65.1%	
Yellow Time (s)	3.3	3.3	3.3					3.0		3.0	3.0	
All-Red Time (s)	2.9	2.9	2.9					3.1		3.1	3.1	
Lost Time Adjust (s)		0.0	0.0					0.0			0.0	
Total Lost Time (s)		6.2	6.2					6.1			6.1	
Lead/Lag												
Lead-Lag Optimize?												
Recall Mode	None	None	None					C-Max		None	C-Max	
Act Effct Green (s)		18.3	18.3					44.4			44.4	
Actuated g/C Ratio		0.24	0.24					0.59			0.59	
v/c Ratio		0.76	0.17					0.52			0.53	
Control Delay		32.8	1.8					10.7			14.3	
Queue Delay		0.0	0.0					0.0			0.0	
Total Delay		32.8	1.8					10.7			14.3	
LOS		C	A					B			B	
Approach Delay		29.4						10.7			14.3	
Approach LOS		C						B			B	
Queue Length 50th (m)		39.7	0.0					41.4			40.2	
Queue Length 95th (m)		56.6	2.4					56.7			m55.8	
Internal Link Dist (m)		296.0			233.4			215.6			90.2	
Turn Bay Length (m)			40.0									
Base Capacity (vph)		858	460					1865			1047	
Starvation Cap Reductn		0	0					0			0	
Spillback Cap Reductn		0	0					0			0	
Storage Cap Reductn		0	0					0			0	
Reduced v/c Ratio		0.69	0.16					0.52			0.53	

Intersection Summary

Cycle Length: 75  
 Actuated Cycle Length: 75  
 Offset: 60 (80%), Referenced to phase 2:NBT and 6:SBTL, Start of Green  
 Natural Cycle: 65  
 Control Type: Actuated-Coordinated  
 Maximum v/c Ratio: 0.76  
 Intersection Signal Delay: 17.3  
 Intersection Capacity Utilization 82.8%  
 Analysis Period (min) 15  
 Intersection LOS: B  
 ICU Level of Service E  
 m Volume for 95th percentile queue is metered by upstream signal.

Splits and Phases: 9: Bank St & Chamberlain Ave/Isabella St

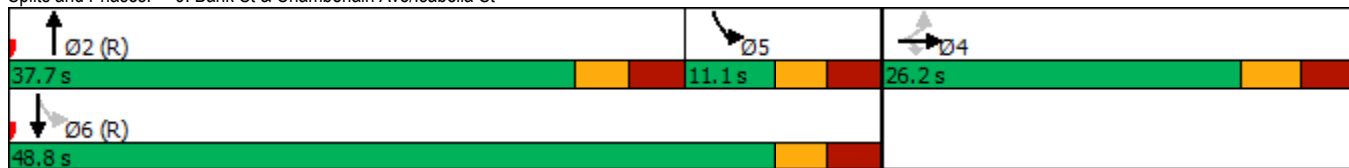

Lanes, Volumes, Timings  
13: Bronson Ave & Catherine St

05/18/2023



Lane Group	EBL	EBT	EBR	WBL	WBT	WBR	NBL	NBT	NBR	SBL	SBT	SBR
Lane Configurations				↖ ↗	↖ ↗		↖ ↗	↖ ↗			↖ ↗	
Traffic Volume (vph)	0	0	0	524	510	368	553	1105	0	0	456	126
Future Volume (vph)	0	0	0	524	510	368	553	1105	0	0	456	126
Satd. Flow (prot)	0	0	0	1430	4136	0	1712	3390	0	0	3087	0
Fit Permitted				0.950	0.992		0.218					
Satd. Flow (perm)	0	0	0	1430	4136	0	393	3390	0	0	3087	0
Satd. Flow (RTOR)					78						29	
Lane Group Flow (vph)	0	0	0	356	1046	0	553	1105	0	0	582	0
Turn Type				Perm	NA		pm+pt	NA			NA	
Protected Phases					8		5	7			2	
Permitted Phases				8			2					
Minimum Split (s)				28.3	28.3			23.8			23.8	
Total Split (s)				36.8	36.8			73.2			28.9	
Total Split (%)				33.5%	33.5%			66.5%			26.3%	
Yellow Time (s)				3.3	3.3			3.3			3.3	
All-Red Time (s)				3.0	3.0			3.5			3.5	
Lost Time Adjust (s)				0.0	0.0			0.0			0.0	
Total Lost Time (s)				6.3	6.3			6.8			6.8	
Lead/Lag												Lag
Lead-Lag Optimize?												Yes
Act Effct Green (s)				30.5	30.5		67.0	66.4			22.1	
Actuated g/C Ratio				0.28	0.28		0.61	0.60			0.20	
v/c Ratio				0.90	0.87		0.89	0.54			0.91	
Control Delay				65.2	44.0		34.2	14.0			60.0	
Queue Delay				0.0	0.0		0.0	0.0			0.0	
Total Delay				65.2	44.0		34.2	14.0			60.0	
LOS				E	D		C	B			E	
Approach Delay					49.4			20.8			60.0	
Approach LOS					D			C			E	
Queue Length 50th (m)				85.4	77.4		63.9	68.4			61.7	
Queue Length 95th (m)				#147.2	#97.8		#122.6	85.5			#93.3	
Internal Link Dist (m)		141.5			120.8			240.1			287.4	
Turn Bay Length (m)				80.0			45.0					
Base Capacity (vph)				396	1203		621	2046			643	
Starvation Cap Reductn				0	0		0	0			0	
Spillback Cap Reductn				0	0		0	0			0	
Storage Cap Reductn				0	0		0	0			0	
Reduced v/c Ratio				0.90	0.87		0.89	0.54			0.91	

**Intersection Summary**  
 Cycle Length: 110  
 Actuated Cycle Length: 110  
 Offset: 60 (55%), Referenced to phase 2:NBT and 6:SBT, Start of Green  
 Natural Cycle: 90  
 Control Type: Pretimed  
 Maximum v/c Ratio: 0.91  
 Intersection Signal Delay: 38.1      Intersection LOS: D  
 Intersection Capacity Utilization 90.1%      ICU Level of Service E  
 Analysis Period (min) 15  
 # 95th percentile volume exceeds capacity, queue may be longer.  
 Queue shown is maximum after two cycles.

Splits and Phases: 13: Bronson Ave & Catherine St



Lanes, Volumes, Timings  
 13: Bronson Ave & Catherine St

05/18/2023

Lane Group	Ø5	Ø7
Lane Configurations		
Traffic Volume (vph)		
Future Volume (vph)		
Satd. Flow (prot)		
Fit Permitted		
Satd. Flow (perm)		
Satd. Flow (RTOR)		
Lane Group Flow (vph)		
Turn Type		
Protected Phases	5	7
Permitted Phases		
Minimum Split (s)	11.2	11.8
Total Split (s)	32.5	11.8
Total Split (%)	30%	11%
Yellow Time (s)	3.3	3.3
All-Red Time (s)	2.9	3.5
Lost Time Adjust (s)		
Total Lost Time (s)		
Lead/Lag	Lead	
Lead-Lag Optimize?	Yes	
Act Effct Green (s)		
Actuated g/C Ratio		
v/c Ratio		
Control Delay		
Queue Delay		
Total Delay		
LOS		
Approach Delay		
Approach LOS		
Queue Length 50th (m)		
Queue Length 95th (m)		
Internal Link Dist (m)		
Turn Bay Length (m)		
Base Capacity (vph)		
Starvation Cap Reductn		
Spillback Cap Reductn		
Storage Cap Reductn		
Reduced v/c Ratio		
Intersection Summary		

Intersection												
Int Delay, s/veh	2											
Movement	EBL	EBT	EBR	WBL	WBT	WBR	NBL	NBT	NBR	SBL	SBT	SBR
Lane Configurations		↔			↔						↔↔	
Traffic Vol, veh/h	0	18	0	11	12	0	0	0	0	44	345	9
Future Vol, veh/h	0	18	0	11	12	0	0	0	0	44	345	9
Conflicting Peds, #/hr	32	0	15	15	0	32	9	0	10	10	0	9
Sign Control	Stop	Stop	Stop	Stop	Stop	Stop	Free	Free	Free	Free	Free	Free
RT Channelized	-	-	None	-	-	None	-	-	None	-	-	None
Storage Length	-	-	-	-	-	-	-	-	-	-	-	-
Veh in Median Storage, #	-	0	-	-	0	-	-	-	-	-	0	-
Grade, %	-	0	-	-	0	-	-	0	-	-	0	-
Peak Hour Factor	100	100	100	100	100	100	100	100	100	100	100	100
Heavy Vehicles, %	0	6	0	9	0	0	0	0	0	5	1	11
Mvmt Flow	0	18	0	11	12	0	0	0	0	44	345	9
Major/Minor	Minor2			Minor1			Major2					
Conflicting Flow All	-	457	201	295	461	-	-	-	10	0	0	-
Stage 1	-	447	-	10	10	-	-	-	-	-	-	-
Stage 2	-	10	-	285	451	-	-	-	-	-	-	-
Critical Hdwy	-	6.62	6.9	7.68	6.5	-	-	-	4.2	-	-	-
Critical Hdwy Stg 1	-	5.62	-	-	-	-	-	-	-	-	-	-
Critical Hdwy Stg 2	-	-	-	6.68	5.5	-	-	-	-	-	-	-
Follow-up Hdwy	-	4.06	3.3	3.59	4	-	-	-	2.25	-	-	-
Pot Cap-1 Maneuver	0	490	813	617	500	0	-	-	1586	-	-	-
Stage 1	0	562	-	-	-	0	-	-	-	-	-	-
Stage 2	0	-	-	679	574	0	-	-	-	-	-	-
Platoon blocked, %	-	-	-	-	-	-	-	-	-	-	-	-
Mov Cap-1 Maneuver	-	465	806	578	475	-	-	-	1571	-	-	-
Mov Cap-2 Maneuver	-	465	-	578	475	-	-	-	-	-	-	-
Stage 1	-	538	-	-	-	-	-	-	-	-	-	-
Stage 2	-	-	-	633	549	-	-	-	-	-	-	-
Approach	EB			WB			SB					
HCM Control Delay, s	13.1			12.3			0.9					
HCM LOS	B			B								
Minor Lane/Major Mvmt	EBLn1	WBLn1	SBL	SBT	SBR							
Capacity (veh/h)	465	519	1571	-	-							
HCM Lane V/C Ratio	0.039	0.044	0.028	-	-							
HCM Control Delay (s)	13.1	12.3	7.4	0.1	-							
HCM Lane LOS	B	B	A	A	-							
HCM 95th %tile Q(veh)	0.1	0.1	0.1	-	-							

Intersection						
Int Delay, s/veh	2.8					
Movement	EBL	EBR	NBL	NBT	SBT	SBR
Lane Configurations	↔			↕	↕	
Traffic Vol, veh/h	21	124	86	691	390	22
Future Vol, veh/h	21	124	86	691	390	22
Conflicting Peds, #/hr	0	0	111	0	0	111
Sign Control	Stop	Stop	Free	Free	Free	Free
RT Channelized	-	None	-	None	-	None
Storage Length	0	-	-	-	-	-
Veh in Median Storage, #	0	-	-	0	0	-
Grade, %	0	-	-	0	0	-
Peak Hour Factor	100	100	100	100	100	100
Heavy Vehicles, %	0	3	2	5	8	5
Mvmt Flow	21	124	86	691	390	22

Major/Minor	Minor2	Major1	Major2			
Conflicting Flow All	1030	317	523	0	-	0
Stage 1	512	-	-	-	-	-
Stage 2	518	-	-	-	-	-
Critical Hdwy	6.8	6.96	4.14	-	-	-
Critical Hdwy Stg 1	5.8	-	-	-	-	-
Critical Hdwy Stg 2	5.8	-	-	-	-	-
Follow-up Hdwy	3.5	3.33	2.22	-	-	-
Pot Cap-1 Maneuver	233	676	1040	-	-	-
Stage 1	572	-	-	-	-	-
Stage 2	568	-	-	-	-	-
Platoon blocked, %				-	-	-
Mov Cap-1 Maneuver	159	607	933	-	-	-
Mov Cap-2 Maneuver	159	-	-	-	-	-
Stage 1	436	-	-	-	-	-
Stage 2	509	-	-	-	-	-

Approach	EB	NB	SB
HCM Control Delay, s	17.5	1.6	0
HCM LOS	C		

Minor Lane/Major Mvmt	NBL	NBT	EBLn1	SBT	SBR
Capacity (veh/h)	933	-	431	-	-
HCM Lane V/C Ratio	0.092	-	0.336	-	-
HCM Control Delay (s)	9.2	0.6	17.5	-	-
HCM Lane LOS	A	A	C	-	-
HCM 95th %tile Q(veh)	0.3	-	1.5	-	-

Lanes, Volumes, Timings

1: Hwy 417 WB On Ramp/Lyon St N & Catherine St

05/18/2023



Lane Group	EBL	EBT	EBR	WBL	WBT	WBR	NBL	NBT	NBR	SBL	SBT	SBR
Lane Configurations					↕↕						↕	↗
Traffic Volume (vph)	0	0	0	210	539	0	0	0	0	0	365	304
Future Volume (vph)	0	0	0	210	539	0	0	0	0	0	365	304
Satd. Flow (prot)	0	0	0	0	3296	0	0	0	0	0	1802	1532
Fit Permitted					0.986							
Satd. Flow (perm)	0	0	0	0	3273	0	0	0	0	0	1802	1490
Satd. Flow (RTOR)					97							184
Lane Group Flow (vph)	0	0	0	0	749	0	0	0	0	0	365	304
Turn Type				Perm	NA						NA	Perm
Protected Phases					8						6	
Permitted Phases				8								6
Minimum Split (s)				26.2	26.2						28.3	28.3
Total Split (s)				38.0	38.0						37.0	37.0
Total Split (%)				50.7%	50.7%						49.3%	49.3%
Yellow Time (s)				3.3	3.3						3.3	3.3
All-Red Time (s)				1.9	1.9						2.0	2.0
Lost Time Adjust (s)					0.0						0.0	0.0
Total Lost Time (s)					5.2						5.3	5.3
Lead/Lag												
Lead-Lag Optimize?												
Act Effct Green (s)					32.8						31.7	31.7
Actuated g/C Ratio					0.44						0.42	0.42
v/c Ratio					0.50						0.48	0.41
Control Delay					13.8						26.7	17.1
Queue Delay					0.0						0.0	0.0
Total Delay					13.8						26.7	17.1
LOS					B						C	B
Approach Delay					13.8						22.3	
Approach LOS					B						C	
Queue Length 50th (m)					56.5						52.2	26.8
Queue Length 95th (m)					73.2						77.5	50.0
Internal Link Dist (m)		271.6			163.9			117.8			52.8	
Turn Bay Length (m)												
Base Capacity (vph)					1485						761	736
Starvation Cap Reductn					0						0	0
Spillback Cap Reductn					0						0	0
Storage Cap Reductn					0						0	0
Reduced v/c Ratio					0.50						0.48	0.41

Intersection Summary

Cycle Length: 75	
Actuated Cycle Length: 75	
Offset: 24 (32%), Referenced to phase 8:WBTL, Start of Green	
Natural Cycle: 55	
Control Type: Pretimed	
Maximum v/c Ratio: 0.50	
Intersection Signal Delay: 17.9	Intersection LOS: B
Intersection Capacity Utilization 54.5%	ICU Level of Service A
Analysis Period (min) 15	

Splits and Phases: 1: Hwy 417 WB On Ramp/Lyon St N & Catherine St

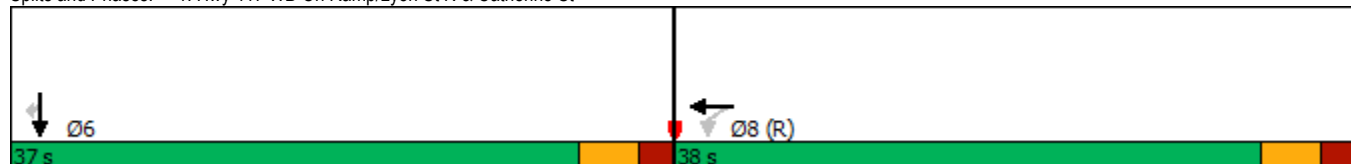

Lanes, Volumes, Timings

2: Hwy 417 EB Off Ramp/Chamberlain Ave/Kent St & Catherine St

05/18/2023



Lane Group	EBL	EBT	EBR	WBL	WBT	WBR	NBL	NBT	NBR	SBL	SBT	SBR
Lane Configurations					↑↑	↑↑		↑↑↑				
Traffic Volume (vph)	0	0	0	0	691	315	27	878	0	0	0	0
Future Volume (vph)	0	0	0	0	691	315	27	878	0	0	0	0
Satd. Flow (prot)	0	0	0	0	3357	2521	0	4863	0	0	0	0
Fit Permitted								0.999				
Satd. Flow (perm)	0	0	0	0	3357	2521	0	4861	0	0	0	0
Satd. Flow (RTOR)								70				
Lane Group Flow (vph)	0	0	0	0	691	315	0	905	0	0	0	0
Turn Type					NA	Prot	Perm	NA				
Protected Phases					8	8		2				
Permitted Phases							2					
Detector Phase					8	8	2	2				
Switch Phase												
Minimum Initial (s)					10.0	10.0	10.0	10.0				
Minimum Split (s)					15.8	15.8	22.5	22.5				
Total Split (s)					34.0	34.0	28.0	28.0				
Total Split (%)					45.3%	45.3%	37.3%	37.3%				
Yellow Time (s)					3.3	3.3	3.3	3.3				
All-Red Time (s)					2.5	2.5	2.5	2.5				
Lost Time Adjust (s)					0.0	0.0		0.0				
Total Lost Time (s)					5.8	5.8		5.8				
Lead/Lag												
Lead-Lag Optimize?												
Recall Mode					C-Max	C-Max	Max	Max				
Act Effct Green (s)					33.4	33.4		22.2				
Actuated g/C Ratio					0.45	0.45		0.30				
v/c Ratio					0.46	0.28		0.61				
Control Delay					27.3	25.1		22.9				
Queue Delay					0.0	0.0		1.2				
Total Delay					27.3	25.1		24.1				
LOS					C	C		C				
Approach Delay					26.6			24.1				
Approach LOS					C			C				
Queue Length 50th (m)					51.4	23.8		36.7				
Queue Length 95th (m)					m62.2	m28.8		49.1				
Internal Link Dist (m)		163.9			131.7			67.4			53.0	
Turn Bay Length (m)						60.0						
Base Capacity (vph)					1495	1122		1488				
Starvation Cap Reductn					0	0		0				
Spillback Cap Reductn					0	0		345				
Storage Cap Reductn					0	0		0				
Reduced v/c Ratio					0.46	0.28		0.79				

Intersection Summary

Cycle Length: 75  
 Actuated Cycle Length: 75  
 Offset: 0 (0%), Referenced to phase 8:WBT, Start of Green  
 Natural Cycle: 60  
 Control Type: Actuated-Coordinated  
 Maximum v/c Ratio: 0.61  
 Intersection Signal Delay: 25.4  
 Intersection Capacity Utilization 50.5%  
 Analysis Period (min) 15  
 Intersection LOS: C  
 ICU Level of Service A  
 m Volume for 95th percentile queue is metered by upstream signal.

Splits and Phases: 2: Hwy 417 EB Off Ramp/Chamberlain Ave/Kent St & Catherine St





Lanes, Volumes, Timings

2: Hwy 417 EB Off Ramp/Chamberlain Ave/Kent St & Catherine St

05/18/2023

Lane Group	Ø9
Lane Configurations	
Traffic Volume (vph)	
Future Volume (vph)	
Satd. Flow (prot)	
Flt Permitted	
Satd. Flow (perm)	
Satd. Flow (RTOR)	
Lane Group Flow (vph)	
Turn Type	
Protected Phases	9
Permitted Phases	
Detector Phase	
Switch Phase	
Minimum Initial (s)	1.0
Minimum Split (s)	13.0
Total Split (s)	13.0
Total Split (%)	17%
Yellow Time (s)	2.0
All-Red Time (s)	0.0
Lost Time Adjust (s)	
Total Lost Time (s)	
Lead/Lag	
Lead-Lag Optimize?	
Recall Mode	None
Act Effct Green (s)	
Actuated g/C Ratio	
v/c Ratio	
Control Delay	
Queue Delay	
Total Delay	
LOS	
Approach Delay	
Approach LOS	
Queue Length 50th (m)	
Queue Length 95th (m)	
Internal Link Dist (m)	
Turn Bay Length (m)	
Base Capacity (vph)	
Starvation Cap Reductn	
Spillback Cap Reductn	
Storage Cap Reductn	
Reduced v/c Ratio	
Intersection Summary	

Lanes, Volumes, Timings  
3: Bank St & Catherine St

05/18/2023



Lane Group	EBL	EBT	EBR	WBL	WBT	WBR	NBL	NBT	NBR	SBL	SBT	SBR
Lane Configurations					↕↕↕			↕↕			↕↕	
Traffic Volume (vph)	0	0	0	236	644	158	188	328	0	0	695	130
Future Volume (vph)	0	0	0	236	644	158	188	328	0	0	695	130
Satd. Flow (prot)	0	0	0	0	4610	0	0	3260	0	0	3110	0
Fit Permitted					0.989			0.536				
Satd. Flow (perm)	0	0	0	0	4530	0	0	1746	0	0	3110	0
Satd. Flow (RTOR)					46			31				
Lane Group Flow (vph)	0	0	0	0	1038	0	0	516	0	0	825	0
Turn Type				Perm	NA		pm+pt	NA			NA	
Protected Phases					8		9	2			6	
Permitted Phases					8		2					
Minimum Split (s)				18.6	18.6		10.4	16.4			16.4	
Total Split (s)				24.4	24.4		10.4	40.6			30.2	
Total Split (%)				32.5%	32.5%		13.9%	54.1%			40.3%	
Yellow Time (s)				3.3	3.3		3.3	3.3			3.3	
All-Red Time (s)				2.3	2.3		2.1	2.1			2.1	
Lost Time Adjust (s)					0.0			0.0			0.0	
Total Lost Time (s)					5.6			5.4			5.4	
Lead/Lag				Lag	Lag		Lag	Lag			Lag	
Lead-Lag Optimize?				Yes	Yes		Yes	Yes			Yes	
Act Effct Green (s)					18.8			35.2			24.8	
Actuated g/C Ratio					0.25			0.47			0.33	
v/c Ratio					0.89			0.56			0.79	
Control Delay					37.0			13.5			28.4	
Queue Delay					0.0			0.0			0.5	
Total Delay					37.0			13.5			28.9	
LOS					D			B			C	
Approach Delay					37.0			13.5			28.9	
Approach LOS					D			B			C	
Queue Length 50th (m)					49.6			15.0			52.8	
Queue Length 95th (m)					#73.0			20.0			73.7	
Internal Link Dist (m)		131.7			201.7			90.2			52.9	
Turn Bay Length (m)												
Base Capacity (vph)					1169			920			1049	
Starvation Cap Reductn					0			0			0	
Spillback Cap Reductn					0			0			45	
Storage Cap Reductn					0			0			0	
Reduced v/c Ratio					0.89			0.56			0.82	

**Intersection Summary**  
 Cycle Length: 75  
 Actuated Cycle Length: 75  
 Offset: 50 (67%), Referenced to phase 2:NBT and 6:SBT, Start of Green  
 Natural Cycle: 70  
 Control Type: Pretimed  
 Maximum v/c Ratio: 0.89  
 Intersection Signal Delay: 29.1      Intersection LOS: C  
 Intersection Capacity Utilization 79.6%      ICU Level of Service D  
 Analysis Period (min) 15  
 # 95th percentile volume exceeds capacity, queue may be longer.  
 Queue shown is maximum after two cycles.

Splits and Phases: 3: Bank St & Catherine St

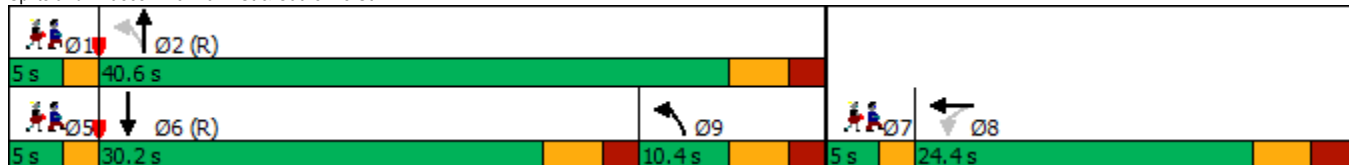

Lanes, Volumes, Timings  
 3: Bank St & Catherine St

05/18/2023

Lane Group	Ø1	Ø5	Ø7
Lane Configurations			
Traffic Volume (vph)			
Future Volume (vph)			
Satd. Flow (prot)			
Fit Permitted			
Satd. Flow (perm)			
Satd. Flow (RTOR)			
Lane Group Flow (vph)			
Turn Type			
Protected Phases	1	5	7
Permitted Phases			
Minimum Split (s)	5.0	5.0	5.0
Total Split (s)	5.0	5.0	5.0
Total Split (%)	7%	7%	7%
Yellow Time (s)	2.0	2.0	2.0
All-Red Time (s)	0.0	0.0	0.0
Lost Time Adjust (s)			
Total Lost Time (s)			
Lead/Lag	Lead	Lead	Lead
Lead-Lag Optimize?	Yes	Yes	Yes
Act Effct Green (s)			
Actuated g/C Ratio			
v/c Ratio			
Control Delay			
Queue Delay			
Total Delay			
LOS			
Approach Delay			
Approach LOS			
Queue Length 50th (m)			
Queue Length 95th (m)			
Internal Link Dist (m)			
Turn Bay Length (m)			
Base Capacity (vph)			
Starvation Cap Reductn			
Spillback Cap Reductn			
Storage Cap Reductn			
Reduced v/c Ratio			
Intersection Summary			

Lanes, Volumes, Timings  
4: Percy St & Catherine St

05/18/2023



Lane Group	EBL	EBT	EBR	WBL	WBT	WBR	NBL	NBT	NBR	SBL	SBT	SBR
Lane Configurations					↕↕						↕	
Traffic Volume (vph)	0	0	0	153	728	0	0	0	0	0	121	39
Future Volume (vph)	0	0	0	153	728	0	0	0	0	0	121	39
Satd. Flow (prot)	0	0	0	0	3354	0	0	0	0	0	1727	0
Fit Permitted					0.991							
Satd. Flow (perm)	0	0	0	0	3341	0	0	0	0	0	1727	0
Satd. Flow (RTOR)					160							
Lane Group Flow (vph)	0	0	0	0	881	0	0	0	0	0	160	0
Turn Type				Perm	NA						NA	
Protected Phases					8						6	
Permitted Phases				8								
Detector Phase				8	8						6	
Switch Phase												
Minimum Initial (s)				10.0	10.0						10.0	
Minimum Split (s)				26.5	26.5						23.4	
Total Split (s)				47.0	47.0						30.2	
Total Split (%)				52.2%	52.2%						33.6%	
Yellow Time (s)				3.3	3.3						3.3	
All-Red Time (s)				2.2	2.2						2.1	
Lost Time Adjust (s)					0.0						0.0	
Total Lost Time (s)					5.5						5.4	
Lead/Lag				Lag	Lag							
Lead-Lag Optimize?				Yes	Yes							
Recall Mode				None	None						Max	
Act Effct Green (s)					19.7						25.0	
Actuated g/C Ratio					0.35						0.45	
v/c Ratio					0.69						0.21	
Control Delay					15.1						11.8	
Queue Delay					0.0						0.0	
Total Delay					15.1						11.8	
LOS					B						B	
Approach Delay					15.1						11.8	
Approach LOS					B						B	
Queue Length 50th (m)					30.8						9.2	
Queue Length 95th (m)					46.3						23.6	
Internal Link Dist (m)		106.8			271.6			106.7			288.0	
Turn Bay Length (m)												
Base Capacity (vph)					2547						774	
Starvation Cap Reductn					0						0	
Spillback Cap Reductn					0						0	
Storage Cap Reductn					0						0	
Reduced v/c Ratio					0.35						0.21	

Intersection Summary

Cycle Length: 90  
 Actuated Cycle Length: 55.7  
 Natural Cycle: 65  
 Control Type: Semi Act-Uncoord  
 Maximum v/c Ratio: 0.69  
 Intersection Signal Delay: 14.6  
 Intersection Capacity Utilization 53.3%  
 Analysis Period (min) 15

Intersection LOS: B  
 ICU Level of Service A

Splits and Phases: 4: Percy St & Catherine St

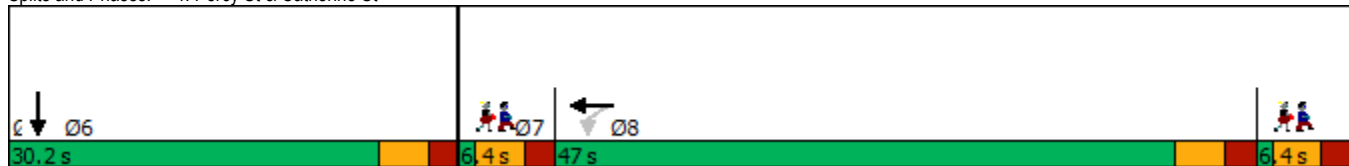

Lanes, Volumes, Timings  
 4: Percy St & Catherine St

05/18/2023

Lane Group	Ø3	Ø7
Lane Configurations		
Traffic Volume (vph)		
Future Volume (vph)		
Satd. Flow (prot)		
Fit Permitted		
Satd. Flow (perm)		
Satd. Flow (RTOR)		
Lane Group Flow (vph)		
Turn Type		
Protected Phases	3	7
Permitted Phases		
Detector Phase		
Switch Phase		
Minimum Initial (s)	1.0	1.0
Minimum Split (s)	6.4	6.4
Total Split (s)	6.4	6.4
Total Split (%)	7%	7%
Yellow Time (s)	3.3	3.3
All-Red Time (s)	2.1	2.1
Lost Time Adjust (s)		
Total Lost Time (s)		
Lead/Lag		Lead
Lead-Lag Optimize?		Yes
Recall Mode	None	None
Act Effct Green (s)		
Actuated g/C Ratio		
v/c Ratio		
Control Delay		
Queue Delay		
Total Delay		
LOS		
Approach Delay		
Approach LOS		
Queue Length 50th (m)		
Queue Length 95th (m)		
Internal Link Dist (m)		
Turn Bay Length (m)		
Base Capacity (vph)		
Starvation Cap Reductn		
Spillback Cap Reductn		
Storage Cap Reductn		
Reduced v/c Ratio		
Intersection Summary		

Lanes, Volumes, Timings  
6: Kent St & Arlington Ave

05/18/2023



Lane Group	EBL	EBT	EBR	WBL	WBT	WBR	NBL	NBT	NBR	SBL	SBT	SBR
Lane Configurations		↕			↕			↕↕↕				
Traffic Volume (vph)	12	61	0	0	18	63	22	1098	93	0	0	0
Future Volume (vph)	12	61	0	0	18	63	22	1098	93	0	0	0
Satd. Flow (prot)	0	1805	0	0	1561	0	0	4825	0	0	0	0
Fit Permitted		0.961						0.999				
Satd. Flow (perm)	0	1739	0	0	1561	0	0	4823	0	0	0	0
Satd. Flow (RTOR)					50			26				
Lane Group Flow (vph)	0	73	0	0	81	0	0	1213	0	0	0	0
Turn Type	Perm	NA			NA		Perm	NA				
Protected Phases		4			8			2				
Permitted Phases	4						2					
Minimum Split (s)	27.3	27.3			27.3		32.3	32.3				
Total Split (s)	31.0	31.0			31.0		44.0	44.0				
Total Split (%)	41.3%	41.3%			41.3%		58.7%	58.7%				
Yellow Time (s)	3.3	3.3			3.3		3.3	3.3				
All-Red Time (s)	2.0	2.0			2.0		2.0	2.0				
Lost Time Adjust (s)		0.0			0.0			0.0				
Total Lost Time (s)		5.3			5.3			5.3				
Lead/Lag												
Lead-Lag Optimize?												
Act Effct Green (s)		25.7			25.7			38.7				
Actuated g/C Ratio		0.34			0.34			0.52				
v/c Ratio		0.12			0.14			0.49				
Control Delay		26.9			9.3			10.5				
Queue Delay		0.0			0.0			49.8				
Total Delay		26.9			9.3			60.3				
LOS		C			A			E				
Approach Delay		26.9			9.3			60.3				
Approach LOS		C			A			E				
Queue Length 50th (m)		9.1			1.3			48.5				
Queue Length 95th (m)		m18.8			m5.6			68.8				
Internal Link Dist (m)		164.0			143.1			53.0			216.0	
Turn Bay Length (m)												
Base Capacity (vph)		595			567			2501				
Starvation Cap Reductn		0			0			1423				
Spillback Cap Reductn		0			0			0				
Storage Cap Reductn		0			0			0				
Reduced v/c Ratio		0.12			0.14			1.13				

**Intersection Summary**  
 Cycle Length: 75  
 Actuated Cycle Length: 75  
 Offset: 50 (67%), Referenced to phase 2:NBT, Start of Green  
 Natural Cycle: 60  
 Control Type: Pretimed  
 Maximum v/c Ratio: 0.49  
 Intersection Signal Delay: 55.5  
 Intersection Capacity Utilization 54.7%  
 Analysis Period (min) 15  
 Intersection LOS: E  
 ICU Level of Service A  
 m Volume for 95th percentile queue is metered by upstream signal.

Splits and Phases: 6: Kent St & Arlington Ave



Lanes, Volumes, Timings  
7: Lyon St N & Gladstone Ave

05/18/2023



Lane Group	EBL	EBT	EBR	WBL	WBT	WBR	NBL	NBT	NBR	SBL	SBT	SBR
Lane Configurations		↑	↗	↖	↑						↕	
Traffic Volume (vph)	0	247	52	28	314	0	0	0	0	86	535	138
Future Volume (vph)	0	247	52	28	314	0	0	0	0	86	535	138
Satd. Flow (prot)	0	1784	1547	1729	1784	0	0	0	0	0	3261	0
Fit Permitted				0.574							0.994	
Satd. Flow (perm)	0	1784	1407	997	1784	0	0	0	0	0	3248	0
Satd. Flow (RTOR)			52								45	
Lane Group Flow (vph)	0	247	52	28	314	0	0	0	0	0	759	0
Turn Type		NA	Perm	Perm	NA					Perm	NA	
Protected Phases		4			8							6
Permitted Phases			4	8						6		
Minimum Split (s)		17.2	17.2	17.2	17.2					22.6	22.6	
Total Split (s)		37.0	37.0	37.0	37.0					38.0	38.0	
Total Split (%)		49.3%	49.3%	49.3%	49.3%					50.7%	50.7%	
Yellow Time (s)		3.3	3.3	3.3	3.3					3.3	3.3	
All-Red Time (s)		1.9	1.9	1.9	1.9					2.3	2.3	
Lost Time Adjust (s)		0.0	0.0	0.0	0.0						0.0	
Total Lost Time (s)		5.2	5.2	5.2	5.2						5.6	
Lead/Lag												
Lead-Lag Optimize?												
Act Effct Green (s)		31.8	31.8	31.8	31.8						32.4	
Actuated g/C Ratio		0.42	0.42	0.42	0.42						0.43	
v/c Ratio		0.33	0.08	0.07	0.42						0.53	
Control Delay		16.0	4.5	8.4	12.7						16.4	
Queue Delay		0.0	0.0	0.0	0.0						0.0	
Total Delay		16.0	4.5	8.4	12.7						16.4	
LOS		B	A	A	B						B	
Approach Delay		14.0			12.3						16.4	
Approach LOS		B			B						B	
Queue Length 50th (m)		22.6	0.0	1.5	35.6						37.5	
Queue Length 95th (m)		38.4	5.7	m3.3	55.1						52.8	
Internal Link Dist (m)		254.8			165.0			215.6			214.3	
Turn Bay Length (m)				25.0								
Base Capacity (vph)		756	626	422	756						1428	
Starvation Cap Reductn		0	0	0	0						0	
Spillback Cap Reductn		0	0	0	0						0	
Storage Cap Reductn		0	0	0	0						0	
Reduced v/c Ratio		0.33	0.08	0.07	0.42						0.53	

**Intersection Summary**  
 Cycle Length: 75  
 Actuated Cycle Length: 75  
 Offset: 45 (60%), Referenced to phase 4:EBT and 8:WBTL, Start of Green  
 Natural Cycle: 40  
 Control Type: Pretimed  
 Maximum v/c Ratio: 0.53  
 Intersection Signal Delay: 14.9  
 Intersection Capacity Utilization 68.0%  
 Analysis Period (min) 15  
 Intersection LOS: B  
 ICU Level of Service C  
 m Volume for 95th percentile queue is metered by upstream signal.

Splits and Phases: 7: Lyon St N & Gladstone Ave

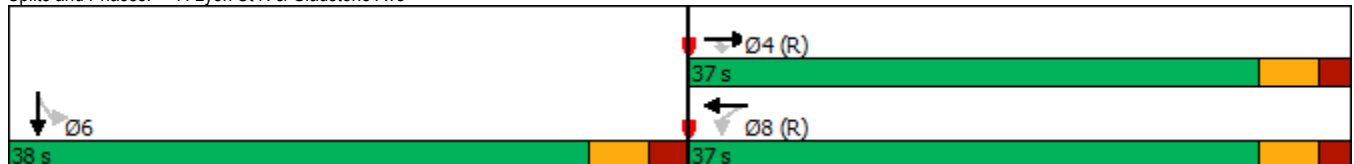

Lanes, Volumes, Timings  
8: Kent St & Gladstone Ave

05/18/2023



Lane Group	EBL	EBT	EBR	WBL	WBT	WBR	NBL	NBT	NBR	SBL	SBT	SBR
Lane Configurations												
Traffic Volume (vph)	75	450	0	0	324	75	67	939	131	0	0	0
Future Volume (vph)	75	450	0	0	324	75	67	939	131	0	0	0
Satd. Flow (prot)	1729	1767	0	0	1720	0	1729	4627	0	0	0	0
Fit Permitted	0.453						0.950					
Satd. Flow (perm)	800	1767	0	0	1720	0	1522	4627	0	0	0	0
Satd. Flow (RTOR)					21			37				
Lane Group Flow (vph)	75	450	0	0	399	0	67	1070	0	0	0	0
Turn Type	Perm	NA			NA		Perm	NA				
Protected Phases		4			8			2				
Permitted Phases	4						2					
Minimum Split (s)	21.4	21.4			21.4		20.4	20.4				
Total Split (s)	43.0	43.0			43.0		32.0	32.0				
Total Split (%)	57.3%	57.3%			57.3%		42.7%	42.7%				
Yellow Time (s)	3.3	3.3			3.3		3.3	3.3				
All-Red Time (s)	2.1	2.1			2.1		2.1	2.1				
Lost Time Adjust (s)	0.0	0.0			0.0		0.0	0.0				
Total Lost Time (s)	5.4	5.4			5.4		5.4	5.4				
Lead/Lag												
Lead-Lag Optimize?												
Act Effct Green (s)	37.6	37.6			37.6		26.6	26.6				
Actuated g/C Ratio	0.50	0.50			0.50		0.35	0.35				
v/c Ratio	0.19	0.51			0.46		0.12	0.64				
Control Delay	18.1	21.5			13.5		8.6	9.7				
Queue Delay	0.0	0.0			0.0		0.0	0.0				
Total Delay	18.1	21.5			13.5		8.6	9.7				
LOS	B	C			B		A	A				
Approach Delay		21.0			13.5			9.6				
Approach LOS		C			B			A				
Queue Length 50th (m)	6.6	49.4			32.3		3.0	16.4				
Queue Length 95th (m)	m16.0	78.6			53.2		m4.7	15.0				
Internal Link Dist (m)		165.0			168.8			216.0			203.6	
Turn Bay Length (m)	30.0						40.0					
Base Capacity (vph)	401	885			872		539	1664				
Starvation Cap Reductn	0	0			0		0	0				
Spillback Cap Reductn	0	0			0		0	0				
Storage Cap Reductn	0	0			0		0	0				
Reduced v/c Ratio	0.19	0.51			0.46		0.12	0.64				

Intersection Summary

Cycle Length: 75  
 Actuated Cycle Length: 75  
 Offset: 23 (31%), Referenced to phase 4:EBTL and 8:WBT, Start of Green  
 Natural Cycle: 45  
 Control Type: Pretimed  
 Maximum v/c Ratio: 0.64  
 Intersection Signal Delay: 13.3  
 Intersection Capacity Utilization 68.0%  
 Analysis Period (min) 15  
 m Volume for 95th percentile queue is metered by upstream signal.

Intersection LOS: B  
 ICU Level of Service C

Splits and Phases: 8: Kent St & Gladstone Ave

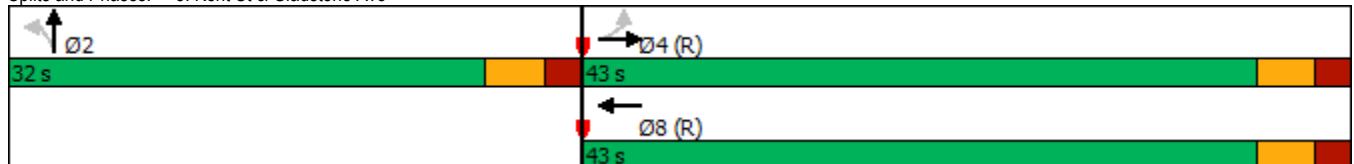



Lanes, Volumes, Timings  
 9: Bank St & Chamberlain Ave/Isabella St

05/18/2023



Lane Group	EBL	EBT	EBR	WBL	WBT	WBR	NBL	NBT	NBR	SBL	SBT	SBR
Lane Configurations		↕↕	↗					↕↕			↕↕	
Traffic Volume (vph)	55	629	120	0	0	0	0	450	93	180	725	0
Future Volume (vph)	55	629	120	0	0	0	0	450	93	180	725	0
Satd. Flow (prot)	0	3346	1547	0	0	0	0	3131	0	0	3324	0
Fit Permitted		0.996									0.722	
Satd. Flow (perm)	0	3343	1402	0	0	0	0	3131	0	0	2373	0
Satd. Flow (RTOR)			134									
Lane Group Flow (vph)	0	684	120	0	0	0	0	543	0	0	905	0
Turn Type	Perm	NA	Perm					NA		pm+pt	NA	
Protected Phases		4						2		5	6	
Permitted Phases	4		4							6		
Detector Phase	4	4	4					2		5	6	
Switch Phase												
Minimum Initial (s)	10.0	10.0	10.0					10.0		5.0	10.0	
Minimum Split (s)	26.2	26.2	26.2					23.1		11.1	23.1	
Total Split (s)	27.0	27.0	27.0					36.9		11.1	48.0	
Total Split (%)	36.0%	36.0%	36.0%					49.2%		14.8%	64.0%	
Yellow Time (s)	3.3	3.3	3.3					3.0		3.0	3.0	
All-Red Time (s)	2.9	2.9	2.9					3.1		3.1	3.1	
Lost Time Adjust (s)		0.0	0.0					0.0			0.0	
Total Lost Time (s)		6.2	6.2					6.1			6.1	
Lead/Lag												
Lead-Lag Optimize?												
Recall Mode	None	None	None					C-Max		None	C-Max	
Act Effct Green (s)		19.5	19.5					43.2			43.2	
Actuated g/C Ratio		0.26	0.26					0.58			0.58	
v/c Ratio		0.79	0.26					0.30			0.66	
Control Delay		32.9	5.1					9.0			12.8	
Queue Delay		0.0	0.0					0.0			1.4	
Total Delay		32.9	5.1					9.0			14.3	
LOS		C	A					A			B	
Approach Delay		28.7						9.0			14.3	
Approach LOS		C						A			B	
Queue Length 50th (m)		46.1	0.0					19.8			71.9	
Queue Length 95th (m)		64.3	9.4					28.5			m90.9	
Internal Link Dist (m)		296.0			233.4			215.6			90.2	
Turn Bay Length (m)			40.0									
Base Capacity (vph)		927	485					1801			1365	
Starvation Cap Reductn		0	0					0			265	
Spillback Cap Reductn		0	0					0			0	
Storage Cap Reductn		0	0					0			0	
Reduced v/c Ratio		0.74	0.25					0.30			0.82	

**Intersection Summary**  
 Cycle Length: 75  
 Actuated Cycle Length: 75  
 Offset: 60 (80%), Referenced to phase 2:NBT and 6:SBTL, Start of Green  
 Natural Cycle: 65  
 Control Type: Actuated-Coordinated  
 Maximum v/c Ratio: 0.79  
 Intersection Signal Delay: 18.2  
 Intersection Capacity Utilization 82.9%  
 Analysis Period (min) 15  
 Intersection LOS: B  
 ICU Level of Service E  
 m Volume for 95th percentile queue is metered by upstream signal.

Splits and Phases: 9: Bank St & Chamberlain Ave/Isabella St

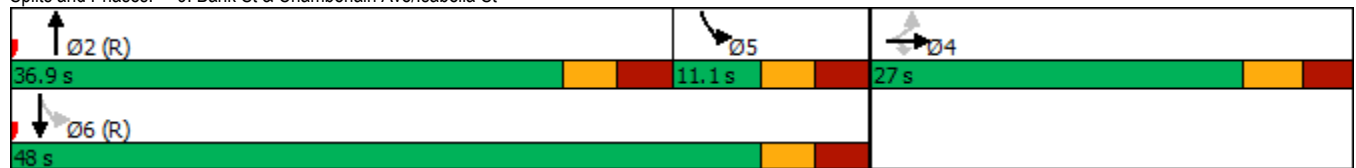

Lanes, Volumes, Timings  
13: Bronson Ave & Catherine St

05/18/2023



Lane Group	EBL	EBT	EBR	WBL	WBT	WBR	NBL	NBT	NBR	SBL	SBT	SBR
Lane Configurations				↖ ↗	↖ ↗		↖ ↗	↖ ↗			↖ ↗	
Traffic Volume (vph)	0	0	0	735	610	288	311	812	0	0	853	176
Future Volume (vph)	0	0	0	735	610	288	311	812	0	0	853	176
Satd. Flow (prot)	0	0	0	1458	4279	0	1679	3390	0	0	3260	0
Fit Permitted				0.950	0.987		0.099					
Satd. Flow (perm)	0	0	0	1458	4279	0	175	3390	0	0	3260	0
Satd. Flow (RTOR)					80						26	
Lane Group Flow (vph)	0	0	0	412	1221	0	311	812	0	0	1029	0
Turn Type				Perm	NA		pm+pt	NA			NA	
Protected Phases					8		5	2				6
Permitted Phases				8			2					
Minimum Split (s)				28.3	28.3		11.2	23.8			23.8	
Total Split (s)				37.0	37.0		22.0	63.0			41.0	
Total Split (%)				37.0%	37.0%		22.0%	63.0%			41.0%	
Yellow Time (s)				3.3	3.3		3.3	3.3			3.3	
All-Red Time (s)				3.0	3.0		2.9	3.5			3.5	
Lost Time Adjust (s)				0.0	0.0		0.0	0.0			0.0	
Total Lost Time (s)				6.3	6.3		6.2	6.8			6.8	
Lead/Lag							Lead				Lag	
Lead-Lag Optimize?							Yes				Yes	
Act Effct Green (s)				30.7	30.7		56.8	56.2			34.2	
Actuated g/C Ratio				0.31	0.31		0.57	0.56			0.34	
v/c Ratio				0.92	0.89		0.92	0.43			0.91	
Control Delay				61.9	40.5		59.4	13.5			43.5	
Queue Delay				0.0	0.0		0.0	0.0			0.0	
Total Delay				61.9	40.5		59.4	13.5			43.5	
LOS				E	D		E	B			D	
Approach Delay					45.9			26.2			43.5	
Approach LOS					D			C			D	
Queue Length 50th (m)				89.3	82.1		44.4	44.8			97.0	
Queue Length 95th (m)				#154.3	#109.4		#94.6	58.3			#136.1	
Internal Link Dist (m)		141.5			120.8			240.1			287.4	
Turn Bay Length (m)				80.0			45.0					
Base Capacity (vph)				447	1369		337	1905			1132	
Starvation Cap Reductn				0	0		0	0			0	
Spillback Cap Reductn				0	0		0	0			0	
Storage Cap Reductn				0	0		0	0			0	
Reduced v/c Ratio				0.92	0.89		0.92	0.43			0.91	

**Intersection Summary**  
 Cycle Length: 100  
 Actuated Cycle Length: 100  
 Offset: 60 (60%), Referenced to phase 2:NBT and 6:SBT, Start of Green  
 Natural Cycle: 90  
 Control Type: Pretimed  
 Maximum v/c Ratio: 0.92  
 Intersection Signal Delay: 39.4      Intersection LOS: D  
 Intersection Capacity Utilization 92.3%      ICU Level of Service F  
 Analysis Period (min) 15  
 # 95th percentile volume exceeds capacity, queue may be longer.  
 Queue shown is maximum after two cycles.

Splits and Phases: 13: Bronson Ave & Catherine St



Intersection												
Int Delay, s/veh	2.1											
Movement	EBL	EBT	EBR	WBL	WBT	WBR	NBL	NBT	NBR	SBL	SBT	SBR
Lane Configurations		↕			↕						↕↕	
Traffic Vol, veh/h	0	19	2	8	37	0	0	0	0	43	601	13
Future Vol, veh/h	0	19	2	8	37	0	0	0	0	43	601	13
Conflicting Peds, #/hr	20	0	8	8	0	20	19	0	3	3	0	19
Sign Control	Stop	Stop	Stop	Stop	Stop	Stop	Free	Free	Free	Free	Free	Free
RT Channelized	-	-	None	-	-	None	-	-	None	-	-	None
Storage Length	-	-	-	-	-	-	-	-	-	-	-	-
Veh in Median Storage, #	-	0	-	-	0	-	-	-	-	-	0	-
Grade, %	-	0	-	-	0	-	-	0	-	-	0	-
Peak Hour Factor	100	100	100	100	100	100	100	100	100	100	100	100
Heavy Vehicles, %	0	5	0	0	5	0	0	0	0	0	0	0
Mvmt Flow	0	19	2	8	37	0	0	0	0	43	601	13

Major/Minor	Minor2			Minor1			Major2			
Conflicting Flow All	-	716	334	407	722	-	-	3	0	0
Stage 1	-	713	-	3	3	-	-	-	-	-
Stage 2	-	3	-	404	719	-	-	-	-	-
Critical Hdwy	-	6.6	6.9	7.5	6.6	-	-	4.1	-	-
Critical Hdwy Stg 1	-	5.6	-	-	-	-	-	-	-	-
Critical Hdwy Stg 2	-	-	-	6.5	5.6	-	-	-	-	-
Follow-up Hdwy	-	4.05	3.3	3.5	4.05	-	-	2.2	-	-
Pot Cap-1 Maneuver	0	348	668	533	346	0	-	1632	-	-
Stage 1	0	426	-	-	0	-	-	-	-	-
Stage 2	0	-	-	600	424	0	-	-	-	-
Platoon blocked, %	-	-	-	-	-	-	-	-	-	-
Mov Cap-1 Maneuver	-	327	656	491	325	-	-	1627	-	-
Mov Cap-2 Maneuver	-	327	-	491	325	-	-	-	-	-
Stage 1	-	402	-	-	-	-	-	-	-	-
Stage 2	-	-	-	547	400	-	-	-	-	-

Approach	EB			WB			SB		
HCM Control Delay, s	16.2			17			0.6		
HCM LOS	C			C					

Minor Lane/Major Mvmt	EBLn1	WBLn1	SBL	SBT	SBR
Capacity (veh/h)	343	346	1627	-	-
HCM Lane V/C Ratio	0.061	0.13	0.026	-	-
HCM Control Delay (s)	16.2	17	7.3	0.1	-
HCM Lane LOS	C	C	A	A	-
HCM 95th %tile Q(veh)	0.2	0.4	0.1	-	-

Intersection						
Int Delay, s/veh	2.2					
Movement	EBL	EBR	NBL	NBT	SBT	SBR
Lane Configurations	↔			↕↕	↕↕	
Traffic Vol, veh/h	20	107	58	428	719	27
Future Vol, veh/h	20	107	58	428	719	27
Conflicting Peds, #/hr	0	0	42	0	0	42
Sign Control	Stop	Stop	Free	Free	Free	Free
RT Channelized	-	None	-	None	-	None
Storage Length	0	-	-	-	-	-
Veh in Median Storage, #	0	-	-	0	0	-
Grade, %	0	-	-	0	0	-
Peak Hour Factor	100	100	100	100	100	100
Heavy Vehicles, %	0	1	0	5	3	0
Mvmt Flow	20	107	58	428	719	27

Major/Minor	Minor2	Major1	Major2			
Conflicting Flow All	1105	415	788	0	-	0
Stage 1	775	-	-	-	-	-
Stage 2	330	-	-	-	-	-
Critical Hdwy	6.8	6.92	4.1	-	-	-
Critical Hdwy Stg 1	5.8	-	-	-	-	-
Critical Hdwy Stg 2	5.8	-	-	-	-	-
Follow-up Hdwy	3.5	3.31	2.2	-	-	-
Pot Cap-1 Maneuver	208	589	840	-	-	-
Stage 1	420	-	-	-	-	-
Stage 2	707	-	-	-	-	-
Platoon blocked, %				-	-	-
Mov Cap-1 Maneuver	174	566	807	-	-	-
Mov Cap-2 Maneuver	174	-	-	-	-	-
Stage 1	366	-	-	-	-	-
Stage 2	679	-	-	-	-	-

Approach	EB	NB	SB
HCM Control Delay, s	17.3	1.5	0
HCM LOS	C		

Minor Lane/Major Mvmt	NBL	NBT	EBLn1	SBT	SBR
Capacity (veh/h)	807	-	418	-	-
HCM Lane V/C Ratio	0.072	-	0.304	-	-
HCM Control Delay (s)	9.8	0.4	17.3	-	-
HCM Lane LOS	A	A	C	-	-
HCM 95th %tile Q(veh)	0.2	-	1.3	-	-

**Total Projected 2026**

Lanes, Volumes, Timings

1: Hwy 417 WB On Ramp/Lyon St N & Catherine St

02/28/2024



Lane Group	WBT	SBT	SBR
Lane Configurations	↕↕↕	↕	↗
Traffic Volume (vph)	260	262	125
Future Volume (vph)	260	262	125
Lane Group Flow (vph)	512	262	125
Turn Type	NA	NA	Perm
Protected Phases	8	6	
Permitted Phases			6
Minimum Split (s)	26.2	28.3	28.3
Total Split (s)	35.0	40.0	40.0
Total Split (%)	46.7%	53.3%	53.3%
Yellow Time (s)	3.3	3.3	3.3
All-Red Time (s)	1.9	2.0	2.0
Lost Time Adjust (s)	0.0	0.0	0.0
Total Lost Time (s)	5.2	5.3	5.3
Lead/Lag			
Lead-Lag Optimize?			
Act Effct Green (s)	29.8	34.7	34.7
Actuated g/C Ratio	0.40	0.46	0.46
v/c Ratio	0.26	0.32	0.16
Control Delay	1.0	22.5	11.4
Queue Delay	0.0	0.0	0.0
Total Delay	1.0	22.5	11.4
LOS	A	C	B
Approach Delay	1.0	18.9	
Approach LOS	A	B	
Queue Length 50th (m)	0.3	34.8	1.9
Queue Length 95th (m)	m1.2	54.1	19.3
Internal Link Dist (m)	109.2	52.8	
Turn Bay Length (m)			
Base Capacity (vph)	1956	825	769
Starvation Cap Reductn	0	0	0
Spillback Cap Reductn	0	0	0
Storage Cap Reductn	0	0	0
Reduced v/c Ratio	0.26	0.32	0.16

Intersection Summary

Cycle Length: 75  
 Actuated Cycle Length: 75  
 Offset: 24 (32%), Referenced to phase 8:WBTL, Start of Green  
 Natural Cycle: 55  
 Control Type: Pretimed  
 Maximum v/c Ratio: 0.32  
 Intersection Signal Delay: 8.7  
 Intersection LOS: A  
 Intersection Capacity Utilization 49.3%  
 ICU Level of Service A  
 Analysis Period (min) 15  
 m Volume for 95th percentile queue is metered by upstream signal.

Splits and Phases: 1: Hwy 417 WB On Ramp/Lyon St N & Catherine St

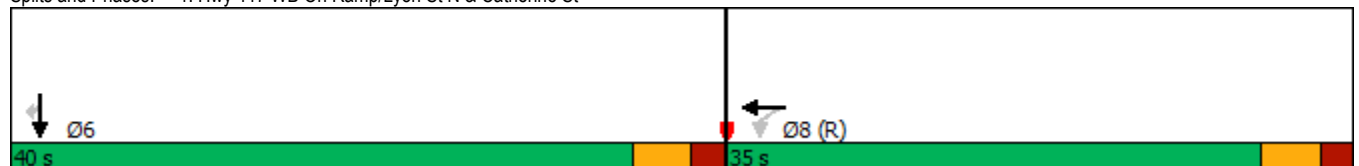

Lanes, Volumes, Timings

2: Hwy 417 EB Off Ramp/Chamberlain Ave/Kent St & Catherine St

02/28/2024



Lane Group	WBT	WBR	NBT	Ø9
Lane Configurations	↕↕	↗	↕↕↕	
Traffic Volume (vph)	426	549	1356	
Future Volume (vph)	426	549	1356	
Lane Group Flow (vph)	673	302	1420	
Turn Type	NA	Perm	NA	
Protected Phases	8		2	9
Permitted Phases		8		
Minimum Split (s)	22.8	22.8	22.5	5.0
Total Split (s)	36.0	36.0	34.0	5.0
Total Split (%)	48.0%	48.0%	45.3%	7%
Yellow Time (s)	3.3	3.3	3.3	2.0
All-Red Time (s)	2.5	2.5	2.5	0.0
Lost Time Adjust (s)	0.0	0.0	0.0	
Total Lost Time (s)	5.8	5.8	5.8	
Lead/Lag				
Lead-Lag Optimize?				
Act Effct Green (s)	30.2	30.2	28.2	
Actuated g/C Ratio	0.40	0.40	0.38	
v/c Ratio	0.57	0.58	0.75	
Control Delay	17.4	19.5	22.4	
Queue Delay	0.0	0.0	3.9	
Total Delay	17.4	19.5	26.2	
LOS	B	B	C	
Approach Delay	18.0		26.3	
Approach LOS	B		C	
Queue Length 50th (m)	31.8	28.5	59.5	
Queue Length 95th (m)	m46.4	m43.0	75.6	
Internal Link Dist (m)	131.7		67.4	
Turn Bay Length (m)				
Base Capacity (vph)	1181	524	1888	
Starvation Cap Reductn	0	0	0	
Spillback Cap Reductn	0	0	377	
Storage Cap Reductn	0	0	0	
Reduced v/c Ratio	0.57	0.58	0.94	

Intersection Summary

Cycle Length: 75  
 Actuated Cycle Length: 75  
 Offset: 12 (16%), Referenced to phase 8:WBT, Start of Green  
 Natural Cycle: 55  
 Control Type: Pretimed  
 Maximum v/c Ratio: 0.75  
 Intersection Signal Delay: 22.9  
 Intersection LOS: C  
 Intersection Capacity Utilization 66.0%  
 ICU Level of Service C  
 Analysis Period (min) 15  
 m Volume for 95th percentile queue is metered by upstream signal.

Splits and Phases: 2: Hwy 417 EB Off Ramp/Chamberlain Ave/Kent St & Catherine St

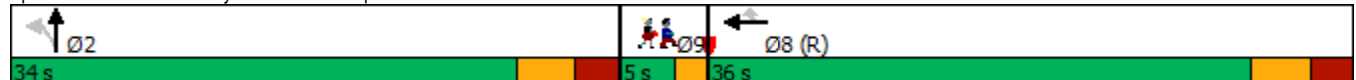

Lanes, Volumes, Timings  
3: Bank St & Catherine St

02/28/2024



Lane Group	WBT	NBL	NBT	SBT	Ø1	Ø5	Ø7
Lane Configurations							
Traffic Volume (vph)	608	275	578	376			
Future Volume (vph)	608	275	578	376			
Lane Group Flow (vph)	986	0	853	520			
Turn Type	NA	pm+pt	NA	NA			
Protected Phases	8	9	2	6	1	5	7
Permitted Phases		2					
Minimum Split (s)	18.6	10.4	16.4	16.4	5.0	5.0	5.0
Total Split (s)	24.7	10.4	40.3	29.9	5.0	5.0	5.0
Total Split (%)	32.9%	13.9%	53.7%	39.9%	7%	7%	7%
Yellow Time (s)	3.3	3.3	3.3	3.3	2.0	2.0	2.0
All-Red Time (s)	2.3	2.1	2.1	2.1	0.0	0.0	0.0
Lost Time Adjust (s)	0.0		0.0	0.0			
Total Lost Time (s)	5.6		5.4	5.4			
Lead/Lag	Lag		Lag	Lag	Lead	Lead	Lead
Lead-Lag Optimize?	Yes		Yes	Yes	Yes	Yes	Yes
Act Effct Green (s)	19.1		34.9	24.5			
Actuated g/C Ratio	0.25		0.47	0.33			
v/c Ratio	0.84		0.84	0.53			
Control Delay	32.2		21.6	19.5			
Queue Delay	0.0		0.0	0.0			
Total Delay	32.2		21.6	19.5			
LOS	C		C	B			
Approach Delay	32.2		21.6	19.5			
Approach LOS	C		C	B			
Queue Length 50th (m)	44.6		27.3	26.0			
Queue Length 95th (m)	#64.9		#45.9	40.2			
Internal Link Dist (m)	201.7		90.2	52.9			
Turn Bay Length (m)							
Base Capacity (vph)	1175		1018	984			
Starvation Cap Reductn	0		0	0			
Spillback Cap Reductn	0		0	0			
Storage Cap Reductn	0		0	0			
Reduced v/c Ratio	0.84		0.84	0.53			

Intersection Summary

Cycle Length: 75  
 Actuated Cycle Length: 75  
 Offset: 50 (67%), Referenced to phase 2:NBT and 6:SBT, Start of Green  
 Natural Cycle: 70  
 Control Type: Pretimed  
 Maximum v/c Ratio: 0.84  
 Intersection Signal Delay: 25.6  
 Intersection Capacity Utilization 80.7%  
 Analysis Period (min) 15  
 # 95th percentile volume exceeds capacity, queue may be longer.  
 Queue shown is maximum after two cycles.

Intersection LOS: C  
 ICU Level of Service D

Splits and Phases: 3: Bank St & Catherine St

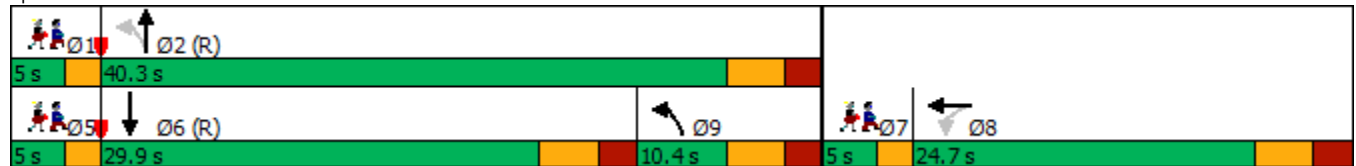



Lanes, Volumes, Timings  
4: Percy St & Catherine St

02/28/2024

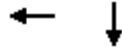

Lane Group	WBT	SBT	Ø3	Ø7
Lane Configurations				
Traffic Volume (vph)	260	129		
Future Volume (vph)	260	129		
Lane Group Flow (vph)	347	186		
Turn Type	NA	NA		
Protected Phases	8	6	3	7
Permitted Phases				
Detector Phase	8	6		
Switch Phase				
Minimum Initial (s)	10.0	10.0	1.0	1.0
Minimum Split (s)	26.5	23.4	6.4	6.4
Total Split (s)	34.0	24.0	16.0	16.0
Total Split (%)	37.8%	26.7%	18%	18%
Yellow Time (s)	3.3	3.3	3.3	3.3
All-Red Time (s)	2.2	2.1	2.1	2.1
Lost Time Adjust (s)	0.0	0.0		
Total Lost Time (s)	5.5	5.4		
Lead/Lag	Lag			Lead
Lead-Lag Optimize?	Yes			Yes
Recall Mode	None	Max	None	None
Act Effct Green (s)	11.9	18.8		
Actuated g/C Ratio	0.29	0.45		
v/c Ratio	0.25	0.25		
Control Delay	6.4	9.4		
Queue Delay	0.0	0.0		
Total Delay	6.4	9.4		
LOS	A	A		
Approach Delay	6.4	9.4		
Approach LOS	A	A		
Queue Length 50th (m)	3.5	6.6		
Queue Length 95th (m)	7.6	23.3		
Internal Link Dist (m)	271.6	288.0		
Turn Bay Length (m)				
Base Capacity (vph)	3171	740		
Starvation Cap Reductn	0	0		
Spillback Cap Reductn	0	0		
Storage Cap Reductn	0	0		
Reduced v/c Ratio	0.11	0.25		

Intersection Summary

Cycle Length: 90	
Actuated Cycle Length: 41.7	
Natural Cycle: 65	
Control Type: Semi Act-Uncoord	
Maximum v/c Ratio: 0.25	
Intersection Signal Delay: 7.4	Intersection LOS: A
Intersection Capacity Utilization 38.4%	ICU Level of Service A
Analysis Period (min) 15	

Splits and Phases: 4: Percy St & Catherine St

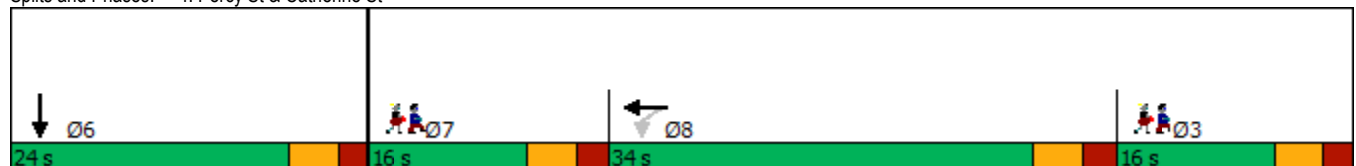

Lanes, Volumes, Timings  
 5: Lyon St N & Arlington Ave

02/28/2024

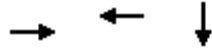

Lane Group	EBT	WBT	SBT
Lane Configurations			
Traffic Volume (vph)	18	12	329
Future Volume (vph)	18	12	329
Lane Group Flow (vph)	18	23	386
Sign Control	Stop	Stop	Free
<b>Intersection Summary</b>			
Control Type: Unsignalized			
Intersection Capacity Utilization 32.9%		ICU Level of Service A	
Analysis Period (min) 15			

Intersection												
Int Delay, s/veh	2.1											
Movement	EBL	EBT	EBR	WBL	WBT	WBR	NBL	NBT	NBR	SBL	SBT	SBR
Lane Configurations		↕			↕						↕↕	
Traffic Vol, veh/h	0	18	0	11	12	0	0	0	0	48	329	9
Future Vol, veh/h	0	18	0	11	12	0	0	0	0	48	329	9
Conflicting Peds, #/hr	32	0	15	15	0	32	9	0	10	10	0	9
Sign Control	Stop	Stop	Stop	Stop	Stop	Stop	Free	Free	Free	Free	Free	Free
RT Channelized	-	-	None	-	-	None	-	-	None	-	-	None
Storage Length	-	-	-	-	-	-	-	-	-	-	-	-
Veh in Median Storage, #	-	0	-	-	0	-	-	-	-	-	0	-
Grade, %	-	0	-	-	0	-	-	0	-	-	0	-
Peak Hour Factor	100	100	100	100	100	100	100	100	100	100	100	100
Heavy Vehicles, %	0	6	0	9	0	0	0	0	0	5	1	11
Mvmt Flow	0	18	0	11	12	0	0	0	0	48	329	9

Major/Minor	Minor2		Minor1			Major2			
Conflicting Flow All	-	449	193	295	453	-	10	0	0
Stage 1	-	439	-	10	10	-	-	-	-
Stage 2	-	10	-	285	443	-	-	-	-
Critical Hdwy	-	6.62	6.9	7.68	6.5	-	4.2	-	-
Critical Hdwy Stg 1	-	5.62	-	-	-	-	-	-	-
Critical Hdwy Stg 2	-	-	-	6.68	5.5	-	-	-	-
Follow-up Hdwy	-	4.06	3.3	3.59	4	-	2.25	-	-
Pot Cap-1 Maneuver	0	495	822	617	506	0	1586	-	-
Stage 1	0	567	-	-	0	-	-	-	-
Stage 2	0	-	-	679	579	0	-	-	-
Platoon blocked, %	-	-	-	-	-	-	-	-	-
Mov Cap-1 Maneuver	-	468	815	576	479	-	1571	-	-
Mov Cap-2 Maneuver	-	468	-	576	479	-	-	-	-
Stage 1	-	541	-	-	-	-	-	-	-
Stage 2	-	-	-	631	552	-	-	-	-

Approach	EB		WB			SB		
HCM Control Delay, s	13		12.2			1		
HCM LOS	B		B					

Minor Lane/Major Mvmt	EBLn1	WBLn1	SBL	SBT	SBR
Capacity (veh/h)	468	521	1571	-	-
HCM Lane V/C Ratio	0.038	0.044	0.031	-	-
HCM Control Delay (s)	13	12.2	7.4	0.1	-
HCM Lane LOS	B	B	A	A	-
HCM 95th %tile Q(veh)	0.1	0.1	0.1	-	-

Lanes, Volumes, Timings  
6: Kent St & Arlington Ave

02/28/2024



Lane Group	EBL	EBT	WBT	NBT
Lane Configurations		↕	↕	↕↕↕
Traffic Volume (vph)	19	52	11	1741
Future Volume (vph)	19	52	11	1741
Lane Group Flow (vph)	0	71	104	1887
Turn Type	Perm	NA	NA	NA
Protected Phases		4	8	2
Permitted Phases	4			
Minimum Split (s)	27.3	27.3	27.3	32.3
Total Split (s)	28.0	28.0	28.0	47.0
Total Split (%)	37.3%	37.3%	37.3%	62.7%
Yellow Time (s)	3.3	3.3	3.3	3.3
All-Red Time (s)	2.0	2.0	2.0	2.0
Lost Time Adjust (s)		0.0	0.0	0.0
Total Lost Time (s)		5.3	5.3	5.3
Lead/Lag				
Lead-Lag Optimize?				
Act Effct Green (s)		22.7	22.7	41.7
Actuated g/C Ratio		0.30	0.30	0.56
v/c Ratio		0.14	0.22	0.71
Control Delay		32.6	16.1	11.5
Queue Delay		0.0	0.0	3.4
Total Delay		32.6	16.1	15.0
LOS		C	B	B
Approach Delay		32.6	16.1	15.0
Approach LOS		C	B	B
Queue Length 50th (m)		9.5	8.3	32.8
Queue Length 95th (m)		20.6	m12.8	52.3
Internal Link Dist (m)		164.0	143.1	53.0
Turn Bay Length (m)				
Base Capacity (vph)		491	475	2676
Starvation Cap Reductn		0	0	676
Spillback Cap Reductn		0	0	0
Storage Cap Reductn		0	0	0
Reduced v/c Ratio		0.14	0.22	0.94

Intersection Summary

Cycle Length: 75  
 Actuated Cycle Length: 75  
 Offset: 50 (67%), Referenced to phase 2:NBTL, Start of Green  
 Natural Cycle: 60  
 Control Type: Pretimed  
 Maximum v/c Ratio: 0.71  
 Intersection Signal Delay: 15.6  
 Intersection LOS: B  
 Intersection Capacity Utilization 68.5%  
 ICU Level of Service C  
 Analysis Period (min) 15  
 m Volume for 95th percentile queue is metered by upstream signal.

Splits and Phases: 6: Kent St & Arlington Ave

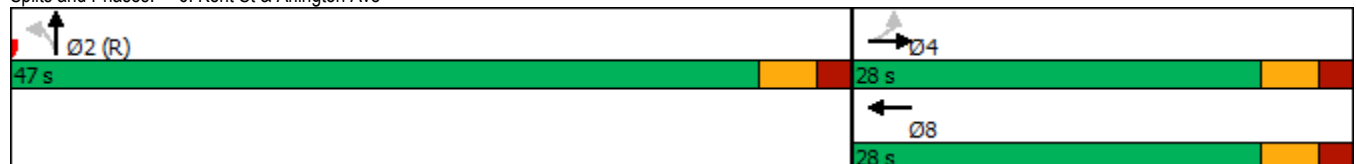

Lanes, Volumes, Timings  
7: Lyon St N & Gladstone Ave

02/28/2024



Lane Group	EBT	EBR	WBL	WBT	SBT
Lane Configurations	↑	↑	↑	↑	↑↓
Traffic Volume (vph)	184	24	15	143	331
Future Volume (vph)	184	24	15	143	331
Lane Group Flow (vph)	184	24	15	143	518
Turn Type	NA	Perm	Perm	NA	NA
Protected Phases	4			8	6
Permitted Phases		4	8		
Minimum Split (s)	17.2	17.2	17.2	17.2	22.6
Total Split (s)	36.0	36.0	36.0	36.0	39.0
Total Split (%)	48.0%	48.0%	48.0%	48.0%	52.0%
Yellow Time (s)	3.3	3.3	3.3	3.3	3.3
All-Red Time (s)	1.9	1.9	1.9	1.9	2.3
Lost Time Adjust (s)	0.0	0.0	0.0	0.0	0.0
Total Lost Time (s)	5.2	5.2	5.2	5.2	5.6
Lead/Lag					
Lead-Lag Optimize?					
Act Effct Green (s)	30.8	30.8	30.8	30.8	33.4
Actuated g/C Ratio	0.41	0.41	0.41	0.41	0.45
v/c Ratio	0.26	0.04	0.03	0.20	0.35
Control Delay	15.8	3.3	5.7	7.7	13.2
Queue Delay	0.0	0.0	0.0	0.0	0.0
Total Delay	15.8	3.3	5.7	7.7	13.2
LOS	B	A	A	A	B
Approach Delay	14.4			7.5	13.2
Approach LOS	B			A	B
Queue Length 50th (m)	16.6	0.0	0.7	10.0	21.7
Queue Length 95th (m)	29.8	2.8	m1.1	14.1	32.5
Internal Link Dist (m)	254.8			165.0	214.3
Turn Bay Length (m)			25.0		
Base Capacity (vph)	711	632	470	718	1460
Starvation Cap Reductn	0	0	0	0	0
Spillback Cap Reductn	0	0	0	0	0
Storage Cap Reductn	0	0	0	0	0
Reduced v/c Ratio	0.26	0.04	0.03	0.20	0.35

Intersection Summary

Cycle Length: 75  
 Actuated Cycle Length: 75  
 Offset: 45 (60%), Referenced to phase 4:EBT and 8:WBTL, Start of Green  
 Natural Cycle: 40  
 Control Type: Pretimed  
 Maximum v/c Ratio: 0.35  
 Intersection Signal Delay: 12.4  
 Intersection LOS: B  
 Intersection Capacity Utilization 80.3%  
 ICU Level of Service D  
 Analysis Period (min) 15  
 m Volume for 95th percentile queue is metered by upstream signal.

Splits and Phases: 7: Lyon St N & Gladstone Ave

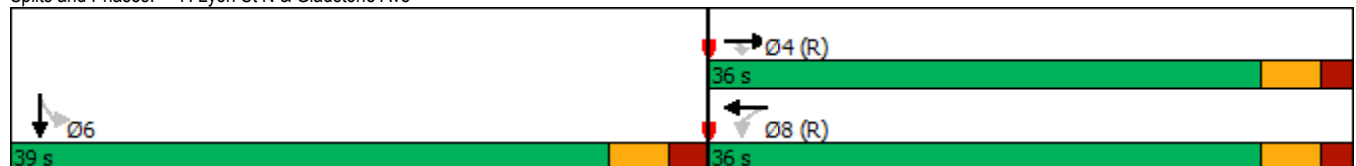

Lanes, Volumes, Timings  
8: Kent St & Gladstone Ave

02/28/2024

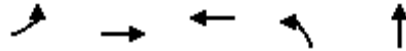

Lane Group	EBL	EBT	WBT	NBL	NBT
Lane Configurations					
Traffic Volume (vph)	82	277	165	36	1723
Future Volume (vph)	82	277	165	36	1723
Lane Group Flow (vph)	82	277	313	36	1820
Turn Type	Perm	NA	NA	Perm	NA
Protected Phases		4	8		2
Permitted Phases	4			2	
Minimum Split (s)	21.4	21.4	21.4	20.4	20.4
Total Split (s)	32.9	32.9	32.9	42.1	42.1
Total Split (%)	43.9%	43.9%	43.9%	56.1%	56.1%
Yellow Time (s)	3.3	3.3	3.3	3.3	3.3
All-Red Time (s)	2.1	2.1	2.1	2.1	2.1
Lost Time Adjust (s)	0.0	0.0	0.0	0.0	0.0
Total Lost Time (s)	5.4	5.4	5.4	5.4	5.4
Lead/Lag					
Lead-Lag Optimize?					
Act Effct Green (s)	27.5	27.5	27.5	36.7	36.7
Actuated g/C Ratio	0.37	0.37	0.37	0.49	0.49
v/c Ratio	0.28	0.44	0.55	0.05	0.77
Control Delay	26.7	27.6	22.8	8.1	8.6
Queue Delay	0.0	0.0	0.0	0.0	0.0
Total Delay	26.7	27.6	22.8	8.1	8.6
LOS	C	C	C	A	A
Approach Delay		27.4	22.8		8.6
Approach LOS		C	C		A
Queue Length 50th (m)	9.8	37.3	33.6	1.0	19.4
Queue Length 95th (m)	23.1	59.2	57.1	m2.8	39.1
Internal Link Dist (m)		165.0	168.8		216.0
Turn Bay Length (m)	30.0			40.0	
Base Capacity (vph)	291	629	572	706	2352
Starvation Cap Reductn	0	0	0	0	0
Spillback Cap Reductn	0	0	0	0	0
Storage Cap Reductn	0	0	0	0	0
Reduced v/c Ratio	0.28	0.44	0.55	0.05	0.77

Intersection Summary

Cycle Length: 75  
 Actuated Cycle Length: 75  
 Offset: 23 (31%), Referenced to phase 4:EBTL and 8:WBT, Start of Green  
 Natural Cycle: 50  
 Control Type: Pretimed  
 Maximum v/c Ratio: 0.77  
 Intersection Signal Delay: 13.1  
 Intersection LOS: B  
 Intersection Capacity Utilization 80.3%  
 ICU Level of Service D  
 Analysis Period (min) 15  
 m Volume for 95th percentile queue is metered by upstream signal.

Splits and Phases: 8: Kent St & Gladstone Ave

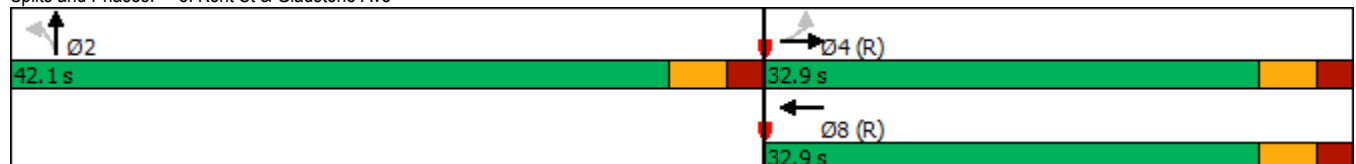

Lanes, Volumes, Timings  
 9: Bank St & Chamberlain Ave/Isabella St

02/28/2024



Lane Group	EBT	EBR	NBT	SBL	SBT
Lane Configurations	↕↕	↗	↕↕		↕↕
Traffic Volume (vph)	506	78	839	176	382
Future Volume (vph)	506	78	839	176	382
Lane Group Flow (vph)	587	78	982	0	558
Turn Type	NA	Perm	NA	pm+pt	NA
Protected Phases	4		2	5	6
Permitted Phases		4		6	
Detector Phase	4	4	2	5	6
Switch Phase					
Minimum Initial (s)	10.0	10.0	10.0	5.0	10.0
Minimum Split (s)	26.2	26.2	23.1	11.1	23.1
Total Split (s)	26.2	26.2	37.7	11.1	48.8
Total Split (%)	34.9%	34.9%	50.3%	14.8%	65.1%
Yellow Time (s)	3.3	3.3	3.0	3.0	3.0
All-Red Time (s)	2.9	2.9	3.1	3.1	3.1
Lost Time Adjust (s)	0.0	0.0	0.0		0.0
Total Lost Time (s)	6.2	6.2	6.1		6.1
Lead/Lag					
Lead-Lag Optimize?					
Recall Mode	None	None	C-Max	None	C-Max
Act Effct Green (s)	18.3	18.3	44.4		44.4
Actuated g/C Ratio	0.24	0.24	0.59		0.59
v/c Ratio	0.75	0.18	0.52		0.53
Control Delay	32.5	2.1	10.3		14.5
Queue Delay	0.0	0.0	0.0		0.0
Total Delay	32.5	2.1	10.3		14.5
LOS	C	A	B		B
Approach Delay	29.0		10.3		14.5
Approach LOS	C		B		B
Queue Length 50th (m)	39.1	0.0	40.0		40.4
Queue Length 95th (m)	55.8	2.9	55.1		m57.5
Internal Link Dist (m)	296.0		215.6		90.2
Turn Bay Length (m)		40.0			
Base Capacity (vph)	858	460	1880		1047
Starvation Cap Reductn	0	0	0		0
Spillback Cap Reductn	0	0	0		0
Storage Cap Reductn	0	0	0		0
Reduced v/c Ratio	0.68	0.17	0.52		0.53

Intersection Summary

Cycle Length: 75  
 Actuated Cycle Length: 75  
 Offset: 60 (80%), Referenced to phase 2:NBT and 6:SBTL, Start of Green  
 Natural Cycle: 65  
 Control Type: Actuated-Coordinated  
 Maximum v/c Ratio: 0.75  
 Intersection Signal Delay: 17.0  
 Intersection LOS: B  
 Intersection Capacity Utilization 82.7%  
 ICU Level of Service E  
 Analysis Period (min) 15  
 m Volume for 95th percentile queue is metered by upstream signal.

Splits and Phases: 9: Bank St & Chamberlain Ave/Isabella St

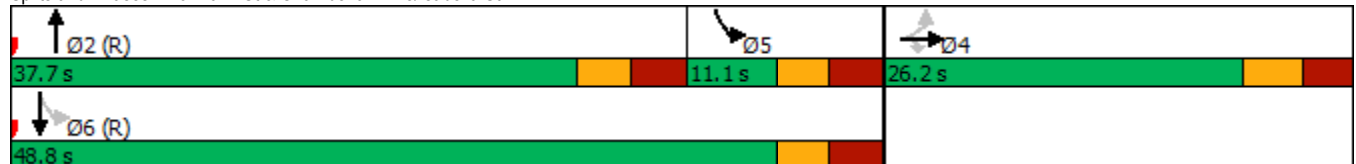

Lanes, Volumes, Timings  
10: Catherine St & Access

02/28/2024

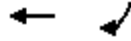

Lane Group	WBT	SBR
Lane Configurations	↑↑↓	↑
Traffic Volume (vph)	457	54
Future Volume (vph)	457	54
Lane Group Flow (vph)	486	54
Sign Control	Free	
<b>Intersection Summary</b>		
Control Type: Unsignalized		
Intersection Capacity Utilization 20.2%		ICU Level of Service A
Analysis Period (min) 15		



Intersection						
Int Delay, s/veh	1.1					
Movement	EBL	EBT	WBT	WBR	SBL	SBR
Lane Configurations			↑↑↑			↑
Traffic Vol, veh/h	0	0	457	29	0	54
Future Vol, veh/h	0	0	457	29	0	54
Conflicting Peds, #/hr	0	0	0	0	0	0
Sign Control	Free	Free	Free	Free	Stop	Stop
RT Channelized	-	None	-	None	-	None
Storage Length	-	-	-	-	-	0
Veh in Median Storage, #	-3538944		0	-	0	-
Grade, %	-	0	0	-	0	-
Peak Hour Factor	100	100	100	100	100	100
Heavy Vehicles, %	2	2	2	2	2	2
Mvmt Flow	0	0	457	29	0	54

Major/Minor	Major2	Minor2		
Conflicting Flow All	-	0	-	243
Stage 1	-	-	-	-
Stage 2	-	-	-	-
Critical Hdwy	-	-	-	7.14
Critical Hdwy Stg 1	-	-	-	-
Critical Hdwy Stg 2	-	-	-	-
Follow-up Hdwy	-	-	-	3.92
Pot Cap-1 Maneuver	-	-	0	646
Stage 1	-	-	0	-
Stage 2	-	-	0	-
Platoon blocked, %	-	-	-	-
Mov Cap-1 Maneuver	-	-	-	646
Mov Cap-2 Maneuver	-	-	-	-
Stage 1	-	-	-	-
Stage 2	-	-	-	-

Approach	WB	SB
HCM Control Delay, s	0	11.1
HCM LOS		B

Minor Lane/Major Mvmt	WBT	WBR	SBLn1
Capacity (veh/h)	-	-	646
HCM Lane V/C Ratio	-	-	0.084
HCM Control Delay (s)	-	-	11.1
HCM Lane LOS	-	-	B
HCM 95th %tile Q(veh)	-	-	0.3

Lanes, Volumes, Timings  
 12: Bank St & Arlington Ave

02/28/2024



Lane Group	EBL	NBT	SBT
Lane Configurations			
Traffic Volume (vph)	21	694	393
Future Volume (vph)	21	694	393
Lane Group Flow (vph)	149	780	415
Sign Control	Stop	Free	Free

Intersection Summary	
Control Type: Unsignalized	
Intersection Capacity Utilization 55.8%	ICU Level of Service B
Analysis Period (min) 15	

Intersection						
Int Delay, s/veh	2.9					
Movement	EBL	EBR	NBL	NBT	SBT	SBR
Lane Configurations	↔			↕	↕	
Traffic Vol, veh/h	21	128	86	694	393	22
Future Vol, veh/h	21	128	86	694	393	22
Conflicting Peds, #/hr	0	0	111	0	0	111
Sign Control	Stop	Stop	Free	Free	Free	Free
RT Channelized	-	None	-	None	-	None
Storage Length	0	-	-	-	-	-
Veh in Median Storage, #	0	-	-	0	0	-
Grade, %	0	-	-	0	0	-
Peak Hour Factor	100	100	100	100	100	100
Heavy Vehicles, %	0	3	2	5	8	5
Mvmt Flow	21	128	86	694	393	22

Major/Minor	Minor2	Major1	Major2			
Conflicting Flow All	1034	319	526	0	-	0
Stage 1	515	-	-	-	-	-
Stage 2	519	-	-	-	-	-
Critical Hdwy	6.8	6.96	4.14	-	-	-
Critical Hdwy Stg 1	5.8	-	-	-	-	-
Critical Hdwy Stg 2	5.8	-	-	-	-	-
Follow-up Hdwy	3.5	3.33	2.22	-	-	-
Pot Cap-1 Maneuver	231	674	1037	-	-	-
Stage 1	570	-	-	-	-	-
Stage 2	568	-	-	-	-	-
Platoon blocked, %				-	-	-
Mov Cap-1 Maneuver	158	605	931	-	-	-
Mov Cap-2 Maneuver	158	-	-	-	-	-
Stage 1	434	-	-	-	-	-
Stage 2	509	-	-	-	-	-

Approach	EB	NB	SB
HCM Control Delay, s	17.6	1.6	0
HCM LOS	C		

Minor Lane/Major Mvmt	NBL	NBT	EBLn1	SBT	SBR
Capacity (veh/h)	931	-	433	-	-
HCM Lane V/C Ratio	0.092	-	0.344	-	-
HCM Control Delay (s)	9.3	0.6	17.6	-	-
HCM Lane LOS	A	A	C	-	-
HCM 95th %tile Q(veh)	0.3	-	1.5	-	-

Lanes, Volumes, Timings  
13: Bronson Ave & Catherine St

02/28/2024



Lane Group	WBL	WBT	NBL	NBT	SBT	Ø5	Ø7
Lane Configurations							
Traffic Volume (vph)	510	486	527	1054	434		
Future Volume (vph)	510	486	527	1054	434		
Lane Group Flow (vph)	347	1011	527	1054	554		
Turn Type	Perm	NA	pm+pt	NA	NA		
Protected Phases		8	5 7	2	6	5	7
Permitted Phases	8		2				
Minimum Split (s)	28.3	28.3		23.8	23.8	11.2	11.8
Total Split (s)	37.0	37.0		73.0	30.2	31.0	11.8
Total Split (%)	33.6%	33.6%		66.4%	27.5%	28%	11%
Yellow Time (s)	3.3	3.3		3.3	3.3	3.3	3.3
All-Red Time (s)	3.0	3.0		3.5	3.5	2.9	3.5
Lost Time Adjust (s)	0.0	0.0		0.0	0.0		
Total Lost Time (s)	6.3	6.3		6.8	6.8		
Lead/Lag					Lag	Lead	
Lead-Lag Optimize?					Yes	Yes	
Act Effct Green (s)	30.7	30.7	66.8	66.2	23.4		
Actuated g/C Ratio	0.28	0.28	0.61	0.60	0.21		
v/c Ratio	0.87	0.83	0.85	0.52	0.82		
Control Delay	60.8	41.0	28.9	13.8	50.0		
Queue Delay	0.0	0.0	0.0	0.0	0.0		
Total Delay	60.8	41.0	28.9	13.8	50.0		
LOS	E	D	C	B	D		
Approach Delay		46.1		18.8	50.0		
Approach LOS		D		B	D		
Queue Length 50th (m)	82.5	72.8	59.8	64.2	57.0		
Queue Length 95th (m)	#140.8	91.0	#106.4	80.4	#81.7		
Internal Link Dist (m)		120.8		240.1	287.4		
Turn Bay Length (m)	80.0		45.0				
Base Capacity (vph)	399	1215	618	2040	679		
Starvation Cap Reductn	0	0	0	0	0		
Spillback Cap Reductn	0	0	0	0	0		
Storage Cap Reductn	0	0	0	0	0		
Reduced v/c Ratio	0.87	0.83	0.85	0.52	0.82		

Intersection Summary

Cycle Length: 110  
 Actuated Cycle Length: 110  
 Offset: 60 (55%), Referenced to phase 2:NBT and 6:SBT, Start of Green  
 Natural Cycle: 90  
 Control Type: Pretimed  
 Maximum v/c Ratio: 0.87  
 Intersection Signal Delay: 34.4  
 Intersection LOS: C  
 Intersection Capacity Utilization 87.1%  
 ICU Level of Service E  
 Analysis Period (min) 15  
 # 95th percentile volume exceeds capacity, queue may be longer.  
 Queue shown is maximum after two cycles.

Splits and Phases: 13: Bronson Ave & Catherine St



Lanes, Volumes, Timings

1: Hwy 417 WB On Ramp/Lyon St N & Catherine St

02/28/2024



Lane Group	WBT	SBT	SBR
Lane Configurations	↕↕↕	↕	↗
Traffic Volume (vph)	540	348	289
Future Volume (vph)	540	348	289
Lane Group Flow (vph)	752	348	289
Turn Type	NA	NA	Perm
Protected Phases	8	6	
Permitted Phases			6
Minimum Split (s)	26.2	28.3	28.3
Total Split (s)	35.0	40.0	40.0
Total Split (%)	46.7%	53.3%	53.3%
Yellow Time (s)	3.3	3.3	3.3
All-Red Time (s)	1.9	2.0	2.0
Lost Time Adjust (s)	0.0	0.0	0.0
Total Lost Time (s)	5.2	5.3	5.3
Lead/Lag			
Lead-Lag Optimize?			
Act Effct Green (s)	29.8	34.7	34.7
Actuated g/C Ratio	0.40	0.46	0.46
v/c Ratio	0.38	0.42	0.37
Control Delay	9.3	23.1	15.8
Queue Delay	0.0	0.0	0.0
Total Delay	9.3	23.1	15.8
LOS	A	C	B
Approach Delay	9.3	19.8	
Approach LOS	A	B	
Queue Length 50th (m)	6.0	47.4	27.1
Queue Length 95th (m)	13.7	72.9	46.4
Internal Link Dist (m)	109.2	52.8	
Turn Bay Length (m)			
Base Capacity (vph)	1962	833	771
Starvation Cap Reductn	0	0	0
Spillback Cap Reductn	0	0	0
Storage Cap Reductn	0	0	0
Reduced v/c Ratio	0.38	0.42	0.37

Intersection Summary

Cycle Length: 75  
 Actuated Cycle Length: 75  
 Offset: 24 (32%), Referenced to phase 8:WBTL, Start of Green  
 Natural Cycle: 55  
 Control Type: Pretimed  
 Maximum v/c Ratio: 0.42  
 Intersection Signal Delay: 14.1  
 Intersection LOS: B  
 Intersection Capacity Utilization 47.1%  
 ICU Level of Service A  
 Analysis Period (min) 15

Splits and Phases: 1: Hwy 417 WB On Ramp/Lyon St N & Catherine St

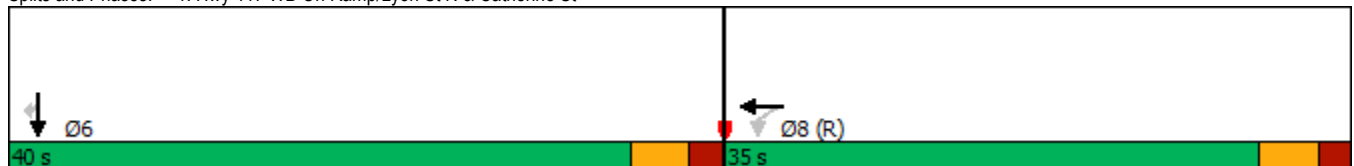

Lanes, Volumes, Timings

2: Hwy 417 EB Off Ramp/Chamberlain Ave/Kent St & Catherine St

02/28/2024



Lane Group	WBT	WBR	NBT	Ø9
Lane Configurations	↕↕	↗	↕↕↕	
Traffic Volume (vph)	693	300	837	
Future Volume (vph)	693	300	837	
Lane Group Flow (vph)	723	270	876	
Turn Type	NA	Perm	NA	
Protected Phases	8		2	9
Permitted Phases		8		
Minimum Split (s)	22.8	22.8	22.5	5.0
Total Split (s)	42.0	42.0	28.0	5.0
Total Split (%)	56.0%	56.0%	37.3%	7%
Yellow Time (s)	3.3	3.3	3.3	2.0
All-Red Time (s)	2.5	2.5	2.5	0.0
Lost Time Adjust (s)	0.0	0.0	0.0	
Total Lost Time (s)	5.8	5.8	5.8	
Lead/Lag				
Lead-Lag Optimize?				
Act Effct Green (s)	36.2	36.2	22.2	
Actuated g/C Ratio	0.48	0.48	0.30	
v/c Ratio	0.47	0.46	0.59	
Control Delay	8.5	9.7	22.5	
Queue Delay	0.0	0.0	0.0	
Total Delay	8.5	9.7	22.5	
LOS	A	A	C	
Approach Delay	8.8		22.5	
Approach LOS	A		C	
Queue Length 50th (m)	21.7	16.1	35.2	
Queue Length 95th (m)	m29.6	m23.2	47.3	
Internal Link Dist (m)	131.7		67.4	
Turn Bay Length (m)				
Base Capacity (vph)	1534	581	1485	
Starvation Cap Reductn	0	0	0	
Spillback Cap Reductn	0	0	0	
Storage Cap Reductn	0	0	0	
Reduced v/c Ratio	0.47	0.46	0.59	

Intersection Summary

Cycle Length: 75  
 Actuated Cycle Length: 75  
 Offset: 12 (16%), Referenced to phase 8:WBT, Start of Green  
 Natural Cycle: 55  
 Control Type: Pretimed  
 Maximum v/c Ratio: 0.59  
 Intersection Signal Delay: 15.2  
 Intersection LOS: B  
 Intersection Capacity Utilization 53.9%  
 ICU Level of Service A  
 Analysis Period (min) 15  
 m Volume for 95th percentile queue is metered by upstream signal.

Splits and Phases: 2: Hwy 417 EB Off Ramp/Chamberlain Ave/Kent St & Catherine St

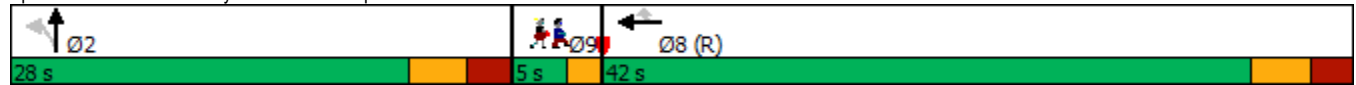

Lanes, Volumes, Timings  
3: Bank St & Catherine St

02/28/2024



Lane Group	WBT	NBL	NBT	SBT	Ø1	Ø5	Ø7
Lane Configurations	↕↕↕		↕↕	↕↕			
Traffic Volume (vph)	624	200	330	695			
Future Volume (vph)	624	200	330	695			
Lane Group Flow (vph)	1018	0	530	837			
Turn Type	NA	pm+pt	NA	NA			
Protected Phases	8	9	2	6	1	5	7
Permitted Phases		2					
Minimum Split (s)	18.6	10.4	16.4	16.4	5.0	5.0	5.0
Total Split (s)	24.6	10.4	40.4	30.0	5.0	5.0	5.0
Total Split (%)	32.8%	13.9%	53.9%	40.0%	7%	7%	7%
Yellow Time (s)	3.3	3.3	3.3	3.3	2.0	2.0	2.0
All-Red Time (s)	2.3	2.1	2.1	2.1	0.0	0.0	0.0
Lost Time Adjust (s)	0.0		0.0	0.0			
Total Lost Time (s)	5.6		5.4	5.4			
Lead/Lag	Lag		Lag	Lag	Lead	Lead	Lead
Lead-Lag Optimize?	Yes		Yes	Yes	Yes	Yes	Yes
Act Effct Green (s)	19.0		35.0	24.6			
Actuated g/C Ratio	0.25		0.47	0.33			
v/c Ratio	0.86		0.58	0.81			
Control Delay	34.7		13.7	29.6			
Queue Delay	0.0		0.0	0.7			
Total Delay	34.7		13.7	30.2			
LOS	C		B	C			
Approach Delay	34.7		13.7	30.2			
Approach LOS	C		B	C			
Queue Length 50th (m)	48.1		16.0	54.0			
Queue Length 95th (m)	#69.9		20.7	#77.2			
Internal Link Dist (m)	201.7		90.2	52.9			
Turn Bay Length (m)							
Base Capacity (vph)	1181		920	1037			
Starvation Cap Reductn	0		0	0			
Spillback Cap Reductn	0		0	43			
Storage Cap Reductn	0		0	0			
Reduced v/c Ratio	0.86		0.58	0.84			

Intersection Summary

Cycle Length: 75  
 Actuated Cycle Length: 75  
 Offset: 50 (67%), Referenced to phase 2:NBT and 6:SBT, Start of Green  
 Natural Cycle: 70  
 Control Type: Pretimed  
 Maximum v/c Ratio: 0.86  
 Intersection Signal Delay: 28.5  
 Intersection LOS: C  
 Intersection Capacity Utilization 80.1%  
 ICU Level of Service D  
 Analysis Period (min) 15  
 # 95th percentile volume exceeds capacity, queue may be longer.  
 Queue shown is maximum after two cycles.

Splits and Phases: 3: Bank St & Catherine St

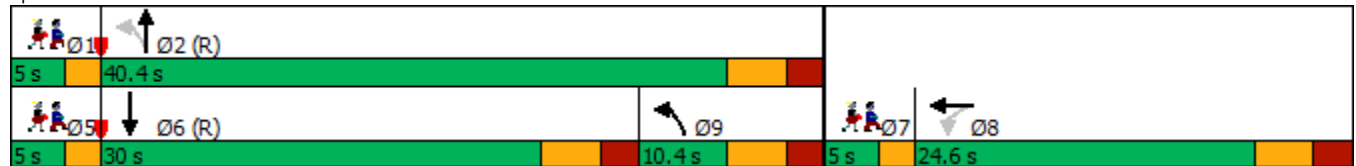

Lanes, Volumes, Timings  
4: Percy St & Catherine St

02/28/2024

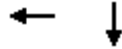

Lane Group	WBT	SBT	Ø3	Ø7
Lane Configurations				
Traffic Volume (vph)	709	121		
Future Volume (vph)	709	121		
Lane Group Flow (vph)	873	160		
Turn Type	NA	NA		
Protected Phases	8	6	3	7
Permitted Phases				
Detector Phase	8	6		
Switch Phase				
Minimum Initial (s)	10.0	10.0	1.0	1.0
Minimum Split (s)	26.5	23.4	6.4	6.4
Total Split (s)	34.0	24.0	16.0	16.0
Total Split (%)	37.8%	26.7%	18%	18%
Yellow Time (s)	3.3	3.3	3.3	3.3
All-Red Time (s)	2.2	2.1	2.1	2.1
Lost Time Adjust (s)	0.0	0.0		
Total Lost Time (s)	5.5	5.4		
Lead/Lag	Lag			Lead
Lead-Lag Optimize?	Yes			Yes
Recall Mode	None	Max	None	None
Act Effct Green (s)	14.6	18.7		
Actuated g/C Ratio	0.33	0.42		
v/c Ratio	0.52	0.22		
Control Delay	10.5	10.4		
Queue Delay	0.0	0.0		
Total Delay	10.5	10.4		
LOS	B	B		
Approach Delay	10.5	10.4		
Approach LOS	B	B		
Queue Length 50th (m)	15.2	7.2		
Queue Length 95th (m)	22.8	20.1		
Internal Link Dist (m)	271.6	288.0		
Turn Bay Length (m)				
Base Capacity (vph)	3166	729		
Starvation Cap Reductn	0	0		
Spillback Cap Reductn	0	0		
Storage Cap Reductn	0	0		
Reduced v/c Ratio	0.28	0.22		

Intersection Summary

Cycle Length: 90	
Actuated Cycle Length: 44.3	
Natural Cycle: 65	
Control Type: Semi Act-Uncoord	
Maximum v/c Ratio: 0.52	
Intersection Signal Delay: 10.5	Intersection LOS: B
Intersection Capacity Utilization 44.2%	ICU Level of Service A
Analysis Period (min) 15	

Splits and Phases: 4: Percy St & Catherine St

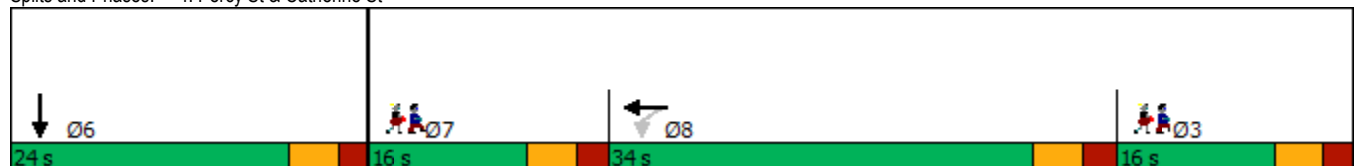



Lanes, Volumes, Timings  
 5: Lyon St N & Arlington Ave

02/28/2024

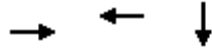

Lane Group	EBT	WBT	SBT
Lane Configurations			
Traffic Volume (vph)	19	37	572
Future Volume (vph)	19	37	572
Lane Group Flow (vph)	21	45	635
Sign Control	Stop	Stop	Free
<b>Intersection Summary</b>			
Control Type: Unsignalized			
Intersection Capacity Utilization 39.9%		ICU Level of Service A	
Analysis Period (min) 15			

HCM 2010 TWSC  
5: Lyon St N & Arlington Ave

02/28/2024

Intersection												
Int Delay, s/veh	2.2											
Movement	EBL	EBT	EBR	WBL	WBT	WBR	NBL	NBT	NBR	SBL	SBT	SBR
Lane Configurations		↕			↕						↕↕	
Traffic Vol, veh/h	0	19	2	8	37	0	0	0	0	50	572	13
Future Vol, veh/h	0	19	2	8	37	0	0	0	0	50	572	13
Conflicting Peds, #/hr	20	0	8	8	0	20	19	0	3	3	0	19
Sign Control	Stop	Stop	Stop	Stop	Stop	Stop	Free	Free	Free	Free	Free	Free
RT Channelized	-	-	None	-	-	None	-	-	None	-	-	None
Storage Length	-	-	-	-	-	-	-	-	-	-	-	-
Veh in Median Storage, #	-	0	-	-	0	-	-	-	-	-	0	-
Grade, %	-	0	-	-	0	-	-	0	-	-	0	-
Peak Hour Factor	100	100	100	100	100	100	100	100	100	100	100	100
Heavy Vehicles, %	0	5	0	0	5	0	0	0	0	0	0	0
Mvmt Flow	0	19	2	8	37	0	0	0	0	50	572	13

Major/Minor	Minor2		Minor1			Major2			
Conflicting Flow All	-	701	320	407	707	-	3	0	0
Stage 1	-	698	-	3	3	-	-	-	-
Stage 2	-	3	-	404	704	-	-	-	-
Critical Hdwy	-	6.6	6.9	7.5	6.6	-	4.1	-	-
Critical Hdwy Stg 1	-	5.6	-	-	-	-	-	-	-
Critical Hdwy Stg 2	-	-	-	6.5	5.6	-	-	-	-
Follow-up Hdwy	-	4.05	3.3	3.5	4.05	-	2.2	-	-
Pot Cap-1 Maneuver	0	355	682	533	353	0	1632	-	-
Stage 1	0	433	-	-	-	0	-	-	-
Stage 2	0	-	-	600	430	0	-	-	-
Platoon blocked, %	-	-	-	-	-	-	-	-	-
Mov Cap-1 Maneuver	-	332	670	489	330	-	1627	-	-
Mov Cap-2 Maneuver	-	332	-	489	330	-	-	-	-
Stage 1	-	406	-	-	-	-	-	-	-
Stage 2	-	-	-	544	403	-	-	-	-

Approach	EB		WB			SB		
HCM Control Delay, s	16		16.8			0.7		
HCM LOS	C		C					

Minor Lane/Major Mvmt	EBLn1	WBLn1	SBL	SBT	SBR
Capacity (veh/h)	349	350	1627	-	-
HCM Lane V/C Ratio	0.06	0.129	0.031	-	-
HCM Control Delay (s)	16	16.8	7.3	0.1	-
HCM Lane LOS	C	C	A	A	-
HCM 95th %tile Q(veh)	0.2	0.4	0.1	-	-

Lanes, Volumes, Timings  
6: Kent St & Arlington Ave

02/28/2024



Lane Group	EBL	EBT	WBT	NBT
Lane Configurations		↕	↕	↕↕↕
Traffic Volume (vph)	12	68	18	1047
Future Volume (vph)	12	68	18	1047
Lane Group Flow (vph)	0	80	81	1162
Turn Type	Perm	NA	NA	NA
Protected Phases		4	8	2
Permitted Phases	4			
Minimum Split (s)	27.3	27.3	27.3	32.3
Total Split (s)	31.0	31.0	31.0	44.0
Total Split (%)	41.3%	41.3%	41.3%	58.7%
Yellow Time (s)	3.3	3.3	3.3	3.3
All-Red Time (s)	2.0	2.0	2.0	2.0
Lost Time Adjust (s)		0.0	0.0	0.0
Total Lost Time (s)		5.3	5.3	5.3
Lead/Lag				
Lead-Lag Optimize?				
Act Effct Green (s)		25.7	25.7	38.7
Actuated g/C Ratio		0.34	0.34	0.52
v/c Ratio		0.13	0.14	0.46
Control Delay		27.6	8.2	5.7
Queue Delay		0.0	0.0	0.2
Total Delay		27.6	8.2	5.9
LOS		C	A	A
Approach Delay		27.6	8.2	5.9
Approach LOS		C	A	A
Queue Length 50th (m)		10.2	1.1	16.1
Queue Length 95th (m)		m20.8	m5.1	19.7
Internal Link Dist (m)		164.0	143.1	53.0
Turn Bay Length (m)				
Base Capacity (vph)		598	573	2501
Starvation Cap Reductn		0	0	491
Spillback Cap Reductn		0	0	0
Storage Cap Reductn		0	0	0
Reduced v/c Ratio		0.13	0.14	0.58

Intersection Summary

Cycle Length: 75  
 Actuated Cycle Length: 75  
 Offset: 50 (67%), Referenced to phase 2:NBTL, Start of Green  
 Natural Cycle: 60  
 Control Type: Pretimed  
 Maximum v/c Ratio: 0.46  
 Intersection Signal Delay: 7.3  
 Intersection Capacity Utilization 53.7%  
 Analysis Period (min) 15  
 m Volume for 95th percentile queue is metered by upstream signal.

Splits and Phases: 6: Kent St & Arlington Ave



Lanes, Volumes, Timings  
7: Lyon St N & Gladstone Ave

02/28/2024



Lane Group	EBT	EBR	WBL	WBT	SBT
Lane Configurations	↑	↑	↑	↑	↑↓
Traffic Volume (vph)	247	52	28	314	517
Future Volume (vph)	247	52	28	314	517
Lane Group Flow (vph)	247	52	28	314	741
Turn Type	NA	Perm	Perm	NA	NA
Protected Phases	4			8	6
Permitted Phases		4	8		
Minimum Split (s)	17.2	17.2	17.2	17.2	22.6
Total Split (s)	37.0	37.0	37.0	37.0	38.0
Total Split (%)	49.3%	49.3%	49.3%	49.3%	50.7%
Yellow Time (s)	3.3	3.3	3.3	3.3	3.3
All-Red Time (s)	1.9	1.9	1.9	1.9	2.3
Lost Time Adjust (s)	0.0	0.0	0.0	0.0	0.0
Total Lost Time (s)	5.2	5.2	5.2	5.2	5.6
Lead/Lag					
Lead-Lag Optimize?					
Act Effct Green (s)	31.8	31.8	31.8	31.8	32.4
Actuated g/C Ratio	0.42	0.42	0.42	0.42	0.43
v/c Ratio	0.33	0.08	0.07	0.42	0.52
Control Delay	16.0	4.5	7.8	12.1	16.1
Queue Delay	0.0	0.0	0.0	0.0	0.0
Total Delay	16.0	4.5	7.8	12.1	16.1
LOS	B	A	A	B	B
Approach Delay	14.0			11.8	16.1
Approach LOS	B			B	B
Queue Length 50th (m)	22.6	0.0	1.5	35.5	36.2
Queue Length 95th (m)	38.4	5.7	m3.3	55.1	51.2
Internal Link Dist (m)	254.8			165.0	214.3
Turn Bay Length (m)			25.0		
Base Capacity (vph)	756	626	422	756	1427
Starvation Cap Reductn	0	0	0	0	0
Spillback Cap Reductn	0	0	0	0	0
Storage Cap Reductn	0	0	0	0	0
Reduced v/c Ratio	0.33	0.08	0.07	0.42	0.52

Intersection Summary

Cycle Length: 75  
 Actuated Cycle Length: 75  
 Offset: 45 (60%), Referenced to phase 4:EBT and 8:WBTL, Start of Green  
 Natural Cycle: 40  
 Control Type: Pretimed  
 Maximum v/c Ratio: 0.52  
 Intersection Signal Delay: 14.6  
 Intersection LOS: B  
 Intersection Capacity Utilization 67.2%  
 ICU Level of Service C  
 Analysis Period (min) 15  
 m Volume for 95th percentile queue is metered by upstream signal.

Splits and Phases: 7: Lyon St N & Gladstone Ave

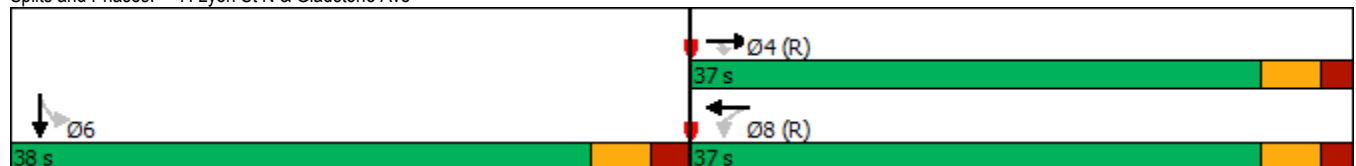

Lanes, Volumes, Timings  
8: Kent St & Gladstone Ave

02/28/2024

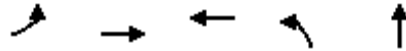

Lane Group	EBL	EBT	WBT	NBL	NBT
Lane Configurations					
Traffic Volume (vph)	75	450	324	67	895
Future Volume (vph)	75	450	324	67	895
Lane Group Flow (vph)	75	450	399	67	1026
Turn Type	Perm	NA	NA	Perm	NA
Protected Phases		4	8		2
Permitted Phases	4			2	
Minimum Split (s)	21.4	21.4	21.4	20.4	20.4
Total Split (s)	43.0	43.0	43.0	32.0	32.0
Total Split (%)	57.3%	57.3%	57.3%	42.7%	42.7%
Yellow Time (s)	3.3	3.3	3.3	3.3	3.3
All-Red Time (s)	2.1	2.1	2.1	2.1	2.1
Lost Time Adjust (s)	0.0	0.0	0.0	0.0	0.0
Total Lost Time (s)	5.4	5.4	5.4	5.4	5.4
Lead/Lag					
Lead-Lag Optimize?					
Act Effct Green (s)	37.6	37.6	37.6	26.6	26.6
Actuated g/C Ratio	0.50	0.50	0.50	0.35	0.35
v/c Ratio	0.19	0.51	0.46	0.12	0.62
Control Delay	18.0	21.5	13.5	5.1	5.7
Queue Delay	0.0	0.0	0.0	0.0	0.0
Total Delay	18.0	21.5	13.5	5.1	5.7
LOS	B	C	B	A	A
Approach Delay		21.0	13.5		5.6
Approach LOS		C	B		A
Queue Length 50th (m)	6.6	49.6	32.2	1.4	6.1
Queue Length 95th (m)	m16.2	78.9	53.1	3.0	8.1
Internal Link Dist (m)		165.0	168.8		216.0
Turn Bay Length (m)	30.0			40.0	
Base Capacity (vph)	401	885	873	539	1664
Starvation Cap Reductn	0	0	0	0	0
Spillback Cap Reductn	0	0	0	0	0
Storage Cap Reductn	0	0	0	0	0
Reduced v/c Ratio	0.19	0.51	0.46	0.12	0.62

Intersection Summary

Cycle Length: 75  
 Actuated Cycle Length: 75  
 Offset: 23 (31%), Referenced to phase 4:EBTL and 8:WBT, Start of Green  
 Natural Cycle: 45  
 Control Type: Pretimed  
 Maximum v/c Ratio: 0.62  
 Intersection Signal Delay: 11.2  
 Intersection LOS: B  
 Intersection Capacity Utilization 67.2%  
 ICU Level of Service C  
 Analysis Period (min) 15  
 m Volume for 95th percentile queue is metered by upstream signal.

Splits and Phases: 8: Kent St & Gladstone Ave

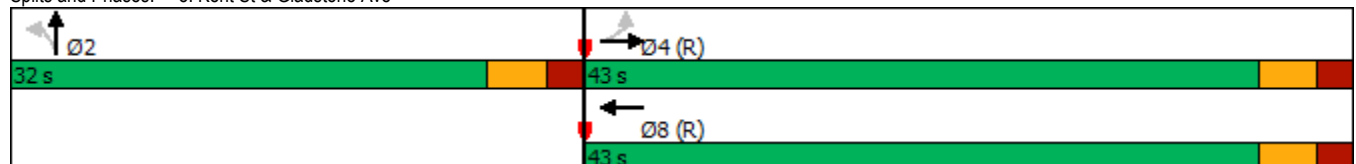

Lanes, Volumes, Timings  
 9: Bank St & Chamberlain Ave/Isabella St

02/28/2024



Lane Group	EBT	EBR	NBT	SBL	SBT
Lane Configurations					
Traffic Volume (vph)	607	122	457	180	725
Future Volume (vph)	607	122	457	180	725
Lane Group Flow (vph)	669	122	550	0	905
Turn Type	NA	Perm	NA	pm+pt	NA
Protected Phases	4		2	5	6
Permitted Phases		4		6	
Detector Phase	4	4	2	5	6
Switch Phase					
Minimum Initial (s)	10.0	10.0	10.0	5.0	10.0
Minimum Split (s)	26.2	26.2	23.1	11.1	23.1
Total Split (s)	28.8	28.8	35.1	11.1	46.2
Total Split (%)	38.4%	38.4%	46.8%	14.8%	61.6%
Yellow Time (s)	3.3	3.3	3.0	3.0	3.0
All-Red Time (s)	2.9	2.9	3.1	3.1	3.1
Lost Time Adjust (s)	0.0	0.0	0.0		0.0
Total Lost Time (s)	6.2	6.2	6.1		6.1
Lead/Lag					
Lead-Lag Optimize?					
Recall Mode	None	None	C-Max	None	C-Max
Act Effct Green (s)	20.5	20.5	42.2		42.2
Actuated g/C Ratio	0.27	0.27	0.56		0.56
v/c Ratio	0.73	0.25	0.31		0.68
Control Delay	29.7	4.9	9.1		12.6
Queue Delay	0.0	0.0	0.0		1.1
Total Delay	29.7	4.9	9.1		13.8
LOS	C	A	A		B
Approach Delay	25.9		9.1		13.8
Approach LOS	C		A		B
Queue Length 50th (m)	43.3	0.0	19.5		71.8
Queue Length 95th (m)	60.4	9.3	29.0		m91.5
Internal Link Dist (m)	296.0		215.6		90.2
Turn Bay Length (m)		40.0			
Base Capacity (vph)	1006	516	1779		1329
Starvation Cap Reductn	0	0	0		211
Spillback Cap Reductn	0	0	0		0
Storage Cap Reductn	0	0	0		0
Reduced v/c Ratio	0.67	0.24	0.31		0.81

Intersection Summary

Cycle Length: 75  
 Actuated Cycle Length: 75  
 Offset: 60 (80%), Referenced to phase 2:NBT and 6:SBTL, Start of Green  
 Natural Cycle: 65  
 Control Type: Actuated-Coordinated  
 Maximum v/c Ratio: 0.73  
 Intersection Signal Delay: 16.9  
 Intersection LOS: B  
 Intersection Capacity Utilization 82.7%  
 ICU Level of Service E  
 Analysis Period (min) 15  
 m Volume for 95th percentile queue is metered by upstream signal.

Splits and Phases: 9: Bank St & Chamberlain Ave/Isabella St

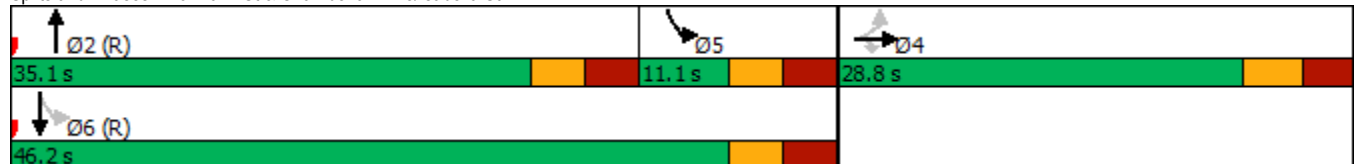

Lanes, Volumes, Timings  
10: Catherine St & Access

02/28/2024

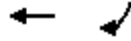

Lane Group	WBT	SBR
Lane Configurations	↑↑↓	↗
Traffic Volume (vph)	631	37
Future Volume (vph)	631	37
Lane Group Flow (vph)	679	37
Sign Control	Free	
<b>Intersection Summary</b>		
Control Type: Unsignalized		
Intersection Capacity Utilization 24.0%		ICU Level of Service A
Analysis Period (min) 15		

Intersection						
Int Delay, s/veh	0.6					
Movement	EBL	EBT	WBT	WBR	SBL	SBR
Lane Configurations			↑↑↑			↑
Traffic Vol, veh/h	0	0	631	48	0	37
Future Vol, veh/h	0	0	631	48	0	37
Conflicting Peds, #/hr	0	0	0	0	0	0
Sign Control	Free	Free	Free	Free	Stop	Stop
RT Channelized	-	None	-	None	-	None
Storage Length	-	-	-	-	-	0
Veh in Median Storage, #	-2424832		0	-	0	-
Grade, %	-	0	0	-	0	-
Peak Hour Factor	100	100	100	100	100	100
Heavy Vehicles, %	2	2	2	2	2	2
Mvmt Flow	0	0	631	48	0	37
Major/Minor	Major2		Minor2			
Conflicting Flow All			-	0	-	340
Stage 1			-	-	-	-
Stage 2			-	-	-	-
Critical Hdwy			-	-	-	7.14
Critical Hdwy Stg 1			-	-	-	-
Critical Hdwy Stg 2			-	-	-	-
Follow-up Hdwy			-	-	-	3.92
Pot Cap-1 Maneuver			-	-	0	560
Stage 1			-	-	0	-
Stage 2			-	-	0	-
Platoon blocked, %			-	-	-	-
Mov Cap-1 Maneuver			-	-	-	560
Mov Cap-2 Maneuver			-	-	-	-
Stage 1			-	-	-	-
Stage 2			-	-	-	-
Approach	WB		SB			
HCM Control Delay, s			0			11.9
HCM LOS						B
Minor Lane/Major Mvmt	WBT	WBR	SBLn1			
Capacity (veh/h)	-	-	560			
HCM Lane V/C Ratio	-	-	0.066			
HCM Control Delay (s)	-	-	11.9			
HCM Lane LOS	-	-	B			
HCM 95th %tile Q(veh)	-	-	0.2			



Lanes, Volumes, Timings  
 12: Bank St & Arlington Ave

02/28/2024



Lane Group	EBL	NBT	SBT
Lane Configurations			
Traffic Volume (vph)	20	430	724
Future Volume (vph)	20	430	724
Lane Group Flow (vph)	134	488	751
Sign Control	Stop	Free	Free

Intersection Summary	
Control Type: Unsignalized	
Intersection Capacity Utilization 55.1%	ICU Level of Service B
Analysis Period (min) 15	

Intersection						
Int Delay, s/veh	2.2					
Movement	EBL	EBR	NBL	NBT	SBT	SBR
Lane Configurations	↔			↕	↕	
Traffic Vol, veh/h	20	114	58	430	724	27
Future Vol, veh/h	20	114	58	430	724	27
Conflicting Peds, #/hr	0	0	42	0	0	42
Sign Control	Stop	Stop	Free	Free	Free	Free
RT Channelized	-	None	-	None	-	None
Storage Length	0	-	-	-	-	-
Veh in Median Storage, #	0	-	-	0	0	-
Grade, %	0	-	-	0	0	-
Peak Hour Factor	100	100	100	100	100	100
Heavy Vehicles, %	0	1	0	5	3	0
Mvmt Flow	20	114	58	430	724	27

Major/Minor	Minor2	Major1	Major2			
Conflicting Flow All	1111	418	793	0	-	0
Stage 1	780	-	-	-	-	-
Stage 2	331	-	-	-	-	-
Critical Hdwy	6.8	6.92	4.1	-	-	-
Critical Hdwy Stg 1	5.8	-	-	-	-	-
Critical Hdwy Stg 2	5.8	-	-	-	-	-
Follow-up Hdwy	3.5	3.31	2.2	-	-	-
Pot Cap-1 Maneuver	206	587	837	-	-	-
Stage 1	418	-	-	-	-	-
Stage 2	706	-	-	-	-	-
Platoon blocked, %				-	-	-
Mov Cap-1 Maneuver	172	564	805	-	-	-
Mov Cap-2 Maneuver	172	-	-	-	-	-
Stage 1	364	-	-	-	-	-
Stage 2	678	-	-	-	-	-

Approach	EB	NB	SB
HCM Control Delay, s	17.5	1.5	0
HCM LOS	C		

Minor Lane/Major Mvmt	NBL	NBT	EBLn1	SBT	SBR
Capacity (veh/h)	805	-	421	-	-
HCM Lane V/C Ratio	0.072	-	0.318	-	-
HCM Control Delay (s)	9.8	0.4	17.5	-	-
HCM Lane LOS	A	A	C	-	-
HCM 95th %tile Q(veh)	0.2	-	1.4	-	-

Lanes, Volumes, Timings  
13: Bronson Ave & Catherine St

02/28/2024



Lane Group	WBL	WBT	NBL	NBT	SBT
Lane Configurations					
Traffic Volume (vph)	707	582	296	773	813
Future Volume (vph)	707	582	296	773	813
Lane Group Flow (vph)	396	1174	296	773	980
Turn Type	Perm	NA	pm+pt	NA	NA
Protected Phases		8	5	2	6
Permitted Phases	8		2		
Minimum Split (s)	28.3	28.3	11.2	23.8	23.8
Total Split (s)	37.0	37.0	23.0	63.0	40.0
Total Split (%)	37.0%	37.0%	23.0%	63.0%	40.0%
Yellow Time (s)	3.3	3.3	3.3	3.3	3.3
All-Red Time (s)	3.0	3.0	2.9	3.5	3.5
Lost Time Adjust (s)	0.0	0.0	0.0	0.0	0.0
Total Lost Time (s)	6.3	6.3	6.2	6.8	6.8
Lead/Lag			Lead		Lag
Lead-Lag Optimize?			Yes		Yes
Act Effct Green (s)	30.7	30.7	56.8	56.2	33.2
Actuated g/C Ratio	0.31	0.31	0.57	0.56	0.33
v/c Ratio	0.89	0.86	0.84	0.41	0.89
Control Delay	56.4	37.9	44.8	13.2	42.4
Queue Delay	0.0	0.0	0.0	0.0	0.0
Total Delay	56.4	37.9	44.8	13.2	42.4
LOS	E	D	D	B	D
Approach Delay		42.5		22.0	42.4
Approach LOS		D		C	D
Queue Length 50th (m)	84.5	77.5	40.1	42.0	92.0
Queue Length 95th (m)	#145.8	96.6	#83.5	54.7	#128.5
Internal Link Dist (m)		120.8		240.1	287.4
Turn Bay Length (m)	80.0		45.0		
Base Capacity (vph)	447	1368	354	1905	1100
Starvation Cap Reductn	0	0	0	0	0
Spillback Cap Reductn	0	0	0	0	0
Storage Cap Reductn	0	0	0	0	0
Reduced v/c Ratio	0.89	0.86	0.84	0.41	0.89

Intersection Summary

Cycle Length: 100  
 Actuated Cycle Length: 100  
 Offset: 60 (60%), Referenced to phase 2:NBT and 6:SBT, Start of Green  
 Natural Cycle: 75  
 Control Type: Pretimed  
 Maximum v/c Ratio: 0.89  
 Intersection Signal Delay: 36.4  
 Intersection LOS: D  
 Intersection Capacity Utilization 89.0%  
 ICU Level of Service E  
 Analysis Period (min) 15  
 # 95th percentile volume exceeds capacity, queue may be longer.  
 Queue shown is maximum after two cycles.

Splits and Phases: 13: Bronson Ave & Catherine St

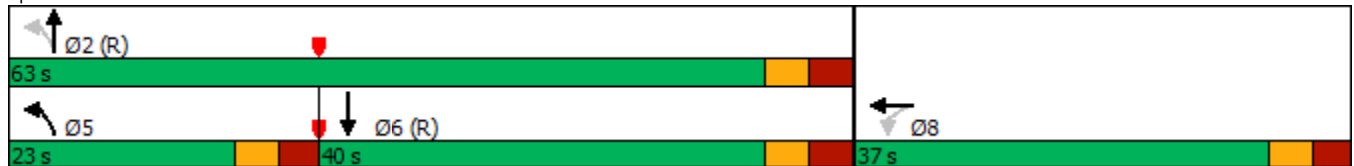

**Total Projected 2031**

Lanes, Volumes, Timings

1: Hwy 417 WB On Ramp/Lyon St N & Catherine St

02/28/2024



Lane Group	WBT	SBT	SBR
Lane Configurations			
Traffic Volume (vph)	270	282	128
Future Volume (vph)	270	282	128
Lane Group Flow (vph)	540	282	128
Turn Type	NA	NA	Perm
Protected Phases	8	6	
Permitted Phases			6
Minimum Split (s)	26.2	28.3	28.3
Total Split (s)	36.0	39.0	39.0
Total Split (%)	48.0%	52.0%	52.0%
Yellow Time (s)	3.3	3.3	3.3
All-Red Time (s)	1.9	2.0	2.0
Lost Time Adjust (s)	0.0	0.0	0.0
Total Lost Time (s)	5.2	5.3	5.3
Lead/Lag			
Lead-Lag Optimize?			
Act Effct Green (s)	30.8	33.7	33.7
Actuated g/C Ratio	0.41	0.45	0.45
v/c Ratio	0.37	0.35	0.17
Control Delay	8.9	23.7	11.5
Queue Delay	0.0	0.0	0.0
Total Delay	8.9	23.7	11.5
LOS	A	C	B
Approach Delay	8.9	19.9	
Approach LOS	A	B	
Queue Length 50th (m)	28.0	37.6	2.0
Queue Length 95th (m)	40.1	60.0	19.5
Internal Link Dist (m)	107.6	52.8	
Turn Bay Length (m)			
Base Capacity (vph)	1457	801	752
Starvation Cap Reductn	0	0	0
Spillback Cap Reductn	0	0	0
Storage Cap Reductn	0	0	0
Reduced v/c Ratio	0.37	0.35	0.17

Intersection Summary

Cycle Length: 75  
 Actuated Cycle Length: 75  
 Offset: 24 (32%), Referenced to phase 8:WBTL, Start of Green  
 Natural Cycle: 55  
 Control Type: Pretimed  
 Maximum v/c Ratio: 0.37  
 Intersection Signal Delay: 13.6  
 Intersection LOS: B  
 Intersection Capacity Utilization 50.4%  
 ICU Level of Service A  
 Analysis Period (min) 15  
 m Volume for 95th percentile queue is metered by upstream signal.

Splits and Phases: 1: Hwy 417 WB On Ramp/Lyon St N & Catherine St

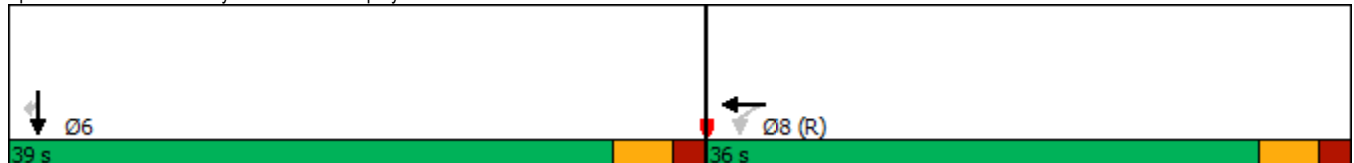

Lanes, Volumes, Timings

2: Hwy 417 EB Off Ramp/Chamberlain Ave/Kent St & Catherine St

02/28/2024



Lane Group	WBT	WBR	NBT	Ø9
Lane Configurations	↑↑	↑↑	↑↑↑	
Traffic Volume (vph)	443	565	1396	
Future Volume (vph)	443	565	1396	
Lane Group Flow (vph)	443	565	1466	
Turn Type	NA	Prot	NA	
Protected Phases	8	8	2	9
Permitted Phases				
Detector Phase	8	8	2	
Switch Phase				
Minimum Initial (s)	10.0	10.0	10.0	1.0
Minimum Split (s)	15.8	15.8	22.5	13.0
Total Split (s)	30.0	30.0	32.0	13.0
Total Split (%)	40.0%	40.0%	42.7%	17%
Yellow Time (s)	3.3	3.3	3.3	2.0
All-Red Time (s)	2.5	2.5	2.5	0.0
Lost Time Adjust (s)	0.0	0.0	0.0	
Total Lost Time (s)	5.8	5.8	5.8	
Lead/Lag				
Lead-Lag Optimize?				
Recall Mode	C-Max	C-Max	Max	None
Act Effct Green (s)	29.4	29.4	26.2	
Actuated g/C Ratio	0.39	0.39	0.35	
v/c Ratio	0.35	0.54	0.83	
Control Delay	22.6	25.3	26.5	
Queue Delay	0.0	0.0	50.6	
Total Delay	22.6	25.3	77.1	
LOS	C	C	E	
Approach Delay	24.1		77.1	
Approach LOS	C		E	
Queue Length 50th (m)	29.6	42.6	65.5	
Queue Length 95th (m)	m35.0	m51.1	82.9	
Internal Link Dist (m)	131.7		67.4	
Turn Bay Length (m)		60.0		
Base Capacity (vph)	1278	1056	1759	
Starvation Cap Reductn	0	0	0	
Spillback Cap Reductn	0	0	1033	
Storage Cap Reductn	0	0	0	
Reduced v/c Ratio	0.35	0.54	2.02	

Intersection Summary

Cycle Length: 75  
 Actuated Cycle Length: 75  
 Offset: 0 (0%), Referenced to phase 8:WBT, Start of Green  
 Natural Cycle: 60  
 Control Type: Actuated-Coordinated  
 Maximum v/c Ratio: 0.83  
 Intersection Signal Delay: 55.5  
 Intersection LOS: E  
 Intersection Capacity Utilization 63.9%  
 ICU Level of Service B  
 Analysis Period (min) 15  
 m Volume for 95th percentile queue is metered by upstream signal.

Splits and Phases: 2: Hwy 417 EB Off Ramp/Chamberlain Ave/Kent St & Catherine St

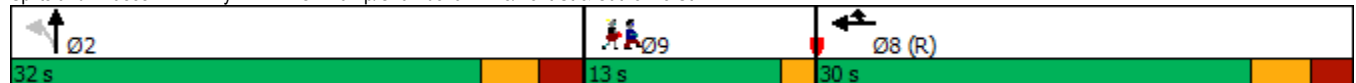

Lanes, Volumes, Timings  
3: Bank St & Catherine St

02/28/2024



Lane Group	WBT	NBL	NBT	SBT	Ø1	Ø5	Ø7
Lane Configurations							
Traffic Volume (vph)	630	278	582	404			
Future Volume (vph)	630	278	582	404			
Lane Group Flow (vph)	1008	0	860	548			
Turn Type	NA	pm+pt	NA	NA			
Protected Phases	8	9	2	6	1	5	7
Permitted Phases		2					
Minimum Split (s)	18.6	10.4	16.4	16.4	5.0	5.0	5.0
Total Split (s)	23.0	10.4	42.0	31.6	5.0	5.0	5.0
Total Split (%)	30.7%	13.9%	56.0%	42.1%	7%	7%	7%
Yellow Time (s)	3.3	3.3	3.3	3.3	2.0	2.0	2.0
All-Red Time (s)	2.3	2.1	2.1	2.1	0.0	0.0	0.0
Lost Time Adjust (s)	0.0		0.0	0.0			
Total Lost Time (s)	5.6		5.4	5.4			
Lead/Lag	Lag		Lag	Lag	Lead	Lead	Lead
Lead-Lag Optimize?	Yes		Yes	Yes	Yes	Yes	Yes
Act Effct Green (s)	17.4		36.6	26.2			
Actuated g/C Ratio	0.23		0.49	0.35			
v/c Ratio	0.94		0.82	0.52			
Control Delay	43.6		19.1	18.7			
Queue Delay	0.0		0.0	0.0			
Total Delay	43.6		19.1	18.7			
LOS	D		B	B			
Approach Delay	43.6		19.1	18.7			
Approach LOS	D		B	B			
Queue Length 50th (m)	47.8		25.3	27.2			
Queue Length 95th (m)	#73.5		#38.8	41.5			
Internal Link Dist (m)	201.7		90.2	52.9			
Turn Bay Length (m)							
Base Capacity (vph)	1075		1054	1050			
Starvation Cap Reductn	0		0	0			
Spillback Cap Reductn	0		0	0			
Storage Cap Reductn	0		0	0			
Reduced v/c Ratio	0.94		0.82	0.52			

Intersection Summary

Cycle Length: 75  
 Actuated Cycle Length: 75  
 Offset: 50 (67%), Referenced to phase 2:NBT and 6:SBT, Start of Green  
 Natural Cycle: 70  
 Control Type: Pretimed  
 Maximum v/c Ratio: 0.94  
 Intersection Signal Delay: 29.2  
 Intersection LOS: C  
 Intersection Capacity Utilization 82.1%  
 ICU Level of Service E  
 Analysis Period (min) 15  
 # 95th percentile volume exceeds capacity, queue may be longer.  
 Queue shown is maximum after two cycles.

Splits and Phases: 3: Bank St & Catherine St

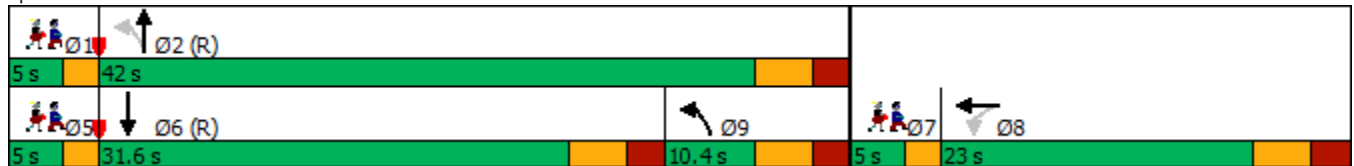

Lanes, Volumes, Timings  
4: Percy St & Catherine St

02/28/2024

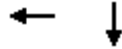

Lane Group	WBT	SBT	Ø3	Ø7
Lane Configurations				
Traffic Volume (vph)	264	129		
Future Volume (vph)	264	129		
Lane Group Flow (vph)	356	186		
Turn Type	NA	NA		
Protected Phases	8	6	3	7
Permitted Phases				
Detector Phase	8	6		
Switch Phase				
Minimum Initial (s)	10.0	10.0	1.0	1.0
Minimum Split (s)	26.5	23.4	6.4	6.4
Total Split (s)	34.0	24.0	16.0	16.0
Total Split (%)	37.8%	26.7%	18%	18%
Yellow Time (s)	3.3	3.3	3.3	3.3
All-Red Time (s)	2.2	2.1	2.1	2.1
Lost Time Adjust (s)	0.0	0.0		
Total Lost Time (s)	5.5	5.4		
Lead/Lag	Lag			Lead
Lead-Lag Optimize?	Yes			Yes
Recall Mode	None	Max	None	None
Act Effct Green (s)	11.9	18.8		
Actuated g/C Ratio	0.29	0.45		
v/c Ratio	0.35	0.25		
Control Delay	7.2	9.4		
Queue Delay	0.0	0.0		
Total Delay	7.2	9.4		
LOS	A	A		
Approach Delay	7.2	9.4		
Approach LOS	A	A		
Queue Length 50th (m)	5.4	6.6		
Queue Length 95th (m)	11.8	23.3		
Internal Link Dist (m)	271.6	288.0		
Turn Bay Length (m)				
Base Capacity (vph)	2220	740		
Starvation Cap Reductn	0	0		
Spillback Cap Reductn	0	0		
Storage Cap Reductn	0	0		
Reduced v/c Ratio	0.16	0.25		

Intersection Summary

Cycle Length: 90	
Actuated Cycle Length: 41.7	
Natural Cycle: 65	
Control Type: Semi Act-Uncoord	
Maximum v/c Ratio: 0.35	
Intersection Signal Delay: 8.0	Intersection LOS: A
Intersection Capacity Utilization 39.6%	ICU Level of Service A
Analysis Period (min) 15	

Splits and Phases: 4: Percy St & Catherine St

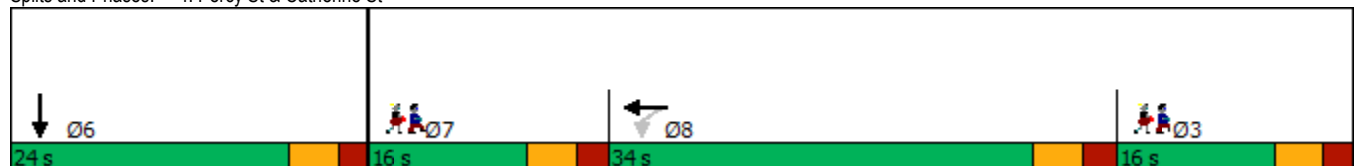



Lanes, Volumes, Timings  
 5: Lyon St N & Arlington Ave

02/28/2024

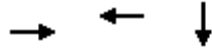

Lane Group	EBT	WBT	SBT
Lane Configurations			
Traffic Volume (vph)	18	12	337
Future Volume (vph)	18	12	337
Lane Group Flow (vph)	18	37	400
Sign Control	Stop	Stop	Free
<b>Intersection Summary</b>			
Control Type: Unsignalized			
Intersection Capacity Utilization 33.6%		ICU Level of Service A	
Analysis Period (min) 15			

Intersection												
Int Delay, s/veh	2.5											
Movement	EBL	EBT	EBR	WBL	WBT	WBR	NBL	NBT	NBR	SBL	SBT	SBR
Lane Configurations		↕			↕						↕↕	
Traffic Vol, veh/h	0	18	0	25	12	0	0	0	0	54	337	9
Future Vol, veh/h	0	18	0	25	12	0	0	0	0	54	337	9
Conflicting Peds, #/hr	32	0	15	15	0	32	9	0	10	10	0	9
Sign Control	Stop	Stop	Stop	Stop	Stop	Stop	Free	Free	Free	Free	Free	Free
RT Channelized	-	-	None	-	-	None	-	-	None	-	-	None
Storage Length	-	-	-	-	-	-	-	-	-	-	-	-
Veh in Median Storage, #	-	0	-	-	0	-	-	-	-	-	0	-
Grade, %	-	0	-	-	0	-	-	0	-	-	0	-
Peak Hour Factor	100	100	100	100	100	100	100	100	100	100	100	100
Heavy Vehicles, %	0	6	0	9	0	0	0	0	0	5	1	11
Mvmt Flow	0	18	0	25	12	0	0	0	0	54	337	9

Major/Minor	Minor2		Minor1			Major2			
Conflicting Flow All	-	469	197	311	473	-	10	0	0
Stage 1	-	459	-	10	10	-	-	-	-
Stage 2	-	10	-	301	463	-	-	-	-
Critical Hdwy	-	6.62	6.9	7.68	6.5	-	4.2	-	-
Critical Hdwy Stg 1	-	5.62	-	-	-	-	-	-	-
Critical Hdwy Stg 2	-	-	-	6.68	5.5	-	-	-	-
Follow-up Hdwy	-	4.06	3.3	3.59	4	-	2.25	-	-
Pot Cap-1 Maneuver	0	482	817	601	493	0	1586	-	-
Stage 1	0	555	-	-	0	-	-	-	-
Stage 2	0	-	-	664	568	0	-	-	-
Platoon blocked, %	-	-	-	-	-	-	-	-	-
Mov Cap-1 Maneuver	-	454	810	558	464	-	1571	-	-
Mov Cap-2 Maneuver	-	454	-	558	464	-	-	-	-
Stage 1	-	527	-	-	-	-	-	-	-
Stage 2	-	-	-	614	539	-	-	-	-

Approach	EB		WB			SB		
HCM Control Delay, s	13.3		12.4			1.1		
HCM LOS	B		B					

Minor Lane/Major Mvmt	EBLn1	WBLn1	SBL	SBT	SBR
Capacity (veh/h)	454	524	1571	-	-
HCM Lane V/C Ratio	0.04	0.071	0.034	-	-
HCM Control Delay (s)	13.3	12.4	7.4	0.1	-
HCM Lane LOS	B	B	A	A	-
HCM 95th %tile Q(veh)	0.1	0.2	0.1	-	-

Lanes, Volumes, Timings  
6: Kent St & Arlington Ave

02/28/2024



Lane Group	EBL	EBT	WBT	NBT
Lane Configurations		↕	↕	↕↕↕
Traffic Volume (vph)	40	83	18	1783
Future Volume (vph)	40	83	18	1783
Lane Group Flow (vph)	0	123	111	1940
Turn Type	Perm	NA	NA	NA
Protected Phases		4	8	2
Permitted Phases	4			
Minimum Split (s)	27.3	27.3	27.3	32.3
Total Split (s)	28.0	28.0	28.0	47.0
Total Split (%)	37.3%	37.3%	37.3%	62.7%
Yellow Time (s)	3.3	3.3	3.3	3.3
All-Red Time (s)	2.0	2.0	2.0	2.0
Lost Time Adjust (s)		0.0	0.0	0.0
Total Lost Time (s)		5.3	5.3	5.3
Lead/Lag				
Lead-Lag Optimize?				
Act Effct Green (s)		22.7	22.7	41.7
Actuated g/C Ratio		0.30	0.30	0.56
v/c Ratio		0.26	0.23	0.73
Control Delay		29.1	15.9	15.4
Queue Delay		0.0	0.0	48.7
Total Delay		29.1	15.9	64.1
LOS		C	B	E
Approach Delay		29.1	15.9	64.1
Approach LOS		C	B	E
Queue Length 50th (m)		15.1	8.7	87.6
Queue Length 95th (m)		29.2	m13.3	106.9
Internal Link Dist (m)		138.7	143.1	53.0
Turn Bay Length (m)				
Base Capacity (vph)		471	479	2672
Starvation Cap Reductn		0	0	1393
Spillback Cap Reductn		0	0	0
Storage Cap Reductn		0	0	0
Reduced v/c Ratio		0.26	0.23	1.52

Intersection Summary

Cycle Length: 75  
 Actuated Cycle Length: 75  
 Offset: 50 (67%), Referenced to phase 2:NBT, Start of Green  
 Natural Cycle: 60  
 Control Type: Pretimed  
 Maximum v/c Ratio: 0.73  
 Intersection Signal Delay: 59.6  
 Intersection LOS: E  
 Intersection Capacity Utilization 69.6%  
 ICU Level of Service C  
 Analysis Period (min) 15  
 m Volume for 95th percentile queue is metered by upstream signal.

Splits and Phases: 6: Kent St & Arlington Ave



Lanes, Volumes, Timings  
7: Lyon St N & Gladstone Ave

02/28/2024



Lane Group	EBT	EBR	WBL	WBT	SBT
Lane Configurations	↑	↑	↑	↑	↑↓
Traffic Volume (vph)	184	24	15	143	345
Future Volume (vph)	184	24	15	143	345
Lane Group Flow (vph)	184	24	15	143	532
Turn Type	NA	Perm	Perm	NA	NA
Protected Phases	4			8	6
Permitted Phases		4	8		
Minimum Split (s)	17.2	17.2	17.2	17.2	22.6
Total Split (s)	36.0	36.0	36.0	36.0	39.0
Total Split (%)	48.0%	48.0%	48.0%	48.0%	52.0%
Yellow Time (s)	3.3	3.3	3.3	3.3	3.3
All-Red Time (s)	1.9	1.9	1.9	1.9	2.3
Lost Time Adjust (s)	0.0	0.0	0.0	0.0	0.0
Total Lost Time (s)	5.2	5.2	5.2	5.2	5.6
Lead/Lag					
Lead-Lag Optimize?					
Act Effct Green (s)	30.8	30.8	30.8	30.8	33.4
Actuated g/C Ratio	0.41	0.41	0.41	0.41	0.45
v/c Ratio	0.26	0.04	0.03	0.20	0.36
Control Delay	15.8	3.3	5.5	7.5	13.3
Queue Delay	0.0	0.0	0.0	0.0	0.0
Total Delay	15.8	3.3	5.5	7.5	13.3
LOS	B	A	A	A	B
Approach Delay	14.4			7.3	13.3
Approach LOS	B			A	B
Queue Length 50th (m)	16.6	0.0	0.7	9.4	22.5
Queue Length 95th (m)	29.8	2.8	m1.1	13.8	33.5
Internal Link Dist (m)	254.8			165.0	214.3
Turn Bay Length (m)			25.0		
Base Capacity (vph)	711	632	470	718	1462
Starvation Cap Reductn	0	0	0	0	0
Spillback Cap Reductn	0	0	0	0	0
Storage Cap Reductn	0	0	0	0	0
Reduced v/c Ratio	0.26	0.04	0.03	0.20	0.36

Intersection Summary

Cycle Length: 75  
 Actuated Cycle Length: 75  
 Offset: 45 (60%), Referenced to phase 4:EBT and 8:WBTL, Start of Green  
 Natural Cycle: 40  
 Control Type: Pretimed  
 Maximum v/c Ratio: 0.36  
 Intersection Signal Delay: 12.5  
 Intersection LOS: B  
 Intersection Capacity Utilization 81.6%  
 ICU Level of Service D  
 Analysis Period (min) 15  
 m Volume for 95th percentile queue is metered by upstream signal.

Splits and Phases: 7: Lyon St N & Gladstone Ave

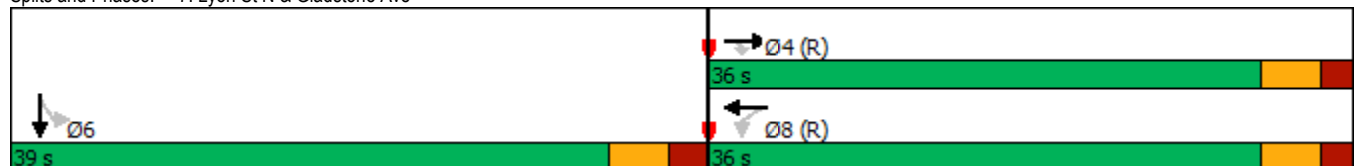

Lanes, Volumes, Timings  
8: Kent St & Gladstone Ave

02/28/2024

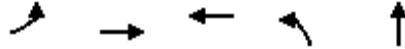

Lane Group	EBL	EBT	WBT	NBL	NBT
Lane Configurations					
Traffic Volume (vph)	82	277	165	36	1787
Future Volume (vph)	82	277	165	36	1787
Lane Group Flow (vph)	82	277	313	36	1884
Turn Type	Perm	NA	NA	Perm	NA
Protected Phases		4	8		2
Permitted Phases	4			2	
Minimum Split (s)	21.4	21.4	21.4	20.4	20.4
Total Split (s)	31.9	31.9	31.9	43.1	43.1
Total Split (%)	42.5%	42.5%	42.5%	57.5%	57.5%
Yellow Time (s)	3.3	3.3	3.3	3.3	3.3
All-Red Time (s)	2.1	2.1	2.1	2.1	2.1
Lost Time Adjust (s)	0.0	0.0	0.0	0.0	0.0
Total Lost Time (s)	5.4	5.4	5.4	5.4	5.4
Lead/Lag					
Lead-Lag Optimize?					
Act Effct Green (s)	26.5	26.5	26.5	37.7	37.7
Actuated g/C Ratio	0.35	0.35	0.35	0.50	0.50
v/c Ratio	0.30	0.46	0.57	0.05	0.78
Control Delay	27.4	28.2	24.1	7.9	8.9
Queue Delay	0.0	0.0	0.0	0.0	0.0
Total Delay	27.4	28.2	24.1	7.9	8.9
LOS	C	C	C	A	A
Approach Delay		28.0	24.1		8.8
Approach LOS		C	C		A
Queue Length 50th (m)	9.9	37.6	34.4	1.5	28.8
Queue Length 95th (m)	23.4	59.7	58.6	m2.9	43.3
Internal Link Dist (m)		165.0	168.8		216.0
Turn Bay Length (m)	30.0			40.0	
Base Capacity (vph)	275	606	552	725	2416
Starvation Cap Reductn	0	0	0	0	0
Spillback Cap Reductn	0	0	0	0	0
Storage Cap Reductn	0	0	0	0	0
Reduced v/c Ratio	0.30	0.46	0.57	0.05	0.78

Intersection Summary

Cycle Length: 75  
 Actuated Cycle Length: 75  
 Offset: 23 (31%), Referenced to phase 4:EBTL and 8:WBT, Start of Green  
 Natural Cycle: 55  
 Control Type: Pretimed  
 Maximum v/c Ratio: 0.78  
 Intersection Signal Delay: 13.3  
 Intersection LOS: B  
 Intersection Capacity Utilization 81.6%  
 ICU Level of Service D  
 Analysis Period (min) 15  
 m Volume for 95th percentile queue is metered by upstream signal.

Splits and Phases: 8: Kent St & Gladstone Ave



Lanes, Volumes, Timings  
 9: Bank St & Chamberlain Ave/Isabella St

02/28/2024



Lane Group	EBT	EBR	NBT	SBL	SBT
Lane Configurations	↕↕	↗	↕↕		↕↕
Traffic Volume (vph)	521	82	845	190	396
Future Volume (vph)	521	82	845	190	396
Lane Group Flow (vph)	603	82	988	0	586
Turn Type	NA	Perm	NA	pm+pt	NA
Protected Phases	4		2	5	6
Permitted Phases		4		6	
Detector Phase	4	4	2	5	6
Switch Phase					
Minimum Initial (s)	10.0	10.0	10.0	5.0	10.0
Minimum Split (s)	26.2	26.2	23.1	11.1	23.1
Total Split (s)	26.2	26.2	37.7	11.1	48.8
Total Split (%)	34.9%	34.9%	50.3%	14.8%	65.1%
Yellow Time (s)	3.3	3.3	3.0	3.0	3.0
All-Red Time (s)	2.9	2.9	3.1	3.1	3.1
Lost Time Adjust (s)	0.0	0.0	0.0		0.0
Total Lost Time (s)	6.2	6.2	6.1		6.1
Lead/Lag					
Lead-Lag Optimize?					
Recall Mode	None	None	C-Max	None	C-Max
Act Effct Green (s)	18.4	18.4	44.3		44.3
Actuated g/C Ratio	0.25	0.25	0.59		0.59
v/c Ratio	0.76	0.19	0.53		0.56
Control Delay	33.1	2.4	10.8		14.2
Queue Delay	0.0	0.0	0.0		0.0
Total Delay	33.1	2.4	10.8		14.2
LOS	C	A	B		B
Approach Delay	29.4		10.8		14.2
Approach LOS	C		B		B
Queue Length 50th (m)	40.3	0.0	42.1		42.4
Queue Length 95th (m)	57.5	3.5	57.5		m58.0
Internal Link Dist (m)	296.0		215.6		90.2
Turn Bay Length (m)		40.0			
Base Capacity (vph)	858	460	1861		1039
Starvation Cap Reductn	0	0	0		0
Spillback Cap Reductn	0	0	0		0
Storage Cap Reductn	0	0	0		0
Reduced v/c Ratio	0.70	0.18	0.53		0.56

Intersection Summary

Cycle Length: 75  
 Actuated Cycle Length: 75  
 Offset: 60 (80%), Referenced to phase 2:NBT and 6:SBTL, Start of Green  
 Natural Cycle: 65  
 Control Type: Actuated-Coordinated  
 Maximum v/c Ratio: 0.76  
 Intersection Signal Delay: 17.3  
 Intersection LOS: B  
 Intersection Capacity Utilization 84.2%  
 ICU Level of Service E  
 Analysis Period (min) 15  
 m Volume for 95th percentile queue is metered by upstream signal.

Splits and Phases: 9: Bank St & Chamberlain Ave/Isabella St

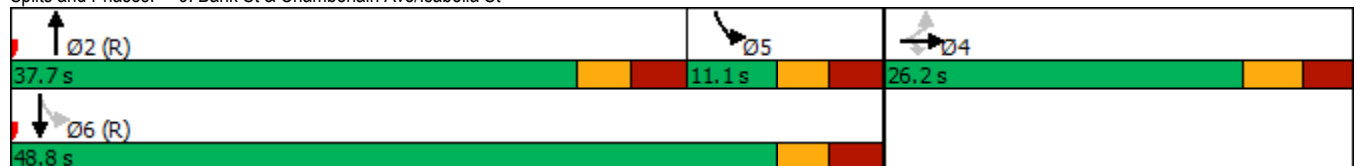

Lanes, Volumes, Timings  
10: Catherine St & Access

02/28/2024

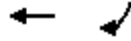

Lane Group	WBT	SBR
Lane Configurations		
Traffic Volume (vph)	468	69
Future Volume (vph)	468	69
Lane Group Flow (vph)	509	69
Sign Control	Free	

**Intersection Summary**

Control Type: Unsignalized  
Intersection Capacity Utilization 26.2%      ICU Level of Service A  
Analysis Period (min) 15

Intersection						
Int Delay, s/veh	1.2					
Movement	EBL	EBT	WBT	WBR	SBL	SBR
Lane Configurations			↑↑			↑
Traffic Vol, veh/h	0	0	468	41	0	69
Future Vol, veh/h	0	0	468	41	0	69
Conflicting Peds, #/hr	0	0	0	0	0	0
Sign Control	Free	Free	Free	Free	Stop	Stop
RT Channelized	-	None	-	None	-	None
Storage Length	-	-	-	-	-	0
Veh in Median Storage, #	-4521984		0	-	0	-
Grade, %	-	0	0	-	0	-
Peak Hour Factor	100	100	100	100	100	100
Heavy Vehicles, %	2	2	2	2	2	2
Mvmt Flow	0	0	468	41	0	69
Major/Minor	Major2		Minor2			
Conflicting Flow All			-	0	-	255
Stage 1			-	-	-	-
Stage 2			-	-	-	-
Critical Hdwy			-	-	-	6.94
Critical Hdwy Stg 1			-	-	-	-
Critical Hdwy Stg 2			-	-	-	-
Follow-up Hdwy			-	-	-	3.32
Pot Cap-1 Maneuver			-	-	0	744
Stage 1			-	-	0	-
Stage 2			-	-	0	-
Platoon blocked, %			-	-	-	-
Mov Cap-1 Maneuver			-	-	-	744
Mov Cap-2 Maneuver			-	-	-	-
Stage 1			-	-	-	-
Stage 2			-	-	-	-
Approach	WB		SB			
HCM Control Delay, s			0		10.3	
HCM LOS					B	
Minor Lane/Major Mvmt	WBT	WBR	SBLn1			
Capacity (veh/h)	-	-	744			
HCM Lane V/C Ratio	-	-	0.093			
HCM Control Delay (s)	-	-	10.3			
HCM Lane LOS	-	-	B			
HCM 95th %tile Q(veh)	-	-	0.3			



Lanes, Volumes, Timings  
 11: Access & Arlington Ave

02/28/2024

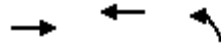

Lane Group	EBT	WBT	NBL
Lane Configurations			
Traffic Volume (vph)	62	23	14
Future Volume (vph)	62	23	14
Lane Group Flow (vph)	72	40	70
Sign Control	Free	Free	Stop

Intersection Summary	
Control Type: Unsignalized	
Intersection Capacity Utilization 20.1%	ICU Level of Service A
Analysis Period (min) 15	

Intersection						
Int Delay, s/veh	4.1					
Movement	EBT	EBR	WBL	WBT	NBL	NBR
Lane Configurations	↔			↕	↔	
Traffic Vol, veh/h	62	10	17	23	14	56
Future Vol, veh/h	62	10	17	23	14	56
Conflicting Peds, #/hr	0	0	0	0	0	0
Sign Control	Free	Free	Free	Free	Stop	Stop
RT Channelized	-	None	-	None	-	None
Storage Length	-	-	-	-	0	-
Veh in Median Storage, #	0	-	-	0	0	-
Grade, %	0	-	-	0	0	-
Peak Hour Factor	100	100	100	100	100	100
Heavy Vehicles, %	2	2	2	2	2	2
Mvmt Flow	62	10	17	23	14	56

Major/Minor	Major1	Major2	Minor1			
Conflicting Flow All	0	0	72	0	124	67
Stage 1	-	-	-	-	67	-
Stage 2	-	-	-	-	57	-
Critical Hdwy	-	-	4.12	-	6.42	6.22
Critical Hdwy Stg 1	-	-	-	-	5.42	-
Critical Hdwy Stg 2	-	-	-	-	5.42	-
Follow-up Hdwy	-	-	2.218	-	3.518	3.318
Pot Cap-1 Maneuver	-	-	1528	-	871	997
Stage 1	-	-	-	-	956	-
Stage 2	-	-	-	-	966	-
Platoon blocked, %	-	-	-	-	-	-
Mov Cap-1 Maneuver	-	-	1528	-	861	997
Mov Cap-2 Maneuver	-	-	-	-	861	-
Stage 1	-	-	-	-	956	-
Stage 2	-	-	-	-	955	-

Approach	EB	WB	NB
HCM Control Delay, s	0	3.1	9
HCM LOS			A

Minor Lane/Major Mvmt	NBLn1	EBT	EBR	WBL	WBT
Capacity (veh/h)	966	-	-	1528	-
HCM Lane V/C Ratio	0.072	-	-	0.011	-
HCM Control Delay (s)	9	-	-	7.4	0
HCM Lane LOS	A	-	-	A	A
HCM 95th %tile Q(veh)	0.2	-	-	0	-

Lanes, Volumes, Timings  
 12: Bank St & Arlington Ave

02/28/2024



Lane Group	EBL	NBT	SBT
Lane Configurations			
Traffic Volume (vph)	28	691	397
Future Volume (vph)	28	691	397
Lane Group Flow (vph)	180	784	419
Sign Control	Stop	Free	Free

Intersection Summary	
Control Type: Unsignalized	
Intersection Capacity Utilization 57.9%	ICU Level of Service B
Analysis Period (min) 15	

Intersection						
Int Delay, s/veh	3.5					
Movement	EBL	EBR	NBL	NBT	SBT	SBR
Lane Configurations	↔			↕	↕	
Traffic Vol, veh/h	28	152	93	691	397	22
Future Vol, veh/h	28	152	93	691	397	22
Conflicting Peds, #/hr	0	0	111	0	0	111
Sign Control	Stop	Stop	Free	Free	Free	Free
RT Channelized	-	None	-	None	-	None
Storage Length	0	-	-	-	-	-
Veh in Median Storage, #	0	-	-	0	0	-
Grade, %	0	-	-	0	0	-
Peak Hour Factor	100	100	100	100	100	100
Heavy Vehicles, %	0	3	2	5	8	5
Mvmt Flow	28	152	93	691	397	22

Major/Minor	Minor2	Major1	Major2			
Conflicting Flow All	1051	321	530	0	-	0
Stage 1	519	-	-	-	-	-
Stage 2	532	-	-	-	-	-
Critical Hdwy	6.8	6.96	4.14	-	-	-
Critical Hdwy Stg 1	5.8	-	-	-	-	-
Critical Hdwy Stg 2	5.8	-	-	-	-	-
Follow-up Hdwy	3.5	3.33	2.22	-	-	-
Pot Cap-1 Maneuver	226	672	1033	-	-	-
Stage 1	568	-	-	-	-	-
Stage 2	559	-	-	-	-	-
Platoon blocked, %				-	-	-
Mov Cap-1 Maneuver	152	603	927	-	-	-
Mov Cap-2 Maneuver	152	-	-	-	-	-
Stage 1	427	-	-	-	-	-
Stage 2	501	-	-	-	-	-

Approach	EB	NB	SB
HCM Control Delay, s	20.3	1.6	0
HCM LOS	C		

Minor Lane/Major Mvmt	NBL	NBT	EBLn1	SBT	SBR
Capacity (veh/h)	927	-	413	-	-
HCM Lane V/C Ratio	0.1	-	0.436	-	-
HCM Control Delay (s)	9.3	0.6	20.3	-	-
HCM Lane LOS	A	A	C	-	-
HCM 95th %tile Q(veh)	0.3	-	2.2	-	-

Lanes, Volumes, Timings  
13: Bronson Ave & Catherine St

02/28/2024



Lane Group	WBL	WBT	NBL	NBT	SBT	Ø5	Ø7
Lane Configurations							
Traffic Volume (vph)	526	498	540	1080	445		
Future Volume (vph)	526	498	540	1080	445		
Lane Group Flow (vph)	352	1039	540	1080	568		
Turn Type	Perm	NA	pm+pt	NA	NA		
Protected Phases		8	5 7	2	6	5	7
Permitted Phases	8		2				
Minimum Split (s)	28.3	28.3		23.8	23.8	11.2	11.8
Total Split (s)	37.0	37.0		73.0	30.2	31.0	11.8
Total Split (%)	33.6%	33.6%		66.4%	27.5%	28%	11%
Yellow Time (s)	3.3	3.3		3.3	3.3	3.3	3.3
All-Red Time (s)	3.0	3.0		3.5	3.5	2.9	3.5
Lost Time Adjust (s)	0.0	0.0		0.0	0.0		
Total Lost Time (s)	6.3	6.3		6.8	6.8		
Lead/Lag					Lag	Lead	
Lead-Lag Optimize?					Yes	Yes	
Act Effct Green (s)	30.7	30.7	66.8	66.2	23.4		
Actuated g/C Ratio	0.28	0.28	0.61	0.60	0.21		
v/c Ratio	0.88	0.86	0.88	0.53	0.84		
Control Delay	62.5	42.8	32.4	14.0	51.5		
Queue Delay	0.0	0.0	0.0	0.0	0.0		
Total Delay	62.5	42.8	32.4	14.0	51.5		
LOS	E	D	C	B	D		
Approach Delay		47.8		20.1	51.5		
Approach LOS		D		C	D		
Queue Length 50th (m)	84.0	76.1	62.1	66.5	58.9		
Queue Length 95th (m)	#143.9	94.8	#114.9	83.1	#85.3		
Internal Link Dist (m)		120.8		240.1	287.4		
Turn Bay Length (m)	80.0		45.0				
Base Capacity (vph)	399	1213	613	2040	679		
Starvation Cap Reductn	0	0	0	0	0		
Spillback Cap Reductn	0	0	0	0	0		
Storage Cap Reductn	0	0	0	0	0		
Reduced v/c Ratio	0.88	0.86	0.88	0.53	0.84		

Intersection Summary

Cycle Length: 110  
 Actuated Cycle Length: 110  
 Offset: 60 (55%), Referenced to phase 2:NBT and 6:SBT, Start of Green  
 Natural Cycle: 90  
 Control Type: Pretimed  
 Maximum v/c Ratio: 0.88  
 Intersection Signal Delay: 35.9  
 Intersection LOS: D  
 Intersection Capacity Utilization 88.8%  
 ICU Level of Service E  
 Analysis Period (min) 15  
 # 95th percentile volume exceeds capacity, queue may be longer.  
 Queue shown is maximum after two cycles.

Splits and Phases: 13: Bronson Ave & Catherine St



Lanes, Volumes, Timings

1: Hwy 417 WB On Ramp/Lyon St N & Catherine St

02/28/2024



Lane Group	WBT	SBT	SBR
Lane Configurations	↕↕	↕	↗
Traffic Volume (vph)	553	366	296
Future Volume (vph)	553	366	296
Lane Group Flow (vph)	777	366	296
Turn Type	NA	NA	Perm
Protected Phases	8	6	
Permitted Phases			6
Minimum Split (s)	26.2	28.3	28.3
Total Split (s)	38.0	37.0	37.0
Total Split (%)	50.7%	49.3%	49.3%
Yellow Time (s)	3.3	3.3	3.3
All-Red Time (s)	1.9	2.0	2.0
Lost Time Adjust (s)	0.0	0.0	0.0
Total Lost Time (s)	5.2	5.3	5.3
Lead/Lag			
Lead-Lag Optimize?			
Act Effct Green (s)	32.8	31.7	31.7
Actuated g/C Ratio	0.44	0.42	0.42
v/c Ratio	0.52	0.48	0.40
Control Delay	13.3	26.7	17.0
Queue Delay	0.0	0.0	0.0
Total Delay	13.3	26.7	17.0
LOS	B	C	B
Approach Delay	13.3	22.3	
Approach LOS	B	C	
Queue Length 50th (m)	53.6	52.3	26.1
Queue Length 95th (m)	71.5	77.8	49.0
Internal Link Dist (m)	107.6	52.8	
Turn Bay Length (m)			
Base Capacity (vph)	1489	761	731
Starvation Cap Reductn	0	0	0
Spillback Cap Reductn	0	0	0
Storage Cap Reductn	0	0	0
Reduced v/c Ratio	0.52	0.48	0.40

Intersection Summary

Cycle Length: 75	
Actuated Cycle Length: 75	
Offset: 24 (32%), Referenced to phase 8:WBTL, Start of Green	
Natural Cycle: 55	
Control Type: Pretimed	
Maximum v/c Ratio: 0.52	
Intersection Signal Delay: 17.5	Intersection LOS: B
Intersection Capacity Utilization 55.4%	ICU Level of Service B
Analysis Period (min) 15	

Splits and Phases: 1: Hwy 417 WB On Ramp/Lyon St N & Catherine St

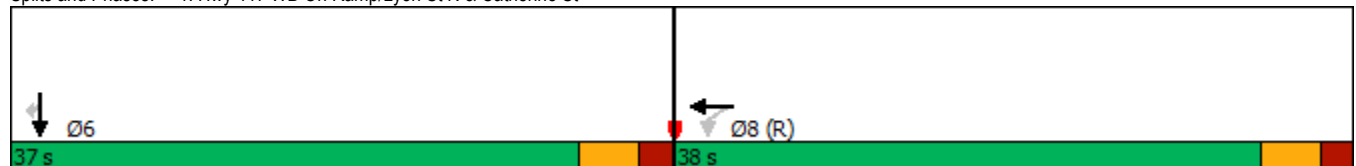

Lanes, Volumes, Timings

2: Hwy 417 EB Off Ramp/Chamberlain Ave/Kent St & Catherine St

02/28/2024



Lane Group	WBT	WBR	NBT	Ø9
Lane Configurations	↑↑	↑↑	↑↑↑	
Traffic Volume (vph)	723	314	870	
Future Volume (vph)	723	314	870	
Lane Group Flow (vph)	723	314	920	
Turn Type	NA	Prot	NA	
Protected Phases	8	8	2	9
Permitted Phases				
Detector Phase	8	8	2	
Switch Phase				
Minimum Initial (s)	10.0	10.0	10.0	1.0
Minimum Split (s)	15.8	15.8	22.5	13.0
Total Split (s)	35.0	35.0	27.0	13.0
Total Split (%)	46.7%	46.7%	36.0%	17%
Yellow Time (s)	3.3	3.3	3.3	2.0
All-Red Time (s)	2.5	2.5	2.5	0.0
Lost Time Adjust (s)	0.0	0.0	0.0	
Total Lost Time (s)	5.8	5.8	5.8	
Lead/Lag				
Lead-Lag Optimize?				
Recall Mode	C-Max	C-Max	Max	None
Act Effct Green (s)	34.4	34.4	21.2	
Actuated g/C Ratio	0.46	0.46	0.28	
v/c Ratio	0.47	0.27	0.65	
Control Delay	26.8	24.3	24.2	
Queue Delay	0.0	0.0	1.3	
Total Delay	26.8	24.3	25.6	
LOS	C	C	C	
Approach Delay	26.1		25.6	
Approach LOS	C		C	
Queue Length 50th (m)	53.8	23.4	38.3	
Queue Length 95th (m)	m63.2	m27.7	51.3	
Internal Link Dist (m)	131.7		67.4	
Turn Bay Length (m)		60.0		
Base Capacity (vph)	1539	1156	1420	
Starvation Cap Reductn	0	0	0	
Spillback Cap Reductn	0	0	289	
Storage Cap Reductn	0	0	0	
Reduced v/c Ratio	0.47	0.27	0.81	

Intersection Summary

Cycle Length: 75  
 Actuated Cycle Length: 75  
 Offset: 0 (0%), Referenced to phase 8:WBT, Start of Green  
 Natural Cycle: 60  
 Control Type: Actuated-Coordinated  
 Maximum v/c Ratio: 0.65  
 Intersection Signal Delay: 25.8  
 Intersection LOS: C  
 Intersection Capacity Utilization 51.8%  
 ICU Level of Service A  
 Analysis Period (min) 15  
 m Volume for 95th percentile queue is metered by upstream signal.

Splits and Phases: 2: Hwy 417 EB Off Ramp/Chamberlain Ave/Kent St & Catherine St



Lanes, Volumes, Timings  
3: Bank St & Catherine St

02/28/2024



Lane Group	WBT	NBL	NBT	SBT	Ø1	Ø5	Ø7
Lane Configurations							
Traffic Volume (vph)	653	206	340	713			
Future Volume (vph)	653	206	340	713			
Lane Group Flow (vph)	1047	0	546	855			
Turn Type	NA	pm+pt	NA	NA			
Protected Phases	8	9	2	6	1	5	7
Permitted Phases		2					
Minimum Split (s)	18.6	10.4	16.4	16.4	5.0	5.0	5.0
Total Split (s)	24.0	10.4	41.0	30.6	5.0	5.0	5.0
Total Split (%)	32.0%	13.9%	54.7%	40.8%	7%	7%	7%
Yellow Time (s)	3.3	3.3	3.3	3.3	2.0	2.0	2.0
All-Red Time (s)	2.3	2.1	2.1	2.1	0.0	0.0	0.0
Lost Time Adjust (s)	0.0		0.0	0.0			
Total Lost Time (s)	5.6		5.4	5.4			
Lead/Lag	Lag		Lag	Lag	Lead	Lead	Lead
Lead-Lag Optimize?	Yes		Yes	Yes	Yes	Yes	Yes
Act Effct Green (s)	18.4		35.6	25.2			
Actuated g/C Ratio	0.25		0.47	0.34			
v/c Ratio	0.92		0.58	0.81			
Control Delay	40.3		13.2	29.0			
Queue Delay	0.0		0.0	0.8			
Total Delay	40.3		13.2	29.8			
LOS	D		B	C			
Approach Delay	40.3		13.2	29.8			
Approach LOS	D		B	C			
Queue Length 50th (m)	50.7		15.6	54.9			
Queue Length 95th (m)	#75.5		20.4	#77.5			
Internal Link Dist (m)	201.7		90.2	52.9			
Turn Bay Length (m)							
Base Capacity (vph)	1144		946	1062			
Starvation Cap Reductn	0		0	0			
Spillback Cap Reductn	0		0	52			
Storage Cap Reductn	0		0	0			
Reduced v/c Ratio	0.92		0.58	0.85			

Intersection Summary

Cycle Length: 75  
 Actuated Cycle Length: 75  
 Offset: 50 (67%), Referenced to phase 2:NBT and 6:SBT, Start of Green  
 Natural Cycle: 75  
 Control Type: Pretimed  
 Maximum v/c Ratio: 0.92  
 Intersection Signal Delay: 30.6  
 Intersection LOS: C  
 Intersection Capacity Utilization 81.7%  
 ICU Level of Service D  
 Analysis Period (min) 15  
 # 95th percentile volume exceeds capacity, queue may be longer.  
 Queue shown is maximum after two cycles.

Splits and Phases: 3: Bank St & Catherine St

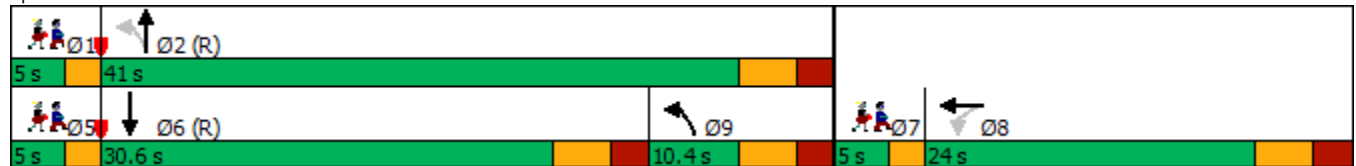



Lanes, Volumes, Timings  
4: Percy St & Catherine St

02/28/2024

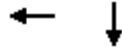

Lane Group	WBT	SBT	Ø3	Ø7
Lane Configurations				
Traffic Volume (vph)	724	121		
Future Volume (vph)	724	121		
Lane Group Flow (vph)	890	160		
Turn Type	NA	NA		
Protected Phases	8	6	3	7
Permitted Phases				
Detector Phase	8	6		
Switch Phase				
Minimum Initial (s)	10.0	10.0	1.0	1.0
Minimum Split (s)	26.5	23.4	6.4	6.4
Total Split (s)	34.0	24.0	16.0	16.0
Total Split (%)	37.8%	26.7%	18%	18%
Yellow Time (s)	3.3	3.3	3.3	3.3
All-Red Time (s)	2.2	2.1	2.1	2.1
Lost Time Adjust (s)	0.0	0.0		
Total Lost Time (s)	5.5	5.4		
Lead/Lag	Lag			Lead
Lead-Lag Optimize?	Yes			Yes
Recall Mode	None	Max	None	None
Act Effct Green (s)	18.6	18.7		
Actuated g/C Ratio	0.39	0.39		
v/c Ratio	0.64	0.24		
Control Delay	11.9	12.6		
Queue Delay	0.0	0.0		
Total Delay	11.9	12.6		
LOS	B	B		
Approach Delay	11.9	12.6		
Approach LOS	B	B		
Queue Length 50th (m)	24.5	8.5		
Queue Length 95th (m)	38.3	22.9		
Internal Link Dist (m)	271.6	288.0		
Turn Bay Length (m)				
Base Capacity (vph)	2050	669		
Starvation Cap Reductn	0	0		
Spillback Cap Reductn	0	0		
Storage Cap Reductn	0	0		
Reduced v/c Ratio	0.43	0.24		

Intersection Summary

Cycle Length: 90	
Actuated Cycle Length: 48.3	
Natural Cycle: 65	
Control Type: Semi Act-Uncoord	
Maximum v/c Ratio: 0.64	
Intersection Signal Delay: 12.0	Intersection LOS: B
Intersection Capacity Utilization 53.6%	ICU Level of Service A
Analysis Period (min) 15	

Splits and Phases: 4: Percy St & Catherine St

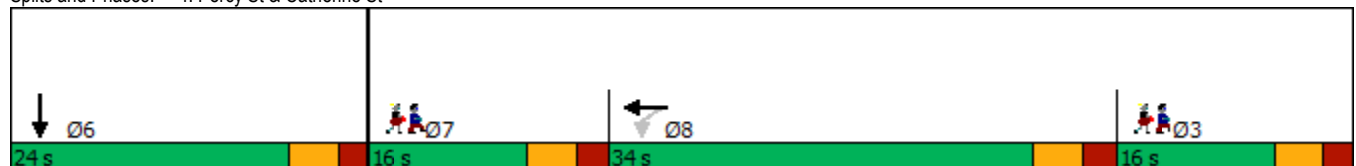

Lanes, Volumes, Timings  
 5: Lyon St N & Arlington Ave

02/28/2024

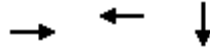

Lane Group	EBT	WBT	SBT
Lane Configurations			
Traffic Volume (vph)	19	37	587
Future Volume (vph)	19	37	587
Lane Group Flow (vph)	21	54	661
Sign Control	Stop	Stop	Free
<b>Intersection Summary</b>			
Control Type: Unsignalized			
Intersection Capacity Utilization 40.9%		ICU Level of Service A	
Analysis Period (min) 15			

Intersection												
Int Delay, s/veh	2.6											
Movement	EBL	EBT	EBR	WBL	WBT	WBR	NBL	NBT	NBR	SBL	SBT	SBR
Lane Configurations		↕			↕						↕↔	
Traffic Vol, veh/h	0	19	2	17	37	0	0	0	0	61	587	13
Future Vol, veh/h	0	19	2	17	37	0	0	0	0	61	587	13
Conflicting Peds, #/hr	20	0	8	8	0	20	19	0	3	3	0	19
Sign Control	Stop	Stop	Stop	Stop	Stop	Stop	Free	Free	Free	Free	Free	Free
RT Channelized	-	-	None	-	-	None	-	-	None	-	-	None
Storage Length	-	-	-	-	-	-	-	-	-	-	-	-
Veh in Median Storage, #	-	0	-	-	0	-	-	-	-	-	0	-
Grade, %	-	0	-	-	0	-	-	0	-	-	0	-
Peak Hour Factor	100	100	100	100	100	100	100	100	100	100	100	100
Heavy Vehicles, %	0	5	0	0	5	0	0	0	0	0	0	0
Mvmt Flow	0	19	2	17	37	0	0	0	0	61	587	13

Major/Minor	Minor2		Minor1			Major2			
Conflicting Flow All	-	738	327	436	744	-	3	0	0
Stage 1	-	735	-	3	3	-	-	-	-
Stage 2	-	3	-	433	741	-	-	-	-
Critical Hdwy	-	6.6	6.9	7.5	6.6	-	4.1	-	-
Critical Hdwy Stg 1	-	5.6	-	-	-	-	-	-	-
Critical Hdwy Stg 2	-	-	-	6.5	5.6	-	-	-	-
Follow-up Hdwy	-	4.05	3.3	3.5	4.05	-	2.2	-	-
Pot Cap-1 Maneuver	0	338	675	509	335	0	1632	-	-
Stage 1	0	416	-	-	0	-	-	-	-
Stage 2	0	-	-	577	414	0	-	-	-
Platoon blocked, %	-	-	-	-	-	-	-	-	-
Mov Cap-1 Maneuver	-	312	663	462	310	-	1627	-	-
Mov Cap-2 Maneuver	-	312	-	462	310	-	-	-	-
Stage 1	-	386	-	-	-	-	-	-	-
Stage 2	-	-	-	516	384	-	-	-	-

Approach	EB		WB			SB		
HCM Control Delay, s	16.7		17.3			0.9		
HCM LOS	C		C					

Minor Lane/Major Mvmt	EBLn1	WBLn1	SBL	SBT	SBR
Capacity (veh/h)	329	346	1627	-	-
HCM Lane V/C Ratio	0.064	0.156	0.037	-	-
HCM Control Delay (s)	16.7	17.3	7.3	0.2	-
HCM Lane LOS	C	C	A	A	-
HCM 95th %tile Q(veh)	0.2	0.5	0.1	-	-

Lanes, Volumes, Timings  
6: Kent St & Arlington Ave

02/28/2024



Lane Group	EBL	EBT	WBT	NBT
Lane Configurations		↕	↕	↕↕↕
Traffic Volume (vph)	25	83	30	1073
Future Volume (vph)	25	83	30	1073
Lane Group Flow (vph)	0	108	93	1206
Turn Type	Perm	NA	NA	NA
Protected Phases		4	8	2
Permitted Phases	4			
Minimum Split (s)	27.3	27.3	27.3	32.3
Total Split (s)	31.0	31.0	31.0	44.0
Total Split (%)	41.3%	41.3%	41.3%	58.7%
Yellow Time (s)	3.3	3.3	3.3	3.3
All-Red Time (s)	2.0	2.0	2.0	2.0
Lost Time Adjust (s)		0.0	0.0	0.0
Total Lost Time (s)		5.3	5.3	5.3
Lead/Lag				
Lead-Lag Optimize?				
Act Effct Green (s)		25.7	25.7	38.7
Actuated g/C Ratio		0.34	0.34	0.52
v/c Ratio		0.19	0.16	0.48
Control Delay		26.0	9.3	9.8
Queue Delay		0.0	0.0	49.8
Total Delay		26.0	9.3	59.6
LOS		C	A	E
Approach Delay		26.0	9.3	59.6
Approach LOS		C	A	E
Queue Length 50th (m)		13.0	1.6	48.0
Queue Length 95th (m)		m25.4	m6.3	68.3
Internal Link Dist (m)		138.7	143.1	53.0
Turn Bay Length (m)				
Base Capacity (vph)		576	582	2498
Starvation Cap Reductn		0	0	1422
Spillback Cap Reductn		0	0	0
Storage Cap Reductn		0	0	0
Reduced v/c Ratio		0.19	0.16	1.12

Intersection Summary

Cycle Length: 75  
 Actuated Cycle Length: 75  
 Offset: 50 (67%), Referenced to phase 2:NBT, Start of Green  
 Natural Cycle: 60  
 Control Type: Pretimed  
 Maximum v/c Ratio: 0.48  
 Intersection Signal Delay: 53.7  
 Intersection LOS: D  
 Intersection Capacity Utilization 54.6%  
 ICU Level of Service A  
 Analysis Period (min) 15  
 m Volume for 95th percentile queue is metered by upstream signal.

Splits and Phases: 6: Kent St & Arlington Ave



Lanes, Volumes, Timings  
7: Lyon St N & Gladstone Ave

02/28/2024



Lane Group	EBT	EBR	WBL	WBT	SBT
Lane Configurations	↑	↑	↑	↑	↑↓
Traffic Volume (vph)	247	52	28	314	541
Future Volume (vph)	247	52	28	314	541
Lane Group Flow (vph)	247	52	28	314	765
Turn Type	NA	Perm	Perm	NA	NA
Protected Phases	4			8	6
Permitted Phases		4	8		
Minimum Split (s)	17.2	17.2	17.2	17.2	22.6
Total Split (s)	37.0	37.0	37.0	37.0	38.0
Total Split (%)	49.3%	49.3%	49.3%	49.3%	50.7%
Yellow Time (s)	3.3	3.3	3.3	3.3	3.3
All-Red Time (s)	1.9	1.9	1.9	1.9	2.3
Lost Time Adjust (s)	0.0	0.0	0.0	0.0	0.0
Total Lost Time (s)	5.2	5.2	5.2	5.2	5.6
Lead/Lag					
Lead-Lag Optimize?					
Act Effct Green (s)	31.8	31.8	31.8	31.8	32.4
Actuated g/C Ratio	0.42	0.42	0.42	0.42	0.43
v/c Ratio	0.33	0.08	0.07	0.42	0.54
Control Delay	16.0	4.5	8.4	12.7	16.4
Queue Delay	0.0	0.0	0.0	0.0	0.0
Total Delay	16.0	4.5	8.4	12.7	16.4
LOS	B	A	A	B	B
Approach Delay	14.0			12.3	16.4
Approach LOS	B			B	B
Queue Length 50th (m)	22.6	0.0	1.5	35.6	38.0
Queue Length 95th (m)	38.4	5.7	m3.3	55.1	53.4
Internal Link Dist (m)	254.8			165.0	214.3
Turn Bay Length (m)			25.0		
Base Capacity (vph)	756	626	422	756	1428
Starvation Cap Reductn	0	0	0	0	0
Spillback Cap Reductn	0	0	0	0	0
Storage Cap Reductn	0	0	0	0	0
Reduced v/c Ratio	0.33	0.08	0.07	0.42	0.54

Intersection Summary

Cycle Length: 75  
 Actuated Cycle Length: 75  
 Offset: 45 (60%), Referenced to phase 4:EBT and 8:WBTL, Start of Green  
 Natural Cycle: 40  
 Control Type: Pretimed  
 Maximum v/c Ratio: 0.54  
 Intersection Signal Delay: 14.9  
 Intersection LOS: B  
 Intersection Capacity Utilization 67.8%  
 ICU Level of Service C  
 Analysis Period (min) 15  
 m Volume for 95th percentile queue is metered by upstream signal.

Splits and Phases: 7: Lyon St N & Gladstone Ave

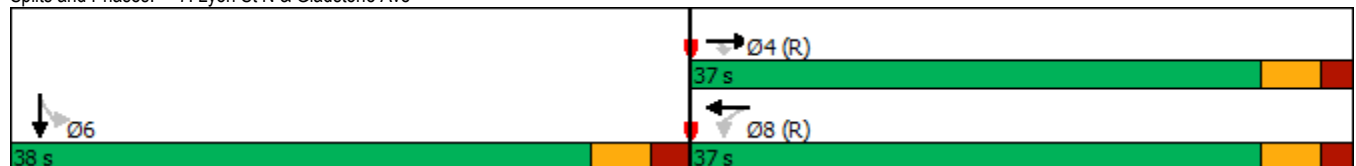

Lanes, Volumes, Timings  
8: Kent St & Gladstone Ave

02/28/2024

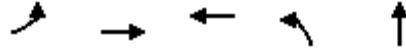

Lane Group	EBL	EBT	WBT	NBL	NBT
Lane Configurations					
Traffic Volume (vph)	75	450	324	67	930
Future Volume (vph)	75	450	324	67	930
Lane Group Flow (vph)	75	450	399	67	1061
Turn Type	Perm	NA	NA	Perm	NA
Protected Phases		4	8		2
Permitted Phases	4			2	
Minimum Split (s)	21.4	21.4	21.4	20.4	20.4
Total Split (s)	43.0	43.0	43.0	32.0	32.0
Total Split (%)	57.3%	57.3%	57.3%	42.7%	42.7%
Yellow Time (s)	3.3	3.3	3.3	3.3	3.3
All-Red Time (s)	2.1	2.1	2.1	2.1	2.1
Lost Time Adjust (s)	0.0	0.0	0.0	0.0	0.0
Total Lost Time (s)	5.4	5.4	5.4	5.4	5.4
Lead/Lag					
Lead-Lag Optimize?					
Act Effct Green (s)	37.6	37.6	37.6	26.6	26.6
Actuated g/C Ratio	0.50	0.50	0.50	0.35	0.35
v/c Ratio	0.19	0.51	0.46	0.12	0.64
Control Delay	18.0	21.5	13.5	9.0	10.1
Queue Delay	0.0	0.0	0.0	0.0	0.0
Total Delay	18.0	21.5	13.5	9.0	10.1
LOS	B	C	B	A	B
Approach Delay		21.0	13.5		10.0
Approach LOS		C	B		A
Queue Length 50th (m)	6.6	49.2	32.3	3.1	16.9
Queue Length 95th (m)	m16.0	78.4	53.2	m5.0	15.6
Internal Link Dist (m)		165.0	168.8		216.0
Turn Bay Length (m)	30.0			40.0	
Base Capacity (vph)	401	885	872	539	1663
Starvation Cap Reductn	0	0	0	0	0
Spillback Cap Reductn	0	0	0	0	0
Storage Cap Reductn	0	0	0	0	0
Reduced v/c Ratio	0.19	0.51	0.46	0.12	0.64

Intersection Summary

Cycle Length: 75  
 Actuated Cycle Length: 75  
 Offset: 23 (31%), Referenced to phase 4:EBTL and 8:WBT, Start of Green  
 Natural Cycle: 45  
 Control Type: Pretimed  
 Maximum v/c Ratio: 0.64  
 Intersection Signal Delay: 13.5  
 Intersection LOS: B  
 Intersection Capacity Utilization 67.8%  
 ICU Level of Service C  
 Analysis Period (min) 15  
 m Volume for 95th percentile queue is metered by upstream signal.

Splits and Phases: 8: Kent St & Gladstone Ave

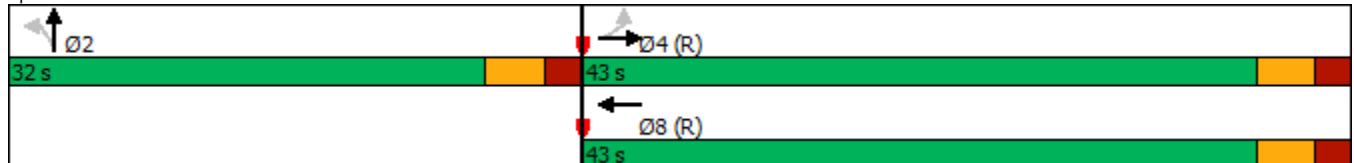

Lanes, Volumes, Timings  
 9: Bank St & Chamberlain Ave/Isabella St

02/28/2024



Lane Group	EBT	EBR	NBT	SBL	SBT
Lane Configurations					
Traffic Volume (vph)	624	124	468	189	734
Future Volume (vph)	624	124	468	189	734
Lane Group Flow (vph)	691	124	561	0	923
Turn Type	NA	Perm	NA	pm+pt	NA
Protected Phases	4		2	5	6
Permitted Phases		4		6	
Detector Phase	4	4	2	5	6
Switch Phase					
Minimum Initial (s)	10.0	10.0	10.0	5.0	10.0
Minimum Split (s)	26.2	26.2	23.1	11.1	23.1
Total Split (s)	28.0	28.0	35.9	11.1	47.0
Total Split (%)	37.3%	37.3%	47.9%	14.8%	62.7%
Yellow Time (s)	3.3	3.3	3.0	3.0	3.0
All-Red Time (s)	2.9	2.9	3.1	3.1	3.1
Lost Time Adjust (s)	0.0	0.0	0.0		0.0
Total Lost Time (s)	6.2	6.2	6.1		6.1
Lead/Lag					
Lead-Lag Optimize?					
Recall Mode	None	None	C-Max	None	C-Max
Act Effct Green (s)	20.3	20.3	42.4		42.4
Actuated g/C Ratio	0.27	0.27	0.57		0.57
v/c Ratio	0.76	0.26	0.32		0.70
Control Delay	31.2	5.2	9.6		13.0
Queue Delay	0.0	0.0	0.0		1.5
Total Delay	31.2	5.2	9.6		14.4
LOS	C	A	A		B
Approach Delay	27.2		9.6		14.4
Approach LOS	C		A		B
Queue Length 50th (m)	45.6	0.0	21.3		74.0
Queue Length 95th (m)	63.8	9.8	30.7		m92.0
Internal Link Dist (m)	296.0		215.6		90.2
Turn Bay Length (m)		40.0			
Base Capacity (vph)	970	502	1772		1320
Starvation Cap Reductn	0	0	0		215
Spillback Cap Reductn	0	0	0		0
Storage Cap Reductn	0	0	0		0
Reduced v/c Ratio	0.71	0.25	0.32		0.84

Intersection Summary

Cycle Length: 75  
 Actuated Cycle Length: 75  
 Offset: 60 (80%), Referenced to phase 2:NBT and 6:SBTL, Start of Green  
 Natural Cycle: 65  
 Control Type: Actuated-Coordinated  
 Maximum v/c Ratio: 0.76  
 Intersection Signal Delay: 17.8  
 Intersection LOS: B  
 Intersection Capacity Utilization 84.2%  
 ICU Level of Service E  
 Analysis Period (min) 15  
 m Volume for 95th percentile queue is metered by upstream signal.

Splits and Phases: 9: Bank St & Chamberlain Ave/Isabella St

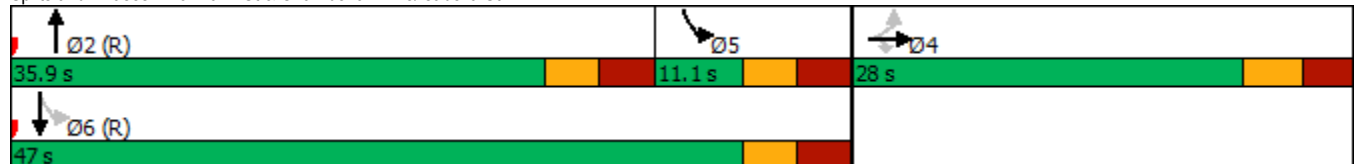





Intersection						
Int Delay, s/veh	0.7					
Movement	EBL	EBT	WBT	WBR	SBL	SBR
Lane Configurations			↑↑			↑
Traffic Vol, veh/h	0	0	647	72	0	45
Future Vol, veh/h	0	0	647	72	0	45
Conflicting Peds, #/hr	0	0	0	0	0	0
Sign Control	Free	Free	Free	Free	Stop	Stop
RT Channelized	-	None	-	None	-	None
Storage Length	-	-	-	-	-	0
Veh in Median Storage, #	-2949	120	0	-	0	-
Grade, %	-	0	0	-	0	-
Peak Hour Factor	100	100	100	100	100	100
Heavy Vehicles, %	2	2	2	2	2	2
Mvmt Flow	0	0	647	72	0	45

Major/Minor	Major2	Minor2
Conflicting Flow All	-	0
Stage 1	-	-
Stage 2	-	-
Critical Hdwy	-	6.94
Critical Hdwy Stg 1	-	-
Critical Hdwy Stg 2	-	-
Follow-up Hdwy	-	3.32
Pot Cap-1 Maneuver	-	0
Stage 1	-	0
Stage 2	-	0
Platoon blocked, %	-	-
Mov Cap-1 Maneuver	-	637
Mov Cap-2 Maneuver	-	-
Stage 1	-	-
Stage 2	-	-

Approach	WB	SB
HCM Control Delay, s	0	11.1
HCM LOS		B

Minor Lane/Major Mvmt	WBT	WBR	SBLn1
Capacity (veh/h)	-	-	637
HCM Lane V/C Ratio	-	-	0.071
HCM Control Delay (s)	-	-	11.1
HCM Lane LOS	-	-	B
HCM 95th %tile Q(veh)	-	-	0.2

Lanes, Volumes, Timings  
 11: Access & Arlington Ave

02/28/2024

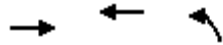

Lane Group	EBT	WBT	NBL
Lane Configurations			
Traffic Volume (vph)	62	45	9
Future Volume (vph)	62	45	9
Lane Group Flow (vph)	80	75	45
Sign Control	Free	Free	Stop

Intersection Summary	
Control Type: Unsignalized	
Intersection Capacity Utilization 20.9%	ICU Level of Service A
Analysis Period (min) 15	

Intersection						
Int Delay, s/veh	3.2					
Movement	EBT	EBR	WBL	WBT	NBL	NBR
Lane Configurations						
Traffic Vol, veh/h	62	18	30	45	9	36
Future Vol, veh/h	62	18	30	45	9	36
Conflicting Peds, #/hr	0	0	0	0	0	0
Sign Control	Free	Free	Free	Free	Stop	Stop
RT Channelized	-	None	-	None	-	None
Storage Length	-	-	-	-	0	-
Veh in Median Storage, #	0	-	-	0	0	-
Grade, %	0	-	-	0	0	-
Peak Hour Factor	100	100	100	100	100	100
Heavy Vehicles, %	2	2	2	2	2	2
Mvmt Flow	62	18	30	45	9	36
Major/Minor	Major1	Major2	Minor1			
Conflicting Flow All	0	0	80	0	176	71
Stage 1	-	-	-	-	71	-
Stage 2	-	-	-	-	105	-
Critical Hdwy	-	-	4.12	-	6.42	6.22
Critical Hdwy Stg 1	-	-	-	-	5.42	-
Critical Hdwy Stg 2	-	-	-	-	5.42	-
Follow-up Hdwy	-	-	2.218	-	3.518	3.318
Pot Cap-1 Maneuver	-	-	1518	-	814	991
Stage 1	-	-	-	-	952	-
Stage 2	-	-	-	-	919	-
Platoon blocked, %	-	-	-	-	-	-
Mov Cap-1 Maneuver	-	-	1518	-	798	991
Mov Cap-2 Maneuver	-	-	-	-	798	-
Stage 1	-	-	-	-	952	-
Stage 2	-	-	-	-	901	-
Approach	EB	WB	NB			
HCM Control Delay, s	0	3	9			
HCM LOS				A		
Minor Lane/Major Mvmt	NBLn1	EBT	EBR	WBL	WBT	
Capacity (veh/h)	945	-	-	1518	-	
HCM Lane V/C Ratio	0.048	-	-	0.02	-	
HCM Control Delay (s)	9	-	-	7.4	0	
HCM Lane LOS	A	-	-	A	A	
HCM 95th %tile Q(veh)	0.1	-	-	0.1	-	

Lanes, Volumes, Timings  
 12: Bank St & Arlington Ave

02/28/2024



Lane Group	EBL	NBT	SBT
Lane Configurations			
Traffic Volume (vph)	24	428	731
Future Volume (vph)	24	428	731
Lane Group Flow (vph)	149	498	758
Sign Control	Stop	Free	Free

Intersection Summary	
Control Type: Unsignalized	
Intersection Capacity Utilization 56.5%	ICU Level of Service B
Analysis Period (min) 15	

Intersection						
Int Delay, s/veh	2.6					
Movement	EBL	EBR	NBL	NBT	SBT	SBR
Lane Configurations	↔			↕	↕	
Traffic Vol, veh/h	24	125	70	428	731	27
Future Vol, veh/h	24	125	70	428	731	27
Conflicting Peds, #/hr	0	0	42	0	0	42
Sign Control	Stop	Stop	Free	Free	Free	Free
RT Channelized	-	None	-	None	-	None
Storage Length	0	-	-	-	-	-
Veh in Median Storage, #	0	-	-	0	0	-
Grade, %	0	-	-	0	0	-
Peak Hour Factor	100	100	100	100	100	100
Heavy Vehicles, %	0	1	0	5	3	0
Mvmt Flow	24	125	70	428	731	27

Major/Minor	Minor2	Major1	Major2			
Conflicting Flow All	1141	421	800	0	-	0
Stage 1	787	-	-	-	-	-
Stage 2	354	-	-	-	-	-
Critical Hdwy	6.8	6.92	4.1	-	-	-
Critical Hdwy Stg 1	5.8	-	-	-	-	-
Critical Hdwy Stg 2	5.8	-	-	-	-	-
Follow-up Hdwy	3.5	3.31	2.2	-	-	-
Pot Cap-1 Maneuver	197	584	832	-	-	-
Stage 1	414	-	-	-	-	-
Stage 2	687	-	-	-	-	-
Platoon blocked, %				-	-	-
Mov Cap-1 Maneuver	161	561	800	-	-	-
Mov Cap-2 Maneuver	161	-	-	-	-	-
Stage 1	352	-	-	-	-	-
Stage 2	660	-	-	-	-	-

Approach	EB	NB	SB
HCM Control Delay, s	19.2	1.7	0
HCM LOS	C		

Minor Lane/Major Mvmt	NBL	NBT	EBLn1	SBT	SBR
Capacity (veh/h)	800	-	401	-	-
HCM Lane V/C Ratio	0.088	-	0.372	-	-
HCM Control Delay (s)	9.9	0.4	19.2	-	-
HCM Lane LOS	A	A	C	-	-
HCM 95th %tile Q(veh)	0.3	-	1.7	-	-

Lanes, Volumes, Timings  
13: Bronson Ave & Catherine St

02/28/2024



Lane Group	WBL	WBT	NBL	NBT	SBT
Lane Configurations					
Traffic Volume (vph)	727	596	304	792	833
Future Volume (vph)	727	596	304	792	833
Lane Group Flow (vph)	407	1201	304	792	1005
Turn Type	Perm	NA	pm+pt	NA	NA
Protected Phases		8	5	2	6
Permitted Phases	8		2		
Minimum Split (s)	28.3	28.3	11.2	23.8	23.8
Total Split (s)	37.0	37.0	22.0	63.0	41.0
Total Split (%)	37.0%	37.0%	22.0%	63.0%	41.0%
Yellow Time (s)	3.3	3.3	3.3	3.3	3.3
All-Red Time (s)	3.0	3.0	2.9	3.5	3.5
Lost Time Adjust (s)	0.0	0.0	0.0	0.0	0.0
Total Lost Time (s)	6.3	6.3	6.2	6.8	6.8
Lead/Lag			Lead		Lag
Lead-Lag Optimize?			Yes		Yes
Act Effct Green (s)	30.7	30.7	56.8	56.2	34.2
Actuated g/C Ratio	0.31	0.31	0.57	0.56	0.34
v/c Ratio	0.91	0.88	0.90	0.42	0.89
Control Delay	60.0	39.3	55.5	13.3	41.4
Queue Delay	0.0	0.0	0.0	0.0	0.0
Total Delay	60.0	39.3	55.5	13.3	41.4
LOS	E	D	E	B	D
Approach Delay		44.6		25.0	41.4
Approach LOS		D		C	D
Queue Length 50th (m)	87.7	80.1	42.8	43.4	93.8
Queue Length 95th (m)	#151.5	#102.4	#90.8	56.4	#130.6
Internal Link Dist (m)		120.8		240.1	287.4
Turn Bay Length (m)	80.0		45.0		
Base Capacity (vph)	447	1368	337	1905	1132
Starvation Cap Reductn	0	0	0	0	0
Spillback Cap Reductn	0	0	0	0	0
Storage Cap Reductn	0	0	0	0	0
Reduced v/c Ratio	0.91	0.88	0.90	0.42	0.89

Intersection Summary

Cycle Length: 100  
 Actuated Cycle Length: 100  
 Offset: 60 (60%), Referenced to phase 2:NBT and 6:SBT, Start of Green  
 Natural Cycle: 75  
 Control Type: Pretimed  
 Maximum v/c Ratio: 0.91  
 Intersection Signal Delay: 37.9  
 Intersection LOS: D  
 Intersection Capacity Utilization 90.8%  
 ICU Level of Service E  
 Analysis Period (min) 15  
 # 95th percentile volume exceeds capacity, queue may be longer.  
 Queue shown is maximum after two cycles.

Splits and Phases: 13: Bronson Ave & Catherine St



**Total Projected 2036**

Lanes, Volumes, Timings

1: Hwy 417 WB On Ramp/Lyon St N & Catherine St

02/28/2024



Lane Group	WBT	SBT	SBR
Lane Configurations	↕↕	↕	↗
Traffic Volume (vph)	275	289	131
Future Volume (vph)	275	289	131
Lane Group Flow (vph)	550	289	131
Turn Type	NA	NA	Perm
Protected Phases	8	6	
Permitted Phases			6
Minimum Split (s)	26.2	28.3	28.3
Total Split (s)	36.0	39.0	39.0
Total Split (%)	48.0%	52.0%	52.0%
Yellow Time (s)	3.3	3.3	3.3
All-Red Time (s)	1.9	2.0	2.0
Lost Time Adjust (s)	0.0	0.0	0.0
Total Lost Time (s)	5.2	5.3	5.3
Lead/Lag			
Lead-Lag Optimize?			
Act Effct Green (s)	30.8	33.7	33.7
Actuated g/C Ratio	0.41	0.45	0.45
v/c Ratio	0.38	0.36	0.17
Control Delay	18.9	23.9	11.6
Queue Delay	0.0	0.0	0.0
Total Delay	18.9	23.9	11.6
LOS	B	C	B
Approach Delay	18.9	20.1	
Approach LOS	B	C	
Queue Length 50th (m)	29.6	38.7	2.3
Queue Length 95th (m)	m43.0	61.4	19.9
Internal Link Dist (m)	107.6	52.8	
Turn Bay Length (m)			
Base Capacity (vph)	1460	801	753
Starvation Cap Reductn	0	0	0
Spillback Cap Reductn	0	0	0
Storage Cap Reductn	0	0	0
Reduced v/c Ratio	0.38	0.36	0.17

Intersection Summary

Cycle Length: 75  
 Actuated Cycle Length: 75  
 Offset: 24 (32%), Referenced to phase 8:WBTL, Start of Green  
 Natural Cycle: 55  
 Control Type: Pretimed  
 Maximum v/c Ratio: 0.38  
 Intersection Signal Delay: 19.4  
 Intersection LOS: B  
 Intersection Capacity Utilization 50.7%  
 ICU Level of Service A  
 Analysis Period (min) 15  
 m Volume for 95th percentile queue is metered by upstream signal.

Splits and Phases: 1: Hwy 417 WB On Ramp/Lyon St N & Catherine St

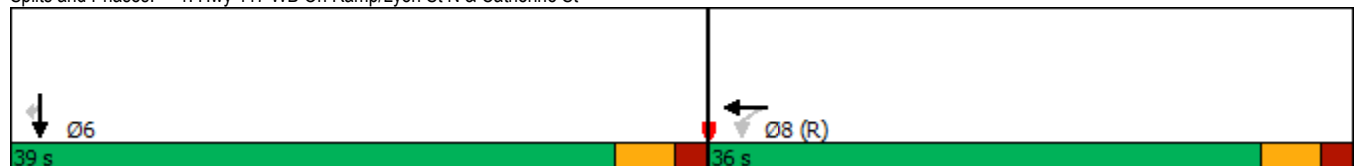



Lanes, Volumes, Timings

2: Hwy 417 EB Off Ramp/Chamberlain Ave/Kent St & Catherine St

02/28/2024



Lane Group	WBT	WBR	NBT	Ø9
Lane Configurations	↑↑	↑↑	↑↑↑	
Traffic Volume (vph)	452	579	1430	
Future Volume (vph)	452	579	1430	
Lane Group Flow (vph)	452	579	1502	
Turn Type	NA	Prot	NA	
Protected Phases	8	8	2	9
Permitted Phases				
Detector Phase	8	8	2	
Switch Phase				
Minimum Initial (s)	10.0	10.0	10.0	1.0
Minimum Split (s)	15.8	15.8	22.5	13.0
Total Split (s)	28.0	28.0	34.0	13.0
Total Split (%)	37.3%	37.3%	45.3%	17%
Yellow Time (s)	3.3	3.3	3.3	2.0
All-Red Time (s)	2.5	2.5	2.5	0.0
Lost Time Adjust (s)	0.0	0.0	0.0	
Total Lost Time (s)	5.8	5.8	5.8	
Lead/Lag				
Lead-Lag Optimize?				
Recall Mode	Max	Max	C-Max	None
Act Effct Green (s)	27.4	27.4	28.2	
Actuated g/C Ratio	0.37	0.37	0.38	
v/c Ratio	0.38	0.59	0.80	
Control Delay	16.4	19.1	23.7	
Queue Delay	0.0	2.2	0.2	
Total Delay	16.4	21.3	23.9	
LOS	B	C	C	
Approach Delay	19.1		23.9	
Approach LOS	B		C	
Queue Length 50th (m)	31.6	44.2	64.6	
Queue Length 95th (m)	m38.6	m53.5	81.9	
Internal Link Dist (m)	131.7		689.6	
Turn Bay Length (m)		60.0		
Base Capacity (vph)	1191	985	1887	
Starvation Cap Reductn	0	0	0	
Spillback Cap Reductn	0	263	56	
Storage Cap Reductn	0	0	0	
Reduced v/c Ratio	0.38	0.80	0.82	

Intersection Summary

Cycle Length: 75  
 Actuated Cycle Length: 75  
 Offset: 0 (0%), Referenced to phase 2:NBT, Start of Green  
 Natural Cycle: 60  
 Control Type: Actuated-Coordinated  
 Maximum v/c Ratio: 0.80  
 Intersection Signal Delay: 22.0  
 Intersection LOS: C  
 Intersection Capacity Utilization 65.1%  
 ICU Level of Service C  
 Analysis Period (min) 15  
 m Volume for 95th percentile queue is metered by upstream signal.

Splits and Phases: 2: Hwy 417 EB Off Ramp/Chamberlain Ave/Kent St & Catherine St

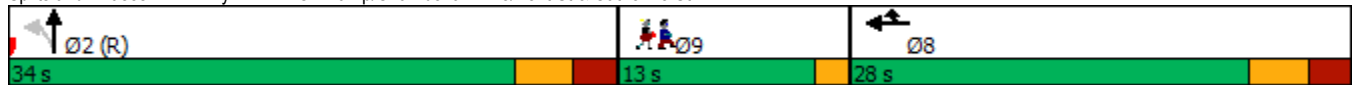

Lanes, Volumes, Timings  
3: Bank St & Catherine St

02/28/2024



Lane Group	WBT	NBL	NBT	SBT	Ø1	Ø5	Ø7
Lane Configurations							
Traffic Volume (vph)	645	278	582	404			
Future Volume (vph)	645	278	582	404			
Lane Group Flow (vph)	1023	0	860	548			
Turn Type	NA	pm+pt	NA	NA			
Protected Phases	8	9	2	6	1	5	7
Permitted Phases		2					
Minimum Split (s)	18.6	10.4	16.4	16.4	5.0	5.0	5.0
Total Split (s)	24.0	10.4	41.0	30.6	5.0	5.0	5.0
Total Split (%)	32.0%	13.9%	54.7%	40.8%	7%	7%	7%
Yellow Time (s)	3.3	3.3	3.3	3.3	2.0	2.0	2.0
All-Red Time (s)	2.3	2.1	2.1	2.1	0.0	0.0	0.0
Lost Time Adjust (s)	0.0		0.0	0.0			
Total Lost Time (s)	5.6		5.4	5.4			
Lead/Lag	Lag		Lag	Lag	Lead	Lead	Lead
Lead-Lag Optimize?	Yes		Yes	Yes	Yes	Yes	Yes
Act Effct Green (s)	18.4		35.6	25.2			
Actuated g/C Ratio	0.25		0.47	0.34			
v/c Ratio	0.90		0.84	0.54			
Control Delay	38.3		21.2	19.8			
Queue Delay	0.0		0.0	0.0			
Total Delay	38.3		21.2	19.8			
LOS	D		C	B			
Approach Delay	38.3		21.2	19.8			
Approach LOS	D		C	B			
Queue Length 50th (m)	47.9		26.2	28.1			
Queue Length 95th (m)	#72.1		#44.5	42.7			
Internal Link Dist (m)	702.3		90.2	52.9			
Turn Bay Length (m)							
Base Capacity (vph)	1131		1025	1011			
Starvation Cap Reductn	0		0	0			
Spillback Cap Reductn	0		0	0			
Storage Cap Reductn	0		0	0			
Reduced v/c Ratio	0.90		0.84	0.54			

Intersection Summary

Cycle Length: 75  
 Actuated Cycle Length: 75  
 Offset: 50 (67%), Referenced to phase 2:NBT and 6:SBT, Start of Green  
 Natural Cycle: 75  
 Control Type: Pretimed  
 Maximum v/c Ratio: 0.90  
 Intersection Signal Delay: 28.1  
 Intersection LOS: C  
 Intersection Capacity Utilization 82.4%  
 ICU Level of Service E  
 Analysis Period (min) 15  
 # 95th percentile volume exceeds capacity, queue may be longer.  
 Queue shown is maximum after two cycles.

Splits and Phases: 3: Bank St & Catherine St

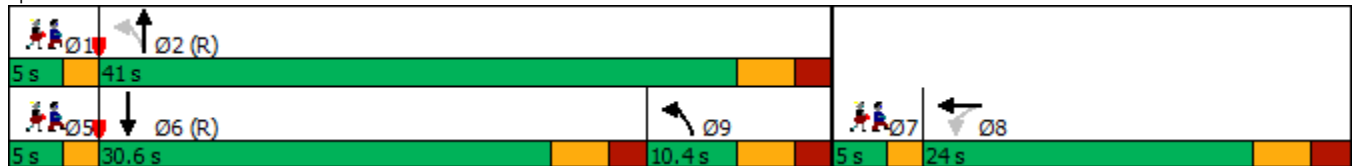

Lanes, Volumes, Timings  
4: Percy St & Catherine St

02/28/2024

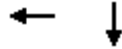

Lane Group	WBT	SBT	Ø3	Ø7
Lane Configurations				
Traffic Volume (vph)	270	129		
Future Volume (vph)	270	129		
Lane Group Flow (vph)	362	186		
Turn Type	NA	NA		
Protected Phases	8	6	3	7
Permitted Phases				
Detector Phase	8	6		
Switch Phase				
Minimum Initial (s)	10.0	10.0	1.0	1.0
Minimum Split (s)	26.5	23.4	6.4	6.4
Total Split (s)	34.0	24.0	16.0	16.0
Total Split (%)	37.8%	26.7%	18%	18%
Yellow Time (s)	3.3	3.3	3.3	3.3
All-Red Time (s)	2.2	2.1	2.1	2.1
Lost Time Adjust (s)	0.0	0.0		
Total Lost Time (s)	5.5	5.4		
Lead/Lag	Lag			Lead
Lead-Lag Optimize?	Yes			Yes
Recall Mode	None	Max	None	None
Act Effct Green (s)	11.9	18.8		
Actuated g/C Ratio	0.29	0.45		
v/c Ratio	0.36	0.25		
Control Delay	7.3	9.4		
Queue Delay	0.0	0.0		
Total Delay	7.3	9.4		
LOS	A	A		
Approach Delay	7.3	9.4		
Approach LOS	A	A		
Queue Length 50th (m)	5.6	6.6		
Queue Length 95th (m)	12.1	23.3		
Internal Link Dist (m)	271.6	288.0		
Turn Bay Length (m)				
Base Capacity (vph)	2220	740		
Starvation Cap Reductn	0	0		
Spillback Cap Reductn	0	0		
Storage Cap Reductn	0	0		
Reduced v/c Ratio	0.16	0.25		

Intersection Summary

Cycle Length: 90	
Actuated Cycle Length: 41.7	
Natural Cycle: 65	
Control Type: Semi Act-Uncoord	
Maximum v/c Ratio: 0.36	
Intersection Signal Delay: 8.0	Intersection LOS: A
Intersection Capacity Utilization 39.7%	ICU Level of Service A
Analysis Period (min) 15	

Splits and Phases: 4: Percy St & Catherine St

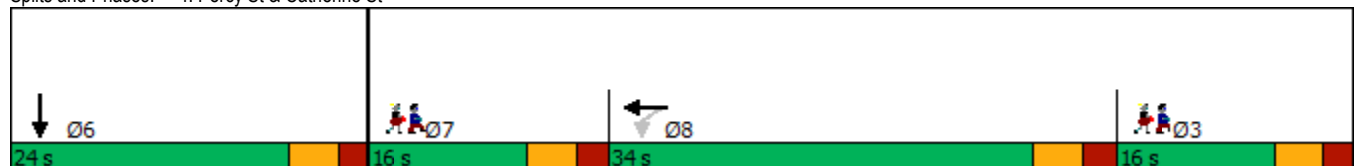

Lanes, Volumes, Timings  
 5: Lyon St N & Arlington Ave

02/28/2024

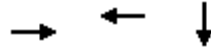

Lane Group	EBT	WBT	SBT
Lane Configurations			
Traffic Volume (vph)	18	12	345
Future Volume (vph)	18	12	345
Lane Group Flow (vph)	18	37	408
Sign Control	Stop	Stop	Free
<b>Intersection Summary</b>			
Control Type: Unsignalized			
Intersection Capacity Utilization 33.8%		ICU Level of Service A	
Analysis Period (min) 15			

Intersection												
Int Delay, s/veh	2.5											
Movement	EBL	EBT	EBR	WBL	WBT	WBR	NBL	NBT	NBR	SBL	SBT	SBR
Lane Configurations		↕			↕						↕↕	
Traffic Vol, veh/h	0	18	0	25	12	0	0	0	0	54	345	9
Future Vol, veh/h	0	18	0	25	12	0	0	0	0	54	345	9
Conflicting Peds, #/hr	32	0	15	15	0	32	9	0	10	10	0	9
Sign Control	Stop	Stop	Stop	Stop	Stop	Stop	Free	Free	Free	Free	Free	Free
RT Channelized	-	-	None	-	-	None	-	-	None	-	-	None
Storage Length	-	-	-	-	-	-	-	-	-	-	-	-
Veh in Median Storage, #	-	0	-	-	0	-	-	-	-	-	0	-
Grade, %	-	0	-	-	0	-	-	0	-	-	0	-
Peak Hour Factor	100	100	100	100	100	100	100	100	100	100	100	100
Heavy Vehicles, %	0	0	0	9	0	0	0	0	0	5	1	11
Mvmt Flow	0	18	0	25	12	0	0	0	0	54	345	9

Major/Minor	Minor2		Minor1			Major2			
Conflicting Flow All	-	477	201	315	481	-	10	0	0
Stage 1	-	467	-	10	10	-	-	-	-
Stage 2	-	10	-	305	471	-	-	-	-
Critical Hdwy	-	6.5	6.9	7.68	6.5	-	4.2	-	-
Critical Hdwy Stg 1	-	5.5	-	-	-	-	-	-	-
Critical Hdwy Stg 2	-	-	-	6.68	5.5	-	-	-	-
Follow-up Hdwy	-	4	3.3	3.59	4	-	2.25	-	-
Pot Cap-1 Maneuver	0	490	813	597	487	0	1586	-	-
Stage 1	0	565	-	-	0	-	-	-	-
Stage 2	0	-	-	660	563	0	-	-	-
Platoon blocked, %	-	-	-	-	-	-	-	-	-
Mov Cap-1 Maneuver	-	461	806	555	458	-	1571	-	-
Mov Cap-2 Maneuver	-	461	-	555	458	-	-	-	-
Stage 1	-	536	-	-	-	-	-	-	-
Stage 2	-	-	-	610	534	-	-	-	-

Approach	EB		WB			SB		
HCM Control Delay, s	13.1		12.5			1.1		
HCM LOS	B		B					

Minor Lane/Major Mvmt	EBLn1	WBLn1	SBL	SBT	SBR
Capacity (veh/h)	461	519	1571	-	-
HCM Lane V/C Ratio	0.039	0.071	0.034	-	-
HCM Control Delay (s)	13.1	12.5	7.4	0.1	-
HCM Lane LOS	B	B	A	A	-
HCM 95th %tile Q(veh)	0.1	0.2	0.1	-	-

Lanes, Volumes, Timings  
6: Kent St & Arlington Ave

02/28/2024



Lane Group	EBL	EBT	WBT	NBT
Lane Configurations		↕	↕	↕↕↕
Traffic Volume (vph)	40	83	18	1826
Future Volume (vph)	40	83	18	1826
Lane Group Flow (vph)	0	123	111	1983
Turn Type	Perm	NA	NA	NA
Protected Phases		4	8	2
Permitted Phases	4			
Minimum Split (s)	27.3	27.3	27.3	32.3
Total Split (s)	27.6	27.6	27.6	47.4
Total Split (%)	36.8%	36.8%	36.8%	63.2%
Yellow Time (s)	3.3	3.3	3.3	3.3
All-Red Time (s)	2.0	2.0	2.0	2.0
Lost Time Adjust (s)		0.0	0.0	0.0
Total Lost Time (s)		5.3	5.3	5.3
Lead/Lag				
Lead-Lag Optimize?				
Act Effct Green (s)		22.3	22.3	42.1
Actuated g/C Ratio		0.30	0.30	0.56
v/c Ratio		0.26	0.23	0.73
Control Delay		29.3	16.6	14.1
Queue Delay		0.0	0.0	11.5
Total Delay		29.3	16.6	25.6
LOS		C	B	C
Approach Delay		29.3	16.6	25.6
Approach LOS		C	B	C
Queue Length 50th (m)		15.2	9.1	47.8
Queue Length 95th (m)		29.2	m13.7	71.5
Internal Link Dist (m)		138.7	143.1	53.0
Turn Bay Length (m)				
Base Capacity (vph)		475	474	2698
Starvation Cap Reductn		0	0	723
Spillback Cap Reductn		0	0	0
Storage Cap Reductn		0	0	0
Reduced v/c Ratio		0.26	0.23	1.00

Intersection Summary

Cycle Length: 75  
 Actuated Cycle Length: 75  
 Offset: 50 (67%), Referenced to phase 2:NBTL, Start of Green  
 Natural Cycle: 60  
 Control Type: Pretimed  
 Maximum v/c Ratio: 0.73  
 Intersection Signal Delay: 25.3  
 Intersection LOS: C  
 Intersection Capacity Utilization 70.5%  
 ICU Level of Service C  
 Analysis Period (min) 15  
 m Volume for 95th percentile queue is metered by upstream signal.

Splits and Phases: 6: Kent St & Arlington Ave



Lanes, Volumes, Timings  
7: Lyon St N & Gladstone Ave

02/28/2024



Lane Group	EBT	EBR	WBL	WBT	SBT
Lane Configurations	↑	↑	↑	↑	↑↓
Traffic Volume (vph)	184	24	15	143	353
Future Volume (vph)	184	24	15	143	353
Lane Group Flow (vph)	184	24	15	143	540
Turn Type	NA	Perm	Perm	NA	NA
Protected Phases	4			8	6
Permitted Phases		4	8		
Minimum Split (s)	17.2	17.2	17.2	17.2	22.6
Total Split (s)	36.0	36.0	36.0	36.0	39.0
Total Split (%)	48.0%	48.0%	48.0%	48.0%	52.0%
Yellow Time (s)	3.3	3.3	3.3	3.3	3.3
All-Red Time (s)	1.9	1.9	1.9	1.9	2.3
Lost Time Adjust (s)	0.0	0.0	0.0	0.0	0.0
Total Lost Time (s)	5.2	5.2	5.2	5.2	5.6
Lead/Lag					
Lead-Lag Optimize?					
Act Effct Green (s)	30.8	30.8	30.8	30.8	33.4
Actuated g/C Ratio	0.41	0.41	0.41	0.41	0.45
v/c Ratio	0.26	0.04	0.03	0.20	0.37
Control Delay	15.8	3.3	5.1	7.0	13.4
Queue Delay	0.0	0.0	0.0	0.0	0.0
Total Delay	15.8	3.3	5.1	7.0	13.4
LOS	B	A	A	A	B
Approach Delay	14.4			6.8	13.4
Approach LOS	B			A	B
Queue Length 50th (m)	16.6	0.0	0.6	8.5	23.1
Queue Length 95th (m)	29.8	2.8	m1.0	m13.4	34.2
Internal Link Dist (m)	254.8			165.0	214.3
Turn Bay Length (m)			25.0		
Base Capacity (vph)	711	632	470	718	1463
Starvation Cap Reductn	0	0	0	0	0
Spillback Cap Reductn	0	0	0	0	0
Storage Cap Reductn	0	0	0	0	0
Reduced v/c Ratio	0.26	0.04	0.03	0.20	0.37

Intersection Summary

Cycle Length: 75  
 Actuated Cycle Length: 75  
 Offset: 45 (60%), Referenced to phase 4:EBT and 8:WBTL, Start of Green  
 Natural Cycle: 40  
 Control Type: Pretimed  
 Maximum v/c Ratio: 0.37  
 Intersection Signal Delay: 12.5  
 Intersection LOS: B  
 Intersection Capacity Utilization 82.4%  
 ICU Level of Service E  
 Analysis Period (min) 15  
 m Volume for 95th percentile queue is metered by upstream signal.

Splits and Phases: 7: Lyon St N & Gladstone Ave

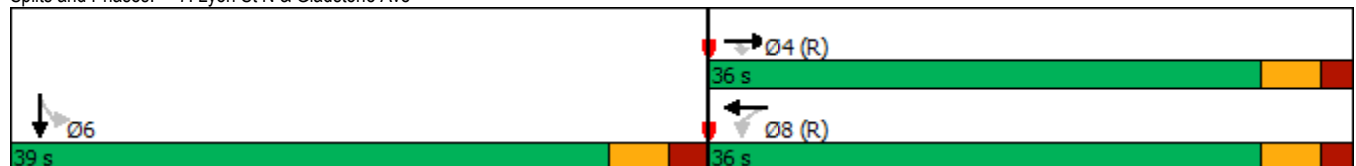

Lanes, Volumes, Timings  
8: Kent St & Gladstone Ave

02/28/2024

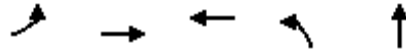

Lane Group	EBL	EBT	WBT	NBL	NBT
Lane Configurations					
Traffic Volume (vph)	82	277	165	36	1829
Future Volume (vph)	82	277	165	36	1829
Lane Group Flow (vph)	82	277	313	36	1926
Turn Type	Perm	NA	NA	Perm	NA
Protected Phases		4	8		2
Permitted Phases	4			2	
Minimum Split (s)	21.4	21.4	21.4	20.4	20.4
Total Split (s)	31.5	31.5	31.5	43.5	43.5
Total Split (%)	42.0%	42.0%	42.0%	58.0%	58.0%
Yellow Time (s)	3.3	3.3	3.3	3.3	3.3
All-Red Time (s)	2.1	2.1	2.1	2.1	2.1
Lost Time Adjust (s)	0.0	0.0	0.0	0.0	0.0
Total Lost Time (s)	5.4	5.4	5.4	5.4	5.4
Lead/Lag					
Lead-Lag Optimize?					
Act Effct Green (s)	26.1	26.1	26.1	38.1	38.1
Actuated g/C Ratio	0.35	0.35	0.35	0.51	0.51
v/c Ratio	0.30	0.46	0.58	0.05	0.79
Control Delay	27.7	28.4	24.7	9.3	14.1
Queue Delay	0.0	0.0	0.0	0.0	0.0
Total Delay	27.7	28.4	24.7	9.3	14.1
LOS	C	C	C	A	B
Approach Delay		28.3	24.7		14.0
Approach LOS		C	C		B
Queue Length 50th (m)	10.0	37.8	34.9	2.3	45.2
Queue Length 95th (m)	23.5	59.9	59.3	m2.9	45.7
Internal Link Dist (m)		165.0	168.8		216.0
Turn Bay Length (m)	30.0			40.0	
Base Capacity (vph)	269	597	543	733	2442
Starvation Cap Reductn	0	0	0	0	0
Spillback Cap Reductn	0	0	0	0	0
Storage Cap Reductn	0	0	0	0	0
Reduced v/c Ratio	0.30	0.46	0.58	0.05	0.79

Intersection Summary

Cycle Length: 75  
 Actuated Cycle Length: 75  
 Offset: 23 (31%), Referenced to phase 4:EBTL and 8:WBT, Start of Green  
 Natural Cycle: 55  
 Control Type: Pretimed  
 Maximum v/c Ratio: 0.79  
 Intersection Signal Delay: 17.2  
 Intersection LOS: B  
 Intersection Capacity Utilization 82.4%  
 ICU Level of Service E  
 Analysis Period (min) 15  
 m Volume for 95th percentile queue is metered by upstream signal.

Splits and Phases: 8: Kent St & Gladstone Ave





Lanes, Volumes, Timings  
 9: Bank St & Chamberlain Ave/Isabella St

02/28/2024



Lane Group	EBT	EBR	NBT	SBL	SBT
Lane Configurations	↕↕	↗	↕↕		↕↕
Traffic Volume (vph)	534	82	845	190	396
Future Volume (vph)	534	82	845	190	396
Lane Group Flow (vph)	616	82	988	0	586
Turn Type	NA	Perm	NA	pm+pt	NA
Protected Phases	4		2	5	6
Permitted Phases		4		6	
Detector Phase	4	4	2	5	6
Switch Phase					
Minimum Initial (s)	10.0	10.0	10.0	5.0	10.0
Minimum Split (s)	26.2	26.2	23.1	11.1	23.1
Total Split (s)	26.2	26.2	37.7	11.1	48.8
Total Split (%)	34.9%	34.9%	50.3%	14.8%	65.1%
Yellow Time (s)	3.3	3.3	3.0	3.0	3.0
All-Red Time (s)	2.9	2.9	3.1	3.1	3.1
Lost Time Adjust (s)	0.0	0.0	0.0		0.0
Total Lost Time (s)	6.2	6.2	6.1		6.1
Lead/Lag					
Lead-Lag Optimize?					
Recall Mode	None	None	C-Max	None	C-Max
Act Effct Green (s)	18.5	18.5	44.2		44.2
Actuated g/C Ratio	0.25	0.25	0.59		0.59
v/c Ratio	0.78	0.19	0.53		0.57
Control Delay	33.6	2.4	10.9		14.6
Queue Delay	0.0	0.0	0.0		0.0
Total Delay	33.6	2.4	10.9		14.6
LOS	C	A	B		B
Approach Delay	30.0		10.9		14.6
Approach LOS	C		B		B
Queue Length 50th (m)	41.5	0.0	42.1		43.0
Queue Length 95th (m)	58.8	3.5	57.5		m59.6
Internal Link Dist (m)	677.2		578.7		90.2
Turn Bay Length (m)		40.0			
Base Capacity (vph)	858	460	1858		1037
Starvation Cap Reductn	0	0	0		0
Spillback Cap Reductn	0	0	0		0
Storage Cap Reductn	0	0	0		0
Reduced v/c Ratio	0.72	0.18	0.53		0.57

Intersection Summary

Cycle Length: 75  
 Actuated Cycle Length: 75  
 Offset: 60 (80%), Referenced to phase 2:NBT and 6:SBTL, Start of Green  
 Natural Cycle: 65  
 Control Type: Actuated-Coordinated  
 Maximum v/c Ratio: 0.78  
 Intersection Signal Delay: 17.7  
 Intersection LOS: B  
 Intersection Capacity Utilization 84.6%  
 ICU Level of Service E  
 Analysis Period (min) 15  
 m Volume for 95th percentile queue is metered by upstream signal.

Splits and Phases: 9: Bank St & Chamberlain Ave/Isabella St

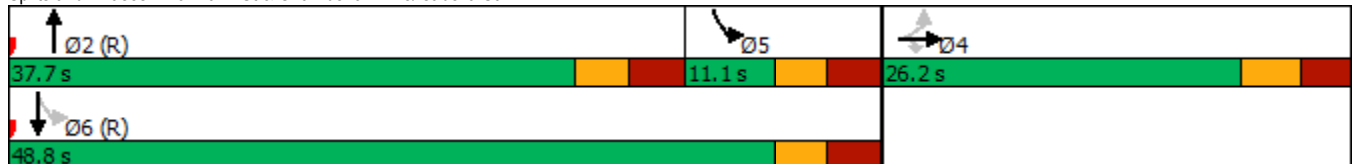



Intersection						
Int Delay, s/veh	1.2					
Movement	EBL	EBT	WBT	WBR	SBL	SBR
Lane Configurations			↑↓			↑
Traffic Vol, veh/h	0	0	479	41	0	69
Future Vol, veh/h	0	0	479	41	0	69
Conflicting Peds, #/hr	0	0	0	0	0	0
Sign Control	Free	Free	Free	Free	Stop	Stop
RT Channelized	-	None	-	None	-	None
Storage Length	-	-	-	-	-	0
Veh in Median Storage, #	-4521984		0	-	0	-
Grade, %	-	0	0	-	0	-
Peak Hour Factor	100	100	100	100	100	100
Heavy Vehicles, %	2	2	2	2	2	2
Mvmt Flow	0	0	479	41	0	69
Major/Minor	Major2		Minor2			
Conflicting Flow All			-	0	-	260
Stage 1			-	-	-	-
Stage 2			-	-	-	-
Critical Hdwy			-	-	-	6.94
Critical Hdwy Stg 1			-	-	-	-
Critical Hdwy Stg 2			-	-	-	-
Follow-up Hdwy			-	-	-	3.32
Pot Cap-1 Maneuver			-	-	0	739
Stage 1			-	-	0	-
Stage 2			-	-	0	-
Platoon blocked, %			-	-	-	-
Mov Cap-1 Maneuver			-	-	-	739
Mov Cap-2 Maneuver			-	-	-	-
Stage 1			-	-	-	-
Stage 2			-	-	-	-
Approach	WB		SB			
HCM Control Delay, s			0			10.4
HCM LOS						B
Minor Lane/Major Mvmt	WBT	WBR	SBLn1			
Capacity (veh/h)	-	-	739			
HCM Lane V/C Ratio	-	-	0.093			
HCM Control Delay (s)	-	-	10.4			
HCM Lane LOS	-	-	B			
HCM 95th %tile Q(veh)	-	-	0.3			

Lanes, Volumes, Timings  
 11: Access & Arlington Ave

02/28/2024

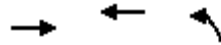

Lane Group	EBT	WBT	NBL
Lane Configurations			
Traffic Volume (vph)	62	23	14
Future Volume (vph)	62	23	14
Lane Group Flow (vph)	72	40	70
Sign Control	Free	Free	Stop

Intersection Summary	
Control Type: Unsignalized	
Intersection Capacity Utilization 20.1%	ICU Level of Service A
Analysis Period (min) 15	

Intersection						
Int Delay, s/veh	4.1					
Movement	EBT	EBR	WBL	WBT	NBL	NBR
Lane Configurations	↔			↔	↔	
Traffic Vol, veh/h	62	10	17	23	14	56
Future Vol, veh/h	62	10	17	23	14	56
Conflicting Peds, #/hr	0	0	0	0	0	0
Sign Control	Free	Free	Free	Free	Stop	Stop
RT Channelized	-	None	-	None	-	None
Storage Length	-	-	-	-	0	-
Veh in Median Storage, #	0	-	-	0	0	-
Grade, %	0	-	-	0	0	-
Peak Hour Factor	100	100	100	100	100	100
Heavy Vehicles, %	2	2	0	0	2	2
Mvmt Flow	62	10	17	23	14	56

Major/Minor	Major1	Major2	Minor1			
Conflicting Flow All	0	0	72	0	124	67
Stage 1	-	-	-	-	67	-
Stage 2	-	-	-	-	57	-
Critical Hdwy	-	-	4.1	-	6.42	6.22
Critical Hdwy Stg 1	-	-	-	-	5.42	-
Critical Hdwy Stg 2	-	-	-	-	5.42	-
Follow-up Hdwy	-	-	2.2	-	3.518	3.318
Pot Cap-1 Maneuver	-	-	1541	-	871	997
Stage 1	-	-	-	-	956	-
Stage 2	-	-	-	-	966	-
Platoon blocked, %	-	-	-	-	-	-
Mov Cap-1 Maneuver	-	-	1541	-	861	997
Mov Cap-2 Maneuver	-	-	-	-	861	-
Stage 1	-	-	-	-	956	-
Stage 2	-	-	-	-	955	-

Approach	EB	WB	NB
HCM Control Delay, s	0	3.1	9
HCM LOS			A

Minor Lane/Major Mvmt	NBLn1	EBT	EBR	WBL	WBT
Capacity (veh/h)	966	-	-	1541	-
HCM Lane V/C Ratio	0.072	-	-	0.011	-
HCM Control Delay (s)	9	-	-	7.4	0
HCM Lane LOS	A	-	-	A	A
HCM 95th %tile Q(veh)	0.2	-	-	0	-

Lanes, Volumes, Timings  
 12: Bank St & Arlington Ave

02/28/2024



Lane Group	EBL	NBT	SBT
Lane Configurations			
Traffic Volume (vph)	28	691	397
Future Volume (vph)	28	691	397
Lane Group Flow (vph)	180	784	419
Sign Control	Stop	Free	Free

Intersection Summary	
Control Type: Unsignalized	
Intersection Capacity Utilization 57.9%	ICU Level of Service B
Analysis Period (min) 15	

Intersection						
Int Delay, s/veh	3.5					
Movement	EBL	EBR	NBL	NBT	SBT	SBR
Lane Configurations	↔			↕	↕	
Traffic Vol, veh/h	28	152	93	691	397	22
Future Vol, veh/h	28	152	93	691	397	22
Conflicting Peds, #/hr	0	0	111	0	0	111
Sign Control	Stop	Stop	Free	Free	Free	Free
RT Channelized	-	None	-	None	-	None
Storage Length	0	-	-	-	-	-
Veh in Median Storage, #	0	-	-	0	0	-
Grade, %	0	-	-	0	0	-
Peak Hour Factor	100	100	100	100	100	100
Heavy Vehicles, %	0	0	2	5	8	5
Mvmt Flow	28	152	93	691	397	22

Major/Minor	Minor2	Major1	Major2			
Conflicting Flow All	1051	321	530	0	-	0
Stage 1	519	-	-	-	-	-
Stage 2	532	-	-	-	-	-
Critical Hdwy	6.8	6.9	4.14	-	-	-
Critical Hdwy Stg 1	5.8	-	-	-	-	-
Critical Hdwy Stg 2	5.8	-	-	-	-	-
Follow-up Hdwy	3.5	3.3	2.22	-	-	-
Pot Cap-1 Maneuver	226	681	1033	-	-	-
Stage 1	568	-	-	-	-	-
Stage 2	559	-	-	-	-	-
Platoon blocked, %				-	-	-
Mov Cap-1 Maneuver	152	611	927	-	-	-
Mov Cap-2 Maneuver	152	-	-	-	-	-
Stage 1	427	-	-	-	-	-
Stage 2	501	-	-	-	-	-

Approach	EB	NB	SB
HCM Control Delay, s	20.1	1.6	0
HCM LOS	C		

Minor Lane/Major Mvmt	NBL	NBT	EBLn1	SBT	SBR
Capacity (veh/h)	927	-	416	-	-
HCM Lane V/C Ratio	0.1	-	0.433	-	-
HCM Control Delay (s)	9.3	0.6	20.1	-	-
HCM Lane LOS	A	A	C	-	-
HCM 95th %tile Q(veh)	0.3	-	2.1	-	-

Lanes, Volumes, Timings  
13: Bronson Ave & Catherine St

02/28/2024



Lane Group	WBL	WBT	NBL	NBT	SBT	Ø5	Ø7
Lane Configurations							
Traffic Volume (vph)	538	510	553	1105	456		
Future Volume (vph)	538	510	553	1105	456		
Lane Group Flow (vph)	324	957	498	995	523		
Turn Type	Perm	NA	pm+pt	NA	NA		
Protected Phases		8	5 7	2	6	5	7
Permitted Phases	8		2				
Minimum Split (s)	28.3	28.3		23.8	23.8	11.2	11.8
Total Split (s)	37.6	37.6		72.4	28.8	31.8	11.8
Total Split (%)	34.2%	34.2%		65.8%	26.2%	29%	11%
Yellow Time (s)	3.3	3.3		3.3	3.3	3.3	3.3
All-Red Time (s)	3.0	3.0		3.5	3.5	2.9	3.5
Lost Time Adjust (s)	0.0	0.0		0.0	0.0		
Total Lost Time (s)	6.3	6.3		6.8	6.8		
Lead/Lag					Lag	Lead	
Lead-Lag Optimize?					Yes	Yes	
Act Effct Green (s)	31.3	31.3	66.2	65.6	22.0		
Actuated g/C Ratio	0.28	0.28	0.60	0.60	0.20		
v/c Ratio	0.80	0.77	0.79	0.49	0.82		
Control Delay	52.6	37.0	23.6	13.7	51.3		
Queue Delay	0.0	0.0	0.0	0.0	0.0		
Total Delay	52.6	37.0	23.6	13.7	51.3		
LOS	D	D	C	B	D		
Approach Delay		41.0		17.0	51.3		
Approach LOS		D		B	D		
Queue Length 50th (m)	74.7	65.8	56.1	60.1	54.0		
Queue Length 95th (m)	#125.2	83.0	#83.4	75.5	#78.2		
Internal Link Dist (m)		120.8		240.1	287.4		
Turn Bay Length (m)	80.0		45.0				
Base Capacity (vph)	406	1246	631	2021	640		
Starvation Cap Reductn	0	0	0	0	0		
Spillback Cap Reductn	0	0	0	0	0		
Storage Cap Reductn	0	0	0	0	0		
Reduced v/c Ratio	0.80	0.77	0.79	0.49	0.82		

Intersection Summary

Cycle Length: 110  
 Actuated Cycle Length: 110  
 Offset: 60 (55%), Referenced to phase 2:NBT and 6:SBT, Start of Green  
 Natural Cycle: 90  
 Control Type: Pretimed  
 Maximum v/c Ratio: 0.82  
 Intersection Signal Delay: 31.8  
 Intersection LOS: C  
 Intersection Capacity Utilization 83.2%  
 ICU Level of Service E  
 Analysis Period (min) 15  
 # 95th percentile volume exceeds capacity, queue may be longer.  
 Queue shown is maximum after two cycles.

Splits and Phases: 13: Bronson Ave & Catherine St





Lanes, Volumes, Timings

1: Hwy 417 WB On Ramp/Lyon St N & Catherine St

02/28/2024



Lane Group	WBT	SBT	SBR
Lane Configurations	↕↕	↕	↗
Traffic Volume (vph)	566	374	304
Future Volume (vph)	566	374	304
Lane Group Flow (vph)	794	374	304
Turn Type	NA	NA	Perm
Protected Phases	8	6	
Permitted Phases			6
Minimum Split (s)	26.2	28.3	28.3
Total Split (s)	38.0	37.0	37.0
Total Split (%)	50.7%	49.3%	49.3%
Yellow Time (s)	3.3	3.3	3.3
All-Red Time (s)	1.9	2.0	2.0
Lost Time Adjust (s)	0.0	0.0	0.0
Total Lost Time (s)	5.2	5.3	5.3
Lead/Lag			
Lead-Lag Optimize?			
Act Effct Green (s)	32.8	31.7	31.7
Actuated g/C Ratio	0.44	0.42	0.42
v/c Ratio	0.53	0.49	0.42
Control Delay	13.6	26.9	17.6
Queue Delay	0.0	0.0	0.0
Total Delay	13.6	26.9	17.6
LOS	B	C	B
Approach Delay	13.6	22.7	
Approach LOS	B	C	
Queue Length 50th (m)	55.1	53.5	27.8
Queue Length 95th (m)	73.1	79.2	51.1
Internal Link Dist (m)	107.6	52.8	
Turn Bay Length (m)			
Base Capacity (vph)	1488	761	727
Starvation Cap Reductn	0	0	0
Spillback Cap Reductn	0	0	0
Storage Cap Reductn	0	0	0
Reduced v/c Ratio	0.53	0.49	0.42

Intersection Summary

Cycle Length: 75  
 Actuated Cycle Length: 75  
 Offset: 24 (32%), Referenced to phase 8:WBTL, Start of Green  
 Natural Cycle: 55  
 Control Type: Pretimed  
 Maximum v/c Ratio: 0.53  
 Intersection Signal Delay: 17.8  
 Intersection LOS: B  
 Intersection Capacity Utilization 56.3%  
 ICU Level of Service B  
 Analysis Period (min) 15

Splits and Phases: 1: Hwy 417 WB On Ramp/Lyon St N & Catherine St

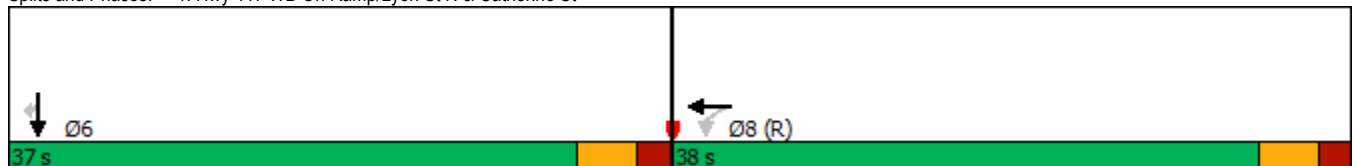

Lanes, Volumes, Timings

2: Hwy 417 EB Off Ramp/Chamberlain Ave/Kent St & Catherine St

02/28/2024



Lane Group	WBT	WBR	NBT	Ø9
Lane Configurations	↑↑	↑↑	↑↑↑	
Traffic Volume (vph)	739	321	890	
Future Volume (vph)	739	321	890	
Lane Group Flow (vph)	739	321	941	
Turn Type	NA	Prot	NA	
Protected Phases	8	8	2	9
Permitted Phases				
Detector Phase	8	8	2	
Switch Phase				
Minimum Initial (s)	10.0	10.0	10.0	1.0
Minimum Split (s)	15.8	15.8	22.5	13.0
Total Split (s)	35.0	35.0	27.0	13.0
Total Split (%)	46.7%	46.7%	36.0%	17%
Yellow Time (s)	3.3	3.3	3.3	2.0
All-Red Time (s)	2.5	2.5	2.5	0.0
Lost Time Adjust (s)	0.0	0.0	0.0	
Total Lost Time (s)	5.8	5.8	5.8	
Lead/Lag				
Lead-Lag Optimize?				
Recall Mode	C-Max	C-Max	Max	None
Act Effct Green (s)	34.4	34.4	21.2	
Actuated g/C Ratio	0.46	0.46	0.28	
v/c Ratio	0.48	0.28	0.66	
Control Delay	27.0	24.4	24.6	
Queue Delay	0.0	0.0	3.8	
Total Delay	27.0	24.4	28.4	
LOS	C	C	C	
Approach Delay	26.2		28.4	
Approach LOS	C		C	
Queue Length 50th (m)	55.2	23.9	39.5	
Queue Length 95th (m)	m64.0	m28.1	52.6	
Internal Link Dist (m)	131.7		689.6	
Turn Bay Length (m)		60.0		
Base Capacity (vph)	1539	1156	1420	
Starvation Cap Reductn	0	0	0	
Spillback Cap Reductn	0	0	382	
Storage Cap Reductn	0	0	0	
Reduced v/c Ratio	0.48	0.28	0.91	

Intersection Summary

Cycle Length: 75  
 Actuated Cycle Length: 75  
 Offset: 0 (0%), Referenced to phase 8:WBT, Start of Green  
 Natural Cycle: 60  
 Control Type: Actuated-Coordinated  
 Maximum v/c Ratio: 0.66  
 Intersection Signal Delay: 27.2  
 Intersection LOS: C  
 Intersection Capacity Utilization 52.7%  
 ICU Level of Service A  
 Analysis Period (min) 15  
 m Volume for 95th percentile queue is metered by upstream signal.

Splits and Phases: 2: Hwy 417 EB Off Ramp/Chamberlain Ave/Kent St & Catherine St



Lanes, Volumes, Timings  
3: Bank St & Catherine St

02/28/2024



Lane Group	WBT	NBL	NBT	SBT	Ø1	Ø5	Ø7
Lane Configurations	↕↕↕		↕↕	↕↕			
Traffic Volume (vph)	668	206	340	713			
Future Volume (vph)	668	206	340	713			
Lane Group Flow (vph)	1062	0	546	855			
Turn Type	NA	pm+pt	NA	NA			
Protected Phases	8	9	2	6	1	5	7
Permitted Phases		2					
Minimum Split (s)	18.6	10.4	16.4	16.4	5.0	5.0	5.0
Total Split (s)	24.0	10.4	41.0	30.6	5.0	5.0	5.0
Total Split (%)	32.0%	13.9%	54.7%	40.8%	7%	7%	7%
Yellow Time (s)	3.3	3.3	3.3	3.3	2.0	2.0	2.0
All-Red Time (s)	2.3	2.1	2.1	2.1	0.0	0.0	0.0
Lost Time Adjust (s)	0.0		0.0	0.0			
Total Lost Time (s)	5.6		5.4	5.4			
Lead/Lag	Lag		Lag	Lag	Lead	Lead	Lead
Lead-Lag Optimize?	Yes		Yes	Yes	Yes	Yes	Yes
Act Effct Green (s)	18.4		35.6	25.2			
Actuated g/C Ratio	0.25		0.47	0.34			
v/c Ratio	0.93		0.58	0.81			
Control Delay	41.7		13.1	29.0			
Queue Delay	0.0		0.0	0.8			
Total Delay	41.7		13.1	29.8			
LOS	D		B	C			
Approach Delay	41.7		13.1	29.8			
Approach LOS	D		B	C			
Queue Length 50th (m)	51.7		15.4	54.9			
Queue Length 95th (m)	#77.2		20.0	#77.5			
Internal Link Dist (m)	702.3		90.2	52.9			
Turn Bay Length (m)							
Base Capacity (vph)	1146		946	1062			
Starvation Cap Reductn	0		0	0			
Spillback Cap Reductn	0		0	52			
Storage Cap Reductn	0		0	0			
Reduced v/c Ratio	0.93		0.58	0.85			

Intersection Summary

Cycle Length: 75  
 Actuated Cycle Length: 75  
 Offset: 50 (67%), Referenced to phase 2:NBT and 6:SBT, Start of Green  
 Natural Cycle: 75  
 Control Type: Pretimed  
 Maximum v/c Ratio: 0.93  
 Intersection Signal Delay: 31.2  
 Intersection LOS: C  
 Intersection Capacity Utilization 82.0%  
 ICU Level of Service D  
 Analysis Period (min) 15  
 # 95th percentile volume exceeds capacity, queue may be longer.  
 Queue shown is maximum after two cycles.

Splits and Phases: 3: Bank St & Catherine St

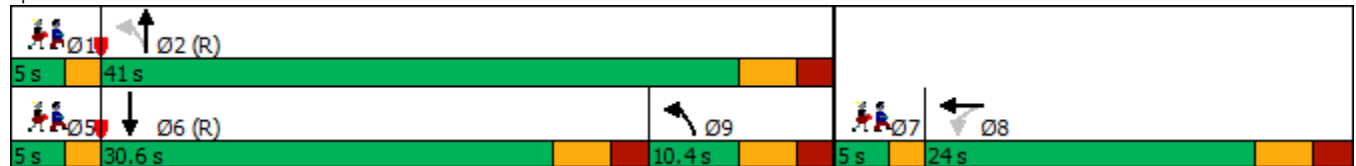

Lanes, Volumes, Timings  
4: Percy St & Catherine St

02/28/2024

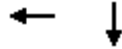

Lane Group	WBT	SBT	Ø3	Ø7
Lane Configurations				
Traffic Volume (vph)	741	121		
Future Volume (vph)	741	121		
Lane Group Flow (vph)	907	160		
Turn Type	NA	NA		
Protected Phases	8	6	3	7
Permitted Phases				
Detector Phase	8	6		
Switch Phase				
Minimum Initial (s)	10.0	10.0	1.0	1.0
Minimum Split (s)	26.5	23.4	6.4	6.4
Total Split (s)	34.0	24.0	16.0	16.0
Total Split (%)	37.8%	26.7%	18%	18%
Yellow Time (s)	3.3	3.3	3.3	3.3
All-Red Time (s)	2.2	2.1	2.1	2.1
Lost Time Adjust (s)	0.0	0.0		
Total Lost Time (s)	5.5	5.4		
Lead/Lag	Lag			Lead
Lead-Lag Optimize?	Yes			Yes
Recall Mode	None	Max	None	None
Act Effct Green (s)	18.9	18.7		
Actuated g/C Ratio	0.39	0.38		
v/c Ratio	0.65	0.24		
Control Delay	12.0	12.8		
Queue Delay	0.0	0.0		
Total Delay	12.0	12.8		
LOS	B	B		
Approach Delay	12.0	12.8		
Approach LOS	B	B		
Queue Length 50th (m)	25.3	8.6		
Queue Length 95th (m)	39.3	23.2		
Internal Link Dist (m)	271.6	288.0		
Turn Bay Length (m)				
Base Capacity (vph)	2039	665		
Starvation Cap Reductn	0	0		
Spillback Cap Reductn	0	0		
Storage Cap Reductn	0	0		
Reduced v/c Ratio	0.44	0.24		

Intersection Summary

Cycle Length: 90	
Actuated Cycle Length: 48.6	
Natural Cycle: 65	
Control Type: Semi Act-Uncoord	
Maximum v/c Ratio: 0.65	
Intersection Signal Delay: 12.1	Intersection LOS: B
Intersection Capacity Utilization 54.1%	ICU Level of Service A
Analysis Period (min) 15	

Splits and Phases: 4: Percy St & Catherine St

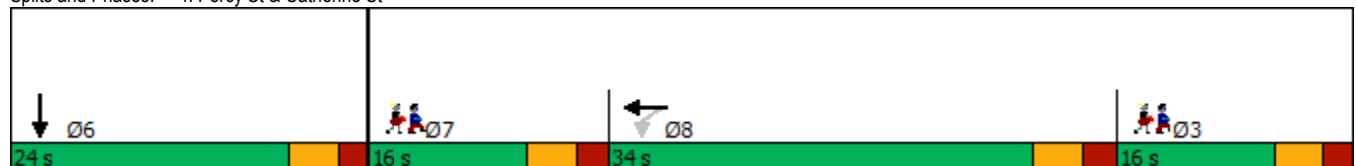

Lanes, Volumes, Timings  
 5: Lyon St N & Arlington Ave

02/28/2024

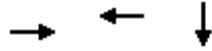

Lane Group	EBT	WBT	SBT
Lane Configurations			
Traffic Volume (vph)	19	37	601
Future Volume (vph)	19	37	601
Lane Group Flow (vph)	21	54	675
Sign Control	Stop	Stop	Free
<b>Intersection Summary</b>			
Control Type: Unsignalized			
Intersection Capacity Utilization 41.3%		ICU Level of Service A	
Analysis Period (min) 15			

HCM 2010 TWSC  
5: Lyon St N & Arlington Ave

02/28/2024

Intersection												
Int Delay, s/veh	2.5											
Movement	EBL	EBT	EBR	WBL	WBT	WBR	NBL	NBT	NBR	SBL	SBT	SBR
Lane Configurations		↕			↕						↕↕	
Traffic Vol, veh/h	0	19	2	17	37	0	0	0	0	61	601	13
Future Vol, veh/h	0	19	2	17	37	0	0	0	0	61	601	13
Conflicting Peds, #/hr	20	0	8	8	0	20	19	0	3	3	0	19
Sign Control	Stop	Stop	Stop	Stop	Stop	Stop	Free	Free	Free	Free	Free	Free
RT Channelized	-	-	None	-	-	None	-	-	None	-	-	None
Storage Length	-	-	-	-	-	-	-	-	-	-	-	-
Veh in Median Storage, #	-	0	-	-	0	-	-	-	-	-	0	-
Grade, %	-	0	-	-	0	-	-	0	-	-	0	-
Peak Hour Factor	100	100	100	100	100	100	100	100	100	100	100	100
Heavy Vehicles, %	0	5	0	0	5	0	0	0	0	0	0	0
Mvmt Flow	0	19	2	17	37	0	0	0	0	61	601	13

Major/Minor	Minor2		Minor1			Major2			
Conflicting Flow All	-	752	334	443	758	-	3	0	0
Stage 1	-	749	-	3	3	-	-	-	-
Stage 2	-	3	-	440	755	-	-	-	-
Critical Hdwy	-	6.6	6.9	7.5	6.6	-	4.1	-	-
Critical Hdwy Stg 1	-	5.6	-	-	-	-	-	-	-
Critical Hdwy Stg 2	-	-	-	6.5	5.6	-	-	-	-
Follow-up Hdwy	-	4.05	3.3	3.5	4.05	-	2.2	-	-
Pot Cap-1 Maneuver	0	332	668	503	329	0	1632	-	-
Stage 1	0	410	-	-	0	-	-	-	-
Stage 2	0	-	-	571	408	0	-	-	-
Platoon blocked, %	-	-	-	-	-	-	-	-	-
Mov Cap-1 Maneuver	-	306	656	456	304	-	1627	-	-
Mov Cap-2 Maneuver	-	306	-	456	304	-	-	-	-
Stage 1	-	380	-	-	-	-	-	-	-
Stage 2	-	-	-	510	378	-	-	-	-

Approach	EB		WB			SB		
HCM Control Delay, s	17		17.6			0.8		
HCM LOS	C		C					

Minor Lane/Major Mvmt	EBLn1	WBLn1	SBL	SBT	SBR
Capacity (veh/h)	322	340	1627	-	-
HCM Lane V/C Ratio	0.065	0.159	0.037	-	-
HCM Control Delay (s)	17	17.6	7.3	0.2	-
HCM Lane LOS	C	C	A	A	-
HCM 95th %tile Q(veh)	0.2	0.6	0.1	-	-

Lanes, Volumes, Timings  
6: Kent St & Arlington Ave

02/28/2024



Lane Group	EBL	EBT	WBT	NBT
Lane Configurations		↕	↕	↕↕↕
Traffic Volume (vph)	25	83	30	1098
Future Volume (vph)	25	83	30	1098
Lane Group Flow (vph)	0	108	93	1231
Turn Type	Perm	NA	NA	NA
Protected Phases		4	8	2
Permitted Phases	4			
Minimum Split (s)	27.3	27.3	27.3	32.3
Total Split (s)	31.0	31.0	31.0	44.0
Total Split (%)	41.3%	41.3%	41.3%	58.7%
Yellow Time (s)	3.3	3.3	3.3	3.3
All-Red Time (s)	2.0	2.0	2.0	2.0
Lost Time Adjust (s)		0.0	0.0	0.0
Total Lost Time (s)		5.3	5.3	5.3
Lead/Lag				
Lead-Lag Optimize?				
Act Effct Green (s)		25.7	25.7	38.7
Actuated g/C Ratio		0.34	0.34	0.52
v/c Ratio		0.19	0.16	0.49
Control Delay		25.9	9.8	10.0
Queue Delay		0.0	0.0	49.8
Total Delay		25.9	9.8	59.7
LOS		C	A	E
Approach Delay		25.9	9.8	59.7
Approach LOS		C	A	E
Queue Length 50th (m)		13.0	1.6	49.7
Queue Length 95th (m)		m25.2	m6.4	69.9
Internal Link Dist (m)		138.7	143.1	53.0
Turn Bay Length (m)				
Base Capacity (vph)		576	579	2501
Starvation Cap Reductn		0	0	1427
Spillback Cap Reductn		0	0	0
Storage Cap Reductn		0	0	0
Reduced v/c Ratio		0.19	0.16	1.15

Intersection Summary

Cycle Length: 75  
 Actuated Cycle Length: 75  
 Offset: 50 (67%), Referenced to phase 2:NBTL, Start of Green  
 Natural Cycle: 60  
 Control Type: Pretimed  
 Maximum v/c Ratio: 0.49  
 Intersection Signal Delay: 53.9  
 Intersection LOS: D  
 Intersection Capacity Utilization 55.1%  
 ICU Level of Service B  
 Analysis Period (min) 15  
 m Volume for 95th percentile queue is metered by upstream signal.

Splits and Phases: 6: Kent St & Arlington Ave



Lanes, Volumes, Timings  
7: Lyon St N & Gladstone Ave

02/28/2024



Lane Group	EBT	EBR	WBL	WBT	SBT
Lane Configurations	↑	↑	↑	↑	↑↓
Traffic Volume (vph)	247	52	28	314	553
Future Volume (vph)	247	52	28	314	553
Lane Group Flow (vph)	247	52	28	314	777
Turn Type	NA	Perm	Perm	NA	NA
Protected Phases	4			8	6
Permitted Phases		4	8		
Minimum Split (s)	17.2	17.2	17.2	17.2	22.6
Total Split (s)	37.0	37.0	37.0	37.0	38.0
Total Split (%)	49.3%	49.3%	49.3%	49.3%	50.7%
Yellow Time (s)	3.3	3.3	3.3	3.3	3.3
All-Red Time (s)	1.9	1.9	1.9	1.9	2.3
Lost Time Adjust (s)	0.0	0.0	0.0	0.0	0.0
Total Lost Time (s)	5.2	5.2	5.2	5.2	5.6
Lead/Lag					
Lead-Lag Optimize?					
Act Effct Green (s)	31.8	31.8	31.8	31.8	32.4
Actuated g/C Ratio	0.42	0.42	0.42	0.42	0.43
v/c Ratio	0.33	0.08	0.07	0.42	0.54
Control Delay	16.0	4.5	8.5	12.8	16.6
Queue Delay	0.0	0.0	0.0	0.0	0.0
Total Delay	16.0	4.5	8.5	12.8	16.6
LOS	B	A	A	B	B
Approach Delay	14.0			12.4	16.6
Approach LOS	B			B	B
Queue Length 50th (m)	22.6	0.0	1.5	36.2	38.8
Queue Length 95th (m)	38.4	5.7	m3.2	55.1	54.6
Internal Link Dist (m)	254.8			165.0	214.3
Turn Bay Length (m)			25.0		
Base Capacity (vph)	756	626	422	756	1428
Starvation Cap Reductn	0	0	0	0	0
Spillback Cap Reductn	0	0	0	0	0
Storage Cap Reductn	0	0	0	0	0
Reduced v/c Ratio	0.33	0.08	0.07	0.42	0.54

Intersection Summary

Cycle Length: 75  
 Actuated Cycle Length: 75  
 Offset: 45 (60%), Referenced to phase 4:EBT and 8:WBTL, Start of Green  
 Natural Cycle: 40  
 Control Type: Pretimed  
 Maximum v/c Ratio: 0.54  
 Intersection Signal Delay: 15.1  
 Intersection LOS: B  
 Intersection Capacity Utilization 68.3%  
 ICU Level of Service C  
 Analysis Period (min) 15  
 m Volume for 95th percentile queue is metered by upstream signal.

Splits and Phases: 7: Lyon St N & Gladstone Ave

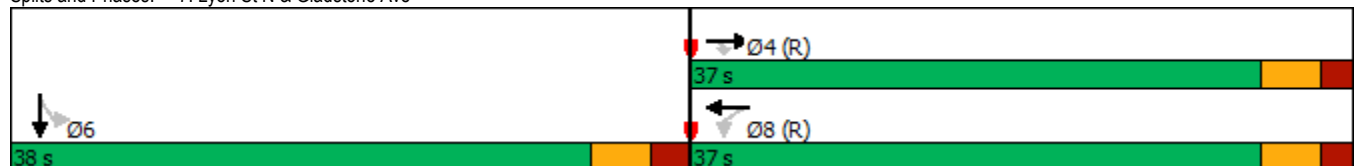



Lanes, Volumes, Timings  
8: Kent St & Gladstone Ave

02/28/2024



Lane Group	EBL	EBT	WBT	NBL	NBT
Lane Configurations					
Traffic Volume (vph)	75	450	324	67	952
Future Volume (vph)	75	450	324	67	952
Lane Group Flow (vph)	75	450	399	67	1083
Turn Type	Perm	NA	NA	Perm	NA
Protected Phases		4	8		2
Permitted Phases	4			2	
Minimum Split (s)	21.4	21.4	21.4	20.4	20.4
Total Split (s)	42.0	42.0	42.0	33.0	33.0
Total Split (%)	56.0%	56.0%	56.0%	44.0%	44.0%
Yellow Time (s)	3.3	3.3	3.3	3.3	3.3
All-Red Time (s)	2.1	2.1	2.1	2.1	2.1
Lost Time Adjust (s)	0.0	0.0	0.0	0.0	0.0
Total Lost Time (s)	5.4	5.4	5.4	5.4	5.4
Lead/Lag					
Lead-Lag Optimize?					
Act Effct Green (s)	36.6	36.6	36.6	27.6	27.6
Actuated g/C Ratio	0.49	0.49	0.49	0.37	0.37
v/c Ratio	0.19	0.52	0.47	0.12	0.63
Control Delay	20.1	24.3	14.2	8.5	9.1
Queue Delay	0.0	0.0	0.0	0.0	0.0
Total Delay	20.1	24.3	14.2	8.5	9.1
LOS	C	C	B	A	A
Approach Delay		23.7	14.2		9.1
Approach LOS		C	B		A
Queue Length 50th (m)	7.3	54.0	33.2	3.1	16.9
Queue Length 95th (m)	m17.0	83.0	54.8	m4.8	15.7
Internal Link Dist (m)		165.0	168.8		216.0
Turn Bay Length (m)	30.0			40.0	
Base Capacity (vph)	385	862	850	560	1726
Starvation Cap Reductn	0	0	0	0	0
Spillback Cap Reductn	0	0	0	0	0
Storage Cap Reductn	0	0	0	0	0
Reduced v/c Ratio	0.19	0.52	0.47	0.12	0.63

Intersection Summary

Cycle Length: 75  
 Actuated Cycle Length: 75  
 Offset: 23 (31%), Referenced to phase 4:EBTL and 8:WBT, Start of Green  
 Natural Cycle: 45  
 Control Type: Pretimed  
 Maximum v/c Ratio: 0.63  
 Intersection Signal Delay: 13.8  
 Intersection LOS: B  
 Intersection Capacity Utilization 68.3%  
 ICU Level of Service C  
 Analysis Period (min) 15  
 m Volume for 95th percentile queue is metered by upstream signal.

Splits and Phases: 8: Kent St & Gladstone Ave

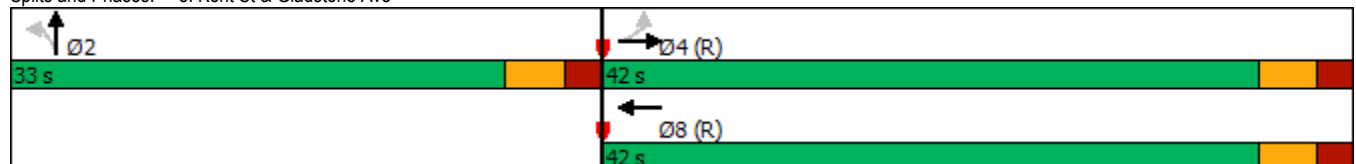

Lanes, Volumes, Timings  
 9: Bank St & Chamberlain Ave/Isabella St

02/28/2024



Lane Group	EBT	EBR	NBT	SBL	SBT
Lane Configurations	↕↕	↗	↕↕		↕↕
Traffic Volume (vph)	638	124	468	189	734
Future Volume (vph)	638	124	468	189	734
Lane Group Flow (vph)	705	124	561	0	923
Turn Type	NA	Perm	NA	pm+pt	NA
Protected Phases	4		2	5	6
Permitted Phases		4		6	
Detector Phase	4	4	2	5	6
Switch Phase					
Minimum Initial (s)	10.0	10.0	10.0	5.0	10.0
Minimum Split (s)	26.2	26.2	23.1	11.1	23.1
Total Split (s)	29.0	29.0	34.9	11.1	46.0
Total Split (%)	38.7%	38.7%	46.5%	14.8%	61.3%
Yellow Time (s)	3.3	3.3	3.0	3.0	3.0
All-Red Time (s)	2.9	2.9	3.1	3.1	3.1
Lost Time Adjust (s)	0.0	0.0	0.0		0.0
Total Lost Time (s)	6.2	6.2	6.1		6.1
Lead/Lag					
Lead-Lag Optimize?					
Recall Mode	None	None	C-Max	None	C-Max
Act Effct Green (s)	21.1	21.1	41.6		41.6
Actuated g/C Ratio	0.28	0.28	0.55		0.55
v/c Ratio	0.75	0.25	0.32		0.71
Control Delay	30.0	5.0	10.1		13.0
Queue Delay	0.0	0.0	0.0		1.3
Total Delay	30.0	5.0	10.1		14.3
LOS	C	A	B		B
Approach Delay	26.3		10.1		14.3
Approach LOS	C		B		B
Queue Length 50th (m)	45.8	0.0	22.1		74.1
Queue Length 95th (m)	63.9	9.6	31.7		m91.8
Internal Link Dist (m)	677.2		578.7		90.2
Turn Bay Length (m)		40.0			
Base Capacity (vph)	1015	519	1742		1296
Starvation Cap Reductn	0	0	0		184
Spillback Cap Reductn	0	0	0		0
Storage Cap Reductn	0	0	0		0
Reduced v/c Ratio	0.69	0.24	0.32		0.83

Intersection Summary

Cycle Length: 75  
 Actuated Cycle Length: 75  
 Offset: 60 (80%), Referenced to phase 2:NBT and 6:SBTL, Start of Green  
 Natural Cycle: 65  
 Control Type: Actuated-Coordinated  
 Maximum v/c Ratio: 0.75  
 Intersection Signal Delay: 17.6  
 Intersection LOS: B  
 Intersection Capacity Utilization 84.6%  
 ICU Level of Service E  
 Analysis Period (min) 15  
 m Volume for 95th percentile queue is metered by upstream signal.

Splits and Phases: 9: Bank St & Chamberlain Ave/Isabella St

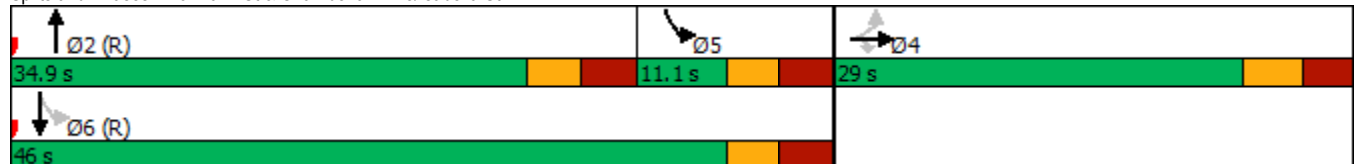

Lanes, Volumes, Timings  
10: Catherine St & Access

02/28/2024

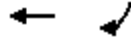

Lane Group	WBT	SBR
Lane Configurations		
Traffic Volume (vph)	662	45
Future Volume (vph)	662	45
Lane Group Flow (vph)	734	45
Sign Control	Free	

**Intersection Summary**

Control Type: Unsignalized  
Intersection Capacity Utilization 31.7%      ICU Level of Service A  
Analysis Period (min) 15

Intersection						
Int Delay, s/veh	0.6					
Movement	EBL	EBT	WBT	WBR	SBL	SBR
Lane Configurations			↑↑			↑
Traffic Vol, veh/h	0	0	662	72	0	45
Future Vol, veh/h	0	0	662	72	0	45
Conflicting Peds, #/hr	0	0	0	0	0	0
Sign Control	Free	Free	Free	Free	Stop	Stop
RT Channelized	-	None	-	None	-	None
Storage Length	-	-	-	-	-	0
Veh in Median Storage, #	-2949	120	0	-	0	-
Grade, %	-	0	0	-	0	-
Peak Hour Factor	100	100	100	100	100	100
Heavy Vehicles, %	2	2	2	2	2	2
Mvmt Flow	0	0	662	72	0	45

Major/Minor	Major2	Minor2		
Conflicting Flow All	-	0	-	367
Stage 1	-	-	-	-
Stage 2	-	-	-	-
Critical Hdwy	-	-	-	6.94
Critical Hdwy Stg 1	-	-	-	-
Critical Hdwy Stg 2	-	-	-	-
Follow-up Hdwy	-	-	-	3.32
Pot Cap-1 Maneuver	-	-	0	630
Stage 1	-	-	0	-
Stage 2	-	-	0	-
Platoon blocked, %	-	-	-	-
Mov Cap-1 Maneuver	-	-	-	630
Mov Cap-2 Maneuver	-	-	-	-
Stage 1	-	-	-	-
Stage 2	-	-	-	-

Approach	WB	SB
HCM Control Delay, s	0	11.2
HCM LOS		B

Minor Lane/Major Mvmt	WBT	WBR	SBLn1
Capacity (veh/h)	-	-	630
HCM Lane V/C Ratio	-	-	0.071
HCM Control Delay (s)	-	-	11.2
HCM Lane LOS	-	-	B
HCM 95th %tile Q(veh)	-	-	0.2

Lanes, Volumes, Timings  
 11: Access & Arlington Ave

02/28/2024

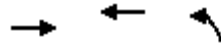

Lane Group	EBT	WBT	NBL
Lane Configurations			
Traffic Volume (vph)	62	45	9
Future Volume (vph)	62	45	9
Lane Group Flow (vph)	80	75	45
Sign Control	Free	Free	Stop

Intersection Summary	
Control Type: Unsignalized	
Intersection Capacity Utilization 20.9%	ICU Level of Service A
Analysis Period (min) 15	

Intersection						
Int Delay, s/veh	3.2					
Movement	EBT	EBR	WBL	WBT	NBL	NBR
Lane Configurations	↔			↕	↕	
Traffic Vol, veh/h	62	18	30	45	9	36
Future Vol, veh/h	62	18	30	45	9	36
Conflicting Peds, #/hr	0	0	0	0	0	0
Sign Control	Free	Free	Free	Free	Stop	Stop
RT Channelized	-	None	-	None	-	None
Storage Length	-	-	-	-	0	-
Veh in Median Storage, #	0	-	-	0	0	-
Grade, %	0	-	-	0	0	-
Peak Hour Factor	100	100	100	100	100	100
Heavy Vehicles, %	2	2	2	2	2	2
Mvmt Flow	62	18	30	45	9	36

Major/Minor	Major1	Major2	Minor1	Minor2	Minor3
Conflicting Flow All	0	0	80	0	176
Stage 1	-	-	-	-	71
Stage 2	-	-	-	-	105
Critical Hdwy	-	-	4.12	-	6.42
Critical Hdwy Stg 1	-	-	-	-	5.42
Critical Hdwy Stg 2	-	-	-	-	5.42
Follow-up Hdwy	-	-	2.218	-	3.518
Pot Cap-1 Maneuver	-	-	1518	-	814
Stage 1	-	-	-	-	952
Stage 2	-	-	-	-	919
Platoon blocked, %	-	-	-	-	-
Mov Cap-1 Maneuver	-	-	1518	-	798
Mov Cap-2 Maneuver	-	-	-	-	798
Stage 1	-	-	-	-	952
Stage 2	-	-	-	-	901

Approach	EB	WB	NB
HCM Control Delay, s	0	3	9
HCM LOS			A

Minor Lane/Major Mvmt	NBLn1	EBT	EBR	WBL	WBT
Capacity (veh/h)	945	-	-	1518	-
HCM Lane V/C Ratio	0.048	-	-	0.02	-
HCM Control Delay (s)	9	-	-	7.4	0
HCM Lane LOS	A	-	-	A	A
HCM 95th %tile Q(veh)	0.1	-	-	0.1	-

Lanes, Volumes, Timings  
 12: Bank St & Arlington Ave

02/28/2024



Lane Group	EBL	NBT	SBT
Lane Configurations			
Traffic Volume (vph)	24	428	731
Future Volume (vph)	24	428	731
Lane Group Flow (vph)	149	498	758
Sign Control	Stop	Free	Free

Intersection Summary	
Control Type: Unsignalized	
Intersection Capacity Utilization 56.5%	ICU Level of Service B
Analysis Period (min) 15	

Intersection						
Int Delay, s/veh	2.6					
Movement	EBL	EBR	NBL	NBT	SBT	SBR
Lane Configurations	↔			↕↕	↕↕	
Traffic Vol, veh/h	24	125	70	428	731	27
Future Vol, veh/h	24	125	70	428	731	27
Conflicting Peds, #/hr	0	0	42	0	0	42
Sign Control	Stop	Stop	Free	Free	Free	Free
RT Channelized	-	None	-	None	-	None
Storage Length	0	-	-	-	-	-
Veh in Median Storage, #	0	-	-	0	0	-
Grade, %	0	-	-	0	0	-
Peak Hour Factor	100	100	100	100	100	100
Heavy Vehicles, %	0	1	0	5	3	0
Mvmt Flow	24	125	70	428	731	27

Major/Minor	Minor2	Major1	Major2			
Conflicting Flow All	1141	421	800	0	-	0
Stage 1	787	-	-	-	-	-
Stage 2	354	-	-	-	-	-
Critical Hdwy	6.8	6.92	4.1	-	-	-
Critical Hdwy Stg 1	5.8	-	-	-	-	-
Critical Hdwy Stg 2	5.8	-	-	-	-	-
Follow-up Hdwy	3.5	3.31	2.2	-	-	-
Pot Cap-1 Maneuver	197	584	832	-	-	-
Stage 1	414	-	-	-	-	-
Stage 2	687	-	-	-	-	-
Platoon blocked, %				-	-	-
Mov Cap-1 Maneuver	161	561	800	-	-	-
Mov Cap-2 Maneuver	161	-	-	-	-	-
Stage 1	352	-	-	-	-	-
Stage 2	660	-	-	-	-	-

Approach	EB	NB	SB
HCM Control Delay, s	19.2	1.7	0
HCM LOS	C		

Minor Lane/Major Mvmt	NBL	NBT	EBLn1	SBT	SBR
Capacity (veh/h)	800	-	401	-	-
HCM Lane V/C Ratio	0.088	-	0.372	-	-
HCM Control Delay (s)	9.9	0.4	19.2	-	-
HCM Lane LOS	A	A	C	-	-
HCM 95th %tile Q(veh)	0.3	-	1.7	-	-



Lanes, Volumes, Timings  
13: Bronson Ave & Catherine St

02/28/2024



Lane Group	WBL	WBT	NBL	NBT	SBT
Lane Configurations					
Traffic Volume (vph)	744	610	311	812	853
Future Volume (vph)	744	610	311	812	853
Lane Group Flow (vph)	417	1229	311	812	1029
Turn Type	Perm	NA	pm+pt	NA	NA
Protected Phases		8	5	2	6
Permitted Phases	8		2		
Minimum Split (s)	28.3	28.3	11.2	23.8	23.8
Total Split (s)	37.0	37.0	22.0	63.0	41.0
Total Split (%)	37.0%	37.0%	22.0%	63.0%	41.0%
Yellow Time (s)	3.3	3.3	3.3	3.3	3.3
All-Red Time (s)	3.0	3.0	2.9	3.5	3.5
Lost Time Adjust (s)	0.0	0.0	0.0	0.0	0.0
Total Lost Time (s)	6.3	6.3	6.2	6.8	6.8
Lead/Lag			Lead		Lag
Lead-Lag Optimize?			Yes		Yes
Act Effct Green (s)	30.7	30.7	56.8	56.2	34.2
Actuated g/C Ratio	0.31	0.31	0.57	0.56	0.34
v/c Ratio	0.93	0.90	0.92	0.43	0.91
Control Delay	63.9	41.1	59.4	13.5	43.5
Queue Delay	0.0	0.0	0.0	0.0	0.0
Total Delay	63.9	41.1	59.4	13.5	43.5
LOS	E	D	E	B	D
Approach Delay		46.8		26.2	43.5
Approach LOS		D		C	D
Queue Length 50th (m)	90.6	82.9	44.4	44.8	97.0
Queue Length 95th (m)	#157.0	#110.9	#94.6	58.3	#136.1
Internal Link Dist (m)		120.8		240.1	287.4
Turn Bay Length (m)	80.0		45.0		
Base Capacity (vph)	447	1368	337	1905	1132
Starvation Cap Reductn	0	0	0	0	0
Spillback Cap Reductn	0	0	0	0	0
Storage Cap Reductn	0	0	0	0	0
Reduced v/c Ratio	0.93	0.90	0.92	0.43	0.91

Intersection Summary

Cycle Length: 100  
 Actuated Cycle Length: 100  
 Offset: 60 (60%), Referenced to phase 2:NBT and 6:SBT, Start of Green  
 Natural Cycle: 90  
 Control Type: Pretimed  
 Maximum v/c Ratio: 0.93  
 Intersection Signal Delay: 39.8  
 Intersection LOS: D  
 Intersection Capacity Utilization 92.5%  
 ICU Level of Service F  
 Analysis Period (min) 15  
 # 95th percentile volume exceeds capacity, queue may be longer.  
 Queue shown is maximum after two cycles.

Splits and Phases: 13: Bronson Ave & Catherine St



# Appendix J:

SimTraffic Summary Reports

**Intersection: 1: Hwy 417 WB On Ramp/Lyon St N & Catherine St**

Movement	WB	WB	SB	SB
Directions Served	LT	T	T	R
Maximum Queue (m)	77.3	52.1	65.5	27.6
Average Queue (m)	47.5	29.7	40.5	13.1
95th Queue (m)	70.3	48.8	61.1	22.2
Link Distance (m)	123.9	123.9	62.4	62.4
Upstream Blk Time (%)			1	
Queuing Penalty (veh)			1	
Storage Bay Dist (m)				
Storage Blk Time (%)				
Queuing Penalty (veh)				

**Intersection: 2: Hwy 417 EB Off Ramp/Chamberlain Ave/Kent St & Catherine St**

Movement	WB	WB	WB	WB	NB	NB	NB
Directions Served	T	T	R	R	LT	T	T
Maximum Queue (m)	53.1	48.9	56.4	64.9	78.7	87.6	86.5
Average Queue (m)	32.1	26.3	33.0	42.5	54.1	56.6	56.0
95th Queue (m)	47.4	43.6	50.8	62.0	72.5	78.0	79.6
Link Distance (m)	132.5	132.5	132.5		711.8	711.8	711.8
Upstream Blk Time (%)							
Queuing Penalty (veh)							
Storage Bay Dist (m)				60.0			
Storage Blk Time (%)			0	1			
Queuing Penalty (veh)			0	2			

**Intersection: 3: Bank St & Catherine St**

Movement	WB	WB	WB	NB	NB	SB	SB
Directions Served	LT	T	R	LT	T	T	TR
Maximum Queue (m)	142.3	145.8	48.7	107.1	102.2	59.9	59.7
Average Queue (m)	78.2	91.4	20.5	61.0	43.6	37.2	30.5
95th Queue (m)	123.5	141.2	37.1	100.8	83.9	58.4	52.6
Link Distance (m)	714.6	714.6	714.6	107.4	107.4	56.5	56.5
Upstream Blk Time (%)				1	0	1	1
Queuing Penalty (veh)				3	0	3	2
Storage Bay Dist (m)							
Storage Blk Time (%)							
Queuing Penalty (veh)							

**Intersection: 4: Percy St & Catherine St**

Movement	WB	WB	SB
Directions Served	LT	T	TR
Maximum Queue (m)	48.1	44.6	39.2
Average Queue (m)	18.7	16.9	17.1
95th Queue (m)	35.0	33.1	33.1
Link Distance (m)	284.8	284.8	302.5
Upstream Blk Time (%)			
Queuing Penalty (veh)			
Storage Bay Dist (m)			
Storage Blk Time (%)			
Queuing Penalty (veh)			

**Intersection: 6: Kent St & Arlington Ave**

Movement	EB	WB	NB	NB	NB
Directions Served	LT	TR	LT	T	TR
Maximum Queue (m)	41.2	22.1	61.1	69.4	64.4
Average Queue (m)	20.0	10.2	47.0	53.1	57.0
95th Queue (m)	35.0	19.9	62.7	69.5	68.4
Link Distance (m)	157.2	142.2	54.3	54.3	54.3
Upstream Blk Time (%)			3	7	12
Queuing Penalty (veh)			17	45	79
Storage Bay Dist (m)					
Storage Blk Time (%)					
Queuing Penalty (veh)					

**Intersection: 7: Lyon St N & Gladstone Ave**

Movement	EB	EB	WB	WB	SB	SB
Directions Served	T	R	L	T	LT	TR
Maximum Queue (m)	50.2	11.6	12.3	25.3	56.6	49.9
Average Queue (m)	21.7	2.8	2.1	10.9	32.3	21.1
95th Queue (m)	39.8	9.8	8.5	21.4	51.6	40.0
Link Distance (m)	269.8	269.8		183.7	231.1	231.1
Upstream Blk Time (%)						
Queuing Penalty (veh)						
Storage Bay Dist (m)			25.0			
Storage Blk Time (%)				0		
Queuing Penalty (veh)				0		

**Intersection: 8: Kent St & Gladstone Ave**

Movement	EB	EB	WB	NB	NB	NB	NB
Directions Served	L	T	TR	L	T	T	TR
Maximum Queue (m)	46.4	79.0	81.6	21.2	90.7	63.5	68.7
Average Queue (m)	14.6	38.8	39.9	4.6	40.6	45.7	48.7
95th Queue (m)	33.0	65.4	69.4	15.0	68.8	59.1	64.4
Link Distance (m)		183.7	178.3		227.2	227.2	227.2
Upstream Blk Time (%)					0		
Queuing Penalty (veh)					0		
Storage Bay Dist (m)	30.0			40.0			
Storage Blk Time (%)	1	17			7		
Queuing Penalty (veh)	1	14			2		

**Intersection: 9: Bank St & Chamberlain Ave/Isabella St**

Movement	EB	EB	EB	NB	NB	SB	SB
Directions Served	LT	T	R	T	TR	LT	T
Maximum Queue (m)	62.3	65.8	38.2	83.5	74.3	97.8	85.4
Average Queue (m)	39.3	41.4	1.3	41.8	42.7	45.4	31.1
95th Queue (m)	57.8	61.0	16.0	68.8	67.6	81.7	65.8
Link Distance (m)	690.7	690.7		591.2	591.2	107.4	107.4
Upstream Blk Time (%)						0	0
Queuing Penalty (veh)						1	0
Storage Bay Dist (m)			40.0				
Storage Blk Time (%)		9					
Queuing Penalty (veh)		7					

**Intersection: 13: Bronson Ave & Catherine St**

Movement	WB	WB	WB	WB	NB	NB	NB	SB	SB
Directions Served	L	LT	T	TR	L	T	T	T	TR
Maximum Queue (m)	85.3	89.0	82.8	120.9	47.4	139.2	112.8	90.8	81.0
Average Queue (m)	51.8	59.5	50.5	71.7	44.2	75.5	57.4	54.5	47.7
95th Queue (m)	76.5	82.1	73.8	109.5	54.0	127.3	97.0	81.2	74.4
Link Distance (m)		126.8	126.8	126.8		261.7	261.7	295.2	295.2
Upstream Blk Time (%)				0					
Queuing Penalty (veh)				1					
Storage Bay Dist (m)	80.0				45.0				
Storage Blk Time (%)	0	2			13	7			
Queuing Penalty (veh)	1	4			63	37			

**Zone Summary**

Zone wide Queuing Penalty: 285

**Intersection: 1: Hwy 417 WB On Ramp/Lyon St N & Catherine St**

Movement	WB	WB	SB	SB
Directions Served	LT	T	T	R
Maximum Queue (m)	78.7	58.9	67.5	53.8
Average Queue (m)	34.9	23.7	48.9	29.2
95th Queue (m)	62.7	45.2	68.8	47.1
Link Distance (m)	123.9	123.9	62.4	62.4
Upstream Blk Time (%)			2	0
Queuing Penalty (veh)			5	0
Storage Bay Dist (m)				
Storage Blk Time (%)				
Queuing Penalty (veh)				

**Intersection: 2: Hwy 417 EB Off Ramp/Chamberlain Ave/Kent St & Catherine St**

Movement	WB	WB	WB	WB	NB	NB	NB
Directions Served	T	T	R	R	LT	T	T
Maximum Queue (m)	62.6	61.4	39.7	43.3	60.8	64.3	63.0
Average Queue (m)	42.9	41.4	19.5	24.5	40.5	40.6	36.6
95th Queue (m)	58.1	55.0	33.0	38.9	57.2	57.9	57.5
Link Distance (m)	132.5	132.5	132.5		711.8	711.8	711.8
Upstream Blk Time (%)							
Queuing Penalty (veh)							
Storage Bay Dist (m)				60.0			
Storage Blk Time (%)							
Queuing Penalty (veh)							

**Intersection: 3: Bank St & Catherine St**

Movement	WB	WB	WB	NB	NB	SB	SB
Directions Served	LT	T	R	LT	T	T	TR
Maximum Queue (m)	183.6	179.8	58.9	111.7	112.5	68.9	62.4
Average Queue (m)	103.2	104.2	16.2	80.7	52.1	49.2	46.3
95th Queue (m)	185.3	185.0	37.3	132.5	116.2	66.7	66.6
Link Distance (m)	714.6	714.6	714.6	107.4	107.4	56.5	56.5
Upstream Blk Time (%)				14	1	5	5
Queuing Penalty (veh)				37	4	21	22
Storage Bay Dist (m)							
Storage Blk Time (%)							
Queuing Penalty (veh)							

**Intersection: 4: Percy St & Catherine St**

Movement	WB	WB	SB
Directions Served	LT	T	TR
Maximum Queue (m)	74.7	61.7	35.5
Average Queue (m)	40.8	30.8	16.3
95th Queue (m)	65.5	52.5	29.4
Link Distance (m)	284.8	284.8	302.5
Upstream Blk Time (%)			
Queuing Penalty (veh)			
Storage Bay Dist (m)			
Storage Blk Time (%)			
Queuing Penalty (veh)			

**Intersection: 6: Kent St & Arlington Ave**

Movement	EB	WB	NB	NB	NB
Directions Served	LT	TR	LT	T	TR
Maximum Queue (m)	37.2	22.4	56.8	60.6	58.9
Average Queue (m)	18.1	9.8	33.5	38.8	41.3
95th Queue (m)	31.4	19.6	52.0	58.1	58.6
Link Distance (m)	157.2	142.2	54.3	54.3	54.3
Upstream Blk Time (%)			0	1	1
Queuing Penalty (veh)			1	2	3
Storage Bay Dist (m)					
Storage Blk Time (%)					
Queuing Penalty (veh)					

**Intersection: 7: Lyon St N & Gladstone Ave**

Movement	EB	EB	WB	WB	SB	SB
Directions Served	T	R	L	T	LT	TR
Maximum Queue (m)	55.5	15.7	21.4	48.2	73.7	68.4
Average Queue (m)	25.7	5.6	4.7	20.6	38.1	37.3
95th Queue (m)	44.7	13.7	14.8	37.5	61.4	58.6
Link Distance (m)	269.8	269.8		183.7	231.1	231.1
Upstream Blk Time (%)						
Queuing Penalty (veh)						
Storage Bay Dist (m)			25.0			
Storage Blk Time (%)			0	2		
Queuing Penalty (veh)			0	1		

**Intersection: 8: Kent St & Gladstone Ave**

Movement	EB	EB	WB	NB	NB	NB	NB
Directions Served	L	T	TR	L	T	T	TR
Maximum Queue (m)	54.8	99.7	74.8	19.6	33.7	33.3	47.1
Average Queue (m)	14.5	51.9	36.2	5.4	14.8	16.9	22.9
95th Queue (m)	37.8	86.7	59.9	15.0	29.4	29.1	37.4
Link Distance (m)		183.7	178.3		227.2	227.2	227.2
Upstream Blk Time (%)							
Queuing Penalty (veh)							
Storage Bay Dist (m)	30.0			40.0			
Storage Blk Time (%)	0	24			0		
Queuing Penalty (veh)	0	18			0		

**Intersection: 9: Bank St & Chamberlain Ave/Isabella St**

Movement	EB	EB	EB	NB	NB	SB	SB
Directions Served	LT	T	R	T	TR	LT	T
Maximum Queue (m)	70.2	70.4	39.5	74.7	78.1	79.6	75.8
Average Queue (m)	41.9	43.7	1.9	34.9	30.6	33.6	27.9
95th Queue (m)	61.2	64.6	18.5	70.0	63.3	60.9	56.5
Link Distance (m)	690.7	690.7		591.2	591.2	107.4	107.4
Upstream Blk Time (%)						0	0
Queuing Penalty (veh)						0	0
Storage Bay Dist (m)			40.0				
Storage Blk Time (%)		11	0				
Queuing Penalty (veh)		13	0				

**Intersection: 13: Bronson Ave & Catherine St**

Movement	WB	WB	WB	WB	NB	NB	NB	SB	SB
Directions Served	L	LT	T	TR	L	T	T	T	TR
Maximum Queue (m)	102.2	110.2	88.2	99.5	47.4	119.2	100.3	173.6	171.0
Average Queue (m)	66.4	73.3	56.8	64.7	41.0	56.9	41.8	101.5	95.8
95th Queue (m)	93.3	99.8	82.3	93.5	55.6	102.1	80.3	162.8	157.3
Link Distance (m)		126.8	126.8	126.8		261.7	261.7	295.2	295.2
Upstream Blk Time (%)		0							
Queuing Penalty (veh)		1							
Storage Bay Dist (m)	80.0				45.0				
Storage Blk Time (%)	3	5			11	4			
Queuing Penalty (veh)	17	20			45	14			

**Zone Summary**

Zone wide Queuing Penalty: 224



# Appendix K:

MMLOS Analysis: Intersections

### Multi-Modal Level of Service - Intersections Form

Consultant  
Scenario  
Comments

<b>Parsons</b>
<b>Existing and Future</b>

<b>Project</b>	<b>478038-01000</b>
<b>Date</b>	<b>29-Feb-24</b>

INTERSECTIONS											
Crossing Side		Catherine/Kent				Catherine/Lyon				Arlington	
		NORTH	SOUTH	EAST	WEST	NORTH	SOUTH	EAST	WEST	NORTH	SOUTH
Pedestrian	Lanes	5	5	4	3	3	4	4	4	4	4
	Median	No Median - 2.4 m	No Median - 2.4 m	No Median - 2.4 m	No Median - 2.4 m	No Median - 2.4 m	No Median - 2.4 m	No Median - 2.4 m	No Median - 2.4 m	No Median - 2.4 m	No Median - 2.4 m
	Conflicting Left Turns	No left turn / Prohib.	No left turn / Prohib.	No left turn / Prohib.	Permissive	No left turn / Prohib.	Permissive	No left turn / Prohib.	No left turn / Prohib.	Permissive	Permissive
	Conflicting Right Turns	Permissive or yield control	No right turn	No right turn	No right turn	No right turn	No right turn	No right turn	Permissive or yield control	Permissive or yield control	Permissive or yield control
	Right Turns on Red (RTor) ?	RTOR prohibited	RTOR prohibited	RTOR prohibited	RTOR prohibited	RTOR prohibited	RTOR prohibited	RTOR prohibited	RTOR allowed	RTOR prohibited	RTOR allowed
	Ped Signal Leading Interval?	Yes	Yes	No	No	No	No	No	No	No	No
	Right Turn Channel	No Right Turn	No Right Turn	No Channel	No Right Turn	No Channel	No Right Turn	No Right Turn	No Right Turn	No Right Turn	No Channel
	Corner Radius	No Right Turn	No Right Turn	3-5m	No Right Turn	5-10m	No Right Turn	No Right Turn	No Right Turn	No Right Turn	10-15m
	Crosswalk Type	Zebra stripe hi-vis markings	Zebra stripe hi-vis markings	Zebra stripe hi-vis markings	Zebra stripe hi-vis markings	Std transverse markings	Std transverse markings	Std transverse markings	Std transverse markings	Std transverse markings	Std transverse markings
	<b>PETSI Score</b>	<b>63</b>	<b>68</b>	<b>74</b>	<b>91</b>	<b>87</b>	<b>71</b>	<b>79</b>	<b>71</b>	<b>66</b>	<b>53</b>
	<b>Ped. Exposure to Traffic LoS</b>	<b>C</b>	<b>C</b>	<b>C</b>	<b>A</b>	<b>B</b>	<b>C</b>	<b>B</b>	<b>C</b>	<b>C</b>	<b>D</b>
	Cycle Length	75	75	75	75	75	75	75	75	75	75
	Effective Walk Time	16	16	27	27	15	15	32	32	11	11
	<b>Average Pedestrian Delay</b>	<b>23</b>	<b>23</b>	<b>15</b>	<b>15</b>	<b>24</b>	<b>24</b>	<b>12</b>	<b>12</b>	<b>27</b>	<b>27</b>
<b>Pedestrian Delay LoS</b>	<b>C</b>	<b>C</b>	<b>B</b>	<b>B</b>	<b>C</b>	<b>C</b>	<b>B</b>	<b>B</b>	<b>C</b>	<b>C</b>	
<b>Level of Service</b>	<b>C</b>	<b>C</b>	<b>C</b>	<b>B</b>	<b>C</b>	<b>C</b>	<b>B</b>	<b>C</b>	<b>C</b>	<b>D</b>	
<b>Approach From</b>		<b>NORTH</b>	<b>SOUTH</b>	<b>EAST</b>	<b>WEST</b>	<b>NORTH</b>	<b>SOUTH</b>	<b>EAST</b>	<b>WEST</b>	<b>NORTH</b>	<b>SOUTH</b>
Bicycle	Bicycle Lane Arrangement on Approach			Mixed Traffic		Mixed Traffic				Mixed Traffic	
	Right Turn Lane Configuration			> 50 m		> 50 m				≤ 50 m	
	Right Turning Speed			≤ 25 km/h		≤ 25 km/h				≤ 25 km/h	
	<b>Cyclist relative to RT motorists</b>	-	-	<b>F</b>	-	<b>F</b>	-	-	-	-	<b>D</b>
	<b>Separated or Mixed Traffic</b>	-	-	<b>Mixed Traffic</b>	-	<b>Mixed Traffic</b>	-	-	-	-	<b>Mixed Traffic</b>
	Left Turn Approach										One lane crossed
	Operating Speed										> 50 to < 60 km/h
<b>Left Turning Cyclist</b>	-	-	-	-	-	-	-	-	-	<b>E</b>	
<b>Level of Service</b>	-	-	-	-	-	-	-	-	-	<b>E</b>	
Transit	Average Signal Delay										
	<b>Level of Service</b>	-	-	-	-	-	-	-	-	-	
Truck	Effective Corner Radius			< 10 m		< 10 m					
	Number of Receiving Lanes on Departure from Intersection			≥ 2		≥ 2					
<b>Level of Service</b>	-	-	<b>D</b>	-	<b>D</b>	-	-	-	-	-	
<b>Level of Service</b>			<b>D</b>				<b>D</b>				

Don/Kent		Bank/Catherine				Gladstone/Lyon				Gladstone/Kent		
EAST	WEST	NORTH	SOUTH	EAST	WEST	NORTH	SOUTH	EAST	WEST	NORTH	SOUTH	EAST
3	3	4	5	3	4	3	3	4	4	4	4	4
No Median - 2.4 m	No Median - 2.4 m	No Median - 2.4 m	No Median - 2.4 m	No Median - 2.4 m	No Median - 2.4 m	No Median - 2.4 m	No Median - 2.4 m	No Median - 2.4 m	No Median - 2.4 m	No Median - 2.4 m	No Median - 2.4 m	No Median - 2.4 m
No left turn / Prohib.	Permissive	No left turn / Prohib.	Permissive	No left turn / Prohib.	Protected/ Permissive	No left turn / Prohib.	Permissive	Permissive	No left turn / Prohib.	Permissive	No left turn / Prohib.	No left turn / Prohib.
Permissive or yield control	No right turn	Permissive or yield control	No right turn	No right turn	Permissive or yield control	No right turn	Permissive or yield control	No right turn	Permissive or yield control	Permissive or yield control	No right turn	Permissive or yield control
RTOR allowed	RTOR prohibited	RTOR allowed	RTOR prohibited	RTOR allowed	RTOR prohibited	RTOR allowed	RTOR prohibited	RTOR prohibited	RTOR allowed	RTOR prohibited	RTOR allowed	RTOR allowed
No	No	Yes	Yes	Yes	Yes	No	No	No	No	No	No	No
No Channel	No Right Turn	No Channel	No Right Turn	No Channel	No Right Turn	No Channel	No Right Turn	No Right Turn	No Channel	No Right Turn	No Channel	No Channel
5-10m	No Right Turn	5-10m	No Right Turn	5-10m	No Right Turn	5-10m	No Right Turn	No Right Turn	5-10m	No Right Turn	3-5m	3-5m
Std transverse markings	Textured/coloured pavement	Zebra stripe hi-vis markings	Zebra stripe hi-vis markings	Zebra stripe hi-vis markings	Zebra stripe hi-vis markings	Zebra stripe hi-vis markings	Zebra stripe hi-vis markings	Zebra stripe hi-vis markings	Zebra stripe hi-vis markings	Std transverse markings	Std transverse markings	Textured/coloured pavement
79	91	67	60	89	71	87	86	74	65	66	68	66
B	A	C	C	B	C	B	B	C	C	C	C	C
75	75	75	75	75	75	75	75	75	75	75	75	75
33	33	13	13	31	16	28	28	21	21	16	16	32
12	12	26	26	13	23	15	15	19	19	23	23	12
B	B	C	C	B	C	B	B	B	B	C	C	B
B	B	C	C	B	C	B	B	C	C	C	C	C
		C				C				C		
EAST	WEST	NORTH	SOUTH	EAST	WEST	NORTH	SOUTH	EAST	WEST	NORTH	SOUTH	EAST
Mixed Traffic		Mixed Traffic		Mixed Traffic		Curb Bike Lane, Cycletrack or MUP				Mixed Traffic		Mixed Traffic
≤ 50 m		≤ 50 m		≤ 50 m		Not Applicable				≤ 50 m		≤ 50 m
≤ 25 km/h		≤ 25 km/h		≤ 25 km/h		Not Applicable				≤ 25 km/h		≤ 25 km/h
D	-	D	-	D	-	Not Applicable	-	-	-	D	-	-
Mixed Traffic	-	Mixed Traffic	-	Mixed Traffic	-	Separated	-	-	-	Mixed Traffic	-	Mixed Traffic
	No lane crossed		One lane crossed	One lane crossed		2-stage, LT box		No lane crossed			≥ 2 lanes crossed	No lane crossed
	≤ 40 km/h		> 50 to < 60 km/h	> 50 to < 60 km/h		> 50 to < 60 km/h		> 50 to < 60 km/h			> 50 to < 60 km/h	> 50 to < 60 km/h
-	B	-	E	E	-	A	-	C	-	-	F	C
-	-	-	-	E	-	A	-	-	-	-	F	-
		E				A				F		
						≤ 20 sec				≤ 20 sec		
-	-	-	-	-	-	-	-	C	C	-	-	D
						C				D		
		10 - 15 m		10 - 15 m		< 10 m		< 10 m		< 10 m		< 10 m
		≥ 2		≥ 2		1		≥ 2		≥ 2		≥ 2
-	-	B	-	B	-	F	-	-	D	-	D	D
		B				F				D		

Catherine/Percy					Catherine/Bronson					Bank/Isabella/Chamberlain			
WEST	NORTH	SOUTH	EAST	WEST	NORTH	SOUTH	EAST	WEST	NORTH	SOUTH	EAST	WEST	
4	4	5	4	3	6		4	4	5	5	4	3	
No Median - 2.4 m	No Median - 2.4 m	No Median - 2.4 m	No Median - 2.4 m	No Median - 2.4 m	No Median - 2.4 m		No Median - 2.4 m	No Median - 2.4 m	No Median - 2.4 m	No Median - 2.4 m	No Median - 2.4 m	No Median - 2.4 m	
Permissive	No left turn / Prohib.	Permissive	No left turn / Prohib.	No left turn / Prohib.	No left turn / Prohib.		No left turn / Prohib.	Protected/ Permissive	Permissive	No left turn / Prohib.	Protected/ Permissive	No left turn / Prohib.	
No right turn	No right turn	No right turn	No right turn	Protected	Permissive or yield control		No right turn	Permissive or yield control	No right turn	Protected/ Permissive	Permissive or yield control	No right turn	
RTOR prohibited	RTOR prohibited	RTOR prohibited	RTOR prohibited	RTOR prohibited	RTOR allowed		RTOR allowed	RTOR prohibited	RTOR prohibited	RTOR allowed	RTOR prohibited	RTOR allowed	
No	No	No	No	Yes	No		No	No	No	No	No	No	
No Right Turn	No Channel	No Right Turn	No Right Turn	No Right Turn	No Channel		No Channel	No Right Turn	No Right Turn	No Channel	No Right Turn	Smart Channel	
No Right Turn	5-10m	No Right Turn	No Right Turn	No Right Turn	10-15m		5-10m	No Right Turn	No Right Turn	10-15m	No Right Turn	5-10m	
Textured/coloured pavement	Std transverse markings	Std transverse markings	Std transverse markings	Std transverse markings	Zebra stripe hi-vis markings		Zebra stripe hi-vis markings	Zebra stripe hi-vis markings	Std transverse markings	Std transverse markings	Std transverse markings	Std transverse markings	
<b>74</b>	<b>70</b>	<b>55</b>	<b>79</b>	<b>98</b>	<b>31</b>		<b>70</b>	<b>69</b>	<b>55</b>	<b>45</b>	<b>66</b>	<b>90</b>	
<b>C</b>	<b>C</b>	<b>D</b>	<b>B</b>	<b>A</b>	<b>E</b>	<b>-</b>	<b>C</b>	<b>C</b>	<b>D</b>	<b>D</b>	<b>C</b>	<b>A</b>	
75	90	90	90	90	100		100	100	75	75	75	75	
32	8	8	22	22	12		50	16	12	12	14	28	
<b>12</b>	<b>37</b>	<b>37</b>	<b>26</b>	<b>26</b>	<b>39</b>		<b>13</b>	<b>35</b>	<b>26</b>	<b>26</b>	<b>25</b>	<b>15</b>	
<b>B</b>	<b>D</b>	<b>D</b>	<b>C</b>	<b>C</b>	<b>D</b>	<b>-</b>	<b>B</b>	<b>D</b>	<b>C</b>	<b>C</b>	<b>C</b>	<b>B</b>	
<b>C</b>	<b>D</b>	<b>D</b>	<b>C</b>	<b>C</b>	<b>E</b>	<b>-</b>	<b>C</b>	<b>D</b>	<b>D</b>	<b>D</b>	<b>C</b>	<b>B</b>	
	<b>D</b>				<b>E</b>				<b>D</b>				
WEST	NORTH	SOUTH	EAST	WEST	NORTH	SOUTH	EAST	WEST	NORTH	SOUTH	EAST	WEST	
Mixed Traffic	Curb Bike Lane, Cycletrack or MUP	Curb Bike Lane, Cycletrack or MUP	Mixed Traffic		Mixed Traffic		Mixed Traffic			Mixed Traffic		Mixed Traffic	
≤ 50 m	Not Applicable	Not Applicable	≤ 50 m		≤ 50 m		≤ 50 m			≤ 50 m		≤ 50 m	
≤ 25 km/h	Not Applicable	Not Applicable	≤ 25 km/h		≤ 25 km/h		≤ 25 km/h			≤ 25 km/h		≤ 25 km/h	
<b>D</b>	<b>Not Applicable</b>	<b>Not Applicable</b>	<b>D</b>	<b>-</b>	<b>D</b>	<b>-</b>	<b>D</b>	<b>-</b>	<b>-</b>	<b>D</b>	<b>-</b>	<b>D</b>	
<b>Mixed Traffic</b>	<b>Separated</b>	<b>Separated</b>	<b>Mixed Traffic</b>	<b>-</b>	<b>Mixed Traffic</b>	<b>-</b>	<b>Mixed Traffic</b>	<b>-</b>	<b>-</b>	<b>Mixed Traffic</b>	<b>-</b>	<b>Mixed Traffic</b>	
		No lane crossed	One lane crossed			One lane crossed	One lane crossed			One lane crossed		One lane crossed	
		≤ 40 km/h	> 50 to < 60 km/h			> 50 to < 60 km/h	> 50 to < 60 km/h			> 40 to ≤ 50 km/h		> 50 to < 60 km/h	
<b>-</b>	<b>-</b>	<b>B</b>	<b>E</b>	<b>-</b>	<b>-</b>	<b>E</b>	<b>E</b>	<b>-</b>	<b>-</b>	<b>D</b>	<b>-</b>	<b>E</b>	
<b>-</b>	<b>-</b>	<b>B</b>	<b>E</b>	<b>-</b>	<b>-</b>	<b>-</b>	<b>E</b>	<b>-</b>	<b>-</b>	<b>-</b>	<b>-</b>	<b>E</b>	
	<b>E</b>				<b>E</b>				<b>E</b>				
≤ 30 sec													
<b>D</b>	<b>-</b>	<b>-</b>	<b>-</b>	<b>-</b>	<b>-</b>	<b>-</b>	<b>-</b>	<b>-</b>	<b>-</b>	<b>-</b>	<b>-</b>	<b>-</b>	
	< 10 m				> 15 m		< 10 m			10 - 15 m		< 10 m	
	≥ 2				≥ 2		≥ 2			≥ 2		≥ 2	
<b>-</b>	<b>D</b>	<b>-</b>	<b>-</b>	<b>-</b>	<b>A</b>	<b>-</b>	<b>D</b>	<b>-</b>	<b>-</b>	<b>B</b>	<b>-</b>	<b>D</b>	
	<b>D</b>				<b>D</b>				<b>D</b>				



Catherine/Percy (Future)			Catherine/Bronson (Future)				Bank/Isabella/Chamberlain (Future)			
SOUTH	EAST	WEST	NORTH	SOUTH	EAST	WEST	NORTH	SOUTH	EAST	WEST
3	3	3	6		4	4	4	5	3	3
No Median - 2.4 m	No Median - 2.4 m	No Median - 2.4 m	No Median - 2.4 m		No Median - 2.4 m	No Median - 2.4 m	No Median - 2.4 m	No Median - 2.4 m	No Median - 2.4 m	No Median - 2.4 m
Permissive	No left turn / Prohib.	No left turn / Prohib.	No left turn / Prohib.		No left turn / Prohib.	Protected/ Permissive	Permissive	No left turn / Prohib.	Protected/ Permissive	No left turn / Prohib.
No right turn	No right turn	Protected	Permissive or yield control		No right turn	Permissive or yield control	No right turn	Protected	Permissive or yield control	No right turn
RTOR prohibited	RTOR prohibited	RTOR prohibited	RTOR allowed		RTOR allowed	RTOR prohibited	RTOR prohibited	RTOR prohibited	RTOR prohibited	RTOR allowed
No	No	Yes	No		No	No	No	No	No	No
No Right Turn	No Right Turn	No Right Turn	No Channel		No Channel	No Right Turn	No Right Turn	No Channel	No Right Turn	Smart Channel
No Right Turn	No Right Turn	No Right Turn	10-15m		5-10m	No Right Turn	No Right Turn	10-15m	No Right Turn	10-15m
Std transverse markings	Std transverse markings	Zebra stripe hi-vis markings	Zebra stripe hi-vis markings		Zebra stripe hi-vis markings	Zebra stripe hi-vis markings	Zebra stripe hi-vis markings	Zebra stripe hi-vis markings	Zebra stripe hi-vis markings	Zebra stripe hi-vis markings
88	96	101	31		70	69	74	56	86	92
B	A	A	E	-	C	C	C	D	B	A
90	90	90	100		100	100	75	75	75	75
8	22	22	12		50	16	12	12	14	28
37	26	26	39		13	35	26	26	25	15
D	C	C	D	-	B	D	C	C	C	B
D	C	C	E	-	C	D	C	D	C	B
D			E				D			
SOUTH	EAST	WEST	NORTH	SOUTH	EAST	WEST	NORTH	SOUTH	EAST	WEST
Curb Bike Lane, Cycletrack or MUP	Mixed Traffic							Curb Bike Lane, Cycletrack or MUP	Curb Bike Lane, Cycletrack or MUP	Curb Bike Lane, Cycletrack or MUP
Not Applicable	> 50 m							Not Applicable	Not Applicable	Not Applicable
Not Applicable	≤ 25 km/h							Not Applicable	Not Applicable	Not Applicable
Not Applicable	F	-	-	-	-	-	-	Not Applicable	Not Applicable	Not Applicable
Separated	Mixed Traffic	-	-	-	-	-	-	Separated	Separated	Separated
No lane crossed	One lane crossed						One lane crossed	2-stage, LT box		1 lane crossed
≤ 40 km/h	> 50 to < 60 km/h						> 40 to ≤ 50 km/h	> 40 to ≤ 50 km/h		> 50 to < 60 km/h
B	E	-	-	-	-	-	D	A	-	D
B	F	-	-	-	-	-	-	A	-	D
F			-				D			
	≤ 20 sec		> 40 sec	≤ 20 sec	> 40 sec		≤ 20 sec	≤ 20 sec		≤ 40 sec
-	C	-	F	C	F	-	C	C	-	E
C			F				E			
								10 - 15 m		10 - 15 m
								≥ 2		≥ 2
-	-	-	-	-	-	-	-	B	-	B
-			-				B			