



265 Catherine Street

TIA Strategy Report

DRAFT

April 2023



TIA Plan Reports

On 14 June 2017, the Council of the City of Ottawa adopted new Transportation Impact Assessment (TIA) Guidelines. In adopting the guidelines, Council established a requirement for those preparing and delivering transportation impact assessments and reports to sign a letter of certification.

Individuals submitting TIA reports will be responsible for all aspects of development-related transportation assessment and reporting, and undertaking such work, in accordance and compliance with the City of Ottawa's Official Plan, the Transportation Master Plan and the Transportation Impact Assessment (2017) Guidelines.

By submitting the attached TIA report (and any associated documents) and signing this document, the individual acknowledges that s/he meets the four criteria listed below.

CERTIFICATION

1. I have reviewed and have a sound understanding of the objectives, needs and requirements of the City of Ottawa's Official Plan, Transportation Master Plan and the Transportation Impact Assessment (2017) Guidelines;
2. I have a sound knowledge of industry standard practice with respect to the preparation of transportation impact assessment reports, including multi modal level of service review;
3. I have substantial experience (more than 5 years) in undertaking and delivering transportation impact studies (analysis, reporting and geometric design) with strong background knowledge in transportation planning, engineering or traffic operations; and
4. I am either a licensed¹ or registered² professional in good standing, whose field of expertise [check appropriate field(s)] is either transportation engineering or transportation planning .

1,2 License of registration body that oversees the profession is required to have a code of conduct and ethics guidelines that will ensure appropriate conduct and representation for transportation planning and/or transportation engineering works.

City Of Ottawa
Infrastructure Services and Community
Sustainability
Planning and Growth Management
110 Laurier Avenue West, 4th fl.
Ottawa, ON K1P 1J1
Tel. : 613-580-2424
Fax: 613-560-6006

Ville d'Ottawa
Services d'infrastructure et Viabilité des
collectivités
Urbanisme et Gestion de la croissance
110, avenue Laurier Ouest
Ottawa (Ontario) K1P 1J1
Tél. : 613-580-2424
Télécopieur: 613-560-6006

Dated at Ottawa this 19 day of May, 2023.
(City)

Name: Austin Shih, M.A.Sc., P.Eng
(Please Print)

Professional Title: Senior Transportation Engineer



Signature of Individual certifier that s/he meets the above four criteria

Office Contact Information (Please Print)
Address: 1223 Michael Street North, Suite 100
City / Postal Code: Ottawa, Ontario, K1J 7T2
Telephone / Extension: 613-691-1569
E-Mail Address: austin.shih@parsons.com



265 Catherine Street

TIA Strategy Report

prepared for:
Brigil Construction Inc.
98 Lois Street
Gatineau, QC
J8Y 3R7

prepared by:
 **PARSONS**
1223 Michael Street North
Suite 100
Ottawa, ON K1J 7T2

May 19, 2023

478038-01000

DOCUMENT CONTROL PAGE

CLIENT:	Brigil Construction
PROJECT NAME:	265 Catherine Street
REPORT TITLE:	TIA Step 4 Strategy Report
PARSONS PROJECT NO:	478038 - 01000
APPLICATION TYPE:	Zoning By-Law Amendment (ZBLA) and Site Plan Control (SPC) Application
VERSION:	Draft
DIGITAL MASTER:	H:\ISO\478038\1000\DOCS\STEP4-Strategy\265 Catherine St - Strategy Report May 2023 Draft Report.docx
ORIGINATOR	Basel Ansari P.Eng. & Juan Lavin, P.Eng.
REVIEWER:	Austin Shih, M.A.Sc., P.Eng.
AUTHORIZATION:	
CIRCULATION LIST:	Wally Dubyk, C.E.T.
HISTORY:	<ul style="list-style-type: none"> - TIA Step 1 Screening Form - June 14, 2022 - TIA Step 2 Scoping Report - June 14, 2022 - TIA Step 3 Forecasting Report - March 13, 2023 - TIA Step 4 Strategy Report - May 19, 2023

TABLE OF CONTENTS

- 1.0 SCREENING FORM1
- 2.0 SCOPING REPORT1
 - 2.1. EXISTING AND PLANNED CONDITIONS1
 - 2.1.1. PROPOSED DEVELOPMENT.....1
 - 2.1.2. EXISTING CONDITIONS.....4
 - 2.1.3. PLANNED CONDITIONS 14
 - 2.1.3.2 Future Transportation Network Changes 14
 - 2.1.3.3 Other Area Developments..... 17
 - 2.2. STUDY AREA AND TIME PERIODS..... 17
 - 2.3. EXEMPTION REVIEW 18
- 3.0 FORECASTING 18
 - 3.1. DEVELOPMENT GENERATED TRAVEL DEMAND 18
 - 3.1.1. TRIP GENERATION AND MODE SHARES..... 18
 - 3.1.2. TRIP DISTRIBUTION AND ASSIGNMENT 25
 - 3.2. BACKGROUND NETWORK TRAFFIC..... 26
 - 3.2.1. TRANSPORTATION NETWORK PLANS..... 26
 - 3.2.2. BACKGROUND GROWTH 27
 - 3.2.3. OTHER DEVELOPMENTS 28
 - 3.3. DEMAND RATIONALIZATION 29
- 4.0 ANALYSIS 31
 - 4.1. DEVELOPMENT DESIGN..... 31
 - 4.1.1. DESIGN FOR SUSTAINABLE MODES..... 31
 - 4.1.2. CIRCULATION AND ACCESS..... 32
 - 4.1.3. NEW STREET NETWORK..... 33
 - 4.2. PARKING 33
 - 4.2.1. PARKING SUPPLY..... 33
 - 4.2.2. PARKING VARIANCE IMPLICATIONS 35
 - 4.3. BOUNDARY STREET DESIGN..... 35
 - 4.4. ACCESS INTERSECTION DESIGN 37
 - 4.5. TRANSPORTATION DEMAND MANAGEMENT..... 38
 - 4.5.1. CONTEXT FOR TDM 38
 - 4.5.2. NEED AND OPPORTUNITY 39
 - 4.5.3. TDM PROGRAM..... 39
 - 4.6. NEIGHBOURHOOD TRAFFIC MANAGEMENT 40
 - 4.7. TRANSIT 41
 - 4.8. REVIEW OF NETWORK CONCEPT 42
 - 4.9. INTERSECTION DESIGN..... 42
 - 4.9.1. INTERSECTION CONTROL..... 42
 - 4.9.2. INTERSECTION DESIGN..... 43
 - 4.9.3. QUEUEING IMPLICATIONS 47
 - 4.9.4. TRANSIT PRIORITY ON CATHERINE STREET 48

5.0 FINDINGS, CONCLUSIONS AND RECOMMENDATIONS..... 48

LIST OF FIGURES

FIGURE 1: LOCAL CONTEXT1
 FIGURE 2: EXISTING SITE ACCESSES AND CIRCULATION2
 FIGURE 3: PROPOSED FULL SITE CONCEPT PLAN.....3
 FIGURE 4: ADJACENT DRIVEWAYS WITHIN 200M OF SITE ACCESS9
 FIGURE 5: STUDY AREA ACTIVE TRANSPORTATION FACILITIES 10
 FIGURE 6: AREA TRANSIT NETWORK..... 11
 FIGURE 7: BUS STOP LOCATIONS..... 11
 FIGURE 8: EXISTING PEAK HOUR TRAFFIC VOLUMES 12
 FIGURE 9: EXISTING PEDESTRIAN AND CYCLISTS PEAK HOUR VOLUMES 13
 FIGURE 10: CENTRETOWN CDP STUDY AREA 16
 FIGURE 11: STUDY AREA..... 17
 FIGURE 12: PHASE 1 SITE-GENERATED TRAFFIC 26
 FIGURE 13: FULL BUILDOUT PHASE 1 + PHASE 2 SITE-GENERATED TRAFFIC..... 26
 FIGURE 14: FUTURE BACKGROUND 2026 TRAFFIC VOLUMES 27
 FIGURE 15: FUTURE BACKGROUND 2031 TRAFFIC VOLUMES 28
 FIGURE 16: FUTURE BACKGROUND 2036 TRAFFIC VOLUMES 28
 FIGURE 17: TOTAL PROJECTED 2026 TRAFFIC VOLUMES 30
 FIGURE 18: TOTAL PROJECTED 2031 TRAFFIC VOLUMES 30
 FIGURE 19: TOTAL PROJECTED 2036 TRAFFIC VOLUMES 31
 FIGURE 20: TRANSIT RIDERSHIP DATA BUS STOP LOCATIONS 41

LIST OF TABLES

TABLE 1: PROPOSED DEVELOPMENT SITE STATISTICS.....2
 TABLE 2: EXEMPTIONS REVIEW SUMMARY..... 18
 TABLE 3: PROPOSED DEVELOPMENT TRIP RATES 18
 TABLE 4: RESIDENTIAL UNITS PEAK PERIOD PERSON TRIP GENERATION 18
 TABLE 5: HIGH-RISE APARTMENTS PEAK PERIOD TRIPS MODE SHARES BREAKDOWN 19
 TABLE 6: TOWNHOMES PEAK PERIOD TRIPS MODE SHARES BREAKDOWN..... 19
 TABLE 7: PEAK PERIOD TO PEAK HOUR CONVERSION FACTORS (2020 TRANS MANUAL) 19
 TABLE 8: HIGH-RISE APARTMENTS PEAK HOUR TRIPS MODE SHARE BREAKDOWN 20
 TABLE 9: TOWNHOMES PEAK HOUR TRIPS MODE SHARE BREAKDOWN..... 20
 TABLE 10: HIGH-RISE APARTMENTS PEAK HOUR TRIPS MODE SHARE BREAKDOWN..... 20
 TABLE 11: TOWNHOMES PEAK HOUR TRIPS MODE SHARE BREAKDOWN 21
 TABLE 12: HIGH-RISE APARTMENTS MODE SHARES BREAKDOWN (2020 TRANS REPORT)..... 21
 TABLE 13: TOWNHOMES MODE SHARES BREAKDOWN (2020 TRANS REPORT)..... 21
 TABLE 14: TOTAL RESIDENTIAL TRIP GENERATION..... 22
 TABLE 15: SUPERMARKET PEAK HOUR PERSON TRIPS 22
 TABLE 16: TRANS 2020 MODE SHARES FOR COMMERCIAL USE AND PROPOSED MODE SHARES 23
 TABLE 17: RETAIL PEAK HOUR TRIPS MODE SHARE BREAKDOWN 23
 TABLE 18: TOTAL NONRESIDENTIAL TRIP GENERATION 24
 TABLE 19: RESIDENTIAL PEAK HOUR TRIPS WITH INTERNAL REDUCTIONS 24
 TABLE 20: TOTAL TRIPS GENERATED..... 25
 TABLE 21: REQUIRED AND PROPOSED VEHICLE PARKING SPACES 34
 TABLE 22: REQUIRED AND PROPOSED BICYCLE PARKING SPACES 34
 TABLE 23: MMLOS ANALYSIS, BOUNDARY ROAD SEGMENTS 36

TABLE 24: MMLOS ANALYSIS, SIGNALIZED INTERSECTION	38
TABLE 25: ARLINGTON AVE EXISTING AND FUTURE TWO-WAY VOLUMES	40
TABLE 26: TRANSIT RIDERSHIP DATA (JAN 5, 2020 - MAR 16, 2020).....	42
TABLE 27: EXISTING CONDITIONS INTERSECTION PERFORMANCE	43
TABLE 28: FUTURE BACKGROUND 2036 CONDITIONS INTERSECTION PERFORMANCE	44
TABLE 29: TOTAL PROJECTED 2026 CONDITIONS INTERSECTION PERFORMANCE - PHASE 1	45
TABLE 30: FUTURE PROJECTED 2031 INTERSECTION PERFORMANCE - PHASE 1 & 2	46
TABLE 31: FUTURE PROJECTED 2036 INTERSECTION PERFORMANCE - PHASE 1 & 2	47
TABLE 32: QUEUEING ANALYSIS FOR SENSITIVE INTERSECTION MOVEMENTS (2036 PROJECTED)	48

LIST OF APPENDICES

APPENDIX A: SCREENING FORM & CITY COMMENT REPOSSES

APPENDIX B: TRANSIT ROUTE MAPS

APPENDIX C: TRAFFIC DATA

APPENDIX D: COLLISION DATA

APPENDIX E: INTERNAL REDUCTION CALCULATIONS

APPENDIX F: TDM CHECKLIST

APPENDIX G: PASSENGER CAR AND TRUCK TURNING TEMPLATES

APPENDIX H: MMLOS ANALYSIS: ROAD SEGMENTS

APPENDIX I: MMLOS ANALYSIS: INTERSECTIONS

APPENDIX J: SYNCHRO ANALYSIS SUMMARY REPORTS

APPENDIX K: SIMTRAFFIC SUMMARY REPORTS

STRATEGY REPORT

Parsons has been retained by Brigil Construction to prepare a TIA in support of Zoning By-Law Amendment (ZBLA) and Site Plan Control (SPC) Application for a three-tower residential development. This document follows the TIA process as outlined in the City Transportation Impact Assessment (TIA) Guidelines (2017). The following report represents Step 4 – Strategy Report. The Screening Form and previous City Comments have been provided in **Appendix A**.

1.0 SCREENING FORM

The Screening Form confirmed the need for a TIA Report based on the Trip Generation and Safety triggers. The Trip Generation trigger was met as the development is anticipated to generate more than 60 person trips during peak hours. The Safety trigger was met following a review of collisions history in the study area.

2.0 SCOPING REPORT

2.1. Existing and Planned Conditions

2.1.1. Proposed Development

The proposed development will be located at the municipal address of 265 Catherine St, replacing the existing Greyhound Bus Station that is no longer active. The local context of the site is illustrated in **Figure 1**.

Figure 1: Local Context

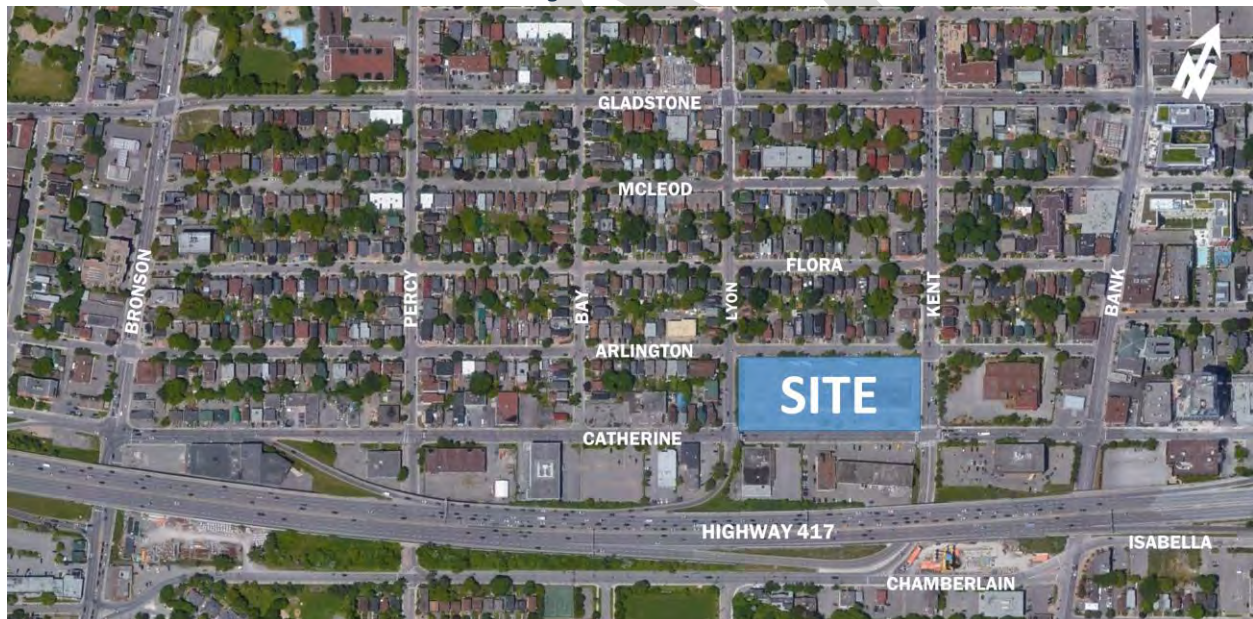

The subject site currently provides accesses onto Catherine St only as shown in **Figure 2**. The site is currently zoned as a General Mixed-Use Zone and is located within the Ontario Ministry of Transportation (MTO) permit control zone.

Figure 2: Existing Site Accesses and Circulation



The proposed development will consist of residential and commercial uses constructed as a two phased development. The site statistics have been summarized in **Table 1**. The full buildout concept plan is illustrated in **Figure 3** (high quality plan provided in **Appendix A**).

Table 1: Proposed Development Site Statistics

Land Use	Storeys	Residential (Units)	Commercial (m ²)	Vehicle Parking	Bike Parking
Phase 1					
Building A (Tower 1)	26	289	1,187	141	347
Phase 1 Total		289	1,187	141	347
Phase 2					
Building B (Towers 2, 3)	36 to 40	732	1,064	253	391
Building C (Townhomes)	3	7	0	-	-
Phase 2 Total		739	1,064	253	391
Full Buildout Total		1,028	2,251	394	738

All vehicle parking will be provided in a two-level underground parking garage accessed by new two-way ramps on Catherine St and Arlington St. A one-way southbound woonerf connecting Arlington St to Catherine St is proposed which will primarily serve as an extension of the expansive pedestrian realm onsite, but has been designed to also accommodate loading and garbage truck operations. Phase 1, including the woonerf is assumed to be completed by 2026 and Phase 2 is assumed to be completed by 2031.

Further detail on site circulation can be found in **Section 4.1**, for vehicle and bike parking in **Section 4.2**, and site access/driveways in **Section 4.4**.

Figure 3: Proposed Full Site Concept Plan

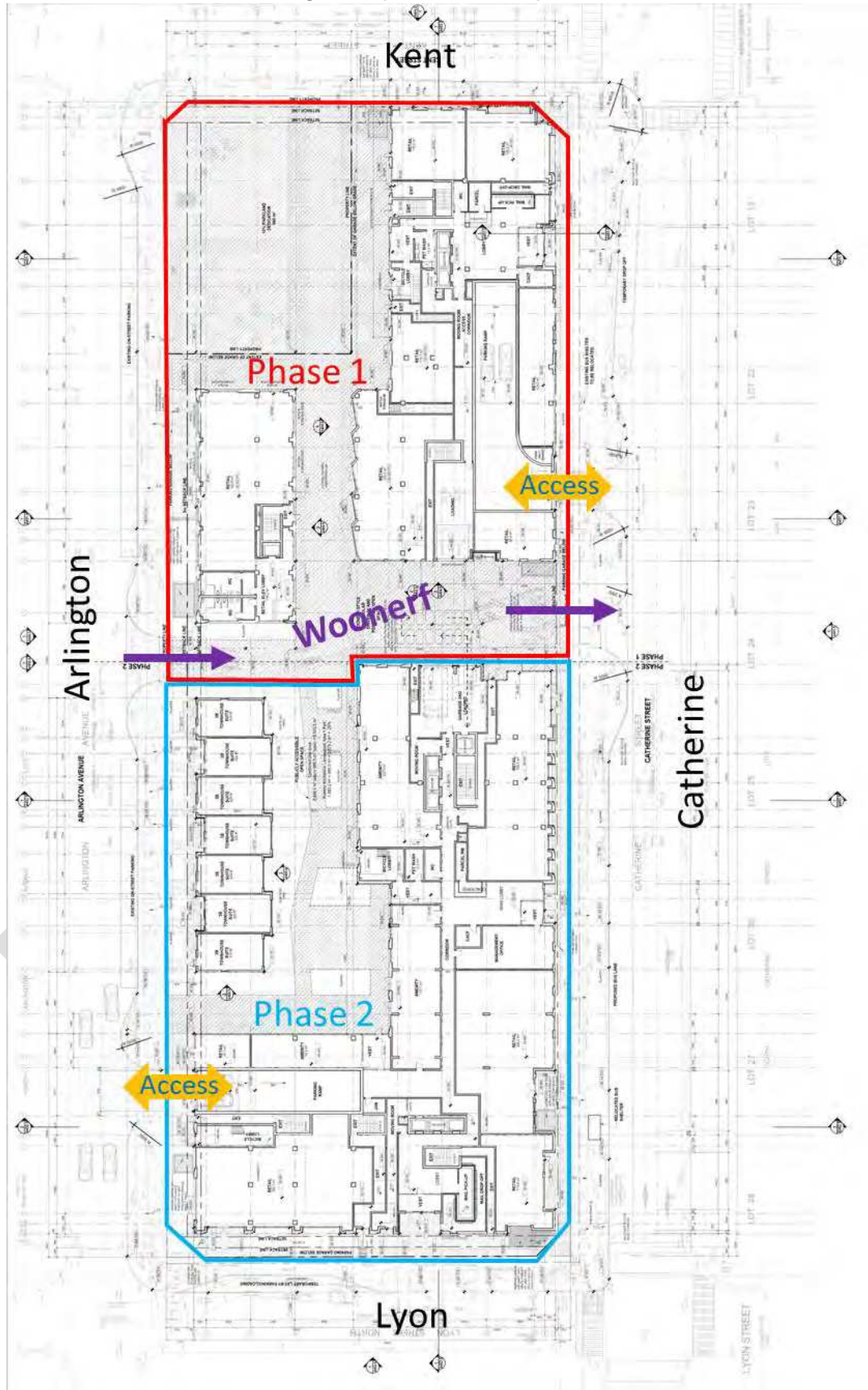

2.1.2. Existing Conditions

Area Road Network

The following roads were included in the TIA. Description for each road within the study area has been provided below.

Kent Street is a north-south municipal arterial road that extends from Wellington St in the north to Chamberlain Ave in the south forming the east boundary road to the site. The roadway operates as a one-way northbound road with a three-lane cross-section and on-street parking. The posted speed limit is 50km/h.

Lyon Street N is a north-south municipal arterial road that extends from Wellington St in the north to Catherine St in the south that forms the western site boundary. The roadway operates as a one-way southbound road with a two-lane cross-section. The speed limit is assumed to be 50km/h.

Catherine Street is an east-west municipal arterial road bordering the site to the south that extends from Queen Elizabeth Dr in the east to Bronson Ave in the west, where it continues as Raymond St. The roadway currently operates as a one-way westbound road with a three-lane cross-section and an assumed speed limit of 50km/h.

Arlington Avenue is an east-west municipal local road that extends from Bank St in the east to Booth St in the west, forming the northern site boundary. The roadway consists of a two-way two-lane cross-section, with a posted speed limit of 30km/h.

Bank Street is a north-south municipal arterial road that extends from Wellington St in the north to past the City of Ottawa's limits in the south. Within the study area, the roadway consists of a two-way two-lane cross-section with a posted speed limit of 50km/h north of Catherine St and 40km/h south of thereof. Additionally, Bank St is designated as a traditional mainstreet in the City of Ottawa Official Plan.

Percy Street is a north-south municipal local road that extends from Laurier Ave W in the north to Fifth Ave in the south. Notably, the southbound through movement is not permitted on Percy St at the Chamberlain Ave intersection. Within the study area, the road consists of a two-way two-lane cross-section with on-street parking, a posted speed limit of 30km/h north of Catherine St and an assumed speed limit of 40km/h south of thereof.

Gladstone Avenue is an east-west municipal major collector road that extends from Parkdale Ave in the west to Cartier St in the east. The roadway consists of a two-lane cross-section along the majority of its length, with a four-lane cross-section between Bank St and Kent St. The speed limit is assumed to be 50km/h in the study area.

Bronson Avenue is a north-south municipal arterial road that extends from Sparks St in the north to Heron St on/off ramps in the south, where it continues as the Airport Parkway. The road consists of a four-lane cross-section, with posted speed limits of 50km/h.

Chamberlain Avenue/Isabella Street are east-west municipal arterial roads that extend from Bronson Ave in the west as Chamberlain Ave to Bank St, where it continues east as Isabella St to Queen Elizabeth Dr in the east. The roadway is one-way eastbound only with a two-lane cross-section and a 50km/h speed limit within the study area.

Existing Study Area Intersections

Lyon/Catherine

The Lyon/Catherine intersection is a four-legged signalized intersection of southbound and westbound one-way streets. The westbound approach consists of two through lanes and a shared through/left-turn lane. The southbound approach consists of a through lane and a right-turn lane. Only westbound and southbound operations are permitted at this intersection. The southbound egress serves the Hwy 417 westbound on-ramp



Kent/Catherine

The Kent/Catherine intersection is a four-legged signalized intersection of northbound and westbound one-way streets. The westbound approach consists of one through lane, one through/right-turn lane and one right-turn lane. The northbound approach consists of two through lanes and a through/left-turn lane. One northbound through lane is separated by a median on the approach. Only westbound and northbound operations are permitted at this intersection and westbound right-turns are not permitted on a red light.



Bank/Catherine

The Bank/Catherine intersection is a signalized four-legged intersection, where Catherine St is westbound only. The northbound approach consists of a through lane and a through/left-turn lane. The southbound approach consists of a through lane and a through/right-turn lane. The westbound approach consists of two through lanes and a through/right-turn lane. There are no eastbound operations at this intersection.



Percy/Catherine

The Percy/Catherine intersection is a four-legged signalized intersection of southbound and westbound one-way streets. The westbound approach consists of two through lanes and a shared through/left-turn lane. The southbound approach consists of a through lane and a right-turn lane. A north-south bidirectional bike crossing with a bike signal is provided on the west leg of the intersection. Only westbound and southbound operations are permitted at this intersection for vehicles. The southbound right-turn on red is prohibited.



Lyon/Arlington

The Lyon/Arlington intersection is an unsignalized four-legged intersection, with Stop control on Arlington Ave. Lyon St operates as one-way southbound. The westbound approach consists of a through/left-turn lane and the eastbound approach consists of a through/right-turn lane. Lyon St consists of a through/left-turn and through/right-turn lanes. There are no northbound operations at this intersection.



Kent/Arlington

The Kent/Arlington intersection is a signalized four-legged intersection, where Kent St is northbound only. The northbound approach consists of a through lane, a through/left-turn lane and a through/right-turn lane. The eastbound approach consists of a through/left-turn lane and the westbound approach consists of a through/right-turn lane. There are no southbound operations at this intersection.



Bank/Arlington

The Bank/Arlington intersection is an unsignaled three-legged “T” intersection, with Stop control on Arlington Ave. The northbound approach consists of a through lane and a shared through/left-turn lane. The southbound approach consists of a through lane and a shared through/right-turn lane. Arlington St consists of a single all-movement lane. There are no restricted movements at this intersection.



Kent/Gladstone

The Kent/Gladstone intersection is a signaled four-legged intersection, where Kent St is northbound only. The northbound approach consists two through lanes, a shared through/right-turn lane and a left-turn lane. The eastbound approach consists of a through lane and a left-turn lane, while the westbound approach consists of a shared through/right-turn lane. There are no southbound operations at the intersection.



Lyon/Gladstone

The Lyon/Gladstone intersection is a signaled four-legged intersection, where Lyon St is southbound only. The southbound approach consists of a shared through/right-turn lane and a shared through-left-turn lane. The eastbound approach consists of a through lane and an unmarked short right-turn lane. The westbound approach consists of a through lane and an unmarked short left-turn lane. There are no northbound operations at this intersection.



Bank/Chamberlain/Isabella

The Bank/Chamberlain/Isabella intersection is a signalized four-legged intersection, where Chamberlain Ave/Isabella St is eastbound only. The northbound approach consists of a through lane and a shared through/right-turn lane. The southbound approach consists of a through lane and a shared through/left-turn lane. The eastbound approach consist of a through lane, a shared through/left-turn lane and a stop-controlled right-turn lane. There are no westbound operations at this intersection.



Bronson/Catherine

The Bronson/Catherine intersection is a signalized four-legged intersection, where Catherine St is westbound only. The northbound approach consists of two through lanes and a left-turn lane. The southbound approach consists of a through lane and a shared through/right-turn lane. The westbound approach consists of a through lane, a shared through/left-turn lane, a left-turn lane and a right-turn lane. There are no eastbound operations at this intersection.



Existing Driveways to Adjacent Developments

Within 200m of the proposed site accesses along Catherine St and Arlington St, there is a total of 37 adjacent driveways as shown in **Figure 4**. Along Arlington St, there are 24 adjacent accesses (21 north side, 3 south side). Nearly all Arlington St accesses are used by individual residential units, with the exception of the access nearest to the northwest corner of the Kent/Arlington intersection, which is used to give access to the parking lot of a small restaurant.

Along Catherine St, there are 13 adjacent accesses (5 north side, 8 south side). On the north side of Catherine St, the four accesses west of Lyon St are for individual residential units, some of which are being used as office/business, while the accesses east of Kent St is for a gas station. All south side accesses are used for office buildings, business, and commercial units of different sizes.

Figure 4: Adjacent Driveways within 200m of Site Access



Existing Area Traffic Management Measures

Various area traffic management measures are currently provided within the study area, including the following:

- Advance pedestrian walk phases at the intersections of Kent/Catherine and Bank/Catherine,
- Bike signal and crossing phase at the intersection of Percy/Catherine,
- Zebra crosswalks on all legs at the intersection of Kent/Catherine, Lyon/Gladstone, Bank/Catherine, and Bronson/Catherine,
- Textured brick crosswalks on the east leg of the intersection of Lyon/Arlington, west leg of Kent/Arlington and west leg of Bank/Arlington,
- Curb extensions on the south side of Arlington Ave at the intersections of Lyon St and Kent St, as well as north side at the intersection of Kent St,
- Curb extension on the east side of Kent St at the intersection of Arlington Ave,
- On-street parking permitted along sections of Arlington Ave (including south side site frontage), Kent St (including east side site frontage), Lyon St, Percy St, Catherine St, and Gladstone Ave,
- Speed humps at different locations along Percy St, Lyon St, and Arlington Ave (including two at site frontage),
- Reduced 30km/h speeds along Percy St north of Catherine St and Arlington Ave,
- Southbound through restriction along Percy St at Chamberlain Ave intersection, where only bikes are permitted, and
- Modal filter along Bay St, 20m north of Catherine St, which prevent vehicles from passing and permits pedestrians and cyclists.

In addition to the above, the City of Ottawa has provided a list of Temporary Traffic Calming (TTC) measures within or near the study area, which includes:

- A “SLOW” pavement marking on Arlington Ave, west of Kent St.
- A speed display board on Kent St, north of Arlington Ave.
- Delineators on Lyon St, north of Gladstone Ave.
- Delineators, painted bulb-out, “SLOW” pavement marking and speed display boards on different locations of Percy St, north of Catherine St.

Pedestrian/Cycling Network

The active transportation network facilities for pedestrians and cyclists are illustrated in **Figure 5** (map obtained from GeoOttawa). As shown, sidewalk facilities are provided throughout the study area, including both sides of all roadways. Southbound bike lanes are provided on Lyon St, north of Arlington Ave, and a bi-directional cycle track is provided along Percy St. Northbound bike lanes are also provided along Bay St, 30m north of Catherine St. Although not identified in the map shown, it is noted that a contraflow (eastbound) bike lane is provided on McLeod St, between Percy St and Lyon St.

Additionally, the City of Ottawa Transportation Master Plan (TMP) designates Arlington Ave, Lyon St (north of Arlington Ave), Percy St and Bay St as cycling spine routes. Bank St and Gladstone Ave are suggested cycling routes, along with a small portion of Arlington Ave, between Percy St and Lyon St. Chamberlain Ave/Isabella St are classified as part of a Crosstown Bikeway route.

Figure 5: Study Area Active Transportation Facilities



Transit Network

Due to the current circumstances regarding COVID-19, some bus services may have been altered by OC Transpo to operate on a different schedule. The following description of OC Transpo routes within the study area reflect the current bus operations (June, 2022):

- **Route #6 (Greenboro <-> Rockcliffe):** identified by OC Transpo as a “Frequent Route”, this route operates all day, 7 days a week and at an average rate of every 15-to-30 minutes during weekday peak hours. The nearest bus stops to the site are at the intersections of Bank/Arlington and Bank/Catherine.
- **Route #7 (Carleton <-> St. Laurent):** identified by OC Transpo as a “Frequent Route”, this route operates all day, 7 days a week and at an average rate of every 15-to-30 minutes during

weekday peak hours. The nearest bus stops to the site are at the intersections of Bank/Arlington and Bank/Catherine.

- **Route #14 (St-Laurent <-> Tunney's Pasture):** identified by OC Transpo as a “Frequent Route”, this route operates all day, 7 days a week and at an average rate of every 15-to-30 minutes during weekday peak hours. The nearest bus stops to the site are at the intersections of Lyon/Gladstone and Kent/Gladstone.
- **Route #55 (Westgate <-> Elmvale):** identified by OC Transpo as a “Local Route”, this route operates throughout the week on a selected trip only basis. The nearest bus stop to the site is along Catherine St, at the frontage of the site.
- **Route #114 (Rideau <-> Carlington):** identified by OC Transpo as a “Local Route”, this route operates from Monday to Friday on a selected trip only basis. The nearest bus stops to the site are at the intersections of Lyon/Gladstone and Kent/Gladstone.

The transit network for the study area is illustrated in **Figure 6** and the transit route maps are provided in **Appendix B**. **Figure 7** illustrates the bus stop locations.

Figure 6: Area Transit Network



Figure 7: Bus Stop Locations



Peak Hour Travel Demands

The existing peak hour traffic volumes at the signalized intersections within the study area were obtained from the City of Ottawa for the following intersections:

- Kent/Catherine – Conducted Wednesday, April 18, 2018
- Lyon/Catherine – Conducted Wednesday, April 18, 2018
- Bank/Catherine – Conducted Thursday, April 19, 2018
- Percy/Catherine – Conducted Thursday, April 19, 2018
- Lyon/Gladstone – Conducted Wednesday, August 24, 2022
- Kent/Gladstone – Conducted Tuesday, April 25, 2017
- Bank/Isabella/Chamberlain – Conducted Wednesday, April 18, 2018
- Catherine/Bronson - Conducted Thursday, April 19, 2018

In addition to the City of Ottawa counts, new traffic counts were obtained separately for the following intersection:

- Kent/Arlington – Conducted Tuesday, April 11, 2023
- Lyon/Arlington – Conducted Tuesday, April 11, 2023
- Bank/Arlington (mainly in/out volumes on Arlington Ave were collected) – Conducted Tuesday, April 18, 2023

The traffic volumes at study area intersections are illustrated in **Figure 8**, While existing active transportations (pedestrian and cyclist) volumes at study area intersections has been provided in **Figure 9**. Raw traffic count data provided in **Appendix C**.

It is important to note that Greyhound shut down their operations in Canada during the COVID-19 pandemic. While some of the traffic counts collected predate the closure, there is no way to verify peak hour traffic activity when the station was still active. The expectation is the weekday morning and afternoon activity was not significant. Therefore, existing traffic counts were not adjusted to remove the bus station traffic from pre-COVID-19 traffic data.

Traffic volumes at study area intersections were balanced conservatively to account for notable differences between adjacent intersections. No additional traffic growth adjustment was applied to the traffic volumes up to the existing horizon year (2023).

However, two developments that have been constructed in recent years, which includes 203 Catherine St and 488-500 Bank St, have been accounted for by adding their estimated vehicle trips to the existing traffic volumes. Note that the transportation memo for 488-500 Bank St was obtained from the City, but City staff have indicated that the TIA brief for 203 Catherine St is outdated (2011) and unavailable. Using the number of units for the 203 Catherine St development (200 units based on developer website), the number of site-generated trips were calculated. Travel mode and trip distribution assumptions followed the same assumptions of 265 Catherine St, as provided in **Section 3.0**.

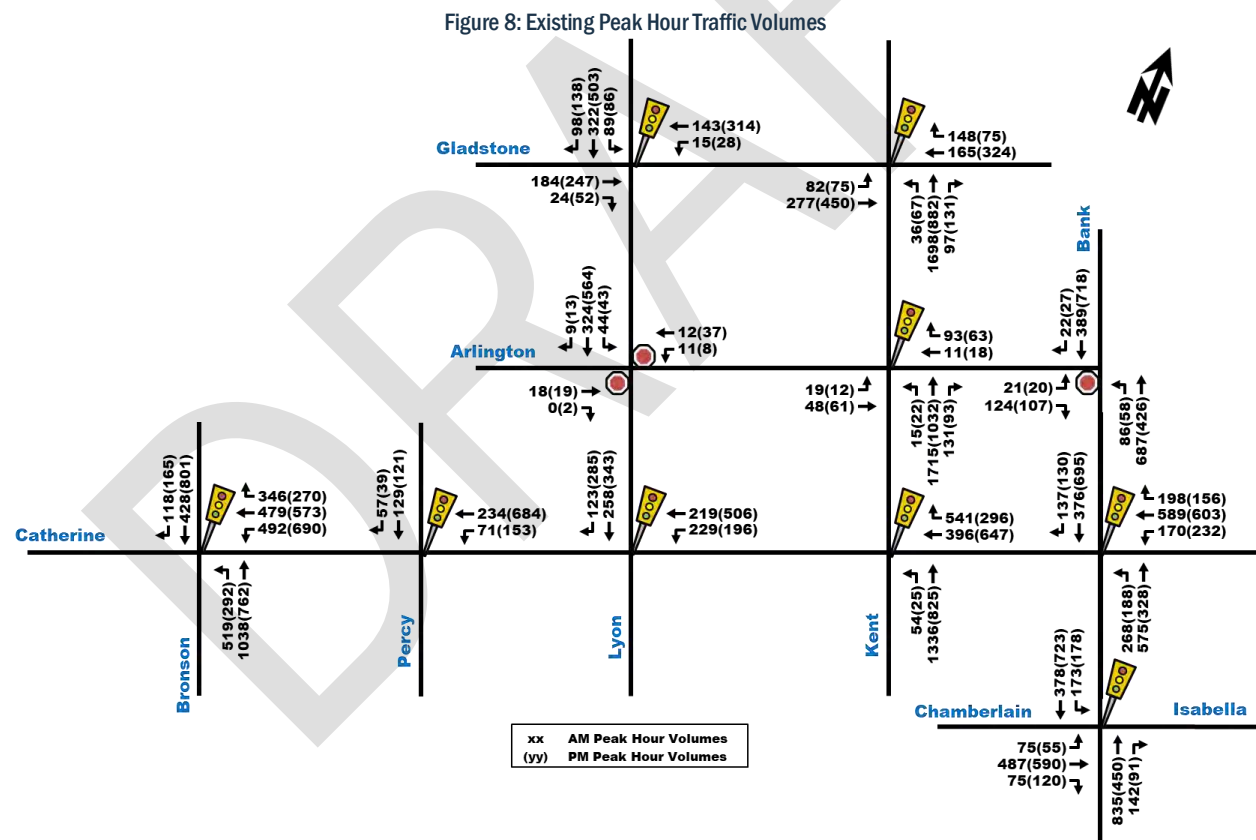
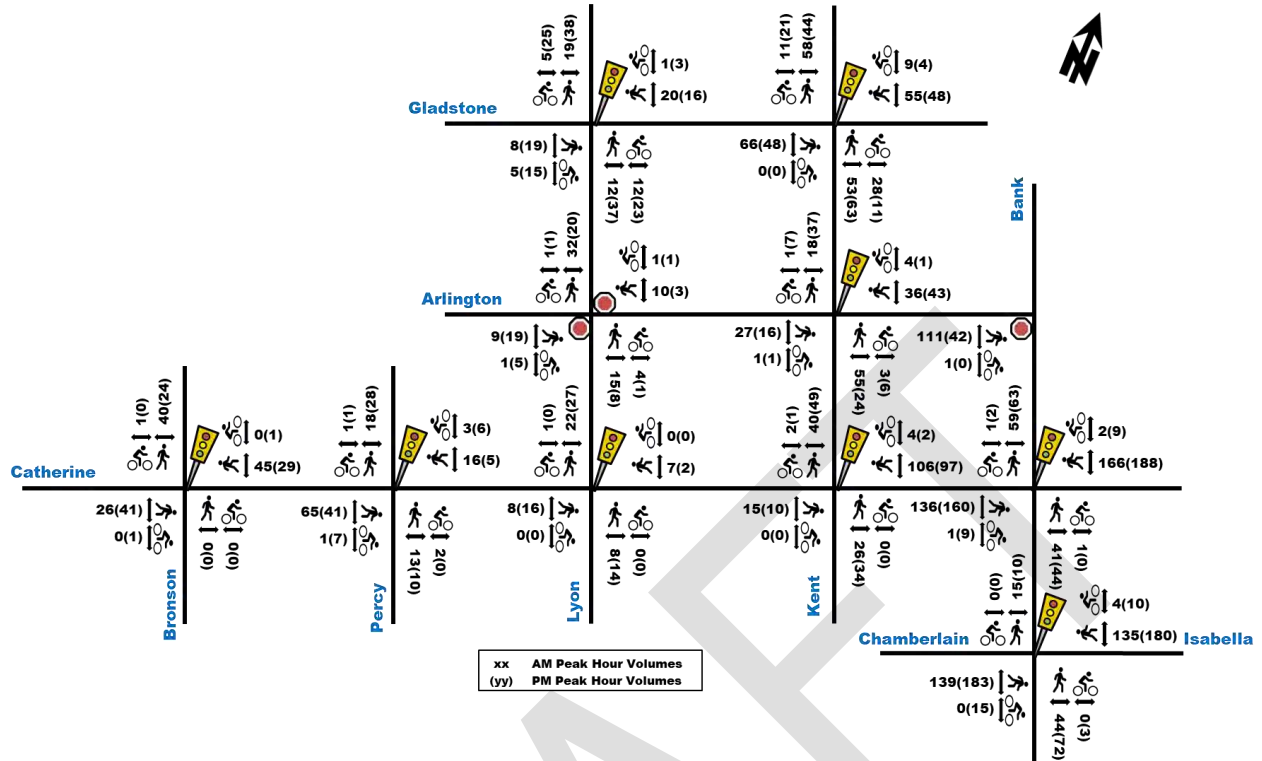

Figure 9: Existing Pedestrian and Cyclists Peak Hour Volumes



Existing Road Safety Conditions

A five-year collision history data (2017-2021, inclusive) was obtained from the City of Ottawa open data source for the 11 study area intersections and segments between intersections. Upon analyzing the collision data, the total number of collisions observed within the broader study area was 427 collisions within the past five-years. The majority of the collisions 359 (84%) resulted in property damage only, and 68 (16%) resulted in non-fatal injury. There were no fatal collisions recorded. Overall, the collisions type frequencies were mainly split in three distinct groups, 117 (27%) were sideswipe, 110 (26%) angle, 98 (23%) turning movement. Rear end collisions accounted for 62 (15%) and the rest less than 25 (<5%) collisions each type.

Within the study area, the quantity of collisions and collisions per million entering vehicles (MEV) at each location has occurred at a rate of:

- Bronson/Catherine: 91, MEV 1.27
- Percy/Catherine: 6, MEV 0.42
- Lyon/Catherine: 17, MEV 0.80
- Kent/Catherine: 96, MEV 2.64
- Bank/Catherine: 61, MEV 1.44
- Gladstone/Lyon: 8, MEV 0.42
- Arlington/Lyon: 2, MEV 0.12
- Gladstone/Kent: 25, MEV 0.59
- Arlington/Kent: 23, MEV 0.82
- Arlington/Bank: 10, MEV 0.41
- Bank/Chamberlain: 41, MEV 0.93
- Mid-block on Catherine (Bronson to Bank): 16 (915m)
- Mid-block on Arlington (Lyon to Bank): 8 (350m)
- Mid-block on Gladstone (Lyon to Kent): 8 (190m)
- Mid-block on Lyon (Gladstone to Catherine): 4 (315m)
- Mid-block on Kent (Gladstone to Catherine): 7 (315m)
- Mid-block on Bank (Arlington to Chamberlain): 4 (185m)
- Collisions with Pedestrians: 13 (3%)
- Collisions with Cyclists: 10 (2%)

Kent/Catherine showed to have a higher-than-average MEV or likelihood of collision than other intersections. The leading types of collisions at this intersection involved turning movements 46 (48%), sideswipe 23 (24%) and angle 20 (21%), accounting for up to 93% of all collision types. All these types of collisions involve a vehicle changing directions, switching lanes, or turning. The City has implemented no right or left turns for the

heavier northbound movement and have added a no-right-on-red for the westbound movement, effectively eliminating potential turning conflicts with opposing movements. Still, turning movements account for the highest collision type, a possible side effect of non-compliance. A red-light camera has been added to the westbound movement as of 2020, which can help mitigate some collisions from the westbound approach. The shared westbound through/right-turn lane may be resulting in unpredictable movements or lane changes by drivers which causes confusion and leads to increased conflict potential. Although there are many collisions at this location, it is believed that they occur at low speeds given that only 7% of all collisions caused non-fatal injuries.

Other intersections with MEV greater than one was all intersections where two arterials meet. The higher quantity of collisions at these intersections are indicative of the high volumes of vehicles, congestion and increased decision-making tasks required by drivers.

The intersection of Bank/Catherine experienced collisions with 6 cyclists and 8 pedestrians, accounting for 61% of all study area active transportation collisions. Bank Street, an arterial mainstreet with plenty of commercial opportunities attracts large crowds of pedestrians, cyclists, and vehicles alike. It is highly recommended that this intersection be redesigned to comply with the recent introduction of the Protected Intersection Design measures to priority the safety of the more vulnerable active transportation users. However, this task of retrofitting this intersection should not be a responsibility of the client.

It is important to note that there are long-term plans to redesign a section of the Catherine St corridor that includes some of the intersections noted above, with the intention of enhancing safety and transit priority that benefits all road users. Further discussion on this design is provided in **Section 2.1.3**.

No other major trends were identified. The source collision data as provided by the City of Ottawa and related analysis is provided as **Appendix D**.

2.1.3. Planned Conditions

2.1.3.2 Future Transportation Network Changes

Transportation Master Plan (TMP)

The City of Ottawa's TMP (2031 affordable Rapid Transit and Transit Priority Network) illustrates Bank St as a transit priority corridor with isolated measures between Albert St in the north and Riverside Dr in the south, along with Gladstone Ave between Elgin St in the east and Preston St in the west.

Catherine St Functional Design Study

A functional design study was completed by the City for Chamberlain Ave, Catherine St, and Isabella St. Within the study area frontage, modifications include:

- A proposed transit priority lane on Catherine St, west of Kent St, which converts one of the three general purpose lanes to two general purpose lanes and a transit lane. The current development proposal would move the start of the transit priority lane further west by approximately 100m.
- A double westbound right-turn lane at the intersection of Catherine/Kent, which allows for separate pedestrian and right-turn traffic signal phases and significantly reduces collision potential at the westbound approach of the intersection.
- No right-turn-on-red for the westbound movement at the intersection of Catherine/Kent.
- A two-way 3.0m wide multi-use pathways on the south side of Chamberlain Ave and Isabella St.

These plans have received formal approval based on traffic study and public consultation. However, the detailed design and subsequent construction are not anticipated to begin until the ongoing MTO bridge rehabilitation work on Highway 417 is completed. City staff confirmed it would be reasonable to assume implementation of the Catherine St design by 2031.

Centretown Community Design Plan (CDP) and Secondary Plan

The CDP and Secondary Plan were completed in 2013 with the purpose of creating a comprehensive design plan to guide and manage future growth in the Centretown area of Ottawa. The purpose of the Secondary Plan is to translate many key aspects of the CDP into statutory policy. As illustrated in **Figure 10**, the CDP spans a wide area from Rideau Canal to Bronson Ave and from the Queensway to Gloucester St. However, the core study area of the CDP is an area bounded by Elgin St to the east, Kent St to the west, Highway 417 to the south and Gloucester St to the north. Nonetheless, recommendations were made in the CDP for the Centretown area as a whole.

Based on the CDP, the Centretown area is divided into four different character areas, which include the Northern Character Area, the Central Character Area, the Southern Character Area, and the Residential Character Area. The proposed 265 Catherine St development is located in the Southern Character Area, which acts as a “buffer” between the busy Highway 417 and the Central and Residential zones. The Southern Area currently consists of mostly low to mid-rise buildings, with few high-rise buildings and primarily retail and employment land uses. The vision for the Southern area anticipates high-rise buildings with at-grade commercial uses in addition to residential uses and “gateway buildings and architecture” on corner sites fronting arterials (such as Catherine St), along with improved streetscape and public park opportunities along all routes, including Catherine St.



The relevant recommendations below were provided in the CDP.

- **Pedestrian Network:** Catherine St intersections at Lyon St, Kent St and Bank St have been identified as potential locations for improved pedestrian crossing. It should be noted that some measures were already in place or may have already taken effect since the CDP and Secondary Plans were introduced in 2013. Some of the measures included providing curb extensions and removing on-street parking, providing zebra crosswalks, prohibiting right-turns on red, and providing pedestrian push buttons and countdown signals.
- **Transit Network:** general suggested strategies include provision of transit priority measures during future roadway reconstruction such as transit lanes, bulbouts and additional shelters, as well as providing enhanced waiting facilities at bus stops. The City has completed a functional design study for Chamberlain, Catherine, and Isabella, which includes the conversion of a general-purpose lane to a new transit priority lane.
- **Cycling Network:** a suggested general strategy included provision of cycling infrastructure as part of new proposed developments, expanding the cycling network and implementing other cycling improvements guided by the Ottawa Cycling Plan and Centretown CDP. The City functional design study also includes new cycling infrastructure and treatments.
- **Transportation Demand Management:** suggested TDM Measures which could be incorporated as part of new developments include the provision of enhanced bicycle and pedestrian access (weather-protected facilities, safe and secure bicycle parking, streetscape improvements), improvements to transit access (provision of shelters and other amenities, service planning changes), and provision of car-sharing facilities. TDM measures were incorporated into the development proposal.
- **Right of Way (ROW) Protection:** the City identifies target widths for ROW protection to be 23m for Catherine St and 20m for Kent St and Lyon St (with a perspective to address the needs of pedestrians

and increase streetscape opportunities). These ROW protection limits were accounted for in the development proposal.

- **Parking Supply:** the CDP suggests encouraging the provision of off-street public parking in new development where appropriate. The amount of available on-street parking is expected to decrease overtime due to providing additional space for pedestrians, cyclists, and public transit.
- **Two-Way Conversion of Roads:** one major recommendation of the CDP involves converting each of Kent St and Lyon St to two-way roads. This would improve the street environment for all users, slow down traffic, create a greater choice of routes and improve wayfinding. The timeline for this modification is unknown and no studies assessing the effects of this modification have been produced yet. It has been assumed this recommendation will not be implemented within the established future horizons for this TIA.
- **Streetscapes:** the Catherine St and Kent St corridors are both illustrated as locations for priority streetscape improvements in the CDP and Secondary Plan, with Catherine St and Lyon St both enlisted in the Secondary Plan as key streets to undertake streetscape improvements as part of the capital budget for any road and infrastructure renewal program. However, limited information is provided regarding the implementation of the streetscape, aside from recommendation of repurposing the green space along Catherine St between O'Conner St and Queen Elizabeth Pkwy as part of a future Catherine/Queensway Linear Landscape.

Figure 10: Centretown CDP Study Area

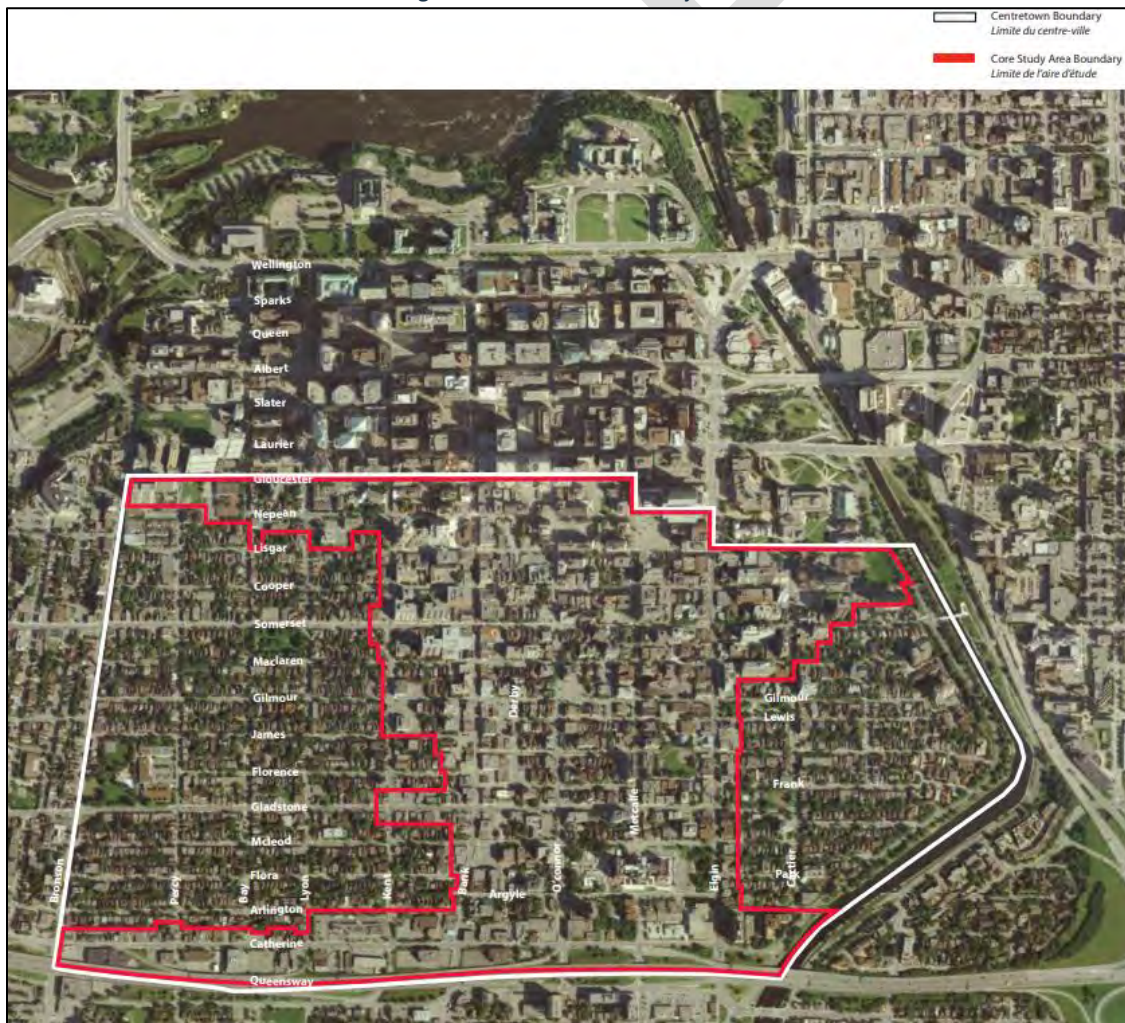

2.1.3.3 Other Area Developments

This section outlines adjacent developments within the study area. Based on the City of Ottawa's Development Applications search tool, several applications have been initiated near the proposed development site. However, the majority of these applications are either for low-rise apartment buildings with minimal traffic generation or for renovating/adding new units to existing low-rise units. Any traffic generated by the minor adjacent future developments will be captured in the background growth rate in traffic forecasting. Only one development has been identified given its relatively larger size:

- **30-48 Chamberlain Avenue:** a TIA report was prepared by CGH in October 2020 in support of a 16-storey apartment building containing 150 apartment units. The development is anticipated to be constructed in a single phase by 2024 and is expected to generate a minimal number of vehicles in the study area with up to 42 total two-way traffic volumes during peak hours. Given the low number of traffic volumes, this development has been captured in the background growth rate in traffic forecasting.

2.2. Study Area and Time Periods

For the purposes of this report, Phase 1 of the proposed development is assumed to be constructed by 2026, while the full buildout is assumed to be completed by 2031. As such, horizon years 2026 and 2031 will be analyzed using the weekday morning and afternoon peak hour time period traffic volumes. Analysis of horizon year 2036 (five-years after full buildout) will also be included as per the requirements of the TIA Guidelines. However, it should be noted that the City of Ottawa TMP, including the affordable networks only provide plans for future City transportation infrastructure up to year 2031.

Proposed study area intersections, agreed to by City staff, are listed below and illustrated in **Figure 11**.

- Lyon/Catherine
- Kent/Catherine
- Bank/Catherine
- Bronson/Catherine
- Percy/Catherine
- Kent/Gladstone
- Lyon/Gladstone
- Lyon/Arlington
- Kent/Arlington
- Bank/Arlington
- Bank/Chamberlain/Isabella

Figure 11: Study Area

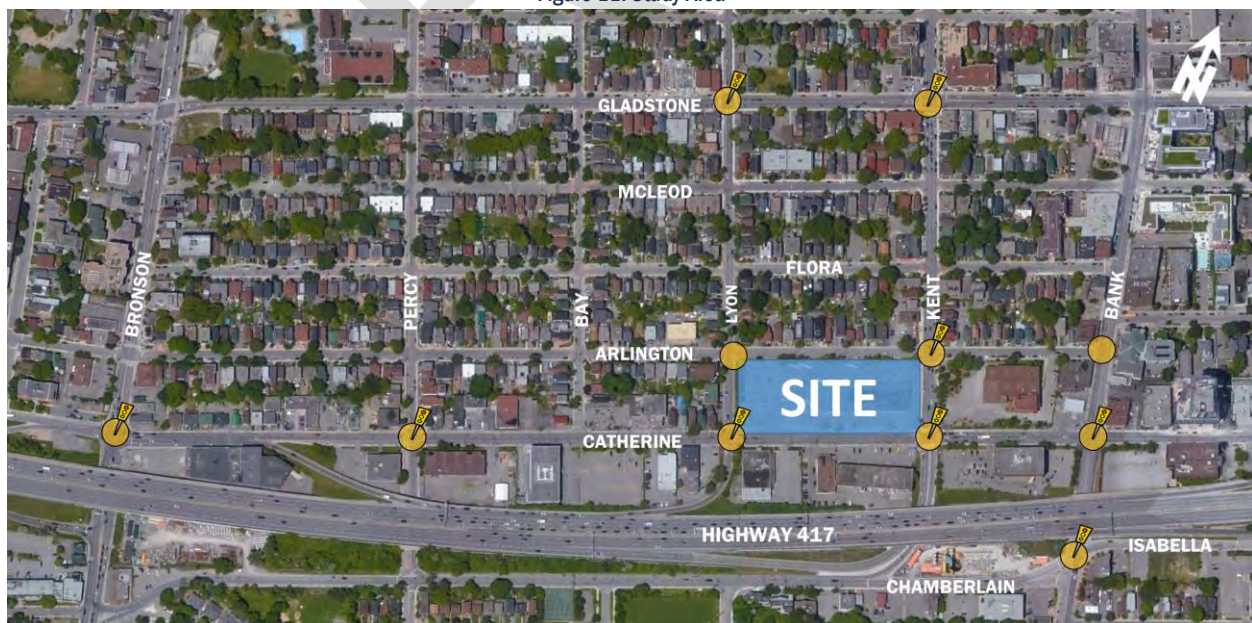

2.3. Exemption Review

The modules/elements of the TIA process in **Table 2** are recommended to be exempt based on the City’s TIA guidelines, the current ZBLA/SPC process and the current site plan arrangement.

Table 2: Exemptions Review Summary

Module	Element	Exemption Consideration
4.1 Development Design	4.1.3 New Street Networks	Only required for plans of subdivision.
4.8 Network Concept	All	To be confirmed. This section is typically only required when proposed development generates more than 200 person-trips peak hour in excess of the equivalent volumes permitted by established zoning.

3.0 FORECASTING

3.1. Development Generated Travel Demand

3.1.1. Trip Generation and Mode Shares

Trip Generation Rates

The proposed development will consist of 7 townhome units, 1,021 apartment units and 2,250m² (24,230ft²) of ground floor retail space. The trip rates for the land uses are summarized in **Table 3** below.

The appropriate trip generation rates for townhomes and high-rise apartment units were obtained from the 2020 TRANS Trip Generation Manual. The Manual provides person-trip rates during the peak AM and PM periods (i.e. 7am-9:30am and 3:30pm-6pm). The peak hour trip generation rates for the non-residential land uses were obtained from the ITE Trip Generation Manual (11th edition), assuming the “Retail Strip Plaza (less than 40,000 ft² GFA)” land use for the total retail area.

Table 3: Proposed Development Trip Rates

Land Use	ITE/TRANS Designation	Data Source	Trip Rates	
			AM Peak	PM Peak
Residential	“High-Rise Apartments”	TRANS	T = 0.8(du);	T = 0.9(du);
	“Townhomes (Low-Rise Units)”	TRANS	T = 1.35(du);	T = 1.58(du);
Commercial	“Retail Strip Plaza”	ITE 822	T = 0.66Ln(x) + 1.84	T = 0.71Ln(x) + 2.72

Notes: T = Average Vehicle Trip Ends
 du = Dwelling unit
 x = Gross Floor Area (1,000 ft²)

Residential Trip Generation

Using the respective residential trip rates in **Table 3**, the total number of vehicles per hour generated by the proposed residential land uses of the development are calculated for the morning and afternoon peak periods, as shown in **Table 4**.

Table 4: Residential Units Peak Period Person Trip Generation

Phase	Land Use	Dwelling Units	AM Peak Period Person Trips	PM Peak Period Person Trips
Phase 1	High-Rise Apartments	289	231	260
Phase 2	High-Rise Apartments	732	586	659
	Townhomes (Low-Rise Units)	7	9	11
Total		1,028	826	930

The proposed development’s residential land use is anticipated to generate a total of approximately 826 and 930 person trips during the morning and afternoon peak periods, respectively. The total peak period person trips in **Table 4** for each land use are then divided into different travel modes using mode share percentages obtained from the 2020 TRANS Manual for the “Ottawa Inner Area” district. **Table 5** and **Table 6** provide the travel mode breakdown for the proposed high-rise apartments and townhomes, respectively.

Table 5: High-Rise Apartments Peak Period Trips Mode Shares Breakdown

Travel Mode	Mode Share	AM Peak Period Person Trip	Mode Share	PM Peak Period Person Trips
Phase 1				
Auto Driver	26%	61	25%	66
Auto Passenger	6%	14	8%	21
Transit	28%	64	21%	56
Cycling	5%	13	6%	15
Walking	34%	79	39%	102
Total Person Trips	100%	231	100%	260
Phase 2				
Auto Driver	26%	153	25%	167
Auto Passenger	6%	36	8%	54
Transit	28%	163	21%	141
Cycling	5%	32	6%	38
Walking	34%	201	39%	259
Total Person Trips	100%	586	100%	659

Table 6: Townhomes Peak Period Trips Mode Shares Breakdown

Travel Mode	Mode Share	AM Peak Period Person Trip	Mode Share	PM Peak Period Person Trips
Phase 2				
Auto Driver	27%	3	31%	3
Auto Passenger	8%	1	9%	1
Transit	26%	2	20%	2
Cycling	9%	1	9%	1
Walking	30%	3	31%	3
Total Person Trips	100%	9	100%	11

Standard traffic analysis is usually conducted using the morning and afternoon peak hour trips as they represent a worst-case scenario. The 2020 TRANS Manual provides conversions rates from peak period to peak hours for different mode shares, as shown in **Table 7** below.

Table 7: Peak Period to Peak Hour Conversion Factors (2020 TRANS Manual)

Travel Mode	Peak Period to Peak Hour Conversion Factors	
	AM	PM
Auto Driver and Passenger	0.48	0.44
Transit	0.55	0.47
Bike	0.58	0.48
Walk	0.58	0.52

Using the conversion rates in **Table 7** and the peak period person trips for different travel modes in **Table 5** and **Table 6**, the peak hour trips for different travel modes can be calculated as shown in **Table 8** and **Table 9**.

Table 8: High-Rise Apartments Peak Hour Trips Mode Share Breakdown

Travel Mode	AM Peak Hour Trips	PM Peak Hour Trips
Phase 1		
Auto Driver	29	29
Auto Passenger	7	9
Transit	35	26
Cycling	7	7
Walking	46	53
Total Person Trips	125	125
Phase 2		
Auto Driver	74	74
Auto Passenger	17	24
Transit	90	66
Cycling	19	18
Walking	117	135
Total Person Trips	316	316

Table 9: Townhomes Peak Hour Trips Mode Share Breakdown

Travel Mode	AM Peak Hour Trips	PM Peak Hour Trips
Phase 2		
Auto Driver	1	2
Auto Passenger	0	0
Transit	1	1
Cycling	1	0
Walking	2	2
Total Person Trips	5	5

As shown above, the residential land use of the proposed development is anticipated to generate a total of up to 446 total person trips, which includes 105 vehicle trips, 126 transit trips and 215 active transportation (walking, cycling, and rolling) trips during peak hours.

Considering the location and context surrounding the proposed development, such as proximity to the Highway 417, and the notable distance from LRT or a rapid transit corridor, it was assumed that a higher auto driver mode share would be more appropriate relative to the district average, which accounts for the Confederation line and several LRT stations. The increase in auto-driver mode share comes at the expense of transit, walking and cycling. The adjusted mode share percentages are shown in **Table 10** and **Table 11** for the high-rise apartments and townhomes, respectively. Note that the same mode share percentages are applied to both the AM and PM peak hours.

Table 10: High-Rise Apartments Peak Hour Trips Mode Share Breakdown

Travel Mode	Mode Share	AM Peak Hour Trips	PM Peak Hour Trips
Phase 1			
Auto Driver	40%	50	50
Auto Passenger	10%	12	12
Transit	20%	25	25
Cycling	5%	6	6
Walking	25%	31	31
Total Person Trips	100%	125	125
Phase 2			
Auto Driver	40%	126	127
Auto Passenger	10%	32	32
Transit	20%	63	63
Cycling	5%	16	16
Walking	25%	79	79
Total Person Trips	100%	316	316

Table 11: Townhomes Peak Hour Trips Mode Share Breakdown

Travel Mode	Mode Share	AM Peak Hour Trips	PM Peak Hour Trips
Phase 2			
Auto Driver	40%	2	2
Auto Passenger	10%	1	1
Transit	20%	1	1
Cycling	5%	0	0
Walking	25%	1	1
Total Person Trips	100%	5	5

Using the modified mode shares above, the breakdown of inbound and outbound trips for the high-rise apartments and townhomes are provided in **Table 12** and **Table 13** respectively. The inbound and outbound percentages were obtained from the 2020 TRANS Manual.

Table 12: High-Rise Apartments Mode Shares Breakdown (2020 TRANS Report)

Travel Mode	AM Peak (Person Trips/h)			PM Peak (Person Trips/h)		
	In (31%)	Out (69%)	Total	In (58%)	Out (42%)	Total
Phase 1						
Auto Driver	16	35	50	29	21	50
Auto Passenger	4	8	12	7	5	12
Transit	8	17	25	15	11	25
Cycling	2	4	6	3	3	6
Walking	10	21	31	18	13	31
Total Person Trips	39	86	125	73	53	125
Phase 2						
Auto Driver	39	87	126	74	53	127
Auto Passenger	10	22	32	19	13	32
Transit	20	43	63	37	26	63
Cycling	5	11	16	9	7	16
Walking	24	55	79	46	33	79
Total Person Trips	98	218	316	183	133	316

Table 13: Townhomes Mode Shares Breakdown (2020 TRANS Report)

Travel Mode	AM Peak (Person Trips/h)			PM Peak (Person Trips/h)		
	In (30%)	Out (70%)	Total	In (56%)	Out (44%)	Total
Phase 2						
Auto Driver	1	1	2	1	1	2
Auto Passenger	0	1	1	1	0	1
Transit	0	1	1	1	0	1
Cycling	0	0	0	0	0	0
Walking	0	1	1	1	0	1
Total Person Trips	2	4	5	3	2	5

Using the tables above, the projected number of trips anticipated to be generated by the residential land uses of the proposed development are provided in **Table 14**.

Table 14: Total Residential Trip Generation

Travel Mode	AM Peak (Person Trips/h)			PM Peak (Person Trips/h)		
	In	Out	Total	In	Out	Total
Phase 1						
Auto Driver	16	35	50	29	21	50
Auto Passenger	4	8	12	7	5	12
Transit	8	17	25	15	11	25
Cycling	2	4	6	3	3	6
Walking	10	21	31	18	13	31
Total Person Trips	39	86	125	73	53	125
Phase 2						
Auto Driver	40	88	128	75	54	129
Auto Passenger	10	23	33	20	13	33
Transit	20	44	64	38	26	64
Cycling	5	11	16	9	7	16
Walking	24	56	80	47	33	80
Total Person Trips	100	222	321	186	135	321
Total						
Auto Driver	56	123	178	104	75	179
Auto Passenger	14	31	45	27	18	45
Transit	28	61	89	53	37	89
Cycling	7	15	22	12	10	22
Walking	34	77	111	65	46	111
Total Person Trips	139	308	446	259	188	446

As shown in **Table 14**, the total number of vehicle trips anticipated to be generated by the residential land uses are 179 vehicles per hour during both the morning and afternoon peak hours.

Retail Units Trip Generation

The proposed non-residential land uses of the site consist of retail units, where the exact occupants of the retail units have not been confirmed as of yet. It is important to note that the development is not located in any retail node and the Catherine St corridor is not utilized for any many retail uses, as opposed to a traditional mainstreet such as Bank St. Therefore, the majority of patrons using the retail units are expected to be either internal site residents or local walking trips from adjacent developments, which would generate a very minimal number of new vehicle trips.

Using the trip rates provided in **Table 3**, the total number of person trips per hour generated by the proposed retail units are multiplied by a factor of 1.28, as per TIA standards, to account for typical North American auto occupancy values of approximately 1.15 and combined transit and non-motorized modal shares of less than 10%. The resulting total person trips per hour are summarized in **Table 15**.

Table 15: Supermarket Peak Hour Person Trips

Land Use	GFA (ft ²)	AM Peak (Person Trips/h)			PM Peak (Person Trips/h)		
		In (59%)	Out (41%)	Total	In (50%)	Out (50%)	Total
Phase 1							
Strip Retail Plaza	12,780	25	18	43	59	60	119
Phase 2							
Strip Retail Plaza	11,450	24	16	40	55	55	110
Total		49	34	83	114	115	229

The commercial elements of the proposed development are intended primarily to serve local residents and nearby communities (the population will increase as future developments and intensification plans continue to progress in the downtown).

Given the mixture of land uses proposed onsite, an internal reduction rate was applied based on mixed-use parameters described in Section 6.5 of the ITE Trip Generation Manual 3rd Edition, to account for multi-purpose trips such as a local resident shopping, getting their hair cut, drycleaners (or any other minor retail tenant that

may occupy) prior to travelling to work or working remote. These trips may be reduced to reflect double counted trips, which has been incorporated in the trip generation tables that follow. The base calculation for determining the quantity of internal reductions has been provided in **Appendix E**.

Pass-by trips were also considered for commercial uses. Pass-by trips are intermediate trips along the original route between the primary origin and destination, such as a trip to the retail use between home and another destination. These are not considered ‘new’ trips, but existing trips already on the network. **Appendix E** of the ITE Trip Generation Manual 3rd edition was used to determine pass-by rates. Pass-by trips were calculated after the internal reduction factor was applied.

The proposed mode shares for commercial uses have been summarized in **Table 16**.

Table 16: TRANS 2020 Mode Shares for Commercial Use and Proposed Mode Shares

Travel Mode	TRANS Commercial Mode Shares		Proposed Mode Share (AM & PM)	Proposed Modal Share Rationale
	AM	PM		
Auto Driver	39%	22%	15%	A reduction in driver mode share from TRANS is justifiable given the small scale of commercial uses proposed. Nearby high-density residential, commercial and office settings, plus low parking availability promote walking and cycling to access the commercial uses on site.
Auto Passenger	2%	4%	5%	
Transit	16%	12%	15%	Transit anticipated to be similar to existing mode shares.
Cycling	4%	4%	5%	The majority of trips are anticipated to be generated locally and will most likely attract nearby pedestrians, cyclists, and residents of the same development.
Walking	40%	58%	60%	

The trip generation rates for commercial land uses from **Table 15** were used along with the proposed sizes for each phase of development and the proposed mode shares from **Table 16**. Note that the internal reductions for Phase 2 use vehicle trips proposed for both phase 1 and 2 combined for residential and commercial.

Table 17: Retail Peak Hour Trips Mode Share Breakdown

Travel Mode	Mode Share	AM Peak (Person Trips/h)			PM Peak (Person Trips/h)		
		In (59%)	Out (41%)	Total	In (50%)	Out (50%)	Total
Phase 1							
Auto Driver	15%	4	3	7	8	7	15
<i>Pre-Internal Reduction</i>		4	3	7	9	9	18
<i>Vehicles Reduced</i>		0	0	0	-1	-2	-3
Auto Passenger	5%	2	1	3	3	3	6
Transit	15%	3	3	6	9	9	18
Cycling	5%	1	1	2	3	3	6
Walking	60%	15	10	25	35	36	71
Pass-By	0%(35%)	0	0	0	-3	-3	-6
Total Person Trips	100%	25	18	43	58	58	116
Total 'New' Vehicle Trips	-	4	3	7	5	4	9
Phase 2							
Auto Driver	15%	3	2	5	7	4	11
<i>Pre-Internal Reduction</i>		4	3	7	9	9	18
<i>Vehicles Reduced</i>		-1	-1	-2	-2	-5	-7
Auto Passenger	5%	2	1	3	3	3	6
Transit	15%	3	2	5	8	8	16
Cycling	5%	1	1	2	3	3	5
Walking	60%	14	9	23	32	32	65
Pass-By	0%(35%)	0	0	0	-2	-2	-4
Total Person Trips	100%	23	15	38	53	50	103
Total 'New' Vehicle Trips	-	3	2	5	5	2	7

As shown in **Table 17**, the retail land uses are expected to generate 45 to 115 person trips during peak hours of Phase 1, as well as 40 to 105 persons trips during the peak hours of Phase 2. In total, the nonresidential land uses are expected to generate trips as shown in **Table 18** below.

Table 18: Total Nonresidential Trip Generation

Travel Mode	AM Peak (Person Trips/h)			PM Peak (Person Trips/h)		
	In	Out	Total	In	Out	Total
Auto Driver	7	5	12	16	13	29
<i>Pre-Internal Reduction</i>	8	6	14	18	18	36
<i>Vehicles Reduced</i>	-1	-1	-2	-2	-5	-7
Auto Passenger	4	2	6	6	6	12
Transit	6	5	11	17	17	34
Cycling	2	2	4	6	6	11
Walking	29	19	48	67	68	136
Pass-By	0	0	0	-6	-6	-12
Total Person Trips	48	33	81	112	110	222
Total 'New' Vehicle Trips	7	5	12	10	7	17

Total Trips Generated

Similar to commercial, an internal reduction to residential trips is applicable, as shown in **Table 19**.

Table 19: Residential Peak Hour Trips with Internal Reductions

Travel Mode	Mode Share	AM Peak (Person Trips/h)			PM Peak (Person Trips/h)		
		In	Out	Total	In	Out	Total
Phase 1							
Auto Driver		16	35	50	27	20	47
<i>Pre-Internal Reduction</i>		16	35	50	29	21	50
<i>Vehicles Reduced</i>		0	0	0	-2	-1	-3
Total 'New' Vehicle Trips		16	35	50	27	20	47
Phase 1 & 2 Combined							
Auto Driver		55	122	177	99	73	172
<i>Pre-Internal Reduction</i>		56	123	179	104	75	179
<i>Vehicles Reduced</i>		-1	-1	-2	-5	-2	-7
Total 'New' Vehicle Trips		55	122	177	99	73	172

The total person trips anticipated to be generated by the residential and non-residential land uses of the proposed future development are provided in **Table 20**, which includes all travel mode shares of the residential units plus the auto driver mode of the nonresidential uses.

Table 20: Total Trips Generated

Travel Mode	AM Peak (Person Trips/h)			PM Peak (Person Trips/h)		
	In	Out	Total	In	Out	Total
Phase 1						
Auto Driver	20	38	57	35	27	62
<i>Pre-Internal Reduction</i>	20	38	57	38	30	68
<i>Vehicles Reduced</i>	0	0	0	-3	-3	-6
Auto Passenger	6	9	15	10	8	18
Transit	11	20	31	24	20	43
Cycling	3	5	8	6	6	12
Walking	25	31	56	53	49	102
Pass-By	0	0	0	-3	-3	-6
Total Person Trips	65	103	167	128	110	237
Total 'New' Vehicle Trips	20	38	57	32	24	56
Phase 1 & 2 Combined						
Auto Driver	62	127	188	115	86	201
<i>Pre-Internal Reduction</i>	64	129	192	122	93	215
<i>Vehicles Reduced</i>	-2	-2	-4	-7	-7	-14
Auto Passenger	18	33	51	33	24	57
Transit	34	66	100	70	54	123
Cycling	9	17	26	18	16	33
Walking	63	96	159	132	114	247
Pass-By	0	0	0	-6	-6	-12
Total Person Trips	186	339	524	368	294	661
Total 'New' Vehicle Trips	62	127	188	109	80	189

Based on the results provided in **Table 20**, the proposed future development is anticipated to generate a total of approximately 530 and 660 person trips during the morning and afternoon peak hours respectively, including roughly 190 'new' vehicle trips in both peak hour periods.

3.1.2. Trip Distribution and Assignment

Based on the 2011 OD Survey (Ottawa Inner Area district) and the location of adjacent arterial roadways and neighbourhoods, the distribution of site-generated traffic volumes was estimated as follows:

- 20% to/from the east via HWY-417;
- 30% to/from the west HWY-417;
- 25% to/from the north via Bronson Ave/Bank St/Lyon St/Kent St; and,
- 25% to/from the south via Bronson Ave/Bank St.

The anticipated 'new' auto trips for the proposed development from **Table 20** were then assigned to the road network as shown in **Figure 12** for Phase 1 and **Figure 13** for total site-generated traffic at full buildout. At Phase 1, the Catherine St garage access and the woonerf are expected to be constructed. The Arlington Ave access is expected to be constructed at Phase 2. Note that no vehicles were modelled using the woonerf as truck traffic using this access will be infrequent and generally occur during off-peak hours.

Figure 12: Phase 1 Site-Generated Traffic

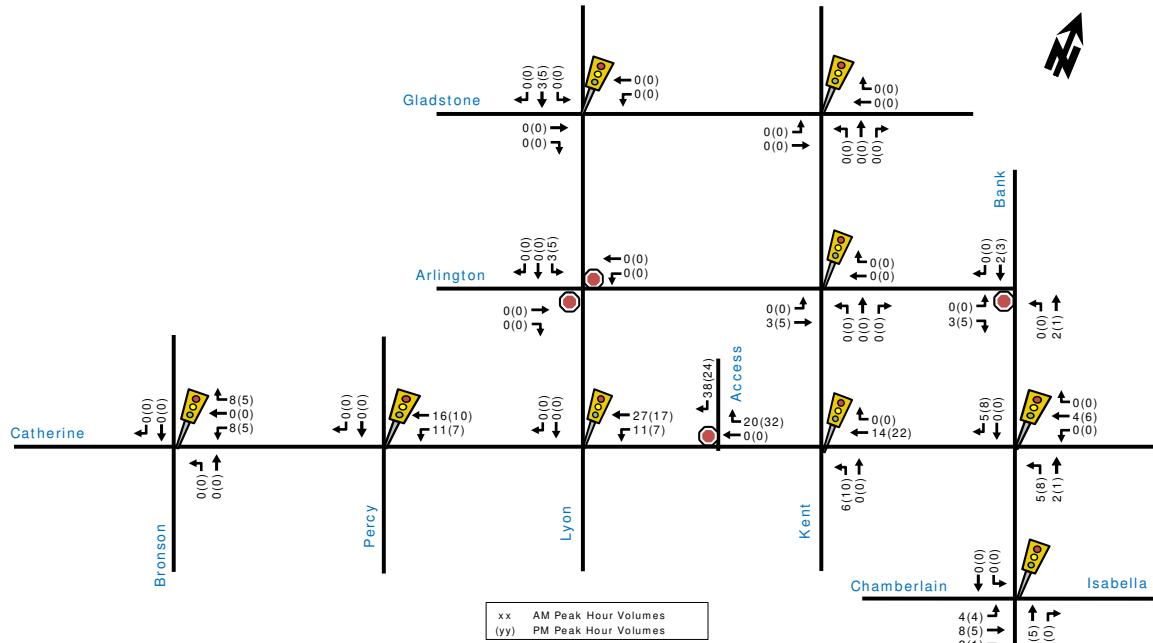
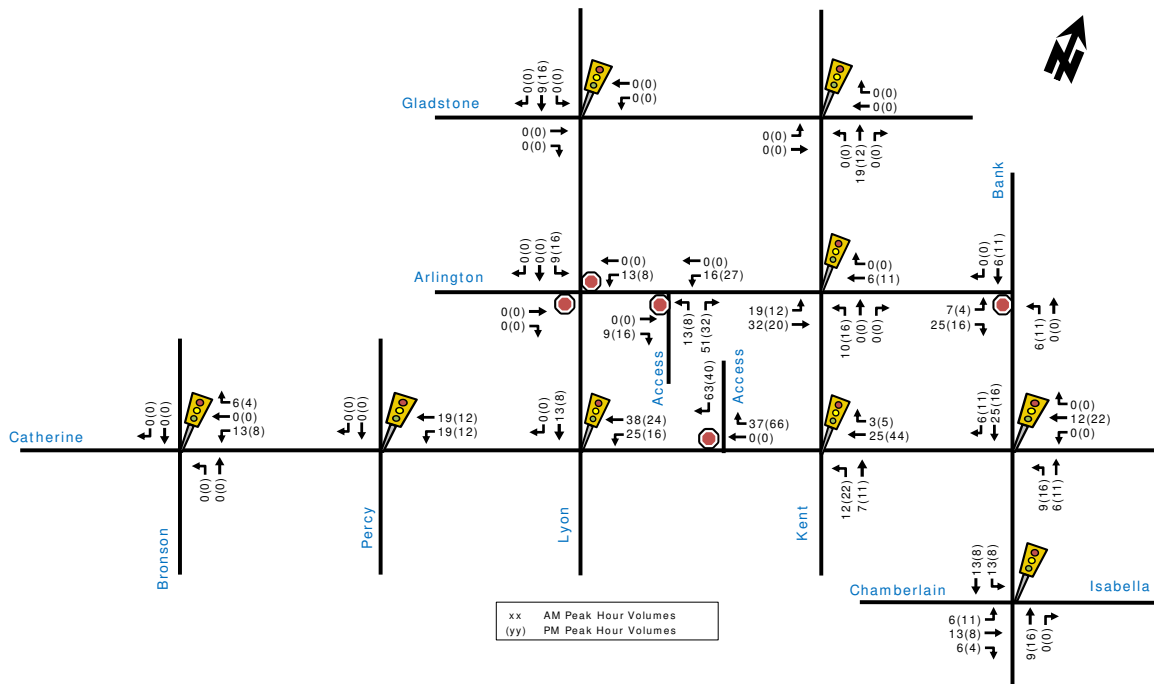

Figure 13: Full Buildout Phase 1 + Phase 2 Site-Generated Traffic



3.2. Background Network Traffic

3.2.1. Transportation network plans

Refer to Section 2.1.3: Planned Conditions.

3.2.2. Background Growth

The development is located in the Downtown Core Transect (as designated within the Official Plan), where policies are aimed towards augmenting and prioritizing the movement of pedestrians, cyclists, and transit users. Traffic flow and parking requirements are secondary priorities, which suggest traffic volumes along study area roadways may not increase as rapidly in the future and may even experience a decline. However, based on the vision of the Centretown CDP and Secondary Plan, more development intensification is planned along Catherine St, which will increase population within the study area. As such, a conservative 0.5% background growth rate was applied to arterial roads within the study area that provide connectivity to and from Highway 417, including Catherine St, Kent St, Lyon St, and Chamberlain Ave. The future background 2026, 2031 and 2036 traffic volumes are illustrated in **Figure 14**, **Figure 15** and **Figure 16**, respectively.

Figure 14: Future Background 2026 Traffic Volumes

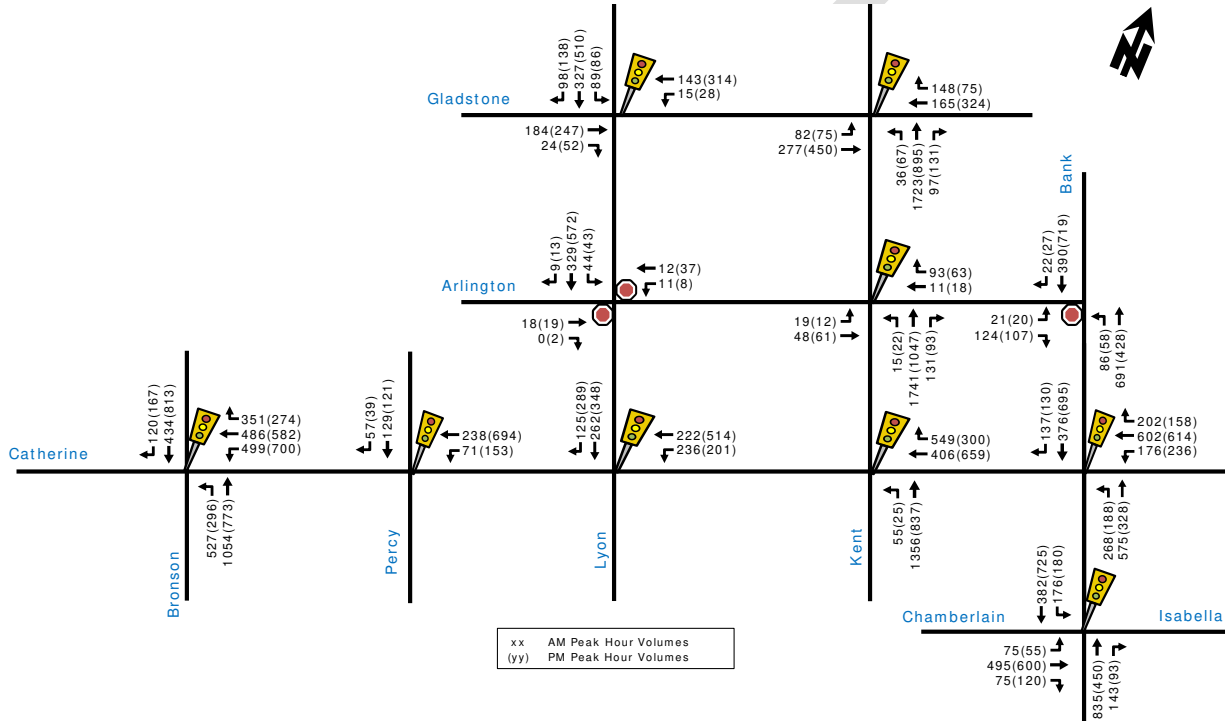

Figure 15: Future Background 2031 Traffic Volumes

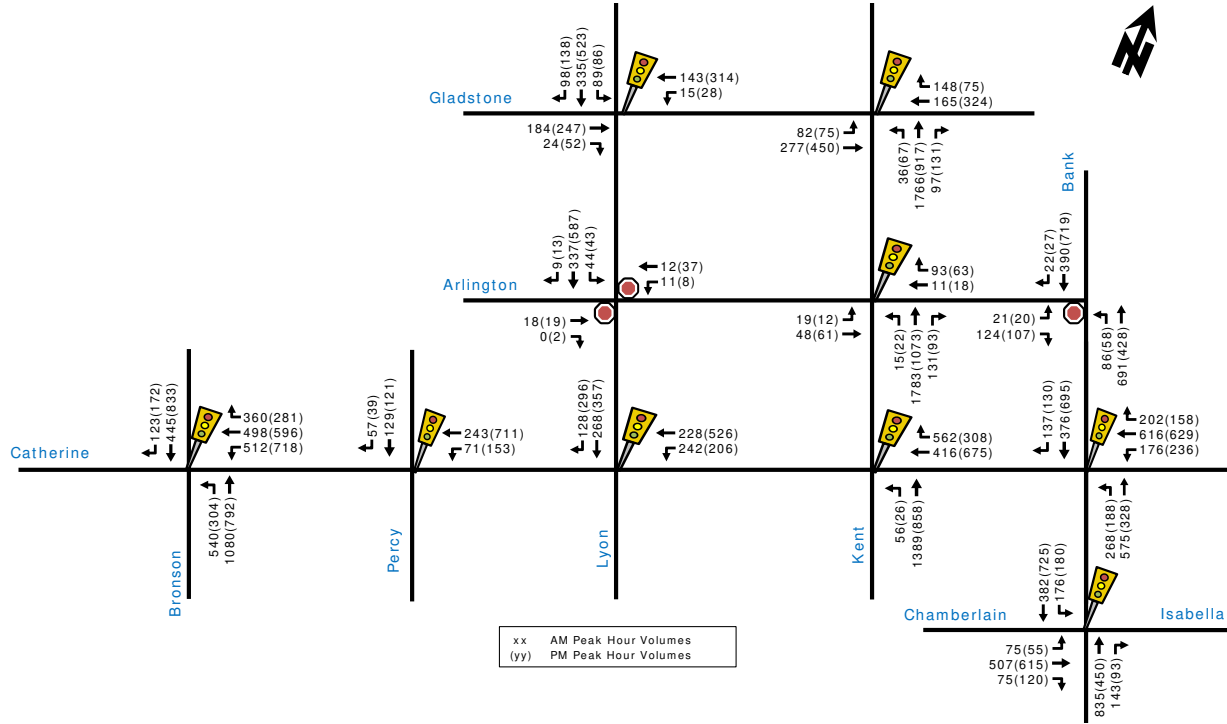
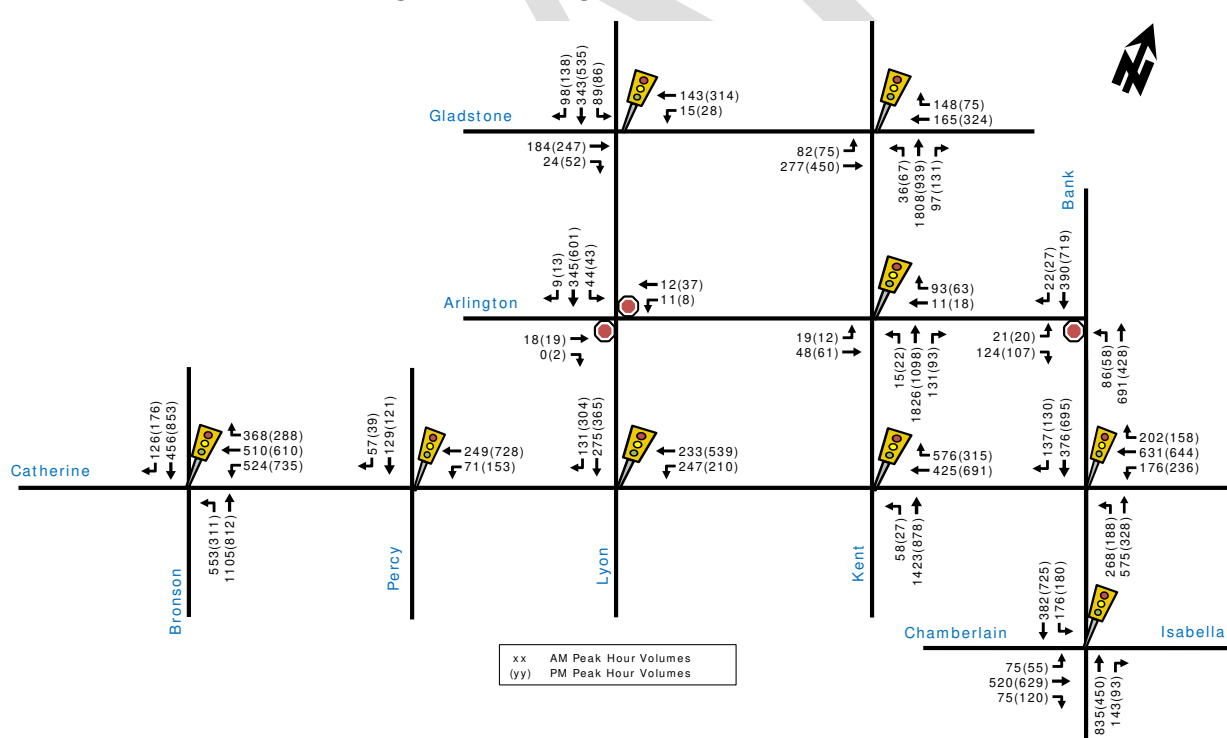

Figure 16: Future Background 2036 Traffic Volumes



3.2.3. Other Developments

Refer to Section 2.1.3.3 - Other Area Developments, no other area development included in future conditions.

3.3. Demand Rationalization

The following section indicates factors that may be used to rationalize the future travel demands in the study area and determine if there are potential capacity limitations and how they may be addressed.

The total projected 2026, 2031 and 2036 traffic volumes can be calculated by superimposing the site-generated traffic in **Figure 12** and **Figure 13**, onto the future background traffic in **Figure 14**, **Figure 15** and **Figure 16**. The total projected 2026, 2031 and 2036 traffic volumes are illustrated in **Figure 17**, **Figure 18** and **Figure 19**, respectively.

It is important to note that the ongoing evolution of travel behaviour post-COVID-19, combined with long-term transportation network changes of the Centretown area and broader City of Ottawa investments in transit and active transportation (as discussed in **Section 2.1.3**), are expected to gradually discourage auto use in the Downtown Transect (as designated in the City Official Plan). Further discussion on elements is provided below.

TDM Measures

The Centretown CDP suggests implementing aggressive TDM Measure as part of new developments in the Southern Area of the Centretown district, where the proposed development is located. These measures include providing enhanced pedestrian, cycling, and transit facilities where possible, as part of new developments. The purpose of such measures is to reduce reliance on vehicle travel modes and encourage alternative travel behaviors. Depending on the size and density of future developments, implementing appropriate TDM measures may help reduce future traffic volumes in the Centretown area. For the future development at 265 Catherine St, aggressive measures may be implemented to incentivize residents to rely on transit and active transportation modes such as walking and cycling. These measures are identified in **Section 4.5**.

LRT

The City of Ottawa LRT construction is underway, where Stage 1 has already been constructed and in use as of 2019, while Stage 2 is under construction and includes further expansions of the LRT corridor in different directions. Lyon Station and Parliament Station are located along Queen St in the Centretown area, where the Lyon Station is located approximately 1.4km north of the proposed development site.

The LRT is expected to have resulted in significant reductions in background traffic volumes, influencing the Centretown area as a whole. Traffic volumes used for the purpose of this TIA Report were mostly conducted in 2018, prior to the opening of the LRT Stage 1. As such, they may not reflect any changes in travel patterns as a result of the LRT. As the LRT continues to expand and the travel behaviors of background trips adjust, it is expected that transit usage would increase, while background traffic decreases.

COVID-19 Changes to Travel Behavior

The COVID-19 pandemic resulted in significant implications to travel behaviors across the country. A significant percentage of the workforce have shifted to a work-from-home only or hybrid home/office work schedule, with such effects expected to have long lasting impacts. This change resulted in a noticeable reduction of traffic volumes during peak hours – anecdotally, interprovincial bridge crossings are currently 75% below pre-covid levels (based on ongoing work for the Wellington Street Closure Assessment by the City of Ottawa).

As businesses continue to adjust to new and more widely desirable work schedules, it is uncertain how persistent the reduction in traffic volumes will remain. Therefore, it is important to acknowledge that any growth applied to background traffic volumes from pre-COVID levels should be considered a conservative assumption.

In this TIA, a 0.5% background traffic growth rate was assumed from pre-COVID traffic volumes (discussed in **Section 3.2.2**) without applying any further reductions to the study area traffic volumes, representing as a worst-case scenario. The impact of the proposed development's site-generated traffic volumes on the study area intersections and roadways will be determined in the subsequent sections of the TIA report.

Figure 17: Total Projected 2026 Traffic Volumes

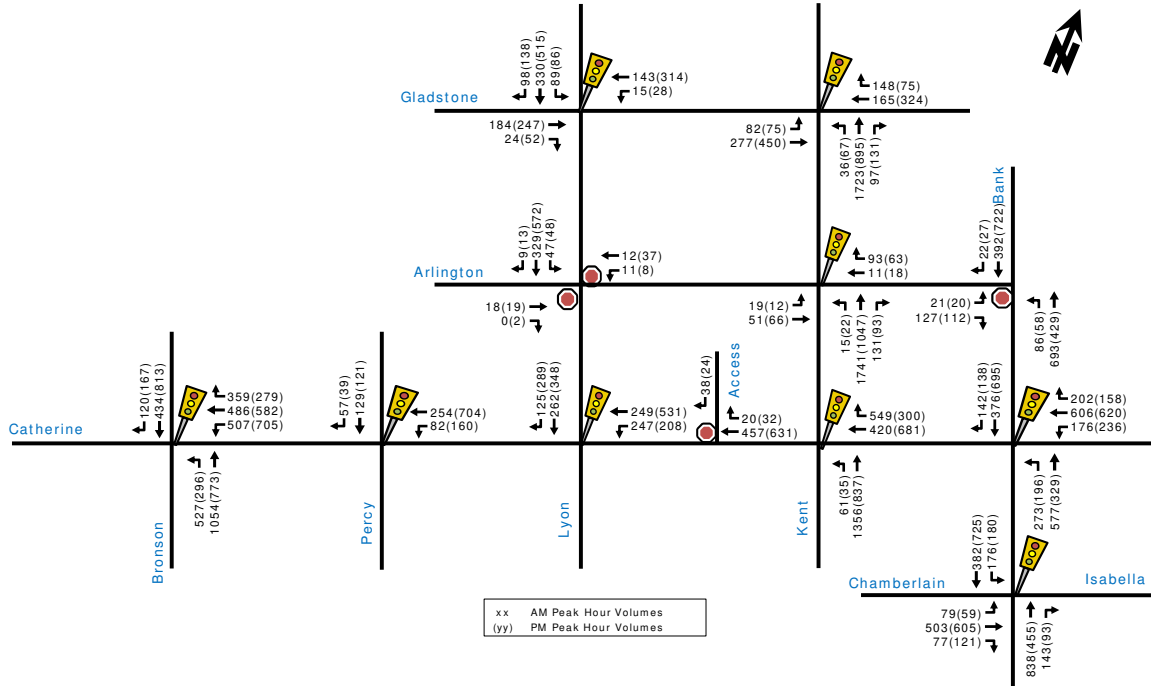

Figure 18: Total Projected 2031 Traffic Volumes

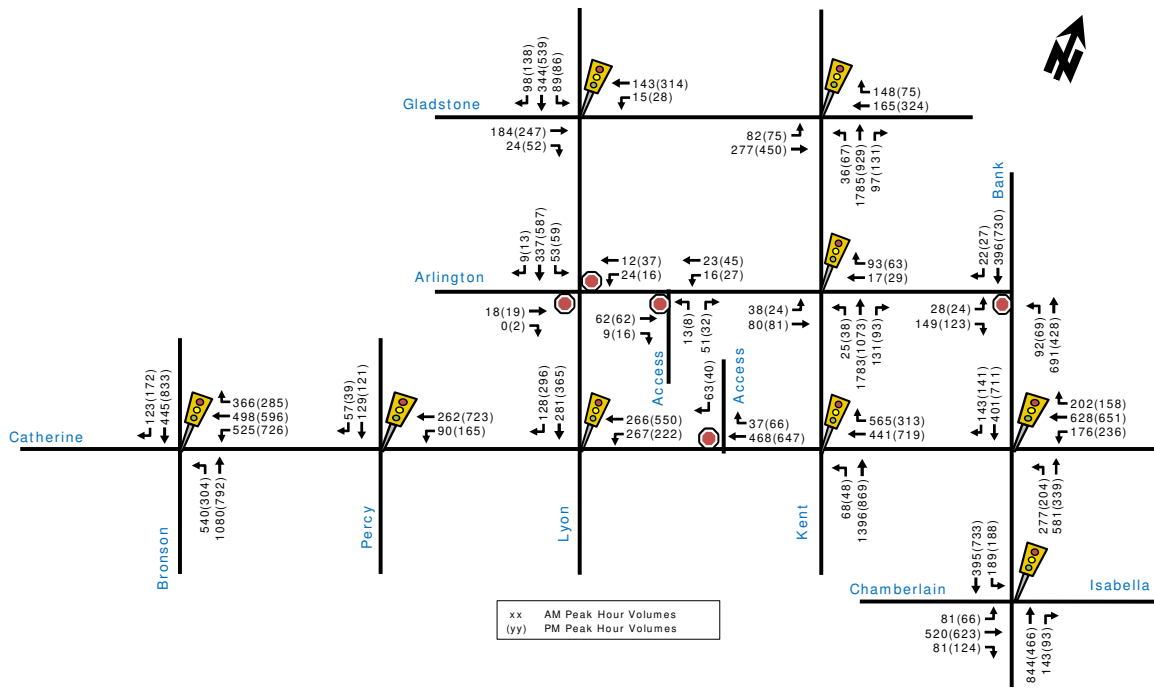
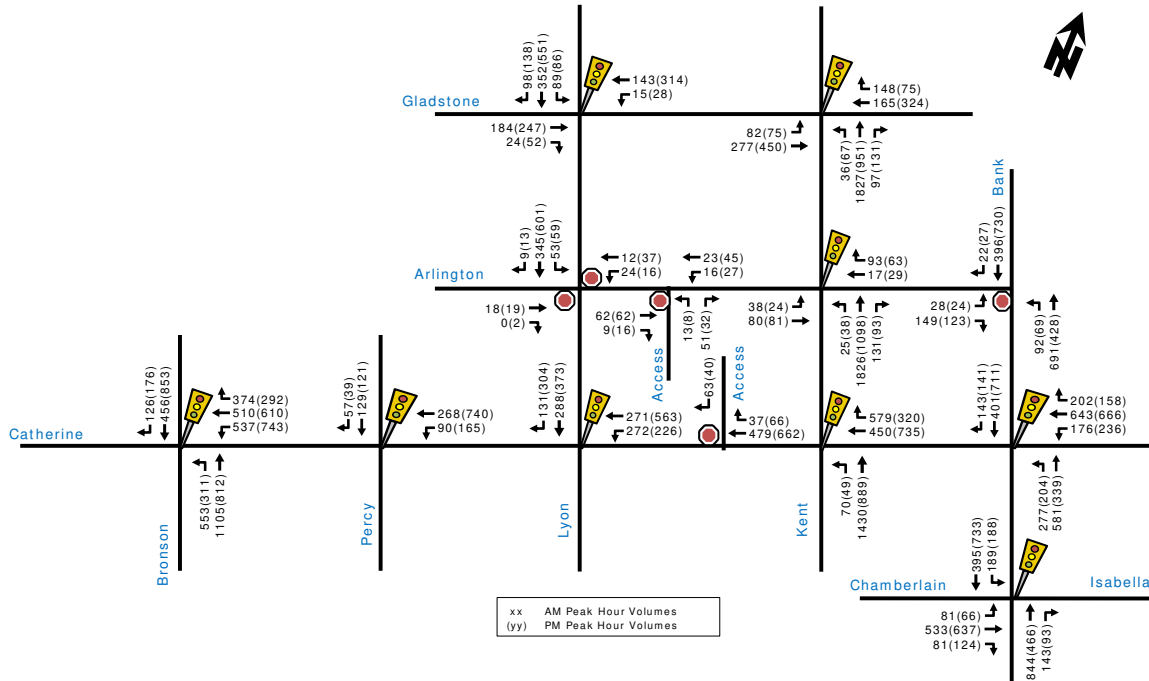

Figure 19: Total Projected 2036 Traffic Volumes



4.0 ANALYSIS

4.1. Development Design

A description of the available and proposed transportation network elements for different travel modes is provided in the sections below.

4.1.1. Design for Sustainable Modes

A woonerf is proposed that bisects the site north-south connecting Catherine St and Arlington Ave. It has been carefully designed as an enhanced pedestrian amenity area that also permits infrequent vehicle access for trucks/loading vehicles (see Section 4.1.2 for further discussion on vehicle access). The woonerf ties into the publicly accessible open spaces within the site, and feature unique pavers, an offset alignment and various landscaping accents that provides strong visual cues to any drivers that this is a calm pedestrian environment. The woonerf provides excellent pedestrian and cycling permeability through the block that ties into the existing municipal active transportation network.

Sidewalk facilities will be provided on all site frontages and will be at least 2.0m wide at all locations. Given the location of the development, pedestrian facilities within the Centretown area are well established and help to provide optimal access to transit stop locations.

Along Catherine St, the existing bus stop along the site frontage (approximately 45m west of Kent St) will be relocated further west to avoid conflicts with the new accesses proposed on Catherine St. The precise location of the bus stop will be confirmed with City Transit Services prior to detailed design to ensure proper corridor coverage is achieved. All buildings will have direct access to the municipal sidewalk network, which ensures optimal access to transit from the proposed development. Existing bus stops on Gladstone Ave at both Lyon St and Kent St are approximately 250m walking distance from the site. While outside of typical walking distance, it is noted that the LRT operates north of the site at approximately 1.4km walking distance.

The City intends to convert the north curbside general purpose travel lane on Catherine St to a transit priority lane between the Kent St and Bronson Ave, as per the Catherine Street Functional Design Study. The

development proposal will shift the start of the transit priority lane approximately 100m west of Kent St, to accommodate the require accesses and pickup/dropoff layby on Catherine St. The potential service and operational implications of this change will be discussed in **Section 4.9**.

Note that the City of Ottawa's TDM-Supportive Development Design and Infrastructure has been provided in **Appendix F** and discussed in more detail in **Section 4.5**.

4.1.2. Circulation and Access

The proposed development will provide two accesses to the underground parking garage:

1. Catherine St, approximately 60m west of Kent St, and
2. Arlington Ave, approximately 25m east of Lyon St.

There will be 2-levels of underground parking, where visitor and retail parking spaces will be provided on the first level and will be separated from resident parking spaces through the use of restricted gate access that only residents can enter.

The proposed woonerf, connecting Arlington Ave to Catherine St, was developed after early discussions with City staff. Current City policies (in the New Official Plan and Centretown CDP) encourage loading activities in the downtown districts to be off-street/internalized rather than on-street. Although the primary function of the woonerf is to provide an enhanced pedestrian environment and meeting place for the local community, its secondary function is to enable garbage pickup for all buildings, and moving/loading operations for Buildings A and B.

General traffic is not permitted within the woonerf, only designated truck traffic (garbage, emergency and moving trucks). This restriction will be reinforced with signage, but is also supported by its various unique design elements, such as:

- One-way southbound – vehicle travel on Arlington Ave is far less intense than Catherine St, which reduces the risk of short-cutting or infiltration of general traffic. Furthermore, the one-way restrictions on the main fronting streets (Catherine St, Kent St, and Lyon St) make shortcutting less prominent or attractive for drivers.
- Materials and landscaping – the aesthetic provides strong visual cues to drivers that the woonerf is not a road.
- Furniture and fixtures – the placement of street furniture and fixtures also offer visual cues as well as added friction to further reinforce the woonerf is not a road.

If the proposed design is shown to be insufficient to maintain compliance, property management may always consider a physical gate in the future.

One limitation to the woonerf location is that it is located too far from the Tower 3 in Building B elevators for realistic loading operations. Therefore, a layby has been proposed along Lyon St to enable loading operations in front of Tower 3. The layby proposal was considered acceptable for the following reasons:

- Lyon St is one-way southbound, which eliminates vehicle conflicts from on-coming vehicles.
- Lyon St is a traffic calmed road, there is a speed hump and on-street parking on the east side of the road just north of Arlington Ave.
- The layby is located as far north as possible along the frontage, ensuring there is as much separation from the Catherine St intersection.
- Lyon St has a wide pavement width (nearly 9m for two travel lanes), which provides ample space for vehicles in the adjacent lane to pass comfortably if a truck is in the layby.
- The proposed design includes a 2.0m continuous sidewalk along the frontage, thus the layby does not impinge on the pedestrian realm.

- Loading operations with large trucks are expected to be infrequent (coinciding with move-ins), and rarely occur during the weekday morning/afternoon peak hour periods.

The Lyon St layby should be signed as a loading zone with time restrictions, which limits use to 15-minutes or less for loading/ unloading operations.

A layby has also been proposed on Catherine St, with one notable difference; it is intended to only serve as a temporary pick up and drop off area for general traffic, it will not be a loading area for trucks. The potential implications of a layby on Catherine St were assessed, and ultimately deemed reasonable for the following reasons:

- The intent for this layby is primarily pickup-drop offs or deliveries to the building on the southeast corner of the property, which are infrequent.
- Vehicle conflict risks related to the lay-by are expected to be less pronounced since Catherine St is a one-way street westbound and Kent St is one-way northbound, which minimizes opposing and oncoming traffic interactions.
- There are two general purpose travel lanes on Catherine St that will reduce the risk of queue spillback or conflicts if a vehicle is maneuvering into or out of the layby.

The Catherine St layby may also be signed a loading zone with time restrictions, or split in order to add space for public paid parking. These choices may be reviewed and decided in collaboration with City Parking Services.

Truck and passenger vehicle turning maneuvers at all site accesses and laybys have been reviewed in significant detail and several iterations and adjustments were made to ensure their ability to accommodate the expected design vehicles. All vehicle turning templates have been provided in **Appendix G**.

4.1.3. New Street Network

Exempt, refer to **Table 2**.

4.2. Parking

4.2.1. Parking Supply

Based on City of Ottawa Parking Provisions, Schedule 1A, the proposed development is located in “Area X”. As such, the required number of parking spaces will be calculated based on the rates set out for this area. The proposed development will locate all vehicle parking spaces in the two-level underground parking garage, while the bicycle parking spaces will be located in various locations with most located on a mezzanine level of the building and some located outdoors. **Table 21** provides a summary of the required and the proposed parking rates for vehicles and **Table 22** for bicycles.

Table 21: Required and Proposed Vehicle Parking Spaces

Land Use	Size	Zoning By-Law Parking Rates		Required Spaces			Proposed Spaces		
		Base	Visitor/Retail	Base	Visitor/Retail	Total	Base	Visitor/Retail	Total
Phase 1									
High-Rise Residential	289 Units	0.5 per unit, excluding first 12 units	0.1 per unit, excluding first 12 units, 30 spaces max per building	139	28	167	96	45 <i>Shared with retail</i>	141
Retail*	599 m ²	-	1.25 per 100 m ²	-	8	8	<i>Shared with Residential visitor parking</i>		-
Phase 1 Total				139	36	175	96	45	141
Phase 2									
High-Rise Residential	732 Units	0.5 per unit, excluding first 12 units per building	0.1 per unit, excluding first 12 units, 30 spaces max per building	354	60	414	199	54 <i>Shared with retail</i>	253
Townhomes	7 units	0.75 per unit	0.1 per unit, excluding first 12 units, 30 spaces max per building	6	0	6			
Retail*	950 m ²	-	1.25 per 100 m ²	-	12	12	<i>Shared with Residential visitor parking</i>		-
Phase 2 Total				360	72	432	199	54	253
Full Buildout Total				499	108	607	295	99	394

*Retail units with an area less than 200 m² do not require off-street vehicle parking to be provided, as per the Parking Provisions.

As shown in **Table 21**, the development intends to provide fewer vehicle parking spaces than the minimum requirements by approximately 200 residential parking spaces. As such, a parking variance is needed as part of the development application.

The potential implications for residential vehicle parking demand are provided in the following section. While the proposed visitor/retail parking spaces are also slightly below the required number (only 18 spaces short), it is not expected to result in any major issues as short-term on-street parking on Arlington Ave and the surrounding area is available.

Table 22: Required and Proposed Bicycle Parking Spaces

Land Use	Size	Zoning By-Law Parking Rates	Required Spaces	Proposed Spaces
		Bicycle	Bicycle	Bicycle
Phase 1				
High-Rise Residential	289 Units	0.5 per unit	145	337
Retail	1,187 m ²	1.0 per 250 m ²	5	10
Phase 1 Total			150	347
Phase 2				
High-Rise Residential	732 Units	0.5 per unit	366	381
Townhomes	7 units	-	-	-
Retail	1,064 m ²	1.0 per 250 m ²	5	10
Phase 2 Total			371	391
Full Buildout Total			521	738

The proposed number of bicycle parking spaces exceed the required minimum by more than 200 spaces that will help promote cycling use. The majority of bicycle parking is proposed in secure indoor storage rooms located in the mezzanine level, with easy access to elevators and the outside. Some bike parking is also proposed outdoor near amenity areas.

4.2.2. Parking Variance Implications

The development proposal provides approximately 200 fewer vehicle parking spaces than the By-Law requirement. To offset the reliance on vehicles and vehicle parking requirements, the site is providing excess bike parking spaces (by over 200) that is supported by high quality pedestrian and cycling facilities in the vicinity, and a mix of different land uses that promotes a walkable neighbourhood. The City's long-term plan for Catherine St includes a new transit priority lane with a bus stop along the development frontage, as well as augmented pedestrian and cycling accommodations at study area intersections. A strong TDM program is proposed to encourage alternate modes of transportation that will leverage the existing and planned infrastructure provided by the City (further details provided in Section 4.5), which reduces the need for excess vehicle parking. Lastly, the reduction in parking is supported by policies in the New Official Plan to maximize the priority of movement for sustainable modes in the Downtown Core Transect and limiting on-site parking where possible.¹

In the unlikely event that parking spillover is observed, the Centretown Local Area Parking Study (LAPS) from 2016 suggests there is available on-street parking supply within the Centretown neighbourhood to accommodate potential demand. The LAPS table 22 documented between 50-57% on-street parking utilization during all time periods, meaning that there is almost half of remaining on-street parking unoccupied and available. During paid periods, an increase in public off-street parking up to a maximum of 80% occupancy was documented. During weekends, the off-street parking utilization is normally less than 10%, providing a large availability of parking². City By-Law is also equipped to respond with greater enforcement if there is an observed increase in parking infractions.

4.3. Boundary Street Design

Using discrete quantitative methods, the Multi-Modal Level of Service (MMLOS) analysis describes the level of convenience and comfort experienced by pedestrians, cyclists, transit, and trucks. MMLOS analysis was conducted at the boundary roads of the proposed development, which includes Catherine St, Kent St, Lyon St, and Arlington Ave. The geometry and features along three of the boundary streets (Catherine St, Kent St, and Lyon St) are anticipated to differ between the existing and future horizon year conditions as a result of both the future Catherine St Functional Design Plan and the proposed development's Site Plan. Below is a description of the proposed development's existing boundary streets and future modifications at the site's frontage:

Catherine St (arterial road classification)

- *Existing*
 - 2.0m wide sidewalk and no boulevard,
 - 3 lanes total (WB only),
 - 3.7m or wider lanes,
 - Operating speed of 50 to 60km/h,
 - Less than 3000 average daily curb lane traffic volume,
 - No on-street parking, cycling facilities or transit facilities, and
 - A designated truck route.
- *Future*
 - New curbside bus lane, and
 - 3.5m wide lanes.

Kent St (arterial road classification)

- *Existing*
 - 1.8m wide sidewalk and no boulevard,
 - 3 lanes total (NB only),

¹ City of Ottawa Official Plan (2021), City of Ottawa, Section 5.1, Pg 133-137.

² <https://pub-ottawa.escribemeetings.com/filestream.ashx?documentid=41676>

- 3.7m or wider lanes,
- Operating speed of 50 to 60km/h,
- More than 3000 average daily curb lane traffic volume,
- No on-street parking, cycling facilities or bus routes, and
- A designated truck route.
- *Future*
 - 2.0m wide sidewalks and no boulevard.

Lyon St (arterial road classification)

- *Existing*
 - 1.5m wide sidewalk and no boulevard,
 - 2 lanes total (SB only),
 - 3.7m or wider lanes,
 - Operating speed of 50 to 60km/h,
 - More than 3000 average daily curb lane traffic volume,
 - No on-street parking, cycling facilities or bus routes, and
 - Not a designated truck route.
- *Future*
 - 2.0m wide sidewalks and no boulevard.

Arlington Ave (local road classification)

- *Existing*
 - 1.5m wide sidewalk and no boulevard,
 - 2 lanes total (1 WB and 1 EB),
 - Operating speed of 30 to 50km/h,
 - Less than 3000 average daily curb lane traffic volume,
 - Permitted on-street parking,
 - No cycling facilities or bus routes, and
 - Not a designated truck route.
- *Future*
 - 2.0m wide sidewalks and no boulevard.

Detailed analysis sheets have been provided in **Appendix H. Table 23** below provides a summary of the results, along with the minimum desirable targets obtained from the MMLoS Guidelines, for each respective travel mode. The targets are based on the proposed development site’s location in a “within 300m of a school” (i.e. Glashan Elementary School) Policy Area for both existing and future conditions.

Table 23: MMLoS Analysis, Boundary Road Segments

Road Segment	Level of Service							
	Pedestrian (PLOS)		Bicycle (BLOS)		Transit (TLOS)		Truck (TkLOS)	
	PLOS	Target	BLOS	Target	TLOS	Target	TkLOS	Target
Catherine St	C	A	E	D	D, B*	C	A, A*	D
Kent St	F, E*	A	E	D	N/A	N/A	A, A*	D
Lyon St	F, E*	A	D	D	N/A	N/A	A, A*	E
Arlington Ave	E, B*	A	A	B	N/A	N/A	N/A	No Target

*Result based on future street design at site frontage.

Red font in the table above indicates that the respective desirable target has not been met. As shown in **Table 23**, the minimum desirable pedestrian LOS targets are not met at any of the road segments in both existing and future conditions. This is due to a combination of factors, which includes high curbside lane traffic volumes, high operating speeds given the arterial designation of three of the boundary roads and limited opportunity for boulevard width.

The minimum desirable bicycle LOS targets are not met on Catherine St and Kent St primarily due to the number of travel lanes (three on-way lanes), which reduces cyclist comfort. The minimum desirable transit LOS target is not met on Catherine St in existing conditions but is expected to be met in the future as a result of the proposed transit lane.

It should be noted that there are no applicable TLOS results or targets for Kent St, Lyon St, or Arlington Ave as there are no active transit routes along these roads. Similarly, there are no minimum desirable truck LOS target along Arlington St given its local road designation with limited truck usage.

4.4. Access Intersection Design

As was described in **Section 4.1.2**, access to the underground parking garage will be provided via two accesses, one along Catherine St that will be constructed as part of Phase 1, and the other access along Arlington Ave to be constructed as part of Phase 2. Both accesses will provide 6m wide ramps. The Catherine St access will be located approximately 60m west of Kent St, while the Arlington Ave access will be located approximately 25m east of Lyon St. The access designs include bulb-outs according to City specifications, which also act as a traffic calming measures along the frontage street (by reducing the effective pavement width).

The two garage access points ensure a balanced spread of traffic (thereby reducing traffic loading to any one access point) and provides more direct access for residents. One of the drawbacks of one-way streets on three frontages is it forces inefficient vehicle routing if access points to the site are limited. A single access off Catherine St would encourage traffic infiltration on surrounding streets (particularly vehicles coming from the northwest), increasing the number of turns and create more pedestrian and cyclist conflicts on the adjacent road network than having a secondary access of Arlington St.

The proposed access design would also reduce traffic loading on any one street. Both Arlington Ave and Catherine St are sensitive corridors for different reasons. Catherine St is a future transit priority corridor and a “feeder” street to Highway 417, which would benefit from fewer vehicle trips turning in and out of the site during peak hour periods. Arlington Ave is a traffic calmed local street with direct residential frontage, which requires more consideration of traffic implications to local residents. Splitting the traffic distribution at two different access points provides reduces long-term operational risks.

The design considerations for the proposed woonerf were previously described in **Section 4.1.2**. It will be constructed as part of Phase 1. The south access point will be located approximately 15m west of the proposed garage access off Catherine St, which does not adhere to the Private Approach By-law (PABL). However, Catherine St is a one-way only street with westbound travel and the woonerf is one-way only southbound. The woonerf would only permit exiting vehicles from the site resulting in very low conflict potential between the woonerf access and the underground parking garage access. The access design includes bulb-outs according to City design specifications, which enables adequate sightlines between accesses. Therefore, the proposed separation distance was considered acceptable. The north woonerf access will be located approximately 60m east of the Arlington Ave access, which adheres to the PABL and is similarly designed based on City specifications.

Providing additional access points from the woonerf was a strategic choice to prioritize off-street loading operations within the woonerf, as well as separate residential traffic from truck traffic, which ultimately balances onsite and adjacent corridor operations.

MMLOS Analysis for Signalized Intersections

As per requirements of the TIA Guidelines, MMLOS analysis was conducted for signalized intersections within the study area. Since the Catherine St Functional Design Plan will result in future modifications at study area intersections, analysis was conducted for each of existing and future conditions.

Similar to boundary street MMLOS analysis, the signalized intersection MMLOS analysis is conducted for four different travel modes, including pedestrian, cyclist, transit, and trucks. For each travel mode, the minimum desirable LOS target is obtained from the City of Ottawa TIA Guidelines. A summary of the analysis results and

respective minimum desirable LOS targets are provided in **Table 24**, with the detailed analysis provided in **Appendix I**.

Table 24: MMLoS Analysis, Signalized Intersection

Intersection	Level of Service							
	Pedestrian (PLOS)		Bicycle (BLOS)		Transit (TLOS)		Truck (TkLOS)	
	PLOS	Target	BLOS	Target	TLOS ₁	Target	TkLOS	Target
Catherine/Kent	C, C*	A	F	D	D	-(D)	D	D
Catherine/Lyon	C, C*	A	F	C	C	-(D)	D	D
Arlington/Kent	D	A	E	D, (C)	-	-	-	-
Bank/Catherine	C, C*	A	E	D, (B)	F	D	B	D
Gladstone/Lyon	C	C	A	C	C	D	F	-
Gladstone/Kent	C	A	F	D, (C)	D	D	D	D
Catherine/Percy	D, D*	C	E, F*	C	C	-(D)	D	D
Catherine/Bronson	E, E*	C	E	D	F	-(D)	D	D
Bank/Isabella/Chamberlain	D, D*	A	E, D*	D, (B)	E	D	D, B*	D

*Result based on Catherine St Functional Design Plan; (xx) = future target when it differs from existing target 1. TLOS was done based on 2036 full buildout operations only.

Red font in the table above indicates that the desirable target LOS is not achieved.

- With regards to pedestrian LOS, the results are largely based on the number of lanes that pedestrians have to cross, followed by the degree of comfort and safety that pedestrians feel while crossing. This includes factors such as the amount of interference with crossing pedestrians due to permissible vehicle left-turns and right-turns.
- With regards to bicycle LOS, the target LOS was only met at Gladstone/Lyon and future Bank/Isabella intersections. Other intersections failed to meet the bicycle LOS target due to the lack of cycling facilities at the intersection or turning movement facilities at the approaches such as two-stage left-turn boxes.
- With regards to transit LOS, the target LOS is achieved at most intersections with the exception of Bank/Catherine, Bank/Isabella, and Catherine/Bronson due to the bus movement approaches exceeding 30 second delays. Buses operate in mixed traffic at various locations, so they experience the same level of delay as general traffic at the intersection. Adjusting the signal timing and phasing of the intersections to provide more dedicated green time to the approaches used by busses may help reduce the traffic delays.
- With regards to truck LOS, all locations with a target goal were met.

4.5. Transportation Demand Management

4.5.1. Context for TDM

Based on the 2021 City of Ottawa Official Plan, the proposed development's boundary roads Catherine St, Kent St and Lyon St are all designated as minor corridors within Design Priority Areas, along with Gladstone Ave. Bank St and Bronson Ave are both designated as mainstreet corridors within Design Priority Areas.

Given the proposed land-use of the development as a residential building, it is assumed that most trips generated will be from residents leaving the site in the AM peak to go to work and returning to the site in the PM peak. **Sections 3.1.1** and **3.1.2** describe how many trips are anticipated per travel mode and anticipates the likely locations that they will travel to and from based on the OD-Survey 2011 for Ottawa.

The development is proposing to provide 1,021 apartment units within 3 towers up to 40-storeys high, along with 7 townhome units and approximately 2,250m² of retail space. A breakdown of the unit types on the Site Plan indicates that the apartment units provided will consist of 436 one-bedroom units, 140 one-bedroom and den units, 400 two-bedroom and den units and 52 three-bedroom units. The property is owned and will be managed by the property developer, Brigil.

4.5.2. Need and Opportunity

The proposed development is located in a well-developed core area of the City of Ottawa, where transit and active transportation facilities are well-maintained and developed, which naturally results in an increased transit and active transportation usage and decreased auto trips. However, given the development's location relative to Highway 417, as well as near the southern limit of the Centretown area, it is reasonable to expect that auto driver mode shares will be higher relative to the typical Centretown mode share splits.

In order to ensure that personal vehicle use remains reasonable given the size of the proposed development, aggressive Transportation Demand Management (TDM) measures will need to be utilized. The proposed development TDM measures are described in detail in **Section 4.5.3** below. Additionally, **Section 4.2** details the rationale for providing a reduced number of parking spaces compared to minimum zoning bylaw requirements.

4.5.3. TDM Program

The TDM Infrastructure and TDM Measures Checklists have been provided in **Appendix F**. The proposed measures in each respective checklists are identified below.

Proposed measures identified in the TDM-supportive Development Design and Infrastructure Checklist are:

- Nine (9) out of the ten (10) "Required" measures have been satisfied, with the exception of providing less vehicle parking than required by zoning.
- Twelve (12) out of fourteen (14) "Basic" measures related to Walking and Cycling and Parking have been satisfied, namely:
 - Locating building close to the street.
 - Locating building entrances to minimize walk distance to sidewalks and transit.
 - Locating building doors and windows to ensure visibility of pedestrians.
 - Providing safe, direct and attractive walking routes to transit.
 - Ensuring walking routes are secure, visible, and lighted.
 - Designing roads for cyclist circulation.
 - Providing lighting, landscaping and benches along walking and cycling routes.
 - Providing wayfinding signage for site access.
 - Providing bicycle parking equivalent to expected number of resident-owned and visitor cyclists.
 - Providing off-site transit shelter at a new location with shelter.
 - Providing a designated area to drop off or pick up passengers.
 - Providing shared parking for different uses (i.e. visitors, commercial, etc.)
- Three (3) out of seven (7) "Better" measures related to Walking and Cycling and Carsharing and Bikesharing have been satisfied, namely:
 - Providing secure bike parking spaces equivalent to at least the number of units.
 - Providing up to three carshare parking spaces.
 - Providing separate areas for short-term and long-term parking with access controls.

Proposed measures identified in the TDM Measures Checklist are:

- Five (5) out of seven (7) "Basic" measures related to Walking and Cycling, Transit, Parking and TDM Marketing have been satisfied. Three (3) of those, which have been designated by an asterisk (*), are considered by the TDM Measures to be some of the most dependably effective tools to encourage sustainable travel modes. This includes:
 - Display walking and cycling information at major entrances.
 - Display transit information at major entrances.
 - *Offer preloaded PRESTO card to residents one monthly transit pass.
 - * Unbundle parking costs from monthly rent.
 - * Provide multi-modal travel information package to new residents.
- Five (5) out of eleven (11) "Better" measures related to Walking and Cycling, Transit, Carsharing and Bikesharing, Parking and TDM Marketing have been satisfied. One (1) of those, which has been

designated by an asterisk (*), is considered by the TDM Measures to be some of the most dependably effective tools to encourage sustainable travel modes. This includes:

- Offer on-site cycling courses for residents or subsidize off-site courses.
- Install on-site bikeshare station.
- Provide residents bikeshare memberships.
- Provide on-site carshare vehicles for residents.
- *Offer personalized trip planning to new residents.

4.6. Neighbourhood Traffic Management

This module compares the maximum one-way traffic of a local road during morning and afternoon peak hours, to the respective threshold provided by the City of Ottawa TIA Guidelines.

Site-generated traffic of the proposed development are expected to use local road Arlington Ave as part of their access route to/from the proposed development. The thresholds provided in the TIA Guidelines indicate a maximum ideal one-way traffic of 120 veh/h for local roads during peak hours. Using the total projected 2036 traffic volumes in **Figure 19**, future traffic volumes along Arlington Ave were compared to existing volumes and the ideal local road threshold as shown in **Table 25**. Arlington Ave was divided into three sections to gain full understanding of traffic activity.

Table 25: Arlington Ave Existing and Future Two-Way Volumes

Roadway	Classification	Ideal Daily Threshold (veh/day)	Ideal Peak Hour Threshold (veh/h)	Section	Peak Hour Two-Way Volumes AM (PM)	
					Existing	Projected
Arlington Ave	Local	1,000	120	West of Lyon St	39 (71)	39 (71)
				Between Lyon St and Kent St	93 (113)	152 (166)
				Between Kent St and Bank St	283 (235)	291 (243)

As shown in **Table 25**, note the following:

- **West of Lyon St:** traffic volumes along this section of Arlington Ave are well below the ideal threshold of a local road in both existing and future conditions. This indicates the majority of this traffic is local traffic and there is very limited cut-through traffic activity occurring on Arlington Ave between Bronson Ave and Lyon St.
- **Between Lyon St and Kent St:** traffic volumes along this section of Arlington Ave are near the ideal threshold of a local road in existing conditions but are expected to exceed the threshold by up to approximately 45 veh/h in future projected conditions.
 - It should be noted that some traffic increase along Arlington Ave would have occurred regardless of whether an access is provided along Arlington Ave. This is due to the one-way nature of the surrounding roads that would have forced southbound traffic on Lyon St to take a circuitous route along Arlington Ave and Bank St to use the access along Catherine St.
 - Traffic volumes exceeding the ideal threshold of a local road is not an automatic indication of traffic operational problems on Arlington Ave. Traffic analysis will identify if there will be any intersection operational concerns at adjacent intersections and any safety concerns can be mitigated through the use of traffic calming measures and speed reduction. It is noted that this section of Arlington Ave has a reduced posted speed of 30km/h, along with intersection curb extensions and two speed humps. The future development is expected to add additional mid-block curb extensions at site accesses that will further narrow the road and help further calm the street.
- **Between Kent St and Bank St:** traffic volumes along this section of Arlington Ave are well above the ideal threshold of a local road in both existing and projected conditions and are approaching the 300veh/h threshold of a collector road. The high traffic volumes are like caused by a combination of the following:

- The drop-off/pick-up activity that would occur during peak hours (especially in the AM) at Glashan Elementary School on the south side of Bank St. Since the school acts as a traffic generator during peak hours, there would be limited opportunity to mitigate these traffic volumes.
- Cut-through traffic may be using Arlington Ave as a quicker route to travel between Kent St and Bank St – more specifically, eastbound traffic exiting Highway 417 at Kent St are likely using Arlington Ave in order to travel access Bank St. Similarly, traffic travelling northbound on Bank St can use Arlington Ave instead of Catherine St to travel northbound on Kent St. There are few opportunities to limit this traffic infiltration besides road closures, which requires further study by the City and Council approval.

While site generated traffic is expected to contribute to this section, it will be to a much smaller proportion compared to existing/background traffic. The city Neighbourhood Traffic Calming Branch may consider investigating this section of Arlington Ave if future concerns are raised and validated through the established city process.

It is important to reiterate that the Arlington St corridor is already traffic calmed, including speed humps. That said, the development proposal introduces four new bulb-outs at the two proposed access points that will narrow the road from existing 10m to 7.0m, which reinforces the traffic calmed environment.

4.7. Transit

As shown in **Table 20**, the proposed development is anticipated to generate up to 125 transit trips during peak hour periods. These trips will have access to existing bus routes within the study area, which includes OC Transpo bus routes #6, #7, #14, #55 and #114.

Existing transit ridership data (pre-COVID to reflect ‘typical’ ridership before pandemic impacts) was obtained from OC Transpo for six bus stops near the proposed development site, as shown in **Figure 20**. The data, as provided in **Table 26**, is a summary of average bus boarding, alighting and occupancy information for bus routes at each of the respective stop numbers, during morning and afternoon peak hours.



Table 26: Transit Ridership Data (Jan 5, 2020 - Mar 16, 2020)

Stop No.	Location	Route	Direction	AM			PM		
				Boarding	Alighting	Avg. Load at Depart.	Boarding	Alighting	Avg. Load at Depart.
2480	Catherine/ Kent	55	WB	11	5	21	11	8	16
6642	Gladstone/ Kent	14	WB	5	6	20	7	12	28
		114	WB	-	-	-	-	-	-
6646	Gladstone/ Kent	14	EB	6	13	19	12	17	16
		114	EB	-	-	-	-	-	-
6850	Chamberlain/ Kent	55	EB	16	8	17	15	17	15
7666	Bank/ Arlington	6	SB	22	34	23	58	54	38
		7	WB	24	26	24	20	38	28
8895	Bank/ Catherine	6	NB	14	28	33	12	16	30
		7	EB	11	5	23	20	19	31

As shown in **Table 26**, the average load of each bus route at its respective bus stop ranges from about 15 to 38 persons during the peak hours. It should be noted that these bus routes serve their respective stops several times during peak hours. Bus route #6, #7 and #14 in particular are “frequent routes” that arrive every 15 minutes or less during peak hours.

Based on information obtained from the OC Transpo website, the person capacity of OC Transpo vehicles, which includes the number of seats on the bus plus the standing capacity, ranges from approximately 57 occupants in its smallest vehicles to approximately 110 occupants in its largest vehicles. Some of these routes connect to the Confederation Line LRT approximately 1.4km north of the development site, which has a significantly higher frequency and ample capacity of 336 occupants.

Therefore, based on the current average bus loads and the future implementation of the Catherine St transit priority lane, the estimated 125 site generated transit trips during the peak hour periods are expected to be adequately accommodated by transit service at full buildout.

4.8. Review of Network Concept

There are no identifiable planning screenlines within or in close proximity of the study area. A strong TDM program in combination with planned City sustainable infrastructure limits the anticipated number of vehicle and transit trips. Therefore, no major modifications are needed for the network to continue to perform acceptably. Transit trips were discussed in **Section 4.7** and is expected to be accommodated by the existing bus operations in the study area. Vehicle trips are also expected to be accommodated along study area roads, where any intersection operational concerns will be confirmed as part of **Section 4.9.2**.

4.9. Intersection Design

4.9.1. Intersection Control

Stop or Yield control may be considered for traffic exiting the underground parking garage ramps and the woonerf, to be confirmed during the detailed design. All other off-site intersection controls in the study area will continue to operate as per existing conditions, with the exceptions of recommended signal timing adjustments at the intersections of Catherine/Kent and Bank/Chamberlain/Isabella, as part of the future Catherine St Functional Design Plan Modifications, which is assumed to be completed in the 2031 and 2036 horizon years.

Additionally, the WBR movement at Catherine/Kent, will be fully protected with no-right-turn-on-red permitted and time separated pedestrian phase. At Bank/Chamberlain/Isabella, the NBR will not permit right-turn-on-red due to the proposed bidirectional crossing on the south leg of the intersection.

4.9.2. Intersection Design

Synchro 11 Trafficware was used to analyze intersection performance of intersections within the study area. Critical movements at each of the intersections were assessed based on either the movement with the highest volume-to-capacity ratio (for signalized intersections), or the movement experiencing the highest average delay (for unsignalized intersections). It should be noted that, as per the TIA Guidelines, the Peak Hour Factor (PHF) used for analysis was 0.90 in existing conditions and 1.0 in all future scenario conditions. All Synchro report outputs for existing and future conditions have been provided in **Appendix J**.

Existing Conditions Intersection Performance

Table 27 below summarizes the intersection performance of study area intersections, based on existing conditions traffic volumes illustrated in **Figure 8**.

Table 27: Existing Conditions Intersection Performance

Intersection	Weekday AM Peak (PM Peak)					
	Critical Movement			Intersection 'As a Whole'		
	LOS	max. v/c or avg. delay (s)	Movement	Delay (s)	LOS	v/c
Catherine/Lyon (S)	A(A)	0.41(0.51)	SBT(WBT)	11.4(16.5)	A(A)	0.29(0.47)
Catherine/Kent (S)	C(A)	0.72(0.56)	NBT(WBR)	24.7(17.4)	C(A)	0.72(0.55)
Bank/Catherine (S)	D(E)	0.89(0.99)	WBT(SBT)	29.1(50.8)	D(D)	0.89(0.88)
Catherine/Percy (S)	A(A)	0.28(0.52)	SBT(WBT)	7.5(10.6)	A(A)	0.26(0.48)
Arlington/Kent (S)	C(A)	0.77(0.47)	NBT(NBT)	16.1(8.1)	C(A)	0.72(0.43)
Gladstone/Lyon (S)	A(A)	0.41(0.60)	SBT(SBT)	16.3(15.5)	A(A)	0.37(0.55)
Gladstone/Kent (S)	C(B)	0.79(0.61)	NBT(EBT)	9.7(13.5)	C(B)	0.76(0.61)
Bank/Isabella/Chamberlain (S)	E(C)	0.91(0.79)	SBT(SBT)	16.7(17.7)	D(C)	0.82(0.76)
Catherine/Bronson (S)	F(F)	1.03(1.11)	WBL(WBL)	45.2(55.8)	E(E)	0.91(0.98)
Arlington/Lyon (U)	B(C)	13(18)	EB(WB)	2(2)	A(A)	-
Arlington/Bank (U)	C(C)	20(20)	EB(EB)	3(3)	A(A)	-

Note: Analysis of signalized intersections assumes a PHF of 0.9 and a saturation flow rate of 1800 veh/h/lane.
(S) – Signalized intersection, movement with highest v/c ratio identified as critical movement.
(U) – Unsignalized intersection, movement with highest average delay identified as critical movement.

As shown in **Table 27**, the signalized intersections 'as a whole' operate at a LOS 'E' or better during the morning and afternoon peak hours.

The Catherine/Bronson intersection had a critical westbound left-turn above capacity for both the AM and PM peak hour. Bronson Ave is a major north-south arterial road in the city, which moves large volumes of commuters from the downtown and from the east end who exit Highway 417 and proceed southbound on Bronson Ave. The resulting performance for the WBL movement was expected. That said, the WB approach queue was shown to be acceptable (further detail provided in **Section 4.9.3**). Considering the Catherine/Bronson intersection was only recently modified as part of the MTO bridge rehabilitation project, only signal timing optimizations should be completed - no further mitigation is recommended at this location.

Future Background 2036 Intersection Performance

The most critical of all background conditions between background 2026, 2031 and 2036 was chosen. The 2036 background accounts for a 0.5% annual growth rate and includes all adjacent developments plus the transit priority lane conversion along Catherine Street resulting in a reduction from three general travel lanes to two general travel lanes as part of the Catherine St Functional Design Plan.

The results from this scenario were compared with intersection performance results within the study area after the proposed development is added, so we can quantify the adjacent road network implications of the proposed development. **Table 28** below summarizes the intersection operational performance at study area intersections using Synchro analysis software for this scenario.

Table 28: Future Background 2036 Conditions Intersection Performance

Intersection	Weekday AM Peak (PM Peak)					
	Critical Movement			Intersection 'As a Whole'		
	LOS	max. v/c or avg. delay (s)	Movement	Delay (s)	LOS	v/c
Catherine/Lyon (S)	A(A)	0.34(0.50)	SBT(WBT)	14.6(17.9)	A(A)	0.33(0.49)
Catherine/Kent (S)	D(B)	0.83(0.61)	NBT(NBT)	55.9(25.4)	C(A)	0.75(0.55)
Bank/Catherine (S)	D(D)	0.89(0.89)	WBT(WBT)	26.6(29.1)	D(C)	0.85(0.78)
Catherine/Percy (S)	A(B)	0.42(0.69)	WBT(WBT)	9.7(14.6)	A(B)	0.34(0.62)
Arlington/Kent (S)	C(A)	0.73(0.49)	NBT(NBT)	60.7(55.5)	B(A)	0.69(0.45)
Gladstone/Lyon (S)	A(A)	0.36(0.53)	SBT(SBT)	12.5(14.9)	A(A)	0.33(0.50)
Gladstone/Kent (S)	C(B)	0.79(0.64)	NBT(NBT)	13.4(13.3)	C(A)	0.74(0.60)
Bank/Isabella/Chamberlain (S)	C(C)	0.76(0.79)	EBT(EBT)	17.3(18.2)	B(C)	0.65(0.72)
Catherine/Bronson (S)	E(E)	0.91(0.92)	SBT(WBL)	38.1(39.4)	D(E)	0.90(0.92)
Arlington/Lyon (U)	B(C)	13(17)	EB(WB)	2(2)	A(A)	-
Arlington/Bank (U)	C(C)	18(17)	EB(EB)	3(2)	A(A)	-

Note: Analysis of signalized intersections assumes a PHF of 1.0 and a saturation flow rate of 1800 veh/h/lane.
(S) – Signalized intersection, movement with highest v/c ratio identified as critical movement.
(U) – Unsignalized intersection, movement with highest average delay identified as critical movement.

As shown in **Table 28** intersections are projected to operate similarly to existing conditions. In general, intersections with roads connecting to Highway 417 and which received a 0.5% annual growth rate experienced a slight worsening in intersection performance, while other intersections a slight improvement due to increasing the PHF to 1.00 compared to existing PHF of 0.90 as per TIA Guidelines.

Total Projected 2026 Intersection Performance

Within this scenario, a new right-in-right-out (RIRO) access to the site has been added to Catherine Street approximately 60m west of Kent St. The Woonerf was not modelled in the scenario as traffic volumes are expected to be very minimal and generally off-peak hours.

Total projected 2026 Phase 1 traffic volumes was developed by adding the site-generated traffic volumes for Phase 1 (**Table 20**) onto the future background 2026 volumes (**Figure 14**) to create the total projected 2026 traffic volumes, as illustrated in **Figure 17**. **Table 29** below summarizes the intersection operational performance at study area intersections using Synchro analysis software for this scenario.

Table 29: Total Projected 2026 Conditions Intersection Performance – Phase 1

Intersection	Weekday AM Peak (PM Peak)					
	Critical Movement			Intersection 'As a Whole'		
	LOS	max. v/c or avg. delay (s)	Movement	Delay (s)	LOS	v/c
Catherine/Lyon (S)	A(A)	0.32(0.42)	SBT(SBT)	8.7(14.7)	A(A)	0.27(0.39)
Catherine/Kent (S)	C(B)	0.75(0.61)	NBT(NBT)	23.6(15.2)	B(A)	0.70(0.54)
Bank/Catherine (S)	E(D)	0.91(0.89)	WBT(WBT)	27.2(28.8)	D(C)	0.85(0.78)
Catherine/Percy (S)	A(A)	0.33(0.59)	WBT(WBT)	9.5(14.9)	A(A)	0.28(0.52)
Arlington/Kent (S)	C(A)	0.71(0.46)	NBT(NBT)	15.7(7.1)	B(A)	0.67(0.42)
Gladstone/Lyon (S)	A(A)	0.35(0.52)	SBT(SBT)	12.4(14.6)	A(A)	0.32(0.49)
Gladstone/Kent (S)	C(B)	0.77(0.62)	NBT(NBT)	13.0(11.3)	C(A)	0.72(0.59)
Bank/Isabella/Chamberlain (S)	C(C)	0.74(0.75)	EBT(EBT)	16.8(17.1)	B(B)	0.64(0.70)
Catherine/Bronson (S)	D(D)	0.86(0.88)	WBL(WBL)	34.2(35.9)	D(D)	0.84(0.87)
Arlington/Lyon (U)	B(C)	13(17)	EB(WB)	2(2)	A(A)	-
Catherine/Site Access (U)	B(B)	11(12)	SB(SB)	1(0)	A(A)	-
Arlington/Bank (U)	C(C)	18(18)	EB(EB)	3(2)	A(A)	-

Note: Analysis of signalized intersections assumes a PHF of 1.0 and a saturation flow rate of 1800 veh/h/lane. Catherine/Bronson was optimized while keeping the same cycle length.
(S) – Signalized intersection, movement with highest v/c ratio identified as critical movement.
(U) – Unsignalized intersection, movement with highest average delay identified as critical movement.

As shown in **Table 29**, the intersections will continue to operate similarly to existing conditions. The site access intersection to Catherine St operates well.

Total Projected 2031 Intersection Performance

Within this scenario, a new full movement site access to Arlington St approximately 25m east of Lyon St has been added. Additionally, a general-purpose travel lane on Catherine St has been removed to a total of two general travel lanes to account for the Catherine St Functional Design Plan. Additionally, as requested by city staff, a time separated pedestrian crossing of the south approach at Catherine/Kent was modelled. The crossing distance was measured at approximately 13m, and as such, a 13s pedestrian phase was modelled assuming 1m/s approach.

Total projected 2031 Phase 1 & 2 full buildout traffic volumes was developed by adding the site-generated traffic volumes for Phase 1 & 2 (**Table 20**) onto the future background 2031 volumes (**Figure 15**), to create the total projected 2031 traffic volumes, as illustrated in **Figure 18**. **Table 30** below summarizes the intersection operational performance at study area intersections using Synchro analysis software for this scenario.

Table 30: Future Projected 2031 Intersection Performance – Phase 1 & 2

Intersection	Weekday AM Peak (PM Peak)					
	Critical Movement			Intersection 'As a Whole'		
	LOS	max. v/c or avg. delay (s)	Movement	Delay (s)	LOS	v/c
Catherine/Lyon (S)	A(C)	0.40(0.73)	SBT(WBT)	15.2(16.9)	A(B)	0.35(0.61)
Catherine/Kent (S)	D(B)	0.83(0.65)	NBT(NBT)	52.8(25.5)	C(A)	0.75(0.57)
Bank/Catherine (S)	D(E)	0.84(0.93)	WBT(SBT)	25.9(37.2)	D(D)	0.83(0.83)
Catherine/Percy (S)	A(B)	0.35(0.65)	WBT(WBT)	7.9(12.1)	A(A)	0.32(0.59)
Arlington/Kent (S)	C(A)	0.73(0.45)	NBT(NBT)	59.7(36.9)	B(A)	0.70(0.43)
Gladstone/Lyon (S)	A(A)	0.39(0.57)	SBT(SBT)	16.1(15.1)	A(A)	0.34(0.52)
Gladstone/Kent (S)	C(A)	0.74(0.57)	NBT(NBT)	10.4(14.9)	C(A)	0.71(0.56)
Bank/Isabella/Chamberlain (S)	C(C)	0.71(0.72)	EBT(SBT)	16.2(16.7)	B(C)	0.65(0.72)
Catherine/Bronson (S)	D(E)	0.88(0.91)	WBL(WBL)	36.3(37.9)	D(D)	0.87(0.90)
Arlington/Lyon (U)	B(C)	13(17)	EB(WB)	3(2)	A(A)	-
Catherine/Site Access (U)	B(B)	10(11)	SB(SB)	1(1)	A(A)	-
Arlington/Site Access (U)	A(A)	9(9)	NB(NB)	4(3)	A(A)	-
Arlington/Bank (U)	C(C)	20(19)	EB(EB)	4(3)	A(A)	-
Note: Analysis of signalized intersections assumes a PHF of 1.0 and a saturation flow rate of 1800 veh/h/lane. Catherine/Bronson was optimized while keeping the same cycle length. (S) – Signalized intersection, movement with highest v/c ratio identified as critical movement. (U) – Unsignalized intersection, movement with highest average delay identified as critical movement.						

As shown in **Table 30**, the study area intersections will continue to operate similarly to existing conditions. All the site accesses operate well.

Total Projected 2036 Intersection Performance

Total projected 2036 model assumes the same road geometries as total projected 2031 scenario. The main difference in this scenario is that a 0.5% annual growth rate has been applied to background traffic volumes for an additional 5 years, which represents a conservative scenario (as previously discussed in Section 3.3).

This scenario was developed by adding site-generated traffic volumes for Phase 1 & 2 (**Table 20**) onto the future background 2036 volumes (**Figure 16**) to create the total projected 2036 traffic volumes, as illustrated in **Figure 19**. **Table 31** below summarizes the intersection operational performance at study area intersections using Synchro analysis software for this scenario.

Table 31: Future Projected 2036 Intersection Performance – Phase 1 & 2

Intersection	Weekday AM Peak (PM Peak)					
	Critical Movement			Intersection 'As a Whole'		
	LOS	max. v/c or avg. delay (s)	Movement	Delay (s)	LOS	v/c
Catherine/Lyon (S)	A(A)	0.37(0.53)	WBT(WBT)	19.5(17.7)	A(A)	0.37(0.52)
Catherine/Kent (S)	C(B)	0.78(0.66)	NBT(NBT)	21.6(27.2)	C(A)	0.73(0.58)
Bank/Catherine (S)	E(D)	0.93(0.90)	WBT(WBT)	28.8(30.2)	D(C)	0.88(0.80)
Catherine/Percy (S)	A(B)	0.46(0.68)	WBT(WBT)	10.5(14.6)	A(B)	0.37(0.61)
Arlington/Kent (S)	C(A)	0.73(0.49)	NBT(NBT)	24.9(54.0)	B(A)	0.70(0.47)
Gladstone/Lyon (S)	A(A)	0.37(0.54)	SBT(SBT)	12.4(15.0)	A(A)	0.34(0.51)
Gladstone/Kent (S)	C(B)	0.80(0.65)	NBT(NBT)	17.3(13.4)	C(B)	0.75(0.61)
Bank/Isabella/Chamberlain (S)	C(C)	0.77(0.80)	EBT(EBT)	17.6(18.6)	B(C)	0.67(0.74)
Catherine/Bronson (S)	E(E)	0.91(0.93)	WBL(WBL)	38.4(39.8)	D(E)	0.90(0.92)
Arlington/Lyon (U)	B(C)	13(18)	EB(WB)	2(2)	A(A)	-
Catherine/Site Access (U)	B(B)	10(11)	EB(EB)	1(1)	A(A)	-
Arlington/Site Access (U)	A(A)	9(9)	NB(NB)	4(3)	A(A)	-
Arlington/Bank (U)	C(C)	20(19)	EB(EB)	4(3)	A(A)	-

Note: Analysis of signalized intersections assumes a PHF of 1.0 and a saturation flow rate of 1800 veh/h/lane. Catherine/Bronson was optimized while keeping the same cycle length.
(S) – Signalized intersection, movement with highest v/c ratio identified as critical movement.
(U) – Unsignalized intersection, movement with highest average delay identified as critical movement.

Even with 5 years of additional background growth, the full buildout volumes plus 2036 background volumes continue to operate well. All intersections as a whole operate within City of Ottawa standards with a v/c below 1.00.

4.9.3. Queuing Implications

SimTraffic and Synchro softwares were used to determine queuing and the risk of spillback on study area intersections. Within the simulation parameters, a few minor tweaks for the SimTraffic scenarios compared to the Synchro network were done to achieve a more realistic flow:

- Bank/Catherine
 - Westbound right-turn was treated as a defacto turn-lane to improve flows.
 - Northbound left-turn was treated as a defacto turn-lane to improve flows.
- Arlington/Bank
 - Eastbound turning critical gap time and follow up time for the STOP-control was slightly reduced to simulate downtown conditions.

Table 32 summarizes sensitive locations for queuing, predominantly on Catherine St which is proposed to have future exclusive transit lanes. Detailed SimTraffic output results have been provided in **Appendix**

Table 32: Queuing Analysis for Sensitive Intersection Movements (2036 Projected)

Intersection – Movement	Available Storage (m)	Synchro Forecasted Queues AM (PM) (m)		SimTraffic Forecasted Queues AM (PM) (m)	
		50 th Percentile	95 th Percentile	50 th Percentile	95 th Percentile
Bank/Catherine – WB ₁	150m	48(51)	#74(#75)	109(120)	191(220)
Kent/Catherine – WBR	130m	44(24)	m53(m29)	41(24)	63(38)
Kent/Catherine – WBT		32(55)	m38(m65)	31(43)	49(58)
Site Access/Catherine – WBT	60m	0(0)	0(0)	0(0)	1(1)
Lyon/Catherine – WBL	85m	30(55)	m43(73)	48(36)	71(63)
Lyon/Catherine – WBT				28(25)	47(47)
Percy/Catherine – WB ₁	275m	9(32)	18(48)	23(35)	43(63)
Bronson/Catherine – WB ₁	120 - 250m ₂	87(90)	#149(#156)	93(72)	135(97)

- 95th percentile volume exceeds capacity; queue may be longer; m - volume for 95th percentile queue is metered by upstream signal. 1. The longest westbound movement queue was used. 2. 120m to terminus of 417 off-ramp and 250m to Percy St and H417.

As shown in **Table 32**, the majority of forecasted vehicle queues within the Catherine St corridor are contained to their respective road segments without spilling back to the upstream signalized intersection. The westbound approach to Bronson/Catherine queues at times during the peak hours close to or occasionally beyond the Highway 417 ramp terminus, but it is not anticipated to create queue spillback on to Highway 417 lanes or beyond Percy St. There is adequate storage at this location.

The Bank/Catherine intersection does have occasional queue spillback beyond Metcalfe St, though this segment is not within the proposed transit priority lanes, it is limited to the peak hour periods, and the queue spillback is not forecasted to extend to the Highway 417 off-ramp.

4.9.4. Transit Priority on Catherine Street

The Catherine St Functional Design Study proposes converting a general-purpose travel lane to a transit priority lane along Catherine St between Kent St and Bronson St. As previously discussed, the proposed development plans on adding two new accesses to Catherine St, one that is two-way servicing the underground parking garage located approximately 60m west of Kent St. The second access is a right-out only for the woonerf, which is located approximately 80m west of Kent St and is anticipated to have very infrequent use.

To reduce conflict between buses in the transit lane and the proposed driveways on Catherine St, the development proposal shifts the start of the transit lane west of the woonerf access, approximately 100m west of Kent St or 85m east of Lyon St. As shown in **Table 32**, vehicle queues on Lyon/Catherine westbound do not exceed 85m, which suggests the risk of buses being blocked from entering the transit priority lane in the future is low. Furthermore, the signal timing plans between Kent St and Lyon St may be optimized to ensure the vehicle queue is “flushed” out prior to the arrival of oncoming vehicles.

The corridor performance along Catherine St in the 2036 horizon (shown in Table 31) does not suggest there will be any notable operational implications to transit operations and travel times with the development proposal. The transit priority lane ensure buses can move efficiently through the corridor unencumbered.

5.0 FINDINGS, CONCLUSIONS AND RECOMMENDATIONS

Based on the results summarized herein, the following transportation related conclusions are offered:

Existing Conditions

- The site is located at the former Greyhound Bus Station (currently not in operation).
- Nearby Bank St and Gladstone Ave are designated transit priority corridors with isolated measures within the 2031 Affordable Network in the TMP.

- Catherine St is currently undergoing a study to include exclusive bus lanes originating between Kent St and Lyon St.
- Overall, there were 427 collisions recorded in five years within the study area. Kent/Catherine showed to have higher than average likeliness of collisions, but most resulted in property damage only. Bank/Catherine intersection broadcasted a disproportionate number of collisions with pedestrians and cyclists compared to other study intersections. Bank St being an arterial mainstreet which attracts active users is recommended to be retrofitted to include Protected Intersection Design Guide measures to priority the safety of vulnerable users.
- The site is currently accessed by three right-in right-out driveways to/from Catherine St.
- Existing intersections operate at acceptable overall LoS 'E' or better. The intersection of Catherine/Bronson has critical movements at capacity during the weekday peak hours for the westbound left-turn.

Proposed Development

- A two phased development is proposed, with the first development occurring on the east side of the site.
- The proposed development will comprise of approximately 1,028 residential units and 24,230 ft² of ground floor commercial/retail, within three towers and podiums ranging from 26 to 40-storeys high and 7 townhomes.
- The proposed development is projected to generate approximately 100 to 125 'new' transit trips during the AM and PM peak hour periods, which can be accommodated by various routes operating near to the site. Local route 50 operates on Catherine St adjacent to the site. Frequent routes 6 and 7 operate on Bank St and frequent route 14 operates on Gladstone Ave. An ongoing study is determining the feasibility of adding exclusive transit lanes on Catherine St.
- A total of 394 parking spaces are proposed which is lower than the city's minimum parking requirements for this location, triggering a parking variance. The development has proposed strong TDM measures and excess bike parking spaces to promote alternate modes of transportation and reduce the reliance on vehicles for this site. In the event of spillover, on-street parking is available, which would help promote slower driving speeds as a traffic calming measure.
- The developer proposes 738 bike parking spaces, the majority located indoors in a well-lit secured area near elevators in the mezzanine level. A total of 20 outdoor bike parking spaces are proposed near the commercial uses. The proposed number of bike parking exceeds the minimum requirement by over 200 bike spaces.
- An extensive list of TDM measures have been proposed for this development to support a parking variance to provide fewer spaces than the By-Law requirement, as well as support the Official Plan policies to encourage sustainable modes of transportation in the Downtown Transect. Please refer to **Section 4.5** or **Appendix F** for further details.
- The proposed development is projected to generate 'new' vehicle volumes of approximately 190 veh/h two-way total during the weekday morning and afternoon peak hours.
- Access to the underground parking lot will be provided via two accesses, where one access will be located along Catherine St and will be constructed as part of Phase 1, and the other access will be located along Arlington Ave and constructed at full buildout. Two access points to the parking garage ensure efficient access for residents and spread of vehicle traffic to the site. This prevents excess traffic infiltration on adjacent streets (increasing pedestrian and cycling conflicts at intersections) with only one access point, due to the one-way operation of the three frontage streets to the subject site.

- A one-way southbound woonerf is proposed connecting Arlington St and Catherine St. This woonerf was added to allow garbage pick-up and delivery drop off internal to the site as dictated in various policies for the City of Ottawa. The risk of short-cutting by general traffic is expected to be very low due to lower traffic volumes on Arlington St and limited route options with Catherine St being one-way westbound. Materials, landscaping, furniture and fixtures were carefully chosen to dissuade drivers as well as promote an enhanced environment for pedestrians.
- The separation distance between the woonerf access and the adjacent parking garage access off Catherine St does not adhere to the Private Approach By-law. However, considering the very low anticipated volume, predominantly off-peak, combined with the one-way operations of Catherine St, the proposed separation distance was deemed appropriate given the context.
- A loading layby has been proposed on Lyon St for commercial uses relating to Phase 2. Given that Lyon St is a one-way traffic calmed street with wide pavement width and loading operations expected to be infrequent and during off-peak hours, the layby was considered acceptable.
- A loading layby has been proposed on Catherine St for pick-up/drop-off for Building A. Given that Catherine St and Kent St are both one-way streets, there are two adjacent general-purpose lanes, and the potential uses will be infrequent and likely during off-peak periods, the layby was considered acceptable.

Future Conditions

- Other nearby developments and a 0.5% growth rate were applied to existing volumes on arterials connecting to Highway 417 to estimate background conditions. The furthest horizon, 2036 background conditions showed overall intersection performance of all study area intersections was LoS 'E' or better and with critical movement of 'E' or better which is similar to existing.
- The MMLOS road segment analysis shows that existing and future conditions on boundary streets do not meet MMLOS area targets for pedestrians due the pedestrian infrastructure and high vehicular volumes, coupled with aggressive targets due to the proximity to a school. The bike targets were only met at Lyon St and Arlington Ave due to the number of travel lanes. There is only a transit route on Catherine St. Transit goals are not met for existing conditions due to mixed traffic, but meet the target in future conditions if a segregated bus lane is built. Truck targets were all met.
- The MMLOS intersection analysis shows that truck target goals are met at all intersections. Given the higher-operating speeds and number of travel lanes, or high target rate due to proximity to a school, it is not possible to meet pedestrian target goals with the exception of Gladstone/Lyon. The bicycle target goals were also not met at most locations given the lack of cycling facilities on all approaches, the quantity of lanes required to be crossed and the higher operating speeds. Only Gladstone/Lyon met the bike targets and future Bank/Isabella. The transit TLoS was met at most intersections with the exception of Bank/Catherine, Bank/Isabella, and Catherine/Bronson due to delays greater than 30 seconds.
- Future phase 1 conditions with the addition of pedestrians, cyclists, transit users and site vehicle traffic performed at acceptable levels of service with respect to v/c and delay resulting in overall LoS 'D' or better and with critical movement of 'E' or better.
- Future full buildout conditions with the addition of pedestrians, cyclists, transit users and site vehicle traffic performed at acceptable levels of service with respect to v/c and delay resulting in overall LoS 'D' or better and with critical movement of 'E' or better.
- The section of Arlington Ave between Kent St and Bank St experiences higher levels of vehicle traffic than the city local road threshold, which is likely triggered by short-cut traffic to/from Kent St (predominantly the Hwy 417 off-ramp) and Bank St. While site generated traffic is expected to contribute to this section, it will be to a much smaller proportion compared to existing/background traffic. It is also

important to reiterate that the Arlington St corridor is already traffic calmed, including speed humps. That said, the development proposal introduces four new bulb-outs at the two proposed access points that will narrow the road from existing 10m to 7.0m, which reinforces the traffic calmed environment. The city Neighbourhood Traffic Calming Branch may consider investigating this section of Arlington Ave if future concerns are raised and validated through the established city process.

- The City of Ottawa has completed a study to convert a general-purpose travel lane to a transit priority lane on Catherine St, between Kent St and Lyon St. The original study suggested starting the transit lanes just west of Kent St, however, this study has recommended shifting the start approximately 100m further west to reduce conflict with the site proposed accesses. Synchro and SimTraffic simulation determined that shifting the start of the transit priority lane west by 100m posed limited risk of buses being blocked from entering the lane by a vehicle queue. Furthermore, the city may consider optimizing signal timing plans of the Lyon St and Kent St intersections on Catherine St to ensure vehicles are “flushed” out prior to the arrival of oncoming vehicles.
- The corridor performance along Catherine St in the 2036 horizon does not suggest there will be any notable operational implications to transit operations and travel times with the development proposal. The transit priority lane ensure buses can move efficiently through the corridor unencumbered.

Based on the foregoing findings, the proposed development located at 265 Catherine St is recommended from a transportation perspective.

Co-Prepared By:

Reviewed By:



Basel Ansari & Juan Lavin, P. Eng.
Transportation Engineers

Austin Shih, P.Eng.
Senior Transportation Engineer

DRAFT

Appendix A:

Screening Form & City Comment Reponses

City of Ottawa 2017 TIA Guidelines

Date

6-Jun-22

TIA Screening Form

Project

265 Catherine TIA

Project Number

478038-01000

Results of Screening	Yes/No
Development Satisfies the Trip Generation Trigger	Yes
Development Satisfies the Location Trigger	No
Development Satisfies the Safety Trigger	Yes

Module 1.1 - Description of Proposed Development

Municipal Address	265 Catherine St
Description of location	At Greyhound Station, borders Kent, Catherine, Lyon, Arlington
Land Use	Residential apartment building
Development Size	1335 units, two towers, townhomes, office building
Number of Accesses and Locations	TBD
Development Phasing	Assumed 1 phase
Buildout Year	Estimated 2025
Sketch Plan / Site Plan	See attached

Module 1.2 - Trip Generation Trigger

Land Use Type	Townhomes or Apartments	
Development Size	1335	Units
Trip Generation Trigger Met?	Yes	

Module 1.3 - Location Triggers

Development Proposes a new driveway to a boundary street that is designated as part of the City's Transit Priority, Rapid Transit, or Spine Bicycle Networks (See Sheet 3)	No
Development is in a Design Priority Area (DPA) or Transit-oriented Development (TOD) zone. (See Sheet 3)	No
Location Trigger Met?	No

Module 1.4 - Safety Triggers

Posted Speed Limit on any boundary road	<80	km/h
Horizontal / Vertical Curvature on a boundary street limits sight lines at a proposed driveway	No	
A proposed driveway is within the area of influence of an adjacent traffic signal or roundabout (i.e. within 300 m of intersection in rural conditions, or within 150 m of intersection in urban/ suburban conditions) or within auxiliary lanes of an intersection;	Yes	
A proposed driveway makes use of an existing median break that serves an existing site	No	
There is a documented history of traffic operations or safety concerns on the boundary streets within 500 m of the development	Yes	
The development includes a drive-thru facility	No	
Safety Trigger Met?	Yes	



REVISION RECORD

ISSUE RECORD

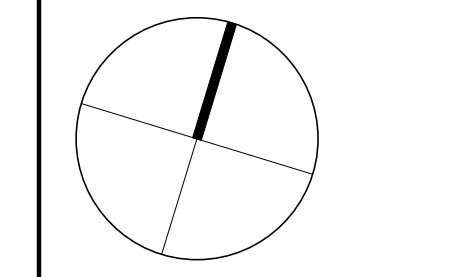

BDP.
Quadrangle

Quadrangle Architects Limited
401 King Street West, Suite 701, Toronto, ON M5V 3P5
416.598.1500 www.bdpquadrangle.com

265 Catherine Street, Ottawa
for
Brigil

21007 1:150 GZ RJL
PROJECT SCALE DRAWN/REVIEWED

Ground Floor Plan

A200.S

Note: This drawing is the property of the Architect and may not be reproduced or used without the expressed consent of the Architect. The Architect is responsible for checking the proposed work against all applicable laws, codes and regulations. It is the responsibility of the Client and other stakeholders to ensure compliance with all applicable laws, codes and regulations.

DRAFT

Appendix B:
Transit Route Maps

ROCKCLIFFE

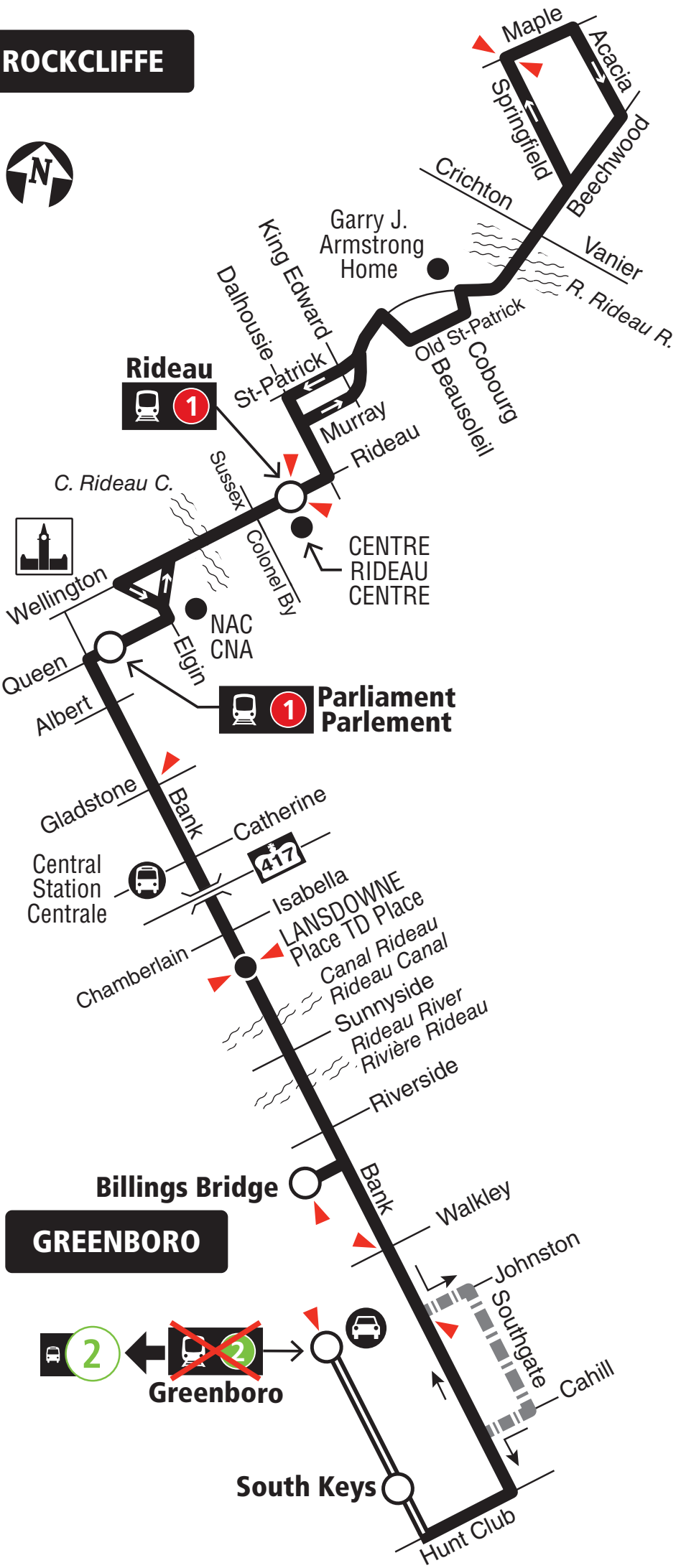

Transitway & Station



No early morning service /
Aucun service matinal



Park & Ride / Parc-o-Bus



Timepoint / Heures de passage

BRITTANY

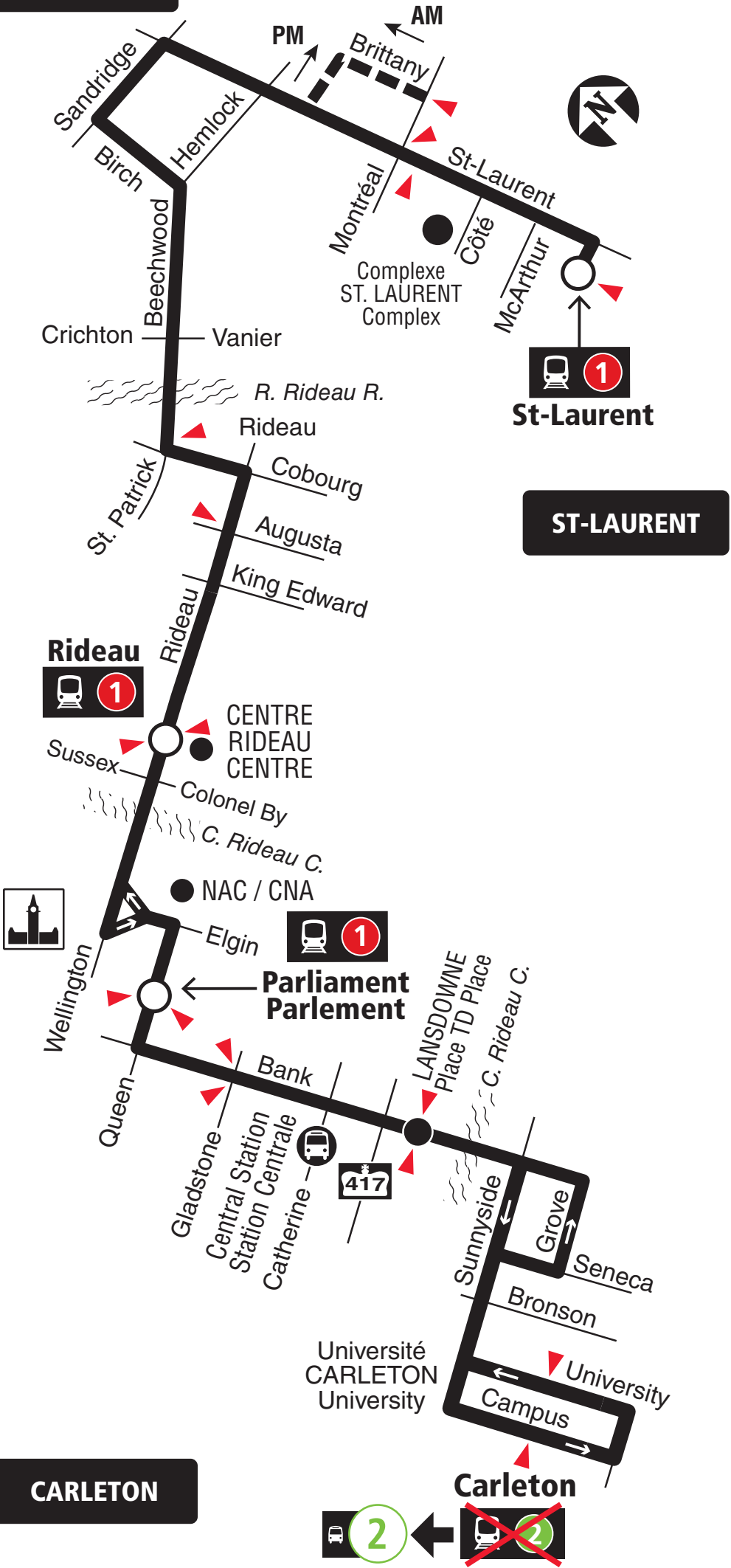

CARLETON

ST-LAURENT

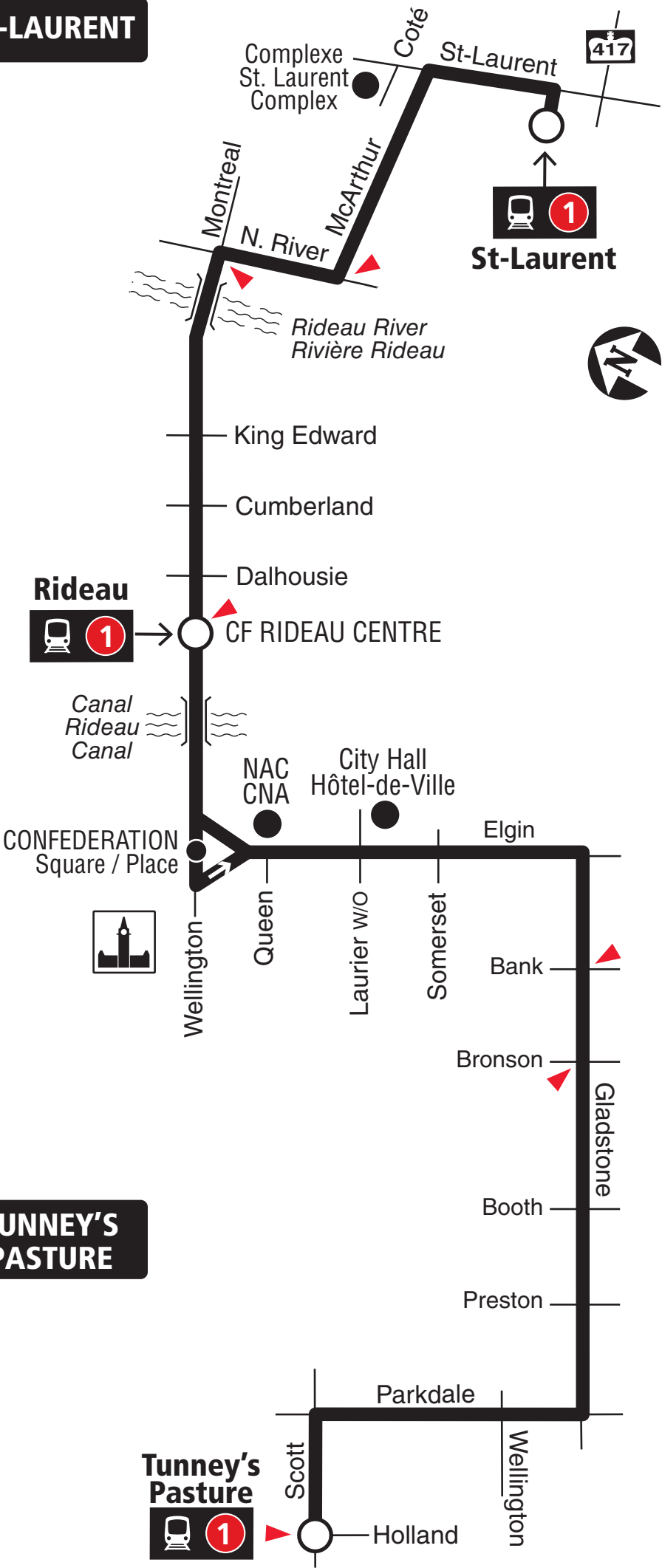

Station



Timepoint / Heures de passage



55

ELMVALE WESTGATE

Local

7 days a week / 7 jours par semaine

ELMVALE

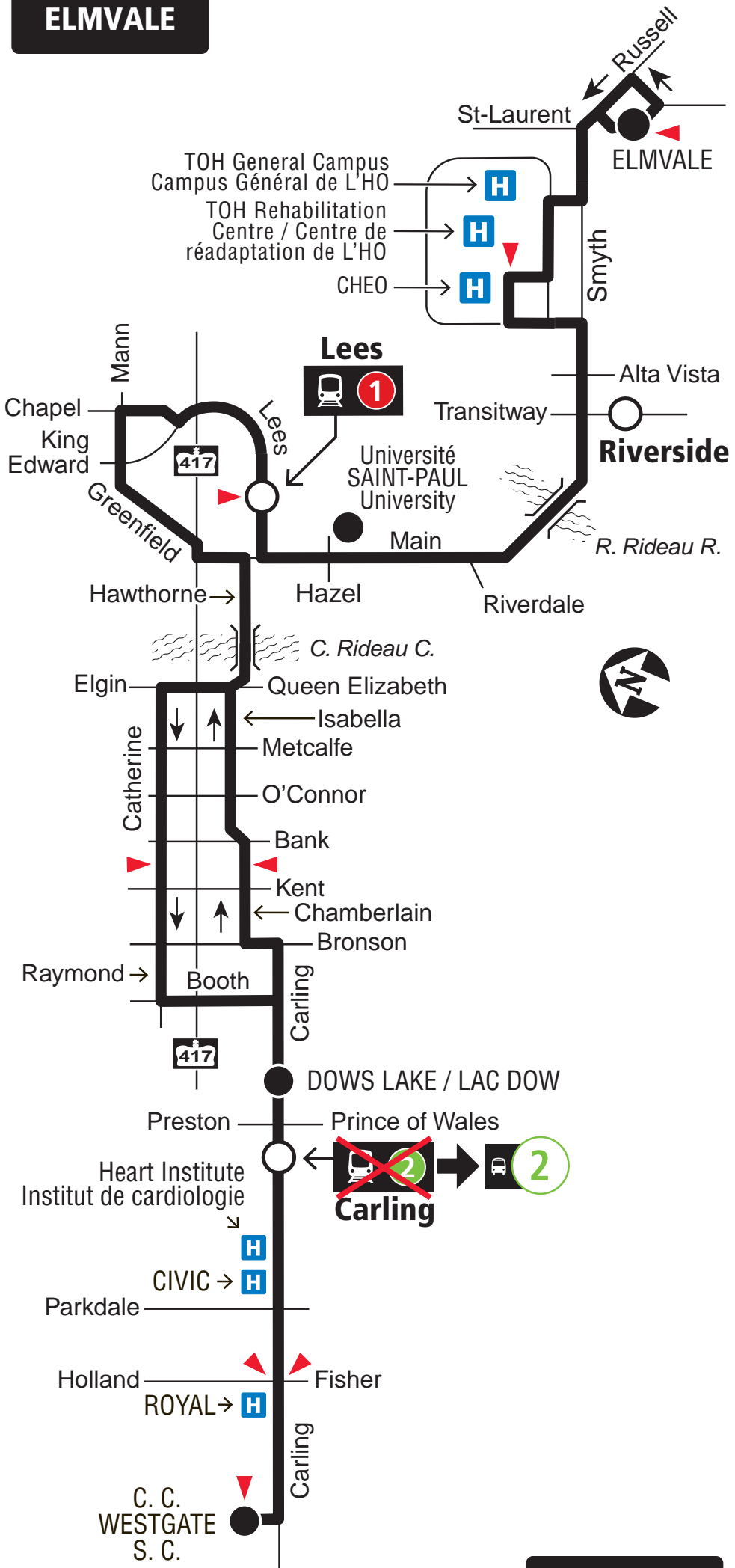

WESTGATE

- Stations
- Timepoint / Heures de passage

2021.06



Schedule / Horaire 613-560-1000

Text / Texto* 560560

plus your four digit bus stop number / plus votre numéro d'arrêt à quatre chiffres

*Standard message rates may apply / Les tarifs réguliers de messagerie texte peuvent s'appliquer

Customer Service / Service à la clientèle **613-741-4390**

Lost and Found / Objets perdus **613-563-4011**

Security / Sécurité **613-741-2478**

**Effective June 20, 2021
En vigueur 20 juin 2021**



**INFO 613-741-4390
octranspo.com**

Rideau



CF RIDEAU CENTRE

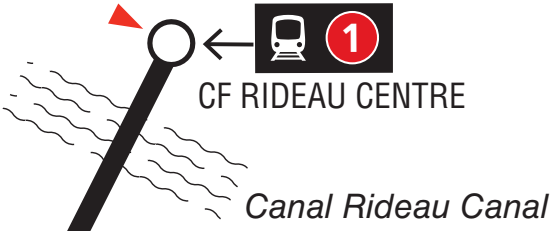

Wellington

Queen

NAC / CNA



Somerset

Elgin

Bank

Bronson

Booth

Gladstone

417

CIVIC



Parkdale

Holland

Carling

Crerar

Fisher

Shillington

Admiral

Hollington

Merivale

Kirkwood

Summerville

Laperriere

McBride

Raven

Cavan

Medford

Edgecliffe

Caldwell

CARLINGTON



Station



Timepoint / Heures de passage

DRAFT

Appendix C:

Traffic Data



Turning Movement Count

Summary Report Including Peak Hours, AADT and Expansion Factors

All Vehicles Except Bicycles



Arlington Street & Kent Street Ottawa, ON

Survey Date: Tuesday, April 11, 2023 **Start Time:** 0700 **AADT Factor:** 0.7
Weather AM: Cloudy 7° C **Survey Duration:** 8 Hrs. **Survey Hours:** 0700-1000, 1130-1330 & 1500-1800
Weather PM: Mostly Sunny 17° C **Surveyor(s):** T. Carmody

Arlington St.					Arlington St.					Kent St.					Kent St.				
Eastbound					Westbound					Northbound					Southbound				

Time Period	LT	ST	RT	UT	E/B Tot	LT	ST	RT	UT	W/B Tot	Street Total	LT	ST	RT	UT	N/B Tot	LT	ST	RT	UT	S/B Tot	Street Total	Grand Total
0700-0800	4	27	0	0	31	0	7	53	0	60	91	9	1524	60	0	1593	0	0	0	0	0	1593	1684
0800-0900	19	48	0	0	67	0	11	93	0	104	171	15	1618	121	0	1754	0	0	0	0	0	1754	1925
0900-1000	7	41	0	0	48	0	9	49	0	58	106	18	1225	103	0	1346	0	0	0	0	0	1346	1452
1130-1230	5	32	0	0	37	0	3	52	0	55	92	19	775	117	0	911	0	0	0	0	0	911	1003
1230-1330	7	31	0	0	38	0	14	40	0	54	92	17	711	114	0	842	0	0	0	0	0	842	934
1500-1600	18	51	0	0	69	0	21	53	0	74	143	17	914	84	0	1015	0	0	0	0	0	1015	1158
1600-1700	7	53	0	0	60	0	14	44	0	58	118	25	923	74	0	1022	0	0	0	0	0	1022	1140
1700-1800	12	61	0	0	73	0	18	63	1	82	155	22	1021	93	0	1136	0	0	0	0	0	1136	1291
Totals	79	344	0	0	423	0	97	447	1	545	968	142	8711	766	0	9619	0	0	0	0	0	9619	10587

Equivalent 12 & 24-hour Vehicle Volumes Including the Annual Average Daily Traffic (AADT) Factor
Applicable to the Day and Month of the Turning Movement Count

Expansion factors are applied exclusively to standard weekday 8-hour turning movement counts conducted during the hours of 0700h - 1000h, 1130h - 1330h and 1500h - 1800h

Equivalent 12-hour vehicle volumes. These volumes are calculated by multiplying the 8-hour totals by the 8 → 12 expansion factor of 1.39

Equ. 12 Hr	110	478	0	0	588	0	135	621	1	758	1346	197	12108	1065	0	13370	0	0	0	0	0	13370	14716
------------	-----	-----	---	---	-----	---	-----	-----	---	-----	------	-----	-------	------	---	-------	---	---	---	---	---	-------	-------

Average daily 12-hour vehicle volumes. These volumes are calculated by multiplying the equivalent 12-hour totals by the AADT factor of: 0.7

AADT 12-hr	77	335	0	0	412	0	94	435	1	530	942	138	8476	745	0	9359	0	0	0	0	0	9359	10301
------------	----	-----	---	---	-----	---	----	-----	---	-----	-----	-----	------	-----	---	------	---	---	---	---	---	------	-------

24-Hour AADT. These volumes are calculated by multiplying the average daily 12-hour vehicle volumes by the 12 → 24 expansion factor of 1.31

AADT 24 Hr	101	438	0	0	539	0	124	570	1	695	1234	181	11103	976	0	12261	0	0	0	0	0	12261	13495
------------	-----	-----	---	---	-----	---	-----	-----	---	-----	------	-----	-------	-----	---	-------	---	---	---	---	---	-------	-------

AADT and expansion factors provided by the City of Ottawa

AM Peak Hour Factor → 0.95											Highest Hourly Vehicle Volume Between 0700h & 1000h												
AM Peak Hr	LT	ST	RT	UT	Total	LT	ST	RT	UT	Total	Str. Tot.	LT	ST	RT	UT	Total	LT	ST	RT	UT	Total	Str. Tot.	Gr. Tot.
0800-0900	19	48	0	0	67	0	11	93	0	104	171	15	1618	121	0	1754	0	0	0	0	0	1754	1925
OFF Peak Hour Factor → 0.90											Highest Hourly Vehicle Volume Between 1130h & 1330h												
OFF Peak Hr	LT	ST	RT	UT	Total	LT	ST	RT	UT	Total	Str. Tot.	LT	ST	RT	UT	Total	LT	ST	RT	UT	Total	Str. Tot.	Gr. Tot.
1130-1230	5	32	0	0	37	0	3	52	0	55	92	19	775	117	0	911	0	0	0	0	0	911	1003
PM Peak Hour Factor → 0.89											Highest Hourly Vehicle Volume Between 1500h & 1800h												
PM Peak Hr	LT	ST	RT	UT	Total	LT	ST	RT	UT	Total	Str. Tot.	LT	ST	RT	UT	Total	LT	ST	RT	UT	Total	Str. Tot.	Gr. Tot.
1700-1800	12	61	0	0	73	0	18	63	1	82	155	22	1021	93	0	1136	0	0	0	0	0	1136	1291

Comments:

OC Transpo and Para Transpo buses, private buses and school buses comprise 20.00% of the heavy vehicle traffic. The bicycle totals include 7 varieties of electric personal transportation types. Many vehicles on Kent Street turn left or right to Arlington Street from the centre lane.

Notes:

1. Includes all vehicle types except bicycles, electric bicycles, and electric scooters.
2. When expansion and AADT factors are applied, the results will differ slightly due to rounding.



Turning Movement Count Summary, AM and PM Peak Hour Flow Diagrams All Vehicles Except Bicycles



Arlington Street & Kent Street Ottawa, ON

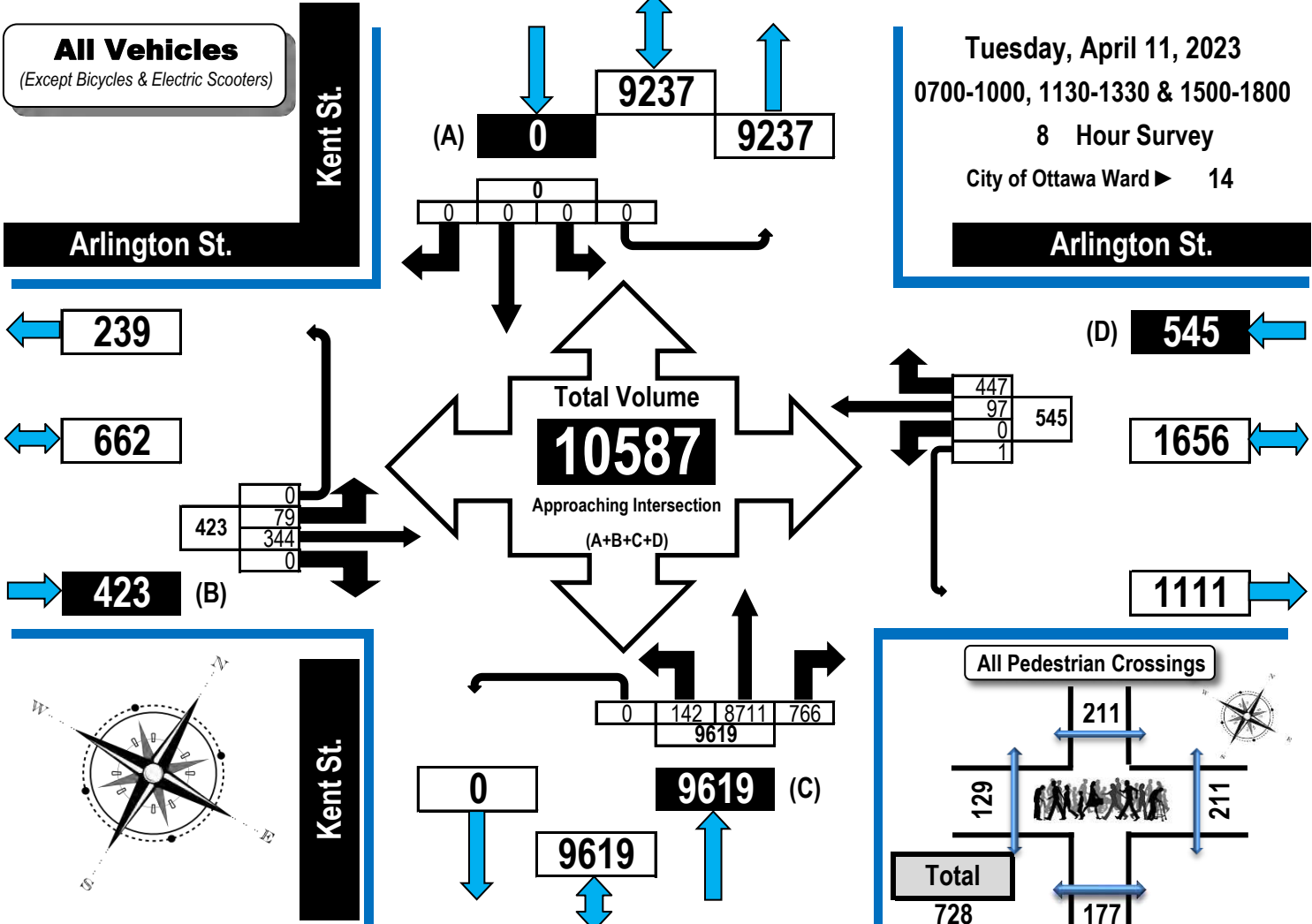

AM Peak Hour Flow Diagram PM Peak Hour Flow Diagram

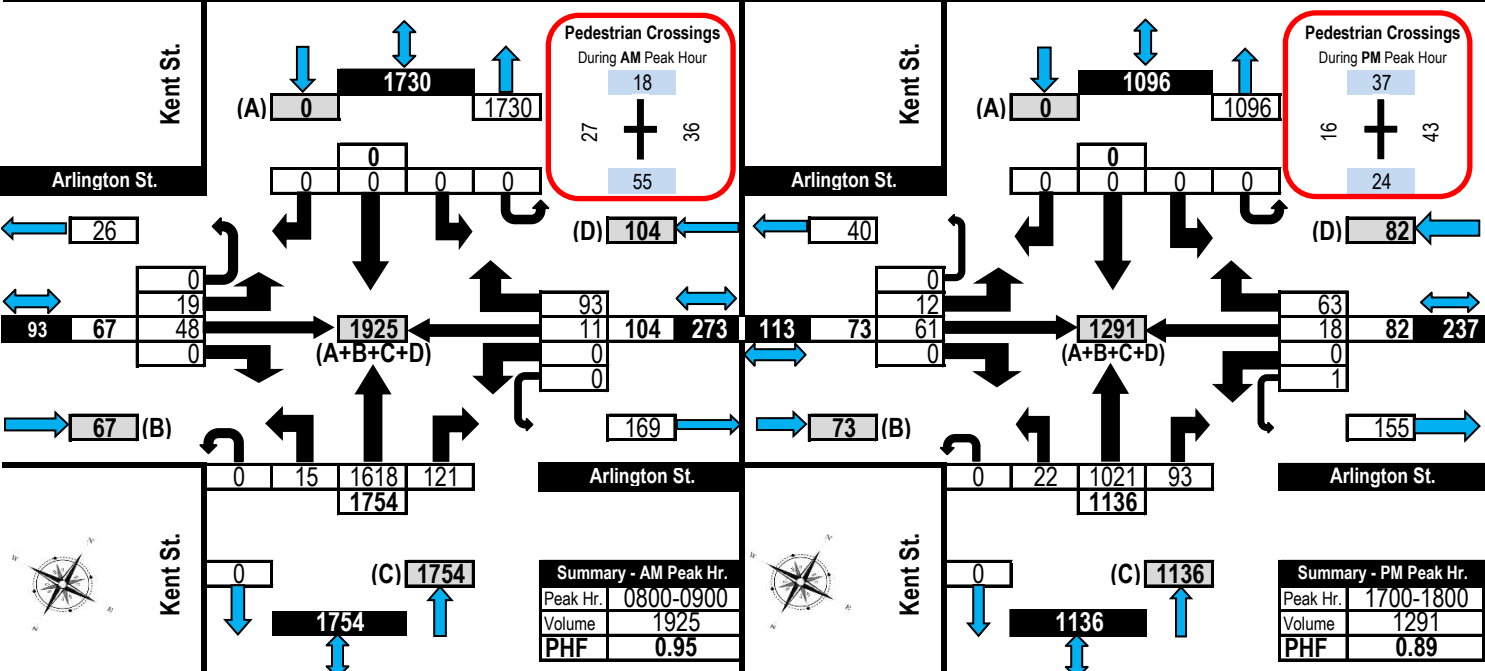



Turning Movement Count

Summary, OFF and EVENING Peak Hour

Flow Diagrams

All Vehicles Except Bicycles



Arlington Street & Kent Street

Ottawa, ON

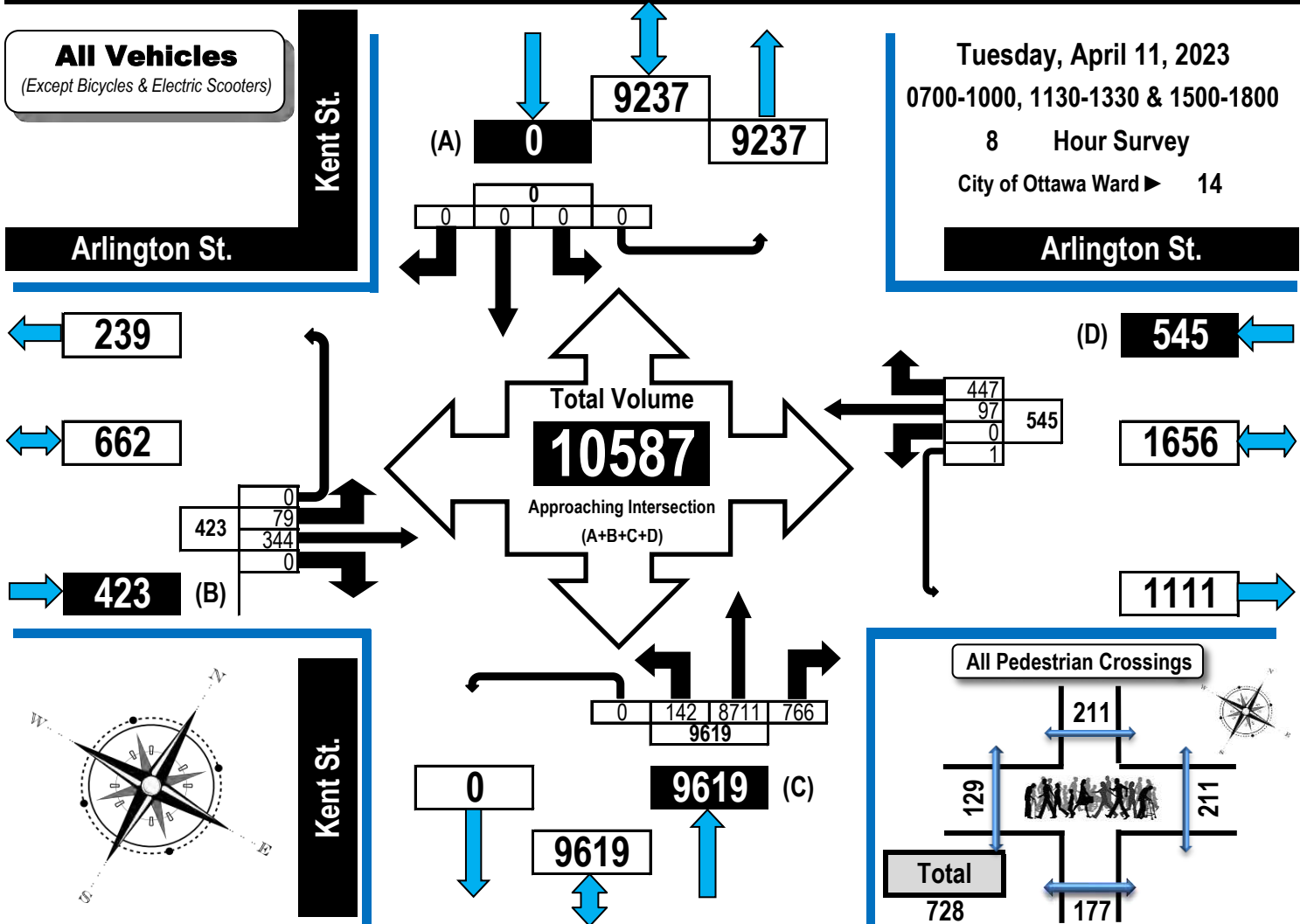

Off Peak Hour Flow Diagram

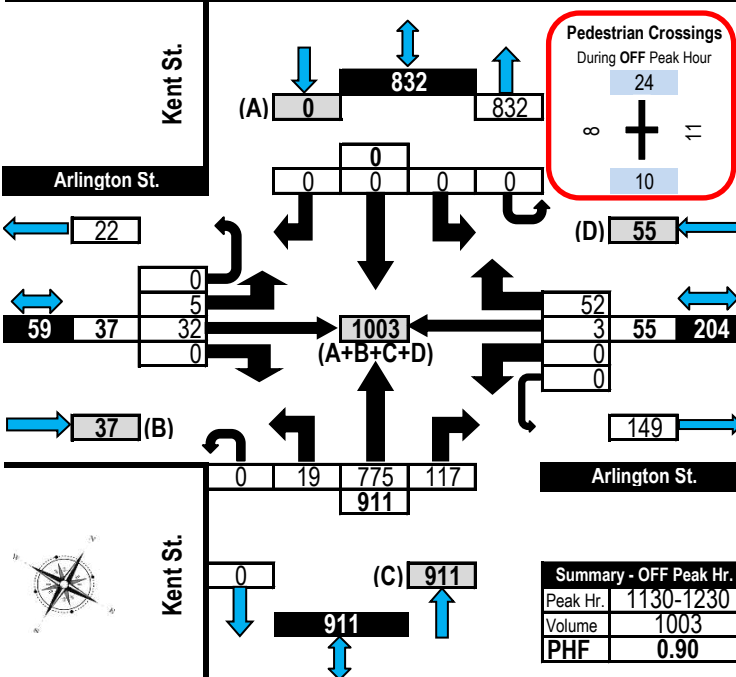

Evening Peak Hour Flow Diagram

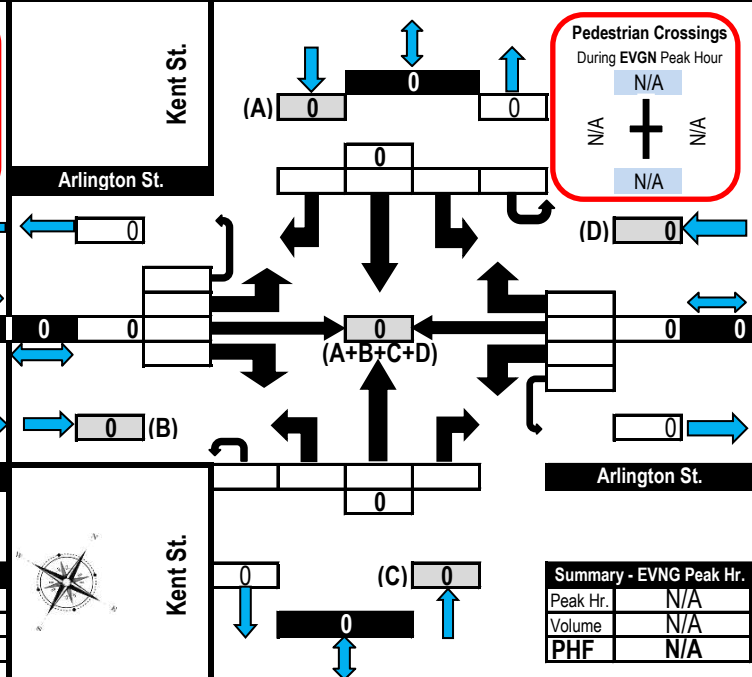



Turning Movement Count Heavy Vehicle Summary (FHWA Class 4-13) Flow Diagram



Arlington Street & Kent Street

Ottawa, ON

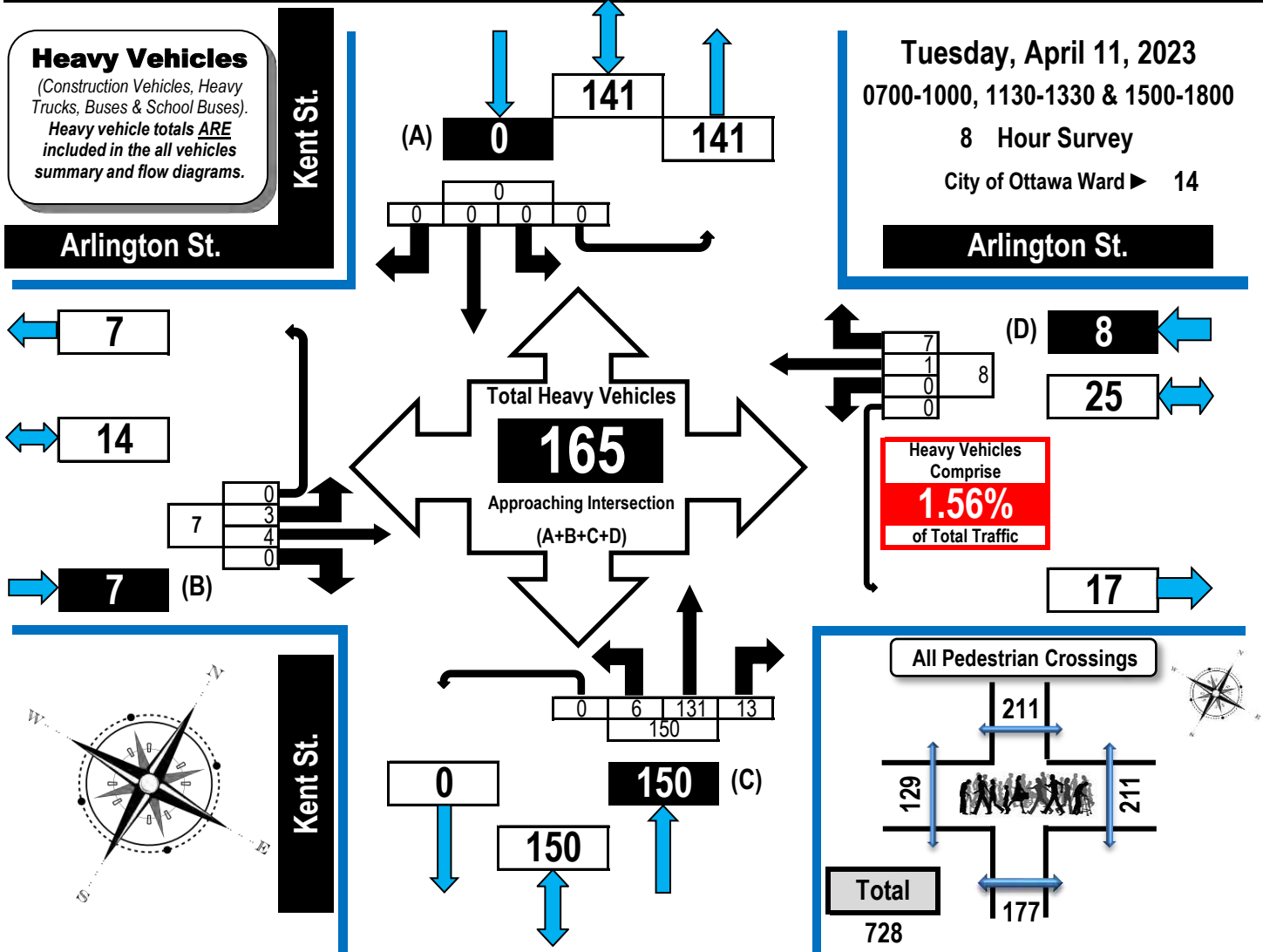

Arlington St. Eastbound					Arlington St. Westbound					Kent St. Northbound					Kent St. Southbound				
-------------------------	--	--	--	--	-------------------------	--	--	--	--	---------------------	--	--	--	--	---------------------	--	--	--	--

Time Period	LT	ST	RT	UT	EB Tot	LT	ST	RT	UT	WB Tot	LT	ST	RT	UT	NB Tot	LT	ST	RT	UT	SB Tot	GR Tot
0700-0800	0	0	0	0	0	0	1	2	0	3	1	17	1	0	19	0	0	0	0	0	22
0800-0900	0	2	0	0	2	0	0	1	0	1	1	27	3	0	31	0	0	0	0	0	34
0900-1000	3	1	0	0	4	0	0	2	0	2	2	29	2	0	33	0	0	0	0	0	39
1130-1230	0	0	0	0	0	0	0	2	0	2	0	12	4	0	16	0	0	0	0	0	18
1230-1330	0	0	0	0	0	0	0	0	0	0	0	20	0	0	20	0	0	0	0	0	20
1500-1600	0	0	0	0	0	0	0	0	0	0	0	9	0	0	9	0	0	0	0	0	9
1600-1700	0	1	0	0	1	0	0	0	0	0	2	10	2	0	14	0	0	0	0	0	15
1700-1800	0	0	0	0	0	0	0	0	0	0	0	7	1	0	8	0	0	0	0	0	8
Totals	3	4	0	0	7	0	1	7	0	8	6	131	13	0	150	0	0	0	0	0	165

Comments:

OC Transpo and Para Transpo buses, private buses and school buses comprise 20.00% of the heavy vehicle traffic. The bicycle totals include 7 varieties of electric personal transportation types. Many vehicles on Kent Street turn left or right to Arlington Street from the centre lane.



Turning Movement Count

All Buses Summary (FHWA Class 4 ONLY)

Flow Diagram



Arlington Street & Kent Street Ottawa, ON

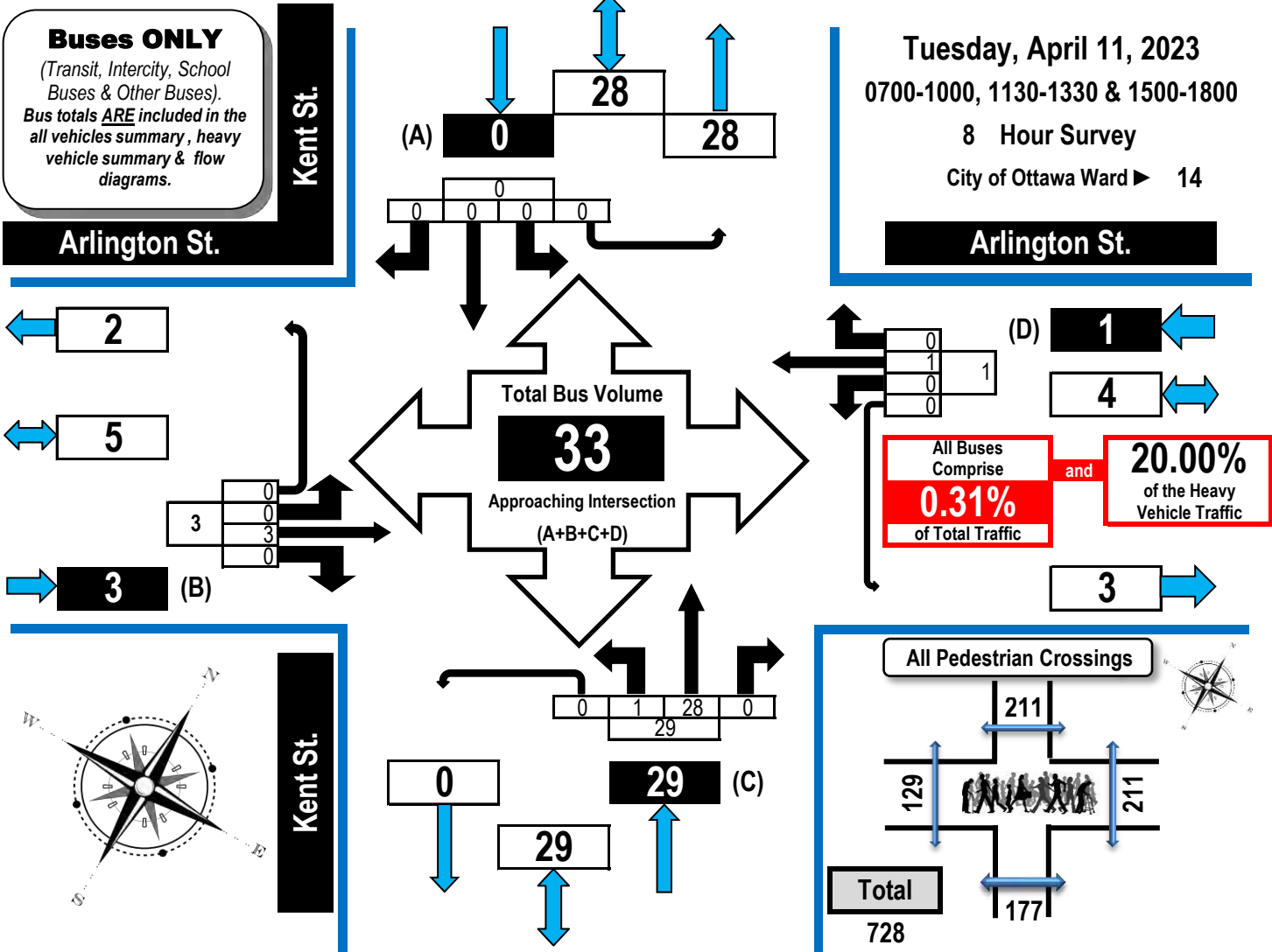

	Arlington St. Eastbound					Arlington St. Westbound					Kent St. Northbound					Kent St. Southbound					
Time Period	LT	ST	RT	UT	EB Tot	LT	ST	RT	UT	WB Tot	LT	ST	RT	UT	NB Tot	LT	ST	RT	UT	SB Tot	GR Tot

Time Period	LT	ST	RT	UT	EB Tot	LT	ST	RT	UT	WB Tot	LT	ST	RT	UT	NB Tot	LT	ST	RT	UT	SB Tot	GR Tot
0700-0800	0	0	0	0	0	0	1	0	0	1	0	2	0	0	2	0	0	0	0	0	3
0800-0900	0	1	0	0	1	0	0	0	0	0	0	2	0	0	2	0	0	0	0	0	3
0900-1000	0	1	0	0	1	0	0	0	0	0	0	4	0	0	4	0	0	0	0	0	5
1130-1230	0	0	0	0	0	0	0	0	0	0	0	2	0	0	2	0	0	0	0	0	2
1230-1330	0	0	0	0	0	0	0	0	0	0	0	2	0	0	2	0	0	0	0	0	2
1500-1600	0	0	0	0	0	0	0	0	0	0	0	3	0	0	3	0	0	0	0	0	3
1600-1700	0	1	0	0	1	0	0	0	0	0	1	8	0	0	9	0	0	0	0	0	10
1700-1800	0	0	0	0	0	0	0	0	0	0	0	5	0	0	5	0	0	0	0	0	5
Totals	0	3	0	0	3	0	1	0	0	1	1	28	0	0	29	0	0	0	0	0	33

Comments:
 OC Transpo and Para Transpo buses, private buses and school buses comprise 20.00% of the heavy vehicle traffic. The bicycle totals include 7 varieties of electric personal transportation types. Many vehicles on Kent Street turn left or right to Arlington Street from the centre lane.



Turning Movement Count Bicycle Summary Flow Diagram



Arlington Street & Kent Street Ottawa, ON

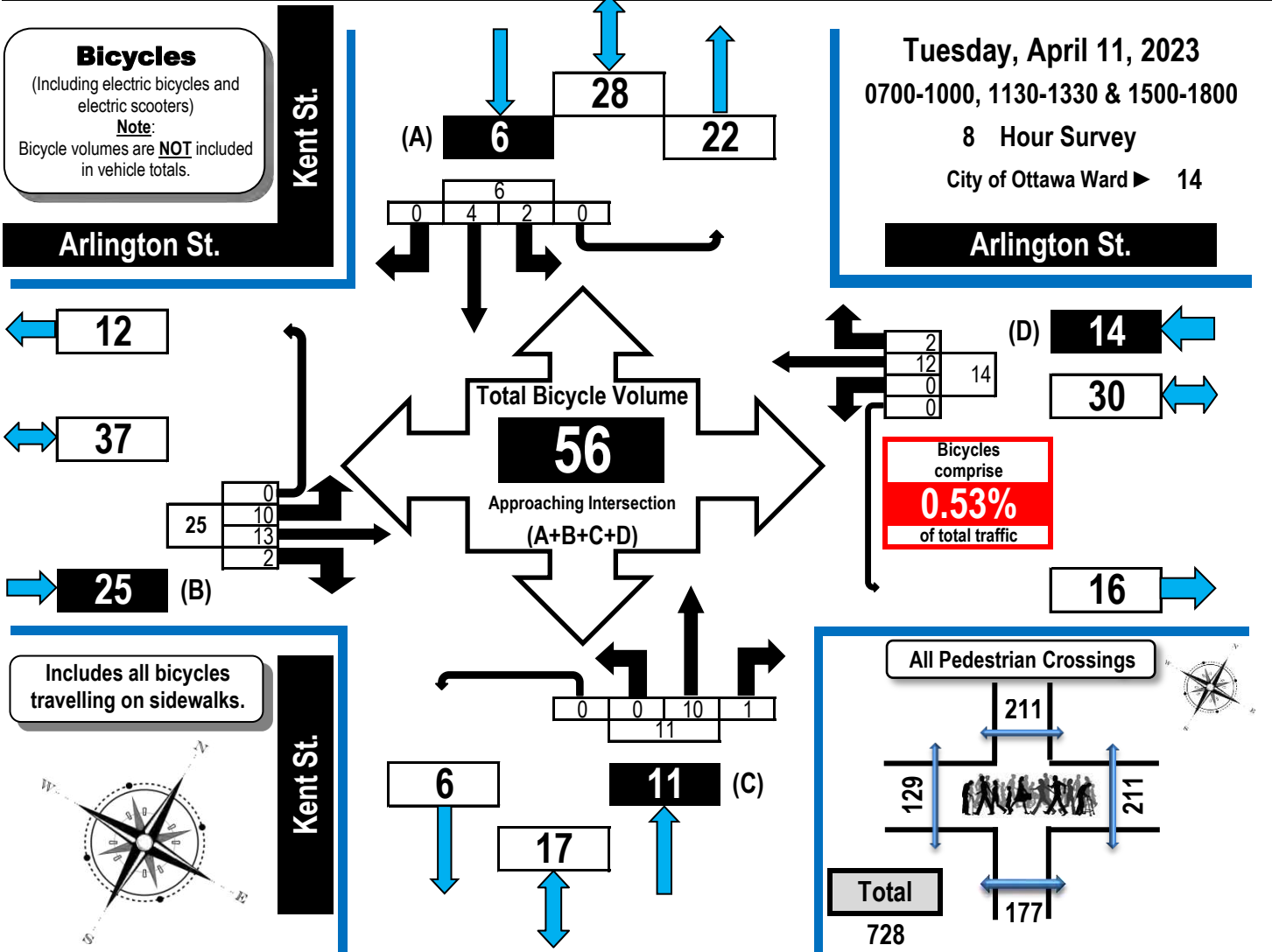

Time Period	Arlington St. Eastbound					Arlington St. Westbound					Kent St. Northbound					Kent St. Southbound					GR Tot
	LT	ST	RT	UT	EB Tot	LT	ST	RT	UT	WB Tot	LT	ST	RT	UT	NB Tot	LT	ST	RT	UT	SB Tot	
0700-0800	1	1	0	0	2	0	0	0	0	0	0	1	0	0	1	0	0	0	0	0	3
0800-0900	3	0	0	0	3	0	1	0	0	1	0	1	0	0	1	0	4	0	0	4	9
0900-1000	1	2	0	0	3	0	0	1	0	1	0	0	1	0	1	0	0	0	0	0	5
1130-1230	1	4	0	0	5	0	0	0	0	0	0	0	0	0	0	0	0	0	0	0	5
1230-1330	1	2	0	0	3	0	1	1	0	2	0	1	0	0	1	1	0	0	0	1	7
1500-1600	0	1	0	0	1	0	1	0	0	1	0	3	0	0	3	0	0	0	0	0	5
1600-1700	1	0	1	0	2	0	2	0	0	2	0	3	0	0	3	0	0	0	0	0	7
1700-1800	2	3	1	0	6	0	7	0	0	7	0	1	0	0	1	1	0	0	0	1	15
Totals	10	13	2	0	25	0	12	2	0	14	0	10	1	0	11	2	4	0	0	6	56

Comments:
OC Transpo and Para Transpo buses, private buses and school buses comprise 20.00% of the heavy vehicle traffic. The bicycle totals include 7 varieties of electric personal transportation types. Many vehicles on Kent Street turn left or right to Arlington Street from the centre lane.



Turning Movement Count Pedestrian Crossings Summary and Flow Diagram



Arlington Street & Kent Street **Ottawa, ON**

**Pedestrian
Crossings**

Tuesday, April 11, 2023
0700-1000, 1130-1330 & 1500-1800
8 Hour Survey
City of Ottawa Ward ► **14**

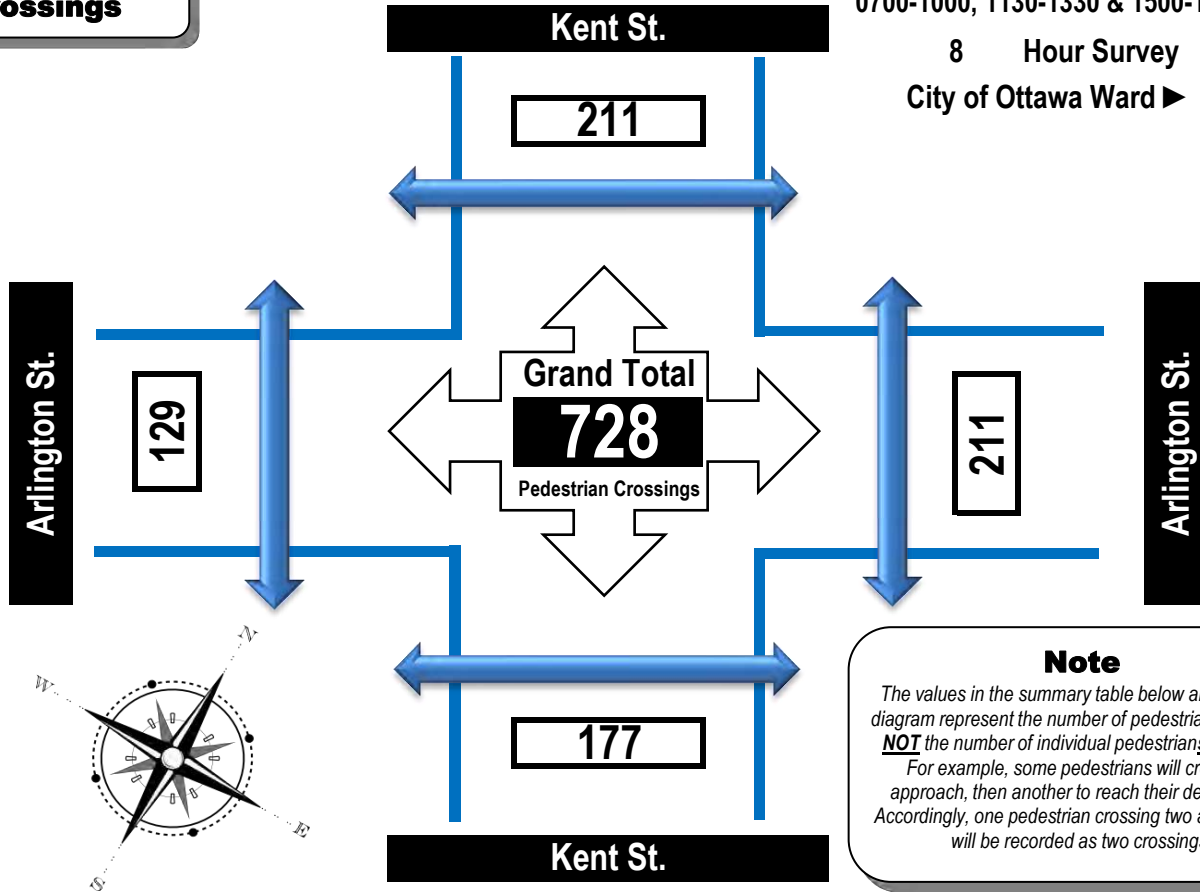

Note

*The values in the summary table below and the flow diagram represent the number of pedestrian crossings **NOT** the number of individual pedestrians crossing. For example, some pedestrians will cross one approach, then another to reach their destination. Accordingly, one pedestrian crossing two approaches will be recorded as two crossings.*

Time Period	West Side Crossing Arlington St.	East Side Crossing Arlington St.	Street Total	South Side Crossing Kent St.	North Side Crossing Kent St.	Street Total	Grand Total
0700-0800	10	16	26	4	21	25	51
0800-0900	27	36	63	55	18	73	136
0900-1000	15	18	33	12	20	32	65
1130-1230	8	11	19	10	24	34	53
1230-1330	9	18	27	3	23	26	53
1500-1600	17	42	59	46	44	90	149
1600-1700	27	27	54	23	24	47	101
1700-1800	16	43	59	24	37	61	120
Totals	129	211	340	177	211	388	728

Comments:

OC Transpo and Para Transpo buses, private buses and school buses comprise 20.00% of the heavy vehicle traffic. The bicycle totals include 7 varieties of electric personal transportation types. Many vehicles on Kent Street turn left or right to Arlington Street from the centre lane.

Diagrams, Maps and Photographs

Arlington Street & Lyon Street

Tuesday, April 11, 2023

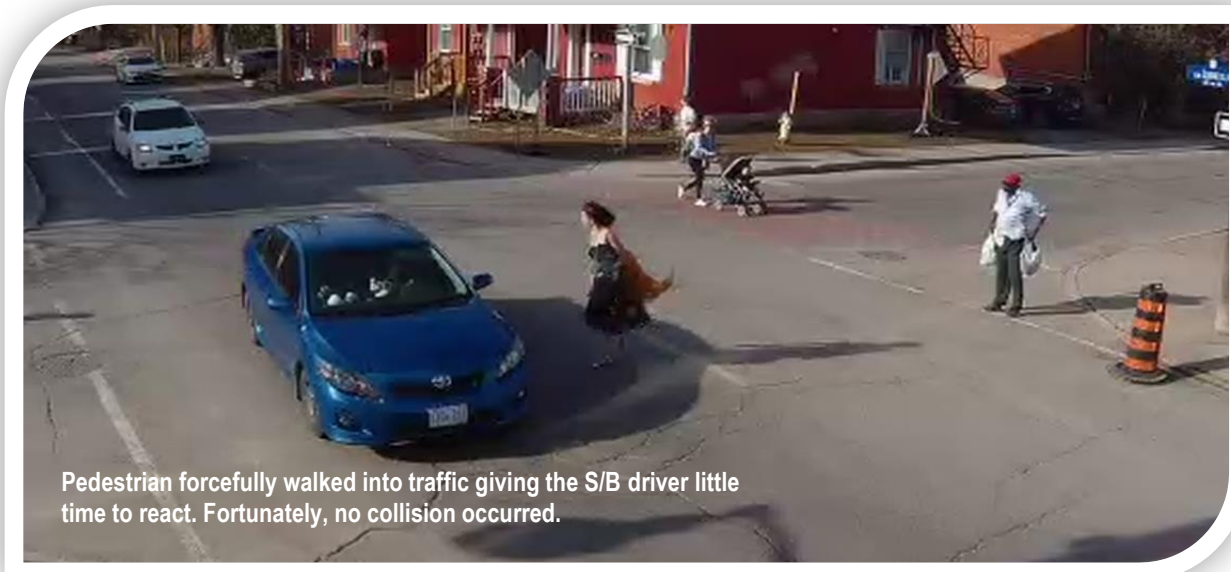



Turning Movement Count

Summary Report Including Peak Hours, AADT and Expansion Factors

All Vehicles Except Bicycles



Arlington Street & Lyon Street Ottawa, ON

Survey Date: Tuesday, April 11, 2023 **Start Time:** 0700 **AADT Factor:** 0.7
Weather AM: Cloudy 7° C **Survey Duration:** 8 Hrs. **Survey Hours:** 0700-1000, 1130-1330 & 1500-1800
Weather PM: Mostly Sunny 17° C **Surveyor(s):** J. Mousseau

Time Period	Arlington St. Eastbound					Arlington St. Westbound					Kent St. Northbound					Kent St. Southbound					Street Total	Grand Total	
	LT	ST	RT	UT	E/B Tot	LT	ST	RT	UT	W/B Tot	LT	ST	RT	UT	N/B Tot	LT	ST	RT	UT	S/B Tot			
0700-0800	0	10	0	1	11	5	7	0	0	12	23	0	0	0	0	0	19	113	2	0	134	134	157
0800-0900	0	19	0	0	19	11	13	0	0	24	43	0	0	0	0	0	44	166	7	0	217	217	260
0900-1000	0	11	4	0	15	7	16	0	0	23	38	0	0	0	0	0	39	161	9	0	209	209	247
1130-1230	0	10	3	0	13	7	13	0	0	20	33	0	0	0	0	0	27	150	13	0	190	190	223
1230-1330	0	5	2	0	7	8	20	0	0	28	35	0	0	0	0	0	35	160	9	0	204	204	239
1500-1600	0	21	4	0	25	12	25	0	1	38	63	0	0	0	0	0	39	344	6	0	389	389	452
1600-1700	0	19	1	0	20	7	33	0	0	40	60	0	0	0	0	0	46	336	12	0	394	394	454
1700-1800	0	17	2	0	19	13	23	0	2	38	57	0	0	0	0	0	42	278	18	0	338	338	395
Totals	0	112	16	1	129	70	150	0	3	223	352	0	0	0	0	0	291	1708	76	0	2075	2075	2427

Equivalent 12 & 24-hour Vehicle Volumes Including the Annual Average Daily Traffic (AADT) Factor
Applicable to the Day and Month of the Turning Movement Count

Expansion factors are applied exclusively to standard weekday 8-hour turning movement counts conducted during the hours of 0700h - 1000h, 1130h - 1330h and 1500h - 1800h

Equivalent 12-hour vehicle volumes. These volumes are calculated by multiplying the 8-hour totals by the 8 → 12 expansion factor of 1.39																							
Equ. 12 Hr	LT	ST	RT	UT	E/B Tot	LT	ST	RT	UT	W/B Tot	Street Total	LT	ST	RT	UT	N/B Tot	LT	ST	RT	UT	S/B Tot	Street Total	Grand Total
0	156	22	1	179	97	209	0	4	310	489	0	0	0	0	0	0	404	2374	106	0	2884	2884	3374

Average daily 12-hour vehicle volumes. These volumes are calculated by multiplying the equivalent 12-hour totals by the AADT factor of: 0.7																							
AADT 12-hr	LT	ST	RT	UT	E/B Tot	LT	ST	RT	UT	W/B Tot	Street Total	LT	ST	RT	UT	N/B Tot	LT	ST	RT	UT	S/B Tot	Street Total	Grand Total
0	109	16	1	126	68	146	0	3	217	342	0	0	0	0	0	0	283	1662	74	0	2019	2019	2361

24-Hour AADT. These volumes are calculated by multiplying the average daily 12-hour vehicle volumes by the 12 → 24 expansion factor of 1.31																							
AADT 24 Hr	LT	ST	RT	UT	E/B Tot	LT	ST	RT	UT	W/B Tot	Street Total	LT	ST	RT	UT	N/B Tot	LT	ST	RT	UT	S/B Tot	Street Total	Grand Total
0	143	20	1	164	89	191	0	4	284	449	0	0	0	0	0	0	371	2177	97	0	2645	2645	3094

AADT and expansion factors provided by the City of Ottawa

AM Peak Hour Factor → 0.89											Highest Hourly Vehicle Volume Between 0700h & 1000h												
AM Peak Hr	LT	ST	RT	UT	Total	LT	ST	RT	UT	Total	Str. Tot.	LT	ST	RT	UT	Total	LT	ST	RT	UT	Total	Str. Tot.	Gr. Tot.
0815-0915	0	18	0	0	18	11	12	0	0	23	41	0	0	0	0	0	44	174	9	0	227	227	268
OFF Peak Hour Factor → 0.95											Highest Hourly Vehicle Volume Between 1130h & 1330h												
OFF Peak Hr	LT	ST	RT	UT	Total	LT	ST	RT	UT	Total	Str. Tot.	LT	ST	RT	UT	Total	LT	ST	RT	UT	Total	Str. Tot.	Gr. Tot.
1230-1330	0	5	2	0	7	8	20	0	0	28	35	0	0	0	0	0	35	160	9	0	204	204	239
PM Peak Hour Factor → 0.93											Highest Hourly Vehicle Volume Between 1500h & 1800h												
PM Peak Hr	LT	ST	RT	UT	Total	LT	ST	RT	UT	Total	Str. Tot.	LT	ST	RT	UT	Total	LT	ST	RT	UT	Total	Str. Tot.	Gr. Tot.
1545-1645	0	19	2	0	21	8	37	0	0	45	66	0	0	0	0	0	43	364	13	0	420	420	486

Comments:

Transit buses and school buses comprise 30.23% of the heavy vehicle traffic. Lyon Street ramp to Highway 417 westbound closed due to construction. Southbound traffic south of Arlington Street is open to right turns to Catherine Street. Many S/B left turning vehicles to Arlington Street E/B do so from the west through lane.

Notes:

1. Includes all vehicle types except bicycles, electric bicycles, and electric scooters.
2. When expansion and AADT factors are applied, the results will differ slightly due to rounding.



Turning Movement Count Summary, AM and PM Peak Hour Flow Diagrams All Vehicles Except Bicycles



Arlington Street & Lyon Street Ottawa, ON

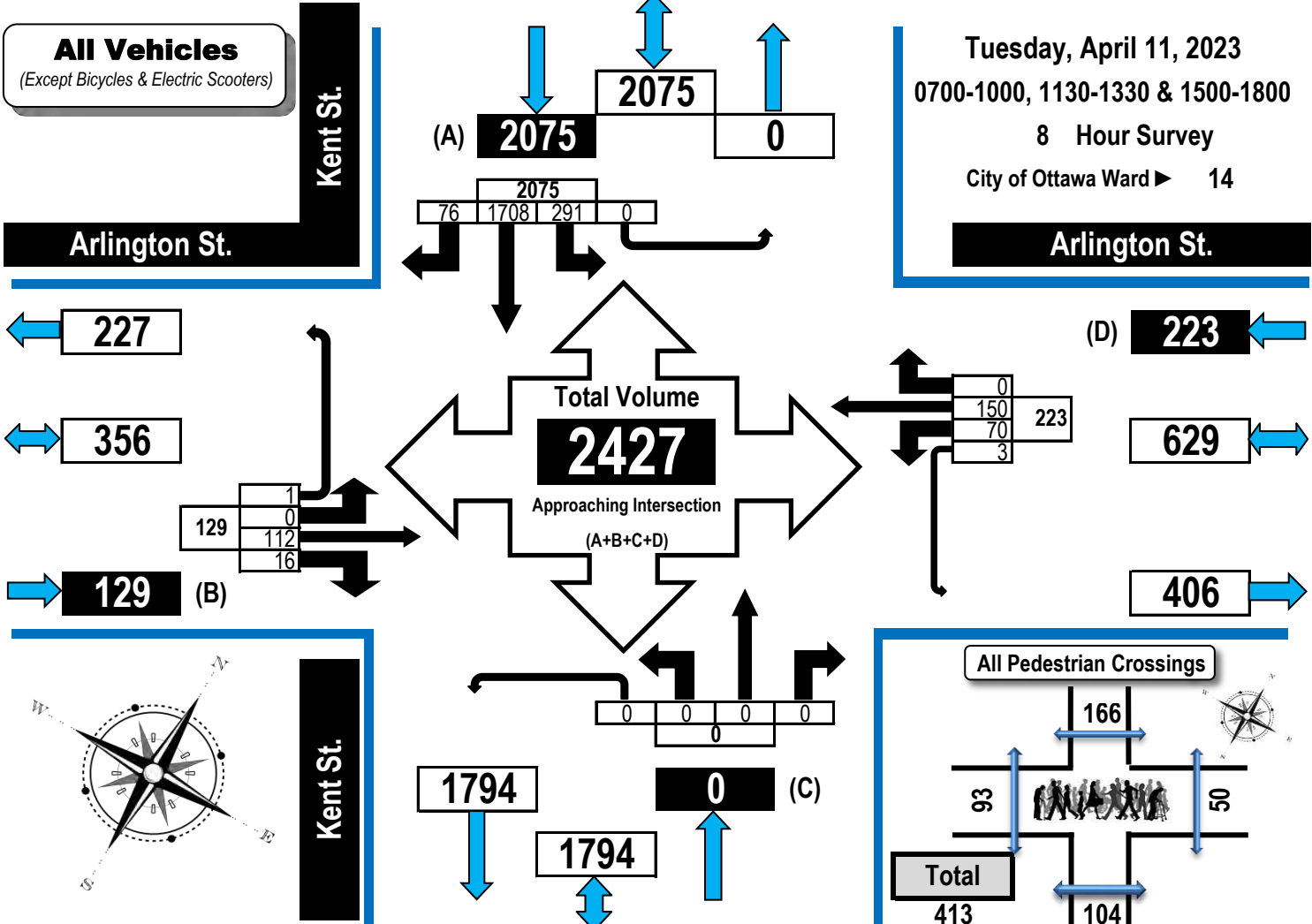

AM Peak Hour Flow Diagram PM Peak Hour Flow Diagram

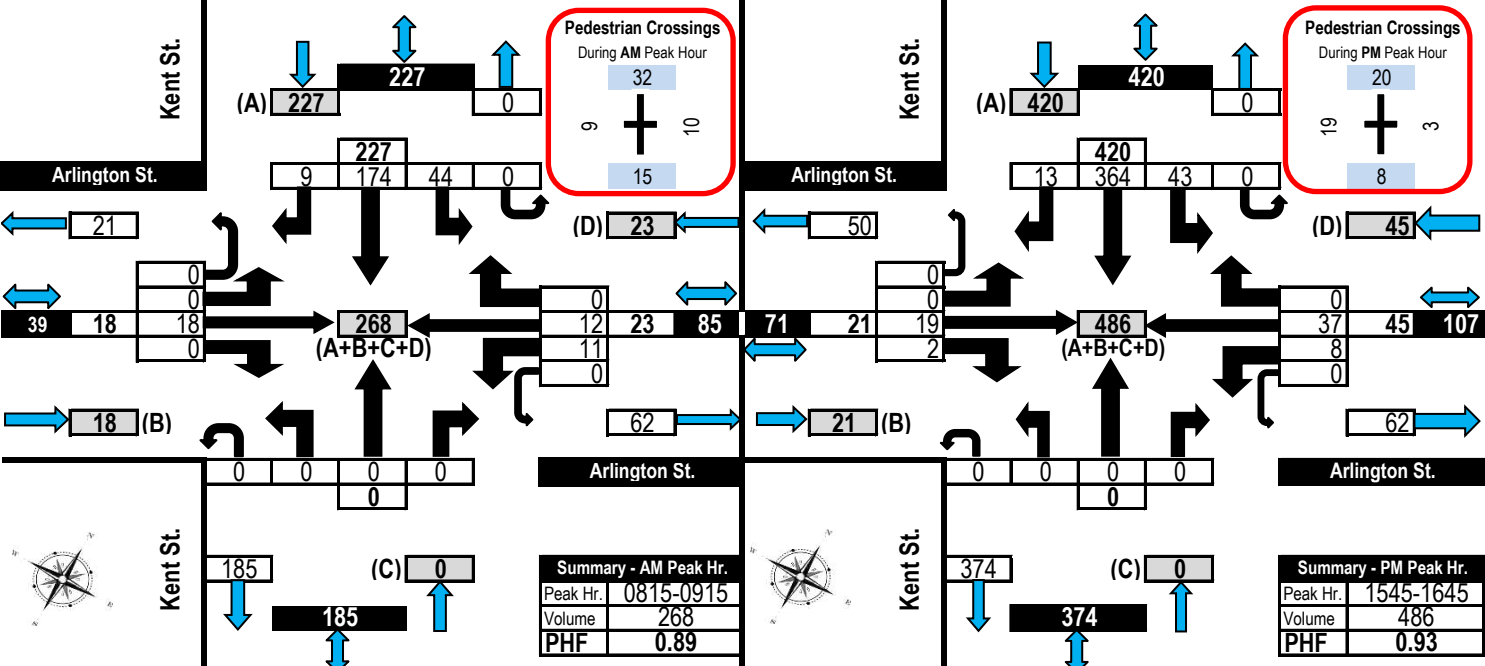



Turning Movement Count

Summary, OFF and EVENING Peak Hour

Flow Diagrams

All Vehicles Except Bicycles



Arlington Street & Lyon Street

Ottawa, ON

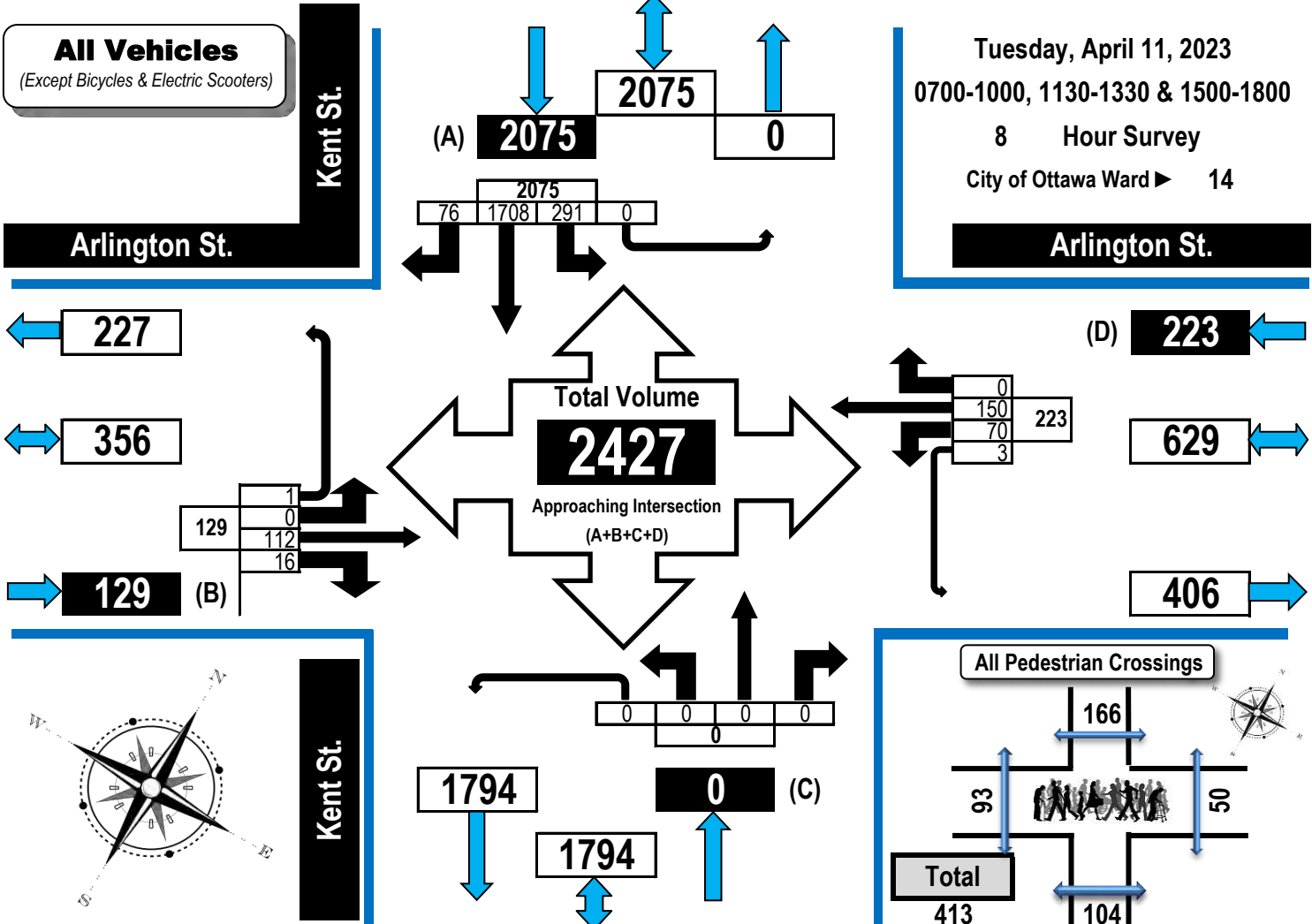

Off Peak Hour Flow Diagram

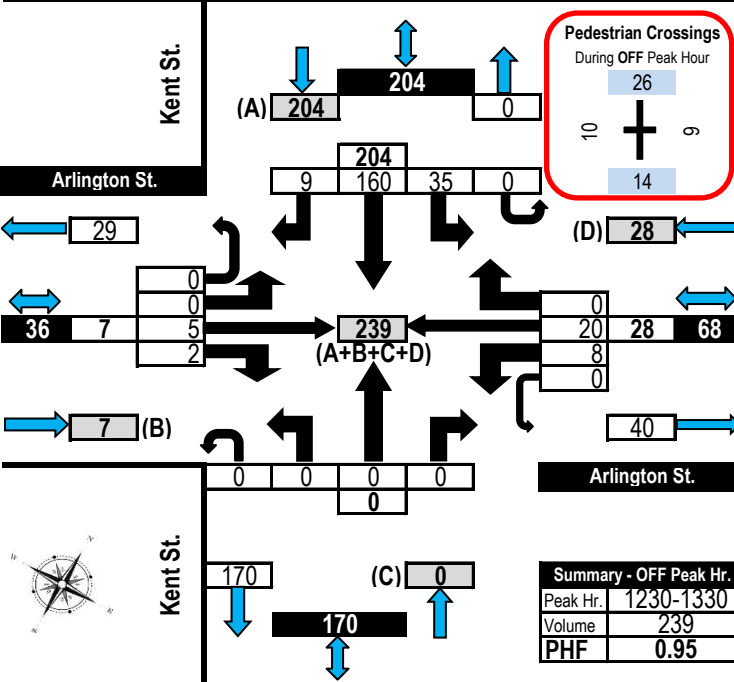

Evening Peak Hour Flow Diagram

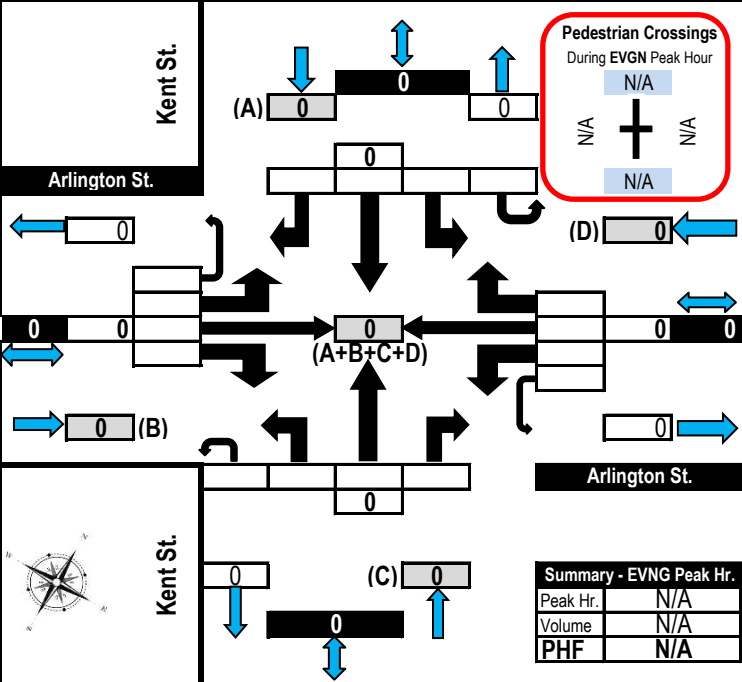



Turning Movement Count

Heavy Vehicle Summary (FHWA Class 4-13)

Flow Diagram



Arlington Street & Lyon Street

Ottawa, ON

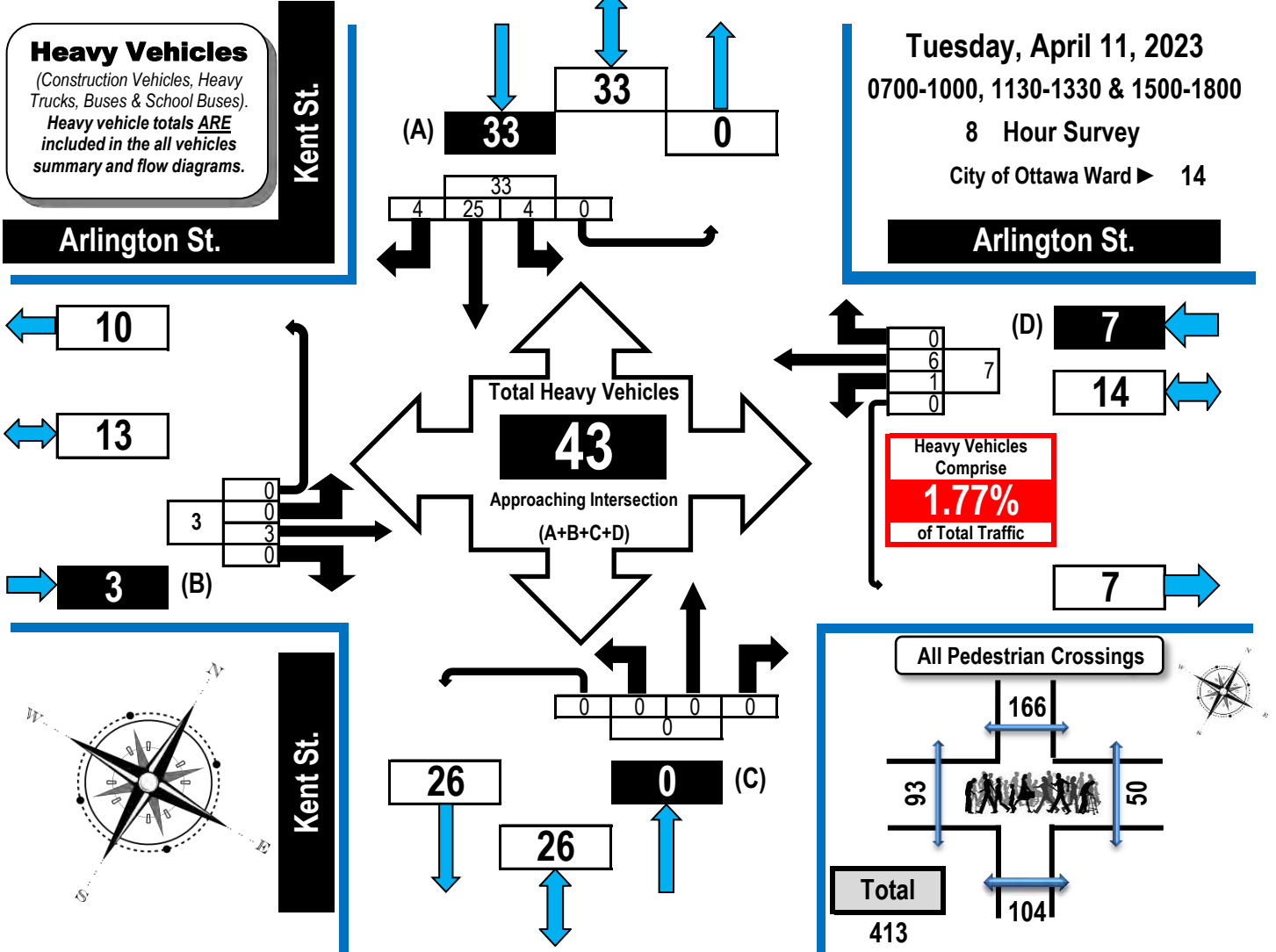

Arlington St. Eastbound	Arlington St. Westbound	Kent St. Northbound	Kent St. Southbound
-------------------------	-------------------------	---------------------	---------------------

Time Period	LT	ST	RT	UT	EB Tot	LT	ST	RT	UT	WB Tot	LT	ST	RT	UT	NB Tot	LT	ST	RT	UT	SB Tot	GR Tot
0700-0800	0	0	0	0	0	0	2	0	0	2	0	0	0	0	0	0	1	0	0	1	3
0800-0900	0	1	0	0	1	1	0	0	0	1	0	0	0	0	0	2	2	1	0	5	7
0900-1000	0	1	0	0	1	0	2	0	0	2	0	0	0	0	0	2	6	2	0	10	13
1130-1230	0	0	0	0	0	0	0	0	0	0	0	0	0	0	0	0	7	1	0	8	8
1230-1330	0	0	0	0	0	0	0	0	0	0	0	0	0	0	0	0	2	0	0	2	2
1500-1600	0	0	0	0	0	0	0	0	0	0	0	0	0	0	0	0	3	0	0	3	3
1600-1700	0	1	0	0	1	0	2	0	0	2	0	0	0	0	0	0	1	0	0	1	4
1700-1800	0	0	0	0	0	0	0	0	0	0	0	0	0	0	0	0	3	0	0	3	3
Totals	0	3	0	0	3	1	6	0	0	7	0	0	0	0	0	4	25	4	0	33	43

Comments:

Transit buses and school buses comprise 30.23% of the heavy vehicle traffic. Lyon Street ramp to Highway 417 westbound closed due to construction. Southbound traffic south of Arlington Street is open to right turns to Catherine Street. Many S/B left turning vehicles to Arlington Street E/B do so from the west through lane.



Turning Movement Count

All Buses Summary (FHWA Class 4 ONLY)

Flow Diagram



Arlington Street & Lyon Street Ottawa, ON

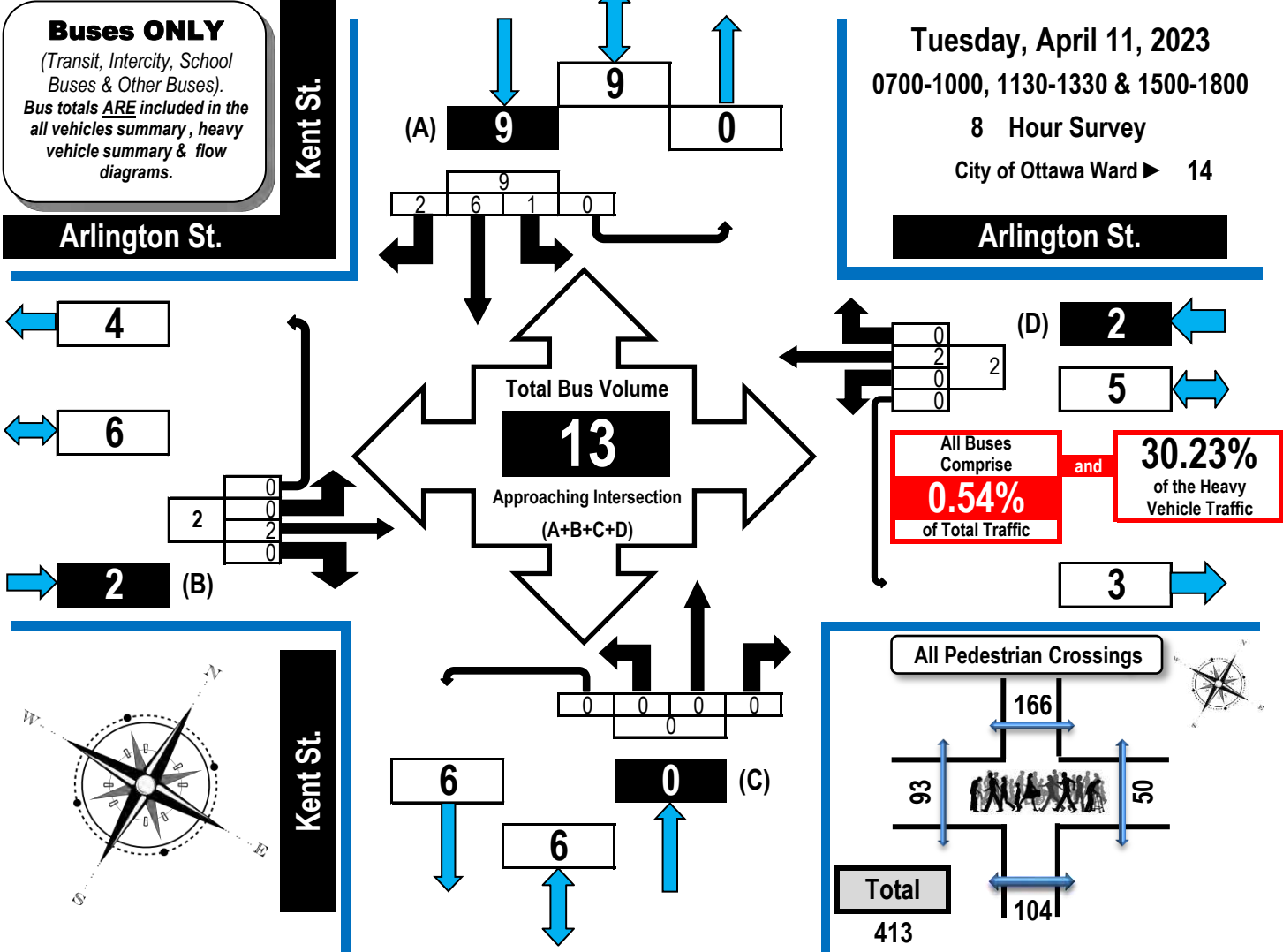

Time Period	Arlington St. Eastbound					Arlington St. Westbound					Kent St. Northbound					Kent St. Southbound					SB Tot	GR Tot
	LT	ST	RT	UT	EB Tot	LT	ST	RT	UT	WB Tot	LT	ST	RT	UT	NB Tot	LT	ST	RT	UT			
0700-0800	0	0	0	0	0	0	1	0	0	1	0	0	0	0	0	0	1	0	0	1	2	
0800-0900	0	1	0	0	1	0	0	0	0	0	0	0	0	0	0	1	0	0	0	1	2	
0900-1000	0	0	0	0	0	0	0	0	0	0	0	0	0	0	0	0	2	1	0	3	3	
1130-1230	0	0	0	0	0	0	0	0	0	0	0	0	0	0	0	0	0	1	0	1	1	
1230-1330	0	0	0	0	0	0	0	0	0	0	0	0	0	0	0	0	1	0	0	1	1	
1500-1600	0	0	0	0	0	0	0	0	0	0	0	0	0	0	0	2	0	0	2	2		
1600-1700	0	1	0	0	1	0	1	0	0	1	0	0	0	0	0	0	0	0	0	0	2	
1700-1800	0	0	0	0	0	0	0	0	0	0	0	0	0	0	0	0	0	0	0	0	0	
Totals	0	2	0	0	2	0	2	0	0	2	0	0	0	0	0	1	6	2	0	9	13	

Comments:
Transit buses and school buses comprise 30.23% of the heavy vehicle traffic. Lyon Street ramp to Highway 417 westbound closed due to construction. Southbound traffic south of Arlington Street is open to right turns to Catherine Street. Many S/B left turning vehicles to Arlington Street E/B do so from the west through lane.



Turning Movement Count Bicycle Summary Flow Diagram



Arlington Street & Lyon Street Ottawa, ON

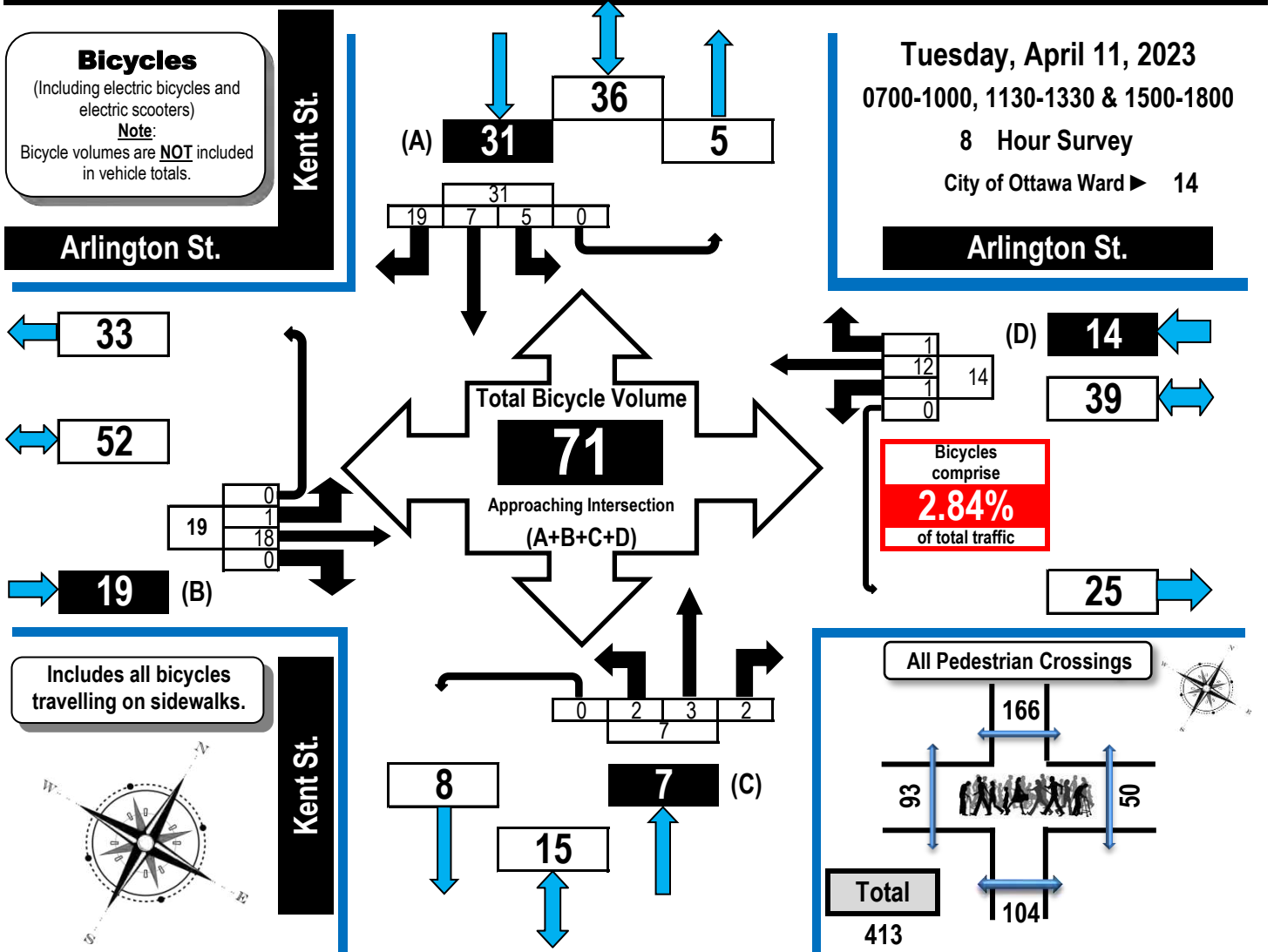

Arlington St. Eastbound	Arlington St. Westbound	Kent St. Northbound	Kent St. Southbound
----------------------------	----------------------------	------------------------	------------------------

Time Period	LT	ST	RT	UT	EB Tot	LT	ST	RT	UT	WB Tot	LT	ST	RT	UT	NB Tot	LT	ST	RT	UT	SB Tot	GR Tot
0700-0800	0	1	0	0	1	0	0	0	0	0	2	0	0	0	2	0	2	0	0	2	5
0800-0900	0	4	0	0	4	0	1	0	0	1	0	1	0	0	1	0	1	0	0	1	7
0900-1000	0	1	0	0	1	0	2	0	0	2	0	1	0	0	1	1	0	1	0	2	6
1130-1230	0	3	0	0	3	0	0	0	0	0	0	0	1	0	1	1	2	1	0	4	8
1230-1330	0	1	0	0	1	0	1	0	0	1	0	1	0	0	1	1	0	0	0	1	4
1500-1600	0	1	0	0	1	0	1	0	0	1	0	0	0	0	0	0	0	5	0	5	7
1600-1700	1	0	0	0	1	0	1	0	0	1	0	0	1	0	1	1	0	4	0	5	8
1700-1800	0	7	0	0	7	1	6	1	0	8	0	0	0	0	0	1	2	8	0	11	26
Totals	1	18	0	0	19	1	12	1	0	14	2	3	2	0	7	5	7	19	0	31	71

Comments:
Transit buses and school buses comprise 30.23% of the heavy vehicle traffic. Lyon Street ramp to Highway 417 westbound closed due to construction. Southbound traffic south of Arlington Street is open to right turns to Catherine Street. Many S/B left turning vehicles to Arlington Street E/B do so from the west through lane.



Turning Movement Count Pedestrian Crossings Summary and Flow Diagram



Arlington Street & Lyon Street

Ottawa, ON

Pedestrian Crossings

Tuesday, April 11, 2023
0700-1000, 1130-1330 & 1500-1800
8 Hour Survey
City of Ottawa Ward ► **14**

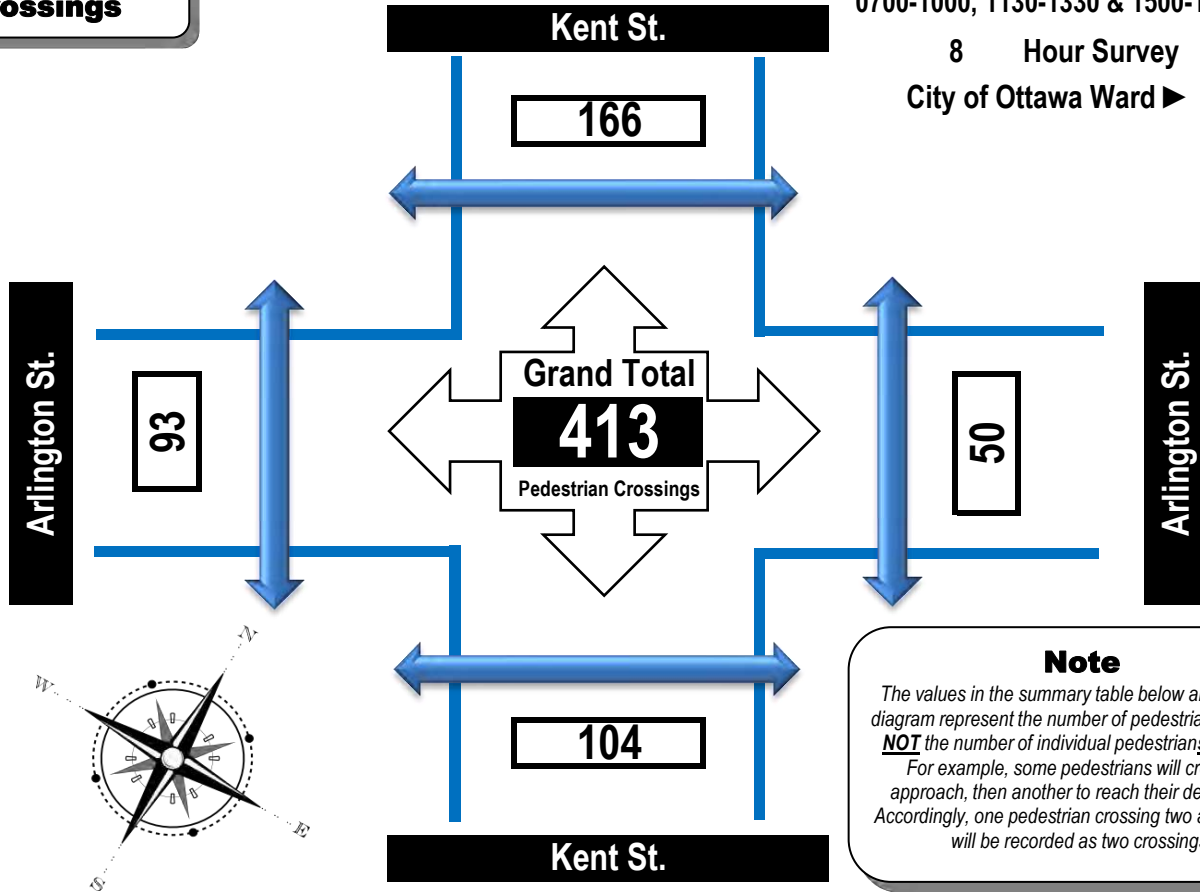

Note
The values in the summary table below and the flow diagram represent the number of pedestrian crossings **NOT** the number of individual pedestrians crossing. For example, some pedestrians will cross one approach, then another to reach their destination. Accordingly, one pedestrian crossing two approaches will be recorded as two crossings.

Time Period	West Side Crossing Arlington St.	East Side Crossing Arlington St.	Street Total	South Side Crossing Kent St.	North Side Crossing Kent St.	Street Total	Grand Total
0700-0800	7	4	11	5	15	20	31
0800-0900	11	11	22	16	31	47	69
0900-1000	3	5	8	4	7	11	19
1130-1230	12	6	18	21	10	31	49
1230-1330	10	9	19	14	26	40	59
1500-1600	16	5	21	23	35	58	79
1600-1700	18	4	22	11	17	28	50
1700-1800	16	6	22	10	25	35	57
Totals	93	50	143	104	166	270	413

Comments:

Transit buses and school buses comprise 30.23% of the heavy vehicle traffic. Lyon Street ramp to Highway 417 westbound closed due to construction. Southbound traffic south of Arlington Street is open to right turns to Catherine Street. Many S/B left turning vehicles to Arlington Street E/B do so from the west through lane.

Turning Movement Count - Peak Hour Diagram

BANK ST @ CATHERINE ST

Survey Date: Thursday, April 19, 2018

Start Time: 07:00

WO No: 39991

Device: Miovision

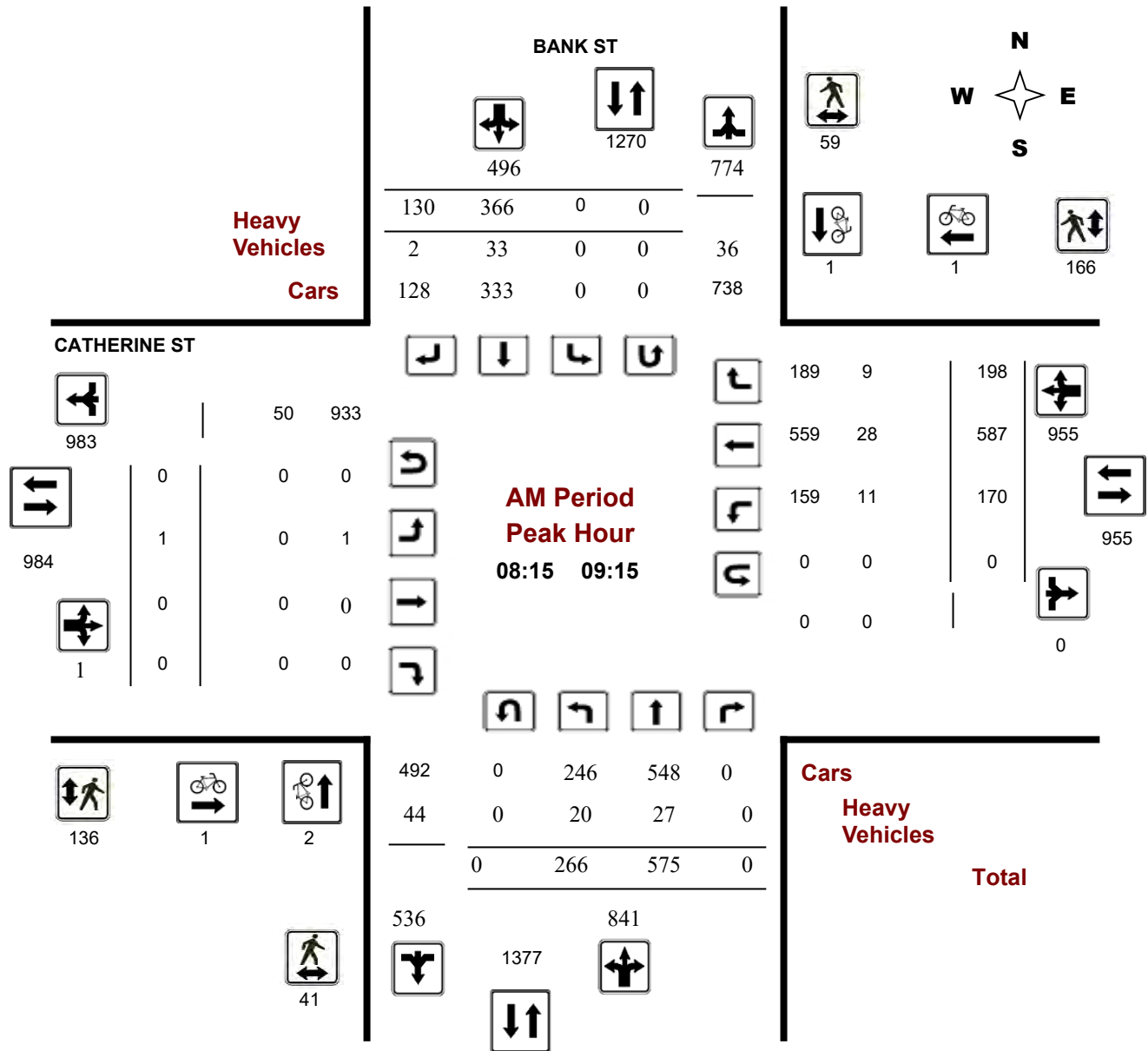

Turning Movement Count - Peak Hour Diagram

BANK ST @ CATHERINE ST

Survey Date: Thursday, April 19, 2018

Start Time: 07:00

WO No: 39991

Device: Miovision

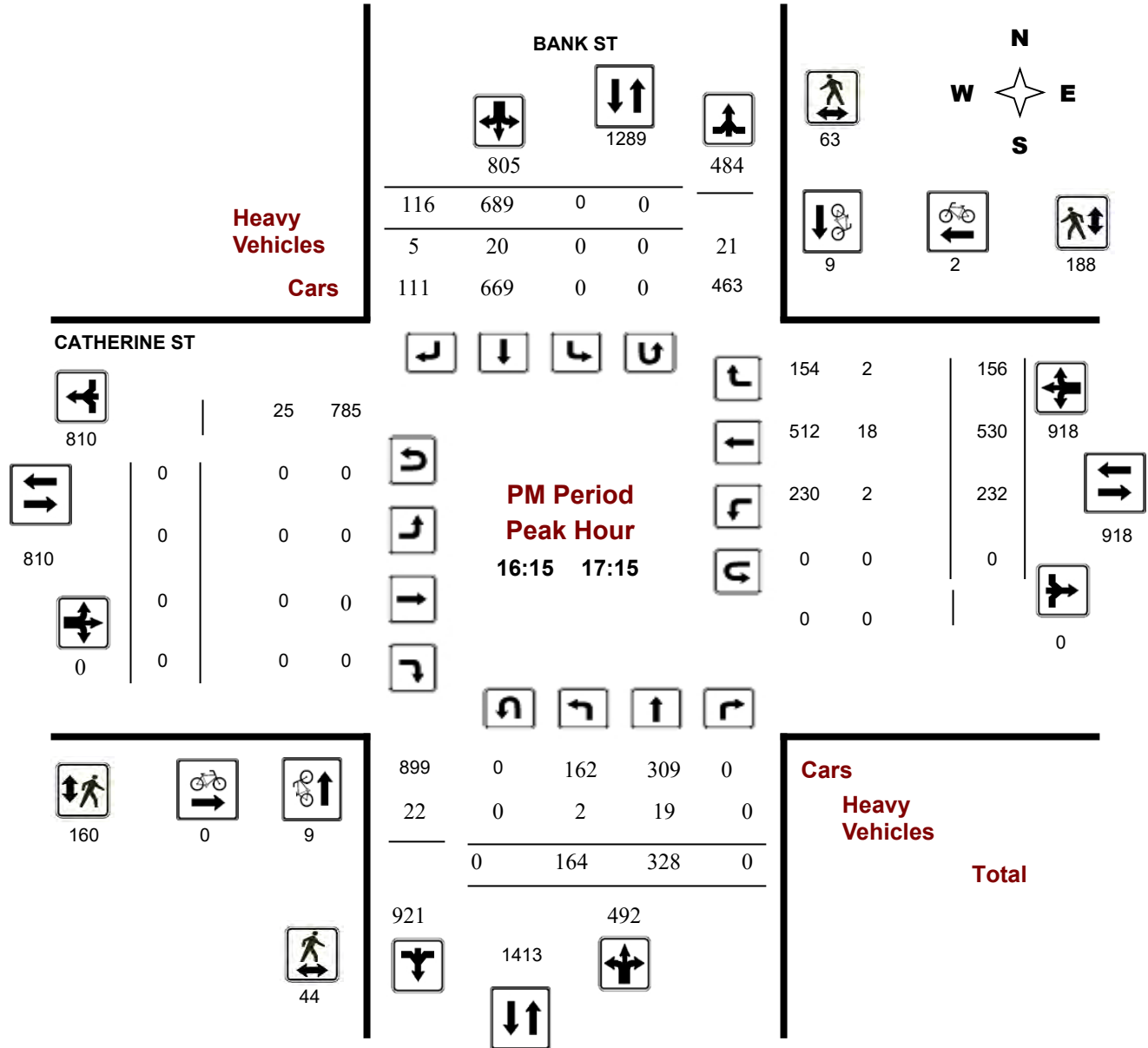



Transportation Services - Traffic Services

Turning Movement Count - Peak Hour Diagram

BANK ST @ CHAMBERLAIN AVE N/ISABELLA ST

Survey Date: Wednesday, April 18, 2018

WO No: 39632

Start Time: 07:00

Device: Miovision

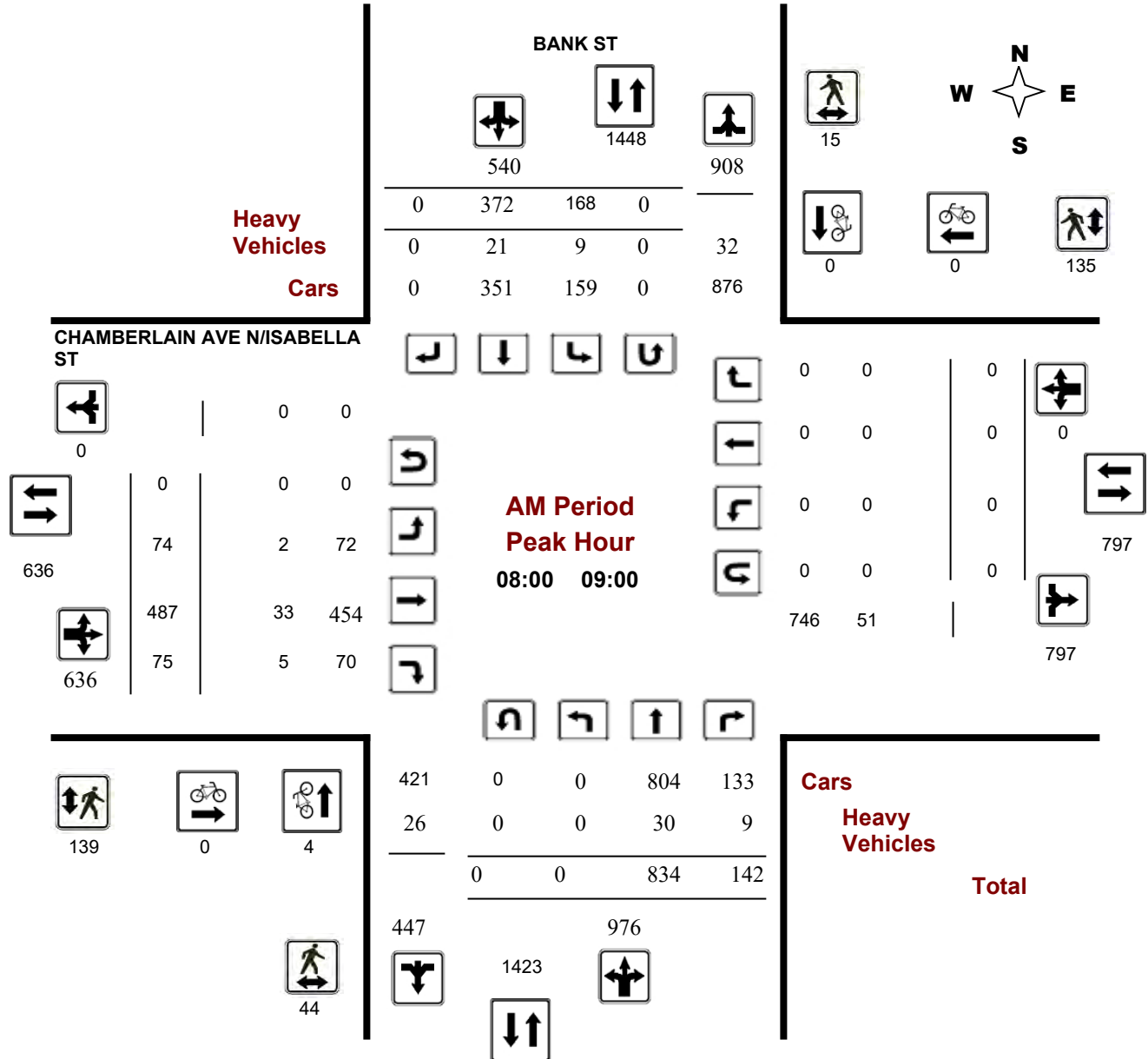

Comments W.O. 5365004 - WED APR 18TH - CONSULTANT - (8HR REIMPORT)



Transportation Services - Traffic Services

Turning Movement Count - Peak Hour Diagram

BANK ST @ CHAMBERLAIN AVE N/ISABELLA ST

Survey Date: Wednesday, April 18, 2018

Start Time: 07:00

WO No: 39632

Device: Miovision

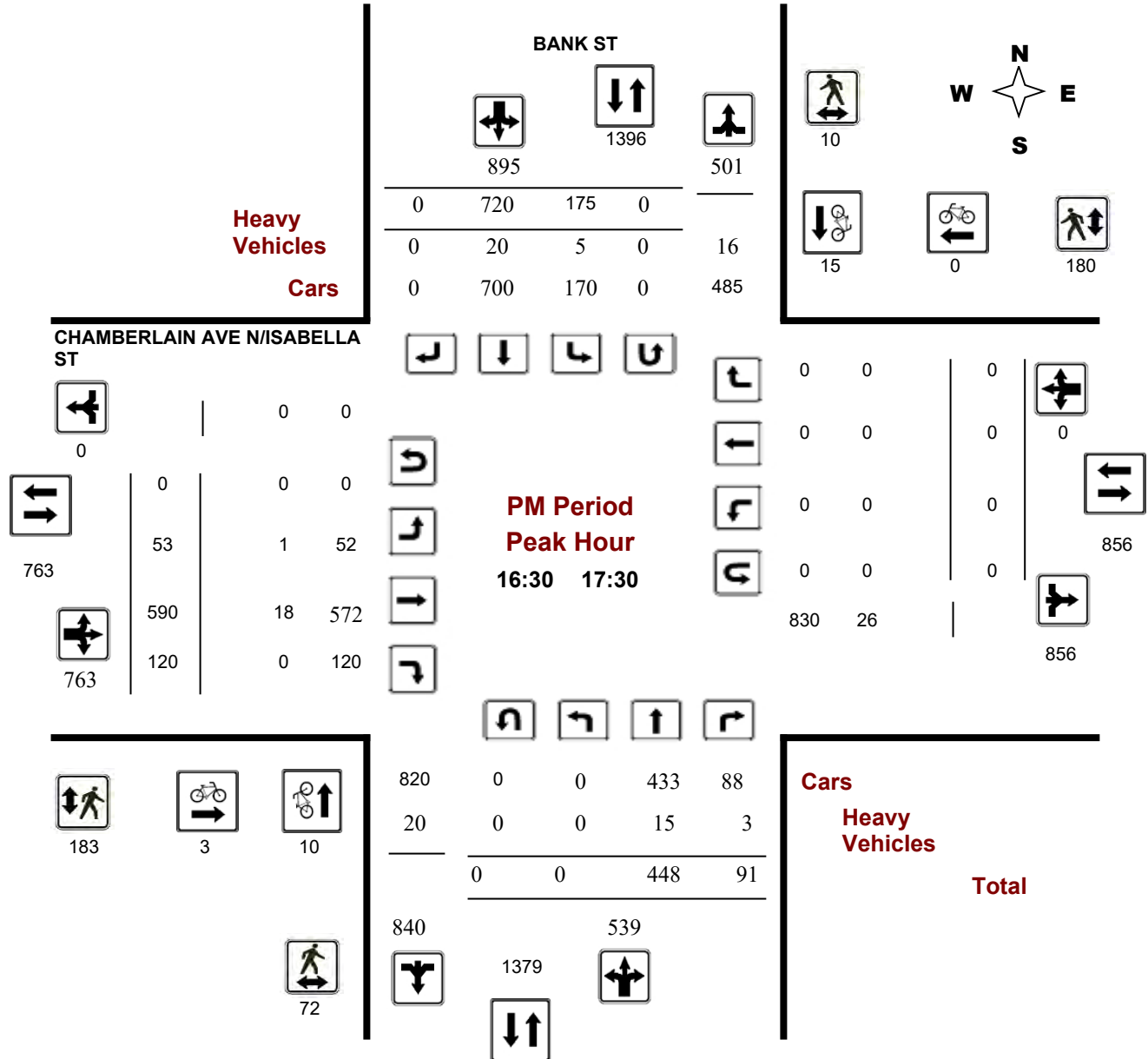

Comments W.O. 5365004 - WED APR 18TH - CONSULTANT - (8HR REIMPORT)

Turning Movement Count - Peak Hour Diagram

BRONSON AVE @ CATHERINE ST/RAYMOND ST

Survey Date: Thursday, April 19, 2018

Start Time: 07:00

WO No: 39598

Device: Miovision

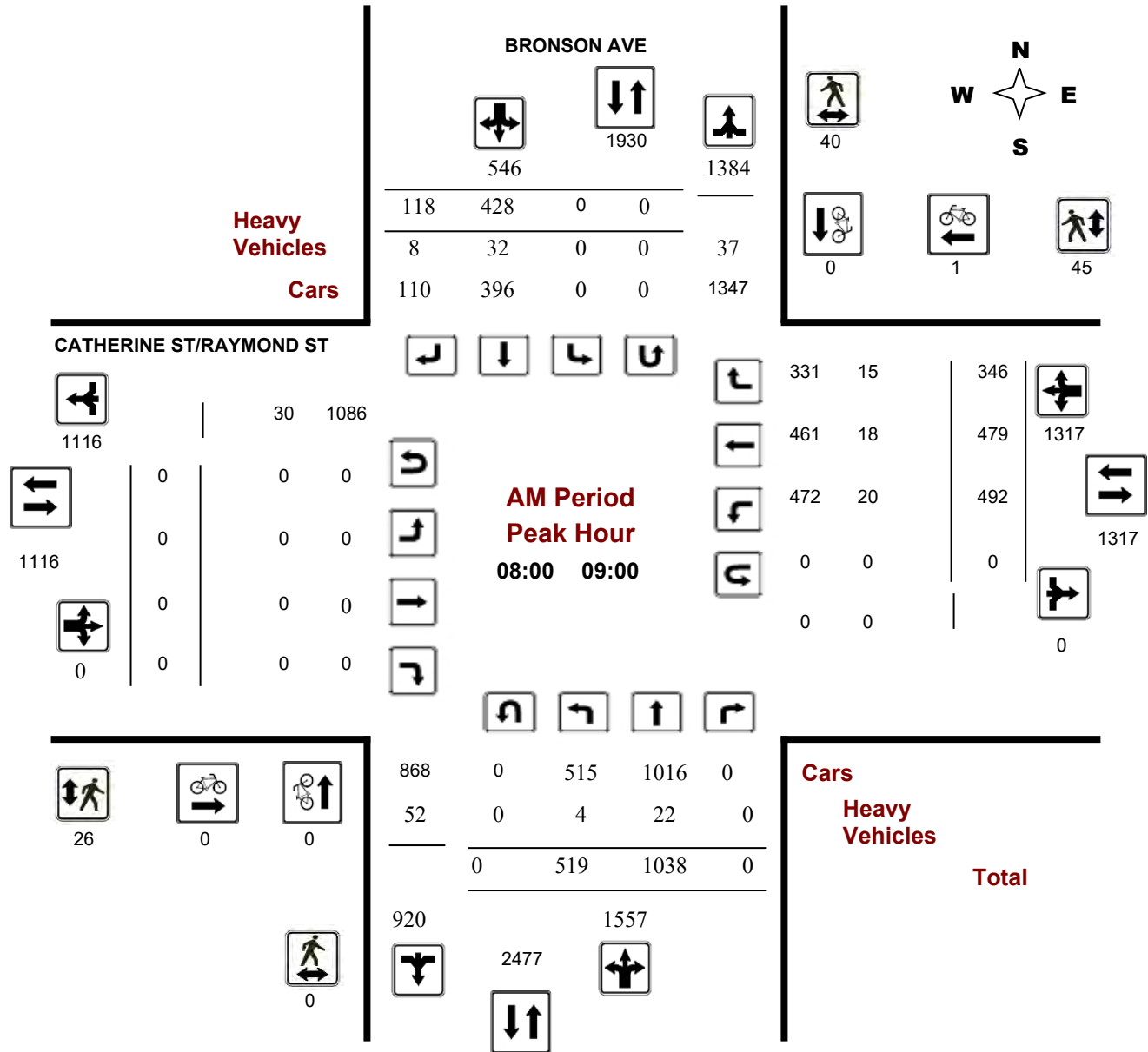

Comments W.O. 5365004 - THURS APR 19TH - CONSULTANT - 48 HRS (REIMPORT - 8HR STANDAR



Transportation Services - Traffic Services

Turning Movement Count - Peak Hour Diagram

BRONSON AVE @ CATHERINE ST/RAYMOND ST

Survey Date: Thursday, April 19, 2018

Start Time: 07:00

WO No: 39598

Device: Miovision

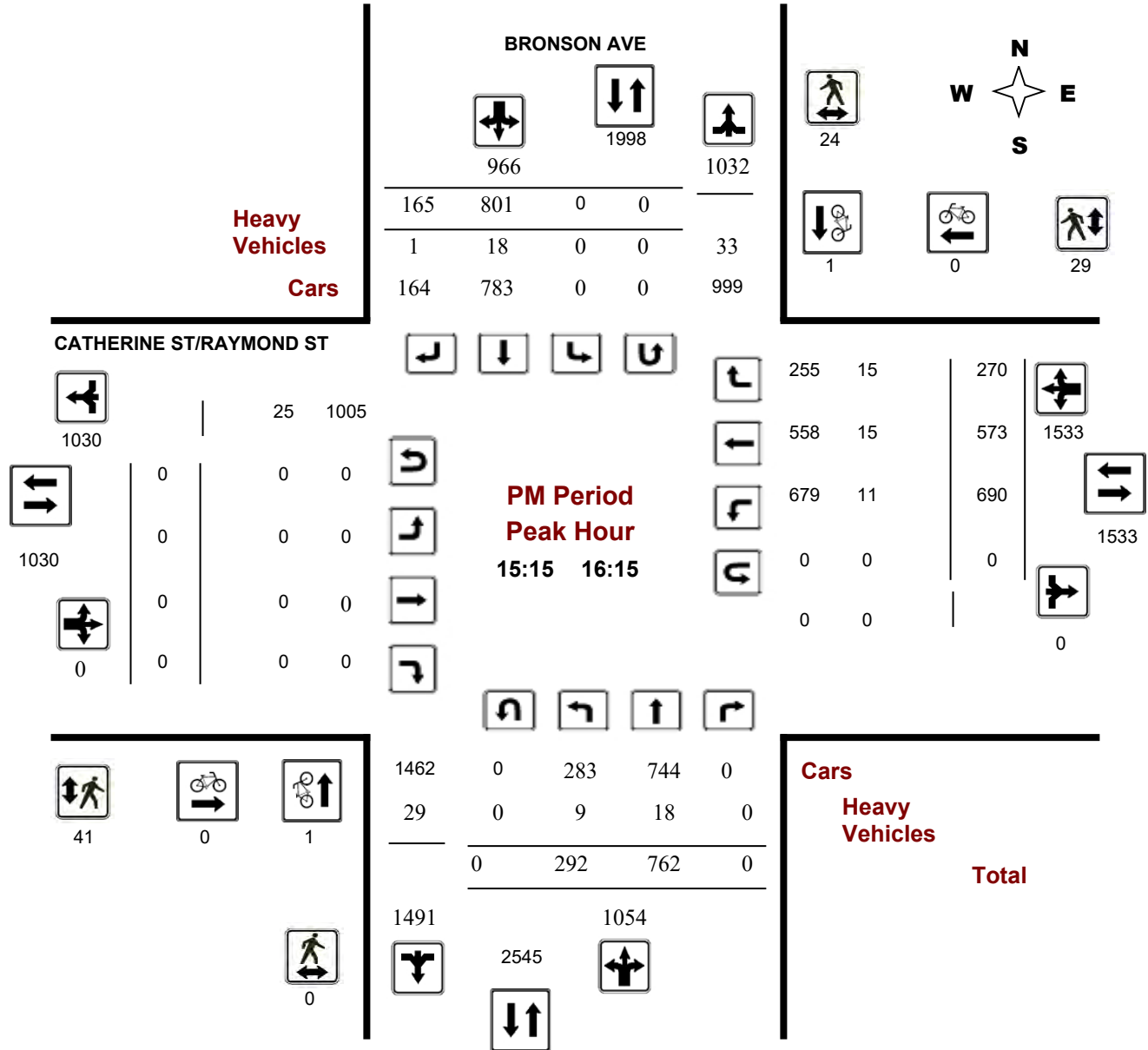

Comments W.O. 5365004 - THURS APR 19TH - CONSULTANT - 48 HRS (REIMPORT - 8HR STANDAR

Turning Movement Count - Peak Hour Diagram

CATHERINE ST @ KENT ST

Survey Date: Wednesday, April 18, 2018

Start Time: 07:00

WO No: 40741

Device: Miovision

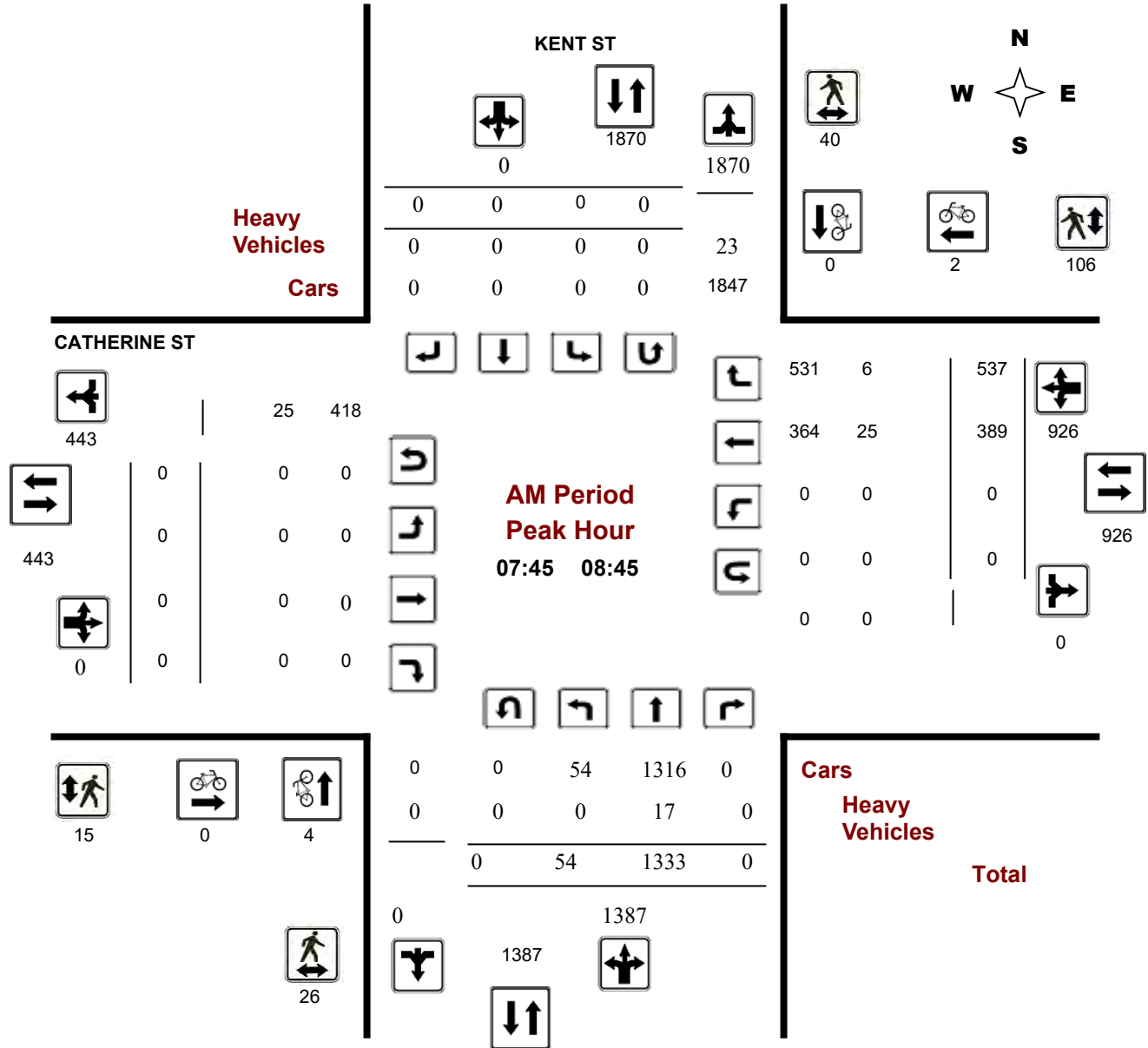

Comments



Transportation Services - Traffic Services

Turning Movement Count - Peak Hour Diagram

CATHERINE ST @ KENT ST

Survey Date: Wednesday, April 18, 2018

Start Time: 07:00

WO No: 40741

Device: Miovision

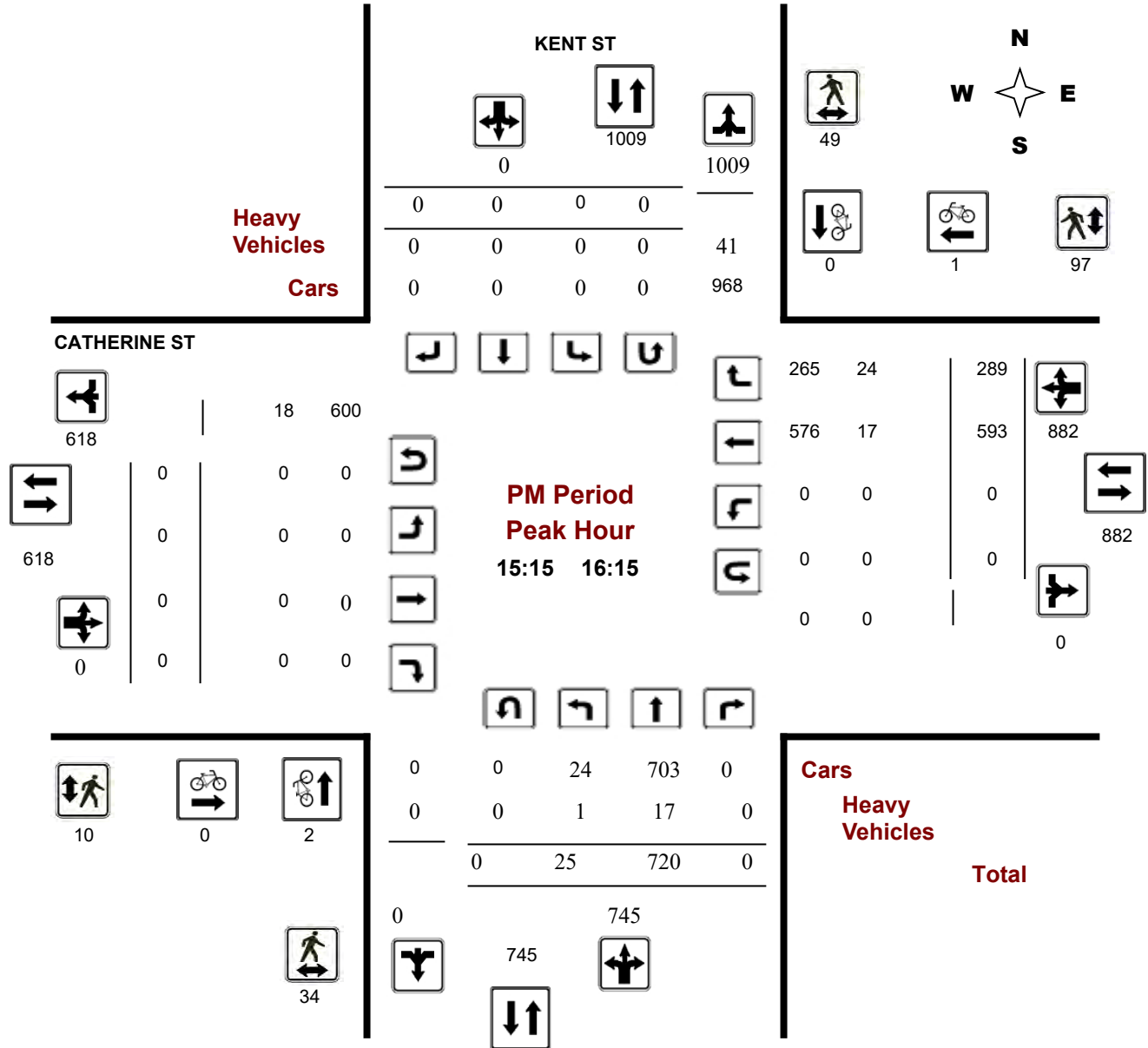

Comments

Turning Movement Count - Peak Hour Diagram

CATHERINE ST @ LYON ST/HWY 417 LYON IC120BR36

Survey Date: Wednesday, April 18, 2018

Start Time: 07:00

WO No: 40740

Device: Miovision

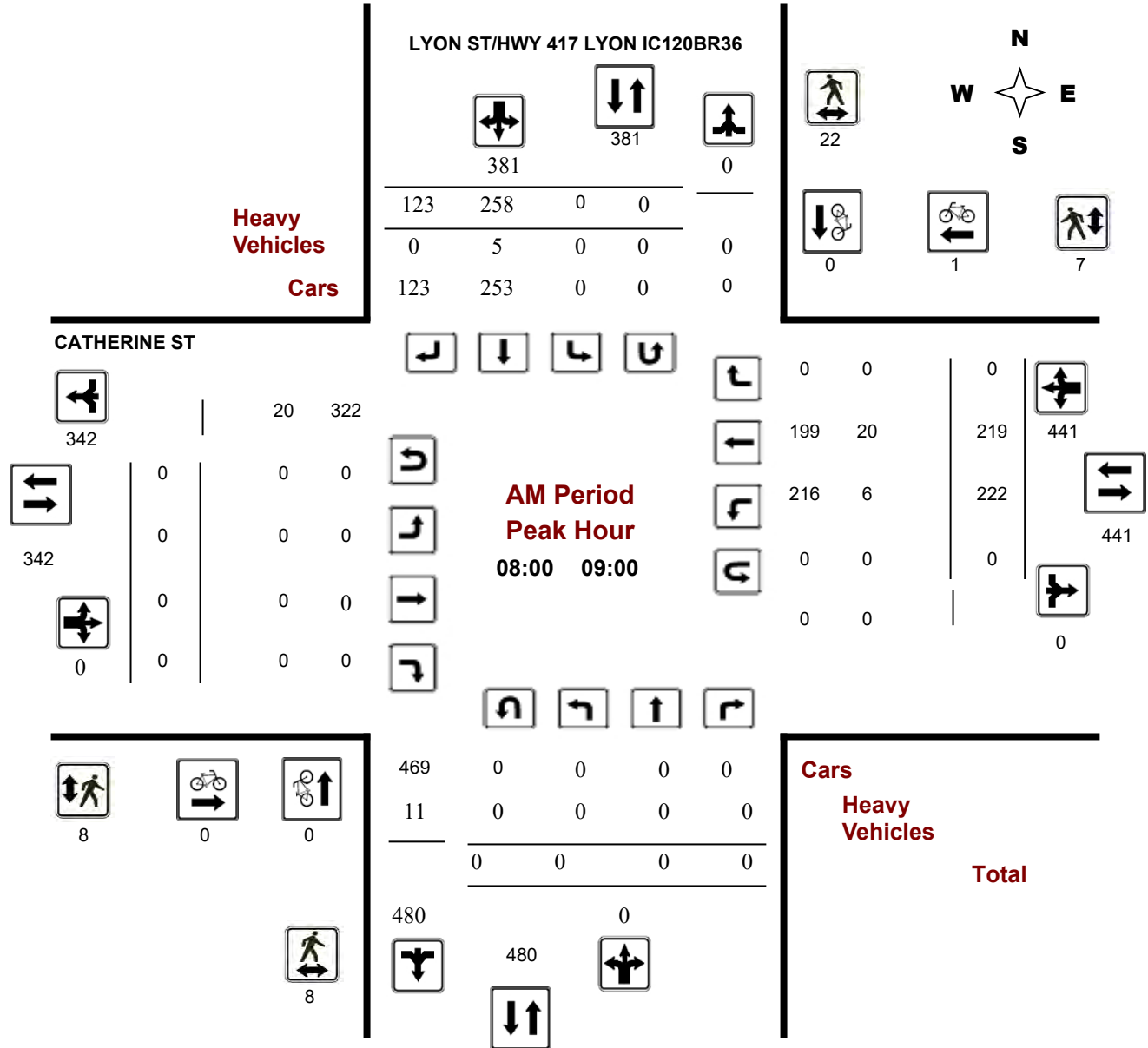

Comments



Transportation Services - Traffic Services

Turning Movement Count - Peak Hour Diagram

CATHERINE ST @ LYON ST/HWY 417 LYON IC120BR36

Survey Date: Wednesday, April 18, 2018

Start Time: 07:00

WO No: 40740

Device: Miovision

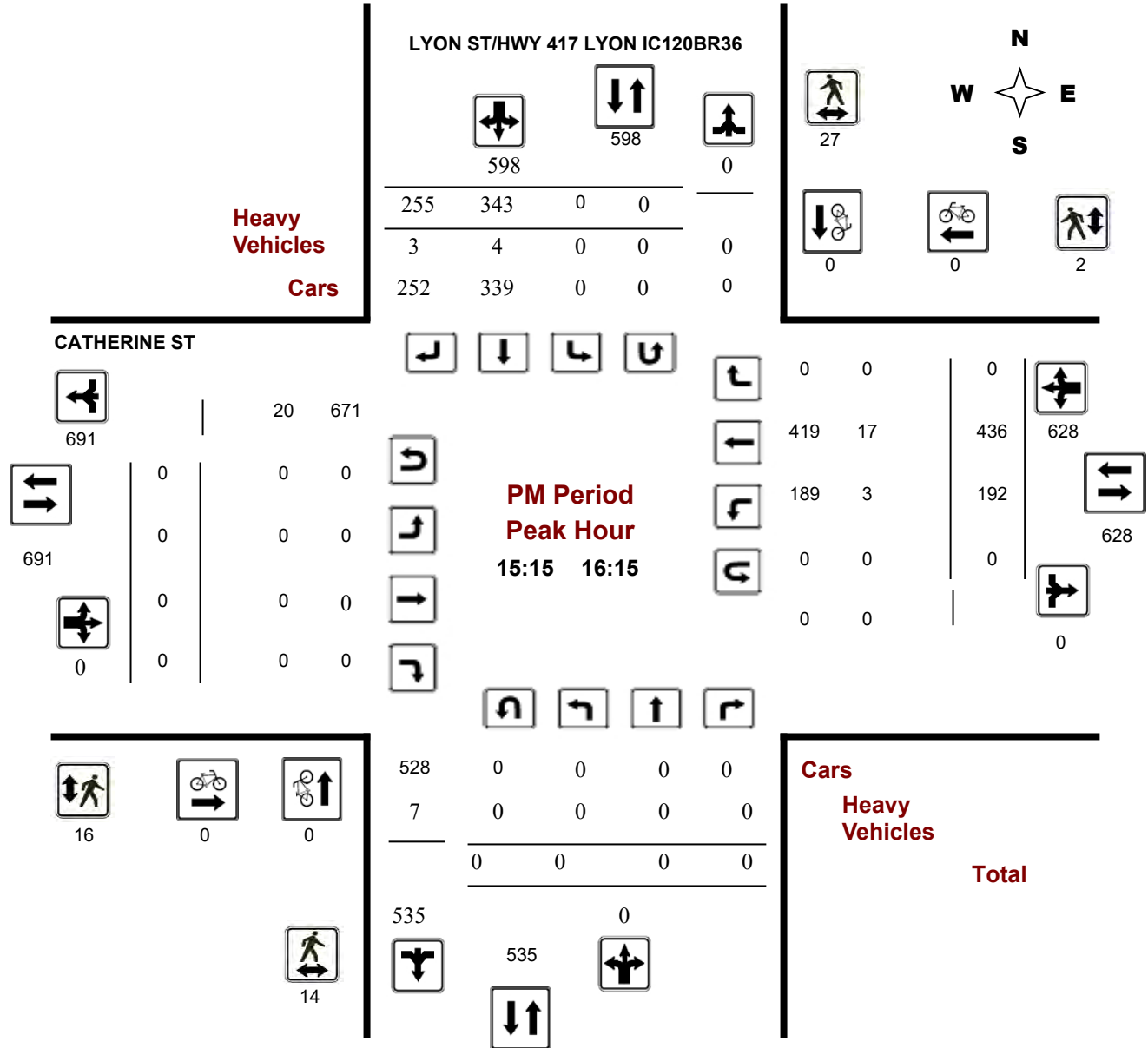



Transportation Services - Traffic Services

Turning Movement Count - Peak Hour Diagram

CATHERINE ST @ PERCY ST

Survey Date: Thursday, April 19, 2018

WO No: 40917

Start Time: 07:00

Device: Miovision

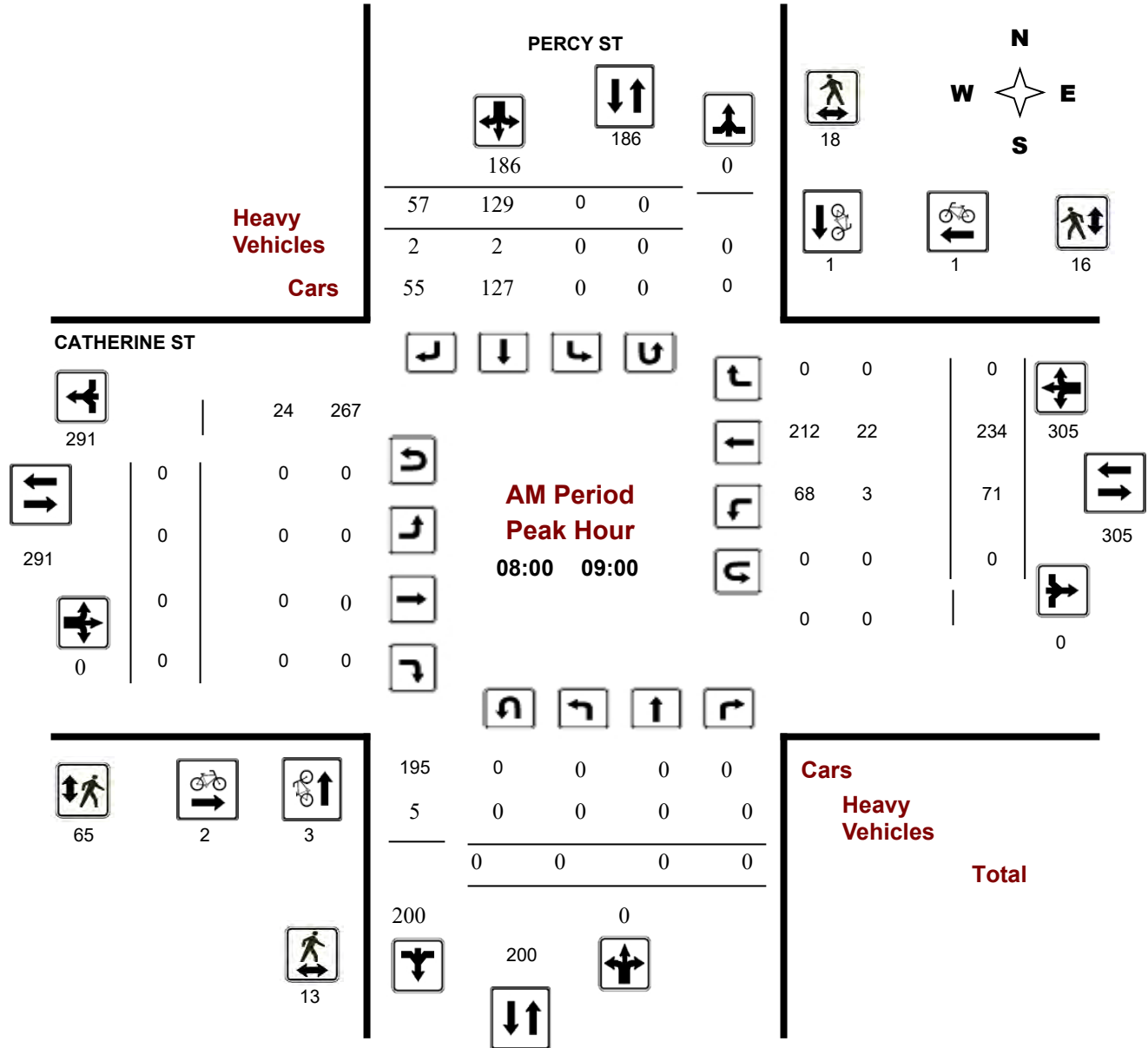

Turning Movement Count - Peak Hour Diagram

CATHERINE ST @ PERCY ST

Survey Date: Thursday, April 19, 2018

Start Time: 07:00

WO No: 40917

Device: Miovision

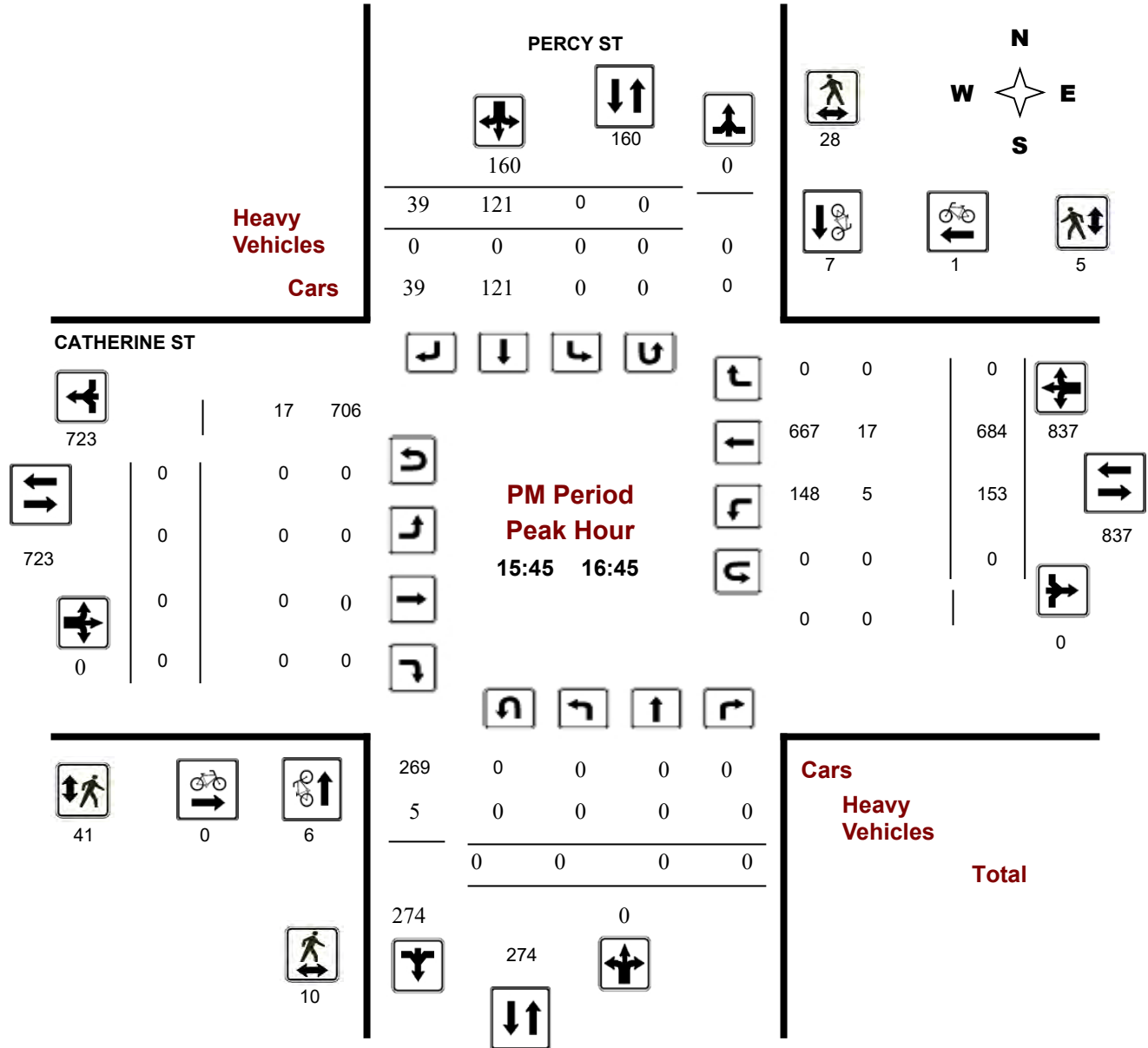

Comments



Transportation Services - Traffic Services

Turning Movement Count - Peak Hour Diagram

GLADSTONE AVE @ KENT ST

Survey Date: Tuesday, April 25, 2017

Start Time: 07:00

WO No: 36848

Device: Miovision

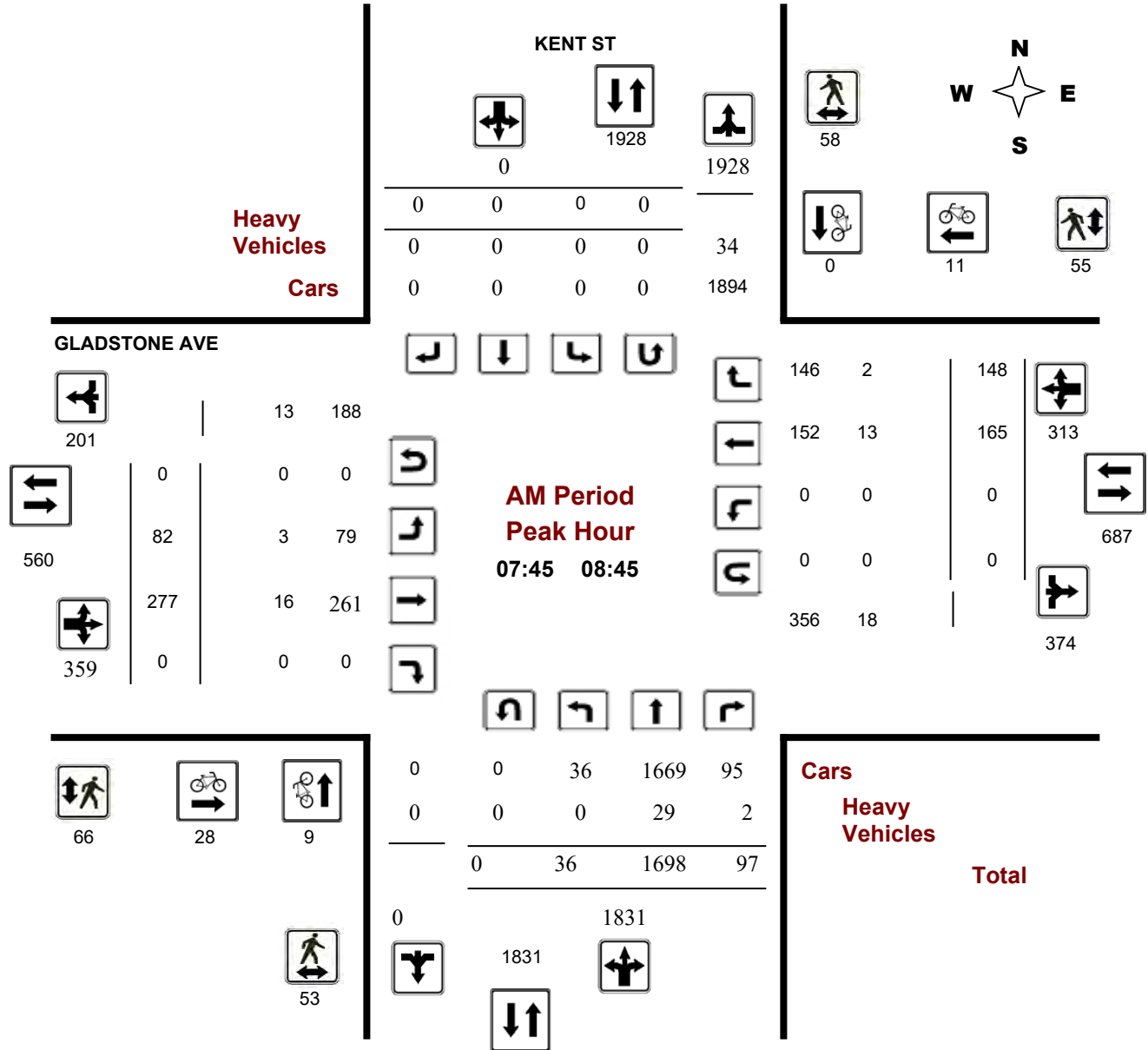



Transportation Services - Traffic Services

Turning Movement Count - Peak Hour Diagram

GLADSTONE AVE @ KENT ST

Survey Date: Tuesday, April 25, 2017

Start Time: 07:00

WO No: 36848

Device: Miovision

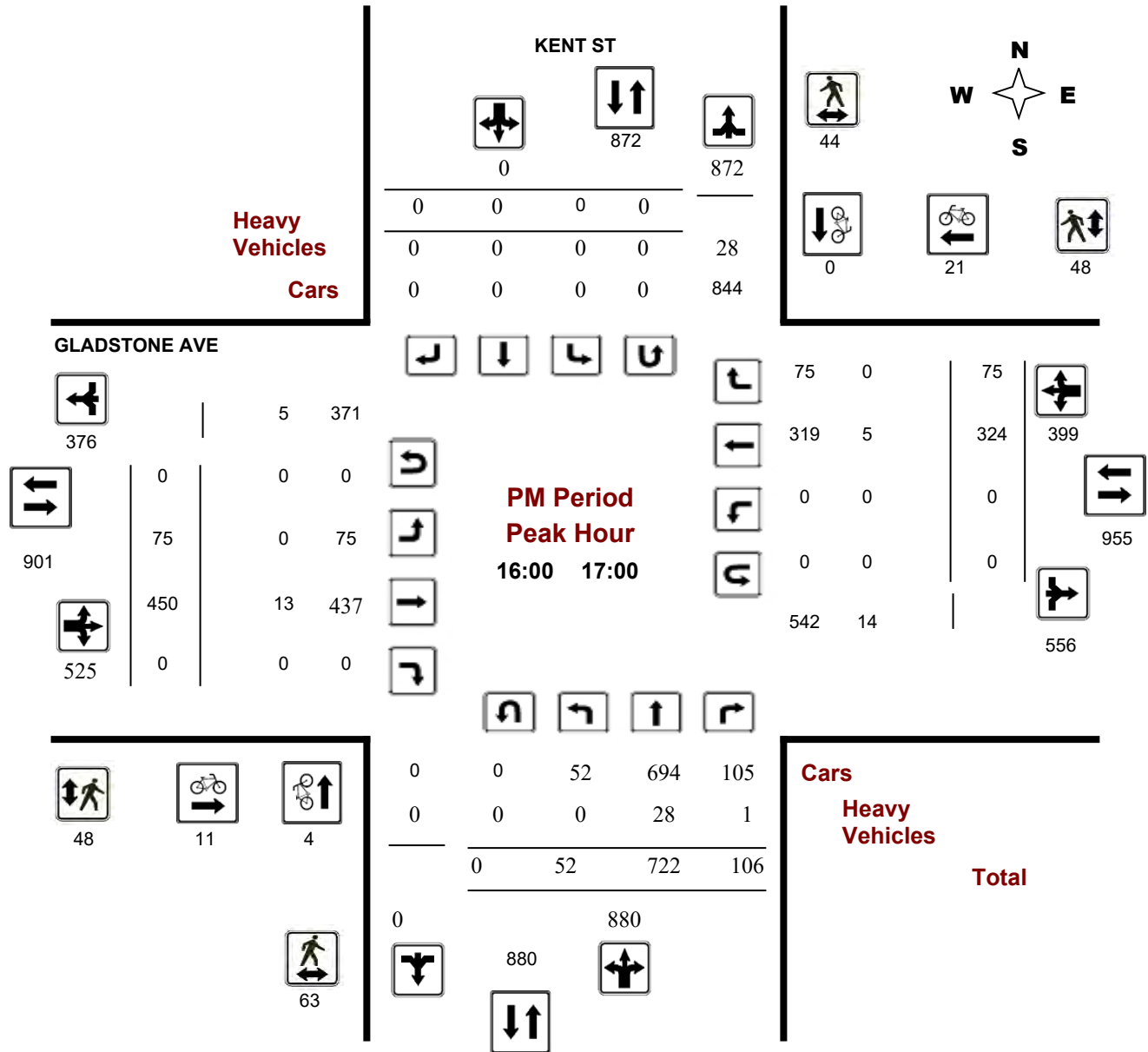

Comments



Transportation Services - Traffic Services

Turning Movement Count - Peak Hour Diagram

GLADSTONE AVE @ LYON ST

Survey Date: Wednesday, August 24, 2022

Start Time: 07:00

WO No: 40574

Device: Miovision

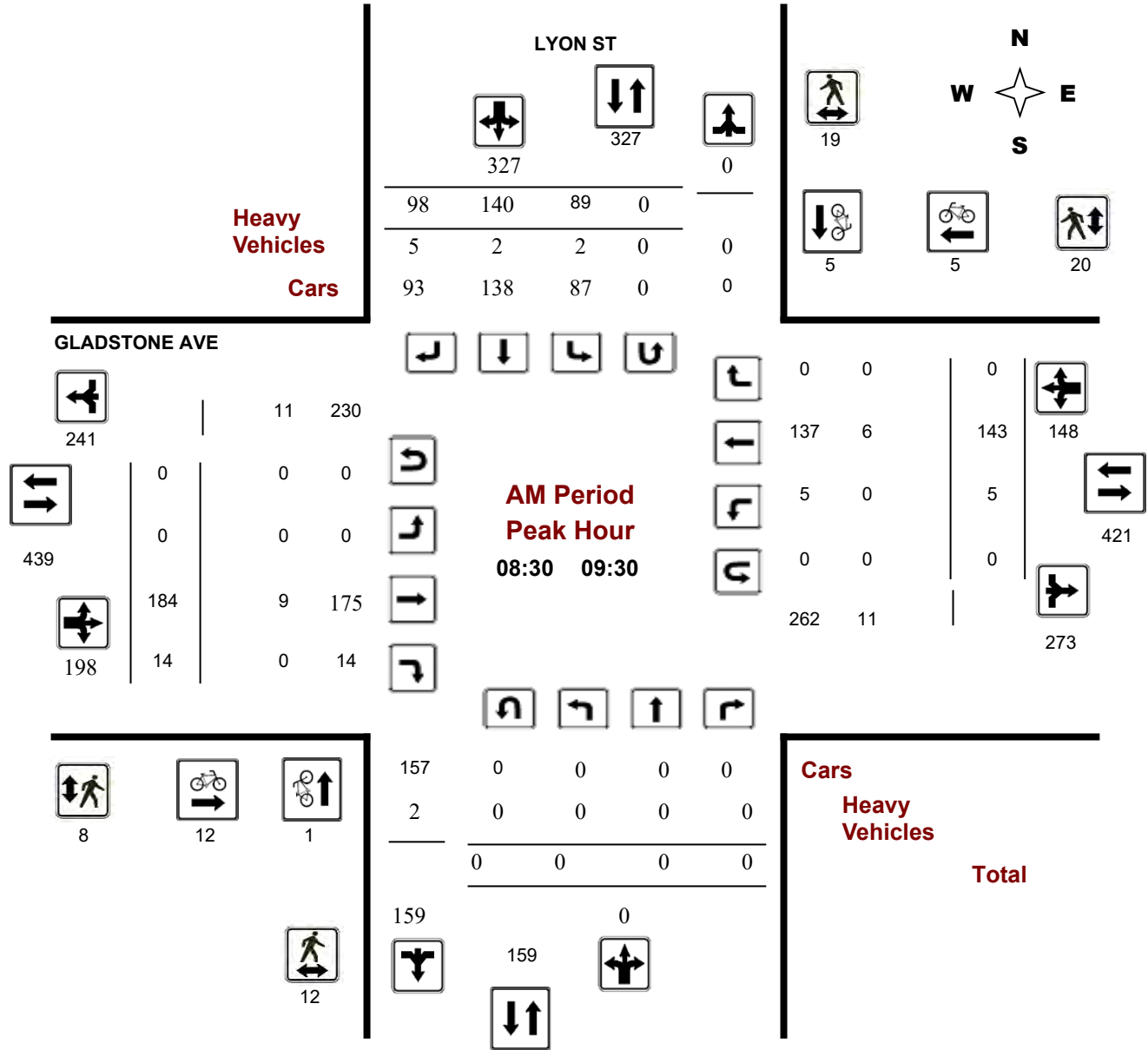

Comments



Transportation Services - Traffic Services

Turning Movement Count - Peak Hour Diagram

GLADSTONE AVE @ LYON ST

Survey Date: Wednesday, August 24, 2022

Start Time: 07:00

WO No: 40574

Device: Miovision

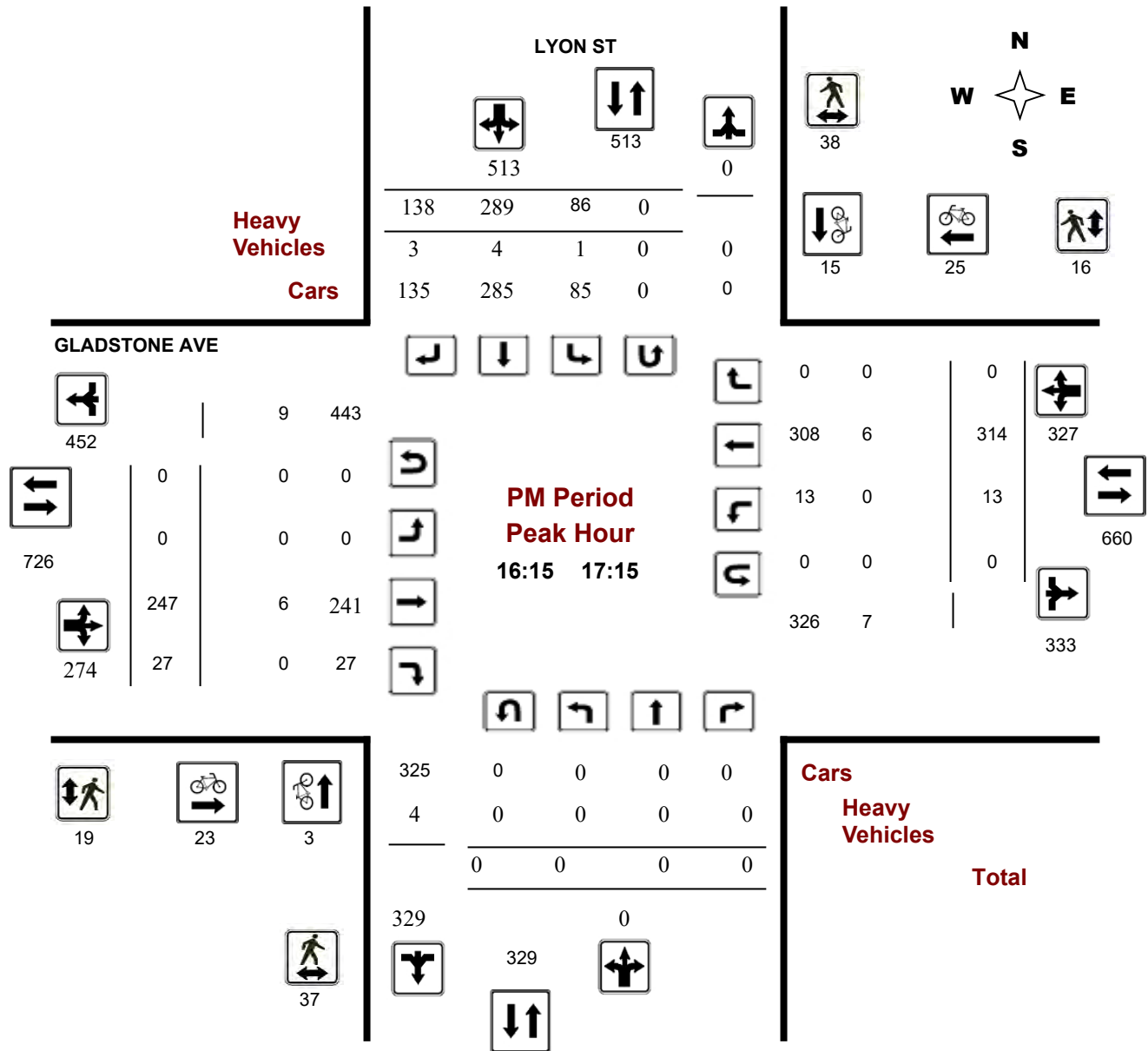

DIRECTIONAL TRAFFIC FLOW

Intersection: Arlington Avenue at Bank Street

DATE: Day: 18 Month: Apr. Year: 2023 Day of Week: Tuesday

Observer: Jordan Terada Weather: Overcast

Chkd by: _____ Date: _____

TIME PERIOD: From: 7 : 35 To: 8 : 35

N



DIRECTIONAL TRAFFIC FLOW

Intersection: Arlington Avenue at Bank Street

DATE: Day: 18 Month: Apr. Year: 2023 Day of Week: Tuesday

Observer: Jordan Terada Weather: Rain

Chkd by: _____ Date: _____

TIME PERIOD: From: 4 : 15 To: 5 : 15

N



Pedestrians

↔	0
↕	42

Street Name:
Arlington Avenue

0	0	0
0	0	0
27		

HV Bikes
Pass. Vehicles

Street Name:
Bank Street

Bikes HV Pass. Vehicles

0	0	20
---	---	----

R
L

0	0	0
---	---	---

S

1	1	106
---	---	-----

Street Name:
Bank Street

Pass. Vehicles
Bikes HV

58	0	0
0	0	0
3	0	0

L
R

	0	
--	---	--

	0	0
--	---	---

S

	0	0
--	---	---

Pass. Vehicles HV Bikes

Street Name:

Pedestrians

↔	0
↕	0

DRAFT

Appendix D:

Collision Data

Total Area

Classification of Accident	Rear End	Turning Movement	Sideswipe	Angle	Approaching	SMV other	SMV unattended vehicle	Other	Total
P.D. only	55	85	112	81	1	8	12	5	359
Non-fatal injury	7	13	5	29	0	13	1	0	68
Non-reportable	0	0	0	0	0	0	0	0	0
Total	62	98	117	110	1	21	13	5	427
	#4 or 15%	#3 or 23%	#1 or 27%	#2 or 26%	#8 or 0%	#5 or 5%	#6 or 3%	#7 or 1%	

84%
16%
0%
100%

BRONSON AVE/CATHERINE ST/RAYMOND ST

Years	Total # Collisions	24 Hr AADT Veh Volume	Days	Collisions/MEV
2017-2019	91	39,156	1825	1.27

Peds	Cyclists
2	1

Classification of Accident	Rear End	Turning Movement	Sideswipe	Angle	Approaching	SMV other	SMV unattended vehicle	Other	Total
P.D. only	16	14	25	16	0	1	0	1	73
Non-fatal injury	1	5	1	9	0	2	0	0	18
Non-reportable	0	0	0	0	0	0	0	0	0
Total	17	19	26	25	0	3	0	1	91
	19%	21%	29%	27%	0%	3%	0%	1%	

80%
20%
0%
100%

CATHERINE ST/PERCY ST

Years	Total # Collisions	24 Hr AADT Veh Volume	Days	Collisions/MEV
2017-2019	6	7,922	1825	0.42

Peds	Cyclists
0	0

Classification of Accident	Rear End	Turning Movement	Sideswipe	Angle	Approaching	SMV other	SMV unattended vehicle	Other	Total
P.D. only	1	2	0	1	0	0	0	1	5
Non-fatal injury	0	0	0	1	0	0	0	0	1
Non-reportable	0	0	0	0	0	0	0	0	0
Total	1	2	0	2	0	0	0	1	6
	17%	33%	0%	33%	0%	0%	0%	17%	

83%
17%
0%
100%

CATHERINE ST/LYON ST/HWY 417 LYON IC120BR36

Years	Total # Collisions	24 Hr AADT Veh Volume	Days	Collisions/MEV
2017-2019	17	11,711	1825	0.80

Peds	Cyclists
0	0

Classification of Accident	Rear End	Turning Movement	Sideswipe	Angle	Approaching	SMV other	SMV unattended vehicle	Other	Total
P.D. only	2	0	1	10	0	1	0	0	14
Non-fatal injury	1	0	0	2	0	0	0	0	3
Non-reportable	0	0	0	0	0	0	0	0	0
Total	3	0	1	12	0	1	0	0	17
	18%	0%	6%	71%	0%	6%	0%	0%	

82%
18%
0%
100%

CATHERINE ST/KENT ST

Years	Total # Collisions	24 Hr AADT Veh Volume	Days	Collisions/MEV
2017-2019	96	19,918	1825	2.64

Peds	Cyclists
0	0

Classification of Accident	Rear End	Turning Movement	Sideswipe	Angle	Approaching	SMV other	SMV unattended vehicle	Other	Total
P.D. only	5	42	22	18	0	0	0	2	89
Non-fatal injury	0	4	1	2	0	0	0	0	7
Non-reportable	0	0	0	0	0	0	0	0	0
Total	5	46	23	20	0	0	0	2	96
	5%	48%	24%	21%	0%	0%	0%	2%	

93%
7%
0%
100%

BANK ST/CATHERINE ST

Years	Total # Collisions	24 Hr AADT Veh Volume	Days	Collisions/MEV
2017-2019	61	23,164	1825	1.44

Peds	Cyclists
8	6

Classification of Accident	Rear End	Turning Movement	Sideswipe	Angle	Approaching	SMV other	SMV unattended vehicle	Other	Total
P.D. only	11	3	15	7	1	2	0	0	39
Non-fatal injury	3	3	1	7	0	8	0	0	22
Non-reportable	0	0	0	0	0	0	0	0	0
Total	14	6	16	14	1	10	0	0	61
	23%	10%	26%	23%	2%	16%	0%	0%	

64%
36%
0%
100%

GLADSTONE AVE/LYON ST

Years	Total # Collisions	24 Hr AADT Veh Volume	Days	Collisions/MEV
2017-2019	8	10,413	1825	0.42

Peds	Cyclists
1	1

Classification of Accident	Rear End	Turning Movement	Sideswipe	Angle	Approaching	SMV other	SMV unattended vehicle	Other	Total
P.D. only	2	1	0	3	0	0	0	0	6
Non-fatal injury	0	0	0	1	0	1	0	0	2
Non-reportable	0	0	0	0	0	0	0	0	0
Total	2	1	0	4	0	1	0	0	8
	25%	13%	0%	50%	0%	13%	0%	0%	

75%
25%
0%
100%

ARLINGTON AVE/LYON ST

Years	Total # Collisions	24 Hr AADT Veh Volume	Days	Collisions/MEV
2017-2019	2	8,854	1825	0.12

Peds	Cyclists
0	0

Classification of Accident	Rear End	Turning Movement	Sideswipe	Angle	Approaching	SMV other	SMV unattended vehicle	Other	Total
P.D. only	0	0	1	1	0	0	0	0	2
Non-fatal injury	0	0	0	0	0	0	0	0	0
Non-reportable	0	0	0	0	0	0	0	0	0
Total	0	0	1	1	0	0	0	0	2
	0%	0%	50%	50%	0%	0%	0%	0%	

100%
0%
0%
100%

GLADSTONE AVE/KENT ST

Years	Total # Collisions	24 Hr AADT Veh Volume	Days	Collisions/MEV
2017-2019	25	23,139	1825	0.59

Peds	Cyclists
1	0

Classification of Accident	Rear End	Turning Movement	Sideswipe	Angle	Approaching	SMV other	SMV unattended vehicle	Other	Total
P.D. only	5	4	5	10	0	0	0	0	24
Non-fatal injury	0	0	0	0	0	1	0	0	1
Non-reportable	0	0	0	0	0	0	0	0	0
Total	5	4	5	10	0	1	0	0	25
	20%	16%	20%	40%	0%	4%	0%	0%	

96%
4%
0%
100%

ARLINGTON AVE/KENT ST

Years	Total # Collisions	24 Hr AADT Veh Volume	Days	Collisions/MEV
2017-2019	23	15,280	1825	0.82

Peds	Cyclists
0	0

Classification of Accident	Rear End	Turning Movement	Sideswipe	Angle	Approaching	SMV other	SMV unattended vehicle	Other	Total
P.D. only	1	6	12	3	0	0	0	0	22
Non-fatal injury	0	0	0	1	0	0	0	0	1
Non-reportable	0	0	0	0	0	0	0	0	0
Total	1	6	12	4	0	0	0	0	23
	4%	26%	52%	17%	0%	0%	0%	0%	

96%
4%
0%
100%

ARLINGTON AVE/BANK ST

Years	Total # Collisions	24 Hr AADT Veh Volume	Days	Collisions/MEV
2017-2019	10	13,240	1825	0.41

Peds	Cyclists
1	1

Classification of Accident	Rear End	Turning Movement	Sideswipe	Angle	Approaching	SMV other	SMV unattended vehicle	Other	Total
P.D. only	1	2	1	3	0	0	0	1	8
Non-fatal injury	0	0	0	1	0	1	0	0	2
Non-reportable	0	0	0	0	0	0	0	0	0
Total	1	2	1	4	0	1	0	1	10
	10%	20%	10%	40%	0%	10%	0%	10%	

80%
20%
0%
100%

BANK ST/CHAMBERLAIN AVE N/ISABELLA ST

Years	Total # Collisions	24 Hr AADT Veh Volume	Days	Collisions/MEV
2017-2019	41	24,224	1825	0.93

Peds	Cyclists
0	0

Classification of Accident	Rear End	Turning Movement	Sideswipe	Angle	Approaching	SMV other	SMV unattended vehicle	Other	Total
P.D. only	8	8	11	5	0	2	0	0	34
Non-fatal injury	2	0	0	5	0	0	0	0	7
Non-reportable	0	0	0	0	0	0	0	0	0
Total	10	8	11	10	0	2	0	0	41
	24%	20%	27%	24%	0%	5%	0%	0%	

83%
17%
0%
100%

ROAD SEGMENTS

CATHERINE ST, BRONSON AVE to PERCY ST

Years	Total # Collisions	24 Hr AADT Veh Volume	Days	Collisions/MEV
2017-2019	5	n/a	1825	n/a

Peds	Cyclists
0	0

Classification of Accident	Rear End	Turning Movement	Sideswipe	Angle	Approaching	SMV other	SMV unattended vehicle	Other	Total
P.D. only	1	0	3	1	0	0	0	0	5
Non-fatal injury	0	0	0	0	0	0	0	0	0
Non-reportable	0	0	0	0	0	0	0	0	0
Total	1	0	3	1	0	0	0	0	5
	20%	0%	60%	20%	0%	0%	0%	0%	

100%
0%
0%
100%

CATHERINE ST, BAY ST to PERCY ST

Years	Total # Collisions	24 Hr AADT Veh Volume	Days	Collisions/MEV
2017-2019	2	n/a	1825	n/a

Peds	Cyclists
0	0

Classification of Accident	Rear End	Turning Movement	Sideswipe	Angle	Approaching	SMV other	SMV unattended vehicle	Other	Total
P.D. only	0	1	0	1	0	0	0	0	2
Non-fatal injury	0	0	0	0	0	0	0	0	0
Non-reportable	0	0	0	0	0	0	0	0	0
Total	0	1	0	1	0	0	0	0	2
	0%	50%	0%	50%	0%	0%	0%	0%	

100%
0%
0%
100%

CATHERINE ST, LYON to KENT ST

Years	Total # Collisions	24 Hr AADT Veh Volume	Days	Collisions/MEV
2017-2019	5	n/a	1825	n/a

Peds	Cyclists
0	0

Classification of Accident	Rear End	Turning Movement	Sideswipe	Angle	Approaching	SMV other	SMV unattended vehicle	Other	Total
P.D. only	0	1	3	0	0	1	0	0	5
Non-fatal injury	0	0	0	0	0	0	0	0	0
Non-reportable	0	0	0	0	0	0	0	0	0
Total	0	1	3	0	0	1	0	0	5
	0%	20%	60%	0%	0%	20%	0%	0%	

100%
0%
0%
100%

CATHERINE ST, BANK ST to KENT ST

Years	Total # Collisions	24 Hr AADT Veh Volume	Days	Collisions/MEV
2017-2019	4	n/a	1825	n/a

Peds	Cyclists
0	0

Classification of Accident	Rear End	Turning Movement	Sideswipe	Angle	Approaching	SMV other	SMV unattended vehicle	Other	Total
P.D. only	0	0	2	2	0	0	0	0	4
Non-fatal injury	0	0	0	0	0	0	0	0	0
Non-reportable	0	0	0	0	0	0	0	0	0
Total	0	0	2	2	0	0	0	0	4
	0%	0%	50%	50%	0%	0%	0%	0%	

100%
0%
0%
100%

LYON ST N, GLADSTONE AVE to CATHERINE ST

Years	Total # Collisions	24 Hr AADT Veh Volume	Days	Collisions/MEV
2017-2019	4	n/a	1825	n/a

Peds	Cyclists
0	0

Classification of Accident	Rear End	Turning Movement	Sideswipe	Angle	Approaching	SMV other	SMV unattended vehicle	Other	Total
P.D. only	0	0	1	0	0	1	2	0	4
Non-fatal injury	0	0	0	0	0	0	0	0	0
Non-reportable	0	0	0	0	0	0	0	0	0
Total	0	0	1	0	0	1	2	0	4
	0%	0%	25%	0%	0%	25%	50%	0%	

100%
0%
0%
100%

GLADSTONE AVE, KENT ST to LYON ST N

Years	Total # Collisions	24 Hr AADT Veh Volume	Days	Collisions/MEV
2017-2019	8	n/a	1825	n/a

Peds	Cyclists
0	0

Classification of Accident	Rear End	Turning Movement	Sideswipe	Angle	Approaching	SMV other	SMV unattended vehicle	Other	Total
P.D. only	1	0	1	0	0	0	4	0	6
Non-fatal injury	0	0	1	0	0	0	1	0	2
Non-reportable	0	0	0	0	0	0	0	0	0
Total	1	0	2	0	0	0	5	0	8
	13%	0%	25%	0%	0%	0%	63%	0%	

75%
25%
0%
100%

KENT ST, FLORA ST to MCLEOD ST

Years	Total # Collisions	24 Hr AADT Veh Volume	Days	Collisions/MEV
2017-2019	2	n/a	1825	n/a

Peds	Cyclists
0	0

Classification of Accident	Rear End	Turning Movement	Sideswipe	Angle	Approaching	SMV other	SMV unattended vehicle	Other	Total
P.D. only	0	0	2	0	0	0	0	0	2
Non-fatal injury	0	0	0	0	0	0	0	0	0
Non-reportable	0	0	0	0	0	0	0	0	0
Total	0	0	2	0	0	0	0	0	2
	0%	0%	100%	0%	0%	0%	0%	0%	

100%
0%
0%
100%

KENT ST, ARLINGTON AVE to CATHERINE ST

Years	Total # Collisions	24 Hr AADT Veh Volume	Days	Collisions/MEV
2017-2019	5	n/a	1825	n/a

Peds	Cyclists
0	0

Classification of Accident	Rear End	Turning Movement	Sideswipe	Angle	Approaching	SMV other	SMV unattended vehicle	Other	Total
P.D. only	0	0	4	0	0	0	0	0	4
Non-fatal injury	0	0	1	0	0	0	0	0	1
Non-reportable	0	0	0	0	0	0	0	0	0
Total	0	0	5	0	0	0	0	0	5
	0%	0%	100%	0%	0%	0%	0%	0%	

80%
20%
0%
100%

ARLINGTON AVE, KENT ST to LYON ST N

Years	Total # Collisions	24 Hr AADT Veh Volume	Days	Collisions/MEV
2017-2019	2	n/a	1825	n/a

Peds	Cyclists
0	0

Classification of Accident	Rear End	Turning Movement	Sideswipe	Angle	Approaching	SMV other	SMV unattended vehicle	Other	Total
P.D. only	0	0	0	0	0	0	2	0	2
Non-fatal injury	0	0	0	0	0	0	0	0	0
Non-reportable	0	0	0	0	0	0	0	0	0
Total	0	0	0	0	0	0	2	0	2
	0%	0%	0%	0%	0%	0%	100%	0%	

100%
0%
0%
100%

ARLINGTON AVE, BANK ST to KENT ST

Years	Total # Collisions	24 Hr AADT Veh Volume	Days	Collisions/MEV
2017-2019	6	n/a	1825	n/a

Peds	Cyclists
0	0

Classification of Accident	Rear End	Turning Movement	Sideswipe	Angle	Approaching	SMV other	SMV unattended vehicle	Other	Total
P.D. only	0	1	1	0	0	0	4	0	6
Non-fatal injury	0	0	0	0	0	0	0	0	0
Non-reportable	0	0	0	0	0	0	0	0	0
Total	0	1	1	0	0	0	4	0	6
	0%	17%	17%	0%	0%	0%	67%	0%	

100%
0%
0%
100%

BANK ST, ARLINGTON AVE to CATHERINE ST

Years	Total # Collisions	24 Hr AADT Veh Volume	Days	Collisions/MEV
2017-2019	4	n/a	1825	n/a

Peds	Cyclists
0	1

Classification of Accident	Rear End	Turning Movement	Sideswipe	Angle	Approaching	SMV other	SMV unattended vehicle	Other	Total
P.D. only	1	0	2	0	0	0	0	0	3
Non-fatal injury	0	1	0	0	0	0	0	0	1
Non-reportable	0	0	0	0	0	0	0	0	0
Total	1	1	2	0	0	0	0	0	4
	25%	25%	50%	0%	0%	0%	0%	0%	

75%
25%
0%
100%

DRAFT

Appendix E:

Internal Reduction Calculations

NCHRP 684 Internal Trip Capture Estimation Tool			
Project Name:	265 Catherine	Organization:	Parsons
Project Location:		Performed By:	
Scenario Description:	AM Internal Reduction	Date:	5/3/2023
Analysis Year:		Checked By:	
Analysis Period:	AM Street Peak Hour	Date:	

Table 1-A: Base Vehicle-Trip Generation Estimates (Single-Use Site Estimate)						
Land Use	Development Data (For Information Only)			Estimated Vehicle-Trips ³		
	ITE LUCs ¹	Quantity	Units	Total	Entering	Exiting
Office				0		
Retail				7	4	3
Restaurant				0		
Cinema/Entertainment				0		
Residential				51	16	35
Hotel				0		
All Other Land Uses ²				0		
				58	20	38

Table 2-A: Mode Split and Vehicle Occupancy Estimates						
Land Use	Entering Trips			Exiting Trips		
	Veh. Occ. ⁴	% Transit	% Non-Motorized	Veh. Occ. ⁴	% Transit	% Non-Motorized
Office						
Retail						
Restaurant						
Cinema/Entertainment						
Residential						
Hotel						
All Other Land Uses ²						

Table 3-A: Average Land Use Interchange Distances (Feet Walking Distance)						
Origin (From)	Destination (To)					
	Office	Retail	Restaurant	Cinema/Entertainment	Residential	Hotel
Office						
Retail						
Restaurant						
Cinema/Entertainment						
Residential						
Hotel						

Table 4-A: Internal Person-Trip Origin-Destination Matrix*						
Origin (From)	Destination (To)					
	Office	Retail	Restaurant	Cinema/Entertainment	Residential	Hotel
Office		0	0	0	0	0
Retail	0		0	0	0	0
Restaurant	0	0		0	0	0
Cinema/Entertainment	0	0	0		0	0
Residential	0	0	0	0		0
Hotel	0	0	0	0	0	

Table 5-A: Computations Summary			
	Total	Entering	Exiting
All Person-Trips	58	20	38
Internal Capture Percentage	0%	0%	0%
External Vehicle-Trips ⁵	58	20	38
External Transit-Trips ⁶	0	0	0
External Non-Motorized Trips ⁶	0	0	0

Table 6-A: Internal Trip Capture Percentages by Land Use		
Land Use	Entering Trips	Exiting Trips
Office	N/A	N/A
Retail	0%	0%
Restaurant	N/A	N/A
Cinema/Entertainment	N/A	N/A
Residential	0%	0%
Hotel	N/A	N/A

¹Land Use Codes (LUCs) from *Trip Generation Manual*, published by the Institute of Transportation Engineers.

²Total estimate for all other land uses at mixed-use development site is not subject to internal trip capture computations in this estimator.

³Enter trips assuming no transit or non-motorized trips (as assumed in *ITE Trip Generation Manual*).

⁴Enter vehicle occupancy assumed in Table 1-A vehicle trips. If vehicle occupancy changes for proposed mixed-use project, manual adjustments must be made to Tables 5-A, 9-A (O and D). Enter transit, non-motorized percentages that will result with proposed mixed-use project complete.

⁵Vehicle-trips computed using the mode split and vehicle occupancy values provided in Table 2-A.

⁶Person-Trips

*Indicates computation that has been rounded to the nearest whole number.

Estimation Tool Developed by the Texas A&M Transportation Institute - Version 2013.1

Project Name:	265 Catherine
Analysis Period:	AM Street Peak Hour

Land Use	Table 7-A (D): Entering Trips			Table 7-A (O): Exiting Trips		
	Veh. Occ.	Vehicle-Trips	Person-Trips*	Veh. Occ.	Vehicle-Trips	Person-Trips*
Office	1.00	0	0	1.00	0	0
Retail	1.00	4	4	1.00	3	3
Restaurant	1.00	0	0	1.00	0	0
Cinema/Entertainment	1.00	0	0	1.00	0	0
Residential	1.00	16	16	1.00	35	35
Hotel	1.00	0	0	1.00	0	0

Origin (From)	Destination (To)					
	Office	Retail	Restaurant	Cinema/Entertainment	Residential	Hotel
Office		0	0	0	0	0
Retail	1		0	0	0	0
Restaurant	0	0		0	0	0
Cinema/Entertainment	0	0	0		0	0
Residential	1	0	7	0		0
Hotel	0	0	0	0	0	

Origin (From)	Destination (To)					
	Office	Retail	Restaurant	Cinema/Entertainment	Residential	Hotel
Office		1	0	0	0	0
Retail	0		0	0	0	0
Restaurant	0	0		0	1	0
Cinema/Entertainment	0	0	0		0	0
Residential	0	1	0	0		0
Hotel	0	0	0	0	0	

Destination Land Use	Person-Trip Estimates			External Trips by Mode*		
	Internal	External	Total	Vehicles ¹	Transit ²	Non-Motorized ²
Office	0	0	0	0	0	0
Retail	0	4	4	4	0	0
Restaurant	0	0	0	0	0	0
Cinema/Entertainment	0	0	0	0	0	0
Residential	0	16	16	16	0	0
Hotel	0	0	0	0	0	0
All Other Land Uses ³	0	0	0	0	0	0

Origin Land Use	Person-Trip Estimates			External Trips by Mode*		
	Internal	External	Total	Vehicles ¹	Transit ²	Non-Motorized ²
Office	0	0	0	0	0	0
Retail	0	3	3	3	0	0
Restaurant	0	0	0	0	0	0
Cinema/Entertainment	0	0	0	0	0	0
Residential	0	35	35	35	0	0
Hotel	0	0	0	0	0	0
All Other Land Uses ³	0	0	0	0	0	0

¹Vehicle-trips computed using the mode split and vehicle occupancy values provided in Table 2-A
²Person-Trips
³Total estimate for all other land uses at mixed-use development site is not subject to internal trip capture computations in this estimator
^aIndicates computation that has been rounded to the nearest whole number.

NCHRP 684 Internal Trip Capture Estimation Tool					
Project Name:	265 Catherine			Organization:	Parsons
Project Location:				Performed By:	
Scenario Description:	PM Internal Reduction			Date:	5/3/2023
Analysis Year:				Checked By:	
Analysis Period:	PM Street Peak Hour			Date:	

Table 1-P: Base Vehicle-Trip Generation Estimates (Single-Use Site Estimate)						
Land Use	Development Data (For Information Only)			Estimated Vehicle-Trips ³		
	ITE LUCs ¹	Quantity	Units	Total	Entering	Exiting
Office				0		
Retail				18	9	9
Restaurant				0		
Cinema/Entertainment				0		
Residential				50	29	21
Hotel				0		
All Other Land Uses ²				0		
				68	38	30

Table 2-P: Mode Split and Vehicle Occupancy Estimates						
Land Use	Entering Trips			Exiting Trips		
	Veh. Occ. ⁴	% Transit	% Non-Motorized	Veh. Occ. ⁴	% Transit	% Non-Motorized
Office						
Retail						
Restaurant						
Cinema/Entertainment						
Residential						
Hotel						
All Other Land Uses ²						

Table 3-P: Average Land Use Interchange Distances (Feet Walking Distance)						
Origin (From)	Destination (To)					
	Office	Retail	Restaurant	Cinema/Entertainment	Residential	Hotel
Office						
Retail					150	
Restaurant						
Cinema/Entertainment						
Residential		150				
Hotel						

Table 4-P: Internal Person-Trip Origin-Destination Matrix*						
Origin (From)	Destination (To)					
	Office	Retail	Restaurant	Cinema/Entertainment	Residential	Hotel
Office		0	0	0	0	0
Retail	0		0	0	2	0
Restaurant	0	0		0	0	0
Cinema/Entertainment	0	0	0		0	0
Residential	0	1	0	0		0
Hotel	0	0	0	0	0	

Table 5-P: Computations Summary			
	Total	Entering	Exiting
All Person-Trips	68	38	30
Internal Capture Percentage	9%	8%	10%
External Vehicle-Trips ⁵	62	35	27
External Transit-Trips ⁶	0	0	0
External Non-Motorized Trips ⁶	0	0	0

Table 6-P: Internal Trip Capture Percentages by Land Use		
Land Use	Entering Trips	Exiting Trips
Office	N/A	N/A
Retail	11%	22%
Restaurant	N/A	N/A
Cinema/Entertainment	N/A	N/A
Residential	7%	5%
Hotel	N/A	N/A

¹Land Use Codes (LUCs) from Trip Generation Manual, published by the Institute of Transportation Engineers.

²Total estimate for all other land uses at mixed-use development site is not subject to internal trip capture computations in this estimator.

³Enter trips assuming no transit or non-motorized trips (as assumed in ITE Trip Generation Manual).

⁴Enter vehicle occupancy assumed in Table 1-P vehicle trips. If vehicle occupancy changes for proposed mixed-use project, manual adjustments must be made.

⁵Vehicle-trips computed using the mode split and vehicle occupancy values provided in Table 2-P.

⁶Person-Trips

⁷Indicates computation that has been rounded to the nearest whole number.

Estimation Tool Developed by the Texas A&M Transportation Institute - Version 2013.1

Project Name:	265 Catherine
Analysis Period:	PM Street Peak Hour

Table 7-P: Conversion of Vehicle-Trip Ends to Person-Trip Ends						
Land Use	Table 7-P (D): Entering Trips			Table 7-P (O): Exiting Trips		
	Veh. Occ.	Vehicle-Trips	Person-Trips*	Veh. Occ.	Vehicle-Trips	Person-Trips*
Office	1.00	0	0	1.00	0	0
Retail	1.00	9	9	1.00	9	9
Restaurant	1.00	0	0	1.00	0	0
Cinema/Entertainment	1.00	0	0	1.00	0	0
Residential	1.00	29	29	1.00	21	21
Hotel	1.00	0	0	1.00	0	0

Table 8-P (O): Internal Person-Trip Origin-Destination Matrix (Computed at Origin)						
Origin (From)	Destination (To)					
	Office	Retail	Restaurant	Cinema/Entertainment	Residential	Hotel
Office		0	0	0	0	0
Retail	0		3	0	2	0
Restaurant	0	0		0	0	0
Cinema/Entertainment	0	0	0		0	0
Residential	1	9	4	0		1
Hotel	0	0	0	0	0	

Table 8-P (D): Internal Person-Trip Origin-Destination Matrix (Computed at Destination)						
Origin (From)	Destination (To)					
	Office	Retail	Restaurant	Cinema/Entertainment	Residential	Hotel
Office		1	0	0	1	0
Retail	0		0	0	13	0
Restaurant	0	5		0	5	0
Cinema/Entertainment	0	0	0		1	0
Residential	0	1	0	0		0
Hotel	0	0	0	0	0	

Table 9-P (D): Internal and External Trips Summary (Entering Trips)						
Destination Land Use	Person-Trip Estimates			External Trips by Mode*		
	Internal	External	Total	Vehicles ¹	Transit ²	Non-Motorized ²
Office	0	0	0	0	0	0
Retail	1	8	9	8	0	0
Restaurant	0	0	0	0	0	0
Cinema/Entertainment	0	0	0	0	0	0
Residential	2	27	29	27	0	0
Hotel	0	0	0	0	0	0
All Other Land Uses ³	0	0	0	0	0	0

Table 9-P (O): Internal and External Trips Summary (Exiting Trips)						
Origin Land Use	Person-Trip Estimates			External Trips by Mode*		
	Internal	External	Total	Vehicles ¹	Transit ²	Non-Motorized ²
Office	0	0	0	0	0	0
Retail	2	7	9	7	0	0
Restaurant	0	0	0	0	0	0
Cinema/Entertainment	0	0	0	0	0	0
Residential	1	20	21	20	0	0
Hotel	0	0	0	0	0	0
All Other Land Uses ³	0	0	0	0	0	0

¹Vehicle-trips computed using the mode split and vehicle occupancy values provided in Table 2-P
²Person-Trips
³Total estimate for all other land uses at mixed-use development site is not subject to internal trip capture computations in this estimator
⁴Indicates computation that has been rounded to the nearest whole number.

NCHRP 684 Internal Trip Capture Estimation Tool			
Project Name:	265 Catherine	Organization:	Parsons
Project Location:		Performed By:	
Scenario Description:	AM Internal Reduction	Date:	5/3/2023
Analysis Year:		Checked By:	
Analysis Period:	AM Street Peak Hour	Date:	

Table 1-A: Base Vehicle-Trip Generation Estimates (Single-Use Site Estimate)						
Land Use	Development Data (For Information Only)			Estimated Vehicle-Trips ³		
	ITE LUCs ¹	Quantity	Units	Total	Entering	Exiting
Office				0		
Retail				14	8	6
Restaurant				0		
Cinema/Entertainment				0		
Residential				179	56	123
Hotel				0		
All Other Land Uses ²				0		
				193	64	129

Table 2-A: Mode Split and Vehicle Occupancy Estimates						
Land Use	Entering Trips			Exiting Trips		
	Veh. Occ. ⁴	% Transit	% Non-Motorized	Veh. Occ. ⁴	% Transit	% Non-Motorized
Office						
Retail						
Restaurant						
Cinema/Entertainment						
Residential						
Hotel						
All Other Land Uses ²						

Table 3-A: Average Land Use Interchange Distances (Feet Walking Distance)						
Origin (From)	Destination (To)					
	Office	Retail	Restaurant	Cinema/Entertainment	Residential	Hotel
Office						
Retail						
Restaurant						
Cinema/Entertainment						
Residential						
Hotel						

Table 4-A: Internal Person-Trip Origin-Destination Matrix*						
Origin (From)	Destination (To)					
	Office	Retail	Restaurant	Cinema/Entertainment	Residential	Hotel
Office		0	0	0	0	0
Retail	0		0	0	1	0
Restaurant	0	0		0	0	0
Cinema/Entertainment	0	0	0		0	0
Residential	0	1	0	0		0
Hotel	0	0	0	0	0	

Table 5-A: Computations Summary			
	Total	Entering	Exiting
All Person-Trips	193	64	129
Internal Capture Percentage	2%	3%	2%
External Vehicle-Trips ⁵	189	62	127
External Transit-Trips ⁶	0	0	0
External Non-Motorized Trips ⁶	0	0	0

Table 6-A: Internal Trip Capture Percentages by Land Use		
Land Use	Entering Trips	Exiting Trips
Office	N/A	N/A
Retail	13%	17%
Restaurant	N/A	N/A
Cinema/Entertainment	N/A	N/A
Residential	2%	1%
Hotel	N/A	N/A

¹Land Use Codes (LUCs) from Trip Generation Manual, published by the Institute of Transportation Engineers.

²Total estimate for all other land uses at mixed-use development site is not subject to internal trip capture computations in this estimator.

³Enter trips assuming no transit or non-motorized trips (as assumed in ITE Trip Generation Manual).

⁴Enter vehicle occupancy assumed in Table 1-A vehicle trips. If vehicle occupancy changes for proposed mixed-use project, manual adjustments must be made to Tables 5-A, 9-A (O and D). Enter transit, non-motorized percentages that will result with proposed mixed-use project complete.

⁵Vehicle-trips computed using the mode split and vehicle occupancy values provided in Table 2-A.

⁶Person-Trips

*Indicates computation that has been rounded to the nearest whole number.

Estimation Tool Developed by the Texas A&M Transportation Institute - Version 2013.1

Project Name:	265 Catherine
Analysis Period:	AM Street Peak Hour

Land Use	Table 7-A (D): Entering Trips			Table 7-A (O): Exiting Trips		
	Veh. Occ.	Vehicle-Trips	Person-Trips*	Veh. Occ.	Vehicle-Trips	Person-Trips*
Office	1.00	0	0	1.00	0	0
Retail	1.00	8	8	1.00	6	6
Restaurant	1.00	0	0	1.00	0	0
Cinema/Entertainment	1.00	0	0	1.00	0	0
Residential	1.00	56	56	1.00	123	123
Hotel	1.00	0	0	1.00	0	0

Origin (From)	Destination (To)					
	Office	Retail	Restaurant	Cinema/Entertainment	Residential	Hotel
Office		0	0	0	0	0
Retail	2		1	0	1	0
Restaurant	0	0		0	0	0
Cinema/Entertainment	0	0	0		0	0
Residential	2	1	25	0		0
Hotel	0	0	0	0	0	

Origin (From)	Destination (To)					
	Office	Retail	Restaurant	Cinema/Entertainment	Residential	Hotel
Office		3	0	0	0	0
Retail	0		0	0	1	0
Restaurant	0	1		0	3	0
Cinema/Entertainment	0	0	0		0	0
Residential	0	1	0	0		0
Hotel	0	0	0	0	0	

Destination Land Use	Person-Trip Estimates			External Trips by Mode*		
	Internal	External	Total	Vehicles ¹	Transit ²	Non-Motorized ²
Office	0	0	0	0	0	0
Retail	1	7	8	7	0	0
Restaurant	0	0	0	0	0	0
Cinema/Entertainment	0	0	0	0	0	0
Residential	1	55	56	55	0	0
Hotel	0	0	0	0	0	0
All Other Land Uses ³	0	0	0	0	0	0

Origin Land Use	Person-Trip Estimates			External Trips by Mode*		
	Internal	External	Total	Vehicles ¹	Transit ²	Non-Motorized ²
Office	0	0	0	0	0	0
Retail	1	5	6	5	0	0
Restaurant	0	0	0	0	0	0
Cinema/Entertainment	0	0	0	0	0	0
Residential	1	122	123	122	0	0
Hotel	0	0	0	0	0	0
All Other Land Uses ³	0	0	0	0	0	0

¹Vehicle-trips computed using the mode split and vehicle occupancy values provided in Table 2-A
²Person-Trips
³Total estimate for all other land uses at mixed-use development site is not subject to internal trip capture computations in this estimator
^{*}Indicates computation that has been rounded to the nearest whole number.

NCHRP 684 Internal Trip Capture Estimation Tool						
Project Name:	265 Catherine			Organization:	Parsons	
Project Location:				Performed By:		
Scenario Description:	PM Internal Reduction			Date:	5/3/2023	
Analysis Year:				Checked By:		
Analysis Period:	PM Street Peak Hour			Date:		

Table 1-P: Base Vehicle-Trip Generation Estimates (Single-Use Site Estimate)						
Land Use	Development Data (For Information Only)			Estimated Vehicle-Trips ³		
	ITE LUCs ¹	Quantity	Units	Total	Entering	Exiting
Office				0		
Retail				36	18	18
Restaurant				0		
Cinema/Entertainment				0		
Residential				179	104	75
Hotel				0		
All Other Land Uses ²				0		
				215	122	93

Table 2-P: Mode Split and Vehicle Occupancy Estimates						
Land Use	Entering Trips			Exiting Trips		
	Veh. Occ. ⁴	% Transit	% Non-Motorized	Veh. Occ. ⁴	% Transit	% Non-Motorized
Office						
Retail						
Restaurant						
Cinema/Entertainment						
Residential						
Hotel						
All Other Land Uses ²						

Table 3-P: Average Land Use Interchange Distances (Feet Walking Distance)						
Origin (From)	Destination (To)					
	Office	Retail	Restaurant	Cinema/Entertainment	Residential	Hotel
Office						
Retail					150	
Restaurant						
Cinema/Entertainment						
Residential		150				
Hotel						

Table 4-P: Internal Person-Trip Origin-Destination Matrix*						
Origin (From)	Destination (To)					
	Office	Retail	Restaurant	Cinema/Entertainment	Residential	Hotel
Office		0	0	0	0	0
Retail	0		0	0	5	0
Restaurant	0	0		0	0	0
Cinema/Entertainment	0	0	0		0	0
Residential	0	2	0	0		0
Hotel	0	0	0	0	0	

Table 5-P: Computations Summary			
	Total	Entering	Exiting
All Person-Trips	215	122	93
Internal Capture Percentage	7%	6%	8%
External Vehicle-Trips ⁵	201	115	86
External Transit-Trips ⁶	0	0	0
External Non-Motorized Trips ⁶	0	0	0

Table 6-P: Internal Trip Capture Percentages by Land Use		
Land Use	Entering Trips	Exiting Trips
Office	N/A	N/A
Retail	11%	28%
Restaurant	N/A	N/A
Cinema/Entertainment	N/A	N/A
Residential	5%	3%
Hotel	N/A	N/A

¹Land Use Codes (LUCs) from Trip Generation Manual, published by the Institute of Transportation Engineers.

²Total estimate for all other land uses at mixed-use development site is not subject to internal trip capture computations in this estimator.

³Enter trips assuming no transit or non-motorized trips (as assumed in ITE Trip Generation Manual).

⁴Enter vehicle occupancy assumed in Table 1-P vehicle trips. If vehicle occupancy changes for proposed mixed-use project, manual adjustments must be made.

⁵Vehicle-trips computed using the mode split and vehicle occupancy values provided in Table 2-P.

⁶Person-Trips

⁷Indicates computation that has been rounded to the nearest whole number.

Estimation Tool Developed by the Texas A&M Transportation Institute - Version 2013.1

Project Name:	265 Catherine
Analysis Period:	PM Street Peak Hour

Table 7-P: Conversion of Vehicle-Trip Ends to Person-Trip Ends						
Land Use	Table 7-P (D): Entering Trips			Table 7-P (O): Exiting Trips		
	Veh. Occ.	Vehicle-Trips	Person-Trips*	Veh. Occ.	Vehicle-Trips	Person-Trips*
Office	1.00	0	0	1.00	0	0
Retail	1.00	18	18	1.00	18	18
Restaurant	1.00	0	0	1.00	0	0
Cinema/Entertainment	1.00	0	0	1.00	0	0
Residential	1.00	104	104	1.00	75	75
Hotel	1.00	0	0	1.00	0	0

Table 8-P (O): Internal Person-Trip Origin-Destination Matrix (Computed at Origin)						
Origin (From)	Destination (To)					
	Office	Retail	Restaurant	Cinema/Entertainment	Residential	Hotel
Office		0	0	0	0	0
Retail	0		5	1	5	1
Restaurant	0	0		0	0	0
Cinema/Entertainment	0	0	0		0	0
Residential	3	32	16	0		2
Hotel	0	0	0	0	0	

Table 8-P (D): Internal Person-Trip Origin-Destination Matrix (Computed at Destination)						
Origin (From)	Destination (To)					
	Office	Retail	Restaurant	Cinema/Entertainment	Residential	Hotel
Office		1	0	0	4	0
Retail	0		0	0	48	0
Restaurant	0	9		0	17	0
Cinema/Entertainment	0	1	0		4	0
Residential	0	2	0	0		0
Hotel	0	0	0	0	0	

Table 9-P (D): Internal and External Trips Summary (Entering Trips)						
Destination Land Use	Person-Trip Estimates			External Trips by Mode*		
	Internal	External	Total	Vehicles ¹	Transit ²	Non-Motorized ²
Office	0	0	0	0	0	0
Retail	2	16	18	16	0	0
Restaurant	0	0	0	0	0	0
Cinema/Entertainment	0	0	0	0	0	0
Residential	5	99	104	99	0	0
Hotel	0	0	0	0	0	0
All Other Land Uses ³	0	0	0	0	0	0

Table 9-P (O): Internal and External Trips Summary (Exiting Trips)						
Origin Land Use	Person-Trip Estimates			External Trips by Mode*		
	Internal	External	Total	Vehicles ¹	Transit ²	Non-Motorized ²
Office	0	0	0	0	0	0
Retail	5	13	18	13	0	0
Restaurant	0	0	0	0	0	0
Cinema/Entertainment	0	0	0	0	0	0
Residential	2	73	75	73	0	0
Hotel	0	0	0	0	0	0
All Other Land Uses ³	0	0	0	0	0	0

¹Vehicle-trips computed using the mode split and vehicle occupancy values provided in Table 2-P
²Person-Trips
³Total estimate for all other land uses at mixed-use development site is not subject to internal trip capture computations in this estimator
⁴Indicates computation that has been rounded to the nearest whole number.

DRAFT

Appendix F:
TDM Checklist

TDM-Supportive Development Design and Infrastructure Checklist:
Residential Developments (multi-family or condominium)

<i>Legend</i>	
REQUIRED	The Official Plan or Zoning By-law provides related guidance that must be followed
BASIC	The measure is generally feasible and effective, and in most cases would benefit the development and its users
BETTER	The measure could maximize support for users of sustainable modes, and optimize development performance

TDM-supportive design & infrastructure measures: <i>Residential developments</i>		Check if completed & add descriptions, explanations or plan/drawing references
1. WALKING & CYCLING: ROUTES		
1.1 Building location & access points		
BASIC	1.1.1 Locate building close to the street, and do not locate parking areas between the street and building entrances	<input checked="" type="checkbox"/>
BASIC	1.1.2 Locate building entrances in order to minimize walking distances to sidewalks and transit stops/stations	<input checked="" type="checkbox"/>
BASIC	1.1.3 Locate building doors and windows to ensure visibility of pedestrians from the building, for their security and comfort	<input checked="" type="checkbox"/>
1.2 Facilities for walking & cycling		
REQUIRED	1.2.1 Provide convenient, direct access to stations or major stops along rapid transit routes within 600 metres; minimize walking distances from buildings to rapid transit; provide pedestrian-friendly, weather-protected (where possible) environment between rapid transit accesses and building entrances; ensure quality linkages from sidewalks through building entrances to integrated stops/stations (<i>see Official Plan policy 4.3.3</i>)	<input checked="" type="checkbox"/>
REQUIRED	1.2.2 Provide safe, direct and attractive pedestrian access from public sidewalks to building entrances through such measures as: reducing distances between public sidewalks and major building entrances; providing walkways from public streets to major building entrances; within a site, providing walkways along the front of adjoining buildings, between adjacent buildings, and connecting areas where people may congregate, such as courtyards and transit stops; and providing weather protection through canopies, colonnades, and other design elements wherever possible (<i>see Official Plan policy 4.3.12</i>)	<input checked="" type="checkbox"/>

TDM-supportive design & infrastructure measures: <i>Residential developments</i>		Check if completed & add descriptions, explanations or plan/drawing references
REQUIRED	1.2.3 Provide sidewalks of smooth, well-drained walking surfaces of contrasting materials or treatments to differentiate pedestrian areas from vehicle areas, and provide marked pedestrian crosswalks at intersection sidewalks (<i>see Official Plan policy 4.3.10</i>)	<input checked="" type="checkbox"/>
REQUIRED	1.2.4 Make sidewalks and open space areas easily accessible through features such as gradual grade transition, depressed curbs at street corners and convenient access to extra-wide parking spaces and ramps (<i>see Official Plan policy 4.3.10</i>)	<input checked="" type="checkbox"/>
REQUIRED	1.2.5 Include adequately spaced inter-block/street cycling and pedestrian connections to facilitate travel by active transportation. Provide links to the existing or planned network of public sidewalks, multi-use pathways and on-road cycle routes. Where public sidewalks and multi-use pathways intersect with roads, consider providing traffic control devices to give priority to cyclists and pedestrians (<i>see Official Plan policy 4.3.11</i>)	<input checked="" type="checkbox"/>
BASIC	1.2.6 Provide safe, direct and attractive walking routes from building entrances to nearby transit stops	<input checked="" type="checkbox"/>
BASIC	1.2.7 Ensure that walking routes to transit stops are secure, visible, lighted, shaded and wind-protected wherever possible	<input checked="" type="checkbox"/>
BASIC	1.2.8 Design roads used for access or circulation by cyclists using a target operating speed of no more than 30 km/h, or provide a separated cycling facility	<input checked="" type="checkbox"/>
1.3 Amenities for walking & cycling		
BASIC	1.3.1 Provide lighting, landscaping and benches along walking and cycling routes between building entrances and streets, sidewalks and trails	<input checked="" type="checkbox"/>
BASIC	1.3.2 Provide wayfinding signage for site access (where required, e.g. when multiple buildings or entrances exist) and egress (where warranted, such as when directions to reach transit stops/stations, trails or other common destinations are not obvious)	<input checked="" type="checkbox"/>

TDM-supportive design & infrastructure measures: <i>Residential developments</i>		Check if completed & add descriptions, explanations or plan/drawing references
2. WALKING & CYCLING: END-OF-TRIP FACILITIES		
2.1 Bicycle parking		
REQUIRED	2.1.1 Provide bicycle parking in highly visible and lighted areas, sheltered from the weather wherever possible (see <i>Official Plan policy 4.3.6</i>)	<input checked="" type="checkbox"/>
REQUIRED	2.1.2 Provide the number of bicycle parking spaces specified for various land uses in different parts of Ottawa; provide convenient access to main entrances or well-used areas (see <i>Zoning By-law Section 111</i>)	<input checked="" type="checkbox"/>
REQUIRED	2.1.3 Ensure that bicycle parking spaces and access aisles meet minimum dimensions; that no more than 50% of spaces are vertical spaces; and that parking racks are securely anchored (see <i>Zoning By-law Section 111</i>)	<input checked="" type="checkbox"/>
BASIC	2.1.4 Provide bicycle parking spaces equivalent to the expected number of resident-owned bicycles, plus the expected peak number of visitor cyclists	<input checked="" type="checkbox"/>
2.2 Secure bicycle parking		
REQUIRED	2.2.1 Where more than 50 bicycle parking spaces are provided for a single residential building, locate at least 25% of spaces within a building/structure, a secure area (e.g. supervised parking lot or enclosure) or bicycle lockers (see <i>Zoning By-law Section 111</i>)	<input checked="" type="checkbox"/>
BETTER	2.2.2 Provide secure bicycle parking spaces equivalent to at least the number of units at condominiums or multi-family residential developments	<input checked="" type="checkbox"/>
2.3 Bicycle repair station		
BETTER	2.3.1 Provide a permanent bike repair station, with commonly used tools and an air pump, adjacent to the main bicycle parking area (or secure bicycle parking area, if provided)	<input type="checkbox"/>
3. TRANSIT		
3.1 Customer amenities		
BASIC	3.1.1 Provide shelters, lighting and benches at any on-site transit stops	<input type="checkbox"/>
BASIC	3.1.2 Where the site abuts an off-site transit stop and insufficient space exists for a transit shelter in the public right-of-way, protect land for a shelter and/or install a shelter	<input checked="" type="checkbox"/>
BETTER	3.1.3 Provide a secure and comfortable interior waiting area by integrating any on-site transit stops into the building	<input type="checkbox"/>

TDM-supportive design & infrastructure measures: <i>Residential developments</i>		Check if completed & add descriptions, explanations or plan/drawing references
4. RIDESHARING		
4.1 Pick-up & drop-off facilities		
BASIC	4.1.1 Provide a designated area for carpool drivers (plus taxis and ride-hailing services) to drop off or pick up passengers without using fire lanes or other no-stopping zones	<input checked="" type="checkbox"/>
5. CARSHARING & BIKESHARING		
5.1 Carshare parking spaces		
BETTER	5.1.1 Provide up to three carshare parking spaces in an R3, R4 or R5 Zone for specified residential uses (<i>see Zoning By-law Section 94</i>)	<input checked="" type="checkbox"/>
5.2 Bikeshare station location		
BETTER	5.2.1 Provide a designated bikeshare station area near a major building entrance, preferably lighted and sheltered with a direct walkway connection	<input type="checkbox"/>
6. PARKING		
6.1 Number of parking spaces		
REQUIRED	6.1.1 Do not provide more parking than permitted by zoning, nor less than required by zoning, unless a variance is being applied for	<input type="checkbox"/>
BASIC	6.1.2 Provide parking for long-term and short-term users that is consistent with mode share targets, considering the potential for visitors to use off-site public parking	<input type="checkbox"/>
BASIC	6.1.3 Where a site features more than one use, provide shared parking and reduce the cumulative number of parking spaces accordingly (<i>see Zoning By-law Section 104</i>)	<input checked="" type="checkbox"/>
BETTER	6.1.4 Reduce the minimum number of parking spaces required by zoning by one space for each 13 square metres of gross floor area provided as shower rooms, change rooms, locker rooms and other facilities for cyclists in conjunction with bicycle parking (<i>see Zoning By-law Section 111</i>)	<input type="checkbox"/>
6.2 Separate long-term & short-term parking areas		
BETTER	6.2.1 Provide separate areas for short-term and long-term parking (using signage or physical barriers) to permit access controls and simplify enforcement (i.e. to discourage residents from parking in visitor spaces, and vice versa)	<input checked="" type="checkbox"/>

TDM Measures Checklist:
Residential Developments (multi-family, condominium or subdivision)

Legend	
BASIC	The measure is generally feasible and effective, and in most cases would benefit the development and its users
BETTER	The measure could maximize support for users of sustainable modes, and optimize development performance
★	The measure is one of the most dependably effective tools to encourage the use of sustainable modes

TDM measures: <i>Residential developments</i>		Check if proposed & add descriptions
1. TDM PROGRAM MANAGEMENT		
1.1 Program coordinator		
BASIC	★ 1.1.1 Designate an internal coordinator, or contract with an external coordinator	<input type="checkbox"/>
1.2 Travel surveys		
BETTER	1.2.1 Conduct periodic surveys to identify travel-related behaviours, attitudes, challenges and solutions, and to track progress	<input type="checkbox"/>
2. WALKING AND CYCLING		
2.1 Information on walking/cycling routes & destinations		
BASIC	2.1.1 Display local area maps with walking/cycling access routes and key destinations at major entrances (<i>multi-family, condominium</i>)	<input checked="" type="checkbox"/>
2.2 Bicycle skills training		
BETTER	2.2.1 Offer on-site cycling courses for residents, or subsidize off-site courses	<input checked="" type="checkbox"/>

TDM measures: <i>Residential developments</i>		Check if proposed & add descriptions
3. TRANSIT		
3.1 Transit information		
BASIC	3.1.1 Display relevant transit schedules and route maps at entrances (<i>multi-family, condominium</i>)	<input checked="" type="checkbox"/>
BETTER	3.1.2 Provide real-time arrival information display at entrances (<i>multi-family, condominium</i>)	<input type="checkbox"/>
3.2 Transit fare incentives		
BASIC ★	3.2.1 Offer PRESTO cards preloaded with one monthly transit pass on residence purchase/move-in, to encourage residents to use transit	<input checked="" type="checkbox"/>
BETTER	3.2.2 Offer at least one year of free monthly transit passes on residence purchase/move-in	<input type="checkbox"/>
3.3 Enhanced public transit service		
BETTER ★	3.3.1 Contract with OC Transpo to provide early transit services until regular services are warranted by occupancy levels (<i>subdivision</i>)	<input type="checkbox"/>
3.4 Private transit service		
BETTER	3.4.1 Provide shuttle service for seniors homes or lifestyle communities (e.g. scheduled mall or supermarket runs)	<input type="checkbox"/>
4. CARSHARING & BIKESHARING		
4.1 Bikeshare stations & memberships		
BETTER	4.1.1 Contract with provider to install on-site bikeshare station (<i>multi-family</i>)	<input checked="" type="checkbox"/>
BETTER	4.1.2 Provide residents with bikeshare memberships, either free or subsidized (<i>multi-family</i>)	<input checked="" type="checkbox"/>
4.2 Carshare vehicles & memberships		
BETTER	4.2.1 Contract with provider to install on-site carshare vehicles and promote their use by residents	<input checked="" type="checkbox"/>
BETTER	4.2.2 Provide residents with carshare memberships, either free or subsidized	<input type="checkbox"/>
5. PARKING		
5.1 Priced parking		
BASIC ★	5.1.1 Unbundle parking cost from purchase price (<i>condominium</i>)	<input type="checkbox"/>
BASIC ★	5.1.2 Unbundle parking cost from monthly rent (<i>multi-family</i>)	<input checked="" type="checkbox"/>

TDM measures: <i>Residential developments</i>		Check if proposed & add descriptions
6. TDM MARKETING & COMMUNICATIONS		
6.1 Multimodal travel information		
BASIC	★ 6.1.1 Provide a multimodal travel option information package to new residents	<input checked="" type="checkbox"/>
6.2 Personalized trip planning		
BETTER	★ 6.2.1 Offer personalized trip planning to new residents	<input checked="" type="checkbox"/>

TDM-Supportive Development Design and Infrastructure Checklist: *Non-Residential Developments (office, institutional, retail or industrial)*

Legend	
REQUIRED	The Official Plan or Zoning By-law provides related guidance that must be followed
BASIC	The measure is generally feasible and effective, and in most cases would benefit the development and its users
BETTER	The measure could maximize support for users of sustainable modes, and optimize development performance

TDM-supportive design & infrastructure measures: <i>Non-residential developments</i>		Check if completed & add descriptions, explanations or plan/drawing references
1. WALKING & CYCLING: ROUTES		
1.1 Building location & access points		
BASIC	1.1.1 Locate building close to the street, and do not locate parking areas between the street and building entrances	<input checked="" type="checkbox"/>
BASIC	1.1.2 Locate building entrances in order to minimize walking distances to sidewalks and transit stops/stations	<input checked="" type="checkbox"/>
BASIC	1.1.3 Locate building doors and windows to ensure visibility of pedestrians from the building, for their security and comfort	<input checked="" type="checkbox"/>
1.2 Facilities for walking & cycling		
REQUIRED	1.2.1 Provide convenient, direct access to stations or major stops along rapid transit routes within 600 metres; minimize walking distances from buildings to rapid transit; provide pedestrian-friendly, weather-protected (where possible) environment between rapid transit accesses and building entrances; ensure quality linkages from sidewalks through building entrances to integrated stops/stations (<i>see Official Plan policy 4.3.3</i>)	<input checked="" type="checkbox"/>
REQUIRED	1.2.2 Provide safe, direct and attractive pedestrian access from public sidewalks to building entrances through such measures as: reducing distances between public sidewalks and major building entrances; providing walkways from public streets to major building entrances; within a site, providing walkways along the front of adjoining buildings, between adjacent buildings, and connecting areas where people may congregate, such as courtyards and transit stops; and providing weather protection through canopies, colonnades, and other design elements wherever possible (<i>see Official Plan policy 4.3.12</i>)	<input checked="" type="checkbox"/>

TDM-supportive design & infrastructure measures: <i>Non-residential developments</i>		Check if completed & add descriptions, explanations or plan/drawing references
REQUIRED	1.2.3 Provide sidewalks of smooth, well-drained walking surfaces of contrasting materials or treatments to differentiate pedestrian areas from vehicle areas, and provide marked pedestrian crosswalks at intersection sidewalks (<i>see Official Plan policy 4.3.10</i>)	<input checked="" type="checkbox"/>
REQUIRED	1.2.4 Make sidewalks and open space areas easily accessible through features such as gradual grade transition, depressed curbs at street corners and convenient access to extra-wide parking spaces and ramps (<i>see Official Plan policy 4.3.10</i>)	<input checked="" type="checkbox"/>
REQUIRED	1.2.5 Include adequately spaced inter-block/street cycling and pedestrian connections to facilitate travel by active transportation. Provide links to the existing or planned network of public sidewalks, multi-use pathways and on-road cycle routes. Where public sidewalks and multi-use pathways intersect with roads, consider providing traffic control devices to give priority to cyclists and pedestrians (<i>see Official Plan policy 4.3.11</i>)	<input checked="" type="checkbox"/>
BASIC	1.2.6 Provide safe, direct and attractive walking routes from building entrances to nearby transit stops	<input checked="" type="checkbox"/>
BASIC	1.2.7 Ensure that walking routes to transit stops are secure, visible, lighted, shaded and wind-protected wherever possible	<input checked="" type="checkbox"/>
BASIC	1.2.8 Design roads used for access or circulation by cyclists using a target operating speed of no more than 30 km/h, or provide a separated cycling facility	<input checked="" type="checkbox"/>
1.3 Amenities for walking & cycling		
BASIC	1.3.1 Provide lighting, landscaping and benches along walking and cycling routes between building entrances and streets, sidewalks and trails	<input checked="" type="checkbox"/>
BASIC	1.3.2 Provide wayfinding signage for site access (where required, e.g. when multiple buildings or entrances exist) and egress (where warranted, such as when directions to reach transit stops/stations, trails or other common destinations are not obvious)	<input checked="" type="checkbox"/>

TDM-supportive design & infrastructure measures: <i>Non-residential developments</i>		Check if completed & add descriptions, explanations or plan/drawing references
2. WALKING & CYCLING: END-OF-TRIP FACILITIES		
2.1 Bicycle parking		
REQUIRED	2.1.1 Provide bicycle parking in highly visible and lighted areas, sheltered from the weather wherever possible (see <i>Official Plan policy 4.3.6</i>)	<input checked="" type="checkbox"/>
REQUIRED	2.1.2 Provide the number of bicycle parking spaces specified for various land uses in different parts of Ottawa; provide convenient access to main entrances or well-used areas (see <i>Zoning By-law Section 111</i>)	<input checked="" type="checkbox"/>
REQUIRED	2.1.3 Ensure that bicycle parking spaces and access aisles meet minimum dimensions; that no more than 50% of spaces are vertical spaces; and that parking racks are securely anchored (see <i>Zoning By-law Section 111</i>)	<input checked="" type="checkbox"/>
BASIC	2.1.4 Provide bicycle parking spaces equivalent to the expected number of commuter cyclists (assuming the cycling mode share target is met), plus the expected peak number of customer/visitor cyclists	<input checked="" type="checkbox"/>
BETTER	2.1.5 Provide bicycle parking spaces equivalent to the expected number of commuter and customer/visitor cyclists, plus an additional buffer (e.g. 25 percent extra) to encourage other cyclists and ensure adequate capacity in peak cycling season	<input checked="" type="checkbox"/>
2.2 Secure bicycle parking		
REQUIRED	2.2.1 Where more than 50 bicycle parking spaces are provided for a single office building, locate at least 25% of spaces within a building/structure, a secure area (e.g. supervised parking lot or enclosure) or bicycle lockers (see <i>Zoning By-law Section 111</i>)	<input checked="" type="checkbox"/>
BETTER	2.2.2 Provide secure bicycle parking spaces equivalent to the expected number of commuter cyclists (assuming the cycling mode share target is met)	<input checked="" type="checkbox"/>
2.3 Shower & change facilities		
BASIC	2.3.1 Provide shower and change facilities for the use of active commuters	<input type="checkbox"/>
BETTER	2.3.2 In addition to shower and change facilities, provide dedicated lockers, grooming stations, drying racks and laundry facilities for the use of active commuters	<input type="checkbox"/>
2.4 Bicycle repair station		
BETTER	2.4.1 Provide a permanent bike repair station, with commonly used tools and an air pump, adjacent to the main bicycle parking area (or secure bicycle parking area, if provided)	<input type="checkbox"/>

TDM-supportive design & infrastructure measures: <i>Non-residential developments</i>		Check if completed & add descriptions, explanations or plan/drawing references
3. TRANSIT		
3.1 Customer amenities		
BASIC	3.1.1 Provide shelters, lighting and benches at any on-site transit stops	<input type="checkbox"/>
BASIC	3.1.2 Where the site abuts an off-site transit stop and insufficient space exists for a transit shelter in the public right-of-way, protect land for a shelter and/or install a shelter	<input checked="" type="checkbox"/>
BETTER	3.1.3 Provide a secure and comfortable interior waiting area by integrating any on-site transit stops into the building	<input type="checkbox"/>
4. RIDESHARING		
4.1 Pick-up & drop-off facilities		
BASIC	4.1.1 Provide a designated area for carpool drivers (plus taxis and ride-hailing services) to drop off or pick up passengers without using fire lanes or other no-stopping zones	<input checked="" type="checkbox"/>
4.2 Carpool parking		
BASIC	4.2.1 Provide signed parking spaces for carpools in a priority location close to a major building entrance, sufficient in number to accommodate the mode share target for carpools	<input type="checkbox"/>
BETTER	4.2.2 At large developments, provide spaces for carpools in a separate, access-controlled parking area to simplify enforcement	<input type="checkbox"/>
5. CARSHARING & BIKESHARING		
5.1 Carshare parking spaces		
BETTER	5.1.1 Provide carshare parking spaces in permitted non-residential zones, occupying either required or provided parking spaces (<i>see Zoning By-law Section 94</i>)	<input type="checkbox"/>
5.2 Bikeshare station location		
BETTER	5.2.1 Provide a designated bikeshare station area near a major building entrance, preferably lighted and sheltered with a direct walkway connection	<input type="checkbox"/>

TDM-supportive design & infrastructure measures: <i>Non-residential developments</i>		Check if completed & add descriptions, explanations or plan/drawing references
6. PARKING		
6.1 Number of parking spaces		
REQUIRED	6.1.1 Do not provide more parking than permitted by zoning, nor less than required by zoning, unless a variance is being applied for	<input checked="" type="checkbox"/>
BASIC	6.1.2 Provide parking for long-term and short-term users that is consistent with mode share targets, considering the potential for visitors to use off-site public parking	<input checked="" type="checkbox"/>
BASIC	6.1.3 Where a site features more than one use, provide shared parking and reduce the cumulative number of parking spaces accordingly (<i>see Zoning By-law Section 104</i>)	<input checked="" type="checkbox"/>
BETTER	6.1.4 Reduce the minimum number of parking spaces required by zoning by one space for each 13 square metres of gross floor area provided as shower rooms, change rooms, locker rooms and other facilities for cyclists in conjunction with bicycle parking (<i>see Zoning By-law Section 111</i>)	<input type="checkbox"/>
6.2 Separate long-term & short-term parking areas		
BETTER	6.2.1 Separate short-term and long-term parking areas using signage or physical barriers, to permit access controls and simplify enforcement (i.e. to discourage employees from parking in visitor spaces, and vice versa)	<input checked="" type="checkbox"/>
7. OTHER		
7.1 On-site amenities to minimize off-site trips		
BETTER	7.1.1 Provide on-site amenities to minimize mid-day or mid-commute errands	<input type="checkbox"/>

TDM Measures Checklist:
Non-Residential Developments (office, institutional, retail or industrial)

Legend	
BASIC	The measure is generally feasible and effective, and in most cases would benefit the development and its users
BETTER	The measure could maximize support for users of sustainable modes, and optimize development performance
★	The measure is one of the most dependably effective tools to encourage the use of sustainable modes

TDM measures: <i>Non-residential developments</i>		Check if proposed & add descriptions
1. TDM PROGRAM MANAGEMENT		
1.1 Program coordinator		
BASIC ★	1.1.1 Designate an internal coordinator, or contract with an external coordinator	<input type="checkbox"/>
1.2 Travel surveys		
BETTER	1.2.1 Conduct periodic surveys to identify travel-related behaviours, attitudes, challenges and solutions, and to track progress	<input type="checkbox"/>
2. WALKING AND CYCLING		
2.1 Information on walking/cycling routes & destinations		
BASIC	2.1.1 Display local area maps with walking/cycling access routes and key destinations at major entrances	<input checked="" type="checkbox"/>
2.2 Bicycle skills training		
<i>Commuter travel</i>		
BETTER ★	2.2.1 Offer on-site cycling courses for commuters, or subsidize off-site courses	<input checked="" type="checkbox"/>
2.3 Valet bike parking		
<i>Visitor travel</i>		
BETTER	2.3.1 Offer secure valet bike parking during public events when demand exceeds fixed supply (e.g. for festivals, concerts, games)	<input type="checkbox"/>

TDM measures: <i>Non-residential developments</i>		Check if proposed & add descriptions
3. TRANSIT		
3.1 Transit information		
BASIC	3.1.1 Display relevant transit schedules and route maps at entrances	<input checked="" type="checkbox"/>
BASIC	3.1.2 Provide online links to OC Transpo and STO information	<input checked="" type="checkbox"/>
BETTER	3.1.3 Provide real-time arrival information display at entrances	<input type="checkbox"/>
3.2 Transit fare incentives		
<i>Commuter travel</i>		
BETTER	3.2.1 Offer preloaded PRESTO cards to encourage commuters to use transit	<input checked="" type="checkbox"/>
BETTER ★	3.2.2 Subsidize or reimburse monthly transit pass purchases by employees	<input type="checkbox"/>
<i>Visitor travel</i>		
BETTER	3.2.3 Arrange inclusion of same-day transit fare in price of tickets (e.g. for festivals, concerts, games)	<input type="checkbox"/>
3.3 Enhanced public transit service		
<i>Commuter travel</i>		
BETTER	3.3.1 Contract with OC Transpo to provide enhanced transit services (e.g. for shift changes, weekends)	<input type="checkbox"/>
<i>Visitor travel</i>		
BETTER	3.3.2 Contract with OC Transpo to provide enhanced transit services (e.g. for festivals, concerts, games)	<input type="checkbox"/>
3.4 Private transit service		
<i>Commuter travel</i>		
BETTER	3.4.1 Provide shuttle service when OC Transpo cannot offer sufficient quality or capacity to serve demand (e.g. for shift changes, weekends)	<input type="checkbox"/>
<i>Visitor travel</i>		
BETTER	3.4.2 Provide shuttle service when OC Transpo cannot offer sufficient quality or capacity to serve demand (e.g. for festivals, concerts, games)	<input type="checkbox"/>

TDM measures: <i>Non-residential developments</i>		Check if proposed & add descriptions
4. RIDESHARING		
4.1 Ridematching service		
<i>Commuter travel</i>		
BASIC	★ 4.1.1 Provide a dedicated ridematching portal at OttawaRideMatch.com	<input type="checkbox"/>
4.2 Carpool parking price incentives		
<i>Commuter travel</i>		
BETTER	4.2.1 Provide discounts on parking costs for registered carpools	<input type="checkbox"/>
4.3 Vanpool service		
<i>Commuter travel</i>		
BETTER	4.3.1 Provide a vanpooling service for long-distance commuters	<input type="checkbox"/>
5. CARSHARING & BIKESHARING		
5.1 Bikeshare stations & memberships		
BETTER	5.1.1 Contract with provider to install on-site bikeshare station for use by commuters and visitors	<input checked="" type="checkbox"/>
<i>Commuter travel</i>		
BETTER	5.1.2 Provide employees with bikeshare memberships for local business travel	<input checked="" type="checkbox"/>
5.2 Carshare vehicles & memberships		
<i>Commuter travel</i>		
BETTER	5.2.1 Contract with provider to install on-site carshare vehicles and promote their use by tenants	<input checked="" type="checkbox"/>
BETTER	5.2.2 Provide employees with carshare memberships for local business travel	<input type="checkbox"/>
6. PARKING		
6.1 Priced parking		
<i>Commuter travel</i>		
BASIC	★ 6.1.1 Charge for long-term parking (daily, weekly, monthly)	<input type="checkbox"/>
BASIC	6.1.2 Unbundle parking cost from lease rates at multi-tenant sites	<input checked="" type="checkbox"/>
<i>Visitor travel</i>		
BETTER	6.1.3 Charge for short-term parking (hourly)	<input type="checkbox"/>

TDM measures: <i>Non-residential developments</i>		Check if proposed & add descriptions
7. TDM MARKETING & COMMUNICATIONS		
7.1 Multimodal travel information		
<i>Commuter travel</i>		
BASIC ★	7.1.1 Provide a multimodal travel option information package to new/relocating employees and students	<input checked="" type="checkbox"/>
<i>Visitor travel</i>		
BETTER ★	7.1.2 Include multimodal travel option information in invitations or advertising that attract visitors or customers (e.g. for festivals, concerts, games)	<input type="checkbox"/>
7.2 Personalized trip planning		
<i>Commuter travel</i>		
BETTER ★	7.2.1 Offer personalized trip planning to new/relocating employees	<input checked="" type="checkbox"/>
7.3 Promotions		
<i>Commuter travel</i>		
BETTER	7.3.1 Deliver promotions and incentives to maintain awareness, build understanding, and encourage trial of sustainable modes	<input type="checkbox"/>
8. OTHER INCENTIVES & AMENITIES		
8.1 Emergency ride home		
<i>Commuter travel</i>		
BETTER ★	8.1.1 Provide emergency ride home service to non-driving commuters	<input type="checkbox"/>
8.2 Alternative work arrangements		
<i>Commuter travel</i>		
BASIC ★	8.2.1 Encourage flexible work hours	<input type="checkbox"/>
BETTER	8.2.2 Encourage compressed workweeks	<input type="checkbox"/>
BETTER ★	8.2.3 Encourage telework	<input type="checkbox"/>
8.3 Local business travel options		
<i>Commuter travel</i>		
BASIC ★	8.3.1 Provide local business travel options that minimize the need for employees to bring a personal car to work	<input type="checkbox"/>
8.4 Commuter incentives		
<i>Commuter travel</i>		
BETTER	8.4.1 Offer employees a taxable, mode-neutral commuting allowance	<input type="checkbox"/>
8.5 On-site amenities		
<i>Commuter travel</i>		
BETTER	8.5.1 Provide on-site amenities/services to minimize mid-day or mid-commute errands	<input type="checkbox"/>

DRAFT

Appendix G:

Passenger Car and Truck Turning Templates

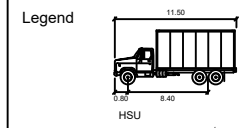
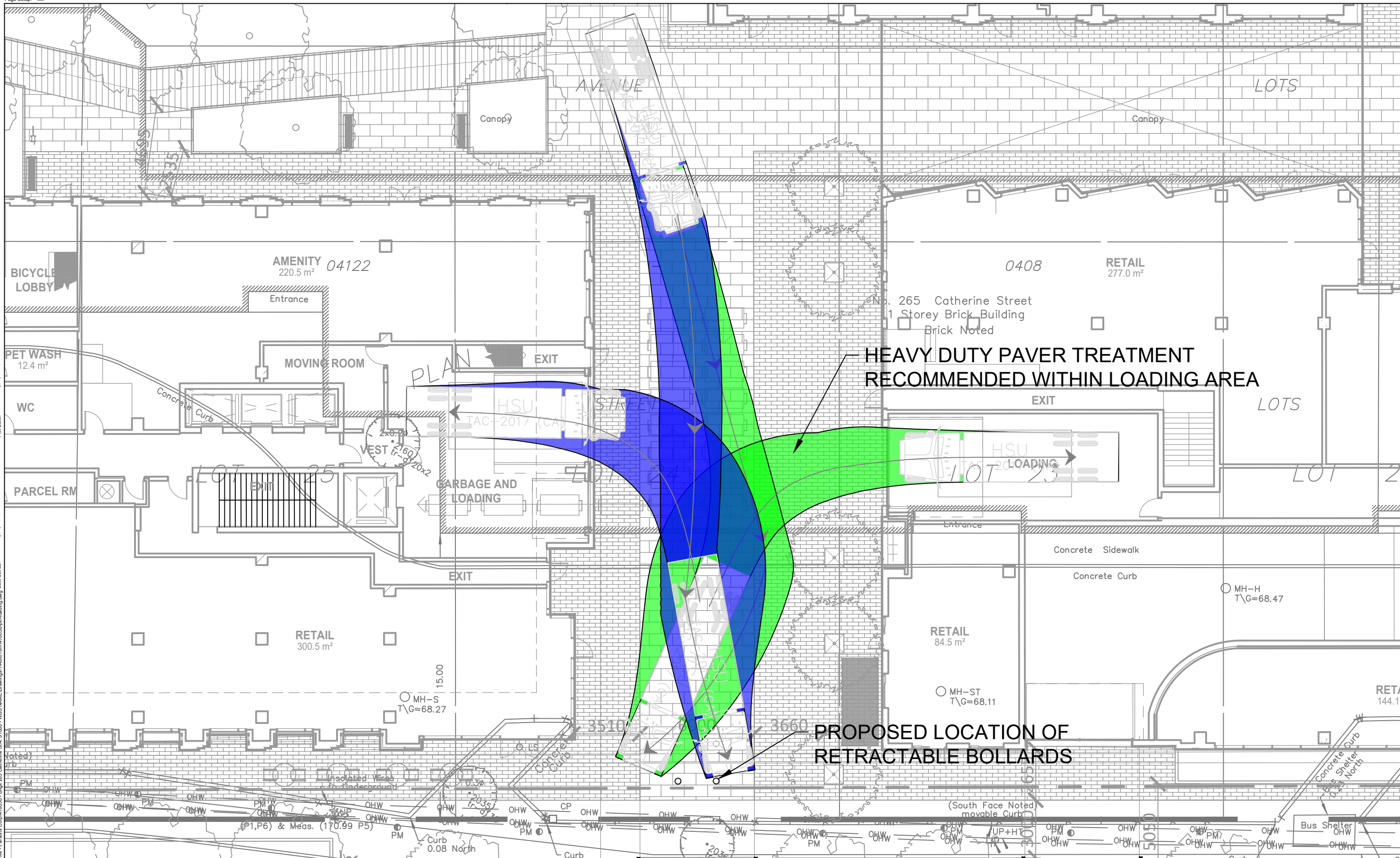

NOTE: The location of utilities is approximate only, the exact location should be determined by consulting the municipal authorities and utility companies concerned. The contractor shall prove the location of utilities and shall be responsible for adequate protection from damage.

Not to Scale

Drawing Description		HSU - On-Site Loading	
Client		Date	Apr 27, 2023
Project Number	478038	Figure Number	001
Project Description		265 Catherine St	

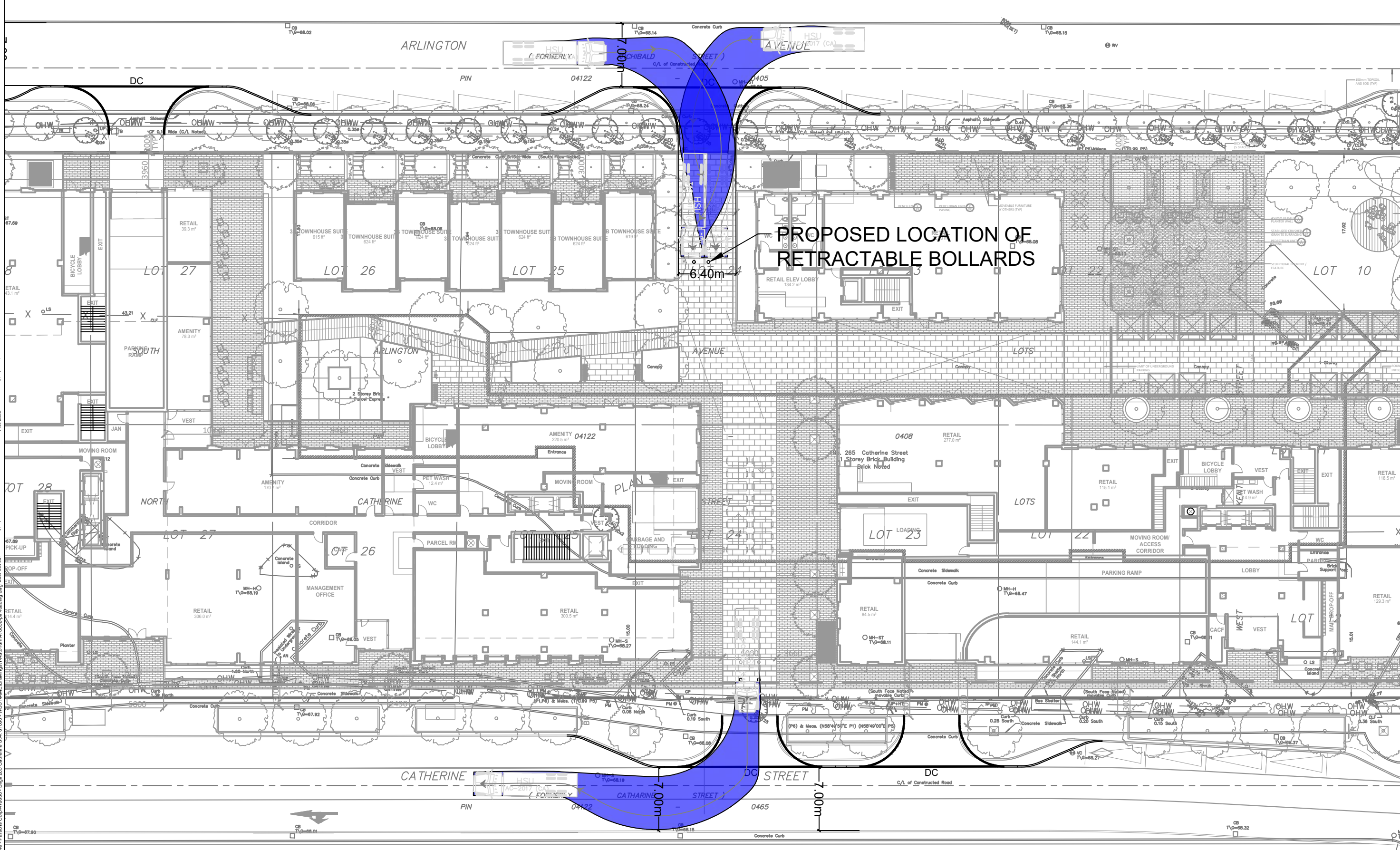

Consultant: C:\Users\049789\OneDrive - Parsons Corp\478038 - Parsons Corp\478038 - Eng\265 Catherine St - 01000 - WS\NAME\Drawings\Auto\478038\478038-ph-loading.dwg, Last Saved: Thursday, April 27, 2023 2:52:28 PM
 Plot Date: Thursday, April 27, 2023 2:54:55 PM

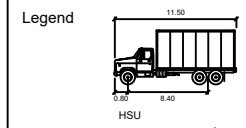

NOTE: The location of utilities is approximate only, the exact location should be determined by consulting the municipal authorities and utility companies concerned. The contractor shall prove the location of utilities and shall be responsible for adequate protection from damage.

Not to Scale

Drawing Description		HSU - Site Access	
Client	Date	Apr 27, 2023	Figure Number
Project Number	478038	Project Description	265 Catherine St
			002

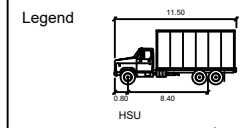
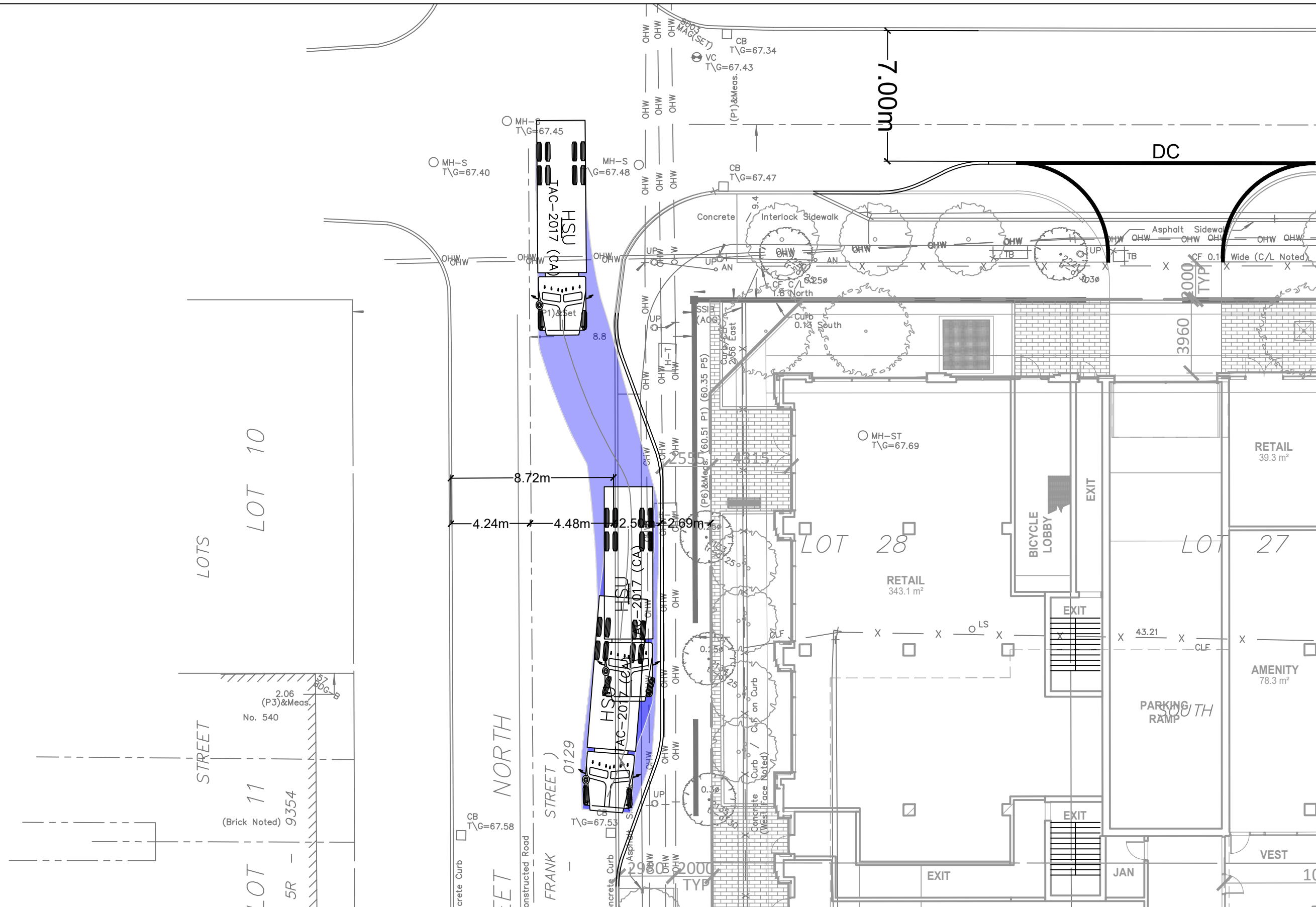

NOTE: The location of utilities is approximate only, the exact location should be determined by consulting the municipal authorities and utility companies concerned. The contractor shall prove the location of utilities and shall be responsible for adequate protection from damage.

Not to Scale

Drawing Description		HSU - Layby	
Client	Date	Apr 27, 2023	Figure Number
Project Number	478038	Project Description	265 Catherine St
			003

7.00m

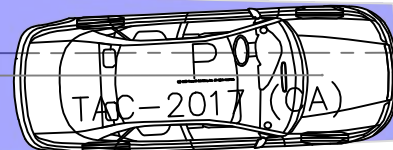
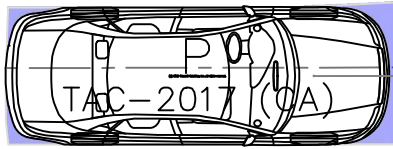
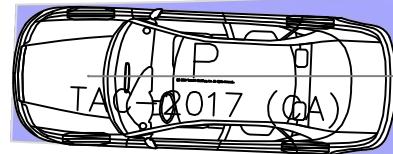

DC

CB
T\G=68.02

CB
T\G=68.06

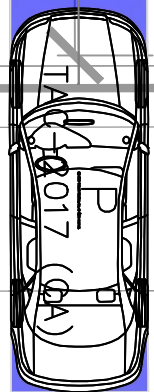
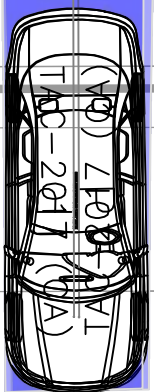
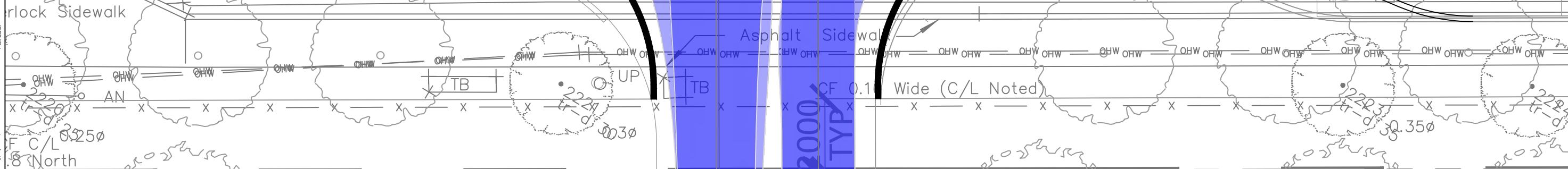

3960
2000
TYP

RETAIL
39.3 m²

3B TOWNHOUSE S
1703
615 ft²

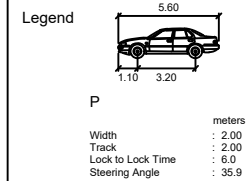

Not to Scale

Drawing Description		P-Car - Arlington	
Client	Date	Figure Number	004
Project Number	478038	Project Description	265 Catherine St

NOTE: The location of utilities is approximate only, the exact location should be determined by consulting the municipal authorities and utility companies concerned. The contractor shall prove the location of utilities and shall be responsible for adequate protection from damage.

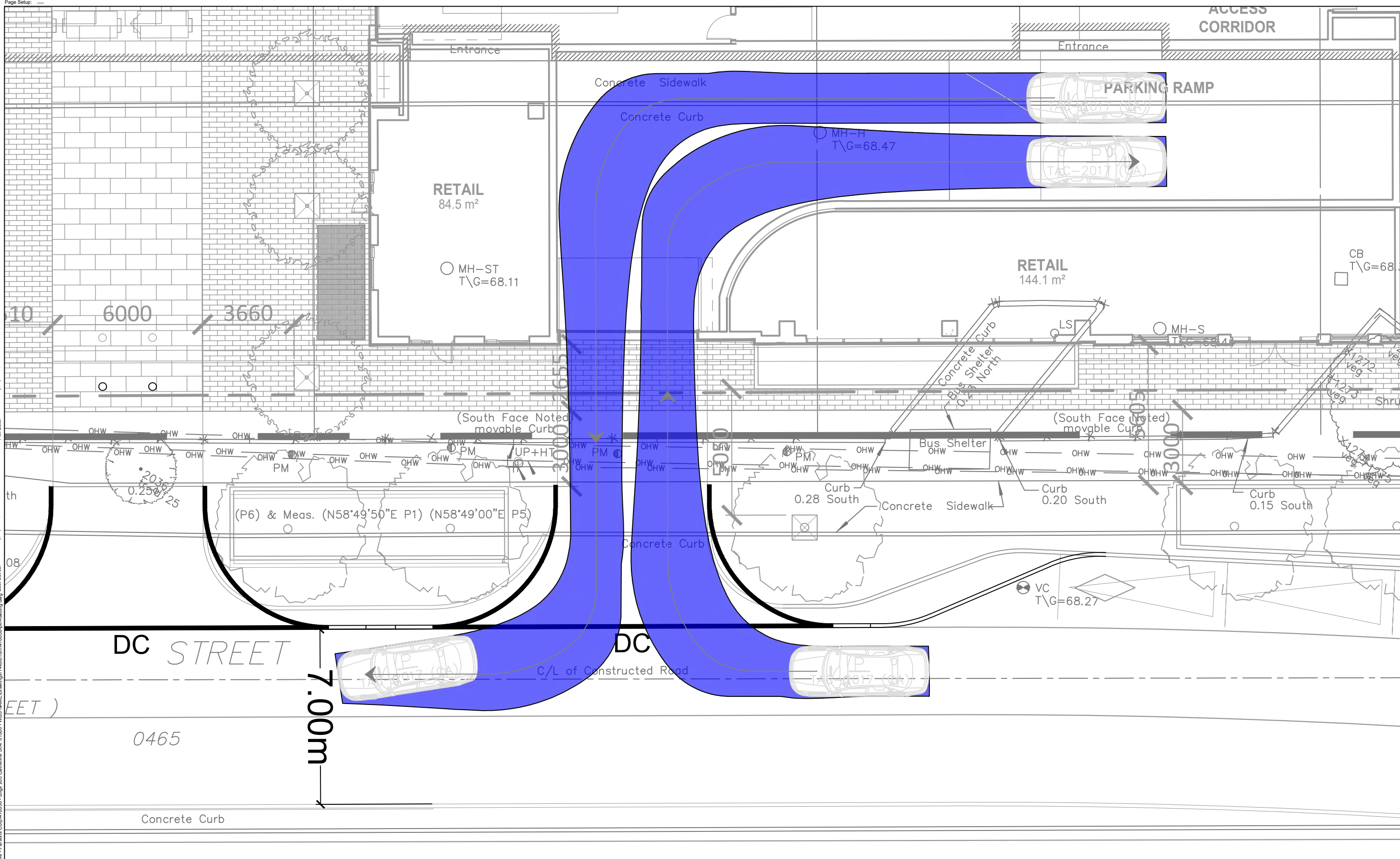

PARSONS



Legend

P

5.60

1.10 3.20

Width : 2.00
Track : 2.00
Lock to Lock Time : 6.0
Steering Angle : 35.9

NOTE: The location of utilities is approximate only, the exact location should be determined by consulting the municipal authorities and utility companies concerned. The contractor shall prove the location of utilities and shall be responsible for adequate protection from damage.

Not to Scale

Drawing Description		P-Car - Catherine	
Client	Date	Figure Number	
	Apr 27, 2023	005	
Project Number	Project Description		
478038	265 Catherine St		

DRAFT

Appendix H:

MMLOS Analysis: Road Segments

Multi-Modal Level of Service - Segments Form

Consultant	Parsons
Scenario	Existing and Future
Comments	

Project	478038-01000
Date	19-Apr-23

SEGMENTS	Street A	Catherine St	Kent St	Lyon St	Arlington Ave	Catherine (future)	Kent (future)	Lyon (future)	Arlington (future)	Section
		1	2	3	4	5	6	7	8	9
Pedestrian	Sidewalk Width	≥ 2 m	1.8 m	1.5 m	1.5 m		≥ 2 m	≥ 2 m	≥ 2 m	
	Boulevard Width	< 0.5	< 0.5 m	< 0.5 m	< 0.5 m		< 0.5	< 0.5	< 0.5	
	Avg Daily Curb Lane Traffic Volume	≤ 3000	> 3000	> 3000	≤ 3000		> 3000	> 3000	≤ 3000	
	Operating Speed	> 50 to 60 km/h	> 50 to 60 km/h	> 50 to 60 km/h	> 30 to 50 km/h		> 50 to 60 km/h	> 50 to 60 km/h	> 30 to 50 km/h	
	On-Street Parking	no	no	no	yes		no	no	yes	
	Exposure to Traffic PLoS	C	F	F	E	-	E	E	B	-
	Effective Sidewalk Width	2.0 m	1.5 m	1.5 m	1.5 m		2.0 m	2.0 m	2.0 m	
	Pedestrian Volume	250 ped/hr	250 ped/hr	250 ped/hr	250 ped/hr		250 ped/hr	250 ped/hr	250 ped/hr	
Crowding PLoS	B	B	B	B	-	B	B	B	-	
Level of Service	C	F	F	E	-	E	E	B	-	
Bicycle	Type of Cycling Facility	Mixed Traffic	Mixed Traffic	Mixed Traffic	Mixed Traffic					
	Number of Travel Lanes	2-3 lanes total	2-3 lanes total	≤ 2 (no centreline)	≤ 2 (no centreline)					
	Operating Speed	≥ 50 to 60 km/h	≥ 50 to 60 km/h	≥ 50 to 60 km/h	≤ 40 km/h					
	# of Lanes & Operating Speed LoS	E	E	D	A	-	-	-	-	-
	Bike Lane (+ Parking Lane) Width									
	Bike Lane Width LoS	-	-	-	-	-	-	-	-	-
	Bike Lane Blockages									
	Blockage LoS	-	-	-	-	-	-	-	-	-
	Median Refuge Width (no median = < 1.8 m)	< 1.8 m refuge	< 1.8 m refuge	< 1.8 m refuge	< 1.8 m refuge					
	No. of Lanes at Unsignalized Crossing	≤ 3 lanes	≤ 3 lanes	≤ 3 lanes	≤ 3 lanes					
	Sidestreet Operating Speed	≤ 40 km/h	≤ 40 km/h	≤ 40 km/h	≤ 40 km/h					
Unsignalized Crossing - Lowest LoS	A	A	A	A	-	-	-	-	-	
Level of Service	E	E	D	A	-	-	-	-	-	
Transit	Facility Type	Mixed Traffic				Bus lane				
	Friction or Ratio Transit:Posted Speed	Vt/Vp ≥ 0.8				Cf ≤ 60				
	Level of Service	D	-	-	-	B	-	-	-	-
Truck	Truck Lane Width	> 3.7 m	> 3.7 m	> 3.7 m		≤ 3.5 m				
	Travel Lanes per Direction	> 1	> 1	> 1		> 1				
	Level of Service	A	A	A	-	A	-	-	-	-

DRAFT

Appendix I:

MMLOS Analysis: Intersections

Multi-Modal Level of Service - Intersections Form

Consultant
Scenario
Comments

Parsons
Existing

Project
Date

478038-01000
19-Apr-23

INTERSECTIONS		Catherine/Kent				Catherine/Lyon				Arlington/Kent				Bank/Ce		
Crossing Side		NORTH	SOUTH	EAST	WEST	NORTH	SOUTH	EAST	WEST	NORTH	SOUTH	EAST	WEST	NORTH	SOUTH	
Pedestrian	Lanes	5	5	4	3	3	4	4	4	4	4	3	3	4	5	
	Median	No Median - 2.4 m	No Median - 2.4 m	No Median - 2.4 m	No Median - 2.4 m	No Median - 2.4 m	No Median - 2.4 m	No Median - 2.4 m	No Median - 2.4 m	No Median - 2.4 m	No Median - 2.4 m	No Median - 2.4 m	No Median - 2.4 m	No Median - 2.4 m	No Median - 2.4 m	
	Conflicting Left Turns	No left turn / Prohib.	No left turn / Prohib.	No left turn / Prohib.	Permissive	No left turn / Prohib.	Permissive	No left turn / Prohib.	No left turn / Prohib.	Permissive	Permissive	No left turn / Prohib.	Permissive	No left turn / Prohib.	Permissive	
	Conflicting Right Turns	Permissive or yield control	No right turn	No right turn	No right turn	No right turn	No right turn	No right turn	Permissive or yield control	Permissive or yield control	Permissive or yield control	Permissive or yield control	No right turn	Permissive or yield control	No right turn	
	Right Turns on Red (RTOR) ?	RTOR prohibited	RTOR prohibited	RTOR prohibited	RTOR prohibited	RTOR prohibited	RTOR prohibited	RTOR prohibited	RTOR allowed	RTOR prohibited	RTOR allowed	RTOR allowed	RTOR prohibited	RTOR allowed	RTOR prohibited	
	Ped Signal Leading Interval?	Yes	Yes	No	No	No	No	No	No	No	No	No	No	Yes	Yes	
	Right Turn Channel	No Right Turn	No Right Turn	No Channel	No Right Turn	No Channel	No Right Turn	No Right Turn	No Right Turn	No Right Turn	No Right Turn	No Channel	No Channel	No Right Turn	No Channel	No Right Turn
	Corner Radius	No Right Turn	No Right Turn	3-5m	No Right Turn	5-10m	No Right Turn	No Right Turn	No Right Turn	No Right Turn	No Right Turn	10-15m	5-10m	No Right Turn	5-10m	No Right Turn
	Crosswalk Type	Zebra stripe hi-vis markings	Zebra stripe hi-vis markings	Zebra stripe hi-vis markings	Zebra stripe hi-vis markings	Std transverse markings	Std transverse markings	Std transverse markings	Std transverse markings	Std transverse markings	Std transverse markings	Std transverse markings	Std transverse markings	Texture/coloured pavement	Zebra stripe hi-vis markings	Zebra stripe hi-vis markings
	PETSI Score	63	68	74	91	87	71	79	71	66	53	79	91	67	60	
	Ped. Exposure to Traffic LoS	C	C	C	A	B	C	B	C	C	D	B	A	C	C	
	Cycle Length	75	75	75	75	75	75	75	75	75	75	75	75	75	75	
	Effective Walk Time	16	16	27	27	15	15	32	32	11	11	33	33	13	13	
	Average Pedestrian Delay	23	23	15	15	24	24	12	12	27	27	12	12	26	26	
Pedestrian Delay LoS	C	C	B	B	C	C	B	B	C	C	B	B	C	C		
Level of Service	C	C	C	B	C	C	B	C	C	D	B	B	C	C		
Approach From		NORTH	SOUTH	EAST	WEST	NORTH	SOUTH	EAST	WEST	NORTH	SOUTH	EAST	WEST	NORTH	SOUTH	
Bicycle	Bicycle Lane Arrangement on Approach	Mixed Traffic				Mixed Traffic				Mixed Traffic				Mixed Traffic		
	Right Turn Lane Configuration	> 50 m				> 50 m				≤ 50 m				≤ 50 m		
	Right Turning Speed	≤ 25 km/h				≤ 25 km/h				≤ 25 km/h				≤ 25 km/h		
	Cyclist relative to RT motorists	-	-	F	-	F	-	-	-	-	D	D	-	D	-	
	Separated or Mixed Traffic	-	-	Mixed Traffic	-	Mixed Traffic	-	-	-	-	Mixed Traffic	Mixed Traffic	-	Mixed Traffic	-	
	Left Turn Approach	One lane crossed				No lane crossed				One lane crossed						
	Operating Speed	> 50 to < 60 km/h				≤ 40 km/h				> 50 to < 60 km/h						
Left Turning Cyclist	-	-	-	-	-	-	-	-	-	E	-	B	-	E		
Level of Service	-	-	-	-	-	-	-	-	-	E	-	-	-	-		
Level of Service		-				-				E				E		
Transit	Average Signal Delay	-														
	Level of Service	-	-	-	-	-	-	-	-	-	-	-	-	-	-	
Truck	Effective Corner Radius	< 10 m				< 10 m				10 - 15 m						
	Number of Receiving Lanes on Departure from Intersection	≥ 2				≥ 2				≥ 2						
	Level of Service	-	-	D	-	D	-	-	-	-	-	-	-	B	-	
Level of Service		D				D				-				E		
Auto	Volume to Capacity Ratio	-														
	Level of Service	-														

Catherine		Gladstone/Lyon				Gladstone/Kent				Catherine/Percy				Catherine/Bronson			
EAST	WEST	NORTH	SOUTH	EAST	WEST	NORTH	SOUTH	EAST	WEST	NORTH	SOUTH	EAST	WEST	NORTH	SOUTH	EAST	WEST
3	4	3	3	4	4	4	4	4	4	4	5	4	3	6		4	4
No Median - 2.4 m	No Median - 2.4 m	No Median - 2.4 m	No Median - 2.4 m	No Median - 2.4 m	No Median - 2.4 m	No Median - 2.4 m	No Median - 2.4 m	No Median - 2.4 m	No Median - 2.4 m	No Median - 2.4 m	No Median - 2.4 m	No Median - 2.4 m	No Median - 2.4 m	No Median - 2.4 m		No Median - 2.4 m	No Median - 2.4 m
No left turn / Prohib.	Protected/ Permissive	No left turn / Prohib.	Permissive	Permissive	No left turn / Prohib.	Permissive	No left turn / Prohib.	No left turn / Prohib.	Permissive	No left turn / Prohib.	Permissive	No left turn / Prohib.	No left turn / Prohib.	No left turn / Prohib.		No left turn / Prohib.	Protected/ Permissive
No right turn	Permissive or yield control	No right turn	Permissive or yield control	No right turn	Permissive or yield control	Permissive or yield control	No right turn	Permissive or yield control	No right turn	No right turn	No right turn	No right turn	Protected	Permissive or yield control		No right turn	Permissive or yield control
RTOR allowed	RTOR prohibited	RTOR allowed	RTOR prohibited	RTOR prohibited	RTOR allowed	RTOR prohibited	RTOR allowed	RTOR allowed	RTOR prohibited	RTOR prohibited	RTOR prohibited	RTOR prohibited	RTOR prohibited	RTOR allowed		RTOR allowed	RTOR prohibited
Yes	Yes	No	No	No	No	No	No	No	No	No	No	No	Yes	No		No	No
No Channel	No Right Turn	No Channel	No Right Turn	No Right Turn	No Channel	No Right Turn	No Channel	No Channel	No Right Turn	No Channel	No Right Turn	No Right Turn	No Right Turn	No Channel		No Channel	No Right Turn
5-10m	No Right Turn	5-10m	No Right Turn	No Right Turn	5-10m	No Right Turn	3-5m	3-5m	No Right Turn	5-10m	No Right Turn	No Right Turn	No Right Turn	10-15m		5-10m	No Right Turn
Zebra stripe hi-vis markings	Zebra stripe hi-vis markings	Zebra stripe hi-vis markings	Zebra stripe hi-vis markings	Zebra stripe hi-vis markings	Zebra stripe hi-vis markings	Std transverse markings	Std transverse markings	Textured/coloured pavement	Textured/coloured pavement	Std transverse markings	Std transverse markings	Std transverse markings	Std transverse markings	Zebra stripe hi-vis markings		Zebra stripe hi-vis markings	Zebra stripe hi-vis markings
89	71	87	86	74	65	66	68	66	74	70	55	79	98	31		70	69
B	C	B	B	C	C	C	C	C	C	C	D	B	A	E	-	C	C
75	75	75	75	75	75	75	75	75	75	90	90	90	90	100		100	100
31	16	28	28	21	21	16	16	32	32	8	8	22	22	12		50	16
13	23	15	15	19	19	23	23	12	12	37	37	26	26	39		13	35
B	C	B	B	B	B	C	C	B	B	D	D	C	C	D	-	B	D
B	C	B	B	C	C	C	C	C	C	D	D	C	C	E	-	C	D
		C				C				D				E			
EAST	WEST	NORTH	SOUTH	EAST	WEST	NORTH	SOUTH	EAST	WEST	NORTH	SOUTH	EAST	WEST	NORTH	SOUTH	EAST	WEST
Mixed Traffic		Curb Bike Lane, Cycletrack or MUP			Mixed Traffic		Mixed Traffic		Mixed Traffic	Curb Bike Lane, Cycletrack or MUP	Curb Bike Lane, Cycletrack or MUP	Mixed Traffic		Mixed Traffic		Mixed Traffic	
≤ 50 m		Not Applicable			≤ 50 m		≤ 50 m		≤ 50 m	Not Applicable	Not Applicable	≤ 50 m		≤ 50 m		≤ 50 m	
≤ 25 km/h		Not Applicable			≤ 25 km/h		≤ 25 km/h		≤ 25 km/h	Not Applicable	Not Applicable	≤ 25 km/h		≤ 25 km/h		≤ 25 km/h	
D	-	Not Applicable		-	D	-	D	-	D	Not Applicable	Not Applicable	D	-	D	-	D	-
Mixed Traffic	-	Separated		-	Mixed Traffic	-	Mixed Traffic	-	Mixed Traffic	Separated	Separated	Mixed Traffic	-	Mixed Traffic	-	Mixed Traffic	-
One lane crossed		2-stage, LT box			No lane crossed		≥ 2 lanes crossed		No lane crossed		No lane crossed		One lane crossed		One lane crossed		One lane crossed
> 50 to < 60 km/h		> 50 to < 60 km/h			> 50 to < 60 km/h		> 50 to < 60 km/h		> 50 to < 60 km/h		≤ 40 km/h		> 50 to < 60 km/h		> 50 to < 60 km/h		> 50 to < 60 km/h
E	-	A	-	C	-	-	F	C	-	-	B	E	-	-	E	E	-
E	-	A	-	-	-	-	F	-	-	-	B	E	-	-	-	E	-
		A				F				E				E			
				≤ 20 sec	≤ 20 sec			≤ 30 sec	≤ 30 sec								
-	-	-	-	C	C	-	-	D	D	-	-	-	-	-	-	-	-
		C				D				-				-			
10 - 15 m		< 10 m			< 10 m		< 10 m		< 10 m		< 10 m		< 10 m		> 15 m		< 10 m
≥ 2		1			≥ 2		≥ 2		≥ 2		≥ 2		≥ 2		≥ 2		≥ 2
B	-	F	-	-	D	-	D	D	-	D	-	-	-	A	-	D	-
B		F				D				D				D			
		-				-				-				-			

Mercury (Future)		Catherine/Bronson (Future)				Bank/Isabella/Chamberlain (Future)			
EAST	WEST	NORTH	SOUTH	EAST	WEST	NORTH	SOUTH	EAST	WEST
3	3	6		4	4	4	5	3	3
No Median - 2.4 m	No Median - 2.4 m	No Median - 2.4 m		No Median - 2.4 m	No Median - 2.4 m	No Median - 2.4 m	No Median - 2.4 m	No Median - 2.4 m	No Median - 2.4 m
No left turn / Prohib.	No left turn / Prohib.	No left turn / Prohib.		No left turn / Prohib.	Protected/ Permissive	Permissive	No left turn / Prohib.	Protected/ Permissive	No left turn / Prohib.
No right turn	Protected	Permissive or yield control		No right turn	Permissive or yield control	No right turn	Protected	Permissive or yield control	No right turn
RTOR prohibited	RTOR prohibited	RTOR allowed		RTOR allowed	RTOR prohibited	RTOR prohibited	RTOR prohibited	RTOR prohibited	RTOR allowed
No	Yes	No		No	No	No	No	No	No
No Right Turn	No Right Turn	No Channel		No Channel	No Right Turn	No Right Turn	No Channel	No Right Turn	Smart Channel
No Right Turn	No Right Turn	10-15m		5-10m	No Right Turn	No Right Turn	10-15m	No Right Turn	10-15m
Std transverse markings	Zebra stripe hi-vis markings	Zebra stripe hi-vis markings		Zebra stripe hi-vis markings	Zebra stripe hi-vis markings	Zebra stripe hi-vis markings	Zebra stripe hi-vis markings	Zebra stripe hi-vis markings	Zebra stripe hi-vis markings
96	101	31		70	69	74	56	86	92
A	A	E	-	C	C	C	D	B	A
90	90	100		100	100	75	75	75	75
22	22	12		50	16	12	12	14	28
26	26	39		13	35	26	26	25	15
C	C	D	-	B	D	C	C	C	B
C	C	E	-	C	D	C	D	C	B
D		E				D			
EAST	WEST	NORTH	SOUTH	EAST	WEST	NORTH	SOUTH	EAST	WEST
Mixed Traffic							Curb Bike Lane, Cycletrack or MUP	Curb Bike Lane, Cycletrack or MUP	Curb Bike Lane, Cycletrack or MUP
> 50 m							Not Applicable	Not Applicable	Not Applicable
≤ 25 km/h							Not Applicable	Not Applicable	Not Applicable
F	-	-	-	-	-	-	Not Applicable	Not Applicable	Not Applicable
Mixed Traffic	-	-	-	-	-	-	Separated	Separated	Separated
One lane crossed						One lane crossed	2-stage, LT box		1 lane crossed
> 50 to < 60 km/h						> 40 to ≤ 50 km/h	> 40 to ≤ 50 km/h		> 50 to < 60 km/h
E	-	-	-	-	-	D	A	-	D
F	-	-	-	-	-	-	A	-	D
F		-				D			
≤ 20 sec		> 40 sec	≤ 20 sec	> 40 sec		≤ 20 sec	≤ 20 sec		≤ 40 sec
C	-	F	C	F	-	C	C	-	E
C		F				E			
						10 - 15 m			10 - 15 m
						≥ 2			≥ 2
-	-	-	-	-	-	-	B	-	B
		-				B			
		-				-			

DRAFT

Appendix J:

Synchro Analysis Summary Reports

Lanes, Volumes, Timings

1: Hwy 417 WB On Ramp/Lyon St N & Catherine St

05/04/2023



Lane Group	EBL	EBT	EBR	WBL	WBT	WBR	NBL	NBT	NBR	SBL	SBT	SBR
Lane Configurations					↕↕↕						↕	↕
Traffic Volume (vph)	0	0	0	222	219	0	0	0	0	0	258	123
Future Volume (vph)	0	0	0	222	219	0	0	0	0	0	258	123
Satd. Flow (prot)	0	0	0	0	4571	0	0	0	0	0	1784	1547
Fit Permitted					0.975							
Satd. Flow (perm)	0	0	0	0	4538	0	0	0	0	0	1784	1517
Satd. Flow (RTOR)					247							137
Lane Group Flow (vph)	0	0	0	0	490	0	0	0	0	0	287	137
Turn Type				Perm	NA						NA	Perm
Protected Phases					8						6	
Permitted Phases				8							6	
Minimum Split (s)				26.2	26.2						28.3	28.3
Total Split (s)				40.0	40.0						35.0	35.0
Total Split (%)				53.3%	53.3%						46.7%	46.7%
Yellow Time (s)				3.3	3.3						3.3	3.3
All-Red Time (s)				1.9	1.9						2.0	2.0
Lost Time Adjust (s)					0.0						0.0	0.0
Total Lost Time (s)					5.2						5.3	5.3
Lead/Lag												
Lead-Lag Optimize?												
Act Effct Green (s)					34.8						29.7	29.7
Actuated g/C Ratio					0.46						0.40	0.40
v/c Ratio					0.22						0.41	0.20
Control Delay					9.9						16.3	6.2
Queue Delay					0.0						0.0	0.0
Total Delay					9.9						16.3	6.2
LOS					A						B	A
Approach Delay					9.9						13.1	
Approach LOS					A						B	
Queue Length 50th (m)					19.9						34.8	3.5
Queue Length 95th (m)					25.4						57.2	18.3
Internal Link Dist (m)		271.6			163.9			117.8			52.8	
Turn Bay Length (m)												
Base Capacity (vph)					2238						706	683
Starvation Cap Reductn					0						0	0
Spillback Cap Reductn					0						0	0
Storage Cap Reductn					0						0	0
Reduced v/c Ratio					0.22						0.41	0.20

Intersection Summary

Cycle Length: 75	
Actuated Cycle Length: 75	
Offset: 48 (64%), Referenced to phase 8:WBTL, Start of Green	
Natural Cycle: 55	
Control Type: Pretimed	
Maximum v/c Ratio: 0.41	
Intersection Signal Delay: 11.4	Intersection LOS: B
Intersection Capacity Utilization 47.6%	ICU Level of Service A
Analysis Period (min) 15	

Splits and Phases: 1: Hwy 417 WB On Ramp/Lyon St N & Catherine St

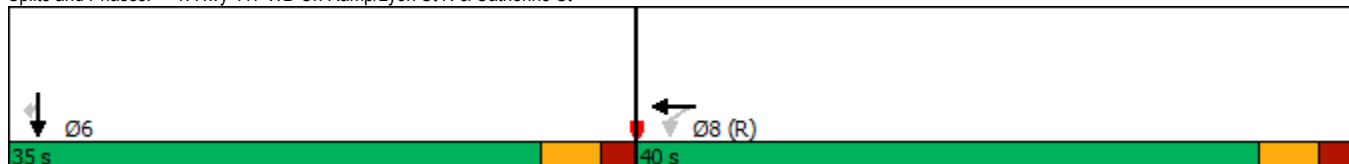

Lanes, Volumes, Timings

2: Hwy 417 EB Off Ramp/Chamberlain Ave/Kent St & Catherine St

05/04/2023



Lane Group	EBL	EBT	EBR	WBL	WBT	WBR	NBL	NBT	NBR	SBL	SBT	SBR
Lane Configurations					↕↕	↗		↕↕↕				
Traffic Volume (vph)	0	0	0	0	389	537	54	1333	0	0	0	0
Future Volume (vph)	0	0	0	0	389	537	54	1333	0	0	0	0
Satd. Flow (prot)	0	0	0	0	2923	1394	0	4911	0	0	0	0
Fit Permitted								0.998				
Satd. Flow (perm)	0	0	0	0	2923	1303	0	4906	0	0	0	0
Satd. Flow (RTOR)								70				
Lane Group Flow (vph)	0	0	0	0	707	322	0	1541	0	0	0	0
Turn Type					NA	Perm	Perm	NA				
Protected Phases					8			2				
Permitted Phases						8		2				
Minimum Split (s)					22.8	22.8		22.5				
Total Split (s)					32.0	32.0		38.0				
Total Split (%)					42.7%	42.7%		50.7%				
Yellow Time (s)					3.3	3.3		3.3				
All-Red Time (s)					2.5	2.5		2.5				
Lost Time Adjust (s)					0.0	0.0		0.0				
Total Lost Time (s)					5.8	5.8		5.8				
Lead/Lag												
Lead-Lag Optimize?												
Act Effct Green (s)					26.2	26.2		32.2				
Actuated g/C Ratio					0.35	0.35		0.43				
v/c Ratio					0.69	0.71		0.72				
Control Delay					26.7	30.2		19.1				
Queue Delay					0.0	0.0		3.4				
Total Delay					26.7	30.2		22.6				
LOS					C	C		C				
Approach Delay					27.8			22.6				
Approach LOS					C			C				
Queue Length 50th (m)					52.0	47.5		60.6				
Queue Length 95th (m)					m60.6	m56.4		76.6				
Internal Link Dist (m)		163.9			131.7			67.4			53.0	
Turn Bay Length (m)												
Base Capacity (vph)					1021	455		2146				
Starvation Cap Reductn					0	0		0				
Spillback Cap Reductn					0	0		496				
Storage Cap Reductn					0	0		0				
Reduced v/c Ratio					0.69	0.71		0.93				

Intersection Summary

Cycle Length: 75
 Actuated Cycle Length: 75
 Offset: 15 (20%), Referenced to phase 8:WBT, Start of Green
 Natural Cycle: 55
 Control Type: Pretimed
 Maximum v/c Ratio: 0.72
 Intersection Signal Delay: 24.7
 Intersection Capacity Utilization 64.8%
 Analysis Period (min) 15
 m Volume for 95th percentile queue is metered by upstream signal.

Splits and Phases: 2: Hwy 417 EB Off Ramp/Chamberlain Ave/Kent St & Catherine St

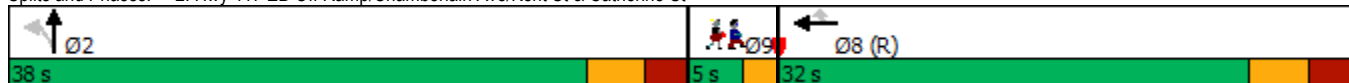

Lanes, Volumes, Timings

2: Hwy 417 EB Off Ramp/Chamberlain Ave/Kent St & Catherine St

05/04/2023

Lane Group	Ø9
Lane Configurations	
Traffic Volume (vph)	
Future Volume (vph)	
Satd. Flow (prot)	
Fit Permitted	
Satd. Flow (perm)	
Satd. Flow (RTOR)	
Lane Group Flow (vph)	
Turn Type	
Protected Phases	9
Permitted Phases	
Minimum Split (s)	5.0
Total Split (s)	5.0
Total Split (%)	7%
Yellow Time (s)	2.0
All-Red Time (s)	0.0
Lost Time Adjust (s)	
Total Lost Time (s)	
Lead/Lag	
Lead-Lag Optimize?	
Act Effct Green (s)	
Actuated g/C Ratio	
v/c Ratio	
Control Delay	
Queue Delay	
Total Delay	
LOS	
Approach Delay	
Approach LOS	
Queue Length 50th (m)	
Queue Length 95th (m)	
Internal Link Dist (m)	
Turn Bay Length (m)	
Base Capacity (vph)	
Starvation Cap Reductn	
Spillback Cap Reductn	
Storage Cap Reductn	
Reduced v/c Ratio	
Intersection Summary	

Lanes, Volumes, Timings
3: Bank St & Catherine St

05/04/2023



Lane Group	EBL	EBT	EBR	WBL	WBT	WBR	NBL	NBT	NBR	SBL	SBT	SBR
Lane Configurations					↕↕↕			↕↕			↕↕	
Traffic Volume (vph)	0	0	0	170	587	198	266	575	0	0	366	130
Future Volume (vph)	0	0	0	170	587	198	266	575	0	0	366	130
Satd. Flow (prot)	0	0	0	0	4430	0	0	3212	0	0	2870	0
Fit Permitted					0.991			0.617				
Satd. Flow (perm)	0	0	0	0	4374	0	0	1951	0	0	2870	0
Satd. Flow (RTOR)					84						64	
Lane Group Flow (vph)	0	0	0	0	1061	0	0	935	0	0	551	0
Turn Type				Perm	NA		pm+pt	NA			NA	
Protected Phases					8		9	2			6	
Permitted Phases					8		2					
Minimum Split (s)				18.6	18.6		10.4	16.4			16.4	
Total Split (s)				25.0	25.0		15.0	40.0			25.0	
Total Split (%)				33.3%	33.3%		20.0%	53.3%			33.3%	
Yellow Time (s)				3.3	3.3		3.3	3.3			3.3	
All-Red Time (s)				2.3	2.3		2.1	2.1			2.1	
Lost Time Adjust (s)					0.0			0.0			0.0	
Total Lost Time (s)					5.6			5.4			5.4	
Lead/Lag				Lag	Lag		Lag	Lag			Lag	
Lead-Lag Optimize?				Yes	Yes		Yes	Yes			Yes	
Act Effct Green (s)					19.4			34.6			19.6	
Actuated g/C Ratio					0.26			0.46			0.26	
v/c Ratio					0.89			0.88			0.69	
Control Delay					35.6			22.7			27.2	
Queue Delay					0.0			0.0			0.0	
Total Delay					35.6			22.7			27.2	
LOS					D			C			C	
Approach Delay					35.6			22.7			27.2	
Approach LOS					D			C			C	
Queue Length 50th (m)					48.9			25.0			32.5	
Queue Length 95th (m)					#72.7			#48.9			49.1	
Internal Link Dist (m)		131.7			201.7			90.2			52.9	
Turn Bay Length (m)												
Base Capacity (vph)					1193			1061			797	
Starvation Cap Reductn					0			0			0	
Spillback Cap Reductn					0			0			0	
Storage Cap Reductn					0			0			0	
Reduced v/c Ratio					0.89			0.88			0.69	

Intersection Summary
 Cycle Length: 75
 Actuated Cycle Length: 75
 Offset: 70 (93%), Referenced to phase 2:NBT and 6:SBT, Start of Green
 Natural Cycle: 90
 Control Type: Pretimed
 Maximum v/c Ratio: 0.89
 Intersection Signal Delay: 29.1 Intersection LOS: C
 Intersection Capacity Utilization 78.9% ICU Level of Service D
 Analysis Period (min) 15
 # 95th percentile volume exceeds capacity, queue may be longer.
 Queue shown is maximum after two cycles.

Splits and Phases: 3: Bank St & Catherine St

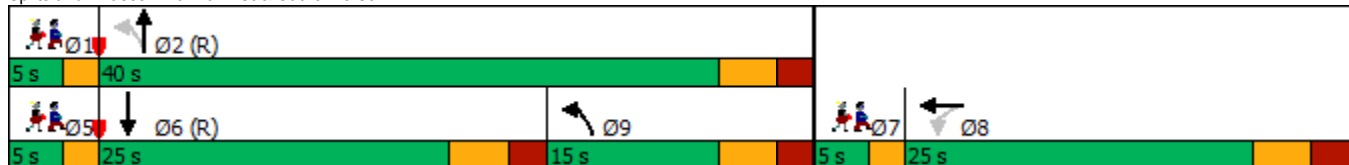

Lanes, Volumes, Timings
 3: Bank St & Catherine St

05/04/2023

Lane Group	Ø1	Ø5	Ø7
Lane Configurations			
Traffic Volume (vph)			
Future Volume (vph)			
Satd. Flow (prot)			
Fit Permitted			
Satd. Flow (perm)			
Satd. Flow (RTOR)			
Lane Group Flow (vph)			
Turn Type			
Protected Phases	1	5	7
Permitted Phases			
Minimum Split (s)	5.0	5.0	5.0
Total Split (s)	5.0	5.0	5.0
Total Split (%)	7%	7%	7%
Yellow Time (s)	2.0	2.0	2.0
All-Red Time (s)	0.0	0.0	0.0
Lost Time Adjust (s)			
Total Lost Time (s)			
Lead/Lag	Lead	Lead	Lead
Lead-Lag Optimize?	Yes	Yes	Yes
Act Effct Green (s)			
Actuated g/C Ratio			
v/c Ratio			
Control Delay			
Queue Delay			
Total Delay			
LOS			
Approach Delay			
Approach LOS			
Queue Length 50th (m)			
Queue Length 95th (m)			
Internal Link Dist (m)			
Turn Bay Length (m)			
Base Capacity (vph)			
Starvation Cap Reductn			
Spillback Cap Reductn			
Storage Cap Reductn			
Reduced v/c Ratio			
Intersection Summary			

Lanes, Volumes, Timings
4: Percy St & Catherine St

05/04/2023



Lane Group	EBL	EBT	EBR	WBL	WBT	WBR	NBL	NBT	NBR	SBL	SBT	SBR
Lane Configurations					↑↑↑						↓	
Traffic Volume (vph)	0	0	0	71	234	0	0	0	0	0	129	57
Future Volume (vph)	0	0	0	71	234	0	0	0	0	0	129	57
Satd. Flow (prot)	0	0	0	0	4552	0	0	0	0	0	1645	0
Fit Permitted					0.988							
Satd. Flow (perm)	0	0	0	0	4523	0	0	0	0	0	1645	0
Satd. Flow (RTOR)					160							
Lane Group Flow (vph)	0	0	0	0	339	0	0	0	0	0	206	0
Turn Type				Perm	NA							NA
Protected Phases					8							6
Permitted Phases				8								
Detector Phase				8	8							6
Switch Phase												
Minimum Initial (s)				10.0	10.0							10.0
Minimum Split (s)				26.5	26.5							23.4
Total Split (s)				34.0	34.0							24.0
Total Split (%)				37.8%	37.8%							26.7%
Yellow Time (s)				3.3	3.3							3.3
All-Red Time (s)				2.2	2.2							2.1
Lost Time Adjust (s)					0.0							0.0
Total Lost Time (s)					5.5							5.4
Lead/Lag				Lag	Lag							
Lead-Lag Optimize?				Yes	Yes							
Recall Mode				None	None							Max
Act Effct Green (s)					11.9							18.8
Actuated g/C Ratio					0.29							0.45
v/c Ratio					0.24							0.28
Control Delay					6.3							9.6
Queue Delay					0.0							0.0
Total Delay					6.3							9.6
LOS					A							A
Approach Delay					6.3							9.6
Approach LOS					A							A
Queue Length 50th (m)					3.4							7.4
Queue Length 95th (m)					7.4							25.6
Internal Link Dist (m)		71.6			271.6			106.7				288.0
Turn Bay Length (m)												
Base Capacity (vph)					3170							740
Starvation Cap Reductn					0							0
Spillback Cap Reductn					0							0
Storage Cap Reductn					0							0
Reduced v/c Ratio					0.11							0.28

Intersection Summary

Cycle Length: 90	
Actuated Cycle Length: 41.7	
Natural Cycle: 65	
Control Type: Semi Act-Uncoord	
Maximum v/c Ratio: 0.28	
Intersection Signal Delay: 7.5	Intersection LOS: A
Intersection Capacity Utilization 37.9%	ICU Level of Service A
Analysis Period (min) 15	

Splits and Phases: 4: Percy St & Catherine St

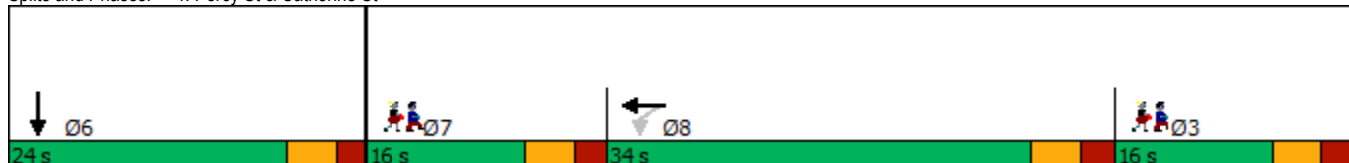

Lanes, Volumes, Timings
4: Percy St & Catherine St

05/04/2023

Lane Group	Ø3	Ø7
Lane Configurations		
Traffic Volume (vph)		
Future Volume (vph)		
Satd. Flow (prot)		
Fit Permitted		
Satd. Flow (perm)		
Satd. Flow (RTOR)		
Lane Group Flow (vph)		
Turn Type		
Protected Phases	3	7
Permitted Phases		
Detector Phase		
Switch Phase		
Minimum Initial (s)	1.0	1.0
Minimum Split (s)	6.4	6.4
Total Split (s)	16.0	16.0
Total Split (%)	18%	18%
Yellow Time (s)	3.3	3.3
All-Red Time (s)	2.1	2.1
Lost Time Adjust (s)		
Total Lost Time (s)		
Lead/Lag		Lead
Lead-Lag Optimize?		Yes
Recall Mode	None	None
Act Effct Green (s)		
Actuated g/C Ratio		
v/c Ratio		
Control Delay		
Queue Delay		
Total Delay		
LOS		
Approach Delay		
Approach LOS		
Queue Length 50th (m)		
Queue Length 95th (m)		
Internal Link Dist (m)		
Turn Bay Length (m)		
Base Capacity (vph)		
Starvation Cap Reductn		
Spillback Cap Reductn		
Storage Cap Reductn		
Reduced v/c Ratio		
Intersection Summary		

Lanes, Volumes, Timings
6: Kent St & Arlington Ave

05/04/2023



Lane Group	EBL	EBT	EBR	WBL	WBT	WBR	NBL	NBT	NBR	SBL	SBT	SBR
Lane Configurations		↕			↕			↕↕↕				
Traffic Volume (vph)	19	48	0	0	11	93	15	1708	131	0	0	0
Future Volume (vph)	19	48	0	0	11	93	15	1708	131	0	0	0
Satd. Flow (prot)	0	1745	0	0	1542	0	0	4790	0	0	0	0
Fit Permitted		0.914										
Satd. Flow (perm)	0	1610	0	0	1542	0	0	4788	0	0	0	0
Satd. Flow (RTOR)					8			26				
Lane Group Flow (vph)	0	74	0	0	115	0	0	2061	0	0	0	0
Turn Type	Perm	NA			NA		Perm	NA				
Protected Phases		4			8			2				
Permitted Phases	4						2					
Minimum Split (s)	27.3	27.3			27.3		32.3	32.3				
Total Split (s)	28.0	28.0			28.0		47.0	47.0				
Total Split (%)	37.3%	37.3%			37.3%		62.7%	62.7%				
Yellow Time (s)	3.3	3.3			3.3		3.3	3.3				
All-Red Time (s)	2.0	2.0			2.0		2.0	2.0				
Lost Time Adjust (s)		0.0			0.0			0.0				
Total Lost Time (s)		5.3			5.3			5.3				
Lead/Lag												
Lead-Lag Optimize?												
Act Effct Green (s)		22.7			22.7			41.7				
Actuated g/C Ratio		0.30			0.30			0.56				
v/c Ratio		0.15			0.24			0.77				
Control Delay		13.3			19.4			13.2				
Queue Delay		0.0			0.0			2.8				
Total Delay		13.3			19.4			16.0				
LOS		B			B			B				
Approach Delay		13.3			19.4			16.0				
Approach LOS		B			B			B				
Queue Length 50th (m)		6.3			9.0			104.4				
Queue Length 95th (m)		13.4			m12.7			113.9				
Internal Link Dist (m)		164.0			143.1			53.0			216.0	
Turn Bay Length (m)												
Base Capacity (vph)		487			472			2673				
Starvation Cap Reductn		0			0			483				
Spillback Cap Reductn		0			0			0				
Storage Cap Reductn		0			0			0				
Reduced v/c Ratio		0.15			0.24			0.94				

Intersection Summary
 Cycle Length: 75
 Actuated Cycle Length: 75
 Offset: 50 (67%), Referenced to phase 2:NBT, Start of Green
 Natural Cycle: 60
 Control Type: Pretimed
 Maximum v/c Ratio: 0.77
 Intersection Signal Delay: 16.1
 Intersection Capacity Utilization 67.8%
 Analysis Period (min) 15
 m Volume for 95th percentile queue is metered by upstream signal.

Splits and Phases: 6: Kent St & Arlington Ave



Lanes, Volumes, Timings
7: Lyon St N & Gladstone Ave

05/04/2023



Lane Group	EBL	EBT	EBR	WBL	WBT	WBR	NBL	NBT	NBR	SBL	SBT	SBR
Lane Configurations		↑	↗	↖	↑						↕	↕
Traffic Volume (vph)	0	184	24	15	143	0	0	0	0	89	320	98
Future Volume (vph)	0	184	24	15	143	0	0	0	0	89	320	98
Satd. Flow (prot)	0	1733	1547	1729	1750	0	0	0	0	0	3240	0
Fit Permitted				0.626							0.991	
Satd. Flow (perm)	0	1733	1485	1120	1750	0	0	0	0	0	3215	0
Satd. Flow (RTOR)			38								48	
Lane Group Flow (vph)	0	204	27	17	159	0	0	0	0	0	564	0
Turn Type		NA	Perm	Perm	NA					Perm	NA	
Protected Phases		4			8							6
Permitted Phases			4	8						6		
Minimum Split (s)		17.2	17.2	17.2	17.2					22.6	22.6	
Total Split (s)		38.0	38.0	38.0	38.0					37.0	37.0	
Total Split (%)		50.7%	50.7%	50.7%	50.7%					49.3%	49.3%	
Yellow Time (s)		3.3	3.3	3.3	3.3					3.3	3.3	
All-Red Time (s)		1.9	1.9	1.9	1.9					2.3	2.3	
Lost Time Adjust (s)		0.0	0.0	0.0	0.0						0.0	
Total Lost Time (s)		5.2	5.2	5.2	5.2						5.6	
Lead/Lag												
Lead-Lag Optimize?												
Act Effct Green (s)		32.8	32.8	32.8	32.8						31.4	
Actuated g/C Ratio		0.44	0.44	0.44	0.44						0.42	
v/c Ratio		0.27	0.04	0.03	0.21						0.41	
Control Delay		14.7	3.5	21.7	24.7						15.0	
Queue Delay		0.0	0.0	0.0	0.0						0.0	
Total Delay		14.7	3.5	21.7	24.7						15.0	
LOS		B	A	C	C						B	
Approach Delay		13.4			24.4						15.0	
Approach LOS		B			C						B	
Queue Length 50th (m)		17.7	0.0	2.2	21.3						25.7	
Queue Length 95th (m)		31.2	3.1	m4.1	m33.2						38.0	
Internal Link Dist (m)		254.8			165.0			215.6			214.3	
Turn Bay Length (m)				25.0								
Base Capacity (vph)		757	670	489	765						1373	
Starvation Cap Reductn		0	0	0	0						0	
Spillback Cap Reductn		0	0	0	0						0	
Storage Cap Reductn		0	0	0	0						0	
Reduced v/c Ratio		0.27	0.04	0.03	0.21						0.41	

Intersection Summary
 Cycle Length: 75
 Actuated Cycle Length: 75
 Offset: 10 (13%), Referenced to phase 4:EBT and 8:WBTL, Start of Green
 Natural Cycle: 40
 Control Type: Pretimed
 Maximum v/c Ratio: 0.41
 Intersection Signal Delay: 16.3
 Intersection Capacity Utilization 79.8%
 Analysis Period (min) 15
 Intersection LOS: B
 ICU Level of Service D
 m Volume for 95th percentile queue is metered by upstream signal.

Splits and Phases: 7: Lyon St N & Gladstone Ave

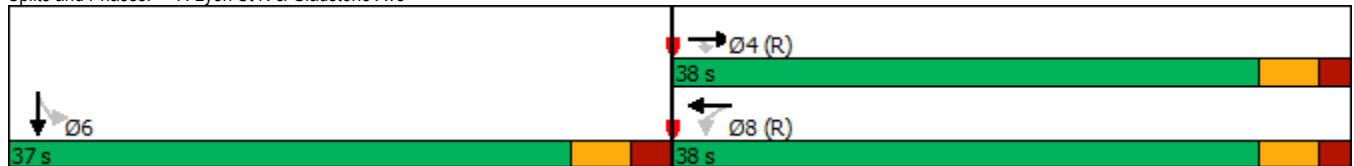

Lanes, Volumes, Timings
8: Kent St & Gladstone Ave

05/04/2023



Lane Group	EBL	EBT	EBR	WBL	WBT	WBR	NBL	NBT	NBR	SBL	SBT	SBR
Lane Configurations												
Traffic Volume (vph)	82	277	0	0	165	148	36	1698	97	0	0	0
Future Volume (vph)	82	277	0	0	165	148	36	1698	97	0	0	0
Satd. Flow (prot)	1662	1717	0	0	1552	0	1729	4790	0	0	0	0
Fit Permitted	0.404						0.950					
Satd. Flow (perm)	679	1717	0	0	1552	0	1444	4790	0	0	0	0
Satd. Flow (RTOR)					6			18				
Lane Group Flow (vph)	91	308	0	0	347	0	40	1995	0	0	0	0
Turn Type	Perm	NA			NA		Perm	NA				
Protected Phases		4			8			2				
Permitted Phases	4						2					
Minimum Split (s)	21.4	21.4			21.4		20.4	20.4				
Total Split (s)	30.0	30.0			30.0		45.0	45.0				
Total Split (%)	40.0%	40.0%			40.0%		60.0%	60.0%				
Yellow Time (s)	3.3	3.3			3.3		3.3	3.3				
All-Red Time (s)	2.1	2.1			2.1		2.1	2.1				
Lost Time Adjust (s)	0.0	0.0			0.0		0.0	0.0				
Total Lost Time (s)	5.4	5.4			5.4		5.4	5.4				
Lead/Lag												
Lead-Lag Optimize?												
Act Effct Green (s)	24.6	24.6			24.6		39.6	39.6				
Actuated g/C Ratio	0.33	0.33			0.33		0.53	0.53				
v/c Ratio	0.41	0.55			0.68		0.05	0.79				
Control Delay	27.1	25.9			29.2		1.5	3.1				
Queue Delay	0.0	0.0			0.0		0.0	0.0				
Total Delay	27.1	25.9			29.2		1.5	3.1				
LOS	C	C			C		A	A				
Approach Delay		26.1			29.2			3.1				
Approach LOS		C			C			A				
Queue Length 50th (m)	11.5	40.4			41.1		0.4	7.3				
Queue Length 95th (m)	25.7	65.2			68.8		m0.6	8.3				
Internal Link Dist (m)		165.0			168.8			216.0			203.6	
Turn Bay Length (m)	30.0						40.0					
Base Capacity (vph)	222	563			513		762	2537				
Starvation Cap Reductn	0	0			0		0	0				
Spillback Cap Reductn	0	0			0		0	0				
Storage Cap Reductn	0	0			0		0	0				
Reduced v/c Ratio	0.41	0.55			0.68		0.05	0.79				

Intersection Summary
 Cycle Length: 75
 Actuated Cycle Length: 75
 Offset: 36 (48%), Referenced to phase 4:EBTL and 8:WBT, Start of Green
 Natural Cycle: 55
 Control Type: Pretimed
 Maximum v/c Ratio: 0.79
 Intersection Signal Delay: 9.7
 Intersection LOS: A
 Intersection Capacity Utilization 79.8%
 ICU Level of Service D
 Analysis Period (min) 15
 m Volume for 95th percentile queue is metered by upstream signal.

Splits and Phases: 8: Kent St & Gladstone Ave



Lanes, Volumes, Timings
 9: Bank St & Chamberlain Ave/Isabella St

05/04/2023



Lane Group	EBL	EBT	EBR	WBL	WBT	WBR	NBL	NBT	NBR	SBL	SBT	SBR
Lane Configurations		↕↕	↗					↕↕			↕↕	
Traffic Volume (vph)	74	487	75	0	0	0	0	834	142	168	372	0
Future Volume (vph)	74	487	75	0	0	0	0	834	142	168	372	0
Satd. Flow (prot)	0	3225	1446	0	0	0	0	3154	0	0	3223	0
Fit Permitted		0.993									0.526	
Satd. Flow (perm)	0	3218	1358	0	0	0	0	3154	0	0	1721	0
Satd. Flow (RTOR)			134					27				
Lane Group Flow (vph)	0	623	83	0	0	0	0	1085	0	0	600	0
Turn Type	Perm	NA	Perm					NA		pm+pt	NA	
Protected Phases		4						2		5	6	
Permitted Phases	4		4							6		
Detector Phase	4	4	4					2		5	6	
Switch Phase												
Minimum Initial (s)	10.0	10.0	10.0					10.0		5.0	10.0	
Minimum Split (s)	26.2	26.2	26.2					23.1		11.1	23.1	
Total Split (s)	29.0	29.0	29.0					31.0		15.0	46.0	
Total Split (%)	38.7%	38.7%	38.7%					41.3%		20.0%	61.3%	
Yellow Time (s)	3.3	3.3	3.3					3.0		3.0	3.0	
All-Red Time (s)	2.9	2.9	2.9					3.1		3.1	3.1	
Lost Time Adjust (s)		0.0	0.0					0.0			0.0	
Total Lost Time (s)		6.2	6.2					6.1			6.1	
Lead/Lag												
Lead-Lag Optimize?												
Recall Mode	None	None	None					C-Max		None	C-Max	
Act Effct Green (s)		19.9	19.9					42.8			42.8	
Actuated g/C Ratio		0.27	0.27					0.57			0.57	
v/c Ratio		0.73	0.18					0.60			0.91dl	
Control Delay		30.2	2.2					12.6			12.2	
Queue Delay		0.0	0.0					0.0			0.0	
Total Delay		30.2	2.2					12.6			12.2	
LOS		C	A					B			B	
Approach Delay		26.9						12.6			12.2	
Approach LOS		C						B			B	
Queue Length 50th (m)		41.1	0.0					48.8			17.2	
Queue Length 95th (m)		56.1	3.4					71.1			m62.0	
Internal Link Dist (m)		296.0			233.4			215.6			90.2	
Turn Bay Length (m)			40.0									
Base Capacity (vph)		978	506					1809			981	
Starvation Cap Reductn		0	0					0			0	
Spillback Cap Reductn		0	0					0			0	
Storage Cap Reductn		0	0					0			0	
Reduced v/c Ratio		0.64	0.16					0.60			0.61	

Intersection Summary

Cycle Length: 75
 Actuated Cycle Length: 75
 Offset: 1 (1%), Referenced to phase 2:NBT and 6:SBTL, Start of Green
 Natural Cycle: 70
 Control Type: Actuated-Coordinated
 Maximum v/c Ratio: 0.73
 Intersection Signal Delay: 16.7
 Intersection Capacity Utilization 81.2%
 Analysis Period (min) 15
 Intersection LOS: B
 ICU Level of Service D

m Volume for 95th percentile queue is metered by upstream signal.
 dl Defacto Left Lane. Recode with 1 though lane as a left lane.

Splits and Phases: 9: Bank St & Chamberlain Ave/Isabella St

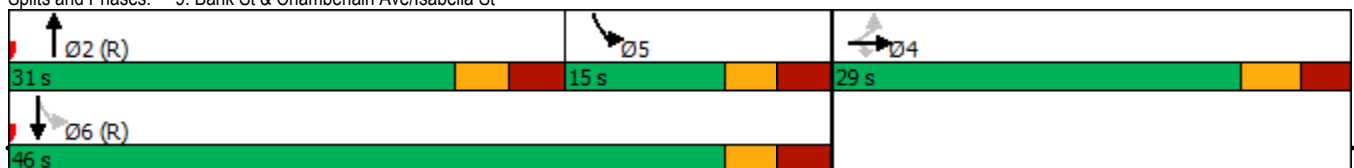

Existing AM

Synchro 11 Report

Lanes, Volumes, Timings
13: Bronson Ave & Catherine St

05/04/2023



Lane Group	EBL	EBT	EBR	WBL	WBT	WBR	NBL	NBT	NBR	SBL	SBT	SBR
Lane Configurations				↖ ↗	↖ ↗		↖ ↗	↖ ↗			↖ ↗	
Traffic Volume (vph)	0	0	0	492	479	346	519	1038	0	0	428	118
Future Volume (vph)	0	0	0	492	479	346	519	1038	0	0	428	118
Satd. Flow (prot)	0	0	0	1430	4136	0	1712	3390	0	0	3087	0
Fit Permitted				0.950	0.992		0.234					
Satd. Flow (perm)	0	0	0	1430	4136	0	422	3390	0	0	3087	0
Satd. Flow (RTOR)					78						30	
Lane Group Flow (vph)	0	0	0	372	1091	0	577	1153	0	0	607	0
Turn Type				Perm	NA		pm+pt	NA			NA	
Protected Phases					8		5 7	2				6
Permitted Phases				8			2					
Minimum Split (s)				28.3	28.3			23.8				23.8
Total Split (s)				34.0	34.0			76.0				33.0
Total Split (%)				30.9%	30.9%			69.1%				30.0%
Yellow Time (s)				3.3	3.3			3.3				3.3
All-Red Time (s)				3.0	3.0			3.5				3.5
Lost Time Adjust (s)				0.0	0.0			0.0				0.0
Total Lost Time (s)				6.3	6.3			6.8				6.8
Lead/Lag												Lag
Lead-Lag Optimize?												Yes
Act Effct Green (s)				27.7	27.7		69.8	69.2				26.2
Actuated g/C Ratio				0.25	0.25		0.63	0.63				0.24
v/c Ratio				1.03	0.99		0.92	0.54				0.80
Control Delay				97.6	64.1		39.1	12.6				46.6
Queue Delay				0.0	0.0		0.0	0.0				0.0
Total Delay				97.6	64.1		39.1	12.6				46.6
LOS				F	E		D	B				D
Approach Delay					72.6			21.5				46.6
Approach LOS					E			C				D
Queue Length 50th (m)				~100.0	85.3		62.9	67.5				61.7
Queue Length 95th (m)				#166.0	#118.8		#123.4	84.3				82.7
Internal Link Dist (m)		141.5			120.8			240.1				287.4
Turn Bay Length (m)				80.0			45.0					
Base Capacity (vph)				360	1099		626	2132				758
Starvation Cap Reductn				0	0		0	0				0
Spillback Cap Reductn				0	0		0	0				0
Storage Cap Reductn				0	0		0	0				0
Reduced v/c Ratio				1.03	0.99		0.92	0.54				0.80

Intersection Summary

Cycle Length: 110
 Actuated Cycle Length: 110
 Offset: 38 (35%), Referenced to phase 2:NBT and 6:SBT, Start of Green
 Natural Cycle: 100
 Control Type: Pretimed
 Maximum v/c Ratio: 1.03
 Intersection Signal Delay: 45.2 Intersection LOS: D
 Intersection Capacity Utilization 85.7% ICU Level of Service E
 Analysis Period (min) 15
 ~ Volume exceeds capacity, queue is theoretically infinite.
 Queue shown is maximum after two cycles.
 # 95th percentile volume exceeds capacity, queue may be longer.
 Queue shown is maximum after two cycles.

Splits and Phases: 13: Bronson Ave & Catherine St

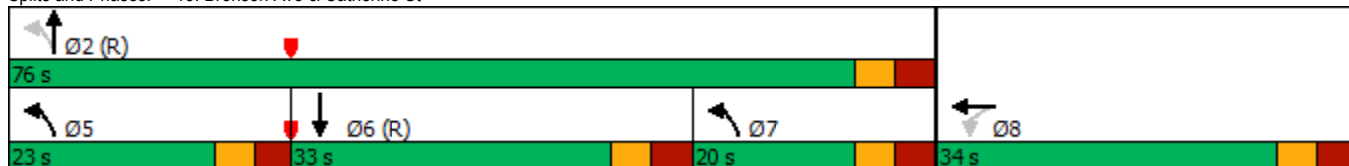

Lanes, Volumes, Timings
 13: Bronson Ave & Catherine St

05/04/2023

Lane Group	Ø5	Ø7
Lane Configurations		
Traffic Volume (vph)		
Future Volume (vph)		
Satd. Flow (prot)		
Fit Permitted		
Satd. Flow (perm)		
Satd. Flow (RTOR)		
Lane Group Flow (vph)		
Turn Type		
Protected Phases	5	7
Permitted Phases		
Minimum Split (s)	11.2	11.8
Total Split (s)	23.0	20.0
Total Split (%)	21%	18%
Yellow Time (s)	3.3	3.3
All-Red Time (s)	2.9	3.5
Lost Time Adjust (s)		
Total Lost Time (s)		
Lead/Lag	Lead	
Lead-Lag Optimize?	Yes	
Act Effct Green (s)		
Actuated g/C Ratio		
v/c Ratio		
Control Delay		
Queue Delay		
Total Delay		
LOS		
Approach Delay		
Approach LOS		
Queue Length 50th (m)		
Queue Length 95th (m)		
Internal Link Dist (m)		
Turn Bay Length (m)		
Base Capacity (vph)		
Starvation Cap Reductn		
Spillback Cap Reductn		
Storage Cap Reductn		
Reduced v/c Ratio		
Intersection Summary		

Intersection												
Int Delay, s/veh	2.1											
Movement	EBL	EBT	EBR	WBL	WBT	WBR	NBL	NBT	NBR	SBL	SBT	SBR
Lane Configurations		↕			↕						↕↔	
Traffic Vol, veh/h	0	18	0	11	12	0	0	0	0	44	324	9
Future Vol, veh/h	0	18	0	11	12	0	0	0	0	44	324	9
Conflicting Peds, #/hr	32	0	15	15	0	32	9	0	10	10	0	9
Sign Control	Stop	Stop	Stop	Stop	Stop	Stop	Free	Free	Free	Free	Free	Free
RT Channelized	-	-	None	-	-	None	-	-	None	-	-	None
Storage Length	-	-	-	-	-	-	-	-	-	-	-	-
Veh in Median Storage, #	-	0	-	-	0	-	-	-	-	-	0	-
Grade, %	-	0	-	-	0	-	-	0	-	-	0	-
Peak Hour Factor	90	90	90	90	90	90	90	90	90	90	90	90
Heavy Vehicles, %	0	6	0	9	0	0	0	0	0	5	1	11
Mvmt Flow	0	20	0	12	13	0	0	0	0	49	360	10
Major/Minor	Minor2			Minor1			Major2					
Conflicting Flow All	-	482	209	313	487	-	-	-	10	0	0	-
Stage 1	-	472	-	10	10	-	-	-	-	-	-	-
Stage 2	-	10	-	303	477	-	-	-	-	-	-	-
Critical Hdwy	-	6.62	6.9	7.68	6.5	-	-	-	4.2	-	-	-
Critical Hdwy Stg 1	-	5.62	-	-	-	-	-	-	-	-	-	-
Critical Hdwy Stg 2	-	-	-	6.68	5.5	-	-	-	-	-	-	-
Follow-up Hdwy	-	4.06	3.3	3.59	4	-	-	-	2.25	-	-	-
Pot Cap-1 Maneuver	0	474	803	599	484	0	-	-	1586	-	-	-
Stage 1	0	547	-	-	-	0	-	-	-	-	-	-
Stage 2	0	-	-	662	559	0	-	-	-	-	-	-
Platoon blocked, %	-	-	-	-	-	-	-	-	-	-	-	-
Mov Cap-1 Maneuver	-	448	796	556	457	-	-	-	1571	-	-	-
Mov Cap-2 Maneuver	-	448	-	556	457	-	-	-	-	-	-	-
Stage 1	-	521	-	-	-	-	-	-	-	-	-	-
Stage 2	-	-	-	612	533	-	-	-	-	-	-	-
Approach	EB			WB			SB					
HCM Control Delay, s	13.4			12.6			0.9					
HCM LOS	B			B								
Minor Lane/Major Mvmt	EBLn1	WBLn1	SBL	SBT	SBR							
Capacity (veh/h)	448	500	1571	-	-							
HCM Lane V/C Ratio	0.045	0.051	0.031	-	-							
HCM Control Delay (s)	13.4	12.6	7.4	0.1	-							
HCM Lane LOS	B	B	A	A	-							
HCM 95th %tile Q(veh)	0.1	0.2	0.1	-	-							

Intersection						
Int Delay, s/veh	3.2					
Movement	EBL	EBR	NBL	NBT	SBT	SBR
Lane Configurations	↔			↕↕	↕↕	
Traffic Vol, veh/h	21	124	86	687	372	22
Future Vol, veh/h	21	124	86	687	372	22
Conflicting Peds, #/hr	0	0	111	0	0	111
Sign Control	Stop	Stop	Free	Free	Free	Free
RT Channelized	-	None	-	None	-	None
Storage Length	0	-	-	-	-	-
Veh in Median Storage, #	0	-	-	0	0	-
Grade, %	0	-	-	0	0	-
Peak Hour Factor	90	90	90	90	90	90
Heavy Vehicles, %	0	3	2	5	8	5
Mvmt Flow	23	138	96	763	413	24

Major/Minor	Minor2	Major1	Major2			
Conflicting Flow All	1110	330	548	0	-	0
Stage 1	536	-	-	-	-	-
Stage 2	574	-	-	-	-	-
Critical Hdwy	6.8	6.96	4.14	-	-	-
Critical Hdwy Stg 1	5.8	-	-	-	-	-
Critical Hdwy Stg 2	5.8	-	-	-	-	-
Follow-up Hdwy	3.5	3.33	2.22	-	-	-
Pot Cap-1 Maneuver	207	663	1018	-	-	-
Stage 1	556	-	-	-	-	-
Stage 2	532	-	-	-	-	-
Platoon blocked, %				-	-	-
Mov Cap-1 Maneuver	136	595	914	-	-	-
Mov Cap-2 Maneuver	136	-	-	-	-	-
Stage 1	408	-	-	-	-	-
Stage 2	477	-	-	-	-	-

Approach	EB	NB	SB
HCM Control Delay, s	19.9	1.7	0
HCM LOS	C		

Minor Lane/Major Mvmt	NBL	NBT	EBLn1	SBT	SBR
Capacity (veh/h)	914	-	400	-	-
HCM Lane V/C Ratio	0.105	-	0.403	-	-
HCM Control Delay (s)	9.4	0.7	19.9	-	-
HCM Lane LOS	A	A	C	-	-
HCM 95th %tile Q(veh)	0.3	-	1.9	-	-

Lanes, Volumes, Timings

1: Hwy 417 WB On Ramp/Lyon St N & Catherine St

05/04/2023



Lane Group	EBL	EBT	EBR	WBL	WBT	WBR	NBL	NBT	NBR	SBL	SBT	SBR
Lane Configurations					↕↕↕						↕	↕
Traffic Volume (vph)	0	0	0	192	506	0	0	0	0	0	343	285
Future Volume (vph)	0	0	0	192	506	0	0	0	0	0	343	285
Satd. Flow (prot)	0	0	0	0	4736	0	0	0	0	0	1802	1532
Fit Permitted					0.986							
Satd. Flow (perm)	0	0	0	0	4703	0	0	0	0	0	1802	1490
Satd. Flow (RTOR)					131							73
Lane Group Flow (vph)	0	0	0	0	775	0	0	0	0	0	381	317
Turn Type				Perm	NA						NA	Perm
Protected Phases					8						6	
Permitted Phases				8							6	
Minimum Split (s)				26.2	26.2						28.3	28.3
Total Split (s)				28.0	28.0						47.0	47.0
Total Split (%)				37.3%	37.3%						62.7%	62.7%
Yellow Time (s)				3.3	3.3						3.3	3.3
All-Red Time (s)				1.9	1.9						2.0	2.0
Lost Time Adjust (s)					0.0						0.0	0.0
Total Lost Time (s)					5.2						5.3	5.3
Lead/Lag												
Lead-Lag Optimize?												
Act Effct Green (s)					22.8						41.7	41.7
Actuated g/C Ratio					0.30						0.56	0.56
v/c Ratio					0.51						0.38	0.37
Control Delay					18.6						15.5	12.8
Queue Delay					0.0						0.0	0.0
Total Delay					18.6						15.5	12.8
LOS					B						B	B
Approach Delay					18.6						14.3	
Approach LOS					B						B	
Queue Length 50th (m)					11.4						48.3	33.7
Queue Length 95th (m)					17.8						72.0	56.8
Internal Link Dist (m)		271.6			163.9			117.8			52.8	
Turn Bay Length (m)												
Base Capacity (vph)					1520						1001	860
Starvation Cap Reductn					0						0	0
Spillback Cap Reductn					0						0	0
Storage Cap Reductn					0						0	0
Reduced v/c Ratio					0.51						0.38	0.37

Intersection Summary

Cycle Length: 75	
Actuated Cycle Length: 75	
Offset: 24 (32%), Referenced to phase 8:WBTL, Start of Green	
Natural Cycle: 55	
Control Type: Pretimed	
Maximum v/c Ratio: 0.51	
Intersection Signal Delay: 16.5	Intersection LOS: B
Intersection Capacity Utilization 46.5%	ICU Level of Service A
Analysis Period (min) 15	

Splits and Phases: 1: Hwy 417 WB On Ramp/Lyon St N & Catherine St



Lanes, Volumes, Timings

2: Hwy 417 EB Off Ramp/Chamberlain Ave/Kent St & Catherine St

05/04/2023



Lane Group	EBL	EBT	EBR	WBL	WBT	WBR	NBL	NBT	NBR	SBL	SBT	SBR
Lane Configurations					↕↕	↗		↕↕↕				
Traffic Volume (vph)	0	0	0	0	643	289	25	820	0	0	0	0
Future Volume (vph)	0	0	0	0	643	289	25	820	0	0	0	0
Satd. Flow (prot)	0	0	0	0	3180	1303	0	4863	0	0	0	0
Fit Permitted								0.999				
Satd. Flow (perm)	0	0	0	0	3180	1204	0	4861	0	0	0	0
Satd. Flow (RTOR)								70				
Lane Group Flow (vph)	0	0	0	0	746	289	0	939	0	0	0	0
Turn Type					NA	Perm	Perm	NA				
Protected Phases					8			2				
Permitted Phases						8		2				
Minimum Split (s)					22.8	22.8	22.5	22.5				
Total Split (s)					38.0	38.0	32.0	32.0				
Total Split (%)					50.7%	50.7%	42.7%	42.7%				
Yellow Time (s)					3.3	3.3	3.3	3.3				
All-Red Time (s)					2.5	2.5	2.5	2.5				
Lost Time Adjust (s)					0.0	0.0		0.0				
Total Lost Time (s)					5.8	5.8		5.8				
Lead/Lag												
Lead-Lag Optimize?												
Act Effct Green (s)					32.2	32.2		26.2				
Actuated g/C Ratio					0.43	0.43		0.35				
v/c Ratio					0.55	0.56		0.54				
Control Delay					15.1	17.1		19.4				
Queue Delay					0.0	0.0		0.0				
Total Delay					15.1	17.1		19.4				
LOS					B	B		B				
Approach Delay					15.7			19.4				
Approach LOS					B			B				
Queue Length 50th (m)					35.2	27.3		35.3				
Queue Length 95th (m)					m38.3	m31.7		46.9				
Internal Link Dist (m)		163.9			131.7			67.4			53.0	
Turn Bay Length (m)												
Base Capacity (vph)					1365	516		1743				
Starvation Cap Reductn					0	0		0				
Spillback Cap Reductn					0	0		21				
Storage Cap Reductn					0	0		0				
Reduced v/c Ratio					0.55	0.56		0.55				

Intersection Summary

Cycle Length: 75
 Actuated Cycle Length: 75
 Offset: 12 (16%), Referenced to phase 8:WBT, Start of Green
 Natural Cycle: 55
 Control Type: Pretimed
 Maximum v/c Ratio: 0.56
 Intersection Signal Delay: 17.4 Intersection LOS: B
 Intersection Capacity Utilization 51.7% ICU Level of Service A
 Analysis Period (min) 15
 m Volume for 95th percentile queue is metered by upstream signal.

Splits and Phases: 2: Hwy 417 EB Off Ramp/Chamberlain Ave/Kent St & Catherine St

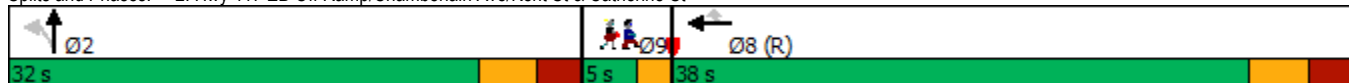

Lanes, Volumes, Timings

2: Hwy 417 EB Off Ramp/Chamberlain Ave/Kent St & Catherine St

05/04/2023

Lane Group	Ø9
Lane Configurations	
Traffic Volume (vph)	
Future Volume (vph)	
Satd. Flow (prot)	
Fit Permitted	
Satd. Flow (perm)	
Satd. Flow (RTOR)	
Lane Group Flow (vph)	
Turn Type	
Protected Phases	9
Permitted Phases	
Minimum Split (s)	5.0
Total Split (s)	5.0
Total Split (%)	7%
Yellow Time (s)	2.0
All-Red Time (s)	0.0
Lost Time Adjust (s)	
Total Lost Time (s)	
Lead/Lag	
Lead-Lag Optimize?	
Act Effct Green (s)	
Actuated g/C Ratio	
v/c Ratio	
Control Delay	
Queue Delay	
Total Delay	
LOS	
Approach Delay	
Approach LOS	
Queue Length 50th (m)	
Queue Length 95th (m)	
Internal Link Dist (m)	
Turn Bay Length (m)	
Base Capacity (vph)	
Starvation Cap Reductn	
Spillback Cap Reductn	
Storage Cap Reductn	
Reduced v/c Ratio	
Intersection Summary	

Lanes, Volumes, Timings
3: Bank St & Catherine St

05/04/2023



Lane Group	EBL	EBT	EBR	WBL	WBT	WBR	NBL	NBT	NBR	SBL	SBT	SBR
Lane Configurations					↕↕↕			↕↕			↕↕	
Traffic Volume (vph)	0	0	0	232	600	156	184	328	0	0	689	126
Future Volume (vph)	0	0	0	232	600	156	184	328	0	0	689	126
Satd. Flow (prot)	0	0	0	0	4598	0	0	3259	0	0	3116	0
Fit Permitted					0.988			0.551				
Satd. Flow (perm)	0	0	0	0	4516	0	0	1828	0	0	3116	0
Satd. Flow (RTOR)					48			28			28	
Lane Group Flow (vph)	0	0	0	0	1098	0	0	568	0	0	906	0
Turn Type				Perm	NA		pm+pt	NA			NA	
Protected Phases					8		9	2			6	
Permitted Phases				8			2					
Minimum Split (s)				18.6	18.6		10.4	16.4			16.4	
Total Split (s)				24.0	24.0		14.0	41.0			27.0	
Total Split (%)				32.0%	32.0%		18.7%	54.7%			36.0%	
Yellow Time (s)				3.3	3.3		3.3	3.3			3.3	
All-Red Time (s)				2.3	2.3		2.1	2.1			2.1	
Lost Time Adjust (s)					0.0			0.0			0.0	
Total Lost Time (s)					5.6			5.4			5.4	
Lead/Lag				Lag	Lag		Lag	Lag			Lag	
Lead-Lag Optimize?				Yes	Yes		Yes	Yes			Yes	
Act Effct Green (s)					18.4			35.6			21.6	
Actuated g/C Ratio					0.25			0.47			0.29	
v/c Ratio					0.96			0.55			0.99	
Control Delay					46.8			12.3			54.8	
Queue Delay					0.1			0.0			25.0	
Total Delay					46.9			12.3			79.7	
LOS					D			B			E	
Approach Delay					46.9			12.3			79.7	
Approach LOS					D			B			E	
Queue Length 50th (m)					53.9			15.8			65.0	
Queue Length 95th (m)					#81.5			20.1			#104.3	
Internal Link Dist (m)		131.7			201.7			90.2			52.9	
Turn Bay Length (m)												
Base Capacity (vph)					1144			1031			917	
Starvation Cap Reductn					0			0			0	
Spillback Cap Reductn					1			0			69	
Storage Cap Reductn					0			0			0	
Reduced v/c Ratio					0.96			0.55			1.07	

Intersection Summary
 Cycle Length: 75
 Actuated Cycle Length: 75
 Offset: 50 (67%), Referenced to phase 2:NBT and 6:SBT, Start of Green
 Natural Cycle: 80
 Control Type: Pretimed
 Maximum v/c Ratio: 0.99
 Intersection Signal Delay: 50.8
 Intersection Capacity Utilization 78.2%
 Analysis Period (min) 15
 # 95th percentile volume exceeds capacity, queue may be longer.
 Queue shown is maximum after two cycles.

Splits and Phases: 3: Bank St & Catherine St

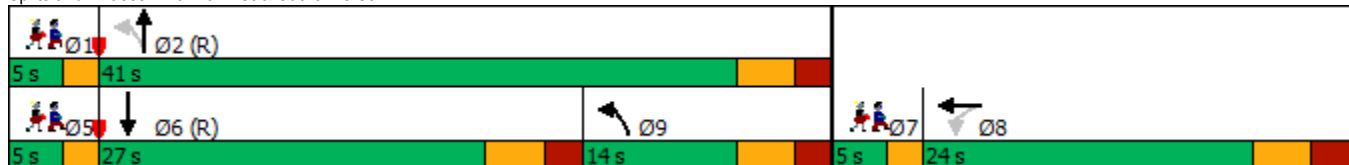

Lanes, Volumes, Timings
 3: Bank St & Catherine St

05/04/2023

Lane Group	Ø1	Ø5	Ø7
Lane Configurations			
Traffic Volume (vph)			
Future Volume (vph)			
Satd. Flow (prot)			
Fit Permitted			
Satd. Flow (perm)			
Satd. Flow (RTOR)			
Lane Group Flow (vph)			
Turn Type			
Protected Phases	1	5	7
Permitted Phases			
Minimum Split (s)	5.0	5.0	5.0
Total Split (s)	5.0	5.0	5.0
Total Split (%)	7%	7%	7%
Yellow Time (s)	2.0	2.0	2.0
All-Red Time (s)	0.0	0.0	0.0
Lost Time Adjust (s)			
Total Lost Time (s)			
Lead/Lag	Lead	Lead	Lead
Lead-Lag Optimize?	Yes	Yes	Yes
Act Effct Green (s)			
Actuated g/C Ratio			
v/c Ratio			
Control Delay			
Queue Delay			
Total Delay			
LOS			
Approach Delay			
Approach LOS			
Queue Length 50th (m)			
Queue Length 95th (m)			
Internal Link Dist (m)			
Turn Bay Length (m)			
Base Capacity (vph)			
Starvation Cap Reductn			
Spillback Cap Reductn			
Storage Cap Reductn			
Reduced v/c Ratio			
Intersection Summary			

Lanes, Volumes, Timings
4: Percy St & Catherine St

05/04/2023



Lane Group	EBL	EBT	EBR	WBL	WBT	WBR	NBL	NBT	NBR	SBL	SBT	SBR
Lane Configurations					↑↑↑						↓	
Traffic Volume (vph)	0	0	0	153	684	0	0	0	0	0	121	39
Future Volume (vph)	0	0	0	153	684	0	0	0	0	0	121	39
Satd. Flow (prot)	0	0	0	0	4819	0	0	0	0	0	1726	0
Fit Permitted					0.991							
Satd. Flow (perm)	0	0	0	0	4800	0	0	0	0	0	1726	0
Satd. Flow (RTOR)					160							
Lane Group Flow (vph)	0	0	0	0	930	0	0	0	0	0	177	0
Turn Type				Perm	NA						NA	
Protected Phases					8						6	
Permitted Phases				8								
Detector Phase				8	8						6	
Switch Phase												
Minimum Initial (s)				10.0	10.0						10.0	
Minimum Split (s)				26.5	26.5						23.4	
Total Split (s)				34.0	34.0						24.0	
Total Split (%)				37.8%	37.8%						26.7%	
Yellow Time (s)				3.3	3.3						3.3	
All-Red Time (s)				2.2	2.2						2.1	
Lost Time Adjust (s)					0.0						0.0	
Total Lost Time (s)					5.5						5.4	
Lead/Lag				Lag	Lag							
Lead-Lag Optimize?				Yes	Yes							
Recall Mode				None	None						Max	
Act Effct Green (s)					15.8						18.7	
Actuated g/C Ratio					0.35						0.41	
v/c Ratio					0.52						0.25	
Control Delay					10.6						11.1	
Queue Delay					0.0						0.0	
Total Delay					10.6						11.1	
LOS					B						B	
Approach Delay					10.6						11.1	
Approach LOS					B						B	
Queue Length 50th (m)					16.6						8.6	
Queue Length 95th (m)					24.8						22.0	
Internal Link Dist (m)		71.6			271.6			106.7			288.0	
Turn Bay Length (m)												
Base Capacity (vph)					3082						709	
Starvation Cap Reductn					0						0	
Spillback Cap Reductn					0						0	
Storage Cap Reductn					0						0	
Reduced v/c Ratio					0.30						0.25	

Intersection Summary
 Cycle Length: 90
 Actuated Cycle Length: 45.5
 Natural Cycle: 65
 Control Type: Semi Act-Uncoord
 Maximum v/c Ratio: 0.52
 Intersection Signal Delay: 10.6
 Intersection Capacity Utilization 43.5%
 Analysis Period (min) 15
 Intersection LOS: B
 ICU Level of Service A

Splits and Phases: 4: Percy St & Catherine St

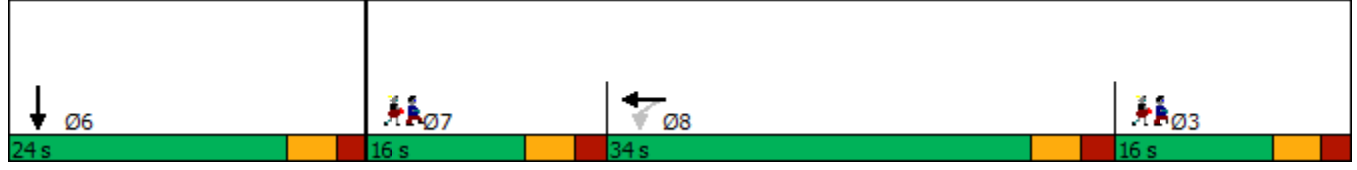

Lanes, Volumes, Timings
4: Percy St & Catherine St

05/04/2023

Lane Group	Ø3	Ø7
Lane Configurations		
Traffic Volume (vph)		
Future Volume (vph)		
Satd. Flow (prot)		
Fit Permitted		
Satd. Flow (perm)		
Satd. Flow (RTOR)		
Lane Group Flow (vph)		
Turn Type		
Protected Phases	3	7
Permitted Phases		
Detector Phase		
Switch Phase		
Minimum Initial (s)	1.0	1.0
Minimum Split (s)	6.4	6.4
Total Split (s)	16.0	16.0
Total Split (%)	18%	18%
Yellow Time (s)	3.3	3.3
All-Red Time (s)	2.1	2.1
Lost Time Adjust (s)		
Total Lost Time (s)		
Lead/Lag		Lead
Lead-Lag Optimize?		Yes
Recall Mode	None	None
Act Effct Green (s)		
Actuated g/C Ratio		
v/c Ratio		
Control Delay		
Queue Delay		
Total Delay		
LOS		
Approach Delay		
Approach LOS		
Queue Length 50th (m)		
Queue Length 95th (m)		
Internal Link Dist (m)		
Turn Bay Length (m)		
Base Capacity (vph)		
Starvation Cap Reductn		
Spillback Cap Reductn		
Storage Cap Reductn		
Reduced v/c Ratio		
Intersection Summary		

Lanes, Volumes, Timings
6: Kent St & Arlington Ave

05/04/2023



Lane Group	EBL	EBT	EBR	WBL	WBT	WBR	NBL	NBT	NBR	SBL	SBT	SBR
Lane Configurations		↕			↕			↕↕↕				
Traffic Volume (vph)	12	61	0	0	18	63	22	1021	93	0	0	0
Future Volume (vph)	12	61	0	0	18	63	22	1021	93	0	0	0
Satd. Flow (prot)	0	1805	0	0	1561	0	0	4823	0	0	0	0
Fit Permitted		0.958						0.999				
Satd. Flow (perm)	0	1734	0	0	1561	0	0	4821	0	0	0	0
Satd. Flow (RTOR)					58			31				
Lane Group Flow (vph)	0	81	0	0	90	0	0	1261	0	0	0	0
Turn Type	Perm	NA			NA		Perm	NA				
Protected Phases		4			8			2				
Permitted Phases	4						2					
Minimum Split (s)	27.3	27.3			27.3		32.3	32.3				
Total Split (s)	28.0	28.0			28.0		47.0	47.0				
Total Split (%)	37.3%	37.3%			37.3%		62.7%	62.7%				
Yellow Time (s)	3.3	3.3			3.3		3.3	3.3				
All-Red Time (s)	2.0	2.0			2.0		2.0	2.0				
Lost Time Adjust (s)		0.0			0.0			0.0				
Total Lost Time (s)		5.3			5.3			5.3				
Lead/Lag												
Lead-Lag Optimize?												
Act Effct Green (s)		22.7			22.7			41.7				
Actuated g/C Ratio		0.30			0.30			0.56				
v/c Ratio		0.15			0.18			0.47				
Control Delay		28.8			9.8			6.4				
Queue Delay		0.0			0.0			0.3				
Total Delay		28.8			9.8			6.6				
LOS		C			A			A				
Approach Delay		28.8			9.8			6.6				
Approach LOS		C			A			A				
Queue Length 50th (m)		10.4			1.3			20.1				
Queue Length 95th (m)		m19.9			m5.6			23.9				
Internal Link Dist (m)		164.0			143.1			53.0			216.0	
Turn Bay Length (m)												
Base Capacity (vph)		524			512			2694				
Starvation Cap Reductn		0			0			659				
Spillback Cap Reductn		0			0			0				
Storage Cap Reductn		0			0			0				
Reduced v/c Ratio		0.15			0.18			0.62				

Intersection Summary
 Cycle Length: 75
 Actuated Cycle Length: 75
 Offset: 50 (67%), Referenced to phase 2:NBT, Start of Green
 Natural Cycle: 60
 Control Type: Pretimed
 Maximum v/c Ratio: 0.47
 Intersection Signal Delay: 8.1
 Intersection LOS: A
 Intersection Capacity Utilization 53.2%
 ICU Level of Service A
 Analysis Period (min) 15
 m Volume for 95th percentile queue is metered by upstream signal.

Splits and Phases: 6: Kent St & Arlington Ave

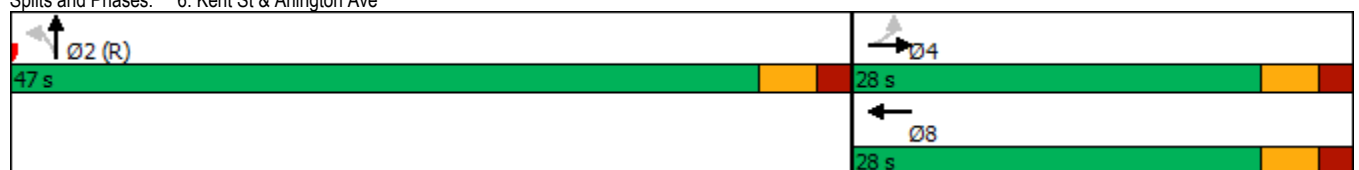

Lanes, Volumes, Timings
7: Lyon St N & Gladstone Ave

05/04/2023



Lane Group	EBL	EBT	EBR	WBL	WBT	WBR	NBL	NBT	NBR	SBL	SBT	SBR
Lane Configurations		↑	↗	↖	↑						↕	↕
Traffic Volume (vph)	0	247	52	28	314	0	0	0	0	86	499	138
Future Volume (vph)	0	247	52	28	314	0	0	0	0	86	499	138
Satd. Flow (prot)	0	1784	1547	1729	1784	0	0	0	0	0	3252	0
Fit Permitted				0.552							0.994	
Satd. Flow (perm)	0	1784	1408	961	1784	0	0	0	0	0	3238	0
Satd. Flow (RTOR)			58								46	
Lane Group Flow (vph)	0	274	58	31	349	0	0	0	0	0	803	0
Turn Type		NA	Perm	Perm	NA					Perm	NA	
Protected Phases		4			8							6
Permitted Phases			4	8						6		
Minimum Split (s)		17.2	17.2	17.2	17.2					22.6	22.6	
Total Split (s)		39.0	39.0	39.0	39.0					36.0	36.0	
Total Split (%)		52.0%	52.0%	52.0%	52.0%					48.0%	48.0%	
Yellow Time (s)		3.3	3.3	3.3	3.3					3.3	3.3	
All-Red Time (s)		1.9	1.9	1.9	1.9					2.3	2.3	
Lost Time Adjust (s)		0.0	0.0	0.0	0.0						0.0	
Total Lost Time (s)		5.2	5.2	5.2	5.2						5.6	
Lead/Lag												
Lead-Lag Optimize?												
Act Effct Green (s)		33.8	33.8	33.8	33.8						30.4	
Actuated g/C Ratio		0.45	0.45	0.45	0.45						0.41	
v/c Ratio		0.34	0.09	0.07	0.43						0.60	
Control Delay		14.9	4.0	6.7	11.3						18.7	
Queue Delay		0.0	0.0	0.0	0.0						0.0	
Total Delay		14.9	4.0	6.7	11.3						18.7	
LOS		B	A	A	B						B	
Approach Delay		13.0			10.9						18.7	
Approach LOS		B			B						B	
Queue Length 50th (m)		24.0	0.0	1.4	39.4						42.7	
Queue Length 95th (m)		40.5	5.7	m2.7	52.4						59.8	
Internal Link Dist (m)		254.8			165.0			215.6			214.3	
Turn Bay Length (m)				25.0								
Base Capacity (vph)		803	666	433	803						1339	
Starvation Cap Reductn		0	0	0	0						0	
Spillback Cap Reductn		0	0	0	0						0	
Storage Cap Reductn		0	0	0	0						0	
Reduced v/c Ratio		0.34	0.09	0.07	0.43						0.60	

Intersection Summary
 Cycle Length: 75
 Actuated Cycle Length: 75
 Offset: 45 (60%), Referenced to phase 4:EBT and 8:WBTL, Start of Green
 Natural Cycle: 40
 Control Type: Pretimed
 Maximum v/c Ratio: 0.60
 Intersection Signal Delay: 15.5
 Intersection Capacity Utilization 66.9%
 Analysis Period (min) 15
 Intersection LOS: B
 ICU Level of Service C
 m Volume for 95th percentile queue is metered by upstream signal.

Splits and Phases: 7: Lyon St N & Gladstone Ave

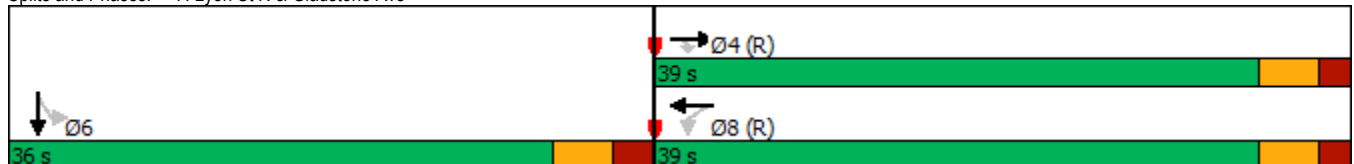

Lanes, Volumes, Timings
8: Kent St & Gladstone Ave

05/04/2023



Lane Group	EBL	EBT	EBR	WBL	WBT	WBR	NBL	NBT	NBR	SBL	SBT	SBR
Lane Configurations												
Traffic Volume (vph)	75	450	0	0	324	75	67	882	131	0	0	0
Future Volume (vph)	75	450	0	0	324	75	67	882	131	0	0	0
Satd. Flow (prot)	1729	1767	0	0	1719	0	1729	4618	0	0	0	0
Fit Permitted	0.392						0.950					
Satd. Flow (perm)	695	1767	0	0	1719	0	1522	4618	0	0	0	0
Satd. Flow (RTOR)					21			44				
Lane Group Flow (vph)	83	500	0	0	443	0	74	1126	0	0	0	0
Turn Type	Perm	NA			NA		Perm	NA				
Protected Phases		4			8			2				
Permitted Phases	4						2					
Minimum Split (s)	21.4	21.4			21.4		20.4	20.4				
Total Split (s)	40.0	40.0			40.0		35.0	35.0				
Total Split (%)	53.3%	53.3%			53.3%		46.7%	46.7%				
Yellow Time (s)	3.3	3.3			3.3		3.3	3.3				
All-Red Time (s)	2.1	2.1			2.1		2.1	2.1				
Lost Time Adjust (s)	0.0	0.0			0.0		0.0	0.0				
Total Lost Time (s)	5.4	5.4			5.4		5.4	5.4				
Lead/Lag												
Lead-Lag Optimize?												
Act Effct Green (s)	34.6	34.6			34.6		29.6	29.6				
Actuated g/C Ratio	0.46	0.46			0.46		0.39	0.39				
v/c Ratio	0.26	0.61			0.55		0.12	0.61				
Control Delay	23.4	28.7			17.1		4.6	5.2				
Queue Delay	0.0	0.0			0.0		0.0	0.0				
Total Delay	23.4	28.7			17.1		4.6	5.2				
LOS	C	C			B		A	A				
Approach Delay		27.9			17.1			5.1				
Approach LOS		C			B			A				
Queue Length 50th (m)	8.9	66.5			40.9		1.5	7.0				
Queue Length 95th (m)	m19.7	97.8			66.8		3.3	9.0				
Internal Link Dist (m)		165.0			168.8			216.0			203.6	
Turn Bay Length (m)	30.0						40.0					
Base Capacity (vph)	320	815			804		600	1849				
Starvation Cap Reductn	0	0			0		0	0				
Spillback Cap Reductn	0	0			0		0	0				
Storage Cap Reductn	0	0			0		0	0				
Reduced v/c Ratio	0.26	0.61			0.55		0.12	0.61				

Intersection Summary
 Cycle Length: 75
 Actuated Cycle Length: 75
 Offset: 23 (31%), Referenced to phase 4:EBTL and 8:WBT, Start of Green
 Natural Cycle: 45
 Control Type: Pretimed
 Maximum v/c Ratio: 0.61
 Intersection Signal Delay: 13.5
 Intersection LOS: B
 Intersection Capacity Utilization 66.9%
 ICU Level of Service C
 Analysis Period (min) 15
 m Volume for 95th percentile queue is metered by upstream signal.

Splits and Phases: 8: Kent St & Gladstone Ave

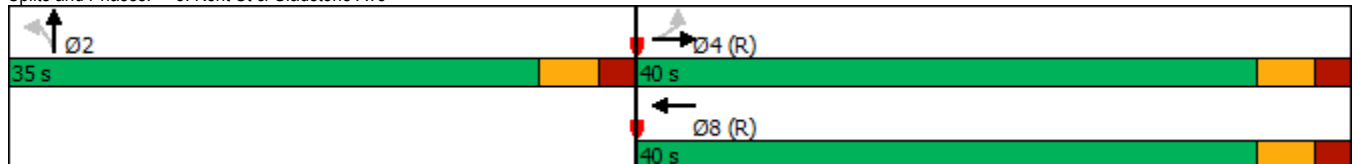

Lanes, Volumes, Timings
 9: Bank St & Chamberlain Ave/Isabella St

05/04/2023



Lane Group	EBL	EBT	EBR	WBL	WBT	WBR	NBL	NBT	NBR	SBL	SBT	SBR
Lane Configurations		↕↕	↗					↕↕			↕↕	
Traffic Volume (vph)	53	590	120	0	0	0	0	448	91	175	720	0
Future Volume (vph)	53	590	120	0	0	0	0	448	91	175	720	0
Satd. Flow (prot)	0	3347	1547	0	0	0	0	3136	0	0	3324	0
Fit Permitted		0.996									0.700	
Satd. Flow (perm)	0	3343	1403	0	0	0	0	3136	0	0	2309	0
Satd. Flow (RTOR)			134					33				
Lane Group Flow (vph)	0	715	133	0	0	0	0	599	0	0	994	0
Turn Type	Perm	NA	Perm					NA		pm+pt	NA	
Protected Phases		4						2		5	6	
Permitted Phases	4		4							6		
Detector Phase	4	4	4					2		5	6	
Switch Phase												
Minimum Initial (s)	10.0	10.0	10.0					10.0		5.0	10.0	
Minimum Split (s)	26.2	26.2	26.2					23.1		11.1	23.1	
Total Split (s)	31.0	31.0	31.0					30.0		14.0	44.0	
Total Split (%)	41.3%	41.3%	41.3%					40.0%		18.7%	58.7%	
Yellow Time (s)	3.3	3.3	3.3					3.0		3.0	3.0	
All-Red Time (s)	2.9	2.9	2.9					3.1		3.1	3.1	
Lost Time Adjust (s)		0.0	0.0					0.0			0.0	
Total Lost Time (s)		6.2	6.2					6.1			6.1	
Lead/Lag												
Lead-Lag Optimize?												
Recall Mode	None	None	None					C-Max		None	C-Max	
Act Effct Green (s)		22.1	22.1					40.6			40.6	
Actuated g/C Ratio		0.29	0.29					0.54			0.54	
v/c Ratio		0.73	0.26					0.35			0.79	
Control Delay		28.2	5.1					10.4			14.1	
Queue Delay		0.0	0.0					0.0			2.1	
Total Delay		28.2	5.1					10.4			16.3	
LOS		C	A					B			B	
Approach Delay		24.6						10.4			16.3	
Approach LOS		C						B			B	
Queue Length 50th (m)		46.2	0.0					22.7			82.3	
Queue Length 95th (m)		62.2	10.5					34.6			m84.1	
Internal Link Dist (m)		296.0			233.4			215.6			90.2	
Turn Bay Length (m)			40.0									
Base Capacity (vph)		1105	553					1714			1251	
Starvation Cap Reductn		0	0					0			139	
Spillback Cap Reductn		0	0					0			0	
Storage Cap Reductn		0	0					0			0	
Reduced v/c Ratio		0.65	0.24					0.35			0.89	

Intersection Summary

Cycle Length: 75
 Actuated Cycle Length: 75
 Offset: 60 (80%), Referenced to phase 2:NBT and 6:SBTL, Start of Green
 Natural Cycle: 65
 Control Type: Actuated-Coordinated
 Maximum v/c Ratio: 0.79
 Intersection Signal Delay: 17.7
 Intersection LOS: B
 Intersection Capacity Utilization 81.3%
 ICU Level of Service D
 Analysis Period (min) 15
 m Volume for 95th percentile queue is metered by upstream signal.

Splits and Phases: 9: Bank St & Chamberlain Ave/Isabella St

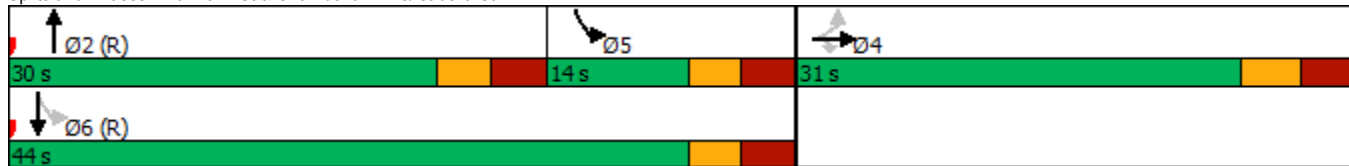

Lanes, Volumes, Timings
13: Bronson Ave & Catherine St

05/04/2023



Lane Group	EBL	EBT	EBR	WBL	WBT	WBR	NBL	NBT	NBR	SBL	SBT	SBR
Lane Configurations				↔↔↔	↔↔↔		↔↔	↔↔			↔↔	
Traffic Volume (vph)	0	0	0	690	573	270	292	762	0	0	801	165
Future Volume (vph)	0	0	0	690	573	270	292	762	0	0	801	165
Satd. Flow (prot)	0	0	0	1458	4279	0	1679	3390	0	0	3261	0
Fit Permitted				0.950	0.987		0.097					
Satd. Flow (perm)	0	0	0	1458	4279	0	171	3390	0	0	3261	0
Satd. Flow (RTOR)					76						27	
Lane Group Flow (vph)	0	0	0	430	1274	0	324	847	0	0	1073	0
Turn Type				Perm	NA		pm+pt	NA			NA	
Protected Phases					8		5	2			6	
Permitted Phases				8			2					
Minimum Split (s)				28.3	28.3		11.2	23.8			23.8	
Total Split (s)				33.0	33.0		25.0	67.0			42.0	
Total Split (%)				33.0%	33.0%		25.0%	67.0%			42.0%	
Yellow Time (s)				3.3	3.3		3.3	3.3			3.3	
All-Red Time (s)				3.0	3.0		2.9	3.5			3.5	
Lost Time Adjust (s)				0.0	0.0		0.0	0.0			0.0	
Total Lost Time (s)				6.3	6.3		6.2	6.8			6.8	
Lead/Lag							Lead				Lag	
Lead-Lag Optimize?							Yes				Yes	
Act Effct Green (s)				26.7	26.7		60.8	60.2			35.2	
Actuated g/C Ratio				0.27	0.27		0.61	0.60			0.35	
v/c Ratio				1.11	1.06		0.84	0.42			0.92	
Control Delay				113.2	78.8		44.0	11.3			44.2	
Queue Delay				0.0	0.0		0.0	0.0			0.0	
Total Delay				113.2	78.8		44.0	11.3			44.2	
LOS				F	E		D	B			D	
Approach Delay					87.5			20.4			44.2	
Approach LOS					F			C			D	
Queue Length 50th (m)				~111.0	~101.7		45.0	42.4			101.6	
Queue Length 95th (m)				#177.9	#132.0		#90.1	54.9			#142.1	
Internal Link Dist (m)		141.5			120.8			240.1			287.4	
Turn Bay Length (m)				80.0			45.0					
Base Capacity (vph)				389	1198		387	2040			1165	
Starvation Cap Reductn				0	0		0	0			0	
Spillback Cap Reductn				0	0		0	0			0	
Storage Cap Reductn				0	0		0	0			0	
Reduced v/c Ratio				1.11	1.06		0.84	0.42			0.92	

Intersection Summary

Cycle Length: 100
 Actuated Cycle Length: 100
 Offset: 60 (60%), Referenced to phase 2:NBT and 6:SBT, Start of Green
 Natural Cycle: 90
 Control Type: Pretimed
 Maximum v/c Ratio: 1.11
 Intersection Signal Delay: 55.8
 Intersection LOS: E
 Intersection Capacity Utilization 87.7%
 ICU Level of Service E
 Analysis Period (min) 15
 ~ Volume exceeds capacity, queue is theoretically infinite.
 Queue shown is maximum after two cycles.
 # 95th percentile volume exceeds capacity, queue may be longer.
 Queue shown is maximum after two cycles.

Splits and Phases: 13: Bronson Ave & Catherine St

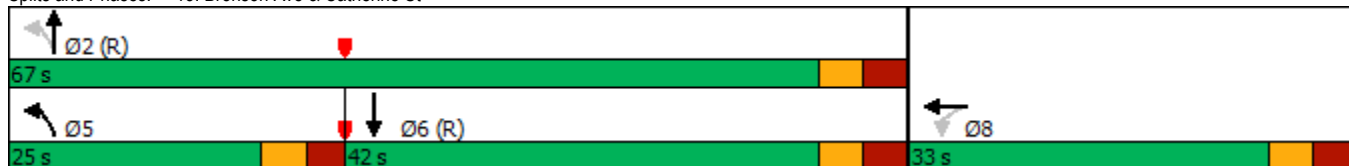

Intersection												
Int Delay, s/veh	2.2											
Movement	EBL	EBT	EBR	WBL	WBT	WBR	NBL	NBT	NBR	SBL	SBT	SBR
Lane Configurations		↕			↕						↕↔	
Traffic Vol, veh/h	0	19	2	8	37	0	0	0	0	43	564	13
Future Vol, veh/h	0	19	2	8	37	0	0	0	0	43	564	13
Conflicting Peds, #/hr	20	0	8	8	0	20	19	0	3	3	0	19
Sign Control	Stop	Stop	Stop	Stop	Stop	Stop	Free	Free	Free	Free	Free	Free
RT Channelized	-	-	None	-	-	None	-	-	None	-	-	None
Storage Length	-	-	-	-	-	-	-	-	-	-	-	-
Veh in Median Storage, #	-	0	-	-	0	-	-	-	-	-	0	-
Grade, %	-	0	-	-	0	-	-	0	-	-	0	-
Peak Hour Factor	90	90	90	90	90	90	90	90	90	90	90	90
Heavy Vehicles, %	0	5	0	0	5	0	0	0	0	0	0	0
Mvmt Flow	0	21	2	9	41	0	0	0	0	48	627	14
Major/Minor	Minor2			Minor1			Major2					
Conflicting Flow All	-	752	348	431	759	-	-	-	3	0	0	-
Stage 1	-	749	-	3	3	-	-	-	-	-	-	-
Stage 2	-	3	-	428	756	-	-	-	-	-	-	-
Critical Hdwy	-	6.6	6.9	7.5	6.6	-	-	-	4.1	-	-	-
Critical Hdwy Stg 1	-	5.6	-	-	-	-	-	-	-	-	-	-
Critical Hdwy Stg 2	-	-	-	6.5	5.6	-	-	-	-	-	-	-
Follow-up Hdwy	-	4.05	3.3	3.5	4.05	-	-	-	2.2	-	-	-
Pot Cap-1 Maneuver	0	332	654	513	329	0	-	-	1632	-	-	-
Stage 1	0	410	-	-	-	0	-	-	-	-	-	-
Stage 2	0	-	-	581	407	0	-	-	-	-	-	-
Platoon blocked, %	-	-	-	-	-	-	-	-	-	-	-	-
Mov Cap-1 Maneuver	-	310	643	466	307	-	-	-	1627	-	-	-
Mov Cap-2 Maneuver	-	310	-	466	307	-	-	-	-	-	-	-
Stage 1	-	384	-	-	-	-	-	-	-	-	-	-
Stage 2	-	-	-	522	381	-	-	-	-	-	-	-
Approach	EB			WB			SB					
HCM Control Delay, s	16.9			18			0.6					
HCM LOS	C			C								
Minor Lane/Major Mvmt	EBLn1	WBLn1	SBL	SBT	SBR							
Capacity (veh/h)	326	327	1627	-	-							
HCM Lane V/C Ratio	0.072	0.153	0.029	-	-							
HCM Control Delay (s)	16.9	18	7.3	0.1	-							
HCM Lane LOS	C	C	A	A	-							
HCM 95th %tile Q(veh)	0.2	0.5	0.1	-	-							

Intersection						
Int Delay, s/veh	2.5					
Movement	EBL	EBR	NBL	NBT	SBT	SBR
Lane Configurations	↔			↕↕	↕↕	
Traffic Vol, veh/h	20	107	58	426	708	27
Future Vol, veh/h	20	107	58	426	708	27
Conflicting Peds, #/hr	0	0	42	0	0	42
Sign Control	Stop	Stop	Free	Free	Free	Free
RT Channelized	-	None	-	None	-	None
Storage Length	0	-	-	-	-	-
Veh in Median Storage, #	0	-	-	0	0	-
Grade, %	0	-	-	0	0	-
Peak Hour Factor	90	90	90	90	90	90
Heavy Vehicles, %	0	1	0	5	3	0
Mvmt Flow	22	119	64	473	787	30

Major/Minor	Minor2	Major1	Major2			
Conflicting Flow All	1209	451	859	0	-	0
Stage 1	844	-	-	-	-	-
Stage 2	365	-	-	-	-	-
Critical Hdwy	6.8	6.92	4.1	-	-	-
Critical Hdwy Stg 1	5.8	-	-	-	-	-
Critical Hdwy Stg 2	5.8	-	-	-	-	-
Follow-up Hdwy	3.5	3.31	2.2	-	-	-
Pot Cap-1 Maneuver	178	558	791	-	-	-
Stage 1	387	-	-	-	-	-
Stage 2	679	-	-	-	-	-
Platoon blocked, %				-	-	-
Mov Cap-1 Maneuver	146	536	760	-	-	-
Mov Cap-2 Maneuver	146	-	-	-	-	-
Stage 1	329	-	-	-	-	-
Stage 2	653	-	-	-	-	-

Approach	EB	NB	SB
HCM Control Delay, s	20.2	1.7	0
HCM LOS	C		

Minor Lane/Major Mvmt	NBL	NBT	EBLn1	SBT	SBR
Capacity (veh/h)	760	-	377	-	-
HCM Lane V/C Ratio	0.085	-	0.374	-	-
HCM Control Delay (s)	10.2	0.5	20.2	-	-
HCM Lane LOS	B	A	C	-	-
HCM 95th %tile Q(veh)	0.3	-	1.7	-	-

Lanes, Volumes, Timings

1: Hwy 417 WB On Ramp/Lyon St N & Catherine St

05/18/2023



Lane Group	EBL	EBT	EBR	WBL	WBT	WBR	NBL	NBT	NBR	SBL	SBT	SBR
Lane Configurations					↕↕						↕	↕
Traffic Volume (vph)	0	0	0	247	233	0	0	0	0	0	275	131
Future Volume (vph)	0	0	0	247	233	0	0	0	0	0	275	131
Satd. Flow (prot)	0	0	0	0	3183	0	0	0	0	0	1784	1547
Fit Permitted					0.975							
Satd. Flow (perm)	0	0	0	0	3160	0	0	0	0	0	1784	1517
Satd. Flow (RTOR)					247							131
Lane Group Flow (vph)	0	0	0	0	480	0	0	0	0	0	275	131
Turn Type				Perm	NA						NA	Perm
Protected Phases					8						6	
Permitted Phases				8								6
Minimum Split (s)				26.2	26.2						28.3	28.3
Total Split (s)				36.0	36.0						39.0	39.0
Total Split (%)				48.0%	48.0%						52.0%	52.0%
Yellow Time (s)				3.3	3.3						3.3	3.3
All-Red Time (s)				1.9	1.9						2.0	2.0
Lost Time Adjust (s)					0.0						0.0	0.0
Total Lost Time (s)					5.2						5.3	5.3
Lead/Lag												
Lead-Lag Optimize?												
Act Effct Green (s)					30.8						33.7	33.7
Actuated g/C Ratio					0.41						0.45	0.45
v/c Ratio					0.33						0.34	0.17
Control Delay					10.2						23.8	11.9
Queue Delay					0.0						0.0	0.0
Total Delay					10.2						23.8	11.9
LOS					B						C	B
Approach Delay					10.2						19.9	
Approach LOS					B						B	
Queue Length 50th (m)					29.0						36.9	2.1
Queue Length 95th (m)					m41.7						59.0	20.4
Internal Link Dist (m)		271.6			163.9			117.8			52.8	
Turn Bay Length (m)												
Base Capacity (vph)					1443						801	753
Starvation Cap Reductn					0						0	0
Spillback Cap Reductn					0						0	0
Storage Cap Reductn					0						0	0
Reduced v/c Ratio					0.33						0.34	0.17

Intersection Summary

Cycle Length: 75
 Actuated Cycle Length: 75
 Offset: 24 (32%), Referenced to phase 8:WBTL, Start of Green
 Natural Cycle: 55
 Control Type: Pretimed
 Maximum v/c Ratio: 0.34
 Intersection Signal Delay: 14.6
 Intersection Capacity Utilization 49.0%
 Analysis Period (min) 15
 m Volume for 95th percentile queue is metered by upstream signal.

Splits and Phases: 1: Hwy 417 WB On Ramp/Lyon St N & Catherine St

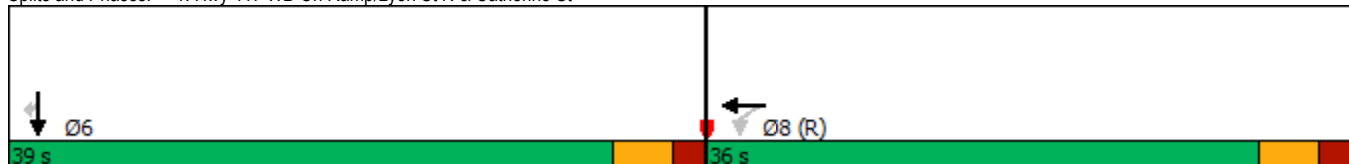

Lanes, Volumes, Timings

2: Hwy 417 EB Off Ramp/Chamberlain Ave/Kent St & Catherine St

05/18/2023



Lane Group	EBL	EBT	EBR	WBL	WBT	WBR	NBL	NBT	NBR	SBL	SBT	SBR
Lane Configurations					↑↑	↑↑		↑↑↑				
Traffic Volume (vph)	0	0	0	0	425	576	58	1423	0	0	0	0
Future Volume (vph)	0	0	0	0	425	576	58	1423	0	0	0	0
Satd. Flow (prot)	0	0	0	0	3262	2696	0	4911	0	0	0	0
Fit Permitted								0.998				
Satd. Flow (perm)	0	0	0	0	3262	2696	0	4906	0	0	0	0
Satd. Flow (RTOR)								70				
Lane Group Flow (vph)	0	0	0	0	425	576	0	1481	0	0	0	0
Turn Type					NA	Prot	Perm	NA				
Protected Phases					8	8		2				
Permitted Phases								2				
Detector Phase					8	8		2	2			
Switch Phase												
Minimum Initial (s)					10.0	10.0	10.0	10.0				
Minimum Split (s)					15.8	15.8	22.5	22.5				
Total Split (s)					29.6	29.6	32.4	32.4				
Total Split (%)					39.5%	39.5%	43.2%	43.2%				
Yellow Time (s)					3.3	3.3	3.3	3.3				
All-Red Time (s)					2.5	2.5	2.5	2.5				
Lost Time Adjust (s)					0.0	0.0		0.0				
Total Lost Time (s)					5.8	5.8		5.8				
Lead/Lag												
Lead-Lag Optimize?												
Recall Mode					C-Max	C-Max	Max	Max				
Act Effct Green (s)					29.0	29.0		26.6				
Actuated g/C Ratio					0.39	0.39		0.35				
v/c Ratio					0.34	0.55		0.83				
Control Delay					23.3	26.5		26.1				
Queue Delay					0.0	0.0		50.5				
Total Delay					23.3	26.5		76.6				
LOS					C	C		E				
Approach Delay					25.2			76.6				
Approach LOS					C			E				
Queue Length 50th (m)					28.7	44.2		65.8				
Queue Length 95th (m)					m35.2	m55.1		83.5				
Internal Link Dist (m)		163.9			131.7			67.4			53.0	
Turn Bay Length (m)						60.0						
Base Capacity (vph)					1261	1042		1785				
Starvation Cap Reductn					0	0		0				
Spillback Cap Reductn					0	0		1050				
Storage Cap Reductn					0	0		0				
Reduced v/c Ratio					0.34	0.55		2.01				

Intersection Summary

Cycle Length: 75
 Actuated Cycle Length: 75
 Offset: 0 (0%), Referenced to phase 8:WBT, Start of Green
 Natural Cycle: 60
 Control Type: Actuated-Coordinated
 Maximum v/c Ratio: 0.83
 Intersection Signal Delay: 55.9
 Intersection LOS: E
 Intersection Capacity Utilization 64.6%
 ICU Level of Service C
 Analysis Period (min) 15
 m Volume for 95th percentile queue is metered by upstream signal.

Splits and Phases: 2: Hwy 417 EB Off Ramp/Chamberlain Ave/Kent St & Catherine St

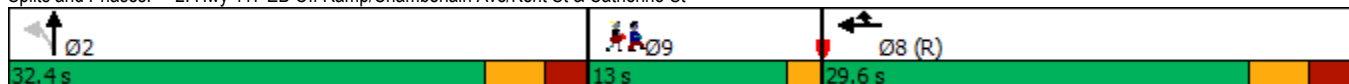

Lanes, Volumes, Timings

2: Hwy 417 EB Off Ramp/Chamberlain Ave/Kent St & Catherine St

05/18/2023

Lane Group	Ø9
Lane Configurations	
Traffic Volume (vph)	
Future Volume (vph)	
Satd. Flow (prot)	
Fit Permitted	
Satd. Flow (perm)	
Satd. Flow (RTOR)	
Lane Group Flow (vph)	
Turn Type	
Protected Phases	9
Permitted Phases	
Detector Phase	
Switch Phase	
Minimum Initial (s)	3.0
Minimum Split (s)	13.0
Total Split (s)	13.0
Total Split (%)	17%
Yellow Time (s)	2.0
All-Red Time (s)	0.0
Lost Time Adjust (s)	
Total Lost Time (s)	
Lead/Lag	
Lead-Lag Optimize?	
Recall Mode	None
Act Effct Green (s)	
Actuated g/C Ratio	
v/c Ratio	
Control Delay	
Queue Delay	
Total Delay	
LOS	
Approach Delay	
Approach LOS	
Queue Length 50th (m)	
Queue Length 95th (m)	
Internal Link Dist (m)	
Turn Bay Length (m)	
Base Capacity (vph)	
Starvation Cap Reductn	
Spillback Cap Reductn	
Storage Cap Reductn	
Reduced v/c Ratio	
Intersection Summary	

Lanes, Volumes, Timings
3: Bank St & Catherine St

05/18/2023



Lane Group	EBL	EBT	EBR	WBL	WBT	WBR	NBL	NBT	NBR	SBL	SBT	SBR
Lane Configurations					↕↕↕			↕↕			↕↕	
Traffic Volume (vph)	0	0	0	176	631	202	268	575	0	0	376	137
Future Volume (vph)	0	0	0	176	631	202	268	575	0	0	376	137
Satd. Flow (prot)	0	0	0	0	4439	0	0	3211	0	0	2863	0
Fit Permitted					0.991			0.648				
Satd. Flow (perm)	0	0	0	0	4384	0	0	2049	0	0	2863	0
Satd. Flow (RTOR)					76						74	
Lane Group Flow (vph)	0	0	0	0	1009	0	0	843	0	0	513	0
Turn Type				Perm	NA		pm+pt	NA			NA	
Protected Phases					8		9	2			6	
Permitted Phases				8			2					
Minimum Split (s)				18.6	18.6		10.4	16.4			16.4	
Total Split (s)				24.0	24.0		10.4	41.0			30.6	
Total Split (%)				32.0%	32.0%		13.9%	54.7%			40.8%	
Yellow Time (s)				3.3	3.3		3.3	3.3			3.3	
All-Red Time (s)				2.3	2.3		2.1	2.1			2.1	
Lost Time Adjust (s)					0.0			0.0			0.0	
Total Lost Time (s)					5.6			5.4			5.4	
Lead/Lag				Lag	Lag		Lag	Lag			Lag	
Lead-Lag Optimize?				Yes	Yes		Yes	Yes			Yes	
Act Effct Green (s)					18.4			35.6			25.2	
Actuated g/C Ratio					0.25			0.47			0.34	
v/c Ratio					0.89			0.80			0.51	
Control Delay					36.9			19.0			19.0	
Queue Delay					0.0			0.0			0.0	
Total Delay					36.9			19.0			19.0	
LOS					D			B			B	
Approach Delay					36.9			19.0			19.0	
Approach LOS					D			B			B	
Queue Length 50th (m)					46.9			25.6			25.4	
Queue Length 95th (m)					#70.3			#39.3			39.2	
Internal Link Dist (m)		131.7			201.7			90.2			52.9	
Turn Bay Length (m)												
Base Capacity (vph)					1132			1050			1011	
Starvation Cap Reductn					0			0			0	
Spillback Cap Reductn					0			0			0	
Storage Cap Reductn					0			0			0	
Reduced v/c Ratio					0.89			0.80			0.51	

Intersection Summary
 Cycle Length: 75
 Actuated Cycle Length: 75
 Offset: 50 (67%), Referenced to phase 2:NBT and 6:SBT, Start of Green
 Natural Cycle: 65
 Control Type: Pretimed
 Maximum v/c Ratio: 0.89
 Intersection Signal Delay: 26.6
 Intersection LOS: C
 Intersection Capacity Utilization 80.6%
 ICU Level of Service D
 Analysis Period (min) 15
 # 95th percentile volume exceeds capacity, queue may be longer.
 Queue shown is maximum after two cycles.

Splits and Phases: 3: Bank St & Catherine St

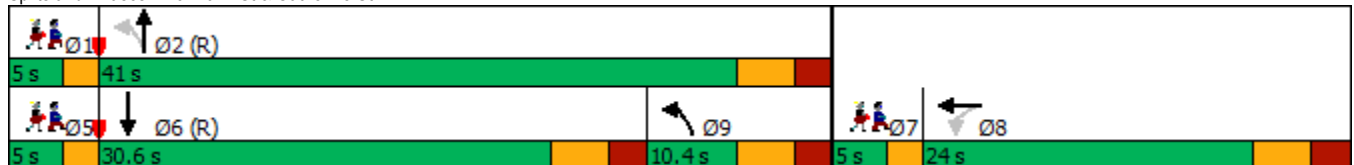

Lanes, Volumes, Timings
 3: Bank St & Catherine St

05/18/2023

Lane Group	Ø1	Ø5	Ø7
Lane Configurations			
Traffic Volume (vph)			
Future Volume (vph)			
Satd. Flow (prot)			
Fit Permitted			
Satd. Flow (perm)			
Satd. Flow (RTOR)			
Lane Group Flow (vph)			
Turn Type			
Protected Phases	1	5	7
Permitted Phases			
Minimum Split (s)	5.0	5.0	5.0
Total Split (s)	5.0	5.0	5.0
Total Split (%)	7%	7%	7%
Yellow Time (s)	2.0	2.0	2.0
All-Red Time (s)	0.0	0.0	0.0
Lost Time Adjust (s)			
Total Lost Time (s)			
Lead/Lag	Lead	Lead	Lead
Lead-Lag Optimize?	Yes	Yes	Yes
Act Effct Green (s)			
Actuated g/C Ratio			
v/c Ratio			
Control Delay			
Queue Delay			
Total Delay			
LOS			
Approach Delay			
Approach LOS			
Queue Length 50th (m)			
Queue Length 95th (m)			
Internal Link Dist (m)			
Turn Bay Length (m)			
Base Capacity (vph)			
Starvation Cap Reductn			
Spillback Cap Reductn			
Storage Cap Reductn			
Reduced v/c Ratio			
Intersection Summary			

Lanes, Volumes, Timings
4: Percy St & Catherine St

05/18/2023



Lane Group	EBL	EBT	EBR	WBL	WBT	WBR	NBL	NBT	NBR	SBL	SBT	SBR
Lane Configurations					↕↕						↕	
Traffic Volume (vph)	0	0	0	71	249	0	0	0	0	0	129	57
Future Volume (vph)	0	0	0	71	249	0	0	0	0	0	129	57
Satd. Flow (prot)	0	0	0	0	3170	0	0	0	0	0	1645	0
Fit Permitted					0.989							
Satd. Flow (perm)	0	0	0	0	3150	0	0	0	0	0	1645	0
Satd. Flow (RTOR)					160							
Lane Group Flow (vph)	0	0	0	0	320	0	0	0	0	0	186	0
Turn Type				Perm	NA						NA	
Protected Phases					8						6	
Permitted Phases				8								
Detector Phase				8	8						6	
Switch Phase												
Minimum Initial (s)				10.0	10.0						10.0	
Minimum Split (s)				26.5	26.5						23.4	
Total Split (s)				36.0	36.0						41.2	
Total Split (%)				40.0%	40.0%						45.8%	
Yellow Time (s)				3.3	3.3						3.3	
All-Red Time (s)				2.2	2.2						2.1	
Lost Time Adjust (s)					0.0						0.0	
Total Lost Time (s)					5.5						5.4	
Lead/Lag				Lag	Lag							
Lead-Lag Optimize?				Yes	Yes							
Recall Mode				None	None						Max	
Act Effct Green (s)					12.0						36.0	
Actuated g/C Ratio					0.20						0.61	
v/c Ratio					0.42						0.19	
Control Delay					11.6						6.4	
Queue Delay					0.0						0.0	
Total Delay					11.6						6.4	
LOS					B						A	
Approach Delay					11.6						6.4	
Approach LOS					B						A	
Queue Length 50th (m)					7.6						6.6	
Queue Length 95th (m)					16.2						21.3	
Internal Link Dist (m)		106.8			271.6			106.7			288.0	
Turn Bay Length (m)												
Base Capacity (vph)					1716						1004	
Starvation Cap Reductn					0						0	
Spillback Cap Reductn					0						0	
Storage Cap Reductn					0						0	
Reduced v/c Ratio					0.19						0.19	

Intersection Summary
 Cycle Length: 90
 Actuated Cycle Length: 58.9
 Natural Cycle: 65
 Control Type: Semi Act-Uncoord
 Maximum v/c Ratio: 0.42
 Intersection Signal Delay: 9.7
 Intersection LOS: A
 Intersection Capacity Utilization 39.0%
 ICU Level of Service A
 Analysis Period (min) 15

Splits and Phases: 4: Percy St & Catherine St

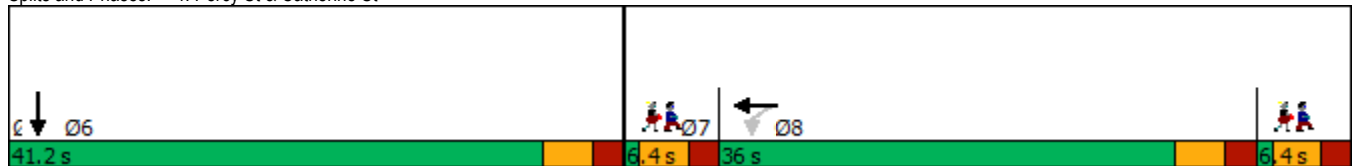

Lanes, Volumes, Timings
 4: Percy St & Catherine St

05/18/2023

Lane Group	Ø3	Ø7
Lane Configurations		
Traffic Volume (vph)		
Future Volume (vph)		
Satd. Flow (prot)		
Fit Permitted		
Satd. Flow (perm)		
Satd. Flow (RTOR)		
Lane Group Flow (vph)		
Turn Type		
Protected Phases	3	7
Permitted Phases		
Detector Phase		
Switch Phase		
Minimum Initial (s)	1.0	1.0
Minimum Split (s)	6.4	6.4
Total Split (s)	6.4	6.4
Total Split (%)	7%	7%
Yellow Time (s)	3.3	3.3
All-Red Time (s)	2.1	2.1
Lost Time Adjust (s)		
Total Lost Time (s)		
Lead/Lag		Lead
Lead-Lag Optimize?		Yes
Recall Mode	None	None
Act Effct Green (s)		
Actuated g/C Ratio		
v/c Ratio		
Control Delay		
Queue Delay		
Total Delay		
LOS		
Approach Delay		
Approach LOS		
Queue Length 50th (m)		
Queue Length 95th (m)		
Internal Link Dist (m)		
Turn Bay Length (m)		
Base Capacity (vph)		
Starvation Cap Reductn		
Spillback Cap Reductn		
Storage Cap Reductn		
Reduced v/c Ratio		
Intersection Summary		

Lanes, Volumes, Timings
6: Kent St & Arlington Ave

05/18/2023



Lane Group	EBL	EBT	EBR	WBL	WBT	WBR	NBL	NBT	NBR	SBL	SBT	SBR
Lane Configurations		↕			↕			↕↕↕				
Traffic Volume (vph)	19	48	0	0	11	93	15	1826	131	0	0	0
Future Volume (vph)	19	48	0	0	11	93	15	1826	131	0	0	0
Satd. Flow (prot)	0	1745	0	0	1542	0	0	4797	0	0	0	0
Fit Permitted		0.918										
Satd. Flow (perm)	0	1617	0	0	1542	0	0	4795	0	0	0	0
Satd. Flow (RTOR)					11			24				
Lane Group Flow (vph)	0	67	0	0	104	0	0	1972	0	0	0	0
Turn Type	Perm	NA			NA		Perm	NA				
Protected Phases		4			8			2				
Permitted Phases	4						2					
Minimum Split (s)	27.3	27.3			27.3		32.3	32.3				
Total Split (s)	27.4	27.4			27.4		47.6	47.6				
Total Split (%)	36.5%	36.5%			36.5%		63.5%	63.5%				
Yellow Time (s)	3.3	3.3			3.3		3.3	3.3				
All-Red Time (s)	2.0	2.0			2.0		2.0	2.0				
Lost Time Adjust (s)		0.0			0.0			0.0				
Total Lost Time (s)		5.3			5.3			5.3				
Lead/Lag												
Lead-Lag Optimize?												
Act Effct Green (s)		22.1			22.1			42.3				
Actuated g/C Ratio		0.29			0.29			0.56				
v/c Ratio		0.14			0.23			0.73				
Control Delay		33.0			16.6			15.3				
Queue Delay		0.0			0.0			48.7				
Total Delay		33.0			16.6			64.0				
LOS		C			B			E				
Approach Delay		33.0			16.6			64.0				
Approach LOS		C			B			E				
Queue Length 50th (m)		9.0			8.3			88.2				
Queue Length 95th (m)		19.9			m13.3			107.7				
Internal Link Dist (m)		164.0			143.1			53.0			216.0	
Turn Bay Length (m)												
Base Capacity (vph)		476			462			2714				
Starvation Cap Reductn		0			0			1414				
Spillback Cap Reductn		0			0			0				
Storage Cap Reductn		0			0			0				
Reduced v/c Ratio		0.14			0.23			1.52				

Intersection Summary
 Cycle Length: 75
 Actuated Cycle Length: 75
 Offset: 50 (67%), Referenced to phase 2:NBT, Start of Green
 Natural Cycle: 60
 Control Type: Pretimed
 Maximum v/c Ratio: 0.73
 Intersection Signal Delay: 60.7
 Intersection Capacity Utilization 70.2%
 Analysis Period (min) 15
 m Volume for 95th percentile queue is metered by upstream signal.

Splits and Phases: 6: Kent St & Arlington Ave



Lanes, Volumes, Timings
7: Lyon St N & Gladstone Ave

05/18/2023



Lane Group	EBL	EBT	EBR	WBL	WBT	WBR	NBL	NBT	NBR	SBL	SBT	SBR
Lane Configurations		↑	↗	↖	↑						↕	↕
Traffic Volume (vph)	0	184	24	15	143	0	0	0	0	89	343	98
Future Volume (vph)	0	184	24	15	143	0	0	0	0	89	343	98
Satd. Flow (prot)	0	1733	1547	1729	1750	0	0	0	0	0	3249	0
Fit Permitted				0.641							0.992	
Satd. Flow (perm)	0	1733	1485	1146	1750	0	0	0	0	0	3225	0
Satd. Flow (RTOR)			38								47	
Lane Group Flow (vph)	0	184	24	15	143	0	0	0	0	0	530	0
Turn Type		NA	Perm	Perm	NA					Perm	NA	
Protected Phases		4			8							6
Permitted Phases			4	8						6		
Minimum Split (s)		17.2	17.2	17.2	17.2					22.6	22.6	
Total Split (s)		36.0	36.0	36.0	36.0					39.0	39.0	
Total Split (%)		48.0%	48.0%	48.0%	48.0%					52.0%	52.0%	
Yellow Time (s)		3.3	3.3	3.3	3.3					3.3	3.3	
All-Red Time (s)		1.9	1.9	1.9	1.9					2.3	2.3	
Lost Time Adjust (s)		0.0	0.0	0.0	0.0						0.0	
Total Lost Time (s)		5.2	5.2	5.2	5.2						5.6	
Lead/Lag												
Lead-Lag Optimize?												
Act Effct Green (s)		30.8	30.8	30.8	30.8						33.4	
Actuated g/C Ratio		0.41	0.41	0.41	0.41						0.45	
v/c Ratio		0.26	0.04	0.03	0.20						0.36	
Control Delay		15.8	3.3	5.4	7.4						13.3	
Queue Delay		0.0	0.0	0.0	0.0						0.0	
Total Delay		15.8	3.3	5.4	7.4						13.3	
LOS		B	A	A	A						B	
Approach Delay		14.4			7.3						13.3	
Approach LOS		B			A						B	
Queue Length 50th (m)		16.6	0.0	0.7	9.4						22.4	
Queue Length 95th (m)		29.8	2.8	m1.1	13.7						33.4	
Internal Link Dist (m)		254.8			165.0			215.6			214.3	
Turn Bay Length (m)				25.0								
Base Capacity (vph)		711	632	470	718						1462	
Starvation Cap Reductn		0	0	0	0						0	
Spillback Cap Reductn		0	0	0	0						0	
Storage Cap Reductn		0	0	0	0						0	
Reduced v/c Ratio		0.26	0.04	0.03	0.20						0.36	

Intersection Summary
 Cycle Length: 75
 Actuated Cycle Length: 75
 Offset: 45 (60%), Referenced to phase 4:EBT and 8:WBTL, Start of Green
 Natural Cycle: 40
 Control Type: Pretimed
 Maximum v/c Ratio: 0.36
 Intersection Signal Delay: 12.5
 Intersection Capacity Utilization 82.0%
 Analysis Period (min) 15
 Intersection LOS: B
 ICU Level of Service D
 m Volume for 95th percentile queue is metered by upstream signal.

Splits and Phases: 7: Lyon St N & Gladstone Ave

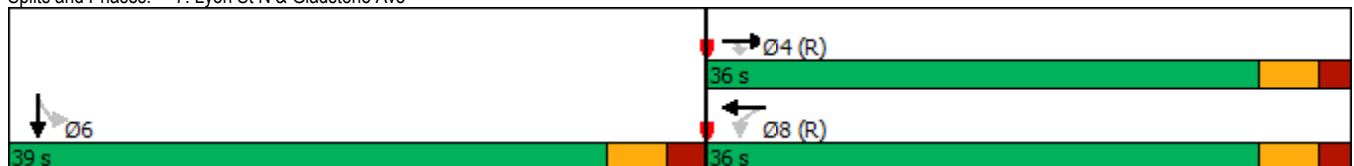

Lanes, Volumes, Timings
8: Kent St & Gladstone Ave

05/18/2023



Lane Group	EBL	EBT	EBR	WBL	WBT	WBR	NBL	NBT	NBR	SBL	SBT	SBR
Lane Configurations												
Traffic Volume (vph)	82	277	0	0	165	148	36	1808	97	0	0	0
Future Volume (vph)	82	277	0	0	165	148	36	1808	97	0	0	0
Satd. Flow (prot)	1662	1717	0	0	1552	0	1729	4793	0	0	0	0
Fit Permitted	0.468						0.950					
Satd. Flow (perm)	786	1717	0	0	1552	0	1444	4793	0	0	0	0
Satd. Flow (RTOR)					5			16				
Lane Group Flow (vph)	82	277	0	0	313	0	36	1905	0	0	0	0
Turn Type	Perm	NA			NA		Perm	NA				
Protected Phases		4			8			2				
Permitted Phases	4						2					
Minimum Split (s)	21.4	21.4			21.4		20.4	20.4				
Total Split (s)	32.0	32.0			32.0		43.0	43.0				
Total Split (%)	42.7%	42.7%			42.7%		57.3%	57.3%				
Yellow Time (s)	3.3	3.3			3.3		3.3	3.3				
All-Red Time (s)	2.1	2.1			2.1		2.1	2.1				
Lost Time Adjust (s)	0.0	0.0			0.0		0.0	0.0				
Total Lost Time (s)	5.4	5.4			5.4		5.4	5.4				
Lead/Lag												
Lead-Lag Optimize?												
Act Effct Green (s)	26.6	26.6			26.6		37.6	37.6				
Actuated g/C Ratio	0.35	0.35			0.35		0.50	0.50				
v/c Ratio	0.29	0.46			0.57		0.05	0.79				
Control Delay	27.3	28.1			24.1		8.1	9.1				
Queue Delay	0.0	0.0			0.0		0.0	0.0				
Total Delay	27.3	28.1			24.1		8.1	9.1				
LOS	C	C			C		A	A				
Approach Delay		27.9			24.1			9.0				
Approach LOS		C			C			A				
Queue Length 50th (m)	9.9	37.6			34.5		1.4	28.4				
Queue Length 95th (m)	23.4	59.7			58.6		m2.9	43.3				
Internal Link Dist (m)		165.0			168.8			216.0			203.6	
Turn Bay Length (m)	30.0						40.0					
Base Capacity (vph)	278	608			553		723	2410				
Starvation Cap Reductn	0	0			0		0	0				
Spillback Cap Reductn	0	0			0		0	0				
Storage Cap Reductn	0	0			0		0	0				
Reduced v/c Ratio	0.29	0.46			0.57		0.05	0.79				

Intersection Summary

Cycle Length: 75
 Actuated Cycle Length: 75
 Offset: 23 (31%), Referenced to phase 4:EBTL and 8:WBT, Start of Green
 Natural Cycle: 55
 Control Type: Pretimed
 Maximum v/c Ratio: 0.79
 Intersection Signal Delay: 13.4
 Intersection Capacity Utilization 82.0%
 Analysis Period (min) 15
 m Volume for 95th percentile queue is metered by upstream signal.

Intersection LOS: B
 ICU Level of Service D

Splits and Phases: 8: Kent St & Gladstone Ave

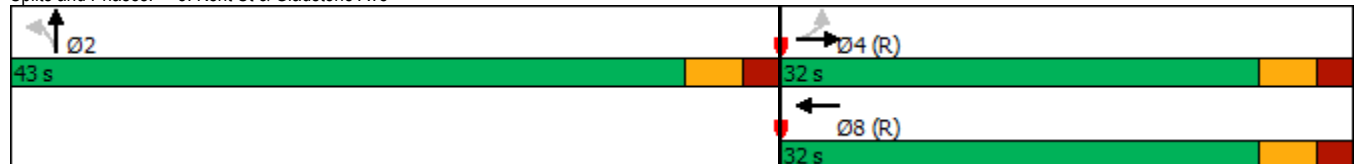

Lanes, Volumes, Timings
 9: Bank St & Chamberlain Ave/Isabella St

05/18/2023



Lane Group	EBL	EBT	EBR	WBL	WBT	WBR	NBL	NBT	NBR	SBL	SBT	SBR
Lane Configurations		↕↕	↗					↕↕			↕↕	
Traffic Volume (vph)	75	520	75	0	0	0	0	835	143	176	382	0
Future Volume (vph)	75	520	75	0	0	0	0	835	143	176	382	0
Satd. Flow (prot)	0	3228	1446	0	0	0	0	3153	0	0	3220	0
Fit Permitted		0.994									0.547	
Satd. Flow (perm)	0	3221	1358	0	0	0	0	3153	0	0	1772	0
Satd. Flow (RTOR)			134									
Lane Group Flow (vph)	0	595	75	0	0	0	0	978	0	0	558	0
Turn Type	Perm	NA	Perm					NA		pm+pt	NA	
Protected Phases		4						2		5	6	
Permitted Phases	4		4							6		
Detector Phase	4	4	4					2		5	6	
Switch Phase												
Minimum Initial (s)	10.0	10.0	10.0					10.0		5.0	10.0	
Minimum Split (s)	26.2	26.2	26.2					23.1		11.1	23.1	
Total Split (s)	26.2	26.2	26.2					37.7		11.1	48.8	
Total Split (%)	34.9%	34.9%	34.9%					50.3%		14.8%	65.1%	
Yellow Time (s)	3.3	3.3	3.3					3.0		3.0	3.0	
All-Red Time (s)	2.9	2.9	2.9					3.1		3.1	3.1	
Lost Time Adjust (s)		0.0	0.0					0.0			0.0	
Total Lost Time (s)		6.2	6.2					6.1			6.1	
Lead/Lag												
Lead-Lag Optimize?												
Recall Mode	None	None	None					C-Max		None	C-Max	
Act Effct Green (s)		18.3	18.3					44.4			44.4	
Actuated g/C Ratio		0.24	0.24					0.59			0.59	
v/c Ratio		0.76	0.17					0.52			0.53	
Control Delay		32.8	1.8					10.7			14.3	
Queue Delay		0.0	0.0					0.0			0.0	
Total Delay		32.8	1.8					10.7			14.3	
LOS		C	A					B			B	
Approach Delay		29.4						10.7			14.3	
Approach LOS		C						B			B	
Queue Length 50th (m)		39.7	0.0					41.4			40.2	
Queue Length 95th (m)		56.6	2.4					56.7			m55.8	
Internal Link Dist (m)		296.0			233.4			215.6			90.2	
Turn Bay Length (m)			40.0									
Base Capacity (vph)		858	460					1865			1047	
Starvation Cap Reductn		0	0					0			0	
Spillback Cap Reductn		0	0					0			0	
Storage Cap Reductn		0	0					0			0	
Reduced v/c Ratio		0.69	0.16					0.52			0.53	

Intersection Summary
 Cycle Length: 75
 Actuated Cycle Length: 75
 Offset: 60 (80%), Referenced to phase 2:NBT and 6:SBTL, Start of Green
 Natural Cycle: 65
 Control Type: Actuated-Coordinated
 Maximum v/c Ratio: 0.76
 Intersection Signal Delay: 17.3
 Intersection Capacity Utilization 82.8%
 Analysis Period (min) 15
 Intersection LOS: B
 ICU Level of Service E
 m Volume for 95th percentile queue is metered by upstream signal.

Splits and Phases: 9: Bank St & Chamberlain Ave/Isabella St

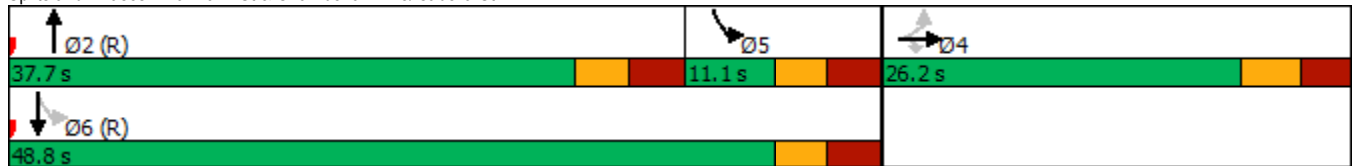

Lanes, Volumes, Timings
13: Bronson Ave & Catherine St

05/18/2023



Lane Group	EBL	EBT	EBR	WBL	WBT	WBR	NBL	NBT	NBR	SBL	SBT	SBR
Lane Configurations				↖ ↗	↖ ↗		↖ ↗	↖ ↗			↖ ↗	
Traffic Volume (vph)	0	0	0	524	510	368	553	1105	0	0	456	126
Future Volume (vph)	0	0	0	524	510	368	553	1105	0	0	456	126
Satd. Flow (prot)	0	0	0	1430	4136	0	1712	3390	0	0	3087	0
Fit Permitted				0.950	0.992		0.218					
Satd. Flow (perm)	0	0	0	1430	4136	0	393	3390	0	0	3087	0
Satd. Flow (RTOR)					78						29	
Lane Group Flow (vph)	0	0	0	356	1046	0	553	1105	0	0	582	0
Turn Type				Perm	NA		pm+pt	NA			NA	
Protected Phases					8		5	7			2	6
Permitted Phases				8			2					
Minimum Split (s)				28.3	28.3			23.8			23.8	
Total Split (s)				36.8	36.8			73.2			28.9	
Total Split (%)				33.5%	33.5%			66.5%			26.3%	
Yellow Time (s)				3.3	3.3			3.3			3.3	
All-Red Time (s)				3.0	3.0			3.5			3.5	
Lost Time Adjust (s)				0.0	0.0			0.0			0.0	
Total Lost Time (s)				6.3	6.3			6.8			6.8	
Lead/Lag												Lag
Lead-Lag Optimize?												Yes
Act Effct Green (s)				30.5	30.5		67.0	66.4			22.1	
Actuated g/C Ratio				0.28	0.28		0.61	0.60			0.20	
v/c Ratio				0.90	0.87		0.89	0.54			0.91	
Control Delay				65.2	44.0		34.2	14.0			60.0	
Queue Delay				0.0	0.0		0.0	0.0			0.0	
Total Delay				65.2	44.0		34.2	14.0			60.0	
LOS				E	D		C	B			E	
Approach Delay					49.4			20.8			60.0	
Approach LOS					D			C			E	
Queue Length 50th (m)				85.4	77.4		63.9	68.4			61.7	
Queue Length 95th (m)				#147.2	#97.8		#122.6	85.5			#93.3	
Internal Link Dist (m)		141.5			120.8			240.1			287.4	
Turn Bay Length (m)				80.0			45.0					
Base Capacity (vph)				396	1203		621	2046			643	
Starvation Cap Reductn				0	0		0	0			0	
Spillback Cap Reductn				0	0		0	0			0	
Storage Cap Reductn				0	0		0	0			0	
Reduced v/c Ratio				0.90	0.87		0.89	0.54			0.91	

Intersection Summary

Cycle Length: 110
 Actuated Cycle Length: 110
 Offset: 60 (55%), Referenced to phase 2:NBT and 6:SBT, Start of Green
 Natural Cycle: 90
 Control Type: Pretimed
 Maximum v/c Ratio: 0.91
 Intersection Signal Delay: 38.1 Intersection LOS: D
 Intersection Capacity Utilization 90.1% ICU Level of Service E
 Analysis Period (min) 15
 # 95th percentile volume exceeds capacity, queue may be longer.
 Queue shown is maximum after two cycles.

Splits and Phases: 13: Bronson Ave & Catherine St

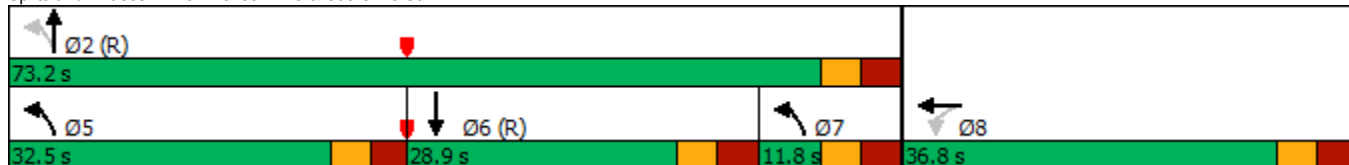

Lanes, Volumes, Timings
 13: Bronson Ave & Catherine St

05/18/2023

Lane Group	Ø5	Ø7
Lane Configurations		
Traffic Volume (vph)		
Future Volume (vph)		
Satd. Flow (prot)		
Fit Permitted		
Satd. Flow (perm)		
Satd. Flow (RTOR)		
Lane Group Flow (vph)		
Turn Type		
Protected Phases	5	7
Permitted Phases		
Minimum Split (s)	11.2	11.8
Total Split (s)	32.5	11.8
Total Split (%)	30%	11%
Yellow Time (s)	3.3	3.3
All-Red Time (s)	2.9	3.5
Lost Time Adjust (s)		
Total Lost Time (s)		
Lead/Lag	Lead	
Lead-Lag Optimize?	Yes	
Act Effct Green (s)		
Actuated g/C Ratio		
v/c Ratio		
Control Delay		
Queue Delay		
Total Delay		
LOS		
Approach Delay		
Approach LOS		
Queue Length 50th (m)		
Queue Length 95th (m)		
Internal Link Dist (m)		
Turn Bay Length (m)		
Base Capacity (vph)		
Starvation Cap Reductn		
Spillback Cap Reductn		
Storage Cap Reductn		
Reduced v/c Ratio		
Intersection Summary		

Intersection												
Int Delay, s/veh	2											
Movement	EBL	EBT	EBR	WBL	WBT	WBR	NBL	NBT	NBR	SBL	SBT	SBR
Lane Configurations		↕			↕						↕↕	
Traffic Vol, veh/h	0	18	0	11	12	0	0	0	0	44	345	9
Future Vol, veh/h	0	18	0	11	12	0	0	0	0	44	345	9
Conflicting Peds, #/hr	32	0	15	15	0	32	9	0	10	10	0	9
Sign Control	Stop	Stop	Stop	Stop	Stop	Stop	Free	Free	Free	Free	Free	Free
RT Channelized	-	-	None	-	-	None	-	-	None	-	-	None
Storage Length	-	-	-	-	-	-	-	-	-	-	-	-
Veh in Median Storage, #	-	0	-	-	0	-	-	-	-	-	0	-
Grade, %	-	0	-	-	0	-	-	0	-	-	0	-
Peak Hour Factor	100	100	100	100	100	100	100	100	100	100	100	100
Heavy Vehicles, %	0	6	0	9	0	0	0	0	0	5	1	11
Mvmt Flow	0	18	0	11	12	0	0	0	0	44	345	9
Major/Minor	Minor2			Minor1			Major2					
Conflicting Flow All	-	457	201	295	461	-	-	-	10	0	0	-
Stage 1	-	447	-	10	10	-	-	-	-	-	-	-
Stage 2	-	10	-	285	451	-	-	-	-	-	-	-
Critical Hdwy	-	6.62	6.9	7.68	6.5	-	-	-	4.2	-	-	-
Critical Hdwy Stg 1	-	5.62	-	-	-	-	-	-	-	-	-	-
Critical Hdwy Stg 2	-	-	-	6.68	5.5	-	-	-	-	-	-	-
Follow-up Hdwy	-	4.06	3.3	3.59	4	-	-	-	2.25	-	-	-
Pot Cap-1 Maneuver	0	490	813	617	500	0	-	-	1586	-	-	-
Stage 1	0	562	-	-	-	0	-	-	-	-	-	-
Stage 2	0	-	-	679	574	0	-	-	-	-	-	-
Platoon blocked, %	-	-	-	-	-	-	-	-	-	-	-	-
Mov Cap-1 Maneuver	-	465	806	578	475	-	-	-	1571	-	-	-
Mov Cap-2 Maneuver	-	465	-	578	475	-	-	-	-	-	-	-
Stage 1	-	538	-	-	-	-	-	-	-	-	-	-
Stage 2	-	-	-	633	549	-	-	-	-	-	-	-
Approach	EB			WB			SB					
HCM Control Delay, s	13.1			12.3			0.9					
HCM LOS	B			B								
Minor Lane/Major Mvmt	EBLn1	WBLn1	SBL	SBT	SBR							
Capacity (veh/h)	465	519	1571	-	-							
HCM Lane V/C Ratio	0.039	0.044	0.028	-	-							
HCM Control Delay (s)	13.1	12.3	7.4	0.1	-							
HCM Lane LOS	B	B	A	A	-							
HCM 95th %tile Q(veh)	0.1	0.1	0.1	-	-							

Intersection						
Int Delay, s/veh	2.8					
Movement	EBL	EBR	NBL	NBT	SBT	SBR
Lane Configurations	↔			↕↕	↕↕	
Traffic Vol, veh/h	21	124	86	691	390	22
Future Vol, veh/h	21	124	86	691	390	22
Conflicting Peds, #/hr	0	0	111	0	0	111
Sign Control	Stop	Stop	Free	Free	Free	Free
RT Channelized	-	None	-	None	-	None
Storage Length	0	-	-	-	-	-
Veh in Median Storage, #	0	-	-	0	0	-
Grade, %	0	-	-	0	0	-
Peak Hour Factor	100	100	100	100	100	100
Heavy Vehicles, %	0	3	2	5	8	5
Mvmt Flow	21	124	86	691	390	22
Major/Minor	Minor2	Major1	Major2			
Conflicting Flow All	1030	317	523	0	-	0
Stage 1	512	-	-	-	-	-
Stage 2	518	-	-	-	-	-
Critical Hdwy	6.8	6.96	4.14	-	-	-
Critical Hdwy Stg 1	5.8	-	-	-	-	-
Critical Hdwy Stg 2	5.8	-	-	-	-	-
Follow-up Hdwy	3.5	3.33	2.22	-	-	-
Pot Cap-1 Maneuver	233	676	1040	-	-	-
Stage 1	572	-	-	-	-	-
Stage 2	568	-	-	-	-	-
Platoon blocked, %				-	-	-
Mov Cap-1 Maneuver	159	607	933	-	-	-
Mov Cap-2 Maneuver	159	-	-	-	-	-
Stage 1	436	-	-	-	-	-
Stage 2	509	-	-	-	-	-
Approach	EB	NB	SB			
HCM Control Delay, s	17.5	1.6	0			
HCM LOS	C					
Minor Lane/Major Mvmt	NBL	NBT	EBLn1	SBT	SBR	
Capacity (veh/h)	933	-	431	-	-	
HCM Lane V/C Ratio	0.092	-	0.336	-	-	
HCM Control Delay (s)	9.2	0.6	17.5	-	-	
HCM Lane LOS	A	A	C	-	-	
HCM 95th %tile Q(veh)	0.3	-	1.5	-	-	

Lanes, Volumes, Timings

1: Hwy 417 WB On Ramp/Lyon St N & Catherine St

05/18/2023



Lane Group	EBL	EBT	EBR	WBL	WBT	WBR	NBL	NBT	NBR	SBL	SBT	SBR
Lane Configurations					↕↕						↕	↗
Traffic Volume (vph)	0	0	0	210	539	0	0	0	0	0	365	304
Future Volume (vph)	0	0	0	210	539	0	0	0	0	0	365	304
Satd. Flow (prot)	0	0	0	0	3296	0	0	0	0	0	1802	1532
Fit Permitted					0.986							
Satd. Flow (perm)	0	0	0	0	3273	0	0	0	0	0	1802	1490
Satd. Flow (RTOR)					97							184
Lane Group Flow (vph)	0	0	0	0	749	0	0	0	0	0	365	304
Turn Type				Perm	NA						NA	Perm
Protected Phases					8						6	
Permitted Phases				8								6
Minimum Split (s)				26.2	26.2						28.3	28.3
Total Split (s)				38.0	38.0						37.0	37.0
Total Split (%)				50.7%	50.7%						49.3%	49.3%
Yellow Time (s)				3.3	3.3						3.3	3.3
All-Red Time (s)				1.9	1.9						2.0	2.0
Lost Time Adjust (s)					0.0						0.0	0.0
Total Lost Time (s)					5.2						5.3	5.3
Lead/Lag												
Lead-Lag Optimize?												
Act Effct Green (s)					32.8						31.7	31.7
Actuated g/C Ratio					0.44						0.42	0.42
v/c Ratio					0.50						0.48	0.41
Control Delay					13.8						26.7	17.1
Queue Delay					0.0						0.0	0.0
Total Delay					13.8						26.7	17.1
LOS					B						C	B
Approach Delay					13.8						22.3	
Approach LOS					B						C	
Queue Length 50th (m)					56.5						52.2	26.8
Queue Length 95th (m)					73.2						77.5	50.0
Internal Link Dist (m)		271.6			163.9			117.8			52.8	
Turn Bay Length (m)												
Base Capacity (vph)					1485						761	736
Starvation Cap Reductn					0						0	0
Spillback Cap Reductn					0						0	0
Storage Cap Reductn					0						0	0
Reduced v/c Ratio					0.50						0.48	0.41

Intersection Summary

Cycle Length: 75	
Actuated Cycle Length: 75	
Offset: 24 (32%), Referenced to phase 8:WBTL, Start of Green	
Natural Cycle: 55	
Control Type: Pretimed	
Maximum v/c Ratio: 0.50	
Intersection Signal Delay: 17.9	Intersection LOS: B
Intersection Capacity Utilization 54.5%	ICU Level of Service A
Analysis Period (min) 15	

Splits and Phases: 1: Hwy 417 WB On Ramp/Lyon St N & Catherine St

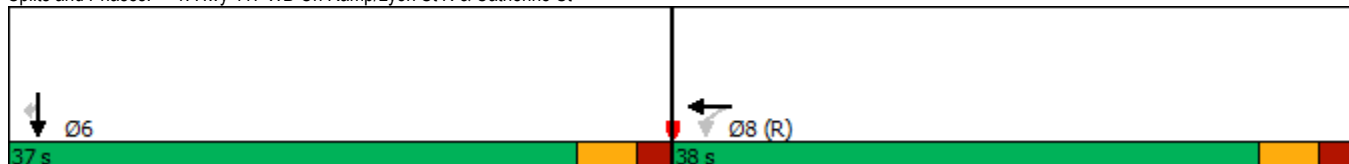

Lanes, Volumes, Timings

2: Hwy 417 EB Off Ramp/Chamberlain Ave/Kent St & Catherine St

05/18/2023



Lane Group	EBL	EBT	EBR	WBL	WBT	WBR	NBL	NBT	NBR	SBL	SBT	SBR
Lane Configurations					↑↑	↑↑		↑↑↑				
Traffic Volume (vph)	0	0	0	0	691	315	27	878	0	0	0	0
Future Volume (vph)	0	0	0	0	691	315	27	878	0	0	0	0
Satd. Flow (prot)	0	0	0	0	3357	2521	0	4863	0	0	0	0
Fit Permitted								0.999				
Satd. Flow (perm)	0	0	0	0	3357	2521	0	4861	0	0	0	0
Satd. Flow (RTOR)								70				
Lane Group Flow (vph)	0	0	0	0	691	315	0	905	0	0	0	0
Turn Type					NA	Prot	Perm	NA				
Protected Phases					8	8		2				
Permitted Phases							2					
Detector Phase					8	8	2	2				
Switch Phase												
Minimum Initial (s)					10.0	10.0	10.0	10.0				
Minimum Split (s)					15.8	15.8	22.5	22.5				
Total Split (s)					34.0	34.0	28.0	28.0				
Total Split (%)					45.3%	45.3%	37.3%	37.3%				
Yellow Time (s)					3.3	3.3	3.3	3.3				
All-Red Time (s)					2.5	2.5	2.5	2.5				
Lost Time Adjust (s)					0.0	0.0		0.0				
Total Lost Time (s)					5.8	5.8		5.8				
Lead/Lag												
Lead-Lag Optimize?												
Recall Mode					C-Max	C-Max	Max	Max				
Act Effct Green (s)					33.4	33.4		22.2				
Actuated g/C Ratio					0.45	0.45		0.30				
v/c Ratio					0.46	0.28		0.61				
Control Delay					27.3	25.1		22.9				
Queue Delay					0.0	0.0		1.2				
Total Delay					27.3	25.1		24.1				
LOS					C	C		C				
Approach Delay					26.6			24.1				
Approach LOS					C			C				
Queue Length 50th (m)					51.4	23.8		36.7				
Queue Length 95th (m)					m62.2	m28.8		49.1				
Internal Link Dist (m)		163.9			131.7			67.4			53.0	
Turn Bay Length (m)						60.0						
Base Capacity (vph)					1495	1122		1488				
Starvation Cap Reductn					0	0		0				
Spillback Cap Reductn					0	0		345				
Storage Cap Reductn					0	0		0				
Reduced v/c Ratio					0.46	0.28		0.79				

Intersection Summary

Cycle Length: 75
 Actuated Cycle Length: 75
 Offset: 0 (0%), Referenced to phase 8:WBT, Start of Green
 Natural Cycle: 60
 Control Type: Actuated-Coordinated
 Maximum v/c Ratio: 0.61
 Intersection Signal Delay: 25.4
 Intersection Capacity Utilization 50.5%
 Analysis Period (min) 15
 m Volume for 95th percentile queue is metered by upstream signal.

Splits and Phases: 2: Hwy 417 EB Off Ramp/Chamberlain Ave/Kent St & Catherine St



Lanes, Volumes, Timings

2: Hwy 417 EB Off Ramp/Chamberlain Ave/Kent St & Catherine St

05/18/2023

Lane Group	Ø9
Lane Configurations	
Traffic Volume (vph)	
Future Volume (vph)	
Satd. Flow (prot)	
Flt Permitted	
Satd. Flow (perm)	
Satd. Flow (RTOR)	
Lane Group Flow (vph)	
Turn Type	
Protected Phases	9
Permitted Phases	
Detector Phase	
Switch Phase	
Minimum Initial (s)	1.0
Minimum Split (s)	13.0
Total Split (s)	13.0
Total Split (%)	17%
Yellow Time (s)	2.0
All-Red Time (s)	0.0
Lost Time Adjust (s)	
Total Lost Time (s)	
Lead/Lag	
Lead-Lag Optimize?	
Recall Mode	None
Act Effct Green (s)	
Actuated g/C Ratio	
v/c Ratio	
Control Delay	
Queue Delay	
Total Delay	
LOS	
Approach Delay	
Approach LOS	
Queue Length 50th (m)	
Queue Length 95th (m)	
Internal Link Dist (m)	
Turn Bay Length (m)	
Base Capacity (vph)	
Starvation Cap Reductn	
Spillback Cap Reductn	
Storage Cap Reductn	
Reduced v/c Ratio	
Intersection Summary	

Lanes, Volumes, Timings
3: Bank St & Catherine St

05/18/2023



Lane Group	EBL	EBT	EBR	WBL	WBT	WBR	NBL	NBT	NBR	SBL	SBT	SBR
Lane Configurations					↕↕↕			↕↕			↕↕	
Traffic Volume (vph)	0	0	0	236	644	158	188	328	0	0	695	130
Future Volume (vph)	0	0	0	236	644	158	188	328	0	0	695	130
Satd. Flow (prot)	0	0	0	0	4610	0	0	3260	0	0	3110	0
Fit Permitted					0.989			0.536				
Satd. Flow (perm)	0	0	0	0	4530	0	0	1746	0	0	3110	0
Satd. Flow (RTOR)					46			31				
Lane Group Flow (vph)	0	0	0	0	1038	0	0	516	0	0	825	0
Turn Type				Perm	NA		pm+pt	NA			NA	
Protected Phases					8		9	2			6	
Permitted Phases					8		2					
Minimum Split (s)				18.6	18.6		10.4	16.4			16.4	
Total Split (s)				24.4	24.4		10.4	40.6			30.2	
Total Split (%)				32.5%	32.5%		13.9%	54.1%			40.3%	
Yellow Time (s)				3.3	3.3		3.3	3.3			3.3	
All-Red Time (s)				2.3	2.3		2.1	2.1			2.1	
Lost Time Adjust (s)					0.0			0.0			0.0	
Total Lost Time (s)					5.6			5.4			5.4	
Lead/Lag				Lag	Lag		Lag	Lag			Lag	
Lead-Lag Optimize?				Yes	Yes		Yes	Yes			Yes	
Act Effct Green (s)					18.8			35.2			24.8	
Actuated g/C Ratio					0.25			0.47			0.33	
v/c Ratio					0.89			0.56			0.79	
Control Delay					37.0			13.5			28.4	
Queue Delay					0.0			0.0			0.5	
Total Delay					37.0			13.5			28.9	
LOS					D			B			C	
Approach Delay					37.0			13.5			28.9	
Approach LOS					D			B			C	
Queue Length 50th (m)					49.6			15.0			52.8	
Queue Length 95th (m)					#73.0			20.0			73.7	
Internal Link Dist (m)		131.7			201.7			90.2			52.9	
Turn Bay Length (m)												
Base Capacity (vph)					1169			920			1049	
Starvation Cap Reductn					0			0			0	
Spillback Cap Reductn					0			0			45	
Storage Cap Reductn					0			0			0	
Reduced v/c Ratio					0.89			0.56			0.82	

Intersection Summary
 Cycle Length: 75
 Actuated Cycle Length: 75
 Offset: 50 (67%), Referenced to phase 2:NBT and 6:SBT, Start of Green
 Natural Cycle: 70
 Control Type: Pretimed
 Maximum v/c Ratio: 0.89
 Intersection Signal Delay: 29.1
 Intersection Capacity Utilization 79.6%
 Analysis Period (min) 15
 # 95th percentile volume exceeds capacity, queue may be longer.
 Queue shown is maximum after two cycles.

Splits and Phases: 3: Bank St & Catherine St

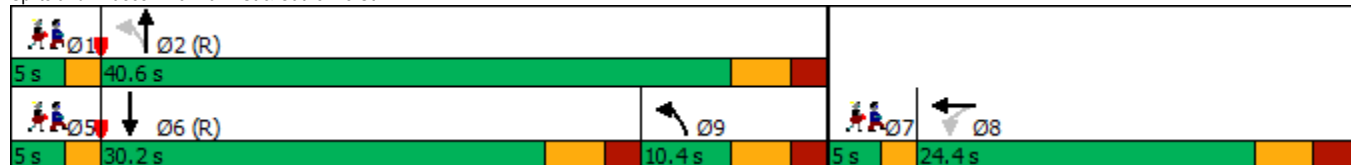

Lanes, Volumes, Timings
 3: Bank St & Catherine St

05/18/2023

Lane Group	Ø1	Ø5	Ø7
Lane Configurations			
Traffic Volume (vph)			
Future Volume (vph)			
Satd. Flow (prot)			
Fit Permitted			
Satd. Flow (perm)			
Satd. Flow (RTOR)			
Lane Group Flow (vph)			
Turn Type			
Protected Phases	1	5	7
Permitted Phases			
Minimum Split (s)	5.0	5.0	5.0
Total Split (s)	5.0	5.0	5.0
Total Split (%)	7%	7%	7%
Yellow Time (s)	2.0	2.0	2.0
All-Red Time (s)	0.0	0.0	0.0
Lost Time Adjust (s)			
Total Lost Time (s)			
Lead/Lag	Lead	Lead	Lead
Lead-Lag Optimize?	Yes	Yes	Yes
Act Effct Green (s)			
Actuated g/C Ratio			
v/c Ratio			
Control Delay			
Queue Delay			
Total Delay			
LOS			
Approach Delay			
Approach LOS			
Queue Length 50th (m)			
Queue Length 95th (m)			
Internal Link Dist (m)			
Turn Bay Length (m)			
Base Capacity (vph)			
Starvation Cap Reductn			
Spillback Cap Reductn			
Storage Cap Reductn			
Reduced v/c Ratio			
Intersection Summary			

Lanes, Volumes, Timings
4: Percy St & Catherine St

05/18/2023



Lane Group	EBL	EBT	EBR	WBL	WBT	WBR	NBL	NBT	NBR	SBL	SBT	SBR
Lane Configurations					↕↕						↕	
Traffic Volume (vph)	0	0	0	153	728	0	0	0	0	0	121	39
Future Volume (vph)	0	0	0	153	728	0	0	0	0	0	121	39
Satd. Flow (prot)	0	0	0	0	3354	0	0	0	0	0	1727	0
Fit Permitted					0.991							
Satd. Flow (perm)	0	0	0	0	3341	0	0	0	0	0	1727	0
Satd. Flow (RTOR)					160							
Lane Group Flow (vph)	0	0	0	0	881	0	0	0	0	0	160	0
Turn Type				Perm	NA						NA	
Protected Phases					8						6	
Permitted Phases				8								
Detector Phase				8	8						6	
Switch Phase												
Minimum Initial (s)				10.0	10.0						10.0	
Minimum Split (s)				26.5	26.5						23.4	
Total Split (s)				47.0	47.0						30.2	
Total Split (%)				52.2%	52.2%						33.6%	
Yellow Time (s)				3.3	3.3						3.3	
All-Red Time (s)				2.2	2.2						2.1	
Lost Time Adjust (s)					0.0						0.0	
Total Lost Time (s)					5.5						5.4	
Lead/Lag				Lag	Lag							
Lead-Lag Optimize?				Yes	Yes							
Recall Mode				None	None						Max	
Act Effct Green (s)					19.7						25.0	
Actuated g/C Ratio					0.35						0.45	
v/c Ratio					0.69						0.21	
Control Delay					15.1						11.8	
Queue Delay					0.0						0.0	
Total Delay					15.1						11.8	
LOS					B						B	
Approach Delay					15.1						11.8	
Approach LOS					B						B	
Queue Length 50th (m)					30.8						9.2	
Queue Length 95th (m)					46.3						23.6	
Internal Link Dist (m)		106.8			271.6			106.7			288.0	
Turn Bay Length (m)												
Base Capacity (vph)					2547						774	
Starvation Cap Reductn					0						0	
Spillback Cap Reductn					0						0	
Storage Cap Reductn					0						0	
Reduced v/c Ratio					0.35						0.21	

Intersection Summary
 Cycle Length: 90
 Actuated Cycle Length: 55.7
 Natural Cycle: 65
 Control Type: Semi Act-Uncoord
 Maximum v/c Ratio: 0.69
 Intersection Signal Delay: 14.6
 Intersection Capacity Utilization 53.3%
 Analysis Period (min) 15
 Intersection LOS: B
 ICU Level of Service A

Splits and Phases: 4: Percy St & Catherine St

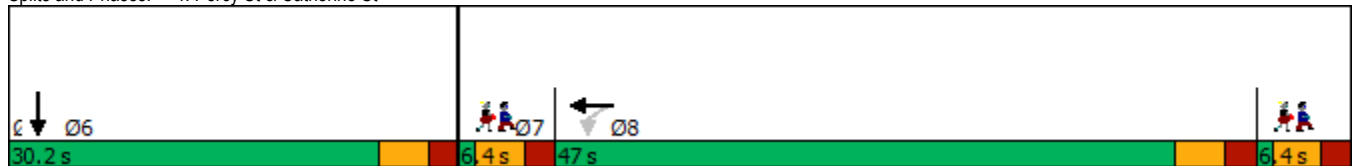

Lanes, Volumes, Timings
 4: Percy St & Catherine St

05/18/2023

Lane Group	Ø3	Ø7
Lane Configurations		
Traffic Volume (vph)		
Future Volume (vph)		
Satd. Flow (prot)		
Fit Permitted		
Satd. Flow (perm)		
Satd. Flow (RTOR)		
Lane Group Flow (vph)		
Turn Type		
Protected Phases	3	7
Permitted Phases		
Detector Phase		
Switch Phase		
Minimum Initial (s)	1.0	1.0
Minimum Split (s)	6.4	6.4
Total Split (s)	6.4	6.4
Total Split (%)	7%	7%
Yellow Time (s)	3.3	3.3
All-Red Time (s)	2.1	2.1
Lost Time Adjust (s)		
Total Lost Time (s)		
Lead/Lag		Lead
Lead-Lag Optimize?		Yes
Recall Mode	None	None
Act Effct Green (s)		
Actuated g/C Ratio		
v/c Ratio		
Control Delay		
Queue Delay		
Total Delay		
LOS		
Approach Delay		
Approach LOS		
Queue Length 50th (m)		
Queue Length 95th (m)		
Internal Link Dist (m)		
Turn Bay Length (m)		
Base Capacity (vph)		
Starvation Cap Reductn		
Spillback Cap Reductn		
Storage Cap Reductn		
Reduced v/c Ratio		
Intersection Summary		

Lanes, Volumes, Timings
6: Kent St & Arlington Ave

05/18/2023



Lane Group	EBL	EBT	EBR	WBL	WBT	WBR	NBL	NBT	NBR	SBL	SBT	SBR
Lane Configurations		↕			↕			↕↕↕				
Traffic Volume (vph)	12	61	0	0	18	63	22	1098	93	0	0	0
Future Volume (vph)	12	61	0	0	18	63	22	1098	93	0	0	0
Satd. Flow (prot)	0	1805	0	0	1561	0	0	4825	0	0	0	0
Fit Permitted		0.961						0.999				
Satd. Flow (perm)	0	1739	0	0	1561	0	0	4823	0	0	0	0
Satd. Flow (RTOR)					50			26				
Lane Group Flow (vph)	0	73	0	0	81	0	0	1213	0	0	0	0
Turn Type	Perm	NA			NA		Perm	NA				
Protected Phases		4			8			2				
Permitted Phases	4						2					
Minimum Split (s)	27.3	27.3			27.3		32.3	32.3				
Total Split (s)	31.0	31.0			31.0		44.0	44.0				
Total Split (%)	41.3%	41.3%			41.3%		58.7%	58.7%				
Yellow Time (s)	3.3	3.3			3.3		3.3	3.3				
All-Red Time (s)	2.0	2.0			2.0		2.0	2.0				
Lost Time Adjust (s)		0.0			0.0			0.0				
Total Lost Time (s)		5.3			5.3			5.3				
Lead/Lag												
Lead-Lag Optimize?												
Act Effct Green (s)		25.7			25.7			38.7				
Actuated g/C Ratio		0.34			0.34			0.52				
v/c Ratio		0.12			0.14			0.49				
Control Delay		26.9			9.3			10.5				
Queue Delay		0.0			0.0			49.8				
Total Delay		26.9			9.3			60.3				
LOS		C			A			E				
Approach Delay		26.9			9.3			60.3				
Approach LOS		C			A			E				
Queue Length 50th (m)		9.1			1.3			48.5				
Queue Length 95th (m)		m18.8			m5.6			68.8				
Internal Link Dist (m)		164.0			143.1			53.0			216.0	
Turn Bay Length (m)												
Base Capacity (vph)		595			567			2501				
Starvation Cap Reductn		0			0			1423				
Spillback Cap Reductn		0			0			0				
Storage Cap Reductn		0			0			0				
Reduced v/c Ratio		0.12			0.14			1.13				

Intersection Summary
 Cycle Length: 75
 Actuated Cycle Length: 75
 Offset: 50 (67%), Referenced to phase 2:NBT, Start of Green
 Natural Cycle: 60
 Control Type: Pretimed
 Maximum v/c Ratio: 0.49
 Intersection Signal Delay: 55.5
 Intersection LOS: E
 Intersection Capacity Utilization 54.7%
 ICU Level of Service A
 Analysis Period (min) 15
 m Volume for 95th percentile queue is metered by upstream signal.

Splits and Phases: 6: Kent St & Arlington Ave



Lanes, Volumes, Timings
7: Lyon St N & Gladstone Ave

05/18/2023



Lane Group	EBL	EBT	EBR	WBL	WBT	WBR	NBL	NBT	NBR	SBL	SBT	SBR
Lane Configurations		↑	↗	↖	↑						↕	
Traffic Volume (vph)	0	247	52	28	314	0	0	0	0	86	535	138
Future Volume (vph)	0	247	52	28	314	0	0	0	0	86	535	138
Satd. Flow (prot)	0	1784	1547	1729	1784	0	0	0	0	0	3261	0
Fit Permitted				0.574							0.994	
Satd. Flow (perm)	0	1784	1407	997	1784	0	0	0	0	0	3248	0
Satd. Flow (RTOR)			52								45	
Lane Group Flow (vph)	0	247	52	28	314	0	0	0	0	0	759	0
Turn Type		NA	Perm	Perm	NA					Perm	NA	
Protected Phases		4			8							6
Permitted Phases			4	8						6		
Minimum Split (s)		17.2	17.2	17.2	17.2					22.6	22.6	
Total Split (s)		37.0	37.0	37.0	37.0					38.0	38.0	
Total Split (%)		49.3%	49.3%	49.3%	49.3%					50.7%	50.7%	
Yellow Time (s)		3.3	3.3	3.3	3.3					3.3	3.3	
All-Red Time (s)		1.9	1.9	1.9	1.9					2.3	2.3	
Lost Time Adjust (s)		0.0	0.0	0.0	0.0						0.0	
Total Lost Time (s)		5.2	5.2	5.2	5.2						5.6	
Lead/Lag												
Lead-Lag Optimize?												
Act Effct Green (s)		31.8	31.8	31.8	31.8						32.4	
Actuated g/C Ratio		0.42	0.42	0.42	0.42						0.43	
v/c Ratio		0.33	0.08	0.07	0.42						0.53	
Control Delay		16.0	4.5	8.4	12.7						16.4	
Queue Delay		0.0	0.0	0.0	0.0						0.0	
Total Delay		16.0	4.5	8.4	12.7						16.4	
LOS		B	A	A	B						B	
Approach Delay		14.0			12.3						16.4	
Approach LOS		B			B						B	
Queue Length 50th (m)		22.6	0.0	1.5	35.6						37.5	
Queue Length 95th (m)		38.4	5.7	m3.3	55.1						52.8	
Internal Link Dist (m)		254.8			165.0			215.6			214.3	
Turn Bay Length (m)				25.0								
Base Capacity (vph)		756	626	422	756						1428	
Starvation Cap Reductn		0	0	0	0						0	
Spillback Cap Reductn		0	0	0	0						0	
Storage Cap Reductn		0	0	0	0						0	
Reduced v/c Ratio		0.33	0.08	0.07	0.42						0.53	

Intersection Summary

Cycle Length: 75
 Actuated Cycle Length: 75
 Offset: 45 (60%), Referenced to phase 4:EBT and 8:WBTL, Start of Green
 Natural Cycle: 40
 Control Type: Pretimed
 Maximum v/c Ratio: 0.53
 Intersection Signal Delay: 14.9
 Intersection Capacity Utilization 68.0%
 Analysis Period (min) 15
 Intersection LOS: B
 ICU Level of Service C
 m Volume for 95th percentile queue is metered by upstream signal.

Splits and Phases: 7: Lyon St N & Gladstone Ave

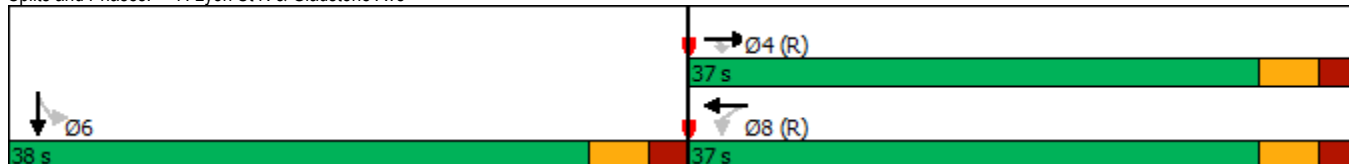

Lanes, Volumes, Timings
8: Kent St & Gladstone Ave

05/18/2023



Lane Group	EBL	EBT	EBR	WBL	WBT	WBR	NBL	NBT	NBR	SBL	SBT	SBR
Lane Configurations												
Traffic Volume (vph)	75	450	0	0	324	75	67	939	131	0	0	0
Future Volume (vph)	75	450	0	0	324	75	67	939	131	0	0	0
Satd. Flow (prot)	1729	1767	0	0	1720	0	1729	4627	0	0	0	0
Fit Permitted	0.453						0.950					
Satd. Flow (perm)	800	1767	0	0	1720	0	1522	4627	0	0	0	0
Satd. Flow (RTOR)					21			37				
Lane Group Flow (vph)	75	450	0	0	399	0	67	1070	0	0	0	0
Turn Type	Perm	NA			NA		Perm	NA				
Protected Phases		4			8			2				
Permitted Phases	4						2					
Minimum Split (s)	21.4	21.4			21.4		20.4	20.4				
Total Split (s)	43.0	43.0			43.0		32.0	32.0				
Total Split (%)	57.3%	57.3%			57.3%		42.7%	42.7%				
Yellow Time (s)	3.3	3.3			3.3		3.3	3.3				
All-Red Time (s)	2.1	2.1			2.1		2.1	2.1				
Lost Time Adjust (s)	0.0	0.0			0.0		0.0	0.0				
Total Lost Time (s)	5.4	5.4			5.4		5.4	5.4				
Lead/Lag												
Lead-Lag Optimize?												
Act Effct Green (s)	37.6	37.6			37.6		26.6	26.6				
Actuated g/C Ratio	0.50	0.50			0.50		0.35	0.35				
v/c Ratio	0.19	0.51			0.46		0.12	0.64				
Control Delay	18.1	21.5			13.5		8.6	9.7				
Queue Delay	0.0	0.0			0.0		0.0	0.0				
Total Delay	18.1	21.5			13.5		8.6	9.7				
LOS	B	C			B		A	A				
Approach Delay		21.0			13.5			9.6				
Approach LOS		C			B			A				
Queue Length 50th (m)	6.6	49.4			32.3		3.0	16.4				
Queue Length 95th (m)	m16.0	78.6			53.2		m4.7	15.0				
Internal Link Dist (m)		165.0			168.8			216.0			203.6	
Turn Bay Length (m)	30.0						40.0					
Base Capacity (vph)	401	885			872		539	1664				
Starvation Cap Reductn	0	0			0		0	0				
Spillback Cap Reductn	0	0			0		0	0				
Storage Cap Reductn	0	0			0		0	0				
Reduced v/c Ratio	0.19	0.51			0.46		0.12	0.64				

Intersection Summary

Cycle Length: 75
 Actuated Cycle Length: 75
 Offset: 23 (31%), Referenced to phase 4:EBTL and 8:WBT, Start of Green
 Natural Cycle: 45
 Control Type: Pretimed
 Maximum v/c Ratio: 0.64
 Intersection Signal Delay: 13.3
 Intersection Capacity Utilization 68.0%
 Analysis Period (min) 15
 m Volume for 95th percentile queue is metered by upstream signal.

Intersection LOS: B
 ICU Level of Service C

Splits and Phases: 8: Kent St & Gladstone Ave

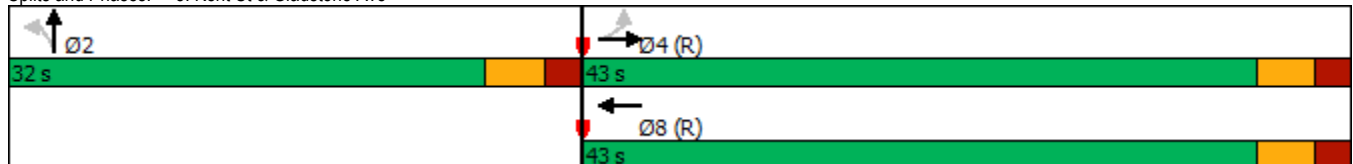

Lanes, Volumes, Timings
 9: Bank St & Chamberlain Ave/Isabella St

05/18/2023



Lane Group	EBL	EBT	EBR	WBL	WBT	WBR	NBL	NBT	NBR	SBL	SBT	SBR
Lane Configurations		↕↕	↗					↕↕			↕↕	
Traffic Volume (vph)	55	629	120	0	0	0	0	450	93	180	725	0
Future Volume (vph)	55	629	120	0	0	0	0	450	93	180	725	0
Satd. Flow (prot)	0	3346	1547	0	0	0	0	3131	0	0	3324	0
Fit Permitted		0.996									0.722	
Satd. Flow (perm)	0	3343	1402	0	0	0	0	3131	0	0	2373	0
Satd. Flow (RTOR)			134									
Lane Group Flow (vph)	0	684	120	0	0	0	0	543	0	0	905	0
Turn Type	Perm	NA	Perm					NA		pm+pt	NA	
Protected Phases		4						2		5	6	
Permitted Phases	4		4							6		
Detector Phase	4	4	4					2		5	6	
Switch Phase												
Minimum Initial (s)	10.0	10.0	10.0					10.0		5.0	10.0	
Minimum Split (s)	26.2	26.2	26.2					23.1		11.1	23.1	
Total Split (s)	27.0	27.0	27.0					36.9		11.1	48.0	
Total Split (%)	36.0%	36.0%	36.0%					49.2%		14.8%	64.0%	
Yellow Time (s)	3.3	3.3	3.3					3.0		3.0	3.0	
All-Red Time (s)	2.9	2.9	2.9					3.1		3.1	3.1	
Lost Time Adjust (s)		0.0	0.0					0.0			0.0	
Total Lost Time (s)		6.2	6.2					6.1			6.1	
Lead/Lag												
Lead-Lag Optimize?												
Recall Mode	None	None	None					C-Max		None	C-Max	
Act Effct Green (s)		19.5	19.5					43.2			43.2	
Actuated g/C Ratio		0.26	0.26					0.58			0.58	
v/c Ratio		0.79	0.26					0.30			0.66	
Control Delay		32.9	5.1					9.0			12.8	
Queue Delay		0.0	0.0					0.0			1.4	
Total Delay		32.9	5.1					9.0			14.3	
LOS		C	A					A			B	
Approach Delay		28.7						9.0			14.3	
Approach LOS		C						A			B	
Queue Length 50th (m)		46.1	0.0					19.8			71.9	
Queue Length 95th (m)		64.3	9.4					28.5			m90.9	
Internal Link Dist (m)		296.0			233.4			215.6			90.2	
Turn Bay Length (m)			40.0									
Base Capacity (vph)		927	485					1801			1365	
Starvation Cap Reductn		0	0					0			265	
Spillback Cap Reductn		0	0					0			0	
Storage Cap Reductn		0	0					0			0	
Reduced v/c Ratio		0.74	0.25					0.30			0.82	

Intersection Summary
 Cycle Length: 75
 Actuated Cycle Length: 75
 Offset: 60 (80%), Referenced to phase 2:NBT and 6:SBTL, Start of Green
 Natural Cycle: 65
 Control Type: Actuated-Coordinated
 Maximum v/c Ratio: 0.79
 Intersection Signal Delay: 18.2
 Intersection Capacity Utilization 82.9%
 Analysis Period (min) 15
 Intersection LOS: B
 ICU Level of Service E
 m Volume for 95th percentile queue is metered by upstream signal.

Splits and Phases: 9: Bank St & Chamberlain Ave/Isabella St

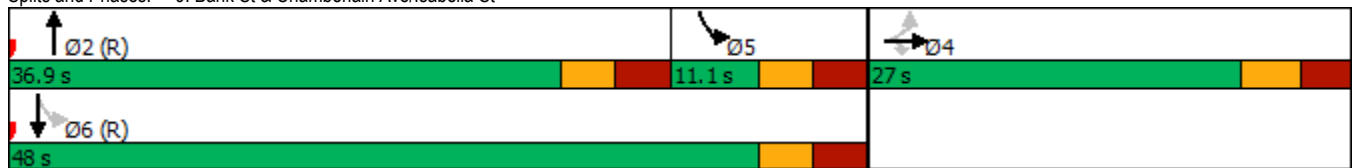

Lanes, Volumes, Timings
13: Bronson Ave & Catherine St

05/18/2023



Lane Group	EBL	EBT	EBR	WBL	WBT	WBR	NBL	NBT	NBR	SBL	SBT	SBR
Lane Configurations				↖ ↗	↖ ↗		↖ ↗	↖ ↗			↖ ↗	
Traffic Volume (vph)	0	0	0	735	610	288	311	812	0	0	853	176
Future Volume (vph)	0	0	0	735	610	288	311	812	0	0	853	176
Satd. Flow (prot)	0	0	0	1458	4279	0	1679	3390	0	0	3260	0
Fit Permitted				0.950	0.987		0.099					
Satd. Flow (perm)	0	0	0	1458	4279	0	175	3390	0	0	3260	0
Satd. Flow (RTOR)					80						26	
Lane Group Flow (vph)	0	0	0	412	1221	0	311	812	0	0	1029	0
Turn Type				Perm	NA		pm+pt	NA			NA	
Protected Phases					8		5	2				6
Permitted Phases				8			2					
Minimum Split (s)				28.3	28.3		11.2	23.8			23.8	
Total Split (s)				37.0	37.0		22.0	63.0			41.0	
Total Split (%)				37.0%	37.0%		22.0%	63.0%			41.0%	
Yellow Time (s)				3.3	3.3		3.3	3.3			3.3	
All-Red Time (s)				3.0	3.0		2.9	3.5			3.5	
Lost Time Adjust (s)				0.0	0.0		0.0	0.0			0.0	
Total Lost Time (s)				6.3	6.3		6.2	6.8			6.8	
Lead/Lag							Lead				Lag	
Lead-Lag Optimize?							Yes				Yes	
Act Effct Green (s)				30.7	30.7		56.8	56.2			34.2	
Actuated g/C Ratio				0.31	0.31		0.57	0.56			0.34	
v/c Ratio				0.92	0.89		0.92	0.43			0.91	
Control Delay				61.9	40.5		59.4	13.5			43.5	
Queue Delay				0.0	0.0		0.0	0.0			0.0	
Total Delay				61.9	40.5		59.4	13.5			43.5	
LOS				E	D		E	B			D	
Approach Delay					45.9			26.2			43.5	
Approach LOS					D			C			D	
Queue Length 50th (m)				89.3	82.1		44.4	44.8			97.0	
Queue Length 95th (m)				#154.3	#109.4		#94.6	58.3			#136.1	
Internal Link Dist (m)		141.5			120.8			240.1			287.4	
Turn Bay Length (m)				80.0			45.0					
Base Capacity (vph)				447	1369		337	1905			1132	
Starvation Cap Reductn				0	0		0	0			0	
Spillback Cap Reductn				0	0		0	0			0	
Storage Cap Reductn				0	0		0	0			0	
Reduced v/c Ratio				0.92	0.89		0.92	0.43			0.91	

Intersection Summary
 Cycle Length: 100
 Actuated Cycle Length: 100
 Offset: 60 (60%), Referenced to phase 2:NBT and 6:SBT, Start of Green
 Natural Cycle: 90
 Control Type: Pretimed
 Maximum v/c Ratio: 0.92
 Intersection Signal Delay: 39.4 Intersection LOS: D
 Intersection Capacity Utilization 92.3% ICU Level of Service F
 Analysis Period (min) 15
 # 95th percentile volume exceeds capacity, queue may be longer.
 Queue shown is maximum after two cycles.

Splits and Phases: 13: Bronson Ave & Catherine St

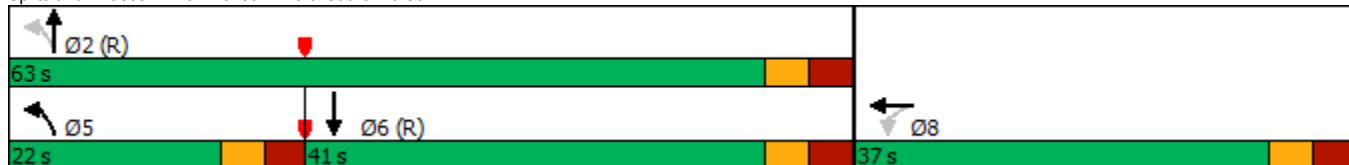

Intersection												
Int Delay, s/veh	2.1											
Movement	EBL	EBT	EBR	WBL	WBT	WBR	NBL	NBT	NBR	SBL	SBT	SBR
Lane Configurations		↕			↕						↕↔	
Traffic Vol, veh/h	0	19	2	8	37	0	0	0	0	43	601	13
Future Vol, veh/h	0	19	2	8	37	0	0	0	0	43	601	13
Conflicting Peds, #/hr	20	0	8	8	0	20	19	0	3	3	0	19
Sign Control	Stop	Stop	Stop	Stop	Stop	Stop	Free	Free	Free	Free	Free	Free
RT Channelized	-	-	None	-	-	None	-	-	None	-	-	None
Storage Length	-	-	-	-	-	-	-	-	-	-	-	-
Veh in Median Storage, #	-	0	-	-	0	-	-	-	-	-	0	-
Grade, %	-	0	-	-	0	-	-	0	-	-	0	-
Peak Hour Factor	100	100	100	100	100	100	100	100	100	100	100	100
Heavy Vehicles, %	0	5	0	0	5	0	0	0	0	0	0	0
Mvmt Flow	0	19	2	8	37	0	0	0	0	43	601	13
Major/Minor	Minor2			Minor1			Major2					
Conflicting Flow All	-	716	334	407	722	-	-	-	3	0	0	-
Stage 1	-	713	-	3	3	-	-	-	-	-	-	-
Stage 2	-	3	-	404	719	-	-	-	-	-	-	-
Critical Hdwy	-	6.6	6.9	7.5	6.6	-	-	-	4.1	-	-	-
Critical Hdwy Stg 1	-	5.6	-	-	-	-	-	-	-	-	-	-
Critical Hdwy Stg 2	-	-	-	6.5	5.6	-	-	-	-	-	-	-
Follow-up Hdwy	-	4.05	3.3	3.5	4.05	-	-	-	2.2	-	-	-
Pot Cap-1 Maneuver	0	348	668	533	346	0	-	-	1632	-	-	-
Stage 1	0	426	-	-	-	0	-	-	-	-	-	-
Stage 2	0	-	-	600	424	0	-	-	-	-	-	-
Platoon blocked, %	-	-	-	-	-	-	-	-	-	-	-	-
Mov Cap-1 Maneuver	-	327	656	491	325	-	-	-	1627	-	-	-
Mov Cap-2 Maneuver	-	327	-	491	325	-	-	-	-	-	-	-
Stage 1	-	402	-	-	-	-	-	-	-	-	-	-
Stage 2	-	-	-	547	400	-	-	-	-	-	-	-
Approach	EB			WB			SB					
HCM Control Delay, s	16.2			17			0.6					
HCM LOS	C			C								
Minor Lane/Major Mvmt	EBLn1	WBLn1	SBL	SBT	SBR							
Capacity (veh/h)	343	346	1627	-	-							
HCM Lane V/C Ratio	0.061	0.13	0.026	-	-							
HCM Control Delay (s)	16.2	17	7.3	0.1	-							
HCM Lane LOS	C	C	A	A	-							
HCM 95th %tile Q(veh)	0.2	0.4	0.1	-	-							

Intersection						
Int Delay, s/veh	2.2					
Movement	EBL	EBR	NBL	NBT	SBT	SBR
Lane Configurations	↔			↕↕	↕↕	
Traffic Vol, veh/h	20	107	58	428	719	27
Future Vol, veh/h	20	107	58	428	719	27
Conflicting Peds, #/hr	0	0	42	0	0	42
Sign Control	Stop	Stop	Free	Free	Free	Free
RT Channelized	-	None	-	None	-	None
Storage Length	0	-	-	-	-	-
Veh in Median Storage, #	0	-	-	0	0	-
Grade, %	0	-	-	0	0	-
Peak Hour Factor	100	100	100	100	100	100
Heavy Vehicles, %	0	1	0	5	3	0
Mvmt Flow	20	107	58	428	719	27
Major/Minor	Minor2	Major1	Major2			
Conflicting Flow All	1105	415	788	0	-	0
Stage 1	775	-	-	-	-	-
Stage 2	330	-	-	-	-	-
Critical Hdwy	6.8	6.92	4.1	-	-	-
Critical Hdwy Stg 1	5.8	-	-	-	-	-
Critical Hdwy Stg 2	5.8	-	-	-	-	-
Follow-up Hdwy	3.5	3.31	2.2	-	-	-
Pot Cap-1 Maneuver	208	589	840	-	-	-
Stage 1	420	-	-	-	-	-
Stage 2	707	-	-	-	-	-
Platoon blocked, %				-	-	-
Mov Cap-1 Maneuver	174	566	807	-	-	-
Mov Cap-2 Maneuver	174	-	-	-	-	-
Stage 1	366	-	-	-	-	-
Stage 2	679	-	-	-	-	-
Approach	EB	NB	SB			
HCM Control Delay, s	17.3	1.5	0			
HCM LOS	C					
Minor Lane/Major Mvmt	NBL	NBT	EBLn1	SBT	SBR	
Capacity (veh/h)	807	-	418	-	-	
HCM Lane V/C Ratio	0.072	-	0.304	-	-	
HCM Control Delay (s)	9.8	0.4	17.3	-	-	
HCM Lane LOS	A	A	C	-	-	
HCM 95th %tile Q(veh)	0.2	-	1.3	-	-	

Lanes, Volumes, Timings

1: Hwy 417 WB On Ramp/Lyon St N & Catherine St

05/18/2023



Lane Group	EBL	EBT	EBR	WBL	WBT	WBR	NBL	NBT	NBR	SBL	SBT	SBR
Lane Configurations					↕↕↕						↕	↕
Traffic Volume (vph)	0	0	0	247	249	0	0	0	0	0	262	125
Future Volume (vph)	0	0	0	247	249	0	0	0	0	0	262	125
Satd. Flow (prot)	0	0	0	0	4574	0	0	0	0	0	1784	1547
Fit Permitted					0.976							
Satd. Flow (perm)	0	0	0	0	4542	0	0	0	0	0	1784	1517
Satd. Flow (RTOR)					247							125
Lane Group Flow (vph)	0	0	0	0	496	0	0	0	0	0	262	125
Turn Type				Perm	NA						NA	Perm
Protected Phases					8						6	
Permitted Phases				8								6
Minimum Split (s)				26.2	26.2						28.3	28.3
Total Split (s)				35.0	35.0						40.0	40.0
Total Split (%)				46.7%	46.7%						53.3%	53.3%
Yellow Time (s)				3.3	3.3						3.3	3.3
All-Red Time (s)				1.9	1.9						2.0	2.0
Lost Time Adjust (s)					0.0						0.0	0.0
Total Lost Time (s)					5.2						5.3	5.3
Lead/Lag												
Lead-Lag Optimize?												
Act Effct Green (s)					29.8						34.7	34.7
Actuated g/C Ratio					0.40						0.46	0.46
v/c Ratio					0.25						0.32	0.16
Control Delay					0.8						22.5	11.4
Queue Delay					0.0						0.0	0.0
Total Delay					0.8						22.5	11.4
LOS					A						C	B
Approach Delay					0.8						18.9	
Approach LOS					A						B	
Queue Length 50th (m)					0.0						34.8	1.8
Queue Length 95th (m)					m0.9						54.0	19.3
Internal Link Dist (m)		271.6			109.2			117.8			52.8	
Turn Bay Length (m)												
Base Capacity (vph)					1953						825	769
Starvation Cap Reductn					0						0	0
Spillback Cap Reductn					0						0	0
Storage Cap Reductn					0						0	0
Reduced v/c Ratio					0.25						0.32	0.16

Intersection Summary

Cycle Length: 75
 Actuated Cycle Length: 75
 Offset: 24 (32%), Referenced to phase 8:WBTL, Start of Green
 Natural Cycle: 55
 Control Type: Pretimed
 Maximum v/c Ratio: 0.32
 Intersection Signal Delay: 8.7
 Intersection LOS: A
 Intersection Capacity Utilization 49.0%
 ICU Level of Service A
 Analysis Period (min) 15
 m Volume for 95th percentile queue is metered by upstream signal.

Splits and Phases: 1: Hwy 417 WB On Ramp/Lyon St N & Catherine St

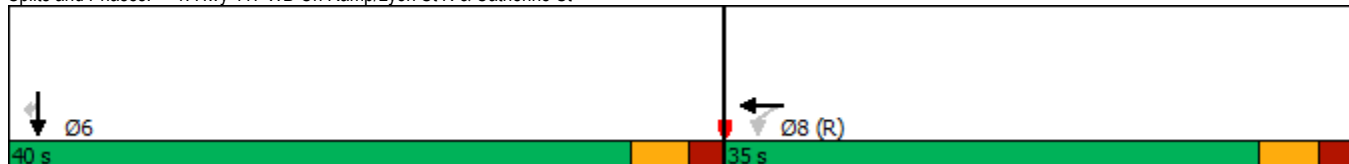

Lanes, Volumes, Timings

2: Hwy 417 EB Off Ramp/Chamberlain Ave/Kent St & Catherine St

05/18/2023



Lane Group	EBL	EBT	EBR	WBL	WBT	WBR	NBL	NBT	NBR	SBL	SBT	SBR
Lane Configurations					↕↕	↗		↕↕↕				
Traffic Volume (vph)	0	0	0	0	420	549	61	1356	0	0	0	0
Future Volume (vph)	0	0	0	0	420	549	61	1356	0	0	0	0
Satd. Flow (prot)	0	0	0	0	2930	1394	0	4912	0	0	0	0
Fit Permitted								0.998				
Satd. Flow (perm)	0	0	0	0	2930	1303	0	4906	0	0	0	0
Satd. Flow (RTOR)								70				
Lane Group Flow (vph)	0	0	0	0	667	302	0	1417	0	0	0	0
Turn Type					NA	Perm	Perm	NA				
Protected Phases					8			2				
Permitted Phases						8		2				
Minimum Split (s)					22.8	22.8		22.5				
Total Split (s)					35.9	35.9		34.1				
Total Split (%)					47.9%	47.9%		45.5%				
Yellow Time (s)					3.3	3.3		3.3				
All-Red Time (s)					2.5	2.5		2.5				
Lost Time Adjust (s)					0.0	0.0		0.0				
Total Lost Time (s)					5.8	5.8		5.8				
Lead/Lag												
Lead-Lag Optimize?												
Act Effct Green (s)					30.1	30.1		28.3				
Actuated g/C Ratio					0.40	0.40		0.38				
v/c Ratio					0.57	0.58		0.75				
Control Delay					19.5	21.6		22.2				
Queue Delay					0.0	0.0		3.8				
Total Delay					19.5	21.6		26.0				
LOS					B	C		C				
Approach Delay					20.1			26.0				
Approach LOS					C			C				
Queue Length 50th (m)					35.3	32.1		59.2				
Queue Length 95th (m)					m44.6	m41.9		75.2				
Internal Link Dist (m)		30.7			131.7			67.4			53.0	
Turn Bay Length (m)												
Base Capacity (vph)					1175	522		1894				
Starvation Cap Reductn					0	0		0				
Spillback Cap Reductn					0	0		383				
Storage Cap Reductn					0	0		0				
Reduced v/c Ratio					0.57	0.58		0.94				

Intersection Summary

Cycle Length: 75
 Actuated Cycle Length: 75
 Offset: 12 (16%), Referenced to phase 8:WBT, Start of Green
 Natural Cycle: 55
 Control Type: Pretimed
 Maximum v/c Ratio: 0.75
 Intersection Signal Delay: 23.6 Intersection LOS: C
 Intersection Capacity Utilization 65.9% ICU Level of Service C
 Analysis Period (min) 15
 m Volume for 95th percentile queue is metered by upstream signal.

Splits and Phases: 2: Hwy 417 EB Off Ramp/Chamberlain Ave/Kent St & Catherine St

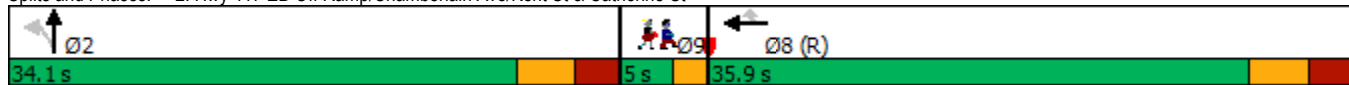

Lanes, Volumes, Timings

2: Hwy 417 EB Off Ramp/Chamberlain Ave/Kent St & Catherine St

05/18/2023

Lane Group	Ø9
Lane Configurations	
Traffic Volume (vph)	
Future Volume (vph)	
Satd. Flow (prot)	
Flt Permitted	
Satd. Flow (perm)	
Satd. Flow (RTOR)	
Lane Group Flow (vph)	
Turn Type	
Protected Phases	9
Permitted Phases	
Minimum Split (s)	5.0
Total Split (s)	5.0
Total Split (%)	7%
Yellow Time (s)	2.0
All-Red Time (s)	0.0
Lost Time Adjust (s)	
Total Lost Time (s)	
Lead/Lag	
Lead-Lag Optimize?	
Act Effct Green (s)	
Actuated g/C Ratio	
v/c Ratio	
Control Delay	
Queue Delay	
Total Delay	
LOS	
Approach Delay	
Approach LOS	
Queue Length 50th (m)	
Queue Length 95th (m)	
Internal Link Dist (m)	
Turn Bay Length (m)	
Base Capacity (vph)	
Starvation Cap Reductn	
Spillback Cap Reductn	
Storage Cap Reductn	
Reduced v/c Ratio	
Intersection Summary	

Lanes, Volumes, Timings
3: Bank St & Catherine St

05/18/2023



Lane Group	EBL	EBT	EBR	WBL	WBT	WBR	NBL	NBT	NBR	SBL	SBT	SBR
Lane Configurations					↕↕↕			↕↕			↕↕	
Traffic Volume (vph)	0	0	0	176	606	202	273	577	0	0	376	142
Future Volume (vph)	0	0	0	176	606	202	273	577	0	0	376	142
Satd. Flow (prot)	0	0	0	0	4431	0	0	3211	0	0	2855	0
Fit Permitted					0.991			0.646				
Satd. Flow (perm)	0	0	0	0	4375	0	0	2033	0	0	2855	0
Satd. Flow (RTOR)					80						80	
Lane Group Flow (vph)	0	0	0	0	984	0	0	850	0	0	518	0
Turn Type				Perm	NA		pm+pt	NA			NA	
Protected Phases					8		9	2			6	
Permitted Phases					8		2					
Minimum Split (s)				18.6	18.6		10.4	16.4			16.4	
Total Split (s)				23.0	23.0		10.4	42.0			31.6	
Total Split (%)				30.7%	30.7%		13.9%	56.0%			42.1%	
Yellow Time (s)				3.3	3.3		3.3	3.3			3.3	
All-Red Time (s)				2.3	2.3		2.1	2.1			2.1	
Lost Time Adjust (s)					0.0			0.0			0.0	
Total Lost Time (s)					5.6			5.4			5.4	
Lead/Lag				Lag	Lag			Lag			Lag	
Lead-Lag Optimize?				Yes	Yes			Yes			Yes	
Act Effct Green (s)					17.4			36.6			26.2	
Actuated g/C Ratio					0.23			0.49			0.35	
v/c Ratio					0.91			0.79			0.49	
Control Delay					40.3			17.7			17.9	
Queue Delay					0.0			0.0			0.0	
Total Delay					40.3			17.7			17.9	
LOS					D			B			B	
Approach Delay					40.3			17.7			17.9	
Approach LOS					D			B			B	
Queue Length 50th (m)					46.0			25.5			24.8	
Queue Length 95th (m)					#70.4			37.8			38.3	
Internal Link Dist (m)		131.7			201.7			90.2			52.9	
Turn Bay Length (m)												
Base Capacity (vph)					1076			1070			1049	
Starvation Cap Reductn					0			0			0	
Spillback Cap Reductn					0			0			0	
Storage Cap Reductn					0			0			0	
Reduced v/c Ratio					0.91			0.79			0.49	

Intersection Summary

Cycle Length: 75
 Actuated Cycle Length: 75
 Offset: 50 (67%), Referenced to phase 2:NBT and 6:SBT, Start of Green
 Natural Cycle: 70
 Control Type: Pretimed
 Maximum v/c Ratio: 0.91
 Intersection Signal Delay: 27.2
 Intersection LOS: C
 Intersection Capacity Utilization 80.5%
 ICU Level of Service D
 Analysis Period (min) 15

95th percentile volume exceeds capacity, queue may be longer.
 Queue shown is maximum after two cycles.

Splits and Phases: 3: Bank St & Catherine St

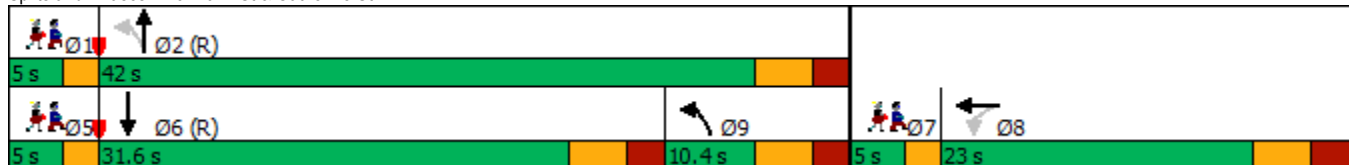

Lanes, Volumes, Timings
 3: Bank St & Catherine St

05/18/2023

Lane Group	Ø1	Ø5	Ø7
Lane Configurations			
Traffic Volume (vph)			
Future Volume (vph)			
Satd. Flow (prot)			
Fit Permitted			
Satd. Flow (perm)			
Satd. Flow (RTOR)			
Lane Group Flow (vph)			
Turn Type			
Protected Phases	1	5	7
Permitted Phases			
Minimum Split (s)	5.0	5.0	5.0
Total Split (s)	5.0	5.0	5.0
Total Split (%)	7%	7%	7%
Yellow Time (s)	2.0	2.0	2.0
All-Red Time (s)	0.0	0.0	0.0
Lost Time Adjust (s)			
Total Lost Time (s)			
Lead/Lag	Lead	Lead	Lead
Lead-Lag Optimize?	Yes	Yes	Yes
Act Effct Green (s)			
Actuated g/C Ratio			
v/c Ratio			
Control Delay			
Queue Delay			
Total Delay			
LOS			
Approach Delay			
Approach LOS			
Queue Length 50th (m)			
Queue Length 95th (m)			
Internal Link Dist (m)			
Turn Bay Length (m)			
Base Capacity (vph)			
Starvation Cap Reductn			
Spillback Cap Reductn			
Storage Cap Reductn			
Reduced v/c Ratio			
Intersection Summary			

Lanes, Volumes, Timings
4: Percy St & Catherine St

05/18/2023



Lane Group	EBL	EBT	EBR	WBL	WBT	WBR	NBL	NBT	NBR	SBL	SBT	SBR
Lane Configurations					↕↕↕						↕	
Traffic Volume (vph)	0	0	0	82	254	0	0	0	0	0	129	57
Future Volume (vph)	0	0	0	82	254	0	0	0	0	0	129	57
Satd. Flow (prot)	0	0	0	0	4555	0	0	0	0	0	1645	0
Fit Permitted					0.988							
Satd. Flow (perm)	0	0	0	0	4524	0	0	0	0	0	1645	0
Satd. Flow (RTOR)					160							
Lane Group Flow (vph)	0	0	0	0	336	0	0	0	0	0	186	0
Turn Type				Perm	NA						NA	
Protected Phases					8						6	
Permitted Phases				8								
Detector Phase				8	8						6	
Switch Phase												
Minimum Initial (s)				10.0	10.0						10.0	
Minimum Split (s)				26.5	26.5						23.4	
Total Split (s)				34.0	34.0						43.2	
Total Split (%)				37.8%	37.8%						48.0%	
Yellow Time (s)				3.3	3.3						3.3	
All-Red Time (s)				2.2	2.2						2.1	
Lost Time Adjust (s)					0.0						0.0	
Total Lost Time (s)					5.5						5.4	
Lead/Lag				Lag	Lag							
Lead-Lag Optimize?				Yes	Yes							
Recall Mode				None	None						Max	
Act Effct Green (s)					12.0						38.0	
Actuated g/C Ratio					0.20						0.62	
v/c Ratio					0.33						0.18	
Control Delay					11.4						6.2	
Queue Delay					0.0						0.0	
Total Delay					11.4						6.2	
LOS					B						A	
Approach Delay					11.4						6.2	
Approach LOS					B						A	
Queue Length 50th (m)					6.0						6.6	
Queue Length 95th (m)					12.0						21.0	
Internal Link Dist (m)		71.6			271.6			106.7			288.0	
Turn Bay Length (m)												
Base Capacity (vph)					2211						1026	
Starvation Cap Reductn					0						0	
Spillback Cap Reductn					0						0	
Storage Cap Reductn					0						0	
Reduced v/c Ratio					0.15						0.18	

Intersection Summary

Cycle Length: 90
 Actuated Cycle Length: 60.9
 Natural Cycle: 65
 Control Type: Semi Act-Uncoord
 Maximum v/c Ratio: 0.33
 Intersection Signal Delay: 9.5
 Intersection Capacity Utilization 38.3%
 Analysis Period (min) 15

Intersection LOS: A
 ICU Level of Service A

Splits and Phases: 4: Percy St & Catherine St

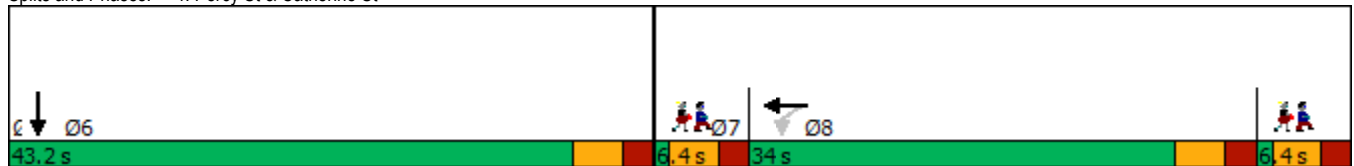

Lanes, Volumes, Timings
 4: Percy St & Catherine St

05/18/2023

Lane Group	Ø3	Ø7
Lane Configurations		
Traffic Volume (vph)		
Future Volume (vph)		
Satd. Flow (prot)		
Fit Permitted		
Satd. Flow (perm)		
Satd. Flow (RTOR)		
Lane Group Flow (vph)		
Turn Type		
Protected Phases	3	7
Permitted Phases		
Detector Phase		
Switch Phase		
Minimum Initial (s)	1.0	1.0
Minimum Split (s)	6.4	6.4
Total Split (s)	6.4	6.4
Total Split (%)	7%	7%
Yellow Time (s)	3.3	3.3
All-Red Time (s)	2.1	2.1
Lost Time Adjust (s)		
Total Lost Time (s)		
Lead/Lag		Lead
Lead-Lag Optimize?		Yes
Recall Mode	None	None
Act Effct Green (s)		
Actuated g/C Ratio		
v/c Ratio		
Control Delay		
Queue Delay		
Total Delay		
LOS		
Approach Delay		
Approach LOS		
Queue Length 50th (m)		
Queue Length 95th (m)		
Internal Link Dist (m)		
Turn Bay Length (m)		
Base Capacity (vph)		
Starvation Cap Reductn		
Spillback Cap Reductn		
Storage Cap Reductn		
Reduced v/c Ratio		
Intersection Summary		

Lanes, Volumes, Timings
6: Kent St & Arlington Ave

05/18/2023



Lane Group	EBL	EBT	EBR	WBL	WBT	WBR	NBL	NBT	NBR	SBL	SBT	SBR
Lane Configurations		↕			↕			↕↕↕				
Traffic Volume (vph)	19	51	0	0	11	93	15	1741	131	0	0	0
Future Volume (vph)	19	51	0	0	11	93	15	1741	131	0	0	0
Satd. Flow (prot)	0	1745	0	0	1542	0	0	4795	0	0	0	0
Fit Permitted		0.922										
Satd. Flow (perm)	0	1623	0	0	1542	0	0	4794	0	0	0	0
Satd. Flow (RTOR)					12			25				
Lane Group Flow (vph)	0	70	0	0	104	0	0	1887	0	0	0	0
Turn Type	Perm	NA			NA		Perm	NA				
Protected Phases		4			8			2				
Permitted Phases	4						2					
Minimum Split (s)	27.3	27.3			27.3		32.3	32.3				
Total Split (s)	28.0	28.0			28.0		47.0	47.0				
Total Split (%)	37.3%	37.3%			37.3%		62.7%	62.7%				
Yellow Time (s)	3.3	3.3			3.3		3.3	3.3				
All-Red Time (s)	2.0	2.0			2.0		2.0	2.0				
Lost Time Adjust (s)		0.0			0.0			0.0				
Total Lost Time (s)		5.3			5.3			5.3				
Lead/Lag												
Lead-Lag Optimize?												
Act Effct Green (s)		22.7			22.7			41.7				
Actuated g/C Ratio		0.30			0.30			0.56				
v/c Ratio		0.14			0.22			0.71				
Control Delay		32.6			15.7			11.7				
Queue Delay		0.0			0.0			3.4				
Total Delay		32.6			15.7			15.1				
LOS		C			B			B				
Approach Delay		32.6			15.7			15.1				
Approach LOS		C			B			B				
Queue Length 50th (m)		9.3			8.1			32.8				
Queue Length 95th (m)		20.4			m12.6			56.0				
Internal Link Dist (m)		164.0			143.1			53.0			216.0	
Turn Bay Length (m)												
Base Capacity (vph)		491			475			2676				
Starvation Cap Reductn		0			0			674				
Spillback Cap Reductn		0			0			0				
Storage Cap Reductn		0			0			0				
Reduced v/c Ratio		0.14			0.22			0.94				

Intersection Summary
 Cycle Length: 75
 Actuated Cycle Length: 75
 Offset: 50 (67%), Referenced to phase 2:NBT, Start of Green
 Natural Cycle: 60
 Control Type: Pretimed
 Maximum v/c Ratio: 0.71
 Intersection Signal Delay: 15.7
 Intersection Capacity Utilization 68.5%
 Analysis Period (min) 15
 m Volume for 95th percentile queue is metered by upstream signal.

Splits and Phases: 6: Kent St & Arlington Ave



Lanes, Volumes, Timings
7: Lyon St N & Gladstone Ave

05/18/2023



Lane Group	EBL	EBT	EBR	WBL	WBT	WBR	NBL	NBT	NBR	SBL	SBT	SBR
Lane Configurations		↑	↗	↖	↑						↕	↕
Traffic Volume (vph)	0	184	24	15	143	0	0	0	0	89	330	98
Future Volume (vph)	0	184	24	15	143	0	0	0	0	89	330	98
Satd. Flow (prot)	0	1733	1547	1729	1750	0	0	0	0	0	3244	0
Fit Permitted				0.641							0.991	
Satd. Flow (perm)	0	1733	1485	1146	1750	0	0	0	0	0	3220	0
Satd. Flow (RTOR)			38								49	
Lane Group Flow (vph)	0	184	24	15	143	0	0	0	0	0	517	0
Turn Type		NA	Perm	Perm	NA					Perm	NA	
Protected Phases		4			8							6
Permitted Phases			4	8						6		
Minimum Split (s)		17.2	17.2	17.2	17.2					22.6	22.6	
Total Split (s)		36.0	36.0	36.0	36.0					39.0	39.0	
Total Split (%)		48.0%	48.0%	48.0%	48.0%					52.0%	52.0%	
Yellow Time (s)		3.3	3.3	3.3	3.3					3.3	3.3	
All-Red Time (s)		1.9	1.9	1.9	1.9					2.3	2.3	
Lost Time Adjust (s)		0.0	0.0	0.0	0.0						0.0	
Total Lost Time (s)		5.2	5.2	5.2	5.2						5.6	
Lead/Lag												
Lead-Lag Optimize?												
Act Effct Green (s)		30.8	30.8	30.8	30.8						33.4	
Actuated g/C Ratio		0.41	0.41	0.41	0.41						0.45	
v/c Ratio		0.26	0.04	0.03	0.20						0.35	
Control Delay		15.8	3.3	5.7	7.7						13.1	
Queue Delay		0.0	0.0	0.0	0.0						0.0	
Total Delay		15.8	3.3	5.7	7.7						13.1	
LOS		B	A	A	A						B	
Approach Delay		14.4			7.5						13.1	
Approach LOS		B			A						B	
Queue Length 50th (m)		16.6	0.0	0.7	10.0						21.7	
Queue Length 95th (m)		29.8	2.8	m1.1	14.1						32.4	
Internal Link Dist (m)		254.8			165.0			215.6			214.3	
Turn Bay Length (m)				25.0								
Base Capacity (vph)		711	632	470	718						1461	
Starvation Cap Reductn		0	0	0	0						0	
Spillback Cap Reductn		0	0	0	0						0	
Storage Cap Reductn		0	0	0	0						0	
Reduced v/c Ratio		0.26	0.04	0.03	0.20						0.35	

Intersection Summary
 Cycle Length: 75
 Actuated Cycle Length: 75
 Offset: 45 (60%), Referenced to phase 4:EBT and 8:WBTL, Start of Green
 Natural Cycle: 40
 Control Type: Pretimed
 Maximum v/c Ratio: 0.35
 Intersection Signal Delay: 12.4 Intersection LOS: B
 Intersection Capacity Utilization 80.3% ICU Level of Service D
 Analysis Period (min) 15
 m Volume for 95th percentile queue is metered by upstream signal.

Splits and Phases: 7: Lyon St N & Gladstone Ave

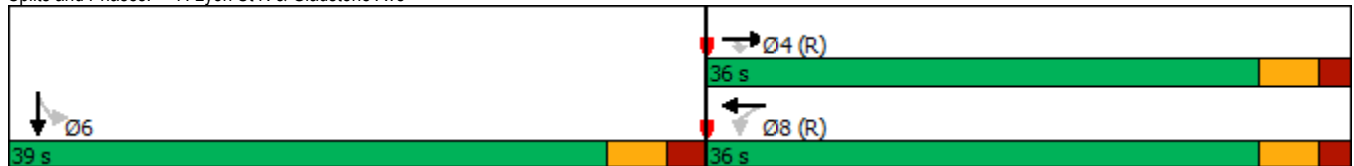

Lanes, Volumes, Timings
8: Kent St & Gladstone Ave

05/18/2023



Lane Group	EBL	EBT	EBR	WBL	WBT	WBR	NBL	NBT	NBR	SBL	SBT	SBR
Lane Configurations												
Traffic Volume (vph)	82	277	0	0	165	148	36	1723	97	0	0	0
Future Volume (vph)	82	277	0	0	165	148	36	1723	97	0	0	0
Satd. Flow (prot)	1662	1717	0	0	1552	0	1729	4791	0	0	0	0
Fit Permitted	0.472						0.950					
Satd. Flow (perm)	790	1717	0	0	1552	0	1444	4791	0	0	0	0
Satd. Flow (RTOR)					6			16				
Lane Group Flow (vph)	82	277	0	0	313	0	36	1820	0	0	0	0
Turn Type	Perm	NA			NA		Perm	NA				
Protected Phases		4			8			2				
Permitted Phases	4						2					
Minimum Split (s)	21.4	21.4			21.4		20.4	20.4				
Total Split (s)	32.6	32.6			32.6		42.4	42.4				
Total Split (%)	43.5%	43.5%			43.5%		56.5%	56.5%				
Yellow Time (s)	3.3	3.3			3.3		3.3	3.3				
All-Red Time (s)	2.1	2.1			2.1		2.1	2.1				
Lost Time Adjust (s)	0.0	0.0			0.0		0.0	0.0				
Total Lost Time (s)	5.4	5.4			5.4		5.4	5.4				
Lead/Lag												
Lead-Lag Optimize?												
Act Effct Green (s)	27.2	27.2			27.2		37.0	37.0				
Actuated g/C Ratio	0.36	0.36			0.36		0.49	0.49				
v/c Ratio	0.29	0.45			0.55		0.05	0.77				
Control Delay	26.9	27.8			23.2		8.0	8.5				
Queue Delay	0.0	0.0			0.0		0.0	0.0				
Total Delay	26.9	27.8			23.2		8.0	8.5				
LOS	C	C			C		A	A				
Approach Delay		27.6			23.2			8.5				
Approach LOS		C			C			A				
Queue Length 50th (m)	9.8	37.5			33.9		1.0	19.4				
Queue Length 95th (m)	23.2	59.4			57.6		m2.8	39.1				
Internal Link Dist (m)		165.0			168.8			216.0			203.6	
Turn Bay Length (m)	30.0						40.0					
Base Capacity (vph)	286	622			566		712	2371				
Starvation Cap Reductn	0	0			0		0	0				
Spillback Cap Reductn	0	0			0		0	0				
Storage Cap Reductn	0	0			0		0	0				
Reduced v/c Ratio	0.29	0.45			0.55		0.05	0.77				

Intersection Summary

Cycle Length: 75
 Actuated Cycle Length: 75
 Offset: 23 (31%), Referenced to phase 4:EBTL and 8:WBT, Start of Green
 Natural Cycle: 50
 Control Type: Pretimed
 Maximum v/c Ratio: 0.77
 Intersection Signal Delay: 13.0
 Intersection Capacity Utilization 80.3%
 Analysis Period (min) 15
 m Volume for 95th percentile queue is metered by upstream signal.

Intersection LOS: B
 ICU Level of Service D

Splits and Phases: 8: Kent St & Gladstone Ave

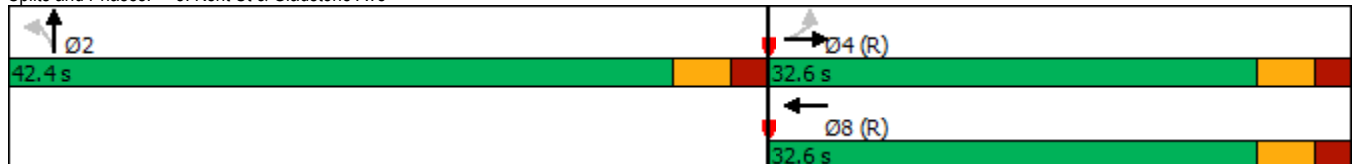

Lanes, Volumes, Timings
 9: Bank St & Chamberlain Ave/Isabella St

05/18/2023



Lane Group	EBL	EBT	EBR	WBL	WBT	WBR	NBL	NBT	NBR	SBL	SBT	SBR
Lane Configurations		↕↕	↗					↕↕			↕↕	
Traffic Volume (vph)	79	503	77	0	0	0	0	838	143	176	382	0
Future Volume (vph)	79	503	77	0	0	0	0	838	143	176	382	0
Satd. Flow (prot)	0	3226	1446	0	0	0	0	3154	0	0	3220	0
Fit Permitted		0.993									0.546	
Satd. Flow (perm)	0	3218	1358	0	0	0	0	3154	0	0	1769	0
Satd. Flow (RTOR)			134					32				
Lane Group Flow (vph)	0	582	77	0	0	0	0	981	0	0	558	0
Turn Type	Perm	NA	Perm					NA		pm+pt	NA	
Protected Phases		4						2		5	6	
Permitted Phases	4		4							6		
Detector Phase	4	4	4					2		5	6	
Switch Phase												
Minimum Initial (s)	10.0	10.0	10.0					10.0		5.0	10.0	
Minimum Split (s)	26.2	26.2	26.2					23.1		11.1	23.1	
Total Split (s)	26.2	26.2	26.2					37.7		11.1	48.8	
Total Split (%)	34.9%	34.9%	34.9%					50.3%		14.8%	65.1%	
Yellow Time (s)	3.3	3.3	3.3					3.0		3.0	3.0	
All-Red Time (s)	2.9	2.9	2.9					3.1		3.1	3.1	
Lost Time Adjust (s)		0.0	0.0					0.0			0.0	
Total Lost Time (s)		6.2	6.2					6.1			6.1	
Lead/Lag												
Lead-Lag Optimize?												
Recall Mode	None	None	None					C-Max		None	C-Max	
Act Effct Green (s)		18.2	18.2					44.5			44.5	
Actuated g/C Ratio		0.24	0.24					0.59			0.59	
v/c Ratio		0.74	0.18					0.52			0.53	
Control Delay		32.4	2.0					10.3			14.0	
Queue Delay		0.0	0.0					0.0			0.0	
Total Delay		32.4	2.0					10.3			14.0	
LOS		C	A					B			B	
Approach Delay		28.9						10.3			14.0	
Approach LOS		C						B			B	
Queue Length 50th (m)		38.7	0.0					40.0			39.6	
Queue Length 95th (m)		55.2	2.6					55.1			m54.3	
Internal Link Dist (m)		296.0			233.4			215.6			90.2	
Turn Bay Length (m)			40.0									
Base Capacity (vph)		858	460					1882			1048	
Starvation Cap Reductn		0	0					0			0	
Spillback Cap Reductn		0	0					0			0	
Storage Cap Reductn		0	0					0			0	
Reduced v/c Ratio		0.68	0.17					0.52			0.53	

Intersection Summary

Cycle Length: 75
 Actuated Cycle Length: 75
 Offset: 60 (80%), Referenced to phase 2:NBT and 6:SBTL, Start of Green
 Natural Cycle: 65
 Control Type: Actuated-Coordinated
 Maximum v/c Ratio: 0.74
 Intersection Signal Delay: 16.8
 Intersection Capacity Utilization 82.5%
 Analysis Period (min) 15
 m Volume for 95th percentile queue is metered by upstream signal.

Intersection LOS: B
 ICU Level of Service E

Splits and Phases: 9: Bank St & Chamberlain Ave/Isabella St

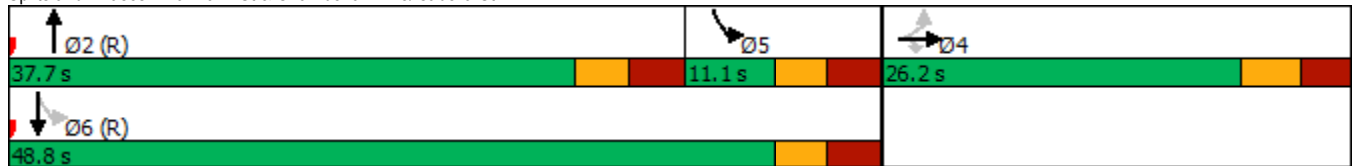

Lanes, Volumes, Timings
13: Bronson Ave & Catherine St

05/18/2023



Lane Group	EBL	EBT	EBR	WBL	WBT	WBR	NBL	NBT	NBR	SBL	SBT	SBR
Lane Configurations				↖ ↗	↖ ↗		↖ ↗	↖ ↗			↖ ↗	
Traffic Volume (vph)	0	0	0	507	486	359	527	1054	0	0	434	120
Future Volume (vph)	0	0	0	507	486	359	527	1054	0	0	434	120
Satd. Flow (prot)	0	0	0	1430	4134	0	1712	3390	0	0	3087	0
Fit Permitted				0.950	0.992		0.247					
Satd. Flow (perm)	0	0	0	1430	4134	0	440	3390	0	0	3087	0
Satd. Flow (RTOR)					87						29	
Lane Group Flow (vph)	0	0	0	345	1007	0	527	1054	0	0	554	0
Turn Type				Perm	NA		pm+pt	NA			NA	
Protected Phases					8		5	7			2	
Permitted Phases				8			2					
Minimum Split (s)				28.3	28.3			23.8			23.8	
Total Split (s)				37.0	37.0			73.0			30.2	
Total Split (%)				33.6%	33.6%			66.4%			27.5%	
Yellow Time (s)				3.3	3.3			3.3			3.3	
All-Red Time (s)				3.0	3.0			3.5			3.5	
Lost Time Adjust (s)				0.0	0.0			0.0			0.0	
Total Lost Time (s)				6.3	6.3			6.8			6.8	
Lead/Lag												Lag
Lead-Lag Optimize?												Yes
Act Effct Green (s)				30.7	30.7		66.8	66.2			23.4	
Actuated g/C Ratio				0.28	0.28		0.61	0.60			0.21	
v/c Ratio				0.86	0.83		0.85	0.52			0.82	
Control Delay				60.2	40.8		28.9	13.8			50.0	
Queue Delay				0.0	0.0		0.0	0.0			0.0	
Total Delay				60.2	40.8		28.9	13.8			50.0	
LOS				E	D		C	B			D	
Approach Delay					45.7			18.8			50.0	
Approach LOS					D			B			D	
Queue Length 50th (m)				81.8	72.4		59.8	64.2			57.0	
Queue Length 95th (m)				#139.7	90.5		#106.4	80.4			#81.7	
Internal Link Dist (m)		141.5			120.8			240.1			287.4	
Turn Bay Length (m)				80.0			45.0					
Base Capacity (vph)				399	1216		618	2040			679	
Starvation Cap Reductn				0	0		0	0			0	
Spillback Cap Reductn				0	0		0	0			0	
Storage Cap Reductn				0	0		0	0			0	
Reduced v/c Ratio				0.86	0.83		0.85	0.52			0.82	

Intersection Summary
 Cycle Length: 110
 Actuated Cycle Length: 110
 Offset: 60 (55%), Referenced to phase 2:NBTL and 6:SBT, Start of Green
 Natural Cycle: 90
 Control Type: Pretimed
 Maximum v/c Ratio: 0.86
 Intersection Signal Delay: 34.2
 Intersection LOS: C
 Intersection Capacity Utilization 87.0%
 ICU Level of Service E
 Analysis Period (min) 15
 # 95th percentile volume exceeds capacity, queue may be longer.
 Queue shown is maximum after two cycles.

Splits and Phases: 13: Bronson Ave & Catherine St



Lanes, Volumes, Timings
 13: Bronson Ave & Catherine St

05/18/2023

Lane Group	Ø5	Ø7
Lane Configurations		
Traffic Volume (vph)		
Future Volume (vph)		
Satd. Flow (prot)		
Fit Permitted		
Satd. Flow (perm)		
Satd. Flow (RTOR)		
Lane Group Flow (vph)		
Turn Type		
Protected Phases	5	7
Permitted Phases		
Minimum Split (s)	11.2	11.8
Total Split (s)	31.0	11.8
Total Split (%)	28%	11%
Yellow Time (s)	3.3	3.3
All-Red Time (s)	2.9	3.5
Lost Time Adjust (s)		
Total Lost Time (s)		
Lead/Lag	Lead	
Lead-Lag Optimize?	Yes	
Act Effct Green (s)		
Actuated g/C Ratio		
v/c Ratio		
Control Delay		
Queue Delay		
Total Delay		
LOS		
Approach Delay		
Approach LOS		
Queue Length 50th (m)		
Queue Length 95th (m)		
Internal Link Dist (m)		
Turn Bay Length (m)		
Base Capacity (vph)		
Starvation Cap Reductn		
Spillback Cap Reductn		
Storage Cap Reductn		
Reduced v/c Ratio		
Intersection Summary		

Intersection												
Int Delay, s/veh	2.1											
Movement	EBL	EBT	EBR	WBL	WBT	WBR	NBL	NBT	NBR	SBL	SBT	SBR
Lane Configurations		↕			↕						↕↔	
Traffic Vol, veh/h	0	18	0	11	12	0	0	0	0	47	329	9
Future Vol, veh/h	0	18	0	11	12	0	0	0	0	47	329	9
Conflicting Peds, #/hr	32	0	15	15	0	32	9	0	10	10	0	9
Sign Control	Stop	Stop	Stop	Stop	Stop	Stop	Free	Free	Free	Free	Free	Free
RT Channelized	-	-	None	-	-	None	-	-	None	-	-	None
Storage Length	-	-	-	-	-	-	-	-	-	-	-	-
Veh in Median Storage, #	-	0	-	-	0	-	-	-	-	-	0	-
Grade, %	-	0	-	-	0	-	-	0	-	-	0	-
Peak Hour Factor	100	100	100	100	100	100	100	100	100	100	100	100
Heavy Vehicles, %	0	6	0	9	0	0	0	0	0	5	1	11
Mvmt Flow	0	18	0	11	12	0	0	0	0	47	329	9

Major/Minor	Minor2			Minor1			Major2			
Conflicting Flow All	-	447	193	293	451	-	-	10	0	0
Stage 1	-	437	-	10	10	-	-	-	-	-
Stage 2	-	10	-	283	441	-	-	-	-	-
Critical Hdwy	-	6.62	6.9	7.68	6.5	-	-	4.2	-	-
Critical Hdwy Stg 1	-	5.62	-	-	-	-	-	-	-	-
Critical Hdwy Stg 2	-	-	-	6.68	5.5	-	-	-	-	-
Follow-up Hdwy	-	4.06	3.3	3.59	4	-	-	2.25	-	-
Pot Cap-1 Maneuver	0	496	822	619	507	0	-	1586	-	-
Stage 1	0	568	-	-	0	-	-	-	-	-
Stage 2	0	-	-	681	580	0	-	-	-	-
Platoon blocked, %	-	-	-	-	-	-	-	-	-	-
Mov Cap-1 Maneuver	-	470	815	579	480	-	-	1571	-	-
Mov Cap-2 Maneuver	-	470	-	579	480	-	-	-	-	-
Stage 1	-	542	-	-	-	-	-	-	-	-
Stage 2	-	-	-	634	554	-	-	-	-	-

Approach	EB			WB			SB		
HCM Control Delay, s	13			12.2			1		
HCM LOS	B			B					

Minor Lane/Major Mvmt	EBLn1	WBLn1	SBL	SBT	SBR
Capacity (veh/h)	470	523	1571	-	-
HCM Lane V/C Ratio	0.038	0.044	0.03	-	-
HCM Control Delay (s)	13	12.2	7.4	0.1	-
HCM Lane LOS	B	B	A	A	-
HCM 95th %tile Q(veh)	0.1	0.1	0.1	-	-

Intersection						
Int Delay, s/veh	0.8					
Movement	EBL	EBT	WBT	WBR	SBL	SBR
Lane Configurations			↑↑↑			↑
Traffic Vol, veh/h	0	0	457	20	0	38
Future Vol, veh/h	0	0	457	20	0	38
Conflicting Peds, #/hr	0	0	0	0	0	0
Sign Control	Free	Free	Free	Free	Stop	Stop
RT Channelized	-	None	-	None	-	None
Storage Length	-	-	-	-	-	0
Veh in Median Storage, #	-2490368		0	-	0	-
Grade, %	-	0	0	-	0	-
Peak Hour Factor	100	100	100	100	100	100
Heavy Vehicles, %	2	2	2	2	2	2
Mvmt Flow	0	0	457	20	0	38

Major/Minor	Major2	Minor2
Conflicting Flow All	-	0
Stage 1	-	-
Stage 2	-	-
Critical Hdwy	-	-
Critical Hdwy Stg 1	-	-
Critical Hdwy Stg 2	-	-
Follow-up Hdwy	-	-
Pot Cap-1 Maneuver	-	0
Stage 1	-	0
Stage 2	-	0
Platoon blocked, %	-	-
Mov Cap-1 Maneuver	-	-
Mov Cap-2 Maneuver	-	-
Stage 1	-	-
Stage 2	-	-

Approach	WB	SB
HCM Control Delay, s	0	10.9
HCM LOS		B

Minor Lane/Major Mvmt	WBT	WBR	SBLn1
Capacity (veh/h)	-	-	649
HCM Lane V/C Ratio	-	-	0.059
HCM Control Delay (s)	-	-	10.9
HCM Lane LOS	-	-	B
HCM 95th %tile Q(veh)	-	-	0.2

Intersection						
Int Delay, s/veh	2.9					
Movement	EBL	EBR	NBL	NBT	SBT	SBR
Lane Configurations	↔			↕	↕	
Traffic Vol, veh/h	21	127	86	693	392	22
Future Vol, veh/h	21	127	86	693	392	22
Conflicting Peds, #/hr	0	0	111	0	0	111
Sign Control	Stop	Stop	Free	Free	Free	Free
RT Channelized	-	None	-	None	-	None
Storage Length	0	-	-	-	-	-
Veh in Median Storage, #	0	-	-	0	0	-
Grade, %	0	-	-	0	0	-
Peak Hour Factor	100	100	100	100	100	100
Heavy Vehicles, %	0	3	2	5	8	5
Mvmt Flow	21	127	86	693	392	22
Major/Minor	Minor2	Major1		Major2		
Conflicting Flow All	1033	318	525	0	-	0
Stage 1	514	-	-	-	-	-
Stage 2	519	-	-	-	-	-
Critical Hdwy	6.8	6.96	4.14	-	-	-
Critical Hdwy Stg 1	5.8	-	-	-	-	-
Critical Hdwy Stg 2	5.8	-	-	-	-	-
Follow-up Hdwy	3.5	3.33	2.22	-	-	-
Pot Cap-1 Maneuver	232	675	1038	-	-	-
Stage 1	571	-	-	-	-	-
Stage 2	568	-	-	-	-	-
Platoon blocked, %				-	-	-
Mov Cap-1 Maneuver	159	606	932	-	-	-
Mov Cap-2 Maneuver	159	-	-	-	-	-
Stage 1	435	-	-	-	-	-
Stage 2	509	-	-	-	-	-
Approach	EB	NB		SB		
HCM Control Delay, s	17.6	1.6		0		
HCM LOS	C					
Minor Lane/Major Mvmt	NBL	NBT	EBLn1	SBT	SBR	
Capacity (veh/h)	932	-	433	-	-	
HCM Lane V/C Ratio	0.092	-	0.342	-	-	
HCM Control Delay (s)	9.3	0.6	17.6	-	-	
HCM Lane LOS	A	A	C	-	-	
HCM 95th %tile Q(veh)	0.3	-	1.5	-	-	

Lanes, Volumes, Timings

1: Hwy 417 WB On Ramp/Lyon St N & Catherine St

05/18/2023



Lane Group	EBL	EBT	EBR	WBL	WBT	WBR	NBL	NBT	NBR	SBL	SBT	SBR
Lane Configurations					↕↕↕						↕	↕
Traffic Volume (vph)	0	0	0	208	531	0	0	0	0	0	348	289
Future Volume (vph)	0	0	0	208	531	0	0	0	0	0	348	289
Satd. Flow (prot)	0	0	0	0	4736	0	0	0	0	0	1802	1532
Fit Permitted					0.986							
Satd. Flow (perm)	0	0	0	0	4703	0	0	0	0	0	1802	1490
Satd. Flow (RTOR)					156							157
Lane Group Flow (vph)	0	0	0	0	739	0	0	0	0	0	348	289
Turn Type				Perm	NA						NA	Perm
Protected Phases					8						6	
Permitted Phases				8								6
Minimum Split (s)				26.2	26.2						28.3	28.3
Total Split (s)				35.0	35.0						40.0	40.0
Total Split (%)				46.7%	46.7%						53.3%	53.3%
Yellow Time (s)				3.3	3.3						3.3	3.3
All-Red Time (s)				1.9	1.9						2.0	2.0
Lost Time Adjust (s)					0.0						0.0	0.0
Total Lost Time (s)					5.2						5.3	5.3
Lead/Lag												
Lead-Lag Optimize?												
Act Effct Green (s)					29.8						34.7	34.7
Actuated g/C Ratio					0.40						0.46	0.46
v/c Ratio					0.38						0.42	0.37
Control Delay					10.4						23.1	15.6
Queue Delay					0.0						0.0	0.0
Total Delay					10.4						23.1	15.6
LOS					B						C	B
Approach Delay					10.4						19.7	
Approach LOS					B						B	
Queue Length 50th (m)					6.7						47.3	26.6
Queue Length 95th (m)					15.0						72.9	46.1
Internal Link Dist (m)		271.6			109.2			117.8			52.8	
Turn Bay Length (m)												
Base Capacity (vph)					1962						833	773
Starvation Cap Reductn					0						0	0
Spillback Cap Reductn					0						0	0
Storage Cap Reductn					0						0	0
Reduced v/c Ratio					0.38						0.42	0.37

Intersection Summary

Cycle Length: 75	
Actuated Cycle Length: 75	
Offset: 24 (32%), Referenced to phase 8:WBTL, Start of Green	
Natural Cycle: 55	
Control Type: Pretimed	
Maximum v/c Ratio: 0.42	
Intersection Signal Delay: 14.7	Intersection LOS: B
Intersection Capacity Utilization 46.9%	ICU Level of Service A
Analysis Period (min) 15	

Splits and Phases: 1: Hwy 417 WB On Ramp/Lyon St N & Catherine St

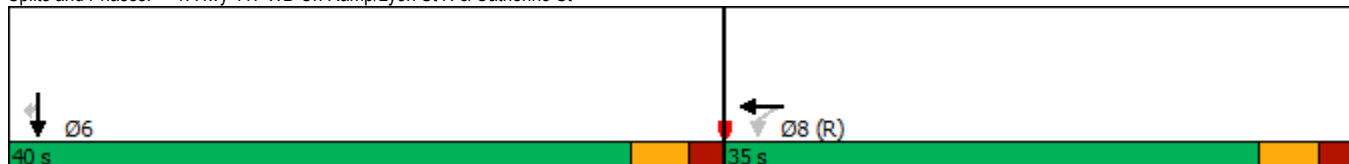

Lanes, Volumes, Timings

2: Hwy 417 EB Off Ramp/Chamberlain Ave/Kent St & Catherine St

05/18/2023



Lane Group	EBL	EBT	EBR	WBL	WBT	WBR	NBL	NBT	NBR	SBL	SBT	SBR
Lane Configurations					↕↕	↗		↕↕↕				
Traffic Volume (vph)	0	0	0	0	681	300	35	837	0	0	0	0
Future Volume (vph)	0	0	0	0	681	300	35	837	0	0	0	0
Satd. Flow (prot)	0	0	0	0	3180	1303	0	4858	0	0	0	0
Fit Permitted								0.998				
Satd. Flow (perm)	0	0	0	0	3180	1204	0	4854	0	0	0	0
Satd. Flow (RTOR)								70				
Lane Group Flow (vph)	0	0	0	0	711	270	0	872	0	0	0	0
Turn Type					NA	Perm	Perm	NA				
Protected Phases					8			2				
Permitted Phases						8		2				
Minimum Split (s)					22.8	22.8	22.5	22.5				
Total Split (s)					43.0	43.0	27.0	27.0				
Total Split (%)					57.3%	57.3%	36.0%	36.0%				
Yellow Time (s)					3.3	3.3	3.3	3.3				
All-Red Time (s)					2.5	2.5	2.5	2.5				
Lost Time Adjust (s)					0.0	0.0		0.0				
Total Lost Time (s)					5.8	5.8		5.8				
Lead/Lag												
Lead-Lag Optimize?												
Act Effct Green (s)					37.2	37.2		21.2				
Actuated g/C Ratio					0.50	0.50		0.28				
v/c Ratio					0.45	0.45		0.61				
Control Delay					7.5	8.6		23.5				
Queue Delay					0.0	0.0		0.0				
Total Delay					7.5	8.6		23.5				
LOS					A	A		C				
Approach Delay					7.8			23.5				
Approach LOS					A			C				
Queue Length 50th (m)					20.4	15.4		35.7				
Queue Length 95th (m)					m25.8	m20.6		48.1				
Internal Link Dist (m)		30.7			131.7			67.4			53.0	
Turn Bay Length (m)												
Base Capacity (vph)					1577	597		1422				
Starvation Cap Reductn					0	0		0				
Spillback Cap Reductn					0	0		0				
Storage Cap Reductn					0	0		0				
Reduced v/c Ratio					0.45	0.45		0.61				

Intersection Summary

Cycle Length: 75
 Actuated Cycle Length: 75
 Offset: 12 (16%), Referenced to phase 8:WBT, Start of Green
 Natural Cycle: 55
 Control Type: Pretimed
 Maximum v/c Ratio: 0.61
 Intersection Signal Delay: 15.2
 Intersection LOS: B
 Intersection Capacity Utilization 53.4%
 ICU Level of Service A
 Analysis Period (min) 15
 m Volume for 95th percentile queue is metered by upstream signal.

Splits and Phases: 2: Hwy 417 EB Off Ramp/Chamberlain Ave/Kent St & Catherine St

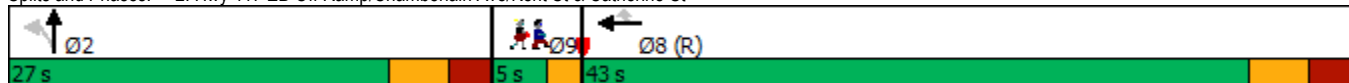

Lanes, Volumes, Timings

2: Hwy 417 EB Off Ramp/Chamberlain Ave/Kent St & Catherine St

05/18/2023

Lane Group	Ø9
Lane Configurations	
Traffic Volume (vph)	
Future Volume (vph)	
Satd. Flow (prot)	
Fit Permitted	
Satd. Flow (perm)	
Satd. Flow (RTOR)	
Lane Group Flow (vph)	
Turn Type	
Protected Phases	9
Permitted Phases	
Minimum Split (s)	5.0
Total Split (s)	5.0
Total Split (%)	7%
Yellow Time (s)	2.0
All-Red Time (s)	0.0
Lost Time Adjust (s)	
Total Lost Time (s)	
Lead/Lag	
Lead-Lag Optimize?	
Act Effct Green (s)	
Actuated g/C Ratio	
v/c Ratio	
Control Delay	
Queue Delay	
Total Delay	
LOS	
Approach Delay	
Approach LOS	
Queue Length 50th (m)	
Queue Length 95th (m)	
Internal Link Dist (m)	
Turn Bay Length (m)	
Base Capacity (vph)	
Starvation Cap Reductn	
Spillback Cap Reductn	
Storage Cap Reductn	
Reduced v/c Ratio	
Intersection Summary	

Lanes, Volumes, Timings
3: Bank St & Catherine St

05/18/2023



Lane Group	EBL	EBT	EBR	WBL	WBT	WBR	NBL	NBT	NBR	SBL	SBT	SBR
Lane Configurations					↕↕↕			↕↕			↕↕	
Traffic Volume (vph)	0	0	0	236	620	158	196	329	0	0	695	138
Future Volume (vph)	0	0	0	236	620	158	196	329	0	0	695	138
Satd. Flow (prot)	0	0	0	0	4604	0	0	3261	0	0	3098	0
Fit Permitted					0.988			0.536				
Satd. Flow (perm)	0	0	0	0	4522	0	0	1747	0	0	3098	0
Satd. Flow (RTOR)					47			33				
Lane Group Flow (vph)	0	0	0	0	1014	0	0	525	0	0	833	0
Turn Type				Perm	NA		pm+pt	NA			NA	
Protected Phases					8		9	2			6	
Permitted Phases				8			2					
Minimum Split (s)				18.6	18.6		10.4	16.4			16.4	
Total Split (s)				24.0	24.0		10.4	41.0			30.6	
Total Split (%)				32.0%	32.0%		13.9%	54.7%			40.8%	
Yellow Time (s)				3.3	3.3		3.3	3.3			3.3	
All-Red Time (s)				2.3	2.3		2.1	2.1			2.1	
Lost Time Adjust (s)					0.0			0.0			0.0	
Total Lost Time (s)					5.6			5.4			5.4	
Lead/Lag				Lag	Lag		Lag	Lag			Lag	
Lead-Lag Optimize?				Yes	Yes		Yes	Yes			Yes	
Act Effct Green (s)					18.4			35.6			25.2	
Actuated g/C Ratio					0.25			0.47			0.34	
v/c Ratio					0.89			0.56			0.78	
Control Delay					37.2			13.4			27.9	
Queue Delay					0.0			0.0			0.5	
Total Delay					37.2			13.4			28.4	
LOS					D			B			C	
Approach Delay					37.2			13.4			28.4	
Approach LOS					D			B			C	
Queue Length 50th (m)					48.5			15.5			52.9	
Queue Length 95th (m)					#71.4			20.3			74.1	
Internal Link Dist (m)		131.7			201.7			90.2			52.9	
Turn Bay Length (m)												
Base Capacity (vph)					1144			930			1062	
Starvation Cap Reductn					0			0			0	
Spillback Cap Reductn					0			0			45	
Storage Cap Reductn					0			0			0	
Reduced v/c Ratio					0.89			0.56			0.82	

Intersection Summary

Cycle Length: 75
 Actuated Cycle Length: 75
 Offset: 50 (67%), Referenced to phase 2:NBT and 6:SBT, Start of Green
 Natural Cycle: 70
 Control Type: Pretimed
 Maximum v/c Ratio: 0.89
 Intersection Signal Delay: 28.8 Intersection LOS: C
 Intersection Capacity Utilization 79.7% ICU Level of Service D
 Analysis Period (min) 15

95th percentile volume exceeds capacity, queue may be longer.
 Queue shown is maximum after two cycles.

Splits and Phases: 3: Bank St & Catherine St

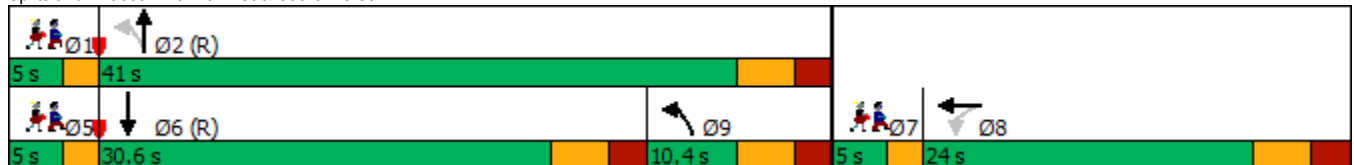

Lanes, Volumes, Timings
 3: Bank St & Catherine St

05/18/2023

Lane Group	Ø1	Ø5	Ø7
Lane Configurations			
Traffic Volume (vph)			
Future Volume (vph)			
Satd. Flow (prot)			
Fit Permitted			
Satd. Flow (perm)			
Satd. Flow (RTOR)			
Lane Group Flow (vph)			
Turn Type			
Protected Phases	1	5	7
Permitted Phases			
Minimum Split (s)	5.0	5.0	5.0
Total Split (s)	5.0	5.0	5.0
Total Split (%)	7%	7%	7%
Yellow Time (s)	2.0	2.0	2.0
All-Red Time (s)	0.0	0.0	0.0
Lost Time Adjust (s)			
Total Lost Time (s)			
Lead/Lag	Lead	Lead	Lead
Lead-Lag Optimize?	Yes	Yes	Yes
Act Effct Green (s)			
Actuated g/C Ratio			
v/c Ratio			
Control Delay			
Queue Delay			
Total Delay			
LOS			
Approach Delay			
Approach LOS			
Queue Length 50th (m)			
Queue Length 95th (m)			
Internal Link Dist (m)			
Turn Bay Length (m)			
Base Capacity (vph)			
Starvation Cap Reductn			
Spillback Cap Reductn			
Storage Cap Reductn			
Reduced v/c Ratio			
Intersection Summary			

Lanes, Volumes, Timings
4: Percy St & Catherine St

05/18/2023



Lane Group	EBL	EBT	EBR	WBL	WBT	WBR	NBL	NBT	NBR	SBL	SBT	SBR
Lane Configurations					↑↑↑						↓	
Traffic Volume (vph)	0	0	0	160	704	0	0	0	0	0	121	39
Future Volume (vph)	0	0	0	160	704	0	0	0	0	0	121	39
Satd. Flow (prot)	0	0	0	0	4819	0	0	0	0	0	1727	0
Fit Permitted					0.991							
Satd. Flow (perm)	0	0	0	0	4799	0	0	0	0	0	1727	0
Satd. Flow (RTOR)					160							
Lane Group Flow (vph)	0	0	0	0	864	0	0	0	0	0	160	0
Turn Type				Perm	NA						NA	
Protected Phases					8						6	
Permitted Phases				8								
Detector Phase				8	8						6	
Switch Phase												
Minimum Initial (s)				10.0	10.0						10.0	
Minimum Split (s)				26.5	26.5						23.4	
Total Split (s)				41.0	41.0						36.2	
Total Split (%)				45.6%	45.6%						40.2%	
Yellow Time (s)				3.3	3.3						3.3	
All-Red Time (s)				2.2	2.2						2.1	
Lost Time Adjust (s)					0.0						0.0	
Total Lost Time (s)					5.5						5.4	
Lead/Lag				Lag	Lag							
Lead-Lag Optimize?				Yes	Yes							
Recall Mode				None	None						Max	
Act Effct Green (s)					16.3						30.9	
Actuated g/C Ratio					0.28						0.53	
v/c Ratio					0.59						0.17	
Control Delay					16.1						8.6	
Queue Delay					0.0						0.0	
Total Delay					16.1						8.6	
LOS					B						A	
Approach Delay					16.1						8.6	
Approach LOS					B						A	
Queue Length 50th (m)					22.8						7.9	
Queue Length 95th (m)					32.8						19.2	
Internal Link Dist (m)		71.6			271.6			106.7			288.0	
Turn Bay Length (m)												
Base Capacity (vph)					3002						917	
Starvation Cap Reductn					0						0	
Spillback Cap Reductn					0						0	
Storage Cap Reductn					0						0	
Reduced v/c Ratio					0.29						0.17	

Intersection Summary
 Cycle Length: 90
 Actuated Cycle Length: 58.2
 Natural Cycle: 65
 Control Type: Semi Act-Uncoord
 Maximum v/c Ratio: 0.59
 Intersection Signal Delay: 14.9
 Intersection Capacity Utilization 44.0%
 Analysis Period (min) 15
 Intersection LOS: B
 ICU Level of Service A

Splits and Phases: 4: Percy St & Catherine St

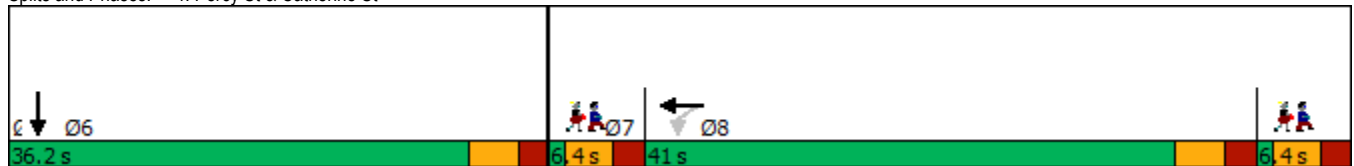

Lanes, Volumes, Timings
 4: Percy St & Catherine St

05/18/2023

Lane Group	Ø3	Ø7
Lane Configurations		
Traffic Volume (vph)		
Future Volume (vph)		
Satd. Flow (prot)		
Fit Permitted		
Satd. Flow (perm)		
Satd. Flow (RTOR)		
Lane Group Flow (vph)		
Turn Type		
Protected Phases	3	7
Permitted Phases		
Detector Phase		
Switch Phase		
Minimum Initial (s)	1.0	1.0
Minimum Split (s)	6.4	6.4
Total Split (s)	6.4	6.4
Total Split (%)	7%	7%
Yellow Time (s)	3.3	3.3
All-Red Time (s)	2.1	2.1
Lost Time Adjust (s)		
Total Lost Time (s)		
Lead/Lag		Lead
Lead-Lag Optimize?		Yes
Recall Mode	None	None
Act Effct Green (s)		
Actuated g/C Ratio		
v/c Ratio		
Control Delay		
Queue Delay		
Total Delay		
LOS		
Approach Delay		
Approach LOS		
Queue Length 50th (m)		
Queue Length 95th (m)		
Internal Link Dist (m)		
Turn Bay Length (m)		
Base Capacity (vph)		
Starvation Cap Reductn		
Spillback Cap Reductn		
Storage Cap Reductn		
Reduced v/c Ratio		
Intersection Summary		

Lanes, Volumes, Timings
6: Kent St & Arlington Ave

05/18/2023



Lane Group	EBL	EBT	EBR	WBL	WBT	WBR	NBL	NBT	NBR	SBL	SBT	SBR
Lane Configurations		↕			↕			↕↕↕				
Traffic Volume (vph)	12	66	0	0	18	63	22	1047	93	0	0	0
Future Volume (vph)	12	66	0	0	18	63	22	1047	93	0	0	0
Satd. Flow (prot)	0	1805	0	0	1561	0	0	4824	0	0	0	0
Fit Permitted		0.964						0.999				
Satd. Flow (perm)	0	1745	0	0	1561	0	0	4822	0	0	0	0
Satd. Flow (RTOR)					58			28				
Lane Group Flow (vph)	0	78	0	0	81	0	0	1162	0	0	0	0
Turn Type	Perm	NA			NA		Perm	NA				
Protected Phases		4			8			2				
Permitted Phases	4						2					
Minimum Split (s)	27.3	27.3			27.3		32.3	32.3				
Total Split (s)	31.0	31.0			31.0		44.0	44.0				
Total Split (%)	41.3%	41.3%			41.3%		58.7%	58.7%				
Yellow Time (s)	3.3	3.3			3.3		3.3	3.3				
All-Red Time (s)	2.0	2.0			2.0		2.0	2.0				
Lost Time Adjust (s)		0.0			0.0			0.0				
Total Lost Time (s)		5.3			5.3			5.3				
Lead/Lag												
Lead-Lag Optimize?												
Act Effct Green (s)		25.7			25.7			38.7				
Actuated g/C Ratio		0.34			0.34			0.52				
v/c Ratio		0.13			0.14			0.46				
Control Delay		27.5			8.2			5.5				
Queue Delay		0.0			0.0			0.2				
Total Delay		27.5			8.2			5.7				
LOS		C			A			A				
Approach Delay		27.5			8.2			5.7				
Approach LOS		C			A			A				
Queue Length 50th (m)		9.9			1.1			15.4				
Queue Length 95th (m)		m20.2			m5.1			18.6				
Internal Link Dist (m)		164.0			143.1			53.0			216.0	
Turn Bay Length (m)												
Base Capacity (vph)		597			573			2501				
Starvation Cap Reductn		0			0			486				
Spillback Cap Reductn		0			0			0				
Storage Cap Reductn		0			0			0				
Reduced v/c Ratio		0.13			0.14			0.58				

Intersection Summary
 Cycle Length: 75
 Actuated Cycle Length: 75
 Offset: 50 (67%), Referenced to phase 2:NBT, Start of Green
 Natural Cycle: 60
 Control Type: Pretimed
 Maximum v/c Ratio: 0.46
 Intersection Signal Delay: 7.1
 Intersection LOS: A
 Intersection Capacity Utilization 53.7%
 ICU Level of Service A
 Analysis Period (min) 15
 m Volume for 95th percentile queue is metered by upstream signal.

Splits and Phases: 6: Kent St & Arlington Ave

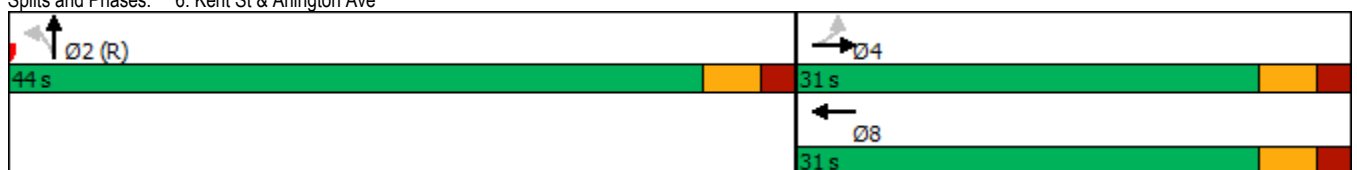

Lanes, Volumes, Timings
7: Lyon St N & Gladstone Ave

05/18/2023



Lane Group	EBL	EBT	EBR	WBL	WBT	WBR	NBL	NBT	NBR	SBL	SBT	SBR
Lane Configurations		↑	↗	↖	↑						↕	↕
Traffic Volume (vph)	0	247	52	28	314	0	0	0	0	86	515	138
Future Volume (vph)	0	247	52	28	314	0	0	0	0	86	515	138
Satd. Flow (prot)	0	1784	1547	1729	1784	0	0	0	0	0	3257	0
Fit Permitted				0.574							0.994	
Satd. Flow (perm)	0	1784	1407	997	1784	0	0	0	0	0	3243	0
Satd. Flow (RTOR)			52								46	
Lane Group Flow (vph)	0	247	52	28	314	0	0	0	0	0	739	0
Turn Type		NA	Perm	Perm	NA					Perm	NA	
Protected Phases		4			8							6
Permitted Phases			4	8						6		
Minimum Split (s)		17.2	17.2	17.2	17.2					22.6	22.6	
Total Split (s)		37.0	37.0	37.0	37.0					38.0	38.0	
Total Split (%)		49.3%	49.3%	49.3%	49.3%					50.7%	50.7%	
Yellow Time (s)		3.3	3.3	3.3	3.3					3.3	3.3	
All-Red Time (s)		1.9	1.9	1.9	1.9					2.3	2.3	
Lost Time Adjust (s)		0.0	0.0	0.0	0.0						0.0	
Total Lost Time (s)		5.2	5.2	5.2	5.2						5.6	
Lead/Lag												
Lead-Lag Optimize?												
Act Effct Green (s)		31.8	31.8	31.8	31.8						32.4	
Actuated g/C Ratio		0.42	0.42	0.42	0.42						0.43	
v/c Ratio		0.33	0.08	0.07	0.42						0.52	
Control Delay		16.0	4.5	7.7	12.0						16.1	
Queue Delay		0.0	0.0	0.0	0.0						0.0	
Total Delay		16.0	4.5	7.7	12.0						16.1	
LOS		B	A	A	B						B	
Approach Delay		14.0			11.7						16.1	
Approach LOS		B			B						B	
Queue Length 50th (m)		22.6	0.0	1.5	35.5						36.1	
Queue Length 95th (m)		38.4	5.7	m3.3	55.1						51.1	
Internal Link Dist (m)		254.8			165.0			215.6			214.3	
Turn Bay Length (m)				25.0								
Base Capacity (vph)		756	626	422	756						1427	
Starvation Cap Reductn		0	0	0	0						0	
Spillback Cap Reductn		0	0	0	0						0	
Storage Cap Reductn		0	0	0	0						0	
Reduced v/c Ratio		0.33	0.08	0.07	0.42						0.52	

Intersection Summary

Cycle Length: 75
 Actuated Cycle Length: 75
 Offset: 45 (60%), Referenced to phase 4:EBT and 8:WBTL, Start of Green
 Natural Cycle: 40
 Control Type: Pretimed
 Maximum v/c Ratio: 0.52
 Intersection Signal Delay: 14.6
 Intersection Capacity Utilization 67.2%
 Analysis Period (min) 15
 Intersection LOS: B
 ICU Level of Service C
 m Volume for 95th percentile queue is metered by upstream signal.

Splits and Phases: 7: Lyon St N & Gladstone Ave

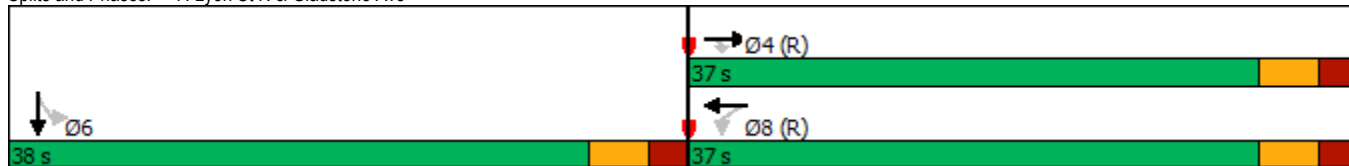

Lanes, Volumes, Timings
8: Kent St & Gladstone Ave

05/18/2023



Lane Group	EBL	EBT	EBR	WBL	WBT	WBR	NBL	NBT	NBR	SBL	SBT	SBR
Lane Configurations												
Traffic Volume (vph)	75	450	0	0	324	75	67	895	131	0	0	0
Future Volume (vph)	75	450	0	0	324	75	67	895	131	0	0	0
Satd. Flow (prot)	1729	1767	0	0	1720	0	1729	4619	0	0	0	0
Fit Permitted	0.453						0.950					
Satd. Flow (perm)	800	1767	0	0	1720	0	1522	4619	0	0	0	0
Satd. Flow (RTOR)					22			40				
Lane Group Flow (vph)	75	450	0	0	399	0	67	1026	0	0	0	0
Turn Type	Perm	NA			NA		Perm	NA				
Protected Phases		4			8			2				
Permitted Phases	4						2					
Minimum Split (s)	21.4	21.4			21.4		20.4	20.4				
Total Split (s)	43.0	43.0			43.0		32.0	32.0				
Total Split (%)	57.3%	57.3%			57.3%		42.7%	42.7%				
Yellow Time (s)	3.3	3.3			3.3		3.3	3.3				
All-Red Time (s)	2.1	2.1			2.1		2.1	2.1				
Lost Time Adjust (s)	0.0	0.0			0.0		0.0	0.0				
Total Lost Time (s)	5.4	5.4			5.4		5.4	5.4				
Lead/Lag												
Lead-Lag Optimize?												
Act Effct Green (s)	37.6	37.6			37.6		26.6	26.6				
Actuated g/C Ratio	0.50	0.50			0.50		0.35	0.35				
v/c Ratio	0.19	0.51			0.46		0.12	0.62				
Control Delay	18.0	21.5			13.5		5.4	5.9				
Queue Delay	0.0	0.0			0.0		0.0	0.0				
Total Delay	18.0	21.5			13.5		5.4	5.9				
LOS	B	C			B		A	A				
Approach Delay		21.0			13.5			5.9				
Approach LOS		C			B			A				
Queue Length 50th (m)	6.6	49.7			32.2		1.4	6.1				
Queue Length 95th (m)	m16.2	79.0			53.1		3.4	9.1				
Internal Link Dist (m)		165.0			168.8			216.0			203.6	
Turn Bay Length (m)	30.0						40.0					
Base Capacity (vph)	401	885			873		539	1664				
Starvation Cap Reductn	0	0			0		0	0				
Spillback Cap Reductn	0	0			0		0	0				
Storage Cap Reductn	0	0			0		0	0				
Reduced v/c Ratio	0.19	0.51			0.46		0.12	0.62				

Intersection Summary

Cycle Length: 75
 Actuated Cycle Length: 75
 Offset: 23 (31%), Referenced to phase 4:EBTL and 8:WBT, Start of Green
 Natural Cycle: 45
 Control Type: Pretimed
 Maximum v/c Ratio: 0.62
 Intersection Signal Delay: 11.3
 Intersection Capacity Utilization 67.2%
 Analysis Period (min) 15
 m Volume for 95th percentile queue is metered by upstream signal.

Intersection LOS: B
 ICU Level of Service C

Splits and Phases: 8: Kent St & Gladstone Ave

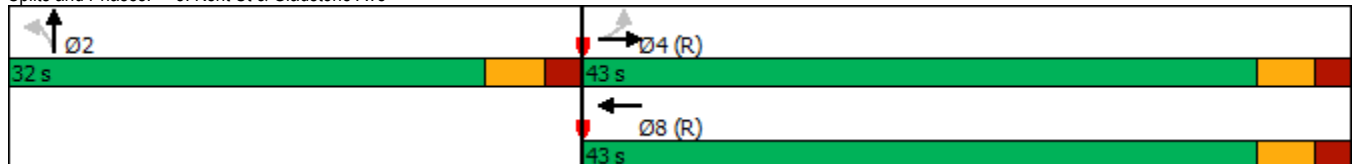

Lanes, Volumes, Timings
 9: Bank St & Chamberlain Ave/Isabella St

05/18/2023



Lane Group	EBL	EBT	EBR	WBL	WBT	WBR	NBL	NBT	NBR	SBL	SBT	SBR
Lane Configurations		↕↕	↗					↕↕			↕↕	
Traffic Volume (vph)	59	605	121	0	0	0	0	455	93	180	725	0
Future Volume (vph)	59	605	121	0	0	0	0	455	93	180	725	0
Satd. Flow (prot)	0	3347	1547	0	0	0	0	3135	0	0	3324	0
Fit Permitted		0.996									0.720	
Satd. Flow (perm)	0	3343	1403	0	0	0	0	3135	0	0	2368	0
Satd. Flow (RTOR)			134					38				
Lane Group Flow (vph)	0	664	121	0	0	0	0	548	0	0	905	0
Turn Type	Perm	NA	Perm					NA		pm+pt	NA	
Protected Phases		4						2		5	6	
Permitted Phases	4		4							6		
Detector Phase	4	4	4					2		5	6	
Switch Phase												
Minimum Initial (s)	10.0	10.0	10.0					10.0		5.0	10.0	
Minimum Split (s)	26.2	26.2	26.2					23.1		11.1	23.1	
Total Split (s)	28.0	28.0	28.0					35.9		11.1	47.0	
Total Split (%)	37.3%	37.3%	37.3%					47.9%		14.8%	62.7%	
Yellow Time (s)	3.3	3.3	3.3					3.0		3.0	3.0	
All-Red Time (s)	2.9	2.9	2.9					3.1		3.1	3.1	
Lost Time Adjust (s)		0.0	0.0					0.0			0.0	
Total Lost Time (s)		6.2	6.2					6.1			6.1	
Lead/Lag												
Lead-Lag Optimize?												
Recall Mode	None	None	None					C-Max		None	C-Max	
Act Effct Green (s)		20.0	20.0					42.7			42.7	
Actuated g/C Ratio		0.27	0.27					0.57			0.57	
v/c Ratio		0.75	0.26					0.30			0.67	
Control Delay		30.7	5.0					8.7			12.5	
Queue Delay		0.0	0.0					0.0			1.3	
Total Delay		30.7	5.0					8.7			13.8	
LOS		C	A					A			B	
Approach Delay		26.7						8.7			13.8	
Approach LOS		C						A			B	
Queue Length 50th (m)		43.7	0.0					18.7			71.0	
Queue Length 95th (m)		60.8	9.3					28.0			m90.9	
Internal Link Dist (m)		296.0			233.4			215.6			90.2	
Turn Bay Length (m)			40.0									
Base Capacity (vph)		971	502					1801			1348	
Starvation Cap Reductn		0	0					0			241	
Spillback Cap Reductn		0	0					0			0	
Storage Cap Reductn		0	0					0			0	
Reduced v/c Ratio		0.68	0.24					0.30			0.82	

Intersection Summary
 Cycle Length: 75
 Actuated Cycle Length: 75
 Offset: 60 (80%), Referenced to phase 2:NBT and 6:SBTL, Start of Green
 Natural Cycle: 65
 Control Type: Actuated-Coordinated
 Maximum v/c Ratio: 0.75
 Intersection Signal Delay: 17.1
 Intersection LOS: B
 Intersection Capacity Utilization 82.5%
 ICU Level of Service E
 Analysis Period (min) 15
 m Volume for 95th percentile queue is metered by upstream signal.

Splits and Phases: 9: Bank St & Chamberlain Ave/Isabella St

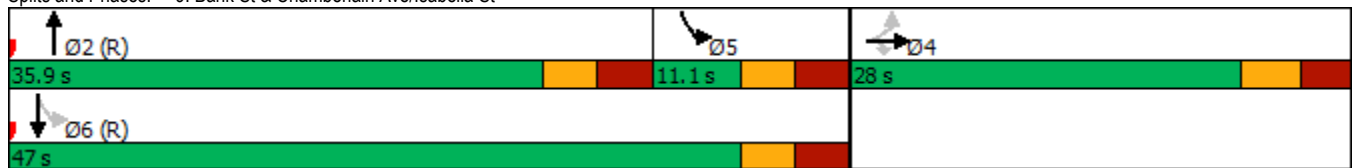

Lanes, Volumes, Timings
13: Bronson Ave & Catherine St

05/18/2023



Lane Group	EBL	EBT	EBR	WBL	WBT	WBR	NBL	NBT	NBR	SBL	SBT	SBR
Lane Configurations				↖ ↗	↖ ↗		↖ ↗	↖ ↗			↖ ↗	
Traffic Volume (vph)	0	0	0	705	582	279	296	773	0	0	813	167
Future Volume (vph)	0	0	0	705	582	279	296	773	0	0	813	167
Satd. Flow (prot)	0	0	0	1458	4273	0	1679	3390	0	0	3261	0
Fit Permitted				0.950	0.987		0.105					
Satd. Flow (perm)	0	0	0	1458	4273	0	186	3390	0	0	3261	0
Satd. Flow (RTOR)					81						26	
Lane Group Flow (vph)	0	0	0	395	1171	0	296	773	0	0	980	0
Turn Type				Perm	NA		pm+pt	NA			NA	
Protected Phases					8		5	2			6	
Permitted Phases				8			2					
Minimum Split (s)				28.3	28.3		11.2	23.8			23.8	
Total Split (s)				37.0	37.0		22.0	63.0			41.0	
Total Split (%)				37.0%	37.0%		22.0%	63.0%			41.0%	
Yellow Time (s)				3.3	3.3		3.3	3.3			3.3	
All-Red Time (s)				3.0	3.0		2.9	3.5			3.5	
Lost Time Adjust (s)				0.0	0.0		0.0	0.0			0.0	
Total Lost Time (s)				6.3	6.3		6.2	6.8			6.8	
Lead/Lag							Lead				Lag	
Lead-Lag Optimize?							Yes				Yes	
Act Effct Green (s)				30.7	30.7		56.8	56.2			34.2	
Actuated g/C Ratio				0.31	0.31		0.57	0.56			0.34	
v/c Ratio				0.88	0.86		0.87	0.41			0.87	
Control Delay				56.0	37.8		49.0	13.2			39.5	
Queue Delay				0.0	0.0		0.0	0.0			0.0	
Total Delay				56.0	37.8		49.0	13.2			39.5	
LOS				E	D		D	B			D	
Approach Delay					42.4			23.1			39.5	
Approach LOS					D			C			D	
Queue Length 50th (m)				84.1	77.2		39.8	42.0			90.4	
Queue Length 95th (m)				#145.3	96.3		#85.2	54.7			#124.9	
Internal Link Dist (m)		141.5			120.8			240.1			287.4	
Turn Bay Length (m)				80.0			45.0					
Base Capacity (vph)				447	1367		341	1905			1132	
Starvation Cap Reductn				0	0		0	0			0	
Spillback Cap Reductn				0	0		0	0			0	
Storage Cap Reductn				0	0		0	0			0	
Reduced v/c Ratio				0.88	0.86		0.87	0.41			0.87	

Intersection Summary
 Cycle Length: 100
 Actuated Cycle Length: 100
 Offset: 60 (60%), Referenced to phase 2:NBT and 6:SBT, Start of Green
 Natural Cycle: 75
 Control Type: Pretimed
 Maximum v/c Ratio: 0.88
 Intersection Signal Delay: 35.9
 Intersection LOS: D
 Intersection Capacity Utilization 88.9%
 ICU Level of Service E
 Analysis Period (min) 15
 # 95th percentile volume exceeds capacity, queue may be longer.
 Queue shown is maximum after two cycles.

Splits and Phases: 13: Bronson Ave & Catherine St

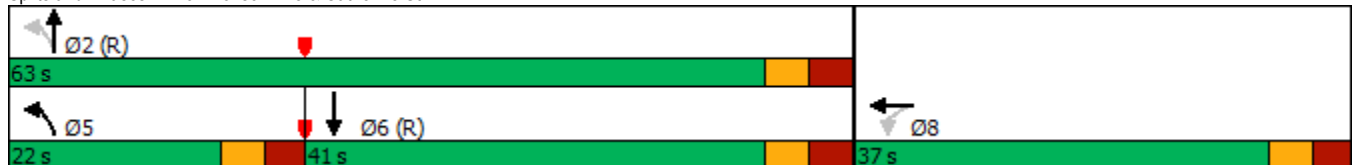

Intersection												
Int Delay, s/veh	2.1											
Movement	EBL	EBT	EBR	WBL	WBT	WBR	NBL	NBT	NBR	SBL	SBT	SBR
Lane Configurations		↕			↕						↕↔	
Traffic Vol, veh/h	0	19	2	8	37	0	0	0	0	48	572	13
Future Vol, veh/h	0	19	2	8	37	0	0	0	0	48	572	13
Conflicting Peds, #/hr	20	0	8	8	0	20	19	0	3	3	0	19
Sign Control	Stop	Stop	Stop	Stop	Stop	Stop	Free	Free	Free	Free	Free	Free
RT Channelized	-	-	None	-	-	None	-	-	None	-	-	None
Storage Length	-	-	-	-	-	-	-	-	-	-	-	-
Veh in Median Storage, #	-	0	-	-	0	-	-	-	-	-	0	-
Grade, %	-	0	-	-	0	-	-	0	-	-	0	-
Peak Hour Factor	100	100	100	100	100	100	100	100	100	100	100	100
Heavy Vehicles, %	0	5	0	0	5	0	0	0	0	0	0	0
Mvmt Flow	0	19	2	8	37	0	0	0	0	48	572	13

Major/Minor	Minor2		Minor1			Major2			
Conflicting Flow All	-	697	320	403	703	-	3	0	0
Stage 1	-	694	-	3	3	-	-	-	-
Stage 2	-	3	-	400	700	-	-	-	-
Critical Hdwy	-	6.6	6.9	7.5	6.6	-	4.1	-	-
Critical Hdwy Stg 1	-	5.6	-	-	-	-	-	-	-
Critical Hdwy Stg 2	-	-	-	6.5	5.6	-	-	-	-
Follow-up Hdwy	-	4.05	3.3	3.5	4.05	-	2.2	-	-
Pot Cap-1 Maneuver	0	357	682	537	354	0	1632	-	-
Stage 1	0	435	-	-	0	-	-	-	-
Stage 2	0	-	-	603	432	0	-	-	-
Platoon blocked, %	-	-	-	-	-	-	-	-	-
Mov Cap-1 Maneuver	-	334	670	494	331	-	1627	-	-
Mov Cap-2 Maneuver	-	334	-	494	331	-	-	-	-
Stage 1	-	408	-	-	-	-	-	-	-
Stage 2	-	-	-	548	406	-	-	-	-

Approach	EB		WB			SB		
HCM Control Delay, s	15.9		16.7			0.6		
HCM LOS	C		C					

Minor Lane/Major Mvmt	EBLn1	WBLn1	SBL	SBT	SBR
Capacity (veh/h)	351	352	1627	-	-
HCM Lane V/C Ratio	0.06	0.128	0.03	-	-
HCM Control Delay (s)	15.9	16.7	7.3	0.1	-
HCM Lane LOS	C	C	A	A	-
HCM 95th %tile Q(veh)	0.2	0.4	0.1	-	-

Intersection						
Int Delay, s/veh	0.4					
Movement	EBL	EBT	WBT	WBR	SBL	SBR
Lane Configurations			↑↑↑			↑
Traffic Vol, veh/h	0	0	631	32	0	24
Future Vol, veh/h	0	0	631	32	0	24
Conflicting Peds, #/hr	0	0	0	0	0	0
Sign Control	Free	Free	Free	Free	Stop	Stop
RT Channelized	-	None	-	None	-	None
Storage Length	-	-	-	-	-	0
Veh in Median Storage, #	-	1572864	0	-	0	-
Grade, %	-	0	0	-	0	-
Peak Hour Factor	100	100	100	100	100	100
Heavy Vehicles, %	2	2	2	2	2	2
Mvmt Flow	0	0	631	32	0	24
Major/Minor	Major2		Minor2			
Conflicting Flow All	-	0	-	332		
Stage 1	-	-	-	-		
Stage 2	-	-	-	-		
Critical Hdwy	-	-	-	7.14		
Critical Hdwy Stg 1	-	-	-	-		
Critical Hdwy Stg 2	-	-	-	-		
Follow-up Hdwy	-	-	-	3.92		
Pot Cap-1 Maneuver	-	-	0	566		
Stage 1	-	-	0	-		
Stage 2	-	-	0	-		
Platoon blocked, %	-	-	-	-		
Mov Cap-1 Maneuver	-	-	-	566		
Mov Cap-2 Maneuver	-	-	-	-		
Stage 1	-	-	-	-		
Stage 2	-	-	-	-		
Approach	WB		SB			
HCM Control Delay, s	0		11.6			
HCM LOS			B			
Minor Lane/Major Mvmt	WBT	WBR	SBLn1			
Capacity (veh/h)	-	-	566			
HCM Lane V/C Ratio	-	-	0.042			
HCM Control Delay (s)	-	-	11.6			
HCM Lane LOS	-	-	B			
HCM 95th %tile Q(veh)	-	-	0.1			

Intersection						
Int Delay, s/veh	2.2					
Movement	EBL	EBR	NBL	NBT	SBT	SBR
Lane Configurations	↔			↕↕	↕↕	
Traffic Vol, veh/h	20	112	58	429	722	27
Future Vol, veh/h	20	112	58	429	722	27
Conflicting Peds, #/hr	0	0	42	0	0	42
Sign Control	Stop	Stop	Free	Free	Free	Free
RT Channelized	-	None	-	None	-	None
Storage Length	0	-	-	-	-	-
Veh in Median Storage, #	0	-	-	0	0	-
Grade, %	0	-	-	0	0	-
Peak Hour Factor	100	100	100	100	100	100
Heavy Vehicles, %	0	1	0	5	3	0
Mvmt Flow	20	112	58	429	722	27

Major/Minor	Minor2	Major1	Major2			
Conflicting Flow All	1109	417	791	0	-	0
Stage 1	778	-	-	-	-	-
Stage 2	331	-	-	-	-	-
Critical Hdwy	6.8	6.92	4.1	-	-	-
Critical Hdwy Stg 1	5.8	-	-	-	-	-
Critical Hdwy Stg 2	5.8	-	-	-	-	-
Follow-up Hdwy	3.5	3.31	2.2	-	-	-
Pot Cap-1 Maneuver	207	587	838	-	-	-
Stage 1	419	-	-	-	-	-
Stage 2	706	-	-	-	-	-
Platoon blocked, %				-	-	-
Mov Cap-1 Maneuver	173	564	805	-	-	-
Mov Cap-2 Maneuver	173	-	-	-	-	-
Stage 1	365	-	-	-	-	-
Stage 2	678	-	-	-	-	-

Approach	EB	NB	SB
HCM Control Delay, s	17.5	1.5	0
HCM LOS	C		

Minor Lane/Major Mvmt	NBL	NBT	EBLn1	SBT	SBR
Capacity (veh/h)	805	-	420	-	-
HCM Lane V/C Ratio	0.072	-	0.314	-	-
HCM Control Delay (s)	9.8	0.4	17.5	-	-
HCM Lane LOS	A	A	C	-	-
HCM 95th %tile Q(veh)	0.2	-	1.3	-	-

Lanes, Volumes, Timings

1: Hwy 417 WB On Ramp/Lyon St N & Catherine St

05/18/2023



Lane Group	EBL	EBT	EBR	WBL	WBT	WBR	NBL	NBT	NBR	SBL	SBT	SBR
Lane Configurations					↕↕						↕	↕
Traffic Volume (vph)	0	0	0	267	266	0	0	0	0	0	281	128
Future Volume (vph)	0	0	0	267	266	0	0	0	0	0	281	128
Satd. Flow (prot)	0	0	0	0	3184	0	0	0	0	0	1784	1547
Fit Permitted					0.976							
Satd. Flow (perm)	0	0	0	0	3161	0	0	0	0	0	1784	1517
Satd. Flow (RTOR)					267							128
Lane Group Flow (vph)	0	0	0	0	533	0	0	0	0	0	281	128
Turn Type				Perm	NA						NA	Perm
Protected Phases					8						6	
Permitted Phases				8								6
Minimum Split (s)				26.2	26.2						28.3	28.3
Total Split (s)				40.0	40.0						35.0	35.0
Total Split (%)				53.3%	53.3%						46.7%	46.7%
Yellow Time (s)				3.3	3.3						3.3	3.3
All-Red Time (s)				1.9	1.9						2.0	2.0
Lost Time Adjust (s)					0.0						0.0	0.0
Total Lost Time (s)					5.2						5.3	5.3
Lead/Lag												
Lead-Lag Optimize?												
Act Effct Green (s)					34.8						29.7	29.7
Actuated g/C Ratio					0.46						0.40	0.40
v/c Ratio					0.33						0.40	0.19
Control Delay					16.7						16.5	6.2
Queue Delay					0.0						0.0	0.0
Total Delay					16.7						16.5	6.2
LOS					B						B	A
Approach Delay					16.7						13.3	
Approach LOS					B						B	
Queue Length 50th (m)					28.5						33.9	2.6
Queue Length 95th (m)					m40.6						56.1	17.3
Internal Link Dist (m)		271.6			107.6			117.8			52.8	
Turn Bay Length (m)												
Base Capacity (vph)					1609						706	678
Starvation Cap Reductn					0						0	0
Spillback Cap Reductn					0						0	0
Storage Cap Reductn					0						0	0
Reduced v/c Ratio					0.33						0.40	0.19

Intersection Summary

Cycle Length: 75
 Actuated Cycle Length: 75
 Offset: 48 (64%), Referenced to phase 8:WBTL, Start of Green
 Natural Cycle: 55
 Control Type: Pretimed
 Maximum v/c Ratio: 0.40
 Intersection Signal Delay: 15.2 Intersection LOS: B
 Intersection Capacity Utilization 50.2% ICU Level of Service A
 Analysis Period (min) 15
 m Volume for 95th percentile queue is metered by upstream signal.

Splits and Phases: 1: Hwy 417 WB On Ramp/Lyon St N & Catherine St

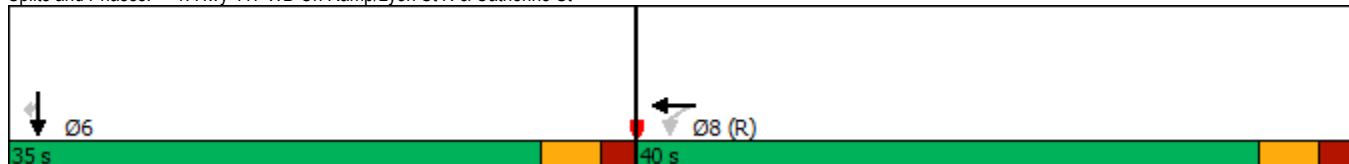

Lanes, Volumes, Timings

2: Hwy 417 EB Off Ramp/Chamberlain Ave/Kent St & Catherine St

05/18/2023



Lane Group	EBL	EBT	EBR	WBL	WBT	WBR	NBL	NBT	NBR	SBL	SBT	SBR
Lane Configurations					↑↑	↑↑		↑↑↑				
Traffic Volume (vph)	0	0	0	0	441	565	68	1396	0	0	0	0
Future Volume (vph)	0	0	0	0	441	565	68	1396	0	0	0	0
Satd. Flow (prot)	0	0	0	0	3262	2696	0	4912	0	0	0	0
Fit Permitted								0.998				
Satd. Flow (perm)	0	0	0	0	3262	2696	0	4905	0	0	0	0
Satd. Flow (RTOR)								70				
Lane Group Flow (vph)	0	0	0	0	441	565	0	1464	0	0	0	0
Turn Type					NA	Prot	Perm	NA				
Protected Phases					8	8		2				
Permitted Phases							2					
Detector Phase					8	8	2	2				
Switch Phase												
Minimum Initial (s)					10.0	10.0	10.0	10.0				
Minimum Split (s)					15.8	15.8	22.5	22.5				
Total Split (s)					30.0	30.0	32.0	32.0				
Total Split (%)					40.0%	40.0%	42.7%	42.7%				
Yellow Time (s)					3.3	3.3	3.3	3.3				
All-Red Time (s)					2.5	2.5	2.5	2.5				
Lost Time Adjust (s)					0.0	0.0		0.0				
Total Lost Time (s)					5.8	5.8		5.8				
Lead/Lag												
Lead-Lag Optimize?												
Recall Mode					C-Max	C-Max	Max	Max				
Act Effct Green (s)					29.4	29.4		26.2				
Actuated g/C Ratio					0.39	0.39		0.35				
v/c Ratio					0.35	0.54		0.83				
Control Delay					16.1	18.5		26.5				
Queue Delay					0.0	0.0		50.6				
Total Delay					16.1	18.5		77.1				
LOS					B	B		E				
Approach Delay					17.5			77.1				
Approach LOS					B			E				
Queue Length 50th (m)					26.8	37.2		65.3				
Queue Length 95th (m)					m33.6	m48.9		82.8				
Internal Link Dist (m)		32.2			131.7			67.4			53.0	
Turn Bay Length (m)						60.0						
Base Capacity (vph)					1278	1056		1759				
Starvation Cap Reductn					0	0		0				
Spillback Cap Reductn					0	0		1033				
Storage Cap Reductn					0	0		0				
Reduced v/c Ratio					0.35	0.54		2.02				

Intersection Summary

Cycle Length: 75
 Actuated Cycle Length: 75
 Offset: 0 (0%), Referenced to phase 8:WBT, Start of Green
 Natural Cycle: 60
 Control Type: Actuated-Coordinated
 Maximum v/c Ratio: 0.83
 Intersection Signal Delay: 52.8
 Intersection Capacity Utilization 63.8%
 Analysis Period (min) 15
 Intersection LOS: D
 ICU Level of Service B
 m Volume for 95th percentile queue is metered by upstream signal.

Splits and Phases: 2: Hwy 417 EB Off Ramp/Chamberlain Ave/Kent St & Catherine St

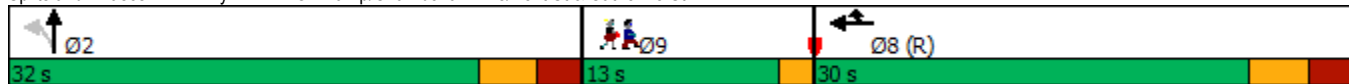

Lanes, Volumes, Timings

2: Hwy 417 EB Off Ramp/Chamberlain Ave/Kent St & Catherine St

05/18/2023

Lane Group	Ø9
Lane Configurations	
Traffic Volume (vph)	
Future Volume (vph)	
Satd. Flow (prot)	
Fit Permitted	
Satd. Flow (perm)	
Satd. Flow (RTOR)	
Lane Group Flow (vph)	
Turn Type	
Protected Phases	9
Permitted Phases	
Detector Phase	
Switch Phase	
Minimum Initial (s)	1.0
Minimum Split (s)	13.0
Total Split (s)	13.0
Total Split (%)	17%
Yellow Time (s)	2.0
All-Red Time (s)	0.0
Lost Time Adjust (s)	
Total Lost Time (s)	
Lead/Lag	
Lead-Lag Optimize?	
Recall Mode	None
Act Effct Green (s)	
Actuated g/C Ratio	
v/c Ratio	
Control Delay	
Queue Delay	
Total Delay	
LOS	
Approach Delay	
Approach LOS	
Queue Length 50th (m)	
Queue Length 95th (m)	
Internal Link Dist (m)	
Turn Bay Length (m)	
Base Capacity (vph)	
Starvation Cap Reductn	
Spillback Cap Reductn	
Storage Cap Reductn	
Reduced v/c Ratio	
Intersection Summary	

Lanes, Volumes, Timings
3: Bank St & Catherine St

05/18/2023



Lane Group	EBL	EBT	EBR	WBL	WBT	WBR	NBL	NBT	NBR	SBL	SBT	SBR
Lane Configurations					↕↕↕			↕↕			↕↕	
Traffic Volume (vph)	0	0	0	176	628	202	277	581	0	0	401	143
Future Volume (vph)	0	0	0	176	628	202	277	581	0	0	401	143
Satd. Flow (prot)	0	0	0	0	4438	0	0	3211	0	0	2869	0
Fit Permitted					0.991			0.618				
Satd. Flow (perm)	0	0	0	0	4383	0	0	1951	0	0	2869	0
Satd. Flow (RTOR)					79						65	
Lane Group Flow (vph)	0	0	0	0	1006	0	0	858	0	0	544	0
Turn Type				Perm	NA		pm+pt	NA			NA	
Protected Phases					8		9	2			6	
Permitted Phases				8			2					
Minimum Split (s)				18.6	18.6		10.4	16.4			16.4	
Total Split (s)				25.0	25.0		15.0	40.0			25.0	
Total Split (%)				33.3%	33.3%		20.0%	53.3%			33.3%	
Yellow Time (s)				3.3	3.3		3.3	3.3			3.3	
All-Red Time (s)				2.3	2.3		2.1	2.1			2.1	
Lost Time Adjust (s)					0.0			0.0			0.0	
Total Lost Time (s)					5.6			5.4			5.4	
Lead/Lag				Lag	Lag		Lag	Lag			Lag	
Lead-Lag Optimize?				Yes	Yes		Yes	Yes			Yes	
Act Effct Green (s)					19.4			34.6			19.6	
Actuated g/C Ratio					0.26			0.46			0.26	
v/c Ratio					0.84			0.81			0.68	
Control Delay					32.3			17.8			26.9	
Queue Delay					0.0			0.0			0.0	
Total Delay					32.3			17.8			26.9	
LOS					C			B			C	
Approach Delay					32.3			17.8			26.9	
Approach LOS					C			B			C	
Queue Length 50th (m)					45.6			22.7			31.9	
Queue Length 95th (m)					#66.3			#34.6			48.2	
Internal Link Dist (m)		131.7			201.7			90.2			52.9	
Turn Bay Length (m)												
Base Capacity (vph)					1192			1061			797	
Starvation Cap Reductn					0			0			0	
Spillback Cap Reductn					0			0			0	
Storage Cap Reductn					0			0			0	
Reduced v/c Ratio					0.84			0.81			0.68	

Intersection Summary
 Cycle Length: 75
 Actuated Cycle Length: 75
 Offset: 70 (93%), Referenced to phase 2:NBT and 6:SBT, Start of Green
 Natural Cycle: 70
 Control Type: Pretimed
 Maximum v/c Ratio: 0.84
 Intersection Signal Delay: 25.9
 Intersection LOS: C
 Intersection Capacity Utilization 81.9%
 ICU Level of Service D
 Analysis Period (min) 15
 # 95th percentile volume exceeds capacity, queue may be longer.
 Queue shown is maximum after two cycles.

Splits and Phases: 3: Bank St & Catherine St

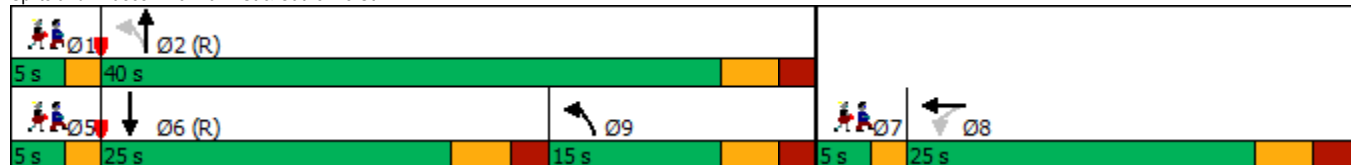

Lanes, Volumes, Timings
 3: Bank St & Catherine St

05/18/2023

Lane Group	Ø1	Ø5	Ø7
Lane Configurations			
Traffic Volume (vph)			
Future Volume (vph)			
Satd. Flow (prot)			
Fit Permitted			
Satd. Flow (perm)			
Satd. Flow (RTOR)			
Lane Group Flow (vph)			
Turn Type			
Protected Phases	1	5	7
Permitted Phases			
Minimum Split (s)	5.0	5.0	5.0
Total Split (s)	5.0	5.0	5.0
Total Split (%)	7%	7%	7%
Yellow Time (s)	2.0	2.0	2.0
All-Red Time (s)	0.0	0.0	0.0
Lost Time Adjust (s)			
Total Lost Time (s)			
Lead/Lag	Lead	Lead	Lead
Lead-Lag Optimize?	Yes	Yes	Yes
Act Effct Green (s)			
Actuated g/C Ratio			
v/c Ratio			
Control Delay			
Queue Delay			
Total Delay			
LOS			
Approach Delay			
Approach LOS			
Queue Length 50th (m)			
Queue Length 95th (m)			
Internal Link Dist (m)			
Turn Bay Length (m)			
Base Capacity (vph)			
Starvation Cap Reductn			
Spillback Cap Reductn			
Storage Cap Reductn			
Reduced v/c Ratio			
Intersection Summary			

Lanes, Volumes, Timings
4: Percy St & Catherine St

05/18/2023



Lane Group	EBL	EBT	EBR	WBL	WBT	WBR	NBL	NBT	NBR	SBL	SBT	SBR
Lane Configurations					↕↕						↕	
Traffic Volume (vph)	0	0	0	90	262	0	0	0	0	0	129	57
Future Volume (vph)	0	0	0	90	262	0	0	0	0	0	129	57
Satd. Flow (prot)	0	0	0	0	3168	0	0	0	0	0	1644	0
Fit Permitted					0.987							
Satd. Flow (perm)	0	0	0	0	3146	0	0	0	0	0	1644	0
Satd. Flow (RTOR)					160							
Lane Group Flow (vph)	0	0	0	0	352	0	0	0	0	0	186	0
Turn Type				Perm	NA							NA
Protected Phases					8							6
Permitted Phases				8								
Detector Phase				8	8							6
Switch Phase												
Minimum Initial (s)				10.0	10.0							10.0
Minimum Split (s)				26.5	26.5							23.4
Total Split (s)				34.0	34.0							24.0
Total Split (%)				37.8%	37.8%							26.7%
Yellow Time (s)				3.3	3.3							3.3
All-Red Time (s)				2.2	2.2							2.1
Lost Time Adjust (s)					0.0							0.0
Total Lost Time (s)					5.5							5.4
Lead/Lag				Lag	Lag							
Lead-Lag Optimize?				Yes	Yes							
Recall Mode				None	None							Max
Act Effct Green (s)					11.9							18.8
Actuated g/C Ratio					0.29							0.45
v/c Ratio					0.35							0.25
Control Delay					7.2							9.4
Queue Delay					0.0							0.0
Total Delay					7.2							9.4
LOS					A							A
Approach Delay					7.2							9.4
Approach LOS					A							A
Queue Length 50th (m)					5.3							6.6
Queue Length 95th (m)					11.6							23.3
Internal Link Dist (m)		106.8			271.6			106.7				288.0
Turn Bay Length (m)												
Base Capacity (vph)					2220							740
Starvation Cap Reductn					0							0
Spillback Cap Reductn					0							0
Storage Cap Reductn					0							0
Reduced v/c Ratio					0.16							0.25

Intersection Summary
 Cycle Length: 90
 Actuated Cycle Length: 41.7
 Natural Cycle: 65
 Control Type: Semi Act-Uncoord
 Maximum v/c Ratio: 0.35
 Intersection Signal Delay: 7.9
 Intersection Capacity Utilization 39.5%
 Analysis Period (min) 15
 Intersection LOS: A
 ICU Level of Service A

Splits and Phases: 4: Percy St & Catherine St

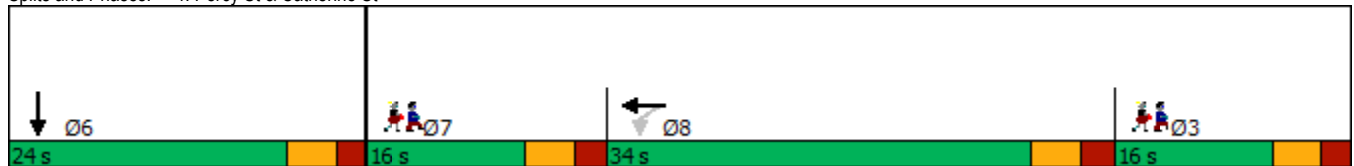

Lanes, Volumes, Timings
 4: Percy St & Catherine St

05/18/2023

Lane Group	Ø3	Ø7
Lane Configurations		
Traffic Volume (vph)		
Future Volume (vph)		
Satd. Flow (prot)		
Fit Permitted		
Satd. Flow (perm)		
Satd. Flow (RTOR)		
Lane Group Flow (vph)		
Turn Type		
Protected Phases	3	7
Permitted Phases		
Detector Phase		
Switch Phase		
Minimum Initial (s)	1.0	1.0
Minimum Split (s)	6.4	6.4
Total Split (s)	16.0	16.0
Total Split (%)	18%	18%
Yellow Time (s)	3.3	3.3
All-Red Time (s)	2.1	2.1
Lost Time Adjust (s)		
Total Lost Time (s)		
Lead/Lag		Lead
Lead-Lag Optimize?		Yes
Recall Mode	None	None
Act Effct Green (s)		
Actuated g/C Ratio		
v/c Ratio		
Control Delay		
Queue Delay		
Total Delay		
LOS		
Approach Delay		
Approach LOS		
Queue Length 50th (m)		
Queue Length 95th (m)		
Internal Link Dist (m)		
Turn Bay Length (m)		
Base Capacity (vph)		
Starvation Cap Reductn		
Spillback Cap Reductn		
Storage Cap Reductn		
Reduced v/c Ratio		
Intersection Summary		

Lanes, Volumes, Timings
6: Kent St & Arlington Ave

05/18/2023



Lane Group	EBL	EBT	EBR	WBL	WBT	WBR	NBL	NBT	NBR	SBL	SBT	SBR
Lane Configurations		↕			↕			↕↕↕				
Traffic Volume (vph)	38	80	0	0	17	93	25	1783	131	0	0	0
Future Volume (vph)	38	80	0	0	17	93	25	1783	131	0	0	0
Satd. Flow (prot)	0	1744	0	0	1557	0	0	4790	0	0	0	0
Fit Permitted		0.887						0.999				
Satd. Flow (perm)	0	1564	0	0	1557	0	0	4788	0	0	0	0
Satd. Flow (RTOR)					11			24				
Lane Group Flow (vph)	0	118	0	0	110	0	0	1939	0	0	0	0
Turn Type	Perm	NA			NA		Perm	NA				
Protected Phases		4			8			2				
Permitted Phases	4						2					
Minimum Split (s)	27.3	27.3			27.3		32.3	32.3				
Total Split (s)	28.0	28.0			28.0		47.0	47.0				
Total Split (%)	37.3%	37.3%			37.3%		62.7%	62.7%				
Yellow Time (s)	3.3	3.3			3.3		3.3	3.3				
All-Red Time (s)	2.0	2.0			2.0		2.0	2.0				
Lost Time Adjust (s)		0.0			0.0			0.0				
Total Lost Time (s)		5.3			5.3			5.3				
Lead/Lag												
Lead-Lag Optimize?												
Act Effct Green (s)		22.7			22.7			41.7				
Actuated g/C Ratio		0.30			0.30			0.56				
v/c Ratio		0.25			0.23			0.73				
Control Delay		17.3			18.4			15.9				
Queue Delay		0.0			0.0			48.7				
Total Delay		17.3			18.4			64.6				
LOS		B			B			E				
Approach Delay		17.3			18.4			64.6				
Approach LOS		B			B			E				
Queue Length 50th (m)		12.3			7.8			87.4				
Queue Length 95th (m)		24.2			m12.4			106.8				
Internal Link Dist (m)		138.7			143.1			53.0			216.0	
Turn Bay Length (m)												
Base Capacity (vph)		473			478			2672				
Starvation Cap Reductn		0			0			1394				
Spillback Cap Reductn		0			0			0				
Storage Cap Reductn		0			0			0				
Reduced v/c Ratio		0.25			0.23			1.52				

Intersection Summary
 Cycle Length: 75
 Actuated Cycle Length: 75
 Offset: 50 (67%), Referenced to phase 2:NBT, Start of Green
 Natural Cycle: 60
 Control Type: Pretimed
 Maximum v/c Ratio: 0.73
 Intersection Signal Delay: 59.7
 Intersection Capacity Utilization 69.6%
 Analysis Period (min) 15
 m Volume for 95th percentile queue is metered by upstream signal.

Splits and Phases: 6: Kent St & Arlington Ave

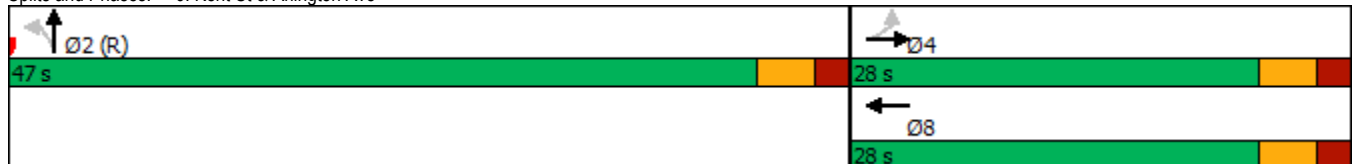

Lanes, Volumes, Timings
7: Lyon St N & Gladstone Ave

05/18/2023



Lane Group	EBL	EBT	EBR	WBL	WBT	WBR	NBL	NBT	NBR	SBL	SBT	SBR
Lane Configurations		↑	↗	↖	↑						↕	
Traffic Volume (vph)	0	184	24	15	143	0	0	0	0	89	344	98
Future Volume (vph)	0	184	24	15	143	0	0	0	0	89	344	98
Satd. Flow (prot)	0	1733	1547	1729	1750	0	0	0	0	0	3249	0
Fit Permitted				0.641							0.992	
Satd. Flow (perm)	0	1733	1485	1146	1750	0	0	0	0	0	3225	0
Satd. Flow (RTOR)			38								45	
Lane Group Flow (vph)	0	184	24	15	143	0	0	0	0	0	531	0
Turn Type		NA	Perm	Perm	NA					Perm	NA	
Protected Phases		4			8							6
Permitted Phases			4	8						6		
Minimum Split (s)		17.2	17.2	17.2	17.2					22.6	22.6	
Total Split (s)		38.0	38.0	38.0	38.0					37.0	37.0	
Total Split (%)		50.7%	50.7%	50.7%	50.7%					49.3%	49.3%	
Yellow Time (s)		3.3	3.3	3.3	3.3					3.3	3.3	
All-Red Time (s)		1.9	1.9	1.9	1.9					2.3	2.3	
Lost Time Adjust (s)		0.0	0.0	0.0	0.0						0.0	
Total Lost Time (s)		5.2	5.2	5.2	5.2						5.6	
Lead/Lag												
Lead-Lag Optimize?												
Act Effct Green (s)		32.8	32.8	32.8	32.8						31.4	
Actuated g/C Ratio		0.44	0.44	0.44	0.44						0.42	
v/c Ratio		0.24	0.04	0.03	0.19						0.39	
Control Delay		14.4	3.0	22.0	25.0						14.7	
Queue Delay		0.0	0.0	0.0	0.0						0.0	
Total Delay		14.4	3.0	22.0	25.0						14.7	
LOS		B	A	C	C						B	
Approach Delay		13.1			24.7						14.7	
Approach LOS		B			C						B	
Queue Length 50th (m)		15.8	0.0	2.0	19.4						23.9	
Queue Length 95th (m)		28.3	2.7	m3.9	m32.8						35.6	
Internal Link Dist (m)		254.8			165.0			215.6			214.3	
Turn Bay Length (m)				25.0								
Base Capacity (vph)		757	670	501	765						1376	
Starvation Cap Reductn		0	0	0	0						0	
Spillback Cap Reductn		0	0	0	0						0	
Storage Cap Reductn		0	0	0	0						0	
Reduced v/c Ratio		0.24	0.04	0.03	0.19						0.39	

Intersection Summary
 Cycle Length: 75
 Actuated Cycle Length: 75
 Offset: 10 (13%), Referenced to phase 4:EBT and 8:WBTL, Start of Green
 Natural Cycle: 40
 Control Type: Pretimed
 Maximum v/c Ratio: 0.39
 Intersection Signal Delay: 16.1
 Intersection Capacity Utilization 81.5%
 Analysis Period (min) 15
 m Volume for 95th percentile queue is metered by upstream signal.

Splits and Phases: 7: Lyon St N & Gladstone Ave

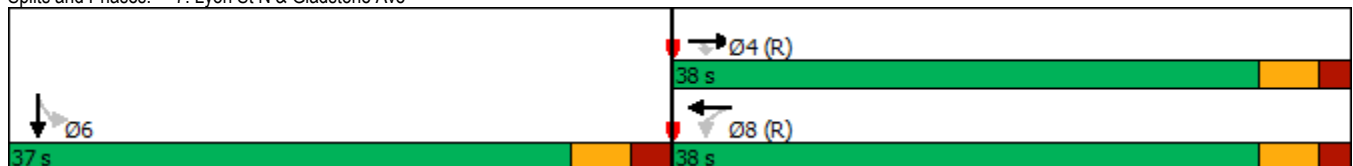

Lanes, Volumes, Timings
8: Kent St & Gladstone Ave

05/18/2023



Lane Group	EBL	EBT	EBR	WBL	WBT	WBR	NBL	NBT	NBR	SBL	SBT	SBR
Lane Configurations												
Traffic Volume (vph)	82	277	0	0	165	148	36	1785	97	0	0	0
Future Volume (vph)	82	277	0	0	165	148	36	1785	97	0	0	0
Satd. Flow (prot)	1662	1717	0	0	1552	0	1729	4792	0	0	0	0
Fit Permitted	0.449						0.950					
Satd. Flow (perm)	751	1717	0	0	1552	0	1444	4792	0	0	0	0
Satd. Flow (RTOR)					8			17				
Lane Group Flow (vph)	82	277	0	0	313	0	36	1882	0	0	0	0
Turn Type	Perm	NA			NA		Perm	NA				
Protected Phases		4			8			2				
Permitted Phases	4						2					
Minimum Split (s)	21.4	21.4			21.4		20.4	20.4				
Total Split (s)	30.0	30.0			30.0		45.0	45.0				
Total Split (%)	40.0%	40.0%			40.0%		60.0%	60.0%				
Yellow Time (s)	3.3	3.3			3.3		3.3	3.3				
All-Red Time (s)	2.1	2.1			2.1		2.1	2.1				
Lost Time Adjust (s)	0.0	0.0			0.0		0.0	0.0				
Total Lost Time (s)	5.4	5.4			5.4		5.4	5.4				
Lead/Lag												
Lead-Lag Optimize?												
Act Effct Green (s)	24.6	24.6			24.6		39.6	39.6				
Actuated g/C Ratio	0.33	0.33			0.33		0.53	0.53				
v/c Ratio	0.33	0.49			0.61		0.05	0.74				
Control Delay	24.4	24.7			26.6		3.2	5.1				
Queue Delay	0.0	0.0			0.0		0.0	0.0				
Total Delay	24.4	24.7			26.6		3.2	5.1				
LOS	C	C			C		A	A				
Approach Delay		24.6			26.6			5.0				
Approach LOS		C			C			A				
Queue Length 50th (m)	10.2	35.8			35.7		0.7	13.8				
Queue Length 95th (m)	22.9	58.6			60.9		m1.0	13.8				
Internal Link Dist (m)		165.0			168.8			216.0			203.6	
Turn Bay Length (m)	30.0						40.0					
Base Capacity (vph)	246	563			514		762	2538				
Starvation Cap Reductn	0	0			0		0	0				
Spillback Cap Reductn	0	0			0		0	0				
Storage Cap Reductn	0	0			0		0	0				
Reduced v/c Ratio	0.33	0.49			0.61		0.05	0.74				

Intersection Summary

Cycle Length: 75
 Actuated Cycle Length: 75
 Offset: 36 (48%), Referenced to phase 4:EBTL and 8:WBT, Start of Green
 Natural Cycle: 55
 Control Type: Pretimed
 Maximum v/c Ratio: 0.74
 Intersection Signal Delay: 10.4
 Intersection Capacity Utilization 81.5%
 Analysis Period (min) 15
 m Volume for 95th percentile queue is metered by upstream signal.

Intersection LOS: B
 ICU Level of Service D

Splits and Phases: 8: Kent St & Gladstone Ave

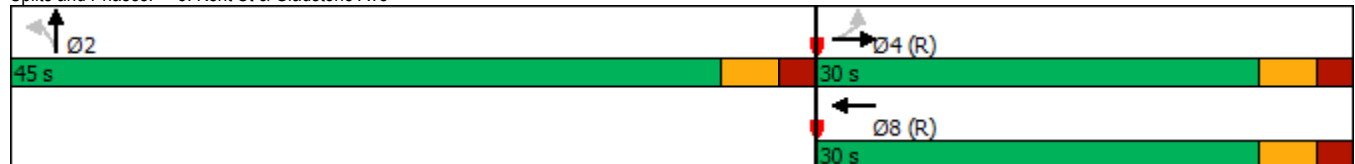

Lanes, Volumes, Timings
 9: Bank St & Chamberlain Ave/Isabella St

05/18/2023



Lane Group	EBL	EBT	EBR	WBL	WBT	WBR	NBL	NBT	NBR	SBL	SBT	SBR
Lane Configurations		↕↕	↗					↕↕			↕↕	
Traffic Volume (vph)	81	520	81	0	0	0	0	844	143	189	395	0
Future Volume (vph)	81	520	81	0	0	0	0	844	143	189	395	0
Satd. Flow (prot)	0	3225	1446	0	0	0	0	3154	0	0	3220	0
Fit Permitted		0.993									0.541	
Satd. Flow (perm)	0	3218	1358	0	0	0	0	3154	0	0	1755	0
Satd. Flow (RTOR)			134									
Lane Group Flow (vph)	0	601	81	0	0	0	0	987	0	0	584	0
Turn Type	Perm	NA	Perm					NA		pm+pt	NA	
Protected Phases		4						2		5	6	
Permitted Phases	4		4							6		
Detector Phase	4	4	4					2		5	6	
Switch Phase												
Minimum Initial (s)	10.0	10.0	10.0					10.0		5.0	10.0	
Minimum Split (s)	26.2	26.2	26.2					23.1		11.1	23.1	
Total Split (s)	29.0	29.0	29.0					31.0		15.0	46.0	
Total Split (%)	38.7%	38.7%	38.7%					41.3%		20.0%	61.3%	
Yellow Time (s)	3.3	3.3	3.3					3.0		3.0	3.0	
All-Red Time (s)	2.9	2.9	2.9					3.1		3.1	3.1	
Lost Time Adjust (s)		0.0	0.0					0.0			0.0	
Total Lost Time (s)		6.2	6.2					6.1			6.1	
Lead/Lag												
Lead-Lag Optimize?												
Recall Mode	None	None	None					C-Max		None	C-Max	
Act Effct Green (s)		19.7	19.7					43.0			43.0	
Actuated g/C Ratio		0.26	0.26					0.57			0.57	
v/c Ratio		0.71	0.18					0.55			0.58	
Control Delay		29.8	2.1					12.0			11.3	
Queue Delay		0.0	0.0					0.0			0.0	
Total Delay		29.8	2.1					12.0			11.3	
LOS		C	A					B			B	
Approach Delay		26.5						12.0			11.3	
Approach LOS		C						B			B	
Queue Length 50th (m)		39.6	0.0					43.1			16.2	
Queue Length 95th (m)		54.0	3.2					63.5			m61.3	
Internal Link Dist (m)		296.0			233.4			215.6			90.2	
Turn Bay Length (m)			40.0									
Base Capacity (vph)		978	506					1808			1006	
Starvation Cap Reductn		0	0					0			0	
Spillback Cap Reductn		0	0					0			0	
Storage Cap Reductn		0	0					0			0	
Reduced v/c Ratio		0.61	0.16					0.55			0.58	

Intersection Summary
 Cycle Length: 75
 Actuated Cycle Length: 75
 Offset: 1 (1%), Referenced to phase 2:NBT and 6:SBTL, Start of Green
 Natural Cycle: 65
 Control Type: Actuated-Coordinated
 Maximum v/c Ratio: 0.71
 Intersection Signal Delay: 16.2
 Intersection Capacity Utilization 84.0%
 Analysis Period (min) 15
 Intersection LOS: B
 ICU Level of Service E
 m Volume for 95th percentile queue is metered by upstream signal.

Splits and Phases: 9: Bank St & Chamberlain Ave/Isabella St

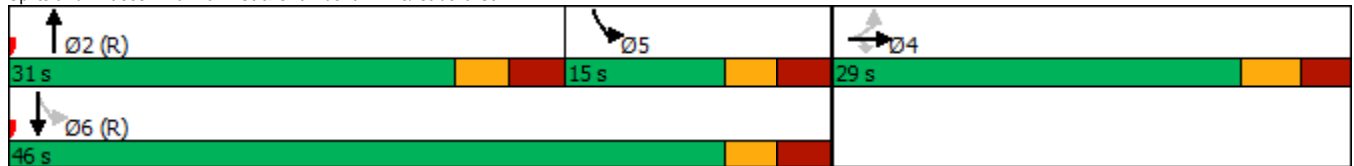

Lanes, Volumes, Timings
13: Bronson Ave & Catherine St

05/18/2023



Lane Group	EBL	EBT	EBR	WBL	WBT	WBR	NBL	NBT	NBR	SBL	SBT	SBR
Lane Configurations				↖ ↗ ↘	↖ ↗ ↘		↖ ↗	↖ ↗			↖ ↗	↖ ↗
Traffic Volume (vph)	0	0	0	525	498	366	540	1080	0	0	445	123
Future Volume (vph)	0	0	0	525	498	366	540	1080	0	0	445	123
Satd. Flow (prot)	0	0	0	1430	4136	0	1712	3390	0	0	3087	0
Fit Permitted				0.950	0.992		0.230					
Satd. Flow (perm)	0	0	0	1430	4136	0	410	3390	0	0	3087	0
Satd. Flow (RTOR)					82						29	
Lane Group Flow (vph)	0	0	0	352	1037	0	540	1080	0	0	568	0
Turn Type				Perm	NA		pm+pt	NA			NA	
Protected Phases					8		5	7			2	6
Permitted Phases				8			2					
Minimum Split (s)				28.3	28.3			23.8			23.8	
Total Split (s)				37.0	37.0			73.0			29.2	
Total Split (%)				33.6%	33.6%			66.4%			26.5%	
Yellow Time (s)				3.3	3.3			3.3			3.3	
All-Red Time (s)				3.0	3.0			3.5			3.5	
Lost Time Adjust (s)				0.0	0.0			0.0			0.0	
Total Lost Time (s)				6.3	6.3			6.8			6.8	
Lead/Lag												Lag
Lead-Lag Optimize?												Yes
Act Effct Green (s)				30.7	30.7		66.8	66.2			22.4	
Actuated g/C Ratio				0.28	0.28		0.61	0.60			0.20	
v/c Ratio				0.88	0.85		0.87	0.53			0.87	
Control Delay				62.5	42.7		31.5	14.0			55.8	
Queue Delay				0.0	0.0		0.0	0.0			0.0	
Total Delay				62.5	42.7		31.5	14.0			55.8	
LOS				E	D		C	B			E	
Approach Delay					47.7			19.8			55.8	
Approach LOS					D			B			E	
Queue Length 50th (m)				84.0	75.9		62.1	66.5			59.6	
Queue Length 95th (m)				#143.9	94.6		#115.2	83.1			#88.6	
Internal Link Dist (m)		141.5			120.8			240.1			287.4	
Turn Bay Length (m)				80.0			45.0					
Base Capacity (vph)				399	1213		620	2040			651	
Starvation Cap Reductn				0	0		0	0			0	
Spillback Cap Reductn				0	0		0	0			0	
Storage Cap Reductn				0	0		0	0			0	
Reduced v/c Ratio				0.88	0.85		0.87	0.53			0.87	

Intersection Summary
 Cycle Length: 110
 Actuated Cycle Length: 110
 Offset: 38 (35%), Referenced to phase 2:NBT and 6:SBT, Start of Green
 Natural Cycle: 90
 Control Type: Pretimed
 Maximum v/c Ratio: 0.88
 Intersection Signal Delay: 36.3
 Intersection LOS: D
 Intersection Capacity Utilization 88.8%
 ICU Level of Service E
 Analysis Period (min) 15
 # 95th percentile volume exceeds capacity, queue may be longer.
 Queue shown is maximum after two cycles.

Splits and Phases: 13: Bronson Ave & Catherine St



Lanes, Volumes, Timings
 13: Bronson Ave & Catherine St

05/18/2023

Lane Group	Ø5	Ø7
Lane Configurations		
Traffic Volume (vph)		
Future Volume (vph)		
Satd. Flow (prot)		
Fit Permitted		
Satd. Flow (perm)		
Satd. Flow (RTOR)		
Lane Group Flow (vph)		
Turn Type		
Protected Phases	5	7
Permitted Phases		
Minimum Split (s)	11.2	11.8
Total Split (s)	32.0	11.8
Total Split (%)	29%	11%
Yellow Time (s)	3.3	3.3
All-Red Time (s)	2.9	3.5
Lost Time Adjust (s)		
Total Lost Time (s)		
Lead/Lag	Lead	
Lead-Lag Optimize?	Yes	
Act Effct Green (s)		
Actuated g/C Ratio		
v/c Ratio		
Control Delay		
Queue Delay		
Total Delay		
LOS		
Approach Delay		
Approach LOS		
Queue Length 50th (m)		
Queue Length 95th (m)		
Internal Link Dist (m)		
Turn Bay Length (m)		
Base Capacity (vph)		
Starvation Cap Reductn		
Spillback Cap Reductn		
Storage Cap Reductn		
Reduced v/c Ratio		
Intersection Summary		

Intersection												
Int Delay, s/veh	2.5											
Movement	EBL	EBT	EBR	WBL	WBT	WBR	NBL	NBT	NBR	SBL	SBT	SBR
Lane Configurations		↕			↕						↕↕	
Traffic Vol, veh/h	0	18	0	24	12	0	0	0	0	53	337	9
Future Vol, veh/h	0	18	0	24	12	0	0	0	0	53	337	9
Conflicting Peds, #/hr	32	0	15	15	0	32	9	0	10	10	0	9
Sign Control	Stop	Stop	Stop	Stop	Stop	Stop	Free	Free	Free	Free	Free	Free
RT Channelized	-	-	None	-	-	None	-	-	None	-	-	None
Storage Length	-	-	-	-	-	-	-	-	-	-	-	-
Veh in Median Storage, #	-	0	-	-	0	-	-	-	-	-	0	-
Grade, %	-	0	-	-	0	-	-	0	-	-	0	-
Peak Hour Factor	100	100	100	100	100	100	100	100	100	100	100	100
Heavy Vehicles, %	0	6	0	9	0	0	0	0	0	5	1	11
Mvmt Flow	0	18	0	24	12	0	0	0	0	53	337	9

Major/Minor	Minor2			Minor1			Major2				
Conflicting Flow All	-	467	197	309	471	-	-	-	10	0	0
Stage 1	-	457	-	10	10	-	-	-	-	-	-
Stage 2	-	10	-	299	461	-	-	-	-	-	-
Critical Hdwy	-	6.62	6.9	7.68	6.5	-	-	-	4.2	-	-
Critical Hdwy Stg 1	-	5.62	-	-	-	-	-	-	-	-	-
Critical Hdwy Stg 2	-	-	-	6.68	5.5	-	-	-	-	-	-
Follow-up Hdwy	-	4.06	3.3	3.59	4	-	-	-	2.25	-	-
Pot Cap-1 Maneuver	0	483	817	603	494	0	-	-	1586	-	-
Stage 1	0	556	-	-	-	0	-	-	-	-	-
Stage 2	0	-	-	666	569	0	-	-	-	-	-
Platoon blocked, %	-	-	-	-	-	-	-	-	-	-	-
Mov Cap-1 Maneuver	-	455	810	561	465	-	-	-	1571	-	-
Mov Cap-2 Maneuver	-	455	-	561	465	-	-	-	-	-	-
Stage 1	-	528	-	-	-	-	-	-	-	-	-
Stage 2	-	-	-	616	541	-	-	-	-	-	-

Approach	EB			WB			SB		
HCM Control Delay, s	13.2			12.4			1.1		
HCM LOS	B			B					

Minor Lane/Major Mvmt	EBLn1	WBLn1	SBL	SBT	SBR
Capacity (veh/h)	455	525	1571	-	-
HCM Lane V/C Ratio	0.04	0.069	0.034	-	-
HCM Control Delay (s)	13.2	12.4	7.4	0.1	-
HCM Lane LOS	B	B	A	A	-
HCM 95th %tile Q(veh)	0.1	0.2	0.1	-	-

Intersection						
Int Delay, s/veh	1.1					
Movement	EBL	EBT	WBT	WBR	SBL	SBR
Lane Configurations			↑↑			↗
Traffic Vol, veh/h	0	0	468	37	0	63
Future Vol, veh/h	0	0	468	37	0	63
Conflicting Peds, #/hr	0	0	0	0	0	0
Sign Control	Free	Free	Free	Free	Stop	Stop
RT Channelized	-	None	-	None	-	None
Storage Length	-	-	-	-	-	0
Veh in Median Storage, #	-4128768		0	-	0	-
Grade, %	-	0	0	-	0	-
Peak Hour Factor	100	100	100	100	100	100
Heavy Vehicles, %	2	2	2	2	2	2
Mvmt Flow	0	0	468	37	0	63
Major/Minor	Major2		Minor2			
Conflicting Flow All			-	0	-	253
Stage 1			-	-	-	-
Stage 2			-	-	-	-
Critical Hdwy			-	-	-	6.94
Critical Hdwy Stg 1			-	-	-	-
Critical Hdwy Stg 2			-	-	-	-
Follow-up Hdwy			-	-	-	3.32
Pot Cap-1 Maneuver			-	-	0	746
Stage 1			-	-	0	-
Stage 2			-	-	0	-
Platoon blocked, %			-	-	-	-
Mov Cap-1 Maneuver			-	-	-	746
Mov Cap-2 Maneuver			-	-	-	-
Stage 1			-	-	-	-
Stage 2			-	-	-	-
Approach	WB		SB			
HCM Control Delay, s			0		10.3	
HCM LOS					B	
Minor Lane/Major Mvmt	WBT	WBR	SBLn1			
Capacity (veh/h)	-	-	746			
HCM Lane V/C Ratio	-	-	0.084			
HCM Control Delay (s)	-	-	10.3			
HCM Lane LOS	-	-	B			
HCM 95th %tile Q(veh)	-	-	0.3			

Intersection						
Int Delay, s/veh	4					
Movement	EBT	EBR	WBL	WBT	NBL	NBR
Lane Configurations						
Traffic Vol, veh/h	62	9	16	23	13	51
Future Vol, veh/h	62	9	16	23	13	51
Conflicting Peds, #/hr	0	0	0	0	0	0
Sign Control	Free	Free	Free	Free	Stop	Stop
RT Channelized	-	None	-	None	-	None
Storage Length	-	-	-	-	0	-
Veh in Median Storage, #	0	-	-	0	0	-
Grade, %	0	-	-	0	0	-
Peak Hour Factor	100	100	100	100	100	100
Heavy Vehicles, %	2	2	2	2	2	2
Mvmt Flow	62	9	16	23	13	51

Major/Minor	Major1	Major2	Minor1	Minor2	Minor3
Conflicting Flow All	0	0	71	0	122
Stage 1	-	-	-	-	67
Stage 2	-	-	-	-	55
Critical Hdwy	-	-	4.12	-	6.42
Critical Hdwy Stg 1	-	-	-	-	5.42
Critical Hdwy Stg 2	-	-	-	-	5.42
Follow-up Hdwy	-	-	2.218	-	3.518
Pot Cap-1 Maneuver	-	-	1529	-	873
Stage 1	-	-	-	-	956
Stage 2	-	-	-	-	968
Platoon blocked, %	-	-	-	-	-
Mov Cap-1 Maneuver	-	-	1529	-	863
Mov Cap-2 Maneuver	-	-	-	-	863
Stage 1	-	-	-	-	956
Stage 2	-	-	-	-	957

Approach	EB	WB	NB
HCM Control Delay, s	0	3	9
HCM LOS			A

Minor Lane/Major Mvmt	NBLn1	EBT	EBR	WBL	WBT
Capacity (veh/h)	967	-	-	1529	-
HCM Lane V/C Ratio	0.066	-	-	0.01	-
HCM Control Delay (s)	9	-	-	7.4	0
HCM Lane LOS	A	-	-	A	A
HCM 95th %tile Q(veh)	0.2	-	-	0	-

Intersection						
Int Delay, s/veh	3.5					
Movement	EBL	EBR	NBL	NBT	SBT	SBR
Lane Configurations	↔			↕	↕	
Traffic Vol, veh/h	28	149	92	691	396	22
Future Vol, veh/h	28	149	92	691	396	22
Conflicting Peds, #/hr	0	0	111	0	0	111
Sign Control	Stop	Stop	Free	Free	Free	Free
RT Channelized	-	None	-	None	-	None
Storage Length	0	-	-	-	-	-
Veh in Median Storage, #	0	-	-	0	0	-
Grade, %	0	-	-	0	0	-
Peak Hour Factor	100	100	100	100	100	100
Heavy Vehicles, %	0	3	2	5	8	5
Mvmt Flow	28	149	92	691	396	22

Major/Minor	Minor2	Major1	Major2			
Conflicting Flow All	1048	320	529	0	-	0
Stage 1	518	-	-	-	-	-
Stage 2	530	-	-	-	-	-
Critical Hdwy	6.8	6.96	4.14	-	-	-
Critical Hdwy Stg 1	5.8	-	-	-	-	-
Critical Hdwy Stg 2	5.8	-	-	-	-	-
Follow-up Hdwy	3.5	3.33	2.22	-	-	-
Pot Cap-1 Maneuver	227	673	1034	-	-	-
Stage 1	568	-	-	-	-	-
Stage 2	560	-	-	-	-	-
Platoon blocked, %				-	-	-
Mov Cap-1 Maneuver	153	604	928	-	-	-
Mov Cap-2 Maneuver	153	-	-	-	-	-
Stage 1	428	-	-	-	-	-
Stage 2	502	-	-	-	-	-

Approach	EB	NB	SB
HCM Control Delay, s	20.2	1.6	0
HCM LOS	C		

Minor Lane/Major Mvmt	NBL	NBT	EBLn1	SBT	SBR
Capacity (veh/h)	928	-	412	-	-
HCM Lane V/C Ratio	0.099	-	0.43	-	-
HCM Control Delay (s)	9.3	0.6	20.2	-	-
HCM Lane LOS	A	A	C	-	-
HCM 95th %tile Q(veh)	0.3	-	2.1	-	-

Lanes, Volumes, Timings

1: Hwy 417 WB On Ramp/Lyon St N & Catherine St

05/18/2023



Lane Group	EBL	EBT	EBR	WBL	WBT	WBR	NBL	NBT	NBR	SBL	SBT	SBR
Lane Configurations					↕↕						↕	↕
Traffic Volume (vph)	0	0	0	222	550	0	0	0	0	0	365	296
Future Volume (vph)	0	0	0	222	550	0	0	0	0	0	365	296
Satd. Flow (prot)	0	0	0	0	3297	0	0	0	0	0	1802	1532
Fit Permitted					0.986							
Satd. Flow (perm)	0	0	0	0	3273	0	0	0	0	0	1802	1490
Satd. Flow (RTOR)					83							77
Lane Group Flow (vph)	0	0	0	0	772	0	0	0	0	0	365	296
Turn Type				Perm	NA						NA	Perm
Protected Phases					8						6	
Permitted Phases				8								6
Minimum Split (s)				26.2	26.2						28.3	28.3
Total Split (s)				28.0	28.0						47.0	47.0
Total Split (%)				37.3%	37.3%						62.7%	62.7%
Yellow Time (s)				3.3	3.3						3.3	3.3
All-Red Time (s)				1.9	1.9						2.0	2.0
Lost Time Adjust (s)					0.0						0.0	0.0
Total Lost Time (s)					5.2						5.3	5.3
Lead/Lag												
Lead-Lag Optimize?												
Act Effct Green (s)					22.8						41.7	41.7
Actuated g/C Ratio					0.30						0.56	0.56
v/c Ratio					0.73						0.36	0.34
Control Delay					19.3						15.5	12.4
Queue Delay					0.0						0.0	0.0
Total Delay					19.3						15.5	12.4
LOS					B						B	B
Approach Delay					19.3						14.1	
Approach LOS					B						B	
Queue Length 50th (m)					57.1						46.2	30.5
Queue Length 95th (m)					75.2						70.0	53.2
Internal Link Dist (m)		271.6			107.6			117.8			52.8	
Turn Bay Length (m)												
Base Capacity (vph)					1052						1001	862
Starvation Cap Reductn					0						0	0
Spillback Cap Reductn					0						0	0
Storage Cap Reductn					0						0	0
Reduced v/c Ratio					0.73						0.36	0.34

Intersection Summary

Cycle Length: 75	
Actuated Cycle Length: 75	
Offset: 24 (32%), Referenced to phase 8:WBTL, Start of Green	
Natural Cycle: 55	
Control Type: Pretimed	
Maximum v/c Ratio: 0.73	
Intersection Signal Delay: 16.9	Intersection LOS: B
Intersection Capacity Utilization 55.2%	ICU Level of Service B
Analysis Period (min) 15	

Splits and Phases: 1: Hwy 417 WB On Ramp/Lyon St N & Catherine St



Lanes, Volumes, Timings

2: Hwy 417 EB Off Ramp/Chamberlain Ave/Kent St & Catherine St

05/18/2023



Lane Group	EBL	EBT	EBR	WBL	WBT	WBR	NBL	NBT	NBR	SBL	SBT	SBR
Lane Configurations					↑↑	↑↑		↑↑↑				
Traffic Volume (vph)	0	0	0	0	719	313	48	869	0	0	0	0
Future Volume (vph)	0	0	0	0	719	313	48	869	0	0	0	0
Satd. Flow (prot)	0	0	0	0	3357	2521	0	4852	0	0	0	0
Fit Permitted								0.997				
Satd. Flow (perm)	0	0	0	0	3357	2521	0	4847	0	0	0	0
Satd. Flow (RTOR)								70				
Lane Group Flow (vph)	0	0	0	0	719	313	0	917	0	0	0	0
Turn Type					NA	Prot	Perm	NA				
Protected Phases					8	8		2				
Permitted Phases							2					
Detector Phase					8	8	2	2				
Switch Phase												
Minimum Initial (s)					10.0	10.0	10.0	10.0				
Minimum Split (s)					15.8	15.8	22.5	22.5				
Total Split (s)					35.0	35.0	27.0	27.0				
Total Split (%)					46.7%	46.7%	36.0%	36.0%				
Yellow Time (s)					3.3	3.3	3.3	3.3				
All-Red Time (s)					2.5	2.5	2.5	2.5				
Lost Time Adjust (s)					0.0	0.0		0.0				
Total Lost Time (s)					5.8	5.8		5.8				
Lead/Lag												
Lead-Lag Optimize?												
Recall Mode					C-Max	C-Max	Max	Max				
Act Effct Green (s)					34.4	34.4		21.2				
Actuated g/C Ratio					0.46	0.46		0.28				
v/c Ratio					0.47	0.27		0.65				
Control Delay					26.9	24.4		24.2				
Queue Delay					0.0	0.0		0.5				
Total Delay					26.9	24.4		24.7				
LOS					C	C		C				
Approach Delay					26.1			24.7				
Approach LOS					C			C				
Queue Length 50th (m)					54.7	23.1		38.2				
Queue Length 95th (m)					m61.2	m27.5		51.0				
Internal Link Dist (m)		32.2			131.7			67.4			53.0	
Turn Bay Length (m)						60.0						
Base Capacity (vph)					1539	1156		1420				
Starvation Cap Reductn					0	0		0				
Spillback Cap Reductn					0	0		179				
Storage Cap Reductn					0	0		0				
Reduced v/c Ratio					0.47	0.27		0.74				

Intersection Summary

Cycle Length: 75
 Actuated Cycle Length: 75
 Offset: 0 (0%), Referenced to phase 8:WBT, Start of Green
 Natural Cycle: 60
 Control Type: Actuated-Coordinated
 Maximum v/c Ratio: 0.65
 Intersection Signal Delay: 25.5
 Intersection Capacity Utilization 51.6%
 Analysis Period (min) 15
 Intersection LOS: C
 ICU Level of Service A
 m Volume for 95th percentile queue is metered by upstream signal.

Splits and Phases: 2: Hwy 417 EB Off Ramp/Chamberlain Ave/Kent St & Catherine St

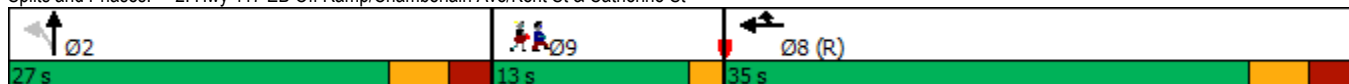

Lanes, Volumes, Timings

2: Hwy 417 EB Off Ramp/Chamberlain Ave/Kent St & Catherine St

05/18/2023

Lane Group	Ø9
Lane Configurations	
Traffic Volume (vph)	
Future Volume (vph)	
Satd. Flow (prot)	
Fit Permitted	
Satd. Flow (perm)	
Satd. Flow (RTOR)	
Lane Group Flow (vph)	
Turn Type	
Protected Phases	9
Permitted Phases	
Detector Phase	
Switch Phase	
Minimum Initial (s)	1.0
Minimum Split (s)	13.0
Total Split (s)	13.0
Total Split (%)	17%
Yellow Time (s)	2.0
All-Red Time (s)	0.0
Lost Time Adjust (s)	
Total Lost Time (s)	
Lead/Lag	
Lead-Lag Optimize?	
Recall Mode	None
Act Effct Green (s)	
Actuated g/C Ratio	
v/c Ratio	
Control Delay	
Queue Delay	
Total Delay	
LOS	
Approach Delay	
Approach LOS	
Queue Length 50th (m)	
Queue Length 95th (m)	
Internal Link Dist (m)	
Turn Bay Length (m)	
Base Capacity (vph)	
Starvation Cap Reductn	
Spillback Cap Reductn	
Storage Cap Reductn	
Reduced v/c Ratio	
Intersection Summary	

Lanes, Volumes, Timings
3: Bank St & Catherine St

05/18/2023



Lane Group	EBL	EBT	EBR	WBL	WBT	WBR	NBL	NBT	NBR	SBL	SBT	SBR
Lane Configurations					↕↕↕			↕↕			↕↕	
Traffic Volume (vph)	0	0	0	236	651	158	204	339	0	0	711	141
Future Volume (vph)	0	0	0	236	651	158	204	339	0	0	711	141
Satd. Flow (prot)	0	0	0	0	4610	0	0	3261	0	0	3098	0
Fit Permitted					0.989			0.550				
Satd. Flow (perm)	0	0	0	0	4531	0	0	1827	0	0	3098	0
Satd. Flow (RTOR)					45						31	
Lane Group Flow (vph)	0	0	0	0	1045	0	0	543	0	0	852	0
Turn Type				Perm	NA		pm+pt	NA			NA	
Protected Phases					8		9	2			6	
Permitted Phases				8			2					
Minimum Split (s)				18.6	18.6		10.4	16.4			16.4	
Total Split (s)				24.0	24.0		14.0	41.0			27.0	
Total Split (%)				32.0%	32.0%		18.7%	54.7%			36.0%	
Yellow Time (s)				3.3	3.3		3.3	3.3			3.3	
All-Red Time (s)				2.3	2.3		2.1	2.1			2.1	
Lost Time Adjust (s)					0.0			0.0			0.0	
Total Lost Time (s)					5.6			5.4			5.4	
Lead/Lag				Lag	Lag		Lag	Lag			Lag	
Lead-Lag Optimize?				Yes	Yes		Yes	Yes			Yes	
Act Effct Green (s)					18.4			35.6			21.6	
Actuated g/C Ratio					0.25			0.47			0.29	
v/c Ratio					0.91			0.53			0.93	
Control Delay					39.9			11.9			44.0	
Queue Delay					0.0			0.0			6.1	
Total Delay					40.0			11.9			50.0	
LOS					D			B			D	
Approach Delay					40.0			11.9			50.0	
Approach LOS					D			B			D	
Queue Length 50th (m)					50.5			15.0			59.3	
Queue Length 95th (m)					#75.2			19.2			#95.1	
Internal Link Dist (m)		131.7			201.7			90.2			52.9	
Turn Bay Length (m)												
Base Capacity (vph)					1145			1031			914	
Starvation Cap Reductn					0			0			0	
Spillback Cap Reductn					1			0			45	
Storage Cap Reductn					0			0			0	
Reduced v/c Ratio					0.91			0.53			0.98	

Intersection Summary
 Cycle Length: 75
 Actuated Cycle Length: 75
 Offset: 50 (67%), Referenced to phase 2:NBT and 6:SBT, Start of Green
 Natural Cycle: 75
 Control Type: Pretimed
 Maximum v/c Ratio: 0.93
 Intersection Signal Delay: 37.2
 Intersection LOS: D
 Intersection Capacity Utilization 81.5%
 ICU Level of Service D
 Analysis Period (min) 15
 # 95th percentile volume exceeds capacity, queue may be longer.
 Queue shown is maximum after two cycles.

Splits and Phases: 3: Bank St & Catherine St

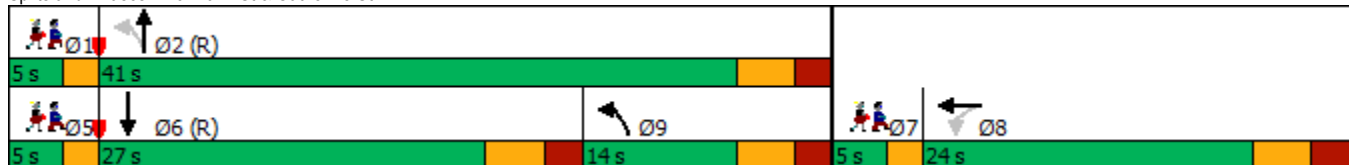

Lanes, Volumes, Timings
 3: Bank St & Catherine St

05/18/2023

Lane Group	Ø1	Ø5	Ø7
Lane Configurations			
Traffic Volume (vph)			
Future Volume (vph)			
Satd. Flow (prot)			
Fit Permitted			
Satd. Flow (perm)			
Satd. Flow (RTOR)			
Lane Group Flow (vph)			
Turn Type			
Protected Phases	1	5	7
Permitted Phases			
Minimum Split (s)	5.0	5.0	5.0
Total Split (s)	5.0	5.0	5.0
Total Split (%)	7%	7%	7%
Yellow Time (s)	2.0	2.0	2.0
All-Red Time (s)	0.0	0.0	0.0
Lost Time Adjust (s)			
Total Lost Time (s)			
Lead/Lag	Lead	Lead	Lead
Lead-Lag Optimize?	Yes	Yes	Yes
Act Effct Green (s)			
Actuated g/C Ratio			
v/c Ratio			
Control Delay			
Queue Delay			
Total Delay			
LOS			
Approach Delay			
Approach LOS			
Queue Length 50th (m)			
Queue Length 95th (m)			
Internal Link Dist (m)			
Turn Bay Length (m)			
Base Capacity (vph)			
Starvation Cap Reductn			
Spillback Cap Reductn			
Storage Cap Reductn			
Reduced v/c Ratio			
Intersection Summary			

Lanes, Volumes, Timings
4: Percy St & Catherine St

05/18/2023



Lane Group	EBL	EBT	EBR	WBL	WBT	WBR	NBL	NBT	NBR	SBL	SBT	SBR
Lane Configurations					↕↕						↕	
Traffic Volume (vph)	0	0	0	165	723	0	0	0	0	0	121	39
Future Volume (vph)	0	0	0	165	723	0	0	0	0	0	121	39
Satd. Flow (prot)	0	0	0	0	3354	0	0	0	0	0	1726	0
Fit Permitted					0.991							
Satd. Flow (perm)	0	0	0	0	3340	0	0	0	0	0	1726	0
Satd. Flow (RTOR)					160							
Lane Group Flow (vph)	0	0	0	0	888	0	0	0	0	0	160	0
Turn Type				Perm	NA						NA	
Protected Phases					8						6	
Permitted Phases				8								
Detector Phase				8	8						6	
Switch Phase												
Minimum Initial (s)				10.0	10.0						10.0	
Minimum Split (s)				26.5	26.5						23.4	
Total Split (s)				34.0	34.0						24.0	
Total Split (%)				37.8%	37.8%						26.7%	
Yellow Time (s)				3.3	3.3						3.3	
All-Red Time (s)				2.2	2.2						2.1	
Lost Time Adjust (s)					0.0						0.0	
Total Lost Time (s)					5.5						5.4	
Lead/Lag				Lag	Lag							
Lead-Lag Optimize?				Yes	Yes							
Recall Mode				None	None						Max	
Act Effct Green (s)					18.3						18.7	
Actuated g/C Ratio					0.38						0.39	
v/c Ratio					0.65						0.24	
Control Delay					12.0						12.5	
Queue Delay					0.0						0.0	
Total Delay					12.0						12.5	
LOS					B						B	
Approach Delay					12.0						12.5	
Approach LOS					B						B	
Queue Length 50th (m)					24.5						8.5	
Queue Length 95th (m)					38.2						22.9	
Internal Link Dist (m)		106.8			271.6			106.7			288.0	
Turn Bay Length (m)												
Base Capacity (vph)					2061						673	
Starvation Cap Reductn					0						0	
Spillback Cap Reductn					0						0	
Storage Cap Reductn					0						0	
Reduced v/c Ratio					0.43						0.24	

Intersection Summary
 Cycle Length: 90
 Actuated Cycle Length: 48
 Natural Cycle: 65
 Control Type: Semi Act-Uncoord
 Maximum v/c Ratio: 0.65
 Intersection Signal Delay: 12.1
 Intersection Capacity Utilization 53.5%
 Analysis Period (min) 15
 Intersection LOS: B
 ICU Level of Service A

Splits and Phases: 4: Percy St & Catherine St

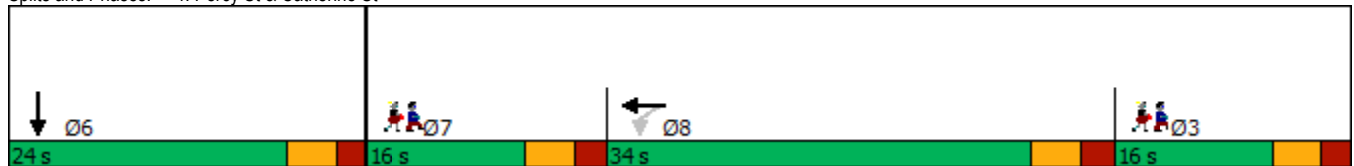

Lanes, Volumes, Timings
 4: Percy St & Catherine St

05/18/2023

Lane Group	Ø3	Ø7
Lane Configurations		
Traffic Volume (vph)		
Future Volume (vph)		
Satd. Flow (prot)		
Fit Permitted		
Satd. Flow (perm)		
Satd. Flow (RTOR)		
Lane Group Flow (vph)		
Turn Type		
Protected Phases	3	7
Permitted Phases		
Detector Phase		
Switch Phase		
Minimum Initial (s)	1.0	1.0
Minimum Split (s)	6.4	6.4
Total Split (s)	16.0	16.0
Total Split (%)	18%	18%
Yellow Time (s)	3.3	3.3
All-Red Time (s)	2.1	2.1
Lost Time Adjust (s)		
Total Lost Time (s)		
Lead/Lag		Lead
Lead-Lag Optimize?		Yes
Recall Mode	None	None
Act Effct Green (s)		
Actuated g/C Ratio		
v/c Ratio		
Control Delay		
Queue Delay		
Total Delay		
LOS		
Approach Delay		
Approach LOS		
Queue Length 50th (m)		
Queue Length 95th (m)		
Internal Link Dist (m)		
Turn Bay Length (m)		
Base Capacity (vph)		
Starvation Cap Reductn		
Spillback Cap Reductn		
Storage Cap Reductn		
Reduced v/c Ratio		
Intersection Summary		

Lanes, Volumes, Timings
6: Kent St & Arlington Ave

05/18/2023



Lane Group	EBL	EBT	EBR	WBL	WBT	WBR	NBL	NBT	NBR	SBL	SBT	SBR
Lane Configurations		↕			↕			↕↕↕				
Traffic Volume (vph)	24	81	0	0	29	63	38	1073	93	0	0	0
Future Volume (vph)	24	81	0	0	29	63	38	1073	93	0	0	0
Satd. Flow (prot)	0	1800	0	0	1592	0	0	4821	0	0	0	0
Fit Permitted		0.930						0.998				
Satd. Flow (perm)	0	1680	0	0	1592	0	0	4817	0	0	0	0
Satd. Flow (RTOR)					63			29				
Lane Group Flow (vph)	0	105	0	0	92	0	0	1204	0	0	0	0
Turn Type	Perm	NA			NA		Perm	NA				
Protected Phases		4			8			2				
Permitted Phases	4						2					
Minimum Split (s)	27.3	27.3			27.3		32.3	32.3				
Total Split (s)	28.0	28.0			28.0		47.0	47.0				
Total Split (%)	37.3%	37.3%			37.3%		62.7%	62.7%				
Yellow Time (s)	3.3	3.3			3.3		3.3	3.3				
All-Red Time (s)	2.0	2.0			2.0		2.0	2.0				
Lost Time Adjust (s)		0.0			0.0			0.0				
Total Lost Time (s)		5.3			5.3			5.3				
Lead/Lag												
Lead-Lag Optimize?												
Act Effct Green (s)		22.7			22.7			41.7				
Actuated g/C Ratio		0.30			0.30			0.56				
v/c Ratio		0.21			0.18			0.45				
Control Delay		28.2			9.2			8.0				
Queue Delay		0.0			0.0			31.7				
Total Delay		28.2			9.2			39.7				
LOS		C			A			D				
Approach Delay		28.2			9.2			39.7				
Approach LOS		C			A			D				
Queue Length 50th (m)		13.1			1.2			46.3				
Queue Length 95th (m)		m25.1			m5.3			62.4				
Internal Link Dist (m)		138.7			143.1			53.0			216.0	
Turn Bay Length (m)												
Base Capacity (vph)		508			525			2691				
Starvation Cap Reductn		0			0			1550				
Spillback Cap Reductn		0			0			0				
Storage Cap Reductn		0			0			0				
Reduced v/c Ratio		0.21			0.18			1.06				

Intersection Summary
 Cycle Length: 75
 Actuated Cycle Length: 75
 Offset: 50 (67%), Referenced to phase 2:NBT, Start of Green
 Natural Cycle: 60
 Control Type: Pretimed
 Maximum v/c Ratio: 0.45
 Intersection Signal Delay: 36.9
 Intersection LOS: D
 Intersection Capacity Utilization 54.5%
 ICU Level of Service A
 Analysis Period (min) 15
 m Volume for 95th percentile queue is metered by upstream signal.

Splits and Phases: 6: Kent St & Arlington Ave

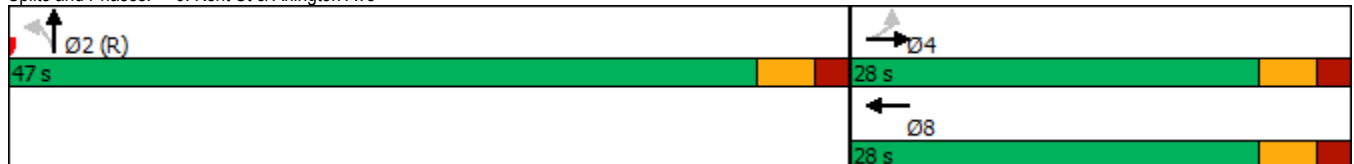

Lanes, Volumes, Timings
7: Lyon St N & Gladstone Ave

05/18/2023



Lane Group	EBL	EBT	EBR	WBL	WBT	WBR	NBL	NBT	NBR	SBL	SBT	SBR
Lane Configurations		↑	↗	↖	↑						↕	↘
Traffic Volume (vph)	0	247	52	28	314	0	0	0	0	86	539	138
Future Volume (vph)	0	247	52	28	314	0	0	0	0	86	539	138
Satd. Flow (prot)	0	1784	1547	1729	1784	0	0	0	0	0	3261	0
Fit Permitted				0.581							0.994	
Satd. Flow (perm)	0	1784	1408	1008	1784	0	0	0	0	0	3248	0
Satd. Flow (RTOR)			52								42	
Lane Group Flow (vph)	0	247	52	28	314	0	0	0	0	0	763	0
Turn Type		NA	Perm	Perm	NA					Perm	NA	
Protected Phases		4			8							6
Permitted Phases			4	8						6		
Minimum Split (s)		17.2	17.2	17.2	17.2					22.6	22.6	
Total Split (s)		39.0	39.0	39.0	39.0					36.0	36.0	
Total Split (%)		52.0%	52.0%	52.0%	52.0%					48.0%	48.0%	
Yellow Time (s)		3.3	3.3	3.3	3.3					3.3	3.3	
All-Red Time (s)		1.9	1.9	1.9	1.9					2.3	2.3	
Lost Time Adjust (s)		0.0	0.0	0.0	0.0						0.0	
Total Lost Time (s)		5.2	5.2	5.2	5.2						5.6	
Lead/Lag												
Lead-Lag Optimize?												
Act Effct Green (s)		33.8	33.8	33.8	33.8						30.4	
Actuated g/C Ratio		0.45	0.45	0.45	0.45						0.41	
v/c Ratio		0.31	0.08	0.06	0.39						0.57	
Control Delay		14.5	4.1	6.3	10.3						18.2	
Queue Delay		0.0	0.0	0.0	0.0						0.0	
Total Delay		14.5	4.1	6.3	10.3						18.2	
LOS		B	A	A	B						B	
Approach Delay		12.7			10.0						18.2	
Approach LOS		B			B						B	
Queue Length 50th (m)		21.3	0.0	1.3	34.3						40.1	
Queue Length 95th (m)		36.3	5.4	m2.5	44.9						56.3	
Internal Link Dist (m)		254.8			165.0			215.6			214.3	
Turn Bay Length (m)				25.0								
Base Capacity (vph)		803	663	454	803						1341	
Starvation Cap Reductn		0	0	0	0						0	
Spillback Cap Reductn		0	0	0	0						0	
Storage Cap Reductn		0	0	0	0						0	
Reduced v/c Ratio		0.31	0.08	0.06	0.39						0.57	

Intersection Summary
 Cycle Length: 75
 Actuated Cycle Length: 75
 Offset: 45 (60%), Referenced to phase 4:EBT and 8:WBTL, Start of Green
 Natural Cycle: 40
 Control Type: Pretimed
 Maximum v/c Ratio: 0.57
 Intersection Signal Delay: 15.1
 Intersection Capacity Utilization 67.8%
 Analysis Period (min) 15
 m Volume for 95th percentile queue is metered by upstream signal.

Splits and Phases: 7: Lyon St N & Gladstone Ave

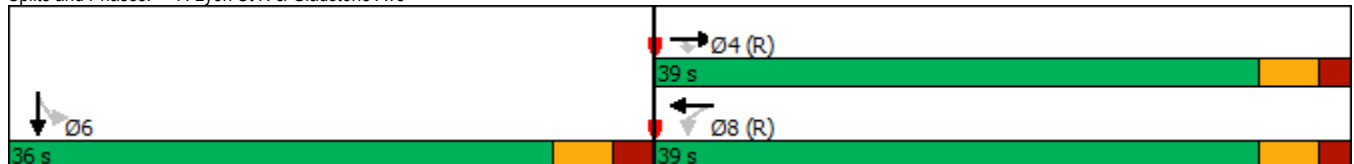

Lanes, Volumes, Timings
8: Kent St & Gladstone Ave

05/18/2023



Lane Group	EBL	EBT	EBR	WBL	WBT	WBR	NBL	NBT	NBR	SBL	SBT	SBR
Lane Configurations												
Traffic Volume (vph)	75	450	0	0	324	75	67	929	131	0	0	0
Future Volume (vph)	75	450	0	0	324	75	67	929	131	0	0	0
Satd. Flow (prot)	1729	1767	0	0	1719	0	1729	4622	0	0	0	0
Fit Permitted	0.434						0.950					
Satd. Flow (perm)	769	1767	0	0	1719	0	1522	4622	0	0	0	0
Satd. Flow (RTOR)					21			40				
Lane Group Flow (vph)	75	450	0	0	399	0	67	1060	0	0	0	0
Turn Type	Perm	NA			NA		Perm	NA				
Protected Phases		4			8			2				
Permitted Phases	4						2					
Minimum Split (s)	21.4	21.4			21.4		20.4	20.4				
Total Split (s)	40.0	40.0			40.0		35.0	35.0				
Total Split (%)	53.3%	53.3%			53.3%		46.7%	46.7%				
Yellow Time (s)	3.3	3.3			3.3		3.3	3.3				
All-Red Time (s)	2.1	2.1			2.1		2.1	2.1				
Lost Time Adjust (s)	0.0	0.0			0.0		0.0	0.0				
Total Lost Time (s)	5.4	5.4			5.4		5.4	5.4				
Lead/Lag												
Lead-Lag Optimize?												
Act Effct Green (s)	34.6	34.6			34.6		29.6	29.6				
Actuated g/C Ratio	0.46	0.46			0.46		0.39	0.39				
v/c Ratio	0.21	0.55			0.50		0.11	0.57				
Control Delay	22.3	27.3			15.9		9.3	9.0				
Queue Delay	0.0	0.0			0.0		0.0	0.0				
Total Delay	22.3	27.3			15.9		9.3	9.0				
LOS	C	C			B		A	A				
Approach Delay		26.5			15.9			9.1				
Approach LOS		C			B			A				
Queue Length 50th (m)	7.9	58.0			35.4		3.3	17.7				
Queue Length 95th (m)	m17.8	87.0			58.3		6.4	19.6				
Internal Link Dist (m)		165.0			168.8			216.0			203.6	
Turn Bay Length (m)	30.0						40.0					
Base Capacity (vph)	354	815			804		600	1848				
Starvation Cap Reductn	0	0			0		0	0				
Spillback Cap Reductn	0	0			0		0	0				
Storage Cap Reductn	0	0			0		0	0				
Reduced v/c Ratio	0.21	0.55			0.50		0.11	0.57				

Intersection Summary
 Cycle Length: 75
 Actuated Cycle Length: 75
 Offset: 23 (31%), Referenced to phase 4:EBTL and 8:WBT, Start of Green
 Natural Cycle: 45
 Control Type: Pretimed
 Maximum v/c Ratio: 0.57
 Intersection Signal Delay: 14.9
 Intersection Capacity Utilization 67.8%
 Analysis Period (min) 15
 m Volume for 95th percentile queue is metered by upstream signal.

Splits and Phases: 8: Kent St & Gladstone Ave

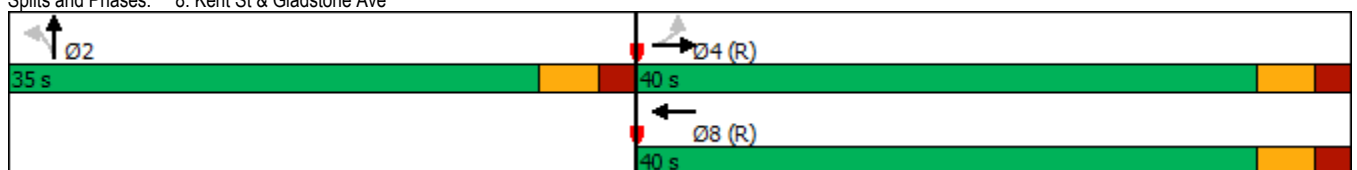

Lanes, Volumes, Timings
 9: Bank St & Chamberlain Ave/Isabella St

05/18/2023



Lane Group	EBL	EBT	EBR	WBL	WBT	WBR	NBL	NBT	NBR	SBL	SBT	SBR
Lane Configurations		↕↕	↗					↕↕			↕↕	
Traffic Volume (vph)	66	623	124	0	0	0	0	466	93	188	733	0
Future Volume (vph)	66	623	124	0	0	0	0	466	93	188	733	0
Satd. Flow (prot)	0	3344	1547	0	0	0	0	3137	0	0	3324	0
Fit Permitted		0.995									0.711	
Satd. Flow (perm)	0	3340	1403	0	0	0	0	3137	0	0	2340	0
Satd. Flow (RTOR)			134									
Lane Group Flow (vph)	0	689	124	0	0	0	0	559	0	0	921	0
Turn Type	Perm	NA	Perm					NA		pm+pt	NA	
Protected Phases		4						2		5	6	
Permitted Phases	4		4							6		
Detector Phase	4	4	4					2		5	6	
Switch Phase												
Minimum Initial (s)	10.0	10.0	10.0					10.0		5.0	10.0	
Minimum Split (s)	26.2	26.2	26.2					23.1		11.1	23.1	
Total Split (s)	31.0	31.0	31.0					30.0		14.0	44.0	
Total Split (%)	41.3%	41.3%	41.3%					40.0%		18.7%	58.7%	
Yellow Time (s)	3.3	3.3	3.3					3.0		3.0	3.0	
All-Red Time (s)	2.9	2.9	2.9					3.1		3.1	3.1	
Lost Time Adjust (s)		0.0	0.0					0.0			0.0	
Total Lost Time (s)		6.2	6.2					6.1			6.1	
Lead/Lag												
Lead-Lag Optimize?												
Recall Mode	None	None	None					C-Max		None	C-Max	
Act Effct Green (s)		21.8	21.8					40.9			40.9	
Actuated g/C Ratio		0.29	0.29					0.55			0.55	
v/c Ratio		0.71	0.25					0.33			0.72	
Control Delay		27.9	4.6					10.7			12.3	
Queue Delay		0.0	0.0					0.0			1.2	
Total Delay		27.9	4.6					10.7			13.5	
LOS		C	A					B			B	
Approach Delay		24.3						10.7			13.5	
Approach LOS		C						B			B	
Queue Length 50th (m)		44.5	0.0					22.0			75.4	
Queue Length 95th (m)		59.5	9.2					33.8			m82.3	
Internal Link Dist (m)		296.0			233.4			215.6			90.2	
Turn Bay Length (m)			40.0									
Base Capacity (vph)		1104	553					1711			1276	
Starvation Cap Reductn		0	0					0			167	
Spillback Cap Reductn		0	0					0			0	
Storage Cap Reductn		0	0					0			0	
Reduced v/c Ratio		0.62	0.22					0.33			0.83	

Intersection Summary

Cycle Length: 75
 Actuated Cycle Length: 75
 Offset: 60 (80%), Referenced to phase 2:NBT and 6:SBTL, Start of Green
 Natural Cycle: 65
 Control Type: Actuated-Coordinated
 Maximum v/c Ratio: 0.72
 Intersection Signal Delay: 16.7
 Intersection Capacity Utilization 84.0%
 Analysis Period (min) 15
 Intersection LOS: B
 ICU Level of Service E
 m Volume for 95th percentile queue is metered by upstream signal.

Splits and Phases: 9: Bank St & Chamberlain Ave/Isabella St

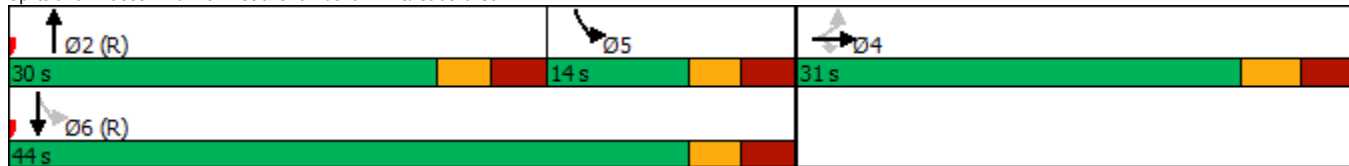

Lanes, Volumes, Timings
13: Bronson Ave & Catherine St

05/18/2023



Lane Group	EBL	EBT	EBR	WBL	WBT	WBR	NBL	NBT	NBR	SBL	SBT	SBR
Lane Configurations				↖ ↗	↖ ↗		↖ ↗	↖ ↗			↖ ↗	
Traffic Volume (vph)	0	0	0	726	596	285	304	792	0	0	833	172
Future Volume (vph)	0	0	0	726	596	285	304	792	0	0	833	172
Satd. Flow (prot)	0	0	0	1458	4274	0	1679	3390	0	0	3260	0
Fit Permitted				0.950	0.987		0.099					
Satd. Flow (perm)	0	0	0	1458	4274	0	175	3390	0	0	3260	0
Satd. Flow (RTOR)					81						26	
Lane Group Flow (vph)	0	0	0	407	1200	0	304	792	0	0	1005	0
Turn Type				Perm	NA		pm+pt	NA			NA	
Protected Phases					8		5	2				6
Permitted Phases				8			2					
Minimum Split (s)				28.3	28.3		11.2	23.8			23.8	
Total Split (s)				37.1	37.1		22.0	62.9			40.9	
Total Split (%)				37.1%	37.1%		22.0%	62.9%			40.9%	
Yellow Time (s)				3.3	3.3		3.3	3.3			3.3	
All-Red Time (s)				3.0	3.0		2.9	3.5			3.5	
Lost Time Adjust (s)				0.0	0.0		0.0	0.0			0.0	
Total Lost Time (s)				6.3	6.3		6.2	6.8			6.8	
Lead/Lag							Lead				Lag	
Lead-Lag Optimize?							Yes				Yes	
Act Effct Green (s)				30.8	30.8		56.7	56.1			34.1	
Actuated g/C Ratio				0.31	0.31		0.57	0.56			0.34	
v/c Ratio				0.91	0.87		0.90	0.42			0.89	
Control Delay				59.3	39.0		56.0	13.4			41.7	
Queue Delay				0.0	0.0		0.0	0.0			0.0	
Total Delay				59.3	39.0		56.0	13.4			41.7	
LOS				E	D		E	B			D	
Approach Delay					44.1			25.2			41.7	
Approach LOS					D			C			D	
Queue Length 50th (m)				87.5	79.9		42.9	43.5			94.0	
Queue Length 95th (m)				#151.1	#101.4		#90.9	56.6			#131.0	
Internal Link Dist (m)		141.5			120.8			240.1			287.4	
Turn Bay Length (m)				80.0			45.0					
Base Capacity (vph)				449	1372		336	1901			1128	
Starvation Cap Reductn				0	0		0	0			0	
Spillback Cap Reductn				0	0		0	0			0	
Storage Cap Reductn				0	0		0	0			0	
Reduced v/c Ratio				0.91	0.87		0.90	0.42			0.89	

Intersection Summary
 Cycle Length: 100
 Actuated Cycle Length: 100
 Offset: 60 (60%), Referenced to phase 2:NBTL and 6:SBT, Start of Green
 Natural Cycle: 75
 Control Type: Pretimed
 Maximum v/c Ratio: 0.91
 Intersection Signal Delay: 37.9
 Intersection LOS: D
 Intersection Capacity Utilization 90.8%
 ICU Level of Service E
 Analysis Period (min) 15
 # 95th percentile volume exceeds capacity, queue may be longer.
 Queue shown is maximum after two cycles.

Splits and Phases: 13: Bronson Ave & Catherine St



Intersection												
Int Delay, s/veh	2.4											
Movement	EBL	EBT	EBR	WBL	WBT	WBR	NBL	NBT	NBR	SBL	SBT	SBR
Lane Configurations		↕			↕						↕↔	
Traffic Vol, veh/h	0	19	2	16	37	0	0	0	0	59	587	13
Future Vol, veh/h	0	19	2	16	37	0	0	0	0	59	587	13
Conflicting Peds, #/hr	20	0	8	8	0	20	19	0	3	3	0	19
Sign Control	Stop	Stop	Stop	Stop	Stop	Stop	Free	Free	Free	Free	Free	Free
RT Channelized	-	-	None	-	-	None	-	-	None	-	-	None
Storage Length	-	-	-	-	-	-	-	-	-	-	-	-
Veh in Median Storage, #	-	0	-	-	0	-	-	-	-	-	0	-
Grade, %	-	0	-	-	0	-	-	0	-	-	0	-
Peak Hour Factor	100	100	100	100	100	100	100	100	100	100	100	100
Heavy Vehicles, %	0	5	0	0	5	0	0	0	0	0	0	0
Mvmt Flow	0	19	2	16	37	0	0	0	0	59	587	13
Major/Minor	Minor2		Minor1				Major2					
Conflicting Flow All	-	734	327	432	740	-	-	-	3	0	0	
Stage 1	-	731	-	3	3	-	-	-	-	-	-	
Stage 2	-	3	-	429	737	-	-	-	-	-	-	
Critical Hdwy	-	6.6	6.9	7.5	6.6	-	-	-	4.1	-	-	
Critical Hdwy Stg 1	-	5.6	-	-	-	-	-	-	-	-	-	
Critical Hdwy Stg 2	-	-	-	6.5	5.6	-	-	-	-	-	-	
Follow-up Hdwy	-	4.05	3.3	3.5	4.05	-	-	-	2.2	-	-	
Pot Cap-1 Maneuver	0	340	675	512	337	0	-	-	1632	-	-	
Stage 1	0	418	-	-	-	0	-	-	-	-	-	
Stage 2	0	-	-	580	416	0	-	-	-	-	-	
Platoon blocked, %	-	-	-	-	-	-	-	-	-	-	-	
Mov Cap-1 Maneuver	-	315	663	465	312	-	-	-	1627	-	-	
Mov Cap-2 Maneuver	-	315	-	465	312	-	-	-	-	-	-	
Stage 1	-	388	-	-	-	-	-	-	-	-	-	
Stage 2	-	-	-	520	386	-	-	-	-	-	-	
Approach	EB		WB				SB					
HCM Control Delay, s	16.6		17.3				0.8					
HCM LOS	C		C									
Minor Lane/Major Mvmt	EBLn1	WBLn1	SBL	SBT	SBR							
Capacity (veh/h)	332	346	1627	-	-							
HCM Lane V/C Ratio	0.063	0.153	0.036	-	-							
HCM Control Delay (s)	16.6	17.3	7.3	0.2	-							
HCM Lane LOS	C	C	A	A	-							
HCM 95th %tile Q(veh)	0.2	0.5	0.1	-	-							

Intersection						
Int Delay, s/veh	0.6					
Movement	EBL	EBT	WBT	WBR	SBL	SBR
Lane Configurations			↑↑			↑
Traffic Vol, veh/h	0	0	647	66	0	40
Future Vol, veh/h	0	0	647	66	0	40
Conflicting Peds, #/hr	0	0	0	0	0	0
Sign Control	Free	Free	Free	Free	Stop	Stop
RT Channelized	-	None	-	None	-	None
Storage Length	-	-	-	-	-	0
Veh in Median Storage, #	-	-	0	-	0	-
Grade, %	-	0	0	-	0	-
Peak Hour Factor	100	100	100	100	100	100
Heavy Vehicles, %	2	2	2	2	2	2
Mvmt Flow	0	0	647	66	0	40
Major/Minor			Major2	Minor2		
Conflicting Flow All			-	0	-	357
Stage 1			-	-	-	-
Stage 2			-	-	-	-
Critical Hdwy			-	-	-	6.94
Critical Hdwy Stg 1			-	-	-	-
Critical Hdwy Stg 2			-	-	-	-
Follow-up Hdwy			-	-	-	3.32
Pot Cap-1 Maneuver			-	-	0	639
Stage 1			-	-	0	-
Stage 2			-	-	0	-
Platoon blocked, %			-	-	-	-
Mov Cap-1 Maneuver			-	-	-	639
Mov Cap-2 Maneuver			-	-	-	-
Stage 1			-	-	-	-
Stage 2			-	-	-	-
Approach			WB	SB		
HCM Control Delay, s			0	11		
HCM LOS				B		
Minor Lane/Major Mvmt	WBT	WBR	SBLn1			
Capacity (veh/h)	-	-	639			
HCM Lane V/C Ratio	-	-	0.063			
HCM Control Delay (s)	-	-	11			
HCM Lane LOS	-	-	B			
HCM 95th %tile Q(veh)	-	-	0.2			

Intersection						
Int Delay, s/veh	3					
Movement	EBT	EBR	WBL	WBT	NBL	NBR
Lane Configurations						
Traffic Vol, veh/h	62	16	27	45	8	32
Future Vol, veh/h	62	16	27	45	8	32
Conflicting Peds, #/hr	0	0	0	0	0	0
Sign Control	Free	Free	Free	Free	Stop	Stop
RT Channelized	-	None	-	None	-	None
Storage Length	-	-	-	-	0	-
Veh in Median Storage, #	0	-	-	0	0	-
Grade, %	0	-	-	0	0	-
Peak Hour Factor	100	100	100	100	100	100
Heavy Vehicles, %	2	2	2	2	2	2
Mvmt Flow	62	16	27	45	8	32
Major/Minor	Major1	Major2	Minor1			
Conflicting Flow All	0	0	78	0	169	70
Stage 1	-	-	-	-	70	-
Stage 2	-	-	-	-	99	-
Critical Hdwy	-	-	4.12	-	6.42	6.22
Critical Hdwy Stg 1	-	-	-	-	5.42	-
Critical Hdwy Stg 2	-	-	-	-	5.42	-
Follow-up Hdwy	-	-	2.218	-	3.518	3.318
Pot Cap-1 Maneuver	-	-	1520	-	821	993
Stage 1	-	-	-	-	953	-
Stage 2	-	-	-	-	925	-
Platoon blocked, %	-	-	-	-	-	-
Mov Cap-1 Maneuver	-	-	1520	-	806	993
Mov Cap-2 Maneuver	-	-	-	-	806	-
Stage 1	-	-	-	-	953	-
Stage 2	-	-	-	-	908	-
Approach	EB	WB	NB			
HCM Control Delay, s	0	2.8	9			
HCM LOS			A			
Minor Lane/Major Mvmt	NBLn1	EBT	EBR	WBL	WBT	
Capacity (veh/h)	949	-	-	1520	-	
HCM Lane V/C Ratio	0.042	-	-	0.018	-	
HCM Control Delay (s)	9	-	-	7.4	0	
HCM Lane LOS	A	-	-	A	A	
HCM 95th %tile Q(veh)	0.1	-	-	0.1	-	

Intersection						
Int Delay, s/veh	2.6					
Movement	EBL	EBR	NBL	NBT	SBT	SBR
Lane Configurations	↔			↕↕	↕↕	
Traffic Vol, veh/h	24	123	69	428	730	27
Future Vol, veh/h	24	123	69	428	730	27
Conflicting Peds, #/hr	0	0	42	0	0	42
Sign Control	Stop	Stop	Free	Free	Free	Free
RT Channelized	-	None	-	None	-	None
Storage Length	0	-	-	-	-	-
Veh in Median Storage, #	0	-	-	0	0	-
Grade, %	0	-	-	0	0	-
Peak Hour Factor	100	100	100	100	100	100
Heavy Vehicles, %	0	1	0	5	3	0
Mvmt Flow	24	123	69	428	730	27

Major/Minor	Minor2	Major1	Major2			
Conflicting Flow All	1138	421	799	0	-	0
Stage 1	786	-	-	-	-	-
Stage 2	352	-	-	-	-	-
Critical Hdwy	6.8	6.92	4.1	-	-	-
Critical Hdwy Stg 1	5.8	-	-	-	-	-
Critical Hdwy Stg 2	5.8	-	-	-	-	-
Follow-up Hdwy	3.5	3.31	2.2	-	-	-
Pot Cap-1 Maneuver	198	584	833	-	-	-
Stage 1	415	-	-	-	-	-
Stage 2	689	-	-	-	-	-
Platoon blocked, %				-	-	-
Mov Cap-1 Maneuver	162	561	801	-	-	-
Mov Cap-2 Maneuver	162	-	-	-	-	-
Stage 1	354	-	-	-	-	-
Stage 2	662	-	-	-	-	-

Approach	EB	NB	SB
HCM Control Delay, s	19.1	1.7	0
HCM LOS	C		

Minor Lane/Major Mvmt	NBL	NBT	EBLn1	SBT	SBR
Capacity (veh/h)	801	-	400	-	-
HCM Lane V/C Ratio	0.086	-	0.368	-	-
HCM Control Delay (s)	9.9	0.4	19.1	-	-
HCM Lane LOS	A	A	C	-	-
HCM 95th %tile Q(veh)	0.3	-	1.7	-	-

Lanes, Volumes, Timings

1: Hwy 417 WB On Ramp/Lyon St N & Catherine St

05/11/2023



Lane Group	EBL	EBT	EBR	WBL	WBT	WBR	NBL	NBT	NBR	SBL	SBT	SBR
Lane Configurations					↕↕						↕	↕
Traffic Volume (vph)	0	0	0	272	271	0	0	0	0	0	288	131
Future Volume (vph)	0	0	0	272	271	0	0	0	0	0	288	131
Satd. Flow (prot)	0	0	0	0	3184	0	0	0	0	0	1784	1547
Fit Permitted					0.976							
Satd. Flow (perm)	0	0	0	0	3161	0	0	0	0	0	1784	1517
Satd. Flow (RTOR)					272							131
Lane Group Flow (vph)	0	0	0	0	543	0	0	0	0	0	288	131
Turn Type				Perm	NA						NA	Perm
Protected Phases					8						6	
Permitted Phases				8								6
Minimum Split (s)				26.2	26.2						28.3	28.3
Total Split (s)				36.0	36.0						39.0	39.0
Total Split (%)				48.0%	48.0%						52.0%	52.0%
Yellow Time (s)				3.3	3.3						3.3	3.3
All-Red Time (s)				1.9	1.9						2.0	2.0
Lost Time Adjust (s)					0.0						0.0	0.0
Total Lost Time (s)					5.2						5.3	5.3
Lead/Lag												
Lead-Lag Optimize?												
Act Effct Green (s)					30.8						33.7	33.7
Actuated g/C Ratio					0.41						0.45	0.45
v/c Ratio					0.37						0.36	0.17
Control Delay					19.0						23.9	11.6
Queue Delay					0.0						0.0	0.0
Total Delay					19.0						23.9	11.6
LOS					B						C	B
Approach Delay					19.0						20.0	
Approach LOS					B						C	
Queue Length 50th (m)					29.8						38.5	2.3
Queue Length 95th (m)					m43.2						60.9	19.8
Internal Link Dist (m)		271.6			107.6			117.8			52.8	
Turn Bay Length (m)												
Base Capacity (vph)					1458						801	753
Starvation Cap Reductn					0						0	0
Spillback Cap Reductn					0						0	0
Storage Cap Reductn					0						0	0
Reduced v/c Ratio					0.37						0.36	0.17

Intersection Summary

Cycle Length: 75
 Actuated Cycle Length: 75
 Offset: 24 (32%), Referenced to phase 8:WBTL, Start of Green
 Natural Cycle: 55
 Control Type: Pretimed
 Maximum v/c Ratio: 0.37
 Intersection Signal Delay: 19.5
 Intersection LOS: B
 Intersection Capacity Utilization 50.5%
 ICU Level of Service A
 Analysis Period (min) 15
 m Volume for 95th percentile queue is metered by upstream signal.

Splits and Phases: 1: Hwy 417 WB On Ramp/Lyon St N & Catherine St

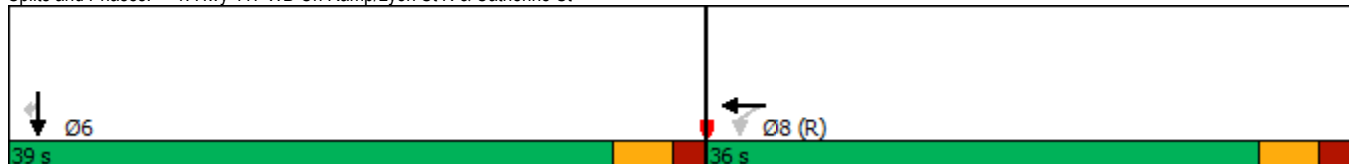

Lanes, Volumes, Timings

2: Hwy 417 EB Off Ramp/Chamberlain Ave/Kent St & Catherine St

05/11/2023



Lane Group	EBL	EBT	EBR	WBL	WBT	WBR	NBL	NBT	NBR	SBL	SBT	SBR
Lane Configurations					↑↑	↑↑		↑↑↑				
Traffic Volume (vph)	0	0	0	0	450	579	70	1430	0	0	0	0
Future Volume (vph)	0	0	0	0	450	579	70	1430	0	0	0	0
Satd. Flow (prot)	0	0	0	0	3262	2696	0	4912	0	0	0	0
Fit Permitted								0.998				
Satd. Flow (perm)	0	0	0	0	3262	2696	0	4905	0	0	0	0
Satd. Flow (RTOR)								70				
Lane Group Flow (vph)	0	0	0	0	450	579	0	1500	0	0	0	0
Turn Type					NA	Prot	Perm	NA				
Protected Phases					8	8		2				
Permitted Phases							2					
Detector Phase					8	8	2	2				
Switch Phase												
Minimum Initial (s)					10.0	10.0	10.0	10.0				
Minimum Split (s)					15.8	15.8	22.5	22.5				
Total Split (s)					27.4	27.4	34.6	34.6				
Total Split (%)					36.5%	36.5%	46.1%	46.1%				
Yellow Time (s)					3.3	3.3	3.3	3.3				
All-Red Time (s)					2.5	2.5	2.5	2.5				
Lost Time Adjust (s)					0.0	0.0		0.0				
Total Lost Time (s)					5.8	5.8		5.8				
Lead/Lag												
Lead-Lag Optimize?												
Recall Mode					Max	Max	C-Max	C-Max				
Act Effct Green (s)					26.8	26.8		28.8				
Actuated g/C Ratio					0.36	0.36		0.38				
v/c Ratio					0.39	0.60		0.78				
Control Delay					16.6	19.6		22.7				
Queue Delay					0.0	2.1		0.2				
Total Delay					16.6	21.7		23.0				
LOS					B	C		C				
Approach Delay					19.5			23.0				
Approach LOS					B			C				
Queue Length 50th (m)					31.6	44.2		63.6				
Queue Length 95th (m)					m38.1	m52.8		80.5				
Internal Link Dist (m)		32.2			131.7			689.6			53.0	
Turn Bay Length (m)						60.0						
Base Capacity (vph)					1165	963		1926				
Starvation Cap Reductn					0	0		0				
Spillback Cap Reductn					0	241		70				
Storage Cap Reductn					0	0		0				
Reduced v/c Ratio					0.39	0.80		0.81				

Intersection Summary

Cycle Length: 75
 Actuated Cycle Length: 75
 Offset: 0 (0%), Referenced to phase 2:NBT, Start of Green
 Natural Cycle: 60
 Control Type: Actuated-Coordinated
 Maximum v/c Ratio: 0.78
 Intersection Signal Delay: 21.6
 Intersection Capacity Utilization 65.1%
 Analysis Period (min) 15
 m Volume for 95th percentile queue is metered by upstream signal.

Splits and Phases: 2: Hwy 417 EB Off Ramp/Chamberlain Ave/Kent St & Catherine St

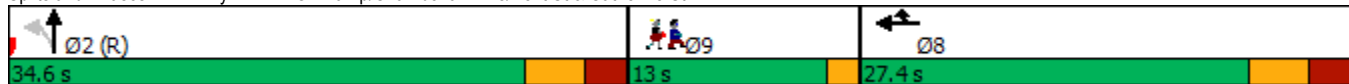

Lanes, Volumes, Timings

2: Hwy 417 EB Off Ramp/Chamberlain Ave/Kent St & Catherine St

05/11/2023

Lane Group	Ø9
Lane Configurations	
Traffic Volume (vph)	
Future Volume (vph)	
Satd. Flow (prot)	
Fit Permitted	
Satd. Flow (perm)	
Satd. Flow (RTOR)	
Lane Group Flow (vph)	
Turn Type	
Protected Phases	9
Permitted Phases	
Detector Phase	
Switch Phase	
Minimum Initial (s)	1.0
Minimum Split (s)	13.0
Total Split (s)	13.0
Total Split (%)	17%
Yellow Time (s)	2.0
All-Red Time (s)	0.0
Lost Time Adjust (s)	
Total Lost Time (s)	
Lead/Lag	
Lead-Lag Optimize?	
Recall Mode	None
Act Effct Green (s)	
Actuated g/C Ratio	
v/c Ratio	
Control Delay	
Queue Delay	
Total Delay	
LOS	
Approach Delay	
Approach LOS	
Queue Length 50th (m)	
Queue Length 95th (m)	
Internal Link Dist (m)	
Turn Bay Length (m)	
Base Capacity (vph)	
Starvation Cap Reductn	
Spillback Cap Reductn	
Storage Cap Reductn	
Reduced v/c Ratio	
Intersection Summary	

Lanes, Volumes, Timings
3: Bank St & Catherine St

05/11/2023



Lane Group	EBL	EBT	EBR	WBL	WBT	WBR	NBL	NBT	NBR	SBL	SBT	SBR
Lane Configurations					↕↕↕			↕↕			↕↕	
Traffic Volume (vph)	0	0	0	176	643	202	277	581	0	0	401	143
Future Volume (vph)	0	0	0	176	643	202	277	581	0	0	401	143
Satd. Flow (prot)	0	0	0	0	4440	0	0	3211	0	0	2869	0
Fit Permitted					0.991			0.634				
Satd. Flow (perm)	0	0	0	0	4386	0	0	1997	0	0	2869	0
Satd. Flow (RTOR)					74						73	
Lane Group Flow (vph)	0	0	0	0	1021	0	0	858	0	0	544	0
Turn Type				Perm	NA		pm+pt	NA			NA	
Protected Phases					8		9	2			6	
Permitted Phases				8			2					
Minimum Split (s)				18.6	18.6		10.4	16.4			16.4	
Total Split (s)				23.5	23.5		10.4	41.5			31.1	
Total Split (%)				31.3%	31.3%		13.9%	55.3%			41.5%	
Yellow Time (s)				3.3	3.3		3.3	3.3			3.3	
All-Red Time (s)				2.3	2.3		2.1	2.1			2.1	
Lost Time Adjust (s)					0.0			0.0			0.0	
Total Lost Time (s)					5.6			5.4			5.4	
Lead/Lag				Lag	Lag			Lag			Lag	
Lead-Lag Optimize?				Yes	Yes			Yes			Yes	
Act Effct Green (s)					17.9			36.1			25.7	
Actuated g/C Ratio					0.24			0.48			0.34	
v/c Ratio					0.93			0.82			0.53	
Control Delay					41.4			19.8			19.2	
Queue Delay					0.0			0.0			0.0	
Total Delay					41.4			19.8			19.2	
LOS					D			B			B	
Approach Delay					41.4			19.8			19.2	
Approach LOS					D			B			B	
Queue Length 50th (m)					48.3			25.6			27.3	
Queue Length 95th (m)					#73.5			#41.1			41.7	
Internal Link Dist (m)		131.7			702.3			90.2			52.9	
Turn Bay Length (m)												
Base Capacity (vph)					1103			1042			1031	
Starvation Cap Reductn					0			0			0	
Spillback Cap Reductn					0			0			0	
Storage Cap Reductn					0			0			0	
Reduced v/c Ratio					0.93			0.82			0.53	

Intersection Summary
 Cycle Length: 75
 Actuated Cycle Length: 75
 Offset: 50 (67%), Referenced to phase 2:NBT and 6:SBT, Start of Green
 Natural Cycle: 75
 Control Type: Pretimed
 Maximum v/c Ratio: 0.93
 Intersection Signal Delay: 28.8 Intersection LOS: C
 Intersection Capacity Utilization 82.2% ICU Level of Service E
 Analysis Period (min) 15
 # 95th percentile volume exceeds capacity, queue may be longer.
 Queue shown is maximum after two cycles.

Splits and Phases: 3: Bank St & Catherine St

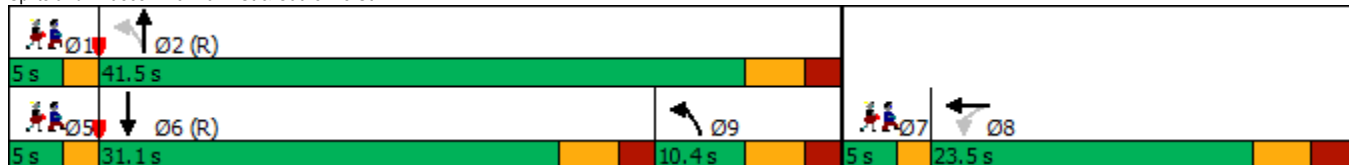

Lanes, Volumes, Timings
 3: Bank St & Catherine St

05/11/2023

Lane Group	Ø1	Ø5	Ø7
Lane Configurations			
Traffic Volume (vph)			
Future Volume (vph)			
Satd. Flow (prot)			
Fit Permitted			
Satd. Flow (perm)			
Satd. Flow (RTOR)			
Lane Group Flow (vph)			
Turn Type			
Protected Phases	1	5	7
Permitted Phases			
Minimum Split (s)	5.0	5.0	5.0
Total Split (s)	5.0	5.0	5.0
Total Split (%)	7%	7%	7%
Yellow Time (s)	2.0	2.0	2.0
All-Red Time (s)	0.0	0.0	0.0
Lost Time Adjust (s)			
Total Lost Time (s)			
Lead/Lag	Lead	Lead	Lead
Lead-Lag Optimize?	Yes	Yes	Yes
Act Effct Green (s)			
Actuated g/C Ratio			
v/c Ratio			
Control Delay			
Queue Delay			
Total Delay			
LOS			
Approach Delay			
Approach LOS			
Queue Length 50th (m)			
Queue Length 95th (m)			
Internal Link Dist (m)			
Turn Bay Length (m)			
Base Capacity (vph)			
Starvation Cap Reductn			
Spillback Cap Reductn			
Storage Cap Reductn			
Reduced v/c Ratio			
Intersection Summary			

Lanes, Volumes, Timings
4: Percy St & Catherine St

05/11/2023



Lane Group	EBL	EBT	EBR	WBL	WBT	WBR	NBL	NBT	NBR	SBL	SBT	SBR
Lane Configurations					↕↕						↕	
Traffic Volume (vph)	0	0	0	90	268	0	0	0	0	0	129	57
Future Volume (vph)	0	0	0	90	268	0	0	0	0	0	129	57
Satd. Flow (prot)	0	0	0	0	3171	0	0	0	0	0	1645	0
Fit Permitted					0.988							
Satd. Flow (perm)	0	0	0	0	3149	0	0	0	0	0	1645	0
Satd. Flow (RTOR)					160							
Lane Group Flow (vph)	0	0	0	0	358	0	0	0	0	0	186	0
Turn Type				Perm	NA						NA	
Protected Phases					8						6	
Permitted Phases				8								
Detector Phase				8	8						6	
Switch Phase												
Minimum Initial (s)				10.0	10.0						10.0	
Minimum Split (s)				26.5	26.5						23.4	
Total Split (s)				37.0	37.0						40.2	
Total Split (%)				41.1%	41.1%						44.7%	
Yellow Time (s)				3.3	3.3						3.3	
All-Red Time (s)				2.2	2.2						2.1	
Lost Time Adjust (s)					0.0						0.0	
Total Lost Time (s)					5.5						5.4	
Lead/Lag				Lag	Lag							
Lead-Lag Optimize?				Yes	Yes							
Recall Mode				None	None						Max	
Act Effct Green (s)					12.0						35.0	
Actuated g/C Ratio					0.21						0.60	
v/c Ratio					0.46						0.19	
Control Delay					12.5						6.6	
Queue Delay					0.0						0.0	
Total Delay					12.5						6.6	
LOS					B						A	
Approach Delay					12.5						6.6	
Approach LOS					B						A	
Queue Length 50th (m)					9.3						6.6	
Queue Length 95th (m)					18.3						21.4	
Internal Link Dist (m)		106.8			271.6			106.7			288.0	
Turn Bay Length (m)												
Base Capacity (vph)					1794						993	
Starvation Cap Reductn					0						0	
Spillback Cap Reductn					0						0	
Storage Cap Reductn					0						0	
Reduced v/c Ratio					0.20						0.19	

Intersection Summary
 Cycle Length: 90
 Actuated Cycle Length: 57.9
 Natural Cycle: 65
 Control Type: Semi Act-Uncoord
 Maximum v/c Ratio: 0.46
 Intersection Signal Delay: 10.5
 Intersection Capacity Utilization 39.6%
 Analysis Period (min) 15
 Intersection LOS: B
 ICU Level of Service A

Splits and Phases: 4: Percy St & Catherine St

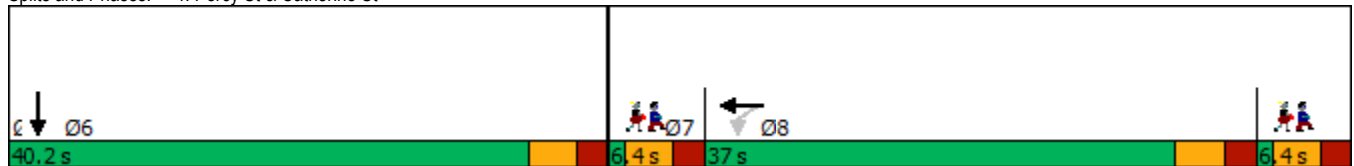

Lanes, Volumes, Timings
 4: Percy St & Catherine St

05/11/2023

Lane Group	Ø3	Ø7
Lane Configurations		
Traffic Volume (vph)		
Future Volume (vph)		
Satd. Flow (prot)		
Fit Permitted		
Satd. Flow (perm)		
Satd. Flow (RTOR)		
Lane Group Flow (vph)		
Turn Type		
Protected Phases	3	7
Permitted Phases		
Detector Phase		
Switch Phase		
Minimum Initial (s)	1.0	1.0
Minimum Split (s)	6.4	6.4
Total Split (s)	6.4	6.4
Total Split (%)	7%	7%
Yellow Time (s)	3.3	3.3
All-Red Time (s)	2.1	2.1
Lost Time Adjust (s)		
Total Lost Time (s)		
Lead/Lag		Lead
Lead-Lag Optimize?		Yes
Recall Mode	None	None
Act Effct Green (s)		
Actuated g/C Ratio		
v/c Ratio		
Control Delay		
Queue Delay		
Total Delay		
LOS		
Approach Delay		
Approach LOS		
Queue Length 50th (m)		
Queue Length 95th (m)		
Internal Link Dist (m)		
Turn Bay Length (m)		
Base Capacity (vph)		
Starvation Cap Reductn		
Spillback Cap Reductn		
Storage Cap Reductn		
Reduced v/c Ratio		
Intersection Summary		

Lanes, Volumes, Timings
6: Kent St & Arlington Ave

05/11/2023



Lane Group	EBL	EBT	EBR	WBL	WBT	WBR	NBL	NBT	NBR	SBL	SBT	SBR
Lane Configurations		↕			↕			↕↕↕				
Traffic Volume (vph)	38	80	0	0	17	93	25	1826	131	0	0	0
Future Volume (vph)	38	80	0	0	17	93	25	1826	131	0	0	0
Satd. Flow (prot)	0	1791	0	0	1571	0	0	4791	0	0	0	0
Fit Permitted		0.886						0.999				
Satd. Flow (perm)	0	1604	0	0	1571	0	0	4788	0	0	0	0
Satd. Flow (RTOR)					10			24				
Lane Group Flow (vph)	0	118	0	0	110	0	0	1982	0	0	0	0
Turn Type	Perm	NA			NA		Perm	NA				
Protected Phases		4			8			2				
Permitted Phases	4						2					
Minimum Split (s)	27.3	27.3			27.3		32.3	32.3				
Total Split (s)	27.6	27.6			27.6		47.4	47.4				
Total Split (%)	36.8%	36.8%			36.8%		63.2%	63.2%				
Yellow Time (s)	3.3	3.3			3.3		3.3	3.3				
All-Red Time (s)	2.0	2.0			2.0		2.0	2.0				
Lost Time Adjust (s)		0.0			0.0			0.0				
Total Lost Time (s)		5.3			5.3			5.3				
Lead/Lag												
Lead-Lag Optimize?												
Act Effct Green (s)		22.3			22.3			42.1				
Actuated g/C Ratio		0.30			0.30			0.56				
v/c Ratio		0.25			0.23			0.73				
Control Delay		29.4			16.5			13.9				
Queue Delay		0.0			0.0			11.3				
Total Delay		29.4			16.5			25.1				
LOS		C			B			C				
Approach Delay		29.4			16.5			25.1				
Approach LOS		C			B			C				
Queue Length 50th (m)		14.7			8.9			44.9				
Queue Length 95th (m)		28.5			m13.6			70.0				
Internal Link Dist (m)		138.7			143.1			53.0			216.0	
Turn Bay Length (m)												
Base Capacity (vph)		476			474			2698				
Starvation Cap Reductn		0			0			722				
Spillback Cap Reductn		0			0			0				
Storage Cap Reductn		0			0			0				
Reduced v/c Ratio		0.25			0.23			1.00				

Intersection Summary

Cycle Length: 75
 Actuated Cycle Length: 75
 Offset: 50 (67%), Referenced to phase 2:NBT, Start of Green
 Natural Cycle: 60
 Control Type: Pretimed
 Maximum v/c Ratio: 0.73
 Intersection Signal Delay: 24.9
 Intersection Capacity Utilization 70.4%
 Analysis Period (min) 15
 m Volume for 95th percentile queue is metered by upstream signal.

Splits and Phases: 6: Kent St & Arlington Ave

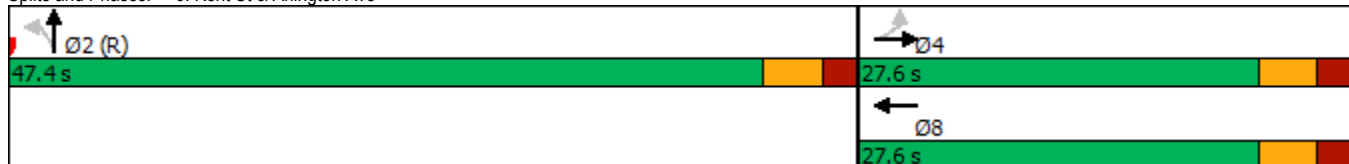

Lanes, Volumes, Timings
7: Lyon St N & Gladstone Ave

05/11/2023



Lane Group	EBL	EBT	EBR	WBL	WBT	WBR	NBL	NBT	NBR	SBL	SBT	SBR
Lane Configurations		↑	↗	↖	↑						↕	↕
Traffic Volume (vph)	0	184	24	15	143	0	0	0	0	89	352	98
Future Volume (vph)	0	184	24	15	143	0	0	0	0	89	352	98
Satd. Flow (prot)	0	1733	1547	1729	1750	0	0	0	0	0	3253	0
Fit Permitted				0.641							0.992	
Satd. Flow (perm)	0	1733	1485	1146	1750	0	0	0	0	0	3229	0
Satd. Flow (RTOR)			38								46	
Lane Group Flow (vph)	0	184	24	15	143	0	0	0	0	0	539	0
Turn Type		NA	Perm	Perm	NA					Perm	NA	
Protected Phases		4			8							6
Permitted Phases			4	8						6		
Minimum Split (s)		17.2	17.2	17.2	17.2					22.6	22.6	
Total Split (s)		36.0	36.0	36.0	36.0					39.0	39.0	
Total Split (%)		48.0%	48.0%	48.0%	48.0%					52.0%	52.0%	
Yellow Time (s)		3.3	3.3	3.3	3.3					3.3	3.3	
All-Red Time (s)		1.9	1.9	1.9	1.9					2.3	2.3	
Lost Time Adjust (s)		0.0	0.0	0.0	0.0						0.0	
Total Lost Time (s)		5.2	5.2	5.2	5.2						5.6	
Lead/Lag												
Lead-Lag Optimize?												
Act Effct Green (s)		30.8	30.8	30.8	30.8						33.4	
Actuated g/C Ratio		0.41	0.41	0.41	0.41						0.45	
v/c Ratio		0.26	0.04	0.03	0.20						0.37	
Control Delay		15.8	3.3	4.9	6.6						13.4	
Queue Delay		0.0	0.0	0.0	0.0						0.0	
Total Delay		15.8	3.3	4.9	6.6						13.4	
LOS		B	A	A	A						B	
Approach Delay		14.4			6.4						13.4	
Approach LOS		B			A						B	
Queue Length 50th (m)		16.6	0.0	0.5	7.3						23.0	
Queue Length 95th (m)		29.8	2.8	m1.1	13.6						34.2	
Internal Link Dist (m)		254.8			165.0			215.6			214.3	
Turn Bay Length (m)				25.0								
Base Capacity (vph)		711	632	470	718						1463	
Starvation Cap Reductn		0	0	0	0						0	
Spillback Cap Reductn		0	0	0	0						0	
Storage Cap Reductn		0	0	0	0						0	
Reduced v/c Ratio		0.26	0.04	0.03	0.20						0.37	

Intersection Summary
 Cycle Length: 75
 Actuated Cycle Length: 75
 Offset: 45 (60%), Referenced to phase 4:EBT and 8:WBTL, Start of Green
 Natural Cycle: 40
 Control Type: Pretimed
 Maximum v/c Ratio: 0.37
 Intersection Signal Delay: 12.4
 Intersection Capacity Utilization 82.4%
 Analysis Period (min) 15
 Intersection LOS: B
 ICU Level of Service E
 m Volume for 95th percentile queue is metered by upstream signal.

Splits and Phases: 7: Lyon St N & Gladstone Ave

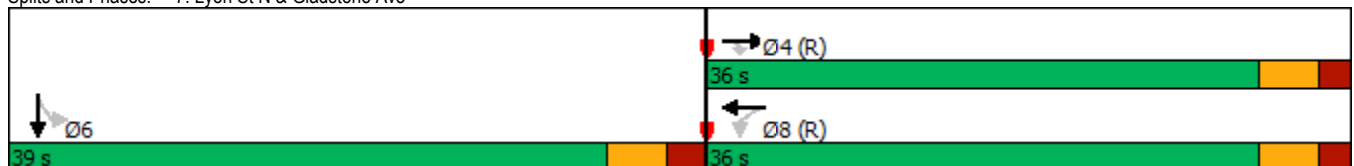

Lanes, Volumes, Timings
8: Kent St & Gladstone Ave

05/11/2023



Lane Group	EBL	EBT	EBR	WBL	WBT	WBR	NBL	NBT	NBR	SBL	SBT	SBR
Lane Configurations												
Traffic Volume (vph)	82	277	0	0	165	148	36	1827	97	0	0	0
Future Volume (vph)	82	277	0	0	165	148	36	1827	97	0	0	0
Satd. Flow (prot)	1662	1717	0	0	1552	0	1729	4793	0	0	0	0
Fit Permitted	0.468						0.950					
Satd. Flow (perm)	782	1717	0	0	1552	0	1444	4793	0	0	0	0
Satd. Flow (RTOR)					5			15				
Lane Group Flow (vph)	82	277	0	0	313	0	36	1924	0	0	0	0
Turn Type	Perm	NA			NA		Perm	NA				
Protected Phases		4			8			2				
Permitted Phases	4						2					
Minimum Split (s)	21.4	21.4			21.4		20.4	20.4				
Total Split (s)	32.0	32.0			32.0		43.0	43.0				
Total Split (%)	42.7%	42.7%			42.7%		57.3%	57.3%				
Yellow Time (s)	3.3	3.3			3.3		3.3	3.3				
All-Red Time (s)	2.1	2.1			2.1		2.1	2.1				
Lost Time Adjust (s)	0.0	0.0			0.0		0.0	0.0				
Total Lost Time (s)	5.4	5.4			5.4		5.4	5.4				
Lead/Lag												
Lead-Lag Optimize?												
Act Effct Green (s)	26.6	26.6			26.6		37.6	37.6				
Actuated g/C Ratio	0.35	0.35			0.35		0.50	0.50				
v/c Ratio	0.30	0.46			0.57		0.05	0.80				
Control Delay	27.2	28.1			24.1		9.6	14.4				
Queue Delay	0.0	0.0			0.0		0.0	0.0				
Total Delay	27.2	28.1			24.1		9.6	14.4				
LOS	C	C			C		A	B				
Approach Delay		27.9			24.1			14.3				
Approach LOS		C			C			B				
Queue Length 50th (m)	9.9	37.6			34.5		2.2	45.1				
Queue Length 95th (m)	23.3	59.6			58.6		m2.9	45.5				
Internal Link Dist (m)		165.0			168.8			216.0			203.6	
Turn Bay Length (m)	30.0						40.0					
Base Capacity (vph)	277	608			553		723	2410				
Starvation Cap Reductn	0	0			0		0	0				
Spillback Cap Reductn	0	0			0		0	0				
Storage Cap Reductn	0	0			0		0	0				
Reduced v/c Ratio	0.30	0.46			0.57		0.05	0.80				

Intersection Summary
 Cycle Length: 75
 Actuated Cycle Length: 75
 Offset: 23 (31%), Referenced to phase 4:EBTL and 8:WBT, Start of Green
 Natural Cycle: 55
 Control Type: Pretimed
 Maximum v/c Ratio: 0.80
 Intersection Signal Delay: 17.3
 Intersection LOS: B
 Intersection Capacity Utilization 82.4%
 ICU Level of Service E
 Analysis Period (min) 15
 m Volume for 95th percentile queue is metered by upstream signal.

Splits and Phases: 8: Kent St & Gladstone Ave

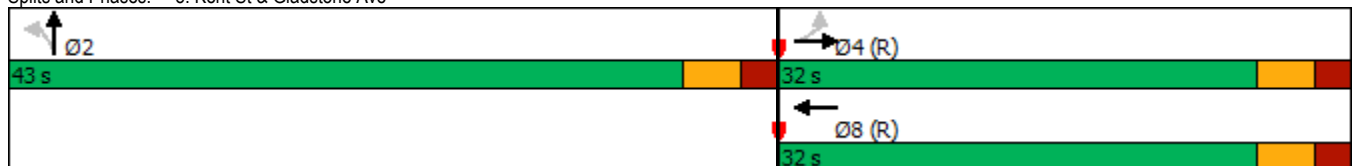

Lanes, Volumes, Timings
 9: Bank St & Chamberlain Ave/Isabella St

05/11/2023



Lane Group	EBL	EBT	EBR	WBL	WBT	WBR	NBL	NBT	NBR	SBL	SBT	SBR
Lane Configurations		↕↕	↗					↕↕			↕↕	
Traffic Volume (vph)	81	533	81	0	0	0	0	844	143	189	395	0
Future Volume (vph)	81	533	81	0	0	0	0	844	143	189	395	0
Satd. Flow (prot)	0	3225	1446	0	0	0	0	3154	0	0	3220	0
Fit Permitted		0.993									0.543	
Satd. Flow (perm)	0	3218	1358	0	0	0	0	3154	0	0	1760	0
Satd. Flow (RTOR)			134									
Lane Group Flow (vph)	0	614	81	0	0	0	0	987	0	0	584	0
Turn Type	Perm	NA	Perm					NA		pm+pt	NA	
Protected Phases		4						2		5	6	
Permitted Phases	4		4							6		
Detector Phase	4	4	4					2		5	6	
Switch Phase												
Minimum Initial (s)	10.0	10.0	10.0					10.0		5.0	10.0	
Minimum Split (s)	26.2	26.2	26.2					23.1		11.1	23.1	
Total Split (s)	26.2	26.2	26.2					37.7		11.1	48.8	
Total Split (%)	34.9%	34.9%	34.9%					50.3%		14.8%	65.1%	
Yellow Time (s)	3.3	3.3	3.3					3.0		3.0	3.0	
All-Red Time (s)	2.9	2.9	2.9					3.1		3.1	3.1	
Lost Time Adjust (s)		0.0	0.0					0.0			0.0	
Total Lost Time (s)		6.2	6.2					6.1			6.1	
Lead/Lag												
Lead-Lag Optimize?												
Recall Mode	None	None	None					C-Max		None	C-Max	
Act Effct Green (s)		18.5	18.5					44.2			44.2	
Actuated g/C Ratio		0.25	0.25					0.59			0.59	
v/c Ratio		0.77	0.19					0.53			0.56	
Control Delay		33.5	2.3					10.9			14.5	
Queue Delay		0.0	0.0					0.0			0.0	
Total Delay		33.5	2.3					10.9			14.5	
LOS		C	A					B			B	
Approach Delay		29.9						10.9			14.5	
Approach LOS		C						B			B	
Queue Length 50th (m)		41.3	0.0					42.0			42.5	
Queue Length 95th (m)		58.5	3.4					57.5			m58.2	
Internal Link Dist (m)		677.2			233.4			578.7			90.2	
Turn Bay Length (m)			40.0									
Base Capacity (vph)		858	460					1858			1037	
Starvation Cap Reductn		0	0					0			0	
Spillback Cap Reductn		0	0					0			0	
Storage Cap Reductn		0	0					0			0	
Reduced v/c Ratio		0.72	0.18					0.53			0.56	

Intersection Summary

Cycle Length: 75
 Actuated Cycle Length: 75
 Offset: 60 (80%), Referenced to phase 2:NBT and 6:SBTL, Start of Green
 Natural Cycle: 65
 Control Type: Actuated-Coordinated
 Maximum v/c Ratio: 0.77
 Intersection Signal Delay: 17.6
 Intersection Capacity Utilization 84.4%
 Analysis Period (min) 15
 Intersection LOS: B
 ICU Level of Service E
 m Volume for 95th percentile queue is metered by upstream signal.

Splits and Phases: 9: Bank St & Chamberlain Ave/Isabella St

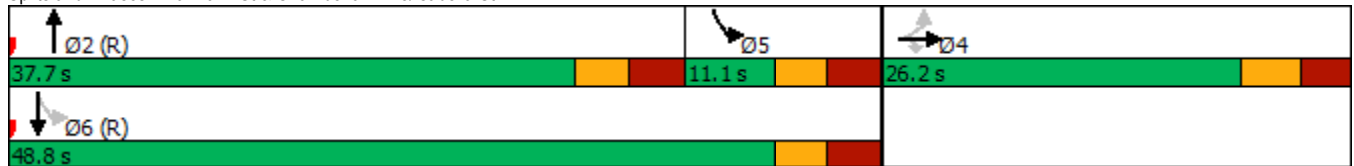

Lanes, Volumes, Timings
13: Bronson Ave & Catherine St

05/11/2023



Lane Group	EBL	EBT	EBR	WBL	WBT	WBR	NBL	NBT	NBR	SBL	SBT	SBR
Lane Configurations				↖ ↗	↖ ↗		↖ ↗	↖ ↗			↖ ↗	
Traffic Volume (vph)	0	0	0	537	510	374	553	1105	0	0	456	126
Future Volume (vph)	0	0	0	537	510	374	553	1105	0	0	456	126
Satd. Flow (prot)	0	0	0	1430	4136	0	1712	3390	0	0	3087	0
Fit Permitted				0.950	0.992		0.220					
Satd. Flow (perm)	0	0	0	1430	4136	0	396	3390	0	0	3087	0
Satd. Flow (RTOR)					78						29	
Lane Group Flow (vph)	0	0	0	360	1061	0	553	1105	0	0	582	0
Turn Type				Perm	NA		pm+pt	NA			NA	
Protected Phases					8		5	7			2	6
Permitted Phases				8			2					
Minimum Split (s)				28.3	28.3			23.8			23.8	
Total Split (s)				36.9	36.9			73.1			29.1	
Total Split (%)				33.5%	33.5%			66.5%			26.5%	
Yellow Time (s)				3.3	3.3			3.3			3.3	
All-Red Time (s)				3.0	3.0			3.5			3.5	
Lost Time Adjust (s)				0.0	0.0			0.0			0.0	
Total Lost Time (s)				6.3	6.3			6.8			6.8	
Lead/Lag												Lag
Lead-Lag Optimize?												Yes
Act Effct Green (s)				30.6	30.6		66.9	66.3			22.3	
Actuated g/C Ratio				0.28	0.28		0.61	0.60			0.20	
v/c Ratio				0.91	0.88		0.89	0.54			0.90	
Control Delay				66.4	44.8		34.8	14.1			58.8	
Queue Delay				0.0	0.0		0.0	0.0			0.0	
Total Delay				66.4	44.8		34.8	14.1			58.8	
LOS				E	D		C	B			E	
Approach Delay					50.3			21.0			58.8	
Approach LOS					D			C			E	
Queue Length 50th (m)				86.7	78.9		64.1	68.6			61.6	
Queue Length 95th (m)				#148.9	#103.9		#122.8	85.6			#92.6	
Internal Link Dist (m)		141.5			120.8			240.1			287.4	
Turn Bay Length (m)				80.0			45.0					
Base Capacity (vph)				397	1206		618	2043			648	
Starvation Cap Reductn				0	0		0	0			0	
Spillback Cap Reductn				0	0		0	0			0	
Storage Cap Reductn				0	0		0	0			0	
Reduced v/c Ratio				0.91	0.88		0.89	0.54			0.90	

Intersection Summary
 Cycle Length: 110
 Actuated Cycle Length: 110
 Offset: 60 (55%), Referenced to phase 2:NBTL and 6:SBT, Start of Green
 Natural Cycle: 90
 Control Type: Pretimed
 Maximum v/c Ratio: 0.91
 Intersection Signal Delay: 38.4 Intersection LOS: D
 Intersection Capacity Utilization 90.5% ICU Level of Service E
 Analysis Period (min) 15
 # 95th percentile volume exceeds capacity, queue may be longer.
 Queue shown is maximum after two cycles.

Splits and Phases: 13: Bronson Ave & Catherine St



Lanes, Volumes, Timings
 13: Bronson Ave & Catherine St

05/11/2023

Lane Group	Ø5	Ø7
Lane Configurations		
Traffic Volume (vph)		
Future Volume (vph)		
Satd. Flow (prot)		
Fit Permitted		
Satd. Flow (perm)		
Satd. Flow (RTOR)		
Lane Group Flow (vph)		
Turn Type		
Protected Phases	5	7
Permitted Phases		
Minimum Split (s)	11.2	11.8
Total Split (s)	32.2	11.8
Total Split (%)	29%	11%
Yellow Time (s)	3.3	3.3
All-Red Time (s)	2.9	3.5
Lost Time Adjust (s)		
Total Lost Time (s)		
Lead/Lag	Lead	
Lead-Lag Optimize?	Yes	
Act Effct Green (s)		
Actuated g/C Ratio		
v/c Ratio		
Control Delay		
Queue Delay		
Total Delay		
LOS		
Approach Delay		
Approach LOS		
Queue Length 50th (m)		
Queue Length 95th (m)		
Internal Link Dist (m)		
Turn Bay Length (m)		
Base Capacity (vph)		
Starvation Cap Reductn		
Spillback Cap Reductn		
Storage Cap Reductn		
Reduced v/c Ratio		
Intersection Summary		

Intersection												
Int Delay, s/veh	2.4											
Movement	EBL	EBT	EBR	WBL	WBT	WBR	NBL	NBT	NBR	SBL	SBT	SBR
Lane Configurations		↕			↕						↕↕	
Traffic Vol, veh/h	0	18	0	24	12	0	0	0	0	53	345	9
Future Vol, veh/h	0	18	0	24	12	0	0	0	0	53	345	9
Conflicting Peds, #/hr	32	0	15	15	0	32	9	0	10	10	0	9
Sign Control	Stop	Stop	Stop	Stop	Stop	Stop	Free	Free	Free	Free	Free	Free
RT Channelized	-	-	None	-	-	None	-	-	None	-	-	None
Storage Length	-	-	-	-	-	-	-	-	-	-	-	-
Veh in Median Storage, #	-	0	-	-	0	-	-	-	-	-	0	-
Grade, %	-	0	-	-	0	-	-	0	-	-	0	-
Peak Hour Factor	100	100	100	100	100	100	100	100	100	100	100	100
Heavy Vehicles, %	0	0	0	9	0	0	0	0	0	5	1	11
Mvmt Flow	0	18	0	24	12	0	0	0	0	53	345	9

Major/Minor	Minor2		Minor1			Major2			
Conflicting Flow All	-	475	201	313	479	-	10	0	0
Stage 1	-	465	-	10	10	-	-	-	-
Stage 2	-	10	-	303	469	-	-	-	-
Critical Hdwy	-	6.5	6.9	7.68	6.5	-	4.2	-	-
Critical Hdwy Stg 1	-	5.5	-	-	-	-	-	-	-
Critical Hdwy Stg 2	-	-	-	6.68	5.5	-	-	-	-
Follow-up Hdwy	-	4	3.3	3.59	4	-	2.25	-	-
Pot Cap-1 Maneuver	0	491	813	599	489	0	1586	-	-
Stage 1	0	566	-	-	0	-	-	-	-
Stage 2	0	-	-	662	564	0	-	-	-
Platoon blocked, %	-	-	-	-	-	-	-	-	-
Mov Cap-1 Maneuver	-	463	806	558	461	-	1571	-	-
Mov Cap-2 Maneuver	-	463	-	558	461	-	-	-	-
Stage 1	-	538	-	-	-	-	-	-	-
Stage 2	-	-	-	613	536	-	-	-	-

Approach	EB		WB			SB		
HCM Control Delay, s	13.1		12.4			1		
HCM LOS	B		B					

Minor Lane/Major Mvmt	EBLn1	WBLn1	SBL	SBT	SBR
Capacity (veh/h)	463	521	1571	-	-
HCM Lane V/C Ratio	0.039	0.069	0.034	-	-
HCM Control Delay (s)	13.1	12.4	7.4	0.1	-
HCM Lane LOS	B	B	A	A	-
HCM 95th %tile Q(veh)	0.1	0.2	0.1	-	-

Intersection						
Int Delay, s/veh	1.1					
Movement	EBL	EBT	WBT	WBR	SBL	SBR
Lane Configurations			↑↑			↗
Traffic Vol, veh/h	0	0	479	37	0	63
Future Vol, veh/h	0	0	479	37	0	63
Conflicting Peds, #/hr	0	0	0	0	0	0
Sign Control	Free	Free	Free	Free	Stop	Stop
RT Channelized	-	None	-	None	-	None
Storage Length	-	-	-	-	-	0
Veh in Median Storage, #	-4128768		0	-	0	-
Grade, %	-	0	0	-	0	-
Peak Hour Factor	100	100	100	100	100	100
Heavy Vehicles, %	2	2	2	2	2	2
Mvmt Flow	0	0	479	37	0	63
Major/Minor	Major2		Minor2			
Conflicting Flow All			-	0	-	258
Stage 1			-	-	-	-
Stage 2			-	-	-	-
Critical Hdwy			-	-	-	6.94
Critical Hdwy Stg 1			-	-	-	-
Critical Hdwy Stg 2			-	-	-	-
Follow-up Hdwy			-	-	-	3.32
Pot Cap-1 Maneuver			-	-	0	741
Stage 1			-	-	0	-
Stage 2			-	-	0	-
Platoon blocked, %			-	-	-	-
Mov Cap-1 Maneuver			-	-	-	741
Mov Cap-2 Maneuver			-	-	-	-
Stage 1			-	-	-	-
Stage 2			-	-	-	-
Approach	WB		SB			
HCM Control Delay, s			0		10.3	
HCM LOS					B	
Minor Lane/Major Mvmt	WBT	WBR	SBLn1			
Capacity (veh/h)	-	-	741			
HCM Lane V/C Ratio	-	-	0.085			
HCM Control Delay (s)	-	-	10.3			
HCM Lane LOS	-	-	B			
HCM 95th %tile Q(veh)	-	-	0.3			

Intersection						
Int Delay, s/veh	4					
Movement	EBT	EBR	WBL	WBT	NBL	NBR
Lane Configurations						
Traffic Vol, veh/h	62	9	16	23	13	51
Future Vol, veh/h	62	9	16	23	13	51
Conflicting Peds, #/hr	0	0	0	0	0	0
Sign Control	Free	Free	Free	Free	Stop	Stop
RT Channelized	-	None	-	None	-	None
Storage Length	-	-	-	-	0	-
Veh in Median Storage, #	0	-	-	0	0	-
Grade, %	0	-	-	0	0	-
Peak Hour Factor	100	100	100	100	100	100
Heavy Vehicles, %	2	2	0	0	2	2
Mvmt Flow	62	9	16	23	13	51

Major/Minor	Major1	Major2	Minor1	Minor2	Minor3
Conflicting Flow All	0	0	71	0	122
Stage 1	-	-	-	-	67
Stage 2	-	-	-	-	55
Critical Hdwy	-	-	4.1	-	6.42
Critical Hdwy Stg 1	-	-	-	-	5.42
Critical Hdwy Stg 2	-	-	-	-	5.42
Follow-up Hdwy	-	-	2.2	-	3.518
Pot Cap-1 Maneuver	-	-	1542	-	873
Stage 1	-	-	-	-	956
Stage 2	-	-	-	-	968
Platoon blocked, %	-	-	-	-	-
Mov Cap-1 Maneuver	-	-	1542	-	863
Mov Cap-2 Maneuver	-	-	-	-	863
Stage 1	-	-	-	-	956
Stage 2	-	-	-	-	957

Approach	EB	WB	NB
HCM Control Delay, s	0	3	9
HCM LOS			A

Minor Lane/Major Mvmt	NBLn1	EBT	EBR	WBL	WBT
Capacity (veh/h)	967	-	-	1542	-
HCM Lane V/C Ratio	0.066	-	-	0.01	-
HCM Control Delay (s)	9	-	-	7.4	0
HCM Lane LOS	A	-	-	A	A
HCM 95th %tile Q(veh)	0.2	-	-	0	-

Intersection						
Int Delay, s/veh	3.5					
Movement	EBL	EBR	NBL	NBT	SBT	SBR
Lane Configurations	↔			↕	↕	
Traffic Vol, veh/h	28	149	92	691	396	22
Future Vol, veh/h	28	149	92	691	396	22
Conflicting Peds, #/hr	0	0	111	0	0	111
Sign Control	Stop	Stop	Free	Free	Free	Free
RT Channelized	-	None	-	None	-	None
Storage Length	0	-	-	-	-	-
Veh in Median Storage, #	0	-	-	0	0	-
Grade, %	0	-	-	0	0	-
Peak Hour Factor	100	100	100	100	100	100
Heavy Vehicles, %	0	0	2	5	8	5
Mvmt Flow	28	149	92	691	396	22

Major/Minor	Minor2	Major1	Major2			
Conflicting Flow All	1048	320	529	0	-	0
Stage 1	518	-	-	-	-	-
Stage 2	530	-	-	-	-	-
Critical Hdwy	6.8	6.9	4.14	-	-	-
Critical Hdwy Stg 1	5.8	-	-	-	-	-
Critical Hdwy Stg 2	5.8	-	-	-	-	-
Follow-up Hdwy	3.5	3.3	2.22	-	-	-
Pot Cap-1 Maneuver	227	682	1034	-	-	-
Stage 1	568	-	-	-	-	-
Stage 2	560	-	-	-	-	-
Platoon blocked, %				-	-	-
Mov Cap-1 Maneuver	153	612	928	-	-	-
Mov Cap-2 Maneuver	153	-	-	-	-	-
Stage 1	428	-	-	-	-	-
Stage 2	502	-	-	-	-	-

Approach	EB	NB	SB
HCM Control Delay, s	20	1.6	0
HCM LOS	C		

Minor Lane/Major Mvmt	NBL	NBT	EBLn1	SBT	SBR
Capacity (veh/h)	928	-	415	-	-
HCM Lane V/C Ratio	0.099	-	0.427	-	-
HCM Control Delay (s)	9.3	0.6	20	-	-
HCM Lane LOS	A	A	C	-	-
HCM 95th %tile Q(veh)	0.3	-	2.1	-	-

Lanes, Volumes, Timings

1: Hwy 417 WB On Ramp/Lyon St N & Catherine St

05/11/2023



Lane Group	EBL	EBT	EBR	WBL	WBT	WBR	NBL	NBT	NBR	SBL	SBT	SBR
Lane Configurations					↕↕						↕	↕
Traffic Volume (vph)	0	0	0	226	563	0	0	0	0	0	373	304
Future Volume (vph)	0	0	0	226	563	0	0	0	0	0	373	304
Satd. Flow (prot)	0	0	0	0	3297	0	0	0	0	0	1802	1532
Fit Permitted					0.986							
Satd. Flow (perm)	0	0	0	0	3273	0	0	0	0	0	1802	1490
Satd. Flow (RTOR)					102							171
Lane Group Flow (vph)	0	0	0	0	789	0	0	0	0	0	373	304
Turn Type				Perm	NA						NA	Perm
Protected Phases					8						6	
Permitted Phases				8								6
Minimum Split (s)				26.2	26.2						28.3	28.3
Total Split (s)				38.0	38.0						37.0	37.0
Total Split (%)				50.7%	50.7%						49.3%	49.3%
Yellow Time (s)				3.3	3.3						3.3	3.3
All-Red Time (s)				1.9	1.9						2.0	2.0
Lost Time Adjust (s)					0.0						0.0	0.0
Total Lost Time (s)					5.2						5.3	5.3
Lead/Lag												
Lead-Lag Optimize?												
Act Effct Green (s)					32.8						31.7	31.7
Actuated g/C Ratio					0.44						0.42	0.42
v/c Ratio					0.53						0.49	0.42
Control Delay					13.5						26.9	17.5
Queue Delay					0.0						0.0	0.0
Total Delay					13.5						26.9	17.5
LOS					B						C	B
Approach Delay					13.5						22.7	
Approach LOS					B						C	
Queue Length 50th (m)					54.9						53.5	27.6
Queue Length 95th (m)					72.8						79.1	51.0
Internal Link Dist (m)		271.6			107.6			117.8			52.8	
Turn Bay Length (m)												
Base Capacity (vph)					1488						761	728
Starvation Cap Reductn					0						0	0
Spillback Cap Reductn					0						0	0
Storage Cap Reductn					0						0	0
Reduced v/c Ratio					0.53						0.49	0.42

Intersection Summary

Cycle Length: 75	
Actuated Cycle Length: 75	
Offset: 24 (32%), Referenced to phase 8:WBTL, Start of Green	
Natural Cycle: 55	
Control Type: Pretimed	
Maximum v/c Ratio: 0.53	
Intersection Signal Delay: 17.7	Intersection LOS: B
Intersection Capacity Utilization 56.1%	ICU Level of Service B
Analysis Period (min) 15	

Splits and Phases: 1: Hwy 417 WB On Ramp/Lyon St N & Catherine St

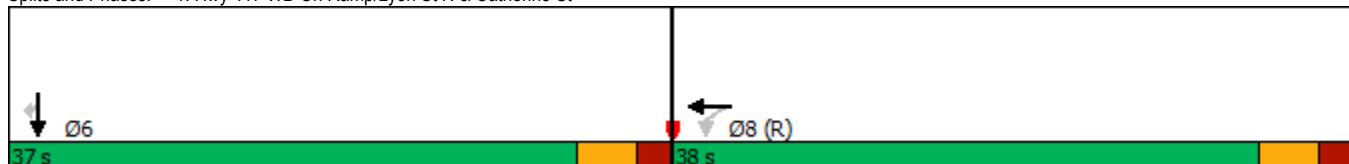

Lanes, Volumes, Timings

2: Hwy 417 EB Off Ramp/Chamberlain Ave/Kent St & Catherine St

05/11/2023



Lane Group	EBL	EBT	EBR	WBL	WBT	WBR	NBL	NBT	NBR	SBL	SBT	SBR
Lane Configurations					↑↑	↑↑		↑↑↑				
Traffic Volume (vph)	0	0	0	0	735	320	49	889	0	0	0	0
Future Volume (vph)	0	0	0	0	735	320	49	889	0	0	0	0
Satd. Flow (prot)	0	0	0	0	3357	2521	0	4852	0	0	0	0
Fit Permitted								0.997				
Satd. Flow (perm)	0	0	0	0	3357	2521	0	4847	0	0	0	0
Satd. Flow (RTOR)								70				
Lane Group Flow (vph)	0	0	0	0	735	320	0	938	0	0	0	0
Turn Type					NA	Prot	Perm	NA				
Protected Phases					8	8		2				
Permitted Phases							2					
Detector Phase					8	8	2	2				
Switch Phase												
Minimum Initial (s)					10.0	10.0	10.0	10.0				
Minimum Split (s)					15.8	15.8	22.5	22.5				
Total Split (s)					35.0	35.0	27.0	27.0				
Total Split (%)					46.7%	46.7%	36.0%	36.0%				
Yellow Time (s)					3.3	3.3	3.3	3.3				
All-Red Time (s)					2.5	2.5	2.5	2.5				
Lost Time Adjust (s)					0.0	0.0		0.0				
Total Lost Time (s)					5.8	5.8		5.8				
Lead/Lag												
Lead-Lag Optimize?												
Recall Mode					C-Max	C-Max	Max	Max				
Act Effct Green (s)					34.4	34.4		21.2				
Actuated g/C Ratio					0.46	0.46		0.28				
v/c Ratio					0.48	0.28		0.66				
Control Delay					27.4	24.8		24.5				
Queue Delay					0.0	0.0		3.3				
Total Delay					27.4	24.8		27.8				
LOS					C	C		C				
Approach Delay					26.6			27.8				
Approach LOS					C			C				
Queue Length 50th (m)					55.3	24.0		39.4				
Queue Length 95th (m)					m65.6	m28.8		52.3				
Internal Link Dist (m)		32.2			131.7			689.6			53.0	
Turn Bay Length (m)						60.0						
Base Capacity (vph)					1539	1156		1420				
Starvation Cap Reductn					0	0		0				
Spillback Cap Reductn					0	0		371				
Storage Cap Reductn					0	0		0				
Reduced v/c Ratio					0.48	0.28		0.89				

Intersection Summary

Cycle Length: 75
 Actuated Cycle Length: 75
 Offset: 0 (0%), Referenced to phase 8:WBT, Start of Green
 Natural Cycle: 60
 Control Type: Actuated-Coordinated
 Maximum v/c Ratio: 0.66
 Intersection Signal Delay: 27.2
 Intersection LOS: C
 Intersection Capacity Utilization 52.5%
 ICU Level of Service A
 Analysis Period (min) 15
 m Volume for 95th percentile queue is metered by upstream signal.

Splits and Phases: 2: Hwy 417 EB Off Ramp/Chamberlain Ave/Kent St & Catherine St



Lanes, Volumes, Timings

2: Hwy 417 EB Off Ramp/Chamberlain Ave/Kent St & Catherine St

05/11/2023

Lane Group	Ø9
Lane Configurations	
Traffic Volume (vph)	
Future Volume (vph)	
Satd. Flow (prot)	
Fit Permitted	
Satd. Flow (perm)	
Satd. Flow (RTOR)	
Lane Group Flow (vph)	
Turn Type	
Protected Phases	9
Permitted Phases	
Detector Phase	
Switch Phase	
Minimum Initial (s)	1.0
Minimum Split (s)	13.0
Total Split (s)	13.0
Total Split (%)	17%
Yellow Time (s)	2.0
All-Red Time (s)	0.0
Lost Time Adjust (s)	
Total Lost Time (s)	
Lead/Lag	
Lead-Lag Optimize?	
Recall Mode	None
Act Effct Green (s)	
Actuated g/C Ratio	
v/c Ratio	
Control Delay	
Queue Delay	
Total Delay	
LOS	
Approach Delay	
Approach LOS	
Queue Length 50th (m)	
Queue Length 95th (m)	
Internal Link Dist (m)	
Turn Bay Length (m)	
Base Capacity (vph)	
Starvation Cap Reductn	
Spillback Cap Reductn	
Storage Cap Reductn	
Reduced v/c Ratio	
Intersection Summary	

Lanes, Volumes, Timings
3: Bank St & Catherine St

05/11/2023



Lane Group	EBL	EBT	EBR	WBL	WBT	WBR	NBL	NBT	NBR	SBL	SBT	SBR
Lane Configurations					↕↕↕			↕↕			↕↕	
Traffic Volume (vph)	0	0	0	236	666	158	204	339	0	0	711	141
Future Volume (vph)	0	0	0	236	666	158	204	339	0	0	711	141
Satd. Flow (prot)	0	0	0	0	4616	0	0	3261	0	0	3098	0
Fit Permitted					0.989			0.539				
Satd. Flow (perm)	0	0	0	0	4537	0	0	1790	0	0	3098	0
Satd. Flow (RTOR)					44						33	
Lane Group Flow (vph)	0	0	0	0	1060	0	0	543	0	0	852	0
Turn Type				Perm	NA		pm+pt	NA			NA	
Protected Phases					8		9	2			6	
Permitted Phases				8			2					
Minimum Split (s)				18.6	18.6		10.4	16.4			16.4	
Total Split (s)				24.6	24.6		10.4	40.4			30.0	
Total Split (%)				32.8%	32.8%		13.9%	53.9%			40.0%	
Yellow Time (s)				3.3	3.3		3.3	3.3			3.3	
All-Red Time (s)				2.3	2.3		2.1	2.1			2.1	
Lost Time Adjust (s)					0.0			0.0			0.0	
Total Lost Time (s)					5.6			5.4			5.4	
Lead/Lag				Lag	Lag		Lag	Lag			Lag	
Lead-Lag Optimize?				Yes	Yes		Yes	Yes			Yes	
Act Effct Green (s)					19.0			35.0			24.6	
Actuated g/C Ratio					0.25			0.47			0.33	
v/c Ratio					0.90			0.58			0.82	
Control Delay					37.6			13.8			30.4	
Queue Delay					0.0			0.0			0.9	
Total Delay					37.6			13.8			31.3	
LOS					D			B			C	
Approach Delay					37.6			13.8			31.3	
Approach LOS					D			B			C	
Queue Length 50th (m)					51.0			16.1			55.3	
Queue Length 95th (m)					#75.0			m21.2			#81.2	
Internal Link Dist (m)		131.7			702.3			90.2			52.9	
Turn Bay Length (m)												
Base Capacity (vph)					1182			933			1038	
Starvation Cap Reductn					0			0			0	
Spillback Cap Reductn					0			0			50	
Storage Cap Reductn					0			0			0	
Reduced v/c Ratio					0.90			0.58			0.86	

Intersection Summary
 Cycle Length: 75
 Actuated Cycle Length: 75
 Offset: 50 (67%), Referenced to phase 2:NBT and 6:SBT, Start of Green
 Natural Cycle: 75
 Control Type: Pretimed
 Maximum v/c Ratio: 0.90
 Intersection Signal Delay: 30.2 Intersection LOS: C
 Intersection Capacity Utilization 81.8% ICU Level of Service D
 Analysis Period (min) 15
 # 95th percentile volume exceeds capacity, queue may be longer.
 Queue shown is maximum after two cycles.
 m Volume for 95th percentile queue is metered by upstream signal.

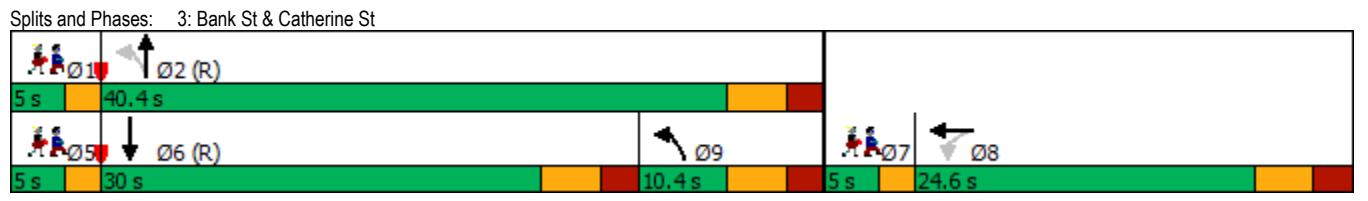

Lanes, Volumes, Timings
 3: Bank St & Catherine St

05/11/2023

Lane Group	Ø1	Ø5	Ø7
Lane Configurations			
Traffic Volume (vph)			
Future Volume (vph)			
Satd. Flow (prot)			
Fit Permitted			
Satd. Flow (perm)			
Satd. Flow (RTOR)			
Lane Group Flow (vph)			
Turn Type			
Protected Phases	1	5	7
Permitted Phases			
Minimum Split (s)	5.0	5.0	5.0
Total Split (s)	5.0	5.0	5.0
Total Split (%)	7%	7%	7%
Yellow Time (s)	2.0	2.0	2.0
All-Red Time (s)	0.0	0.0	0.0
Lost Time Adjust (s)			
Total Lost Time (s)			
Lead/Lag	Lead	Lead	Lead
Lead-Lag Optimize?	Yes	Yes	Yes
Act Effct Green (s)			
Actuated g/C Ratio			
v/c Ratio			
Control Delay			
Queue Delay			
Total Delay			
LOS			
Approach Delay			
Approach LOS			
Queue Length 50th (m)			
Queue Length 95th (m)			
Internal Link Dist (m)			
Turn Bay Length (m)			
Base Capacity (vph)			
Starvation Cap Reductn			
Spillback Cap Reductn			
Storage Cap Reductn			
Reduced v/c Ratio			
Intersection Summary			

Lanes, Volumes, Timings
4: Percy St & Catherine St

05/11/2023



Lane Group	EBL	EBT	EBR	WBL	WBT	WBR	NBL	NBT	NBR	SBL	SBT	SBR
Lane Configurations					↕↕						↕	
Traffic Volume (vph)	0	0	0	165	740	0	0	0	0	0	121	39
Future Volume (vph)	0	0	0	165	740	0	0	0	0	0	121	39
Satd. Flow (prot)	0	0	0	0	3354	0	0	0	0	0	1727	0
Fit Permitted					0.991							
Satd. Flow (perm)	0	0	0	0	3341	0	0	0	0	0	1727	0
Satd. Flow (RTOR)					160							
Lane Group Flow (vph)	0	0	0	0	905	0	0	0	0	0	160	0
Turn Type				Perm	NA						NA	
Protected Phases					8						6	
Permitted Phases				8								
Detector Phase				8	8						6	
Switch Phase												
Minimum Initial (s)				10.0	10.0						10.0	
Minimum Split (s)				26.5	26.5						23.4	
Total Split (s)				47.0	47.0						30.2	
Total Split (%)				52.2%	52.2%						33.6%	
Yellow Time (s)				3.3	3.3						3.3	
All-Red Time (s)				2.2	2.2						2.1	
Lost Time Adjust (s)					0.0						0.0	
Total Lost Time (s)					5.5						5.4	
Lead/Lag				Lag	Lag							
Lead-Lag Optimize?				Yes	Yes							
Recall Mode				None	None						Max	
Act Effct Green (s)					20.7						25.0	
Actuated g/C Ratio					0.37						0.44	
v/c Ratio					0.68						0.21	
Control Delay					15.0						12.2	
Queue Delay					0.0						0.0	
Total Delay					15.0						12.2	
LOS					B						B	
Approach Delay					15.0						12.2	
Approach LOS					B						B	
Queue Length 50th (m)					32.3						9.3	
Queue Length 95th (m)					48.0						24.1	
Internal Link Dist (m)		106.8			271.6			106.7			288.0	
Turn Bay Length (m)												
Base Capacity (vph)					2505						760	
Starvation Cap Reductn					0						0	
Spillback Cap Reductn					0						0	
Storage Cap Reductn					0						0	
Reduced v/c Ratio					0.36						0.21	

Intersection Summary
 Cycle Length: 90
 Actuated Cycle Length: 56.7
 Natural Cycle: 65
 Control Type: Semi Act-Uncoord
 Maximum v/c Ratio: 0.68
 Intersection Signal Delay: 14.6
 Intersection Capacity Utilization 54.0%
 Analysis Period (min) 15
 Intersection LOS: B
 ICU Level of Service A

Splits and Phases: 4: Percy St & Catherine St

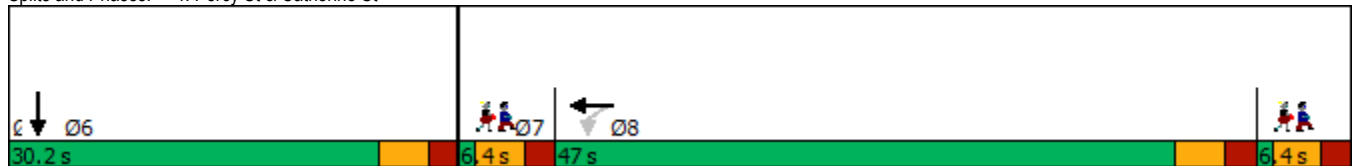

Lanes, Volumes, Timings
 4: Percy St & Catherine St

05/11/2023

Lane Group	Ø3	Ø7
Lane Configurations		
Traffic Volume (vph)		
Future Volume (vph)		
Satd. Flow (prot)		
Fit Permitted		
Satd. Flow (perm)		
Satd. Flow (RTOR)		
Lane Group Flow (vph)		
Turn Type		
Protected Phases	3	7
Permitted Phases		
Detector Phase		
Switch Phase		
Minimum Initial (s)	1.0	1.0
Minimum Split (s)	6.4	6.4
Total Split (s)	6.4	6.4
Total Split (%)	7%	7%
Yellow Time (s)	3.3	3.3
All-Red Time (s)	2.1	2.1
Lost Time Adjust (s)		
Total Lost Time (s)		
Lead/Lag		Lead
Lead-Lag Optimize?		Yes
Recall Mode	None	None
Act Effct Green (s)		
Actuated g/C Ratio		
v/c Ratio		
Control Delay		
Queue Delay		
Total Delay		
LOS		
Approach Delay		
Approach LOS		
Queue Length 50th (m)		
Queue Length 95th (m)		
Internal Link Dist (m)		
Turn Bay Length (m)		
Base Capacity (vph)		
Starvation Cap Reductn		
Spillback Cap Reductn		
Storage Cap Reductn		
Reduced v/c Ratio		
Intersection Summary		

Lanes, Volumes, Timings
6: Kent St & Arlington Ave

05/11/2023



Lane Group	EBL	EBT	EBR	WBL	WBT	WBR	NBL	NBT	NBR	SBL	SBT	SBR
Lane Configurations		↕			↕			↕↕↕				
Traffic Volume (vph)	24	81	0	0	29	63	38	1098	93	0	0	0
Future Volume (vph)	24	81	0	0	29	63	38	1098	93	0	0	0
Satd. Flow (prot)	0	1800	0	0	1592	0	0	4826	0	0	0	0
Fit Permitted		0.933						0.998				
Satd. Flow (perm)	0	1685	0	0	1592	0	0	4823	0	0	0	0
Satd. Flow (RTOR)					50			26				
Lane Group Flow (vph)	0	105	0	0	92	0	0	1229	0	0	0	0
Turn Type	Perm	NA			NA		Perm	NA				
Protected Phases		4			8			2				
Permitted Phases	4						2					
Minimum Split (s)	27.3	27.3			27.3		32.3	32.3				
Total Split (s)	31.0	31.0			31.0		44.0	44.0				
Total Split (%)	41.3%	41.3%			41.3%		58.7%	58.7%				
Yellow Time (s)	3.3	3.3			3.3		3.3	3.3				
All-Red Time (s)	2.0	2.0			2.0		2.0	2.0				
Lost Time Adjust (s)		0.0			0.0			0.0				
Total Lost Time (s)		5.3			5.3			5.3				
Lead/Lag												
Lead-Lag Optimize?												
Act Effct Green (s)		25.7			25.7			38.7				
Actuated g/C Ratio		0.34			0.34			0.52				
v/c Ratio		0.18			0.16			0.49				
Control Delay		26.0			9.9			10.0				
Queue Delay		0.0			0.0			49.8				
Total Delay		26.0			9.9			59.7				
LOS		C			A			E				
Approach Delay		26.0			9.9			59.7				
Approach LOS		C			A			E				
Queue Length 50th (m)		12.6			1.8			49.5				
Queue Length 95th (m)		m24.7			m6.9			69.8				
Internal Link Dist (m)		138.7			143.1			53.0			216.0	
Turn Bay Length (m)												
Base Capacity (vph)		577			578			2501				
Starvation Cap Reductn		0			0			1427				
Spillback Cap Reductn		0			0			0				
Storage Cap Reductn		0			0			0				
Reduced v/c Ratio		0.18			0.16			1.14				

Intersection Summary
 Cycle Length: 75
 Actuated Cycle Length: 75
 Offset: 50 (67%), Referenced to phase 2:NBT, Start of Green
 Natural Cycle: 60
 Control Type: Pretimed
 Maximum v/c Ratio: 0.49
 Intersection Signal Delay: 54.0
 Intersection LOS: D
 Intersection Capacity Utilization 55.0%
 ICU Level of Service B
 Analysis Period (min) 15
 m Volume for 95th percentile queue is metered by upstream signal.

Splits and Phases: 6: Kent St & Arlington Ave



Lanes, Volumes, Timings
7: Lyon St N & Gladstone Ave

05/11/2023



Lane Group	EBL	EBT	EBR	WBL	WBT	WBR	NBL	NBT	NBR	SBL	SBT	SBR
Lane Configurations		↑	↗	↖	↑						↕	
Traffic Volume (vph)	0	247	52	28	314	0	0	0	0	86	551	138
Future Volume (vph)	0	247	52	28	314	0	0	0	0	86	551	138
Satd. Flow (prot)	0	1784	1547	1729	1784	0	0	0	0	0	3262	0
Fit Permitted				0.574							0.994	
Satd. Flow (perm)	0	1784	1407	997	1784	0	0	0	0	0	3250	0
Satd. Flow (RTOR)			52								43	
Lane Group Flow (vph)	0	247	52	28	314	0	0	0	0	0	775	0
Turn Type		NA	Perm	Perm	NA					Perm	NA	
Protected Phases		4			8							6
Permitted Phases			4	8						6		
Minimum Split (s)		17.2	17.2	17.2	17.2					22.6	22.6	
Total Split (s)		37.0	37.0	37.0	37.0					38.0	38.0	
Total Split (%)		49.3%	49.3%	49.3%	49.3%					50.7%	50.7%	
Yellow Time (s)		3.3	3.3	3.3	3.3					3.3	3.3	
All-Red Time (s)		1.9	1.9	1.9	1.9					2.3	2.3	
Lost Time Adjust (s)		0.0	0.0	0.0	0.0						0.0	
Total Lost Time (s)		5.2	5.2	5.2	5.2						5.6	
Lead/Lag												
Lead-Lag Optimize?												
Act Effct Green (s)		31.8	31.8	31.8	31.8						32.4	
Actuated g/C Ratio		0.42	0.42	0.42	0.42						0.43	
v/c Ratio		0.33	0.08	0.07	0.42						0.54	
Control Delay		16.0	4.5	8.4	12.6						16.6	
Queue Delay		0.0	0.0	0.0	0.0						0.0	
Total Delay		16.0	4.5	8.4	12.6						16.6	
LOS		B	A	A	B						B	
Approach Delay		14.0			12.3						16.6	
Approach LOS		B			B						B	
Queue Length 50th (m)		22.6	0.0	1.5	35.6						38.6	
Queue Length 95th (m)		38.4	5.7	m3.3	55.1						54.3	
Internal Link Dist (m)		254.8			165.0			215.6			214.3	
Turn Bay Length (m)				25.0								
Base Capacity (vph)		756	626	422	756						1428	
Starvation Cap Reductn		0	0	0	0						0	
Spillback Cap Reductn		0	0	0	0						0	
Storage Cap Reductn		0	0	0	0						0	
Reduced v/c Ratio		0.33	0.08	0.07	0.42						0.54	

Intersection Summary

Cycle Length: 75
 Actuated Cycle Length: 75
 Offset: 45 (60%), Referenced to phase 4:EBT and 8:WBTL, Start of Green
 Natural Cycle: 40
 Control Type: Pretimed
 Maximum v/c Ratio: 0.54
 Intersection Signal Delay: 15.0
 Intersection Capacity Utilization 68.3%
 Analysis Period (min) 15
 Intersection LOS: B
 ICU Level of Service C
 m Volume for 95th percentile queue is metered by upstream signal.

Splits and Phases: 7: Lyon St N & Gladstone Ave

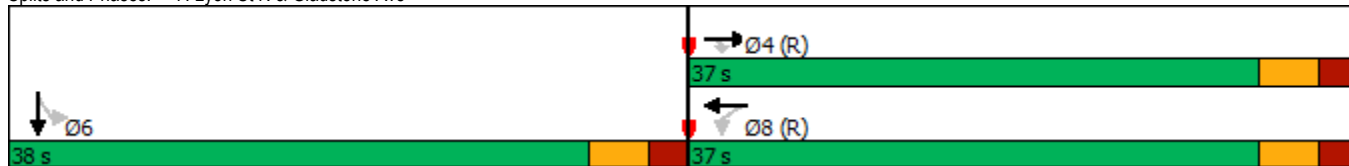

Lanes, Volumes, Timings
 9: Bank St & Chamberlain Ave/Isabella St

05/11/2023



Lane Group	EBL	EBT	EBR	WBL	WBT	WBR	NBL	NBT	NBR	SBL	SBT	SBR
Lane Configurations		↕↕	↗					↕↕			↕↕	
Traffic Volume (vph)	66	637	124	0	0	0	0	466	93	188	733	0
Future Volume (vph)	66	637	124	0	0	0	0	466	93	188	733	0
Satd. Flow (prot)	0	3344	1547	0	0	0	0	3138	0	0	3324	0
Fit Permitted		0.995									0.713	
Satd. Flow (perm)	0	3340	1402	0	0	0	0	3138	0	0	2344	0
Satd. Flow (RTOR)			134									
Lane Group Flow (vph)	0	703	124	0	0	0	0	559	0	0	921	0
Turn Type	Perm	NA	Perm					NA		pm+pt	NA	
Protected Phases		4						2		5	6	
Permitted Phases	4		4							6		
Detector Phase	4	4	4					2		5	6	
Switch Phase												
Minimum Initial (s)	10.0	10.0	10.0					10.0		5.0	10.0	
Minimum Split (s)	26.2	26.2	26.2					23.1		11.1	23.1	
Total Split (s)	27.0	27.0	27.0					36.9		11.1	48.0	
Total Split (%)	36.0%	36.0%	36.0%					49.2%		14.8%	64.0%	
Yellow Time (s)	3.3	3.3	3.3					3.0		3.0	3.0	
All-Red Time (s)	2.9	2.9	2.9					3.1		3.1	3.1	
Lost Time Adjust (s)		0.0	0.0					0.0			0.0	
Total Lost Time (s)		6.2	6.2					6.1			6.1	
Lead/Lag												
Lead-Lag Optimize?												
Recall Mode	None	None	None					C-Max		None	C-Max	
Act Effct Green (s)		19.9	19.9					42.8			42.8	
Actuated g/C Ratio		0.27	0.27					0.57			0.57	
v/c Ratio		0.80	0.26					0.31			0.69	
Control Delay		33.2	5.4					9.2			13.3	
Queue Delay		0.0	0.0					0.0			1.8	
Total Delay		33.2	5.4					9.2			15.0	
LOS		C	A					A			B	
Approach Delay		29.0						9.2			15.0	
Approach LOS		C						A			B	
Queue Length 50th (m)		47.6	0.0					20.4			74.2	
Queue Length 95th (m)		66.5	10.0					29.5			m91.0	
Internal Link Dist (m)		677.2			233.4			578.7			90.2	
Turn Bay Length (m)			40.0									
Base Capacity (vph)		926	485					1792			1338	
Starvation Cap Reductn		0	0					0			250	
Spillback Cap Reductn		0	0					0			0	
Storage Cap Reductn		0	0					0			0	
Reduced v/c Ratio		0.76	0.26					0.31			0.85	

Intersection Summary

Cycle Length: 75
 Actuated Cycle Length: 75
 Offset: 60 (80%), Referenced to phase 2:NBT and 6:SBTL, Start of Green
 Natural Cycle: 65
 Control Type: Actuated-Coordinated
 Maximum v/c Ratio: 0.80
 Intersection Signal Delay: 18.6
 Intersection Capacity Utilization 84.4%
 Analysis Period (min) 15
 Intersection LOS: B
 ICU Level of Service E
 m Volume for 95th percentile queue is metered by upstream signal.

Splits and Phases: 9: Bank St & Chamberlain Ave/Isabella St

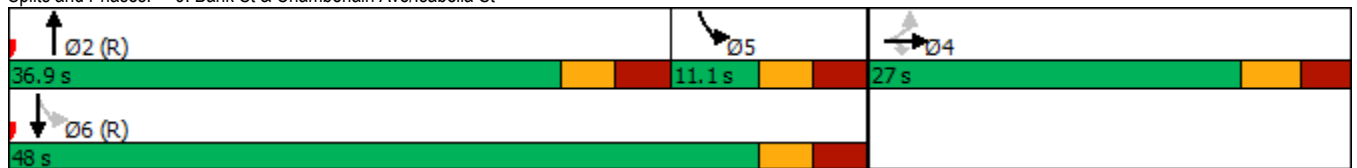

Lanes, Volumes, Timings
13: Bronson Ave & Catherine St

05/11/2023



Lane Group	EBL	EBT	EBR	WBL	WBT	WBR	NBL	NBT	NBR	SBL	SBT	SBR
Lane Configurations				↖ ↗	↖ ↗		↖ ↗	↖ ↗			↖ ↗	
Traffic Volume (vph)	0	0	0	743	610	292	311	812	0	0	853	176
Future Volume (vph)	0	0	0	743	610	292	311	812	0	0	853	176
Satd. Flow (prot)	0	0	0	1458	4274	0	1679	3390	0	0	3260	0
Fit Permitted				0.950	0.987		0.099					
Satd. Flow (perm)	0	0	0	1458	4274	0	175	3390	0	0	3260	0
Satd. Flow (RTOR)					81						26	
Lane Group Flow (vph)	0	0	0	416	1229	0	311	812	0	0	1029	0
Turn Type				Perm	NA		pm+pt	NA			NA	
Protected Phases					8		5	2				6
Permitted Phases				8			2					
Minimum Split (s)				28.3	28.3		11.2	23.8			23.8	
Total Split (s)				37.0	37.0		22.0	63.0			41.0	
Total Split (%)				37.0%	37.0%		22.0%	63.0%			41.0%	
Yellow Time (s)				3.3	3.3		3.3	3.3			3.3	
All-Red Time (s)				3.0	3.0		2.9	3.5			3.5	
Lost Time Adjust (s)				0.0	0.0		0.0	0.0			0.0	
Total Lost Time (s)				6.3	6.3		6.2	6.8			6.8	
Lead/Lag							Lead				Lag	
Lead-Lag Optimize?							Yes				Yes	
Act Effct Green (s)				30.7	30.7		56.8	56.2			34.2	
Actuated g/C Ratio				0.31	0.31		0.57	0.56			0.34	
v/c Ratio				0.93	0.90		0.92	0.43			0.91	
Control Delay				63.5	41.1		59.4	13.5			43.5	
Queue Delay				0.0	0.0		0.0	0.0			0.0	
Total Delay				63.5	41.1		59.4	13.5			43.5	
LOS				E	D		E	B			D	
Approach Delay					46.7			26.2			43.5	
Approach LOS					D			C			D	
Queue Length 50th (m)				90.4	82.9		44.4	44.8			97.0	
Queue Length 95th (m)				#156.1	#110.9		#94.6	58.3			#136.1	
Internal Link Dist (m)		141.5			120.8			240.1			287.4	
Turn Bay Length (m)				80.0			45.0					
Base Capacity (vph)				447	1368		337	1905			1132	
Starvation Cap Reductn				0	0		0	0			0	
Spillback Cap Reductn				0	0		0	0			0	
Storage Cap Reductn				0	0		0	0			0	
Reduced v/c Ratio				0.93	0.90		0.92	0.43			0.91	

Intersection Summary
 Cycle Length: 100
 Actuated Cycle Length: 100
 Offset: 60 (60%), Referenced to phase 2:NBTL and 6:SBT, Start of Green
 Natural Cycle: 90
 Control Type: Pretimed
 Maximum v/c Ratio: 0.93
 Intersection Signal Delay: 39.8 Intersection LOS: D
 Intersection Capacity Utilization 92.5% ICU Level of Service F
 Analysis Period (min) 15
 # 95th percentile volume exceeds capacity, queue may be longer.
 Queue shown is maximum after two cycles.

Splits and Phases: 13: Bronson Ave & Catherine St

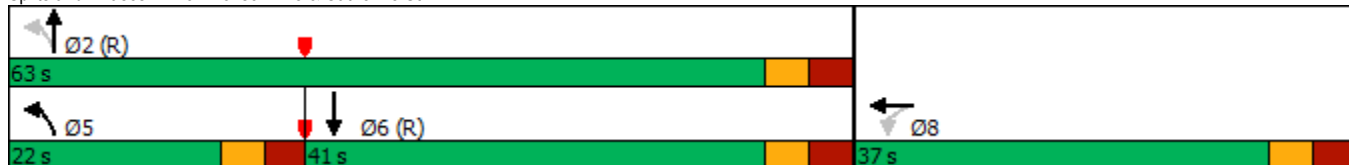

Intersection												
Int Delay, s/veh	2.4											
Movement	EBL	EBT	EBR	WBL	WBT	WBR	NBL	NBT	NBR	SBL	SBT	SBR
Lane Configurations		↕			↕						↕↔	
Traffic Vol, veh/h	0	19	2	16	37	0	0	0	0	59	601	13
Future Vol, veh/h	0	19	2	16	37	0	0	0	0	59	601	13
Conflicting Peds, #/hr	20	0	8	8	0	20	19	0	3	3	0	19
Sign Control	Stop	Stop	Stop	Stop	Stop	Stop	Free	Free	Free	Free	Free	Free
RT Channelized	-	-	None	-	-	None	-	-	None	-	-	None
Storage Length	-	-	-	-	-	-	-	-	-	-	-	-
Veh in Median Storage, #	-	0	-	-	0	-	-	-	-	-	0	-
Grade, %	-	0	-	-	0	-	-	0	-	-	0	-
Peak Hour Factor	100	100	100	100	100	100	100	100	100	100	100	100
Heavy Vehicles, %	0	5	0	0	5	0	0	0	0	0	0	0
Mvmt Flow	0	19	2	16	37	0	0	0	0	59	601	13
Major/Minor	Minor2		Minor1				Major2					
Conflicting Flow All	-	748	334	439	754	-	-	-	3	0	0	-
Stage 1	-	745	-	3	3	-	-	-	-	-	-	-
Stage 2	-	3	-	436	751	-	-	-	-	-	-	-
Critical Hdwy	-	6.6	6.9	7.5	6.6	-	-	-	4.1	-	-	-
Critical Hdwy Stg 1	-	5.6	-	-	-	-	-	-	-	-	-	-
Critical Hdwy Stg 2	-	-	-	6.5	5.6	-	-	-	-	-	-	-
Follow-up Hdwy	-	4.05	3.3	3.5	4.05	-	-	-	2.2	-	-	-
Pot Cap-1 Maneuver	0	334	668	506	331	0	-	-	1632	-	-	-
Stage 1	0	412	-	-	-	0	-	-	-	-	-	-
Stage 2	0	-	-	574	409	0	-	-	-	-	-	-
Platoon blocked, %	-	-	-	-	-	-	-	-	-	-	-	-
Mov Cap-1 Maneuver	-	309	656	459	306	-	-	-	1627	-	-	-
Mov Cap-2 Maneuver	-	309	-	459	306	-	-	-	-	-	-	-
Stage 1	-	382	-	-	-	-	-	-	-	-	-	-
Stage 2	-	-	-	514	380	-	-	-	-	-	-	-
Approach	EB		WB				SB					
HCM Control Delay, s	16.8		17.5				0.8					
HCM LOS	C		C									
Minor Lane/Major Mvmt	EBLn1	WBLn1	SBL	SBT	SBR							
Capacity (veh/h)	325	340	1627	-	-							
HCM Lane V/C Ratio	0.065	0.156	0.036	-	-							
HCM Control Delay (s)	16.8	17.5	7.3	0.2	-							
HCM Lane LOS	C	C	A	A	-							
HCM 95th %tile Q(veh)	0.2	0.5	0.1	-	-							

Intersection						
Int Delay, s/veh	0.6					
Movement	EBL	EBT	WBT	WBR	SBL	SBR
Lane Configurations			↑↑			↑
Traffic Vol, veh/h	0	0	662	66	0	40
Future Vol, veh/h	0	0	662	66	0	40
Conflicting Peds, #/hr	0	0	0	0	0	0
Sign Control	Free	Free	Free	Free	Stop	Stop
RT Channelized	-	None	-	None	-	None
Storage Length	-	-	-	-	-	0
Veh in Median Storage, #	-2621440		0	-	0	-
Grade, %	-	0	0	-	0	-
Peak Hour Factor	100	100	100	100	100	100
Heavy Vehicles, %	2	2	2	2	2	2
Mvmt Flow	0	0	662	66	0	40
Major/Minor	Major2		Minor2			
Conflicting Flow All			-	0	-	364
Stage 1			-	-	-	-
Stage 2			-	-	-	-
Critical Hdwy			-	-	-	6.94
Critical Hdwy Stg 1			-	-	-	-
Critical Hdwy Stg 2			-	-	-	-
Follow-up Hdwy			-	-	-	3.32
Pot Cap-1 Maneuver			-	-	0	633
Stage 1			-	-	0	-
Stage 2			-	-	0	-
Platoon blocked, %			-	-	-	-
Mov Cap-1 Maneuver			-	-	-	633
Mov Cap-2 Maneuver			-	-	-	-
Stage 1			-	-	-	-
Stage 2			-	-	-	-
Approach	WB		SB			
HCM Control Delay, s			0		11.1	
HCM LOS					B	
Minor Lane/Major Mvmt	WBT	WBR	SBLn1			
Capacity (veh/h)	-	-	633			
HCM Lane V/C Ratio	-	-	0.063			
HCM Control Delay (s)	-	-	11.1			
HCM Lane LOS	-	-	B			
HCM 95th %tile Q(veh)	-	-	0.2			

Intersection						
Int Delay, s/veh	3					
Movement	EBT	EBR	WBL	WBT	NBL	NBR
Lane Configurations						
Traffic Vol, veh/h	62	16	27	45	8	32
Future Vol, veh/h	62	16	27	45	8	32
Conflicting Peds, #/hr	0	0	0	0	0	0
Sign Control	Free	Free	Free	Free	Stop	Stop
RT Channelized	-	None	-	None	-	None
Storage Length	-	-	-	-	0	-
Veh in Median Storage, #	0	-	-	0	0	-
Grade, %	0	-	-	0	0	-
Peak Hour Factor	100	100	100	100	100	100
Heavy Vehicles, %	2	2	2	2	2	2
Mvmt Flow	62	16	27	45	8	32
Major/Minor	Major1	Major2	Minor1			
Conflicting Flow All	0	0	78	0	169	70
Stage 1	-	-	-	-	70	-
Stage 2	-	-	-	-	99	-
Critical Hdwy	-	-	4.12	-	6.42	6.22
Critical Hdwy Stg 1	-	-	-	-	5.42	-
Critical Hdwy Stg 2	-	-	-	-	5.42	-
Follow-up Hdwy	-	-	2.218	-	3.518	3.318
Pot Cap-1 Maneuver	-	-	1520	-	821	993
Stage 1	-	-	-	-	953	-
Stage 2	-	-	-	-	925	-
Platoon blocked, %	-	-	-	-	-	-
Mov Cap-1 Maneuver	-	-	1520	-	806	993
Mov Cap-2 Maneuver	-	-	-	-	806	-
Stage 1	-	-	-	-	953	-
Stage 2	-	-	-	-	908	-
Approach	EB	WB	NB			
HCM Control Delay, s	0	2.8	9			
HCM LOS			A			
Minor Lane/Major Mvmt	NBLn1	EBT	EBR	WBL	WBT	
Capacity (veh/h)	949	-	-	1520	-	
HCM Lane V/C Ratio	0.042	-	-	0.018	-	
HCM Control Delay (s)	9	-	-	7.4	0	
HCM Lane LOS	A	-	-	A	A	
HCM 95th %tile Q(veh)	0.1	-	-	0.1	-	

Intersection						
Int Delay, s/veh	2.6					
Movement	EBL	EBR	NBL	NBT	SBT	SBR
Lane Configurations	↔			↕↕	↕↕	
Traffic Vol, veh/h	24	123	69	428	730	27
Future Vol, veh/h	24	123	69	428	730	27
Conflicting Peds, #/hr	0	0	42	0	0	42
Sign Control	Stop	Stop	Free	Free	Free	Free
RT Channelized	-	None	-	None	-	None
Storage Length	0	-	-	-	-	-
Veh in Median Storage, #	0	-	-	0	0	-
Grade, %	0	-	-	0	0	-
Peak Hour Factor	100	100	100	100	100	100
Heavy Vehicles, %	0	1	0	5	3	0
Mvmt Flow	24	123	69	428	730	27

Major/Minor	Minor2	Major1	Major2			
Conflicting Flow All	1138	421	799	0	-	0
Stage 1	786	-	-	-	-	-
Stage 2	352	-	-	-	-	-
Critical Hdwy	6.8	6.92	4.1	-	-	-
Critical Hdwy Stg 1	5.8	-	-	-	-	-
Critical Hdwy Stg 2	5.8	-	-	-	-	-
Follow-up Hdwy	3.5	3.31	2.2	-	-	-
Pot Cap-1 Maneuver	198	584	833	-	-	-
Stage 1	415	-	-	-	-	-
Stage 2	689	-	-	-	-	-
Platoon blocked, %				-	-	-
Mov Cap-1 Maneuver	162	561	801	-	-	-
Mov Cap-2 Maneuver	162	-	-	-	-	-
Stage 1	354	-	-	-	-	-
Stage 2	662	-	-	-	-	-

Approach	EB	NB	SB
HCM Control Delay, s	19.1	1.7	0
HCM LOS	C		

Minor Lane/Major Mvmt	NBL	NBT	EBLn1	SBT	SBR
Capacity (veh/h)	801	-	400	-	-
HCM Lane V/C Ratio	0.086	-	0.368	-	-
HCM Control Delay (s)	9.9	0.4	19.1	-	-
HCM Lane LOS	A	A	C	-	-
HCM 95th %tile Q(veh)	0.3	-	1.7	-	-

DRAFT

Appendix K:

SimTraffic Summary Reports

Intersection: 1: Hwy 417 WB On Ramp/Lyon St N & Catherine St

Movement	WB	WB	SB	SB
Directions Served	LT	T	T	R
Maximum Queue (m)	75.8	53.3	64.8	30.6
Average Queue (m)	47.8	28.3	41.1	14.0
95th Queue (m)	71.3	46.8	62.0	24.9
Link Distance (m)	123.9	123.9	62.4	62.4
Upstream Blk Time (%)			1	
Queuing Penalty (veh)			1	
Storage Bay Dist (m)				
Storage Blk Time (%)				
Queuing Penalty (veh)				

Intersection: 2: Hwy 417 EB Off Ramp/Chamberlain Ave/Kent St & Catherine St

Movement	WB	WB	WB	WB	NB	NB	NB
Directions Served	T	T	R	R	LT	T	T
Maximum Queue (m)	55.8	53.1	64.3	68.8	85.6	88.9	86.2
Average Queue (m)	30.6	24.8	31.9	40.8	51.4	54.1	52.9
95th Queue (m)	49.2	44.7	54.6	62.5	75.7	78.6	79.5
Link Distance (m)	130.7	130.7	130.7		711.8	711.8	711.8
Upstream Blk Time (%)			0	0			
Queuing Penalty (veh)			1	0			
Storage Bay Dist (m)				60.0			
Storage Blk Time (%)			1	1			
Queuing Penalty (veh)			3	4			

Intersection: 3: Bank St & Catherine St

Movement	WB	WB	WB	NB	NB	SB	SB
Directions Served	LT	T	R	L	T	T	TR
Maximum Queue (m)	166.9	175.4	62.6	106.6	95.5	60.3	61.1
Average Queue (m)	94.9	108.7	21.8	50.5	60.2	36.7	32.2
95th Queue (m)	175.8	190.9	43.5	99.5	88.1	59.7	57.4
Link Distance (m)	713.1	713.1	713.1	107.4	107.4	56.2	56.2
Upstream Blk Time (%)				3	0	5	3
Queuing Penalty (veh)				12	1	15	8
Storage Bay Dist (m)							
Storage Blk Time (%)							
Queuing Penalty (veh)							

Intersection: 4: Percy St & Catherine St

Movement	WB	WB	SB
Directions Served	LT	T	TR
Maximum Queue (m)	53.7	45.2	37.6
Average Queue (m)	23.0	19.3	16.9
95th Queue (m)	43.1	36.5	32.0
Link Distance (m)	284.8	284.8	302.5
Upstream Blk Time (%)			
Queuing Penalty (veh)			
Storage Bay Dist (m)			
Storage Blk Time (%)			
Queuing Penalty (veh)			

Intersection: 5: Lyon St N & Arlington Ave

Movement	EB	WB	SB	SB
Directions Served	TR	LT	LT	TR
Maximum Queue (m)	12.0	16.8	25.1	6.9
Average Queue (m)	4.3	7.3	3.2	0.3
95th Queue (m)	12.0	16.0	14.3	3.1
Link Distance (m)	266.5	16.6	223.2	223.2
Upstream Blk Time (%)		1		
Queuing Penalty (veh)		0		
Storage Bay Dist (m)				
Storage Blk Time (%)				
Queuing Penalty (veh)				

Intersection: 6: Kent St & Arlington Ave

Movement	EB	WB	NB	NB	NB
Directions Served	LT	TR	LT	T	TR
Maximum Queue (m)	41.7	26.5	57.5	68.8	63.9
Average Queue (m)	19.1	11.9	45.2	52.1	54.6
95th Queue (m)	35.8	22.1	60.6	71.1	70.3
Link Distance (m)	157.2	141.9	54.3	54.3	54.3
Upstream Blk Time (%)			2	7	12
Queuing Penalty (veh)			11	45	78
Storage Bay Dist (m)					
Storage Blk Time (%)					
Queuing Penalty (veh)					

Intersection: 7: Lyon St N & Gladstone Ave

Movement	EB	EB	WB	WB	SB	SB
Directions Served	T	R	L	T	LT	TR
Maximum Queue (m)	45.6	12.6	15.5	24.8	59.2	53.0
Average Queue (m)	20.4	3.5	2.8	10.6	31.6	21.8
95th Queue (m)	38.2	11.0	10.4	20.9	50.9	40.7
Link Distance (m)	269.8	269.8		183.7	231.1	231.1
Upstream Blk Time (%)						
Queuing Penalty (veh)						
Storage Bay Dist (m)	25.0					
Storage Blk Time (%)	0					
Queuing Penalty (veh)	0					

Intersection: 8: Kent St & Gladstone Ave

Movement	EB	EB	WB	NB	NB	NB	NB
Directions Served	L	T	TR	L	T	T	TR
Maximum Queue (m)	54.7	76.3	67.6	27.3	55.3	60.1	65.1
Average Queue (m)	17.6	37.5	34.4	5.5	37.9	44.6	48.3
95th Queue (m)	39.6	63.8	57.9	17.6	51.1	56.9	61.3
Link Distance (m)		183.7	178.3		227.2	227.2	227.2
Upstream Blk Time (%)							
Queuing Penalty (veh)							
Storage Bay Dist (m)	30.0			40.0			
Storage Blk Time (%)	1	15			6		
Queuing Penalty (veh)	2	12			2		

Intersection: 9: Bank St & Chamberlain Ave/Isabella St

Movement	EB	EB	EB	NB	NB	SB	SB
Directions Served	LT	T	R	T	TR	LT	T
Maximum Queue (m)	69.8	76.1	51.5	116.9	135.4	113.7	112.0
Average Queue (m)	40.7	42.2	3.6	44.5	68.2	71.2	54.4
95th Queue (m)	62.9	66.3	28.1	91.4	111.0	121.1	110.1
Link Distance (m)	690.7	690.7		591.2	591.2	107.4	107.4
Upstream Blk Time (%)						7	1
Queuing Penalty (veh)						19	2
Storage Bay Dist (m)	40.0						
Storage Blk Time (%)	10						
Queuing Penalty (veh)	8						

Intersection: 10: Catherine St & Access

Movement	WB	SB
Directions Served	TR	R
Maximum Queue (m)	0.7	17.5
Average Queue (m)	0.0	8.8
95th Queue (m)	0.7	15.5
Link Distance (m)	49.7	47.6
Upstream Blk Time (%)		
Queuing Penalty (veh)		
Storage Bay Dist (m)		
Storage Blk Time (%)		
Queuing Penalty (veh)		

Intersection: 11: Access & Arlington Ave

Movement	WB	NB
Directions Served	LT	LR
Maximum Queue (m)	7.2	17.8
Average Queue (m)	0.3	8.4
95th Queue (m)	3.1	14.7
Link Distance (m)	157.2	52.2
Upstream Blk Time (%)		
Queuing Penalty (veh)		
Storage Bay Dist (m)		
Storage Blk Time (%)		
Queuing Penalty (veh)		

Intersection: 12: Bank St & Arlington Ave

Movement	EB	NB	SB	SB
Directions Served	LR	LT	T	TR
Maximum Queue (m)	60.9	25.6	33.5	27.8
Average Queue (m)	20.4	8.9	3.9	2.8
95th Queue (m)	53.7	20.1	23.3	20.5
Link Distance (m)	141.9	56.2	218.8	218.8
Upstream Blk Time (%)	1			
Queuing Penalty (veh)	3			
Storage Bay Dist (m)				
Storage Blk Time (%)				
Queuing Penalty (veh)				

Intersection: 13: Bronson Ave & Catherine St

Movement	WB	WB	WB	WB	NB	NB	NB	SB	SB
Directions Served	L	LT	T	TR	L	T	T	T	TR
Maximum Queue (m)	96.1	102.5	90.8	128.9	47.4	222.6	206.5	123.0	118.2
Average Queue (m)	59.5	68.7	61.8	93.2	46.3	118.3	95.9	73.6	68.2
95th Queue (m)	87.9	94.1	86.4	134.5	51.8	211.3	183.6	122.4	119.0
Link Distance (m)		126.8	126.8	126.8		261.7	261.7	295.2	295.2
Upstream Blk Time (%)		0		4		1	0		
Queuing Penalty (veh)		0		18		0	0		
Storage Bay Dist (m)	80.0				45.0				
Storage Blk Time (%)	1	4			29	13			
Queuing Penalty (veh)	6	10			160	73			

Intersection: 14: Bronson Hwy 417 WB Off Ramp & Catherine St

Movement	WB	WB	NB
Directions Served	T	T	L
Maximum Queue (m)	25.0	21.0	173.9
Average Queue (m)	6.0	2.7	79.2
95th Queue (m)	17.5	12.1	251.5
Link Distance (m)	123.0	123.0	342.8
Upstream Blk Time (%)			5
Queuing Penalty (veh)			0
Storage Bay Dist (m)			
Storage Blk Time (%)			
Queuing Penalty (veh)			

Network Summary

Network wide Queuing Penalty: 494

Intersection: 1: Hwy 417 WB On Ramp/Lyon St N & Catherine St

Movement	WB	WB	SB	SB
Directions Served	LT	T	T	R
Maximum Queue (m)	70.9	57.3	68.4	53.7
Average Queue (m)	36.1	24.6	47.2	28.2
95th Queue (m)	63.2	47.2	68.1	46.6
Link Distance (m)	123.9	123.9	62.4	62.4
Upstream Blk Time (%)			2	0
Queuing Penalty (veh)			5	0
Storage Bay Dist (m)				
Storage Blk Time (%)				
Queuing Penalty (veh)				

Intersection: 2: Hwy 417 EB Off Ramp/Chamberlain Ave/Kent St & Catherine St

Movement	WB	WB	WB	WB	NB	NB	NB
Directions Served	T	T	R	R	LT	T	T
Maximum Queue (m)	61.0	61.0	38.9	41.2	63.5	63.8	68.6
Average Queue (m)	42.8	42.2	20.4	24.3	40.8	40.3	36.9
95th Queue (m)	57.4	57.7	34.6	38.1	56.6	57.2	58.4
Link Distance (m)	130.7	130.7	130.7		711.8	711.8	711.8
Upstream Blk Time (%)							
Queuing Penalty (veh)							
Storage Bay Dist (m)				60.0			
Storage Blk Time (%)							
Queuing Penalty (veh)							

Intersection: 3: Bank St & Catherine St

Movement	WB	WB	WB	NB	NB	SB	SB
Directions Served	LT	T	R	L	T	T	TR
Maximum Queue (m)	188.2	192.8	53.9	90.0	66.1	65.9	61.5
Average Queue (m)	119.8	121.2	16.7	41.1	28.5	50.4	47.4
95th Queue (m)	215.5	220.0	36.0	84.0	53.0	67.3	66.2
Link Distance (m)	713.1	713.1	713.1	107.4	107.4	56.2	56.2
Upstream Blk Time (%)				0		7	6
Queuing Penalty (veh)				1		30	24
Storage Bay Dist (m)							
Storage Blk Time (%)							
Queuing Penalty (veh)							

Intersection: 4: Percy St & Catherine St

Movement	WB	WB	SB
Directions Served	LT	T	TR
Maximum Queue (m)	73.5	59.2	42.9
Average Queue (m)	35.2	28.0	19.7
95th Queue (m)	63.3	52.3	35.4
Link Distance (m)	284.8	284.8	302.5
Upstream Blk Time (%)			
Queuing Penalty (veh)			
Storage Bay Dist (m)			
Storage Blk Time (%)			
Queuing Penalty (veh)			

Intersection: 5: Lyon St N & Arlington Ave

Movement	EB	WB	SB	SB
Directions Served	TR	LT	LT	TR
Maximum Queue (m)	18.5	19.1	31.4	17.4
Average Queue (m)	5.4	8.9	5.0	1.6
95th Queue (m)	14.4	17.1	20.2	9.2
Link Distance (m)	266.5	16.6	223.2	223.2
Upstream Blk Time (%)		1		
Queuing Penalty (veh)		1		
Storage Bay Dist (m)				
Storage Blk Time (%)				
Queuing Penalty (veh)				

Intersection: 6: Kent St & Arlington Ave

Movement	EB	WB	NB	NB	NB
Directions Served	LT	TR	LT	T	TR
Maximum Queue (m)	36.6	24.2	58.0	62.2	60.8
Average Queue (m)	16.9	10.5	34.4	39.4	41.2
95th Queue (m)	31.3	20.8	52.9	58.5	60.5
Link Distance (m)	157.2	141.9	54.3	54.3	54.3
Upstream Blk Time (%)			0	1	1
Queuing Penalty (veh)			1	2	4
Storage Bay Dist (m)					
Storage Blk Time (%)					
Queuing Penalty (veh)					

Intersection: 7: Lyon St N & Gladstone Ave

Movement	EB	EB	WB	WB	SB	SB
Directions Served	T	R	L	T	LT	TR
Maximum Queue (m)	54.6	17.2	18.7	43.9	65.0	66.2
Average Queue (m)	25.8	6.2	5.1	20.1	37.3	36.1
95th Queue (m)	43.6	14.7	14.7	35.8	57.3	56.7
Link Distance (m)	269.8	269.8		183.7	231.1	231.1
Upstream Blk Time (%)						
Queuing Penalty (veh)						
Storage Bay Dist (m)			25.0			
Storage Blk Time (%)			0	2		
Queuing Penalty (veh)			0	1		

Intersection: 8: Kent St & Gladstone Ave

Movement	EB	EB	WB	NB	NB	NB	NB
Directions Served	L	T	TR	L	T	T	TR
Maximum Queue (m)	52.7	91.5	62.7	17.4	37.2	32.2	41.4
Average Queue (m)	16.4	50.7	32.0	5.8	14.2	16.8	23.2
95th Queue (m)	40.5	81.0	53.7	15.1	30.1	28.2	35.3
Link Distance (m)		183.7	178.3		227.2	227.2	227.2
Upstream Blk Time (%)							
Queuing Penalty (veh)							
Storage Bay Dist (m)	30.0			40.0			
Storage Blk Time (%)	0	23			0		
Queuing Penalty (veh)	1	17			0		

Intersection: 9: Bank St & Chamberlain Ave/Isabella St

Movement	EB	EB	EB	NB	NB	SB	SB
Directions Served	LT	T	R	T	TR	LT	T
Maximum Queue (m)	71.6	75.3	57.9	54.2	71.4	63.1	59.5
Average Queue (m)	43.7	46.1	4.3	18.0	35.6	34.0	26.8
95th Queue (m)	63.9	68.2	29.9	38.4	61.0	55.1	50.2
Link Distance (m)	690.7	690.7		591.2	591.2	107.4	107.4
Upstream Blk Time (%)							
Queuing Penalty (veh)							
Storage Bay Dist (m)			40.0				
Storage Blk Time (%)		14	0				
Queuing Penalty (veh)		17	0				

Intersection: 10: Catherine St & Access

Movement	WB	SB
Directions Served	TR	R
Maximum Queue (m)	0.8	18.8
Average Queue (m)	0.0	7.2
95th Queue (m)	0.8	15.4
Link Distance (m)	49.7	47.6
Upstream Blk Time (%)		
Queuing Penalty (veh)		
Storage Bay Dist (m)		
Storage Blk Time (%)		
Queuing Penalty (veh)		

Intersection: 11: Access & Arlington Ave

Movement	WB	NB
Directions Served	LT	LR
Maximum Queue (m)	10.9	17.4
Average Queue (m)	0.7	7.1
95th Queue (m)	5.4	15.2
Link Distance (m)	157.2	52.2
Upstream Blk Time (%)		
Queuing Penalty (veh)		
Storage Bay Dist (m)		
Storage Blk Time (%)		
Queuing Penalty (veh)		

Intersection: 12: Bank St & Arlington Ave

Movement	EB	NB	NB	SB	SB
Directions Served	LR	LT	T	T	TR
Maximum Queue (m)	44.8	21.6	1.7	39.3	33.8
Average Queue (m)	17.2	9.0	0.1	8.1	4.5
95th Queue (m)	32.7	18.6	1.6	27.7	21.6
Link Distance (m)	141.9	56.2	56.2	218.8	218.8
Upstream Blk Time (%)					
Queuing Penalty (veh)					
Storage Bay Dist (m)					
Storage Blk Time (%)					
Queuing Penalty (veh)					

Intersection: 13: Bronson Ave & Catherine St

Movement	WB	WB	WB	WB	NB	NB	NB	SB	SB
Directions Served	L	LT	T	TR	L	T	T	T	TR
Maximum Queue (m)	100.2	109.2	88.0	108.9	47.4	113.4	102.1	187.3	180.1
Average Queue (m)	65.8	72.3	57.5	68.8	39.6	54.5	41.6	110.0	105.6
95th Queue (m)	92.4	97.4	80.8	97.3	55.1	100.8	80.0	176.0	170.7
Link Distance (m)		126.8	126.8	126.8		261.7	261.7	295.2	295.2
Upstream Blk Time (%)		0		0					
Queuing Penalty (veh)		0		0					
Storage Bay Dist (m)	80.0				45.0				
Storage Blk Time (%)	2	5			10	4			
Queuing Penalty (veh)	11	17			42	12			

Intersection: 14: Bronson Hwy 417 WB Off Ramp & Catherine St

Movement	WB	WB	NB
Directions Served	T	T	L
Maximum Queue (m)	36.9	26.2	169.9
Average Queue (m)	6.3	2.4	69.2
95th Queue (m)	23.0	13.9	140.4
Link Distance (m)	123.0	123.0	342.8
Upstream Blk Time (%)			
Queuing Penalty (veh)			
Storage Bay Dist (m)			
Storage Blk Time (%)			
Queuing Penalty (veh)			

Network Summary

Network wide Queuing Penalty: 187