

725 Somerset Street, Ottawa
Assessment of Adequacy of Public Services
& Stormwater Management Report



Project # CW-09-22

City Application #

Prepared for:

Upstay Canada Inc., OTTAWA,
ON, K4M 1B8

By;

Arch-Nova Design Inc.

May 2023

Table of Contents

1. Introduction.....	2
2. Public Services Capacity.....	3
2.1 Water Supply	3
2.2.1 Fire Flow.....	5
2.2 Sanitary Sewer	7
2.3 Site Stormwater Services.....	9
2.4 Foundation Drainage	10
3. Conclusion and Recommendation.....	11
3.1 Water Supply	11
3.2 Sanitary Sewer	11
3.3 Stormwater and Foundation Drainage	12
Appendix A: Calculations	
Appendix B: Correspondence	

1. Introduction

The subject property is located at 725 Somerset Street Ottawa. The proposed work comprises of a 9-storey+ground level garage apartment building with total of 94 apartments, a commercial space and garage on the ground level and, a mechanical room and bicycles storage in the basement. For the purpose of this report the site is considered to run north-south. Somerset Street is extending east-west along the property's south edge and Empress Street extends north-south along the west edge of the property.

Currently the property is used as a commercial with a single building a parking along the north and south-west part of the property.

Existing services locations are known and they will be disconnected before the demolition and will be recorded in the construction diary. The area is serviced by:

- Sewer: Combined 300 mm PVC sewer .
- Water: 305 mm PVC watermain

The sidewalk in front of the property is at elevation between 77.08 and 77.79 m a.s.l.

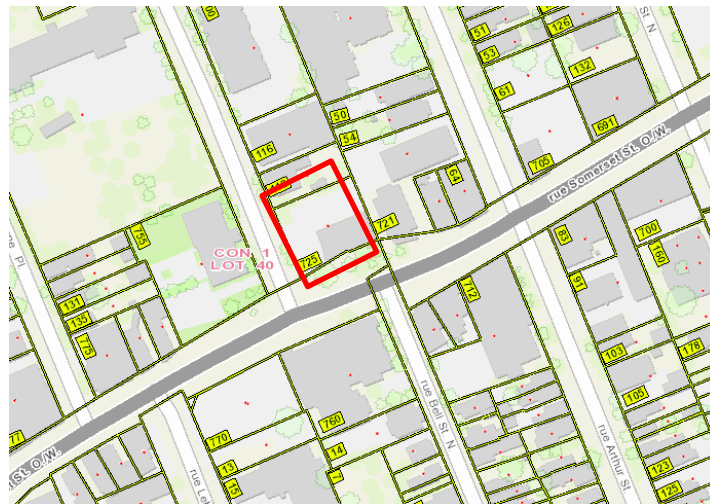

725 Somerset Street, Ottawa: Location

2. Public Services Capacity

This section of the report will analyze existing municipal services and the potential impact of the proposed building at 725 Somerset Street. on the existing service capacity.

2.1 Water Supply

Existing building is supplied from PVC 305 mm pipe and estimated current consumption is **0.30 l/sec** for the peak period. At the time of preparation of this report, current commercial building appears occupied with mostly a food service operation on the main floor and some commercial operations on the second floor.

Design Parameter	Value
Residential Average Apartment	1.8 P/unit
Residential Average Daily Demand	280 L/d/P
Residential Maximum Daily Demand	9.5 x Average Daily *
Residential Maximum Hourly	1.5 x Maximum Daily *
Commercial Demand	2.5 L / m ² /d
Commercial Maximum Daily Demand	1.5 x Average Daily
Commercial Maximum Hourly	1.8 x Maximum Daily
Minimum Watermain Size	150mm diameter
Minimum Depth of Cover	2.4m from top of watermain to finished grade
During Peak Hourly Demand operating pressure must remain within	275kPa and 552kPa
During fire flow operating pressure must not drop below	140kPa
* Residential Max. Daily and Max. Hourly peaking factors per MOE Guidelines for Drinking-Water Systems Table 3-3 for 0 to 500 persons.	

Table 1: Water Supply Design Criteria

¹The following are boundary conditions, HGL, for hydraulic analysis at Somerset Street assumed to be connected to the 305 mm watermain on Somerset Street (see attached PDF for location):

¹ City of Ottawa boundary condition information is based on current operation of the city water distribution system (also see Appendix B for complete correspondence information)

Min HGL: 107.2 m

Max HGL: 115.4 m

Max Day + FF (166.7 L/s): 109.4 m (Somerset Connection), 108.8 m (Empress Connection)

Max Day + FF (224.4 L/s): 108.9 m (Somerset Connection), 107.9 m (Empress Connection)

Design Parameter	Anticipated Demand ¹ (L/sec)	Boundary Condition ² (m)
Average Daily Demand	0.50	115.4
Max Day + Fire Flow	204.61	108.9

Ground Elevation = 78.09 m

Proposed building height is 30.81 m (108.9 m.a.s.l) and will be equipped with a sprinkler system so the minimum HGL will be sufficient for the fire protection.

The consumption is expected to be **6.92 l/sec** for peak period. Total domestic consumption consists of two components: use/person (280/cap/day) and use for amenities and commercial spaces of 2.5 l/m²/day.

Using Darcy-Weisbach calculation, as shown below, it was determined that 100 mm lateral would provide required flow of 6.92 l/sec at 0.88 m/s velocity and the pressure loss at the building of 0.08 m bar. For calculation estimated length of the lateral is 15 m.

Project: 725 Somerset Street		
		1
1. Flow medium		
Flow medium		Water 20 °C
Condition		liquid
Volume flow	l/s	6.92
Mass flow	kg/h	24867.30787
Volume flow branch.pipe	l/s	---
Density	kg/m ³	998.206
Dyn.Viscos.	10 ⁻⁶ kg/ms	1001.61
Kin.Viscos.	10 ⁻⁶ m ² /s	1.003410118
2. Additional data for gases		
3. Element of pipe		
Element of pipe		circular
Number		1
Dimensions of element	SI	Diameter of pipe D: 100.00 mm Length of pipe L: 15.00 m
4. Result of calculation		
Veloc.of flow	m/s	0.881081765
Reynolds number		87808.73836
Flow		turbulent
Absolute roughness	mm	0.0013
Resistance coefficient		2.78
Sum Pressure drop	mbar	10.78

2.2.1 Fire Flow

The FUS fire flow calculation will be used as the flow demand is higher than 9,000 l/min.

The fire flow based on FUS calculation is 12,000 l/min (200 l/sec). A sprinkler system is required as the building is more than 3 story high.

Fire protection will be provided from the nearest hydrant (1.8 m). The second nearest hydrant is located north from the property at 42.7 m distance and a third hydrant is at distance of 97.3 m.

In accordance with Table 18.5.4.3 of ISTB-2018-02 they have combined capacity of 15,141.0 l/min which is sufficient for the fire protection of the proposed building.



725 Somerset Street, Ottawa: Hydrants location and distance

2.2 Sanitary Sewer

Using the criteria of 28,000 l/ha/day sanitary sewer outflow for the current buildings is estimated 0.01 l/sec.

The estimated outflow for the new building is **2.04 l/sec** (peak flow + wet weather).

Design Parameter	Value
Residential Average Apartment	1.8 P/unit
Average Daily Demand	280 L/cap/day
Peaking Factor	Harmon's Peaking Factor. Max 4.0, Min 2.0
Correction Factor (City of Ottawa Tech.Bulletin ISTB-2018-01)	0.8
Commercial Space	28,000 L/ha/day
Infiltration and Inflow Allowance	0.33L/s/ha
Sanitary sewers are to be sized employing the Manning's Equation	$Q = (1/n)AR^{2/3}S^{1/2}$
Minimum Sewer Size	200mm diameter
Minimum Manning's 'n'	0.013
Minimum Depth of Cover	2.5m from crown of sewer to grade
Minimum Full Flowing Velocity	0.6m/s
Maximum Full Flowing Velocity	3.0m/s
<i>Extracted from Sections 4 and 6 of the City of Ottawa Sewer Design Guidelines, November 2012 & Infrastructure Technical Bulletins 2018</i>	

Table 2: Wastewater Design Criteria

Existing combined sewer 300 mm has a capacity of 117.12 l/sec for 5.0% slope and 50% full. The City officer confirmed that there is sufficient residual capacity at the location (see Appendix B: Correspondence).

Increase of 2% of outflow is considered as insignificant.

725 Somerset Street, Ottawa

Inputs:

Pipe Diameter, d_o	300.0000	mm
Manning Roughness, n	0.0130	
Pressure slope (possibly equal to pipe slope), S_o	5.0000	% slope
Percent of (or ratio to) full depth (100% or 1 if flowing full)	50.0000	%

Results:

Flow, Q	108.1147	l/s
Velocity, v	3.0590	m/s
Velocity head, hv	0.4771	m
Flow Area, A	0.0353	m ²
Wetted Perimeter, P	0.4712	m
Hydraulic Radius	0.0750	m
Top Width, T	0.3000	m
Froude Number, F	2.85	
Shear Stress (tractive force), τ	73.5450	N/m ²

The Manning formula was also used to assess the sewer lateral's size.. For given outflow and maximum achievable slope of 1.5% slope, the velocity in 200 mm lateral is 0.07159 m/sec which is sufficient for the self-cleaning of the lateral.

Proposed monitoring manhole can be used for inspection and periodical cleaning of the lateral by vacuum and flushing machine.

725 Somerset Street Ottawa- sanitary lateral

Inputs:

Pipe Diameter, d_o	200.0000	mm
Manning Roughness, n	0.0120	
Pressure slope (possibly equal to pipe slope), S_o	1.5000	% slope
Percent of (or ratio to) full depth (100% or 1 if flowing full)	15.0000	%

Results:

Flow, Q	2.1153	l/s
Velocity, v	0.7159	m/s
Velocity head, hv	0.0261	m
Flow Area, A	0.0030	m ²
Wetted Perimeter, P	0.1591	m
Hydraulic Radius	0.0186	m
Top Width, T	0.1428	m
Froude Number, F	1.59	
Shear Stress (tractive force), τ	4.4127	N/m ²

Detailed calculation of water and sanitary flow is presented in Appendix A.

2.3 Site Stormwater Services

Current building and the rest of surface of the lot at 725 Somerset Street represent a typical urban commercial site. All stormwater runoff is under uncontrolled condition for the entire site. For the purpose of protecting the municipal sewer system, the City of Ottawa requires that the newly developed site must store certain amount of water and release it to the system under the 2-year predevelopment conditions.

Proposed stormwater retention will reduce the stormwater inflow into the system. The stormwater storage is proposed on the new building's flat roof. Total storage required for the 100 year event is 14.11 m³ under a condition of maximum 6 l/sec of controlled runoff.

The proposed north side landscape and the driveway grading will direct water toward Empress Street. Also, the lower level's roof (1st and 2nd floor) will drain over scuppers under uncontrolled conditions toward Empress Street and Somerset Street and then overland to nearby catch basins.

The City of Ottawa in its "Pre-Application Consult Feedback document dated 5.10.2021, for the SWM Criteria required C coefficient for predevelopment to be maximum 0.4 where in reality the C coefficient is 0.8. In addition, the site is very small, only 1,000 m² and it will be covered with building and driveway to 80%. This, as a result would have significantly larger uncontrolled 100-year runoff and practically it would require an entire volume to be stored on site.

Having in mind the climate of the area and potential freezing, it is advisable to have the roof storage emptied within maximum 2 hour.

The flat roof drains with low outflow have a tendency of clogging so the roof drains have to provide at least 1.0 l/sec of flow.

A total of 6 roof drains are proposed, each 1.0 l/sec of capacity. Preferred roof drain specification sheet is included in the Appendix A.

Total post-development 100-year runoff will be reduced to 27.43l/sec from 39.72 l/sec (31%) predevelopment runoff and under assumptions listed above.

Inputs: storm lateral

Pipe Diameter, d_o	200.0000	mm
Manning Roughness, n	0.0130	
Pressure slope (possibly equal to pipe slope), S_o	1.5000	% slope
Percent of (or ratio to) full depth (100% or 1 if flowing full)	4.5000	%

Results:

Flow, Q	0.1540	l/s
Velocity, v	0.3067	m/s
Velocity head, h_v	0.0048	m
Flow Area, A	0.0005	m^2
Wetted Perimeter, P	0.0855	m
Hydraulic Radius	0.0059	m
Top Width, T	0.0829	m
Froude Number, F	1.26	
Shear Stress (tractive force), τ	1.3238	N/m^2

Rideau Valley Conservation Authorities (RVCA) was contacted for comments or requirements for the sediment control so they responded as “*Given recent legislative changes to our scope of work, the Conservation Authority can no longer comment or provide advice on matters related to stormwater quality. If the City does not have stormwater quality criteria for the sewer catchment, the practice has been in place is not to require quality control if the receiver is more than 2 km away from the site (i.e. piped more than 2 km) and the site has limited surface parking. Also, quality control typically is not required if the sewer is combined. However, we will have to defer the final decision on this to the City.*”

2.4 Foundation Drainage

Proposed building will have only a small portion of the footprint as a basement where the foundation drain is proposed to be installed. The extraneous inflow is based on 0.33 l/s/Ha. Total extraneous inflow is 0.033l/sec. The foundation draining system will be connected to the combined 300 mm pipe by a lateral 100 mm. A backflow prevention valve and connection to the lateral has to be as per

STD.DWG 14 or 14.1 and entire set is to be installed inside the mechanical room (please refer to mechanical design).

3. Conclusion and Recommendation

3.1 Water Supply

Proposed building height is 30.81 m (108.9 m.a.s.l) and will be equipped with a sprinkler system so the minimum HGL will be sufficient for the fire protection.

The consumption is expected to be 6.92 l/sec for peak period. Total domestic consumption consists of two components: use/person (280/cap/day) and use for amenities and commercial spaces of 2.5 l/m²/day.

Using Darcy-Weisbach calculation, as shown below, it was determined that 100 mm lateral would provide required flow of 6.92 l/sec at 0.88 m/s velocity and the pressure loss at the building of 0.08 m bar. For calculation estimated length of the lateral is 15 m.

The fire flow based on FUS calculation is 12,000 l/min (200 l/sec). A sprinkler system is required as the building is more than 3 story high.

Fire protection will be provided from the nearest hydrant (1.8 m). The second nearest hydrant is located north from the property at 42.7 m distance and a third hydrant is at distance of 97.3 m.

In accordance with Table 18.5.4.3 of ISTB-2018-02 they have combined capacity of 15,141.0 l/min which is sufficient for the fire protection of the proposed building.

3.2 Sanitary Sewer

The estimated outflow for the new building is **2.04 l/sec** (peak flow + wet weather).

Existing combined sewer 300 mm has a capacity of 117.12 l/sec for 5.0% slope and 50% full. The City officer confirmed that there is sufficient residual capacity at the location.

Increase of 2% of outflow is considered as insignificant.

3.3 Stormwater and Foundation Drainage

The City of Ottawa in its "Pre-Application Consult Feedback document dated 5.10.2021, for the SWM Criteria required C coefficient for predevelopment to be maximum 0.4 where in reality the C coefficient is 0.8. In addition, the site is very small, only 1,000 m² and it will be covered with building and driveway to 80%. This, as a result would have significantly larger uncontrolled 100-year runoff and practically it would require an entire volume to be stored on site.

Having in mind the climate of the area and potential freezing, it is advisable to have the roof storage emptied within maximum 2 hour.

The flat roof drains with low outflow have a tendency of clogging so the roof drains have to provide at least 1.0 l/sec of flow.

A total of 6 roof drains are proposed, each 1.0 l/sec of capacity. Preferred roof drain specification sheet is included in the Appendix A.

Total post-development 100-year runoff will be reduced to 27.43l/sec from 39.72 l/sec (31%) predevelopment runoff

. Total extraneous inflow is 0.033l/sec. The foundation draining system will be connected to the combined 300 mm pipe by a lateral 100 mm. A backflow prevention valve and connection to the lateral has to be as per STD.DWG 14 or 14.1 and entire set is to be installed inside the mechanical room (please refer to mechanical design).

Existing municipal water and sewer have adequate capacity to provide services to proposed building at 725 Somerset Street.

Prepared by:
Zoran Mrdja, P.Eng.

May 2023.



Professional Engineers
Ontario

Authorized by Professional Engineers of Ontario to
provide professional services to public

Appendix A: Calculations

Somerset Street, Ottawa
New

Water Supply Design Criteria

Design Parameter	Value
Residential Average Apartment	1.8 P/unit
Residential Average Daily Demand	280 L/d/P
Residential Maximum Daily Demand	9.5 x Average Daily *
Residential Maximum Hourly	1.5 x Maximum Daily *
Commercial Demand	2.5 L / m ² /d
Commercial Maximum Daily Demand	1.5 x Average Daily
Commercial Maximum Hourly	1.8 x Maximum Daily
Minimum Watermain Size	150mm diameter
Minimum Depth of Cover	2.4m from top of watermain to finished grade
must remain within	275kPa and 552kPa (40-80 psi; 28-56m)
During fire flow operating pressure must not drop below	140kPa (20 psi; 14 m)
* Residential Max. Daily and Max. Hourly peaking factors per MOE Guidelines for Drinking-Water Systems Table 3-3 for 0 to 500 persons.	

Somerset Street, Ottawa
New

Domestic Demand

Type of Housing	Per / Unit	Units	Pop
Single Family	3.4	0	0
Semi-detached	2.7		0
Townhouse	2.7		0
Apartment			0
Bachelor	1.4	29	41
1 Bedroom	1.4	39	55
2 Bedroom	2.1	26	55
3 Bedroom	3.1	0	0
4 Bedroom	4.2	0	0

	Pop	Avg. Daily		Max Day		Peak Hour	
		m ³ /d	L/sec	m ³ /d	L/sec	m ³ /d	L/sec
Total Domestic Demand	150	41.94	0.49	398.47	4.61	597.70	6.92

Institutional / Commercial / Industrial Demand

Property Type	Unit Rate	Units	Avg. Daily		Max Day		Peak Hour	
			m ³ /d	L/sec	m ³ /d	L/sec	m ³ /d	L/sec
Commercial floor space and lobby	2.5 L/m ² /d	518	1.29	0.015	1.94	0.02	3.50	0.04
Office	75.0 L/9.3m ² /d	0	0.00	0.00	0.00	0.00	0.00	0.00
Restaurant*	125.0 L/seat/d							
Industrial -Light	35,000.0 L/gross ha/d							
Industrial -Heavy	55,000.0 L/gross ha/d							
Total I/C/I Demand			1.29	0.01	1.94	0.02	3.50	0.04

Total Demand	43.24	0.50	400.41	4.63	601.20	6.96
---------------------	-------	------	--------	------	--------	------

* Estimated number of seats at 1seat per 9.3m²

Water Demand and Boundary Conditions

Proposed Conditions

Design Parameter	Anticipated Demand ¹ (L/min)	Boundary Condition ² (m)
Average Daily Demand	30.00	115.4
Max Day + Fire Flow	12,277.80	108.9
Peak Hour	417.60	*

¹) Water demand calculation per Water Supply Guidelines. See Appendix B for detailed calculations.
²) Boundary conditions supplied by the City of Ottawa. See Appendix B for correspondence with the City.

* City to provide

Somerset Street, Ottawa
New

Wastewater Design Criteria

Design Parameter	Value
Residential Average Apartment	1.8 P/unit
Average Daily Demand	280 L/cap/day
Peaking Factor	Harmon's Peaking Factor. Max 4.0, Min 2.0
Correction Factor (City of Ottawa Tech.Bulletin ISTB-2018-0	0.8
Commercial Space	28,000 L/ha/day
Infiltration and Inflow Allowance	0.28L/s/ha
Sanitary sewers are to be sized employing the Manning's Equation	$Q = (1/n)AR^{2/3}S^{1/2}$
Minimum Sewer Size	200mm diameter
Minimum Manning's 'n'	0.013
Minimum Depth of Cover	2.5m from crown of sewer to grade
Minimum Full Flowing Velocity	0.6m/s
Maximum Full Flowing Velocity	3.0m/s
<i>Extracted from Sections 4 and 6 of the City of Ottawa Sewer Design Guidelines, November 2012.</i>	

Somerset Street, Ottawa
New

Sanitary Sewer Post Development Outflow

Site Area	0.10004 ha
Extraneous Flow Allowances	
Infiltration / Inflow	0.03301 L/s

Domestic Contributions

Unit Type	Unit Rate	Units	Pop
Single Family	3.4	0	0
Semi-detached and duplex	2.7		0
Duplex	2.3		0
Townhouse	2.7		0
Apartment			
Bachelor	1.4	29	40.6
1 Bedroom	1.4	39	54.6
2 Bedroom	2.1	26	54.6
3 Bedroom	3.1	0	0
4 Bedroom	4.2	0	0
Total Population			150
Average Domestic Flow			0.49 L/s
Peaking Factor			4.1
Peak Domestic Flow			2.00 L/s

Institutional / Commercial / Industrial Contributions

Property Type	Unit Rate	No. of Units	Avg Wastewater (L/s)
Commercial	28,000 L/gross ha/d	0.045000	0.01
Institutional	28,000 L/gross ha/d	0	0.00
Industrial - Light	35,000 L/gross ha/d	0	0.00
Industrial - Heavy	55,000 L/gross ha/d	0	0.00
Average I/C/I Flow			0.01
Peak Institutional / Commercial Flow*			0.01
Peak Industrial Flow**			0.00
Peak I/C/I Flow			0.0146

Total Estimated Average Dry Weather Flow Rate	0.50
Total Estimated Peak Dry Weather Flow Rate	2.01
Total Estimated Peak Wet Weather Flow Rate	2.04

Ottawa TechBulletin ISTB-2018-01 Section 4.4.1 Page 4.5

**Use Appendix 4B diagram

Fire Flow Calculation Ontario Building Code 2017 (Appendix A)

Project: Somerset Street, Ottawa

Date: **May 30, 2023**

Data input by: Zoran Mrdja, P.Eng.



Type of Construction	Building Classification	Water Supply Coefficient (K)		
Non-combustable construction, or a heavy timber conforming to article 3.1.4.6	A-2; B1-; B-2; B-3 C; D	16		
			Total Building Volume (V)(m3)	
Building Height (incl. Basement)	33.00	16,830.00		
Building Width	30.00			
Building Length	17.00			
Side	Exposure Distance (m)	Spatial Coefficient	Total Spatial Coefficient S_{tot}*	
North	4.50	0	1.5	
East	4.10	0.5		
South	20.00	0		
West	15.00	0		
Total Volume of Water Required Q**		403,920.00		
Minimum Required Fire Flow (L/min) ***		13,464.00		
Minimum Required Fire Flow (L/sec)		224.4		

Note:

* $S_{tot} = 1 + (S_{side1} + S_{side2} + S_{side3} + S_{side4})$

** $V = KVS_{tot}$

*** Flow = Q/30 (min) for min. duration of 30 min

Summary:

1. City of Ottawa: available flow _____) ***
2. Nearest fire hydrant distance _____ m;

Somerset Street, Ottawa
New

FUS Fire Flow Calculations

Project: 725 Somerset Street, Ottawa

Calculations Based on 2020 Publication "Water Supply for Public Fire Protection" by Fire Underwriters' Survey (FUS)

Fire Flow Calculation #: 1

Date: May 30, 2023 Building Type/Description/Name: Apartment building

Data input by: Zoran Mrdja, P.Eng.

Table A: Fire Underwriters Survey Determination of Required Fire Flow - Long Method										
Step	Task	Term	Options	Multiplier Associated with Option	Choose:	Value Used	Unit	Total Fire Flow (L/min)		
1	Choose Frame Used for Construction of Unit	Coefficient related to type of construction (C)	Framing Material						0.80	
			Wood Frame	1.50	Non-combustible construction					
			Ordinary construction	1.00						
			Non-combustible construction	0.80						
			Fire resistive construction (< 2 hrs)	0.70						
Fire resistive construction (> 2 hrs)	0.60									
2	Choose Type of Housing (if TH, Enter Number of Units Per TH Block)	Type of Housing	Floor Space Area							
			Single Family	1	Other (Comm, ind)	1	Units			
			Townhouse - indicate # of units	1						
Other (Comm, Ind, etc.)	1									
2.2	# of Storeys	Number of Floors/ Storeys in the Unit (do not include basement):			9	9	Storeys			
3	Enter Ground Floor Area of One Unit	Enter Ground Floor Area (A) of One Unit Only :						3318	Area in Square Meters (m2)	
		Measurement Units	Square Feet (ft2)	0.000	Square Metres (m2)					
			Square Metres (m2)	918						
			Hectares (ha)	0						
4	Obtain Required Fire Flow without Reductions	Required Fire Flow(without reductions or increases per FUS) ($F = 220 * C * \sqrt{A}$) Round to nearest 1000L/min						10,138		
5	Apply Factors Affecting Burning	Reductions/Increases Due to Factors Affecting Burning								
5.1	Choose Combustibility of Building Contents	Occupancy content hazard reduction or surcharge	Non-combustible	0.25	Non-combustible		N/A			
			Limited combustible	-0.15						
			Combustible	0.00						
			Free burning	0.15						
			Rapid burning	0.25						
5.2	Choose Reduction Due to Presence of Sprinklers	Sprinkler reduction	Complete Automatic Sprinkler Protection	-0.3	Complete Automatic Sprinkler Protection	-0.30	N/A	-3,041		
5.3	Choose Separation Distance Between Units	Exposure Distance Between Units	North Side	0-3 m	0.25	0.70	m	7,097		
			East Side	3.1-10 m	0.2					
			South Side	20.1-30 m	0.1					
			West Side	10.1-20 m	0.15					
6	Obtain Required Fire Flow, Duration & Volume	Total Required Fire Flow, rounded to nearest 1000 L/min, with max/min limits applied:						12,000		
		Total Required Fire Flow (above) in L/s:						200		
		Required Duration of Fire Flow (hrs)						2.00		
		Required Volume of Fire Flow (m³)						1440		

Note: The most current FUS document should be referenced before design to ensure that the above figures are consistent with the intent of the Guideline

Legend	
	Drop down menu - choose option, or enter value.
	No information, No input required.

Note:
The most current FUS document should be referenced before design to ensure that the above figures are consistent with the intent of the Guideline.
Step 3: Total effective area calculated based on FUS (2020): "Total Effective Area" Page 22, Section 2), a).

1. Flow medium

Flow medium		Water 20 °C
Condition		liquid
Volume flow	l/s	6.92
Mass flow	kg/h	24867.30787
Volume flow branch.pipe	l/s	---
Density	kg/m3	998.206
Dyn.Visvos.	10-6 kg/ms	1001.61
Kin.Viscos.	10-6 m2/s	1.003410118

2. Additional data for gases**3. Element of pipe**

Element of pipe		circular
Number		1
Dimensions of element	SI	Diameter of pipe D: 100.00 mm Lenght of pipe L: 15.00 m

4. Result of calculation

Veloc.of flow	m/s	0.881081765
Reynolds number		87808.73836
Flow		turbulent
Absolute roughness	mm	0.0013
Resistance coefficient		2.78
Sum Pressure drop	mbar	10.78

Manning Formula Uniform Pipe Flow at Given Slope and Depth

725 Somerset Street, Ottawa: Combined Sewer 300 mm PVC

Inputs:

Pipe Diameter, d_o	300.0000	mm
Manning Roughness, n	0.0130	
Pressure slope (possibly equal to pipe slope), S_o	5.0000	% slope
Percent of (or ratio to) full depth (100% or 1 if flowing full)	50.0000	%

Results:

Flow, Q	108.1147	l/s
Velocity, v	3.0590	m/s
Velocity head, h_v	0.4771	m
Flow Area, A	0.0353	m ²
Wetted Perimeter, P	0.4712	m
Hydraulic Radius	0.0750	m
Top Width, T	0.3000	m
Froude Number, F	2.85	
Shear Stress (tractive force), τ	73.5450	N/m ²

Manning Formula Uniform Pipe Flow at Given Slope and Depth

725 Somerset Street: 300 mm combined sewer capacity at 39.72 l/sec

Inputs:

Pipe Diameter, d_o	300.0000	mm
Manning Roughness, n	0.0120	
Pressure slope (possibly equal to pipe slope), S_o	5.0000	% slope
Percent of (or ratio to) full depth (100% or 1 if flowing full)	27.8600	%

Results:

Flow, Q	39.7193	l/s
Velocity, v	2.4688	m/s
Velocity head, h_v	0.3108	m
Flow Area, A	0.0161	m ²
Wetted Perimeter, P	0.3336	m
Hydraulic Radius	0.0482	m
Top Width, T	0.2690	m
Froude Number, F	3.23	
Shear Stress (tractive force), τ	40.9793	N/m ²

Manning Formula Uniform Pipe Flow at Given Slope and Depth

725 Somerset Street Ottawa- sanitary lateral

Inputs:

Pipe Diameter, d_o	200.0000	mm
Manning Roughness, n	0.0120	
Pressure slope (possibly equal to pipe slope), S_o	1.5000	% slope
Percent of (or ratio to) full depth (100% or 1 if flowing full)	15.0000	%

Results:

Flow, Q	2.1153	l/s
Velocity, v	0.7159	m/s
Velocity head, h_v	0.0261	m
Flow Area, A	0.0030	m ²
Wetted Perimeter, P	0.1591	m
Hydraulic Radius	0.0186	m
Top Width, T	0.1428	m
Froude Number, F	1.59	
Shear Stress (tractive force), τ	4.4127	N/m ²

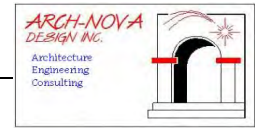

PRE-DEVELOPMENT (CONTROLLED RUNOFF)

The pre-development time of concentration is **10** minutes

where:

$$I_2 = 732.951 / (Tc + 6.199)^{0.810}$$

$$I_2 = \mathbf{76.8 \text{ mm/hr}}$$

$$I_{100} = 1735.688 / (Tc + 6.014)^{0.820}$$

$$I_{100} = \mathbf{178.6 \text{ mm/hr}}$$

Surface Type	ID	Area (ha)	Percent of total Area	C	A X C (ha)
Site	A1	0.00000	0.0%	0.90	0.000
TOTAL		0.0000	0.0%		0.000
Weighted C =					0.00

$$Q_{2pre} = (2.78) * (C) * (I_2) * (A)$$

$$Q_{2pre} = 2.78 \times 0.00 \times 76.8 \times 0.0000$$

$$Q_{2pre} = \mathbf{0.00 \text{ L/s}}$$

$$Q_{100pre} = (2.78) * (C) * (I_{100}) * (A)$$

$$Q_{100pre} = 2.78 \times 0.00 \times 178.6 \times 0.0000$$

$$Q_{100pre} = \mathbf{0.00 \text{ L/s}}$$

C=0.6 used for predevelopment calculation (City of Ottawa requirement)

POST-DEVELOPMENT (CONTROLLED RUNOFF)

The post-development time of concentration is **10** minutes

where:

$$I_2 = 732.951 / (Tc + 6.199)^{0.810}$$

$$I_2 = \mathbf{76.8 \text{ mm/hr}}$$

$$I_{100} = 1735.688 / (Tc + 6.014)^{0.820}$$

$$I_{100} = \mathbf{178.6 \text{ mm/hr}}$$

Surface Type	ID	Area (ha)	Percent of total Area	C	A X C (ha)
Roof/storage	A4	0.0560	100.0%	0.90	0.050
TOTAL		0.05600	0.0%		0.050
Weighted C =					0.90

$$Q_{2post} = (2.78) * (C) * (I_2) * (A)$$

$$Q_{2post} = 2.78 \times 0.90 \times 76.8 \times 0.0560$$

$$Q_{2post} = \mathbf{10.76 \text{ L/s}}$$

$$Q_{100post} = (2.78) * (C) * (I_{100}) * (A)$$

$$Q_{100post} = 2.78 \times 1.00 \times 178.6 \times 0.0560$$

$$Q_{100post} = \mathbf{27.80 \text{ L/s}}$$

Note: 100-year C factor increased to Max=1.0

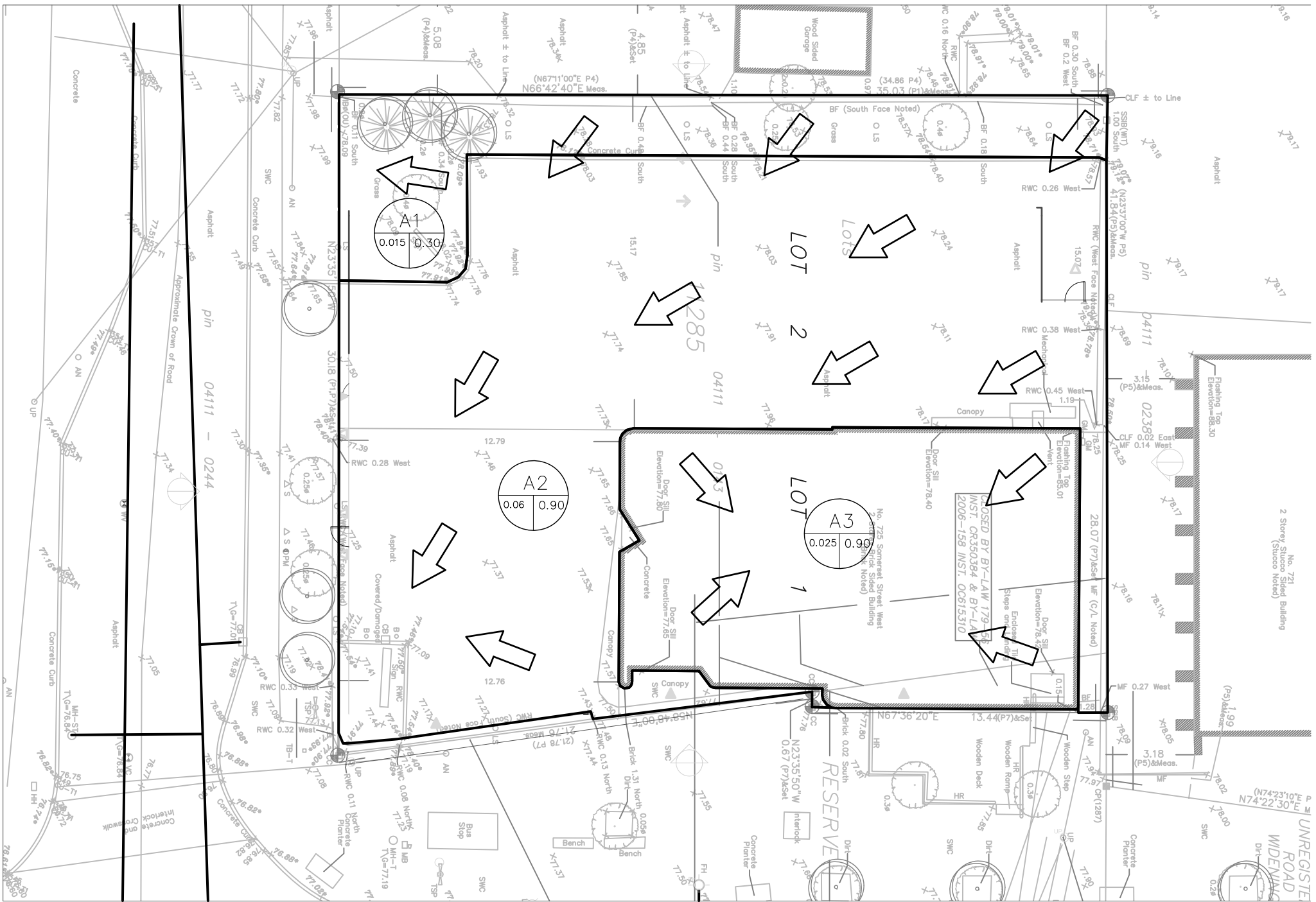

725 SOMERSET STREET, OTTAWA
 SWM PREDEVELOPMENT

ARCH-NOVA Design Inc.

45 Banner Road NEPEAN ON K2H 8X5
 613-702-3403 contact@archnova.ca

LEGEND:+

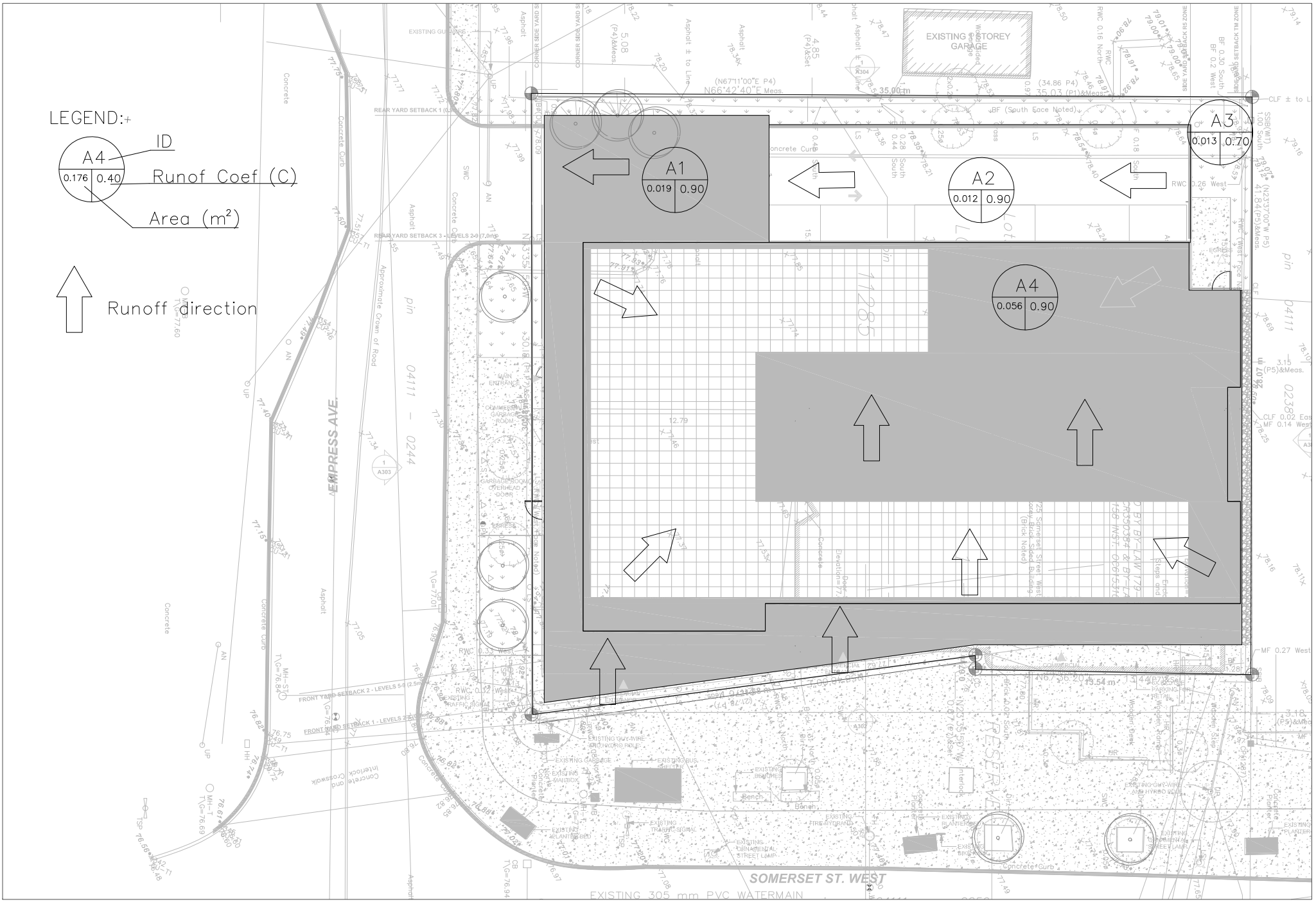
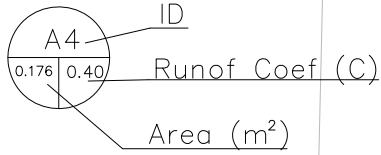

725 SOMERSET STREET, OTTAWA
SWM POSTDEVELOPMENT

ARCH-NOVA Design Inc.

45 Banner Road NEPEAN ON K2H 8X5
613-702-3403 contact@archnova.ca

ALLOWABLE RUNOFF



Predevelopment Runoff:

Uncontrolled Runoff		
2-year	17.08	l/sec
100-year	39.72	l/sec

Controlled Runoff:		
2-year	0.00	l/sec
100-year	0.00	l/sec

Postdevelopment Runoff:

Uncontrolled Runoff		
2-year	6.67	l/sec
100-year	19.39	l/sec

Controlled Runoff:		
2-year	10.76	l/sec
100-year	27.80	l/sec

Sanitary sewer and infiltration

2.04

Controlled allowable runoff

Controlled Runoff:		
2-year	6.00	l/sec

Storage Volumes (2-Year Storm)

Project: 725 Somerset Street, Ottawa

$$T_c = \frac{20}{1} \text{ (mins)}$$

$$C_{AVG} = \frac{0.95}{1} \text{ (dimensionless)}$$

$$\text{Area} = \frac{0.0560}{1} \text{ (hectares)}$$

$$\text{Storm} = \frac{2}{1} \text{ (year)}$$

$$\text{Release Rate} = \frac{6.00}{1} \text{ (L/sec)}$$

$$\text{Time Interval} = \frac{10}{1} \text{ (mins)}$$

Duration (min)	Rainfall Intensity (mm/hr)	Peak Flow (L/sec)	Release Rate (L/sec)	Storage Rate (L/sec)	Storage (m ³)
1	148	1.1	6.00		
11	73	6.0	6.00	-0.05	-0.03
21	50	7.5	6.00	1.47	1.85
31	39	5.8	6.00	-0.21	-0.39
41	32	4.8	6.00	-1.22	-3.01
51	28	4.1	6.00	-1.91	-5.85
61	24	3.6	6.00	-2.41	-8.83
71	22	3.2	6.00	-2.79	-11.90
81	20	2.9	6.00	-3.09	-15.04
91	18	2.7	6.00	-3.34	-18.23
101	17	2.5	6.00	-3.54	-21.46
111	15	2.3	6.00	-3.71	-24.73
121	14	2.1	6.00	-3.86	-28.02
131	14	2.0	6.00	-3.99	-31.34
141	13	1.9	6.00	-4.10	-34.68
151	12	1.8	6.00	-4.20	-38.03
161	12	1.7	6.00	-4.29	-41.40
171	11	1.6	6.00	-4.36	-44.77
181	11	1.6	6.00	-4.44	-48.17
191	10	1.5	6.00	-4.50	-51.57
201	10	1.4	6.00	-4.56	-54.98
211	9	1.4	6.00	-4.61	-58.40
221	9	1.3	6.00	-4.66	-61.82
231	9	1.3	6.00	-4.71	-65.26
241	8	1.2	6.00	-4.75	-68.70
251	8	1.2	6.00	-4.79	-72.14
261	8	1.2	6.00	-4.83	-75.59
271	7.7	1.1	6.00	-4.86	-79.05

Notes

- 1) For a storm duration that is less than the time of concentration the peak flow is equal to the product of 2.78CIA and the ratio of the storm duration to the time of concentration.
- 2) Rainfall Intensity, I = 732.951 / (Tc + 6.199)^{0.810} (2 year, City of Ottawa)
- 3) Peak Flow = Duration/Tc x 2.78 x C x I x A (Duration < Tc)
- 4) Peak Flow = 2.78 x C x I x A (Duration > Tc)
- 5) Storage = Duration x Storage Rate

Storage Volumes (100-Year Storm)

$$T_c = \frac{20}{1} \text{ (mins)}$$

$$C_{AVG} = \frac{0.95}{1} \text{ (dimensionless)}$$

$$\text{Area} = \frac{0.0560}{1} \text{ (hectares)}$$

$$\text{Storm} = \frac{100}{1} \text{ (year)}$$

$$\text{Release Rate} = \frac{6.00}{1} \text{ (L/sec)}$$

$$\text{Time Interval} = \frac{10}{1} \text{ (mins)}$$

Duration (min)	Rainfall Intensity (mm/hr)	Peak Flow (L/sec)	Release Rate (L/sec)	Storage Rate (L/sec)	Storage (m ³)
1	351	2.6	6.00		
11	170	13.8	6.00	7.82	5.16
21	116	17.2	6.00	11.20	14.11
31	90	13.3	6.00	7.29	13.55
41	74	10.9	6.00	4.92	12.10
51	63	9.3	6.00	3.32	10.17
61	55	8.2	6.00	2.17	7.93
71	49	7.3	6.00	1.29	5.47
81	45	6.6	6.00	0.59	2.87
91	41	6.0	6.00	0.03	0.16
101	38	5.6	6.00	-0.44	-2.65
111	35	5.2	6.00	-0.83	-5.53
121	33	4.8	6.00	-1.17	-8.47
131	31	4.5	6.00	-1.46	-11.46
141	29	4.3	6.00	-1.71	-14.49
151	27	4.1	6.00	-1.94	-17.56
161	26	3.9	6.00	-2.14	-20.66
171	25	3.7	6.00	-2.32	-23.78
181	24	3.5	6.00	-2.48	-26.94
191	23	3.4	6.00	-2.63	-30.11
201	22	3.2	6.00	-2.76	-33.31
211	21	3.1	6.00	-2.88	-36.52
221	20	3.0	6.00	-3.00	-39.75
231	20	2.9	6.00	-3.10	-42.99
241	19	2.8	6.00	-3.20	-46.25
251	18	2.7	6.00	-3.29	-49.52
261	18	2.6	6.00	-3.37	-52.80
271	17	2.6	6.00	-3.45	-56.09

Notes

- 1) For a storm duration that is less than the time of concentration the peak flow is equal to the product of 2.78CIA and the ratio of the storm duration to the time of concentration.
- 2) Rainfall Intensity, I = 1735.688 / (Tc + 6.014)^{0.820} (100 year, City of Ottawa)
- 3) Peak Flow = Duration/Tc x 2.78 x C x I x A (Duration < Tc)
- 4) Peak Flow = 2.78 x C x I x A (Duration > Tc)
- 5) Storage = Duration x Storage Rate



Storage Requirements

2-year **1.85 m³**
 100-year **14.11 m³**

Surface Type	ID	Area (m ²)	Percent of total Area	Required Storage 2 year	Required Storage 100 year	Max Allowed Drain Outflow l/s	Max Allowed Drain Outflow GPM
Roof	D1	73.43	19.1%	0.35	2.70	1.15	18.20
Roof	D2	55.80	14.5%	0.27	2.05	0.87	13.83
Roof	D3	62.36	16.3%	0.30	2.29	0.98	15.46
Roof	D4	49.06	12.8%	0.24	1.80	0.77	12.16
Roof	D5	69.80	18.2%	0.34	2.57	1.09	17.30
Roof	D6	73.15	19.1%	0.35	2.69	1.14	18.14
TOTAL		383.60	100.0%	1.85	14.11	6.00	32.04

Legend:
data for 2-year event
data for 100-year event

Stage-Storage

RD1			RD2			RD3			RD4			RD5			RD6		
Depth m	Area m ²	Volume m ³	Depth m	Area m ²	Volume m ³	Depth m	Area m ²	Volume m ³	Depth m	Area m ²	Volume m ³	Depth m	Area m ²	Volume m ³	Depth m	Area m ²	Volume m ³
0.020	17.0	0.11	0.020	14.0	0.09	0.020	17.0	0.11	0.020	17.0	0.11	0.020	17.0	0.11	0.020	17.0	0.11
0.04	26.0	0.35	0.04	20.0	0.27	0.04	23.0	0.31	0.04	18.0	0.24	0.04	25.5	0.34	0.04	26.0	0.35
0.08	50.0	1.33	0.08	35.0	0.93	0.08	47.0	1.25	0.08	39.0	1.04	0.08	47.0	1.25	0.08	50.0	1.33
0.11	73.4	2.69	0.11	55.8	2.05	0.11	62.4	2.29	0.11	49.1	1.80	0.11	69.8	2.56	0.11	73.15	2.68

Notes:

Roof drains with controlled flow to be specified by manufacturer using the allowable flow rates presented in this chart



Adjustable Accutrol Weir
 Tag: _____

**Adjustable Flow Control
 for Roof Drains**

ADJUSTABLE ACCUTROL (for Large Sump Roof Drains only)

For more flexibility in controlling flow with heads deeper than 2", Watts Drainage offers the Adjustable Accutrol. The Adjustable Accutrol Weir is designed with a single parabolic opening that can be covered to restrict flow above 2" of head to less than 5 gpm per inch, up to 6" of head. To adjust the flow rate for depths over 2" of head, set the slot in the adjustable upper cone according to the flow rate required. Refer to Table 1 below.
 Note: Flow rates are directly proportional to the amount of weir opening that is exposed.

EXAMPLE:

For example, if the adjustable upper cone is set to cover 1/2 of the weir opening, flow rates above 2" of head will be restricted to 2-1/2 gpm per inch of head.

Therefore, at 3" of head, the flow rate through the Accutrol Weir that has 1/2 the slot exposed will be:
 [5 gpm (per inch of head) x 2 inches of head] + 2-1/2 gpm (for the third inch of head) = 12-1/2 gpm.

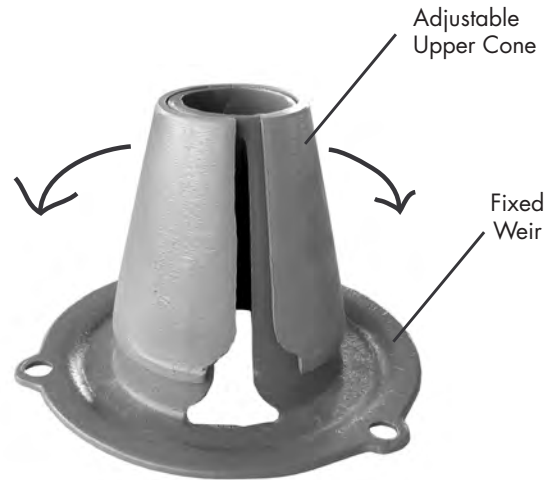
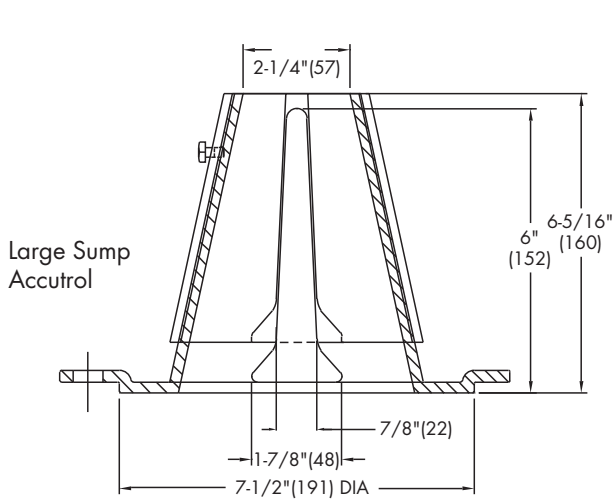

1/2 Weir Opening Exposed Shown Above

TABLE 1. Adjustable Accutrol Flow Rate Settings

Weir Opening Exposed	1"	2"	3"	4"	5"	6"
	Flow Rate (gallons per minute)					
Fully Exposed	5	10	15	20	25	30
3/4	5	10	13.75	17.5	21.25	25
1/2	5	10	12.5	15	17.5	20
1/4	5	10	11.25	12.5	13.75	15
Closed	5	5	5	5	5	5

Job Name _____
 Job Location _____
 Engineer _____

Contractor _____
 Contractor's P.O. No. _____
 Representative _____

Watts product specifications in U.S. customary units and metric are approximate and are provided for reference only. For precise measurements, please contact Watts Technical Service. Watts reserves the right to change or modify product design, construction, specifications, or materials without prior notice and without incurring any obligation to make such changes and modifications on Watts products previously or subsequently sold.

USA: Tel: (800) 338-2581 • Fax: (828) 248-3929 • Watts.com
Canada: Tel: (905) 332-4090 • Fax: (905) 332-7068 • Watts.ca
Latin America: Tel: (52) 81-1001-8600 • Fax: (52) 81-8000-7091 • Watts.com



Appendix B: Correspondence



Andrew Lenjosek <andrew@upstay.com>

725 Somerset St. W - PC2021-0035

2 messages

Bernier, John <John.Bernier@ottawa.ca>

Mon, May 10, 2021 at 11:48 AM

To: Nathan Petryshyn <petryshyn@fotenn.com>, Brian Casagrande <casagrande@fotenn.com>

Cc: "Moise, Christopher" <christopher.moise@ottawa.ca>, "Paudel, Neeti" <neeti.paudel@ottawa.ca>, "Bakhit, Reza" <reza.bakhit@ottawa.ca>, "Richardson, Mark" <Mark.Richardson@ottawa.ca>, "andrew@upstay.io" <andrew@upstay.io>, "ericdarwin1@gmail.com" <ericdarwin1@gmail.com>, "thesycamore@sympatico.ca" <thesycamore@sympatico.ca>, "Kotarba, Ashley" <Ashley.Kotarba@ottawa.ca>

Good afternoon,

Apologies for the delay – I had thought that I had already sent this follow-up. Let me know if you have any questions.

Please refer to the below [and/or attached notes] regarding the Pre-Application Consultation (pre-con) Meeting held on February 25th, 2020 for the property at 725 Somerset St. W. for a Site Plan Control Application in order to allow the development of a nine-storey, mixed-use building consisting of 76 residential units and hotel units at the ground floor. I have also attached the required Plans & Study List for application submission.

Below and attached are staff's preliminary comments based on the information available at the time of pre-con meeting:

Planning

- Relevant Policies:
 - **OP 3.6.3 - Traditional Mainstreet / Transit Priority Corridor**
 - **Zoning By-law: TM[112] H(16)**
 - **Urban Design Guidelines for Development along Traditional Mainstreets**
 - **UDGS for Transit-Oriented Development - within 600m to LRT Station**

- Minor Zoning By-law Amendment:
 - **Max 2m front yard setback** from Somerset, as the lot line jogs - front yard setback means the shortest distance between the front lot line and any part of a building, not including a projection
 - **16m height** - mid-rise is permitted, but a lower height was built into the zoning based on the site conditions, existing character and compatibility. Require a rationale based on

those. However, I suggest exploring a lower building based on the context (due grades, nearby heritage elements, site operational requirements, etc.)

- Parking relief for 3 visitor spaces.
- May be more based on the final product.

Big questions/Concerns:

Some operational elements are not shown in the concepts and needs to be explored:

- How is waste being handled on-site? This doesn't seem to have been considered in the design.
- Where is the amenity space?
- Are there balconies proposed? Please show and dimension – ensure that these meet the setback requirements, including permitted Projections Sec. 65
- Where is snow proposed? Cannot be located within required drive aisles or parking spaces.

Zoning

- As noted on the plan - Appears as though the building is within the 5m setback from the hydro pole. Contact Hydro Ottawa if you can't meet this setback to see whether they would accommodate a reduction.
- Active entrance onto Somerset is required for each use
- Per Sec 111: Bicycle rate of 0.5/dwelling // 1 per 1000 square metres GFA for hotel.
 - Suggest separating the two. i.e access to lockup room for only the mid-rise residents.
- Provide width of parking spaces.
- Plan shows 11, but table indicates 10 spaces.

Design

- Design Priority Area
- UDGS for Dev along Mainstreets:
 - Would like to see more on how the development will contribute to the public realm. No approved streetscape plan, match the existing context. Provide a boulevard for street furniture, trees, and utilities.
 - Clear windows and doors - animated uses to the front of the building etc.
 - Special treatments that wrap around the building on the corner
 - Providing buildings with rich architectural detail and pick up on the established rhythm and pattern.

- OP: Provide building format that encloses and defines the street edge with active frontages that provide direct pedestrian access to the sidewalk

Additional Comments

1. Where in a commercial or mixed use building and located on the ground floor abutting a street having direct pedestrian access to that street, residential, **office** and **research and development centre** uses must not be located within a depth of six metres of the front wall of the main building abutting the street;
2. A minimum of 50% of the ground floor façade facing the main street, measured from the average grade to a height of 4.5 metres, must comprise transparent windows and active entrances; and where an active entrance is angled on the corner of the building, such that it faces the intersection of the main street and an intersecting side street, it is deemed to face the main street;(By-law 2015-190)
3. Parking garage, provided that 100% of the ground floor fronting on the street excluding any related mechanical room or pedestrian or vehicular access, is occupied for a depth of three metres by other uses permitted to be located on the ground floor; and
4. Parkland dedication will be required – per the Parkland Dedication By-law 2009-95.
5. Applications Required: Site Plan Control – Complex (Manager Approval – Subject to Public Notification) & Minor Zoning By-law Amendment

-

Urban Design

- This proposal runs along one of the City's Design Priority Areas and must attend the City's UDRP. We recommend the proposal attend an Informal visit (prior to a full submission and is not a public meeting), with the City's UDRP to further discuss and evaluate various scenarios of development for the project;
- Recognizing some of the challenges a similar project of nine storeys has had close to this proposal we note the following areas of sensitivity which need to be addressed moving forward:
 - **Transitioning:** For a nine storey proposal we recommend a close analysis of transitionaing to the neighbouring heritage properties be addressed;
 - **Blank wall:** We recommend a sensitive approach be adopted to the potential blank wall condition adjacent to a heritage building to the east be considered in the design;
 - **Ground floor use:** We recommend that a sensitive approach to providing active uses at grade be considered including but not limited to active entrances, shared communal spaces, and visibility through large glazing;
 - **Hotel use:** We recommend this use be further considered as it appears to replace other more active uses at grade as currently presented;
 - **Heritage:** We recommend that the design of the building address the heritage context and unique surrounding buildings in the development of the design and materiality;
- A Design Brief is a required submittal for all Site Plan/Re-zoning applications. Please see the Design Brief Terms of Reference provided and consult the City's website for details regarding the UDRP schedule.

Heritage Comments

The property at [725 Somerset Street West](#) is not a heritage property, however is adjacent on all sides to properties listed on the Heritage Register or designated under Part IV of the *Ontario Heritage Act*. Heritage staff would like to see a Cultural Heritage Impact Statement (CHIS) as part of this development application in accordance to Official Plan Policy 4.6.1. This CHIS should examine potential impacts on the designated resource across the street at [760 Somerset Street West](#), and should outline how the proposal is compatible with the adjacent Listed properties and streetscape. Policies in the Official Plan regarding Cultural Heritage Impact Statements can be found here:

[Section 4 - Review of Development Applications | City of Ottawa](#)

For more information on the scope of the CHIS please contact Ashley Kotarba.

Engineering

The subject site is located within a combined sewershed therefore the approval exemption under O.Reg. 525/98 would not apply and an Environmental Compliance Approval ([ECA](#)) application will be required.

Ontario Regulation 525/98:

3. Subsection 53(1) and (3) of the Act do not apply to the use, operation, establishment, alteration, extension or replacement of or a change in a storm water management facility that,
- (a) is designed to service one lot or parcel of land;
 - (b) discharges into a storm sewer that is not a combined sewer;**
 - (c) does not service industrial land or a structure located on industrial land; and
 - (d) is not located on industrial land.

The ECA applications will be a Direct Submission for Private Sewage Works discharging to a combined sewer.

A deep excavation and dewatering operations have the potential to cause damages to the neighboring adjacent buildings/ City infrastructure. Document that construction activities

(excavation, dewatering, vibrations associated with construction, etc.) will not have an impact on any adjacent buildings and infrastructure.

A **Record of Site Condition (RSC)** in accordance with O.Reg. 153/04 will be required to be filed and acknowledged by the Ministry prior to issuance of a building permit due to a change

to a more sensitive property use.



General:

It is the sole responsibility of the consultant to investigate the location of existing underground utilities in the proposed servicing area to avoid any conflict with utilities. The

location of existing utilities and services shall be documented on an Existing Conditions Plan. Verify all the information related to the infrastructures by using as built drawings or field visit and inspection as required. Include a note on the Servicing and Grading Plan stating the existing utilities in the proposed servicing area have been investigated.

All underground and above ground building footprints and permanent walls need to be shown on the plans to confirm that any permanent structure does not extend either above or below into the existing property lines and sight triangles and/or future road widening protection limits.

- Please note that the proposed servicing design and site works shall be in accordance with the following documents:
 - Ottawa Sewer Design Guidelines (October 2012)
 - Technical Bulletin PIEDTB-2016-01
 - Technical Bulletins ISTB-2018-01, ISTB-2018-02 and ISTB-2018-03.
 - Ottawa Design Guidelines - Water Distribution (2010)
 - Design Guidelines for Sewage Works, MECP, 2008
 - Stormwater Planning and Design Manual, MECP, March 2003
 - Geotechnical Investigation and Reporting Guidelines for Development Applications in the City of Ottawa (2007)
 - City of Ottawa Slope Stability Guidelines for Development Applications (revised 2012)
 - City of Ottawa Environmental Noise Control Guidelines (January 2016)

- City of Ottawa Accessibility Design Standards (November 2015) (City recommends development be in accordance with these standards on private property)
- Ottawa Standard Tender Documents (latest version)
- Ontario Provincial Standards for Roads & Public Works (2013)
- Record drawings and utility plans are also available for purchase from the City (Contact the City's Information Centre by email at InformationCentre@ottawa.ca or by phone at (613) 580-424 x.44455). **Include copies in the Appendix of the report as supporting documentation.**

SWM Criteria: Connecting directly the Combined Sewer on Concord St. N

- Total (storm +sanitary+foundation drainage) allowable release rate will be **2-year pre-development rate**.
- C Coefficient of runoff will need to be determined **as per existing conditions but in no case more than 0.4**
- TC =20 minutes or can be calculated,
- TC should not be less than 10 minutes, since the IDF curves become unrealistic less than 10min.
- The total combined flow from the site (storm, sanitary and foundation drain) shall not exceed the allowable release rate. The allowable stormwater flow for the site is to be calculated by subtracting the contributing peak wastewater flow and groundwater from the foundation drain from the total allowable release rate.
- Attenuate storms up to and including the 100-year design event on site. SWM measures will be subject to review.
- Any storm events greater than 2 year, up to 100 year, and including 100-year storm event must be detained on site.

Two service laterals connections (sanitary and storm) to the combined sewer system will be required.

- **Water Quality:** Please consult with the local conservation authority (RVCA) regarding water quality criteria and requirements prior to submission of an application. It is consultant's responsibility to check with the RVCA for quality control issues and include this information and discussion in the SWM report. Please contact the RVCA for further information.
- If **rooftop control and storage** is considered as part of the SWM solution sufficient details (Cl. 8.3.8.4) shall be discussed and documented in the report and on the plans. A roof drainage plan and detailed roof drain summary table with supporting drain manufacturer information will be required. Any note indicating *to be designed by others* will not be sufficient. The roof drainage plan will need to document roof drain type, flow rates, emergency scupper locations and spill over elevations and ponding areas. Roof drains are to be connected downstream of any incorporated ICDs within the SWM system and not to the foundation drain system. Provide a **Roof Drain Plan** as part of the submission.
- Please note that the HGL within the receiving sewer system will need to be assessed if underground storage (cistern) is proposed as part of the stormwater management solution to

ensure the system does not become surcharged and thereby ineffective do to a loss in available storage.

- **Underground Storage: Underground storage volumes are to be based on 50% peak flow rates or use dynamic compute model.** The Modified Rational Method for storage computation in the Sewer Design Guidelines was originally intended to be used for above ground storage (i.e. parking lot) where the change in head over the orifice varied from 1.5 m to 1.2 m (assuming a 1.2 m deep CB and a max ponding depth of 0.3 m). This change in head was small and hence the release rate fluctuated little, therefore there was no need to use an average release rate.

When underground storage is used, the release rate fluctuates from a maximum peak flow based on maximum head down to a release rate of zero. This difference is large and has a significant impact on storage requirements. **We therefore require that an average release rate equal to 50% of the peak allowable rate shall be applied to estimate the required volume. Alternatively, the consultant may choose to use a submersible pump in the design to ensure a constant release rate.**

- If a storage tank (cistern) is considered as part of the SWM solution sufficient details and system information will need to be provided. A detailed cross-section of such system (provided from the mechanical engineer and shown on the plans) with sufficient details and information (HWLs, release rate, volume, location, size (dimensions), control device, emergency flow outlet and backflow protection, etc.) will need to be provided. An appropriate emergency overflow location will need to be determined and documented. Backup power supply necessary if pump controlled. Details regarding the proposed on-site stormwater management system are to be provided for review.
- The minimum orifice dia. for a plug style ICD is 83mm and the minimum flow rate from a vortex ICD is 6 L/s in order to reduce the likelihood of plugging.
- Please include a Pre-Development Drainage Area Plan to define the pre-development drainage areas/patterns. Existing drainage patterns shall be maintained and discussed as part of the proposed SWM solution. Runoff shall not be directed toward any adjacent properties. Post-development site grading shall match existing property line grades in order to minimize disruption to the adjacent residential properties.

Sewer:

- The site is located within a combined sewershed.
- An analysis and demonstration that there is sufficient/adequate residual capacity to accommodate any increase in wastewater flows in the receiving and downstream wastewater system is required to be provided. It is suggested to **calculate the total peak wastewater demand for the proposed development and send it to the City as soon as possible in advance of a submission of an application, as an initial step to determine and verify whether or not there is sufficient capacity in the city sewer system to accommodate the proposed wastewater flow.** Please note that it takes approx. 10 business days to get a response back from the internal circulation.
- A storm sewer monitoring maintenance hole is required to be installed at the property line (on the private side of the property) as per City of Ottawa Sewer-Use By-Law 2003-514.
- As-built drawings of the existing infrastructure within the vicinity of the site are available and road, sewer and watermain reconstruction plans are to be obtained from Infrastructure Services and reviewed in order to determine proper servicing and SWM plan for the subject site.
- Foundation drainage system details are to be discussed in the report and document how the system will be integrated into the servicing design. Please note that foundation drain is to be

independently connected to sewermain unless being pumped with appropriate back up power, sufficient sized pump and back flow prevention.

- A backwater valve is required on all service laterals for protection.
- The sanitary sewer criteria shall reflect the new *Technical Bulletin PIEDTB-2018-01*.
- A sanitary sewer monitoring maintenance hole is required to be installed at the property line (on the private side of the property) as per City of Ottawa Sewer-Use By-Law 2003-514.

A backwater valve is required on the sanitary service for protection

Water:

- A local 305mm dia. UCI watermain is located within Somerset St.
- Existing residential service to be blanked at the main.
- Water Supply Redundancy: Residential buildings with a basic day demand greater than 50m³/day (0.57 L/s) are required to be connected to a minimum of two water services separated by an isolation valve to avoid a vulnerable service area as per the Ottawa Design Guidelines - Water Distribution, WDG001, July 2010 Clause 4.3.1 Configuration. The basic day demand for this site not expected to exceed 50m³/day.
- Please review **Technical Bulletin ISTB-2018-0**, maximum fire flow hydrant capacity is provided in Section 3 Table 1 of Appendix I. A hydrant coverage figure shall be provided and **demonstrate there is adequate fire protection** for the proposal. Two or more public hydrants are anticipated to be required to handle fire flow.
- Boundary conditions are required to confirm that the require fire flows can be achieved as well as availability of the domestic water pressure on the City street in front of the development. Use Table 3-3 of the MOE Design Guidelines for Drinking-Water System to determine Maximum Day and Maximum Hour peaking factors for 0 to 500 persons and use Table 4.2 of the Ottawa Design Guidelines, Water Distribution for 501 to 3,000 persons. Please provide the following information to the City of Ottawa via email to request water distribution network boundary conditions for the subject site. Please note that once this information has been provided to the City of Ottawa it takes approximately 5-10 business days to receive boundary conditions.

- **Type of Development and Units**
- **Site Address**
- **A plan showing the proposed water service connection location.**
- **Average Daily Demand (L/s)**
- **Maximum Daily Demand (L/s)**
- **Peak Hour Demand (L/s)**
- **Fire Flow (L/min)**

[Fire flow demand requirements shall be based on **Fire Underwriters Survey (FUS) Water Supply for Public Fire Protection 1999**]

Exposure separation distances shall be defined on a figure to support the FUS calculation and required fore flow (RFF).

- **Hydrant capacity shall be assessed to demonstrate the RFF can be achieved.** Please identify which hydrants are being considered to meet the RFF on a fire hydrant coverage plan as part of the boundary conditions request.

Snow Storage:

- Any portion of the subject property which is intended to be used for permanent or temporary snow storage shall be as shown on the approved site plan and grading plan. Snow storage shall not interfere with approved grading and drainage patterns or servicing. Snow storage areas shall be setback from the property lines, foundations, fencing or landscaping a minimum of 1.5m. Snow storage areas shall not occupy driveways, aisles, required parking spaces or any portion of a road allowance. If snow is to be removed from the site please indicate this on the plan(s).

Permits and Approvals:

- Please note that this project will be subject to an Environmental Compliance Approval (ECA) for Private Sewage Works. (Any connection to a combined Sewer system required the Ministry (MECP) approval)

Required Engineering Plans and Studies in Support of SPC application:**PLANS:**

- Existing Conditions and Removals Plan
- Site Servicing Plan (Plan and Profile Drawings required for MECP ECA Application)
- Grade Control and Drainage Plan
- Erosion and Sediment Control Plan
- Pre-Development Drainage Area Plan
- Post-Development Drainage Area Plan
- Roof Drainage Plan w/ Roof Drain Summary Table (if rooftop SWM storage is being considered)
- Foundation Drainage System Details
- Legal Survey Plan

REPORTS:

- Site Servicing and Stormwater Management Report
- Geotechnical Study
- Wind study (For the proposals of 9 story buildings and higher)
- Detailed Noise Study (Transportation Noise Assessment and Stationary Noise Assessment)
- Phase I ESA (in accordance with Ontario Regulation 153/04)
- Phase II ESA (depending on results and recommendation of the Phase I-ESA)
- Record of Site Condition (RSC) will be required for this property.

Please refer to the **City of Ottawa Guide to Preparing Studies and Plans [Engineering]:**

<https://ottawa.ca/en/planning-development-and-construction/developing-property/development-application-review-process/development-application-submission/guide-preparing-studies-and-plans>

Phase One Environmental Site Assessment (Official Plan Section 4.8.4):

- A **Phase I ESA** is required to be completed in accordance with Ontario Regulation 153/04 (not per CSA standards) in support of this development proposal to determine the potential for site contamination. A **Phase II ESA** may be required depending on the results and recommendations of the Phase I-ESA.
- The Phase I ESA shall discuss the requirement to file a RSC with the Ministry. A **Record of Site Condition (RSC)** in accordance with O.Reg. 153/04 will be required to be filed and acknowledged by the Ministry prior to issuance of a building permit due to the change in property use. As per the Official Plan (4.8.4) we do not consider an RSC acknowledged by the Ministry until either it's has been confirmed that it will not be audited or it has passed the Ministry audit.
- Please also note that in the event soil and/or groundwater contamination is identified on this site and the proposal is for a more sensitive land use, the MECP will require approximately 1-1.5 years to review the RSC. PIED will apply appropriate conditions, based on Environmental Protection Act (Section 168.3.1 (1)) and O.Reg. 153/04 (Parts IV and V) regarding requirements for RSC prior to building permit issuance. Dependent on the levels/types of contamination, timelines for building permit issuance may be longer than expected and we recommend applicant speak to Building Code Services, at the earliest convenience, so as to discuss these timelines in more detail, if deemed applicable.
- Environmental Risk Information Services (ERIS) report is required to be included as part of the Phase I ESA.

<https://www.ontario.ca/page/guide-completing-phase-one-environmental-site-assessments-under-ontario-regulation-15304>

<https://www.ontario.ca/laws/regulation/040153#BK43>

Geotechnical Investigation (Official Plan Section 4.8.3):

- A **Geotechnical Study/Investigation** shall be prepared in support of this development proposal.
- Investigate the effect of short-term and long-term lowering of the groundwater level and the impact on the adjacent lands and existing neighboring structures. The City is concerned that reducing the groundwater level in this area can lead to damages to surrounding structures due to excessive differential settlements of the ground. The impact of groundwater lowering on adjacent properties needs to be discussed and investigated to ensure there will be no short term and long term damages associated with lowering the groundwater in this area.
- Geotechnical Study shall be consistent with the **Geotechnical Investigation and Reporting Guidelines for Development Applications**.

<https://documents.ottawa.ca/sites/default/files/documents/cap137602.pdf>

Detailed Noise Study:

- A **Transportation Noise Assessment** is required as the subject development is located on Greenfield Ave. (arterial road classification) and within 500m of HWY 417.
- A **Stationary Noise Assessment** is required in order to assess the noise impact of the proposed sources of stationary noise (mechanical HVAC system/equipment) of the development onto the surrounding residential area to ensure the noise levels do not exceed allowable limits specified in the City Environmental Noise Control Guidelines.

- Noise Study shall be consistent with the City's **Environmental Noise Control Guidelines**.

https://documents.ottawa.ca/sites/default/files/documents/enviro_noise_guide_en.pdf

Exterior Site Lighting:

- Any proposed light fixtures (both pole-mounted and wall mounted) must be part of the approved Site Plan. All external light fixtures must meet the criteria for Full Cut-off Classification as recognized by the Illuminating Engineering Society of North America (IESNA or IES), and must result in minimal light spillage onto adjacent properties (as a guideline, 0.5 fc is normally the maximum allowable spillage). In order to satisfy these criteria, the please provide the City with a **Site Lighting Plan, and Certification (Statement) Letter** from an acceptable professional engineer stating that the design is compliant.

Wind study :

- A wind analysis must be prepared, signed and stamped by an engineer who specializes in pedestrian level wind evaluation

https://documents.ottawa.ca/sites/documents/files/torwindanalysis_en.pdf

Feel free to contact Project Manager, Reza Bakhit at ext. 19346 or at reza.bakhit@ottawa.ca

Transportation

- Site is within a TOD area – therefore TOD measures would apply. To achieve target mode shares within TOD zones, we highly recommend developments to provide as many TDM measures as possible to enable and encourage travel by sustainable modes. Please complete the TDM Measures Checklist.
- Upgrade the sidewalk along the site frontages.
- As the site proposed is residential, AODA legislation applies for all areas accessible to the public (i.e. outdoor pathways, parking, etc.).
- On site plan:
 - Turning templates will be required for all accesses showing the largest vehicle to access the site; required for internal movements and at all access (entering and exiting and going in both directions).
 - Show all curb radii measurements; ensure that all curb radii are reduced as much as possible
 - Show lane/aisle widths.
 - Sidewalk is to be continuous across access as per City Specification 7.1.

Forestry

TCR requirements:

1. a Tree Conservation Report (TCR) must be supplied for review along with the suite of other plans/reports required by the City
 - a. an approved TCR is a requirement of Site Plan approval.
2. As of January 1 2021, any removal of privately or publicly (City) owned trees 10cm or larger in diameter requires a tree permit issued under the Tree Protection Bylaw (Bylaw

2020 – 340); the permit will be based on an approved TCR and made available at or near plan approval.

3. The Planning Forester from Planning and Growth Management as well as foresters from Forestry Services will review the submitted TCR

a. If tree removal is required, both municipal and privately-owned trees will be addressed in a single permit issued through the Planning Forester

b. Compensation may be required for city owned trees – if so, it will need to be paid prior to the release of the tree permit

4. the TCR must list all trees on site by species, diameter and health condition

5. the TCR must list all trees on adjacent sites if they have a critical root zone that extends onto the development site

6. If trees are to be removed, the TCR must clearly show where they are, and document the reason they cannot be retained

7. All retained trees must be shown and all retained trees within the area impacted by the development process must be protected as per City guidelines available at [Tree Protection Specification](#) or by searching [Ottawa.ca](#)

a. the location of tree protection fencing must be shown on a plan

b. show the critical root zone of the retained trees

c. if excavation will occur within the critical root zone, please show the limits of excavation

8. the City encourages the retention of healthy trees; if possible, please seek opportunities for retention of trees that will contribute to the design/function of the site.

9. For more information on the process or help with tree retention options, contact Mark Richardson mark.richardson@ottawa.ca or on [City of Ottawa](#)

LP tree planting requirements:

For additional information on the following please contact Tracy.Smith@Ottawa.ca

Minimum Setbacks

- Maintain 1.5m from sidewalk or MUP/cycle track.
- Maintain 2.5m from curb
- Coniferous species require a minimum 4.5m setback from curb, sidewalk or MUP/cycle track/pathway.
- Maintain 7.5m between large growing trees, and 4m between small growing trees. Park or open space planting should consider 10m spacing.
- Adhere to Ottawa Hydro's planting guidelines (species and setbacks) when planting around overhead primary conductors.

Tree specifications

- Minimum stock size: 50mm tree caliper for deciduous, 200cm height for coniferous.
- Maximize the use of large deciduous species wherever possible to maximize future canopy coverage
- Tree planting on city property shall be in accordance with the City of Ottawa's Tree Planting Specification; and include watering and warranty as described in the specification (can be provided by Forestry Services).
- Plant native trees whenever possible
- No root barriers, dead-man anchor systems, or planters are permitted.
- No tree stakes unless necessary (and only 1 on the prevailing winds side of the tree)

Hard surface planting

- Curb style planter is highly recommended
- No grates are to be used and if guards are required, City of Ottawa standard (which can be provided) shall be used.
- Trees are to be planted at grade

Soil Volume

- Please ensure adequate soil volumes are met:

Tree Type/Size	Single Tree Soil Volume (m3)	Multiple Tree Soil Volume (m3/tree)
Ornamental	15	9
Columnar	15	9
Small	20	12
Medium	25	15
Large	30	18
Conifer	25	15

Please note that these soil volumes are not applicable in cases with Sensitive Marine Clay.

Sensitive Marine Clay

- Please follow the City's 2017 Tree Planting in Sensitive Marine Clay guidelines

Community Association

- Active Frontage req'd on TM and critical because of gap in active frontage immediately east and west. Suggest hotel or residence entry on Empress to maximize active frontage on Somerset and reduction in width on Somerset.
- Height: we are opposed to an increase beyond the community developed 16m zoning.
- Parking: Visitor parking is critical, and with the enormous relief the zoning allows for residential parking, and the dearth of street parking, visitor parking should be fully provided.
- Hotel vs Residential: We are not opposed to either use, but if, as mentioned by the applicant, the hotel might expand beyond the 10 units shown, then more hotel parking for is necessary. The applicants business, "UpStay", is about 'short term rentals'. Hopefully this is not contrary to the imminent STR bylaw, and sufficient parking is provided for this.
- The existing building may have heritage value. I vaguely recall it may have received an architecture award and it is included in books on architecture in Ottawa. It used to be a Desjardins coop??
- If there are community benefits, or if the developer wishes, the front plaza where the bus stop and dead trees are, was created in the early 80s when a curve in the street was straightened out. But the trees were planted in minimalist holes in the road base, and never thrive despite frequent replacement. The area in front of the building should be properly landscaped, with the sidewalk either close to the building or on the curb line, and the rest of space soft landscaped (not hardscaped due to the injection site, food kitchen, and problem with street loitering already frustrating the BIA and residents) with trees, shrubs, and possibly fenced with a decorative railing to provide a look-but-don't-sit greenspace. A sidewalk bench would be appropriate adjacent to the bus stop.
- The 15' height for the ground floor is good, to permit a variety of uses over time
- Rather than hotel rooms, the street facing units might be better as live work lofts with residential space on the loft level and residential / commercial flex spaces on the ground level. I do not think storefronts are required to make a TMS, there can be a mix of uses. The neighbourhood has had a surplus of commercial space for years, with numerous storefronts being misused as warehouse and wholesale space, and some have been converted back to residential uses. I oppose the whole groundfloor being used for a parking level should the "hotel" uses expand to upper floors.
- I remain very concerned and suspicious that the hotel use is insincere, and that it might turn out to be a boardinghouse, coshare, or rooming house use, or that the the hotel will "grow" to include (some of) the upper floors
- The front facade of the building should have a kink or over all curve to follow the lot line and reinforce the general alignment and built form of the street. This building currently looks like it's a rectangle from anywhere plopped down without regard to the characteristics of the lot or site or neighbours.
- Somerset street suffers from some inferior building conditions and cheaper facades. The new apt building across the street last time I saw the plan had a huge white smooth cube facade that, due to its position on a hill, may be a sore thumb visible for miles from the west. I would like to see this building have a traditional red brick podium with rough cut limestone accents to reinforce the fabric of the neighbourhood limestone foundations and limestone buildings. Portrait shaped windows (rather than landscape) might also help the character.
- I know the BIA will oppose any materials that are black brick or dark gray cladding. The developer should reach out to the CBIA regarding materials acceptable to the BIA and Chinatown "look".
- Both the Empress and the north side of the building, or at least the podium on the north, will be highly visible and should be finished with quality

Other

- You are encouraged to contact the Ward Councillor, Catherin McKenney.

Please refer to the links to [“Guide to preparing studies and plans”](#) and [fees](#) for general information. Additional information is available related to [building permits](#), [development charges](#), and the [Accessibility Design Standards](#). Be aware that other fees and permits may be required, outside of the development review process. You may obtain background drawings by contacting informationcentre@ottawa.ca.

These pre-con comments are valid for one year. If you submit a development application(s) after this time, you may be required to meet for another pre-consultation meeting and/or the submission requirements may change. You are as well encouraged to contact us for a follow-up meeting if the plan/concept will be further refined.

Please do not hesitate to contact me if you have any questions.

Regards,

John Bernier, MCIP, RPP

Planner II | Urbaniste II

Development Review, Central | *Examen des projets d'aménagement, Central*

Planning, Infrastructure and Economic Development Department | *Services de la planification, de l'infrastructure et du développement économique*

City of Ottawa | *Ville d'Ottawa*

110 Laurier Avenue West. Ottawa, ON | *110, avenue. Laurier Ouest. Ottawa (Ontario) K1P 1J1*

613.580.2424 ext./poste 21576

ottawa.ca/planning / ottawa.ca/urbanisme

Please note that during the current public health emergency I am working remotely. Email is the easiest and most reliable way of reaching me at this time. Thank you for your cooperation.

This e-mail originates from the City of Ottawa e-mail system. Any distribution, use or copying of this e-mail or the information it contains by other than the intended recipient(s) is unauthorized. Thank you.

Le présent courriel a été expédié par le système de courriels de la Ville d'Ottawa. Toute distribution, utilisation ou reproduction du courriel ou des renseignements qui s'y trouvent par une personne autre que son destinataire prévu est interdite. Je vous remercie de votre collaboration.

7 attachments



image002.jpg
24K

 **Somerset, 725_Design Brief.pdf**
88K

 **tdm_measures_checklist_en.pdf**
464K

 **AODA Checklist.docx**
251K

 **725 Somerset_Lenjosek_2021-01-27 L1-1 (1).pdf**
862K

 **725 Somerset_Lenjosek_2021-01-27 L1-3 (1).pdf**
640K

 **725 Somerset_Lenjosek_2021-01-27 L1-2 (1).pdf**
649K

Andrew Lenjosek <andrew@upstay.com>

Mon, May 10, 2021 at 11:56 AM

To: Erick Soulière <esouliere@rossmannarchitecture.ca>, Erik Rossmann <erik@rossmannarchitecture.ca>, Nathan Petryshyn <petryshyn@fotenn.com>, Brian Casagrande <casagrande@fotenn.com>

FYI. Nathan, I'd appreciate it if you can review this in advance of Friday. If there are any important points here, please let me know. For the most part, it all looks in-line with what was discussed in the meeting but I only scrolled high level over the engineering details since I don't really understand them.

Warm regards,
Andrew

----- Forwarded message -----

From: **Bernier, John** <John.Bernier@ottawa.ca>

Date: Mon, May 10, 2021 at 11:48 AM

Subject: 725 Somerset St. W - PC2021-0035

To: Nathan Petryshyn <petryshyn@fotenn.com>, Brian Casagrande <casagrande@fotenn.com>

Cc: Moise, Christopher <christopher.moise@ottawa.ca>, Paudel, Neeti <neeti.paudel@ottawa.ca>, Bakhit, Reza <reza.bakhit@ottawa.ca>, Richardson, Mark <Mark.Richardson@ottawa.ca>, andrew@upstay.io <andrew@upstay.io>, ericdarwin1@gmail.com <ericdarwin1@gmail.com>, thesycamore@sympatico.ca <thesycamore@sympatico.ca>, Kotarba, Ashley <Ashley.Kotarba@ottawa.ca>

Good afternoon,

Apologies for the delay – I had thought that I had already sent this follow-up. Let me know if you have any questions.

Please refer to the below [and/or attached notes] regarding the Pre-Application Consultation (pre-con) Meeting held on February 25th, 2020 for the property at 725 Somerset St. W. for a Site Plan Control Application in order to allow the development of a nine-storey, mixed-use building consisting of 76 residential units and hotel units at the ground floor. I have also attached the required Plans & Study List for application submission.

Below and attached are staff's preliminary comments based on the information available at the time of pre-con meeting:

Planning

- Relevant Policies:
 - **OP 3.6.3 - Traditional Mainstreet / Transit Priority Corridor**
 - **Zoning By-law: TM[112] H(16)**
 - **Urban Design Guidelines for Development along Traditional Mainstreets**

- **UDGS for Transit-Oriented Development - within 600m to LRT Station**
- Minor Zoning By-law Amendment:
 - **Max 2m front yard setback** from Somerset, as the lot line jogs - front yard setback means the shortest distance between the front lot line and any part of a building, not including a projection
 - **16m height** - mid-rise is permitted, but a lower height was built into the zoning based on the site conditions, existing character and compatibility. Require a rationale based on those. However, I suggest exploring a lower building based on the context (due grades, nearby heritage elements, site operational requirements, etc.)
 - Parking relief for 3 visitor spaces.
 - May be more based on the final product.

Big questions/Concerns:

Some operational elements are not shown in the concepts and needs to be explored:

- How is waste being handled on-site? This doesn't seem to have been considered in the design.
- Where is the amenity space?
- Are there balconies proposed? Please show and dimension – ensure that these meet the setback requirements, including permitted Projections Sec. 65
- Where is snow proposed? Cannot be located within required drive aisles or parking spaces.

Zoning

- As noted on the plan - Appears as though the building is within the 5m setback from the hydro pole. Contact Hydro Ottawa if you can't meet this setback to see whether they would accommodate a reduction.
- Active entrance onto Somerset is required for each use
- Per Sec 111: Bicycle rate of 0.5/dwelling // 1 per 1000 square metres GFA for hotel.
 - Suggest separating the two. i.e access to lockup room for only the mid-rise residents.
- Provide width of parking spaces.
- Plan shows 11, but table indicates 10 spaces.

Design

- Design Priority Area
- UDGS for Dev along Mainstreets:

- Would like to see more on how the development will contribute to the public realm. No approved streetscape plan, match the existing context. Provide a boulevard for street furniture, trees, and utilities.
- Clear windows and doors - animated uses to the front of the building etc.
- Special treatments that wrap around the building on the corner
- Providing buildings with rich architectural detail and pick up on the established rhythm and pattern.
- OP: Provide building format that encloses and defines the street edge with active frontages that provide direct pedestrian access to the sidewalk

Additional Comments

1. Where in a commercial or mixed use building and located on the ground floor abutting a street having direct pedestrian access to that street, residential, **office** and **research and development centre** uses must not be located within a depth of six metres of the front wall of the main building abutting the street;
2. A minimum of 50% of the ground floor façade facing the main street, measured from the average grade to a height of 4.5 metres, must comprise transparent windows and active entrances; and where an active entrance is angled on the corner of the building, such that it faces the intersection of the main street and an intersecting side street, it is deemed to face the main street;(By-law 2015-190)
3. Parking garage, provided that 100% of the ground floor fronting on the street excluding any related mechanical room or pedestrian or vehicular access, is occupied for a depth of three metres by other uses permitted to be located on the ground floor; and
4. Parkland dedication will be required – per the Parkland Dedication By-law 2009-95.
5. Applications Required: Site Plan Control – Complex (Manager Approval – Subject to Public Notification) & Minor Zoning By-law Amendment

-

Urban Design

- This proposal runs along one of the City's Design Priority Areas and must attend the City's UDRP. We recommend the proposal attend an Informal visit (prior to a full submission and is not a public meeting), with the City's UDRP to further discuss and evaluate various scenarios of development for the project;
- Recognizing some of the challenges a similar project of nine storeys has had close to this proposal we note the following areas of sensitivity which need to be addressed moving forward:
 - **Transitioning:** For a nine storey proposal we recommend a close analysis of transitioning to the neighbouring heritage properties be addressed;
 - **Blank wall:** We recommend a sensitive approach be adopted to the potential blank wall condition adjacent to a heritage building to the east be considered in the design;

- **Ground floor use:** We recommend that a sensitive approach to providing active uses at grade be considered including but not limited to active entrances, shared communal spaces, and visibility through large glazing;
 - **Hotel use:** We recommend this use be further considered as it appears to replace other more active uses at grade as currently presented;
 - **Heritage:** We recommend that the design of the building address the heritage context and unique surrounding buildings in the development of the design and materiality;
- A Design Brief is a required submittal for all Site Plan/Re-zoning applications. Please see the Design Brief Terms of Reference provided and consult the City's website for details regarding the UDRP schedule.

Heritage Comments

The property at 725 Somerset Street West is not a heritage property, however is adjacent on all sides to properties listed on the Heritage Register or designated under Part IV of the *Ontario Heritage Act*. Heritage staff would like to see a Cultural Heritage Impact Statement (CHIS) as part of this development application in accordance to Official Plan Policy 4.6.1. This CHIS should examine potential impacts on the designated resource across the street at 760 Somerset Street West, and should outline how the proposal is compatible with the adjacent Listed properties and streetscape. Policies in the Official Plan regarding Cultural Heritage Impact Statements can be found here:

[Section 4 - Review of Development Applications | City of Ottawa](#)

For more information on the scope of the CHIS please contact Ashley Kotarba.

Engineering

The subject site is located within a combined sewershed therefore the approval exemption under O.Reg. 525/98 would not apply and an Environmental Compliance Approval ([ECA](#)) application will be required.

Ontario Regulation 525/98:

3. Subsection 53(1) and (3) of the Act do not apply to the use, operation, establishment, alteration, extension or replacement of or a change in a storm water management facility that,

(a) is designed to service one lot or parcel of land;

(b) discharges into a storm sewer that is not a combined sewer;

(c) does not service industrial land or a structure located on industrial land; and

(d) is not located on industrial land.

The ECA applications will be a Direct Submission for Private Sewage Works discharging to a combined sewer.

A deep excavation and dewatering operations have the potential to cause damages to the neighboring adjacent buildings/ City infrastructure. Document that construction activities

(excavation, dewatering, vibrations associated with construction, etc.) will not have an impact on any adjacent buildings and infrastructure.

A **Record of Site Condition (RSC)** in accordance with O.Reg. 153/04 will be required to be filed and acknowledged by the Ministry prior to issuance of a building permit due to a change

to a more sensitive property use.



General:

It is the sole responsibility of the consultant to investigate the location of existing underground utilities in the proposed servicing area to avoid any conflict with utilities. The

location of existing utilities and services shall be documented on an Existing Conditions Plan. Verify all the information related to the infrastructures by using as built drawings or field visit and inspection as required. Include a note on the Servicing and Grading Plan stating the existing utilities in the proposed servicing area have been investigated.

All underground and above ground building footprints and permanent walls need to be shown on the plans to confirm that any permanent structure does not extend either above or below into the existing property lines and sight triangles and/or future road widening protection limits.

- Please note that the proposed servicing design and site works shall be in accordance with the following documents:

- Ottawa Sewer Design Guidelines (October 2012)
- Technical Bulletin PIEDTB-2016-01
- Technical Bulletins ISTB-2018-01, ISTB-2018-02 and ISTB-2018-03.
- Ottawa Design Guidelines - Water Distribution (2010)
- Design Guidelines for Sewage Works, MECP, 2008
- Stormwater Planning and Design Manual, MECP, March 2003
- Geotechnical Investigation and Reporting Guidelines for Development Applications in the City of Ottawa (2007)
- City of Ottawa Slope Stability Guidelines for Development Applications (revised 2012)
- City of Ottawa Environmental Noise Control Guidelines (January 2016)
- City of Ottawa Accessibility Design Standards (November 2015) (City recommends development be in accordance with these standards on private property)
- Ottawa Standard Tender Documents (latest version)
- Ontario Provincial Standards for Roads & Public Works (2013)
- Record drawings and utility plans are also available for purchase from the City (Contact the City's Information Centre by email at InformationCentre@ottawa.ca or by phone at (613) 580-424 x.44455). **Include copies in the Appendix of the report as supporting documentation.**

SWM Criteria: Connecting directly the Combined Sewer on Concord St. N

- Total (storm +sanitary+foundation drainage) allowable release rate will be **2-year pre-development rate**.
- C Coefficient of runoff will need to be determined **as per existing conditions but in no case more than 0.4**
- TC =20 minutes or can be calculated,
- TC should not be less than 10 minutes, since the IDF curves become unrealistic less than 10min.
- The total combined flow from the site (storm, sanitary and foundation drain) shall not exceed the allowable release rate. The allowable stormwater flow for the site is to be calculated by subtracting the contributing peak wastewater flow and groundwater from the foundation drain from the total allowable release rate.
- Attenuate storms up to and including the 100-year design event on site. SWM measures will be subject to review.
- Any storm events greater than 2 year, up to 100 year, and including 100-year storm event must be detained on site.

Two service laterals connections (sanitary and storm) to the combined sewer system will be required.

- **Water Quality:** Please consult with the local conservation authority (RVCA) regarding water quality criteria and requirements prior to submission of an application. It is consultant's responsibility to check with the RVCA for quality control issues and include this information and discussion in the SWM report. Please contact the RVCA for further information.
- If **rooftop control and storage** is considered as part of the SWM solution sufficient details (Cl. 8.3.8.4) shall be discussed and documented in the report and on the plans. A roof drainage plan and detailed roof drain summary table with supporting drain manufacturer

information will be required. Any note indicating *to be designed by others* will not be sufficient. The roof drainage plan will need to document roof drain type, flow rates, emergency scupper locations and spill over elevations and ponding areas. Roof drains are to be connected downstream of any incorporated ICDs within the SWM system and not to the foundation drain system. Provide a **Roof Drain Plan** as part of the submission.

- Please note that the HGL within the receiving sewer system will need to be assessed if underground storage (cistern) is proposed as part of the stormwater management solution to ensure the system does not become surcharged and thereby ineffective do to a loss in available storage.
- **Underground Storage: Underground storage volumes are to be based on 50% peak flow rates or use dynamic compute model.** The Modified Rational Method for storage computation in the Sewer Design Guidelines was originally intended to be used for above ground storage (i.e. parking lot) where the change in head over the orifice varied from 1.5 m to 1.2 m (assuming a 1.2 m deep CB and a max ponding depth of 0.3 m). This change in head was small and hence the release rate fluctuated little, therefore there was no need to use an average release rate.

When underground storage is used, the release rate fluctuates from a maximum peak flow based on maximum head down to a release rate of zero. This difference is large and has a significant impact on storage requirements. **We therefore require that an average release rate equal to 50% of the peak allowable rate shall be applied to estimate the required volume. Alternatively, the consultant may choose to use a submersible pump in the design to ensure a constant release rate.**

- If a storage tank (cistern) is considered as part of the SWM solution sufficient details and system information will need to be provided. A detailed cross-section of such system (provided from the mechanical engineer and shown on the plans) with sufficient details and information (HWLs, release rate, volume, location, size (dimensions), control device, emergency flow outlet and backflow protection, etc.) will need to be provided. An appropriate emergency overflow location will need to be determined and documented. Backup power supply necessary if pump controlled. Details regarding the proposed on-site stormwater management system are to be provided for review.
- The minimum orifice dia. for a plug style ICD is 83mm and the minimum flow rate from a vortex ICD is 6 L/s in order to reduce the likelihood of plugging.
- Please include a Pre-Development Drainage Area Plan to define the pre-development drainage areas/patterns. Existing drainage patterns shall be maintained and discussed as part of the proposed SWM solution. Runoff shall not be directed toward any adjacent properties. Post-development site grading shall match existing property line grades in order to minimize disruption to the adjacent residential properties.

Sewer:

- The site is located within a combined sewershed.
- An analysis and demonstration that there is sufficient/adequate residual capacity to accommodate any increase in wastewater flows in the receiving and downstream wastewater system is required to be provided. It is suggested to **calculate the total peak wastewater demand for the proposed development and send it to the City as soon as possible in advance of a submission of an application, as an initial step to determine and verify whether or not there is sufficient capacity in the city sewer system to accommodate**

the proposed wastewater flow. Please note that it takes approx. 10 business days to get a response back from the internal circulation.

- A storm sewer monitoring maintenance hole is required to be installed at the property line (on the private side of the property) as per City of Ottawa Sewer-Use By-Law 2003-514.
- As-built drawings of the existing infrastructure within the vicinity of the site are available and road, sewer and watermain reconstruction plans are to be obtained from Infrastructure Services and reviewed in order to determine proper servicing and SWM plan for the subject site.
- Foundation drainage system details are to be discussed in the report and document how the system will be integrated into the servicing design. Please note that foundation drain is to be independently connected to sewermain unless being pumped with appropriate back up power, sufficient sized pump and back flow prevention.
- A backwater valve is required on all service laterals for protection.
- The sanitary sewer criteria shall reflect the new *Technical Bulletin PIEDTB-2018-01*.
- A sanitary sewer monitoring maintenance hole is required to be installed at the property line (on the private side of the property) as per City of Ottawa Sewer-Use By-Law 2003-514.

A backwater valve is required on the sanitary service for protection

Water:

- A local 305mm dia. UCI watermain is located within Somerset St.
- Existing residential service to be blanked at the main.
- Water Supply Redundancy: Residential buildings with a basic day demand greater than 50m³/day (0.57 L/s) are required to be connected to a minimum of two water services separated by an isolation valve to avoid a vulnerable service area as per the Ottawa Design Guidelines - Water Distribution, WDG001, July 2010 Clause 4.3.1 Configuration. The basic day demand for this site not expected to exceed 50m³/day.
- Please review **Technical Bulletin ISTB-2018-0**, maximum fire flow hydrant capacity is provided in Section 3 Table 1 of Appendix I. A hydrant coverage figure shall be provided and **demonstrate there is adequate fire protection** for the proposal. Two or more public hydrants are anticipated to be required to handle fire flow.
- Boundary conditions are required to confirm that the require fire flows can be achieved as well as availability of the domestic water pressure on the City street in front of the development. Use Table 3-3 of the MOE Design Guidelines for Drinking-Water System to determine Maximum Day and Maximum Hour peaking factors for 0 to 500 persons and use Table 4.2 of the Ottawa Design Guidelines, Water Distribution for 501 to 3,000 persons. Please provide the following information to the City of Ottawa via email to request water distribution network boundary conditions for the subject site. Please note that once this information has been provided to the City of Ottawa it takes approximately 5-10 business days to receive boundary conditions.

- **Type of Development and Units**
- **Site Address**
- **A plan showing the proposed water service connection location.**
- **Average Daily Demand (L/s)**
- **Maximum Daily Demand (L/s)**
- **Peak Hour Demand (L/s)**
- **Fire Flow (L/min)**

[Fire flow demand requirements shall be based on **Fire Underwriters Survey (FUS) Water Supply for Public Fire Protection 1999**]

Exposure separation distances shall be defined on a figure to support the FUS calculation and required fore flow (RFF).

- **Hydrant capacity shall be assessed to demonstrate the RFF can be achieved.** Please identify which hydrants are being considered to meet the RFF on a fire hydrant coverage plan as part of the boundary conditions request.

Snow Storage:

- Any portion of the subject property which is intended to be used for permanent or temporary snow storage shall be as shown on the approved site plan and grading plan. Snow storage shall not interfere with approved grading and drainage patterns or servicing. Snow storage areas shall be setback from the property lines, foundations, fencing or landscaping a minimum of 1.5m. Snow storage areas shall not occupy driveways, aisles, required parking spaces or any portion of a road allowance. If snow is to be removed from the site please indicate this on the plan(s).

Permits and Approvals:

- Please note that this project will be subject to an Environmental Compliance Approval (ECA) for Private Sewage Works. (Any connection to a combined Sewer system required the Ministry (MECP) approval)

Required Engineering Plans and Studies in Support of SPC application:

PLANS:

- Existing Conditions and Removals Plan
- Site Servicing Plan (Plan and Profile Drawings required for MECP ECA Application)
- Grade Control and Drainage Plan
- Erosion and Sediment Control Plan
- Pre-Development Drainage Area Plan
- Post-Development Drainage Area Plan
- Roof Drainage Plan w/ Roof Drain Summary Table (if rooftop SWM storage is being considered)
- Foundation Drainage System Details
- Legal Survey Plan

REPORTS:

- Site Servicing and Stormwater Management Report
- Geotechnical Study
- Wind study (For the proposals of 9 story buildings and higher)
- Detailed Noise Study (Transportation Noise Assessment and Stationary Noise Assessment)
- Phase I ESA (in accordance with Ontario Regulation 153/04)

- Phase II ESA (depending on results and recommendation of the Phase I-ESA)
- Record of Site Condition (RSC) will be required for this property.

Please refer to the **City of Ottawa Guide to Preparing Studies and Plans [Engineering]**:

<https://ottawa.ca/en/planning-development-and-construction/developing-property/development-application-review-process/development-application-submission/guide-preparing-studies-and-plans>

Phase One Environmental Site Assessment (Official Plan Section 4.8.4):

- A **Phase I ESA** is required to be completed in accordance with Ontario Regulation 153/04 (not per CSA standards) in support of this development proposal to determine the potential for site contamination. A **Phase II ESA** may be required depending on the results and recommendations of the Phase I-ESA.
- The Phase I ESA shall discuss the requirement to file a RSC with the Ministry. A **Record of Site Condition (RSC)** in accordance with O.Reg. 153/04 will be required to be filed and acknowledged by the Ministry prior to issuance of a building permit due to the change in property use. As per the Official Plan (4.8.4) we do not consider an RSC acknowledged by the Ministry until either it's has been confirmed that it will not be audited or it has passed the Ministry audit.
- Please also note that in the event soil and/or groundwater contamination is identified on this site and the proposal is for a more sensitive land use, the MECP will require approximately 1-1.5 years to review the RSC. PIED will apply appropriate conditions, based on Environmental Protection Act (Section 168.3.1 (1)) and O.Reg. 153/04 (Parts IV and V) regarding requirements for RSC prior to building permit issuance. Dependent on the levels/types of contamination, timelines for building permit issuance may be longer than expected and we recommend applicant speak to Building Code Services, at the earliest convenience, so as to discuss these timelines in more detail, if deemed applicable.
- Environmental Risk Information Services (ERIS) report is required to be included as part of the Phase I ESA.

<https://www.ontario.ca/page/guide-completing-phase-one-environmental-site-assessments-under-ontario-regulation-15304>

<https://www.ontario.ca/laws/regulation/040153#BK43>

Geotechnical Investigation (Official Plan Section 4.8.3):

- A **Geotechnical Study/Investigation** shall be prepared in support of this development proposal.
- Investigate the effect of short-term and long-term lowering of the groundwater level and the impact on the adjacent lands and existing neighboring structures. The City is concerned that reducing the groundwater level in this area can lead to damages to surrounding structures due to excessive differential settlements of the ground. The impact of groundwater lowering on adjacent properties needs to be discussed and investigated to ensure there will be no short term and long term damages associated with lowering the groundwater in this area.
- Geotechnical Study shall be consistent with the **Geotechnical Investigation and Reporting Guidelines for Development Applications**.

<https://documents.ottawa.ca/sites/default/files/documents/cap137602.pdf>

Detailed Noise Study:

- A **Transportation Noise Assessment** is required as the subject development is located on Greenfield Ave. (arterial road classification) and within 500m of HWY 417.
- A **Stationary Noise Assessment** is required in order to assess the noise impact of the proposed sources of stationary noise (mechanical HVAC system/equipment) of the development onto the surrounding residential area to ensure the noise levels do not exceed allowable limits specified in the City Environmental Noise Control Guidelines.
- Noise Study shall be consistent with the City's **Environmental Noise Control Guidelines**.

https://documents.ottawa.ca/sites/default/files/documents/enviro_noise_guide_en.pdf

Exterior Site Lighting:

- Any proposed light fixtures (both pole-mounted and wall mounted) must be part of the approved Site Plan. All external light fixtures must meet the criteria for Full Cut-off Classification as recognized by the Illuminating Engineering Society of North America (IESNA or IES), and must result in minimal light spillage onto adjacent properties (as a guideline, 0.5 fc is normally the maximum allowable spillage). In order to satisfy these criteria, the please provide the City with a **Site Lighting Plan, and Certification (Statement) Letter** from an acceptable professional engineer stating that the design is compliant.

Wind study :

- A wind analysis must be prepared, signed and stamped by an engineer who specializes in pedestrian level wind evaluation

https://documents.ottawa.ca/sites/documents/files/torwindanalysis_en.pdf

Feel free to contact Project Manager, Reza Bakhit at ext. 19346 or at reza.bakhit@ottawa.ca

Transportation

- Site is within a TOD area – therefore TOD measures would apply. To achieve target mode shares within TOD zones, we highly recommend developments to provide as many TDM measures as possible to enable and encourage travel by sustainable modes. Please complete the TDM Measures Checklist.
- Upgrade the sidewalk along the site frontages.
- As the site proposed is residential, AODA legislation applies for all areas accessible to the public (i.e. outdoor pathways, parking, etc.).
- On site plan:
 - Turning templates will be required for all accesses showing the largest vehicle to access the site; required for internal movements and at all access (entering and exiting and going in both directions).
 - Show all curb radii measurements; ensure that all curb radii are reduced as much as possible
 - Show lane/aisle widths.
 - Sidewalk is to be continuous across access as per City Specification 7.1.

Forestry

TCR requirements:

1. a Tree Conservation Report (TCR) must be supplied for review along with the suite of other plans/reports required by the City
 - a. an approved TCR is a requirement of Site Plan approval.
2. As of January 1 2021, any removal of privately or publicly (City) owned trees 10cm or larger in diameter requires a tree permit issued under the Tree Protection Bylaw (Bylaw 2020 – 340); the permit will be based on an approved TCR and made available at or near plan approval.
3. The Planning Forester from Planning and Growth Management as well as foresters from Forestry Services will review the submitted TCR
 - a. If tree removal is required, both municipal and privately-owned trees will be addressed in a single permit issued through the Planning Forester
 - b. Compensation may be required for city owned trees – if so, it will need to be paid prior to the release of the tree permit
4. the TCR must list all trees on site by species, diameter and health condition
5. the TCR must list all trees on adjacent sites if they have a critical root zone that extends onto the development site
6. If trees are to be removed, the TCR must clearly show where they are, and document the reason they cannot be retained
7. All retained trees must be shown and all retained trees within the area impacted by the development process must be protected as per City guidelines available at [Tree Protection Specification](#) or by searching [Ottawa.ca](#)
 - a. the location of tree protection fencing must be shown on a plan
 - b. show the critical root zone of the retained trees
 - c. if excavation will occur within the critical root zone, please show the limits of excavation
8. the City encourages the retention of healthy trees; if possible, please seek opportunities for retention of trees that will contribute to the design/function of the site.
9. For more information on the process or help with tree retention options, contact Mark Richardson mark.richardson@ottawa.ca or on [City of Ottawa](#)

LP tree planting requirements:

For additional information on the following please contact Tracy.Smith@Ottawa.ca

Minimum Setbacks

- Maintain 1.5m from sidewalk or MUP/cycle track.
- Maintain 2.5m from curb

- Coniferous species require a minimum 4.5m setback from curb, sidewalk or MUP/cycle track/pathway.
- Maintain 7.5m between large growing trees, and 4m between small growing trees. Park or open space planting should consider 10m spacing.
- Adhere to Ottawa Hydro's planting guidelines (species and setbacks) when planting around overhead primary conductors.

Tree specifications

- Minimum stock size: 50mm tree caliper for deciduous, 200cm height for coniferous.
- Maximize the use of large deciduous species wherever possible to maximize future canopy coverage
- Tree planting on city property shall be in accordance with the City of Ottawa's Tree Planting Specification; and include watering and warranty as described in the specification (can be provided by Forestry Services).
- Plant native trees whenever possible
- No root barriers, dead-man anchor systems, or planters are permitted.
- No tree stakes unless necessary (and only 1 on the prevailing winds side of the tree)

Hard surface planting

- Curb style planter is highly recommended
- No grates are to be used and if guards are required, City of Ottawa standard (which can be provided) shall be used.
- Trees are to be planted at grade

Soil Volume

- Please ensure adequate soil volumes are met:

Tree Type/Size	Single Tree Soil Volume (m3)	Multiple Tree Soil Volume (m3/tree)
Ornamental	15	9
Columnar	15	9
Small	20	12
Medium	25	15
Large	30	18
Conifer	25	15

Please note that these soil volumes are not applicable in cases with Sensitive Marine Clay.

Sensitive Marine Clay

- Please follow the City's 2017 Tree Planting in Sensitive Marine Clay guidelines

Community Association

- Active Frontage req'd on TM and critical because of gap in active frontage immediately east and west. Suggest hotel or residence entry on Empress to maximize active frontage on Somerset and reduction in width on Somerset.
- Height: we are opposed to an increase beyond the community developed 16m zoning.
- Parking: Visitor parking is critical, and with the enormous relief the zoning allows for residential parking, and the dearth of street parking, visitor parking should be fully provided.
- Hotel vs Residential: We are not opposed to either use, but if, as mentioned by the applicant, the hotel might expand beyond the 10 units shown, then more hotel parking for is necessary. The applicants business, "UpStay", is about 'short term rentals '. Hopefully this is not contrary to the imminent STR bylaw, and sufficient parking is provided for this.
- The existing building may have heritage value. I vaguely recall it may have received an architecture award and it is included in books on architecture in Ottawa. It used to be a Desjardins coop??
- If there are community benefits, or if the developer wishes, the front plaza where the bus stop and dead trees are, was created in the early 80s when a curve in the street was straightened out. But the trees were planted in minimalist holes in the road base, and never thrive despite frequent replacement. The area in front of the building should be properly landscaped, with the sidewalk either close to the building or on the curb line, and the rest of space soft landscaped (not hardscaped due to the injection site, food kitchen, and problem with street loitering already frustrating the BIA and residents) with trees, shrubs, and possibly fenced with a decorative railing to provide a look-but-don't-sit greenspace. A sidewalk bench would be appropriate adjacent to the bus stop.
- The 15' height for the ground floor is good, to permit a variety of uses over time
- Rather than hotel rooms, the street facing units might be better as live work lofts with residential space on the loft level and residential / commercial flex spaces on the ground level. I do not think storefronts are required to make a TMS, there can be a mix of uses. The neighbourhood has had a surplus of commercial space for years, with numerous storefronts being misused as warehouse and wholesale space, and some have been converted back to residential uses. I oppose the whole groundfloor being used for a parking level should the "hotel" uses expand to upper floors.
- I remain very concerned and suspicious that the hotel use is insincere, and that it might turn out to be a boardinghouse, coshare, or rooming house use, or that the the hotel will "grow" to include (some of) the upper floors
- The front facade of the building should have a kink or over all curve to follow the lot line and reinforce the general alignment and built form of the street. This building currently looks like it's a rectangle from anywhere plopped down without regard to the characteristics of the lot or site or neighbours.
- Somerset street suffers from some inferior building conditions and cheaper facades. The new apt building across the street last time I saw the plan had a huge white smooth cube facade that, due to its position on a hill, may be a sore thumb visible for miles from the west. I would like to see this building have a traditional red brick podium with rough cut limestone accents to reinforce the fabric of the neighbourhood limestone foundations and limestone buildings. Portrait shaped windows (rather than landscape) might also help the character.
- I know the BIA will oppose any materials that are black brick or dark gray cladding. The developer should reach out to the CBIA regarding materials acceptable to the BIA and Chinatown "look".
- Both the Empress and the north side of the building, or at least the podium on the north, will be highly visible and should be finished with quality

Other

- You are encouraged to contact the Ward Councillor, Catherin McKenney.

Please refer to the links to [“Guide to preparing studies and plans”](#) and [fees](#) for general information. Additional information is available related to [building permits](#), [development charges](#), and the [Accessibility Design Standards](#). Be aware that other fees and permits may be required, outside of the development review process. You may obtain background drawings by contacting informationcentre@ottawa.ca.

These pre-con comments are valid for one year. If you submit a development application(s) after this time, you may be required to meet for another pre-consultation meeting and/or the submission requirements may change. You are as well encouraged to contact us for a follow-up meeting if the plan/concept will be further refined.

Please do not hesitate to contact me if you have any questions.

Regards,

John Bernier, MCIP, RPP

Planner II | Urbaniste II

Development Review, Central | *Examen des projets d'aménagement, Central*

Planning, Infrastructure and Economic Development Department | *Services de la planification, de l'infrastructure et du développement économique*

City of Ottawa | *Ville d'Ottawa*

110 Laurier Avenue West. Ottawa, ON | *110, avenue. Laurier Ouest. Ottawa (Ontario) K1P 1J1*

613.580.2424 ext./poste 21576

ottawa.ca/planning / ottawa.ca/urbanisme

Please note that during the current public health emergency I am working remotely. Email is the easiest and most reliable way of reaching me at this time. Thank you for your cooperation.

This e-mail originates from the City of Ottawa e-mail system. Any distribution, use or copying of this e-mail or the information it contains by other than the intended recipient(s) is unauthorized. Thank you.

Le présent courriel a été expédié par le système de courriels de la Ville d'Ottawa. Toute distribution, utilisation ou reproduction du courriel ou des renseignements qui s'y trouvent par une personne autre que son destinataire prévu est interdite. Je vous remercie de votre collaboration.

6 attachments

 **Somerset, 725_Design Brief.pdf**
88K

 **tdm_measures_checklist_en.pdf**
464K

 **AODA Checklist.docx**
251K

 **725 Somerset_Lenjosek_2021-01-27 L1-1 (1).pdf**
862K

 **725 Somerset_Lenjosek_2021-01-27 L1-3 (1).pdf**

640K



725 Somerset_Lenjosek_2021-01-27 L1-2 (1).pdf

649K

zor@archnova.ca

From: Bakhit, Reza <reza.bakhit@ottawa.ca>
Sent: May 23, 2023 2:48 PM
To: zor@archnova.ca
Subject: RE: 725 Somerset Street

Hi Zoran,

I can confirm there is sufficient residual capacity for the municipal combined sewer at the location. I will update you for the boundary conditions as soon as we got the results back.

Regards,

Reza

From: zor@archnova.ca <zor@archnova.ca>
Sent: Tuesday, May 16, 2023 8:52 AM
To: Bakhit, Reza <reza.bakhit@ottawa.ca>
Subject: 725 Somerset Street

CAUTION: This email originated from an External Sender. Please do not click links or open attachments unless you recognize the source.

ATTENTION : Ce courriel provient d'un expéditeur externe. Ne cliquez sur aucun lien et n'ouvrez pas de pièce jointe, excepté si vous connaissez l'expéditeur.

Hello Reza,

Please could you provide the boundary conditions for the location of 725 Somerset Street Ottawa? The owner is planning to construct a new residential building with an underground garage at this location. Attached are the water and sewer calculations, the fire flow calculation and the site plan for proposed development.

Type of development: apartment building (9 stories; 94 units + commercial space on the ground floor)

Average daily demand: 0.50 l/s

Maximum daily demand: 4.63/s.

Maximum hourly daily demand: 6.96 l/s.

Fire flow: 167 l/sec (FUS); 224.4 l/sec (OBC)

Ground elevation 78.09 m.a.s.l

Top of the building: (30.81 m) 108.90 m a.s.l.

Also, please could you confirm the residual capacity for the municipal combined sewer at the location?

Regards,

Zoran Mrdja, P.Eng., FEC

[Arh-Nova Design Inc.](#)

613-818-3884

'

This e-mail originates from the City of Ottawa e-mail system. Any distribution, use or copying of this e-mail or the information it contains by other than the intended recipient(s) is unauthorized. Thank you.

Le présent courriel a été expédié par le système de courriels de la Ville d'Ottawa. Toute distribution, utilisation ou reproduction du courriel ou des renseignements qui s'y trouvent par une personne autre que son destinataire prévu est interdite. Je vous remercie de votre collaboration.

'

zoran@archnova.ca

From: Bakhit, Reza <reza.bakhit@ottawa.ca>
Sent: May 29, 2023 11:08 PM
To: Andrew Lenjosek
Cc: zoran@archnova.ca; Thomas Freeman; Nathan Petryshyn; Brian Casagrande; Erick Soulière
Subject: RE: 725 Somerset Street
Attachments: 725 Somerset Street May 2023.pdf

Hi Andrew,

The following are boundary conditions, HGL, for hydraulic analysis at 725 Somerset Street, (zone 1W) assumed to be a dual connection to the 305 mm watermain on Somerset Street AND/OR the 305 mm on Empress (see attached PDF for location).

Both Connections :

Min HGL: 107.2 m

Max HGL: 115.4 m

Max Day + FF (166.7 L/s): 109.4 m (Somerset Connection), 108.8 m (Empress Connection)

Max Day + FF (224.4 L/s): 108.9 m (Somerset Connection), 107.9 m (Empress Connection)

These are for current conditions and are based on computer model simulation.

Disclaimer: The boundary condition information is based on current operation of the city water distribution system. The computer model simulation is based on the best information available at the time. The operation of the water distribution system can change on a regular basis, resulting in a variation in boundary conditions. The physical properties of watermains deteriorate over time, as such must be assumed in the absence of actual field test data. The variation in physical watermain properties can therefore alter the results of the computer model simulation.

Regards,

Reza Bakhit, P.Eng, C.E.T

Project Manager

Planning, Real Estate and Economic Development Department / Direction générale de la planification, des biens immobiliers et du développement économique

Development Review - Central Branch

City of Ottawa | Ville d'Ottawa

110 Laurier Avenue West Ottawa, ON | 110, avenue. Laurier Ouest. Ottawa (Ontario) K1P 1J1

613.580.2424 ext./poste 19346, reza.bakhit@ottawa.ca

Please note: Given the current pandemic, I will be working from home until further notice; reaching me by email is the easiest. I will be checking my voicemail, just not as frequently as I normally would be.

From: Andrew Lenjosek <andrew@upstay.com>

Sent: Monday, May 29, 2023 2:31 PM

To: Bakhit, Reza <reza.bakhit@ottawa.ca>

Cc: zoran@archnova.ca; Thomas Freeman <freeman@fotenn.com>; Nathan Petryshyn <petryshyn@fotenn.com>; Brian Casagrande <casagrande@fotenn.com>; Erick Soulière <esouliere@rossmannarchitecture.ca>

Subject: Re: 725 Somerset Street

Boundary Conditions for 725 Somerset Street



av. Empress Ave
←

305

118

725

Empress Connection

152

Somerset Connection

rue Somerset St. C.

203

rue Bell St. A

Legend

- Public
- Private

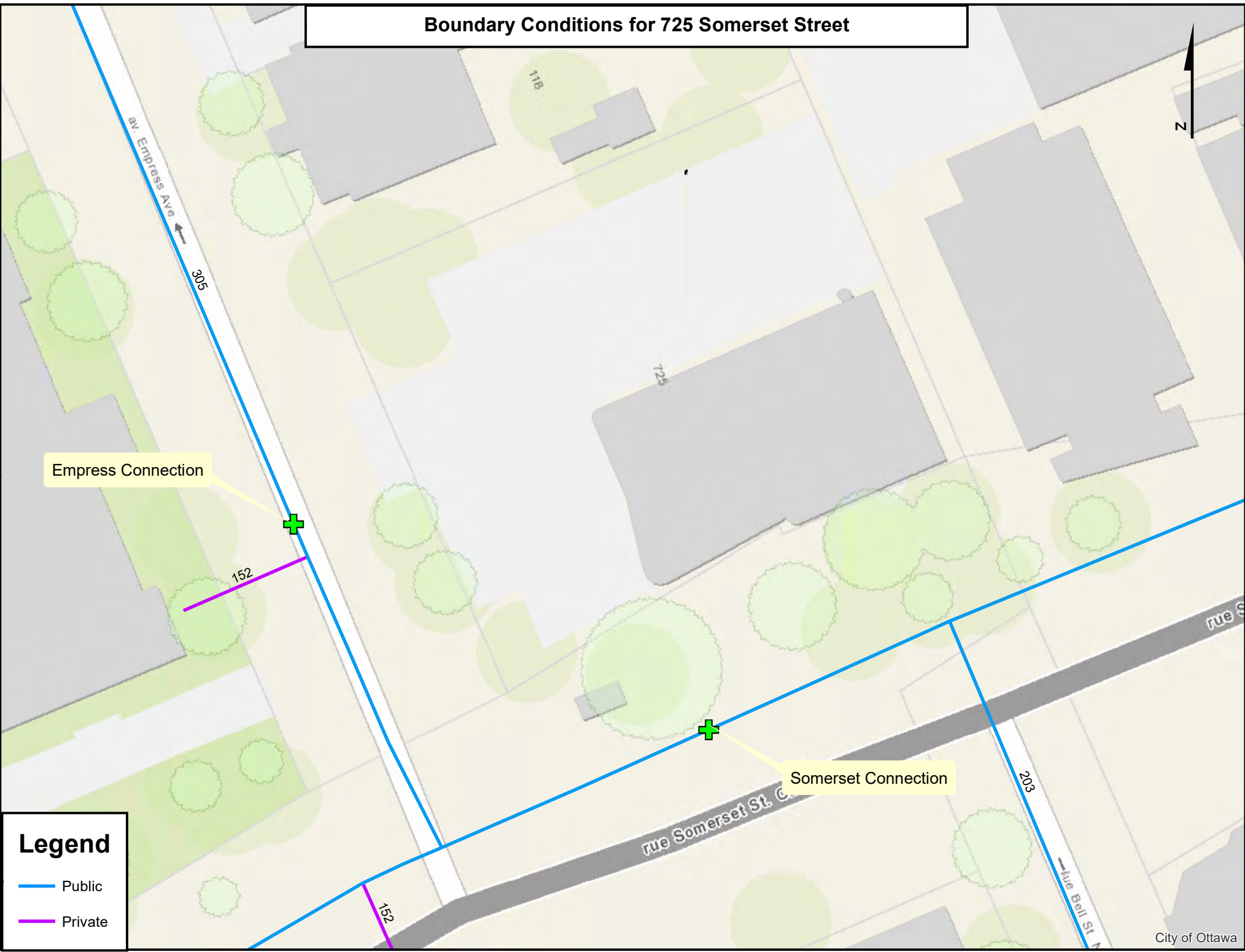

CAUTION: This email originated from an External Sender. Please do not click links or open attachments unless you recognize the source.

ATTENTION : Ce courriel provient d'un expéditeur externe. Ne cliquez sur aucun lien et n'ouvrez pas de pièce jointe, excepté si vous connaissez l'expéditeur.

Thanks Reza!

On May 29, 2023, at 8:26 PM, Bakhit, Reza <reza.bakhit@ottawa.ca> wrote:

Hi Andrew,

I have followed up with the modeling team and will update you as soon as we got the results back.

Thanks,

Reza Bakhit, P.Eng, C.E.T

Project Manager

Planning, Real Estate and Economic Development Department / Direction générale de la planification, des biens immobiliers et du développement économique

Development Review - Central Branch

City of Ottawa | Ville d'Ottawa

110 Laurier Avenue West Ottawa, ON | 110, avenue. Laurier Ouest. Ottawa (Ontario) K1P 1J1

613.580.2424 ext./poste 19346, reza.bakhit@ottawa.ca

Please note: Given the current pandemic, I will be working from home until further notice; reaching me by email is the easiest. I will be checking my voicemail, just not as frequently as I normally would be.

From: Andrew Lenjosek <andrew@upstay.com>

Sent: Monday, May 29, 2023 2:17 PM

To: zoran@archnova.ca

Cc: Bakhit, Reza <reza.bakhit@ottawa.ca>; Thomas Freeman <freeman@fotenn.com>; Nathan Petryshyn <petryshyn@fotenn.com>; Brian Casagrande <casagrande@fotenn.com>; Erick Soulière <esouliere@rossmannarchitecture.ca>

Subject: Re: 725 Somerset Street

CAUTION: This email originated from an External Sender. Please do not click links or open attachments unless you recognize the source.

ATTENTION : Ce courriel provient d'un expéditeur externe. Ne cliquez sur aucun lien et n'ouvrez pas de pièce jointe, excepté si vous connaissez l'expéditeur.

Hi Reza,

I hope you're having a wonderful day!

I wanted to follow up on the below -- this is literally the very last item until we can submit our SPA, and the City of Ottawa is rolling out a new deadline for SPA's (transitioning to a new format) on June 14 and

we need about 2 weeks for the planner to review / mark as complete. Accordingly, we need to submit by May 31 and I'm *really* hoping this can get sent over today or worst case, tomorrow.

I will have to send daily emails about this to follow up until then -- it's not to be annoying, but because we *really* need this to get finished and it's our only outstanding item.

I've copied my planning consultant team from Fotenn and our architect, Erick. Thomas, perhaps we can connect with the City planner to help nudge this?

Thanks,
Andrew

On Mon, May 29, 2023 at 7:55 AM <zoran@archnova.ca> wrote:

Hi Reza,

Can we expect the boundary conditions by today-tomorrow the latest?

Regards,

Zoran

From: Bakhit, Reza <reza.bakhit@ottawa.ca>
Sent: May 24, 2023 11:10 AM
To: zoran@archnova.ca
Subject: RE: 725 Somerset Street

Hi Zoran,

Could you please provide a concept sketch that shows the approximate location of the proposed water connection . (Requested by the modeling team for the boundary condition) .

Thanks,

Reza

From: zoran@archnova.ca <zoran@archnova.ca>

Sent: Tuesday, May 16, 2023 8:52 AM

To: Bakhit, Reza <reza.bakhit@ottawa.ca>

Subject: 725 Somerset Street

CAUTION: This email originated from an External Sender. Please do not click links or open attachments unless you recognize the source.

ATTENTION : Ce courriel provient d'un expéditeur externe. Ne cliquez sur aucun lien et n'ouvrez pas de pièce jointe, excepté si vous connaissez l'expéditeur.

Hello Reza,

Please could you provide the boundary conditions for the location of 725 Somerset Street Ottawa? The owner is planning to construct a new residential building with an underground garage at this location. Attached are the water and sewer calculations, the fire flow calculation and the site plan for proposed development.

Type of development: apartment building (9 stories; 94 units + commercial space on the ground floor)

Average daily demand: 0.50 l/s

Maximum daily demand: 4.63/s.

Maximum hourly daily demand: 6.96 l/s.

Fire flow: 167 l/sec (FUS); 224.4 l/sec (OBC)

Ground elevation 78.09 m.a.s.l

Top of the building: (30.81 m) 108.90 m a.s.l.

Also, please could you confirm the residual capacity for the municipal combined sewer at the location?

Regards,

Zoran Mrdja, P.Eng., FEC

Arch-Nova Design Inc.

613-818-3884

This e-mail originates from the City of Ottawa e-mail system. Any distribution, use or copying of this e-mail or the information it contains by other than the intended recipient(s) is unauthorized. Thank you.

Le présent courriel a été expédié par le système de courriels de la Ville d'Ottawa. Toute distribution, utilisation ou reproduction du courriel ou des renseignements qui s'y trouvent par une personne autre que son destinataire prévu est interdite. Je vous remercie de votre collaboration.

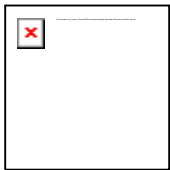

--



Andrew Lenjosek

CEO,
Upstay

 andrew@upstay.com  [14078636255](tel:14078636255)

 [14243248834](tel:14243248834)  upstay.com



;

This e-mail originates from the City of Ottawa e-mail system. Any distribution, use or copying of this e-mail or the information it contains by other than the intended recipient(s) is unauthorized. Thank you.

Le présent courriel a été expédié par le système de courriels de la Ville d'Ottawa. Toute distribution, utilisation ou reproduction du courriel ou des renseignements qui s'y trouvent par une personne autre que son destinataire prévu est interdite. Je vous remercie de votre collaboration.

This e-mail originates from the City of Ottawa e-mail system. Any distribution, use or copying of this e-mail or the information it contains by other than the intended recipient(s) is unauthorized. Thank you.

Le présent courriel a été expédié par le système de courriels de la Ville d'Ottawa. Toute distribution, utilisation ou reproduction du courriel ou des renseignements qui s'y trouvent par une personne autre que son destinataire prévu est interdite. Je vous remercie de votre collaboration.

zoran@archnova.ca

From: Glen McDonald <glen.mcdonald@rvca.ca>
Sent: May 30, 2023 12:06 PM
To: zoran@archnova.ca
Subject: RE: 725 Somerset street- water quality/sediment control

Zoran,

Given recent legislative changes to our scope of work, the Conservation Authority can no longer comment or provide advice on matters related to stormwater quality. If the City does not have stormwater quality criteria for the sewer catchment, the practice has been in place is not to require quality control if the receiver is more than 2 km away from the site (i.e. piped more than 2 km) and the site has limited surface parking. Also, quality control typically is not required if the sewer is combined. However, we will have to defer the final decision on this to the City.

Glen

From: zoran@archnova.ca <zoran@archnova.ca>
Sent: Monday, May 29, 2023 7:10 PM
To: Glen McDonald <glen.mcdonald@rvca.ca>
Subject: 725 Somerset street- water quality/sediment control

Hello Glen,

Hope you are doing well.

I am a municipal services engineer for the project at 725 Somerset Street and the City required us to contact RVCA for a comment or requirements for the stormwater quality.

Attached are architectural plans as well as the services plan for the proposed building.

Currently on the site there is a building (flat roof) and the rest of the site is basically a parking (asphalt). The municipal sewer is combined 300 mm. For the post development we are proposing to have the roof storage (connected over the roof drains and the lateral to the combined sewer) to attenuate the post development 100-year to 2-year predevelopment runoff from the site. The site is very small (1,000 m²).

I have assumed that the predevelopment runoff is completely uncontrolled where about 60% of post development runoff would be controlled. The new building is residential with 3 commercial spaces on the main floor. All storage and ponding will be on the roof. The indoor garage is on the main floor.

Would you please confirm if the sediment control is required?

Should you need more information please do not hesitate to contact me.

We are trying to submit the documentation by June 01 so your quick response is appreciated very much.

Regards,

Zoran Mrdja, P.Eng., FEC

[Dufk0Qryd Ghvjg Iqfl](mailto:zoran@archnova.ca)

613-818-3884