

1531 St-Laurent Boulevard

Transportation Impact Assessment

Step 1 Screening Report

Step 2 Scoping Report

Step 3 Forecasting Report

Step 4 Strategy Report

Prepared for:

Katasa Group

69, rue Jean-Proulx unité #301
Gatineau, Québec J8Z 1W2

Prepared by:



6 Plaza Court
Ottawa, ON K2H 7W1

June 2023

PN: 2023-053

Table of Contents

1	Screening.....	1
2	Existing and Planned Conditions.....	1
2.1	Proposed Development.....	1
2.2	Existing Conditions.....	3
2.2.1	Area Road Network.....	3
2.2.2	Existing Intersections.....	3
2.2.3	Existing Driveways.....	4
2.2.4	Cycling and Pedestrian Facilities.....	5
2.2.5	Existing Transit.....	8
2.2.6	Existing Area Traffic Management Measures.....	9
2.2.7	Existing Peak Hour Travel Demand.....	10
2.2.8	Collision Analysis.....	12
2.3	Planned Conditions.....	15
2.3.1	Changes to the Area Transportation Network.....	15
2.3.2	Other Study Area Developments.....	17
3	Study Area and Time Periods.....	19
3.1	Study Area.....	19
3.2	Time Periods.....	19
3.3	Horizon Years.....	19
4	Exemption Review.....	19
5	Development-Generated Travel Demand.....	20
5.1	Mode Shares.....	20
5.2	Trip Generation.....	20
5.3	Trip Distribution.....	22
5.4	Trip Assignment.....	22
6	Background Network Travel Demands.....	24
6.1	Transportation Network Plans.....	24
6.2	Background Growth.....	24
6.3	Other Developments.....	25
7	Demand Rationalization.....	25
7.1	2026 Future Background Operations.....	25
7.2	2031 Future Background Operations.....	27
7.3	2026 Future Total Operations.....	29
7.4	2031 Future Total Operations.....	32
7.5	Modal Share Sensitivity and Demand Rationalization Conclusions.....	34
7.5.1	Network Rationalization.....	34
7.5.2	Development Rationalization.....	34
8	Development Design.....	34
8.1	Design for Sustainable Modes.....	34
8.2	Circulation and Access.....	34
9	Parking.....	35
9.1	Parking Supply.....	35

10	Boundary Street Design.....	35
11	Access Intersections Design	36
11.1	Location and Design of Access.....	36
11.2	Intersection Control.....	36
11.3	Access Intersection Design	36
11.3.1	Future Access Intersection Operations	36
11.3.2	Access Intersection MMLOS	36
11.3.3	Recommended Design Elements.....	36
12	Transportation Demand Management	36
12.1	Context for TDM	36
12.2	Need and Opportunity.....	36
12.3	TDM Program	36
13	Neighbourhood Traffic Management.....	37
14	Transit.....	37
14.1	Route Capacity.....	37
14.2	Transit Priority	38
15	Network Intersection Design.....	38
15.1	Network Intersection Control.....	38
15.2	Network Intersection Design.....	38
15.2.1	Future Total Network Intersection Operations	38
15.2.2	Network Intersection MMLOS.....	38
15.2.3	Recommended Design Elements.....	39
16	Summary of Improvements Indicated and Modifications Options.....	39
17	Conclusion	42

List of Figures

Figure 1: Area Context Plan.....	1
Figure 2: Concept Plan.....	2
Figure 3: Existing Driveways	5
Figure 4: Study Area Pedestrian Facilities	6
Figure 5: Study Area Cycling Facilities	6
Figure 6: Existing Pedestrian Volumes	7
Figure 7: Existing Cyclist Volumes	8
Figure 8: Existing Study Area Transit Service.....	9
Figure 9: Existing Study Area Transit Stops	9
Figure 10: Existing Traffic Counts	10
Figure 11: Study Area Collision Records.....	13
Figure 12: St-Laurent TOD Street Network	16
Figure 13: St-Laurent TOD Pedestrian Network.....	16
Figure 14: St-Laurent TOD Bicycle Network	17
Figure 15: New Site Generation Auto Volumes.....	23
Figure 16: New Site Pass-By and Diverted Volumes.....	24
Figure 17: 2026 Future Background Volumes	26

Figure 18: 2031 Future Background Volumes 28
 Figure 19: 2026 Future Total Volumes 30
 Figure 20: 2031 Future Total Volumes 32

Table of Tables

Table 1: Intersection Count Date..... 10
 Table 2: Existing Intersection Operations..... 11
 Table 3: Study Area Collision Summary, 2016-2020 12
 Table 4: Summary of Collision Locations, 2016-2020..... 13
 Table 5: Intersection of Belfast Rd at St-Laurent Blvd Collision Summary..... 13
 Table 6: Intersection of Belfast Rd at Lagan Wy Collision Summary..... 14
 Table 7: Exemption Review 19
 Table 8: TRANS Trip Generation Manual Recommended Mode Shares – Alta Vista 20
 Table 9: Trip Generation Person Trip Rates..... 20
 Table 10: Total Person Trip Generation 21
 Table 11: Internal Capture Rates..... 21
 Table 12: Trip Generation by Mode 21
 Table 13: OD Survey Distribution – Alta Vista 22
 Table 14: TRANS Regional Model Projections – Study Area Growth Rates..... 25
 Table 15: 2026 Future Background Intersection Operations 26
 Table 16: 2031 Future Background Intersection Operations 28
 Table 17: 2026 Future Total Intersection Operations 30
 Table 18: 2031 Future Total Intersection Operations 33
 Table 19: Boundary Street MMLoS Analysis..... 35
 Table 20: Trip Generation by Transit Mode 37
 Table 21: Forecasted Site-Generated Transit Ridership..... 37
 Table 22: Study Area Intersection MMLoS Analysis 38

List of Appendices

Appendix A – TIA Screening Form and Certification Form
 Appendix B – Turning Movement Count Data
 Appendix C – Synchro Intersection Worksheets – Existing Conditions
 Appendix D – Collision Data
 Appendix E – TRANS Plots
 Appendix F – Background Volumes
 Appendix G – Synchro Intersection Worksheets – 2026 Future Background Conditions
 Appendix H – Synchro Intersection Worksheets – 2031 Future Background Conditions
 Appendix I – Synchro Intersection Worksheets – 2026 Future Total Conditions
 Appendix J – Synchro Intersection Worksheets – 2031 Future Total Conditions
 Appendix K – TDM Checklist
 Appendix L – MMLoS Analysis

1 Screening

This study has been prepared according to the City of Ottawa’s 2017 Transportation Impact Assessment (TIA) Guidelines. Accordingly, a Step 1 Screening Form has been prepared and is included as Appendix A, along with the Certification Form for the TIA Study PM. As shown in the Screening Form, a TIA is required including the Design Review component and the Network Impact Component. This study has been prepared to support a zoning bylaw amendment and site plan application.

2 Existing and Planned Conditions

2.1 Proposed Development

The development site is located at 1531 St-Laurent Boulevard and is zoned as Arterial Mainstreet (AM, AM[263]). The proposed development consists of a 25-storey mixed-use building with 235 dwelling units fronting St-Laurent Boulevard, a 20-storey residential building comprising 189 dwelling units on the east side of the parcel, and a total of 507 m² of retail space. Access is proposed via a one-way drive aisle with an inbound access on Belfast Road and an outbound access on Lagan Way. Parking for 351 vehicles is to be provided in and underground garage and 11 spaces within a surface lot. Construction will occur in a single phase with an anticipated full build-out and occupancy horizon of 2026. Figure 1 illustrates the study area context. Figure 2 illustrates the proposed concept plan.

Figure 1: Area Context Plan

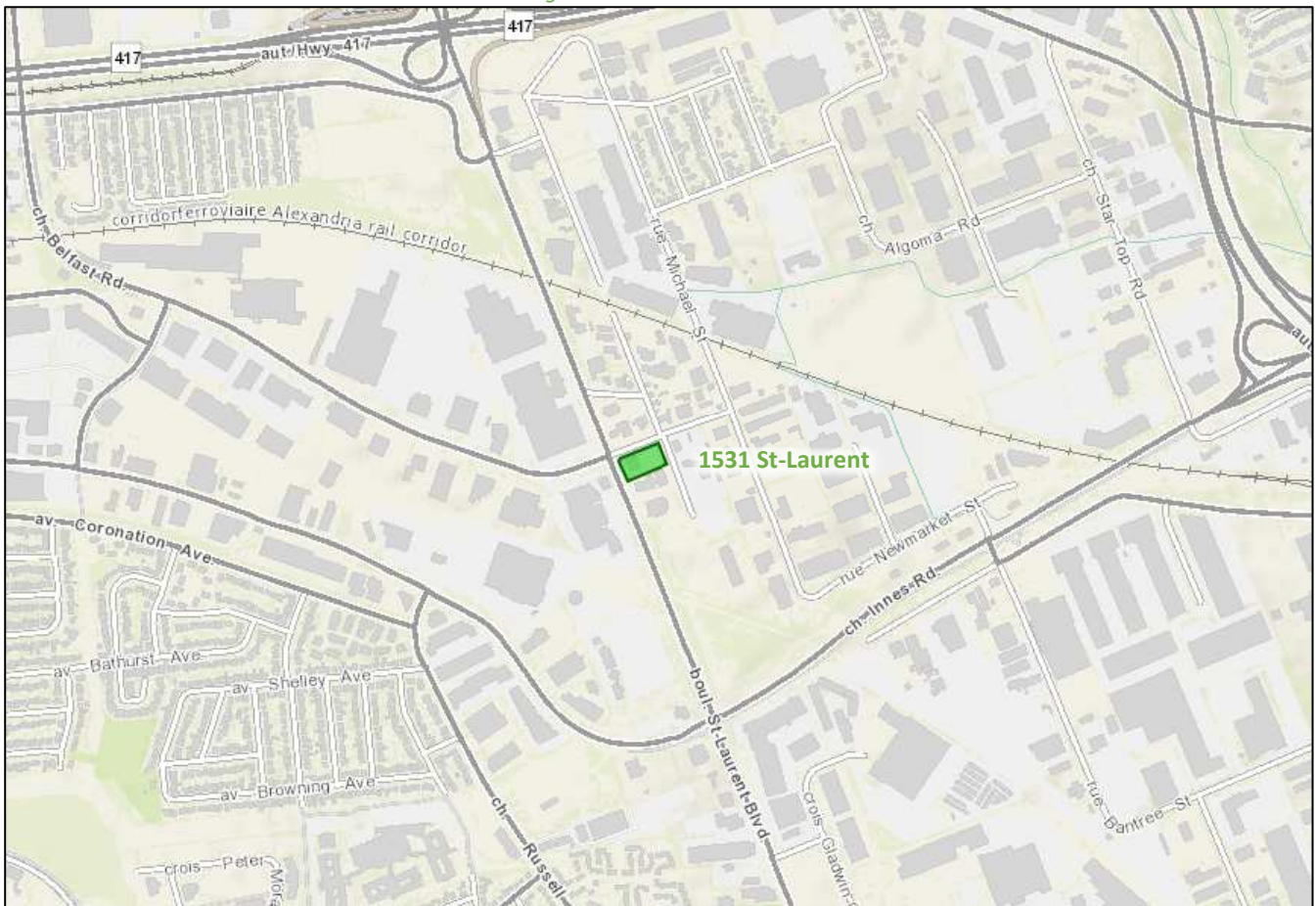

Source: <http://maps.ottawa.ca/geoOttawa/> Accessed: May 2, 2023

NO.	DATE	DESCRIPTION
1	2024-03-25	INITIAL CONCEPT
2	2024-04-15	REVISED CONCEPT
3	2024-05-10	FINAL CONCEPT
4	2024-06-01	PRELIMINARY DESIGN
5	2024-07-01	FINAL DESIGN
6	2024-08-01	CONSTRUCTION PERMITS
7	2024-09-01	CONSTRUCTION START
8	2024-10-01	CONSTRUCTION PROGRESS
9	2024-11-01	CONSTRUCTION PROGRESS
10	2024-12-01	CONSTRUCTION PROGRESS
11	2025-01-01	CONSTRUCTION PROGRESS
12	2025-02-01	CONSTRUCTION PROGRESS
13	2025-03-01	CONSTRUCTION PROGRESS
14	2025-04-01	CONSTRUCTION PROGRESS
15	2025-05-01	CONSTRUCTION PROGRESS
16	2025-06-01	CONSTRUCTION PROGRESS
17	2025-07-01	CONSTRUCTION PROGRESS
18	2025-08-01	CONSTRUCTION PROGRESS
19	2025-09-01	CONSTRUCTION PROGRESS
20	2025-10-01	CONSTRUCTION PROGRESS
21	2025-11-01	CONSTRUCTION PROGRESS
22	2025-12-01	CONSTRUCTION PROGRESS
23	2026-01-01	CONSTRUCTION PROGRESS
24	2026-02-01	CONSTRUCTION PROGRESS
25	2026-03-01	CONSTRUCTION PROGRESS
26	2026-04-01	CONSTRUCTION PROGRESS
27	2026-05-01	CONSTRUCTION PROGRESS
28	2026-06-01	CONSTRUCTION PROGRESS
29	2026-07-01	CONSTRUCTION PROGRESS
30	2026-08-01	CONSTRUCTION PROGRESS
31	2026-09-01	CONSTRUCTION PROGRESS
32	2026-10-01	CONSTRUCTION PROGRESS
33	2026-11-01	CONSTRUCTION PROGRESS
34	2026-12-01	CONSTRUCTION PROGRESS
35	2027-01-01	CONSTRUCTION PROGRESS
36	2027-02-01	CONSTRUCTION PROGRESS
37	2027-03-01	CONSTRUCTION PROGRESS
38	2027-04-01	CONSTRUCTION PROGRESS
39	2027-05-01	CONSTRUCTION PROGRESS
40	2027-06-01	CONSTRUCTION PROGRESS
41	2027-07-01	CONSTRUCTION PROGRESS
42	2027-08-01	CONSTRUCTION PROGRESS
43	2027-09-01	CONSTRUCTION PROGRESS
44	2027-10-01	CONSTRUCTION PROGRESS
45	2027-11-01	CONSTRUCTION PROGRESS
46	2027-12-01	CONSTRUCTION PROGRESS
47	2028-01-01	CONSTRUCTION PROGRESS
48	2028-02-01	CONSTRUCTION PROGRESS
49	2028-03-01	CONSTRUCTION PROGRESS
50	2028-04-01	CONSTRUCTION PROGRESS
51	2028-05-01	CONSTRUCTION PROGRESS
52	2028-06-01	CONSTRUCTION PROGRESS
53	2028-07-01	CONSTRUCTION PROGRESS
54	2028-08-01	CONSTRUCTION PROGRESS
55	2028-09-01	CONSTRUCTION PROGRESS
56	2028-10-01	CONSTRUCTION PROGRESS
57	2028-11-01	CONSTRUCTION PROGRESS
58	2028-12-01	CONSTRUCTION PROGRESS
59	2029-01-01	CONSTRUCTION PROGRESS
60	2029-02-01	CONSTRUCTION PROGRESS
61	2029-03-01	CONSTRUCTION PROGRESS
62	2029-04-01	CONSTRUCTION PROGRESS
63	2029-05-01	CONSTRUCTION PROGRESS
64	2029-06-01	CONSTRUCTION PROGRESS
65	2029-07-01	CONSTRUCTION PROGRESS
66	2029-08-01	CONSTRUCTION PROGRESS
67	2029-09-01	CONSTRUCTION PROGRESS
68	2029-10-01	CONSTRUCTION PROGRESS
69	2029-11-01	CONSTRUCTION PROGRESS
70	2029-12-01	CONSTRUCTION PROGRESS
71	2030-01-01	CONSTRUCTION PROGRESS
72	2030-02-01	CONSTRUCTION PROGRESS
73	2030-03-01	CONSTRUCTION PROGRESS
74	2030-04-01	CONSTRUCTION PROGRESS
75	2030-05-01	CONSTRUCTION PROGRESS
76	2030-06-01	CONSTRUCTION PROGRESS
77	2030-07-01	CONSTRUCTION PROGRESS
78	2030-08-01	CONSTRUCTION PROGRESS
79	2030-09-01	CONSTRUCTION PROGRESS
80	2030-10-01	CONSTRUCTION PROGRESS
81	2030-11-01	CONSTRUCTION PROGRESS
82	2030-12-01	CONSTRUCTION PROGRESS
83	2031-01-01	CONSTRUCTION PROGRESS
84	2031-02-01	CONSTRUCTION PROGRESS
85	2031-03-01	CONSTRUCTION PROGRESS
86	2031-04-01	CONSTRUCTION PROGRESS
87	2031-05-01	CONSTRUCTION PROGRESS
88	2031-06-01	CONSTRUCTION PROGRESS
89	2031-07-01	CONSTRUCTION PROGRESS
90	2031-08-01	CONSTRUCTION PROGRESS
91	2031-09-01	CONSTRUCTION PROGRESS
92	2031-10-01	CONSTRUCTION PROGRESS
93	2031-11-01	CONSTRUCTION PROGRESS
94	2031-12-01	CONSTRUCTION PROGRESS
95	2032-01-01	CONSTRUCTION PROGRESS
96	2032-02-01	CONSTRUCTION PROGRESS
97	2032-03-01	CONSTRUCTION PROGRESS
98	2032-04-01	CONSTRUCTION PROGRESS
99	2032-05-01	CONSTRUCTION PROGRESS
100	2032-06-01	CONSTRUCTION PROGRESS

PROPERTY DESCRIPTION
 25.00 STOREY RESIDENTIAL BUILDING
 PROJECT NUMBER: 101 BELFAST BLVD
 MUNICIPAL ADDRESS: 101 BELFAST BLVD
 LOT AREA: 4981.50 sqm
 LOT FRONTAGE: 186.30m (610ft)
 LOT DEPTH: 26.55m (87ft 2in) (A to B)
 ZONING: R1-10 (RESIDENTIAL)
 BUILDING FLOOR AREA: TOWER A: 2014 sqm (7168.8 sq ft)
 BUILDING FLOOR AREA: TOWER B: 2014 sqm (7168.8 sq ft)
 PROPOSED USE: MID-RISE RESIDENTIAL - HIGH-RISE
 UNIT BREAKDOWN: TOWER A: UNIT MIX: 2, 87, 74, 180, 1, 280
 LEVELS: 26, 11 UNITS
 UNIT BREAKDOWN: TOWER B: UNIT MIX: 2, 87, 74, 180, 1, 280
 LEVELS: 26, 11 UNITS
 TOTAL: 232 UNITS
 UNIT BREAKDOWN: TOWER A: UNIT MIX: 2, 87, 74, 180, 1, 280
 LEVELS: 26, 11 UNITS
 UNIT BREAKDOWN: TOWER B: UNIT MIX: 2, 87, 74, 180, 1, 280
 LEVELS: 26, 11 UNITS
 TOTAL: 464 UNITS

NO.	DESCRIPTION	REQUIRED	PROPOSED
1	MINIMUM LOT AREA	NO MINIMUM	4981.50 sqm
2	MINIMUM FRONT SETBACK (STAIRWELL)	NO MINIMUM	3.05m
3	MINIMUM CORNER SIDE YARD SETBACK (BELFAST)	NO MINIMUM	1.52m
4	MINIMUM SIDE YARD SETBACK (SOUTH)	NO MINIMUM	2.29m
5	MINIMUM REAR YARD SETBACK (LAGAN WAY)	3.05m	4.57m
6	MINIMUM BUILDING HEIGHT (THIRD STOREY)	5.18m	5.18m
7	MINIMUM SIDE YARD SETBACK (AREA C SIDEWALK)	NO MINIMUM	1.52m
8	MINIMUM REAR YARD SETBACK (AREA C SIDEWALK)	NO MINIMUM	1.52m
9	MINIMUM SIDE YARD SETBACK (AREA C SIDEWALK)	NO MINIMUM	1.52m
10	MINIMUM REAR YARD SETBACK (AREA C SIDEWALK)	NO MINIMUM	1.52m

CLIENT: GIBCO J. AMILIO landscape architect
 115 Dufferin Street, Toronto, Ontario M5T 1C2
 TEL: 416-922-1111
 WWW.GIBCOJ.COM

DESIGNER: KATASA
 115 Dufferin Street, Toronto, Ontario M5T 1C2
 TEL: 416-922-1111
 WWW.KATASA.COM

FIGURI
 115 Dufferin Street, Toronto, Ontario M5T 1C2
 TEL: 416-922-1111
 WWW.FIGURI.COM

ST-LAURENT DEVELOPMENT

101 BELFAST BLVD
 TORONTO, ONTARIO
 M5T 1C2

SITE PLAN

DATE: 2024-03-25
 SCALE: AS SHOWN
 DRAWN BY: [NAME]
 CHECKED BY: [NAME]

A010

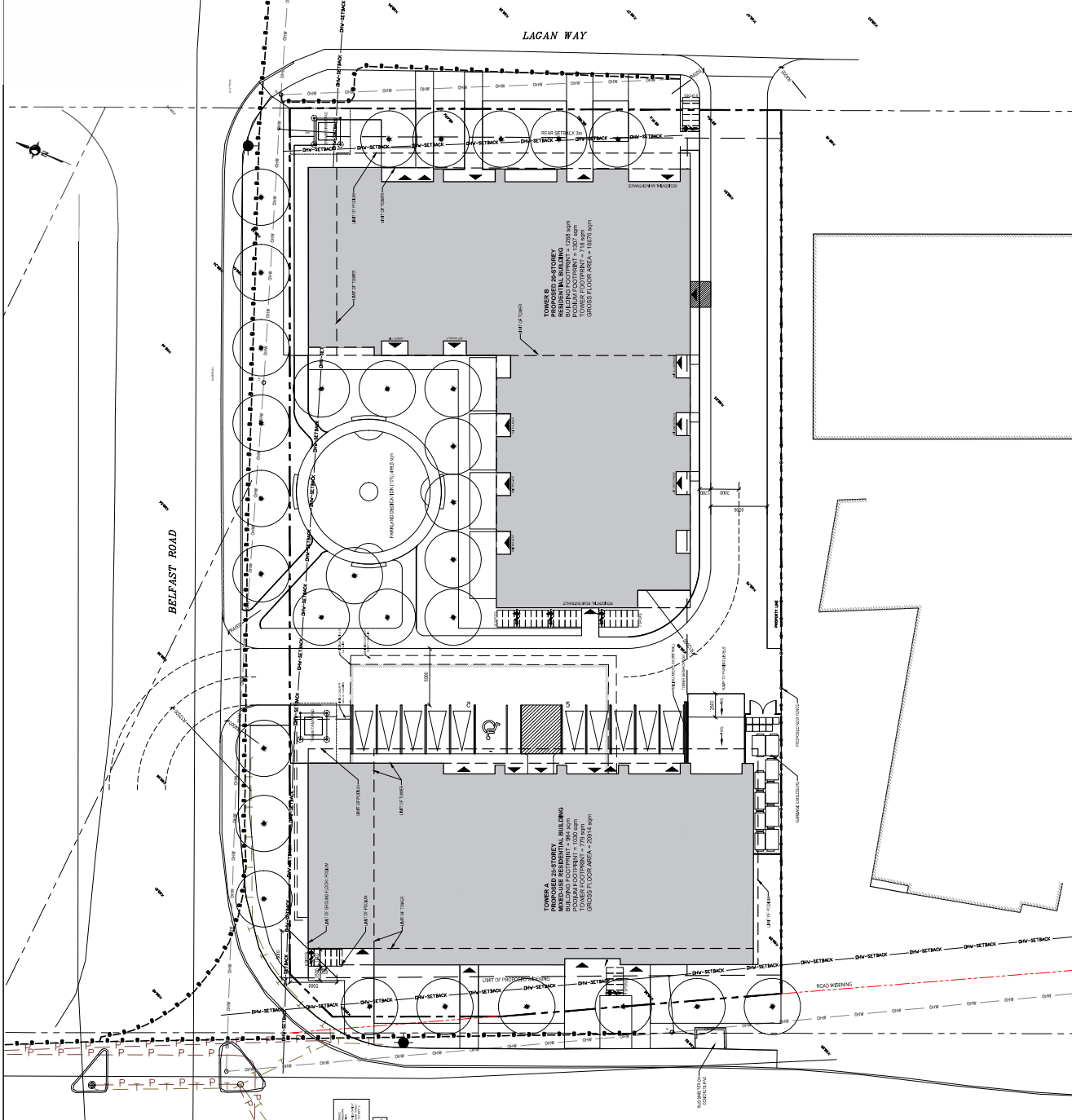
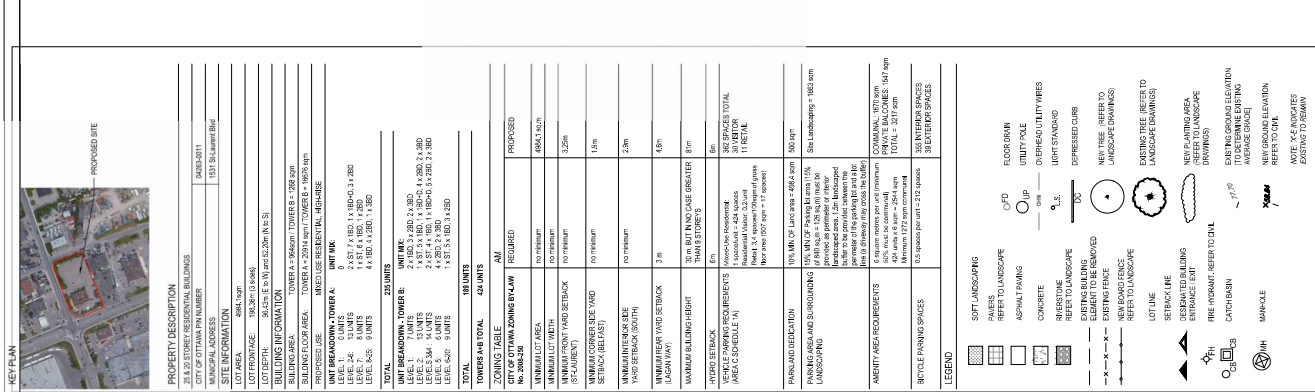

PROPERTY DESCRIPTION
 25.00 STOREY RESIDENTIAL BUILDING
 PROJECT NUMBER: 101 BELFAST BLVD
 MUNICIPAL ADDRESS: 101 BELFAST BLVD
 LOT AREA: 4981.50 sqm
 LOT FRONTAGE: 186.30m (610ft)
 LOT DEPTH: 26.55m (87ft 2in) (A to B)
 ZONING: R1-10 (RESIDENTIAL)
 BUILDING FLOOR AREA: TOWER A: 2014 sqm (7168.8 sq ft)
 BUILDING FLOOR AREA: TOWER B: 2014 sqm (7168.8 sq ft)
 PROPOSED USE: MID-RISE RESIDENTIAL - HIGH-RISE
 UNIT BREAKDOWN: TOWER A: UNIT MIX: 2, 87, 74, 180, 1, 280
 LEVELS: 26, 11 UNITS
 UNIT BREAKDOWN: TOWER B: UNIT MIX: 2, 87, 74, 180, 1, 280
 LEVELS: 26, 11 UNITS
 TOTAL: 232 UNITS
 UNIT BREAKDOWN: TOWER A: UNIT MIX: 2, 87, 74, 180, 1, 280
 LEVELS: 26, 11 UNITS
 UNIT BREAKDOWN: TOWER B: UNIT MIX: 2, 87, 74, 180, 1, 280
 LEVELS: 26, 11 UNITS
 TOTAL: 464 UNITS

ZONING TABLE

NO.	DESCRIPTION	REQUIRED	PROPOSED
1	MINIMUM LOT AREA	NO MINIMUM	4981.50 sqm
2	MINIMUM FRONT SETBACK (STAIRWELL)	NO MINIMUM	3.05m
3	MINIMUM CORNER SIDE YARD SETBACK (BELFAST)	NO MINIMUM	1.52m
4	MINIMUM SIDE YARD SETBACK (SOUTH)	NO MINIMUM	2.29m
5	MINIMUM REAR YARD SETBACK (LAGAN WAY)	3.05m	4.57m
6	MINIMUM BUILDING HEIGHT (THIRD STOREY)	5.18m	5.18m
7	MINIMUM SIDE YARD SETBACK (AREA C SIDEWALK)	NO MINIMUM	1.52m
8	MINIMUM REAR YARD SETBACK (AREA C SIDEWALK)	NO MINIMUM	1.52m
9	MINIMUM SIDE YARD SETBACK (AREA C SIDEWALK)	NO MINIMUM	1.52m
10	MINIMUM REAR YARD SETBACK (AREA C SIDEWALK)	NO MINIMUM	1.52m

CLIENT: GIBCO J. AMILIO landscape architect
 115 Dufferin Street, Toronto, Ontario M5T 1C2
 TEL: 416-922-1111
 WWW.GIBCOJ.COM

DESIGNER: KATASA
 115 Dufferin Street, Toronto, Ontario M5T 1C2
 TEL: 416-922-1111
 WWW.KATASA.COM

FIGURI
 115 Dufferin Street, Toronto, Ontario M5T 1C2
 TEL: 416-922-1111
 WWW.FIGURI.COM

ST-LAURENT DEVELOPMENT

101 BELFAST BLVD
 TORONTO, ONTARIO
 M5T 1C2

SITE PLAN

DATE: 2024-03-25
 SCALE: AS SHOWN
 DRAWN BY: [NAME]
 CHECKED BY: [NAME]

A010

2.2 Existing Conditions

2.2.1 Area Road Network

St-Laurent Boulevard: St-Laurent Boulevard is a City of Ottawa arterial road. Within the study area, it has a divided six-lane urban cross-section north of Tremblay Road, a divided four-lane urban cross-section between Tremblay Road and Innes Road, and a divided six-lane urban cross-section and includes dedicated bus lanes and cycletracks on both sides of the road south of Innes Road. Sidewalks are present on both sides of the road. North of Tremblay Road the posted speed limit is 60 km/h, and is 70 km/h to the south. Schedule C16 of the Official Plan reserves a 44.5-metre right-of-way within the study area. St-Laurent Boulevard is designated as a truck route.

Industrial Avenue: Industrial Avenue is a City of Ottawa arterial road with a four-lane urban cross-section with a sidewalk on the north side of the road, and, within the study area for 200 metres west of St-Laurent Boulevard, with a bike lane that diverts onto the boulevard around the bus stop on the north side of the road and a mixed-use path (MUP) on the south side of the road. The posted speed limit is 60 km/h, and the Schedule C16 of the Official Plan reserves a 37.5-metre right-of-way. Industrial Avenue is designated as a truck route.

Innes Road: and Innes Road is a City of Ottawa arterial road with a divided four-lane urban cross-section with a MUP on the south side of the road. Within the study area, the posted speed limit is 60 km/h, and the Schedule C16 of the Official Plan reserves a 44.5-metre right-of-way. Industrial Avenue is designated as a truck route.

Tremblay Road: Tremblay Road is a City of Ottawa major collector road with a two-lane urban cross-section. West of the Avenue U, a sidewalk is present on the south side of the road, and a MUP is present on the north side of the road. East of Avenue U, a sidewalk is present on the south side of the road. The posted speed limit is 50 km/h. West of St-Laurent Boulevard, Schedule C16 of the Official Plan reserves a 26.0-metre right-of-way, and the measured right-of-way is 18.0 metres to the east.

Belfast Road: Belfast Road is a City of Ottawa collector road west of St-Laurent Boulevard and a local road to the east, each with a two-lane cross-section. Within the study area, the cross-section is urban and includes sidewalks on both sides of the road east of 940 Belfast Road, and alternates between rural and semi-urban to the west, where a sidewalk, discontinuous through site accesses, is present on the north side of the road. The posted speed limit is 50 km/h and the measured right-of-way is 26.0 metres. Belfast Road is designated as a truck route.

2.2.2 Existing Intersections

The existing key area intersections have been summarized below:

St-Laurent Boulevard at Tremblay Road The intersection of Tremblay Road at St-Laurent Boulevard is a signalized intersection. The northbound approach consists of an auxiliary left-turn lane, two through lanes, and a shared through/right-turn lane, and the southbound approach consists of an auxiliary left-turn lane, two through lanes, and an auxiliary right-turn lane. The eastbound and westbound approaches each consists of an auxiliary left-turn lane and a shared through/right-turn lane. No turn restrictions are noted.

St-Laurent Boulevard at Belfast Road The intersection of St-Laurent Boulevard at Belfast Road is a signalized intersection. The northbound and southbound approaches each consist of an auxiliary left-turn lane, two through lanes, and an auxiliary channelized right-turn lane. The eastbound approach consists of an auxiliary left-turn lane, a through lane, and an auxiliary channelized right-turn lane, and the

westbound approach consists of an auxiliary left-turn lane and a shared through/channelized right-turn lane. No turn restrictions were noted.

St-Laurent Boulevard at Industrial Avenue / Innes Road

The intersection of St-Laurent Boulevard at Industrial Avenue/Innes Road is a signalized intersection. The northbound approach consists of two auxiliary left-turn lanes, two through lanes, a transit priority queue jump, and an auxiliary channelized right-turn lane and the southbound approach consists of two auxiliary left-turn lanes, two through lanes, a transit priority queue jump, and an auxiliary channelized right-turn lane. The eastbound approach consists of two auxiliary left-turn lanes, two through lanes, and an auxiliary channelized right-turn lane, and the westbound approach consists of two auxiliary left-turn lanes, two through lanes, a bike pocket that connects to the curbside bike lane on the approach through the right-turn channel, and an auxiliary channelized right-turn lane. An east-west two-way crossride is located on the south side of the intersection. The east and west pedestrian crossings pass through the two-way crossride across the south leg of the intersection, with the east crossing possessing an additional refuge island between the crossride and the westbound right-turn channel. Southbound, eastbound, and westbound U-turns are prohibited at this intersection.

Lagan Way at Belfast Road

The intersection of Lagan Way at Belfast Road is an unsignalized intersection with stop control on the minor approaches of Lagan Way. All approaches consist of a shared all-movements lane. No turn restrictions were noted.

2.2.3 Existing Driveways

Within 200 metres of the proposed site access, 15 driveways are present on Belfast Road auto parts, service, and sales businesses, a gas station, the Belfast Park commercial plaza, an OC Transpo facility, and other commercial service businesses. Fifteen driveways are present on Lagan Way to various industrial, heavy equipment rental or storage, auto parts, service, and sales businesses, commercial service businesses, and a small commercial plaza. Six driveways are present on St-Laurent Boulevard to a commercial plaza, auto parts, service, and sales businesses, a gas station, and a restaurant are present. Figure 3 illustrates the existing driveways.

Figure 3: Existing Driveways

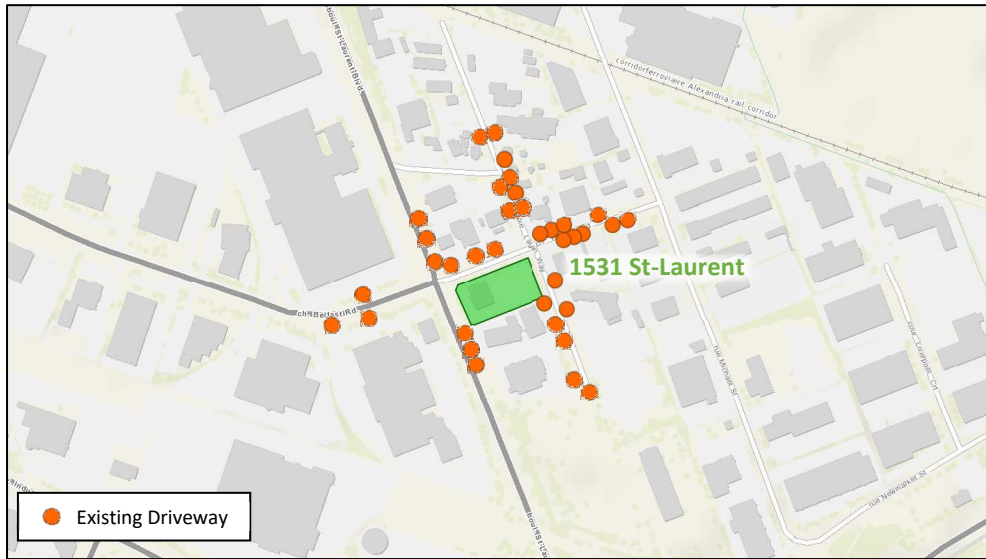

2.2.4 Cycling and Pedestrian Facilities

Figure 4 illustrates the pedestrian facilities in the study area and Figure 5 illustrates the cycling facilities.

Within the study area, sidewalks are provided along both sides of St-Laurent Boulevard, Belfast Road east of the 940 Belfast Road parcel, and of Smyth Road, and a sidewalk is provided on the south side of Tremblay Road and the north side of Industrial Avenue. Industrial Avenue and Innes Road have a MUP on the south of the road.

Beyond facilities provided at intersections, study area cycling facilities include a cycletrack on each side of St-Laurent Boulevard south of Innes Road. Within the study area, St-Laurent Boulevard, Industrial Avenue, and Innes Road are spine routes, and Belfast Road and Tremblay Road east of St-Laurent Boulevard are local routes.

Figure 4: Study Area Pedestrian Facilities

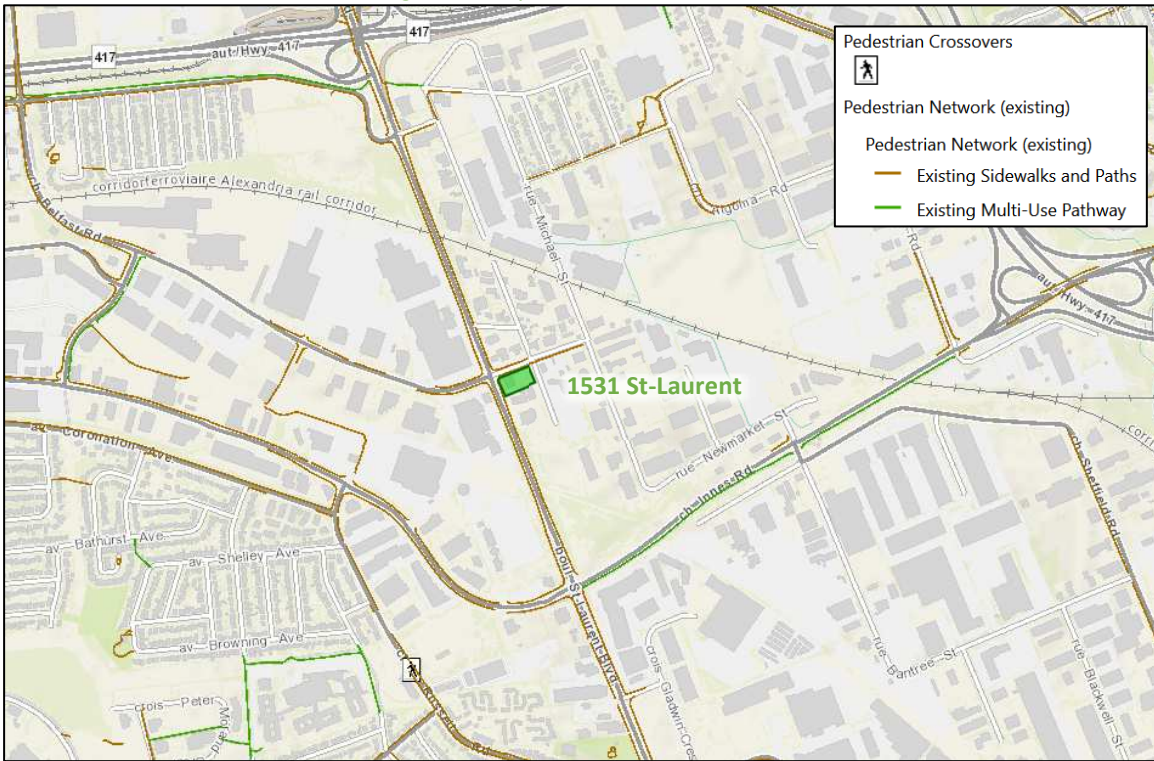

Source: <http://maps.ottawa.ca/geoOttawa/> Accessed: May 2, 2023

Figure 5: Study Area Cycling Facilities

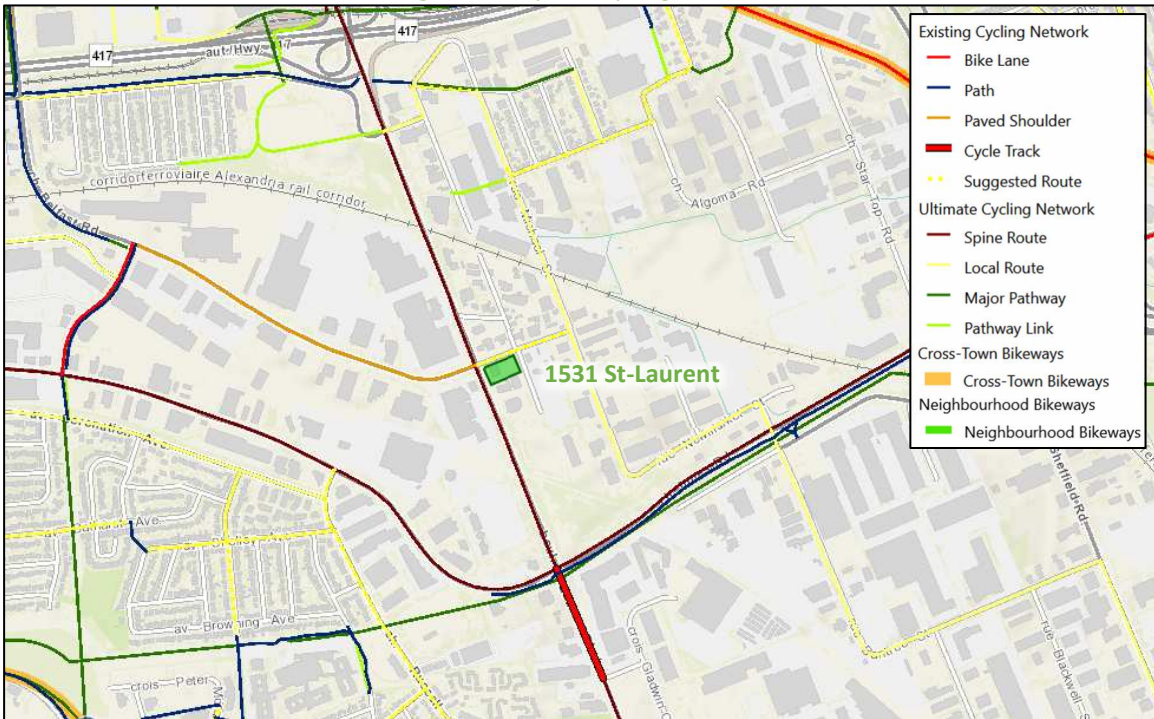

Source: <http://maps.ottawa.ca/geoOttawa/> Accessed: May 2, 2023

Pedestrian and cyclist volumes included in study area intersection counts, presented in Section 2.2.7, have been compiled and are illustrated in Figure 6 and Figure 7, respectively.

Figure 6: Existing Pedestrian Volumes

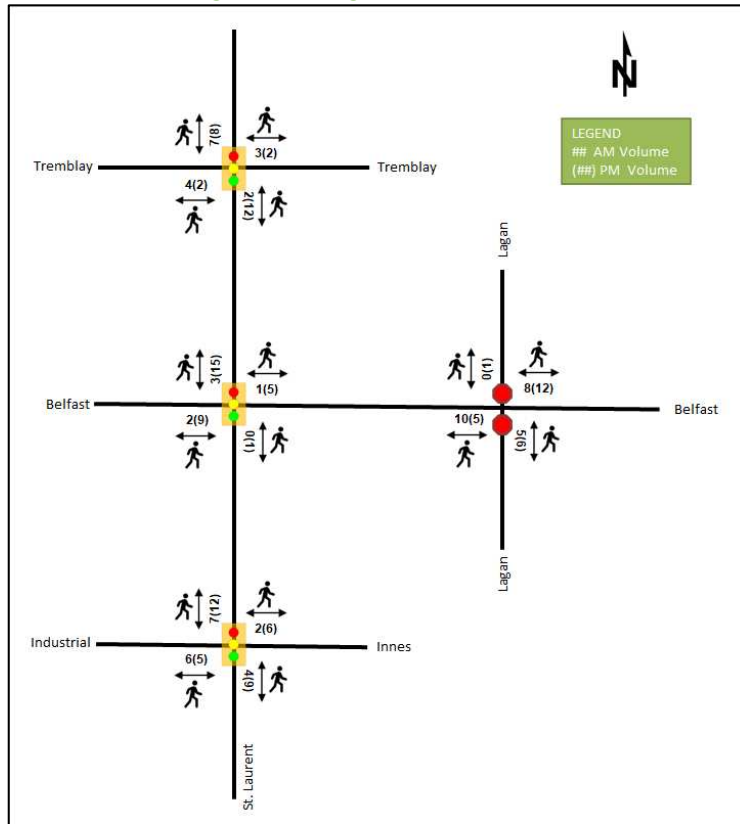
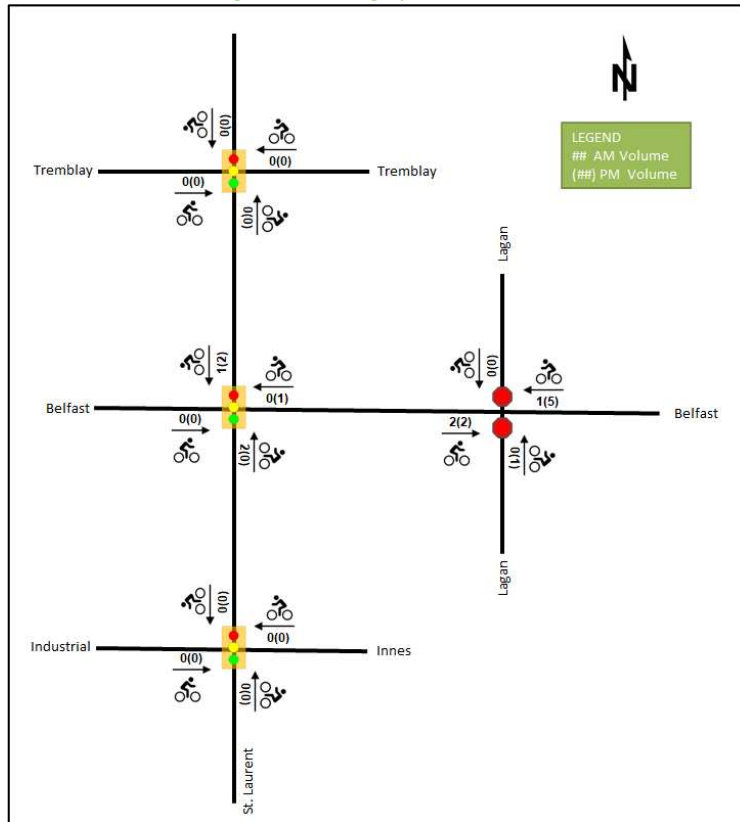

Figure 7: Existing Cyclist Volumes



2.2.5 Existing Transit

Figure 8 illustrates the transit system map in the study area and Figure 9 illustrates nearby transit stops. All transit information is from May 3, 2023 and is included for general information purposes and context to the surrounding area.

Within the study area, route #19 travels along St-Laurent Boulevard continuing to Belfast Road, the route #40 travels along St-Laurent Boulevard, and the route #47 travels along Michael Street to the east of the site. The frequency of these routes within proximity of the proposed site based on May 3, 2023 service levels are:

- Route # 19 – 30-minute service all day
- Route # 40 – 15-minute daytime service, 30-minute service after 7:00PM
- Route # 47 – Eight buses in the peak direction/hour only

Figure 8: Existing Study Area Transit Service



Source: <http://www.octranspo.com/> Accessed: May 3, 2023

Figure 9: Existing Study Area Transit Stops

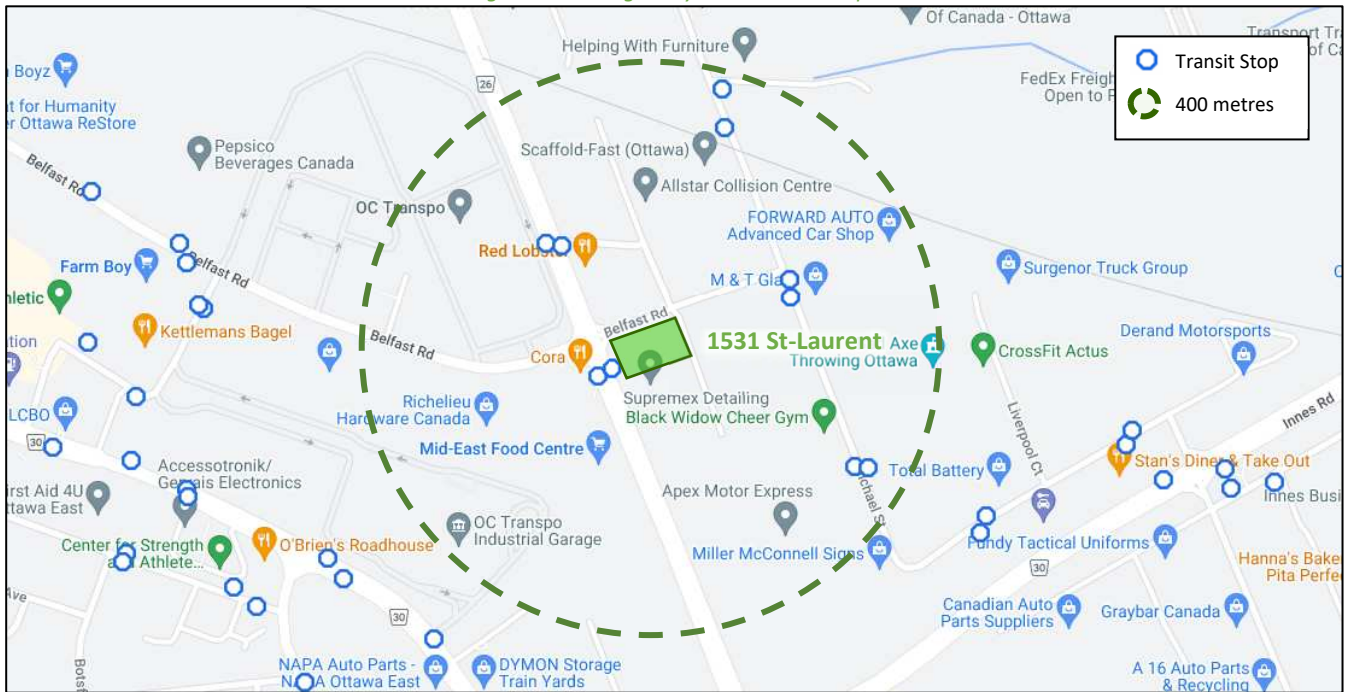

Source: <http://www.octranspo.com/> Accessed: May 3, 2023

2.2.6 Existing Area Traffic Management Measures

There are no existing area traffic management measures within the study area.

2.2.7 Existing Peak Hour Travel Demand

Existing turning movement counts were acquired from the City of Ottawa and the Traffic Specialist for the existing study area intersections. Table 1 summarizes the intersection count dates and sources.

Table 1: Intersection Count Date

Intersection	Count Date	Source
St-Laurent Blvd at Tremblay Rd	Wednesday, January 30, 2019	City of Ottawa
St-Laurent Blvd at Belfast Rd	Tuesday, February 6, 2018	City of Ottawa
St-Laurent Blvd at Industrial Ave/Innes Rd	Wednesday, January 30, 2019	City of Ottawa
Lagan Wy at Belfast Rd	Thursday, May 11, 2023	The Traffic Specialist

Figure 10 illustrates the existing traffic counts and Table 2 summarizes the existing intersection operations. The level of service for signalized intersections is based on volume to capacity ratio (v/c) calculations for individual lane movements and HCM 2000 v/c calculations for the overall intersection. Detailed turning movement count data is included in Appendix B and the Synchro worksheets are provided in Appendix C.

Figure 10: Existing Traffic Counts

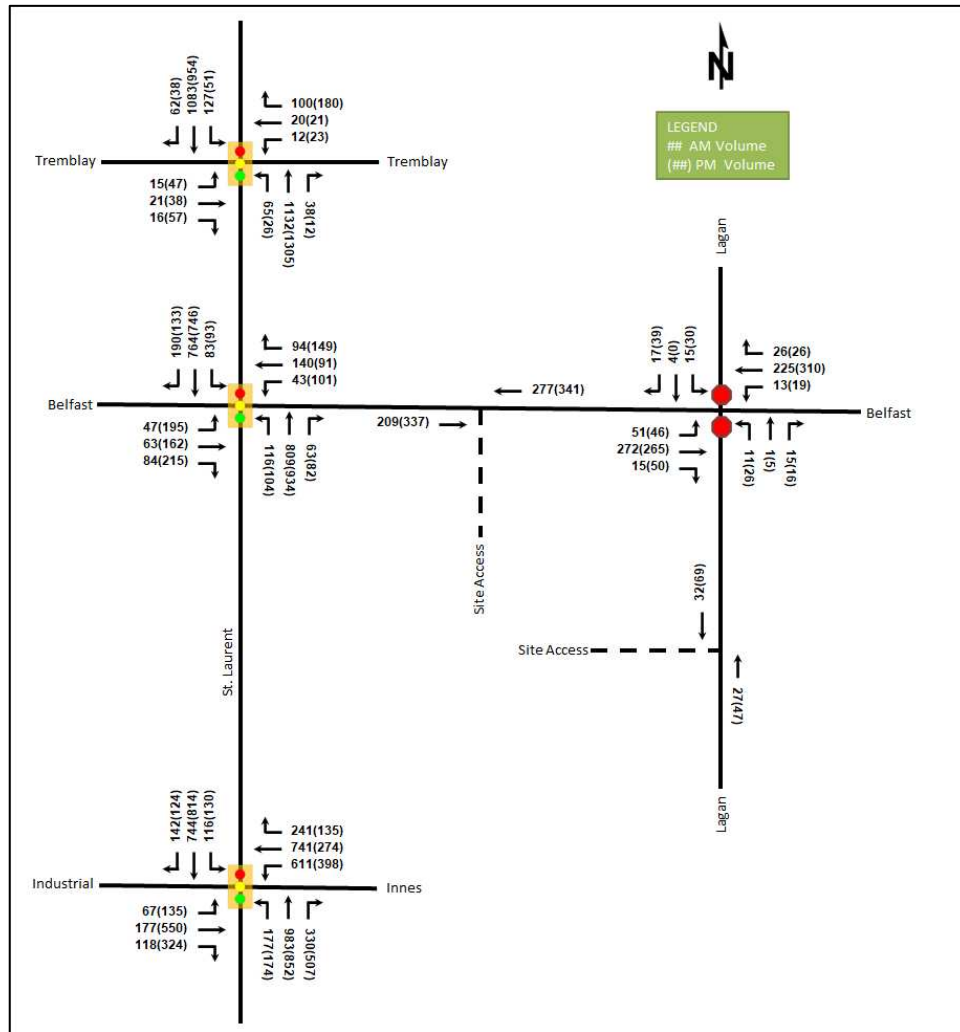

Table 2: Existing Intersection Operations

Intersection	Lane	AM Peak Hour				PM Peak Hour			
		LOS	V/C	Delay (s)	Q (95 th)	LOS	V/C	Delay (s)	Q (95 th)
St-Laurent Blvd at Tremblay Rd <i>Signalized</i>	EBL	A	0.21	54.3	10.0	D	0.83	118.0	23.5
	EBT/R	A	0.21	33.5	13.8	A	0.40	23.8	21.7
	WBL/T	A	0.10	48.9	8.1	A	0.16	43.4	11.9
	WBR	A	0.53	20.2	21.0	B	0.62	18.6	29.0
	NBL	A	0.26	13.6	22.7	A	0.09	14.5	m5.8
	NBT/R	A	0.43	10.9	93.5	A	0.45	12.2	m94.0
	SBL	A	0.44	8.3	20.0	A	0.22	6.9	9.5
	SBT	A	0.50	6.7	103.9	A	0.44	7.1	84.7
	SBR	A	0.07	1.6	5.0	A	0.04	2.3	4.1
Overall	A	0.48	10.0	-	A	0.52	13.1	-	
St-Laurent Blvd at Belfast Rd <i>Signalized</i>	EBL	A	0.26	30.4	17.1	F	1.07	117.7	#85.0
	EBT	A	0.14	28.6	21.5	A	0.38	34.2	48.8
	EBR	A	0.21	6.6	11.1	A	0.41	7.2	20.5
	WBL	A	0.23	42.3	20.3	B	0.61	58.6	41.0
	WBT/R	D	0.87	69.7	#92.9	D	0.83	56.2	73.0
	NBL	A	0.42	16.5	24.2	A	0.36	15.0	22.4
	NBT	A	0.57	25.4	109.2	B	0.65	27.0	130.7
	NBR	A	0.09	0.2	0.1	A	0.14	1.7	3.9
	SBL	A	0.33	15.5	18.1	A	0.44	21.5	25.8
	SBT	A	0.56	25.5	102.8	A	0.52	19.2	52.8
	SBR	A	0.31	4.1	14.0	A	0.19	2.3	5.9
Overall	C	-	26.4	-	C	-	30.9	-	
Lagan Way at Belfast Rd <i>Unsignalized</i>	EB	A	0.05	8.2	1.5	A	0.05	8.7	1.5
	WB	A	0.01	8.3	0.0	A	0.02	8.1	0.8
	NB	C	0.08	15.3	2.3	C	0.17	18.7	4.5
	SB	C	0.10	15.0	2.3	C	0.20	17.1	6.0
Overall	A	-	2.2	-	A	-	3.1	-	
St-Laurent Blvd at Industrial Ave / Innes Rd <i>Signalized</i>	EBL	A	0.39	68.6	18.2	A	0.56	66.6	32.9
	EBT	A	0.42	54.5	35.6	D	0.83	58.7	#112.0
	EBR	A	0.36	4.4	5.1	B	0.64	14.6	46.9
	WBL	F	1.01	90.6	#138.6	C	0.77	60.2	77.6
	WBT	D	0.81	50.6	128.7	A	0.30	33.7	44.5
	WBR	A	0.44	6.3	20.5	A	0.26	5.9	14.7
	NBL	B	0.65	70.9	39.8	A	0.59	64.0	39.3
	NBT	E	0.95	60.4	#241.3	E	0.97	68.2	#197.5
	NBR	A	0.51	9.8	42.7	C	0.75	15.5	76.5
	SBL	A	0.52	69.1	28.0	A	0.53	64.5	31.1
	SBT	C	0.74	46.6	#163.6	E	0.97	70.2	#192.7
SBR	A	0.29	5.0	12.3	A	0.26	4.1	9.7	
Overall	E	0.95	51.2	-	D	0.85	50.5	-	

Notes: Saturation flow rate of 1800 veh/h/lane
Queue is measured in metres
Peak Hour Factor = 0.90

Delay = average vehicle delay in seconds
m = metered queue
= volume for the 95th %ile cycle exceeds capacity

During both the AM and PM peak hours, capacity issues are noted individual movements, but the network intersections typically operate adequately.

The eastbound left movement at the intersection of St-Laurent Boulevard at Tremblay Road may be subject to high delays during the PM peak hour.

At the intersection of St-Laurent Boulevard at Belfast Road, during the AM peak hour, the westbound through/right movement may exhibit extended queues and during the PM peak hour, the eastbound left movement is over capacity with high delays and extended queues. Shifting two seconds of split during the PM peak hour from the westbound through phase to the eastbound left phase would reduce v/c of all movements at the intersection to 1.00 or below.

At the intersection of St-Laurent Boulevard at Industrial Avenue/Innes Road, during the AM peak hour, the westbound left-turn movement is over theoretical capacity during with high delays and extended queues, and the northbound through and southbound through movements may exhibit extended queues. During the PM peak hour, the eastbound through, northbound through, and southbound through movements may exhibit extended queues. Shifting one second of split during the AM peak hour from the northbound through/southbound through phase to the westbound left/eastbound through phase would reduce v/c of all movements at the intersection to 1.00 or below.

2.2.8 Collision Analysis

Collision data have been acquired from the City of Ottawa open data website (data.ottawa.ca) for five years prior to the commencement of this TIA for the surrounding study area road network. Table 3 summarizes the collision types and conditions in the study area, Figure 11 illustrates the intersections and segments analyzed, and Table 4 summarizes the total collisions for each of these locations. Collision data are included in Appendix D.

Table 3: Study Area Collision Summary, 2016-2020

		Number	%
Total Collisions		119	100%
Classification	Fatality	0	0%
	Non-Fatal Injury	25	21%
	Property Damage Only	94	79%
Initial Impact Type	Approaching	1	1%
	Angle	20	17%
	Rear end	35	29%
	Sideswipe	15	13%
	Turning Movement	34	29%
	SMV Unattended	2	2%
	SMV Other	9	8%
	Other	3	3%
Road Surface Condition	Dry	74	62%
	Wet	26	22%
	Loose Snow	8	7%
	Slush	6	5%
	Packed Snow	2	2%
	Ice	3	3%
Pedestrian Involved		3	3%
Cyclists Involved		0	0%

Figure 11: Study Area Collision Records

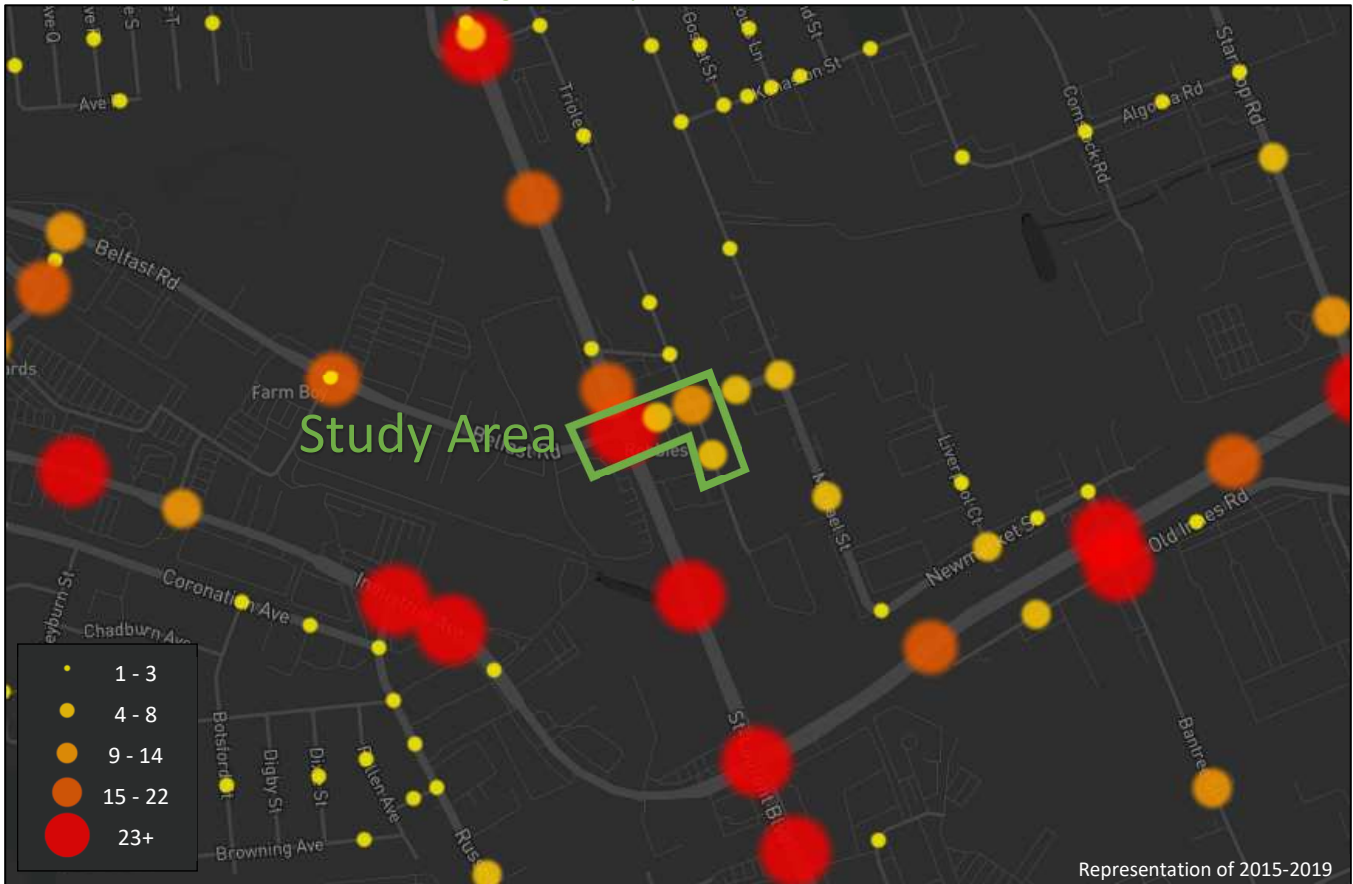

Table 4: Summary of Collision Locations, 2016-2020

Intersections / Segments	Number	%
Intersections / Segments	119	100%
Belfast Rd @ St-Laurent Blvd	101	85%
Belfast Rd @ Lagan Wy	10	8%
Lagan Wy btwn Belfast Rd & End	5	4%
Belfast Rd btwn St-Laurent Blvd & Lagan Wy	3	3%

Within the study area, the intersections of Belfast Road at St-Laurent Boulevard and Belfast Road at Lagan Way are noted to have experienced higher collisions than other locations. Table 5 and Table 6 summarize the collision types and conditions for the intersection of Belfast Road at Coventry Road.

Table 5: Intersection of Belfast Rd at St-Laurent Blvd Collision Summary

Total Collisions		Number	%
Total Collisions		101	100%
Classification	Fatality	0	0%
	Non-Fatal Injury	21	21%
	Property Damage Only	80	79%
Initial Impact Type	Angle	12	12%
	Rear end	33	33%
	Sideswipe	13	13%
	Turning Movement	34	34%
	SMV Other	7	7%

		Number	%
Total Collisions		101	100%
	Other	2	2%
Road Surface Condition	Dry	61	60%
	Wet	23	23%
	Loose Snow	8	8%
	Slush	5	5%
	Packed Snow	2	2%
	Ice	2	2%
Pedestrian Involved		2	2%
Cyclists Involved		0	0%

The Belfast Road at Coventry Road intersection had a total of 101 collisions during the 2016-2020 time period, with 80 involving property damage only and the remaining 21 having non-fatal injuries. The collision types are most represented by turning movement with 34 collisions and rear end with 33 collisions, followed by 13 sideswipe collisions, 12 angle collisions, seven SMV (other) collisions, and two collisions as other. Turning movement and angle collisions may be influenced by the four right-turn channels at the intersection or by the interaction of the bus movements between the north and west legs or the bus stops on both sides of the south leg. Rear end and sideswipe collisions are typical of congested conditions. Weather conditions may impact collisions at this location. No further collision analysis is required as part of this study.

Table 6: Intersection of Belfast Rd at Lagan Wy Collision Summary

		Number	%
Total Collisions		10	100%
Classification	Fatality	0	0%
	Non-Fatal Injury	4	40%
	Property Damage Only	6	60%
Initial Impact Type	Approaching	1	10%
	Angle	5	50%
	Rear end	1	10%
	SMV Other	2	20%
	Other	1	10%
	Road Surface Condition	Dry	6
Wet		2	20%
Slush		1	10%
Ice		1	10%
Pedestrian Involved		0	0%
Cyclists Involved		0	0%

The Belfast Road at Lagan Way intersection had a total of 10 collisions during the 2016-2020 time period, with six involving property damage only and the remaining four having non-fatal injuries. The collision types are most represented by angle with five collisions, followed by SMV (other) with two collisions, and one each as the approaching, rear end, and other collision types. Angle collisions are typical of minor stop-controlled intersections, where drivers on the minor approach, and may be influenced by the existing fence along the subject property line, which is proposed as being removed as part of development. Weather conditions may affect collisions at this location. No further collision analysis is required as part of this study.

2.3 Planned Conditions

2.3.1 Changes to the Area Transportation Network

The subject development is not within a Community Design Plan (CDP) Area.

2.3.1.1 *Current Transportation Master Plan*

Within the Transportation Master Plan (TMP), the Rapid Transit and Transit Priority Network's Network Concept diagram shows an at-grade bus rapid transit (BRT) corridor along St-Laurent Boulevard south of Industrial Avenue. Within the Affordable Network diagram, however, this section and the remaining corridor are shown as having isolated transit priority measures which have been partially implemented as part of corridor upgrades in 2017.

Within the TMP, the Road Network's Network Concept diagram shows Tremblay Road as widened collector. Within the Affordable Network diagram, this project is shown as a phase 3 (2026-2031) widening. The scope of the work per the Affordable Network is the widening of Tremblay Road from two lanes to four between Pickering Place and St-Laurent Boulevard. Since the project timeline is unknown, it is assumed that the widening will be completed beyond the study horizons.

2.3.1.2 *Draft Transportation Master Plan*

The Draft TMP, updated as of March 2023, currently considers pedestrian infrastructure projects on the north side of Belfast Road to connect existing sidewalks, and a cross-town bikeway from Industrial Avenue continuing south on St-Laurent Boulevard.

2.3.1.3 *St. Laurent Boulevard Transit Priority Corridor Environmental Assessment (EA) Study*

The City of Ottawa has initiated an EA study to assess the options for improvements to transit, and all travel modes, along the St-Laurent Boulevard transit priority corridor between Hemlock Road and Innes Road. The study is currently undergoing a consultation process and is anticipated to recommend a plan to Transportation Committee in Fall of 2023. No design alternatives have been presented to date and no timelines for implementation of a future plan are available.

2.3.1.4 *St-Laurent TOD Plan*

Approximately 400 metres north of the site is the St-Laurent TOD Plan area. The TOD plan outlines the realignment of Tremblay Road west of St-Laurent Boulevard, new sidewalks on both sides of Belfast Road and Michael Street, and dedicated cycling facilities along St Laurent Boulevard and Tremblay Road. Figure 12, Figure 13, and Figure 14 illustrate the St-Laurent TOD street, pedestrian, and cycling plans, respectively.

Figure 12: St-Laurent TOD Street Network

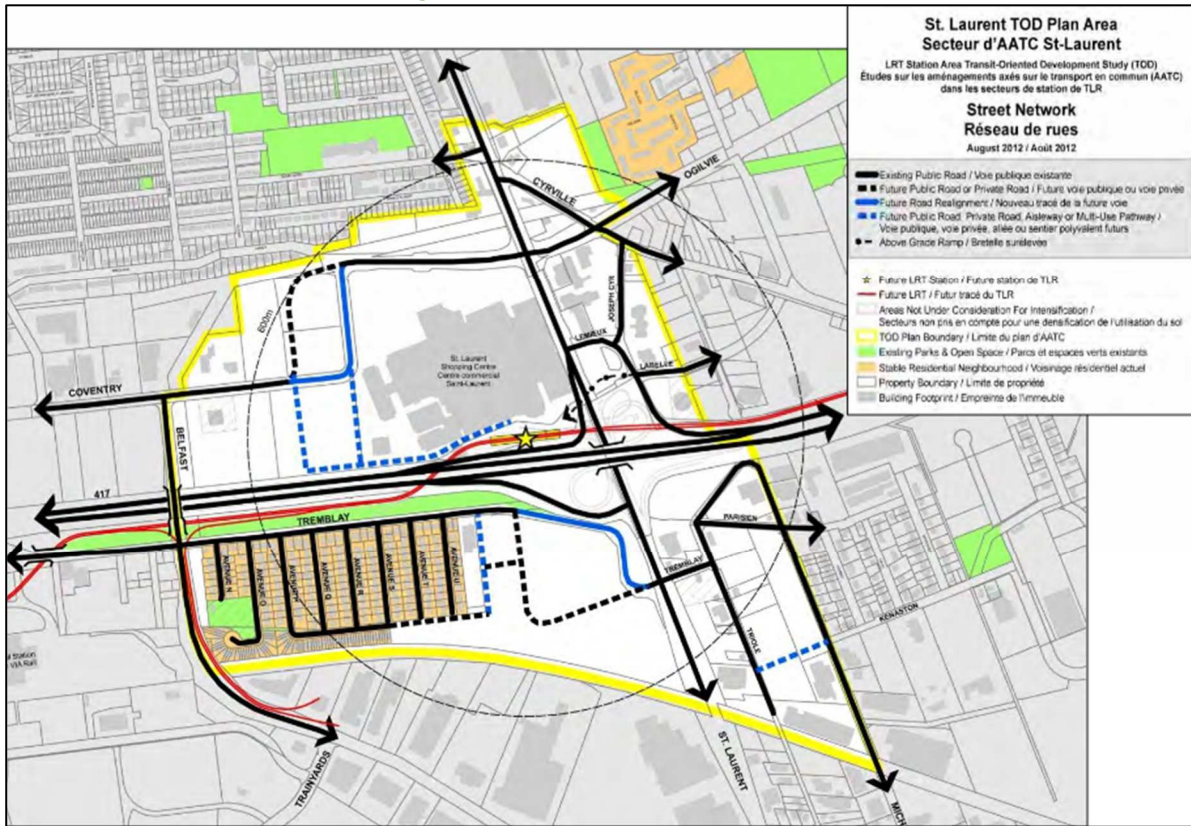

Figure 13: St-Laurent TOD Pedestrian Network

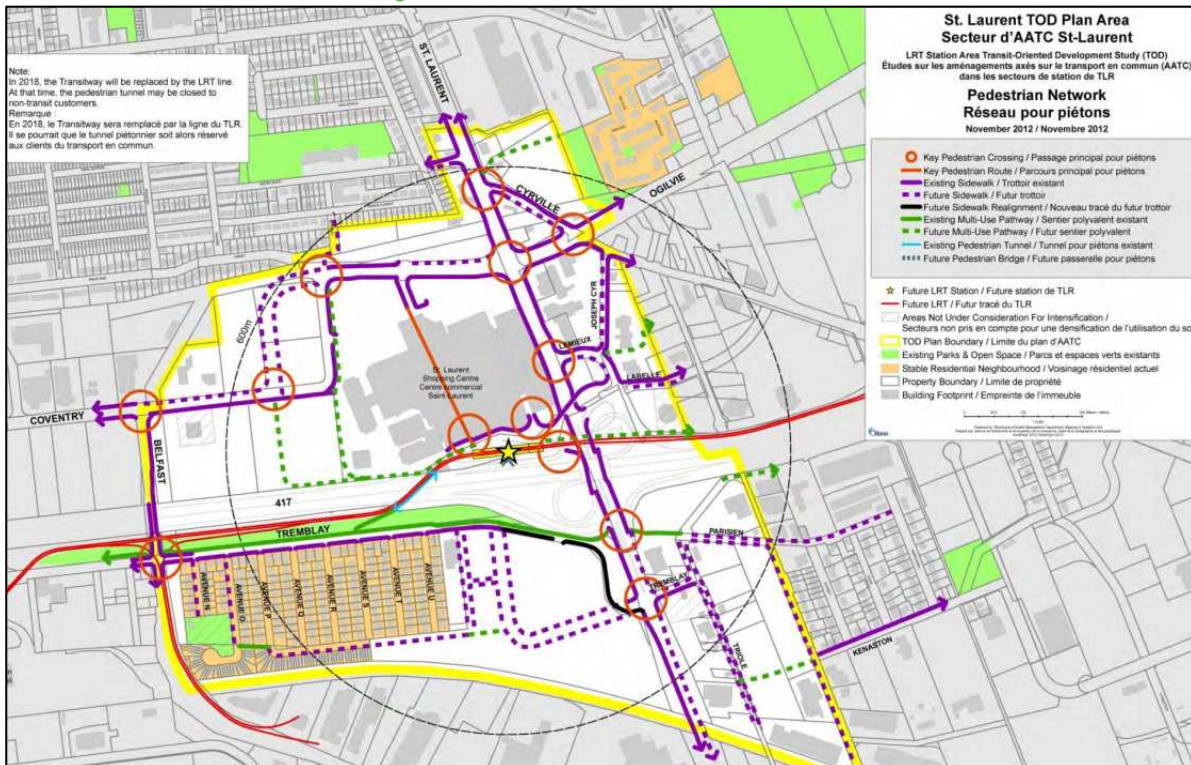
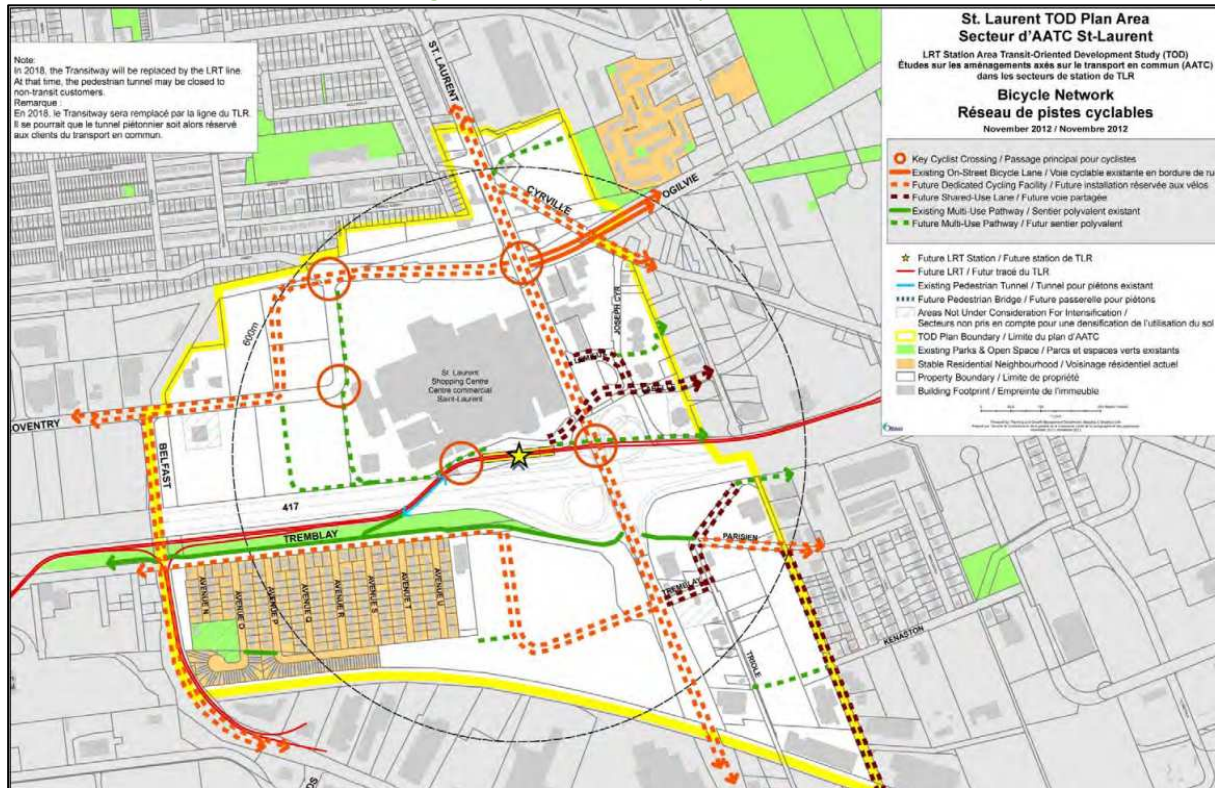

Figure 14: St-Laurent TOD Bicycle Network



2.3.2 Other Study Area Developments

1330 Avenue K

The proposed development application includes a Zoning By-law Amendment to include residential uses along with complementary commercial uses. No TIA is available.

200, 230, 260 Streamline Street

The proposed development application includes a site plan for seven-storey high-rise buildings with a total of 1890 units. Phase one is to construct 420 dwelling units and was forecast to be built out by 2021. Phase two is to comprise 865 dwelling units is forecast to be built out by 2027. Phase three is to comprise the remaining 605 dwelling units is forecast to be built out by 2031. Phase one has not been constructed and it will be assumed to be completed by 2023. (Halpenny, 2018)

25 Pickering Place

The proposed development application includes a site plan for a hotel, a senior residence, and four high-rise residential towers. Phase one is to construct a nine-storey hotel with 119 units, a twelve-storey senior residence comprising 164 dwelling units, and a 20-storey tower comprising 211 dwelling units and is forecast to be built out by 2025. Phase two is to construct three high-rise towers with a total of 849 units is forecast to be built out by 2030. (CIMA+, 2020)

400 Coventry Road

The proposed development application includes a Zoning By-law Amendment to allow seven towers on mixed use podiums totalling 1,690 residential dwelling units and 18,299 sq. ft. of commercial space. The development is forecast to be built out by 2032 and to generate 107 new AM and 130 new PM peak hour two-way auto trips. (CGH, 2022)

453 & 455 Coventry Road

The proposed development application includes a Zoning By-law Amendment to allow 650 residential units and 1,115m² gross floor area (GFA) of commercial space. The development is forecast to be built out by 2027 and to generate 113 new AM and 135 new PM two-way peak hour auto trips. (Novatech, 2022)

500, 525, 535 Coventry Road & 1200 St-Laurent Boulevard

The proposed development application includes a zoning by-law amendment to permit the construction of freestanding retail buildings with associated surface parking areas. No TIA is included as part of this application, and the file was last updated in 2014.

530 Tremblay Road & 2098 Avenue P & 1399 Avenue U

The proposed development application includes a site plan to construct two apartment buildings with a total of 124 dwelling units. The development is forecast to be built out by 2023. (CGH Transportation, 2019)

599 Tremblay Road

The proposed development application includes a plan of subdivision for the construction of 500 apartment units and 150,000 m² of federal Office in three phases. Phase one is to comprise 200 dwelling units and 150,000 m² of office space and is forecast to be built out by 2025. Phase two is to comprise 200 dwelling units and is forecast to be built out by 2029. Phase three is to comprise the remaining 100 units, is forecast to be built out by 2033. (WSP, 2021)

1209 St Laurent Boulevard & 1200 Lemieux Street

The proposed development application includes a site plan for two 30-storey residential buildings including 640 units. The development is expected to generate 35 new AM and 38 new PM peak hour two-way auto trips, and the anticipated build-out horizon is assumed to be 2026. (CGH Transportation, 2022)

1500 St-Laurent Boulevard

The proposed development application includes a site plan to include OC Transpo E-Bus Facility. No TIA is available.

1740-1760 St-Laurent Boulevard

The proposed development application includes a site plan for the construction of four buildings, two mixed use towers at 15-storeys and two residential towers at 12-storeys. The development is anticipated to be built-out by 2024 and to generate 228 new AM and 263 new PM peak hour two-way auto trips. (Parsons, 2021)

1802 St-Laurent Boulevard

The proposed development application includes a zoning amendment to allow the construction of two residential buildings comprising 512 dwelling units. The development is anticipated to be built-out by 2025 and to generate 185 new AM and 212 new PM peak hour two-way auto trips. (CGH, 2021)

1300 Michael Street

The proposed development application includes a site plan for approximately 15,000 sq. ft. of commercial and/or industrial space. The anticipated build-out horizon is 2023. No TIA is available.

1591-1611 Michael Street

The proposed development application includes a site plan for approximately 40,900 sq. ft. of light industrial space. No TIA is available.

1195 Newmarket Street

The proposed development application includes a site plan for approximately 115,000 sq. ft. warehouse space. The development is anticipated to be built out by 2025 and to generate 35 two-way AM and 37 two-way PM peak hour auto trips. (Ortam Groupe, 2022)

3 Study Area and Time Periods

3.1 Study Area

While only one signalized intersection is present within 400 metres of the site, to better understand area impacts, the study area has been expanded to include the intersections of:

- St-Laurent Boulevard at:
 - Tremblay Road
 - Belfast Road
 - Industrial Avenue/Innes Road
- Belfast Road at:
 - Lagan Way
 - Site Access (Future Conditions)
- Lagan Way at Site Access (Future Conditions)

The boundary roads will be St-Laurent Boulevard, Belfast Road, and Lagan Way. TRANS screenline SL 54 is located south of Innes Road, and no screenline analysis will be performed as part of the study.

3.2 Time Periods

As the proposed development is composed primarily of residential units the AM and PM peak hours will be examined.

3.3 Horizon Years

The anticipated build-out year is 2026. As a result, the full build-out plus five years horizon year is 2031.

4 Exemption Review

Table 7 summarizes the exemptions for this TIA.

Table 7: Exemption Review

Module	Element	Explanation	Exempt/Required
Design Review Component			
4.1 Development Design	4.1.2 Circulation and Access	Only required for site plans	Required
	4.1.3 New Street Networks	Only required for plans of subdivision	Exempt
4.2 Parking	4.2.1 Parking Supply	Only required for site plans	Required
	4.2.2 Spillover Parking	Only required for site plans where parking supply is 15% below unconstrained demand	Exempt
Network Impact Component			
4.5 Transportation Demand Management	All Elements	Not required for site plans expected to have fewer than 60 employees and/or students on location at any given time	Required

Module	Element	Explanation	Exempt/Required
4.6 Neighbourhood Traffic Management	4.6.1 Adjacent Neighbourhoods	Only required when the development relies on local or collector streets for access and total volumes exceed ATM capacity thresholds	Required
4.8 Network Concept		Only required when proposed development generates more than 200 person-trips during the peak hour in excess of equivalent volume permitted by established zoning	Exempt

5 Development-Generated Travel Demand

5.1 Mode Shares

Examining the mode shares recommended in the TRANS Trip Generation Manual (2020) for the subject district, derived from the most recent National Capital Region Origin-Destination survey (OD Survey), the existing average district mode shares by land use for Alta Vista have been summarized in Table 8.

Table 8: TRANS Trip Generation Manual Recommended Mode Shares – Alta Vista

Travel Mode	Multi-Unit (High-Rise)		Commercial Generator	
	AM	PM	AM	PM
Auto Driver	38%	45%	64%	60%
Auto Passenger	12%	16%	9%	20%
Transit	41%	28%	12%	9%
Cycling	2%	2%	1%	0%
Walking	7%	9%	14%	11%
Total	100%	100%	100%	100%

5.2 Trip Generation

This TIA has been prepared using the vehicle and person trip rates for the residential dwellings using the TRANS Trip Generation Manual (2020) and the vehicle trip rates and derived person trip rates for commercial component from the ITE Trip Generation Manual 11th Edition (2021) using the City-prescribed conversion factor of 1.28. Table 9 summarizes the person trip rates for the proposed residential land use for each peak period and the person trip rates for the non-residential land use by peak hour.

Table 9: Trip Generation Person Trip Rates

Land Use	Land Use Code	Peak	Peak Period		Peak Hour	
			Vehicle Trip Rate	Person Trip Rates	Vehicle Trip Rate	Person Trip Rates
Multi-Unit (High-Rise)	221 & 222 (TRANS)	AM	-	0.80	-	-
		PM	-	0.90	-	-
Retail <40k sq. ft.	822 (ITE)	AM	-	-	2.36	3.02
		PM	-	-	6.59	8.44

Using the above person trip rates, the total person trip generation has been estimated. Table 10 summarizes the total person trip generation for the residential land use by peak period and for the non-residential land use by peak hour.

Table 10: Total Person Trip Generation

Land Use	Units	AM Peak Period			PM Peak Period		
		In	Out	Total	In	Out	Total
Multi-Unit (High-Rise)	424	105	234	339	222	160	382
Land Use	GFA (sq. ft.)	AM Peak Hour			PM Peak Hour		
		In	Out	Total	In	Out	Total
Retail <40k sq. ft.	5,465	10	7	17	23	23	46

Internal capture rates from the ITE Trip Generation Handbook 3rd Edition have been assigned to the development’s retail component for mixed-use developments. The rates summarized in Table 11 represent the percentage of trips to/from the retail use based on the residential component.

Table 11: Internal Capture Rates

Land Use	AM		PM	
	In	Out	In	Out
Residential to/from Shopping Centre	17%	14%	10%	26%

Pass-by/diverted trip reductions applied to the retail trip generation at a rate of 40% have been included using the recommended value presented in the ITE Trip Generation Manual 11th Edition (2021) for the most similar land use with a recommended rate, “Retail (40k – 150k sq. ft.)”.

Using the above mode share targets, the internal capture and pass-by rates, and the person trip rates, the person trips by mode have been projected. Trip generation by peak hour has been forecasted using the prescribed peak period conversion factors presented in the TRANS Trip Generation Manual (2020) for the residential component. Table 12 summarizes the residential trip generation and the non-residential trip generation by mode and peak hour.

Table 12: Trip Generation by Mode

Travel Mode		AM Peak Hour				PM Peak Hour			
		Mode Share	In	Out	Total	Mode Share	In	Out	Total
Multi-Unit (High-Rise)	Auto Driver	38%	19	43	62	45%	44	32	76
	Auto Passenger	12%	6	13	20	16%	16	11	27
	Transit	41%	24	53	76	28%	29	21	50
	Cycling	2%	1	3	4	2%	2	1	4
	Walking	7%	4	9	14	9%	10	7	18
	Total	100%	54	121	176	100%	101	72	175
Retail <40k sq. ft.	Auto Driver	64%	2	1	3	60%	4	2	7
	Auto Passenger	9%	1	1	1	20%	4	4	8
	Transit	12%	1	1	2	9%	2	2	4
	Cycling	1%	0	0	0	0%	0	0	0
	Walking	14%	1	1	2	11%	2	2	5
	Pass-by	40%	-4	-3	-7	40%	-9	-9	-18
	Internal Capture	varies	-1	-1	-2	varies	-1	-4	-5
	Total	100%	5	3	8	100%	12	10	24
Total	Auto Driver	-	21	44	65	-	48	34	83
	Auto Passenger	-	7	14	21	-	20	15	35
	Transit	-	25	54	78	-	31	23	54
	Cycling	-	1	3	4	-	2	1	4
	Walking	-	5	10	16	-	12	9	23
	Total	-	59	125	184	-	113	82	199

As shown above, a total of 65 AM and 83 PM new peak hour two-way vehicle trips are projected as a result of the proposed development.

5.3 Trip Distribution

To understand the travel patterns of the subject development, the OD Survey has been reviewed to determine the travel for the residential component, and these patterns were applied based on the build-out of Alta Vista. Table 13 below summarizes the distributions.

Table 13: OD Survey Distribution – Alta Vista

To/From	Residential % of Trips	Via
North	15%	15% St-Laurent Blvd (N)
South	35%	35% St-Laurent Blvd (S)
East	5%	5% Innes Rd (E)
West	45%	20% St-Laurent Blvd (N) 5% Tremblay Rd (W), 15% Belfast Rd (W), 5% St-Laurent Blvd (S)
Total	100%	100%

5.4 Trip Assignment

Using the distribution outlined above, turning movement splits, and access to major transportation infrastructure, the trips generated by the site have been assigned to the study area road network. Figure 15 illustrates the new site generated volumes and Figure 16 illustrates the new site pass-by and diverted volumes.

Figure 15: New Site Generation Auto Volumes

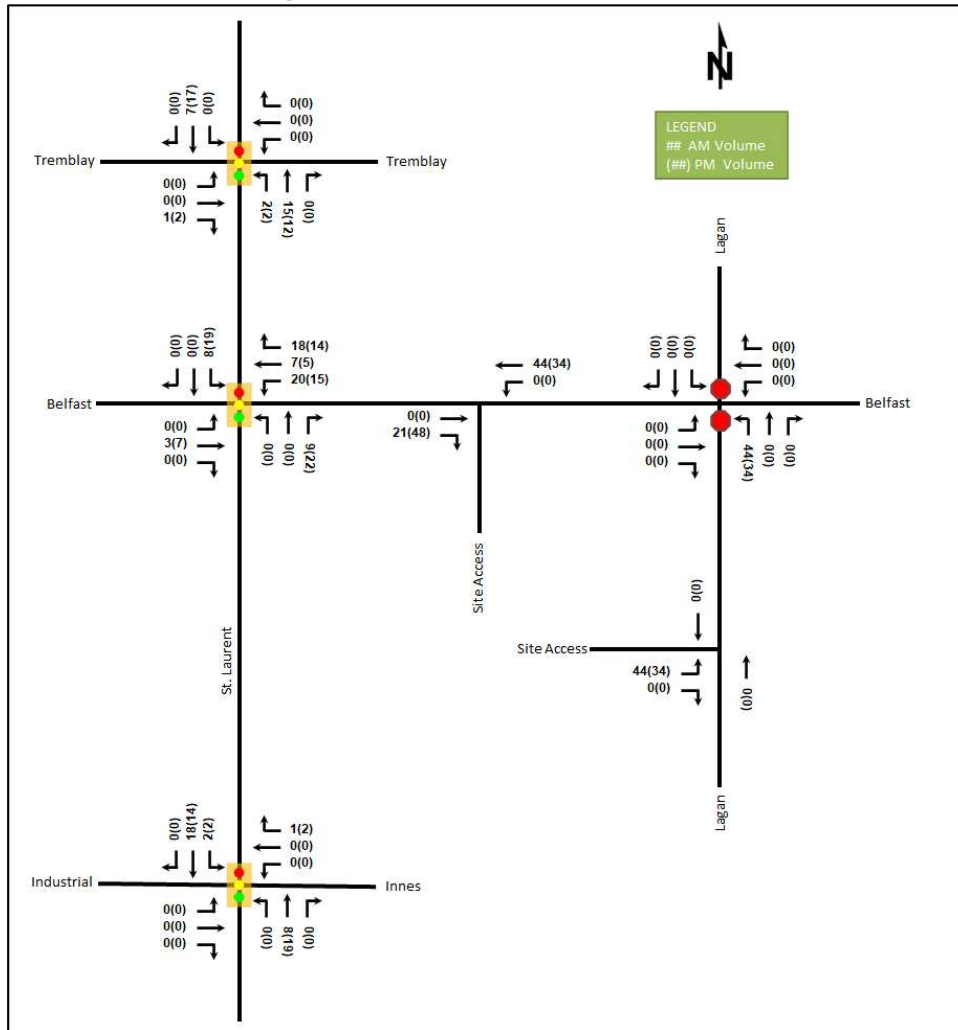
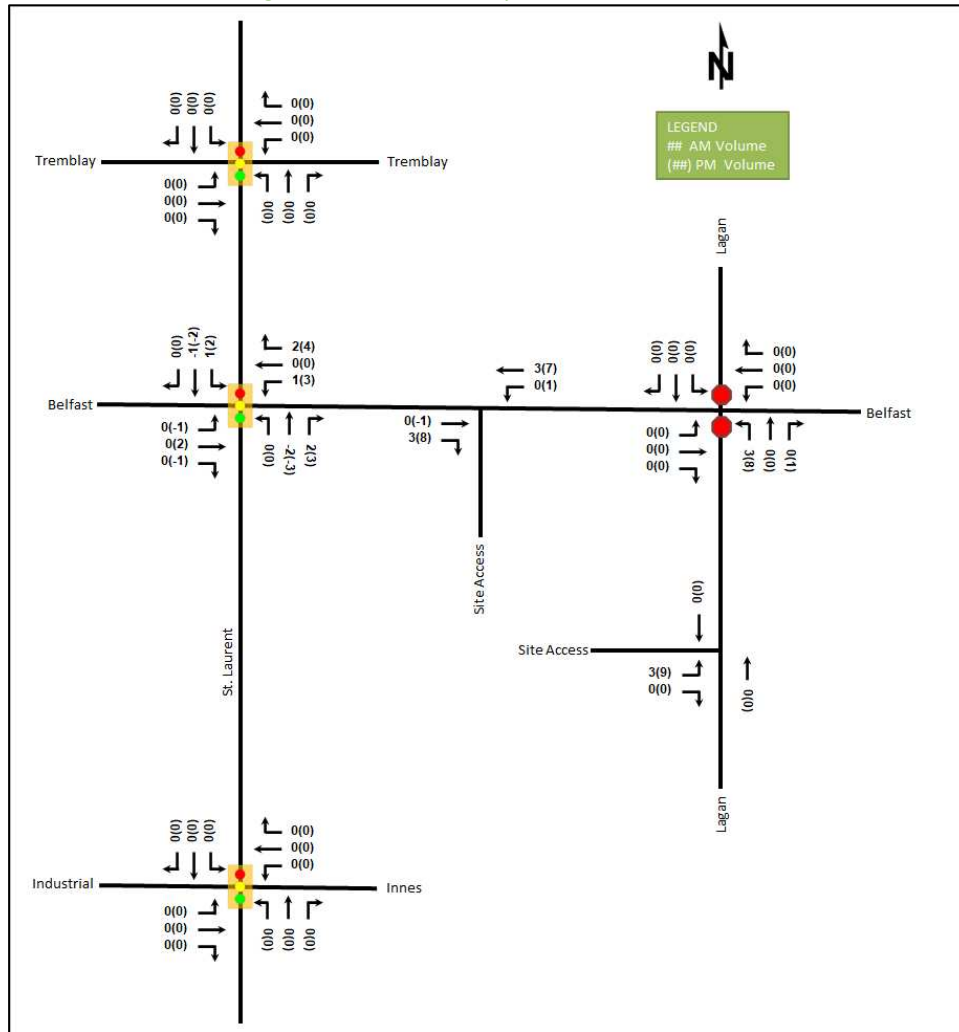

Figure 16: New Site Pass-By and Diverted Volumes



6 Background Network Travel Demands

6.1 Transportation Network Plans

The transportation network plans were discussed in Section 2.3. No recommended plan has been arrived at by the transit priority EA study, and no improvements associated with this project are included as part of the future conditions within this study. No other changes to the approach geometries at network intersections are planned within the study horizons.

6.2 Background Growth

A review of the background projections from the City’s TRANS Regional Model for the 2011 and 2031 horizons was completed to determine the background growth for each of the study area roadways. The TRANS model plots are provided in Appendix E.

Growth rates derived from the existing horizon to the 2031 model horizon rounded to the nearest 0.25% will be peak-directionally applied to the appropriate roadway’s mainline volumes and to the appropriate major turning movements at the intersections. Table 14 summarizes the growth rates applied within the study area.

Table 14: TRANS Regional Model Projections – Study Area Growth Rates

Street	AM Peak Hour		PM Peak Hour	
	Eastbound	Westbound	Eastbound	Westbound
Tremblay Rd	0.25%	1.75%	1.75%	0.25%
Belfast Rd	-	-	-	-
Industrial Ave	0.75%	0.25%	0.25%	0.75%
Innes Rd	-	-	-	-
	Northbound	Southbound	Northbound	Southbound
St-Laurent Blvd	0.25%	-	-	0.25%

6.3 Other Developments

The background developments explicitly considered in the background conditions (Section 6.2) include:

- 200, 230, 260 Streamline Street
- 25 Pickering Place
- 400 Coventry Road
- 453 & 455 Coventry Road
- 530 Tremblay Road & 2098 Avenue P & 1399 Avenue U
- 599 Tremblay Road
- 1209 St Laurent Boulevard & 1200 Lemieux Street
- 1740-1760 St-Laurent Boulevard
- 1802 St-Laurent Boulevard

The background development volumes within the study area have been provided in Appendix F.

7 Demand Rationalization

7.1 2026 Future Background Operations

Figure 17 illustrates the 2026 background volumes and Table 15 summarizes the 2026 background intersection operations. The level of service for signalized intersections is based on v/c calculations for individual lane movements and HCM 2000 v/c calculations for the overall intersection, and average delay for unsignalized intersections. The synchro worksheets for the 2026 future background horizon are provided in Appendix G.

Figure 17: 2026 Future Background Volumes

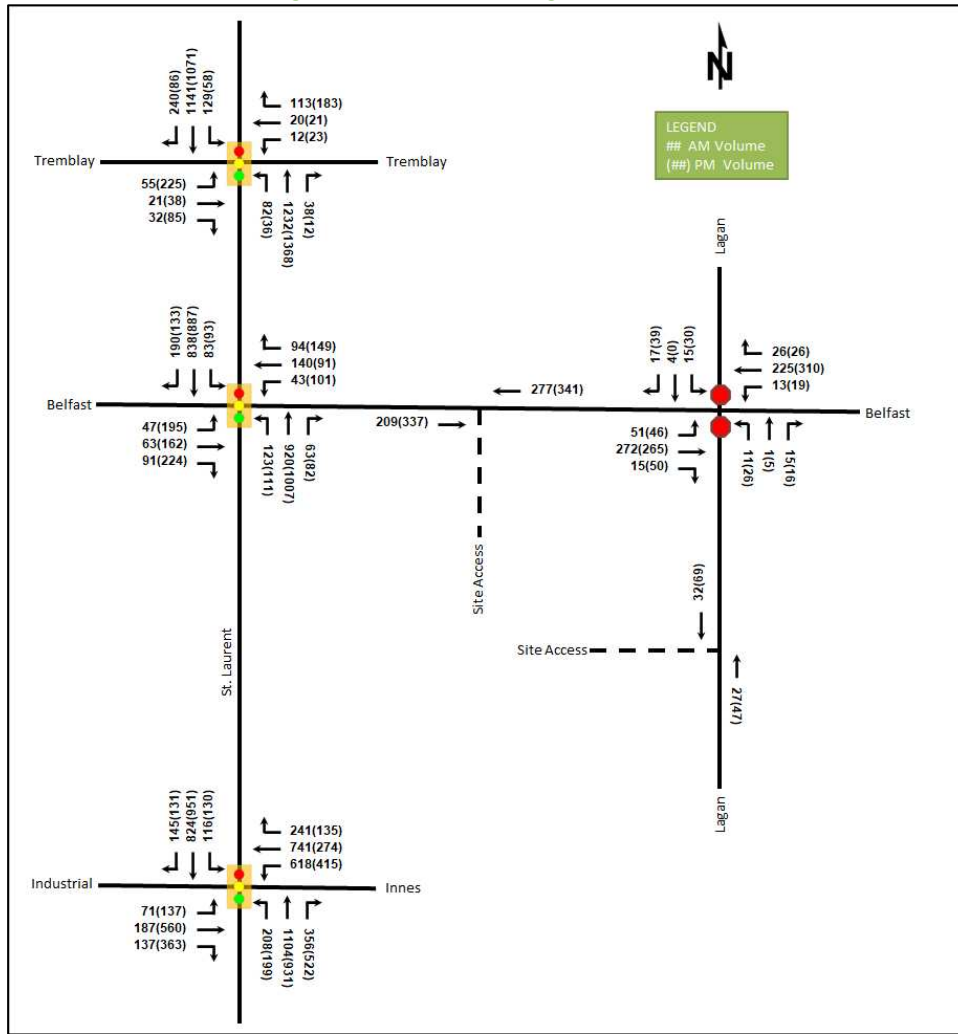

Table 15: 2026 Future Background Intersection Operations

Intersection	Lane	AM Peak Hour				PM Peak Hour			
		LOS	V/C	Delay	Q (95 th)	LOS	V/C	Delay	Q (95 th)
St-Laurent Blvd at Tremblay Rd <i>Signalized</i>	EBL	A	0.58	74.3	24.2	F	1.01	106.5	#104.1
	EBT/R	A	0.24	25.2	14.7	A	0.26	13.7	21.5
	WBL/T	A	0.09	46.3	7.7	A	0.07	32.7	10.6
	WBR	A	0.49	17.8	20.6	A	0.37	8.8	22.2
	NBL	A	0.28	14.6	25.1	A	0.16	19.3	m7.9
	NBT/R	A	0.43	11.5	89.7	A	0.54	18.0	m88.2
	SBL	A	0.40	8.0	18.3	A	0.26	11.5	10.0
	SBT	A	0.48	7.0	95.6	A	0.55	14.7	89.3
	SBR	A	0.23	1.4	8.6	A	0.10	2.2	6.0
Overall		A	0.51	10.7	-	C	0.72	22.0	-

Intersection	Lane	AM Peak Hour				PM Peak Hour			
		LOS	V/C	Delay	Q (95 th)	LOS	V/C	Delay	Q (95 th)
St-Laurent Blvd at Belfast Rd Signalized	EBL	A	0.23	30.4	15.9	E	0.95	86.6	#68.0
	EBT	A	0.13	29.0	19.9	A	0.35	34.7	44.1
	EBR	A	0.22	6.7	10.9	A	0.40	7.3	19.4
	WBL	A	0.22	42.7	18.7	A	0.59	58.9	37.5
	WBT/R	D	0.84	66.1	#75.9	C	0.79	53.0	63.9
	NBL	A	0.38	15.2	23.2	A	0.36	14.4	21.5
	NBT	A	0.55	23.6	112.7	B	0.61	24.9	125.4
	NBR	A	0.08	0.2	0.0	A	0.12	1.1	2.4
	SBL	A	0.29	14.4	16.7	A	0.38	17.2	20.9
	SBT	A	0.54	24.0	100.9	A	0.54	18.3	59.4
	SBR	A	0.27	4.1	13.3	A	0.17	2.8	6.6
Overall	A	0.60	24.8	-	C	0.72	27.1	-	
Lagan Way at Belfast Rd Unsignalized	EB	A	0.04	8.1	0.8	A	0.04	8.5	0.8
	WB	A	0.01	8.2	0.0	A	0.02	8.0	0.0
	NB	B	0.06	14.1	1.5	C	0.13	16.5	3.0
	SB	B	0.08	13.9	2.3	C	0.16	15.2	4.5
	Overall	A	-	2.1	-	A	-	2.8	-
St-Laurent Blvd at Industrial Ave / Innes Rd Signalized	EBL	A	0.38	68.5	17.7	A	0.51	64.0	30.3
	EBT	A	0.46	57.4	34.0	C	0.80	57.0	99.1
	EBR	A	0.40	5.5	7.1	B	0.66	14.9	46.4
	WBL	E	0.93	76.4	#120.0	C	0.75	58.8	73.0
	WBT	C	0.78	51.2	113.0	A	0.28	34.0	40.5
	WBR	A	0.42	6.2	17.8	A	0.25	6.3	14.2
	NBL	B	0.67	71.2	41.7	A	0.59	62.2	39.9
	NBT	D	0.89	50.8	#242.2	E	0.91	56.0	#186.0
	NBR	A	0.48	9.4	42.2	B	0.67	10.1	48.7
	SBL	A	0.49	69.0	25.7	A	0.49	63.1	28.7
	SBT	B	0.70	43.3	#162.7	E	1.00	73.1	#204.8
	SBR	A	0.26	3.5	8.8	A	0.24	3.4	7.5
Overall	E	0.91	46.6	-	D	0.83	48.1	-	

Notes: Saturation flow rate of 1800 veh/h/lane
Queue is measured in metres
Peak Hour Factor = 1.00

Delay = average vehicle delay in seconds
m = metered queue
= volume for the 95th %ile cycle exceeds capacity

During both the AM and PM peak hours, the study area intersections at the 2026 future background horizon operate similarly to the existing conditions. Some improved operations are noted on various movements throughout the study area with the peak hour factor of 1.00 for future conditions.

During the PM peak hour, the eastbound left movement at the intersection of St-Laurent Boulevard at Tremblay Road is forecast to be over theoretical capacity and may exhibit extended queues at this horizon. Shifting one second of split from the north-south phases to the east-west phases would reduce v/c of all movements at the intersection to 1.00 or lower.

7.2 2031 Future Background Operations

Figure 18 illustrates the 2031 background volumes and Table 16 summarizes the 2031 background intersection operations. The level of service for signalized intersections is based on v/c calculations for individual lane movements and HCM 2000 v/c calculations for the overall intersection, and average delay for unsignalized intersections. The synchro worksheets for the 2031 future background horizon are provided in Appendix H.

Figure 18: 2031 Future Background Volumes

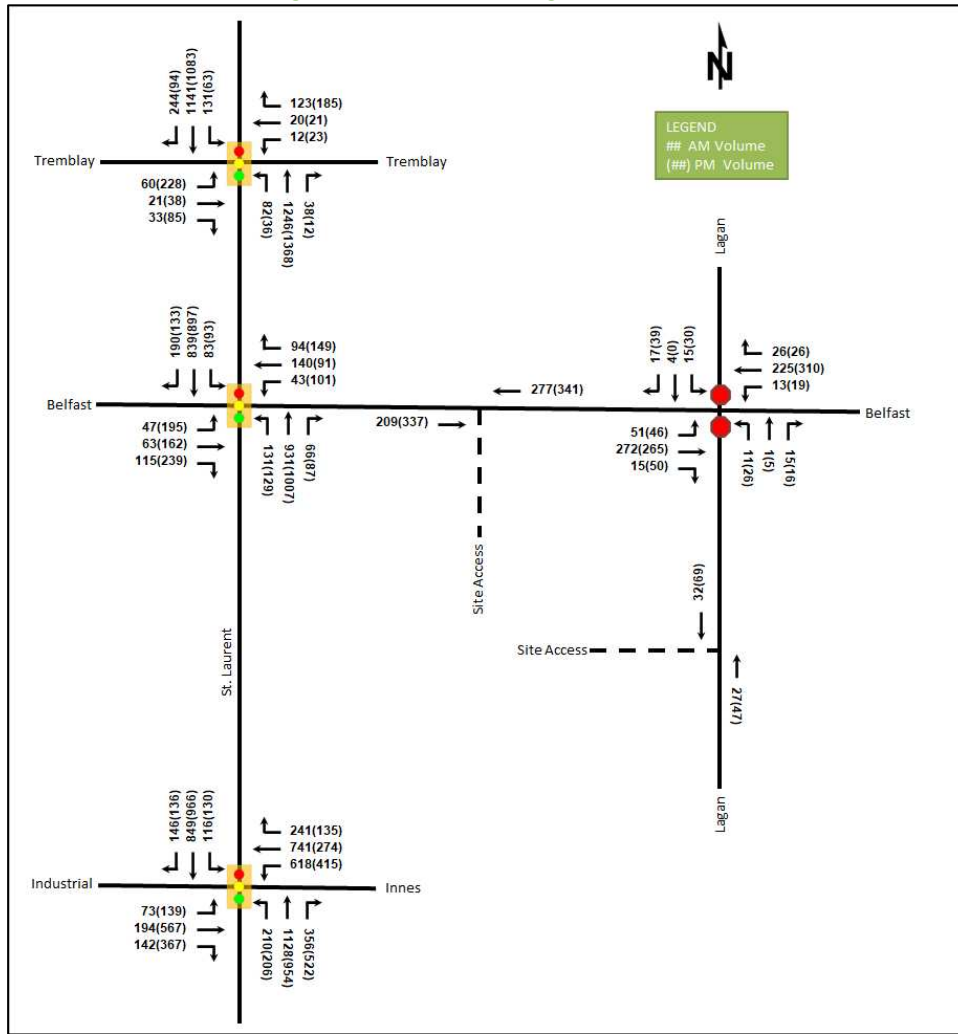

Table 16: 2031 Future Background Intersection Operations

Intersection	Lane	AM Peak Hour				PM Peak Hour			
		LOS	V/C	Delay	Q (95 th)	LOS	V/C	Delay	Q (95 th)
St-Laurent Blvd at Tremblay Rd <i>Signalized</i>	EBL	B	0.65	80.6	26.3	F	1.03	112.2	#106.4
	EBT/R	A	0.24	24.5	14.9	A	0.26	13.7	21.5
	WBL/T	A	0.08	45.7	7.7	A	0.07	32.7	10.6
	WBR	A	0.50	17.1	21.1	A	0.38	9.0	22.7
	NBL	A	0.28	14.9	25.1	A	0.16	19.5	m7.9
	NBT/R	A	0.44	11.9	91.2	A	0.54	18.1	m88.3
	SBL	A	0.41	8.4	18.7	A	0.28	11.8	10.8
	SBT	A	0.48	7.2	95.6	A	0.55	14.8	90.8
	SBR	A	0.24	1.4	8.6	A	0.11	2.2	6.2
Overall		A	0.52	11.2	-	C	0.73	22.4	-

Intersection	Lane	AM Peak Hour				PM Peak Hour			
		LOS	V/C	Delay	Q (95 th)	LOS	V/C	Delay	Q (95 th)
St-Laurent Blvd at Belfast Rd Signalized	EBL	A	0.23	30.4	15.9	E	0.95	86.6	#68.0
	EBT	A	0.13	29.0	19.9	A	0.35	34.7	44.1
	EBR	A	0.26	6.4	12.3	A	0.43	8.6	23.2
	WBL	A	0.22	42.7	18.7	A	0.59	58.9	37.5
	WBT/R	D	0.84	66.1	#75.9	C	0.79	53.0	63.9
	NBL	A	0.41	15.6	24.6	A	0.41	15.3	24.6
	NBT	A	0.55	23.8	114.3	B	0.61	24.9	125.4
	NBR	A	0.08	0.2	0.0	A	0.13	1.4	3.2
	SBL	A	0.30	14.5	16.7	A	0.38	17.1	20.8
	SBT	A	0.54	24.1	101.1	A	0.55	18.6	60.6
	SBR	A	0.27	4.1	13.3	A	0.17	2.9	7.0
Overall	A	0.60	24.7	-	C	0.73	27.1	-	
Lagan Way at Belfast Rd Unsignalized	EB	A	0.04	8.1	0.8	A	0.04	8.5	0.8
	WB	A	0.01	8.2	0.0	A	0.02	8.0	0.0
	NB	B	0.06	14.1	1.5	C	0.13	16.5	3.0
	SB	B	0.08	13.9	2.3	C	0.16	15.2	4.5
	Overall	A	-	2.1	-	A	-	2.8	-
St-Laurent Blvd at Industrial Ave / Innes Rd Signalized	EBL	A	0.39	68.5	18.1	A	0.52	64.4	30.7
	EBT	A	0.47	57.7	35.1	D	0.81	57.5	101.0
	EBR	A	0.41	6.0	8.2	B	0.67	15.4	48.2
	WBL	E	0.93	76.4	#120.0	C	0.75	59.1	73.3
	WBT	C	0.78	51.2	113.1	A	0.28	34.1	40.7
	WBR	A	0.42	6.2	17.8	A	0.25	6.3	14.2
	NBL	B	0.68	71.4	42.2	A	0.60	62.5	41.3
	NBT	E	0.92	53.0	#249.5	E	0.93	58.7	#193.0
	NBR	A	0.49	9.9	44.2	B	0.68	10.7	52.7
	SBL	A	0.49	69.0	25.7	A	0.49	63.3	28.6
	SBT	C	0.72	44.2	#170.6	F	1.02	78.0	#210.3
	SBR	A	0.26	3.6	9.0	A	0.25	3.8	9.1
Overall	E	0.92	47.4	-	D	0.85	50.0	-	

Notes: Saturation flow rate of 1800 veh/h/lane
Queue is measured in metres
Peak Hour Factor = 1.00

Delay = average vehicle delay in seconds
m = metered queue
= volume for the 95th %ile cycle exceeds capacity

During both the AM and PM peak hours, the study area intersections at the 2031 operate similarly to the 2026 future background conditions.

As in the 2026 future background conditions, shifting one second of split from the north-south phases to the east-west phases at the intersection of St-Laurent Boulevard at Tremblay Road would reduce v/c of all movements at the intersection to 1.00 or lower during the PM peak hour at this horizon.

At the intersection of St-Laurent Boulevard at Industrial Avenue/Innes Road, during the PM peak hour, the southbound through movement is forecast to be over theoretical capacity at this horizon. Shifting one second of split from the northbound and southbound left-turn phases to the northbound and southbound through phases would reduce the v/c of all movements to 1.00 or lower at the intersection at this horizon.

7.3 2026 Future Total Operations

Figure 19 illustrates the 2026 total volumes and Table 17 summarizes the 2026 total intersection operations. The level of service for signalized intersections is based on v/c calculations for individual lane movements and HCM

2000 v/c calculations for the overall intersection The synchro worksheets for the 2026 total horizon are provided in Appendix I.

Figure 19: 2026 Future Total Volumes

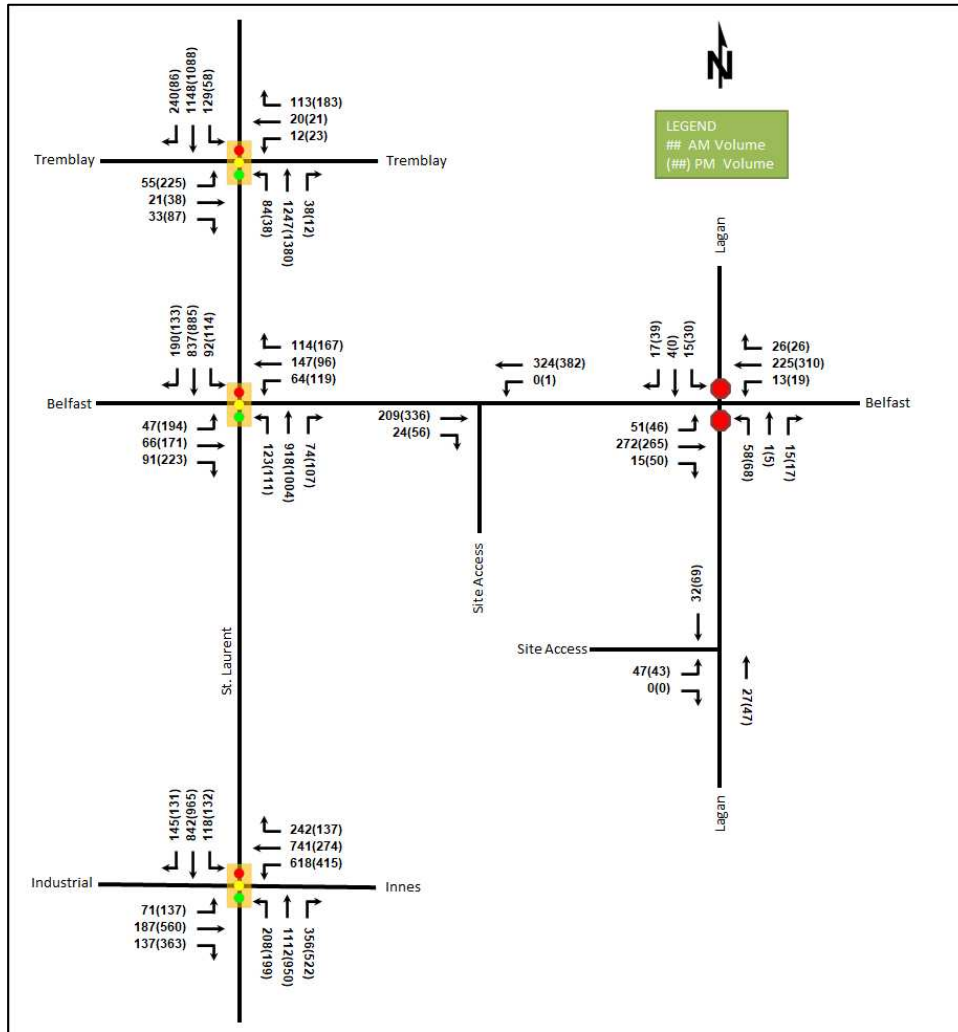

Table 17: 2026 Future Total Intersection Operations

Intersection	Lane	AM Peak Hour				PM Peak Hour			
		LOS	V/C	Delay	Q (95 th)	LOS	V/C	Delay	Q (95 th)
St-Laurent Blvd at Tremblay Rd <i>Signalized</i>	EBL	A	0.57	73.4	24.2	F	1.01	106.5	#104.1
	EBT/R	A	0.24	24.9	14.9	A	0.26	13.6	21.5
	WBL/T	A	0.09	46.2	7.7	A	0.07	32.7	10.6
	WBR	A	0.49	17.7	20.6	A	0.37	8.9	22.5
	NBL	A	0.29	14.9	26.0	A	0.17	20.1	m8.0
	NBT/R	A	0.44	11.6	91.2	A	0.55	18.7	m89.3
	SBL	A	0.41	8.2	18.3	A	0.26	11.6	10.0
	SBT	A	0.48	7.1	96.4	A	0.55	14.8	91.5
	SBR	A	0.23	1.4	8.6	A	0.10	2.2	6.0
Overall	A	0.51	10.8	-	C	0.73	22.3	-	

Intersection	Lane	AM Peak Hour				PM Peak Hour			
		LOS	V/C	Delay	Q (95 th)	LOS	V/C	Delay	Q (95 th)
St-Laurent Blvd at Belfast Rd Signalized	EBL	A	0.24	29.9	15.9	E	0.96	89.7	#70.1
	EBT	A	0.13	28.4	20.5	A	0.36	34.0	46.5
	EBR	A	0.22	6.7	10.9	A	0.41	7.4	20.0
	WBL	A	0.33	45.2	25.8	B	0.68	65.1	43.9
	WBT/R	D	0.88	69.8	#93.2	D	0.82	55.4	70.8
	NBL	A	0.40	16.0	23.2	A	0.37	15.1	21.5
	NBT	A	0.58	25.6	112.3	B	0.63	26.4	124.8
	NBR	A	0.10	0.5	0.9	A	0.17	2.7	6.9
	SBL	A	0.34	15.7	18.1	A	0.47	23.6	29.2
	SBT	A	0.55	25.2	100.8	A	0.55	19.0	60.3
	SBR	A	0.29	4.2	13.4	A	0.18	3.0	7.1
Overall	B	0.62	26.7	-	C	0.75	28.8	-	
Lagan Way at Belfast Rd Unsignalized	EB	A	0.04	8.1	0.8	A	0.04	8.5	0.8
	WB	A	0.01	8.2	0.0	A	0.02	8.0	0.0
	NB	C	0.24	20.2	6.8	C	0.29	21.2	9.0
	SB	B	0.08	13.9	2.3	C	0.17	15.3	4.5
	Overall	A	-	3.5	-	A	-	4.0	-
St-Laurent Blvd at Industrial Ave / Innes Rd Signalized	EBL	A	0.38	68.5	17.7	A	0.51	64.0	30.3
	EBT	A	0.46	57.4	34.0	C	0.80	57.0	99.1
	EBR	A	0.40	5.5	7.1	B	0.66	15.0	46.4
	WBL	E	0.93	76.4	#120.0	C	0.75	58.8	73.0
	WBT	C	0.78	51.2	113.0	A	0.28	34.0	40.5
	WBR	A	0.42	6.2	18.0	A	0.26	6.3	14.4
	NBL	B	0.67	71.2	41.7	A	0.59	62.2	39.9
	NBT	D	0.90	51.6	#245.3	E	0.93	58.6	#192.2
	NBR	A	0.49	9.6	43.0	B	0.68	10.8	52.3
	SBL	A	0.50	69.0	26.1	A	0.50	63.0	28.8
	SBT	C	0.71	43.8	#168.4	F	1.01	76.3	#209.1
	SBR	A	0.26	3.5	8.8	A	0.24	3.4	7.5
	Overall	E	0.92	46.9	-	D	0.84	49.5	-
Lagan Way at Site Access Unsignalized	EBL/R	A	0.05	9.0	1.5	A	0.05	9.3	1.5
	NBL/T	-	-	-	-	-	-	-	-
	SBT/R	-	-	-	-	-	-	-	-
	Overall	A	-	4.0	-	A	-	2.5	-

Notes: Saturation flow rate of 1800 veh/h/lane
 Queue is measured in metres
 Peak Hour Factor = 1.00

Delay = average vehicle delay in seconds
 m = metered queue
 # = volume for the 95th %ile cycle exceeds capacity

During both the AM and PM peak hours, the study area intersections at the 2026 future total horizon operate similarly to the 2026 future background horizon.

As in the 2026 future background conditions, shifting one second of split from the north-south phases to the east-west phases at the intersection of St-Laurent Boulevard at Tremblay Road would reduce v/c of all movements at the intersection to 1.00 or lower during the PM peak hour at this horizon.

At the intersection of St-Laurent Boulevard at Industrial Avenue/Innes Road, the southbound through movement's v/c has increased by 0.01 to be over theoretical capacity with the addition of site-generated traffic, similar to the 2031 future background conditions. Shifting one second of split from the northbound and southbound left-turn

phases to the northbound and southbound through phases would reduce the v/c of all movements to 1.00 or lower at the intersection at this horizon.

7.4 2031 Future Total Operations

Figure 20 illustrates the 2031 total volumes and Table 18 summarizes the 2031 total intersection operations. The level of service for signalized intersections is based on v/c calculations for individual lane movements and HCM 2000 v/c calculations for the overall intersection. The synchro worksheets for the 2031 future total horizon are provided in Appendix J.

Figure 20: 2031 Future Total Volumes

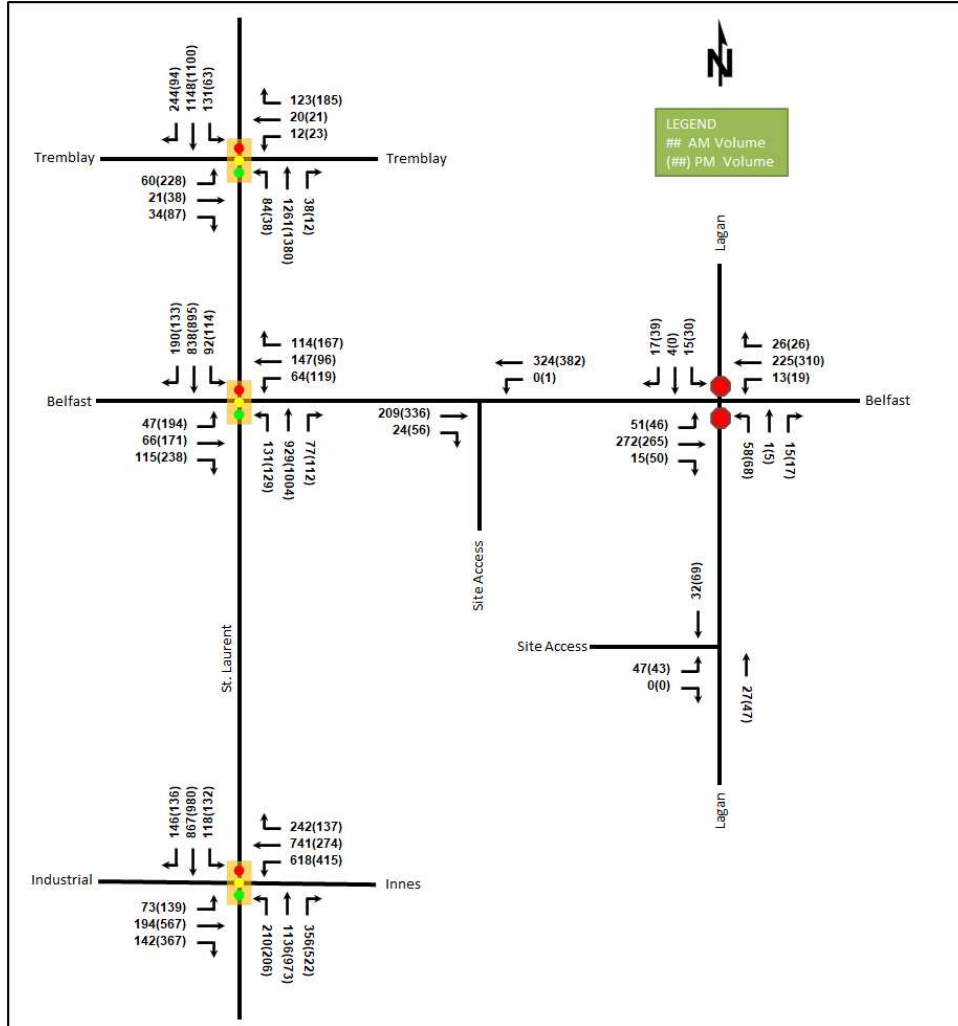

Table 18: 2031 Future Total Intersection Operations

Intersection	Lane	AM Peak Hour				PM Peak Hour			
		LOS	V/C	Delay	Q (95 th)	LOS	V/C	Delay	Q (95 th)
St-Laurent Blvd at Tremblay Rd <i>Signalized</i>	EBL	B	0.63	78.9	26.3	F	1.03	112.2	#106.4
	EBT/R	A	0.24	24.1	14.9	A	0.26	13.6	21.5
	WBL/T	A	0.08	45.5	7.7	A	0.07	32.7	10.6
	WBR	A	0.50	17.0	21.1	A	0.38	9.1	23.0
	NBL	A	0.29	15.3	26.0	A	0.18	20.3	m8.0
	NBT/R	A	0.45	12.0	92.7	A	0.55	18.8	m89.3
	SBL	A	0.42	8.7	18.7	A	0.28	11.9	10.8
	SBT	A	0.48	7.3	96.4	A	0.56	15.0	92.9
	SBR	A	0.24	1.4	8.6	A	0.11	2.2	6.2
Overall	A	0.53	11.3	-	C	0.74	22.7	-	
St-Laurent Blvd at Belfast Rd <i>Signalized</i>	EBL	A	0.24	30.0	15.9	E	0.96	89.7	#70.1
	EBT	A	0.13	28.5	20.5	A	0.36	34.0	46.5
	EBR	A	0.27	6.5	12.3	A	0.44	8.8	24.1
	WBL	A	0.33	45.1	25.8	B	0.68	65.1	43.9
	WBT/R	D	0.88	69.4	#93.1	D	0.82	55.4	70.8
	NBL	A	0.42	16.4	24.6	A	0.42	16.1	24.6
	NBT	A	0.59	25.7	114.1	B	0.63	26.4	124.8
	NBR	A	0.11	0.8	1.3	A	0.17	3.1	7.8
	SBL	A	0.35	15.8	18.1	A	0.47	23.3	29.0
	SBT	A	0.55	25.2	100.9	A	0.56	19.4	61.7
	SBR	A	0.29	4.2	13.4	A	0.18	3.1	7.5
	Overall	B	0.63	26.5	-	C	0.75	28.8	-
Lagan Way at Belfast Rd <i>Unsignalized</i>	EB	A	0.04	8.1	0.8	A	0.04	8.5	0.8
	WB	A	0.01	8.2	0.0	A	0.02	8.0	0.0
	NB	C	0.24	20.2	6.8	C	0.29	21.2	9.0
	SB	B	0.08	13.9	2.3	C	0.17	15.3	4.5
	Overall	A	-	3.5	-	A	-	4.0	-
St-Laurent Blvd at Industrial Ave / Innes Rd <i>Signalized</i>	EBL	A	0.39	68.5	18.1	A	0.52	64.4	30.7
	EBT	A	0.47	57.7	35.1	D	0.81	57.5	101.0
	EBR	A	0.41	6.0	8.2	B	0.67	15.4	48.2
	WBL	E	0.93	76.4	#120.0	C	0.75	59.1	73.3
	WBT	C	0.78	51.2	113.1	A	0.28	34.1	40.7
	WBR	A	0.42	6.2	18.0	A	0.26	6.3	14.4
	NBL	B	0.68	71.4	42.2	A	0.60	62.5	41.3
	NBT	E	0.92	54.1	#252.6	E	0.95	61.8	#199.1
	NBR	A	0.49	10.1	45.0	B	0.68	11.5	56.8
	SBL	A	0.50	69.0	26.1	A	0.50	63.4	28.8
	SBT	C	0.74	44.7	#176.3	F	1.03	81.6	#214.6
	SBR	A	0.26	3.6	9.0	A	0.25	3.8	9.1
Overall	E	0.93	47.7	-	D	0.85	51.5	-	
Lagan Way at Site Access <i>Unsignalized</i>	EBL/R	A	0.05	9.0	1.5	A	0.05	9.3	1.5
	NBL/T	-	-	-	-	-	-	-	-
	SBT/R	-	-	-	-	-	-	-	-
	Overall	A	-	4.0	-	A	-	2.5	-

Notes: Saturation flow rate of 1800 veh/h/lane
Queue is measured in metres
Peak Hour Factor = 1.00

Delay = average vehicle delay in seconds
m = metered queue
= volume for the 95th %ile cycle exceeds capacity

During both the AM and PM peak hours, the study area intersections at the 2031 future total horizon operate similarly to the 2031 future background conditions.

Similarly to in the future background conditions, at the intersection of St-Laurent Boulevard at Tremblay Road, shifting one second of split from the north-south phases to the east-west phases would reduce v/c of all movements at the intersection to 1.00 or lower.

At the intersection of St-Laurent Boulevard at Industrial Avenue/Innes Road, during the PM peak hour the southbound through movement may be subject to high delays with an increase of 3.6 seconds from the background conditions. Shifting two seconds of split from the northbound and southbound left-turn phases to the northbound and southbound through phases would reduce the v/c of all movements at the intersection to 1.00 or lower at this horizon.

7.5 Modal Share Sensitivity and Demand Rationalization Conclusions

7.5.1 Network Rationalization

No capacity issues were noted at the study area intersections that could not be mitigated through minor readjustments to signal timing phase splits. It is also noted that the future St Laurent Transit Priority improvements may increase transit adoption, reducing the network auto dependency. Therefore, no rationalization for background travel demand is required for this study.

7.5.2 Development Rationalization

The mode shares used within the TIA represent the unmodified district mode shares for Alta Vista. The selected mode shares and resultant site trip generation was found to have minor impact on the network. As in the background conditions, no capacity issues were noted at the study area intersections that could not be mitigated through minor readjustments to signal timing phase splits. Therefore, no further rationalization for site traffic or modal share selection is required.

8 Development Design

8.1 Design for Sustainable Modes

The proposed development is comprised of one mixed use building and one residential building separated by a one-way drive aisle with surface parking. Hard surface connections are provided between the building entrances and the surrounding sidewalks and internal pedestrian walkways and park. Bicycle parking is located in secure rooms on the main floor, within the underground parking levels and in surface racks interspersed around the site. Stops for the bus routes discussed in Section 2.2.5 are within 400 metres walking distance of all building entrances.

The infrastructure TDM Checklist is provided in Appendix K.

8.2 Circulation and Access

Access is provided via a one-way drive aisle from Belfast Road to Lagan Way. Garbage collection will occur on-site, and emergency services can circulate the site via the 6.0-metre-wide internal drive aisle with 12.0-metre centreline radius on the 90-degree bend in the aisle.

9 Parking

9.1 Parking Supply

The site is to provide 362 vehicle parking spaces including 30 visitor and 11 retail vehicle spaces. A total of 355 bicycle parking spaces are to be provided internal to the building across the parking levels and the main floor, and 39 spaces are to be provided in surface racks throughout the site.

While the site is located within Area C of Schedule 1A, Area B is located directly on the opposite side of St Laurent Boulevard and is considered to be applicable for the parcels directly fronting on the east side of St Laurent Boulevard. As such, the zoning by-law requires a minimum tenant vehicle parking of 212 (0.5 spaces/dwelling unit) resident parking spaces, minimum visitor vehicle parking of 60 spaces (0.2 spaces/dwelling unit to a max of 60), the minimum retail vehicle parking of 13 spaces (2.5 per 100 m² of GFA) and the minimum bicycle parking is 212 spaces.

The current allocation of spaces noted on the site plan do not meet the minimum visitor or retail parking space minimums, the tenant parking exceeds the minimum and can be re-allocated to meet each land use requirement. Therefore, the site is considered to meet the minimum parking requirements.

10 Boundary Street Design

Table 19 summarizes the MMLOS analysis for the boundary streets of St-Laurent Boulevard, Belfast Road, and Lagan Way. Where the existing and future conditions will be the same, they are considered in one row. The boundary street analysis is based on the land use designation of “Arterial Mainstreet” for St-Laurent Boulevard, and “Employment Area” for Belfast Road and Lagan Way. The MMLOS worksheets has been provided in Appendix L.

Table 19: Boundary Street MMLOS Analysis

Segment	Horizon	Pedestrian LOS		Bicycle LOS		Transit LOS		Truck LOS	
		PLOS	Target	BLOS	Target	TLOS	Target	TrLOS	Target
St-Laurent Blvd	Ex./Fut.	C	C	F	C	D	D	A	D
Belfast Rd	Ex./Fut.	E	C	F	C	-	-	B	B
Lagan Way	Ex.	F	C	D	-	-	-	-	-
	Fut.	B	C	D	-	-	-	-	-

Belfast Road and the existing configuration of Lagan Way do not meet the pedestrian MMLOS targets. To meet the PLOS target along the segment of Belfast Road, operating speed would need to be lower than 50 km/h or at least two metres of boulevard width would need to be provided. This treatment would be inconsistent with the urban setting and the remainder of the Belfast Road corridor on both sides of St-Laurent Boulevard. PLOS targets will be met in the future on Lagan Way with the planned provision of a sidewalk.

The bicycle LOS targets will not be met along St. Laurent Boulevard and Belfast Road. To meet the theoretical bicycle LOS targets, curbside bike lanes would be required to be provided on both boundary streets. Bicycle infrastructure is best implemented in a corridor-wide approach, which are the responsibility of the City. The St-Laurent Boulevard Transit Priority Corridor EA Study is exploring improvements to all travel modes within the corridor, including cycling. No local improvements are recommended.

11 Access Intersections Design

11.1 Location and Design of Access

Access is proposed via a one-way drive aisle with an inbound access on Belfast Road and an outbound access on Lagan Way. The driveways are proposed to be 6.0 metres in width.

The throat length of the inbound access on Belfast Road is approximately 10 metres, and the throat length of the outbound access on Lagan Way is approximately 20 metres. A minimum throat length of 8 metres would be recommended for these locations and are satisfied by the site plan.

The access on Belfast Road is approximately 35 metres from the St-Laurent Boulevard at Belfast Road intersection and access on Lagan Way is approximately 47 metres from the Lagan Way at Belfast Road intersection. The TAC Geometric Design Guidelines' suggested minimum corner clearance is 15 metres for the accesses on Belfast Road and Lagan Way which are proposed to be met by the site plan.

11.2 Intersection Control

Based upon the projected volumes and functions, the access on Belfast Road, which is inbound only will be uncontrolled, and the access on Lagan Way, which is outbound only, will have stop-control on the minor site access approach.

11.3 Access Intersection Design

11.3.1 Future Access Intersection Operations

The operations are noted in Section 7.4 and both 2026 and 2031 future total horizons, the access intersection at Lagan Way operates well with all movements and the overall intersection operating at LOS A. As the access intersection on Belfast Road is inbound only, no operational issues are anticipated.

11.3.2 Access Intersection MMLOS

As the access intersections are unsignalized, MMLOS analysis is possible or required.

11.3.3 Recommended Design Elements

The proposed site accesses on both Belfast Road and Lagan Way are recommended to be constructed in compliance with City standard SC7.1, including a continuous sidewalk through a depressed curb.

12 Transportation Demand Management

12.1 Context for TDM

The mode shares used within the TIA represent the unmodified recommended shares for the Alta Vista TRANS district. Overall, the modal shares are likely to be achieved and supporting TDM measures should be provided to encourage shifts towards sustainable modes.

12.2 Need and Opportunity

The subject site has been assumed to rely predominantly on auto travel and transit, and those assumptions have been carried through the analysis. The unmodified district mode shares have been applied, risks to other network users from failing to meet mode share targets are low.

12.3 TDM Program

The "suite of post occupancy TDM measures" has been summarized in the TDM checklists. The checklist is provided in Appendix K. The key TDM measures recommended include:

- Display local area maps with walking and cycling routes, and transit route information and schedules at major entrances
- Inclusion of a 6-month Presto card for first time new condo purchase or apartment rental, with a set time frame for this offer (e.g. 6-months) from the initial opening of the site
- Unbundle parking cost from purchase/rental costs

13 Neighbourhood Traffic Management

The proposed development will connect to the arterial network via Belfast Road (a local road) and Lagan Way (a local road). The TIA guidelines have outlined thresholds for two-way traffic on local road of 120 vehicles per peak hour. Notably, City staff has acknowledged that these thresholds are too low for the purposes of this and that they are under review for future update.

In general, Belfast Road is anticipated to convey between 554 to 771 vehicles during the peak hours, and Lagan Way will range between 104 to 158 vehicles during the peak hours. The amount of access Belfast Road provides for industrial and employment land uses is high and, given this context, the application of local road volume thresholds for traffic calming is considered inappropriate.

Further to the limited applicability of this framework to these land use contexts, Lagan Way south of Belfast Road is no-exit and is only approximately 175 metres in length and is exceeding local road thresholds. Therefore, no impacts to the existing function or classifications of the roads are forecast by the addition of site traffic, and no traffic management would be considered appropriate for the area context.

14 Transit

14.1 Route Capacity

In Section 5.1 the trip generation by mode was estimated, including an estimate of the number of transit trips that will be generated by the proposed development. Table 20 summarizes the transit trip generation.

Table 20: Trip Generation by Transit Mode

Travel Mode	Residential Mode Share AM(PM)	AM Peak Hour			PM Peak Hour		
		In	Out	Total	In	Out	Total
Transit	41%(28%)	24	52	76	30	22	52

The proposed development is anticipated to generate an additional 76 AM and 52 PM peak hour two-way transit trips. From the trip distribution found in section 5.3, these values can be further broken down, where trips east and west can be made through the connection to the LRT Confederation Line approximately a 1.5-kilometre bus trip north of the site. Table 21 summarizes forecasted site-generated transit ridership trips by direction and the equivalent bus loads.

Table 21: Forecasted Site-Generated Transit Ridership

Direction	AM Peak Hour		PM Peak Hour		Service Type	Approximate Equivalent Peak Hour/Direction Bus Loads
	In	Out	In	Out		
North	4	8	5	3	Bus	Negligible
South	8	18	11	8	Bus	One-third of a standard bus
East	1	3	2	1	Bus, Bus/LRT	Negligible
West	11	23	14	10	Bus, Bus/LRT	Half of a standard bus

14.2 Transit Priority

Increases in outbound transit ridership during the AM peak hour is equivalent to a single standard bus load over the hour and is not anticipated to impact the current or future transit priority corridor on St-Laurent Boulevard. No changes to transit LOS on any study area intersection approaches are resultant from the addition of site vehicle traffic to the network. The site will accommodate the space anticipated for the future St-Laurent transit priority lanes and cross-sectional elements through the reserved right-of-way on the St-Laurent Boulevard frontage.

15 Network Intersection Design

15.1 Network Intersection Control

No change to the existing signalized control is recommended for the network intersections.

15.2 Network Intersection Design

15.2.1 Future Total Network Intersection Operations

The operations are noted in Section 7.3 and 7.4. No capacity issues were noted that could not be mitigated through signal timing optimization.

15.2.2 Network Intersection MMLOS

Table 22 summarizes the MMLOS analysis for the network intersections. The existing and future conditions for the intersections will be the same and are considered in one row. The intersection analysis is based on the policy area of “Within 600m of a rapid transit station” for the intersection of St-Laurent Boulevard at Tremblay Road, and on the land use designation of “Arterial Mainstreet” for the intersections of St-Laurent Boulevard at Belfast Road and St-Laurent Boulevard at Industrial Avenue/Innes Road. The MMLOS worksheets has been provided in Appendix L.

Table 22: Study Area Intersection MMLOS Analysis

Intersection	Pedestrian LOS		Bicycle LOS		Transit LOS		Truck LOS		Auto LOS	
	PLOS	Target	BLOS	Target	TLOS	Target	TrLOS	Target	ALOS	Target
St-Laurent Boulevard at Tremblay Road	F	A	F	B	F	D	C	D	C	E
St-Laurent Boulevard at Belfast Rd	F	C	F	C	F	B	C	D	C	D
St-Laurent Blvd at Industrial Ave/Innes Rd	F	C	F	C	F	B	A	D	E	D

The pedestrian LOS targets will not be met at the study area intersections. As typical for arterial roads, the crossing distance does not permit the targets to be met. To meet pedestrian LOS targets, the maximum crossing distance on all pedestrian crossings would need to be reduced to two lane-widths for the intersection of St-Laurent Boulevard at Tremblay Road and three lane widths for the remaining intersections.

The bicycle LOS targets will not be met at the study area intersections. To meet bicycle LOS targets, the left-turn configurations would need to be two-stage or include turn boxes. It is noted that the St-Laurent TOD plan outlines dedicated cycling facilities along St Laurent Boulevard through Tremblay Road, and the intersection of St-Laurent Boulevard at Industrial Road/Innes Road has recently been reconstructed with a prototypical protected intersection design. With respect to cycling improvements at the intersection of St-Laurent Boulevard at Belfast Road, reconstructing the intersection for a protected intersection design would improve cycling conditions at the intersection. It is assumed that protected intersection design will be explored as part of the ongoing EA study.

The transit LOS will not be met at the study area intersections and the delay would need to be reduced to below 30 seconds, and auto LOS will not be met at the intersection of St-Laurent Boulevard at Industrial Avenue/Innes Road.

The City's planned and recent improvements at these intersections are expected to satisfy the City's desired balance of MMLOS tradeoffs in the future. No improvements are recommended as part of this study to address MMLOS.

15.2.3 Recommended Design Elements

No study area intersection design elements are proposed as part of this study.

16 Summary of Improvements Indicated and Modifications Options

The following summarizes the analysis and results presented in this TIA report:

Proposed Site and Screening

- The proposed site plan consists of a 25-storey mixed-use building with 235 dwelling units fronting St-Laurent Boulevard, a 20-storey residential building comprising 189 dwelling units on the east side of the parcel and a total of 507 m² of retail space
- Access is proposed via a one-way drive aisle with an inbound access on Belfast Road and an outbound access on Lagan Way
- Parking for 351 vehicles is to be provided on underground levels and 11 spaces within a surface lot
- Construction will occur in a single phase with an anticipated full build-out and occupancy horizon of 2026
- The trip generation and safety triggers were met for the TIA Screening

Existing Conditions

- St-Laurent Boulevard, Industrial Avenue, and Innes Road are arterial roads, and Tremblay Road and Belfast Road are collector roads in the study area
- Sidewalks are provided along both sides of St-Laurent Boulevard, Belfast Road east of the 940 Belfast Road parcel, and of Smyth Road, on the south side of Tremblay Road, and on the north side of Industrial Avenue
- MUPs are provided on the south side of Industrial Avenue and Innes Road
- Cycletracks are provided on each side of St-Laurent Boulevard south of Innes Road
- St-Laurent Boulevard, Industrial Avenue, and Innes Road are spine routes, and Belfast Road and Tremblay Road east of St-Laurent Boulevard are local routes
- The intersection of Belfast Road at St-Laurent Boulevard is noted to have experienced a high incidence of collisions which may be influenced by the four right-turn channels at the intersection, by the interaction with the bus movements with intersection bus stops, and by congestion
- During both the AM and PM peak hours, capacity issues are noted on individual movements, but the network intersections typically operate adequately
- Signal timing adjustment would reduce v/c of all movements within the study area to 1.00 or below
- A transit priority EA study is presently ongoing for St-Laurent Boulevard north of Innes Road through the study area which is presently engaging in consultation and has no recommendations

Development Generated Travel Demand

- A total of 65 AM and 83 PM new peak hour two-way vehicle trips are projected as a result of the proposed development

- Unmodified recommended district mode shares have been applied to the development traffic including a 38% AM and 45% PM peak period auto mode share for the residential dwellings
- Of the forecasted trips, 15 % are anticipated to travel north, 35% travel south, 5% travel east, and 45 % travel west

Background Conditions

- The background developments were explicitly included in the background conditions, along with a total background growth applied to Tremblay Road, Industrial Avenue, and St-Laurent Boulevard along the mainline volumes and major turning movements
- During both the AM and PM peak hours, the study area intersections at the future background conditions operate similarly to the existing conditions
- No capacity issues were noted at the study area intersections that could not be mitigated through minor readjustments to signal timing phase splits
- The St-Laurent Transit Priority improvements may increase transit adoption in the future, reducing the network auto dependency
- No rationalization for background travel demand is required for this study

Development Design

- Hard surface connections are provided between the building entrances and the surrounding sidewalks and internal pedestrian walkways and park
- Bicycle parking is located in secure rooms on the main floor and within the underground parking levels, and in surface racks interspersed around the site
- Garbage collection will occur on-site, and emergency services can circulate the site via the 6.0-metre-wide internal drive aisle with 12.0-metre centreline radius on the 90-degree bend in the aisle

Parking

- The site is to provide 362 vehicle parking spaces including 30 visitor and 11 retail vehicle spaces
- A total of 355 bicycle parking spaces are to be provided internal to the building across the parking levels and the main floor, and 39 spaces are to be provided in surface racks throughout the site
- The total parking meets the required minimums for a parcel fronting St-Laurent Boulevard, and can be re-allocated to meet each land use requirement and thus no further review is required as part of this study

Boundary Street Design

- Belfast Road and the existing configuration of Lagan Way do not meet the pedestrian MMLOS targets
- PLOS targets will be met in the future on Lagan Way with the planned provision of a sidewalk
- Operating speed lower than 50 km/h or at least 2 metres of boulevard width would need to be provided along Belfast Road to meet the PLOS targets, and treatment would be inconsistent with the urban setting and the remainder of the Belfast Road corridor on both sides of St-Laurent Boulevard
- The bicycle LOS targets will not be met along St. Laurent Boulevard and Belfast Road, and curbside bike lanes would be required to be provided on both boundary streets to meet targets
- Bicycle infrastructure is best implemented in a corridor-wide approach, which are the responsibility of the City, and cycling improvements will be explored as part of the St-Laurent Boulevard Transit Priority Corridor EA Study
- No local improvements are recommended

Access Intersections Design

- Access is proposed via a one-way drive aisle with an inbound access on Belfast Road and an outbound access on Lagan Way, each proposed to be 6.0 metres in width
- The throat length of the inbound access on Belfast Road is approximately 10 metres, and the throat length of the outbound access on Lagan Way is approximately 20 metres which exceed the recommended eight metres
- The access on Belfast Road is approximately 35 metres from the St-Laurent Boulevard at Belfast Road intersection and access on Lagan Way is approximately 47 metres from the Lagan Way at Belfast Road intersection which exceeds the suggested minimum corner clearance
- The inbound access on Belfast Road will be uncontrolled, and the outbound access on Lagan Way will have stop-control on the minor site access approach
- The proposed site accesses on both Belfast Road and Lagan Way are recommended to be constructed in compliance with City standard SC7.1, including a continuous sidewalk through a depressed curb

TDM

- Supportive TDM measures to be included within the proposed development should include:
 - Display local area maps with walking and cycling routes, and transit route information and schedules at major entrances
 - Inclusion of a 6-month Presto card for first time new condo purchase or apartment rental, with a set time frame for this offer (e.g. 6-months) from the initial opening of the site
 - Unbundle parking cost from purchase/rental costs

NTM

- The proposed development will connect to the arterial network via Belfast Road (a local road) and Lagan Way (a local road)
- In general, Belfast Road is anticipated to convey between 554 to 771 vehicles during the peak hours, and Lagan Way will range between 104 to 158 vehicles during the peak hours
- The amount of access Belfast Road provides for industrial and employment land uses is high, and the application of local road volume thresholds for traffic calming is considered inappropriate, as supported by the observation that Lagan Way south of Belfast Road is no-exit and is only approximately 175 metres and is exceeding local road thresholds
- No impacts to the existing function or classifications of the roads is forecast by the addition of site traffic, and no traffic management would be considered appropriate for the area context

Transit

- The proposed development is anticipated to generate an additional 76 AM and 52 PM peak hour two-way transit trips
- Peak hour increases in transit ridership resulting from the site equate to one-third of a standard bus load southerly of the site, half of a standard bus load westerly of the site, and negligible impact northerly and easterly
- Increases in outbound transit ridership during the AM peak hour is equivalent to a single standard bus load over the hour and is not anticipated to impact the existing or future transit priority corridor on St-Laurent Boulevard

- No changes to transit LOS on any study area intersection approaches are resultant from the addition of site vehicle traffic to the network
- The future transit priority corridor requirements will be accommodated on site through the reserved right-of-way on the frontage

Network Intersection Design

- During both the AM and PM peak hours, the study area intersections at the future total conditions operate similarly to the future background conditions
- The mode shares used within the TIA represent the unmodified district mode shares for Alta Vista and the resultant site auto trips was found to have only minor impacts on the network
- Signal timing adjustment would reduce v/c of all movements within the study area to 1.00 or below at the future total horizons
- No rationalization for site traffic or modal share selection is required
- The pedestrian LOS targets will not be met at the study area intersections
- To meet pedestrian LOS targets, the maximum crossing distance on all pedestrian crossings would need to be reduced to two lane-widths for the intersection of St-Laurent Boulevard at Tremblay Road and three lane widths for the remaining intersections
- The bicycle LOS targets will not be met at the study area intersections
- The transit LOS will not be met at the study area intersections and the delay would need to be reduced to below 30 seconds
- The auto LOS will not be met at the intersection of St-Laurent Boulevard at Industrial Avenue/Innes Road
- The City’s planned and recent improvements at the study area intersections are expected to satisfy the City’s desired balance of MMLOS tradeoffs in the future
- No improvements are recommended as part of this study to address multimodal LOS

17 Conclusion

It is recommended that, from a transportation perspective, the proposed development applications proceed.

Prepared By:



John Kingsley, EIT
Transportation Engineering Intern

Reviewed By:



Andrew Harte, P.Eng.
Senior Transportation Engineer

Appendix A

TIA Screening Form and PM Certification Form

City of Ottawa 2017 TIA Guidelines
Step 1 - Screening Form

Date: 09-May-23
Project Number: 2023-053
Project Reference: 1531 St-Laurent

1.1 Description of Proposed Development	
Municipal Address	1531 St-Laurent Blvd
Description of Location	Southeast corner of the intersection of St-Laurent Blvd at Belfast Rd
Land Use Classification	Arterial Mainstreet (AM, AM[263])
Development Size	409 dwelling units, plus ground floor retail
Accesses	One inbound on Belfast Rd, one outbound on Lagan Wy
Phase of Development	Single
Buildout Year	2026
TIA Requirement	Full TIA Required

1.2 Trip Generation Trigger	
Land Use Type	Townhomes or apartments
Development Size	409 Units
Trip Generation Trigger	Yes

1.3 Location Triggers	
Does the development propose a new driveway to a boundary street that is designated as part of the City's Transit Priority, Rapid Transit or Spine Bicycle Networks?	No
Is the development in a Design Priority Area (DPA) or Transit-oriented Development (TOD) zone?	No
Location Trigger	No

1.4. Safety Triggers		
Are posted speed limits on a boundary street 80 km/hr or greater?	No	
Are there any horizontal/vertical curvatures on a boundary street limits sight lines at a proposed driveway?	No	
Is the proposed driveway within the area of influence of an adjacent traffic signal or roundabout (i.e. within 300 m of intersection in rural conditions, or within 150 m of intersection in urban/ suburban conditions)?	Yes	
Is the proposed driveway within auxiliary lanes of an intersection?	Yes	
Does the proposed driveway make use of an existing median break that serves an existing site?	No	
Is there is a documented history of traffic operations or safety concerns on the boundary streets within 500 m of the development?	Yes	High collisions at St-Laurent Blvd at Belfast Rd
Does the development include a drive-thru facility?	No	
Safety Trigger	Yes	



TIA Plan Reports

On 14 June 2017, the Council of the City of Ottawa adopted new Transportation Impact Assessment (TIA) Guidelines. In adopting the guidelines, Council established a requirement for those preparing and delivering transportation impact assessments and reports to sign a letter of certification.

Individuals submitting TIA reports will be responsible for all aspects of development-related transportation assessment and reporting, and undertaking such work, in accordance and compliance with the City of Ottawa's Official Plan, the Transportation Master Plan and the Transportation Impact Assessment (2017) Guidelines.

By submitting the attached TIA report (and any associated documents) and signing this document, the individual acknowledges that s/he meets the four criteria listed below.

CERTIFICATION

1. I have reviewed and have a sound understanding of the objectives, needs and requirements of the City of Ottawa's Official Plan, Transportation Master Plan and the Transportation Impact Assessment (2017) Guidelines;
2. I have a sound knowledge of industry standard practice with respect to the preparation of transportation impact assessment reports, including multi modal level of service review;
3. I have substantial experience (more than 5 years) in undertaking and delivering transportation impact studies (analysis, reporting and geometric design) with strong background knowledge in transportation planning, engineering or traffic operations; and
4. I am either a licensed¹ or registered² professional in good standing, whose field of expertise [check appropriate field(s)] is either transportation engineering or transportation planning .

1,2 License of registration body that oversees the profession is required to have a code of conduct and ethics guidelines that will ensure appropriate conduct and representation for transportation planning and/or transportation engineering works.

City Of Ottawa
Infrastructure Services and Community
Sustainability
Planning and Growth Management
110 Laurier Avenue West, 4th fl.
Ottawa, ON K1P 1J1
Tel. : 613-580-2424
Fax: 613-560-6006

Ville d'Ottawa
Services d'infrastructure et Viabilité des
collectivités
Urbanisme et Gestion de la croissance
110, avenue Laurier Ouest
Ottawa (Ontario) K1P 1J1
Tél. : 613-580-2424
Télécopieur: 613-560-6006

Dated at Ottawa this 20 day of September, 2018.
(City)

Name: Andrew Harte
(Please Print)

Professional Title: Professional Engineer

Signature of Individual certifier that s/he meets the above four criteria

Office Contact Information (Please Print)
Address: 6 Plaza Court
City / Postal Code: Ottawa / K2H 7W1
Telephone / Extension: (613) 697-3797
E-Mail Address: Andrew.Harte@CGHTransportation.com



Appendix B

Turning Movement Counts



Transportation Services - Traffic Services
Turning Movement Count - Peak Hour Diagram
ST. LAURENT BLVD @ TREMBLAY RD

Survey Date: Wednesday, January 30, 2019
 Start Time: 07:00

WO No: 38338
 Device: Miovision

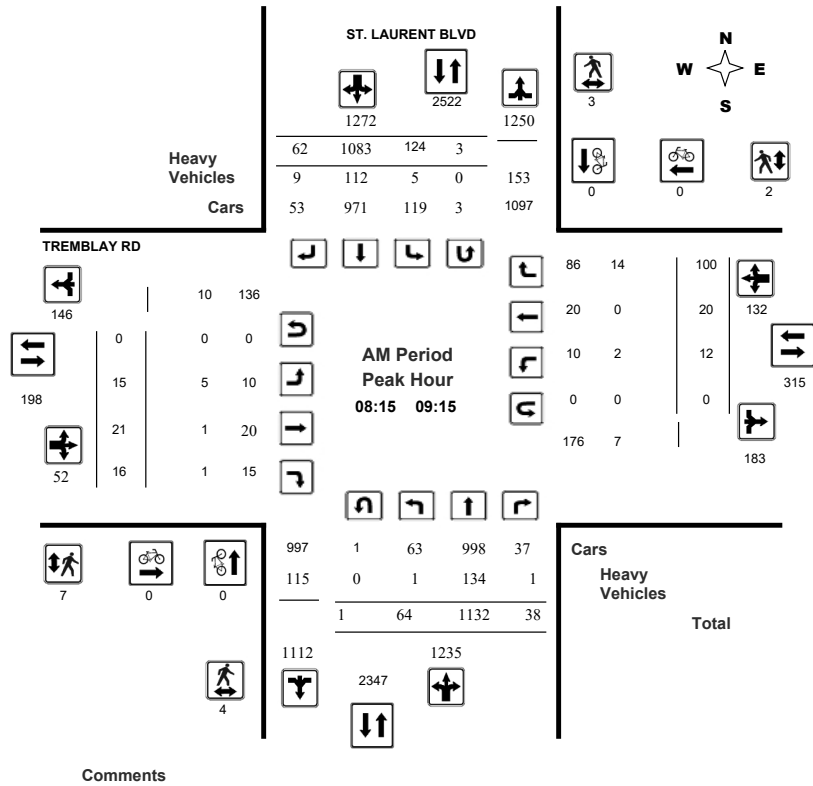

Transportation Services - Traffic Services
Turning Movement Count - Peak Hour Diagram
ST. LAURENT BLVD @ TREMBLAY RD

Survey Date: Wednesday, January 30, 2019
 Start Time: 07:00

WO No: 38338
 Device: Miovision

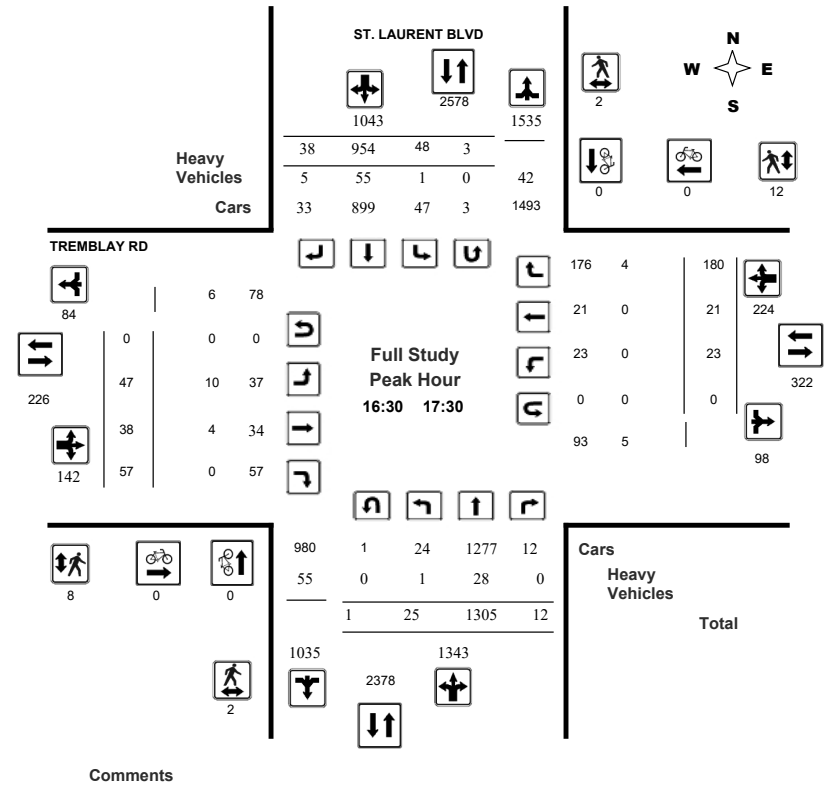



Transportation Services - Traffic Services
Turning Movement Count - Peak Hour Diagram
ST. LAURENT BLVD @ TREMBLAY RD

Survey Date: Wednesday, January 30, 2019
 Start Time: 07:00

WO No: 38338
 Device: Miovision

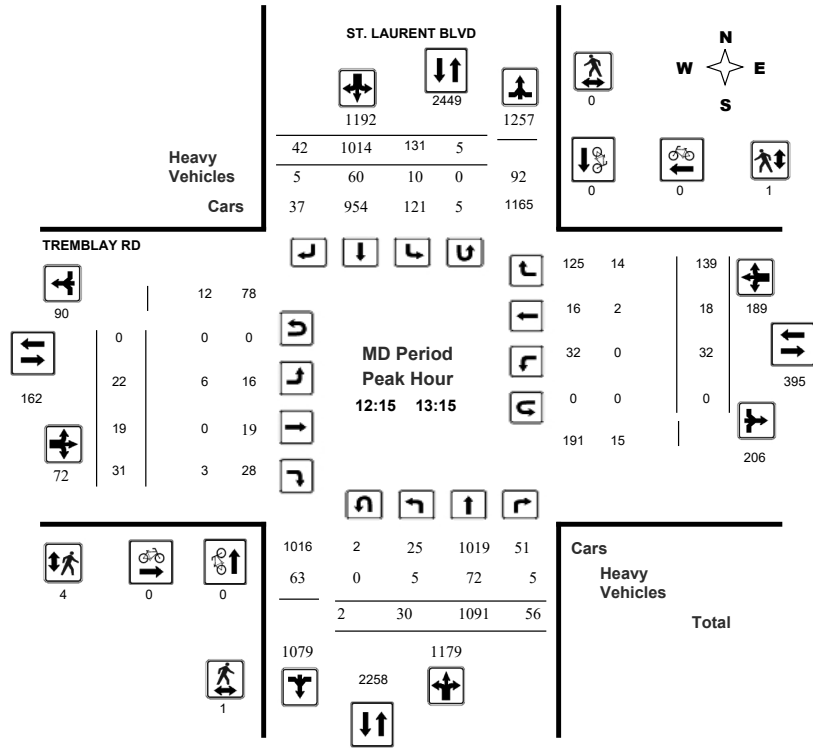

Comments



Transportation Services - Traffic Services
Turning Movement Count - Peak Hour Diagram
ST. LAURENT BLVD @ TREMBLAY RD

Survey Date: Wednesday, January 30, 2019
 Start Time: 07:00

WO No: 38338
 Device: Miovision

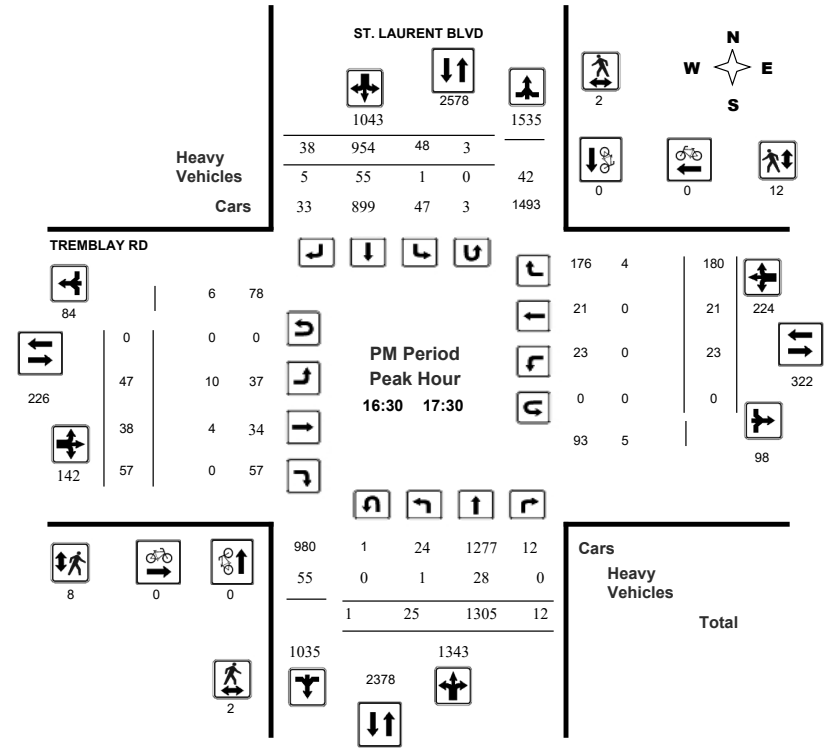

Comments



Transportation Services - Traffic Services W.O. 38338
Turning Movement Count - 15 Minute Summary Report

ST. LAURENT BLVD @ TREMBLAY RD

Survey Date: Wednesday, January 30, 2019

Total Observed U-Turns

Northbound: 8 Southbound: 38
 Eastbound: 0 Westbound: 0

Time Period	ST. LAURENT BLVD									TREMBLAY RD									Grand Total
	Northbound			Southbound			Eastbound			Westbound			W			STR			
	LT	ST	RT	N TOT	LT	ST	RT	S TOT	STR TOT	LT	ST	RT	E TOT	LT	ST	RT	W TOT	STR TOT	
07:00 07:15	3	159	9	171	42	228	12	283	454	5	6	5	16	5	2	14	21	37	491
07:15 07:30	10	189	6	205	42	234	14	290	495	2	7	3	12	1	1	13	15	27	522
07:30 07:45	9	228	9	246	45	241	14	300	546	6	5	4	15	5	10	23	38	53	599
07:45 08:00	12	251	5	268	39	275	18	334	602	8	7	3	18	2	6	18	26	44	646
08:00 08:15	14	277	11	302	22	235	18	275	577	4	5	8	17	7	5	20	32	49	626
08:15 08:30	13	294	10	317	26	279	14	319	636	2	6	5	13	5	1	23	29	42	678
08:30 08:45	17	283	12	313	29	270	23	322	635	3	4	2	9	3	6	26	35	44	679
08:45 09:00	18	303	7	328	31	271	12	316	644	5	5	6	16	1	5	32	38	54	698
09:00 09:15	16	252	9	277	38	263	13	315	592	5	6	3	14	3	8	19	30	44	636
09:15 09:30	4	212	4	221	24	271	18	313	534	3	9	3	15	3	3	17	23	38	572
09:30 09:45	5	222	5	232	32	252	8	295	527	7	5	5	17	5	3	18	26	43	570
09:45 10:00	4	199	5	208	39	252	7	300	508	8	3	6	17	1	7	22	30	47	555
11:30 11:45	5	237	7	250	21	248	7	277	527	11	4	4	19	7	5	30	42	61	588
11:45 12:00	8	258	8	274	34	250	15	302	576	7	2	6	15	7	7	43	57	72	648
12:00 12:15	9	241	8	258	33	223	10	267	525	8	4	11	23	19	7	39	65	88	613
12:15 12:30	10	272	14	297	25	283	16	325	622	3	0	7	10	8	5	32	45	55	677
12:30 12:45	6	277	16	300	36	237	12	285	585	4	4	7	15	9	4	37	50	65	650
12:45 13:00	6	257	12	275	39	263	7	312	587	9	8	10	27	6	6	32	44	71	658
13:00 13:15	8	285	14	307	31	231	7	270	577	6	7	7	20	9	3	38	50	70	647
13:15 13:30	8	239	6	253	27	244	12	285	538	5	1	6	12	6	6	33	45	57	595
15:00 15:15	9	295	2	307	31	219	14	266	573	7	4	5	16	11	8	59	78	94	667
15:15 15:30	5	316	6	327	22	226	4	253	580	8	4	4	16	7	5	40	52	68	648
15:30 15:45	9	307	6	322	19	190	9	218	540	10	6	11	27	7	5	47	59	86	626
15:45 16:00	8	264	5	277	28	152	7	189	466	9	7	3	19	9	6	40	55	74	540
16:00 16:15	6	270	8	284	14	168	13	195	479	10	10	1	21	13	8	68	89	110	589
16:15 16:30	10	284	6	300	23	150	13	188	488	8	5	4	17	10	5	35	50	67	555
16:30 16:45	9	299	3	311	9	232	9	250	561	16	9	17	42	9	5	66	80	122	683
16:45 17:00	9	339	6	354	22	257	6	286	640	8	7	7	22	4	5	24	33	55	695
17:00 17:15	3	318	1	322	10	237	13	261	583	13	11	16	40	8	5	54	67	107	690
17:15 17:30	4	349	2	356	7	228	10	246	602	10	11	17	38	2	6	36	44	82	684
17:30 17:45	4	282	3	289	9	212	11	235	524	9	1	7	17	6	5	25	36	53	577
17:45 18:00	3	253	2	259	10	273	10	295	554	12	2	4	18	5	4	27	36	54	608
TOTAL:	264	8511	227	9010	859	7594	376	8867	17877	231	175	207	613	203	167	1050	1420	2033	19910

Note: U-Turns are included in Totals.

Comment:



Transportation Services - Traffic Services
Turning Movement Count - Cyclist Volume Report

Work Order
38338

ST. LAURENT BLVD @ TREMBLAY RD

Count Date: Wednesday, January 30, 2019

Start Time: 07:00

Time Period	ST. LAURENT BLVD			TREMBLAY RD			Grand Total
	Northbound	Southbound	Street Total	Eastbound	Westbound	Street Total	
07:00 08:00	0	0	0	0	0	0	0
08:00 09:00	0	0	0	0	0	0	0
09:00 10:00	1	0	1	0	0	0	1
11:30 12:30	0	0	0	0	0	0	0
12:30 13:30	0	0	0	0	0	0	0
15:00 16:00	0	0	0	0	0	0	0
16:00 17:00	0	0	0	0	0	0	0
17:00 18:00	0	0	0	0	0	0	0
Total	1	0	1	0	0	0	1

Comment:

Note: These volumes consists of bicycles only (no mopeds or motorcycles) and ARE NOT included in the Turning Movement Count Summary.



Transportation Services - Traffic Services

W.O.
38338

Turning Movement Count - Heavy Vehicle Report

ST. LAURENT BLVD @ TREMBLAY RD

Survey Date: Wednesday, January 30, 2019

ST. LAURENT BLVD										TREMBLAY RD										Grand Total
Northbound					Southbound					Eastbound					Westbound					
Time Period	LT	ST	RT	N TOT	LT	ST	RT	S TOT	STR TOT	LT	ST	RT	E TOT	LT	ST	RT	W TOT	STR TOT		
07:00 08:00	2	134	1	137	10	52	10	72	209	9	1	0	10	4	0	9	13	23	232	
08:00 09:00	2	124	1	127	3	80	11	94	221	4	1	1	6	4	0	15	19	25	246	
09:00 10:00	3	116	1	120	6	183	5	194	314	9	1	1	11	0	2	8	10	21	335	
11:30 12:30	2	66	1	69	8	68	8	84	153	8	0	5	13	1	0	11	12	25	178	
12:30 13:30	5	80	5	90	7	62	7	76	166	6	0	3	9	0	2	11	13	22	188	
15:00 16:00	4	112	0	116	10	74	5	89	205	7	1	3	11	3	2	6	11	22	227	
16:00 17:00	2	40	1	43	3	65	10	78	121	10	1	1	12	0	0	2	2	14	135	
17:00 18:00	0	27	0	27	3	47	4	54	81	9	4	0	13	1	0	4	5	18	99	
Sub Total	20	699	10	729	50	631	60	741	1470	62	9	14	85	13	6	66	85	170	1640	
U-Turns (Heavy Vehicles)	0	0	0	0	0	0	0	0	0	0	0	0	0	0	0	0	0	0	0	
Total	20	699	10	741	50	631	60	741	1470	62	9	14	85	13	6	66	85	170	1640	

Heavy Vehicles include Buses, Single-Unit Trucks and Articulated Trucks. Further, they ARE included in the Turning Movement Count Summary.



Transportation Services - Traffic Services

Work Order
38338

Turning Movement Count - Pedestrian Volume Report

ST. LAURENT BLVD @ TREMBLAY RD

Count Date: Wednesday, January 30, 2019

Start Time: 07:00

Time Period	NB Approach (E or W Crossing)	SB Approach (E or W Crossing)	Total	EB Approach (N or S Crossing)	WB Approach (N or S Crossing)	Total	Grand Total
07:00 07:15	0	1	1	0	6	6	7
07:15 07:30	0	0	0	0	1	1	1
07:30 07:45	1	0	1	2	4	6	7
07:45 08:00	1	0	1	1	1	2	3
07:00 08:00	2	1	3	3	12	15	18
08:00 08:15	0	0	0	0	0	0	0
08:15 08:30	1	0	1	0	0	0	1
08:30 08:45	0	0	0	1	0	1	1
08:45 09:00	3	1	4	3	1	4	8
08:00 09:00	4	1	5	4	1	5	10
09:00 09:15	0	2	2	3	1	4	6
09:15 09:30	0	0	0	1	4	5	5
09:30 09:45	0	0	0	0	0	0	0
09:45 10:00	0	0	0	1	2	3	3
09:00 10:00	0	2	2	5	7	12	14
11:30 11:45	0	0	0	0	1	1	1
11:45 12:00	0	1	1	0	1	1	2
12:00 12:15	0	0	0	0	0	0	0
12:15 12:30	0	0	0	0	0	0	0
11:30 12:30	0	1	1	0	2	2	3
12:30 12:45	0	0	0	1	0	1	1
12:45 13:00	1	0	1	1	1	2	3
13:00 13:15	0	0	0	2	0	2	2
13:15 13:30	0	1	1	0	1	1	2
12:30 13:30	1	1	2	4	2	6	8
15:00 15:15	0	0	0	1	2	3	3
15:15 15:30	1	4	5	2	2	4	9
15:30 15:45	0	1	1	0	3	3	4
15:45 16:00	0	1	1	1	0	1	2
15:00 16:00	1	6	7	4	7	11	18
16:00 16:15	0	1	1	0	3	3	4
16:15 16:30	1	0	1	1	2	3	4
16:30 16:45	2	0	2	3	5	8	10
16:45 17:00	0	1	1	2	4	6	7
16:00 17:00	3	2	5	6	14	20	25
17:00 17:15	0	0	0	1	1	2	2
17:15 17:30	0	1	1	2	2	4	5
17:30 17:45	0	1	1	2	1	3	4
17:45 18:00	0	0	0	0	1	1	1
17:00 18:00	0	2	2	5	5	10	12
Total	11	16	27	31	50	81	108

Comment:



Transportation Services - Traffic Services

Work Order
38338

Turning Movement Count - 15 Min U-Turn Total Report

ST. LAURENT BLVD @ TREMBLAY RD

Survey Date: Wednesday, January 30, 2019

Time Period	Northbound U-Turn Total	Southbound U-Turn Total	Eastbound U-Turn Total	Westbound U-Turn Total	Total
07:00 - 07:15	0	1	0	0	1
07:15 - 07:30	0	0	0	0	0
07:30 - 07:45	0	0	0	0	0
07:45 - 08:00	0	2	0	0	2
08:00 - 08:15	0	0	0	0	0
08:15 - 08:30	0	0	0	0	0
08:30 - 08:45	1	0	0	0	1
08:45 - 09:00	0	2	0	0	2
09:00 - 09:15	0	1	0	0	1
09:15 - 09:30	1	0	0	0	1
09:30 - 09:45	0	3	0	0	3
09:45 - 10:00	0	2	0	0	2
11:30 - 11:45	1	1	0	0	2
11:45 - 12:00	0	3	0	0	3
12:00 - 12:15	0	1	0	0	1
12:15 - 12:30	1	1	0	0	2
12:30 - 12:45	1	0	0	0	1
12:45 - 13:00	0	3	0	0	3
13:00 - 13:15	0	1	0	0	1
13:15 - 13:30	0	2	0	0	2
15:00 - 15:15	1	2	0	0	3
15:15 - 15:30	0	1	0	0	1
15:30 - 15:45	0	0	0	0	0
15:45 - 16:00	0	2	0	0	2
16:00 - 16:15	0	0	0	0	0
16:15 - 16:30	0	2	0	0	2
16:30 - 16:45	0	0	0	0	0
16:45 - 17:00	0	1	0	0	1
17:00 - 17:15	0	1	0	0	1
17:15 - 17:30	1	1	0	0	2
17:30 - 17:45	0	3	0	0	3
17:45 - 18:00	1	2	0	0	3
Total	8	38	0	0	46



Transportation Services - Traffic Services

Turning Movement Count - Study Results

BELFAST RD @ ST. LAURENT BLVD

Survey Date: Tuesday, February 06, 2018

WO No: 37494

Start Time: 07:00

Device: Miovision

Full Study Diagram

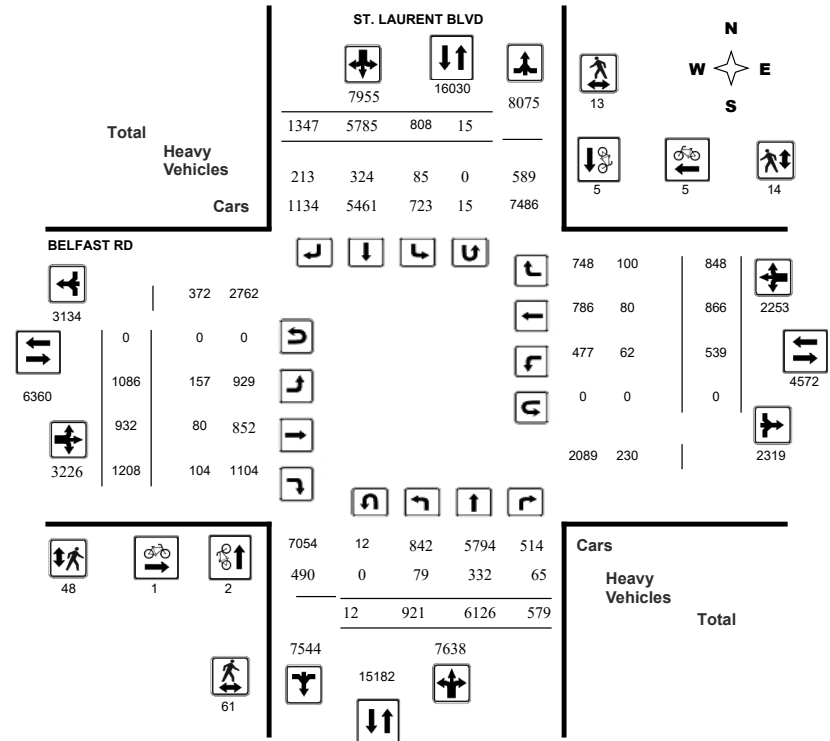



Transportation Services - Traffic Services

Turning Movement Count - Study Results

BELFAST RD @ ST. LAURENT BLVD

Survey Date: Tuesday, February 06, 2018

WO No: 37494

Start Time: 07:00

Device: Miovision

Full Study Peak Hour Diagram

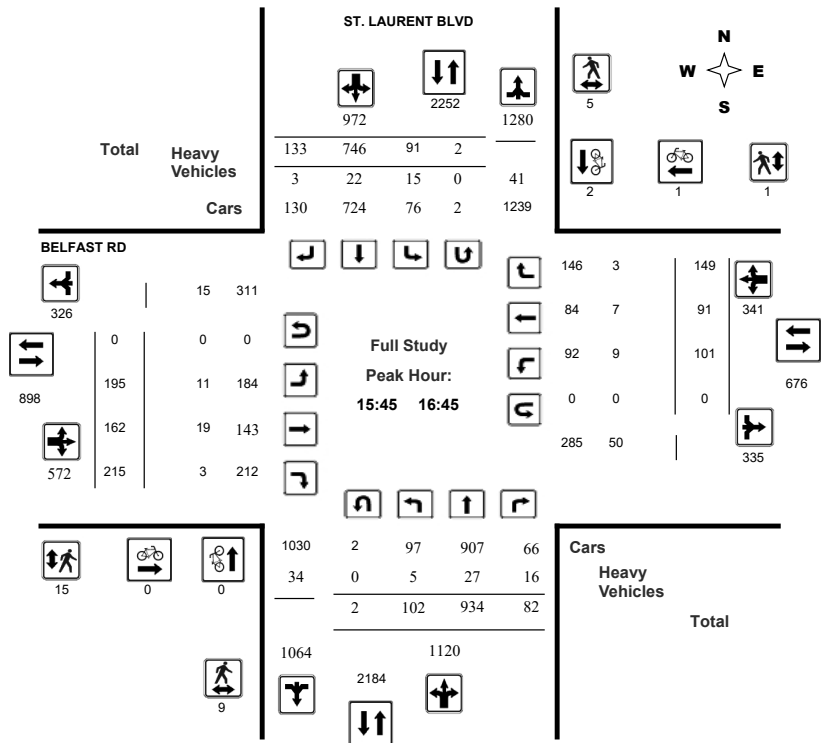

Transportation Services - Traffic Services

Turning Movement Count - Peak Hour Diagram

BELFAST RD @ ST. LAURENT BLVD

Survey Date: Tuesday, February 06, 2018

WO No: 37494

Start Time: 07:00

Device: Miovision

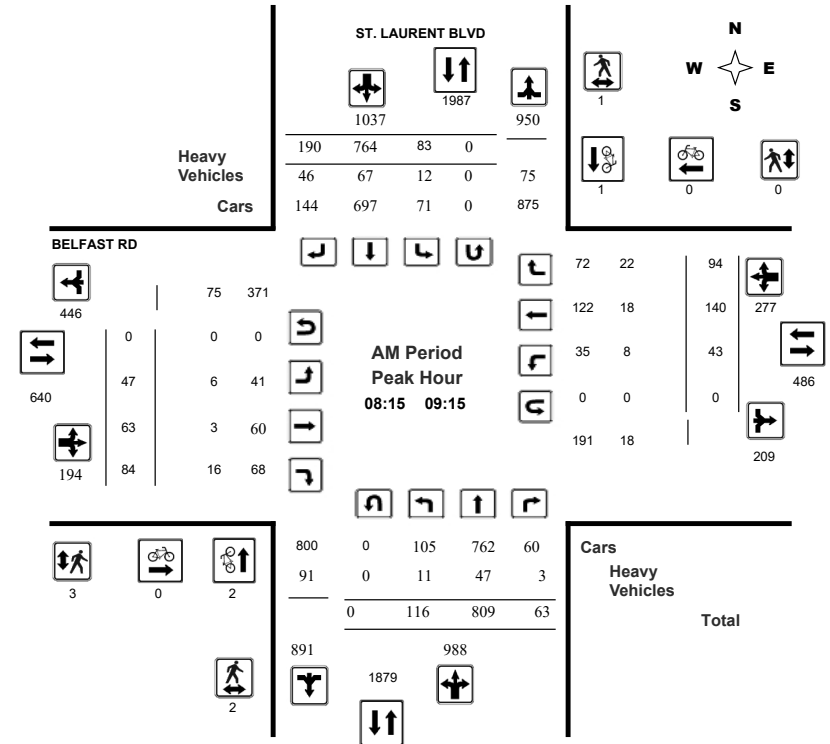

Comments



Transportation Services - Traffic Services

Turning Movement Count - Peak Hour Diagram

BELFAST RD @ ST. LAURENT BLVD

Survey Date: Tuesday, February 06, 2018
Start Time: 07:00

WO No: 37494
Device: Miovision

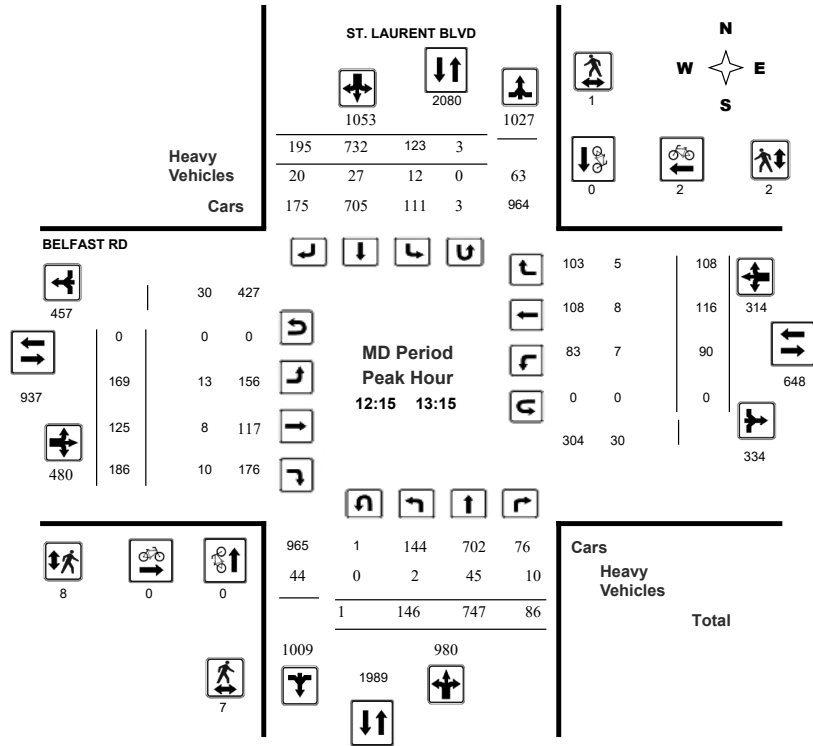

Transportation Services - Traffic Services

Turning Movement Count - Peak Hour Diagram

BELFAST RD @ ST. LAURENT BLVD

Survey Date: Tuesday, February 06, 2018
Start Time: 07:00

WO No: 37494
Device: Miovision

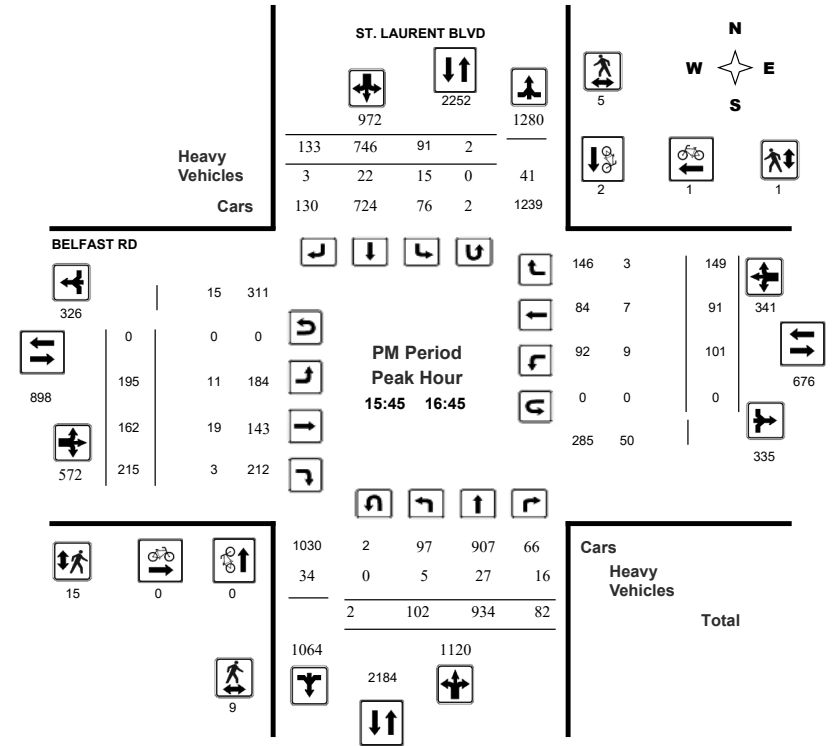



Transportation Services - Traffic Services

Turning Movement Count - Study Results

BELFAST RD @ ST. LAURENT BLVD

Survey Date: Tuesday, February 06, 2018

WO No: 37494

Start Time: 07:00

Device: Miovision

Full Study Summary (8 HR Standard)

Survey Date: Tuesday, February 06, 2018

Total Observed U-Turns AADT Factor

Northbound: 12 Southbound: 15 1.00

Eastbound: 0 Westbound: 0

Period	ST. LAURENT BLVD									BELFAST RD									WB TOT	STR TOT	Grand Total
	Northbound			Southbound			SB TOT	STR TOT	Eastbound			Westbound									
	LT	ST	RT	LT	ST	RT			LT	ST	RT	LT	ST	RT							
07:00 08:00	111	693	51	855	101	745	143	989	1844	69	75	102	246	33	101	94	228	474	2318		
08:00 09:00	116	848	66	1030	85	780	156	1021	2051	49	69	66	184	44	136	81	261	445	2496		
09:00 10:00	123	648	62	833	100	656	233	989	1822	80	91	115	286	47	125	91	263	549	2371		
11:30 12:30	154	661	97	912	143	722	202	1067	1979	172	128	175	475	80	120	111	311	786	2765		
12:30 13:30	139	754	79	972	112	722	194	1028	2000	152	122	177	451	85	111	108	304	755	2755		
15:00 16:00	103	843	65	1011	88	774	144	1006	2017	220	169	218	607	62	86	113	261	868	2885		
16:00 17:00	95	919	89	1103	87	714	129	930	2033	184	163	211	558	96	89	146	331	889	2922		
17:00 18:00	80	760	70	910	92	672	146	910	1820	160	115	144	419	92	98	104	294	713	2533		
Sub Total	921	6126	579	7626	808	5785	1347	7940	15566	1086	932	1208	3226	539	866	848	2253	5479	21045		
U Turns	12			12	15			15	27	0	0	0	0	0	0	0	0	0	27		
Total	933	6126	579	7638	823	5785	1347	7955	15593	1086	932	1208	3226	539	866	848	2253	5479	21072		
EQ 12Hr	1297	8515	805	10617	1144	8041	1872	11057	21674	1510	1295	1679	4484	749	1204	1179	3132	7616	29290		
Note: These values are calculated by multiplying the totals by the appropriate expansion factor.																			1.39		
AVG 12Hr	1297	8515	805	10617	1144	8041	1872	11057	21674	1510	1295	1679	4484	749	1204	1179	3132	7616	29290		
Note: These volumes are calculated by multiplying the Equivalent 12 hr. totals by the AADT factor.																			1.00		
AVG 24Hr	1699	11155	1055	13909	1499	10534	2452	14485	28394	1978	1696	2199	5873	981	1577	1544	4102	9975	38369		
Note: These volumes are calculated by multiplying the Average Daily 12 hr. totals by 12 to 24 expansion factor.																			1.31		
Note: U-Turns provided for approach totals. Refer to 'U-Turn' Report for specific breakdown.																					



Transportation Services - Traffic Services

Turning Movement Count - Study Results

BELFAST RD @ ST. LAURENT BLVD

Survey Date: Tuesday, February 06, 2018

WO No: 37494

Start Time: 07:00

Device: Miovision

Full Study 15 Minute Increments

Time Period	ST. LAURENT BLVD					BELFAST RD					W TOT	STR TOT	Grand Total						
	Northbound		Southbound		N TOT	Eastbound		Westbound											
	LT	ST	RT	LT		ST	RT	LT	ST	RT									
07:00 07:15		139	17			141	33		375		22	27		21	13		121	496	
07:15 07:30		175	6			174	39		455		16	25		22	24		104	559	
07:30 07:45		180	13			183	34		466		19	27		34	30		134	600	
07:45 08:00		199	15			247	37		549		18	23		24	27		115	664	
08:00 08:15		188	14			180	26		465		23	16		37	15		118	583	
08:15 08:30		222	15			199	34		516		14	16		30	27		103	619	
08:30 08:45		204	17			192	43		501		20	14		44	19		117	618	
08:45 09:00		234	20			209	53		569		12	20		25	20		107	676	
09:00 09:15		149	11			164	60		439		17	34		41	28		144	583	
09:15 09:30		184	17			166	66		488		15	20		23	18		108	596	
09:30 09:45		173	18			161	43		457		31	36		27	20		148	605	
09:45 10:00		142	16			165	64		440		28	25		34	25		149	589	
11:30 11:45		164	25			169	46		477		26	46		26	33		186	663	
11:45 12:00		163	21			170	50		480		32	39		34	20		193	673	
12:00 12:15		168	21			185	46		493		36	35		31	26		180	673	
12:15 12:30		166	30			198	60		536		34	55		29	32		227	763	
12:30 12:45		212	15			179	51		520		31	53		22	18		185	705	
12:45 13:00		194	22			161	44		492		29	36		29	27		179	671	
13:00 13:15		175	19			194	40		485		31	42		36	31		203	688	
13:15 13:30		173	23			188	59		507		31	46		24	32		188	695	
15:00 15:15		224	17			186	38		516		48	62		20	21		238	754	
15:15 15:30		217	18			210	36		528		34	60		23	23		216	744	
15:30 15:45		203	16			181	29		480		52	48		23	37		210	690	
15:45 16:00		199	14			197	41		497		35	48		20	32		204	701	
16:00 16:15		231	21			190	23		518		26	54		20	46		224	742	
16:15 16:30		267	27			193	30		565		48	69		24	30		247	812	
16:30 16:45		237	20			166	39		512		53	44		27	41		238	750	
16:45 17:00		184	21			165	37		441		36	44		18	29		180	621	
17:00 17:15		216	18			158	39		476		39	34		36	48		229	705	
17:15 17:30		172	19			181	39		450		34	48		32	22		209	659	
17:30 17:45		208	19			163	31		463		25	27		15	19		139	602	
17:45 18:00		164	14			170	37		437		17	35		15	15		136	573	
Total:	0	6126	579	0	0	5785	1347	0	15593	0	932	1208	0	0	866	848	0	15593	21,072

Note: U-Turns are included in Totals.



Transportation Services - Traffic Services

Turning Movement Count - Study Results

BELFAST RD @ ST. LAURENT BLVD

Survey Date: Tuesday, February 06, 2018

WO No: 37494

Start Time: 07:00

Device: Miovision

Full Study Cyclist Volume

Time Period	ST. LAURENT BLVD			BELFAST RD			Grand Total
	Northbound	Southbound	Street Total	Eastbound	Westbound	Street Total	
07:00 07:15	0	0	0	0	0	0	0
07:15 07:30	0	0	0	0	0	0	0
07:30 07:45	0	0	0	0	0	0	0
07:45 08:00	0	0	0	0	0	0	0
08:00 08:15	0	0	0	1	0	1	1
08:15 08:30	0	0	0	0	0	0	0
08:30 08:45	1	1	2	0	0	0	2
08:45 09:00	0	0	0	0	0	0	0
09:00 09:15	1	0	1	0	0	0	1
09:15 09:30	0	0	0	0	0	0	0
09:30 09:45	0	0	0	0	0	0	0
09:45 10:00	0	0	0	0	0	0	0
11:30 11:45	0	0	0	0	0	0	0
11:45 12:00	0	0	0	0	0	0	0
12:00 12:15	0	0	0	0	2	2	2
12:15 12:30	0	0	0	0	2	2	2
12:30 12:45	0	0	0	0	0	0	0
12:45 13:00	0	0	0	0	0	0	0
13:00 13:15	0	0	0	0	0	0	0
13:15 13:30	0	0	0	0	0	0	0
15:00 15:15	0	0	0	0	0	0	0
15:15 15:30	0	0	0	0	0	0	0
15:30 15:45	0	0	0	0	0	0	0
15:45 16:00	0	0	0	0	0	0	0
16:00 16:15	0	0	0	0	0	0	0
16:15 16:30	0	2	2	0	1	1	3
16:30 16:45	0	0	0	0	0	0	0
16:45 17:00	0	0	0	0	0	0	0
17:00 17:15	0	0	0	0	0	0	0
17:15 17:30	0	0	0	0	0	0	0
17:30 17:45	0	1	1	0	0	0	1
17:45 18:00	0	1	1	0	0	0	1
Total	2	5	7	1	5	6	13



Transportation Services - Traffic Services

Turning Movement Count - Study Results

BELFAST RD @ ST. LAURENT BLVD

Survey Date: Tuesday, February 06, 2018

WO No: 37494

Start Time: 07:00

Device: Miovision

Full Study Pedestrian Volume

Time Period	ST. LAURENT BLVD			BELFAST RD			Grand Total
	NB Approach (E or W Crossing)	SB Approach (E or W Crossing)	Total	EB Approach (N or S Crossing)	WB Approach (N or S Crossing)	Total	
07:00 07:15	2	0	2	1	1	2	4
07:15 07:30	0	1	1	1	0	1	2
07:30 07:45	1	1	2	0	1	1	3
07:45 08:00	1	0	1	1	2	3	4
08:00 08:15	2	1	3	1	0	1	4
08:15 08:30	2	0	2	3	0	3	5
08:30 08:45	0	0	0	0	0	0	0
08:45 09:00	0	1	1	0	0	0	1
09:00 09:15	0	0	0	0	0	0	0
09:15 09:30	0	0	0	3	0	3	3
09:30 09:45	1	0	1	1	0	1	2
09:45 10:00	3	0	3	0	0	0	3
11:30 11:45	2	0	2	2	3	5	7
11:45 12:00	0	0	0	3	0	3	3
12:00 12:15	5	0	5	4	1	5	10
12:15 12:30	0	1	1	2	0	2	3
12:30 12:45	2	0	2	2	2	4	6
12:45 13:00	1	0	1	1	0	1	2
13:00 13:15	4	0	4	3	0	3	7
13:15 13:30	4	1	5	0	2	2	7
15:00 15:15	2	1	3	0	1	1	4
15:15 15:30	3	0	3	2	0	2	5
15:30 15:45	0	0	0	0	0	0	0
15:45 16:00	4	0	4	2	0	2	6
16:00 16:15	2	3	5	7	0	7	12
16:15 16:30	0	1	1	5	1	6	7
16:30 16:45	3	1	4	1	0	1	5
16:45 17:00	4	0	4	0	0	0	4
17:00 17:15	8	0	8	1	0	1	9
17:15 17:30	2	0	2	0	0	0	2
17:30 17:45	1	1	2	2	0	2	4
17:45 18:00	2	0	2	0	0	0	2
Total	61	13	74	48	14	62	136



Transportation Services - Traffic Services

Turning Movement Count - Study Results

BELFAST RD @ ST. LAURENT BLVD

Survey Date: Tuesday, February 06, 2018

WO No: 37494

Start Time: 07:00

Device: Miovision

Full Study Heavy Vehicles

ST. LAURENT BLVD										BELFAST RD										Grand Total
Northbound					Southbound					Eastbound					Westbound					
Time Period	LT	ST	RT	N TOT	LT	ST	RT	S TOT	STR TOT	LT	ST	RT	E TOT	LT	ST	RT	W TOT	STR TOT		
07:00	07:15	0	12	0	3	16	0	31	21	3	15	5	4	2	50	81				
07:15	07:30	2	21	1	0	10	1	35	5	1	12	4	2	13	37	72				
07:30	07:45	1	13	2	1	9	0	26	4	0	5	3	5	15	32	58				
07:45	08:00	0	14	0	1	8	2	25	1	1	1	1	1	7	12	37				
08:00	08:15	0	16	1	2	8	1	28	1	0	1	2	5	2	11	39				
08:15	08:30	3	14	1	1	6	4	29	2	0	2	1	5	8	18	47				
08:30	08:45	2	10	0	0	21	9	42	0	1	3	2	5	4	15	57				
08:45	09:00	3	11	2	5	22	11	54	3	1	0	3	4	4	15	69				
09:00	09:15	3	12	0	6	18	22	61	1	1	11	2	4	6	25	86				
09:15	09:30	4	20	5	3	20	30	82	3	3	2	1	3	3	15	97				
09:30	09:45	7	13	2	0	23	27	72	3	6	3	2	6	1	21	93				
09:45	10:00	7	21	2	1	10	24	65	2	1	1	4	4	4	16	81				
11:30	11:45	6	7	5	3	16	7	44	1	1	3	3	2	2	12	56				
11:45	12:00	3	8	2	5	5	5	28	4	2	2	1	0	6	15	43				
12:00	12:15	2	6	2	5	9	6	30	1	4	1	1	3	2	12	42				
12:15	12:30	1	7	2	2	6	5	23	3	1	3	0	1	1	9	32				
12:30	12:45	0	17	0	3	9	5	34	3	0	6	1	2	2	14	48				
12:45	13:00	0	14	2	3	1	5	25	2	5	0	0	1	2	10	35				
13:00	13:15	1	7	6	4	11	5	34	5	2	1	6	4	0	18	52				
13:15	13:30	1	9	2	3	9	3	27	5	2	5	0	2	6	20	47				
15:00	15:15	2	11	1	4	10	4	32	32	7	10	0	0	2	51	83				
15:15	15:30	3	8	1	4	6	0	22	21	2	10	2	2	1	38	60				
15:30	15:45	3	7	4	3	8	1	26	14	4	2	2	2	1	25	51				
15:45	16:00	2	8	3	3	6	1	23	6	6	1	2	0	1	16	39				
16:00	16:15	2	3	4	6	4	1	20	0	2	0	3	2	1	8	28				
16:15	16:30	1	4	7	3	5	1	21	4	5	0	2	3	0	14	35				
16:30	16:45	0	12	2	3	7	0	24	1	6	2	2	2	1	14	38				
16:45	17:00	2	7	2	1	9	0	21	1	5	1	2	1	2	12	33				
17:00	17:15	3	9	2	0	7	5	26	1	3	1	0	2	0	7	33				
17:15	17:30	3	4	1	2	9	6	25	2	4	0	1	3	0	10	35				
17:30	17:45	3	5	1	3	10	10	32	1	0	0	2	0	1	4	36				
17:45	18:00	9	2	0	2	6	12	31	4	1	0	2	0	0	7	38				
Total:	None	79	332	65	0	85	324	213	0	1098	157	80	104	0	62	80	100	0	583	1,681



Transportation Services - Traffic Services

Turning Movement Count - Study Results

BELFAST RD @ ST. LAURENT BLVD

Survey Date: Tuesday, February 06, 2018

WO No: 37494

Start Time: 07:00

Device: Miovision

Full Study 15 Minute U-Turn Total

Time Period		ST. LAURENT BLVD		BELFAST RD		Total
Northbound U-Turn Total	Southbound U-Turn Total	Eastbound U-Turn Total	Westbound U-Turn Total			
07:00	07:15	0	0	0	0	0
07:15	07:30	0	0	0	0	0
07:30	07:45	0	1	0	0	1
07:45	08:00	0	0	0	0	0
08:00	08:15	0	0	0	0	0
08:15	08:30	0	0	0	0	0
08:30	08:45	0	0	0	0	0
08:45	09:00	0	0	0	0	0
09:00	09:15	0	0	0	0	0
09:15	09:30	1	0	0	0	1
09:30	09:45	0	0	0	0	0
09:45	10:00	1	0	0	0	1
11:30	11:45	0	2	0	0	2
11:45	12:00	1	0	0	0	1
12:00	12:15	1	2	0	0	3
12:15	12:30	0	1	0	0	1
12:30	12:45	0	0	0	0	0
12:45	13:00	1	1	0	0	2
13:00	13:15	0	1	0	0	1
13:15	13:30	1	0	0	0	1
15:00	15:15	0	0	0	0	0
15:15	15:30	1	1	0	0	2
15:30	15:45	1	0	0	0	1
15:45	16:00	0	1	0	0	1
16:00	16:15	0	1	0	0	1
16:15	16:30	1	0	0	0	1
16:30	16:45	1	0	0	0	1
16:45	17:00	0	0	0	0	0
17:00	17:15	1	0	0	0	1
17:15	17:30	0	2	0	0	2
17:30	17:45	1	1	0	0	2
17:45	18:00	0	1	0	0	1
Total		12	15	0	0	27



Transportation Services - Traffic Services

Turning Movement Count - Peak Hour Diagram

INDUSTRIAL AVE/INNES RD @ ST. LAURENT BLVD

Survey Date: Wednesday, January 30, 2019
Start Time: 07:00

WO No: 38336
Device: Miovision

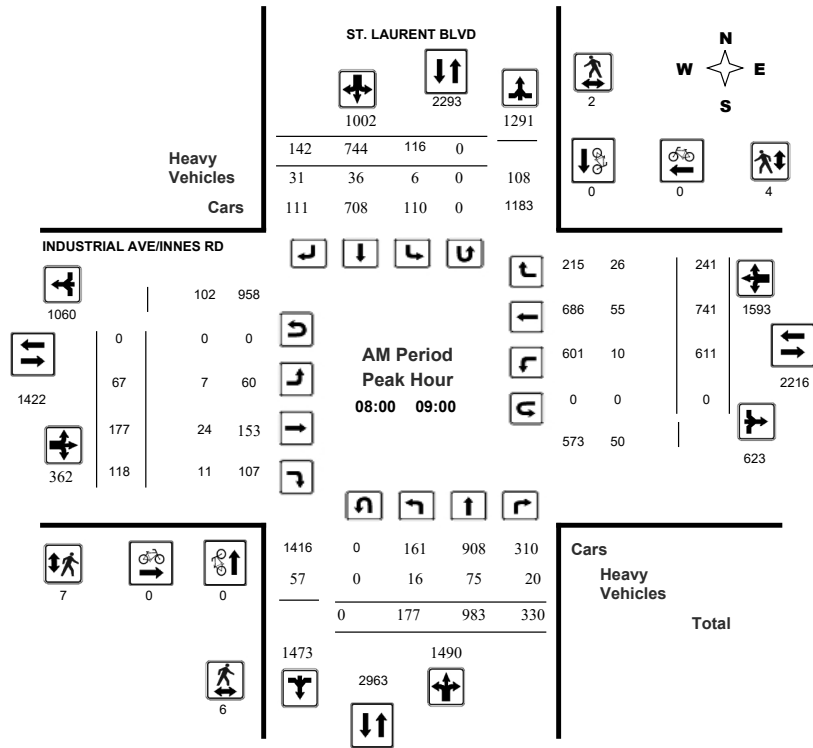

Comments



Transportation Services - Traffic Services

Turning Movement Count - Peak Hour Diagram

INDUSTRIAL AVE/INNES RD @ ST. LAURENT BLVD

Survey Date: Wednesday, January 30, 2019
Start Time: 07:00

WO No: 38336
Device: Miovision

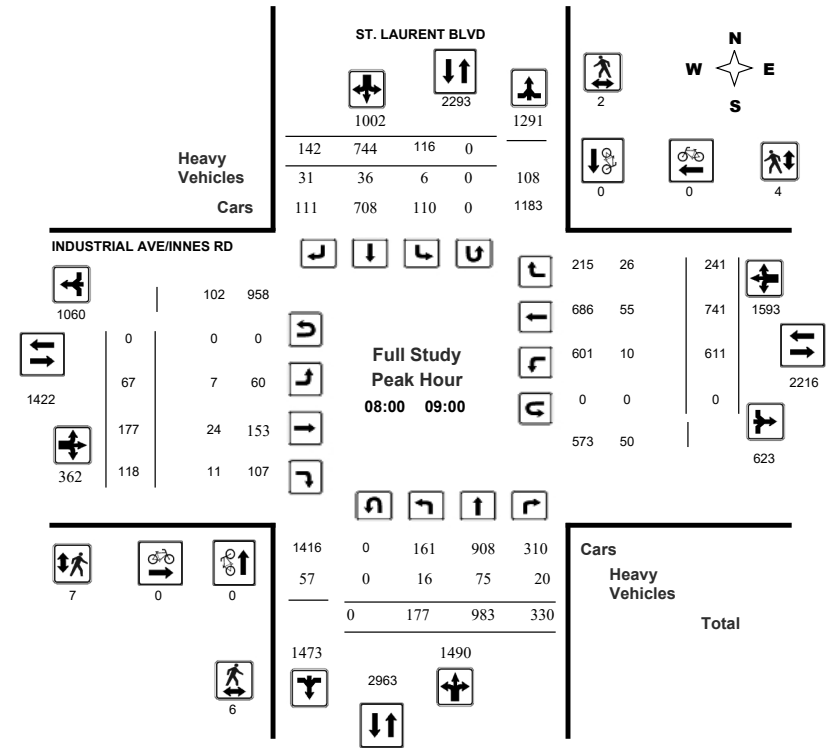

Comments



Transportation Services - Traffic Services

Turning Movement Count - Peak Hour Diagram

INDUSTRIAL AVE/INNES RD @ ST. LAURENT BLVD

Survey Date: Wednesday, January 30, 2019
Start Time: 07:00

WO No: 38336
Device: Miovision

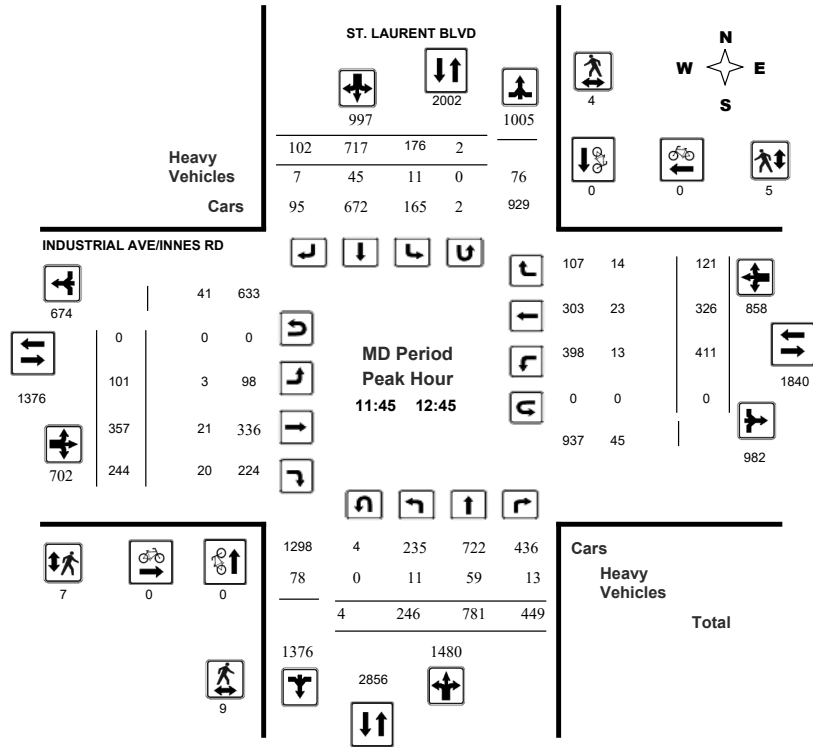

Transportation Services - Traffic Services

Turning Movement Count - Peak Hour Diagram

INDUSTRIAL AVE/INNES RD @ ST. LAURENT BLVD

Survey Date: Wednesday, January 30, 2019
Start Time: 07:00

WO No: 38336
Device: Miovision

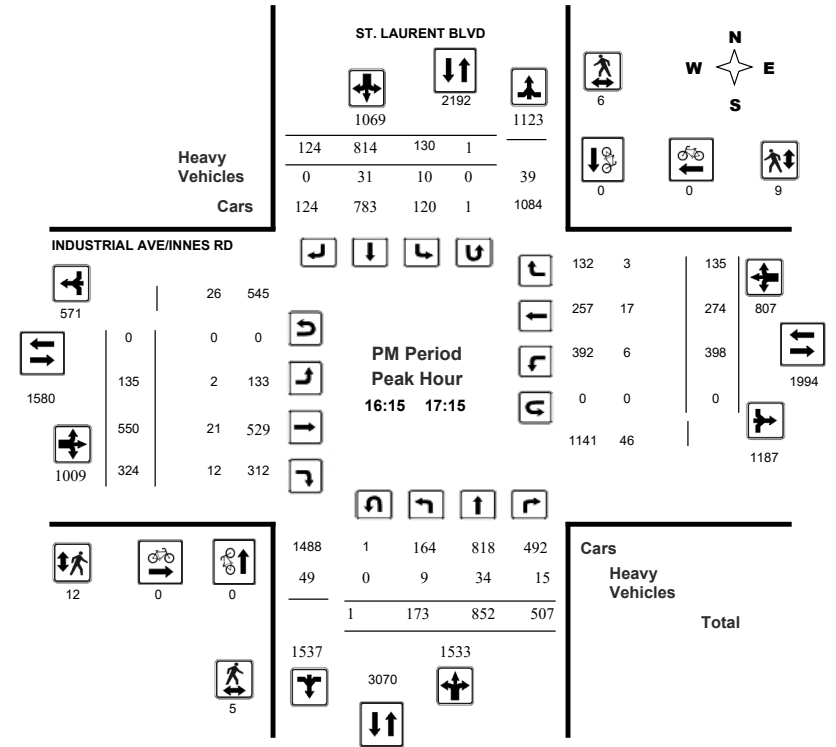



Transportation Services - Traffic Services
Turning Movement Count - Full Study Diagram

INDUSTRIAL AVE/INNES RD @ ST. LAURENT BLVD

Survey Date: Wednesday, January 30, 2019

WO#: 38336
Device: Miovision

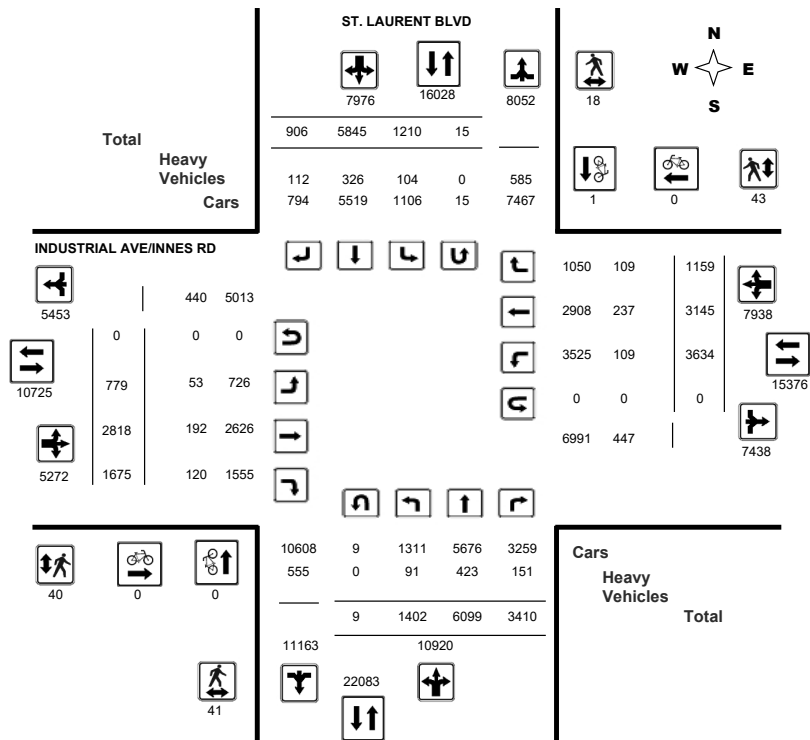

Comments



Transportation Services - Traffic Services

Work Order
38336

Turning Movement Count - Full Study Summary Report

INDUSTRIAL AVE/INNES RD @ ST. LAURENT BLVD

Survey Date: Wednesday, January 30, 201

Total Observed U-Turns
Northbound: 9 Southbound: 15
Eastbound: 0 Westbound: 0

AADT Factor
1.00

Full Study

Period	ST. LAURENT BLVD								INDUSTRIAL AVE/INNES RD								Grand Total					
	Northbound				Southbound				Eastbound				Westbound									
	LT	ST	RT	NB TOT	LT	ST	RT	SB TOT	STR TOT	LT	ST	RT	EB TOT	LT	ST	RT		WB TOT	STR TOT			
07:00 08:00	188	680	345	1213	158	631	79	868	2081	50	178	139	367	608	530	136	1274	1641	3722			
08:00 09:00	177	983	330	1490	116	744	142	1002	2492	67	177	118	362	611	741	241	1593	1955	4447			
09:00 10:00	179	657	366	1202	144	625	123	892	2094	79	211	130	420	446	398	145	989	1409	3503			
11:30 12:30	237	760	434	1431	172	721	110	1003	2434	91	337	226	654	403	328	135	866	1520	3954			
12:30 13:30	171	711	429	1311	191	679	113	983	2294	118	343	222	683	408	310	108	826	1509	3803			
15:00 16:00	112	711	554	1377	169	796	119	1084	2461	126	567	238	931	377	323	140	840	1771	4232			
16:00 17:00	162	774	528	1464	138	794	115	1047	2511	121	584	313	1018	385	266	130	781	1799	4310			
17:00 18:00	176	823	424	1423	122	855	105	1082	2505	127	421	289	837	396	249	124	769	1606	4111			
Sub Total	1402	6099	3410	10911	1210	5845	906	7961	18872	779	2818	1675	5272	3634	3145	1159	7938	13210	32082			
U Turns	9								15				24				0		0		24	
Total	1402	6099	3410	10920	1210	5845	906	7976	18896	779	2818	1675	5272	3634	3145	1159	7938	13210	32106			
EQ 12Hr	1949	8478	4740	15179	1682	8125	1259	11087	26266	1083	3917	2328	7328	5051	4372	1611	11034	18362	44628			
Note: These values are calculated by multiplying the totals by the appropriate expansion factor.													1.39									
AVG 12Hr	1949	8478	4740	15179	1682	8125	1259	11087	26266	1083	3917	2328	7328	5051	4372	1611	11034	18362	44628			
Note: These volumes are calculated by multiplying the Equivalent 12 hr. totals by the AADT factor.													1.00									
AVG 24Hr	2553	11106	6209	19884	2203	10643	1650	14523	34407	1418	5131	3050	9600	6617	5727	2110	14454	24054	58461			
Note: These volumes are calculated by multiplying the Average Daily 12 hr. totals by 12 to 24 expansion factor.													1.31									

Comments:

Note: U-Turns provided for approach totals. Refer to 'U-Turn' Report for specific breakdown.



Transportation Services - Traffic Services W.O. 38336

Turning Movement Count - 15 Minute Summary Report

INDUSTRIAL AVE/INNES RD @ ST. LAURENT BLVD

Survey Date: Wednesday, January 30, 2019

Total Observed U-Turns

Northbound: 9 Southbound: 15
Eastbound: 0 Westbound: 0

Time Period	ST. LAURENT BLVD									INDUSTRIAL AVE/INNES RD									Grand Total
	Northbound			Southbound			Eastbound			Westbound			W			STR			
	LT	ST	RT	N TOT	LT	ST	RT	S TOT	STR TOT	LT	ST	RT	E TOT	LT	ST	RT	W TOT	STR TOT	
07:00 07:15	24	125	67	216	33	120	12	165	381	7	50	25	82	164	124	24	312	394	775
07:15 07:30	44	171	76	291	45	180	26	251	542	11	39	38	88	133	100	24	257	345	887
07:30 07:45	53	185	104	342	32	148	19	199	541	12	49	45	106	156	165	45	366	472	1013
07:45 08:00	67	199	98	364	48	183	22	253	617	20	40	31	91	155	141	43	339	430	1047
08:00 08:15	39	265	77	381	31	186	28	245	626	10	52	22	84	147	191	40	378	462	1088
08:15 08:30	41	238	77	356	26	161	42	229	585	20	38	37	95	161	169	61	391	486	1071
08:30 08:45	42	249	91	382	27	206	33	266	648	15	38	27	80	142	202	62	406	486	1134
08:45 09:00	55	231	85	371	32	191	39	262	633	22	49	32	103	161	179	78	418	521	1154
09:00 09:15	55	183	86	324	37	179	25	245	569	20	41	25	86	130	111	55	296	382	951
09:15 09:30	47	160	105	312	37	151	33	221	533	22	59	29	110	117	110	35	262	372	905
09:30 09:45	37	162	90	289	38	148	32	218	507	17	56	34	107	93	86	35	214	321	828
09:45 10:00	40	152	85	277	32	147	33	212	489	20	55	42	117	106	91	20	217	334	823
11:30 11:45	41	158	110	309	40	170	31	241	550	15	70	47	132	107	80	37	224	356	906
11:45 12:00	63	205	109	380	40	167	30	237	617	28	80	54	162	94	91	34	219	381	998
12:00 12:15	64	184	113	361	54	178	26	258	619	27	81	54	162	113	81	26	220	382	1001
12:15 12:30	69	213	102	385	38	206	23	269	654	21	106	71	198	89	76	38	203	401	1055
12:30 12:45	50	179	125	354	44	166	23	233	587	25	90	65	180	115	78	23	216	396	983
12:45 13:00	36	184	99	320	44	176	30	250	570	27	71	54	152	90	80	23	193	345	915
13:00 13:15	43	175	99	317	57	159	28	244	561	34	86	50	170	124	69	33	226	396	957
13:15 13:30	42	173	106	321	46	178	32	256	577	32	96	53	181	79	83	29	191	372	949
15:00 15:15	42	163	127	332	47	184	27	258	590	39	129	52	220	97	92	37	226	446	1036
15:15 15:30	24	207	144	375	35	185	33	253	628	34	158	69	261	105	80	35	220	481	1109
15:30 15:45	18	176	148	342	46	204	34	284	626	21	147	57	225	85	87	40	212	437	1063
15:45 16:00	28	165	135	328	41	223	25	289	617	32	133	60	225	90	64	28	182	407	1024
16:00 16:15	33	164	130	327	40	197	22	259	586	25	141	86	252	96	58	31	185	437	1023
16:15 16:30	48	202	148	398	31	196	33	260	658	32	149	67	248	94	79	29	202	450	1108
16:30 16:45	36	200	134	370	35	214	30	279	649	39	164	87	290	111	68	37	216	506	1155
16:45 17:00	45	208	116	370	32	187	30	249	619	25	130	73	228	84	61	33	178	406	1025
17:00 17:15	44	242	109	395	32	217	31	281	676	39	107	97	243	109	66	36	211	454	1130
17:15 17:30	46	223	105	375	36	245	26	311	686	29	108	64	201	103	73	28	204	405	1091
17:30 17:45	51	180	116	348	28	169	14	214	562	31	105	64	200	84	57	33	174	374	936
17:45 18:00	35	178	94	308	26	224	34	285	593	28	101	64	193	100	53	27	180	373	966
TOTAL:	1402	6099	3410	10920	1210	5845	906	7976	18896	779	2818	1675	5272	3634	3145	1159	7938	13210	32106

Note: U-Turns are included in Totals.

Comment:



Transportation Services - Traffic Services
Turning Movement Count - Cyclist Volume Report

Work Order 38336

INDUSTRIAL AVE/INNES RD @ ST. LAURENT BLVD

Count Date: Wednesday, January 30, 2019

Start Time: 07:00

Time Period	ST. LAURENT BLVD			INDUSTRIAL AVE/INNES RD			Grand Total
	Northbound	Southbound	Street Total	Eastbound	Westbound	Street Total	
07:00 08:00	0	0	0	0	0	0	0
08:00 09:00	0	0	0	0	0	0	0
09:00 10:00	0	0	0	0	0	0	0
11:30 12:30	0	0	0	0	0	0	0
12:30 13:30	0	1	1	0	0	0	1
15:00 16:00	0	0	0	0	0	0	0
16:00 17:00	0	0	0	0	0	0	0
17:00 18:00	0	0	0	0	0	0	0
Total	0	1	1	0	0	0	1

Comment:

Note: These volumes consists of bicycles only (no mopeds or motorcycles) and ARE NOT included in the Turning Movement Count Summary.



Transportation Services - Traffic Services

W.O.
38336

Turning Movement Count - Heavy Vehicle Report

INDUSTRIAL AVE/INNES RD @ ST. LAURENT BLVD

Survey Date: Wednesday, January 30, 2019

ST. LAURENT BLVD										INDUSTRIAL AVE/INNES RD										Grand Total
Northbound					Southbound					Eastbound					Westbound					
Time Period	LT	ST	RT	N TOT	LT	ST	RT	S TOT	STR TOT	LT	ST	RT	E TOT	LT	ST	RT	W TOT	STR TOT		
07:00 08:00	16	48	17	81	33	54	7	94	175	5	23	27	55	32	37	19	88	143	318	
08:00 09:00	16	75	20	111	6	36	31	73	184	7	24	11	42	10	55	26	91	133	317	
09:00 10:00	16	78	34	128	14	44	39	97	225	13	29	5	47	8	42	16	66	113	338	
11:30 12:30	10	56	17	83	11	52	9	72	155	3	22	13	38	15	27	13	55	93	248	
12:30 13:30	5	53	20	78	13	36	10	59	137	8	26	22	56	19	13	11	43	99	236	
15:00 16:00	5	38	21	64	11	47	7	65	129	12	22	16	50	11	24	12	47	97	226	
16:00 17:00	10	46	15	71	11	34	3	48	119	2	32	16	50	7	22	6	35	85	204	
17:00 18:00	13	29	7	49	5	23	6	34	83	3	14	10	27	7	17	6	30	57	140	
Sub Total	91	423	151	665	104	326	112	542	1207	53	192	120	365	109	237	109	455	820	2027	
U-Turns (Heavy Vehicles)	0	0	0	0	0	0	0	0	0	0	0	0	0	0	0	0	0	0	0	
Total	91	423	151	0	104	326	112	542	1207	53	192	120	365	109	237	109	455	820	2027	

Heavy Vehicles include Buses, Single-Unit Trucks and Articulated Trucks. Further, they ARE included in the Turning Movement Count Summary.



Transportation Services - Traffic Services

Work Order
38336

Turning Movement Count - Pedestrian Volume Report

INDUSTRIAL AVE/INNES RD @ ST. LAURENT BLVD

Count Date: Wednesday, January 30, 2019

Start Time: 07:00

Time Period	NB Approach (E or W Crossing)	SB Approach (E or W Crossing)	Total	EB Approach (N or S Crossing)	WB Approach (N or S Crossing)	Total	Grand Total
07:00 07:15	1	1	2	1	0	1	3
07:15 07:30	1	0	1	2	0	2	3
07:30 07:45	0	1	1	1	0	1	2
07:45 08:00	0	0	0	0	0	0	0
07:00 08:00	2	2	4	4	0	4	8
08:00 08:15	1	0	1	0	0	0	1
08:15 08:30	2	2	4	3	1	4	8
08:30 08:45	3	0	3	3	2	5	8
08:45 09:00	0	0	0	1	1	2	2
08:00 09:00	6	2	8	7	4	11	19
09:00 09:15	2	0	2	0	2	2	4
09:15 09:30	2	0	2	0	0	0	2
09:30 09:45	0	0	0	0	0	0	0
09:45 10:00	0	0	0	0	0	0	0
09:00 10:00	4	0	4	0	2	2	6
11:30 11:45	1	0	1	0	1	1	2
11:45 12:00	1	0	1	1	1	2	3
12:00 12:15	1	2	3	4	0	4	7
12:15 12:30	4	2	6	1	2	3	9
11:30 12:30	7	4	11	6	4	10	21
12:30 12:45	3	0	3	1	2	3	6
12:45 13:00	2	0	2	1	3	4	6
13:00 13:15	2	0	2	0	1	1	3
13:15 13:30	1	0	1	2	2	4	5
12:30 13:30	8	0	8	4	8	12	20
15:00 15:15	1	1	2	1	2	3	5
15:15 15:30	1	0	1	1	2	3	4
15:30 15:45	1	1	2	0	1	1	3
15:45 16:00	1	0	1	0	2	2	3
15:00 16:00	4	2	6	2	7	9	15
16:00 16:15	0	0	0	1	0	1	1
16:15 16:30	0	2	2	1	2	3	5
16:30 16:45	3	2	5	5	1	6	11
16:45 17:00	1	1	2	3	3	6	8
16:00 17:00	4	5	9	10	6	16	25
17:00 17:15	1	1	2	3	3	6	8
17:15 17:30	2	2	4	3	1	4	8
17:30 17:45	1	0	1	0	7	7	8
17:45 18:00	2	0	2	1	1	2	4
17:00 18:00	6	3	9	7	12	19	28
Total	41	18	59	40	43	83	142

Comment:



Transportation Services - Traffic Services

Work Order
38336

Turning Movement Count - 15 Min U-Turn Total Report INDUSTRIAL AVE/INNES RD @ ST. LAURENT BLVD

Survey Date: Wednesday, January 30, 2019

Time Period	Northbound U-Turn Total	Southbound U-Turn Total	Eastbound U-Turn Total	Westbound U-Turn Total	Total
07:00 07:15	0	0	0	0	0
07:15 07:30	0	0	0	0	0
07:30 07:45	0	0	0	0	0
07:45 08:00	0	0	0	0	0
08:00 08:15	0	0	0	0	0
08:15 08:30	0	0	0	0	0
08:30 08:45	0	0	0	0	0
08:45 09:00	0	0	0	0	0
09:00 09:15	0	4	0	0	4
09:15 09:30	0	0	0	0	0
09:30 09:45	0	0	0	0	0
09:45 10:00	0	0	0	0	0
11:30 11:45	0	0	0	0	0
11:45 12:00	3	0	0	0	3
12:00 12:15	0	0	0	0	0
12:15 12:30	1	2	0	0	3
12:30 12:45	0	0	0	0	0
12:45 13:00	1	0	0	0	1
13:00 13:15	0	0	0	0	0
13:15 13:30	0	0	0	0	0
15:00 15:15	0	0	0	0	0
15:15 15:30	0	0	0	0	0
15:30 15:45	0	0	0	0	0
15:45 16:00	0	0	0	0	0
16:00 16:15	0	0	0	0	0
16:15 16:30	0	0	0	0	0
16:30 16:45	0	0	0	0	0
16:45 17:00	1	0	0	0	1
17:00 17:15	0	1	0	0	1
17:15 17:30	1	4	0	0	5
17:30 17:45	1	3	0	0	4
17:45 18:00	1	1	0	0	2
Total	9	15	0	0	24



Turning Movement Count Summary Report Including Peak Hours, AADT and Expansion Factors All Vehicles Except Bicycles



Belfast Road & Lagan Way Ottawa, ON

Survey Date: Thursday, May 11, 2023 Start Time: 0700 AADT Factor: 0.9
 Weather AM: Mostly Sunny 13° C Survey Duration: 8 Hrs. Survey Hours: 0700-1000, 1130-1330 & 1500-1800
 Weather PM: Cloudy 25° C Surveyor(s): T. Carmody

Time Period	Belfast Rd. Eastbound					Belfast Rd. Westbound					Lagan Way Northbound					Lagan Way Southbound					Grand Total		
	LT	ST	RT	UT	E/B Tot	LT	ST	RT	UT	W/B Tot	Street Total	LT	ST	RT	UT	N/B Tot	Street Total	S/B Tot	Street Total				
	0700-0800	22	240	33	0	295	6	177	10	0	193	488	21	0	5	0	26	7	1	15		0	23
0800-0900	21	206	16	1	244	6	195	8	0	209	453	16	0	8	0	24	4	0	13	0	17	41	494
0900-1000	50	272	15	1	338	13	225	26	0	264	602	11	1	15	0	27	15	4	17	0	36	63	665
1130-1230	44	254	22	0	320	19	282	18	0	319	639	21	2	10	0	33	17	1	30	0	48	81	720
1230-1330	52	272	31	1	356	14	260	17	0	291	647	23	2	6	0	31	17	2	32	0	51	82	729
1500-1600	39	281	30	0	350	15	258	15	0	288	638	18	2	19	0	39	20	1	27	0	48	87	725
1600-1700	58	262	48	1	369	16	307	24	3	350	719	25	4	11	0	40	26	0	46	0	72	112	831
1700-1800	38	186	31	0	255	12	220	15	0	247	502	30	1	17	0	48	24	1	33	0	58	106	608
Totals	324	1973	226	4	2527	101	1924	133	3	2161	4688	165	12	91	0	268	130	10	213	0	353	621	5309

Equivalent 12 & 24-hour Vehicle Volumes Including the Annual Average Daily Traffic (AADT) Factor
Applicable to the Day and Month of the Turning Movement Count
Expansion factors are applied exclusively to standard weekday 8-hour turning movement counts
conducted during the hours of 0700h - 1000h, 1130h - 1330h and 1500h - 1800h

Equivalent 12-hour vehicle volumes. These volumes are calculated by multiplying the 8-hour totals by the 8 → 12 expansion factor of 1.39
 Equ. 12 Hr 450 2742 314 6 3513 140 2674 185 4 3004 6516 229 17 126 0 373 181 14 296 0 491 863 7380

Average daily 12-hour vehicle volumes. These volumes are calculated by multiplying the equivalent 12-hour totals by the AADT factor of: 0.9
 AADT 12-hr 405 2468 283 5 3161 126 2407 166 4 2703 5865 206 15 114 0 335 163 13 266 0 442 777 6642

24-Hour AADT. These volumes are calculated by multiplying the average daily 12-hour vehicle volumes by the 12 → 24 expansion factor of 1.31
 AADT 24 Hr 531 3233 370 7 4141 166 3153 218 5 3541 7683 270 20 149 0 439 213 16 349 0 578 1018 8700

AADT and expansion factors provided by the City of Ottawa

AM Peak Hour Factor →	0.91					Highest Hourly Vehicle Volume Between 0700h & 1000h																	
AM Peak Hr	LT	ST	RT	UT	Total	LT	ST	RT	UT	Total	Str. Tot.	LT	ST	RT	UT	Total	LT	ST	RT	UT	Total	Str. Tot.	Gr. Tot.
0900-1000	50	272	15	1	338	13	225	26	0	264	602	11	1	15	0	27	15	4	17	0	36	63	665
OFF Peak Hour Factor →	0.87					Highest Hourly Vehicle Volume Between 1130h & 1330h																	
OFF Peak Hr	LT	ST	RT	UT	Total	LT	ST	RT	UT	Total	Str. Tot.	LT	ST	RT	UT	Total	LT	ST	RT	UT	Total	Str. Tot.	Gr. Tot.
1230-1330	52	272	31	1	356	14	260	17	0	291	647	23	2	6	0	31	17	2	32	0	51	82	729
PM Peak Hour Factor →	0.90					Highest Hourly Vehicle Volume Between 1500h & 1800h																	
PM Peak Hr	LT	ST	RT	UT	Total	LT	ST	RT	UT	Total	Str. Tot.	LT	ST	RT	UT	Total	LT	ST	RT	UT	Total	Str. Tot.	Gr. Tot.
1545-1645	46	265	50	0	361	17	310	26	2	355	716	26	5	16	0	47	30	0	39	0	69	116	832

Comments:

OC Transpo and Para Transpo buses, private buses and school buses comprise 9.07% of the heavy vehicle traffic.

Notes:

1. Includes all vehicle types except bicycles, electric bicycles, and electric scooters.
2. When expansion and AADT factors are applied, the results will differ slightly due to rounding.



Turning Movement Count Summary, AM and PM Peak Hour Flow Diagrams All Vehicles Except Bicycles

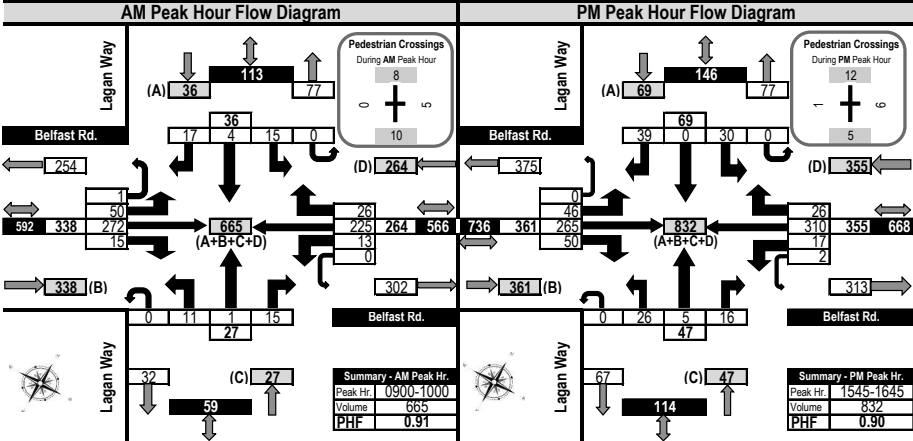
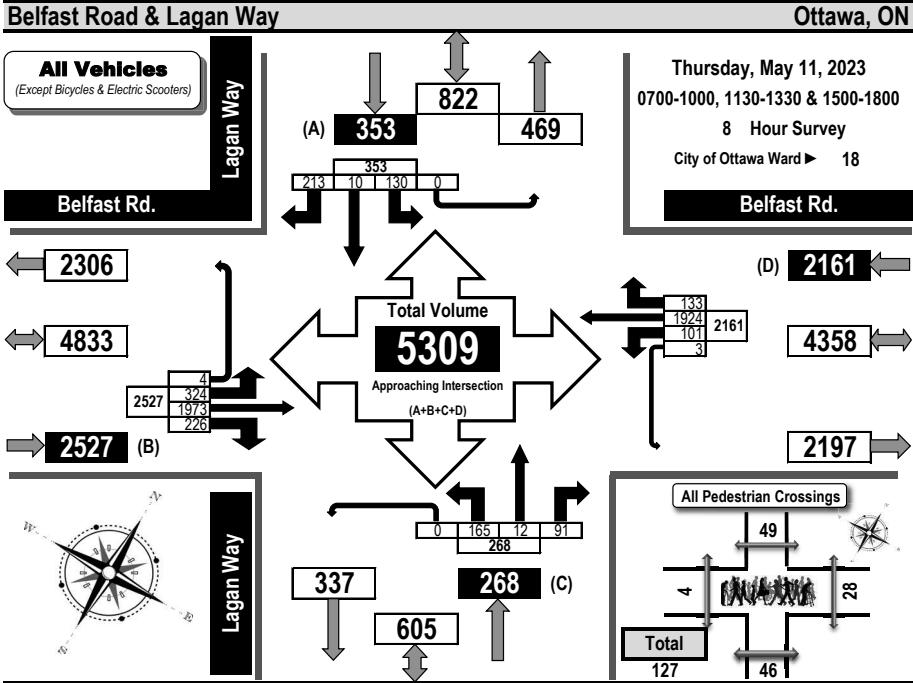

Turning Movement Count Summary, OFF and EVENING Peak Hour Flow Diagrams All Vehicles Except Bicycles

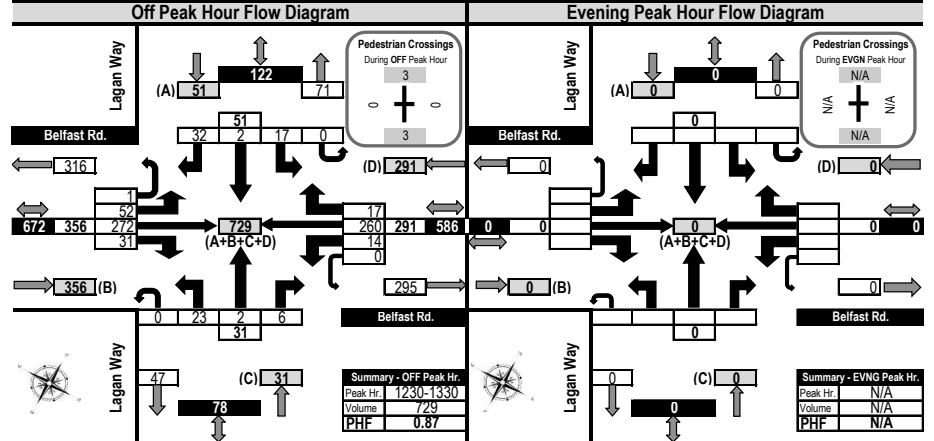
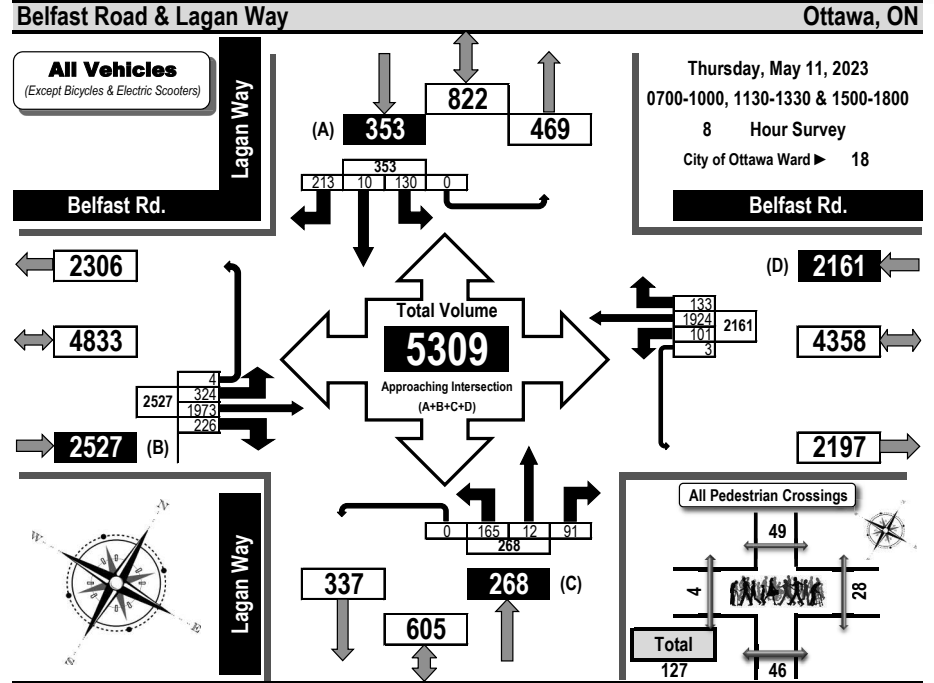



Turning Movement Count Heavy Vehicle Summary (FHWA Class 4-13) Flow Diagram

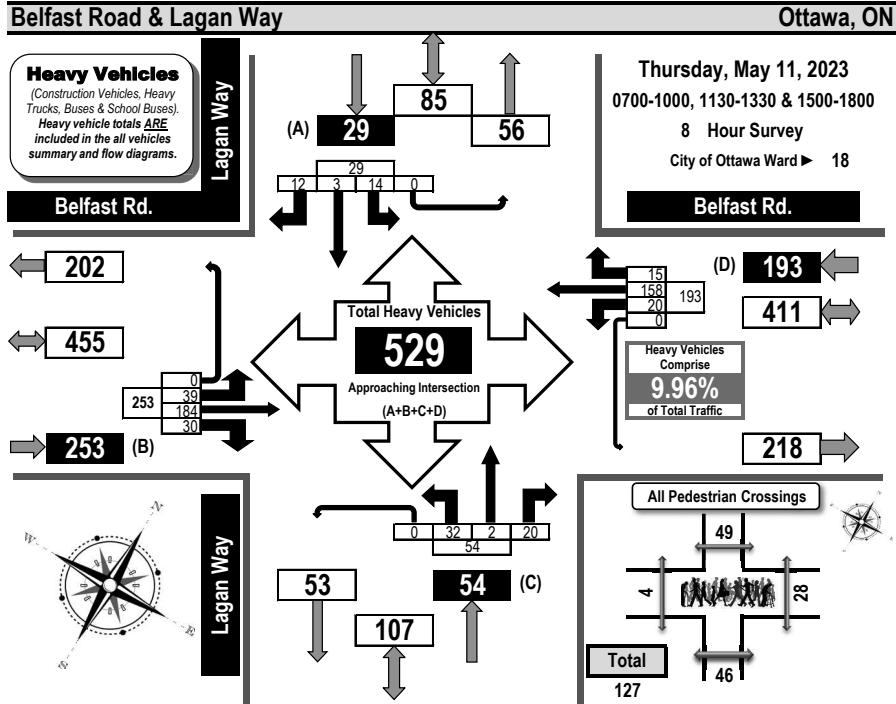

Time Period	Belfast Rd. Eastbound				Belfast Rd. Westbound				Lagan Way Northbound				Lagan Way Southbound				SB Tot	GR Tot			
	LT	ST	RT	UT	LT	ST	RT	UT	LT	ST	RT	UT	LT	ST	RT	UT					
0700-0800	2	19	4	0	25	2	30	2	0	34	7	0	3	0	10	2	1	4	0	7	76
0800-0900	2	25	3	0	30	1	34	2	0	37	5	0	6	0	11	0	0	1	0	1	79
0900-1000	10	32	1	0	43	3	33	4	0	40	6	0	5	0	11	3	1	2	0	6	100
1130-1230	3	23	5	0	31	3	20	3	0	26	6	0	2	0	8	3	1	2	0	6	71
1230-1330	1	22	5	0	28	8	12	0	0	20	5	1	2	0	8	1	0	2	0	3	59
1500-1600	4	25	4	0	33	2	15	0	0	17	1	1	2	0	4	0	0	0	0	0	54
1600-1700	14	16	6	0	36	1	10	2	0	13	1	0	0	0	1	3	0	0	0	3	53
1700-1800	3	22	2	0	27	0	4	2	0	6	1	0	0	0	1	2	0	1	0	3	37
Totals	39	184	30	0	253	20	158	15	0	193	32	2	20	0	54	14	3	12	0	29	529

Comments:
OC Transpo and Para Transpo buses, private buses and school buses comprise 9.07% of the heavy vehicle traffic.



Turning Movement Count All Buses Summary (FHWA Class 4 ONLY) Flow Diagram

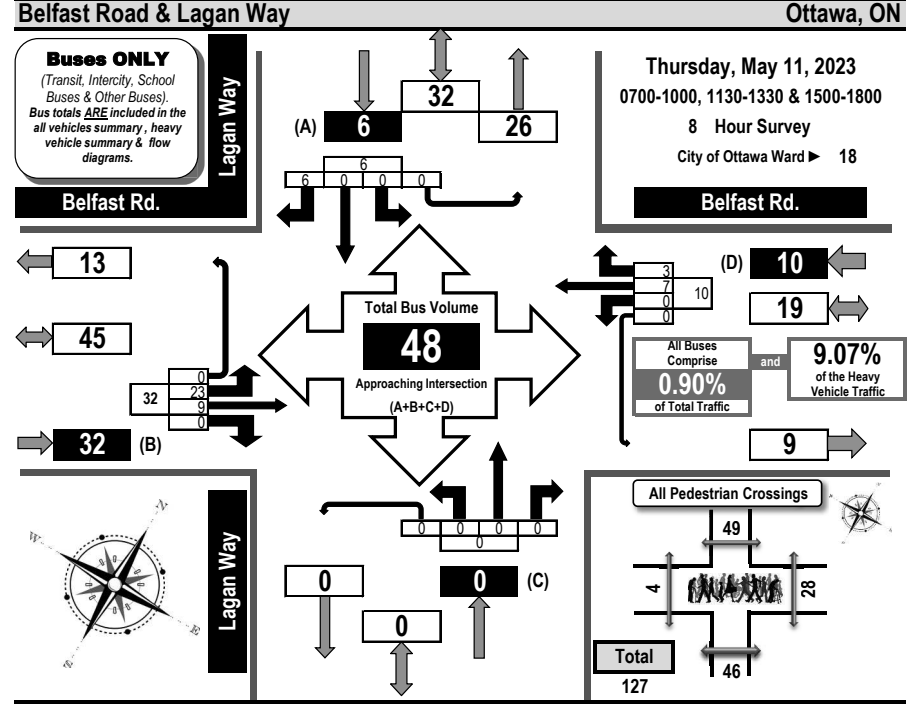

Time Period	Belfast Rd. Eastbound				Belfast Rd. Westbound				Lagan Way Northbound				Lagan Way Southbound				SB Tot	GR Tot			
	LT	ST	RT	UT	LT	ST	RT	UT	LT	ST	RT	UT	LT	ST	RT	UT					
0700-0800	0	0	0	0	0	0	1	0	0	1	0	0	0	0	0	0	0	4	0	4	5
0800-0900	0	1	0	0	1	0	2	0	0	2	0	0	0	0	0	0	0	0	0	0	3
0900-1000	8	2	0	0	10	0	2	2	0	4	0	0	0	0	0	0	0	0	0	0	14
1130-1230	0	1	0	0	1	0	0	0	0	0	0	0	0	0	0	0	0	0	0	0	1
1230-1330	0	0	0	0	0	0	1	0	0	1	0	0	0	0	0	0	0	2	0	2	3
1500-1600	0	0	0	0	0	0	1	0	0	1	0	0	0	0	0	0	0	0	0	0	1
1600-1700	13	1	0	0	14	0	0	0	0	0	0	0	0	0	0	0	0	0	0	0	14
1700-1800	2	4	0	0	6	0	0	1	0	1	0	0	0	0	0	0	0	0	0	0	7
Totals	23	9	0	0	32	0	7	3	0	10	0	0	0	0	0	0	0	6	0	6	48

Comments:
OC Transpo and Para Transpo buses, private buses and school buses comprise 9.07% of the heavy vehicle traffic.



Turning Movement Count Bicycle Summary Flow Diagram



Belfast Road & Lagan Way Ottawa, ON

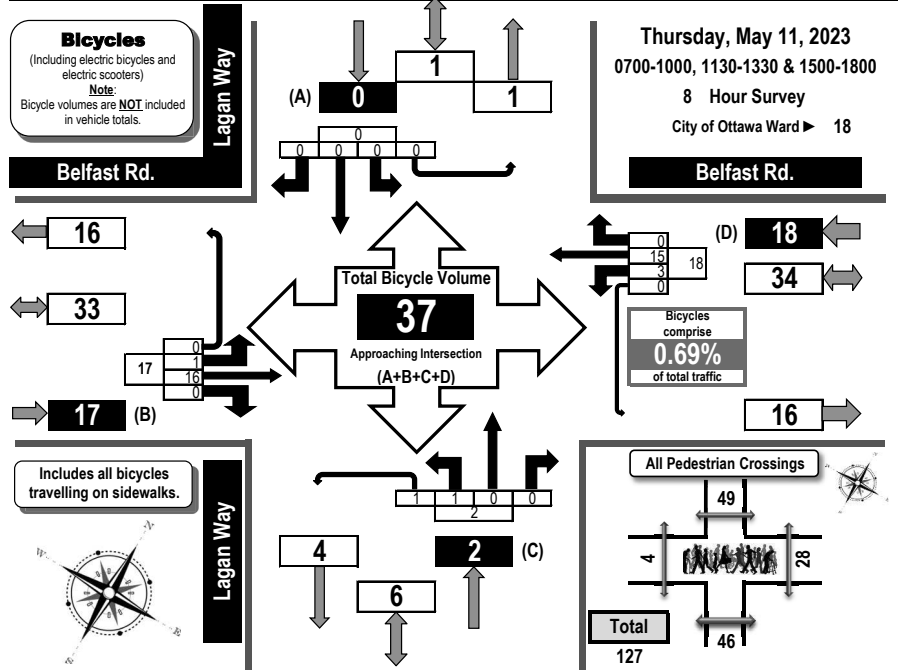

Time Period	Belfast Rd. Eastbound				Belfast Rd. Westbound				Lagan Way Northbound				Lagan Way Southbound				GR Tot		
	LT	ST	RT	UT	LT	ST	RT	UT	LT	ST	RT	UT	LT	ST	RT	UT			
	EB Tot				WB Tot				NB Tot				SB Tot						
0700-0800	1	4	0	0	5	0	1	0	0	1	0	0	0	0	0	0	0	0	6
0800-0900	0	3	0	0	3	0	2	0	0	2	0	0	0	0	0	0	0	0	5
0900-1000	0	2	0	0	2	0	1	0	0	1	0	0	0	0	0	0	0	0	3
1130-1230	0	1	0	0	1	0	0	0	0	0	0	0	0	0	0	0	0	0	1
1230-1330	0	3	0	0	3	0	3	0	0	3	0	0	0	0	0	0	0	0	6
1500-1600	0	1	0	0	1	1	3	0	0	4	0	0	0	0	0	0	0	0	5
1600-1700	0	2	0	0	2	2	3	0	0	5	1	0	0	0	1	0	0	0	8
1700-1800	0	0	0	0	0	2	0	0	0	2	0	0	0	1	1	0	0	0	3
Totals	1	16	0	0	17	3	15	0	0	18	1	0	0	1	2	0	0	0	37

Comments:
OC Transpo and Para Transpo buses, private buses and school buses comprise 9.07% of the heavy vehicle traffic.



Turning Movement Count Pedestrian Crossings Summary and Flow Diagram



Belfast Road & Lagan Way Ottawa, ON

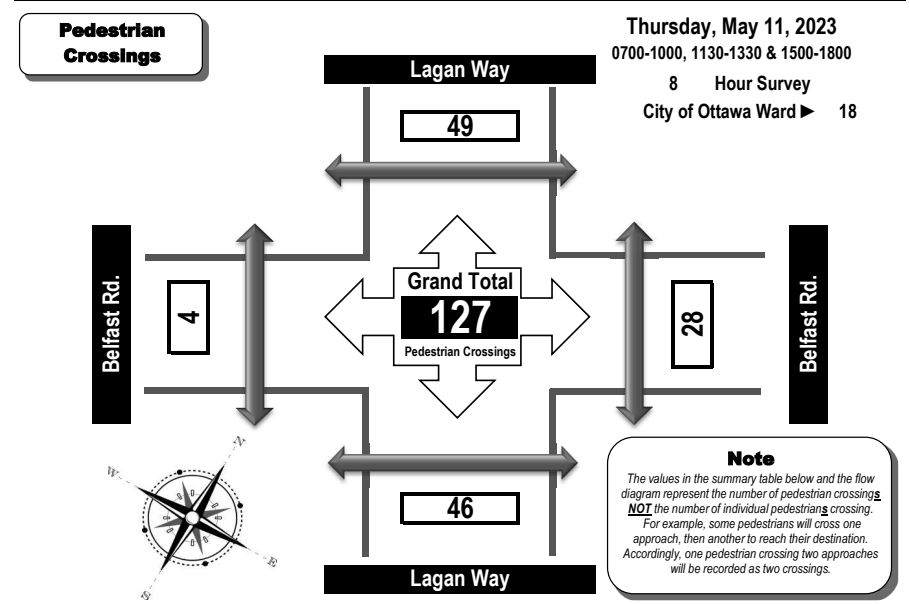

Time Period	West Side Crossing	East Side Crossing	Street Total	South Side Crossing	North Side Crossing	Street Total	Grand Total
	Belfast Rd.	Belfast Rd.		Lagan Way	Lagan Way		
0700-0800	1	5	6	5	6	11	17
0800-0900	0	5	5	11	1	12	17
0900-1000	0	5	5	10	8	18	23
1130-1230	0	0	0	2	9	11	11
1230-1330	0	0	0	3	3	6	6
1500-1600	1	1	2	4	6	10	12
1600-1700	1	9	10	6	10	16	26
1700-1800	1	3	4	5	6	11	15
Totals	4	28	32	46	49	95	127

Comments:
OC Transpo and Para Transpo buses, private buses and school buses comprise 9.07% of the heavy vehicle traffic.

Appendix C

Synchro Intersection Worksheets – Existing Conditions

Lanes, Volumes, Timings
1: St-Laurent & Tremblay

Existing AM Peak Hour
1531 St-Laurent Blvd

	↖	→	↗	←	↖	↑	↗	↓	↖
Lane Group	EBL	EBT	WBL	WBT	NBL	NBT	SBL	SBT	SBR
Lane Configurations	↖	↗	↖	↗	↖	↗	↖	↗	↖
Traffic Volume (vph)	15	21	12	20	65	1132	127	1083	62
Future Volume (vph)	15	21	12	20	65	1132	127	1083	62
Lane Group Flow (vph)	17	41	13	133	72	1300	141	1203	69
Turn Type	Perm	NA	Perm	NA	Perm	NA	pm+pt	NA	Perm
Protected Phases		4		8		2	1	6	
Permitted Phases	4		8		2		6		6
Detector Phase	4	4	8	8	2	2	1	6	6
Switch Phase									
Minimum Initial (s)	10.0	10.0	10.0	10.0	10.0	10.0	5.0	10.0	10.0
Minimum Split (s)	38.5	38.5	38.5	38.5	39.2	39.2	9.7	39.2	39.2
Total Split (s)	40.0	40.0	40.0	40.0	72.0	72.0	18.0	90.0	90.0
Total Split (%)	30.8%	30.8%	30.8%	30.8%	55.4%	55.4%	13.8%	69.2%	69.2%
Maximum Green (s)	33.5	33.5	33.5	33.5	65.8	65.8	13.3	83.8	83.8
Yellow Time (s)	3.3	3.3	3.3	3.3	3.7	3.7	3.7	3.7	3.7
All-Red Time (s)	3.2	3.2	3.2	3.2	2.5	2.5	1.0	2.5	2.5
Lost Time Adjust (s)	0.0	0.0	0.0	0.0	0.0	0.0	0.0	0.0	0.0
Total Lost Time (s)	6.5	6.5	6.5	6.5	6.2	6.2	4.7	6.2	6.2
Lead/Lag					Lag	Lag	Lead		
Lead-Lag Optimize?					Yes	Yes	Yes		
Vehicle Extension (s)	3.0	3.0	3.0	3.0	3.0	3.0	3.0	3.0	3.0
Recall Mode	None	None	None	None	C-Max	C-Max	None	C-Max	C-Max
Walk Time (s)	7.0	7.0	7.0	7.0	11.0	11.0		11.0	11.0
Flash Dont Walk (s)	25.0	25.0	25.0	25.0	22.0	22.0		22.0	22.0
Pedestrian Calls (#/hr)	4	4	3	3	2	2		7	7
Act Effct Green (s)	14.6	14.6	14.6	14.6	89.8	89.8	104.2	102.7	102.7
Actuated g/C Ratio	0.11	0.11	0.11	0.11	0.69	0.69	0.80	0.79	0.79
v/c Ratio	0.21	0.21	0.10	0.53	0.26	0.43	0.44	0.50	0.07
Control Delay	54.3	33.5	48.9	20.2	13.6	10.9	8.3	6.7	1.6
Queue Delay	0.0	0.0	0.0	0.0	0.0	0.0	0.0	0.0	0.0
Total Delay	54.3	33.5	48.9	20.2	13.6	10.9	8.3	6.7	1.6
LOS	D	C	D	C	B	B	A	A	A
Approach Delay		39.6		22.8		11.0		6.6	
Approach LOS		D		C		B		A	
Queue Length 50th (m)	4.2	5.6	3.2	5.4	5.3	41.4	5.0	36.6	0.0
Queue Length 95th (m)	10.0	13.8	8.1	21.0	22.7	93.5	20.0	103.9	5.0
Internal Link Dist (m)		396.6		0.1		682.5		144.8	
Turn Bay Length (m)	38.0		38.0		45.0		75.0		
Base Capacity (vph)	188	416	284	435	281	2989	373	2429	1019
Starvation Cap Reductn	0	0	0	0	0	0	0	0	0
Spillback Cap Reductn	0	0	0	0	0	0	0	0	0
Storage Cap Reductn	0	0	0	0	0	0	0	0	0
Reduced v/c Ratio	0.09	0.10	0.05	0.31	0.26	0.43	0.38	0.50	0.07

Intersection Summary

Cycle Length: 130
 Actuated Cycle Length: 130
 Offset: 53 (41%), Referenced to phase 2:NBTL and 6:SBTL, Start of Green
 Natural Cycle: 90

Lanes, Volumes, Timings
1: St-Laurent & Tremblay

Existing AM Peak Hour
1531 St-Laurent Blvd

Control Type: Actuated-Coordinated	
Maximum v/c Ratio: 0.53	
Intersection Signal Delay: 10.0	Intersection LOS: B
Intersection Capacity Utilization 66.3%	ICU Level of Service C
Analysis Period (min) 15	

Splits and Phases: 1: St-Laurent & Tremblay



Lanes, Volumes, Timings
2: St-Laurent & Belfast

Existing AM Peak Hour
1531 St-Laurent Blvd

	EBL	EBT	EBR	WBL	WBT	NBL	NBT	NBR	SBL	SBT	SBR
Lane Configurations	↖	↑	↗	↖	↗	↖	↑	↗	↖	↗	↖
Traffic Volume (vph)	47	63	84	43	140	116	809	63	83	764	190
Future Volume (vph)	47	63	84	43	140	116	809	63	83	764	190
Lane Group Flow (vph)	52	70	93	48	260	129	899	70	92	849	211
Turn Type	pm+pt	NA	Perm	Perm	NA	pm+pt	NA	Perm	pm+pt	NA	Perm
Protected Phases	7	4			8	5	2		1	6	
Permitted Phases	4		4	8			2	2	6		6
Detector Phase	7	4	4	8	8	5	2	2	1	6	6
Switch Phase											
Minimum Initial (s)	5.0	10.0	10.0	10.0	10.0	5.0	10.0	10.0	5.0	10.0	10.0
Minimum Split (s)	10.8	27.8	27.8	27.8	27.8	10.7	36.6	36.6	10.7	36.6	36.6
Total Split (s)	16.0	48.0	48.0	32.0	32.0	15.0	57.0	57.0	15.0	57.0	57.0
Total Split (%)	13.3%	40.0%	40.0%	26.7%	26.7%	12.5%	47.5%	47.5%	12.5%	47.5%	47.5%
Maximum Green (s)	10.2	42.2	42.2	26.2	26.2	9.3	51.4	51.4	9.3	51.4	51.4
Yellow Time (s)	3.3	3.3	3.3	3.3	3.3	4.2	4.2	4.2	4.2	4.2	4.2
All-Red Time (s)	2.5	2.5	2.5	2.5	2.5	1.5	1.4	1.4	1.5	1.4	1.4
Lost Time Adjust (s)	0.0	0.0	0.0	0.0	0.0	0.0	0.0	0.0	0.0	0.0	0.0
Total Lost Time (s)	5.8	5.8	5.8	5.8	5.8	5.7	5.6	5.6	5.7	5.6	5.6
Lead/Lag	Lead			Lag	Lag	Lead	Lag	Lag	Lead	Lag	Lag
Lead-Lag Optimize?	Yes			Yes	Yes	Yes	Yes	Yes	Yes	Yes	Yes
Vehicle Extension (s)	3.0	3.0	3.0	3.0	3.0	3.0	3.0	3.0	3.0	3.0	3.0
Recall Mode	None	None	None	None	None	C-Max	C-Max	None	C-Max	C-Max	C-Max
Walk Time (s)	7.0	7.0	7.0	7.0	7.0	25.0	25.0	25.0	25.0	25.0	25.0
Flash Dont Walk (s)	15.0	15.0	15.0	15.0	15.0	6.0	6.0	6.0	6.0	6.0	6.0
Pedestrian Calls (#/hr)	2	2	1	1	1	0	0	0	3	3	3
Act Effct Green (s)	35.6	35.6	35.6	23.4	23.4	67.8	59.1	59.1	66.6	58.5	58.5
Actuated g/C Ratio	0.30	0.30	0.30	0.20	0.20	0.56	0.49	0.49	0.56	0.49	0.49
v/c Ratio	0.26	0.14	0.21	0.23	0.87	0.42	0.57	0.09	0.33	0.56	0.31
Control Delay	30.4	28.6	6.6	42.3	69.7	16.5	25.4	0.2	15.5	25.5	4.1
Queue Delay	0.0	0.0	0.0	0.0	0.0	0.0	0.0	0.0	0.0	0.0	0.0
Total Delay	30.4	28.6	6.6	42.3	69.7	16.5	25.4	0.2	15.5	25.5	4.1
LOS	C	C	A	D	E	B	C	A	B	C	A
Approach Delay		19.5			65.4		22.7			20.8	
Approach LOS		B			E		C			C	
Queue Length 50th (m)	8.3	11.2	0.0	9.4	52.8	13.9	85.1	0.0	9.7	81.1	0.0
Queue Length 95th (m)	17.1	21.5	11.1	20.3	#92.9	24.2	109.2	0.1	18.1	102.8	14.0
Internal Link Dist (m)		518.7			103.5		597.8			682.5	
Turn Bay Length (m)	75.0		200.0	65.0		75.0		55.0	75.0		85.0
Base Capacity (vph)	215	596	500	231	330	317	1571	760	289	1513	687
Starvation Cap Reductn	0	0	0	0	0	0	0	0	0	0	0
Spillback Cap Reductn	0	0	0	0	0	0	0	0	0	0	0
Storage Cap Reductn	0	0	0	0	0	0	0	0	0	0	0
Reduced v/c Ratio	0.24	0.12	0.19	0.21	0.79	0.41	0.57	0.09	0.32	0.56	0.31

Intersection Summary

Cycle Length: 120
 Actuated Cycle Length: 120
 Offset: 53 (44%), Referenced to phase 2:NBTL and 6:SBTL, Start of Green
 Natural Cycle: 90

Lanes, Volumes, Timings
2: St-Laurent & Belfast

Existing AM Peak Hour
1531 St-Laurent Blvd

Control Type: Actuated-Coordinated	
Maximum v/c Ratio: 0.87	
Intersection Signal Delay: 26.4	Intersection LOS: C
Intersection Capacity Utilization 69.9%	ICU Level of Service C
Analysis Period (min) 15	
# 95th percentile volume exceeds capacity, queue may be longer.	
Queue shown is maximum after two cycles.	

Splits and Phases: 2: St-Laurent & Belfast

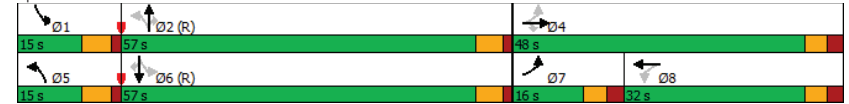

Lanes, Volumes, Timings
3: St-Laurent & Industrial/Innes

Existing AM Peak Hour
1531 St-Laurent Blvd

	↖	→	↘	↙	←	↖	↙	↘	↙	↘	↙	↘
Lane Group	EBL	EBT	EBR	WBL	WBT	WBR	NBL	NBT	NBR	SBL	SBT	SBR
Lane Configurations	↖↗	↖↗	↖↗	↖↗	↖↗	↖↗	↖↗	↖↗	↖↗	↖↗	↖↗	↖↗
Traffic Volume (vph)	67	177	118	611	741	241	177	983	330	116	744	142
Future Volume (vph)	67	177	118	611	741	241	177	983	330	116	744	142
Lane Group Flow (vph)	74	197	131	679	823	268	197	1092	367	129	827	158
Turn Type	Prot	NA	Perm	Prot	NA	Perm	Prot	NA	Perm	Prot	NA	Perm
Protected Phases	7	4		3	8		5	2		1	6	
Permitted Phases			4			8			2			6
Detector Phase	7	4	4	3	8	8	5	2	2	1	6	6
Switch Phase												
Minimum Initial (s)	5.0	10.0	10.0	5.0	10.0	10.0	5.0	10.0	10.0	5.0	10.0	10.0
Minimum Split (s)	11.6	38.6	38.6	11.6	38.6	38.6	11.3	37.6	37.6	11.3	37.6	37.6
Total Split (s)	25.0	38.0	38.0	36.0	49.0	49.0	23.0	43.0	43.0	23.0	43.0	43.0
Total Split (%)	17.9%	27.1%	27.1%	25.7%	35.0%	35.0%	16.4%	30.7%	30.7%	16.4%	30.7%	30.7%
Maximum Green (s)	18.4	31.4	31.4	29.4	42.4	42.4	16.7	36.4	36.4	16.7	36.4	36.4
Yellow Time (s)	3.7	3.7	3.7	3.7	3.7	3.7	4.2	4.2	4.2	4.2	4.2	4.2
All-Red Time (s)	2.9	2.9	2.9	2.9	2.9	2.9	2.1	2.4	2.4	2.1	2.4	2.4
Lost Time Adjust (s)	0.0	0.0	0.0	0.0	0.0	0.0	0.0	0.0	0.0	0.0	0.0	0.0
Total Lost Time (s)	6.6	6.6	6.6	6.6	6.6	6.6	6.3	6.6	6.6	6.3	6.6	6.6
Lead/Lag	Lead	Lag	Lag	Lead	Lag	Lag	Lead	Lag	Lag	Lead	Lag	Lag
Lead-Lag Optimize?	Yes	Yes	Yes	Yes	Yes	Yes	Yes	Yes	Yes	Yes	Yes	Yes
Vehicle Extension (s)	3.0	3.0	3.0	3.0	3.0	3.0	3.0	3.0	3.0	3.0	3.0	3.0
Recall Mode	None	None	None	None	None	None	C-Max	C-Max	None	C-Max	C-Max	C-Max
Walk Time (s)	7.0	7.0	7.0	7.0	7.0	7.0	7.0	7.0	7.0	7.0	7.0	7.0
Flash Dont Walk (s)	25.0	25.0	25.0	25.0	25.0	25.0	24.0	24.0	24.0	24.0	24.0	24.0
Pedestrian Calls (#/hr)	6	6	6	6	2	2	4	4	4	7	7	7
Act Effct Green (s)	8.9	22.0	22.0	29.4	45.1	45.1	14.0	51.4	51.4	11.1	48.5	48.5
Actuated g/C Ratio	0.06	0.16	0.16	0.21	0.32	0.32	0.10	0.37	0.37	0.08	0.35	0.35
v/c Ratio	0.39	0.42	0.36	1.01	0.81	0.44	0.65	0.95	0.51	0.52	0.74	0.29
Control Delay	68.6	54.5	4.4	90.6	50.6	6.3	70.9	60.4	9.8	69.1	46.6	5.0
Queue Delay	0.0	0.0	0.0	0.0	0.0	0.0	0.0	0.0	0.0	0.0	0.0	0.0
Total Delay	68.6	54.5	4.4	90.6	50.6	6.3	70.9	60.4	9.8	69.1	46.6	5.0
LOS	E	D	A	F	D	A	E	E	A	E	D	A
Approach Delay		40.8			59.3			50.4			43.3	
Approach LOS		D			E			D			D	
Queue Length 50th (m)	10.3	26.1	0.0	-98.7	112.4	1.0	27.4	155.0	9.7	17.9	107.0	0.0
Queue Length 95th (m)	18.2	35.6	5.1	#138.6	128.7	20.5	39.8	#241.3	42.7	28.0	#163.6	12.3
Internal Link Dist (m)		745.6			700.4			316.7			597.8	
Turn Bay Length (m)	38.0		120.0	150.0		80.0	100.0		100.0	125.0		150.0
Base Capacity (vph)	391	665	444	675	1028	614	359	1149	713	372	1115	537
Starvation Cap Reductn	0	0	0	0	0	0	0	0	0	0	0	0
Spillback Cap Reductn	0	0	0	0	0	0	0	0	0	0	0	0
Storage Cap Reductn	0	0	0	0	0	0	0	0	0	0	0	0
Reduced v/c Ratio	0.19	0.30	0.30	1.01	0.80	0.44	0.55	0.95	0.51	0.35	0.74	0.29

Intersection Summary

Cycle Length: 140
Actuated Cycle Length: 140
Offset: 0 (0%), Referenced to phase 2:NBT and 6:SBT, Start of Green
Natural Cycle: 150

Lanes, Volumes, Timings
3: St-Laurent & Industrial/Innes

Existing AM Peak Hour
1531 St-Laurent Blvd

Control Type: Actuated-Coordinated
Maximum v/c Ratio: 1.01
Intersection Signal Delay: 51.2
Intersection LOS: D
Intersection Capacity Utilization 84.7%
ICU Level of Service E
Analysis Period (min) 15
~ Volume exceeds capacity, queue is theoretically infinite.
Queue shown is maximum after two cycles.
95th percentile volume exceeds capacity, queue may be longer.
Queue shown is maximum after two cycles.

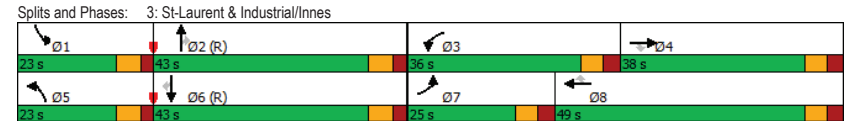

HCM 2010 TWSC
5: Lagan & Belfast

Existing AM Peak Hour
1531 St-Laurent Blvd

Intersection												
Int Delay, s/veh	2.2											
Movement	EBL	EBT	EBR	WBL	WBT	WBR	NBL	NBT	NBR	SBL	SBT	SBR
Lane Configurations	↔		↔		↔		↔		↔		↔	
Traffic Vol, veh/h	51	272	15	13	225	26	11	1	15	15	4	17
Future Vol, veh/h	51	272	15	13	225	26	11	1	15	15	4	17
Conflicting Peds, #/hr	8	0	10	10	0	8	0	0	5	5	0	0
Sign Control	Free	Free	Free	Free	Free	Free	Stop	Stop	Stop	Stop	Stop	Stop
RT Channelized	-	-	None	-	-	None	-	-	None	-	-	None
Storage Length	-	-	-	-	-	-	-	-	-	-	-	-
Veh in Median Storage, #	-	0	-	-	0	-	-	0	-	-	0	-
Grade, %	-	0	-	-	0	-	-	0	-	-	0	-
Peak Hour Factor	90	90	90	90	90	90	90	90	90	90	90	90
Heavy Vehicles, %	20	12	7	23	15	15	55	2	33	20	25	12
Mvmt Flow	57	302	17	14	250	29	12	1	17	17	4	19

Major/Minor	Major1		Major2		Minor1		Minor2	
Conflicting Flow All	287	0	0	329	0	0	739	750
Stage 1	-	-	-	-	-	-	435	435
Stage 2	-	-	-	-	-	-	304	315
Critical Hdwy	4.3	-	-	4.33	-	-	7.65	6.52
Critical Hdwy Stg 1	-	-	-	-	-	-	6.65	5.52
Critical Hdwy Stg 2	-	-	-	-	-	-	6.65	5.52
Follow-up Hdwy	2.38	-	-	2.407	-	-	3.995	4.018
Pot Cap-1 Maneuver	1179	-	-	1122	-	-	275	340
Stage 1	-	-	-	-	-	-	509	580
Stage 2	-	-	-	-	-	-	605	656
Platoon blocked, %	-	-	-	-	-	-	-	-
Mov Cap-1 Maneuver	1172	-	-	1113	-	-	248	311
Mov Cap-2 Maneuver	-	-	-	-	-	-	248	311
Stage 1	-	-	-	-	-	-	475	541
Stage 2	-	-	-	-	-	-	576	642

Approach	EB	WB	NB	SB
HCM Control Delay, s	1.2	0.4	15.3	15
HCM LOS			C	C

Minor Lane/Major Mvmt	NBLn1	EBL	EBT	EBR	WBL	WBT	WBR	SBLn1
Capacity (veh/h)	380	1172	-	-	1113	-	-	400
HCM Lane V/C Ratio	0.079	0.048	-	-	0.013	-	-	0.1
HCM Control Delay (s)	15.3	8.2	0	-	8.3	0	-	15
HCM Lane LOS	C	A	A	-	A	A	-	C
HCM 95th %tile Q(veh)	0.3	0.2	-	-	0	-	-	0.3

Lanes, Volumes, Timings
1: St-Laurent & Tremblay

Existing PM Peak Hour
1531 St-Laurent Blvd

Lane Group	EBL	EBT	WBL	WBT	NBL	NBT	SBL	SBT	SBR	
Lane Configurations	↔	↔	↔	↔	↔	↔	↔	↔	↔	
Traffic Volume (vph)	47	38	23	21	26	1305	51	954	38	
Future Volume (vph)	47	38	23	21	26	1305	51	954	38	
Lane Group Flow (vph)	52	105	26	223	29	1463	57	1060	42	
Turn Type	Perm	NA	Perm	NA	Perm	NA	pm+pt	NA	Perm	
Protected Phases	4		8		8		2		6	
Permitted Phases	4		8		2		6		6	
Detector Phase	4		4		8		2		2	
Switch Phase	4		4		8		2		2	
Minimum Initial (s)	10.0	10.0	10.0	10.0	10.0	10.0	5.0	10.0	10.0	
Minimum Split (s)	38.5	38.5	38.5	38.5	39.2	39.2	9.7	39.2	39.2	
Total Split (s)	40.0	40.0	40.0	40.0	65.0	65.0	15.0	80.0	80.0	
Total Split (%)	33.3%	33.3%	33.3%	33.3%	54.2%	54.2%	12.5%	66.7%	66.7%	
Maximum Green (s)	33.5	33.5	33.5	33.5	58.8	58.8	10.3	73.8	73.8	
Yellow Time (s)	3.3	3.3	3.3	3.3	3.7	3.7	3.7	3.7	3.7	
All-Red Time (s)	3.2	3.2	3.2	3.2	2.5	2.5	1.0	2.5	2.5	
Lost Time Adjust (s)	0.0	0.0	0.0	0.0	0.0	0.0	0.0	0.0	0.0	
Total Lost Time (s)	6.5	6.5	6.5	6.5	6.2	6.2	4.7	6.2	6.2	
Lead/Lag	Lag		Lag		Lag		Lead		Lead	
Lead-Lag Optimize?	Yes		Yes		Yes		Yes		Yes	
Vehicle Extension (s)	3.0	3.0	3.0	3.0	3.0	3.0	3.0	3.0	3.0	
Recall Mode	None	None	None	None	C-Max	C-Max	None	C-Max	C-Max	
Walk Time (s)	7.0	7.0	7.0	7.0	11.0	11.0		11.0	11.0	
Flash Dont Walk (s)	25.0	25.0	25.0	25.0	22.0	22.0		22.0	22.0	
Pedestrian Calls (#/hr)	2	2	2	2	12	12		8	8	
Act Effct Green (s)	16.6	16.6	16.6	16.6	81.4	81.4	92.2	90.7	90.7	
Actuated g/C Ratio	0.14	0.14	0.14	0.14	0.68	0.68	0.77	0.76	0.76	
v/c Ratio	0.83	0.40	0.16	0.62	0.09	0.45	0.22	0.44	0.04	
Control Delay	118.0	23.8	43.4	18.6	14.5	12.2	6.9	7.1	2.3	
Queue Delay	0.0	0.0	0.0	0.0	0.0	0.0	0.0	0.0	0.0	
Total Delay	118.0	23.8	43.4	18.6	14.5	12.2	6.9	7.1	2.3	
LOS	F	C	D	B	B	B	A	A	A	
Approach Delay	55.0		21.2		12.2		6.9		6.9	
Approach LOS	E		C		B		A		A	
Queue Length 50th (m)	12.4	9.4	5.6	9.8	1.5	37.0	2.3	35.8	0.0	
Queue Length 95th (m)	23.5	21.7	11.9	29.0	m5.8	m94.0	9.5	84.7	4.1	
Internal Link Dist (m)	390.4		0.1		682.5		144.8		144.8	
Turn Bay Length (m)	38.0		38.0		45.0		75.0		75.0	
Base Capacity (vph)	129	469	335	544	312	3229	306	2412	987	
Starvation Cap Reductn	0	0	0	0	0	0	0	0	0	
Spillback Cap Reductn	0	0	0	0	0	0	0	0	0	
Storage Cap Reductn	0	0	0	0	0	0	0	0	0	
Reduced v/c Ratio	0.40	0.22	0.08	0.41	0.09	0.45	0.19	0.44	0.04	

Intersection Summary									
Cycle Length: 120									
Actuated Cycle Length: 120									
Offset: 49 (41%), Referenced to phase 2:NBT and 6:SBTL, Start of Green									
Natural Cycle: 90									

Lanes, Volumes, Timings
1: St-Laurent & Tremblay

Existing PM Peak Hour
1531 St-Laurent Blvd

Control Type: Actuated-Coordinated	
Maximum v/c Ratio: 0.83	
Intersection Signal Delay: 13.1	Intersection LOS: B
Intersection Capacity Utilization 79.6%	ICU Level of Service D
Analysis Period (min) 15	
m Volume for 95th percentile queue is metered by upstream signal.	

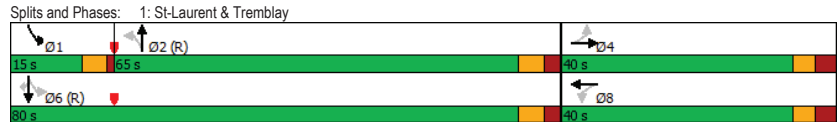

Lanes, Volumes, Timings
2: St-Laurent & Belfast

Existing PM Peak Hour
1531 St-Laurent Blvd

Lane Group	EBL	EBT	EBR	WBL	WBT	NBL	NBT	NBR	SBL	SBT	SBR
Lane Configurations	↔	↕	↔	↔	↕	↔	↕	↔	↔	↕	↔
Traffic Volume (vph)	195	162	215	101	91	104	934	82	93	746	133
Future Volume (vph)	195	162	215	101	91	104	934	82	93	746	133
Lane Group Flow (vph)	217	180	239	112	267	116	1038	91	103	829	148
Turn Type	pm+pt	NA	Perm	Perm	NA	pm+pt	NA	Perm	pm+pt	NA	Perm
Protected Phases	7	4			8	5	2		1	6	
Permitted Phases	4		4	8		2		2	6		6
Detector Phase	7	4	4	8	8	5	2	2	1	6	6
Switch Phase											
Minimum Initial (s)	5.0	10.0	10.0	10.0	10.0	5.0	10.0	10.0	5.0	10.0	10.0
Minimum Split (s)	10.8	27.8	27.8	27.8	27.8	10.7	36.6	36.6	10.7	36.6	36.6
Total Split (s)	15.0	49.0	49.0	34.0	34.0	14.0	57.0	57.0	14.0	57.0	57.0
Total Split (%)	12.5%	40.8%	40.8%	28.3%	28.3%	11.7%	47.5%	47.5%	11.7%	47.5%	47.5%
Maximum Green (s)	9.2	43.2	43.2	28.2	28.2	8.3	51.4	51.4	8.3	51.4	51.4
Yellow Time (s)	3.3	3.3	3.3	3.3	3.3	4.2	4.2	4.2	4.2	4.2	4.2
All-Red Time (s)	2.5	2.5	2.5	2.5	2.5	1.5	1.4	1.4	1.5	1.4	1.4
Lost Time Adjust (s)	0.0	0.0	0.0	0.0	0.0	0.0	0.0	0.0	0.0	0.0	0.0
Total Lost Time (s)	5.8	5.8	5.8	5.8	5.8	5.7	5.6	5.6	5.7	5.6	5.6
Lead/Lag	Lead			Lag	Lag	Lead	Lag	Lag	Lead	Lag	Lag
Lead-Lag Optimize?	Yes			Yes	Yes	Yes	Yes	Yes	Yes	Yes	Yes
Vehicle Extension (s)	3.0	3.0	3.0	3.0	3.0	3.0	3.0	3.0	3.0	3.0	3.0
Recall Mode	None	None	None	None	None	None	C-Max	C-Max	None	C-Max	C-Max
Walk Time (s)	7.0	7.0	7.0	7.0	7.0	25.0	25.0	25.0	25.0	25.0	25.0
Flash Dont Walk (s)	15.0	15.0	15.0	15.0	15.0	6.0	6.0	6.0	6.0	6.0	6.0
Pedestrian Calls (#/hr)	9	9	5	5	5	1	1	1	15	15	15
Act Effct Green (s)	36.2	36.2	36.2	21.2	21.2	66.6	58.2	58.2	66.5	58.2	58.2
Actuated g/C Ratio	0.30	0.30	0.30	0.18	0.18	0.56	0.48	0.48	0.55	0.48	0.48
v/c Ratio	1.07	0.38	0.41	0.61	0.83	0.36	0.65	0.14	0.44	0.52	0.19
Control Delay	117.7	34.2	7.2	58.6	56.2	15.0	27.0	1.7	21.5	19.2	2.3
Queue Delay	0.0	0.0	0.0	0.0	0.0	0.0	0.0	0.0	0.0	0.0	0.0
Total Delay	117.7	34.2	7.2	58.6	56.2	15.0	27.0	1.7	21.5	19.2	2.3
LOS	F	C	A	E	E	B	C	A	C	B	A
Approach Delay		52.5			56.9		24.0			17.1	
Approach LOS		D			E		C			B	
Queue Length 50th (m)	~44.0	33.1	3.6	24.4	46.9	11.2	96.3	0.0	9.1	44.3	0.0
Queue Length 95th (m)	#85.0	48.8	20.5	41.0	73.0	22.4	130.7	3.9	25.8	52.8	5.9
Internal Link Dist (m)		518.7			103.5		597.8			682.5	
Turn Bay Length (m)	75.0		200.0	65.0		75.0		55.0	75.0		85.0
Base Capacity (vph)	203	572	658	244	408	329	1593	665	238	1591	759
Starvation Cap Reductn	0	0	0	0	0	0	0	0	0	0	0
Spillback Cap Reductn	0	0	0	0	0	0	0	0	0	0	0
Storage Cap Reductn	0	0	0	0	0	0	0	0	0	0	0
Reduced v/c Ratio	1.07	0.31	0.36	0.46	0.65	0.35	0.65	0.14	0.43	0.52	0.19

Intersection Summary											
Cycle Length: 120											
Actuated Cycle Length: 120											
Offset: 49 (41%), Referenced to phase 2:NBTL and 6:SBTL, Start of Green											
Natural Cycle: 90											

Lanes, Volumes, Timings
2: St-Laurent & Belfast

Existing PM Peak Hour
1531 St-Laurent Blvd

Control Type: Actuated-Coordinated
 Maximum v/c Ratio: 1.07
 Intersection Signal Delay: 30.9 Intersection LOS: C
 Intersection Capacity Utilization 78.7% ICU Level of Service D
 Analysis Period (min) 15
 ~ Volume exceeds capacity, queue is theoretically infinite.
 Queue shown is maximum after two cycles.
 # 95th percentile volume exceeds capacity, queue may be longer.
 Queue shown is maximum after two cycles.

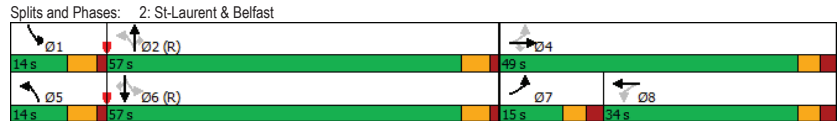

Lanes, Volumes, Timings
3: St-Laurent & Industrial/Innes

Existing PM Peak Hour
1531 St-Laurent Blvd

Lane Group	EBL	EBT	EBR	WBL	WBT	WBR	NBL	NBT	NBR	SBL	SBT	SBR
Lane Configurations	↔↔	↕↕	↔↔	↔↔	↕↕	↔↔	↔↔	↕↕	↔↔	↔↔	↕↕	↔↔
Traffic Volume (vph)	135	550	324	398	274	135	174	852	507	130	814	124
Future Volume (vph)	135	550	324	398	274	135	174	852	507	130	814	124
Lane Group Flow (vph)	150	611	360	442	304	150	193	947	563	144	904	138
Turn Type	Prot	NA	Perm	Prot	NA	Perm	Prot	NA	Perm	Prot	NA	Perm
Protected Phases	7	4		3	8		5	2		1	6	
Permitted Phases			4			8			2			6
Detector Phase	7	4	4	3	8	8	5	2	2	1	6	6
Switch Phase												
Minimum Initial (s)	5.0	10.0	10.0	5.0	10.0	10.0	5.0	10.0	10.0	5.0	10.0	10.0
Minimum Split (s)	11.6	38.6	38.6	11.6	38.6	38.6	11.3	37.6	37.6	11.3	37.6	37.6
Total Split (s)	19.0	38.0	38.0	41.0	60.0	60.0	28.0	43.0	43.0	28.0	43.0	43.0
Total Split (%)	12.7%	25.3%	25.3%	27.3%	40.0%	40.0%	18.7%	28.7%	28.7%	18.7%	28.7%	28.7%
Maximum Green (s)	12.4	31.4	31.4	34.4	53.4	53.4	21.7	36.4	36.4	21.7	36.4	36.4
Yellow Time (s)	3.7	3.7	3.7	3.7	3.7	3.7	4.2	4.2	4.2	4.2	4.2	4.2
All-Red Time (s)	2.9	2.9	2.9	2.9	2.9	2.9	2.1	2.4	2.4	2.1	2.4	2.4
Lost Time Adjust (s)	0.0	0.0	0.0	0.0	0.0	0.0	0.0	0.0	0.0	0.0	0.0	0.0
Total Lost Time (s)	6.6	6.6	6.6	6.6	6.6	6.6	6.3	6.6	6.6	6.3	6.6	6.6
Lead/Lag	Lead	Lag	Lag	Lead	Lag	Lag	Lead	Lag	Lag	Lead	Lag	Lag
Lead-Lag Optimize?	Yes	Yes	Yes	Yes	Yes	Yes	Yes	Yes	Yes	Yes	Yes	Yes
Vehicle Extension (s)	3.0	3.0	3.0	3.0	3.0	3.0	3.0	3.0	3.0	3.0	3.0	3.0
Recall Mode	None	None	None	None	None	None	None	Max	Max	None	Max	Max
Walk Time (s)	7.0	7.0			7.0	7.0		7.0	7.0		7.0	7.0
Flash Dont Walk (s)		25.0	25.0		25.0	25.0		24.0	24.0		24.0	24.0
Pedestrian Calls (#/hr)		5	5		6	6		9	9		12	12
Act Effct Green (s)	10.8	29.1	29.1	23.0	41.4	41.4	13.4	38.5	38.5	11.6	36.7	36.7
Actuated g/C Ratio	0.08	0.23	0.23	0.18	0.32	0.32	0.10	0.30	0.30	0.09	0.29	0.29
v/c Ratio	0.56	0.83	0.64	0.77	0.30	0.26	0.59	0.97	0.75	0.53	0.97	0.26
Control Delay	66.6	58.7	14.6	60.2	33.7	5.9	64.0	68.2	15.5	64.5	70.2	4.1
Queue Delay	0.0	0.0	0.0	0.0	0.0	0.0	0.0	0.0	0.0	0.0	0.0	0.0
Total Delay	66.6	58.7	14.6	60.2	33.7	5.9	64.0	68.2	15.5	64.5	70.2	4.1
LOS	E	E	B	E	C	A	E	E	B	E	E	A
Approach Delay		45.6			42.1			50.3				61.8
Approach LOS		D			D			D				E
Queue Length 50th (m)	19.3	77.7	11.3	56.4	30.3	0.0	24.8	127.8	20.8	18.5	122.4	0.0
Queue Length 95th (m)	32.9	#112.0	46.9	77.6	44.5	14.7	39.3	#197.5	76.5	31.1	#192.7	9.7
Internal Link Dist (m)		745.6			700.4			316.7			597.8	
Turn Bay Length (m)	38.0		120.0	150.0		80.0	100.0		100.0	125.0		150.0
Base Capacity (vph)	312	803	582	867	1335	695	531	974	752	516	928	531
Starvation Cap Reductn	0	0	0	0	0	0	0	0	0	0	0	0
Spillback Cap Reductn	0	0	0	0	0	0	0	0	0	0	0	0
Storage Cap Reductn	0	0	0	0	0	0	0	0	0	0	0	0
Reduced v/c Ratio	0.48	0.76	0.62	0.51	0.23	0.22	0.36	0.97	0.75	0.28	0.97	0.26

Intersection Summary
 Cycle Length: 150
 Actuated Cycle Length: 128.5
 Natural Cycle: 110
 Control Type: Actuated-Uncoordinated

Lanes, Volumes, Timings
3: St-Laurent & Industrial/Innes

Existing PM Peak Hour
1531 St-Laurent Blvd

Maximum v/c Ratio: 0.97	Intersection LOS: D
Intersection Signal Delay: 50.5	ICU Level of Service E
Intersection Capacity Utilization 82.5%	
Analysis Period (min) 15	
# 95th percentile volume exceeds capacity, queue may be longer.	
Queue shown is maximum after two cycles.	

Splits and Phases: 3: St-Laurent & Industrial/Innes

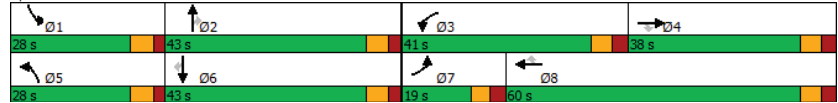

HCM 2010 TWSC
5: Lagan & Belfast

Existing PM Peak Hour
1531 St-Laurent Blvd

Intersection												
Int Delay, s/veh	3.1											
Movement	EBL	EBT	EBR	WBL	WBT	WBR	NBL	NBT	NBR	SBL	SBT	SBR
Lane Configurations	↕		↕		↕		↕		↕		↕	
Traffic Vol, veh/h	46	265	50	19	310	26	26	5	16	30	0	39
Future Vol, veh/h	46	265	50	19	310	26	26	5	16	30	0	39
Conflicting Peds, #/hr	12	0	5	5	0	12	1	0	6	6	0	1
Sign Control	Free	Free	Free	Free	Free	Free	Stop	Stop	Stop	Stop	Stop	Stop
RT Channelized	-	-	None	-	-	None	-	-	None	-	-	None
Storage Length	-	-	-	-	-	-	-	-	-	-	-	-
Veh in Median Storage, #	-	0	-	-	0	-	-	0	-	-	0	-
Grade, %	-	0	-	-	0	-	-	0	-	-	0	-
Peak Hour Factor	90	90	90	90	90	90	90	90	90	90	90	90
Heavy Vehicles, %	30	6	12	5	3	8	4	2	2	10	2	2
Mvmt Flow	51	294	56	21	344	29	29	6	18	33	0	43

Major/Minor	Major1	Major2	Minor1	Minor2
Conflicting Flow All	385	0	355	0
Stage 1	-	-	-	-
Stage 2	-	-	-	-
Critical Hdwy	4.4	-	4.15	-
Critical Hdwy Stg 1	-	-	-	-
Critical Hdwy Stg 2	-	-	-	-
Follow-up Hdwy	2.47	-	2.245	-
Pot Cap-1 Maneuver	1036	-	1187	-
Stage 1	-	-	-	-
Stage 2	-	-	-	-
Platoon blocked, %	-	-	-	-
Mov Cap-1 Maneuver	1026	-	1182	-
Mov Cap-2 Maneuver	-	-	-	-
Stage 1	-	-	-	-
Stage 2	-	-	-	-

Approach	EB	WB	NB	SB
HCM Control Delay, s	1.1	0.4	18.7	17.1
HCM LOS			C	C

Minor Lane/Major Mvmt	NBLn1	EBL	EBT	EBR	WBL	WBT	WBR	SBLn1
Capacity (veh/h)	315	1026	-	-	1182	-	-	375
HCM Lane V/C Ratio	0.166	0.05	-	-	0.018	-	-	0.204
HCM Control Delay (s)	18.7	8.7	0	-	8.1	0	-	17.1
HCM Lane LOS	C	A	A	-	A	A	-	C
HCM 95th %tile Q(veh)	0.6	0.2	-	-	0.1	-	-	0.8

Appendix D

Collision Data

12/20/2019	2019	13:35	BELFAST RD @ TRIOLE ST (0008405)	01 - Clear	01 - Daylight	02 - Stop sign	01 - Functioning	02 - Non-fatal injury	07 - SMV other	04 - Slush	2	0	0	0
6/11/2019	2019	17:30	BELFAST RD @ TRIOLE ST (0008405)	01 - Clear	01 - Daylight	02 - Stop sign	01 - Functioning	02 - Non-fatal injury	03 - Rear end	01 - Dry	2	0	0	0
1/18/2019	2019	11:53	BELFAST RD @ TRIOLE ST (0008405)	01 - Clear	01 - Daylight	02 - Stop sign	01 - Functioning	03 - P.D. only	01 - Approaching	02 - Wet	2	0	0	0
6/22/2017	2017	12:28	BELFAST RD btwn ST. LAURENT BLVD & TRIOLE ST (__32A791)	01 - Clear	01 - Daylight	10 - No control	0	03 - P.D. only	02 - Angle	01 - Dry	2	0	0	0
9/20/2017	2017	11:15	BELFAST RD btwn ST. LAURENT BLVD & TRIOLE ST (__32A791)	01 - Clear	01 - Daylight	10 - No control	0	03 - P.D. only	02 - Angle	01 - Dry	1	0	0	1
12/3/2019	2019	8:00	BELFAST RD btwn ST. LAURENT BLVD & TRIOLE ST (__32A791)	01 - Clear	01 - Daylight	10 - No control	0	03 - P.D. only	03 - Rear end	01 - Dry	1	0	0	0
3/29/2017	2017	Unknown	TRIOLE ST btwn BELFAST RD & END (__32A79Y)	01 - Clear	00 - Unknown	10 - No control	0	03 - P.D. only	06 - SMV unattended vehicle	01 - Dry	2	0	0	0
4/13/2017	2017	11:30	TRIOLE ST btwn BELFAST RD & END (__32A79Y)	01 - Clear	01 - Daylight	10 - No control	0	03 - P.D. only	06 - SMV unattended vehicle	01 - Dry	2	0	0	0
3/7/2018	2018	10:54	TRIOLE ST btwn BELFAST RD & END (__32A79Y)	03 - Snow	01 - Daylight	10 - No control	0	03 - P.D. only	04 - Sideswipe	02 - Wet	2	0	0	0
8/23/2019	2019	20:10	TRIOLE ST btwn BELFAST RD & END (__32A79Y)	01 - Clear	05 - Dusk	10 - No control	0	03 - P.D. only	04 - Sideswipe	01 - Dry	2	0	0	0
8/21/2020	2020	8:30	TRIOLE ST btwn BELFAST RD & END (__32A79Y)	01 - Clear	01 - Daylight	10 - No control	0	03 - P.D. only	02 - Angle	01 - Dry	2	0	0	0

Appendix E

TRANS Plots

TRANS Regional Model

Version 2.15 - Assigned June 16, 2020

AM Peak Hour Total Traffic Volume

Coventry Road

2011 Model - Basecase

N/A

User Initials: KN

Plot Prepared: Aug 18, 2022

EMME Scenario: 21713



Legend

AM Peak Hour Total Traffic Volume

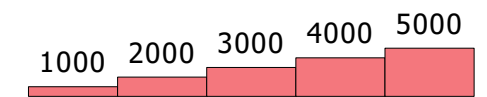

Distance (m)

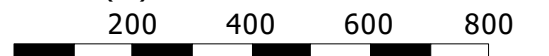

The TRANS model is continuously refined & maintained, and all information is provided in good faith. However, model outputs are provided "as is", and no warranty or guarantee is provided as to the accuracy, reliability or reasonableness of the results. In using this data, you agree to accept any and all risks arising from any incorrect, incomplete, or misleading information.

Recipients are required to use caution and professional judgement in using and interpreting model outputs. In particular, caution should be used when focusing on a geographically limited area (such as a single road or intersection), as the model is primarily designed to simulate regional-scale phenomena and has been calibrated at a regional level.

As general good practice, it is recommended that the user confirm the network coding within the area of interest, and compare base year forecasts against traffic count data to assess the extent to which the model may be over- or under-estimating the travel demand.

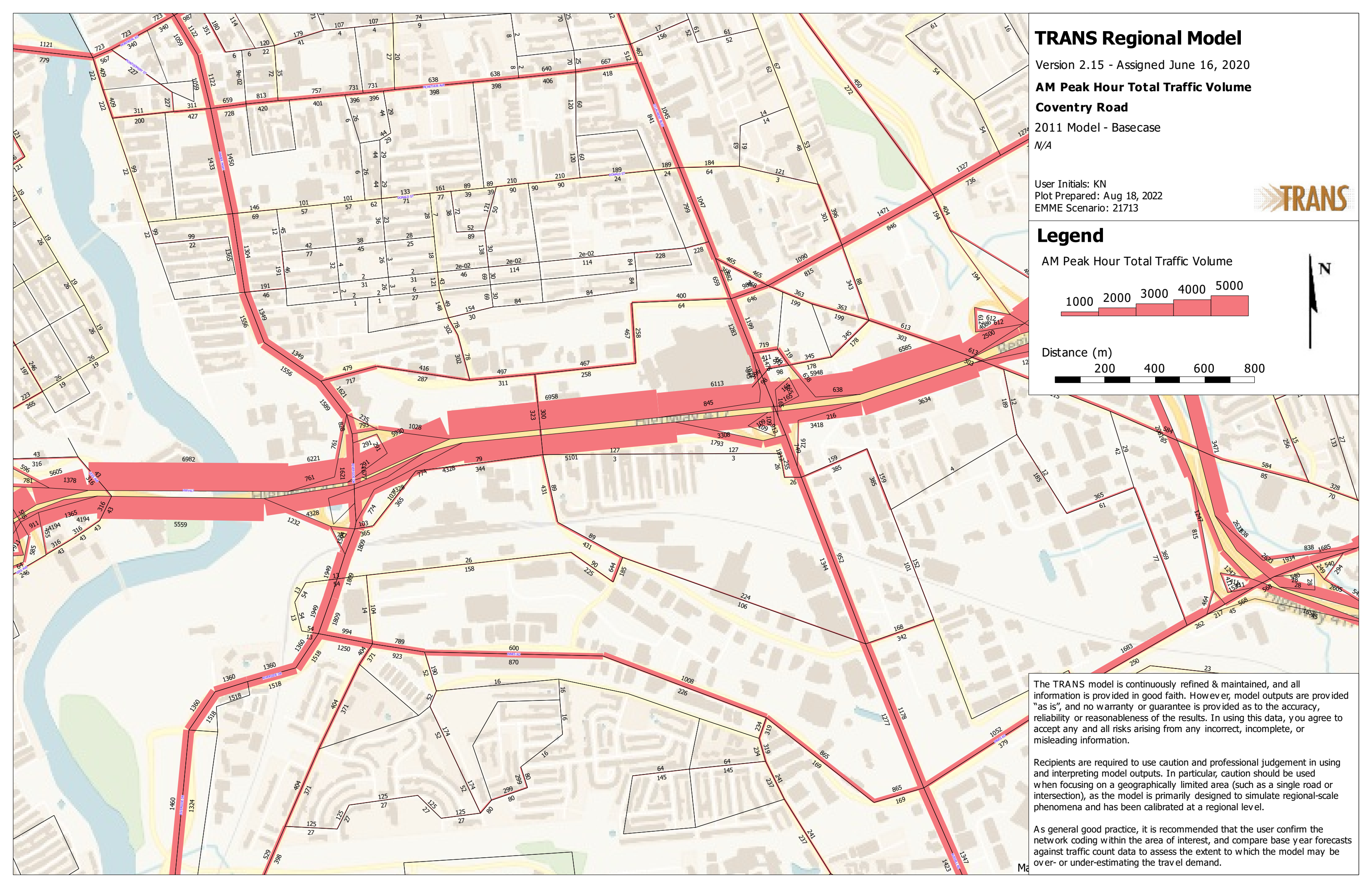

TRANS Regional Model

Version 2.15 - Assigned June 16, 2020

AM Peak Hour Total Traffic Volume

Coventry Road

2031 Model - Basecase

N/A

User Initials: KN

Plot Prepared: Aug 18, 2022

EMME Scenario: 21715



Legend

AM Peak Hour Total Traffic Volume

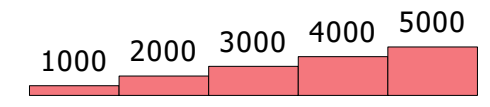

Distance (m)

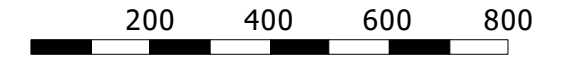

The TRANS model is continuously refined & maintained, and all information is provided in good faith. However, model outputs are provided "as is", and no warranty or guarantee is provided as to the accuracy, reliability or reasonableness of the results. In using this data, you agree to accept any and all risks arising from any incorrect, incomplete, or misleading information.

Recipients are required to use caution and professional judgement in using and interpreting model outputs. In particular, caution should be used when focusing on a geographically limited area (such as a single road or intersection), as the model is primarily designed to simulate regional-scale phenomena and has been calibrated at a regional level.

As a general good practice, it is recommended that the user confirm the network coding within the area of interest, and compare base year forecasts against traffic count data to assess the extent to which the model may be over- or under-estimating the travel demand.

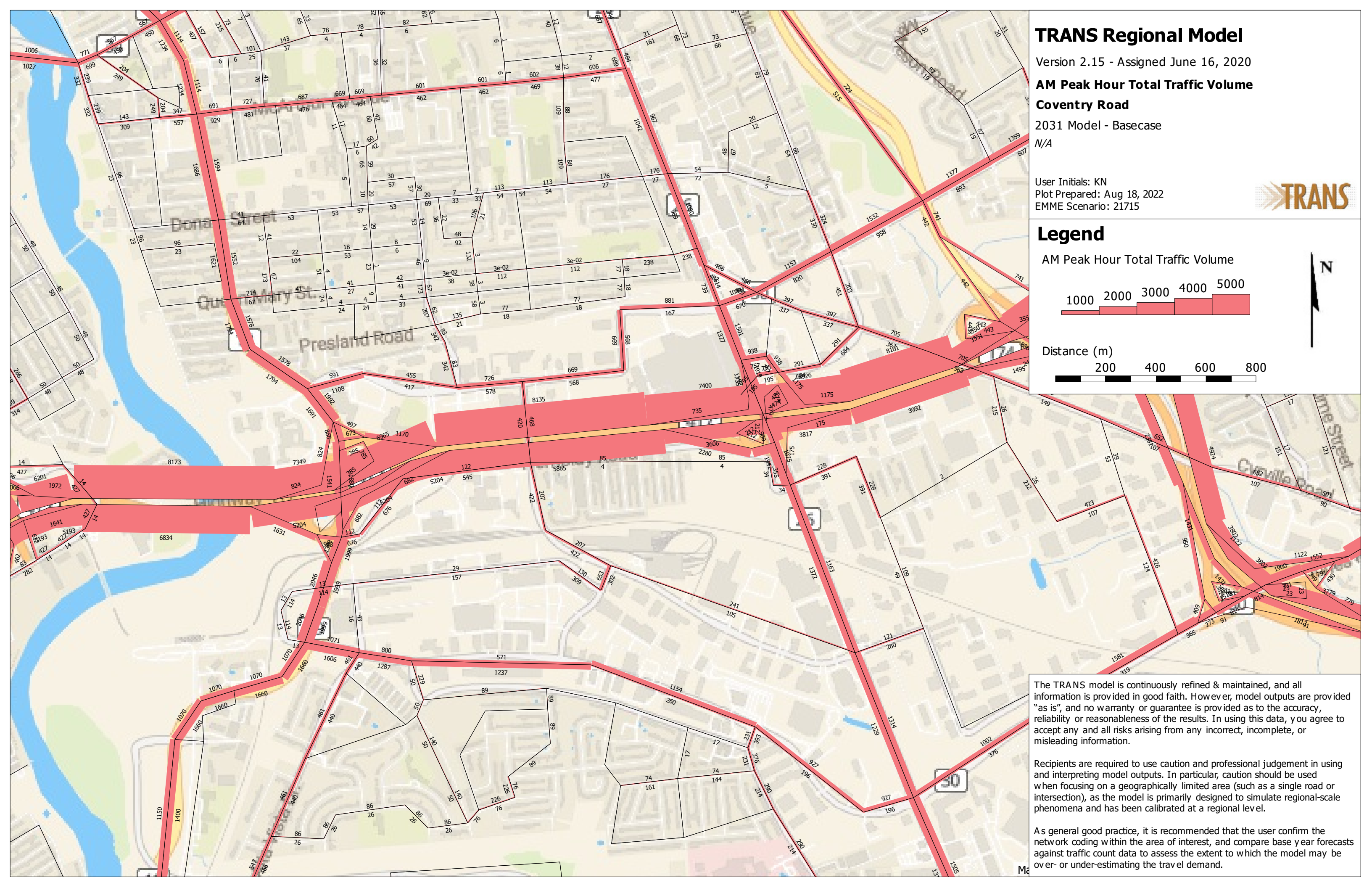

Appendix F

Background Volumes

Trip Distribution

The projected distribution of site-generated traffic was derived based on existing travel patterns, the site's connections to/from the surrounding road network, and our local area knowledge. (e.g. the location and proximity of other area shopping, communities, recreational opportunities, etc.). For analysis purposes, the following approximate distribution of projected site-generated traffic was assumed:

- 70% to/from the west via HWY 417 (via Tremblay);
 - 10% to/from the east via Tremblay Road;
 - 10% to/from the north via Belfast Road; and
 - + 10% to/from the south via Belfast Road.
-
- 100%

Trip Assignment

Based on the above assumed distribution, projected 'new' site-generated traffic was assigned to the study area network and is depicted in the following **Figure 12** and **Figure 14** for phase 1 and phase 2, respectively. Similarly, projected 'pass-by' site-generated traffic, which represents existing traffic temporarily diverted to/from the subject site, is depicted in the following **Figure 13** and **Figure 15** for phase 1 and phase 2, respectively.

It should be noted that Avenue J is a private driveway owned by PIPSC (Professional Institute of the Public Service Canada) and there are currently no plans for this to be a connection to/from the subject development.

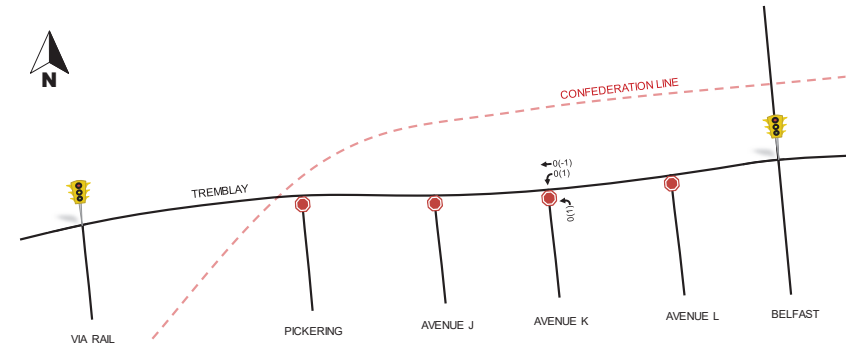

Figure 14: 'Pass-by' Projected Site-Generated Traffic - Phase 1

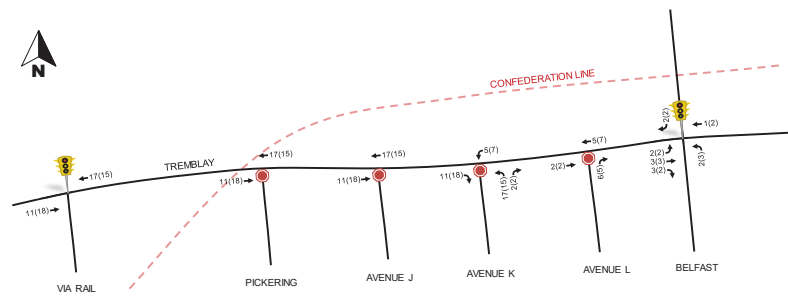

Figure 13: 'New' Projected Site-Generated Traffic - Phase 1

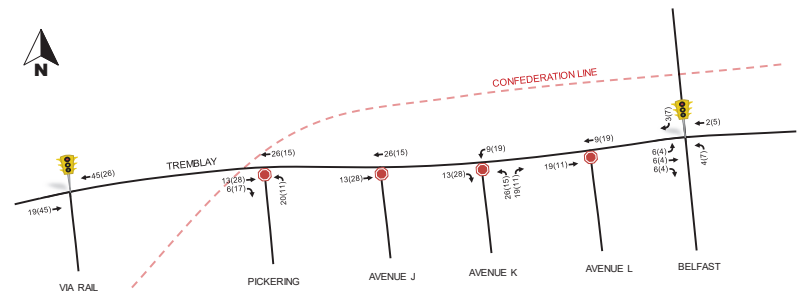

Figure 15: 'New' Projected Site-Generated Traffic - Phase 2

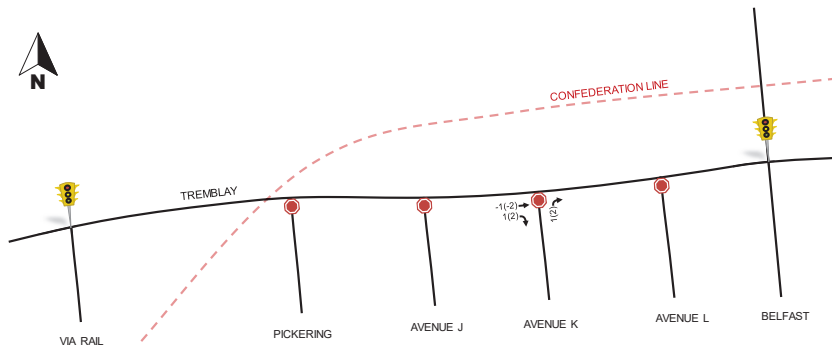

Figure 16: 'Pass-by' Projected Site-Generated Traffic - Phase 2

Given a 0% growth rate for general background traffic and given all area development is assumed to be fully built-out by the horizon year 2025, projected background traffic volumes for the horizon years 2030 and 2035 will be the same as the background traffic volumes for the 2025 horizon year. Therefore, the following **Figure 17** depicts projected background traffic volumes for the 2025 horizon year and beyond.

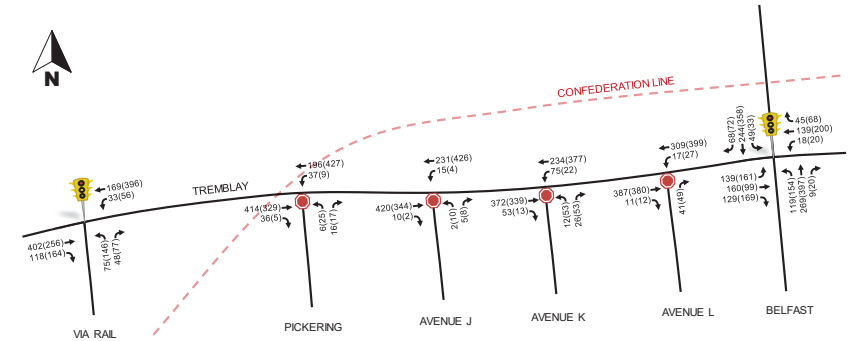

Figure 17: Background Traffic Volumes (2025, 2030, 2035)

3.3 Demand Rationalization

The following section summarizes the vehicular intersection capacity analysis of existing, future background and future total volume scenarios.

Using the intersection capacity analysis software Synchro (v9), study area intersections were assessed in terms of vehicle delay, 95th percentile queues, a volume-to-capacity ratio (v/c) and a corresponding Level of Service (LOS). It should be noted that the overall performance of a signalized intersection is calculated as a weighted v/c ratio and assigned a corresponding LOS, with critical movements assigned a LOS based on their respective v/c ratio. The overall performance of an unsignalized intersection is a LOS output from Synchro, which is based on an Intersection Capacity Utilization (ICU) method, and critical movements are assigned a LOS based on delay.

Existing and Background Conditions

The following **Table 8**, **Table 9** summarize existing and projected background conditions at study area intersections, in the absence of the proposed development. The objective of this analysis is to determine if network improvements are, or will be required to support background traffic. Detailed Synchro output data for existing and background conditions is provided as **Appendix E**.

FIGURE 4.3
PHASE 1 to 3 – PEAK AM AND PM HOUR SITE GENERATED TRIPS

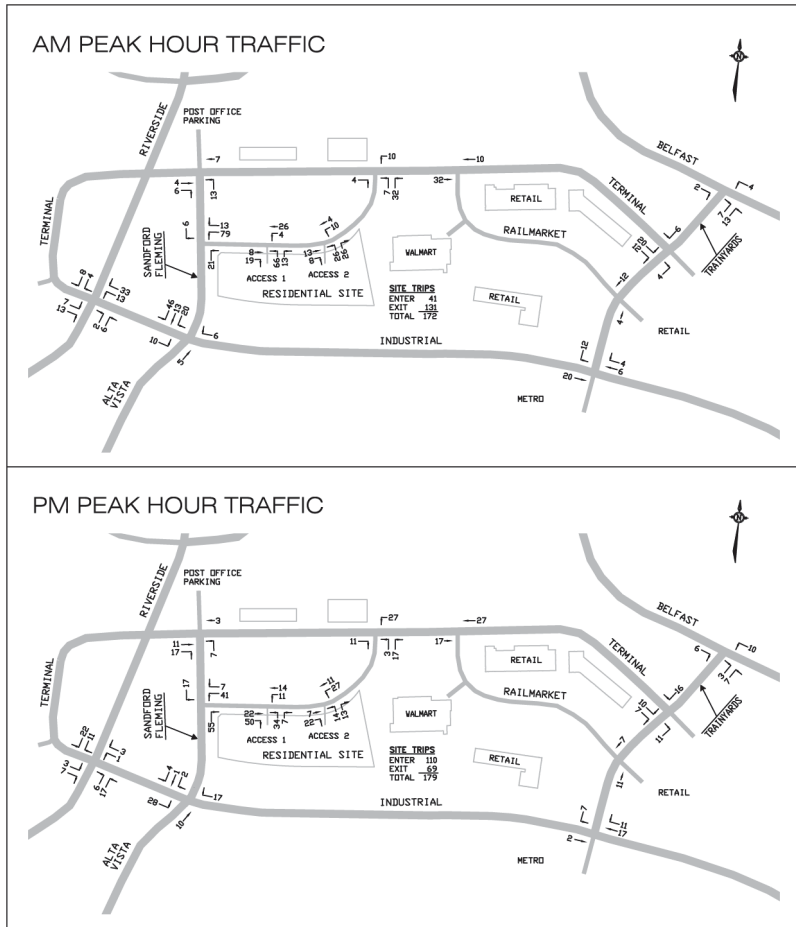

NOT TO SCALE

proportional assignment to the study area roadways, Figure 18 and Figure 19 illustrate the new site-generated volumes and pass-by volumes, respectively.

Table 14: Trip Assignment

To/From	Via
North	5% Vanier Parkway (N)
	5% Lola Street (N)
	15% St. Laurent Boulevard (N)
South	5% Belfast Road (S)
	10% St. Laurent Boulevard (S)
East	15% to/from Highway 417/174 (E)
West	10% Ogilvie Road (E)
	25% to/from Highway 417 (W)
Total	100%

Figure 18: New Site-Generated Auto Volumes

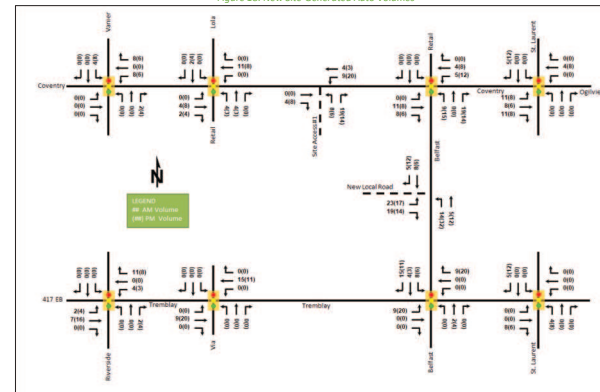

Figure 6: Net Assignment of Trips with Redevelopment

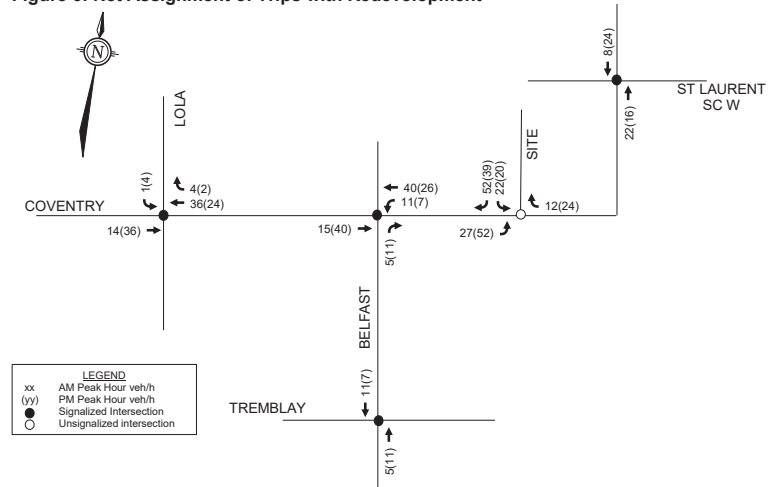
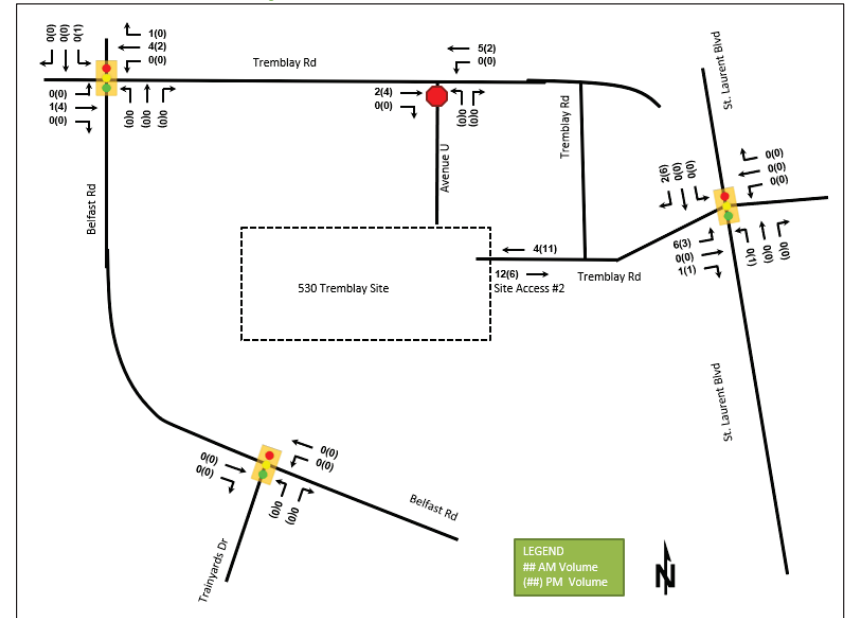
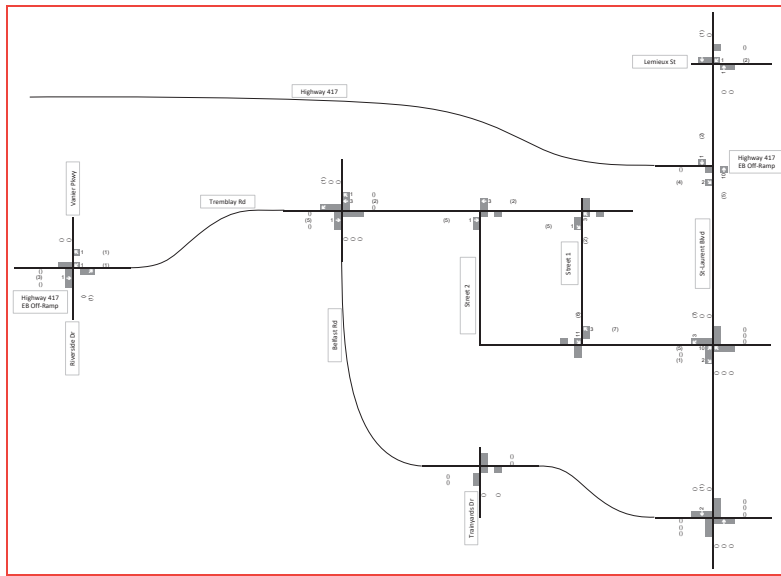

Figure 20: New Site Generation Auto Volumes Scenario 2





Legend
 (x) A.M. Peak Hour Traffic Volume (o) P.M. Peak Hour Traffic Volume

Figure 3-2
 2025 Residential Trips Generated

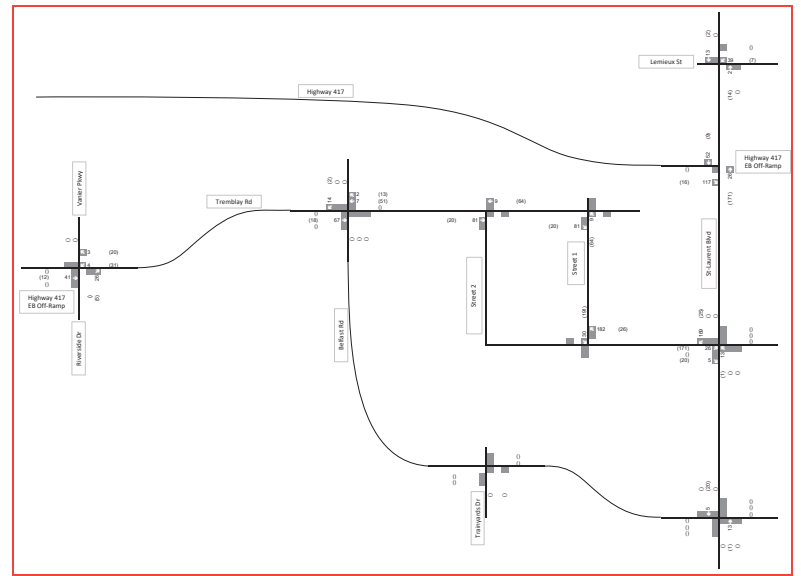

Legend
 (x) A.M. Peak Hour Traffic Volume (o) P.M. Peak Hour Traffic Volume

Figure 3-3
 2025 Office Trips Generated

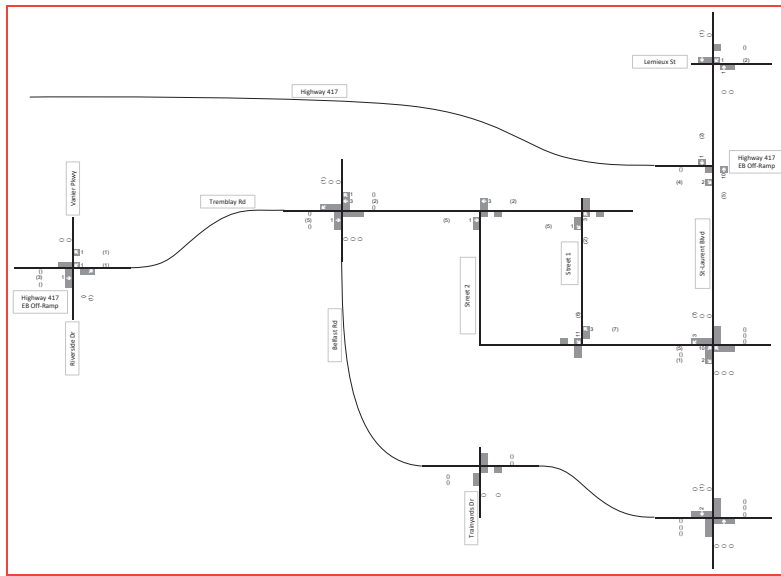

Legend
 AM Peak Hour Traffic Volume (Black bar)
 PM Peak Hour Traffic Volume (White bar)

Figure 3-4
 2029 Residential Trip Generation

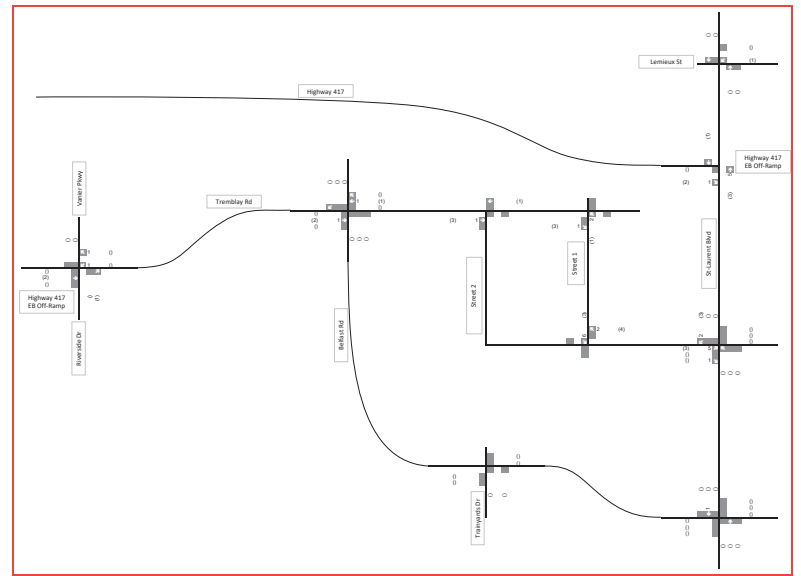

Legend
 AM Peak Hour Traffic Volume (Black bar)
 PM Peak Hour Traffic Volume (White bar)

Figure 3-5
 2033 Residential Trip Generation

Figure 14: New Site Generation Auto Volumes

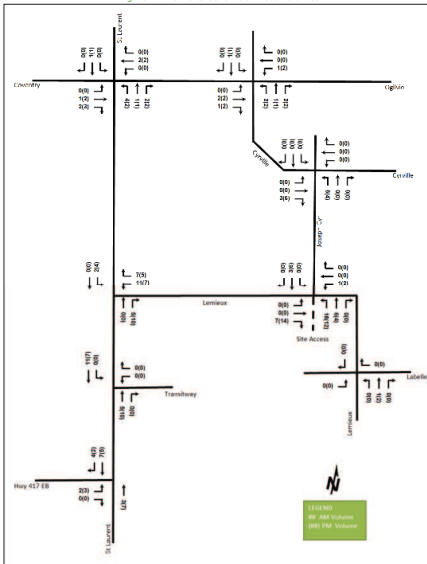
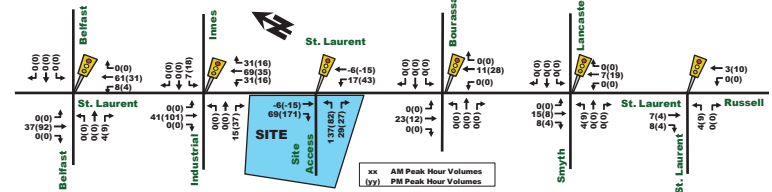

Figure 12: 'New' Site-Generated Traffic



3.2. Background Network Travel Demands

3.2.1. Transportation Network Plans

As mentioned in **Section 2.1.3** Planned Conditions, St. Laurent Boulevard is designated as a 'transit priority corridor with isolated measures' from Montreal Road to Elmvale Shopping Center within the 2031 Affordable Network. Though no design is currently available, there is the potential that segments of St. Laurent Boulevard that have not received transit retrofits yet could be upgraded to provide better transit service within the corridor (segments adjacent to the site were retrofitted around 2017). Cycling improvements are also anticipated as discussed in **Section 2.1.3**.

3.2.2. Background Growth

The emphasis in the City's recent Official Plan and Transportation Master Plan is to place priority on transit, encourage intensification around transit stations, encourage mixed-use developments and provide "complete streets" that better accommodate the active transportation needs of its residents and reduce the use of the private auto. Given the location of the site near frequent bus service within the St. Laurent transit priority corridor, close bus connectivity to the LRT Confederation Line and Elmvale Mall, the trips generated from this development as well as nearby developments will likely choose alternate modes of transportation over driving as transit infrastructure improves.

The following background traffic growth (summarized in **Table 12**) was calculated based on historical traffic count data (years 2001, 2009, 2014, 2016 and 2020) provided by the City of Ottawa at the Smyth/St. Laurent intersection near the site. Note that the year 2012 was omitted as counts were almost double any other year count and it was considered an anomaly year or miscount. Detailed background traffic growth analysis is included as **Appendix E**.

Table 12: Smyth/St. Laurent Historical Background Growth (2001-2020)

Time Period	Percent Annual Change				
	North Leg	South Leg	East Leg	West Leg	Overall
8 hrs	-0.17%	-0.13%	1.66%	0.47%	0.17%
AM Peak	-0.24%	0.00%	1.77%	0.52%	0.23%
PM Peak	-0.48%	-0.42%	1.53%	0.33%	-0.06%

As shown in **Table 12**, the Smyth/St. Laurent intersection, has experienced between 0.25% to 0% overall annual growth in traffic within recent years. A conservative growth rate of 1% annually will be added to background growth to account for future potential growth to the south and surrounding areas.

3.2.3. Other Developments

The volumes from the other area development as mentioned in **Section 2.1.3** were layered onto the existing traffic volumes for the future analysis volumes. **Figure 13** and **Figure 14** outlines the site generated volumes for 1910 St. Laurent development and 355-374 Everest development respectively.

Figure 11: New Site Generation Auto Volumes

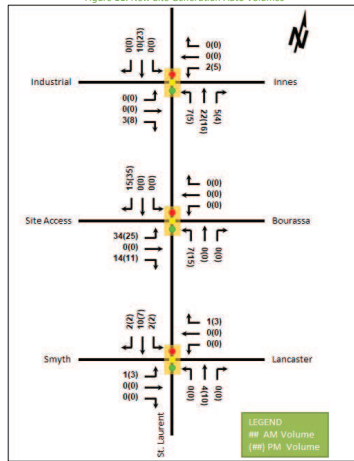

6 Background Network Travel Demands

6.1 Transportation Network Plans

The transportation network plans were discussed in Section 2.3. None of the proposed changes are considered to have any notable impact on the study area traffic volumes and travel patterns.

6.2 Background Growth

A review of the background projections from the City's TRANS Regional Model for the 2011 and 2031 horizons was completed to determine the background growth for each of the study area roadways. The study area roadways have generally achieved any predicted growth or are forecasted to contract in on the study area roadways. Table 16 summarizes the results of the model, and the projections are provided in Appendix E.

Appendix G

Synchro Intersection Worksheets – 2026 Future Background Conditions

Lanes, Volumes, Timings
1: St-Laurent & Tremblay

Future Background 2026AM Peak Hour
1531 St-Laurent Blvd

Lane Group	EBL	EBT	WBL	WBT	NBL	NBT	SBL	SBT	SBR
Lane Configurations	↔	↔	↔	↔	↔	↔	↔	↔	↔
Traffic Volume (vph)	55	21	12	20	82	1232	129	1141	240
Future Volume (vph)	55	21	12	20	82	1232	129	1141	240
Lane Group Flow (vph)	55	53	12	133	82	1270	129	1141	240
Turn Type	Perm	NA	Perm	NA	Perm	NA	pm+pt	NA	Perm
Protected Phases		4		8		2		1	6
Permitted Phases	4		8		2		6		6
Detector Phase	4	4	8	8	2	2	1	6	6
Switch Phase									
Minimum Initial (s)	10.0	10.0	10.0	10.0	10.0	10.0	5.0	10.0	10.0
Minimum Split (s)	38.5	38.5	38.5	38.5	39.2	39.2	9.7	39.2	39.2
Total Split (s)	40.0	40.0	40.0	40.0	72.0	72.0	18.0	90.0	90.0
Total Split (%)	30.8%	30.8%	30.8%	30.8%	55.4%	55.4%	13.8%	69.2%	69.2%
Maximum Green (s)	33.5	33.5	33.5	33.5	65.8	65.8	13.3	83.8	83.8
Yellow Time (s)	3.3	3.3	3.3	3.3	3.7	3.7	3.7	3.7	3.7
All-Red Time (s)	3.2	3.2	3.2	3.2	2.5	2.5	1.0	2.5	2.5
Lost Time Adjust (s)	0.0	0.0	0.0	0.0	0.0	0.0	0.0	0.0	0.0
Total Lost Time (s)	6.5	6.5	6.5	6.5	6.2	6.2	4.7	6.2	6.2
Lead/Lag					Lag	Lag	Lead		
Lead-Lag Optimize?					Yes	Yes	Yes		
Vehicle Extension (s)	3.0	3.0	3.0	3.0	3.0	3.0	3.0	3.0	3.0
Recall Mode	None	None	None	None	C-Max	C-Max	None	C-Max	C-Max
Walk Time (s)	7.0	7.0	7.0	7.0	11.0	11.0		11.0	11.0
Flash Dont Walk (s)	25.0	25.0	25.0	25.0	22.0	22.0		22.0	22.0
Pedestrian Calls (#/hr)	4	4	3	3	2	2		7	7
Act Effct Green (s)	16.4	16.4	16.4	16.4	88.1	88.1	102.4	100.9	100.9
Actuated g/C Ratio	0.13	0.13	0.13	0.13	0.68	0.68	0.79	0.78	0.78
v/c Ratio	0.58	0.24	0.09	0.49	0.28	0.43	0.40	0.48	0.23
Control Delay	74.3	25.2	46.3	17.8	14.6	11.5	8.0	7.0	1.4
Queue Delay	0.0	0.0	0.0	0.0	0.0	0.0	0.0	0.0	0.0
Total Delay	74.3	25.2	46.3	17.8	14.6	11.5	8.0	7.0	1.4
LOS	E	C	D	B	B	B	A	A	A
Approach Delay		50.2		20.2		11.7		6.2	
Approach LOS		D		C		B		A	
Queue Length 50th (m)	13.9	5.0	2.8	4.8	6.9	44.6	5.5	40.3	0.0
Queue Length 95th (m)	24.2	14.7	7.7	20.6	25.1	89.7	18.3	95.6	8.6
Internal Link Dist (m)		396.6		0.1		682.5		144.8	
Turn Bay Length (m)	38.0		38.0		45.0		75.0		
Base Capacity (vph)	195	414	281	436	293	2934	375	2387	1041
Starvation Cap Reductn	0	0	0	0	0	0	0	0	0
Spillback Cap Reductn	0	0	0	0	0	0	0	0	0
Storage Cap Reductn	0	0	0	0	0	0	0	0	0
Reduced v/c Ratio	0.28	0.13	0.04	0.31	0.28	0.43	0.34	0.48	0.23

Intersection Summary

Cycle Length: 130
 Actuated Cycle Length: 130
 Offset: 53 (41%), Referenced to phase 2:NBTL and 6:SBTL, Start of Green
 Natural Cycle: 90

Lanes, Volumes, Timings
1: St-Laurent & Tremblay

Future Background 2026AM Peak Hour
1531 St-Laurent Blvd

Control Type: Actuated-Coordinated
 Maximum v/c Ratio: 0.58
 Intersection Signal Delay: 10.7
 Intersection LOS: B
 Intersection Capacity Utilization 81.7%
 ICU Level of Service D
 Analysis Period (min) 15

Splits and Phases: 1: St-Laurent & Tremblay



Lanes, Volumes, Timings
2: St-Laurent & Belfast

Future Background 2026AM Peak Hour
1531 St-Laurent Blvd

Lane Group	EBL	EBT	EBR	WBL	WBT	NBL	NBT	NBR	SBL	SBT	SBR
Lane Configurations	↖	↗	↘	↙	↘	↙	↘	↙	↘	↙	↘
Traffic Volume (vph)	47	63	91	43	140	123	920	63	83	838	190
Future Volume (vph)	47	63	91	43	140	123	920	63	83	838	190
Lane Group Flow (vph)	47	63	91	43	234	123	920	63	83	838	190
Turn Type	pm+pt	NA	Perm	Perm	NA	pm+pt	NA	Perm	pm+pt	NA	Perm
Protected Phases	7	4			8	5	2		1	6	
Permitted Phases	4		4	8				2	6		6
Detector Phase	7	4	4	8	8	5	2	2	1	6	6
Switch Phase											
Minimum Initial (s)	5.0	10.0	10.0	10.0	10.0	5.0	10.0	10.0	5.0	10.0	10.0
Minimum Split (s)	10.8	27.8	27.8	27.8	27.8	10.7	36.6	36.6	10.7	36.6	36.6
Total Split (s)	16.0	48.0	48.0	32.0	32.0	15.0	57.0	57.0	15.0	57.0	57.0
Total Split (%)	13.3%	40.0%	40.0%	26.7%	26.7%	12.5%	47.5%	47.5%	12.5%	47.5%	47.5%
Maximum Green (s)	10.2	42.2	42.2	26.2	26.2	9.3	51.4	51.4	9.3	51.4	51.4
Yellow Time (s)	3.3	3.3	3.3	3.3	3.3	4.2	4.2	4.2	4.2	4.2	4.2
All-Red Time (s)	2.5	2.5	2.5	2.5	2.5	1.5	1.4	1.4	1.5	1.4	1.4
Lost Time Adjust (s)	0.0	0.0	0.0	0.0	0.0	0.0	0.0	0.0	0.0	0.0	0.0
Total Lost Time (s)	5.8	5.8	5.8	5.8	5.8	5.7	5.6	5.6	5.7	5.6	5.6
Lead/Lag	Lead			Lag	Lag	Lead	Lag	Lag	Lead	Lag	Lag
Lead-Lag Optimize?	Yes			Yes	Yes	Yes	Yes	Yes	Yes	Yes	Yes
Vehicle Extension (s)	3.0	3.0	3.0	3.0	3.0	3.0	3.0	3.0	3.0	3.0	3.0
Recall Mode	None	None	None	None	None	None	C-Max	C-Max	None	C-Max	C-Max
Walk Time (s)	7.0	7.0	7.0	7.0	7.0	25.0	25.0	25.0	25.0	25.0	25.0
Flash Dont Walk (s)	15.0	15.0	15.0	15.0	15.0	6.0	6.0	6.0	6.0	6.0	6.0
Pedestrian Calls (#/hr)	2	2	1	1	1	0	0	0	3	3	3
Act Effct Green (s)	33.9	33.9	33.9	21.9	21.9	70.5	63.3	63.3	68.4	60.5	60.5
Actuated g/C Ratio	0.28	0.28	0.28	0.18	0.18	0.59	0.53	0.53	0.57	0.50	0.50
v/c Ratio	0.23	0.13	0.22	0.22	0.84	0.38	0.55	0.08	0.29	0.54	0.27
Control Delay	30.4	29.0	6.7	42.7	66.1	15.2	23.6	0.2	14.4	24.0	4.1
Queue Delay	0.0	0.0	0.0	0.0	0.0	0.0	0.0	0.0	0.0	0.0	0.0
Total Delay	30.4	29.0	6.7	42.7	66.1	15.2	23.6	0.2	14.4	24.0	4.1
LOS	C	C	A	D	E	B	C	A	B	C	A
Approach Delay	19.2				62.5		21.4			19.9	
Approach LOS	B				E		C			B	
Queue Length 50th (m)	7.8	10.5	0.0	8.6	47.3	12.3	82.6	0.0	8.1	75.0	0.0
Queue Length 95th (m)	15.9	19.9	10.9	18.7	#75.9	23.2	112.7	0.0	16.7	100.9	13.3
Internal Link Dist (m)		518.7			103.5		597.8			682.5	
Turn Bay Length (m)	75.0		200.0	65.0		75.0		55.0	75.0		85.0
Base Capacity (vph)	217	596	499	233	330	328	1683	805	299	1563	692
Starvation Cap Reductn	0	0	0	0	0	0	0	0	0	0	0
Spillback Cap Reductn	0	0	0	0	0	0	0	0	0	0	0
Storage Cap Reductn	0	0	0	0	0	0	0	0	0	0	0
Reduced v/c Ratio	0.22	0.11	0.18	0.18	0.71	0.38	0.55	0.08	0.28	0.54	0.27

Intersection Summary

Cycle Length: 120
 Actuated Cycle Length: 120
 Offset: 53 (44%), Referenced to phase 2:NBTL and 6:SBTL, Start of Green
 Natural Cycle: 90

Lanes, Volumes, Timings
2: St-Laurent & Belfast

Future Background 2026AM Peak Hour
1531 St-Laurent Blvd

Control Type: Actuated-Coordinated
 Maximum v/c Ratio: 0.84
 Intersection Signal Delay: 24.8
 Intersection LOS: C
 Intersection Capacity Utilization 70.3%
 ICU Level of Service C
 Analysis Period (min) 15
 # 95th percentile volume exceeds capacity, queue may be longer.
 Queue shown is maximum after two cycles.

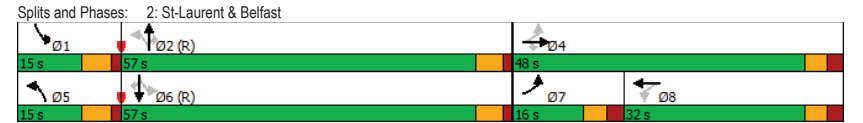

Lanes, Volumes, Timings
3: St-Laurent & Industrial/Innes

Future Background 2026AM Peak Hour
1531 St-Laurent Blvd

Lane Group	EBL	EBT	EBR	WBL	WBT	WBR	NBL	NBT	NBR	SBL	SBT	SBR
Lane Configurations	↔	↔	↔	↔	↔	↔	↔	↔	↔	↔	↔	↔
Traffic Volume (vph)	71	187	137	618	741	241	208	1104	356	116	824	145
Future Volume (vph)	71	187	137	618	741	241	208	1104	356	116	824	145
Lane Group Flow (vph)	71	187	137	618	741	241	208	1104	356	116	824	145
Turn Type	Prot	NA	Perm	Prot	NA	Perm	Prot	NA	Perm	Prot	NA	Perm
Protected Phases	7	4		3	8		5	2		1	6	
Permitted Phases			4			8			2			6
Detector Phase	7	4	4	3	8	8	5	2	2	1	6	6
Switch Phase												
Minimum Initial (s)	5.0	10.0	10.0	5.0	10.0	10.0	5.0	10.0	10.0	5.0	10.0	10.0
Minimum Split (s)	11.6	38.6	38.6	11.6	38.6	38.6	11.3	37.6	37.6	11.3	37.6	37.6
Total Split (s)	25.0	38.0	38.0	36.0	49.0	49.0	23.0	43.0	43.0	23.0	43.0	43.0
Total Split (%)	17.9%	27.1%	27.1%	25.7%	35.0%	35.0%	16.4%	30.7%	30.7%	16.4%	30.7%	30.7%
Maximum Green (s)	18.4	31.4	31.4	29.4	42.4	42.4	16.7	36.4	36.4	16.7	36.4	36.4
Yellow Time (s)	3.7	3.7	3.7	3.7	3.7	3.7	4.2	4.2	4.2	4.2	4.2	4.2
All-Red Time (s)	2.9	2.9	2.9	2.9	2.9	2.9	2.1	2.4	2.4	2.1	2.4	2.4
Lost Time Adjust (s)	0.0	0.0	0.0	0.0	0.0	0.0	0.0	0.0	0.0	0.0	0.0	0.0
Total Lost Time (s)	6.6	6.6	6.6	6.6	6.6	6.6	6.3	6.6	6.6	6.3	6.6	6.6
Lead/Lag	Lead	Lag	Lag	Lead	Lag	Lag	Lead	Lag	Lag	Lead	Lag	Lag
Lead-Lag Optimize?	Yes	Yes	Yes	Yes	Yes	Yes	Yes	Yes	Yes	Yes	Yes	Yes
Vehicle Extension (s)	3.0	3.0	3.0	3.0	3.0	3.0	3.0	3.0	3.0	3.0	3.0	3.0
Recall Mode	None	None	None	None	None	None	None	C-Max	C-Max	None	C-Max	C-Max
Walk Time (s)	7.0	7.0	7.0	7.0	7.0	7.0	7.0	7.0	7.0	7.0	7.0	7.0
Flash Dont Walk (s)	25.0	25.0	25.0	25.0	25.0	25.0	24.0	24.0	24.0	24.0	24.0	24.0
Pedestrian Calls (#/hr)	6	6	6	6	6	6	2	2	2	2	2	2
Act Effct Green (s)	8.7	19.3	19.3	28.8	42.0	42.0	14.4	55.2	55.2	10.5	51.3	51.3
Actuated g/C Ratio	0.06	0.14	0.14	0.21	0.30	0.30	0.10	0.39	0.39	0.08	0.37	0.37
v/c Ratio	0.38	0.46	0.40	0.93	0.78	0.42	0.67	0.89	0.48	0.49	0.70	0.26
Control Delay	68.5	57.4	5.5	76.4	51.2	6.2	71.2	50.8	9.4	69.0	43.3	3.5
Queue Delay	0.0	0.0	0.0	0.0	0.0	0.0	0.0	0.0	0.0	0.0	0.0	0.0
Total Delay	68.5	57.4	5.5	76.4	51.2	6.2	71.2	50.8	9.4	69.0	43.3	3.5
LOS	E	E	A	E	D	A	E	D	A	E	D	A
Approach Delay	41.4				54.2			44.5				40.7
Approach LOS	D				D			D				D
Queue Length 50th (m)	9.9	25.5	0.0	87.1	101.7	0.0	28.9	149.1	9.5	16.1	102.3	0.0
Queue Length 95th (m)	17.7	34.0	7.1	#120.0	113.0	17.8	41.7	#242.2	42.2	25.7	#162.7	8.8
Internal Link Dist (m)		745.6			700.4			316.7			597.8	
Turn Bay Length (m)	38.0		120.0	150.0		80.0	100.0		100.0	125.0		150.0
Base Capacity (vph)	391	665	444	675	993	587	359	1234	735	372	1180	558
Starvation Cap Reductn	0	0	0	0	0	0	0	0	0	0	0	0
Spillback Cap Reductn	0	0	0	0	0	0	0	0	0	0	0	0
Storage Cap Reductn	0	0	0	0	0	0	0	0	0	0	0	0
Reduced v/c Ratio	0.18	0.28	0.31	0.92	0.75	0.41	0.58	0.89	0.48	0.31	0.70	0.26

Intersection Summary

Cycle Length: 140
 Actuated Cycle Length: 140
 Offset: 0 (0%), Referenced to phase 2:NBT and 6:SBT, Start of Green
 Natural Cycle: 140

Lanes, Volumes, Timings
3: St-Laurent & Industrial/Innes

Future Background 2026AM Peak Hour
1531 St-Laurent Blvd

Control Type: Actuated-Coordinated
 Maximum v/c Ratio: 0.93
 Intersection Signal Delay: 46.6
 Intersection LOS: D
 Intersection Capacity Utilization 88.4%
 ICU Level of Service E
 Analysis Period (min) 15
 # 95th percentile volume exceeds capacity, queue may be longer.
 Queue shown is maximum after two cycles.

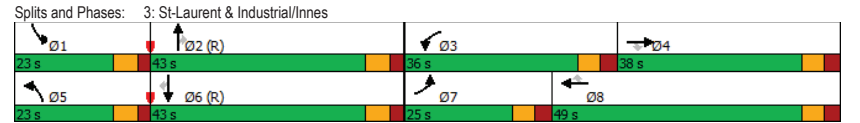

HCM 2010 TWSC
5: Lagan & Belfast

Future Background 2026AM Peak Hour
1531 St-Laurent Blvd

Intersection												
Int Delay, s/veh	2.1											
Movement	EBL	EBT	EBR	WBL	WBT	WBR	NBL	NBT	NBR	SBL	SBT	SBR
Lane Configurations	↔		↔		↔		↔		↔		↔	
Traffic Vol, veh/h	51	272	15	13	225	26	11	1	15	15	4	17
Future Vol, veh/h	51	272	15	13	225	26	11	1	15	15	4	17
Conflicting Peds, #/hr	8	0	10	10	0	8	0	0	5	5	0	0
Sign Control	Free	Free	Free	Free	Free	Free	Stop	Stop	Stop	Stop	Stop	Stop
RT Channelized	-	-	None	-	-	None	-	-	None	-	-	None
Storage Length	-	-	-	-	-	-	-	-	-	-	-	-
Veh in Median Storage, #	-	0	-	-	0	-	-	0	-	-	0	-
Grade, %	-	0	-	-	0	-	-	0	-	-	0	-
Peak Hour Factor	100	100	100	100	100	100	100	100	100	100	100	100
Heavy Vehicles, %	20	12	7	23	15	15	55	2	33	20	25	12
Mvmt Flow	51	272	15	13	225	26	11	1	15	15	4	17

Major/Minor	Major1	Major2	Minor1	Minor2
Conflicting Flow All	259	0	0	297
Stage 1	-	-	-	-
Stage 2	-	-	-	-
Critical Hdwy	4.3	-	-	4.33
Critical Hdwy Stg 1	-	-	-	-
Critical Hdwy Stg 2	-	-	-	-
Follow-up Hdwy	2.38	-	-	2.407
Pot Cap-1 Maneuver	1208	-	-	1154
Stage 1	-	-	-	-
Stage 2	-	-	-	-
Platoon blocked, %	-	-	-	-
Mov Cap-1 Maneuver	1200	-	-	1145
Mov Cap-2 Maneuver	-	-	-	-
Stage 1	-	-	-	-
Stage 2	-	-	-	-

Approach	EB	WB	NB	SB
HCM Control Delay, s	1.2	0.4	14.1	13.9
HCM LOS			B	B

Minor Lane/Major Mvmt	NBLn1	EBL	EBT	EBR	WBL	WBT	WBR	SBLn1
Capacity (veh/h)	421	1200	-	-	1145	-	-	442
HCM Lane V/C Ratio	0.064	0.043	-	-	0.011	-	-	0.081
HCM Control Delay (s)	14.1	8.1	0	-	8.2	0	-	13.9
HCM Lane LOS	B	A	A	-	A	A	-	B
HCM 95th %tile Q(veh)	0.2	0.1	-	-	0	-	-	0.3

Lanes, Volumes, Timings
1: St-Laurent & Tremblay

Future Background 2026PM Peak Hour
1531 St-Laurent Blvd

Lane Group	EBL	EBT	WBL	WBT	NBL	NBT	SBL	SBT	SBR	
Lane Configurations	↔	↔	↔	↔	↔	↔	↔	↔	↔	
Traffic Volume (vph)	225	38	23	21	36	1368	58	1071	86	
Future Volume (vph)	225	38	23	21	36	1368	58	1071	86	
Lane Group Flow (vph)	225	123	23	204	36	1360	58	1071	86	
Turn Type	Perm	NA	Perm	NA	Perm	NA	pm+pt	NA	Perm	
Protected Phases	4		8		8		2		6	
Permitted Phases	4		8		2		6		6	
Detector Phase	4		4		8		8		2	
Switch Phase	4		4		8		8		2	
Minimum Initial (s)	10.0	10.0	10.0	10.0	10.0	10.0	5.0	10.0	10.0	
Minimum Split (s)	38.5	38.5	38.5	38.5	39.2	39.2	9.7	39.2	39.2	
Total Split (s)	40.0	40.0	40.0	40.0	65.0	65.0	15.0	80.0	80.0	
Total Split (%)	33.3%	33.3%	33.3%	33.3%	54.2%	54.2%	12.5%	66.7%	66.7%	
Maximum Green (s)	33.5	33.5	33.5	33.5	58.8	58.8	10.3	73.8	73.8	
Yellow Time (s)	3.3	3.3	3.3	3.3	3.7	3.7	3.7	3.7	3.7	
All-Red Time (s)	3.2	3.2	3.2	3.2	2.5	2.5	1.0	2.5	2.5	
Lost Time Adjust (s)	0.0	0.0	0.0	0.0	0.0	0.0	0.0	0.0	0.0	
Total Lost Time (s)	6.5	6.5	6.5	6.5	6.2	6.2	4.7	6.2	6.2	
Lead/Lag					Lag	Lag	Lead			
Lead-Lag Optimize?					Yes	Yes	Yes			
Vehicle Extension (s)	3.0	3.0	3.0	3.0	3.0	3.0	3.0	3.0	3.0	
Recall Mode	None	None	None	None	C-Max	C-Max	None	C-Max	C-Max	
Walk Time (s)	7.0	7.0	7.0	7.0	11.0	11.0		11.0	11.0	
Flash Dont Walk (s)	25.0	25.0	25.0	25.0	22.0	22.0		22.0	22.0	
Pedestrian Calls (#/hr)	2	2	2	2	12	12		8	8	
Act Effct Green (s)	33.5	33.5	33.5	33.5	64.1	64.1	75.3	73.8	73.8	
Actuated g/C Ratio	0.28	0.28	0.28	0.28	0.53	0.53	0.63	0.62	0.62	
v/c Ratio	1.01	0.26	0.07	0.37	0.16	0.54	0.26	0.55	0.10	
Control Delay	106.5	13.7	32.7	8.8	19.3	18.0	11.5	14.7	2.2	
Queue Delay	0.0	0.0	0.0	0.0	0.0	0.0	0.0	0.0	0.0	
Total Delay	106.5	13.7	32.7	8.8	19.3	18.0	11.5	14.7	2.2	
LOS	F	B	C	A	B	B	B	B	A	
Approach Delay	73.7				11.2		18.1		13.7	
Approach LOS	E				B		B		B	
Queue Length 50th (m)	~53.9	6.6	4.0	3.8	3.3	54.2	4.9	72.0	0.0	
Queue Length 95th (m)	#104.1	21.5	10.6	22.2	m7.9	m88.2	10.0	89.3	6.0	
Internal Link Dist (m)	390.4		0.1		682.5		144.8			
Turn Bay Length (m)	38.0		38.0		45.0		75.0			
Base Capacity (vph)	223	481	329	547	226	2540	263	1962	828	
Starvation Cap Reductn	0	0	0	0	0	0	0	0	0	
Spillback Cap Reductn	0	0	0	0	0	0	0	0	0	
Storage Cap Reductn	0	0	0	0	0	0	0	0	0	
Reduced v/c Ratio	1.01	0.26	0.07	0.37	0.16	0.54	0.22	0.55	0.10	

Intersection Summary	
Cycle Length:	120
Actuated Cycle Length:	120
Offset:	49 (41%), Referenced to phase 2:NBT and 6:SBTL, Start of Green
Natural Cycle:	90

Lanes, Volumes, Timings
1: St-Laurent & Tremblay

Future Background 2026PM Peak Hour
1531 St-Laurent Blvd

Control Type: Actuated-Coordinated
 Maximum v/c Ratio: 1.01
 Intersection Signal Delay: 22.0 Intersection LOS: C
 Intersection Capacity Utilization 88.1% ICU Level of Service E
 Analysis Period (min) 15
 ~ Volume exceeds capacity, queue is theoretically infinite.
 Queue shown is maximum after two cycles.
 # 95th percentile volume exceeds capacity, queue may be longer.
 Queue shown is maximum after two cycles.
 m Volume for 95th percentile queue is metered by upstream signal.

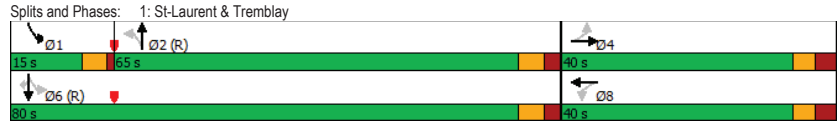

Lanes, Volumes, Timings
2: St-Laurent & Belfast

Future Background 2026PM Peak Hour
1531 St-Laurent Blvd

Lane Group	EBL	EBT	EBR	WBL	WBT	NBL	NBT	NBR	SBL	SBT	SBR
Lane Configurations	↔	↔	↔	↔	↔	↔	↔	↔	↔	↔	↔
Traffic Volume (vph)	195	162	224	101	91	111	1007	82	93	887	133
Future Volume (vph)	195	162	224	101	91	111	1007	82	93	887	133
Lane Group Flow (vph)	195	162	224	101	240	111	1007	82	93	887	133
Turn Type	pm+pt	NA	Perm	Perm	NA	pm+pt	NA	Perm	pm+pt	NA	Perm
Protected Phases	7	4			8	5	2		1	6	
Permitted Phases	4		4	8		2		2	6		6
Detector Phase	7	4	4	8	8	5	2	2	1	6	6
Switch Phase											
Minimum Initial (s)	5.0	10.0	10.0	10.0	10.0	5.0	10.0	10.0	5.0	10.0	10.0
Minimum Split (s)	10.8	27.8	27.8	27.8	27.8	10.7	36.6	36.6	10.7	36.6	36.6
Total Split (s)	15.0	49.0	49.0	34.0	34.0	14.0	57.0	57.0	14.0	57.0	57.0
Total Split (%)	12.5%	40.8%	40.8%	28.3%	28.3%	11.7%	47.5%	47.5%	11.7%	47.5%	47.5%
Maximum Green (s)	9.2	43.2	43.2	28.2	28.2	8.3	51.4	51.4	8.3	51.4	51.4
Yellow Time (s)	3.3	3.3	3.3	3.3	3.3	4.2	4.2	4.2	4.2	4.2	4.2
All-Red Time (s)	2.5	2.5	2.5	2.5	2.5	1.5	1.4	1.4	1.5	1.4	1.4
Lost Time Adjust (s)	0.0	0.0	0.0	0.0	0.0	0.0	0.0	0.0	0.0	0.0	0.0
Total Lost Time (s)	5.8	5.8	5.8	5.8	5.8	5.7	5.6	5.6	5.7	5.6	5.6
Lead/Lag	Lead			Lag	Lag	Lead	Lag	Lag	Lead	Lag	Lag
Lead-Lag Optimize?	Yes			Yes	Yes	Yes	Yes	Yes	Yes	Yes	Yes
Vehicle Extension (s)	3.0	3.0	3.0	3.0	3.0	3.0	3.0	3.0	3.0	3.0	3.0
Recall Mode	None	None	None	None	None	None	C-Max	C-Max	None	C-Max	C-Max
Walk Time (s)	7.0	7.0	7.0	7.0	7.0	25.0	25.0	25.0	25.0	25.0	25.0
Flash Dont Walk (s)	15.0	15.0	15.0	15.0	15.0	6.0	6.0	6.0	6.0	6.0	6.0
Pedestrian Calls (#/hr)	9	9	5	5	5	1	1	1	15	15	15
Act Effct Green (s)	34.6	34.6	34.6	19.6	19.6	68.4	60.2	60.2	68.0	60.0	60.0
Actuated g/C Ratio	0.29	0.29	0.29	0.16	0.16	0.57	0.50	0.50	0.57	0.50	0.50
v/c Ratio	0.95	0.35	0.40	0.59	0.79	0.36	0.61	0.12	0.38	0.54	0.17
Control Delay	86.6	34.7	7.3	58.9	53.0	14.4	24.9	1.1	17.2	18.3	2.8
Queue Delay	0.0	0.0	0.0	0.0	0.0	0.0	0.0	0.0	0.0	0.0	0.0
Total Delay	86.6	34.7	7.3	58.9	53.0	14.4	24.9	1.1	17.2	18.3	2.8
LOS	F	C	A	E	D	B	C	A	B	B	A
Approach Delay		41.6			54.7		22.3			16.3	
Approach LOS		D			D		C			B	
Queue Length 50th (m)	37.2	30.2	3.2	22.3	40.6	10.1	87.8	0.0	8.1	46.8	0.0
Queue Length 95th (m)	#68.0	44.1	19.4	37.5	63.9	21.5	125.4	2.4	20.9	59.4	6.6
Internal Link Dist (m)		518.7			103.5		597.8			682.5	
Turn Bay Length (m)	75.0		200.0	65.0		75.0		55.0	75.0		85.0
Base Capacity (vph)	206	572	651	247	408	318	1647	683	254	1642	771
Starvation Cap Reductn	0	0	0	0	0	0	0	0	0	0	0
Spillback Cap Reductn	0	0	0	0	0	0	0	0	0	0	0
Storage Cap Reductn	0	0	0	0	0	0	0	0	0	0	0
Reduced v/c Ratio	0.95	0.28	0.34	0.41	0.59	0.35	0.61	0.12	0.37	0.54	0.17

Intersection Summary
 Cycle Length: 120
 Actuated Cycle Length: 120
 Offset: 49 (41%), Referenced to phase 2:NBTL and 6:SBTL, Start of Green
 Natural Cycle: 90

Lanes, Volumes, Timings
2: St-Laurent & Belfast

Future Background 2026PM Peak Hour
1531 St-Laurent Blvd

Control Type: Actuated-Coordinated
 Maximum v/c Ratio: 0.95
 Intersection Signal Delay: 27.1 Intersection LOS: C
 Intersection Capacity Utilization 80.8% ICU Level of Service D
 Analysis Period (min) 15
 # 95th percentile volume exceeds capacity, queue may be longer.
 Queue shown is maximum after two cycles.

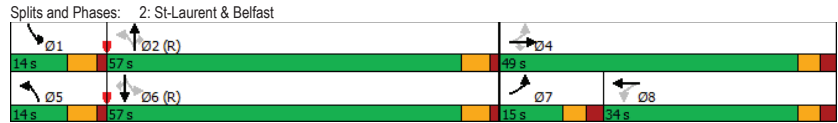

Lanes, Volumes, Timings
3: St-Laurent & Industrial/Innes

Future Background 2026PM Peak Hour
1531 St-Laurent Blvd

	EBL	EBT	EBR	WBL	WBT	WBR	NBL	NBT	NBR	SBL	SBT	SBR
Lane Group	EBL	EBT	EBR	WBL	WBT	WBR	NBL	NBT	NBR	SBL	SBT	SBR
Lane Configurations	↔	↔	↔	↔	↔	↔	↔	↔	↔	↔	↔	↔
Traffic Volume (vph)	137	560	363	415	274	135	199	931	522	130	951	131
Future Volume (vph)	137	560	363	415	274	135	199	931	522	130	951	131
Lane Group Flow (vph)	137	560	363	415	274	135	199	931	522	130	951	131
Turn Type	Prot	NA	Perm	Prot	NA	Perm	Prot	NA	Perm	Prot	NA	Perm
Protected Phases	7	4		3	8		5	2		1	6	
Permitted Phases			4			8			2			6
Detector Phase	7	4	4	3	8	8	5	2	2	1	6	6
Switch Phase												
Minimum Initial (s)	5.0	10.0	10.0	5.0	10.0	10.0	5.0	10.0	10.0	5.0	10.0	10.0
Minimum Split (s)	11.6	38.6	38.6	11.6	38.6	38.6	11.3	37.6	37.6	11.3	37.6	37.6
Total Split (s)	19.0	38.0	38.0	41.0	60.0	60.0	28.0	43.0	43.0	28.0	43.0	43.0
Total Split (%)	12.7%	25.3%	25.3%	27.3%	40.0%	40.0%	18.7%	28.7%	28.7%	18.7%	28.7%	28.7%
Maximum Green (s)	12.4	31.4	31.4	34.4	53.4	53.4	21.7	36.4	36.4	21.7	36.4	36.4
Yellow Time (s)	3.7	3.7	3.7	3.7	3.7	3.7	4.2	4.2	4.2	4.2	4.2	4.2
All-Red Time (s)	2.9	2.9	2.9	2.9	2.9	2.9	2.1	2.4	2.4	2.1	2.4	2.4
Lost Time Adjust (s)	0.0	0.0	0.0	0.0	0.0	0.0	0.0	0.0	0.0	0.0	0.0	0.0
Total Lost Time (s)	6.6	6.6	6.6	6.6	6.6	6.6	6.3	6.6	6.6	6.3	6.6	6.6
Lead/Lag	Lead	Lag	Lag	Lead	Lag	Lag	Lead	Lag	Lag	Lead	Lag	Lag
Lead-Lag Optimize?	Yes	Yes	Yes	Yes	Yes	Yes	Yes	Yes	Yes	Yes	Yes	Yes
Vehicle Extension (s)	3.0	3.0	3.0	3.0	3.0	3.0	3.0	3.0	3.0	3.0	3.0	3.0
Recall Mode	None	None	None	None	None	None	None	Max	Max	None	Max	Max
Walk Time (s)	7.0	7.0		7.0	7.0		7.0	7.0	7.0		7.0	7.0
Flash Dont Walk (s)	25.0	25.0		25.0	25.0		24.0	24.0	24.0		24.0	24.0
Pedestrian Calls (#/hr)	5	5		6	6		9	9	9		12	12
Act Effct Green (s)	10.5	26.8	26.8	21.7	38.0	38.0	13.5	39.4	39.4	10.9	36.8	36.8
Actuated g/C Ratio	0.08	0.21	0.21	0.17	0.30	0.30	0.11	0.31	0.31	0.09	0.29	0.29
v/c Ratio	0.51	0.80	0.66	0.75	0.28	0.25	0.59	0.91	0.67	0.49	1.00	0.24
Control Delay	64.0	57.0	14.9	58.8	34.0	6.3	62.2	56.0	10.1	63.1	73.1	3.4
Queue Delay	0.0	0.0	0.0	0.0	0.0	0.0	0.0	0.0	0.0	0.0	0.0	0.0
Total Delay	64.0	57.0	14.9	58.8	34.0	6.3	62.2	56.0	10.1	63.1	73.1	3.4
LOS	E	E	B	E	C	A	E	E	B	E	E	A
Approach Delay		43.5			41.9			42.2				64.5
Approach LOS		D			D			D				E
Queue Length 50th (m)	17.0	69.1	10.9	50.9	26.9	0.0	24.6	117.3	8.0	16.1	~127.4	0.0
Queue Length 95th (m)	30.3	99.1	46.4	73.0	40.5	14.2	39.9	#186.0	48.7	28.7	#204.8	7.5
Internal Link Dist (m)		745.6			700.4			316.7			597.8	
Turn Bay Length (m)	38.0		120.0	150.0		80.0	100.0		100.0	125.0		150.0
Base Capacity (vph)	321	826	593	893	1375	703	547	1023	777	532	955	541
Starvation Cap Reductn	0	0	0	0	0	0	0	0	0	0	0	0
Spillback Cap Reductn	0	0	0	0	0	0	0	0	0	0	0	0
Storage Cap Reductn	0	0	0	0	0	0	0	0	0	0	0	0
Reduced v/c Ratio	0.43	0.68	0.61	0.46	0.20	0.19	0.36	0.91	0.67	0.24	1.00	0.24

Intersection Summary
 Cycle Length: 150
 Actuated Cycle Length: 125.1
 Natural Cycle: 110
 Control Type: Actuated-Uncoordinated

Lanes, Volumes, Timings
3: St-Laurent & Industrial/Innes

Future Background 2026PM Peak Hour
1531 St-Laurent Blvd

Maximum v/c Ratio: 1.00	Intersection LOS: D
Intersection Signal Delay: 48.1	ICU Level of Service E
Intersection Capacity Utilization 85.9%	
Analysis Period (min) 15	
~ Volume exceeds capacity, queue is theoretically infinite.	
Queue shown is maximum after two cycles.	
# 95th percentile volume exceeds capacity, queue may be longer.	
Queue shown is maximum after two cycles.	

Splits and Phases: 3: St-Laurent & Industrial/Innes

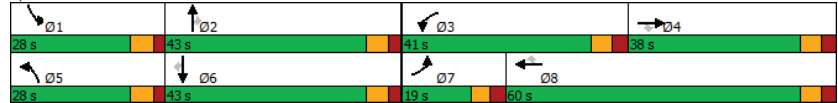

HCM 2010 TWSC
5: Lagan & Belfast

Future Background 2026PM Peak Hour
1531 St-Laurent Blvd

Intersection												
Int Delay, s/veh	2.8											
Movement	EBL	EBT	EBR	WBL	WBT	WBR	NBL	NBT	NBR	SBL	SBT	SBR
Lane Configurations	↔			↔			↔			↔		
Traffic Vol, veh/h	46	265	50	19	310	26	26	5	16	30	0	39
Future Vol, veh/h	46	265	50	19	310	26	26	5	16	30	0	39
Conflicting Peds, #/hr	12	0	5	5	0	12	1	0	6	6	0	1
Sign Control	Free	Free	Free	Free	Free	Free	Stop	Stop	Stop	Stop	Stop	Stop
RT Channelized	-	-	None	-	-	None	-	-	None	-	-	None
Storage Length	-	-	-	-	-	-	-	-	-	-	-	-
Veh in Median Storage, #	-	0	-	-	0	-	-	0	-	-	0	-
Grade, %	-	0	-	-	0	-	-	0	-	-	0	-
Peak Hour Factor	100	100	100	100	100	100	100	100	100	100	100	100
Heavy Vehicles, %	30	6	12	5	3	8	4	2	2	10	2	2
Mvmt Flow	46	265	50	19	310	26	26	5	16	30	0	39

Major/Minor	Major1	Major2	Minor1	Minor2
Conflicting Flow All	348	0	320	0
Stage 1	-	-	-	-
Stage 2	-	-	-	-
Critical Hdwy	4.4	-	4.15	-
Critical Hdwy Stg 1	-	-	-	-
Critical Hdwy Stg 2	-	-	-	-
Follow-up Hdwy	2.47	-	2.245	-
Pot Cap-1 Maneuver	1071	-	1223	-
Stage 1	-	-	-	-
Stage 2	-	-	-	-
Platoon blocked, %	-	-	-	-
Mov Cap-1 Maneuver	1061	-	1218	-
Mov Cap-2 Maneuver	-	-	-	-
Stage 1	-	-	-	-
Stage 2	-	-	-	-

Approach	EB	WB	NB	SB
HCM Control Delay, s	1.1	0.4	16.5	15.2
HCM LOS			C	C

Minor Lane/Major Mvmt	NBLn1	EBL	EBT	EBR	WBL	WBT	WBR	SBLn1
Capacity (veh/h)	359	1061	-	-	1218	-	-	420
HCM Lane V/C Ratio	0.131	0.043	-	-	0.016	-	-	0.164
HCM Control Delay (s)	16.5	8.5	0	-	8	0	-	15.2
HCM Lane LOS	C	A	A	-	A	A	-	C
HCM 95th %tile Q(veh)	0.4	0.1	-	-	0	-	-	0.6

Appendix H

Synchro Intersection Worksheets – 2031 Future Background Conditions

Lanes, Volumes, Timings
1: St-Laurent & Tremblay

Future Background 2031AM Peak Hour
1531 St-Laurent Blvd

	↖	→	↗	←	↖	↑	↗	↓	↖
Lane Group	EBL	EBT	WBL	WBT	NBL	NBT	SBL	SBT	SBR
Lane Configurations	↖	↖	↖	↖	↖	↖	↖	↖	↖
Traffic Volume (vph)	60	21	12	20	82	1246	131	1141	244
Future Volume (vph)	60	21	12	20	82	1246	131	1141	244
Lane Group Flow (vph)	60	54	12	143	82	1284	131	1141	244
Turn Type	Perm	NA	Perm	NA	Perm	NA	pm+pt	NA	Perm
Protected Phases		4		8		2		1	6
Permitted Phases	4		8		2		6		6
Detector Phase	4	4	8	8	2	2	1	6	6
Switch Phase									
Minimum Initial (s)	10.0	10.0	10.0	10.0	10.0	10.0	5.0	10.0	10.0
Minimum Split (s)	38.5	38.5	38.5	38.5	39.2	39.2	9.7	39.2	39.2
Total Split (s)	40.0	40.0	40.0	40.0	72.0	72.0	18.0	90.0	90.0
Total Split (%)	30.8%	30.8%	30.8%	30.8%	55.4%	55.4%	13.8%	69.2%	69.2%
Maximum Green (s)	33.5	33.5	33.5	33.5	65.8	65.8	13.3	83.8	83.8
Yellow Time (s)	3.3	3.3	3.3	3.3	3.7	3.7	3.7	3.7	3.7
All-Red Time (s)	3.2	3.2	3.2	3.2	2.5	2.5	1.0	2.5	2.5
Lost Time Adjust (s)	0.0	0.0	0.0	0.0	0.0	0.0	0.0	0.0	0.0
Total Lost Time (s)	6.5	6.5	6.5	6.5	6.2	6.2	4.7	6.2	6.2
Lead/Lag					Lag	Lag	Lead		
Lead-Lag Optimize?					Yes	Yes	Yes		
Vehicle Extension (s)	3.0	3.0	3.0	3.0	3.0	3.0	3.0	3.0	3.0
Recall Mode	None	None	None	None	C-Max	C-Max	None	C-Max	C-Max
Walk Time (s)	7.0	7.0	7.0	7.0	11.0	11.0		11.0	11.0
Flash Dont Walk (s)	25.0	25.0	25.0	25.0	22.0	22.0		22.0	22.0
Pedestrian Calls (#/hr)	4	4	3	3	2	2		7	7
Act Effct Green (s)	17.0	17.0	17.0	17.0	87.3	87.3	101.8	100.3	100.3
Actuated g/C Ratio	0.13	0.13	0.13	0.13	0.67	0.67	0.78	0.77	0.77
v/c Ratio	0.65	0.24	0.08	0.50	0.28	0.44	0.41	0.48	0.24
Control Delay	80.6	24.5	45.7	17.1	14.9	11.9	8.4	7.2	1.4
Queue Delay	0.0	0.0	0.0	0.0	0.0	0.0	0.0	0.0	0.0
Total Delay	80.6	24.5	45.7	17.1	14.9	11.9	8.4	7.2	1.4
LOS	F	C	D	B	B	B	A	A	A
Approach Delay		54.0		19.3		12.1		6.4	
Approach LOS		D		B		B		A	
Queue Length 50th (m)	15.2	4.9	2.8	4.7	7.2	47.0	5.9	42.5	0.0
Queue Length 95th (m)	26.3	14.9	7.7	21.1	25.1	91.2	18.7	95.6	8.6
Internal Link Dist (m)		396.6		0.1		682.5		144.8	
Turn Bay Length (m)	38.0		38.0		45.0		75.0		
Base Capacity (vph)	185	414	281	442	291	2910	369	2371	1037
Starvation Cap Reductn	0	0	0	0	0	0	0	0	0
Spillback Cap Reductn	0	0	0	0	0	0	0	0	0
Storage Cap Reductn	0	0	0	0	0	0	0	0	0
Reduced v/c Ratio	0.32	0.13	0.04	0.32	0.28	0.44	0.36	0.48	0.24

Intersection Summary

Cycle Length: 130
 Actuated Cycle Length: 130
 Offset: 53 (41%), Referenced to phase 2:NBTL and 6:SBTL, Start of Green
 Natural Cycle: 90

Lanes, Volumes, Timings
1: St-Laurent & Tremblay

Future Background 2031AM Peak Hour
1531 St-Laurent Blvd

Control Type: Actuated-Coordinated
 Maximum v/c Ratio: 0.65
 Intersection Signal Delay: 11.2
 Intersection LOS: B
 Intersection Capacity Utilization 82.2%
 ICU Level of Service E
 Analysis Period (min) 15

Splits and Phases: 1: St-Laurent & Tremblay



Lanes, Volumes, Timings
2: St-Laurent & Belfast

Future Background 2031AM Peak Hour
1531 St-Laurent Blvd

Lane Group	EBL	EBT	EBR	WBL	WBT	NBL	NBT	NBR	SBL	SBT	SBR
Lane Configurations	↖	↗	↘	↙	↘	↙	↘	↙	↘	↙	↘
Traffic Volume (vph)	47	63	115	43	140	131	931	66	83	839	190
Future Volume (vph)	47	63	115	43	140	131	931	66	83	839	190
Lane Group Flow (vph)	47	63	115	43	234	131	931	66	83	839	190
Turn Type	pm+pt	NA	Perm	Perm	NA	pm+pt	NA	Perm	pm+pt	NA	Perm
Protected Phases	7	4			8	5	2		1	6	
Permitted Phases	4		4	8				2	6		6
Detector Phase	7	4	4	8	8	5	2	2	1	6	6
Switch Phase											
Minimum Initial (s)	5.0	10.0	10.0	10.0	10.0	5.0	10.0	10.0	5.0	10.0	10.0
Minimum Split (s)	10.8	27.8	27.8	27.8	27.8	10.7	36.6	36.6	10.7	36.6	36.6
Total Split (s)	16.0	48.0	48.0	32.0	32.0	15.0	57.0	57.0	15.0	57.0	57.0
Total Split (%)	13.3%	40.0%	40.0%	26.7%	26.7%	12.5%	47.5%	47.5%	12.5%	47.5%	47.5%
Maximum Green (s)	10.2	42.2	42.2	26.2	26.2	9.3	51.4	51.4	9.3	51.4	51.4
Yellow Time (s)	3.3	3.3	3.3	3.3	3.3	4.2	4.2	4.2	4.2	4.2	4.2
All-Red Time (s)	2.5	2.5	2.5	2.5	2.5	1.5	1.4	1.4	1.5	1.4	1.4
Lost Time Adjust (s)	0.0	0.0	0.0	0.0	0.0	0.0	0.0	0.0	0.0	0.0	0.0
Total Lost Time (s)	5.8	5.8	5.8	5.8	5.8	5.7	5.6	5.6	5.7	5.6	5.6
Lead/Lag	Lead			Lag	Lag	Lead	Lag	Lag	Lead	Lag	Lag
Lead-Lag Optimize?	Yes			Yes	Yes	Yes	Yes	Yes	Yes	Yes	Yes
Vehicle Extension (s)	3.0	3.0	3.0	3.0	3.0	3.0	3.0	3.0	3.0	3.0	3.0
Recall Mode	None	None	None	None	None	None	C-Max	C-Max	None	C-Max	C-Max
Walk Time (s)	7.0	7.0	7.0	7.0	7.0	7.0	25.0	25.0	25.0	25.0	25.0
Flash Dont Walk (s)	15.0	15.0	15.0	15.0	15.0	6.0	6.0	6.0	6.0	6.0	6.0
Pedestrian Calls (#/hr)	2	2	1	1	1	0	0	0	3	3	3
Act Effct Green (s)	33.9	33.9	33.9	21.9	21.9	70.6	63.3	63.3	68.2	60.3	60.3
Actuated g/C Ratio	0.28	0.28	0.28	0.18	0.18	0.59	0.53	0.53	0.57	0.50	0.50
v/c Ratio	0.23	0.13	0.26	0.22	0.84	0.41	0.55	0.08	0.30	0.54	0.27
Control Delay	30.4	29.0	6.4	42.7	66.1	15.6	23.8	0.2	14.5	24.1	4.1
Queue Delay	0.0	0.0	0.0	0.0	0.0	0.0	0.0	0.0	0.0	0.0	0.0
Total Delay	30.4	29.0	6.4	42.7	66.1	15.6	23.8	0.2	14.5	24.1	4.1
LOS	C	C	A	D	E	B	C	A	B	C	A
Approach Delay	17.8				62.5		21.4			20.0	
Approach LOS	B				E		C			B	
Queue Length 50th (m)	7.8	10.5	0.0	8.6	47.3	13.2	84.0	0.0	8.1	75.5	0.0
Queue Length 95th (m)	15.9	19.9	12.3	18.7	#75.9	24.6	114.3	0.0	16.7	101.1	13.3
Internal Link Dist (m)		518.7			103.5		597.8			682.5	
Turn Bay Length (m)	75.0		200.0	65.0		75.0		55.0	75.0		85.0
Base Capacity (vph)	217	596	514	233	330	327	1683	805	296	1560	691
Starvation Cap Reductn	0	0	0	0	0	0	0	0	0	0	0
Spillback Cap Reductn	0	0	0	0	0	0	0	0	0	0	0
Storage Cap Reductn	0	0	0	0	0	0	0	0	0	0	0
Reduced v/c Ratio	0.22	0.11	0.22	0.18	0.71	0.40	0.55	0.08	0.28	0.54	0.27

Intersection Summary

Cycle Length: 120
 Actuated Cycle Length: 120
 Offset: 53 (44%), Referenced to phase 2:NBTL and 6:SBTL, Start of Green
 Natural Cycle: 90

Lanes, Volumes, Timings
2: St-Laurent & Belfast

Future Background 2031AM Peak Hour
1531 St-Laurent Blvd

Control Type: Actuated-Coordinated
 Maximum v/c Ratio: 0.84
 Intersection Signal Delay: 24.7
 Intersection LOS: C
 Intersection Capacity Utilization 70.8%
 ICU Level of Service C
 Analysis Period (min) 15
 # 95th percentile volume exceeds capacity, queue may be longer.
 Queue shown is maximum after two cycles.

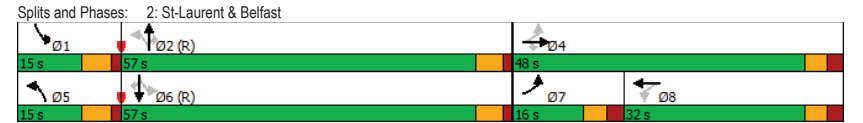

Lanes, Volumes, Timings
3: St-Laurent & Industrial/Innes

Future Background 2031AM Peak Hour
1531 St-Laurent Blvd

Lane Group	EBL	EBT	EBR	WBL	WBT	WBR	NBL	NBT	NBR	SBL	SBT	SBR
Lane Configurations	↔	↔	↔	↔	↔	↔	↔	↔	↔	↔	↔	↔
Traffic Volume (vph)	73	194	142	618	741	241	210	1128	356	116	849	146
Future Volume (vph)	73	194	142	618	741	241	210	1128	356	116	849	146
Lane Group Flow (vph)	73	194	142	618	741	241	210	1128	356	116	849	146
Turn Type	Prot	NA	Perm	Prot	NA	Perm	Prot	NA	Perm	Prot	NA	Perm
Protected Phases	7	4		3	8		5	2		1	6	
Permitted Phases			4			8			2			6
Detector Phase	7	4	4	3	8	8	5	2	2	1	6	6
Switch Phase												
Minimum Initial (s)	5.0	10.0	10.0	5.0	10.0	10.0	5.0	10.0	10.0	5.0	10.0	10.0
Minimum Split (s)	11.6	38.6	38.6	11.6	38.6	38.6	11.3	37.6	37.6	11.3	37.6	37.6
Total Split (s)	25.0	38.0	38.0	36.0	49.0	49.0	23.0	43.0	43.0	23.0	43.0	43.0
Total Split (%)	17.9%	27.1%	27.1%	25.7%	35.0%	35.0%	16.4%	30.7%	30.7%	16.4%	30.7%	30.7%
Maximum Green (s)	18.4	31.4	31.4	29.4	42.4	42.4	16.7	36.4	36.4	16.7	36.4	36.4
Yellow Time (s)	3.7	3.7	3.7	3.7	3.7	3.7	4.2	4.2	4.2	4.2	4.2	4.2
All-Red Time (s)	2.9	2.9	2.9	2.9	2.9	2.9	2.1	2.4	2.4	2.1	2.4	2.4
Lost Time Adjust (s)	0.0	0.0	0.0	0.0	0.0	0.0	0.0	0.0	0.0	0.0	0.0	0.0
Total Lost Time (s)	6.6	6.6	6.6	6.6	6.6	6.6	6.3	6.6	6.6	6.3	6.6	6.6
Lead/Lag	Lead	Lag	Lag	Lead	Lag	Lag	Lead	Lag	Lag	Lead	Lag	Lag
Lead-Lag Optimize?	Yes	Yes	Yes	Yes	Yes	Yes	Yes	Yes	Yes	Yes	Yes	Yes
Vehicle Extension (s)	3.0	3.0	3.0	3.0	3.0	3.0	3.0	3.0	3.0	3.0	3.0	3.0
Recall Mode	None	None	None	None	None	None	C-Max	C-Max	None	C-Max	C-Max	C-Max
Walk Time (s)	7.0	7.0			7.0	7.0			7.0		7.0	7.0
Flash Dont Walk (s)	25.0	25.0			25.0	25.0			24.0		24.0	24.0
Pedestrian Calls (#/hr)	6	6			2	2			4		4	7
Act Effct Green (s)	8.8	19.4	19.4	28.8	42.0	42.0	14.5	55.1	55.1	10.5	51.1	51.1
Actuated g/C Ratio	0.06	0.14	0.14	0.21	0.30	0.30	0.10	0.39	0.39	0.08	0.36	0.36
v/c Ratio	0.39	0.47	0.41	0.93	0.78	0.42	0.68	0.92	0.49	0.49	0.72	0.26
Control Delay	68.5	57.7	6.0	76.4	51.2	6.2	71.4	53.0	9.9	69.0	44.2	3.6
Queue Delay	0.0	0.0	0.0	0.0	0.0	0.0	0.0	0.0	0.0	0.0	0.0	0.0
Total Delay	68.5	57.7	6.0	76.4	51.2	6.2	71.4	53.0	9.9	69.0	44.2	3.6
LOS	E	E	A	E	D	A	E	D	A	E	D	A
Approach Delay		41.7			54.2			46.2			41.4	
Approach LOS		D			D			D			D	
Queue Length 50th (m)	10.2	26.5	0.0	87.1	101.7	0.0	29.2	154.4	10.6	16.1	106.7	0.0
Queue Length 95th (m)	18.1	35.1	8.2	#120.0	113.1	17.8	42.2	#249.5	44.2	25.7	#170.6	9.0
Internal Link Dist (m)		745.6			700.4			316.7			597.8	
Turn Bay Length (m)	38.0		120.0	150.0		80.0	100.0		100.0	125.0		150.0
Base Capacity (vph)	391	665	444	675	993	587	359	1231	730	372	1176	557
Starvation Cap Reductn	0	0	0	0	0	0	0	0	0	0	0	0
Spillback Cap Reductn	0	0	0	0	0	0	0	0	0	0	0	0
Storage Cap Reductn	0	0	0	0	0	0	0	0	0	0	0	0
Reduced v/c Ratio	0.19	0.29	0.32	0.92	0.75	0.41	0.58	0.92	0.49	0.31	0.72	0.26

Intersection Summary

Cycle Length: 140
 Actuated Cycle Length: 140
 Offset: 0 (0%), Referenced to phase 2:NBT and 6:SBT, Start of Green
 Natural Cycle: 140

Lanes, Volumes, Timings
3: St-Laurent & Industrial/Innes

Future Background 2031AM Peak Hour
1531 St-Laurent Blvd

Control Type: Actuated-Coordinated	
Maximum v/c Ratio: 0.93	
Intersection Signal Delay: 47.4	Intersection LOS: D
Intersection Capacity Utilization 89.1%	ICU Level of Service E
Analysis Period (min) 15	
# 95th percentile volume exceeds capacity, queue may be longer.	
Queue shown is maximum after two cycles.	

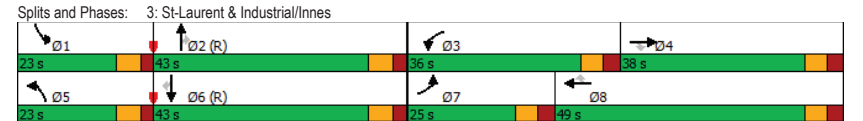

HCM 2010 TWSC
5: Lagan & Belfast

Future Background 2031AM Peak Hour
1531 St-Laurent Blvd

Intersection												
Int Delay, s/veh	2.1											
Movement	EBL	EBT	EBR	WBL	WBT	WBR	NBL	NBT	NBR	SBL	SBT	SBR
Lane Configurations	↔		↔		↔		↔		↔		↔	
Traffic Vol, veh/h	51	272	15	13	225	26	11	1	15	15	4	17
Future Vol, veh/h	51	272	15	13	225	26	11	1	15	15	4	17
Conflicting Peds, #/hr	8	0	10	10	0	8	0	0	5	5	0	0
Sign Control	Free	Free	Free	Free	Free	Free	Stop	Stop	Stop	Stop	Stop	Stop
RT Channelized	-	-	None	-	-	None	-	-	None	-	-	None
Storage Length	-	-	-	-	-	-	-	-	-	-	-	-
Veh in Median Storage, #	-	0	-	-	0	-	-	0	-	-	0	-
Grade, %	-	0	-	-	0	-	-	0	-	-	0	-
Peak Hour Factor	100	100	100	100	100	100	100	100	100	100	100	100
Heavy Vehicles, %	20	12	7	23	15	15	55	2	33	20	25	12
Mvmt Flow	51	272	15	13	225	26	11	1	15	15	4	17
Major/Minor	Major1			Major2			Minor1			Minor2		
Conflicting Flow All	259	0	0	297	0	0	667	677	295	667	671	246
Stage 1	-	-	-	-	-	-	392	392	-	272	272	-
Stage 2	-	-	-	-	-	-	275	285	-	395	399	-
Critical Hdwy	4.3	-	-	4.33	-	-	7.65	6.52	6.53	7.3	6.75	6.32
Critical Hdwy Stg 1	-	-	-	-	-	-	6.65	5.52	-	6.3	5.75	-
Critical Hdwy Stg 2	-	-	-	-	-	-	6.65	5.52	-	6.3	5.75	-
Follow-up Hdwy	2.38	-	-	2.407	-	-	3.995	4.018	3.597	3.68	4.225	3.408
Pot Cap-1 Maneuver	1208	-	-	1154	-	-	309	375	677	349	350	769
Stage 1	-	-	-	-	-	-	539	606	-	696	645	-
Stage 2	-	-	-	-	-	-	629	676	-	596	564	-
Platoon blocked, %	-	-	-	-	-	-	-	-	-	-	-	-
Mov Cap-1 Maneuver	1200	-	-	1145	-	-	283	347	669	321	323	764
Mov Cap-2 Maneuver	-	-	-	-	-	-	283	347	-	321	323	-
Stage 1	-	-	-	-	-	-	508	570	-	656	633	-
Stage 2	-	-	-	-	-	-	603	663	-	550	531	-
Approach	EB			WB			NB			SB		
HCM Control Delay, s	1.2			0.4			14.1			13.9		
HCM LOS	B			B			B			B		
Minor Lane/Major Mvmt	NBLn1	EBL	EBT	EBR	WBL	WBT	WBR	SBLn1				
Capacity (veh/h)	421	1200	-	-	1145	-	-	442				
HCM Lane V/C Ratio	0.064	0.043	-	-	0.011	-	-	0.081				
HCM Control Delay (s)	14.1	8.1	0	-	8.2	0	-	13.9				
HCM Lane LOS	B	A	A	-	A	A	-	B				
HCM 95th %tile Q(veh)	0.2	0.1	-	-	0	-	-	0.3				

Lanes, Volumes, Timings
1: St-Laurent & Tremblay

Future Background 2031PM Peak Hour
1531 St-Laurent Blvd

Lane Group	EBL	EBT	WBL	WBT	NBL	NBT	SBL	SBT	SBR	
Lane Configurations	↔	↔	↔	↔	↔	↔	↔	↔	↔	
Traffic Volume (vph)	228	38	23	21	36	1368	63	1083	94	
Future Volume (vph)	228	38	23	21	36	1368	63	1083	94	
Lane Group Flow (vph)	228	123	23	206	36	1360	63	1083	94	
Turn Type	Perm	NA	Perm	NA	Perm	NA	pm+pt	NA	Perm	
Protected Phases	4		8		8		2		6	
Permitted Phases	4		8		2		6		6	
Detector Phase	4		4		8		8		2	
Switch Phase	4		4		8		8		2	
Minimum Initial (s)	10.0	10.0	10.0	10.0	10.0	10.0	5.0	10.0	10.0	
Minimum Split (s)	38.5	38.5	38.5	38.5	39.2	39.2	9.7	39.2	39.2	
Total Split (s)	40.0	40.0	40.0	40.0	65.0	65.0	15.0	80.0	80.0	
Total Split (%)	33.3%	33.3%	33.3%	33.3%	54.2%	54.2%	12.5%	66.7%	66.7%	
Maximum Green (s)	33.5	33.5	33.5	33.5	58.8	58.8	10.3	73.8	73.8	
Yellow Time (s)	3.3	3.3	3.3	3.3	3.7	3.7	3.7	3.7	3.7	
All-Red Time (s)	3.2	3.2	3.2	3.2	2.5	2.5	1.0	2.5	2.5	
Lost Time Adjust (s)	0.0	0.0	0.0	0.0	0.0	0.0	0.0	0.0	0.0	
Total Lost Time (s)	6.5	6.5	6.5	6.5	6.2	6.2	4.7	6.2	6.2	
Lead/Lag					Lag	Lag	Lead			
Lead-Lag Optimize?					Yes	Yes	Yes			
Vehicle Extension (s)	3.0	3.0	3.0	3.0	3.0	3.0	3.0	3.0	3.0	
Recall Mode	None	None	None	None	C-Max	C-Max	None	C-Max	C-Max	
Walk Time (s)	7.0	7.0	7.0	7.0	11.0	11.0	11.0	11.0	11.0	
Flash Dont Walk (s)	25.0	25.0	25.0	25.0	22.0	22.0	22.0	22.0	22.0	
Pedestrian Calls (#/hr)	2	2	2	2	12	12	8	8	8	
Act Effct Green (s)	33.5	33.5	33.5	33.5	63.9	63.9	75.3	73.8	73.8	
Actuated g/C Ratio	0.28	0.28	0.28	0.28	0.53	0.53	0.63	0.62	0.62	
v/c Ratio	1.03	0.26	0.07	0.38	0.16	0.54	0.28	0.55	0.11	
Control Delay	112.2	13.7	32.7	9.0	19.5	18.1	11.8	14.8	2.2	
Queue Delay	0.0	0.0	0.0	0.0	0.0	0.0	0.0	0.0	0.0	
Total Delay	112.2	13.7	32.7	9.0	19.5	18.1	11.8	14.8	2.2	
LOS	F	B	C	A	B	B	B	B	A	
Approach Delay	77.7			11.3			18.1			
Approach LOS	E			B			B			
Queue Length 50th (m)	~57.4	6.6	4.0	4.1	3.3	54.2	5.4	73.2	0.0	
Queue Length 95th (m)	#106.4	21.5	10.6	22.7	m7.9	m88.3	10.8	90.8	6.2	
Internal Link Dist (m)	390.4		0.1		682.5		144.8			
Turn Bay Length (m)	38.0		38.0		45.0		75.0			
Base Capacity (vph)	221	481	329	547	222	2534	263	1962	831	
Starvation Cap Reductn	0	0	0	0	0	0	0	0	0	
Spillback Cap Reductn	0	0	0	0	0	0	0	0	0	
Storage Cap Reductn	0	0	0	0	0	0	0	0	0	
Reduced v/c Ratio	1.03	0.26	0.07	0.38	0.16	0.54	0.24	0.55	0.11	

Intersection Summary

Cycle Length: 120
 Actuated Cycle Length: 120
 Offset: 49 (41%), Referenced to phase 2:NBT and 6:SBTL, Start of Green
 Natural Cycle: 90

Lanes, Volumes, Timings
1: St-Laurent & Tremblay

Future Background 2031PM Peak Hour
1531 St-Laurent Blvd

Control Type: Actuated-Coordinated
 Maximum v/c Ratio: 1.03
 Intersection Signal Delay: 22.4 Intersection LOS: C
 Intersection Capacity Utilization 88.7% ICU Level of Service E
 Analysis Period (min) 15
 ~ Volume exceeds capacity, queue is theoretically infinite.
 Queue shown is maximum after two cycles.
 # 95th percentile volume exceeds capacity, queue may be longer.
 Queue shown is maximum after two cycles.
 m Volume for 95th percentile queue is metered by upstream signal.

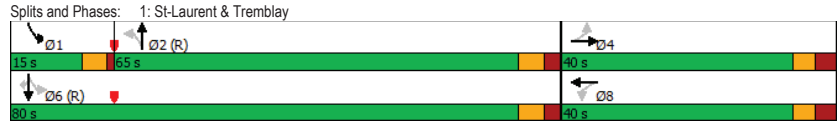

Lanes, Volumes, Timings
2: St-Laurent & Belfast

Future Background 2031PM Peak Hour
1531 St-Laurent Blvd

Lane Group	EBL	EBT	EBR	WBL	WBT	NBL	NBT	NBR	SBL	SBT	SBR
Lane Configurations	↔	↔	↔	↔	↔	↔	↔	↔	↔	↔	↔
Traffic Volume (vph)	195	162	239	101	91	129	1007	87	93	897	133
Future Volume (vph)	195	162	239	101	91	129	1007	87	93	897	133
Lane Group Flow (vph)	195	162	239	101	240	129	1007	87	93	897	133
Turn Type	pm+pt	NA	Perm	Perm	NA	pm+pt	NA	Perm	pm+pt	NA	Perm
Protected Phases	7	4			8	5	2		1	6	
Permitted Phases	4		4	8		2		2	6		6
Detector Phase	7	4	4	8	8	5	2	2	1	6	6
Switch Phase											
Minimum Initial (s)	5.0	10.0	10.0	10.0	10.0	5.0	10.0	10.0	5.0	10.0	10.0
Minimum Split (s)	10.8	27.8	27.8	27.8	27.8	10.7	36.6	36.6	10.7	36.6	36.6
Total Split (s)	15.0	49.0	49.0	34.0	34.0	14.0	57.0	57.0	14.0	57.0	57.0
Total Split (%)	12.5%	40.8%	40.8%	28.3%	28.3%	11.7%	47.5%	47.5%	11.7%	47.5%	47.5%
Maximum Green (s)	9.2	43.2	43.2	28.2	28.2	8.3	51.4	51.4	8.3	51.4	51.4
Yellow Time (s)	3.3	3.3	3.3	3.3	3.3	4.2	4.2	4.2	4.2	4.2	4.2
All-Red Time (s)	2.5	2.5	2.5	2.5	2.5	1.5	1.4	1.4	1.5	1.4	1.4
Lost Time Adjust (s)	0.0	0.0	0.0	0.0	0.0	0.0	0.0	0.0	0.0	0.0	0.0
Total Lost Time (s)	5.8	5.8	5.8	5.8	5.8	5.7	5.6	5.6	5.7	5.6	5.6
Lead/Lag	Lead			Lag	Lag	Lead	Lag	Lag	Lead	Lag	Lag
Lead-Lag Optimize?	Yes			Yes	Yes	Yes	Yes	Yes	Yes	Yes	Yes
Vehicle Extension (s)	3.0	3.0	3.0	3.0	3.0	3.0	3.0	3.0	3.0	3.0	3.0
Recall Mode	None	None	None	None	None	None	C-Max	C-Max	None	C-Max	C-Max
Walk Time (s)	7.0	7.0	7.0	7.0	7.0	25.0	25.0	25.0	25.0	25.0	25.0
Flash Dont Walk (s)	15.0	15.0	15.0	15.0	15.0	6.0	6.0	6.0	6.0	6.0	6.0
Pedestrian Calls (#/hr)	9	9	5	5	5	1	1	1	15	15	15
Act Effct Green (s)	34.6	34.6	34.6	19.6	19.6	68.8	60.2	60.2	67.6	59.6	59.6
Actuated g/C Ratio	0.29	0.29	0.29	0.16	0.16	0.57	0.50	0.50	0.56	0.50	0.50
v/c Ratio	0.95	0.35	0.43	0.59	0.79	0.41	0.61	0.13	0.38	0.55	0.17
Control Delay	86.6	34.7	8.6	58.9	53.0	15.3	24.9	1.4	17.1	18.6	2.9
Queue Delay	0.0	0.0	0.0	0.0	0.0	0.0	0.0	0.0	0.0	0.0	0.0
Total Delay	86.6	34.7	8.6	58.9	53.0	15.3	24.9	1.4	17.1	18.6	2.9
LOS	F	C	A	E	D	B	C	A	B	B	A
Approach Delay		41.2			54.7		22.2			16.6	
Approach LOS		D			D		C			B	
Queue Length 50th (m)	37.2	30.2	6.0	22.3	40.6	11.9	87.8	0.0	8.1	47.3	0.0
Queue Length 95th (m)	#68.0	44.1	23.2	37.5	63.9	24.6	125.4	3.2	20.8	60.6	7.0
Internal Link Dist (m)		518.7			103.5		597.8			682.5	
Turn Bay Length (m)	75.0		200.0	65.0		75.0		55.0	75.0		85.0
Base Capacity (vph)	206	572	650	247	408	316	1647	683	253	1630	766
Starvation Cap Reductn	0	0	0	0	0	0	0	0	0	0	0
Spillback Cap Reductn	0	0	0	0	0	0	0	0	0	0	0
Storage Cap Reductn	0	0	0	0	0	0	0	0	0	0	0
Reduced v/c Ratio	0.95	0.28	0.37	0.41	0.59	0.41	0.61	0.13	0.37	0.55	0.17

Intersection Summary
 Cycle Length: 120
 Actuated Cycle Length: 120
 Offset: 49 (41%), Referenced to phase 2:NBT and 6:SBTL, Start of Green
 Natural Cycle: 90

Lanes, Volumes, Timings
2: St-Laurent & Belfast

Future Background 2031PM Peak Hour
1531 St-Laurent Blvd

Control Type: Actuated-Coordinated
 Maximum v/c Ratio: 0.95
 Intersection Signal Delay: 27.1 Intersection LOS: C
 Intersection Capacity Utilization 80.8% ICU Level of Service D
 Analysis Period (min) 15
 # 95th percentile volume exceeds capacity, queue may be longer.
 Queue shown is maximum after two cycles.

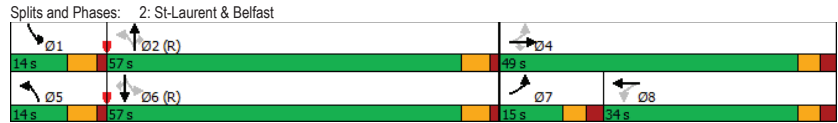

Lanes, Volumes, Timings
3: St-Laurent & Industrial/Innes

Future Background 2031PM Peak Hour
1531 St-Laurent Blvd

	EBL	EBT	EBR	WBL	WBT	WBR	NBL	NBT	NBR	SBL	SBT	SBR
Lane Group	EBL	EBT	EBR	WBL	WBT	WBR	NBL	NBT	NBR	SBL	SBT	SBR
Lane Configurations	↔↔	↕↕	↔↔	↔↔	↕↕	↔↔	↔↔	↕↕	↔↔	↔↔	↕↕	↔↔
Traffic Volume (vph)	139	567	367	415	274	135	206	954	522	130	966	136
Future Volume (vph)	139	567	367	415	274	135	206	954	522	130	966	136
Lane Group Flow (vph)	139	567	367	415	274	135	206	954	522	130	966	136
Turn Type	Prot	NA	Perm	Prot	NA	Perm	Prot	NA	Perm	Prot	NA	Perm
Protected Phases	7	4		3	8		5	2		1	6	
Permitted Phases			4			8			2			6
Detector Phase	7	4	4	3	8	8	5	2	2	1	6	6
Switch Phase												
Minimum Initial (s)	5.0	10.0	10.0	5.0	10.0	10.0	5.0	10.0	10.0	5.0	10.0	10.0
Minimum Split (s)	11.6	38.6	38.6	11.6	38.6	38.6	11.3	37.6	37.6	11.3	37.6	37.6
Total Split (s)	19.0	38.0	38.0	41.0	60.0	60.0	28.0	43.0	43.0	28.0	43.0	43.0
Total Split (%)	12.7%	25.3%	25.3%	27.3%	40.0%	40.0%	18.7%	28.7%	28.7%	18.7%	28.7%	28.7%
Maximum Green (s)	12.4	31.4	31.4	34.4	53.4	53.4	21.7	36.4	36.4	21.7	36.4	36.4
Yellow Time (s)	3.7	3.7	3.7	3.7	3.7	3.7	4.2	4.2	4.2	4.2	4.2	4.2
All-Red Time (s)	2.9	2.9	2.9	2.9	2.9	2.9	2.1	2.4	2.4	2.1	2.4	2.4
Lost Time Adjust (s)	0.0	0.0	0.0	0.0	0.0	0.0	0.0	0.0	0.0	0.0	0.0	0.0
Total Lost Time (s)	6.6	6.6	6.6	6.6	6.6	6.6	6.3	6.6	6.6	6.3	6.6	6.6
Lead/Lag	Lead	Lag	Lag	Lead	Lag	Lag	Lead	Lag	Lag	Lead	Lag	Lag
Lead-Lag Optimize?	Yes	Yes	Yes	Yes	Yes	Yes	Yes	Yes	Yes	Yes	Yes	Yes
Vehicle Extension (s)	3.0	3.0	3.0	3.0	3.0	3.0	3.0	3.0	3.0	3.0	3.0	3.0
Recall Mode	None	None	None	None	None	None	None	Max	Max	None	Max	Max
Walk Time (s)	7.0	7.0			7.0	7.0		7.0	7.0		7.0	7.0
Flash Dont Walk (s)		25.0	25.0		25.0	25.0		24.0	24.0		24.0	24.0
Pedestrian Calls (#/hr)		5	5		6	6		9	9		12	12
Act Effct Green (s)	10.5	27.1	27.1	21.7	38.3	38.3	13.8	39.6	39.6	10.9	36.8	36.8
Actuated g/C Ratio	0.08	0.22	0.22	0.17	0.30	0.30	0.11	0.32	0.32	0.09	0.29	0.29
v/c Ratio	0.52	0.81	0.67	0.75	0.28	0.25	0.60	0.93	0.68	0.49	1.02	0.25
Control Delay	64.4	57.5	15.4	59.1	34.1	6.3	62.5	58.7	10.7	63.3	78.0	3.8
Queue Delay	0.0	0.0	0.0	0.0	0.0	0.0	0.0	0.0	0.0	0.0	0.0	0.0
Total Delay	64.4	57.5	15.4	59.1	34.1	6.3	62.5	58.7	10.7	63.3	78.0	3.8
LOS	E	E	B	E	C	A	E	E	B	E	E	A
Approach Delay		44.0			42.2			44.3				68.3
Approach LOS		D			D			D				E
Queue Length 50th (m)	17.3	70.4	11.8	51.3	27.1	0.0	25.6	122.2	9.9	16.2	-136.5	0.0
Queue Length 95th (m)	30.7	101.0	48.2	73.3	40.7	14.2	41.3	#193.0	52.7	28.6	#210.3	9.1
Internal Link Dist (m)		745.6			700.4			316.7			597.8	
Turn Bay Length (m)	38.0		120.0	150.0		80.0	100.0		100.0	125.0		150.0
Base Capacity (vph)	320	822	591	888	1368	700	544	1025	771	529	950	539
Starvation Cap Reductn	0	0	0	0	0	0	0	0	0	0	0	0
Spillback Cap Reductn	0	0	0	0	0	0	0	0	0	0	0	0
Storage Cap Reductn	0	0	0	0	0	0	0	0	0	0	0	0
Reduced v/c Ratio	0.43	0.69	0.62	0.47	0.20	0.19	0.38	0.93	0.68	0.25	1.02	0.25

Intersection Summary
 Cycle Length: 150
 Actuated Cycle Length: 125.7
 Natural Cycle: 110
 Control Type: Actuated-Uncoordinated

Lanes, Volumes, Timings
3: St-Laurent & Industrial/Innes

Future Background 2031PM Peak Hour
1531 St-Laurent Blvd

Maximum v/c Ratio: 1.02	Intersection LOS: D
Intersection Signal Delay: 50.0	ICU Level of Service E
Intersection Capacity Utilization 86.7%	
Analysis Period (min) 15	
~ Volume exceeds capacity, queue is theoretically infinite.	
Queue shown is maximum after two cycles.	
# 95th percentile volume exceeds capacity, queue may be longer.	
Queue shown is maximum after two cycles.	

Splits and Phases: 3: St-Laurent & Industrial/Innes

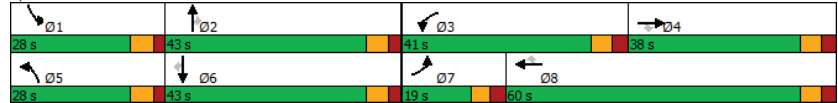

HCM 2010 TWSC
5: Lagan & Belfast

Future Background 2031PM Peak Hour
1531 St-Laurent Blvd

Intersection												
Int Delay, s/veh	2.8											
Movement	EBL	EBT	EBR	WBL	WBT	WBR	NBL	NBT	NBR	SBL	SBT	SBR
Lane Configurations	↔			↔			↔			↔		
Traffic Vol, veh/h	46	265	50	19	310	26	26	5	16	30	0	39
Future Vol, veh/h	46	265	50	19	310	26	26	5	16	30	0	39
Conflicting Peds, #/hr	12	0	5	5	0	12	1	0	6	6	0	1
Sign Control	Free	Free	Free	Free	Free	Free	Stop	Stop	Stop	Stop	Stop	Stop
RT Channelized	-	-	None	-	-	None	-	-	None	-	-	None
Storage Length	-	-	-	-	-	-	-	-	-	-	-	-
Veh in Median Storage, #	-	0	-	-	0	-	-	0	-	-	0	-
Grade, %	-	0	-	-	0	-	-	0	-	-	0	-
Peak Hour Factor	100	100	100	100	100	100	100	100	100	100	100	100
Heavy Vehicles, %	30	6	12	5	3	8	4	2	2	10	2	2
Mvmt Flow	46	265	50	19	310	26	26	5	16	30	0	39

Major/Minor	Major1	Major2	Minor1	Minor2
Conflicting Flow All	348	0	320	0
Stage 1	-	-	-	-
Stage 2	-	-	-	-
Critical Hdwy	4.4	-	4.15	-
Critical Hdwy Stg 1	-	-	-	-
Critical Hdwy Stg 2	-	-	-	-
Follow-up Hdwy	2.47	-	2.245	-
Pot Cap-1 Maneuver	1071	-	1223	-
Stage 1	-	-	-	-
Stage 2	-	-	-	-
Platoon blocked, %	-	-	-	-
Mov Cap-1 Maneuver	1061	-	1218	-
Mov Cap-2 Maneuver	-	-	-	-
Stage 1	-	-	-	-
Stage 2	-	-	-	-

Approach	EB	WB	NB	SB
HCM Control Delay, s	1.1	0.4	16.5	15.2
HCM LOS			C	C

Minor Lane/Major Mvmt	NBLn1	EBL	EBT	EBR	WBL	WBT	WBR	SBLn1
Capacity (veh/h)	359	1061	-	-	1218	-	-	420
HCM Lane V/C Ratio	0.131	0.043	-	-	0.016	-	-	0.164
HCM Control Delay (s)	16.5	8.5	0	-	8	0	-	15.2
HCM Lane LOS	C	A	A	-	A	A	-	C
HCM 95th %tile Q(veh)	0.4	0.1	-	-	0	-	-	0.6

Appendix I

Synchro Intersection Worksheets – 2026 Future Total Conditions

Lanes, Volumes, Timings
1: St-Laurent & Tremblay

Future Total 2026AM Peak Hour
1531 St-Laurent Blvd

	↖	→	↗	←	↖	↑	↗	↓	↖
Lane Group	EBL	EBT	WBL	WBT	NBL	NBT	SBL	SBT	SBR
Lane Configurations	↖	↖	↖	↖	↖	↖	↖	↖	↖
Traffic Volume (vph)	55	21	12	20	84	1247	129	1148	240
Future Volume (vph)	55	21	12	20	84	1247	129	1148	240
Lane Group Flow (vph)	55	54	12	133	84	1285	129	1148	240
Turn Type	Perm	NA	Perm	NA	Perm	NA	pm+pt	NA	Perm
Protected Phases		4		8		2	1	6	
Permitted Phases	4		8		2		6		6
Detector Phase	4	4	8	8	2	2	1	6	6
Switch Phase									
Minimum Initial (s)	10.0	10.0	10.0	10.0	10.0	10.0	5.0	10.0	10.0
Minimum Split (s)	38.5	38.5	38.5	38.5	39.2	39.2	9.7	39.2	39.2
Total Split (s)	40.0	40.0	40.0	40.0	72.0	72.0	18.0	90.0	90.0
Total Split (%)	30.8%	30.8%	30.8%	30.8%	55.4%	55.4%	13.8%	69.2%	69.2%
Maximum Green (s)	33.5	33.5	33.5	33.5	65.8	65.8	13.3	83.8	83.8
Yellow Time (s)	3.3	3.3	3.3	3.3	3.7	3.7	3.7	3.7	3.7
All-Red Time (s)	3.2	3.2	3.2	3.2	2.5	2.5	1.0	2.5	2.5
Lost Time Adjust (s)	0.0	0.0	0.0	0.0	0.0	0.0	0.0	0.0	0.0
Total Lost Time (s)	6.5	6.5	6.5	6.5	6.2	6.2	4.7	6.2	6.2
Lead/Lag					Lag	Lag	Lead		
Lead-Lag Optimize?					Yes	Yes	Yes		
Vehicle Extension (s)	3.0	3.0	3.0	3.0	3.0	3.0	3.0	3.0	3.0
Recall Mode	None	None	None	None	C-Max	C-Max	None	C-Max	C-Max
Walk Time (s)	7.0	7.0	7.0	7.0	11.0	11.0		11.0	11.0
Flash Dont Walk (s)	25.0	25.0	25.0	25.0	22.0	22.0		22.0	22.0
Pedestrian Calls (#/hr)	9	9	3	3	7	7		12	12
Act Effct Green (s)	16.6	16.6	16.6	16.6	87.9	87.9	102.2	100.7	100.7
Actuated g/C Ratio	0.13	0.13	0.13	0.13	0.68	0.68	0.79	0.77	0.77
v/c Ratio	0.57	0.24	0.09	0.49	0.29	0.44	0.41	0.48	0.23
Control Delay	73.4	24.9	46.2	17.7	14.9	11.6	8.2	7.1	1.4
Queue Delay	0.0	0.0	0.0	0.0	0.0	0.0	0.0	0.0	0.0
Total Delay	73.4	24.9	46.2	17.7	14.9	11.6	8.2	7.1	1.4
LOS	E	C	D	B	B	B	A	A	A
Approach Delay		49.3		20.0		11.8		6.3	
Approach LOS		D		C		B		A	
Queue Length 50th (m)	13.8	5.0	2.8	4.7	7.2	45.8	5.6	41.4	0.0
Queue Length 95th (m)	24.2	14.9	7.7	20.6	26.0	91.2	18.3	96.4	8.6
Internal Link Dist (m)		396.6		0.1		682.5		144.8	
Turn Bay Length (m)	38.0		38.0		45.0		75.0		
Base Capacity (vph)	195	413	280	436	290	2926	369	2382	1029
Starvation Cap Reductn	0	0	0	0	0	0	0	0	0
Spillback Cap Reductn	0	0	0	0	0	0	0	0	0
Storage Cap Reductn	0	0	0	0	0	0	0	0	0
Reduced v/c Ratio	0.28	0.13	0.04	0.31	0.29	0.44	0.35	0.48	0.23

Intersection Summary

Cycle Length: 130
 Actuated Cycle Length: 130
 Offset: 53 (41%), Referenced to phase 2:NBTL and 6:SBTL, Start of Green
 Natural Cycle: 90

Lanes, Volumes, Timings
1: St-Laurent & Tremblay

Future Total 2026AM Peak Hour
1531 St-Laurent Blvd

Control Type: Actuated-Coordinated
 Maximum v/c Ratio: 0.57
 Intersection Signal Delay: 10.8
 Intersection LOS: B
 Intersection Capacity Utilization 84.4%
 ICU Level of Service E
 Analysis Period (min) 15

Splits and Phases: 1: St-Laurent & Tremblay



Lanes, Volumes, Timings
2: St-Laurent & Belfast

Future Total 2026AM Peak Hour
1531 St-Laurent Blvd

Lane Group	EBL	EBT	EBR	WBL	WBT	NBL	NBT	NBR	SBL	SBT	SBR
Lane Configurations	↖	↗	↘	↙	↘	↙	↘	↙	↘	↙	↘
Traffic Volume (vph)	47	66	91	64	147	123	918	74	92	837	190
Future Volume (vph)	47	66	91	64	147	123	918	74	92	837	190
Lane Group Flow (vph)	47	66	91	64	261	123	918	74	92	837	190
Turn Type	pm+pt	NA	Perm	Perm	NA	pm+pt	NA	Perm	pm+pt	NA	Perm
Protected Phases	7	4			8	5	2		1	6	
Permitted Phases	4		4	8				2	6		6
Detector Phase	7	4	4	8	8	5	2	2	1	6	6
Switch Phase											
Minimum Initial (s)	5.0	10.0	10.0	10.0	10.0	5.0	10.0	10.0	5.0	10.0	10.0
Minimum Split (s)	10.8	27.8	27.8	27.8	27.8	10.7	36.6	36.6	10.7	36.6	36.6
Total Split (s)	16.0	48.0	48.0	32.0	32.0	15.0	57.0	57.0	15.0	57.0	57.0
Total Split (%)	13.3%	40.0%	40.0%	26.7%	26.7%	12.5%	47.5%	47.5%	12.5%	47.5%	47.5%
Maximum Green (s)	10.2	42.2	42.2	26.2	26.2	9.3	51.4	51.4	9.3	51.4	51.4
Yellow Time (s)	3.3	3.3	3.3	3.3	3.3	4.2	4.2	4.2	4.2	4.2	4.2
All-Red Time (s)	2.5	2.5	2.5	2.5	2.5	1.5	1.4	1.4	1.5	1.4	1.4
Lost Time Adjust (s)	0.0	0.0	0.0	0.0	0.0	0.0	0.0	0.0	0.0	0.0	0.0
Total Lost Time (s)	5.8	5.8	5.8	5.8	5.8	5.7	5.6	5.6	5.7	5.6	5.6
Lead/Lag	Lead			Lag	Lag	Lead	Lag	Lag	Lead	Lag	Lag
Lead-Lag Optimize?	Yes			Yes	Yes	Yes	Yes	Yes	Yes	Yes	Yes
Vehicle Extension (s)	3.0	3.0	3.0	3.0	3.0	3.0	3.0	3.0	3.0	3.0	3.0
Recall Mode	None	None	None	None	None	None	C-Max	C-Max	None	C-Max	C-Max
Walk Time (s)	7.0	7.0	7.0	7.0	7.0		25.0	25.0		25.0	25.0
Flash Dont Walk (s)	15.0	15.0	15.0	15.0	15.0		6.0	6.0		6.0	6.0
Pedestrian Calls (#/hr)	9	9	42	42	42		22	22		13	13
Act Effct Green (s)	35.5	35.5	35.5	23.5	23.5	67.7	59.2	59.2	66.8	58.7	58.7
Actuated g/C Ratio	0.30	0.30	0.30	0.20	0.20	0.56	0.49	0.49	0.56	0.49	0.49
v/c Ratio	0.24	0.13	0.22	0.33	0.88	0.40	0.58	0.10	0.34	0.55	0.29
Control Delay	29.9	28.4	6.7	45.2	69.8	16.0	25.6	0.5	15.7	25.2	4.2
Queue Delay	0.0	0.0	0.0	0.0	0.0	0.0	0.0	0.0	0.0	0.0	0.0
Total Delay	29.9	28.4	6.7	45.2	69.8	16.0	25.6	0.5	15.7	25.2	4.2
LOS	C	C	A	D	E	B	C	A	B	C	A
Approach Delay		19.1					64.9				20.8
Approach LOS		B					C				C
Queue Length 50th (m)	7.5	10.6	0.0	12.7	52.2	13.1	87.3	0.0	9.6	79.1	0.0
Queue Length 95th (m)	15.9	20.5	10.9	25.8	#93.2	23.2	112.3	0.9	18.1	100.8	13.4
Internal Link Dist (m)		518.7			23.5		597.8			682.5	
Turn Bay Length (m)	75.0		200.0	65.0		75.0		55.0	75.0		85.0
Base Capacity (vph)	214	596	470	218	328	320	1572	731	282	1518	666
Starvation Cap Reductn	0	0	0	0	0	0	0	0	0	0	0
Spillback Cap Reductn	0	0	0	0	0	0	0	0	0	0	0
Storage Cap Reductn	0	0	0	0	0	0	0	0	0	0	0
Reduced v/c Ratio	0.22	0.11	0.19	0.29	0.80	0.38	0.58	0.10	0.33	0.55	0.29

Intersection Summary

Cycle Length: 120
 Actuated Cycle Length: 120
 Offset: 53 (44%), Referenced to phase 2:NBTL and 6:SBTL, Start of Green
 Natural Cycle: 90

Lanes, Volumes, Timings
2: St-Laurent & Belfast

Future Total 2026AM Peak Hour
1531 St-Laurent Blvd

Control Type: Actuated-Coordinated	
Maximum v/c Ratio: 0.88	
Intersection Signal Delay: 26.7	Intersection LOS: C
Intersection Capacity Utilization 76.3%	ICU Level of Service D
Analysis Period (min) 15	
# 95th percentile volume exceeds capacity, queue may be longer.	
Queue shown is maximum after two cycles.	

Splits and Phases: 2: St-Laurent & Belfast

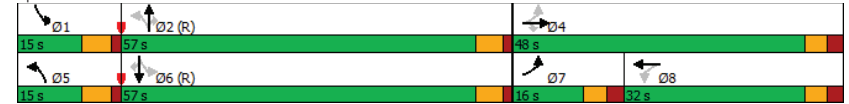

Lanes, Volumes, Timings
3: St-Laurent & Industrial/Innes

Future Total 2026AM Peak Hour
1531 St-Laurent Blvd

Lane Group	EBL	EBT	EBR	WBL	WBT	WBR	NBL	NBT	NBR	SBL	SBT	SBR
Lane Configurations	↔	↔	↔	↔	↔	↔	↔	↔	↔	↔	↔	↔
Traffic Volume (vph)	71	187	137	618	741	242	208	1112	356	118	842	145
Future Volume (vph)	71	187	137	618	741	242	208	1112	356	118	842	145
Lane Group Flow (vph)	71	187	137	618	741	242	208	1112	356	118	842	145
Turn Type	Prot	NA	Perm	Prot	NA	Perm	Prot	NA	Perm	Prot	NA	Perm
Protected Phases	7	4		3	8		5	2		1	6	
Permitted Phases			4			8			2			6
Detector Phase	7	4	4	3	8	8	5	2	2	1	6	6
Switch Phase												
Minimum Initial (s)	5.0	10.0	10.0	5.0	10.0	10.0	5.0	10.0	10.0	5.0	10.0	10.0
Minimum Split (s)	11.6	38.6	38.6	11.6	38.6	38.6	11.3	37.6	37.6	11.3	37.6	37.6
Total Split (s)	25.0	38.0	38.0	36.0	49.0	49.0	23.0	43.0	43.0	23.0	43.0	43.0
Total Split (%)	17.9%	27.1%	27.1%	25.7%	35.0%	35.0%	16.4%	30.7%	30.7%	16.4%	30.7%	30.7%
Maximum Green (s)	18.4	31.4	31.4	29.4	42.4	42.4	16.7	36.4	36.4	16.7	36.4	36.4
Yellow Time (s)	3.7	3.7	3.7	3.7	3.7	3.7	4.2	4.2	4.2	4.2	4.2	4.2
All-Red Time (s)	2.9	2.9	2.9	2.9	2.9	2.9	2.1	2.4	2.4	2.1	2.4	2.4
Lost Time Adjust (s)	0.0	0.0	0.0	0.0	0.0	0.0	0.0	0.0	0.0	0.0	0.0	0.0
Total Lost Time (s)	6.6	6.6	6.6	6.6	6.6	6.6	6.3	6.6	6.6	6.3	6.6	6.6
Lead/Lag	Lead	Lag	Lag	Lead	Lag	Lag	Lead	Lag	Lag	Lead	Lag	Lag
Lead-Lag Optimize?	Yes	Yes	Yes	Yes	Yes	Yes	Yes	Yes	Yes	Yes	Yes	Yes
Vehicle Extension (s)	3.0	3.0	3.0	3.0	3.0	3.0	3.0	3.0	3.0	3.0	3.0	3.0
Recall Mode	None	None	None	None	None	None	C-Max	C-Max	None	C-Max	C-Max	C-Max
Walk Time (s)	7.0	7.0			7.0	7.0			7.0		7.0	7.0
Flash Dont Walk (s)	25.0	25.0			25.0	25.0			24.0		24.0	24.0
Pedestrian Calls (#/hr)	7	7			3	3			5		9	9
Act Effct Green (s)	8.7	19.3	19.3	28.8	42.0	42.0	14.4	55.1	55.1	10.6	51.3	51.3
Actuated g/C Ratio	0.06	0.14	0.14	0.21	0.30	0.30	0.10	0.39	0.39	0.08	0.37	0.37
v/c Ratio	0.38	0.46	0.40	0.93	0.78	0.42	0.67	0.90	0.49	0.50	0.71	0.26
Control Delay	68.5	57.4	5.5	76.4	51.2	6.2	71.2	51.6	9.6	69.0	43.8	3.5
Queue Delay	0.0	0.0	0.0	0.0	0.0	0.0	0.0	0.0	0.0	0.0	0.0	0.0
Total Delay	68.5	57.4	5.5	76.4	51.2	6.2	71.2	51.6	9.6	69.0	43.8	3.5
LOS	E	E	A	E	D	A	E	D	A	E	D	A
Approach Delay		41.4			54.1			45.1				41.2
Approach LOS		D			D			D				D
Queue Length 50th (m)	9.9	25.5	0.0	87.1	101.7	0.0	28.9	151.0	9.9	16.4	105.3	0.0
Queue Length 95th (m)	17.7	34.0	7.1	#120.0	113.0	18.0	41.7	#245.3	43.0	26.1	#168.4	8.8
Internal Link Dist (m)		745.6			700.4			316.7			597.8	
Turn Bay Length (m)	38.0		120.0	150.0		80.0	100.0		100.0	125.0		150.0
Base Capacity (vph)	391	665	444	675	993	587	359	1231	732	372	1180	557
Starvation Cap Reductn	0	0	0	0	0	0	0	0	0	0	0	0
Spillback Cap Reductn	0	0	0	0	0	0	0	0	0	0	0	0
Storage Cap Reductn	0	0	0	0	0	0	0	0	0	0	0	0
Reduced v/c Ratio	0.18	0.28	0.31	0.92	0.75	0.41	0.58	0.90	0.49	0.32	0.71	0.26

Intersection Summary

Cycle Length: 140
 Actuated Cycle Length: 140
 Offset: 0 (0%), Referenced to phase 2:NBT and 6:SBT, Start of Green
 Natural Cycle: 140

Lanes, Volumes, Timings
3: St-Laurent & Industrial/Innes

Future Total 2026AM Peak Hour
1531 St-Laurent Blvd

Control Type: Actuated-Coordinated
 Maximum v/c Ratio: 0.93
 Intersection Signal Delay: 46.9
 Intersection LOS: D
 Intersection Capacity Utilization 89.1%
 ICU Level of Service E
 Analysis Period (min) 15
 # 95th percentile volume exceeds capacity, queue may be longer.
 Queue shown is maximum after two cycles.

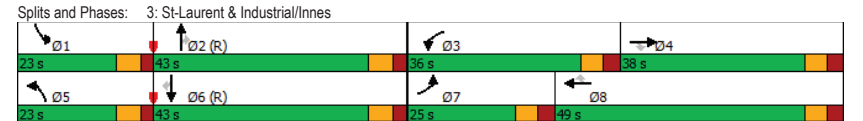

Lanes, Volumes, Timings
4: Access & Belfast

Future Total 2026AM Peak Hour
1531 St-Laurent Blvd

→ ←

Lane Group	EBT	WBT
Lane Configurations	↕ ↕	↕ ↕
Traffic Volume (vph)	209	324
Future Volume (vph)	209	324
Lane Group Flow (vph)	233	324
Sign Control	Free	Free

Intersection Summary	
Control Type: Unsignalized	
Intersection Capacity Utilization 16.5%	ICU Level of Service A
Analysis Period (min) 15	

HCM 2010 TWSC
5: Lagan & Belfast

Future Total 2026AM Peak Hour
1531 St-Laurent Blvd

Intersection												
Int Delay, s/veh	3.5											
Movement	EBL	EBT	EBR	WBL	WBT	WBR	NBL	NBT	NBR	SBL	SBT	SBR
Lane Configurations	↕ ↕			↕ ↕			↕ ↕			↕ ↕		
Traffic Vol, veh/h	51	272	15	13	225	26	58	1	15	15	4	17
Future Vol, veh/h	51	272	15	13	225	26	58	1	15	15	4	17
Conflicting Peds, #/hr	8	0	23	23	0	8	0	0	5	5	0	0
Sign Control	Free	Free	Free	Free	Free	Free	Stop	Stop	Stop	Stop	Stop	Stop
RT Channelized	-	-	None	-	-	None	-	-	None	-	-	None
Storage Length	-	-	-	-	-	-	-	-	-	-	-	-
Veh in Median Storage, #	-	0	-	-	0	-	-	0	-	-	0	-
Grade, %	-	0	-	-	0	-	-	0	-	-	0	-
Peak Hour Factor	100	100	100	100	100	100	100	100	100	100	100	100
Heavy Vehicles, %	20	12	7	23	15	15	55	2	33	20	25	12
Mvmt Flow	51	272	15	13	225	26	58	1	15	15	4	17

Major/Minor	Major1		Major2		Minor1		Minor2				
Conflicting Flow All	259	0	0	310	0	680	690	308	667	684	246
Stage 1	-	-	-	-	-	405	405	-	272	272	-
Stage 2	-	-	-	-	-	275	285	-	395	412	-
Critical Hdwy	4.3	-	-	4.33	-	7.65	6.52	6.53	7.3	6.75	6.32
Critical Hdwy Stg 1	-	-	-	-	-	6.65	5.52	-	6.3	5.75	-
Critical Hdwy Stg 2	-	-	-	-	-	6.65	5.52	-	6.3	5.75	-
Follow-up Hdwy	2.38	-	-	2.407	-	3.995	4.018	3.597	3.68	4.225	3.408
Pot Cap-1 Maneuver	1208	-	-	1141	-	303	368	665	349	344	769
Stage 1	-	-	-	-	-	529	598	-	696	645	-
Stage 2	-	-	-	-	-	629	676	-	596	556	-
Platoon blocked, %	-	-	-	-	-	-	-	-	-	-	-
Mov Cap-1 Maneuver	1200	-	-	1121	-	274	336	651	320	314	764
Mov Cap-2 Maneuver	-	-	-	-	-	274	336	-	320	314	-
Stage 1	-	-	-	-	-	493	557	-	656	632	-
Stage 2	-	-	-	-	-	603	662	-	549	518	-

Approach	EB	WB	NB	SB
HCM Control Delay, s	1.2	0.4	20.2	13.9
HCM LOS			C	B

Minor Lane/Major Mvmt	NBLn1	EBL	EBT	EBR	WBL	WBT	WBR	SBLn1
Capacity (veh/h)	311	1200	-	-	1121	-	-	440
HCM Lane V/C Ratio	0.238	0.043	-	-	0.012	-	-	0.082
HCM Control Delay (s)	20.2	8.1	0	-	8.2	0	-	13.9
HCM Lane LOS	C	A	A	-	A	A	-	B
HCM 95th %tile Q(veh)	0.9	0.1	-	-	0	-	-	0.3

HCM 2010 TWSC
6: Lagan & Access

Future Total 2026AM Peak Hour
1531 St-Laurent Blvd

Intersection						
Int Delay, s/veh	4					
Movement	EBL	EBR	NBL	NBT	SBT	SBR
Lane Configurations	↔			↑	↑	
Traffic Vol, veh/h	47	0	0	27	32	0
Future Vol, veh/h	47	0	0	27	32	0
Conflicting Peds, #/hr	0	0	0	0	0	0
Sign Control	Stop	Stop	Free	Free	Free	Free
RT Channelized	-	None	-	None	-	None
Storage Length	0	-	-	-	-	-
Veh in Median Storage, #	0	-	-	0	0	-
Grade, %	0	-	-	0	0	-
Peak Hour Factor	100	100	100	100	100	100
Heavy Vehicles, %	2	2	2	2	2	2
Mvmt Flow	47	0	0	27	32	0
Major/Minor						
	Minor2	Major1	Major2			
Conflicting Flow All	59	32	-	0	-	0
Stage 1	32	-	-	-	-	-
Stage 2	27	-	-	-	-	-
Critical Hdwy	6.42	6.22	-	-	-	-
Critical Hdwy Stg 1	5.42	-	-	-	-	-
Critical Hdwy Stg 2	5.42	-	-	-	-	-
Follow-up Hdwy	3.518	3.318	-	-	-	-
Pot Cap-1 Maneuver	948	1042	0	-	-	0
Stage 1	991	-	0	-	-	0
Stage 2	996	-	0	-	-	0
Platoon blocked, %						
Mov Cap-1 Maneuver	948	1042	-	-	-	-
Mov Cap-2 Maneuver	948	-	-	-	-	-
Stage 1	991	-	-	-	-	-
Stage 2	996	-	-	-	-	-
Approach						
	EB	NB	SB			
HCM Control Delay, s	9	0	0			
HCM LOS	A					
Minor Lane/Major Mvmt						
	NBT	EBLn1	SBT			
Capacity (veh/h)	-	948	-			
HCM Lane V/C Ratio	-	0.05	-			
HCM Control Delay (s)	-	9	-			
HCM Lane LOS	-	A	-			
HCM 95th %tile Q(veh)	-	0.2	-			

Lanes, Volumes, Timings
1: St-Laurent & Tremblay

Future Total 2026PM Peak Hour
1531 St-Laurent Blvd

	↖	→	↗	←	↙	↑	↘	↓	↕	
Lane Group	EBL	EBT	WBL	WBT	NBL	NBT	SBL	SBT	SBR	
Lane Configurations	↖	↗	↖	↗	↖	↗	↖	↗	↖	
Traffic Volume (vph)	225	38	23	21	38	1380	58	1088	86	
Future Volume (vph)	225	38	23	21	38	1380	58	1088	86	
Lane Group Flow (vph)	225	125	23	204	38	1392	58	1088	86	
Turn Type	Perm	NA	Perm	NA	Perm	NA	pm+pt	NA	Perm	
Protected Phases	4				8		2		6	
Permitted Phases	4		8		2		6		6	
Detector Phase	4		4		8		8		2	
Switch Phase	4		4		8		8		2	
Minimum Initial (s)	10.0	10.0	10.0	10.0	10.0	10.0	5.0	10.0	10.0	
Minimum Split (s)	38.5	38.5	38.5	38.5	39.2	39.2	9.7	39.2	39.2	
Total Split (s)	40.0	40.0	40.0	40.0	65.0	65.0	15.0	80.0	80.0	
Total Split (%)	33.3%	33.3%	33.3%	33.3%	54.2%	54.2%	12.5%	66.7%	66.7%	
Maximum Green (s)	33.5	33.5	33.5	33.5	58.8	58.8	10.3	73.8	73.8	
Yellow Time (s)	3.3	3.3	3.3	3.3	3.7	3.7	3.7	3.7	3.7	
All-Red Time (s)	3.2	3.2	3.2	3.2	2.5	2.5	1.0	2.5	2.5	
Lost Time Adjust (s)	0.0	0.0	0.0	0.0	0.0	0.0	0.0	0.0	0.0	
Total Lost Time (s)	6.5	6.5	6.5	6.5	6.2	6.2	4.7	6.2	6.2	
Lead/Lag					Lag	Lag	Lead			
Lead-Lag Optimize?					Yes	Yes	Yes			
Vehicle Extension (s)	3.0	3.0	3.0	3.0	3.0	3.0	3.0	3.0	3.0	
Recall Mode	None	None	None	None	C-Max	C-Max	None	C-Max	C-Max	
Walk Time (s)	7.0	7.0	7.0	7.0	11.0	11.0	11.0	11.0	11.0	
Flash Dont Walk (s)	25.0	25.0	25.0	25.0	22.0	22.0	22.0	22.0	22.0	
Pedestrian Calls (#/hr)	6	6	2	2	16	16	12	12	12	
Act Effct Green (s)	33.5	33.5	33.5	33.5	64.1	64.1	75.3	73.8	73.8	
Actuated g/C Ratio	0.28	0.28	0.28	0.28	0.53	0.53	0.63	0.62	0.62	
v/c Ratio	1.01	0.26	0.07	0.37	0.17	0.55	0.26	0.55	0.10	
Control Delay	106.5	13.6	32.7	8.9	20.1	18.7	11.6	14.8	2.2	
Queue Delay	0.0	0.0	0.0	0.0	0.0	0.0	0.0	0.0	0.0	
Total Delay	106.5	13.6	32.7	8.9	20.1	18.7	11.6	14.8	2.2	
LOS	F	B	C	A	C	B	B	B	A	
Approach Delay	73.3			11.3		18.8		13.8		
Approach LOS	E			B		B		B		
Queue Length 50th (m)	~53.9	6.6	4.0	4.0	3.5	55.1	4.9	73.7	0.0	
Queue Length 95th (m)	#104.1	21.5	10.6	22.5	m8.0	m89.3	10.0	91.5	6.0	
Internal Link Dist (m)	390.4			0.1		682.5		144.8		
Turn Bay Length (m)	38.0		38.0		45.0		75.0			
Base Capacity (vph)	223	482	328	546	220	2539	260	1962	822	
Starvation Cap Reductn	0	0	0	0	0	0	0	0	0	
Spillback Cap Reductn	0	0	0	0	0	0	0	0	0	
Storage Cap Reductn	0	0	0	0	0	0	0	0	0	
Reduced v/c Ratio	1.01	0.26	0.07	0.37	0.17	0.55	0.22	0.55	0.10	

Intersection Summary	
Cycle Length:	120
Actuated Cycle Length:	120
Offset:	49 (41%), Referenced to phase 2:NBT and 6:SBTL, Start of Green
Natural Cycle:	90

Lanes, Volumes, Timings
1: St-Laurent & Tremblay

Future Total 2026PM Peak Hour
1531 St-Laurent Blvd

Control Type: Actuated-Coordinated
 Maximum v/c Ratio: 1.01
 Intersection Signal Delay: 22.3 Intersection LOS: C
 Intersection Capacity Utilization 88.6% ICU Level of Service E
 Analysis Period (min) 15
 ~ Volume exceeds capacity, queue is theoretically infinite.
 Queue shown is maximum after two cycles.
 # 95th percentile volume exceeds capacity, queue may be longer.
 Queue shown is maximum after two cycles.
 m Volume for 95th percentile queue is metered by upstream signal.

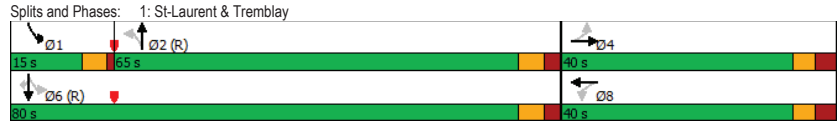

Lanes, Volumes, Timings
2: St-Laurent & Belfast

Future Total 2026PM Peak Hour
1531 St-Laurent Blvd

Lane Group	EBL	EBT	EBR	WBL	WBT	NBL	NBT	NBR	SBL	SBT	SBR
Lane Configurations	↖	↖	↖	↖	↖	↖	↖	↖	↖	↖	↖
Traffic Volume (vph)	194	171	223	119	96	111	1004	107	114	885	133
Future Volume (vph)	194	171	223	119	96	111	1004	107	114	885	133
Lane Group Flow (vph)	194	171	223	119	263	111	1004	107	114	885	133
Turn Type	pm+pt	NA	Perm	Perm	NA	pm+pt	NA	Perm	pm+pt	NA	Perm
Protected Phases	7	4			8	5	2		1	6	
Permitted Phases	4		4	8		2		2	6		6
Detector Phase	7	4	4	8	8	5	2	2	1	6	6
Switch Phase											
Minimum Initial (s)	5.0	10.0	10.0	10.0	10.0	5.0	10.0	10.0	5.0	10.0	10.0
Minimum Split (s)	10.8	27.8	27.8	27.8	27.8	10.7	36.6	36.6	10.7	36.6	36.6
Total Split (s)	15.0	49.0	49.0	34.0	34.0	14.0	57.0	57.0	14.0	57.0	57.0
Total Split (%)	12.5%	40.8%	40.8%	28.3%	28.3%	11.7%	47.5%	47.5%	11.7%	47.5%	47.5%
Maximum Green (s)	9.2	43.2	43.2	28.2	28.2	8.3	51.4	51.4	8.3	51.4	51.4
Yellow Time (s)	3.3	3.3	3.3	3.3	3.3	4.2	4.2	4.2	4.2	4.2	4.2
All-Red Time (s)	2.5	2.5	2.5	2.5	2.5	1.5	1.4	1.4	1.5	1.4	1.4
Lost Time Adjust (s)	0.0	0.0	0.0	0.0	0.0	0.0	0.0	0.0	0.0	0.0	0.0
Total Lost Time (s)	5.8	5.8	5.8	5.8	5.8	5.7	5.6	5.6	5.7	5.6	5.6
Lead/Lag	Lead			Lag	Lag	Lead	Lag	Lag	Lead	Lag	Lag
Lead-Lag Optimize?	Yes			Yes	Yes	Yes	Yes	Yes	Yes	Yes	Yes
Vehicle Extension (s)	3.0	3.0	3.0	3.0	3.0	3.0	3.0	3.0	3.0	3.0	3.0
Recall Mode	None	None	None	None	None	None	C-Max	C-Max	None	C-Max	C-Max
Walk Time (s)	7.0	7.0	7.0	7.0	7.0	25.0	25.0	25.0	25.0	25.0	25.0
Flash Dont Walk (s)	15.0	15.0	15.0	15.0	15.0	6.0	6.0	6.0	6.0	6.0	6.0
Pedestrian Calls (#/hr)	44	44	14	14	14	20	20	20	23	23	23
Act Effct Green (s)	35.9	35.9	35.9	20.9	20.9	66.6	58.3	58.3	67.2	58.6	58.6
Actuated g/C Ratio	0.30	0.30	0.30	0.17	0.17	0.56	0.49	0.49	0.56	0.49	0.49
v/c Ratio	0.96	0.36	0.41	0.68	0.82	0.37	0.63	0.17	0.47	0.55	0.18
Control Delay	89.7	34.0	7.4	65.1	55.4	15.1	26.4	2.7	23.6	19.0	3.0
Queue Delay	0.0	0.0	0.0	0.0	0.0	0.0	0.0	0.0	0.0	0.0	0.0
Total Delay	89.7	34.0	7.4	65.1	55.4	15.1	26.4	2.7	23.6	19.0	3.0
LOS	F	C	A	E	E	B	C	A	C	B	A
Approach Delay		42.3			58.4		23.3			17.6	
Approach LOS		D			E		C			B	
Queue Length 50th (m)	36.2	31.4	3.3	26.4	45.1	10.6	91.6	0.0	10.2	46.8	0.0
Queue Length 95th (m)	#70.1	46.5	20.0	43.9	70.8	21.5	124.8	6.9	29.2	60.3	7.1
Internal Link Dist (m)		518.7			23.5		597.8			682.5	
Turn Bay Length (m)	75.0		200.0	65.0		75.0		55.0	75.0		85.0
Base Capacity (vph)	202	572	619	235	406	310	1594	643	249	1603	745
Starvation Cap Reductn	0	0	0	0	0	0	0	0	0	0	0
Spillback Cap Reductn	0	0	0	0	0	0	0	0	0	0	0
Storage Cap Reductn	0	0	0	0	0	0	0	0	0	0	0
Reduced v/c Ratio	0.96	0.30	0.36	0.51	0.65	0.36	0.63	0.17	0.46	0.55	0.18

Intersection Summary
 Cycle Length: 120
 Actuated Cycle Length: 120
 Offset: 49 (41%), Referenced to phase 2:NBT and 6:SBTL, Start of Green
 Natural Cycle: 90

Lanes, Volumes, Timings
2: St-Laurent & Belfast

Future Total 2026PM Peak Hour
1531 St-Laurent Blvd

Control Type: Actuated-Coordinated	
Maximum v/c Ratio: 0.96	
Intersection Signal Delay: 28.8	Intersection LOS: C
Intersection Capacity Utilization 83.9%	ICU Level of Service E
Analysis Period (min) 15	
# 95th percentile volume exceeds capacity, queue may be longer.	
Queue shown is maximum after two cycles.	

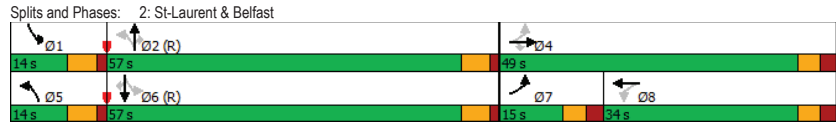

Lanes, Volumes, Timings
3: St-Laurent & Industrial/Innes

Future Total 2026PM Peak Hour
1531 St-Laurent Blvd

Lane Group	EBL	EBT	EBR	WBL	WBT	WBR	NBL	NBT	NBR	SBL	SBT	SBR
Lane Configurations	↔	↕	↔	↔	↕	↔	↔	↕	↔	↔	↕	↔
Traffic Volume (vph)	137	560	363	415	274	137	199	950	522	132	965	131
Future Volume (vph)	137	560	363	415	274	137	199	950	522	132	965	131
Lane Group Flow (vph)	137	560	363	415	274	137	199	950	522	132	965	131
Turn Type	Prot	NA	Perm	Prot	NA	Perm	Prot	NA	Perm	Prot	NA	Perm
Protected Phases	7	4		3	8		5	2		1	6	
Permitted Phases			4			8			2			6
Detector Phase	7	4	4	3	8	8	5	2	2	1	6	6
Switch Phase												
Minimum Initial (s)	5.0	10.0	10.0	5.0	10.0	10.0	5.0	10.0	10.0	5.0	10.0	10.0
Minimum Split (s)	11.6	38.6	38.6	11.6	38.6	38.6	11.3	37.6	37.6	11.3	37.6	37.6
Total Split (s)	19.0	38.0	38.0	41.0	60.0	60.0	28.0	43.0	43.0	28.0	43.0	43.0
Total Split (%)	12.7%	25.3%	25.3%	27.3%	40.0%	40.0%	18.7%	28.7%	28.7%	18.7%	28.7%	28.7%
Maximum Green (s)	12.4	31.4	31.4	34.4	53.4	53.4	21.7	36.4	36.4	21.7	36.4	36.4
Yellow Time (s)	3.7	3.7	3.7	3.7	3.7	3.7	4.2	4.2	4.2	4.2	4.2	4.2
All-Red Time (s)	2.9	2.9	2.9	2.9	2.9	2.9	2.1	2.4	2.4	2.1	2.4	2.4
Lost Time Adjust (s)	0.0	0.0	0.0	0.0	0.0	0.0	0.0	0.0	0.0	0.0	0.0	0.0
Total Lost Time (s)	6.6	6.6	6.6	6.6	6.6	6.6	6.3	6.6	6.6	6.3	6.6	6.6
Lead/Lag	Lead	Lag	Lag	Lead	Lag	Lag	Lead	Lag	Lag	Lead	Lag	Lag
Lead-Lag Optimize?	Yes	Yes	Yes	Yes	Yes	Yes	Yes	Yes	Yes	Yes	Yes	Yes
Vehicle Extension (s)	3.0	3.0	3.0	3.0	3.0	3.0	3.0	3.0	3.0	3.0	3.0	3.0
Recall Mode	None	None	None	None	None	None	None	Max	Max	None	Max	Max
Walk Time (s)	7.0	7.0	7.0	7.0	7.0	7.0	7.0	7.0	7.0	7.0	7.0	7.0
Flash Dont Walk (s)	25.0	25.0	25.0	25.0	25.0	25.0	24.0	24.0	24.0	24.0	24.0	24.0
Pedestrian Calls (#/hr)	6	6	6	6	7	7	10	10	10	14	14	14
Act Effct Green (s)	10.5	26.8	26.8	21.7	38.0	38.0	13.5	39.3	39.3	10.9	36.8	36.8
Actuated g/C Ratio	0.08	0.21	0.21	0.17	0.30	0.30	0.11	0.31	0.31	0.09	0.29	0.29
v/c Ratio	0.51	0.80	0.66	0.75	0.28	0.26	0.59	0.93	0.68	0.50	1.01	0.24
Control Delay	64.0	57.0	15.0	58.8	34.0	6.3	62.2	58.6	10.8	63.0	76.3	3.4
Queue Delay	0.0	0.0	0.0	0.0	0.0	0.0	0.0	0.0	0.0	0.0	0.0	0.0
Total Delay	64.0	57.0	15.0	58.8	34.0	6.3	62.2	58.6	10.8	63.0	76.3	3.4
LOS	E	E	B	E	C	A	E	E	B	E	E	A
Approach Delay		43.5			41.8			44.1				67.1
Approach LOS		D			D			D				E
Queue Length 50th (m)	17.0	69.1	10.9	50.9	26.9	0.0	24.6	120.9	9.6	16.3	-134.5	0.0
Queue Length 95th (m)	30.3	99.1	46.4	73.0	40.5	14.4	39.9	#192.2	52.3	28.8	#209.1	7.5
Internal Link Dist (m)		745.6			700.4			316.7				597.8
Turn Bay Length (m)	38.0		120.0	150.0		80.0	100.0		100.0	125.0		150.0
Base Capacity (vph)	321	826	592	893	1375	703	547	1021	770	532	955	540
Starvation Cap Reductn	0	0	0	0	0	0	0	0	0	0	0	0
Spillback Cap Reductn	0	0	0	0	0	0	0	0	0	0	0	0
Storage Cap Reductn	0	0	0	0	0	0	0	0	0	0	0	0
Reduced v/c Ratio	0.43	0.68	0.61	0.46	0.20	0.19	0.36	0.93	0.68	0.25	1.01	0.24

Intersection Summary												
Cycle Length: 150												
Actuated Cycle Length: 125.1												
Natural Cycle: 110												
Control Type: Actuated-Uncoordinated												

Lanes, Volumes, Timings
3: St-Laurent & Industrial/Innes

Future Total 2026PM Peak Hour
1531 St-Laurent Blvd

Maximum v/c Ratio: 1.01	
Intersection Signal Delay: 49.5	Intersection LOS: D
Intersection Capacity Utilization 86.6%	ICU Level of Service E
Analysis Period (min) 15	
~ Volume exceeds capacity, queue is theoretically infinite. Queue shown is maximum after two cycles.	
# 95th percentile volume exceeds capacity, queue may be longer. Queue shown is maximum after two cycles.	

Splits and Phases: 3: St-Laurent & Industrial/Innes

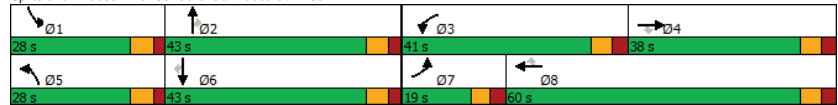

Lanes, Volumes, Timings
4: Access & Belfast

Future Total 2026PM Peak Hour
1531 St-Laurent Blvd

Lane Group	EBT	WBT
Lane Configurations	↶ ↷	↶ ↷
Traffic Volume (vph)	336	382
Future Volume (vph)	336	382
Lane Group Flow (vph)	392	383
Sign Control	Free	Free

Intersection Summary	
Control Type: Unsignalized	
Intersection Capacity Utilization 25.6%	ICU Level of Service A
Analysis Period (min) 15	

HCM 2010 TWSC
5: Lagan & Belfast

Future Total 2026PM Peak Hour
1531 St-Laurent Blvd

Intersection												
Int Delay, s/veh	4											
Movement	EBL	EBT	EBR	WBL	WBT	WBR	NBL	NBT	NBR	SBL	SBT	SBR
Lane Configurations	↕			↕			↕			↕		
Traffic Vol, veh/h	46	265	50	19	310	26	68	5	17	30	0	39
Future Vol, veh/h	46	265	50	19	310	26	68	5	17	30	0	39
Conflicting Peds, #/hr	12	0	14	14	0	12	1	0	6	6	0	1
Sign Control	Free	Free	Free	Free	Free	Free	Stop	Stop	Stop	Stop	Stop	Stop
RT Channelized	-	-	None	-	-	None	-	-	None	-	-	None
Storage Length	-	-	-	-	-	-	-	-	-	-	-	-
Veh in Median Storage, #	-	0	-	-	0	-	-	0	-	-	0	-
Grade, %	-	0	-	-	0	-	-	0	-	-	0	-
Peak Hour Factor	100	100	100	100	100	100	100	100	100	100	100	100
Heavy Vehicles, %	30	6	12	5	3	8	4	2	2	10	2	2
Mvmt Flow	46	265	50	19	310	26	68	5	17	30	0	39

Major/Minor	Major1	Major2	Minor1	Minor2
Conflicting Flow All	348	0	0	329
Stage 1	-	-	-	-
Stage 2	-	-	-	-
Critical Hdwy	4.4	-	-	4.15
Critical Hdwy Stg 1	-	-	-	-
Critical Hdwy Stg 2	-	-	-	-
Follow-up Hdwy	2.47	-	-	2.245
Pot Cap-1 Maneuver	1071	-	-	1214
Stage 1	-	-	-	-
Stage 2	-	-	-	-
Platoon blocked, %	-	-	-	-
Mov Cap-1 Maneuver	1061	-	-	1201
Mov Cap-2 Maneuver	-	-	-	-
Stage 1	-	-	-	-
Stage 2	-	-	-	-

Approach	EB	WB	NB	SB
HCM Control Delay, s	1.1	0.4	21.2	15.3
HCM LOS			C	C

Minor Lane/Major Mvmt	NBLn1	EBL	EBT	EBR	WBL	WBT	WBR	SBLn1
Capacity (veh/h)	312	1061	-	-	1201	-	-	419
HCM Lane V/C Ratio	0.288	0.043	-	-	0.016	-	-	0.165
HCM Control Delay (s)	21.2	8.5	0	-	8	0	-	15.3
HCM Lane LOS	C	A	A	-	A	A	-	C
HCM 95th %tile Q(veh)	1.2	0.1	-	-	0	-	-	0.6

HCM 2010 TWSC
6: Lagan & Access

Future Total 2026PM Peak Hour
1531 St-Laurent Blvd

Intersection						
Int Delay, s/veh	2.5					
Movement	EBL	EBR	NBL	NBT	SBT	SBR
Lane Configurations	↕			↕		
Traffic Vol, veh/h	43	0	0	47	69	0
Future Vol, veh/h	43	0	0	47	69	0
Conflicting Peds, #/hr	0	0	0	0	0	0
Sign Control	Stop	Stop	Free	Free	Free	Free
RT Channelized	-	None	-	None	-	None
Storage Length	0	-	-	-	-	-
Veh in Median Storage, #	0	-	-	0	0	-
Grade, %	0	-	-	0	0	-
Peak Hour Factor	100	100	100	100	100	100
Heavy Vehicles, %	2	2	2	2	2	2
Mvmt Flow	43	0	0	47	69	0

Major/Minor	Minor2	Major1	Major2
Conflicting Flow All	116	69	0
Stage 1	69	-	-
Stage 2	47	-	-
Critical Hdwy	6.42	6.22	-
Critical Hdwy Stg 1	5.42	-	-
Critical Hdwy Stg 2	5.42	-	-
Follow-up Hdwy	3.518	3.318	-
Pot Cap-1 Maneuver	880	994	0
Stage 1	954	-	0
Stage 2	975	-	0
Platoon blocked, %	-	-	-
Mov Cap-1 Maneuver	880	994	-
Mov Cap-2 Maneuver	880	-	-
Stage 1	954	-	-
Stage 2	975	-	-

Approach	EB	NB	SB
HCM Control Delay, s	9.3	0	0
HCM LOS	A		

Minor Lane/Major Mvmt	NBT	EBLn1	SBT
Capacity (veh/h)	-	880	-
HCM Lane V/C Ratio	-	0.049	-
HCM Control Delay (s)	-	9.3	-
HCM Lane LOS	-	A	-
HCM 95th %tile Q(veh)	-	0.2	-

Appendix J

Synchro Intersection Worksheets – 2031 Future Total Conditions

Lanes, Volumes, Timings
1: St-Laurent & Tremblay

Future Total 2031AM Peak Hour
1531 St-Laurent Blvd

	↖	→	↗	←	↖	↑	↗	↓	↖
Lane Group	EBL	EBT	WBL	WBT	NBL	NBT	SBL	SBT	SBR
Lane Configurations	↖	↖	↖	↖	↖	↖	↖	↖	↖
Traffic Volume (vph)	60	21	12	20	84	1261	131	1148	244
Future Volume (vph)	60	21	12	20	84	1261	131	1148	244
Lane Group Flow (vph)	60	55	12	143	84	1299	131	1148	244
Turn Type	Perm	NA	Perm	NA	Perm	NA	pm+pt	NA	Perm
Protected Phases		4		8		2	1	6	
Permitted Phases	4		8		2		6		6
Detector Phase	4	4	8	8	2	2	1	6	6
Switch Phase									
Minimum Initial (s)	10.0	10.0	10.0	10.0	10.0	10.0	5.0	10.0	10.0
Minimum Split (s)	38.5	38.5	38.5	38.5	39.2	39.2	9.7	39.2	39.2
Total Split (s)	40.0	40.0	40.0	40.0	72.0	72.0	18.0	90.0	90.0
Total Split (%)	30.8%	30.8%	30.8%	30.8%	55.4%	55.4%	13.8%	69.2%	69.2%
Maximum Green (s)	33.5	33.5	33.5	33.5	65.8	65.8	13.3	83.8	83.8
Yellow Time (s)	3.3	3.3	3.3	3.3	3.7	3.7	3.7	3.7	3.7
All-Red Time (s)	3.2	3.2	3.2	3.2	2.5	2.5	1.0	2.5	2.5
Lost Time Adjust (s)	0.0	0.0	0.0	0.0	0.0	0.0	0.0	0.0	0.0
Total Lost Time (s)	6.5	6.5	6.5	6.5	6.2	6.2	4.7	6.2	6.2
Lead/Lag					Lag	Lag	Lead		
Lead-Lag Optimize?					Yes	Yes	Yes		
Vehicle Extension (s)	3.0	3.0	3.0	3.0	3.0	3.0	3.0	3.0	3.0
Recall Mode	None	None	None	None	C-Max	C-Max	None	C-Max	C-Max
Walk Time (s)	7.0	7.0	7.0	7.0	11.0	11.0		11.0	11.0
Flash Dont Walk (s)	25.0	25.0	25.0	25.0	22.0	22.0		22.0	22.0
Pedestrian Calls (#/hr)	9	9	3	3	7	7		12	12
Act Effct Green (s)	17.2	17.2	17.2	17.2	87.2	87.2	101.6	100.1	100.1
Actuated g/C Ratio	0.13	0.13	0.13	0.13	0.67	0.67	0.78	0.77	0.77
v/c Ratio	0.63	0.24	0.08	0.50	0.29	0.45	0.42	0.48	0.24
Control Delay	78.9	24.1	45.5	17.0	15.3	12.0	8.7	7.3	1.4
Queue Delay	0.0	0.0	0.0	0.0	0.0	0.0	0.0	0.0	0.0
Total Delay	78.9	24.1	45.5	17.0	15.3	12.0	8.7	7.3	1.4
LOS	E	C	D	B	B	B	A	A	A
Approach Delay		52.7		19.2		12.2		6.5	
Approach LOS		D		B		B		A	
Queue Length 50th (m)	15.1	4.9	2.8	4.7	7.5	48.2	6.0	43.4	0.0
Queue Length 95th (m)	26.3	14.9	7.7	21.1	26.0	92.7	18.7	96.4	8.6
Internal Link Dist (m)		396.6		0.1		682.5		144.8	
Turn Bay Length (m)	38.0		38.0		45.0		75.0		
Base Capacity (vph)	186	413	279	442	288	2902	363	2368	1035
Starvation Cap Reductn	0	0	0	0	0	0	0	0	0
Spillback Cap Reductn	0	0	0	0	0	0	0	0	0
Storage Cap Reductn	0	0	0	0	0	0	0	0	0
Reduced v/c Ratio	0.32	0.13	0.04	0.32	0.29	0.45	0.36	0.48	0.24

Intersection Summary

Cycle Length: 130
 Actuated Cycle Length: 130
 Offset: 53 (41%), Referenced to phase 2:NBTL and 6:SBTL, Start of Green
 Natural Cycle: 90

Lanes, Volumes, Timings
1: St-Laurent & Tremblay

Future Total 2031AM Peak Hour
1531 St-Laurent Blvd

Control Type: Actuated-Coordinated
 Maximum v/c Ratio: 0.63
 Intersection Signal Delay: 11.3
 Intersection LOS: B
 Intersection Capacity Utilization 84.4%
 ICU Level of Service E
 Analysis Period (min) 15

Splits and Phases: 1: St-Laurent & Tremblay



Lanes, Volumes, Timings
2: St-Laurent & Belfast

Future Total 2031AM Peak Hour
1531 St-Laurent Blvd

Lane Group	EBL	EBT	EBR	WBL	WBT	NBL	NBT	NBR	SBL	SBT	SBR
Lane Configurations	↖	↗	↘	↙	↘	↙	↘	↙	↘	↙	↘
Traffic Volume (vph)	47	66	115	64	147	131	929	77	92	838	190
Future Volume (vph)	47	66	115	64	147	131	929	77	92	838	190
Lane Group Flow (vph)	47	66	115	64	261	131	929	77	92	838	190
Turn Type	pm+pt	NA	Perm	Perm	NA	pm+pt	NA	Perm	pm+pt	NA	Perm
Protected Phases	7	4			8	5	2		1	6	
Permitted Phases	4		4	8			2	2	6		6
Detector Phase	7	4	4	8	8	5	2	2	1	6	6
Switch Phase											
Minimum Initial (s)	5.0	10.0	10.0	10.0	10.0	5.0	10.0	10.0	5.0	10.0	10.0
Minimum Split (s)	10.8	27.8	27.8	27.8	27.8	10.7	36.6	36.6	10.7	36.6	36.6
Total Split (s)	16.0	48.0	48.0	32.0	32.0	15.0	57.0	57.0	15.0	57.0	57.0
Total Split (%)	13.3%	40.0%	40.0%	26.7%	26.7%	12.5%	47.5%	47.5%	12.5%	47.5%	47.5%
Maximum Green (s)	10.2	42.2	42.2	26.2	26.2	9.3	51.4	51.4	9.3	51.4	51.4
Yellow Time (s)	3.3	3.3	3.3	3.3	3.3	4.2	4.2	4.2	4.2	4.2	4.2
All-Red Time (s)	2.5	2.5	2.5	2.5	2.5	1.5	1.4	1.4	1.5	1.4	1.4
Lost Time Adjust (s)	0.0	0.0	0.0	0.0	0.0	0.0	0.0	0.0	0.0	0.0	0.0
Total Lost Time (s)	5.8	5.8	5.8	5.8	5.8	5.7	5.6	5.6	5.7	5.6	5.6
Lead/Lag	Lead			Lag	Lag	Lead	Lag	Lag	Lead	Lag	Lag
Lead-Lag Optimize?	Yes			Yes	Yes	Yes	Yes	Yes	Yes	Yes	Yes
Vehicle Extension (s)	3.0	3.0	3.0	3.0	3.0	3.0	3.0	3.0	3.0	3.0	3.0
Recall Mode	None	None	None	None	None	None	C-Max	C-Max	None	C-Max	C-Max
Walk Time (s)	7.0	7.0	7.0	7.0	7.0	25.0	25.0	25.0	25.0	25.0	25.0
Flash Dont Walk (s)	15.0	15.0	15.0	15.0	15.0	6.0	6.0	6.0	6.0	6.0	6.0
Pedestrian Calls (#/hr)	42	42	9	9	9	22	22	22	13	13	13
Act Effct Green (s)	35.5	35.5	35.5	23.6	23.6	67.9	59.2	59.2	66.8	58.7	58.7
Actuated g/C Ratio	0.30	0.30	0.30	0.20	0.20	0.57	0.49	0.49	0.56	0.49	0.49
v/c Ratio	0.24	0.13	0.27	0.33	0.88	0.42	0.59	0.11	0.35	0.55	0.29
Control Delay	30.0	28.5	6.5	45.1	69.4	16.4	25.7	0.8	15.8	25.2	4.2
Queue Delay	0.0	0.0	0.0	0.0	0.0	0.0	0.0	0.0	0.0	0.0	0.0
Total Delay	30.0	28.5	6.5	45.1	69.4	16.4	25.7	0.8	15.8	25.2	4.2
LOS	C	C	A	D	E	B	C	A	B	C	A
Approach Delay	17.7				64.6		22.9			20.9	
Approach LOS	B				E		C			C	
Queue Length 50th (m)	7.5	10.7	0.0	12.7	52.2	14.0	88.3	0.0	9.6	79.1	0.0
Queue Length 95th (m)	15.9	20.5	12.3	25.8	#93.1	24.6	114.1	1.3	18.1	100.9	13.4
Internal Link Dist (m)		518.7			23.5		597.8			682.5	
Turn Bay Length (m)	75.0		200.0	65.0		75.0		55.0	75.0		85.0
Base Capacity (vph)	214	596	485	218	329	321	1574	732	278	1517	666
Starvation Cap Reductn	0	0	0	0	0	0	0	0	0	0	0
Spillback Cap Reductn	0	0	0	0	0	0	0	0	0	0	0
Storage Cap Reductn	0	0	0	0	0	0	0	0	0	0	0
Reduced v/c Ratio	0.22	0.11	0.24	0.29	0.79	0.41	0.59	0.11	0.33	0.55	0.29

Intersection Summary

Cycle Length: 120
 Actuated Cycle Length: 120
 Offset: 53 (44%), Referenced to phase 2:NBTL and 6:SBTL, Start of Green
 Natural Cycle: 90

Lanes, Volumes, Timings
2: St-Laurent & Belfast

Future Total 2031AM Peak Hour
1531 St-Laurent Blvd

Control Type: Actuated-Coordinated
 Maximum v/c Ratio: 0.88
 Intersection Signal Delay: 26.5
 Intersection LOS: C
 Intersection Capacity Utilization 76.8%
 ICU Level of Service D
 Analysis Period (min) 15
 # 95th percentile volume exceeds capacity, queue may be longer.
 Queue shown is maximum after two cycles.

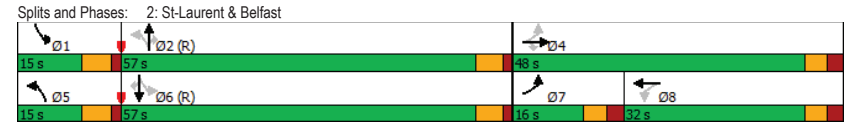

Lanes, Volumes, Timings
3: St-Laurent & Industrial/Innes

Future Total 2031AM Peak Hour
1531 St-Laurent Blvd

Lane Group	EBL	EBT	EBR	WBL	WBT	WBR	NBL	NBT	NBR	SBL	SBT	SBR
Lane Configurations	↔	↔	↔	↔	↔	↔	↔	↔	↔	↔	↔	↔
Traffic Volume (vph)	73	194	142	618	741	242	210	1136	356	118	867	146
Future Volume (vph)	73	194	142	618	741	242	210	1136	356	118	867	146
Lane Group Flow (vph)	73	194	142	618	741	242	210	1136	356	118	867	146
Turn Type	Prot	NA	Perm	Prot	NA	Perm	Prot	NA	Perm	Prot	NA	Perm
Protected Phases	7	4		3	8		5	2		1	6	
Permitted Phases			4			8			2			6
Detector Phase	7	4	4	3	8	8	5	2	2	1	6	6
Switch Phase												
Minimum Initial (s)	5.0	10.0	10.0	5.0	10.0	10.0	5.0	10.0	10.0	5.0	10.0	10.0
Minimum Split (s)	11.6	38.6	38.6	11.6	38.6	38.6	11.3	37.6	37.6	11.3	37.6	37.6
Total Split (s)	25.0	38.0	38.0	36.0	49.0	49.0	23.0	43.0	43.0	23.0	43.0	43.0
Total Split (%)	17.9%	27.1%	27.1%	25.7%	35.0%	35.0%	16.4%	30.7%	30.7%	16.4%	30.7%	30.7%
Maximum Green (s)	18.4	31.4	31.4	29.4	42.4	42.4	16.7	36.4	36.4	16.7	36.4	36.4
Yellow Time (s)	3.7	3.7	3.7	3.7	3.7	3.7	4.2	4.2	4.2	4.2	4.2	4.2
All-Red Time (s)	2.9	2.9	2.9	2.9	2.9	2.9	2.1	2.4	2.4	2.1	2.4	2.4
Lost Time Adjust (s)	0.0	0.0	0.0	0.0	0.0	0.0	0.0	0.0	0.0	0.0	0.0	0.0
Total Lost Time (s)	6.6	6.6	6.6	6.6	6.6	6.6	6.3	6.6	6.6	6.3	6.6	6.6
Lead/Lag	Lead	Lag	Lag	Lead	Lag	Lag	Lead	Lag	Lag	Lead	Lag	Lag
Lead-Lag Optimize?	Yes	Yes	Yes	Yes	Yes	Yes	Yes	Yes	Yes	Yes	Yes	Yes
Vehicle Extension (s)	3.0	3.0	3.0	3.0	3.0	3.0	3.0	3.0	3.0	3.0	3.0	3.0
Recall Mode	None	None	None	None	None	None	None	C-Max	C-Max	None	C-Max	C-Max
Walk Time (s)	7.0	7.0	7.0	7.0	7.0	7.0	7.0	7.0	7.0	7.0	7.0	7.0
Flash Dont Walk (s)	25.0	25.0	25.0	25.0	25.0	25.0	24.0	24.0	24.0	24.0	24.0	24.0
Pedestrian Calls (#/hr)	7	7	7	3	3	3	5	5	5	9	9	9
Act Effct Green (s)	8.8	19.4	19.4	28.8	42.0	42.0	14.5	55.0	55.0	10.6	51.1	51.1
Actuated g/C Ratio	0.06	0.14	0.14	0.21	0.30	0.30	0.10	0.39	0.39	0.08	0.36	0.36
v/c Ratio	0.39	0.47	0.41	0.93	0.78	0.42	0.68	0.92	0.49	0.50	0.74	0.26
Control Delay	68.5	57.7	6.0	76.4	51.2	6.2	71.4	54.1	10.1	69.0	44.7	3.6
Queue Delay	0.0	0.0	0.0	0.0	0.0	0.0	0.0	0.0	0.0	0.0	0.0	0.0
Total Delay	68.5	57.7	6.0	76.4	51.2	6.2	71.4	54.1	10.1	69.0	44.7	3.6
LOS	E	E	A	E	D	A	E	D	B	E	D	A
Approach Delay		41.7			54.1			47.0			41.9	
Approach LOS		D			D			D			D	
Queue Length 50th (m)	10.2	26.5	0.0	87.1	101.7	0.0	29.2	156.3	11.0	16.4	109.7	0.0
Queue Length 95th (m)	18.1	35.1	8.2	#120.0	113.1	18.0	42.2	#252.6	45.0	26.1	#176.3	9.0
Internal Link Dist (m)		745.6			700.4			316.7			597.8	
Turn Bay Length (m)	38.0		120.0	150.0		80.0	100.0		100.0	125.0		150.0
Base Capacity (vph)	391	665	444	675	993	587	359	1229	728	372	1176	556
Starvation Cap Reductn	0	0	0	0	0	0	0	0	0	0	0	0
Spillback Cap Reductn	0	0	0	0	0	0	0	0	0	0	0	0
Storage Cap Reductn	0	0	0	0	0	0	0	0	0	0	0	0
Reduced v/c Ratio	0.19	0.29	0.32	0.92	0.75	0.41	0.58	0.92	0.49	0.32	0.74	0.26

Intersection Summary

Cycle Length: 140
 Actuated Cycle Length: 140
 Offset: 0 (0%), Referenced to phase 2:NBT and 6:SBT, Start of Green
 Natural Cycle: 140

Lanes, Volumes, Timings
3: St-Laurent & Industrial/Innes

Future Total 2031AM Peak Hour
1531 St-Laurent Blvd

Control Type: Actuated-Coordinated
 Maximum v/c Ratio: 0.93
 Intersection Signal Delay: 47.7
 Intersection LOS: D
 Intersection Capacity Utilization 89.8%
 ICU Level of Service E
 Analysis Period (min) 15
 # 95th percentile volume exceeds capacity, queue may be longer.
 Queue shown is maximum after two cycles.

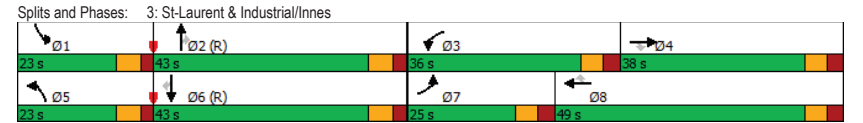

Lanes, Volumes, Timings
4: Access & Belfast

Future Total 2031AM Peak Hour
1531 St-Laurent Blvd

Lane Group	EBT	WBT
Lane Configurations	↕ ↕	↕ ↕
Traffic Volume (vph)	209	324
Future Volume (vph)	209	324
Lane Group Flow (vph)	233	324
Sign Control	Free	Free

Intersection Summary	
Control Type: Unsignalized	
Intersection Capacity Utilization 16.5%	ICU Level of Service A
Analysis Period (min) 15	

HCM 2010 TWSC
5: Lagan & Belfast

Future Total 2031AM Peak Hour
1531 St-Laurent Blvd

Intersection												
Int Delay, s/veh	3.5											
Movement	EBL	EBT	EBR	WBL	WBT	WBR	NBL	NBT	NBR	SBL	SBT	SBR
Lane Configurations	↕			↕			↕			↕		
Traffic Vol, veh/h	51	272	15	13	225	26	58	1	15	15	4	17
Future Vol, veh/h	51	272	15	13	225	26	58	1	15	15	4	17
Conflicting Peds, #/hr	8	0	23	23	0	8	0	0	5	5	0	0
Sign Control	Free	Free	Free	Free	Free	Free	Stop	Stop	Stop	Stop	Stop	Stop
RT Channelized	-	-	None	-	-	None	-	-	None	-	-	None
Storage Length	-	-	-	-	-	-	-	-	-	-	-	-
Veh in Median Storage, #	-	0	-	-	0	-	-	0	-	-	0	-
Grade, %	-	0	-	-	0	-	-	0	-	-	0	-
Peak Hour Factor	100	100	100	100	100	100	100	100	100	100	100	100
Heavy Vehicles, %	20	12	7	23	15	15	55	2	33	20	25	12
Mvmt Flow	51	272	15	13	225	26	58	1	15	15	4	17

Major/Minor	Major1		Major2		Minor1		Minor2				
Conflicting Flow All	259	0	0	310	0	680	690	308	667	684	246
Stage 1	-	-	-	-	-	405	405	-	272	272	-
Stage 2	-	-	-	-	-	275	285	-	395	412	-
Critical Hdwy	4.3	-	-	4.33	-	7.65	6.52	6.53	7.3	6.75	6.32
Critical Hdwy Stg 1	-	-	-	-	-	6.65	5.52	-	6.3	5.75	-
Critical Hdwy Stg 2	-	-	-	-	-	6.65	5.52	-	6.3	5.75	-
Follow-up Hdwy	2.38	-	-	2.407	-	3.995	4.018	3.597	3.68	4.225	3.408
Pot Cap-1 Maneuver	1208	-	-	1141	-	303	368	665	349	344	769
Stage 1	-	-	-	-	-	529	598	-	696	645	-
Stage 2	-	-	-	-	-	629	676	-	596	556	-
Platoon blocked, %	-	-	-	-	-	-	-	-	-	-	-
Mov Cap-1 Maneuver	1200	-	-	1121	-	274	336	651	320	314	764
Mov Cap-2 Maneuver	-	-	-	-	-	274	336	-	320	314	-
Stage 1	-	-	-	-	-	493	557	-	656	632	-
Stage 2	-	-	-	-	-	603	662	-	549	518	-

Approach	EB	WB	NB	SB
HCM Control Delay, s	1.2	0.4	20.2	13.9
HCM LOS			C	B

Minor Lane/Major Mvmt	NBLn1	EBL	EBT	EBR	WBL	WBT	WBR	SBLn1
Capacity (veh/h)	311	1200	-	-	1121	-	-	440
HCM Lane V/C Ratio	0.238	0.043	-	-	0.012	-	-	0.082
HCM Control Delay (s)	20.2	8.1	0	-	8.2	0	-	13.9
HCM Lane LOS	C	A	A	-	A	A	-	B
HCM 95th %tile Q(veh)	0.9	0.1	-	-	0	-	-	0.3

HCM 2010 TWSC
6: Lagan & Access

Future Total 2031AM Peak Hour
1531 St-Laurent Blvd

Intersection						
Int Delay, s/veh	4					
Movement	EBL	EBR	NBL	NBT	SBT	SBR
Lane Configurations	↔			↑	↑	
Traffic Vol, veh/h	47	0	0	27	32	0
Future Vol, veh/h	47	0	0	27	32	0
Conflicting Peds, #/hr	0	0	0	0	0	0
Sign Control	Stop	Stop	Free	Free	Free	Free
RT Channelized	-	None	-	None	-	None
Storage Length	0	-	-	-	-	-
Veh in Median Storage, #	0	-	-	0	0	-
Grade, %	0	-	-	0	0	-
Peak Hour Factor	100	100	100	100	100	100
Heavy Vehicles, %	2	2	2	2	2	2
Mvmt Flow	47	0	0	27	32	0
Major/Minor	Minor2	Major1	Major2			
Conflicting Flow All	59	32	-	0	-	0
Stage 1	32	-	-	-	-	-
Stage 2	27	-	-	-	-	-
Critical Hdwy	6.42	6.22	-	-	-	-
Critical Hdwy Stg 1	5.42	-	-	-	-	-
Critical Hdwy Stg 2	5.42	-	-	-	-	-
Follow-up Hdwy	3.518	3.318	-	-	-	-
Pot Cap-1 Maneuver	948	1042	0	-	-	0
Stage 1	991	-	0	-	-	0
Stage 2	996	-	0	-	-	0
Platoon blocked, %						
Mov Cap-1 Maneuver	948	1042	-	-	-	-
Mov Cap-2 Maneuver	948	-	-	-	-	-
Stage 1	991	-	-	-	-	-
Stage 2	996	-	-	-	-	-
Approach	EB	NB	SB			
HCM Control Delay, s	9	0	0			
HCM LOS	A					
Minor Lane/Major Mvmt	NBT	EBLn1	SBT			
Capacity (veh/h)	-	948	-			
HCM Lane V/C Ratio	-	0.05	-			
HCM Control Delay (s)	-	9	-			
HCM Lane LOS	-	A	-			
HCM 95th %tile Q(veh)	-	0.2	-			

Lanes, Volumes, Timings
1: St-Laurent & Tremblay

Future Total 2031PM Peak Hour
1531 St-Laurent Blvd

Lane Group	EBL	EBT	WBL	WBT	NBL	NBT	SBL	SBT	SBR
Lane Configurations	↔	↔	↔	↔	↔	↔	↔	↔	↔
Traffic Volume (vph)	228	38	23	21	38	1380	63	1100	94
Future Volume (vph)	228	38	23	21	38	1380	63	1100	94
Lane Group Flow (vph)	228	125	23	206	38	1392	63	1100	94
Turn Type	Perm	NA	Perm	NA	Perm	NA	pm+pt	NA	Perm
Protected Phases	4				8		2		6
Permitted Phases	4				8		2		6
Detector Phase	4				4		8		2
Switch Phase	4				4		8		2
Minimum Initial (s)	10.0	10.0	10.0	10.0	10.0	10.0	5.0	10.0	10.0
Minimum Split (s)	38.5	38.5	38.5	38.5	39.2	39.2	9.7	39.2	39.2
Total Split (s)	40.0	40.0	40.0	40.0	65.0	65.0	15.0	80.0	80.0
Total Split (%)	33.3%	33.3%	33.3%	33.3%	54.2%	54.2%	12.5%	66.7%	66.7%
Maximum Green (s)	33.5	33.5	33.5	33.5	58.8	58.8	10.3	73.8	73.8
Yellow Time (s)	3.3	3.3	3.3	3.3	3.7	3.7	3.7	3.7	3.7
All-Red Time (s)	3.2	3.2	3.2	3.2	2.5	2.5	1.0	2.5	2.5
Lost Time Adjust (s)	0.0	0.0	0.0	0.0	0.0	0.0	0.0	0.0	0.0
Total Lost Time (s)	6.5	6.5	6.5	6.5	6.2	6.2	4.7	6.2	6.2
Lead/Lag					Lag	Lag	Lead		
Lead-Lag Optimize?					Yes	Yes	Yes		
Vehicle Extension (s)	3.0	3.0	3.0	3.0	3.0	3.0	3.0	3.0	3.0
Recall Mode	None	None	None	None	C-Max	C-Max	None	C-Max	C-Max
Walk Time (s)	7.0	7.0	7.0	7.0	11.0	11.0	11.0	11.0	11.0
Flash Dont Walk (s)	25.0	25.0	25.0	25.0	22.0	22.0	22.0	22.0	22.0
Pedestrian Calls (#/hr)	6	6	2	2	16	16	12	12	12
Act Effct Green (s)	33.5	33.5	33.5	33.5	63.9	63.9	75.3	73.8	73.8
Actuated g/C Ratio	0.28	0.28	0.28	0.28	0.53	0.53	0.63	0.62	0.62
v/c Ratio	1.03	0.26	0.07	0.38	0.18	0.55	0.28	0.56	0.11
Control Delay	112.2	13.6	32.7	9.1	20.3	18.8	11.9	15.0	2.2
Queue Delay	0.0	0.0	0.0	0.0	0.0	0.0	0.0	0.0	0.0
Total Delay	112.2	13.6	32.7	9.1	20.3	18.8	11.9	15.0	2.2
LOS	F	B	C	A	C	B	B	B	A
Approach Delay	77.3			11.5		18.8		13.9	
Approach LOS	E			B		B		B	
Queue Length 50th (m)	~57.4	6.6	4.0	4.3	3.5	55.2	5.4	75.1	0.0
Queue Length 95th (m)	#106.4	21.5	10.6	23.0	m8.0	m89.3	10.8	92.9	6.2
Internal Link Dist (m)	390.4			0.1		682.5		144.8	
Turn Bay Length (m)	38.0		38.0		45.0		75.0		
Base Capacity (vph)	221	482	328	546	216	2534	260	1962	825
Starvation Cap Reductn	0	0	0	0	0	0	0	0	0
Spillback Cap Reductn	0	0	0	0	0	0	0	0	0
Storage Cap Reductn	0	0	0	0	0	0	0	0	0
Reduced v/c Ratio	1.03	0.26	0.07	0.38	0.18	0.55	0.24	0.56	0.11

Intersection Summary	
Cycle Length:	120
Actuated Cycle Length:	120
Offset:	49 (41%), Referenced to phase 2:NBT and 6:SBTL, Start of Green
Natural Cycle:	90

Lanes, Volumes, Timings
1: St-Laurent & Tremblay

Future Total 2031PM Peak Hour
1531 St-Laurent Blvd

Control Type: Actuated-Coordinated
 Maximum v/c Ratio: 1.03
 Intersection Signal Delay: 22.7 Intersection LOS: C
 Intersection Capacity Utilization 89.2% ICU Level of Service E
 Analysis Period (min) 15
 ~ Volume exceeds capacity, queue is theoretically infinite.
 Queue shown is maximum after two cycles.
 # 95th percentile volume exceeds capacity, queue may be longer.
 Queue shown is maximum after two cycles.
 m Volume for 95th percentile queue is metered by upstream signal.

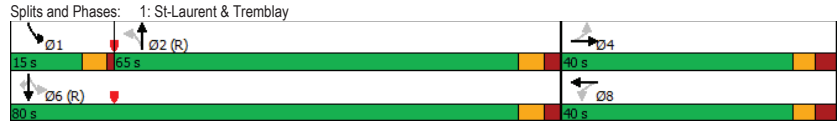

Lanes, Volumes, Timings
2: St-Laurent & Belfast

Future Total 2031PM Peak Hour
1531 St-Laurent Blvd

Lane Group	EBL	EBT	EBR	WBL	WBT	NBL	NBT	NBR	SBL	SBT	SBR
Lane Configurations	↖ ↗	↖ ↗	↖ ↗	↖ ↗	↖ ↗	↖ ↗	↖ ↗	↖ ↗	↖ ↗	↖ ↗	↖ ↗
Traffic Volume (vph)	194	171	238	119	96	129	1004	112	114	895	133
Future Volume (vph)	194	171	238	119	96	129	1004	112	114	895	133
Lane Group Flow (vph)	194	171	238	119	263	129	1004	112	114	895	133
Turn Type	pm+pt	NA	Perm	Perm	NA	pm+pt	NA	Perm	pm+pt	NA	Perm
Protected Phases	7	4			8	5	2		1	6	
Permitted Phases	4		4	8		2		2	6		6
Detector Phase	7	4	4	8	8	5	2	2	1	6	6
Switch Phase											
Minimum Initial (s)	5.0	10.0	10.0	10.0	10.0	5.0	10.0	10.0	5.0	10.0	10.0
Minimum Split (s)	10.8	27.8	27.8	27.8	27.8	10.7	36.6	36.6	10.7	36.6	36.6
Total Split (s)	15.0	49.0	49.0	34.0	34.0	14.0	57.0	57.0	14.0	57.0	57.0
Total Split (%)	12.5%	40.8%	40.8%	28.3%	28.3%	11.7%	47.5%	47.5%	11.7%	47.5%	47.5%
Maximum Green (s)	9.2	43.2	43.2	28.2	28.2	8.3	51.4	51.4	8.3	51.4	51.4
Yellow Time (s)	3.3	3.3	3.3	3.3	3.3	4.2	4.2	4.2	4.2	4.2	4.2
All-Red Time (s)	2.5	2.5	2.5	2.5	2.5	1.5	1.4	1.4	1.5	1.4	1.4
Lost Time Adjust (s)	0.0	0.0	0.0	0.0	0.0	0.0	0.0	0.0	0.0	0.0	0.0
Total Lost Time (s)	5.8	5.8	5.8	5.8	5.8	5.7	5.6	5.6	5.7	5.6	5.6
Lead/Lag	Lead			Lag	Lag	Lead	Lag	Lag	Lead	Lag	Lag
Lead-Lag Optimize?	Yes			Yes	Yes	Yes	Yes	Yes	Yes	Yes	Yes
Vehicle Extension (s)	3.0	3.0	3.0	3.0	3.0	3.0	3.0	3.0	3.0	3.0	3.0
Recall Mode	None	None	None	None	None	None	C-Max	C-Max	None	C-Max	C-Max
Walk Time (s)	7.0	7.0	7.0	7.0	7.0	25.0	25.0	25.0	25.0	25.0	25.0
Flash Dont Walk (s)	15.0	15.0	15.0	15.0	15.0	6.0	6.0	6.0	6.0	6.0	6.0
Pedestrian Calls (#/hr)	44	44	14	14	14	20	20	20	23	23	23
Act Effct Green (s)	35.9	35.9	35.9	20.9	20.9	67.0	58.3	58.3	66.8	58.2	58.2
Actuated g/C Ratio	0.30	0.30	0.30	0.17	0.17	0.56	0.49	0.49	0.56	0.48	0.48
v/c Ratio	0.96	0.36	0.44	0.68	0.82	0.42	0.63	0.17	0.47	0.56	0.18
Control Delay	89.7	34.0	8.8	65.1	55.4	16.1	26.4	3.1	23.3	19.4	3.1
Queue Delay	0.0	0.0	0.0	0.0	0.0	0.0	0.0	0.0	0.0	0.0	0.0
Total Delay	89.7	34.0	8.8	65.1	55.4	16.1	26.4	3.1	23.3	19.4	3.1
LOS	F	C	A	E	E	B	C	A	C	B	A
Approach Delay		42.0			58.4		23.2			17.9	
Approach LOS		D			E		C			B	
Queue Length 50th (m)	36.2	31.4	6.2	26.4	45.1	12.4	91.6	0.0	10.2	47.3	0.0
Queue Length 95th (m)	#70.1	46.5	24.1	43.9	70.8	24.6	124.8	7.8	29.0	61.7	7.5
Internal Link Dist (m)		518.7			23.5		597.8			682.5	
Turn Bay Length (m)	75.0		200.0	65.0		75.0		55.0	75.0		85.0
Base Capacity (vph)	202	572	617	235	406	309	1594	643	249	1592	741
Starvation Cap Reductn	0	0	0	0	0	0	0	0	0	0	0
Spillback Cap Reductn	0	0	0	0	0	0	0	0	0	0	0
Storage Cap Reductn	0	0	0	0	0	0	0	0	0	0	0
Reduced v/c Ratio	0.96	0.30	0.39	0.51	0.65	0.42	0.63	0.17	0.46	0.56	0.18

Intersection Summary
 Cycle Length: 120
 Actuated Cycle Length: 120
 Offset: 49 (41%), Referenced to phase 2:NBTL and 6:SBTL, Start of Green
 Natural Cycle: 90

Lanes, Volumes, Timings
2: St-Laurent & Belfast

Future Total 2031PM Peak Hour
1531 St-Laurent Blvd

Control Type: Actuated-Coordinated
Maximum v/c Ratio: 0.96
Intersection Signal Delay: 28.8 Intersection LOS: C
Intersection Capacity Utilization 83.9% ICU Level of Service E
Analysis Period (min) 15
95th percentile volume exceeds capacity, queue may be longer.
Queue shown is maximum after two cycles.

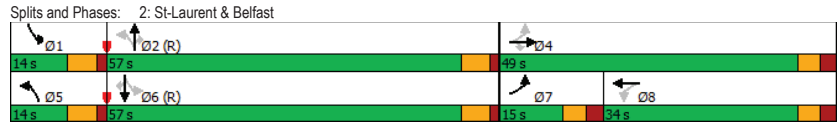

Lanes, Volumes, Timings
3: St-Laurent & Industrial/Innes

Future Total 2031PM Peak Hour
1531 St-Laurent Blvd

Lane Group	EBL	EBT	EBR	WBL	WBT	WBR	NBL	NBT	NBR	SBL	SBT	SBR
Lane Configurations	↔	↔	↔	↔	↔	↔	↔	↔	↔	↔	↔	↔
Traffic Volume (vph)	139	567	367	415	274	137	206	973	522	132	980	136
Future Volume (vph)	139	567	367	415	274	137	206	973	522	132	980	136
Lane Group Flow (vph)	139	567	367	415	274	137	206	973	522	132	980	136
Turn Type	Prot	NA	Perm	Prot	NA	Perm	Prot	NA	Perm	Prot	NA	Perm
Protected Phases	7	4		3	8		5	2		1	6	
Permitted Phases			4			8			2			6
Detector Phase	7	4	4	3	8	8	5	2	2	1	6	6
Switch Phase												
Minimum Initial (s)	5.0	10.0	10.0	5.0	10.0	10.0	5.0	10.0	10.0	5.0	10.0	10.0
Minimum Split (s)	11.6	38.6	38.6	11.6	38.6	38.6	11.3	37.6	37.6	11.3	37.6	37.6
Total Split (s)	19.0	38.0	38.0	41.0	60.0	60.0	28.0	43.0	43.0	28.0	43.0	43.0
Total Split (%)	12.7%	25.3%	25.3%	27.3%	40.0%	40.0%	18.7%	28.7%	28.7%	18.7%	28.7%	28.7%
Maximum Green (s)	12.4	31.4	31.4	34.4	53.4	53.4	21.7	36.4	36.4	21.7	36.4	36.4
Yellow Time (s)	3.7	3.7	3.7	3.7	3.7	3.7	4.2	4.2	4.2	4.2	4.2	4.2
All-Red Time (s)	2.9	2.9	2.9	2.9	2.9	2.9	2.1	2.4	2.4	2.1	2.4	2.4
Lost Time Adjust (s)	0.0	0.0	0.0	0.0	0.0	0.0	0.0	0.0	0.0	0.0	0.0	0.0
Total Lost Time (s)	6.6	6.6	6.6	6.6	6.6	6.6	6.3	6.6	6.6	6.3	6.6	6.6
Lead/Lag	Lead	Lag	Lag	Lead	Lag	Lag	Lead	Lag	Lag	Lead	Lag	Lag
Lead-Lag Optimize?	Yes	Yes	Yes	Yes	Yes	Yes	Yes	Yes	Yes	Yes	Yes	Yes
Vehicle Extension (s)	3.0	3.0	3.0	3.0	3.0	3.0	3.0	3.0	3.0	3.0	3.0	3.0
Recall Mode	None	None	None	None	None	None	None	Max	Max	None	Max	Max
Walk Time (s)	7.0	7.0	7.0	7.0	7.0	7.0	7.0	7.0	7.0	7.0	7.0	7.0
Flash Dont Walk (s)	25.0	25.0	25.0	25.0	25.0	25.0	24.0	24.0	24.0	24.0	24.0	24.0
Pedestrian Calls (#/hr)	6	6	6	6	7	7	10	10	10	14	14	14
Act Effct Green (s)	10.5	27.1	27.1	21.7	38.3	38.3	13.8	39.6	39.6	11.0	36.8	36.8
Actuated g/C Ratio	0.08	0.22	0.22	0.17	0.30	0.30	0.11	0.32	0.32	0.09	0.29	0.29
v/c Ratio	0.52	0.81	0.67	0.75	0.28	0.26	0.60	0.95	0.68	0.50	1.03	0.25
Control Delay	64.4	57.5	15.4	59.1	34.1	6.3	62.5	61.8	11.5	63.4	81.6	3.8
Queue Delay	0.0	0.0	0.0	0.0	0.0	0.0	0.0	0.0	0.0	0.0	0.0	0.0
Total Delay	64.4	57.5	15.4	59.1	34.1	6.3	62.5	61.8	11.5	63.4	81.6	3.8
LOS	E	E	B	E	C	A	E	E	B	E	F	A
Approach Delay		44.0			42.1			46.4			71.2	
Approach LOS		D			D			D			E	
Queue Length 50th (m)	17.3	70.4	11.8	51.3	27.1	0.0	25.6	125.8	11.8	16.4	~140.3	0.0
Queue Length 95th (m)	30.7	101.0	48.2	73.3	40.7	14.4	41.3	#199.1	56.8	28.8	#214.6	9.1
Internal Link Dist (m)		745.6			700.4			316.7			597.8	
Turn Bay Length (m)	38.0		120.0	150.0		80.0	100.0		100.0	125.0		150.0
Base Capacity (vph)	320	822	591	888	1368	700	544	1023	763	529	950	538
Starvation Cap Reductn	0	0	0	0	0	0	0	0	0	0	0	0
Spillback Cap Reductn	0	0	0	0	0	0	0	0	0	0	0	0
Storage Cap Reductn	0	0	0	0	0	0	0	0	0	0	0	0
Reduced v/c Ratio	0.43	0.69	0.62	0.47	0.20	0.20	0.38	0.95	0.68	0.25	1.03	0.25

Intersection Summary
Cycle Length: 150
Actuated Cycle Length: 125.7
Natural Cycle: 120
Control Type: Actuated-Uncoordinated

Lanes, Volumes, Timings
3: St-Laurent & Industrial/Innes

Future Total 2031PM Peak Hour
 1531 St-Laurent Blvd

Maximum v/c Ratio: 1.03	
Intersection Signal Delay: 51.5	Intersection LOS: D
Intersection Capacity Utilization 87.4%	ICU Level of Service E
Analysis Period (min) 15	
~ Volume exceeds capacity, queue is theoretically infinite. Queue shown is maximum after two cycles.	
# 95th percentile volume exceeds capacity, queue may be longer. Queue shown is maximum after two cycles.	

Splits and Phases: 3: St-Laurent & Industrial/Innes

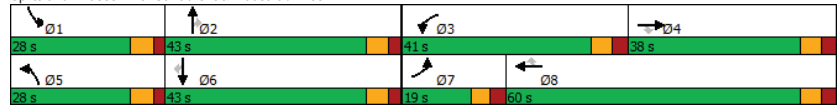

Lanes, Volumes, Timings
4: Access & Belfast

Future Total 2031PM Peak Hour
 1531 St-Laurent Blvd

Lane Group	EBT	WBT
Lane Configurations	↶ ↷	↶ ↷
Traffic Volume (vph)	336	382
Future Volume (vph)	336	382
Lane Group Flow (vph)	392	383
Sign Control	Free	Free

Intersection Summary	
Control Type: Unsignalized	
Intersection Capacity Utilization 25.6%	ICU Level of Service A
Analysis Period (min) 15	

HCM 2010 TWSC
5: Lagan & Belfast

Future Total 2031PM Peak Hour
1531 St-Laurent Blvd

Intersection												
Int Delay, s/veh	4											
Movement	EBL	EBT	EBR	WBL	WBT	WBR	NBL	NBT	NBR	SBL	SBT	SBR
Lane Configurations	↕			↕			↕			↕		
Traffic Vol, veh/h	46	265	50	19	310	26	68	5	17	30	0	39
Future Vol, veh/h	46	265	50	19	310	26	68	5	17	30	0	39
Conflicting Peds, #/hr	12	0	14	14	0	12	1	0	6	6	0	1
Sign Control	Free	Free	Free	Free	Free	Free	Stop	Stop	Stop	Stop	Stop	Stop
RT Channelized	-	-	None	-	-	None	-	-	None	-	-	None
Storage Length	-	-	-	-	-	-	-	-	-	-	-	-
Veh in Median Storage, #	-	0	-	-	0	-	-	0	-	-	0	-
Grade, %	-	0	-	-	0	-	-	0	-	-	0	-
Peak Hour Factor	100	100	100	100	100	100	100	100	100	100	100	100
Heavy Vehicles, %	30	6	12	5	3	8	4	2	2	10	2	2
Mvmt Flow	46	265	50	19	310	26	68	5	17	30	0	39

Major/Minor	Major1	Major2	Minor1	Minor2
Conflicting Flow All	348	0	0	329
Stage 1	-	-	-	-
Stage 2	-	-	-	-
Critical Hdwy	4.4	-	-	4.15
Critical Hdwy Stg 1	-	-	-	-
Critical Hdwy Stg 2	-	-	-	-
Follow-up Hdwy	2.47	-	-	2.245
Pot Cap-1 Maneuver	1071	-	-	1214
Stage 1	-	-	-	-
Stage 2	-	-	-	-
Platoon blocked, %	-	-	-	-
Mov Cap-1 Maneuver	1061	-	-	1201
Mov Cap-2 Maneuver	-	-	-	-
Stage 1	-	-	-	-
Stage 2	-	-	-	-

Approach	EB	WB	NB	SB
HCM Control Delay, s	1.1	0.4	21.2	15.3
HCM LOS			C	C

Minor Lane/Major Mvmt	NBLn1	EBL	EBT	EBR	WBL	WBT	WBR	SBLn1
Capacity (veh/h)	312	1061	-	-	1201	-	-	419
HCM Lane V/C Ratio	0.288	0.043	-	-	0.016	-	-	0.165
HCM Control Delay (s)	21.2	8.5	0	-	8	0	-	15.3
HCM Lane LOS	C	A	A	-	A	A	-	C
HCM 95th %tile Q(veh)	1.2	0.1	-	-	0	-	-	0.6

HCM 2010 TWSC
6: Lagan & Access

Future Total 2031PM Peak Hour
1531 St-Laurent Blvd

Intersection						
Int Delay, s/veh	2.5					
Movement	EBL	EBR	NBL	NBT	SBT	SBR
Lane Configurations	↕			↑		↑
Traffic Vol, veh/h	43	0	0	47	69	0
Future Vol, veh/h	43	0	0	47	69	0
Conflicting Peds, #/hr	0	0	0	0	0	0
Sign Control	Stop	Stop	Free	Free	Free	Free
RT Channelized	-	None	-	None	-	None
Storage Length	0	-	-	-	-	-
Veh in Median Storage, #	0	-	-	0	0	-
Grade, %	0	-	-	0	0	-
Peak Hour Factor	100	100	100	100	100	100
Heavy Vehicles, %	2	2	2	2	2	2
Mvmt Flow	43	0	0	47	69	0

Major/Minor	Minor2	Major1	Major2
Conflicting Flow All	116	69	-
Stage 1	69	-	-
Stage 2	47	-	-
Critical Hdwy	6.42	6.22	-
Critical Hdwy Stg 1	5.42	-	-
Critical Hdwy Stg 2	5.42	-	-
Follow-up Hdwy	3.518	3.318	-
Pot Cap-1 Maneuver	880	994	0
Stage 1	954	-	0
Stage 2	975	-	0
Platoon blocked, %	-	-	-
Mov Cap-1 Maneuver	880	994	-
Mov Cap-2 Maneuver	880	-	-
Stage 1	954	-	-
Stage 2	975	-	-

Approach	EB	NB	SB
HCM Control Delay, s	9.3	0	0
HCM LOS	A		

Minor Lane/Major Mvmt	NBT	EBLn1	SBT
Capacity (veh/h)	-	880	-
HCM Lane V/C Ratio	-	0.049	-
HCM Control Delay (s)	-	9.3	-
HCM Lane LOS	-	A	-
HCM 95th %tile Q(veh)	-	0.2	-

Appendix K

TDM Checklist

TDM Measures Checklist:
Non-Residential Developments (office, institutional, retail or industrial)

Legend	
	BASIC The measure is generally feasible and effective, and in most cases would benefit the development and its users
	BETTER The measure could maximize support for users of sustainable modes, and optimize development performance
★	The measure is one of the most dependably effective tools to encourage the use of sustainable modes

TDM measures: <i>Non-residential developments</i>		Check if proposed & add descriptions
1. TDM PROGRAM MANAGEMENT		
1.1 Program coordinator		
BASIC	★ 1.1.1 Designate an internal coordinator, or contract with an external coordinator	<input type="checkbox"/>
1.2 Travel surveys		
BETTER	1.2.1 Conduct periodic surveys to identify travel-related behaviours, attitudes, challenges and solutions, and to track progress	<input type="checkbox"/>
2. WALKING AND CYCLING		
2.1 Information on walking/cycling routes & destinations		
BASIC	2.1.1 Display local area maps with walking/cycling access routes and key destinations at major entrances	<input checked="" type="checkbox"/>
2.2 Bicycle skills training		
<i>Commuter travel</i>		
BETTER	★ 2.2.1 Offer on-site cycling courses for commuters, or subsidize off-site courses	<input type="checkbox"/>
2.3 Valet bike parking		
<i>Visitor travel</i>		
BETTER	2.3.1 Offer secure valet bike parking during public events when demand exceeds fixed supply (e.g. for festivals, concerts, games)	<input type="checkbox"/>

TDM measures: <i>Non-residential developments</i>		Check if proposed & add descriptions
3. TRANSIT		
3.1 Transit information		
BASIC	3.1.1 Display relevant transit schedules and route maps at entrances	<input checked="" type="checkbox"/>
BASIC	3.1.2 Provide online links to OC Transpo and STO information	<input type="checkbox"/>
BETTER	3.1.3 Provide real-time arrival information display at entrances	<input type="checkbox"/>
3.2 Transit fare incentives		
<i>Commuter travel</i>		
BETTER	3.2.1 Offer preloaded PRESTO cards to encourage commuters to use transit	<input type="checkbox"/>
BETTER	★ 3.2.2 Subsidize or reimburse monthly transit pass purchases by employees	<input type="checkbox"/>
<i>Visitor travel</i>		
BETTER	3.2.3 Arrange inclusion of same-day transit fare in price of tickets (e.g. for festivals, concerts, games)	<input type="checkbox"/>
3.3 Enhanced public transit service		
<i>Commuter travel</i>		
BETTER	3.3.1 Contract with OC Transpo to provide enhanced transit services (e.g. for shift changes, weekends)	<input type="checkbox"/>
<i>Visitor travel</i>		
BETTER	3.3.2 Contract with OC Transpo to provide enhanced transit services (e.g. for festivals, concerts, games)	<input type="checkbox"/>
3.4 Private transit service		
<i>Commuter travel</i>		
BETTER	3.4.1 Provide shuttle service when OC Transpo cannot offer sufficient quality or capacity to serve demand (e.g. for shift changes, weekends)	<input type="checkbox"/>
<i>Visitor travel</i>		
BETTER	3.4.2 Provide shuttle service when OC Transpo cannot offer sufficient quality or capacity to serve demand (e.g. for festivals, concerts, games)	<input type="checkbox"/>

TDM measures: <i>Non-residential developments</i>		Check if proposed & add descriptions
4. RIDESHARING		
4.1 Ridematching service		
<i>Commuter travel</i>		
BASIC ★	4.1.1 Provide a dedicated ridematching portal at OttawaRideMatch.com	<input type="checkbox"/>
4.2 Carpool parking price incentives		
<i>Commuter travel</i>		
BETTER	4.2.1 Provide discounts on parking costs for registered carpools	<input type="checkbox"/>
4.3 Vanpool service		
<i>Commuter travel</i>		
BETTER	4.3.1 Provide a vanpooling service for long-distance commuters	<input type="checkbox"/>
5. CARSHARING & BIKESHARING		
5.1 Bikeshare stations & memberships		
BETTER	5.1.1 Contract with provider to install on-site bikeshare station for use by commuters and visitors	<input type="checkbox"/>
<i>Commuter travel</i>		
BETTER	5.1.2 Provide employees with bikeshare memberships for local business travel	<input type="checkbox"/>
5.2 Carshare vehicles & memberships		
<i>Commuter travel</i>		
BETTER	5.2.1 Contract with provider to install on-site carshare vehicles and promote their use by tenants	<input type="checkbox"/>
BETTER	5.2.2 Provide employees with carshare memberships for local business travel	<input type="checkbox"/>
6. PARKING		
6.1 Priced parking		
<i>Commuter travel</i>		
BASIC ★	6.1.1 Charge for long-term parking (daily, weekly, monthly)	<input type="checkbox"/>
BASIC	6.1.2 Unbundle parking cost from lease rates at multi-tenant sites	<input type="checkbox"/>
<i>Visitor travel</i>		
BETTER	6.1.3 Charge for short-term parking (hourly)	<input type="checkbox"/>

TDM measures: <i>Non-residential developments</i>		Check if proposed & add descriptions
7. TDM MARKETING & COMMUNICATIONS		
7.1 Multimodal travel information		
<i>Commuter travel</i>		
BASIC ★	7.1.1 Provide a multimodal travel option information package to new/relocating employees and students	<input checked="" type="checkbox"/>
<i>Visitor travel</i>		
BETTER ★	7.1.2 Include multimodal travel option information in invitations or advertising that attract visitors or customers (e.g. for festivals, concerts, games)	<input type="checkbox"/>
7.2 Personalized trip planning		
<i>Commuter travel</i>		
BETTER ★	7.2.1 Offer personalized trip planning to new/relocating employees	<input type="checkbox"/>
7.3 Promotions		
<i>Commuter travel</i>		
BETTER	7.3.1 Deliver promotions and incentives to maintain awareness, build understanding, and encourage trial of sustainable modes	<input type="checkbox"/>
8. OTHER INCENTIVES & AMENITIES		
8.1 Emergency ride home		
<i>Commuter travel</i>		
BETTER ★	8.1.1 Provide emergency ride home service to non-driving commuters	<input type="checkbox"/>
8.2 Alternative work arrangements		
<i>Commuter travel</i>		
BASIC ★	8.2.1 Encourage flexible work hours	<input type="checkbox"/>
BETTER	8.2.2 Encourage compressed workweeks	<input type="checkbox"/>
BETTER ★	8.2.3 Encourage telework	<input type="checkbox"/>
8.3 Local business travel options		
<i>Commuter travel</i>		
BASIC ★	8.3.1 Provide local business travel options that minimize the need for employees to bring a personal car to work	<input type="checkbox"/>
8.4 Commuter incentives		
<i>Commuter travel</i>		
BETTER	8.4.1 Offer employees a taxable, mode-neutral commuting allowance	<input type="checkbox"/>
8.5 On-site amenities		
<i>Commuter travel</i>		
BETTER	8.5.1 Provide on-site amenities/services to minimize mid-day or mid-commute errands	<input type="checkbox"/>

TDM Measures Checklist:
Residential Developments (multi-family, condominium or subdivision)

Legend	
BASIC	The measure is generally feasible and effective, and in most cases would benefit the development and its users
BETTER	The measure could maximize support for users of sustainable modes, and optimize development performance
★	The measure is one of the most dependably effective tools to encourage the use of sustainable modes

TDM measures: Residential developments		Check if proposed & add descriptions
1. TDM PROGRAM MANAGEMENT		
1.1 Program coordinator		
BASIC ★	1.1.1 Designate an internal coordinator, or contract with an external coordinator	<input type="checkbox"/>
1.2 Travel surveys		
BETTER	1.2.1 Conduct periodic surveys to identify travel-related behaviours, attitudes, challenges and solutions, and to track progress	<input type="checkbox"/>
2. WALKING AND CYCLING		
2.1 Information on walking/cycling routes & destinations		
BASIC	2.1.1 Display local area maps with walking/cycling access routes and key destinations at major entrances (<i>multi-family, condominium</i>)	<input checked="" type="checkbox"/>
2.2 Bicycle skills training		
BETTER	2.2.1 Offer on-site cycling courses for residents, or subsidize off-site courses	<input type="checkbox"/>

TDM measures: Residential developments		Check if proposed & add descriptions
3. TRANSIT		
3.1 Transit information		
BASIC	3.1.1 Display relevant transit schedules and route maps at entrances (<i>multi-family, condominium</i>)	<input checked="" type="checkbox"/>
BETTER	3.1.2 Provide real-time arrival information display at entrances (<i>multi-family, condominium</i>)	<input type="checkbox"/>
3.2 Transit fare incentives		
BASIC ★	3.2.1 Offer PRESTO cards preloaded with one monthly transit pass on residence purchase/move-in, to encourage residents to use transit	<input checked="" type="checkbox"/>
BETTER	3.2.2 Offer at least one year of free monthly transit passes on residence purchase/move-in	<input type="checkbox"/>
3.3 Enhanced public transit service		
BETTER ★	3.3.1 Contract with OC Transpo to provide early transit services until regular services are warranted by occupancy levels (<i>subdivision</i>)	<input type="checkbox"/>
3.4 Private transit service		
BETTER	3.4.1 Provide shuttle service for seniors homes or lifestyle communities (e.g. scheduled mall or supermarket runs)	<input type="checkbox"/>
4. CARSHARING & BIKESHARING		
4.1 Bikeshare stations & memberships		
BETTER	4.1.1 Contract with provider to install on-site bikeshare station (<i>multi-family</i>)	<input type="checkbox"/>
BETTER	4.1.2 Provide residents with bikeshare memberships, either free or subsidized (<i>multi-family</i>)	<input type="checkbox"/>
4.2 Carshare vehicles & memberships		
BETTER	4.2.1 Contract with provider to install on-site carshare vehicles and promote their use by residents	<input type="checkbox"/>
BETTER	4.2.2 Provide residents with carshare memberships, either free or subsidized	<input type="checkbox"/>
5. PARKING		
5.1 Priced parking		
BASIC ★	5.1.1 Unbundle parking cost from purchase price (<i>condominium</i>)	<input checked="" type="checkbox"/>
BASIC ★	5.1.2 Unbundle parking cost from monthly rent (<i>multi-family</i>)	<input checked="" type="checkbox"/>

TDM measures: Residential developments		Check if proposed & add descriptions
6. TDM MARKETING & COMMUNICATIONS		
6.1 Multimodal travel information		
BASIC ★	6.1.1 Provide a multimodal travel option information package to new residents	<input checked="" type="checkbox"/>
6.2 Personalized trip planning		
BETTER ★	6.2.1 Offer personalized trip planning to new residents	<input type="checkbox"/>

TDM-Supportive Development Design and Infrastructure Checklist:
Non-Residential Developments (office, institutional, retail or industrial)

Legend	
REQUIRED	The Official Plan or Zoning By-law provides related guidance that must be followed
BASIC	The measure is generally feasible and effective, and in most cases would benefit the development and its users
BETTER	The measure could maximize support for users of sustainable modes, and optimize development performance

TDM-supportive design & infrastructure measures: Non-residential developments		Check if completed & add descriptions, explanations or plan/drawing references
1. WALKING & CYCLING: ROUTES		
1.1 Building location & access points		
BASIC	1.1.1 Locate building close to the street, and do not locate parking areas between the street and building entrances	<input type="checkbox"/>
BASIC	1.1.2 Locate building entrances in order to minimize walking distances to sidewalks and transit stops/stations	<input type="checkbox"/>
BASIC	1.1.3 Locate building doors and windows to ensure visibility of pedestrians from the building, for their security and comfort	<input type="checkbox"/>
1.2 Facilities for walking & cycling		
REQUIRED	1.2.1 Provide convenient, direct access to stations or major stops along rapid transit routes within 600 metres; minimize walking distances from buildings to rapid transit; provide pedestrian-friendly, weather-protected (where possible) environment between rapid transit accesses and building entrances; ensure quality linkages from sidewalks through building entrances to integrated stops/stations (see Official Plan policy 4.3.3)	<input type="checkbox"/>
REQUIRED	1.2.2 Provide safe, direct and attractive pedestrian access from public sidewalks to building entrances through such measures as: reducing distances between public sidewalks and major building entrances; providing walkways from public streets to major building entrances; within a site, providing walkways along the front of adjoining buildings, between adjacent buildings, and connecting areas where people may congregate, such as courtyards and transit stops; and providing weather protection through canopies, colonnades, and other design elements wherever possible (see Official Plan policy 4.3.12)	<input checked="" type="checkbox"/>

TDM-supportive design & infrastructure measures: <i>Non-residential developments</i>		Check if completed & add descriptions, explanations or plan/drawing references
REQUIRED	1.2.3 Provide sidewalks of smooth, well-drained walking surfaces of contrasting materials or treatments to differentiate pedestrian areas from vehicle areas, and provide marked pedestrian crosswalks at intersection sidewalks (see <i>Official Plan policy 4.3.10</i>)	<input checked="" type="checkbox"/>
REQUIRED	1.2.4 Make sidewalks and open space areas easily accessible through features such as gradual grade transition, depressed curbs at street corners and convenient access to extra-wide parking spaces and ramps (see <i>Official Plan policy 4.3.10</i>)	<input checked="" type="checkbox"/>
REQUIRED	1.2.5 Include adequately spaced inter-block/street cycling and pedestrian connections to facilitate travel by active transportation. Provide links to the existing or planned network of public sidewalks, multi-use pathways and on-road cycle routes. Where public sidewalks and multi-use pathways intersect with roads, consider providing traffic control devices to give priority to cyclists and pedestrians (see <i>Official Plan policy 4.3.11</i>)	<input checked="" type="checkbox"/>
BASIC	1.2.6 Provide safe, direct and attractive walking routes from building entrances to nearby transit stops	<input type="checkbox"/>
BASIC	1.2.7 Ensure that walking routes to transit stops are secure, visible, lighted, shaded and wind-protected wherever possible	<input type="checkbox"/>
BASIC	1.2.8 Design roads used for access or circulation by cyclists using a target operating speed of no more than 30 km/h, or provide a separated cycling facility	<input type="checkbox"/>
1.3 Amenities for walking & cycling		
BASIC	1.3.1 Provide lighting, landscaping and benches along walking and cycling routes between building entrances and streets, sidewalks and trails	<input type="checkbox"/>
BASIC	1.3.2 Provide wayfinding signage for site access (where required, e.g. when multiple buildings or entrances exist) and egress (where warranted, such as when directions to reach transit stops/stations, trails or other common destinations are not obvious)	<input type="checkbox"/>

TDM-supportive design & infrastructure measures: <i>Non-residential developments</i>		Check if completed & add descriptions, explanations or plan/drawing references
2. WALKING & CYCLING: END-OF-TRIP FACILITIES		
2.1 Bicycle parking		
REQUIRED	2.1.1 Provide bicycle parking in highly visible and lighted areas, sheltered from the weather wherever possible (see <i>Official Plan policy 4.3.6</i>)	<input checked="" type="checkbox"/>
REQUIRED	2.1.2 Provide the number of bicycle parking spaces specified for various land uses in different parts of Ottawa; provide convenient access to main entrances or well-used areas (see <i>Zoning By-law Section 111</i>)	<input checked="" type="checkbox"/>
REQUIRED	2.1.3 Ensure that bicycle parking spaces and access aisles meet minimum dimensions; that no more than 50% of spaces are vertical spaces; and that parking racks are securely anchored (see <i>Zoning By-law Section 111</i>)	<input checked="" type="checkbox"/>
BASIC	2.1.4 Provide bicycle parking spaces equivalent to the expected number of commuter cyclists (assuming the cycling mode share target is met), plus the expected peak number of customer/visitor cyclists	<input type="checkbox"/>
BETTER	2.1.5 Provide bicycle parking spaces equivalent to the expected number of commuter and customer/visitor cyclists, plus an additional buffer (e.g. 25 percent extra) to encourage other cyclists and ensure adequate capacity in peak cycling season	<input type="checkbox"/>
2.2 Secure bicycle parking		
REQUIRED	2.2.1 Where more than 50 bicycle parking spaces are provided for a single office building, locate at least 25% of spaces within a building/structure, a secure area (e.g. supervised parking lot or enclosure) or bicycle lockers (see <i>Zoning By-law Section 111</i>)	<input checked="" type="checkbox"/>
BETTER	2.2.2 Provide secure bicycle parking spaces equivalent to the expected number of commuter cyclists (assuming the cycling mode share target is met)	<input type="checkbox"/>
2.3 Shower & change facilities		
BASIC	2.3.1 Provide shower and change facilities for the use of active commuters	<input type="checkbox"/>
BETTER	2.3.2 In addition to shower and change facilities, provide dedicated lockers, grooming stations, drying racks and laundry facilities for the use of active commuters	<input type="checkbox"/>
2.4 Bicycle repair station		
BETTER	2.4.1 Provide a permanent bike repair station, with commonly used tools and an air pump, adjacent to the main bicycle parking area (or secure bicycle parking area, if provided)	<input type="checkbox"/>

TDM-supportive design & infrastructure measures: <i>Non-residential developments</i>		Check if completed & add descriptions, explanations or plan/drawing references
3. TRANSIT		
3.1 Customer amenities		
BASIC	3.1.1 Provide shelters, lighting and benches at any on-site transit stops	<input type="checkbox"/>
BASIC	3.1.2 Where the site abuts an off-site transit stop and insufficient space exists for a transit shelter in the public right-of-way, protect land for a shelter and/or install a shelter	<input type="checkbox"/>
BETTER	3.1.3 Provide a secure and comfortable interior waiting area by integrating any on-site transit stops into the building	<input type="checkbox"/>
4. RIDESHARING		
4.1 Pick-up & drop-off facilities		
BASIC	4.1.1 Provide a designated area for carpool drivers (plus taxis and ride-hailing services) to drop off or pick up passengers without using fire lanes or other no-stopping zones	<input type="checkbox"/>
4.2 Carpool parking		
BASIC	4.2.1 Provide signed parking spaces for carpools in a priority location close to a major building entrance, sufficient in number to accommodate the mode share target for carpools	<input type="checkbox"/>
BETTER	4.2.2 At large developments, provide spaces for carpools in a separate, access-controlled parking area to simplify enforcement	<input type="checkbox"/>
5. CARSHARING & BIKESHARING		
5.1 Carshare parking spaces		
BETTER	5.1.1 Provide carshare parking spaces in permitted non-residential zones, occupying either required or provided parking spaces (<i>see Zoning By-law Section 94</i>)	<input type="checkbox"/>
5.2 Bikeshare station location		
BETTER	5.2.1 Provide a designated bikeshare station area near a major building entrance, preferably lighted and sheltered with a direct walkway connection	<input type="checkbox"/>

TDM-supportive design & infrastructure measures: <i>Non-residential developments</i>		Check if completed & add descriptions, explanations or plan/drawing references
6. PARKING		
6.1 Number of parking spaces		
REQUIRED	6.1.1 Do not provide more parking than permitted by zoning, nor less than required by zoning, unless a variance is being applied for	<input checked="" type="checkbox"/>
BASIC	6.1.2 Provide parking for long-term and short-term users that is consistent with mode share targets, considering the potential for visitors to use off-site public parking	<input type="checkbox"/>
BASIC	6.1.3 Where a site features more than one use, provide shared parking and reduce the cumulative number of parking spaces accordingly (<i>see Zoning By-law Section 104</i>)	<input checked="" type="checkbox"/>
BETTER	6.1.4 Reduce the minimum number of parking spaces required by zoning by one space for each 13 square metres of gross floor area provided as shower rooms, change rooms, locker rooms and other facilities for cyclists in conjunction with bicycle parking (<i>see Zoning By-law Section 111</i>)	<input type="checkbox"/>
6.2 Separate long-term & short-term parking areas		
BETTER	6.2.1 Separate short-term and long-term parking areas using signage or physical barriers, to permit access controls and simplify enforcement (i.e. to discourage employees from parking in visitor spaces, and vice versa)	<input type="checkbox"/>
7. OTHER		
7.1 On-site amenities to minimize off-site trips		
BETTER	7.1.1 Provide on-site amenities to minimize mid-day or mid-commute errands	<input type="checkbox"/>

TDM-Supportive Development Design and Infrastructure Checklist:
Residential Developments (multi-family or condominium)

Legend	
REQUIRED	The Official Plan or Zoning By-law provides related guidance that must be followed
BASIC	The measure is generally feasible and effective, and in most cases would benefit the development and its users
BETTER	The measure could maximize support for users of sustainable modes, and optimize development performance

TDM-supportive design & infrastructure measures: <i>Residential developments</i>		Check if completed & add descriptions, explanations or plan/drawing references
1. WALKING & CYCLING: ROUTES		
1.1 Building location & access points		
BASIC	1.1.1 Locate building close to the street, and do not locate parking areas between the street and building entrances	<input checked="" type="checkbox"/>
BASIC	1.1.2 Locate building entrances in order to minimize walking distances to sidewalks and transit stops/stations	<input checked="" type="checkbox"/>
BASIC	1.1.3 Locate building doors and windows to ensure visibility of pedestrians from the building, for their security and comfort	<input type="checkbox"/>
1.2 Facilities for walking & cycling		
REQUIRED	1.2.1 Provide convenient, direct access to stations or major stops along rapid transit routes within 600 metres; minimize walking distances from buildings to rapid transit; provide pedestrian-friendly, weather-protected (where possible) environment between rapid transit accesses and building entrances; ensure quality linkages from sidewalks through building entrances to integrated stops/stations (see <i>Official Plan policy 4.3.3</i>)	<input type="checkbox"/>
REQUIRED	1.2.2 Provide safe, direct and attractive pedestrian access from public sidewalks to building entrances through such measures as: reducing distances between public sidewalks and major building entrances; providing walkways from public streets to major building entrances; within a site, providing walkways along the front of adjoining buildings, between adjacent buildings, and connecting areas where people may congregate, such as courtyards and transit stops; and providing weather protection through canopies, colonnades, and other design elements wherever possible (see <i>Official Plan policy 4.3.12</i>)	<input checked="" type="checkbox"/>

TDM-supportive design & infrastructure measures: <i>Residential developments</i>		Check if completed & add descriptions, explanations or plan/drawing references
REQUIRED	1.2.3 Provide sidewalks of smooth, well-drained walking surfaces of contrasting materials or treatments to differentiate pedestrian areas from vehicle areas, and provide marked pedestrian crosswalks at intersection sidewalks (see <i>Official Plan policy 4.3.10</i>)	<input checked="" type="checkbox"/>
REQUIRED	1.2.4 Make sidewalks and open space areas easily accessible through features such as gradual grade transition, depressed curbs at street corners and convenient access to extra-wide parking spaces and ramps (see <i>Official Plan policy 4.3.10</i>)	<input checked="" type="checkbox"/>
REQUIRED	1.2.5 Include adequately spaced inter-block/street cycling and pedestrian connections to facilitate travel by active transportation. Provide links to the existing or planned network of public sidewalks, multi-use pathways and on-road cycle routes. Where public sidewalks and multi-use pathways intersect with roads, consider providing traffic control devices to give priority to cyclists and pedestrians (see <i>Official Plan policy 4.3.11</i>)	<input checked="" type="checkbox"/>
BASIC	1.2.6 Provide safe, direct and attractive walking routes from building entrances to nearby transit stops	<input checked="" type="checkbox"/>
BASIC	1.2.7 Ensure that walking routes to transit stops are secure, visible, lighted, shaded and wind-protected wherever possible	<input type="checkbox"/>
BASIC	1.2.8 Design roads used for access or circulation by cyclists using a target operating speed of no more than 30 km/h, or provide a separated cycling facility	<input type="checkbox"/>
1.3 Amenities for walking & cycling		
BASIC	1.3.1 Provide lighting, landscaping and benches along walking and cycling routes between building entrances and streets, sidewalks and trails	<input type="checkbox"/>
BASIC	1.3.2 Provide wayfinding signage for site access (where required, e.g. when multiple buildings or entrances exist) and egress (where warranted, such as when directions to reach transit stops/stations, trails or other common destinations are not obvious)	<input type="checkbox"/>

TDM-supportive design & infrastructure measures: <i>Residential developments</i>		Check if completed & add descriptions, explanations or plan/drawing references
2. WALKING & CYCLING: END-OF-TRIP FACILITIES		
2.1 Bicycle parking		
REQUIRED	2.1.1 Provide bicycle parking in highly visible and lighted areas, sheltered from the weather wherever possible (see <i>Official Plan policy 4.3.6</i>)	<input checked="" type="checkbox"/>
REQUIRED	2.1.2 Provide the number of bicycle parking spaces specified for various land uses in different parts of Ottawa; provide convenient access to main entrances or well-used areas (see <i>Zoning By-law Section 111</i>)	<input checked="" type="checkbox"/>
REQUIRED	2.1.3 Ensure that bicycle parking spaces and access aisles meet minimum dimensions; that no more than 50% of spaces are vertical spaces; and that parking racks are securely anchored (see <i>Zoning By-law Section 111</i>)	<input checked="" type="checkbox"/>
BASIC	2.1.4 Provide bicycle parking spaces equivalent to the expected number of resident-owned bicycles, plus the expected peak number of visitor cyclists	<input type="checkbox"/>
2.2 Secure bicycle parking		
REQUIRED	2.2.1 Where more than 50 bicycle parking spaces are provided for a single residential building, locate at least 25% of spaces within a building/structure, a secure area (e.g. supervised parking lot or enclosure) or bicycle lockers (see <i>Zoning By-law Section 111</i>)	<input checked="" type="checkbox"/>
BETTER	2.2.2 Provide secure bicycle parking spaces equivalent to at least the number of units at condominiums or multi-family residential developments	<input type="checkbox"/>
2.3 Bicycle repair station		
BETTER	2.3.1 Provide a permanent bike repair station, with commonly used tools and an air pump, adjacent to the main bicycle parking area (or secure bicycle parking area, if provided)	<input type="checkbox"/>
3. TRANSIT		
3.1 Customer amenities		
BASIC	3.1.1 Provide shelters, lighting and benches at any on-site transit stops	<input type="checkbox"/>
BASIC	3.1.2 Where the site abuts an off-site transit stop and insufficient space exists for a transit shelter in the public right-of-way, protect land for a shelter and/or install a shelter	<input type="checkbox"/>
BETTER	3.1.3 Provide a secure and comfortable interior waiting area by integrating any on-site transit stops into the building	<input type="checkbox"/>

TDM-supportive design & infrastructure measures: <i>Residential developments</i>		Check if completed & add descriptions, explanations or plan/drawing references
4. RIDESHARING		
4.1 Pick-up & drop-off facilities		
BASIC	4.1.1 Provide a designated area for carpool drivers (plus taxis and ride-hailing services) to drop off or pick up passengers without using fire lanes or other no-stopping zones	<input type="checkbox"/>
5. CARSHARING & BIKESHARING		
5.1 Carshare parking spaces		
BETTER	5.1.1 Provide up to three carshare parking spaces in an R3, R4 or R5 Zone for specified residential uses (see <i>Zoning By-law Section 94</i>)	<input type="checkbox"/>
5.2 Bikeshare station location		
BETTER	5.2.1 Provide a designated bikeshare station area near a major building entrance, preferably lighted and sheltered with a direct walkway connection	<input type="checkbox"/>
6. PARKING		
6.1 Number of parking spaces		
REQUIRED	6.1.1 Do not provide more parking than permitted by zoning, nor less than required by zoning, unless a variance is being applied for	<input checked="" type="checkbox"/>
BASIC	6.1.2 Provide parking for long-term and short-term users that is consistent with mode share targets, considering the potential for visitors to use off-site public parking	<input type="checkbox"/>
BASIC	6.1.3 Where a site features more than one use, provide shared parking and reduce the cumulative number of parking spaces accordingly (see <i>Zoning By-law Section 104</i>)	<input checked="" type="checkbox"/>
BETTER	6.1.4 Reduce the minimum number of parking spaces required by zoning by one space for each 13 square metres of gross floor area provided as shower rooms, change rooms, locker rooms and other facilities for cyclists in conjunction with bicycle parking (see <i>Zoning By-law Section 111</i>)	<input type="checkbox"/>
6.2 Separate long-term & short-term parking areas		
BETTER	6.2.1 Provide separate areas for short-term and long-term parking (using signage or physical barriers) to permit access controls and simplify enforcement (i.e. to discourage residents from parking in visitor spaces, and vice versa)	<input type="checkbox"/>

Appendix L

MMLOS Analysis

Multi-Modal Level of Service - Intersections Form

Consultant
Scenario
Comments

CGH Transportation
Existing/Future

Project
Date

2023-053
2023-05-19

INTERSECTIONS													
Crossing Side		St-Laurent Boulevard at Tremblay Road				St-Laurent Boulevard at Belfast Rd				St-Laurent Blvd at Industrial Ave/Innes Rd			
		NORTH	SOUTH	EAST	WEST	NORTH	SOUTH	EAST	WEST	NORTH	SOUTH	EAST	WEST
Pedestrian	Lanes	9	8	6	8	6	6	3	3	8	9	7	8
	Median	No Median - 2.4 m	No Median - 2.4 m	No Median - 2.4 m	No Median - 2.4 m	No Median - 2.4 m	No Median - 2.4 m	No Median - 2.4 m	No Median - 2.4 m	No Median - 2.4 m	No Median - 2.4 m	No Median - 2.4 m	No Median - 2.4 m
	Conflicting Left Turns	Permissive	Permissive	Protected/ Permissive	Permissive	Protected/ Permissive	Permissive	Protected/ Permissive	Protected/ Permissive	Protected	Protected	Protected	Protected
	Conflicting Right Turns	Permissive or yield control	Permissive or yield control	Permissive or yield control	Permissive or yield control	Permissive or yield control	Permissive or yield control	Permissive or yield control	Permissive or yield control	Permissive or yield control	Permissive or yield control	Permissive or yield control	Permissive or yield control
	Right Turns on Red (RTor) ?	RTOR allowed	RTOR allowed	RTOR allowed	RTOR allowed	RTOR prohibited	RTOR prohibited	RTOR prohibited	RTOR prohibited	RTOR prohibited	RTOR prohibited	RTOR prohibited	RTOR prohibited
	Ped Signal Leading Interval?	No	No	No	No	No	No	No	No	No	No	No	No
	Right Turn Channel	No Channel	No Channel	No Channel	No Channel	Conv'tl without Receiving Lane	Conv'tl without Receiving Lane	Conv'tl without Receiving Lane	Conventional with Receiving Lane	Smart Channel	Smart Channel	Smart Channel	Smart Channel
	Corner Radius	10-15m	5-10m	15-25m	10-15m	10-15m	10-15m	15-25m	15-25m	15-25m	15-25m	15-25m	15-25m
	Crosswalk Type	Std transverse markings	Std transverse markings	Std transverse markings	Std transverse markings	Std transverse markings	Std transverse markings	Std transverse markings	Std transverse markings	Std transverse markings	Std transverse markings	Std transverse markings	Std transverse markings
	PETSI Score	-29	-11	18	-12	27	27	75	72	3	-14	19	3
	Ped. Exposure to Traffic LoS	F	F	F	F	F	F	B	C	F	F	F	F
	Cycle Length	120	120	120	120								
	Effective Walk Time	37	52	9	9								
	Average Pedestrian Delay	29	19	51	51								
Pedestrian Delay LoS	C	B	E	E	-	-	-	-	-	-	-	-	
Level of Service	F	F	F	F	F	F	B	C	F	F	F	F	
	F				F				F				
Approach From		NORTH	SOUTH	EAST	WEST	NORTH	SOUTH	EAST	WEST	NORTH	SOUTH	EAST	WEST
Bicycle	Bicycle Lane Arrangement on Approach	Mixed Traffic	Mixed Traffic	Mixed Traffic	Mixed Traffic	Mixed Traffic	Mixed Traffic		Mixed Traffic	Mixed Traffic	Curb Bike Lane, Cycletrack or MUP	Curb Bike Lane, Cycletrack or MUP	Curb Bike Lane, Cycletrack or MUP
	Right Turn Lane Configuration	> 50 m	≤ 50 m			> 50 m	> 50 m		> 50 m	> 50 m	Not Applicable	Not Applicable	Not Applicable
	Right Turning Speed	≤ 25 km/h	>25 km/h			>25 km/h	>25 km/h		>25 km/h	>25 km/h	Not Applicable	Not Applicable	Not Applicable
	Cyclist relative to RT motorists	F	E	-	-	F	F	-	F	F	Not Applicable	Not Applicable	Not Applicable
	Separated or Mixed Traffic	Mixed Traffic	Mixed Traffic	Mixed Traffic	Mixed Traffic	Mixed Traffic	Mixed Traffic	-	Mixed Traffic	Mixed Traffic	Separated	Separated	Separated
	Left Turn Approach	≥ 2 lanes crossed	≥ 2 lanes crossed	One lane crossed	One lane crossed	≥ 2 lanes crossed	≥ 2 lanes crossed	No lane crossed	No lane crossed	≥ 2 lanes crossed	2-stage, LT box	2-stage, LT box	2-stage, LT box
	Operating Speed	≥ 60 km/h	≥ 60 km/h	> 50 to < 60 km/h	> 50 to < 60 km/h	≥ 60 km/h	≥ 60 km/h	≥ 60 km/h	≥ 60 km/h	≥ 60 km/h	≥ 60 km/h	≥ 60 km/h	≥ 60 km/h
	Left Turning Cyclist	F	F	E	E	F	F	C	C	F	A	A	A
Level of Service	F	F	E	E	F	F	-	F	F	A	A	A	
	F				F				F				
Transit	Average Signal Delay	≤ 20 sec	≤ 20 sec	> 40 sec	≤ 20 sec	≤ 30 sec	≤ 30 sec		> 40 sec	> 40 sec	> 40 sec	> 40 sec	> 40 sec
	Level of Service	C	C	F	C	D	D	-	F	F	F	F	F
	F				F				F				
Truck	Effective Corner Radius	> 15 m	10 - 15 m	10 - 15 m	> 15 m	> 15 m	> 15 m	10 - 15 m	10 - 15 m	> 15 m	> 15 m	> 15 m	> 15 m
	Number of Receiving Lanes on Departure from Intersection	1	≥ 2	≥ 2	1	≥ 2	1	≥ 2	≥ 2	≥ 2	≥ 2	≥ 2	≥ 2
Level of Service	C	B	B	C	A	C	B	B	A	A	A	A	
	C				C				A				
Auto	Volume to Capacity Ratio	0.71 - 0.80				0.71 - 0.80				0.91 - 1.00			
	Level of Service	C				C				E			

Multi-Modal Level of Service - Segments Form

Consultant	CGH Transportation
Scenario	Existing/Future
Comments	

Project	2023-053
Date	2023-05-19

SEGMENTS			St-Laurent	Belfast	Lagan	Lagan
			Ex/Fut	Ex/Fut	Ex	Fut
Pedestrian	Sidewalk Width	-	≥ 2 m	≥ 2 m	no sidewalk	≥ 2 m
	Boulevard Width		< 0.5	< 0.5	n/a	< 0.5
	Avg Daily Curb Lane Traffic Volume		≤ 3000	> 3000	≤ 3000	≤ 3000
	Operating Speed		> 50 to 60 km/h	> 50 to 60 km/h	> 30 to 50 km/h	> 30 to 50 km/h
	On-Street Parking		no	no	yes	no
	Exposure to Traffic PLoS		C	E	F	B
	Effective Sidewalk Width					
Pedestrian Volume						
Crowding PLoS	-	-	-	-		
Level of Service	-	-	-	-		
Bicycle	Type of Cycling Facility	F	Mixed Traffic	Mixed Traffic	Mixed Traffic	Mixed Traffic
	Number of Travel Lanes		4-5 lanes total	2-3 lanes total	≤ 2 (no centreline)	≤ 2 (no centreline)
	Operating Speed		≥ 60 km/h	≥ 60 km/h	≥ 50 to 60 km/h	≥ 50 to 60 km/h
	# of Lanes & Operating Speed LoS		F	F	D	D
	Bike Lane (+ Parking Lane) Width					
	Bike Lane Width LoS		-	-	-	-
	Bike Lane Blockages					
	Blockage LoS		-	-	-	-
	Median Refuge Width (no median = < 1.8 m)		< 1.8 m refuge	< 1.8 m refuge	< 1.8 m refuge	< 1.8 m refuge
	No. of Lanes at Unsignalized Crossing		≤ 3 lanes	≤ 3 lanes	≤ 3 lanes	≤ 3 lanes
Sidestreet Operating Speed	≤ 40 km/h	≤ 40 km/h	≤ 40 km/h	≤ 40 km/h		
Unsignalized Crossing - Lowest LoS	A	A	A	A		
Level of Service	F	F	D	D		
Transit	Facility Type	D	Mixed Traffic			
	Friction or Ratio Transit:Posted Speed		Vt/Vp ≥ 0.8			
Level of Service	D	-	-	-		
Truck	Truck Lane Width	B	> 3.7 m	> 3.7 m		
	Travel Lanes per Direction		> 1	1		
Level of Service	A	B	-	-		