

# 1531 St-Laurent Boulevard

## Transportation Impact Assessment

Step 1 Screening Report

Step 2 Scoping Report

Step 3 Strategy Report (Rev#1)

Prepared for:

1531 St Laurent Limited Partnership  
265 Carling Ave unit 401  
Ottawa, ON K1S 2E1

Prepared by:



6 Plaza Court  
Ottawa, ON K2H 7W1

June 2024

PN: 2023-053

## Table of Contents

1	Screening .....	1
2	Existing and Planned Conditions .....	1
2.1	Proposed Development.....	1
2.2	Existing Conditions .....	3
2.2.1	Area Road Network.....	3
2.2.2	Existing Intersections.....	3
2.2.3	Existing Driveways .....	4
2.2.4	Cycling and Pedestrian Facilities.....	5
2.2.5	Existing Transit.....	8
2.2.6	Existing Area Traffic Management Measures.....	9
2.2.7	Existing Peak Hour Travel Demand.....	10
2.2.8	Collision Analysis.....	12
2.3	Planned Conditions.....	15
2.3.1	Changes to the Area Transportation Network .....	15
2.3.2	Other Study Area Developments .....	17
3	Study Area and Time Periods .....	19
3.1	Study Area .....	19
3.2	Time Periods .....	19
3.3	Horizon Years.....	19
4	Development-Generated Travel Demand .....	19
4.1	Mode Shares.....	19
4.2	Trip Generation .....	20
4.3	Trip Distribution.....	21
4.4	Trip Assignment.....	21
5	Exemption Review .....	23
6	Development Design .....	25
6.1	Design for Sustainable Modes .....	25
6.2	Circulation and Access.....	25
7	Parking.....	25
7.1	Parking Supply .....	25
8	Boundary Street Design.....	26
9	Transportation Demand Management .....	26
9.1	Context for TDM .....	26
9.2	Need and Opportunity.....	26
9.3	TDM Program .....	26
10	Background Network Travel Demands.....	27
10.1	Transportation Network Plans .....	27
10.2	Background Growth.....	27
10.3	Other Developments .....	27
11	Demand Rationalization .....	28
11.1	2026 Future Background Operations .....	28
11.2	2031 Future Background Operations .....	30

11.3 2026 Future Total Operations ..... 32

11.4 2031 Future Total Operations ..... 34

11.5 Modal Share Sensitivity and Demand Rationalization Conclusions ..... 36

    11.5.1 Network Rationalization..... 36

    11.5.2 Development Rationalization..... 36

12 Transit..... 36

    12.1 Route Capacity..... 36

    12.2 Transit Priority ..... 37

13 Intersection Design..... 37

    13.1 Location and Design of Access..... 37

    13.2 Access Intersection Control..... 37

    13.3 Access Intersection Design ..... 38

        13.3.1 Future Access Intersection Operations ..... 38

        13.3.2 Access Intersection MMLOS..... 38

        13.3.3 Recommended Design Elements..... 38

14 Network Intersection Design..... 38

    14.1 Network Intersection Control..... 38

    14.2 Network Intersection Design..... 38

        14.2.1 Future Total Network Intersection Operations..... 38

        14.2.2 Network Intersection MMLOS..... 38

        14.2.3 Recommended Design Elements..... 39

15 Summary of Improvements Indicated and Modifications Options..... 39

16 Conclusion ..... 43

List of Figures

Figure 1: Area Context Plan ..... 1

Figure 2: Concept Plan..... 2

Figure 3: Existing Driveways ..... 5

Figure 4: Study Area Pedestrian Facilities ..... 6

Figure 5: Study Area Cycling Facilities ..... 6

Figure 6: Existing Pedestrian Volumes ..... 7

Figure 7: Existing Cyclist Volumes ..... 8

Figure 8: Existing Study Area Transit Service..... 9

Figure 9: Existing Study Area Transit Stops ..... 9

Figure 10: Existing Traffic Counts ..... 10

Figure 11: Study Area Collision Records, 2018-2022..... 13

Figure 12: St-Laurent TOD Street Network ..... 16

Figure 13: St-Laurent TOD Pedestrian Network..... 16

Figure 14: St-Laurent TOD Bicycle Network ..... 17

Figure 15: New Site Generation Auto Volumes..... 22

Figure 16: New Site Pass-By Volumes ..... 23

Figure 17: 2026 Future Background Volumes ..... 28

Figure 18: 2031 Future Background Volumes ..... 30

Figure 19: 2026 Future Total Volumes ..... 32  
 Figure 20: 2031 Future Total Volumes ..... 34

## Table of Tables

Table 1: Intersection Count Date..... 10  
 Table 2: Existing Intersection Operations..... 11  
 Table 3: Study Area Collision Summary, 2018-2022 ..... 12  
 Table 4: Summary of Collision Locations, 2018-2022 ..... 13  
 Table 5: Intersection of Belfast Rd at St-Laurent Blvd Collision Summary..... 13  
 Table 6: Segment of St-Laurent Blvd btwn Belfast Rd & Industrial Ave Collision Summary ..... 14  
 Table 7: TRANS Trip Generation Manual Recommended Mode Shares – Alta Vista ..... 19  
 Table 8: Trip Generation Person Trip Rates ..... 20  
 Table 9: Total Person Trip Generation ..... 20  
 Table 10: Internal Capture Rates..... 20  
 Table 11: Trip Generation by Mode ..... 21  
 Table 12: OD Survey Distribution – Alta Vista ..... 21  
 Table 13: Exemption Review ..... 23  
 Table 14: Boundary Street MMLOS Analysis ..... 26  
 Table 15: TRANS Regional Model Projections – Study Area Growth Rates..... 27  
 Table 16: 2026 Future Background Intersection Operations ..... 29  
 Table 17: 2031 Future Background Intersection Operations ..... 31  
 Table 18: 2026 Future Total Intersection Operations ..... 33  
 Table 19: 2031 Future Total Intersection Operations ..... 35  
 Table 20: Trip Generation by Transit Mode ..... 36  
 Table 21: Forecasted Site-Generated Transit Ridership..... 36  
 Table 22: Study Area Intersection MMLOS Analysis ..... 39

## List of Appendices

Appendix A – TIA Screening Form and Certification Form  
 Appendix B – Turning Movement Count Data  
 Appendix C – Synchro Intersection Worksheets – Existing Conditions  
 Appendix D – Collision Data  
 Appendix E – TDM Checklist  
 Appendix F – Turning Templates  
 Appendix G – MMLOS Analysis  
 Appendix H – TRANS Plots  
 Appendix I – Background Development Volumes  
 Appendix J – Synchro Intersection Worksheets – 2026 Future Background Conditions  
 Appendix K – Synchro Intersection Worksheets – 2031 Future Background Conditions  
 Appendix L – Synchro Intersection Worksheets – 2026 Future Total Conditions  
 Appendix M – Synchro Intersection Worksheets – 2031 Future Total Conditions  
 Appendix N – Signage Plan

## 1 Screening

This study has been prepared according to the City of Ottawa’s 2017 Transportation Impact Assessment (TIA) Guidelines, incorporating the 2023 Revision to Transportation Impact Assessment Guidelines. Accordingly, a Step 1 Screening Form has been prepared and is included as Appendix A, along with the Certification Form for the TIA Study PM. As shown in the Screening Form, a TIA is required, and this study has been prepared to support a zoning bylaw amendment and site plan application.

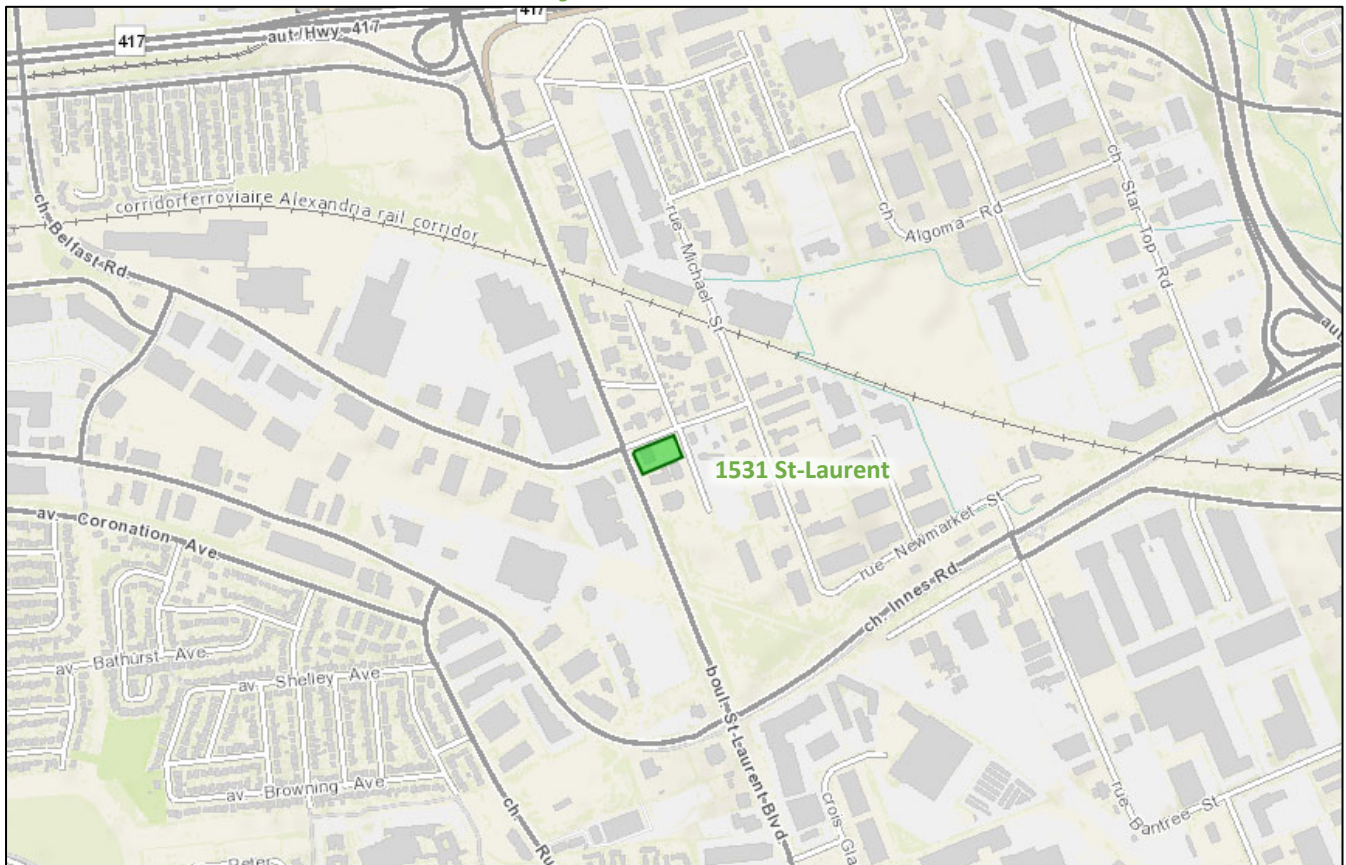
## 2 Existing and Planned Conditions

### 2.1 Proposed Development

The development site is located at 1531 St-Laurent Boulevard and is zoned as Arterial Mainstreet (AM, AM[263]). The proposed development consists of a 25-storey mixed-use building with 247 dwelling units fronting St-Laurent Boulevard, a 20-storey residential building comprising 188 dwelling units on the east side of the parcel, and a total of 3,085 ft<sup>2</sup> of retail space. Access is proposed via a one-way drive aisle with an inbound access on Belfast Road and an outbound access on Lagan Way. The site proposes a total of 395 vehicle parking spaces, including 354 residential, 30 visitor, and 11 retail vehicle spaces. A total of 407 internal bicycle parking spaces and 40 external bicycle parking spaces are proposed. Construction will occur in a single phase with an anticipated full build-out and occupancy horizon of 2026.

Figure 1 illustrates the study area context. Figure 2 illustrates the proposed concept plan.

Figure 1: Area Context Plan



Source: <http://maps.ottawa.ca/geoOttawa/> Accessed: May 2, 2023



## 2.2 Existing Conditions

### 2.2.1 Area Road Network

*St-Laurent Boulevard:* St-Laurent Boulevard is a City of Ottawa arterial road. Within the study area, it has a divided six-lane urban cross-section north of Tremblay Road, a divided four-lane urban cross-section between Tremblay Road and Innes Road, and a divided six-lane urban cross-section and includes dedicated bus lanes and cycletracks on both sides of the road south of Innes Road. Sidewalks are present on both sides of the road. North of Tremblay Road the posted speed limit is 60 km/h and is 70 km/h to the south. The Official Plan reserves a 44.5-metre right-of-way within the study area, and the St-Laurent Boulevard Transit Priority Corridor Environmental Assessment Study will require widening beyond the Official Plan designation. St-Laurent Boulevard is designated as a truck route.

*Industrial Avenue:* Industrial Avenue is a City of Ottawa arterial road with a four-lane urban cross-section with a sidewalk on the north side of the road, and, within the study area for 200 metres west of St-Laurent Boulevard, with a bike lane that diverts onto the boulevard around the bus stop on the north side of the road and a mixed-use path (MUP) on the south side of the road. The posted speed limit is 60 km/h, and the Official Plan reserves a 37.5-metre right-of-way. Industrial Avenue is designated as a truck route.

*Innes Road:* and Innes Road is a City of Ottawa arterial road with a divided four-lane urban cross-section with a MUP on the south side of the road. Within the study area, the posted speed limit is 60 km/h, and the Official Plan reserves a 44.5-metre right-of-way. Innes Road is designated as a truck route.

*Tremblay Road:* Tremblay Road is a City of Ottawa major collector road with a two-lane urban cross-section. West of the Avenue U, a sidewalk is present on the south side of the road, and a MUP is present on the north side of the road. East of Avenue U, a sidewalk is present on the south side of the road. The posted speed limit is 50 km/h. West of St-Laurent Boulevard. The Official Plan reserves a s 26.0-metre right-of-way, and the measured right-of-way is 18.0 metres to the east.

*Belfast Road:* Belfast Road is a City of Ottawa collector road west of St-Laurent Boulevard and a local road to the east, each with a two-lane cross-section. Within the study area, the cross-section is urban and includes sidewalks on both sides of the road east of 940 Belfast Road, and alternates between rural and semi-urban to the west, where a sidewalk, discontinuous through site accesses, is present on the north side of the road. The posted speed limit is 50 km/h. The Official Plan reserves a 26.9-metre to a 29.2-metre right-of-way between Trainyards Drive and St-Laurent Boulevard subject to the Hospital Link and Cumberland Transitway Westerly EA, and the measured right-of-way is 26.0 metres east of St-Laurent Boulevard. Belfast Road is designated as a truck route.

### 2.2.2 Existing Intersections

The existing key area intersections have been summarized below:

*St-Laurent Boulevard at Tremblay Road* The intersection of Tremblay Road at St-Laurent Boulevard is a signalized intersection. The northbound approach consists of an auxiliary left-turn lane, two through lanes, and a shared through/right-turn lane, and the southbound approach consists of an auxiliary left-turn lane, two through lanes, and an auxiliary right-turn lane. The eastbound and westbound approaches each consists of an auxiliary left-turn lane and a shared through/right-turn lane. No turn restrictions are noted.

*St-Laurent Boulevard at Belfast Road* The intersection of St-Laurent Boulevard at Belfast Road is a signalized intersection. The northbound and southbound approaches each consist of an auxiliary left-turn lane, two through lanes, and an auxiliary channelized

right-turn lane. The eastbound approach consists of an auxiliary left-turn lane, a through lane, and an auxiliary channelized right-turn lane, and the westbound approach consists of an auxiliary left-turn lane and a shared through/channelized right-turn lane. No turn restrictions were noted.

*St-Laurent Boulevard at Industrial Avenue / Innes Road*

The intersection of St-Laurent Boulevard at Industrial Avenue/Innes Road is a signalized intersection. The northbound approach consists of two auxiliary left-turn lanes, two through lanes, a transit priority queue jump, and an auxiliary channelized right-turn lane and the southbound approach consists of two auxiliary left-turn lanes, two through lanes, a transit priority queue jump, and an auxiliary channelized right-turn lane. The eastbound approach consists of two auxiliary left-turn lanes, two through lanes, and an auxiliary channelized right-turn lane, and the westbound approach consists of two auxiliary left-turn lanes, two through lanes, a bike pocket that connects to the curbside bike lane on the approach through the right-turn channel, and an auxiliary channelized right-turn lane. An east-west two-way crossride is located on the south side of the intersection. The east and west pedestrian crossings pass through the two-way crossride across the south leg of the intersection, with the east crossing possessing an additional refuge island between the crossride and the westbound right-turn channel. Southbound, eastbound, and westbound U-turns are prohibited at this intersection.

*Lagan Way at Belfast Road*

The intersection of Lagan Way at Belfast Road is an unsignalized intersection with stop control on the minor approaches of Lagan Way. All approaches consist of a shared all-movements lane. No turn restrictions were noted.

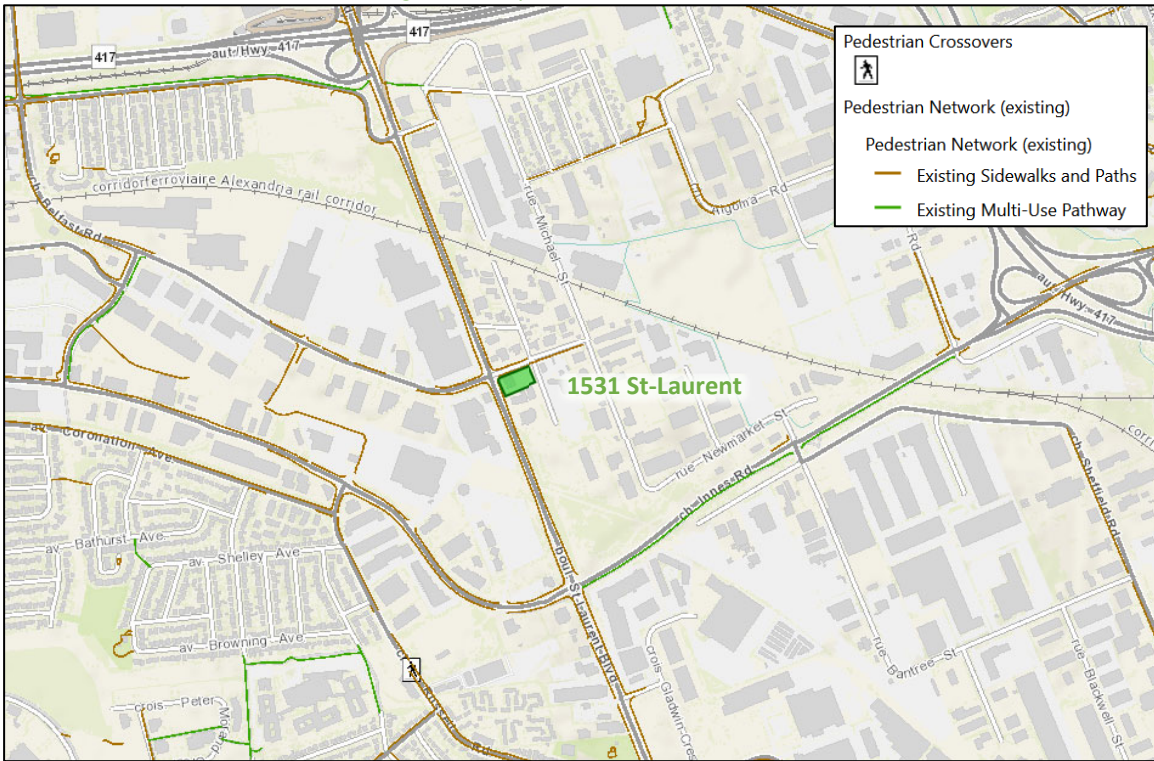
2.2.3 Existing Driveways

Within 200 metres of the proposed site access, 15 driveways are present on Belfast Road auto parts, service, and sales businesses, a gas station, the Belfast Park commercial plaza, an OC Transpo facility, and other commercial service businesses. Fifteen driveways are present on Lagan Way to various industrial, heavy equipment rental or storage, auto parts, service, and sales businesses, commercial service businesses, and a small commercial plaza. Six driveways are present on St-Laurent Boulevard to a commercial plaza, auto parts, service, and sales businesses, a gas station, and a restaurant are present. Figure 3 illustrates the existing driveways.



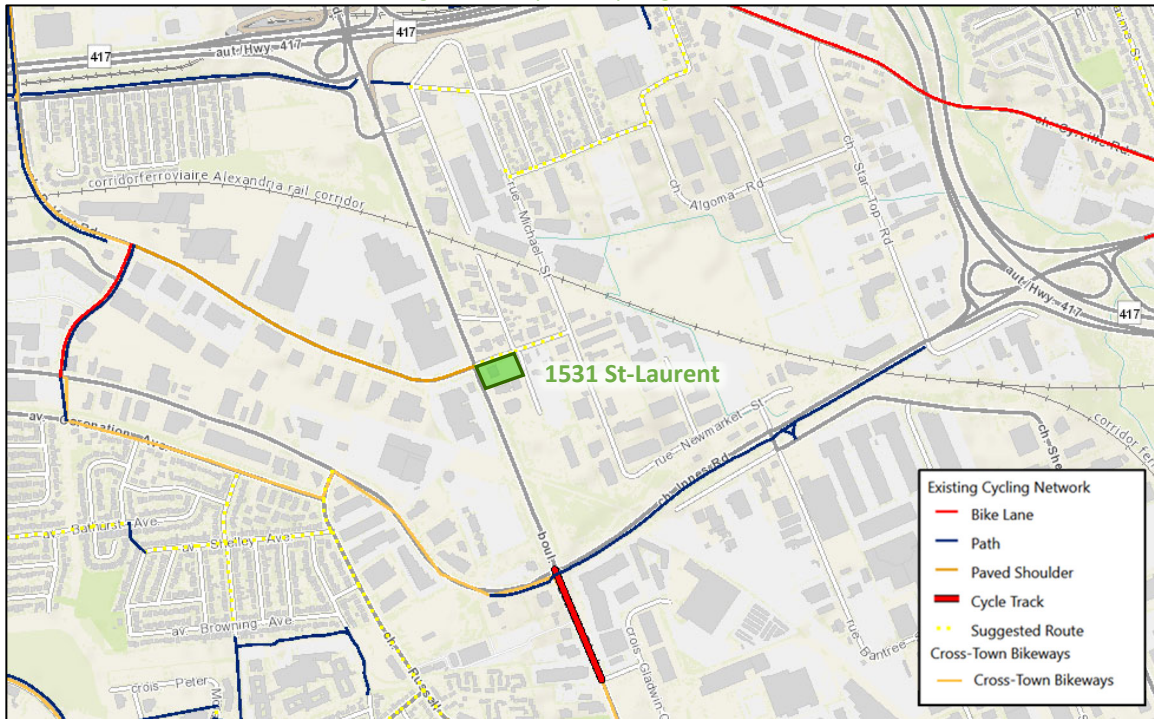


Figure 4: Study Area Pedestrian Facilities



Source: <http://maps.ottawa.ca/geoOttawa/> Accessed: May 2, 2023

Figure 5: Study Area Cycling Facilities



Source: <http://maps.ottawa.ca/geoOttawa/> Accessed: June 14, 2024

Pedestrian and cyclist volumes included in study area intersection counts, presented in Section 2.2.7, have been compiled and are illustrated in Figure 6 and Figure 7, respectively. The City of Ottawa notes that the active mode volumes collected in winter may vary from counts conducted at other times of the year.

Figure 6: Existing Pedestrian Volumes

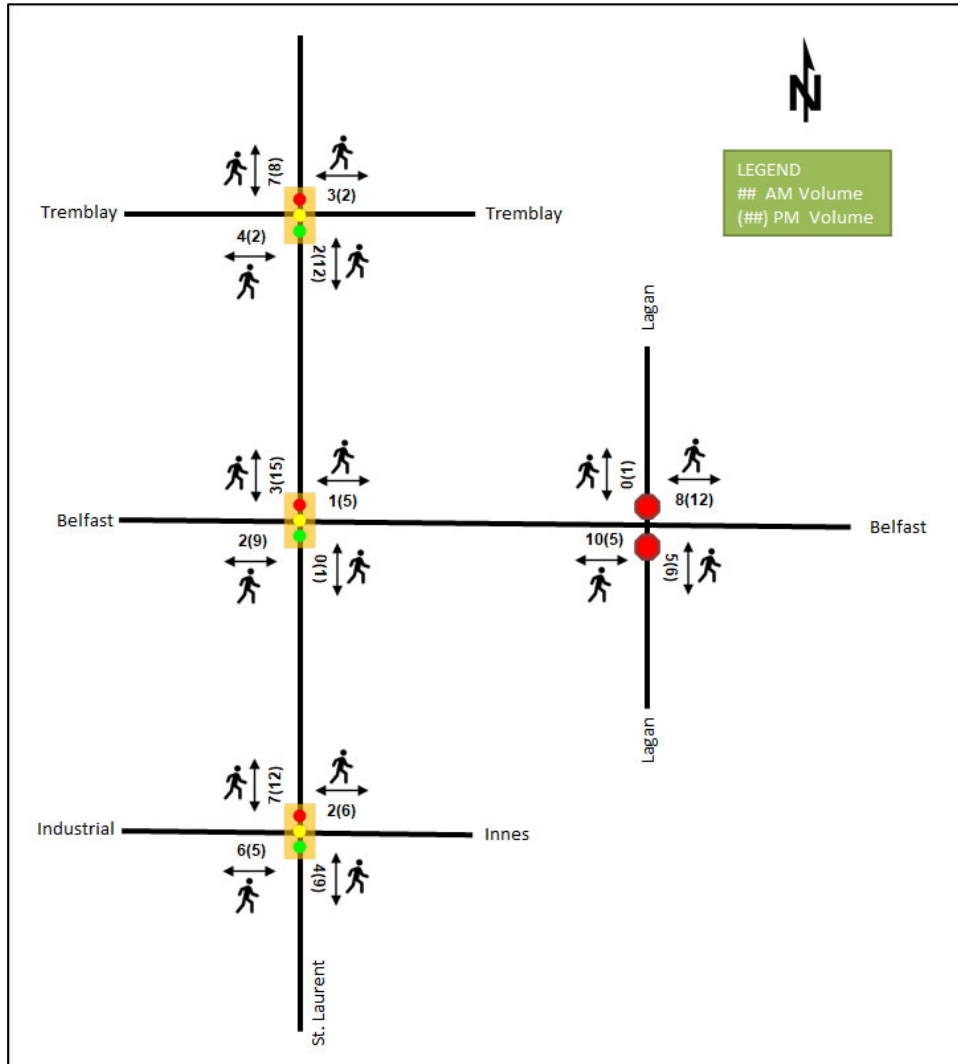
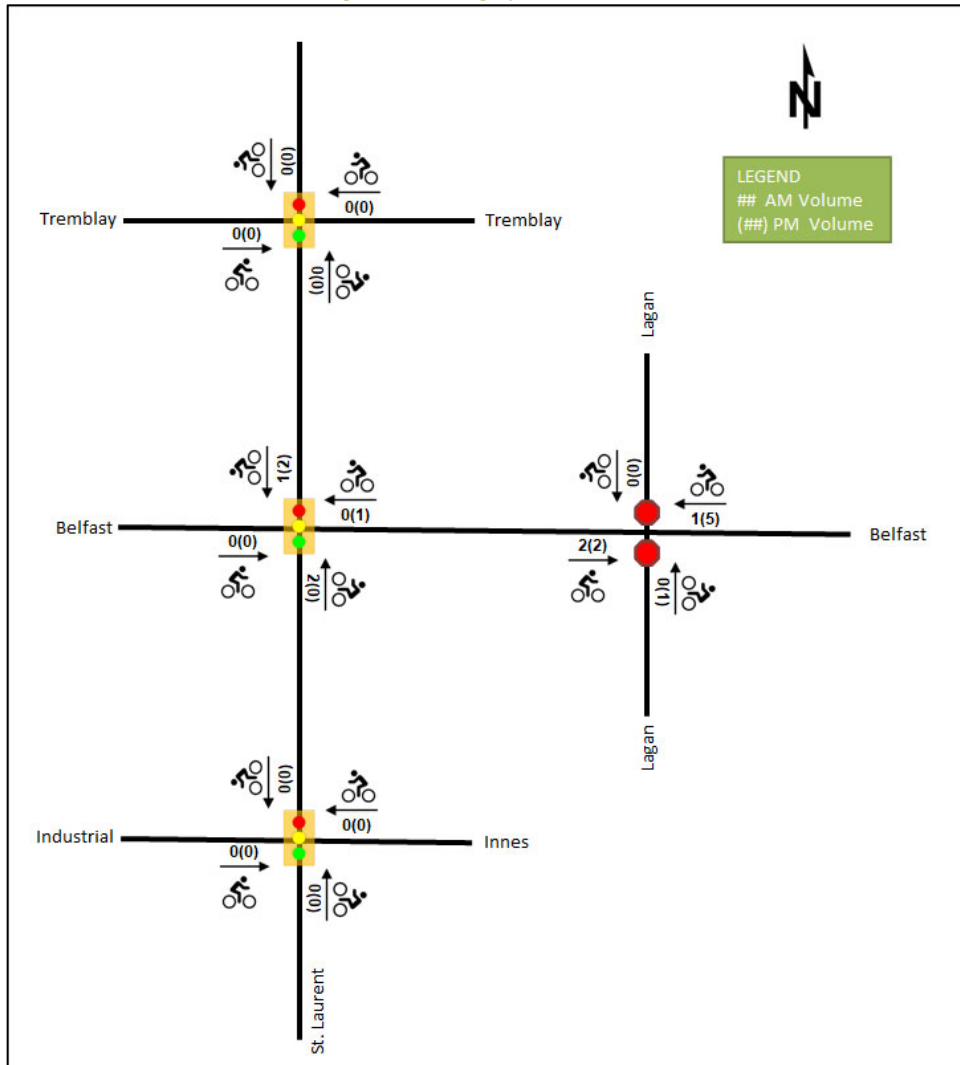


Figure 7: Existing Cyclist Volumes



### 2.2.5 Existing Transit

Figure 8 illustrates the transit system map in the study area and Figure 9 illustrates nearby transit stops. All transit information is from May 3, 2023 and is included for general information purposes and context to the surrounding area.

Within the study area, route #19 travels along St-Laurent Boulevard continuing to Belfast Road, the route #40 travels along St-Laurent Boulevard, and the route #47 travels along Michael Street to the east of the site. Additionally, while an OC Transpo garage and maintenance facility is on the northwest corner of the intersection of St-Laurent Boulevard and Belfast Road and a high volume of bus traffic is anticipated from the facility at all times of day. The frequency of these routes within proximity of the proposed site based on May 3, 2023 service levels are:

- Route # 19 – 30-minute service all day
- Route # 40 – 15-minute daytime service, 30-minute service after 7:00PM
- Route # 47 – Eight buses in the peak direction/period only

Figure 8: Existing Study Area Transit Service



Source: <http://www.octranspo.com/> Accessed: May 3, 2023

Figure 9: Existing Study Area Transit Stops



Source: <http://www.octranspo.com/> Accessed: May 3, 2023

### 2.2.6 Existing Area Traffic Management Measures

There are no existing area traffic management measures within the study area.

2.2.7 Existing Peak Hour Travel Demand

Existing turning movement counts were acquired from the City of Ottawa and the Traffic Specialist for the existing study area intersections. Table 1 summarizes the intersection count dates and sources.

Table 1: Intersection Count Date

Intersection	Count Date	Source
St-Laurent Blvd at Tremblay Rd	Wednesday, January 30, 2019	City of Ottawa
St-Laurent Blvd at Belfast Rd	Tuesday, February 6, 2018	City of Ottawa
St-Laurent Blvd at Industrial Ave/Innes Rd	Wednesday, January 30, 2019	City of Ottawa
Lagan Wy at Belfast Rd	Thursday, May 11, 2023	The Traffic Specialist

Figure 10 illustrates the existing traffic counts and Table 2 summarizes the existing intersection operations. The level of service for signalized intersections is based on volume to capacity ratio (v/c) calculations for individual lane movements and HCM 2000 v/c calculations for the overall intersection. Detailed turning movement count data is included in Appendix B and the Synchro worksheets are provided in Appendix C.

Figure 10: Existing Traffic Counts

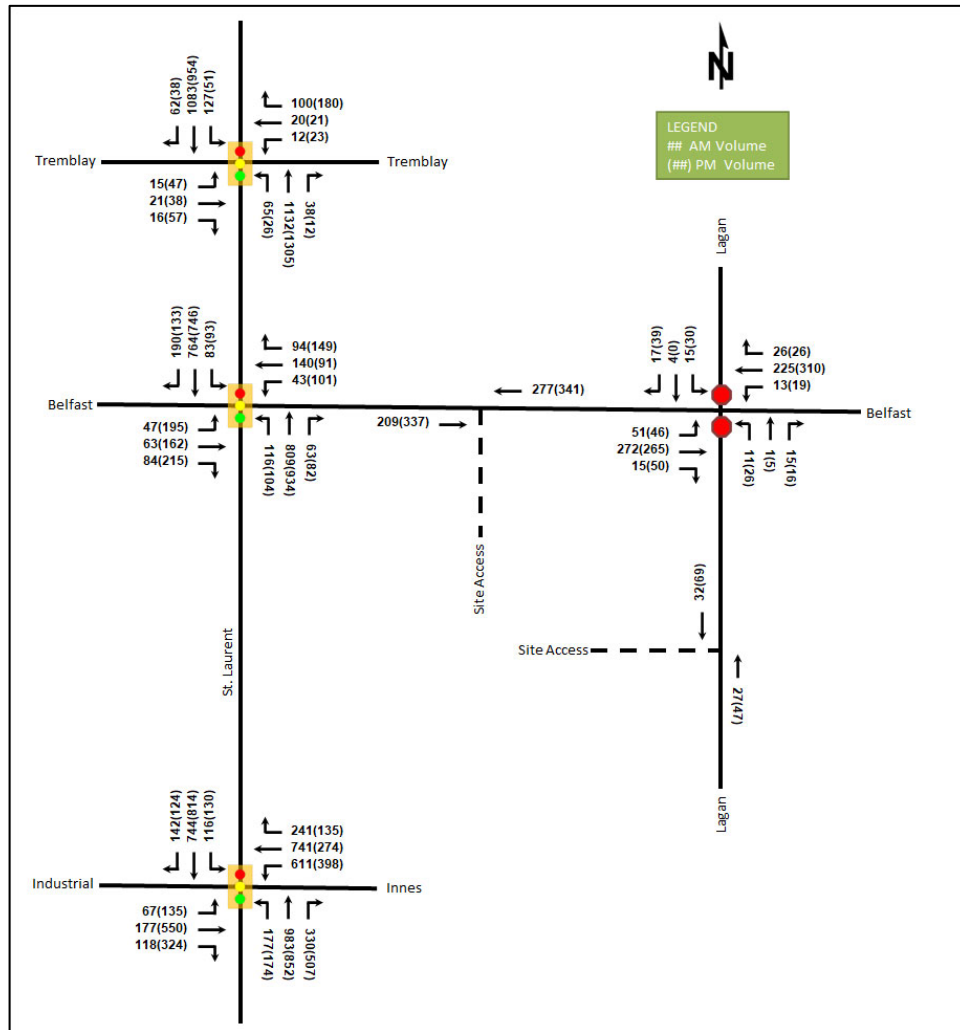


Table 2: Existing Intersection Operations

Intersection	Lane	AM Peak Hour				PM Peak Hour			
		LOS	V/C	Delay (s)	Q (95 <sup>th</sup> )	LOS	V/C	Delay (s)	Q (95 <sup>th</sup> )
St-Laurent Blvd at Tremblay Rd <i>Signalized</i>	EBL	A	0.21	54.3	10.0	D	0.83	<b>118.0</b>	23.5
	EBT/R	A	0.21	33.5	13.8	A	0.40	23.8	21.7
	WBL/T	A	0.10	48.9	8.1	A	0.16	43.4	11.9
	WBR	A	0.53	20.2	21.0	B	0.62	18.6	29.0
	NBL	A	0.26	13.6	22.7	A	0.09	14.5	m5.8
	NBT/R	A	0.43	10.9	93.5	A	0.45	12.2	m94.0
	SBL	A	0.44	8.3	20.0	A	0.22	6.9	9.5
	SBT	A	0.50	6.7	103.9	A	0.44	7.1	84.7
	SBR	A	0.07	1.6	5.0	A	0.04	2.3	4.1
<b>Overall</b>	<b>A</b>	<b>0.48</b>	<b>10.0</b>	-	<b>A</b>	<b>0.52</b>	<b>13.1</b>	-	
St-Laurent Blvd at Belfast Rd <i>Signalized</i>	EBL	A	0.26	30.4	17.1	<b>F</b>	<b>1.07</b>	<b>117.7</b>	<b>#85.0</b>
	EBT	A	0.14	28.6	21.5	A	0.38	34.2	48.8
	EBR	A	0.21	6.6	11.1	A	0.41	7.2	20.5
	WBL	A	0.23	42.3	20.3	B	0.61	58.6	41.0
	WBT/R	D	0.87	69.7	<b>#92.9</b>	D	0.83	56.2	73.0
	NBL	A	0.42	16.5	24.2	A	0.36	15.0	22.4
	NBT	A	0.57	25.4	109.2	B	0.65	27.0	130.7
	NBR	A	0.09	0.2	0.1	A	0.14	1.7	3.9
	SBL	A	0.33	15.5	18.1	A	0.44	21.5	25.8
	SBT	A	0.56	25.5	102.8	A	0.52	19.2	52.8
	SBR	A	0.31	4.1	14.0	A	0.19	2.3	5.9
<b>Overall</b>	<b>C</b>	-	<b>26.4</b>	-	<b>C</b>	-	<b>30.9</b>	-	
Lagan Way at Belfast Rd <i>Unsignalized</i>	EB	A	0.05	8.2	1.5	A	0.05	8.7	1.5
	WB	A	0.01	8.3	0.0	A	0.02	8.1	0.8
	NB	C	0.08	15.3	2.3	C	0.17	18.7	4.5
	SB	C	0.10	15.0	2.3	C	0.20	17.1	6.0
<b>Overall</b>	<b>A</b>	-	<b>2.2</b>	-	<b>A</b>	-	<b>3.1</b>	-	
St-Laurent Blvd at Industrial Ave / Innes Rd <i>Signalized</i>	EBL	A	0.39	68.6	18.2	A	0.56	66.6	32.9
	EBT	A	0.42	54.5	35.6	D	0.83	58.7	<b>#112.0</b>
	EBR	A	0.36	4.4	5.1	B	0.64	14.6	46.9
	WBL	<b>F</b>	<b>1.01</b>	<b>90.6</b>	<b>#138.6</b>	C	0.77	60.2	77.6
	WBT	D	0.81	50.6	128.7	A	0.30	33.7	44.5
	WBR	A	0.44	6.3	20.5	A	0.26	5.9	14.7
	NBL	B	0.65	70.9	39.8	A	0.59	64.0	39.3
	NBT	E	0.95	60.4	<b>#241.3</b>	E	0.97	68.2	<b>#197.5</b>
	NBR	A	0.51	9.8	42.7	C	0.75	15.5	76.5
	SBL	A	0.52	69.1	28.0	A	0.53	64.5	31.1
	SBT	C	0.74	46.6	<b>#163.6</b>	E	0.97	70.2	<b>#192.7</b>
SBR	A	0.29	5.0	12.3	A	0.26	4.1	9.7	
<b>Overall</b>	<b>E</b>	<b>0.95</b>	<b>51.2</b>	-	<b>D</b>	<b>0.85</b>	<b>50.5</b>	-	

Notes: Saturation flow rate of 1800 veh/h/lane  
Queue is measured in metres  
Peak Hour Factor = 0.90

Delay = average vehicle delay in seconds  
m = metered queue  
# = volume for the 95th %ile cycle exceeds capacity

During both the AM and PM peak hours, capacity issues are noted individual movements, but the network intersections typically operate adequately.

The eastbound left movement at the intersection of St-Laurent Boulevard at Tremblay Road may be subject to high delays during the PM peak hour.

At the intersection of St-Laurent Boulevard at Belfast Road, during the AM peak hour, the westbound through/right movement may exhibit extended queues and during the PM peak hour, the eastbound left movement is over capacity with high delays and extended queues. Shifting two seconds of split during the PM peak hour from the westbound through phase to the eastbound left phase would reduce v/c of all movements at the intersection to 1.00 or below.

At the intersection of St-Laurent Boulevard at Industrial Avenue/Innes Road, during the AM peak hour, the westbound left-turn movement is over theoretical capacity during with high delays and extended queues, and the northbound through and southbound through movements may exhibit extended queues. During the PM peak hour, the eastbound through, northbound through, and southbound through movements may exhibit extended queues. Shifting one second of split during the AM peak hour from the northbound through/southbound through phase to the westbound left/eastbound through phase would reduce v/c of all movements at the intersection to 1.00 or below.

2.2.8 Collision Analysis

Collision data have been acquired from the City of Ottawa open data website (data.ottawa.ca) for five years prior to the commencement of this TIA for the surrounding study area road network. Table 3 summarizes the collision types and conditions in the study area, Figure 11 illustrates the intersections and segments analyzed, and Table 4 summarizes the total collisions for each of these locations. Collision data are included in Appendix D.

Table 3: Study Area Collision Summary, 2018-2022

		Number	%
<b>Total Collisions</b>		<b>101</b>	<b>100%</b>
<b>Classification</b>	<b>Fatality</b>	0	0%
	<b>Non-Fatal Injury</b>	22	22%
	<b>Property Damage Only</b>	79	78%
<b>Initial Impact Type</b>	<b>Approaching</b>	1	1%
	<b>Angle</b>	12	12%
	<b>Rear end</b>	32	32%
	<b>Sideswipe</b>	14	14%
	<b>Turning Movement</b>	30	30%
	<b>SMV Unattended</b>	2	2%
	<b>SMV Other</b>	7	7%
	<b>Other</b>	3	3%
<b>Road Surface Condition</b>	<b>Dry</b>	66	65%
	<b>Wet</b>	16	16%
	<b>Loose Snow</b>	7	7%
	<b>Slush</b>	9	9%
	<b>Packed Snow</b>	1	1%
	<b>Ice</b>	2	2%
<b>Pedestrian Involved</b>		2	2%
<b>Cyclists Involved</b>		0	0%



Figure 11: Study Area Collision Records, 2018-2022

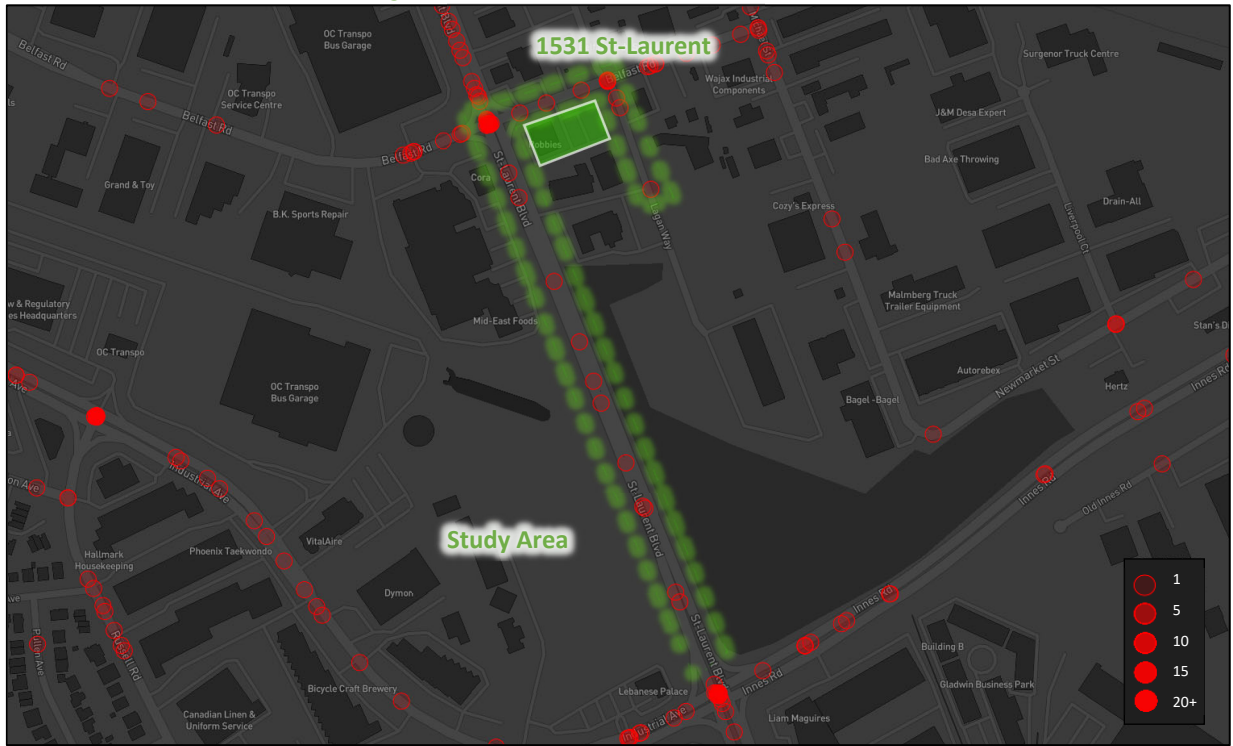


Table 4: Summary of Collision Locations, 2018-2022

Intersections / Segments	Number	%
<b>Intersections / Segments</b>	<b>119</b>	<b>100%</b>
<b>Belfast Rd @ St-Laurent Blvd</b>	75	74%
<b>St-Laurent Blvd btwn Belfast Rd &amp; Industrial Ave</b>	13	13%
<b>Belfast Rd @ Lagan Wy</b>	7	7%
<b>Lagan Wy btwn Belfast Rd &amp; End</b>	3	3%
<b>Belfast Rd btwn St-Laurent Blvd &amp; Lagan Wy</b>	3	3%

Within the study area, the intersection of Belfast Road at St-Laurent Boulevard and the segment of St-Laurent Boulevard between Belfast Road and Industrial Avenue are noted to have experienced higher collisions than other locations. Table 5 and Table 6 summarize the collision types and conditions for these locations, respectively.

Outside of these locations, one collision at the intersection of Belfast Road at Lagan Way involved a pedestrian during the five-year period. The collision occurred at 1:35 PM in clear conditions with slush on the roadway. No patterns can be discerned from a single pedestrian collision, and no modifications outside of the proposed redevelopment of the southwest corner of the intersection, removing a fence at the property line and providing a 3.0-metre by 3.0-metre sight triangle is recommended to address collisions at this location. No further review for collisions at this location is required as part of this study.

Table 5: Intersection of Belfast Rd at St-Laurent Blvd Collision Summary

Total Collisions		Number	%
Total Collisions		75	100%
Classification	Fatality	0	0%
	Non-Fatal Injury	17	23%
	Property Damage Only	58	77%
Initial Impact Type	Angle	7	9%

		Number	%
<b>Total Collisions</b>		<b>75</b>	<b>100%</b>
	Rear end	25	33%
	Sideswipe	6	8%
	Turning Movement	29	39%
	SMV Unattended	1	1%
	SMV Other	5	7%
	Other	2	3%
<b>Road Surface Condition</b>	Dry	51	68%
	Wet	10	13%
	Loose Snow	4	5%
	Slush	7	9%
	Packed Snow	1	1%
	Ice	2	3%
<b>Pedestrian Involved</b>		1	1%
<b>Cyclists Involved</b>		0	0%

The Belfast Road at Coventry Road intersection had a total of 75 collisions during the 2018-2022 time period, with 58 involving property damage only and the remaining 17 having non-fatal injuries. The collision types are most represented by turning movement with 29 collisions and rear end with 25 collisions, followed by seven angle collisions, six sideswipe collisions, five SMV (other) collisions, two collisions as other, and one collision as SMV (unattended). Turning movement and angle collisions may be influenced by the four right-turn channels at the intersection or by the interaction of the bus movements between the north and west legs or the bus stops on both sides of the south leg. Rear end and sideswipe collisions are typical of congested conditions. One collision involving a pedestrian was noted during the five-year period, occurring at 11:30 AM in clear, dry conditions, and no patterns can be discerned from a single pedestrian collision. Weather conditions are not considered to impact collisions at this location.

It is anticipated that any geometric design factors contributing to collisions will be reviewed and mitigated as part of the St-Laurent Boulevard Transit Priority Corridor Environmental Assessment (EA) Study discussed in Section 2.3.1.3. No further collision analysis is required as part of this study.

*Table 6: Segment of St-Laurent Blvd btwn Belfast Rd & Industrial Ave Collision Summary*

		Number	%
<b>Total Collisions</b>		<b>13</b>	<b>100%</b>
<b>Classification</b>	Fatality	0	0%
	Non-Fatal Injury	1	8%
	Property Damage Only	12	92%
<b>Initial Impact Type</b>	Rear end	5	38%
	Sideswipe	6	46%
	SMV Unattended	1	8%
	SMV Other	1	8%
<b>Road Surface Condition</b>	Dry	7	54%
	Wet	4	31%
	Loose Snow	2	15%
<b>Pedestrian Involved</b>		0	0%
<b>Cyclists Involved</b>		0	0%

The segment of St-Laurent Boulevard between Belfast Road and Industrial Avenue had a total of 13 collisions during the 2018-2022 time period, with 12 involving property damage only and the remaining one having non-

fatal injuries. The collision types are most represented by sideswipe with six collisions, followed by rear end with five collisions, and one collision each as SMV (other) and SMV (unattended). Higher incidence of rear end and sideswipe collisions are typical of congested conditions. Weather conditions may affect collisions at this location and paving treatments may be investigated to address collisions on this segment.

It is anticipated that any geometric design factors contributing to collisions will be reviewed and mitigated as part of the St-Laurent Boulevard Transit Priority Corridor EA Study discussed in Section 2.3.1.3. No further collision analysis is required as part of this study.

## 2.3 Planned Conditions

### 2.3.1 Changes to the Area Transportation Network

The subject development is not within a Community Design Plan (CDP) Area.

#### 2.3.1.1 *Transportation Master Plan (2013)*

Within the legacy Transportation Master Plan (TMP) (2013), the Rapid Transit and Transit Priority Network's Network Concept diagram shows an at-grade bus rapid transit (BRT) corridor along St-Laurent Boulevard south of Industrial Avenue. Within the Affordable Network diagram, however, this section and the remaining corridor are shown as having isolated transit priority measures which have been partially implemented as part of corridor upgrades in 2017.

Within the TMP (2013), the Road Network's Network Concept diagram shows Tremblay Road as widened collector. Within the Affordable Network diagram, this project is shown as a phase 3 (2026-2031) widening. The scope of the work per the Affordable Network is the widening of Tremblay Road from two lanes to four between Pickering Place and St-Laurent Boulevard. Since the project timeline is unknown, it is assumed that the widening will be completed beyond the study horizons.

#### 2.3.1.2 *Transportation Master Plan – Part 1 (2023)*

The 2023 TMP Part 1 includes pedestrian infrastructure projects on the north side of Belfast Road west of St-Laurent Boulevard to connect existing sidewalks, and sidewalks along Michael Street and Parisien Street in the neighbourhood to the northeast of the site.

#### 2.3.1.3 *St-Laurent Boulevard Transit Priority Corridor Environmental Assessment (EA) Study*

The City of Ottawa has initiated an EA study to assess the options for improvements to transit, and all travel modes, along the St-Laurent Boulevard transit priority corridor between Hemlock Road and Innes Road. No timeline for design and implementation of a future plan are available, and the improvements are assumed to occur outside of the study horizons.

#### 2.3.1.4 *St-Laurent TOD Plan*

Approximately 400 metres north of the site is the St-Laurent TOD Plan area. The TOD plan outlines the realignment of Tremblay Road west of St-Laurent Boulevard, new sidewalks on both sides of Belfast Road and Michael Street, and dedicated cycling facilities along St-Laurent Boulevard and Tremblay Road. Figure 12, Figure 13, and Figure 14 illustrate the St-Laurent TOD street, pedestrian, and cycling plans, respectively.

Figure 12: St-Laurent TOD Street Network

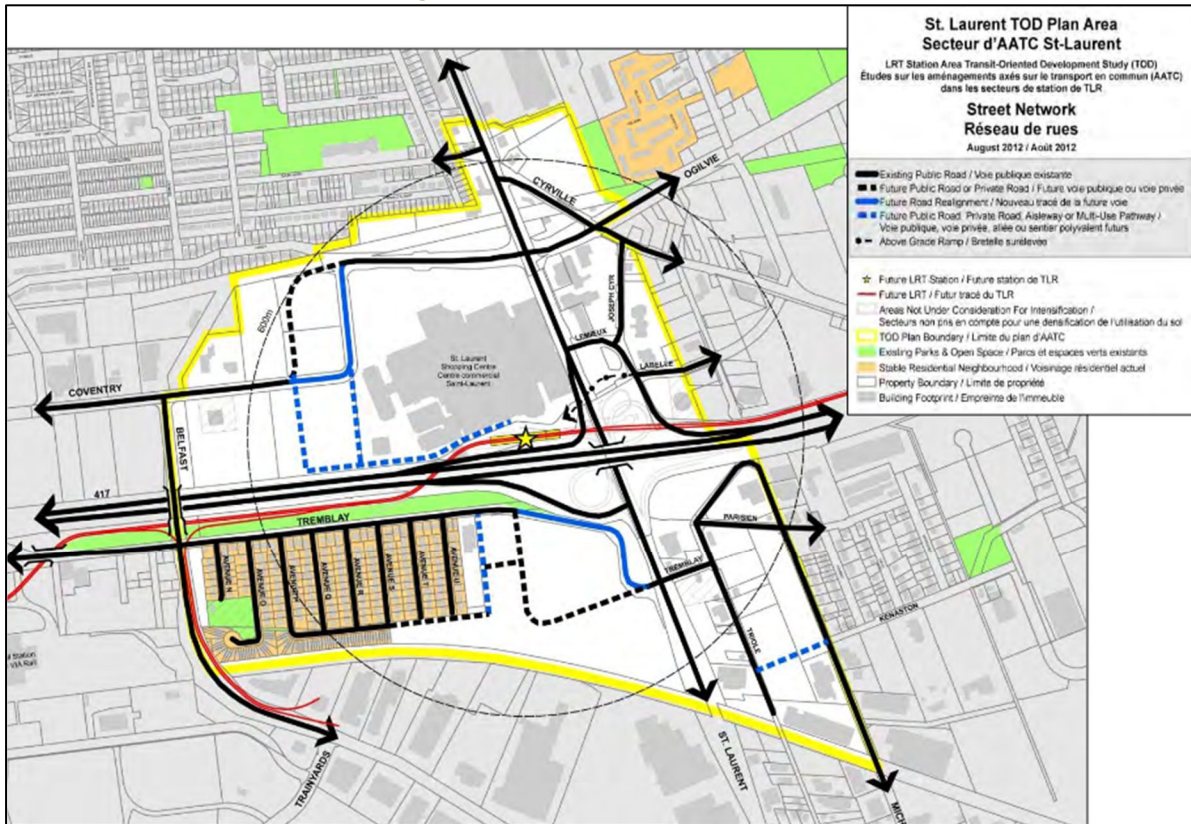


Figure 13: St-Laurent TOD Pedestrian Network

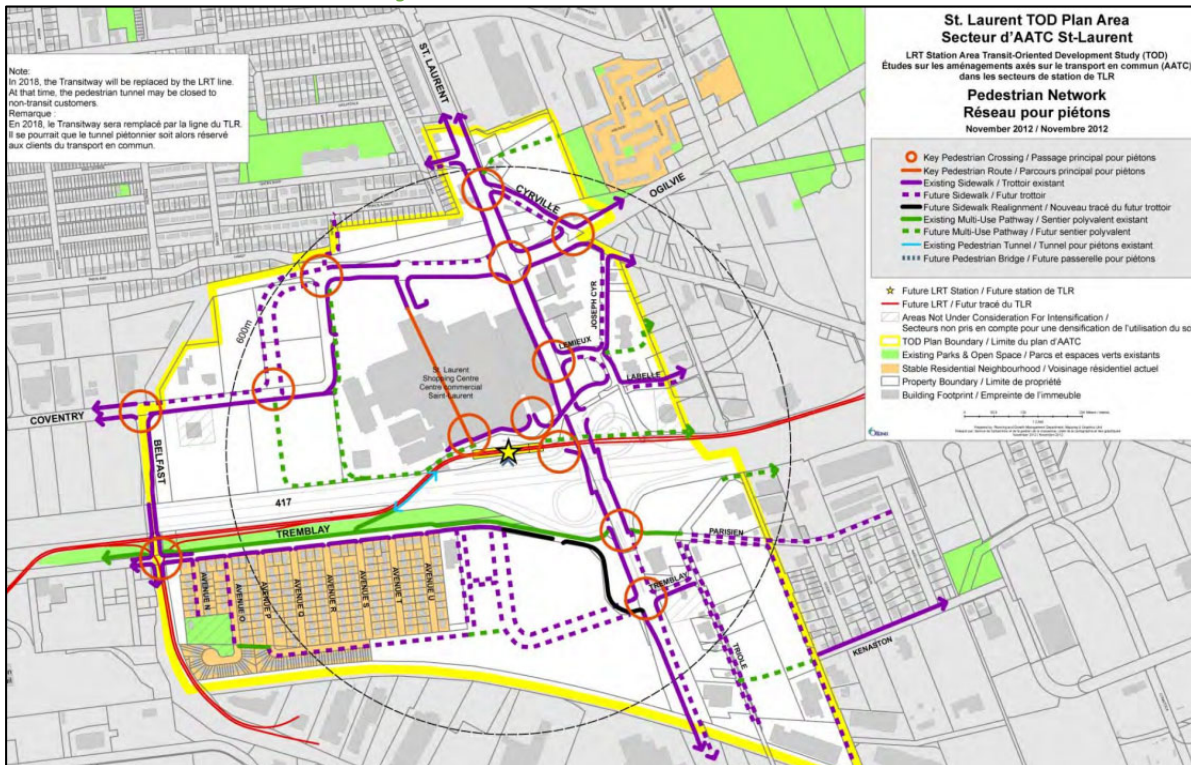
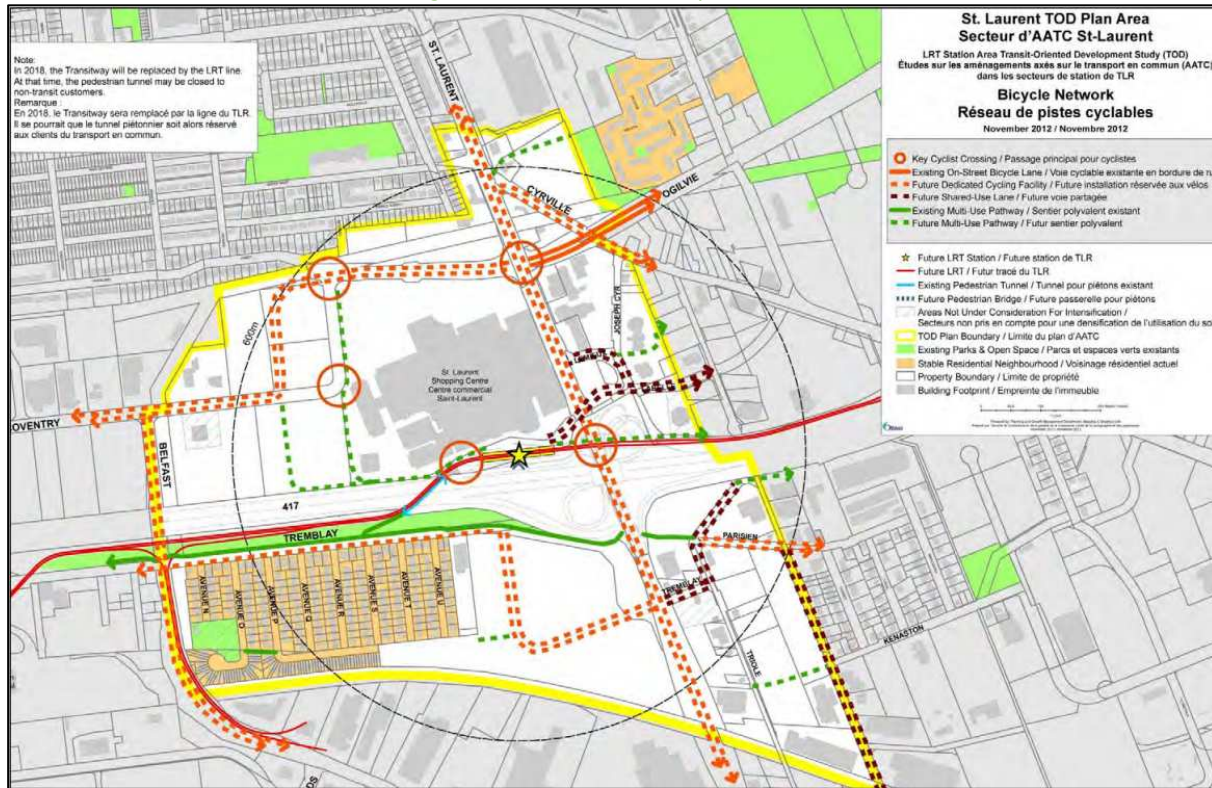


Figure 14: St-Laurent TOD Bicycle Network



### 2.3.2 Other Study Area Developments

#### 1330 Avenue K

The proposed development application includes a Zoning By-Law Amendment to include residential uses along with complementary commercial uses. No TIA is available.

#### 200, 230, 260 Streamline Street

The proposed development application includes a site plan for seven-storey high-rise buildings with a total of 1890 units. Phase one is to construct 420 dwelling units and was forecast to be built out by 2021. Phase two is to comprise 865 dwelling units is forecast to be built out by 2027. Phase three is to comprise the remaining 605 dwelling units is forecast to be built out by 2031. Phase one has not been constructed and it will be assumed to be completed by 2023. (Halpenny, 2018)

#### 25 Pickering Place

The proposed development application includes a site plan for a hotel, a senior residence, and four high-rise residential towers. Phase one is to construct a nine-storey hotel with 119 units, a twelve-storey senior residence comprising 164 dwelling units, and a 20-storey tower comprising 211 dwelling units and is forecast to be built out by 2025. Phase two is to construct three high-rise towers with a total of 849 units is forecast to be built out by 2030. (CIMA+, 2020)

#### 400 Coventry Road

The proposed development application includes a Zoning By-Law Amendment to allow seven towers on mixed use podiums totalling 1,690 residential dwelling units and 18,299 sq. ft. of commercial space. The development is forecast to be built out by 2032 and to generate 107 new AM and 130 new PM peak hour two-way auto trips. (CGH, 2022)

*453 & 455 Coventry Road*

The proposed development application includes a Zoning By-Law Amendment to allow 650 residential units and 1,115m<sup>2</sup> gross floor area (GFA) of commercial space. The development is forecast to be built out by 2027 and to generate 113 new AM and 135 new PM two-way peak hour auto trips. (Novatech, 2022)

*500, 525, 535 Coventry Road & 1200 St-Laurent Boulevard*

The proposed development application includes a Zoning By-Law amendment to permit the construction of freestanding retail buildings with associated surface parking areas. No TIA is included as part of this application, and the file was last updated in 2014.

*530 Tremblay Road & 2098 Avenue P & 1399 Avenue U*

The proposed development application includes a site plan to construct two apartment buildings with a total of 124 dwelling units. The development is forecast to be built out by 2023. (CGH Transportation, 2019)

*599 Tremblay Road*

The proposed development application includes a plan of subdivision for the construction of 500 apartment units and 150,000 m<sup>2</sup> of federal Office in three phases. Phase one is to comprise 200 dwelling units and 150,000 m<sup>2</sup> of office space and is forecast to be built out by 2025. Phase two is to comprise 200 dwelling units and is forecast to be built out by 2029. Phase three is to comprise the remaining 100 units, is forecast to be built out by 2033. (WSP, 2021)

*1209 St-Laurent Boulevard & 1200 Lemieux Street*

The proposed development application includes a site plan for two 30-storey residential buildings including 640 units. The development is expected to generate 35 new AM and 38 new PM peak hour two-way auto trips, and the anticipated build-out horizon is assumed to be 2026. (CGH Transportation, 2022)

*1500 St-Laurent Boulevard*

The proposed development application includes a site plan to include OC Transpo E-Bus Facility. No TIA is available.

*1740-1760 St-Laurent Boulevard*

The proposed development application includes a site plan for the construction of four buildings, two mixed use towers at 15-storeys and two residential towers at 12-storeys. The development is anticipated to be built-out by 2024 and to generate 228 new AM and 263 new PM peak hour two-way auto trips. (Parsons, 2021)

*1802 St-Laurent Boulevard*

The proposed development application includes a zoning amendment to allow the construction of two residential buildings comprising 512 dwelling units. The development is anticipated to be built-out by 2025 and to generate 185 new AM and 212 new PM peak hour two-way auto trips. (CGH, 2021)

*1300 Michael Street*

The proposed development application includes a site plan for approximately 15,000 sq. ft. of commercial and/or industrial space. The anticipated build-out horizon is 2023. No TIA is available.

*1591-1611 Michael Street*

The proposed development application includes a site plan for approximately 40,900 sq. ft. of light industrial space. No TIA is available.

*1195 Newmarket Street*

The proposed development application includes a site plan for approximately 115,000 sq. ft. warehouse space. The development is anticipated to be built out by 2025 and to generate 35 two-way AM and 37 two-way PM peak hour auto trips. (Ortam Groupe, 2022)

### 3 Study Area and Time Periods

#### 3.1 Study Area

While only one signalized intersection is present within 400 metres of the site, to better understand area impacts, the study area has been expanded to include the intersections of:

- St-Laurent Boulevard at:
  - Tremblay Road
  - Belfast Road
  - Industrial Avenue/Innes Road
- Belfast Road at:
  - Lagan Way
  - Site Access (Future Conditions)
- Lagan Way at Site Access (Future Conditions)

The boundary roads will be St-Laurent Boulevard, Belfast Road, and Lagan Way. TRANS screenline SL 54 is located south of Innes Road, and no screenline analysis will be performed as part of the study.

#### 3.2 Time Periods

As the proposed development is composed primarily of residential units the AM and PM peak hours will be examined.

#### 3.3 Horizon Years

The anticipated build-out year is 2026. As a result, the full build-out plus five years horizon year is 2031.

## 4 Development-Generated Travel Demand

#### 4.1 Mode Shares

Examining the mode shares recommended in the TRANS Trip Generation Manual (2020) for the subject district, derived from the most recent National Capital Region Origin-Destination survey (OD Survey), the existing average district mode shares by land use for Alta Vista have been summarized in Table 7.

*Table 7: TRANS Trip Generation Manual Recommended Mode Shares – Alta Vista*

Travel Mode	Multi-Unit (High-Rise)		Commercial Generator	
	AM	PM	AM	PM
<b>Auto Driver</b>	38%	45%	64%	60%
<b>Auto Passenger</b>	12%	16%	9%	20%
<b>Transit</b>	41%	28%	12%	9%
<b>Cycling</b>	2%	2%	1%	0%
<b>Walking</b>	7%	9%	14%	11%
<b>Total</b>	<b>100%</b>	<b>100%</b>	<b>100%</b>	<b>100%</b>

## 4.2 Trip Generation

This TIA has been prepared using the vehicle and person trip rates for the residential dwellings using the TRANS Trip Generation Manual (2020) and the vehicle trip rates and derived person trip rates for commercial component from the ITE Trip Generation Manual 11th Edition (2021) using the City-prescribed conversion factor of 1.28. Table 8 summarizes the person trip rates for the proposed residential land use for each peak period and the person trip rates for the non-residential land use by peak hour.

*Table 8: Trip Generation Person Trip Rates*

Land Use	Land Use Code	Peak	Peak Period		Peak Hour	
			Vehicle Trip Rate	Person Trip Rates	Vehicle Trip Rate	Person Trip Rates
Multi-Unit (High-Rise)	221 & 222 (TRANS)	AM	-	0.80	-	-
		PM	-	0.90	-	-
Retail <40k sq. ft	822 (ITE)	AM	-	-	2.36	3.02
		PM	-	-	6.59	8.44

Using the above person trip rates, the total person trip generation has been estimated. Table 9 summarizes the total person trip generation for the residential land use by peak period and for the non-residential land use by peak hour.

*Table 9: Total Person Trip Generation*

Land Use	Units	AM Peak Period			PM Peak Period		
		In	Out	Total	In	Out	Total
Multi-Unit (High-Rise)	435	108	240	348	227	165	392
Land Use	GFA (sq. ft.)	AM Peak Hour			PM Peak Hour		
		In	Out	Total	In	Out	Total
Retail <40k sq. ft	3,085	5	4	9	13	13	26

Internal capture rates from the ITE Trip Generation Handbook 3<sup>rd</sup> Edition have been assigned to the development’s retail component for mixed-use developments. The rates summarized in Table 10 represent the percentage of trips to/from the retail use based on the residential component.

*Table 10: Internal Capture Rates*

Land Use	AM		PM	
	In	Out	In	Out
Residential to/from Shopping Centre	17%	14%	10%	26%

Typical pass-by reductions applied to the retail land use’s trip generation are 40%, which is derived from the recommended value presented in the ITE Trip Generation Manual 11th Edition (2021) for the most similar land use with a recommended rate, “Retail (40k – 150k sq. ft).” The subject development is one quadrant of an intersection with an arterial as the major roadway and with a collector and local as the minor roadway. Given this proximity, and that the site access is onto the lower classification roadway, the application of the pass-by percentage to Belfast Road would not be considered to reflect the expected pass-by component of the site trips. Due to this context, the analysis will forgo the application of diverted trips and will apply the 40% pass-by to the major movements at the intersection of St-Laurent Boulevard at Belfast Road.

Using the above mode share targets, the internal capture and pass-by rates, and the person trip rates, the person trips by mode have been projected. Trip generation by peak hour has been forecasted using the prescribed peak period conversion factors presented in the TRANS Trip Generation Manual (2020) for the residential component.



Table 11 summarizes the residential trip generation and the non-residential trip generation by mode and peak hour.

Table 11: Trip Generation by Mode

Travel Mode		AM Peak Hour				PM Peak Hour			
		Mode Share	In	Out	Total	Mode Share	In	Out	Total
Multi-Unit (High-Rise)	Auto Driver	38%	20	44	63	45%	45	33	77
	Auto Passenger	12%	6	14	20	16%	16	11	28
	Transit	41%	24	54	79	28%	30	22	52
	Cycling	2%	1	3	4	2%	2	1	4
	Walking	7%	5	10	14	9%	10	8	18
	<b>Total</b>	<b>100%</b>	<b>56</b>	<b>125</b>	<b>180</b>	<b>100%</b>	<b>103</b>	<b>75</b>	<b>179</b>
Retail <40k sq. ft.	Auto Driver	64%	1	1	2	60%	2	2	4
	Auto Passenger	9%	0	0	0	20%	2	2	4
	Transit	12%	0	0	0	9%	1	1	2
	Cycling	1%	0	0	0	0%	0	0	0
	Walking	14%	1	1	2	11%	1	1	2
	Pass-by	40%	-2	-2	-4	40%	-5	-5	-10
	Internal Capture	varies	-1	0	-1	varies	-1	-2	-3
<b>Total</b>	<b>100%</b>	<b>2</b>	<b>2</b>	<b>4</b>	<b>100%</b>	<b>6</b>	<b>6</b>	<b>12</b>	
Total	Auto Driver	-	21	45	65	-	47	35	81
	Auto Passenger	-	6	14	20	-	18	13	32
	Transit	-	24	54	79	-	31	23	54
	Cycling	-	1	3	4	-	2	1	4
	Walking	-	6	11	16	-	11	9	20
	<b>Total</b>	<b>-</b>	<b>58</b>	<b>127</b>	<b>184</b>	<b>-</b>	<b>109</b>	<b>81</b>	<b>191</b>

As shown above, a total of 65 AM and 81 PM new peak hour two-way vehicle trips are projected as a result of the proposed development.

### 4.3 Trip Distribution

To understand the travel patterns of the subject development, the OD Survey has been reviewed to determine the travel for the residential component, and these patterns were applied based on the build-out of Alta Vista. Table 12 below summarizes the distributions.

Table 12: OD Survey Distribution – Alta Vista

To/From	Residential % of Trips	Via
North	15%	15% St-Laurent Blvd (N)
South	35%	35% St-Laurent Blvd (S)
East	5%	5% Innes Rd (E)
West	45%	20% St-Laurent Blvd (N) 5% Tremblay Rd (W), 15% Belfast Rd (W), 5% St-Laurent Blvd (S)
<b>Total</b>	<b>100%</b>	<b>100%</b>

### 4.4 Trip Assignment

Using the distribution outlined above, turning movement splits, and access to major transportation infrastructure, the trips generated by the site have been assigned to the study area road network. Figure 15 illustrates the new site generated volumes and Figure 16 illustrates the new site pass-by volumes.

Figure 15: New Site Generation Auto Volumes

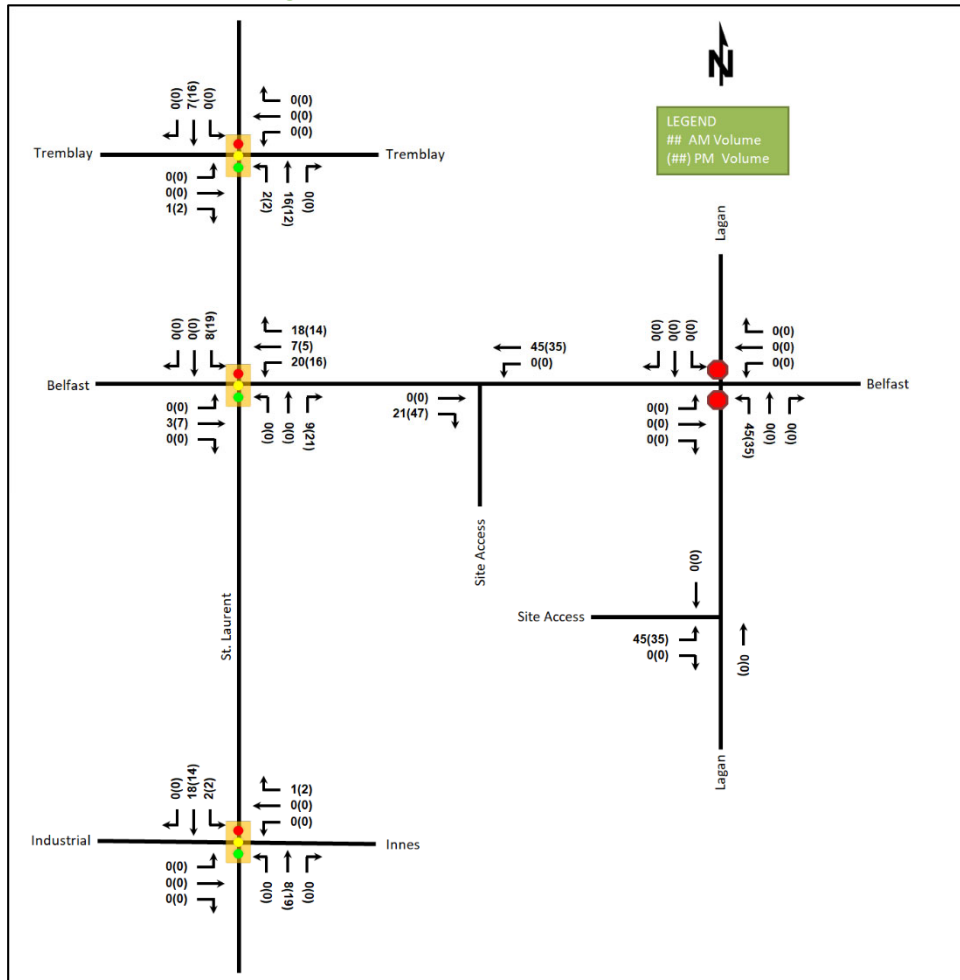
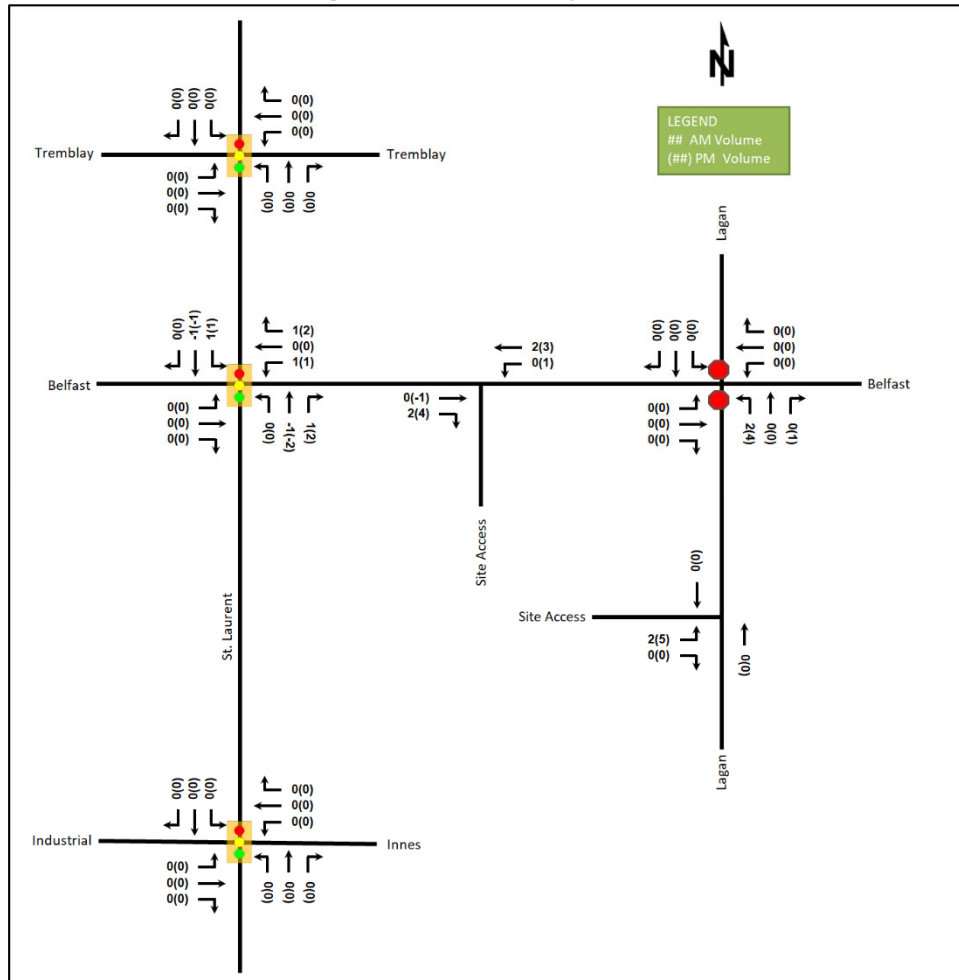


Figure 16: New Site Pass-By Volumes



## 5 Exemption Review

Table 13 summarizes the exemptions for this TIA.

Table 13: Exemption Review

Module	Element	Explanation	Exempt/Required
<b>Site Design and TDM</b>			
<b>4.1 Development Design</b>	4.1.2 Circulation and Access	Only required for site plan and zoning by-law applications	Required
	4.1.3 New Street Networks	Only required for plans of subdivision	Exempt
<b>4.2 Parking</b>	4.2.1 Parking Supply	Only required for site plan and zoning by-law applications	Required
<b>4.3 Boundary Street Design</b>		All applications	Required
<b>4.5 Transportation Demand Management</b>	All Elements	Only required when the development generates more than 60 person-trips	Required

Module	Element	Explanation	Exempt/Required
<b>Network Impact</b>			
<b>3.2 Background Network Travel Demand</b>	All Elements	Only required when one or more other Network Impact Modules are triggered	Required
<b>3.3 Demand Rationalization</b>		Only required when one or more other Network Impact Modules are triggered	Required
<b>4.6 Neighbourhood Traffic Calming</b>	4.6.1 Adjacent Neighbourhoods	<p>If the development meets all of the following criteria along the route(s) site generated traffic is expected to utilize between an arterial road and the site’s access:</p> <ol style="list-style-type: none"> <li>1. Access to Collector or Local;</li> <li>2. “Significant sensitive land use presence” exists, where there is at least two of the following adjacent to the subject street segment: <ul style="list-style-type: none"> <li>• School (within 250m walking distance);</li> <li>• Park;</li> <li>• Retirement / Older Adult Facility (i.e. long-term care and retirement homes);</li> <li>• Licenced Child Care Centre;</li> <li>• Community Centre; or</li> <li>• 50%, or greater, of adjacent property along the route(s) is occupied by residential lands and a minimum of 10 occupied residential units are present on the route.</li> </ul> </li> <li>3. Application is for Zoning By-Law Amendment or Draft Plan of Subdivision;</li> <li>4. At least 75 site-generated auto trips;</li> <li>5. Site Trip Infiltration is expected. Site traffic will increase peak hour vehicle volumes along the route by 50% or more.</li> </ol>	Exempt
<b>4.7 Transit</b>	4.7.1 Transit Route Capacity	Only required when the development generates more than 75 transit trips	Required
	4.7.2 Transit Priority Requirements	Only required when the development generates more than 75 auto trips	Required
<b>4.8 Network Concept</b>		Only required when proposed development generates more than 200 person-trips during the peak hour in excess of equivalent volume permitted by established zoning	Exempt
<b>4.9 Intersection Design</b>	4.9.1 Intersection Control	Only required when the development generates more than 75 auto trips	Required

Module	Element	Explanation	Exempt/Required
	4.9.2 Intersection Design	Only required when the development generates more than 75 auto trips	

## 6 Development Design

### 6.1 Design for Sustainable Modes

The proposed development is comprised of one mixed use building and one residential building separated by a one-way drive aisle with surface parking. Hard surface connections are provided between the building entrances and the surrounding sidewalks and internal pedestrian walkways and the public park on the northeast corner of the parcel. Bicycle parking is located in secure rooms on the main floor, within the underground parking levels and in surface racks interspersed around the site. Stops for the bus routes discussed in Section 2.2.5 are within 400 metres walking distance of all building entrances.

The infrastructure TDM Checklist is provided in Appendix E.

### 6.2 Circulation and Access

Access is provided via a one-way drive aisle from Belfast Road to Lagan Way. Garbage collection will occur on-site, and emergency services can circulate the site via the 6.0-metre-wide internal drive aisle with 12.0-metre centreline radius on the 90-degree bend in the aisle. Turning templates are provided in Appendix F.

## 7 Parking

### 7.1 Parking Supply

The site proposes 395 total vehicle parking spaces, including 354 residential, 30 visitor, and 11 retail vehicle spaces. A total of 407 bicycle parking spaces are to be provided internal to the building across the parking levels and the main floor, and 40 spaces are to be provided in surface racks throughout the site.

While the site is located within Area C of the Zoning By-Law’s Schedule 1A, Area B is located directly on the opposite side of St-Laurent Boulevard and is considered to be applicable for the parcels with direct frontage on the east side of St-Laurent Boulevard. This analysis is more consistent with the direction of the new Official Plan policy framework concerning corridors but is a departure from how current Zoning By-Law 2008-250, which historically uses the centreline of the roadway to delineate changes in policy areas. The subject development is at an intersection, and no difference in character or context is distinguishable for parcels facing one side or the other of St-Laurent Boulevard. The proposed changes to the Zoning By-Law are expected to include no minimum parking requirements and render this rationalization obsolete upon adoption.

Considering the Area B rates, the Zoning By-Law requires a minimum tenant vehicle parking of 218 spaces (0.5 spaces/dwelling unit), minimum visitor vehicle parking of 60 spaces (0.2 spaces/dwelling unit after the first twelve units to a max of 60), a minimum retail vehicle parking of seven spaces (2.5 spaces/100 m<sup>2</sup> of GFA) and a minimum bicycle parking of 219 spaces (0.5 spaces/dwelling unit and 1 per 250 m<sup>2</sup> of retail GFA). Area C rates would require a minimum tenant vehicle parking of 522 (1.2 spaces/dwelling unit), visitor vehicle parking of 87 spaces (0.2 spaces/dwelling unit), and retail vehicle parking of ten spaces (3.4 spaces/100 m<sup>2</sup> of GFA).

The current allocation of vehicle spaces noted on the site plan do not meet the minimum visitor or retail parking space minimums for Area B, the tenant parking exceeds the minimum and can be re-allocated to meet each land use requirement. Therefore, the site is considered to meet the Area B minimum parking requirements. Bicycle parking minimums are proposed as being exceeded by more than a factor of two.

## 8 Boundary Street Design

Table 14 summarizes the MMLOS analysis for the boundary streets of St-Laurent Boulevard, Belfast Road, and Lagan Way. It is anticipated that in the ultimate conditions, pedestrian and cycling facilities and transit lanes will be modified as part of the St-Laurent Boulevard Transit Priority Corridor project, and these modifications will be considered in the future conditions for the MMLOS analysis. Belfast Road LOS will be the same existing and future conditions, and these are considered in one row. The boundary street analysis is based on the land use designation of “Arterial Mainstreet” for St-Laurent Boulevard, and “Employment Area” for Belfast Road and Lagan Way. The MMLOS worksheets has been provided in Appendix G.

Table 14: Boundary Street MMLOS Analysis

Segment	Horizon	Pedestrian LOS		Bicycle LOS		Transit LOS		Truck LOS	
		PLOS	Target	BLOS	Target	TLOS	Target	TrLOS	Target
St-Laurent Blvd	Ex.	C	C	F	C	D	D	A	D
	Fut.	A	C	A	C	D	D	A	D
Belfast Rd	Ex./Fut.	E	C	F	C	-	-	B	B
Lagan Way	Ex.	F	C	D	-	-	-	-	-
	Fut.	B	C	D	-	-	-	-	-

Belfast Road and the existing configuration of Lagan Way do not meet the pedestrian MMLOS targets. To meet the PLOS target along the segment of Belfast Road, operating speed would need to be lower than 50 km/h or at least two metres of boulevard width would need to be provided. PLOS targets will be met in the future along Lagan Way with the planned provision of a sidewalk. It is expected that once the St-Laurent Boulevard Transit Priority Corridor project is completed, the St-Laurent Boulevard PLOS will be improved from C to A.

Belfast Road and the existing configuration of St-Laurent Boulevard do not meet the bicycle LOS targets. It is anticipated that the bicycle LOS along boundary street of St-Laurent Boulevard will become 'A' once the St-Laurent Boulevard Transit Priority Corridor project is completed. A curbside bike lane would be required along Belfast Road to meet BLOS targets, the preliminary St-Laurent Boulevard Transit Priority Corridor project includes approximately 40 meters of cycletrack along the south side of Belfast Road east of the St-Laurent Boulevard. No additional improvements are recommended beyond the new sidewalk to be provided on Lagan Way.

## 9 Transportation Demand Management

### 9.1 Context for TDM

The mode shares used within the TIA represent the unmodified recommended shares for the Alta Vista TRANS district. Overall, the modal shares are likely to be achieved and supporting TDM measures should be provided to encourage shifts towards sustainable mode.

### 9.2 Need and Opportunity

The subject site has been assumed to rely predominantly on auto travel and transit, and those assumptions have been carried through the analysis. The unmodified district mode shares have been applied, risks to other network users from failing to meet mode share targets are low.

### 9.3 TDM Program

The “suite of post occupancy TDM measures” has been summarized in the TDM checklists. The checklist is provided in Appendix E. The key TDM measures recommended include:

- Display local area maps with walking and cycling routes, and transit route information and schedules at major entrances
- Inclusion of a 6-month Presto card for first time new condo purchase or apartment rental, with a set time frame for this offer (e.g. 6-months) from the initial opening of the site
- Unbundle parking cost from purchase/rental costs

## 10 Background Network Travel Demands

### 10.1 Transportation Network Plans

The transportation network plans were discussed in Section 2.3. No recommended plan has been arrived at by the transit priority EA study, and no improvements associated with this project are included as part of the future conditions within the study horizons. No other changes to the approach geometries at network intersections are planned within the study horizons.

### 10.2 Background Growth

A review of the background projections from the City’s TRANS Regional Model for the 2011 and 2031 horizons was completed to determine the background growth for each of the study area roadways. The TRANS model plots are provided in Appendix H.

Growth rates derived from the existing horizon to the 2031 model horizon rounded to the nearest 0.25% will be peak-directionally applied to the appropriate roadway’s mainline volumes and to the appropriate major turning movements at the intersections. Table 15 summarizes the growth rates applied within the study area.

*Table 15: TRANS Regional Model Projections – Study Area Growth Rates*

Street	AM Peak Hour		PM Peak Hour	
	Eastbound	Westbound	Eastbound	Westbound
Tremblay Rd	0.25%	1.75%	1.75%	0.25%
Belfast Rd	-	-	-	-
Industrial Ave	0.75%	0.25%	0.25%	0.75%
Innes Rd	-	-	-	-
	Northbound	Southbound	Northbound	Southbound
St-Laurent Blvd	0.25%	-	-	0.25%

### 10.3 Other Developments

The background developments explicitly considered in the background conditions (Section 10.2) include:

- 200, 230, 260 Streamline Street
- 25 Pickering Place
- 400 Coventry Road
- 453 & 455 Coventry Road
- 530 Tremblay Road & 2098 Avenue P & 1399 Avenue U
- 599 Tremblay Road
- 1209 St-Laurent Boulevard & 1200 Lemieux Street
- 1740-1760 St-Laurent Boulevard
- 1802 St-Laurent Boulevard

The background development volumes within the study area have been provided in Appendix I.

## 11 Demand Rationalization

### 11.1 2026 Future Background Operations

Figure 17 illustrates the 2026 background volumes and Table 16 summarizes the 2026 background intersection operations. The level of service for signalized intersections is based on v/c calculations for individual lane movements and HCM 2000 v/c calculations for the overall intersection, and average delay for unsignalized intersections. The synchro worksheets for the 2026 future background horizon are provided in Appendix J.

Figure 17: 2026 Future Background Volumes

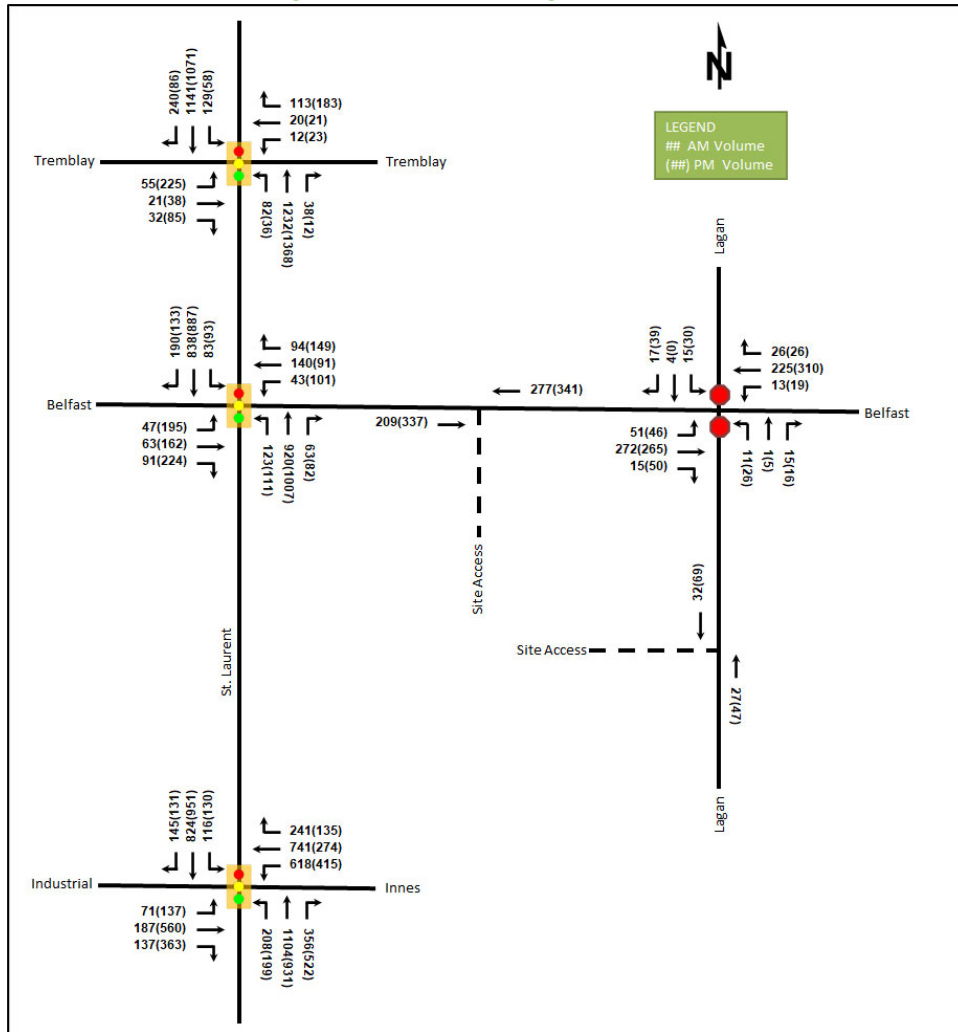




Table 16: 2026 Future Background Intersection Operations

Intersection	Lane	AM Peak Hour				PM Peak Hour			
		LOS	V/C	Delay	Q (95 <sup>th</sup> )	LOS	V/C	Delay	Q (95 <sup>th</sup> )
St-Laurent Blvd at Tremblay Rd <i>Signalized</i>	EBL	A	0.58	74.3	24.2	<b>F</b>	<b>1.01</b>	<b>106.5</b>	<b>#104.1</b>
	EBT/R	A	0.24	25.2	14.7	A	0.26	13.7	21.5
	WBL/T	A	0.09	46.3	7.7	A	0.07	32.7	10.6
	WBR	A	0.49	17.8	20.6	A	0.37	8.8	22.2
	NBL	A	0.28	14.6	25.1	A	0.16	19.3	m7.9
	NBT/R	A	0.43	11.5	89.7	A	0.54	18.0	m88.2
	SBL	A	0.40	8.0	18.3	A	0.26	11.5	10.0
	SBT	A	0.48	7.0	95.6	A	0.55	14.7	89.3
	SBR	A	0.23	1.4	8.6	A	0.10	2.2	6.0
<b>Overall</b>	<b>A</b>	<b>0.51</b>	<b>10.7</b>	-	<b>C</b>	<b>0.72</b>	<b>22.0</b>	-	
St-Laurent Blvd at Belfast Rd <i>Signalized</i>	EBL	A	0.23	30.4	15.9	E	0.95	<b>86.6</b>	<b>#68.0</b>
	EBT	A	0.13	29.0	19.9	A	0.35	34.7	44.1
	EBR	A	0.22	6.7	10.9	A	0.40	7.3	19.4
	WBL	A	0.22	42.7	18.7	A	0.59	58.9	37.5
	WBT/R	D	0.84	66.1	<b>#75.9</b>	C	0.79	53.0	63.9
	NBL	A	0.38	15.2	23.2	A	0.36	14.4	21.5
	NBT	A	0.55	23.6	112.7	B	0.61	24.9	125.4
	NBR	A	0.08	0.2	0.0	A	0.12	1.1	2.4
	SBL	A	0.29	14.4	16.7	A	0.38	17.2	20.9
	SBT	A	0.54	24.0	100.9	A	0.54	18.3	59.4
	SBR	A	0.27	4.1	13.3	A	0.17	2.8	6.6
<b>Overall</b>	<b>A</b>	<b>0.60</b>	<b>24.8</b>	-	<b>C</b>	<b>0.72</b>	<b>27.1</b>	-	
Lagan Way at Belfast Rd <i>Unsignalized</i>	EB	A	0.04	8.1	0.8	A	0.04	8.5	0.8
	WB	A	0.01	8.2	0.0	A	0.02	8.0	0.0
	NB	B	0.06	14.1	1.5	C	0.13	16.5	3.0
	SB	B	0.08	13.9	2.3	C	0.16	15.2	4.5
<b>Overall</b>	<b>A</b>	-	<b>2.1</b>	-	<b>A</b>	-	<b>2.8</b>	-	
St-Laurent Blvd at Industrial Ave / Innes Rd <i>Signalized</i>	EBL	A	0.38	68.5	17.7	A	0.51	64.0	30.3
	EBT	A	0.46	57.4	34.0	C	0.80	57.0	99.1
	EBR	A	0.40	5.5	7.1	B	0.66	14.9	46.4
	WBL	E	0.93	76.4	<b>#120.0</b>	C	0.75	58.8	73.0
	WBT	C	0.78	51.2	113.0	A	0.28	34.0	40.5
	WBR	A	0.42	6.2	17.8	A	0.25	6.3	14.2
	NBL	B	0.67	71.2	41.7	A	0.59	62.2	39.9
	NBT	D	0.89	50.8	<b>#242.2</b>	E	0.91	56.0	<b>#186.0</b>
	NBR	A	0.48	9.4	42.2	B	0.67	10.1	48.7
	SBL	A	0.49	69.0	25.7	A	0.49	63.1	28.7
	SBT	B	0.70	43.3	<b>#162.7</b>	E	1.00	73.1	<b>#204.8</b>
SBR	A	0.26	3.5	8.8	A	0.24	3.4	7.5	
<b>Overall</b>	<b>E</b>	<b>0.91</b>	<b>46.6</b>	-	<b>D</b>	<b>0.83</b>	<b>48.1</b>	-	

Notes: Saturation flow rate of 1800 veh/h/lane  
Queue is measured in metres  
Peak Hour Factor = 1.00

Delay = average vehicle delay in seconds  
m = metered queue  
# = volume for the 95th %ile cycle exceeds capacity

During both the AM and PM peak hours, the study area intersections at the 2026 future background horizon operate similarly to the existing conditions. Some improved operations are noted on various movements throughout the study area with the peak hour factor of 1.00 for future conditions.

During the PM peak hour, the eastbound left movement at the intersection of St-Laurent Boulevard at Tremblay Road is forecast to be over theoretical capacity and may exhibit extended queues at this horizon. Shifting one second of split from the north-south phases to the east-west phases would reduce v/c of all movements at the intersection to 1.00 or lower.

### 11.2 2031 Future Background Operations

Figure 18 illustrates the 2031 background volumes and Table 17 summarizes the 2031 background intersection operations. The level of service for signalized intersections is based on v/c calculations for individual lane movements and HCM 2000 v/c calculations for the overall intersection, and average delay for unsignalized intersections. The synchro worksheets for the 2031 future background horizon are provided in Appendix K.

Figure 18: 2031 Future Background Volumes

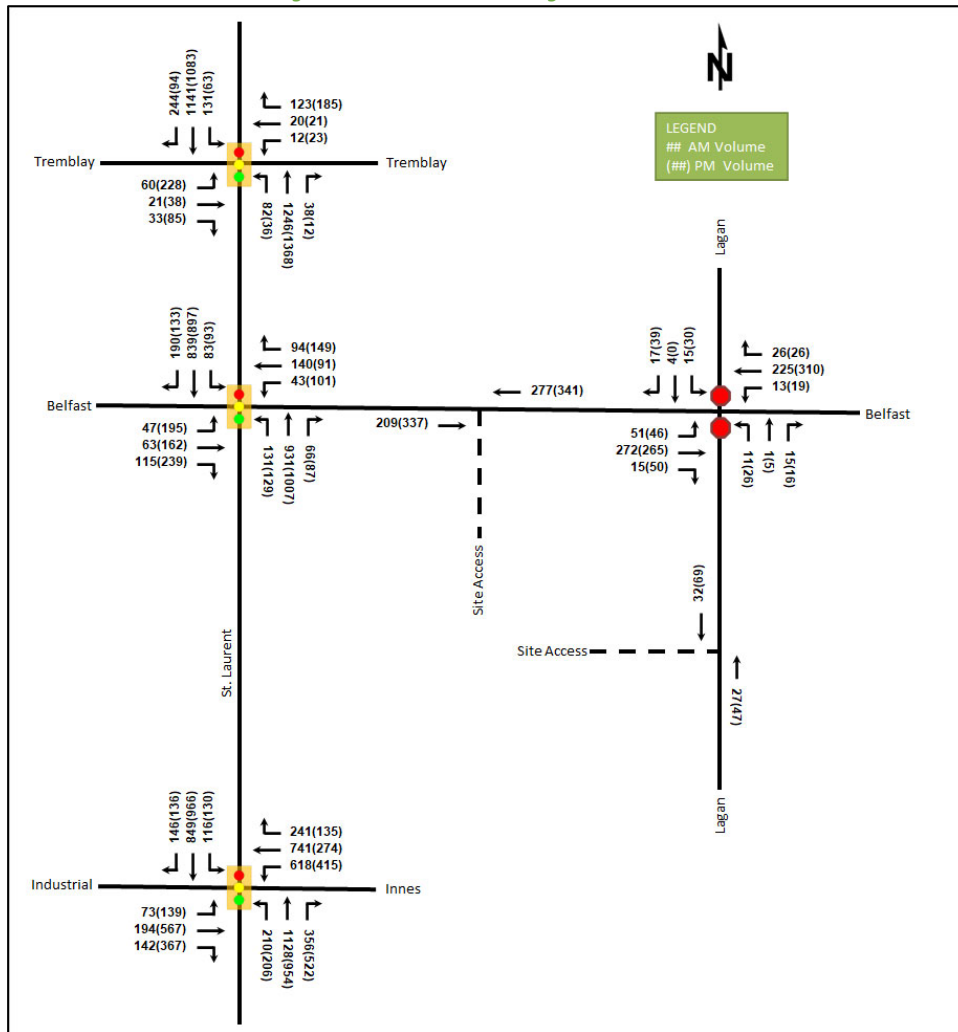


Table 17: 2031 Future Background Intersection Operations

Intersection	Lane	AM Peak Hour				PM Peak Hour			
		LOS	V/C	Delay	Q (95 <sup>th</sup> )	LOS	V/C	Delay	Q (95 <sup>th</sup> )
St-Laurent Blvd at Tremblay Rd <i>Signalized</i>	EBL	B	0.65	80.6	26.3	F	1.03	112.2	#106.4
	EBT/R	A	0.24	24.5	14.9	A	0.26	13.7	21.5
	WBL/T	A	0.08	45.7	7.7	A	0.07	32.7	10.6
	WBR	A	0.50	17.1	21.1	A	0.38	9.0	22.7
	NBL	A	0.28	14.9	25.1	A	0.16	19.5	m7.9
	NBT/R	A	0.44	11.9	91.2	A	0.54	18.1	m88.3
	SBL	A	0.41	8.4	18.7	A	0.28	11.8	10.8
	SBT	A	0.48	7.2	95.6	A	0.55	14.8	90.8
	SBR	A	0.24	1.4	8.6	A	0.11	2.2	6.2
<b>Overall</b>	<b>A</b>	<b>0.52</b>	<b>11.2</b>	-	<b>C</b>	<b>0.73</b>	<b>22.4</b>	-	
St-Laurent Blvd at Belfast Rd <i>Signalized</i>	EBL	A	0.23	30.4	15.9	E	0.95	86.6	#68.0
	EBT	A	0.13	29.0	19.9	A	0.35	34.7	44.1
	EBR	A	0.26	6.4	12.3	A	0.43	8.6	23.2
	WBL	A	0.22	42.7	18.7	A	0.59	58.9	37.5
	WBT/R	D	0.84	66.1	#75.9	C	0.79	53.0	63.9
	NBL	A	0.41	15.6	24.6	A	0.41	15.3	24.6
	NBT	A	0.55	23.8	114.3	B	0.61	24.9	125.4
	NBR	A	0.08	0.2	0.0	A	0.13	1.4	3.2
	SBL	A	0.30	14.5	16.7	A	0.38	17.1	20.8
	SBT	A	0.54	24.1	101.1	A	0.55	18.6	60.6
	SBR	A	0.27	4.1	13.3	A	0.17	2.9	7.0
	<b>Overall</b>	<b>A</b>	<b>0.60</b>	<b>24.7</b>	-	<b>C</b>	<b>0.73</b>	<b>27.1</b>	-
Lagan Way at Belfast Rd <i>Unsignalized</i>	EB	A	0.04	8.1	0.8	A	0.04	8.5	0.8
	WB	A	0.01	8.2	0.0	A	0.02	8.0	0.0
	NB	B	0.06	14.1	1.5	C	0.13	16.5	3.0
	SB	B	0.08	13.9	2.3	C	0.16	15.2	4.5
	<b>Overall</b>	<b>A</b>	-	<b>2.1</b>	-	<b>A</b>	-	<b>2.8</b>	-
St-Laurent Blvd at Industrial Ave / Innes Rd <i>Signalized</i>	EBL	A	0.39	68.5	18.1	A	0.52	64.4	30.7
	EBT	A	0.47	57.7	35.1	D	0.81	57.5	101.0
	EBR	A	0.41	6.0	8.2	B	0.67	15.4	48.2
	WBL	E	0.93	76.4	#120.0	C	0.75	59.1	73.3
	WBT	C	0.78	51.2	113.1	A	0.28	34.1	40.7
	WBR	A	0.42	6.2	17.8	A	0.25	6.3	14.2
	NBL	B	0.68	71.4	42.2	A	0.60	62.5	41.3
	NBT	E	0.92	53.0	#249.5	E	0.93	58.7	#193.0
	NBR	A	0.49	9.9	44.2	B	0.68	10.7	52.7
	SBL	A	0.49	69.0	25.7	A	0.49	63.3	28.6
	SBT	C	0.72	44.2	#170.6	F	1.02	78.0	#210.3
	SBR	A	0.26	3.6	9.0	A	0.25	3.8	9.1
<b>Overall</b>	<b>E</b>	<b>0.92</b>	<b>47.4</b>	-	<b>D</b>	<b>0.85</b>	<b>50.0</b>	-	

Notes: Saturation flow rate of 1800 veh/h/lane  
Queue is measured in metres  
Peak Hour Factor = 1.00

Delay = average vehicle delay in seconds  
m = metered queue  
# = volume for the 95th %ile cycle exceeds capacity

During both the AM and PM peak hours, the study area intersections at the 2031 operate similarly to the 2026 future background conditions.

As in the 2026 future background conditions, shifting one second of split from the north-south phases to the east-west phases at the intersection of St-Laurent Boulevard at Tremblay Road would reduce v/c of all movements at the intersection to 1.00 or lower during the PM peak hour at this horizon.

At the intersection of St-Laurent Boulevard at Industrial Avenue/Innes Road, during the PM peak hour, the southbound through movement is forecast to be over theoretical capacity at this horizon. Shifting one second of split from the northbound and southbound left-turn phases to the northbound and southbound through phases would reduce the v/c of all movements to 1.00 or lower at the intersection at this horizon.

### 11.3 2026 Future Total Operations

The 2026 future total intersection volumes are illustrated in Figure 19 and the intersection operations are summarized below in Table 18. The level of service for signalized intersections is based on v/c calculations for individual lane movements and HCM 2000 v/c calculations for the overall intersection. The synchro worksheets for the 2026 total horizon are provided in Appendix L.

Figure 19: 2026 Future Total Volumes

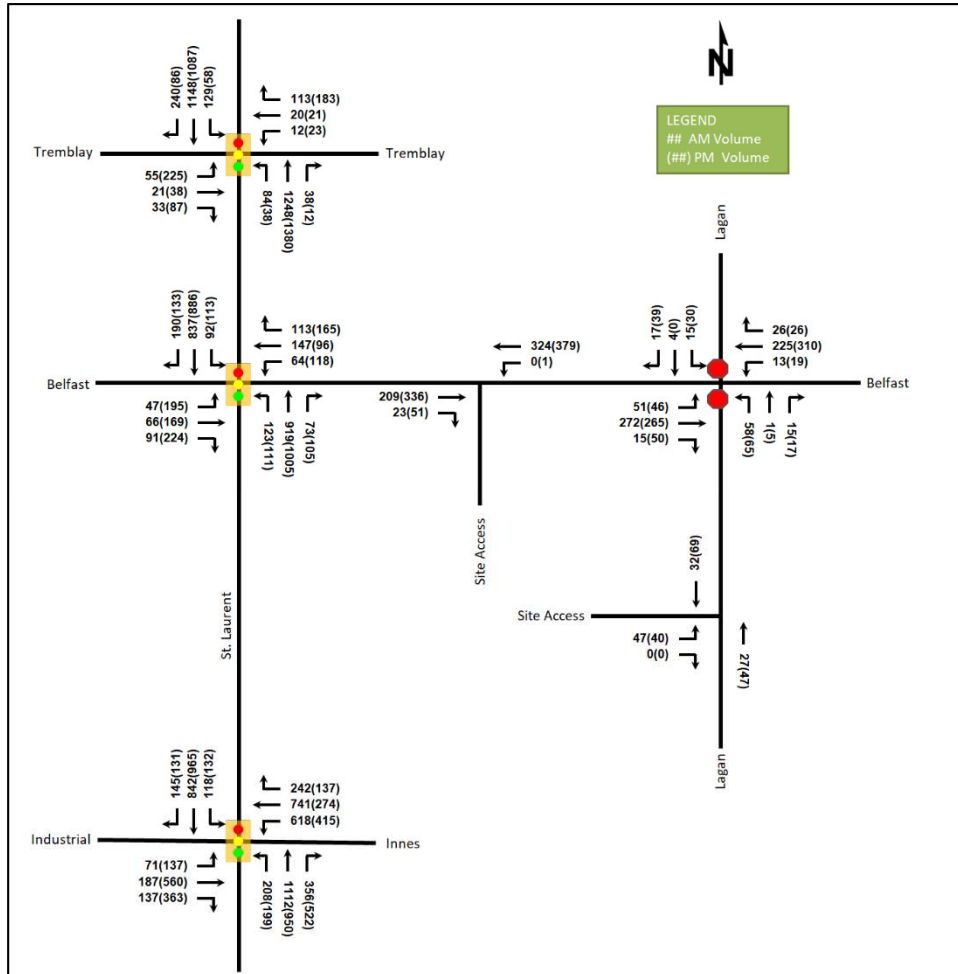


Table 18: 2026 Future Total Intersection Operations

Intersection	Lane	AM Peak Hour				PM Peak Hour			
		LOS	V/C	Delay	Q (95 <sup>th</sup> )	LOS	V/C	Delay	Q (95 <sup>th</sup> )
St-Laurent Blvd at Tremblay Rd <i>Signalized</i>	EBL	A	0.57	73.4	24.2	<b>F</b>	<b>1.01</b>	<b>106.5</b>	<b>#104.1</b>
	EBT/R	A	0.24	24.9	14.9	A	0.26	13.6	21.5
	WBL/T	A	0.09	46.2	7.7	A	0.07	32.7	10.6
	WBR	A	0.49	17.7	20.6	A	0.37	8.9	22.5
	NBL	A	0.29	14.9	26.0	A	0.17	20.0	m8.0
	NBT/R	A	0.44	11.6	91.2	A	0.55	18.7	m89.3
	SBL	A	0.41	8.2	18.3	A	0.26	11.6	10.0
	SBT	A	0.48	7.1	96.4	A	0.55	14.8	91.3
	SBR	A	0.23	1.4	8.6	A	0.10	2.2	6.0
<b>Overall</b>	<b>A</b>	<b>0.51</b>	<b>10.8</b>	-	<b>C</b>	<b>0.73</b>	<b>22.2</b>	-	
St-Laurent Blvd at Belfast Rd <i>Signalized</i>	EBL	A	0.24	30.0	15.9	E	0.96	<b>89.1</b>	<b>#70.5</b>
	EBT	A	0.13	28.5	20.5	A	0.36	34.0	45.9
	EBR	A	0.22	6.7	10.9	A	0.41	7.5	20.2
	WBL	A	0.33	45.3	25.8	B	0.68	64.8	43.6
	WBT/R	D	0.88	69.5	<b>#92.6</b>	D	0.82	55.3	70.4
	NBL	A	0.40	16.0	23.2	A	0.37	15.1	21.5
	NBT	A	0.58	25.6	112.4	B	0.63	26.3	125.1
	NBR	A	0.10	0.4	0.7	A	0.16	2.5	6.5
	SBL	A	0.34	15.7	18.1	A	0.46	23.4	29.0
	SBT	A	0.55	25.1	100.8	A	0.55	19.0	60.4
	SBR	A	0.28	4.2	13.4	A	0.18	2.9	7.1
<b>Overall</b>	<b>B</b>	<b>0.62</b>	<b>26.6</b>	-	<b>C</b>	<b>0.75</b>	<b>28.7</b>	-	
Lagan Way at Belfast Rd <i>Unsignalized</i>	EB	A	0.04	8.1	0.8	A	0.04	8.5	0.8
	WB	A	0.01	8.2	0.0	A	0.02	8.0	0.0
	NB	C	0.24	20.2	6.8	C	0.28	20.9	8.3
	SB	B	0.08	13.9	2.3	C	0.17	15.3	4.5
<b>Overall</b>	<b>A</b>	-	<b>3.5</b>	-	<b>A</b>	-	<b>3.9</b>	-	
St-Laurent Blvd at Industrial Ave / Innes Rd <i>Signalized</i>	EBL	A	0.38	68.5	17.7	A	0.51	64.0	30.3
	EBT	A	0.46	57.4	34.0	C	0.80	57.0	99.1
	EBR	A	0.40	5.5	7.1	B	0.66	15.0	46.4
	WBL	E	0.93	76.4	<b>#120.0</b>	C	0.75	58.8	73.0
	WBT	C	0.78	51.2	113.0	A	0.28	34.0	40.5
	WBR	A	0.42	6.2	18.0	A	0.26	6.3	14.4
	NBL	B	0.67	71.2	41.7	A	0.59	62.2	39.9
	NBT	D	0.90	51.6	<b>#245.3</b>	E	0.93	58.6	<b>#192.2</b>
	NBR	A	0.49	9.6	43.0	B	0.68	10.8	52.3
	SBL	A	0.50	69.0	26.1	A	0.50	63.0	28.8
	SBT	C	0.71	43.8	<b>#168.4</b>	<b>F</b>	<b>1.01</b>	<b>76.3</b>	<b>#209.1</b>
	SBR	A	0.26	3.5	8.8	A	0.24	3.4	7.5
<b>Overall</b>	<b>E</b>	<b>0.92</b>	<b>46.9</b>	-	<b>D</b>	<b>0.84</b>	<b>49.5</b>	-	
Lagan Way at Site Access <i>Unsignalized</i>	EBL/R	A	0.05	9.0	1.5	A	0.05	9.3	0.8
	NBL/T	-	-	-	-	-	-	-	-
	SBT/R	-	-	-	-	-	-	-	-
<b>Overall</b>	<b>A</b>	-	<b>4.0</b>	-	<b>A</b>	-	<b>2.4</b>	-	

Notes: Saturation flow rate of 1800 veh/h/lane  
Queue is measured in metres  
Peak Hour Factor = 1.00

Delay = average vehicle delay in seconds  
m = metered queue  
# = volume for the 95th %ile cycle exceeds capacity

During both the AM and PM peak hours, the study area intersections at the 2026 future total horizon operate similarly to the 2026 future background horizon.

As in the 2026 future background conditions, shifting one second of split from the north-south phases to the east-west phases at the intersection of St-Laurent Boulevard at Tremblay Road would reduce v/c of all movements at the intersection to 1.00 or lower during the PM peak hour at this horizon.

At the intersection of St-Laurent Boulevard at Industrial Avenue/Innes Road, the southbound through movement's v/c has increased by 0.01 to be over theoretical capacity with the addition of site-generated traffic, similar to the 2031 future background conditions. Shifting one second of split from the northbound and southbound left-turn phases to the northbound and southbound through phases would reduce the v/c of all movements to 1.00 or lower at the intersection at this horizon.

### 11.4 2031 Future Total Operations

Figure 20 illustrates the 2031 total volumes and Table 19 summarizes the 2031 total intersection operations. The level of service for signalized intersections is based on v/c calculations for individual lane movements and HCM 2000 v/c calculations for the overall intersection. The synchro worksheets for the 2031 future total horizon are provided in Appendix M.

Figure 20: 2031 Future Total Volumes

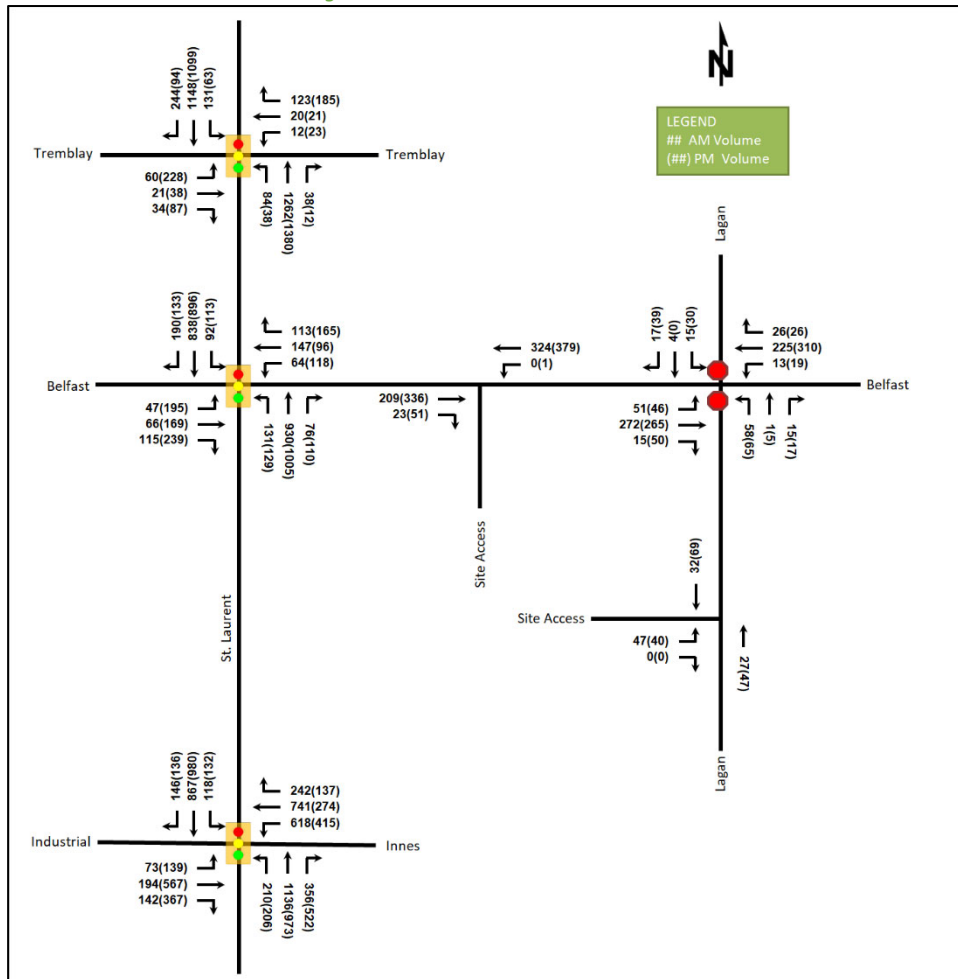


Table 19: 2031 Future Total Intersection Operations

Intersection	Lane	AM Peak Hour				PM Peak Hour			
		LOS	V/C	Delay	Q (95 <sup>th</sup> )	LOS	V/C	Delay	Q (95 <sup>th</sup> )
St-Laurent Blvd at Tremblay Rd <i>Signalized</i>	EBL	B	0.63	78.9	26.3	<b>F</b>	<b>1.03</b>	<b>112.2</b>	<b>#106.4</b>
	EBT/R	A	0.24	24.1	14.9	A	0.26	13.6	21.5
	WBL/T	A	0.08	45.5	7.7	A	0.07	32.7	10.6
	WBR	A	0.50	17.0	21.1	A	0.38	9.1	23.0
	NBL	A	0.29	15.3	26.0	A	0.18	20.2	m8.1
	NBT/R	A	0.45	12.0	92.8	A	0.55	18.7	m89.3
	SBL	A	0.42	8.7	18.7	A	0.28	11.9	10.8
	SBT	A	0.48	7.3	96.4	A	0.56	15.0	92.8
	SBR	A	0.24	1.4	8.6	A	0.11	2.2	6.2
<b>Overall</b>	<b>A</b>	<b>0.53</b>	<b>11.3</b>	-	<b>C</b>	<b>0.74</b>	<b>22.7</b>	-	
St-Laurent Blvd at Belfast Rd <i>Signalized</i>	EBL	A	0.24	30.0	15.9	E	0.96	<b>89.1</b>	<b>#70.5</b>
	EBT	A	0.13	28.5	20.5	A	0.36	34.0	45.9
	EBR	A	0.27	6.5	12.3	A	0.44	8.9	24.3
	WBL	A	0.33	45.2	25.8	B	0.68	64.8	43.6
	WBT/R	D	0.87	69.1	<b>#92.5</b>	D	0.82	55.3	70.4
	NBL	A	0.42	16.4	24.6	A	0.42	16.1	24.6
	NBT	A	0.59	25.6	114.3	B	0.63	26.3	125.1
	NBR	A	0.10	0.6	1.3	A	0.17	3.0	7.5
	SBL	A	0.35	15.8	18.1	A	0.47	23.3	28.9
	SBT	A	0.55	25.1	100.9	A	0.56	19.4	61.8
	SBR	A	0.28	4.2	13.4	A	0.18	3.1	7.5
	<b>Overall</b>	<b>B</b>	<b>0.63</b>	<b>26.4</b>	-	<b>C</b>	<b>0.75</b>	<b>28.7</b>	-
Lagan Way at Belfast Rd <i>Unsignalized</i>	EB	A	0.04	8.1	0.8	A	0.04	8.5	0.8
	WB	A	0.01	8.2	0.0	A	0.02	8.0	0.0
	NB	C	0.24	20.2	6.8	C	0.28	20.9	8.3
	SB	B	0.08	13.9	2.3	C	0.17	15.3	4.5
	<b>Overall</b>	<b>A</b>	-	<b>3.5</b>	-	<b>A</b>	-	<b>3.9</b>	-
St-Laurent Blvd at Industrial Ave / Innes Rd <i>Signalized</i>	EBL	A	0.39	68.5	18.1	A	0.52	64.4	30.7
	EBT	A	0.47	57.7	35.1	D	0.81	57.5	101.0
	EBR	A	0.41	6.0	8.2	B	0.67	15.4	48.2
	WBL	E	0.93	76.4	<b>#120.0</b>	C	0.75	59.1	73.3
	WBT	C	0.78	51.2	113.1	A	0.28	34.1	40.7
	WBR	A	0.42	6.2	18.0	A	0.26	6.3	14.4
	NBL	B	0.68	71.4	42.2	A	0.60	62.5	41.3
	NBT	E	0.92	54.1	<b>#252.6</b>	E	0.95	61.8	<b>#199.1</b>
	NBR	A	0.49	10.1	45.0	B	0.68	11.5	56.8
	SBL	A	0.50	69.0	26.1	A	0.50	63.4	28.8
	SBT	C	0.74	44.7	<b>#176.3</b>	<b>F</b>	<b>1.03</b>	<b>81.6</b>	<b>#214.6</b>
	SBR	A	0.26	3.6	9.0	A	0.25	3.8	9.1
<b>Overall</b>	<b>E</b>	<b>0.93</b>	<b>47.7</b>	-	<b>D</b>	<b>0.85</b>	<b>51.5</b>	-	
Lagan Way at Site Access <i>Unsignalized</i>	EBL/R	A	0.05	9.0	1.5	A	0.05	9.3	0.8
	NBL/T	-	-	-	-	-	-	-	-
	SBT/R	-	-	-	-	-	-	-	-
	<b>Overall</b>	<b>A</b>	-	<b>4.0</b>	-	<b>A</b>	-	<b>2.4</b>	-

Notes: Saturation flow rate of 1800 veh/h/lane  
Queue is measured in metres  
Peak Hour Factor = 1.00

Delay = average vehicle delay in seconds  
m = metered queue  
# = volume for the 95th %ile cycle exceeds capacity

During both the AM and PM peak hours, the study area intersections at the 2031 future total horizon operate similarly to the 2031 future background conditions.

Similarly to in the future background conditions, at the intersection of St-Laurent Boulevard at Tremblay Road, shifting one second of split from the north-south phases to the east-west phases would reduce v/c of all movements at the intersection to 1.00 or lower.

At the intersection of St-Laurent Boulevard at Industrial Avenue/Innes Road, during the PM peak hour the southbound through movement may be subject to high delays with an increase of 3.6 seconds from the background conditions. Shifting two seconds of split from the northbound and southbound left-turn phases to the northbound and southbound through phases would reduce the v/c of all movements at the intersection to 1.00 or lower at this horizon.

### 11.5 Modal Share Sensitivity and Demand Rationalization Conclusions

#### 11.5.1 Network Rationalization

No capacity issues were noted at the study area intersections that could not be mitigated through minor readjustments to signal timing phase splits. It is also noted that the future St Laurent Transit Priority improvements may increase transit adoption, reducing the network auto dependency. Therefore, no rationalization for background travel demand is required for this study.

#### 11.5.2 Development Rationalization

The mode shares used within the TIA represent the unmodified district mode shares for Alta Vista. The selected mode shares and resultant site trip generation was found to have minor impact on the network. As in the background conditions, no capacity issues were noted at the study area intersections that could not be mitigated through minor readjustments to signal timing phase splits. Therefore, no further rationalization for site traffic or modal share selection is required.

## 12 Transit

### 12.1 Route Capacity

In Section 5.1 the trip generation by mode was estimated, including an estimate of the number of transit trips that will be generated by the proposed development. Table 20 summarizes the transit trip generation.

Table 20: Trip Generation by Transit Mode

Travel Mode	Residential Mode Share AM(PM)	AM Peak Hour			PM Peak Hour		
		In	Out	Total	In	Out	Total
Transit	41% (28%)	24	54	79	31	23	54

The proposed development is anticipated to generate an additional 79 AM and 54 PM peak hour two-way transit trips. From the trip distribution found in section 5.3, these values can be further broken down, where trips east and west can be made through the connection to the LRT Confederation Line approximately a 1.5-kilometre bus trip north of the site. Table 21 summarizes forecasted site-generated transit ridership trips by direction and the equivalent bus loads.

Table 21: Forecasted Site-Generated Transit Ridership

Direction	AM Peak Hour		PM Peak Hour		Service Type	Approximate Equivalent Peak Hour/Direction Bus Loads
	In	Out	In	Out		
North	4	8	5	3	Bus	Negligible
South	8	19	11	8	Bus	One-third of a standard bus



Direction	AM Peak Hour		PM Peak Hour		Service Type	Approximate Equivalent Peak Hour/Direction Bus Loads
	In	Out	In	Out		
East	1	3	2	1	Bus, Bus/LRT	Negligible
West	11	24	14	10	Bus, Bus/LRT	Half of a standard bus

### 12.2 Transit Priority

Increases in outbound transit ridership during the AM peak hour is equivalent to a single standard bus load over the hour and is not anticipated to impact the current or future transit priority corridor on St-Laurent Boulevard. No changes to transit LOS on any study area intersection approaches are resultant from the addition of site vehicle traffic to the network. The site will accommodate the space anticipated for the future St-Laurent transit priority lanes and cross-sectional elements through the reserved right-of-way on the St-Laurent Boulevard frontage.

## 13 Intersection Design

### 13.1 Location and Design of Access

Access is proposed via a one-way drive aisle with an inbound access on Belfast Road and an outbound access on Lagan Way. The driveways are proposed to be 6.0 metres in width, meeting the fire route minimum width.

While the corner radius of the inbound access is 7.0 metres to support the vehicle turning movements, the effective throat length from the back of the sidewalk to the first parking stall is 8.0 metres, permitting storage of a single vehicle on the access. The effective throat length of the outbound access on Lagan Way between a move-in room and the back of the proposed sidewalk is approximately 31 metres. Given the local road designations of Belfast Road and Lagan Way along the site frontage, a minimum throat length of 8 metres is recommended for these locations which are effectively satisfied by the site plan.

The access on Belfast Road is approximately 39 metres from the St-Laurent Boulevard roadway approaching the Belfast Road intersection and the access on Lagan Way is approximately 52 metres from the Lagan Way at Belfast Road intersection. The TAC Geometric Design Guidelines’ suggested minimum corner clearance is 15 metres for the accesses on Belfast Road and Lagan Way which are proposed to be met by the site plan.

The Private Approach By-Law’s provision 25(1)(m) stipulates that private approaches for developments providing access to over 300 parking spaces be offset a minimum of 60 metres from the nearest intersecting street line. The proposed driveway on Belfast Road is located 33 metres from the existing and 29 metres from the future St-Laurent Boulevard right-of-way. While the access location meets the TAC requirements, the operation of the access has been proposed as a one-way inbound access to mitigate the Private Approach By-Law requirement. It is recommended that an exemption to the above-cited Private Approach By-Law provisions be granted.

The outbound access on Lagan Way is proposed to be located 1.5 metres from the adjacent property line, which is lower than the 3.0-metre minimum stipulated in provision 25(1)(p) of the Private Approach By-Law, but is recommended to be approved in accordance with provision 25(1)(r) given clear sightlines are present between the proposed access and that of the adjacent parcel, and demand will be towards Belfast Road given Lagan Way is no exit south of the site access.

### 13.2 Access Intersection Control

Based upon the projected volumes and functions, the access on Belfast Road, which is inbound only will be uncontrolled, and the access on Lagan Way, which is outbound only, will have stop-control on the minor site access approach.

### 13.3 Access Intersection Design

#### 13.3.1 Future Access Intersection Operations

The operations are noted in Section 7.4 and both 2026 and 2031 future total horizons, the access intersection at Lagan Way operates well with all movements and the overall intersection operating at LOS A. As the access intersection on Belfast Road is inbound only, no operational issues are anticipated.

#### 13.3.2 Access Intersection MMLOS

As the access intersections are unsignalized, MMLOS analysis is possible or required.

#### 13.3.3 Recommended Design Elements

The proposed site accesses on both Belfast Road and Lagan Way are recommended to be constructed in compliance with City standard SC7.1, including a continuous sidewalk through a depressed curb. One-way signage will be included at each access and at the ramp to the underground parking, to restrict the aisle to one-way. The signage plan for proposed signs visible from the public right-of-way is included in Appendix N.

## 14 Network Intersection Design

### 14.1 Network Intersection Control

No change to the existing signalized control is recommended for the network intersections.

### 14.2 Network Intersection Design

#### 14.2.1 Future Total Network Intersection Operations

The operations are noted in Section 11.3 and 11.4. No capacity issues were noted that could not be mitigated through signal timing optimization.

#### 14.2.2 Network Intersection MMLOS

Table 22 summarizes the MMLOS analysis for the network intersections. It is anticipated that in the ultimate conditions, the pedestrian and cycling facilities and transit lanes will be modified as part of the St-Laurent Boulevard Transit Priority Corridor project, and these modifications will be considered in the future conditions for the MMLOS analysis. Since the St-Laurent Boulevard Transit Priority Corridor project are anticipated to be completed beyond the study horizons, the future LOS and auto LOS are not available for the ultimate conditions.

The intersection analysis is based on the policy area of “Within 600m of a rapid transit station” for the intersection of St-Laurent Boulevard at Tremblay Road, and on the land use designation of “Arterial Mainstreet” for the intersections of St-Laurent Boulevard at Belfast Road and St-Laurent Boulevard at Industrial Avenue/Innes Road. The MMLOS worksheets has been provided in Appendix G.

Table 22: Study Area Intersection MMLOS Analysis

Intersection	Horizon	Pedestrian LOS		Bicycle LOS		Transit LOS		Truck LOS		Auto LOS	
		PLOS	Target	BLOS	Target	TLOS	Target	TrLOS	Target	ALOS	Target
St-Laurent Blvd at Tremblay Road	Ex.	F	A	F	B	F	D	C	D	C	E
	Fut.	F	A	A	B	-	D	C	D	-	E
St-Laurent Blvd at Belfast Rd	Ex.	F	C	F	C	F	B	C	D	C	D
	Fut.	F	C	A	A	-	B	C	D	-	D
St-Laurent Blvd at Industrial Ave/Innes Rd	Ex.	F	C	F	C	F	B	A	D	E	D
	Fut.	F	C	A	C	-	B	A	D	-	D

The study area intersections do not meet the pedestrian LOS targets. The crossing distances do not permit the PLOS targets to be met, which is a common result of the MMLOS methodology for arterial road intersections. To meet pedestrian LOS targets within this methodology, the maximum crossing distance on all pedestrian crossings would need to be reduced to two lane-widths at the intersection of St-Laurent Boulevard at Tremblay Road and three lane widths at the intersections of St-Laurent Boulevard at Belfast Road and St-Laurent Boulevard at Industrial Avenue/Innes Road. This is not recommended.

The study area intersections do not meet the bicycle LOS targets in the existing conditions. It is anticipated that once the St-Laurent Boulevard Transit Priority Corridor project is completed, all study area intersections will meet the bicycle LOS targets with separated facilities.

The study area intersections do not meet the transit LOS targets, and the delay would need to be reduced to below 30 seconds to achieve the MMLOS targets. Given the need to balance all modes, this is not expected to be achievable.

The intersection of St-Laurent Boulevard at Industrial Avenue/Innes Road does not meet the auto LOS targets during the AM peak hour. All movements operate at LOS E or better, therefore not improvements are recommended.

It is recommended that the City continue to assess the St Laurent Boulevard intersections as part of the Transit Corridor project to ensure the balancing operations for all modes is considered.

#### 14.2.3 Recommended Design Elements

No study area intersection design elements are proposed as part of this study.

## 15 Summary of Improvements Indicated and Modifications Options

The following summarizes the analysis and results presented in this TIA report:

### Proposed Site and Screening

- The proposed site plan consists of a 25-storey mixed-use building with 247 dwelling units fronting St-Laurent Boulevard, a 20-storey residential building comprising 188 dwelling units on the east side of the parcel and a total of 3,085 ft<sup>2</sup> of retail space
- Access is proposed via a one-way drive aisle with an inbound access on Belfast Road and an outbound access on Lagan Way
- The site proposes a total of 395 vehicle parking spaces, including 354 residential, 30 visitor, and 11 retail vehicle spaces

- A total of 407 internal bicycle parking spaces and 40 external bicycle parking spaces are proposed
- Construction will occur in a single phase with an anticipated full build-out and occupancy horizon of 2026
- The trip generation and safety triggers were met for the TIA Screening

#### **Existing Conditions**

- St-Laurent Boulevard, Industrial Avenue, and Innes Road are arterial roads, and Tremblay Road and Belfast Road are collector roads in the study area
- Sidewalks are provided along both sides of St-Laurent Boulevard, Belfast Road east of the 940 Belfast Road parcel, and of Smyth Road, on the south side of Tremblay Road, and on the north side of Industrial Avenue
- MUPs are provided on the south side of Industrial Avenue and Innes Road
- Cycletracks are provided on each side of St-Laurent Boulevard south of Innes Road
- St-Laurent Boulevard, Industrial Avenue, and Innes Road are spine routes, and Belfast Road and Tremblay Road east of St-Laurent Boulevard are local routes
- The intersection of Belfast Road at St-Laurent Boulevard is noted to have experienced a high incidence of collisions which may be influenced by the four right-turn channels at the intersection, by the interaction with the bus movements with intersection bus stops, and by congestion
- During both the AM and PM peak hours, capacity issues are noted on individual movements, but the network intersections typically operate adequately
- Signal timing adjustment would reduce v/c of all movements within the study area to 1.00 or below
- A transit priority EA study is presently ongoing for St-Laurent Boulevard north of Innes Road through the study area which is presently engaging in consultation and has no recommendations

#### **Development Generated Travel Demand**

- A total of 65 AM and 81 PM new peak hour two-way vehicle trips are projected as a result of the proposed development
- Unmodified recommended district mode shares have been applied to the development traffic including a 38% AM and 45% PM peak period auto mode share for the residential dwellings
- Of the forecasted trips, 15% are anticipated to travel north, 35% travel south, 5% travel east, and 45% travel west

#### **Development Design**

- Hard surface connections are provided between the building entrances and the surrounding sidewalks and internal pedestrian walkways and the public park on the northeast corner of the parcel
- Bicycle parking is located in secure rooms on the main floor and within the underground parking levels, and in surface racks interspersed around the site
- Garbage collection will occur on-site, and emergency services can circulate the site via the 6.0-metre-wide internal drive aisle with 12.0-metre centreline radius on the 90-degree bend in the aisle

#### **Parking**

- The site is to provide 395 vehicle parking spaces including 30 visitor and 11 retail vehicle spaces
- A total of 407 bicycle parking spaces are to be provided internal to the building across the parking levels and the main floor, and 40 spaces are to be provided in surface racks throughout the site

- The total parking does not meet the required minimums based on a mid-street delineation for the areas in Zoning By-Law Schedule 1A, but meets the requirements of a parcel fronting the opposite side of St-Laurent Boulevard, re-allocated to meet each land use requirement
- The proposed Zoning By-Law update is expected to include no minimum parking requirements, and the parking rate context discussion would no longer be relevant upon its adoption

### **Boundary Street Design**

- Belfast Road and the existing configuration of Lagan Way do not meet the pedestrian MMLOS targets
- PLOS targets will be met in the future on Lagan Way with the planned provision of a sidewalk
- The St-Laurent Boulevard PLOS is expected to be improved from C to A once the St-Laurent Boulevard Transit Priority Corridor project is completed
- The existing configuration of St-Laurent Boulevard and Belfast Road do not meet the bicycle LOS targets
- The St-Laurent Boulevard bicycle LOS are anticipated to become 'A' once the St-Laurent Boulevard Transit Priority Corridor project is completed
- Approximately 40 meters of cycletrack is anticipated to be provided along the boundary street of Belfast Road to the St-Laurent Boulevard at Belfast Road intersection as part of the St-Laurent Boulevard Transit Priority Corridor project
- No improvements are recommended on boundary streets beyond the sidewalks proposed as part of the site plan

### **TDM**

- Supportive TDM measures to be included within the proposed development should include:
  - Display local area maps with walking and cycling routes, and transit route information and schedules at major entrances
  - Inclusion of a 6-month Presto card for first time new condo purchase or apartment rental, with a set time frame for this offer (e.g. 6-months) from the initial opening of the site
  - Unbundle parking cost from purchase/rental costs

### **Background and Total Conditions**

- The background developments were explicitly included in the background conditions, along with a total background growth applied to Tremblay Road, Industrial Avenue, and St-Laurent Boulevard along the mainline volumes and major turning movements
- During both the AM and PM peak hours, the study area intersections at the future background conditions operate similarly to the existing conditions
- No capacity issues were noted at the study area intersections that could not be mitigated through minor readjustments to signal timing phase splits
- The St-Laurent Transit Priority improvements may increase transit adoption in the future, reducing the network auto dependency
- The study area intersections at the future total horizons are forecast to operate similarly to the background conditions
- No rationalization for background or development travel demand is required for this study

## Transit

- The proposed development is anticipated to generate an additional 79 AM and 54 PM peak hour two-way transit trips
- Peak hour increases in transit ridership resulting from the site equate to one-third of a standard bus load southerly of the site, half of a standard bus load westerly of the site, and negligible impact northerly and easterly
- Increases in outbound transit ridership during the AM peak hour is equivalent to a single standard bus load over the hour and is not anticipated to impact the existing or future transit priority corridor on St-Laurent Boulevard
- No changes to transit LOS on any study area intersection approaches are resultant from the addition of site vehicle traffic to the network
- The future transit priority corridor requirements will be accommodated on site through the reserved right-of-way on the frontage

## Intersection Design

- Access is proposed via a one-way drive aisle with an inbound access on Belfast Road and an outbound access on Lagan Way, each proposed to be 6.0 metres in width
- The effective throat length of the inbound access on Belfast Road is 8.0 metres, and the throat length of the outbound access on Lagan Way is approximately 31 metres which meet or exceed the recommended eight metres
- The access on Belfast Road is approximately 39 metres from the St-Laurent Boulevard at Belfast Road intersection and access on Lagan Way is approximately 52 metres from the Lagan Way at Belfast Road intersection which exceed the suggested 15-metre minimum corner clearance
- The proposed access on Belfast Road is located 33 metres from the existing and 29 metres from the future St-Laurent Boulevard right-of-way, which is less than the 60 metres stipulated in the Private Approach By-Law, and it is recommended that the TAC criteria govern the design
- The inbound access on Belfast Road will be uncontrolled, and the outbound access on Lagan Way will have stop-control on the minor site access approach
- The proposed site accesses on both Belfast Road and Lagan Way are recommended to be constructed in compliance with City standard SC7.1, including a continuous sidewalk through a depressed curb
- One-way signage will be included as appropriate along the drive aisle and site accesses

## Network Intersection Design

- The study area intersections will not meet the pedestrian LOS targets, subject to the constraints of the MMLOS methodology
- To meet pedestrian LOS targets, the maximum crossing distance on all pedestrian crossings would need to be reduced to two or three lanes for all area intersections and this is not considered feasible
- The study area intersections are expected to meet the bicycle LOS targets once the St-Laurent Boulevard Transit Priority Corridor project is completed
- The study area intersections do not meet the transit LOS targets, which would require the signal timing to be adjusted to prioritize all transit movements so that no delay above 30 seconds was imposed on transit vehicles
- The adjustments above are not considered feasible for the balancing of all modes at these intersections

- The intersection of St-Laurent Boulevard at Industrial Avenue/Innes Road does not meet the auto LOS targets during the AM peak hour, although all movements operate at an LOS E or better and do not require mitigation
- It is recommended that the City continue to assess the St Laurent Boulevard intersections as part of the Transit Corridor project to ensure the balancing operations for all modes is considered.

## 16 Conclusion

It is recommended that, from a transportation perspective, the proposed development applications proceed.

Prepared By:



John Kingsley  
Transportation Engineering Intern

Reviewed By:



Andrew Harte, P.Eng.  
Senior Transportation Engineer

# Appendix A

TIA Screening Form and PM Certification Form



City of Ottawa 2017 TIA Guidelines  
Step 1 - Screening Form

Date: 09-May-23  
Project Number: 2023-053  
Project Reference: 1531 St-Laurent

1.1 Description of Proposed Development	
Municipal Address	1531 St-Laurent Blvd
Description of Location	Southeast corner of the intersection of St-Laurent Blvd at Belfast Rd
Land Use Classification	Arterial Mainstreet (AM, AM[263])
Development Size	409 dwelling units, plus ground floor retail
Accesses	One inbound on Belfast Rd, one outbound on Lagan Wy
Phase of Development	Single
Buildout Year	2026
TIA Requirement	Full TIA Required

1.2 Trip Generation Trigger	
Land Use Type	Townhomes or apartments
Development Size	409 Units
Trip Generation Trigger	Yes

1.3 Location Triggers	
Does the development propose a new driveway to a boundary street that is designated as part of the City's Transit Priority, Rapid Transit or Spine Bicycle Networks?	No
Is the development in a Design Priority Area (DPA) or Transit-oriented Development (TOD) zone?	No
Location Trigger	No

1.4. Safety Triggers		
Are posted speed limits on a boundary street 80 km/hr or greater?	No	
Are there any horizontal/vertical curvatures on a boundary street limits sight lines at a proposed driveway?	No	
Is the proposed driveway within the area of influence of an adjacent traffic signal or roundabout (i.e. within 300 m of intersection in rural conditions, or within 150 m of intersection in urban/ suburban conditions)?	Yes	
Is the proposed driveway within auxiliary lanes of an intersection?	Yes	
Does the proposed driveway make use of an existing median break that serves an existing site?	No	
Is there is a documented history of traffic operations or safety concerns on the boundary streets within 500 m of the development?	Yes	High collisions at St-Laurent Blvd at Belfast Rd
Does the development include a drive-thru facility?	No	
Safety Trigger	Yes	



## **TIA Plan Reports**

On 14 June 2017, the Council of the City of Ottawa adopted new Transportation Impact Assessment (TIA) Guidelines. In adopting the guidelines, Council established a requirement for those preparing and delivering transportation impact assessments and reports to sign a letter of certification.

Individuals submitting TIA reports will be responsible for all aspects of development-related transportation assessment and reporting, and undertaking such work, in accordance and compliance with the City of Ottawa's Official Plan, the Transportation Master Plan and the Transportation Impact Assessment (2017) Guidelines.

By submitting the attached TIA report (and any associated documents) and signing this document, the individual acknowledges that s/he meets the four criteria listed below.

### **CERTIFICATION**

1. I have reviewed and have a sound understanding of the objectives, needs and requirements of the City of Ottawa's Official Plan, Transportation Master Plan and the Transportation Impact Assessment (2017) Guidelines;
2. I have a sound knowledge of industry standard practice with respect to the preparation of transportation impact assessment reports, including multi modal level of service review;
3. I have substantial experience (more than 5 years) in undertaking and delivering transportation impact studies (analysis, reporting and geometric design) with strong background knowledge in transportation planning, engineering or traffic operations; and
4. I am either a licensed<sup>1</sup> or registered<sup>2</sup> professional in good standing, whose field of expertise [check  appropriate field(s)] is either transportation engineering  or transportation planning .

**1,2 License of registration body that oversees the profession is required to have a code of conduct and ethics guidelines that will ensure appropriate conduct and representation for transportation planning and/or transportation engineering works.**


City Of Ottawa  
Infrastructure Services and Community  
Sustainability  
Planning and Growth Management  
110 Laurier Avenue West, 4th fl.  
Ottawa, ON K1P 1J1  
Tel. : 613-580-2424  
Fax: 613-560-6006

Ville d'Ottawa  
Services d'infrastructure et Viabilité des  
collectivités  
Urbanisme et Gestion de la croissance  
110, avenue Laurier Ouest  
Ottawa (Ontario) K1P 1J1  
Tél. : 613-580-2424  
Télécopieur: 613-560-6006

Dated at Ottawa this 20 day of September, 2018.  
(City)

Name: Andrew Harte  
(Please Print)

Professional Title: Professional Engineer

  
\_\_\_\_\_  
Signature of Individual certifier that s/he meets the above four criteria

<b>Office Contact Information (Please Print)</b>
Address: 6 Plaza Court
City / Postal Code: Ottawa / K2H 7W1
Telephone / Extension: (613) 697-3797
E-Mail Address: Andrew.Harte@CGHTransportation.com



# Appendix B

Turning Movement Counts



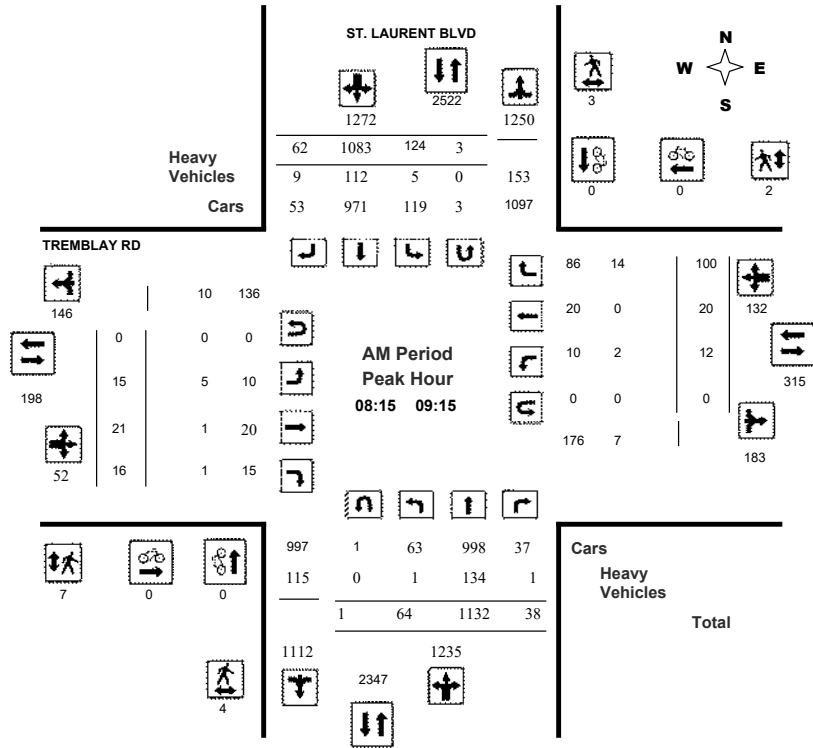
# Transportation Services - Traffic Services

## Turning Movement Count - Peak Hour Diagram

### ST. LAURENT BLVD @ TREMBLAY RD

Survey Date: Wednesday, January 30, 2019  
Start Time: 07:00

WO No: 38338  
Device: Miovision



Comments



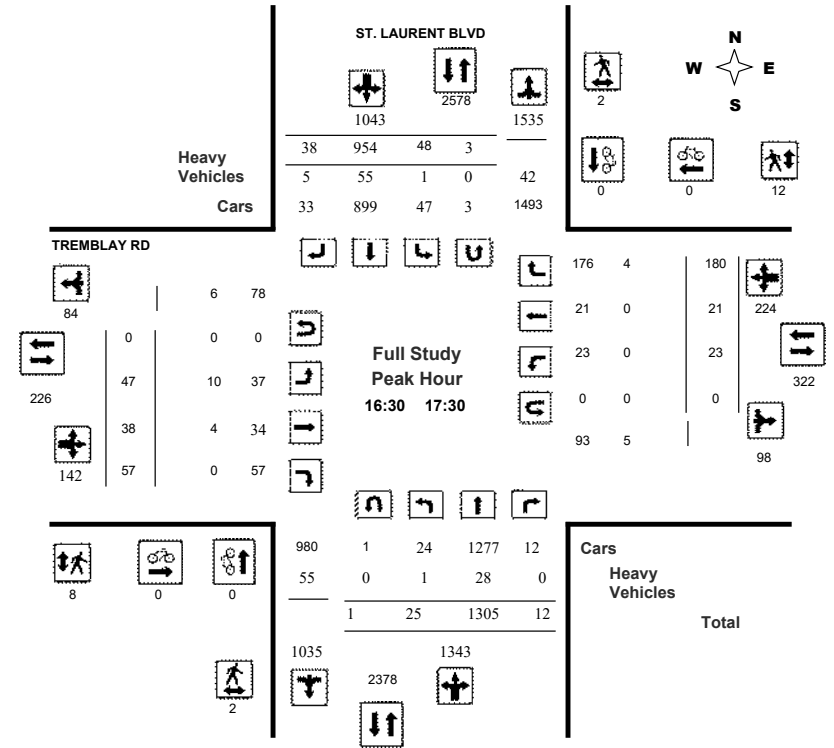
# Transportation Services - Traffic Services

## Turning Movement Count - Peak Hour Diagram

### ST. LAURENT BLVD @ TREMBLAY RD

Survey Date: Wednesday, January 30, 2019  
Start Time: 07:00

WO No: 38338  
Device: Miovision



Comments



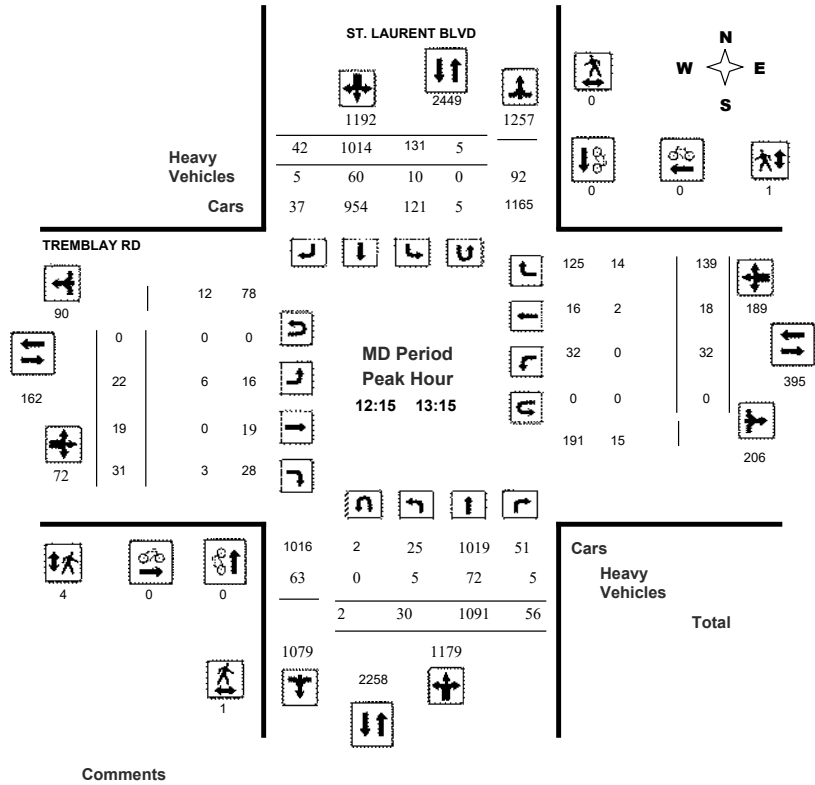
### Transportation Services - Traffic Services

#### Turning Movement Count - Peak Hour Diagram

#### ST. LAURENT BLVD @ TREMBLAY RD

Survey Date: Wednesday, January 30, 2019  
Start Time: 07:00

WO No: 38338  
Device: Miovision



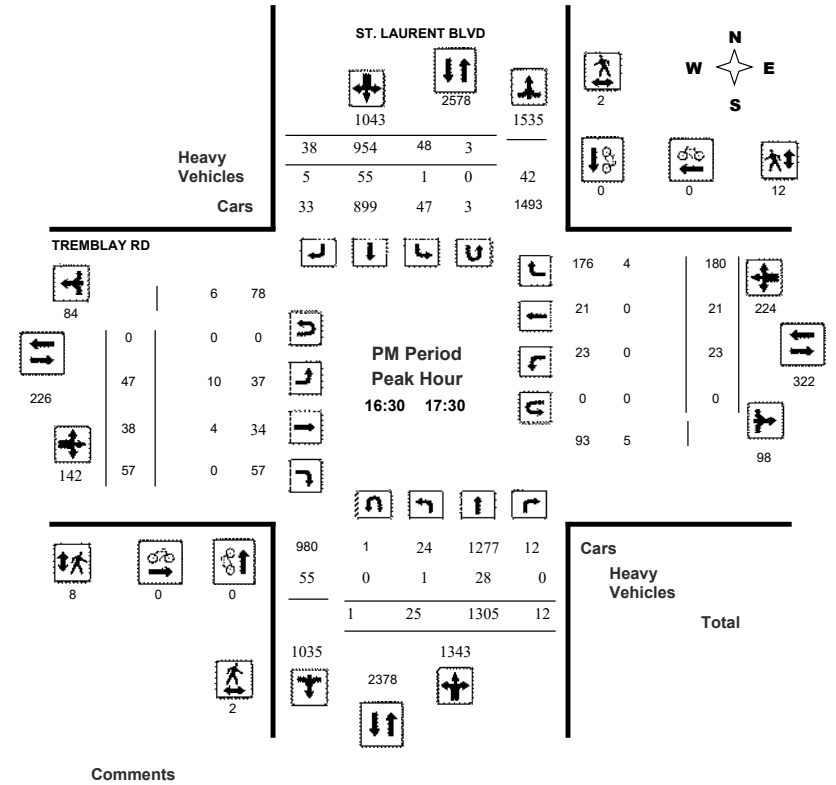
### Transportation Services - Traffic Services

#### Turning Movement Count - Peak Hour Diagram

#### ST. LAURENT BLVD @ TREMBLAY RD

Survey Date: Wednesday, January 30, 2019  
Start Time: 07:00

WO No: 38338  
Device: Miovision



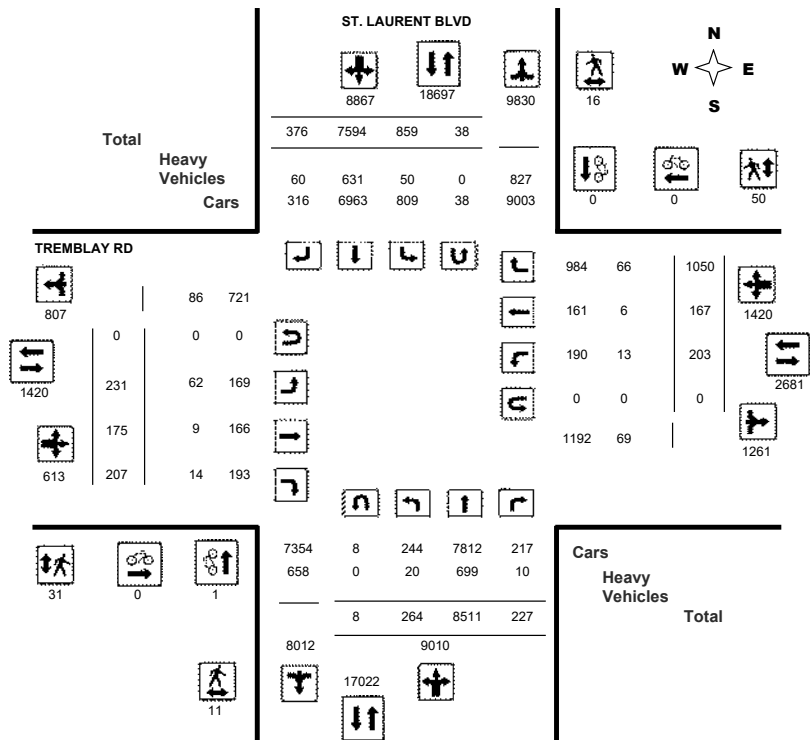


**Transportation Services - Traffic Services**  
Turning Movement Count - Full Study Diagram

**ST. LAURENT BLVD @ TREMBLAY RD**

Survey Date: Wednesday, January 30, 2019

WO#: 38338  
Device: Miovision



Comments



**Transportation Services - Traffic Services**

Work Order  
38338

**Turning Movement Count - Full Study Summary Report**

**ST. LAURENT BLVD @ TREMBLAY RD**

Survey Date: Wednesday, January 30, 201

Total Observed U-Turns  
Northbound: 8 Southbound: 38  
Eastbound: 0 Westbound: 0

AADT Factor  
1.00

**Full Study**

Period	ST. LAURENT BLVD Northbound				ST. LAURENT BLVD Southbound				TREMBLAY RD Eastbound				TREMBLAY RD Westbound				WB TOT	STR TOT	Grand Total
	LT	ST	RT	NB TOT	LT	ST	RT	SB TOT	STR TOT	LT	ST	RT	EB TOT	LT	ST	RT			
07:00 08:00	34	827	29	890	168	978	58	1204	2094	21	25	15	61	13	19	68	100	161	2255
08:00 09:00	62	1157	40	1259	108	1055	67	1230	2489	14	20	21	55	16	17	101	134	189	2678
09:00 10:00	29	885	23	937	133	1038	46	1217	2154	23	23	17	63	12	21	76	109	172	2326
11:30 12:30	32	1008	37	1077	113	1004	48	1165	2242	29	10	28	67	41	24	144	209	276	2518
12:30 13:30	28	1058	48	1134	133	975	38	1146	2280	24	20	30	74	30	19	140	189	263	2543
15:00 16:00	31	1182	19	1232	100	787	34	921	2153	34	21	23	78	34	24	186	244	322	2475
16:00 17:00	34	1192	23	1249	68	807	41	916	2165	42	31	29	102	36	23	193	252	354	2519
17:00 18:00	14	1202	8	1224	36	950	44	1030	2254	44	25	44	113	21	20	142	183	296	2550
<b>Sub Total</b>	264	8511	227	9002	859	7594	376	8829	17831	231	175	207	613	203	167	1050	1420	2033	19864
<b>U Turns</b>				8				38	46				0				0	0	46
<b>Total</b>	264	8511	227	9010	859	7594	376	8867	17877	231	175	207	613	203	167	1050	1420	2033	19910
<b>EQ 12Hr</b>	367	11830	316	12524	1194	10556	523	12325	24849	321	243	288	852	282	232	1460	1974	2826	27675
Note: These values are calculated by multiplying the totals by the appropriate expansion factor.																<b>1.39</b>			
<b>AVG 12Hr</b>	367	11830	316	12524	1194	10556	523	12325	24849	321	243	288	852	282	232	1460	1974	2826	27675
Note: These volumes are calculated by multiplying the Equivalent 12 hr. totals by the AADT factor.																<b>1.00</b>			
<b>AVG 24Hr</b>	481	15498	413	16406	1564	13828	685	16146	32552	421	319	377	1116	370	304	1912	2586	3702	36254
Note: These volumes are calculated by multiplying the Average Daily 12 hr. totals by 12 to 24 expansion factor.																<b>1.31</b>			

Comments:

Note: U-Turns provided for approach totals. Refer to 'U-Turn' Report for specific breakdown.



**Transportation Services - Traffic Services** W.O. 38338  
**Turning Movement Count - 15 Minute Summary Report**

**ST. LAURENT BLVD @ TREMBLAY RD**

Survey Date: Wednesday, January 30, 2019

Total Observed U-Turns

Northbound: 8 Southbound: 38  
 Eastbound: 0 Westbound: 0

		ST. LAURENT BLVD						TREMBLAY RD												
		Northbound			Southbound			Eastbound			Westbound									
Time Period		LT	ST	RT	N TOT	LT	ST	RT	S TOT	STR TOT	LT	ST	RT	E TOT	LT	ST	RT	W TOT	STR TOT	Grand Total
07:00	07:15	3	159	9	171	42	228	12	283	454	5	6	5	16	5	2	14	21	37	491
07:15	07:30	10	189	6	205	42	234	14	290	495	2	7	3	12	1	1	13	15	27	522
07:30	07:45	9	228	9	246	45	241	14	300	546	6	5	4	15	5	10	23	38	53	599
07:45	08:00	12	251	5	268	39	275	18	334	602	8	7	3	18	2	6	18	26	44	646
08:00	08:15	14	277	11	302	22	235	18	275	577	4	5	8	17	7	5	20	32	49	626
08:15	08:30	13	294	10	317	26	279	14	319	636	2	6	5	13	5	1	23	29	42	678
08:30	08:45	17	283	12	313	29	270	23	322	635	3	4	2	9	3	6	26	35	44	679
08:45	09:00	18	303	7	328	31	271	12	316	644	5	5	6	16	1	5	32	38	54	698
09:00	09:15	16	252	9	277	38	263	13	315	592	5	6	3	14	3	8	19	30	44	636
09:15	09:30	4	212	4	221	24	271	18	313	534	3	9	3	15	3	3	17	23	38	572
09:30	09:45	5	222	5	232	32	252	8	295	527	7	5	5	17	5	3	18	26	43	570
09:45	10:00	4	199	5	208	39	252	7	300	508	8	3	6	17	1	7	22	30	47	555
11:30	11:45	5	237	7	250	21	248	7	277	527	11	4	4	19	7	5	30	42	61	588
11:45	12:00	8	258	8	274	34	250	15	302	576	7	2	6	15	7	7	43	57	72	648
12:00	12:15	9	241	8	258	33	223	10	267	525	8	4	11	23	19	7	39	65	88	613
12:15	12:30	10	272	14	297	25	283	16	325	622	3	0	7	10	8	5	32	45	55	677
12:30	12:45	6	277	16	300	36	237	12	285	585	4	4	7	15	9	4	37	50	65	650
12:45	13:00	6	257	12	275	39	263	7	312	587	9	8	10	27	6	6	32	44	71	658
13:00	13:15	8	285	14	307	31	231	7	270	577	6	7	7	20	9	3	38	50	70	647
13:15	13:30	8	239	6	253	27	244	12	285	538	5	1	6	12	6	6	33	45	57	595
15:00	15:15	9	295	2	307	31	219	14	266	573	7	4	5	16	11	8	59	78	94	667
15:15	15:30	5	316	6	327	22	226	4	253	580	8	4	4	16	7	5	40	52	68	648
15:30	15:45	9	307	6	322	19	190	9	218	540	10	6	11	27	7	5	47	59	86	626
15:45	16:00	8	264	5	277	28	152	7	189	466	9	7	3	19	9	6	40	55	74	540
16:00	16:15	6	270	8	284	14	168	13	195	479	10	10	1	21	13	8	68	89	110	589
16:15	16:30	10	284	6	300	23	150	13	188	488	8	5	4	17	10	5	35	50	67	555
16:30	16:45	9	299	3	311	9	232	9	250	561	16	9	17	42	9	5	66	80	122	683
16:45	17:00	9	339	6	354	22	257	6	286	640	8	7	7	22	4	5	24	33	55	695
17:00	17:15	3	318	1	322	10	237	13	261	583	13	11	16	40	8	5	54	67	107	690
17:15	17:30	4	349	2	356	7	228	10	246	602	10	11	17	38	2	6	36	44	82	684
17:30	17:45	4	282	3	289	9	212	11	235	524	9	1	7	17	6	5	25	36	53	577
17:45	18:00	3	253	2	259	10	273	10	295	554	12	2	4	18	5	4	27	36	54	608
<b>TOTAL:</b>		264	8511	227	9010	859	7594	376	8867	17877	231	175	207	613	203	167	1050	1420	2033	19910

Note: U-Turns are included in Totals.

Comment:



**Transportation Services - Traffic Services**  
**Turning Movement Count - Cyclist Volume Report**

Work Order  
38338

**ST. LAURENT BLVD @ TREMBLAY RD**

Count Date: Wednesday, January 30, 2019

Start Time: 07:00

		ST. LAURENT BLVD			TREMBLAY RD				
		Northbound	Southbound	Street Total	Eastbound	Westbound	Street Total	Grand Total	
07:00	08:00	0	0	0	0	0	0	0	
08:00	09:00	0	0	0	0	0	0	0	
09:00	10:00	1	0	1	0	0	0	1	
11:30	12:30	0	0	0	0	0	0	0	
12:30	13:30	0	0	0	0	0	0	0	
15:00	16:00	0	0	0	0	0	0	0	
16:00	17:00	0	0	0	0	0	0	0	
17:00	18:00	0	0	0	0	0	0	0	
<b>Total</b>	.....	1	0	1	0	0	0	1	

Comment:

Note: These volumes consists of bicycles only (no mopeds or motorcycles) and ARE NOT included in the Turning Movement Count Summary.





# Transportation Services - Traffic Services

W.O.  
38338

## Turning Movement Count - Heavy Vehicle Report

### ST. LAURENT BLVD @ TREMBLAY RD

Survey Date: Wednesday, January 30, 2019

ST. LAURENT BLVD										TREMBLAY RD										Grand Total
Northbound					Southbound					Eastbound					Westbound					
Time Period	LT	ST	RT	N TOT	LT	ST	RT	S TOT	STR TOT	LT	ST	RT	E TOT	LT	ST	RT	W TOT	STR TOT		
07:00 08:00	2	134	1	137	10	52	10	72	209	9	1	0	10	4	0	9	13	23	232	
08:00 09:00	2	124	1	127	3	80	11	94	221	4	1	1	6	4	0	15	19	25	246	
09:00 10:00	3	116	1	120	6	183	5	194	314	9	1	1	11	0	2	8	10	21	335	
11:30 12:30	2	66	1	69	8	68	8	84	153	8	0	5	13	1	0	11	12	25	178	
12:30 13:30	5	80	5	90	7	62	7	76	166	6	0	3	9	0	2	11	13	22	188	
15:00 16:00	4	112	0	116	10	74	5	89	205	7	1	3	11	3	2	6	11	22	227	
16:00 17:00	2	40	1	43	3	65	10	78	121	10	1	1	12	0	0	2	2	14	135	
17:00 18:00	0	27	0	27	3	47	4	54	81	9	4	0	13	1	0	4	5	18	99	
<b>Sub Total</b>	<b>20</b>	<b>699</b>	<b>10</b>	<b>729</b>	<b>50</b>	<b>631</b>	<b>60</b>	<b>741</b>	<b>1470</b>	<b>62</b>	<b>9</b>	<b>14</b>	<b>85</b>	<b>13</b>	<b>6</b>	<b>66</b>	<b>85</b>	<b>170</b>	<b>1640</b>	
<b>U-Turns (Heavy Vehicles)</b>	<b>0</b>	<b>0</b>	<b>0</b>	<b>0</b>	<b>0</b>	<b>0</b>	<b>0</b>	<b>0</b>	<b>0</b>	<b>0</b>	<b>0</b>	<b>0</b>	<b>0</b>	<b>0</b>	<b>0</b>	<b>0</b>	<b>0</b>	<b>0</b>	<b>0</b>	
<b>Total</b>	<b>20</b>	<b>699</b>	<b>10</b>	<b>741</b>	<b>50</b>	<b>631</b>	<b>60</b>	<b>741</b>	<b>1470</b>	<b>62</b>	<b>9</b>	<b>14</b>	<b>85</b>	<b>13</b>	<b>6</b>	<b>66</b>	<b>85</b>	<b>170</b>	<b>1640</b>	

Heavy Vehicles include Buses, Single-Unit Trucks and Articulated Trucks. Further, they ARE included in the Turning Movement Count Summary.



# Transportation Services - Traffic Services

Work Order  
38338

## Turning Movement Count - Pedestrian Volume Report

### ST. LAURENT BLVD @ TREMBLAY RD

Count Date: Wednesday, January 30, 2019

Start Time: 07:00

Time Period	NB Approach (E or W Crossing)	SB Approach (E or W Crossing)	Total	EB Approach (N or S Crossing)	WB Approach (N or S Crossing)	Total	Grand Total
07:00 07:15	0	1	1	0	6	6	7
07:15 07:30	0	0	0	0	1	1	1
07:30 07:45	1	0	1	2	4	6	7
07:45 08:00	1	0	1	1	1	2	3
07:00 08:00	2	1	3	3	12	15	18
08:00 08:15	0	0	0	0	0	0	0
08:15 08:30	1	0	1	0	0	0	1
08:30 08:45	0	0	0	1	0	1	1
08:45 09:00	3	1	4	3	1	4	8
08:00 09:00	4	1	5	4	1	5	10
09:00 09:15	0	2	2	3	1	4	6
09:15 09:30	0	0	0	1	4	5	5
09:30 09:45	0	0	0	0	0	0	0
09:45 10:00	0	0	0	1	2	3	3
09:00 10:00	0	2	2	5	7	12	14
11:30 11:45	0	0	0	0	1	1	1
11:45 12:00	0	1	1	0	1	1	2
12:00 12:15	0	0	0	0	0	0	0
12:15 12:30	0	0	0	0	0	0	0
11:30 12:30	0	1	1	0	2	2	3
12:30 12:45	0	0	0	1	0	1	1
12:45 13:00	1	0	1	1	1	2	3
13:00 13:15	0	0	0	2	0	2	2
13:15 13:30	0	1	1	0	1	1	2
12:30 13:30	1	1	2	4	2	6	8
15:00 15:15	0	0	0	1	2	3	3
15:15 15:30	1	4	5	2	2	4	9
15:30 15:45	0	1	1	0	3	3	4
15:45 16:00	0	1	1	1	0	1	2
15:00 16:00	1	6	7	4	7	11	18
16:00 16:15	0	1	1	0	3	3	4
16:15 16:30	1	0	1	1	2	3	4
16:30 16:45	2	0	2	3	5	8	10
16:45 17:00	0	1	1	2	4	6	7
16:00 17:00	3	2	5	6	14	20	25
17:00 17:15	0	0	0	1	1	2	2
17:15 17:30	0	1	1	2	2	4	5
17:30 17:45	0	1	1	2	1	3	4
17:45 18:00	0	0	0	0	1	1	1
17:00 18:00	0	2	2	5	5	10	12
Total .....	11	16	27	31	50	81	108

Comment:





# Transportation Services - Traffic Services

## Turning Movement Count - Study Results

### BELFAST RD @ ST. LAURENT BLVD

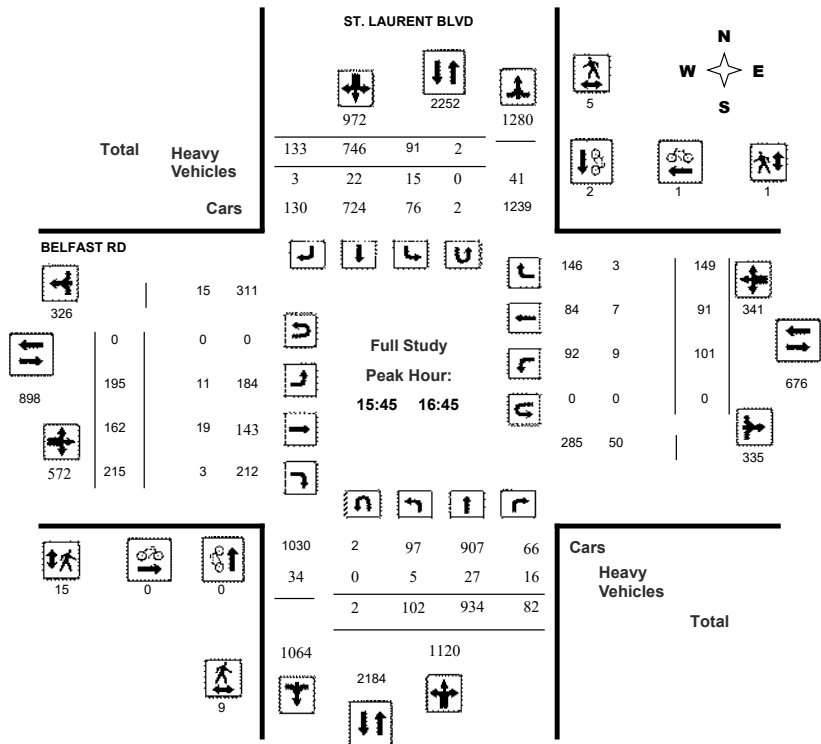
Survey Date: Tuesday, February 06, 2018

WO No: 37494

Start Time: 07:00

Device: Miovision

### Full Study Peak Hour Diagram



# Transportation Services - Traffic Services

## Turning Movement Count - Peak Hour Diagram

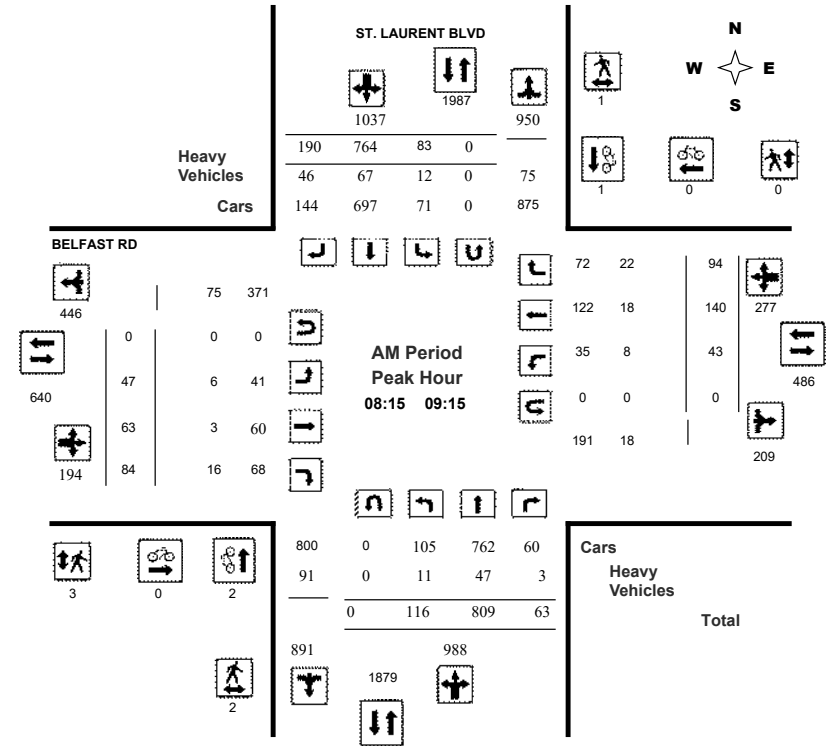
### BELFAST RD @ ST. LAURENT BLVD

Survey Date: Tuesday, February 06, 2018

WO No: 37494

Start Time: 07:00

Device: Miovision



Comments



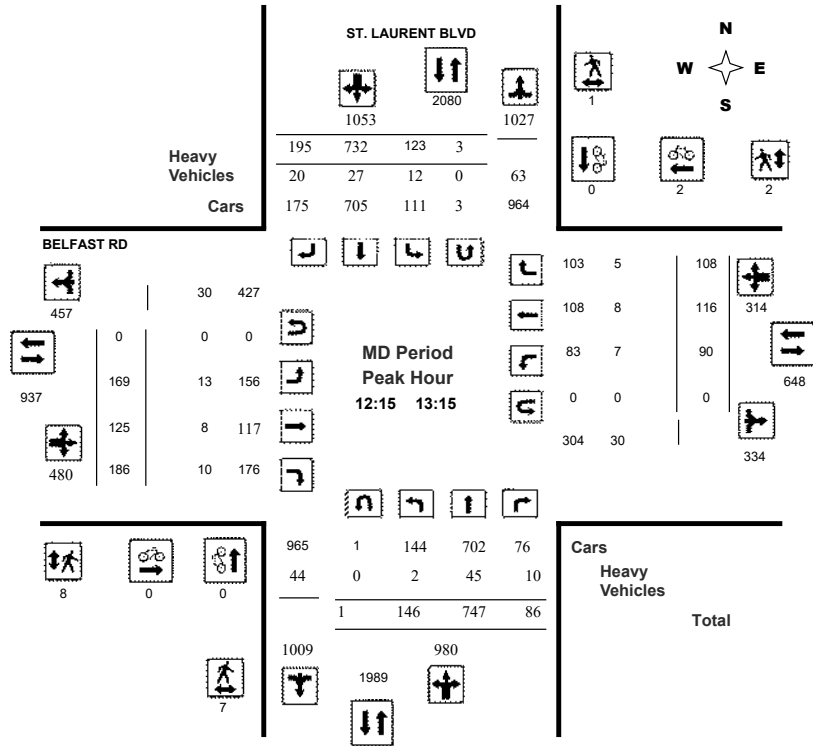
# Transportation Services - Traffic Services

## Turning Movement Count - Peak Hour Diagram

### BELFAST RD @ ST. LAURENT BLVD

Survey Date: Tuesday, February 06, 2018  
Start Time: 07:00

WO No: 37494  
Device: Miovision



Comments



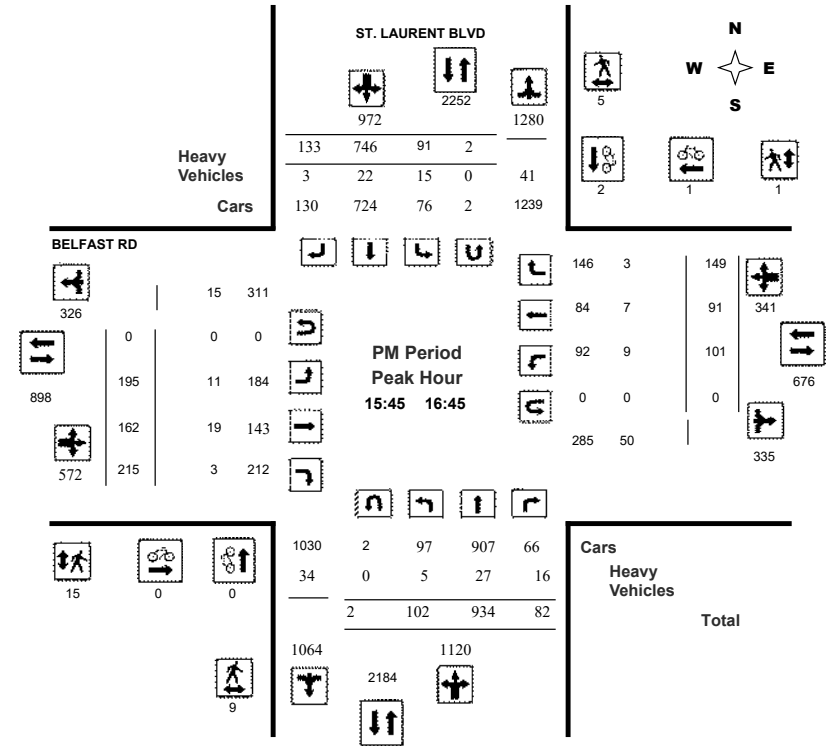
# Transportation Services - Traffic Services

## Turning Movement Count - Peak Hour Diagram

### BELFAST RD @ ST. LAURENT BLVD

Survey Date: Tuesday, February 06, 2018  
Start Time: 07:00

WO No: 37494  
Device: Miovision



Comments



Transportation Services - Traffic Services

Turning Movement Count - Study Results

BELFAST RD @ ST. LAURENT BLVD

Survey Date: Tuesday, February 06, 2018

WO No: 37494

Start Time: 07:00

Device: Miovision

Full Study Summary (8 HR Standard)

Survey Date: Tuesday, February 06, 2018

Total Observed U-Turns AADT Factor
Northbound: 12 Southbound: 15 Eastbound: 0 Westbound: 0 1.00

Table with columns for ST. LAURENT BLVD (Northbound, Southbound) and BELFAST RD (Eastbound, Westbound). Rows show traffic counts for various time periods from 07:00 to 17:00, including sub-totals and grand totals.

Note: These values are calculated by multiplying the totals by the appropriate expansion factor.

EQ 12Hr 1297 8515 805 10617 1144 8041 1872 11057 21674 1510 1295 1679 4484 749 1204 1179 3132 7616 29290

Note: These volumes are calculated by multiplying the Equivalent 12 hr. totals by the AADT factor.

AVG 12Hr 1297 8515 805 10617 1144 8041 1872 11057 21674 1510 1295 1679 4484 749 1204 1179 3132 7616 29290

Note: These volumes are calculated by multiplying the Average Daily 12 hr. totals by 12 to 24 expansion factor.

AVG 24Hr 1699 11155 1055 13909 1499 10534 2452 14485 28394 1978 1696 2199 5873 981 1577 1544 4102 9975 38369

Note: U-Turns provided for approach totals. Refer to 'U-Turn' Report for specific breakdown.



Transportation Services - Traffic Services

Turning Movement Count - Study Results

BELFAST RD @ ST. LAURENT BLVD

Survey Date: Tuesday, February 06, 2018

WO No: 37494

Start Time: 07:00

Device: Miovision

Full Study 15 Minute Increments

Table showing 15-minute increments of traffic counts for ST. LAURENT BLVD and BELFAST RD. Columns include Time Period, Northbound (LT, ST, RT, N TOT), Southbound (LT, ST, RT, S TOT), Eastbound (LT, ST, RT, E TOT), Westbound (LT, ST, RT, W TOT), STR TOT, and Grand Total.

Note: U-Turns are included in Totals.



Transportation Services - Traffic Services

Turning Movement Count - Study Results

BELFAST RD @ ST. LAURENT BLVD

Survey Date: Tuesday, February 06, 2018

WO No: 37494

Start Time: 07:00

Device: Miovision

Full Study Cyclist Volume

Time Period	ST. LAURENT BLVD			BELFAST RD			Grand Total
	Northbound	Southbound	Street Total	Eastbound	Westbound	Street Total	
07:00 07:15	0	0	0	0	0	0	0
07:15 07:30	0	0	0	0	0	0	0
07:30 07:45	0	0	0	0	0	0	0
07:45 08:00	0	0	0	0	0	0	0
08:00 08:15	0	0	0	1	0	1	1
08:15 08:30	0	0	0	0	0	0	0
08:30 08:45	1	1	2	0	0	0	2
08:45 09:00	0	0	0	0	0	0	0
09:00 09:15	1	0	1	0	0	0	1
09:15 09:30	0	0	0	0	0	0	0
09:30 09:45	0	0	0	0	0	0	0
09:45 10:00	0	0	0	0	0	0	0
11:30 11:45	0	0	0	0	0	0	0
11:45 12:00	0	0	0	0	0	0	0
12:00 12:15	0	0	0	0	2	2	2
12:15 12:30	0	0	0	0	2	2	2
12:30 12:45	0	0	0	0	0	0	0
12:45 13:00	0	0	0	0	0	0	0
13:00 13:15	0	0	0	0	0	0	0
13:15 13:30	0	0	0	0	0	0	0
15:00 15:15	0	0	0	0	0	0	0
15:15 15:30	0	0	0	0	0	0	0
15:30 15:45	0	0	0	0	0	0	0
15:45 16:00	0	0	0	0	0	0	0
16:00 16:15	0	0	0	0	0	0	0
16:15 16:30	0	2	2	0	1	1	3
16:30 16:45	0	0	0	0	0	0	0
16:45 17:00	0	0	0	0	0	0	0
17:00 17:15	0	0	0	0	0	0	0
17:15 17:30	0	0	0	0	0	0	0
17:30 17:45	0	1	1	0	0	0	1
17:45 18:00	0	1	1	0	0	0	1
Total	2	5	7	1	5	6	13



Transportation Services - Traffic Services

Turning Movement Count - Study Results

BELFAST RD @ ST. LAURENT BLVD

Survey Date: Tuesday, February 06, 2018

WO No: 37494

Start Time: 07:00

Device: Miovision

Full Study Pedestrian Volume

Time Period	ST. LAURENT BLVD			BELFAST RD			Grand Total
	NB Approach (E or W Crossing)	SB Approach (E or W Crossing)	Total	EB Approach (N or S Crossing)	WB Approach (N or S Crossing)	Total	
07:00 07:15	2	0	2	1	1	2	4
07:15 07:30	0	1	1	1	0	1	2
07:30 07:45	1	1	2	0	1	1	3
07:45 08:00	1	0	1	1	2	3	4
08:00 08:15	2	1	3	1	0	1	4
08:15 08:30	2	0	2	3	0	3	5
08:30 08:45	0	0	0	0	0	0	0
08:45 09:00	0	1	1	0	0	0	1
09:00 09:15	0	0	0	0	0	0	0
09:15 09:30	0	0	0	3	0	3	3
09:30 09:45	1	0	1	1	0	1	2
09:45 10:00	3	0	3	0	0	0	3
11:30 11:45	2	0	2	2	3	5	7
11:45 12:00	0	0	0	3	0	3	3
12:00 12:15	5	0	5	4	1	5	10
12:15 12:30	0	1	1	2	0	2	3
12:30 12:45	2	0	2	2	2	4	6
12:45 13:00	1	0	1	1	0	1	2
13:00 13:15	4	0	4	3	0	3	7
13:15 13:30	4	1	5	0	2	2	7
15:00 15:15	2	1	3	0	1	1	4
15:15 15:30	3	0	3	2	0	2	5
15:30 15:45	0	0	0	0	0	0	0
15:45 16:00	4	0	4	2	0	2	6
16:00 16:15	2	3	5	7	0	7	12
16:15 16:30	0	1	1	5	1	6	7
16:30 16:45	3	1	4	1	0	1	5
16:45 17:00	4	0	4	0	0	0	4
17:00 17:15	8	0	8	1	0	1	9
17:15 17:30	2	0	2	0	0	0	2
17:30 17:45	1	1	2	2	0	2	4
17:45 18:00	2	0	2	0	0	0	2
Total	61	13	74	48	14	62	136



Transportation Services - Traffic Services

Turning Movement Count - Study Results

BELFAST RD @ ST. LAURENT BLVD

Survey Date: Tuesday, February 06, 2018

WO No: 37494

Start Time: 07:00

Device: Miovision

Full Study Heavy Vehicles

ST. LAURENT BLVD										BELFAST RD										Grand Total
Northbound					Southbound					Eastbound					Westbound					
Time Period	LT	ST	RT	N TOT	LT	ST	RT	S TOT	STR TOT	LT	ST	RT	E TOT	LT	ST	RT	W TOT	STR TOT		
07:00	07:15	0	12	0	3	16	0	31	21	3	15	5	4	2	50	81				
07:15	07:30	2	21	1	0	10	1	35	5	1	12	4	2	13	37	72				
07:30	07:45	1	13	2	1	9	0	26	4	0	5	3	5	15	32	58				
07:45	08:00	0	14	0	1	8	2	25	1	1	1	1	1	7	12	37				
08:00	08:15	0	16	1	2	8	1	28	1	0	1	2	5	2	11	39				
08:15	08:30	3	14	1	1	6	4	29	2	0	2	1	5	8	18	47				
08:30	08:45	2	10	0	0	21	9	42	0	1	3	2	5	4	15	57				
08:45	09:00	3	11	2	5	22	11	54	3	1	0	3	4	4	15	69				
09:00	09:15	3	12	0	6	18	22	61	1	1	11	2	4	6	25	86				
09:15	09:30	4	20	5	3	20	30	82	3	3	2	1	3	3	15	97				
09:30	09:45	7	13	2	0	23	27	72	3	6	3	2	6	1	21	93				
09:45	10:00	7	21	2	1	10	24	65	2	1	1	4	4	4	16	81				
11:30	11:45	6	7	5	3	16	7	44	1	1	3	3	2	2	12	56				
11:45	12:00	3	8	2	5	5	5	28	4	2	2	1	0	6	15	43				
12:00	12:15	2	6	2	5	9	6	30	1	4	1	1	3	2	12	42				
12:15	12:30	1	7	2	2	6	5	23	3	1	3	0	1	1	9	32				
12:30	12:45	0	17	0	3	9	5	34	3	0	6	1	2	2	14	48				
12:45	13:00	0	14	2	3	1	5	25	2	5	0	0	1	2	10	35				
13:00	13:15	1	7	6	4	11	5	34	5	2	1	6	4	0	18	52				
13:15	13:30	1	9	2	3	9	3	27	5	2	5	0	2	6	20	47				
15:00	15:15	2	11	1	4	10	4	32	32	7	10	0	0	2	51	83				
15:15	15:30	3	8	1	4	6	0	22	21	2	10	2	2	1	38	60				
15:30	15:45	3	7	4	3	8	1	26	14	4	2	2	2	1	25	51				
15:45	16:00	2	8	3	3	6	1	23	6	6	1	2	0	1	16	39				
16:00	16:15	2	3	4	6	4	1	20	0	2	0	3	2	1	8	28				
16:15	16:30	1	4	7	3	5	1	21	4	5	0	2	3	0	14	35				
16:30	16:45	0	12	2	3	7	0	24	1	6	2	2	2	1	14	38				
16:45	17:00	2	7	2	1	9	0	21	1	5	1	2	1	2	12	33				
17:00	17:15	3	9	2	0	7	5	26	1	3	1	0	2	0	7	33				
17:15	17:30	3	4	1	2	9	6	25	2	4	0	1	3	0	10	35				
17:30	17:45	3	5	1	3	10	10	32	1	0	0	2	0	1	4	36				
17:45	18:00	9	2	0	2	6	12	31	4	1	0	2	0	0	7	38				
Total:	None	79	332	65	0	85	324	213	0	1098	157	80	104	0	62	80	100	0	583	1,681



Transportation Services - Traffic Services

Turning Movement Count - Study Results

BELFAST RD @ ST. LAURENT BLVD

Survey Date: Tuesday, February 06, 2018

WO No: 37494

Start Time: 07:00

Device: Miovision

Full Study 15 Minute U-Turn Total

Time Period		ST. LAURENT BLVD		BELFAST RD		Total
Northbound U-Turn Total	Southbound U-Turn Total	Eastbound U-Turn Total	Westbound U-Turn Total			
07:00	07:15	0	0	0	0	0
07:15	07:30	0	0	0	0	0
07:30	07:45	0	1	0	0	1
07:45	08:00	0	0	0	0	0
08:00	08:15	0	0	0	0	0
08:15	08:30	0	0	0	0	0
08:30	08:45	0	0	0	0	0
08:45	09:00	0	0	0	0	0
09:00	09:15	0	0	0	0	0
09:15	09:30	1	0	0	0	1
09:30	09:45	0	0	0	0	0
09:45	10:00	1	0	0	0	1
11:30	11:45	0	2	0	0	2
11:45	12:00	1	0	0	0	1
12:00	12:15	1	2	0	0	3
12:15	12:30	0	1	0	0	1
12:30	12:45	0	0	0	0	0
12:45	13:00	1	1	0	0	2
13:00	13:15	0	1	0	0	1
13:15	13:30	1	0	0	0	1
15:00	15:15	0	0	0	0	0
15:15	15:30	1	1	0	0	2
15:30	15:45	1	0	0	0	1
15:45	16:00	0	1	0	0	1
16:00	16:15	0	1	0	0	1
16:15	16:30	1	0	0	0	1
16:30	16:45	1	0	0	0	1
16:45	17:00	0	0	0	0	0
17:00	17:15	1	0	0	0	1
17:15	17:30	0	2	0	0	2
17:30	17:45	1	1	0	0	2
17:45	18:00	0	1	0	0	1
Total		12	15	0	0	27



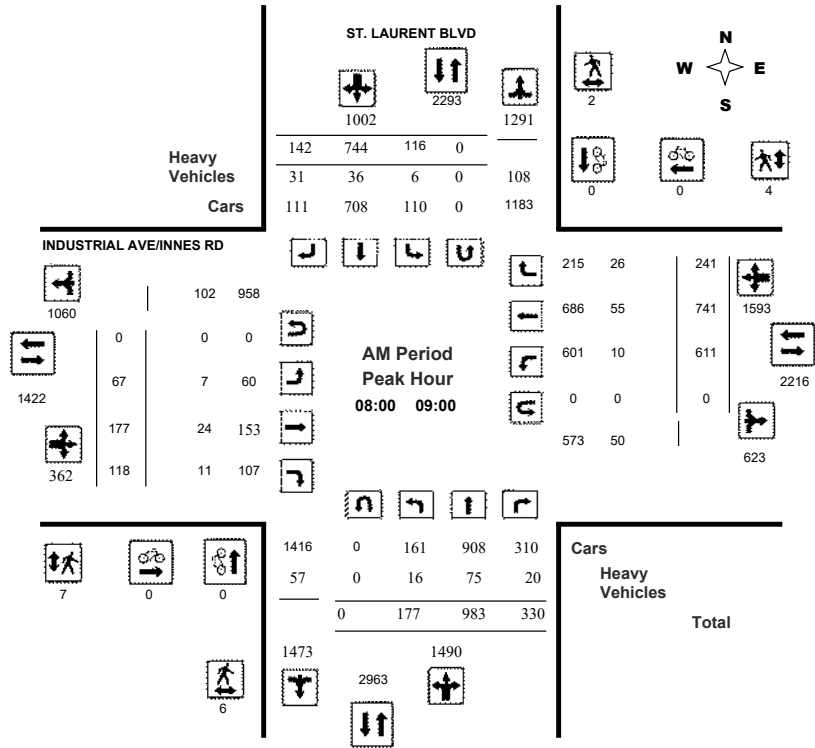
# Transportation Services - Traffic Services

## Turning Movement Count - Peak Hour Diagram

### INDUSTRIAL AVE/INNES RD @ ST. LAURENT BLVD

Survey Date: Wednesday, January 30, 2019  
Start Time: 07:00

WO No: 38336  
Device: Miovision



Comments



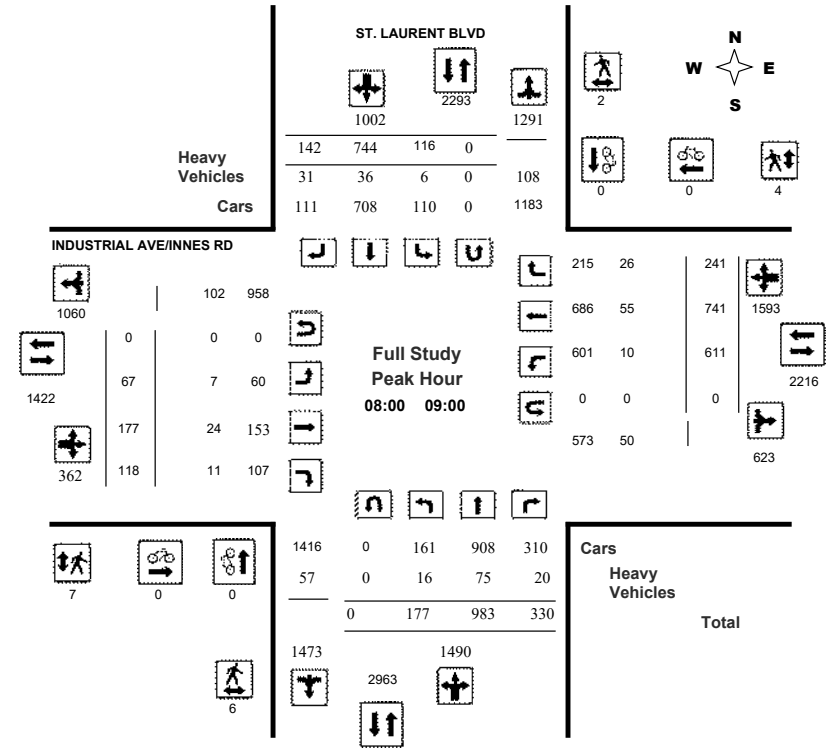
# Transportation Services - Traffic Services

## Turning Movement Count - Peak Hour Diagram

### INDUSTRIAL AVE/INNES RD @ ST. LAURENT BLVD

Survey Date: Wednesday, January 30, 2019  
Start Time: 07:00

WO No: 38336  
Device: Miovision



Comments





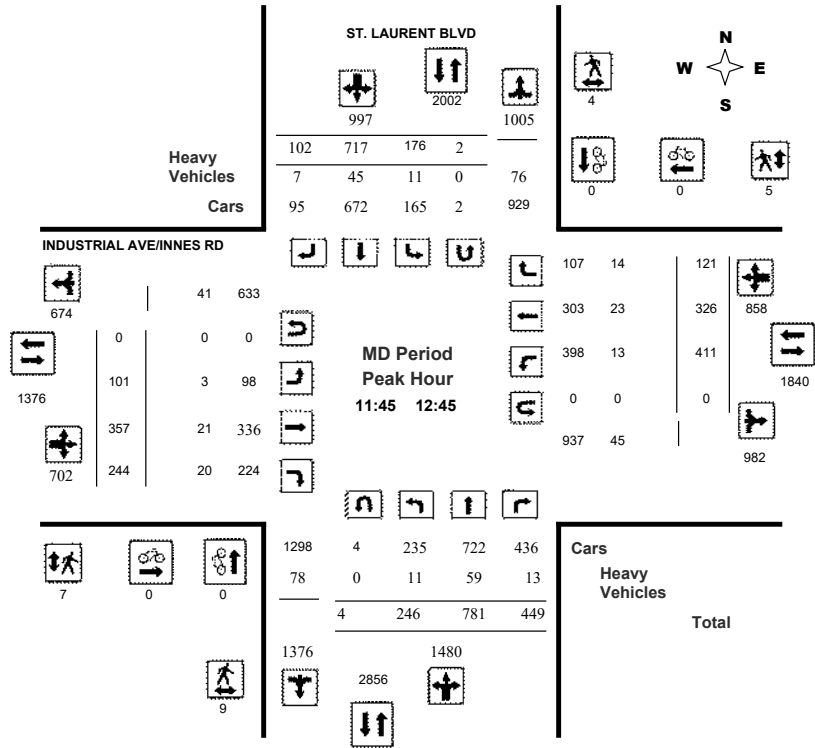
### Transportation Services - Traffic Services

#### Turning Movement Count - Peak Hour Diagram

#### INDUSTRIAL AVE/INNES RD @ ST. LAURENT BLVD

Survey Date: Wednesday, January 30, 2019  
Start Time: 07:00

WO No: 38336  
Device: Miovision



Comments



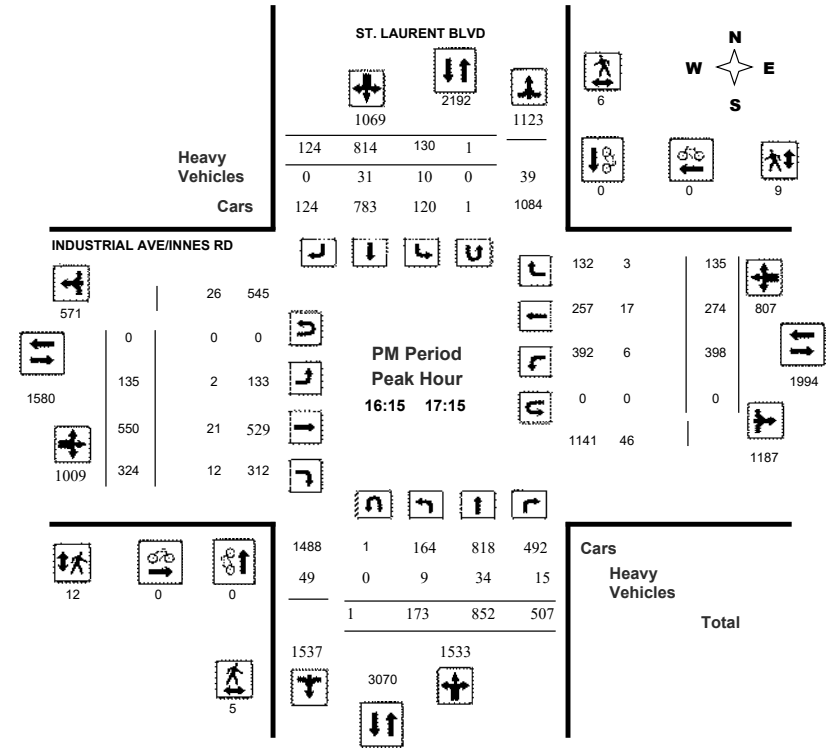
### Transportation Services - Traffic Services

#### Turning Movement Count - Peak Hour Diagram

#### INDUSTRIAL AVE/INNES RD @ ST. LAURENT BLVD

Survey Date: Wednesday, January 30, 2019  
Start Time: 07:00

WO No: 38336  
Device: Miovision



Comments

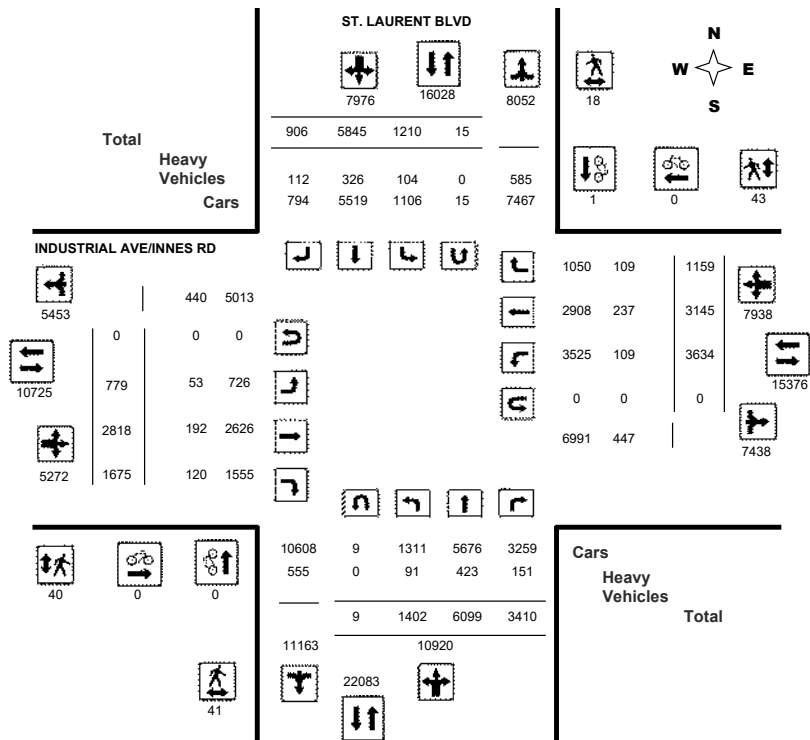


**Transportation Services - Traffic Services**  
Turning Movement Count - Full Study Diagram

**INDUSTRIAL AVE/INNES RD @ ST. LAURENT BLVD**

Survey Date: Wednesday, January 30, 2019

WO#: 38336  
Device: Miovision



Comments



**Transportation Services - Traffic Services**

Work Order  
38336

**Turning Movement Count - Full Study Summary Report**

**INDUSTRIAL AVE/INNES RD @ ST. LAURENT BLVD**

Survey Date: Wednesday, January 30, 201

Total Observed U-Turns  
Northbound: 9 Southbound: 15  
Eastbound: 0 Westbound: 0

AADT Factor  
1.00

**Full Study**

Period	ST. LAURENT BLVD								INDUSTRIAL AVE/INNES RD								Grand Total		
	Northbound				Southbound				Eastbound				Westbound						
	LT	ST	RT	NB TOT	LT	ST	RT	SB TOT	STR TOT	LT	ST	RT	EB TOT	LT	ST	RT		WB TOT	STR TOT
07:00 08:00	188	680	345	1213	158	631	79	868	2081	50	178	139	367	608	530	136	1274	1641	3722
08:00 09:00	177	983	330	1490	116	744	142	1002	2492	67	177	118	362	611	741	241	1593	1955	4447
09:00 10:00	179	657	366	1202	144	625	123	892	2094	79	211	130	420	446	398	145	989	1409	3503
11:30 12:30	237	760	434	1431	172	721	110	1003	2434	91	337	226	654	403	328	135	866	1520	3954
12:30 13:30	171	711	429	1311	191	679	113	983	2294	118	343	222	683	408	310	108	826	1509	3803
15:00 16:00	112	711	554	1377	169	796	119	1084	2461	126	567	238	931	377	323	140	840	1771	4232
16:00 17:00	162	774	528	1464	138	794	115	1047	2511	121	584	313	1018	385	266	130	781	1799	4310
17:00 18:00	176	823	424	1423	122	855	105	1082	2505	127	421	289	837	396	249	124	769	1606	4111
<b>Sub Total</b>	<b>1402</b>	<b>6099</b>	<b>3410</b>	<b>10911</b>	<b>1210</b>	<b>5845</b>	<b>906</b>	<b>7961</b>	<b>18872</b>	<b>779</b>	<b>2818</b>	<b>1675</b>	<b>5272</b>	<b>3634</b>	<b>3145</b>	<b>1159</b>	<b>7938</b>	<b>13210</b>	<b>32082</b>
<b>U Turns</b>				<b>9</b>				<b>15</b>	<b>24</b>				<b>0</b>				<b>0</b>	<b>0</b>	<b>24</b>
<b>Total</b>	<b>1402</b>	<b>6099</b>	<b>3410</b>	<b>10920</b>	<b>1210</b>	<b>5845</b>	<b>906</b>	<b>7976</b>	<b>18896</b>	<b>779</b>	<b>2818</b>	<b>1675</b>	<b>5272</b>	<b>3634</b>	<b>3145</b>	<b>1159</b>	<b>7938</b>	<b>13210</b>	<b>32106</b>
<b>EQ 12Hr</b>	<b>1949</b>	<b>8478</b>	<b>4740</b>	<b>15179</b>	<b>1682</b>	<b>8125</b>	<b>1259</b>	<b>11087</b>	<b>26266</b>	<b>1083</b>	<b>3917</b>	<b>2328</b>	<b>7328</b>	<b>5051</b>	<b>4372</b>	<b>1611</b>	<b>11034</b>	<b>18362</b>	<b>44628</b>
Note: These values are calculated by multiplying the totals by the appropriate expansion factor.													<b>1.39</b>						
<b>AVG 12Hr</b>	<b>1949</b>	<b>8478</b>	<b>4740</b>	<b>15179</b>	<b>1682</b>	<b>8125</b>	<b>1259</b>	<b>11087</b>	<b>26266</b>	<b>1083</b>	<b>3917</b>	<b>2328</b>	<b>7328</b>	<b>5051</b>	<b>4372</b>	<b>1611</b>	<b>11034</b>	<b>18362</b>	<b>44628</b>
Note: These volumes are calculated by multiplying the Equivalent 12 hr. totals by the AADT factor.													<b>1.00</b>						
<b>AVG 24Hr</b>	<b>2553</b>	<b>11106</b>	<b>6209</b>	<b>19884</b>	<b>2203</b>	<b>10643</b>	<b>1650</b>	<b>14523</b>	<b>34407</b>	<b>1418</b>	<b>5131</b>	<b>3050</b>	<b>9600</b>	<b>6617</b>	<b>5727</b>	<b>2110</b>	<b>14454</b>	<b>24054</b>	<b>58461</b>
Note: These volumes are calculated by multiplying the Average Daily 12 hr. totals by 12 to 24 expansion factor.													<b>1.31</b>						

**Comments:**

Note: U-Turns provided for approach totals. Refer to 'U-Turn' Report for specific breakdown.



**Transportation Services - Traffic Services** W.O. 38336

**Turning Movement Count - 15 Minute Summary Report**

**INDUSTRIAL AVE/INNES RD @ ST. LAURENT BLVD**

Survey Date: Wednesday, January 30, 2019

Total Observed U-Turns

Northbound: 9 Southbound: 15  
Eastbound: 0 Westbound: 0

ST. LAURENT BLVD										INDUSTRIAL AVE/INNES RD										Grand Total
Northbound					Southbound					Eastbound					Westbound					
Time Period	LT	ST	RT	N TOT	LT	ST	RT	S TOT	STR TOT	LT	ST	RT	E TOT	LT	ST	RT	W TOT	STR TOT		
07:00 07:15	24	125	67	216	33	120	12	165	381	7	50	25	82	164	124	24	312	394	775	
07:15 07:30	44	171	76	291	45	180	26	251	542	11	39	38	88	133	100	24	257	345	887	
07:30 07:45	53	185	104	342	32	148	19	199	541	12	49	45	106	156	165	45	366	472	1013	
07:45 08:00	67	199	98	364	48	183	22	253	617	20	40	31	91	155	141	43	339	430	1047	
08:00 08:15	39	265	77	381	31	186	28	245	626	10	52	22	84	147	191	40	378	462	1088	
08:15 08:30	41	238	77	356	26	161	42	229	585	20	38	37	95	161	169	61	391	486	1071	
08:30 08:45	42	249	91	382	27	206	33	266	648	15	38	27	80	142	202	62	406	486	1134	
08:45 09:00	55	231	85	371	32	191	39	262	633	22	49	32	103	161	179	78	418	521	1154	
09:00 09:15	55	183	86	324	37	179	25	245	569	20	41	25	86	130	111	55	296	382	951	
09:15 09:30	47	160	105	312	37	151	33	221	533	22	59	29	110	117	110	35	262	372	905	
09:30 09:45	37	162	90	289	38	148	32	218	507	17	56	34	107	93	86	35	214	321	828	
09:45 10:00	40	152	85	277	32	147	33	212	489	20	55	42	117	106	91	20	217	334	823	
11:30 11:45	41	158	110	309	40	170	31	241	550	15	70	47	132	107	80	37	224	356	906	
11:45 12:00	63	205	109	380	40	167	30	237	617	28	80	54	162	94	91	34	219	381	998	
12:00 12:15	64	184	113	361	54	178	26	258	619	27	81	54	162	113	81	26	220	382	1001	
12:15 12:30	69	213	102	385	38	206	23	269	654	21	106	71	198	89	76	38	203	401	1055	
12:30 12:45	50	179	125	354	44	166	23	233	587	25	90	65	180	115	78	23	216	396	983	
12:45 13:00	36	184	99	320	44	176	30	250	570	27	71	54	152	90	80	23	193	345	915	
13:00 13:15	43	175	99	317	57	159	28	244	561	34	86	50	170	124	69	33	226	396	957	
13:15 13:30	42	173	106	321	46	178	32	256	577	32	96	53	181	79	83	29	191	372	949	
15:00 15:15	42	163	127	332	47	184	27	258	590	39	129	52	220	97	92	37	226	446	1036	
15:15 15:30	24	207	144	375	35	185	33	253	628	34	158	69	261	105	80	35	220	481	1109	
15:30 15:45	18	176	148	342	46	204	34	284	626	21	147	57	225	85	87	40	212	437	1063	
15:45 16:00	28	165	135	328	41	223	25	289	617	32	133	60	225	90	64	28	182	407	1024	
16:00 16:15	33	164	130	327	40	197	22	259	586	25	141	86	252	96	58	31	185	437	1023	
16:15 16:30	48	202	148	398	31	196	33	260	658	32	149	67	248	94	79	29	202	450	1108	
16:30 16:45	36	200	134	370	35	214	30	279	649	39	164	87	290	111	68	37	216	506	1155	
16:45 17:00	45	208	116	370	32	187	30	249	619	25	130	73	228	84	61	33	178	406	1025	
17:00 17:15	44	242	109	395	32	217	31	281	676	39	107	97	243	109	66	36	211	454	1130	
17:15 17:30	46	223	105	375	36	245	26	311	686	29	108	64	201	103	73	28	204	405	1091	
17:30 17:45	51	180	116	348	28	169	14	214	562	31	105	64	200	84	57	33	174	374	936	
17:45 18:00	35	178	94	308	26	224	34	285	593	28	101	64	193	100	53	27	180	373	966	
<b>TOTAL:</b>	1402	6099	3410	10920	1210	5845	906	7976	18896	779	2818	1675	5272	3634	3145	1159	7938	13210	32106	

Note: U-Turns are included in Totals.

Comment:



**Transportation Services - Traffic Services**  
**Turning Movement Count - Cyclist Volume Report**

Work Order 38336

**INDUSTRIAL AVE/INNES RD @ ST. LAURENT BLVD**

Count Date: Wednesday, January 30, 2019

Start Time: 07:00

Time Period	ST. LAURENT BLVD			INDUSTRIAL AVE/INNES RD			Grand Total
	Northbound	Southbound	Street Total	Eastbound	Westbound	Street Total	
07:00 08:00	0	0	0	0	0	0	0
08:00 09:00	0	0	0	0	0	0	0
09:00 10:00	0	0	0	0	0	0	0
11:30 12:30	0	0	0	0	0	0	0
12:30 13:30	0	1	1	0	0	0	1
15:00 16:00	0	0	0	0	0	0	0
16:00 17:00	0	0	0	0	0	0	0
17:00 18:00	0	0	0	0	0	0	0
<b>Total</b>	0	1	1	0	0	0	1

Comment:

Note: These volumes consists of bicycles only (no mopeds or motorcycles) and ARE NOT included in the Turning Movement Count Summary.



# Transportation Services - Traffic Services

W.O.  
38336

## Turning Movement Count - Heavy Vehicle Report

### INDUSTRIAL AVE/INNES RD @ ST. LAURENT BLVD

Survey Date: Wednesday, January 30, 2019

ST. LAURENT BLVD										INDUSTRIAL AVE/INNES RD										Grand Total
Northbound					Southbound					Eastbound					Westbound					
Time Period	LT	ST	RT	N TOT	LT	ST	RT	S TOT	STR TOT	LT	ST	RT	E TOT	LT	ST	RT	W TOT	STR TOT		
07:00 08:00	16	48	17	81	33	54	7	94	175	5	23	27	55	32	37	19	88	143	318	
08:00 09:00	16	75	20	111	6	36	31	73	184	7	24	11	42	10	55	26	91	133	317	
09:00 10:00	16	78	34	128	14	44	39	97	225	13	29	5	47	8	42	16	66	113	338	
11:30 12:30	10	56	17	83	11	52	9	72	155	3	22	13	38	15	27	13	55	93	248	
12:30 13:30	5	53	20	78	13	36	10	59	137	8	26	22	56	19	13	11	43	99	236	
15:00 16:00	5	38	21	64	11	47	7	65	129	12	22	16	50	11	24	12	47	97	226	
16:00 17:00	10	46	15	71	11	34	3	48	119	2	32	16	50	7	22	6	35	85	204	
17:00 18:00	13	29	7	49	5	23	6	34	83	3	14	10	27	7	17	6	30	57	140	
<b>Sub Total</b>	<b>91</b>	<b>423</b>	<b>151</b>	<b>665</b>	<b>104</b>	<b>326</b>	<b>112</b>	<b>542</b>	<b>1207</b>	<b>53</b>	<b>192</b>	<b>120</b>	<b>365</b>	<b>109</b>	<b>237</b>	<b>109</b>	<b>455</b>	<b>820</b>	<b>2027</b>	
<b>U-Turns (Heavy Vehicles)</b>	<b>0</b>	<b>0</b>	<b>0</b>	<b>0</b>	<b>0</b>	<b>0</b>	<b>0</b>	<b>0</b>	<b>0</b>	<b>0</b>	<b>0</b>	<b>0</b>	<b>0</b>	<b>0</b>	<b>0</b>	<b>0</b>	<b>0</b>	<b>0</b>	<b>0</b>	
<b>Total</b>	<b>91</b>	<b>423</b>	<b>151</b>	<b>665</b>	<b>104</b>	<b>326</b>	<b>112</b>	<b>542</b>	<b>1207</b>	<b>53</b>	<b>192</b>	<b>120</b>	<b>365</b>	<b>109</b>	<b>237</b>	<b>109</b>	<b>455</b>	<b>820</b>	<b>2027</b>	

Heavy Vehicles include Buses, Single-Unit Trucks and Articulated Trucks. Further, they ARE included in the Turning Movement Count Summary.



# Transportation Services - Traffic Services

Work Order  
38336

## Turning Movement Count - Pedestrian Volume Report

### INDUSTRIAL AVE/INNES RD @ ST. LAURENT BLVD

Count Date: Wednesday, January 30, 2019

Start Time: 07:00

Time Period	NB Approach (E or W Crossing)	SB Approach (E or W Crossing)	Total	EB Approach (N or S Crossing)	WB Approach (N or S Crossing)	Total	Grand Total
07:00 07:15	1	1	2	1	0	1	3
07:15 07:30	1	0	1	2	0	2	3
07:30 07:45	0	1	1	1	0	1	2
07:45 08:00	0	0	0	0	0	0	0
07:00 08:00	2	2	4	4	0	4	8
08:00 08:15	1	0	1	0	0	0	1
08:15 08:30	2	2	4	3	1	4	8
08:30 08:45	3	0	3	3	2	5	8
08:45 09:00	0	0	0	1	1	2	2
08:00 09:00	6	2	8	7	4	11	19
09:00 09:15	2	0	2	2	0	2	4
09:15 09:30	2	0	2	0	0	0	2
09:30 09:45	0	0	0	0	0	0	0
09:45 10:00	0	0	0	0	0	0	0
09:00 10:00	4	0	4	0	2	2	6
11:30 11:45	1	0	1	0	1	1	2
11:45 12:00	1	0	1	1	1	2	3
12:00 12:15	1	2	3	4	0	4	7
12:15 12:30	4	2	6	1	2	3	9
11:30 12:30	7	4	11	6	4	10	21
12:30 12:45	3	0	3	1	2	3	6
12:45 13:00	2	0	2	1	3	4	6
13:00 13:15	2	0	2	0	1	1	3
13:15 13:30	1	0	1	2	2	4	5
12:30 13:30	8	0	8	4	8	12	20
15:00 15:15	1	1	2	1	2	3	5
15:15 15:30	1	0	1	1	2	3	4
15:30 15:45	1	1	2	0	1	1	3
15:45 16:00	1	0	1	0	2	2	3
15:00 16:00	4	2	6	2	7	9	15
16:00 16:15	0	0	0	1	0	1	1
16:15 16:30	0	2	2	1	2	3	5
16:30 16:45	3	2	5	5	1	6	11
16:45 17:00	1	1	2	3	3	6	8
16:00 17:00	4	5	9	10	6	16	25
17:00 17:15	1	1	2	3	3	6	8
17:15 17:30	2	2	4	3	1	4	8
17:30 17:45	1	0	1	0	7	7	8
17:45 18:00	2	0	2	1	1	2	4
17:00 18:00	6	3	9	7	12	19	28
Total .....	41	18	59	40	43	83	142

Comment:



Transportation Services - Traffic Services

Work Order 38336

Turning Movement Count - 15 Min U-Turn Total Report INDUSTRIAL AVE/INNES RD @ ST. LAURENT BLVD

Survey Date: Wednesday, January 30, 2019

Table with columns: Time Period, Northbound U-Turn Total, Southbound U-Turn Total, Eastbound U-Turn Total, Westbound U-Turn Total, Total. Rows show 15-minute intervals from 07:00 to 18:00.



Turning Movement Count Summary Report Including Peak Hours, AADT and Expansion Factors All Vehicles Except Bicycles



Belfast Road & Lagan Way

Ottawa, ON

Survey Date: Thursday, May 11, 2023 Start Time: 0700 AADT Factor: 0.9
Weather AM: Mostly Sunny 13° C Survey Duration: 8 Hrs. Survey Hours: 0700-1000, 1130-1330 & 1500-1800
Weather PM: Cloudy 25° C Surveyor(s): T. Carmody

Table with columns: Time Period, Belfast Rd. Eastbound, Belfast Rd. Westbound, Lagan Way Northbound, Lagan Way Southbound. Rows show 15-minute intervals and a Totals row.

Equivalent 12 & 24-hour Vehicle Volumes Including the Annual Average Daily Traffic (AADT) Factor
Applicable to the Day and Month of the Turning Movement Count
Expansion factors are applied exclusively to standard weekday 8-hour turning movement counts conducted during the hours of 0700h - 1000h, 1130h - 1330h and 1500h - 1800h

Table for Equivalent 12-hour vehicle volumes. Columns: Equ. 12 Hr, 450, 2742, 314, 6, 3513, 140, 2674, 185, 4, 3004, 6516, 229, 17, 126, 0, 373, 181, 14, 296, 0, 491, 863, 7380

Table for Average daily 12-hour vehicle volumes. Columns: AADT 12-hr, 405, 2468, 283, 5, 3161, 126, 2407, 166, 4, 2703, 5865, 206, 15, 114, 0, 335, 163, 13, 266, 0, 442, 777, 6642

Table for 24-Hour AADT. Columns: AADT 24 Hr, 531, 3233, 370, 7, 4141, 166, 3153, 218, 5, 3541, 7683, 270, 20, 149, 0, 439, 213, 16, 349, 0, 578, 1018, 8700

AADT and expansion factors provided by the City of Ottawa

Table with columns: AM Peak Hour Factor, OFF Peak Hour Factor, PM Peak Hour Factor, Highest Hourly Vehicle Volume Between 0700h & 1000h, Highest Hourly Vehicle Volume Between 1130h & 1330h, Highest Hourly Vehicle Volume Between 1500h & 1800h. Rows show peak hour factors and highest hourly volumes.

Comments:

OC Transpo and Para Transpo buses, private buses and school buses comprise 9.07% of the heavy vehicle traffic.

Notes:

- 1. Includes all vehicle types except bicycles, electric bicycles, and electric scooters.
2. When expansion and AADT factors are applied, the results will differ slightly due to rounding.

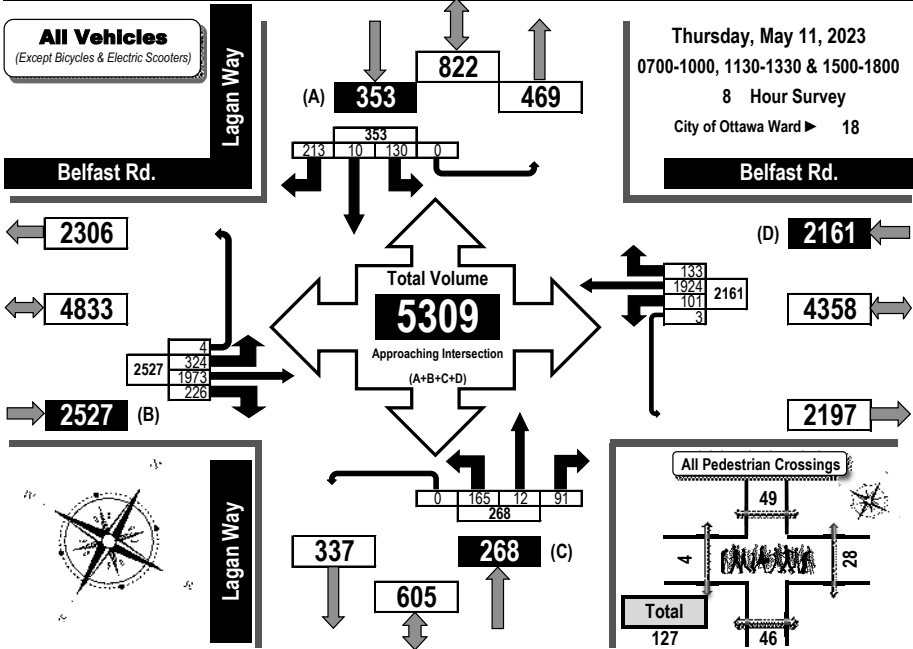


### Turning Movement Count Summary, AM and PM Peak Hour Flow Diagrams

All Vehicles Except Bicycles

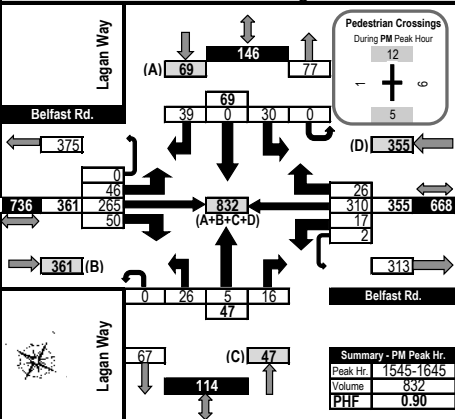
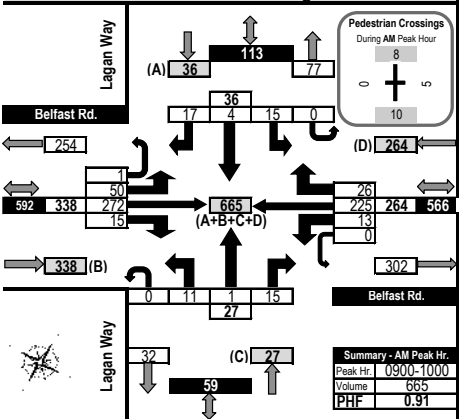


#### Belfast Road & Lagan Way Ottawa, ON



#### AM Peak Hour Flow Diagram

#### PM Peak Hour Flow Diagram

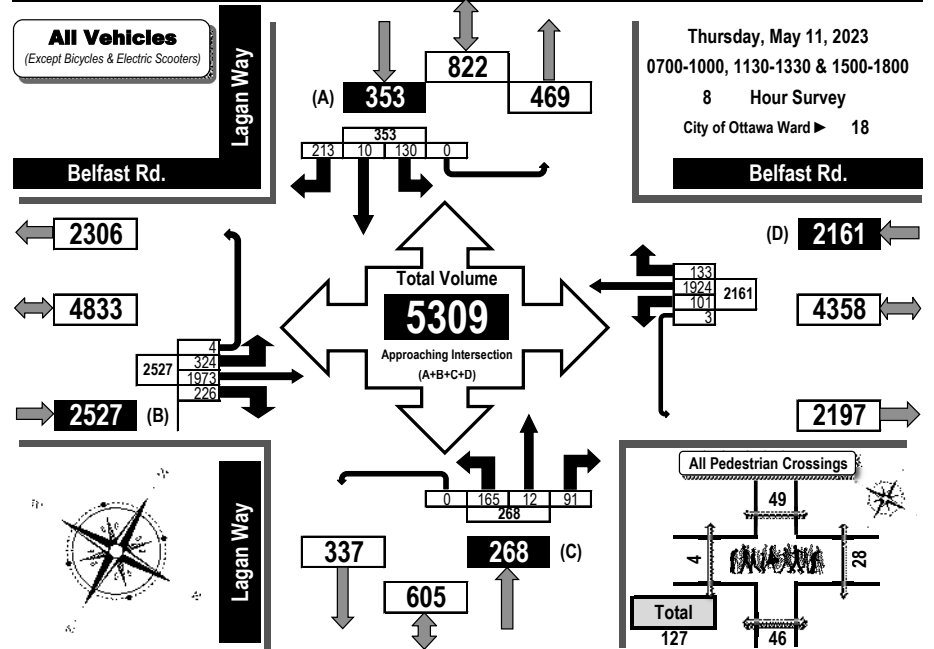


### Turning Movement Count Summary, OFF and EVENING Peak Hour Flow Diagrams

All Vehicles Except Bicycles

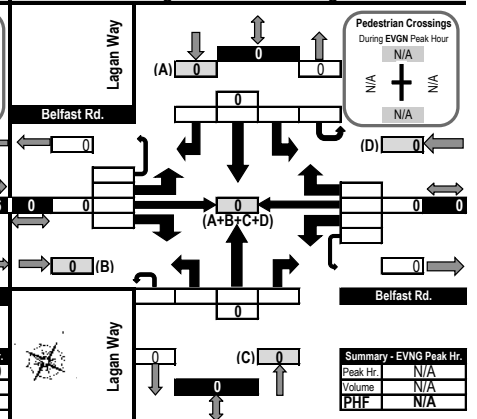
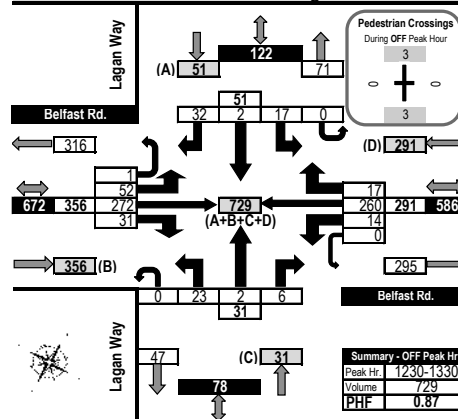


#### Belfast Road & Lagan Way Ottawa, ON



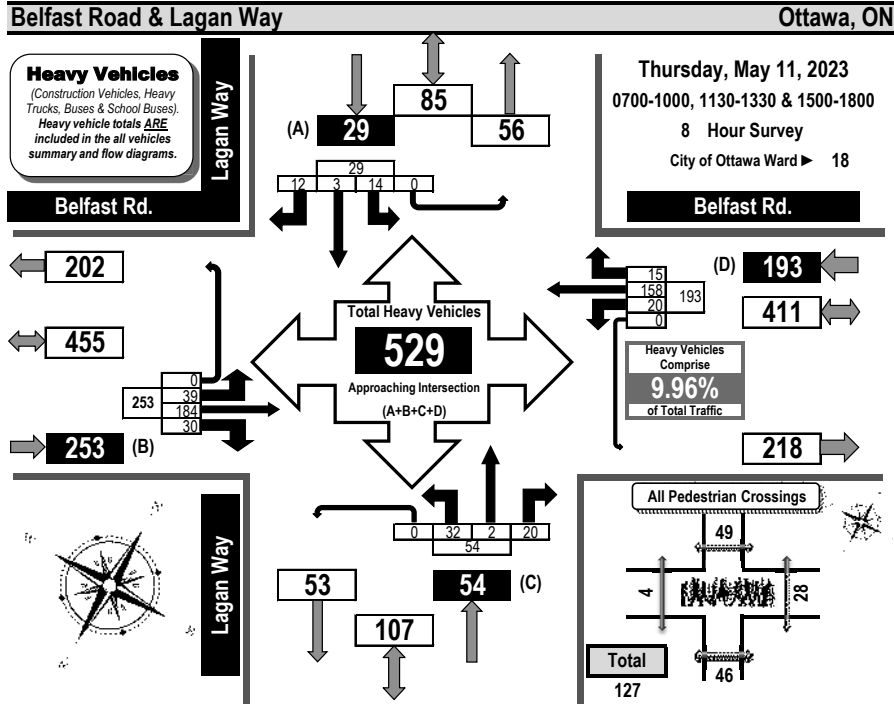
#### Off Peak Hour Flow Diagram

#### Evening Peak Hour Flow Diagram





### Turning Movement Count Heavy Vehicle Summary (FHWA Class 4-13) Flow Diagram

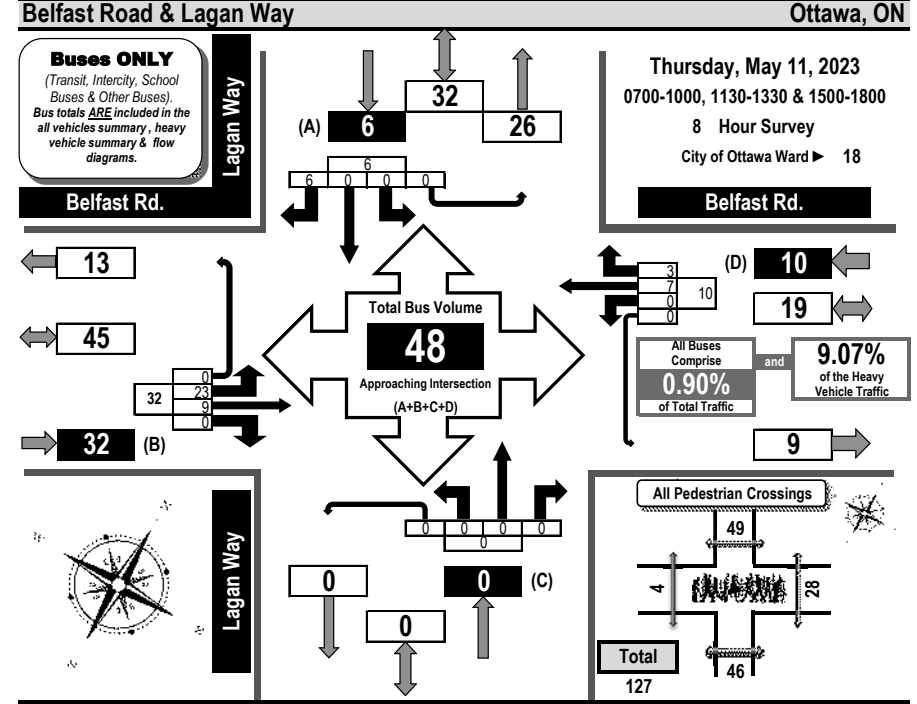


Time Period	Belfast Rd. Eastbound				Belfast Rd. Westbound				Lagan Way Northbound				Lagan Way Southbound				SB Tot	GR Tot			
	LT	ST	RT	UT	LT	ST	RT	UT	LT	ST	RT	UT	LT	ST	RT	UT					
0700-0800	2	19	4	0	25	2	30	2	0	34	7	0	3	0	10	2	1	4	0	7	76
0800-0900	2	25	3	0	30	1	34	2	0	37	5	0	6	0	11	0	0	1	0	1	79
0900-1000	10	32	1	0	43	3	33	4	0	40	6	0	5	0	11	3	1	2	0	6	100
1130-1230	3	23	5	0	31	3	20	3	0	26	6	0	2	0	8	3	1	2	0	6	71
1230-1330	1	22	5	0	28	8	12	0	0	20	5	1	2	0	8	1	0	2	0	3	59
1500-1600	4	25	4	0	33	2	15	0	0	17	1	1	2	0	4	0	0	0	0	0	54
1600-1700	14	16	6	0	36	1	10	2	0	13	1	0	0	0	1	3	0	0	0	3	53
1700-1800	3	22	2	0	27	0	4	2	0	6	1	0	0	0	1	2	0	1	0	3	37
<b>Totals</b>	<b>39</b>	<b>184</b>	<b>30</b>	<b>0</b>	<b>253</b>	<b>20</b>	<b>158</b>	<b>15</b>	<b>0</b>	<b>193</b>	<b>32</b>	<b>2</b>	<b>20</b>	<b>0</b>	<b>54</b>	<b>14</b>	<b>3</b>	<b>12</b>	<b>0</b>	<b>29</b>	<b>529</b>

Comments:  
OC Transpo and Para Transpo buses, private buses and school buses comprise 9.07% of the heavy vehicle traffic.



### Turning Movement Count All Buses Summary (FHWA Class 4 ONLY) Flow Diagram



Time Period	Belfast Rd. Eastbound				Belfast Rd. Westbound				Lagan Way Northbound				Lagan Way Southbound				SB Tot	GR Tot			
	LT	ST	RT	UT	LT	ST	RT	UT	LT	ST	RT	UT	LT	ST	RT	UT					
0700-0800	0	0	0	0	0	0	1	0	0	1	0	0	0	0	0	0	0	4	0	4	5
0800-0900	0	1	0	0	1	0	2	0	0	2	0	0	0	0	0	0	0	0	0	0	3
0900-1000	8	2	0	0	10	0	2	2	0	4	0	0	0	0	0	0	0	0	0	0	14
1130-1230	0	1	0	0	1	0	0	0	0	0	0	0	0	0	0	0	0	0	0	0	1
1230-1330	0	0	0	0	0	0	1	0	0	1	0	0	0	0	0	0	0	2	0	2	3
1500-1600	0	0	0	0	0	0	1	0	0	1	0	0	0	0	0	0	0	0	0	0	1
1600-1700	13	1	0	0	14	0	0	0	0	0	0	0	0	0	0	0	0	0	0	0	14
1700-1800	2	4	0	0	6	0	0	1	0	1	0	0	0	0	0	0	0	0	0	0	7
<b>Totals</b>	<b>23</b>	<b>9</b>	<b>0</b>	<b>0</b>	<b>32</b>	<b>0</b>	<b>7</b>	<b>3</b>	<b>0</b>	<b>10</b>	<b>0</b>	<b>0</b>	<b>0</b>	<b>0</b>	<b>0</b>	<b>0</b>	<b>0</b>	<b>6</b>	<b>0</b>	<b>6</b>	<b>48</b>

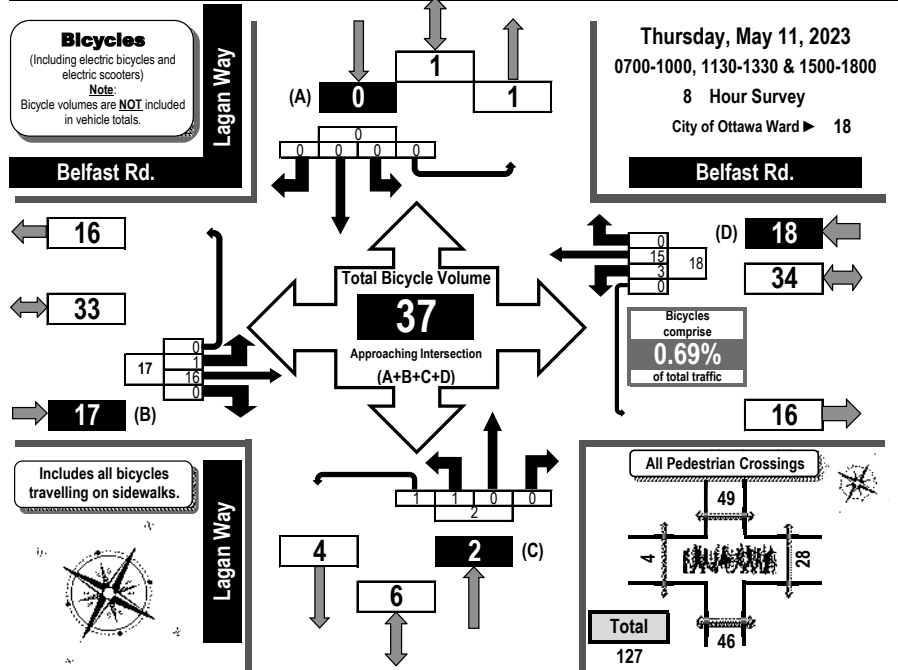
Comments:  
OC Transpo and Para Transpo buses, private buses and school buses comprise 9.07% of the heavy vehicle traffic.



### Turning Movement Count Bicycle Summary Flow Diagram



#### Belfast Road & Lagan Way Ottawa, ON



Time Period	Belfast Rd. Eastbound				Belfast Rd. Westbound				Lagan Way Northbound				Lagan Way Southbound				GR Tot		
	LT	ST	RT	UT	LT	ST	RT	UT	LT	ST	RT	UT	LT	ST	RT	UT			
	EB Tot	WB Tot	NB Tot	SB Tot	EB Tot	WB Tot	NB Tot	SB Tot	EB Tot	WB Tot	NB Tot	SB Tot	EB Tot	WB Tot	NB Tot	SB Tot			
0700-0800	1	4	0	0	5	0	1	0	0	1	0	0	0	0	0	0	0	0	6
0800-0900	0	3	0	0	3	0	2	0	0	2	0	0	0	0	0	0	0	0	5
0900-1000	0	2	0	0	2	0	1	0	0	1	0	0	0	0	0	0	0	0	3
1130-1230	0	1	0	0	1	0	0	0	0	0	0	0	0	0	0	0	0	0	1
1230-1330	0	3	0	0	3	0	3	0	0	3	0	0	0	0	0	0	0	0	6
1500-1600	0	1	0	0	1	1	3	0	0	4	0	0	0	0	0	0	0	0	5
1600-1700	0	2	0	0	2	2	3	0	0	5	1	0	0	0	1	0	0	0	8
1700-1800	0	0	0	0	0	2	0	0	0	2	0	0	0	1	1	0	0	0	3
<b>Totals</b>	<b>1</b>	<b>16</b>	<b>0</b>	<b>0</b>	<b>17</b>	<b>3</b>	<b>15</b>	<b>0</b>	<b>0</b>	<b>18</b>	<b>1</b>	<b>0</b>	<b>0</b>	<b>1</b>	<b>2</b>	<b>0</b>	<b>0</b>	<b>0</b>	<b>37</b>

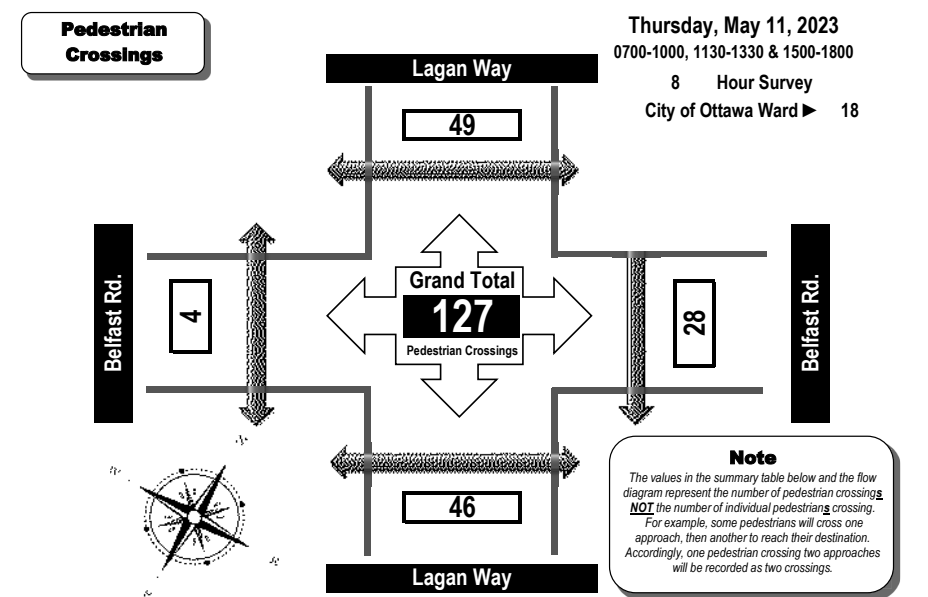
**Comments:**  
OC Transpo and Para Transpo buses, private buses and school buses comprise 9.07% of the heavy vehicle traffic.



### Turning Movement Count Pedestrian Crossings Summary and Flow Diagram



#### Belfast Road & Lagan Way Ottawa, ON



Time Period	West Side Crossing Belfast Rd.	East Side Crossing Belfast Rd.	Street Total	South Side Crossing Lagan Way	North Side Crossing Lagan Way	Street Total	Grand Total
0700-0800	1	5	6	5	6	11	17
0800-0900	0	5	5	11	1	12	17
0900-1000	0	5	5	10	8	18	23
1130-1230	0	0	0	2	9	11	11
1230-1330	0	0	0	3	3	6	6
1500-1600	1	1	2	4	6	10	12
1600-1700	1	9	10	6	10	16	26
1700-1800	1	3	4	5	6	11	15
<b>Totals</b>	<b>4</b>	<b>28</b>	<b>32</b>	<b>46</b>	<b>49</b>	<b>95</b>	<b>127</b>

**Comments:**  
OC Transpo and Para Transpo buses, private buses and school buses comprise 9.07% of the heavy vehicle traffic.



# Appendix C

Synchro Intersection Worksheets – Existing Conditions

Lanes, Volumes, Timings  
1: St-Laurent & Tremblay

Existing AM Peak Hour  
1531 St-Laurent Blvd

	↖	→	↗	←	↖	↑	↗	↓	↖
Lane Group	EBL	EBT	WBL	WBT	NBL	NBT	SBL	SBT	SBR
Lane Configurations	↖	↗	↖	↗	↖	↗	↖	↗	↖
Traffic Volume (vph)	15	21	12	20	65	1132	127	1083	62
Future Volume (vph)	15	21	12	20	65	1132	127	1083	62
Lane Group Flow (vph)	17	41	13	133	72	1300	141	1203	69
Turn Type	Perm	NA	Perm	NA	Perm	NA	pm+pt	NA	Perm
Protected Phases		4		8		2	1	6	
Permitted Phases	4		8		2		6		6
Detector Phase	4	4	8	8	2	2	1	6	6
Switch Phase									
Minimum Initial (s)	10.0	10.0	10.0	10.0	10.0	10.0	5.0	10.0	10.0
Minimum Split (s)	38.5	38.5	38.5	38.5	39.2	39.2	9.7	39.2	39.2
Total Split (s)	40.0	40.0	40.0	40.0	72.0	72.0	18.0	90.0	90.0
Total Split (%)	30.8%	30.8%	30.8%	30.8%	55.4%	55.4%	13.8%	69.2%	69.2%
Maximum Green (s)	33.5	33.5	33.5	33.5	65.8	65.8	13.3	83.8	83.8
Yellow Time (s)	3.3	3.3	3.3	3.3	3.7	3.7	3.7	3.7	3.7
All-Red Time (s)	3.2	3.2	3.2	3.2	2.5	2.5	1.0	2.5	2.5
Lost Time Adjust (s)	0.0	0.0	0.0	0.0	0.0	0.0	0.0	0.0	0.0
Total Lost Time (s)	6.5	6.5	6.5	6.5	6.2	6.2	4.7	6.2	6.2
Lead/Lag					Lag	Lag	Lead		
Lead-Lag Optimize?					Yes	Yes	Yes		
Vehicle Extension (s)	3.0	3.0	3.0	3.0	3.0	3.0	3.0	3.0	3.0
Recall Mode	None	None	None	None	C-Max	C-Max	None	C-Max	C-Max
Walk Time (s)	7.0	7.0	7.0	7.0	11.0	11.0		11.0	11.0
Flash Dont Walk (s)	25.0	25.0	25.0	25.0	22.0	22.0		22.0	22.0
Pedestrian Calls (#/hr)	4	4	3	3	2	2		7	7
Act Effct Green (s)	14.6	14.6	14.6	14.6	89.8	89.8	104.2	102.7	102.7
Actuated g/C Ratio	0.11	0.11	0.11	0.11	0.69	0.69	0.80	0.79	0.79
v/c Ratio	0.21	0.21	0.10	0.53	0.26	0.43	0.44	0.50	0.07
Control Delay	54.3	33.5	48.9	20.2	13.6	10.9	8.3	6.7	1.6
Queue Delay	0.0	0.0	0.0	0.0	0.0	0.0	0.0	0.0	0.0
Total Delay	54.3	33.5	48.9	20.2	13.6	10.9	8.3	6.7	1.6
LOS	D	C	D	C	B	B	A	A	A
Approach Delay		39.6		22.8		11.0		6.6	
Approach LOS		D		C		B		A	
Queue Length 50th (m)	4.2	5.6	3.2	5.4	5.3	41.4	5.0	36.6	0.0
Queue Length 95th (m)	10.0	13.8	8.1	21.0	22.7	93.5	20.0	103.9	5.0
Internal Link Dist (m)		396.6		0.1		682.5		144.8	
Turn Bay Length (m)	38.0		38.0		45.0		75.0		
Base Capacity (vph)	188	416	284	435	281	2989	373	2429	1019
Starvation Cap Reductn	0	0	0	0	0	0	0	0	0
Spillback Cap Reductn	0	0	0	0	0	0	0	0	0
Storage Cap Reductn	0	0	0	0	0	0	0	0	0
Reduced v/c Ratio	0.09	0.10	0.05	0.31	0.26	0.43	0.38	0.50	0.07

**Intersection Summary**  
 Cycle Length: 130  
 Actuated Cycle Length: 130  
 Offset: 53 (41%), Referenced to phase 2:NBTL and 6:SBTL, Start of Green  
 Natural Cycle: 90

Lanes, Volumes, Timings  
1: St-Laurent & Tremblay

Existing AM Peak Hour  
1531 St-Laurent Blvd

Control Type: Actuated-Coordinated  
 Maximum v/c Ratio: 0.53  
 Intersection Signal Delay: 10.0  
 Intersection LOS: B  
 Intersection Capacity Utilization 66.3%  
 ICU Level of Service C  
 Analysis Period (min) 15

Splits and Phases: 1: St-Laurent & Tremblay



Lanes, Volumes, Timings  
2: St-Laurent & Belfast

Existing AM Peak Hour  
1531 St-Laurent Blvd

Lane Group	EBL	EBT	EBR	WBL	WBT	NBL	NBT	NBR	SBL	SBT	SBR
Lane Configurations	↖	↑	↗	↖	↑	↗	↖	↑	↗	↖	↑
Traffic Volume (vph)	47	63	84	43	140	116	809	63	83	764	190
Future Volume (vph)	47	63	84	43	140	116	809	63	83	764	190
Lane Group Flow (vph)	52	70	93	48	260	129	899	70	92	849	211
Turn Type	pm+pt	NA	Perm	Perm	NA	pm+pt	NA	Perm	pm+pt	NA	Perm
Protected Phases	7	4			8	5	2		1	6	
Permitted Phases	4		4	8			2	2	6		6
Detector Phase	7	4	4	8	8	5	2	2	1	6	6
Switch Phase											
Minimum Initial (s)	5.0	10.0	10.0	10.0	10.0	5.0	10.0	10.0	5.0	10.0	10.0
Minimum Split (s)	10.8	27.8	27.8	27.8	27.8	10.7	36.6	36.6	10.7	36.6	36.6
Total Split (s)	16.0	48.0	48.0	32.0	32.0	15.0	57.0	57.0	15.0	57.0	57.0
Total Split (%)	13.3%	40.0%	40.0%	26.7%	26.7%	12.5%	47.5%	47.5%	12.5%	47.5%	47.5%
Maximum Green (s)	10.2	42.2	42.2	26.2	26.2	9.3	51.4	51.4	9.3	51.4	51.4
Yellow Time (s)	3.3	3.3	3.3	3.3	3.3	4.2	4.2	4.2	4.2	4.2	4.2
All-Red Time (s)	2.5	2.5	2.5	2.5	2.5	1.5	1.4	1.4	1.5	1.4	1.4
Lost Time Adjust (s)	0.0	0.0	0.0	0.0	0.0	0.0	0.0	0.0	0.0	0.0	0.0
Total Lost Time (s)	5.8	5.8	5.8	5.8	5.8	5.7	5.6	5.6	5.7	5.6	5.6
Lead/Lag	Lead			Lag	Lag	Lead	Lag	Lag	Lead	Lag	Lag
Lead-Lag Optimize?	Yes			Yes	Yes	Yes	Yes	Yes	Yes	Yes	Yes
Vehicle Extension (s)	3.0	3.0	3.0	3.0	3.0	3.0	3.0	3.0	3.0	3.0	3.0
Recall Mode	None	None	None	None	None	C-Max	C-Max	None	C-Max	C-Max	C-Max
Walk Time (s)	7.0	7.0	7.0	7.0	7.0	25.0	25.0	25.0	25.0	25.0	25.0
Flash Dont Walk (s)	15.0	15.0	15.0	15.0	15.0	6.0	6.0	6.0	6.0	6.0	6.0
Pedestrian Calls (#/hr)	2	2	1	1	1	0	0	0	3	3	3
Act Effct Green (s)	35.6	35.6	35.6	23.4	23.4	67.8	59.1	59.1	66.6	58.5	58.5
Actuated g/C Ratio	0.30	0.30	0.30	0.20	0.20	0.56	0.49	0.49	0.56	0.49	0.49
v/c Ratio	0.26	0.14	0.21	0.23	0.87	0.42	0.57	0.09	0.33	0.56	0.31
Control Delay	30.4	28.6	6.6	42.3	69.7	16.5	25.4	0.2	15.5	25.5	4.1
Queue Delay	0.0	0.0	0.0	0.0	0.0	0.0	0.0	0.0	0.0	0.0	0.0
Total Delay	30.4	28.6	6.6	42.3	69.7	16.5	25.4	0.2	15.5	25.5	4.1
LOS	C	C	A	D	E	B	C	A	B	C	A
Approach Delay		19.5			65.4		22.7			20.8	
Approach LOS		B			E		C			C	
Queue Length 50th (m)	8.3	11.2	0.0	9.4	52.8	13.9	85.1	0.0	9.7	81.1	0.0
Queue Length 95th (m)	17.1	21.5	11.1	20.3	#92.9	24.2	109.2	0.1	18.1	102.8	14.0
Internal Link Dist (m)		518.7			103.5		597.8			682.5	
Turn Bay Length (m)	75.0		200.0	65.0		75.0		55.0	75.0		85.0
Base Capacity (vph)	215	596	500	231	330	317	1571	760	289	1513	687
Starvation Cap Reductn	0	0	0	0	0	0	0	0	0	0	0
Spillback Cap Reductn	0	0	0	0	0	0	0	0	0	0	0
Storage Cap Reductn	0	0	0	0	0	0	0	0	0	0	0
Reduced v/c Ratio	0.24	0.12	0.19	0.21	0.79	0.41	0.57	0.09	0.32	0.56	0.31

Intersection Summary

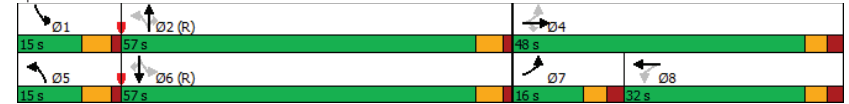
Cycle Length: 120  
 Actuated Cycle Length: 120  
 Offset: 53 (44%), Referenced to phase 2:NBTL and 6:SBTL, Start of Green  
 Natural Cycle: 90

Lanes, Volumes, Timings  
2: St-Laurent & Belfast

Existing AM Peak Hour  
1531 St-Laurent Blvd

Control Type: Actuated-Coordinated	
Maximum v/c Ratio: 0.87	
Intersection Signal Delay: 26.4	Intersection LOS: C
Intersection Capacity Utilization 69.9%	ICU Level of Service C
Analysis Period (min) 15	
# 95th percentile volume exceeds capacity, queue may be longer.	
Queue shown is maximum after two cycles.	

Splits and Phases: 2: St-Laurent & Belfast



Lanes, Volumes, Timings  
3: St-Laurent & Industrial/Innes

Existing AM Peak Hour  
1531 St-Laurent Blvd

Lane Group	EBL	EBT	EBR	WBL	WBT	WBR	NBL	NBT	NBR	SBL	SBT	SBR
Lane Configurations	↔	↕	↔	↔	↕	↔	↔	↕	↔	↔	↕	↔
Traffic Volume (vph)	67	177	118	611	741	241	177	983	330	116	744	142
Future Volume (vph)	67	177	118	611	741	241	177	983	330	116	744	142
Lane Group Flow (vph)	74	197	131	679	823	268	197	1092	367	129	827	158
Turn Type	Prot	NA	Perm	Prot	NA	Perm	Prot	NA	Perm	Prot	NA	Perm
Protected Phases	7	4		3	8		5	2		1	6	
Permitted Phases			4			8			2			6
Detector Phase	7	4	4	3	8	8	5	2	2	1	6	6
Switch Phase												
Minimum Initial (s)	5.0	10.0	10.0	5.0	10.0	10.0	5.0	10.0	10.0	5.0	10.0	10.0
Minimum Split (s)	11.6	38.6	38.6	11.6	38.6	38.6	11.3	37.6	37.6	11.3	37.6	37.6
Total Split (s)	25.0	38.0	38.0	36.0	49.0	49.0	23.0	43.0	43.0	23.0	43.0	43.0
Total Split (%)	17.9%	27.1%	27.1%	25.7%	35.0%	35.0%	16.4%	30.7%	30.7%	16.4%	30.7%	30.7%
Maximum Green (s)	18.4	31.4	31.4	29.4	42.4	42.4	16.7	36.4	36.4	16.7	36.4	36.4
Yellow Time (s)	3.7	3.7	3.7	3.7	3.7	3.7	4.2	4.2	4.2	4.2	4.2	4.2
All-Red Time (s)	2.9	2.9	2.9	2.9	2.9	2.9	2.1	2.4	2.4	2.1	2.4	2.4
Lost Time Adjust (s)	0.0	0.0	0.0	0.0	0.0	0.0	0.0	0.0	0.0	0.0	0.0	0.0
Total Lost Time (s)	6.6	6.6	6.6	6.6	6.6	6.6	6.3	6.6	6.6	6.3	6.6	6.6
Lead/Lag	Lead	Lag	Lag	Lead	Lag	Lag	Lead	Lag	Lag	Lead	Lag	Lag
Lead-Lag Optimize?	Yes	Yes	Yes	Yes	Yes	Yes	Yes	Yes	Yes	Yes	Yes	Yes
Vehicle Extension (s)	3.0	3.0	3.0	3.0	3.0	3.0	3.0	3.0	3.0	3.0	3.0	3.0
Recall Mode	None	None	None	None	None	None	C-Max	C-Max	None	C-Max	C-Max	C-Max
Walk Time (s)	7.0	7.0			7.0	7.0		7.0			7.0	7.0
Flash Dont Walk (s)	25.0	25.0			25.0	25.0		24.0			24.0	24.0
Pedestrian Calls (#/hr)	6	6			2	2		4			7	7
Act Effct Green (s)	8.9	22.0	22.0	29.4	45.1	45.1	14.0	51.4	51.4	11.1	48.5	48.5
Actuated g/C Ratio	0.06	0.16	0.16	0.21	0.32	0.32	0.10	0.37	0.37	0.08	0.35	0.35
v/c Ratio	0.39	0.42	0.36	1.01	0.81	0.44	0.65	0.95	0.51	0.52	0.74	0.29
Control Delay	68.6	54.5	4.4	90.6	50.6	6.3	70.9	60.4	9.8	69.1	46.6	5.0
Queue Delay	0.0	0.0	0.0	0.0	0.0	0.0	0.0	0.0	0.0	0.0	0.0	0.0
Total Delay	68.6	54.5	4.4	90.6	50.6	6.3	70.9	60.4	9.8	69.1	46.6	5.0
LOS	E	D	A	F	D	A	E	E	A	E	D	A
Approach Delay		40.8			59.3			50.4			43.3	
Approach LOS		D			E			D			D	
Queue Length 50th (m)	10.3	26.1	0.0	-98.7	112.4	1.0	27.4	155.0	9.7	17.9	107.0	0.0
Queue Length 95th (m)	18.2	35.6	5.1	#138.6	128.7	20.5	39.8	#241.3	42.7	28.0	#163.6	12.3
Internal Link Dist (m)		745.6			700.4			316.7			597.8	
Turn Bay Length (m)	38.0		120.0	150.0		80.0	100.0		100.0	125.0		150.0
Base Capacity (vph)	391	665	444	675	1028	614	359	1149	713	372	1115	537
Starvation Cap Reductn	0	0	0	0	0	0	0	0	0	0	0	0
Spillback Cap Reductn	0	0	0	0	0	0	0	0	0	0	0	0
Storage Cap Reductn	0	0	0	0	0	0	0	0	0	0	0	0
Reduced v/c Ratio	0.19	0.30	0.30	1.01	0.80	0.44	0.55	0.95	0.51	0.35	0.74	0.29

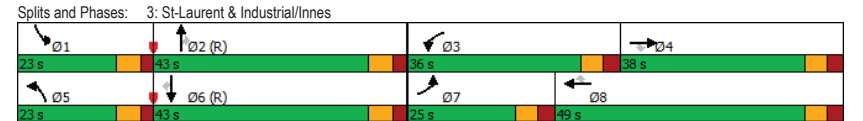
Intersection Summary

Cycle Length: 140  
Actuated Cycle Length: 140  
Offset: 0 (0%), Referenced to phase 2:NBT and 6:SBT, Start of Green  
Natural Cycle: 150

Lanes, Volumes, Timings  
3: St-Laurent & Industrial/Innes

Existing AM Peak Hour  
1531 St-Laurent Blvd

Control Type: Actuated-Coordinated  
Maximum v/c Ratio: 1.01  
Intersection Signal Delay: 51.2  
Intersection LOS: D  
Intersection Capacity Utilization 84.7%  
ICU Level of Service E  
Analysis Period (min) 15  
~ Volume exceeds capacity, queue is theoretically infinite.  
Queue shown is maximum after two cycles.  
# 95th percentile volume exceeds capacity, queue may be longer.  
Queue shown is maximum after two cycles.



Intersection												
Int Delay, s/veh	2.2											
Movement	EBL	EBT	EBR	WBL	WBT	WBR	NBL	NBT	NBR	SBL	SBT	SBR
Lane Configurations	↔		↔		↔		↔		↔		↔	
Traffic Vol, veh/h	51	272	15	13	225	26	11	1	15	15	4	17
Future Vol, veh/h	51	272	15	13	225	26	11	1	15	15	4	17
Conflicting Peds, #/hr	8	0	10	10	0	8	0	0	5	5	0	0
Sign Control	Free	Free	Free	Free	Free	Free	Stop	Stop	Stop	Stop	Stop	Stop
RT Channelized	-	-	None	-	-	None	-	-	None	-	-	None
Storage Length	-	-	-	-	-	-	-	-	-	-	-	-
Veh in Median Storage, #	-	0	-	-	0	-	-	0	-	-	0	-
Grade, %	-	0	-	-	0	-	-	0	-	-	0	-
Peak Hour Factor	90	90	90	90	90	90	90	90	90	90	90	90
Heavy Vehicles, %	20	12	7	23	15	15	55	2	33	20	25	12
Mvmt Flow	57	302	17	14	250	29	12	1	17	17	4	19
Major/Minor	Major1			Major2			Minor1			Minor2		
Conflicting Flow All	287	0	0	329	0	0	739	750	326	740	744	273
Stage 1	-	-	-	-	-	-	435	435	-	301	301	-
Stage 2	-	-	-	-	-	-	304	315	-	439	443	-
Critical Hdwy	4.3	-	-	4.33	-	-	7.65	6.52	6.53	7.3	6.75	6.32
Critical Hdwy Stg 1	-	-	-	-	-	-	6.65	5.52	-	6.3	5.75	-
Critical Hdwy Stg 2	-	-	-	-	-	-	6.65	5.52	-	6.3	5.75	-
Follow-up Hdwy	2.38	-	-	2.407	-	-	3.995	4.018	3.597	3.68	4.225	3.408
Pot Cap-1 Maneuver	1179	-	-	1122	-	-	275	340	649	311	317	742
Stage 1	-	-	-	-	-	-	509	580	-	671	625	-
Stage 2	-	-	-	-	-	-	605	656	-	563	539	-
Platoon blocked, %	-	-	-	-	-	-	-	-	-	-	-	-
Mov Cap-1 Maneuver	1172	-	-	1113	-	-	248	311	641	282	290	737
Mov Cap-2 Maneuver	-	-	-	-	-	-	248	311	-	282	290	-
Stage 1	-	-	-	-	-	-	475	541	-	627	612	-
Stage 2	-	-	-	-	-	-	576	642	-	513	503	-
Approach	EB			WB			NB			SB		
HCM Control Delay, s	1.2			0.4			15.3			15		
HCM LOS	C			C			C			C		
Minor Lane/Major Mvmt	NBLn1	EBL	EBT	EBR	WBL	WBT	WBR	SBLn1				
Capacity (veh/h)	380	1172	-	-	1113	-	-	400				
HCM Lane V/C Ratio	0.079	0.048	-	-	0.013	-	-	0.1				
HCM Control Delay (s)	15.3	8.2	0	-	8.3	0	-	15				
HCM Lane LOS	C	A	A	-	A	A	-	C				
HCM 95th %tile Q(veh)	0.3	0.2	-	-	0	-	-	0.3				

Lane Group	EBL	EBT	WBL	WBT	NBL	NBT	SBL	SBT	SBR	
Lane Configurations	↔	↔	↔	↔	↔	↔	↔	↔	↔	
Traffic Volume (vph)	47	38	23	21	26	1305	51	954	38	
Future Volume (vph)	47	38	23	21	26	1305	51	954	38	
Lane Group Flow (vph)	52	105	26	223	29	1463	57	1060	42	
Turn Type	Perm	NA	Perm	NA	Perm	NA	pm+pt	NA	Perm	
Protected Phases	4		8		8		2		6	
Permitted Phases	4		8		2		6		6	
Detector Phase	4		4		8		2		2	
Switch Phase	4		4		8		2		2	
Minimum Initial (s)	10.0	10.0	10.0	10.0	10.0	10.0	5.0	10.0	10.0	
Minimum Split (s)	38.5	38.5	38.5	38.5	39.2	39.2	9.7	39.2	39.2	
Total Split (s)	40.0	40.0	40.0	40.0	65.0	65.0	15.0	80.0	80.0	
Total Split (%)	33.3%	33.3%	33.3%	33.3%	54.2%	54.2%	12.5%	66.7%	66.7%	
Maximum Green (s)	33.5	33.5	33.5	33.5	58.8	58.8	10.3	73.8	73.8	
Yellow Time (s)	3.3	3.3	3.3	3.3	3.7	3.7	3.7	3.7	3.7	
All-Red Time (s)	3.2	3.2	3.2	3.2	2.5	2.5	1.0	2.5	2.5	
Lost Time Adjust (s)	0.0	0.0	0.0	0.0	0.0	0.0	0.0	0.0	0.0	
Total Lost Time (s)	6.5	6.5	6.5	6.5	6.2	6.2	4.7	6.2	6.2	
Lead/Lag					Lag	Lag	Lead			
Lead-Lag Optimize?					Yes	Yes	Yes			
Vehicle Extension (s)	3.0	3.0	3.0	3.0	3.0	3.0	3.0	3.0	3.0	
Recall Mode	None	None	None	None	C-Max	C-Max	None	C-Max	C-Max	
Walk Time (s)	7.0	7.0	7.0	7.0	11.0	11.0		11.0	11.0	
Flash Dont Walk (s)	25.0	25.0	25.0	25.0	22.0	22.0		22.0	22.0	
Pedestrian Calls (#/hr)	2	2	2	2	12	12		8	8	
Act Effct Green (s)	16.6	16.6	16.6	16.6	81.4	81.4	92.2	90.7	90.7	
Actuated g/C Ratio	0.14	0.14	0.14	0.14	0.68	0.68	0.77	0.76	0.76	
v/c Ratio	0.83	0.40	0.16	0.62	0.09	0.45	0.22	0.44	0.04	
Control Delay	118.0	23.8	43.4	18.6	14.5	12.2	6.9	7.1	2.3	
Queue Delay	0.0	0.0	0.0	0.0	0.0	0.0	0.0	0.0	0.0	
Total Delay	118.0	23.8	43.4	18.6	14.5	12.2	6.9	7.1	2.3	
LOS	F	C	D	B	B	B	A	A	A	
Approach Delay	55.0				21.2		12.2		6.9	
Approach LOS	E				C		B		A	
Queue Length 50th (m)	12.4	9.4	5.6	9.8	1.5	37.0	2.3	35.8	0.0	
Queue Length 95th (m)	23.5	21.7	11.9	29.0	m5.8	m94.0	9.5	84.7	4.1	
Internal Link Dist (m)	390.4			0.1		682.5		144.8		
Turn Bay Length (m)	38.0		38.0		45.0		75.0			
Base Capacity (vph)	129	469	335	544	312	3229	306	2412	987	
Starvation Cap Reductn	0	0	0	0	0	0	0	0	0	
Spillback Cap Reductn	0	0	0	0	0	0	0	0	0	
Storage Cap Reductn	0	0	0	0	0	0	0	0	0	
Reduced v/c Ratio	0.40	0.22	0.08	0.41	0.09	0.45	0.19	0.44	0.04	

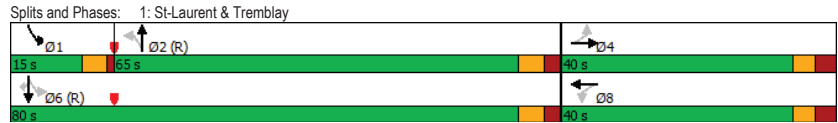
Intersection Summary

Cycle Length: 120  
 Actuated Cycle Length: 120  
 Offset: 49 (41%), Referenced to phase 2:NBT and 6:SBTL, Start of Green  
 Natural Cycle: 90

Lanes, Volumes, Timings  
1: St-Laurent & Tremblay

Existing PM Peak Hour  
1531 St-Laurent Blvd

Control Type: Actuated-Coordinated	
Maximum v/c Ratio: 0.83	
Intersection Signal Delay: 13.1	Intersection LOS: B
Intersection Capacity Utilization 79.6%	ICU Level of Service D
Analysis Period (min) 15	
m Volume for 95th percentile queue is metered by upstream signal.	



Lanes, Volumes, Timings  
2: St-Laurent & Belfast

Existing PM Peak Hour  
1531 St-Laurent Blvd

Lane Group	EBL	EBT	EBR	WBL	WBT	NBL	NBT	NBR	SBL	SBT	SBR
Lane Configurations	↔	↕	↔	↔	↕	↔	↕	↔	↔	↕	↔
Traffic Volume (vph)	195	162	215	101	91	104	934	82	93	746	133
Future Volume (vph)	195	162	215	101	91	104	934	82	93	746	133
Lane Group Flow (vph)	217	180	239	112	267	116	1038	91	103	829	148
Turn Type	pm+pt	NA	Perm	Perm	NA	pm+pt	NA	Perm	pm+pt	NA	Perm
Protected Phases	7	4			8	5	2		1	6	
Permitted Phases	4		4	8		2		2	6		6
Detector Phase	7	4	4	8	8	5	2	2	1	6	6
Switch Phase											
Minimum Initial (s)	5.0	10.0	10.0	10.0	10.0	5.0	10.0	10.0	5.0	10.0	10.0
Minimum Split (s)	10.8	27.8	27.8	27.8	27.8	10.7	36.6	36.6	10.7	36.6	36.6
Total Split (s)	15.0	49.0	49.0	34.0	34.0	14.0	57.0	57.0	14.0	57.0	57.0
Total Split (%)	12.5%	40.8%	40.8%	28.3%	28.3%	11.7%	47.5%	47.5%	11.7%	47.5%	47.5%
Maximum Green (s)	9.2	43.2	43.2	28.2	28.2	8.3	51.4	51.4	8.3	51.4	51.4
Yellow Time (s)	3.3	3.3	3.3	3.3	3.3	4.2	4.2	4.2	4.2	4.2	4.2
All-Red Time (s)	2.5	2.5	2.5	2.5	2.5	1.5	1.4	1.4	1.5	1.4	1.4
Lost Time Adjust (s)	0.0	0.0	0.0	0.0	0.0	0.0	0.0	0.0	0.0	0.0	0.0
Total Lost Time (s)	5.8	5.8	5.8	5.8	5.8	5.7	5.6	5.6	5.7	5.6	5.6
Lead/Lag	Lead			Lag	Lag	Lead	Lag	Lag	Lead	Lag	Lag
Lead-Lag Optimize?	Yes			Yes	Yes	Yes	Yes	Yes	Yes	Yes	Yes
Vehicle Extension (s)	3.0	3.0	3.0	3.0	3.0	3.0	3.0	3.0	3.0	3.0	3.0
Recall Mode	None	None	None	None	None	None	C-Max	C-Max	None	C-Max	C-Max
Walk Time (s)	7.0	7.0	7.0	7.0	7.0	25.0	25.0	25.0	25.0	25.0	25.0
Flash Dont Walk (s)	15.0	15.0	15.0	15.0	15.0	6.0	6.0	6.0	6.0	6.0	6.0
Pedestrian Calls (#/hr)	9	9	5	5	5	1	1	1	15	15	15
Act Effct Green (s)	36.2	36.2	36.2	21.2	21.2	66.6	58.2	58.2	66.5	58.2	58.2
Actuated g/C Ratio	0.30	0.30	0.30	0.18	0.18	0.56	0.48	0.48	0.55	0.48	0.48
v/c Ratio	1.07	0.38	0.41	0.61	0.83	0.36	0.65	0.14	0.44	0.52	0.19
Control Delay	117.7	34.2	7.2	58.6	56.2	15.0	27.0	1.7	21.5	19.2	2.3
Queue Delay	0.0	0.0	0.0	0.0	0.0	0.0	0.0	0.0	0.0	0.0	0.0
Total Delay	117.7	34.2	7.2	58.6	56.2	15.0	27.0	1.7	21.5	19.2	2.3
LOS	F	C	A	E	E	B	C	A	C	B	A
Approach Delay		52.5			56.9		24.0			17.1	
Approach LOS		D			E		C			B	
Queue Length 50th (m)	-44.0	33.1	3.6	24.4	46.9	11.2	96.3	0.0	9.1	44.3	0.0
Queue Length 95th (m)	#85.0	48.8	20.5	41.0	73.0	22.4	130.7	3.9	25.8	52.8	5.9
Internal Link Dist (m)		518.7			103.5		597.8			682.5	
Turn Bay Length (m)	75.0		200.0	65.0		75.0		55.0	75.0		85.0
Base Capacity (vph)	203	572	658	244	408	329	1593	665	238	1591	759
Starvation Cap Reductn	0	0	0	0	0	0	0	0	0	0	0
Spillback Cap Reductn	0	0	0	0	0	0	0	0	0	0	0
Storage Cap Reductn	0	0	0	0	0	0	0	0	0	0	0
Reduced v/c Ratio	1.07	0.31	0.36	0.46	0.65	0.35	0.65	0.14	0.43	0.52	0.19

<b>Intersection Summary</b>											
Cycle Length: 120											
Actuated Cycle Length: 120											
Offset: 49 (41%), Referenced to phase 2:NBTL and 6:SBTL, Start of Green											
Natural Cycle: 90											

Lanes, Volumes, Timings  
2: St-Laurent & Belfast

Existing PM Peak Hour  
1531 St-Laurent Blvd

Control Type: Actuated-Coordinated  
 Maximum v/c Ratio: 1.07  
 Intersection Signal Delay: 30.9 Intersection LOS: C  
 Intersection Capacity Utilization 78.7% ICU Level of Service D  
 Analysis Period (min) 15  
 ~ Volume exceeds capacity, queue is theoretically infinite.  
 Queue shown is maximum after two cycles.  
 # 95th percentile volume exceeds capacity, queue may be longer.  
 Queue shown is maximum after two cycles.



Lanes, Volumes, Timings  
3: St-Laurent & Industrial/Innes

Existing PM Peak Hour  
1531 St-Laurent Blvd

Lane Group	EBL	EBT	EBR	WBL	WBT	WBR	NBL	NBT	NBR	SBL	SBT	SBR
Lane Configurations	↔	↕	↔	↔	↕	↔	↔	↕	↔	↔	↕	↔
Traffic Volume (vph)	135	550	324	398	274	135	174	852	507	130	814	124
Future Volume (vph)	135	550	324	398	274	135	174	852	507	130	814	124
Lane Group Flow (vph)	150	611	360	442	304	150	193	947	563	144	904	138
Turn Type	Prot	NA	Perm	Prot	NA	Perm	Prot	NA	Perm	Prot	NA	Perm
Protected Phases	7	4		3	8		5	2		1	6	
Permitted Phases			4			8			2			6
Detector Phase	7	4	4	3	8	8	5	2	2	1	6	6
Switch Phase												
Minimum Initial (s)	5.0	10.0	10.0	5.0	10.0	10.0	5.0	10.0	10.0	5.0	10.0	10.0
Minimum Split (s)	11.6	38.6	38.6	11.6	38.6	38.6	11.3	37.6	37.6	11.3	37.6	37.6
Total Split (s)	19.0	38.0	38.0	41.0	60.0	60.0	28.0	43.0	43.0	28.0	43.0	43.0
Total Split (%)	12.7%	25.3%	25.3%	27.3%	40.0%	40.0%	18.7%	28.7%	28.7%	18.7%	28.7%	28.7%
Maximum Green (s)	12.4	31.4	31.4	34.4	53.4	53.4	21.7	36.4	36.4	21.7	36.4	36.4
Yellow Time (s)	3.7	3.7	3.7	3.7	3.7	3.7	4.2	4.2	4.2	4.2	4.2	4.2
All-Red Time (s)	2.9	2.9	2.9	2.9	2.9	2.9	2.1	2.4	2.4	2.1	2.4	2.4
Lost Time Adjust (s)	0.0	0.0	0.0	0.0	0.0	0.0	0.0	0.0	0.0	0.0	0.0	0.0
Total Lost Time (s)	6.6	6.6	6.6	6.6	6.6	6.6	6.3	6.6	6.6	6.3	6.6	6.6
Lead/Lag	Lead	Lag	Lag	Lead	Lag	Lag	Lead	Lag	Lag	Lead	Lag	Lag
Lead-Lag Optimize?	Yes	Yes	Yes	Yes	Yes	Yes	Yes	Yes	Yes	Yes	Yes	Yes
Vehicle Extension (s)	3.0	3.0	3.0	3.0	3.0	3.0	3.0	3.0	3.0	3.0	3.0	3.0
Recall Mode	None	None	None	None	None	None	None	Max	Max	None	Max	Max
Walk Time (s)	7.0	7.0			7.0	7.0		7.0	7.0		7.0	7.0
Flash Dont Walk (s)		25.0	25.0		25.0	25.0		24.0	24.0		24.0	24.0
Pedestrian Calls (#/hr)		5	5		6	6		9	9		12	12
Act Effct Green (s)	10.8	29.1	29.1	23.0	41.4	41.4	13.4	38.5	38.5	11.6	36.7	36.7
Actuated g/C Ratio	0.08	0.23	0.23	0.18	0.32	0.32	0.10	0.30	0.30	0.09	0.29	0.29
v/c Ratio	0.56	0.83	0.64	0.77	0.30	0.26	0.59	0.97	0.75	0.53	0.97	0.26
Control Delay	66.6	58.7	14.6	60.2	33.7	5.9	64.0	68.2	15.5	64.5	70.2	4.1
Queue Delay	0.0	0.0	0.0	0.0	0.0	0.0	0.0	0.0	0.0	0.0	0.0	0.0
Total Delay	66.6	58.7	14.6	60.2	33.7	5.9	64.0	68.2	15.5	64.5	70.2	4.1
LOS	E	E	B	E	C	A	E	E	B	E	E	A
Approach Delay		45.6			42.1			50.3				61.8
Approach LOS		D			D			D				E
Queue Length 50th (m)	19.3	77.7	11.3	56.4	30.3	0.0	24.8	127.8	20.8	18.5	122.4	0.0
Queue Length 95th (m)	32.9	#112.0	46.9	77.6	44.5	14.7	39.3	#197.5	76.5	31.1	#192.7	9.7
Internal Link Dist (m)		745.6			700.4			316.7			597.8	
Turn Bay Length (m)	38.0		120.0	150.0		80.0	100.0		100.0	125.0		150.0
Base Capacity (vph)	312	803	582	867	1335	695	531	974	752	516	928	531
Starvation Cap Reductn	0	0	0	0	0	0	0	0	0	0	0	0
Spillback Cap Reductn	0	0	0	0	0	0	0	0	0	0	0	0
Storage Cap Reductn	0	0	0	0	0	0	0	0	0	0	0	0
Reduced v/c Ratio	0.48	0.76	0.62	0.51	0.23	0.22	0.36	0.97	0.75	0.28	0.97	0.26

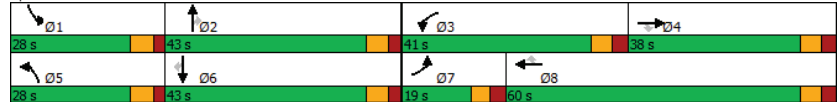
**Intersection Summary**  
 Cycle Length: 150  
 Actuated Cycle Length: 128.5  
 Natural Cycle: 110  
 Control Type: Actuated-Uncoordinated

Lanes, Volumes, Timings  
3: St-Laurent & Industrial/Innes

Existing PM Peak Hour  
1531 St-Laurent Blvd

Maximum v/c Ratio: 0.97	Intersection LOS: D
Intersection Signal Delay: 50.5	ICU Level of Service E
Intersection Capacity Utilization 82.5%	
Analysis Period (min) 15	
# 95th percentile volume exceeds capacity, queue may be longer.	
Queue shown is maximum after two cycles.	

Splits and Phases: 3: St-Laurent & Industrial/Innes



HCM 2010 TWSC  
5: Lagan & Belfast

Existing PM Peak Hour  
1531 St-Laurent Blvd

Intersection												
Int Delay, s/veh	3.1											
Movement	EBL	EBT	EBR	WBL	WBT	WBR	NBL	NBT	NBR	SBL	SBT	SBR
Lane Configurations	↕			↕			↕			↕		
Traffic Vol, veh/h	46	265	50	19	310	26	26	5	16	30	0	39
Future Vol, veh/h	46	265	50	19	310	26	26	5	16	30	0	39
Conflicting Peds, #/hr	12	0	5	5	0	12	1	0	6	6	0	1
Sign Control	Free	Free	Free	Free	Free	Free	Stop	Stop	Stop	Stop	Stop	Stop
RT Channelized	-	-	None	-	-	None	-	-	None	-	-	None
Storage Length	-	-	-	-	-	-	-	-	-	-	-	-
Veh in Median Storage, #	-	0	-	-	0	-	-	0	-	-	0	-
Grade, %	-	0	-	-	0	-	-	0	-	-	0	-
Peak Hour Factor	90	90	90	90	90	90	90	90	90	90	90	90
Heavy Vehicles, %	30	6	12	5	3	8	4	2	2	10	2	2
Mvmt Flow	51	294	56	21	344	29	29	6	18	33	0	43

Major/Minor	Major1	Major2	Minor1	Minor2
Conflicting Flow All	385	0	355	0
Stage 1	-	-	-	-
Stage 2	-	-	-	-
Critical Hdwy	4.4	-	4.15	-
Critical Hdwy Stg 1	-	-	-	-
Critical Hdwy Stg 2	-	-	-	-
Follow-up Hdwy	2.47	-	2.245	-
Pot Cap-1 Maneuver	1036	-	1187	-
Stage 1	-	-	-	-
Stage 2	-	-	-	-
Platoon blocked, %	-	-	-	-
Mov Cap-1 Maneuver	1026	-	1182	-
Mov Cap-2 Maneuver	-	-	-	-
Stage 1	-	-	-	-
Stage 2	-	-	-	-

Approach	EB	WB	NB	SB
HCM Control Delay, s	1.1	0.4	18.7	17.1
HCM LOS			C	C

Minor Lane/Major Mvmt	NBLn1	EBL	EBT	EBR	WBL	WBT	WBR	SBLn1
Capacity (veh/h)	315	1026	-	-	1182	-	-	375
HCM Lane V/C Ratio	0.166	0.05	-	-	0.018	-	-	0.204
HCM Control Delay (s)	18.7	8.7	0	-	8.1	0	-	17.1
HCM Lane LOS	C	A	A	-	A	A	-	C
HCM 95th %tile Q(veh)	0.6	0.2	-	-	0.1	-	-	0.8



# Appendix D

Collision Data

Accident Date	Accident Year	Accident Time	Location	Environment Condition	Light	Traffic Control	Traffic Control Condition	Classification Of Accident	Initial Impact Type	Road Surface Condition	# Vehicles	# Motorcycles	# Bicycles	# Pedestrians
1/2/2018	2018	13:33	BELFAST RD @ ST. LAURENT BLVD (0007658)	03 - Snow	01 - Daylight	01 - Traffic signal	0	03 - P-D only	03 - Rear end	03 - Loose snow	0	0	0	0
1/4/2018	2018	12:22	BELFAST RD @ ST. LAURENT BLVD (0007658)	01 - Clear	01 - Daylight	01 - Traffic signal	0	03 - P-D only	05 - Turning movement	02 - Wet	0	0	0	0
1/6/2018	2018	10:20	BELFAST RD @ ST. LAURENT BLVD (0007658)	01 - Clear	01 - Daylight	01 - Traffic signal	0	03 - P-D only	07 - SMV other	06 - Ice	0	0	0	0
1/7/2018	2018	14:56	BELFAST RD @ ST. LAURENT BLVD (0007658)	03 - Snow	01 - Daylight	01 - Traffic signal	0	03 - P-D only	05 - Turning movement	02 - Wet	0	0	0	0
3/3/2018	2018	20:09	BELFAST RD @ ST. LAURENT BLVD (0007658)	01 - Clear	07 - Dark	01 - Traffic signal	0	03 - P-D only	03 - Rear end	01 - Dry	0	0	0	0
3/23/2018	2018	13:45	BELFAST RD @ ST. LAURENT BLVD (0007658)	01 - Clear	01 - Daylight	01 - Traffic signal	0	03 - P-D only	05 - Turning movement	01 - Dry	0	0	0	0
5/15/2018	2018	15:56	BELFAST RD @ ST. LAURENT BLVD (0007658)	01 - Clear	01 - Daylight	01 - Traffic signal	0	03 - P-D only	04 - Sideswipe	01 - Dry	0	0	0	0
5/18/2018	2018	12:37	BELFAST RD @ ST. LAURENT BLVD (0007658)	01 - Clear	01 - Daylight	01 - Traffic signal	0	02 - Non-fatal injury	03 - Rear end	01 - Dry	0	0	0	0
5/23/2018	2018	13:25	BELFAST RD @ ST. LAURENT BLVD (0007658)	01 - Clear	01 - Daylight	01 - Traffic signal	0	03 - P-D only	05 - Turning movement	01 - Dry	0	0	0	0
5/23/2018	2018	17:12	BELFAST RD @ ST. LAURENT BLVD (0007658)	01 - Clear	01 - Daylight	01 - Traffic signal	0	03 - P-D only	07 - SMV other	01 - Dry	0	0	0	0
6/18/2018	2018	9:15	BELFAST RD @ ST. LAURENT BLVD (0007658)	01 - Clear	01 - Daylight	01 - Traffic signal	0	03 - P-D only	05 - Turning movement	01 - Dry	0	0	0	0
6/20/2018	2018	18:10	BELFAST RD @ ST. LAURENT BLVD (0007658)	01 - Clear	01 - Daylight	01 - Traffic signal	0	02 - Non-fatal injury	05 - Turning movement	01 - Dry	0	0	0	0
7/4/2018	2018	18:48	BELFAST RD @ ST. LAURENT BLVD (0007658)	01 - Clear	01 - Daylight	01 - Traffic signal	0	03 - P-D only	03 - Rear end	01 - Dry	0	0	0	0
7/9/2018	2018	18:47	BELFAST RD @ ST. LAURENT BLVD (0007658)	01 - Clear	01 - Daylight	01 - Traffic signal	0	03 - P-D only	03 - Rear end	01 - Dry	0	0	0	0
7/18/2018	2018	18:19	BELFAST RD @ ST. LAURENT BLVD (0007658)	01 - Clear	01 - Daylight	01 - Traffic signal	0	03 - P-D only	05 - Turning movement	01 - Dry	0	0	0	0
8/23/2018	2018	15:45	BELFAST RD @ ST. LAURENT BLVD (0007658)	01 - Clear	01 - Daylight	01 - Traffic signal	0	02 - Non-fatal injury	03 - Rear end	01 - Dry	0	0	0	0
10/17/2018	2018	7:37	BELFAST RD @ ST. LAURENT BLVD (0007658)	01 - Clear	01 - Daylight	01 - Traffic signal	0	03 - P-D only	03 - Rear end	01 - Dry	0	0	0	0
11/6/2018	2018	7:11	BELFAST RD @ ST. LAURENT BLVD (0007658)	01 - Clear	03 - Dawn	01 - Traffic signal	0	02 - Non-fatal injury	05 - Turning movement	01 - Dry	0	0	0	0
11/9/2018	2018	9:25	BELFAST RD @ ST. LAURENT BLVD (0007658)	01 - Clear	01 - Daylight	01 - Traffic signal	0	03 - P-D only	04 - Sideswipe	01 - Dry	0	0	0	0
11/20/2018	2018	8:37	BELFAST RD @ ST. LAURENT BLVD (0007658)	03 - Snow	01 - Daylight	01 - Traffic signal	0	03 - P-D only	03 - Rear end	03 - Loose snow	0	0	0	0
11/20/2018	2018	6:30	BELFAST RD @ ST. LAURENT BLVD (0007658)	03 - Snow	07 - Dark	01 - Traffic signal	0	03 - P-D only	05 - Turning movement	03 - Loose snow	0	0	0	0
12/12/2018	2018	9:32	BELFAST RD @ ST. LAURENT BLVD (0007658)	01 - Clear	01 - Daylight	01 - Traffic signal	0	03 - P-D only	02 - Angle	02 - Wet	0	0	0	0
12/17/2018	2018	7:40	BELFAST RD @ ST. LAURENT BLVD (0007658)	01 - Clear	03 - Dawn	01 - Traffic signal	0	03 - P-D only	05 - Turning movement	02 - Wet	0	0	0	0
1/14/2019	2019	10:24	BELFAST RD @ ST. LAURENT BLVD (0007658)	01 - Clear	01 - Daylight	01 - Traffic signal	0	03 - P-D only	03 - Rear end	01 - Dry	0	0	0	0
2/1/2019	2019	15:20	BELFAST RD @ ST. LAURENT BLVD (0007658)	01 - Clear	01 - Daylight	01 - Traffic signal	0	03 - P-D only	03 - Rear end	04 - Slush	0	0	0	0
2/2/2019	2019	15:09	BELFAST RD @ ST. LAURENT BLVD (0007658)	03 - Snow	01 - Daylight	01 - Traffic signal	0	03 - P-D only	05 - Turning movement	04 - Slush	0	0	0	0
3/10/2019	2019	19:29	BELFAST RD @ ST. LAURENT BLVD (0007658)	02 - Rain	07 - Dark	01 - Traffic signal	0	03 - P-D only	03 - Rear end	02 - Wet	0	0	0	0
3/15/2019	2019	14:03	BELFAST RD @ ST. LAURENT BLVD (0007658)	01 - Clear	01 - Daylight	01 - Traffic signal	0	03 - P-D only	02 - Angle	01 - Dry	0	0	0	0
3/19/2019	2019	12:04	BELFAST RD @ ST. LAURENT BLVD (0007658)	01 - Clear	01 - Daylight	01 - Traffic signal	0	02 - Non-fatal injury	05 - Turning movement	01 - Dry	0	0	0	0
5/27/2019	2019	14:14	BELFAST RD @ ST. LAURENT BLVD (0007658)	01 - Clear	01 - Daylight	01 - Traffic signal	0	02 - Non-fatal injury	03 - Rear end	01 - Dry	0	0	0	0
8/30/2019	2019	14:22	BELFAST RD @ ST. LAURENT BLVD (0007658)	01 - Clear	01 - Daylight	01 - Traffic signal	0	03 - P-D only	02 - Angle	01 - Dry	0	0	0	0
9/12/2019	2019	17:25	BELFAST RD @ ST. LAURENT BLVD (0007658)	01 - Clear	03 - Dawn	01 - Traffic signal	0	02 - Non-fatal injury	05 - Turning movement	01 - Dry	0	0	0	0
9/25/2019	2019	15:24	BELFAST RD @ ST. LAURENT BLVD (0007658)	01 - Clear	01 - Daylight	01 - Traffic signal	0	02 - Non-fatal injury	05 - Turning movement	01 - Dry	0	0	0	0
10/3/2019	2019	11:30	BELFAST RD @ ST. LAURENT BLVD (0007658)	01 - Clear	01 - Daylight	01 - Traffic signal	0	03 - P-D only	05 - Turning movement	01 - Dry	0	0	0	0
10/6/2019	2019	23:15	BELFAST RD @ ST. LAURENT BLVD (0007658)	01 - Clear	07 - Dark	01 - Traffic signal	0	03 - P-D only	04 - Sideswipe	01 - Dry	0	0	0	0
10/16/2019	2019	7:50	BELFAST RD @ ST. LAURENT BLVD (0007658)	01 - Clear	01 - Daylight	01 - Traffic signal	0	03 - P-D only	03 - Rear end	01 - Dry	0	0	0	0
12/18/2019	2019	18:22	BELFAST RD @ ST. LAURENT BLVD (0007658)	01 - Clear	07 - Dark	01 - Traffic signal	0	03 - P-D only	05 - Turning movement	01 - Dry	0	0	0	0
12/20/2019	2019	11:30	BELFAST RD @ ST. LAURENT BLVD (0007658)	01 - Clear	01 - Daylight	01 - Traffic signal	0	03 - P-D only	03 - Rear end	06 - Ice	0	0	0	0
1/20/2020	2020	9:34	BELFAST RD @ ST. LAURENT BLVD (0007658)	01 - Clear	01 - Daylight	01 - Traffic signal	0	03 - P-D only	05 - Turning movement	04 - Slush	0	0	0	0
1/28/2020	2020	11:30	BELFAST RD @ ST. LAURENT BLVD (0007658)	03 - Snow	01 - Daylight	01 - Traffic signal	0	03 - P-D only	04 - Sideswipe	02 - Wet	0	0	0	0
2/8/2020	2020	15:15	BELFAST RD @ ST. LAURENT BLVD (0007658)	01 - Clear	01 - Daylight	01 - Traffic signal	0	03 - P-D only	03 - Rear end	01 - Dry	0	0	0	0
2/27/2020	2020	8:05	BELFAST RD @ ST. LAURENT BLVD (0007658)	03 - Snow	01 - Daylight	01 - Traffic signal	0	03 - P-D only	99 - Other	03 - Loose snow	0	0	0	0
3/7/2020	2020	15:55	BELFAST RD @ ST. LAURENT BLVD (0007658)	01 - Clear	01 - Daylight	01 - Traffic signal	0	03 - P-D only	02 - Angle	01 - Dry	0	0	0	0
4/1/2020	2020	6:05	BELFAST RD @ ST. LAURENT BLVD (0007658)	01 - Clear	03 - Dawn	01 - Traffic signal	0	03 - P-D only	03 - Rear end	03 - Dry	0	0	0	0
4/30/2020	2020	18:10	BELFAST RD @ ST. LAURENT BLVD (0007658)	02 - Rain	03 - Dawn	01 - Traffic signal	0	03 - P-D only	05 - Turning movement	02 - Wet	0	0	0	0
8/19/2020	2020	11:30	BELFAST RD @ ST. LAURENT BLVD (0007658)	01 - Clear	01 - Daylight	01 - Traffic signal	0	02 - Non-fatal injury	07 - SMV other	01 - Dry	0	0	0	0
9/8/2020	2020	12:45	BELFAST RD @ ST. LAURENT BLVD (0007658)	01 - Clear	01 - Daylight	01 - Traffic signal	0	03 - P-D only	05 - Turning movement	01 - Dry	0	0	0	0
9/13/2020	2020	6:30	BELFAST RD @ ST. LAURENT BLVD (0007658)	01 - Clear	03 - Dawn	01 - Traffic signal	0	03 - P-D only	07 - SMV other	02 - Wet	0	0	0	0
9/22/2020	2020	18:06	BELFAST RD @ ST. LAURENT BLVD (0007658)	01 - Clear	01 - Daylight	01 - Traffic signal	0	03 - P-D only	05 - Turning movement	01 - Dry	0	0	0	0
10/19/2020	2020	13:46	BELFAST RD @ ST. LAURENT BLVD (0007658)	01 - Clear	01 - Daylight	01 - Traffic signal	0	03 - P-D only	03 - Rear end	01 - Dry	0	0	0	0
10/26/2020	2020	9:35	BELFAST RD @ ST. LAURENT BLVD (0007658)	02 - Rain	01 - Daylight	01 - Traffic signal	0	03 - P-D only	04 - Sideswipe	02 - Wet	0	0	0	1
11/20/2020	2020	15:19	BELFAST RD @ ST. LAURENT BLVD (0007658)	01 - Clear	01 - Daylight	01 - Traffic signal	0	03 - P-D only	02 - Angle	01 - Dry	0	0	0	0
1/13/2021	2021	5:29	BELFAST RD @ ST. LAURENT BLVD (0007658)	01 - Clear	07 - Dark	01 - Traffic signal	0	02 - Non-fatal injury	05 - Turning movement	01 - Dry	0	0	0	0
2/12/2021	2021	17:20	BELFAST RD @ ST. LAURENT BLVD (0007658)	01 - Clear	07 - Dark	01 - Traffic signal	0	03 - P-D only	05 - Turning movement	01 - Dry	0	0	0	0
2/24/2021	2021	17:00	BELFAST RD @ ST. LAURENT BLVD (0007658)	03 - Snow	01 - Daylight	01 - Traffic signal	0	03 - P-D only	03 - Rear end	04 - Slush	0	0	0	0
5/27/2021	2021	11:38	BELFAST RD @ ST. LAURENT BLVD (0007658)	01 - Clear	01 - Daylight	01 - Traffic signal	0	02 - Non-fatal injury	05 - Turning movement	01 - Dry	0	0	0	0
6/12/2021	2021	12:15	BELFAST RD @ ST. LAURENT BLVD (0007658)	01 - Clear	01 - Daylight	01 - Traffic signal	0	03 - P-D only	04 - Sideswipe	01 - Dry	0	0	0	0
6/15/2021	2021	15:54	BELFAST RD @ ST. LAURENT BLVD (0007658)	01 - Clear	01 - Daylight	01 - Traffic signal	0	02 - Non-fatal injury	03 - Rear end	01 - Dry	0	0	0	0
7/22/2021	2021	19:02	BELFAST RD @ ST. LAURENT BLVD (0007658)	02 - Rain	01 - Daylight	01 - Traffic signal	0	02 - Non-fatal injury	02 - Angle	02 - Wet	0	0	0	0
8/4/2021	2021	16:23	BELFAST RD @ ST. LAURENT BLVD (0007658)	01 - Clear	01 - Daylight	01 - Traffic signal	0	02 - Non-fatal injury	03 - Rear end	01 - Dry	0	0	0	0
9/21/2021	2021	7:30	BELFAST RD @ ST. LAURENT BLVD (0007658)	01 - Clear	01 - Daylight	01 - Traffic signal	0	03 - P-D only	03 - Rear end	01 - Dry	0	0	0	0
10/6/2021	2021	18:40	BELFAST RD @ ST. LAURENT BLVD (0007658)	01 - Clear	07 - Dark	01 - Traffic signal	0	03 - P-D only	05 - Turning movement	01 - Dry	0	0	0	1
11/9/2021	2021	18:20	BELFAST RD @ ST. LAURENT BLVD (0007658)	01 - Clear	07 - Dark	01 - Traffic signal	0	03 - P-D only	06 - SMV unattended vehicle	01 - Dry	0	0	0	0
11/22/2021	2021	21:00	BELFAST RD @ ST. LAURENT BLVD (0007658)	01 - Clear	07 - Dark	01 - Traffic signal	0	03 - P-D only	05 - Turning movement	01 - Dry	0	0	0	0
11/27/2021	2021	17:00	BELFAST RD @ ST. LAURENT BLVD (0007658)	01 - Clear	07 - Dark	01 - Traffic signal	0	02 - Non-fatal injury	05 - Turning movement	01 - Dry	0	0	0	0
12/4/2021	2021	15:30	BELFAST RD @ ST. LAURENT BLVD (0007658)	03 - Snow	01 - Daylight	01 - Traffic signal	0	03 - P-D only	05 - Turning movement	05 - Packed snow	0	0	0	0
12/6/2021	2021	6:03	BELFAST RD @ ST. LAURENT BLVD (0007658)	04 - Freezing Rain	07 - Dark	01 - Traffic signal	0	03 - P-D only	02 - Angle	04 - Slush	0	0	0	0
12/7/2021	2021	9:34	BELFAST RD @ ST. LAURENT BLVD (0007658)	01 - Clear	01 - Daylight	01 - Traffic signal	0	03 - P-D only	05 - Turning movement	01 - Dry	0	0	0	0
12/15/2021	2021	19:14	BELFAST RD @ ST. LAURENT BLVD (0007658)	03 - Snow	07 - Dark	01 - Traffic signal	0	03 - P-D only	03 - Rear end	04 - Slush	0	0	0	0
12/17/2021	2021	22:15	BELFAST RD @ ST. LAURENT BLVD (0007658)	01 - Clear	07 - Dark	01 - Traffic signal	0	03 - P-D only	03 - Rear end	01 - Dry	0	0	0	0
1/18/2022	2022	16:06	BELFAST RD @ ST. LAURENT BLVD (0007658)	01 - Clear	01 - Daylight	01 - Traffic signal	0	03 - P-D only	05 - Turning movement	04 - Slush	0	0	0	0
2/6/2022	2022	0:46	BELFAST RD @ ST. LAURENT BLVD (0007658)	01 - Clear	07 - Dark	01 - Traffic signal	0	03 - P-D only	03 - Rear end	01 - Dry	0	0	0	0
2/7/2022	2022	15:16	BELFAST RD @ ST. LAURENT BLVD (0007658)	01 - Clear	01 - Daylight	01 - Traffic signal	0	02 - Non-fatal injury	03 - Rear end	01 - Dry	0	0	0	0
10/23/2022	2022	0:30	BELFAST RD @ ST. LAURENT BLVD (0007658)	01 - Clear	07 - Dark	01 - Traffic signal	0	02 - Non-fatal injury	07 - SMV other	01 - Dry	0	0	0	0
11/1/2022	2022	13:00	BELFAST RD @ ST. LAURENT BLVD (0007658)	01 - Clear	01 - Daylight	01 - Traffic signal	0	03 - P-D only	99 - Other	01 - Dry	0	0	0	0
9/2/2018	2018	14:47	BELFAST RD @ TROILE ST (0008405)	01 - Clear	01 - Daylight	02 - Stop sign	0	02 - Non-fatal injury	02 - Angle	01 - Dry	0	0	0	0
1/18/2019	2019	11:53	BELFAST RD @ TROILE ST (0008405)	01 - Clear	01 - Daylight	02 - Stop sign	0	03 - P-D only	01 - Approaching	02 - Wet	0	0	0	0
6/11/2019	2019	17:30	BELFAST RD @ TROILE ST (0008405)	01 - Clear	01 - Daylight	02 - Stop sign	0	02 - Non-fatal injury	03 - Rear end	01 - Dry	0	0	0	0
9/23/2019	2019	14:07	BELFAST RD @ TROILE ST (0008405)	01 - Clear	01 - Daylight	02 - Stop sign	0	03 - P-D only	99 - Other	01 - Dry	0	0	0	0
11/20/2019	2019	13:36	BELFAST RD @ TROILE ST (0008405)	01 - Clear	01 - Daylight	02 - Stop sign	0	02 - Non-fatal injury	07 - SMV other	01 - Dry	0	0	0	0
2/17/2021	2021	16:19	BELFAST RD @ TROILE ST (0008405)	01 - Clear	01 - Daylight	02 - Stop sign	0	03 - P-D only	02 - Angle	04 - Slush	0	0	0	0

# Appendix E

TDM Checklist

**TDM Measures Checklist:**  
*Non-Residential Developments (office, institutional, retail or industrial)*

Legend	
BASIC	The measure is generally feasible and effective, and in most cases would benefit the development and its users
BETTER	The measure could maximize support for users of sustainable modes, and optimize development performance
★	The measure is one of the most dependably effective tools to encourage the use of sustainable modes

TDM measures: <i>Non-residential developments</i>		Check if proposed & add descriptions
<b>1. TDM PROGRAM MANAGEMENT</b>		
<b>1.1 Program coordinator</b>		
BASIC	★ 1.1.1 Designate an internal coordinator, or contract with an external coordinator	<input type="checkbox"/>
<b>1.2 Travel surveys</b>		
BETTER	1.2.1 Conduct periodic surveys to identify travel-related behaviours, attitudes, challenges and solutions, and to track progress	<input type="checkbox"/>
<b>2. WALKING AND CYCLING</b>		
<b>2.1 Information on walking/cycling routes &amp; destinations</b>		
BASIC	2.1.1 Display local area maps with walking/cycling access routes and key destinations at major entrances	<input checked="" type="checkbox"/>
<b>2.2 Bicycle skills training</b>		
<i>Commuter travel</i>		
BETTER	★ 2.2.1 Offer on-site cycling courses for commuters, or subsidize off-site courses	<input type="checkbox"/>
<b>2.3 Valet bike parking</b>		
<i>Visitor travel</i>		
BETTER	2.3.1 Offer secure valet bike parking during public events when demand exceeds fixed supply (e.g. for festivals, concerts, games)	<input type="checkbox"/>

TDM measures: <i>Non-residential developments</i>		Check if proposed & add descriptions
<b>3. TRANSIT</b>		
<b>3.1 Transit information</b>		
BASIC	3.1.1 Display relevant transit schedules and route maps at entrances	<input checked="" type="checkbox"/>
BASIC	3.1.2 Provide online links to OC Transpo and STO information	<input type="checkbox"/>
BETTER	3.1.3 Provide real-time arrival information display at entrances	<input type="checkbox"/>
<b>3.2 Transit fare incentives</b>		
<i>Commuter travel</i>		
BETTER	3.2.1 Offer preloaded PRESTO cards to encourage commuters to use transit	<input type="checkbox"/>
BETTER	★ 3.2.2 Subsidize or reimburse monthly transit pass purchases by employees	<input type="checkbox"/>
<i>Visitor travel</i>		
BETTER	3.2.3 Arrange inclusion of same-day transit fare in price of tickets (e.g. for festivals, concerts, games)	<input type="checkbox"/>
<b>3.3 Enhanced public transit service</b>		
<i>Commuter travel</i>		
BETTER	3.3.1 Contract with OC Transpo to provide enhanced transit services (e.g. for shift changes, weekends)	<input type="checkbox"/>
<i>Visitor travel</i>		
BETTER	3.3.2 Contract with OC Transpo to provide enhanced transit services (e.g. for festivals, concerts, games)	<input type="checkbox"/>
<b>3.4 Private transit service</b>		
<i>Commuter travel</i>		
BETTER	3.4.1 Provide shuttle service when OC Transpo cannot offer sufficient quality or capacity to serve demand (e.g. for shift changes, weekends)	<input type="checkbox"/>
<i>Visitor travel</i>		
BETTER	3.4.2 Provide shuttle service when OC Transpo cannot offer sufficient quality or capacity to serve demand (e.g. for festivals, concerts, games)	<input type="checkbox"/>

TDM measures: <i>Non-residential developments</i>		Check if proposed & add descriptions
<b>4. RIDESHARING</b>		
<b>4.1 Ridematching service</b>		
<i>Commuter travel</i>		
BASIC ★	4.1.1 Provide a dedicated ridematching portal at OttawaRideMatch.com	<input type="checkbox"/>
<b>4.2 Carpool parking price incentives</b>		
<i>Commuter travel</i>		
BETTER	4.2.1 Provide discounts on parking costs for registered carpools	<input type="checkbox"/>
<b>4.3 Vanpool service</b>		
<i>Commuter travel</i>		
BETTER	4.3.1 Provide a vanpooling service for long-distance commuters	<input type="checkbox"/>
<b>5. CARSHARING &amp; BIKESHARING</b>		
<b>5.1 Bikeshare stations &amp; memberships</b>		
BETTER	5.1.1 Contract with provider to install on-site bikeshare station for use by commuters and visitors	<input type="checkbox"/>
<i>Commuter travel</i>		
BETTER	5.1.2 Provide employees with bikeshare memberships for local business travel	<input type="checkbox"/>
<b>5.2 Carshare vehicles &amp; memberships</b>		
<i>Commuter travel</i>		
BETTER	5.2.1 Contract with provider to install on-site carshare vehicles and promote their use by tenants	<input type="checkbox"/>
BETTER	5.2.2 Provide employees with carshare memberships for local business travel	<input type="checkbox"/>
<b>6. PARKING</b>		
<b>6.1 Priced parking</b>		
<i>Commuter travel</i>		
BASIC ★	6.1.1 Charge for long-term parking (daily, weekly, monthly)	<input type="checkbox"/>
BASIC	6.1.2 Unbundle parking cost from lease rates at multi-tenant sites	<input type="checkbox"/>
<i>Visitor travel</i>		
BETTER	6.1.3 Charge for short-term parking (hourly)	<input type="checkbox"/>

TDM measures: <i>Non-residential developments</i>		Check if proposed & add descriptions
<b>7. TDM MARKETING &amp; COMMUNICATIONS</b>		
<b>7.1 Multimodal travel information</b>		
<i>Commuter travel</i>		
BASIC ★	7.1.1 Provide a multimodal travel option information package to new/relocating employees and students	<input checked="" type="checkbox"/>
<i>Visitor travel</i>		
BETTER ★	7.1.2 Include multimodal travel option information in invitations or advertising that attract visitors or customers (e.g. for festivals, concerts, games)	<input type="checkbox"/>
<b>7.2 Personalized trip planning</b>		
<i>Commuter travel</i>		
BETTER ★	7.2.1 Offer personalized trip planning to new/relocating employees	<input type="checkbox"/>
<b>7.3 Promotions</b>		
<i>Commuter travel</i>		
BETTER	7.3.1 Deliver promotions and incentives to maintain awareness, build understanding, and encourage trial of sustainable modes	<input type="checkbox"/>
<b>8. OTHER INCENTIVES &amp; AMENITIES</b>		
<b>8.1 Emergency ride home</b>		
<i>Commuter travel</i>		
BETTER ★	8.1.1 Provide emergency ride home service to non-driving commuters	<input type="checkbox"/>
<b>8.2 Alternative work arrangements</b>		
<i>Commuter travel</i>		
BASIC ★	8.2.1 Encourage flexible work hours	<input type="checkbox"/>
BETTER	8.2.2 Encourage compressed workweeks	<input type="checkbox"/>
BETTER ★	8.2.3 Encourage telework	<input type="checkbox"/>
<b>8.3 Local business travel options</b>		
<i>Commuter travel</i>		
BASIC ★	8.3.1 Provide local business travel options that minimize the need for employees to bring a personal car to work	<input type="checkbox"/>
<b>8.4 Commuter incentives</b>		
<i>Commuter travel</i>		
BETTER	8.4.1 Offer employees a taxable, mode-neutral commuting allowance	<input type="checkbox"/>
<b>8.5 On-site amenities</b>		
<i>Commuter travel</i>		
BETTER	8.5.1 Provide on-site amenities/services to minimize mid-day or mid-commute errands	<input type="checkbox"/>

**TDM Measures Checklist:**  
*Residential Developments (multi-family, condominium or subdivision)*

Legend	
<b>BASIC</b>	The measure is generally feasible and effective, and in most cases would benefit the development and its users
<b>BETTER</b>	The measure could maximize support for users of sustainable modes, and optimize development performance
<b>★</b>	The measure is one of the most dependably effective tools to encourage the use of sustainable modes

TDM measures: Residential developments		Check if proposed & add descriptions
<b>1. TDM PROGRAM MANAGEMENT</b>		
<b>1.1 Program coordinator</b>		
<b>BASIC</b> ★	1.1.1 Designate an internal coordinator, or contract with an external coordinator	<input type="checkbox"/>
<b>1.2 Travel surveys</b>		
<b>BETTER</b>	1.2.1 Conduct periodic surveys to identify travel-related behaviours, attitudes, challenges and solutions, and to track progress	<input type="checkbox"/>
<b>2. WALKING AND CYCLING</b>		
<b>2.1 Information on walking/cycling routes &amp; destinations</b>		
<b>BASIC</b>	2.1.1 Display local area maps with walking/cycling access routes and key destinations at major entrances ( <i>multi-family, condominium</i> )	<input checked="" type="checkbox"/>
<b>2.2 Bicycle skills training</b>		
<b>BETTER</b>	2.2.1 Offer on-site cycling courses for residents, or subsidize off-site courses	<input type="checkbox"/>

TDM measures: Residential developments		Check if proposed & add descriptions
<b>3. TRANSIT</b>		
<b>3.1 Transit information</b>		
<b>BASIC</b>	3.1.1 Display relevant transit schedules and route maps at entrances ( <i>multi-family, condominium</i> )	<input checked="" type="checkbox"/>
<b>BETTER</b>	3.1.2 Provide real-time arrival information display at entrances ( <i>multi-family, condominium</i> )	<input type="checkbox"/>
<b>3.2 Transit fare incentives</b>		
<b>BASIC</b> ★	3.2.1 Offer PRESTO cards preloaded with one monthly transit pass on residence purchase/move-in, to encourage residents to use transit	<input checked="" type="checkbox"/>
<b>BETTER</b>	3.2.2 Offer at least one year of free monthly transit passes on residence purchase/move-in	<input type="checkbox"/>
<b>3.3 Enhanced public transit service</b>		
<b>BETTER</b> ★	3.3.1 Contract with OC Transpo to provide early transit services until regular services are warranted by occupancy levels ( <i>subdivision</i> )	<input type="checkbox"/>
<b>3.4 Private transit service</b>		
<b>BETTER</b>	3.4.1 Provide shuttle service for seniors homes or lifestyle communities (e.g. scheduled mall or supermarket runs)	<input type="checkbox"/>
<b>4. CARSHARING &amp; BIKESHARING</b>		
<b>4.1 Bikeshare stations &amp; memberships</b>		
<b>BETTER</b>	4.1.1 Contract with provider to install on-site bikeshare station ( <i>multi-family</i> )	<input type="checkbox"/>
<b>BETTER</b>	4.1.2 Provide residents with bikeshare memberships, either free or subsidized ( <i>multi-family</i> )	<input type="checkbox"/>
<b>4.2 Carshare vehicles &amp; memberships</b>		
<b>BETTER</b>	4.2.1 Contract with provider to install on-site carshare vehicles and promote their use by residents	<input type="checkbox"/>
<b>BETTER</b>	4.2.2 Provide residents with carshare memberships, either free or subsidized	<input type="checkbox"/>
<b>5. PARKING</b>		
<b>5.1 Priced parking</b>		
<b>BASIC</b> ★	5.1.1 Unbundle parking cost from purchase price ( <i>condominium</i> )	<input checked="" type="checkbox"/>
<b>BASIC</b> ★	5.1.2 Unbundle parking cost from monthly rent ( <i>multi-family</i> )	<input checked="" type="checkbox"/>

TDM measures: Residential developments		Check if proposed & add descriptions
<b>6. TDM MARKETING &amp; COMMUNICATIONS</b>		
<b>6.1 Multimodal travel information</b>		
BASIC ★	6.1.1 Provide a multimodal travel option information package to new residents	<input checked="" type="checkbox"/>
<b>6.2 Personalized trip planning</b>		
BETTER ★	6.2.1 Offer personalized trip planning to new residents	<input type="checkbox"/>

**TDM-Supportive Development Design and Infrastructure Checklist:**  
*Non-Residential Developments (office, institutional, retail or industrial)*

Legend	
<b>REQUIRED</b>	The Official Plan or Zoning By-law provides related guidance that must be followed
<b>BASIC</b>	The measure is generally feasible and effective, and in most cases would benefit the development and its users
<b>BETTER</b>	The measure could maximize support for users of sustainable modes, and optimize development performance

TDM-supportive design & infrastructure measures: Non-residential developments		Check if completed & add descriptions, explanations or plan/drawing references
<b>1. WALKING &amp; CYCLING: ROUTES</b>		
<b>1.1 Building location &amp; access points</b>		
BASIC	1.1.1 Locate building close to the street, and do not locate parking areas between the street and building entrances	<input type="checkbox"/>
BASIC	1.1.2 Locate building entrances in order to minimize walking distances to sidewalks and transit stops/stations	<input type="checkbox"/>
BASIC	1.1.3 Locate building doors and windows to ensure visibility of pedestrians from the building, for their security and comfort	<input type="checkbox"/>
<b>1.2 Facilities for walking &amp; cycling</b>		
REQUIRED	1.2.1 Provide convenient, direct access to stations or major stops along rapid transit routes within 600 metres; minimize walking distances from buildings to rapid transit; provide pedestrian-friendly, weather-protected (where possible) environment between rapid transit accesses and building entrances; ensure quality linkages from sidewalks through building entrances to integrated stops/stations (see <i>Official Plan policy 4.3.3</i> )	<input type="checkbox"/>
REQUIRED	1.2.2 Provide safe, direct and attractive pedestrian access from public sidewalks to building entrances through such measures as: reducing distances between public sidewalks and major building entrances; providing walkways from public streets to major building entrances; within a site, providing walkways along the front of adjoining buildings, between adjacent buildings, and connecting areas where people may congregate, such as courtyards and transit stops; and providing weather protection through canopies, colonnades, and other design elements wherever possible (see <i>Official Plan policy 4.3.12</i> )	<input checked="" type="checkbox"/>

TDM-supportive design & infrastructure measures: <i>Non-residential developments</i>		Check if completed & add descriptions, explanations or plan/drawing references
REQUIRED	1.2.3 Provide sidewalks of smooth, well-drained walking surfaces of contrasting materials or treatments to differentiate pedestrian areas from vehicle areas, and provide marked pedestrian crosswalks at intersection sidewalks (see <i>Official Plan policy 4.3.10</i> )	<input checked="" type="checkbox"/>
REQUIRED	1.2.4 Make sidewalks and open space areas easily accessible through features such as gradual grade transition, depressed curbs at street corners and convenient access to extra-wide parking spaces and ramps (see <i>Official Plan policy 4.3.10</i> )	<input checked="" type="checkbox"/>
REQUIRED	1.2.5 Include adequately spaced inter-block/street cycling and pedestrian connections to facilitate travel by active transportation. Provide links to the existing or planned network of public sidewalks, multi-use pathways and on-road cycle routes. Where public sidewalks and multi-use pathways intersect with roads, consider providing traffic control devices to give priority to cyclists and pedestrians (see <i>Official Plan policy 4.3.11</i> )	<input checked="" type="checkbox"/>
BASIC	1.2.6 Provide safe, direct and attractive walking routes from building entrances to nearby transit stops	<input type="checkbox"/>
BASIC	1.2.7 Ensure that walking routes to transit stops are secure, visible, lighted, shaded and wind-protected wherever possible	<input type="checkbox"/>
BASIC	1.2.8 Design roads used for access or circulation by cyclists using a target operating speed of no more than 30 km/h, or provide a separated cycling facility	<input type="checkbox"/>
<b>1.3 Amenities for walking &amp; cycling</b>		
BASIC	1.3.1 Provide lighting, landscaping and benches along walking and cycling routes between building entrances and streets, sidewalks and trails	<input type="checkbox"/>
BASIC	1.3.2 Provide wayfinding signage for site access (where required, e.g. when multiple buildings or entrances exist) and egress (where warranted, such as when directions to reach transit stops/stations, trails or other common destinations are not obvious)	<input type="checkbox"/>

TDM-supportive design & infrastructure measures: <i>Non-residential developments</i>		Check if completed & add descriptions, explanations or plan/drawing references
<b>2. WALKING &amp; CYCLING: END-OF-TRIP FACILITIES</b>		
<b>2.1 Bicycle parking</b>		
REQUIRED	2.1.1 Provide bicycle parking in highly visible and lighted areas, sheltered from the weather wherever possible (see <i>Official Plan policy 4.3.6</i> )	<input checked="" type="checkbox"/>
REQUIRED	2.1.2 Provide the number of bicycle parking spaces specified for various land uses in different parts of Ottawa; provide convenient access to main entrances or well-used areas (see <i>Zoning By-law Section 111</i> )	<input checked="" type="checkbox"/>
REQUIRED	2.1.3 Ensure that bicycle parking spaces and access aisles meet minimum dimensions; that no more than 50% of spaces are vertical spaces; and that parking racks are securely anchored (see <i>Zoning By-law Section 111</i> )	<input checked="" type="checkbox"/>
BASIC	2.1.4 Provide bicycle parking spaces equivalent to the expected number of commuter cyclists (assuming the cycling mode share target is met), plus the expected peak number of customer/visitor cyclists	<input type="checkbox"/>
BETTER	2.1.5 Provide bicycle parking spaces equivalent to the expected number of commuter and customer/visitor cyclists, plus an additional buffer (e.g. 25 percent extra) to encourage other cyclists and ensure adequate capacity in peak cycling season	<input type="checkbox"/>
<b>2.2 Secure bicycle parking</b>		
REQUIRED	2.2.1 Where more than 50 bicycle parking spaces are provided for a single office building, locate at least 25% of spaces within a building/structure, a secure area (e.g. supervised parking lot or enclosure) or bicycle lockers (see <i>Zoning By-law Section 111</i> )	<input checked="" type="checkbox"/>
BETTER	2.2.2 Provide secure bicycle parking spaces equivalent to the expected number of commuter cyclists (assuming the cycling mode share target is met)	<input type="checkbox"/>
<b>2.3 Shower &amp; change facilities</b>		
BASIC	2.3.1 Provide shower and change facilities for the use of active commuters	<input type="checkbox"/>
BETTER	2.3.2 In addition to shower and change facilities, provide dedicated lockers, grooming stations, drying racks and laundry facilities for the use of active commuters	<input type="checkbox"/>
<b>2.4 Bicycle repair station</b>		
BETTER	2.4.1 Provide a permanent bike repair station, with commonly used tools and an air pump, adjacent to the main bicycle parking area (or secure bicycle parking area, if provided)	<input type="checkbox"/>



TDM-supportive design & infrastructure measures: <i>Non-residential developments</i>		Check if completed & add descriptions, explanations or plan/drawing references
<b>3. TRANSIT</b>		
<b>3.1 Customer amenities</b>		
BASIC	3.1.1 Provide shelters, lighting and benches at any on-site transit stops	<input type="checkbox"/>
BASIC	3.1.2 Where the site abuts an off-site transit stop and insufficient space exists for a transit shelter in the public right-of-way, protect land for a shelter and/or install a shelter	<input type="checkbox"/>
BETTER	3.1.3 Provide a secure and comfortable interior waiting area by integrating any on-site transit stops into the building	<input type="checkbox"/>
<b>4. RIDESHARING</b>		
<b>4.1 Pick-up &amp; drop-off facilities</b>		
BASIC	4.1.1 Provide a designated area for carpool drivers (plus taxis and ride-hailing services) to drop off or pick up passengers without using fire lanes or other no-stopping zones	<input type="checkbox"/>
<b>4.2 Carpool parking</b>		
BASIC	4.2.1 Provide signed parking spaces for carpools in a priority location close to a major building entrance, sufficient in number to accommodate the mode share target for carpools	<input type="checkbox"/>
BETTER	4.2.2 At large developments, provide spaces for carpools in a separate, access-controlled parking area to simplify enforcement	<input type="checkbox"/>
<b>5. CARSHARING &amp; BIKESHARING</b>		
<b>5.1 Carshare parking spaces</b>		
BETTER	5.1.1 Provide carshare parking spaces in permitted non-residential zones, occupying either required or provided parking spaces ( <i>see Zoning By-law Section 94</i> )	<input type="checkbox"/>
<b>5.2 Bikeshare station location</b>		
BETTER	5.2.1 Provide a designated bikeshare station area near a major building entrance, preferably lighted and sheltered with a direct walkway connection	<input type="checkbox"/>

TDM-supportive design & infrastructure measures: <i>Non-residential developments</i>		Check if completed & add descriptions, explanations or plan/drawing references
<b>6. PARKING</b>		
<b>6.1 Number of parking spaces</b>		
REQUIRED	6.1.1 Do not provide more parking than permitted by zoning, nor less than required by zoning, unless a variance is being applied for	<input checked="" type="checkbox"/>
BASIC	6.1.2 Provide parking for long-term and short-term users that is consistent with mode share targets, considering the potential for visitors to use off-site public parking	<input type="checkbox"/>
BASIC	6.1.3 Where a site features more than one use, provide shared parking and reduce the cumulative number of parking spaces accordingly ( <i>see Zoning By-law Section 104</i> )	<input checked="" type="checkbox"/>
BETTER	6.1.4 Reduce the minimum number of parking spaces required by zoning by one space for each 13 square metres of gross floor area provided as shower rooms, change rooms, locker rooms and other facilities for cyclists in conjunction with bicycle parking ( <i>see Zoning By-law Section 111</i> )	<input type="checkbox"/>
<b>6.2 Separate long-term &amp; short-term parking areas</b>		
BETTER	6.2.1 Separate short-term and long-term parking areas using signage or physical barriers, to permit access controls and simplify enforcement (i.e. to discourage employees from parking in visitor spaces, and vice versa)	<input type="checkbox"/>
<b>7. OTHER</b>		
<b>7.1 On-site amenities to minimize off-site trips</b>		
BETTER	7.1.1 Provide on-site amenities to minimize mid-day or mid-commute errands	<input type="checkbox"/>

**TDM-Supportive Development Design and Infrastructure Checklist:**  
*Residential Developments (multi-family or condominium)*

Legend	
REQUIRED	The Official Plan or Zoning By-law provides related guidance that must be followed
BASIC	The measure is generally feasible and effective, and in most cases would benefit the development and its users
BETTER	The measure could maximize support for users of sustainable modes, and optimize development performance

TDM-supportive design & infrastructure measures: <i>Residential developments</i>		Check if completed & add descriptions, explanations or plan/drawing references
<b>1. WALKING &amp; CYCLING: ROUTES</b>		
<b>1.1 Building location &amp; access points</b>		
BASIC	1.1.1 Locate building close to the street, and do not locate parking areas between the street and building entrances	<input checked="" type="checkbox"/>
BASIC	1.1.2 Locate building entrances in order to minimize walking distances to sidewalks and transit stops/stations	<input checked="" type="checkbox"/>
BASIC	1.1.3 Locate building doors and windows to ensure visibility of pedestrians from the building, for their security and comfort	<input type="checkbox"/>
<b>1.2 Facilities for walking &amp; cycling</b>		
REQUIRED	1.2.1 Provide convenient, direct access to stations or major stops along rapid transit routes within 600 metres; minimize walking distances from buildings to rapid transit; provide pedestrian-friendly, weather-protected (where possible) environment between rapid transit accesses and building entrances; ensure quality linkages from sidewalks through building entrances to integrated stops/stations (see <i>Official Plan policy 4.3.3</i> )	<input type="checkbox"/>
REQUIRED	1.2.2 Provide safe, direct and attractive pedestrian access from public sidewalks to building entrances through such measures as: reducing distances between public sidewalks and major building entrances; providing walkways from public streets to major building entrances; within a site, providing walkways along the front of adjoining buildings, between adjacent buildings, and connecting areas where people may congregate, such as courtyards and transit stops; and providing weather protection through canopies, colonnades, and other design elements wherever possible (see <i>Official Plan policy 4.3.12</i> )	<input checked="" type="checkbox"/>

TDM-supportive design & infrastructure measures: <i>Residential developments</i>		Check if completed & add descriptions, explanations or plan/drawing references
REQUIRED	1.2.3 Provide sidewalks of smooth, well-drained walking surfaces of contrasting materials or treatments to differentiate pedestrian areas from vehicle areas, and provide marked pedestrian crosswalks at intersection sidewalks (see <i>Official Plan policy 4.3.10</i> )	<input checked="" type="checkbox"/>
REQUIRED	1.2.4 Make sidewalks and open space areas easily accessible through features such as gradual grade transition, depressed curbs at street corners and convenient access to extra-wide parking spaces and ramps (see <i>Official Plan policy 4.3.10</i> )	<input checked="" type="checkbox"/>
REQUIRED	1.2.5 Include adequately spaced inter-block/street cycling and pedestrian connections to facilitate travel by active transportation. Provide links to the existing or planned network of public sidewalks, multi-use pathways and on-road cycle routes. Where public sidewalks and multi-use pathways intersect with roads, consider providing traffic control devices to give priority to cyclists and pedestrians (see <i>Official Plan policy 4.3.11</i> )	<input checked="" type="checkbox"/>
BASIC	1.2.6 Provide safe, direct and attractive walking routes from building entrances to nearby transit stops	<input checked="" type="checkbox"/>
BASIC	1.2.7 Ensure that walking routes to transit stops are secure, visible, lighted, shaded and wind-protected wherever possible	<input type="checkbox"/>
BASIC	1.2.8 Design roads used for access or circulation by cyclists using a target operating speed of no more than 30 km/h, or provide a separated cycling facility	<input type="checkbox"/>
<b>1.3 Amenities for walking &amp; cycling</b>		
BASIC	1.3.1 Provide lighting, landscaping and benches along walking and cycling routes between building entrances and streets, sidewalks and trails	<input type="checkbox"/>
BASIC	1.3.2 Provide wayfinding signage for site access (where required, e.g. when multiple buildings or entrances exist) and egress (where warranted, such as when directions to reach transit stops/stations, trails or other common destinations are not obvious)	<input type="checkbox"/>

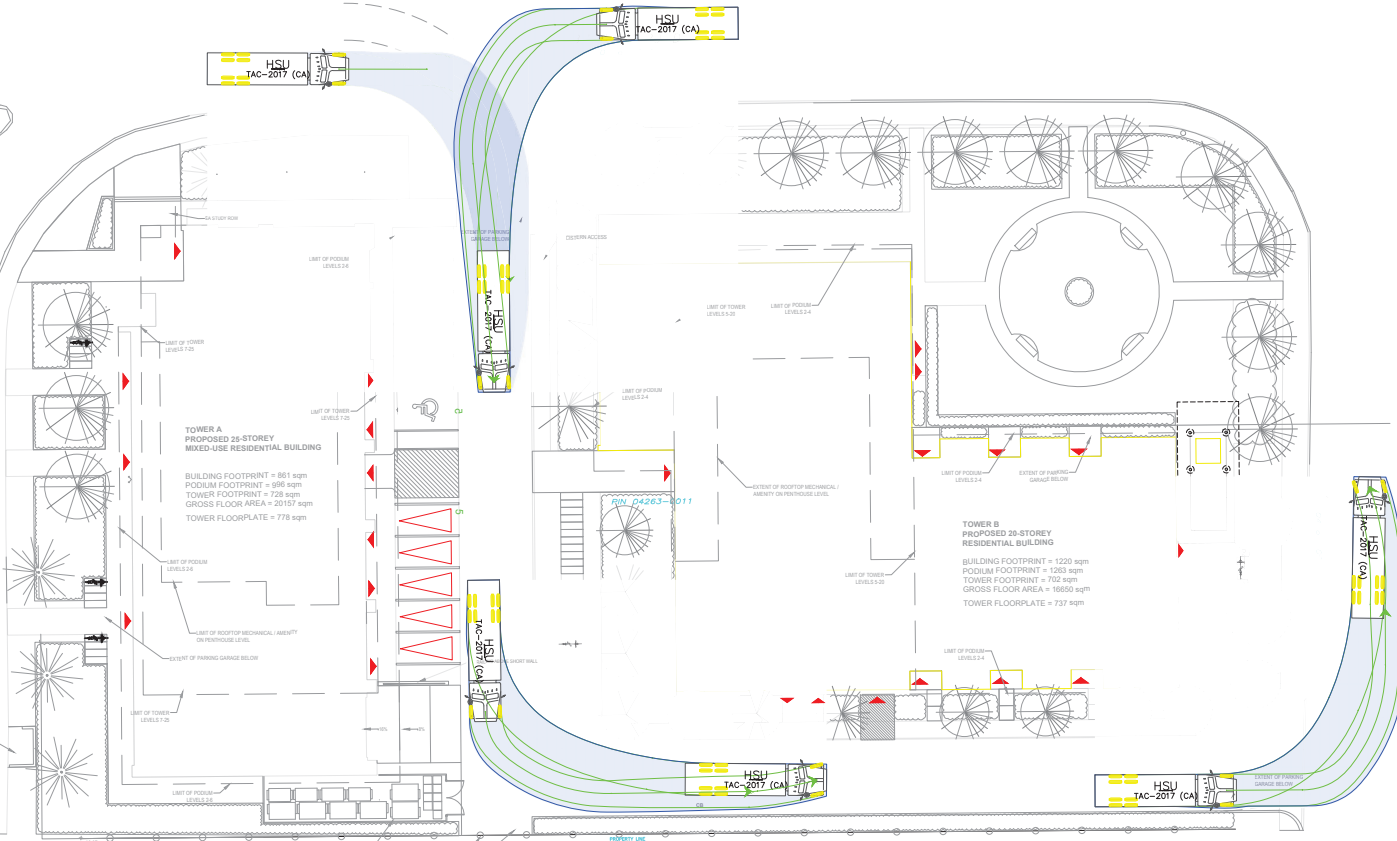
TDM-supportive design & infrastructure measures: <i>Residential developments</i>		Check if completed & add descriptions, explanations or plan/drawing references
<b>2. WALKING &amp; CYCLING: END-OF-TRIP FACILITIES</b>		
<b>2.1 Bicycle parking</b>		
REQUIRED	2.1.1 Provide bicycle parking in highly visible and lighted areas, sheltered from the weather wherever possible (see <i>Official Plan policy 4.3.6</i> )	<input checked="" type="checkbox"/>
REQUIRED	2.1.2 Provide the number of bicycle parking spaces specified for various land uses in different parts of Ottawa; provide convenient access to main entrances or well-used areas (see <i>Zoning By-law Section 111</i> )	<input checked="" type="checkbox"/>
REQUIRED	2.1.3 Ensure that bicycle parking spaces and access aisles meet minimum dimensions; that no more than 50% of spaces are vertical spaces; and that parking racks are securely anchored (see <i>Zoning By-law Section 111</i> )	<input checked="" type="checkbox"/>
BASIC	2.1.4 Provide bicycle parking spaces equivalent to the expected number of resident-owned bicycles, plus the expected peak number of visitor cyclists	<input type="checkbox"/>
<b>2.2 Secure bicycle parking</b>		
REQUIRED	2.2.1 Where more than 50 bicycle parking spaces are provided for a single residential building, locate at least 25% of spaces within a building/structure, a secure area (e.g. supervised parking lot or enclosure) or bicycle lockers (see <i>Zoning By-law Section 111</i> )	<input checked="" type="checkbox"/>
BETTER	2.2.2 Provide secure bicycle parking spaces equivalent to at least the number of units at condominiums or multi-family residential developments	<input type="checkbox"/>
<b>2.3 Bicycle repair station</b>		
BETTER	2.3.1 Provide a permanent bike repair station, with commonly used tools and an air pump, adjacent to the main bicycle parking area (or secure bicycle parking area, if provided)	<input type="checkbox"/>
<b>3. TRANSIT</b>		
<b>3.1 Customer amenities</b>		
BASIC	3.1.1 Provide shelters, lighting and benches at any on-site transit stops	<input type="checkbox"/>
BASIC	3.1.2 Where the site abuts an off-site transit stop and insufficient space exists for a transit shelter in the public right-of-way, protect land for a shelter and/or install a shelter	<input type="checkbox"/>
BETTER	3.1.3 Provide a secure and comfortable interior waiting area by integrating any on-site transit stops into the building	<input type="checkbox"/>

TDM-supportive design & infrastructure measures: <i>Residential developments</i>		Check if completed & add descriptions, explanations or plan/drawing references
<b>4. RIDESHARING</b>		
<b>4.1 Pick-up &amp; drop-off facilities</b>		
BASIC	4.1.1 Provide a designated area for carpool drivers (plus taxis and ride-hailing services) to drop off or pick up passengers without using fire lanes or other no-stopping zones	<input type="checkbox"/>
<b>5. CARSHARING &amp; BIKESHARING</b>		
<b>5.1 Carshare parking spaces</b>		
BETTER	5.1.1 Provide up to three carshare parking spaces in an R3, R4 or R5 Zone for specified residential uses (see <i>Zoning By-law Section 94</i> )	<input type="checkbox"/>
<b>5.2 Bikeshare station location</b>		
BETTER	5.2.1 Provide a designated bikeshare station area near a major building entrance, preferably lighted and sheltered with a direct walkway connection	<input type="checkbox"/>
<b>6. PARKING</b>		
<b>6.1 Number of parking spaces</b>		
REQUIRED	6.1.1 Do not provide more parking than permitted by zoning, nor less than required by zoning, unless a variance is being applied for	<input checked="" type="checkbox"/>
BASIC	6.1.2 Provide parking for long-term and short-term users that is consistent with mode share targets, considering the potential for visitors to use off-site public parking	<input type="checkbox"/>
BASIC	6.1.3 Where a site features more than one use, provide shared parking and reduce the cumulative number of parking spaces accordingly (see <i>Zoning By-law Section 104</i> )	<input checked="" type="checkbox"/>
BETTER	6.1.4 Reduce the minimum number of parking spaces required by zoning by one space for each 13 square metres of gross floor area provided as shower rooms, change rooms, locker rooms and other facilities for cyclists in conjunction with bicycle parking (see <i>Zoning By-law Section 111</i> )	<input type="checkbox"/>
<b>6.2 Separate long-term &amp; short-term parking areas</b>		
BETTER	6.2.1 Provide separate areas for short-term and long-term parking (using signage or physical barriers) to permit access controls and simplify enforcement (i.e. to discourage residents from parking in visitor spaces, and vice versa)	<input type="checkbox"/>

# Appendix F

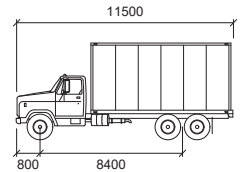
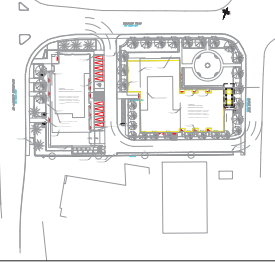
Turning Templates

ST-LAURENT BOULEVARD  
PIN: 02463-0000



Notes:

Key Map:



**HSU**

mm

Width : 2600  
 Track : 2600  
 Lock to Lock Time : 6.0  
 Steering Angle : 40.0

01	Issued for Review	AN	2024-06-07
REV:	DESCRIPTION:	BY:	DATE:
STATUS:			

**CGH Transportation**  
 6 Plaza Court  
 Ottawa, ON  
 K2H 7W1  
 (343) 999-9117

CLIENT: KTS

ARCHITECT:

SITE: 1531 St Laurent

TITLE: Turning Movement Analysis  
 HSU Turning Movements

SCALE AT A3:	DATE:	DRAWN:	CHECKED:
NTS	2024-06-07	AN	JK
PROJECT NO:	DRAWING NO:	REVISION:	
2023-053	001	01	

# Appendix G

MMLOS Analysis

# Multi-Modal Level of Service - Segments Form

Consultant	CGH Transportation
Scenario	Existing/Future
Comments	

Project	2023-053
Date	2023-05-19

SEGMENTS			St-Laurent	Belfast	Lagan	Lagan
			Ex/Fut	Ex/Fut	Ex	Fut
Pedestrian	Sidewalk Width	-	≥ 2 m	≥ 2 m	no sidewalk	≥ 2 m
	Boulevard Width		< 0.5	< 0.5	n/a	< 0.5
	Avg Daily Curb Lane Traffic Volume		≤ 3000	> 3000	≤ 3000	≤ 3000
	Operating Speed		> 50 to 60 km/h	> 50 to 60 km/h	> 30 to 50 km/h	> 30 to 50 km/h
	On-Street Parking		no	no	yes	no
	<b>Exposure to Traffic PLoS</b>		<b>C</b>	<b>E</b>	<b>F</b>	<b>B</b>
	Effective Sidewalk Width					
Pedestrian Volume						
<b>Crowding PLoS</b>	-	-	-	-		
<b>Level of Service</b>	-	-	-	-		
Bicycle	Type of Cycling Facility	F	Mixed Traffic	Mixed Traffic	Mixed Traffic	Mixed Traffic
	Number of Travel Lanes		4-5 lanes total	2-3 lanes total	≤ 2 (no centreline)	≤ 2 (no centreline)
	Operating Speed		≥ 60 km/h	≥ 60 km/h	≥ 50 to 60 km/h	≥ 50 to 60 km/h
	<b># of Lanes &amp; Operating Speed LoS</b>		<b>F</b>	<b>F</b>	<b>D</b>	<b>D</b>
	Bike Lane (+ Parking Lane) Width					
	<b>Bike Lane Width LoS</b>		-	-	-	-
	Bike Lane Blockages					
	<b>Blockage LoS</b>		-	-	-	-
	Median Refuge Width (no median = < 1.8 m)		< 1.8 m refuge	< 1.8 m refuge	< 1.8 m refuge	< 1.8 m refuge
	No. of Lanes at Unsignalized Crossing		≤ 3 lanes	≤ 3 lanes	≤ 3 lanes	≤ 3 lanes
Sidestreet Operating Speed	≤ 40 km/h	≤ 40 km/h	≤ 40 km/h	≤ 40 km/h		
<b>Unsignalized Crossing - Lowest LoS</b>	<b>A</b>	<b>A</b>	<b>A</b>	<b>A</b>		
<b>Level of Service</b>	<b>F</b>	<b>F</b>	<b>D</b>	<b>D</b>		
Transit	Facility Type	D	Mixed Traffic			
	Friction or Ratio Transit:Posted Speed		Vt/Vp ≥ 0.8			
<b>Level of Service</b>	<b>D</b>	-	-	-		
Truck	Truck Lane Width	B	> 3.7 m	> 3.7 m		
	Travel Lanes per Direction		> 1	1		
<b>Level of Service</b>	<b>A</b>	<b>B</b>	-	-		

**Multi-Modal Level of Service - Intersections Form**

Consultant  
Scenario  
Comments

<b>CGH Transportation</b>
<b>Existing/Future</b>

Project  
Date

<b>2023-053</b>
<b>2023-05-19</b>

INTERSECTIONS													
Crossing Side		St-Laurent Boulevard at Tremblay Road				St-Laurent Boulevard at Belfast Rd				St-Laurent Blvd at Industrial Ave/Innes Rd			
		NORTH	SOUTH	EAST	WEST	NORTH	SOUTH	EAST	WEST	NORTH	SOUTH	EAST	WEST
<b>Pedestrian</b>	Lanes	9	8	6	8	6	6	3	3	8	9	7	8
	Median	No Median - 2.4 m	No Median - 2.4 m	No Median - 2.4 m	No Median - 2.4 m	No Median - 2.4 m	No Median - 2.4 m	No Median - 2.4 m	No Median - 2.4 m	No Median - 2.4 m	No Median - 2.4 m	No Median - 2.4 m	No Median - 2.4 m
	Conflicting Left Turns	Permissive	Permissive	Protected/ Permissive	Permissive	Protected/ Permissive	Permissive	Protected/ Permissive	Protected/ Permissive	Protected	Protected	Protected	Protected
	Conflicting Right Turns	Permissive or yield control	Permissive or yield control	Permissive or yield control	Permissive or yield control	Permissive or yield control	Permissive or yield control	Permissive or yield control	Permissive or yield control	Permissive or yield control	Permissive or yield control	Permissive or yield control	Permissive or yield control
	Right Turns on Red (RTor) ?	RTOR allowed	RTOR allowed	RTOR allowed	RTOR allowed	RTOR prohibited	RTOR prohibited	RTOR prohibited	RTOR prohibited	RTOR prohibited	RTOR prohibited	RTOR prohibited	RTOR prohibited
	Ped Signal Leading Interval?	No	No	No	No	No	No	No	No	No	No	No	No
	Right Turn Channel	No Channel	No Channel	No Channel	No Channel	Conv'tl without Receiving Lane	Conv'tl without Receiving Lane	Conv'tl without Receiving Lane	Conventional with Receiving Lane	Smart Channel	Smart Channel	Smart Channel	Smart Channel
	Corner Radius	10-15m	5-10m	15-25m	10-15m	10-15m	10-15m	15-25m	15-25m	15-25m	15-25m	15-25m	15-25m
	Crosswalk Type	Std transverse markings	Std transverse markings	Std transverse markings	Std transverse markings	Std transverse markings	Std transverse markings	Std transverse markings	Std transverse markings	Std transverse markings	Std transverse markings	Std transverse markings	Std transverse markings
	<b>PETSI Score</b>	<b>-29</b>	<b>-11</b>	<b>18</b>	<b>-12</b>	<b>27</b>	<b>27</b>	<b>75</b>	<b>72</b>	<b>3</b>	<b>-14</b>	<b>19</b>	<b>3</b>
	<b>Ped. Exposure to Traffic LoS</b>	<b>F</b>	<b>F</b>	<b>F</b>	<b>F</b>	<b>F</b>	<b>F</b>	<b>B</b>	<b>C</b>	<b>F</b>	<b>F</b>	<b>F</b>	<b>F</b>
	Cycle Length	120	120	120	120								
	Effective Walk Time	37	52	9	9								
	<b>Average Pedestrian Delay</b>	<b>29</b>	<b>19</b>	<b>51</b>	<b>51</b>								
<b>Pedestrian Delay LoS</b>	<b>C</b>	<b>B</b>	<b>E</b>	<b>E</b>	<b>-</b>	<b>-</b>	<b>-</b>	<b>-</b>	<b>-</b>	<b>-</b>	<b>-</b>	<b>-</b>	
<b>Level of Service</b>	<b>F</b>	<b>F</b>	<b>F</b>	<b>F</b>	<b>F</b>	<b>F</b>	<b>B</b>	<b>C</b>	<b>F</b>	<b>F</b>	<b>F</b>	<b>F</b>	
	<b>F</b>				<b>F</b>				<b>F</b>				
Approach From		NORTH	SOUTH	EAST	WEST	NORTH	SOUTH	EAST	WEST	NORTH	SOUTH	EAST	WEST
<b>Bicycle</b>	Bicycle Lane Arrangement on Approach	Mixed Traffic	Mixed Traffic	Mixed Traffic	Mixed Traffic	Mixed Traffic	Mixed Traffic		Mixed Traffic	Mixed Traffic	Curb Bike Lane, Cycletrack or MUP	Curb Bike Lane, Cycletrack or MUP	Curb Bike Lane, Cycletrack or MUP
	Right Turn Lane Configuration	> 50 m	≤ 50 m			> 50 m	> 50 m		> 50 m	> 50 m	Not Applicable	Not Applicable	Not Applicable
	Right Turning Speed	≤ 25 km/h	>25 km/h			>25 km/h	>25 km/h		>25 km/h	>25 km/h	Not Applicable	Not Applicable	Not Applicable
	<b>Cyclist relative to RT motorists</b>	<b>F</b>	<b>E</b>	<b>-</b>	<b>-</b>	<b>F</b>	<b>F</b>	<b>-</b>	<b>F</b>	<b>F</b>	<b>Not Applicable</b>	<b>Not Applicable</b>	<b>Not Applicable</b>
	<b>Separated or Mixed Traffic</b>	<b>Mixed Traffic</b>	<b>Mixed Traffic</b>	<b>Mixed Traffic</b>	<b>Mixed Traffic</b>	<b>Mixed Traffic</b>	<b>Mixed Traffic</b>	<b>-</b>	<b>Mixed Traffic</b>	<b>Mixed Traffic</b>	<b>Separated</b>	<b>Separated</b>	<b>Separated</b>
	Left Turn Approach	≥ 2 lanes crossed	≥ 2 lanes crossed	One lane crossed	One lane crossed	≥ 2 lanes crossed	≥ 2 lanes crossed	No lane crossed	No lane crossed	≥ 2 lanes crossed	2-stage, LT box	2-stage, LT box	2-stage, LT box
	Operating Speed	≥ 60 km/h	≥ 60 km/h	> 50 to < 60 km/h	> 50 to < 60 km/h	≥ 60 km/h	≥ 60 km/h	≥ 60 km/h	≥ 60 km/h	≥ 60 km/h	≥ 60 km/h	≥ 60 km/h	≥ 60 km/h
	<b>Left Turning Cyclist</b>	<b>F</b>	<b>F</b>	<b>E</b>	<b>E</b>	<b>F</b>	<b>F</b>	<b>C</b>	<b>C</b>	<b>F</b>	<b>A</b>	<b>A</b>	<b>A</b>
<b>Level of Service</b>	<b>F</b>	<b>F</b>	<b>E</b>	<b>E</b>	<b>F</b>	<b>F</b>	<b>-</b>	<b>F</b>	<b>F</b>	<b>A</b>	<b>A</b>	<b>A</b>	
	<b>F</b>				<b>F</b>				<b>F</b>				
<b>Transit</b>	Average Signal Delay	≤ 20 sec	≤ 20 sec	> 40 sec	≤ 20 sec	≤ 30 sec	≤ 30 sec		> 40 sec	> 40 sec	> 40 sec	> 40 sec	> 40 sec
	<b>Level of Service</b>	<b>C</b>	<b>C</b>	<b>F</b>	<b>C</b>	<b>D</b>	<b>D</b>	<b>-</b>	<b>F</b>	<b>F</b>	<b>F</b>	<b>F</b>	<b>F</b>
	<b>F</b>				<b>F</b>				<b>F</b>				
<b>Truck</b>	Effective Corner Radius	> 15 m	10 - 15 m	10 - 15 m	> 15 m	> 15 m	> 15 m	10 - 15 m	10 - 15 m	> 15 m	> 15 m	> 15 m	> 15 m
	Number of Receiving Lanes on Departure from Intersection	1	≥ 2	≥ 2	1	≥ 2	1	≥ 2	≥ 2	≥ 2	≥ 2	≥ 2	≥ 2
<b>Level of Service</b>	<b>C</b>	<b>B</b>	<b>B</b>	<b>C</b>	<b>A</b>	<b>C</b>	<b>B</b>	<b>B</b>	<b>A</b>	<b>A</b>	<b>A</b>	<b>A</b>	
	<b>C</b>				<b>C</b>				<b>A</b>				
<b>Auto</b>	Volume to Capacity Ratio	0.71 - 0.80				0.71 - 0.80				0.91 - 1.00			
	<b>Level of Service</b>	<b>C</b>				<b>C</b>				<b>E</b>			



# Appendix H

TRANS Plots

# TRANS Regional Model

Version 2.15 - Assigned June 16, 2020

## AM Peak Hour Total Traffic Volume

### Coventry Road

2011 Model - Basecase

N/A

User Initials: KN

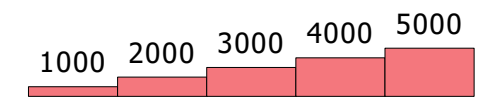
Plot Prepared: Aug 18, 2022

EMME Scenario: 21713

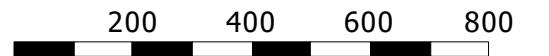


## Legend

AM Peak Hour Total Traffic Volume



Distance (m)



The TRANS model is continuously refined & maintained, and all information is provided in good faith. However, model outputs are provided "as is", and no warranty or guarantee is provided as to the accuracy, reliability or reasonableness of the results. In using this data, you agree to accept any and all risks arising from any incorrect, incomplete, or misleading information.

Recipients are required to use caution and professional judgement in using and interpreting model outputs. In particular, caution should be used when focusing on a geographically limited area (such as a single road or intersection), as the model is primarily designed to simulate regional-scale phenomena and has been calibrated at a regional level.

As general good practice, it is recommended that the user confirm the network coding within the area of interest, and compare base year forecasts against traffic count data to assess the extent to which the model may be over- or under-estimating the travel demand.

Ma

# TRANS Regional Model

Version 2.15 - Assigned June 16, 2020

## AM Peak Hour Total Traffic Volume

### Coventry Road

2031 Model - Basecase

N/A

User Initials: KN

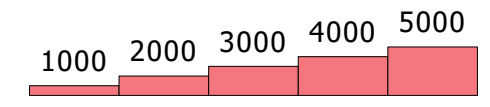
Plot Prepared: Aug 18, 2022

EMME Scenario: 21715

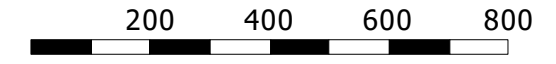


## Legend

AM Peak Hour Total Traffic Volume



Distance (m)



The TRANS model is continuously refined & maintained, and all information is provided in good faith. However, model outputs are provided "as is", and no warranty or guarantee is provided as to the accuracy, reliability or reasonableness of the results. In using this data, you agree to accept any and all risks arising from any incorrect, incomplete, or misleading information.

Recipients are required to use caution and professional judgement in using and interpreting model outputs. In particular, caution should be used when focusing on a geographically limited area (such as a single road or intersection), as the model is primarily designed to simulate regional-scale phenomena and has been calibrated at a regional level.

As a general good practice, it is recommended that the user confirm the network coding within the area of interest, and compare base year forecasts against traffic count data to assess the extent to which the model may be over- or under-estimating the travel demand.

# Appendix I

Background Development Volumes

### Trip Distribution

The projected distribution of site-generated traffic was derived based on existing travel patterns, the site's connections to/from the surrounding road network, and our local area knowledge. (e.g. the location and proximity of other area shopping, communities, recreational opportunities, etc.). For analysis purposes, the following approximate distribution of projected site-generated traffic was assumed:

- 70% to/from the west via HWY 417 (via Tremblay);
  - 10% to/from the east via Tremblay Road;
  - 10% to/from the north via Belfast Road; and
  - + 10% to/from the south via Belfast Road.
- 
- 100%

### Trip Assignment

Based on the above assumed distribution, projected 'new' site-generated traffic was assigned to the study area network and is depicted in the following **Figure 12** and **Figure 14** for phase 1 and phase 2, respectively. Similarly, projected 'pass-by' site-generated traffic, which represents existing traffic temporarily diverted to/from the subject site, is depicted in the following **Figure 13** and **Figure 15** for phase 1 and phase 2, respectively.

It should be noted that Avenue J is a private driveway owned by PIPSC (Professional Institute of the Public Service Canada) and there are currently no plans for this to be a connection to/from the subject development.

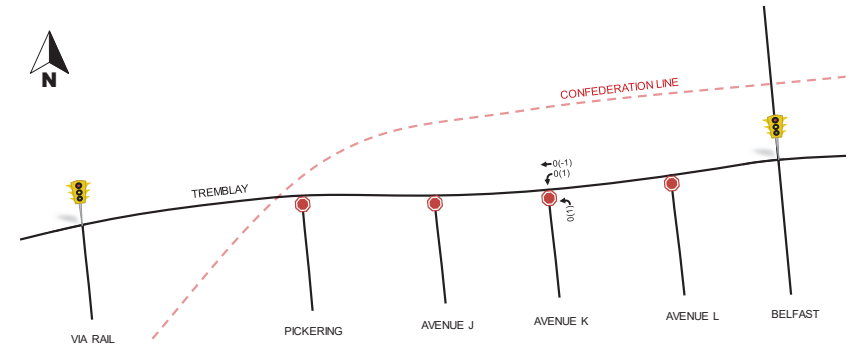


Figure 14: 'Pass-by' Projected Site-Generated Traffic - Phase 1

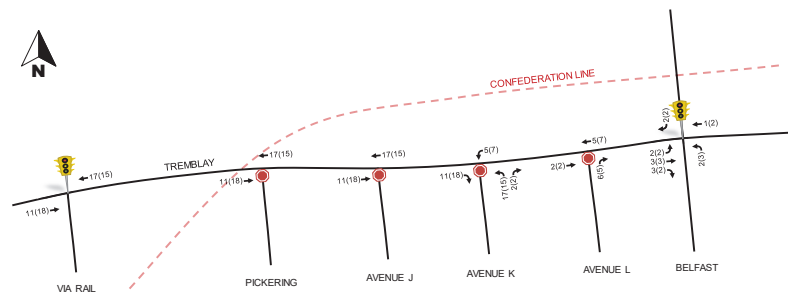


Figure 13: 'New' Projected Site-Generated Traffic - Phase 1

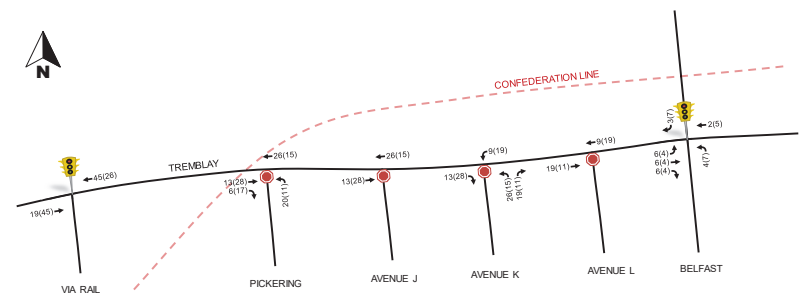


Figure 15: 'New' Projected Site-Generated Traffic - Phase 2

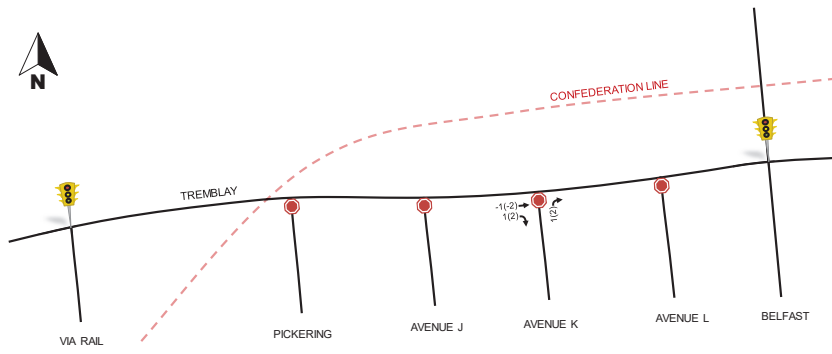


Figure 16: 'Pass-by' Projected Site-Generated Traffic - Phase 2

Given a 0% growth rate for general background traffic and given all area development is assumed to be fully built-out by the horizon year 2025, projected background traffic volumes for the horizon years 2030 and 2035 will be the same as the background traffic volumes for the 2025 horizon year. Therefore, the following Figure 17 depicts projected background traffic volumes for the 2025 horizon year and beyond.

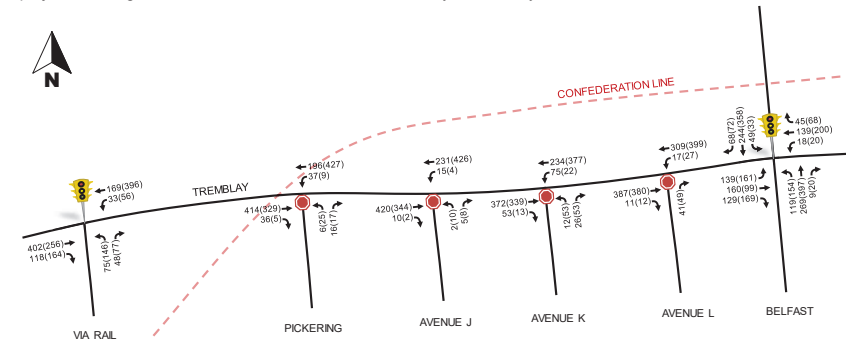


Figure 17: Background Traffic Volumes (2025, 2030, 2035)

### 3.3 Demand Rationalization

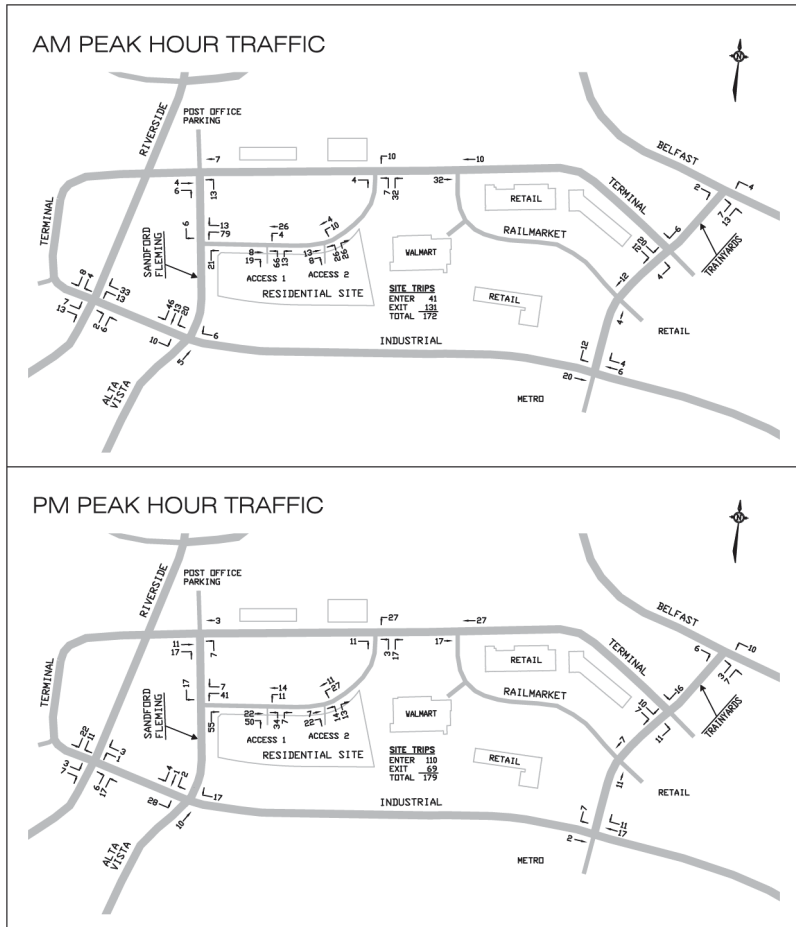
The following section summarizes the vehicular intersection capacity analysis of existing, future background and future total volume scenarios.

Using the intersection capacity analysis software Synchro (v9), study area intersections were assessed in terms of vehicle delay, 95<sup>th</sup> percentile queues, a volume-to-capacity ratio (v/c) and a corresponding Level of Service (LOS). It should be noted that the overall performance of a signalized intersection is calculated as a weighted v/c ratio and assigned a corresponding LOS, with critical movements assigned a LOS based on their respective v/c ratio. The overall performance of an unsignalized intersection is a LOS output from Synchro, which is based on an Intersection Capacity Utilization (ICU) method, and critical movements are assigned a LOS based on delay.

#### Existing and Background Conditions

The following Table 8, Table 9 summarize existing and projected background conditions at study area intersections, in the absence of the proposed development. The objective of this analysis is to determine if network improvements are, or will be required to support background traffic. Detailed Synchro output data for existing and background conditions is provided as Appendix E.

**FIGURE 4.3**  
**PHASE 1 to 3 – PEAK AM AND PM HOUR SITE GENERATED TRIPS**



NOT TO SCALE

proportional assignment to the study area roadways, Figure 18 and Figure 19 illustrate the new site-generated volumes and pass-by volumes, respectively.

Table 14: Trip Assignment

To/From	Via
North	5% Vanier Parkway (N)
	5% Lola Street (N)
	15% St. Laurent Boulevard (N)
South	5% Belfast Road (S)
	10% St. Laurent Boulevard (S)
East	15% to/from Highway 417/174 (E)
West	10% Ogilvie Road (E)
	25% to/from Highway 417 (W)
Total	100%

Figure 18: New Site-Generated Auto Volumes

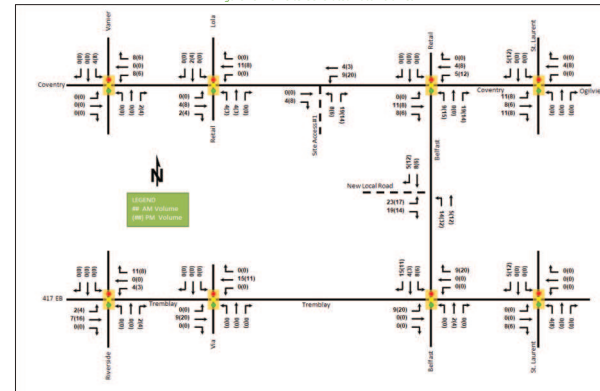


Figure 6: Net Assignment of Trips with Redevelopment

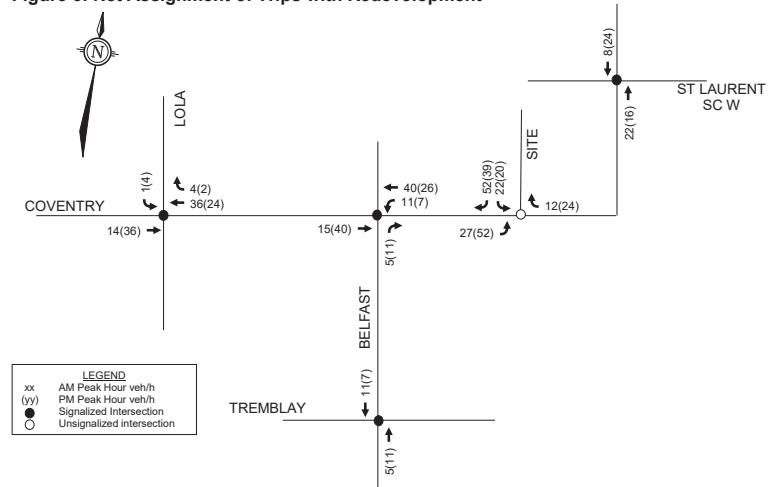
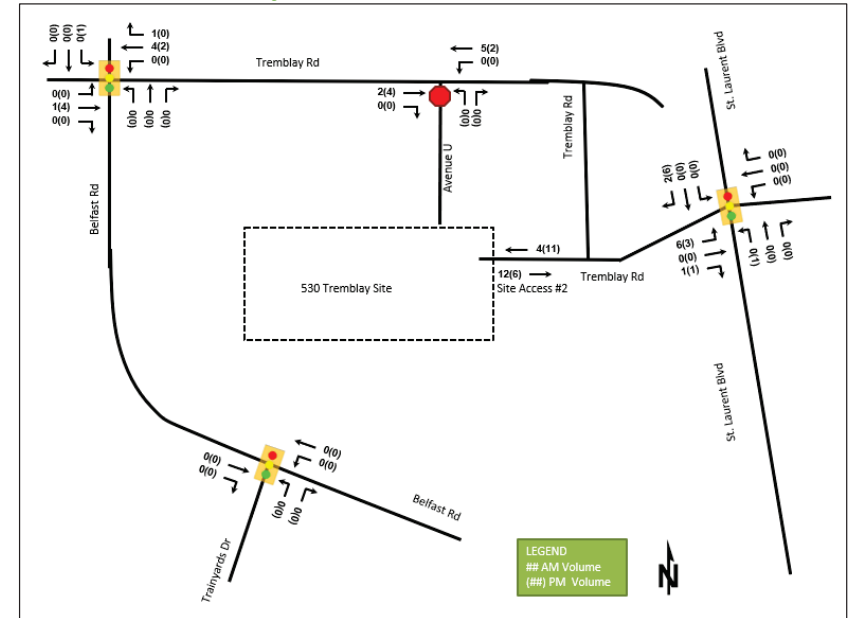


Figure 20: New Site Generation Auto Volumes Scenario 2





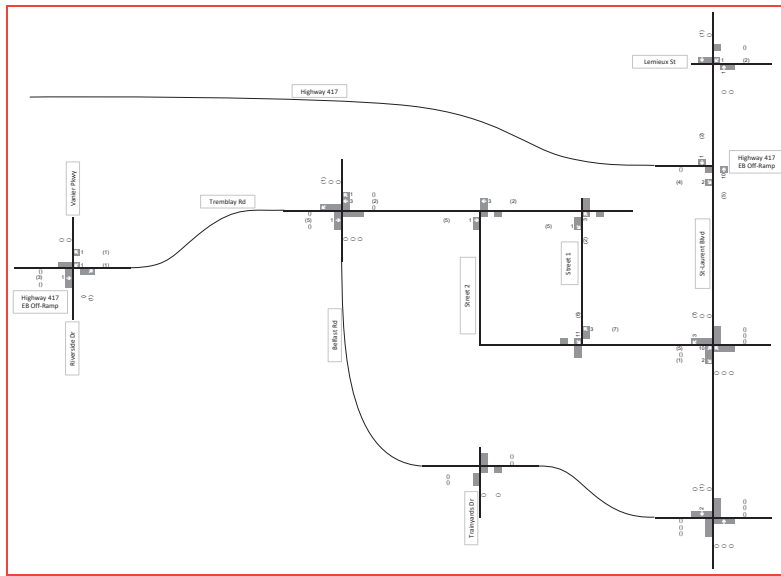


Figure 3-2  
2025 Residential  
Trips Generated

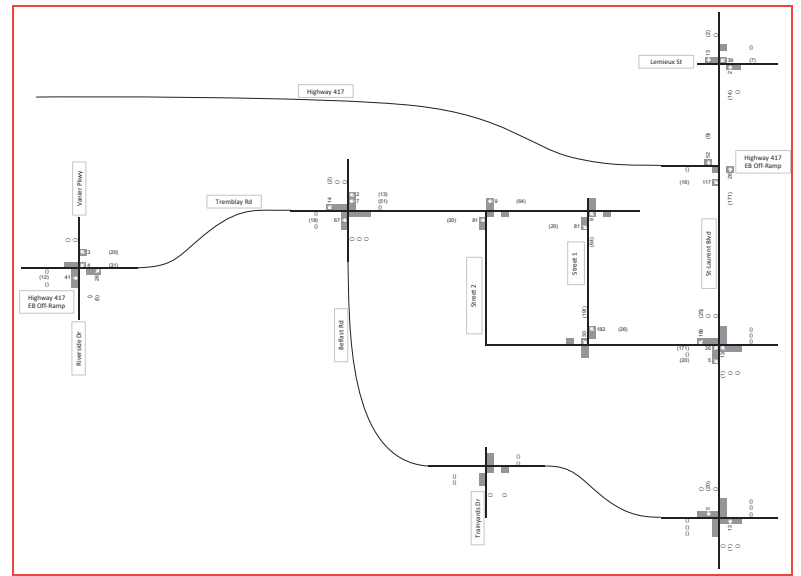


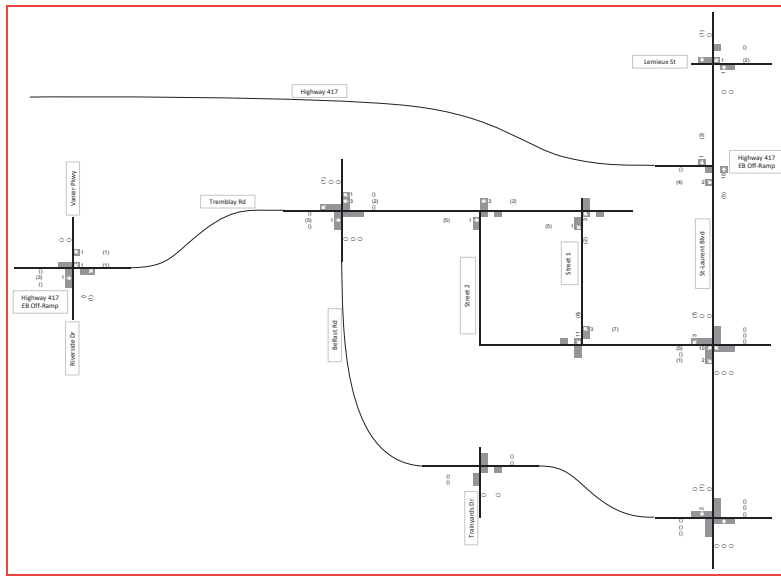
Figure 3-3  
2025 Office Trips  
Generated



Legend  
 AM Peak Hour Traffic Volume (M) PM Peak Hour Traffic Volume (P)

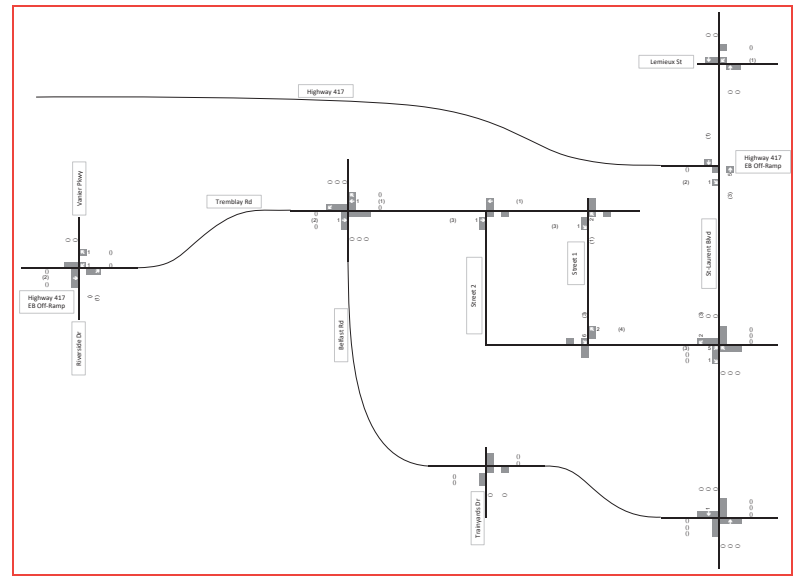


Legend  
 AM Peak Hour Traffic Volume (M) PM Peak Hour Traffic Volume (P)



Legend  
 AM Peak Hour Traffic Volume (Black bar)  
 PM Peak Hour Traffic Volume (White bar)

Figure 3-4  
 2029 Residential Trip Generation



Legend  
 AM Peak Hour Traffic Volume (Black bar)  
 PM Peak Hour Traffic Volume (White bar)

Figure 3-5  
 2033 Residential Trip Generation

Figure 14: New Site Generation Auto Volumes

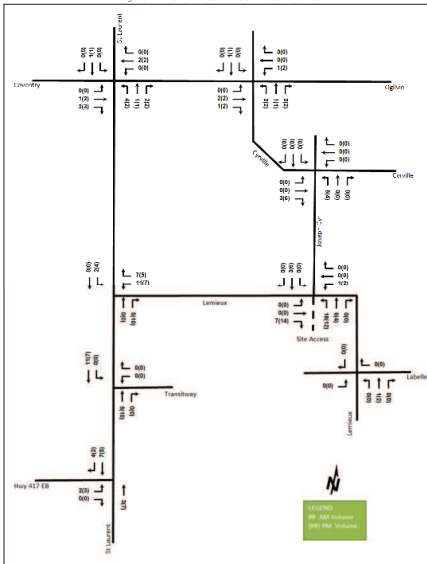
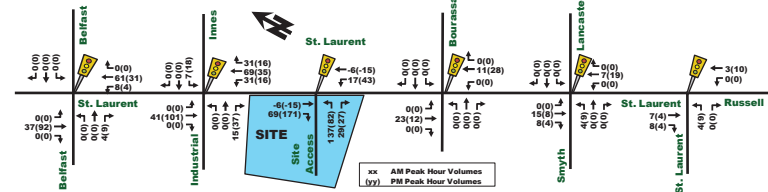


Figure 12: 'New' Site-Generated Traffic



### 3.2. Background Network Travel Demands

#### 3.2.1. Transportation Network Plans

As mentioned in **Section 2.1.3** Planned Conditions, St. Laurent Boulevard is designated as a 'transit priority corridor with isolated measures' from Montreal Road to Elmvale Shopping Center within the 2031 Affordable Network. Though no design is currently available, there is the potential that segments of St. Laurent Boulevard that have not received transit retrofits yet could be upgraded to provide better transit service within the corridor (segments adjacent to the site were retrofitted around 2017). Cycling improvements are also anticipated as discussed in **Section 2.1.3**.

#### 3.2.2. Background Growth

The emphasis in the City's recent Official Plan and Transportation Master Plan is to place priority on transit, encourage intensification around transit stations, encourage mixed-use developments and provide "complete streets" that better accommodate the active transportation needs of its residents and reduce the use of the private auto. Given the location of the site near frequent bus service within the St. Laurent transit priority corridor, close bus connectivity to the LRT Confederation Line and Elmvale Mall, the trips generated from this development as well as nearby developments will likely choose alternate modes of transportation over driving as transit infrastructure improves.

The following background traffic growth (summarized in **Table 12**) was calculated based on historical traffic count data (years 2001, 2009, 2014, 2016 and 2020) provided by the City of Ottawa at the Smyth/St. Laurent intersection near the site. Note that the year 2012 was omitted as counts were almost double any other year count and it was considered an anomaly year or miscount. Detailed background traffic growth analysis is included as **Appendix E**.

Table 12: Smyth/St. Laurent Historical Background Growth (2001-2020)

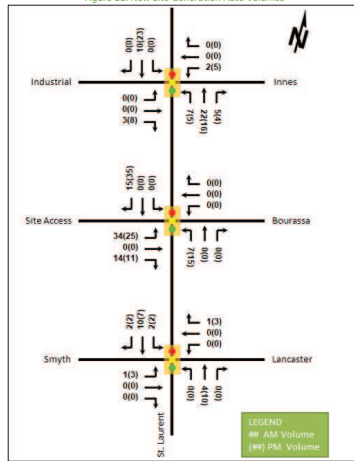
Time Period	Percent Annual Change				
	North Leg	South Leg	East Leg	West Leg	Overall
8 hrs	-0.17%	-0.13%	1.66%	0.47%	0.17%
AM Peak	-0.24%	0.00%	1.77%	0.52%	0.23%
PM Peak	-0.48%	-0.42%	1.53%	0.33%	-0.06%

As shown in **Table 12**, the Smyth/St. Laurent intersection, has experienced between 0.25% to 0% overall annual growth in traffic within recent years. A conservative growth rate of 1% annually will be added to background growth to account for future potential growth to the south and surrounding areas.

#### 3.2.3. Other Developments

The volumes from the other area development as mentioned in **Section 2.1.3** were layered onto the existing traffic volumes for the future analysis volumes. **Figure 13** and **Figure 14** outlines the site generated volumes for 1910 St. Laurent development and 355-374 Everest development respectively.

Figure 11: New Site Generation Auto Volumes



## 6 Background Network Travel Demands

### 6.1 Transportation Network Plans

The transportation network plans were discussed in Section 2.3. None of the proposed changes are considered to have any notable impact on the study area traffic volumes and travel patterns.

### 6.2 Background Growth

A review of the background projections from the City's TRANS Regional Model for the 2011 and 2031 horizons was completed to determine the background growth for each of the study area roadways. The study area roadways have generally achieved any predicted growth or are forecasted to contract in on the study area roadways. Table 16 summarizes the results of the model, and the projections are provided in Appendix E.

# Appendix J

Synchro Intersection Worksheets – 2026 Future Background Conditions

Lanes, Volumes, Timings  
1: St-Laurent & Tremblay

Future Background 2026AM Peak Hour  
1531 St-Laurent Blvd

Lane Group	EBL	EBT	WBL	WBT	NBL	NBT	SBL	SBT	SBR
Lane Configurations	↔	↔	↔	↔	↔	↔	↔	↔	↔
Traffic Volume (vph)	55	21	12	20	82	1232	129	1141	240
Future Volume (vph)	55	21	12	20	82	1232	129	1141	240
Lane Group Flow (vph)	55	53	12	133	82	1270	129	1141	240
Turn Type	Perm	NA	Perm	NA	Perm	NA	pm+pt	NA	Perm
Protected Phases		4		8		2	1	6	
Permitted Phases	4		8		2		6		6
Detector Phase	4	4	8	8	2	2	1	6	6
Switch Phase									
Minimum Initial (s)	10.0	10.0	10.0	10.0	10.0	10.0	5.0	10.0	10.0
Minimum Split (s)	38.5	38.5	38.5	38.5	39.2	39.2	9.7	39.2	39.2
Total Split (s)	40.0	40.0	40.0	40.0	72.0	72.0	18.0	90.0	90.0
Total Split (%)	30.8%	30.8%	30.8%	30.8%	55.4%	55.4%	13.8%	69.2%	69.2%
Maximum Green (s)	33.5	33.5	33.5	33.5	65.8	65.8	13.3	83.8	83.8
Yellow Time (s)	3.3	3.3	3.3	3.3	3.7	3.7	3.7	3.7	3.7
All-Red Time (s)	3.2	3.2	3.2	3.2	2.5	2.5	1.0	2.5	2.5
Lost Time Adjust (s)	0.0	0.0	0.0	0.0	0.0	0.0	0.0	0.0	0.0
Total Lost Time (s)	6.5	6.5	6.5	6.5	6.2	6.2	4.7	6.2	6.2
Lead/Lag					Lag	Lag	Lead		
Lead-Lag Optimize?					Yes	Yes	Yes		
Vehicle Extension (s)	3.0	3.0	3.0	3.0	3.0	3.0	3.0	3.0	3.0
Recall Mode	None	None	None	None	C-Max	C-Max	None	C-Max	C-Max
Walk Time (s)	7.0	7.0	7.0	7.0	11.0	11.0		11.0	11.0
Flash Dont Walk (s)	25.0	25.0	25.0	25.0	22.0	22.0		22.0	22.0
Pedestrian Calls (#/hr)	4	4	3	3	2	2		7	7
Act Effct Green (s)	16.4	16.4	16.4	16.4	88.1	88.1	102.4	100.9	100.9
Actuated g/C Ratio	0.13	0.13	0.13	0.13	0.68	0.68	0.79	0.78	0.78
v/c Ratio	0.58	0.24	0.09	0.49	0.28	0.43	0.40	0.48	0.23
Control Delay	74.3	25.2	46.3	17.8	14.6	11.5	8.0	7.0	1.4
Queue Delay	0.0	0.0	0.0	0.0	0.0	0.0	0.0	0.0	0.0
Total Delay	74.3	25.2	46.3	17.8	14.6	11.5	8.0	7.0	1.4
LOS	E	C	D	B	B	B	A	A	A
Approach Delay		50.2		20.2		11.7		6.2	
Approach LOS		D		C		B		A	
Queue Length 50th (m)	13.9	5.0	2.8	4.8	6.9	44.6	5.5	40.3	0.0
Queue Length 95th (m)	24.2	14.7	7.7	20.6	25.1	89.7	18.3	95.6	8.6
Internal Link Dist (m)		396.6		0.1		682.5		144.8	
Turn Bay Length (m)	38.0		38.0		45.0		75.0		
Base Capacity (vph)	195	414	281	436	293	2934	375	2387	1041
Starvation Cap Reductn	0	0	0	0	0	0	0	0	0
Spillback Cap Reductn	0	0	0	0	0	0	0	0	0
Storage Cap Reductn	0	0	0	0	0	0	0	0	0
Reduced v/c Ratio	0.28	0.13	0.04	0.31	0.28	0.43	0.34	0.48	0.23

Intersection Summary

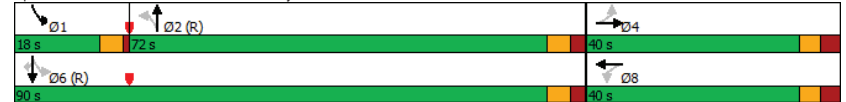
Cycle Length: 130  
 Actuated Cycle Length: 130  
 Offset: 53 (41%), Referenced to phase 2:NBTL and 6:SBTL, Start of Green  
 Natural Cycle: 90

Lanes, Volumes, Timings  
1: St-Laurent & Tremblay

Future Background 2026AM Peak Hour  
1531 St-Laurent Blvd

Control Type: Actuated-Coordinated  
 Maximum v/c Ratio: 0.58  
 Intersection Signal Delay: 10.7  
 Intersection LOS: B  
 Intersection Capacity Utilization 81.7%  
 ICU Level of Service D  
 Analysis Period (min) 15

Splits and Phases: 1: St-Laurent & Tremblay



Lanes, Volumes, Timings  
2: St-Laurent & Belfast

Future Background 2026AM Peak Hour  
1531 St-Laurent Blvd

Lane Group	EBL	EBT	EBR	WBL	WBT	NBL	NBT	NBR	SBL	SBT	SBR
Lane Configurations	↖	↗	↘	↖	↗	↖	↗	↘	↖	↗	↘
Traffic Volume (vph)	47	63	91	43	140	123	920	63	83	838	190
Future Volume (vph)	47	63	91	43	140	123	920	63	83	838	190
Lane Group Flow (vph)	47	63	91	43	234	123	920	63	83	838	190
Turn Type	pm+pt	NA	Perm	Perm	NA	pm+pt	NA	Perm	pm+pt	NA	Perm
Protected Phases	7	4			8	5	2		1	6	
Permitted Phases	4		4	8			2	2	6		6
Detector Phase	7	4	4	8	8	5	2	2	1	6	6
Switch Phase											
Minimum Initial (s)	5.0	10.0	10.0	10.0	10.0	5.0	10.0	10.0	5.0	10.0	10.0
Minimum Split (s)	10.8	27.8	27.8	27.8	27.8	10.7	36.6	36.6	10.7	36.6	36.6
Total Split (s)	16.0	48.0	48.0	32.0	32.0	15.0	57.0	57.0	15.0	57.0	57.0
Total Split (%)	13.3%	40.0%	40.0%	26.7%	26.7%	12.5%	47.5%	47.5%	12.5%	47.5%	47.5%
Maximum Green (s)	10.2	42.2	42.2	26.2	26.2	9.3	51.4	51.4	9.3	51.4	51.4
Yellow Time (s)	3.3	3.3	3.3	3.3	3.3	4.2	4.2	4.2	4.2	4.2	4.2
All-Red Time (s)	2.5	2.5	2.5	2.5	2.5	1.5	1.4	1.4	1.5	1.4	1.4
Lost Time Adjust (s)	0.0	0.0	0.0	0.0	0.0	0.0	0.0	0.0	0.0	0.0	0.0
Total Lost Time (s)	5.8	5.8	5.8	5.8	5.8	5.7	5.6	5.6	5.7	5.6	5.6
Lead/Lag	Lead			Lag	Lag	Lead	Lag	Lag	Lead	Lag	Lag
Lead-Lag Optimize?	Yes			Yes	Yes	Yes	Yes	Yes	Yes	Yes	Yes
Vehicle Extension (s)	3.0	3.0	3.0	3.0	3.0	3.0	3.0	3.0	3.0	3.0	3.0
Recall Mode	None	None	None	None	None	None	C-Max	C-Max	None	C-Max	C-Max
Walk Time (s)	7.0	7.0	7.0	7.0	7.0	25.0	25.0	25.0	25.0	25.0	25.0
Flash Dont Walk (s)	15.0	15.0	15.0	15.0	15.0	6.0	6.0	6.0	6.0	6.0	6.0
Pedestrian Calls (#/hr)	2	2	1	1	1	0	0	0	3	3	3
Act Effct Green (s)	33.9	33.9	33.9	21.9	21.9	70.5	63.3	63.3	68.4	60.5	60.5
Actuated g/C Ratio	0.28	0.28	0.28	0.18	0.18	0.59	0.53	0.53	0.57	0.50	0.50
v/c Ratio	0.23	0.13	0.22	0.22	0.84	0.38	0.55	0.08	0.29	0.54	0.27
Control Delay	30.4	29.0	6.7	42.7	66.1	15.2	23.6	0.2	14.4	24.0	4.1
Queue Delay	0.0	0.0	0.0	0.0	0.0	0.0	0.0	0.0	0.0	0.0	0.0
Total Delay	30.4	29.0	6.7	42.7	66.1	15.2	23.6	0.2	14.4	24.0	4.1
LOS	C	C	A	D	E	B	C	A	B	C	A
Approach Delay	19.2				62.5		21.4			19.9	
Approach LOS	B				E		C			B	
Queue Length 50th (m)	7.8	10.5	0.0	8.6	47.3	12.3	82.6	0.0	8.1	75.0	0.0
Queue Length 95th (m)	15.9	19.9	10.9	18.7	#75.9	23.2	112.7	0.0	16.7	100.9	13.3
Internal Link Dist (m)		518.7			103.5		597.8			682.5	
Turn Bay Length (m)	75.0		200.0	65.0		75.0		55.0	75.0		85.0
Base Capacity (vph)	217	596	499	233	330	328	1683	805	299	1563	692
Starvation Cap Reductn	0	0	0	0	0	0	0	0	0	0	0
Spillback Cap Reductn	0	0	0	0	0	0	0	0	0	0	0
Storage Cap Reductn	0	0	0	0	0	0	0	0	0	0	0
Reduced v/c Ratio	0.22	0.11	0.18	0.18	0.71	0.38	0.55	0.08	0.28	0.54	0.27

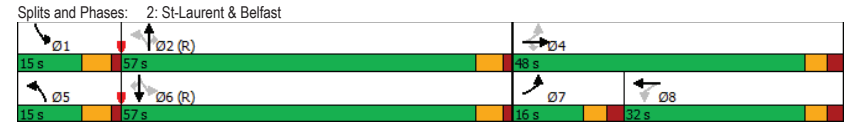
Intersection Summary

Cycle Length: 120  
 Actuated Cycle Length: 120  
 Offset: 53 (44%), Referenced to phase 2:NBTL and 6:SBTL, Start of Green  
 Natural Cycle: 90

Lanes, Volumes, Timings  
2: St-Laurent & Belfast

Future Background 2026AM Peak Hour  
1531 St-Laurent Blvd

Control Type: Actuated-Coordinated  
 Maximum v/c Ratio: 0.84  
 Intersection Signal Delay: 24.8  
 Intersection LOS: C  
 Intersection Capacity Utilization 70.3%  
 ICU Level of Service C  
 Analysis Period (min) 15  
 # 95th percentile volume exceeds capacity, queue may be longer.  
 Queue shown is maximum after two cycles.



Lanes, Volumes, Timings  
3: St-Laurent & Industrial/Innes

Future Background 2026AM Peak Hour  
1531 St-Laurent Blvd

Lane Group	EBL	EBT	EBR	WBL	WBT	WBR	NBL	NBT	NBR	SBL	SBT	SBR
Lane Configurations	↔	↔	↔	↔	↔	↔	↔	↔	↔	↔	↔	↔
Traffic Volume (vph)	71	187	137	618	741	241	208	1104	356	116	824	145
Future Volume (vph)	71	187	137	618	741	241	208	1104	356	116	824	145
Lane Group Flow (vph)	71	187	137	618	741	241	208	1104	356	116	824	145
Turn Type	Prot	NA	Perm	Prot	NA	Perm	Prot	NA	Perm	Prot	NA	Perm
Protected Phases	7	4		3	8		5	2		1	6	
Permitted Phases			4			8			2			6
Detector Phase	7	4	4	3	8	8	5	2	2	1	6	6
Switch Phase												
Minimum Initial (s)	5.0	10.0	10.0	5.0	10.0	10.0	5.0	10.0	10.0	5.0	10.0	10.0
Minimum Split (s)	11.6	38.6	38.6	11.6	38.6	38.6	11.3	37.6	37.6	11.3	37.6	37.6
Total Split (s)	25.0	38.0	38.0	36.0	49.0	49.0	23.0	43.0	43.0	23.0	43.0	43.0
Total Split (%)	17.9%	27.1%	27.1%	25.7%	35.0%	35.0%	16.4%	30.7%	30.7%	16.4%	30.7%	30.7%
Maximum Green (s)	18.4	31.4	31.4	29.4	42.4	42.4	16.7	36.4	36.4	16.7	36.4	36.4
Yellow Time (s)	3.7	3.7	3.7	3.7	3.7	3.7	4.2	4.2	4.2	4.2	4.2	4.2
All-Red Time (s)	2.9	2.9	2.9	2.9	2.9	2.9	2.1	2.4	2.4	2.1	2.4	2.4
Lost Time Adjust (s)	0.0	0.0	0.0	0.0	0.0	0.0	0.0	0.0	0.0	0.0	0.0	0.0
Total Lost Time (s)	6.6	6.6	6.6	6.6	6.6	6.6	6.3	6.6	6.6	6.3	6.6	6.6
Lead/Lag	Lead	Lag	Lag	Lead	Lag	Lag	Lead	Lag	Lag	Lead	Lag	Lag
Lead-Lag Optimize?	Yes	Yes	Yes	Yes	Yes	Yes	Yes	Yes	Yes	Yes	Yes	Yes
Vehicle Extension (s)	3.0	3.0	3.0	3.0	3.0	3.0	3.0	3.0	3.0	3.0	3.0	3.0
Recall Mode	None	None	None	None	None	None	C-Max	C-Max	None	C-Max	C-Max	C-Max
Walk Time (s)	7.0	7.0	7.0	7.0	7.0	7.0	7.0	7.0	7.0	7.0	7.0	7.0
Flash Dont Walk (s)	25.0	25.0	25.0	25.0	25.0	25.0	24.0	24.0	24.0	24.0	24.0	24.0
Pedestrian Calls (#/hr)	6	6	6	6	6	6	2	2	2	2	2	2
Act Effct Green (s)	8.7	19.3	19.3	28.8	42.0	42.0	14.4	55.2	55.2	10.5	51.3	51.3
Actuated g/C Ratio	0.06	0.14	0.14	0.21	0.30	0.30	0.10	0.39	0.39	0.08	0.37	0.37
v/c Ratio	0.38	0.46	0.40	0.93	0.78	0.42	0.67	0.89	0.48	0.49	0.70	0.26
Control Delay	68.5	57.4	5.5	76.4	51.2	6.2	71.2	50.8	9.4	69.0	43.3	3.5
Queue Delay	0.0	0.0	0.0	0.0	0.0	0.0	0.0	0.0	0.0	0.0	0.0	0.0
Total Delay	68.5	57.4	5.5	76.4	51.2	6.2	71.2	50.8	9.4	69.0	43.3	3.5
LOS	E	E	A	E	D	A	E	D	A	E	D	A
Approach Delay	41.4				54.2			44.5				40.7
Approach LOS	D				D			D				D
Queue Length 50th (m)	9.9	25.5	0.0	87.1	101.7	0.0	28.9	149.1	9.5	16.1	102.3	0.0
Queue Length 95th (m)	17.7	34.0	7.1	#120.0	113.0	17.8	41.7	#242.2	42.2	25.7	#162.7	8.8
Internal Link Dist (m)		745.6			700.4			316.7			597.8	
Turn Bay Length (m)	38.0		120.0	150.0		80.0	100.0		100.0	125.0		150.0
Base Capacity (vph)	391	665	444	675	993	587	359	1234	735	372	1180	558
Starvation Cap Reductn	0	0	0	0	0	0	0	0	0	0	0	0
Spillback Cap Reductn	0	0	0	0	0	0	0	0	0	0	0	0
Storage Cap Reductn	0	0	0	0	0	0	0	0	0	0	0	0
Reduced v/c Ratio	0.18	0.28	0.31	0.92	0.75	0.41	0.58	0.89	0.48	0.31	0.70	0.26

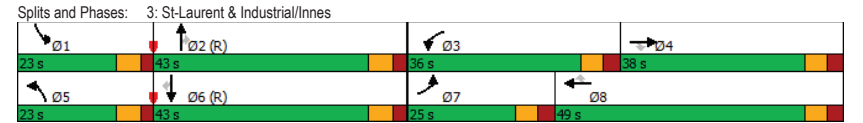
Intersection Summary

Cycle Length: 140  
 Actuated Cycle Length: 140  
 Offset: 0 (0%), Referenced to phase 2:NBT and 6:SBT, Start of Green  
 Natural Cycle: 140

Lanes, Volumes, Timings  
3: St-Laurent & Industrial/Innes

Future Background 2026AM Peak Hour  
1531 St-Laurent Blvd

Control Type: Actuated-Coordinated  
 Maximum v/c Ratio: 0.93  
 Intersection Signal Delay: 46.6  
 Intersection LOS: D  
 Intersection Capacity Utilization 88.4%  
 ICU Level of Service E  
 Analysis Period (min) 15  
 # 95th percentile volume exceeds capacity, queue may be longer.  
 Queue shown is maximum after two cycles.





HCM 2010 TWSC  
5: Lagan & Belfast

Future Background 2026AM Peak Hour  
1531 St-Laurent Blvd

Intersection												
Int Delay, s/veh	2.1											
Movement	EBL	EBT	EBR	WBL	WBT	WBR	NBL	NBT	NBR	SBL	SBT	SBR
Lane Configurations	↔		↔		↔		↔		↔		↔	
Traffic Vol, veh/h	51	272	15	13	225	26	11	1	15	15	4	17
Future Vol, veh/h	51	272	15	13	225	26	11	1	15	15	4	17
Conflicting Peds, #/hr	8	0	10	10	0	8	0	0	5	5	0	0
Sign Control	Free	Free	Free	Free	Free	Free	Stop	Stop	Stop	Stop	Stop	Stop
RT Channelized	-	-	None	-	-	None	-	-	None	-	-	None
Storage Length	-	-	-	-	-	-	-	-	-	-	-	-
Veh in Median Storage, #	-	0	-	-	0	-	-	0	-	-	0	-
Grade, %	-	0	-	-	0	-	-	0	-	-	0	-
Peak Hour Factor	100	100	100	100	100	100	100	100	100	100	100	100
Heavy Vehicles, %	20	12	7	23	15	15	55	2	33	20	25	12
Mvmt Flow	51	272	15	13	225	26	11	1	15	15	4	17

Major/Minor	Major1	Major2	Minor1	Minor2
Conflicting Flow All	259	0	0	297
Stage 1	-	-	-	-
Stage 2	-	-	-	-
Critical Hdwy	4.3	-	-	4.33
Critical Hdwy Stg 1	-	-	-	-
Critical Hdwy Stg 2	-	-	-	-
Follow-up Hdwy	2.38	-	-	2.407
Pot Cap-1 Maneuver	1208	-	-	1154
Stage 1	-	-	-	-
Stage 2	-	-	-	-
Platoon blocked, %	-	-	-	-
Mov Cap-1 Maneuver	1200	-	-	1145
Mov Cap-2 Maneuver	-	-	-	-
Stage 1	-	-	-	-
Stage 2	-	-	-	-

Approach	EB	WB	NB	SB
HCM Control Delay, s	1.2	0.4	14.1	13.9
HCM LOS			B	B

Minor Lane/Major Mvmt	NBLn1	EBL	EBT	EBR	WBL	WBT	WBR	SBLn1
Capacity (veh/h)	421	1200	-	-	1145	-	-	442
HCM Lane V/C Ratio	0.064	0.043	-	-	0.011	-	-	0.081
HCM Control Delay (s)	14.1	8.1	0	-	8.2	0	-	13.9
HCM Lane LOS	B	A	A	-	A	A	-	B
HCM 95th %tile Q(veh)	0.2	0.1	-	-	0	-	-	0.3

Lanes, Volumes, Timings  
1: St-Laurent & Tremblay

Future Background 2026PM Peak Hour  
1531 St-Laurent Blvd

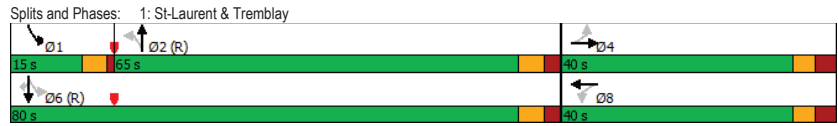
Lane Group	EBL	EBT	WBL	WBT	NBL	NBT	SBL	SBT	SBR	
Lane Configurations	↔	↔	↔	↔	↔	↔	↔	↔	↔	
Traffic Volume (vph)	225	38	23	21	36	1368	58	1071	86	
Future Volume (vph)	225	38	23	21	36	1368	58	1071	86	
Lane Group Flow (vph)	225	123	23	204	36	1360	58	1071	86	
Turn Type	Perm	NA	Perm	NA	Perm	NA	pm+pt	NA	Perm	
Protected Phases	4		8		8		2		6	
Permitted Phases	4		8		2		6		6	
Detector Phase	4		4		8		8		2	
Switch Phase	4		4		8		8		2	
Minimum Initial (s)	10.0	10.0	10.0	10.0	10.0	10.0	5.0	10.0	10.0	
Minimum Split (s)	38.5	38.5	38.5	38.5	39.2	39.2	9.7	39.2	39.2	
Total Split (s)	40.0	40.0	40.0	40.0	65.0	65.0	15.0	80.0	80.0	
Total Split (%)	33.3%	33.3%	33.3%	33.3%	54.2%	54.2%	12.5%	66.7%	66.7%	
Maximum Green (s)	33.5	33.5	33.5	33.5	58.8	58.8	10.3	73.8	73.8	
Yellow Time (s)	3.3	3.3	3.3	3.3	3.7	3.7	3.7	3.7	3.7	
All-Red Time (s)	3.2	3.2	3.2	3.2	2.5	2.5	1.0	2.5	2.5	
Lost Time Adjust (s)	0.0	0.0	0.0	0.0	0.0	0.0	0.0	0.0	0.0	
Total Lost Time (s)	6.5	6.5	6.5	6.5	6.2	6.2	4.7	6.2	6.2	
Lead/Lag	-		-		Lag	Lag	Lead	-		
Lead-Lag Optimize?	-		-		Yes	Yes	Yes	-		
Vehicle Extension (s)	3.0	3.0	3.0	3.0	3.0	3.0	3.0	3.0	3.0	
Recall Mode	None	None	None	None	C-Max	C-Max	None	C-Max	C-Max	
Walk Time (s)	7.0	7.0	7.0	7.0	11.0	11.0	11.0	11.0	11.0	
Flash Dont Walk (s)	25.0	25.0	25.0	25.0	22.0	22.0	22.0	22.0	22.0	
Pedestrian Calls (#/hr)	2	2	2	2	12	12	8	8	8	
Act Effct Green (s)	33.5	33.5	33.5	33.5	64.1	64.1	75.3	73.8	73.8	
Actuated g/C Ratio	0.28	0.28	0.28	0.28	0.53	0.53	0.63	0.62	0.62	
v/c Ratio	1.01	0.26	0.07	0.37	0.16	0.54	0.26	0.55	0.10	
Control Delay	106.5	13.7	32.7	8.8	19.3	18.0	11.5	14.7	2.2	
Queue Delay	0.0	0.0	0.0	0.0	0.0	0.0	0.0	0.0	0.0	
Total Delay	106.5	13.7	32.7	8.8	19.3	18.0	11.5	14.7	2.2	
LOS	F	B	C	A	B	B	B	B	A	
Approach Delay	73.7		11.2		18.1		13.7		-	
Approach LOS	E		B		B		B		-	
Queue Length 50th (m)	~53.9	6.6	4.0	3.8	3.3	54.2	4.9	72.0	0.0	
Queue Length 95th (m)	#104.1	21.5	10.6	22.2	m7.9	m88.2	10.0	89.3	6.0	
Internal Link Dist (m)	390.4		0.1		682.5		144.8		-	
Turn Bay Length (m)	38.0		38.0		45.0		75.0		-	
Base Capacity (vph)	223	481	329	547	226	2540	263	1962	828	
Starvation Cap Reductn	0	0	0	0	0	0	0	0	0	
Spillback Cap Reductn	0	0	0	0	0	0	0	0	0	
Storage Cap Reductn	0	0	0	0	0	0	0	0	0	
Reduced v/c Ratio	1.01	0.26	0.07	0.37	0.16	0.54	0.22	0.55	0.10	

Intersection Summary	
Cycle Length:	120
Actuated Cycle Length:	120
Offset:	49 (41%), Referenced to phase 2:NBT and 6:SBTL, Start of Green
Natural Cycle:	90

Lanes, Volumes, Timings  
1: St-Laurent & Tremblay

Future Background 2026PM Peak Hour  
1531 St-Laurent Blvd

Control Type: Actuated-Coordinated  
 Maximum v/c Ratio: 1.01  
 Intersection Signal Delay: 22.0 Intersection LOS: C  
 Intersection Capacity Utilization 88.1% ICU Level of Service E  
 Analysis Period (min) 15  
 ~ Volume exceeds capacity, queue is theoretically infinite.  
 Queue shown is maximum after two cycles.  
 # 95th percentile volume exceeds capacity, queue may be longer.  
 Queue shown is maximum after two cycles.  
 m Volume for 95th percentile queue is metered by upstream signal.



Lanes, Volumes, Timings  
2: St-Laurent & Belfast

Future Background 2026PM Peak Hour  
1531 St-Laurent Blvd

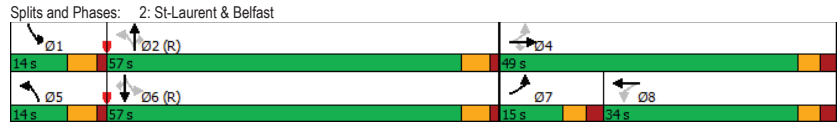
Lane Group	EBL	EBT	EBR	WBL	WBT	NBL	NBT	NBR	SBL	SBT	SBR
Lane Configurations	↖	↖	↖	↖	↖	↖	↖	↖	↖	↖	↖
Traffic Volume (vph)	195	162	224	101	91	111	1007	82	93	887	133
Future Volume (vph)	195	162	224	101	91	111	1007	82	93	887	133
Lane Group Flow (vph)	195	162	224	101	240	111	1007	82	93	887	133
Turn Type	pm+pt	NA	Perm	Perm	NA	pm+pt	NA	Perm	pm+pt	NA	Perm
Protected Phases	7	4			8	5	2		1	6	
Permitted Phases	4		4	8		2		2	6		6
Detector Phase	7	4	4	8	8	5	2	2	1	6	6
Switch Phase											
Minimum Initial (s)	5.0	10.0	10.0	10.0	10.0	5.0	10.0	10.0	5.0	10.0	10.0
Minimum Split (s)	10.8	27.8	27.8	27.8	27.8	10.7	36.6	36.6	10.7	36.6	36.6
Total Split (s)	15.0	49.0	49.0	34.0	34.0	14.0	57.0	57.0	14.0	57.0	57.0
Total Split (%)	12.5%	40.8%	40.8%	28.3%	28.3%	11.7%	47.5%	47.5%	11.7%	47.5%	47.5%
Maximum Green (s)	9.2	43.2	43.2	28.2	28.2	8.3	51.4	51.4	8.3	51.4	51.4
Yellow Time (s)	3.3	3.3	3.3	3.3	3.3	4.2	4.2	4.2	4.2	4.2	4.2
All-Red Time (s)	2.5	2.5	2.5	2.5	2.5	1.5	1.4	1.4	1.5	1.4	1.4
Lost Time Adjust (s)	0.0	0.0	0.0	0.0	0.0	0.0	0.0	0.0	0.0	0.0	0.0
Total Lost Time (s)	5.8	5.8	5.8	5.8	5.8	5.7	5.6	5.6	5.7	5.6	5.6
Lead/Lag	Lead			Lag	Lag	Lead	Lag	Lag	Lead	Lag	Lag
Lead-Lag Optimize?	Yes			Yes	Yes	Yes	Yes	Yes	Yes	Yes	Yes
Vehicle Extension (s)	3.0	3.0	3.0	3.0	3.0	3.0	3.0	3.0	3.0	3.0	3.0
Recall Mode	None	None	None	None	None	None	C-Max	C-Max	None	C-Max	C-Max
Walk Time (s)	7.0	7.0	7.0	7.0	7.0	25.0	25.0	25.0	25.0	25.0	25.0
Flash Dont Walk (s)	15.0	15.0	15.0	15.0	15.0	6.0	6.0	6.0	6.0	6.0	6.0
Pedestrian Calls (#/hr)	9	9	5	5	5	1	1	1	15	15	15
Act Effct Green (s)	34.6	34.6	34.6	19.6	19.6	68.4	60.2	60.2	68.0	60.0	60.0
Actuated g/C Ratio	0.29	0.29	0.29	0.16	0.16	0.57	0.50	0.50	0.57	0.50	0.50
v/c Ratio	0.95	0.35	0.40	0.59	0.79	0.36	0.61	0.12	0.38	0.54	0.17
Control Delay	86.6	34.7	7.3	58.9	53.0	14.4	24.9	1.1	17.2	18.3	2.8
Queue Delay	0.0	0.0	0.0	0.0	0.0	0.0	0.0	0.0	0.0	0.0	0.0
Total Delay	86.6	34.7	7.3	58.9	53.0	14.4	24.9	1.1	17.2	18.3	2.8
LOS	F	C	A	E	D	B	C	A	B	B	A
Approach Delay		41.6			54.7		22.3			16.3	
Approach LOS		D			D		C			B	
Queue Length 50th (m)	37.2	30.2	3.2	22.3	40.6	10.1	87.8	0.0	8.1	46.8	0.0
Queue Length 95th (m)	#68.0	44.1	19.4	37.5	63.9	21.5	125.4	2.4	20.9	59.4	6.6
Internal Link Dist (m)		518.7			103.5		597.8			682.5	
Turn Bay Length (m)	75.0		200.0	65.0		75.0		55.0	75.0		85.0
Base Capacity (vph)	206	572	651	247	408	318	1647	683	254	1642	771
Starvation Cap Reductn	0	0	0	0	0	0	0	0	0	0	0
Spillback Cap Reductn	0	0	0	0	0	0	0	0	0	0	0
Storage Cap Reductn	0	0	0	0	0	0	0	0	0	0	0
Reduced v/c Ratio	0.95	0.28	0.34	0.41	0.59	0.35	0.61	0.12	0.37	0.54	0.17

**Intersection Summary**  
 Cycle Length: 120  
 Actuated Cycle Length: 120  
 Offset: 49 (41%), Referenced to phase 2:NBT and 6:SBTL, Start of Green  
 Natural Cycle: 90

Lanes, Volumes, Timings  
2: St-Laurent & Belfast

Future Background 2026PM Peak Hour  
1531 St-Laurent Blvd

Control Type: Actuated-Coordinated  
 Maximum v/c Ratio: 0.95  
 Intersection Signal Delay: 27.1 Intersection LOS: C  
 Intersection Capacity Utilization 80.8% ICU Level of Service D  
 Analysis Period (min) 15  
 # 95th percentile volume exceeds capacity, queue may be longer.  
 Queue shown is maximum after two cycles.



Lanes, Volumes, Timings  
3: St-Laurent & Industrial/Innes

Future Background 2026PM Peak Hour  
1531 St-Laurent Blvd

	EBL	EBT	EBR	WBL	WBT	WBR	NBL	NBT	NBR	SBL	SBT	SBR
Lane Group	EBL	EBT	EBR	WBL	WBT	WBR	NBL	NBT	NBR	SBL	SBT	SBR
Lane Configurations	↔	↔	↔	↔	↔	↔	↔	↔	↔	↔	↔	↔
Traffic Volume (vph)	137	560	363	415	274	135	199	931	522	130	951	131
Future Volume (vph)	137	560	363	415	274	135	199	931	522	130	951	131
Lane Group Flow (vph)	137	560	363	415	274	135	199	931	522	130	951	131
Turn Type	Prot	NA	Perm	Prot	NA	Perm	Prot	NA	Perm	Prot	NA	Perm
Protected Phases	7	4		3	8		5	2		1	6	
Permitted Phases			4			8			2			6
Detector Phase	7	4	4	3	8	8	5	2	2	1	6	6
Switch Phase												
Minimum Initial (s)	5.0	10.0	10.0	5.0	10.0	10.0	5.0	10.0	10.0	5.0	10.0	10.0
Minimum Split (s)	11.6	38.6	38.6	11.6	38.6	38.6	11.3	37.6	37.6	11.3	37.6	37.6
Total Split (s)	19.0	38.0	38.0	41.0	60.0	60.0	28.0	43.0	43.0	28.0	43.0	43.0
Total Split (%)	12.7%	25.3%	25.3%	27.3%	40.0%	40.0%	18.7%	28.7%	28.7%	18.7%	28.7%	28.7%
Maximum Green (s)	12.4	31.4	31.4	34.4	53.4	53.4	21.7	36.4	36.4	21.7	36.4	36.4
Yellow Time (s)	3.7	3.7	3.7	3.7	3.7	3.7	4.2	4.2	4.2	4.2	4.2	4.2
All-Red Time (s)	2.9	2.9	2.9	2.9	2.9	2.9	2.1	2.4	2.4	2.1	2.4	2.4
Lost Time Adjust (s)	0.0	0.0	0.0	0.0	0.0	0.0	0.0	0.0	0.0	0.0	0.0	0.0
Total Lost Time (s)	6.6	6.6	6.6	6.6	6.6	6.6	6.3	6.6	6.6	6.3	6.6	6.6
Lead/Lag	Lead	Lag	Lag	Lead	Lag	Lag	Lead	Lag	Lag	Lead	Lag	Lag
Lead-Lag Optimize?	Yes	Yes	Yes	Yes	Yes	Yes	Yes	Yes	Yes	Yes	Yes	Yes
Vehicle Extension (s)	3.0	3.0	3.0	3.0	3.0	3.0	3.0	3.0	3.0	3.0	3.0	3.0
Recall Mode	None	None	None	None	None	None	None	Max	Max	None	Max	Max
Walk Time (s)	7.0	7.0			7.0	7.0		7.0	7.0		7.0	7.0
Flash Dont Walk (s)		25.0	25.0		25.0	25.0		24.0	24.0		24.0	24.0
Pedestrian Calls (#/hr)		5	5		6	6		9	9		12	12
Act Effct Green (s)	10.5	26.8	26.8	21.7	38.0	38.0	13.5	39.4	39.4	10.9	36.8	36.8
Actuated g/C Ratio	0.08	0.21	0.21	0.17	0.30	0.30	0.11	0.31	0.31	0.09	0.29	0.29
v/c Ratio	0.51	0.80	0.66	0.75	0.28	0.25	0.59	0.91	0.67	0.49	1.00	0.24
Control Delay	64.0	57.0	14.9	58.8	34.0	6.3	62.2	56.0	10.1	63.1	73.1	3.4
Queue Delay	0.0	0.0	0.0	0.0	0.0	0.0	0.0	0.0	0.0	0.0	0.0	0.0
Total Delay	64.0	57.0	14.9	58.8	34.0	6.3	62.2	56.0	10.1	63.1	73.1	3.4
LOS	E	E	B	E	C	A	E	E	B	E	E	A
Approach Delay		43.5			41.9			42.2			64.5	
Approach LOS		D			D			D			E	
Queue Length 50th (m)	17.0	69.1	10.9	50.9	26.9	0.0	24.6	117.3	8.0	16.1	~127.4	0.0
Queue Length 95th (m)	30.3	99.1	46.4	73.0	40.5	14.2	39.9	#186.0	48.7	28.7	#204.8	7.5
Internal Link Dist (m)		745.6			700.4			316.7			597.8	
Turn Bay Length (m)	38.0		120.0	150.0		80.0	100.0		100.0	125.0		150.0
Base Capacity (vph)	321	826	593	893	1375	703	547	1023	777	532	955	541
Starvation Cap Reductn	0	0	0	0	0	0	0	0	0	0	0	0
Spillback Cap Reductn	0	0	0	0	0	0	0	0	0	0	0	0
Storage Cap Reductn	0	0	0	0	0	0	0	0	0	0	0	0
Reduced v/c Ratio	0.43	0.68	0.61	0.46	0.20	0.19	0.36	0.91	0.67	0.24	1.00	0.24

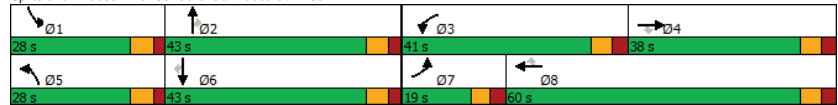
Intersection Summary  
 Cycle Length: 150  
 Actuated Cycle Length: 125.1  
 Natural Cycle: 110  
 Control Type: Actuated-Uncoordinated

Lanes, Volumes, Timings  
3: St-Laurent & Industrial/Innes

Future Background 2026PM Peak Hour  
1531 St-Laurent Blvd

Maximum v/c Ratio: 1.00	Intersection LOS: D
Intersection Signal Delay: 48.1	ICU Level of Service E
Intersection Capacity Utilization 85.9%	
Analysis Period (min) 15	
~ Volume exceeds capacity, queue is theoretically infinite.	
Queue shown is maximum after two cycles.	
# 95th percentile volume exceeds capacity, queue may be longer.	
Queue shown is maximum after two cycles.	

Splits and Phases: 3: St-Laurent & Industrial/Innes



HCM 2010 TWSC  
5: Lagan & Belfast

Future Background 2026PM Peak Hour  
1531 St-Laurent Blvd

Intersection												
Int Delay, s/veh	2.8											
Movement	EBL	EBT	EBR	WBL	WBT	WBR	NBL	NBT	NBR	SBL	SBT	SBR
Lane Configurations	↔			↔			↔			↔		
Traffic Vol, veh/h	46	265	50	19	310	26	26	5	16	30	0	39
Future Vol, veh/h	46	265	50	19	310	26	26	5	16	30	0	39
Conflicting Peds, #/hr	12	0	5	5	0	12	1	0	6	6	0	1
Sign Control	Free	Free	Free	Free	Free	Free	Stop	Stop	Stop	Stop	Stop	Stop
RT Channelized	-	-	None	-	-	None	-	-	None	-	-	None
Storage Length	-	-	-	-	-	-	-	-	-	-	-	-
Veh in Median Storage, #	-	0	-	-	0	-	-	0	-	-	0	-
Grade, %	-	0	-	-	0	-	-	0	-	-	0	-
Peak Hour Factor	100	100	100	100	100	100	100	100	100	100	100	100
Heavy Vehicles, %	30	6	12	5	3	8	4	2	2	10	2	2
Mvmt Flow	46	265	50	19	310	26	26	5	16	30	0	39

Major/Minor	Major1	Major2	Minor1	Minor2
Conflicting Flow All	348	0	320	0
Stage 1	-	-	-	-
Stage 2	-	-	-	-
Critical Hdwy	4.4	-	4.15	-
Critical Hdwy Stg 1	-	-	-	-
Critical Hdwy Stg 2	-	-	-	-
Follow-up Hdwy	2.47	-	2.245	-
Pot Cap-1 Maneuver	1071	-	1223	-
Stage 1	-	-	-	-
Stage 2	-	-	-	-
Platoon blocked, %	-	-	-	-
Mov Cap-1 Maneuver	1061	-	1218	-
Mov Cap-2 Maneuver	-	-	-	-
Stage 1	-	-	-	-
Stage 2	-	-	-	-

Approach	EB	WB	NB	SB
HCM Control Delay, s	1.1	0.4	16.5	15.2
HCM LOS			C	C

Minor Lane/Major Mvmt	NBLn1	EBL	EBT	EBR	WBL	WBT	WBR	SBLn1
Capacity (veh/h)	359	1061	-	-	1218	-	-	420
HCM Lane V/C Ratio	0.131	0.043	-	-	0.016	-	-	0.164
HCM Control Delay (s)	16.5	8.5	0	-	8	0	-	15.2
HCM Lane LOS	C	A	A	-	A	A	-	C
HCM 95th %tile Q(veh)	0.4	0.1	-	-	0	-	-	0.6

# Appendix K

Synchro Intersection Worksheets – 2031 Future Background Conditions

Lanes, Volumes, Timings  
1: St-Laurent & Tremblay

Future Background 2031AM Peak Hour  
1531 St-Laurent Blvd

	↖	→	↗	←	↖	↑	↗	↓	↖
Lane Group	EBL	EBT	WBL	WBT	NBL	NBT	SBL	SBT	SBR
Lane Configurations	↖	↖	↖	↖	↖	↖	↖	↖	↖
Traffic Volume (vph)	60	21	12	20	82	1246	131	1141	244
Future Volume (vph)	60	21	12	20	82	1246	131	1141	244
Lane Group Flow (vph)	60	54	12	143	82	1284	131	1141	244
Turn Type	Perm	NA	Perm	NA	Perm	NA	pm+pt	NA	Perm
Protected Phases		4		8		2		1	6
Permitted Phases	4		8		2		6		6
Detector Phase	4	4	8	8	2	2	1	6	6
Switch Phase									
Minimum Initial (s)	10.0	10.0	10.0	10.0	10.0	10.0	5.0	10.0	10.0
Minimum Split (s)	38.5	38.5	38.5	38.5	39.2	39.2	9.7	39.2	39.2
Total Split (s)	40.0	40.0	40.0	40.0	72.0	72.0	18.0	90.0	90.0
Total Split (%)	30.8%	30.8%	30.8%	30.8%	55.4%	55.4%	13.8%	69.2%	69.2%
Maximum Green (s)	33.5	33.5	33.5	33.5	65.8	65.8	13.3	83.8	83.8
Yellow Time (s)	3.3	3.3	3.3	3.3	3.7	3.7	3.7	3.7	3.7
All-Red Time (s)	3.2	3.2	3.2	3.2	2.5	2.5	1.0	2.5	2.5
Lost Time Adjust (s)	0.0	0.0	0.0	0.0	0.0	0.0	0.0	0.0	0.0
Total Lost Time (s)	6.5	6.5	6.5	6.5	6.2	6.2	4.7	6.2	6.2
Lead/Lag					Lag	Lag	Lead		
Lead-Lag Optimize?					Yes	Yes	Yes		
Vehicle Extension (s)	3.0	3.0	3.0	3.0	3.0	3.0	3.0	3.0	3.0
Recall Mode	None	None	None	None	C-Max	C-Max	None	C-Max	C-Max
Walk Time (s)	7.0	7.0	7.0	7.0	11.0	11.0		11.0	11.0
Flash Dont Walk (s)	25.0	25.0	25.0	25.0	22.0	22.0		22.0	22.0
Pedestrian Calls (#/hr)	4	4	3	3	2	2		7	7
Act Effct Green (s)	17.0	17.0	17.0	17.0	87.3	87.3	101.8	100.3	100.3
Actuated g/C Ratio	0.13	0.13	0.13	0.13	0.67	0.67	0.78	0.77	0.77
v/c Ratio	0.65	0.24	0.08	0.50	0.28	0.44	0.41	0.48	0.24
Control Delay	80.6	24.5	45.7	17.1	14.9	11.9	8.4	7.2	1.4
Queue Delay	0.0	0.0	0.0	0.0	0.0	0.0	0.0	0.0	0.0
Total Delay	80.6	24.5	45.7	17.1	14.9	11.9	8.4	7.2	1.4
LOS	F	C	D	B	B	B	A	A	A
Approach Delay		54.0		19.3		12.1		6.4	
Approach LOS		D		B		B		A	
Queue Length 50th (m)	15.2	4.9	2.8	4.7	7.2	47.0	5.9	42.5	0.0
Queue Length 95th (m)	26.3	14.9	7.7	21.1	25.1	91.2	18.7	95.6	8.6
Internal Link Dist (m)		396.6		0.1		682.5		144.8	
Turn Bay Length (m)	38.0		38.0		45.0		75.0		
Base Capacity (vph)	185	414	281	442	291	2910	369	2371	1037
Starvation Cap Reductn	0	0	0	0	0	0	0	0	0
Spillback Cap Reductn	0	0	0	0	0	0	0	0	0
Storage Cap Reductn	0	0	0	0	0	0	0	0	0
Reduced v/c Ratio	0.32	0.13	0.04	0.32	0.28	0.44	0.36	0.48	0.24

Intersection Summary

Cycle Length: 130  
 Actuated Cycle Length: 130  
 Offset: 53 (41%), Referenced to phase 2:NBTL and 6:SBTL, Start of Green  
 Natural Cycle: 90

Lanes, Volumes, Timings  
1: St-Laurent & Tremblay

Future Background 2031AM Peak Hour  
1531 St-Laurent Blvd

Control Type: Actuated-Coordinated  
 Maximum v/c Ratio: 0.65  
 Intersection Signal Delay: 11.2  
 Intersection LOS: B  
 Intersection Capacity Utilization 82.2%  
 ICU Level of Service E  
 Analysis Period (min) 15

Splits and Phases: 1: St-Laurent & Tremblay



Lanes, Volumes, Timings  
2: St-Laurent & Belfast

Future Background 2031AM Peak Hour  
1531 St-Laurent Blvd

Lane Group	EBL	EBT	EBR	WBL	WBT	NBL	NBT	NBR	SBL	SBT	SBR
Lane Configurations	↖	↗	↘	↙	↘	↙	↘	↙	↘	↙	↘
Traffic Volume (vph)	47	63	115	43	140	131	931	66	83	839	190
Future Volume (vph)	47	63	115	43	140	131	931	66	83	839	190
Lane Group Flow (vph)	47	63	115	43	234	131	931	66	83	839	190
Turn Type	pm+pt	NA	Perm	Perm	NA	pm+pt	NA	Perm	pm+pt	NA	Perm
Protected Phases	7	4			8	5	2		1	6	
Permitted Phases	4		4	8				2	6		6
Detector Phase	7	4	4	8	8	5	2	2	1	6	6
Switch Phase											
Minimum Initial (s)	5.0	10.0	10.0	10.0	10.0	5.0	10.0	10.0	5.0	10.0	10.0
Minimum Split (s)	10.8	27.8	27.8	27.8	27.8	10.7	36.6	36.6	10.7	36.6	36.6
Total Split (s)	16.0	48.0	48.0	32.0	32.0	15.0	57.0	57.0	15.0	57.0	57.0
Total Split (%)	13.3%	40.0%	40.0%	26.7%	26.7%	12.5%	47.5%	47.5%	12.5%	47.5%	47.5%
Maximum Green (s)	10.2	42.2	42.2	26.2	26.2	9.3	51.4	51.4	9.3	51.4	51.4
Yellow Time (s)	3.3	3.3	3.3	3.3	3.3	4.2	4.2	4.2	4.2	4.2	4.2
All-Red Time (s)	2.5	2.5	2.5	2.5	2.5	1.5	1.4	1.4	1.5	1.4	1.4
Lost Time Adjust (s)	0.0	0.0	0.0	0.0	0.0	0.0	0.0	0.0	0.0	0.0	0.0
Total Lost Time (s)	5.8	5.8	5.8	5.8	5.8	5.7	5.6	5.6	5.7	5.6	5.6
Lead/Lag	Lead			Lag	Lag	Lead	Lag	Lag	Lead	Lag	Lag
Lead-Lag Optimize?	Yes			Yes	Yes	Yes	Yes	Yes	Yes	Yes	Yes
Vehicle Extension (s)	3.0	3.0	3.0	3.0	3.0	3.0	3.0	3.0	3.0	3.0	3.0
Recall Mode	None	None	None	None	None	None	C-Max	C-Max	None	C-Max	C-Max
Walk Time (s)	7.0	7.0	7.0	7.0	7.0	7.0	25.0	25.0	25.0	25.0	25.0
Flash Dont Walk (s)	15.0	15.0	15.0	15.0	15.0	6.0	6.0	6.0	6.0	6.0	6.0
Pedestrian Calls (#/hr)	2	2	1	1	1	0	0	0	3	3	3
Act Effct Green (s)	33.9	33.9	33.9	21.9	21.9	70.6	63.3	63.3	68.2	60.3	60.3
Actuated g/C Ratio	0.28	0.28	0.28	0.18	0.18	0.59	0.53	0.53	0.57	0.50	0.50
v/c Ratio	0.23	0.13	0.26	0.22	0.84	0.41	0.55	0.08	0.30	0.54	0.27
Control Delay	30.4	29.0	6.4	42.7	66.1	15.6	23.8	0.2	14.5	24.1	4.1
Queue Delay	0.0	0.0	0.0	0.0	0.0	0.0	0.0	0.0	0.0	0.0	0.0
Total Delay	30.4	29.0	6.4	42.7	66.1	15.6	23.8	0.2	14.5	24.1	4.1
LOS	C	C	A	D	E	B	C	A	B	C	A
Approach Delay	17.8				62.5		21.4			20.0	
Approach LOS	B				E		C			B	
Queue Length 50th (m)	7.8	10.5	0.0	8.6	47.3	13.2	84.0	0.0	8.1	75.5	0.0
Queue Length 95th (m)	15.9	19.9	12.3	18.7	#75.9	24.6	114.3	0.0	16.7	101.1	13.3
Internal Link Dist (m)		518.7			103.5		597.8			682.5	
Turn Bay Length (m)	75.0		200.0	65.0		75.0		55.0	75.0		85.0
Base Capacity (vph)	217	596	514	233	330	327	1683	805	296	1560	691
Starvation Cap Reductn	0	0	0	0	0	0	0	0	0	0	0
Spillback Cap Reductn	0	0	0	0	0	0	0	0	0	0	0
Storage Cap Reductn	0	0	0	0	0	0	0	0	0	0	0
Reduced v/c Ratio	0.22	0.11	0.22	0.18	0.71	0.40	0.55	0.08	0.28	0.54	0.27

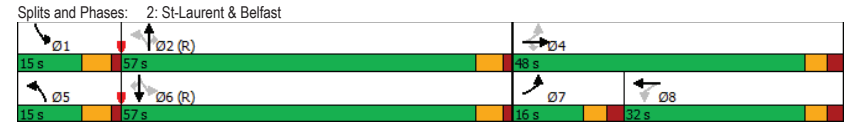
Intersection Summary

Cycle Length: 120  
 Actuated Cycle Length: 120  
 Offset: 53 (44%), Referenced to phase 2:NBTL and 6:SBTL, Start of Green  
 Natural Cycle: 90

Lanes, Volumes, Timings  
2: St-Laurent & Belfast

Future Background 2031AM Peak Hour  
1531 St-Laurent Blvd

Control Type: Actuated-Coordinated  
 Maximum v/c Ratio: 0.84  
 Intersection Signal Delay: 24.7  
 Intersection LOS: C  
 Intersection Capacity Utilization 70.8%  
 ICU Level of Service C  
 Analysis Period (min) 15  
 # 95th percentile volume exceeds capacity, queue may be longer.  
 Queue shown is maximum after two cycles.



Lanes, Volumes, Timings  
3: St-Laurent & Industrial/Innes

Future Background 2031AM Peak Hour  
1531 St-Laurent Blvd

Lane Group	EBL	EBT	EBR	WBL	WBT	WBR	NBL	NBT	NBR	SBL	SBT	SBR
Lane Configurations	↔	↔	↔	↔	↔	↔	↔	↔	↔	↔	↔	↔
Traffic Volume (vph)	73	194	142	618	741	241	210	1128	356	116	849	146
Future Volume (vph)	73	194	142	618	741	241	210	1128	356	116	849	146
Lane Group Flow (vph)	73	194	142	618	741	241	210	1128	356	116	849	146
Turn Type	Prot	NA	Perm	Prot	NA	Perm	Prot	NA	Perm	Prot	NA	Perm
Protected Phases	7	4		3	8		5	2		1	6	
Permitted Phases			4			8			2			6
Detector Phase	7	4	4	3	8	8	5	2	2	1	6	6
Switch Phase												
Minimum Initial (s)	5.0	10.0	10.0	5.0	10.0	10.0	5.0	10.0	10.0	5.0	10.0	10.0
Minimum Split (s)	11.6	38.6	38.6	11.6	38.6	38.6	11.3	37.6	37.6	11.3	37.6	37.6
Total Split (s)	25.0	38.0	38.0	36.0	49.0	49.0	23.0	43.0	43.0	23.0	43.0	43.0
Total Split (%)	17.9%	27.1%	27.1%	25.7%	35.0%	35.0%	16.4%	30.7%	30.7%	16.4%	30.7%	30.7%
Maximum Green (s)	18.4	31.4	31.4	29.4	42.4	42.4	16.7	36.4	36.4	16.7	36.4	36.4
Yellow Time (s)	3.7	3.7	3.7	3.7	3.7	3.7	4.2	4.2	4.2	4.2	4.2	4.2
All-Red Time (s)	2.9	2.9	2.9	2.9	2.9	2.9	2.1	2.4	2.4	2.1	2.4	2.4
Lost Time Adjust (s)	0.0	0.0	0.0	0.0	0.0	0.0	0.0	0.0	0.0	0.0	0.0	0.0
Total Lost Time (s)	6.6	6.6	6.6	6.6	6.6	6.6	6.3	6.6	6.6	6.3	6.6	6.6
Lead/Lag	Lead	Lag	Lag	Lead	Lag	Lag	Lead	Lag	Lag	Lead	Lag	Lag
Lead-Lag Optimize?	Yes	Yes	Yes	Yes	Yes	Yes	Yes	Yes	Yes	Yes	Yes	Yes
Vehicle Extension (s)	3.0	3.0	3.0	3.0	3.0	3.0	3.0	3.0	3.0	3.0	3.0	3.0
Recall Mode	None	None	None	None	None	None	C-Max	C-Max	None	C-Max	C-Max	C-Max
Walk Time (s)	7.0	7.0			7.0	7.0			7.0		7.0	7.0
Flash Dont Walk (s)	25.0	25.0			25.0	25.0			24.0		24.0	24.0
Pedestrian Calls (#/hr)	6	6			2	2			4		4	7
Act Effct Green (s)	8.8	19.4	19.4	28.8	42.0	42.0	14.5	55.1	55.1	10.5	51.1	51.1
Actuated g/C Ratio	0.06	0.14	0.14	0.21	0.30	0.30	0.10	0.39	0.39	0.08	0.36	0.36
v/c Ratio	0.39	0.47	0.41	0.93	0.78	0.42	0.68	0.92	0.49	0.49	0.72	0.26
Control Delay	68.5	57.7	6.0	76.4	51.2	6.2	71.4	53.0	9.9	69.0	44.2	3.6
Queue Delay	0.0	0.0	0.0	0.0	0.0	0.0	0.0	0.0	0.0	0.0	0.0	0.0
Total Delay	68.5	57.7	6.0	76.4	51.2	6.2	71.4	53.0	9.9	69.0	44.2	3.6
LOS	E	E	A	E	D	A	E	D	A	E	D	A
Approach Delay		41.7			54.2			46.2			41.4	
Approach LOS		D			D			D			D	
Queue Length 50th (m)	10.2	26.5	0.0	87.1	101.7	0.0	29.2	154.4	10.6	16.1	106.7	0.0
Queue Length 95th (m)	18.1	35.1	8.2	#120.0	113.1	17.8	42.2	#249.5	44.2	25.7	#170.6	9.0
Internal Link Dist (m)		745.6			700.4			316.7			597.8	
Turn Bay Length (m)	38.0		120.0	150.0		80.0	100.0		100.0	125.0		150.0
Base Capacity (vph)	391	665	444	675	993	587	359	1231	730	372	1176	557
Starvation Cap Reductn	0	0	0	0	0	0	0	0	0	0	0	0
Spillback Cap Reductn	0	0	0	0	0	0	0	0	0	0	0	0
Storage Cap Reductn	0	0	0	0	0	0	0	0	0	0	0	0
Reduced v/c Ratio	0.19	0.29	0.32	0.92	0.75	0.41	0.58	0.92	0.49	0.31	0.72	0.26

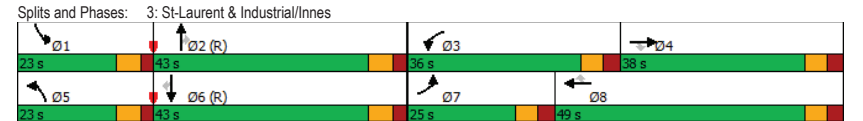
Intersection Summary

Cycle Length: 140  
 Actuated Cycle Length: 140  
 Offset: 0 (0%), Referenced to phase 2:NBT and 6:SBT, Start of Green  
 Natural Cycle: 140

Lanes, Volumes, Timings  
3: St-Laurent & Industrial/Innes

Future Background 2031AM Peak Hour  
1531 St-Laurent Blvd

Control Type: Actuated-Coordinated	
Maximum v/c Ratio: 0.93	
Intersection Signal Delay: 47.4	Intersection LOS: D
Intersection Capacity Utilization 89.1%	ICU Level of Service E
Analysis Period (min) 15	
# 95th percentile volume exceeds capacity, queue may be longer.	
Queue shown is maximum after two cycles.	





HCM 2010 TWSC  
5: Lagan & Belfast

Future Background 2031AM Peak Hour  
1531 St-Laurent Blvd

Intersection												
Int Delay, s/veh	2.1											
Movement	EBL	EBT	EBR	WBL	WBT	WBR	NBL	NBT	NBR	SBL	SBT	SBR
Lane Configurations	↔		↔		↔		↔		↔		↔	
Traffic Vol, veh/h	51	272	15	13	225	26	11	1	15	15	4	17
Future Vol, veh/h	51	272	15	13	225	26	11	1	15	15	4	17
Conflicting Peds, #/hr	8	0	10	10	0	8	0	0	5	5	0	0
Sign Control	Free	Free	Free	Free	Free	Free	Stop	Stop	Stop	Stop	Stop	Stop
RT Channelized	-	-	None	-	-	None	-	-	None	-	-	None
Storage Length	-	-	-	-	-	-	-	-	-	-	-	-
Veh in Median Storage, #	-	0	-	-	0	-	-	0	-	-	0	-
Grade, %	-	0	-	-	0	-	-	0	-	-	0	-
Peak Hour Factor	100	100	100	100	100	100	100	100	100	100	100	100
Heavy Vehicles, %	20	12	7	23	15	15	55	2	33	20	25	12
Mvmt Flow	51	272	15	13	225	26	11	1	15	15	4	17
Major/Minor	Major1			Major2			Minor1			Minor2		
Conflicting Flow All	259	0	0	297	0	0	667	677	295	667	671	246
Stage 1	-	-	-	-	-	-	392	392	-	272	272	-
Stage 2	-	-	-	-	-	-	275	285	-	395	399	-
Critical Hdwy	4.3	-	-	4.33	-	-	7.65	6.52	6.53	7.3	6.75	6.32
Critical Hdwy Stg 1	-	-	-	-	-	-	6.65	5.52	-	6.3	5.75	-
Critical Hdwy Stg 2	-	-	-	-	-	-	6.65	5.52	-	6.3	5.75	-
Follow-up Hdwy	2.38	-	-	2.407	-	-	3.995	4.018	3.597	3.68	4.225	3.408
Pot Cap-1 Maneuver	1208	-	-	1154	-	-	309	375	677	349	350	769
Stage 1	-	-	-	-	-	-	539	606	-	696	645	-
Stage 2	-	-	-	-	-	-	629	676	-	596	564	-
Platoon blocked, %	-	-	-	-	-	-	-	-	-	-	-	-
Mov Cap-1 Maneuver	1200	-	-	1145	-	-	283	347	669	321	323	764
Mov Cap-2 Maneuver	-	-	-	-	-	-	283	347	-	321	323	-
Stage 1	-	-	-	-	-	-	508	570	-	656	633	-
Stage 2	-	-	-	-	-	-	603	663	-	550	531	-
Approach	EB			WB			NB			SB		
HCM Control Delay, s	1.2			0.4			14.1			13.9		
HCM LOS	B			B			B			B		
Minor Lane/Major Mvmt	NBLn1	EBL	EBT	EBR	WBL	WBT	WBR	SBLn1				
Capacity (veh/h)	421	1200	-	-	1145	-	-	442				
HCM Lane V/C Ratio	0.064	0.043	-	-	0.011	-	-	0.081				
HCM Control Delay (s)	14.1	8.1	0	-	8.2	0	-	13.9				
HCM Lane LOS	B	A	A	-	A	A	-	B				
HCM 95th %tile Q(veh)	0.2	0.1	-	-	0	-	-	0.3				

Lanes, Volumes, Timings  
1: St-Laurent & Tremblay

Future Background 2031PM Peak Hour  
1531 St-Laurent Blvd

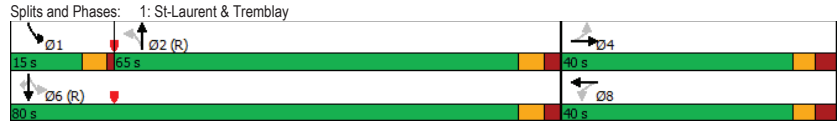
Lane Group	EBL	EBT	WBL	WBT	NBL	NBT	SBL	SBT	SBR	
Lane Configurations	↔	↔	↔	↔	↔	↔	↔	↔	↔	
Traffic Volume (vph)	228	38	23	21	36	1368	63	1083	94	
Future Volume (vph)	228	38	23	21	36	1368	63	1083	94	
Lane Group Flow (vph)	228	123	23	206	36	1360	63	1083	94	
Turn Type	Perm	NA	Perm	NA	Perm	NA	pm+pt	NA	Perm	
Protected Phases	4		8		8		2		6	
Permitted Phases	4		8		2		6		6	
Detector Phase	4		4		8		8		2	
Switch Phase	4		4		8		8		2	
Minimum Initial (s)	10.0	10.0	10.0	10.0	10.0	10.0	5.0	10.0	10.0	
Minimum Split (s)	38.5	38.5	38.5	38.5	39.2	39.2	9.7	39.2	39.2	
Total Split (s)	40.0	40.0	40.0	40.0	65.0	65.0	15.0	80.0	80.0	
Total Split (%)	33.3%	33.3%	33.3%	33.3%	54.2%	54.2%	12.5%	66.7%	66.7%	
Maximum Green (s)	33.5	33.5	33.5	33.5	58.8	58.8	10.3	73.8	73.8	
Yellow Time (s)	3.3	3.3	3.3	3.3	3.7	3.7	3.7	3.7	3.7	
All-Red Time (s)	3.2	3.2	3.2	3.2	2.5	2.5	1.0	2.5	2.5	
Lost Time Adjust (s)	0.0	0.0	0.0	0.0	0.0	0.0	0.0	0.0	0.0	
Total Lost Time (s)	6.5	6.5	6.5	6.5	6.2	6.2	4.7	6.2	6.2	
Lead/Lag					Lag	Lag	Lead			
Lead-Lag Optimize?					Yes	Yes	Yes			
Vehicle Extension (s)	3.0	3.0	3.0	3.0	3.0	3.0	3.0	3.0	3.0	
Recall Mode	None	None	None	None	C-Max	C-Max	None	C-Max	C-Max	
Walk Time (s)	7.0	7.0	7.0	7.0	11.0	11.0	11.0	11.0	11.0	
Flash Dont Walk (s)	25.0	25.0	25.0	25.0	22.0	22.0	22.0	22.0	22.0	
Pedestrian Calls (#/hr)	2	2	2	2	12	12	8	8	8	
Act Effct Green (s)	33.5	33.5	33.5	33.5	63.9	63.9	75.3	73.8	73.8	
Actuated g/C Ratio	0.28	0.28	0.28	0.28	0.53	0.53	0.63	0.62	0.62	
v/c Ratio	1.03	0.26	0.07	0.38	0.16	0.54	0.28	0.55	0.11	
Control Delay	112.2	13.7	32.7	9.0	19.5	18.1	11.8	14.8	2.2	
Queue Delay	0.0	0.0	0.0	0.0	0.0	0.0	0.0	0.0	0.0	
Total Delay	112.2	13.7	32.7	9.0	19.5	18.1	11.8	14.8	2.2	
LOS	F	B	C	A	B	B	B	B	A	
Approach Delay	77.7				11.3		18.1		13.7	
Approach LOS	E				B		B		B	
Queue Length 50th (m)	~57.4	6.6	4.0	4.1	3.3	54.2	5.4	73.2	0.0	
Queue Length 95th (m)	#106.4	21.5	10.6	22.7	m7.9	m88.3	10.8	90.8	6.2	
Internal Link Dist (m)	390.4		0.1		682.5		144.8			
Turn Bay Length (m)	38.0		38.0		45.0		75.0			
Base Capacity (vph)	221	481	329	547	222	2534	263	1962	831	
Starvation Cap Reductn	0	0	0	0	0	0	0	0	0	
Spillback Cap Reductn	0	0	0	0	0	0	0	0	0	
Storage Cap Reductn	0	0	0	0	0	0	0	0	0	
Reduced v/c Ratio	1.03	0.26	0.07	0.38	0.16	0.54	0.24	0.55	0.11	

Intersection Summary									
Cycle Length: 120									
Actuated Cycle Length: 120									
Offset: 49 (41%), Referenced to phase 2:NBT and 6:SBTL, Start of Green									
Natural Cycle: 90									

Lanes, Volumes, Timings  
1: St-Laurent & Tremblay

Future Background 2031PM Peak Hour  
1531 St-Laurent Blvd

Control Type: Actuated-Coordinated  
 Maximum v/c Ratio: 1.03  
 Intersection Signal Delay: 22.4 Intersection LOS: C  
 Intersection Capacity Utilization 88.7% ICU Level of Service E  
 Analysis Period (min) 15  
 ~ Volume exceeds capacity, queue is theoretically infinite.  
 Queue shown is maximum after two cycles.  
 # 95th percentile volume exceeds capacity, queue may be longer.  
 Queue shown is maximum after two cycles.  
 m Volume for 95th percentile queue is metered by upstream signal.



Lanes, Volumes, Timings  
2: St-Laurent & Belfast

Future Background 2031PM Peak Hour  
1531 St-Laurent Blvd

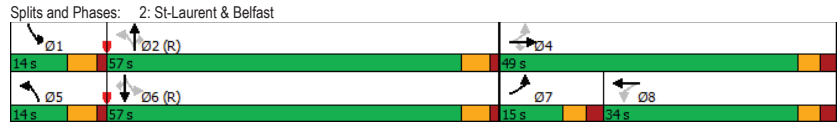
Lane Group	EBL	EBT	EBR	WBL	WBT	NBL	NBT	NBR	SBL	SBT	SBR
Lane Configurations	↔	↕	↔	↔	↕	↔	↕	↔	↕	↕	↕
Traffic Volume (vph)	195	162	239	101	91	129	1007	87	93	897	133
Future Volume (vph)	195	162	239	101	91	129	1007	87	93	897	133
Lane Group Flow (vph)	195	162	239	101	240	129	1007	87	93	897	133
Turn Type	pm+pt	NA	Perm	Perm	NA	pm+pt	NA	Perm	pm+pt	NA	Perm
Protected Phases	7	4			8	5	2		1	6	
Permitted Phases	4		4	8		2		2	6		6
Detector Phase	7	4	4	8	8	5	2	2	1	6	6
Switch Phase											
Minimum Initial (s)	5.0	10.0	10.0	10.0	10.0	5.0	10.0	10.0	5.0	10.0	10.0
Minimum Split (s)	10.8	27.8	27.8	27.8	27.8	10.7	36.6	36.6	10.7	36.6	36.6
Total Split (s)	15.0	49.0	49.0	34.0	34.0	14.0	57.0	57.0	14.0	57.0	57.0
Total Split (%)	12.5%	40.8%	40.8%	28.3%	28.3%	11.7%	47.5%	47.5%	11.7%	47.5%	47.5%
Maximum Green (s)	9.2	43.2	43.2	28.2	28.2	8.3	51.4	51.4	8.3	51.4	51.4
Yellow Time (s)	3.3	3.3	3.3	3.3	3.3	4.2	4.2	4.2	4.2	4.2	4.2
All-Red Time (s)	2.5	2.5	2.5	2.5	2.5	1.5	1.4	1.4	1.5	1.4	1.4
Lost Time Adjust (s)	0.0	0.0	0.0	0.0	0.0	0.0	0.0	0.0	0.0	0.0	0.0
Total Lost Time (s)	5.8	5.8	5.8	5.8	5.8	5.7	5.6	5.6	5.7	5.6	5.6
Lead/Lag	Lead			Lag	Lag	Lead	Lag	Lag	Lead	Lag	Lag
Lead-Lag Optimize?	Yes			Yes	Yes	Yes	Yes	Yes	Yes	Yes	Yes
Vehicle Extension (s)	3.0	3.0	3.0	3.0	3.0	3.0	3.0	3.0	3.0	3.0	3.0
Recall Mode	None	None	None	None	None	None	C-Max	C-Max	None	C-Max	C-Max
Walk Time (s)	7.0	7.0	7.0	7.0	7.0	25.0	25.0	25.0	25.0	25.0	25.0
Flash Dont Walk (s)	15.0	15.0	15.0	15.0	15.0	6.0	6.0	6.0	6.0	6.0	6.0
Pedestrian Calls (#/hr)	9	9	5	5	5	1	1	1	15	15	15
Act Effct Green (s)	34.6	34.6	34.6	19.6	19.6	68.8	60.2	60.2	67.6	59.6	59.6
Actuated g/C Ratio	0.29	0.29	0.29	0.16	0.16	0.57	0.50	0.50	0.56	0.50	0.50
v/c Ratio	0.95	0.35	0.43	0.59	0.79	0.41	0.61	0.13	0.38	0.55	0.17
Control Delay	86.6	34.7	8.6	58.9	53.0	15.3	24.9	1.4	17.1	18.6	2.9
Queue Delay	0.0	0.0	0.0	0.0	0.0	0.0	0.0	0.0	0.0	0.0	0.0
Total Delay	86.6	34.7	8.6	58.9	53.0	15.3	24.9	1.4	17.1	18.6	2.9
LOS	F	C	A	E	D	B	C	A	B	B	A
Approach Delay		41.2			54.7		22.2			16.6	
Approach LOS		D			D		C			B	
Queue Length 50th (m)	37.2	30.2	6.0	22.3	40.6	11.9	87.8	0.0	8.1	47.3	0.0
Queue Length 95th (m)	#68.0	44.1	23.2	37.5	63.9	24.6	125.4	3.2	20.8	60.6	7.0
Internal Link Dist (m)		518.7			103.5		597.8			682.5	
Turn Bay Length (m)	75.0		200.0	65.0		75.0		55.0	75.0		85.0
Base Capacity (vph)	206	572	650	247	408	316	1647	683	253	1630	766
Starvation Cap Reductn	0	0	0	0	0	0	0	0	0	0	0
Spillback Cap Reductn	0	0	0	0	0	0	0	0	0	0	0
Storage Cap Reductn	0	0	0	0	0	0	0	0	0	0	0
Reduced v/c Ratio	0.95	0.28	0.37	0.41	0.59	0.41	0.61	0.13	0.37	0.55	0.17

Intersection Summary  
 Cycle Length: 120  
 Actuated Cycle Length: 120  
 Offset: 49 (41%), Referenced to phase 2:NBT and 6:SBTL, Start of Green  
 Natural Cycle: 90

Lanes, Volumes, Timings  
2: St-Laurent & Belfast

Future Background 2031PM Peak Hour  
1531 St-Laurent Blvd

Control Type: Actuated-Coordinated	
Maximum v/c Ratio: 0.95	
Intersection Signal Delay: 27.1	Intersection LOS: C
Intersection Capacity Utilization 80.8%	ICU Level of Service D
Analysis Period (min) 15	
# 95th percentile volume exceeds capacity, queue may be longer.	
Queue shown is maximum after two cycles.	



Lanes, Volumes, Timings  
3: St-Laurent & Industrial/Innes

Future Background 2031PM Peak Hour  
1531 St-Laurent Blvd

Lane Group	EBL	EBT	EBR	WBL	WBT	WBR	NBL	NBT	NBR	SBL	SBT	SBR
Lane Configurations	↔	↔	↔	↔	↔	↔	↔	↔	↔	↔	↔	↔
Traffic Volume (vph)	139	567	367	415	274	135	206	954	522	130	966	136
Future Volume (vph)	139	567	367	415	274	135	206	954	522	130	966	136
Lane Group Flow (vph)	139	567	367	415	274	135	206	954	522	130	966	136
Turn Type	Prot	NA	Perm	Prot	NA	Perm	Prot	NA	Perm	Prot	NA	Perm
Protected Phases	7	4		3	8		5	2		1	6	
Permitted Phases			4			8			2			6
Detector Phase	7	4	4	3	8	8	5	2	2	1	6	6
Switch Phase												
Minimum Initial (s)	5.0	10.0	10.0	5.0	10.0	10.0	5.0	10.0	10.0	5.0	10.0	10.0
Minimum Split (s)	11.6	38.6	38.6	11.6	38.6	38.6	11.3	37.6	37.6	11.3	37.6	37.6
Total Split (s)	19.0	38.0	38.0	41.0	60.0	60.0	28.0	43.0	43.0	28.0	43.0	43.0
Total Split (%)	12.7%	25.3%	25.3%	27.3%	40.0%	40.0%	18.7%	28.7%	28.7%	18.7%	28.7%	28.7%
Maximum Green (s)	12.4	31.4	31.4	34.4	53.4	53.4	21.7	36.4	36.4	21.7	36.4	36.4
Yellow Time (s)	3.7	3.7	3.7	3.7	3.7	3.7	4.2	4.2	4.2	4.2	4.2	4.2
All-Red Time (s)	2.9	2.9	2.9	2.9	2.9	2.9	2.1	2.4	2.4	2.1	2.4	2.4
Lost Time Adjust (s)	0.0	0.0	0.0	0.0	0.0	0.0	0.0	0.0	0.0	0.0	0.0	0.0
Total Lost Time (s)	6.6	6.6	6.6	6.6	6.6	6.6	6.3	6.6	6.6	6.3	6.6	6.6
Lead/Lag	Lead	Lag	Lag	Lead	Lag	Lag	Lead	Lag	Lag	Lead	Lag	Lag
Lead-Lag Optimize?	Yes	Yes	Yes	Yes	Yes	Yes	Yes	Yes	Yes	Yes	Yes	Yes
Vehicle Extension (s)	3.0	3.0	3.0	3.0	3.0	3.0	3.0	3.0	3.0	3.0	3.0	3.0
Recall Mode	None	None	None	None	None	None	None	Max	Max	None	Max	Max
Walk Time (s)	7.0	7.0		7.0	7.0		7.0	7.0	7.0		7.0	7.0
Flash Dont Walk (s)	25.0	25.0		25.0	25.0		24.0	24.0		24.0	24.0	24.0
Pedestrian Calls (#/hr)	5	5		6	6		9	9		12	12	12
Act Effct Green (s)	10.5	27.1	27.1	21.7	38.3	38.3	13.8	39.6	39.6	10.9	36.8	36.8
Actuated g/C Ratio	0.08	0.22	0.22	0.17	0.30	0.30	0.11	0.32	0.32	0.09	0.29	0.29
v/c Ratio	0.52	0.81	0.67	0.75	0.28	0.25	0.60	0.93	0.68	0.49	1.02	0.25
Control Delay	64.4	57.5	15.4	59.1	34.1	6.3	62.5	58.7	10.7	63.3	78.0	3.8
Queue Delay	0.0	0.0	0.0	0.0	0.0	0.0	0.0	0.0	0.0	0.0	0.0	0.0
Total Delay	64.4	57.5	15.4	59.1	34.1	6.3	62.5	58.7	10.7	63.3	78.0	3.8
LOS	E	E	B	E	C	A	E	E	B	E	E	A
Approach Delay		44.0			42.2			44.3				68.3
Approach LOS		D			D			D				E
Queue Length 50th (m)	17.3	70.4	11.8	51.3	27.1	0.0	25.6	122.2	9.9	16.2	-136.5	0.0
Queue Length 95th (m)	30.7	101.0	48.2	73.3	40.7	14.2	41.3	#193.0	52.7	28.6	#210.3	9.1
Internal Link Dist (m)		745.6			700.4			316.7			597.8	
Turn Bay Length (m)	38.0		120.0	150.0		80.0	100.0		100.0	125.0		150.0
Base Capacity (vph)	320	822	591	888	1368	700	544	1025	771	529	950	539
Starvation Cap Reductn	0	0	0	0	0	0	0	0	0	0	0	0
Spillback Cap Reductn	0	0	0	0	0	0	0	0	0	0	0	0
Storage Cap Reductn	0	0	0	0	0	0	0	0	0	0	0	0
Reduced v/c Ratio	0.43	0.69	0.62	0.47	0.20	0.19	0.38	0.93	0.68	0.25	1.02	0.25

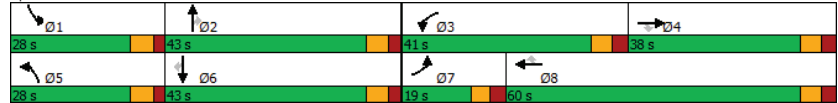
<b>Intersection Summary</b>												
Cycle Length: 150												
Actuated Cycle Length: 125.7												
Natural Cycle: 110												
Control Type: Actuated-Uncoordinated												

Lanes, Volumes, Timings  
3: St-Laurent & Industrial/Innes

Future Background 2031PM Peak Hour  
1531 St-Laurent Blvd

Maximum v/c Ratio: 1.02	Intersection LOS: D
Intersection Signal Delay: 50.0	ICU Level of Service E
Intersection Capacity Utilization 86.7%	
Analysis Period (min) 15	
~ Volume exceeds capacity, queue is theoretically infinite.	
Queue shown is maximum after two cycles.	
# 95th percentile volume exceeds capacity, queue may be longer.	
Queue shown is maximum after two cycles.	

Splits and Phases: 3: St-Laurent & Industrial/Innes



HCM 2010 TWSC  
5: Lagan & Belfast

Future Background 2031PM Peak Hour  
1531 St-Laurent Blvd

Intersection												
Int Delay, s/veh	2.8											
Movement	EBL	EBT	EBR	WBL	WBT	WBR	NBL	NBT	NBR	SBL	SBT	SBR
Lane Configurations	↔			↔			↔			↔		
Traffic Vol, veh/h	46	265	50	19	310	26	26	5	16	30	0	39
Future Vol, veh/h	46	265	50	19	310	26	26	5	16	30	0	39
Conflicting Peds, #/hr	12	0	5	5	0	12	1	0	6	6	0	1
Sign Control	Free	Free	Free	Free	Free	Free	Stop	Stop	Stop	Stop	Stop	Stop
RT Channelized	-	-	None	-	-	None	-	-	None	-	-	None
Storage Length	-	-	-	-	-	-	-	-	-	-	-	-
Veh in Median Storage, #	-	0	-	-	0	-	-	0	-	-	0	-
Grade, %	-	0	-	-	0	-	-	0	-	-	0	-
Peak Hour Factor	100	100	100	100	100	100	100	100	100	100	100	100
Heavy Vehicles, %	30	6	12	5	3	8	4	2	2	10	2	2
Mvmt Flow	46	265	50	19	310	26	26	5	16	30	0	39

Major/Minor	Major1	Major2	Minor1	Minor2
Conflicting Flow All	348	0	320	0
Stage 1	-	-	-	-
Stage 2	-	-	-	-
Critical Hdwy	4.4	-	4.15	-
Critical Hdwy Stg 1	-	-	-	-
Critical Hdwy Stg 2	-	-	-	-
Follow-up Hdwy	2.47	-	2.245	-
Pot Cap-1 Maneuver	1071	-	1223	-
Stage 1	-	-	-	-
Stage 2	-	-	-	-
Platoon blocked, %	-	-	-	-
Mov Cap-1 Maneuver	1061	-	1218	-
Mov Cap-2 Maneuver	-	-	-	-
Stage 1	-	-	-	-
Stage 2	-	-	-	-

Approach	EB	WB	NB	SB
HCM Control Delay, s	1.1	0.4	16.5	15.2
HCM LOS			C	C

Minor Lane/Major Mvmt	NBLn1	EBL	EBT	EBR	WBL	WBT	WBR	SBLn1
Capacity (veh/h)	359	1061	-	-	1218	-	-	420
HCM Lane V/C Ratio	0.131	0.043	-	-	0.016	-	-	0.164
HCM Control Delay (s)	16.5	8.5	0	-	8	0	-	15.2
HCM Lane LOS	C	A	A	-	A	A	-	C
HCM 95th %tile Q(veh)	0.4	0.1	-	-	0	-	-	0.6

# Appendix L

Synchro Intersection Worksheets – 2026 Future Total Conditions

Lanes, Volumes, Timings  
1: St-Laurent & Tremblay

Future Total 2026AM Peak Hour  
1531 St-Laurent Blvd

	↖	→	↗	←	↖	↑	↗	↓	↖
Lane Group	EBL	EBT	WBL	WBT	NBL	NBT	SBL	SBT	SBR
Lane Configurations	↖	↖	↖	↖	↖	↖	↖	↖	↖
Traffic Volume (vph)	55	21	12	20	84	1248	129	1148	240
Future Volume (vph)	55	21	12	20	84	1248	129	1148	240
Lane Group Flow (vph)	55	54	12	133	84	1286	129	1148	240
Turn Type	Perm	NA	Perm	NA	Perm	NA	pm+pt	NA	Perm
Protected Phases		4		8		2		1	6
Permitted Phases	4		8		2		6		6
Detector Phase	4	4	8	8	2	2	1	6	6
Switch Phase									
Minimum Initial (s)	10.0	10.0	10.0	10.0	10.0	10.0	5.0	10.0	10.0
Minimum Split (s)	38.5	38.5	38.5	38.5	39.2	39.2	9.7	39.2	39.2
Total Split (s)	40.0	40.0	40.0	40.0	72.0	72.0	18.0	90.0	90.0
Total Split (%)	30.8%	30.8%	30.8%	30.8%	55.4%	55.4%	13.8%	69.2%	69.2%
Maximum Green (s)	33.5	33.5	33.5	33.5	65.8	65.8	13.3	83.8	83.8
Yellow Time (s)	3.3	3.3	3.3	3.3	3.7	3.7	3.7	3.7	3.7
All-Red Time (s)	3.2	3.2	3.2	3.2	2.5	2.5	1.0	2.5	2.5
Lost Time Adjust (s)	0.0	0.0	0.0	0.0	0.0	0.0	0.0	0.0	0.0
Total Lost Time (s)	6.5	6.5	6.5	6.5	6.2	6.2	4.7	6.2	6.2
Lead/Lag					Lag	Lag	Lead		
Lead-Lag Optimize?					Yes	Yes	Yes		
Vehicle Extension (s)	3.0	3.0	3.0	3.0	3.0	3.0	3.0	3.0	3.0
Recall Mode	None	None	None	None	C-Max	C-Max	None	C-Max	C-Max
Walk Time (s)	7.0	7.0	7.0	7.0	11.0	11.0		11.0	11.0
Flash Dont Walk (s)	25.0	25.0	25.0	25.0	22.0	22.0		22.0	22.0
Pedestrian Calls (#/hr)	9	9	3	3	7	7		12	12
Act Effct Green (s)	16.6	16.6	16.6	16.6	87.9	87.9	102.2	100.7	100.7
Actuated g/C Ratio	0.13	0.13	0.13	0.13	0.68	0.68	0.79	0.77	0.77
v/c Ratio	0.57	0.24	0.09	0.49	0.29	0.44	0.41	0.48	0.23
Control Delay	73.4	24.9	46.2	17.7	14.9	11.6	8.2	7.1	1.4
Queue Delay	0.0	0.0	0.0	0.0	0.0	0.0	0.0	0.0	0.0
Total Delay	73.4	24.9	46.2	17.7	14.9	11.6	8.2	7.1	1.4
LOS	E	C	D	B	B	B	A	A	A
Approach Delay		49.3		20.0		11.8		6.3	
Approach LOS		D		C		B		A	
Queue Length 50th (m)	13.8	5.0	2.8	4.7	7.2	45.9	5.6	41.4	0.0
Queue Length 95th (m)	24.2	14.9	7.7	20.6	26.0	91.2	18.3	96.4	8.6
Internal Link Dist (m)		396.6		0.1		682.5		144.8	
Turn Bay Length (m)	38.0		38.0		45.0		75.0		
Base Capacity (vph)	195	413	280	436	290	2926	369	2382	1029
Starvation Cap Reductn	0	0	0	0	0	0	0	0	0
Spillback Cap Reductn	0	0	0	0	0	0	0	0	0
Storage Cap Reductn	0	0	0	0	0	0	0	0	0
Reduced v/c Ratio	0.28	0.13	0.04	0.31	0.29	0.44	0.35	0.48	0.23

Intersection Summary

Cycle Length: 130  
 Actuated Cycle Length: 130  
 Offset: 53 (41%), Referenced to phase 2:NBL and 6:SBTL, Start of Green  
 Natural Cycle: 90

Lanes, Volumes, Timings  
1: St-Laurent & Tremblay

Future Total 2026AM Peak Hour  
1531 St-Laurent Blvd

Control Type: Actuated-Coordinated  
 Maximum v/c Ratio: 0.57  
 Intersection Signal Delay: 10.8  
 Intersection LOS: B  
 Intersection Capacity Utilization 84.4%  
 ICU Level of Service E  
 Analysis Period (min) 15

Splits and Phases: 1: St-Laurent & Tremblay



Lanes, Volumes, Timings  
2: St-Laurent & Belfast

Future Total 2026AM Peak Hour  
1531 St-Laurent Blvd

Lane Group	EBL	EBT	EBR	WBL	WBT	NBL	NBT	NBR	SBL	SBT	SBR
Lane Configurations	↖	↗	↘	↖	↗	↖	↗	↘	↖	↗	↘
Traffic Volume (vph)	47	66	91	64	147	123	919	73	92	837	190
Future Volume (vph)	47	66	91	64	147	123	919	73	92	837	190
Lane Group Flow (vph)	47	66	91	64	260	123	919	73	92	837	190
Turn Type	pm+pt	NA	Perm	Perm	NA	pm+pt	NA	Perm	pm+pt	NA	Perm
Protected Phases	7	4			8	5	2		1	6	
Permitted Phases	4		4	8			2	2	6		6
Detector Phase	7	4	4	8	8	5	2	2	1	6	6
Switch Phase											
Minimum Initial (s)	5.0	10.0	10.0	10.0	10.0	5.0	10.0	10.0	5.0	10.0	10.0
Minimum Split (s)	10.8	27.8	27.8	27.8	27.8	10.7	36.6	36.6	10.7	36.6	36.6
Total Split (s)	16.0	48.0	48.0	32.0	32.0	15.0	57.0	57.0	15.0	57.0	57.0
Total Split (%)	13.3%	40.0%	40.0%	26.7%	26.7%	12.5%	47.5%	47.5%	12.5%	47.5%	47.5%
Maximum Green (s)	10.2	42.2	42.2	26.2	26.2	9.3	51.4	51.4	9.3	51.4	51.4
Yellow Time (s)	3.3	3.3	3.3	3.3	3.3	4.2	4.2	4.2	4.2	4.2	4.2
All-Red Time (s)	2.5	2.5	2.5	2.5	2.5	1.5	1.4	1.4	1.5	1.4	1.4
Lost Time Adjust (s)	0.0	0.0	0.0	0.0	0.0	0.0	0.0	0.0	0.0	0.0	0.0
Total Lost Time (s)	5.8	5.8	5.8	5.8	5.8	5.7	5.6	5.6	5.7	5.6	5.6
Lead/Lag	Lead			Lag	Lag	Lead	Lag	Lag	Lead	Lag	Lag
Lead-Lag Optimize?	Yes			Yes	Yes	Yes	Yes	Yes	Yes	Yes	Yes
Vehicle Extension (s)	3.0	3.0	3.0	3.0	3.0	3.0	3.0	3.0	3.0	3.0	3.0
Recall Mode	None	None	None	None	None	None	C-Max	C-Max	None	C-Max	C-Max
Walk Time (s)	7.0	7.0	7.0	7.0	7.0	25.0	25.0	25.0	25.0	25.0	25.0
Flash Dont Walk (s)	15.0	15.0	15.0	15.0	15.0	6.0	6.0	6.0	6.0	6.0	6.0
Pedestrian Calls (#/hr)	9	9	42	42		22	22	22	13	13	13
Act Effct Green (s)	35.5	35.5	35.5	23.4	23.4	67.8	59.2	59.2	66.9	58.8	58.8
Actuated g/C Ratio	0.30	0.30	0.30	0.20	0.20	0.56	0.49	0.49	0.56	0.49	0.49
v/c Ratio	0.24	0.13	0.22	0.33	0.88	0.40	0.58	0.10	0.34	0.55	0.28
Control Delay	30.0	28.5	6.7	45.3	69.5	16.0	25.6	0.4	15.7	25.1	4.2
Queue Delay	0.0	0.0	0.0	0.0	0.0	0.0	0.0	0.0	0.0	0.0	0.0
Total Delay	30.0	28.5	6.7	45.3	69.5	16.0	25.6	0.4	15.7	25.1	4.2
LOS	C	C	A	D	E	B	C	A	B	C	A
Approach Delay		19.1				64.7		22.9			20.8
Approach LOS		B			E		C			C	
Queue Length 50th (m)	7.5	10.6	0.0	12.7	51.9	13.1	87.3	0.0	9.6	79.0	0.0
Queue Length 95th (m)	15.9	20.5	10.9	25.8	#92.6	23.2	112.4	0.7	18.1	100.8	13.4
Internal Link Dist (m)		518.7			23.5		597.8			682.5	
Turn Bay Length (m)	75.0		200.0	65.0		75.0		55.0	75.0		85.0
Base Capacity (vph)	214	596	470	218	329	320	1575	732	282	1520	667
Starvation Cap Reductn	0	0	0	0	0	0	0	0	0	0	0
Spillback Cap Reductn	0	0	0	0	0	0	0	0	0	0	0
Storage Cap Reductn	0	0	0	0	0	0	0	0	0	0	0
Reduced v/c Ratio	0.22	0.11	0.19	0.29	0.79	0.38	0.58	0.10	0.33	0.55	0.28

Intersection Summary

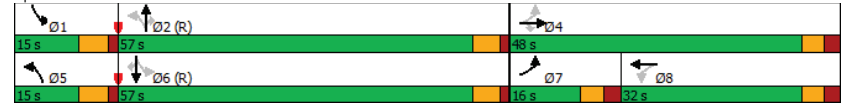
Cycle Length: 120  
 Actuated Cycle Length: 120  
 Offset: 53 (44%), Referenced to phase 2:NBL and 6:SBTL, Start of Green  
 Natural Cycle: 90

Lanes, Volumes, Timings  
2: St-Laurent & Belfast

Future Total 2026AM Peak Hour  
1531 St-Laurent Blvd

Control Type: Actuated-Coordinated  
 Maximum v/c Ratio: 0.88  
 Intersection Signal Delay: 26.6  
 Intersection LOS: C  
 Intersection Capacity Utilization 76.3%  
 ICU Level of Service D  
 Analysis Period (min) 15  
 # 95th percentile volume exceeds capacity, queue may be longer.  
 Queue shown is maximum after two cycles.

Splits and Phases: 2: St-Laurent & Belfast



Lanes, Volumes, Timings  
3: St-Laurent & Industrial/Innes

Future Total 2026AM Peak Hour  
1531 St-Laurent Blvd

Lane Group	EBL	EBT	EBR	WBL	WBT	WBR	NBL	NBT	NBR	SBL	SBT	SBR
Lane Configurations	↔	↕	↔	↔	↕	↔	↔	↕	↔	↔	↕	↔
Traffic Volume (vph)	71	187	137	618	741	242	208	1112	356	118	842	145
Future Volume (vph)	71	187	137	618	741	242	208	1112	356	118	842	145
Lane Group Flow (vph)	71	187	137	618	741	242	208	1112	356	118	842	145
Turn Type	Prot	NA	Perm	Prot	NA	Perm	Prot	NA	Perm	Prot	NA	Perm
Protected Phases	7	4		3	8		5	2		1	6	
Permitted Phases			4			8			2			6
Detector Phase	7	4	4	3	8	8	5	2	2	1	6	6
Switch Phase												
Minimum Initial (s)	5.0	10.0	10.0	5.0	10.0	10.0	5.0	10.0	10.0	5.0	10.0	10.0
Minimum Split (s)	11.6	38.6	38.6	11.6	38.6	38.6	11.3	37.6	37.6	11.3	37.6	37.6
Total Split (s)	25.0	38.0	38.0	36.0	49.0	49.0	23.0	43.0	43.0	23.0	43.0	43.0
Total Split (%)	17.9%	27.1%	27.1%	25.7%	35.0%	35.0%	16.4%	30.7%	30.7%	16.4%	30.7%	30.7%
Maximum Green (s)	18.4	31.4	31.4	29.4	42.4	42.4	16.7	36.4	36.4	16.7	36.4	36.4
Yellow Time (s)	3.7	3.7	3.7	3.7	3.7	3.7	4.2	4.2	4.2	4.2	4.2	4.2
All-Red Time (s)	2.9	2.9	2.9	2.9	2.9	2.9	2.1	2.4	2.4	2.1	2.4	2.4
Lost Time Adjust (s)	0.0	0.0	0.0	0.0	0.0	0.0	0.0	0.0	0.0	0.0	0.0	0.0
Total Lost Time (s)	6.6	6.6	6.6	6.6	6.6	6.6	6.3	6.6	6.6	6.3	6.6	6.6
Lead/Lag	Lead	Lag	Lag	Lead	Lag	Lag	Lead	Lag	Lag	Lead	Lag	Lag
Lead-Lag Optimize?	Yes	Yes	Yes	Yes	Yes	Yes	Yes	Yes	Yes	Yes	Yes	Yes
Vehicle Extension (s)	3.0	3.0	3.0	3.0	3.0	3.0	3.0	3.0	3.0	3.0	3.0	3.0
Recall Mode	None	None	None	None	None	None	C-Max	C-Max	None	C-Max	C-Max	C-Max
Walk Time (s)	7.0	7.0	7.0	7.0	7.0	7.0	7.0	7.0	7.0	7.0	7.0	7.0
Flash Dont Walk (s)	25.0	25.0	25.0	25.0	25.0	25.0	24.0	24.0	24.0	24.0	24.0	24.0
Pedestrian Calls (#/hr)	7	7	7	3	3	3	5	5	5	9	9	9
Act Effct Green (s)	8.7	19.3	19.3	28.8	42.0	42.0	14.4	55.1	55.1	10.6	51.3	51.3
Actuated g/C Ratio	0.06	0.14	0.14	0.21	0.30	0.30	0.10	0.39	0.39	0.08	0.37	0.37
v/c Ratio	0.38	0.46	0.40	0.93	0.78	0.42	0.67	0.90	0.49	0.50	0.71	0.26
Control Delay	68.5	57.4	5.5	76.4	51.2	6.2	71.2	51.6	9.6	69.0	43.8	3.5
Queue Delay	0.0	0.0	0.0	0.0	0.0	0.0	0.0	0.0	0.0	0.0	0.0	0.0
Total Delay	68.5	57.4	5.5	76.4	51.2	6.2	71.2	51.6	9.6	69.0	43.8	3.5
LOS	E	E	A	E	D	A	E	D	A	E	D	A
Approach Delay	41.4				54.1			45.1				41.2
Approach LOS	D				D			D				D
Queue Length 50th (m)	9.9	25.5	0.0	87.1	101.7	0.0	28.9	151.0	9.9	16.4	105.3	0.0
Queue Length 95th (m)	17.7	34.0	7.1	#120.0	113.0	18.0	41.7	#245.3	43.0	26.1	#168.4	8.8
Internal Link Dist (m)		745.6			700.4			316.7			597.8	
Turn Bay Length (m)	38.0		120.0	150.0		80.0	100.0		100.0	125.0		150.0
Base Capacity (vph)	391	665	444	675	993	587	359	1231	732	372	1180	557
Starvation Cap Reductn	0	0	0	0	0	0	0	0	0	0	0	0
Spillback Cap Reductn	0	0	0	0	0	0	0	0	0	0	0	0
Storage Cap Reductn	0	0	0	0	0	0	0	0	0	0	0	0
Reduced v/c Ratio	0.18	0.28	0.31	0.92	0.75	0.41	0.58	0.90	0.49	0.32	0.71	0.26

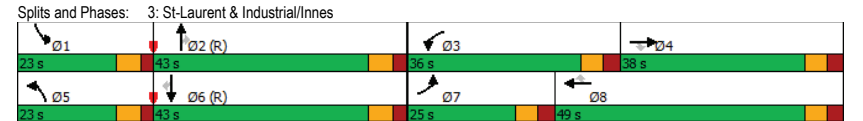
Intersection Summary

Cycle Length: 140  
 Actuated Cycle Length: 140  
 Offset: 0 (0%), Referenced to phase 2:NBT and 6:SBT, Start of Green  
 Natural Cycle: 140

Lanes, Volumes, Timings  
3: St-Laurent & Industrial/Innes

Future Total 2026AM Peak Hour  
1531 St-Laurent Blvd

Control Type: Actuated-Coordinated  
 Maximum v/c Ratio: 0.93  
 Intersection Signal Delay: 46.9  
 Intersection LOS: D  
 Intersection Capacity Utilization 89.1%  
 ICU Level of Service E  
 Analysis Period (min) 15  
 # 95th percentile volume exceeds capacity, queue may be longer.  
 Queue shown is maximum after two cycles.





Lanes, Volumes, Timings  
4: Access & Belfast

Future Total 2026AM Peak Hour  
1531 St-Laurent Blvd

	→	←
Lane Group	EBT	WBT
Lane Configurations	↔	↔
Traffic Volume (vph)	209	324
Future Volume (vph)	209	324
Lane Group Flow (vph)	232	324
Sign Control	Free	Free

Intersection Summary	
Control Type: Unsignalized	
Intersection Capacity Utilization 16.4%	ICU Level of Service A
Analysis Period (min) 15	

Lanes, Volumes, Timings  
5: Lagan & Belfast

Future Total 2026AM Peak Hour  
1531 St-Laurent Blvd

	→	←	↑	↓
Lane Group	EBT	WBT	NBT	SBT
Lane Configurations	↔	↔	↕	↕
Traffic Volume (vph)	272	225	1	4
Future Volume (vph)	272	225	1	4
Lane Group Flow (vph)	338	264	74	36
Sign Control	Free	Free	Stop	Stop

Intersection Summary	
Control Type: Unsignalized	
Intersection Capacity Utilization 51.8%	ICU Level of Service A
Analysis Period (min) 15	

HCM 2010 TWSC  
5: Lagan & Belfast

Future Total 2026AM Peak Hour  
1531 St-Laurent Blvd

Intersection												
Int Delay, s/veh	3.5											
Movement	EBL	EBT	EBR	WBL	WBT	WBR	NBL	NBT	NBR	SBL	SBT	SBR
Lane Configurations	↕			↕			↕			↕		
Traffic Vol, veh/h	51	272	15	13	225	26	58	1	15	15	4	17
Future Vol, veh/h	51	272	15	13	225	26	58	1	15	15	4	17
Conflicting Peds, #/hr	8	0	23	23	0	8	0	0	5	5	0	0
Sign Control	Free	Free	Free	Free	Free	Free	Stop	Stop	Stop	Stop	Stop	Stop
RT Channelized	-	-	None	-	-	None	-	-	None	-	-	None
Storage Length	-	-	-	-	-	-	-	-	-	-	-	-
Veh in Median Storage, #	-	0	-	-	0	-	-	0	-	-	0	-
Grade, %	-	0	-	-	0	-	-	0	-	-	0	-
Peak Hour Factor	100	100	100	100	100	100	100	100	100	100	100	100
Heavy Vehicles, %	20	12	7	23	15	15	55	2	33	20	25	12
Mvmt Flow	51	272	15	13	225	26	58	1	15	15	4	17

Major/Minor	Major1		Major2		Minor1		Minor2	
Conflicting Flow All	259	0	0	310	0	0	680	308
Stage 1	-	-	-	-	-	-	405	405
Stage 2	-	-	-	-	-	-	275	285
Critical Hdwy	4.3	-	-	4.33	-	-	7.65	6.52
Critical Hdwy Stg 1	-	-	-	-	-	-	6.65	5.52
Critical Hdwy Stg 2	-	-	-	-	-	-	6.65	5.52
Follow-up Hdwy	2.38	-	-	2.407	-	-	3.995	4.018
Pot Cap-1 Maneuver	1208	-	-	1141	-	-	303	368
Stage 1	-	-	-	-	-	-	529	598
Stage 2	-	-	-	-	-	-	629	676
Platoon blocked, %	-	-	-	-	-	-	-	-
Mov Cap-1 Maneuver	1200	-	-	1121	-	-	274	336
Mov Cap-2 Maneuver	-	-	-	-	-	-	274	336
Stage 1	-	-	-	-	-	-	493	557
Stage 2	-	-	-	-	-	-	603	662

Approach	EB	WB	NB	SB
HCM Control Delay, s	1.2	0.4	20.2	13.9
HCM LOS			C	B

Minor Lane/Major Mvmt	NBLn1	EBL	EBT	EBR	WBL	WBT	WBR	SBLn1
Capacity (veh/h)	311	1200	-	-	1121	-	-	440
HCM Lane V/C Ratio	0.238	0.043	-	-	0.012	-	-	0.082
HCM Control Delay (s)	20.2	8.1	0	-	8.2	0	-	13.9
HCM Lane LOS	C	A	A	-	A	A	-	B
HCM 95th %tile Q(veh)	0.9	0.1	-	-	0	-	-	0.3

Lanes, Volumes, Timings  
6: Lagan & Access

Future Total 2026AM Peak Hour  
1531 St-Laurent Blvd

Lane Group	EBL	NBT	SBT
Lane Configurations	↕	↑	↑
Traffic Volume (vph)	47	27	32
Future Volume (vph)	47	27	32
Lane Group Flow (vph)	47	27	32
Sign Control	Stop	Free	Free

Intersection Summary	
Control Type: Unsignalized	
Intersection Capacity Utilization 13.3%	ICU Level of Service A
Analysis Period (min) 15	

HCM 2010 TWSC  
6: Lagan & Access

Future Total 2026AM Peak Hour  
1531 St-Laurent Blvd

Intersection						
Int Delay, s/veh	4					
Movement	EBL	EBR	NBL	NBT	SBT	SBR
Lane Configurations	↔			↑	↑	
Traffic Vol, veh/h	47	0	0	27	32	0
Future Vol, veh/h	47	0	0	27	32	0
Conflicting Peds, #/hr	0	0	0	0	0	0
Sign Control	Stop	Stop	Free	Free	Free	Free
RT Channelized	-	None	-	None	-	None
Storage Length	0	-	-	-	-	-
Veh in Median Storage, #	0	-	-	0	0	-
Grade, %	0	-	-	0	0	-
Peak Hour Factor	100	100	100	100	100	100
Heavy Vehicles, %	2	2	2	2	2	2
Mvmt Flow	47	0	0	27	32	0
Major/Minor	Minor2	Major1	Major2			
Conflicting Flow All	59	32	-	0	-	0
Stage 1	32	-	-	-	-	-
Stage 2	27	-	-	-	-	-
Critical Hdwy	6.42	6.22	-	-	-	-
Critical Hdwy Stg 1	5.42	-	-	-	-	-
Critical Hdwy Stg 2	5.42	-	-	-	-	-
Follow-up Hdwy	3.518	3.318	-	-	-	-
Pot Cap-1 Maneuver	948	1042	0	-	-	0
Stage 1	991	-	0	-	-	0
Stage 2	996	-	0	-	-	0
Platoon blocked, %						
Mov Cap-1 Maneuver	948	1042	-	-	-	-
Mov Cap-2 Maneuver	948	-	-	-	-	-
Stage 1	991	-	-	-	-	-
Stage 2	996	-	-	-	-	-
Approach	EB	NB	SB			
HCM Control Delay, s	9	0	0			
HCM LOS	A					
Minor Lane/Major Mvmt	NBT	EBLn1	SBT			
Capacity (veh/h)	-	948	-			
HCM Lane V/C Ratio	-	0.05	-			
HCM Control Delay (s)	-	9	-			
HCM Lane LOS	-	A	-			
HCM 95th %tile Q(veh)	-	0.2	-			

Lanes, Volumes, Timings  
1: St-Laurent & Tremblay

Future Total 2026PM Peak Hour  
1531 St-Laurent Blvd

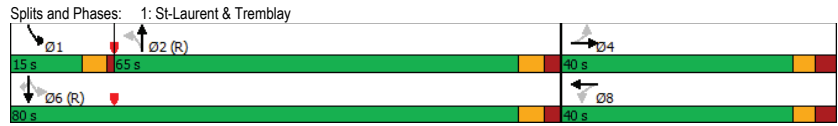
	EBL	EBT	WBL	WBT	NBL	NBT	SBL	SBT	SBR
Lane Group	↔	↔	↔	↔	↔	↔	↔	↔	↔
Lane Configurations	↔	↔	↔	↔	↔	↔	↔	↔	↔
Traffic Volume (vph)	225	38	23	21	38	1380	58	1087	86
Future Volume (vph)	225	38	23	21	38	1380	58	1087	86
Lane Group Flow (vph)	225	125	23	204	38	1392	58	1087	86
Turn Type	Perm	NA	Perm	NA	Perm	NA	pm+pt	NA	Perm
Protected Phases	4		8		2		1		6
Permitted Phases	4		8		2		6		6
Detector Phase	4		8		2		1		6
Switch Phase									
Minimum Initial (s)	10.0	10.0	10.0	10.0	10.0	10.0	5.0	10.0	10.0
Minimum Split (s)	38.5	38.5	38.5	38.5	39.2	39.2	9.7	39.2	39.2
Total Split (s)	40.0	40.0	40.0	40.0	65.0	65.0	15.0	80.0	80.0
Total Split (%)	33.3%	33.3%	33.3%	33.3%	54.2%	54.2%	12.5%	66.7%	66.7%
Maximum Green (s)	33.5	33.5	33.5	33.5	58.8	58.8	10.3	73.8	73.8
Yellow Time (s)	3.3	3.3	3.3	3.3	3.7	3.7	3.7	3.7	3.7
All-Red Time (s)	3.2	3.2	3.2	3.2	2.5	2.5	1.0	2.5	2.5
Lost Time Adjust (s)	0.0	0.0	0.0	0.0	0.0	0.0	0.0	0.0	0.0
Total Lost Time (s)	6.5	6.5	6.5	6.5	6.2	6.2	4.7	6.2	6.2
Lead/Lag					Lag	Lag	Lead		
Lead-Lag Optimize?					Yes	Yes	Yes		
Vehicle Extension (s)	3.0	3.0	3.0	3.0	3.0	3.0	3.0	3.0	3.0
Recall Mode	None	None	None	None	C-Max	C-Max	None	C-Max	C-Max
Walk Time (s)	7.0	7.0	7.0	7.0	11.0	11.0		11.0	11.0
Flash Dont Walk (s)	25.0	25.0	25.0	25.0	22.0	22.0		22.0	22.0
Pedestrian Calls (#/hr)	6	6	2	2	16	16		12	12
Act Effct Calls (s)	33.5	33.5	33.5	33.5	64.1	64.1	75.3	73.8	73.8
Actuated g/C Ratio	0.28	0.28	0.28	0.28	0.53	0.53	0.63	0.62	0.62
v/c Ratio	1.01	0.26	0.07	0.37	0.17	0.55	0.26	0.55	0.10
Control Delay	106.5	13.6	32.7	8.9	20.0	18.7	11.6	14.8	2.2
Queue Delay	0.0	0.0	0.0	0.0	0.0	0.0	0.0	0.0	0.0
Total Delay	106.5	13.6	32.7	8.9	20.0	18.7	11.6	14.8	2.2
LOS	F	B	C	A	B	B	B	B	A
Approach Delay	73.3			11.3		18.7		13.8	
Approach LOS	E			B		B		B	
Queue Length 50th (m)	-53.9	6.6	4.0	4.0	3.4	55.1	4.9	73.6	0.0
Queue Length 95th (m)	#104.1	21.5	10.6	22.5	m8.0	m89.3	10.0	91.3	6.0
Internal Link Dist (m)	390.4		0.1		682.5		144.8		
Turn Bay Length (m)	38.0		38.0		45.0		75.0		
Base Capacity (vph)	223	482	328	546	221	2539	260	1962	822
Starvation Cap Reductn	0	0	0	0	0	0	0	0	0
Spillback Cap Reductn	0	0	0	0	0	0	0	0	0
Storage Cap Reductn	0	0	0	0	0	0	0	0	0
Reduced v/c Ratio	1.01	0.26	0.07	0.37	0.17	0.55	0.22	0.55	0.10

Intersection Summary	
Cycle Length:	120
Actuated Cycle Length:	120
Offset:	49 (41%), Referenced to phase 2:NBTL and 6:SBTL, Start of Green
Natural Cycle:	90

Lanes, Volumes, Timings  
1: St-Laurent & Tremblay

Future Total 2026PM Peak Hour  
1531 St-Laurent Blvd

Control Type: Actuated-Coordinated  
 Maximum v/c Ratio: 1.01  
 Intersection Signal Delay: 22.2 Intersection LOS: C  
 Intersection Capacity Utilization 88.5% ICU Level of Service E  
 Analysis Period (min) 15  
 ~ Volume exceeds capacity, queue is theoretically infinite.  
 Queue shown is maximum after two cycles.  
 # 95th percentile volume exceeds capacity, queue may be longer.  
 Queue shown is maximum after two cycles.  
 m Volume for 95th percentile queue is metered by upstream signal.



Lanes, Volumes, Timings  
2: St-Laurent & Belfast

Future Total 2026PM Peak Hour  
1531 St-Laurent Blvd

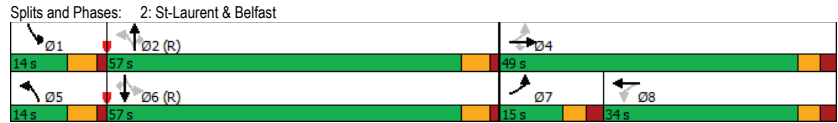
Lane Group	EBL	EBT	EBR	WBL	WBT	NBL	NBT	NBR	SBL	SBT	SBR
Lane Configurations	↔	↕	↔	↔	↕	↔	↕	↔	↔	↕	↕
Traffic Volume (vph)	195	169	224	118	96	111	1005	105	113	886	133
Future Volume (vph)	195	169	224	118	96	111	1005	105	113	886	133
Lane Group Flow (vph)	195	169	224	118	261	111	1005	105	113	886	133
Turn Type	pm+pt	NA	Perm	Perm	NA	pm+pt	NA	Perm	pm+pt	NA	Perm
Protected Phases	7	4			8	5	2		1	6	
Permitted Phases	4		4	8		2		2	6		6
Detector Phase	7	4	4	8	8	5	2	2	1	6	6
Switch Phase											
Minimum Initial (s)	5.0	10.0	10.0	10.0	10.0	5.0	10.0	10.0	5.0	10.0	10.0
Minimum Split (s)	10.8	27.8	27.8	27.8	27.8	10.7	36.6	36.6	10.7	36.6	36.6
Total Split (s)	15.0	49.0	49.0	34.0	34.0	14.0	57.0	57.0	14.0	57.0	57.0
Total Split (%)	12.5%	40.8%	40.8%	28.3%	28.3%	11.7%	47.5%	47.5%	11.7%	47.5%	47.5%
Maximum Green (s)	9.2	43.2	43.2	28.2	28.2	8.3	51.4	51.4	8.3	51.4	51.4
Yellow Time (s)	3.3	3.3	3.3	3.3	3.3	4.2	4.2	4.2	4.2	4.2	4.2
All-Red Time (s)	2.5	2.5	2.5	2.5	2.5	1.5	1.4	1.4	1.5	1.4	1.4
Lost Time Adjust (s)	0.0	0.0	0.0	0.0	0.0	0.0	0.0	0.0	0.0	0.0	0.0
Total Lost Time (s)	5.8	5.8	5.8	5.8	5.8	5.7	5.6	5.6	5.7	5.6	5.6
Lead/Lag	Lead			Lag	Lag	Lead	Lag	Lag	Lead	Lag	Lag
Lead-Lag Optimize?	Yes			Yes	Yes	Yes	Yes	Yes	Yes	Yes	Yes
Vehicle Extension (s)	3.0	3.0	3.0	3.0	3.0	3.0	3.0	3.0	3.0	3.0	3.0
Recall Mode	None	None	None	None	None	None	C-Max	C-Max	None	C-Max	C-Max
Walk Time (s)	7.0	7.0	7.0	7.0	7.0	25.0	25.0	25.0	25.0	25.0	25.0
Flash Dont Walk (s)	15.0	15.0	15.0	15.0	15.0	6.0	6.0	6.0	6.0	6.0	6.0
Pedestrian Calls (#/hr)	44	44	14	14	14	20	20	20	23	23	23
Act Effct Green (s)	35.9	35.9	35.9	20.9	20.9	66.6	58.3	58.3	67.3	58.7	58.7
Actuated g/C Ratio	0.30	0.30	0.30	0.17	0.17	0.56	0.49	0.49	0.56	0.49	0.49
v/c Ratio	0.96	0.36	0.41	0.68	0.82	0.37	0.63	0.16	0.46	0.55	0.18
Control Delay	89.1	34.0	7.5	64.8	55.3	15.1	26.3	2.5	23.4	19.0	2.9
Queue Delay	0.0	0.0	0.0	0.0	0.0	0.0	0.0	0.0	0.0	0.0	0.0
Total Delay	89.1	34.0	7.5	64.8	55.3	15.1	26.3	2.5	23.4	19.0	2.9
LOS	F	C	A	E	E	B	C	A	C	B	A
Approach Delay		42.2			58.2		23.3			17.6	
Approach LOS		D			E		C			B	
Queue Length 50th (m)	36.4	31.0	3.5	26.2	44.9	10.6	91.7	0.0	10.1	46.9	0.0
Queue Length 95th (m)	#70.5	45.9	20.2	43.6	70.4	21.5	125.1	6.5	29.0	60.4	7.1
Internal Link Dist (m)		518.7			23.5		597.8			682.5	
Turn Bay Length (m)	75.0		200.0	65.0		75.0		55.0	75.0		85.0
Base Capacity (vph)	204	572	619	235	406	310	1596	644	249	1604	746
Starvation Cap Reductn	0	0	0	0	0	0	0	0	0	0	0
Spillback Cap Reductn	0	0	0	0	0	0	0	0	0	0	0
Storage Cap Reductn	0	0	0	0	0	0	0	0	0	0	0
Reduced v/c Ratio	0.96	0.30	0.36	0.50	0.64	0.36	0.63	0.16	0.45	0.55	0.18

Intersection Summary  
 Cycle Length: 120  
 Actuated Cycle Length: 120  
 Offset: 49 (41%), Referenced to phase 2:NBTL and 6:SBTL, Start of Green  
 Natural Cycle: 90

Lanes, Volumes, Timings  
2: St-Laurent & Belfast

Future Total 2026PM Peak Hour  
1531 St-Laurent Blvd

Control Type: Actuated-Coordinated  
 Maximum v/c Ratio: 0.96  
 Intersection Signal Delay: 28.7 Intersection LOS: C  
 Intersection Capacity Utilization 83.9% ICU Level of Service E  
 Analysis Period (min) 15  
 # 95th percentile volume exceeds capacity, queue may be longer.  
 Queue shown is maximum after two cycles.



Lanes, Volumes, Timings  
3: St-Laurent & Industrial/Innes

Future Total 2026PM Peak Hour  
1531 St-Laurent Blvd

	EBL	EBT	EBR	WBL	WBT	WBR	NBL	NBT	NBR	SBL	SBT	SBR
Lane Configurations	↔↔	↕↕	↔↔	↔↔	↕↕	↔↔	↔↔	↕↕	↔↔	↔↔	↕↕	↔↔
Traffic Volume (vph)	137	560	363	415	274	137	199	950	522	132	965	131
Future Volume (vph)	137	560	363	415	274	137	199	950	522	132	965	131
Lane Group Flow (vph)	137	560	363	415	274	137	199	950	522	132	965	131
Turn Type	Prot	NA	Perm	Prot	NA	Perm	Prot	NA	Perm	Prot	NA	Perm
Protected Phases	7	4		3	8		5	2		1	6	
Permitted Phases			4			8			2			6
Detector Phase	7	4	4	3	8	8	5	2	2	1	6	6
Switch Phase												
Minimum Initial (s)	5.0	10.0	10.0	5.0	10.0	10.0	5.0	10.0	10.0	5.0	10.0	10.0
Minimum Split (s)	11.6	38.6	38.6	11.6	38.6	38.6	11.3	37.6	37.6	11.3	37.6	37.6
Total Split (s)	19.0	38.0	38.0	41.0	60.0	60.0	28.0	43.0	43.0	28.0	43.0	43.0
Total Split (%)	12.7%	25.3%	25.3%	27.3%	40.0%	40.0%	18.7%	28.7%	28.7%	18.7%	28.7%	28.7%
Maximum Green (s)	12.4	31.4	31.4	34.4	53.4	53.4	21.7	36.4	36.4	21.7	36.4	36.4
Yellow Time (s)	3.7	3.7	3.7	3.7	3.7	3.7	4.2	4.2	4.2	4.2	4.2	4.2
All-Red Time (s)	2.9	2.9	2.9	2.9	2.9	2.9	2.1	2.4	2.4	2.1	2.4	2.4
Lost Time Adjust (s)	0.0	0.0	0.0	0.0	0.0	0.0	0.0	0.0	0.0	0.0	0.0	0.0
Total Lost Time (s)	6.6	6.6	6.6	6.6	6.6	6.6	6.3	6.6	6.6	6.3	6.6	6.6
Lead/Lag	Lead	Lag	Lag	Lead	Lag	Lag	Lead	Lag	Lag	Lead	Lag	Lag
Lead-Lag Optimize?	Yes	Yes	Yes	Yes	Yes	Yes	Yes	Yes	Yes	Yes	Yes	Yes
Vehicle Extension (s)	3.0	3.0	3.0	3.0	3.0	3.0	3.0	3.0	3.0	3.0	3.0	3.0
Recall Mode	None	None	None	None	None	None	None	Max	Max	None	Max	Max
Walk Time (s)	7.0	7.0	7.0	7.0	7.0	7.0	7.0	7.0	7.0	7.0	7.0	7.0
Flash Dont Walk (s)	25.0	25.0	25.0	25.0	25.0	25.0	24.0	24.0	24.0	24.0	24.0	24.0
Pedestrian Calls (#/hr)	6	6	6	6	7	7	10	10	10	14	14	14
Act Effct Green (s)	10.5	26.8	26.8	21.7	38.0	38.0	13.5	39.3	39.3	10.9	36.8	36.8
Actuated g/C Ratio	0.08	0.21	0.21	0.17	0.30	0.30	0.11	0.31	0.31	0.09	0.29	0.29
v/c Ratio	0.51	0.80	0.66	0.75	0.28	0.26	0.59	0.93	0.68	0.50	1.01	0.24
Control Delay	64.0	57.0	15.0	58.8	34.0	6.3	62.2	58.6	10.8	63.0	76.3	3.4
Queue Delay	0.0	0.0	0.0	0.0	0.0	0.0	0.0	0.0	0.0	0.0	0.0	0.0
Total Delay	64.0	57.0	15.0	58.8	34.0	6.3	62.2	58.6	10.8	63.0	76.3	3.4
LOS	E	E	B	E	C	A	E	E	B	E	E	A
Approach Delay		43.5			41.8			44.1			67.1	
Approach LOS		D			D			D			E	
Queue Length 50th (m)	17.0	69.1	10.9	50.9	26.9	0.0	24.6	120.9	9.6	16.3	-134.5	0.0
Queue Length 95th (m)	30.3	99.1	46.4	73.0	40.5	14.4	39.9	#192.2	52.3	28.8	#209.1	7.5
Internal Link Dist (m)		745.6			700.4			316.7			597.8	
Turn Bay Length (m)	38.0		120.0	150.0		80.0	100.0		100.0	125.0		150.0
Base Capacity (vph)	321	826	592	893	1375	703	547	1021	770	532	955	540
Starvation Cap Reductn	0	0	0	0	0	0	0	0	0	0	0	0
Spillback Cap Reductn	0	0	0	0	0	0	0	0	0	0	0	0
Storage Cap Reductn	0	0	0	0	0	0	0	0	0	0	0	0
Reduced v/c Ratio	0.43	0.68	0.61	0.46	0.20	0.19	0.36	0.93	0.68	0.25	1.01	0.24

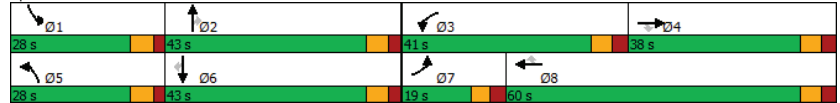
Intersection Summary  
 Cycle Length: 150  
 Actuated Cycle Length: 125.1  
 Natural Cycle: 110  
 Control Type: Actuated-Uncoordinated

Lanes, Volumes, Timings  
**3: St-Laurent & Industrial/Innes**

Future Total 2026PM Peak Hour  
 1531 St-Laurent Blvd

Maximum v/c Ratio: 1.01	Intersection LOS: D
Intersection Signal Delay: 49.5	ICU Level of Service E
Intersection Capacity Utilization 86.6%	
Analysis Period (min) 15	
~ Volume exceeds capacity, queue is theoretically infinite. Queue shown is maximum after two cycles.	
# 95th percentile volume exceeds capacity, queue may be longer. Queue shown is maximum after two cycles.	

Splits and Phases: 3: St-Laurent & Industrial/Innes



Lanes, Volumes, Timings  
**4: Access & Belfast**

Future Total 2026PM Peak Hour  
 1531 St-Laurent Blvd

Lane Group	EBT	WBT
Lane Configurations	↶ ↷	↶ ↷
Traffic Volume (vph)	336	379
Future Volume (vph)	336	379
Lane Group Flow (vph)	387	380
Sign Control	Free	Free

**Intersection Summary**

Control Type: Unsignalized	ICU Level of Service A
Intersection Capacity Utilization 25.3%	
Analysis Period (min) 15	

Lanes, Volumes, Timings  
5: Lagan & Belfast

Future Total 2026PM Peak Hour  
1531 St-Laurent Blvd

Lane Group	EBT	WBT	NBT	SBT
Lane Configurations	↔	↔	↔	↔
Traffic Volume (vph)	265	310	5	0
Future Volume (vph)	265	310	5	0
Lane Group Flow (vph)	361	355	87	69
Sign Control	Free	Free	Stop	Stop

Intersection Summary	
Control Type: Unsignalized	
Intersection Capacity Utilization 51.6%	ICU Level of Service A
Analysis Period (min) 15	

HCM 2010 TWSC  
5: Lagan & Belfast

Future Total 2026PM Peak Hour  
1531 St-Laurent Blvd

Intersection												
Int Delay, s/veh	3.9											
Movement	EBL	EBT	EBR	WBL	WBT	WBR	NBL	NBT	NBR	SBL	SBT	SBR
Lane Configurations	↔			↔			↔			↔		
Traffic Vol, veh/h	46	265	50	19	310	26	65	5	17	30	0	39
Future Vol, veh/h	46	265	50	19	310	26	65	5	17	30	0	39
Conflicting Peds, #/hr	12	0	14	14	0	12	1	0	6	6	0	1
Sign Control	Free	Free	Free	Free	Free	Free	Stop	Stop	Stop	Stop	Stop	Stop
RT Channelized	-	-	None	-	-	None	-	-	None	-	-	None
Storage Length	-	-	-	-	-	-	-	-	-	-	-	-
Veh in Median Storage, #	-	0	-	-	0	-	-	0	-	-	0	-
Grade, %	-	0	-	-	0	-	-	0	-	-	0	-
Peak Hour Factor	100	100	100	100	100	100	100	100	100	100	100	100
Heavy Vehicles, %	30	6	12	5	3	8	4	2	2	10	2	2
Mvmt Flow	46	265	50	19	310	26	65	5	17	30	0	39

Major/Minor	Major1		Major2		Minor1		Minor2	
Conflicting Flow All	348	0	0	329	0	0	778	782
Stage 1	-	-	-	-	-	-	396	396
Stage 2	-	-	-	-	-	-	382	386
Critical Hdwy	4.4	-	-	4.15	-	-	7.14	6.52
Critical Hdwy Stg 1	-	-	-	-	-	-	6.14	5.52
Critical Hdwy Stg 2	-	-	-	-	-	-	6.14	5.52
Follow-up Hdwy	2.47	-	-	2.245	-	-	3.536	4.018
Pot Cap-1 Maneuver	1071	-	-	1214	-	-	311	326
Stage 1	-	-	-	-	-	-	625	604
Stage 2	-	-	-	-	-	-	636	610
Platoon blocked, %	-	-	-	-	-	-	-	-
Mov Cap-1 Maneuver	1061	-	-	1201	-	-	274	297
Mov Cap-2 Maneuver	-	-	-	-	-	-	274	297
Stage 1	-	-	-	-	-	-	586	566
Stage 2	-	-	-	-	-	-	588	592

Approach	EB	WB	NB	SB
HCM Control Delay, s	1.1	0.4	20.9	15.3
HCM LOS			C	C

Minor Lane/Major Mvmt	NBLn1	EBL	EBT	EBR	WBL	WBT	WBR	SBLn1
Capacity (veh/h)	313	1061	-	-	1201	-	-	419
HCM Lane V/C Ratio	0.278	0.043	-	-	0.016	-	-	0.165
HCM Control Delay (s)	20.9	8.5	0	-	8	0	-	15.3
HCM Lane LOS	C	A	A	-	A	A	-	C
HCM 95th %tile Q(veh)	1.1	0.1	-	-	0	-	-	0.6

Lanes, Volumes, Timings  
6: Lagan & Access

Future Total 2026PM Peak Hour  
1531 St-Laurent Blvd

Lane Group	EBL	NBT	SBT
Lane Configurations	↕	↑	↑
Traffic Volume (vph)	40	47	69
Future Volume (vph)	40	47	69
Lane Group Flow (vph)	40	47	69
Sign Control	Stop	Free	Free

Intersection Summary		
Control Type: Unsignalized		
Intersection Capacity Utilization 13.8%	ICU Level of Service A	
Analysis Period (min) 15		

HCM 2010 TWSC  
6: Lagan & Access

Future Total 2026PM Peak Hour  
1531 St-Laurent Blvd

Intersection						
Int Delay, s/veh	2.4					
Movement	EBL	EBR	NBL	NBT	SBT	SBR
Lane Configurations	↕			↑	↑	
Traffic Vol, veh/h	40	0	0	47	69	0
Future Vol, veh/h	40	0	0	47	69	0
Conflicting Peds, #/hr	0	0	0	0	0	0
Sign Control	Stop	Stop	Free	Free	Free	Free
RT Channelized	-	None	-	None	-	None
Storage Length	0	-	-	-	-	-
Veh in Median Storage, #	0	-	-	0	0	-
Grade, %	0	-	-	0	0	-
Peak Hour Factor	100	100	100	100	100	100
Heavy Vehicles, %	2	2	2	2	2	2
Mvmt Flow	40	0	0	47	69	0

Major/Minor	Minor2	Major1	Major2
Conflicting Flow All	116	69	0
Stage 1	69	-	-
Stage 2	47	-	-
Critical Hdwy	6.42	6.22	-
Critical Hdwy Stg 1	5.42	-	-
Critical Hdwy Stg 2	5.42	-	-
Follow-up Hdwy	3.518	3.318	-
Pot Cap-1 Maneuver	880	994	0
Stage 1	954	-	0
Stage 2	975	-	0
Platoon blocked, %	-	-	-
Mov Cap-1 Maneuver	880	994	-
Mov Cap-2 Maneuver	880	-	-
Stage 1	954	-	-
Stage 2	975	-	-

Approach	EB	NB	SB
HCM Control Delay, s	9.3	0	0
HCM LOS	A		

Minor Lane/Major Mvmt	NBT EBLn1	SBT
Capacity (veh/h)	-	880
HCM Lane V/C Ratio	-	0.045
HCM Control Delay (s)	-	9.3
HCM Lane LOS	-	A
HCM 95th %tile Q(veh)	-	0.1



# Appendix M

Synchro Intersection Worksheets – 2031 Future Total Conditions

Lanes, Volumes, Timings  
1: St-Laurent & Tremblay

Future Total 2031AM Peak Hour  
1531 St-Laurent Blvd

Lane Group	EBL	EBT	WBL	WBT	NBL	NBT	SBL	SBT	SBR
Lane Configurations	↔	↔	↔	↔	↔	↔	↔	↔	↔
Traffic Volume (vph)	60	21	12	20	84	1262	131	1148	244
Future Volume (vph)	60	21	12	20	84	1262	131	1148	244
Lane Group Flow (vph)	60	55	12	143	84	1300	131	1148	244
Turn Type	Perm	NA	Perm	NA	Perm	NA	pm+pt	NA	Perm
Protected Phases		4		8		2		1	6
Permitted Phases	4		8		2		6		6
Detector Phase	4	4	8	8	2	2	1	6	6
Switch Phase									
Minimum Initial (s)	10.0	10.0	10.0	10.0	10.0	10.0	5.0	10.0	10.0
Minimum Split (s)	38.5	38.5	38.5	38.5	39.2	39.2	9.7	39.2	39.2
Total Split (s)	40.0	40.0	40.0	40.0	72.0	72.0	18.0	90.0	90.0
Total Split (%)	30.8%	30.8%	30.8%	30.8%	55.4%	55.4%	13.8%	69.2%	69.2%
Maximum Green (s)	33.5	33.5	33.5	33.5	65.8	65.8	13.3	83.8	83.8
Yellow Time (s)	3.3	3.3	3.3	3.3	3.7	3.7	3.7	3.7	3.7
All-Red Time (s)	3.2	3.2	3.2	3.2	2.5	2.5	1.0	2.5	2.5
Lost Time Adjust (s)	0.0	0.0	0.0	0.0	0.0	0.0	0.0	0.0	0.0
Total Lost Time (s)	6.5	6.5	6.5	6.5	6.2	6.2	4.7	6.2	6.2
Lead/Lag					Lag	Lag	Lead		
Lead-Lag Optimize?					Yes	Yes	Yes		
Vehicle Extension (s)	3.0	3.0	3.0	3.0	3.0	3.0	3.0	3.0	3.0
Recall Mode	None	None	None	None	C-Max	C-Max	None	C-Max	C-Max
Walk Time (s)	7.0	7.0	7.0	7.0	11.0	11.0		11.0	11.0
Flash Dont Walk (s)	25.0	25.0	25.0	25.0	22.0	22.0		22.0	22.0
Pedestrian Calls (#/hr)	9	9	3	3	7	7		12	12
Act Effct Green (s)	17.2	17.2	17.2	17.2	87.2	87.2	101.6	100.1	100.1
Actuated g/C Ratio	0.13	0.13	0.13	0.13	0.67	0.67	0.78	0.77	0.77
v/c Ratio	0.63	0.24	0.08	0.50	0.29	0.45	0.42	0.48	0.24
Control Delay	78.9	24.1	45.5	17.0	15.3	12.0	8.7	7.3	1.4
Queue Delay	0.0	0.0	0.0	0.0	0.0	0.0	0.0	0.0	0.0
Total Delay	78.9	24.1	45.5	17.0	15.3	12.0	8.7	7.3	1.4
LOS	E	C	D	B	B	B	A	A	A
Approach Delay		52.7		19.2		12.2		6.5	
Approach LOS		D		B		B		A	
Queue Length 50th (m)	15.1	4.9	2.8	4.7	7.5	48.2	6.0	43.4	0.0
Queue Length 95th (m)	26.3	14.9	7.7	21.1	26.0	92.8	18.7	96.4	8.6
Internal Link Dist (m)		396.6		0.1		682.5		144.8	
Turn Bay Length (m)	38.0		38.0		45.0		75.0		
Base Capacity (vph)	186	413	279	442	288	2902	363	2368	1035
Starvation Cap Reductn	0	0	0	0	0	0	0	0	0
Spillback Cap Reductn	0	0	0	0	0	0	0	0	0
Storage Cap Reductn	0	0	0	0	0	0	0	0	0
Reduced v/c Ratio	0.32	0.13	0.04	0.32	0.29	0.45	0.36	0.48	0.24

Intersection Summary

Cycle Length: 130  
 Actuated Cycle Length: 130  
 Offset: 53 (41%), Referenced to phase 2:NBL and 6:SBTL, Start of Green  
 Natural Cycle: 90

Lanes, Volumes, Timings  
1: St-Laurent & Tremblay

Future Total 2031AM Peak Hour  
1531 St-Laurent Blvd

Control Type: Actuated-Coordinated  
 Maximum v/c Ratio: 0.63  
 Intersection Signal Delay: 11.3  
 Intersection LOS: B  
 Intersection Capacity Utilization 84.4%  
 ICU Level of Service E  
 Analysis Period (min) 15

Splits and Phases: 1: St-Laurent & Tremblay



Lanes, Volumes, Timings  
2: St-Laurent & Belfast

Future Total 2031AM Peak Hour  
1531 St-Laurent Blvd

Lane Group	EBL	EBT	EBR	WBL	WBT	NBL	NBT	NBR	SBL	SBT	SBR
Lane Configurations	↖	↗	↘	↖	↗	↖	↗	↘	↖	↗	↘
Traffic Volume (vph)	47	66	115	64	147	131	930	76	92	838	190
Future Volume (vph)	47	66	115	64	147	131	930	76	92	838	190
Lane Group Flow (vph)	47	66	115	64	260	131	930	76	92	838	190
Turn Type	pm+pt	NA	Perm	Perm	NA	pm+pt	NA	Perm	pm+pt	NA	Perm
Protected Phases	7	4			8	5	2		1	6	
Permitted Phases	4		4	8				2	6		6
Detector Phase	7	4	4	8	8	5	2	2	1	6	6
Switch Phase											
Minimum Initial (s)	5.0	10.0	10.0	10.0	10.0	5.0	10.0	10.0	5.0	10.0	10.0
Minimum Split (s)	10.8	27.8	27.8	27.8	27.8	10.7	36.6	36.6	10.7	36.6	36.6
Total Split (s)	16.0	48.0	48.0	32.0	32.0	15.0	57.0	57.0	15.0	57.0	57.0
Total Split (%)	13.3%	40.0%	40.0%	26.7%	26.7%	12.5%	47.5%	47.5%	12.5%	47.5%	47.5%
Maximum Green (s)	10.2	42.2	42.2	26.2	26.2	9.3	51.4	51.4	9.3	51.4	51.4
Yellow Time (s)	3.3	3.3	3.3	3.3	3.3	4.2	4.2	4.2	4.2	4.2	4.2
All-Red Time (s)	2.5	2.5	2.5	2.5	2.5	1.5	1.4	1.4	1.5	1.4	1.4
Lost Time Adjust (s)	0.0	0.0	0.0	0.0	0.0	0.0	0.0	0.0	0.0	0.0	0.0
Total Lost Time (s)	5.8	5.8	5.8	5.8	5.8	5.7	5.6	5.6	5.7	5.6	5.6
Lead/Lag	Lead			Lag	Lag	Lead	Lag	Lag	Lead	Lag	Lag
Lead-Lag Optimize?	Yes			Yes	Yes	Yes	Yes	Yes	Yes	Yes	Yes
Vehicle Extension (s)	3.0	3.0	3.0	3.0	3.0	3.0	3.0	3.0	3.0	3.0	3.0
Recall Mode	None	None	None	None	None	None	C-Max	C-Max	None	C-Max	C-Max
Walk Time (s)	7.0	7.0	7.0	7.0	7.0	7.0	25.0	25.0	25.0	25.0	25.0
Flash Dont Walk (s)	15.0	15.0	15.0	15.0	15.0	6.0	6.0	6.0	6.0	6.0	6.0
Pedestrian Calls (#/hr)	42	42	9	9	9	22	22	22	13	13	13
Act Effct Green (s)	35.4	35.4	35.4	23.5	23.5	68.0	59.3	59.3	66.9	58.8	58.8
Actuated g/C Ratio	0.30	0.30	0.30	0.20	0.20	0.57	0.49	0.49	0.56	0.49	0.49
v/c Ratio	0.24	0.13	0.27	0.33	0.87	0.42	0.59	0.10	0.35	0.55	0.28
Control Delay	30.0	28.5	6.5	45.2	69.1	16.4	25.6	0.6	15.8	25.1	4.2
Queue Delay	0.0	0.0	0.0	0.0	0.0	0.0	0.0	0.0	0.0	0.0	0.0
Total Delay	30.0	28.5	6.5	45.2	69.1	16.4	25.6	0.6	15.8	25.1	4.2
LOS	C	C	A	D	E	B	C	A	B	C	A
Approach Delay	17.7				64.4		22.9			20.8	
Approach LOS		B			E		C			C	
Queue Length 50th (m)	7.5	10.7	0.0	12.7	51.9	13.9	88.3	0.0	9.5	78.8	0.0
Queue Length 95th (m)	15.9	20.5	12.3	25.8	#92.5	24.6	114.3	1.3	18.1	100.9	13.4
Internal Link Dist (m)		518.7			23.5		597.8			682.5	
Turn Bay Length (m)	75.0		200.0	65.0		75.0		55.0	75.0		85.0
Base Capacity (vph)	214	596	485	218	329	321	1577	732	279	1519	667
Starvation Cap Reductn	0	0	0	0	0	0	0	0	0	0	0
Spillback Cap Reductn	0	0	0	0	0	0	0	0	0	0	0
Storage Cap Reductn	0	0	0	0	0	0	0	0	0	0	0
Reduced v/c Ratio	0.22	0.11	0.24	0.29	0.79	0.41	0.59	0.10	0.33	0.55	0.28

Intersection Summary

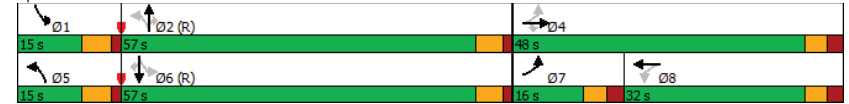
Cycle Length: 120  
 Actuated Cycle Length: 120  
 Offset: 53 (44%), Referenced to phase 2:NBL and 6:SBTL, Start of Green  
 Natural Cycle: 90

Lanes, Volumes, Timings  
2: St-Laurent & Belfast

Future Total 2031AM Peak Hour  
1531 St-Laurent Blvd

Control Type: Actuated-Coordinated	
Maximum v/c Ratio: 0.87	
Intersection Signal Delay: 26.4	Intersection LOS: C
Intersection Capacity Utilization 76.8%	ICU Level of Service D
Analysis Period (min) 15	
# 95th percentile volume exceeds capacity, queue may be longer.	
Queue shown is maximum after two cycles.	

Splits and Phases: 2: St-Laurent & Belfast



Lanes, Volumes, Timings  
3: St-Laurent & Industrial/Innes

Future Total 2031AM Peak Hour  
1531 St-Laurent Blvd

Lane Group	EBL	EBT	EBR	WBL	WBT	WBR	NBL	NBT	NBR	SBL	SBT	SBR
Lane Configurations	↔	↔	↔	↔	↔	↔	↔	↔	↔	↔	↔	↔
Traffic Volume (vph)	73	194	142	618	741	242	210	1136	356	118	867	146
Future Volume (vph)	73	194	142	618	741	242	210	1136	356	118	867	146
Lane Group Flow (vph)	73	194	142	618	741	242	210	1136	356	118	867	146
Turn Type	Prot	NA	Perm	Prot	NA	Perm	Prot	NA	Perm	Prot	NA	Perm
Protected Phases	7	4		3	8		5	2		1	6	
Permitted Phases			4			8			2			6
Detector Phase	7	4	4	3	8	8	5	2	2	1	6	6
Switch Phase												
Minimum Initial (s)	5.0	10.0	10.0	5.0	10.0	10.0	5.0	10.0	10.0	5.0	10.0	10.0
Minimum Split (s)	11.6	38.6	38.6	11.6	38.6	38.6	11.3	37.6	37.6	11.3	37.6	37.6
Total Split (s)	25.0	38.0	38.0	36.0	49.0	49.0	23.0	43.0	43.0	23.0	43.0	43.0
Total Split (%)	17.9%	27.1%	27.1%	25.7%	35.0%	35.0%	16.4%	30.7%	30.7%	16.4%	30.7%	30.7%
Maximum Green (s)	18.4	31.4	31.4	29.4	42.4	42.4	16.7	36.4	36.4	16.7	36.4	36.4
Yellow Time (s)	3.7	3.7	3.7	3.7	3.7	3.7	4.2	4.2	4.2	4.2	4.2	4.2
All-Red Time (s)	2.9	2.9	2.9	2.9	2.9	2.9	2.1	2.4	2.4	2.1	2.4	2.4
Lost Time Adjust (s)	0.0	0.0	0.0	0.0	0.0	0.0	0.0	0.0	0.0	0.0	0.0	0.0
Total Lost Time (s)	6.6	6.6	6.6	6.6	6.6	6.6	6.3	6.6	6.6	6.3	6.6	6.6
Lead/Lag	Lead	Lag	Lag	Lead	Lag	Lag	Lead	Lag	Lag	Lead	Lag	Lag
Lead-Lag Optimize?	Yes	Yes	Yes	Yes	Yes	Yes	Yes	Yes	Yes	Yes	Yes	Yes
Vehicle Extension (s)	3.0	3.0	3.0	3.0	3.0	3.0	3.0	3.0	3.0	3.0	3.0	3.0
Recall Mode	None	None	None	None	None	None	C-Max	C-Max	None	C-Max	C-Max	C-Max
Walk Time (s)	7.0	7.0	7.0	7.0	7.0	7.0	7.0	7.0	7.0	7.0	7.0	7.0
Flash Dont Walk (s)	25.0	25.0	25.0	25.0	25.0	25.0	24.0	24.0	24.0	24.0	24.0	24.0
Pedestrian Calls (#/hr)	7	7	7	3	3	3	5	5	5	9	9	9
Act Effct Green (s)	8.8	19.4	19.4	28.8	42.0	42.0	14.5	55.0	55.0	10.6	51.1	51.1
Actuated g/C Ratio	0.06	0.14	0.14	0.21	0.30	0.30	0.10	0.39	0.39	0.08	0.36	0.36
v/c Ratio	0.39	0.47	0.41	0.93	0.78	0.42	0.68	0.92	0.49	0.50	0.74	0.26
Control Delay	68.5	57.7	6.0	76.4	51.2	6.2	71.4	54.1	10.1	69.0	44.7	3.6
Queue Delay	0.0	0.0	0.0	0.0	0.0	0.0	0.0	0.0	0.0	0.0	0.0	0.0
Total Delay	68.5	57.7	6.0	76.4	51.2	6.2	71.4	54.1	10.1	69.0	44.7	3.6
LOS	E	E	A	E	D	A	E	D	B	E	D	A
Approach Delay	41.7				54.1			47.0				41.9
Approach LOS	D				D			D				D
Queue Length 50th (m)	10.2	26.5	0.0	87.1	101.7	0.0	29.2	156.3	11.0	16.4	109.7	0.0
Queue Length 95th (m)	18.1	35.1	8.2	#120.0	113.1	18.0	42.2	#252.6	45.0	26.1	#176.3	9.0
Internal Link Dist (m)		745.6			700.4			316.7			597.8	
Turn Bay Length (m)	38.0		120.0	150.0		80.0	100.0		100.0	125.0		150.0
Base Capacity (vph)	391	665	444	675	993	587	359	1229	728	372	1176	556
Starvation Cap Reductn	0	0	0	0	0	0	0	0	0	0	0	0
Spillback Cap Reductn	0	0	0	0	0	0	0	0	0	0	0	0
Storage Cap Reductn	0	0	0	0	0	0	0	0	0	0	0	0
Reduced v/c Ratio	0.19	0.29	0.32	0.92	0.75	0.41	0.58	0.92	0.49	0.32	0.74	0.26

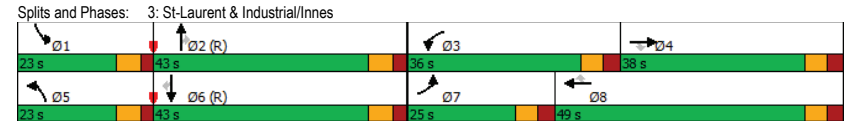
Intersection Summary

Cycle Length: 140  
 Actuated Cycle Length: 140  
 Offset: 0 (0%), Referenced to phase 2:NBT and 6:SBT, Start of Green  
 Natural Cycle: 140

Lanes, Volumes, Timings  
3: St-Laurent & Industrial/Innes

Future Total 2031AM Peak Hour  
1531 St-Laurent Blvd

Control Type: Actuated-Coordinated  
 Maximum v/c Ratio: 0.93  
 Intersection Signal Delay: 47.7  
 Intersection LOS: D  
 Intersection Capacity Utilization 89.8%  
 ICU Level of Service E  
 Analysis Period (min) 15  
 # 95th percentile volume exceeds capacity, queue may be longer.  
 Queue shown is maximum after two cycles.



Lanes, Volumes, Timings  
4: Access & Belfast

Future Total 2031AM Peak Hour  
1531 St-Laurent Blvd

	→	←
Lane Group	EBT	WBT
Lane Configurations	↔	↔
Traffic Volume (vph)	209	324
Future Volume (vph)	209	324
Lane Group Flow (vph)	232	324
Sign Control	Free	Free

Intersection Summary	
Control Type: Unsignalized	
Intersection Capacity Utilization 16.4%	ICU Level of Service A
Analysis Period (min) 15	

Lanes, Volumes, Timings  
5: Lagan & Belfast

Future Total 2031AM Peak Hour  
1531 St-Laurent Blvd

	→	←	↑	↓
Lane Group	EBT	WBT	NBT	SBT
Lane Configurations	↔	↔	↕	↕
Traffic Volume (vph)	272	225	1	4
Future Volume (vph)	272	225	1	4
Lane Group Flow (vph)	338	264	74	36
Sign Control	Free	Free	Stop	Stop

Intersection Summary	
Control Type: Unsignalized	
Intersection Capacity Utilization 51.8%	ICU Level of Service A
Analysis Period (min) 15	

HCM 2010 TWSC  
5: Lagan & Belfast

Future Total 2031AM Peak Hour  
1531 St-Laurent Blvd

Intersection												
Int Delay, s/veh	3.5											
Movement	EBL	EBT	EBR	WBL	WBT	WBR	NBL	NBT	NBR	SBL	SBT	SBR
Lane Configurations	↕			↕			↕			↕		
Traffic Vol, veh/h	51	272	15	13	225	26	58	1	15	15	4	17
Future Vol, veh/h	51	272	15	13	225	26	58	1	15	15	4	17
Conflicting Peds, #/hr	8	0	23	23	0	8	0	0	5	5	0	0
Sign Control	Free	Free	Free	Free	Free	Free	Stop	Stop	Stop	Stop	Stop	Stop
RT Channelized	-	-	None	-	-	None	-	-	None	-	-	None
Storage Length	-	-	-	-	-	-	-	-	-	-	-	-
Veh in Median Storage, #	-	0	-	-	0	-	-	0	-	-	0	-
Grade, %	-	0	-	-	0	-	-	0	-	-	0	-
Peak Hour Factor	100	100	100	100	100	100	100	100	100	100	100	100
Heavy Vehicles, %	20	12	7	23	15	15	55	2	33	20	25	12
Mvmt Flow	51	272	15	13	225	26	58	1	15	15	4	17

Major/Minor	Major1	Major2	Minor1	Minor2
Conflicting Flow All	259	0	310	0
Stage 1	-	-	-	-
Stage 2	-	-	-	-
Critical Hdwy	4.3	-	4.33	-
Critical Hdwy Stg 1	-	-	-	-
Critical Hdwy Stg 2	-	-	-	-
Follow-up Hdwy	2.38	-	2.407	-
Pot Cap-1 Maneuver	1208	-	1141	-
Stage 1	-	-	-	-
Stage 2	-	-	-	-
Platoon blocked, %	-	-	-	-
Mov Cap-1 Maneuver	1200	-	1121	-
Mov Cap-2 Maneuver	-	-	-	-
Stage 1	-	-	-	-
Stage 2	-	-	-	-

Approach	EB	WB	NB	SB
HCM Control Delay, s	1.2	0.4	20.2	13.9
HCM LOS			C	B

Minor Lane/Major Mvmt	NBLn1	EBL	EBT	EBR	WBL	WBT	WBR	SBLn1
Capacity (veh/h)	311	1200	-	-	1121	-	-	440
HCM Lane V/C Ratio	0.238	0.043	-	-	0.012	-	-	0.082
HCM Control Delay (s)	20.2	8.1	0	-	8.2	0	-	13.9
HCM Lane LOS	C	A	A	-	A	A	-	B
HCM 95th %tile Q(veh)	0.9	0.1	-	-	0	-	-	0.3

Lanes, Volumes, Timings  
6: Lagan & Access

Future Total 2031AM Peak Hour  
1531 St-Laurent Blvd

Lane Group	EBL	NBT	SBT
Lane Configurations	↕	↑	↑
Traffic Volume (vph)	47	27	32
Future Volume (vph)	47	27	32
Lane Group Flow (vph)	47	27	32
Sign Control	Stop	Free	Free

Intersection Summary	
Control Type: Unsignalized	
Intersection Capacity Utilization 13.3%	ICU Level of Service A
Analysis Period (min) 15	

HCM 2010 TWSC  
6: Lagan & Access

Future Total 2031AM Peak Hour  
1531 St-Laurent Blvd

Intersection						
Int Delay, s/veh	4					
Movement	EBL	EBR	NBL	NBT	SBT	SBR
Lane Configurations	↔		↑		↑	
Traffic Vol, veh/h	47	0	0	27	32	0
Future Vol, veh/h	47	0	0	27	32	0
Conflicting Peds, #/hr	0	0	0	0	0	0
Sign Control	Stop	Stop	Free	Free	Free	Free
RT Channelized	-	None	-	None	-	None
Storage Length	0	-	-	-	-	-
Veh in Median Storage, #	0	-	-	0	0	-
Grade, %	0	-	-	0	0	-
Peak Hour Factor	100	100	100	100	100	100
Heavy Vehicles, %	2	2	2	2	2	2
Mvmt Flow	47	0	0	27	32	0
Major/Minor	Minor2	Major1	Major2			
Conflicting Flow All	59	32	-	0	-	0
Stage 1	32	-	-	-	-	-
Stage 2	27	-	-	-	-	-
Critical Hdwy	6.42	6.22	-	-	-	-
Critical Hdwy Stg 1	5.42	-	-	-	-	-
Critical Hdwy Stg 2	5.42	-	-	-	-	-
Follow-up Hdwy	3.518	3.318	-	-	-	-
Pot Cap-1 Maneuver	948	1042	0	-	-	0
Stage 1	991	-	0	-	-	0
Stage 2	996	-	0	-	-	0
Platoon blocked, %	-	-	-	-	-	-
Mov Cap-1 Maneuver	948	1042	-	-	-	-
Mov Cap-2 Maneuver	948	-	-	-	-	-
Stage 1	991	-	-	-	-	-
Stage 2	996	-	-	-	-	-
Approach	EB	NB	SB			
HCM Control Delay, s	9	0	0			
HCM LOS	A					
Minor Lane/Major Mvmt	NBT	EBLn1	SBT			
Capacity (veh/h)	-	948	-			
HCM Lane V/C Ratio	-	0.05	-			
HCM Control Delay (s)	-	9	-			
HCM Lane LOS	-	A	-			
HCM 95th %tile Q(veh)	-	0.2	-			

Lanes, Volumes, Timings  
1: St-Laurent & Tremblay

Future Total 2031PM Peak Hour  
1531 St-Laurent Blvd

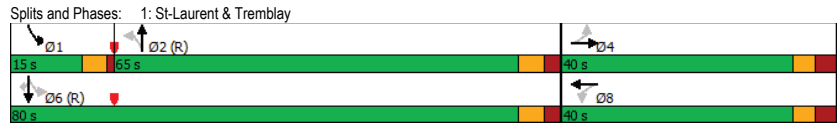
	↖	→	↗	←	↖	↑	↗	↓	↖
Lane Group	EBL	EBT	WBL	WBT	NBL	NBT	SBL	SBT	SBR
Lane Configurations	↔		↔		↔		↔		↔
Traffic Volume (vph)	228	38	23	21	38	1380	63	1099	94
Future Volume (vph)	228	38	23	21	38	1380	63	1099	94
Lane Group Flow (vph)	228	125	23	206	38	1392	63	1099	94
Turn Type	Perm	NA	Perm	NA	Perm	NA	pm+pt	NA	Perm
Protected Phases	4				8		2		6
Permitted Phases	4				8		2		6
Detector Phase	4				8		2		6
Switch Phase	4				8		2		6
Minimum Initial (s)	10.0	10.0	10.0	10.0	10.0	10.0	5.0	10.0	10.0
Minimum Split (s)	38.5	38.5	38.5	38.5	39.2	39.2	9.7	39.2	39.2
Total Split (s)	40.0	40.0	40.0	40.0	65.0	65.0	15.0	80.0	80.0
Total Split (%)	33.3%	33.3%	33.3%	33.3%	54.2%	54.2%	12.5%	66.7%	66.7%
Maximum Green (s)	33.5	33.5	33.5	33.5	58.8	58.8	10.3	73.8	73.8
Yellow Time (s)	3.3	3.3	3.3	3.3	3.7	3.7	3.7	3.7	3.7
All-Red Time (s)	3.2	3.2	3.2	3.2	2.5	2.5	1.0	2.5	2.5
Lost Time Adjust (s)	0.0	0.0	0.0	0.0	0.0	0.0	0.0	0.0	0.0
Total Lost Time (s)	6.5	6.5	6.5	6.5	6.2	6.2	4.7	6.2	6.2
Lead/Lag					Lag	Lag	Lead		
Lead-Lag Optimize?					Yes	Yes	Yes		
Vehicle Extension (s)	3.0	3.0	3.0	3.0	3.0	3.0	3.0	3.0	3.0
Recall Mode	None	None	None	None	C-Max	C-Max	None	C-Max	C-Max
Walk Time (s)	7.0	7.0	7.0	7.0	11.0	11.0	11.0	11.0	11.0
Flash Dont Walk (s)	25.0	25.0	25.0	25.0	22.0	22.0	22.0	22.0	22.0
Pedestrian Calls (#/hr)	6	6	2	2	16	16	12	12	12
Act Effct Calls (#/hr)	33.5	33.5	33.5	33.5	63.9	63.9	75.3	73.8	73.8
Actuated g/C Ratio	0.28	0.28	0.28	0.28	0.53	0.53	0.63	0.62	0.62
v/c Ratio	1.03	0.26	0.07	0.38	0.18	0.55	0.28	0.56	0.11
Control Delay	112.2	13.6	32.7	9.1	20.2	18.7	11.9	15.0	2.2
Queue Delay	0.0	0.0	0.0	0.0	0.0	0.0	0.0	0.0	0.0
Total Delay	112.2	13.6	32.7	9.1	20.2	18.7	11.9	15.0	2.2
LOS	F	B	C	A	C	B	B	B	A
Approach Delay	77.3			11.5		18.8		13.8	
Approach LOS	E			B		B		B	
Queue Length 50th (m)	-57.4	6.6	4.0	4.3	3.4	55.1	5.4	74.8	0.0
Queue Length 95th (m)	#106.4	21.5	10.6	23.0	m8.1	m89.3	10.8	92.8	6.2
Internal Link Dist (m)	390.4			0.1		682.5		144.8	
Turn Bay Length (m)	38.0		38.0		45.0		75.0		
Base Capacity (vph)	221	482	328	546	217	2534	260	1962	825
Starvation Cap Reductn	0	0	0	0	0	0	0	0	0
Spillback Cap Reductn	0	0	0	0	0	0	0	0	0
Storage Cap Reductn	0	0	0	0	0	0	0	0	0
Reduced v/c Ratio	1.03	0.26	0.07	0.38	0.18	0.55	0.24	0.56	0.11

Intersection Summary	
Cycle Length:	120
Actuated Cycle Length:	120
Offset:	49 (41%), Referenced to phase 2:NBTL and 6:SBTL, Start of Green
Natural Cycle:	90

Lanes, Volumes, Timings  
1: St-Laurent & Tremblay

Future Total 2031PM Peak Hour  
1531 St-Laurent Blvd

Control Type: Actuated-Coordinated	
Maximum v/c Ratio: 1.03	
Intersection Signal Delay: 22.7	Intersection LOS: C
Intersection Capacity Utilization 89.2%	ICU Level of Service E
Analysis Period (min) 15	
~ Volume exceeds capacity, queue is theoretically infinite.	
Queue shown is maximum after two cycles.	
# 95th percentile volume exceeds capacity, queue may be longer.	
Queue shown is maximum after two cycles.	
m Volume for 95th percentile queue is metered by upstream signal.	



Lanes, Volumes, Timings  
2: St-Laurent & Belfast

Future Total 2031PM Peak Hour  
1531 St-Laurent Blvd

Lane Group	EBL	EBT	EBR	WBL	WBT	NBL	NBT	NBR	SBL	SBT	SBR
Lane Configurations	↔	↕	↔	↔	↕	↔	↕	↔	↔	↕	↕
Traffic Volume (vph)	195	169	239	118	96	129	1005	110	113	896	133
Future Volume (vph)	195	169	239	118	96	129	1005	110	113	896	133
Lane Group Flow (vph)	195	169	239	118	261	129	1005	110	113	896	133
Turn Type	pm+pt	NA	Perm	Perm	NA	pm+pt	NA	Perm	pm+pt	NA	Perm
Protected Phases	7	4			8	5	2		1	6	
Permitted Phases	4		4	8		2		2	6		6
Detector Phase	7	4	4	8	8	5	2	2	1	6	6
Switch Phase											
Minimum Initial (s)	5.0	10.0	10.0	10.0	10.0	5.0	10.0	10.0	5.0	10.0	10.0
Minimum Split (s)	10.8	27.8	27.8	27.8	27.8	10.7	36.6	36.6	10.7	36.6	36.6
Total Split (s)	15.0	49.0	49.0	34.0	34.0	14.0	57.0	57.0	14.0	57.0	57.0
Total Split (%)	12.5%	40.8%	40.8%	28.3%	28.3%	11.7%	47.5%	47.5%	11.7%	47.5%	47.5%
Maximum Green (s)	9.2	43.2	43.2	28.2	28.2	8.3	51.4	51.4	8.3	51.4	51.4
Yellow Time (s)	3.3	3.3	3.3	3.3	3.3	4.2	4.2	4.2	4.2	4.2	4.2
All-Red Time (s)	2.5	2.5	2.5	2.5	2.5	1.5	1.4	1.4	1.5	1.4	1.4
Lost Time Adjust (s)	0.0	0.0	0.0	0.0	0.0	0.0	0.0	0.0	0.0	0.0	0.0
Total Lost Time (s)	5.8	5.8	5.8	5.8	5.8	5.7	5.6	5.6	5.7	5.6	5.6
Lead/Lag	Lead			Lag	Lag	Lead	Lag	Lag	Lead	Lag	Lag
Lead-Lag Optimize?	Yes			Yes	Yes	Yes	Yes	Yes	Yes	Yes	Yes
Vehicle Extension (s)	3.0	3.0	3.0	3.0	3.0	3.0	3.0	3.0	3.0	3.0	3.0
Recall Mode	None	None	None	None	None	None	C-Max	C-Max	None	C-Max	C-Max
Walk Time (s)	7.0	7.0	7.0	7.0	7.0	25.0	25.0	25.0	25.0	25.0	25.0
Flash Dont Walk (s)	15.0	15.0	15.0	15.0	15.0	6.0	6.0	6.0	6.0	6.0	6.0
Pedestrian Calls (#/hr)	44	44	44	14	14	20	20	20	23	23	23
Act Effct Green (s)	35.9	35.9	35.9	20.9	20.9	67.0	58.3	58.3	66.8	58.2	58.2
Actuated g/C Ratio	0.30	0.30	0.30	0.17	0.17	0.56	0.49	0.49	0.56	0.48	0.48
v/c Ratio	0.96	0.36	0.44	0.68	0.82	0.42	0.63	0.17	0.47	0.56	0.18
Control Delay	89.1	34.0	8.9	64.8	55.3	16.1	26.3	3.0	23.3	19.4	3.1
Queue Delay	0.0	0.0	0.0	0.0	0.0	0.0	0.0	0.0	0.0	0.0	0.0
Total Delay	89.1	34.0	8.9	64.8	55.3	16.1	26.3	3.0	23.3	19.4	3.1
LOS	F	C	A	E	E	B	C	A	C	B	A
Approach Delay		41.9			58.2		23.2			17.9	
Approach LOS		D			E		C			B	
Queue Length 50th (m)	36.4	31.0	6.4	26.2	44.9	12.4	91.7	0.0	10.1	47.4	0.0
Queue Length 95th (m)	#70.5	45.9	24.3	43.6	70.4	24.6	125.1	7.5	28.9	61.8	7.5
Internal Link Dist (m)		518.7			23.5		597.8			682.5	
Turn Bay Length (m)	75.0		200.0	65.0		75.0		55.0	75.0		85.0
Base Capacity (vph)	204	572	617	235	406	308	1596	644	248	1593	741
Starvation Cap Reductn	0	0	0	0	0	0	0	0	0	0	0
Spillback Cap Reductn	0	0	0	0	0	0	0	0	0	0	0
Storage Cap Reductn	0	0	0	0	0	0	0	0	0	0	0
Reduced v/c Ratio	0.96	0.30	0.39	0.50	0.64	0.42	0.63	0.17	0.46	0.56	0.18

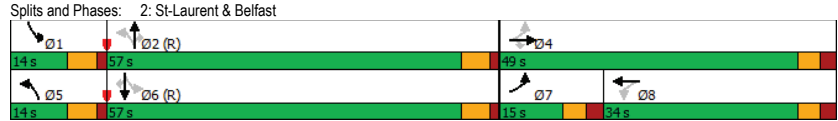
<b>Intersection Summary</b>											
Cycle Length: 120											
Actuated Cycle Length: 120											
Offset: 49 (41%), Referenced to phase 2:NBTL and 6:SBTL, Start of Green											
Natural Cycle: 90											



Lanes, Volumes, Timings  
2: St-Laurent & Belfast

Future Total 2031PM Peak Hour  
1531 St-Laurent Blvd

Control Type: Actuated-Coordinated  
Maximum v/c Ratio: 0.96  
Intersection Signal Delay: 28.7 Intersection LOS: C  
Intersection Capacity Utilization 83.9% ICU Level of Service E  
Analysis Period (min) 15  
# 95th percentile volume exceeds capacity, queue may be longer.  
Queue shown is maximum after two cycles.



Lanes, Volumes, Timings  
3: St-Laurent & Industrial/Innes

Future Total 2031PM Peak Hour  
1531 St-Laurent Blvd

	EBL	EBT	EBR	WBL	WBT	WBR	NBL	NBT	NBR	SBL	SBT	SBR
Lane Configurations	↔↔	↕↕	↔↔	↔↔	↕↕	↔↔	↔↔	↕↕	↔↔	↔↔	↕↕	↔↔
Traffic Volume (vph)	139	567	367	415	274	137	206	973	522	132	980	136
Future Volume (vph)	139	567	367	415	274	137	206	973	522	132	980	136
Lane Group Flow (vph)	139	567	367	415	274	137	206	973	522	132	980	136
Turn Type	Prot	NA	Perm	Prot	NA	Perm	Prot	NA	Perm	Prot	NA	Perm
Protected Phases	7	4		3	8		5	2		1	6	
Permitted Phases			4			8			2			6
Detector Phase	7	4	4	3	8	8	5	2	2	1	6	6
Switch Phase												
Minimum Initial (s)	5.0	10.0	10.0	5.0	10.0	10.0	5.0	10.0	10.0	5.0	10.0	10.0
Minimum Split (s)	11.6	38.6	38.6	11.6	38.6	38.6	11.3	37.6	37.6	11.3	37.6	37.6
Total Split (s)	19.0	38.0	38.0	41.0	60.0	60.0	28.0	43.0	43.0	28.0	43.0	43.0
Total Split (%)	12.7%	25.3%	25.3%	27.3%	40.0%	40.0%	18.7%	28.7%	28.7%	18.7%	28.7%	28.7%
Maximum Green (s)	12.4	31.4	31.4	34.4	53.4	53.4	21.7	36.4	36.4	21.7	36.4	36.4
Yellow Time (s)	3.7	3.7	3.7	3.7	3.7	3.7	4.2	4.2	4.2	4.2	4.2	4.2
All-Red Time (s)	2.9	2.9	2.9	2.9	2.9	2.9	2.1	2.4	2.4	2.1	2.4	2.4
Lost Time Adjust (s)	0.0	0.0	0.0	0.0	0.0	0.0	0.0	0.0	0.0	0.0	0.0	0.0
Total Lost Time (s)	6.6	6.6	6.6	6.6	6.6	6.6	6.3	6.6	6.6	6.3	6.6	6.6
Lead/Lag	Lead	Lag	Lag	Lead	Lag	Lag	Lead	Lag	Lag	Lead	Lag	Lag
Lead-Lag Optimize?	Yes	Yes	Yes	Yes	Yes	Yes	Yes	Yes	Yes	Yes	Yes	Yes
Vehicle Extension (s)	3.0	3.0	3.0	3.0	3.0	3.0	3.0	3.0	3.0	3.0	3.0	3.0
Recall Mode	None	None	None	None	None	None	None	Max	Max	None	Max	Max
Walk Time (s)	7.0	7.0	7.0	7.0	7.0	7.0	7.0	7.0	7.0	7.0	7.0	7.0
Flash Dont Walk (s)	25.0	25.0	25.0	25.0	25.0	25.0	24.0	24.0	24.0	24.0	24.0	24.0
Pedestrian Calls (#/hr)	6	6	6	6	7	7	10	10	10	10	14	14
Act Effct Green (s)	10.5	27.1	27.1	21.7	38.3	38.3	13.8	39.6	39.6	11.0	36.8	36.8
Actuated g/C Ratio	0.08	0.22	0.22	0.17	0.30	0.30	0.11	0.32	0.32	0.09	0.29	0.29
v/c Ratio	0.52	0.81	0.67	0.75	0.28	0.26	0.60	0.95	0.68	0.50	1.03	0.25
Control Delay	64.4	57.5	15.4	59.1	34.1	6.3	62.5	61.8	11.5	63.4	81.6	3.8
Queue Delay	0.0	0.0	0.0	0.0	0.0	0.0	0.0	0.0	0.0	0.0	0.0	0.0
Total Delay	64.4	57.5	15.4	59.1	34.1	6.3	62.5	61.8	11.5	63.4	81.6	3.8
LOS	E	E	B	E	C	A	E	E	B	E	F	A
Approach Delay		44.0			42.1			46.4			71.2	
Approach LOS		D			D			D			E	
Queue Length 50th (m)	17.3	70.4	11.8	51.3	27.1	0.0	25.6	125.8	11.8	16.4	-140.3	0.0
Queue Length 95th (m)	30.7	101.0	48.2	73.3	40.7	14.4	41.3	#199.1	56.8	28.8	#214.6	9.1
Internal Link Dist (m)		745.6			700.4			316.7			597.8	
Turn Bay Length (m)	38.0		120.0	150.0		80.0	100.0		100.0	125.0		150.0
Base Capacity (vph)	320	822	591	888	1368	700	544	1023	763	529	950	538
Starvation Cap Reductn	0	0	0	0	0	0	0	0	0	0	0	0
Spillback Cap Reductn	0	0	0	0	0	0	0	0	0	0	0	0
Storage Cap Reductn	0	0	0	0	0	0	0	0	0	0	0	0
Reduced v/c Ratio	0.43	0.69	0.62	0.47	0.20	0.20	0.38	0.95	0.68	0.25	1.03	0.25

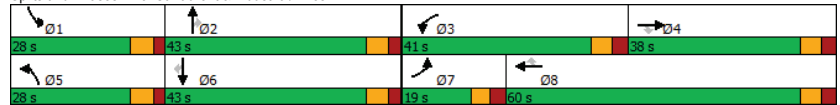
Intersection Summary  
Cycle Length: 150  
Actuated Cycle Length: 125.7  
Natural Cycle: 120  
Control Type: Actuated-Uncoordinated

Lanes, Volumes, Timings  
**3: St-Laurent & Industrial/Innes**

Future Total 2031PM Peak Hour  
 1531 St-Laurent Blvd

Maximum v/c Ratio: 1.03	
Intersection Signal Delay: 51.5	Intersection LOS: D
Intersection Capacity Utilization 87.4%	ICU Level of Service E
Analysis Period (min) 15	
~ Volume exceeds capacity, queue is theoretically infinite. Queue shown is maximum after two cycles.	
# 95th percentile volume exceeds capacity, queue may be longer. Queue shown is maximum after two cycles.	

Splits and Phases: 3: St-Laurent & Industrial/Innes



Lanes, Volumes, Timings  
**4: Access & Belfast**

Future Total 2031PM Peak Hour  
 1531 St-Laurent Blvd

	→ ←	
Lane Group	EBT	WBT
Lane Configurations	↶ ↷	↶ ↷
Traffic Volume (vph)	336	379
Future Volume (vph)	336	379
Lane Group Flow (vph)	387	380
Sign Control	Free	Free

<b>Intersection Summary</b>	
Control Type: Unsignalized	
Intersection Capacity Utilization 25.3%	ICU Level of Service A
Analysis Period (min) 15	

Lanes, Volumes, Timings  
5: Lagan & Belfast

Future Total 2031PM Peak Hour  
1531 St-Laurent Blvd

Lane Group	EBT	WBT	NBT	SBT
Lane Configurations	↕	↕	↕	↕
Traffic Volume (vph)	265	310	5	0
Future Volume (vph)	265	310	5	0
Lane Group Flow (vph)	361	355	87	69
Sign Control	Free	Free	Stop	Stop

Intersection Summary	
Control Type: Unsignalized	
Intersection Capacity Utilization 51.6%	ICU Level of Service A
Analysis Period (min) 15	

HCM 2010 TWSC  
5: Lagan & Belfast

Future Total 2031PM Peak Hour  
1531 St-Laurent Blvd

Intersection												
Int Delay, s/veh	3.9											
Movement	EBL	EBT	EBR	WBL	WBT	WBR	NBL	NBT	NBR	SBL	SBT	SBR
Lane Configurations		↕			↕			↕			↕	
Traffic Vol, veh/h	46	265	50	19	310	26	65	5	17	30	0	39
Future Vol, veh/h	46	265	50	19	310	26	65	5	17	30	0	39
Conflicting Peds, #/hr	12	0	14	14	0	12	1	0	6	6	0	1
Sign Control	Free	Free	Free	Free	Free	Free	Stop	Stop	Stop	Stop	Stop	Stop
RT Channelized	-	-	None	-	-	None	-	-	None	-	-	None
Storage Length	-	-	-	-	-	-	-	-	-	-	-	-
Veh in Median Storage, #	-	0	-	-	0	-	-	0	-	-	0	-
Grade, %	-	0	-	-	0	-	-	0	-	-	0	-
Peak Hour Factor	100	100	100	100	100	100	100	100	100	100	100	100
Heavy Vehicles, %	30	6	12	5	3	8	4	2	2	10	2	2
Mvmt Flow	46	265	50	19	310	26	65	5	17	30	0	39

Major/Minor	Major1		Major2		Minor1		Minor2					
Conflicting Flow All	348	0	0	329	0	0	778	782	310	772	794	336
Stage 1	-	-	-	-	-	-	396	396	-	373	373	-
Stage 2	-	-	-	-	-	-	382	386	-	399	421	-
Critical Hdwy	4.4	-	-	4.15	-	-	7.14	6.52	6.22	7.2	6.52	6.22
Critical Hdwy Stg 1	-	-	-	-	-	-	6.14	5.52	-	6.2	5.52	-
Critical Hdwy Stg 2	-	-	-	-	-	-	6.14	5.52	-	6.2	5.52	-
Follow-up Hdwy	2.47	-	-	2.245	-	-	3.536	4.018	3.318	3.59	4.018	3.318
Pot Cap-1 Maneuver	1071	-	-	1214	-	-	311	326	730	307	321	706
Stage 1	-	-	-	-	-	-	625	604	-	632	618	-
Stage 2	-	-	-	-	-	-	636	610	-	611	589	-
Platoon blocked, %	-	-	-	-	-	-	-	-	-	-	-	-
Mov Cap-1 Maneuver	1061	-	-	1201	-	-	274	297	719	276	292	699
Mov Cap-2 Maneuver	-	-	-	-	-	-	274	297	-	276	292	-
Stage 1	-	-	-	-	-	-	586	566	-	593	600	-
Stage 2	-	-	-	-	-	-	588	592	-	557	552	-

Approach	EB	WB	NB	SB
HCM Control Delay, s	1.1	0.4	20.9	15.3
HCM LOS			C	C

Minor Lane/Major Mvmt	NBLn1	EBL	EBT	EBR	WBL	WBT	WBR	SBLn1
Capacity (veh/h)	313	1061	-	-	1201	-	-	419
HCM Lane V/C Ratio	0.278	0.043	-	-	0.016	-	-	0.165
HCM Control Delay (s)	20.9	8.5	0	-	8	0	-	15.3
HCM Lane LOS	C	A	A	-	A	A	-	C
HCM 95th %tile Q(veh)	1.1	0.1	-	-	0	-	-	0.6

Lanes, Volumes, Timings  
6: Lagan & Access

Future Total 2031PM Peak Hour  
1531 St-Laurent Blvd

Lane Group	EBL	NBT	SBT
Lane Configurations	↔	↑	↑
Traffic Volume (vph)	40	47	69
Future Volume (vph)	40	47	69
Lane Group Flow (vph)	40	47	69
Sign Control	Stop	Free	Free

Intersection Summary		
Control Type: Unsignalized		
Intersection Capacity Utilization 13.8%		ICU Level of Service A
Analysis Period (min) 15		

HCM 2010 TWSC  
6: Lagan & Access

Future Total 2031PM Peak Hour  
1531 St-Laurent Blvd

Intersection						
Int Delay, s/veh	2.4					
Movement	EBL	EBR	NBL	NBT	SBT	SBR
Lane Configurations	↔			↑	↑	
Traffic Vol, veh/h	40	0	0	47	69	0
Future Vol, veh/h	40	0	0	47	69	0
Conflicting Peds, #/hr	0	0	0	0	0	0
Sign Control	Stop	Stop	Free	Free	Free	Free
RT Channelized	-	None	-	None	-	None
Storage Length	0	-	-	-	-	-
Veh in Median Storage, #	0	-	-	0	0	-
Grade, %	0	-	-	0	0	-
Peak Hour Factor	100	100	100	100	100	100
Heavy Vehicles, %	2	2	2	2	2	2
Mvmt Flow	40	0	0	47	69	0

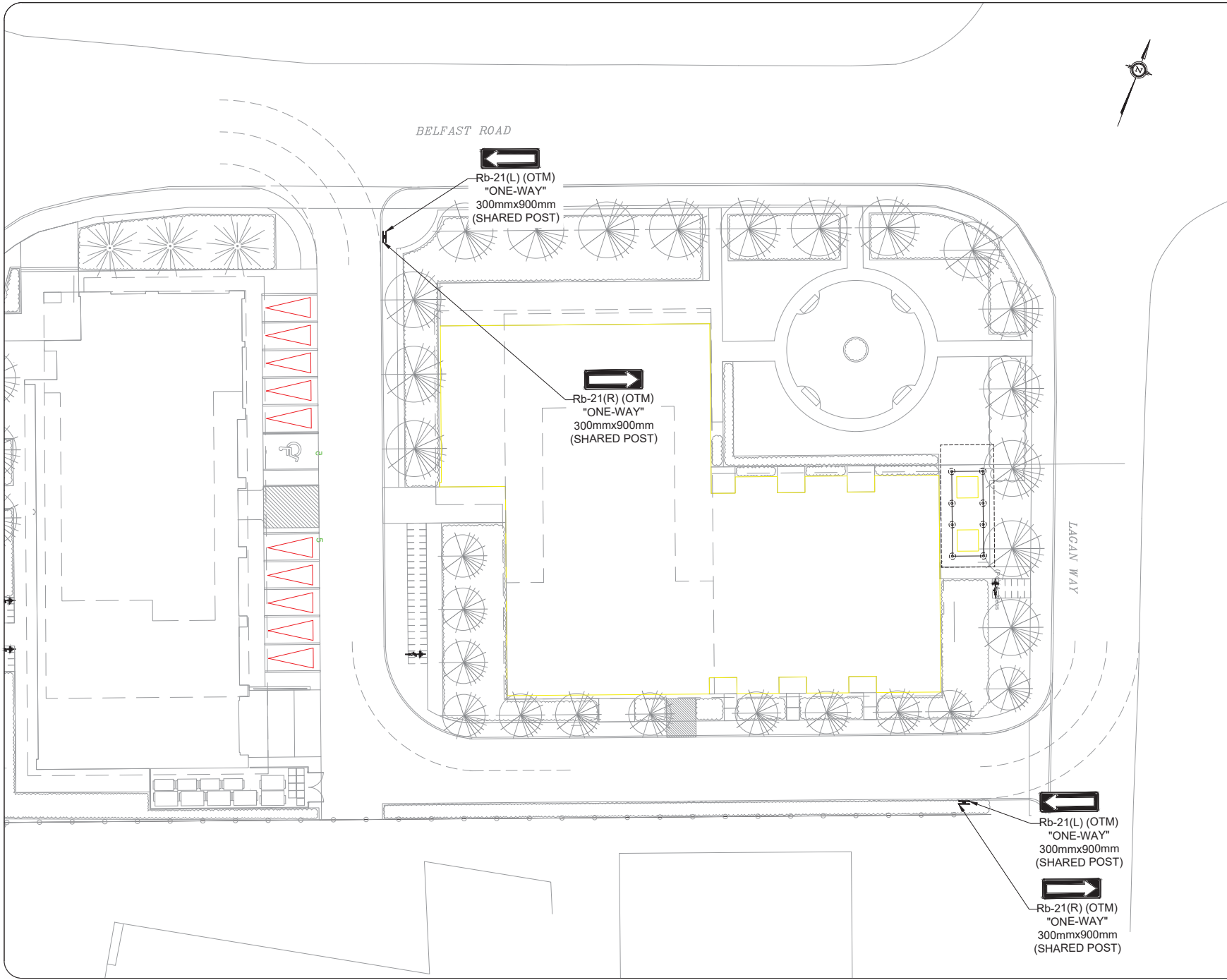
Major/Minor	Minor2	Major1	Major2
Conflicting Flow All	116	69	0
Stage 1	69	-	-
Stage 2	47	-	-
Critical Hdwy	6.42	6.22	-
Critical Hdwy Stg 1	5.42	-	-
Critical Hdwy Stg 2	5.42	-	-
Follow-up Hdwy	3.518	3.318	-
Pot Cap-1 Maneuver	880	994	0
Stage 1	954	-	0
Stage 2	975	-	0
Platoon blocked, %	-	-	-
Mov Cap-1 Maneuver	880	994	-
Mov Cap-2 Maneuver	880	-	-
Stage 1	954	-	-
Stage 2	975	-	-

Approach	EB	NB	SB
HCM Control Delay, s	9.3	0	0
HCM LOS	A		

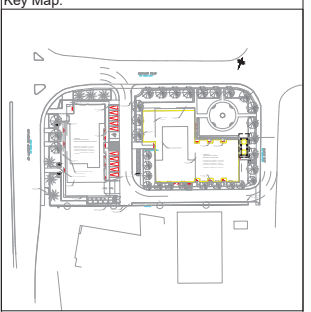
Minor Lane/Major Mvmt	NBT EBLn1	SBT
Capacity (veh/h)	-	880
HCM Lane V/C Ratio	-	0.045
HCM Control Delay (s)	-	9.3
HCM Lane LOS	-	A
HCM 95th %tile Q(veh)	-	0.1

# Appendix N

Signage Plan



Notes:



01	Issued for Review	JK	2024-06-17
REV:	DESCRIPTION:	BY:	DATE:
STATUS:			

**CGH Transportation**  
 6 Plaza Court  
 Ottawa, ON  
 K2H 7W1  
 (343) 999-9117

CLIENT: KTS  
 ARCHITECT:

SITE: 1531 St Laurent  
 TITLE: Signage Plan

SCALE AT A3:	DATE:	DRAWN:	CHECKED:
NTS	2024-06-17	AN	JK
PROJECT NO:	DRAWING NO:	REVISION:	
2023-053	001	01	