

# **Transportation Impact Assessment**

## **1280 Trim Road**





## Certification Form for TIA Study PM

### TIA Plan Reports

On 14 June 2017, the Council of the City of Ottawa adopted new Transportation Impact Assessment (TIA) Guidelines. In adopting the guidelines, Council established a requirement for those preparing and delivering transportation impact assessments and reports to sign a letter of certification.

Individuals submitting TIA reports will be responsible for all aspects of development-related transportation assessment and reporting, and undertaking such work, in accordance and compliance with the City of Ottawa's Official Plan, the Transportation Master Plan and the Transportation Impact Assessment (2017) Guidelines.

By submitting the attached TIA report (and any associated documents) and signing this document, the individual acknowledges that s/he meets the four criteria listed below.

### CERTIFICATION



I have reviewed and have a sound understanding of the objectives, needs and requirements of the City of Ottawa's Official Plan, Transportation Master Plan, and the Transportation Impact Assessment (2017) Guidelines;



I have a sound knowledge of industry standard practice with respect to the preparation of transportation impact assessment reports, including multi modal level of service review;



I have substantial experience (more than 5 years) in undertaking and delivering transportation impact studies (analysis, reporting and geometric design) with strong background knowledge in transportation planning, engineering, or traffic operations; and



I am either a licensed<sup>1</sup> or registered<sup>2</sup> professional in good standing, whose field of expertise.



is either transportation engineering



or transportation planning.

<sup>1,2</sup> License of registration body that oversees the profession is required to have a code of conduct and ethics guidelines that will ensure appropriate conduct and representation for transportation planning and/or transportation engineering works.

Dated at Ottawa this 25 day of January, 2024.  
(City)

Name: Rani Nahas, P.Eng.  
(Please Print)

Professional Title: Transportation Engineer

  
Signature of Individual certifier that she meets the above four criteria.

<b>Office Contact Information (Please Print)</b>	
Address:	343 Preston Street, Suite 1000
City / Postal Code:	Ottawa, ON K1S 1N4
Telephone / Extension:	613 728-3571
E-Mail Address:	rnahas@jrichards.ca

Stamp

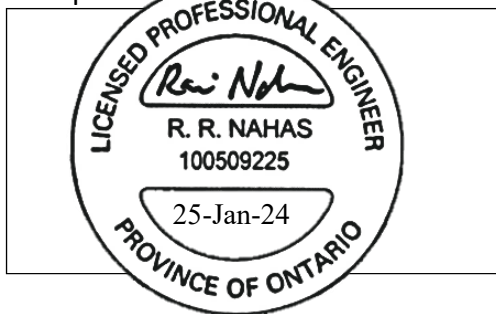

# Transportation Impact Assessment

1280 Trim Road

---

## Table of Contents

---

<b>Introduction</b> .....	<b>1</b>
<b>1.0 Screening</b> .....	<b>1</b>
<b>2.0 Scoping</b> .....	<b>1</b>
2.1 Existing and Planned Conditions .....	1
Description of Proposed Development.....	1
Existing Conditions.....	4
Area Road Network.....	4
Study Area Intersections .....	5
Existing Driveways to Adjacent Development.....	6
Pedestrian/Cycling Network .....	7
Transit Network .....	9
Area Traffic Management.....	11
Peak Hour Travel Demands.....	11
Existing Road Safety Conditions.....	11
Planned Conditions .....	14
Study Area Transportation Network Changes.....	14
Other Area Development .....	15
2.2 Study Area and Time Periods .....	16
Study Area .....	16
Time Periods .....	17
Horizon Years .....	17
2.3 Exemptions Review.....	17
<b>3.0 Forecasting</b> .....	<b>18</b>
3.1 Development Related Travel Demand .....	18
Trip Generation .....	18
Travel Mode Shares .....	20
Trip Distribution .....	23
Trip Assignment .....	23
3.2 Background Network Travel Demands .....	23
Transportation Network Plans.....	23
Other Area Developments.....	23
Background Growth .....	27
3.3 Demand Rationalization .....	30
Existing Conditions.....	30
Background 2026 Conditions .....	32
Background 2031 Conditions .....	34
Adjustments to Background Network Demand .....	36
Total Projected Conditions .....	37
Adjustments to Site-Generated Demand .....	44
<b>4.0 Analysis</b> .....	<b>44</b>
4.1 Development Design .....	44
Design for Sustainable Modes .....	44
Circulation and Access.....	44
4.2 Parking .....	45
Parking Supply .....	45

# Transportation Impact Assessment

## 1280 Trim Road

---

	Vehicular Parking .....	45
	Bike Parking .....	46
	Spillover Parking .....	46
4.3	Boundary Street Design .....	46
	Mobility .....	47
	Segment MMLOS Summary .....	47
	Pedestrian LOS .....	47
	Bike LOS .....	47
	Transit LOS .....	47
	Truck LOS .....	48
	Road Safety .....	48
	Neighbourhood Traffic Management (NTM) .....	50
4.4	Access Intersections .....	50
4.5	Transportation Demand Management .....	50
4.6	Neighborhood Traffic Management.....	51
4.7	Transit51	
	Route Capacity.....	51
	Transit Priority .....	51
4.8	Review of Network Concept.....	51
4.9	Access and Intersection Design .....	51
	Location and Design of Access .....	51
	New Street Networks .....	56
	Intersection Control .....	56
	Intersection Design .....	56
	Intersection MMLOS Summary .....	56
	Pedestrian LOS .....	56
	Bike LOS .....	57
	Transit LOS .....	57
	Truck LOS .....	57
	Auto LOS.....	57
<b>5.0</b>	<b>Findings and Recommendations.....</b>	<b>57</b>

### List of Figures

Figure 1: Local Context.....	2
Figure 2: Proposed Site Plan .....	3
Figure 3: Adjacent Driveways .....	6
Figure 4: Crosstown Bikeway Network .....	7
Figure 5: Existing Pedestrian Network .....	8
Figure 6: Existing Cycling Network .....	8
Figure 7: Transit Routes Within Study Area.....	9
Figure 8: Transit Stops Within Study Area .....	10
Figure 9: Existing Peak Hour Traffic Volumes .....	12
Figure 10: Existing Peak Hour Active Mode Volumes .....	13
Figure 11: Collision Frequency .....	14
Figure 12: Stage 2 LRT Network .....	15
Figure 13: 'New' Projected Site-Generated Traffic .....	24
Figure 14: 'Pass-By' Projected Site-Generated Traffic .....	25
Figure 15: Other Area Development Traffic .....	26
Figure 16: Background Traffic Volumes (2026) .....	28

# Transportation Impact Assessment

1280 Trim Road

---

Figure 17: Background Traffic Volumes (2031) .....	29
Figure 18: Total Projected Traffic Volumes (2026) .....	38
Figure 19: Total Projected Traffic Volumes (2031) .....	41
Figure 20: Clear Throat Lengths – Measured from the Curb Return Radii .....	54
Figure 21: Number of Conflicts at a Full-Movement vs. Right-In/Right-Out Connection.....	54

## List of Tables

---

Table 1: OC Transpo Stop Information .....	9
Table 2: OC Transpo Route Information .....	10
Table 3: Area Development .....	16
Table 4: Module Exemption Review .....	17
Table 5: ITE Peak Hour Trip Generation Rates .....	18
Table 6: Modified Peak Period Person Trips .....	19
Table 7: Projected Site Generated Trips – Fast Food Restaurant with Drive-Thru.....	21
Table 8: Projected Site Generated Trips – Small Office Building .....	21
Table 9: Projected Site Generated Trips – Automobile Parts and Service Centre.....	21
Table 10: Projected Site Generated Trips – Fast Food Restaurant without Drive-Thru .....	22
Table 11: Total Projected Site Generated Trips.....	22
Table 12: Study Area Intersection Operations – Existing Conditions .....	30
Table 13: Study Area Intersection Operations – 2026 Background Conditions .....	32
Table 14: Study Area Intersection Operations – 2031 Background Conditions .....	34
Table 15: Study Area Intersection Operations – Total Projected Conditions (2026).....	39
Table 16: Study Area Intersection Operations – Total Projected Conditions (2031).....	42
Table 17: Vehicular Parking Supply .....	46
Table 18: Bicycle Parking Supply .....	46
Table 19: Segment MMLOS – Existing LOS (Target LOS).....	47
Table 20: Historical Collision Data Summary by Road Segment.....	48
Table 21: Historical Collision Data Summary by Intersection .....	49
Table 22: Intersection MMLOS – Existing LOS(Target LOS) .....	56

## List of Appendices

---

Appendix A – TIA Screening Form
Appendix B – Existing Traffic Counts
Appendix C – Collision Data
Appendix D – Existing and Background Conditions Synchro Analysis
Appendix E – Future Total Conditions Synchro Analysis
Appendix F – MMLOS Analysis
Appendix G – Collision Analysis
Appendix H – Transportation Demand Management Checklists
Appendix I – A & W Drive-Through Stacking Study

# Transportation Impact Assessment

1280 Trim Road

---

## Introduction

---

With respect to the City of Ottawa's updated 2023 Transportation Impact Assessment (TIA) Guidelines, a total of four separate submissions are required for City review/approval. Each submission is a component/section of a formal TIA, which includes:

- *Step 1 – Screening*
- *Step 2 – Scoping*
- *Step 3 – Analysis*
- *Step 4 – TIA Submission* (i.e., Findings and Recommendations)

This report has been structured with these above noted *Steps 1-4* as numbered sections, accordingly, as outlined in the City's TIA Guidelines.

## 1.0 Screening

---

Regarding *Step 1 – Screening*, this is a form that contains a list of triggers to determine if the proposed size, type, and location of a proposed development will require a formal TIA, as part of the City's development application approval process (e.g., not all new developments require a TIA).

In accordance with the City of Ottawa's 2023 Transportation Impact Assessment (TIA) Guidelines, the proposed development (described below in Section 2.1) triggered the trip generation, location and the safety criteria outlined in the City's TIA Step 1 – Screening form. Given these triggers were met, a formal TIA (i.e., completed Steps 1-4) must accompany the subject development application.

## 2.0 Scoping

---

### 2.1 Existing and Planned Conditions

#### Description of Proposed Development

Based on the information provided, it is our understanding that the proponent is seeking City approval for the development of approximately 5,900 m<sup>2</sup> of predominantly vacant land municipally known as 1280 Trim Road within Ottawa's Orleans community. The subject site is currently zoned as a Light Industrial Zone (IL) and is located approximately 103 m south of the Trim/Taylor Creek intersection and 207 m north of the Trim/Old Montréal intersection.

The latest Site Plan illustrates that the proposed development will include two buildings that are composed of office/personal services (up to five units for future tenants, totaling approximately 550 m<sup>2</sup>), automotive service building (one unit totaling approximately 680 m<sup>2</sup>), and two restaurant spaces (totaling approximately 325 m<sup>2</sup>), one of which will include a drive-through facility that is planned to be an A&W restaurant. Access/egress to approximately 75 vehicle parking spaces will be provided via a single right-in/right-out driveway connection to Trim Road. The proposed site is also located within 600 m of the future Trim Road LRT station (located north of Taylor Creek Drive, at the intersection of Trim Road and Highway 174). The subject development will be constructed in a single phase, with an estimated build-out year of 2026.

The local context surrounding the subject development site is depicted in the following **Figure 1**, and the proposed Site Plan is depicted in the subsequent **Figure 2**.

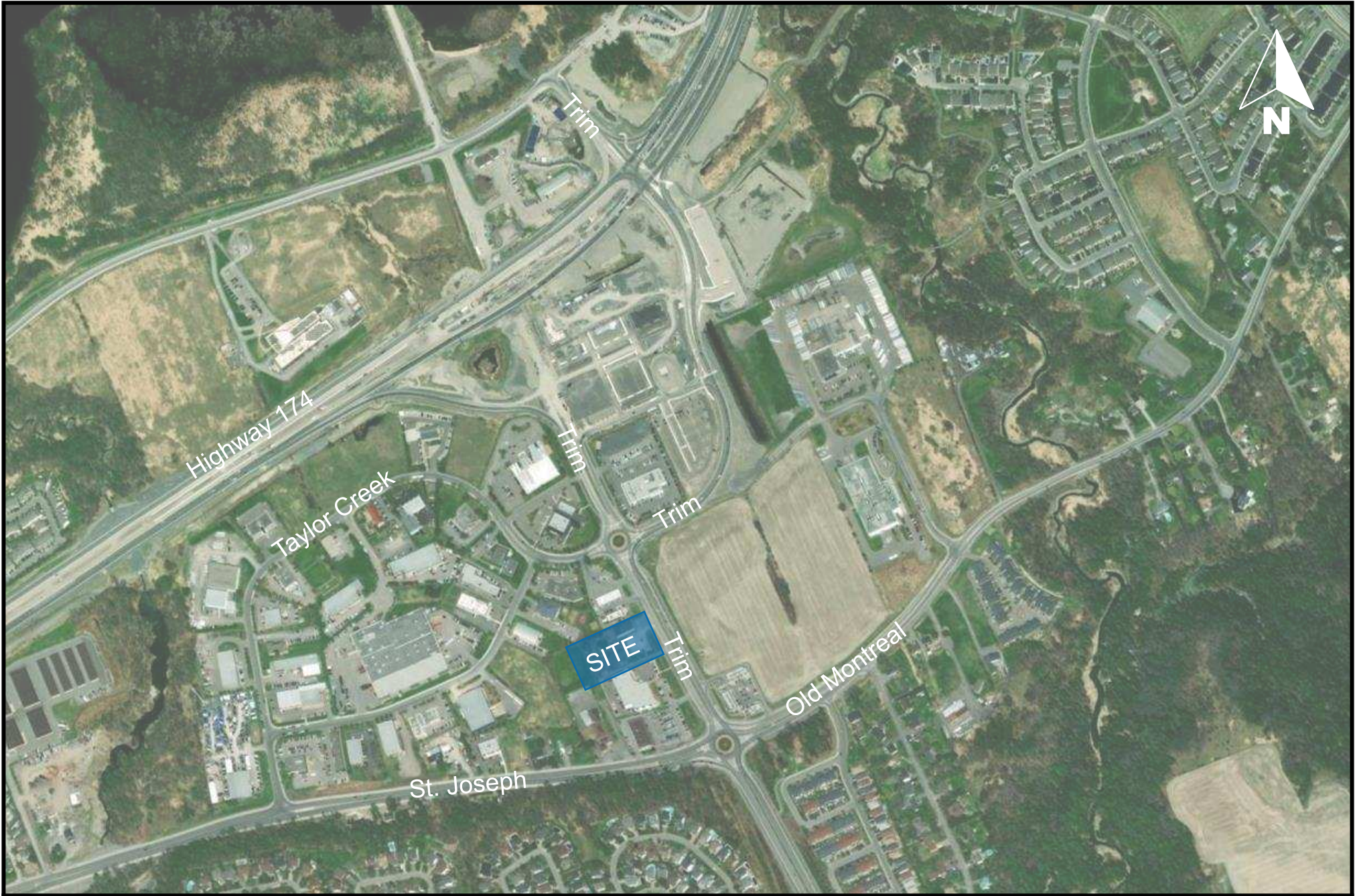

**Figure 1: Local Context**



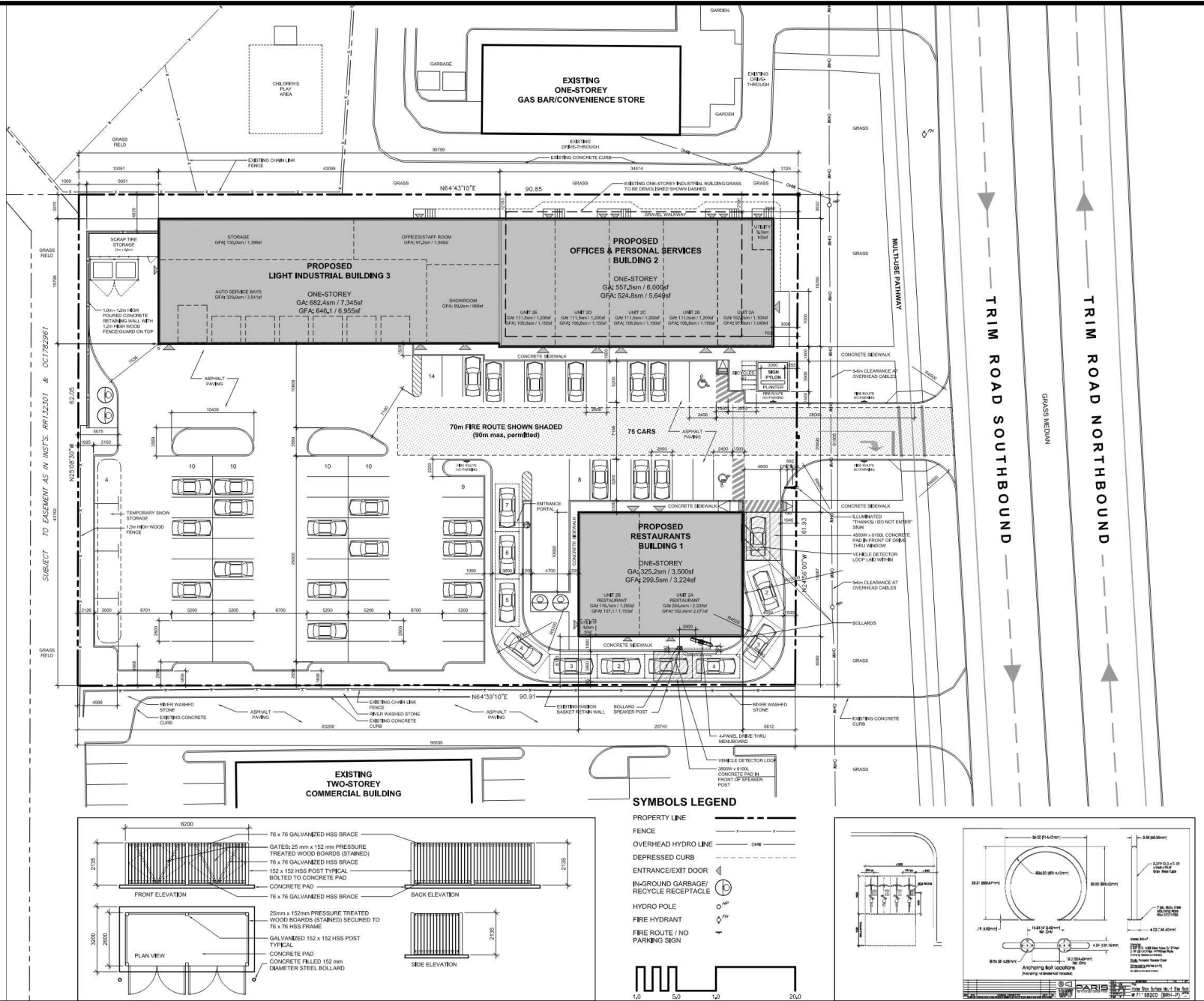

**Figure 2: Proposed Site Plan**

# Transportation Impact Assessment

1280 Trim Road

---

## Existing Conditions

### Area Road Network

**Highway 174** is a four-lane east-west municipal freeway (i.e., two travel lanes per direction) that extends from Highway 417 in the west to Canaan Road, where it continues as Highway 17. Highway 174 is classified as an arterial roadway approximately 600 m east of Trim Road to Canaan Road. Within the vicinity of the subject development site, the posted speed limit is 90 km/h and on-street parking regulations are unposted. With respect to City By-Law, on-street parking is prohibited on any portion of a highway not intended for vehicle parking. Highway 174 is a designated truck route for full loads.

**Trim Road** is a four-lane north-south arterial roadway (i.e., two travel lanes per direction) with a center median along the subject site's frontage. It extends from Highway 174 in the north to Perrault Road in the south. Within the vicinity of the subject development site, the posted speed limit is 60 km/h and 30 km/h within the roundabout zone (i.e., within 200 m of the roundabout). On-street parking is not permitted. Trim Road is a designated truck route for full loads.

**Old Montréal Road** is a two-lane east-west arterial roadway (i.e., one travel lane per direction). It extends from the St. Joseph/Trim roundabout in the west to Highway 174 in the east. Within the subject development site, the posted speed limit is 60 km/h and 30 km/h within 130 m of the roundabout. On-street parking is not permitted on both sides of the roadway. Old Montréal Road is a designated truck route for full loads.

**St. Joseph Boulevard** is a four-lane east-west arterial roadway (i.e., two travel lanes per direction). It extends between Highway 174 in the west and the Trim/Old Montreal roundabout in the east. East of Trim Road, the roadway continues as Old Montréal Road. Within the vicinity of the subject development site, the posted speed limit is 60 km/h and 30 km/h approaching the roundabout intersection at Trim/Old Montréal (i.e., within 200 m of the roundabout). On-street parking regulations are unposted. St. Joseph Boulevard is a designated truck route for full loads.

**Taylor Creek Drive** is a two-lane east-west collector roadway (i.e., one travel lane per direction). It begins as a north-south roadway intersecting with St. Joseph Boulevard in the west and terminates at Trim Road in the east. Within the vicinity of the subject development site, the unposted speed limit is understood to be 50 km/h and within 100 m of the roundabout, the posted speed limit is 30 km/h. On-street parking regulations are unposted. With respect to City By-Law, on-street parking is permitted for a maximum of 3 hours along both sides of the roadway, where possible (e.g., you may only park on-street, if you can be completely clear of the adjacent travel lane).

# Transportation Impact Assessment

## 1280 Trim Road

---

### Study Area Intersections

#### Trim/Highway 174

The Trim/Highway 174 is a signalized four-legged intersection. The northbound approach consists of dual auxiliary left-turn lanes, a through lane, and a channelized right-turn lane. The southbound approach consists of an auxiliary left-turn lane, a through lane, and a channelized right-turn lane. The eastbound approach consists of an auxiliary left-turn lane and two through lanes. The westbound approaches consist of an auxiliary left-turn lane, two through lanes and a channelized right-turn lane.

Right-turns are prohibited on the eastbound approach. Note there are “No-Right-Turn” signs posted for all approaches, however, right-turns are permitted for the northbound, southbound, and westbound directions such that drivers use the provided right-turn channel. All other movements are permitted at this location.

The Highway 174 eastbound off-ramp is provided as a channelized right-turn to Trim Road north of Taylor Creek Road approximately 575 m west of the signalized Trim/Highway 174 intersection.

#### Trim/Taylor Creek

The Trim/Taylor Creek intersection is a YIELD controlled four-legged roundabout. The northbound and southbound approaches consist of a shared left-turn/through lane and a shared through/right-turn lane. The westbound and eastbound approaches consist of a single shared lane that accommodates all possible movements.

All movements are permitted at this location.



# Transportation Impact Assessment

## 1280 Trim Road

### Trim/Old Montréal

The Trim/Old Montréal intersection is a YIELD controlled four-legged roundabout. The northbound and southbound approaches consist of a shared left-turn/through lane and a shared through/right-turn lane. The eastbound and westbound approaches consist of a shared left-turn/through lane, a through lane, and a channelized right-turn lane.

All movements are permitted at this location.

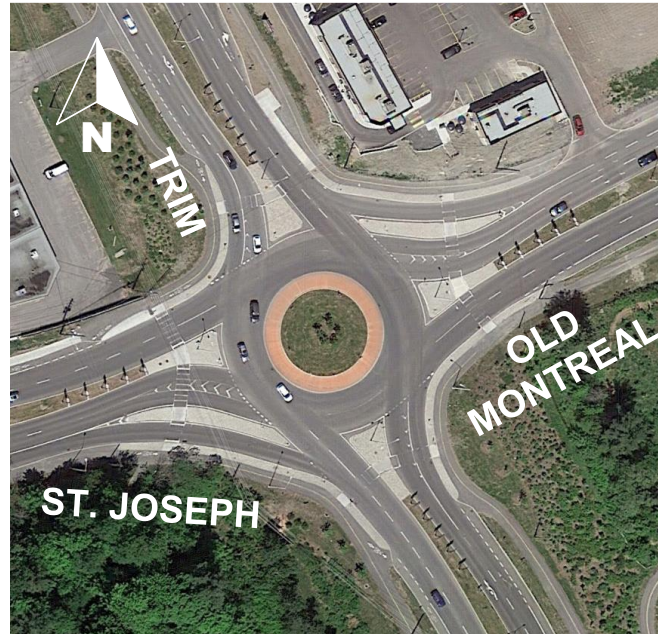

### Existing Driveways to Adjacent Development

As depicted in the following **Figure 3**, there are approximately 5 driveway connections within a 200 m boundary of the future site driveway connections. All the driveways adjacent to the subject development provide access/egress to commercial developments.

**Figure 3: Adjacent Driveways**



# Transportation Impact Assessment

## 1280 Trim Road

### Pedestrian/Cycling Network

The pedestrian network along the site's frontage is currently comprised of an asphalt multi-use pathway (MUP) that run along both sides of Trim Road and Old Montréal Road between St. Joseph Boulevard and Antigonish Avenue. However, beyond Antigonish Avenue, asphalt sidewalks exist only on the south side of Old Montréal Road with concrete sidewalks on the north side up until Aveia Private/Dairy Drive. Beyond Aveia Private, there are no existing pedestrian facilities.

On Taylor Creek Drive, concrete sidewalks are provided on both sides of the roadway for approximately 140 m where the concrete sidewalks exist on only the south side of the roadway. Additionally, concrete sidewalks are provided on both sides of St. Joseph Boulevard and the north side of Montreal Road.

With respect to cyclists, the current network consists of the aforementioned MUPs on Trim Road, pocket bike lanes on both sides of Trim Road, Old Montréal Road, and St. Joseph Boulevard. These roadways are all classified as 'Spine Routes' in the City's 2013 TMP. Trim Road and St. Joseph Boulevard are also designated as Crosstown Bikeways in the City's 2013 TMP - *Crosstown Bikeway Network* as shown in **Figure 4** below.

**Figure 4: Crosstown Bikeway Network**

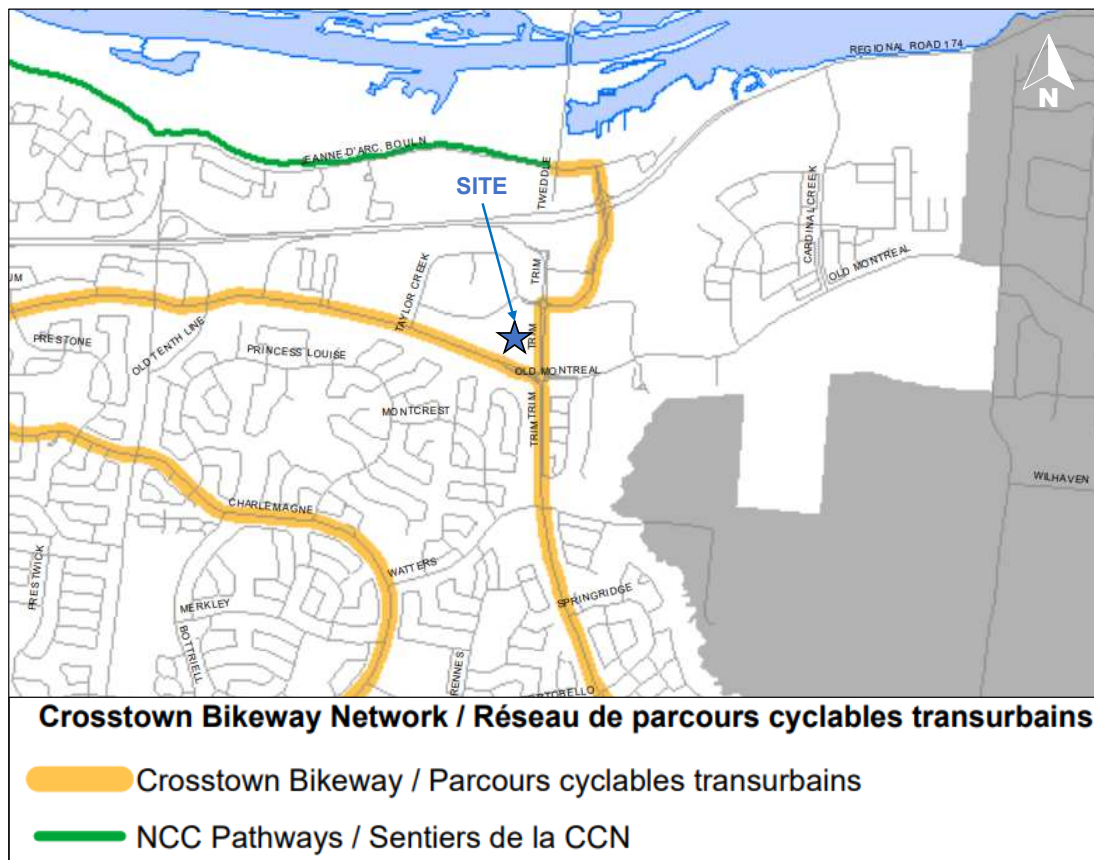

Source: <https://engage.ottawa.ca/11511/widgets/45934/documents/100586>, accessed 2023-04-18

Detailed maps of the existing study area pedestrian/cycling network, and how it connects to the greater network is depicted in the following **Figure 5** and **Figure 6**, as sourced from GeoOttawa.

# Transportation Impact Assessment

## 1280 Trim Road

It should be noted that the pedestrian network has not been updated on the City's data sources, since a number of new facilities have been implemented (i.e., concrete sidewalks on St. Joseph Boulevard and Trim Road opposite Taylor Creek Drive and the MUP along Trim Road). However, an up-to-date description of all existing area facilities has been provided above.

**Figure 5: Existing Pedestrian Network**

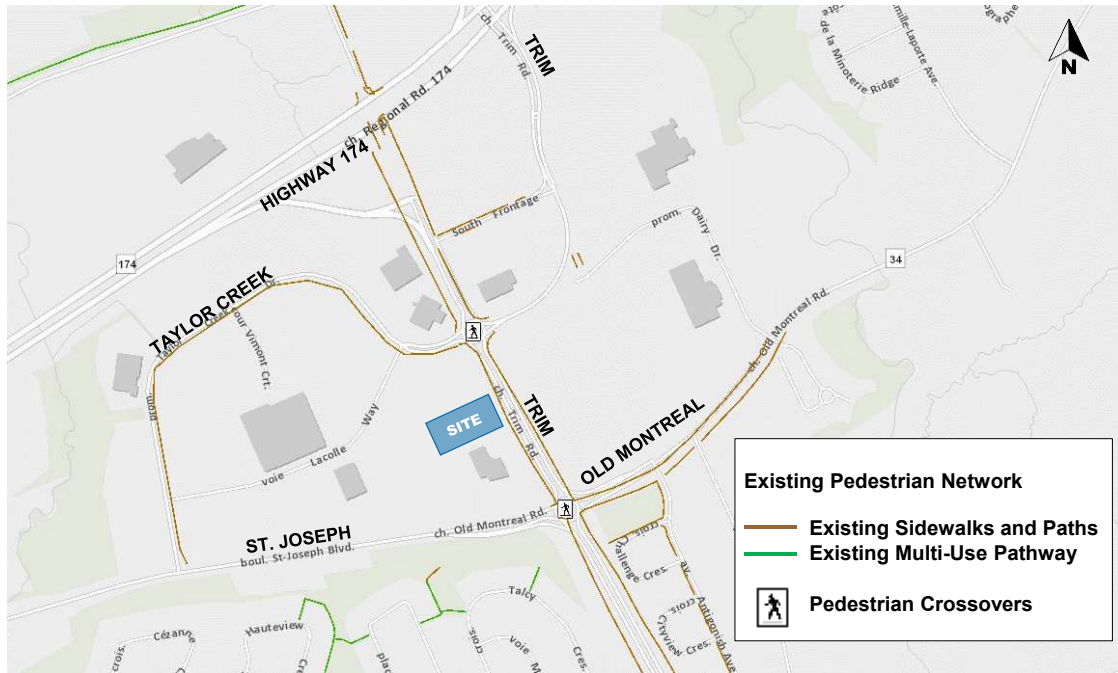

**Figure 6: Existing Cycling Network**

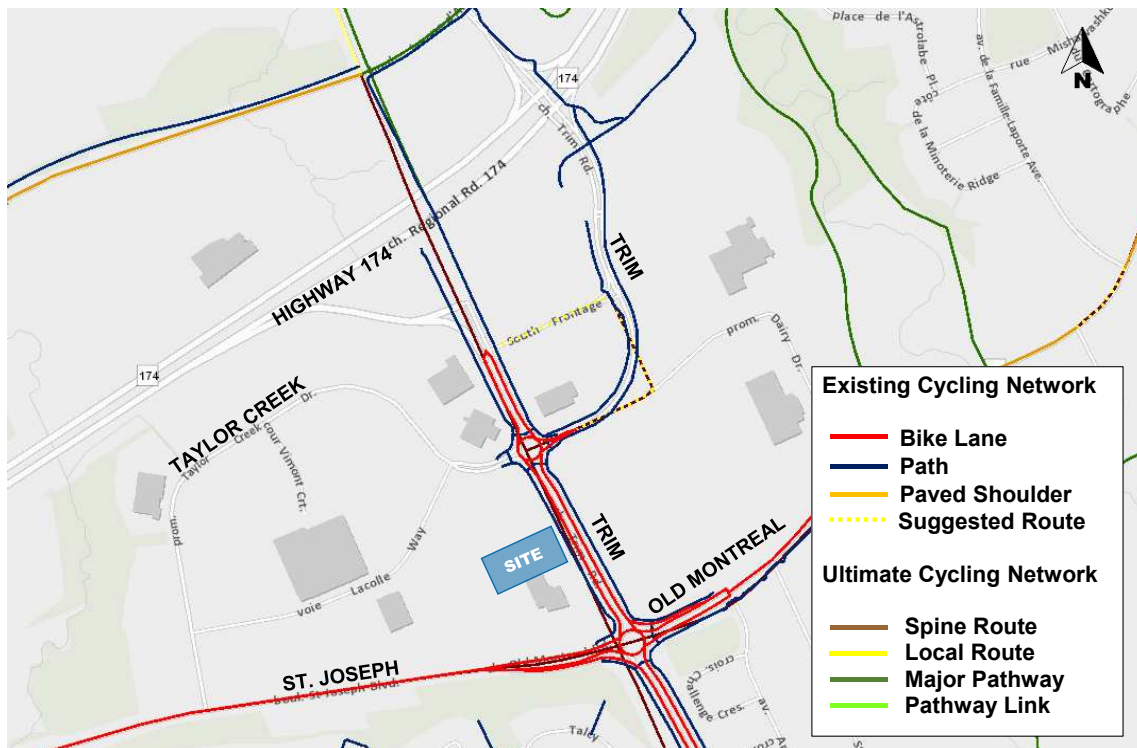

# Transportation Impact Assessment

## 1280 Trim Road

### Transit Network

There are ten (10) OC Transpo bus stops that are located within a 200 m walking distance to/from the subject development site. The following **Table 1** summarizes existing bus stops and their associated routes.

**Table 1: OC Transpo Stop Information**

Stop #	Location	Route Identifier	Direction
3029	Trim 2A	38, 39, 221, 639	Southbound/Eastbound
3029	Trim 1A	38, 39, 221, 639	Southbound/Eastbound
2781	Taylor Creek/Trim	39, 639	Southbound
0753	Taylor Creek/Trim	39, 639	Northbound
2780	Taylor Creek/Lacolle	39, 639	Southbound
1204	Taylor Creek/Lacolle	39, 639	Northbound
0699	Trim/Taylor Creek	39, 221	Southbound/Eastbound
1403	Trim/Dairy	39, 221	Northbound/Westbound
1406	Trim/Old Montréal	39, 221	Northbound/Westbound
0748	St. Joseph/Trim	39, 639	Southbound
2745	St. Joseph/Trim	39, 639	Northbound

*Note: Routes numbered in the 600's are designated school routes and OC Transpo does not consider these routes as part of regular service.*

The following **Figure 7** depicts the OC Transpo routes within the vicinity of the subject development, and **Table 2** provides additional information with respect to OC Transpo services identified in **Table 1**.

**Figure 7: Transit Routes Within Study Area**

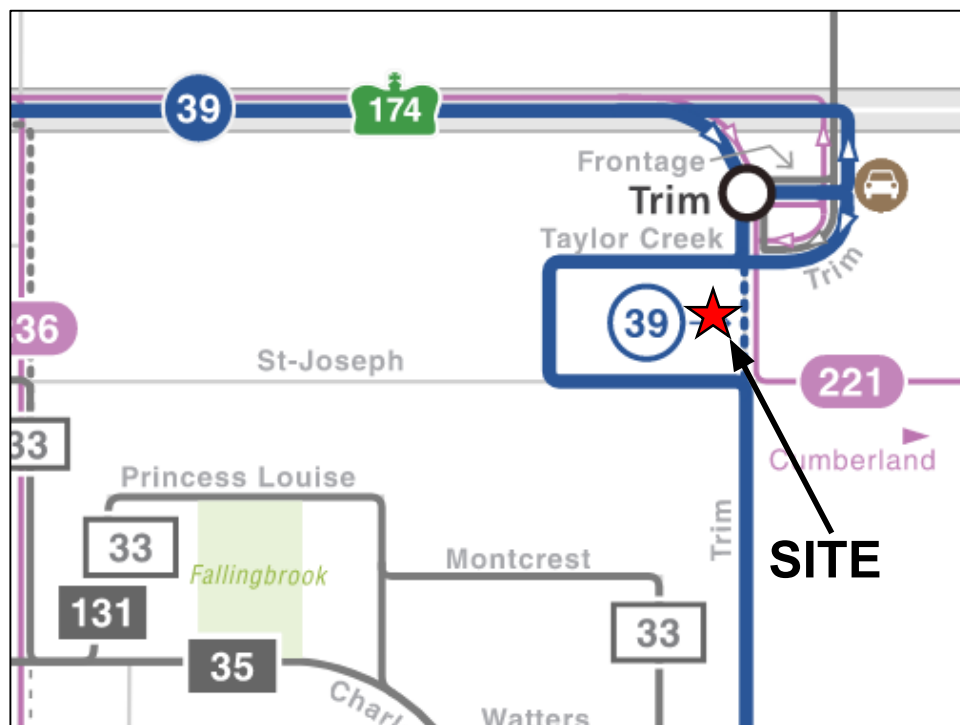

Source: <https://www.octranspo.com/images/files/maps/systemmap.pdf>, accessed 2023-04-18

# Transportation Impact Assessment

## 1280 Trim Road

**Table 2: OC Transpo Route Information**

Route	Origin/Destination	Service Type	Peak Hour Peak Direction Headway AM Peak (PM Peak)
38	Blair ↔ Jeanne d'Arc/Trim	Local	30 (15) mins
39	Blair & North Rideau ↔ Millennium	Rapid	5 - 10 (5 - 10) mins
221	Blair ↔ Cumberland	Connexion	Mon – Fri Peak Periods Only
639	Gisèle Lalonde ↔ Place D'Orléans	Limited Service	Mon – Fri Peak Periods Only

The following **Figure 8** depicts transit stop locations within the vicinity of the subject development site.

**Figure 8: Transit Stops Within Study Area**





# Transportation Impact Assessment

## 1280 Trim Road

---

### Area Traffic Management

Below are the existing area traffic management measures within the study area:

- Roundabouts (i.e., Trim/Taylor Creek and Trim/ Old Montréal)
- Information signage (e.g., area speed limit 30 km/h at roundabout intersections)
- Pavement markings (e.g., roundabout approaching markings and pedestrian crossings at the Trim/Taylor Creek and Trim/Old Montréal roundabouts, bike lane markings on Trim Road, Old Montréal Road, and St. Joseph Blvd. etc.)
- Vertical line treatments to give drivers a lane-narrowing effect (e.g., centreline)
- Raised medians (i.e., on Trim Road between Highway 174 EB off-ramp and Old Montréal Road)
- Vehicular directional closures (e.g., one-way roundabout directional signs, “No Right-Turn” at Highway 174/Trim Road)
- Intersection channelization

### Peak Hour Travel Demands

For the purpose of this assessment and based on discussions with the City staff, the following study area intersections have been identified for intersection capacity analysis:

- Trim/Highway 174
- Trim/Taylor Creek
- Trim/Old Montréal

The following **Figure 9** depicts the observed weekday morning and afternoon peak hour vehicular volumes at study area intersections, **Figure 10** and depicts pedestrian and cyclist movements over the same peak hours. Note that traffic counts for the Trim/Taylor Creek and Trim/Old Montréal intersections were completed by a JLR subconsultant on April 20, 2023. Additionally, the Trim/Highway 174 count was conducted in February and as such, the number of pedestrians and cyclists crossing may be underestimated compared to what would otherwise be observed during warmer months. Detailed traffic volume data is provided as **Appendix A**.

### Existing Road Safety Conditions

The most recent collision history for the past five (5) years was obtained from the City (i.e., available collision data for the years of 2016 – 2020, inclusive). The collision data includes all collisions occurring at intersections and roadway segments within the study area surrounding the subject development site.

Based on the most recent available historical collision data, the five-year total number of recorded collisions within the study area is 253 collisions. Most of the collisions within the study area resulted in property damage only (a total of 218 collisions, or 86%), and the remaining collisions resulted in non-fatal injuries (a total of 35 collisions, or 14%). The most frequent types of collisions, as cited by police, were rear-end (33%), sideswipe (26%), and angle (25%) type collisions within the study area.

The following **Figure 11** is a map that depicts the location and year of collisions within the study area.

# Transportation Impact Assessment

## 1280 Trim Road

Figure 9: Existing Peak Hour Traffic Volumes

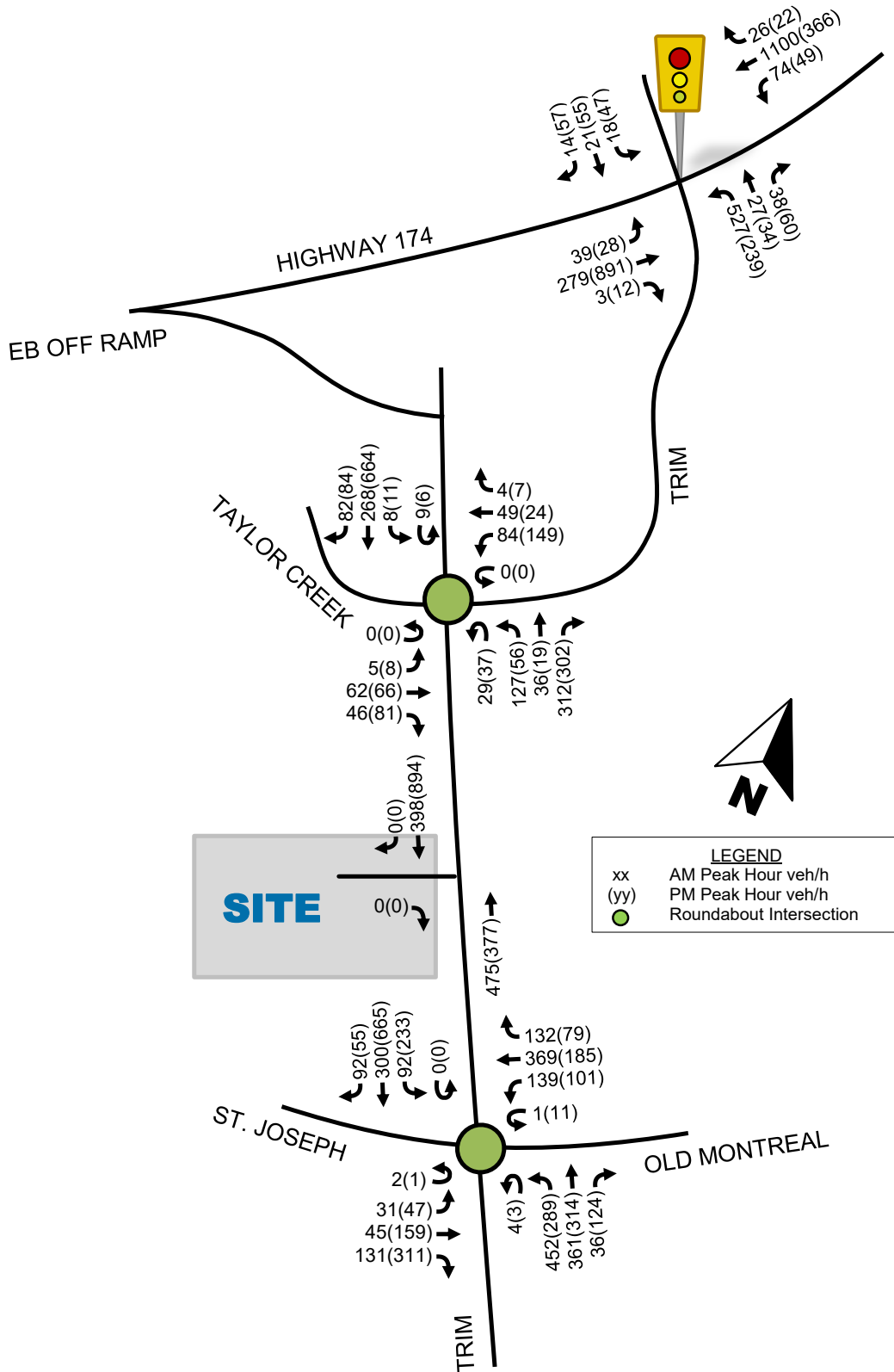

# Transportation Impact Assessment

## 1280 Trim Road

Figure 10: Existing Peak Hour Active Mode Volumes

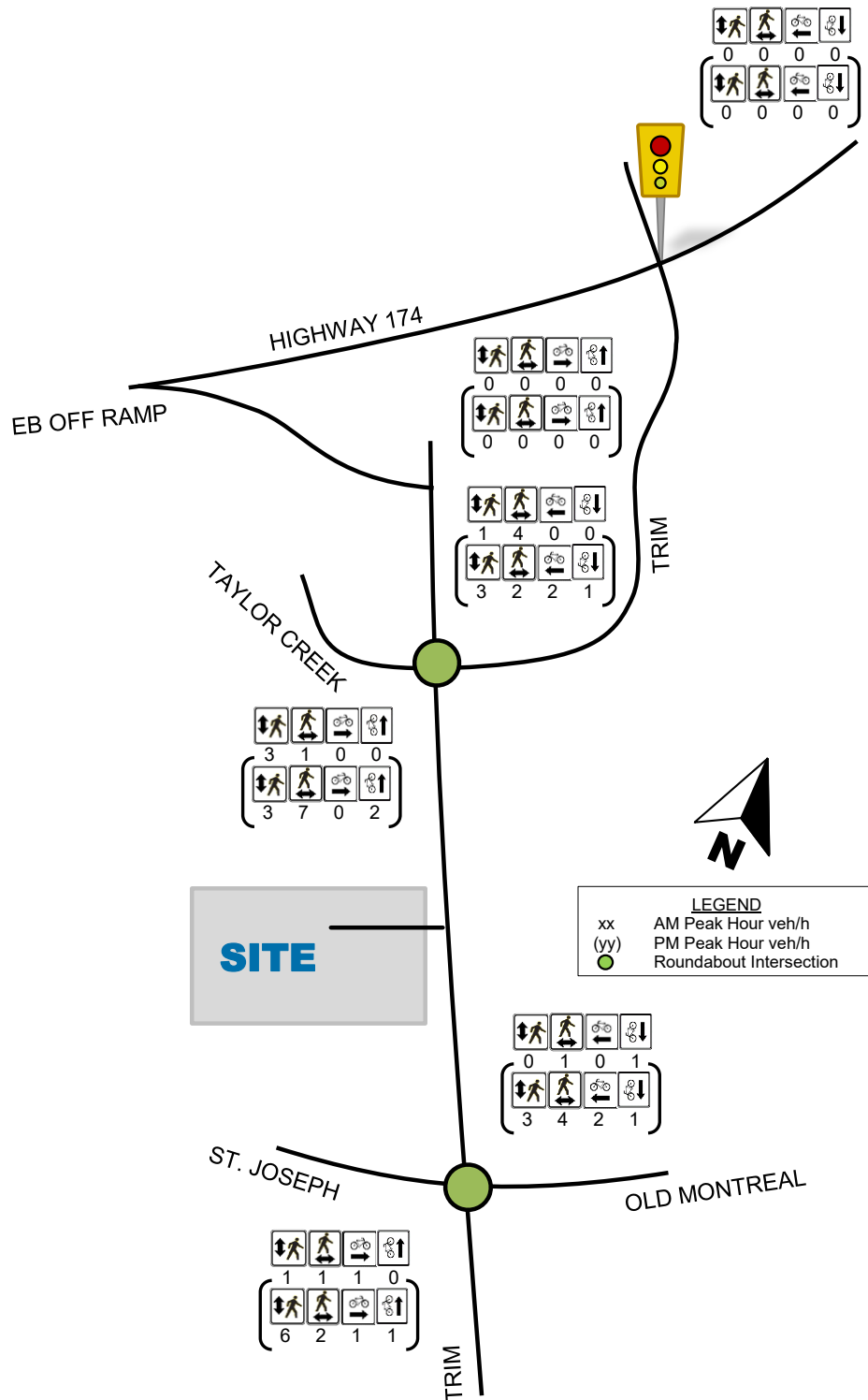
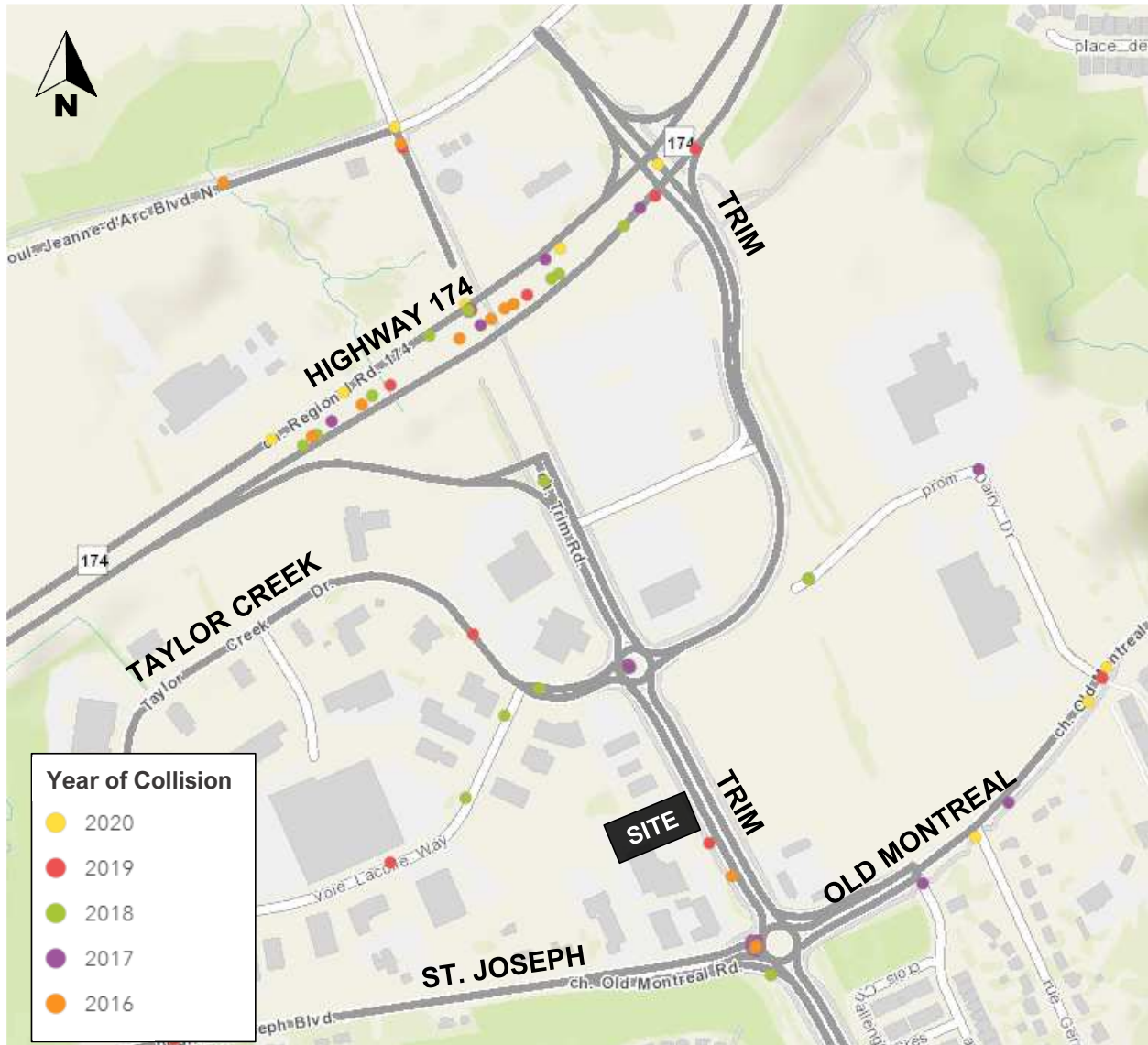

Figure 11: Collision Frequency



The source collision data is provided in **Appendix B**, and a more detail collision analysis is included in the subsequent **Section 4.3** of the report.

### Planned Conditions

#### Study Area Transportation Network Changes

##### Transit Projects

Outlined in the 2013 TMP's *2031 Network Concept* is the road widening of Highway 174 from four to six lanes between Highway 417 and Trim Road and from two to four lanes between Trim Road and the city boundary. Also included in the Network Concept is the road widening of Old Montréal Road from two to four lanes between Trim Road and Cox Country Road (i.e., the edge of the urban boundary).

# Transportation Impact Assessment

## 1280 Trim Road

### Road Projects

The following is a list of planned road projects within the subject development site as sourced from the City's Construction and Infrastructure Projects website:

- Highway 174 – New Transit (Targeted Start: 2023)
- Taylor Creek Drive – Waterman Cathodic Protection (Targeted Start: 2023)
- Trim Road – Road Crack Sealing (Targeted Start: 2023)

### Stage 2 LRT – Confederation Line East Extension

A notable transportation network change is the Confederation Line East extension to Ottawa's Light Rail Transit (LRT) system which will continue east from Blair Road to Trim Road. This O-Train extension will add 12 km of rail and 5 new stations, including one at Trim Road. The Trim LRT Station is anticipated to be completed in 2025. The following **Figure 12** illustrates the future Stage 2 LRT network.

**Figure 12: Stage 2 LRT Network**

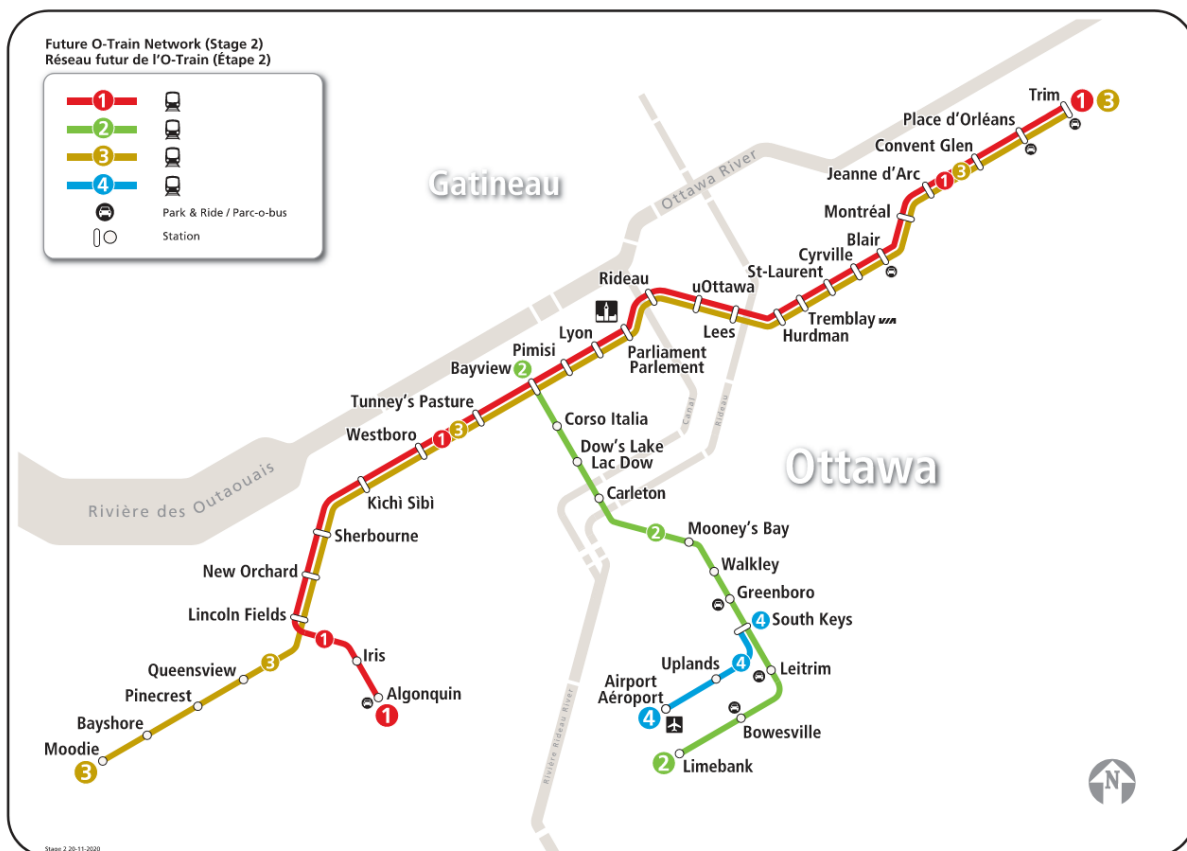

Source: <https://www.octranspo.com/images/files/stage2/future-otrain-network-map.pdf>, accessed 2023-04-18

### Other Area Development

Planned developments within the vicinity of the subject development site were identified using the City's online Development Application Tool. The following **Table 3** below summarizes the registered developments within the vicinity of the subject site.

# Transportation Impact Assessment

## 1280 Trim Road

**Table 3: Area Development**

Location	Anticipated Build-Out Year	Size	Land Use
3745 St. Joseph Boulevard	2025	Six-storey mixed-use building with 61 hotel units, 5,400 m <sup>2</sup> first-floor commercial area and 475 m <sup>2</sup> rooftop amenity area	Mixed Use
1296 & 1400 Old Montreal Road	2027	454 townhomes and 304 single detached units	Residential
1009 Trim Road / 1015 Tweedle Road	2029	956 residential units and 55,760 ft <sup>2</sup> commercial	Mixed Use
Cardinal Creek Village	2023	58 semi-detached and 87 townhouse units	Residential
Petrie's Landing II	2024	300 to 430 residential units	Residential
Petrie's Landing III	2029	370,000 ft <sup>2</sup> of office, 23,000 ft <sup>2</sup> and 790 residential units	Mixed Use

It should be noted that the projected impact of the developments summarized in **Table 3** has been included in the subsequent *Step 3 – Forecasting* section of this report.

## 2.2 Study Area and Time Periods

### Study Area

As discussed previously, City staff confirmed the following study area intersections for the purpose of this assessment:

- Trim/Highway 174
- Trim/Taylor Creek
- Trim/Old Montréal

Given the proposed development will be comprised of a small office building, an auto repair shop and two small restaurants, a quick trip generation indicates that the office and auto shop land uses will be low vehicle trip generators (e.g., less than 40 person/trips per hour, two-way. The drive-through restaurant land use will be a higher trip generator e.g., over 100 person/trip per hour, two-way); however, given the nature of this land use, most of these trips will be pass-by traffic (i.e., not a lot of new traffic). As such, impacts to the network beyond the immediate area of the subject site should be relatively negligible.

# Transportation Impact Assessment

1280 Trim Road

## Time Periods

Given the surrounding road network (Trim Road and Highway 174) typically experience the heaviest volumes during the weekday morning and afternoon peak hours, this assessment considered weekday morning and afternoon peak hours for analysis purposes only.

## Horizon Years

For the purpose of this assessment, the following development timeline was assumed:

- **2026** – Estimated full build-out of the subject development
- **2031** – 5-years beyond full build-out, required under the City’s TIA Guidelines

## 2.3 Exemptions Review

Given the size and nature of the proposed subject development site, **Table 4** outlines which elements identified in the 2017 Transportation Impact Assessment Guidelines that can be exempt from this analysis.

**Table 4: Module Exemption Review**

Module	Element	Exemption Criteria	Exemption Status
<i>Design Review</i>			
4.1 Development Design	4.1.2 Circulation and Access	Required for Site Plans	<b>Not Exempt</b>
	4.1.3 New Street Network	Required for Plans of Subdivisions	Exempt
<i>Network Impact</i>			
4.6 Neighborhood Traffic Management	4.6.1 Adjacent Neighborhoods	Required when the development relies on local or collector streets for access and total volumes exceed ATM capacity thresholds	Exempt
4.7 Transit	4.7.1 Transit Route Capacity	Required when projected site new site transit trips are greater than 75	Exempt
	4.7.2 Transit Priority Requirements	Required when projected site new site auto trips are greater than 75	<b>Not Exempt</b>
4.8 Network Concept	All Elements	Required when development is projected to generate more than 200 person-trips during the peak hour in excess of the equivalent	Exempt

# Transportation Impact Assessment

1280 Trim Road

Module	Element	Exemption Criteria	Exemption Status
		volume permitted by established zoning	
4.9 Intersection Design	All Elements	Required when projected site new site auto trips are greater than 75	<b>Not Exempt</b>

## 3.0 Forecasting

### 3.1 Development Related Travel Demand

#### Trip Generation

As previously described, the latest Site Plan illustrates that the proposed development will consist of approximately 6,000 ft<sup>2</sup> of office/personal services, approximately 7,345 ft<sup>2</sup> automotive service space, and two restaurant spaces (2,200 ft<sup>2</sup> and 1,250ft<sup>2</sup>), the larger of which will include a drive-through facility that is planned to be an A&W restaurant. It has been assumed that the proposed development will be constructed in a single phase, with an anticipated buildout year of 2026.

Consistent with the City's TIA guidelines, projected site-generated traffic was estimated using appropriate trip generation rates from the 11<sup>th</sup> Edition of the Institute of Transportation Engineers (ITE) Trip Generation Manual. Based on the location and type of development envisioned, the following **Table 5** summarizes the appropriate trip generation rates for estimating projected site-generated traffic.

**Table 5: ITE Peak Hour Trip Generation Rates**

Land Use	ITE Land Use Code	AM Peak Hour	PM Peak Hour
Fast Food Restaurant with Drive-Through Window	ITE 934 General Urban/Suburban Vehicle Trips	$T_A = 40.19(X)$ ; $T_F = n/a$	$T_A = 32.67(X)$ ; $T_F = n/a$
Small Office Building	ITE 712 General Urban/Suburban Vehicle Trips	$T_A = 1.67(X)$ ; $T_F = n/a$	$T_A = 2.16(X)$ ; $T_F = n/a$
Automobile Parts and Service Centre	ITE 943 General Urban/Suburban Vehicle Trips	$T_A = 1.91(X)$ ; $T_F = n/a$	$T_A = 2.06(X)$ ; $T_F = 2.41(x) + 11.83$
Fast Food Restaurant without Drive-Through Window	ITE 933 General Urban/Suburban Vehicle Trips	$T_A = 43.18(X)$ ; $T_F = n/a$	$T_A = 33.21(X)$ ; $T_F = 25.22(x) + 18.31$
<b>Notes:</b> $T_A$ = Average Vehicle Trips $T_F$ = Vehicle Trips by Fitted Curve $X$ = 1,000 ft <sup>2</sup> of Gross Floor Area (GFA)			



# Transportation Impact Assessment

1280 Trim Road

With respect to ITE trip generation rates, the data used to develop these rates only include vehicle trips (i.e., walking, cycling and transit trips are not captured in this data). To properly consider the multi-modal trips generated by the proposed development, projected site-generated traffic (estimated using the ITE trip generation rates) are converted to projected site-generated person trips, which can then be subdivided into different transportation modes based on area travel patterns and available facilities/network connections (e.g., the availability of transit, walking and cycling facilities).

To convert projected ITE vehicle trips to person trips, an auto occupancy factor and non-auto trip factor is applied to the ITE trip generation rates. With respect to the City’s TIA Guidelines, and based on available American Census data, the typical modal share of non-auto person trips is approximately 10% and the typical auto occupancy is 1.15. Therefore, when combined, a factor of 1.28 is used to convert vehicle trips to person trips.

It should also be noted that given trip generation rates are predominantly developed using standalone land uses, it can be expected that a mixed-use development will generate multi-purpose trips. For example, someone going to an auto shop may also go to the fast-food restaurant on the same site (i.e., a single trip with multiple purposes). Given multi-purpose trips often do not require individuals to leave and return to a site (to visit two different land uses on the same site), a multi-purpose trip is observed as a single trip. In order to account for multi-purpose trips for mixed-use developments, a percent reduction is applied to the total projected site-generated trips. This approach mitigates “double counting” when using trip generation rates that are predominantly developed using standalone land uses. This is considered a standard industry practice.

Based on the foregoing, the projected weekday morning and afternoon peak hour person trip generation for the proposed development is summarized in **Table 6**.

**Table 6: Modified Peak Period Person Trips**

Land Use	Area	AM Peak Hour (Person Trips/h)			PM Peak Hour (Person Trips/h)		
		In	Out	Total	In	Out	Total
Fast Food Restaurant with Drive-Through Window	2,200 ft <sup>2</sup>	64	62	126	48	45	93
Small Office Building	2,900 ft <sup>2</sup>	10	3	13	5	12	17
Automobile Parts and Service Centre	7,435 ft <sup>2</sup>	12	6	18	14	20	38
Fast Food Restaurant without Drive-Through Window	1,250 ft <sup>2</sup>	40	29	69	39	25	64
Total Person Trips		126	100	226	106	102	212
10% Multi-Purpose Trip Reduction		-13	-10	-23	-11	-10	-25
<b>Total 'New' Person Trips</b>		<b>113</b>	<b>90</b>	<b>203</b>	<b>95</b>	<b>92</b>	<b>187</b>

# Transportation Impact Assessment

1280 Trim Road

---

As summarized in **Table 6**, the proposed development is projected to generate an approximate two-way total of 203 and 187 person trips/h during weekday morning and afternoon peak hours, respectively. Directional splits (i.e., inbound vs outbound trips) were obtained from the ITE Trip Generation Manual. Additionally, given the proposed development is considered mixed-use, a 'multi-purpose' trip reduction of 10% was applied based on the Trip Generation Handbook 3<sup>rd</sup> Edition to account for the internal trips between residential and commercial land uses.

To determine the number of person trips arriving/departing by travel mode, total projected person trips were subdivided by percent mode shares. With respect to the TRANS Trip Generation Manual Summary Report, mode shares have been developed for select land uses, specific to City of Ottawa districts (e.g., Kanata-Stittsville, Orleans, Hunt Club, Ottawa Centre, etc.). Using mode share values from the TRANS Trip Generation Manual Summary Report as a baseline, other key factors were also taken into consideration, including; employment, proximity and quality of transit, pedestrian and cycling facilities, purpose of trips, etc. The following **Table 7**, **Table 8**, **Table 9**, **Table 10**, and **Table 11**, summarize the appropriate mode share values that were used for analysis purposes, based on the proposed land uses.

Given the nature of the proposed land uses, it should be noted that a percentage of the projected site-generated trips can be attributed to 'pass-by' traffic (i.e., a quick diversion to/from the subject development on someone's otherwise, normal daily commute). This additional 'pass-by' traffic does not impact overall network capacity, as this traffic already exists and is using the adjacent transportation network; however, 'pass-by' trips do impact the performance of turning movements at intersections within close proximity to the proposed development, typically where development site access/egress is provided. As such, and for analysis purposes, 45% and 50% of projected site-generated traffic will be comprised of 'pass-by' trips for the proposed fast-food without and with a drive-thru window land uses, respectively, based on rates outlined in the Trip Generation Handbook 3<sup>rd</sup> Edition.

## Travel Mode Shares

With respect to the TRANS Summary Report, the proposed development is located in the Orleans district and the AM/PM peak period modal splits within this district, reveal person trips are generally comprised of 70% auto drivers, 5% auto passengers, 15% transit and 10% non-motorized modes of travel.

Based on TRANS mode share values for specific land uses and other key factors that can affect mode choice, the projected site-generated person trips were subdivided into separate travel modes and summarized in the following **Table 7**, **Table 8**, **Table 9**, **Table 10**, and **Table 11** below.

# Transportation Impact Assessment

## 1280 Trim Road

**Table 7: Projected Site Generated Trips – Fast Food Restaurant with Drive-Thru**

Travel Mode	Mode Share	AM Peak Hour (Person Trips/h)			PM Peak Hour (Person Trips/h)		
		In	Out	Total	In	Out	Total
Auto Driver	70%	41	40	81	31	29	60
Auto Passenger	5%	3	3	6	2	2	4
Transit	15%	9	8	17	6	6	12
Non-motorized	10%	5	5	10	4	4	8
Total Person Trips	100%	58	56	114	43	41	84
<i>Less Pass-by 50%</i>		-20	-20	-40	-15	-15	-30
<b>Total 'New' Vehicle Trips</b>		<b>21</b>	<b>20</b>	<b>41</b>	<b>16</b>	<b>14</b>	<b>30</b>

**Table 8: Projected Site Generated Trips – Small Office Building**

Travel Mode	Mode Share	AM Peak Hour (Person Trips/h)			PM Peak Hour (Person Trips/h)		
		In	Out	Total	In	Out	Total
Auto Driver	70%	7	3	10	4	8	12
Auto Passenger	5%	1	0	1	1	1	2
Transit	15%	1	0	1	0	1	1
Non-motorized	10%	0	0	0	0	1	1
Total Person Trips	100%	9	3	12	5	11	16
<b>Total 'New' Vehicle Trips</b>		<b>7</b>	<b>3</b>	<b>10</b>	<b>4</b>	<b>8</b>	<b>12</b>

**Table 9: Projected Site Generated Trips – Automobile Parts and Service Centre**

Travel Mode	Mode Share	AM Peak Hour (Person Trips/h)			PM Peak Hour (Person Trips/h)		
		In	Out	Total	In	Out	Total
Auto Driver	70%	8	4	12	10	13	23
Auto Passenger	5%	1	1	2	1	1	2
Transit	15%	1	0	1	1	3	4
Non-motorized	10%	1	0	1	1	1	2
Total Person Trips	100%	11	5	16	13	18	31
<b>Total 'New' Vehicle Trips</b>		<b>8</b>	<b>4</b>	<b>12</b>	<b>10</b>	<b>13</b>	<b>23</b>

# Transportation Impact Assessment

## 1280 Trim Road

**Table 10: Projected Site Generated Trips – Fast Food Restaurant without Drive-Thru**

Travel Mode	Mode Share	AM Peak Hour (Person Trips/h)			PM Peak Hour (Person Trips/h)		
		In	Out	Total	In	Out	Total
Auto Driver	70%	26	19	45	25	17	42
Auto Passenger	5%	2	2	4	2	1	3
Transit	15%	5	3	8	5	3	8
Non-motorized	10%	3	2	5	3	2	5
Total Person Trips	100%	36	26	62	35	23	58
<i>Less Pass-by 45%</i>		-10	-10	-20	-9	-9	-18
<b>Total 'New' Vehicle Trips</b>		<b>16</b>	<b>9</b>	<b>25</b>	<b>16</b>	<b>8</b>	<b>24</b>

**Table 11: Total Projected Site Generated Trips**

Travel Mode	Mode Share	AM Peak Hour (Person Trips/h)			PM Peak Hour (Person Trips/h)		
		In	Out	Total	In	Out	Total
Auto Driver	70%	82	66	148	70	67	137
Auto Passenger	5%	7	6	13	6	5	11
Transit	15%	16	11	27	12	13	25
Non-motorized	10%	9	7	16	8	8	16
Total Person Trips	100%	114	90	204	96	93	189
<i>Less Pass-by 45% / 50%</i>		-30	-30	-60	-24	-24	-48
<b>Total 'New' Vehicle Trips</b>		<b>52</b>	<b>36</b>	<b>88</b>	<b>46</b>	<b>43</b>	<b>89</b>

As shown in **Table 11**, the total projected 'new' vehicle trips summarized in, the proposed development is projected to generate approximate two-way vehicle volumes of 88 veh/h and 89 veh/h during weekday morning and afternoon peak hours, respectively.

With regard to active modes, the proposed development is projected to generate approximate two-way person trips of 16 trips/h during both weekday morning and afternoon peak hours, and site-generated transit trips are projected to be in the order of 27 trips/h and 25 trips/h, during weekday morning and afternoon peak hours, respectively.

With regard to transit trips during weekday morning and afternoon peak hours, the proposed development is projected to generate approximately two-way person trips of 27 trips/h and 25 trips/h, respectively.

# Transportation Impact Assessment

1280 Trim Road

---

## Trip Distribution

The projected distribution of site-generated traffic was derived based on existing travel patterns, the site's connections to/from the surrounding road network, our local area knowledge (e.g., the location and proximity of employment, other area shopping, communities, recreational opportunities, etc.). For analysis purposes and to be consistent with other area studies, the following approximate distribution of projected site-generated traffic was assumed:

5%	to/from the north via Trim Road;
20%	to/from the east via Highway 174 and Old Montreal Road;
65%	to/from the west via Highway 174 and St. Joseph Boulevard; and,
+ 10%	to/from the south via Trim Road;
<hr/>	
100%	

## Trip Assignment

Based on the above assumed distribution, projected 'new' site-generated traffic was assigned to the study area network and is depicted in the following **Figure 13**. Similarly, projected 'pass-by' site-generated traffic, which represents existing traffic temporarily diverted to/from the subject site, is depicted in the following **Figure 14**.

## 3.2 Background Network Travel Demands

### Transportation Network Plans

As identified in Ottawa's 2013 TMP's *2031 Network Concept*, a road widening is planned on Highway 174 from four to six lanes between Highway 417 and Trim Road and from two to four lanes between Trim Road and the city boundary. Also included in the Network Concept is the road widening of Old Montréal Road from two to four lanes between Trim Road and Cox Country Road (i.e., the edge of the urban boundary).

The Confederation Line East extension to Ottawa's Light Rail Transit (LRT) system which will continue east from Blair Road to Trim Road is anticipated to be completed in 2025.

### Other Area Developments

Using the City's online Development Application Tool, six proposed developments were identified as having potential impacts on the study area network, namely;

- 3745 St. Joseph Boulevard;
- 1296 & 1400 Old Montreal Road
- 1009 Trim Road
- Cardinal Creek Village
- Petrie's Landing II
- Petrie's Landing III

The site-generated traffic from the above-mentioned future area developments were accounted for in the subsequent analysis using an assumed background traffic growth rate, which is further described below. **Figure 15** below illustrates the other area development traffic from these developments affecting study area intersections.

# Transportation Impact Assessment

## 1280 Trim Road

Figure 13: 'New' Projected Site-Generated Traffic

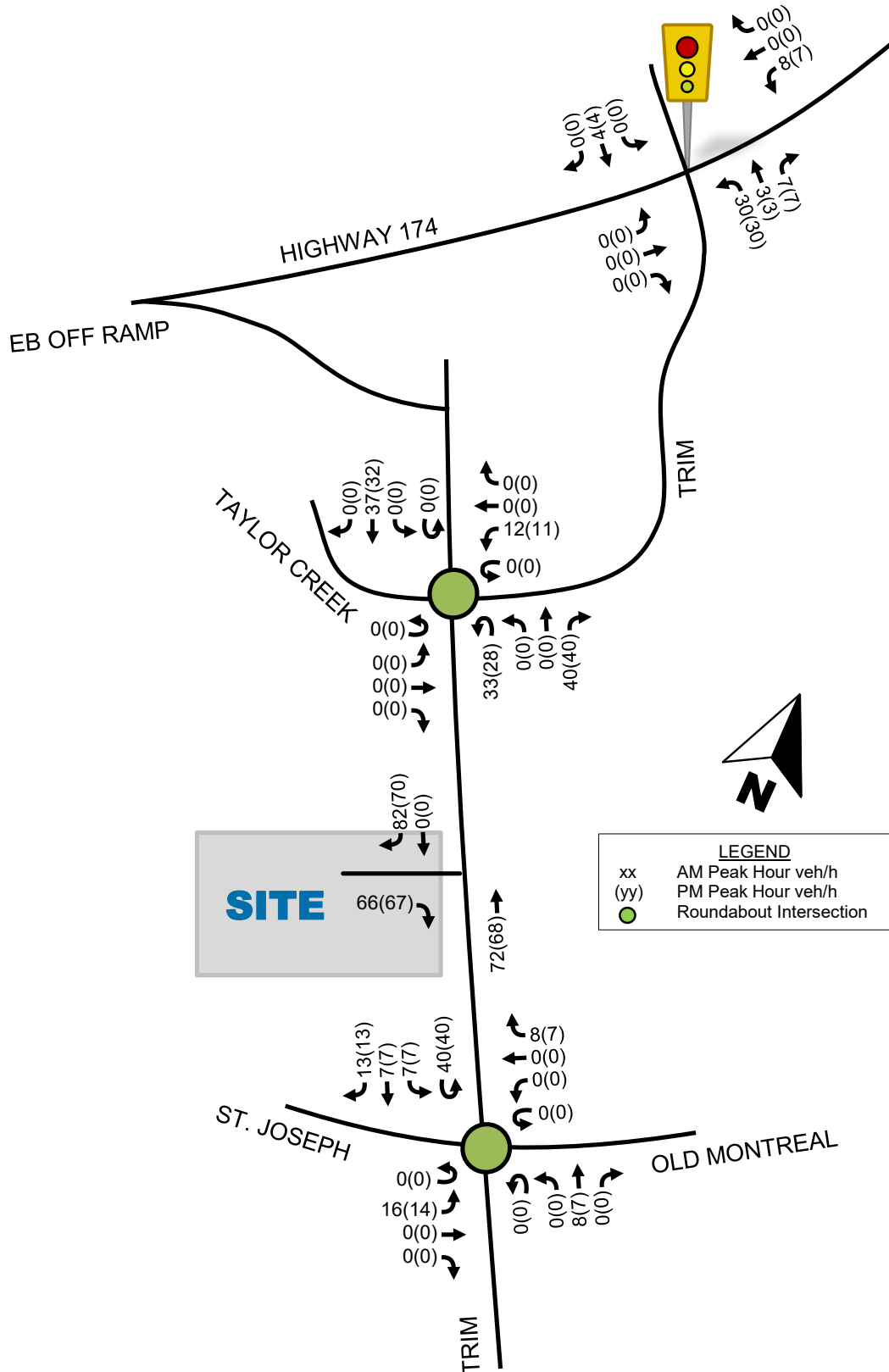

# Transportation Impact Assessment

## 1280 Trim Road

Figure 14: 'Pass-By' Projected Site-Generated Traffic

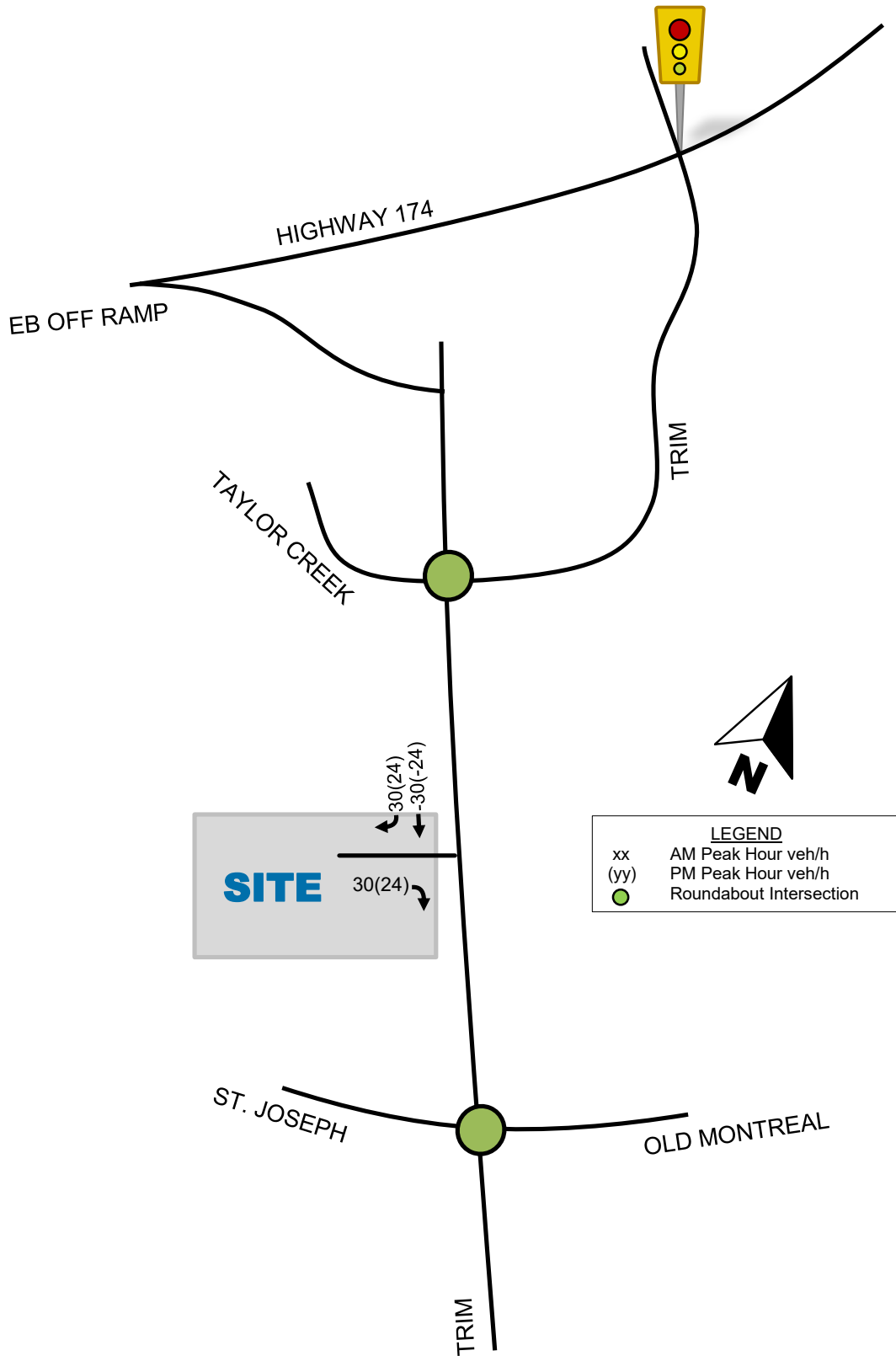
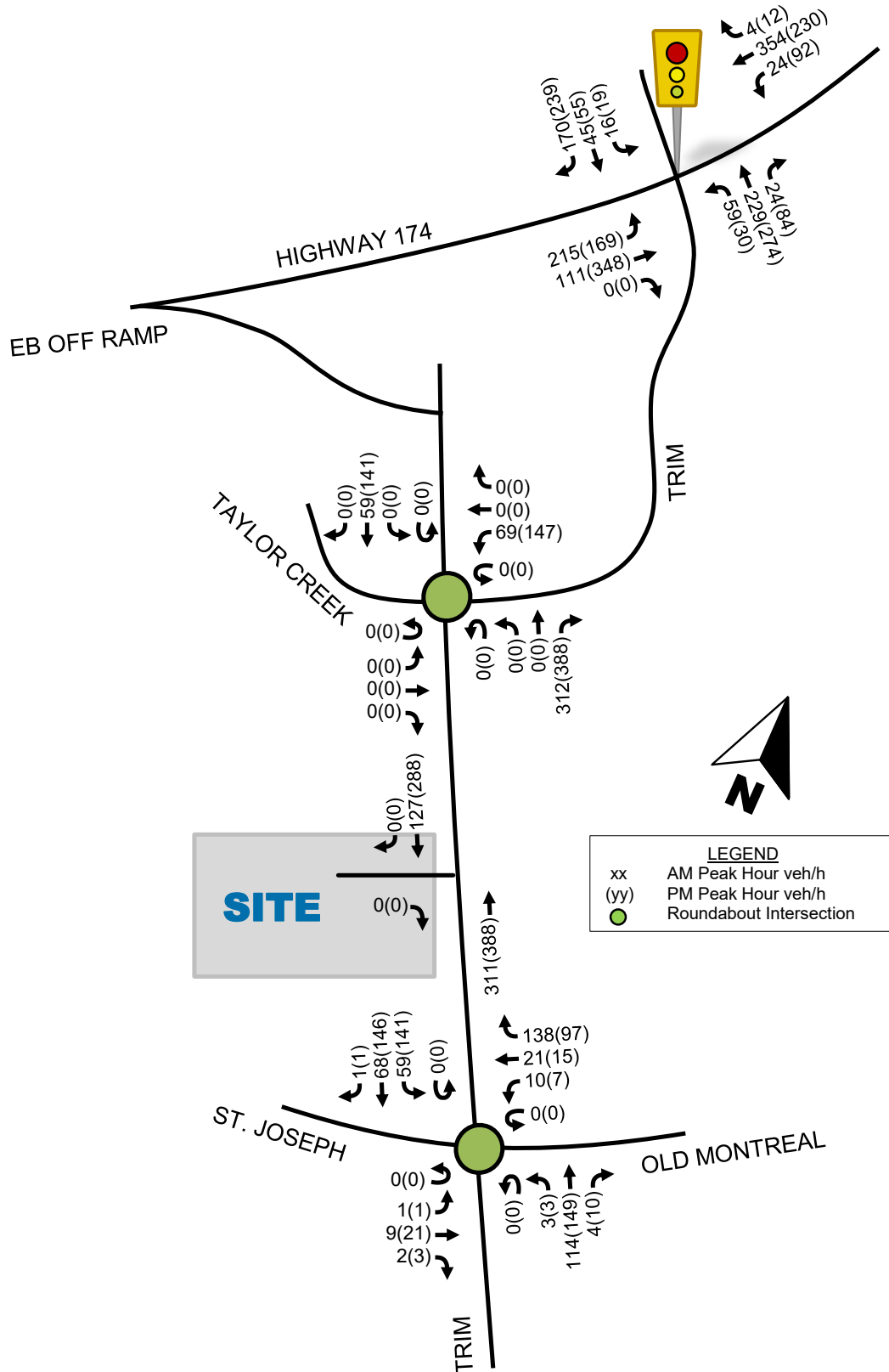

Figure 15: Other Area Development Traffic





# Transportation Impact Assessment

## 1280 Trim Road

---

### Background Growth

Following a review of the TIA studies prepared for the previously mentioned area developments (published between 2021 – 2023) outlined in **Section 2.1**, a 3% per annum general background traffic growth rate was assumed for study area intersections. Therefore, to be consistent with previously completed TIA studies for area developments, the same 3% per annum background traffic growth rate was assumed for the subsequent analysis.

Based on a 3% per annum background traffic growth rate and other area developments, the following **Figure 16** and **Figure 17** depict total projected 'background' traffic volumes for the 2026 and 2031 horizon years.

# Transportation Impact Assessment

## 1280 Trim Road

Figure 16: Background Traffic Volumes (2026)

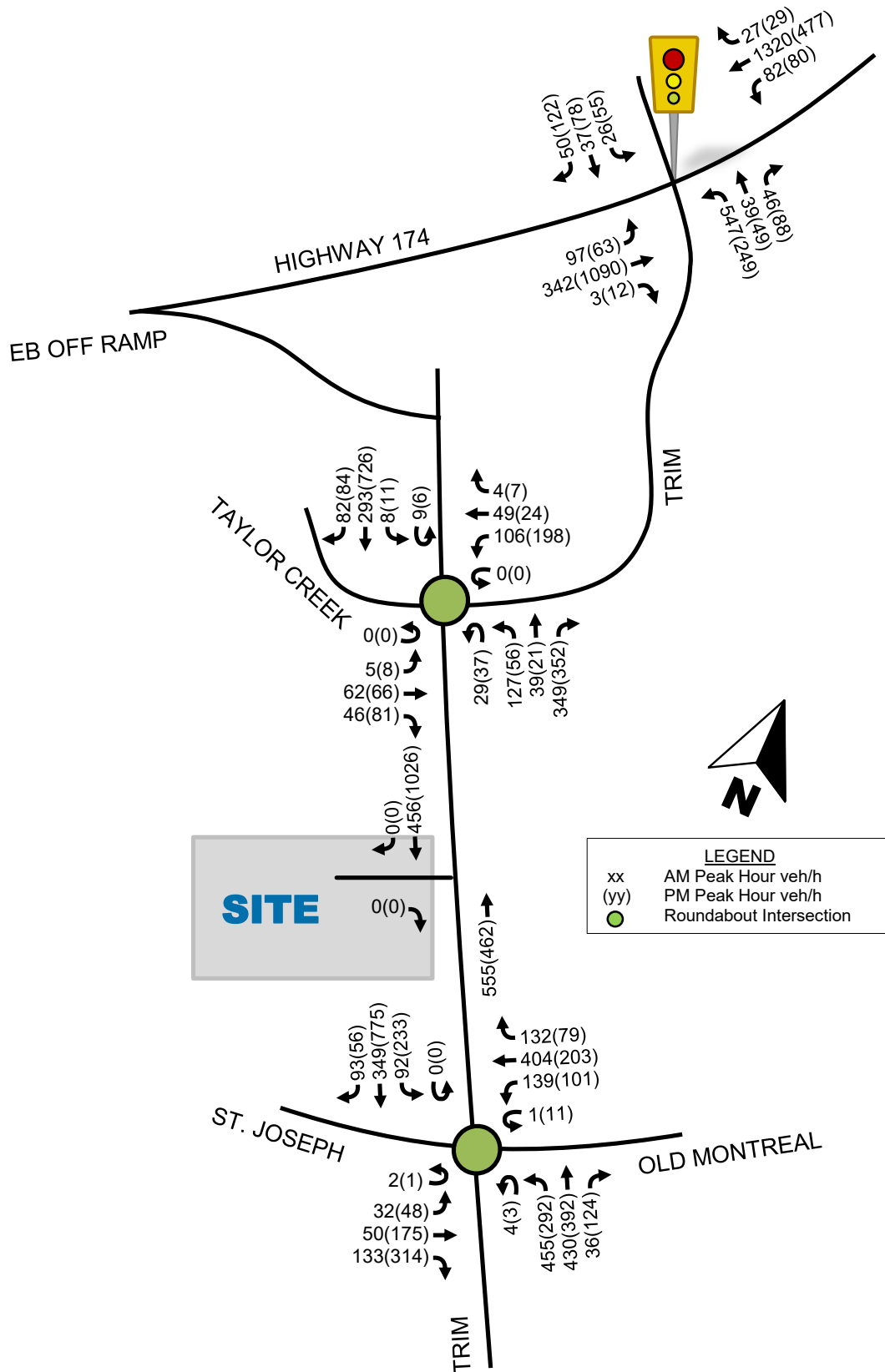

# Transportation Impact Assessment

## 1280 Trim Road

Figure 17: Background Traffic Volumes (2031)

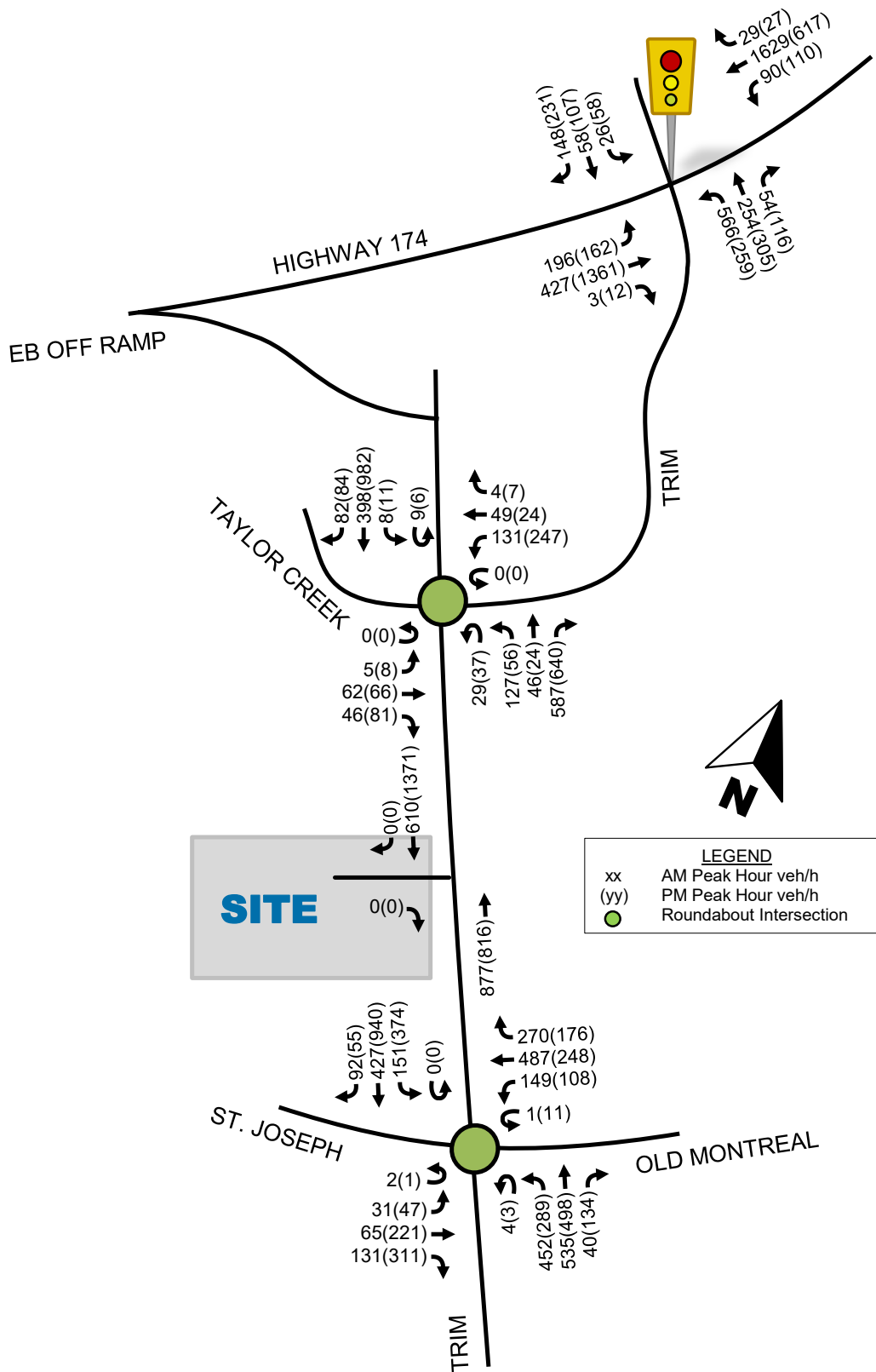

# Transportation Impact Assessment

## 1280 Trim Road

### 3.3 Demand Rationalization

The following section summarizes the vehicular intersection capacity analysis of existing, future background and future total volume scenarios.

Using the intersection capacity analysis software Synchro (v11), study area intersections were assessed in terms of vehicle delay (seconds), 95<sup>th</sup> percentile queues (meters), a volume-to-capacity ratio (V/C ratio) and a corresponding Auto Level of Service (LOS or LOS). It should be noted that the overall performance of a signalized intersection is calculated as a weighted V/C ratio and assigned a corresponding LOS, and individual vehicular movements are assigned a LOS based on their respective V/C ratio. The overall performance of an unsignalized intersection is an LOS output from Synchro, which is based on an Intersection Capacity Utilization (ICU) method, and each movement is assigned a LOS based on their respective V/C ratio.

#### Existing Conditions

The following **Table 12**, **Table 13**, and **Table 14** summarize existing and projected background conditions at study area intersections, in the absence of the proposed development. The objective of this analysis is to determine if network improvements are, or will be required to support background traffic, or if projected future demand should be adjusted (e.g., once an auto network becomes saturated, a modal shift can be expected). Detailed Synchro output data for existing and background conditions are provided in **Appendix C**.

**Table 12: Study Area Intersection Operations – Existing Conditions**

Dir.	Lanes	AM Peak Hour				PM Peak Hour			
		v/c	Delay (s)	LOS	Queue (m)	v/c	Delay (s)	LOS	Queue (m)
<b>Trim Rd/Highway 174 - Actuated-Coordinated Signal</b>									
<b>EBL</b>	1 L	0.40	75.8	A	25	0.32	74.0	A	20
<b>EBT</b>	2 T	0.18	25.3	A	46	0.52	23.7	A	137
<b>WBL</b>	1 L	0.56	78.5	A	40	0.46	77.0	A	30
<b>WBT</b>	2 T	0.67	32.1	B	#210.8	0.20	16.6	A	47
<b>WBR</b>	1 R	0.03	0.1	A	0	0.02	0.0	A	0
<b>NBL</b>	2 L	0.81	64.3	D	99	0.68	70.7	B	52
<b>NBT</b>	1 T	0.07	42.3	A	15	0.14	55.1	A	20
<b>NBR</b>	1 R	0.09	0.4	A	0	0.18	1.1	A	0
<b>SBL</b>	1 L	0.25	74.1	A	15	0.49	82.7	A	#32.4
<b>SBT</b>	1 T	0.18	67.5	A	16	0.43	73.4	A	32
<b>SBR</b>	1 R	0.05	0.4	A	0	0.20	1.5	A	0
<b>Overall</b>		<b>0.70</b>	<b>41.1</b>	<b>C</b>	<b>-</b>	<b>0.54</b>	<b>32.3</b>	<b>A</b>	<b>-</b>
<b>Trim Rd/Taylor Creek Dr - Roundabout</b>									
<b>EB</b>	1 L/T/R	0.13	5.4	A	0	0.31	11.5	A	1
<b>WB</b>	1 L/T/R	0.13	4.5	A	0	0.16	4.4	A	1
<b>NBT</b>	1 T/L	0.16	4.8	A	1	0.10	4.7	A	0

# Transportation Impact Assessment

## 1280 Trim Road

Dir.	Lanes	AM Peak Hour				PM Peak Hour			
		v/c	Delay (s)	LOS	Queue (m)	v/c	Delay (s)	LOS	Queue (m)
<b>NBR</b>	1 R	0.26	4.8	A	1	0.26	4.7	A	1
<b>SBT</b>	1 T/L	0.29	5.8	A	1	0.67	12.1	B	5
<b>SBR</b>	1 T/R	0.08	5.8	A	0	0.08	12.1	A	0
<b>Overall</b>			<b>5.1</b>	<b>A</b>	<b>-</b>		<b>9.1</b>	<b>A</b>	<b>-</b>
<b>Trim Rd/St. Joseph Blvd/Old Montreal Rd - Roundabout</b>									
<b>EBT</b>	1 T/L	0.10	5.8	A	0	0.42	15.5	A	2
<b>EBR</b>	1 R	0.17	5.8	A	1	0.56	15.5	A	3
<b>WBT</b>	1 T/L	0.88	32.4	D	10	0.43	9.4	A	2
<b>WBR</b>	1 R	0.16	32.4	A	1	0.09	9.4	A	0
<b>NBL</b>	1 L	0.73	14.0	C	7	0.71	14.9	C	6
<b>NBR</b>	1 R	0.03	14.0	A	0	0.15	14.9	A	1
<b>SBL</b>	1 L	0.76	25.0	C	7	<b>1.21</b>	117.9	<b>F</b>	32
<b>SBT</b>	1 T/R	0.18	25.0	A	1	0.07	117.9	A	0
<b>Overall</b>			<b>21.0</b>	<b>C</b>	<b>-</b>		<b>52.3</b>	<b>F</b>	<b>-</b>
<b>Notes:</b> # - denotes 95 <sup>th</sup> percentile volume exceeding capacity Ideal saturation flow rate assumed to be 1,800 veh/h/lane PHF assumed to be 0.95									

As shown in **Table 12**, study area intersections are currently operating with an acceptable overall LOS 'C' or better during weekday morning and afternoon peak hours, with the exception of the Trim/St. Joseph/Old Montreal roundabout, which is currently operating near or at capacity with an overall LOS of 'F' during the afternoon peak hour.

With regard to 'critical' movements (i.e., the worst performing movement at each intersection per peak period), they are operating with an LOS of 'D' or better during both peak hours, with the exception of the southbound left-turn movement at the Trim/St. Joseph/Old Montreal intersection operating with an LOS 'F' during the afternoon peak hour, exceeding available capacity.

In terms of 95<sup>th</sup> percentile queues, sufficient vehicle storage is provided, such that vehicle queues do not spill or block adjacent lanes or intersections. However, it should be noted that there are a number of critical movements that operate with long 95<sup>th</sup> percentile queues and delays. The westbound through queue during the morning peak hour and the southbound left-turn queue during the afternoon peak hour exceed the existing storage capacity at the Trim/Highway 174 intersection.

Based on our local area knowledge, the above quantitative study area intersection operations summary is consistent with actual operations.

Potential measures to improve individual movements that are operating near or over capacity during peak hours include:

# Transportation Impact Assessment

## 1280 Trim Road

- Implementation of transportation demand management strategies that will reduce single vehicle occupancy rates and increase the use of alternative modes of transportation. As previously mentioned, the LRT Trim extension is currently under construction. It is expected that this extension will reduce vehicular traffic within the study area and in turn, improve the capacity of the study area roadways.
- It should be noted that as Trim/St. Joseph/Old Montreal is a roundabout intersection, limited opportunities exist to change the intersection configuration. Any required operational improvements will depend on network volume reductions.

These suggested improvement measures mentioned above are only provided for information/decision making purposes and will not be assumed subsequent analysis. If any of these possible measures are desirable by the City, further investigation of their feasibility may be required to support their justification. It should be noted that the above suggested measures to improve network operations are provided to mitigate impacts related to background traffic only (i.e., the above suggested measures to improve network operations are not required to support the projected traffic generated by the subject development).

### Background 2026 Conditions

The following **Table 13** summarizes intersection operations for the 2026 horizon year with the addition of background traffic volumes only. This future background scenario assumes no intersection or network improvements for comparison purposes (e.g., comparing apples to apples).

**Table 13: Study Area Intersection Operations – 2026 Background Conditions**

Dir.	Lanes	AM Peak Hour				PM Peak Hour			
		v/c	Delay (s)	LOS	Queue (m)	v/c	Delay (s)	LOS	Queue (m)
<b>Trim Rd/Highway 174 - Actuated-Coordinated Signal</b>									
EBL	1 L	0.50	68.7	A	50	0.50	76.7	A	36
EBT	2 T	0.25	28.8	A	58	0.70	33.1	B	198
WBL	1 L	0.59	78.8	A	43	0.53	74.3	A	42
WBT	2 T	1.02	72.2	F	#319.6	0.29	22.6	A	69
WBR	1 R	0.04	0.1	A	0	0.04	0.1	A	0
NBL	2 L	0.82	63.9	D	102	0.68	70.4	B	54
NBT	1 T	0.09	40.1	A	19	0.17	52.2	A	26
NBR	1 R	0.10	0.4	A	0	0.25	2.9	A	3
SBL	1 L	0.34	78.3	A	19	0.69	104.8	B	#40.5
SBT	1 T	0.31	70.6	A	24	0.54	75.9	A	41
SBR	1 R	0.18	1.4	A	0	0.41	4.2	A	0
<b>Overall</b>		<b>0.93</b>	<b>61.0</b>	<b>E</b>	<b>-</b>	<b>0.67</b>	<b>37.9</b>	<b>B</b>	<b>-</b>
<b>Trim Rd/Taylor Creek Dr - Roundabout</b>									
EB	1 L/T/R	0.14	5.7	A	0	0.35	13.6	A	2

# Transportation Impact Assessment

## 1280 Trim Road

Dir.	Lanes	AM Peak Hour				PM Peak Hour			
		v/c	Delay (s)	LOS	Queue (m)	v/c	Delay (s)	LOS	Queue (m)
<b>WB</b>	1 L/T/R	0.16	4.7	A	1	0.20	4.9	A	1
<b>NBT</b>	1 T/L	0.17	5.1	A	1	0.10	5.2	A	0
<b>NBR</b>	1 R	0.29	5.1	A	1	0.30	5.2	A	1
<b>SBT</b>	1 T/L	0.32	6.2	A	1	0.76	16.3	C	8
<b>SBR</b>	1 T/R	0.08	6.2	A	0	0.09	16.3	A	0
<b>Overall</b>			<b>5.5</b>	<b>A</b>	-		<b>11.4</b>	<b>B</b>	-
<b>Trim Rd/St. Joseph Blvd/Old Montreal Rd - Roundabout</b>									
<b>EBT</b>	1 T/L	0.11	6.2	A	0	0.51	20.2	A	3
<b>EBR</b>	1 R	0.18	6.2	A	1	0.64	20.2	B	4
<b>WBT</b>	1 T/L	<b>1.01</b>	56.5	<b>F</b>	15	0.49	11.2	A	3
<b>WBR</b>	1 R	0.17	56.5	A	1	0.10	11.2	A	0
<b>NBL</b>	1 L	0.80	56.5	C	9	0.82	11.2	D	9
<b>NBR</b>	1 R	0.03	17.5	A	0	0.15	21.0	A	1
<b>SBL</b>	1 L	0.89	17.5	D	10	<b>1.38</b>	21.0	<b>F</b>	45
<b>SBT</b>	1 T/R	0.19	38.3	A	1	0.08	187.4	A	0
<b>Overall</b>			<b>32.4</b>	<b>D</b>	-		<b>82.5</b>	<b>F</b>	-
<b>Notes:</b> # - denotes 95 <sup>th</sup> percentile volume exceeding capacity Ideal saturation flow rate assumed to be 1,800 veh/h/lane PHF assumed to be 0.95									

As shown in **Table 13**, study area intersections are projected to continue operating with an acceptable overall LOS 'D' or better during weekday morning and afternoon peak hours, with the exception of the Trim/St. Joseph/Old Montreal roundabout, which is projected to continue operating over capacity with an overall LOS of 'F' during the afternoon peak hour. The Highway 174/Trim intersection is also projected to operate near capacity with an overall LOS of 'E' during the morning peak hour.

With regard to 'critical' movements (i.e., the worst performing movement at each intersection per peak period), some individual movements are projected to operate with an LOS of 'C' or better during both peak hours; however, there are a number of 'critical' movements that are projected to operate near or over capacity, including:

- Westbound through movement at the Trim/Highway 174 intersection, projected to operate with an LOS 'F' during the AM peak hour;
- Westbound through movement at the Trim/St. Joseph/Old Montreal intersection, projected to operate with an LOS 'F' during the AM peak hour, and the;
- Southbound left-turn movement at the Trim/St. Joseph/Old Montreal intersection, projected to operate with an LOS 'F' during the PM peak hour.

# Transportation Impact Assessment

1280 Trim Road

In terms of 95<sup>th</sup> percentile queues, the westbound through queue during the morning peak hour and the southbound left-turn queue during the afternoon peak hour exceed the existing storage capacity at the Trim/Highway 174 intersection, similar to existing conditions.

As previously mentioned, potential measures to improve individual movements that are operating near or over capacity during peak hours include:

- Signal timing adjustment and optimization which will permit the intersection to operate satisfactorily. At Highway 174/Trim, adjust the timing of the eastbound and westbound through movements to increase the minimum green time. However, this may adversely impact cycle length timing.
- As Trim/St. Joseph/Old Montreal is a roundabout intersection, limited opportunities exist to change the intersection configuration. Any required operational improvements will depend on network volume reductions. Implementation of transportation demand management strategies will reduce single vehicle occupancy rates and increase the use of alternative modes of transportation.

These suggested improvement measures mentioned above are only provided for information/decision making purposes and will not be assumed subsequent analysis. If any of these possible measures are desirable by the City, further investigation of their feasibility may be required to support their justification.

## Background 2031 Conditions

The following **Table 14** summarizes intersection operations for the 2031 horizon year with the addition of background traffic volumes only. This future background scenario assumes no intersection improvements or network improvements.

**Table 14: Study Area Intersection Operations – 2031 Background Conditions**

Dir.	Lanes	AM Peak Hour				PM Peak Hour			
		v/c	Delay (s)	LOS	Queue (m)	v/c	Delay (s)	LOS	Queue (m)
<b>Trim Rd/Highway 174 - Actuated-Coordinated Signal</b>									
EBL	1 L	0.77	78.0	C	#135.6	0.53	61.0	A	#89.7
EBT	2 T	0.34	33.4	A	76	1.12	105.0	F	#344.5
WBL	1 L	0.61	78.7	B	47	0.52	67.6	A	55
WBT	2 T	1.54	282.6	F	#426.5	0.59	43.5	A	108
WBR	1 R	0.05	0.1	A	0	0.04	0.1	A	0
NBL	2 L	0.82	63.5	D	105	0.69	70.4	B	55
NBT	1 T	0.52	47.4	A	94	0.83	70.9	D	120
NBR	1 R	0.11	0.4	A	0	0.28	5.5	A	11
SBL	1 L	0.34	78.3	A	19	0.72	108.4	C	#43.7
SBT	1 T	0.44	73.6	A	33	0.43	60.1	A	50
SBR	1 R	0.52	9.3	A	10	0.56	11.3	A	25



# Transportation Impact Assessment

## 1280 Trim Road

Dir.	Lanes	AM Peak Hour				PM Peak Hour			
		v/c	Delay (s)	LOS	Queue (m)	v/c	Delay (s)	LOS	Queue (m)
<b>Overall</b>		<b>1.29</b>	<b>158.8</b>	<b>F</b>	<b>-</b>	<b>1.02</b>	<b>72.6</b>	<b>F</b>	<b>-</b>
<b>Trim Rd/Taylor Creek Dr - Roundabout</b>									
<b>EB</b>	1 L/T/R	0.16	6.8	A	1	0.49	23.2	A	3
<b>WB</b>	1 L/T/R	0.18	5.0	A	1	0.25	5.3	A	1
<b>NBT</b>	1 T/L	0.17	7.1	A	1	0.10	8.2	A	0
<b>NBR</b>	1 R	0.49	7.1	A	3	0.54	8.2	A	3
<b>SBT</b>	1 T/L	0.44	7.8	A	2	<b>1.08</b>	66.7	<b>F</b>	25
<b>SBR</b>	1 T/R	0.09	7.8	A	0	0.09	66.7	A	0
<b>Overall</b>			<b>7.1</b>	<b>A</b>	<b>-</b>		<b>36.7</b>	<b>E</b>	<b>-</b>
<b>Trim Rd/St. Joseph Blvd/Old Montreal Rd - Roundabout</b>									
<b>EBT</b>	1 T/L	0.15	7.1	A	1	0.83	41.6	D	7
<b>EBR</b>	1 R	0.19	7.1	A	1	0.76	41.6	C	6
<b>WBT</b>	1 T/L	<b>1.31</b>	127.4	<b>F</b>	29	0.63	14.9	B	4
<b>WBR</b>	1 R	0.39	127.4	A	2	0.25	14.9	A	1
<b>NBL</b>	1 L	0.96	35.9	E	17	<b>1.13</b>	84.2	<b>F</b>	25
<b>NBR</b>	1 R	0.04	35.9	A	0	0.19	84.2	A	1
<b>SBL</b>	1 L	<b>1.27</b>	142.9	<b>F</b>	25	<b>1.89</b>	405.0	<b>F</b>	87
<b>SBT</b>	1 T/R	0.20	142.9	A	1	0.08	405.0	A	0
<b>Overall</b>			<b>88.1</b>	<b>F</b>	<b>-</b>		<b>194.6</b>	<b>F</b>	<b>-</b>
<b>Notes:</b> # - denotes 95 <sup>th</sup> percentile volume exceeding capacity Ideal saturation flow rate assumed to be 1,800 veh/h/lane PHF assumed to be 0.95									

As shown in **Table 14**, assuming no signal timing or network modifications for the 2031 horizon year, study area intersections continue to decline in the overall intersection LOS, with increases in volumes and delays due to the projected increases in background traffic (i.e., in the absence of traffic generated by the subject development site).

With regard to 'critical' movements (i.e., the worst performing movement at each intersection per peak period), the northbound right-turn movement at the Trim/Taylor Creek intersection is projected to operate at an excellent LOS 'A'. However, there are number of 'critical' movements that are projected to operate near or over capacity, including:

- Eastbound through movement at the Trim/Highway 174 intersection, projected to operate with an LOS 'F' during the PM peak hour;
- Westbound through movement at the Trim/Highway 174 intersection, projected to operate with an LOS 'F' during the AM peak hour;
- Southbound through movement at the Trim/Taylor Creek intersection, projected to operate with an LOS 'F' during the PM peak hour;

# Transportation Impact Assessment

## 1280 Trim Road

---

- Westbound through movement at the Trim/St. Joseph/Old Montreal intersection, projected to operate with an LOS 'F' during the AM peak hour, and the;
- Southbound left-turn movement at the Trim/St. Joseph/Old Montreal intersection, projected to operate with an LOS 'F' during the PM peak hour.

In terms of 95<sup>th</sup> percentile queues, the following movements exceed the existing storage capacity at the Trim/Highway 174 intersection:

- Eastbound left-turn movement during the morning and afternoon peak hour
- Eastbound through movement during the afternoon peak hour
- Westbound through movement during the morning peak hour
- Southbound left-turn movement during the afternoon peak hour

Similar to existing and background 2026 conditions, there are some individual movements that are operating near or over capacity during peak hours. Potential measures to improve these movements include:

- Signal timing adjustment and optimization which will permit the intersection to operate satisfactorily. At Highway 174/Trim, adjust the timing of the eastbound and westbound through movements to increase the minimum green time. However, this may adversely impact cycle length timing.
- As previously mentioned, the LRT Trim extension will provide an opportunity for a reduction in the east-west travel demand on the Highway 174 corridor resulting in a modal shift from automobile-based travel to rail.
- As Trim/St. Joseph/Old Montreal is a roundabout intersection, limited opportunities exist to change the intersection configuration. Any required operational improvements will depend on network volume reductions. Implementation of transportation demand management strategies will reduce single vehicle occupancy rates and increase the use of alternative modes of transportation.

These suggested improvement measures mentioned above are only provided for information/decision making purposes and will not be assumed subsequent analysis. If any of these possible measures are desirable by the City, further investigation of their feasibility may be required to support their justification. It should be noted that the above suggested measures to improve network operations are provided to mitigate impacts related to background traffic only (i.e., the above suggested measures to improve network operations are not required to support the projected traffic generated by the subject development).

### Adjustments to Background Network Demand

Given all study area intersections are projected to operate near or at capacity for future background conditions, it may be necessary to adjust projected background demands at this time (i.e., accounting for modal shift from auto to transit/auto mode choices may be considered if the surrounding auto network becomes saturated.) Completion of the LRT Trim station is anticipated to reduce the travel demand on the auto network.

# Transportation Impact Assessment

## 1280 Trim Road

---

### Total Projected Conditions

The following **Figure 18** depicts 'total' projected volumes for the horizon year of 2026, which were derived by superimposing site-generated traffic volumes (i.e. 'new' and 'pass-by' trips) onto projected background traffic volumes (e.g. summing together volumes depicted in **Figure 13**, **Figure 14** and **Figure 16** resulting in **Figure 18**).

Similar to existing and future background conditions, total projected conditions were assessed using the intersection capacity analysis software Synchro (v11). Metrics such as LOS, V/C ratio, 95<sup>th</sup> percentile queue (metres) and vehicular delay (seconds) were analyzed. Assuming no intersection improvements, the following **Table 15** summarizes the intersection operational analysis of the study area intersections for the total projected 2026 horizon year.

Detailed Synchro output data for future total projected conditions is provided in **Appendix D**.

# Transportation Impact Assessment

## 1280 Trim Road

Figure 18: Total Projected Traffic Volumes (2026)

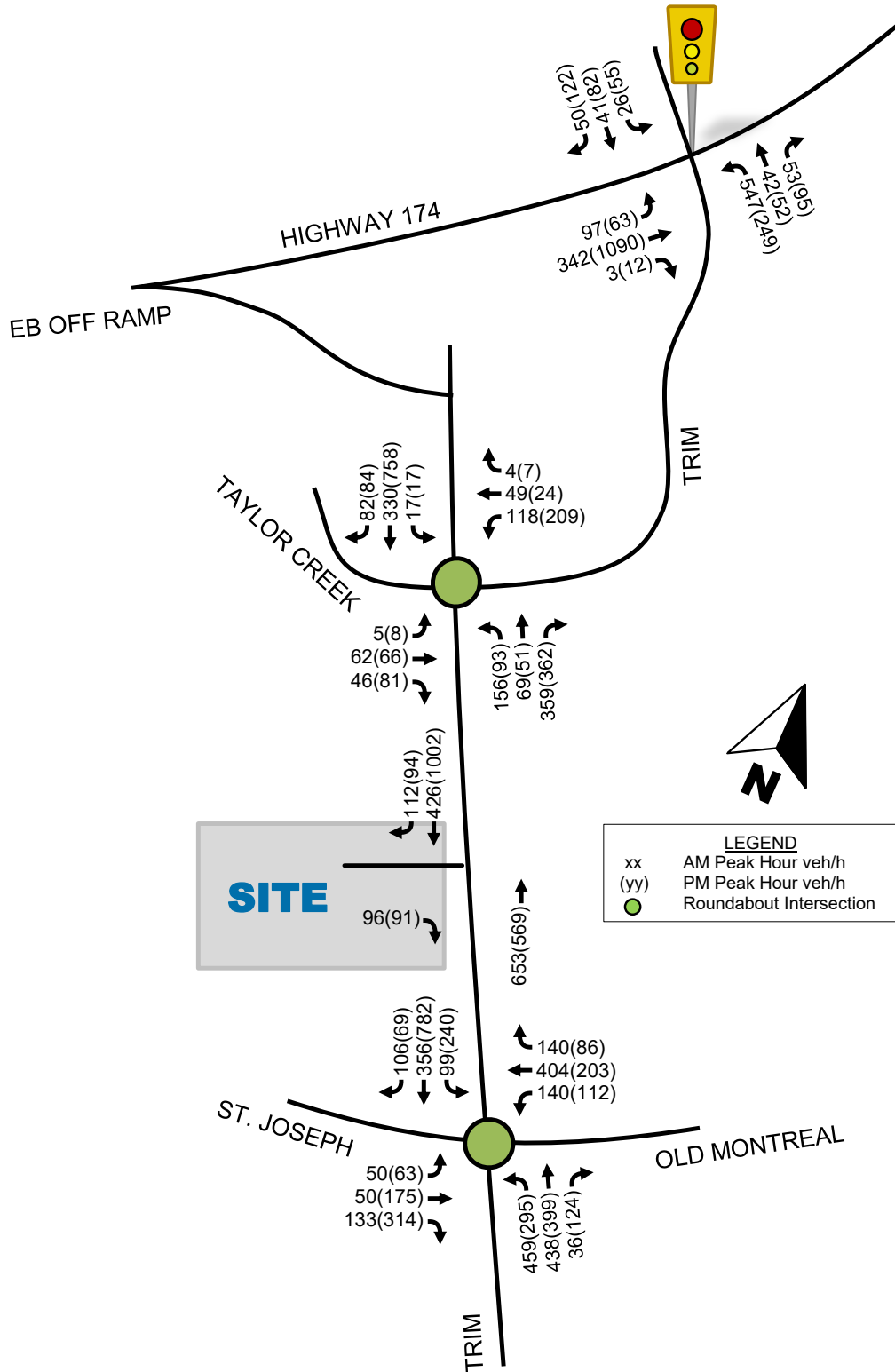

# Transportation Impact Assessment

## 1280 Trim Road

**Table 15: Study Area Intersection Operations – Total Projected Conditions (2026)**

Dir.	Lanes	AM Peak Hour				PM Peak Hour			
		v/c	Delay (s)	LOS	Queue (m)	v/c	Delay (s)	LOS	Queue (m)
<b>Trim Rd/Highway 174 - Actuated-Coordinated Signal</b>									
EBL	1 L	0.51	69.9	A	51	0.50	76.7	A	36
EBT	2 T	0.26	30.6	A	60	0.73	35.9	C	#206.5
WBL	1 L	0.60	78.0	A	47	0.53	72.7	A	46
WBT	2 T	1.04	78.3	F	#319.6	0.30	23.7	A	71
WBR	1 R	0.04	0.1	A	0	0.04	0.1	A	0
NBL	2 L	0.83	63.3	D	107	0.71	70.0	C	59
NBT	1 T	0.10	39.0	A	20	0.17	50.6	A	26
NBR	1 R	0.11	0.5	A	0	0.26	3.6	A	6
SBL	1 L	0.34	78.3	A	19	0.69	104.8	B	#40.5
SBT	1 T	0.34	71.2	A	26	0.55	76.1	A	43
SBR	1 R	0.18	1.4	A	0	0.41	4.1	A	0
<b>Overall</b>		<b>0.94</b>	<b>64.1</b>	<b>E</b>	<b>-</b>	<b>0.71</b>	<b>39.7</b>	<b>C</b>	<b>-</b>
<b>Trim Rd/Taylor Creek Dr - Roundabout</b>									
EB	1 L/T/R	0.15	6.1	A	1	0.37	14.6	A	2
WB	1 L/T/R	0.17	4.8	A	1	0.21	4.9	A	1
NBT	1 T/L	0.14	5.4	A	1	0.10	5.5	A	0
NBR	1 R	0.33	5.4	A	1	0.33	5.5	A	1
SBT	1 T/L	0.36	6.7	A	2	0.81	18.8	D	9
SBR	1 T/R	0.09	6.7	A	0	0.09	18.8	A	0
<b>Overall</b>			<b>5.8</b>	<b>A</b>	<b>-</b>		<b>12.7</b>	<b>B</b>	<b>-</b>
<b>Trim Rd/Site Driveway - Unsignalized</b>									
EBR	1 R	0.14	10.9	A	4	0.21	14.9	A	6
NBT	1 T	0.19	0.0	A	0	0.16	0.0	A	0
SBT	1 T	0.18	0.0	A	0	0.41	0.0	A	0
SBR	1 T/R	0.16	0.0	A	0	0.27	0.0	A	0
<b>Overall</b>			<b>0.8</b>	<b>A</b>	<b>-</b>			<b>A</b>	<b>-</b>
<b>Trim Rd/St. Joseph Blvd/Old Montreal Rd - Roundabout</b>									
EBT	1 T/L	0.14	6.3	A	0	0.55	21.0	A	3
EBR	1 R	0.18	6.3	A	1	0.65	21.0	B	5
WBT	1 T/L	1.04	61.7	F	16	0.50	11.5	A	3
WBR	1 R	0.19	61.7	A	1	0.11	11.5	A	0
NBL	1 L	0.83	19.4	D	10	0.85	23.3	D	10
NBR	1 R	0.03	19.4	A	0	0.15	23.3	A	1

# Transportation Impact Assessment

## 1280 Trim Road

Dir.	Lanes	AM Peak Hour				PM Peak Hour			
		v/c	Delay (s)	LOS	Queue (m)	v/c	Delay (s)	LOS	Queue (m)
<b>SBL</b>	1 L	0.92	41.8	E	11	1.40	193.0	F	47
<b>SBT</b>	1 T/R	0.21	41.8	A	1	0.10	193.0	A	0
<b>Overall</b>			<b>35.3</b>	<b>E</b>	-		<b>85.9</b>	<b>F</b>	-
<i>.Notes: # - denotes 95<sup>th</sup> percentile volume exceeding capacity  Ideal saturation flow rate assumed to be 1,800 veh/h/lane  PHF assumed to be 0.95</i>									

As shown in **Table 15**, assuming no intersection improvements, study area intersections are projected to continue operating similar to background 2026 conditions, only with relatively minor increases in volumes and delays due to added site-generated traffic.

With regard to ‘critical’ movements (i.e., the worst performing movement at each intersection per peak period), some individual movements are projected to operate with an LOS of ‘D’ or better during both peak hours; however, there are a number of ‘critical’ movements that are projected to operate near or over capacity, including:

- Westbound through movement at the Trim/Highway 174 intersection, projected to operate with an LOS ‘F’ during the AM peak hour;
- Westbound through movement at the Trim/St. Joseph/Old Montreal intersection, projected to operate with an LOS ‘F’ during the AM peak hour, and the;
- Southbound left-turn movement at the Trim/St. Joseph/Old Montreal intersection, projected to operate with an LOS ‘F’ during the PM peak hour.

In terms of 95<sup>th</sup> percentile queues, the following movements exceed the existing storage capacity at the Trim/Highway 174 intersection:

- Eastbound through movement during the afternoon peak hour
- Westbound through movement during the morning peak hour
- Southbound left-turn movement during the afternoon peak hour

Similar to existing and background conditions, there are some individual movements that are operating near or over capacity during peak hours, which can be improved with the measures mentioned previously.

Five years beyond full site build-out, the following **Figure 19** depicts the future ‘total’ volumes for the horizon year of 2031, which were derived by superimposing site-generated traffic (i.e. ‘new’ and ‘pass-by’ trips) volumes onto projected background traffic volumes (e.g. summing volumes together from **Figure 13**, **Figure 14**, and **Figure 17**, resulting in **Figure 19**).

# Transportation Impact Assessment

## 1280 Trim Road

Figure 19: Total Projected Traffic Volumes (2031)

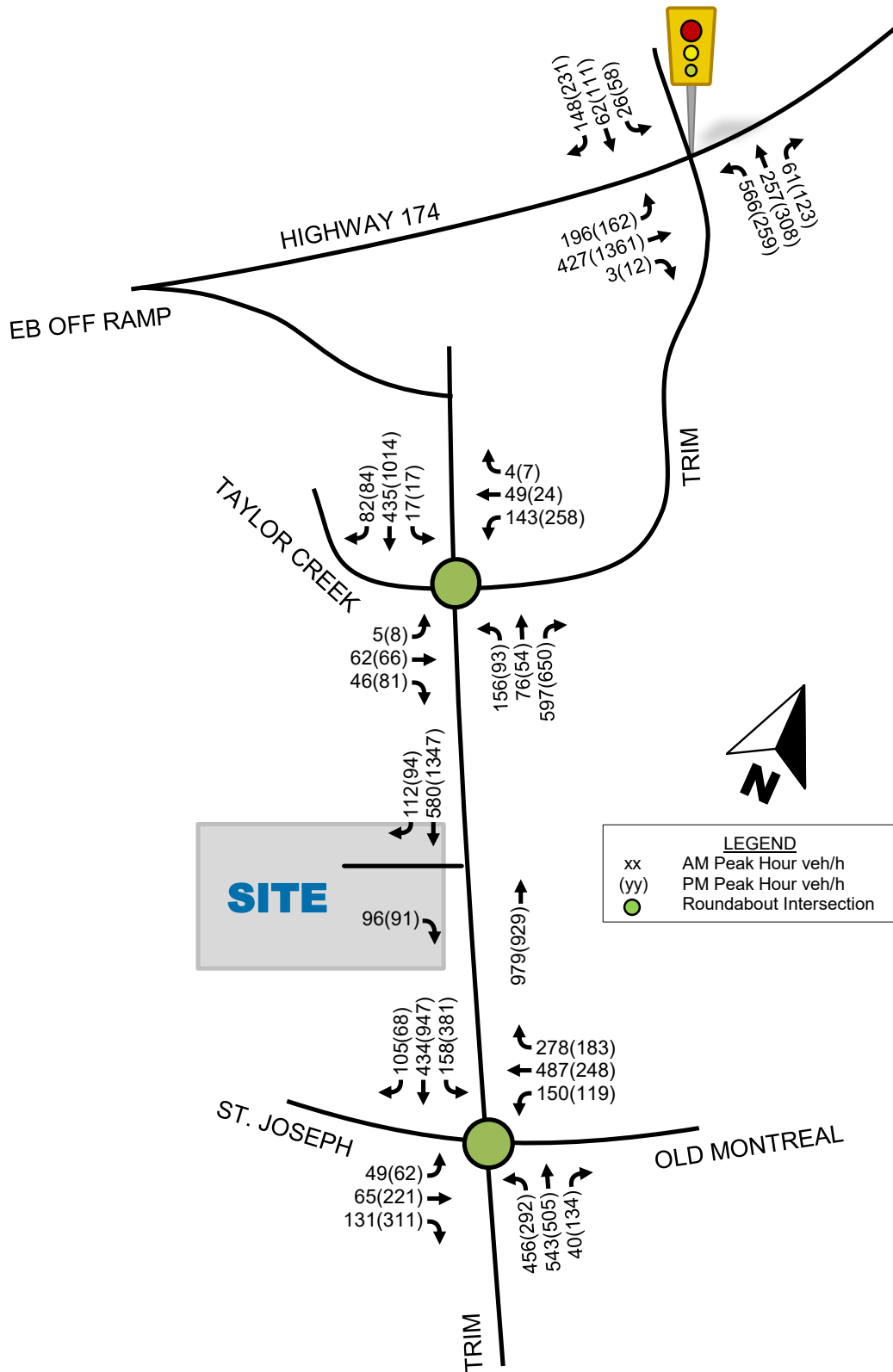

**LEGEND**

- xx AM Peak Hour veh/h
- (yy) PM Peak Hour veh/h
- Roundabout Intersection

# Transportation Impact Assessment

## 1280 Trim Road

The following **Table 16** summarizes the intersection operational analysis of the study area intersections for the total projected 2031 horizon year and detailed Synchro output data for future total projected conditions is provided in **Appendix C**.

**Table 16: Study Area Intersection Operations – Total Projected Conditions (2031)**

Dir.	Lanes	AM Peak Hour				PM Peak Hour			
		v/c	Delay (s)	LOS	Queue (m)	v/c	Delay (s)	LOS	Queue (m)
<b>Trim Rd/Highway 174 - Actuated-Coordinated Signal</b>									
EBL	1 L	0.83	85.9	D	#142.5	0.53	61.2	A	#90.8
EBT	2 T	0.35	34.7	A	76	1.15	117.3	F	#344.5
WBL	1 L	0.64	81.1	B	51	0.51	66.6	A	59
WBT	2 T	1.54	282.6	F	#426.5	0.59	43.6	A	108
WBR	1 R	0.05	0.1	A	0	0.04	0.1	A	0
NBL	2 L	0.83	62.9	D	110	0.72	69.9	C	60
NBT	1 T	0.51	45.8	A	93	0.83	70.8	D	121
NBR	1 R	0.12	0.4	A	0	0.29	6.4	A	13
SBL	1 L	0.34	78.3	A	19	0.72	108.4	C	#43.7
SBT	1 T	0.46	74.1	A	35	0.47	62.5	A	52
SBR	1 R	0.52	9.2	A	10	0.58	11.8	A	25
<b>Overall</b>		<b>1.29</b>	<b>157.8</b>	<b>F</b>	<b>-</b>	<b>1.04</b>	<b>77.4</b>	<b>F</b>	<b>-</b>
<b>Trim Rd/Taylor Creek Dr - Roundabout</b>									
EB	1 L/T/R	0.17	7.2	A	1	0.51	25.2	A	3
WB	1 L/T/R	0.19	5.1	A	1	0.26	5.4	A	1
NBT	1 T/L	0.17	7.6	A	1	0.10	8.8	A	0
NBR	1 R	0.53	7.6	A	3	0.58	8.8	A	4
SBT	1 T/L	0.48	8.6	A	3	1.12	81.6	F	29
SBR	1 T/R	0.09	8.6	A	0	0.09	81.6	A	0
<b>Overall</b>			<b>7.6</b>	<b>A</b>	<b>-</b>		<b>43.9</b>	<b>E</b>	<b>-</b>
<b>Trim Rd/Site Driveway - Unsignalized</b>									
EBR	1 R	0.16	11.8	A	5	0.27	19.2	A	9
NBT	1 T	0.29	0.0	A	0	0.27	0.0	A	0
SBT	1 T	0.24	0.0	A	0	0.56	0.0	A	0
SBR	1 T/R	0.19	0.0	A	0	0.34	0.0	A	0
<b>Overall</b>			<b>0.7</b>	<b>A</b>	<b>-</b>		<b>0.7</b>	<b>A</b>	<b>-</b>
<b>Trim Rd/St. Joseph Blvd/Old Montreal Rd - Roundabout</b>									
EBT	1 T/L	0.18	7.3	A	1	0.88	46.7	D	8
EBR	1 R	0.19	7.3	A	1	0.77	46.7	C	7



# Transportation Impact Assessment

1280 Trim Road

Dir.	Lanes	AM Peak Hour				PM Peak Hour			
		v/c	Delay (s)	LOS	Queue (m)	v/c	Delay (s)	LOS	Queue (m)
WBT	1 T/L	1.34	135.5	F	30	0.64	15.5	B	5
WBR	1 R	0.41	135.5	A	2	0.27	15.5	A	1
NBL	1 L	0.99	42.1	E	19	1.17	95.9	F	27
NBR	1 R	0.04	42.1	A	0	0.20	95.9	A	1
SBL	1 L	1.30	151.3	F	27	1.91	409.9	F	89
SBT	1 T/R	0.23	151.3	A	1	0.10	409.9	A	0
<b>Overall</b>			<b>95.0</b>	<b>F</b>	-		<b>201.0</b>	<b>F</b>	-
<b>Notes:</b> # - denotes 95 <sup>th</sup> percentile volume exceeding capacity Ideal saturation flow rate assumed to be 1,800 veh/h/lane PHF assumed to be 0.95									

As shown in **Table 16**, assuming no intersection improvements, study area intersections are projected to continue operating similar to background 2031 conditions, only with relatively minor increases in volumes and delays due to added site-generated traffic.

With regard to ‘critical’ movements (i.e., the worst performing movement at each intersection per peak period), some individual movements are projected to operate with an LOS of ‘A’ during both peak hours; however, there are a number of ‘critical’ movements that are projected to operate near or over capacity, including:

- Eastbound through movement at the Trim/Highway 174 intersection, projected to operate with an LOS ‘F’ during the PM peak hour;
- Westbound through movement at the Trim/Highway 174 intersection, projected to operate with an LOS ‘F’ during the AM peak hour;
- Southbound through movement at the Trim/Taylor Creek intersection, projected to operate with an LOS ‘F’ during the PM peak hour;
- Westbound through movement at the Trim/St. Joseph/Old Montreal intersection, projected to operate with an LOS ‘F’ during the AM peak hour, and the;
- Southbound left-turn movement at the Trim/St. Joseph/Old Montreal intersection, projected to operate with an LOS ‘F’ during the PM peak hour.

In terms of 95<sup>th</sup> percentile queues, the following movements exceed the existing storage capacity at the Trim/Highway 174 intersection, similar to background conditions:

- Eastbound left-turn movement during the morning and afternoon peak hour
- Eastbound through movement during the afternoon peak hour
- Westbound through movement during the morning peak hour
- Southbound left-turn movement during the afternoon peak hour

# Transportation Impact Assessment

1280 Trim Road

---

Similar to existing and background conditions, there are some individual movements that are operating near or over capacity during peak hours, which can be improved with the measures mentioned previously.

## Adjustments to Site-Generated Demand

With respect to projected site-generated traffic for the subject development land and other area developments, adjusting modal splits away from projected auto trips further, is difficult to justify, as certain individuals will ultimately be required to drive for one reason or another (e.g. distance between origin/destination is too great, travel is a requirement for employment, physical disabilities limit travel options to personal vehicle, etc.). Additionally, adjusting the auto modal share for site-generated traffic much lower will have a negligible affect on the performance of study area network (note: study area intersections are projected to continue operating similar to background conditions, only with minor increases in volumes and delays).

The main objective of this TIA study, from a broader network perspective, will be to identify any additional mitigation measures that may be necessary to support the subject development site (e.g. evaluate the need for auxiliary turn lanes, modifications to intersection traffic control, transportation demand management strategies, traffic calming, etc.), which will be discussed in the subsequent *Step 4 – Analysis* section of this report.

## 4.0 Analysis

---

With respect to the City of Ottawa TIA Guidelines, this module reviews the proposed transportation network elements within the development study area to ensure that they provide effective access for all users, while creating an environment that encourages walking, cycling, and transit use and prioritizes safety.

### 4.1 Development Design

#### Design for Sustainable Modes

**Pedestrian Facilities:** The pedestrian network within the vicinity of the subject site is currently comprised of bi-directional asphalt MUPs that run along both sides of Trim Road. Concrete sidewalks will be provided within the subject development site, fully integrating pedestrians with the existing pedestrian network.

**Cycle Facilities:** As mentioned in the *Step 2 – Scoping* section, Trim Road, St. Joseph Boulevard and Old Montréal Road are all classified as cycling spine routes with MUPs provided along Trim Road within the study area. On all approaches for both the Trim/Taylor Creek and Trim/Old Montréal roundabout, the concrete sidewalks and bike lanes on each roadway merge into multi-use pathways within the intersections.

**Transit Facilities:** As mentioned in the *Step 2 – Scoping* section, the subject site is located within a 350 m radius to/from ten existing OC Transpo bus stops and the future LRT stop at Trim Station.

With respect to the City's TIA Guidelines, design for these facilities is in accordance with the *TDM – Supportive Development Design and Infrastructure*. This TDM checklist is provided in **Appendix G** and is further discussed in **Section 4.5**.

#### Circulation and Access

As illustrated in **Figure 2**, the proposed access is 7.0 m wide and 6.7 to 7.0 m drive aisles are provided on site. Note that the proposed auto service centre requires approximately 12.3 m of

# Transportation Impact Assessment

## 1280 Trim Road

---

clear space in front of the service bays which has been provided. This satisfies the City's Zoning By-Law provisions for "*Aisles and Driveways*". In addition, this also complies with Building Code requirements for emergency vehicle access that requires a clear 6 m wide fire route, which is provided for both the residential and commercial portions of the site.

With regard to on-site circulation and access, an AutoTurn truck turning analysis was conducted throughout the site to ensure sufficient turning radii will be provided for delivery trucks, garbage trucks, and emergency vehicles. The design vehicle for this exercise was a garbage truck. The fire route as shown in the latest site plan is considered acceptable as it complies with Section 3.2.5 (Provisions for Firefighting) of the Ontario Building Code.

Following the *Step 2 – Scoping Report* submission on August 29<sup>th</sup>, 2023, preliminary site plan comments from the City of Ottawa received on September 8<sup>th</sup>, 2023, suggested that the drive-thru aisle between the restaurant building and Trim Road is inconsistent with Section 4.6.5 (2) and 4.5.6 (3) of the Official Plan. While it is preferred that development should generally be located such that a drive-thru aisle is not located between the building and the street, per the latest site plan, an effort is made to ensure that the main entrances are visible from public sidewalks. There is emphasis of the pedestrian crossing throughout the site and both buildings facing the street have an attractive façade and/or an entrance facing Trim Road.

It should be noted that Section 4.5.6 (3) states that conflicts should be minimized and need not be fully eliminated. In this case, further site re-configuration compromises other design features. For example, elimination of the drive-through fast-food lane reduces pedestrian conflicts, however the lane is required to support the economical viability of the site. Examples of preferred drive-thru configurations were provided in the *Scoping Report* comments (such as Tim Hortons at 2016 Ogilvie Road or the Starbucks at 1914 Bank Street). However, these sites have a much larger site footprint thus providing more flexibility with building/drive-thru placement.

## 4.2 Parking

### Parking Supply

The proposed development is located in Area C (Suburban), as identified in Schedule 1A of the City's Zoning By-law provisions for "*Parking, Queuing and Loading Provisions*". The following **Table 17** and **Table 18** summarize the minimum parking and bicycle parking space requirements for the proposed land uses, in accordance with the City's Zoning By-law, *Section 101 - Minimum Parking Space Rates*, *Section 102 - Minimum Visitor Parking Space Rates* and *Section 111 - Bicycle Parking Space Rates and Provisions*.

### Vehicular Parking

Given the proposed non-residential development exceeds 300 m from a rapid-transit station, the minimum parking requirements are to be calculated using the rates for Area C, as outlined under Section 101 of the City's Zoning By-Law (i.e., Column IV of Table 101 in Section 101 of the Zoning By-Law). As outlined under Section 102 of the City's Zoning By-Law, visitor parking is to be calculated using the rates for Area C (i.e., Column III of Table 102 in Section 102 of the Zoning By-Law).

The following **Table 17** summarizes appropriate vehicle parking rates and minimum parking requirements for the subject development.

# Transportation Impact Assessment

## 1280 Trim Road

**Table 17: Vehicular Parking Supply**

Land Use	Zoning Requirement	GFA	Minimum Parking Requirement	Vehicle Provided Parking
Personal Services	3.4 per 100 m <sup>2</sup> of GFA	557.5 m <sup>2</sup>	19	-
Automobile Service Centre	2 per service bay	682.4 m <sup>2</sup>	14	-
Restaurant	10 per 100 m <sup>2</sup> of GFA	325.2 m <sup>2</sup>	32	-
<b>Total Required</b>			<b>65</b>	<b>75</b>

As summarized in **Table 17**, the minimum vehicle parking space requirement for the subject development is 65 vehicle parking spaces. This minimum by-law is met as there will be 77 vehicle parking spaces provided.

### Bike Parking

As outlined under Section 111 of the City's Zoning By-Law, bike parking is to be calculated using the rates found in Table 111A (i.e., Column II of Table 111A in Section 111 of the Zoning By-Law).

**Table 18: Bicycle Parking Supply**

Land Use	Zoning Requirement	GFA	Minimum Parking Requirement	Bicycle Parking Provided
Personal Services	1 per 500 m <sup>2</sup> of GFA	557.5 m <sup>2</sup>	1	-
Automobile Service Centre	per 500 m <sup>2</sup> of GFA	682 m <sup>2</sup>	1	-
Restaurant	1 per 250 m <sup>2</sup> of GFA	325.2 m <sup>2</sup>	1	-
<b>Total Required</b>			<b>3</b>	<b>6</b>

As summarized in **Table 18**, the subject development is required to have a minimum of 3 bicycle parking spaces, provided in well-lit areas and close to the main entrances of buildings. The proponent will be providing 6 bicycle parking spaces on-site.

### Spillover Parking

With respect to the City's TIA Guidelines, this module is exempt.

## 4.3 Boundary Street Design

With respect to the City's TIA Guidelines, this module determines design elements of boundary streets required to accommodate the proposed development, consistent with the City's complete streets philosophy and its urban design objectives for the development area. The identified boundary street for the subject site is Trim Road which is owned and maintained by the City of Ottawa.

# Transportation Impact Assessment

1280 Trim Road

---

## Mobility

A Multi-Modal Level of Service (MMLOS) analysis was conducted for the subject site’s boundary street, Trim Road which is a measure of risk, comfort and stress for active modes and a measure of impedance, delay and reliability for trucks/buses. With respect to the City of Ottawa’s MMLOS guidelines, target MMLOS values were obtained from Exhibit 22 of the MMLOS guidelines and are identified in brackets in the following **Table 19**. The detailed MMLOS assessment is included as **Appendix E**.

## Segment MMLOS Summary

Trim Road is an arterial road that consists of the following features within the study area:

- Four-lane roadway (i.e., two travel lanes per direction) with a center median;
- 4.0 m MUP and 3.5 m boulevard on both sides of the road;
- 3.5 m wide lane
- Posted speed limit of 60 km/h
- No on-street parking
- Designated truck route
- Greater than 3000 average daily curb lane traffic

The following **Table 19** is a MMLOS analysis summary of existing conditions for non-auto modes (i.e., pedestrian, cycling, transit, and trucks) along the road segments described above. Any LOS results highlighted in red indicate that the target MMLOS was not met for that segment. It should be noted that a MMLOS segment analysis focuses on local transit provided along boundary streets only (i.e., MMLOS worksheets are not sensitive to dedicated rapid transit facilities).

**Table 19: Segment MMLOS – Existing LOS (Target LOS)**

Road Segment	PLOS	BLOS	TLOS	TkLOS
Trim Road	C(A)	A(A)	D(N/A)	A(D)

Based on the results summarized in **Table 19**, the following should be noted/considered:

### Pedestrian LOS

- Pedestrian target LOS is not met along Trim Road as the roadway is an arterial that experiences an average daily curb lane traffic greater than 3000 vehicles.
- To meet the target PLOS, the overall traffic volume would need to be reduced. However, as Trim Road is a major arterial roadway with lots of planned developments in the future, a significant reduction is unlikely to occur.

### Bike LOS

- Bike target LOS is met along Trim Road.

### Transit LOS

- There is no transit target LOS along Trim Road as there are no transit facilities provided along the roadway.

# Transportation Impact Assessment

## 1280 Trim Road

### Truck LOS

- Truck target LOS is met and exceeded along Trim Road.

### Road Safety

For the purpose of a road safety review, collision records for boundary streets were examined to determine if locations exhibit any collision trends that might be mitigated by engineering intervention. If there is a collision trend that is outside the norm of what is expected, then the potential exists to reduce the collision experience by addressing the over-represented collision trend. Whenever changes are being made to the road environment, it is an opportunity to examine whether a safety intervention could result in meaningful safety benefits. Where there are identifiable safety trends, it is worthwhile to mitigate those, such that the added traffic from a new development does not increase the risk of new collisions.

Based on a review of the most recent five (5) years of historical collision data (collected from January 1<sup>st</sup>, 2016 to December 31<sup>st</sup>, 2020, inclusive), the following **Table 20** summarizes the number and rate of collisions within the vicinity of the subject development site, along study area road segments (i.e. collisions and collisions per million vehicle kilometers).

**Table 20: Historical Collision Data Summary by Road Segment**

Segment	Between	Total Collisions (5-year Total)	Rate (C/MVK)	Classification		
				Property Damage	Non- fatal Injury	Fatal Injury
Trim	Taylor Creek & St. Joseph	2	0.11	2	0	0
<b>Total</b>		2	-	2	0	0
<b>Notes:</b> C/MVK = Collisions per Million Vehicle Kilometers						

As summarized in **Table 20**, the number of collisions for all road segments adjacent to the subject development site are considered to be low, and the severity of collisions along all road segments are also low, based on the available data.

Based on the same most recent five (5) years of historical collision data, the following **Table 21** summarizes the number and rate of collisions within the vicinity of the subject development site, at study area intersections (i.e. collisions and collisions per million entering vehicles).

# Transportation Impact Assessment

## 1280 Trim Road

**Table 21: Historical Collision Data Summary by Intersection**

Intersection	Total Collisions (5-year Total)	Rate (C/MEV)	Classification		
			Property Damage	Non-fatal Injury	Fatal Injury
Trim/Highway 174	50	1.48	42	8	0
Trim/Taylor Creek	33	1.19	26	7	0
Trim/St. Joseph-Old Montreal	142	3.02	124	18	0
<b>Total</b>	<b>225</b>	<b>-</b>	<b>192</b>	<b>33</b>	<b>0</b>

**Notes:** C/MEV = Collisions per Million Entering Vehicles

As summarized in **Table 21**, the number and rate of collisions at study area intersections are higher than 1.0 collisions / MEV which indicates a higher risk of collisions at an intersection. With regard to the Trim/Highway intersection, the intersection was redesigned and relocated in 2022. As such the reported collision rate does not apply to the current intersection configuration.

With regard to the Trim/Taylor Creek intersection, there was a total of 33 collisions of which 26 (79%) resulted in property damage only with the remaining 7 (21%) resulting in non-fatal injury.

With regard to the Trim/St. Joseph-Old Montreal intersection, there was a total of 142 collisions. However, 124 (87%) of these collisions resulted in property damage only with the remaining 18 (13%) resulting in non-fatal injury.

Although the Trim/Taylor Creek and the Trim/St. Joseph-Old Montreal intersections have high rates of collisions, **Table 21** shows that majority of these collisions resulted in property damage only, with a few collisions resulting in non-fatal injury. This is consistent with the presence of roundabout intersections which are designed to eliminate severe collisions (i.e., fatal injury). The high rate of non-severe collisions may be due to drivers ignoring pavement markings on the multi-lane approach of these intersections or speeding through the roundabout without yielding to oncoming vehicles.

It should also be noted that within the five years of recorded collision data, there was one (1) collision involving a cyclist and none involving a pedestrian. This reported collision involving a cyclist was non-fatal; however, person-vehicle collisions usually result in serious injuries that require medical attention.

With respect to the City's latest Road Safety Action Plan, and the vision/goal of progressing towards zero fatalities and major injuries, the City may want to conduct an In-Service-Road-Safety-Review (ISRSR) for the Trim/St. Joseph-Old Montreal intersection as part of their regular road safety investigations.

A more detailed collision analysis for study area road segments and intersections is included as **Appendix F**. As previously mentioned, source collision data is included as **Appendix B**.

# Transportation Impact Assessment

1280 Trim Road

---

## Neighbourhood Traffic Management (NTM)

This section reviews the development location to determine if the proposed development will exacerbate existing operational concerns on boundary streets, if the subject development will rely on collector or local roads.

Given the subject development will only provide a connection to an arterial roadway (i.e., Trim Road), a review of potential NTM strategies is not required, with respect to the City's TIA Guidelines.

### 4.4 Access Intersections

With respect to the City's TIA Guidelines, this module has been combined with **Section 4.9 Network Intersections**.

### 4.5 Transportation Demand Management

With respect to the City's TIA Guidelines, a review of Transportation Demand Management (TDM) strategies is a requirement for the subject development. Determining, which TDM strategies maybe appropriate for implementation, formal TDM checklists are provided by the City for review by the proponent and consultant completing the TIA Report.

With respect to the City's TIA Guidelines, TDM checklists, provided by the City and titled *TDM – Supportive Development Design and Infrastructure* and the *TDM – Measures Checklist*, have been completed and are included as **Appendix G**. Given the proposed development is currently in the early stages of planning/approvals, not all TDM measures identified as 'required' in the TDM checklist can be committed to at this time. Further refinements to the proposed development design are anticipated during subsequent phases of the City's development application approval process.

Measures identified in both checklists include:

- Display local area maps with walking/cycling access routes and key destinations at major entrances.
- Locate building entrances in order to minimize walking distances to sidewalks and transit stops/stations.
- Locate building doors and windows to ensure visibility of pedestrians from the building, for their security and comfort.
- Provide safe, direct, and attractive pedestrian access from public sidewalks to building entrances.
- Provide sidewalks of smooth, well-drained walking surfaces of contrasting materials or treatments to differentiate pedestrian areas from vehicle areas and provide marked pedestrian crosswalks at intersection sidewalks.
- Provide bicycle parking in highly visible and lighted areas.

As the site is designed to accommodate multiple businesses and tenants, it is important to note that additional measures from the *TDM – Measures Checklist* cannot be committed to at this time. These measures are dependent on each tenant and may vary based on their specific needs and requirements.



# Transportation Impact Assessment

1280 Trim Road

---

## 4.6 Neighborhood Traffic Management

With respect to the City's TIA Guidelines, this module reviews significant access routes to/from the development and identifies any required neighborhood traffic management (NTM) measures to mitigate impacts on collector and local roads.

As mentioned previously in the 4.3 – *Boundary Street Design* section of this report, the proposed development does not rely on local or collector streets for access and therefore, a review of potential NTM strategies is not required, with respect to the City's TIA Guidelines.

## 4.7 Transit

Transit stops that serve the development site were previously mentioned in the *Step 2 – Scoping* section of this report, which included stop number, location, route identifier and directional information (summarized in **Table 1**). Additionally, transit route information, including frequency and service type, were previously summarized in **Table 2**. All transit stops are located within the OC Transpo service design guidelines (i.e., within 400 m walking distance to/from the site) with the exception of the two transit stops located along the Trim Park & Ride south frontage. It should be noted that these stops are located within approximately 475 m walking distance to/from the subject development site.

### Route Capacity

With respect to the City's TIA Guidelines, this module is exempt.

### Transit Priority

Given the relatively low volume of projected site-generated traffic, transit travel times should not be impacted. However, as mentioned previously in **Section 3.3**, study area intersections are currently operating near or at capacity during weekday morning and afternoon peak hours. With near completion of the LRT Trim extension, transit service and reliability will be significantly improved.

## 4.8 Review of Network Concept

With respect to the City's TIA Guidelines, this module is exempt.

## 4.9 Access and Intersection Design

With respect to the City's TIA Guidelines, this module determines the design elements of the points of access to/from the subject development site, and study area intersections required to accommodate the proposed development, consistent with the City's Complete Streets philosophy, MMLOS guidelines, and its urban design objectives for the development area.

With respect to the City's TIA Guidelines, this module determines design elements of the points of access to/from the subject development site, consistent with the City's Complete Streets philosophy, MMLOS guidelines, and its urban design objectives for the development area.

### Location and Design of Access

There is one site driveway connection to/from the subject development being proposed, a right-in/right-out access to Trim Road. It is located approximately 175 m north of the Trim/St. Joseph-Old Montreal roundabout and 110 m south of the Trim/Taylor Creek roundabout.

# Transportation Impact Assessment

## 1280 Trim Road

All proposed site driveways satisfy the City's Private Approach By-Law No. 2003-447 (i.e., it is within the maximum width of 7.5 m for a private approach, it is further than 30 m from adjacent intersecting roadways, it is at least 2 m from adjacent driveways, and it is at least 3 m from the property line).

### Site Access Throat Length Discussion

During the pre-consultation meeting with the City of Ottawa held on March 23<sup>rd</sup>, 2023, City staff provided comment on the length of the proposed right-in/right-out driveway connection. It was noted that with respect to the Transportation Association of Canada's (TAC) *Geometric Design Guidelines*, a minimum clear throat length for a driveway connection to an arterial roadway should be 25 m. Following the *Step 3/4 – Forecasting and Analysis Report* submission on August 29<sup>th</sup>, 2023, preliminary site plan comments from the City of Ottawa received on September 8<sup>th</sup>, 2023, indicated an insufficient throat length for the site driveway and that the minimum clear throat length for the proposed development is 40 m. As depicted in **Figure 2**, the proposed driveway clear throat length, measured from the curb return radii, is approximately 25 m.

The following analysis has been completed to provide the City with additional rationale to allow a driveway with a 25 m clear throat length, measured from the curb return radii, for the proposed development at 1280 Trim Road.

### TAC Guidelines

As described in *Chapter 8 – Access* of the TAC Guidelines, a clear throat length for driveways is measured as *the ends of the driveway curb return radii at the roadway and the point of first conflict on-site*, which is shown in Figure 8.5.2 within the TAC Guidelines (depicted below).

**Figure 8.5.2: Auxiliary Lane Mid-Block Access for Major Developments**

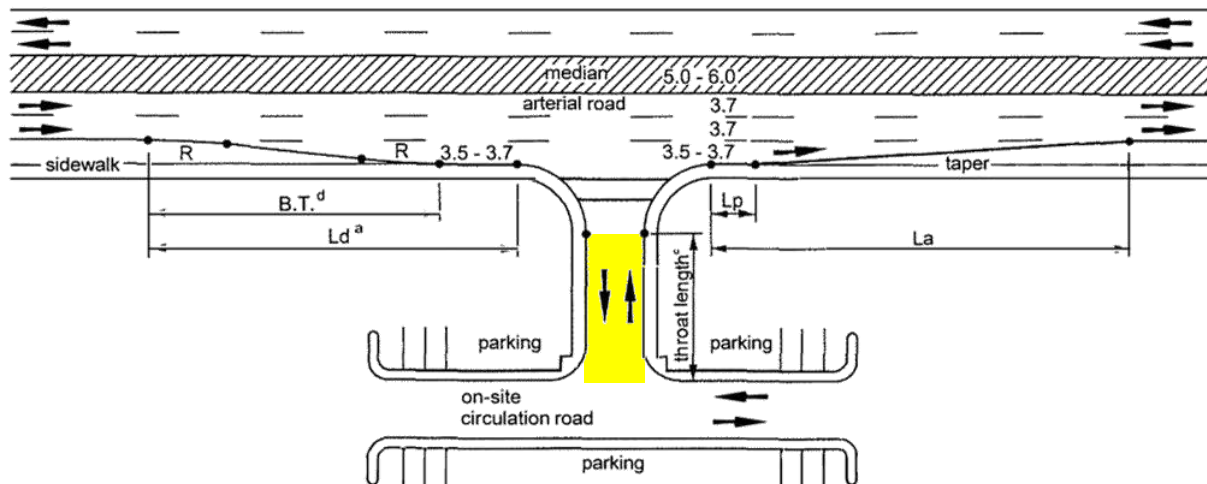

Also described in *Chapter 8 – Access* of the TAC Guidelines, a clear throat length for driveways is determined by the size and type of development, and the road classification the driveway is connected to. As shown in Table 8.9.3 within the TAC Guidelines (depicted below), the governing land use for the proposed subject development suggests that a 40 m clear throat length should be provided to ensure efficient operations. Providing a sufficiently long clear zone is critical for storing potential vehicle queues, in a way that they do not create conflicts. This clear zone is particularly important for developments with drive-through services that can generate queues of entering vehicles, which could block on-site circulation and/or block vehicles from entering the site (e.g., queues spilling onto the adjacent roadway).

# Transportation Impact Assessment

## 1280 Trim Road

**Table 8.9.3: Suggested Minimum Clear Throat Lengths for Major Driveways<sup>14</sup>**

Land Use	Development Size	Minimum Clear Throat Length (m)	
		Collector	Arterial
Light Industrial	<10,000 m <sup>2</sup>	8	15
	10,000 – 45,000 m <sup>2</sup>	15	30
	>45,000 m <sup>2</sup>	15	60
Discount Store	>3,000 m <sup>2</sup>	8	15-25
Shopping Centre	<25,000 m <sup>2</sup>	8	15
	25,000 – 45,000 m <sup>2</sup>	15	25
	45,001 – 70,000 m <sup>2</sup>	25	60
	>70,000 m <sup>2</sup>	40	75
Supermarket	<2,000 m <sup>2</sup>	15	25
	>2,000 m <sup>2</sup>	25	40
Apartments	<100 units	8	15
	100 – 200 units	15	25
	>200 units	25	40
Quality restaurant	<1,500 m <sup>2</sup>	8	15
	>1,500 m <sup>2</sup>	8	25
Fast food restaurant	<200 m <sup>2</sup>	8	25
	>200 m <sup>2</sup>	15	40
General office	<5,000 m <sup>2</sup>	8	15
	5,000 – 10,000 m <sup>2</sup>	8	25
	10,001 – 20,000 m <sup>2</sup>	15	30
	20,001 – 45,000 m <sup>2</sup>	30	45
	>40,000 m <sup>2</sup>	40	75
Motel	<150 rooms	8	25
	>150 rooms	8	30

- Notes
1. Refer to Figure 8.5.2 for method of measurement
  2. For major developments, it is desirable to determine throat lengths and queue on the basis of a site-specific traffic study

Noted in the footnotes of Table 8.9.3 within the TAC Guidelines, Note #2 indicates that a site-specific traffic study can form the basis for determining a desirable throat length. As such, the following review will serve as the basis for determining a desirable driveway throat length.

It is important to note, TAC Guidelines were developed as a national standard; and therefore, take into consideration rural communities and higher speed roadways. Given the previously depicted Table 8.9.3 only speaks to collector vs. arterial roadway designations (as opposed to having different criteria for urban vs. rural contexts, high vs. low-speed roadways, right-in/right-out vs. full-movement driveways, etc.), TAC Guidelines are commonly regarded as being conservative, particularly in urban contexts.

### Site Constraints

With respect to the TAC Guidelines, the following **Figure 20** depicts what the impact of a 40 m clear throat length would have on what is considered a relatively small site.

# Transportation Impact Assessment 1280 Trim Road

**Figure 20: Clear Throat Lengths – Measured from the Curb Return Radii**

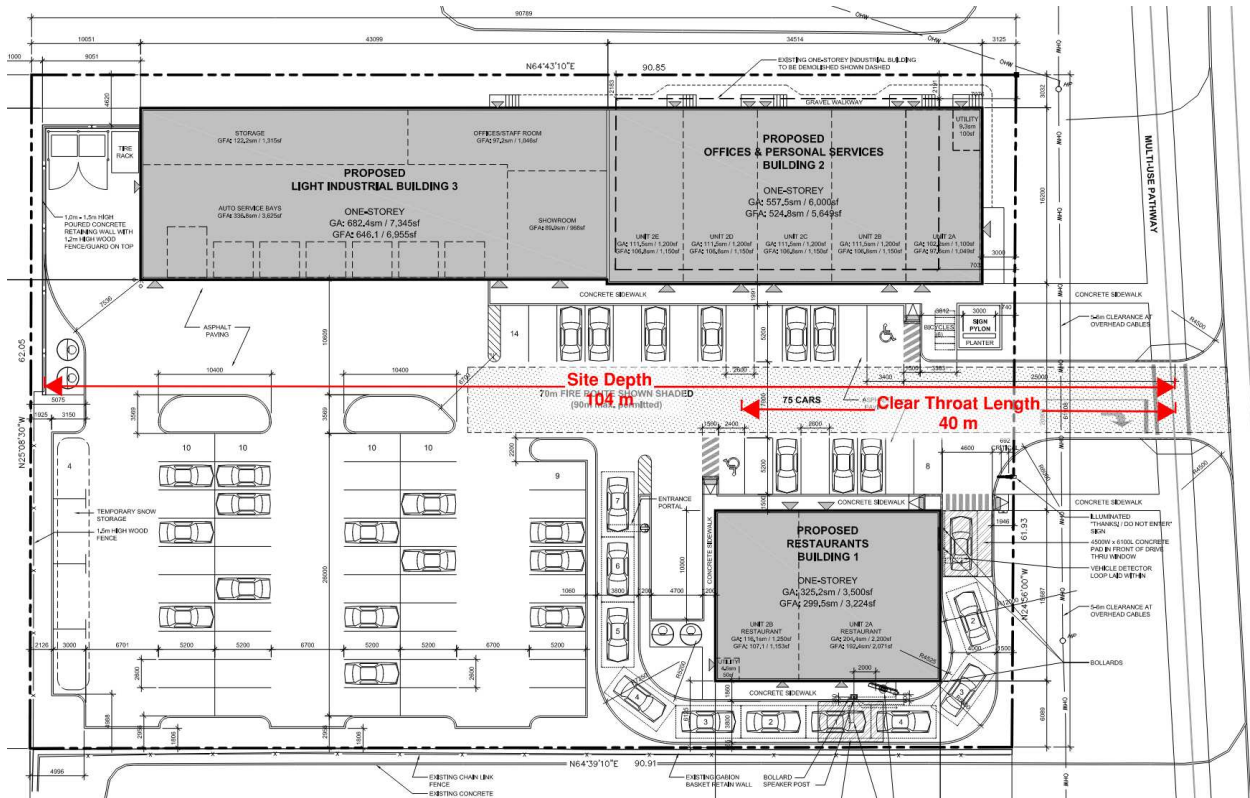

As shown in **Figure 20**, a 40 m throat length would bisect almost half the length of the site and would result in approximately 8 fewer parking spaces. Note that any reduction in parking may compromise the development, as it is located in a predominately industrial neighbourhood with few opportunities for street parking. Additionally, accessible parking spaces would need to be relocated further from main building entrances, which is not desirable from an AODA perspective.

It is also important to note that the proposed driveway connection will be restricted to right-in/right-out only and TAC Guidelines take into consideration driveways being full-movement. Given right-in/right-out connections five less conflict points, there is less of a need for a long driveway clear throat length. The following **Figure 21** depicts the number of conflicts points for a full-movement driveway connection vs. a right-in/right-out connection.

**Figure 21: Number of Conflicts at a Full-Movement vs. Right-In/Right-Out Connection**

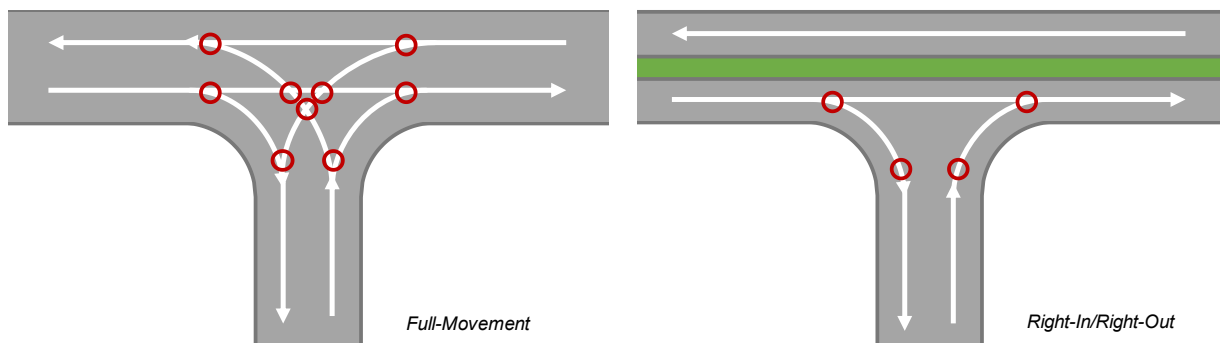

# Transportation Impact Assessment

## 1280 Trim Road

---

As depicted in **Figure 21**, the number of vehicle conflict points, identified as red circles, are significantly less and there are no severe vehicle conflict points for a right-in/right-out connection.

Given the aforementioned reasons, the City staff noted in the pre-consultation meeting held on November 23<sup>rd</sup>, 2023, that a 25 m throat length as measured from the end of the curb return radii is deemed acceptable.

### Projected Operations

In 2016, A&W Food Services of Canada Inc. conducted a Drive-Through Stacking Study in support of a proposed A&W restaurant located at 751 Strasburg Road, Kitchener, ON (attached as **Appendix H**). This study analyzed the drive-through operations of three (3) A&W proxy sites to determine the drive-through demand and vehicle queue lengths of typical A&W high-volume restaurants in Ontario during peak periods. Vehicle queue surveys were conducted during A&W lunch and dinner peak periods, specifically from 11:30 AM to 1:30 PM and from 5:00 PM to 7:00 PM, respectively.

From the study, it was observed that on average, all three drive-through facilities had a maximum of four (4) vehicles in queue between the pick-up window and the drive-through entrance at any time interval. The highest recorded maximum queue length was seven (7) vehicles at one of the sites.

The latest Site Plan for the proposed subject development at 1280 Trim Road, provides space for 11 vehicles in total between the pick-up window and the drive-through entrance. Based on this, it can be concluded that the proposed development provides sufficient vehicle space to accommodate the maximum vehicle queues for a typical A&W restaurant (i.e., the need for a long driveway clear throat length is not apparent with the amount of drive-through storage provided).

### Throat Length Discussion Summary

From a transportation perspective and based on the foregoing analysis, providing an approximate 25 m clear driveway throat length, measured from the curb return radii to the point of first conflict on-site, will be sufficient. In summary, the following are the main points for justification:

- The TAC Guidelines were developed as a national standard and take into consideration rural communities and higher speed roadways. As such, TAC Guidelines are commonly regarded as being conservative, as there are no separate criteria for urban vs. rural contexts, high vs. low-speed roadways, right-in/right-out vs. full-movement driveways, etc.
- Given the proposed right-in/right-out driveway connection will have five less vehicle conflict points (none of which are severe vehicle conflict points), there is less of a need for a long driveway clear throat length.
- Based on data collected at three existing proxy sites, with similar land uses as the proposed development (i.e., existing A&W sites), the amount of proposed drive-through storage will be more than sufficient to accommodate the maximum queue lengths (i.e., conflicts generated by drive-through queues are not anticipated for the proposed subject development).
- Any reduction in on-site parking (e.g., in favour of a longer clear throat length) may compromise the development, as it is located in a predominately industrial neighbourhood with few opportunities for street parking.

# Transportation Impact Assessment

1280 Trim Road

---

If required, post-development monitoring can be provided. If post-development operations prove to be problematic, possible mitigation measures can be discussed with City staff for their consideration at that time.

## New Street Networks

With respect to the City's TIA Guidelines, this module is exempt as the proposed development is a Site Plan and not a subdivision.

## Intersection Control

The site driveway is currently proposed to be STOP-controlled on the minor approach. Based on the intersection capacity analysis included in the **Section 3.3** of this report, and consistent with the City's policies, goals and objectives, additional signal or intersection control will not be warranted.

## Intersection Design

The design of the proposed site access intersection is discussed in **Section 4.1.2** above. As the proposed access is unsignalized, it is not included in the MMLOS analysis.

The following is a MMLOS analysis for signalized study area intersections only. As previously mentioned, MMLOS is a measure of risk, comfort and stress for active modes and a measure of impedance, delay, and reliability for trucks/buses. With respect to the City of Ottawa's MMLOS guidelines, target MMLOS values were obtained from Exhibit 22 of the MMLOS guidelines and are identified in brackets in the following **Table 22**.

## Intersection MMLOS Summary

Similar to the MMLOS analysis conducted in Section 4.2 of this report, the following **Table 22** summarizes existing MMLOS conditions at signalized study area intersections. As there are no proposed geometric changes to study area intersections, the future 2026 and 2031 MMLOS will be the same as existing. The detailed intersection MMLOS analysis for both existing and projected conditions are provided in **Appendix E**.

**Table 22: Intersection MMLOS – Existing LOS(Target LOS)**

No.	Intersection	PLOS	BLOS	TLOS	TkLOS	AutoLOS
1	Trim/Highway 174	F (A)	N/A (D)	F (N/A)	C (D)	E to F (E)

Based on the results summarized in **Table 22**, the following should be noted/considered:

## Pedestrian LOS

- The signalized study area intersection does not meet the PLOS 'A' target.
- It should be noted that failing PLOS targets is due to a single crosswalk provided at this intersection (on the East approach) and is the result of a wide the intersection requiring pedestrians to cross multiple lanes.

# Transportation Impact Assessment

1280 Trim Road

---

## Bike LOS

- As cyclists are not permitted to turn onto Highway 174, there are not enough parameters to determine the existing BLOS.

## Transit LOS

- There are no TLOS targets for this intersection as neither Highway 174 and Trim Road are rapid transit corridors or transit priority roadways.

## Truck LOS

- The signalized study area intersection meets the TkLOS target.

## Auto LOS

- The signalized study area intersection does not meet the AutoLOS 'E' target
- Failing AutoLOS targets are due to volume-to-capacity ratios greater than 1.0 (i.e., high traffic congestion.)

## 5.0 Findings and Recommendations

---

As with any infill development, the introduction of a new land use will have impacts on the surrounding transportation network. J.L. Richards and Associates Limited has completed a review of these impacts and summarized the findings within this transportation assessment, which follows the format of a Transportation Impact Assessment (TIA) Study, as requested by the City of Ottawa. At this stage, and with respect to the City's TIA Guidelines, the following findings and conclusions are offered:

- Study area intersections are currently operating near or at capacity and are projected to continue operating near or at capacity with the additional traffic generated by the proposed development.
- Based on historical collision data, the Trim/St. Joseph-Old Montreal intersection has a high collision rate. With respect to the City's latest Road Safety Action Plan, and the vision/goal of progressing towards zero fatalities and major injuries, the City may want to conduct an In-Service-Road-Safety-Review (ISRSR) for the Trim/St. Joseph-Old Montreal intersection as part of their regular road safety investigations.
- Given the local context, the private auto is projected to be the primary mode choice for travel for all proposed land uses.
- The proposed development is projected to generate 'new' two-way vehicles volumes of 88 veh/h and 89 veh/h during weekday morning and afternoon peak hours, respectively.
- With regard to active modes, the proposed development is projected to generate approximate two-way person trips of 16 trips/h during both weekday morning and afternoon peak hours.
- With regard to transit trips during weekday morning and afternoon peak hours, the proposed development is projected to generate approximately two-way person trips of 27 trips/h and 25 trips/h, respectively.

# Transportation Impact Assessment

1280 Trim Road

---

- With regard to the site driveway throat length, providing an approximate 25 m clear driveway throat length, measured from the edge of the roadway curb lane to the point of first conflict on-site, will be sufficient.
- The proposed parking supply for the subject development is proposed to meet minimum By-Law requirements.
- Current and projected intersection MMLOS targets are not met for pedestrians and cyclists for the signalized Trim/Highway 174 study area intersection; however, this is because the intersection leads into the Highway 174 which is primarily intended for vehicular traffic.
- Current and projected intersection MMLOS targets are met for trucks for the signalized Trim/Highway 174 study area intersection.
- Based on the projected volumes and intersection capacity analysis, additional network modifications are not warranted.
- The overall layout of the site is laid out effectively and should operate acceptably and satisfies applicable By-Laws. AutoTurn truck turning analysis was conducted using a garbage truck as the design vehicle and it was determined that efficient turning radii is provided for larger vehicles (e.g., fire and garbage truck, etc.).

The proposed development fits well into the context of the surrounding area and it is projected to have minimal impact on the surrounding transportation network. The design and location of the proposed development serves the City of Ottawa's policies, goals, and objectives.

Based on the foregoing, the proposed development located at 1280 Trim Road is recommended from a transportation perspective.

J.L. RICHARDS & ASSOCIATES LIMITED

Prepared by:

Reviewed by:



Bomo Dambo, E.I.T.  
Civil Engineer-In-Training, Transportation

Rani Nahas, P.Eng.  
Civil Engineer, Transportation



---

# **Appendix A**

TIA Screening Form

## City of Ottawa 2017 TIA Guidelines Screening Form

### 1. Description of Proposed Development

Municipal Address	<b>1280 Trim Road</b>
Description of Location	Trim Road, North of Montreal Road
Land Use Classification	Industrial (IL Zone)
Development Size (units)	3 buildings total, 8 units
Development Size (m <sup>2</sup> )	Total GFA 1,546 m <sup>2</sup>
Number of Accesses and Locations	1 access to Trim Road
Phase of Development	Single phase
Buildout Year	2024

**If available, please attach a sketch of the development or site plan to this form.**

### 2. Trip Generation Trigger

Considering the Development's Land Use type and Size (as filled out in the previous section), please refer to the Trip Generation Trigger checks below.

Land Use Type	Minimum Development Size
Single-family homes	60 units
Multi-Use Family (Low-Rise)	90 units
Multi-Use Family (High-Rise)	150 units
Office	1,400 m <sup>2</sup>
Industrial	7,000 m <sup>2</sup>
Fast-food restaurant or coffee shop	110 m <sup>2</sup> <span style="color: red; font-size: 1.5em;">✓</span>
Destination retail	1,800 m <sup>2</sup>
Gas station or convenience market	90 m <sup>2</sup>

*\* If the development has a land use type other than what is presented in the table above, estimates of person-trip generation may be made based on average trip generation characteristics represented in the current edition of the Institute of Transportation Engineers (ITE) Trip Generation Manual.*

**If the proposed development size is greater than the sizes identified above, the Trip Generation Trigger is satisfied.**

### 3. Location Triggers

	Yes	No
Does the development propose a new driveway to a boundary street that is designated as part of the City's Transit Priority, Rapid Transit or Cross-Town Bikeways?		✓
Is the development in a Design Priority Area (DPA) or Transit-oriented Development (TOD) zone?*	✓	
Is the development in a Protected Major Transit Station Areas (PMTSAs) and identified in Schedule C1-Protected Major Transit Station Areas (PMTSA)	✓	

\*DPA and TOD are identified in the City of Ottawa Official Plan (DPA in Section 2.5.1 and Schedules A and B; TOD in Annex 6). See Chapter 4 for a list of City of Ottawa Planning and Engineering documents that support the completion of TIA).

**If any of the above questions were answered with 'Yes,' the Location Trigger is satisfied.**

### 4. Safety Triggers

	Yes	No
Are posted speed limits on a boundary street are 80 km/hr or greater?		✓
Are there any horizontal/vertical curvatures on a boundary street limits sight lines at a proposed driveway?		✓
Is the proposed driveway within the area of influence of an adjacent traffic signal or roundabout (i.e. within 300 m of intersection in rural conditions, or within 150 m of intersection in urban/suburban conditions)?	✓	
Is the proposed driveway within auxiliary lanes of an intersection?		✓
Does the proposed driveway make use of an existing median break that serves an existing site?		✓
Is there is a documented history of traffic operations or safety concerns on the boundary streets within 500 m of the development?	✓	
Does the development include a drive-thru facility?	✓	

**If any of the above questions were answered with 'Yes,' the Safety Trigger is satisfied.**

### 5. Summary

	Yes	No
Does the development satisfy the Trip Generation Trigger?	✓	
Does the development satisfy the Location Trigger?	✓	
Does the development satisfy the Safety Trigger?	✓	

**If none of the triggers are satisfied, the TIA Study is complete. If one or more of the triggers is satisfied, the TIA Study must continue into the next stage (Screening and Scoping).**

---

**Appendix B**  
Existing Traffic Counts

**Survey Date:** Tuesday, February 07, 2023

**WO No:** 40774

**Start Time:** 07:00

**Device:** Miovision

### Full Study Diagram

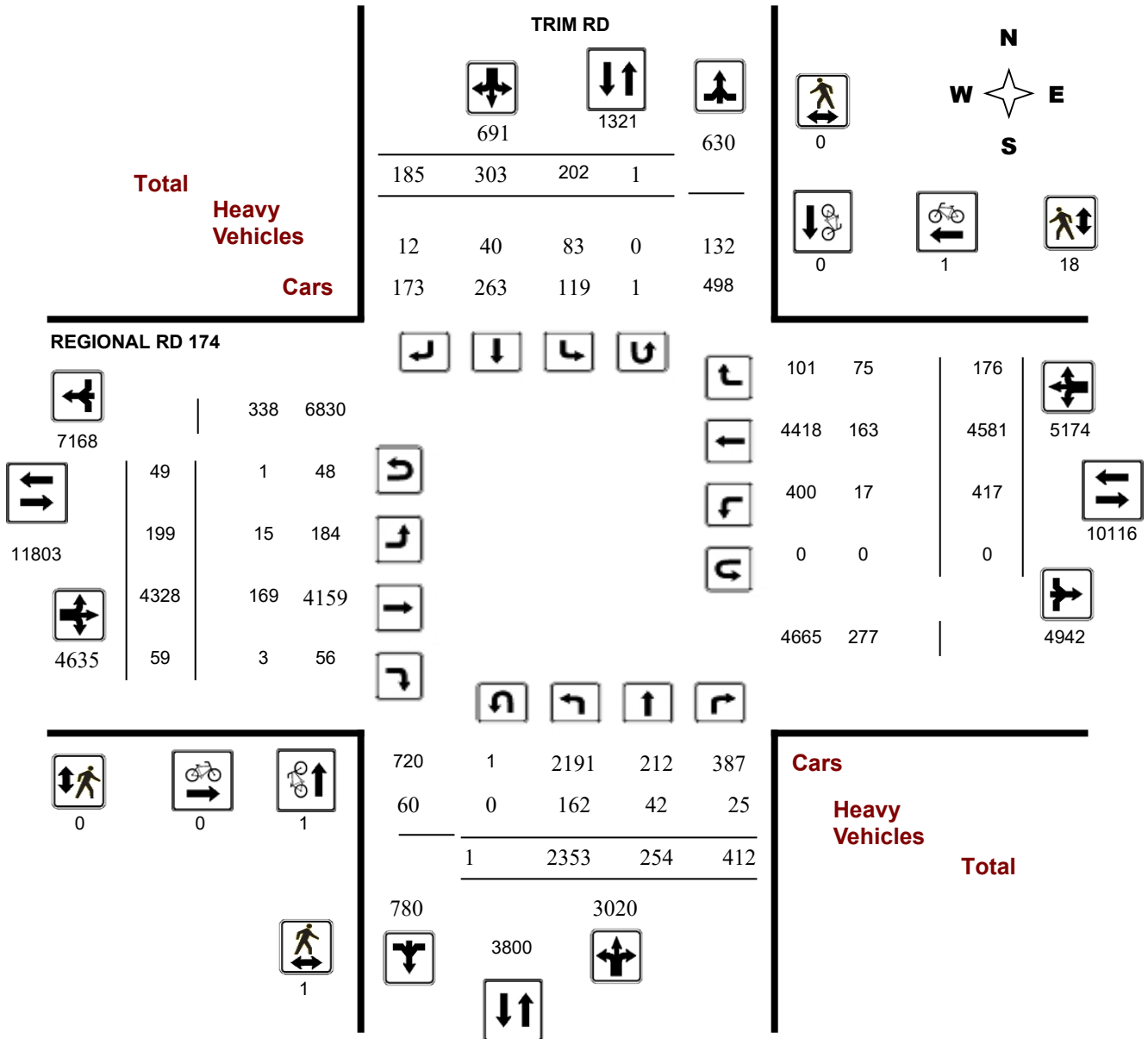

## Turning Movement Count - Study Results

### REGIONAL RD 174 @ TRIM RD

**Survey Date:** Tuesday, February 07, 2023

**WO No:** 40774

**Start Time:** 07:00

**Device:** Miovision

### Full Study Peak Hour Diagram

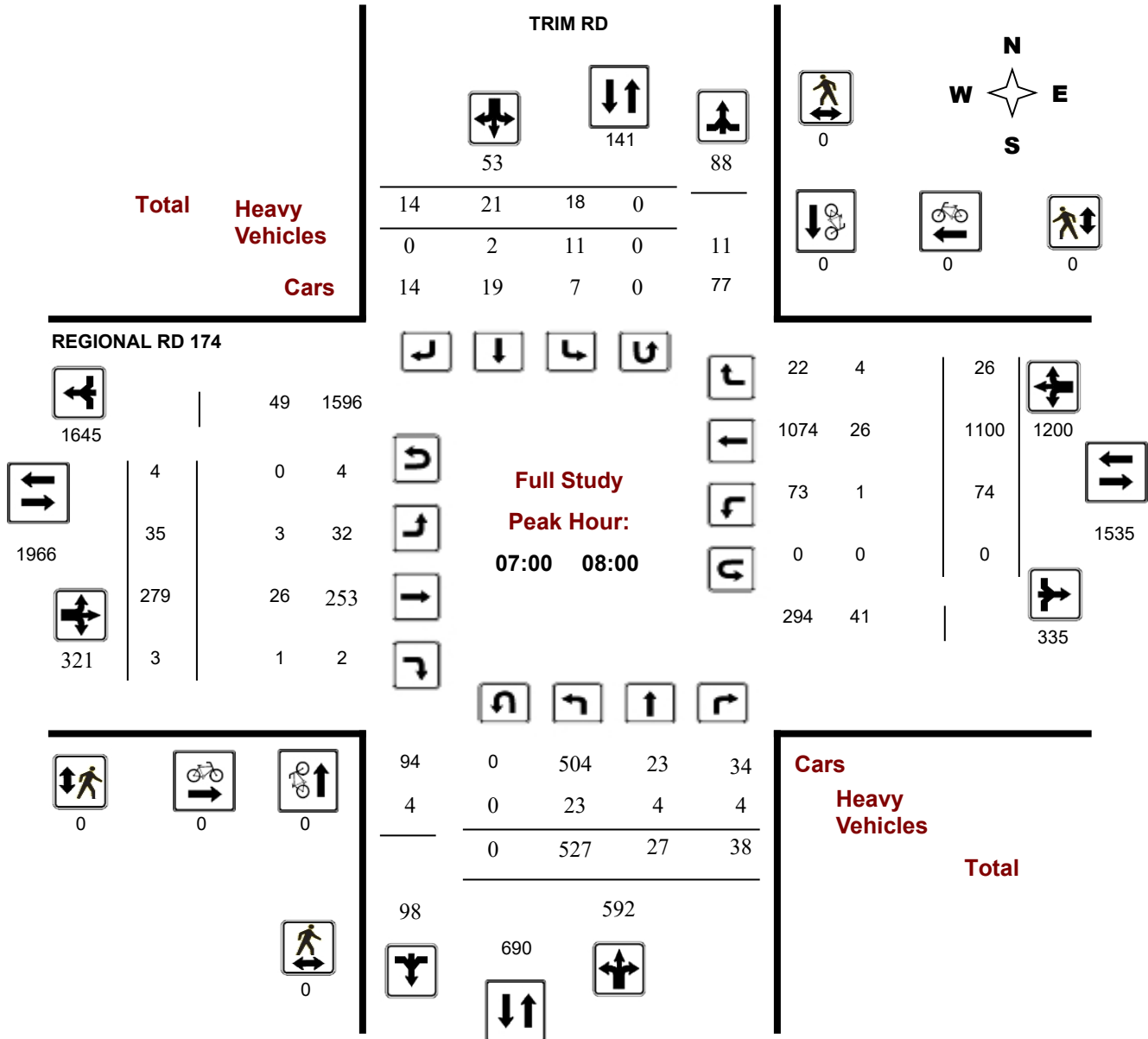



# Transportation Services - Traffic Services

## Turning Movement Count - Peak Hour Diagram

### REGIONAL RD 174 @ TRIM RD

**Survey Date:** Tuesday, February 07, 2023

**Start Time:** 07:00

**WO No:** 40774

**Device:** Miovision

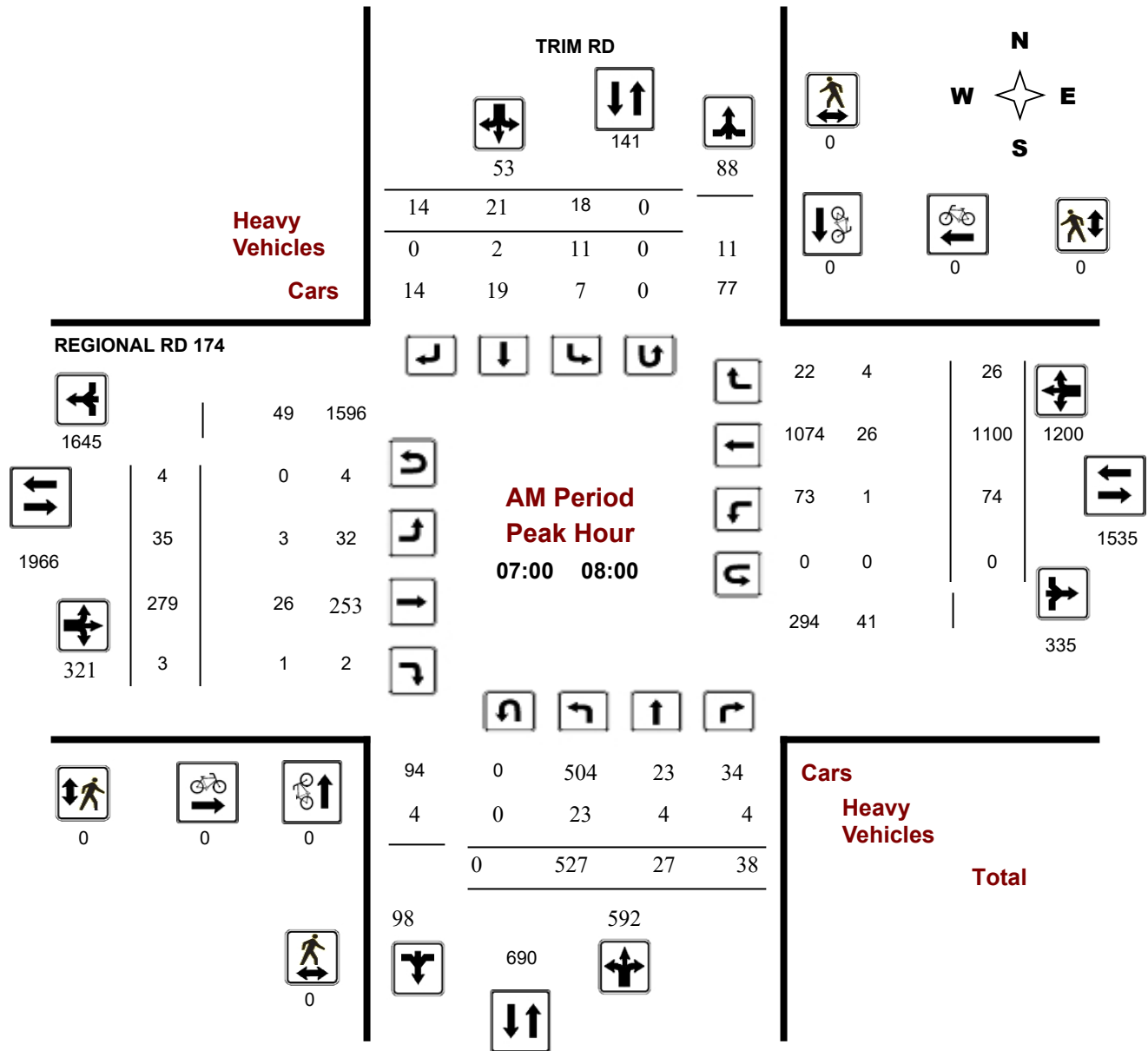

## Turning Movement Count - Peak Hour Diagram

### REGIONAL RD 174 @ TRIM RD

**Survey Date:** Tuesday, February 07, 2023

**Start Time:** 07:00

**WO No:** 40774

**Device:** Miovision

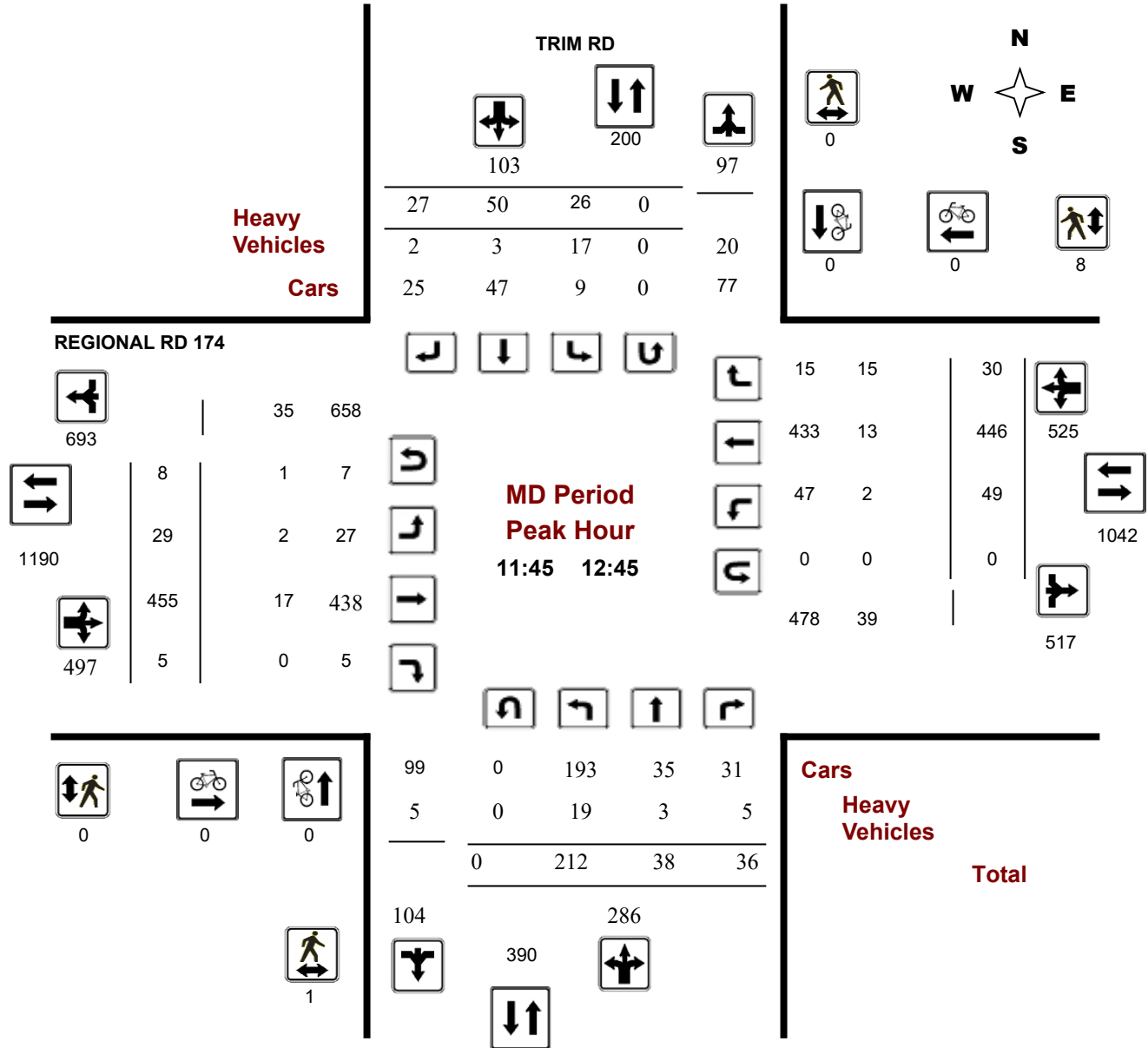





# Transportation Services - Traffic Services

## Turning Movement Count - Peak Hour Diagram

### REGIONAL RD 174 @ TRIM RD

**Survey Date:** Tuesday, February 07, 2023

**Start Time:** 07:00

**WO No:** 40774

**Device:** Miovision

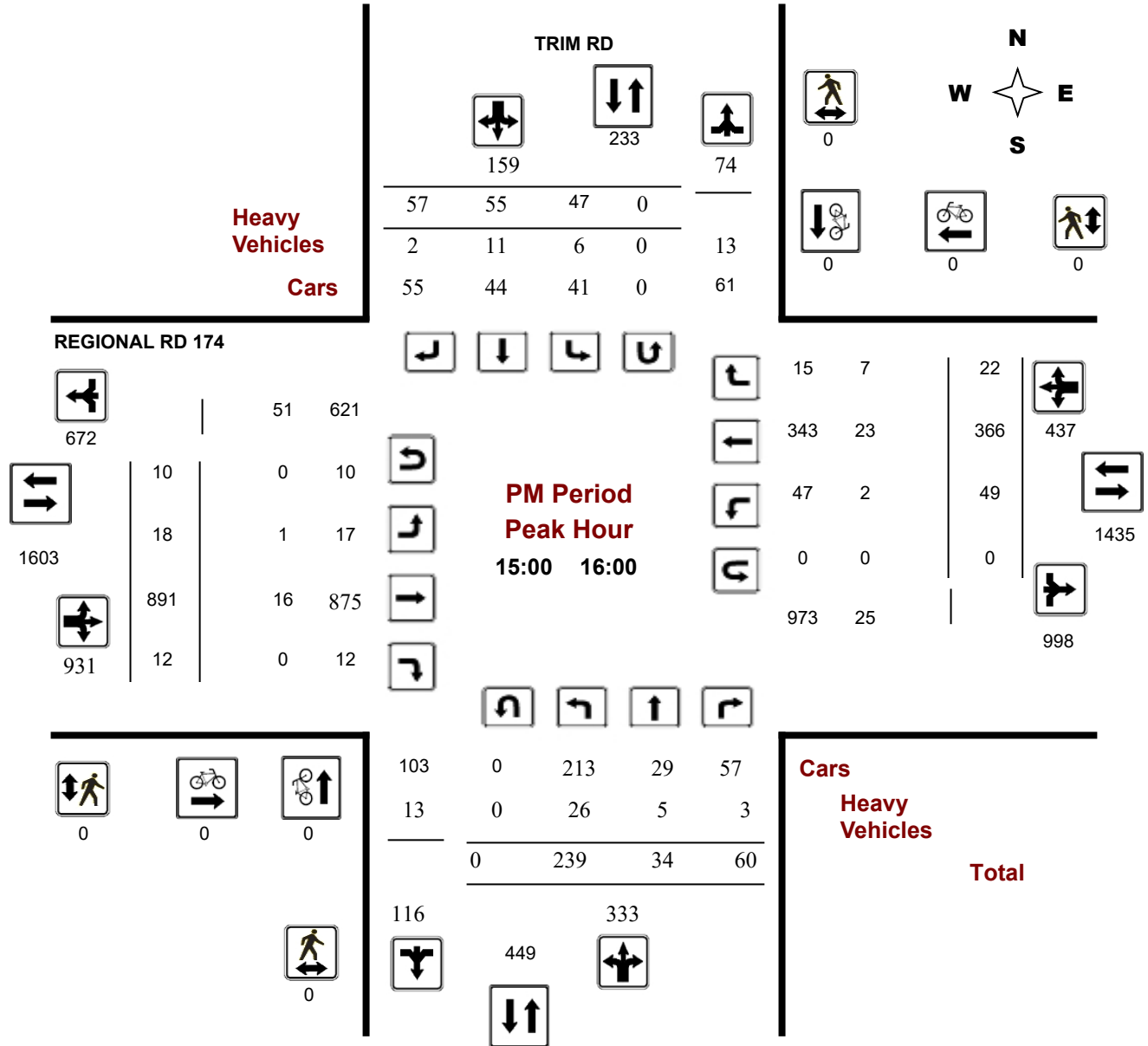



# Transportation Services - Traffic Services

## Turning Movement Count - Study Results

### REGIONAL RD 174 @ TRIM RD

**Survey Date:** Tuesday, February 07, 2023

**WO No:** 40774

**Start Time:** 07:00

**Device:** Miovision

### Full Study Summary (8 HR Standard)

**Survey Date:** Tuesday, February 07, 2023

**Total Observed U-Turns**

**AADT Factor**

Northbound: 1      Southbound: 1  
 Eastbound: 49      Westbound: 0

1.00

Period	TRIM RD										REGIONAL RD 174										Grand Total
	Northbound					Southbound					Eastbound					Westbound					
	LT	ST	RT	NB TOT	STR TOT	LT	ST	RT	SB TOT	STR TOT	LT	ST	RT	EB TOT	STR TOT	LT	ST	RT	WB TOT	STR TOT	
07:00 08:00	527	27	38	592	645	18	21	14	53	645	35	279	3	317	317	74	1100	26	1200	1517	2162
08:00 09:00	377	41	41	459	524	24	26	15	65	524	31	326	8	365	365	54	848	29	931	1296	1820
09:00 10:00	316	27	50	393	471	23	34	21	78	471	23	264	6	293	293	56	643	23	722	1015	1486
11:30 12:30	212	39	30	281	375	26	47	21	94	375	33	439	10	482	482	44	420	26	490	972	1347
12:30 13:30	201	27	61	289	380	26	42	23	91	380	19	476	6	501	501	41	448	24	513	1014	1394
15:00 16:00	239	34	60	333	492	47	55	57	159	492	18	891	12	921	921	49	366	22	437	1358	1850
16:00 17:00	237	36	50	323	407	25	42	17	84	407	21	845	4	870	870	37	401	14	452	1322	1729
17:00 18:00	244	23	82	349	415	13	36	17	66	415	19	808	10	837	837	62	355	12	429	1266	1681
<b>Sub Total</b>	2353	254	412	3019	3709	202	303	185	690	3709	199	4328	59	4586	4586	417	4581	176	5174	9760	13469
<b>U Turns</b>				1	2				1	2				49	49				0	49	51
<b>Total</b>	2353	254	412	3020	3711	202	303	185	691	3711	199	4328	59	4635	4635	417	4581	176	5174	9809	13520
<b>EQ 12Hr</b>	3271	353	573	4198	5158	281	421	257	960	5158	277	6016	82	6443	6443	580	6368	245	7192	13635	18793
Note: These values are calculated by multiplying the totals by the appropriate expansion factor.														<b>1.39</b>							
<b>AVG 12Hr</b>	3271	353	573	4198	5158	281	552	337	960	5158	277	6016	82	6443	6443	580	6368	245	7192	13635	18793
Note: These volumes are calculated by multiplying the Equivalent 12 hr. totals by the AADT factor.														<b>1.00</b>							
<b>AVG 24Hr</b>	4285	462	751	5499	6757	368	723	441	1258	6757	363	7881	107	8440	8440	760	8342	321	9422	17862	24619
Note: These volumes are calculated by multiplying the Average Daily 12 hr. totals by 12 to 24 expansion factor.														<b>1.31</b>							
Note: U-Turns provided for approach totals. Refer to 'U-Turn' Report for specific breakdown.																					



# Transportation Services - Traffic Services

## Turning Movement Count - Study Results

### REGIONAL RD 174 @ TRIM RD

**Survey Date:** Tuesday, February 07, 2023

**WO No:** 40774

**Start Time:** 07:00

**Device:** Miovision

### Full Study 15 Minute Increments

#### TRIM RD

#### REGIONAL RD 174

Northbound

Southbound

Eastbound

Westbound

Time Period	LT	ST	RT	N TOT	LT	ST	RT	S TOT	STR TOT	LT	ST	RT	E TOT	LT	ST	RT	W TOT	STR TOT	Grand Total	
07:00	07:15	131	4	9	144	1	7	2	10	154	12	54	0	67	15	266	5	286	353	507
07:15	07:30	160	5	10	175	4	2	7	13	188	14	55	0	71	18	328	5	351	422	610
07:30	07:45	113	7	14	134	5	6	3	14	148	4	87	1	93	17	275	7	299	392	540
07:45	08:00	123	11	5	139	8	6	2	16	155	5	83	2	90	24	231	9	264	354	509
08:00	08:15	97	6	10	113	4	5	2	11	124	9	78	2	90	16	241	6	263	353	477
08:15	08:30	107	6	7	120	6	8	4	18	138	5	75	4	85	12	247	10	269	354	492
08:30	08:45	96	15	16	127	8	5	7	20	147	9	89	2	101	14	187	7	208	309	456
08:45	09:00	77	14	8	99	6	8	2	16	115	8	84	0	98	12	173	6	191	289	404
09:00	09:15	98	5	13	116	8	6	6	20	136	4	65	3	73	13	170	5	188	261	397
09:15	09:30	76	3	9	88	6	10	5	21	109	3	67	0	72	9	165	5	179	251	360
09:30	09:45	71	8	18	97	5	6	6	17	114	11	62	1	74	15	132	6	153	227	341
09:45	10:00	71	11	10	92	4	12	4	20	112	5	70	2	81	19	176	7	202	283	395
11:30	11:45	49	7	5	61	6	10	3	19	80	11	90	5	107	10	103	4	117	224	304
11:45	12:00	49	11	7	67	8	16	5	29	96	10	113	1	127	10	113	6	129	256	352
12:00	12:15	59	10	6	75	5	13	7	25	100	7	115	2	125	11	96	8	115	240	340
12:15	12:30	55	11	12	78	7	8	6	21	99	5	121	2	131	13	108	8	129	260	359
12:30	12:45	49	6	11	66	6	13	9	28	94	7	106	0	114	15	129	8	152	266	360
12:45	13:00	49	5	17	71	5	5	7	17	88	4	114	2	120	8	111	7	126	246	334
13:00	13:15	39	9	15	63	9	13	4	26	89	3	120	1	126	11	100	5	116	242	331
13:15	13:30	64	7	18	89	6	11	3	21	110	5	136	3	148	7	108	4	119	267	377
15:00	15:15	52	3	12	67	10	14	13	37	104	4	234	4	247	10	106	7	123	370	474
15:15	15:30	76	17	21	114	7	16	21	44	158	2	207	4	216	11	106	7	124	340	498
15:30	15:45	59	7	15	81	22	11	13	46	127	3	224	2	231	11	69	3	83	314	441
15:45	16:00	52	7	12	71	8	14	10	32	103	9	226	2	237	17	85	5	107	344	447
16:00	16:15	61	12	16	89	12	11	5	28	117	4	235	0	239	10	91	3	104	343	460
16:15	16:30	68	9	12	90	4	12	5	21	111	6	239	1	250	9	95	5	109	359	470
16:30	16:45	61	10	13	84	8	11	5	24	108	7	170	1	178	6	104	2	112	290	398
16:45	17:00	47	5	9	61	1	8	2	11	72	4	201	2	207	12	111	4	127	334	406
17:00	17:15	75	3	27	105	3	6	7	16	121	5	225	3	233	8	31	0	39	272	393
17:15	17:30	51	9	23	83	5	18	2	25	108	7	202	3	212	22	150	11	183	395	503
17:30	17:45	62	6	19	87	3	6	6	15	102	5	218	3	226	12	76	1	89	315	417
17:45	18:00	56	5	13	74	2	6	2	10	84	2	163	1	166	20	98	0	118	284	368
<b>Total:</b>		<b>2353</b>	<b>254</b>	<b>412</b>	<b>3020</b>	<b>202</b>	<b>303</b>	<b>185</b>	<b>691</b>	<b>3711</b>	<b>199</b>	<b>4328</b>	<b>59</b>	<b>4635</b>	<b>417</b>	<b>4581</b>	<b>176</b>	<b>5174</b>	<b>9809</b>	<b>13,520</b>

Note: U-Turns are included in Totals.



# Transportation Services - Traffic Services

## Turning Movement Count - Study Results

### REGIONAL RD 174 @ TRIM RD

**Survey Date:** Tuesday, February 07, 2023

**WO No:** 40774

**Start Time:** 07:00

**Device:** Miovision

### Full Study Cyclist Volume

Time Period	TRIM RD			REGIONAL RD 174			Grand Total
	Northbound	Southbound	Street Total	Eastbound	Westbound	Street Total	
07:00 07:15	0	0	0	0	0	0	0
07:15 07:30	0	0	0	0	0	0	0
07:30 07:45	0	0	0	0	0	0	0
07:45 08:00	0	0	0	0	0	0	0
08:00 08:15	0	0	0	0	1	1	1
08:15 08:30	0	0	0	0	0	0	0
08:30 08:45	0	0	0	0	0	0	0
08:45 09:00	0	0	0	0	0	0	0
09:00 09:15	0	0	0	0	0	0	0
09:15 09:30	1	0	1	0	0	0	1
09:30 09:45	0	0	0	0	0	0	0
09:45 10:00	0	0	0	0	0	0	0
11:30 11:45	0	0	0	0	0	0	0
11:45 12:00	0	0	0	0	0	0	0
12:00 12:15	0	0	0	0	0	0	0
12:15 12:30	0	0	0	0	0	0	0
12:30 12:45	0	0	0	0	0	0	0
12:45 13:00	0	0	0	0	0	0	0
13:00 13:15	0	0	0	0	0	0	0
13:15 13:30	0	0	0	0	0	0	0
15:00 15:15	0	0	0	0	0	0	0
15:15 15:30	0	0	0	0	0	0	0
15:30 15:45	0	0	0	0	0	0	0
15:45 16:00	0	0	0	0	0	0	0
16:00 16:15	0	0	0	0	0	0	0
16:15 16:30	0	0	0	0	0	0	0
16:30 16:45	0	0	0	0	0	0	0
16:45 17:00	0	0	0	0	0	0	0
17:00 17:15	0	0	0	0	0	0	0
17:15 17:30	0	0	0	0	0	0	0
17:30 17:45	0	0	0	0	0	0	0
17:45 18:00	0	0	0	0	0	0	0
<b>Total</b>	<b>1</b>	<b>0</b>	<b>1</b>	<b>0</b>	<b>1</b>	<b>1</b>	<b>2</b>



# Transportation Services - Traffic Services

## Turning Movement Count - Study Results

### REGIONAL RD 174 @ TRIM RD

**Survey Date:** Tuesday, February 07, 2023

**WO No:** 40774

**Start Time:** 07:00

**Device:** Miovision

### Full Study Pedestrian Volume

#### TRIM RD

#### REGIONAL RD 174

Time Period	NB Approach (E or W Crossing)	SB Approach (E or W Crossing)	Total	EB Approach (N or S Crossing)	WB Approach (N or S Crossing)	Total	Grand Total
07:00 07:15	0	0	0	0	0	0	0
07:15 07:30	0	0	0	0	0	0	0
07:30 07:45	0	0	0	0	0	0	0
07:45 08:00	0	0	0	0	0	0	0
08:00 08:15	0	0	0	0	0	0	0
08:15 08:30	0	0	0	0	0	0	0
08:30 08:45	0	0	0	0	1	1	1
08:45 09:00	0	0	0	0	2	2	2
09:00 09:15	0	0	0	0	0	0	0
09:15 09:30	0	0	0	0	2	2	2
09:30 09:45	0	0	0	0	1	1	1
09:45 10:00	0	0	0	0	1	1	1
11:30 11:45	0	0	0	0	0	0	0
11:45 12:00	1	0	1	0	2	2	3
12:00 12:15	0	0	0	0	2	2	2
12:15 12:30	0	0	0	0	1	1	1
12:30 12:45	0	0	0	0	3	3	3
12:45 13:00	0	0	0	0	0	0	0
13:00 13:15	0	0	0	0	1	1	1
13:15 13:30	0	0	0	0	1	1	1
15:00 15:15	0	0	0	0	0	0	0
15:15 15:30	0	0	0	0	0	0	0
15:30 15:45	0	0	0	0	0	0	0
15:45 16:00	0	0	0	0	0	0	0
16:00 16:15	0	0	0	0	1	1	1
16:15 16:30	0	0	0	0	0	0	0
16:30 16:45	0	0	0	0	0	0	0
16:45 17:00	0	0	0	0	0	0	0
17:00 17:15	0	0	0	0	0	0	0
17:15 17:30	0	0	0	0	0	0	0
17:30 17:45	0	0	0	0	0	0	0
17:45 18:00	0	0	0	0	0	0	0
<b>Total .....</b>	<b>1</b>	<b>0</b>	<b>1</b>	<b>0</b>	<b>18</b>	<b>18</b>	<b>19</b>



# Transportation Services - Traffic Services

## Turning Movement Count - Study Results

### REGIONAL RD 174 @ TRIM RD

**Survey Date:** Tuesday, February 07, 2023

**WO No:** 40774

**Start Time:** 07:00

**Device:** Miovision

### Full Study Heavy Vehicles

#### TRIM RD

#### REGIONAL RD 174

Northbound

Southbound

Eastbound

Westbound

Time Period	Northbound			N TOT	Southbound			S TOT	STR TOT	Eastbound			E TOT	Westbound			W TOT	STR TOT	Grand Total
	LT	ST	RT		LT	ST	RT			LT	ST	RT		LT	ST	RT			
07:00 07:15	9	0	1	11	0	1	0	2	13	1	7	0	22	0	5	0	13	35	24
07:15 07:30	4	1	1	6	1	0	0	3	9	1	5	0	17	0	7	0	14	31	20
07:30 07:45	3	2	0	7	5	0	0	8	15	0	8	1	20	1	8	1	23	43	29
07:45 08:00	7	1	2	11	5	1	0	11	22	1	6	0	20	0	6	3	22	42	32
08:00 08:15	4	2	3	10	3	1	1	11	21	0	4	0	18	0	9	4	23	41	31
08:15 08:30	12	2	0	17	5	3	1	17	34	0	5	0	21	0	3	6	19	40	37
08:30 08:45	3	0	2	8	4	1	0	8	16	1	6	0	14	2	4	2	20	34	25
08:45 09:00	3	6	0	10	4	1	0	16	26	1	9	0	20	0	7	4	24	44	35
09:00 09:15	8	1	0	10	5	0	1	12	22	0	5	0	20	1	6	5	22	42	32
09:15 09:30	2	0	0	3	4	1	0	8	11	0	12	0	20	0	6	3	25	45	28
09:30 09:45	3	2	2	8	4	0	0	12	20	1	11	0	16	1	1	5	24	40	30
09:45 10:00	6	1	0	10	3	1	0	12	22	1	6	0	19	2	6	6	23	42	32
11:30 11:45	3	0	0	6	4	1	0	9	15	2	12	1	22	1	4	2	23	45	30
11:45 12:00	6	1	2	10	4	0	1	10	20	0	6	0	18	1	5	4	22	40	30
12:00 12:15	4	1	0	7	3	1	0	11	18	1	4	0	11	1	2	5	15	26	22
12:15 12:30	5	1	2	8	5	0	0	11	19	0	1	0	9	0	1	5	14	23	21
12:30 12:45	4	0	1	7	5	2	1	10	17	1	6	0	17	0	5	1	18	35	26
12:45 13:00	6	1	2	9	3	0	1	9	18	0	4	0	15	0	4	4	17	32	25
13:00 13:15	2	1	0	6	4	1	0	10	16	0	7	0	17	2	8	4	25	42	29
13:15 13:30	8	2	3	14	4	0	0	10	24	1	6	1	26	0	10	3	26	52	38
15:00 15:15	5	0	1	11	1	3	0	8	19	1	6	0	15	2	3	3	16	31	25
15:15 15:30	7	4	1	17	2	5	2	16	33	0	4	0	23	0	10	3	20	43	38
15:30 15:45	6	0	0	7	3	1	0	4	11	0	3	0	14	0	5	0	11	25	18
15:45 16:00	8	1	1	12	0	2	0	4	16	0	3	0	16	0	5	1	10	26	21
16:00 16:15	4	1	0	9	2	3	0	6	15	0	6	0	16	1	6	0	15	31	23
16:15 16:30	6	5	0	13	0	2	0	7	20	0	4	0	16	0	6	0	10	26	23
16:30 16:45	6	1	0	9	0	1	2	5	14	1	3	0	17	1	5	0	9	26	20
16:45 17:00	1	1	0	3	0	1	0	2	5	0	5	0	14	0	8	0	13	27	16
17:00 17:15	5	0	0	8	0	3	0	3	11	0	1	0	6	0	0	0	1	7	9
17:15 17:30	4	2	1	9	0	2	0	6	15	1	1	0	12	0	6	1	9	21	18
17:30 17:45	3	2	0	5	0	0	1	3	8	0	0	0	5	0	1	0	1	6	7
17:45 18:00	5	0	0	8	0	2	1	3	11	0	3	0	10	1	1	0	5	15	13
Total: None	162	42	25	289	83	40	12	267	556	15	169	3	526	17	163	75	532	1058	807



# Transportation Services - Traffic Services

## Turning Movement Count - Study Results

### REGIONAL RD 174 @ TRIM RD

**Survey Date:** Tuesday, February 07, 2023

**WO No:** 40774

**Start Time:** 07:00

**Device:** Miovision

### Full Study 15 Minute U-Turn Total

TRIM RD

REGIONAL RD 174

Time Period		Northbound U-Turn Total	Southbound U-Turn Total	Eastbound U-Turn Total	Westbound U-Turn Total	Total
07:00	07:15	0	0	1	0	1
07:15	07:30	0	0	2	0	2
07:30	07:45	0	0	1	0	1
07:45	08:00	0	0	0	0	0
08:00	08:15	0	0	1	0	1
08:15	08:30	0	0	1	0	1
08:30	08:45	0	0	1	0	1
08:45	09:00	0	0	6	0	6
09:00	09:15	0	0	1	0	1
09:15	09:30	0	0	2	0	2
09:30	09:45	0	0	0	0	0
09:45	10:00	0	0	4	0	4
11:30	11:45	0	0	1	0	1
11:45	12:00	0	0	3	0	3
12:00	12:15	0	0	1	0	1
12:15	12:30	0	0	3	0	3
12:30	12:45	0	0	1	0	1
12:45	13:00	0	0	0	0	0
13:00	13:15	0	0	2	0	2
13:15	13:30	0	1	4	0	5
15:00	15:15	0	0	5	0	5
15:15	15:30	0	0	3	0	3
15:30	15:45	0	0	2	0	2
15:45	16:00	0	0	0	0	0
16:00	16:15	0	0	0	0	0
16:15	16:30	1	0	4	0	5
16:30	16:45	0	0	0	0	0
16:45	17:00	0	0	0	0	0
17:00	17:15	0	0	0	0	0
17:15	17:30	0	0	0	0	0
17:30	17:45	0	0	0	0	0
17:45	18:00	0	0	0	0	0
Total		1	1	49	0	51

# Diagrams, Maps and Photographs

## Taylor Creek Drive & Trim Road (Roundabout)

Thursday, April 20, 2023







# Turning Movement Count Summary Report Including AM and PM Peak Hours All Vehicles Except Bicycles



## Taylor Creek Drive & Trim Road (Roundabout)

Orléans, ON

**Survey Date:** Thursday, April 20, 2023      **Start Time:** 0700      **AADT Factor:** 0.9  
**Weather AM:** Mostly Sunny 1° C      **Survey Duration:** 2 Hrs.      **Survey Hours:** 0700-0800 & 1500-1600  
**Weather PM:** Mostly Sunny 9° C      **Surveyor(s):** T. Carmody

Time Period	Taylor Creek Dr.					Trim Rd.					Trim Rd.					Trim Rd.					Street Total	Grand Total	
	Eastbound					Westbound					Northbound					Southbound							
	LT	ST	RT	UT	E/B Tot	LT	ST	RT	UT	W/B Tot	LT	ST	RT	UT	N/B Tot	LT	ST	RT	UT	S/B Tot			
0700-0800	5	62	46	0	113	84	49	4	0	137	250	127	36	312	29	504	8	268	82	9	367	871	1121
1500-1600	8	66	81	0	155	149	24	7	0	180	335	56	19	302	37	414	11	664	84	6	765	1179	1514
<b>Totals</b>	<b>13</b>	<b>128</b>	<b>127</b>	<b>0</b>	<b>268</b>	<b>233</b>	<b>73</b>	<b>11</b>	<b>0</b>	<b>317</b>	<b>585</b>	<b>183</b>	<b>55</b>	<b>614</b>	<b>66</b>	<b>918</b>	<b>19</b>	<b>932</b>	<b>166</b>	<b>15</b>	<b>1132</b>	<b>2050</b>	<b>2635</b>

**Equivalent 12 & 24-hour Vehicle Volumes Including the Annual Average Daily Traffic (AADT) Factor  
Applicable to the Day and Month of the Turning Movement Count**

**Expansion factors are applied exclusively to standard weekday 8-hour turning movement counts conducted during the hours of 0700h - 1000h, 1130h - 1330h and 1500h - 1800h**

Equivalent 12-hour vehicle volumes. These volumes are calculated by multiplying the 8-hour totals by the 8 → 12 expansion factor of 1.39																						
Equ. 12 Hr	n/a	n/a	n/a	n/a	n/a	n/a	n/a	n/a	n/a	n/a	n/a	n/a	n/a	n/a	n/a	n/a	n/a	n/a	n/a	n/a	n/a	n/a
Average daily 12-hour vehicle volumes. These volumes are calculated by multiplying the equivalent 12-hour totals by the AADT factor of: 0.9																						
AADT 12-hr	n/a	n/a	n/a	n/a	n/a	n/a	n/a	n/a	n/a	n/a	n/a	n/a	n/a	n/a	n/a	n/a	n/a	n/a	n/a	n/a	n/a	n/a
24-Hour AADT. These volumes are calculated by multiplying the average daily 12-hour vehicle volumes by the 12 → 24 expansion factor of 1.31																						
AADT 24 Hr	n/a	n/a	n/a	n/a	n/a	n/a	n/a	n/a	n/a	n/a	n/a	n/a	n/a	n/a	n/a	n/a	n/a	n/a	n/a	n/a	n/a	n/a

**AADT and expansion factors provided by the City of Ottawa**

<b>AM Peak Hour Factor → 0.84</b>											<b>Highest Hourly Vehicle Volume Between 0700h &amp; 1000h</b>												
AM Peak Hr	LT	ST	RT	UT	Total	LT	ST	RT	UT	Total	Str. Tot.	LT	ST	RT	UT	Total	LT	ST	RT	UT	Total	Str. Tot.	Gr. Tot.
0700-0800	5	62	46	0	113	84	49	4	0	137	250	127	36	312	29	504	8	268	82	9	367	871	1121

<b>PM Peak Hour Factor → 0.92</b>											<b>Highest Hourly Vehicle Volume Between 1500h &amp; 1800h</b>												
PM Peak Hr	LT	ST	RT	UT	Total	LT	ST	RT	UT	Total	Str. Tot.	LT	ST	RT	UT	Total	LT	ST	RT	UT	Total	Str. Tot.	Gr. Tot.
1500-1600	8	66	81	0	155	149	24	7	0	180	335	56	19	302	37	414	11	664	84	6	765	1179	1514

**Comments:**

OC Transpo buses and school buses comprise 42.86% of the heavy vehicle traffic.

**Notes:**

1. Includes all vehicle types except bicycles, electric bicycles, and electric scooters.
2. When expansion and AADT factors are applied, the results will differ slightly due to rounding.



# Turning Movement Count

## Summary, AM and PM Peak Hour

### Flow Diagrams

All Vehicles Except Bicycles



## Taylor Creek Drive & Trim Road (Roundabout) Orléans, ON

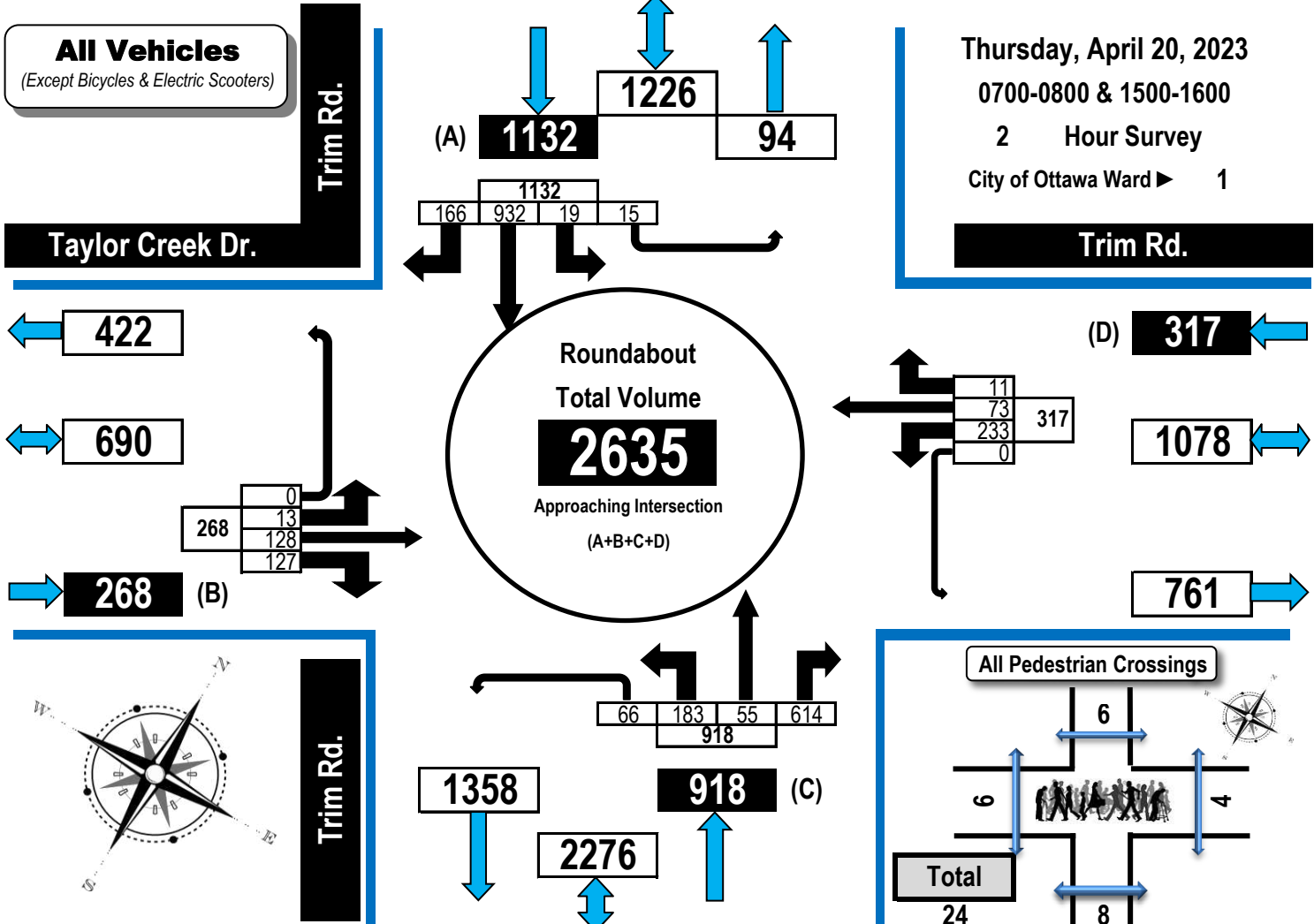

### AM Peak Hour Flow Diagram PM Peak Hour Flow Diagram

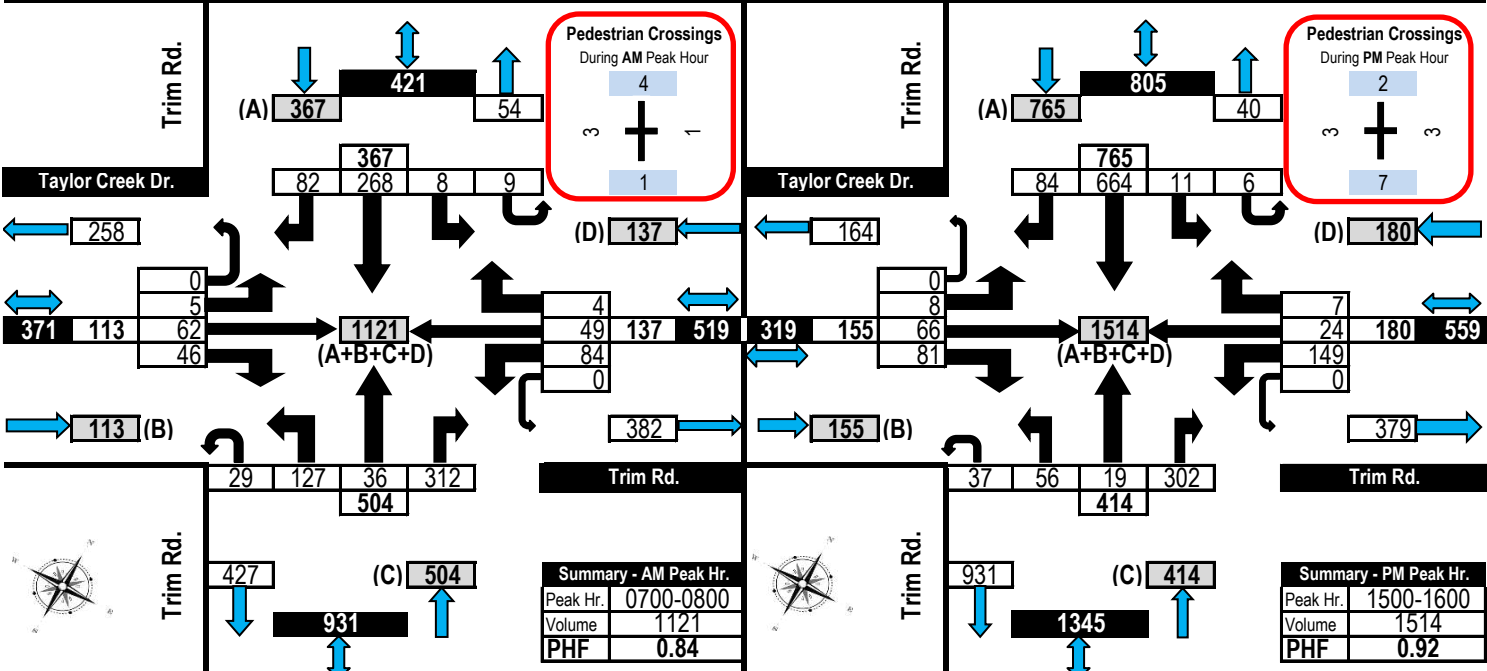



# Turning Movement Count Heavy Vehicle Summary (FHWA Class 4-13) Flow Diagram



## Taylor Creek Drive & Trim Road (Roundabout) Orléans, ON

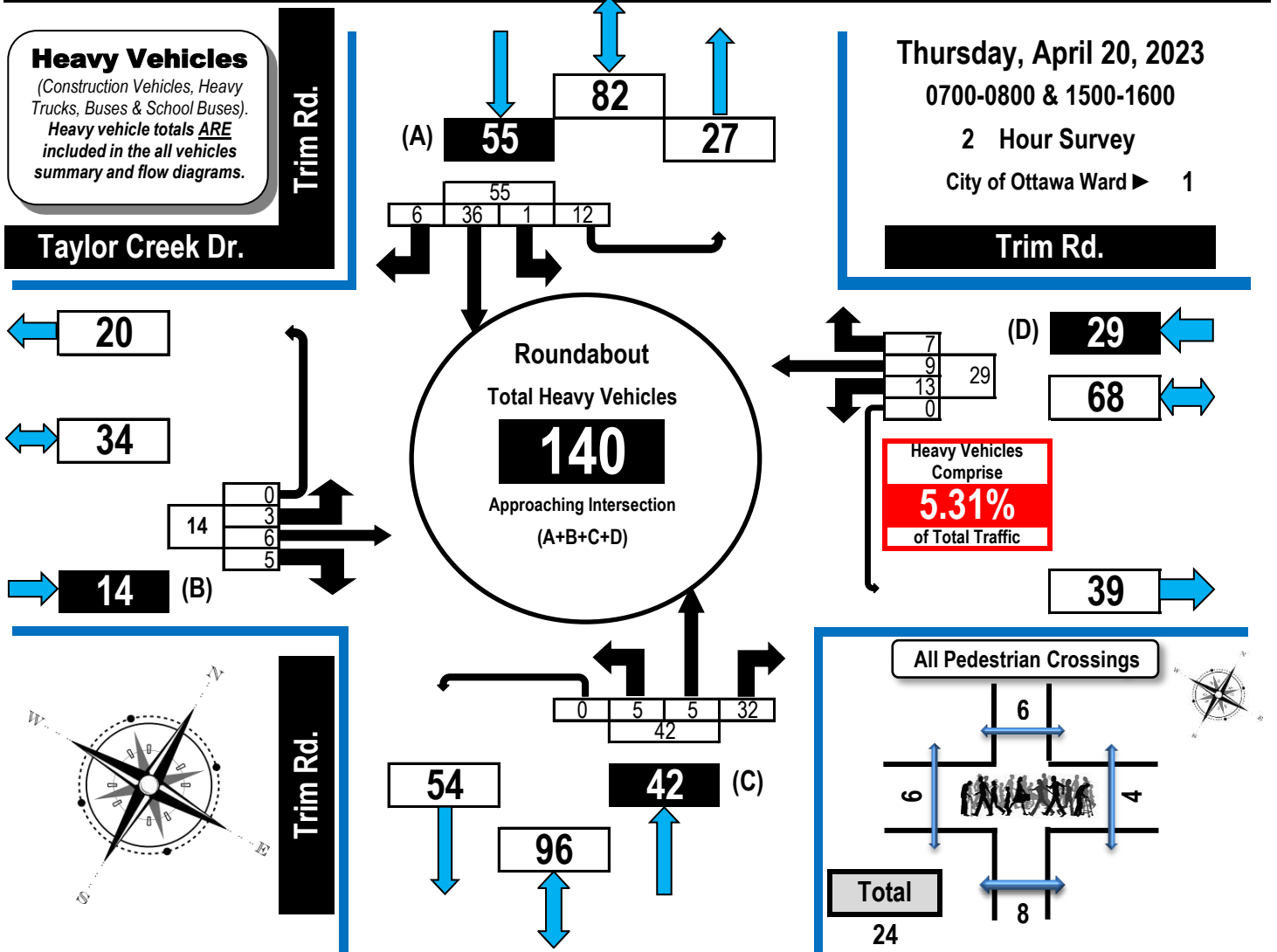

Taylor Creek Dr.	Trim Rd.	Trim Rd.	Trim Rd.
Eastbound	Westbound	Northbound	Southbound

Time Period	LT	ST	RT	UT	EB Tot	LT	ST	RT	UT	WB Tot	LT	ST	RT	UT	NB Tot	LT	ST	RT	UT	SB Tot	GR Tot
0700-0800	0	3	2	0	5	5	5	3	0	13	5	4	13	0	22	0	13	3	7	23	63
1500-1600	3	3	3	0	9	8	4	4	0	16	0	1	19	0	20	1	23	3	5	32	77
<b>Totals</b>	<b>3</b>	<b>6</b>	<b>5</b>	<b>0</b>	<b>14</b>	<b>13</b>	<b>9</b>	<b>7</b>	<b>0</b>	<b>29</b>	<b>5</b>	<b>5</b>	<b>32</b>	<b>0</b>	<b>42</b>	<b>1</b>	<b>36</b>	<b>6</b>	<b>12</b>	<b>55</b>	<b>140</b>

**Comments:**

OC Transpo buses and school buses comprise 42.86% of the heavy vehicle traffic.



# Turning Movement Count All Buses Summary (FHWA Class 4 ONLY) Flow Diagram



## Taylor Creek Drive & Trim Road (Roundabout) Orléans, ON

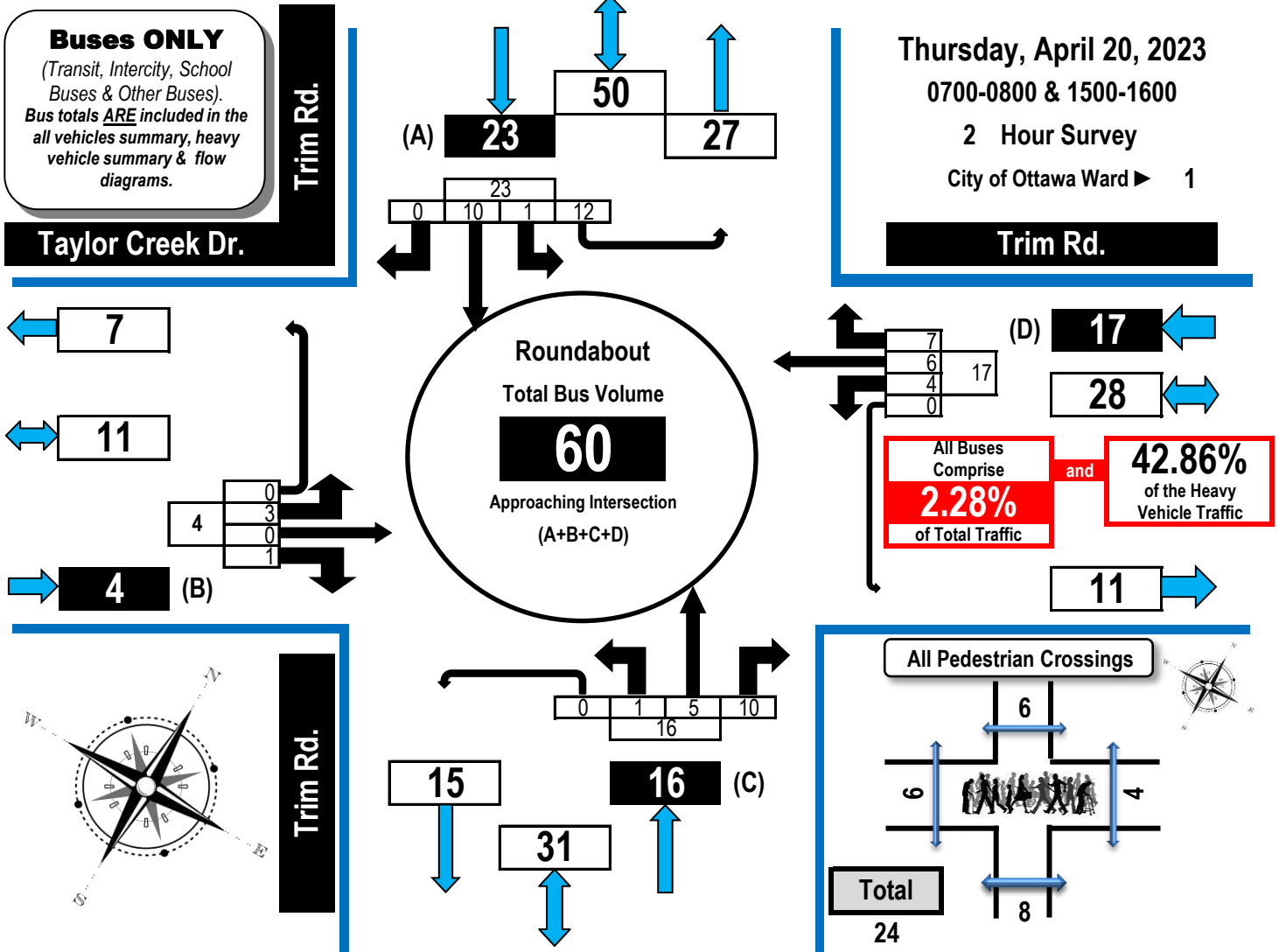

	Taylor Creek Dr. Eastbound					Trim Rd. Westbound					Trim Rd. Northbound					Trim Rd. Southbound					
Time Period	LT	ST	RT	UT	EB Tot	LT	ST	RT	UT	WB Tot	LT	ST	RT	UT	NB Tot	LT	ST	RT	UT	SB Tot	GR Tot

	Taylor Creek Dr. Eastbound					Trim Rd. Westbound					Trim Rd. Northbound					Trim Rd. Southbound					
Time Period	LT	ST	RT	UT	EB Tot	LT	ST	RT	UT	WB Tot	LT	ST	RT	UT	NB Tot	LT	ST	RT	UT	SB Tot	GR Tot
0700-0800	0	0	0	0	0	0	2	3	0	5	1	4	3	0	8	0	5	0	7	12	25
1500-1600	3	0	1	0	4	4	4	4	0	12	0	1	7	0	8	1	5	0	5	11	35
<b>Totals</b>	<b>3</b>	<b>0</b>	<b>1</b>	<b>0</b>	<b>4</b>	<b>4</b>	<b>6</b>	<b>7</b>	<b>0</b>	<b>17</b>	<b>1</b>	<b>5</b>	<b>10</b>	<b>0</b>	<b>16</b>	<b>1</b>	<b>10</b>	<b>0</b>	<b>12</b>	<b>23</b>	<b>60</b>

**Comments:**  
OC Transpo buses and school buses comprise 42.86% of the heavy vehicle traffic.



# Turning Movement Count Bicycle Summary Flow Diagram



## Taylor Creek Drive & Trim Road (Roundabout) Orléans, ON

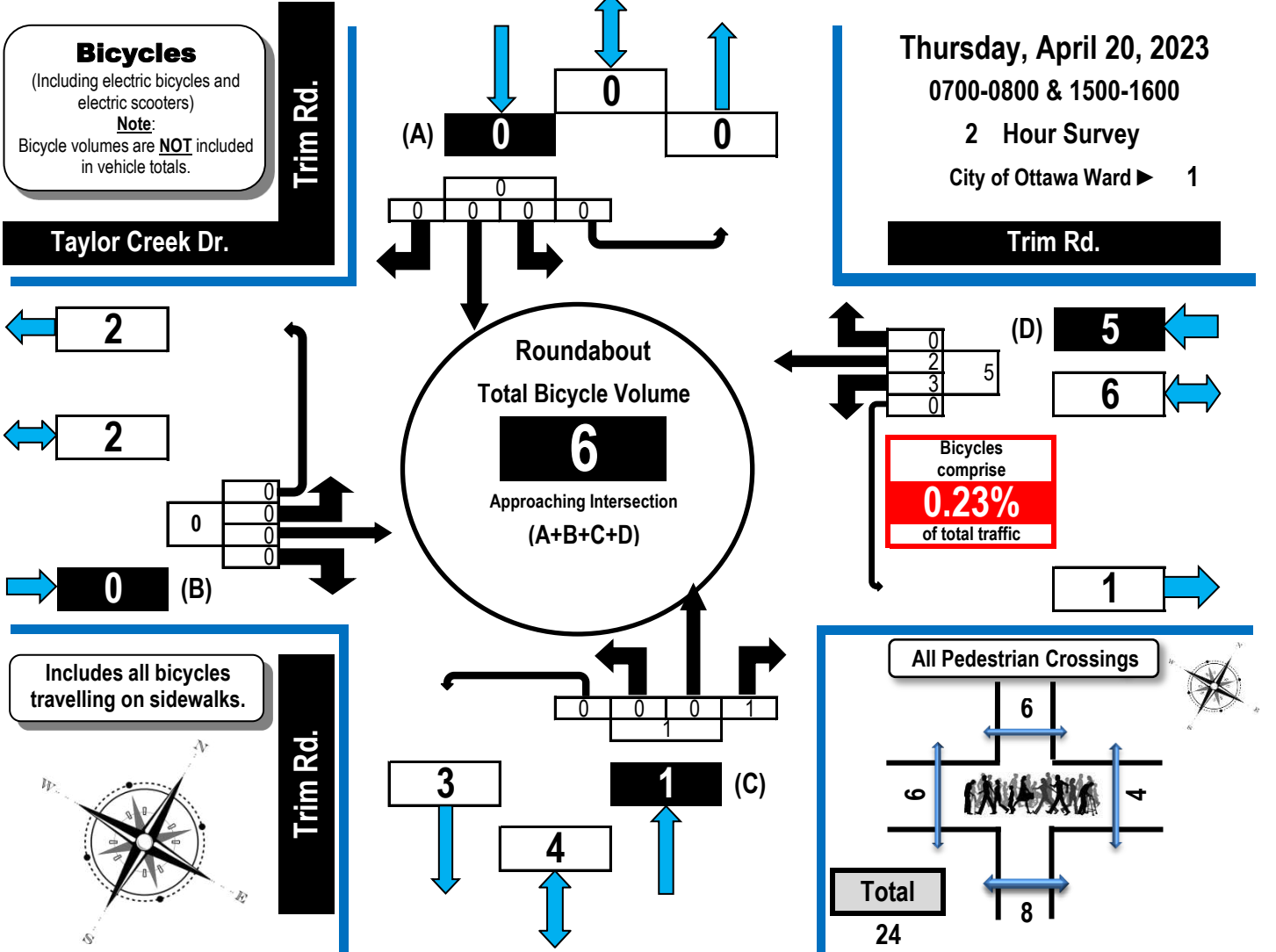

Time Period	Taylor Creek Dr.					Trim Rd.					Trim Rd.					Trim Rd.					
	LT	ST	RT	UT	EB Tot	LT	ST	RT	UT	WB Tot	LT	ST	RT	UT	NB Tot	LT	ST	RT	UT	SB Tot	GR Tot
0700-0800	0	0	0	0	0	0	0	0	0	0	0	0	0	0	0	0	0	0	0	0	0
1500-1600	0	0	0	0	0	3	2	0	0	5	0	0	1	0	1	0	0	0	0	0	6
<b>Totals</b>	0	0	0	0	0	3	2	0	0	5	0	0	1	0	1	0	0	0	0	0	6

**Comments:**  
OC Transpo buses and school buses comprise 42.86% of the heavy vehicle traffic.



# Turning Movement Count Pedestrian Crossings Summary and Flow Diagram



## Taylor Creek Drive & Trim Road (Roundabout) Orléans, ON

**Pedestrian Crossings**

Thursday, April 20, 2023

0700-0800 & 1500-1600

2 Hour Survey

City of Ottawa Ward ▶ 1

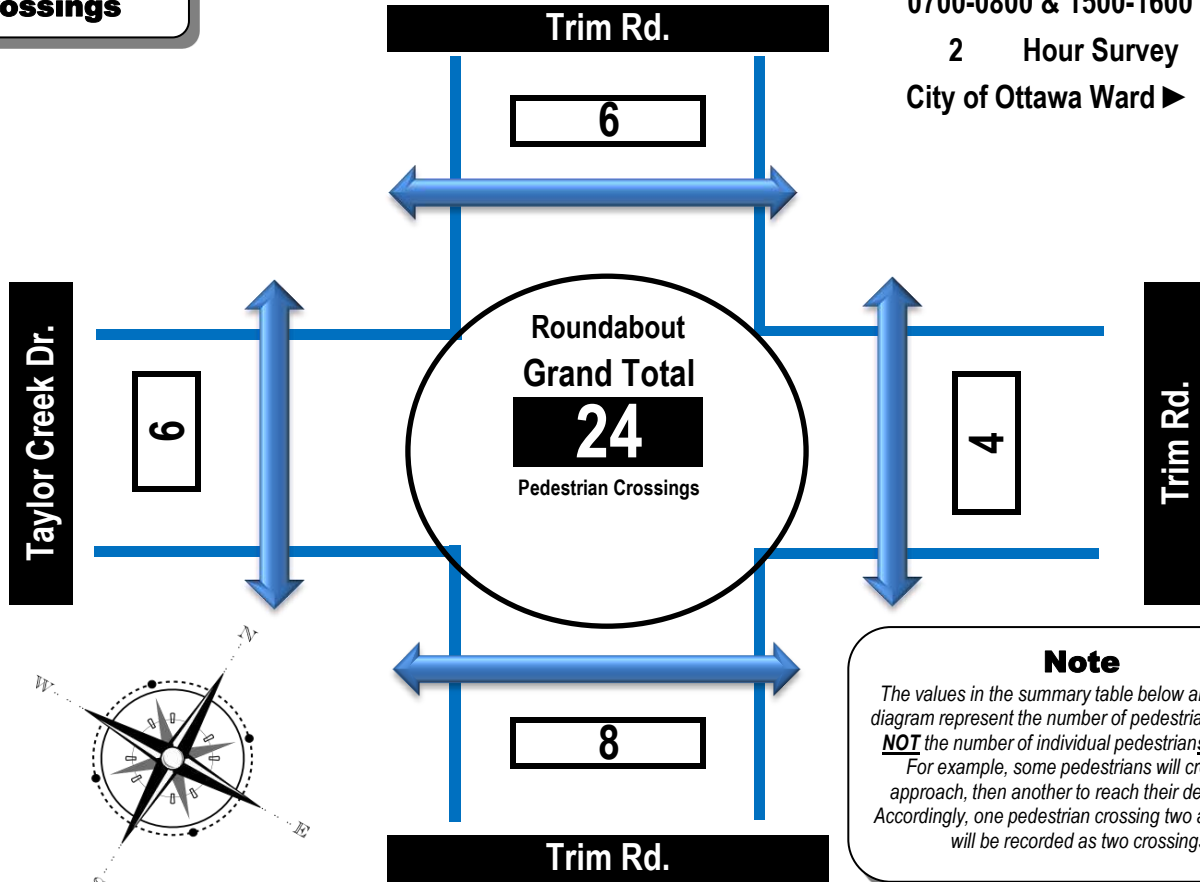

**Note**  
The values in the summary table below and the flow diagram represent the number of pedestrian crossings **NOT** the number of individual pedestrians crossing. For example, some pedestrians will cross one approach, then another to reach their destination. Accordingly, one pedestrian crossing two approaches will be recorded as two crossings.

Time Period	West Side Crossing Taylor Creek Dr.	East Side Crossing Trim Rd.	Street Total	South Side Crossing Trim Rd.	North Side Crossing Trim Rd.	Street Total	Grand Total
0700-0800	3	1	4	1	4	5	9
1500-1600	3	3	6	7	2	9	15
<b>Totals</b>	<b>6</b>	<b>4</b>	<b>10</b>	<b>8</b>	<b>6</b>	<b>14</b>	<b>24</b>

**Comments:**

OC Transpo buses and school buses comprise 42.86% of the heavy vehicle traffic.

# Diagrams, Maps and Photographs

## Old Montreal Road/St. Joseph Boulevard & Trim Road (Roundabout)

Thursday, April 20, 2023





# Turning Movement Count Summary Report Including AM and PM Peak Hours All Vehicles Except Bicycles



## Old Montreal Road/St. Joseph Boulevard & Trim Road (Roundabout) Orléans, ON

**Survey Date:** Thursday, April 20, 2023      **Start Time:** 0700      **AADT Factor:** 0.9  
**Weather AM:** Mostly Sunny 1° C      **Survey Duration:** 2 Hrs.      **Survey Hours:** 0700-0800 & 1500-1600  
**Weather PM:** Mostly Sunny 9° C      **Surveyor(s):** T. Carmody

St. Joseph Blvd.	Old Montreal Rd.	Trim Rd.	Trim Rd.
Eastbound	Westbound	Northbound	Southbound

Time Period	LT	ST	RT	UT	E/B Tot	LT	ST	RT	UT	W/B Tot	Street Total	LT	ST	RT	UT	N/B Tot	LT	ST	RT	UT	S/B Tot	Street Total	Grand Total
0700-0800	31	45	131	2	209	139	369	132	1	641	850	452	361	36	4	853	92	300	92	0	484	1337	2187
1500-1600	47	159	311	1	518	101	185	79	11	376	894	289	314	124	3	730	233	665	55	0	953	1683	2577
<b>Totals</b>	<b>78</b>	<b>204</b>	<b>442</b>	<b>3</b>	<b>727</b>	<b>240</b>	<b>554</b>	<b>211</b>	<b>12</b>	<b>1017</b>	<b>1744</b>	<b>741</b>	<b>675</b>	<b>160</b>	<b>7</b>	<b>1583</b>	<b>325</b>	<b>965</b>	<b>147</b>	<b>0</b>	<b>1437</b>	<b>3020</b>	<b>4764</b>

### Equivalent 12 & 24-hour Vehicle Volumes Including the Annual Average Daily Traffic (AADT) Factor Applicable to the Day and Month of the Turning Movement Count

**Expansion factors are applied exclusively to standard weekday 8-hour turning movement counts conducted during the hours of 0700h - 1000h, 1130h - 1330h and 1500h - 1800h**

Equivalent 12-hour vehicle volumes. These volumes are calculated by multiplying the 8-hour totals by the 8 → 12 expansion factor of 1.39																							
Equ. 12 Hr	n/a	n/a	n/a	n/a	n/a	n/a	n/a	n/a	n/a	n/a	n/a	n/a	n/a	n/a	n/a	n/a	n/a	n/a	n/a	n/a	n/a	n/a	n/a
Average daily 12-hour vehicle volumes. These volumes are calculated by multiplying the equivalent 12-hour totals by the AADT factor of: 0.9																							
AADT 12-hr	n/a	n/a	n/a	n/a	n/a	n/a	n/a	n/a	n/a	n/a	n/a	n/a	n/a	n/a	n/a	n/a	n/a	n/a	n/a	n/a	n/a	n/a	n/a
24-Hour AADT. These volumes are calculated by multiplying the average daily 12-hour vehicle volumes by the 12 → 24 expansion factor of 1.31																							
AADT 24 Hr	n/a	n/a	n/a	n/a	n/a	n/a	n/a	n/a	n/a	n/a	n/a	n/a	n/a	n/a	n/a	n/a	n/a	n/a	n/a	n/a	n/a	n/a	n/a

### AADT and expansion factors provided by the City of Ottawa

<b>AM Peak Hour Factor → 0.85</b>											<b>Highest Hourly Vehicle Volume Between 0700h &amp; 1000h</b>												
AM Peak Hr	LT	ST	RT	UT	Total	LT	ST	RT	UT	Total	Str. Tot.	LT	ST	RT	UT	Total	LT	ST	RT	UT	Total	Str. Tot.	Gr. Tot.
0700-0800	31	45	131	2	209	139	369	132	1	641	850	452	361	36	4	853	92	300	92	0	484	1337	2187

<b>PM Peak Hour Factor → 0.98</b>											<b>Highest Hourly Vehicle Volume Between 1500h &amp; 1800h</b>												
PM Peak Hr	LT	ST	RT	UT	Total	LT	ST	RT	UT	Total	Str. Tot.	LT	ST	RT	UT	Total	LT	ST	RT	UT	Total	Str. Tot.	Gr. Tot.
1500-1600	47	159	311	1	518	101	185	79	11	376	894	289	314	124	3	730	233	665	55	0	953	1683	2577

**Comments:**

OC Transpo buses and school buses comprise 37.28% of the heavy vehicle traffic.

**Notes:**

1. Includes all vehicle types except bicycles, electric bicycles, and electric scooters.
2. When expansion and AADT factors are applied, the results will differ slightly due to rounding.





# Turning Movement Count Summary, AM and PM Peak Hour Flow Diagrams



All Vehicles Except Bicycles

Old Montreal Road/St. Joseph Boulevard & Trim Road (Roundabout) Orléans, ON

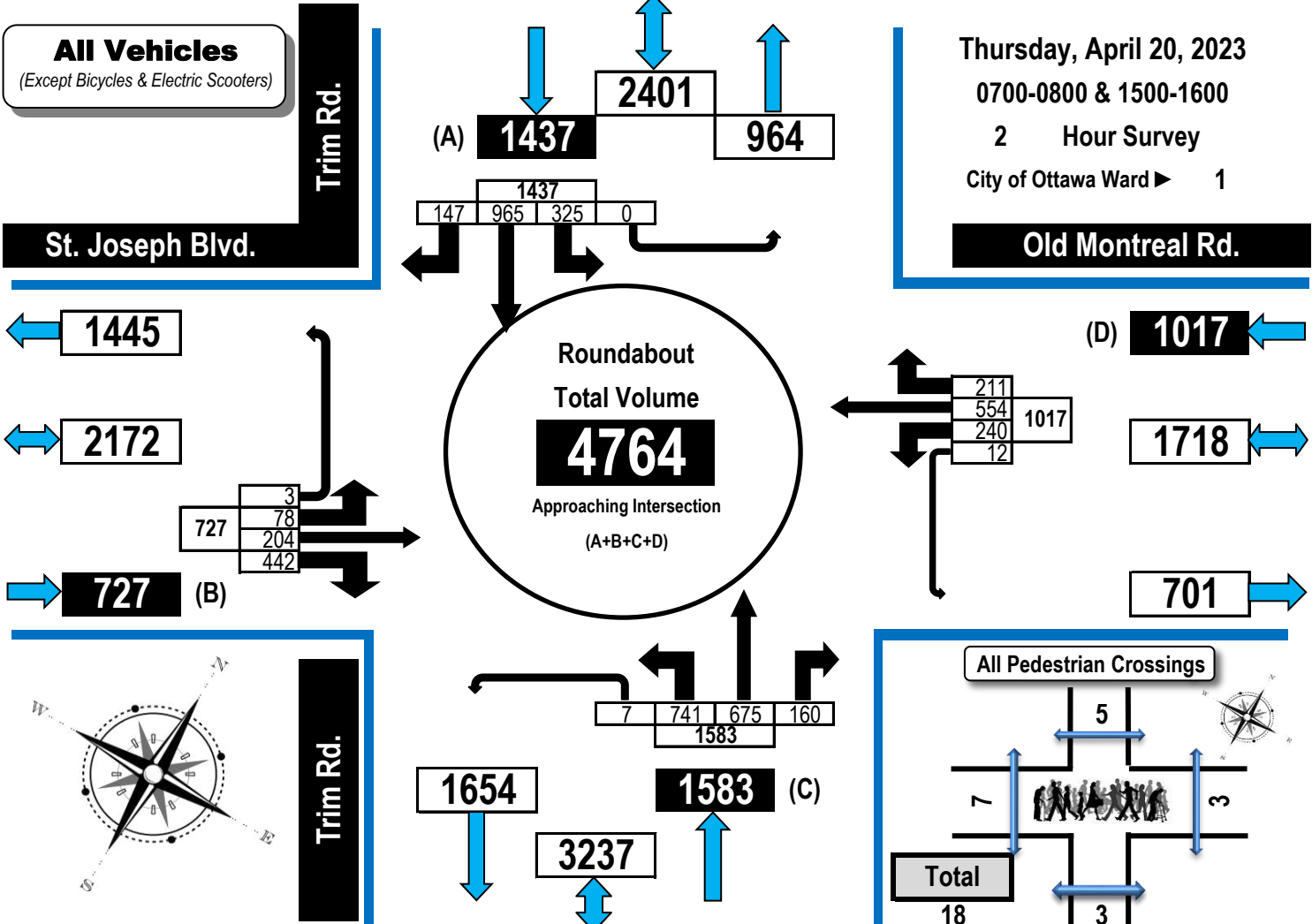

AM Peak Hour Flow Diagram PM Peak Hour Flow Diagram

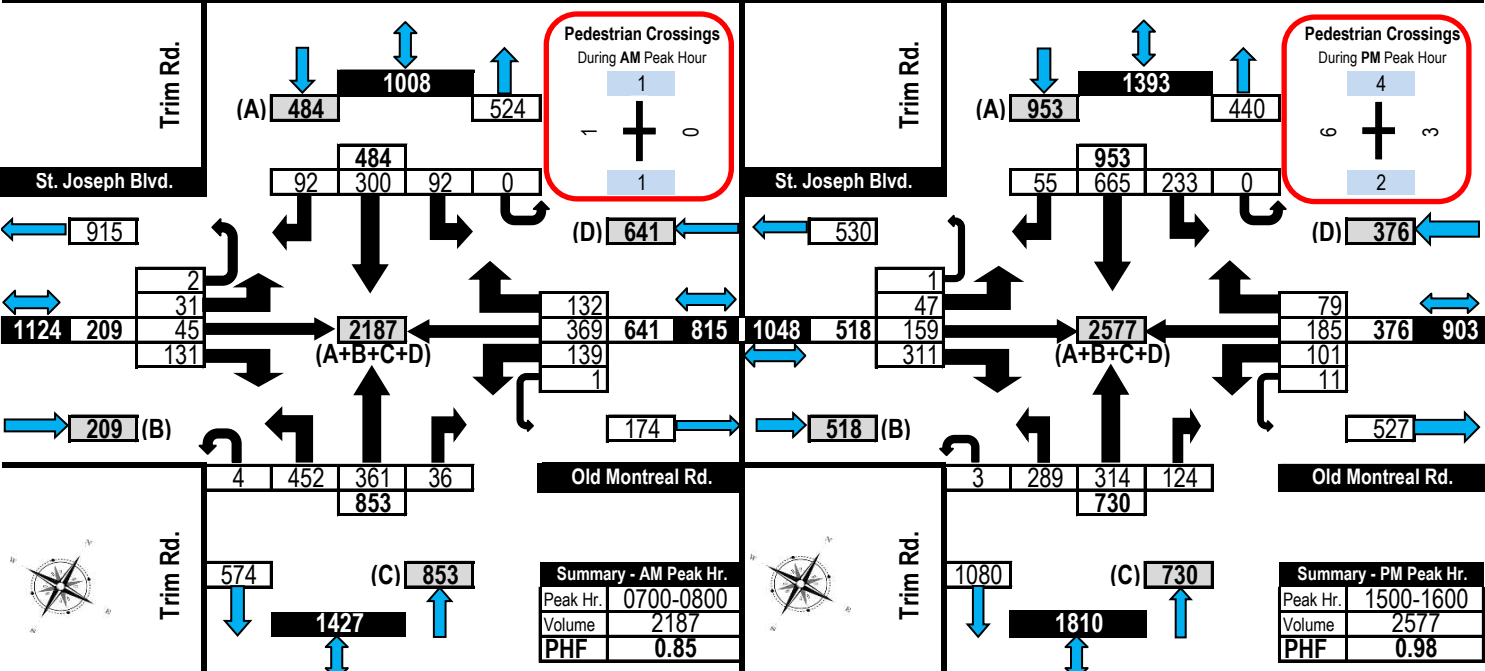



# Turning Movement Count Heavy Vehicle Summary (FHWA Class 4-13) Flow Diagram



**Old Montreal Road/St. Joseph Boulevard & Trim Road (Roundabout)      Orléans, ON**

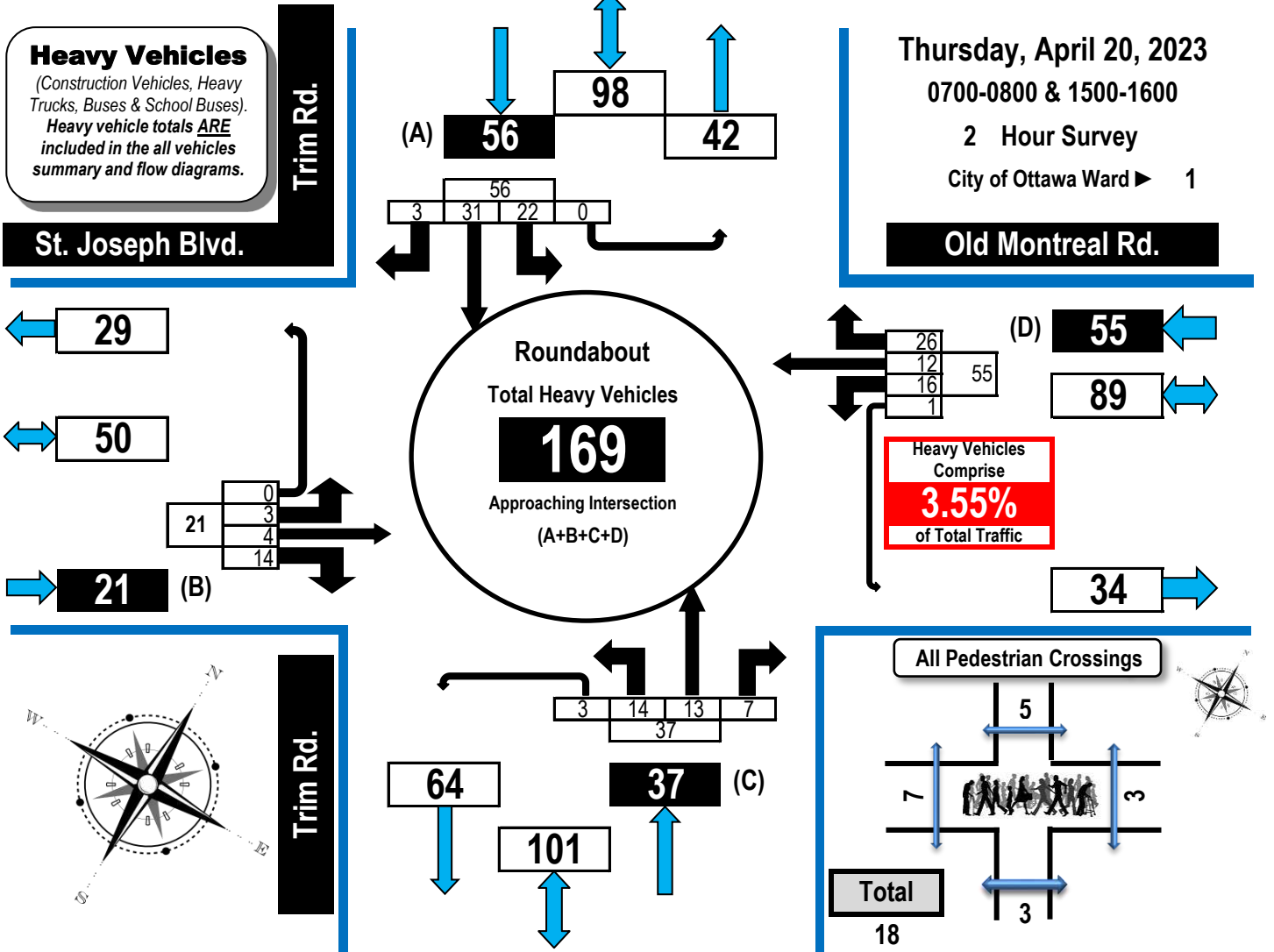

St. Joseph Blvd.	Old Montreal Rd.	Trim Rd.	Trim Rd.
Eastbound	Westbound	Northbound	Southbound

Time Period	St. Joseph Blvd. Eastbound					Old Montreal Rd. Westbound					Trim Rd. Northbound					Trim Rd. Southbound					GR Tot
	LT	ST	RT	UT	EB Tot	LT	ST	RT	UT	WB Tot	LT	ST	RT	UT	NB Tot	LT	ST	RT	UT	SB Tot	
0700-0800	1	3	6	0	10	9	8	16	1	34	4	5	4	3	16	5	14	3	0	22	82
1500-1600	2	1	8	0	11	7	4	10	0	21	10	8	3	0	21	17	17	0	0	34	87
<b>Totals</b>	<b>3</b>	<b>4</b>	<b>14</b>	<b>0</b>	<b>21</b>	<b>16</b>	<b>12</b>	<b>26</b>	<b>1</b>	<b>55</b>	<b>14</b>	<b>13</b>	<b>7</b>	<b>3</b>	<b>37</b>	<b>22</b>	<b>31</b>	<b>3</b>	<b>0</b>	<b>56</b>	<b>169</b>

**Comments:**

OC Transpo buses and school buses comprise 37.28% of the heavy vehicle traffic.



# Turning Movement Count All Buses Summary (FHWA Class 4 ONLY) Flow Diagram



Old Montreal Road/St. Joseph Boulevard & Trim Road (Roundabout)

Orléans, ON

**Buses ONLY**  
(Transit, Intercity, School Buses & Other Buses).  
Bus totals **ARE** included in the all vehicles summary, heavy vehicle summary & flow diagrams.

Thursday, April 20, 2023  
0700-0800 & 1500-1600  
2 Hour Survey  
City of Ottawa Ward 1

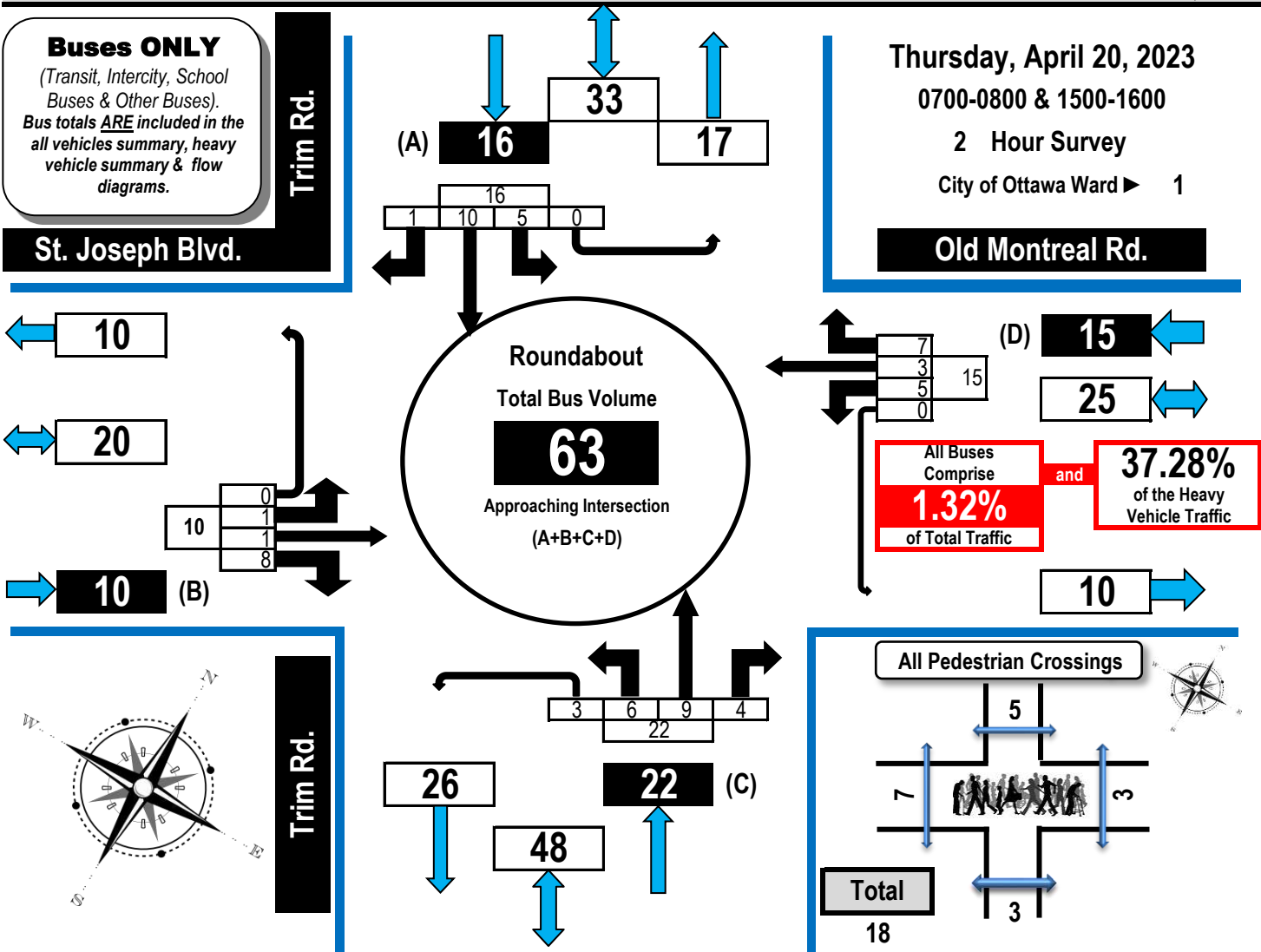

St. Joseph Blvd. Eastbound
Old Montreal Rd. Westbound
Trim Rd. Northbound
Trim Rd. Southbound

Time Period	St. Joseph Blvd. Eastbound				EB Tot	Old Montreal Rd. Westbound				WB Tot	Trim Rd. Northbound				NB Tot	Trim Rd. Southbound				SB Tot	GR Tot
	LT	ST	RT	UT		LT	ST	RT	UT		LT	ST	RT	UT		LT	ST	RT	UT		
0700-0800	0	1	3	0	4	4	1	5	0	10	1	3	1	3	8	0	5	1	0	6	28
1500-1600	1	0	5	0	6	1	2	2	0	5	5	6	3	0	14	5	5	0	0	10	35
<b>Totals</b>	1	1	8	0	10	5	3	7	0	15	6	9	4	3	22	5	10	1	0	16	63

**Comments:**  
OC Transpo buses and school buses comprise 37.28% of the heavy vehicle traffic.



# Turning Movement Count Bicycle Summary Flow Diagram



**Old Montreal Road/St. Joseph Boulevard & Trim Road (Roundabout)      Orléans, ON**

**Bicycles**  
(Including electric bicycles and electric scooters)  
**Note:**  
Bicycle volumes are **NOT** included in vehicle totals.

**Trim Rd.**

**St. Joseph Blvd.**

**Thursday, April 20, 2023**  
**0700-0800 & 1500-1600**  
**2 Hour Survey**  
City of Ottawa Ward ► 1

**Old Montreal Rd.**

← 2

↔ 4

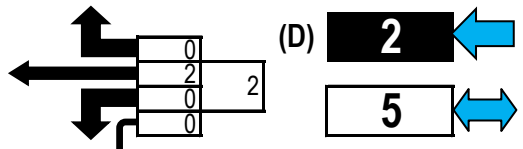
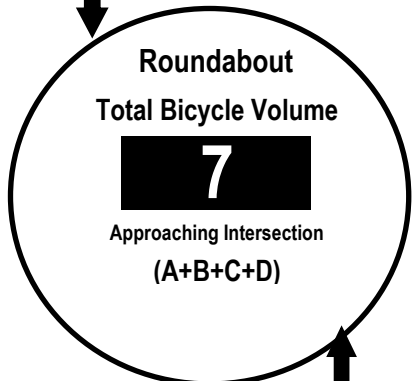
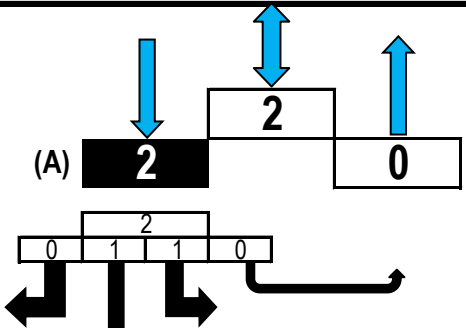
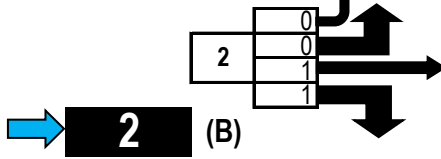

Bicycles  
comprise  
**0.15%**  
of total traffic

→ 3

Includes all bicycles travelling on sidewalks.

**Trim Rd.**

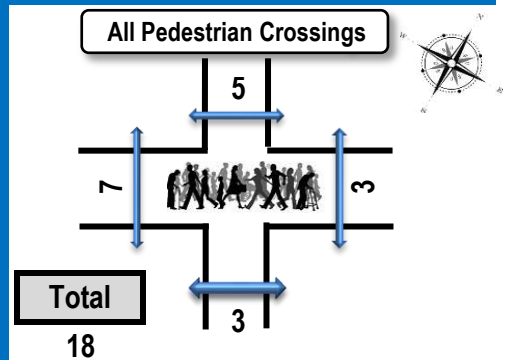
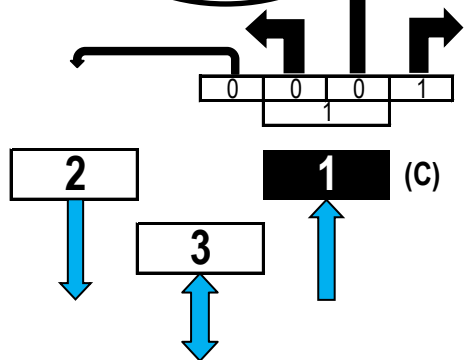
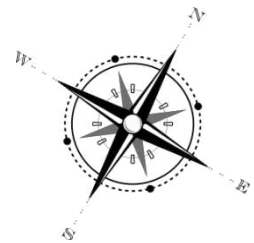

St. Joseph Blvd.	Old Montreal Rd.	Trim Rd.	Trim Rd.
Eastbound	Westbound	Northbound	Southbound

Time Period	LT	ST	RT	UT	EB Tot	LT	ST	RT	UT	WB Tot	LT	ST	RT	UT	NB Tot	LT	ST	RT	UT	SB Tot	GR Tot	
0700-0800	0	0	1	0	1	0	0	0	0	0	0	0	0	0	0	0	1	0	0	0	1	2
1500-1600	0	1	0	0	1	0	2	0	0	2	0	0	1	0	1	1	0	0	0	0	1	5
<b>Totals</b>	0	1	1	0	2	0	2	0	0	2	0	0	1	0	1	1	1	0	0	0	2	7

**Comments:**

OC Transpo buses and school buses comprise 37.28% of the heavy vehicle traffic.



# Turning Movement Count Pedestrian Crossings Summary and Flow Diagram



**Old Montreal Road/St. Joseph Boulevard & Trim Road (Roundabout) Orléans, ON**

**Pedestrian Crossings**

**Thursday, April 20, 2023**

0700-0800 & 1500-1600

2 Hour Survey

City of Ottawa Ward ▶ 1

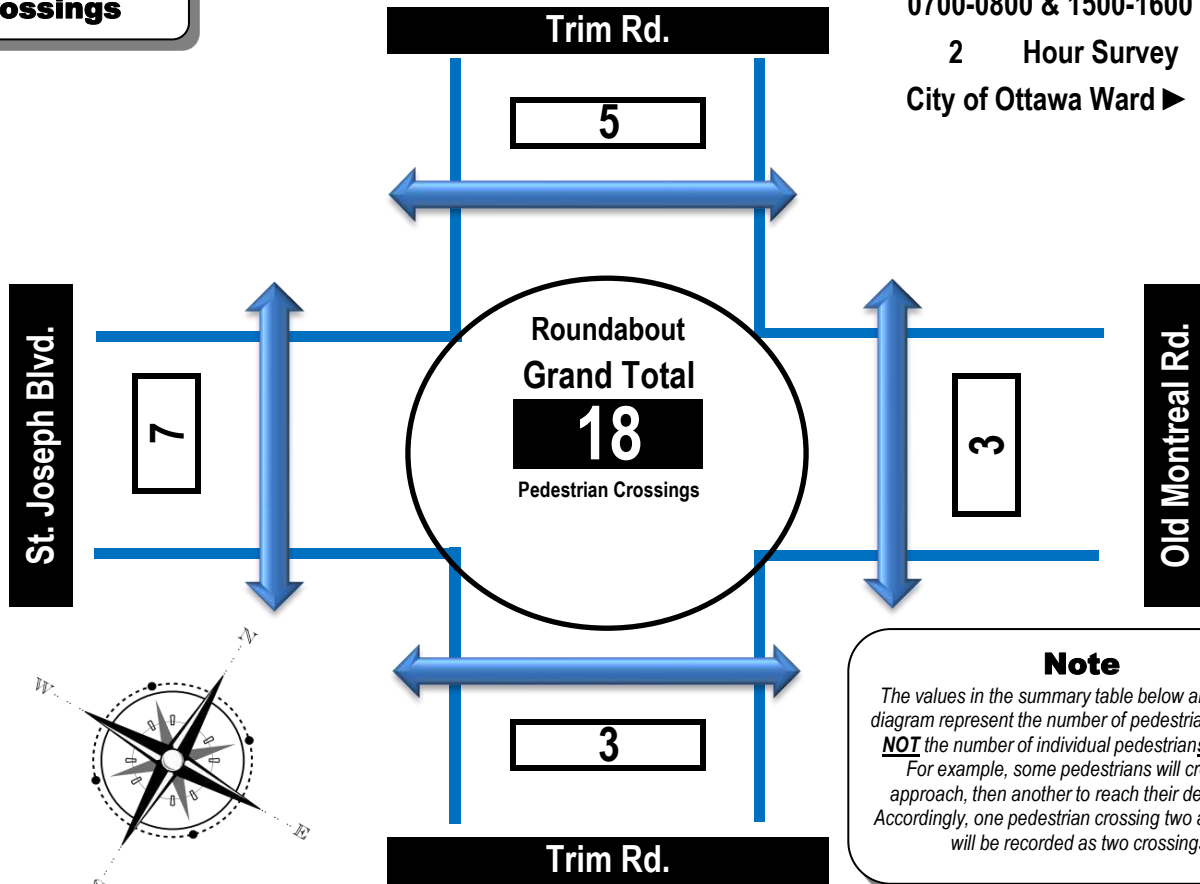

**Note**

*The values in the summary table below and the flow diagram represent the number of pedestrian crossings **NOT** the number of individual pedestrians crossing. For example, some pedestrians will cross one approach, then another to reach their destination. Accordingly, one pedestrian crossing two approaches will be recorded as two crossings.*

Time Period	West Side Crossing St. Joseph Blvd.	East Side Crossing Old Montreal Rd.	Street Total	South Side Crossing Trim Rd.	North Side Crossing Trim Rd.	Street Total	Grand Total
0700-0800	1	0	1	1	1	2	3
1500-1600	6	3	9	2	4	6	15
Totals	7	3	10	3	5	8	18

**Comments:**

OC Transpo buses and school buses comprise 37.28% of the heavy vehicle traffic.

---

**Appendix C**  
Collision Data









---

## **Appendix D**

Existing and Background  
Conditions Synchro Analysis

Existing Conditions  
1: Trim Rd & Highway 174

AM.syn



Lane Group	EBL	EBT	EBR	WBL	WBT	WBR	NBL	NBT	NBR	SBL	SBT	SBR
Lane Configurations												
Traffic Volume (vph)	39	279	0	74	1100	26	527	27	38	18	21	14
Future Volume (vph)	39	279	0	74	1100	26	527	27	38	18	21	14
Peak Hour Factor	0.95	0.95	0.95	0.95	0.95	0.95	0.95	0.95	0.95	0.95	0.95	0.95
Shared Lane Traffic (%)												
Lane Group Flow (vph)	41	294	0	78	1158	27	555	28	40	19	22	15
Turn Type	Prot	NA		Prot	NA	Perm	Prot	NA	Perm	Prot	NA	Perm
Protected Phases	5	2		1	6		3	8		7	4	
Permitted Phases						6			8			4
Detector Phase	5	2		1	6	6	3	8	8	7	4	4
Switch Phase												
Minimum Initial (s)	5.0	34.0		5.0	34.0	34.0	5.0	10.0	10.0	5.0	10.0	10.0
Minimum Split (s)	12.4	40.9		12.4	40.9	40.9	12.5	59.4	59.4	12.5	18.4	18.4
Total Split (s)	15.0	50.0		20.0	55.0	55.0	56.0	60.0	60.0	15.0	19.0	19.0
Total Split (%)	10.3%	34.5%		13.8%	37.9%	37.9%	38.6%	41.4%	41.4%	10.3%	13.1%	13.1%
Yellow Time (s)	4.6	4.6		4.6	4.6	4.6	3.3	3.3	3.3	3.3	3.3	3.3
All-Red Time (s)	2.8	2.3		2.8	2.3	2.3	4.2	5.1	5.1	4.2	5.1	5.1
Lost Time Adjust (s)	0.0	0.0		0.0	0.0	0.0	0.0	0.0	0.0	0.0	0.0	0.0
Total Lost Time (s)	7.4	6.9		7.4	6.9	6.9	7.5	8.4	8.4	7.5	8.4	8.4
Lead/Lag	Lead	Lag		Lead	Lag	Lag	Lead	Lag	Lag	Lead	Lag	Lag
Lead-Lag Optimize?	Yes	Yes		Yes	Yes	Yes	Yes	Yes	Yes	Yes	Yes	Yes
Recall Mode	None	C-Min		None	C-Min	C-Min	None	None	None	None	None	None
Act Effct Green (s)	8.9	69.6		12.1	75.3	75.3	30.5	31.7	31.7	6.7	10.0	10.0
Actuated g/C Ratio	0.06	0.48		0.08	0.52	0.52	0.21	0.22	0.22	0.05	0.07	0.07
v/c Ratio	0.40	0.18		0.56	0.67	0.03	0.81	0.07	0.09	0.25	0.18	0.05
Control Delay	75.8	25.3		78.5	32.1	0.1	64.3	42.3	0.4	74.1	67.5	0.4
Queue Delay	0.0	0.0		0.0	0.0	0.0	0.0	0.0	0.0	0.0	0.0	0.0
Total Delay	75.8	25.3		78.5	32.1	0.1	64.3	42.3	0.4	74.1	67.5	0.4
LOS	E	C		E	C	A	E	D	A	E	E	A
Approach Delay		31.5			34.3			59.2				51.7
Approach LOS		C			C			E				D
Queue Length 50th (m)	12.2	28.9		23.1	152.3	0.0	83.1	6.7	0.0	5.6	6.4	0.0
Queue Length 95th (m)	24.9	45.7		39.9	#210.8	0.0	98.9	14.7	0.0	15.1	16.0	0.0
Internal Link Dist (m)		598.8			203.8			305.9			174.2	
Turn Bay Length (m)	205.0			245.0		200.0	160.0		80.0	85.0		110.0
Base Capacity (vph)	108	1609		158	1741	879	1087	628	624	86	129	293
Starvation Cap Reductn	0	0		0	0	0	0	0	0	0	0	0
Spillback Cap Reductn	0	0		0	0	0	0	0	0	0	0	0
Storage Cap Reductn	0	0		0	0	0	0	0	0	0	0	0
Reduced v/c Ratio	0.38	0.18		0.49	0.67	0.03	0.51	0.04	0.06	0.22	0.17	0.05

Intersection Summary

Cycle Length: 145  
 Actuated Cycle Length: 145  
 Offset: 0 (0%), Referenced to phase 2:EBT and 6:WBT, Start of Green  
 Natural Cycle: 140  
 Control Type: Actuated-Coordinated  
 Maximum v/c Ratio: 0.81  
 Intersection Signal Delay: 41.1  
 Intersection Capacity Utilization 77.7%  
 Analysis Period (min) 15  
 # 95th percentile volume exceeds capacity, queue may be longer.  
 Queue shown is maximum after two cycles.

Splits and Phases: 1: Trim Rd & Highway 174

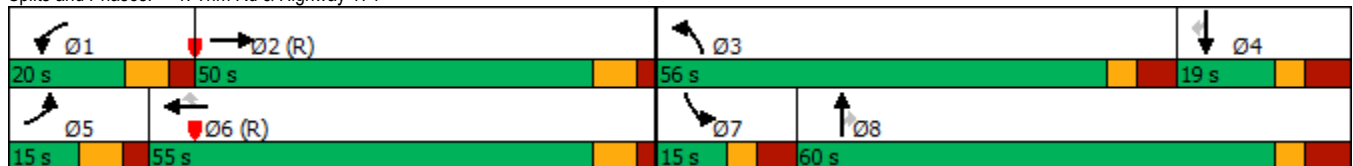

Existing Conditions  
2: Trim Rd & Taylor Creek Dr

AM.syn

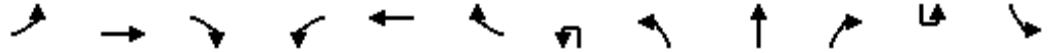

Lane Group	EBL	EBT	EBR	WBL	WBT	WBR	NBU	NBL	NBT	NBR	SBU	SBL
Lane Configurations												
Traffic Volume (vph)	5	62	46	84	49	4	29	127	36	312	9	8
Future Volume (vph)	5	62	46	84	49	4	29	127	36	312	9	8
Peak Hour Factor	0.95	0.95	0.95	0.95	0.95	0.95	0.95	0.95	0.95	0.95	0.95	0.95
Shared Lane Traffic (%)												
Lane Group Flow (vph)	0	118	0	0	144	0	0	0	531	0	0	0
Sign Control		Yield			Yield				Yield			

Intersection Summary

Control Type: Roundabout  
 Intersection Capacity Utilization 52.1%  
 Analysis Period (min) 15  
 ICU Level of Service A

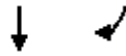

Lane Group	SBT	SBR
Lane Configurations		
Traffic Volume (vph)	268	82
Future Volume (vph)	268	82
Peak Hour Factor	0.95	0.95
Shared Lane Traffic (%)		
Lane Group Flow (vph)	385	0
Sign Control	Yield	

Intersection Summary

Existing Conditions  
2: Trim Rd & Taylor Creek Dr

AM.syn

Intersection							
Intersection Delay, s/veh	5.1						
Intersection LOS	A						
Approach	EB	WB	NB	SB			
Entry Lanes	1	1	2	2			
Conflicting Circle Lanes	1	1	1	1			
Adj Approach Flow, veh/h	118	144	531	385			
Demand Flow Rate, veh/h	120	147	543	393			
Vehicles Circulating, veh/h	427	222	88	312			
Vehicles Exiting, veh/h	278	74	459	57			
Ped Vol Crossing Leg, #/h	0	0	0	0			
Ped Cap Adj	1.000	1.000	1.000	1.000			
Approach Delay, s/veh	5.4	4.5	4.8	5.8			
Approach LOS	A	A	A	A			
Lane	Left	Left	Left	Bypass	Left	Right	
Designated Moves	LTR	LTR	LT	R	LT	R	
Assumed Moves	LTR	LTR	LT	R	LT	R	
RT Channelized				Yield			
Lane Util	1.000	1.000	1.000		0.776	0.224	
Follow-Up Headway, s	2.609	2.609	2.535		2.535	2.535	
Critical Headway, s	4.976	4.976	4.544	335	4.544	4.544	
Entry Flow, veh/h	120	147	208	1280	305	88	
Cap Entry Lane, veh/h	893	1100	1311	0.980	1069	1069	
Entry HV Adj Factor	0.981	0.979	0.979	328	0.981	0.977	
Flow Entry, veh/h	118	144	204	1254	299	86	
Cap Entry, veh/h	876	1078	1283	0.261	1049	1045	
V/C Ratio	0.134	0.134	0.159	5.2	0.285	0.082	
Control Delay, s/veh	5.4	4.5	4.1	A	6.2	4.2	
LOS	A	A	A	1	A	A	
95th %tile Queue, veh	0	0	1		1	0	

Existing Conditions

4: Trim Rd & St. Joseph Blvd/Old Montreal Rd

AM.syn



Lane Group	EBU	EBL	EBT	EBR	WBU	WBL	WBT	WBR	NBU	NBL	NBT	NBR
Lane Configurations			↕↕	↗			↕↕	↗			↕↕	
Traffic Volume (vph)	2	31	45	131	1	139	369	132	4	452	361	36
Future Volume (vph)	2	31	45	131	1	139	369	132	4	452	361	36
Peak Hour Factor	0.95	0.95	0.95	0.95	0.95	0.95	0.95	0.95	0.95	0.95	0.95	0.95
Shared Lane Traffic (%)												
Lane Group Flow (vph)	0	0	82	138	0	0	535	139	0	0	898	0
Sign Control			Yield				Yield				Yield	

Intersection Summary

Control Type: Roundabout

Intersection Capacity Utilization 78.1%

ICU Level of Service D

Analysis Period (min) 15



Lane Group	SBL	SBT	SBR
Lane Configurations		↕↕	
Traffic Volume (vph)	92	300	92
Future Volume (vph)	92	300	92
Peak Hour Factor	0.95	0.95	0.95
Shared Lane Traffic (%)			
Lane Group Flow (vph)	0	510	0
Sign Control		Yield	

Intersection Summary

## Existing Conditions

## 4: Trim Rd &amp; St. Joseph Blvd/Old Montreal Rd

AM.syn

Intersection									
Intersection Delay, s/veh	21.0								
Intersection LOS	C								
Approach	EB		WB		NB		SB		
Entry Lanes	2		2		2		2		
Conflicting Circle Lanes	1		1		1		1		
Adj Approach Flow, veh/h	220		674		898		510		
Demand Flow Rate, veh/h	225		688		917		520		
Vehicles Circulating, veh/h	575		914		184		1038		
Vehicles Exiting, veh/h	983		187		475		422		
Ped Vol Crossing Leg, #/h	0		0		0		0		
Ped Cap Adj	1.000		1.000		1.000		1.000		
Approach Delay, s/veh	5.8		32.4		14.0		25.0		
Approach LOS	A		D		B		C		
Lane	Left	Bypass	Left	Bypass	Left	Right	Left	Right	
Designated Moves	LT	R	LT	R	LT	R	LT	R	
Assumed Moves	LT	R	LT	R	LT	R	LT	R	
RT Channelized		Yield		Yield					
Lane Util	1.000		1.000		0.957	0.043	0.810	0.190	
Follow-Up Headway, s	2.535		2.535		2.535	2.535	2.535	2.535	
Critical Headway, s	4.544	141	4.544	142	4.544	4.544	4.544	4.544	
Entry Flow, veh/h	84	850	546	897	878	39	421	99	
Cap Entry Lane, veh/h	841	0.980	618	0.980	1201	1201	552	552	
Entry HV Adj Factor	0.976	138	0.980	139	0.980	0.974	0.980	0.980	
Flow Entry, veh/h	82	833	535	880	860	38	413	97	
Cap Entry, veh/h	822	0.166	606	0.158	1177	1170	541	541	
V/C Ratio	0.100	6.0	0.883	5.6	0.731	0.032	0.763	0.179	
Control Delay, s/veh	5.4	A	39.3	A	14.5	3.3	28.7	9.0	
LOS	A	1	E	1	B	A	D	A	
95th %tile Queue, veh	0		10		7	0	7	1	

Background 2026 Conditions  
1: Trim Rd & Highway 174

AM.syn



Lane Group	EBL	EBT	EBR	WBL	WBT	WBR	NBL	NBT	NBR	SBL	SBT	SBR
Lane Configurations												
Traffic Volume (vph)	97	342	3	82	1320	27	547	39	46	26	37	50
Future Volume (vph)	97	342	3	82	1320	27	547	39	46	26	37	50
Ideal Flow (vphpl)	1800	1800	1800	1800	1800	1800	1800	1800	1800	1800	1800	1800
Storage Length (m)	205.0		0.0	245.0		200.0	160.0		80.0	85.0		110.0
Storage Lanes	1		0	1		1	2		1	1		1
Taper Length (m)	30.0			30.0			100.0			30.0		
Lane Util. Factor	1.00	0.95	0.95	1.00	0.95	1.00	0.97	1.00	1.00	1.00	1.00	1.00
Frt		0.999				0.850			0.850			0.850
Flt Protected	0.950			0.950			0.950			0.950		
Satd. Flow (prot)	1676	3350	0	1676	3353	1500	3252	1765	1500	1676	1765	1500
Flt Permitted	0.950			0.950			0.950			0.950		
Satd. Flow (perm)	1676	3350	0	1676	3353	1500	3252	1765	1500	1676	1765	1500
Right Turn on Red			Yes			Yes			Yes			Yes
Satd. Flow (RTOR)		1				209			141			198
Link Speed (k/h)		90			90			60				60
Link Distance (m)		622.8			227.8			329.9				198.2
Travel Time (s)		24.9			9.1			19.8				11.9
Peak Hour Factor	0.95	0.95	0.95	0.95	0.95	0.95	0.95	0.95	0.95	0.95	0.95	0.95
Adj. Flow (vph)	102	360	3	86	1389	28	576	41	48	27	39	53
Shared Lane Traffic (%)												
Lane Group Flow (vph)	102	363	0	86	1389	28	576	41	48	27	39	53
Enter Blocked Intersection	No	No	No	No	No	No	No	No	No	No	No	No
Lane Alignment	Left	Left	Right	Left	Left	Right	Left	Left	Right	Left	Left	Right
Median Width(m)		3.6			3.6			7.2				7.2
Link Offset(m)		0.0			0.0			0.0				0.0
Crosswalk Width(m)		4.8			4.8			4.8				4.8
Two way Left Turn Lane												
Headway Factor	1.07	1.07	1.07	1.07	1.07	1.07	1.07	1.07	1.07	1.07	1.07	1.07
Turning Speed (k/h)	25		15	25		15	25		15	25		15
Number of Detectors	1	2		1	2	1	1	2	1	1	2	1
Detector Template	Left	Thru		Left	Thru	Right	Left	Thru	Right	Left	Thru	Right
Leading Detector (m)	2.0	10.0		2.0	10.0	2.0	2.0	10.0	2.0	2.0	10.0	2.0
Trailing Detector (m)	0.0	0.0		0.0	0.0	0.0	0.0	0.0	0.0	0.0	0.0	0.0
Detector 1 Position(m)	0.0	0.0		0.0	0.0	0.0	0.0	0.0	0.0	0.0	0.0	0.0
Detector 1 Size(m)	2.0	0.6		2.0	0.6	2.0	2.0	0.6	2.0	2.0	0.6	2.0
Detector 1 Type	Cl+Ex	Cl+Ex		Cl+Ex	Cl+Ex	Cl+Ex	Cl+Ex	Cl+Ex	Cl+Ex	Cl+Ex	Cl+Ex	Cl+Ex
Detector 1 Channel												
Detector 1 Extend (s)	0.0	0.0		0.0	0.0	0.0	0.0	0.0	0.0	0.0	0.0	0.0
Detector 1 Queue (s)	0.0	0.0		0.0	0.0	0.0	0.0	0.0	0.0	0.0	0.0	0.0
Detector 1 Delay (s)	0.0	0.0		0.0	0.0	0.0	0.0	0.0	0.0	0.0	0.0	0.0
Detector 2 Position(m)		9.4			9.4			9.4				9.4
Detector 2 Size(m)		0.6			0.6			0.6				0.6
Detector 2 Type		Cl+Ex			Cl+Ex			Cl+Ex				Cl+Ex
Detector 2 Channel												
Detector 2 Extend (s)		0.0			0.0			0.0				0.0
Turn Type	Prot	NA		Prot	NA	Perm	Prot	NA	Perm	Prot	NA	Perm
Protected Phases	5	2		1	6		3	8		7	4	
Permitted Phases						6			8			4



Background 2026 Conditions

1: Trim Rd & Highway 174

AM.syn



Lane Group	EBL	EBT	EBR	WBL	WBT	WBR	NBL	NBT	NBR	SBL	SBT	SBR
Detector Phase	5	2		1	6	6	3	8	8	7	4	4
Switch Phase												
Minimum Initial (s)	5.0	34.0		5.0	34.0	34.0	5.0	10.0	10.0	5.0	10.0	10.0
Minimum Split (s)	12.4	40.9		12.4	40.9	40.9	12.5	59.4	59.4	12.5	18.4	18.4
Total Split (s)	15.0	50.0		20.0	55.0	55.0	56.0	60.0	60.0	15.0	19.0	19.0
Total Split (%)	10.3%	34.5%		13.8%	37.9%	37.9%	38.6%	41.4%	41.4%	10.3%	13.1%	13.1%
Maximum Green (s)	7.6	43.1		12.6	48.1	48.1	48.5	51.6	51.6	7.5	10.6	10.6
Yellow Time (s)	4.6	4.6		4.6	4.6	4.6	3.3	3.3	3.3	3.3	3.3	3.3
All-Red Time (s)	2.8	2.3		2.8	2.3	2.3	4.2	5.1	5.1	4.2	5.1	5.1
Lost Time Adjust (s)	0.0	0.0		0.0	0.0	0.0	0.0	0.0	0.0	0.0	0.0	0.0
Total Lost Time (s)	7.4	6.9		7.4	6.9	6.9	7.5	8.4	8.4	7.5	8.4	8.4
Lead/Lag	Lead	Lag		Lead	Lag	Lag	Lead	Lag	Lag	Lead	Lag	Lag
Lead-Lag Optimize?	Yes	Yes		Yes	Yes	Yes	Yes	Yes	Yes	Yes	Yes	Yes
Vehicle Extension (s)	3.0	3.0		3.0	3.0	3.0	3.0	3.0	3.0	3.0	3.0	3.0
Recall Mode	None	C-Min		None	C-Min	C-Min	None	None	None	None	None	None
Walk Time (s)								7.0	7.0			
Flash Dont Walk (s)								44.0	44.0			
Pedestrian Calls (#/hr)								0	0			
Act Effct Green (s)	17.9	64.0		12.7	58.9	58.9	31.4	36.6	36.6	6.9	10.4	10.4
Actuated g/C Ratio	0.12	0.44		0.09	0.41	0.41	0.22	0.25	0.25	0.05	0.07	0.07
v/c Ratio	0.50	0.25		0.59	1.02	0.04	0.82	0.09	0.10	0.34	0.31	0.18
Control Delay	68.7	28.8		78.8	72.2	0.1	63.9	40.1	0.4	78.3	70.6	1.4
Queue Delay	0.0	0.0		0.0	0.0	0.0	0.0	0.0	0.0	0.0	0.0	0.0
Total Delay	68.7	28.8		78.8	72.2	0.1	63.9	40.1	0.4	78.3	70.6	1.4
LOS	E	C		E	E	A	E	D	A	E	E	A
Approach Delay		37.6			71.3			57.8			41.5	
Approach LOS		D			E			E			D	
Queue Length 50th (m)	29.3	37.2		25.5	~245.0	0.0	86.2	9.8	0.0	8.0	11.4	0.0
Queue Length 95th (m)	50.4	58.2		43.1	#319.6	0.0	102.2	18.9	0.0	19.1	24.0	0.0
Internal Link Dist (m)		598.8			203.8			305.9			174.2	
Turn Bay Length (m)	205.0			245.0		200.0	160.0		80.0	85.0		110.0
Base Capacity (vph)	206	1478		162	1361	733	1087	628	624	86	132	295
Starvation Cap Reductn	0	0		0	0	0	0	0	0	0	0	0
Spillback Cap Reductn	0	0		0	0	0	0	0	0	0	0	0
Storage Cap Reductn	0	0		0	0	0	0	0	0	0	0	0
Reduced v/c Ratio	0.50	0.25		0.53	1.02	0.04	0.53	0.07	0.08	0.31	0.30	0.18

Intersection Summary

Area Type: Other  
 Cycle Length: 145  
 Actuated Cycle Length: 145  
 Offset: 0 (0%), Referenced to phase 2:EBT and 6:WBT, Start of Green  
 Natural Cycle: 150  
 Control Type: Actuated-Coordinated  
 Maximum v/c Ratio: 1.02  
 Intersection Signal Delay: 61.0 Intersection LOS: E  
 Intersection Capacity Utilization 86.2% ICU Level of Service E  
 Analysis Period (min) 15

~ Volume exceeds capacity, queue is theoretically infinite.

# Background 2026 Conditions

## 1: Trim Rd & Highway 174

AM.syn

Queue shown is maximum after two cycles.

# 95th percentile volume exceeds capacity, queue may be longer.

Queue shown is maximum after two cycles.

Splits and Phases: 1: Trim Rd & Highway 174

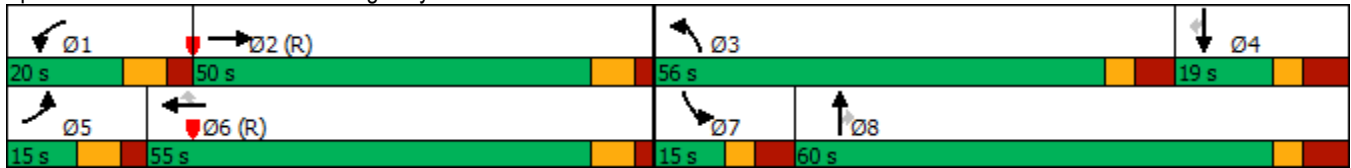

Background 2026 Conditions  
2: Trim Rd & Taylor Creek Dr

AM.syn



Lane Group	EBL	EBT	EBR	WBL	WBT	WBR	NBU	NBL	NBT	NBR	SBU	SBL
Lane Configurations		↕			↕				↕	↕		
Traffic Volume (vph)	5	62	46	106	49	4	29	127	39	349	9	8
Future Volume (vph)	5	62	46	106	49	4	29	127	39	349	9	8
Ideal Flow (vphp)	1800	1800	1800	1800	1800	1800	1800	1800	1800	1800	1800	1800
Lane Util. Factor	1.00	1.00	1.00	1.00	1.00	1.00	1.00	1.00	1.00	1.00	0.95	0.95
Fr <sub>t</sub>		0.945			0.997					0.850		
Fl <sub>t</sub> Protected		0.998			0.968				0.961			
Satd. Flow (prot)	0	1664	0	0	1703	0	0	0	1696	1500	0	0
Fl <sub>t</sub> Permitted		0.998			0.968				0.961			
Satd. Flow (perm)	0	1664	0	0	1703	0	0	0	1696	1500	0	0
Link Speed (k/h)		50			60				60			
Link Distance (m)		109.2			341.0				349.4			
Travel Time (s)		7.9			20.5				21.0			
Peak Hour Factor	0.95	0.95	0.95	0.95	0.95	0.95	0.95	0.95	0.95	0.95	0.95	0.95
Adj. Flow (vph)	5	65	48	112	52	4	31	134	41	367	9	8
Shared Lane Traffic (%)												
Lane Group Flow (vph)	0	118	0	0	168	0	0	0	206	367	0	0
Enter Blocked Intersection	No	No	No	No	No	No	No	No	No	No	No	No
Lane Alignment	Left	Left	Right	Left	Left	Right	R NA	Left	Left	Right	R NA	Left
Median Width(m)		0.0			0.0				0.0			
Link Offset(m)		0.0			0.0				0.0			
Crosswalk Width(m)		4.8			4.8				4.8			
Two way Left Turn Lane												
Headway Factor	1.07	1.07	1.07	1.07	1.07	1.07	1.07	1.07	1.07	1.07	1.07	1.07
Turning Speed (k/h)	25		15	25		15	15	25		15	15	25
Sign Control		Yield			Yield				Yield			

Intersection Summary

Area Type:	Other
Control Type:	Roundabout
Intersection Capacity Utilization	51.3%
Analysis Period (min)	15
	ICU Level of Service A

Background 2026 Conditions  
 2: Trim Rd & Taylor Creek Dr

AM.syn



Lane Group	SBT	SBR
Lane Configurations		
Traffic Volume (vph)	293	82
Future Volume (vph)	293	82
Ideal Flow (vphpl)	1800	1800
Lane Util. Factor	0.95	0.95
Frt	0.969	
Flt Protected	0.998	
Satd. Flow (prot)	3243	0
Flt Permitted	0.998	
Satd. Flow (perm)	3243	0
Link Speed (k/h)	60	
Link Distance (m)	295.7	
Travel Time (s)	17.7	
Peak Hour Factor	0.95	0.95
Adj. Flow (vph)	308	86
Shared Lane Traffic (%)		
Lane Group Flow (vph)	411	0
Enter Blocked Intersection	No	No
Lane Alignment	Left	Right
Median Width(m)	0.0	
Link Offset(m)	0.0	
Crosswalk Width(m)	4.8	
Two way Left Turn Lane		
Headway Factor	1.07	1.07
Turning Speed (k/h)	15	
Sign Control	Yield	
Intersection Summary		

Background 2026 Conditions  
2: Trim Rd & Taylor Creek Dr

AM.syn

Intersection						
Intersection Delay, s/veh	5.5					
Intersection LOS	A					
Approach	EB	WB	NB	SB		
Entry Lanes	1	1	1	2		
Conflicting Circle Lanes	1	1	1	1		
Adj Approach Flow, veh/h	118	168	573	411		
Demand Flow Rate, veh/h	120	171	585	419		
Vehicles Circulating, veh/h	477	225	88	336		
Vehicles Exiting, veh/h	278	74	509	60		
Ped Vol Crossing Leg, #/h	0	0	0	0		
Ped Cap Adj	1.000	1.000	1.000	1.000		
Approach Delay, s/veh	5.7	4.7	5.1	6.2		
Approach LOS	A	A	A	A		
Lane	Left	Left	Left	Bypass	Left	Right
Designated Moves	LTR	LTR	LT	R	LT	R
Assumed Moves	LTR	LTR	LT	R	LT	R
RT Channelized	Yield					
Lane Util	1.000	1.000	1.000		0.790	0.210
Follow-Up Headway, s	2.609	2.609	2.609		2.535	2.535
Critical Headway, s	4.976	4.976	4.976	374	4.544	4.544
Entry Flow, veh/h	120	171	211	1280	331	88
Cap Entry Lane, veh/h	848	1097	1261	0.980	1046	1046
Entry HV Adj Factor	0.981	0.982	0.979	367	0.981	0.977
Flow Entry, veh/h	118	168	207	1254	325	86
Cap Entry, veh/h	832	1077	1235	0.293	1026	1022
V/C Ratio	0.141	0.156	0.167	5.5	0.316	0.084
Control Delay, s/veh	5.7	4.7	4.3	A	6.7	4.3
LOS	A	A	A	1	A	A
95th %tile Queue, veh	0	1	1		1	0

Background 2026 Conditions  
 4: Trim Rd & St. Joseph Blvd/Old Montreal Rd

AM.syn

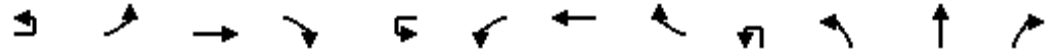

Lane Group	EBU	EBL	EBT	EBR	WBU	WBL	WBT	WBR	NBU	NBL	NBT	NBR
Lane Configurations			↕↕	↗			↕↕	↗			↕↕	
Traffic Volume (vph)	2	32	50	133	1	139	404	132	4	455	430	36
Future Volume (vph)	2	32	50	133	1	139	404	132	4	455	430	36
Ideal Flow (vphpl)	1800	1800	1800	1800	1800	1800	1800	1800	1800	1800	1800	1800
Storage Length (m)		0.0		140.0		0.0		90.0		0.0		0.0
Storage Lanes		0		1		0		1		0		0
Taper Length (m)		0.0				0.0				0.0		
Lane Util. Factor	0.95	0.95	0.95	1.00	0.95	0.95	0.95	1.00	0.95	0.95	0.95	0.95
Frt				0.850				0.850				0.994
Flt Protected			0.980				0.987				0.976	
Satd. Flow (prot)	0	0	3286	1500	0	0	3309	1500	0	0	3253	0
Flt Permitted			0.980				0.987				0.976	
Satd. Flow (perm)	0	0	3286	1500	0	0	3309	1500	0	0	3253	0
Link Speed (k/h)			50				50				60	
Link Distance (m)			262.9				210.8				183.2	
Travel Time (s)			18.9				15.2				11.0	
Peak Hour Factor	0.95	0.95	0.95	0.95	0.95	0.95	0.95	0.95	0.95	0.95	0.95	0.95
Adj. Flow (vph)	2	34	53	140	1	146	425	139	4	479	453	38
Shared Lane Traffic (%)												
Lane Group Flow (vph)	0	0	89	140	0	0	572	139	0	0	974	0
Enter Blocked Intersection	No	No	No	No	No	No	No	No	No	No	No	No
Lane Alignment	R NA	Left	Left	Right	R NA	Left	Left	Right	R NA	Left	Left	Right
Median Width(m)			0.0				0.0				0.0	
Link Offset(m)			0.0				0.0				0.0	
Crosswalk Width(m)			4.8				4.8				4.8	
Two way Left Turn Lane												
Headway Factor	1.07	1.07	1.07	1.07	1.07	1.07	1.07	1.07	1.07	1.07	1.07	1.07
Turning Speed (k/h)	15	25		15	15	25		15	15	25		15
Sign Control			Yield				Yield				Yield	

Intersection Summary

Area Type:	Other
Control Type:	Roundabout
Intersection Capacity Utilization	82.1%
ICU Level of Service	E
Analysis Period (min)	15

Background 2026 Conditions  
 4: Trim Rd & St. Joseph Blvd/Old Montreal Rd

AM.syn



Lane Group	SBL	SBT	SBR
Lane Configurations		↕↕	
Traffic Volume (vph)	92	349	93
Future Volume (vph)	92	349	93
Ideal Flow (vphpl)	1800	1800	1800
Storage Length (m)	0.0		0.0
Storage Lanes	0		0
Taper Length (m)	0.0		
Lane Util. Factor	0.95	0.95	0.95
Frt		0.974	
Flt Protected		0.991	
Satd. Flow (prot)	0	3236	0
Flt Permitted		0.991	
Satd. Flow (perm)	0	3236	0
Link Speed (k/h)		60	
Link Distance (m)		349.4	
Travel Time (s)		21.0	
Peak Hour Factor	0.95	0.95	0.95
Adj. Flow (vph)	97	367	98
Shared Lane Traffic (%)			
Lane Group Flow (vph)	0	562	0
Enter Blocked Intersection	No	No	No
Lane Alignment	Left	Left	Right
Median Width(m)		0.0	
Link Offset(m)		0.0	
Crosswalk Width(m)		4.8	
Two way Left Turn Lane			
Headway Factor	1.07	1.07	1.07
Turning Speed (k/h)	25		15
Sign Control		Yield	
<b>Intersection Summary</b>			

Background 2026 Conditions  
 4: Trim Rd & St. Joseph Blvd/Old Montreal Rd

AM.syn

Intersection								
Intersection Delay, s/veh	32.4							
Intersection LOS	D							
Approach	EB		WB		NB		SB	
Entry Lanes	2		2		2		2	
Conflicting Circle Lanes	1		1		1		1	
Adj Approach Flow, veh/h	229		711		974		562	
Demand Flow Rate, veh/h	234		726		994		573	
Vehicles Circulating, veh/h	627		992		191		1078	
Vehicles Exiting, veh/h	1024		193		527		497	
Ped Vol Crossing Leg, #/h	0		0		0		0	
Ped Cap Adj	1.000		1.000		1.000		1.000	
Approach Delay, s/veh	6.2		56.5		17.5		38.3	
Approach LOS	A		F		C		E	
Lane	Left	Bypass	Left	Bypass	Left	Right	Left	Right
Designated Moves	LT	R	LT	R	LT	R	LT	R
Assumed Moves	LT	R	LT	R	LT	R	LT	R
RT Channelized		Yield		Yield				
Lane Util	1.000		1.000		0.961	0.039	0.825	0.175
Follow-Up Headway, s	2.535		2.535		2.535	2.535	2.535	2.535
Critical Headway, s	4.544	143	4.544	142	4.544	4.544	4.544	4.544
Entry Flow, veh/h	91	806	584	831	955	39	473	100
Cap Entry Lane, veh/h	803	0.980	576	0.980	1194	1194	532	532
Entry HV Adj Factor	0.977	140	0.980	139	0.980	0.974	0.980	0.980
Flow Entry, veh/h	89	790	572	815	936	38	464	98
Cap Entry, veh/h	784	0.177	564	0.171	1170	1163	522	522
V/C Ratio	0.113	6.4	1.014	6.2	0.800	0.033	0.888	0.188
Control Delay, s/veh	5.7	A	68.7	A	18.1	3.4	44.4	9.4
LOS	A	1	F	1	C	A	E	A
95th %tile Queue, veh	0		15		9	0	10	1



Existing Conditions  
1: Trim Rd & Highway 174

PM.syn

Lane Group	EBL	EBT	EBR	WBL	WBT	WBR	NBL	NBT	NBR	SBL	SBT	SBR
Lane Configurations												
Traffic Volume (vph)	28	891	12	49	366	22	239	34	60	47	55	57
Future Volume (vph)	28	891	12	49	366	22	239	34	60	47	55	57
Peak Hour Factor	0.95	0.95	0.95	0.95	0.95	0.95	0.95	0.95	0.95	0.95	0.95	0.95
Shared Lane Traffic (%)												
Lane Group Flow (vph)	29	951	0	52	385	23	252	36	63	49	58	60
Turn Type	Prot	NA		Prot	NA	Perm	Prot	NA	Perm	Prot	NA	Perm
Protected Phases	5	2		1	6		3	8		7	4	
Permitted Phases						6			8			4
Detector Phase	5	2		1	6	6	3	8	8	7	4	4
Switch Phase												
Minimum Initial (s)	5.0	34.0		5.0	34.0	34.0	5.0	10.0	10.0	5.0	10.0	10.0
Minimum Split (s)	12.4	40.9		12.4	40.9	40.9	12.5	59.4	59.4	12.5	18.4	18.4
Total Split (s)	16.0	54.0		16.0	54.0	54.0	48.0	60.0	60.0	15.0	27.0	27.0
Total Split (%)	11.0%	37.2%		11.0%	37.2%	37.2%	33.1%	41.4%	41.4%	10.3%	18.6%	18.6%
Yellow Time (s)	4.6	4.6		4.6	4.6	4.6	3.3	3.3	3.3	3.3	3.3	3.3
All-Red Time (s)	2.8	2.3		2.8	2.3	2.3	4.2	5.1	5.1	4.2	5.1	5.1
Lost Time Adjust (s)	0.0	0.0		0.0	0.0	0.0	0.0	0.0	0.0	0.0	0.0	0.0
Total Lost Time (s)	7.4	6.9		7.4	6.9	6.9	7.5	8.4	8.4	7.5	8.4	8.4
Lead/Lag	Lead	Lag		Lead	Lag	Lag	Lead	Lag	Lag	Lead	Lag	Lag
Lead-Lag Optimize?	Yes	Yes		Yes	Yes	Yes	Yes	Yes	Yes	Yes	Yes	Yes
Recall Mode	None	C-Min		None	C-Min	C-Min	None	None	None	None	None	None
Act Effct Green (s)	8.0	79.8		9.9	84.4	84.4	16.6	21.9	21.9	8.6	11.2	11.2
Actuated g/C Ratio	0.06	0.55		0.07	0.58	0.58	0.11	0.15	0.15	0.06	0.08	0.08
v/c Ratio	0.32	0.52		0.46	0.20	0.02	0.68	0.14	0.18	0.49	0.43	0.20
Control Delay	74.0	23.7		77.0	16.6	0.0	70.7	55.1	1.1	82.7	73.4	1.5
Queue Delay	0.0	0.0		0.0	0.0	0.0	0.0	0.0	0.0	0.0	0.0	0.0
Total Delay	74.0	23.7		77.0	16.6	0.0	70.7	55.1	1.1	82.7	73.4	1.5
LOS	E	C		E	B	A	E	E	A	F	E	A
Approach Delay		25.1			22.6			56.6			50.3	
Approach LOS		C			C			E			D	
Queue Length 50th (m)	8.6	94.4		15.4	29.9	0.0	38.2	10.0	0.0	14.5	17.2	0.0
Queue Length 95th (m)	19.6	137.2		29.6	47.3	0.0	51.9	19.9	0.0	#32.4	31.9	0.0
Internal Link Dist (m)		598.8			203.8			305.9			174.2	
Turn Bay Length (m)	205.0			245.0		200.0	160.0		80.0	85.0		110.0
Base Capacity (vph)	105	1842		120	1951	960	908	628	624	102	226	365
Starvation Cap Reductn	0	0		0	0	0	0	0	0	0	0	0
Spillback Cap Reductn	0	0		0	0	0	0	0	0	0	0	0
Storage Cap Reductn	0	0		0	0	0	0	0	0	0	0	0
Reduced v/c Ratio	0.28	0.52		0.43	0.20	0.02	0.28	0.06	0.10	0.48	0.26	0.16

Intersection Summary

Cycle Length: 145

Actuated Cycle Length: 145

Offset: 0 (0%), Referenced to phase 2:EBT and 6:WBT, Start of Green

Natural Cycle: 130

Control Type: Actuated-Coordinated

Maximum v/c Ratio: 0.68

Intersection Signal Delay: 32.3

Intersection LOS: C

Intersection Capacity Utilization 65.3%

ICU Level of Service C

Analysis Period (min) 15

# 95th percentile volume exceeds capacity, queue may be longer.

Queue shown is maximum after two cycles.

Splits and Phases: 1: Trim Rd & Highway 174

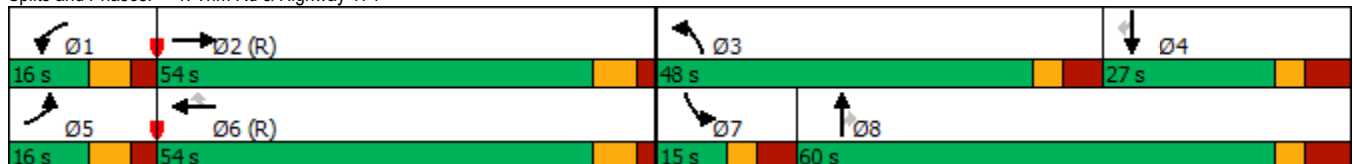

Existing Conditions  
2: Trim Rd & Taylor Creek Dr

PM.syn



Lane Group	EBL	EBT	EBR	WBL	WBT	WBR	NBU	NBL	NBT	NBR	SBU	SBL
Lane Configurations												
Traffic Volume (vph)	8	66	81	149	24	7	37	56	19	302	6	11
Future Volume (vph)	8	66	81	149	24	7	37	56	19	302	6	11
Peak Hour Factor	0.95	0.95	0.95	0.95	0.95	0.95	0.95	0.95	0.95	0.95	0.95	0.95
Shared Lane Traffic (%)												
Lane Group Flow (vph)	0	162	0	0	189	0	0	0	436	0	0	0
Sign Control		Yield			Yield				Yield			

Intersection Summary

Control Type: Roundabout

Intersection Capacity Utilization 69.6%

ICU Level of Service C

Analysis Period (min) 15



Lane Group	SBT	SBR
Lane Configurations		
Traffic Volume (vph)	664	84
Future Volume (vph)	664	84
Peak Hour Factor	0.95	0.95
Shared Lane Traffic (%)		
Lane Group Flow (vph)	805	0
Sign Control	Yield	

Intersection Summary

Existing Conditions  
2: Trim Rd & Taylor Creek Dr

PM.syn

Intersection							
Intersection Delay, s/veh	9.1						
Intersection LOS	A						
Approach	EB	WB	NB	SB			
Entry Lanes	1	1	2	2			
Conflicting Circle Lanes	1	1	1	1			
Adj Approach Flow, veh/h	162	189	436	805			
Demand Flow Rate, veh/h	165	193	444	821			
Vehicles Circulating, veh/h	931	134	96	285			
Vehicles Exiting, veh/h	175	82	1000	41			
Ped Vol Crossing Leg, #/h	0	0	0	0			
Ped Cap Adj	1.000	1.000	1.000	1.000			
Approach Delay, s/veh	11.5	4.4	4.7	12.1			
Approach LOS	B	A	A	B			
Lane	Left	Left	Left	Bypass	Left	Right	
Designated Moves	LTR	LTR	LT	R	LT	R	
Assumed Moves	LTR	LTR	LT	R	LT	R	
RT Channelized	Yield						
Lane Util	1.000	1.000	1.000		0.890	0.110	
Follow-Up Headway, s	2.609	2.609	2.535		2.535	2.535	
Critical Headway, s	4.976	4.976	4.544	324	4.544	4.544	
Entry Flow, veh/h	165	193	120	1269	731	90	
Cap Entry Lane, veh/h	534	1204	1301	0.980	1096	1096	
Entry HV Adj Factor	0.980	0.982	0.982	318	0.981	0.978	
Flow Entry, veh/h	162	189	118	1244	717	88	
Cap Entry, veh/h	523	1182	1278	0.256	1075	1071	
V/C Ratio	0.309	0.160	0.092	5.2	0.667	0.082	
Control Delay, s/veh	11.5	4.4	3.6	A	13.1	4.1	
LOS	B	A	A	1	B	A	
95th %tile Queue, veh	1	1	0		5	0	

Existing Conditions

4: Trim Rd & St. Joseph Blvd/Old Montreal Rd

PM.syn



Lane Group	EBU	EBL	EBT	EBR	WBU	WBL	WBT	WBR	NBU	NBL	NBT	NBR
Lane Configurations			↕↕	↗			↕↕	↗			↕↕	
Traffic Volume (vph)	1	47	159	311	11	101	185	79	3	289	314	124
Future Volume (vph)	1	47	159	311	11	101	185	79	3	289	314	124
Peak Hour Factor	0.95	0.95	0.95	0.95	0.95	0.95	0.95	0.95	0.95	0.95	0.95	0.95
Shared Lane Traffic (%)												
Lane Group Flow (vph)	0	0	217	327	0	0	313	83	0	0	769	0
Sign Control			Yield				Yield				Yield	

Intersection Summary

Control Type: Roundabout

Intersection Capacity Utilization 93.2%

ICU Level of Service F

Analysis Period (min) 15



Lane Group	SBL	SBT	SBR
Lane Configurations		↕↕	
Traffic Volume (vph)	233	665	55
Future Volume (vph)	233	665	55
Peak Hour Factor	0.95	0.95	0.95
Shared Lane Traffic (%)			
Lane Group Flow (vph)	0	1003	0
Sign Control		Yield	

Intersection Summary

## Existing Conditions

## 4: Trim Rd &amp; St. Joseph Blvd/Old Montreal Rd

PM.syn

Intersection									
Intersection Delay, s/veh	52.3								
Intersection LOS	F								
Approach	EB	WB		NB		SB			
Entry Lanes	2	2		2		2			
Conflicting Circle Lanes	1	1		1		1			
Adj Approach Flow, veh/h	544	396		769		1003			
Demand Flow Rate, veh/h	555	404		785		1023			
Vehicles Circulating, veh/h	1087	702		483		633			
Vehicles Exiting, veh/h	569	566		825		388			
Ped Vol Crossing Leg, #/h	0	0		0		0			
Ped Cap Adj	1.000	1.000		1.000		1.000			
Approach Delay, s/veh	15.5	9.4		14.9		117.9			
Approach LOS	C	A		B		F			
Lane	Left	Bypass	Left	Bypass	Left	Right	Left	Right	
Designated Moves	LT	R	LT	R	LT	R	LT	R	
Assumed Moves	LT	R	LT	R	LT	R	LT	R	
RT Channelized		Yield		Yield					
Lane Util	1.000		1.000		0.829	0.171	0.942	0.058	
Follow-Up Headway, s	2.535		2.535		2.535	2.535	2.535	2.535	
Critical Headway, s	4.544	334	4.544	85	4.544	4.544	4.544	4.544	
Entry Flow, veh/h	221	595	319	929	651	134	964	59	
Cap Entry Lane, veh/h	528	0.980	750	0.980	915	915	798	798	
Entry HV Adj Factor	0.980	327	0.981	83	0.981	0.978	0.980	0.983	
Flow Entry, veh/h	217	583	313	911	638	131	945	58	
Cap Entry, veh/h	518	0.561	735	0.091	897	894	782	785	
V/C Ratio	0.419	16.6	0.426	4.8	0.711	0.146	1.208	0.074	
Control Delay, s/veh	14.0	C	10.6	A	16.8	5.4	124.8	5.3	
LOS	B	3	B	0	C	A	F	A	
95th %tile Queue, veh	2		2		6	1	32	0	

Background 2026 Conditions  
1: Trim Rd & Highway 174

PM.syn



Lane Group	EBL	EBT	EBR	WBL	WBT	WBR	NBL	NBT	NBR	SBL	SBT	SBR
Lane Configurations												
Traffic Volume (vph)	63	1090	12	80	477	29	249	49	88	55	78	122
Future Volume (vph)	63	1090	12	80	477	29	249	49	88	55	78	122
Ideal Flow (vphpl)	1800	1800	1800	1800	1800	1800	1800	1800	1800	1800	1800	1800
Storage Length (m)	205.0		0.0	245.0		200.0	160.0		80.0	85.0		110.0
Storage Lanes	1		0	1		1	2		1	1		1
Taper Length (m)	30.0			30.0			100.0			30.0		
Lane Util. Factor	1.00	0.95	0.95	1.00	0.95	1.00	0.97	1.00	1.00	1.00	1.00	1.00
Frt		0.998				0.850			0.850			0.850
Flt Protected	0.950			0.950			0.950			0.950		
Satd. Flow (prot)	1676	3346	0	1676	3353	1500	3252	1765	1500	1676	1765	1500
Flt Permitted	0.950			0.950			0.950			0.950		
Satd. Flow (perm)	1676	3346	0	1676	3353	1500	3252	1765	1500	1676	1765	1500
Right Turn on Red			Yes			Yes			Yes			Yes
Satd. Flow (RTOR)		1				209			141			198
Link Speed (k/h)		90			90			60				60
Link Distance (m)		622.8			227.8			329.9				198.2
Travel Time (s)		24.9			9.1			19.8				11.9
Peak Hour Factor	0.95	0.95	0.95	0.95	0.95	0.95	0.95	0.95	0.95	0.95	0.95	0.95
Adj. Flow (vph)	66	1147	13	84	502	31	262	52	93	58	82	128
Shared Lane Traffic (%)												
Lane Group Flow (vph)	66	1160	0	84	502	31	262	52	93	58	82	128
Enter Blocked Intersection	No	No	No	No	No	No	No	No	No	No	No	No
Lane Alignment	Left	Left	Right	Left	Left	Right	Left	Left	Right	Left	Left	Right
Median Width(m)		3.6			3.6			7.2				7.2
Link Offset(m)		0.0			0.0			0.0				0.0
Crosswalk Width(m)		4.8			4.8			4.8				4.8
Two way Left Turn Lane												
Headway Factor	1.07	1.07	1.07	1.07	1.07	1.07	1.07	1.07	1.07	1.07	1.07	1.07
Turning Speed (k/h)	25		15	25		15	25		15	25		15
Number of Detectors	1	2		1	2	1	1	2	1	1	2	1
Detector Template	Left	Thru		Left	Thru	Right	Left	Thru	Right	Left	Thru	Right
Leading Detector (m)	2.0	10.0		2.0	10.0	2.0	2.0	10.0	2.0	2.0	10.0	2.0
Trailing Detector (m)	0.0	0.0		0.0	0.0	0.0	0.0	0.0	0.0	0.0	0.0	0.0
Detector 1 Position(m)	0.0	0.0		0.0	0.0	0.0	0.0	0.0	0.0	0.0	0.0	0.0
Detector 1 Size(m)	2.0	0.6		2.0	0.6	2.0	2.0	0.6	2.0	2.0	0.6	2.0
Detector 1 Type	Cl+Ex	Cl+Ex		Cl+Ex	Cl+Ex	Cl+Ex	Cl+Ex	Cl+Ex	Cl+Ex	Cl+Ex	Cl+Ex	Cl+Ex
Detector 1 Channel												
Detector 1 Extend (s)	0.0	0.0		0.0	0.0	0.0	0.0	0.0	0.0	0.0	0.0	0.0
Detector 1 Queue (s)	0.0	0.0		0.0	0.0	0.0	0.0	0.0	0.0	0.0	0.0	0.0
Detector 1 Delay (s)	0.0	0.0		0.0	0.0	0.0	0.0	0.0	0.0	0.0	0.0	0.0
Detector 2 Position(m)		9.4			9.4			9.4				9.4
Detector 2 Size(m)		0.6			0.6			0.6				0.6
Detector 2 Type		Cl+Ex			Cl+Ex			Cl+Ex				Cl+Ex
Detector 2 Channel												
Detector 2 Extend (s)		0.0			0.0			0.0				0.0
Turn Type	Prot	NA		Prot	NA	Perm	Prot	NA	Perm	Prot	NA	Perm
Protected Phases	5	2		1	6		3	8		7	4	
Permitted Phases						6			8			4

Background 2026 Conditions

1: Trim Rd & Highway 174

PM.syn



Lane Group	EBL	EBT	EBR	WBL	WBT	WBR	NBL	NBT	NBR	SBL	SBT	SBR
Detector Phase	5	2		1	6	6	3	8	8	7	4	4
Switch Phase												
Minimum Initial (s)	5.0	34.0		5.0	34.0	34.0	5.0	10.0	10.0	5.0	10.0	10.0
Minimum Split (s)	12.4	40.9		12.4	40.9	40.9	12.5	59.4	59.4	12.5	18.4	18.4
Total Split (s)	16.0	54.0		16.0	54.0	54.0	48.0	60.0	60.0	15.0	27.0	27.0
Total Split (%)	11.0%	37.2%		11.0%	37.2%	37.2%	33.1%	41.4%	41.4%	10.3%	18.6%	18.6%
Maximum Green (s)	8.6	47.1		8.6	47.1	47.1	40.5	51.6	51.6	7.5	18.6	18.6
Yellow Time (s)	4.6	4.6		4.6	4.6	4.6	3.3	3.3	3.3	3.3	3.3	3.3
All-Red Time (s)	2.8	2.3		2.8	2.3	2.3	4.2	5.1	5.1	4.2	5.1	5.1
Lost Time Adjust (s)	0.0	0.0		0.0	0.0	0.0	0.0	0.0	0.0	0.0	0.0	0.0
Total Lost Time (s)	7.4	6.9		7.4	6.9	6.9	7.5	8.4	8.4	7.5	8.4	8.4
Lead/Lag	Lead	Lag		Lead	Lag	Lag	Lead	Lag	Lag	Lead	Lag	Lag
Lead-Lag Optimize?	Yes	Yes		Yes	Yes	Yes	Yes	Yes	Yes	Yes	Yes	Yes
Vehicle Extension (s)	3.0	3.0		3.0	3.0	3.0	3.0	3.0	3.0	3.0	3.0	3.0
Recall Mode	None	C-Min		None	C-Min	C-Min	None	None	None	None	None	None
Walk Time (s)								7.0	7.0			
Flash Dont Walk (s)								44.0	44.0			
Pedestrian Calls (#/hr)								0	0			
Act Effct Green (s)	11.3	71.4		13.7	73.8	73.8	17.1	25.2	25.2	7.3	12.6	12.6
Actuated g/C Ratio	0.08	0.49		0.09	0.51	0.51	0.12	0.17	0.17	0.05	0.09	0.09
v/c Ratio	0.50	0.70		0.53	0.29	0.04	0.68	0.17	0.25	0.69	0.54	0.41
Control Delay	76.7	33.1		74.3	22.6	0.1	70.4	52.2	2.9	104.8	75.9	4.2
Queue Delay	0.0	0.0		0.0	0.0	0.0	0.0	0.0	0.0	0.0	0.0	0.0
Total Delay	76.7	33.1		74.3	22.6	0.1	70.4	52.2	2.9	104.8	75.9	4.2
LOS	E	C		E	C	A	E	D	A	F	E	A
Approach Delay		35.4			28.5			52.7			47.9	
Approach LOS		D			C			D			D	
Queue Length 50th (m)	19.5	140.0		24.6	44.7	0.0	39.8	14.0	0.0	17.6	24.2	0.0
Queue Length 95th (m)	35.5	197.7		42.2	69.0	0.0	53.7	25.5	3.4	#40.5	41.3	0.3
Internal Link Dist (m)		598.8			203.8			305.9			174.2	
Turn Bay Length (m)	205.0			245.0		200.0	160.0		80.0	85.0		110.0
Base Capacity (vph)	134	1648		158	1706	865	908	628	624	86	226	365
Starvation Cap Reductn	0	0		0	0	0	0	0	0	0	0	0
Spillback Cap Reductn	0	0		0	0	0	0	0	0	0	0	0
Storage Cap Reductn	0	0		0	0	0	0	0	0	0	0	0
Reduced v/c Ratio	0.49	0.70		0.53	0.29	0.04	0.29	0.08	0.15	0.67	0.36	0.35

Intersection Summary

Area Type: Other  
 Cycle Length: 145  
 Actuated Cycle Length: 145  
 Offset: 0 (0%), Referenced to phase 2:EBT and 6:WBT, Start of Green  
 Natural Cycle: 140  
 Control Type: Actuated-Coordinated  
 Maximum v/c Ratio: 0.70  
 Intersection Signal Delay: 37.9 Intersection LOS: D  
 Intersection Capacity Utilization 70.0% ICU Level of Service C  
 Analysis Period (min) 15  
 # 95th percentile volume exceeds capacity, queue may be longer.

Background 2026 Conditions  
1: Trim Rd & Highway 174

PM.syn

Queue shown is maximum after two cycles.

Splits and Phases: 1: Trim Rd & Highway 174

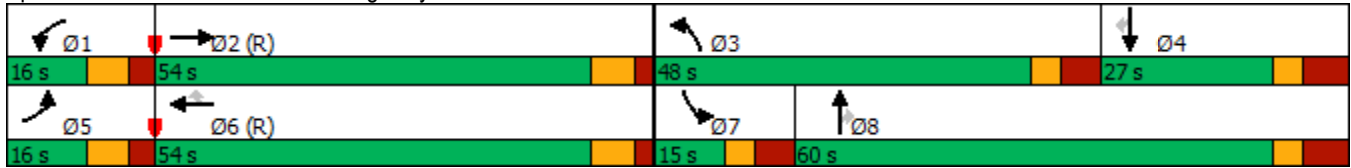



Background 2026 Conditions  
2: Trim Rd & Taylor Creek Dr

PM.syn

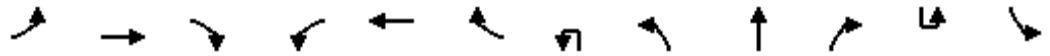

Lane Group	EBL	EBT	EBR	WBL	WBT	WBR	NBU	NBL	NBT	NBR	SBU	SBL
Lane Configurations		↕			↕				↕	↕		
Traffic Volume (vph)	8	66	81	198	24	7	37	56	21	352	6	11
Future Volume (vph)	8	66	81	198	24	7	37	56	21	352	6	11
Ideal Flow (vphp)	1800	1800	1800	1800	1800	1800	1800	1800	1800	1800	1800	1800
Lane Util. Factor	1.00	1.00	1.00	1.00	1.00	1.00	1.00	1.00	1.00	1.00	0.95	0.95
Fr <sub>t</sub>		0.929			0.996					0.850		
Fl <sub>t</sub> Protected		0.998			0.958				0.961			
Satd. Flow (prot)	0	1636	0	0	1684	0	0	0	1696	1500	0	0
Fl <sub>t</sub> Permitted		0.998			0.958				0.961			
Satd. Flow (perm)	0	1636	0	0	1684	0	0	0	1696	1500	0	0
Link Speed (k/h)		50			60				60			
Link Distance (m)		109.2			341.0				349.4			
Travel Time (s)		7.9			20.5				21.0			
Peak Hour Factor	0.95	0.95	0.95	0.95	0.95	0.95	0.95	0.95	0.95	0.95	0.95	0.95
Adj. Flow (vph)	8	69	85	208	25	7	39	59	22	371	6	12
Shared Lane Traffic (%)												
Lane Group Flow (vph)	0	162	0	0	240	0	0	0	120	371	0	0
Enter Blocked Intersection	No	No	No	No	No	No	No	No	No	No	No	No
Lane Alignment	Left	Left	Right	Left	Left	Right	R NA	Left	Left	Right	R NA	Left
Median Width(m)		0.0			0.0				0.0			
Link Offset(m)		0.0			0.0				0.0			
Crosswalk Width(m)		4.8			4.8				4.8			
Two way Left Turn Lane												
Headway Factor	1.07	1.07	1.07	1.07	1.07	1.07	1.07	1.07	1.07	1.07	1.07	1.07
Turning Speed (k/h)	25		15	25		15	15	25		15	15	25
Sign Control		Yield			Yield				Yield			

Intersection Summary

Area Type:	Other
Control Type:	Roundabout
Intersection Capacity Utilization	67.2%
ICU Level of Service	C
Analysis Period (min)	15

Background 2026 Conditions  
 2: Trim Rd & Taylor Creek Dr

PM.syn



Lane Group	SBT	SBR
Lane Configurations	↕	
Traffic Volume (vph)	726	84
Future Volume (vph)	726	84
Ideal Flow (vphpl)	1800	1800
Lane Util. Factor	0.95	0.95
Frt	0.985	
Flt Protected	0.999	
Satd. Flow (prot)	3299	0
Flt Permitted	0.999	
Satd. Flow (perm)	3299	0
Link Speed (k/h)	60	
Link Distance (m)	295.7	
Travel Time (s)	17.7	
Peak Hour Factor	0.95	0.95
Adj. Flow (vph)	764	88
Shared Lane Traffic (%)		
Lane Group Flow (vph)	870	0
Enter Blocked Intersection	No	No
Lane Alignment	Left	Right
Median Width(m)	0.0	
Link Offset(m)	0.0	
Crosswalk Width(m)	4.8	
Two way Left Turn Lane		
Headway Factor	1.07	1.07
Turning Speed (k/h)		15
Sign Control	Yield	
<b>Intersection Summary</b>		

Background 2026 Conditions  
2: Trim Rd & Taylor Creek Dr

PM.syn

Intersection						
Intersection Delay, s/veh	11.4					
Intersection LOS	B					
Approach	EB	WB	NB	SB		
Entry Lanes	1	1	1	2		
Conflicting Circle Lanes	1	1	1	1		
Adj Approach Flow, veh/h	162	240	491	870		
Demand Flow Rate, veh/h	165	245	500	887		
Vehicles Circulating, veh/h	1049	136	96	337		
Vehicles Exiting, veh/h	175	82	1118	43		
Ped Vol Crossing Leg, #/h	0	0	0	0		
Ped Cap Adj	1.000	1.000	1.000	1.000		
Approach Delay, s/veh	13.6	4.9	5.2	16.3		
Approach LOS	B	A	A	C		
Lane	Left	Left	Left	Bypass	Left	Right
Designated Moves	LTR	LTR	LT	R	LT	R
Assumed Moves	LTR	LTR	LT	R	LT	R
RT Channelized	Yield					
Lane Util	1.000	1.000	1.000		0.899	0.101
Follow-Up Headway, s	2.609	2.609	2.609		2.535	2.535
Critical Headway, s	4.976	4.976	4.976	378	4.544	4.544
Entry Flow, veh/h	165	245	122	1269	797	90
Cap Entry Lane, veh/h	473	1201	1251	0.980	1045	1045
Entry HV Adj Factor	0.980	0.982	0.982	371	0.981	0.978
Flow Entry, veh/h	162	240	120	1244	782	88
Cap Entry, veh/h	464	1179	1228	0.298	1025	1022
V/C Ratio	0.349	0.204	0.098	5.6	0.763	0.086
Control Delay, s/veh	13.6	4.9	3.7	A	17.6	4.3
LOS	B	A	A	1	C	A
95th %tile Queue, veh	2	1	0		8	0

Background 2026 Conditions  
 4: Trim Rd & St. Joseph Blvd/Old Montreal Rd

PM.syn

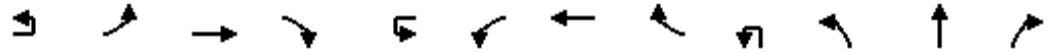

Lane Group	EBU	EBL	EBT	EBR	WBU	WBL	WBT	WBR	NBU	NBL	NBT	NBR
Lane Configurations			↕↕	↗			↕↕	↗			↕↕	
Traffic Volume (vph)	1	48	175	314	11	101	203	79	3	292	392	124
Future Volume (vph)	1	48	175	314	11	101	203	79	3	292	392	124
Ideal Flow (vphpl)	1800	1800	1800	1800	1800	1800	1800	1800	1800	1800	1800	1800
Storage Length (m)		0.0		140.0			0.0	90.0		0.0		0.0
Storage Lanes		0		1			0	1		0		0
Taper Length (m)		0.0					0.0			0.0		
Lane Util. Factor	0.95	0.95	0.95	1.00	0.95	0.95	0.95	1.00	0.95	0.95	0.95	0.95
Frt				0.850				0.850				0.977
Flt Protected			0.989				0.983				0.982	
Satd. Flow (prot)	0	0	3316	1500	0	0	3296	1500	0	0	3217	0
Flt Permitted			0.989				0.983				0.982	
Satd. Flow (perm)	0	0	3316	1500	0	0	3296	1500	0	0	3217	0
Link Speed (k/h)			50				50				60	
Link Distance (m)			262.9				210.8				183.2	
Travel Time (s)			18.9				15.2				11.0	
Peak Hour Factor	0.95	0.95	0.95	0.95	0.95	0.95	0.95	0.95	0.95	0.95	0.95	0.95
Adj. Flow (vph)	1	51	184	331	12	106	214	83	3	307	413	131
Shared Lane Traffic (%)												
Lane Group Flow (vph)	0	0	236	331	0	0	332	83	0	0	854	0
Enter Blocked Intersection	No	No	No	No	No	No	No	No	No	No	No	No
Lane Alignment	R NA	Left	Left	Right	R NA	Left	Left	Right	R NA	Left	Left	Right
Median Width(m)			0.0				0.0				0.0	
Link Offset(m)			0.0				0.0				0.0	
Crosswalk Width(m)			4.8				4.8				4.8	
Two way Left Turn Lane												
Headway Factor	1.07	1.07	1.07	1.07	1.07	1.07	1.07	1.07	1.07	1.07	1.07	1.07
Turning Speed (k/h)	15	25		15	15	25		15	15	25		15
Sign Control			Yield				Yield				Yield	

Intersection Summary

Area Type:	Other
Control Type:	Roundabout
Intersection Capacity Utilization	99.5%
ICU Level of Service	F
Analysis Period (min)	15

Background 2026 Conditions  
 4: Trim Rd & St. Joseph Blvd/Old Montreal Rd

PM.syn



Lane Group	SBL	SBT	SBR
Lane Configurations		↕↕	
Traffic Volume (vph)	233	775	56
Future Volume (vph)	233	775	56
Ideal Flow (vphpl)	1800	1800	1800
Storage Length (m)	0.0		0.0
Storage Lanes	0		0
Taper Length (m)	0.0		
Lane Util. Factor	0.95	0.95	0.95
Frt		0.992	
Flt Protected		0.989	
Satd. Flow (prot)	0	3290	0
Flt Permitted		0.989	
Satd. Flow (perm)	0	3290	0
Link Speed (k/h)		60	
Link Distance (m)		349.4	
Travel Time (s)		21.0	
Peak Hour Factor	0.95	0.95	0.95
Adj. Flow (vph)	245	816	59
Shared Lane Traffic (%)			
Lane Group Flow (vph)	0	1120	0
Enter Blocked Intersection	No	No	No
Lane Alignment	Left	Left	Right
Median Width(m)		0.0	
Link Offset(m)		0.0	
Crosswalk Width(m)		4.8	
Two way Left Turn Lane			
Headway Factor	1.07	1.07	1.07
Turning Speed (k/h)	25		15
Sign Control		Yield	
<b>Intersection Summary</b>			























Background 2026 Conditions  
 4: Trim Rd & St. Joseph Blvd/Old Montreal Rd

PM.syn

Intersection								
Intersection Delay, s/veh	82.5							
Intersection LOS	F							
Approach	EB		WB		NB		SB	
Entry Lanes	2		2		2		2	
Conflicting Circle Lanes	1		1		1		1	
Adj Approach Flow, veh/h	567		415		854		1120	
Demand Flow Rate, veh/h	579		423		871		1142	
Vehicles Circulating, veh/h	1205		790		503		655	
Vehicles Exiting, veh/h	592		584		943		473	
Ped Vol Crossing Leg, #/h	0		0		0		0	
Ped Cap Adj	1.000		1.000		1.000		1.000	
Approach Delay, s/veh	20.2		11.2		21.0		187.4	
Approach LOS	C		B		C		F	
Lane	Left	Bypass	Left	Bypass	Left	Right	Left	Right
Designated Moves	LT	R	LT	R	LT	R	LT	R
Assumed Moves	LT	R	LT	R	LT	R	LT	R
RT Channelized		Yield		Yield				
Lane Util	1.000		1.000		0.846	0.154	0.947	0.053
Follow-Up Headway, s	2.535		2.535		2.535	2.535	2.535	2.535
Critical Headway, s	4.544	338	4.544	85	4.544	4.544	4.544	4.544
Entry Flow, veh/h	241	527	338	852	737	134	1082	60
Cap Entry Lane, veh/h	474	0.980	692	0.980	898	898	782	782
Entry HV Adj Factor	0.980	331	0.981	83	0.981	0.978	0.980	0.983
Flow Entry, veh/h	236	517	331	835	723	131	1061	59
Cap Entry, veh/h	465	0.640	679	0.099	881	878	767	769
V/C Ratio	0.508	21.7	0.488	5.3	0.820	0.149	1.383	0.077
Control Delay, s/veh	18.0	C	12.7	A	23.8	5.6	197.6	5.5
LOS	C	4	B	0	C	A	F	A
95th %tile Queue, veh	3		3		9	1	45	0

Background 2031 Conditions  
1: Trim Rd & Highway 174

AM.syn

												
Lane Group	EBL	EBT	EBR	WBL	WBT	WBR	NBL	NBT	NBR	SBL	SBT	SBR
Lane Configurations												
Traffic Volume (vph)	196	427	3	90	1629	29	566	254	54	26	58	148
Future Volume (vph)	196	427	3	90	1629	29	566	254	54	26	58	148
Ideal Flow (vphpl)	1800	1800	1800	1800	1800	1800	1800	1800	1800	1800	1800	1800
Storage Length (m)	205.0		0.0	245.0		200.0	160.0		80.0	85.0		110.0
Storage Lanes	1		0	1		1	2		1	1		1
Taper Length (m)	30.0			30.0			100.0			30.0		
Lane Util. Factor	1.00	0.95	0.95	1.00	0.95	1.00	0.97	1.00	1.00	1.00	1.00	1.00
Frt		0.999				0.850			0.850			0.850
Flt Protected	0.950			0.950			0.950			0.950		
Satd. Flow (prot)	1676	3350	0	1676	3353	1500	3252	1765	1500	1676	1765	1500
Flt Permitted	0.950			0.950			0.950			0.950		
Satd. Flow (perm)	1676	3350	0	1676	3353	1500	3252	1765	1500	1676	1765	1500
Right Turn on Red			Yes			Yes			Yes			Yes
Satd. Flow (RTOR)						209			141			198
Link Speed (k/h)		90			90			60			60	
Link Distance (m)		622.8			227.8			329.9			198.2	
Travel Time (s)		24.9			9.1			19.8			11.9	
Peak Hour Factor	0.95	0.95	0.95	0.95	0.95	0.95	0.95	0.95	0.95	0.95	0.95	0.95
Adj. Flow (vph)	206	449	3	95	1715	31	596	267	57	27	61	156
Shared Lane Traffic (%)												
Lane Group Flow (vph)	206	452	0	95	1715	31	596	267	57	27	61	156
Enter Blocked Intersection	No	No	No	No	No	No	No	No	No	No	No	No
Lane Alignment	Left	Left	Right	Left	Left	Right	Left	Left	Right	Left	Left	Right
Median Width(m)		3.6			3.6			7.2			7.2	
Link Offset(m)		0.0			0.0			0.0			0.0	
Crosswalk Width(m)		4.8			4.8			4.8			4.8	
Two way Left Turn Lane												
Headway Factor	1.07	1.07	1.07	1.07	1.07	1.07	1.07	1.07	1.07	1.07	1.07	1.07
Turning Speed (k/h)	25		15	25		15	25		15	25		15
Number of Detectors	1	2		1	2	1	1	2	1	1	2	1
Detector Template	Left	Thru		Left	Thru	Right	Left	Thru	Right	Left	Thru	Right
Leading Detector (m)	2.0	10.0		2.0	10.0	2.0	2.0	10.0	2.0	2.0	10.0	2.0
Trailing Detector (m)	0.0	0.0		0.0	0.0	0.0	0.0	0.0	0.0	0.0	0.0	0.0
Detector 1 Position(m)	0.0	0.0		0.0	0.0	0.0	0.0	0.0	0.0	0.0	0.0	0.0
Detector 1 Size(m)	2.0	0.6		2.0	0.6	2.0	2.0	0.6	2.0	2.0	0.6	2.0
Detector 1 Type	Cl+Ex	Cl+Ex		Cl+Ex	Cl+Ex	Cl+Ex	Cl+Ex	Cl+Ex	Cl+Ex	Cl+Ex	Cl+Ex	Cl+Ex
Detector 1 Channel												
Detector 1 Extend (s)	0.0	0.0		0.0	0.0	0.0	0.0	0.0	0.0	0.0	0.0	0.0
Detector 1 Queue (s)	0.0	0.0		0.0	0.0	0.0	0.0	0.0	0.0	0.0	0.0	0.0
Detector 1 Delay (s)	0.0	0.0		0.0	0.0	0.0	0.0	0.0	0.0	0.0	0.0	0.0
Detector 2 Position(m)		9.4			9.4			9.4			9.4	
Detector 2 Size(m)		0.6			0.6			0.6			0.6	
Detector 2 Type		Cl+Ex			Cl+Ex			Cl+Ex			Cl+Ex	
Detector 2 Channel												
Detector 2 Extend (s)		0.0			0.0			0.0			0.0	
Turn Type	Prot	NA		Prot	NA	Perm	Prot	NA	Perm	Prot	NA	Perm
Protected Phases	5	2		1	6		3	8		7	4	
Permitted Phases						6			8			4

Background 2031 Conditions

1: Trim Rd & Highway 174

AM.syn



Lane Group	EBL	EBT	EBR	WBL	WBT	WBR	NBL	NBT	NBR	SBL	SBT	SBR
Detector Phase	5	2		1	6	6	3	8	8	7	4	4
Switch Phase												
Minimum Initial (s)	5.0	34.0		5.0	34.0	34.0	5.0	10.0	10.0	5.0	10.0	10.0
Minimum Split (s)	12.4	40.9		12.4	40.9	40.9	12.5	59.4	59.4	12.5	18.4	18.4
Total Split (s)	15.0	50.0		20.0	55.0	55.0	56.0	60.0	60.0	15.0	19.0	19.0
Total Split (%)	10.3%	34.5%		13.8%	37.9%	37.9%	38.6%	41.4%	41.4%	10.3%	13.1%	13.1%
Maximum Green (s)	7.6	43.1		12.6	48.1	48.1	48.5	51.6	51.6	7.5	10.6	10.6
Yellow Time (s)	4.6	4.6		4.6	4.6	4.6	3.3	3.3	3.3	3.3	3.3	3.3
All-Red Time (s)	2.8	2.3		2.8	2.3	2.3	4.2	5.1	5.1	4.2	5.1	5.1
Lost Time Adjust (s)	0.0	0.0		0.0	0.0	0.0	0.0	0.0	0.0	0.0	0.0	0.0
Total Lost Time (s)	7.4	6.9		7.4	6.9	6.9	7.5	8.4	8.4	7.5	8.4	8.4
Lead/Lag	Lead	Lag		Lead	Lag	Lag	Lead	Lag	Lag	Lead	Lag	Lag
Lead-Lag Optimize?	Yes	Yes		Yes	Yes	Yes	Yes	Yes	Yes	Yes	Yes	Yes
Vehicle Extension (s)	3.0	3.0		3.0	3.0	3.0	3.0	3.0	3.0	3.0	3.0	3.0
Recall Mode	None	C-Min		None	C-Min	C-Min	None	None	None	None	None	None
Walk Time (s)								7.0	7.0			
Flash Dont Walk (s)								44.0	44.0			
Pedestrian Calls (#/hr)								0	0			
Act Effct Green (s)	23.1	57.6		13.6	48.1	48.1	32.3	42.1	42.1	6.9	11.4	11.4
Actuated g/C Ratio	0.16	0.40		0.09	0.33	0.33	0.22	0.29	0.29	0.05	0.08	0.08
v/c Ratio	0.77	0.34		0.61	1.54	0.05	0.82	0.52	0.11	0.34	0.44	0.52
Control Delay	78.0	33.4		78.7	282.6	0.1	63.5	47.4	0.4	78.3	73.6	9.3
Queue Delay	0.0	0.0		0.0	0.0	0.0	0.0	0.0	0.0	0.0	0.0	0.0
Total Delay	78.0	33.4		78.7	282.6	0.1	63.5	47.4	0.4	78.3	73.6	9.3
LOS	E	C		E	F	A	E	D	A	E	E	A
Approach Delay		47.3			267.3			54.9			33.0	
Approach LOS		D			F			D			C	
Queue Length 50th (m)	60.0	49.3		28.0	~382.3	0.0	89.1	72.5	0.0	8.0	18.1	0.0
Queue Length 95th (m)	#135.6	75.8		46.9	#426.5	0.0	104.9	93.8	0.0	19.1	33.4	9.6
Internal Link Dist (m)		598.8			203.8			305.9			174.2	
Turn Bay Length (m)	205.0			245.0		200.0	160.0		80.0	85.0		110.0
Base Capacity (vph)	266	1330		168	1112	637	1087	628	624	86	142	302
Starvation Cap Reductn	0	0		0	0	0	0	0	0	0	0	0
Spillback Cap Reductn	0	0		0	0	0	0	0	0	0	0	0
Storage Cap Reductn	0	0		0	0	0	0	0	0	0	0	0
Reduced v/c Ratio	0.77	0.34		0.57	1.54	0.05	0.55	0.43	0.09	0.31	0.43	0.52

Intersection Summary

Area Type:	Other
Cycle Length:	145
Actuated Cycle Length:	145
Offset:	0 (0%), Referenced to phase 2:EBT and 6:WBT, Start of Green
Natural Cycle:	150
Control Type:	Actuated-Coordinated
Maximum v/c Ratio:	1.54
Intersection Signal Delay:	158.8
Intersection LOS:	F
Intersection Capacity Utilization:	101.6%
ICU Level of Service:	G
Analysis Period (min):	15

~ Volume exceeds capacity, queue is theoretically infinite.



# Background 2031 Conditions

## 1: Trim Rd & Highway 174

AM.syn

Queue shown is maximum after two cycles.

# 95th percentile volume exceeds capacity, queue may be longer.

Queue shown is maximum after two cycles.

Splits and Phases: 1: Trim Rd & Highway 174

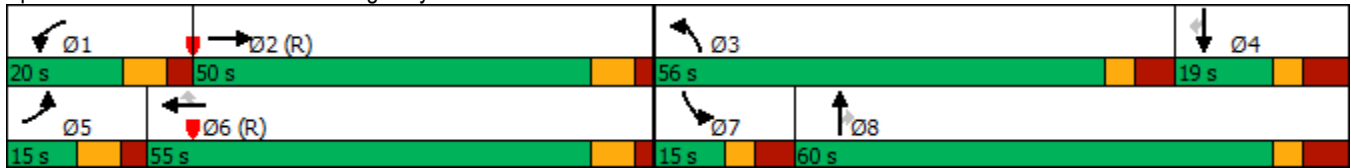

Background 2031 Conditions  
2: Trim Rd & Taylor Creek Dr

AM.syn



Lane Group	EBL	EBT	EBR	WBL	WBT	WBR	NBU	NBL	NBT	NBR	SBU	SBL
Lane Configurations												
Traffic Volume (vph)	5	62	46	131	49	4	29	127	46	587	9	8
Future Volume (vph)	5	62	46	131	49	4	29	127	46	587	9	8
Ideal Flow (vphp)	1800	1800	1800	1800	1800	1800	1800	1800	1800	1800	1800	1800
Lane Util. Factor	1.00	1.00	1.00	1.00	1.00	1.00	1.00	1.00	1.00	1.00	0.95	0.95
Fr <sub>t</sub>		0.945			0.997					0.850		
Fl <sub>t</sub> Protected		0.998			0.966				0.963			
Satd. Flow (prot)	0	1664	0	0	1700	0	0	0	1699	1500	0	0
Fl <sub>t</sub> Permitted		0.998			0.966				0.963			
Satd. Flow (perm)	0	1664	0	0	1700	0	0	0	1699	1500	0	0
Link Speed (k/h)		50			60				60			
Link Distance (m)		109.2			341.0				349.4			
Travel Time (s)		7.9			20.5				21.0			
Peak Hour Factor	0.95	0.95	0.95	0.95	0.95	0.95	0.95	0.95	0.95	0.95	0.95	0.95
Adj. Flow (vph)	5	65	48	138	52	4	31	134	48	618	9	8
Shared Lane Traffic (%)												
Lane Group Flow (vph)	0	118	0	0	194	0	0	0	213	618	0	0
Enter Blocked Intersection	No	No	No	No	No	No	No	No	No	No	No	No
Lane Alignment	Left	Left	Right	Left	Left	Right	R NA	Left	Left	Right	R NA	Left
Median Width(m)		0.0			0.0				0.0			
Link Offset(m)		0.0			0.0				0.0			
Crosswalk Width(m)		4.8			4.8				4.8			
Two way Left Turn Lane												
Headway Factor	1.07	1.07	1.07	1.07	1.07	1.07	1.07	1.07	1.07	1.07	1.07	1.07
Turning Speed (k/h)	25		15	25		15	15	25		15	15	25
Sign Control		Yield			Yield				Yield			

Intersection Summary

Area Type:	Other
Control Type:	Roundabout
Intersection Capacity Utilization	69.9%
ICU Level of Service	C
Analysis Period (min)	15

Background 2031 Conditions  
 2: Trim Rd & Taylor Creek Dr

AM.syn

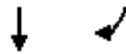

Lane Group	SBT	SBR
Lane Configurations	↔	
Traffic Volume (vph)	398	82
Future Volume (vph)	398	82
Ideal Flow (vphpl)	1800	1800
Lane Util. Factor	0.95	0.95
Frt	0.975	
Flt Protected	0.998	
Satd. Flow (prot)	3263	0
Flt Permitted	0.998	
Satd. Flow (perm)	3263	0
Link Speed (k/h)	60	
Link Distance (m)	295.7	
Travel Time (s)	17.7	
Peak Hour Factor	0.95	0.95
Adj. Flow (vph)	419	86
Shared Lane Traffic (%)		
Lane Group Flow (vph)	522	0
Enter Blocked Intersection	No	No
Lane Alignment	Left	Right
Median Width(m)	0.0	
Link Offset(m)	0.0	
Crosswalk Width(m)	4.8	
Two way Left Turn Lane		
Headway Factor	1.07	1.07
Turning Speed (k/h)		15
Sign Control	Yield	
<b>Intersection Summary</b>		

Background 2031 Conditions  
2: Trim Rd & Taylor Creek Dr

AM.syn

Intersection						
Intersection Delay, s/veh	7.1					
Intersection LOS	A					
Approach	EB	WB	NB	SB		
Entry Lanes	1	1	1	2		
Conflicting Circle Lanes	1	1	1	1		
Adj Approach Flow, veh/h	118	194	831	522		
Demand Flow Rate, veh/h	120	198	848	532		
Vehicles Circulating, veh/h	617	232	88	363		
Vehicles Exiting, veh/h	278	74	649	67		
Ped Vol Crossing Leg, #/h	0	0	0	0		
Ped Cap Adj	1.000	1.000	1.000	1.000		
Approach Delay, s/veh	6.8	5.0	7.1	7.8		
Approach LOS	A	A	A	A		
Lane	Left	Left	Left	Bypass	Left	Right
Designated Moves	LTR	LTR	LT	R	LT	R
Assumed Moves	LTR	LTR	LT	R	LT	R
RT Channelized	Yield					
Lane Util	1.000	1.000	1.000		0.835	0.165
Follow-Up Headway, s	2.609	2.609	2.609		2.535	2.535
Critical Headway, s	4.976	4.976	4.976	630	4.544	4.544
Entry Flow, veh/h	120	198	218	1280	444	88
Cap Entry Lane, veh/h	735	1089	1261	0.980	1021	1021
Entry HV Adj Factor	0.981	0.980	0.979	618	0.981	0.977
Flow Entry, veh/h	118	194	213	1254	435	86
Cap Entry, veh/h	721	1067	1235	0.493	1001	997
V/C Ratio	0.163	0.182	0.173	8.1	0.435	0.086
Control Delay, s/veh	6.8	5.0	4.4	A	8.5	4.4
LOS	A	A	A	3	A	A
95th %tile Queue, veh	1	1	1		2	0

Background 2031 Conditions  
 4: Trim Rd & St. Joseph Blvd/Old Montreal Rd

AM.syn

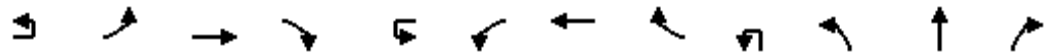

Lane Group	EBU	EBL	EBT	EBR	WBU	WBL	WBT	WBR	NBU	NBL	NBT	NBR
Lane Configurations			↕↕	↗			↕↕	↗			↕↕	
Traffic Volume (vph)	2	31	65	131	1	149	487	270	4	452	535	40
Future Volume (vph)	2	31	65	131	1	149	487	270	4	452	535	40
Ideal Flow (vphpl)	1800	1800	1800	1800	1800	1800	1800	1800	1800	1800	1800	1800
Storage Length (m)		0.0		140.0			0.0	90.0		0.0		0.0
Storage Lanes		0		1			0	1		0		0
Taper Length (m)		0.0					0.0			0.0		
Lane Util. Factor	0.95	0.95	0.95	1.00	0.95	0.95	0.95	1.00	0.95	0.95	0.95	0.95
Frt				0.850				0.850				0.994
Flt Protected			0.983				0.988				0.978	
Satd. Flow (prot)	0	0	3296	1500	0	0	3313	1500	0	0	3260	0
Flt Permitted			0.983				0.988				0.978	
Satd. Flow (perm)	0	0	3296	1500	0	0	3313	1500	0	0	3260	0
Link Speed (k/h)			50				50				60	
Link Distance (m)			262.9				210.8				183.2	
Travel Time (s)			18.9				15.2				11.0	
Peak Hour Factor	0.95	0.95	0.95	0.95	0.95	0.95	0.95	0.95	0.95	0.95	0.95	0.95
Adj. Flow (vph)	2	33	68	138	1	157	513	284	4	476	563	42
Shared Lane Traffic (%)												
Lane Group Flow (vph)	0	0	103	138	0	0	671	284	0	0	1085	0
Enter Blocked Intersection	No	No	No	No	No	No	No	No	No	No	No	No
Lane Alignment	R NA	Left	Left	Right	R NA	Left	Left	Right	R NA	Left	Left	Right
Median Width(m)			0.0				0.0				0.0	
Link Offset(m)			0.0				0.0				0.0	
Crosswalk Width(m)			4.8				4.8				4.8	
Two way Left Turn Lane												
Headway Factor	1.07	1.07	1.07	1.07	1.07	1.07	1.07	1.07	1.07	1.07	1.07	1.07
Turning Speed (k/h)	15	25		15	15	25		15	15	25		15
Sign Control			Yield				Yield				Yield	

Intersection Summary

Area Type:	Other
Control Type:	Roundabout
Intersection Capacity Utilization	91.8%
ICU Level of Service	F
Analysis Period (min)	15

Background 2031 Conditions  
 4: Trim Rd & St. Joseph Blvd/Old Montreal Rd

AM.syn



Lane Group	SBL	SBT	SBR
Lane Configurations		↔↔	
Traffic Volume (vph)	151	427	92
Future Volume (vph)	151	427	92
Ideal Flow (vphpl)	1800	1800	1800
Storage Length (m)	0.0		0.0
Storage Lanes	0		0
Taper Length (m)	0.0		
Lane Util. Factor	0.95	0.95	0.95
Frt		0.979	
Flt Protected		0.989	
Satd. Flow (prot)	0	3246	0
Flt Permitted		0.989	
Satd. Flow (perm)	0	3246	0
Link Speed (k/h)		60	
Link Distance (m)		349.4	
Travel Time (s)		21.0	
Peak Hour Factor	0.95	0.95	0.95
Adj. Flow (vph)	159	449	97
Shared Lane Traffic (%)			
Lane Group Flow (vph)	0	705	0
Enter Blocked Intersection	No	No	No
Lane Alignment	Left	Left	Right
Median Width(m)		0.0	
Link Offset(m)		0.0	
Crosswalk Width(m)		4.8	
Two way Left Turn Lane			
Headway Factor	1.07	1.07	1.07
Turning Speed (k/h)	25		15
Sign Control		Yield	
<b>Intersection Summary</b>			

Background 2031 Conditions  
 4: Trim Rd & St. Joseph Blvd/Old Montreal Rd

AM.syn

Intersection								
Intersection Delay, s/veh	88.1							
Intersection LOS	F							
Approach	EB		WB		NB		SB	
Entry Lanes	2		2		2		2	
Conflicting Circle Lanes	1		1		1		1	
Adj Approach Flow, veh/h	241		955		1085		705	
Demand Flow Rate, veh/h	246		974		1107		719	
Vehicles Circulating, veh/h	785		1100		268		1176	
Vehicles Exiting, veh/h	1110		275		622		608	
Ped Vol Crossing Leg, #/h	0		0		0		0	
Ped Cap Adj	1.000		1.000		1.000		1.000	
Approach Delay, s/veh	7.1		127.4		35.9		142.9	
Approach LOS	A		F		E		F	
Lane	Left	Bypass	Left	Bypass	Left	Right	Left	Right
Designated Moves	LT	R	LT	R	LT	R	LT	R
Assumed Moves	LT	R	LT	R	LT	R	LT	R
RT Channelized		Yield		Yield				
Lane Util	1.000		1.000		0.961	0.039	0.862	0.138
Follow-Up Headway, s	2.535		2.535		2.535	2.535	2.535	2.535
Critical Headway, s	4.544	141	4.544	290	4.544	4.544	4.544	4.544
Entry Flow, veh/h	105	732	684	742	1064	43	620	99
Cap Entry Lane, veh/h	695	0.980	522	0.980	1113	1113	487	487
Entry HV Adj Factor	0.977	138	0.981	284	0.980	0.977	0.981	0.980
Flow Entry, veh/h	103	717	671	728	1043	42	608	97
Cap Entry, veh/h	679	0.192	512	0.390	1090	1087	478	477
V/C Ratio	0.151	7.2	1.311	10.0	0.956	0.039	1.273	0.203
Control Delay, s/veh	7.0	A	177.0	B	37.2	3.6	164.0	10.5
LOS	A	1	F	2	E	A	F	B
95th %tile Queue, veh	1		29		17	0	25	1

Background 2031 Conditions  
1: Trim Rd & Highway 174

PM.syn



Lane Group	EBL	EBT	EBR	WBL	WBT	WBR	NBL	NBT	NBR	SBL	SBT	SBR
Lane Configurations												
Traffic Volume (vph)	162	1361	12	110	617	27	259	305	116	58	107	231
Future Volume (vph)	162	1361	12	110	617	27	259	305	116	58	107	231
Ideal Flow (vphpl)	1800	1800	1800	1800	1800	1800	1800	1800	1800	1800	1800	1800
Storage Length (m)	205.0		0.0	245.0		200.0	160.0		80.0	85.0		110.0
Storage Lanes	1		0	1		1	2		1	1		1
Taper Length (m)	30.0			30.0			100.0			30.0		
Lane Util. Factor	1.00	0.95	0.95	1.00	0.95	1.00	0.97	1.00	1.00	1.00	1.00	1.00
Frt		0.999				0.850			0.850			0.850
Flt Protected	0.950			0.950			0.950			0.950		
Satd. Flow (prot)	1676	3350	0	1676	3353	1500	3252	1765	1500	1676	1765	1500
Flt Permitted	0.950			0.950			0.950			0.950		
Satd. Flow (perm)	1676	3350	0	1676	3353	1500	3252	1765	1500	1676	1765	1500
Right Turn on Red			Yes			Yes			Yes			Yes
Satd. Flow (RTOR)		1				209			141			243
Link Speed (k/h)		90			90			60				60
Link Distance (m)		622.8			227.8			329.9				198.2
Travel Time (s)		24.9			9.1			19.8				11.9
Peak Hour Factor	0.95	0.95	0.95	0.95	0.95	0.95	0.95	0.95	0.95	0.95	0.95	0.95
Adj. Flow (vph)	171	1433	13	116	649	28	273	321	122	61	113	243
Shared Lane Traffic (%)												
Lane Group Flow (vph)	171	1446	0	116	649	28	273	321	122	61	113	243
Enter Blocked Intersection	No	No	No	No	No	No	No	No	No	No	No	No
Lane Alignment	Left	Left	Right	Left	Left	Right	Left	Left	Right	Left	Left	Right
Median Width(m)		3.6			3.6			7.2				7.2
Link Offset(m)		0.0			0.0			0.0				0.0
Crosswalk Width(m)		4.8			4.8			4.8				4.8
Two way Left Turn Lane												
Headway Factor	1.07	1.07	1.07	1.07	1.07	1.07	1.07	1.07	1.07	1.07	1.07	1.07
Turning Speed (k/h)	25		15	25		15	25		15	25		15
Number of Detectors	1	2		1	2	1	1	2	1	1	2	1
Detector Template	Left	Thru		Left	Thru	Right	Left	Thru	Right	Left	Thru	Right
Leading Detector (m)	2.0	10.0		2.0	10.0	2.0	2.0	10.0	2.0	2.0	10.0	2.0
Trailing Detector (m)	0.0	0.0		0.0	0.0	0.0	0.0	0.0	0.0	0.0	0.0	0.0
Detector 1 Position(m)	0.0	0.0		0.0	0.0	0.0	0.0	0.0	0.0	0.0	0.0	0.0
Detector 1 Size(m)	2.0	0.6		2.0	0.6	2.0	2.0	0.6	2.0	2.0	0.6	2.0
Detector 1 Type	Cl+Ex	Cl+Ex		Cl+Ex	Cl+Ex	Cl+Ex	Cl+Ex	Cl+Ex	Cl+Ex	Cl+Ex	Cl+Ex	Cl+Ex
Detector 1 Channel												
Detector 1 Extend (s)	0.0	0.0		0.0	0.0	0.0	0.0	0.0	0.0	0.0	0.0	0.0
Detector 1 Queue (s)	0.0	0.0		0.0	0.0	0.0	0.0	0.0	0.0	0.0	0.0	0.0
Detector 1 Delay (s)	0.0	0.0		0.0	0.0	0.0	0.0	0.0	0.0	0.0	0.0	0.0
Detector 2 Position(m)		9.4			9.4			9.4				9.4
Detector 2 Size(m)		0.6			0.6			0.6				0.6
Detector 2 Type		Cl+Ex			Cl+Ex			Cl+Ex				Cl+Ex
Detector 2 Channel												
Detector 2 Extend (s)		0.0			0.0			0.0				0.0
Turn Type	Prot	NA		Prot	NA	Perm	Prot	NA	Perm	Prot	NA	Perm
Protected Phases	5	2		1	6		3	8		7	4	
Permitted Phases						6			8			4



Background 2031 Conditions

1: Trim Rd & Highway 174

PM.syn



Lane Group	EBL	EBT	EBR	WBL	WBT	WBR	NBL	NBT	NBR	SBL	SBT	SBR
Detector Phase	5	2		1	6	6	3	8	8	7	4	4
Switch Phase												
Minimum Initial (s)	5.0	34.0		5.0	34.0	34.0	5.0	10.0	10.0	5.0	10.0	10.0
Minimum Split (s)	12.4	40.9		12.4	40.9	40.9	12.5	59.4	59.4	12.5	18.4	18.4
Total Split (s)	16.0	54.0		16.0	54.0	54.0	48.0	60.0	60.0	15.0	27.0	27.0
Total Split (%)	11.0%	37.2%		11.0%	37.2%	37.2%	33.1%	41.4%	41.4%	10.3%	18.6%	18.6%
Maximum Green (s)	8.6	47.1		8.6	47.1	47.1	40.5	51.6	51.6	7.5	18.6	18.6
Yellow Time (s)	4.6	4.6		4.6	4.6	4.6	3.3	3.3	3.3	3.3	3.3	3.3
All-Red Time (s)	2.8	2.3		2.8	2.3	2.3	4.2	5.1	5.1	4.2	5.1	5.1
Lost Time Adjust (s)	0.0	0.0		0.0	0.0	0.0	0.0	0.0	0.0	0.0	0.0	0.0
Total Lost Time (s)	7.4	6.9		7.4	6.9	6.9	7.5	8.4	8.4	7.5	8.4	8.4
Lead/Lag	Lead	Lag		Lead	Lag	Lag	Lead	Lag	Lag	Lead	Lag	Lag
Lead-Lag Optimize?	Yes	Yes		Yes	Yes	Yes	Yes	Yes	Yes	Yes	Yes	Yes
Vehicle Extension (s)	3.0	3.0		3.0	3.0	3.0	3.0	3.0	3.0	3.0	3.0	3.0
Recall Mode	None	C-Min		None	C-Min	C-Min	None	None	None	None	None	None
Walk Time (s)								7.0	7.0			
Flash Dont Walk (s)								44.0	44.0			
Pedestrian Calls (#/hr)								0	0			
Act Effct Green (s)	28.1	56.0		19.5	47.3	47.3	17.6	31.9	31.9	7.4	21.8	21.8
Actuated g/C Ratio	0.19	0.39		0.13	0.33	0.33	0.12	0.22	0.22	0.05	0.15	0.15
v/c Ratio	0.53	1.12		0.52	0.59	0.04	0.69	0.83	0.28	0.72	0.43	0.56
Control Delay	61.0	105.0		67.6	43.5	0.1	70.4	70.9	5.5	108.4	60.1	11.3
Queue Delay	0.0	0.0		0.0	0.0	0.0	0.0	0.0	0.0	0.0	0.0	0.0
Total Delay	61.0	105.0		67.6	43.5	0.1	70.4	70.9	5.5	108.4	60.1	11.3
LOS	E	F		E	D	A	E	E	A	F	E	B
Approach Delay		100.3			45.5			59.6			38.7	
Approach LOS		F			D			E			D	
Queue Length 50th (m)	47.3	~264.1		33.3	85.9	0.0	41.4	93.1	0.0	18.5	31.3	0.0
Queue Length 95th (m)	#89.7	#344.5		55.4	107.7	0.0	55.3	119.5	11.4	#43.7	50.0	25.0
Internal Link Dist (m)		598.8			203.8			305.9			174.2	
Turn Bay Length (m)	205.0			245.0		200.0	160.0		80.0	85.0		110.0
Base Capacity (vph)	324	1293		225	1095	630	908	628	624	86	272	437
Starvation Cap Reductn	0	0		0	0	0	0	0	0	0	0	0
Spillback Cap Reductn	0	0		0	0	0	0	0	0	0	0	0
Storage Cap Reductn	0	0		0	0	0	0	0	0	0	0	0
Reduced v/c Ratio	0.53	1.12		0.52	0.59	0.04	0.30	0.51	0.20	0.71	0.42	0.56

Intersection Summary

Area Type:	Other
Cycle Length:	145
Actuated Cycle Length:	145
Offset:	0 (0%), Referenced to phase 2:EBT and 6:WBT, Start of Green
Natural Cycle:	150
Control Type:	Actuated-Coordinated
Maximum v/c Ratio:	1.12
Intersection Signal Delay:	72.6
Intersection LOS:	E
Intersection Capacity Utilization:	92.8%
ICU Level of Service:	F
Analysis Period (min):	15

~ Volume exceeds capacity, queue is theoretically infinite.

# Background 2031 Conditions

## 1: Trim Rd & Highway 174

PM.syn

Queue shown is maximum after two cycles.

# 95th percentile volume exceeds capacity, queue may be longer.

Queue shown is maximum after two cycles.

Splits and Phases: 1: Trim Rd & Highway 174

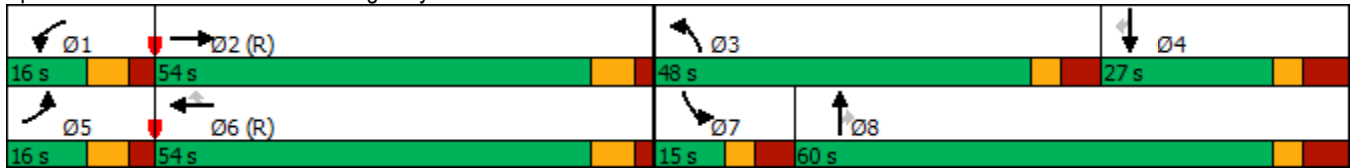

Background 2031 Conditions  
2: Trim Rd & Taylor Creek Dr

PM.syn



Lane Group	EBL	EBT	EBR	WBL	WBT	WBR	NBU	NBL	NBT	NBR	SBU	SBL
Lane Configurations												
Traffic Volume (vph)	8	66	81	247	24	7	37	56	24	640	6	11
Future Volume (vph)	8	66	81	247	24	7	37	56	24	640	6	11
Ideal Flow (vphpl)	1800	1800	1800	1800	1800	1800	1800	1800	1800	1800	1800	1800
Lane Util. Factor	1.00	1.00	1.00	1.00	1.00	1.00	1.00	1.00	1.00	1.00	0.95	0.95
Fr <sub>t</sub>		0.929			0.997					0.850		
Fl <sub>t</sub> Protected		0.998			0.957				0.962			
Satd. Flow (prot)	0	1636	0	0	1684	0	0	0	1698	1500	0	0
Fl <sub>t</sub> Permitted		0.998			0.957				0.962			
Satd. Flow (perm)	0	1636	0	0	1684	0	0	0	1698	1500	0	0
Link Speed (k/h)		50			60				60			
Link Distance (m)		109.2			341.0				349.4			
Travel Time (s)		7.9			20.5				21.0			
Peak Hour Factor	0.95	0.95	0.95	0.95	0.95	0.95	0.95	0.95	0.95	0.95	0.95	0.95
Adj. Flow (vph)	8	69	85	260	25	7	39	59	25	674	6	12
Shared Lane Traffic (%)												
Lane Group Flow (vph)	0	162	0	0	292	0	0	0	123	674	0	0
Enter Blocked Intersection	No	No	No	No	No	No	No	No	No	No	No	No
Lane Alignment	Left	Left	Right	Left	Left	Right	R NA	Left	Left	Right	R NA	Left
Median Width(m)		0.0			0.0				0.0			
Link Offset(m)		0.0			0.0				0.0			
Crosswalk Width(m)		4.8			4.8				4.8			
Two way Left Turn Lane												
Headway Factor	1.07	1.07	1.07	1.07	1.07	1.07	1.07	1.07	1.07	1.07	1.07	1.07
Turning Speed (k/h)	25		15	25		15	15	25		15	15	25
Sign Control		Yield			Yield				Yield			

Intersection Summary

Area Type:	Other
Control Type:	Roundabout
Intersection Capacity Utilization	93.0%
ICU Level of Service	F
Analysis Period (min)	15

Background 2031 Conditions  
2: Trim Rd & Taylor Creek Dr

PM.syn



Lane Group	SBT	SBR
Lane Configurations	↕	
Traffic Volume (vph)	982	84
Future Volume (vph)	982	84
Ideal Flow (vphpl)	1800	1800
Lane Util. Factor	0.95	0.95
Frt	0.988	
Flt Protected	0.999	
Satd. Flow (prot)	3309	0
Flt Permitted	0.999	
Satd. Flow (perm)	3309	0
Link Speed (k/h)	60	
Link Distance (m)	295.7	
Travel Time (s)	17.7	
Peak Hour Factor	0.95	0.95
Adj. Flow (vph)	1034	88
Shared Lane Traffic (%)		
Lane Group Flow (vph)	1140	0
Enter Blocked Intersection	No	No
Lane Alignment	Left	Right
Median Width(m)	0.0	
Link Offset(m)	0.0	
Crosswalk Width(m)	4.8	
Two way Left Turn Lane		
Headway Factor	1.07	1.07
Turning Speed (k/h)		15
Sign Control	Yield	
<b>Intersection Summary</b>		

Background 2031 Conditions  
2: Trim Rd & Taylor Creek Dr

PM.syn

Intersection						
Intersection Delay, s/veh	36.7					
Intersection LOS	E					
Approach	EB	WB	NB	SB		
Entry Lanes	1	1	1	2		
Conflicting Circle Lanes	1	1	1	1		
Adj Approach Flow, veh/h	162	292	797	1140		
Demand Flow Rate, veh/h	165	298	813	1163		
Vehicles Circulating, veh/h	1378	139	96	390		
Vehicles Exiting, veh/h	175	82	1447	46		
Ped Vol Crossing Leg, #/h	0	0	0	0		
Ped Cap Adj	1.000	1.000	1.000	1.000		
Approach Delay, s/veh	23.2	5.3	8.2	66.7		
Approach LOS	C	A	A	F		
Lane	Left	Left	Left	Bypass	Left	Right
Designated Moves	LTR	LTR	LT	R	LT	R
Assumed Moves	LTR	LTR	LT	R	LT	R
RT Channelized	Yield					
Lane Util	1.000	1.000	1.000		0.923	0.077
Follow-Up Headway, s	2.609	2.609	2.609		2.535	2.535
Critical Headway, s	4.976	4.976	4.976	687	4.544	4.544
Entry Flow, veh/h	165	298	126	1269	1073	90
Cap Entry Lane, veh/h	338	1197	1251	0.980	996	996
Entry HV Adj Factor	0.980	0.982	0.982	674	0.981	0.978
Flow Entry, veh/h	162	292	124	1244	1052	88
Cap Entry, veh/h	332	1175	1228	0.542	976	974
V/C Ratio	0.488	0.249	0.101	9.0	1.078	0.090
Control Delay, s/veh	23.2	5.3	3.8	A	71.9	4.5
LOS	C	A	A	3	F	A
95th %tile Queue, veh	3	1	0		25	0

Background 2031 Conditions  
 4: Trim Rd & St. Joseph Blvd/Old Montreal Rd

PM.syn

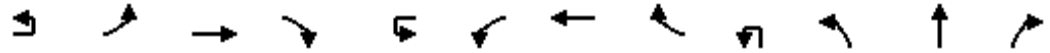

Lane Group	EBU	EBL	EBT	EBR	WBU	WBL	WBT	WBR	NBU	NBL	NBT	NBR
Lane Configurations			↕↕	↗			↕↕	↗			↕↕	
Traffic Volume (vph)	1	47	221	311	11	108	248	176	3	289	498	134
Future Volume (vph)	1	47	221	311	11	108	248	176	3	289	498	134
Ideal Flow (vphpl)	1800	1800	1800	1800	1800	1800	1800	1800	1800	1800	1800	1800
Storage Length (m)		0.0		140.0		0.0		90.0		0.0		0.0
Storage Lanes		0		1		0		1		0		0
Taper Length (m)		0.0				0.0				0.0		
Lane Util. Factor	0.95	0.95	0.95	1.00	0.95	0.95	0.95	1.00	0.95	0.95	0.95	0.95
Frt				0.850				0.850				0.978
Flt Protected			0.991				0.984				0.984	
Satd. Flow (prot)	0	0	3323	1500	0	0	3299	1500	0	0	3227	0
Flt Permitted			0.991				0.984				0.984	
Satd. Flow (perm)	0	0	3323	1500	0	0	3299	1500	0	0	3227	0
Link Speed (k/h)			50				50				60	
Link Distance (m)			262.9				210.8				183.2	
Travel Time (s)			18.9				15.2				11.0	
Peak Hour Factor	0.95	0.95	0.95	0.95	0.95	0.95	0.95	0.95	0.95	0.95	0.95	0.95
Adj. Flow (vph)	1	49	233	327	12	114	261	185	3	304	524	141
Shared Lane Traffic (%)												
Lane Group Flow (vph)	0	0	283	327	0	0	387	185	0	0	972	0
Enter Blocked Intersection	No	No	No	No	No	No	No	No	No	No	No	No
Lane Alignment	R NA	Left	Left	Right	R NA	Left	Left	Right	R NA	Left	Left	Right
Median Width(m)			0.0				0.0				0.0	
Link Offset(m)			0.0				0.0				0.0	
Crosswalk Width(m)			4.8				4.8				4.8	
Two way Left Turn Lane												
Headway Factor	1.07	1.07	1.07	1.07	1.07	1.07	1.07	1.07	1.07	1.07	1.07	1.07
Turning Speed (k/h)	15	25		15	15	25		15	15	25		15
Sign Control			Yield				Yield				Yield	

Intersection Summary

Area Type:	Other
Control Type:	Roundabout
Intersection Capacity Utilization	113.3%
ICU Level of Service	H
Analysis Period (min)	15

Background 2031 Conditions  
 4: Trim Rd & St. Joseph Blvd/Old Montreal Rd

PM.syn



Lane Group	SBL	SBT	SBR
Lane Configurations		↕↕	
Traffic Volume (vph)	374	940	55
Future Volume (vph)	374	940	55
Ideal Flow (vphpl)	1800	1800	1800
Storage Length (m)	0.0		0.0
Storage Lanes	0		0
Taper Length (m)	0.0		
Lane Util. Factor	0.95	0.95	0.95
Frt		0.994	
Flt Protected		0.987	
Satd. Flow (prot)	0	3289	0
Flt Permitted		0.987	
Satd. Flow (perm)	0	3289	0
Link Speed (k/h)		60	
Link Distance (m)		349.4	
Travel Time (s)		21.0	
Peak Hour Factor	0.95	0.95	0.95
Adj. Flow (vph)	394	989	58
Shared Lane Traffic (%)			
Lane Group Flow (vph)	0	1441	0
Enter Blocked Intersection	No	No	No
Lane Alignment	Left	Left	Right
Median Width(m)		0.0	
Link Offset(m)		0.0	
Crosswalk Width(m)		4.8	
Two way Left Turn Lane			
Headway Factor	1.07	1.07	1.07
Turning Speed (k/h)	25		15
Sign Control		Yield	
<b>Intersection Summary</b>			

Background 2031 Conditions  
 4: Trim Rd & St. Joseph Blvd/Old Montreal Rd

PM.syn

Intersection								
Intersection Delay, s/veh	194.6							
Intersection LOS	F							
Approach	EB		WB		NB		SB	
Entry Lanes	2		2		2		2	
Conflicting Circle Lanes	1		1		1		1	
Adj Approach Flow, veh/h	610		572		972		1441	
Demand Flow Rate, veh/h	623		583		991		1470	
Vehicles Circulating, veh/h	1542		898		703		708	
Vehicles Exiting, veh/h	636		796		1128		584	
Ped Vol Crossing Leg, #/h	0		0		0		0	
Ped Cap Adj	1.000		1.000		1.000		1.000	
Approach Delay, s/veh	41.6		14.9		84.2		405.0	
Approach LOS	E		B		F		F	
Lane	Left	Bypass	Left	Bypass	Left	Right	Left	Right
Designated Moves	LT	R	LT	R	LT	R	LT	R
Assumed Moves	LT	R	LT	R	LT	R	LT	R
RT Channelized		Yield		Yield				
Lane Util	1.000		1.000		0.855	0.145	0.960	0.040
Follow-Up Headway, s	2.535		2.535		2.535	2.535	2.535	2.535
Critical Headway, s	4.544	334	4.544	189	4.544	4.544	4.544	4.544
Entry Flow, veh/h	289	437	394	761	847	144	1411	59
Cap Entry Lane, veh/h	349	0.980	627	0.980	749	749	746	746
Entry HV Adj Factor	0.980	327	0.981	185	0.980	0.979	0.980	0.983
Flow Entry, veh/h	283	428	387	746	830	141	1383	58
Cap Entry, veh/h	342	0.764	615	0.248	734	733	731	733
V/C Ratio	0.828	34.7	0.628	7.7	1.131	0.192	1.893	0.079
Control Delay, s/veh	49.6	D	18.4	A	97.3	7.0	421.8	5.7
LOS	E	6	C	1	F	A	F	A
95th %tile Queue, veh	7		4		25	1	87	0

























---

## **Appendix E**

Future Total Conditions  
Synchro Analysis

Total Projected 2026 Conditions  
1: Trim Rd & Highway 174

AM.syn

												
Lane Group	EBL	EBT	EBR	WBL	WBT	WBR	NBL	NBT	NBR	SBL	SBT	SBR
Lane Configurations												
Traffic Volume (vph)	97	342	3	90	1320	27	577	42	53	26	41	50
Future Volume (vph)	97	342	3	90	1320	27	577	42	53	26	41	50
Ideal Flow (vphpl)	1800	1800	1800	1800	1800	1800	1800	1800	1800	1800	1800	1800
Storage Length (m)	205.0		0.0	245.0		200.0	160.0		80.0	85.0		110.0
Storage Lanes	1		0	1		1	2		1	1		1
Taper Length (m)	30.0			30.0			100.0			30.0		
Lane Util. Factor	1.00	0.95	0.95	1.00	0.95	1.00	0.97	1.00	1.00	1.00	1.00	1.00
Frt		0.999				0.850			0.850			0.850
Flt Protected	0.950			0.950			0.950			0.950		
Satd. Flow (prot)	1676	3350	0	1676	3353	1500	3252	1765	1500	1676	1765	1500
Flt Permitted	0.950			0.950			0.950			0.950		
Satd. Flow (perm)	1676	3350	0	1676	3353	1500	3252	1765	1500	1676	1765	1500
Right Turn on Red			Yes			Yes			Yes			Yes
Satd. Flow (RTOR)		1				209			141			198
Link Speed (k/h)		90			90			60			60	
Link Distance (m)		622.8			227.8			329.9			198.2	
Travel Time (s)		24.9			9.1			19.8			11.9	
Peak Hour Factor	0.95	0.95	0.95	0.95	0.95	0.95	0.95	0.95	0.95	0.95	0.95	0.95
Adj. Flow (vph)	102	360	3	95	1389	28	607	44	56	27	43	53
Shared Lane Traffic (%)												
Lane Group Flow (vph)	102	363	0	95	1389	28	607	44	56	27	43	53
Enter Blocked Intersection	No	No	No	No	No	No	No	No	No	No	No	No
Lane Alignment	Left	Left	Right	Left	Left	Right	Left	Left	Right	Left	Left	Right
Median Width(m)		3.6			3.6			7.2			7.2	
Link Offset(m)		0.0			0.0			0.0			0.0	
Crosswalk Width(m)		4.8			4.8			4.8			4.8	
Two way Left Turn Lane												
Headway Factor	1.07	1.07	1.07	1.07	1.07	1.07	1.07	1.07	1.07	1.07	1.07	1.07
Turning Speed (k/h)	25		15	25		15	25		15	25		15
Number of Detectors	1	2		1	2	1	1	2	1	1	2	1
Detector Template	Left	Thru		Left	Thru	Right	Left	Thru	Right	Left	Thru	Right
Leading Detector (m)	2.0	10.0		2.0	10.0	2.0	2.0	10.0	2.0	2.0	10.0	2.0
Trailing Detector (m)	0.0	0.0		0.0	0.0	0.0	0.0	0.0	0.0	0.0	0.0	0.0
Detector 1 Position(m)	0.0	0.0		0.0	0.0	0.0	0.0	0.0	0.0	0.0	0.0	0.0
Detector 1 Size(m)	2.0	0.6		2.0	0.6	2.0	2.0	0.6	2.0	2.0	0.6	2.0
Detector 1 Type	Cl+Ex	Cl+Ex		Cl+Ex	Cl+Ex	Cl+Ex	Cl+Ex	Cl+Ex	Cl+Ex	Cl+Ex	Cl+Ex	Cl+Ex
Detector 1 Channel												
Detector 1 Extend (s)	0.0	0.0		0.0	0.0	0.0	0.0	0.0	0.0	0.0	0.0	0.0
Detector 1 Queue (s)	0.0	0.0		0.0	0.0	0.0	0.0	0.0	0.0	0.0	0.0	0.0
Detector 1 Delay (s)	0.0	0.0		0.0	0.0	0.0	0.0	0.0	0.0	0.0	0.0	0.0
Detector 2 Position(m)		9.4			9.4			9.4			9.4	
Detector 2 Size(m)		0.6			0.6			0.6			0.6	
Detector 2 Type		Cl+Ex			Cl+Ex			Cl+Ex			Cl+Ex	
Detector 2 Channel												
Detector 2 Extend (s)		0.0			0.0			0.0			0.0	
Turn Type	Prot	NA		Prot	NA	Perm	Prot	NA	Perm	Prot	NA	Perm
Protected Phases	5	2		1	6		3	8		7	4	
Permitted Phases						6			8			4

Total Projected 2026 Conditions  
1: Trim Rd & Highway 174

AM.syn



Lane Group	EBL	EBT	EBR	WBL	WBT	WBR	NBL	NBT	NBR	SBL	SBT	SBR
Detector Phase	5	2		1	6	6	3	8	8	7	4	4
Switch Phase												
Minimum Initial (s)	5.0	34.0		5.0	34.0	34.0	5.0	10.0	10.0	5.0	10.0	10.0
Minimum Split (s)	12.4	40.9		12.4	40.9	40.9	12.5	59.4	59.4	12.5	18.4	18.4
Total Split (s)	15.0	50.0		20.0	55.0	55.0	56.0	60.0	60.0	15.0	19.0	19.0
Total Split (%)	10.3%	34.5%		13.8%	37.9%	37.9%	38.6%	41.4%	41.4%	10.3%	13.1%	13.1%
Maximum Green (s)	7.6	43.1		12.6	48.1	48.1	48.5	51.6	51.6	7.5	10.6	10.6
Yellow Time (s)	4.6	4.6		4.6	4.6	4.6	3.3	3.3	3.3	3.3	3.3	3.3
All-Red Time (s)	2.8	2.3		2.8	2.3	2.3	4.2	5.1	5.1	4.2	5.1	5.1
Lost Time Adjust (s)	0.0	0.0		0.0	0.0	0.0	0.0	0.0	0.0	0.0	0.0	0.0
Total Lost Time (s)	7.4	6.9		7.4	6.9	6.9	7.5	8.4	8.4	7.5	8.4	8.4
Lead/Lag	Lead	Lag		Lead	Lag	Lag	Lead	Lag	Lag	Lead	Lag	Lag
Lead-Lag Optimize?	Yes	Yes		Yes	Yes	Yes	Yes	Yes	Yes	Yes	Yes	Yes
Vehicle Extension (s)	3.0	3.0		3.0	3.0	3.0	3.0	3.0	3.0	3.0	3.0	3.0
Recall Mode	None	C-Min		None	C-Min	C-Min	None	None	None	None	None	None
Walk Time (s)								7.0	7.0			
Flash Dont Walk (s)								44.0	44.0			
Pedestrian Calls (#/hr)								0	0			
Act Effct Green (s)	17.5	61.5		13.7	57.7	57.7	32.8	38.1	38.1	6.9	10.5	10.5
Actuated g/C Ratio	0.12	0.42		0.09	0.40	0.40	0.23	0.26	0.26	0.05	0.07	0.07
v/c Ratio	0.51	0.26		0.60	1.04	0.04	0.83	0.10	0.11	0.34	0.34	0.18
Control Delay	69.9	30.6		78.0	78.3	0.1	63.3	39.0	0.5	78.3	71.2	1.4
Queue Delay	0.0	0.0		0.0	0.0	0.0	0.0	0.0	0.0	0.0	0.0	0.0
Total Delay	69.9	30.6		78.0	78.3	0.1	63.3	39.0	0.5	78.3	71.2	1.4
LOS	E	C		E	E	A	E	D	A	E	E	A
Approach Delay		39.3			76.8			56.8			42.7	
Approach LOS		D			E			E			D	
Queue Length 50th (m)	29.3	38.3		28.0	~250.3	0.0	90.7	10.4	0.0	8.0	12.6	0.0
Queue Length 95th (m)	51.2	60.1		46.7	#319.6	0.0	106.7	19.5	0.0	19.1	25.8	0.0
Internal Link Dist (m)		598.8			203.8			305.9			174.2	
Turn Bay Length (m)	205.0			245.0		200.0	160.0		80.0	85.0		110.0
Base Capacity (vph)	201	1421		170	1335	723	1087	628	624	86	133	296
Starvation Cap Reductn	0	0		0	0	0	0	0	0	0	0	0
Spillback Cap Reductn	0	0		0	0	0	0	0	0	0	0	0
Storage Cap Reductn	0	0		0	0	0	0	0	0	0	0	0
Reduced v/c Ratio	0.51	0.26		0.56	1.04	0.04	0.56	0.07	0.09	0.31	0.32	0.18

Intersection Summary

Area Type:	Other
Cycle Length:	145
Actuated Cycle Length:	145
Offset:	0 (0%), Referenced to phase 2:EBT and 6:WBT, Start of Green
Natural Cycle:	150
Control Type:	Actuated-Coordinated
Maximum v/c Ratio:	1.04
Intersection Signal Delay:	64.1
Intersection LOS:	E
Intersection Capacity Utilization:	87.1%
ICU Level of Service:	E
Analysis Period (min):	15

~ Volume exceeds capacity, queue is theoretically infinite.

Total Projected 2026 Conditions  
 1: Trim Rd & Highway 174

AM.syn

Queue shown is maximum after two cycles.

# 95th percentile volume exceeds capacity, queue may be longer.

Queue shown is maximum after two cycles.

Splits and Phases: 1: Trim Rd & Highway 174

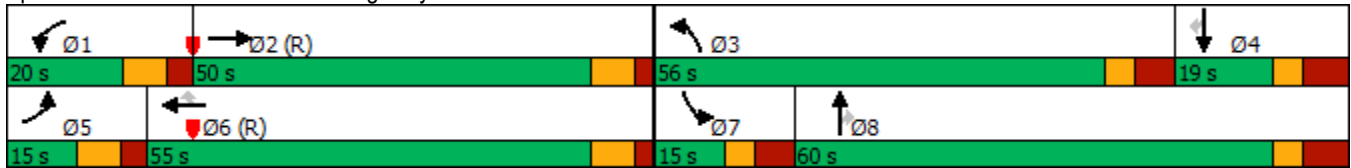

Total Projected 2026 Conditions  
2: Trim Rd & Taylor Creek Dr

AM.syn



Lane Group	EBL	EBT	EBR	WBL	WBT	WBR	NBU	NBL	NBT	NBR	SBU	SBL
Lane Configurations												
Traffic Volume (vph)	5	62	46	118	49	4	29	127	39	389	9	8
Future Volume (vph)	5	62	46	118	49	4	29	127	39	389	9	8
Ideal Flow (vphpl)	1800	1800	1800	1800	1800	1800	1800	1800	1800	1800	1800	1800
Lane Util. Factor	1.00	1.00	1.00	1.00	1.00	1.00	1.00	1.00	1.00	1.00	0.95	0.95
Fr <sub>t</sub>		0.945			0.997					0.850		
Fl <sub>t</sub> Protected		0.998			0.967				0.961			
Satd. Flow (prot)	0	1664	0	0	1701	0	0	0	1696	1500	0	0
Fl <sub>t</sub> Permitted		0.998			0.967				0.961			
Satd. Flow (perm)	0	1664	0	0	1701	0	0	0	1696	1500	0	0
Link Speed (k/h)		50			60				60			
Link Distance (m)		109.2			341.0				177.0			
Travel Time (s)		7.9			20.5				10.6			
Peak Hour Factor	0.95	0.95	0.95	0.95	0.95	0.95	0.95	0.95	0.95	0.95	0.95	0.95
Adj. Flow (vph)	5	65	48	124	52	4	31	134	41	409	9	8
Shared Lane Traffic (%)												
Lane Group Flow (vph)	0	118	0	0	180	0	0	0	206	409	0	0
Enter Blocked Intersection	No	No	No	No	No	No	No	No	No	No	No	No
Lane Alignment	Left	Left	Right	Left	Left	Right	R NA	Left	Left	Right	R NA	Left
Median Width(m)		0.0			0.0				0.0			
Link Offset(m)		0.0			0.0				0.0			
Crosswalk Width(m)		4.8			4.8				4.8			
Two way Left Turn Lane												
Headway Factor	1.07	1.07	1.07	1.07	1.07	1.07	1.07	1.07	1.07	1.07	1.07	1.07
Turning Speed (k/h)	25		15	25		15	15	25		15	15	25
Sign Control		Yield			Yield				Yield			

Intersection Summary

Area Type:	Other
Control Type:	Roundabout
Intersection Capacity Utilization	55.0%
Analysis Period (min)	15
	ICU Level of Service A

Total Projected 2026 Conditions  
 2: Trim Rd & Taylor Creek Dr

AM.syn



Lane Group	SBT	SBR
Lane Configurations	↔	
Traffic Volume (vph)	330	82
Future Volume (vph)	330	82
Ideal Flow (vphpl)	1800	1800
Lane Util. Factor	0.95	0.95
Frt	0.971	
Flt Protected	0.998	
Satd. Flow (prot)	3249	0
Flt Permitted	0.998	
Satd. Flow (perm)	3249	0
Link Speed (k/h)	60	
Link Distance (m)	295.7	
Travel Time (s)	17.7	
Peak Hour Factor	0.95	0.95
Adj. Flow (vph)	347	86
Shared Lane Traffic (%)		
Lane Group Flow (vph)	450	0
Enter Blocked Intersection	No	No
Lane Alignment	Left	Right
Median Width(m)	0.0	
Link Offset(m)	0.0	
Crosswalk Width(m)	4.8	
Two way Left Turn Lane		
Headway Factor	1.07	1.07
Turning Speed (k/h)		15
Sign Control	Yield	
Intersection Summary		

Total Projected 2026 Conditions  
2: Trim Rd & Taylor Creek Dr

AM.syn

Intersection						
Intersection Delay, s/veh	5.8					
Intersection LOS	A					
Approach	EB	WB	NB	SB		
Entry Lanes	1	1	1	2		
Conflicting Circle Lanes	1	1	1	1		
Adj Approach Flow, veh/h	118	180	615	450		
Demand Flow Rate, veh/h	120	183	628	459		
Vehicles Circulating, veh/h	529	225	88	348		
Vehicles Exiting, veh/h	278	74	561	60		
Ped Vol Crossing Leg, #/h	0	0	0	0		
Ped Cap Adj	1.000	1.000	1.000	1.000		
Approach Delay, s/veh	6.1	4.8	5.4	6.7		
Approach LOS	A	A	A	A		
Lane	Left	Left	Left	Bypass	Left	Right
Designated Moves	LTR	LTR	LT	R	LT	R
Assumed Moves	LTR	LTR	LT	R	LT	R
RT Channelized				Yield		
Lane Util	1.000	1.000	1.000		0.808	0.192
Follow-Up Headway, s	2.609	2.609	2.609		2.535	2.535
Critical Headway, s	4.976	4.976	4.976	417	4.544	4.544
Entry Flow, veh/h	120	183	211	1280	371	88
Cap Entry Lane, veh/h	804	1097	1261	0.980	1035	1035
Entry HV Adj Factor	0.981	0.983	0.979	409	0.981	0.977
Flow Entry, veh/h	118	180	207	1254	364	86
Cap Entry, veh/h	789	1079	1235	0.326	1015	1011
V/C Ratio	0.149	0.167	0.167	5.9	0.359	0.085
Control Delay, s/veh	6.1	4.8	4.3	A	7.3	4.3
LOS	A	A	A	1	A	A
95th %tile Queue, veh	1	1	1		2	0

Total Projected 2026 Conditions  
3: Trim Rd & Site Driveway

AM.syn



Lane Group	EBL	EBR	NBL	NBT	SBT	SBR
Lane Configurations						
Traffic Volume (vph)	0	96	0	621	426	112
Future Volume (vph)	0	96	0	621	426	112
Ideal Flow (vphpl)	1800	1800	1800	1800	1800	1800
Lane Util. Factor	1.00	1.00	1.00	0.95	0.95	0.95
Fr <sub>t</sub>		0.865			0.969	
Fl <sub>t</sub> Protected						
Satd. Flow (prot)	0	1526	0	3353	3249	0
Fl <sub>t</sub> Permitted						
Satd. Flow (perm)	0	1526	0	3353	3249	0
Link Speed (k/h)	50			60	60	
Link Distance (m)	153.6			172.4	177.0	
Travel Time (s)	11.1			10.3	10.6	
Peak Hour Factor	0.95	0.95	0.95	0.95	0.95	0.95
Adj. Flow (vph)	0	101	0	654	448	118
Shared Lane Traffic (%)						
Lane Group Flow (vph)	0	101	0	654	566	0
Enter Blocked Intersection	No	No	No	No	No	No
Lane Alignment	Left	Right	Left	Left	Left	Right
Median Width(m)	0.0			0.0	0.0	
Link Offset(m)	0.0			0.0	0.0	
Crosswalk Width(m)	4.8			4.8	4.8	
Two way Left Turn Lane						
Headway Factor	1.07	1.07	1.07	1.07	1.07	1.07
Turning Speed (k/h)	25	15	25			15
Sign Control	Stop			Free	Free	
<b>Intersection Summary</b>						
Area Type:	Other					
Control Type:	Unsignalized					
Intersection Capacity Utilization	29.1%			ICU Level of Service A		
Analysis Period (min)	15					



Total Projected 2026 Conditions  
 4: Trim Rd & St. Joseph Blvd/Old Montreal Rd

AM.syn

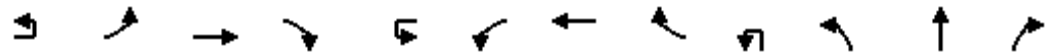

Lane Group	EBU	EBL	EBT	EBR	WBU	WBL	WBT	WBR	NBU	NBL	NBT	NBR
Lane Configurations			↕↕	↗			↕↕	↗			↕↕	
Traffic Volume (vph)	2	48	50	133	1	139	404	140	4	455	438	36
Future Volume (vph)	2	48	50	133	1	139	404	140	4	455	438	36
Ideal Flow (vphpl)	1800	1800	1800	1800	1800	1800	1800	1800	1800	1800	1800	1800
Storage Length (m)		0.0		140.0		0.0		90.0		0.0		0.0
Storage Lanes		0		1		0		1		0		0
Taper Length (m)		0.0				0.0				0.0		
Lane Util. Factor	0.95	0.95	0.95	1.00	0.95	0.95	0.95	1.00	0.95	0.95	0.95	0.95
Frt				0.850				0.850				0.994
Flt Protected			0.976				0.987				0.976	
Satd. Flow (prot)	0	0	3272	1500	0	0	3309	1500	0	0	3253	0
Flt Permitted			0.976				0.987				0.976	
Satd. Flow (perm)	0	0	3272	1500	0	0	3309	1500	0	0	3253	0
Link Speed (k/h)			50				50				60	
Link Distance (m)			262.9				210.8				183.2	
Travel Time (s)			18.9				15.2				11.0	
Peak Hour Factor	0.95	0.95	0.95	0.95	0.95	0.95	0.95	0.95	0.95	0.95	0.95	0.95
Adj. Flow (vph)	2	51	53	140	1	146	425	147	4	479	461	38
Shared Lane Traffic (%)												
Lane Group Flow (vph)	0	0	106	140	0	0	572	147	0	0	982	0
Enter Blocked Intersection	No	No	No	No	No	No	No	No	No	No	No	No
Lane Alignment	R NA	Left	Left	Right	R NA	Left	Left	Right	R NA	Left	Left	Right
Median Width(m)			0.0				0.0				0.0	
Link Offset(m)			0.0				0.0				0.0	
Crosswalk Width(m)			4.8				4.8				4.8	
Two way Left Turn Lane												
Headway Factor	1.07	1.07	1.07	1.07	1.07	1.07	1.07	1.07	1.07	1.07	1.07	1.07
Turning Speed (k/h)	15	25		15	15	25		15	15	25		15
Sign Control			Yield				Yield				Yield	

Intersection Summary

Area Type:	Other
Control Type:	Roundabout
Intersection Capacity Utilization	83.2%
ICU Level of Service	E
Analysis Period (min)	15

Total Projected 2026 Conditions  
 4: Trim Rd & St. Joseph Blvd/Old Montreal Rd

AM.syn



Lane Group	SBL	SBT	SBR
Lane Configurations		↕↕	
Traffic Volume (vph)	99	356	106
Future Volume (vph)	99	356	106
Ideal Flow (vphpl)	1800	1800	1800
Storage Length (m)	0.0		0.0
Storage Lanes	0		0
Taper Length (m)	0.0		
Lane Util. Factor	0.95	0.95	0.95
Frt		0.972	
Flt Protected		0.991	
Satd. Flow (prot)	0	3230	0
Flt Permitted		0.991	
Satd. Flow (perm)	0	3230	0
Link Speed (k/h)		60	
Link Distance (m)		172.4	
Travel Time (s)		10.3	
Peak Hour Factor	0.95	0.95	0.95
Adj. Flow (vph)	104	375	112
Shared Lane Traffic (%)			
Lane Group Flow (vph)	0	591	0
Enter Blocked Intersection	No	No	No
Lane Alignment	Left	Left	Right
Median Width(m)		0.0	
Link Offset(m)		0.0	
Crosswalk Width(m)		4.8	
Two way Left Turn Lane			
Headway Factor	1.07	1.07	1.07
Turning Speed (k/h)	25		15
Sign Control		Yield	
<b>Intersection Summary</b>			























Total Projected 2026 Conditions  
4: Trim Rd & St. Joseph Blvd/Old Montreal Rd

AM.syn

Intersection								
Intersection Delay, s/veh	35.3							
Intersection LOS	E							
Approach	EB		WB		NB		SB	
Entry Lanes	2		2		2		2	
Conflicting Circle Lanes	1		1		1		1	
Adj Approach Flow, veh/h	246		719		982		591	
Demand Flow Rate, veh/h	251		734		1002		602	
Vehicles Circulating, veh/h	642		1017		215		1078	
Vehicles Exiting, veh/h	1038		200		535		522	
Ped Vol Crossing Leg, #/h	0		0		0		0	
Ped Cap Adj	1.000		1.000		1.000		1.000	
Approach Delay, s/veh	6.3		61.7		19.4		41.8	
Approach LOS	A		F		C		E	
Lane	Left	Bypass	Left	Bypass	Left	Right	Left	Right
Designated Moves	LT	R	LT	R	LT	R	LT	R
Assumed Moves	LT	R	LT	R	LT	R	LT	R
RT Channelized		Yield		Yield				
Lane Util	1.000		1.000		0.961	0.039	0.811	0.189
Follow-Up Headway, s	2.535		2.535		2.535	2.535	2.535	2.535
Critical Headway, s	4.544	143	4.544	150	4.544	4.544	4.544	4.544
Entry Flow, veh/h	108	800	584	810	963	39	488	114
Cap Entry Lane, veh/h	792	0.980	563	0.980	1168	1168	532	532
Entry HV Adj Factor	0.981	140	0.980	147	0.980	0.974	0.981	0.982
Flow Entry, veh/h	106	784	572	794	944	38	479	112
Cap Entry, veh/h	776	0.179	552	0.185	1144	1138	522	523
V/C Ratio	0.136	6.5	1.038	6.5	0.825	0.033	0.917	0.214
Control Delay, s/veh	6.1	A	75.9	A	20.0	3.4	49.3	9.8
LOS	A	1	F	1	C	A	E	A
95th %tile Queue, veh	0		16		10	0	11	1

Total Projected 2026 Conditions  
1: Trim Rd & Highway 174

PM.syn

												
Lane Group	EBL	EBT	EBR	WBL	WBT	WBR	NBL	NBT	NBR	SBL	SBT	SBR
Lane Configurations												
Traffic Volume (vph)	63	1090	12	87	477	29	279	52	95	55	82	122
Future Volume (vph)	63	1090	12	87	477	29	279	52	95	55	82	122
Ideal Flow (vphpl)	1800	1800	1800	1800	1800	1800	1800	1800	1800	1800	1800	1800
Storage Length (m)	205.0		0.0	245.0		200.0	160.0		80.0	85.0		110.0
Storage Lanes	1		0	1		1	2		1	1		1
Taper Length (m)	30.0			30.0			100.0			30.0		
Lane Util. Factor	1.00	0.95	0.95	1.00	0.95	1.00	0.97	1.00	1.00	1.00	1.00	1.00
Frt		0.998				0.850			0.850			0.850
Flt Protected	0.950			0.950			0.950			0.950		
Satd. Flow (prot)	1676	3346	0	1676	3353	1500	3252	1765	1500	1676	1765	1500
Flt Permitted	0.950			0.950			0.950			0.950		
Satd. Flow (perm)	1676	3346	0	1676	3353	1500	3252	1765	1500	1676	1765	1500
Right Turn on Red			Yes			Yes			Yes			Yes
Satd. Flow (RTOR)		1				209			141			198
Link Speed (k/h)		90			90			60			60	
Link Distance (m)		622.8			227.8			329.9			198.2	
Travel Time (s)		24.9			9.1			19.8			11.9	
Peak Hour Factor	0.95	0.95	0.95	0.95	0.95	0.95	0.95	0.95	0.95	0.95	0.95	0.95
Adj. Flow (vph)	66	1147	13	92	502	31	294	55	100	58	86	128
Shared Lane Traffic (%)												
Lane Group Flow (vph)	66	1160	0	92	502	31	294	55	100	58	86	128
Enter Blocked Intersection	No	No	No	No	No	No	No	No	No	No	No	No
Lane Alignment	Left	Left	Right	Left	Left	Right	Left	Left	Right	Left	Left	Right
Median Width(m)		3.6			3.6			7.2			7.2	
Link Offset(m)		0.0			0.0			0.0			0.0	
Crosswalk Width(m)		4.8			4.8			4.8			4.8	
Two way Left Turn Lane												
Headway Factor	1.07	1.07	1.07	1.07	1.07	1.07	1.07	1.07	1.07	1.07	1.07	1.07
Turning Speed (k/h)	25		15	25		15	25		15	25		15
Number of Detectors	1	2		1	2	1	1	2	1	1	2	1
Detector Template	Left	Thru		Left	Thru	Right	Left	Thru	Right	Left	Thru	Right
Leading Detector (m)	2.0	10.0		2.0	10.0	2.0	2.0	10.0	2.0	2.0	10.0	2.0
Trailing Detector (m)	0.0	0.0		0.0	0.0	0.0	0.0	0.0	0.0	0.0	0.0	0.0
Detector 1 Position(m)	0.0	0.0		0.0	0.0	0.0	0.0	0.0	0.0	0.0	0.0	0.0
Detector 1 Size(m)	2.0	0.6		2.0	0.6	2.0	2.0	0.6	2.0	2.0	0.6	2.0
Detector 1 Type	Cl+Ex	Cl+Ex		Cl+Ex	Cl+Ex	Cl+Ex	Cl+Ex	Cl+Ex	Cl+Ex	Cl+Ex	Cl+Ex	Cl+Ex
Detector 1 Channel												
Detector 1 Extend (s)	0.0	0.0		0.0	0.0	0.0	0.0	0.0	0.0	0.0	0.0	0.0
Detector 1 Queue (s)	0.0	0.0		0.0	0.0	0.0	0.0	0.0	0.0	0.0	0.0	0.0
Detector 1 Delay (s)	0.0	0.0		0.0	0.0	0.0	0.0	0.0	0.0	0.0	0.0	0.0
Detector 2 Position(m)		9.4			9.4			9.4			9.4	
Detector 2 Size(m)		0.6			0.6			0.6			0.6	
Detector 2 Type		Cl+Ex			Cl+Ex			Cl+Ex			Cl+Ex	
Detector 2 Channel												
Detector 2 Extend (s)		0.0			0.0			0.0			0.0	
Turn Type	Prot	NA		Prot	NA	Perm	Prot	NA	Perm	Prot	NA	Perm
Protected Phases	5	2		1	6		3	8		7	4	
Permitted Phases						6			8			4

Total Projected 2026 Conditions  
1: Trim Rd & Highway 174

PM.syn



Lane Group	EBL	EBT	EBR	WBL	WBT	WBR	NBL	NBT	NBR	SBL	SBT	SBR
Detector Phase	5	2		1	6	6	3	8	8	7	4	4
Switch Phase												
Minimum Initial (s)	5.0	34.0		5.0	34.0	34.0	5.0	10.0	10.0	5.0	10.0	10.0
Minimum Split (s)	12.4	40.9		12.4	40.9	40.9	12.5	59.4	59.4	12.5	18.4	18.4
Total Split (s)	16.0	54.0		16.0	54.0	54.0	48.0	60.0	60.0	15.0	27.0	27.0
Total Split (%)	11.0%	37.2%		11.0%	37.2%	37.2%	33.1%	41.4%	41.4%	10.3%	18.6%	18.6%
Maximum Green (s)	8.6	47.1		8.6	47.1	47.1	40.5	51.6	51.6	7.5	18.6	18.6
Yellow Time (s)	4.6	4.6		4.6	4.6	4.6	3.3	3.3	3.3	3.3	3.3	3.3
All-Red Time (s)	2.8	2.3		2.8	2.3	2.3	4.2	5.1	5.1	4.2	5.1	5.1
Lost Time Adjust (s)	0.0	0.0		0.0	0.0	0.0	0.0	0.0	0.0	0.0	0.0	0.0
Total Lost Time (s)	7.4	6.9		7.4	6.9	6.9	7.5	8.4	8.4	7.5	8.4	8.4
Lead/Lag	Lead	Lag		Lead	Lag	Lag	Lead	Lag	Lag	Lead	Lag	Lag
Lead-Lag Optimize?	Yes	Yes		Yes	Yes	Yes	Yes	Yes	Yes	Yes	Yes	Yes
Vehicle Extension (s)	3.0	3.0		3.0	3.0	3.0	3.0	3.0	3.0	3.0	3.0	3.0
Recall Mode	None	C-Min		None	C-Min	C-Min	None	None	None	None	None	None
Walk Time (s)								7.0	7.0			
Flash Dont Walk (s)								44.0	44.0			
Pedestrian Calls (#/hr)								0	0			
Act Effct Green (s)	11.3	68.4		15.0	72.1	72.1	18.5	26.9	26.9	7.3	12.9	12.9
Actuated g/C Ratio	0.08	0.47		0.10	0.50	0.50	0.13	0.19	0.19	0.05	0.09	0.09
v/c Ratio	0.50	0.73		0.53	0.30	0.04	0.71	0.17	0.26	0.69	0.55	0.41
Control Delay	76.7	35.9		72.7	23.7	0.1	70.0	50.6	3.6	104.8	76.1	4.1
Queue Delay	0.0	0.0		0.0	0.0	0.0	0.0	0.0	0.0	0.0	0.0	0.0
Total Delay	76.7	35.9		72.7	23.7	0.1	70.0	50.6	3.6	104.8	76.1	4.1
LOS	E	D		E	C	A	E	D	A	F	E	A
Approach Delay		38.1			29.7			52.8			48.3	
Approach LOS		D			C			D			D	
Queue Length 50th (m)	19.5	146.1		26.8	45.9	0.0	44.5	14.6	0.0	17.6	25.4	0.0
Queue Length 95th (m)	35.5	#206.5		45.5	71.0	0.0	58.9	26.0	5.5	#40.5	43.1	0.3
Internal Link Dist (m)		598.8			203.8			305.9			174.2	
Turn Bay Length (m)	205.0			245.0		200.0	160.0		80.0	85.0		110.0
Base Capacity (vph)	134	1579		172	1666	850	908	628	624	86	226	365
Starvation Cap Reductn	0	0		0	0	0	0	0	0	0	0	0
Spillback Cap Reductn	0	0		0	0	0	0	0	0	0	0	0
Storage Cap Reductn	0	0		0	0	0	0	0	0	0	0	0
Reduced v/c Ratio	0.49	0.73		0.53	0.30	0.04	0.32	0.09	0.16	0.67	0.38	0.35

Intersection Summary

Area Type: Other  
 Cycle Length: 145  
 Actuated Cycle Length: 145  
 Offset: 0 (0%), Referenced to phase 2:EBT and 6:WBT, Start of Green  
 Natural Cycle: 140  
 Control Type: Actuated-Coordinated  
 Maximum v/c Ratio: 0.73  
 Intersection Signal Delay: 39.7 Intersection LOS: D  
 Intersection Capacity Utilization 71.3% ICU Level of Service C  
 Analysis Period (min) 15  
 # 95th percentile volume exceeds capacity, queue may be longer.

Total Projected 2026 Conditions  
 1: Trim Rd & Highway 174

PM.syn





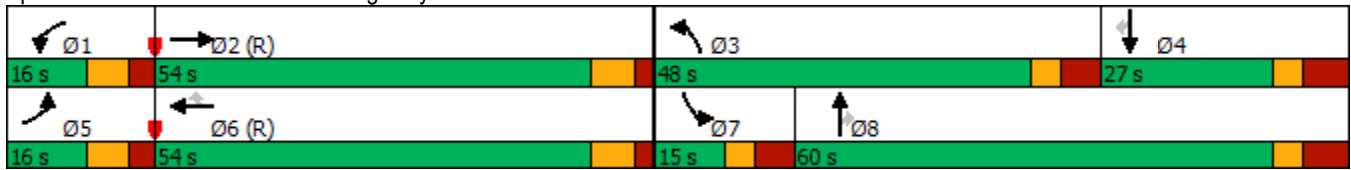











Queue shown is maximum after two cycles.

Splits and Phases: 1: Trim Rd & Highway 174



Total Projected 2026 Conditions  
2: Trim Rd & Taylor Creek Dr

PM.syn

												
Lane Group	EBL	EBT	EBR	WBL	WBT	WBR	NBU	NBL	NBT	NBR	SBU	SBL
Lane Configurations												
Traffic Volume (vph)	8	66	81	209	24	7	37	56	21	392	6	11
Future Volume (vph)	8	66	81	209	24	7	37	56	21	392	6	11
Ideal Flow (vphpl)	1800	1800	1800	1800	1800	1800	1800	1800	1800	1800	1800	1800
Lane Util. Factor	1.00	1.00	1.00	1.00	1.00	1.00	1.00	1.00	1.00	1.00	0.95	0.95
Fr <sub>t</sub>		0.929			0.996					0.850		
Fl <sub>t</sub> Protected		0.998			0.958				0.961			
Satd. Flow (prot)	0	1636	0	0	1684	0	0	0	1696	1500	0	0
Fl <sub>t</sub> Permitted		0.998			0.958				0.961			
Satd. Flow (perm)	0	1636	0	0	1684	0	0	0	1696	1500	0	0
Link Speed (k/h)		50			60				60			
Link Distance (m)		109.2			341.0				179.2			
Travel Time (s)		7.9			20.5				10.8			
Peak Hour Factor	0.95	0.95	0.95	0.95	0.95	0.95	0.95	0.95	0.95	0.95	0.95	0.95
Adj. Flow (vph)	8	69	85	220	25	7	39	59	22	413	6	12
Shared Lane Traffic (%)												
Lane Group Flow (vph)	0	162	0	0	252	0	0	0	120	413	0	0
Enter Blocked Intersection	No	No	No	No	No	No	No	No	No	No	No	No
Lane Alignment	Left	Left	Right	Left	Left	Right	R NA	Left	Left	Right	R NA	Left
Median Width(m)		0.0			0.0				0.0			
Link Offset(m)		0.0			0.0				0.0			
Crosswalk Width(m)		4.8			4.8				4.8			
Two way Left Turn Lane												
Headway Factor	1.07	1.07	1.07	1.07	1.07	1.07	1.07	1.07	1.07	1.07	1.07	1.07
Turning Speed (k/h)	25		15	25		15	15	25		15	15	25
Sign Control		Yield			Yield				Yield			
Intersection Summary												
Area Type:	Other											
Control Type:	Roundabout											
Intersection Capacity Utilization	70.3%						ICU Level of Service C					
Analysis Period (min)	15											

Total Projected 2026 Conditions  
2: Trim Rd & Taylor Creek Dr

PM.syn



Lane Group	SBT	SBR
Lane Configurations	↕	
Traffic Volume (vph)	758	84
Future Volume (vph)	758	84
Ideal Flow (vphpl)	1800	1800
Lane Util. Factor	0.95	0.95
Fr <sub>t</sub>	0.985	
Fl <sub>t</sub> Protected	0.999	
Satd. Flow (prot)	3299	0
Fl <sub>t</sub> Permitted	0.999	
Satd. Flow (perm)	3299	0
Link Speed (k/h)	60	
Link Distance (m)	295.7	
Travel Time (s)	17.7	
Peak Hour Factor	0.95	0.95
Adj. Flow (vph)	798	88
Shared Lane Traffic (%)		
Lane Group Flow (vph)	904	0
Enter Blocked Intersection	No	No
Lane Alignment	Left	Right
Median Width(m)	0.0	
Link Offset(m)	0.0	
Crosswalk Width(m)	4.8	
Two way Left Turn Lane		
Headway Factor	1.07	1.07
Turning Speed (k/h)		15
Sign Control	Yield	
Intersection Summary		



Total Projected 2026 Conditions  
2: Trim Rd & Taylor Creek Dr

PM.syn

Intersection						
Intersection Delay, s/veh	12.7					
Intersection LOS	B					
Approach	EB	WB	NB	SB		
Entry Lanes	1	1	1	2		
Conflicting Circle Lanes	1	1	1	1		
Adj Approach Flow, veh/h	162	252	533	904		
Demand Flow Rate, veh/h	165	257	543	922		
Vehicles Circulating, veh/h	1096	136	96	349		
Vehicles Exiting, veh/h	175	82	1165	43		
Ped Vol Crossing Leg, #/h	0	0	0	0		
Ped Cap Adj	1.000	1.000	1.000	1.000		
Approach Delay, s/veh	14.6	4.9	5.5	18.8		
Approach LOS	B	A	A	C		
Lane	Left	Left	Left	Bypass	Left	Right
Designated Moves	LTR	LTR	LT	R	LT	R
Assumed Moves	LTR	LTR	LT	R	LT	R
RT Channelized				Yield		
Lane Util	1.000	1.000	1.000		0.902	0.098
Follow-Up Headway, s	2.609	2.609	2.609		2.535	2.535
Critical Headway, s	4.976	4.976	4.976	421	4.544	4.544
Entry Flow, veh/h	165	257	122	1269	832	90
Cap Entry Lane, veh/h	451	1201	1251	0.980	1034	1034
Entry HV Adj Factor	0.980	0.982	0.982	413	0.981	0.978
Flow Entry, veh/h	162	252	120	1244	816	88
Cap Entry, veh/h	442	1180	1228	0.332	1014	1011
V/C Ratio	0.366	0.214	0.098	6.0	0.805	0.087
Control Delay, s/veh	14.6	4.9	3.7	A	20.4	4.3
LOS	B	A	A	1	C	A
95th %tile Queue, veh	2	1	0		9	0

Total Projected 2026 Conditions  
3: Trim Rd & Site Driveway

PM.syn



Lane Group	EBL	EBR	NBL	NBT	SBT	SBR
Lane Configurations						
Traffic Volume (vph)	0	91	0	529	1002	94
Future Volume (vph)	0	91	0	529	1002	94
Ideal Flow (vphpl)	1800	1800	1800	1800	1800	1800
Lane Util. Factor	1.00	1.00	1.00	0.95	0.95	0.95
Fr <sub>t</sub>		0.865			0.987	
Fl <sub>t</sub> Protected						
Satd. Flow (prot)	0	1526	0	3353	3309	0
Fl <sub>t</sub> Permitted						
Satd. Flow (perm)	0	1526	0	3353	3309	0
Link Speed (k/h)	50			60	60	
Link Distance (m)	171.8			170.3	179.2	
Travel Time (s)	12.4			10.2	10.8	
Peak Hour Factor	0.95	0.95	0.95	0.95	0.95	0.95
Adj. Flow (vph)	0	96	0	557	1055	99
Shared Lane Traffic (%)						
Lane Group Flow (vph)	0	96	0	557	1154	0
Enter Blocked Intersection	No	No	No	No	No	No
Lane Alignment	Left	Right	Left	Left	Left	Right
Median Width(m)	0.0			0.0	0.0	
Link Offset(m)	0.0			0.0	0.0	
Crosswalk Width(m)	4.8			4.8	4.8	
Two way Left Turn Lane						
Headway Factor	1.07	1.07	1.07	1.07	1.07	1.07
Turning Speed (k/h)	25	15	25			15
Sign Control	Stop			Free	Free	
<b>Intersection Summary</b>						
Area Type:	Other					
Control Type:	Unsignalized					
Intersection Capacity Utilization	45.0%			ICU Level of Service A		
Analysis Period (min)	15					

Total Projected 2026 Conditions  
 4: Trim Rd & St. Joseph Blvd/Old Montreal Rd

PM.syn

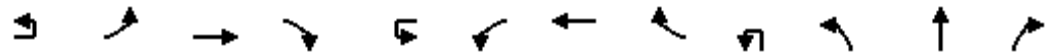

Lane Group	EBU	EBL	EBT	EBR	WBU	WBL	WBT	WBR	NBU	NBL	NBT	NBR
Lane Configurations			↕↕	↗			↕↕	↗			↕↕	
Traffic Volume (vph)	1	62	175	314	11	101	203	86	3	292	399	124
Future Volume (vph)	1	62	175	314	11	101	203	86	3	292	399	124
Ideal Flow (vphpl)	1800	1800	1800	1800	1800	1800	1800	1800	1800	1800	1800	1800
Storage Length (m)		0.0		140.0		0.0		90.0		0.0		0.0
Storage Lanes		0		1		0		1		0		0
Taper Length (m)		0.0				0.0				0.0		
Lane Util. Factor	0.95	0.95	0.95	1.00	0.95	0.95	0.95	1.00	0.95	0.95	0.95	0.95
Frt				0.850				0.850				0.977
Flt Protected			0.987				0.983				0.982	
Satd. Flow (prot)	0	0	3309	1500	0	0	3296	1500	0	0	3217	0
Flt Permitted			0.987				0.983				0.982	
Satd. Flow (perm)	0	0	3309	1500	0	0	3296	1500	0	0	3217	0
Link Speed (k/h)			50				50				60	
Link Distance (m)			262.9				210.8				183.2	
Travel Time (s)			18.9				15.2				11.0	
Peak Hour Factor	0.95	0.95	0.95	0.95	0.95	0.95	0.95	0.95	0.95	0.95	0.95	0.95
Adj. Flow (vph)	1	65	184	331	12	106	214	91	3	307	420	131
Shared Lane Traffic (%)												
Lane Group Flow (vph)	0	0	250	331	0	0	332	91	0	0	861	0
Enter Blocked Intersection	No	No	No	No	No	No	No	No	No	No	No	No
Lane Alignment	R NA	Left	Left	Right	R NA	Left	Left	Right	R NA	Left	Left	Right
Median Width(m)			0.0				0.0				0.0	
Link Offset(m)			0.0				0.0				0.0	
Crosswalk Width(m)			4.8				4.8				4.8	
Two way Left Turn Lane												
Headway Factor	1.07	1.07	1.07	1.07	1.07	1.07	1.07	1.07	1.07	1.07	1.07	1.07
Turning Speed (k/h)	15	25		15	15	25		15	15	25		15
Sign Control			Yield				Yield				Yield	

Intersection Summary

Area Type:	Other
Control Type:	Roundabout
Intersection Capacity Utilization	100.6%
ICU Level of Service	G
Analysis Period (min)	15

Total Projected 2026 Conditions  
 4: Trim Rd & St. Joseph Blvd/Old Montreal Rd

PM.syn



Lane Group	SBL	SBT	SBR
Lane Configurations		↕↕	
Traffic Volume (vph)	240	782	69
Future Volume (vph)	240	782	69
Ideal Flow (vphpl)	1800	1800	1800
Storage Length (m)	0.0		0.0
Storage Lanes	0		0
Taper Length (m)	0.0		
Lane Util. Factor	0.95	0.95	0.95
Frt		0.990	
Flt Protected		0.989	
Satd. Flow (prot)	0	3283	0
Flt Permitted		0.989	
Satd. Flow (perm)	0	3283	0
Link Speed (k/h)		60	
Link Distance (m)		170.3	
Travel Time (s)		10.2	
Peak Hour Factor	0.95	0.95	0.95
Adj. Flow (vph)	253	823	73
Shared Lane Traffic (%)			
Lane Group Flow (vph)	0	1149	0
Enter Blocked Intersection	No	No	No
Lane Alignment	Left	Left	Right
Median Width(m)		0.0	
Link Offset(m)		0.0	
Crosswalk Width(m)		4.8	
Two way Left Turn Lane			
Headway Factor	1.07	1.07	1.07
Turning Speed (k/h)	25		15
Sign Control		Yield	
<b>Intersection Summary</b>			























Total Projected 2026 Conditions  
 4: Trim Rd & St. Joseph Blvd/Old Montreal Rd

PM.syn

Intersection								
Intersection Delay, s/veh	85.9							
Intersection LOS	F							
Approach	EB		WB		NB		SB	
Entry Lanes	2		2		2		2	
Conflicting Circle Lanes	1		1		1		1	
Adj Approach Flow, veh/h	581		423		861		1149	
Demand Flow Rate, veh/h	593		431		878		1171	
Vehicles Circulating, veh/h	1220		811		525		655	
Vehicles Exiting, veh/h	606		592		950		494	
Ped Vol Crossing Leg, #/h	0		0		0		0	
Ped Cap Adj	1.000		1.000		1.000		1.000	
Approach Delay, s/veh	21.0		11.5		23.3		193.0	
Approach LOS	C		B		C		F	
Lane	Left	Bypass	Left	Bypass	Left	Right	Left	Right
Designated Moves	LT	R	LT	R	LT	R	LT	R
Assumed Moves	LT	R	LT	R	LT	R	LT	R
RT Channelized		Yield		Yield				
Lane Util	1.000		1.000		0.847	0.153	0.937	0.063
Follow-Up Headway, s	2.535		2.535		2.535	2.535	2.535	2.535
Critical Headway, s	4.544	338	4.544	93	4.544	4.544	4.544	4.544
Entry Flow, veh/h	255	524	338	834	744	134	1097	74
Cap Entry Lane, veh/h	468	0.980	679	0.980	881	881	782	782
Entry HV Adj Factor	0.982	331	0.981	91	0.981	0.978	0.980	0.986
Flow Entry, veh/h	250	513	331	817	730	131	1076	73
Cap Entry, veh/h	459	0.645	666	0.111	864	861	767	772
V/C Ratio	0.545	22.1	0.498	5.5	0.845	0.152	1.402	0.095
Control Delay, s/veh	19.6	C	13.1	A	26.4	5.7	205.7	5.6
LOS	C	5	B	0	D	A	F	A
95th %tile Queue, veh	3		3		10	1	47	0

Total Projected 2031 Conditions  
1: Trim Rd & Highway 174

AM.syn

												
Lane Group	EBL	EBT	EBR	WBL	WBT	WBR	NBL	NBT	NBR	SBL	SBT	SBR
Lane Configurations												
Traffic Volume (vph)	196	427	3	98	1629	29	596	257	61	26	62	148
Future Volume (vph)	196	427	3	98	1629	29	596	257	61	26	62	148
Ideal Flow (vphpl)	1800	1800	1800	1800	1800	1800	1800	1800	1800	1800	1800	1800
Storage Length (m)	205.0		0.0	245.0		200.0	160.0		80.0	85.0		110.0
Storage Lanes	1		0	1		1	2		1	1		1
Taper Length (m)	30.0			30.0			100.0			30.0		
Lane Util. Factor	1.00	0.95	0.95	1.00	0.95	1.00	0.97	1.00	1.00	1.00	1.00	1.00
Frt		0.999				0.850			0.850			0.850
Flt Protected	0.950			0.950			0.950			0.950		
Satd. Flow (prot)	1676	3350	0	1676	3353	1500	3252	1765	1500	1676	1765	1500
Flt Permitted	0.950			0.950			0.950			0.950		
Satd. Flow (perm)	1676	3350	0	1676	3353	1500	3252	1765	1500	1676	1765	1500
Right Turn on Red			Yes			Yes			Yes			Yes
Satd. Flow (RTOR)						209			141			198
Link Speed (k/h)		90			90			60				60
Link Distance (m)		622.8			227.8			329.9				198.2
Travel Time (s)		24.9			9.1			19.8				11.9
Peak Hour Factor	0.95	0.95	0.95	0.95	0.95	0.95	0.95	0.95	0.95	0.95	0.95	0.95
Adj. Flow (vph)	206	449	3	103	1715	31	627	271	64	27	65	156
Shared Lane Traffic (%)												
Lane Group Flow (vph)	206	452	0	103	1715	31	627	271	64	27	65	156
Enter Blocked Intersection	No	No	No	No	No	No	No	No	No	No	No	No
Lane Alignment	Left	Left	Right	Left	Left	Right	Left	Left	Right	Left	Left	Right
Median Width(m)		3.6			3.6			7.2				7.2
Link Offset(m)		0.0			0.0			0.0				0.0
Crosswalk Width(m)		4.8			4.8			4.8				4.8
Two way Left Turn Lane												
Headway Factor	1.07	1.07	1.07	1.07	1.07	1.07	1.07	1.07	1.07	1.07	1.07	1.07
Turning Speed (k/h)	25		15	25		15	25		15	25		15
Number of Detectors	1	2		1	2	1	1	2	1	1	2	1
Detector Template	Left	Thru		Left	Thru	Right	Left	Thru	Right	Left	Thru	Right
Leading Detector (m)	2.0	10.0		2.0	10.0	2.0	2.0	10.0	2.0	2.0	10.0	2.0
Trailing Detector (m)	0.0	0.0		0.0	0.0	0.0	0.0	0.0	0.0	0.0	0.0	0.0
Detector 1 Position(m)	0.0	0.0		0.0	0.0	0.0	0.0	0.0	0.0	0.0	0.0	0.0
Detector 1 Size(m)	2.0	0.6		2.0	0.6	2.0	2.0	0.6	2.0	2.0	0.6	2.0
Detector 1 Type	Cl+Ex	Cl+Ex		Cl+Ex	Cl+Ex	Cl+Ex	Cl+Ex	Cl+Ex	Cl+Ex	Cl+Ex	Cl+Ex	Cl+Ex
Detector 1 Channel												
Detector 1 Extend (s)	0.0	0.0		0.0	0.0	0.0	0.0	0.0	0.0	0.0	0.0	0.0
Detector 1 Queue (s)	0.0	0.0		0.0	0.0	0.0	0.0	0.0	0.0	0.0	0.0	0.0
Detector 1 Delay (s)	0.0	0.0		0.0	0.0	0.0	0.0	0.0	0.0	0.0	0.0	0.0
Detector 2 Position(m)		9.4			9.4			9.4				9.4
Detector 2 Size(m)		0.6			0.6			0.6				0.6
Detector 2 Type		Cl+Ex			Cl+Ex			Cl+Ex				Cl+Ex
Detector 2 Channel												
Detector 2 Extend (s)		0.0			0.0			0.0				0.0
Turn Type	Prot	NA		Prot	NA	Perm	Prot	NA	Perm	Prot	NA	Perm
Protected Phases	5	2		1	6		3	8		7	4	
Permitted Phases						6			8			4

Total Projected 2031 Conditions  
1: Trim Rd & Highway 174

AM.syn



Lane Group	EBL	EBT	EBR	WBL	WBT	WBR	NBL	NBT	NBR	SBL	SBT	SBR
Detector Phase	5	2		1	6	6	3	8	8	7	4	4
Switch Phase												
Minimum Initial (s)	5.0	34.0		5.0	34.0	34.0	5.0	10.0	10.0	5.0	10.0	10.0
Minimum Split (s)	12.4	40.9		12.4	40.9	40.9	12.5	59.4	59.4	12.5	18.4	18.4
Total Split (s)	15.0	50.0		20.0	55.0	55.0	56.0	60.0	60.0	15.0	19.0	19.0
Total Split (%)	10.3%	34.5%		13.8%	37.9%	37.9%	38.6%	41.4%	41.4%	10.3%	13.1%	13.1%
Maximum Green (s)	7.6	43.1		12.6	48.1	48.1	48.5	51.6	51.6	7.5	10.6	10.6
Yellow Time (s)	4.6	4.6		4.6	4.6	4.6	3.3	3.3	3.3	3.3	3.3	3.3
All-Red Time (s)	2.8	2.3		2.8	2.3	2.3	4.2	5.1	5.1	4.2	5.1	5.1
Lost Time Adjust (s)	0.0	0.0		0.0	0.0	0.0	0.0	0.0	0.0	0.0	0.0	0.0
Total Lost Time (s)	7.4	6.9		7.4	6.9	6.9	7.5	8.4	8.4	7.5	8.4	8.4
Lead/Lag	Lead	Lag		Lead	Lag	Lag	Lead	Lag	Lag	Lead	Lag	Lag
Lead-Lag Optimize?	Yes	Yes		Yes	Yes	Yes	Yes	Yes	Yes	Yes	Yes	Yes
Vehicle Extension (s)	3.0	3.0		3.0	3.0	3.0	3.0	3.0	3.0	3.0	3.0	3.0
Recall Mode	None	C-Min		None	C-Min	C-Min	None	None	None	None	None	None
Walk Time (s)								7.0	7.0			
Flash Dont Walk (s)								44.0	44.0			
Pedestrian Calls (#/hr)								0	0			
Act Effct Green (s)	21.5	55.7		13.9	48.1	48.1	33.7	43.7	43.7	6.9	11.6	11.6
Actuated g/C Ratio	0.15	0.38		0.10	0.33	0.33	0.23	0.30	0.30	0.05	0.08	0.08
v/c Ratio	0.83	0.35		0.64	1.54	0.05	0.83	0.51	0.12	0.34	0.46	0.52
Control Delay	85.9	34.7		81.1	282.6	0.1	62.9	45.8	0.4	78.3	74.1	9.2
Queue Delay	0.0	0.0		0.0	0.0	0.0	0.0	0.0	0.0	0.0	0.0	0.0
Total Delay	85.9	34.7		81.1	282.6	0.1	62.9	45.8	0.4	78.3	74.1	9.2
LOS	F	C		F	F	A	E	D	A	E	E	A
Approach Delay		50.7			266.6			53.9			33.7	
Approach LOS		D			F			D			C	
Queue Length 50th (m)	60.9	50.9		30.3	~382.3	0.0	93.7	72.7	0.0	8.0	19.3	0.0
Queue Length 95th (m)	#142.5	75.8		50.6	#426.5	0.0	109.5	93.0	0.0	19.1	34.9	9.6
Internal Link Dist (m)		598.8			203.8			305.9			174.2	
Turn Bay Length (m)	205.0			245.0		200.0	160.0		80.0	85.0		110.0
Base Capacity (vph)	248	1286		168	1112	637	1087	628	624	86	144	304
Starvation Cap Reductn	0	0		0	0	0	0	0	0	0	0	0
Spillback Cap Reductn	0	0		0	0	0	0	0	0	0	0	0
Storage Cap Reductn	0	0		0	0	0	0	0	0	0	0	0
Reduced v/c Ratio	0.83	0.35		0.61	1.54	0.05	0.58	0.43	0.10	0.31	0.45	0.51

Intersection Summary

Area Type: Other  
 Cycle Length: 145  
 Actuated Cycle Length: 145  
 Offset: 0 (0%), Referenced to phase 2:EBT and 6:WBT, Start of Green  
 Natural Cycle: 150  
 Control Type: Actuated-Coordinated  
 Maximum v/c Ratio: 1.54  
 Intersection Signal Delay: 157.8  
 Intersection LOS: F  
 Intersection Capacity Utilization 102.5%  
 ICU Level of Service G  
 Analysis Period (min) 15

~ Volume exceeds capacity, queue is theoretically infinite.

Total Projected 2031 Conditions  
 1: Trim Rd & Highway 174

AM.syn

Queue shown is maximum after two cycles.

# 95th percentile volume exceeds capacity, queue may be longer.

Queue shown is maximum after two cycles.



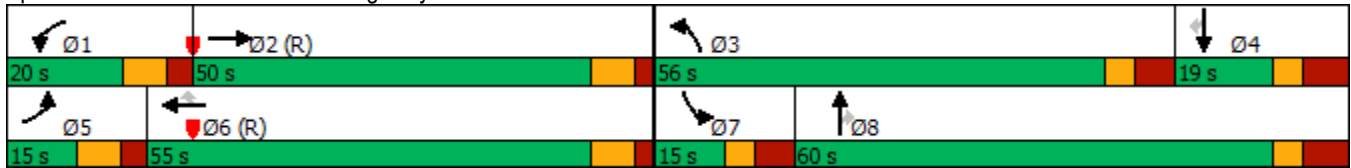













Splits and Phases: 1: Trim Rd & Highway 174





Total Projected 2031 Conditions  
2: Trim Rd & Taylor Creek Dr

AM.syn

												
Lane Group	EBL	EBT	EBR	WBL	WBT	WBR	NBU	NBL	NBT	NBR	SBU	SBL
Lane Configurations												
Traffic Volume (vph)	5	62	46	143	49	4	29	127	46	627	9	8
Future Volume (vph)	5	62	46	143	49	4	29	127	46	627	9	8
Ideal Flow (vphpl)	1800	1800	1800	1800	1800	1800	1800	1800	1800	1800	1800	1800
Lane Util. Factor	1.00	1.00	1.00	1.00	1.00	1.00	1.00	1.00	1.00	1.00	0.95	0.95
Fr <sub>t</sub>		0.945			0.997					0.850		
Fl <sub>t</sub> Protected		0.998			0.965				0.963			
Satd. Flow (prot)	0	1664	0	0	1698	0	0	0	1699	1500	0	0
Fl <sub>t</sub> Permitted		0.998			0.965				0.963			
Satd. Flow (perm)	0	1664	0	0	1698	0	0	0	1699	1500	0	0
Link Speed (k/h)		50			60				60			
Link Distance (m)		109.2			341.0				177.0			
Travel Time (s)		7.9			20.5				10.6			
Peak Hour Factor	0.95	0.95	0.95	0.95	0.95	0.95	0.95	0.95	0.95	0.95	0.95	0.95
Adj. Flow (vph)	5	65	48	151	52	4	31	134	48	660	9	8
Shared Lane Traffic (%)												
Lane Group Flow (vph)	0	118	0	0	207	0	0	0	213	660	0	0
Enter Blocked Intersection	No	No	No	No	No	No	No	No	No	No	No	No
Lane Alignment	Left	Left	Right	Left	Left	Right	R NA	Left	Left	Right	R NA	Left
Median Width(m)		0.0			0.0				0.0			
Link Offset(m)		0.0			0.0				0.0			
Crosswalk Width(m)		4.8			4.8				4.8			
Two way Left Turn Lane												
Headway Factor	1.07	1.07	1.07	1.07	1.07	1.07	1.07	1.07	1.07	1.07	1.07	1.07
Turning Speed (k/h)	25		15	25		15	15	25		15	15	25
Sign Control		Yield			Yield				Yield			
<b>Intersection Summary</b>												
Area Type:	Other											
Control Type:	Roundabout											
Intersection Capacity Utilization	73.6%					ICU Level of Service D						
Analysis Period (min)	15											

Total Projected 2031 Conditions  
 2: Trim Rd & Taylor Creek Dr

AM.syn



Lane Group	SBT	SBR
Lane Configurations		
Traffic Volume (vph)	435	82
Future Volume (vph)	435	82
Ideal Flow (vphpl)	1800	1800
Lane Util. Factor	0.95	0.95
Frt	0.977	
Flt Protected	0.998	
Satd. Flow (prot)	3269	0
Flt Permitted	0.998	
Satd. Flow (perm)	3269	0
Link Speed (k/h)	60	
Link Distance (m)	295.7	
Travel Time (s)	17.7	
Peak Hour Factor	0.95	0.95
Adj. Flow (vph)	458	86
Shared Lane Traffic (%)		
Lane Group Flow (vph)	561	0
Enter Blocked Intersection	No	No
Lane Alignment	Left	Right
Median Width(m)	0.0	
Link Offset(m)	0.0	
Crosswalk Width(m)	4.8	
Two way Left Turn Lane		
Headway Factor	1.07	1.07
Turning Speed (k/h)		15
Sign Control	Yield	
Intersection Summary		

Total Projected 2031 Conditions  
2: Trim Rd & Taylor Creek Dr

AM.syn

Intersection						
Intersection Delay, s/veh	7.6					
Intersection LOS	A					
Approach	EB	WB	NB	SB		
Entry Lanes	1	1	1	2		
Conflicting Circle Lanes	1	1	1	1		
Adj Approach Flow, veh/h	118	207	873	561		
Demand Flow Rate, veh/h	120	211	891	572		
Vehicles Circulating, veh/h	670	232	88	376		
Vehicles Exiting, veh/h	278	74	702	67		
Ped Vol Crossing Leg, #/h	0	0	0	0		
Ped Cap Adj	1.000	1.000	1.000	1.000		
Approach Delay, s/veh	7.2	5.1	7.6	8.6		
Approach LOS	A	A	A	A		
Lane	Left	Left	Left	Bypass	Left	Right
Designated Moves	LTR	LTR	LT	R	LT	R
Assumed Moves	LTR	LTR	LT	R	LT	R
RT Channelized				Yield		
Lane Util	1.000	1.000	1.000		0.846	0.154
Follow-Up Headway, s	2.609	2.609	2.609		2.535	2.535
Critical Headway, s	4.976	4.976	4.976	673	4.544	4.544
Entry Flow, veh/h	120	211	218	1280	484	88
Cap Entry Lane, veh/h	697	1089	1261	0.980	1009	1009
Entry HV Adj Factor	0.981	0.981	0.979	660	0.981	0.977
Flow Entry, veh/h	118	207	213	1254	475	86
Cap Entry, veh/h	683	1068	1235	0.526	989	986
V/C Ratio	0.172	0.194	0.173	8.6	0.480	0.087
Control Delay, s/veh	7.2	5.1	4.4	A	9.4	4.4
LOS	A	A	A	3	A	A
95th %tile Queue, veh	1	1	1		3	0

Total Projected 2031 Conditions  
 3: Trim Rd & Site Driveway

AM.syn



Lane Group	EBL	EBR	NBL	NBT	SBT	SBR
Lane Configurations						
Traffic Volume (vph)	0	96	0	943	580	112
Future Volume (vph)	0	96	0	943	580	112
Ideal Flow (vphpl)	1800	1800	1800	1800	1800	1800
Lane Util. Factor	1.00	1.00	1.00	0.95	0.95	0.95
Fr <sub>t</sub>		0.865			0.976	
Fl <sub>t</sub> Protected						
Satd. Flow (prot)	0	1526	0	3353	3272	0
Fl <sub>t</sub> Permitted						
Satd. Flow (perm)	0	1526	0	3353	3272	0
Link Speed (k/h)	50			60	60	
Link Distance (m)	153.6			172.4	177.0	
Travel Time (s)	11.1			10.3	10.6	
Peak Hour Factor	0.95	0.95	0.95	0.95	0.95	0.95
Adj. Flow (vph)	0	101	0	993	611	118
Shared Lane Traffic (%)						
Lane Group Flow (vph)	0	101	0	993	729	0
Enter Blocked Intersection	No	No	No	No	No	No
Lane Alignment	Left	Right	Left	Left	Left	Right
Median Width(m)	0.0			0.0	0.0	
Link Offset(m)	0.0			0.0	0.0	
Crosswalk Width(m)	4.8			4.8	4.8	
Two way Left Turn Lane						
Headway Factor	1.07	1.07	1.07	1.07	1.07	1.07
Turning Speed (k/h)	25	15	25			15
Sign Control	Stop			Free	Free	
<b>Intersection Summary</b>						
Area Type:	Other					
Control Type:	Unsignalized					
Intersection Capacity Utilization	33.6%			ICU Level of Service A		
Analysis Period (min)	15					

Total Projected 2031 Conditions  
 4: Trim Rd & St. Joseph Blvd/Old Montreal Rd

AM.syn

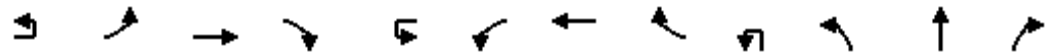

Lane Group	EBU	EBL	EBT	EBR	WBU	WBL	WBT	WBR	NBU	NBL	NBT	NBR
Lane Configurations			↕↕	↗			↕↕	↗			↕↕	
Traffic Volume (vph)	2	47	65	131	1	149	487	278	4	452	543	40
Future Volume (vph)	2	47	65	131	1	149	487	278	4	452	543	40
Ideal Flow (vphpl)	1800	1800	1800	1800	1800	1800	1800	1800	1800	1800	1800	1800
Storage Length (m)		0.0		140.0		0.0		90.0		0.0		0.0
Storage Lanes		0		1		0		1		0		0
Taper Length (m)		0.0				0.0				0.0		
Lane Util. Factor	0.95	0.95	0.95	1.00	0.95	0.95	0.95	1.00	0.95	0.95	0.95	0.95
Frt				0.850				0.850				0.994
Flt Protected			0.979				0.988				0.979	
Satd. Flow (prot)	0	0	3283	1500	0	0	3313	1500	0	0	3263	0
Flt Permitted			0.979				0.988				0.979	
Satd. Flow (perm)	0	0	3283	1500	0	0	3313	1500	0	0	3263	0
Link Speed (k/h)			50				50				60	
Link Distance (m)			262.9				210.8				183.2	
Travel Time (s)			18.9				15.2				11.0	
Peak Hour Factor	0.95	0.95	0.95	0.95	0.95	0.95	0.95	0.95	0.95	0.95	0.95	0.95
Adj. Flow (vph)	2	49	68	138	1	157	513	293	4	476	572	42
Shared Lane Traffic (%)												
Lane Group Flow (vph)	0	0	119	138	0	0	671	293	0	0	1094	0
Enter Blocked Intersection	No	No	No	No	No	No	No	No	No	No	No	No
Lane Alignment	R NA	Left	Left	Right	R NA	Left	Left	Right	R NA	Left	Left	Right
Median Width(m)			0.0				0.0				0.0	
Link Offset(m)			0.0				0.0				0.0	
Crosswalk Width(m)			4.8				4.8				4.8	
Two way Left Turn Lane												
Headway Factor	1.07	1.07	1.07	1.07	1.07	1.07	1.07	1.07	1.07	1.07	1.07	1.07
Turning Speed (k/h)	15	25		15	15	25		15	15	25		15
Sign Control			Yield				Yield				Yield	

Intersection Summary

Area Type:	Other
Control Type:	Roundabout
Intersection Capacity Utilization	92.9%
ICU Level of Service	F
Analysis Period (min)	15

Total Projected 2031 Conditions  
 4: Trim Rd & St. Joseph Blvd/Old Montreal Rd

AM.syn



Lane Group	SBL	SBT	SBR
Lane Configurations		↔↔	
Traffic Volume (vph)	158	434	105
Future Volume (vph)	158	434	105
Ideal Flow (vphpl)	1800	1800	1800
Storage Length (m)	0.0		0.0
Storage Lanes	0		0
Taper Length (m)	0.0		
Lane Util. Factor	0.95	0.95	0.95
Frt		0.977	
Flt Protected		0.989	
Satd. Flow (prot)	0	3240	0
Flt Permitted		0.989	
Satd. Flow (perm)	0	3240	0
Link Speed (k/h)		60	
Link Distance (m)		172.4	
Travel Time (s)		10.3	
Peak Hour Factor	0.95	0.95	0.95
Adj. Flow (vph)	166	457	111
Shared Lane Traffic (%)			
Lane Group Flow (vph)	0	734	0
Enter Blocked Intersection	No	No	No
Lane Alignment	Left	Left	Right
Median Width(m)		0.0	
Link Offset(m)		0.0	
Crosswalk Width(m)		4.8	
Two way Left Turn Lane			
Headway Factor	1.07	1.07	1.07
Turning Speed (k/h)	25		15
Sign Control		Yield	
<b>Intersection Summary</b>			























Total Projected 2031 Conditions  
 4: Trim Rd & St. Joseph Blvd/Old Montreal Rd

AM.syn

Intersection								
Intersection Delay, s/veh	95.0							
Intersection LOS	F							
Approach	EB		WB		NB		SB	
Entry Lanes	2		2		2		2	
Conflicting Circle Lanes	1		1		1		1	
Adj Approach Flow, veh/h	257		964		1094		734	
Demand Flow Rate, veh/h	262		983		1116		748	
Vehicles Circulating, veh/h	800		1125		291		1176	
Vehicles Exiting, veh/h	1124		282		630		633	
Ped Vol Crossing Leg, #/h	0		0		0		0	
Ped Cap Adj	1.000		1.000		1.000		1.000	
Approach Delay, s/veh	7.3		135.5		42.1		151.3	
Approach LOS	A		F		E		F	
Lane	Left	Bypass	Left	Bypass	Left	Right	Left	Right
Designated Moves	LT	R	LT	R	LT	R	LT	R
Assumed Moves	LT	R	LT	R	LT	R	LT	R
RT Channelized		Yield		Yield				
Lane Util	1.000		1.000		0.961	0.039	0.849	0.151
Follow-Up Headway, s	2.535		2.535		2.535	2.535	2.535	2.535
Critical Headway, s	4.544	141	4.544	299	4.544	4.544	4.544	4.544
Entry Flow, veh/h	121	726	684	724	1073	43	635	113
Cap Entry Lane, veh/h	686	0.980	510	0.980	1090	1090	487	487
Entry HV Adj Factor	0.980	138	0.981	293	0.980	0.977	0.981	0.982
Flow Entry, veh/h	119	712	671	709	1051	42	623	111
Cap Entry, veh/h	672	0.194	500	0.413	1068	1064	478	478
V/C Ratio	0.176	7.2	1.341	10.7	0.985	0.039	1.304	0.232
Control Delay, s/veh	7.4	A	190.0	B	43.7	3.7	176.3	10.9
LOS	A	1	F	2	E	A	F	B
95th %tile Queue, veh	1		30		19	0	27	1

Total Projected 2031 Conditions  
1: Trim Rd & Highway 174

PM.syn

												
Lane Group	EBL	EBT	EBR	WBL	WBT	WBR	NBL	NBT	NBR	SBL	SBT	SBR
Lane Configurations												
Traffic Volume (vph)	162	1361	12	117	617	27	289	308	123	58	111	231
Future Volume (vph)	162	1361	12	117	617	27	289	308	123	58	111	231
Ideal Flow (vphpl)	1800	1800	1800	1800	1800	1800	1800	1800	1800	1800	1800	1800
Storage Length (m)	205.0		0.0	245.0		200.0	160.0		80.0	85.0		110.0
Storage Lanes	1		0	1		1	2		1	1		1
Taper Length (m)	30.0			30.0			100.0			30.0		
Lane Util. Factor	1.00	0.95	0.95	1.00	0.95	1.00	0.97	1.00	1.00	1.00	1.00	1.00
Frt		0.999				0.850			0.850			0.850
Flt Protected	0.950			0.950			0.950			0.950		
Satd. Flow (prot)	1676	3350	0	1676	3353	1500	3252	1765	1500	1676	1765	1500
Flt Permitted	0.950			0.950			0.950			0.950		
Satd. Flow (perm)	1676	3350	0	1676	3353	1500	3252	1765	1500	1676	1765	1500
Right Turn on Red			Yes			Yes			Yes			Yes
Satd. Flow (RTOR)		1				209			141			243
Link Speed (k/h)		90			90			60			60	
Link Distance (m)		622.8			227.8			329.9			198.2	
Travel Time (s)		24.9			9.1			19.8			11.9	
Peak Hour Factor	0.95	0.95	0.95	0.95	0.95	0.95	0.95	0.95	0.95	0.95	0.95	0.95
Adj. Flow (vph)	171	1433	13	123	649	28	304	324	129	61	117	243
Shared Lane Traffic (%)												
Lane Group Flow (vph)	171	1446	0	123	649	28	304	324	129	61	117	243
Enter Blocked Intersection	No	No	No	No	No	No	No	No	No	No	No	No
Lane Alignment	Left	Left	Right	Left	Left	Right	Left	Left	Right	Left	Left	Right
Median Width(m)		3.6			3.6			7.2			7.2	
Link Offset(m)		0.0			0.0			0.0			0.0	
Crosswalk Width(m)		4.8			4.8			4.8			4.8	
Two way Left Turn Lane												
Headway Factor	1.07	1.07	1.07	1.07	1.07	1.07	1.07	1.07	1.07	1.07	1.07	1.07
Turning Speed (k/h)	25		15	25		15	25		15	25		15
Number of Detectors	1	2		1	2	1	1	2	1	1	2	1
Detector Template	Left	Thru		Left	Thru	Right	Left	Thru	Right	Left	Thru	Right
Leading Detector (m)	2.0	10.0		2.0	10.0	2.0	2.0	10.0	2.0	2.0	10.0	2.0
Trailing Detector (m)	0.0	0.0		0.0	0.0	0.0	0.0	0.0	0.0	0.0	0.0	0.0
Detector 1 Position(m)	0.0	0.0		0.0	0.0	0.0	0.0	0.0	0.0	0.0	0.0	0.0
Detector 1 Size(m)	2.0	0.6		2.0	0.6	2.0	2.0	0.6	2.0	2.0	0.6	2.0
Detector 1 Type	Cl+Ex	Cl+Ex		Cl+Ex	Cl+Ex	Cl+Ex	Cl+Ex	Cl+Ex	Cl+Ex	Cl+Ex	Cl+Ex	Cl+Ex
Detector 1 Channel												
Detector 1 Extend (s)	0.0	0.0		0.0	0.0	0.0	0.0	0.0	0.0	0.0	0.0	0.0
Detector 1 Queue (s)	0.0	0.0		0.0	0.0	0.0	0.0	0.0	0.0	0.0	0.0	0.0
Detector 1 Delay (s)	0.0	0.0		0.0	0.0	0.0	0.0	0.0	0.0	0.0	0.0	0.0
Detector 2 Position(m)		9.4			9.4			9.4			9.4	
Detector 2 Size(m)		0.6			0.6			0.6			0.6	
Detector 2 Type		Cl+Ex			Cl+Ex			Cl+Ex			Cl+Ex	
Detector 2 Channel												
Detector 2 Extend (s)		0.0			0.0			0.0			0.0	
Turn Type	Prot	NA		Prot	NA	Perm	Prot	NA	Perm	Prot	NA	Perm
Protected Phases	5	2		1	6		3	8		7	4	
Permitted Phases						6			8			4



Total Projected 2031 Conditions  
1: Trim Rd & Highway 174

PM.syn



Lane Group	EBL	EBT	EBR	WBL	WBT	WBR	NBL	NBT	NBR	SBL	SBT	SBR
Detector Phase	5	2		1	6	6	3	8	8	7	4	4
Switch Phase												
Minimum Initial (s)	5.0	34.0		5.0	34.0	34.0	5.0	10.0	10.0	5.0	10.0	10.0
Minimum Split (s)	12.4	40.9		12.4	40.9	40.9	12.5	59.4	59.4	12.5	18.4	18.4
Total Split (s)	16.0	54.0		16.0	54.0	54.0	48.0	60.0	60.0	15.0	27.0	27.0
Total Split (%)	11.0%	37.2%		11.0%	37.2%	37.2%	33.1%	41.4%	41.4%	10.3%	18.6%	18.6%
Maximum Green (s)	8.6	47.1		8.6	47.1	47.1	40.5	51.6	51.6	7.5	18.6	18.6
Yellow Time (s)	4.6	4.6		4.6	4.6	4.6	3.3	3.3	3.3	3.3	3.3	3.3
All-Red Time (s)	2.8	2.3		2.8	2.3	2.3	4.2	5.1	5.1	4.2	5.1	5.1
Lost Time Adjust (s)	0.0	0.0		0.0	0.0	0.0	0.0	0.0	0.0	0.0	0.0	0.0
Total Lost Time (s)	7.4	6.9		7.4	6.9	6.9	7.5	8.4	8.4	7.5	8.4	8.4
Lead/Lag	Lead	Lag		Lead	Lag	Lag	Lead	Lag	Lag	Lead	Lag	Lag
Lead-Lag Optimize?	Yes	Yes		Yes	Yes	Yes	Yes	Yes	Yes	Yes	Yes	Yes
Vehicle Extension (s)	3.0	3.0		3.0	3.0	3.0	3.0	3.0	3.0	3.0	3.0	3.0
Recall Mode	None	C-Min		None	C-Min	C-Min	None	None	None	None	None	None
Walk Time (s)								7.0	7.0			
Flash Dont Walk (s)								44.0	44.0			
Pedestrian Calls (#/hr)								0	0			
Act Effct Green (s)	28.0	54.5		20.7	47.2	47.2	19.0	32.2	32.2	7.4	20.6	20.6
Actuated g/C Ratio	0.19	0.38		0.14	0.33	0.33	0.13	0.22	0.22	0.05	0.14	0.14
v/c Ratio	0.53	1.15		0.51	0.59	0.04	0.72	0.83	0.29	0.72	0.47	0.58
Control Delay	61.2	117.3		66.6	43.6	0.1	69.9	70.8	6.4	108.4	62.5	11.8
Queue Delay	0.0	0.0		0.0	0.0	0.0	0.0	0.0	0.0	0.0	0.0	0.0
Total Delay	61.2	117.3		66.6	43.6	0.1	69.9	70.8	6.4	108.4	62.5	11.8
LOS	E	F		E	D	A	E	E	A	F	E	B
Approach Delay		111.3			45.6			59.5			39.9	
Approach LOS		F			D			E			D	
Queue Length 50th (m)	47.3	~269.2		35.1	86.2	0.0	46.0	93.9	0.0	18.5	32.9	0.0
Queue Length 95th (m)	#90.8	#344.5		58.6	107.7	0.0	60.4	120.7	13.2	#43.7	52.1	25.4
Internal Link Dist (m)		598.8			203.8			305.9			174.2	
Turn Bay Length (m)	205.0			245.0		200.0	160.0		80.0	85.0		110.0
Base Capacity (vph)	323	1259		239	1092	629	908	628	624	86	261	429
Starvation Cap Reductn	0	0		0	0	0	0	0	0	0	0	0
Spillback Cap Reductn	0	0		0	0	0	0	0	0	0	0	0
Storage Cap Reductn	0	0		0	0	0	0	0	0	0	0	0
Reduced v/c Ratio	0.53	1.15		0.51	0.59	0.04	0.33	0.52	0.21	0.71	0.45	0.57

Intersection Summary

Area Type: Other  
 Cycle Length: 145  
 Actuated Cycle Length: 145  
 Offset: 0 (0%), Referenced to phase 2:EBT and 6:WBT, Start of Green  
 Natural Cycle: 150  
 Control Type: Actuated-Coordinated  
 Maximum v/c Ratio: 1.15  
 Intersection Signal Delay: 77.4      Intersection LOS: E  
 Intersection Capacity Utilization 93.4%      ICU Level of Service F  
 Analysis Period (min) 15

~ Volume exceeds capacity, queue is theoretically infinite.

# Total Projected 2031 Conditions

## 1: Trim Rd & Highway 174

PM.syn

Queue shown is maximum after two cycles.

# 95th percentile volume exceeds capacity, queue may be longer.





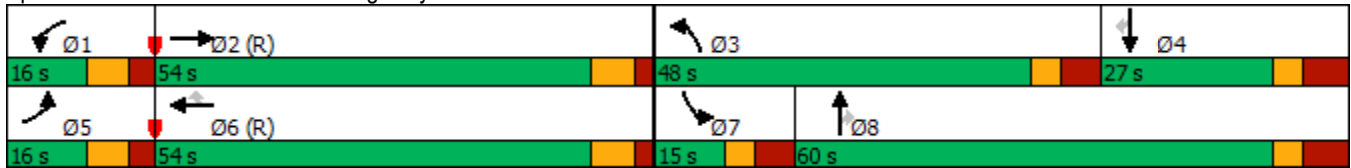











Queue shown is maximum after two cycles.

Splits and Phases: 1: Trim Rd & Highway 174



Total Projected 2031 Conditions  
2: Trim Rd & Taylor Creek Dr

PM.syn

												
Lane Group	EBL	EBT	EBR	WBL	WBT	WBR	NBU	NBL	NBT	NBR	SBU	SBL
Lane Configurations												
Traffic Volume (vph)	8	66	81	258	24	7	37	56	24	680	6	11
Future Volume (vph)	8	66	81	258	24	7	37	56	24	680	6	11
Ideal Flow (vphpl)	1800	1800	1800	1800	1800	1800	1800	1800	1800	1800	1800	1800
Lane Util. Factor	1.00	1.00	1.00	1.00	1.00	1.00	1.00	1.00	1.00	1.00	0.95	0.95
Fr <sub>t</sub>		0.929			0.997					0.850		
Fl <sub>t</sub> Protected		0.998			0.957				0.962			
Satd. Flow (prot)	0	1636	0	0	1684	0	0	0	1698	1500	0	0
Fl <sub>t</sub> Permitted		0.998			0.957				0.962			
Satd. Flow (perm)	0	1636	0	0	1684	0	0	0	1698	1500	0	0
Link Speed (k/h)		50			60				60			
Link Distance (m)		109.2			341.0				179.2			
Travel Time (s)		7.9			20.5				10.8			
Peak Hour Factor	0.95	0.95	0.95	0.95	0.95	0.95	0.95	0.95	0.95	0.95	0.95	0.95
Adj. Flow (vph)	8	69	85	272	25	7	39	59	25	716	6	12
Shared Lane Traffic (%)												
Lane Group Flow (vph)	0	162	0	0	304	0	0	0	123	716	0	0
Enter Blocked Intersection	No	No	No	No	No	No	No	No	No	No	No	No
Lane Alignment	Left	Left	Right	Left	Left	Right	R NA	Left	Left	Right	R NA	Left
Median Width(m)		0.0			0.0				0.0			
Link Offset(m)		0.0			0.0				0.0			
Crosswalk Width(m)		4.8			4.8				4.8			
Two way Left Turn Lane												
Headway Factor	1.07	1.07	1.07	1.07	1.07	1.07	1.07	1.07	1.07	1.07	1.07	1.07
Turning Speed (k/h)	25		15	25		15	15	25		15	15	25
Sign Control		Yield			Yield				Yield			
<b>Intersection Summary</b>												
Area Type:	Other											
Control Type:	Roundabout											
Intersection Capacity Utilization	96.5%						ICU Level of Service F					
Analysis Period (min)	15											

Total Projected 2031 Conditions  
 2: Trim Rd & Taylor Creek Dr

PM.syn



Lane Group	SBT	SBR
Lane Configurations	↕	
Traffic Volume (vph)	1014	84
Future Volume (vph)	1014	84
Ideal Flow (vphpl)	1800	1800
Lane Util. Factor	0.95	0.95
Frt	0.989	
Flt Protected	0.999	
Satd. Flow (prot)	3313	0
Flt Permitted	0.999	
Satd. Flow (perm)	3313	0
Link Speed (k/h)	60	
Link Distance (m)	295.7	
Travel Time (s)	17.7	
Peak Hour Factor	0.95	0.95
Adj. Flow (vph)	1067	88
Shared Lane Traffic (%)		
Lane Group Flow (vph)	1173	0
Enter Blocked Intersection	No	No
Lane Alignment	Left	Right
Median Width(m)	0.0	
Link Offset(m)	0.0	
Crosswalk Width(m)	4.8	
Two way Left Turn Lane		
Headway Factor	1.07	1.07
Turning Speed (k/h)		15
Sign Control	Yield	
<b>Intersection Summary</b>		

Total Projected 2031 Conditions  
2: Trim Rd & Taylor Creek Dr

PM.syn

Intersection						
Intersection Delay, s/veh	43.9					
Intersection LOS	E					
Approach	EB	WB	NB	SB		
Entry Lanes	1	1	1	2		
Conflicting Circle Lanes	1	1	1	1		
Adj Approach Flow, veh/h	162	304	839	1173		
Demand Flow Rate, veh/h	165	310	856	1196		
Vehicles Circulating, veh/h	1423	139	96	402		
Vehicles Exiting, veh/h	175	82	1492	46		
Ped Vol Crossing Leg, #/h	0	0	0	0		
Ped Cap Adj	1.000	1.000	1.000	1.000		
Approach Delay, s/veh	25.2	5.4	8.8	81.6		
Approach LOS	D	A	A	F		
Lane	Left	Left	Left	Bypass	Left	Right
Designated Moves	LTR	LTR	LT	R	LT	R
Assumed Moves	LTR	LTR	LT	R	LT	R
RT Channelized				Yield		
Lane Util	1.000	1.000	1.000		0.925	0.075
Follow-Up Headway, s	2.609	2.609	2.609		2.535	2.535
Critical Headway, s	4.976	4.976	4.976	730	4.544	4.544
Entry Flow, veh/h	165	310	126	1269	1106	90
Cap Entry Lane, veh/h	323	1197	1251	0.980	985	985
Entry HV Adj Factor	0.980	0.982	0.982	716	0.981	0.978
Flow Entry, veh/h	162	304	124	1244	1085	88
Cap Entry, veh/h	317	1176	1228	0.575	966	963
V/C Ratio	0.510	0.259	0.101	9.6	1.123	0.091
Control Delay, s/veh	25.2	5.4	3.8	A	87.8	4.6
LOS	D	A	A	4	F	A
95th %tile Queue, veh	3	1	0		29	0

Total Projected 2031 Conditions  
3: Trim Rd & Site Driveway

PM.syn



Lane Group	EBL	EBR	NBL	NBT	SBT	SBR
Lane Configurations						
Traffic Volume (vph)	0	91	0	883	1347	94
Future Volume (vph)	0	91	0	883	1347	94
Ideal Flow (vphpl)	1800	1800	1800	1800	1800	1800
Lane Util. Factor	1.00	1.00	1.00	0.95	0.95	0.95
Fr <sub>t</sub>		0.865			0.990	
Fl <sub>t</sub> Protected						
Satd. Flow (prot)	0	1526	0	3353	3319	0
Fl <sub>t</sub> Permitted						
Satd. Flow (perm)	0	1526	0	3353	3319	0
Link Speed (k/h)	50			60	60	
Link Distance (m)	171.8			170.3	179.2	
Travel Time (s)	12.4			10.2	10.8	
Peak Hour Factor	0.95	0.95	0.95	0.95	0.95	0.95
Adj. Flow (vph)	0	96	0	929	1418	99
Shared Lane Traffic (%)						
Lane Group Flow (vph)	0	96	0	929	1517	0
Enter Blocked Intersection	No	No	No	No	No	No
Lane Alignment	Left	Right	Left	Left	Left	Right
Median Width(m)	0.0			0.0	0.0	
Link Offset(m)	0.0			0.0	0.0	
Crosswalk Width(m)	4.8			4.8	4.8	
Two way Left Turn Lane						
Headway Factor	1.07	1.07	1.07	1.07	1.07	1.07
Turning Speed (k/h)	25	15	25			15
Sign Control	Stop			Free	Free	
<b>Intersection Summary</b>						
Area Type:	Other					
Control Type:	Unsignalized					
Intersection Capacity Utilization	55.1%			ICU Level of Service B		
Analysis Period (min)	15					

Total Projected 2031 Conditions  
 4: Trim Rd & St. Joseph Blvd/Old Montreal Rd

PM.syn

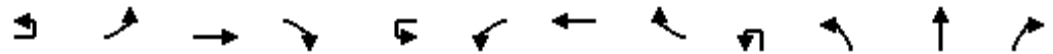

Lane Group	EBU	EBL	EBT	EBR	WBU	WBL	WBT	WBR	NBU	NBL	NBT	NBR
Lane Configurations			↕↕	↗			↕↕	↗			↕↕	
Traffic Volume (vph)	1	61	221	311	11	108	248	183	3	289	505	134
Future Volume (vph)	1	61	221	311	11	108	248	183	3	289	505	134
Ideal Flow (vphpl)	1800	1800	1800	1800	1800	1800	1800	1800	1800	1800	1800	1800
Storage Length (m)		0.0		140.0		0.0		90.0		0.0		0.0
Storage Lanes		0		1		0		1		0		0
Taper Length (m)		0.0				0.0				0.0		
Lane Util. Factor	0.95	0.95	0.95	1.00	0.95	0.95	0.95	1.00	0.95	0.95	0.95	0.95
Frt				0.850				0.850				0.978
Flt Protected			0.989				0.984				0.985	
Satd. Flow (prot)	0	0	3316	1500	0	0	3299	1500	0	0	3230	0
Flt Permitted			0.989				0.984				0.985	
Satd. Flow (perm)	0	0	3316	1500	0	0	3299	1500	0	0	3230	0
Link Speed (k/h)			50				50				60	
Link Distance (m)			262.9				210.8				183.2	
Travel Time (s)			18.9				15.2				11.0	
Peak Hour Factor	0.95	0.95	0.95	0.95	0.95	0.95	0.95	0.95	0.95	0.95	0.95	0.95
Adj. Flow (vph)	1	64	233	327	12	114	261	193	3	304	532	141
Shared Lane Traffic (%)												
Lane Group Flow (vph)	0	0	298	327	0	0	387	193	0	0	980	0
Enter Blocked Intersection	No	No	No	No	No	No	No	No	No	No	No	No
Lane Alignment	R NA	Left	Left	Right	R NA	Left	Left	Right	R NA	Left	Left	Right
Median Width(m)			0.0				0.0				0.0	
Link Offset(m)			0.0				0.0				0.0	
Crosswalk Width(m)			4.8				4.8				4.8	
Two way Left Turn Lane												
Headway Factor	1.07	1.07	1.07	1.07	1.07	1.07	1.07	1.07	1.07	1.07	1.07	1.07
Turning Speed (k/h)	15	25		15	15	25		15	15	25		15
Sign Control			Yield				Yield				Yield	

Intersection Summary

Area Type:	Other
Control Type:	Roundabout
Intersection Capacity Utilization	114.4%
ICU Level of Service	H
Analysis Period (min)	15

Total Projected 2031 Conditions  
 4: Trim Rd & St. Joseph Blvd/Old Montreal Rd

PM.syn



Lane Group	SBL	SBT	SBR
Lane Configurations		↔↔	
Traffic Volume (vph)	381	947	68
Future Volume (vph)	381	947	68
Ideal Flow (vphpl)	1800	1800	1800
Storage Length (m)	0.0		0.0
Storage Lanes	0		0
Taper Length (m)	0.0		
Lane Util. Factor	0.95	0.95	0.95
Frt		0.993	
Flt Protected		0.987	
Satd. Flow (prot)	0	3286	0
Flt Permitted		0.987	
Satd. Flow (perm)	0	3286	0
Link Speed (k/h)		60	
Link Distance (m)		170.3	
Travel Time (s)		10.2	
Peak Hour Factor	0.95	0.95	0.95
Adj. Flow (vph)	401	997	72
Shared Lane Traffic (%)			
Lane Group Flow (vph)	0	1470	0
Enter Blocked Intersection	No	No	No
Lane Alignment	Left	Left	Right
Median Width(m)		0.0	
Link Offset(m)		0.0	
Crosswalk Width(m)		4.8	
Two way Left Turn Lane			
Headway Factor	1.07	1.07	1.07
Turning Speed (k/h)	25		15
Sign Control		Yield	
<b>Intersection Summary</b>			



Total Projected 2031 Conditions  
 4: Trim Rd & St. Joseph Blvd/Old Montreal Rd

PM.syn

Intersection								
Intersection Delay, s/veh	201.0							
Intersection LOS	F							
Approach	EB		WB		NB		SB	
Entry Lanes	2		2		2		2	
Conflicting Circle Lanes	1		1		1		1	
Adj Approach Flow, veh/h	625		580		980		1470	
Demand Flow Rate, veh/h	638		591		1000		1499	
Vehicles Circulating, veh/h	1557		922		725		708	
Vehicles Exiting, veh/h	650		803		1136		608	
Ped Vol Crossing Leg, #/h	0		0		0		0	
Ped Cap Adj	1.000		1.000		1.000		1.000	
Approach Delay, s/veh	46.7		15.5		95.9		409.9	
Approach LOS	E		C		F		F	
Lane	Left	Bypass	Left	Bypass	Left	Right	Left	Right
Designated Moves	LT	R	LT	R	LT	R	LT	R
Assumed Moves	LT	R	LT	R	LT	R	LT	R
RT Channelized		Yield		Yield				
Lane Util	1.000		1.000		0.856	0.144	0.951	0.049
Follow-Up Headway, s	2.535		2.535		2.535	2.535	2.535	2.535
Critical Headway, s	4.544	334	4.544	197	4.544	4.544	4.544	4.544
Entry Flow, veh/h	304	433	394	742	856	144	1426	73
Cap Entry Lane, veh/h	344	0.980	614	0.980	734	734	746	746
Entry HV Adj Factor	0.981	327	0.981	193	0.980	0.979	0.980	0.986
Flow Entry, veh/h	298	425	387	728	839	141	1398	72
Cap Entry, veh/h	338	0.770	602	0.265	720	719	731	735
V/C Ratio	0.883	35.5	0.642	8.0	1.166	0.196	1.913	0.098
Control Delay, s/veh	58.9	E	19.3	A	110.8	7.2	430.7	5.9
LOS	F	7	C	1	F	A	F	A
95th %tile Queue, veh	8		5		27	1	89	0

---

# **Appendix F**

MMLOS Analysis

### Multi-Modal Level of Service - Intersections Form

Consultant	J.L. Richards and Associates	Project	1280 Trim Road
Scenario	Existing Conditions	Date	2023-10-02
Comments			

INTERSECTIONS		Trim/Highway 174			
Crossing Side		NORTH	SOUTH	EAST	WEST
Pedestrian	Lanes	7			
	Median	Median > 2.4 m			
	Conflicting Left Turns	Protected			
	Conflicting Right Turns	Permissive or yield control			
	Right Turns on Red (RTorR) ?	RTOR allowed			
	Ped Signal Leading Interval?	No			
	Right Turn Channel	Smart Channel			
	Corner Radius	>25m			
	Crosswalk Type	Zebra stripe hi-vis markings			
	<b>PETSI Score</b>	<b>24</b>			
	<b>Ped. Exposure to Traffic LoS</b>	-	-	F	-
	Cycle Length	145			
Effective Walk Time	42				
<b>Average Pedestrian Delay</b>	<b>37</b>				
<b>Pedestrian Delay LoS</b>	-	-	D	-	
<b>Level of Service</b>	-	-	F	-	
<b>Level of Service</b>		<b>F</b>			
Approach From		NORTH	SOUTH	EAST	WEST
Bicycle	Bicycle Lane Arrangement on Approach				
	Right Turn Lane Configuration				
	Right Turning Speed				
	<b>Cyclist relative to RT motorists</b>	-	-	-	-
	<b>Separated or Mixed Traffic</b>	-	-	-	-
	Left Turn Approach				
	Operating Speed				
	<b>Left Turning Cyclist</b>	-	-	-	-
<b>Level of Service</b>	-	-	-	-	
<b>Level of Service</b>		<b>-</b>			
Transit	Average Signal Delay	> 40 sec	> 40 sec		
	<b>Level of Service</b>	<b>F</b>	<b>F</b>	-	-
<b>Level of Service</b>		<b>F</b>			
Truck	Effective Corner Radius	> 15 m	> 15 m	> 15 m	
	Number of Receiving Lanes on Departure from Intersection	≥ 2	≥ 2	1	
	<b>Level of Service</b>	<b>A</b>	<b>A</b>	<b>C</b>	-
<b>Level of Service</b>		<b>C</b>			
Auto	Volume to Capacity Ratio	> 1.00			
	<b>Level of Service</b>	<b>F</b>			

## Multi-Modal Level of Service - Segments Form

Consultant	J.L. Richards and Associates	Project	1280 Trim Road
Scenario	Existing Conditions	Date	2023-10-02
Comments			

SEGMENTS		Street A	Trim Road			
			1			
Pedestrian	Sidewalk Width	-	≥ 2 m			
	Boulevard Width		> 2 m			
	Avg Daily Curb Lane Traffic Volume		> 3000			
	Operating Speed		> 50 to 60 km/h			
	On-Street Parking		no			
	<b>Exposure to Traffic PLoS</b>		<b>C</b>	-	-	-
	Effective Sidewalk Width					
Pedestrian Volume						
<b>Crowding PLoS</b>	-	-	-	-		
<b>Level of Service</b>	-	-	-	-		
Bicycle	Type of Cycling Facility	A	Physically Separated			
	Number of Travel Lanes					
	Operating Speed					
	<b># of Lanes &amp; Operating Speed LoS</b>		-	-	-	
	Bike Lane (+ Parking Lane) Width					
	<b>Bike Lane Width LoS</b>		-	-	-	
	Bike Lane Blockages					
	<b>Blockage LoS</b>		-	-	-	
	Median Refuge Width (no median = < 1.8 m)					
	No. of Lanes at Unsignalized Crossing					
Sidestreet Operating Speed						
<b>Unsignalized Crossing - Lowest LoS</b>	<b>A</b>	-	-	-		
<b>Level of Service</b>	<b>A</b>	-	-	-		
Transit	Facility Type	E	Mixed Traffic			
	Friction or Ratio Transit:Posted Speed		Vt/Vp ≤ 0.6			
<b>Level of Service</b>	<b>E</b>	-	-	-		
Truck	Truck Lane Width	A	≤ 3.5 m			
	Travel Lanes per Direction		> 1			
<b>Level of Service</b>	<b>A</b>	-	-	-		
Auto	<b>Level of Service</b>	<b>Not Applicable</b>				

---

## **Appendix G**

Collision Analysis

**Total Area**

Classification of Accident	01 - Approaching	02 - Angle	03 - Rear end	04 - Sideswipe	05 - Turning movement	06 - SMV unattended vehicle	07 - SMV other	99 - Other	Total
04 - Non-reportable	0	0	0	0	0	0	0	0	0
03 - P.D. only	1	54	67	64	6	1	21	4	218
02 - Non-fatal injury	0	8	17	3	1	0	3	3	35
01 - Fatal injury	0	0	0	0	0	0	0	0	0
<b>Total</b>	<b>1</b>	<b>62</b>	<b>84</b>	<b>67</b>	<b>7</b>	<b>1</b>	<b>24</b>	<b>7</b>	<b>253</b>
	#7 or 0%	#3 or 25%	#1 or 33%	#2 or 26%	#5 or 3%	#7 or 0%	#4 or 9%	#5 or 3%	

0%  
86%  
14%  
0%  
100%

**EB RAMP btwn REGIONAL ROAD 174 & TRIM RD**

Years	Total # Collisions	24 Hr AADT Veh Volume	Days	Collisions/MKV
2016-2020	1	n/a	1825	n/a

Classification of Accident	01 - Approaching	02 - Angle	03 - Rear end	04 - Sideswipe	05 - Turning movement	06 - SMV unattended vehicle	07 - SMV other	99 - Other	Total
04 - Non-reportable	0	0	0	0	0	0	0	0	0
03 - P.D. only	0	0	1	0	0	0	0	0	1
02 - Non-fatal injury	0	0	0	0	0	0	0	0	0
01 - Fatal injury	0	0	0	0	0	0	0	0	0
<b>Total</b>	<b>0</b>	<b>0</b>	<b>1</b>	<b>0</b>	<b>0</b>	<b>0</b>	<b>0</b>	<b>0</b>	<b>1</b>
	0%	0%	100%	0%	0%	0%	0%	0%	

100%  
0%  
0%  
100%

**TRIM RD @ DAIRY DR/TAYLOR CREEK DR**

Years	Total # Collisions	24 Hr AADT Veh Volume	Days	Collisions/MEV
2016-2020	33	15,140	1825	1.19

Classification of Accident	01 - Approaching	02 - Angle	03 - Rear end	04 - Sideswipe	05 - Turning movement	06 - SMV unattended vehicle	07 - SMV other	99 - Other	Total
04 - Non-reportable	0	0	0	0	0	0	0	0	0
03 - P.D. only	0	7	8	6	0	0	4	1	26
02 - Non-fatal injury	0	0	3	2	0	0	2	0	7
01 - Fatal injury	0	0	0	0	0	0	0	0	0
<b>Total</b>	<b>0</b>	<b>7</b>	<b>11</b>	<b>8</b>	<b>0</b>	<b>0</b>	<b>6</b>	<b>1</b>	<b>33</b>
	0%	21%	33%	24%	0%	0%	18%	3%	

79%  
21%  
0%  
100%

**REGIONAL ROAD 174 btwn EB RAMP & TRIM RD**

Years	Total # Collisions	24 Hr AADT Veh Volume	Days	Collisions/MKV
2016-2020	25	n/a	1825	n/a

Classification of Accident	01 - Approaching	02 - Angle	03 - Rear end	04 - Sideswipe	05 - Turning movement	06 - SMV unattended vehicle	07 - SMV other	99 - Other	Total
04 - Non-reportable	0	0	0	0	0	0	0	0	0
03 - P.D. only	0	0	7	6	0	1	6	3	23
02 - Non-fatal injury	0	0	2	0	0	0	0	0	2
01 - Fatal injury	0	0	0	0	0	0	0	0	0
<b>Total</b>	<b>0</b>	<b>0</b>	<b>9</b>	<b>6</b>	<b>0</b>	<b>1</b>	<b>6</b>	<b>3</b>	<b>25</b>
	0%	0%	36%	24%	0%	4%	24%	12%	

92%  
8%  
0%  
100%

**REGIONAL RD 174 @ TRIM RD**

Years	Total # Collisions	24 Hr AADT Veh Volume	Days	Collisions/MEV
2016-2020	50	18,500	1825	1.48

Classification of Accident	01 - Approaching	02 - Angle	03 - Rear end	04 - Sideswipe	05 - Turning movement	06 - SMV unattended vehicle	07 - SMV other	99 - Other	Total
04 - Non-reportable	0	0	0	0	0	0	0	0	0
03 - P.D. only	0	0	31	6	2	0	3	0	42
02 - Non-fatal injury	0	1	6	0	0	0	0	1	8
01 - Fatal injury	0	0	0	0	0	0	0	0	0
<b>Total</b>	<b>0</b>	<b>1</b>	<b>37</b>	<b>6</b>	<b>2</b>	<b>0</b>	<b>3</b>	<b>1</b>	<b>50</b>
	0%	2%	74%	12%	4%	0%	6%	2%	

84%  
16%  
0%  
100%

**TRIM RD btwn TAYLOR CREEK DR & ST. JOSEPH BLVD**

Years	Total # Collisions	24 Hr AADT Veh Volume	Days	Collisions/MKV
2016-2020	2	9,604	1825	0.11

Classification of Accident	01 - Approaching	02 - Angle	03 - Rear end	04 - Sideswipe	05 - Turning movement	06 - SMV unattended vehicle	07 - SMV other	99 - Other	Total
04 - Non-reportable	0	0	0	0	0	0	0	0	0
03 - P.D. only	0	0	1	1	0	0	0	0	2
02 - Non-fatal injury	0	0	0	0	0	0	0	0	0
01 - Fatal injury	0	0	0	0	0	0	0	0	0
<b>Total</b>	<b>0</b>	<b>0</b>	<b>1</b>	<b>1</b>	<b>0</b>	<b>0</b>	<b>0</b>	<b>0</b>	<b>2</b>
	0%	0%	50%	50%	0%	0%	0%	0%	

100%  
0%  
0%  
100%

**ST. JOSEPH BLVD/OLD MONTREAL RD @ TRIM RD**

Years	Total # Collisions	24 Hr AADT Veh Volume	Days	Collisions/MEV
2016-2020	142	25,770	1825	3.02

Classification of Accident	01 - Approaching	02 - Angle	03 - Rear end	04 - Sideswipe	05 - Turning movement	06 - SMV unattended vehicle	07 - SMV other	99 - Other	Total
04 - Non-reportable	0	0	0	0	0	0	0	0	0
03 - P.D. only	1	47	19	45	4	0	8	0	124
02 - Non-fatal injury	0	7	6	1	1	0	1	2	18
01 - Fatal injury	0	0	0	0	0	0	0	0	0
<b>Total</b>	<b>1</b>	<b>54</b>	<b>25</b>	<b>46</b>	<b>5</b>	<b>0</b>	<b>9</b>	<b>2</b>	<b>142</b>
	1%	38%	18%	32%	4%	0%	6%	1%	

87%  
13%  
0%  
100%

---

## **Appendix H**

Transportation Demand  
Management Checklists

**TDM-Supportive Development Design and Infrastructure Checklist:**  
*Non-Residential Developments (office, institutional, retail or industrial)*

<b>Legend</b>	
<b>REQUIRED</b>	The Official Plan or Zoning By-law provides related guidance that must be followed
<b>BASIC</b>	The measure is generally feasible and effective, and in most cases would benefit the development and its users
<b>BETTER</b>	The measure could maximize support for users of sustainable modes, and optimize development performance

TDM-supportive design & infrastructure measures: <i>Non-residential developments</i>		Check if completed & add descriptions, explanations or plan/drawing references
<b>1. WALKING &amp; CYCLING: ROUTES</b>		
<b>1.1 Building location &amp; access points</b>		
<b>BASIC</b>	1.1.1 Locate building close to the street, and do not locate parking areas between the street and building entrances	<input type="checkbox"/>
<b>BASIC</b>	1.1.2 Locate building entrances in order to minimize walking distances to sidewalks and transit stops/stations	<input checked="" type="checkbox"/>
<b>BASIC</b>	1.1.3 Locate building doors and windows to ensure visibility of pedestrians from the building, for their security and comfort	<input checked="" type="checkbox"/>
<b>1.2 Facilities for walking &amp; cycling</b>		
<b>REQUIRED</b>	1.2.1 Provide convenient, direct access to stations or major stops along rapid transit routes within 600 metres; minimize walking distances from buildings to rapid transit; provide pedestrian-friendly, weather-protected (where possible) environment between rapid transit accesses and building entrances; ensure quality linkages from sidewalks through building entrances to integrated stops/stations ( <i>see Official Plan policy 4.3.3</i> )	<input checked="" type="checkbox"/>
<b>REQUIRED</b>	1.2.2 Provide safe, direct and attractive pedestrian access from public sidewalks to building entrances through such measures as: reducing distances between public sidewalks and major building entrances; providing walkways from public streets to major building entrances; within a site, providing walkways along the front of adjoining buildings, between adjacent buildings, and connecting areas where people may congregate, such as courtyards and transit stops; and providing weather protection through canopies, colonnades, and other design elements wherever possible ( <i>see Official Plan policy 4.3.12</i> )	<input checked="" type="checkbox"/>



TDM-supportive design & infrastructure measures: <i>Non-residential developments</i>		Check if completed & add descriptions, explanations or plan/drawing references
REQUIRED	1.2.3 Provide sidewalks of smooth, well-drained walking surfaces of contrasting materials or treatments to differentiate pedestrian areas from vehicle areas, and provide marked pedestrian crosswalks at intersection sidewalks (see <i>Official Plan policy 4.3.10</i> )	<input checked="" type="checkbox"/>
REQUIRED	1.2.4 Make sidewalks and open space areas easily accessible through features such as gradual grade transition, depressed curbs at street corners and convenient access to extra-wide parking spaces and ramps (see <i>Official Plan policy 4.3.10</i> )	<input checked="" type="checkbox"/>
REQUIRED	1.2.5 Include adequately spaced inter-block/street cycling and pedestrian connections to facilitate travel by active transportation. Provide links to the existing or planned network of public sidewalks, multi-use pathways and on-road cycle routes. Where public sidewalks and multi-use pathways intersect with roads, consider providing traffic control devices to give priority to cyclists and pedestrians (see <i>Official Plan policy 4.3.11</i> )	<input checked="" type="checkbox"/>
BASIC	1.2.6 Provide safe, direct and attractive walking routes from building entrances to nearby transit stops	<input type="checkbox"/>
BASIC	1.2.7 Ensure that walking routes to transit stops are secure, visible, lighted, shaded and wind-protected wherever possible	<input type="checkbox"/>
BASIC	1.2.8 Design roads used for access or circulation by cyclists using a target operating speed of no more than 30 km/h, or provide a separated cycling facility	<input type="checkbox"/>
<b>1.3 Amenities for walking &amp; cycling</b>		
BASIC	1.3.1 Provide lighting, landscaping and benches along walking and cycling routes between building entrances and streets, sidewalks and trails	<input type="checkbox"/>
BASIC	1.3.2 Provide wayfinding signage for site access (where required, e.g. when multiple buildings or entrances exist) and egress (where warranted, such as when directions to reach transit stops/stations, trails or other common destinations are not obvious)	<input type="checkbox"/>

TDM-supportive design & infrastructure measures: <i>Non-residential developments</i>		Check if completed & add descriptions, explanations or plan/drawing references
<b>2. WALKING &amp; CYCLING: END-OF-TRIP FACILITIES</b>		
<b>2.1 Bicycle parking</b>		
REQUIRED	2.1.1 Provide bicycle parking in highly visible and lighted areas, sheltered from the weather wherever possible (see <i>Official Plan policy 4.3.6</i> )	<input checked="" type="checkbox"/>
REQUIRED	2.1.2 Provide the number of bicycle parking spaces specified for various land uses in different parts of Ottawa; provide convenient access to main entrances or well-used areas (see <i>Zoning By-law Section 111</i> )	<input checked="" type="checkbox"/>
REQUIRED	2.1.3 Ensure that bicycle parking spaces and access aisles meet minimum dimensions; that no more than 50% of spaces are vertical spaces; and that parking racks are securely anchored (see <i>Zoning By-law Section 111</i> )	<input checked="" type="checkbox"/>
BASIC	2.1.4 Provide bicycle parking spaces equivalent to the expected number of commuter cyclists (assuming the cycling mode share target is met), plus the expected peak number of customer/visitor cyclists	<input type="checkbox"/>
BETTER	2.1.5 Provide bicycle parking spaces equivalent to the expected number of commuter and customer/visitor cyclists, plus an additional buffer (e.g. 25 percent extra) to encourage other cyclists and ensure adequate capacity in peak cycling season	<input type="checkbox"/>
<b>2.2 Secure bicycle parking</b>		
REQUIRED	2.2.1 Where more than 50 bicycle parking spaces are provided for a single office building, locate at least 25% of spaces within a building/structure, a secure area (e.g. supervised parking lot or enclosure) or bicycle lockers (see <i>Zoning By-law Section 111</i> )	<input type="checkbox"/> N/A
BETTER	2.2.2 Provide secure bicycle parking spaces equivalent to the expected number of commuter cyclists (assuming the cycling mode share target is met)	<input type="checkbox"/>
<b>2.3 Shower &amp; change facilities</b>		
BASIC	2.3.1 Provide shower and change facilities for the use of active commuters	<input type="checkbox"/>
BETTER	2.3.2 In addition to shower and change facilities, provide dedicated lockers, grooming stations, drying racks and laundry facilities for the use of active commuters	<input type="checkbox"/>
<b>2.4 Bicycle repair station</b>		
BETTER	2.4.1 Provide a permanent bike repair station, with commonly used tools and an air pump, adjacent to the main bicycle parking area (or secure bicycle parking area, if provided)	<input type="checkbox"/>

TDM-supportive design & infrastructure measures: <i>Non-residential developments</i>		Check if completed & add descriptions, explanations or plan/drawing references
<b>3. TRANSIT</b>		
<b>3.1 Customer amenities</b>		
BASIC	3.1.1 Provide shelters, lighting and benches at any on-site transit stops	<input type="checkbox"/> N/A
BASIC	3.1.2 Where the site abuts an off-site transit stop and insufficient space exists for a transit shelter in the public right-of-way, protect land for a shelter and/or install a shelter	<input type="checkbox"/> N/A
BETTER	3.1.3 Provide a secure and comfortable interior waiting area by integrating any on-site transit stops into the building	<input type="checkbox"/>
<b>4. RIDESHARING</b>		
<b>4.1 Pick-up &amp; drop-off facilities</b>		
BASIC	4.1.1 Provide a designated area for carpool drivers (plus taxis and ride-hailing services) to drop off or pick up passengers without using fire lanes or other no-stopping zones	<input type="checkbox"/>
<b>4.2 Carpool parking</b>		
BASIC	4.2.1 Provide signed parking spaces for carpools in a priority location close to a major building entrance, sufficient in number to accommodate the mode share target for carpools	<input type="checkbox"/>
BETTER	4.2.2 At large developments, provide spaces for carpools in a separate, access-controlled parking area to simplify enforcement	<input type="checkbox"/>
<b>5. CARSHARING &amp; BIKESHARING</b>		
<b>5.1 Carshare parking spaces</b>		
BETTER	5.1.1 Provide carshare parking spaces in permitted non-residential zones, occupying either required or provided parking spaces ( <i>see Zoning By-law Section 94</i> )	<input type="checkbox"/>
<b>5.2 Bikeshare station location</b>		
BETTER	5.2.1 Provide a designated bikeshare station area near a major building entrance, preferably lighted and sheltered with a direct walkway connection	<input type="checkbox"/>

TDM-supportive design & infrastructure measures: <i>Non-residential developments</i>		Check if completed & add descriptions, explanations or plan/drawing references
<b>6. PARKING</b>		
<b>6.1 Number of parking spaces</b>		
<b>REQUIRED</b>	6.1.1 Do not provide more parking than permitted by zoning, nor less than required by zoning, unless a variance is being applied for	<input type="checkbox"/>
<b>BASIC</b>	6.1.2 Provide parking for long-term and short-term users that is consistent with mode share targets, considering the potential for visitors to use off-site public parking	<input type="checkbox"/>
<b>BASIC</b>	6.1.3 Where a site features more than one use, provide shared parking and reduce the cumulative number of parking spaces accordingly ( <i>see Zoning By-law Section 104</i> )	<input type="checkbox"/>
<b>BETTER</b>	6.1.4 Reduce the minimum number of parking spaces required by zoning by one space for each 13 square metres of gross floor area provided as shower rooms, change rooms, locker rooms and other facilities for cyclists in conjunction with bicycle parking ( <i>see Zoning By-law Section 111</i> )	<input type="checkbox"/>
<b>6.2 Separate long-term &amp; short-term parking areas</b>		
<b>BETTER</b>	6.2.1 Separate short-term and long-term parking areas using signage or physical barriers, to permit access controls and simplify enforcement (i.e. to discourage employees from parking in visitor spaces, and vice versa)	<input type="checkbox"/>
<b>7. OTHER</b>		
<b>7.1 On-site amenities to minimize off-site trips</b>		
<b>BETTER</b>	7.1.1 Provide on-site amenities to minimize mid-day or mid-commute errands	<input type="checkbox"/>

**TDM Measures Checklist:**  
*Non-Residential Developments (office, institutional, retail or industrial)*

<b>Legend</b>	
<b>BASIC</b>	The measure is generally feasible and effective, and in most cases would benefit the development and its users
<b>BETTER</b>	The measure could maximize support for users of sustainable modes, and optimize development performance
<b>*</b>	The measure is one of the most dependably effective tools to encourage the use of sustainable modes

TDM measures: <i>Non-residential developments</i>		Check if proposed & add descriptions
<b>1. TDM PROGRAM MANAGEMENT</b>		
<b>1.1 Program coordinator</b>		
<b>BASIC</b>	<b>*</b> 1.1.1 Designate an internal coordinator, or contract with an external coordinator	<input type="checkbox"/>
<b>1.2 Travel surveys</b>		
<b>BETTER</b>	1.2.1 Conduct periodic surveys to identify travel-related behaviours, attitudes, challenges and solutions, and to track progress	<input type="checkbox"/>
<b>2. WALKING AND CYCLING</b>		
<b>2.1 Information on walking/cycling routes &amp; destinations</b>		
<b>BASIC</b>	2.1.1 Display local area maps with walking/cycling access routes and key destinations at major entrances	<input checked="" type="checkbox"/>
<b>2.2 Bicycle skills training</b>		
<i>Commuter travel</i>		
<b>BETTER</b>	<b>*</b> 2.2.1 Offer on-site cycling courses for commuters, or subsidize off-site courses	<input type="checkbox"/>
<b>2.3 Valet bike parking</b>		
<i>Visitor travel</i>		
<b>BETTER</b>	2.3.1 Offer secure valet bike parking during public events when demand exceeds fixed supply (e.g., for festivals, concerts, games)	<input type="checkbox"/>

TDM measures: <i>Non-residential developments</i>		Check if proposed & add descriptions
<b>3. TRANSIT</b>		
<b>3.1 Transit information</b>		
BASIC	3.1.1 Display relevant transit schedules and route maps at entrances	<input type="checkbox"/> Provision of transit information will depend on future tenants of this development.
BASIC	3.1.2 Provide online links to OC Transpo and STO information	<input type="checkbox"/>
BETTER	3.1.3 Provide real-time arrival information display at entrances	<input type="checkbox"/>
<b>3.2 Transit fare incentives</b>		
<i>Commuter travel</i>		
BETTER	3.2.1 Offer preloaded PRESTO cards to encourage commuters to use transit	<input type="checkbox"/>
BETTER	3.2.2 Subsidize or reimburse monthly transit pass purchases by employees	<input type="checkbox"/> The developer cannot commit to providing transit fare incentives at this time as this is dependent on the future tenants of each building.
<i>Visitor travel</i>		
BETTER	3.2.3 Arrange inclusion of same-day transit fare in price of tickets (e.g. for festivals, concerts, games)	<input type="checkbox"/>
<b>3.3 Enhanced public transit service</b>		
<i>Commuter travel</i>		
BETTER	3.3.1 Contract with OC Transpo to provide enhanced transit services (e.g. for shift changes, weekends)	<input type="checkbox"/>
<i>Visitor travel</i>		
BETTER	3.3.2 Contract with OC Transpo to provide enhanced transit services (e.g. for festivals, concerts, games)	<input type="checkbox"/>
<b>3.4 Private transit service</b>		
<i>Commuter travel</i>		
BETTER	3.4.1 Provide shuttle service when OC Transpo cannot offer sufficient quality or capacity to serve demand (e.g. for shift changes, weekends)	<input type="checkbox"/>
<i>Visitor travel</i>		
BETTER	3.4.2 Provide shuttle service when OC Transpo cannot offer sufficient quality or capacity to serve demand (e.g. for festivals, concerts, games)	<input type="checkbox"/>

TDM measures: <i>Non-residential developments</i>		Check if proposed & add descriptions
<b>4. RIDESHARING</b>		
<b>4.1 Ridematching service</b>		
<i>Commuter travel</i>		
BASIC	✖ 4.1.1 Provide a dedicated ridematching portal at OttawaRideMatch.com	<input type="checkbox"/>
<b>4.2 Carpool parking price incentives</b>		
<i>Commuter travel</i>		
BETTER	4.2.1 Provide discounts on parking costs for registered carpools	<input type="checkbox"/>
<b>4.3 Vanpool service</b>		
<i>Commuter travel</i>		
BETTER	4.3.1 Provide a vanpooling service for long-distance commuters	<input type="checkbox"/>
<b>5. CARSHARING &amp; BIKESHARING</b>		
<b>5.1 Bikeshare stations &amp; memberships</b>		
BETTER	5.1.1 Contract with provider to install on-site bikeshare station for use by commuters and visitors	<input type="checkbox"/>
<i>Commuter travel</i>		
BETTER	5.1.2 Provide employees with bikeshare memberships for local business travel	<input type="checkbox"/>
<b>5.2 Carshare vehicles &amp; memberships</b>		
<i>Commuter travel</i>		
BETTER	5.2.1 Contract with provider to install on-site carshare vehicles and promote their use by tenants	<input type="checkbox"/>
BETTER	5.2.2 Provide employees with carshare memberships for local business travel	<input type="checkbox"/>
<b>6. PARKING</b>		
<b>6.1 Priced parking</b>		
<i>Commuter travel</i>		
BASIC	✖ 6.1.1 Charge for long-term parking (daily, weekly, monthly)	<input type="checkbox"/>
BASIC	6.1.2 Unbundle parking cost from lease rates at multi-tenant sites	<input type="checkbox"/>
<i>Visitor travel</i>		
BETTER	6.1.3 Charge for short-term parking (hourly)	<input type="checkbox"/>

TDM measures: <i>Non-residential developments</i>		Check if proposed & add descriptions
<b>7. TDM MARKETING &amp; COMMUNICATIONS</b>		
<b>7.1 Multimodal travel information</b>		
<i>Commuter travel</i>		
BASIC	* 7.1.1 Provide a multimodal travel option information package to new/relocating employees and students	<input type="checkbox"/>
<i>Visitor travel</i>		
BETTER	* 7.1.2 Include multimodal travel option information in invitations or advertising that attract visitors or customers (e.g. for festivals, concerts, games)	<input type="checkbox"/>
<b>7.2 Personalized trip planning</b>		
<i>Commuter travel</i>		
BETTER	* 7.2.1 Offer personalized trip planning to new/relocating employees	<input type="checkbox"/>
<b>7.3 Promotions</b>		
<i>Commuter travel</i>		
BETTER	7.3.1 Deliver promotions and incentives to maintain awareness, build understanding, and encourage trial of sustainable modes	<input type="checkbox"/>
<b>8. OTHER INCENTIVES &amp; AMENITIES</b>		
<b>8.1 Emergency ride home</b>		
<i>Commuter travel</i>		
BETTER	* 8.1.1 Provide emergency ride home service to non-driving commuters	<input type="checkbox"/>
<b>8.2 Alternative work arrangements</b>		
<i>Commuter travel</i>		
BASIC	* 8.2.1 Encourage flexible work hours	<input type="checkbox"/>
BETTER	8.2.2 Encourage compressed workweeks	<input type="checkbox"/>
BETTER	* 8.2.3 Encourage telework	<input type="checkbox"/>
<b>8.3 Local business travel options</b>		
<i>Commuter travel</i>		
BASIC	* 8.3.1 Provide local business travel options that minimize the need for employees to bring a personal car to work	<input type="checkbox"/>
<b>8.4 Commuter incentives</b>		
<i>Commuter travel</i>		
BETTER	8.4.1 Offer employees a taxable, mode-neutral commuting allowance	<input type="checkbox"/>
<b>8.5 On-site amenities</b>		
<i>Commuter travel</i>		
BETTER	8.5.1 Provide on-site amenities/services to minimize mid-day or mid-commute errands	<input type="checkbox"/>



---

## **Appendix I**

A & W Drive-Through  
Stacking Study

REPORT N<sup>o</sup> 161-10600

**PROPOSED A&W  
RESTAURANT AT 751  
STRASBURG ROAD,  
KITCHENER, DRIVE-THROUGH  
STACKING STUDY**

FINAL

AUGUST 2016



Project # 161-10600-00

August 12, 2016

Ms. S. Lewis  
Manager, Real Estate – Ontario  
A&W Food Services of Canada Inc.  
171 West Esplanade  
Suite 300  
West Vancouver, BC V7M 3K9

**Subject: Proposed A&W Restaurant at 751 Strasburg Road, Kitchener, Drive-Through Stacking Study**

Dear Ms. Lewis,

This letter is to document our findings of drive-through stacking queuing studies at three A&W Restaurant proxy sites, confirm the proposed drive-through stacking spaces for the proposed A&W Restaurant at 751 Strasburg Road, Kitchener, and make any recommendations if necessary.

## 1. PROPOSED SITE PLAN

The proposed Site Plan, dated August 9, 2016, is provided in **Attachment A** and has the following stacking spaces:

- six (6) stacking spaces between the order screen (including one at the order screen) and the drive-through entrance
- two (2) stacking spaces between the pick-up window (including one at the pick-up window) and the order screen (excluded)
- a total of eight (8) stacking spaces in the drive-through facility, measured from the pick-up window (including one at the order screen and one at the pick-up window) and the drive-thru entrance

## 2. CITY DESIGN REQUIREMENTS

The design requirements for the drive-through stacking spaces are identified in Section 2.1, Part B of the City's 2010 Urban Design Manual. The extracted sections are provided in **Attachment B**. The City design requirements are summarized as follows:

- 10 stacking spaces between the order screen (including one at the order screen) and the drive-through entrance
- three(3) stacking spaces between the pick-up window (including one at the pick-up window) and the order screen (excluded)

- a total of 13 stacking spaces in the drive-through facility, measured from the pick-up window (including one at the order screen and one at the pick-up window) and the drive-through entrance

### 3. A&W RESTAURANT PROXY SITE SURVEY

WSP (formerly GENIVAR) has completed a comprehensive study of drive-through operations in Ontario on behalf of A&W Food Services of Canada Inc. The purpose of the surveys was to observe and record actual numbers of drive-through queues at their high volume restaurants and determine the typical A&W drive-through demand during peak periods. The surveys were done between 2009 and 2010. A summary of the survey results was provided to the City of Kitchener with a maximum of eight vehicle queues in the surveyed drive-through facilities. The City requested a survey of an A&W proxy site, which is located at 933 Victoria Street North, Kitchener to confirm that the result is still acceptable. The City also requested the survey time periods and days.

#### PROXY SITES

WSP commissioned a stacking queuing study in the same study methodology as the previous surveys, at the following three A&W proxy sites:

- 933 Victoria Street North, Kitchener (requested by the City)
- 315 Lincoln Road, Waterloo
- 270 Bleams Road, Kitchener (was surveyed in 2009)

These three sites have similar surrounding location settings to the proposed Restaurant.

#### STUDY METHODOLOGY

Drive-through vehicle queue length and duration surveys were completed on Friday (not falling before a long weekend), July 22, 2016. The survey periods included:

- the restaurant lunch period: 11:30AM to 1:30PM (two hours)
- the restaurant dinner period: 5:00PM to 7:00PM (two hours)

Vehicle queue surveys were conducted to record the number of vehicles waiting at the drive-through facility (queues behind the order screen and queues behind the pick-up window). The sum of the number of vehicles waiting behind the order screen and the number of vehicles waiting behind the pick-up window gives the total number of vehicle queues in a drive-through facility at a given time interval. Vehicle queues were recorded at one-minute intervals during the survey periods.

The original survey reports are provided in **Attachment C**.

### 4. SURVEY RESULT SUMMARY

The summary of drive-through stacking queuing survey results for three proxy sites is provided in Exhibit 1 of **Attachment D**. The 2009 and 2016 survey results for the A&W Restaurant located at 270 Bleams Road, Kitchener are provided in Exhibit 2 of **Attachment D**.

Note that the surveyed queues do not include the vehicle being serviced at the order screen and the vehicle being serviced at the pick-up window. Therefore, one vehicle needs to be added to both surveyed queues behind the order screen and queues behind the pick-up window so that they are comparable to the measurements of the City requirements.

## 5. FINDINGS AND CONCLUSIONS

Based on the above review and the complete stacking queuing study, the following conclusions can be made:

- The stacking demand at the surveyed drive-through facility was:
  - a maximum of five (5) vehicle queues between the order screen (including one at the order screen) and the drive-through entrance at any time intervals; an average of the maximum vehicle queues for all three sites was three (3)
  - a maximum of four (4) vehicle queues between the pick-up window (including one at the pick-up window) and the order screen (excluded) at any time intervals; an average of the maximum vehicle queues for all three sites was three (3)
  - a maximum of a total of seven (7) vehicle queues in the drive-through facility, measured from the pick-up window (including one at the order screen and one at the pick-up window) and the drive-thru entrance at any time intervals; an average of the maximum vehicle queues for all three sites was four (4)
- The survey results in 2009 and 2016 for the A&W Restaurant located at 270 Bleams Road, Kitchener are consistent. The 2016 survey results are also consistent with the 2010 study results.
- The average of maximum vehicle queues or even the maximum vehicle queues for all three sites are less than the City's design requirements for stacking space, except that the maximum vehicle queue before the pick-up window at one site is one space greater than the City's requirement of three spaces.

## 6. RECOMMENDATIONS

The following recommendations can be made:

- Given the surveyed stacking demand in the drive-through facilities at typical A&W Restaurants, WSP proposes:
  - five (5) stacking spaces between the order screen (including one at the order screen) and the drive-through entrance
  - three(3) stacking spaces between the pick-up window (including one at the pick-up window) and the order screen (excluded), which is the City's design requirement
  - a total of eight (8) stacking spaces in the drive-through facility, measured from the pick-up window (including one at the order screen and one at the pick-up window) and the drive-through entrance
- The proposed total supply of eight (8) stacking spaces in the drive-through facility for the proposed Restaurant is sufficient to accommodate the maximum vehicle queues observed in A&W sites with similar characteristics to the proposed site.

- The proposed order screen can be moved one stacking space behind in the drive-through facility, which will result in:
  - five (5) stacking spaces between the order screen (including one at the order screen) and the drive-through entrance, reduced from six (6)
  - three (3) stacking spaces between the pick-up window (including one at the pick-up window) and the order screen (excluded), increased from two (2)

Table 1 summarizes the proposed supply, City’s requirements, survey results, recommendations and proposed modifications for stacking spaces.

**Table 1 Proposed Stacking Spaces, City Requirements, Survey Results and Recommendations**

	<b>Before Order Screen</b> <small>(including 1 Space at Order Screen)</small>	<b>Before Pick-Up Window</b> <small>(including 1 Space at Pick-Up Window excluding 1 Space at Order Screen)</small>	<b>Total Stacking Space in Drive-Through</b> <small>(including 1 Space at Order Screen &amp; 1 Space at Order Screen)</small>
On Draft Site Plan	6	2	8
City Requirement	10	3	13
<b>Survey Result</b>	<b>5</b>	<b>4</b>	<b>7</b>
Recommendation	5	3	8
Modification	5	3	8

I trust that the above documentation, study and analyses fully addresses the reduction of stacking lane capacity for the proposed A&W development located at 751 Strasburg Road in the city of Kitchener to your satisfaction.

Should you have any questions, please feel free to contact us.

Yours truly,

**WSP Canada Inc.**

A handwritten signature in blue ink, appearing to read "Thomas You".

Thomas You, M.A.Sc., P.Eng.  
Transportation Engineer – Transportation

**Attachments:**

Attachment A – Proposed Site Plan

Attachment B – City's Design Requirements

Attachment C – Drive-Through Stacking Queuing Survey Report at Three A&W Proxy Sites

Attachment D – Survey Result Summary

**Exhibit 1:** 2016 Survey Results of Proxy A&W Restaurant Drive-through Facility Operations

**Exhibit 2:** 2009 and 2016 Survey Results of A&W Restaurant Drive-through Facility Operations at 270 Bleams Road, Kitchener

TY/MD

161-10600-00\_RPT\_A&W751OttawaSt\_Stacking\_v1.0\_20160812.docx





# ATTACHMENT A

**PROPOSED SITE PLAN**







# ATTACHMENT B

**CITY'S DESIGN REQUIREMENTS**



The following guidelines apply to location of parking and site services:

**Section 6 of the City of Kitchener's Zoning By-law 85-1 outlines the parking and loading requirements for specified land uses.**

- Locate parking and loading areas to maximize their functionality and use.
- Show loading areas (i.e. for material drop-off or garbage pick-up) on the site plan to illustrate that their design satisfies the following minimum **exterior** turning radius requirements:
  - 6.4m - drive-through aisle (passenger cars, vans)
  - 12.8m - garbage trucks
  - 14.5m - heavy trucks
- Do not locate service and loading zones in any area that would be visually prominent from the street, or any area that could cause conflict with other site circulation.
- Clearly indicate vehicular traffic movements throughout the entirety of the site, including entrance and exits points of the drive aisle, by using the required signage and pavement markings. Use an alternate material to asphalt for the drive-through aisle when it is not clearly delineated.
- Plan the site to include areas for temporary snow storage without conflicting with site circulation, landscaping, utility boxes and sightlines.
- Design garbage and recycling enclosures that are internal to the building, or fully enclosed, roofed and secure, and use the same materials and architectural style as the primary building.
- An appropriately located deep well garbage and recycling system is a preferred alternative for garbage and recycling storage. Locate these systems within a concrete pad.

- Enclose all utility equipment within buildings or screen them from both public streets and private properties. These include utility boxes, garbage and recycling container storage, loading docks and ramps, and HVAC equipment.
- Surface parking areas and drive-through aisles should be located in the interior side yard or rear yard of buildings where possible.
- Locate noise-generating areas, including order board speakers, outdoor loading areas and garbage storage, away from sensitive uses such as residential and institutional.
- Design lighting to minimize light spillage, glare or light cast over adjacent uses. Direct and/or shield lighting sources away from adjacent properties and provide screening as necessary.

## Drive-through Aisle

Sufficient vehicle stacking space in the drive-through aisle is critical to ensuring that drive-through facilities do not cause on- or off-site traffic concerns. There are two distinct parts of a drive-through aisle; the area between the pick-up window and order menu station (if applicable) and the area between the order menu station and the beginning of the drive-through aisle. The drive-through aisle includes the entirety of the lane; the point from which a vehicle leaves the circulation of street or parking flow until that vehicle re-enters the circulation of traffic flow.

The following guidelines apply to the design of the drive-through aisle:

- Design vehicle stacking spaces to the following dimensions:
  - length - minimum 6.5 metres
  - width - minimum 2.6 metres
- Ensure adequate throat widths (3.66m – 4.57m) for each access point and minimize the potential movements around such access locations.
- Locate drive-through aisles so that stacked vehicles do not impede adjacent on- or off-site traffic. A minimum setback of 16.5 metres is required from the entrance of the drive-through



aisle and the edge of the public road allowance to accommodate vehicle movement into and out of the site.

- Drive-through aisles should be located at the side or rear of buildings and not between the building and the street. Alternate configurations which adequately address both Urban Design concerns and pedestrian safety and access may be considered.
- Provide a drive-through aisle to accommodate a minimum of 13 total vehicle stacking spaces on site for each restaurant or food sale use. Locate at least 10 spaces between the order menu station and the entrance of the drive-through aisle and 3 spaces between the order menu station and the pick-up window.
- Provide drive-through aisle to accommodate a minimum of 3 stacking spaces on site for all non-food related use drive-through facilities except car wash.
- Provide a drive-through aisle to accommodate a minimum of 10 vehicle stacking spaces on site for an automated car wash.



*An example showing vehicles stacking into the principle entrance and onto the adjacent street.*

- Locate the entrance of the drive-through aisle so that queued vehicles do not block pedestrian and vehicular circulation throughout the site or along public streets.



*Drive-through aisles should avoid disruption to internal traffic flow, site access and pedestrian routes.*



*An example of a drive-through aisle distinguished through use of alternate surfacing material.*



*This drive-through facility provides an attractive portico with a soft landscaped edge to delineate the drive-through aisle.*

## Double/Multiple Drive-through Facilities

A site with multiple drive-through order stations or windows poses a particular challenge in site planning. A double drive-through can be described as one

# ATTACHMENT C

**DRIVE-THROUGH STACKING QUEUING SURVEY REPORT AT  
THREE A&W PROXY SITES**



# A&W Restaurant- 933 Victoria Rd

## Queue

Friday, July 22, 2016

11:30 AM - 1:30 PM

Time	Order Point	Pickup Window	Total
11:30			
11:31			
11:32			
11:33			
11:34			
11:35			
11:36			
11:37			
11:38			
11:39			
11:40			
11:41	1		1
11:42			
11:43	1		1
11:44			
11:45			
11:46			
11:47		1	1
11:48			
11:49			
11:50	1		1
11:51			
11:52		1	1
11:53	1		1
11:54		1	1
11:55			
11:56			
11:57			
11:58			
11:59			
12:00	1		1
12:01	1		1
12:02			
12:03			
12:04	1		1
12:05			
12:06			
12:07			
12:08			
12:09			
12:10			
12:11	1		1
12:12	1	1	2
12:13		1	1
12:14			

## A&W Restaurant- 933 Victoria Rd

### Queue

12:15	1		1
12:16		1	1
12:17		1	1
12:18			
12:19	1		1
12:20			
12:21	1		1
12:22	2		2
12:23	3		3
12:24	2		2
12:25	1		1
12:26			
12:27			
12:28			
12:29			
12:30	1		1
12:31			
12:32			
12:33			
12:34			
12:35			
12:36			
12:37	2		2
12:38	3		3
12:39	1	1	2
12:40			
12:41			
12:42			
12:43			
12:44			
12:45			
12:46			
12:47			
12:48			
12:49			
12:50			
12:51			
12:52			
12:53	2		2
12:54	3		3
12:55	1		1
12:56	2	1	3
12:57	3		3

## A&W Restaurant- 933 Victoria Rd

### Queue

12:58	3		3
12:59	2		2
13:00	1	1	2
13:01		1	1
13:02			
13:03			
13:04			
13:05			
13:06			
13:07	3		3
13:08	4		4
13:09	3		3
13:10	3	1	4
13:11	2		2
13:12	2	1	3
13:13	2		2
13:14		1	1
13:15	1		1
13:16	1		1
13:17	1	1	2
13:18	1		1
13:19	3	1	4
13:20	2		2
13:21	1		1
13:22	1	1	2
13:23			
13:24			
13:25			
13:26			
13:27	1		1
13:28	1		1
13:29	1	1	2
13:30			
<b>Max</b>	<b>4</b>	<b>1</b>	<b>4</b>
<b>Min</b>	<b>1</b>	<b>1</b>	<b>1</b>
<b>Avg</b>	<b>2</b>	<b>1</b>	<b>2</b>

Note:1. The maximum/average/minimum vehicle queues at the order window are calculated as maximum/average of the observed vehicle queues during all observation intervals at the order screen. So are the maximum/average/minimum vehicle queues at the pick-up window and in the drive-through. Therefore, the maximum/average/maximum/average/minimum vehicle queues in the drive-through do not necessarily equal to total of the maximum/average vehicles queues at the order screen and the maximum/average vehicle queues at the pick-up window.

2. The queues do not include 1 space at the pick-up window and 1 space at the order screen.

**A&W Restaurant- 933 Victoria Rd**  
**Queue**  
**A&W Restaurant- 933 Victoria Rd**  
**Queue**

**Friday, July 22, 2016**  
**5:00 - 7:00 PM**

Time	Order Point	Pickup Window	Total
17:00			
17:01			
17:02			
17:03		1	1
17:04		1	1
17:05		2	2
17:06		1	1
17:07			
17:08	1		1
17:09			
17:10			
17:11			
17:12			
17:13		1	1
17:14	1	2	3
17:15		1	1
17:16			
17:17			
17:18			
17:19			
17:20			
17:21	1		1
17:22			
17:23	1		1
17:24			
17:25			
17:26			
17:27			
17:28			
17:29			
17:30			
17:31			
17:32			
17:33			
17:34			
17:35	1		1
17:36			
17:37			
17:38			
17:39			
17:40			
17:41			
17:42			
17:43			

## A&W Restaurant- 933 Victoria Rd

### Queue

17:44			
17:45			
17:46			
17:47			
17:48			
17:49			
17:50			
17:51			
17:52			
17:53			
17:54			
17:55			
17:56			
17:57			
17:58			
17:59			
18:00			
18:01			
18:02			
18:03			
18:04			
18:05		1	1
18:06		2	2
18:07		1	1
18:08		1	1
18:09		2	2
18:10		2	2
18:11		1	1
18:12			
18:13			
18:14			
18:15			
18:16			
18:17			
18:18			
18:19			
18:20			
18:21			
18:22			
18:23			
18:24			
18:25			
18:26			
18:27			
18:28			
18:29			
18:30			
18:31			
18:32			
18:33			



## A&W Restaurant- 933 Victoria Rd

### Queue

18:34			
18:35			
18:36			
18:37			
18:38			
18:39			
18:40			
18:41			
18:42			
18:43			
18:44			
18:45			
18:46			
18:47			
18:48			
18:49			
18:50			
18:51			
18:52			
18:53			
18:54		1	1
18:55			
18:56			
18:57			
18:58			
18:59			
19:00			
<b>Max</b>	<b>1</b>	<b>2</b>	<b>3</b>
<b>Min</b>	<b>1</b>	<b>1</b>	<b>1</b>
<b>Avg</b>	<b>1</b>	<b>1</b>	<b>1</b>

Note:1. The maximum/average/minimum vehicle queues at the order window are calculated as maximum/average of the observed vehicle queues during all observation intervals at the order screen. So are the maximum/average/minimum vehicle queues at the pick-up window and in the drive-through. Therefore, the maximum/average/maximum/average/minimum vehicle queues in the drive-through do not necessarily equal to total of the maximum/average vehicles queues at the order screen and the maximum/average vehicle queues at the pick-up window.

2. The queues do not include 1 space at the pick-up window and 1 space at the order screen.

# A&W Restaurant- 315 Lincoln Rd

## Queue

Friday, July 22, 2016

11:30 AM - 1:30 PM

Time	Order Point	Pickup Window	Total
11:30			
11:31		1	1
11:32		2	2
11:33		1	1
11:34			
11:35			
11:36			
11:37			
11:38		1	1
11:39		1	1
11:40			
11:41			
11:42			
11:43			
11:44			
11:45			
11:46			
11:47		1	1
11:48			
11:49			
11:50			
11:51			
11:52			
11:53			
11:54			
11:55		1	1
11:56			
11:57			
11:58			
11:59			
12:00			
12:01			
12:02			
12:03			
12:04			
12:05			
12:06	1		1
12:07	2	1	3
12:08	1	1	2
12:09		2	2

## A&W Restaurant- 315 Lincoln Rd

### Queue

12:10		1	1
12:11		1	1
12:12			
12:13			
12:14			
12:15			
12:16			
12:17			
12:18	1		1
12:19			
12:20			
12:21			
12:22			
12:23			
12:24			
12:25			
12:26			
12:27			
12:28			
12:29			
12:30		1	1
12:31			
12:32			
12:33			
12:34			
12:35			
12:36			
12:37			
12:38			
12:39			
12:40	3		3
12:41	2	1	3
12:42		1	1
12:43		2	2
12:44		1	1
12:45	2	1	3
12:46	2	1	3
12:47	2	1	3
12:48	1	1	2
12:49		1	1
12:50		1	1
12:51			
12:52			
12:53		1	1
12:54			
12:55			
12:56			

## A&W Restaurant- 315 Lincoln Rd

### Queue

12:57			
12:58			
12:59			
13:00			
13:01			
13:02			
13:03			
13:04			
13:05			
13:06			
13:07			
13:08			
13:09			
13:10			
13:11			
13:12			
13:13			
13:14			
13:15			
13:16			
13:17			
13:18			
13:19			
13:20			
13:21			
13:22			
13:23			
13:24			
13:25			
13:26			
13:27			
13:28			
13:29			
13:30			
<b>Max</b>	<b>3</b>	<b>2</b>	<b>3</b>
<b>Min</b>	<b>1</b>	<b>1</b>	<b>1</b>
<b>Avg</b>	<b>2</b>	<b>1</b>	<b>2</b>

Note:1. The maximum/average/minimum vehicle queues at the order window are calculated as maximum/average of the observed vehicle queues during all observation intervals at the order screen. So are the maximum/average/minimum vehicle queues at the pick-up window and in the drive-through. Therefore, the maximum/average/maximum/average/minimum vehicle queues in the drive-through do not necessarily equal to total of the maximum/average vehicles queues at the order screen and the maximum/average vehicle queues at the pick-up window.

2. The queues do not include 1 space at the pick-up window and 1 space at the order screen.

**A&W Restaurant- 315 Lincoln Rd**  
**Queue**

**A&W Restaurant- 315 Lincoln Rd**  
**Queue**

Friday, July 22, 2016

5:00 - 7:00 PM

Time	Order Point	Pickup Window	Total
17:00			
17:01			
17:02			
17:03			
17:04			
17:05			
17:06			
17:07			
17:08			
17:09			
17:10		1	1
17:11			
17:12			
17:13			
17:14		1	1
17:15			
17:16			
17:17			
17:18			
17:19			
17:20			
17:21			
17:22			
17:23	1		1
17:24		1	1
17:25			
17:26			
17:27			
17:28			
17:29			
17:30			
17:31			
17:32			
17:33			
17:34			
17:35			
17:36			
17:37			
17:38			
17:39			
17:40			

## A&W Restaurant- 315 Lincoln Rd

### Queue

17:41			
17:42	1		1
17:43	1		1
17:44		2	2
17:45		1	1
17:46			
17:47			
17:48			
17:49			
17:50			
17:51			
17:52			
17:53			
17:54			
17:55			
17:56			
17:57			
17:58			
17:59		1	1
18:00			
18:01			
18:02			
18:03			
18:04			
18:05			
18:06			
18:07			
18:08			
18:09			
18:10			
18:11			
18:12			
18:13			
18:14			
18:15			
18:16			
18:17			
18:18			
18:19			
18:20			
18:21			
18:22			
18:23			
18:24			
18:25			
18:26			
18:27			

## A&W Restaurant- 315 Lincoln Rd

### Queue

18:28		1	1
18:29		1	1
18:30		1	1
18:31			
18:32			
18:33			
18:34			
18:35			
18:36			
18:37			
18:38			
18:39			
18:40			
18:41		1	1
18:42		1	1
18:43			
18:44			
18:45			
18:46			
18:47			
18:48	1		1
18:49			
18:50		1	1
18:51		1	1
18:52		1	1
18:53			
18:54			
18:55	1		1
18:56	1	1	2
18:57	1	1	2
18:58		2	2
18:59		2	2
19:00		1	1
<b>Max</b>	<b>1</b>	<b>2</b>	<b>2</b>
<b>Min</b>	<b>1</b>	<b>1</b>	<b>1</b>
<b>Avg</b>	<b>1</b>	<b>1</b>	<b>1</b>

Note:1. The maximum/average/minimum vehicle queues at the order window are calculated as maximum/average of the observed vehicle queues during all observation intervals at the order screen. So are the maximum/average/minimum vehicle queues at the pick-up window and in the drive-through. Therefore, the maximum/average/maximum/average/minimum vehicle queues in the drive-through do not necessarily equal to total of the maximum/average vehicles queues at the order screen and the maximum/average vehicle queues at the pick-up window.

2. The queues do not include 1 space at the pick-up window and 1 space at the order screen.

# A&W Restaurant-270 Bleams Rd

## Queue

Friday, July 22, 2016

11:30 AM - 1:30 PM

Time	Order Point	Pickup Window	Total
11:30			
11:31			
11:32	2		2
11:33	2	1	3
11:34		1	1
11:35			
11:36			
11:37			
11:38	1		1
11:39	1	1	2
11:40		1	1
11:41			
11:42			
11:43			
11:44			
11:45			
11:46		2	2
11:47			
11:48			
11:49			
11:50			
11:51			
11:52			
11:53	1		1
11:54		1	1
11:55			
11:56	1		1
11:57	1		1
11:58	1		1
11:59			
12:00			
12:01	1		1
12:02	2	1	3
12:03	1	2	3
12:04	1	2	3
12:05	1	2	3
12:06		3	3
12:07	1	2	3
12:08		2	2
12:09		3	3



## A&W Restaurant-270 Bleams Rd

### Queue

12:10		2	2
12:11	2	1	3
12:12	2	3	5
12:13	2	2	4
12:14	1	2	3
12:15		2	2
12:16		2	2
12:17			
12:18			
12:19			
12:20	1		1
12:21			
12:22	1		1
12:23	1	1	2
12:24		2	2
12:25		1	1
12:26		1	1
12:27			
12:28	1	1	2
12:29		2	2
12:30		2	2
12:31		1	1
12:32			
12:33	1	1	2
12:34	2	2	4
12:35		2	2
12:36		2	2
12:37		1	1
12:38	1		1
12:39	1	1	2
12:40	1	1	2
12:41		1	1
12:42	1	1	2
12:43	1	2	3
12:44	1	2	3
12:45	1	2	3
12:46	1	2	3
12:47		2	2
12:48		2	2
12:49	1	2	3
12:50		2	2
12:51			
12:52			
12:53			
12:54			
12:55			
12:56			

## A&W Restaurant-270 Bleams Rd

### Queue

12:57			
12:58			
12:59			
13:00			
13:01			
13:02			
13:03			
13:04		1	1
13:05			
13:06			
13:07			
13:08			
13:09			
13:10			
13:11			
13:12			
13:13			
13:14			
13:15			
13:16			
13:17			
13:18			
13:19			
13:20			
13:21			
13:22			
13:23			
13:24			
13:25			
13:26			
13:27			
13:28			
13:29			
13:30			
<b>Max</b>	<b>2</b>	<b>3</b>	<b>5</b>
<b>Min</b>	<b>1</b>	<b>1</b>	<b>1</b>
<b>Avg</b>	<b>1</b>	<b>2</b>	<b>2</b>

Note:1. The maximum/average/minimum vehicle queues at the order window are calculated as maximum/average of the observed vehicle queues during all observation intervals at the order screen. So are the maximum/average/minimum vehicle queues at the pick-up window and in the drive-through. Therefore, the maximum/average/maximum/average/minimum vehicle queues in the drive-through do not necessarily equal to total of the maximum/average vehicles queues at the order screen and the maximum/average vehicle queues at the pick-up window.

2. The queues do not include 1 space at the pick-up window and 1 space at the order screen.

**A&W Restaurant-270 Bleams Rd**

**Queue**

**A&W Restaurant-270 Bleams Rd**

**Queue**

Friday, July 22, 2016

5:00 - 7:00 PM

Time	Order Point	Pickup Window	Total
17:00			
17:01			
17:02			
17:03			
17:04	1		1
17:05		1	1
17:06			
17:07			
17:08			
17:09			
17:10			
17:11			
17:12			
17:13			
17:14			
17:15			
17:16			
17:17			
17:18			
17:19			
17:20			
17:21			
17:22			
17:23			
17:24			
17:25			
17:26			
17:27			
17:28			
17:29			
17:30			
17:31			
17:32			
17:33			
17:34			
17:35			
17:36			
17:37			
17:38			
17:39			
17:40			

## A&W Restaurant-270 Bleams Rd

### Queue

17:41			
17:42			
17:43			
17:44			
17:45			
17:46			
17:47			
17:48			
17:49			
17:50			
17:51			
17:52			
17:53			
17:54			
17:55			
17:56			
17:57			
17:58			
17:59			
18:00			
18:01			
18:02			
18:03		1	1
18:04			
18:05			
18:06			
18:07			
18:08			
18:09			
18:10			
18:11			
18:12	1	1	2
18:13		1	1
18:14			
18:15			
18:16			
18:17			
18:18			
18:19		1	1
18:20		1	1
18:21			
18:22			
18:23			
18:24			
18:25			
18:26			
18:27	1	1	2

## A&W Restaurant-270 Bleams Rd

### Queue

18:28		1	1
18:29			
18:30			
18:31			
18:32			
18:33			
18:34			
18:35			
18:36			
18:37			
18:38	1		1
18:39			
18:40			
18:41		1	1
18:42		1	1
18:43			
18:44			
18:45			
18:46			
18:47			
18:48			
18:49			
18:50			
18:51			
18:52			
18:53			
18:54			
18:55			
18:56			
18:57			
18:58			
18:59			
19:00			
<b>Max</b>	<b>1</b>	<b>1</b>	<b>2</b>
<b>Min</b>	<b>1</b>	<b>1</b>	<b>1</b>
<b>Avg</b>	<b>1</b>	<b>1</b>	<b>1</b>

Note:1. The maximum/average/minimum vehicle queues at the order window are calculated as maximum/average of the observed vehicle queues during all observation internals at the order screen. So are the maximum/average/minimum vehicle queues at the pick-up window and in the drive-through. Therefore, the maximum/average/maximum/average/minimum vehicle queues in the drive-through do not necessarily equal to total of the maximum/average vehicles queues at the order screen and the maximum/average vehicle queues at the pick-up window.

2. The queues do not include 1 space at the pick-up window and 1 space at the order screen.

# ATTACHMENT D

**SURVEY RESULT SUMMARY**



## Exhibit 1: 2016 Survey Results of Proxy A&W Restaurant Drive-through Facility Operations

Observed Average and Maximum Vehicle Queue Lengths and Observed Average and Maximum Vehicle Duration of Stay

NO.	Municipality	Survey Date	Survey Period	Survey Hours	Number of Vehicles Recorded	Observed Queues During Survey Period [Vehicles]						Observed Service Time (Duration) During Survey Period [Min:Sec]							
						Average Queue Length			Maximum Queue Length			Average Duration				Maximum Duration			
						Before Order Screen	Before Pick up Window	Total Drive-through <sup>1</sup>	Before Order Screen	Before Pick up Window	Total Drive-through <sup>1</sup>	Before Order Screen	In Queue	Before Pick up Window	At Drive-through	Before Order Screen	In Queue	Before Pick up Window	At Drive-through
1	Waterloo 315 Lincoln Road	Fri July 22, 2016	Midday	11:30am to 1:30pm	44	2	1	2	3	2	3	00:30	00:30	00:53	01:55	01:41	01:53	03:14	04:13
			Evening	5:00pm to 7:00pm	29	1	1	1	1	2	2	00:43	00:46	01:18	02:47	02:08	02:26	02:45	05:03
2	Kitchener 270 Bleams Road	Fri July 22, 2016	Midday	11:30am to 1:30pm	118	1	2	2	2	3	5	00:33	01:43	01:01	03:18	01:36	08:58	03:08	12:59
			Evening	5:00pm to 7:00pm	14	1	1	1	1	1	2	00:37	00:24	01:16	02:18	02:03	01:33	06:22	08:33
3	Kitchener 933 Victoria St. N,	Fri July 22, 2016	Midday	11:30am to 1:30pm	95	2	1	2	4	1	4	00:38	00:38	01:09	02:25	01:34	02:18	02:33	04:18
			Evening	5:00pm to 7:00pm	25	1	1	1	1	2	3	00:48	00:40	01:17	02:45	02:50	04:33	03:34	06:09
<b>Maximum Result</b>						2	2	2	4	3	5	00:48	01:43	01:18	03:18	02:50	08:58	06:22	12:59
<b>Average Result</b>						1	1	2	2	2	3	00:38	00:47	01:09	02:35	01:59	03:37	03:36	06:53

Note <sup>1</sup>: The maximum/average vehicle queues at the order window are calculated as maximum/average of the observed vehicle queues during all observation intervals at the order screen. So are the maximum/average vehicle queues at the pick-up window and in the drive-through. Therefore, the maximum/average vehicle queues in the drive-through do not necessarily equal to total of the maximum/average vehicles queues at the order screen and the maximum/average vehicle queues at the pick-up window.





## Exhibit 2: 2009 and 2016 Survey Results of A&W Restaurant Drive-through Facility Operations at 270 Bleams Road, Kitchener

Observed Average and Maximum Vehicle Queue Lengths and Observed Average and Maximum Vehicle Duration of Stay

NO.	Municipality	Survey Date	Survey Period	Survey Hours	Number of Vehicles Recorded	Observed Queues During Survey Period [Vehicles]						Observed Service Time (Duration) During Survey Period [Min:Sec]							
						Average Queue Length			Maximum Queue Length			Average Duration				Maximum Duration			
						Before Order Screen	Before Pick up Window	Total Drive-through <sup>1</sup>	Before Order Screen	Before Pick up Window	Total Drive-through <sup>1</sup>	Before Order Screen	Before In Queue	Before Pick up Window	At Drive-through	Before Order Screen	Before In Queue	Before Pick up Window	At Drive-through
2	Kitchener 270 Bleams Road	Sat Nov 21, 2009	Morning	7:00am - 9:00am	8	0	0	0	1	1	2	0:23	0:08	0:33	1:05	1:17	0:07	0:41	2:05
			Midday	11:30am - 1:30pm	33	0	1	1	2	4	6	0:42	2:35	1:00	4:16	0:38	10:31	1:37	12:46
			Evening	5:00pm - 7:00pm	44	1	2	3	4	4	6	1:17	1:51	2:01	5:09	1:32	6:50	3:55	12:17
2	Kitchener 270 Bleams Road	Fri July 22, 2016	Midday	11:30am to 1:30pm	118	1	2	2	2	3	5	00:33	01:43	01:01	03:18	01:36	08:58	03:08	12:59
			Evening	5:00pm to 7:00pm	14	1	1	1	1	1	2	00:37	00:24	01:16	02:18	02:03	01:33	06:22	08:33

Note <sup>1</sup>: The maximum/average vehicle queues at the order window are calculated as maximum/average of the observed vehicle queues during all observation intervals at the order screen. So are the maximum/average vehicle queues at the pick-up window and in the drive-through. Therefore, the maximum/average vehicle queues in the drive-through do not necessarily equal to total of the maximum/average vehicles queues at the order screen and the maximum/average vehicle queues at the pick-up window.





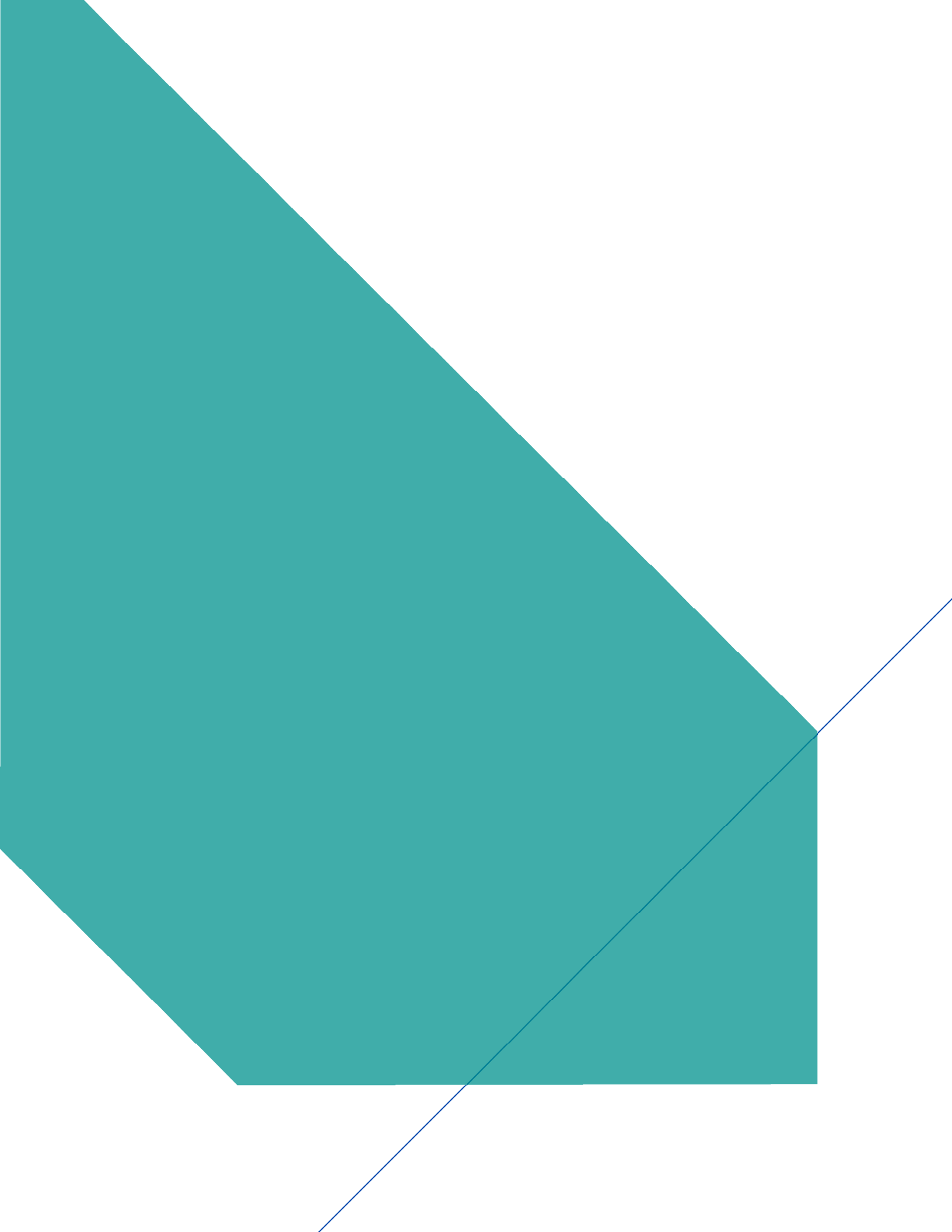



Platinum  
member

[www.jlrichards.ca](http://www.jlrichards.ca)

#### Ottawa

343 Preston Street  
Tower II, Suite 1000  
Ottawa ON Canada  
K1S 1N4  
Tel: 613 728-3571  
[ottawa@jlrichards.ca](mailto:ottawa@jlrichards.ca)

#### Kingston

203-863 Princess Street  
Kingston ON Canada  
K7L 5N4  
Tel: 613 544-1424  
[kingston@jlrichards.ca](mailto:kingston@jlrichards.ca)

#### Sudbury

314 Countryside Drive  
Sudbury ON Canada  
P3E 6G2  
Tel: 705 522-8174  
[sudbury@jlrichards.ca](mailto:sudbury@jlrichards.ca)

#### Timmins

834 Mountjoy Street S  
Timmins ON Canada  
P4N 7C5  
Tel: 705 360-1899  
[timmins@jlrichards.ca](mailto:timmins@jlrichards.ca)

#### North Bay

501-555 Oak Street E  
North Bay ON Canada  
P1B 8L3  
Tel: 705 495-7597

[northbay@jlrichards.ca](mailto:northbay@jlrichards.ca)

#### Hawkesbury

326 Bertha Street  
Hawkesbury ON Canada  
K6A 2A8  
Tel: 613 632-0287

[hawkesbury@jlrichards.ca](mailto:hawkesbury@jlrichards.ca)

#### Guelph

107-450 Speedvale Ave. West  
Guelph ON Canada  
N1H 7Y6  
Tel: 519 763-0713

[guelph@jlrichards.ca](mailto:guelph@jlrichards.ca)

