

Q9

planning  
+ design

# URBAN DESIGN BRIEF

MINOR ZONING BY-LAW AMENDMENT

SUBJECT SITE: 1280 TRIM ROAD, OTTAWA



REPORT DATE: JULY 2, 2024

REPORT PREPARED FOR: TRIM WORKS DEVELOPMENT LIMITED

PREPARED BY: Q9 PLANNING + DESIGN

**Prepared by:**



**Christine McCuaig, MCIP RPP**  
www.q9planning.com  
Ottawa, ON

**P :** +613 850 8345  
**E:** christine@q9planning.com

This Urban Design Brief is prepared in support of a Zoning By-law Amendment Application for the proposed commercial development at 1280 Trim Road.

# TABLE OF CONTENTS

- 1.0 OVERVIEW..... 3**
  - 1.1 DESIGN BRIEF REQUIREMENTS..... 3**
- 2.0 PROJECT DESCRIPTION ..... 4**
  - 2.1 PROJECT STATISTICS ..... 4**
- 3.0 DESIGN DIRECTIVES..... 6**
  - 3.1 GOALS AND VISION ..... 6**
  - 3.2 CITY OF OTTAWA: OFFICIAL PLAN (2022) DESIGN POLICIES..... 7**
  - 3.3 ORLÉANS CORRIDOR SECONDARY PLAN (2022)..... 8**
  - 3.4 URBAN DESIGN GUIDELINES FOR DEVELOPMENT ALONG ARTERIAL MAINSTREETS ..... 13**
  - 3.5 URBAN DESIGN GUIDELINES FOR DRIVE-THROUGH FACILITES..... 15**
  - 3.6 RESPONSES TO COMMENTS FROM STAFF AT PRE-APPLICATION CONSULTATION MEETING ..... 16**
- 4.0 SITE, CONTEXT & ANALYSIS..... 22**
  - 4.1 PRESCEDENT IMAGE..... 22**
  - 4.2 EXISTING SITE CONDITIONS ..... 22**
  - 4.3 SURROUNDING CONTEXT ..... 27**
  - 4.4 MOBILITY NETWORKS: PEDESTRIAN, CYCLIST AND TRANSIT ..... 30**
  - 4.5 MASSING, ORIENTATION AND DESIGN..... 32**
  - 4.6 URBAN PATTERNS ..... 35**
- 5.0 DESIGN RESEARCH ..... 36**
  - 5.1 EXPLORING SITE LAYOUT OPTIONS ..... 36**
  - 5.2 ENERGY EFFICIENCY & SUSTAINABLE DESIGN..... 44**
- 6.0 LIMITATIONS OF REPORT..... 46**

# 1.0 OVERVIEW

The development application being submitted for 1280 Trim Road is for a Minor Zoning By-law Amendment Application. The proposal will consist of three, one-storey (7 metres) light industrial buildings, which will contain a mix of uses including personal services, office, restaurant, and an automobile service centre (with warehousing, a showroom and office). Building 2 will contain five units and will feature offices and personal service businesses. It will be located on the southern half of the property closer to Trim Road. Unit sizes will generally be 129 m<sup>2</sup>, except for one unit sized at 119.9 m<sup>2</sup>. Building 1 will contain a drive-through restaurant and will be located on the northern portion of the property closer to Trim Road and directly across from Building A. The drive-thru stacking lane will access the building interior to the site. Finally, Building 3 will contain an automotive service, warehouse, showroom/office building, featuring 7 service bays and with a total GFA of 646.1 m<sup>2</sup>. A total of 68 parking spaces will be provided on the site.



Figure 1: East Elevation, View from Trim Road (McRobie Architects)

## 1.1 DESIGN BRIEF REQUIREMENTS

The review of Official Plan policy and other relevant documents and guidelines incorporated into this report addresses the requirement in Section 1 of the Terms of Reference for a Design Brief. A contextual analysis map and summary are provided in the beginning sections of this report. Images of the surrounding areas are also provided. As per the Section 2 requirements of the Terms of Reference, we have submitted 3D illustrations, a cross section, context maps, elevations, and renders.



## 2.0 PROJECT DESCRIPTION

### 2.1 PROJECT STATISTICS

The proposed commercial buildings will each be a single storey in height, with a maximum height of 7.0 metres. The building setbacks for all three buildings is 3.0 metres from the front lot line along Trim Road, 3.0 metres from the northerly interior lot line abutting the gas station and drive-through restaurant, 1.2 metres from the southerly interior lot line abutting the daycare, and 9.9 metres from the rear lot line abutting the church property.

The following table outlines the project statistics:

Dimension	Building 1	Building 2	Building 3	Total
Number of storeys	1	1	1	-
Total units	1	5	1	7
Gross Floor Area	194.4 m <sup>2</sup>	635.9 m <sup>2</sup>	646.1 m <sup>2</sup>	1,476.4 m <sup>2</sup>
Total parking spaces				68
Bicycle parking spaces				6

The following table outlines the proposed zoning performance standards and relief request:

Provision	Requirement	Proposed	Section
Minimum lot area	2,000 m <sup>2</sup>	5,620 m <sup>2</sup>	S.203, Table 203
Minimum lot width	No minimum	61.93 m	S.203, Table 203
Maximum lot coverage	65%	28%	S.203, Table 203
Maximum building height	21 m	7 m	S.203, Table 203
Minimum Front and Corner Yard setback	7.5 m	<b>3.0 m</b>	S.203, Table 203
Minimum Interior Yard Setback	7.5 m	<b>3.0 m north</b> <b>1.2 m south</b>	S.203, Table 203
Minimum rear yard setback	Abutting an institutional zone = 15 m	<b>9.5 m</b>	S.203, Table 203
Maximum Floor Space Index	2	0.28	S.203, Table 203
Minimum width of landscaped area	Abutting a street = 3 m	3.0 m	S.203, Table 203
Parking	Restaurant: 10 cars per 100m <sup>2</sup> = 32; Personal Service: 3.4 cars per 100m <sup>2</sup> = 18 cars; Automobile Service Use: 2 cars per service bay = 14 cars  Total 64 parking spaces	66 standard, 2 barrier-free: Total 68 spaces.  (Four spaces used as temporary snow storage leaving 64 spaces available, which would meet the By-law requirement in the winter months)	S.101, Table 101A; S.102, Table 102
Drive-Through Operations	Restaurant (with order board):  7 at or before board and a minimum total of 11  A queuing space must be 3m by 5.7 m	7 at or before board, total of 11	

<b>Bicycle parking</b>	<p>1 per 250 m<sup>2</sup> of office and restaurant = 3 spaces</p> <p>1 per 500 m<sup>2</sup> of personal service = 1 space</p> <p>1 per 1500 m<sup>2</sup> of automobile service use = 1 space</p> <p>Total = 5 spaces</p>	6 spaces	S.111, Table 111A
<b>Gross Floor Area of Permitted Uses</b>	A personal service business is permitted provided that the use does not exceed a 300 m <sup>2</sup> gross floor area	>300 m <sup>2</sup>	S. 203.2(c)
<b>Gross Floor Area of Permitted Uses</b>	A restaurant is permitted provided that the use does not exceed a 300 m <sup>2</sup> gross floor area	194.4 m <sup>2</sup>	S. 203.2(c)
<b>Gross Floor Area of Permitted Uses</b>	A automobile service station is permitted provided that the use does not exceed a 300 m <sup>2</sup> gross floor area	646.1 m <sup>2</sup>	S. 203.2(c)

### 3.0 DESIGN DIRECTIVES

#### 3.1 GOALS AND VISION

In developing the design of the proposed buildings and sites, a variety of options were considered, including the retention of the existing building and buildings of different sites and layouts explored. Ultimately, the site is on the small size for a commercial/light industrial site and therefore factors such as landscaping, vehicular movement, the industrial zone building setbacks and the parking requirements played a large role in the final site development.

The architecture of the site focuses on the use clean lines and clear signage and contemporary high-quality materials with wood accents, which provides a natural feel juxtaposed against the

landscaping and trees canopy which will be provided at the frontage, perimeter and interior to the site.

When developing a building and site concept for the property on Trim, the main goals and objectives of the development are to (1) provide light industrial uses that serve the local community (2) activate the Trim street frontages through massing orientation, signage, building design, pedestrian access and landscaping, (3) provide commercial and light industrial uses in close proximity to a transit area, (4) bring new landscaping and trees to an underutilized, vacant site, (5) design high quality buildings that fits contextually within the local community.

### **3.2 CITY OF OTTAWA: OFFICIAL PLAN (2022) DESIGN POLICIES**

Section 4.6 of the Official Plan provides urban design policies that are designed to guide new development in Ottawa. Urban design plays an important role in supporting the City's objectives such as building healthy 15- minute neighbourhoods, growing the urban tree canopy and developing resilience to climate change. New development should be designed to make healthier, more environmentally sustainable living accessible for people of all ages, genders and social statuses.

The urban design policies outline six (6) distinct goals as follows:

- (1) Promote design excellence in Design Priority Areas;
- (2) Protect views and enhance Scenic Routes including those associated with national symbols;
- (3) Ensure capital investments enhance the City's streets, sidewalks and other public spaces supporting a healthy lifestyle;
- (4) Encourage innovative design practices and technologies in site planning and building design;
- (5) Ensure effective site planning that supports the objectives of Corridors, Hubs, Neighbourhoods and the character of our villages and rural landscapes; and
- (6) Enable the sensitive integration of new development of Low-rise, Mid-rise and High-rise buildings to ensure Ottawa meets its intensification targets while considering liveability for all.

The following policies from Section 4.2 are highlighted that are particularly relevant to the development proposal:

*Policy 4.6.5(2) states that development in Hubs and along Corridors shall respond to context, transect area and overlay policies. The development should generally be located to frame the adjacent street, park or greenspace, and should provide an appropriate setback within the street context, with clearly visible main entrances from public sidewalks. Visual impacts associated with above grade utilities should be mitigated.*

*Policy 4.6.5(3) states that development shall minimize conflict between vehicles and pedestrians and improve the attractiveness of the public realm by internalizing all servicing, loading areas, mechanical equipment and utilities into the design of the building, and by accommodating space on the site for trees, where possible. Shared service areas, and accesses should be used to limit interruptions along sidewalks. Where underground parking is not viable, surface parking must be visually screened from the public realm.*

*Policy 4.6.5(4) states that development shall demonstrate universal accessibility, in accordance with the City's Accessibility Design Standards. Designing universally accessible places ensures*

*that the built environment addresses the needs of diverse users and provides a healthy, equitable and inclusive environment.*

*Policy 4.6.6(5) states that 5) Where large sites such as shopping centres are developed or redeveloped, their site design shall support walkable 15-minute neighbourhoods, sustainable modes of transportation and help to achieve the economic development and health goals of the Official Plan by: a) Locating buildings and store entrances along public streets, with minimum built frontages determined by the Zoning By-law, depending on transect location; b) Establishing an internal circulation pattern that supports future intensification, including direct and safe street and multi-use path connections to the surrounding built, or planned urban fabric; c) Including a public street grid or equivalent pedestrian and cycling network to maximize connectivity to the surrounding street network, with vehicular parking screened from the street edge, or located underground; and d) Building arrangement and design that includes façade treatments, articulation, building materials and site furnishings that are comfortable at the pedestrian scale.*

**Comment:** The proposed development frames the street on both sides by providing buildings with activated facades along the street edge. The parking and the drive-thru (the auto-centric component of the design) is provided behind and to the sides of the buildings and screened from public view. The siting of the buildings allows for future redevelopment of the rear parking lot if parking is no longer required. There are two provided sidewalk entrances to the site from the Trim Road frontage and the multi-use pathway. Trees and landscaping have been provided along the frontage of the site. Conflict between vehicles and pedestrians is minimized through dedicated entrances to the site (2 for pedestrians and 1 for vehicles), an enhanced vehicle crossing through the site between Building 1 and 2 and an enhanced demarcation of the multi-use trail boundaries for the sake of sightlines.

### **3.3 ORLÉANS CORRIDOR SECONDARY PLAN (2022)**

Within the Orléans Corridor Secondary Plan (council approved in September 2022 under appeal), the subject property is designated 'Trim Minor Corridor' and six storey mid-rise buildings are envisaged. The vision of the plan is for the Orléans corridor to evolve from a late 20<sup>th</sup> century auto-centric suburb into vibrant urban neighbourhoods centred around the O-Train stations and the St. Joseph Blvd mainstreet, where residents and visitors can walk, cycle or take transit to daily destinations.

The following outlines key policies in the Orleans Corridor Secondary Plan.

#### **Section 2.4 Goals & Objectives**

**Goal 1:** *Accommodate a wide range and mix of uses in Station Areas such as residential, office, commercial, retail, arts and culture, entertainment, service, recreational, and institutional in Station Areas. Integrate the O-Train Station Areas with neighbourhoods to the north and south by supporting safe pedestrian access to 15-minute neighbourhood services and amenities, including transit. Improve pedestrian and cycling networks with safe and efficient options to replace automobile trips for day-to-day needs. Utilize City-owned lands, including by repurposing, disposing of, or co-locating services to achieve a vibrant mix of uses, increase density, provide affordable housing, and provide public spaces for people to gather, meet, and engage in the local economy.*



**Goal 2:** *Accommodate new jobs and residents in a compact and urban built form close to stations to maximize transit ridership. Allow the tallest building heights at Station Core Areas. Permit and encourage a variety of building typologies to support a diverse range of housing and unit types, catering to different affordability levels. Provide a diversity of ground-oriented housing forms in the podium of high-rise buildings. Apply limited high rise development permissions beyond 400 metres of O-Train stations. Generally, prohibit surface parking within 400 metres of O-Train stations with the exception of accessible and short-term visitor parking. At the site level, access for active transportation modes will be prioritized over vehicular circulation.*

**Goal 3:** *Plan for additions and enhancements to the public realm, greenspaces, and promote climate resilience and prioritize and improve mobility for pedestrians and cyclists to support positive health outcomes and reduce greenhouse gas emissions.*

**Goal 4:** *Require all development within 400 metres of an O-Train station to preferentially accommodate pedestrian and cycling movements. Prioritize walking, cycling, and transit for development in the Station Areas, on the streets leading to O-Train stations and on St. Joseph Blvd mainstreet, and in the management of on-site vehicle circulation and parking. Establish all new public streets as 'complete streets' to ensure broad and consistent support to active transportation modes that are safe for people of all ages and abilities. Minimize potential conflict points with pedestrians and cyclists, such as curb cuts. To require outdoor pedestrian connectivity across sites and within sites where high-rise and mid-rise development is permitted.*

**Goal 5:** *Plan and design new development so that sustainable transportation movements are prioritized on-site, and through new connections to streets and pathways. Create places of interest, that foster identity, and support neighbourhood recreation and commerce in the Station Core, and Station Periphery designations. Provide safe and enjoyable cycling and walking environments to connect to O-Train stations. Require slow speed driving environments on all internal streets within the Station Area – Core and Station Area - Periphery Require soft landscaping, enhanced street tree planting and integration of buffers to natural heritage features in new development.*

**Comment |** The proposed development provides a mix of uses on a small site in proximity a residential community that contributes to a 15-minute neighbourhood. Two pedestrian entrances have been provided on each side of the frontage that connect to the existing multi-use trail. Six bicycle parking spaces have been relocated to the rear of the pylon sign, directly accessible to a pedestrian entryway. Enhanced landscaping has been added to the along interior rear and front lot lines, as well to interior traffic islands to promote climate resilience, contribute to the urban tree canopy and to reduce greenhouse gas emissions. The drive-through has been relocated to the rear of the site to avoid a stacking lane that is visible from the street frontage. Four parking spaces at the rear of the site have been converted to snow storage spaces which can be removed in the future if the demand for parking decreases with the use of other modes of transportation.

In order to support use of the LRT station and related park'n'ride it is critical to identify that residents using this station will frequently drive by the subject site. Maintaining uses that support

this portion of travelling public on their route to the station is highly appropriate as a transitional use.

#### **Section 4.5 Corridors**

*The vision for corridors within the Plan is to provide a greater degree of mixed uses and a higher level of street transit service than abutting Neighbourhoods, but lower density than nearby Hubs. Corridors are intended to become walkable environments that prioritize pedestrians and sustainable modes of transportation. Active frontages will be required to enhance the public realm and animate the street.*

**Comment** | The proposed development is located in a Minor Corridor directly adjacent to a multi-use pathway. The development will provide two pedestrian/cycling entrances directly from the public walkway with bicycle parking. A mid-size pedestrian connection will be provided that will connect Building 1 to Buildings 2 & 3. Both buildings at the street frontage will be activated through the use of windows and doors. Building 2 provides a door facing the public street. The front building walls will be screened with landscaping and the drive-through has been located to the rear of the site.

#### **Section 4.2 Built Form & Public Realm Policies**

Responses have been provided to applicable provisions.

- 1) *Space on certain streets, such as those with direct connections to O-Train stations, and mainstreets, may be reallocated from vehicular use in favour of active transportation or the gathering of people. This will include space in the right-of-way for active transportation facilities, transit priority measures, outdoor commercial patios, temporary or permanent plazas, street trees or new soft and hard landscaping.*

**Response:** *Entirety of right-of-way with the exception of a single vehicular access (which is limited to right-in / right-out due to the grass median) is landscaped with soft landscaping and two pedestrian linkages. Bike parking is provided directly beside the pylon sign for wayfinding.*

- 2) *Development and capital projects will enhance the public realm in accordance with the vision, goals and objectives of this Plan.*
- 3) *Development shall minimize conflict between vehicles, pedestrians and cyclists and improve the attractiveness of the public realm by internalizing all servicing, loading areas, mechanical equipment, and utilities, where possible, into the design of the building.*

**Response:** *With only one vehicular access, and clearly identified pedestrian routes including a separate pedestrian route on either side of the vehicular access, the proposed development minimizes, where possible, conflict between different modes. The drive-through has been provided at the rear of the site which further minimizes conflict between pedestrians and cyclists at the front of the site.*

- 4) *Co-location of cultural, institutional, and recreational uses in mid-rise and high-rise buildings is encouraged. This may include locating schools, community centres or museums in the podium of a mixed-use building containing apartments or offices on the*

upper floors.

5) All new local and private streets shall be designed as follows: a. Include sidewalks, soft landscaping and street trees; b. Be designed for operating speeds of 30 kilometers per hour or less; c. May establish pedestrian-only or woonerf streets in high-density mixed-use and residential areas; d. Provide direct connections to the existing or planned network of public sidewalks, pathways and cycling facilities; and e. Winter maintenance standards shall support the priority of active transportation networks.

6) New buildings shall, wherever possible, include active frontages facing the public realm, such as along public or private streets, multi-use pathways, City parks (including linear parks and the Voyageur Creek Greenway) and Privately-Owned Public Spaces (POPS).

**Response:** The new buildings, where possible, have included active frontages, and where an active frontage was not possible, landscaping and a pedestrian walkway have been provided to activate the public realm.

7) Buildings will locate the main entrance fronting an adjacent street with a direct connection to the nearest sidewalk.

**Response:** Site orientation in a narrow, deep lot configuration means that not all unit entrances are capable of fronting the street. Building 2 has a front entrance facing the street. Building 1 is not possible but contain a public walkway that provides a direct connection to the front door.

8) Residential units at-grade that face a public or private street will each be designed with an individual entrance.

9) Mid-rise and high-rise buildings are required to provide a height transition to abutting Neighbourhood designated properties to create a liveable environment with a gradual change in height and massing, through setbacks and stepbacks generally guided by the application of an angular plane in accordance with Council approved Plans and design guidelines.

10) New development shall frame their adjacent streets and parks to animate public spaces and create comfortable pedestrian environments in the public realm and avoid long expanses of blank walls.

**Response:** No long blank walls are proposed and with the exception of the single vehicle access, new building walls are positioned so that they frame the public realm along with detailed landscaping.

11) To increase opportunities for larger households, corner units of residential mid-rise buildings or podia of high-rise buildings should be designed as larger units that maximize the number of bedrooms.

12) Units in high-rise buildings that can accommodate large households should be ground-oriented where possible or be located on levels that have easy access and sight lines toward amenity areas used by children.

13) Wayfinding signage should be installed throughout Station Core and Periphery Areas, concurrent to the installation of paths and/or cycling facilities.

14) The City will plan for and support the burial of hydroelectric infrastructure on St Joseph Boulevard.

## Section 4.8 Active Transportation Policies

*The Plan will increase the availability of safe and convenient sustainable transportation options within neighbourhoods, and between neighbourhoods and key destinations like mainstreets and O-Train stations. An equity lens can help highlight the need for improvements, especially when considering the needs of vulnerable populations such as children, women, and racialized groups. 1) Plan and design new development to prioritize sustainable transportation. 2) Create new active transportation connections to key community destinations. 3) Mid-block crossings and traffic calming measures will be considered in proximity to community destinations such as schools and parks. 4) Publicly accessible through-block connections should be provided as part of the design and redevelopment of large properties, including shopping centres, commercial plazas and places of worship. 5) A winter-maintained cycling network in the Orléans Corridor will be developed that prioritizes travel to community destinations and O-Train stations, and transit stops. This policy would be used in the interim until such time that a City-wide network is established through the update to the Transportation Master Plan.*

**Comment** | The proposed development minimizes conflicts between vehicles and pedestrians by providing dedicated pedestrian pathways and an enhanced pedestrian crossing through the site. Direct connections to the public multi-use pathway have been provided at two locations from the site. New development frames the street by providing buildings with windows and doors fronting along Trim Road where possible. The parking and the drive-through have been provided to the rear of the buildings. Additional soft landscaping and larger trees have been provided along the side, rear and front lot lines, but also via traffic islands interior to the site.

## Section 5.6 Trim Minor Corridor

*The Trim Minor Corridor is intended to support the adjacent Local Production and Entertainment designation and the Trim O-train Station. 1) In addition to the uses permitted in the Local Production and Entertainment designation, commercial, restaurant and hotel uses may be permitted. 2) Residential is not permitted. 3) New or enhanced cycling and pedestrian connections will be pursued through tools such as: Site Plan Control, Community Benefits Agreements and traffic calming, in association with proposals for new development. 4) Development of sensitive uses such as a hotel is conditional on the submission of a Noise and Vibration study, and an analysis of existing or potential land use conflicts demonstrating compatibility. 5) Design strategies shall be implemented which may include locating non-residential sensitive land uses in a manner that shields them from nearby Class I or Class II industrial uses, framing the building to the adjacent street, maximizing setbacks in accordance with Provincial land use compatibility guidelines, and installing walls, fences, or landscaping to mitigate nuisances, where there is a current, or anticipated need.*

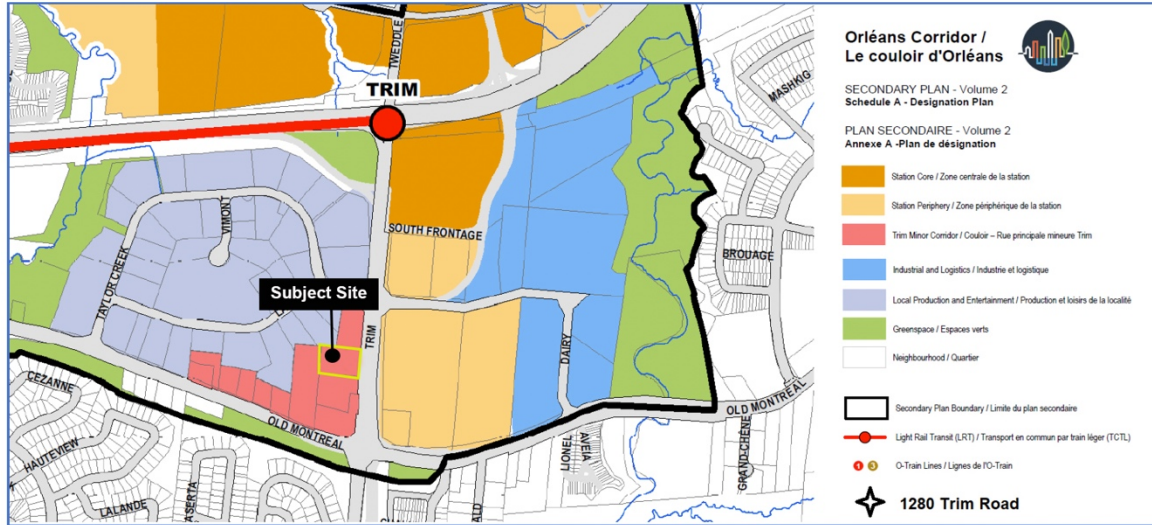

Figure 2: Excerpt of Orleans Corridor Secondary Plan

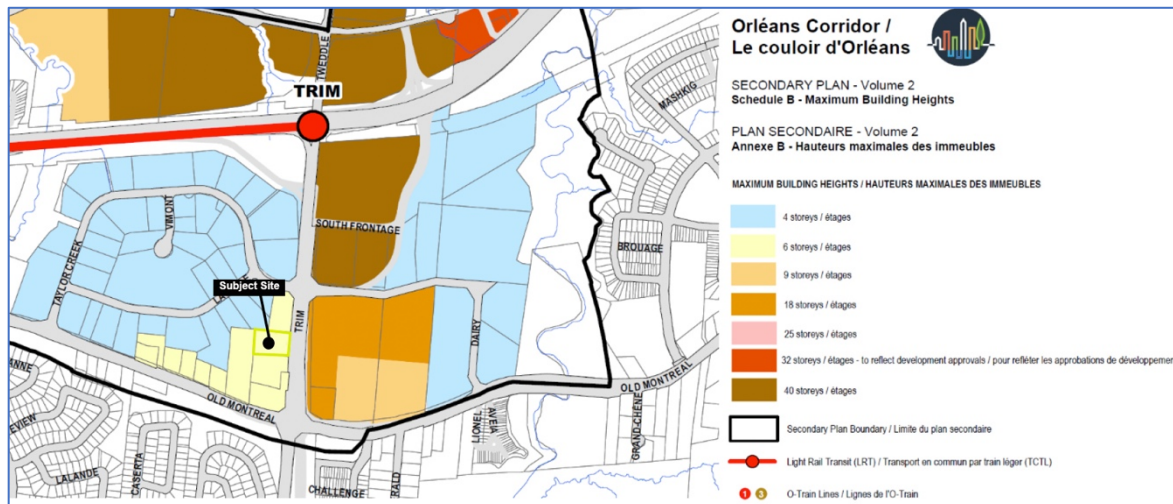

Figure 3: Excerpt of Orleans Corridor Secondary Plan

**Comment** | The proposed development will employ design strategies such as enhanced landscaping, framing the buildings towards the street, and using fencing and retaining walls due to the grade drop to mitigate noise off and on-site. Buildings will frame the street and any small portions of blank walls will be screened with landscaping.

### 3.4 URBAN DESIGN GUIDELINES FOR DEVELOPMENT ALONG ARTERIAL MAINSTREETS

The following section will provide an overview of how the proposed drive-through will meet the guidelines and standards outlined as part of the City's Urban Design Guidelines for Development Along Arterial Mainstreets:

Streetscape:

- [ Buildings are located along the street edge.



- [ A 2.0 m unobstructed public sidewalk has been provided along the frontage of the site connecting both the north and south portion of the site to the Trim Road multi-use pathway
- [ Plant trees in the boulevard.
- [ The development uses buildings, landscaping and other streetscape elements to create continuous streetscapes. Provide streetscape elements such as trees and bicycle parking between the building and the curb.
- [ New buildings will be setback 3.0 metres back from the front property line.
- [ Drive-thru stacking lane has been provided interior to the site to provide a streetscape that focuses on built form and pedestrian connection.

#### Built Form:

- [ The development has been designed to be compatible with the general physical character of adjacent neighbourhoods;
- [ The development is based on an internal circulation pattern that allows logical movement throughout the site that will accommodate, and not preclude, intensification over time;
- [ Buildings to occupy the majority of the lot frontage;
- [ The area in front of the building wall has been landscaped;
- [ Orient the front façade to face the public street and locate front doors to be visible, and directly accessible, from the public street.

#### Pedestrians and Cyclists:

- [ Provide direct, safe, continuous and clearly defined pedestrian access from public sidewalks to building entrances;
- [ Unobstructed pedestrian walkways are provided along any façade with a customer entrance, along any façade adjacent to parking areas, and between the primary entrance and the public sidewalk;
- [ A bike rack has been provided at the entrance to the site and does not conflict with pedestrian circulation.

#### Vehicles & Parking:

- [ Surface parking and the drive-thru is located at the side or rear of buildings.
- [ The development will provide close to the minimum number of parking spaces required by the Zoning By-law.

#### Landscape & Environment:

- [ Continuous landscaping is provided to reinforce pedestrian walkways within parking areas;
- [ Trees, shrubs and other vegetation have been selected according to their tolerance to urban conditions, such as road salt or heat. Give preference to native species of the region of equal suitability;
- [ Trees and street-light locations have been coordinated with above and below-grade utilities;
- [ A landscaped area has been provided which may include a solid wall or fence in addition to planting, at the edges of sites adjacent to residential or institutional properties;
- [ A landscaped area has been provided along the site's side and rear yards in order to provide screening and enhance environmental benefits.

Signs:

- [ Signs have been designed to respect building scale, architectural features, signage uniformity and established streetscape design objectives.

Servicing & Utilities:

- [ Utility equipment will be enclosed within buildings or screened from both the arterial mainstreet and private properties to the rear. These include utility boxes, garbage and recycling container storage, loading docks and ramps and air conditioner compressors;
- [ Lighting will be designed so that there is no glare or light spilling on surrounding sites;
- [ Lighting will be provided that is appropriate to the street character and mainstreet ground floor use with a focus on pedestrian areas.

### **3.5 URBAN DESIGN GUIDELINES FOR DRIVE-THROUGH FACILITIES**

The following section will provide an overview of how the proposed drive-through will meet the guidelines and standards outlined as part of the City's Urban Design Guidelines for Drive-Through Facilities:

Streetscape and Built Form:

- [ Massing is directed to the street frontage providing buildings that interface with the street, the multi-use pathway and define the street edge;
- [ Ample landscaping is provided in front of the buildings, on-site and adjacent to pedestrian entrances to enhance the street edge and the pedestrian rights-of-way;
- [ Bicycle racks are located close to building entrances;
- [ The street facing elevations contain adequate glazing to animate the public street and to provide view in and out of the buildings;
- [ Landscaping has been provided in front of blank walls to reduce the visual size of unglazed walls.

Pedestrians and Cyclists:

- [ An unobstructed walkway has been provided across private access driveways to connect Building 1 & 2;
- [ The walkway will be treated with a distinct paving material;
- [ Doors are close to parking area and a door has been provided facing the street and adjacent to the pedestrian site access and the bicycle parking area;
- [ Two pedestrian access have been provided directly from the multi-use pathway. This will allow pedestrians to safely access each side of the site;
- [ Landscaping has been added to delineate the pedestrian walkways and pedestrian access to the buildings;
- [ Bicycle parking has been located close to a building entrance in a manner that does not impede pedestrian movement;

Vehicles and Parking:

- [ Surface parking area and the drive-thru stacking lane is located at the sides and rear of

the building;

- [ Only a single access to the site is provided;
- [ Stacking lanes are located away from adjacent sensitive uses (located adjacent to the rear of the site) to reduce the impacts of noise and pollution that could be caused by stacking cars. Landscaping and fencing have been provided to help buffer such uses;
- [ The starting point to the stacking lane is located towards the rear of the site so that queued vehicles do not block traffic along public streets or the movement of other vehicles on-site;
- [ Stacking lanes have been separated from parking area using a landscaped island;
- [ The uses (A&W restaurants) will likely not see as many cars queuing on-site as a coffee shop use might;
- [ On-site circulation has been designed to minimize the conflicts between pedestrians and vehicles. The drive-through will wrap around the side of the building away from a pedestrian entrance.

#### Landscape and Environment:

- [ Trees, shrubs, ornamental grasses, and flower perennials have been planted throughout the site, as well as at the frontage of the site along Trim Road;
- [ A fence and a landscape buffer has been provided at the rear of the property where the site abuts a property zoned institutional;
- [ A tree canopy cover of 20% has been provided;
- [ Landscaped islands have been provided to break up the paved area and to store and filter stormwater.

#### Signs:

- [ A ground mounted sign will be located on the site which will complement that character and scale of the area. The sign will integrate landscaping at the base;
- [ Pavement markings will enhance clarity of movement patterns on-site;
- [ Buildings will include signs that respect building scale, architectural features and streetscape design objectives.

### **3.6 RESPONSES TO COMMENTS FROM STAFF AT PRE-APPLICATION CONSULTATION MEETING**

#### **Responses to Comments from Staff at Pre-Application Consultation Meeting (Phase 1):**

- [ *Comment:* The proposed office building should have glazing and windows facing Trim Road.
- [ *Response:* The proposed offices and personal services building (Building 2) will have windows and signage facing Trim Road. Please refer to Building Elevations.
  
- [ *Comment:* The parking should be consolidated near the automobile service station.
- [ *Response:* The greatest quantity of parking spaces on the site is located directly in front of the Automobile Service Building. A broad area in front of the proposed building without parking will permit vehicles to enter the service bays of the garage.

- [ *Comment:* How come there are three different waste locations? They should be consolidated.
- [ *Response:* Two Molocks locations are proposed because the two locations are required to serve the various tenant on the site and it is recommended to have waste / recycling for a food service building close to the building due to more frequent use. In addition, having two locations will allow smaller Molock containers to be used.
- [ *Comment:* Molocks need to be screened by landscaping as per the Zoning By-law.  
*Response:* The Molocks will be screened in accordance the Zoning By-law.
- [ *Comment:* Bicycle parking should be near the entrance of the drive-through and office building.
- [ *Response:* Bicycle parking has been added at the east side of the Offices & Personal Services Building.

**Responses to Comments from Staff at Pre-Application Consultation Meeting (Phase 2):**

- [ *Comment:* Active Entrances: Thank you for adding an active entrance to Building 2. Per policy 4.2.7 of the secondary plan, further emphasize this entrance through a direct pedestrian connection to the multi-use pathway.
- [ *Response:* There is an unimpeded direct connection from the entrance to the multi-use pathway. The bicycle parking has been moved away from the entrance towards a dedicated space behind the pylon sign to further empathize and provide accessibility to the entrance.
- [ *Comment:* You need to add an active entrance for Building 1 (restaurants with drive-through).
- [ *Response:* No active entrance can be provided for Building 1 as this will create a conflict between the vehicle (in the drive-through) and the pedestrian. While no door is provided along the frontage of the building, ample glazing and signage will be provided to activate the street fronting elevation. Further, the pedestrian walkway extends from the main door directly to the multi-use pathway.
- [ *Comment:* Drive-through Location: Staff do not support the request for a reduced width of a landscaped area abutting a street to 0.35 m whereas 3 m is required, as the relief requested is to accommodate a site design that Staff do not support. The restaurant building should have an active entrance from Trim Road, the drive-through facility should not be located between the building and the street. Instead, a seating area and bicycle parking should be next to the street, see figure three and four for a precedent of an A&W restaurant along Hunt Club Road where this was done. This would allow for an east-facing restaurant entrance and an unimpeded crossing for pedestrians. You should design the on-site circulation to minimize the conflicts between pedestrian and vehicles.
- [ *Response:* The building has been pushed back to accommodate a 1.5 m landscape buffer with trees and landscaping to provide screening along Trim Road. The drive-thru location is complicated by a narrow site (which makes accommodating it on the correct side of the building/vehicle challenging). In order to avoid conflict with the stacking lane and other vehicular circulation, it has been located behind the building.

- [ *Comment:* It is appreciated that well-located pedestrian crossings have been added within the site to facilitate pedestrian crossings. Provide curb extensions at the proposed north-south pedestrian crossing to increase safety and reduce the crossing distance. This change will require shifting the accessible parking locations slightly to maintain the required access aisle for the adjacent accessible parking stalls.
- [ *Response:* The pedestrian crossing has been moved further toward the front of the site to provide a more direct path of travel for the pedestrian.
  
- [ *Comment:* The multi-use pathway along Trim should be clearly demarcated to turning vehicles.
- [ *Response:* The multi-use pathway has been clearly demarcated. See the revision to the site plan.
  
- [ *Comment:* Provide a vegetated buffer from the existing childcare facility to the south (Kids Kingdom at 1290 Trim Road). This would also help to implement Official Plan policies relating to the urban forest canopy cover target (4.8.2) and reducing the urban heat island effect (2.2.3).
- [ *Response:* Additional planting along the southern property line has been provided in addition to more landscaping and mature trees throughout the site. This will increase the tree canopy on site and contribute to reducing the urban heat island effect. Also noted is that the site grading necessitates retaining walls and fencing that will contribute to significant buffer.
  
- [ *Comment:* I asked if you could reduce the size of the automotive service use, this was not done. The automotive service station use is capped at 300 square metres size, and Staff will not support increasing the size of this use past 300 square metres. The vision for this area is for the Orléans corridor to evolve from a late 20<sup>th</sup> century auto-centric suburb into vibrant urban neighbourhoods centred around the O-Train stations and the St. Joseph Blvd mainstreet, where residents and visitors can walk, cycle or take transit to daily destinations.
- [ *Response:* The automobile service use has been broken down into the applicable uses and the automotive use is only 330 m<sup>2</sup>. The building has been broken up into other uses which include a storage warehouse and office/showroom. Further, the proposed use is highly appropriate given that the site is located along a vehicular route to the park'n'ride facility. The LRT station is the last stop in the east link and will be used primarily to support weekday commuters who will travel from the residential area south of Old Montreal Road and park at the park'n'ride north of the subject site.
  
- [ *Comment:* The restaurant drive-through queuing lane needs to be relocated from between Trim Road and the building, see configuration in figure below.



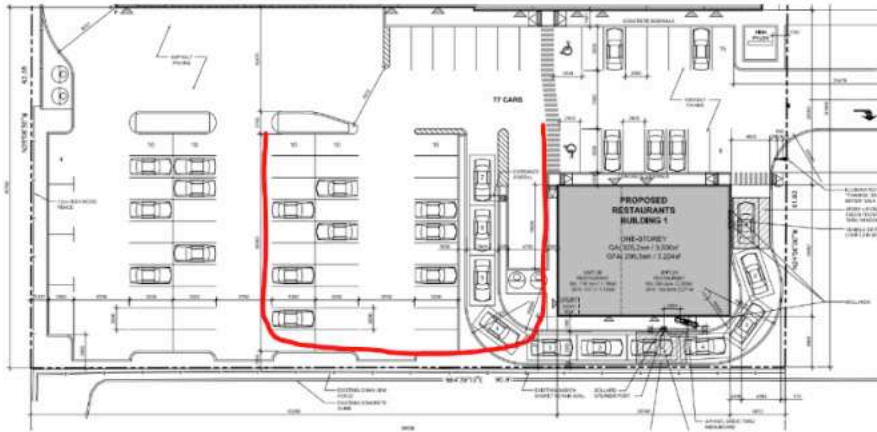

There are concerns with the distance of the deposited queuing lane and the access to the site. This would eliminate the landscape reduction along Trim Road and meet guidelines for Drive-Throughs. Parking and the waste collection area can be configured within the u-shape. If this option is not viable, it must be discussed in the design brief as to why.

- [ *Response:* This option is not viable as it would result in a situation where the passenger side window comes in contact with the drive-thru pickup window.
- [ *Comment:* A more significant tree line along Trim Road is requested. The landscape plan must show underground services (as per the City's TOR) to understand if there are underground constraints. If there are underground constraints paired with overhead wires, alternative areas within the site for large canopy trees will need to be explored. It is recommended that the parallel parking stalls (4 stalls) at the rear of the site are removed so that large canopy trees can be provided. Shift the tire rack and waste area south so that large canopy trees can be planted in the rear, see Figure 8. Understood there is a doorway in the vicinity, switch the tire rack and waste area so that the waste doors do not conflict with the doorway.
- [ *Response:* Tree planting has been maximized with the site's constraints for geotechnical offset, hydro line and servicing. Tree locations are also designed to be cognizant of wayfinding.
- [ *Comment:* Please ensure there is a pedestrian crossing shown on the plan (MUP). Please show the snow storage location on both the Site Plan and Landscape Plan. Please locate this area away from new tree plantings to prevent undue pressure and damage to tree trunks. Please consider switching shrub plantings to columnar tree plantings on the north side of the site, behind the buildings. While its great to see so much planting, this would require a robust maintenance plan. The City objectives of increasing tree canopies would benefit if some shrubs in the area highlighted below could be changed to cedars or columnar deciduous trees. If there are plantings, pavers or landscape elements within the right-of-way (ROW), then a maintenance and liability agreement be required for those elements.
- [ *Response:* A pedestrian connection will be provided on both the landscape and site plan. A 3 by 20 metres snow storage area is provided at the 4 parallel parking spots at back. A snow fence will be added during the winter months to protect the tree planting. The landscape plan has increased the tree canopy with 4 ornamental trees and 5

medium trees along the north side of the building which fits within the Geotech offset. 5 upright junipers plus 1 additional conifer is added behind the garbage enclosure.

### **May 2024 Update:**

In May 2024, our team updated the Site Plan to address many of the comments and concerns heard from City Staff. The following provides an overview of the changes. A plan revision follow up meeting with City staff was held on May 29th, 2024. The responses from that meeting indicated support from most disciplines.

- [ The drive-through has been relocated behind the building and building 1 has been moved to the north. Unit 2 on Building 1 had to be removed and the plan lost 3 parking spaces even with Unit 2 removed.
- [ The tire storage is located inside of an enclosed accessory structure and does not need to be located internally to the building. Per our conversation, we will provide a render / 3D image of the proposed structure for review.
- [ The location of Building 1 is swapped with the location of Building 2 and 3. In this layout the restaurants with drive-through will be located next to the adjacent Tim Hortons restaurant with drive-through.
- [ In the proposed revision, building 2 had to be moved closer to the property line but the overall amount of landscaping on site is improved from the previous version. The north interior and rear yard do not have buildings abutting the lot line for the majority of the expanse and given that, the setback for the building as a performance standard adjustment is considered to be highly appropriate.

Lastly, tree planting is able to be provided around the perimeter, in the front, within the parking lot and within the drive-through area. This is an appropriate balance that allows both functional parking, sufficient leasable space on site for viability, and tree planting. A tree canopy of 20.73% is provided.

### **Responses to Comments from Staff at Pre-Application Consultation Meeting (Phase 2):**

- [ *Comment:* There is no discussion of the Orleans Corridor Secondary Plan in the Design Brief.
- [ *Response:* The design brief has been modified to include a discussion of the Orleans Corridor Secondary Plan.
- [ *Comment:* The description on page 25? (there are no page numbers) for figure 15 states that there are transit stops nearby. There is an LRT station north but where are the stops? This should be shown visually at a scale that can be understood a pedestrian walking distance.
- [ *Response:* An additional graphic, Figure 19 was added to the report to show adjacent transit stops.
- [ *Comment:* The Design Brief is missing “Massing of the proposed development in the existing context”. Please show this visually.

- [ *Response:* An additional graphic, Figure 24, was added to show the proposed buildings within the existing context.
- [ *Comment:* The Design Brief is missing an analysis of “Response to abutting public realm conditions beyond the boundaries of the site”. This should be shown visually.
- [ *Response:* Shown visually in Figure 25.

## 4.0 SITE, CONTEXT & ANALYSIS

### 4.1 PRECEDENT IMAGE



Figure 4: Precedent Image

As is outlined in the precedent image, when developing a building and site concept for the property on Trim, the main goals and objectives of the development are to (1) provide light industrial uses that serve the local community (2) activate the Trim street frontages through massing orientation, signage, building design, pedestrian access and landscaping, (3) provide commercial and light industrial uses in close proximity to a transit area, (4) bring new landscaping and trees to an underutilized, vacant site, (5) design high quality buildings that fits contextually within the local community.

### 4.2 EXISTING SITE CONDITIONS

The subject property contains a two-storey industrial building that is currently not in use. The site is also occupied by a food truck and is used as a storage yard for a landscaping and snow removal contractor. The property has frontage along the west side of Trim Road and abuts a gas station with a drive-through restaurant to the north, a large daycare facility to the south, and a church property and another daycare to the west. The property across the street is currently undeveloped. The site is located between the intersections of Taylor Creek Drive / Trim Road and Old Montreal Road / Trim Road, both of which are controlled with traffic circles.

The area consists of a mix of commercial and industrial uses, along with a large undeveloped parcel on the east side of Trim Road and residential uses to the south of Old Montreal Road. The site is noted for its relative proximity to Old Montreal Road / St. Joseph Boulevard and Highway 174, which connects the property with nearby towns to the east and the rest of Ottawa to the west. The disused industrial building is located on the northern portion of the site closer to the front of the lot. An L-shaped asphalt parking lot is also located at the front of the site off the existing access from Trim Road. Most of the property is grassed, with some trees located on the property. Site images are provided on the following pages.



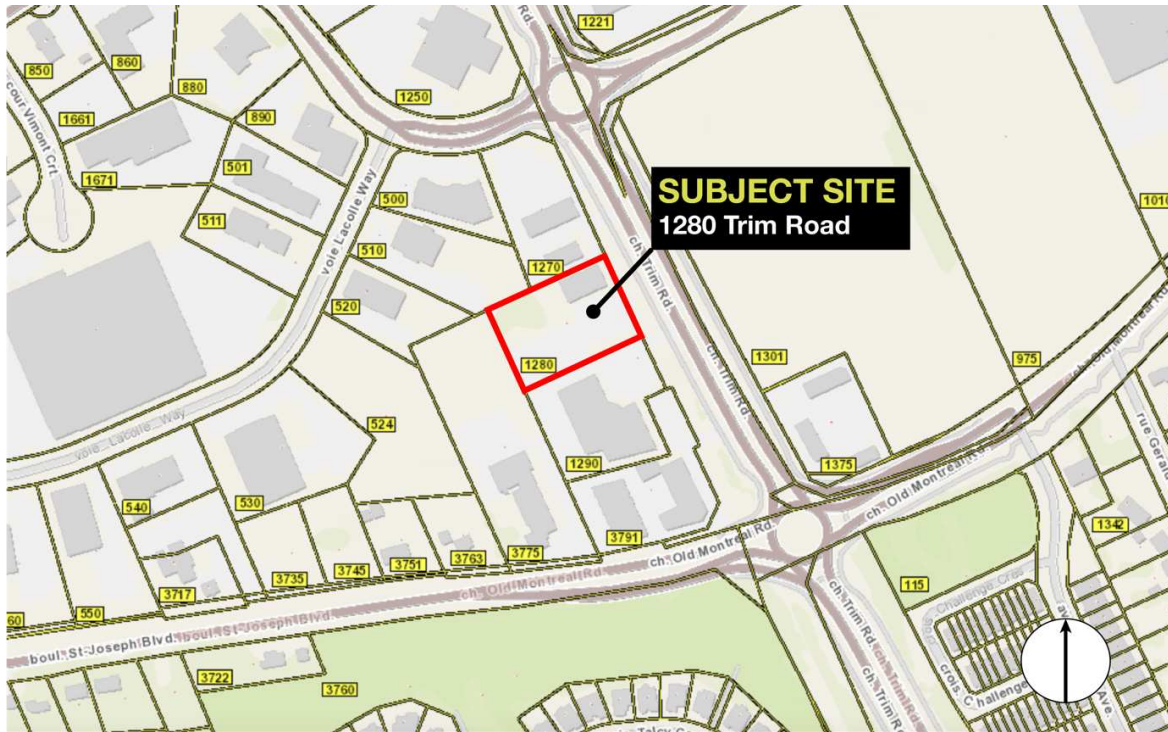

Figure 5: Site Map. (Source: GeoOttawa).

The following represents the site's current dimensions:

- [ Lot Area: 5,620 m<sup>2</sup>
- [ Lot Frontage: 61.90 m
- [ Lot Depth: Irregular, 90.56 – 90.77 m



Figure 6: View of the site from the frontage of the property looking north along Trim Road. The black building on the left side of the photo is location on the subject property.





*Figure 7: View of the south side of the subject property. The building in the photo is located on the adjacent property to the south*



*Figure 8: View across the street from the subject site on Trim Road, looking east*





Figure 9: Streetscape along Trim Road, looking north from the subject site.



Figure 10: View of the frontage of the site (right side of photo) including a food truck currently located on the subject property, looking south along Trim Road.





Figure 11: View of the site looking west. The building (left side of the photo) is on the adjacent site to the south. Note the retaining wall along the southern property line and the landscaping in the rear.



Figure 12: View of the site from the rear of the property. The building (left in the photo) is located on the subject property.

### 4.3 SURROUNDING CONTEXT

The property is located within the Fallingbrook neighbourhood in Ward 1 – Orléans-East Cumberland. Fallingbrook is located in the northeastern part of Orleans outside the Greenbelt in Ottawa's east end.

The surrounding neighbourhood is characterized by arterial commercial properties along Trim Road, Old Montreal Road, and Taylor Creek Drive. A variety of commercial uses are present including daycares, drive-through restaurants, and an auto dealership. Industrial and commercial uses on large lots are also located to the west of the property along Taylor Creek Drive and Lacolle Way. Residential subdivisions are located nearby further down Trim Road south of St. Joseph Boulevard and Old Montreal Road. The area is also noted for the proximity of Highway 174, which runs east towards Cumberland and west towards Highway 417. The property is also located near the OC Transpo Trim Road Park & Ride, which provides transit connection to Millennium Station in southeastern Orleans and rapid transit connection to Blair Station. Most of the commercial and industrial properties are characterized by low-rise, large floorplate buildings with large surface parking areas and landscaped areas.

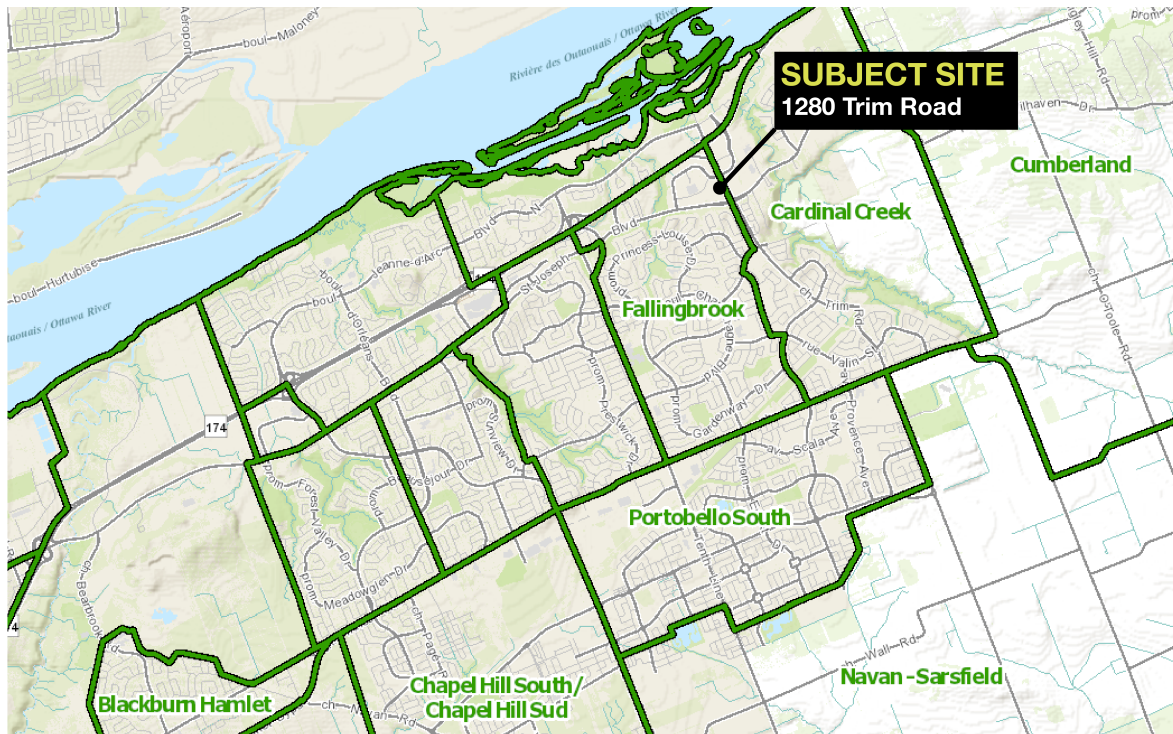

Figure 13: Neighbourhood Context Map





Figure 14: Site Context Map

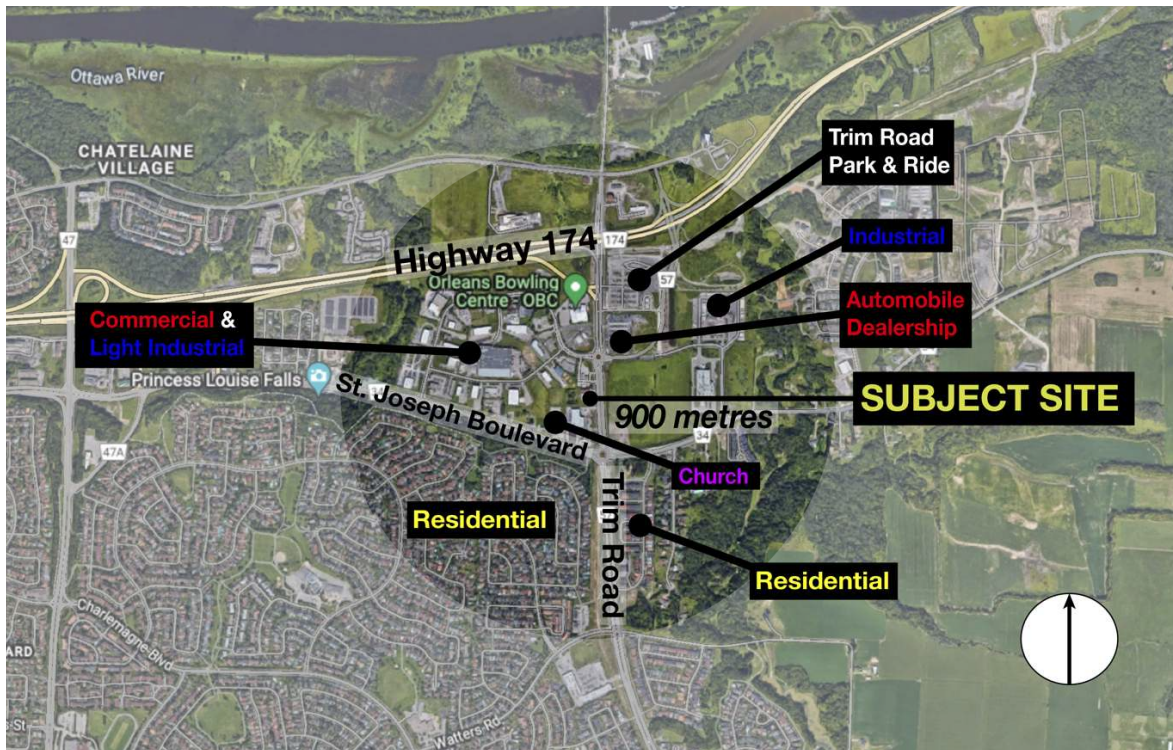

Figure 15: Overall Context Map, 900 m radius









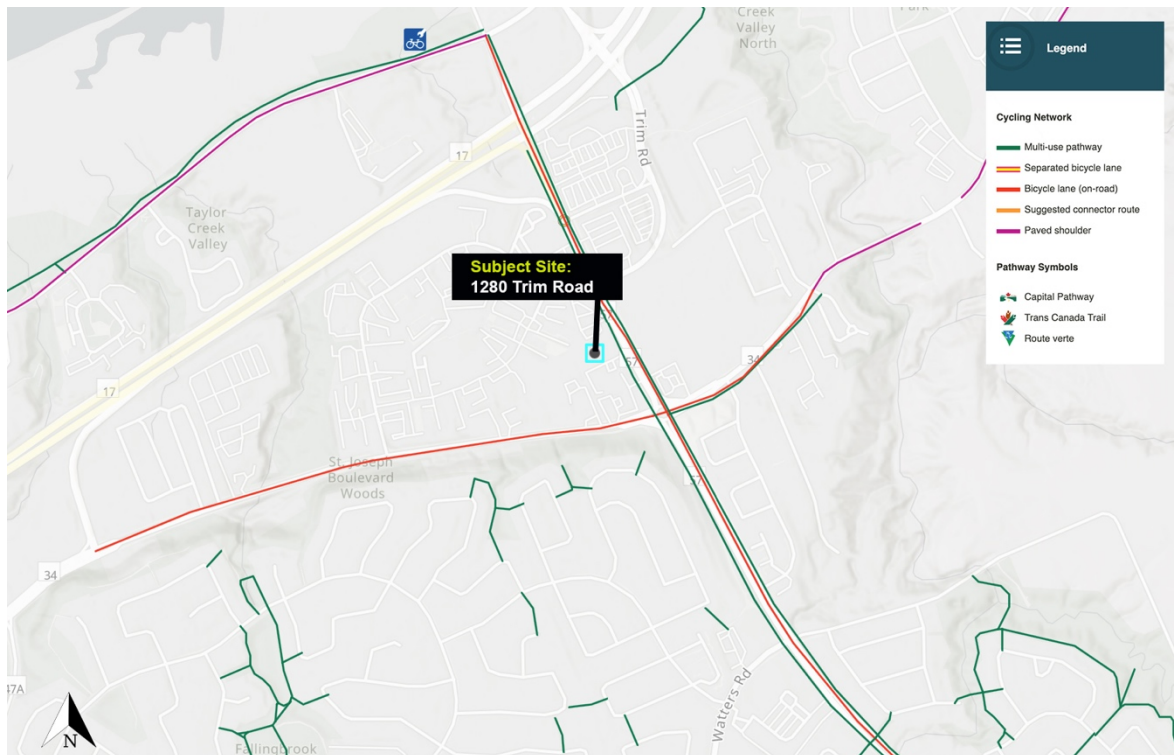

Figure 18: Mobility Networks Transportation Map (Source: NCC)

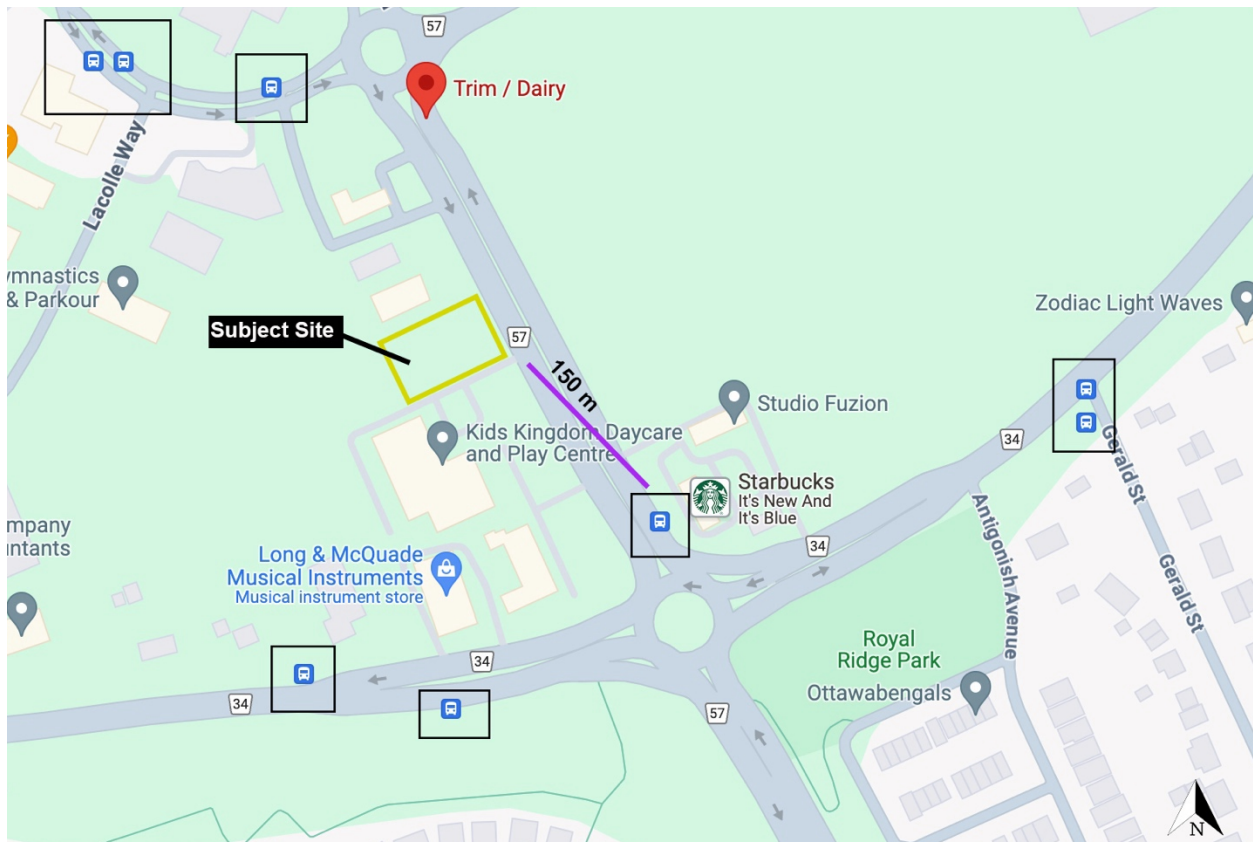

Figure 19: Adjacent transit stops (Source: Google maps)

## 4.5 MASSING, ORIENTATION AND DESIGN

Two of the proposed commercial and light industrial buildings will be situated along the frontage of the Trim Street property, addressing the street, and providing easy pedestrian access to the site. The larger automobile service use will be located towards the rear of the site.

The site is located approximately just north of Old Montreal Road and just south of Highway 174. The building will front onto Trim Road and importantly, a multi-use path which will run in front of the site. The following image shows the multi-use path that travels across the frontage of the property bringing customers by foot and bike. The following graphic shows the pedestrian circulation through the site, accessing all three buildings including an area at the front of the site which can serve as bicycle parking.

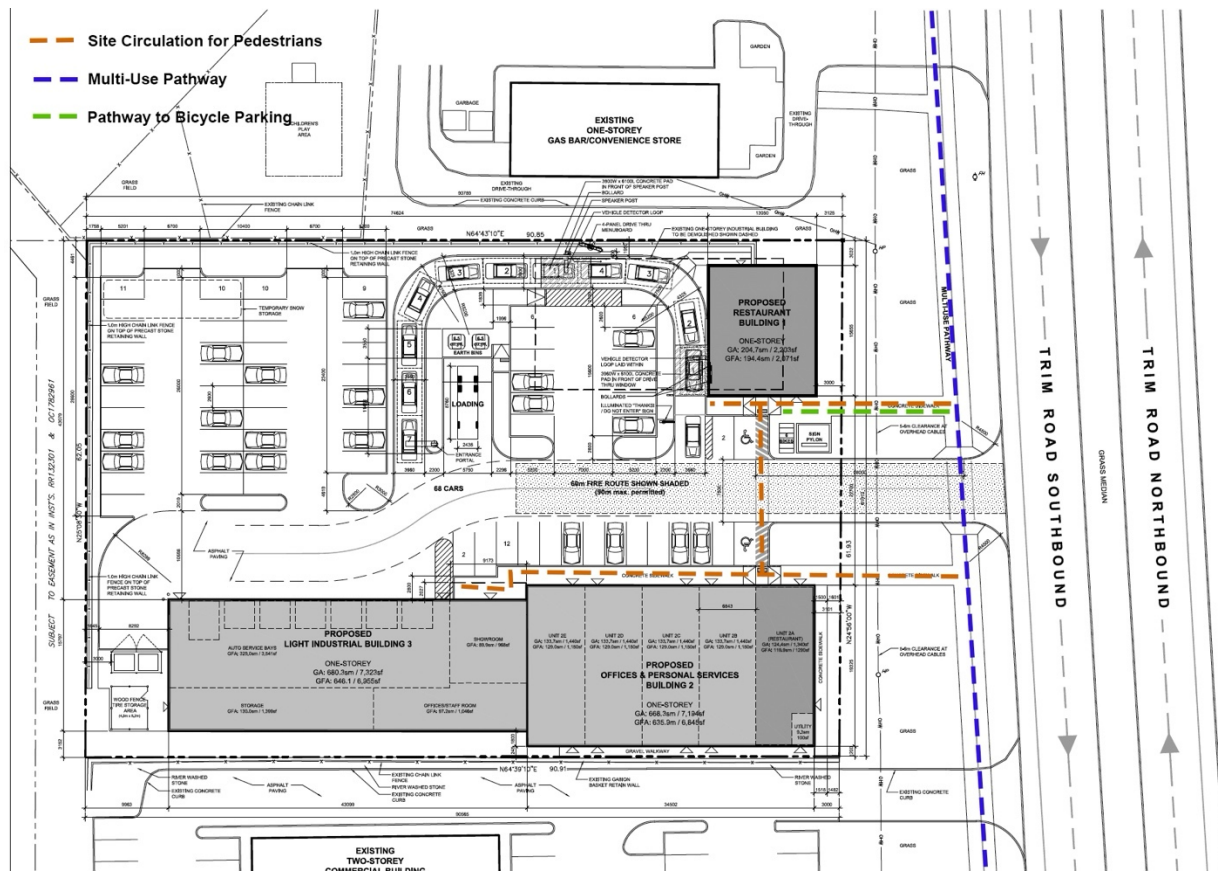

Figure 20: Site Circulation for pedestrians and cyclists

The images below demonstrate the depiction of the building and site in the form of renderings and elevations:





Figure 21: East elevation, looking directly at the site from Trim Road (McRobie Architects)



Figure 22: Birds eye view of the site and proposed development (McRobie Architects)



02 BUILDING 2 and 3 ELEVATIONS



01 BUILDING 1 ELEVATIONS

Figure 23: Coloured Building Elevations (McRobie Architects)

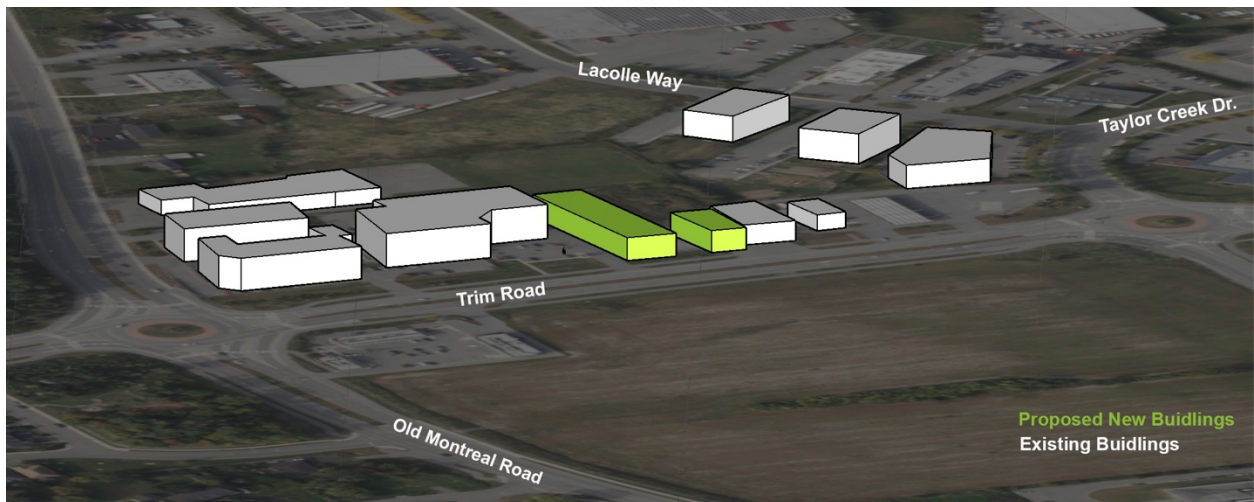

Figure 24: Massing model showing proposed buildings (green) within the existing context



#### 4.6 URBAN PATTERNS

The street pattern adjacent to the subject site are arterials at Trim and Montreal with local roads connecting to the arterials in a non-grid like pattern. Streets are curvilinear with irregular lot fabrics and cul-de-sacs. There are a few existing parks south of the subject lands along Old Montreal Road. There exists a pedestrian network that connects the area to the west to the multi-use trail that runs along the frontage of the subject property.

#### 4.7 PUBLIC REALM CONDITIONS BEYOND SITE

There are a few existing parks south of the subject lands along Old Montreal Road. There exists a pedestrian network that connects the area to the west to the multi-use trail that runs along the frontage of the subject property. Royal Ridge Park is located at the southeast intersection of Old Montreal Road and Trim Road and is located approximately 200 m from the subject site. The park is mostly forested and contains a trail and outdoor rink. St. Joseph Boulevard Woods is located at the southwest intersection of Trim and Old Montreal Road and extends along Old Montreal Road.



Figure 25: This image shows the street pattern and the park space and pedestrian path within greater context



## 5.0 DESIGN RESEARCH

### 5.1 EXPLORING SITE LAYOUT OPTIONS

During the preliminary design phase, we explored all options for the placement of three (3) buildings on the site. We explored the placement of the buildings in various positions on the site. We did note a few constraints that limit where buildings could be placed;

- (1) Vehicle access needs to be provided
- (2) As a result of the sites industrial zoning, larger building setbacks provided than generally typical corridor sites
- (3) Anchor tenants necessary to maintain project viability
- (4) Sufficient parking in consideration of temporary snow storage and the site's location along a commuter route to a park'n'ride facility
- (5) Site circulation that is efficient and appropriate

## Option 1: Three Buildings, Building 3 at Rear of the Site with Drive-Through

Our design team explored the placement of three buildings on the site, arranged with two buildings fronting on Trim Road and one building at the rear of the site. Given the property adjacent to the rear yard is used for institutional purposes, the option below results in off-site compatibility issues, circulation issues, and results in a very inefficient parking layout. Providing three separate buildings on site, resulted in challenging site circulation and wrapping a drive-through behind the building would not provide an ideal scenario for the abutting institutional uses. This option results in an efficient parking layout that would be challenging for snow removal and separating the buildings is a less sustainable form of construction.

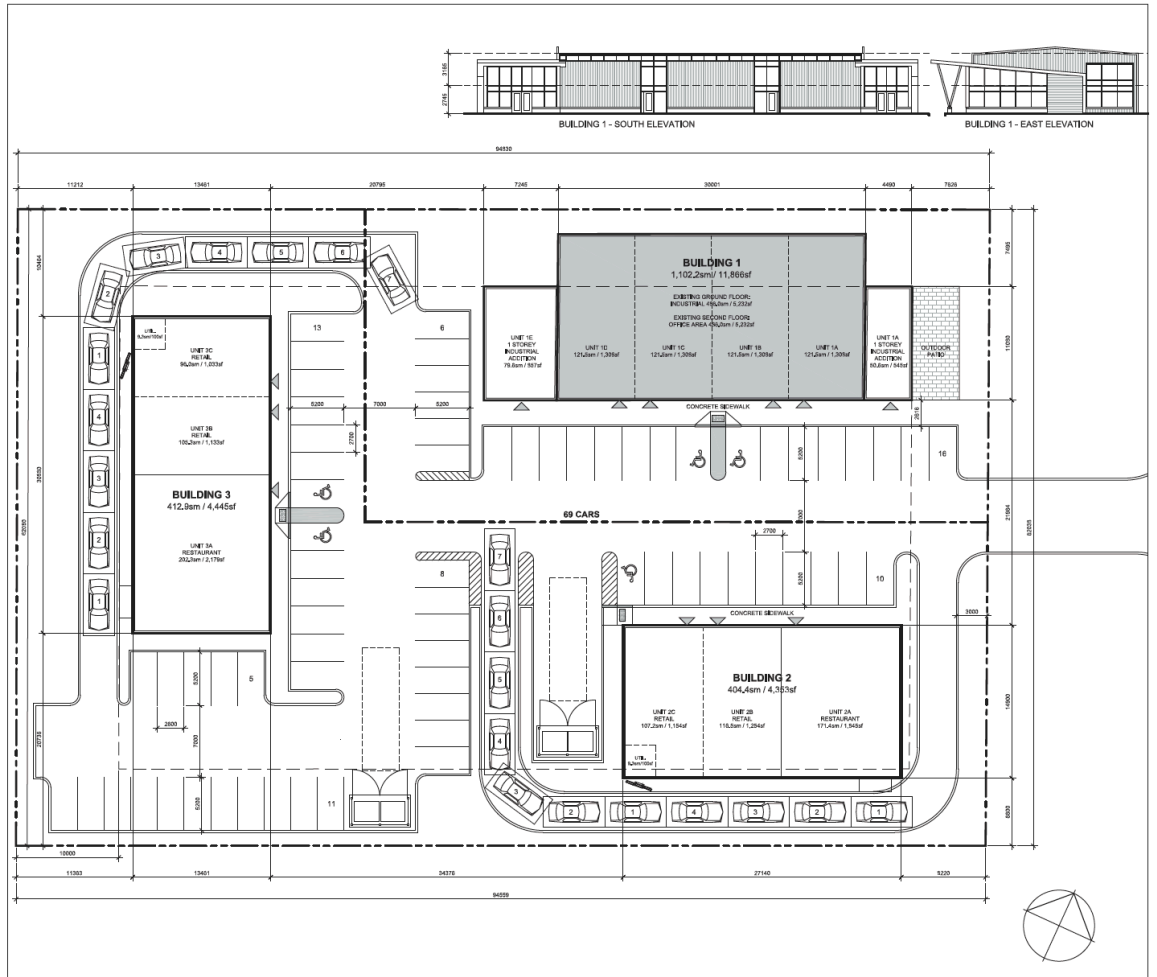

Figure 26: Exploring Site Options: Option 1

## Option 2: Three Buildings, Building 3 at Rear of the Site

Option 2 looked at the placement of Building 3 at the rear of the site with parking behind the building. Situating building 3 at the rear of the site makes it more difficult to provide safe pedestrian and bike access to the building at the rear of the site. In order to optimize for the safest site circulation, this option was not selected. Similar challenges in this version which resulted in inefficient parking layouts and separated building masses which is an inefficient use of the site.

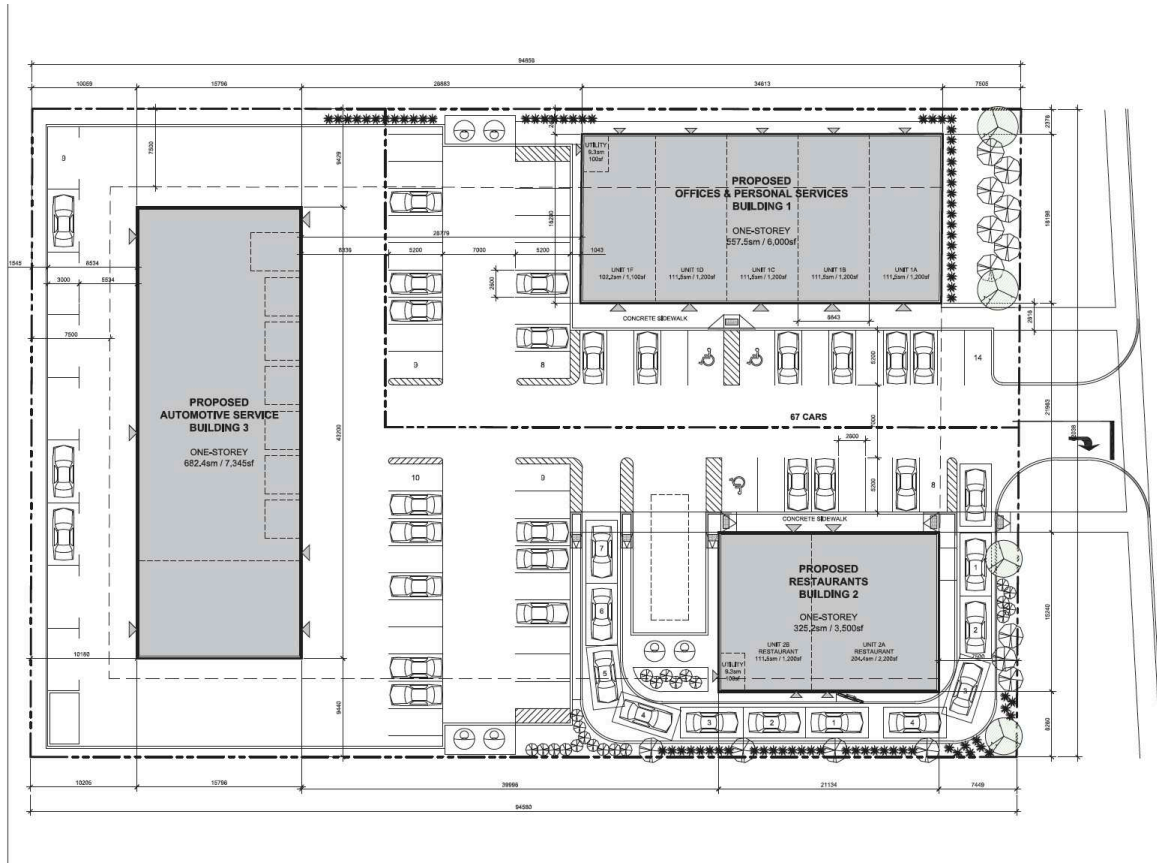

Figure 27: Exploring Site Options: Option 2

### Option 3: Three Buildings with Associated Parking

Option 3 looked at providing three buildings on-site with a parking lot in the rear. All of the three buildings were broken down into smaller units. When the option for an automobile service use came available, this concept had to be reworked and was no longer suitable for the intended program and anchor tenants needed to support the redevelopment of the site. Further, separating the buildings in this manner was an inefficient form of development over the proposed option.

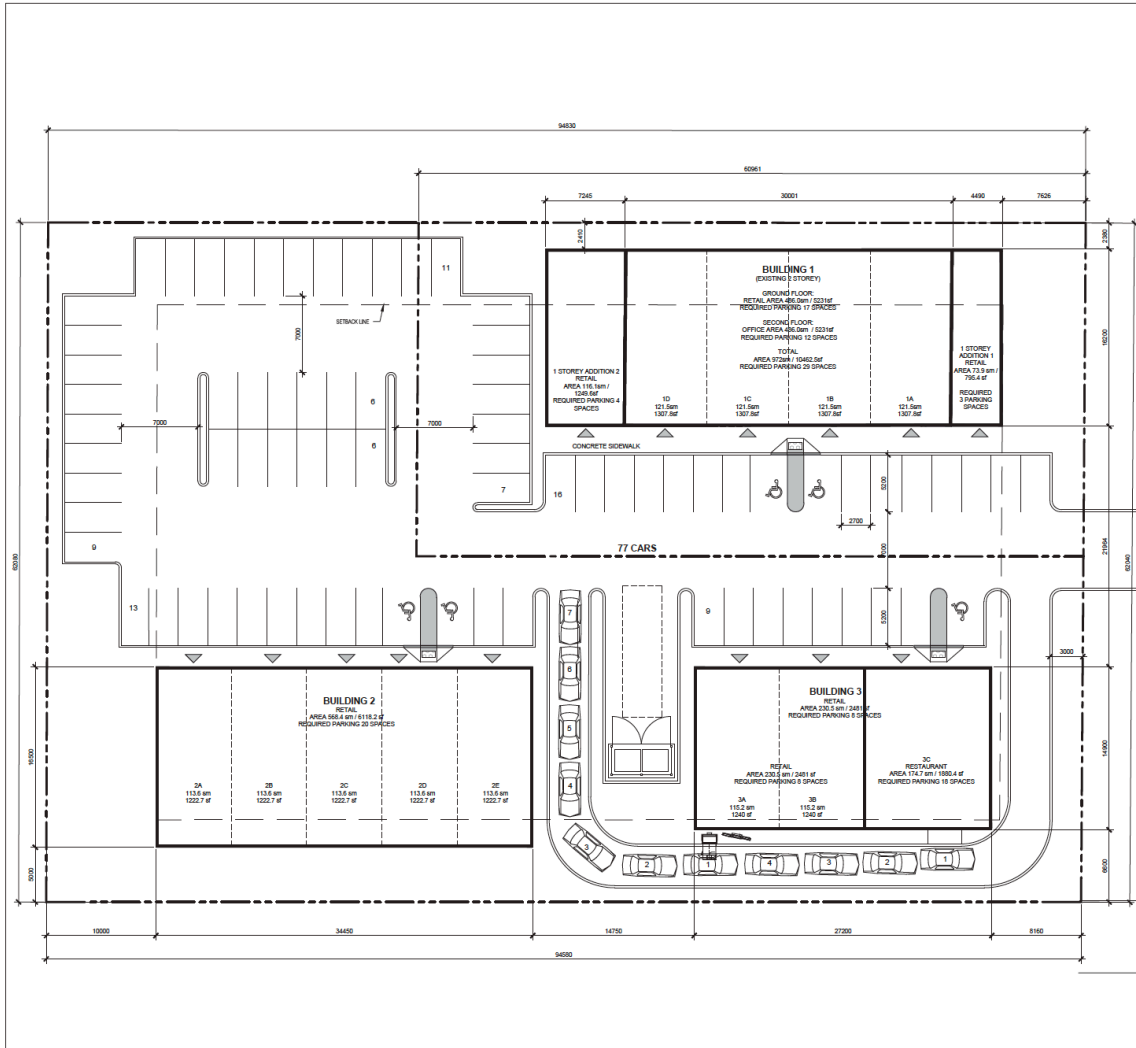

Figure 28: Exploring Site Options: Option 3

### Option 4: Drive-Through in Front of Building

Option 4 results in two buildings that frame the street and a connected building at the back that would screen adjacent properties from the parking. The buildings are all single storey but from a massing perspective, due the commercial/light industrial nature, may read more as 2 storey buildings. The concept also permitted garbage locations to be somewhat consolidated on the subject property to avoid and limit unnecessary garbage truck movement. The drawback to Option 4 is that the drive-through wraps around the front of Building 1 along the street edge.

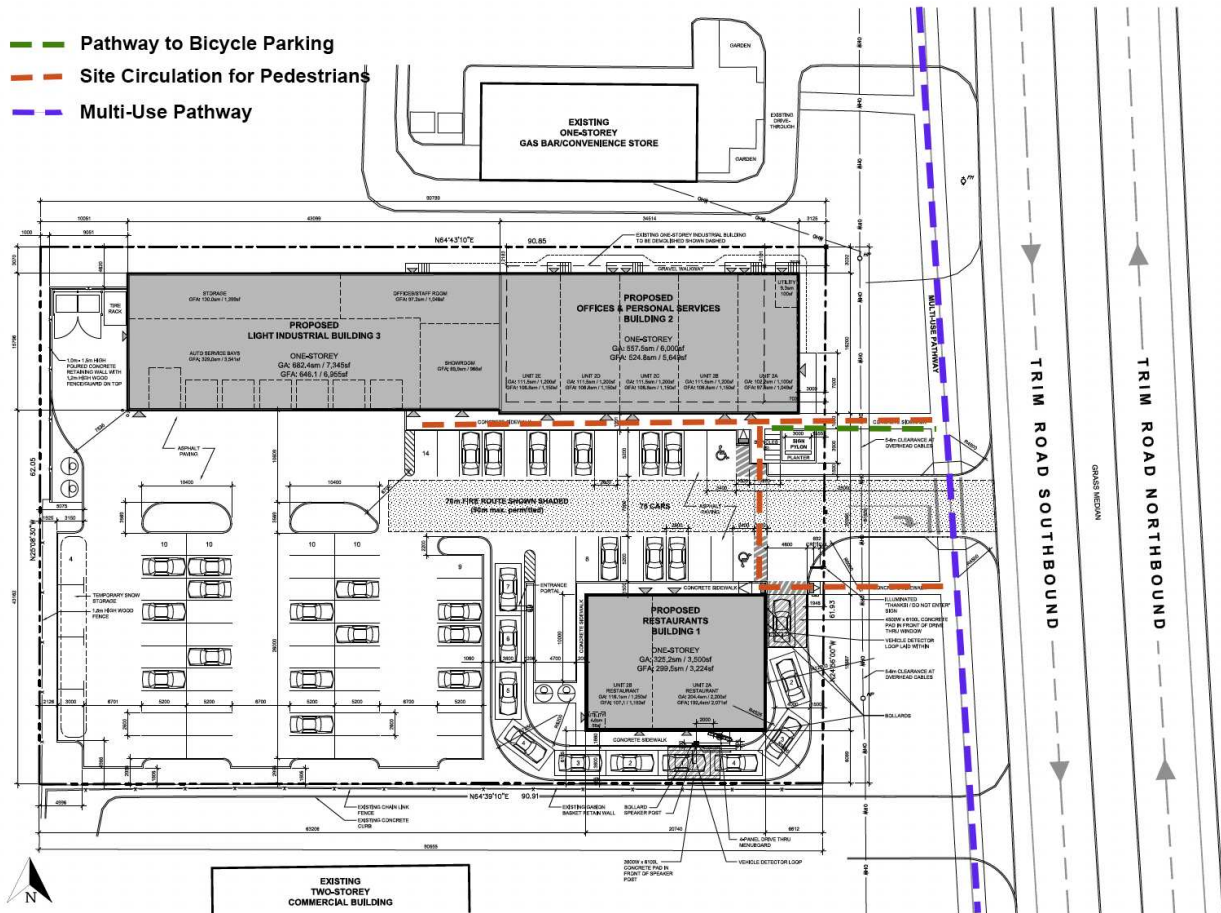

Figure 29: Exploring Site Options: Option 4

### Opportunities and Site Constraints

When considering the constraints, we looked at the building uses, sizes, site circulation and access, and appropriate setbacks. Given the largest building will contain an automobile service use, we felt it would make sense to place this at the rear of the site as this would be accessible and used by people arriving in a vehicle. The restaurant, office and personal services uses were placed at the front of the site, as while some users will arrive in vehicle, the buildings are more accessible to those utilizing the multi-use pathway at the front of the property and those that might access the site from the transit stop. The smaller buildings with more finer grain commercial space will further lend themselves to providing building frontages that better address the street though design, landscaping, fenestration, articulation, and material changes. Glazing would be difficult to provide on the side/front elevation (addressing the street) of an automobile service shop, therefore it was felt that this building was better suited for the rear of the site.

The proposed option results in two buildings that frame the street and a connected building at the back that would screen adjacent properties from the parking. The buildings are all single storey but from a massing perspective, due the commercial/light industrial nature, may read more as 2 storey buildings. The drive-thru has been relocated to the interior of the site to avoid cars moving across the street frontage. In the final concept the restaurant has been provided to the north of the site and the office/personal service/automobile service uses are to the south. The site to the north of the subject property also contains a drive-through that will abut the





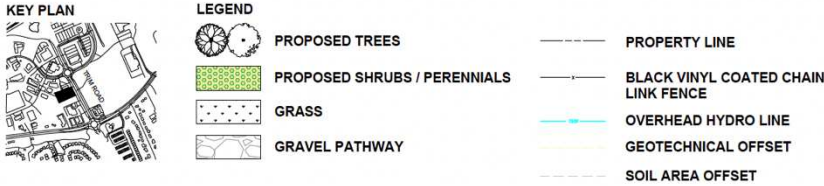
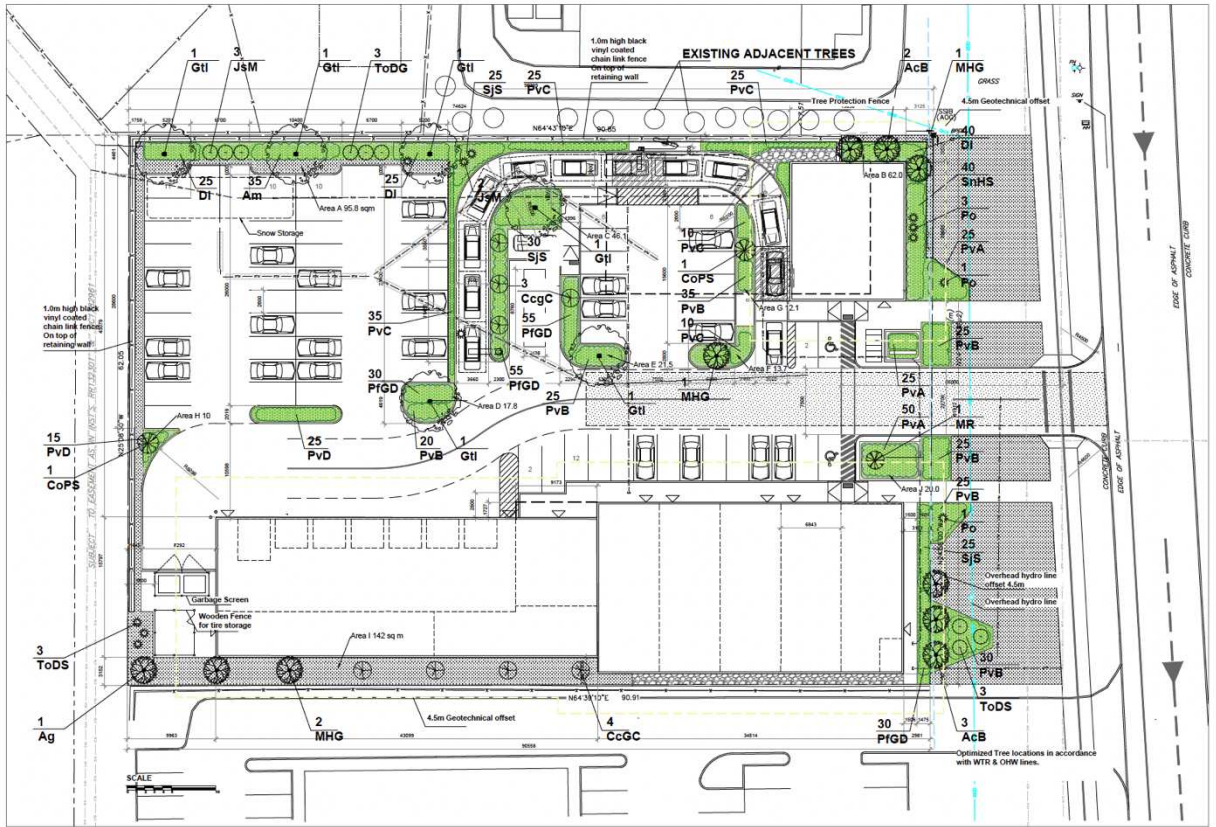

Figure 31: Proposed Site Plan with Landscaping (McRobie Architects + Ruhland + Associates)

#### TREE CANOPY COVERAGE

TOTAL CANOPY AREA	1165	m <sup>2</sup>
TOTAL SITE AREA	5619	m <sup>2</sup>
PERCENT COVERAGE	20.73%	

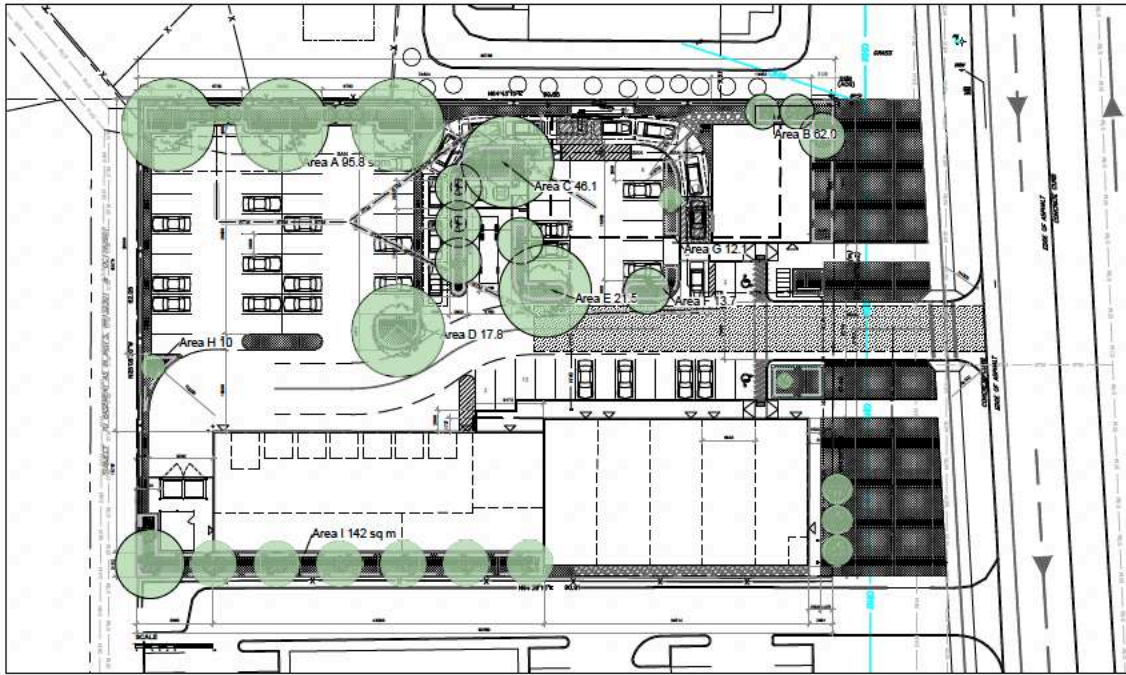

Figure 32: Proposed Tree Canopy Cover (McRobie Architects + Ruhland + Associates)

The proposed massing works to appropriately transition between the existing light industrial uses to the side and rear of the subject site, and the frontage of the property along Trim Road. The rear of the buildings will abut the neighbouring sites which will allow for landscaping buffering and the concentration of the movement and noise to the interior of the site. Two buildings will front onto Trim Road to have the built form address the street and the multi-use pathway. While the restaurant use will require a drive-through, the stacking lane will be screened from the side by the building, change in grade, retaining wall, and landscaping and to the front of the site by generous landscaping. Given the nature of the restaurant (A&W), it is anticipated that the drive-through will be less frequently used than a coffee shop drive-through and will have fewer cars persisting in the stacking lane.

Material changes and subtle architectural detailing further articulate the facades, breaking them down to provide a more human scale experience. Wood accents are emphasized throughout the design, adding warmth, unifying the design, and contextually aligning with the neighbouring properties.

The development will provide 68 vehicular parking space which includes and barrier free spaces, all provided in various locations on the site for maximum accessibility. The parking will meet the requirement in the By-law which will ensure there is enough parking, without detracting from the ability to provide landscaping on the site. The development will also provide 6 bicycle parking spaces, all of which will be located securely at the front of the site, behind the sign, in a bicycle parking rack easily accessible from the multi-use trail.

The overall development will provide an appropriate built form, which aligns with the building height of the surrounding neighbourhood. The buildings are designed to frame the street, with setbacks and articulation providing sufficient space to accommodate trees and landscaping. The proposed density will support planned 15-minute communities in the area while ensuring a transit-supportive density that will allow for optimal use of existing and planned transit services to the community.

### Street Cross Section

The cross section provided below of the site as it interfaces with Trim Road (looking south). The section shows that the one-storey buildings at the front of the site are appropriate in scale and placement with the street. The section illustrates landscaping that has been provided both on-site and in the right-of-way in front of the building providing buffer between the buildings and street. As noted on the cross section looking south, the garbage and tire storages are enclosed, therefore no outdoor storage is provided on the site.

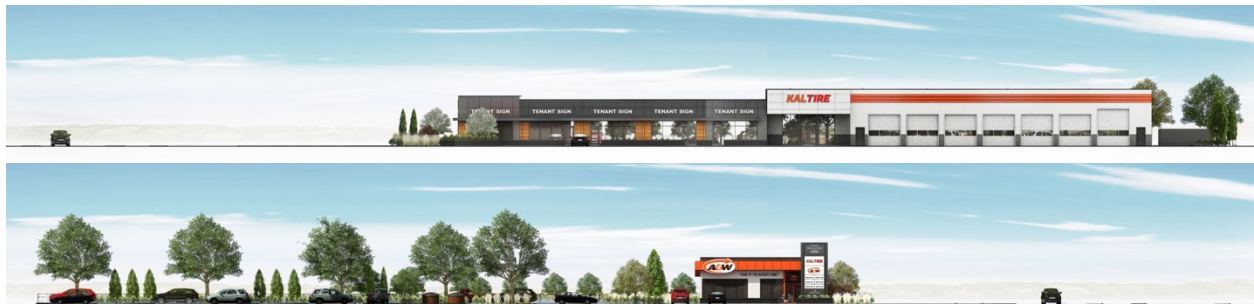

Figure 33: Top: Site cross sections looking south; Bottom: looking north (McRobie Architects)

Overall, the development will result in well-designed low-rise light industrial / commercial development that will support the needs of a significant number of dwellings to the area and support the planned function of Trim Road as a commercial corridor as well as a safe and healthy neighbourhood.

## 5.2 ENERGY EFFICIENCY & SUSTAINABLE DESIGN

The following is an overview of the elements about the design that support energy efficiency and sustainable design principles:

- [ **General:**
- [ The location of the proposed development makes use of existing infrastructure and promotes intensification by providing goods and services in close proximity to established residential neighbourhoods, public transit, bicycle and pedestrian routes.
- [ The larger building running east-west along the north property line takes full advantage of access to natural light.
- [
- [ **Landscaping:**
- [ The site will rely on the use of native and adaptive trees and shrubs that are hardy to the Ottawa area and have proven to succeed in this type of development.
- [ Exterior planting will be more diverse due to the changing conditions.
- [ Hardy deciduous trees will provide shade for parking and pedestrian spaces and reduce

heat island effect in the summer months.

- [ A tree canopy cover of 20% will be provided.

- [ **Storm Water Management:**

- [ The project includes storm water management designed to attenuate the post development storm water flows to the pre-development levels.

- [ **Energy Efficient Design:**

- [ The building envelope, mechanical and electrical systems and equipment will be designed in accordance with SB-10 of the Ontario Building Code for energy efficiency.

- [ **Construction Methods:**

- [ A waste management strategy and waste reduction workplan will be implemented during construction.

- [ During all construction activities, erosion and sedimentation shall be controlled in accordance with Ontario Provincial and City of Ottawa standards.

- [ Mud mats will be used to limit movement of soil off-site.

- [ Nearby roadways will be cleaned regularly.

- [ Careful timing of noise producing activities will limit noise pollution.

- [ **Building Materials:**

- [ Building envelope will be made up of durable, mold and moisture resistant materials.

- [ Low VOC materials will be used for insulation, paints, adhesives, sealant, and flooring.

- [ Window glazing will incorporate low e coatings resulting in a very low solar heat gain reducing the impact on extreme heat events.

- [ Roofing material will be light-coloured and reflective to reduce heat island effect.

- [ Site lighting will be designed with cut-offs to limit light spillage beyond the property lines.

## 6.0 LIMITATIONS OF REPORT

This report has been prepared for the exclusive use of Trim Works Development Limited for the stated purpose. Its discussions and conclusions are not to be used or interpreted for other purposes without obtaining written permission from Q9 Planning + Design Inc. as well as Trim Works Development Limited.

This report was prepared for the sole benefit and use of Trim Works Development Limited and may not be used or relied on by any other party without the express written consent of Q9 Planning + Design Inc.

This report is copyright protected and may not be reproduced or used, other than for the stated purpose, without the express written consent of Q9 Planning + Design Inc.

Prepared by :



**Dayna Edwards, MCIP RPP**  
www.q9planning.com  
Ottawa, ON

**P :** +519 501-1115  
**E :** dayna@q9planning.com



Reviewed by :



**Christine McCuaig, MCIP RPP**  
www.q9planning.com  
Ottawa, ON

**P :** +613 850 8345  
**E :** christine@q9planning.com





**OWNER:**  
**TRIM WORKS DEVELOPMENT LTD.**  
110 Place d'Orleans Drive  
Orleans, ON K1C 2L9

**PLANNING CONSULTANT:**  
**Q9 PLANNING + DESIGN**  
C-43 Eccles Street  
OTTAWA, ON K1R 6S3

**CIVIL ENGINEER:**  
**LRL ENGINEERING**  
5430 Canotek Road  
Ottawa, ON K1J 9G2

**LANDSCAPE ARCHITECTS:**  
**RUHLAND & ASSOCIATES LTD.**  
200-1750 Courtwood Crescent  
Ottawa, ON K2C 2B5

**TRAFFIC ENGINEERING**  
**J.L.RICHARDS & ASSOCIATES LTD.**  
1000-343 Preston Street  
Ottawa, ON K1J 1N4



**03 LOCATION PLAN**  
SCALE: NTS

**SITE INFORMATION**

SITE AREA: 5,620sm

**BUILDING DATA:**

AREA CALCULATIONS:

	GA	GFA
Building 1:	204.7sm	194.4sm
Building 2:	668.3sm	635.9sm
Building 3:	680.3sm	646.1sm
<b>TOTAL</b>	<b>1,553.3sm</b>	<b>1,476.4sm</b>
	16,720sf	15,892sf

**ZONING**

**DESIGNATION:**

IL (H21) Light Industrial Zone (Section 203 and 204)

**PERMITTED USES:**

- Day care
- Drive-through facility
- Medical facility
- Office
- Personal brewing facility
- Place of assembly
- Post office
- Production studio
- Service and repair shop
- Training centre
- Warehouse

**PERMITTED USES LESS THAN 300sm PER USE TO A MAXIMUM CUMULATIVE OF 2,999sm:**

- Automotive service station
- Bar
- Convenience store
- Personal service business
- Recreational and athletic facility (no area limitation)
- Restaurant

**MAXIMUM FSI (Table 203):**

2 times coverage  
Permitted: 11,754sm  
Proposed: 1,553.3sm (.28 times coverage)

**SETBACKS (Table 203):**

	Required	Proposed
Front & corner side yard:	7.5m	3.0m (north) 6.0m (south)
Rear yard:	15.0m	9.5m (west)

**MAXIMUM BUILDING HEIGHT (Table 203):**

Permitted: 18m maximum  
Proposed: 7m

**MAXIMUM LOT COVERAGE (Table 203):**

Permitted: 65% = 3,653sm  
Proposed: 28% = 1,553sm

**PARKING (Table 101):**

Restaurant: 10.0 cars per 100 sm of GFA = 32  
Pers. Serv.: 3.4 cars per 100sm of GFA = 18  
Auto Serv.: 2.0 per service bay = 14

Required: 64 cars  
Provided: 68 cars

**PROVISIONS FOR DRIVE-THROUGH (Table 112):**

7 before/at order board and a minimum total of 11

**BICYCLE PARKING (Section 111):**

Required: 6  
Provided: 6

North

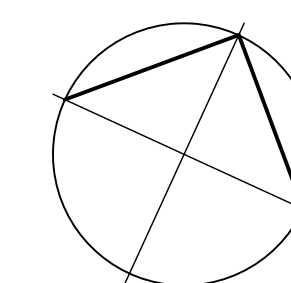

**Revisions**

No.	By	Description	Date
06	JAS	ISSUED FOR PRE-CONSULT	2023-03-02
07	JAS	ISSUED FOR REVIEW	2023-03-30
08	JAS	REVISED FOR REVIEW	2023-08-02
10	JAS	ISSUED FOR COORD.	2023-08-21
12	JAS	REVISED FOR COORD.	2023-09-14
13	JAS	ISSUED FOR SPA	2023-10-26
14	JAS	REVISED FOR COORD.	2024-01-18
15	JAS	REVISED FOR SPA	2024-01-29
16	JAS	REVISED FOR REVIEW	2024-05-17
17	JAS	REVISED FOR SPA	2024-06-25

Project

**PLAZA TRIM WORKS DEVELOPMENT**

1280 TRIM ROAD, ORLEANS, ON

Drawing

**SITE PLAN**

**LEGAL DESCRIPTION:**

PART OF LOT 30 CONCESSION 1  
TOWNSHIP OF CUMBERLAND

Scale AS SHOWN

Stamp

Drawn

Checked

AK

JS

Project No. Drawing No.

22-168

Date

07 JUNE 2022

**SP-A01**

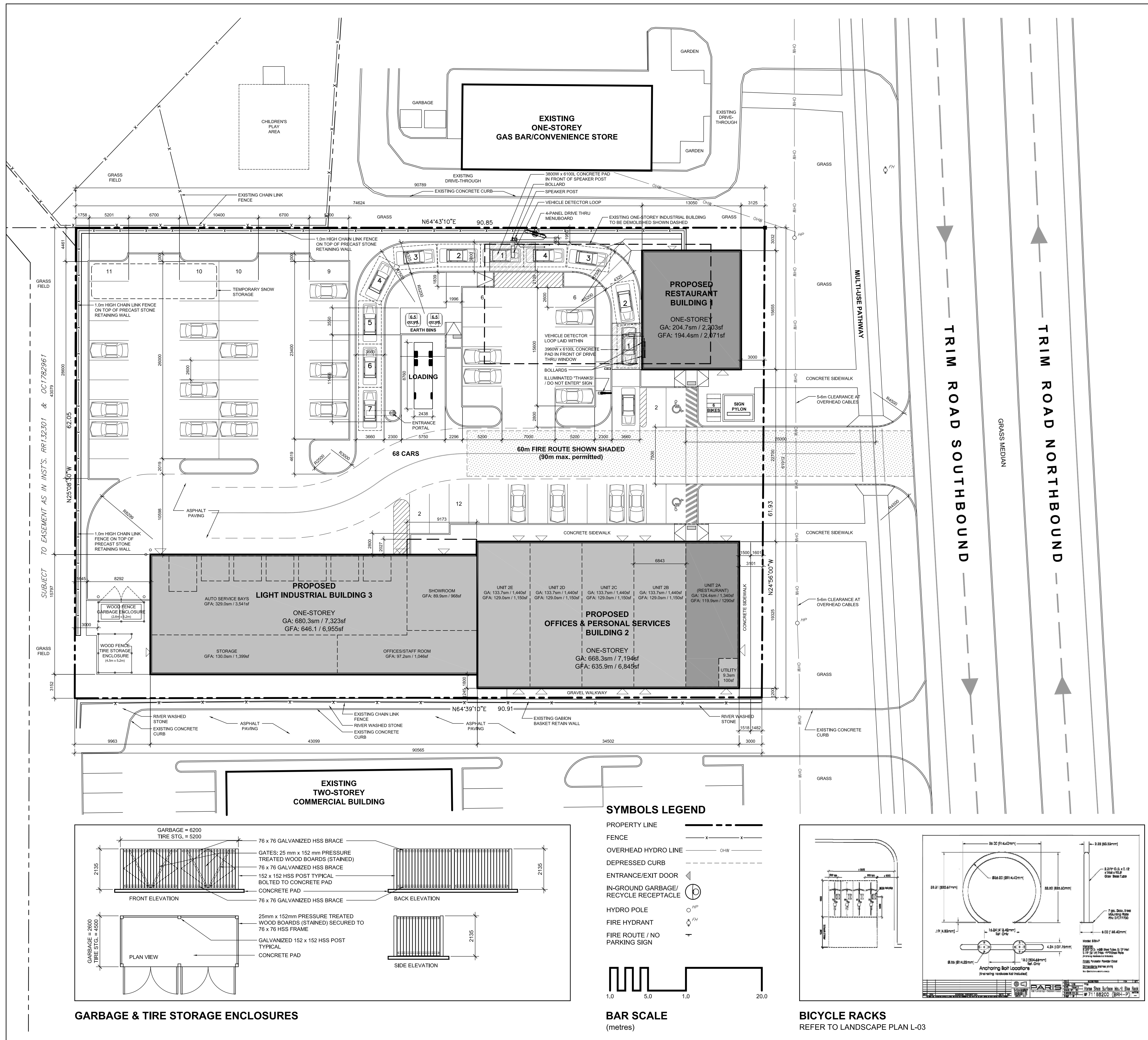

**02 SITE PLAN**  
SCALE: 1:250

**01 SITE, BUILDING and ZONING DATA**  
SCALE: NTS



**OWNER:**  
**TRIM WORKS DEVELOPMENT LTD.**  
110 Place d'Orleans Drive  
Orleans, ON K1C 2L9

**PLANNING CONSULTANT:**  
**Q9 PLANNING + DESIGN**  
C-43 Eccles Street  
OTTAWA, ON K1R 6S3

**CIVIL ENGINEER:**  
**LRL ENGINEERING**  
5430 Canotek Road  
Ottawa, ON K1J 9G2

**LANDSCAPE ARCHITECTS:**  
**RUHLAND & ASSOCIATES LTD.**  
200-1750 Courtwood Crescent  
Ottawa, ON K2C 2B5

**TRAFFIC ENGINEERING**  
**J.L.RICHARDS & ASSOCIATES LTD.**  
1000-343 Preston Street  
Ottawa, ON K1J 1N4

North

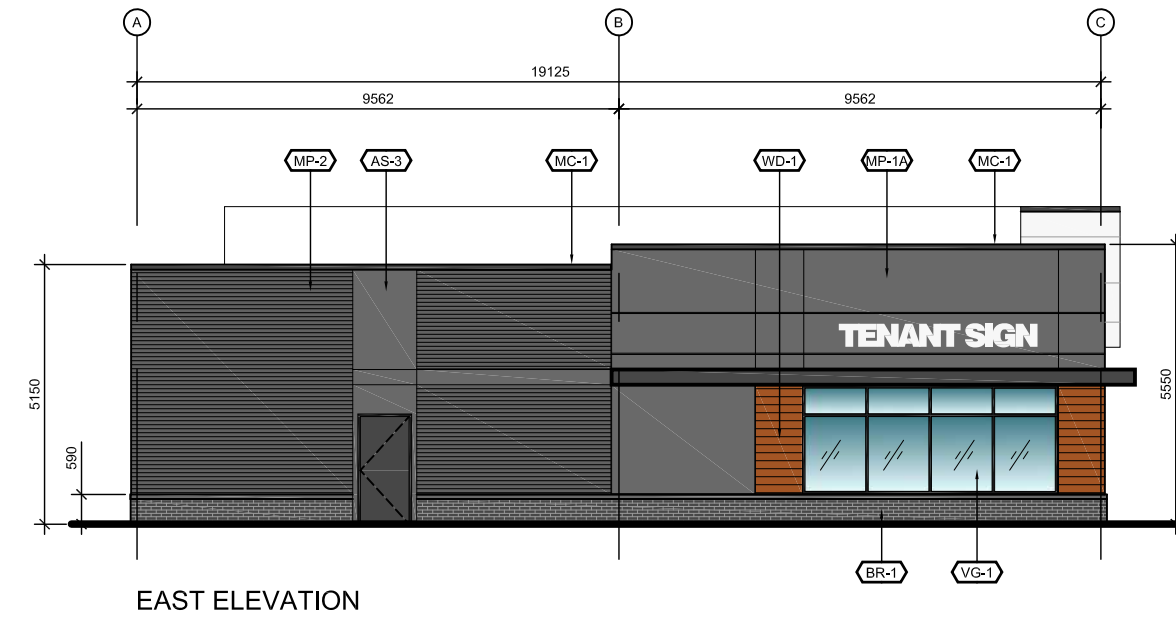
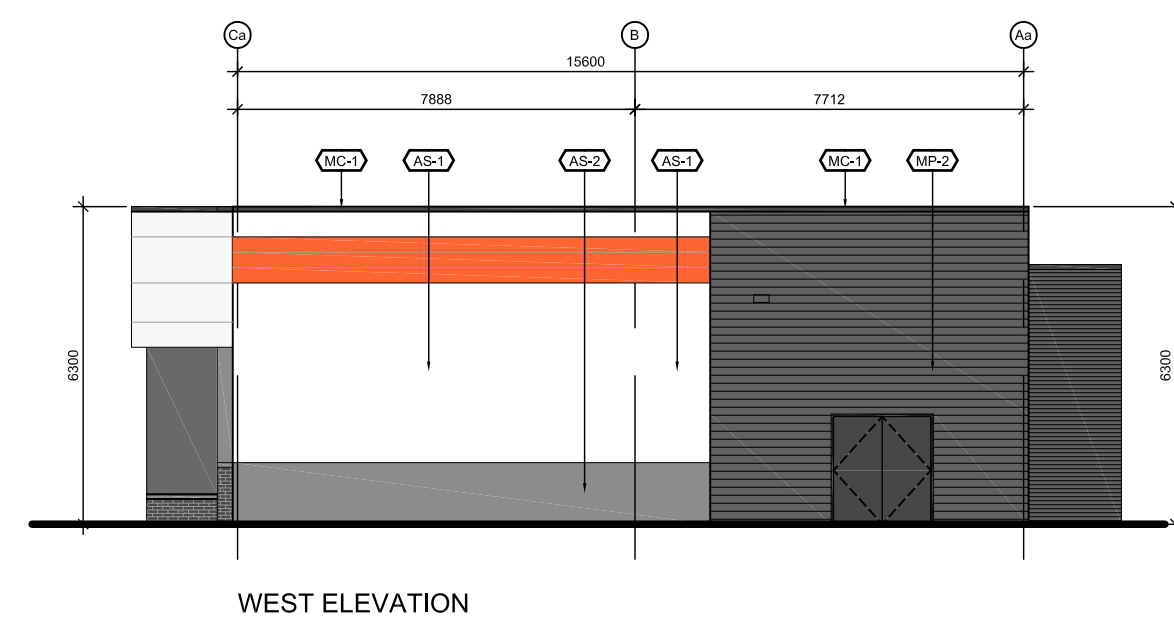
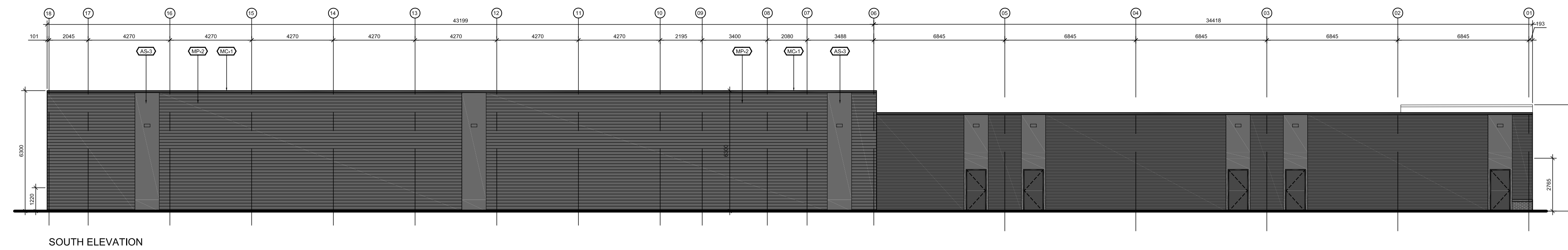

- EXTERIOR MATERIAL LEGEND**
- AS1 ACRYLIC STUCCO 1 WHITE
  - AS2 ACRYLIC STUCCO 2 LIGHT GREY
  - AS3 ACRYLIC STUCCO 3 DARK GREY
  - BS1 BRICK MASONRY BELDEN BRICK - BLACK DIAMOND VELOUR
  - MS1 METAL CORING ISOL. INSULATION - BLACK R402
  - MP1 METAL PANEL 1A METALLIC CHARCOAL COMPOSITE ALUMINUM
  - MP2 METAL PANEL 1B WHITE COMPOSITE ALUMINUM
  - MP3 METAL PANEL 1C ORANGE COMPOSITE ALUMINUM
  - MP4 METAL PANEL 2 AGWAY 6-150 (NF - 28mm) DEEP GREY SC-R0114
  - AP1 ALUMINUM INFILL PANEL BLACK ANODIZED
  - VS1 VISION GLASS 1 SOLARIAN 60 CLEAR GLASS IN BLACK ANODIZED ALUMINUM FRAMES & MULLION CAPS
  - SP1 SPANREL GLASS 1 BACKPAINT SOLARIAN 60 CLEAR GLASS IN BLACK ANODIZED ALUMINUM FRAMES & MULLION CAPS
  - WD1 WOOD GLAZING 1 MABEC MODERN EM 25 (H x 102 mm) BRUSHED FACE MIRROR FINISH 003
- ALL PREFINISHED METAL TRIMS AND FLASHING TO MATCH MCT UNLESS NOTED OTHERWISE

**Revisions**

No.	By	Description	Date
01	AK	ISSUED FOR REVIEW	2023-01-27
02	AK	ISSUED FOR SPA	2023-10-26
03	JAS	REVISED FOR SPA	2024-01-29
04	AK	ISSUED FOR REVIEW	2024-06-11
05	JAS	REVISED FOR SPA	2024-06-25

**02 BUILDING 2 and 3 ELEVATIONS**  
A201 SCALE: 1:150

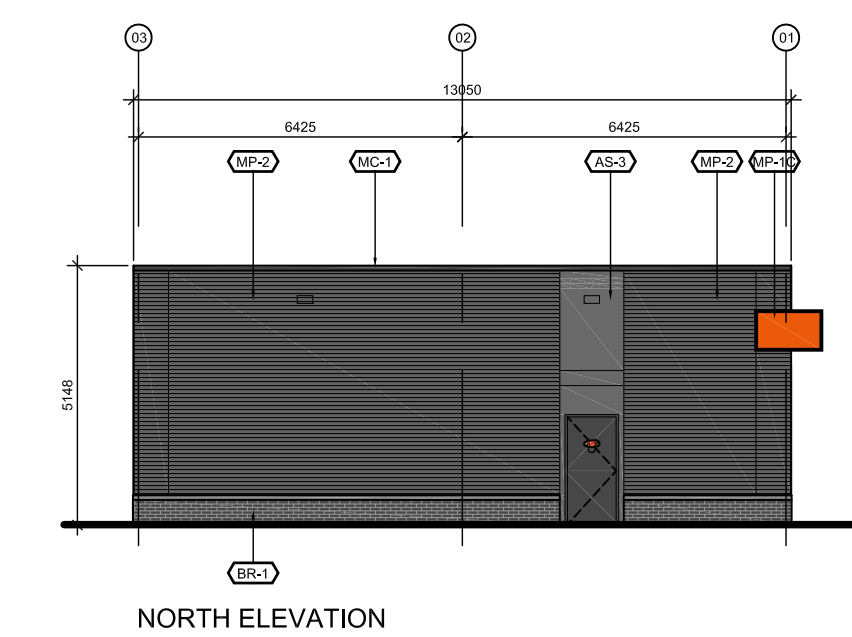
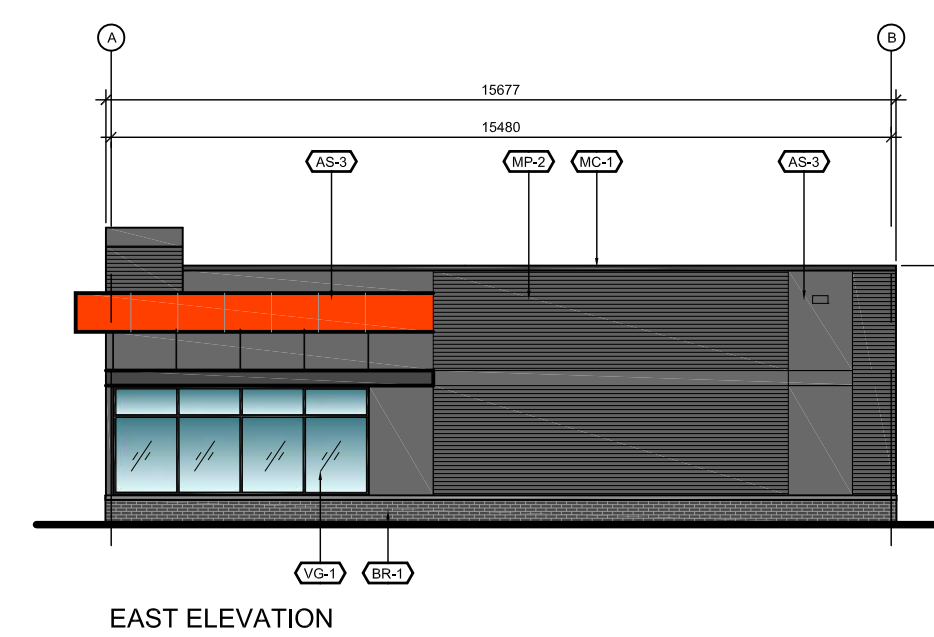
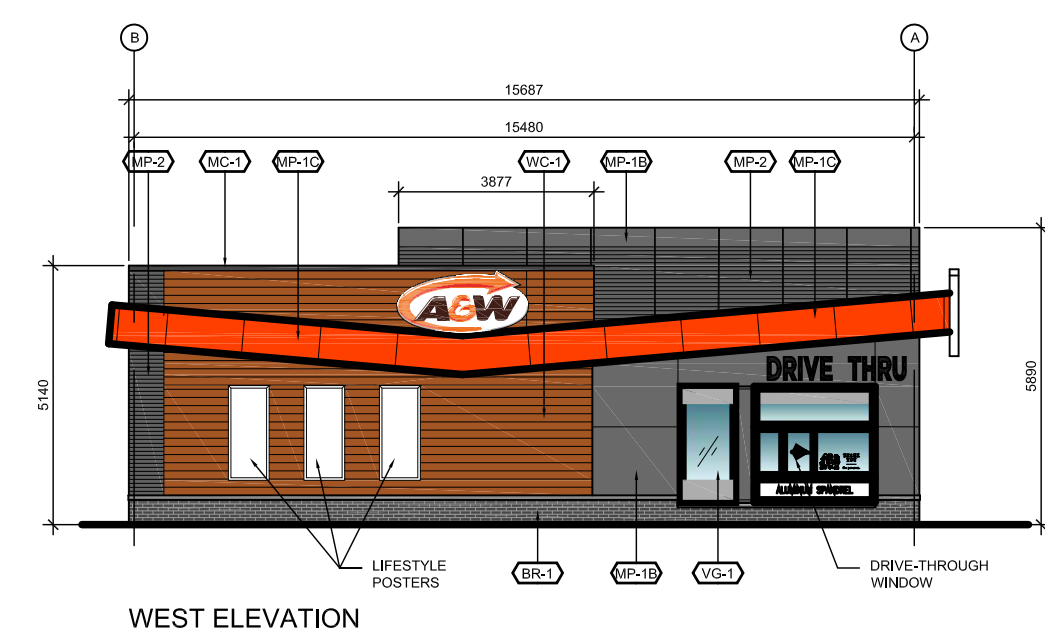

**01 BUILDING 1 ELEVATIONS**  
A201 SCALE: 1:150

**Project**

**PLAZA TRIM WORKS DEVELOPMENT**

1280 TRIM ROAD, ORLEANS, ON

Drawing

**BUILDING ELEVATIONS**

**LEGAL DESCRIPTION:**  
PART OF LOT 30 CONCESSION 1  
TOWNSHIP OF CUMBERLAND

Scale AS SHOWN Stamp

Drawn

Checked

AK

JS

Project No. Drawing No.

22-168

Date

**A201**

07 JUNE 2022



**OWNER:**  
TRIM WORKS DEVELOPMENT LTD.  
110 Place d'Orleans Drive  
Orleans, ON K1C 2L9

**PLANNING CONSULTANT:**  
Q9 PLANNING + DESIGN  
C-43 Eccles Street  
OTTAWA, ON K1R 6S3

**CIVIL ENGINEER:**  
LRL ENGINEERING  
5430 Canotek Road  
Ottawa, ON K1J 9G2

**LANDSCAPE ARCHITECTS:**  
RUHLAND & ASSOCIATES LTD.  
200-1750 Courtwood Crescent  
Ottawa, ON K2C 2B5

**TRAFFIC ENGINEERING**  
J.L.RICHARDS & ASSOCIATES LTD.  
1000-343 Preston Street  
Ottawa, ON K1J 1N4

**GENERAL NOTES**

1. All general site information and conditions compiled from existing plans, surveys and consultant's field notes. Report all discrepancies prior to any work. No responsibility is born by the Consultant for unknown subsurface conditions.
  2. The location of the utilities is approximate only, and the exact location should be determined by consulting the municipal authorities and utility companies concerned. The Contractor shall prove the location of utilities and shall be responsible for adequate protection from damage.
  3. All dimensions shown are to be verified on site prior to any construction. No deviations are to be made from the layouts as shown on this plan without prior consultation with the Landscape Architect and Owner.
  4. No other trees to be removed without prior approval by Landscape Architect.
- SPC NOTES**
1. THIS PLAN IS ISSUED FOR SITE PLAN CONTROL SUBMISSION ONLY.
  2. ADDITIONAL DETAILING AND SPECIFICATIONS ARE REQUIRED PRIOR TO TENDERING OR CONSTRUCTION.
  3. DRAWING TO BE READ IN CONJUNCTION WITH TREE CONSERVATION REPORT. REFER TO TREE CONSERVATION REPORT PREPARED BY IFS ASSOCIATES DATED 2023-09-11 FOR TREE PROTECTION MEASURES AND DETAILS.
  4. SERVICING INFORMATION SHOWN AS REFERENCE ONLY. REFER TO CIVIL DRAWINGS.
  5. TREE PLANTING PREPARED IN ACCORDANCE WITH: GEOTECHNICAL INVESTIGATION - Proposed Site Redevelopment, 1280 Trim Road. Prepared by LRL Engineering, May 2023.
  6. Garbage screen / Wooden fence - Refer to Architectural Drawings.
  7. Retaining wall - Refer to Civil Drawings.

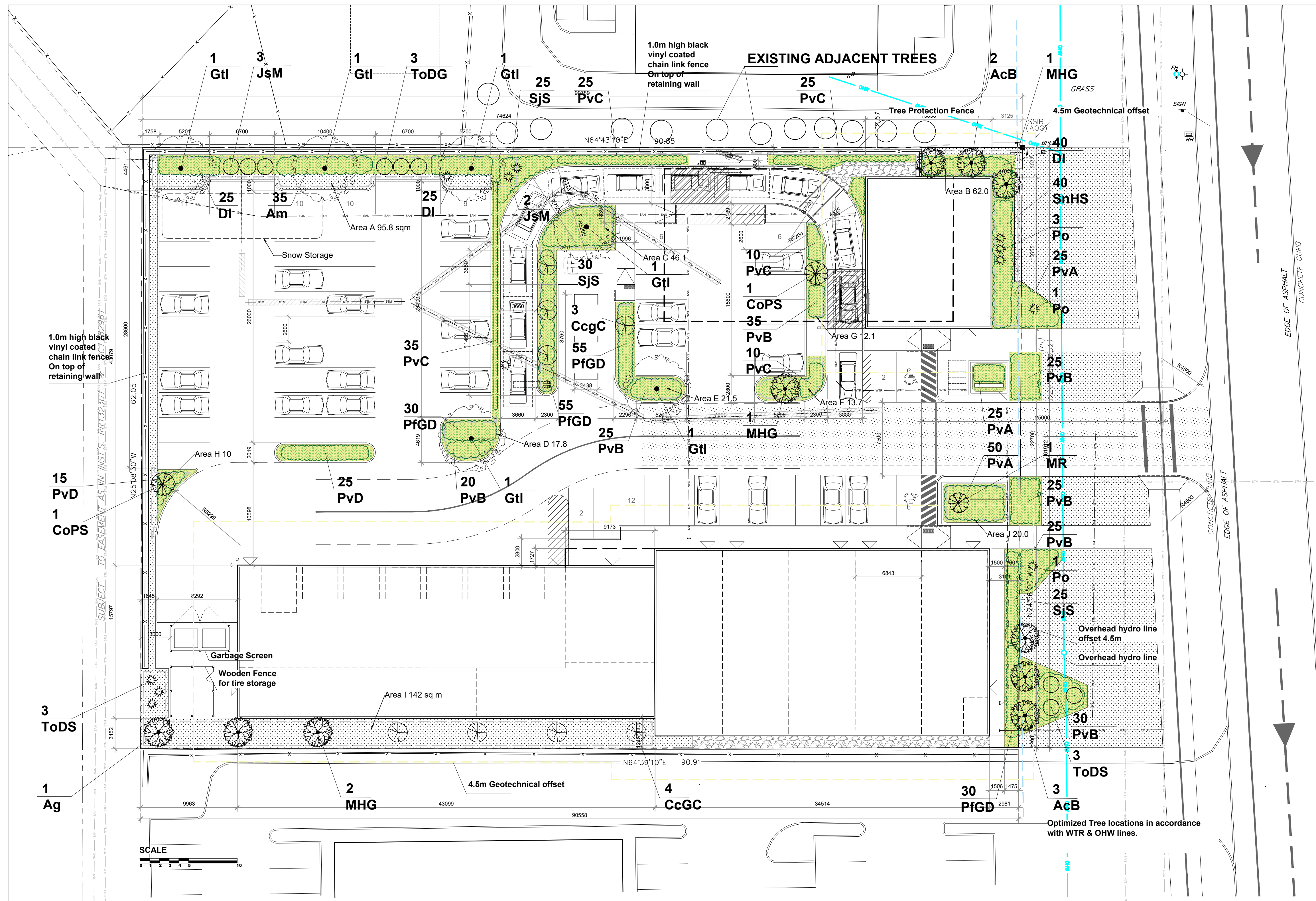

**KEY PLAN**

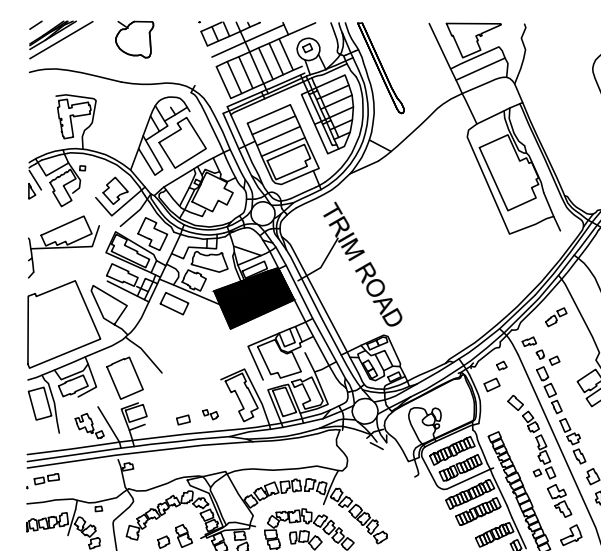

**LEGEND**

- PROPOSED TREES
- PROPOSED SHRUBS / PERENNIALS
- GRASS
- GRAVEL PATHWAY
- PROPERTY LINE
- BLACK VINYL COATED CHAIN LINK FENCE
- OVERHEAD HYDRO LINE
- GEOTECHNICAL OFFSET
- SOIL AREA OFFSET

7		
6		
5		
4	Re-issued for Site Plan Control	2024/06/27
3	Re-issued for Site Plan Control	2024/01/18
2	Issued for Site Plan Control	2023/10/26
1	Issued for Site Plan Control	2023/10/16

no.	issue / revision	date
-----	------------------	------

North seal

**Ruhlhand & Associates Ltd**  
200-1750 Courtwood Crescent, Ottawa, Ontario K2C 2B5  
P (613) 224-4744 x 222 F (613) 224-1131 info@rala.ca www.rala.ca

project

**PLAZA TRIM WORKS DEVELOPMENT**

**LEGAL DESCRIPTION:**  
PART OF LOT 30 CONCESSION 1  
TOWNSHIP OF CUMBERLAND

scale NTS	drawn by M. Malkov	designed by R. Ruhlhand
date Sep. 2023	checked by R. Ruhlhand	plot date

project number <b>23-1713</b>	drawing number <b>L - 01</b> Landscape Plan
----------------------------------	---

Contractor to check and verify all dimensions on the job



**OWNER:**  
**TRIM WORKS DEVELOPMENT LTD.**  
110 Place d'Orleans Drive  
Orleans, ON K1C 2L9

**PLANNING CONSULTANT:**  
**Q9 PLANNING + DESIGN**  
C-43 Eccles Street  
OTTAWA, ON K1R 6S3

**CIVIL ENGINEER:**  
**LRL ENGINEERING**  
5430 Canotek Road  
Ottawa, ON K1J 9G2

**LANDSCAPE ARCHITECTS:**  
**RUHLAND & ASSOCIATES LTD.**  
200-1750 Courtwood Crescent  
Ottawa, ON K2C 2B5

**TRAFFIC ENGINEERING**  
**J.L.RICHARDS & ASSOCIATES LTD.**  
1000-343 Preston Street  
Ottawa, ON K1J 1N4

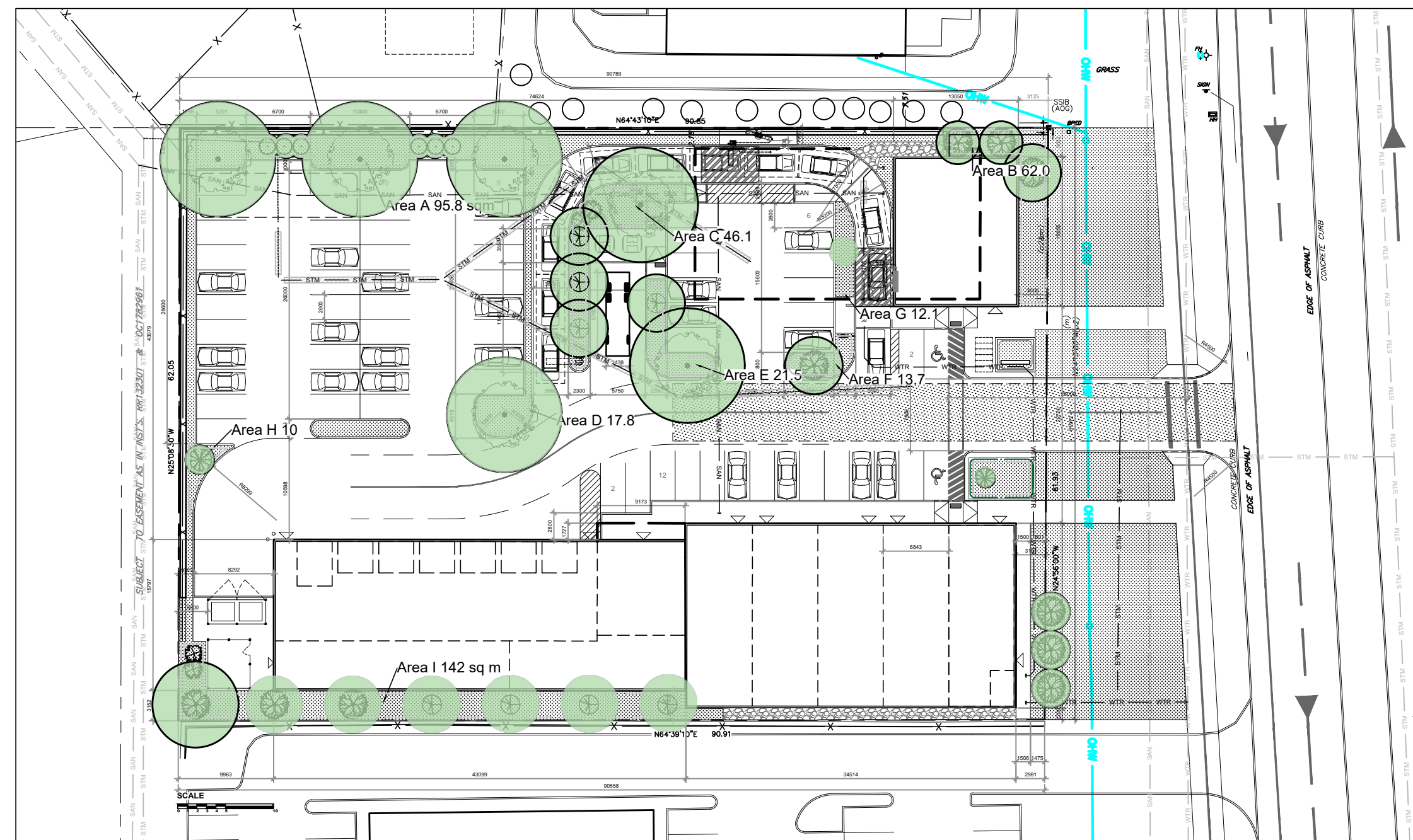

**TREE CANOPY COVERAGE**  
TOTAL CANOPY AREA 1165 m<sup>2</sup>  
TOTAL SITE AREA 5619 m<sup>2</sup>  
PERCENT COVERAGE 20.73%

Plant List ID	Qty	Botanical Name	Common Name	Mature Height	Scheduled Size	Remarks
<b>DECIDUOUS TREES</b>						
Ag	1	Aesculus glabra	Ohio Buckeye	10-15m	50mm caliper	WB, Staked
AcB	5	Amelanchier canadensis 'Ballerina'	Ballerina Serviceberry (tree form)	>3 - 5m	40mm caliper	WB, Staked
CoPS	2	Celtis occidentalis 'Prairie Sentinel'	Prairie Sentinel Hackberry	6-8m	60mm caliper	WB, Staked
CcgC	7	Crataegus crus-galli inermis 'Cruzam'	Thornless Crusader Cockspur Hawthorn	6.5m	45mm caliper	WB, Staked
Gtl	5	Gleditsia triacanthos var. inermis 'Impc'	Imperial Honeylocust	12m	70mm caliper	WB, Staked
MHG	4	Malus x 'Harvest Gold'	Harvest Gold Crabapple	6-7m	50mm caliper	WB, Staked
MR	1	Malus 'Rinki'	Rinki Crabapple	5-6m	35mm caliper	WB, Staked
UF	3	Ulmus minor x parvifolia 'Frontier'	Frontier Elm	8-10m	60mm caliper	WB, Staked
<b>CONIFERS</b>						
JsM	2	Juniperus scopulorum 'Medora'	Medora Juniper	4m	125cm ht	150-175cm ht
ToDG	3	Thuja occidentalis 'Degroot's Spire'	Degroot's Spire Arborvitae	3-4m	150 cm ht.	Potted
<b>SHRUBS</b>						
Am	35	Aronia melanocarpa	Black Chokeberry		50 cm ht.	Bare root
DI	90	Diervilla lonicera	Dwarf Bush-honeysuckle			2 gallon pot
Po	2	Physocarpus opulifolius	Ninebark		50cm ht.	Potted
PfGD	170	Potentilla fruticosa 'Gold Drop'	Gold Drop Potentilla		2 gallon pot	Potted
SJS	80	Spiraea japonica 'Shirobana'	Shirobana Spirea		50cm ht	0.9m o.c.
SnHS	40	Spiraea nipponica 'Halward's Silver'	Halward's Silver Spirea		50cm ht.	Potted, 0.9cm o.c.
ToDS	6	Thuja occidentalis 'Degroot's Spire'	Degroot's Spire White Cedar		200cm ht	Full clumps
<b>PERENNIALS</b>						
PvA	100	Low to mid flowering Perennials			150mm pot	50-60cm o.c.
PvB	185	Mid to high Flowering Perennials			150mm pot	60-70cm o.c.
PvC	105	Calamagrostis acutifolia 'Karl Forester'	Karl Foerster Reed Grass		1 Gallon pot	70cm o.c.
PvB	40	Panicum virgatum 'Heavy Metal'	Heavy Metal Switch Grass		1 Gallon pot	65cm o.c.

1280 Trim Road				
Soil Volume Area, Tree Quantity and Size	Tree Quantity	OTTAWA Target Soil Volume (m <sup>3</sup> )	Design Soil Volume	Soil Adequacy percentage
<b>AREA A - 3 Medium Trees, 6 Small Conifers</b>				
plant bed (95.8 sq m x 0.9 ave metre deep)	9	99.0	86.2	87%
<b>AREA B - 3 Medium Trees, Shrubs</b>				
plant bed (63.4 sq m x 0.9 ave metre deep)	3	45.0	57.1	127%
<b>AREA C - 1 Medium, 3 Small Trees</b>				
plant bed (46.1 sq m x 0.9 ave metre deep)	4	42.0	41.5	99%
<b>AREA D - 1 Medium tree</b>				
plant bed (17.8 sq m x 0.9 ave metre deep)	1	20.0	16.0	80%
<b>AREA E - 1 Medium, 1 Small Tree</b>				
plant bed (21.5 sq m x 0.9ave metre deep)	2	21.0	19.4	92%
<b>AREA F - 1 Medium Tree</b>				
plant bed (13.7 sq m x 1.2ave metre deep)	1	20.0	16.4	82%
<b>AREA G - 1 Medium Tree</b>				
plant bed (12.1 sq m x 1.2ave metre deep)	1	15.0	14.5	97%
<b>AREA H - 1 Ornamental Tree</b>				
plant bed (10 sq m x 1.2ave metre deep)	1	15.0	12.0	80%
<b>AREA H - 7 Medium Trees</b>				
plant bed (140.4 sq m x 0.9ave metre deep)	7	140.0	126.4	90%
<b>AREA J - 1 Medium Trees</b>				
plant bed (20 sq m x 1.2ave metre deep)	1	25.0	24.0	96%

**NOTES:**  
**AREAS WHERE SITE CONSTRAINTS (such as parking lot islands, adjacent hard surface areas): 0.9 TO 1.2 METRE DEPTH IMPORTED TOPSOIL (average depth of 1000mm).**

**AREAS WITHIN OR ADJACENT TO LARGER SOFT LANDSCAPE AREAS (such as wide boulevards, lawns, etc): 0.4 METRE AVERAGE DEPTH OF IMPORTED TOPSOIL OVER APPROVED EXISTING SUBSOIL. ADDITIONAL IMPORTED TOPSOIL OR APPROVED SUBSOIL TO BE ADDED WHERE SUBGRADE BELOW THE 400mm IMPORTED TOPSOIL IS NOT CONDUSIVE TO PLANT GROWTH.**

Total proposed city owned trees are 3-AcB, 3-ToDS, 2-Po, 105-PvB and 30-PvA. The rest are private.  
Tree dimensions are taken from consensus of tree lists by Universities and Nurseries

- A SUBSOIL / SUBGRADE CULTIVATED LAYER
- B PLANTING MEDIUM
- C ROOTBALL / POT
- D TOP OF ROOT CROWN TO BE FLUSH WITH PLANTING SOIL
- E 2-METAL POSTS (40x 40x 2100 mm) PLACE AT OUTSIDE OF ROOTBALL AND FASTEN TO TRUNK WITH 3 mmØ GALVANIZED WIRE AND 25 mmØ 2 PLY REINFORCED HOSE (PARALLEL TO CURB).
- F 50-75 mm MULCH LAYER, KEEP MULCH AWAY FROM STEMS AND PROVIDE 100mm DEEP SAUCER.
- G PRUNE DAMAGE, DISEASED OR WEAK BRANCHES AS PER ACCEPTED HORTICULTURAL PRACTICE. DO NOT DAMAGE OR REMOVE LEADER
- H FIRST ROW OF SHRUBS TO BE PLANTED 600mm MINIMUM FROM FRONT OF CURB (AT TREE LOCATIONS, 900mm ELSEWHERE).

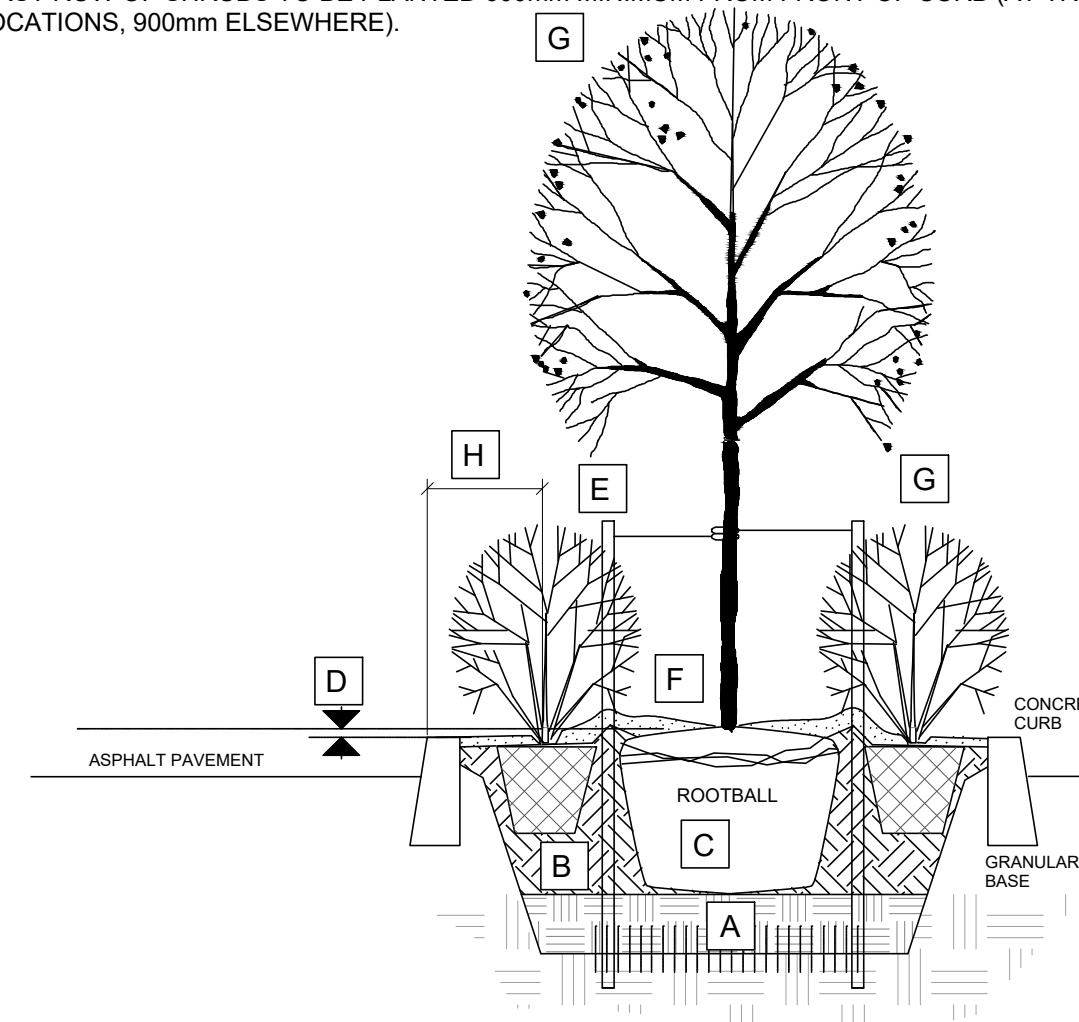

**PLANTING IN MEDIAN**

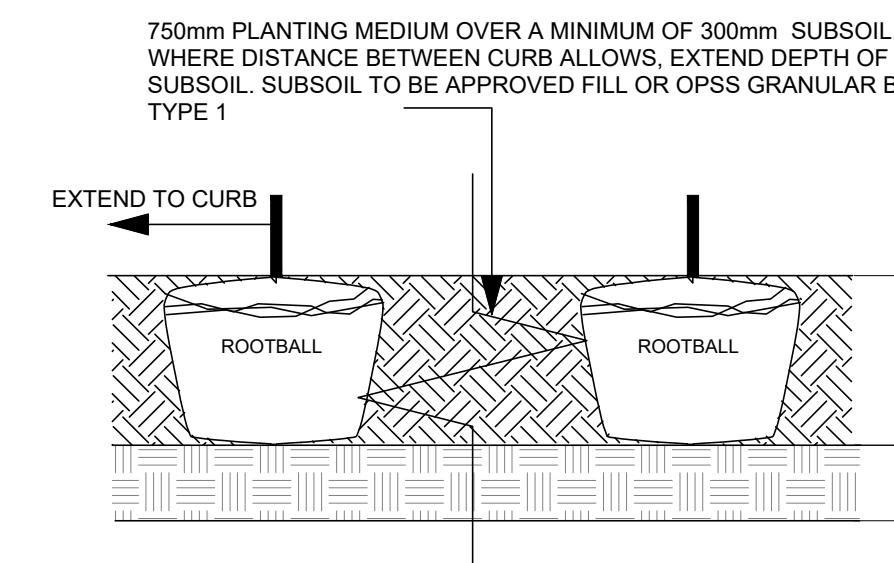

**SECTION LENGTHWISE THROUGH MEDIAN**

**Bed Preparation**

- 1 EXCAVATE OR PLACE FILL FOR PLANTING BED TO PROVIDE 750mm MINIMUM DEPTH OF PLANTING MEDIUM AND 300mm DEPTH SUBSOIL (CONTINUOUS BETWEEN TREES). CULTIVATE PLANTING SUBSOIL INTO SUBGRADE TO A DEPTH OF 150mm.
- 2 PLACE COMPACTED PLANTING MEDIUM ON SUBSOIL TO ACHIEVE FINAL GRADE.
- 3 CENTRE OF BED TO BE CROWNED ABOVE ADJACENT GRADE TO APPROVAL OF CONSULTANT.

7		
6		
5		
4	Re-issued for Site Plan Control	2024/06/27
3	Re-issued for Site Plan Control	2024/01/18
2	Issued for Site Plan Control	2023/10/26
1	Issued for Site Plan Control	2023/10/16

no.	issue / revision	date
	North	seal

**Ruhland & Associates Ltd**  
200-1750 Courtwood Crescent, Ottawa, Ontario K2C 2B5  
P (613) 224-4744 x 232 F (613) 224-1131 info@ralta.ca www.ralta.ca

project  
**PLAZA TRIM WORKS DEVELOPMENT**  
LEGAL DESCRIPTION:  
PART OF LOT 30 CONCESSION 1 TOWNSHIP OF CUMBERLAND

scale NTS	drawn by M. Malkov	designed by R. Ruhland
date Sep. 2023	checked by R. Ruhland	plot date
project number <b>23-1713</b>	drawing number <b>L - 02</b>	Canopy coverage Plan, Soil volume and Plant List

Contractor to check and verify all dimensions on the job



**OWNER:**  
TRIM WORKS DEVELOPMENT LTD.  
110 Place d'Orleans Drive  
Orleans, ON K1C 2L9

**PLANNING CONSULTANT:**  
Q9 PLANNING + DESIGN  
C-43 Eccles Street  
OTTAWA, ON K1R 6S3

**CIVIL ENGINEER:**  
LRL ENGINEERING  
5430 Canotek Road  
Ottawa, ON K1J 9G2

**LANDSCAPE ARCHITECTS:**  
RUHLAND & ASSOCIATES LTD.  
200-1750 Courtwood Crescent  
Ottawa, ON K2C 2B5

**TRAFFIC ENGINEERING**  
J.L.RICHARDS & ASSOCIATES LTD.  
1000-343 Preston Street  
Ottawa, ON K1J 1N4

**NOTES:**  
TREES ARE TO BE INSTALLED AS PER CITY STANDARD DETAILS; SOIL VOLUME AS PER BELOW NOTES AND MATRIX ON SHEET L-01.  
- STANDARD TREE SOIL VOLUMES QUANTITIES INCLUDE THE TOP 900-1000mm OF SOIL/EXISTING SUBSOIL LAYER TO CALCULATE TOTAL SOIL VOLUMES REQUIRED BY THE CITY OF OTTAWA FOR SUSTAINABLE TREE GROWTH. WHERE LARGER SOFT AREAS ARE AVAILABLE, THE TOP 400-500mm LAYER IS USED TO CALCULATE SOIL VOLUMES.  
- WHERE EXISTING MATERIAL BELOW THE SPECIFIED TOPSOIL IS NOT CONDUCTIVE TO TREE GROWTH, AN ADDITIONAL LAYER OF PLANTING MEDIUM IS TO BE INSTALLED BELOW SPECIFIED TOPSOIL DEPTH TO OBTAIN THE SOIL VOLUME DEPTH REQUIRED.  
- REFER TO SOIL VOLUME MATRIX AND PLANS FOR AREA WHERE TREE SOIL VOLUMES ARE REQUIRED.

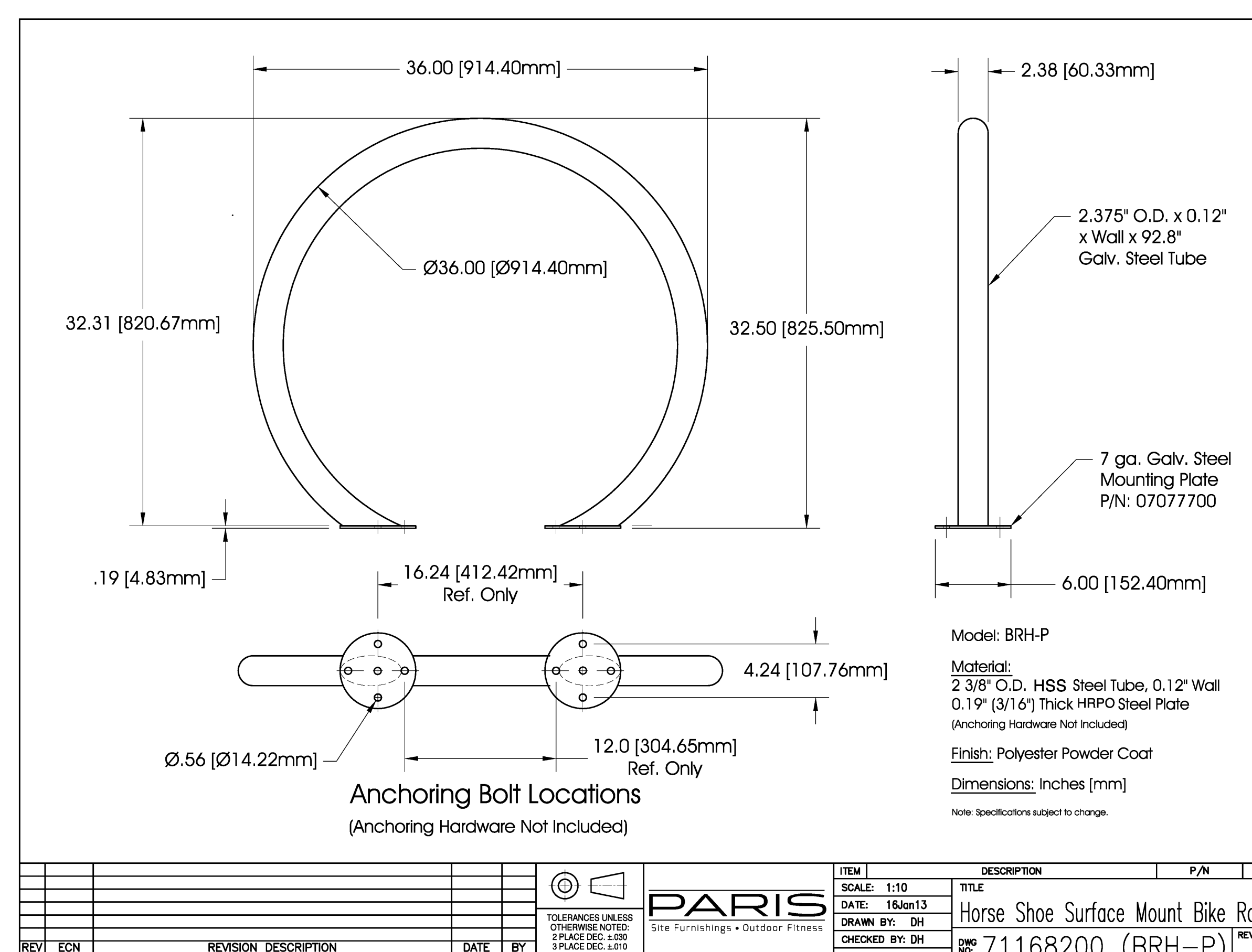
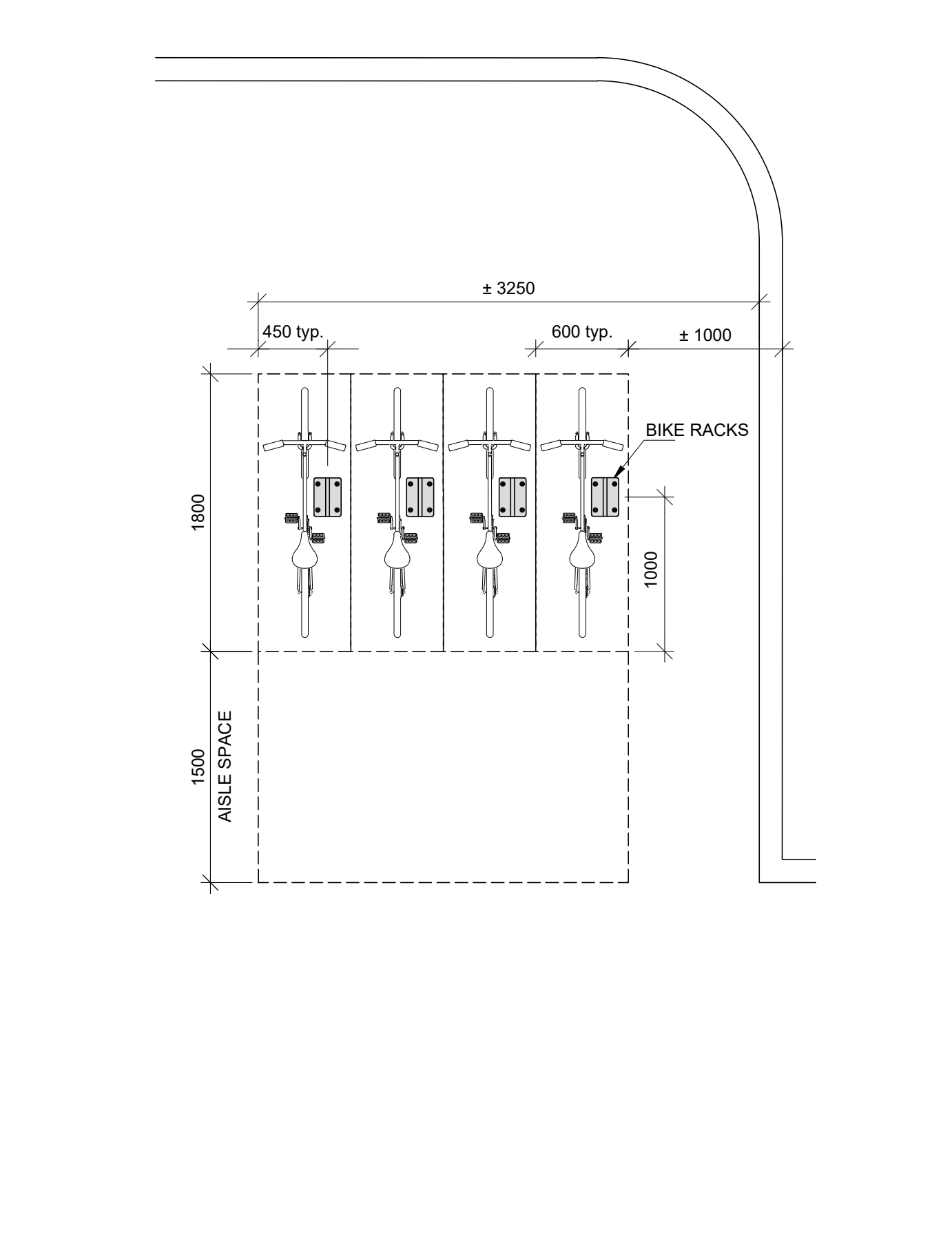
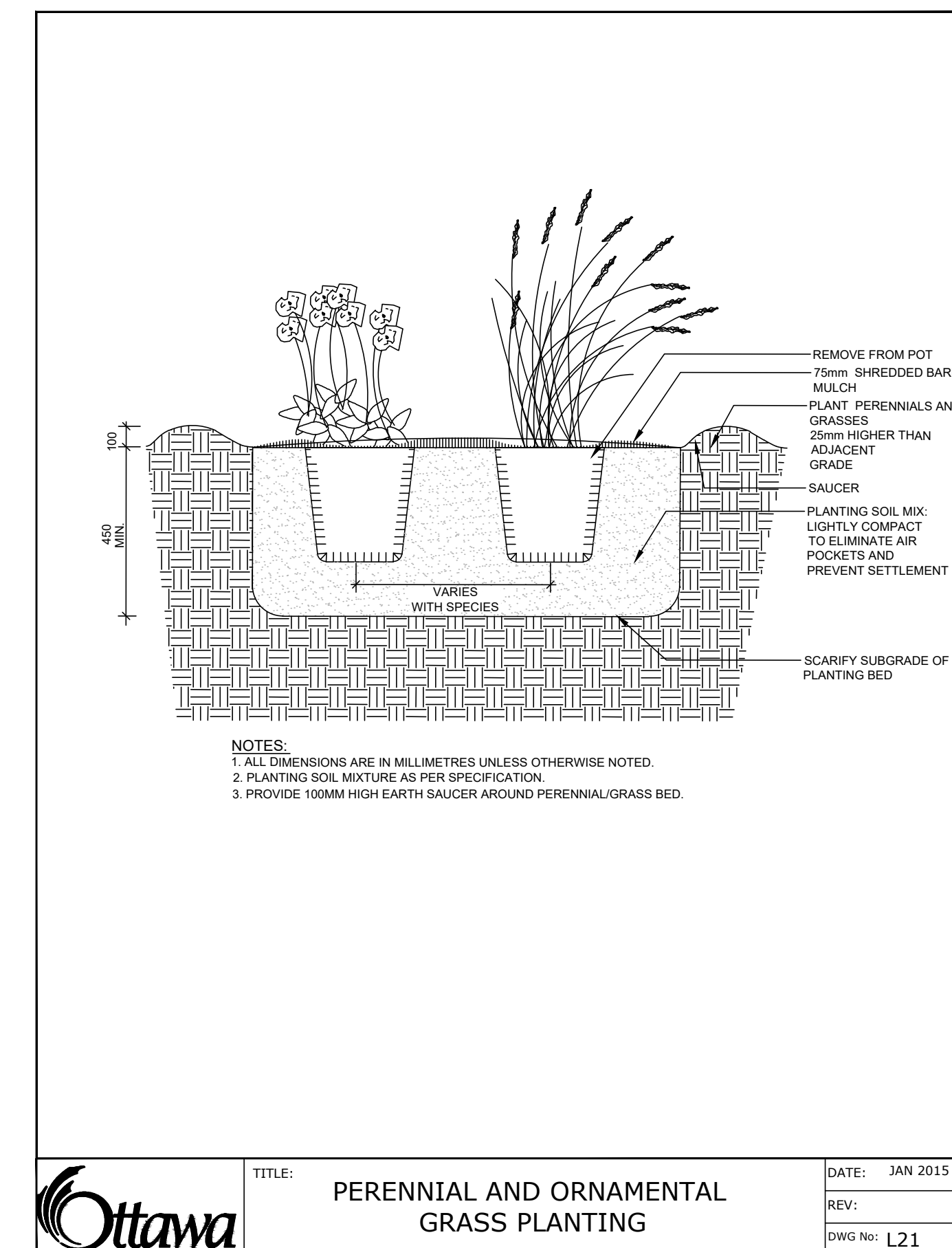
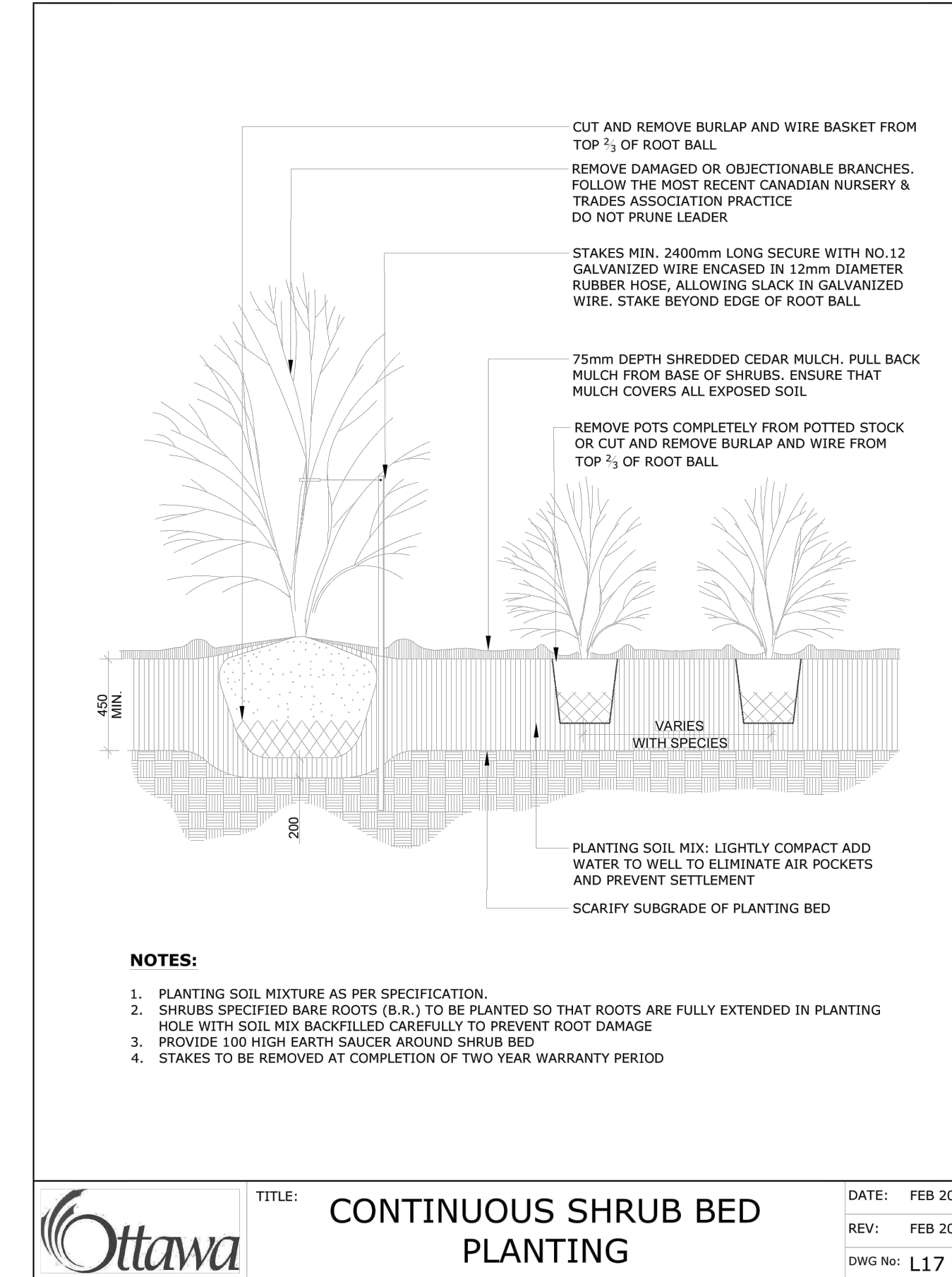
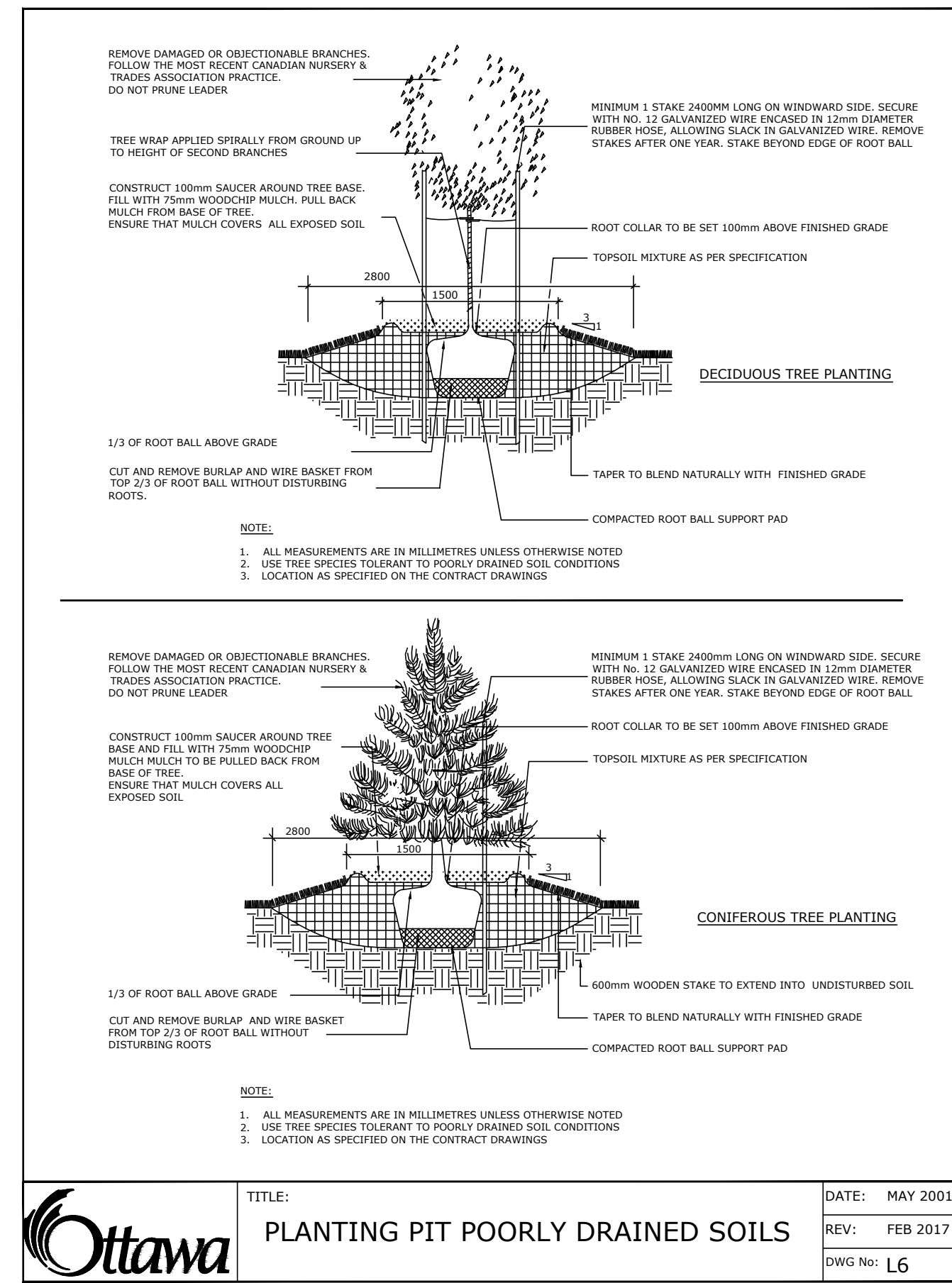
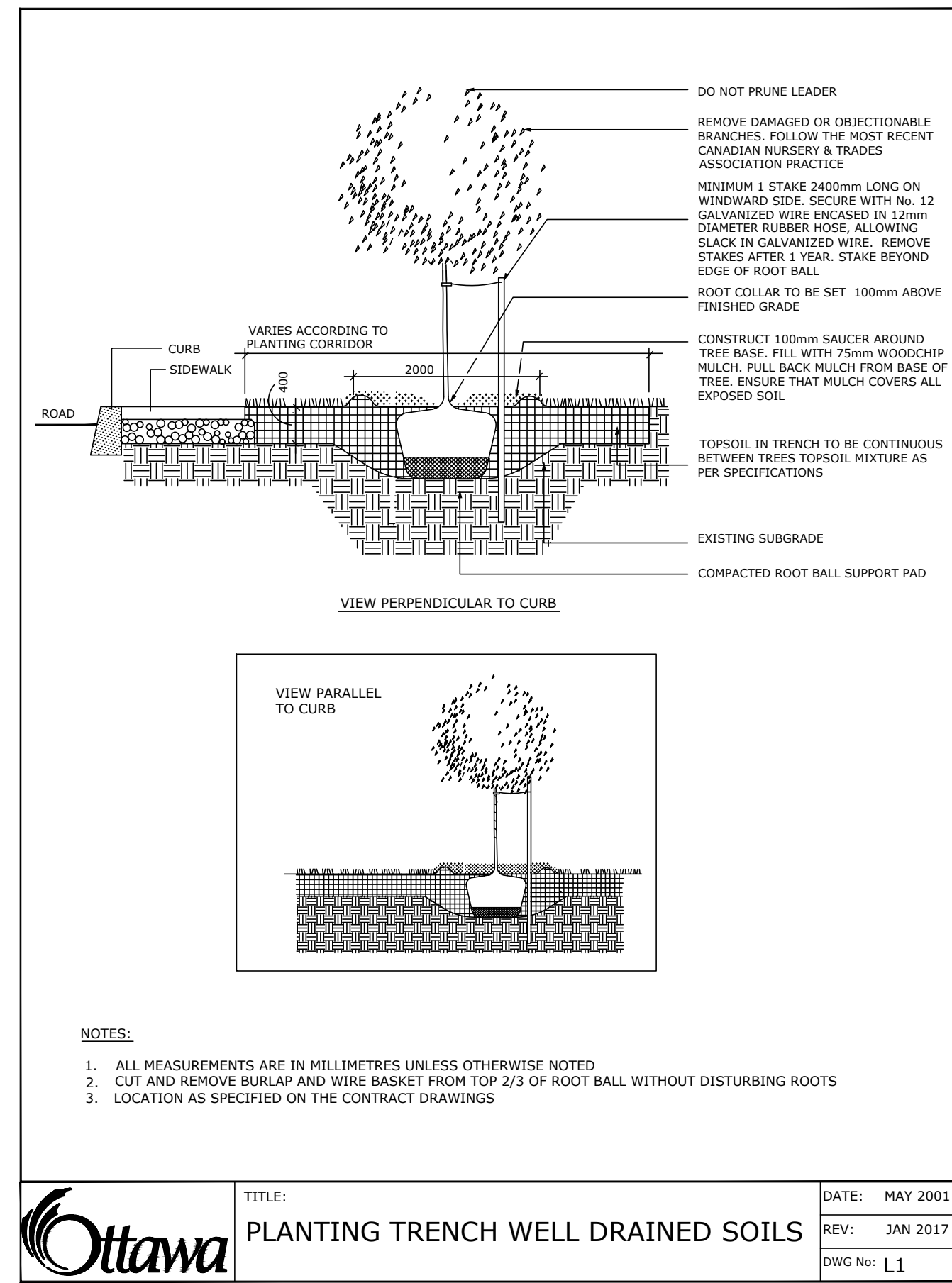

7		
6		
5		
4	Re-issued for Site Plan Control	2024/06/27
3	Re-issued for Site Plan Control	2024/01/18
2	Issued for Site Plan Control	2023/10/26
1	Issued for Site Plan Control	2023/10/16

no.	issue / revision	date
North	seal	



**Ruhland & Associates Ltd**  
200-1750 Courtwood Crescent, Ottawa, Ontario K2C 2B5  
P (613) 224-4744 x 232 F (613) 224-1131 info@rala.ca www.rala.ca

project  
**PLAZA TRIM WORKS DEVELOPMENT**  
LEGAL DESCRIPTION:  
PART OF LOT 30 CONCESSION 1  
TOWNSHIP OF CUMBERLAND

scale	NTS	drawn by	M. Malkov	designed by	R. Ruhland
date	Sep. 2023	checked by	R. Ruhland	plot date	
project number	23-1713	drawing number	L - 03	revision	

Contractor to check and verify all dimensions on the job