



BA Group

RIVERSIDE SOUTH COMMERCIAL 1420 EARL ARMSTRONG ROAD TRANSPORTATION IMPACT STUDY

SE Corner of Limebank Road
& Earl Armstrong Road, City of Ottawa

Prepared For: Morguard Investments Limited

August, 2014



**MOVEMENT
IN URBAN
ENVIRONMENTS**

BAGROUP.COM



© BA Consulting Group Ltd.
45 St. Clair Avenue West, Suite 300
Toronto, ON M4V 1K9
www.bagroup.com

TABLE OF CONTENTS

1.0	INTRODUCTION	1
1.1	Background	1
1.2	Development Proposal	1
1.3	Scope of Analysis.....	2
2.0	EXISTING CONDITIONS	7
2.1	Existing Road Network	7
2.2	Existing Transit Service	7
2.3	Pedestrian and Cycling Facilities.....	8
2.4	Existing Traffic volumes.....	8
3.0	ASSESSMENT SCENARIOS.....	11
3.1	Zero & Unconstrained Interaction Scenarios	11
4.0	FURTURE BACKGROUND CONDITIONS.....	12
4.1	Anticipated road network Changes (2014 – 2021)	12
4.2	Forecasted background Growth	12
4.3	Background Transit Network	13
5.0	TRAVEL DEMAND FORECASTS	16
5.1	transit modal split	16
5.2	site trip generation	16
5.3	trip distribution and assignment.....	17
5.4	Future Total Traffic Volumes	17
6.0	TRAFFIC IMPACT ANALYSIS	28
6.1	Signalized Intersections – Analysis Parameters	28
6.2	Unsignalized Intersections	30
6.3	Sensitivity Analysis.....	31
7.0	PUBLIC TRANSIT INFRASTRUCTURE & OPERATIONS.....	35
8.0	SUMMARY AND CONCLUSIONS	36



LIST OF TABLES

Table 1	Site Traffic Generation	16
Table 2	Site Traffic Distribution	17
Table 3	Capacity Analysis Summary – Signalized Intersections (2016)	28
Table 4	Capacity Analysis Summary – Signalized Intersections (2021)	29
Table 5	Capacity Analysis Summary – Unsignalized Intersections (2016)	31
Table 6	Capacity Analysis Summary – Unsignalized Intersections (2021)	32
Table 7	Sensitivity Analysis – Earl Armstrong / Limebank Intersection 2021	32

LIST OF FIGURES

Figure 1:	Site Location	3
Figure 2:	Community Design Plan	4
Figure 3:	Site Context.....	5
Figure 4:	Site Plan.....	6
Figure 5:	Existing Transit Service	9
Figure 6:	Existing Traffic Volumes	10
Figure 7:	Future Background 2016 Traffic Volumes – Zero Interaction	14
Figure 8:	Future Background 2016 Traffic Volumes – Unconstrained Interaction	15
Figure 9:	Net Site 2016 Traffic Volumes – Zero Interaction.....	18
Figure 10:	Net Site 2016 Traffic Volumes – Unconstrained Interaction.....	19
Figure 11:	Future Total 2016 Traffic Volumes – Zero Interaction	20
Figure 12:	Future Total 2016 Traffic Volumes – Unconstrained Interaction	21
Figure 13:	Future Background 2021 Traffic Volumes – Zero Interaction.....	22
Figure 14:	Future Background 2021 Traffic Volumes – Unconstrained Interaction	23
Figure 15:	Net Additional Site 2021 Traffic Volumes – Zero Interaction.....	24
Figure 16:	Net Additional Site 2021 Traffic Volumes – Unconstrained Interaction	25
Figure 17:	Future Total 2021 Traffic Volumes – Zero Interaction	26
Figure 18:	Future Total 2021 Traffic Volumes – Unconstrained Interaction	27
Figure 19:	Limebank Road – Site Access & Road Improvements (PRM01)	33
Figure 20:	Earl Armstrong Road – Site Access & Road Improvements (PRM02).....	34



TABLE OF APPENDICES

- APPENDIX A: Appendix Figures and Tables
- APPENDIX B: Turning Movement Counts and Signal Timing Plan
- APPENDIX C: Synchro Analysis – Future Background 2016 zero interaction
- APPENDIX D: Synchro Analysis – Future Background 2016 unconstrained interaction
- APPENDIX E: Synchro Analysis – Future Total 2016 zero interaction
- APPENDIX F: Synchro Analysis – Future Total 2016 unconstrained interaction
- APPENDIX G: Synchro Analysis – Future Background & Future Total 2021 zero interaction
- APPENDIX H: Synchro Analysis – Future Background & Future Total 2021 unconstrained interaction
- APPENDIX I: Sensitivity Analysis - Future Background & Future Total 2021 Zero & Unconstrained interaction



1.0 INTRODUCTION

1.1 BACKGROUND

BA Consulting Group Ltd. (BA Group) is retained by Morguard Investments Limited (Morguard) to carry out a Transportation Impact Study (TIS) in support of the proposed Riverside South Commercial Development. The purpose of this study is to quantify the traffic impact of the subject development on the transportation network and to ensure that infrastructure is planned to mitigate potential development-related impacts.

The subject site is generally located south of the Ottawa International Airport as illustrated in **Figure 1**. The site is generally bounded by Limebank Road to the west, Earl Armstrong Road to the north, the proposed City of Ottawa transit corridor to the south and the proposed Collector Road 'D' to the east.

Figure 3 illustrates the site context.

A Community Design Plan (CDP) was prepared for the Riverside South Community. The CDP was approved in 2004 and updated in 2010. A Community Transportation Study was also prepared as supporting information for the original CDP. **Figure 2** illustrates the Riverside South CDP.

1.2 DEVELOPMENT PROPOSAL

The Riverside South Commercial Development encompasses an area of approximately 6.58 hectares (16.15 acres). The subject site is anticipated to be developed in two phases: Phase 1 and Phase 2 which are expected to be built and occupied by 2016 and potentially 2021, respectively consists of the following:

	Ground Floor Gross Floor Area (GFA)	Second Floor Gross Floor Area (GFA)	Parking Provided
Phase 1:	10,637.31 m ² (114,499 ft ²)	464.52 m ² (5,000 ft ²)	577 spaces
Phase 2	4,433.79 m ² (47,725 ft ²)	3,783.48 m ² (40,725 ft ²)	168 spaces
Totals	15,071.10 m² (162,224 ft²)	4,247.99 m² (45,725 ft²)	745 spaces

Vehicular access will be provided via a right in / right out access onto Earl Armstrong Road located approximately mid-block between Limebank Road and Collector Road D, a full movement access onto Limebank Road located approximately 213.7 metres south of Earl Armstrong Road and two full movement access driveways onto Collector Road 'D'.

Figure 4 illustrates the site plan for the subject site.



1.3 SCOPE OF ANALYSIS

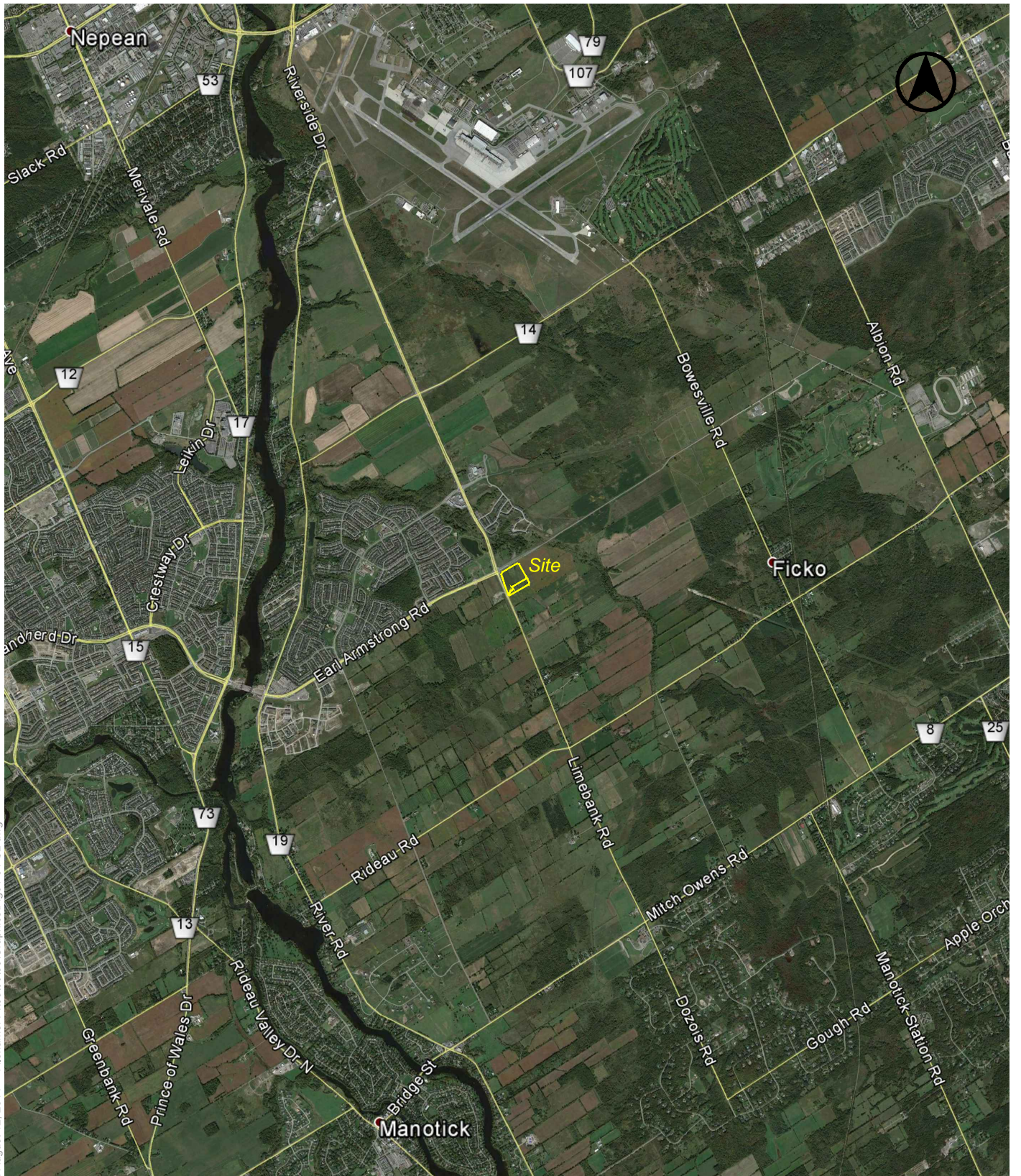
Phase 1 of the subject development is anticipated to be completed within the next two years. As such, this TIS evaluates future background and future total traffic conditions for the 2016 and 2021 horizons for the development phases. Analyses were conducted for AM and PM peak hours consistent with the Riverside South Phase 5 Transportation Impact Study report prepared by Dillon Consulting Limited and dated January 2011.

Through pre-consultation with City of Ottawa staff, it was agreed that the study area intersections for analyses include:

- Limebank Road and Earl Armstrong Road signalized intersection;
- Earl Armstrong Road / Collector Road 'D' signalized intersection;
- Earl Armstrong Road / Site Access unsignalized intersection; and
- Limebank Road / Site Access unsignalized intersection.

The Transportation Impact Study for the subject development was prepared in accordance with the City of Ottawa's Transportation Impact Assessment Guidelines, October 2006. Intersection operational level of service (LOS) analysis was completed using Trafficware's Synchro® software version 6.0. This software package, which uses the methodologies of the Highway Capacity Manual (HCM), produces results in terms of volume to capacity ratio (v/c). Intersections with an overall v/c ratio greater than 0.90 are regarded as critical, and therefore should be considered for further improvements.



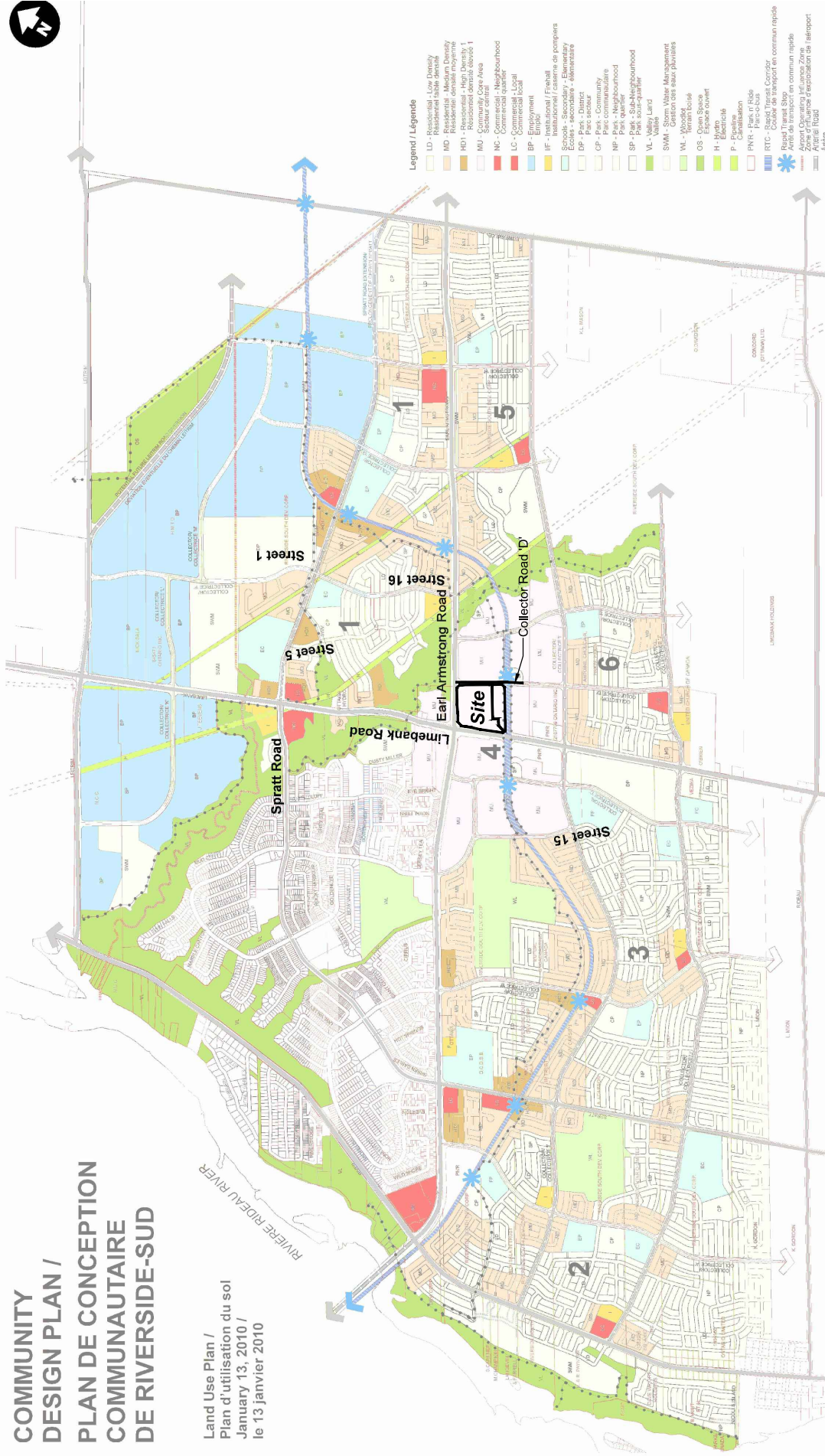


Date Plotted: August 12, 2014
Filename: P:\58190\38\Graphics\Fig01-04-SL.dwg

SITE LOCATION

**COMMUNITY DESIGN PLAN /
PLAN DE CONCEPTION
COMMUNAUTAIRE
DE RIVERSIDE-SUD**

Land Use Plan /
Plan d'utilisation du sol
January 13, 2010 /
le 13 janvier 2010



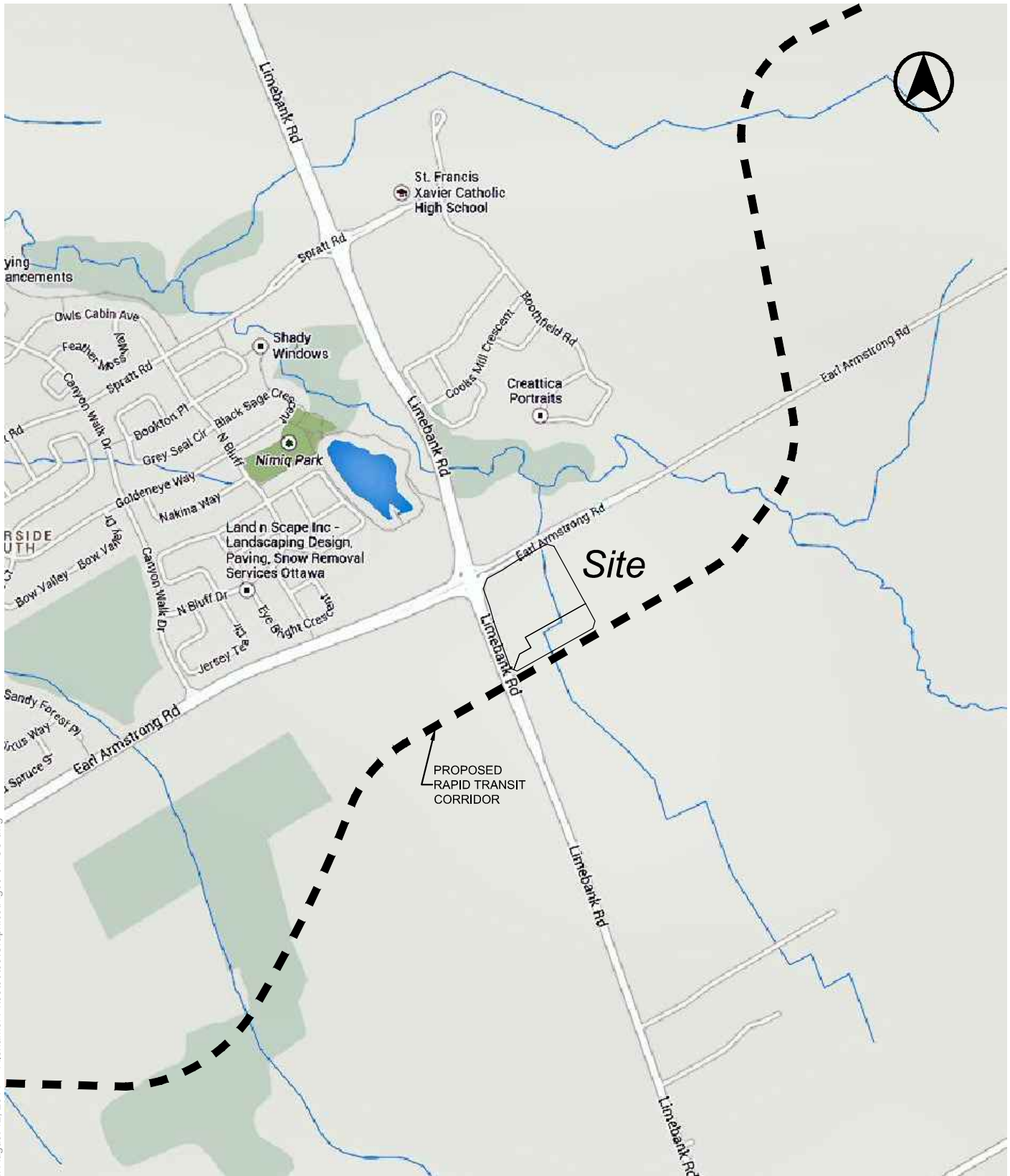
Date Plotted: August 12, 2014 Filename: P:\58190\38\Graphics\Fig02-04-CP.dwg

COMMUNITY DESIGN / LAND USE PLAN

Riverside South Commercial Development
5890-38 August 2014

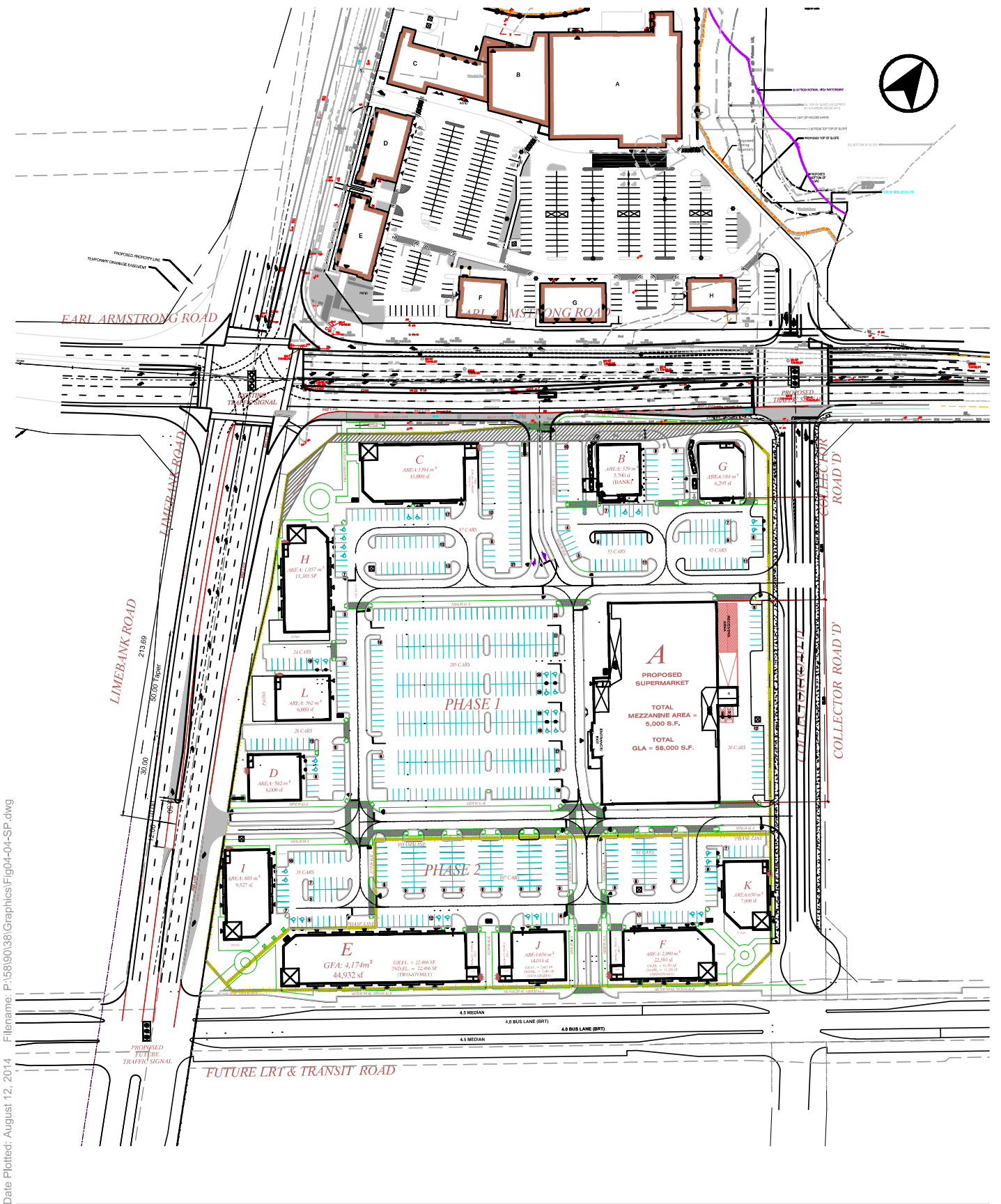


Figure 2



Date Plotted: August 12, 2014
 Filename: P:\58190\38\Graphics\Fig03-04-SC.dwg

SITE CONTEXT



Date Plotted: August 12, 2014
 Filename: P:\58190\38\Graphics\Fig04-04-SP.dwg

SITE PLAN

2.0 EXISTING CONDITIONS

2.1 EXISTING ROAD NETWORK

Limebank Road is designated as an arterial road in the City of Ottawa Official Plan. Limebank Road extends north/south from River Road in the north to Mitch Owens Road in the south. The City of Ottawa has recently completed widening Limebank Road to a four lane cross-section from River Road to just south of Earl Armstrong Road. The speed limit is posted at 80 km/h in sections that have been widened to a four lane cross-section.

Earl Armstrong Road is designated as an arterial road in the City of Ottawa Official Plan. Earl Armstrong Road extends east/west from River Road in the west to High Road in the east. The City of Ottawa has recently completed widening of Earl Armstrong Road to a four lane urban cross-section from River Road to just east of Limebank Road.

2.2 EXISTING TRANSIT SERVICE

The proposed development is located in close proximity to existing transit service and to the existing Riverview Park & Ride (PNR) lot south of Earl Armstrong and east of River Road. The PNR lot was expanded to 364 spaces in 2010 and will be operational in 2011. The proposed development is also in close proximity to the Leitrim PNR lot, which currently has 290 parking spaces.

Route #145 provides local transit; this route is classified as a regular route. Route #145 operates from 5:45 a.m. to 12:00 a.m. during weekdays with limited weekend service. Route #145 operates under 20 minute headways during peak commuter hours and 30 minute headways during regular hours. Route #145 currently runs along the Earl Armstrong Road, Spratt Road, Shoreline Drive, and Canyon Walk Drive to provide access to the Riverview PNR facility.

Route #99 provides rapid transit service to the Riverside South community from the Riverview PNR facility. Route #99 operates from 5:49 am to 12:00 a.m. during weekdays, and typically runs under 10 minute headways during peak commuter hours and 30 minute headways during regular hours. Route #99 currently runs along Spratt Road, and Leitrim Road connecting to the Leitrim PNR facility. Beyond the Leitrim PNR, Route #99 connects to the southeast Transitway via Albion Road and Lester Road.

Route #189 provides weekday peak hour transit service to the Riverside South community to Greenboro Station. Route #189 operates under 30 minute headways from and to the Riverview PNR facility during the AM and PM peak commuter hours. Route #189 currently runs along River Road.

Route #245 provides rural express transit service to the Riverview PNR facility from Manotick via River Road. Route #245 currently operates under a 20 minute headway schedule during weekday peak commuter hours for the peak direction. Route #245 does not currently operate outside of peak commuter hours or during weekends.

Figure 5 shows the existing transit network which serves the Riverside South Community.



2.3 PEDESTRIAN AND CYCLING FACILITIES

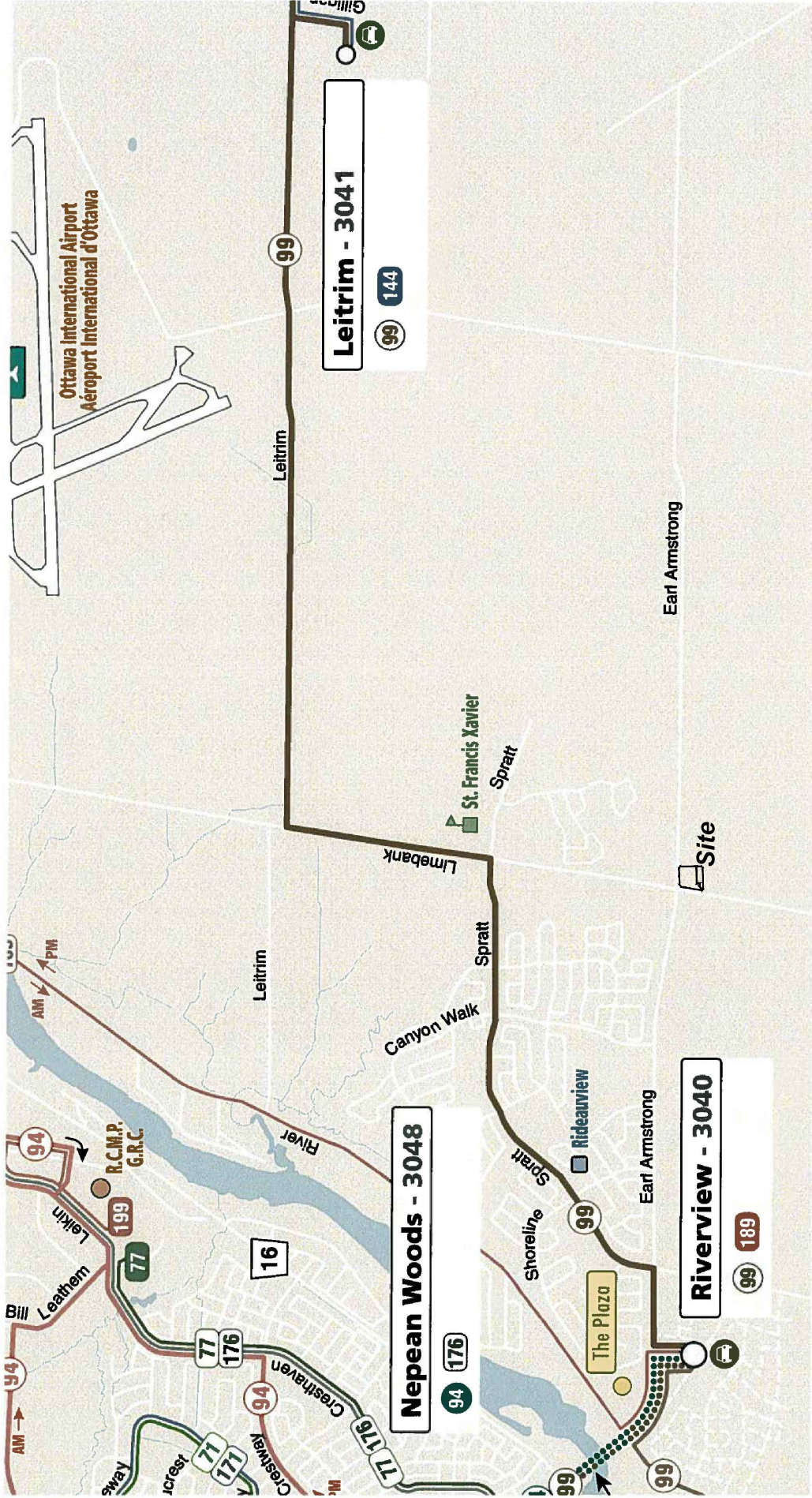
Dedicated cycling lanes are currently provided on both sides of Earl Armstrong Road and Limebank Road. Pedestrian sidewalks are provided on both sides of Earl Armstrong Road.

2.4 EXISTING TRAFFIC VOLUMES

Existing AM and PM peak hour traffic volumes for the Limebank / Earl Armstrong intersection were obtained from the City of Ottawa from turning movement counts conducted by in August 2012.

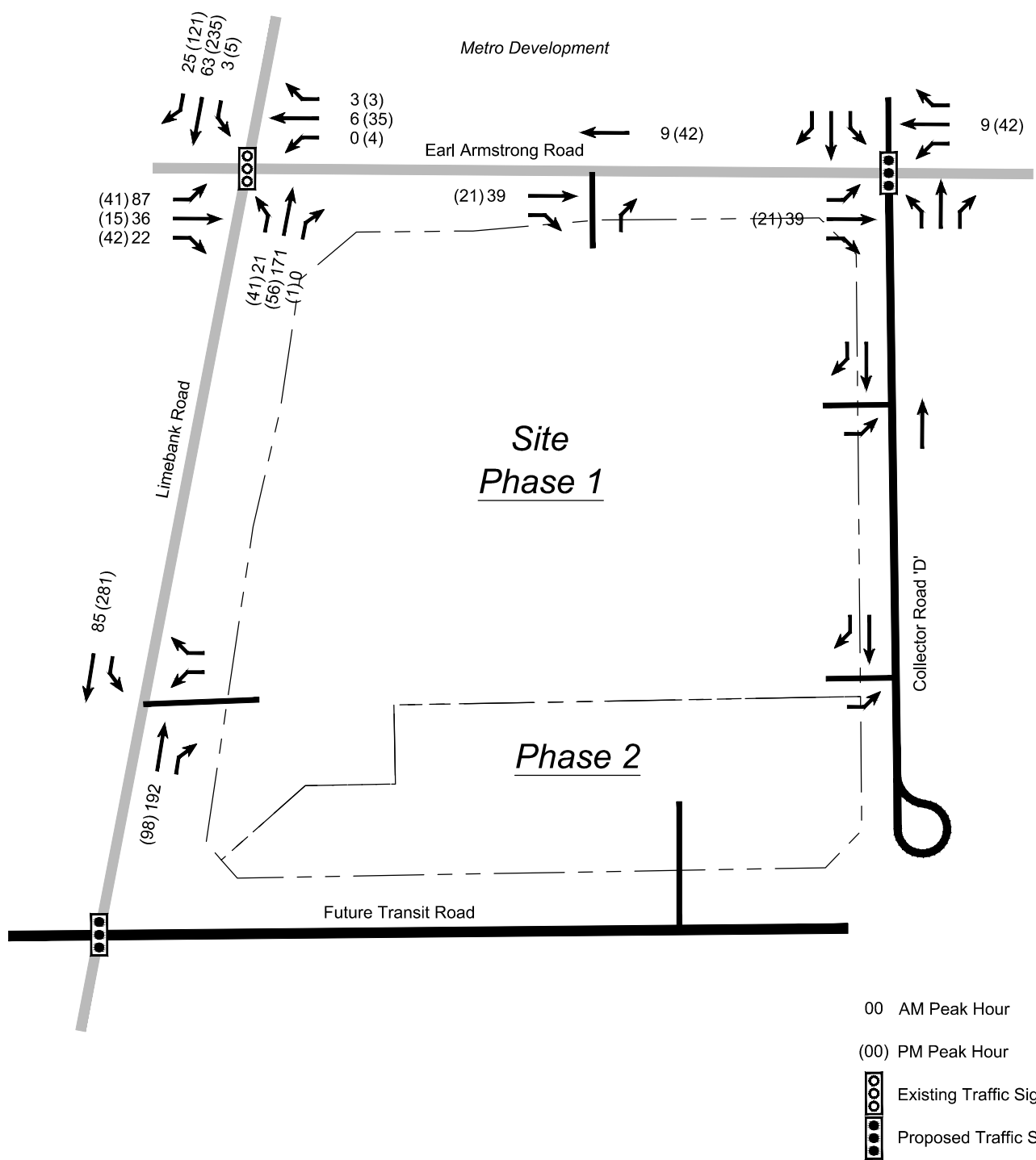
Figure 6 illustrates existing AM and PM peak hour traffic volumes.





Date Plotted: August 12, 2014 File Name: P:\58190\38\Graphics\Fig05-04-TRANS.dwg

EXISTING TRANSIT SERVICE



Date Plotted: August 12, 2014
 Filename: P:\58190\38\Graphics\Fig06-04-EXT.dwg

EXISTING TRAFFIC VOLUMES

3.0 ASSESSMENT SCENARIOS

3.1 ZERO & UNCONSTRAINED INTERACTION SCENARIOS

Construction of the Strandherd-Armstrong Bridge, which is scheduled for completion in September 2014, will create opportunities for residents of Barrhaven and South Nepean to change their travel patterns that may reduce overall travel time to / from their destinations.

Consistent with the Riverside South Phase 5 Transportation Impact Study report prepared by Dillon Consulting Limited and dated January 2011, two assessment scenarios were reviewed to test the potential magnitude of impact that the Strandherd-Armstrong Bridge will have on road network volumes in Riverside South and to test the sensitivity of road improvements which may be required a result of traffic interaction between areas east and west of the Rideau River from Barrhaven and South Nepean.

The following two assessment scenarios were considered: (1) Zero Interaction Scenario, and (2) Unconstrained Interaction Scenario. An explanation of both scenarios is provided below.

3.1.1 Zero Interaction Scenario

The Zero Interaction Scenario assumes that existing residents from Barrhaven and South Nepean will not utilize the Strandherd-Armstrong Bridge (and by extension, key arterial roads within Riverside South such as Earl Armstrong Road, River Road and Limebank Road) to infiltrate through the Riverside South community as part of a longer trip to areas north and east (i.e. the Downtown core). Similarly, this scenario also assumes that existing Riverside South residents will not use the bridge to infiltrate South Nepean and Barrhaven as part of a longer trip to areas to the west.

3.1.2 Unconstrained Interaction Scenario

The Unconstrained Interaction Scenario presents the opposite end of the spectrum to the Zero Interaction Scenario. It assumes that the level of interaction between South Nepean / Barrhaven and Riverside South (including both regional trips and local destination-based trips), will not be constrained by the physical capacity of transportation network elements on either side of the bridge (i.e. they would not be constrained by the residual capacity of controlling intersections, or the number of travel lanes, etc.).



4.0 FUTURE BACKGROUND CONDITIONS

Allowances were made for planned changes to the road network changes, including traffic redistribution that may result and for forecasted background traffic growth.

4.1 ANTICIPATED ROAD NETWORK CHANGES (2014 – 2021)

4.1.1 2014 Background Road Network

Construction of the Strandherd-Armstrong Bridge is slated to be completed in September 2014. As such, the analysis contained in this report assumes the bridge structure to be in place by the 2016 horizon.

The City of Ottawa has recently completed the widening of Limebank Road to a four lane cross-section from south of River Road to south of Earl Armstrong Road. Also, the City of Ottawa has recently completed the widening of Earl Armstrong Road to a four lane cross-section from River Road to just east of Limebank Road. Both roads feature four-lane urban cross-sections with auxiliary turn lanes and cycling facilities. The intersection of Earl Armstrong Road and Limebank Road is under traffic signal control.

The northerly section of Collector Road 'D', i.e., between Earl Armstrong Road and the Future Transitway, will be constructed within the next two years. As such, the analysis contained in this report assumes the Collector Road 'D' to be in place by the 2016 horizon. The intersection of Earl Armstrong Road and Collector Road 'D' is anticipated to be signalized.

There are no other significant background road network modifications anticipated during the 2018 - 2021 horizon years in the vicinity of the subject development site.

4.2 FORECASTED BACKGROUND GROWTH

There are two sources of growth in future background transportation demands:

- Explicit consideration of known / planned future developments; and
- Application of growth rates based on historical trends to account for growth in through volumes.

4.2.1 Future Background Traffic Volumes

For the purposes of this study, future (2013) Total Traffic Volumes from the Riverside South Phase 5 TIS report (Dillon January 2011) shown in Appendix A, were used as background traffic volumes.

As indicated in the Riverside South Phase 5 TIS report (Dillon January 2011), background developments assumed within the TIS are consistent with the Riverside South Community Design Plan. In total, other background developments within Riverside South are expected to generate over 7,000 residential units, in excess of 1.3 million square feet of commercial, retail and office space, business park land uses that generate approximately 3,000 employees as well as other ancillary land uses (i.e., institutional, schools, gas stations, park and ride expansion etc.). Additional information related to trip generation assumptions and trips generated by development block can be found in Appendix A.



We note that revisions were made to vehicle trips generated by the uses in Block 'P' on the Appendix Table. An equivalent GFA, i.e., 207,949 ft², representing the subject development were deducted from the future total traffic volumes shown in Appendix Figure (from the January 2011 TIS report).

Based upon traffic assignments provided by Novatech Engineering Consultants Ltd., allowances were also made for the proposed Limebank Metro development at 1423 Earl Armstrong Road, at the northeast corner of the Earl Armstrong Road / Limebank Road intersection. The proposed Limebank Metro development will include a total GFA of approximately 87,500 ft² of retail commercial uses several buildings.

In addition to explicitly accounting for planned developments within Riverside South, a 2.0% annual rate of growth (compounded) was applied to 2013 background traffic volumes to account for growth in through traffic volumes and other developments not explicitly accounted for in Appendix Table.

Appendix Figure 1 illustrates the location of background developments which are expected to be built during the horizon of the study. Appendix Table 1 provides a summary of the Riverside South background developments including additional information on the type of development expected.

Future background traffic volumes for horizon year 2016 are summarized in **Figures 7 and 8** for the zero interaction and unconstrained interaction scenarios, respectively.

Future background traffic volumes for horizon year 2021 are summarized in **Figures 13 and 14** for the zero interaction and unconstrained interaction scenarios, respectively.

4.3 BACKGROUND TRANSIT NETWORK

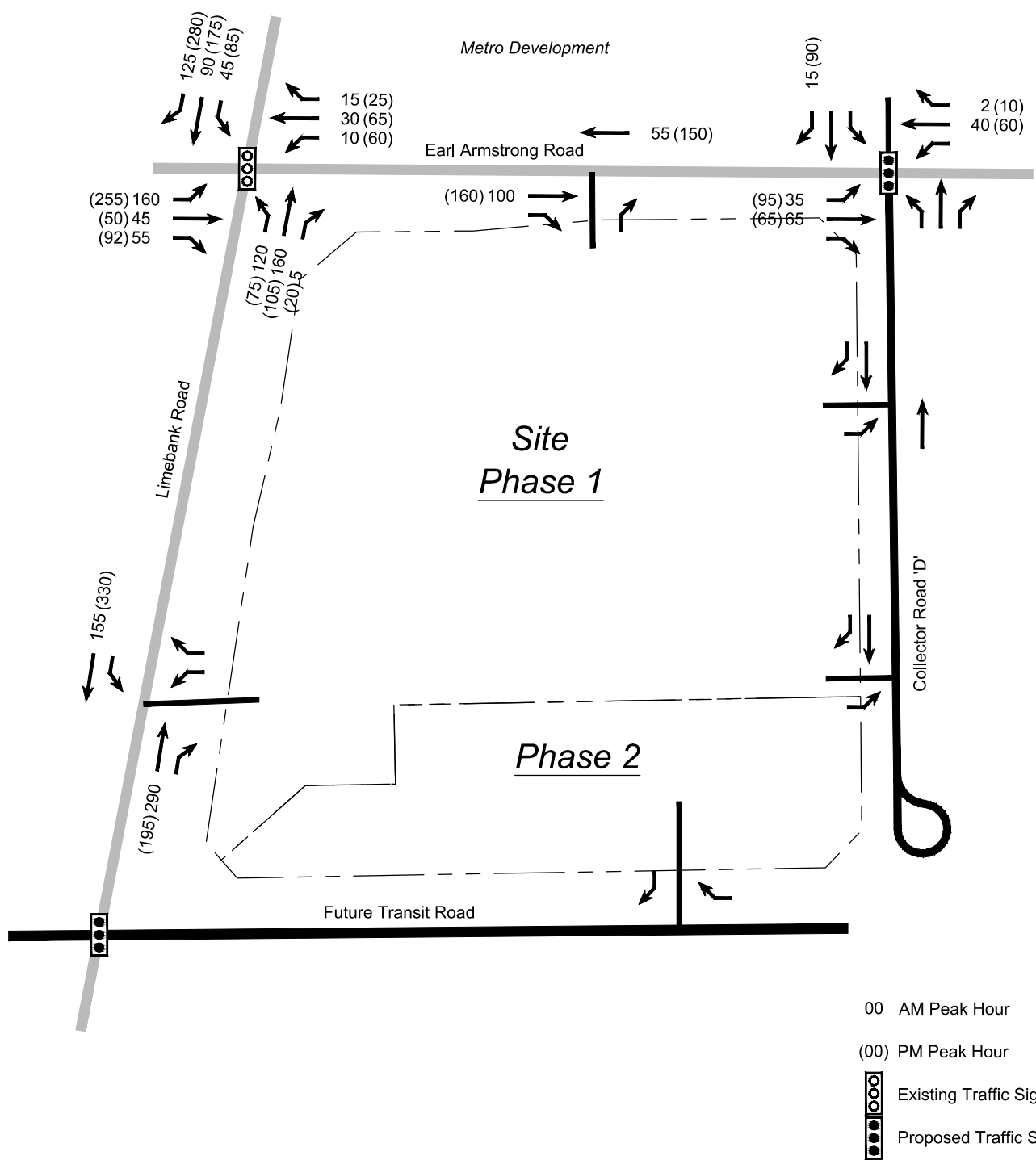
An extension of the Rapid Transit corridor into Riverside South is identified in the City of Ottawa's 2009 Transportation Master Plan (TMP). Rapid transit will extend from the South Keys Rapid Transit station to the Riverside South Town Centre. This corridor would pass along the eastern edge of the study area. This extension of the Rapid Transit corridor is assumed to occur beyond the 2021 horizon of this study.

Bus Rapid Transit (BRT) which is planned to extend from the Barrhaven Town Centre east to the Riverside South Town Centre is assumed to occur beyond the 2021 horizon.

Expectation in the TMP is that the transit mode split across the Leirtrim Screenline will grow from 5% to 25% by 2031, primarily as a result of the introduction of Rapid Transit from both the north and the west.

The Rapid Transit corridor extension to Riverside South was not anticipated within the time horizon of this study, given its anticipated timing.

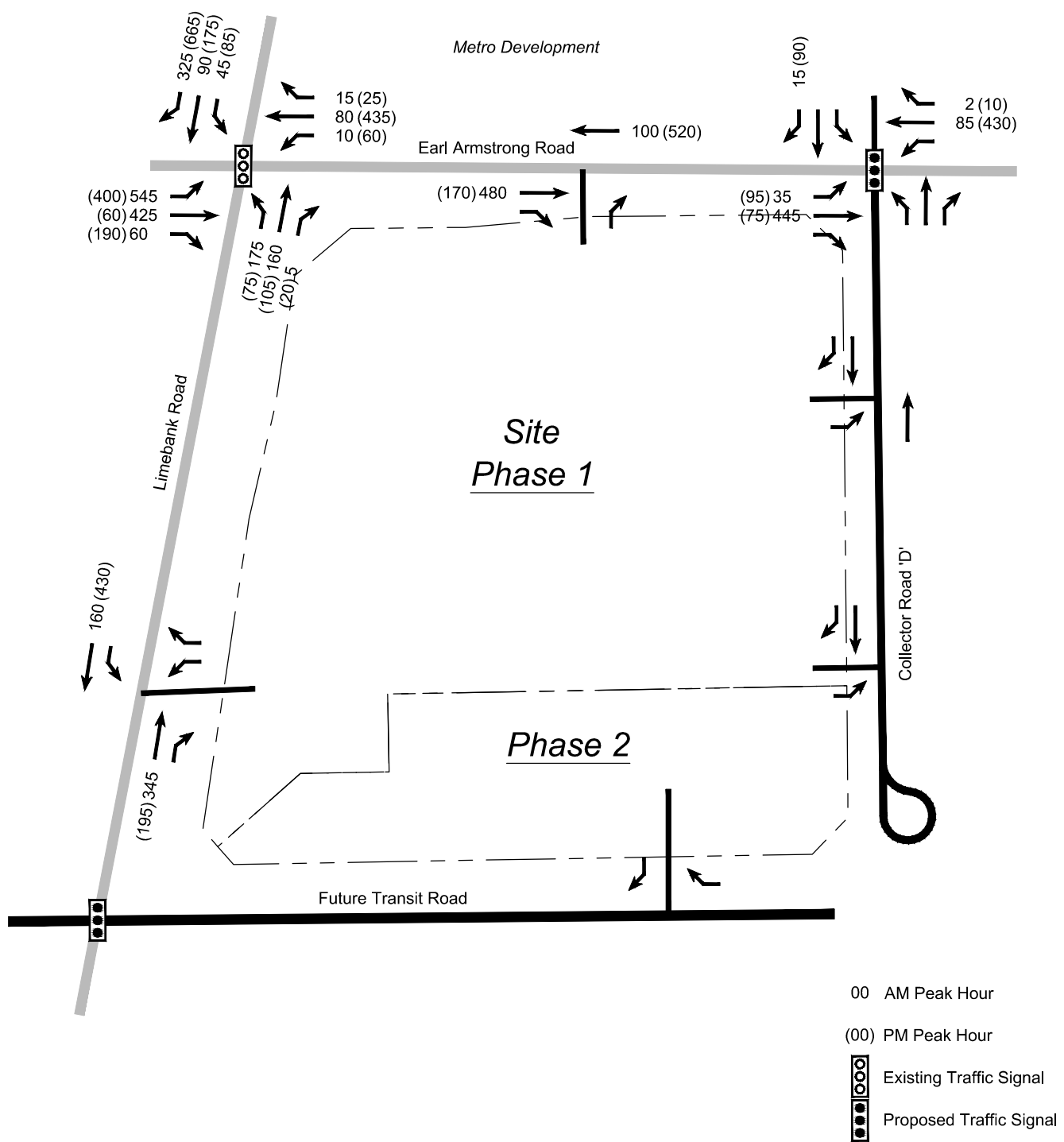




Date Plotted: August 12, 2014
 Filename: P:\58190\38\Graphics\Fig07-04-FBT.dwg

FUTURE BACKGROUND 2016 TRAFFIC VOLUMES

Zero Interaction



Date Plotted: August 12, 2014
 Filename: P:\58190\38\Graphics\Fig08-04-FBT.dwg

FUTURE BACKGROUND 2016 TRAFFIC VOLUMES

Unconstrained Interaction

5.0 TRAVEL DEMAND FORECASTS

5.1 TRANSIT MODAL SPLIT

Modal shares were determined based on the results of the 2011 TRANS O-D Survey Report for trips made within the Gloucester / Leitrim Area as well as the projected 2031 transit, walking and cycling mode shares for the Leitrim screenline as identified in the 2013 TMP. Modal share assumptions were as follows: 45% auto driver; 25% auto passenger; 5% transit; and 25% other.

5.2 SITE TRIP GENERATION

Trip generation estimates for the subject development were derived based on data extracted from the Institute of Transportation Engineers (ITE) Trip Generation Manual (9th Edition). The data was drawn from ITE land use code 820 – Shopping Centres.

Allowances for pass-by traffic were incorporated at a rate of 35 percent during the weekday p.m. peak hour for Phase 1 and 30% pass-by for the Phase 2. Trip generation data for this site are outlined in **Table 1** below. Pass-by trips were estimated using rates identified in the ITE Trip Generation Handbook, 9th Edition. Pass-by trips will be estimated using rates identified in the ITE Trip Generation Handbook, 9th Edition.

Phase 1 retail development will generate approximately 180 and 675 vehicle trips during weekday am and pm hours, respectively. With allowances for pass-by traffic, net new trips for Phase 1 will be 180 and 435 trips for am and pm hours, respectively.

Net additional vehicle trips generated by Phase 2 retail / commercial development will be 75 and 290 trips during weekday am and pm hours, respectively.

TABLE 1 SITE TRAFFIC GENERATION

Retail Commercial	AM Peak Hour			PM Peak Hour		
	In	Out	2-Way	In	Out	2-Way
PHASE 1						
119,499 ft ² ITE LUC 820 -Primary Trips	110	70	180	205	230	435
Pass-by Trips 35%	0	0	0	120	120	240
Phase 1 Gross Trips	110	70	180	325	350	675
PHASES 1 & 2						
207,949 ft ² ITE LUC 820 - Primary Trips	155	100	255	320	365	685
Pass-by Trips – 30%	0	0	0	145	145	290
Phases 1 & 2 Gross Trips	155	100	255	465	510	975
Phase 2 Net Additional Trips	45	30	75	145	145	290



5.3 TRIP DISTRIBUTION AND ASSIGNMENT

Trips generated by the subject development are expected to follow a local traffic distribution trip distribution assumption. Table 2 provides a summary of the distribution of site trips.

TABLE 2 SITE TRAFFIC DISTRIBUTION

From / To	ROUTE	Weekday AM & PM Peak Hour
North	via Limebank Road	40%
South	via Limebank Road	30%
East	via Earl Armstrong Road	5%
West	via Earl Armstrong Road	25%
		100%

Phase 1 net, site traffic assignments for horizon year 2016 are illustrated in **Figures 9 and 10** for zero interaction and unconstrained interaction, respectively.

Phase 2 net, additional site traffic assignments for horizon year 2021 are illustrated in **Figures 15 and 16** for zero interaction and unconstrained interaction, respectively.

5.4 FUTURE TOTAL TRAFFIC VOLUMES

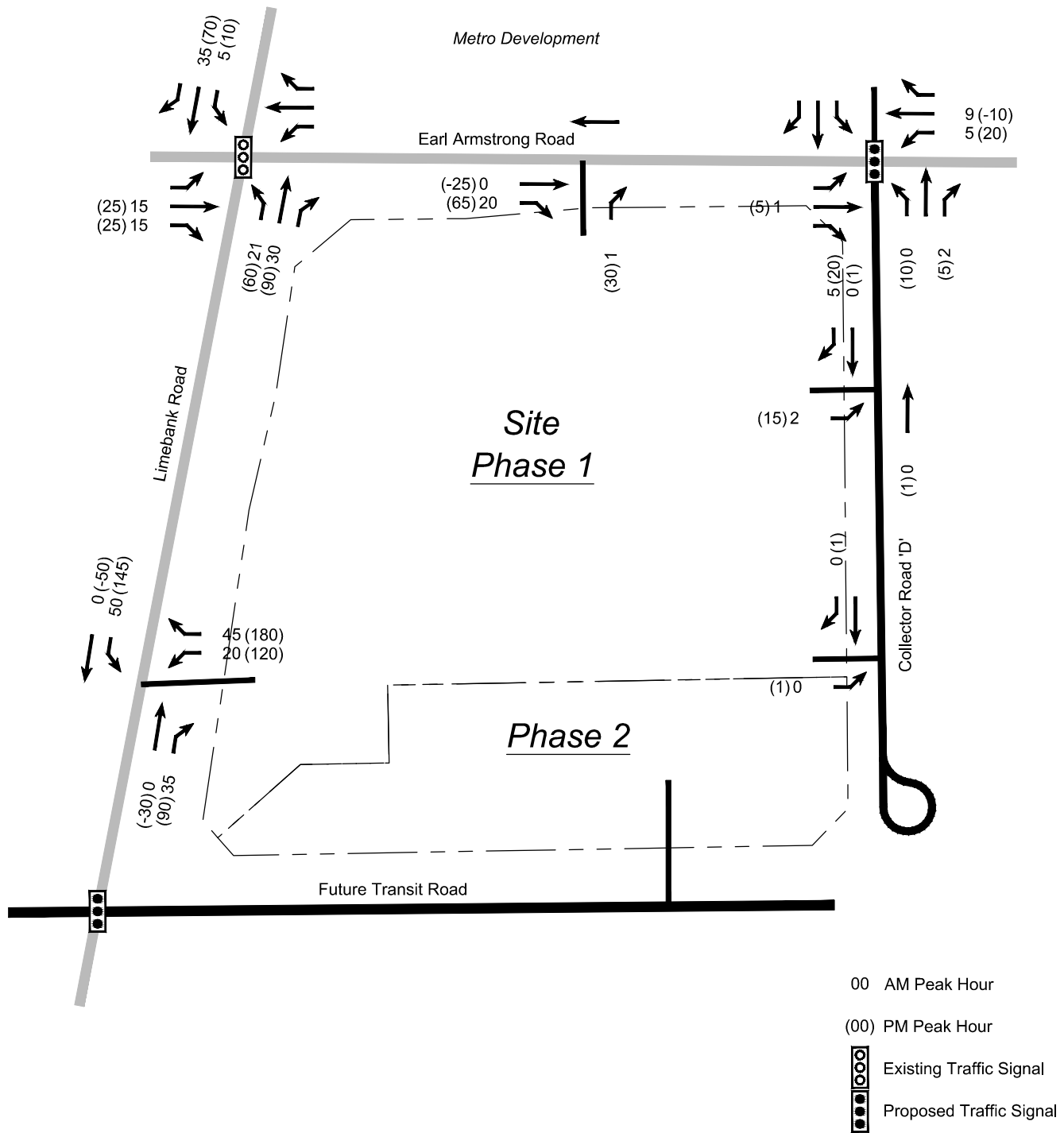
Future total traffic volumes at opening day (2016), zero interaction, shown on **Figure 11** represent the sum of traffic volumes shown on **Figures 7 and 9**. Future total traffic volumes at opening day (2016), unconstrained interaction, shown on **Figure 12** represent the sum of traffic volumes shown on **Figures 8 and 10**.

Future total traffic volumes at opening day (2021), zero interaction, shown on **Figure 17** represent the sum of traffic volumes shown on **Figures 13 and 15**. Future total traffic volumes at opening day (2021), unconstrained interaction, shown on **Figure 18** represent the sum of traffic volumes shown on **Figures 14 and 16**.





Date Plotted: August 12, 2014 File name: P:\58190\38\Graphics\Fig09-04-NST.dwg

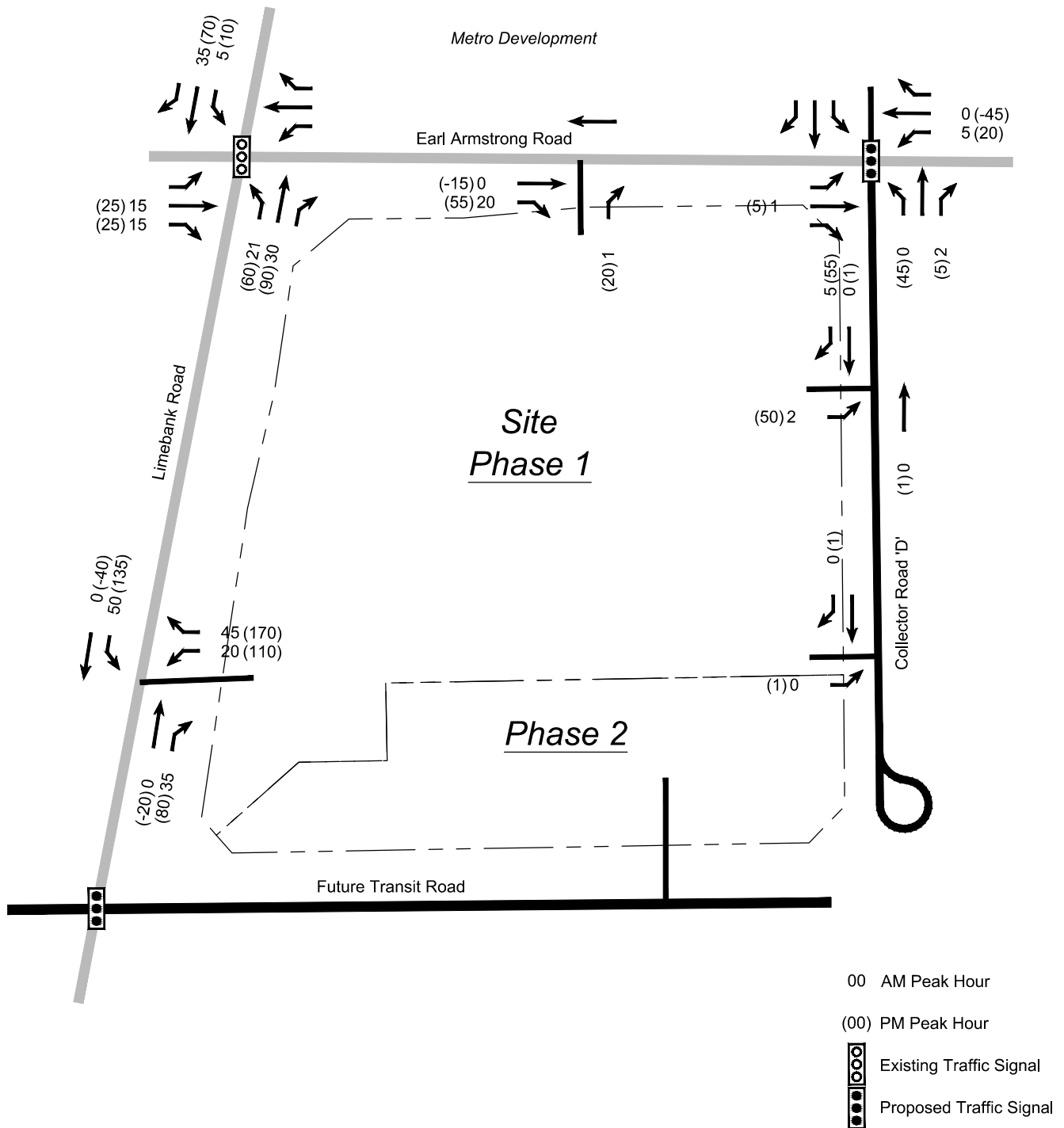


NET SITE 2016 TRAFFIC VOLUMES

Zero Interaction

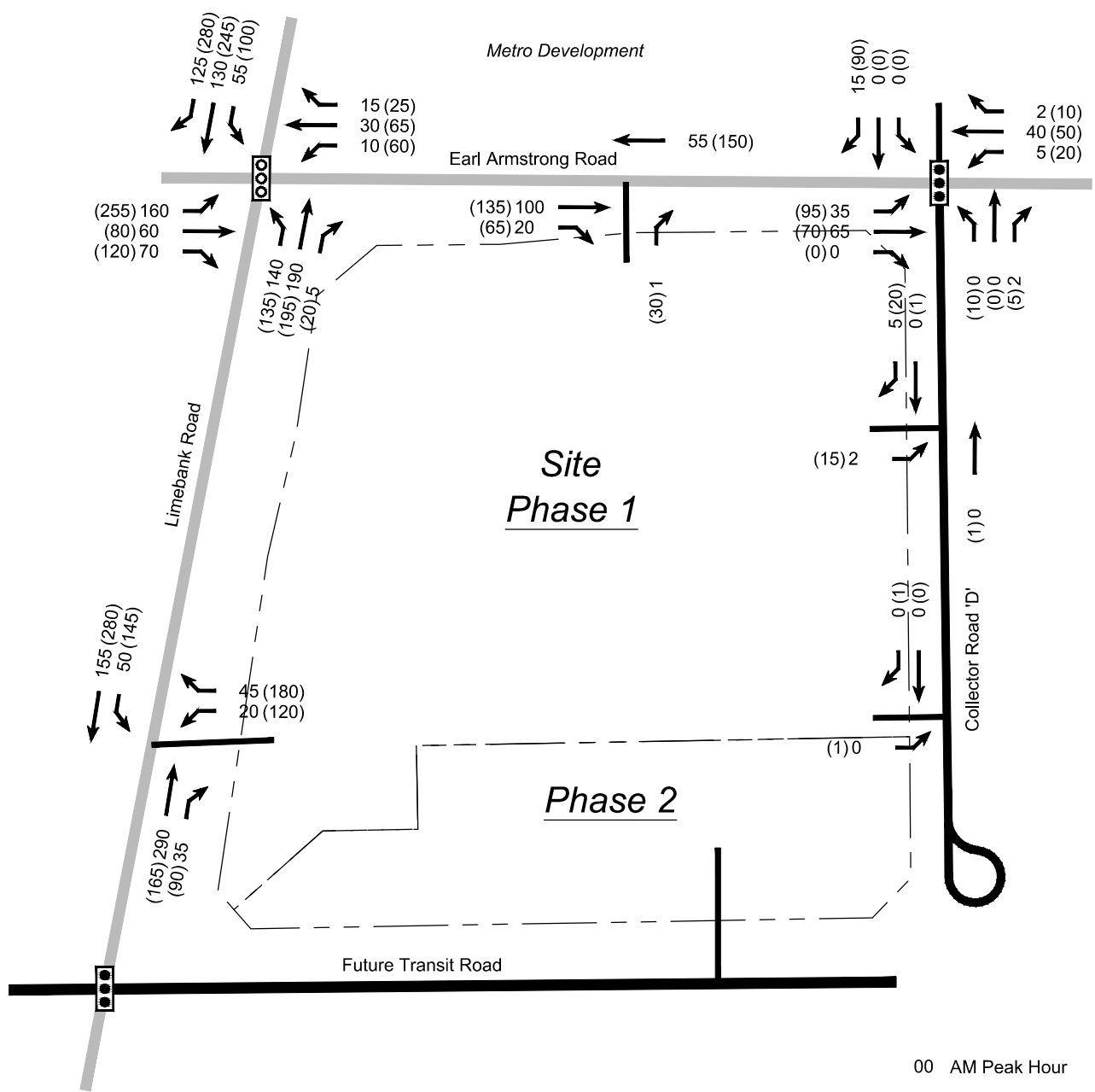


Date Plotted: August 12, 2014 File name: P:\58190\38\Graphics\Fig10-04-NST.dwg



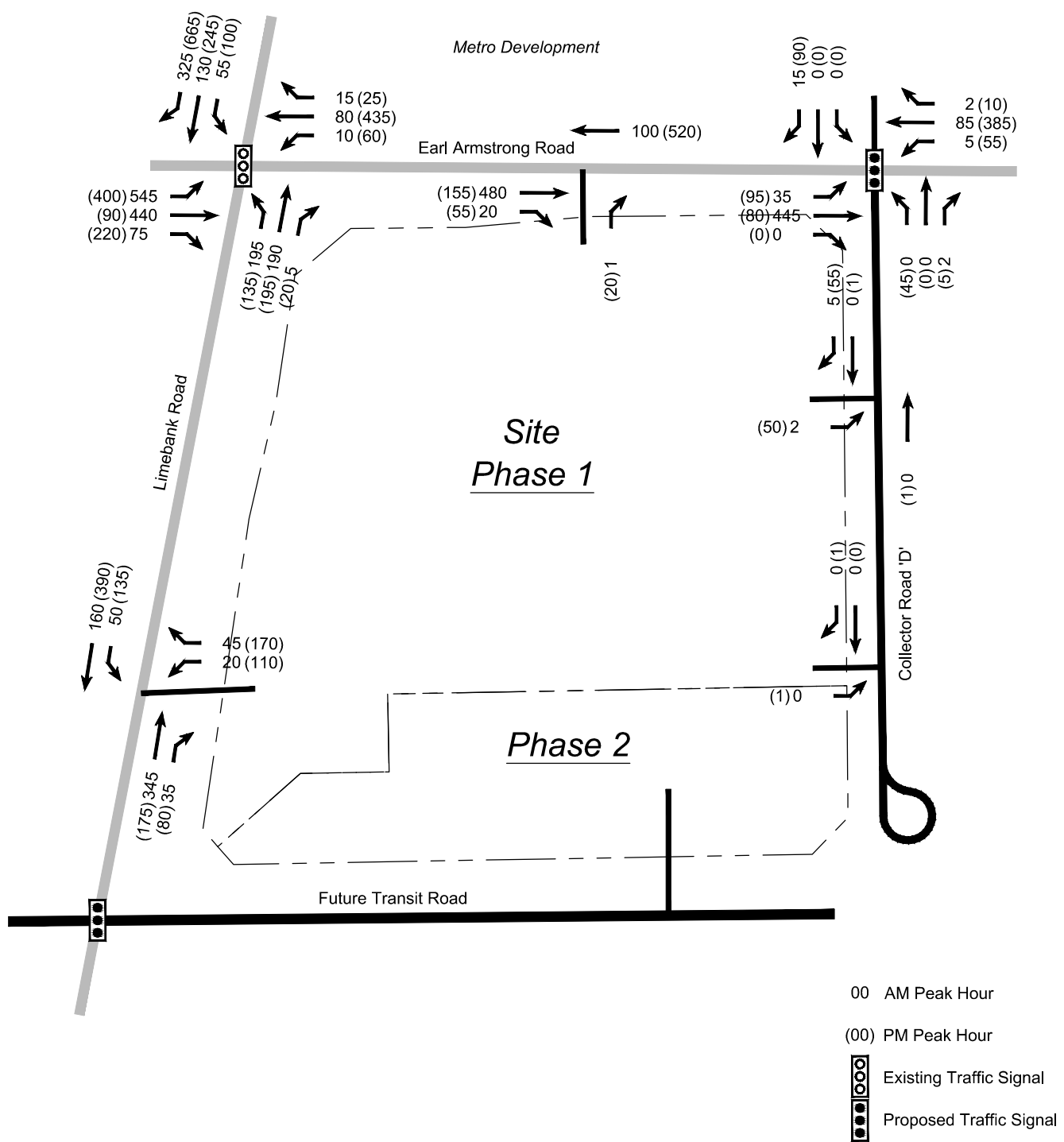
NET SITE 2016 TRAFFIC VOLUMES

Unconstrained Interaction



Date Plotted: August 12, 2014
 Filename: P:\58190\38\Graphics\Fig11-04-FTT.dwg

FUTURE TOTAL 2016 TRAFFIC VOLUMES
 Zero Interaction



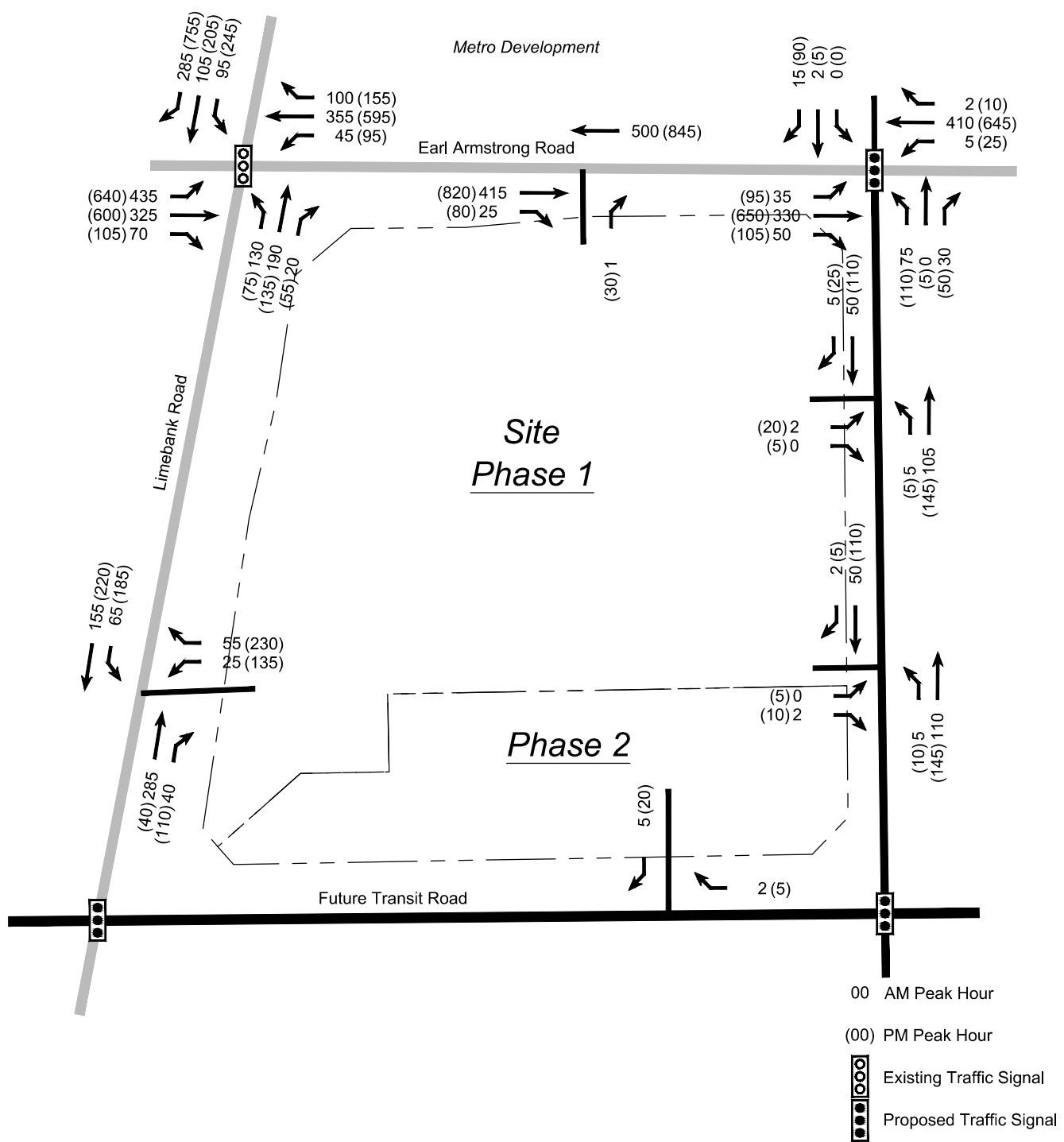
Date Plotted: August 12, 2014
 Filename: P:\58190\38\Graphics\Fig12-04-FTT.dwg

FUTURE TOTAL 2016 TRAFFIC VOLUMES

Unconstrained Interaction

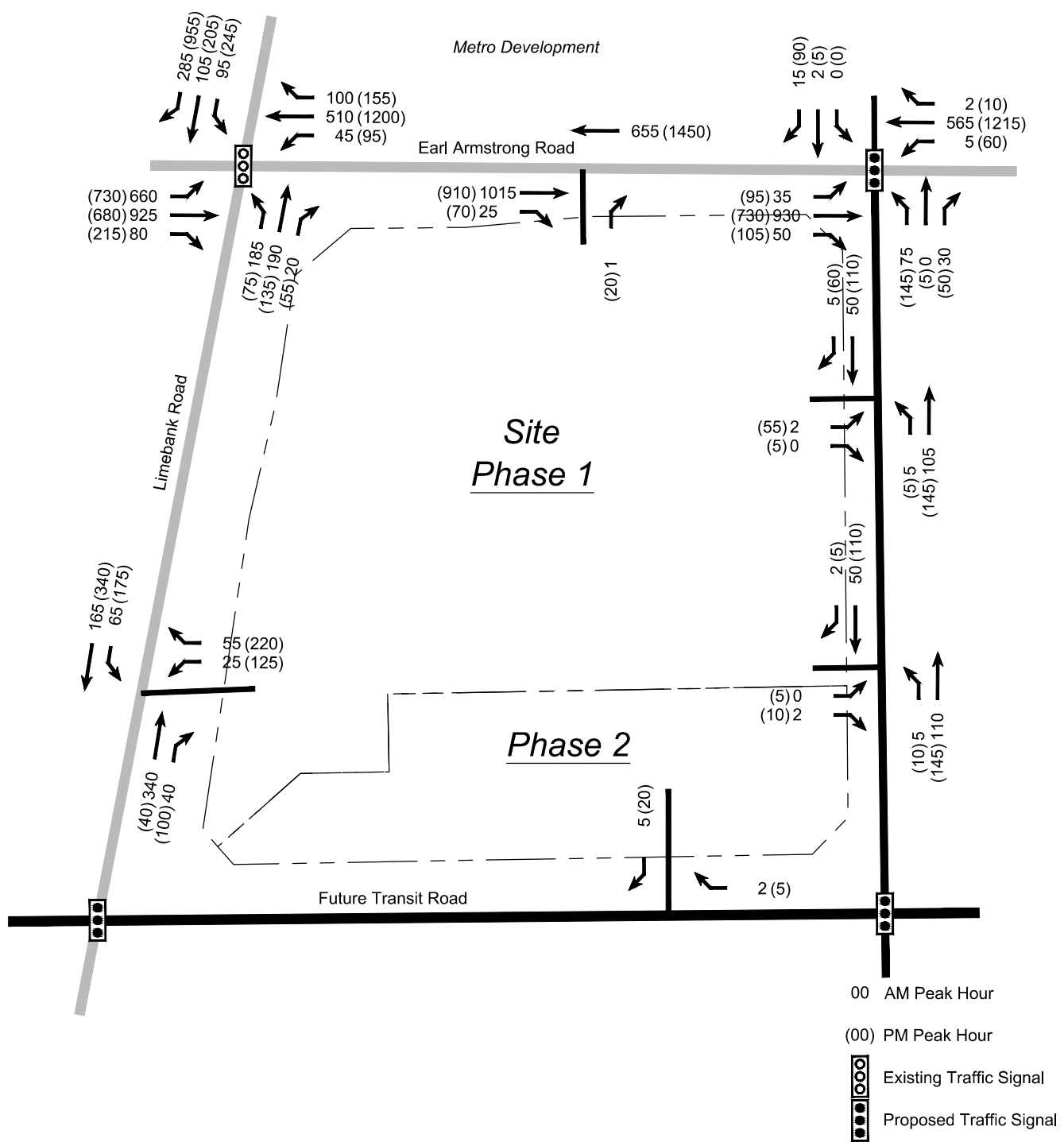


Date Plotted: August 12, 2014
Filename: P:\58190\38\Graphics\Fig13-04-FBT.dwg



FUTURE BACKGROUND 2021 TRAFFIC VOLUMES

Zero Interaction



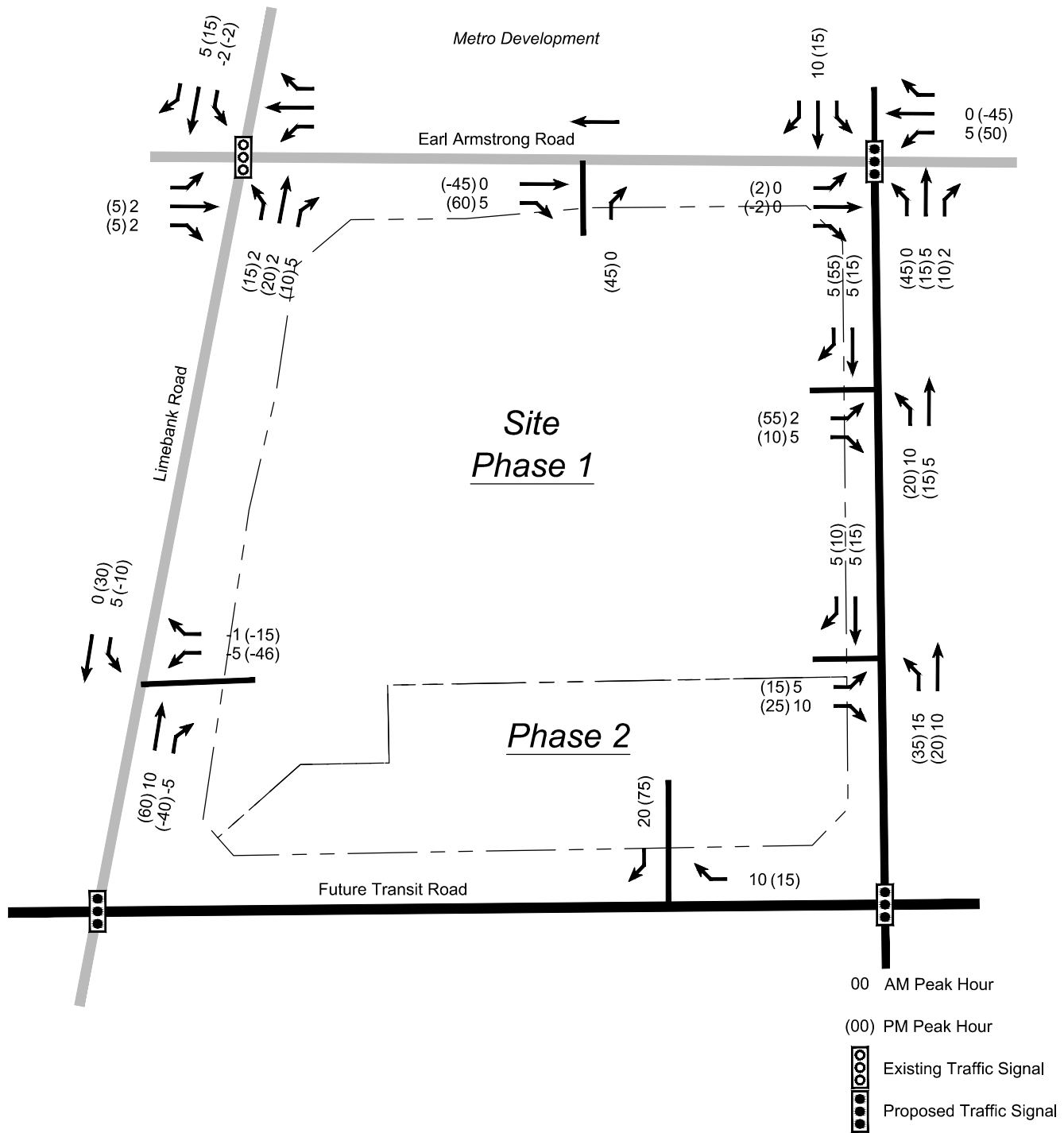
Date Plotted: August 12, 2014
 Filename: P:\58190\38\Graphics\Fig14-04-FBT.dwg

FUTURE BACKGROUND 2021 TRAFFIC VOLUMES

Unconstrained Interaction



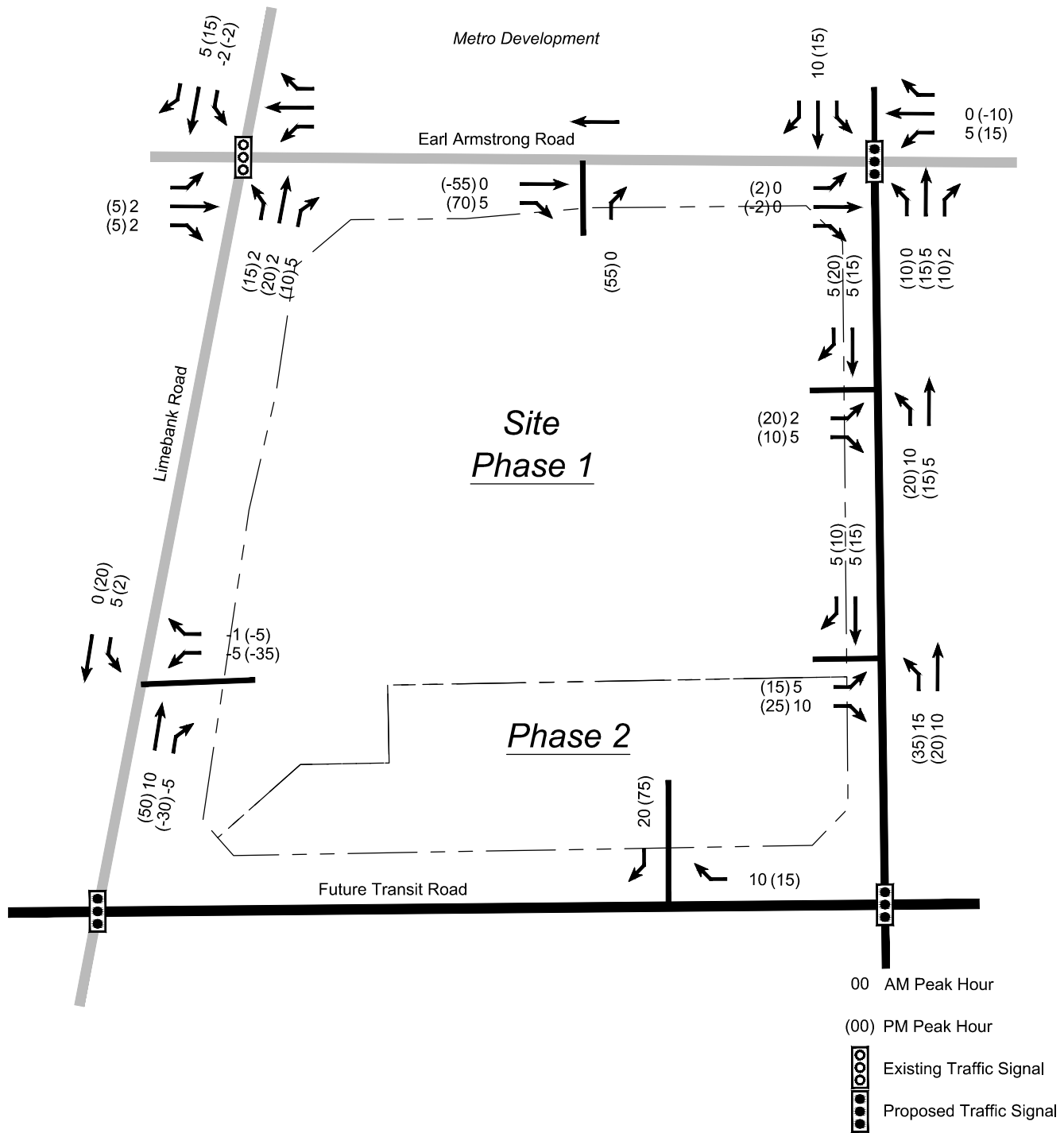
Date Plotted: August 12, 2014
Filename: P:\58190\38\Graphics\Fig15-04-NAST.dwg

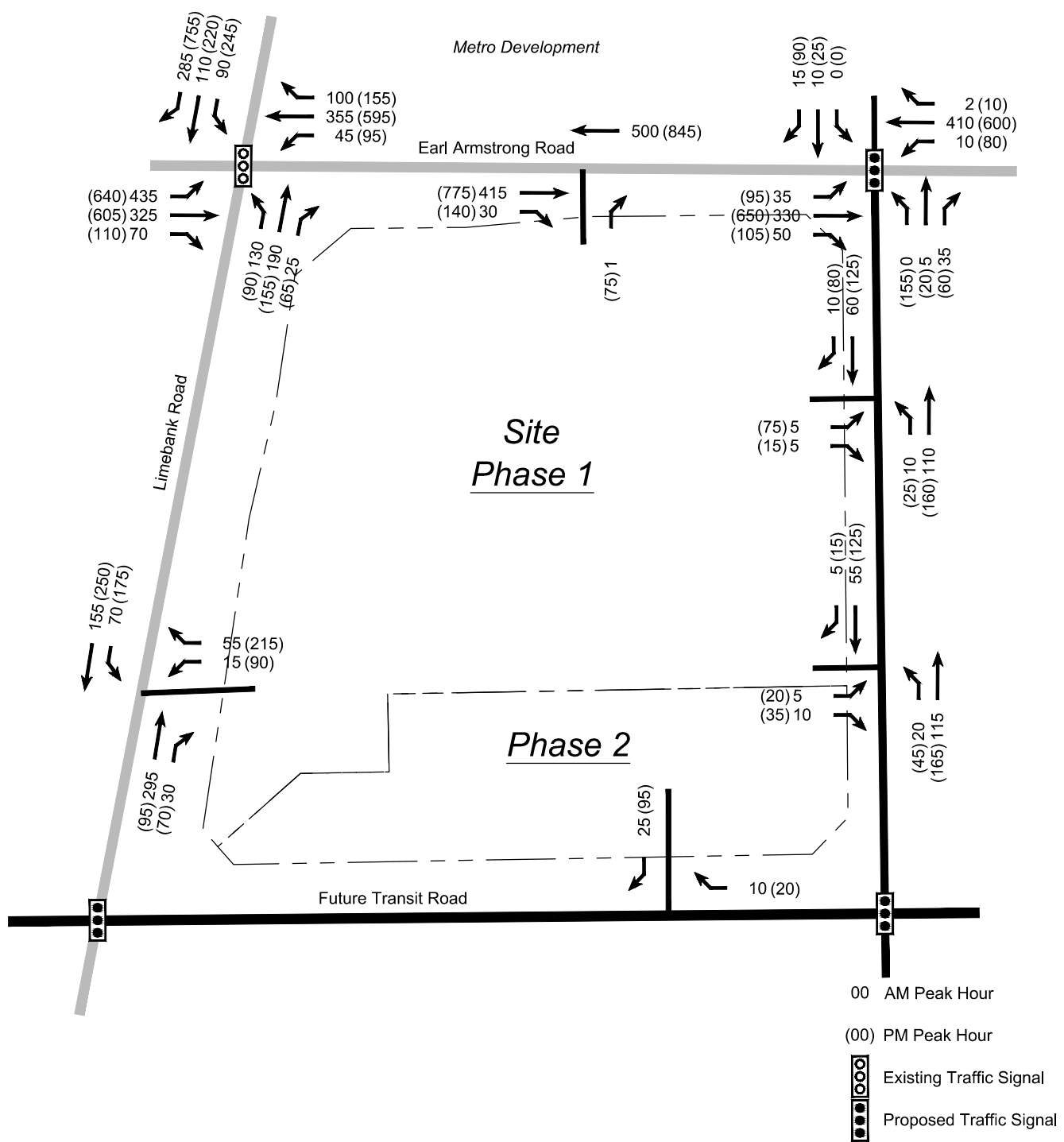


NET ADDITIONAL SITE 2021 TRAFFIC VOLUMES
 Zero Interaction



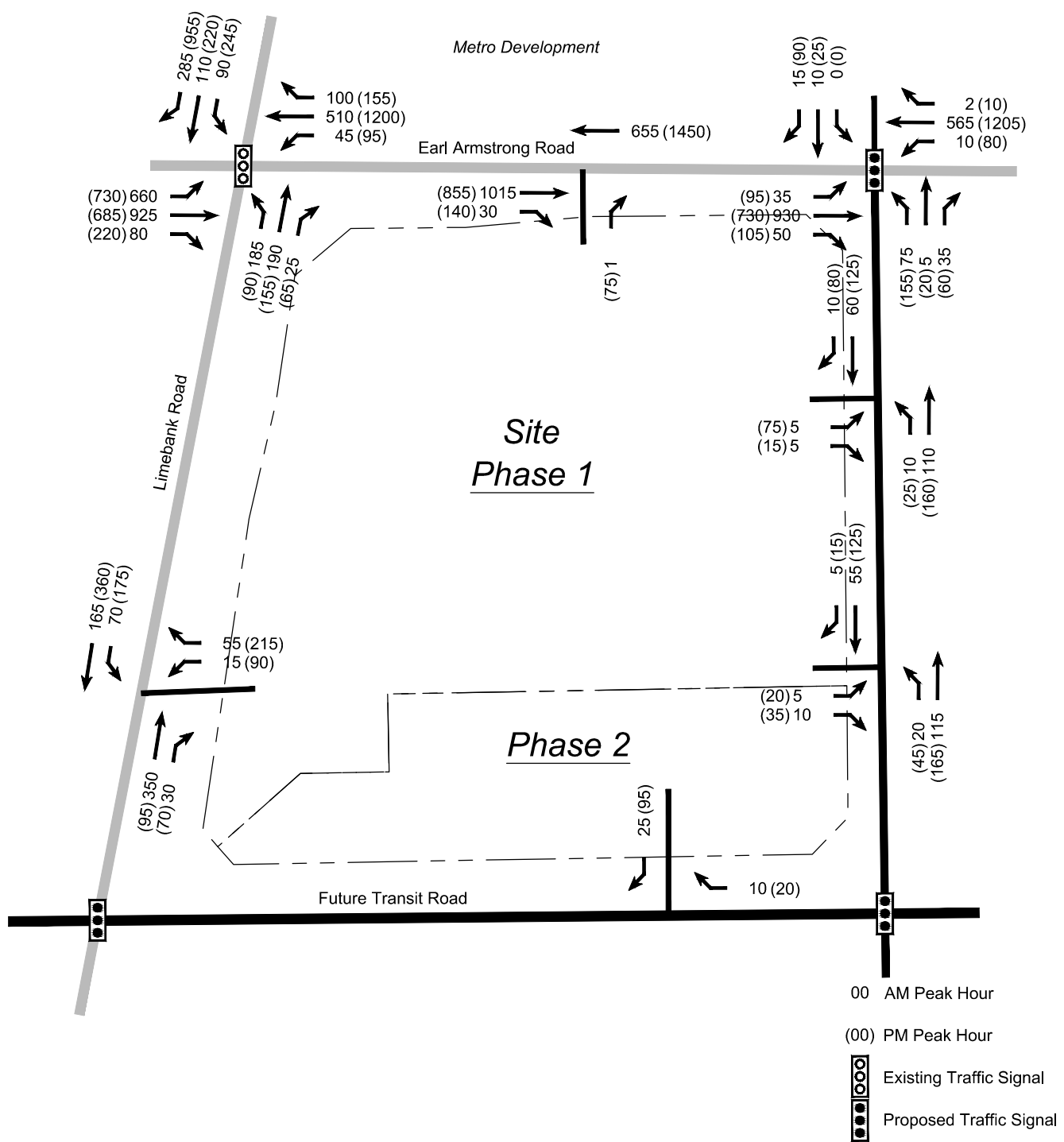
Date Plotted: August 12, 2014 Filename: P:\58190\38\Graphics\Fig16-04-NAST.dwg





FUTURE TOTAL 2021 TRAFFIC VOLUMES
 Zero Interaction

Date Plotted: August 12, 2014
 Filename: P:\58190\38\Graphics\Fig17-04-FTT.dwg



FUTURE TOTAL 2021 TRAFFIC VOLUMES
Unconstrained Interaction

Date Plotted: August 12, 2014 File name: P:\58190\38\Graphics\Fig18-04-FTT.dwg

6.0 TRAFFIC IMPACT ANALYSIS

6.1 SIGNALIZED INTERSECTIONS – ANALYSIS PARAMETERS

Analysis of the study area signalized intersections were analyzed based on procedures set out in Highway Capacity Manual (2000) with the assistance of Trafficware Traffic Signal Timing software - Synchro Version 7.0. Signal cycle lengths and timings currently in effect at the intersections were provided by City of Ottawa Traffic Operations Department. Adjustments were made to reflect future operating conditions as required. Relevant performance indicators for the weekday am and pm peak hours are summarized on Tables 3 and 4 for the 2016 and 2021 horizon years.

TABLE 3 CAPACITY ANALYSIS SUMMARY – SIGNALIZED INTERSECTIONS (2016)

Intersection	Future Background Zero Interaction			Future Background Unconstrained			Future Total Zero Interaction			Future Total Unconstrained		
	v/c	Delay sec.	LOS	v/c	Delay sec.	LOS	v/c	Delay sec.	LOS	v/c	Delay sec.	LOS
AM Peak Hour												
Earl Armstrong / Limebank	0.17	30.8	C	0.39	33.2	C	0.18	30.6	C	0.38	33.4	C
Earl Armstrong / Collector 'D'	0.03	5.4	A	0.14	1.6	A	0.03	5.8	A	0.14	1.8	A
PM Peak Hour												
Earl Armstrong / Limebank	0.20	28.3	C	0.48	28.8	C	0.26	28.4	C	0.53	29.5	C
Earl Armstrong / Collector 'D'	0.09	12.9	B	0.14	7.4	A	0.09	13.7	B	0.16	9.7	A

1. City of Ottawa criteria that relate v/c ratio to a LOS rating.

Level of Service

A
B
C
D
E
F

Volume to Capacity Ratio

0.0 to 0.60
0.61 to 0.70
0.71 to 0.80
0.81 to 0.90
0.91 to 1.00
>1.00

6.1.1 Future (2016) Traffic Conditions

Under future background and future total traffic conditions, no operational issues were identified at the Limebank / Earl Armstrong and the Earl Armstrong / Collector Road 'D' signalized intersections for both the Zero Interaction and Unconstrained Interaction scenarios. Both intersections will operate at good levels of service LOS A (based upon City of Ottawa criteria) with no critical movements. Site traffic generated by the subject development, therefore, is not expected to impact intersection operations.



TABLE 4 CAPACITY ANALYSIS SUMMARY – SIGNALIZED INTERSECTIONS (2021)

Intersection	Future Background Zero Interaction			Future Background Unconstrained			Future Total Zero Interaction			Future Total Unconstrained		
	v/c	Delay sec.	LOS	v/c	Delay sec.	LOS	v/c	Delay sec.	LOS	v/c	Delay sec.	LOS
AM PEAK HOUR												
Earl Armstrong / Limebank	0.38	33.3	C	0.51	35.3	D	0.40	33.0	C	0.54	35.2	D
Earl Armstrong / Collector 'D'	0.19	7.6	A	0.35	4.7	A	0.19	8.3	A	0.35	5.2	A
PM PEAK HOUR												
Earl Armstrong / Limebank	0.74	34.1	C	1.01	84.8	F	0.74	33.8	C	1.01	84.2	F
Earl Armstrong / Collector 'D'	0.30	7.8	A	0.51	8.9	A	0.35	9.8	A	0.52	9.8	A

1. City of Ottawa criteria that relate v/c ratio to a LOS rating.

Level of Service

A
B
C
D
E
F

Volume to Capacity Ratio

0.0 to 0.60
0.61 to 0.70
0.71 to 0.80
0.81 to 0.90
0.91 to 1.00
>1.00

6.1.2 Future (2021) Traffic Conditions

Earl Armstrong Road / Collector Road 'D': Analysis results reflect good traffic operating characteristics under future (2021) conditions with no critical movements and significant reserve capacity.

The installation of traffic control signals is required at the Earl Armstrong Road / Collector Road 'D' intersection.

Limebank Road and Earl Armstrong Road: Under future background and future 2021 condition, the Limebank / Earl Armstrong intersection is expected to operate with an acceptable overall level of service during both peak hours under the Zero interaction scenario. This intersection is also expected to operate with an acceptable overall level of service during the am peak hour and poor overall levels of service during the pm peak hour under the unconstrained scenario.



6.2 UNSIGNALIZED INTERSECTIONS

Relevant performance indicators for the weekday am and pm peak hours are summarized on Tables 5 and 6 for the 2016 and 2021 horizon years.

Earl Armstrong Road / Site Access: Details of the capacity analysis indicate that the northbound right turn movement at the Earl Armstrong Road right in / right out site access will operate good levels of service, LOS A under 2016 and 2021 future traffic conditions.

Specific recommendations for the subject development include the following items:

- Widen the pavement on the south side of Earl Armstrong Road to provide a continuous eastbound right turn lane between Limebank Road and the site access driveway, as illustrated in drawing PRM02. The continuous right turn lane will also accommodate a future far side bus stop west of the site access driveway.
- Provide appropriate traffic control signs on the centre median and at the site driveway to preclude left turns.

Limebank Road / Site Access: Details of the capacity analysis indicate that westbound left turn movements will operate at acceptable levels of service, LOS C or better, under 2021 future total condition based upon the Zero and Unconstrained scenarios. Southbound left and westbound right turn movements will operate at good levels, LOS A, in the future, based upon the Zero and Unconstrained scenarios.

Specific recommendations for the subject development include the following items:

- Widen the pavement on the east side of Limebank Road to provide a northbound right turn lane with 30 metres storage and 50 metres taper, as illustrated in drawing PRM01.
- Modify the existing centre median on Limebank Road to accommodate a southbound left turn lane with 30 metres storage and 50 metres taper.
- Provide appropriate traffic control signs on centre median and at the site driveway.

The proposed access will be located approximately 213.10 metres south of Earl Armstrong Road signalized intersection which is beyond the horizon of this study. Construction of this future signalized intersection would provide opportunities for drivers with destinations south of subject site to make westbound left turns.

The functional design drawing indicates that the southbound and westbound turning movements can be physically accommodated respecting TAC Geometric Design guidelines. Site distance requirements are exceeded. The analysis results indicate that back-to-back left turns between Earl Armstrong Road (northbound) and the site driveway (southbound) can readily be accommodated without conflict.

A **full movement access** onto Limebank Road is, therefore, recommended as an appropriate strategy for the subject development.



6.3 SENSITIVITY ANALYSIS

A sensitivity analysis of the signalized intersection indicates that, without full turning movements at the Limebank Road access, the Limebank / Earl Armstrong intersection will operate at poor overall levels of service during the pm peak hour under future background and future total 2021 conditions (for both zero and unconstrained scenarios). The additional southbound and westbound left turn vehicles at the intersection will have a 13% impact on the overall v/c ratio and increases in delay per vehicle of approximately 18 seconds. Also, without full turning movements at the Limebank Road access the delay per vehicle for eastbound left turns and southbound left turns will **increase** by 46 and 42 seconds, respectively. The analysis results are summarized in Table 7.

Therefore, taking into consideration the significant impact a right in / right out only access onto Limebank Road would have on the Earl Armstrong / Limebank intersection, a **full movement access** onto Limebank Road is, therefore, recommended as an appropriate strategy for the subject development.

TABLE 5 CAPACITY ANALYSIS SUMMARY – UNSIGNALIZED INTERSECTIONS (2016)

Intersection	Future Total Zero Interaction			Future Total Unconstrained Interaction		
	V/C	Delay (s)	LOS	V/C	Delay (s)	LOS
AM PEAK HOUR						
Earl Armstrong / Site Access		0			0	
NB Right Out	0	8.6	A	0	8.7	A
Limebank Rd Access		1.8			1.7	
WB Left	0.04	12.7	B	0.04	13.4	B
WB Right	0.05	9.5	A	0.05	9.6	A
SB Left	0.04	8.0	A	0.04	8.2	A
PM PEAK HOUR						
Earl Armstrong / Site Access		0.7			0.2	
NB Right Out	0.03	9.0	A	0.02	9.0	A
Limebank Rd Access		5.5			4.7	
WB Left	0.33	19.8	C	0.31	19.9	C
WB Right	0.20	10.0	B	0.19	9.9	A
SB Left	0.11	8.1	A	0.10	8.1	A

TABLE 6 CAPACITY ANALYSIS SUMMARY – UNSIGNALIZED INTERSECTIONS (2021)

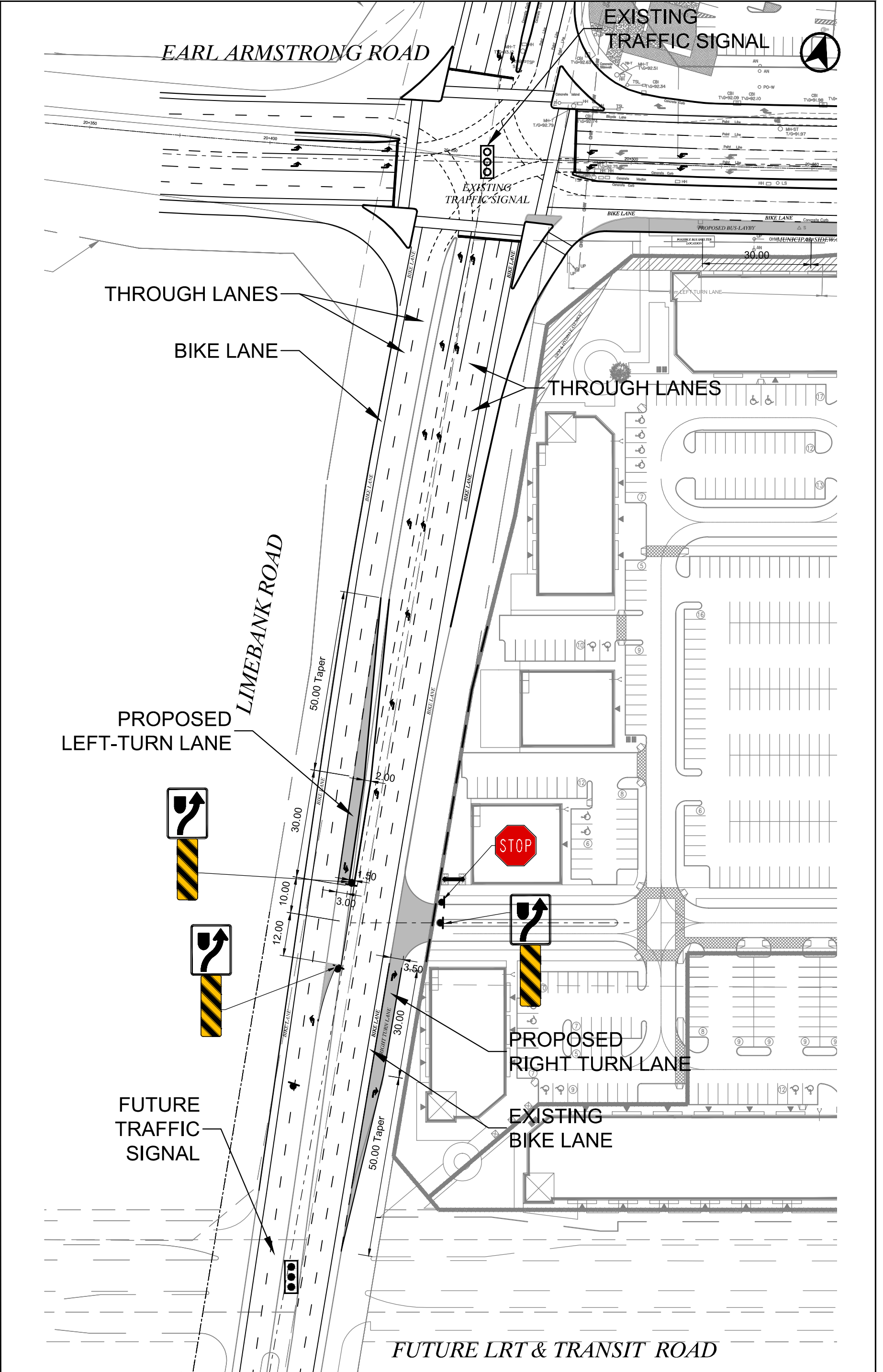
Intersection	Future Background Zero Interaction			Future Background Unconstrained			Future Total Zero Interaction			Future Total Unconstrained		
	v/c	Delay sec.	LOS	v/c	Delay sec.	LOS	v/c	Delay sec.	LOS	v/c	Delay sec.	LOS
AM PEAK HOUR												
Earl Armstrong / Access		0			0			0			0	
NB Right Out	0	8.7	A	0	9.2	A	0	8.8	A	0	9.2	A
Limebank Rd Access		2.2			2.1			2.1			1.9	
WB Left	0.05	13.2	B	0.06	14.0	B	0.03	13.2	B	0.04	14.0	B
WB Right	0.05	9.5	A	0.07	9.7	A	0.06	9.5	A	0.07	9.7	A
SB Left	0.05	8.1	A	0.06	8.2	A	0.06	8.1	A	0.06	8.3	A
PM PEAK HOUR												
Earl Armstrong / Access		0.2			0.1			0.4			0.3	
NB Right Out	0.04	9.4	A	0.02	9.4	A	0.09	9.8	A	0.09	9.8	A
Limebank Rd Access		6.8			5.9			5.7			5.2	
WB Left	0.35	19.0	C	0.34	19.7	C	0.24	17.6	C	0.26	19.0	C
WB Right	0.24	9.9	A	0.23	9.8	A	0.22	9.8	A	0.22	9.8	A
SB Left	0.13	7.9	A	0.12	7.9	A	0.12	7.9	A	0.12	7.9	A

TABLE 7 SENSITIVITY ANALYSIS – EARL ARMSTRONG / LIMEBANK INTERSECTION 2021

PM PEAK HOUR	Future Background Zero Interaction			Future Background Unconstrained			Future Total Zero Interaction			Future Total Unconstrained		
	v/c	Delay sec.	LOS	v/c	Delay sec.	LOS	v/c	Delay sec.	LOS	v/c	Delay sec.	LOS
Earl Armstrong / Limebank	0.73	50.4	D	1.14	108.4	F	0.78	0.78	D	1.14	102.0	F
Eastbound Left	1.19	145.1	F	1.55	300.6	F	1.07	100.7	F	1.55	301.0	F
Southbound Left	0.84	57.1	E	1.33	218.3	F	0.98	86.3	F	1.33	218.0	F

Note: This sensitivity analysis assumes right in / right out movements only at the Limebank Road access.

Date Plotted: April 09, 2014. Filename: J:\5890-38\BA\2014\Proposed Road Modification\Bus Lay-By\RM01-WBLB-05-589038.dwg

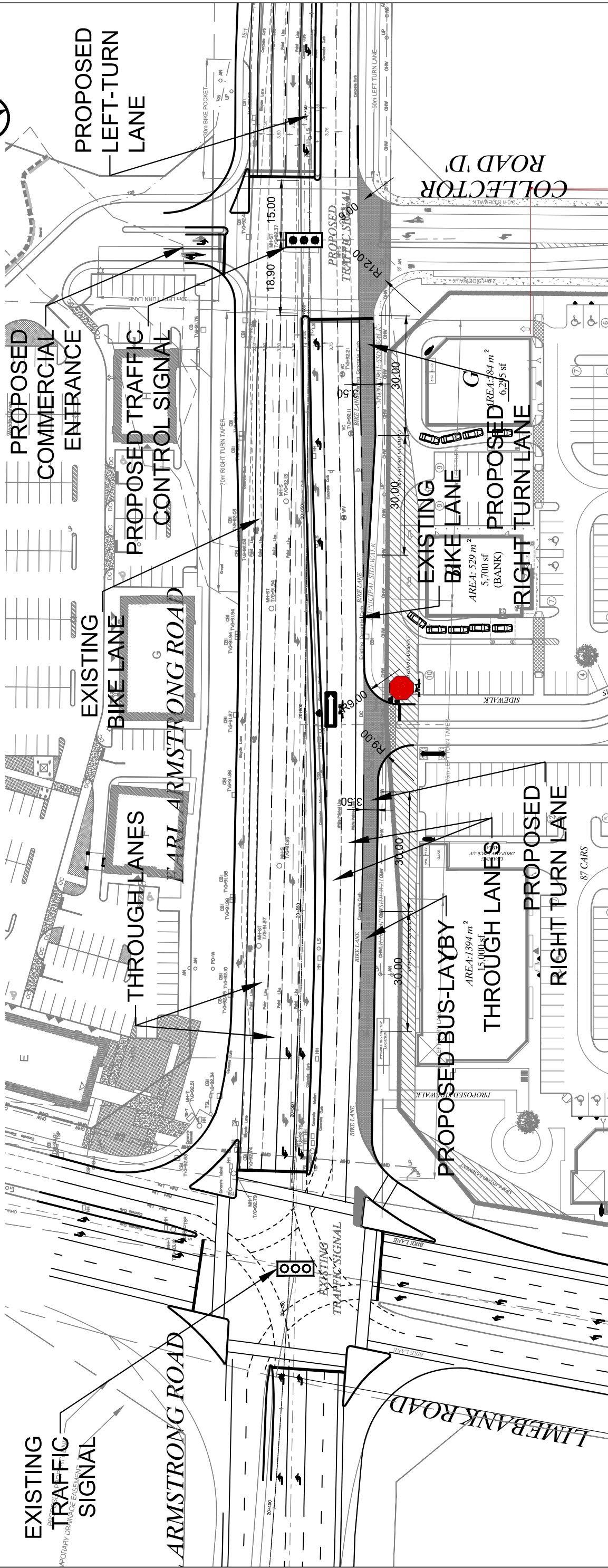



**PROPOSED ROAD
MODIFICATION
LIMEBANK ROAD**

Project: Riverside South
 Project No. 5890-38
 Date: April 09, 2014
 Revised: August 12, 2014

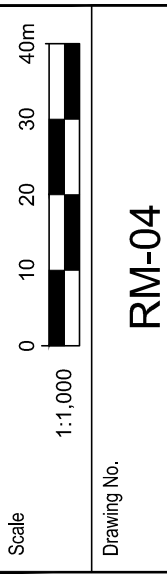
Scale 0 10 20 30 40m
 1:1,000

Drawing No. **RM-03**



 Proposed Traffic Features

**PROPOSED ROAD MODIFICATION
EARL ARMSTRONG ROAD**



Project: Riverside South
 Project No. 5890-38
 Date: April 09, 2014
 Revised: August 12, 2014

Drawing No. **RM-04**



7.0 PUBLIC TRANSIT INFRASTRUCTURE & OPERATIONS

As illustrated in Figure 5 there is currently limited direct transit service to the study area. The nature of this development provides an opportunity for transit to play a key role in the transportation needs of retail employees. The City of Ottawa has recognized the transit potential of Riverside South as a whole and has slated the community for several transit investments over the coming years.

In the longer term, beyond the study horizon, the Riverside South Community Design Plan includes a rapid transit corridor that extends to connect the proposed transit service in South Nepean (Chapman Mills) and the future extension of the rapid transit corridor proposed to extend from the north (South Keys) into the Riverside South town centre. The Community Design Plan envisions the higher order transit corridor providing direct access to Riverside South Phase 5 at two points, both of which are located east between the Spratt Road extension and Earl Armstrong Road.



8.0 SUMMARY AND CONCLUSIONS

BA Group has completed a Transportation Impact Study for the proposed Riverside South Commercial Development that will be located at the southeast corner of Limebank Road and Earl Armstrong Road signalized intersection.

The subject development which includes a total GFA of approximately 19,319.11 m² (207,949 ft²) is anticipated to be developed in two phases: Phase 1 and Phase 2 which are expected to be built and occupied by 2016 and potentially 2021.

Vehicular access will be provided via a right in / right out access onto Earl Armstrong Road a full movement access onto Limebank Road located approximately 213.10 metres south of Earl Armstrong Road and two full movement access driveways onto Collector Road 'D'.

The TIS evaluated existing future 2016 and 2021 traffic conditions. Two assessment scenarios were developed to test the potential magnitude of the impact of the Strandherd-Armstrong Bridge on road network volumes in Riverside South. The two scenarios tested were the "Zero Interaction Scenario" and the "Unconstrained Interaction Scenario".

The findings of the transportation impact study are set out below:

- The site has a high degree of road accessibility. It is well served by major arterial roads, i.e., Limebank Road and Earl Armstrong Road, are located along the north and west site periphery.
- Phase 1 retail development will generate approximately 180 and 675 vehicle trips during weekday am and pm hours, respectively. With allowances for pass-by traffic, net new trips for Phase 1 will be 180 and 435 trips for am and pm hours, respectively. Net additional vehicle trips generated by Phase 2 retail / commercial development will be 75 and 290 trips during weekday am and pm hours, respectively.
- Under future 2016 background and future total traffic conditions, no operational issues were identified at the Limebank / Earl Armstrong and the Earl Armstrong / Collector Road 'D' signalized intersections for both the Zero Interaction and Unconstrained Interaction scenarios. Both intersections will operate at good levels of service LOS A (based upon City of Ottawa criteria) with no critical movements. Site traffic generated by the subject development, therefore, is not expected to impact intersection operations.
- Under future 2021 conditions Earl Armstrong Road / Collector Road 'D' no operational issues were identified at the Limebank / Earl Armstrong and the Earl Armstrong / Collector Road 'D' signalized intersections for both the Zero Interaction and Unconstrained Interaction scenarios.
- **The installation of traffic control signals is required at the Earl Armstrong Road / Collector Road 'D' intersection.**
- Under future background and future total 2021 condition, the Limebank / Earl Armstrong intersection is expected to operate with an acceptable overall level of service during both peak hours under the Zero interaction scenario. This intersection is also expected to operate with an acceptable overall



level of service during the am peak hour and poor overall level of service during the pm peak hour under the unconstrained scenario.

- Northbound right turn movement at the **Earl Armstrong Road right in / right out site access** will operate good levels of service, LOS A under 2016 and 2021 future traffic conditions. Specific recommendations for the Earl Armstrong Access include the following items:
 - Widen the pavement on the south side of Earl Armstrong Road to provide a continuous eastbound right turn lane between Limebank Road and the site access driveway, as illustrated in drawing PRM02. The continuous right turn lane will also accommodate a future far side bus stop west of the site access driveway.
 - Provide appropriate traffic control signs on the centre median and at the site driveway to preclude left turns.
- Westbound left turn movements at the **Limebank Road / Site Access** will operate at acceptable levels of service, LOS C or better, under 2021 future total condition based upon the Zero and Unconstrained scenarios. Southbound left and westbound right turn movements will operate at good levels, LOS A, in the future, based upon the Zero and Unconstrained scenarios. Specific recommendations for the subject development include the following items:
 - Widen the pavement on the east side of Limebank Road to provide a northbound right turn lane with 30 metres storage and 50 metres taper, as illustrated in drawing PRM01.
 - Modify the existing centre median on Limebank Road to accommodate a southbound left turn lane with 30 metres storage and 50 metres taper.
 - Provide appropriate traffic control signs on centre median and at the site driveway.
- The proposed southbound and westbound turning movements can be physically accommodated at the proposed T-intersection, respecting TAC Geometric Design guidelines. Site distance requirements are exceeded. Back-to-back left turns between Earl Armstrong Road (northbound) and the site driveway (southbound) can readily be accommodated without conflict.
- Taking into consideration the significant impact a right in / right out only access onto Limebank Road would have on the Earl Armstrong / Limebank intersection, a **full movement access** onto Limebank Road is, therefore, recommended as an appropriate strategy for the subject development, until westbound left turn movements can be provided at the future Limebank / Future Transit Road signalized intersection.

Conclusion

New traffic generated by the proposed Riverside South Commercial Development can be acceptably accommodated on the area road network with implementation of other planned improvements and road improvements.

The proposed site access and vehicular systems will acceptably accommodate site traffic demands and will appropriate support the proposed development.

Prepared By:



Gary H. Wang, P.Eng, PTOE
Senior Transportation Engineer

Reviewed By:



John E. Barrington, B.A., CET,
Senior Associate

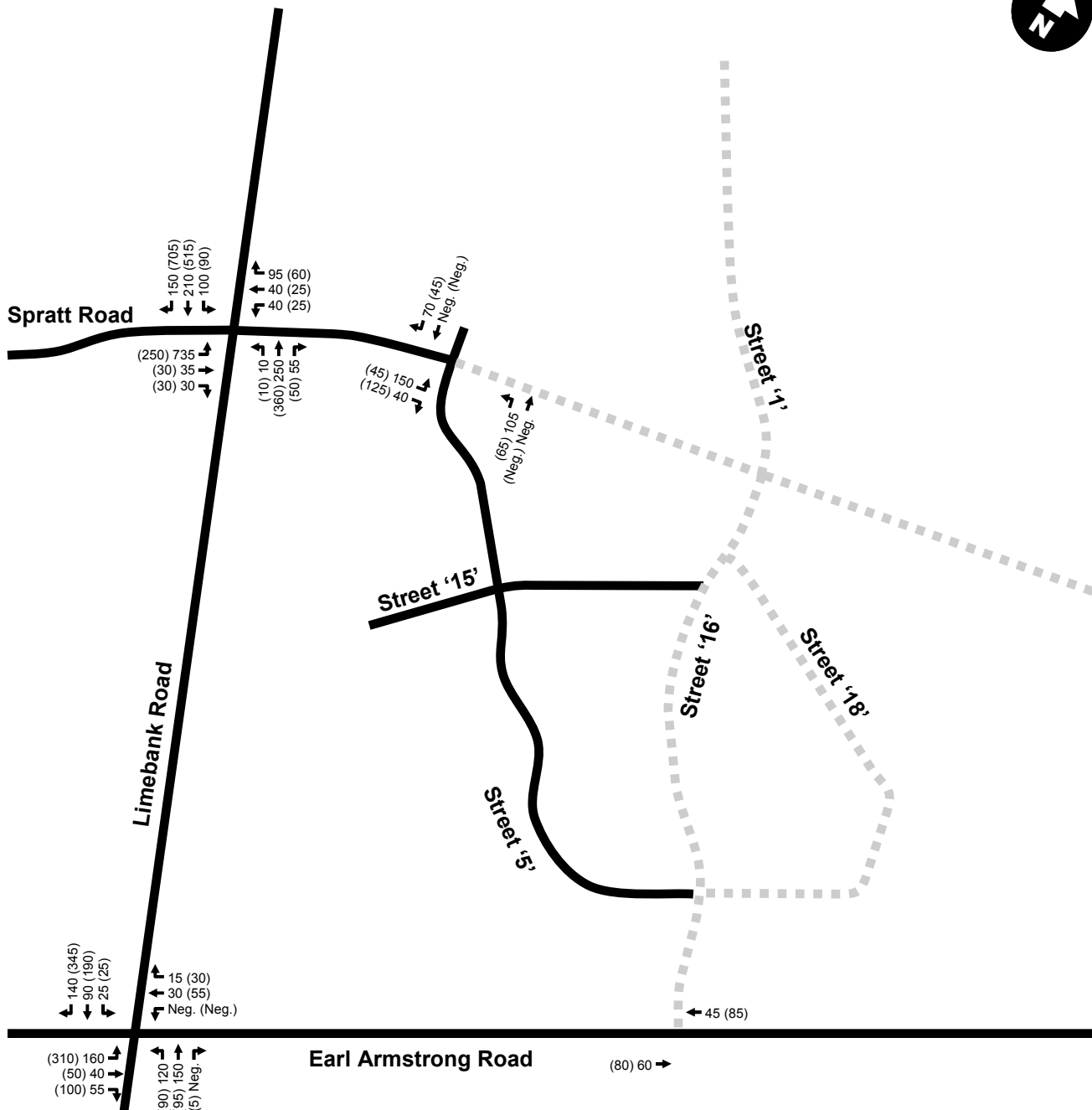
Date: August 28, 2014

Date: August 28, 2014



APPENDIX A: Appendix Figures and Tables





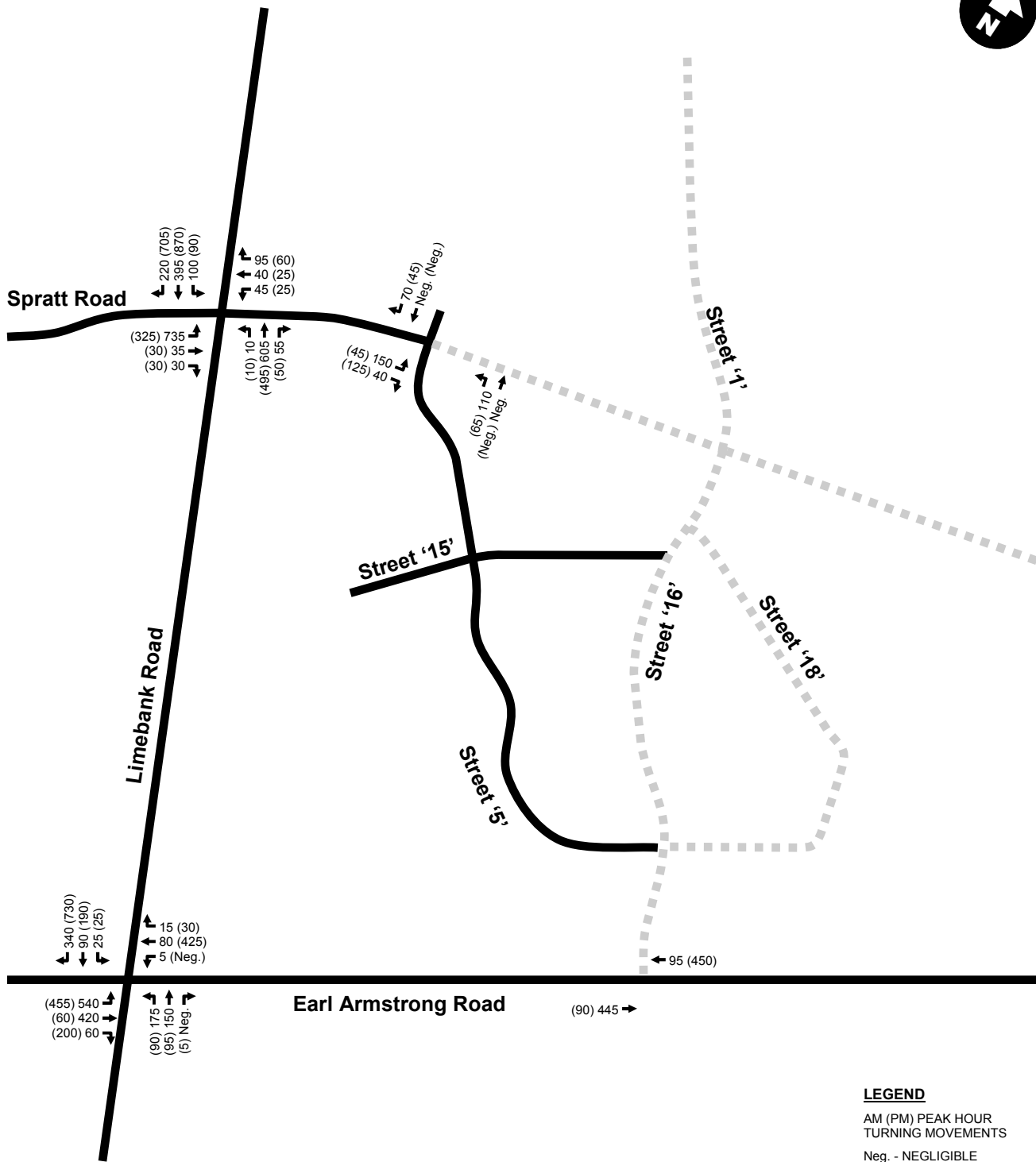
LEGEND
 AM (PM) PEAK HOUR TURNING MOVEMENTS
 Neg. - NEGLIGIBLE
 ■ ROADS TO BE BUILT IN FUTURE PHASES

NOT TO SCALE



**Riverside South Phase 5
 Transportation Impact Assessment**

**Figure 15
 Zero Interaction Scenario 2013 Total Future Traffic Volumes**



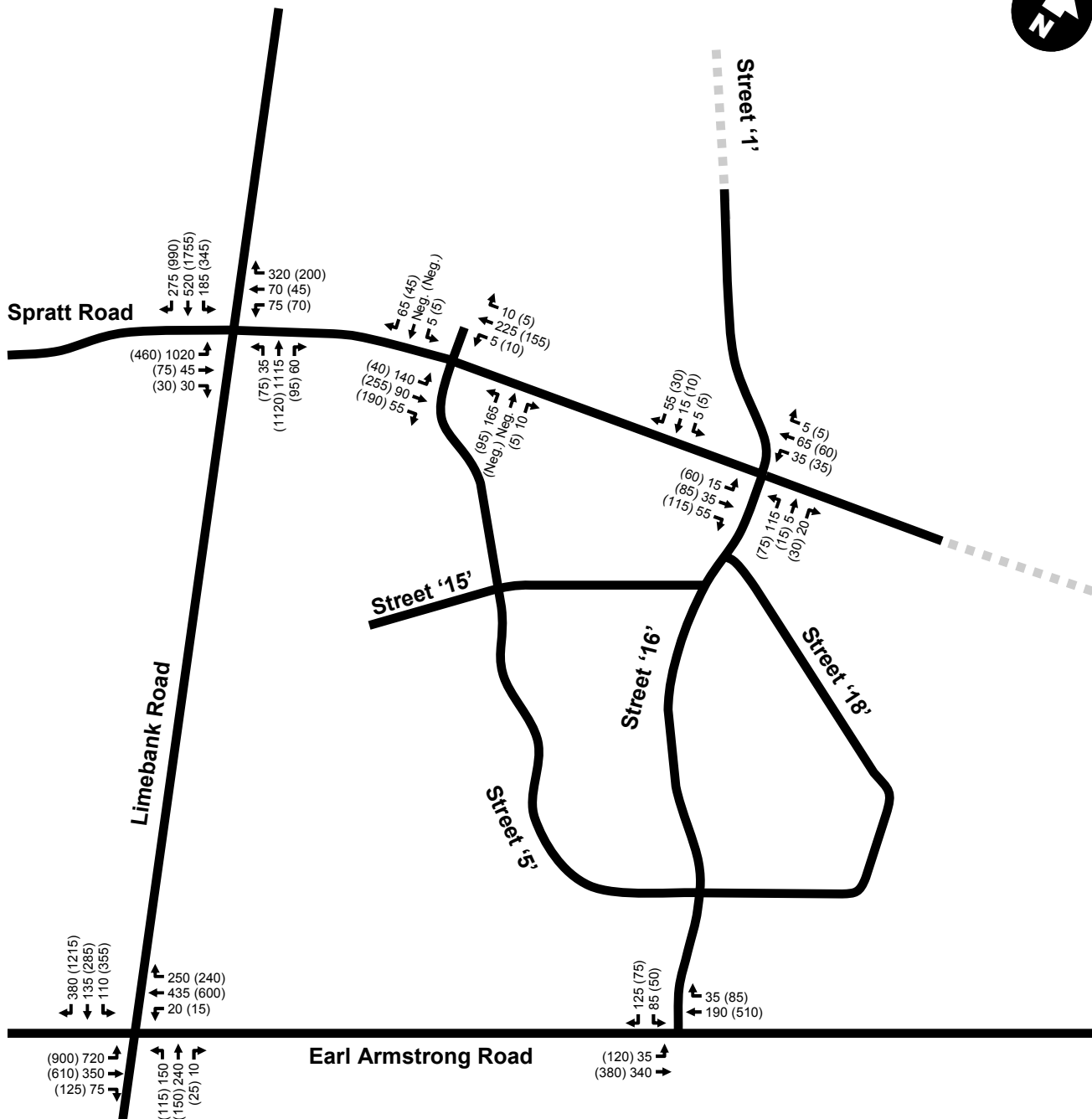
NOT TO SCALE

LEGEND
AM (PM) PEAK HOUR
TURNING MOVEMENTS
Neg. - NEGLIGIBLE
ROADS TO BE BUILT
IN FUTURE PHASES



Riverside South Phase 5 Transportation Impact Assessment

Figure 16
Unconstrained Interaction Scenario 2013 Total Future Traffic Volumes



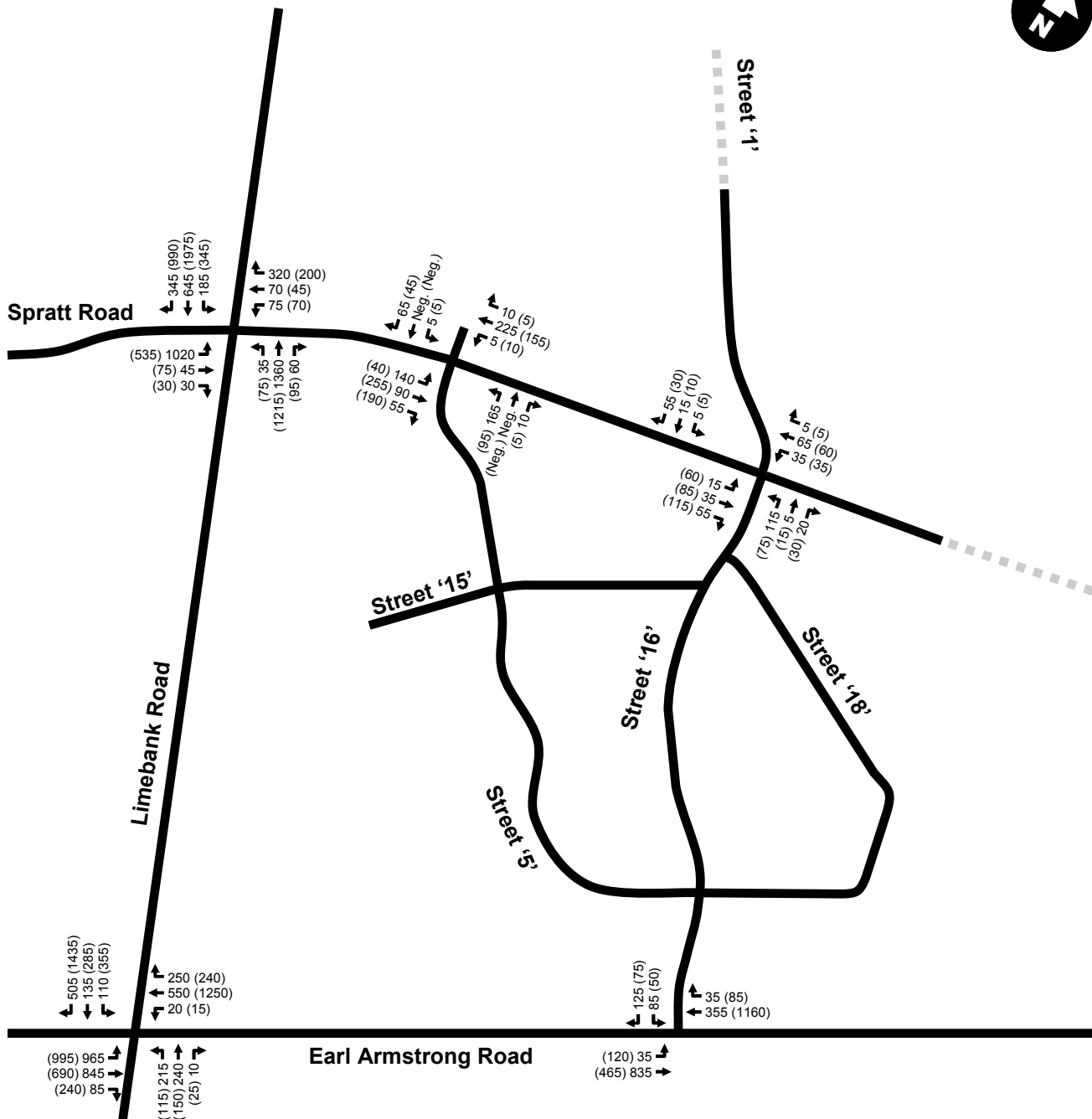
NOT TO SCALE

LEGEND
AM (PM) PEAK HOUR
TURNING MOVEMENTS
Neg. - NEGLIGIBLE
■ ROADS TO BE BUILT
IN FUTURE PHASES



Riverside South Phase 5 Transportation Impact Assessment

Figure 22
Zero Interaction Scenario 2023 Horizon Traffic Volumes



NOT TO SCALE

LEGEND
 AM (PM) PEAK HOUR TURNING MOVEMENTS
 Neg. - NEGLIGIBLE
 ■ ROADS TO BE BUILT IN FUTURE PHASES



**Riverside South Phase 5
 Transportation Impact Assessment**

**Figure 23
 Unconstrained Interaction Scenario 2023 Horizon Traffic Volumes**

APPENDIX B: Turning Movement Counts and Signal Timing Plan



Traffic Signal Timing

City of Ottawa, Public Works & Services Department

Traffic Operations Unit

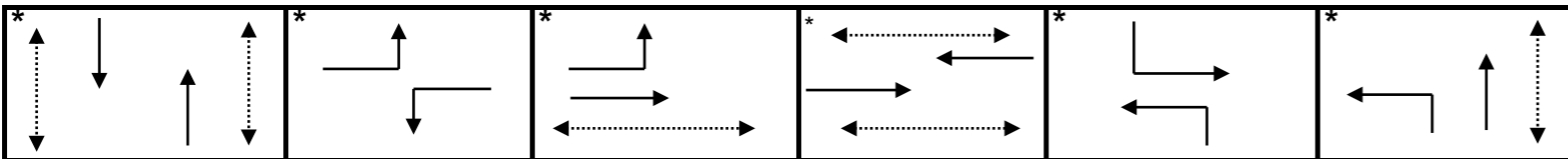
Intersection: Main: Earl Armstrong Side: Limebank
 Controller: ATC-3 TSD: 6725
 Author: Chong Luo Date: January 28th, 2014

Existing Timing Plans†

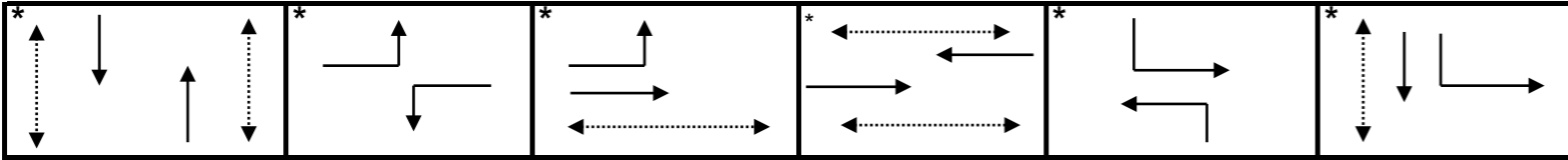
	Plan				Ped Minimum Time		
	AM Peak 1	Off Peak 2	PM Peak 3	Off Peak 4	Walk	DW	A+R
Cycle	Free	Free	Free	Free			
Offset	X	X	X	X			
NB Thru	36.9	31.9	31.9	31.9	7	18	4.6+2.3
SB Thru	31.9	41.9	31.9	31.9	7	18	4.6+2.3
WB Left (fp)	11.9	21.9	11.9	16.9	-	-	4.6+2.3
EB Left (fp)	31.9	31.9	21.9	16.9	-	-	4.6+2.3
WB Thru	31.9	31.9	31.9	31.9	7	18	4.6+2.3
EB Thru	51.9	41.9	41.9	31.9	7	18	4.6+2.3
NB Left (fp)	16.9	21.9	16.9	16.9	-	-	4.6+2.3
SB Left (fp)	11.9	31.9	16.9	16.9	-	-	4.6+2.3

Phasing Sequence†

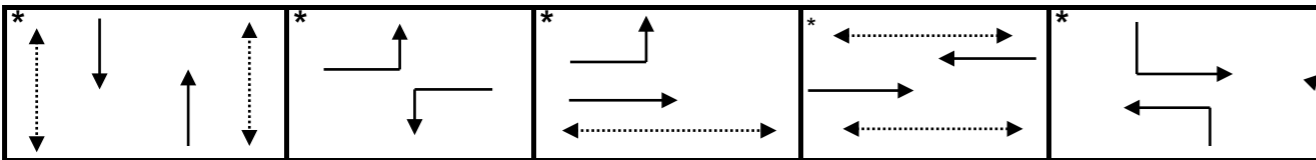
Plans: 1



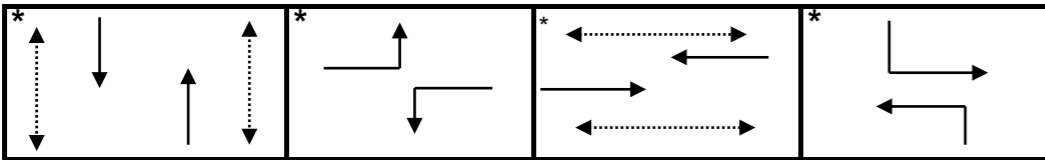
Plans: 2



Plans: 3



Plans: 4



Note: For all plans, the NS Thru phase has a minimum recall of 10 seconds green

Schedule

Weekday

Time	Plan
0:15	4
6:30	1
9:30	2
15:00	3
18:00	2
23:30	4

Weekend

Time	Plan
0:15	4
8:00	2
23:30	4

Notes

†: Time for each direction includes amber and all red intervals
 ‡: Start of first phase should be used as reference point for offset
 Asterix (*) Indicates actuated phase
 (fp): Fully Protected Left Turn

←.....→ Pedestrian signal

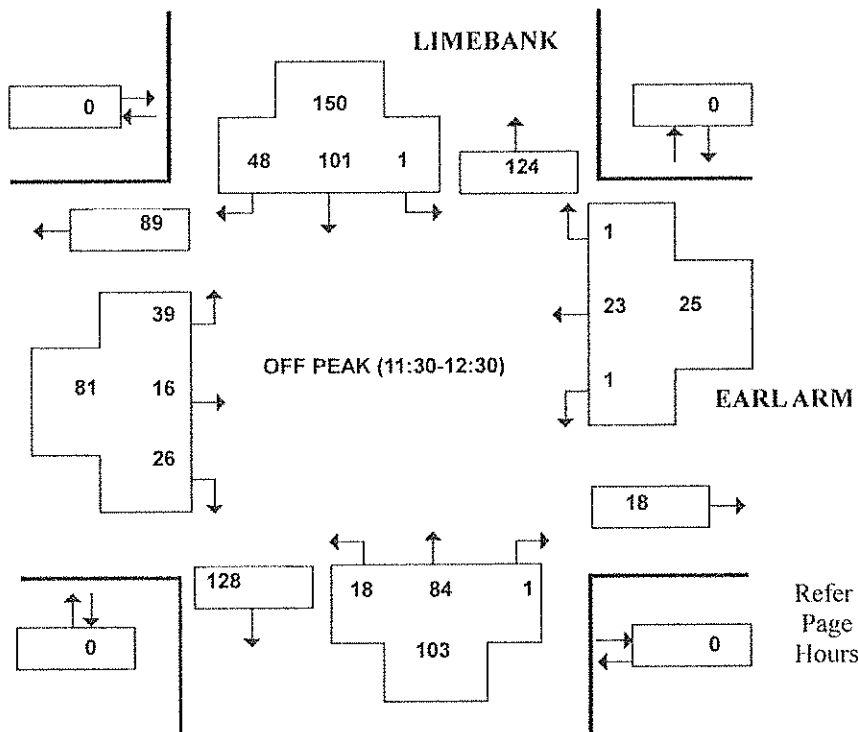
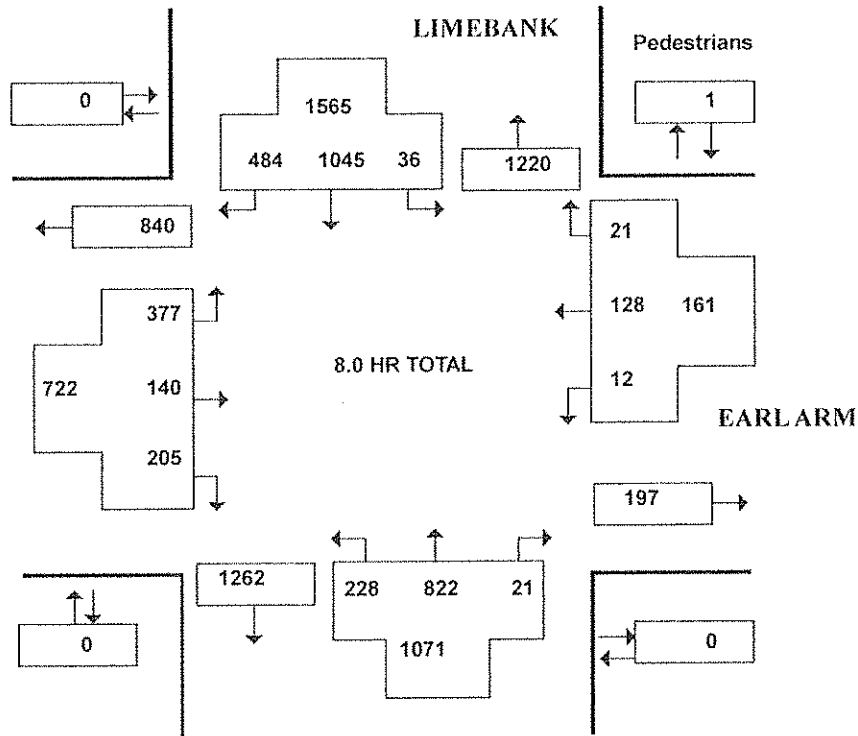
Cost is \$56.50 (\$50 + HST)

EARL ARMSTRONG RD and LIMEBANK RD
(ULRS Listing EARL ARM & LIMEBANK)

Survey Date: Friday 10 August 2012
 Conditions: dry
 Start Time: 0700

Total Observed U-Turns
 Northbound: 1 Southbound: 2
 Eastbound: 0 Westbound: 0

AADT Factor
 Friday in August is
 0.9



Refer to Summary Page for Survey Hours.

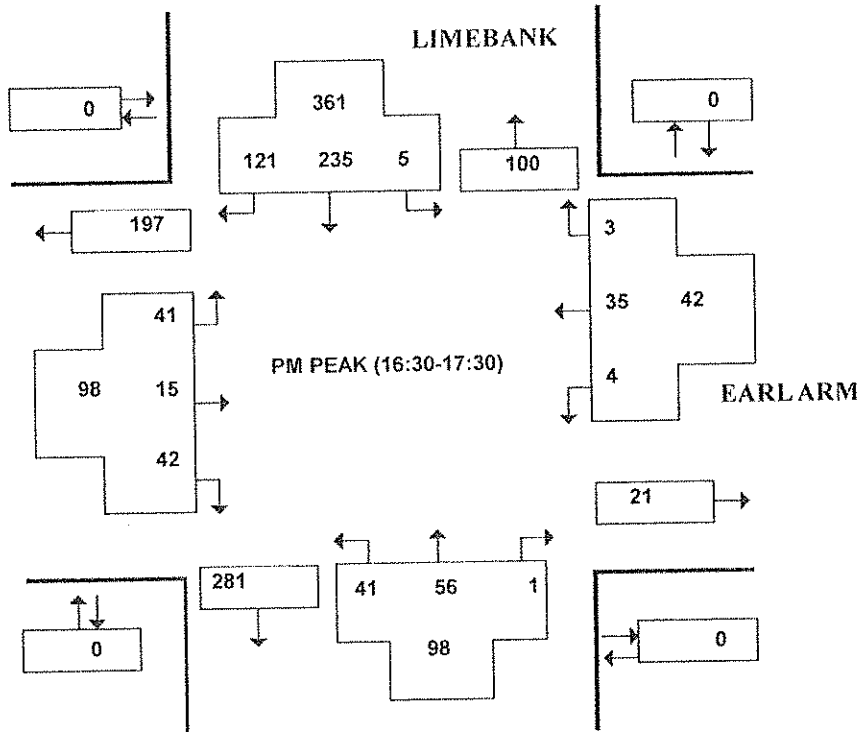
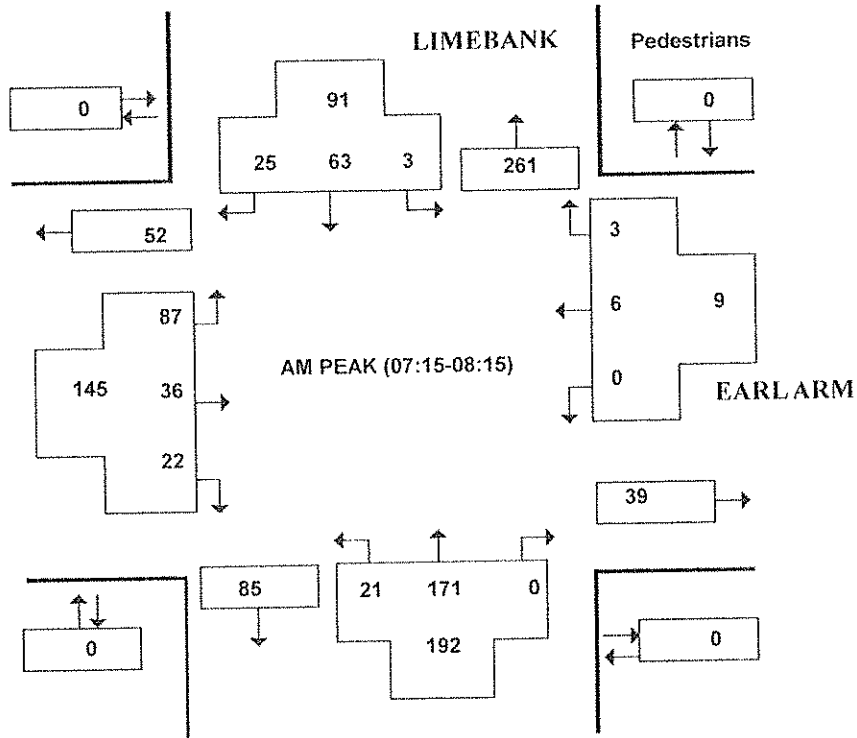
EARLARMSTRONG RD and LIMEBANK RD

(ULRS Listing EARL ARM & LIMEBANK)

Survey Date: Friday 10 August 2012
 Conditions: dry
 Start Time: 0700

Total Observed U-Turns
 Northbound: 1 Southbound: 2
 Eastbound: 0 Westbound: 0

AADT Factor
 Friday in August is
 0.9



Vehicular Turning Movements - Summary

EARL ARMSTRONG RD and LIMEBANK RD

(ULRS Listing EARL ARM & LIMEBANK)

Survey Date: Friday 10 August 2012
 Conditions: dry
 Start Time: 0700

Total Observed U-Turns
 Northbound: 1 Southbound: 2
 Eastbound: 0 Westbound: 0

AADT Factor
 Friday in August is
 0.9

Time Period	LIMEBANK									EARLARM									
	Northbound			SUB TOT	Southbound			SUB TOT	STR TOT	Eastbound			SUB TOT	Westbound			SUB TOT	STR TOT	GRAND TOT
	LT	ST	RT		LT	ST	RT			LT	ST	RT		LT	ST	RT			
07:00-08:00	20	166	3	189	1	55	27	83	272	71	27	23	121	1	3	3	7	128	400
08:00-09:00	17	179	4	200	5	71	28	104	304	70	28	17	115	2	8	3	13	128	432
09:00-10:00	28	121	6	155	4	80	46	130	285	41	14	8	63	0	8	5	13	76	361
11:30-12:30	18	84	1	103	1	101	48	150	253	39	16	26	81	1	23	1	25	106	359
12:30-13:30	44	77	2	123	3	101	27	131	254	51	12	20	83	0	5	2	7	90	344
15:00-16:00	24	67	0	91	11	184	93	288	379	27	14	32	73	1	24	3	28	101	480
16:00-17:00	38	54	2	94	8	221	115	344	438	40	11	31	82	4	40	2	46	128	566
17:00-18:00	39	74	3	116	3	232	100	335	451	38	18	48	104	3	17	2	22	126	577
8.0 HR TOTAL	228	822	21	1071	36	1045	484	1565	2636	377	140	205	722	12	128	21	161	883	3519

EQU. 12 HR TOTAL 316 1142 29 1487 50 1452 672 2174 3661 524 194 284 1002 16 177 29 222 1224 4885

Note: These values are calculated by multiplying the totals by the appropriate expansion factor.

AVG. 12 HR TOTAL 284 1027 26 1337 45 1306 604 1955 3292 471 174 255 900 14 159 26 199 1099 4391

Note: These volumes are calculated by multiplying the Equivalent 12 hr. totals by the AADT factor.

AVG. 24 HR TOTAL 372 1345 34 1751 58 1710 791 2559 4310 617 227 334 1178 18 208 34 260 1438 5748

Note: These volumes were calculated by multiplying the Average Daily 12 hr totals by 1.31.

AM TOTAL (0700-0900) 37 345 7 389 6 126 55 187 576 141 55 40 236 3 11 6 20 256 832

PM TOTAL (1530-1730) 75 117 3 195 13 428 220 661 856 73 28 71 172 6 68 3 77 249 1105

Vehicular Turning Movements (15 Min. Volumes)

EARL ARMSTRONG RD and LIMEBANK RD

(ULRS Listing EARL ARM & LIMEBANK)

Survey Date: Friday 10 August 2012
 Conditions: dry
 Start Time: 07:00

Total Observed U-Turns
 Northbound: 1 Southbound: 2
 Eastbound: 0 Westbound: 0

AADT Factor
 Friday in August is
 0.9

Time Period	LIMEBANK									EARL ARM									SUB TOT	STR TOT	GRAND TOT
	Northbound				Southbound					Eastbound			Westbound								
	LT	ST	RT	SUB TOT	LT	ST	RT	SUB TOT	STR TOT	LT	ST	RT	SUB TOT	LT	ST	RT	SUB TOT	STR TOT			
07:00-07:15	4	39	3	46	0	9	4	13	59	8	0	3	11	1	0	1	2	13	72		
07:15-07:30	2	41	0	43	0	17	10	27	70	19	9	6	34	0	1	0	1	35	105		
07:30-07:45	7	42	0	49	1	17	4	22	71	23	7	9	39	0	2	2	4	43	114		
07:45-08:00	7	44	0	51	0	12	9	21	72	21	11	5	37	0	0	0	0	37	109		
08:00-08:15	5	44	0	49	2	17	2	21	70	24	9	2	35	0	3	1	4	39	109		
08:15-08:30	4	46	0	50	0	17	4	21	71	17	7	5	29	1	0	1	2	31	102		
08:30-08:45	2	39	2	43	2	22	3	27	70	15	6	6	27	1	4	0	5	32	102		
08:45-09:00	6	50	2	58	1	15	19	35	93	14	6	4	24	0	1	1	2	26	119		
09:00-09:15	13	33	2	48	1	20	9	30	78	8	5	1	14	0	1	1	2	16	94		
09:15-09:30	3	27	1	31	1	18	14	33	64	13	3	4	20	0	4	0	4	24	88		
09:30-09:45	7	32	2	41	0	22	11	33	74	9	3	2	14	0	2	2	4	18	92		
09:45-10:00	5	29	1	35	2	20	12	34	69	11	3	1	15	0	1	2	3	18	87		
11:30-11:45	4	19	0	23	0	31	15	46	69	12	5	8	25	0	7	0	7	32	101		
11:45-12:00	6	21	0	27	0	24	15	39	66	6	6	5	17	0	4	0	4	21	87		
12:00-12:15	5	19	1	25	0	22	9	31	56	13	1	6	20	0	4	0	4	24	80		
12:15-12:30	3	25	0	28	1	24	9	34	62	8	4	7	19	1	8	1	10	29	91		
12:30-12:45	6	20	0	26	1	18	9	28	54	8	4	1	13	0	2	0	2	15	69		
12:45-13:00	7	20	0	27	2	26	5	33	60	16	4	6	26	0	2	1	3	29	89		
13:00-13:15	16	19	0	35	0	28	7	35	70	12	1	8	21	0	0	0	0	21	91		
13:15-13:30	15	18	2	35	0	29	6	35	70	15	3	5	23	0	1	1	2	25	95		
15:00-15:15	4	17	0	21	3	47	24	74	95	8	3	9	20	0	3	2	5	25	120		
15:15-15:30	5	24	0	29	5	46	22	73	102	4	3	8	15	1	5	1	7	22	124		
15:30-15:45	5	12	0	17	0	38	24	62	79	8	3	9	20	0	8	0	8	28	107		
15:45-16:00	10	14	0	24	3	53	23	79	103	7	5	6	18	0	8	0	8	26	129		
16:00-16:15	10	17	1	28	2	53	15	70	98	8	1	4	13	1	11	0	12	25	123		
16:15-16:30	9	18	1	28	3	49	37	89	117	9	4	10	23	1	6	0	7	30	147		
16:30-16:45	7	8	0	15	0	57	31	88	103	12	2	9	23	1	11	1	13	36	139		
16:45-17:00	12	11	0	23	3	62	32	97	120	11	4	8	23	1	12	1	14	37	157		
17:00-17:15	14	12	0	26	1	52	34	87	113	7	4	15	26	2	9	1	12	38	151		
17:15-17:30	8	25	1	34	1	64	24	89	123	11	5	10	26	0	3	0	3	29	152		
17:30-17:45	7	14	0	21	0	57	19	76	97	9	5	12	26	1	2	0	3	29	126		
17:45-18:00	10	23	2	35	1	59	23	83	118	11	4	11	26	0	3	1	4	30	148		

Pedestrian Volume Summary Sheet - Hourly Volumes

EARL ARMSTRONG RD and LIMEBANK RD

(ULRS Listing EARL ARM & LIMEBANK)

Survey Date: Friday 10 August 2012

Conditions: dry

Start Time: 0700

Time Period	CROSSING LIMEBANK N/B APPROACH	CROSSING LIMEBANK S/B APPROACH	STREET TOTAL	CROSSING EARL ARM E/B APPROACH	CROSSING EARL ARM W/B APPROACH	STREET TOTAL	GRAND TOTAL
07:00-08:00	0	0	0	0	0	0	0
08:00-09:00	0	0	0	0	0	0	0
09:00-10:00	0	0	0	0	0	0	0
11:30-12:30	0	0	0	0	0	0	0
12:30-13:30	0	0	0	0	0	0	0
15:00-16:00	0	0	0	0	0	0	0
16:00-17:00	0	0	0	0	0	0	0
17:00-18:00	0	0	0	0	1	1	1
8.0 HR TOTAL	0	0	0	0	1	1	1

PEAK PERIOD SUMMARIES

AM PEAK PERIOD (7:00-9:00)

07:00-07:15	0	0	0	0	0	0	0
07:15-07:30	0	0	0	0	0	0	0
07:30-07:45	0	0	0	0	0	0	0
07:45-08:00	0	0	0	0	0	0	0
08:00-08:15	0	0	0	0	0	0	0
08:15-08:30	0	0	0	0	0	0	0
08:30-08:45	0	0	0	0	0	0	0
08:45-09:00	0	0	0	0	0	0	0
TOTALS	0	0	0	0	0	0	0

OFF PEAK PERIOD (11:30-13:30)

11:30-11:45	0	0	0	0	0	0	0
11:45-12:00	0	0	0	0	0	0	0
12:00-12:15	0	0	0	0	0	0	0
12:15-12:30	0	0	0	0	0	0	0
12:30-12:45	0	0	0	0	0	0	0
12:45-13:00	0	0	0	0	0	0	0
13:00-13:15	0	0	0	0	0	0	0
13:15-13:30	0	0	0	0	0	0	0
TOTALS	0	0	0	0	0	0	0

PM PEAK PERIOD (15:30-17:30)

15:30-15:45	0	0	0	0	0	0	0
15:45-16:00	0	0	0	0	0	0	0
16:00-16:15	0	0	0	0	0	0	0
16:15-16:30	0	0	0	0	0	0	0
16:30-16:45	0	0	0	0	0	0	0
16:45-17:00	0	0	0	0	0	0	0
17:00-17:15	0	0	0	0	0	0	0
17:15-17:30	0	0	0	0	0	0	0
TOTALS	0	0	0	0	0	0	0

Approved by: AWD

Printed on : 24/01/2014

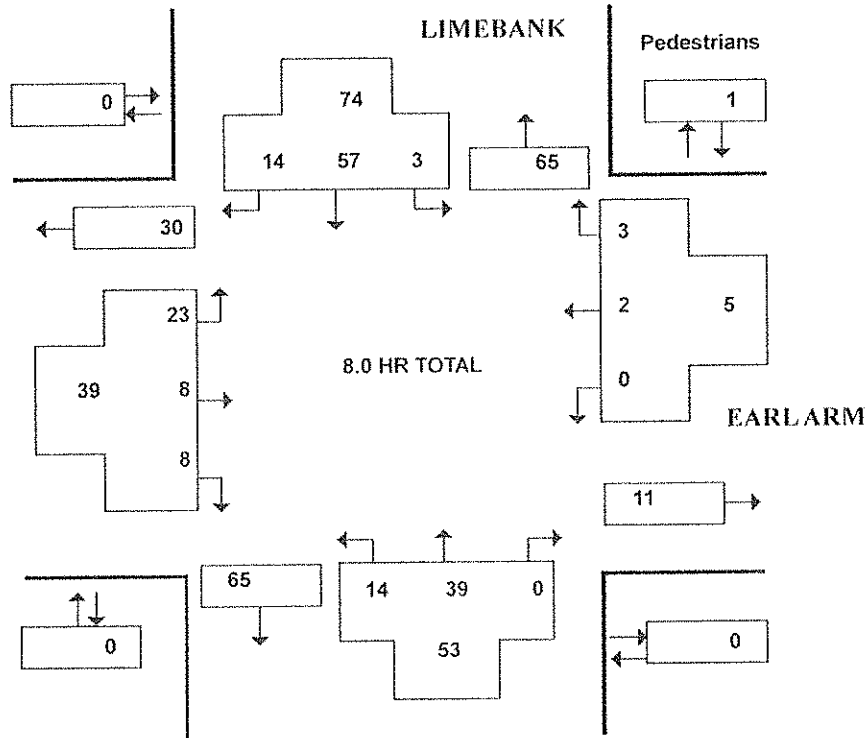
Heavy Vehicle Summary Sheet - Hourly Volumes

EARL ARMSTRONG RD and LIMEBANK RD
(ULRS Listing EARL ARM & LIMEBANK)

Survey Date : Friday 10 August 2012

Conditions : dry

Start Time : 0700



———— LIMEBANK ————

———— EARLARM ————

Time Period	LIMEBANK					EARLARM					GRAND								
	Northbound			SUB	Southbound			SUB	STR	Eastbound			Westbound			SUB	STR	GRAND	
	LT	ST	RT	TOT	LT	ST	RT	TOT	TOF	LT	ST	RT	TOT	LT	ST	RT	TOT	TOT	TOT
07:00-08:00	3	6	0	9	0	5	0	5	14	2	2	5	9	0	0	0	0	9	23
08:00-09:00	1	6	0	7	1	6	4	11	18	2	0	0	2	0	1	0	1	3	21
09:00-10:00	3	8	0	11	0	6	1	7	18	4	2	1	7	0	0	3	3	10	28
11:30-12:30	2	7	0	9	1	11	0	12	21	2	2	0	4	0	1	0	1	5	26
12:30-13:30	0	8	0	8	1	11	2	14	22	3	1	0	4	0	0	0	0	4	26
15:00-16:00	2	4	0	6	0	7	3	10	16	0	1	1	2	0	0	0	0	2	18
16:00-17:00	2	0	0	2	0	7	1	8	10	4	0	0	4	0	0	0	0	4	14
17:00-18:00	1	0	0	1	0	4	3	7	8	6	0	1	7	0	0	0	0	7	15
8.0 HR TOTAL	14	39	0	53	3	57	14	74	127	23	8	8	39	0	2	3	5	44	171

Heavy Vehicles are vehicles having one rear axle with four or more wheels, or having two or more rear axles. These vehicles include most O.C. Transpo, school and inter-city buses. Further, they ARE included in the Turning Movement Count Summary.

Approved by: AWD

Printed on: 24/01/2014

Bicycle Volume Summary Sheet - Hourly Volumes

EARL ARMSTRONG RD and LIMEBANK RD

(ULRS Listing EARL ARM & LIMEBANK)

Survey Date: Friday 10 August 2012

Conditions: dry

Start Time: 0700

Time Period	NORTHBOUND APPROACH ON LIMEBANK	SOUTHBOUND APPROACH ON LIMEBANK	STREET TOTAL	EASTBOUND APPROACH ON EARL ARM	WESTBOUND APPROACH ON EARL ARM	STREET TOTAL	GRAND TOTAL
07:00-08:00	0	0	0	0	0	0	0
08:00-09:00	0	0	0	0	0	0	0
09:00-10:00	0	0	0	0	0	0	0
11:30-12:30	0	0	0	0	0	0	0
12:30-13:30	0	0	0	0	0	0	0
15:00-16:00	0	0	0	0	0	0	0
16:00-17:00	0	0	0	0	0	0	0
17:00-18:00	0	2	2	1	0	1	3
8.0 HR TOTAL	0	2	2	1	0	1	3

Note: These volumes consists of bicycles only (no mopeds or motorcycles) and ARE NOT included in the Turning Movement Count Summary.

APPENDIX C: Synchro Analysis – Future Background 2016 zero interaction



Queues

3: Earl Armstrong & Limebank

Future Background - 2016

Weekday AM Peak Hour - Zero Interaction

Lane Group	EBL	EBT	EBR	WBL	WBT	WBR	NBL	NBT	NBR	SBL	SBT	SBR
Lane Configurations												
Volume (vph)	160	45	55	10	30	15	120	160	5	45	90	125
Lane Group Flow (vph)	160	45	55	10	30	15	120	160	5	45	90	125
Turn Type	Prot		Perm	Prot		Perm	Prot		Perm	Prot		custom
Protected Phases	7	4		3	8		5	2		1	6	6 7
Permitted Phases			4			8			2			6
Detector Phase	7	4	4	3	8	8	5	2	2	1	6	6 7
Switch Phase												
Minimum Initial (s)	5.0	10.0	10.0	5.0	10.0	10.0	5.0	10.0	10.0	5.0	10.0	
Minimum Split (s)	11.9	31.9	31.9	11.9	31.9	31.9	11.9	31.9	31.9	11.9	31.9	
Total Split (s)	23.0	40.0	40.0	15.0	32.0	32.0	21.0	41.6	41.6	16.0	36.6	59.6
Total Split (%)	20.4%	35.5%	35.5%	13.3%	28.4%	28.4%	18.7%	36.9%	36.9%	14.2%	32.5%	52.9%
Yellow Time (s)	4.6	4.6	4.6	4.6	4.6	4.6	4.6	4.6	4.6	4.6	4.6	4.6
All-Red Time (s)	2.3	2.3	2.3	2.3	2.3	2.3	2.3	2.3	2.3	2.3	2.3	2.3
Lost Time Adjust (s)	-1.0	-1.0	-1.0	-1.0	-1.0	-1.0	-1.0	-1.0	-1.0	-1.0	-1.0	-1.0
Total Lost Time (s)	5.9	5.9	5.9	5.9	5.9	5.9	5.9	5.9	5.9	5.9	5.9	5.9
Lead/Lag	Lead	Lag	Lag	Lead	Lag	Lag	Lead	Lag	Lag	Lead	Lag	
Lead-Lag Optimize?	Yes	Yes	Yes	Yes	Yes	Yes	Yes	Yes	Yes	Yes	Yes	Yes
Recall Mode	None	None	None	None	None	None	None	C-Max	C-Max	None	C-Max	
v/c Ratio	0.43	0.07	0.17	0.05	0.09	0.09	0.38	0.08	0.01	0.19	0.05	0.06
Control Delay	50.5	37.1	11.7	50.0	46.1	20.9	51.3	12.7	9.0	50.6	14.6	1.5
Queue Delay	0.0	0.0	0.0	0.0	0.0	0.0	0.0	0.0	0.0	0.0	0.0	0.0
Total Delay	50.5	37.1	11.7	50.0	46.1	20.9	51.3	12.7	9.0	50.6	14.6	1.5
Queue Length 50th (m)	17.1	3.8	0.0	1.0	3.1	0.0	12.8	8.8	0.0	4.8	5.1	0.0
Queue Length 95th (m)	26.7	9.5	10.9	3.8	7.7	6.3	21.3	15.5	2.0	10.3	10.2	3.5
Internal Link Dist (m)		131.0			112.8			120.2			61.2	
Turn Bay Length (m)	100.0		50.0	30.0		50.0	50.0		50.0	50.0		100.0
Base Capacity (vph)	521	1072	518	277	820	378	460	2110	946	308	1958	2142
Starvation Cap Reductn	0	0	0	0	0	0	0	0	0	0	0	0
Spillback Cap Reductn	0	0	0	0	0	0	0	0	0	0	0	0
Storage Cap Reductn	0	0	0	0	0	0	0	0	0	0	0	0
Reduced v/c Ratio	0.31	0.04	0.11	0.04	0.04	0.04	0.26	0.08	0.01	0.15	0.05	0.06

Intersection Summary

Cycle Length: 112.6

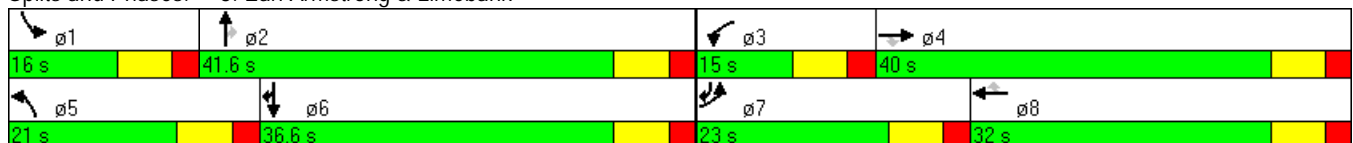
Actuated Cycle Length: 112.6

Offset: 82 (73%), Referenced to phase 2:NBT and 6:SBT, Start of Green

Natural Cycle: 90

Control Type: Actuated-Coordinated

























Splits and Phases: 3: Earl Armstrong & Limebank



HCM Signalized Intersection Capacity Analysis

3: Earl Armstrong & Limebank

Future Background - 2016
Weekday AM Peak Hour - Zero Interaction

													
Movement	EBL	EBT	EBR	WBL	WBT	WBR	NBL	NBT	NBR	SBL	SBT	SBR	
Lane Configurations													
Volume (vph)	160	45	55	10	30	15	120	160	5	45	90	125	
Ideal Flow (vphpl)	1900	1900	1900	1900	1900	1900	1900	1900	1900	1900	1900	1900	
Total Lost time (s)	5.9	5.9	5.9	5.9	5.9	5.9	5.9	5.9	5.9	5.9	5.9	5.9	
Lane Util. Factor	0.97	0.95	1.00	0.97	0.95	1.00	0.97	0.95	1.00	0.97	0.95	0.88	
Frt	1.00	1.00	0.85	1.00	1.00	0.85	1.00	1.00	0.85	1.00	1.00	0.85	
Flt Protected	0.95	1.00	1.00	0.95	1.00	1.00	0.95	1.00	1.00	0.95	1.00	1.00	
Satd. Flow (prot)	3433	3539	1583	3433	3539	1583	3433	3539	1583	3433	3539	2787	
Flt Permitted	0.95	1.00	1.00	0.95	1.00	1.00	0.95	1.00	1.00	0.95	1.00	1.00	
Satd. Flow (perm)	3433	3539	1583	3433	3539	1583	3433	3539	1583	3433	3539	2787	
Peak-hour factor, PHF	1.00	1.00	1.00	1.00	1.00	1.00	1.00	1.00	1.00	1.00	1.00	1.00	
Adj. Flow (vph)	160	45	55	10	30	15	120	160	5	45	90	125	
RTOR Reduction (vph)	0	0	45	0	0	14	0	0	2	0	0	42	
Lane Group Flow (vph)	160	45	10	10	30	1	120	160	3	45	90	83	
Turn Type	Prot		Perm	Prot		Perm	Prot		Perm	Prot		custom	
Protected Phases	7	4		3	8		5	2		1	6	6	
Permitted Phases			4			8			2			6	
Actuated Green, G (s)	11.2	18.6	18.6	1.3	8.7	8.7	9.3	59.3	59.3	5.8	55.8	73.9	
Effective Green, g (s)	12.2	19.6	19.6	2.3	9.7	9.7	10.3	60.3	60.3	6.8	56.8	74.9	
Actuated g/C Ratio	0.11	0.17	0.17	0.02	0.09	0.09	0.09	0.54	0.54	0.06	0.50	0.67	
Clearance Time (s)	6.9	6.9	6.9	6.9	6.9	6.9	6.9	6.9	6.9	6.9	6.9	6.9	
Vehicle Extension (s)	3.0	3.0	3.0	3.0	3.0	3.0	3.0	3.0	3.0	3.0	3.0	3.0	
Lane Grp Cap (vph)	372	616	276	70	305	136	314	1895	848	207	1785	1854	
v/s Ratio Prot	c0.05	0.01		0.00	c0.01		c0.03	c0.05		0.01	0.03	0.03	
v/s Ratio Perm			0.01			0.00			0.00				
v/c Ratio	0.43	0.07	0.03	0.14	0.10	0.01	0.38	0.08	0.00	0.22	0.05	0.04	
Uniform Delay, d1	46.9	38.9	38.6	54.2	47.4	47.1	48.2	12.7	12.2	50.4	14.2	6.5	
Progression Factor	1.00	1.00	1.00	1.00	0.98	0.96	1.00	1.00	1.00	1.00	1.00	1.00	
Incremental Delay, d2	0.8	0.1	0.1	0.9	0.1	0.0	0.8	0.1	0.0	0.5	0.1	0.0	
Delay (s)	47.7	39.0	38.7	55.1	46.7	45.2	48.9	12.8	12.2	50.9	14.2	6.5	
Level of Service	D	D	D	E	D	D	D	B	B	D	B	A	
Approach Delay (s)		44.3			47.8			28.0			16.9		
Approach LOS		D			D			C			B		
Intersection Summary													
HCM Average Control Delay			30.8									HCM Level of Service	C
HCM Volume to Capacity ratio			0.17										
Actuated Cycle Length (s)			112.6									Sum of lost time (s)	23.6
Intersection Capacity Utilization			38.5%									ICU Level of Service	A
Analysis Period (min)			15										
c Critical Lane Group													

Queues
6: Earl Armstrong & Proposed New Road

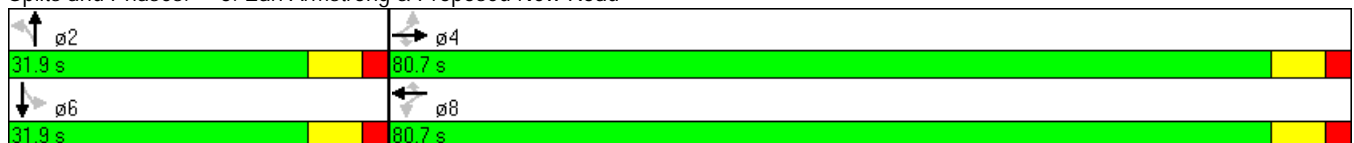
Future Background - 2016
Weekday AM Peak Hour - Zero Interaction

Lane Group	EBL	EBT	WBT	WBR	SBT	ø2
Lane Configurations						
Volume (vph)	35	65	40	2	0	
Lane Group Flow (vph)	35	65	40	2	15	
Turn Type	Perm			Perm		
Protected Phases		4	8		6	2
Permitted Phases	4			8		
Detector Phase	4	4	8	8	6	
Switch Phase						
Minimum Initial (s)	10.0	10.0	10.0	10.0	10.0	10.0
Minimum Split (s)	31.9	31.9	31.9	31.9	31.9	31.9
Total Split (s)	80.7	80.7	80.7	80.7	31.9	31.9
Total Split (%)	71.7%	71.7%	71.7%	71.7%	28.3%	28%
Yellow Time (s)	4.6	4.6	4.6	4.6	4.6	4.6
All-Red Time (s)	2.3	2.3	2.3	2.3	2.3	2.3
Lost Time Adjust (s)	-1.0	-1.0	-1.0	-1.0	-1.0	
Total Lost Time (s)	5.9	5.9	5.9	5.9	5.9	
Lead/Lag						
Lead-Lag Optimize?						
Recall Mode	C-Max	C-Max	C-Max	C-Max	None	None
v/c Ratio	0.03	0.02	0.01	0.00	0.01	
Control Delay	0.2	0.2	1.6	1.5	0.0	
Queue Delay	0.0	0.0	0.0	0.0	0.0	
Total Delay	0.2	0.2	1.6	1.5	0.0	
Queue Length 50th (m)	0.0	0.0	0.0	0.0	0.0	
Queue Length 95th (m)	0.3	0.3	1.6	0.4	0.0	
Internal Link Dist (m)		95.8	43.9		67.0	
Turn Bay Length (m)	30.0			30.0		
Base Capacity (vph)	1250	3252	3252	1455	1143	
Starvation Cap Reductn	0	0	0	0	0	
Spillback Cap Reductn	0	0	0	0	0	
Storage Cap Reductn	0	0	0	0	0	
Reduced v/c Ratio	0.03	0.02	0.01	0.00	0.01	

Intersection Summary

Cycle Length: 112.6
 Actuated Cycle Length: 112.6
 Offset: 0 (0%), Referenced to phase 4:EBTL and 8:WBTL, Start of Green
 Natural Cycle: 65
 Control Type: Actuated-Coordinated





























Splits and Phases: 6: Earl Armstrong & Proposed New Road



HCM Signalized Intersection Capacity Analysis

6: Earl Armstrong & Proposed New Road

Future Background - 2016
Weekday AM Peak Hour - Zero Interaction

												
Movement	EBL	EBT	EBR	WBL	WBT	WBR	NBL	NBT	NBR	SBL	SBT	SBR
Lane Configurations		 			 			 			 	
Volume (vph)	35	65	0	0	40	2	0	0	0	0	0	15
Ideal Flow (vphpl)	1900	1900	1900	1900	1900	1900	1900	1900	1900	1900	1900	1900
Total Lost time (s)	5.9	5.9			5.9	5.9						5.9
Lane Util. Factor	1.00	0.95			0.95	1.00						1.00
Frt	1.00	1.00			1.00	0.85						0.85
Flt Protected	0.95	1.00			1.00	1.00						1.00
Satd. Flow (prot)	1770	3539			3539	1583						1583
Flt Permitted	0.73	1.00			1.00	1.00						1.00
Satd. Flow (perm)	1359	3539			3539	1583						1583
Peak-hour factor, PHF	1.00	1.00	1.00	1.00	1.00	1.00	1.00	1.00	1.00	1.00	1.00	1.00
Adj. Flow (vph)	35	65	0	0	40	2	0	0	0	0	0	15
RTOR Reduction (vph)	0	0	0	0	0	0	0	0	0	0	14	0
Lane Group Flow (vph)	35	65	0	0	40	2	0	0	0	0	1	0
Turn Type	Perm		Perm	Perm		Perm	Perm				Perm	
Protected Phases		4			8			2				6
Permitted Phases	4		4	8		8	2			6		
Actuated Green, G (s)	94.8	94.8			94.8	94.8						4.0
Effective Green, g (s)	95.8	95.8			95.8	95.8						5.0
Actuated g/C Ratio	0.85	0.85			0.85	0.85						0.04
Clearance Time (s)	6.9	6.9			6.9	6.9						6.9
Vehicle Extension (s)	3.0	3.0			3.0	3.0						3.0
Lane Grp Cap (vph)	1156	3011			3011	1347						70
v/s Ratio Prot		0.02			0.01							c0.00
v/s Ratio Perm	c0.03					0.00						
v/c Ratio	0.03	0.02			0.01	0.00						0.01
Uniform Delay, d1	1.3	1.3			1.3	1.3						51.4
Progression Factor	0.10	0.10			1.00	1.00						1.00
Incremental Delay, d2	0.0	0.0			0.0	0.0						0.1
Delay (s)	0.2	0.1			1.3	1.3						51.5
Level of Service	A	A			A	A						D
Approach Delay (s)		0.2			1.3			0.0				51.5
Approach LOS		A			A			A				D
Intersection Summary												
HCM Average Control Delay			5.4				HCM Level of Service				A	
HCM Volume to Capacity ratio			0.03									
Actuated Cycle Length (s)			112.6				Sum of lost time (s)			11.8		
Intersection Capacity Utilization			26.8%				ICU Level of Service			A		
Analysis Period (min)			15									
c Critical Lane Group												












HCM Unsignalized Intersection Capacity Analysis
 9: Earl Armstrong & RIRO Site Access

Future Background - 2016
 Weekday AM Peak Hour - Zero Interaction

	→	↘	↙	←	↖	↗
Movement	EBT	EBR	WBL	WBT	NBL	NBR
Lane Configurations	↑↑			↑↑		↗
Volume (veh/h)	100	0	0	55	0	0
Sign Control	Free			Free	Stop	
Grade	0%			0%	0%	
Peak Hour Factor	1.00	1.00	1.00	1.00	1.00	1.00
Hourly flow rate (vph)	100	0	0	55	0	0
Pedestrians						
Lane Width (m)						
Walking Speed (m/s)						
Percent Blockage						
Right turn flare (veh)						
Median type	None			None		
Median storage (veh)						
Upstream signal (m)	137			120		
pX, platoon unblocked						
vC, conflicting volume			100		128	50
vC1, stage 1 conf vol						
vC2, stage 2 conf vol						
vCu, unblocked vol			100		128	50
tC, single (s)			4.1		6.8	6.9
tC, 2 stage (s)						
tF (s)			2.2		3.5	3.3
p0 queue free %			100		100	100
cM capacity (veh/h)			1490		854	1008
Direction, Lane #	EB 1	EB 2	WB 1	WB 2	NB 1	
Volume Total	67	33	28	28	0	
Volume Left	0	0	0	0	0	
Volume Right	0	0	0	0	0	
cSH	1700	1700	1700	1700	1700	
Volume to Capacity	0.04	0.02	0.02	0.02	0.00	
Queue Length 95th (m)	0.0	0.0	0.0	0.0	0.0	
Control Delay (s)	0.0	0.0	0.0	0.0	0.0	
Lane LOS					A	
Approach Delay (s)	0.0		0.0		0.0	
Approach LOS					A	
Intersection Summary						
Average Delay			0.0			
Intersection Capacity Utilization			6.7%	ICU Level of Service		A
Analysis Period (min)			15			










HCM Unsignalized Intersection Capacity Analysis
 11: Site Access & Limebank

Future Background - 2016
 Weekday AM Peak Hour - Zero Interaction

							
Movement	WBL	WBR	NBT	NBR	SBL	SBT	
Lane Configurations							
Volume (veh/h)	0	0	290	0	0	155	
Sign Control	Stop		Free			Free	
Grade	0%		0%			0%	
Peak Hour Factor	1.00	1.00	1.00	1.00	1.00	1.00	
Hourly flow rate (vph)	0	0	290	0	0	155	
Pedestrians							
Lane Width (m)							
Walking Speed (m/s)							
Percent Blockage							
Right turn flare (veh)							
Median type			None			None	
Median storage (veh)							
Upstream signal (m)						144	
pX, platoon unblocked							
vC, conflicting volume	368	145			290		
vC1, stage 1 conf vol							
vC2, stage 2 conf vol							
vCu, unblocked vol	368	145			290		
tC, single (s)	6.8	6.9			4.1		
tC, 2 stage (s)							
tF (s)	3.5	3.3			2.2		
p0 queue free %	100	100			100		
cM capacity (veh/h)	606	876			1269		
Direction, Lane #	WB 1	WB 2	NB 1	NB 2	SB 1	SB 2	SB 3
Volume Total	0	0	193	97	0	78	78
Volume Left	0	0	0	0	0	0	0
Volume Right	0	0	0	0	0	0	0
cSH	1700	1700	1700	1700	1700	1700	1700
Volume to Capacity	0.00	0.00	0.11	0.06	0.00	0.05	0.05
Queue Length 95th (m)	0.0	0.0	0.0	0.0	0.0	0.0	0.0
Control Delay (s)	0.0	0.0	0.0	0.0	0.0	0.0	0.0
Lane LOS	A	A					
Approach Delay (s)	0.0		0.0		0.0		
Approach LOS	A						
Intersection Summary							
Average Delay			0.0				
Intersection Capacity Utilization			11.3%		ICU Level of Service		A
Analysis Period (min)			15				










HCM Unsignalized Intersection Capacity Analysis
 13: N. Site Access & Proposed New Road

Future Background - 2016
 Weekday AM Peak Hour - Zero Interaction

						
Movement	EBL	EBR	NBL	NBT	SBT	SBR
Lane Configurations						
Volume (veh/h)	0	0	0	0	0	0
Sign Control	Stop			Free	Free	
Grade	0%			0%	0%	
Peak Hour Factor	1.00	1.00	1.00	1.00	1.00	1.00
Hourly flow rate (vph)	0	0	0	0	0	0
Pedestrians						
Lane Width (m)						
Walking Speed (m/s)						
Percent Blockage						
Right turn flare (veh)						
Median type				None	None	
Median storage (veh)						
Upstream signal (m)					96	
pX, platoon unblocked						
vC, conflicting volume	0	0	0			
vC1, stage 1 conf vol						
vC2, stage 2 conf vol						
vCu, unblocked vol	0	0	0			
tC, single (s)	6.4	6.2	4.1			
tC, 2 stage (s)						
tF (s)	3.5	3.3	2.2			
p0 queue free %	100	100	100			
cM capacity (veh/h)	1023	1085	1623			
Direction, Lane #	EB 1	NB 1	SB 1			
Volume Total	0	0	0			
Volume Left	0	0	0			
Volume Right	0	0	0			
cSH	1700	1700	1700			
Volume to Capacity	0.00	0.00	0.00			
Queue Length 95th (m)	0.0	0.0	0.0			
Control Delay (s)	0.0	0.0	0.0			
Lane LOS						
Approach Delay (s)	0.0	0.0	0.0			
Approach LOS	A					
Intersection Summary						
Average Delay			0.0			
Intersection Capacity Utilization			0.0%	ICU Level of Service		A
Analysis Period (min)			15			

HCM Unsignalized Intersection Capacity Analysis
 15: S. Site Access & Proposed New Road

Future Background - 2016
 Weekday AM Peak Hour - Zero Interaction

						
Movement	EBL	EBR	NBL	NBT	SBT	SBR
Lane Configurations						
Volume (veh/h)	0	0	0	0	0	0
Sign Control	Stop			Free	Free	
Grade	0%			0%	0%	
Peak Hour Factor	1.00	1.00	1.00	1.00	1.00	1.00
Hourly flow rate (vph)	0	0	0	0	0	0
Pedestrians						
Lane Width (m)						
Walking Speed (m/s)						
Percent Blockage						
Right turn flare (veh)						
Median type				None	None	
Median storage (veh)						
Upstream signal (m)					187	
pX, platoon unblocked						
vC, conflicting volume	0	0	0			
vC1, stage 1 conf vol						
vC2, stage 2 conf vol						
vCu, unblocked vol	0	0	0			
tC, single (s)	6.4	6.2	4.1			
tC, 2 stage (s)						
tF (s)	3.5	3.3	2.2			
p0 queue free %	100	100	100			
cM capacity (veh/h)	1023	1085	1623			
Direction, Lane #	EB 1	NB 1	SB 1			
Volume Total	0	0	0			
Volume Left	0	0	0			
Volume Right	0	0	0			
cSH	1700	1700	1700			
Volume to Capacity	0.00	0.00	0.00			
Queue Length 95th (m)	0.0	0.0	0.0			
Control Delay (s)	0.0	0.0	0.0			
Lane LOS	A					
Approach Delay (s)	0.0	0.0	0.0			
Approach LOS	A					
Intersection Summary						
Average Delay			0.0			
Intersection Capacity Utilization			0.0%	ICU Level of Service		A
Analysis Period (min)			15			

Queues

Future Background Traffic-2016

3: Earl Armstrong & Limebank

Weekday PM Peak Hour Zero Interaction

Lane Group	EBL	EBT	EBR	WBL	WBT	WBR	NBL	NBT	NBR	SBL	SBT	SBR
Lane Configurations												
Volume (vph)	255	50	95	60	65	25	75	105	20	85	175	280
Lane Group Flow (vph)	255	50	95	60	65	25	75	105	20	85	175	280
Turn Type	Prot		Perm	Prot		Perm	Prot		Perm	Prot		custom
Protected Phases	7	4		3	8		5	2		1	6	6 7
Permitted Phases			4			8			2			6
Detector Phase	7	4	4	3	8	8	5	2	2	1	6	6 7
Switch Phase												
Minimum Initial (s)	5.0	10.0	10.0	5.0	10.0	10.0	5.0	10.0	10.0	5.0	10.0	
Minimum Split (s)	11.9	31.9	31.9	11.9	31.9	31.9	11.9	31.9	31.9	11.9	31.9	
Total Split (s)	22.0	41.0	41.0	13.0	32.0	32.0	13.0	35.6	35.6	13.0	35.6	57.6
Total Split (%)	21.4%	40.0%	40.0%	12.7%	31.2%	31.2%	12.7%	34.7%	34.7%	12.7%	34.7%	56.1%
Yellow Time (s)	4.6	4.6	4.6	4.6	4.6	4.6	4.6	4.6	4.6	4.6	4.6	4.6
All-Red Time (s)	2.3	2.3	2.3	2.3	2.3	2.3	2.3	2.3	2.3	2.3	2.3	2.3
Lost Time Adjust (s)	-1.0	-1.0	-1.0	-1.0	-1.0	-1.0	-1.0	-1.0	-1.0	-1.0	-1.0	-1.0
Total Lost Time (s)	5.9	5.9	5.9	5.9	5.9	5.9	5.9	5.9	5.9	5.9	5.9	5.9
Lead/Lag	Lead	Lag	Lag	Lead	Lag	Lag	Lead	Lag	Lag	Lead	Lag	
Lead-Lag Optimize?	Yes	Yes	Yes	Yes	Yes	Yes	Yes	Yes	Yes	Yes	Yes	Yes
Recall Mode	None	None	None	None	None	None	None	C-Max	C-Max	None	C-Max	
v/c Ratio	0.55	0.09	0.28	0.26	0.17	0.13	0.26	0.06	0.02	0.28	0.10	0.14
Control Delay	46.1	35.1	9.7	46.8	43.7	18.1	45.8	17.1	7.8	45.8	16.7	1.1
Queue Delay	0.0	0.0	0.0	0.0	0.0	0.0	0.0	0.0	0.0	0.0	0.0	0.0
Total Delay	46.1	35.1	9.7	46.8	43.7	18.1	45.8	17.1	7.8	45.8	16.7	1.1
Queue Length 50th (m)	24.4	4.3	0.0	5.8	6.1	0.2	7.2	6.1	0.0	8.1	10.3	0.0
Queue Length 95th (m)	35.8	9.2	12.7	12.1	12.0	7.1	13.8	11.8	4.5	15.2	18.0	4.8
Internal Link Dist (m)		131.0			113.3			120.8			61.2	
Turn Bay Length (m)	100.0		50.0	30.0		50.0	50.0		50.0	50.0		100.0
Base Capacity (vph)	539	1211	604	238	900	421	291	1769	802	300	1779	2077
Starvation Cap Reductn	0	0	0	0	0	0	0	0	0	0	0	0
Spillback Cap Reductn	0	0	0	0	0	0	0	0	0	0	0	0
Storage Cap Reductn	0	0	0	0	0	0	0	0	0	0	0	0
Reduced v/c Ratio	0.47	0.04	0.16	0.25	0.07	0.06	0.26	0.06	0.02	0.28	0.10	0.13

Intersection Summary

Cycle Length: 102.6

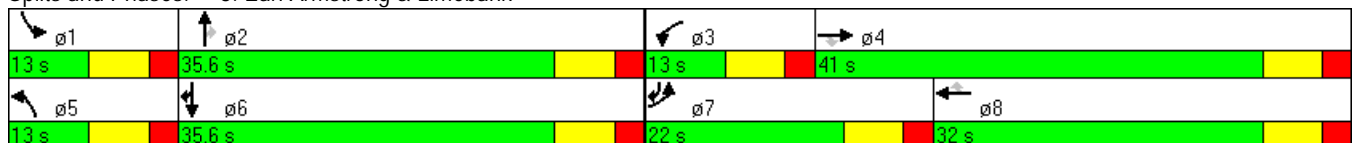
Actuated Cycle Length: 102.6

Offset: 27 (26%), Referenced to phase 2:NBT and 6:SBT, Start of Green

Natural Cycle: 90


































Control Type: Actuated-Coordinated

Splits and Phases: 3: Earl Armstrong & Limebank



HCM Signalized Intersection Capacity Analysis
3: Earl Armstrong & Limebank

Future Background Traffic-2016
Weekday PM Peak Hour Zero Interaction

												
Movement	EBL	EBT	EBR	WBL	WBT	WBR	NBL	NBT	NBR	SBL	SBT	SBR
Lane Configurations	 	 		 	 		 	 		 	 	 
Volume (vph)	255	50	95	60	65	25	75	105	20	85	175	280
Ideal Flow (vphpl)	1900	1900	1900	1900	1900	1900	1900	1900	1900	1900	1900	1900
Total Lost time (s)	5.9	5.9	5.9	5.9	5.9	5.9	5.9	5.9	5.9	5.9	5.9	5.9
Lane Util. Factor	0.97	0.95	1.00	0.97	0.95	1.00	0.97	0.95	1.00	0.97	0.95	0.88
Frt	1.00	1.00	0.85	1.00	1.00	0.85	1.00	1.00	0.85	1.00	1.00	0.85
Flt Protected	0.95	1.00	1.00	0.95	1.00	1.00	0.95	1.00	1.00	0.95	1.00	1.00
Satd. Flow (prot)	3433	3539	1583	3433	3539	1583	3433	3539	1583	3433	3539	2787
Flt Permitted	0.95	1.00	1.00	0.95	1.00	1.00	0.95	1.00	1.00	0.95	1.00	1.00
Satd. Flow (perm)	3433	3539	1583	3433	3539	1583	3433	3539	1583	3433	3539	2787
Peak-hour factor, PHF	1.00	1.00	1.00	1.00	1.00	1.00	1.00	1.00	1.00	1.00	1.00	1.00
Adj. Flow (vph)	255	50	95	60	65	25	75	105	20	85	175	280
RTOR Reduction (vph)	0	0	79	0	0	23	0	0	11	0	0	94
Lane Group Flow (vph)	255	50	16	60	65	2	75	105	9	85	175	186
Turn Type	Prot		Perm	Prot		Perm	Prot		Perm	Prot		custom
Protected Phases	7	4		3	8		5	2		1	6	6
Permitted Phases			4			8			2			6
Actuated Green, G (s)	12.7	15.9	15.9	4.9	8.1	8.1	6.5	47.5	47.5	6.7	47.7	67.3
Effective Green, g (s)	13.7	16.9	16.9	5.9	9.1	9.1	7.5	48.5	48.5	7.7	48.7	68.3
Actuated g/C Ratio	0.13	0.16	0.16	0.06	0.09	0.09	0.07	0.47	0.47	0.08	0.47	0.67
Clearance Time (s)	6.9	6.9	6.9	6.9	6.9	6.9	6.9	6.9	6.9	6.9	6.9	6.9
Vehicle Extension (s)	3.0	3.0	3.0	3.0	3.0	3.0	3.0	3.0	3.0	3.0	3.0	3.0
Lane Grp Cap (vph)	458	583	261	197	314	140	251	1673	748	258	1680	1855
v/s Ratio Prot	c0.07	0.01		0.02	c0.02		0.02	0.03		c0.02	0.05	c0.07
v/s Ratio Perm			0.01			0.00			0.01			
v/c Ratio	0.56	0.09	0.06	0.30	0.21	0.02	0.30	0.06	0.01	0.33	0.10	0.10
Uniform Delay, d1	41.6	36.3	36.1	46.4	43.4	42.7	45.1	14.7	14.3	45.0	14.9	6.1
Progression Factor	1.00	1.00	1.00	0.97	1.02	1.02	1.00	1.00	1.00	1.00	1.00	1.00
Incremental Delay, d2	1.5	0.1	0.1	0.9	0.3	0.0	0.7	0.1	0.0	0.8	0.1	0.0
Delay (s)	43.1	36.4	36.2	45.9	44.5	43.7	45.7	14.8	14.4	45.8	15.0	6.2
Level of Service	D	D	D	D	D	D	D	B	B	D	B	A
Approach Delay (s)		40.6			44.9			26.3			15.3	
Approach LOS		D			D			C			B	
Intersection Summary												
HCM Average Control Delay			28.3				HCM Level of Service			C		
HCM Volume to Capacity ratio			0.20									
Actuated Cycle Length (s)			102.6				Sum of lost time (s)		17.7			
Intersection Capacity Utilization			41.2%				ICU Level of Service		A			
Analysis Period (min)			15									
c Critical Lane Group												

Queues
6: Earl Armstrong & Proposed New Road

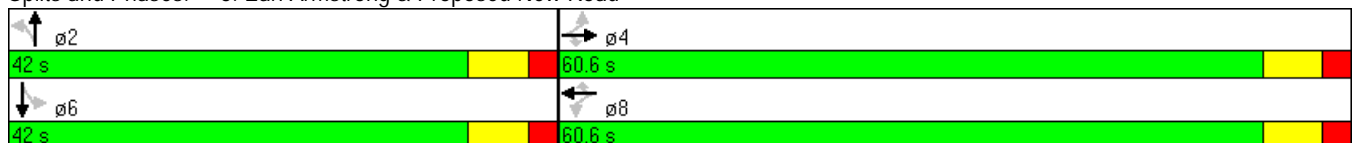
Future Background Traffic-2016
Weekday PM Peak Hour Zero Interaction

	↖	→	←	↗	↓	
Lane Group	EBL	EBT	WBT	WBR	SBT	ø2
Lane Configurations	↖	↗↗	↗↗	↖	↖	
Volume (vph)	95	65	60	10	0	
Lane Group Flow (vph)	95	65	60	10	90	
Turn Type	Perm			Perm		
Protected Phases		4	8		6	2
Permitted Phases	4			8		
Detector Phase	4	4	8	8	6	
Switch Phase						
Minimum Initial (s)	10.0	10.0	10.0	10.0	10.0	10.0
Minimum Split (s)	31.9	31.9	31.9	31.9	31.9	31.9
Total Split (s)	60.6	60.6	60.6	60.6	42.0	42.0
Total Split (%)	59.1%	59.1%	59.1%	59.1%	40.9%	41%
Yellow Time (s)	4.6	4.6	4.6	4.6	4.6	4.6
All-Red Time (s)	2.3	2.3	2.3	2.3	2.3	2.3
Lost Time Adjust (s)	-1.0	-1.0	-1.0	-1.0	-1.0	
Total Lost Time (s)	5.9	5.9	5.9	5.9	5.9	
Lead/Lag						
Lead-Lag Optimize?						
Recall Mode	C-Max	C-Max	C-Max	C-Max	None	None
v/c Ratio	0.09	0.02	0.02	0.01	0.09	
Control Delay	1.1	0.4	2.6	1.4	0.2	
Queue Delay	0.0	0.0	0.0	0.0	0.0	
Total Delay	1.1	0.4	2.6	1.4	0.2	
Queue Length 50th (m)	0.5	0.2	1.1	0.0	0.0	
Queue Length 95th (m)	1.0	0.4	2.3	1.0	0.0	
Internal Link Dist (m)		96.0	43.9		67.0	
Turn Bay Length (m)	30.0			30.0		
Base Capacity (vph)	1097	2910	2910	1303	1169	
Starvation Cap Reductn	0	0	0	0	0	
Spillback Cap Reductn	0	0	0	0	0	
Storage Cap Reductn	0	0	0	0	0	
Reduced v/c Ratio	0.09	0.02	0.02	0.01	0.08	

Intersection Summary

Cycle Length: 102.6
 Actuated Cycle Length: 102.6
 Offset: 0 (0%), Referenced to phase 4:EBTL and 8:WBTL, Start of Green
 Natural Cycle: 65
 Control Type: Actuated-Coordinated





























Splits and Phases: 6: Earl Armstrong & Proposed New Road



HCM Signalized Intersection Capacity Analysis

6: Earl Armstrong & Proposed New Road

Future Background Traffic-2016
Weekday PM Peak Hour Zero Interaction

												
Movement	EBL	EBT	EBR	WBL	WBT	WBR	NBL	NBT	NBR	SBL	SBT	SBR
Lane Configurations		 			 			 			 	
Volume (vph)	95	65	0	0	60	10	0	0	0	0	0	90
Ideal Flow (vphpl)	1900	1900	1900	1900	1900	1900	1900	1900	1900	1900	1900	1900
Total Lost time (s)	5.9	5.9			5.9	5.9						5.9
Lane Util. Factor	1.00	0.95			0.95	1.00						1.00
Frt	1.00	1.00			1.00	0.85						0.85
Flt Protected	0.95	1.00			1.00	1.00						1.00
Satd. Flow (prot)	1770	3539			3539	1583						1583
Flt Permitted	0.72	1.00			1.00	1.00						1.00
Satd. Flow (perm)	1333	3539			3539	1583						1583
Peak-hour factor, PHF	1.00	1.00	1.00	1.00	1.00	1.00	1.00	1.00	1.00	1.00	1.00	1.00
Adj. Flow (vph)	95	65	0	0	60	10	0	0	0	0	0	90
RTOR Reduction (vph)	0	0	0	0	0	2	0	0	0	0	82	0
Lane Group Flow (vph)	95	65	0	0	60	8	0	0	0	0	8	0
Turn Type	Perm		Perm	Perm		Perm	Perm				Perm	
Protected Phases		4			8			2				6
Permitted Phases	4		4	8		8	2			6		
Actuated Green, G (s)	80.8	80.8			80.8	80.8						8.0
Effective Green, g (s)	81.8	81.8			81.8	81.8						9.0
Actuated g/C Ratio	0.80	0.80			0.80	0.80						0.09
Clearance Time (s)	6.9	6.9			6.9	6.9						6.9
Vehicle Extension (s)	3.0	3.0			3.0	3.0						3.0
Lane Grp Cap (vph)	1063	2822			2822	1262						139
v/s Ratio Prot		0.02			0.02							c0.00
v/s Ratio Perm	c0.07					0.01						
v/c Ratio	0.09	0.02			0.02	0.01						0.06
Uniform Delay, d1	2.3	2.1			2.1	2.1						42.9
Progression Factor	0.34	0.15			1.00	1.00						1.00
Incremental Delay, d2	0.2	0.0			0.0	0.0						0.2
Delay (s)	0.9	0.3			2.2	2.1						43.1
Level of Service	A	A			A	A						D
Approach Delay (s)		0.7			2.2			0.0				43.1
Approach LOS		A			A			A				D
Intersection Summary												
HCM Average Control Delay			12.9				HCM Level of Service					B
HCM Volume to Capacity ratio			0.09									
Actuated Cycle Length (s)			102.6				Sum of lost time (s)			11.8		
Intersection Capacity Utilization			30.1%				ICU Level of Service			A		
Analysis Period (min)			15									
c Critical Lane Group												

HCM Unsignalized Intersection Capacity Analysis














9: Earl Armstrong & RIRO Site Access

Future Background Traffic-2016
Weekday PM Peak Hour Zero Interaction

	→	↘	↙	←	↖	↗
Movement	EBT	EBR	WBL	WBT	NBL	NBR
Lane Configurations	↑↑			↑↑		↗
Volume (veh/h)	160	0	0	150	0	0
Sign Control	Free			Free	Stop	
Grade	0%			0%	0%	
Peak Hour Factor	1.00	1.00	1.00	1.00	1.00	1.00
Hourly flow rate (vph)	160	0	0	150	0	0
Pedestrians						
Lane Width (m)						
Walking Speed (m/s)						
Percent Blockage						
Right turn flare (veh)						
Median type	None		None			
Median storage (veh)						
Upstream signal (m)	137			120		
pX, platoon unblocked						
vC, conflicting volume			160	235		80
vC1, stage 1 conf vol						
vC2, stage 2 conf vol						
vCu, unblocked vol			160	235		80
tC, single (s)			4.1	6.8		6.9
tC, 2 stage (s)						
tF (s)			2.2	3.5		3.3
p0 queue free %			100	100		100
cM capacity (veh/h)			1417	732		964
Direction, Lane #	EB 1	EB 2	WB 1	WB 2	NB 1	
Volume Total	107	53	75	75	0	
Volume Left	0	0	0	0	0	
Volume Right	0	0	0	0	0	
cSH	1700	1700	1700	1700	1700	
Volume to Capacity	0.06	0.03	0.04	0.04	0.00	
Queue Length 95th (m)	0.0	0.0	0.0	0.0	0.0	
Control Delay (s)	0.0	0.0	0.0	0.0	0.0	
Lane LOS					A	
Approach Delay (s)	0.0	0.0		0.0		
Approach LOS					A	
Intersection Summary						
Average Delay			0.0			
Intersection Capacity Utilization			7.8%	ICU Level of Service		A
Analysis Period (min)			15			










HCM Unsignalized Intersection Capacity Analysis
 11: Site Access & Limebank

Future Background Traffic-2016
 Weekday PM Peak Hour Zero Interaction

							
Movement	WBL	WBR	NBT	NBR	SBL	SBT	
Lane Configurations			 			 	
Volume (veh/h)	0	0	195	0	0	330	
Sign Control	Stop		Free			Free	
Grade	0%		0%			0%	
Peak Hour Factor	1.00	1.00	1.00	1.00	1.00	1.00	
Hourly flow rate (vph)	0	0	195	0	0	330	
Pedestrians							
Lane Width (m)							
Walking Speed (m/s)							
Percent Blockage							
Right turn flare (veh)							
Median type			None			None	
Median storage (veh)							
Upstream signal (m)						145	
pX, platoon unblocked							
vC, conflicting volume	360	98			195		
vC1, stage 1 conf vol							
vC2, stage 2 conf vol							
vCu, unblocked vol	360	98			195		
tC, single (s)	6.8	6.9			4.1		
tC, 2 stage (s)							
tF (s)	3.5	3.3			2.2		
p0 queue free %	100	100			100		
cM capacity (veh/h)	612	940			1375		
Direction, Lane #	WB 1	WB 2	NB 1	NB 2	SB 1	SB 2	SB 3
Volume Total	0	0	130	65	0	165	165
Volume Left	0	0	0	0	0	0	0
Volume Right	0	0	0	0	0	0	0
cSH	1700	1700	1700	1700	1700	1700	1700
Volume to Capacity	0.00	0.00	0.08	0.04	0.00	0.10	0.10
Queue Length 95th (m)	0.0	0.0	0.0	0.0	0.0	0.0	0.0
Control Delay (s)	0.0	0.0	0.0	0.0	0.0	0.0	0.0
Lane LOS	A	A					
Approach Delay (s)	0.0		0.0		0.0		
Approach LOS	A						
Intersection Summary							
Average Delay			0.0				
Intersection Capacity Utilization			12.5%		ICU Level of Service		A
Analysis Period (min)			15				










HCM Unsignalized Intersection Capacity Analysis
 13: N. Site Access & Proposed New Road

Future Background Traffic-2016
 Weekday PM Peak Hour Zero Interaction

						
Movement	EBL	EBR	NBL	NBT	SBT	SBR
Lane Configurations						
Volume (veh/h)	0	0	0	0	0	0
Sign Control	Stop			Free	Free	
Grade	0%			0%	0%	
Peak Hour Factor	1.00	1.00	1.00	1.00	1.00	1.00
Hourly flow rate (vph)	0	0	0	0	0	0
Pedestrians						
Lane Width (m)						
Walking Speed (m/s)						
Percent Blockage						
Right turn flare (veh)						
Median type				None	None	
Median storage (veh)						
Upstream signal (m)					96	
pX, platoon unblocked						
vC, conflicting volume	0	0	0			
vC1, stage 1 conf vol						
vC2, stage 2 conf vol						
vCu, unblocked vol	0	0	0			
tC, single (s)	6.4	6.2	4.1			
tC, 2 stage (s)						
tF (s)	3.5	3.3	2.2			
p0 queue free %	100	100	100			
cM capacity (veh/h)	1023	1085	1623			
Direction, Lane #	EB 1	NB 1	SB 1			
Volume Total	0	0	0			
Volume Left	0	0	0			
Volume Right	0	0	0			
cSH	1700	1700	1700			
Volume to Capacity	0.00	0.00	0.00			
Queue Length 95th (m)	0.0	0.0	0.0			
Control Delay (s)	0.0	0.0	0.0			
Lane LOS	A					
Approach Delay (s)	0.0	0.0	0.0			
Approach LOS	A					
Intersection Summary						
Average Delay			0.0			
Intersection Capacity Utilization			0.0%	ICU Level of Service		A
Analysis Period (min)			15			

HCM Unsignalized Intersection Capacity Analysis
 15: S. Site Access & Proposed New Road

Future Background Traffic-2016
 Weekday PM Peak Hour Zero Interaction

						
Movement	EBL	EBR	NBL	NBT	SBT	SBR
Lane Configurations						
Volume (veh/h)	0	0	0	0	0	0
Sign Control	Stop			Free	Free	
Grade	0%			0%	0%	
Peak Hour Factor	1.00	1.00	1.00	1.00	1.00	1.00
Hourly flow rate (vph)	0	0	0	0	0	0
Pedestrians						
Lane Width (m)						
Walking Speed (m/s)						
Percent Blockage						
Right turn flare (veh)						
Median type				None	None	
Median storage (veh)						
Upstream signal (m)					185	
pX, platoon unblocked						
vC, conflicting volume	0	0	0			
vC1, stage 1 conf vol						
vC2, stage 2 conf vol						
vCu, unblocked vol	0	0	0			
tC, single (s)	6.4	6.2	4.1			
tC, 2 stage (s)						
tF (s)	3.5	3.3	2.2			
p0 queue free %	100	100	100			
cM capacity (veh/h)	1023	1085	1623			
Direction, Lane #	EB 1	NB 1	SB 1			
Volume Total	0	0	0			
Volume Left	0	0	0			
Volume Right	0	0	0			
cSH	1700	1700	1700			
Volume to Capacity	0.00	0.00	0.00			
Queue Length 95th (m)	0.0	0.0	0.0			
Control Delay (s)	0.0	0.0	0.0			
Lane LOS						
Approach Delay (s)	0.0	0.0	0.0			
Approach LOS	A					
Intersection Summary						
Average Delay			0.0			
Intersection Capacity Utilization			0.0%	ICU Level of Service		A
Analysis Period (min)			15			

APPENDIX D: Synchro Analysis – Future Background 2016 unconstrained interaction



Queues

Future Background Traffic-2016

3: Earl Armstrong & Limebank

Weekday AM Peak Hour Unconstrained

Lane Group	EBL	EBT	EBR	WBL	WBT	WBR	NBL	NBT	NBR	SBL	SBT	SBR
Lane Configurations												
Volume (vph)	545	425	60	10	80	15	175	160	5	45	90	325
Lane Group Flow (vph)	545	425	60	10	80	15	175	160	5	45	90	325
Turn Type	Prot		Perm	Prot		Perm	Prot		Perm	Prot		custom
Protected Phases	7	4		3	8		5	2		1	6	6 7
Permitted Phases			4			8			2			6
Detector Phase	7	4	4	3	8	8	5	2	2	1	6	6 7
Switch Phase												
Minimum Initial (s)	5.0	10.0	10.0	5.0	10.0	10.0	5.0	10.0	10.0	5.0	10.0	
Minimum Split (s)	11.9	31.9	31.9	11.9	31.9	31.9	11.9	31.9	31.9	11.9	31.9	
Total Split (s)	31.8	51.8	51.8	11.9	31.9	31.9	16.3	36.9	36.9	12.0	32.6	64.4
Total Split (%)	28.2%	46.0%	46.0%	10.6%	28.3%	28.3%	14.5%	32.8%	32.8%	10.7%	29.0%	57.2%
Yellow Time (s)	4.6	4.6	4.6	4.6	4.6	4.6	4.6	4.6	4.6	4.6	4.6	4.6
All-Red Time (s)	2.3	2.3	2.3	2.3	2.3	2.3	2.3	2.3	2.3	2.3	2.3	2.3
Lost Time Adjust (s)	-1.0	-1.0	-1.0	-1.0	-1.0	-1.0	-1.0	-1.0	-1.0	-1.0	-1.0	-1.0
Total Lost Time (s)	5.9	5.9	5.9	5.9	5.9	5.9	5.9	5.9	5.9	5.9	5.9	5.9
Lead/Lag	Lead	Lag	Lag	Lead	Lag	Lag	Lead	Lag	Lag	Lead	Lag	
Lead-Lag Optimize?	Yes	Yes	Yes	Yes	Yes	Yes	Yes	Yes	Yes	Yes	Yes	Yes
Recall Mode	None	None	None	None	None	None	None	C-Max	C-Max	None	C-Max	
v/c Ratio	0.76	0.39	0.11	0.05	0.23	0.09	0.48	0.10	0.01	0.19	0.06	0.16
Control Delay	49.5	31.6	7.9	49.2	47.8	20.1	51.3	20.4	13.2	50.6	23.9	1.2
Queue Delay	0.0	0.0	0.0	0.0	0.0	0.0	0.0	0.0	0.0	0.0	0.0	0.0
Total Delay	49.5	31.6	7.9	49.2	47.8	20.1	51.3	20.4	13.2	50.6	23.9	1.2
Queue Length 50th (m)	56.9	34.4	0.0	0.9	8.5	0.0	18.7	11.2	0.0	4.8	6.6	0.0
Queue Length 95th (m)	74.2	54.6	9.7	3.9	13.1	4.6	28.5	18.8	2.4	10.3	12.7	5.5
Internal Link Dist (m)		131.0			112.8			120.2			61.2	
Turn Bay Length (m)	100.0		50.0	30.0		50.0	50.0		50.0	50.0		100.0
Base Capacity (vph)	790	1443	681	183	817	377	375	1652	742	242	1444	2025
Starvation Cap Reductn	0	0	0	0	0	0	0	0	0	0	0	0
Spillback Cap Reductn	0	0	0	0	0	0	0	0	0	0	0	0
Storage Cap Reductn	0	0	0	0	0	0	0	0	0	0	0	0
Reduced v/c Ratio	0.69	0.29	0.09	0.05	0.10	0.04	0.47	0.10	0.01	0.19	0.06	0.16

Intersection Summary

Cycle Length: 112.6

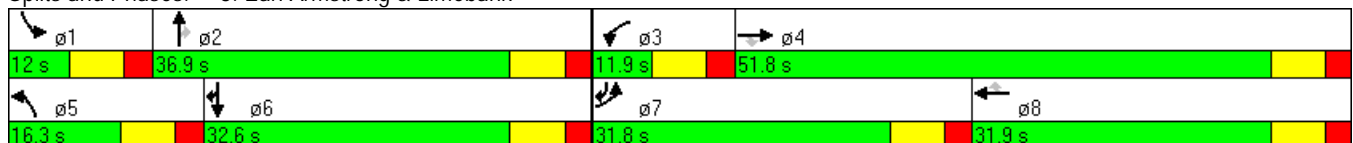
Actuated Cycle Length: 112.6

Offset: 51 (45%), Referenced to phase 2:NBT and 6:SBT, Start of Green

Natural Cycle: 90

Control Type: Actuated-Coordinated

Splits and Phases: 3: Earl Armstrong & Limebank



HCM Signalized Intersection Capacity Analysis
3: Earl Armstrong & Limebank

Future Background Traffic-2016
Weekday AM Peak Hour Unconstrained

Movement	EBL	EBT	EBR	WBL	WBT	WBR	NBL	NBT	NBR	SBL	SBT	SBR
Lane Configurations												
Volume (vph)	545	425	60	10	80	15	175	160	5	45	90	325
Ideal Flow (vphpl)	1900	1900	1900	1900	1900	1900	1900	1900	1900	1900	1900	1900
Total Lost time (s)	5.9	5.9	5.9	5.9	5.9	5.9	5.9	5.9	5.9	5.9	5.9	5.9
Lane Util. Factor	0.97	0.95	1.00	0.97	0.95	1.00	0.97	0.95	1.00	0.97	0.95	0.88
Frt	1.00	1.00	0.85	1.00	1.00	0.85	1.00	1.00	0.85	1.00	1.00	0.85
Flt Protected	0.95	1.00	1.00	0.95	1.00	1.00	0.95	1.00	1.00	0.95	1.00	1.00
Satd. Flow (prot)	3433	3539	1583	3433	3539	1583	3433	3539	1583	3433	3539	2787
Flt Permitted	0.95	1.00	1.00	0.95	1.00	1.00	0.95	1.00	1.00	0.95	1.00	1.00
Satd. Flow (perm)	3433	3539	1583	3433	3539	1583	3433	3539	1583	3433	3539	2787
Peak-hour factor, PHF	1.00	1.00	1.00	1.00	1.00	1.00	1.00	1.00	1.00	1.00	1.00	1.00
Adj. Flow (vph)	545	425	60	10	80	15	175	160	5	45	90	325
RTOR Reduction (vph)	0	0	42	0	0	13	0	0	3	0	0	124
Lane Group Flow (vph)	545	425	18	10	80	2	175	160	2	45	90	201
Turn Type	Prot		Perm	Prot		Perm	Prot		Perm	Prot		custom
Protected Phases	7	4		3	8		5	2		1	6	6
Permitted Phases			4			8			2			6
Actuated Green, G (s)	22.4	33.5	33.5	1.0	12.1	12.1	11.0	44.7	44.7	5.8	39.5	68.8
Effective Green, g (s)	23.4	34.5	34.5	2.0	13.1	13.1	12.0	45.7	45.7	6.8	40.5	69.8
Actuated g/C Ratio	0.21	0.31	0.31	0.02	0.12	0.12	0.11	0.41	0.41	0.06	0.36	0.62
Clearance Time (s)	6.9	6.9	6.9	6.9	6.9	6.9	6.9	6.9	6.9	6.9	6.9	6.9
Vehicle Extension (s)	3.0	3.0	3.0	3.0	3.0	3.0	3.0	3.0	3.0	3.0	3.0	3.0
Lane Grp Cap (vph)	713	1084	485	61	412	184	366	1436	642	207	1273	1728
v/s Ratio Prot	c0.16	c0.12		0.00	0.02		c0.05	c0.05		0.01	0.03	c0.07
v/s Ratio Perm			0.01			0.00			0.00			
v/c Ratio	0.76	0.39	0.04	0.16	0.19	0.01	0.48	0.11	0.00	0.22	0.07	0.12
Uniform Delay, d1	42.0	30.8	27.4	54.5	45.0	44.0	47.4	20.8	19.9	50.4	23.7	8.8
Progression Factor	1.00	1.00	1.00	0.96	0.98	0.93	1.00	1.00	1.00	1.00	1.00	1.00
Incremental Delay, d2	4.9	0.2	0.0	1.3	0.2	0.0	1.0	0.2	0.0	0.5	0.1	0.0
Delay (s)	46.9	31.0	27.4	53.4	44.3	40.7	48.3	21.0	19.9	50.9	23.8	8.8
Level of Service	D	C	C	D	D	D	D	C	B	D	C	A
Approach Delay (s)		39.2			44.6			35.0			15.9	
Approach LOS		D			D			D			B	
Intersection Summary												
HCM Average Control Delay			33.2				HCM Level of Service			C		
HCM Volume to Capacity ratio			0.39									
Actuated Cycle Length (s)			112.6				Sum of lost time (s)		23.6			
Intersection Capacity Utilization			50.3%				ICU Level of Service		A			
Analysis Period (min)			15									
c Critical Lane Group												

Queues
6: Earl Armstrong & Proposed New Road

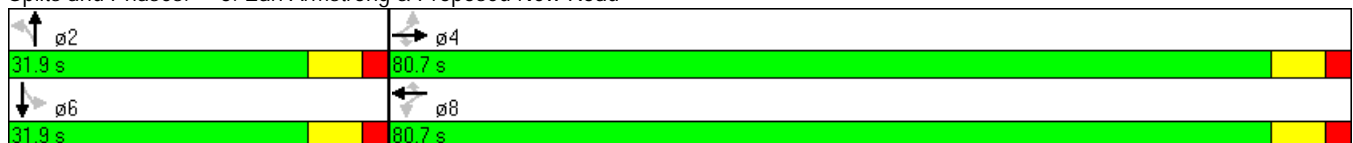
Future Background Traffic-2016
Weekday AM Peak Hour Unconstrained

Lane Group	EBL	EBT	WBT	WBR	SBT	ø2
Lane Configurations						
Volume (vph)	35	445	85	2	0	
Lane Group Flow (vph)	35	445	85	2	15	
Turn Type	Perm			Perm		
Protected Phases		4	8		6	2
Permitted Phases	4			8		
Detector Phase	4	4	8	8	6	
Switch Phase						
Minimum Initial (s)	10.0	10.0	10.0	10.0	10.0	10.0
Minimum Split (s)	31.9	31.9	31.9	31.9	31.9	31.9
Total Split (s)	80.7	80.7	80.7	80.7	31.9	31.9
Total Split (%)	71.7%	71.7%	71.7%	71.7%	28.3%	28%
Yellow Time (s)	4.6	4.6	4.6	4.6	4.6	4.6
All-Red Time (s)	2.3	2.3	2.3	2.3	2.3	2.3
Lost Time Adjust (s)	-1.0	-1.0	-1.0	-1.0	-1.0	
Total Lost Time (s)	5.9	5.9	5.9	5.9	5.9	
Lead/Lag						
Lead-Lag Optimize?						
Recall Mode	C-Max	C-Max	C-Max	C-Max	None	None
v/c Ratio	0.03	0.14	0.03	0.00	0.02	
Control Delay	0.1	0.1	1.5	1.5	0.0	
Queue Delay	0.0	0.0	0.0	0.0	0.0	
Total Delay	0.1	0.1	1.5	1.5	0.0	
Queue Length 50th (m)	0.0	0.0	0.0	0.0	0.0	
Queue Length 95th (m)	0.1	0.2	2.9	0.4	0.0	
Internal Link Dist (m)		95.8	43.9		67.0	
Turn Bay Length (m)	30.0			30.0		
Base Capacity (vph)	1196	3252	3252	1455	1078	
Starvation Cap Reductn	0	0	0	0	0	
Spillback Cap Reductn	0	0	0	0	0	
Storage Cap Reductn	0	0	0	0	0	
Reduced v/c Ratio	0.03	0.14	0.03	0.00	0.01	

Intersection Summary

Cycle Length: 112.6
 Actuated Cycle Length: 112.6
 Offset: 0 (0%), Referenced to phase 4:EBTL and 8:WBTL, Start of Green
 Natural Cycle: 65
 Control Type: Actuated-Coordinated





























Splits and Phases: 6: Earl Armstrong & Proposed New Road



HCM Signalized Intersection Capacity Analysis













6: Earl Armstrong & Proposed New Road

Future Background Traffic-2016
Weekday AM Peak Hour Unconstrained

												
Movement	EBL	EBT	EBR	WBL	WBT	WBR	NBL	NBT	NBR	SBL	SBT	SBR
Lane Configurations		 			 			 			 	
Volume (vph)	35	445	0	0	85	2	0	0	0	0	0	15
Ideal Flow (vphpl)	1900	1900	1900	1900	1900	1900	1900	1900	1900	1900	1900	1900
Total Lost time (s)	5.9	5.9			5.9	5.9						5.9
Lane Util. Factor	1.00	0.95			0.95	1.00						1.00
Frt	1.00	1.00			1.00	0.85						0.85
Flt Protected	0.95	1.00			1.00	1.00						1.00
Satd. Flow (prot)	1770	3539			3539	1583						1583
Flt Permitted	0.70	1.00			1.00	1.00						1.00
Satd. Flow (perm)	1302	3539			3539	1583						1583
Peak-hour factor, PHF	1.00	1.00	1.00	1.00	1.00	1.00	1.00	1.00	1.00	1.00	1.00	1.00
Adj. Flow (vph)	35	445	0	0	85	2	0	0	0	0	0	15
RTOR Reduction (vph)	0	0	0	0	0	0	0	0	0	0	14	0
Lane Group Flow (vph)	35	445	0	0	85	2	0	0	0	0	1	0
Turn Type	Perm		Perm	Perm		Perm	Perm			Perm		
Protected Phases		4			8			2				6
Permitted Phases	4		4	8		8	2			6		
Actuated Green, G (s)	94.8	94.8			94.8	94.8						4.0
Effective Green, g (s)	95.8	95.8			95.8	95.8						5.0
Actuated g/C Ratio	0.85	0.85			0.85	0.85						0.04
Clearance Time (s)	6.9	6.9			6.9	6.9						6.9
Vehicle Extension (s)	3.0	3.0			3.0	3.0						3.0
Lane Grp Cap (vph)	1108	3011			3011	1347						70
v/s Ratio Prot		c0.13			0.02							c0.00
v/s Ratio Perm	0.03					0.00						
v/c Ratio	0.03	0.15			0.03	0.00						0.01
Uniform Delay, d1	1.3	1.4			1.3	1.3						51.4
Progression Factor	0.03	0.02			1.00	1.00						1.00
Incremental Delay, d2	0.1	0.1			0.0	0.0						0.1
Delay (s)	0.1	0.1			1.3	1.3						51.5
Level of Service	A	A			A	A						D
Approach Delay (s)		0.1			1.3			0.0				51.5
Approach LOS		A			A			A				D
Intersection Summary												
HCM Average Control Delay			1.6				HCM Level of Service			A		
HCM Volume to Capacity ratio			0.14									
Actuated Cycle Length (s)			112.6				Sum of lost time (s)			11.8		
Intersection Capacity Utilization			30.5%				ICU Level of Service			A		
Analysis Period (min)			15									
c Critical Lane Group												












HCM Unsignalized Intersection Capacity Analysis
 9: Earl Armstrong & RIRO Site Access

Future Background Traffic-2016
 Weekday AM Peak Hour Unconstrained

						
Movement	EBT	EBR	WBL	WBT	NBL	NBR
Lane Configurations	 			 		 
Volume (veh/h)	480	0	0	100	0	0
Sign Control	Free			Free	Stop	
Grade	0%			0%	0%	
Peak Hour Factor	1.00	1.00	1.00	1.00	1.00	1.00
Hourly flow rate (vph)	480	0	0	100	0	0
Pedestrians						
Lane Width (m)						
Walking Speed (m/s)						
Percent Blockage						
Right turn flare (veh)						
Median type	None		None			
Median storage (veh)						
Upstream signal (m)	137			120		
pX, platoon unblocked			0.91		0.91	0.91
vC, conflicting volume			480		530	240
vC1, stage 1 conf vol						
vC2, stage 2 conf vol						
vCu, unblocked vol			233		288	0
tC, single (s)			4.1		6.8	6.9
tC, 2 stage (s)						
tF (s)			2.2		3.5	3.3
p0 queue free %			100		100	100
cM capacity (veh/h)			1213		618	988
Direction, Lane #	EB 1	EB 2	WB 1	WB 2	NB 1	
Volume Total	320	160	50	50	0	
Volume Left	0	0	0	0	0	
Volume Right	0	0	0	0	0	
cSH	1700	1700	1700	1700	1700	
Volume to Capacity	0.19	0.09	0.03	0.03	0.00	
Queue Length 95th (m)	0.0	0.0	0.0	0.0	0.0	
Control Delay (s)	0.0	0.0	0.0	0.0	0.0	
Lane LOS						A
Approach Delay (s)	0.0		0.0		0.0	
Approach LOS						A
Intersection Summary						
Average Delay			0.0			
Intersection Capacity Utilization			16.6%	ICU Level of Service	A	
Analysis Period (min)			15			










HCM Unsignalized Intersection Capacity Analysis
 11: Site Access & Limebank

Future Background Traffic-2016
 Weekday AM Peak Hour Unconstrained

							
Movement	WBL	WBR	NBT	NBR	SBL	SBT	
Lane Configurations							
Volume (veh/h)	0	0	345	0	0	160	
Sign Control	Stop		Free			Free	
Grade	0%		0%			0%	
Peak Hour Factor	1.00	1.00	1.00	1.00	1.00	1.00	
Hourly flow rate (vph)	0	0	345	0	0	160	
Pedestrians							
Lane Width (m)							
Walking Speed (m/s)							
Percent Blockage							
Right turn flare (veh)							
Median type	None			None			
Median storage (veh)							
Upstream signal (m)	144						
pX, platoon unblocked							
vC, conflicting volume	425	172			345		
vC1, stage 1 conf vol							
vC2, stage 2 conf vol							
vCu, unblocked vol	425	172			345		
tC, single (s)	6.8	6.9			4.1		
tC, 2 stage (s)							
tF (s)	3.5	3.3			2.2		
p0 queue free %	100	100			100		
cM capacity (veh/h)	557	841			1211		
Direction, Lane #	WB 1	WB 2	NB 1	NB 2	SB 1	SB 2	SB 3
Volume Total	0	0	230	115	0	80	80
Volume Left	0	0	0	0	0	0	0
Volume Right	0	0	0	0	0	0	0
cSH	1700	1700	1700	1700	1700	1700	1700
Volume to Capacity	0.00	0.00	0.14	0.07	0.00	0.05	0.05
Queue Length 95th (m)	0.0	0.0	0.0	0.0	0.0	0.0	0.0
Control Delay (s)	0.0	0.0	0.0	0.0	0.0	0.0	0.0
Lane LOS	A	A					
Approach Delay (s)	0.0		0.0		0.0		
Approach LOS	A						
Intersection Summary							
Average Delay			0.0				
Intersection Capacity Utilization			12.9%	ICU Level of Service	A		
Analysis Period (min)			15				










HCM Unsignalized Intersection Capacity Analysis
 13: N. Site Access & Proposed New Road

Future Background Traffic-2016
 Weekday AM Peak Hour Unconstrained

						
Movement	EBL	EBR	NBL	NBT	SBT	SBR
Lane Configurations						
Volume (veh/h)	0	0	0	0	0	0
Sign Control	Stop			Free	Free	
Grade	0%			0%	0%	
Peak Hour Factor	1.00	1.00	1.00	1.00	1.00	1.00
Hourly flow rate (vph)	0	0	0	0	0	0
Pedestrians						
Lane Width (m)						
Walking Speed (m/s)						
Percent Blockage						
Right turn flare (veh)						
Median type				None	None	
Median storage (veh)						
Upstream signal (m)					96	
pX, platoon unblocked						
vC, conflicting volume	0	0	0			
vC1, stage 1 conf vol						
vC2, stage 2 conf vol						
vCu, unblocked vol	0	0	0			
tC, single (s)	6.4	6.2	4.1			
tC, 2 stage (s)						
tF (s)	3.5	3.3	2.2			
p0 queue free %	100	100	100			
cM capacity (veh/h)	1023	1085	1623			
Direction, Lane #	EB 1	NB 1	SB 1			
Volume Total	0	0	0			
Volume Left	0	0	0			
Volume Right	0	0	0			
cSH	1700	1700	1700			
Volume to Capacity	0.00	0.00	0.00			
Queue Length 95th (m)	0.0	0.0	0.0			
Control Delay (s)	0.0	0.0	0.0			
Lane LOS	A					
Approach Delay (s)	0.0	0.0	0.0			
Approach LOS	A					
Intersection Summary						
Average Delay			0.0			
Intersection Capacity Utilization			0.0%	ICU Level of Service		A
Analysis Period (min)			15			

HCM Unsignalized Intersection Capacity Analysis
 15: S. Site Access & Proposed New Road

Future Background Traffic-2016
 Weekday AM Peak Hour Unconstrained

						
Movement	EBL	EBR	NBL	NBT	SBT	SBR
Lane Configurations						
Volume (veh/h)	0	0	0	0	0	0
Sign Control	Stop			Free	Free	
Grade	0%			0%	0%	
Peak Hour Factor	1.00	1.00	1.00	1.00	1.00	1.00
Hourly flow rate (vph)	0	0	0	0	0	0
Pedestrians						
Lane Width (m)						
Walking Speed (m/s)						
Percent Blockage						
Right turn flare (veh)						
Median type				None	None	
Median storage (veh)						
Upstream signal (m)					187	
pX, platoon unblocked						
vC, conflicting volume	0	0	0			
vC1, stage 1 conf vol						
vC2, stage 2 conf vol						
vCu, unblocked vol	0	0	0			
tC, single (s)	6.4	6.2	4.1			
tC, 2 stage (s)						
tF (s)	3.5	3.3	2.2			
p0 queue free %	100	100	100			
cM capacity (veh/h)	1023	1085	1623			
Direction, Lane #	EB 1	NB 1	SB 1			
Volume Total	0	0	0			
Volume Left	0	0	0			
Volume Right	0	0	0			
cSH	1700	1700	1700			
Volume to Capacity	0.00	0.00	0.00			
Queue Length 95th (m)	0.0	0.0	0.0			
Control Delay (s)	0.0	0.0	0.0			
Lane LOS	A					
Approach Delay (s)	0.0	0.0	0.0			
Approach LOS	A					
Intersection Summary						
Average Delay			0.0			
Intersection Capacity Utilization			0.0%	ICU Level of Service		A
Analysis Period (min)			15			

Queues
3: Earl Armstrong & Limebank

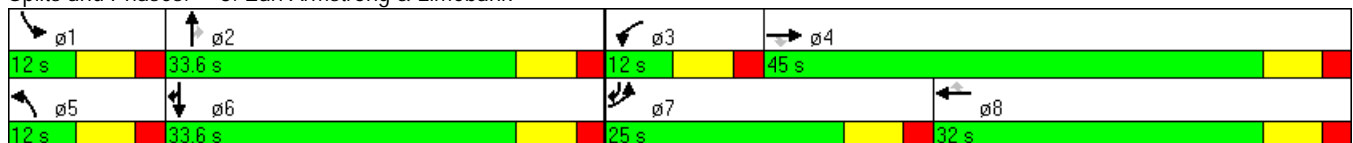
Future Background Traffic-2016
 Weekday PM Peak Hour Unconstrained

Lane Group	EBL	EBT	EBR	WBL	WBT	WBR	NBL	NBT	NBR	SBL	SBT	SBR
Lane Configurations												
Volume (vph)	400	60	195	60	435	25	75	105	20	85	175	665
Lane Group Flow (vph)	400	60	195	60	435	25	75	105	20	85	175	665
Turn Type	Prot		Perm	Prot		Perm	Prot		Perm	Prot		custom
Protected Phases	7	4		3	8		5	2		1	6	6 7
Permitted Phases			4			8			2			6
Detector Phase	7	4	4	3	8	8	5	2	2	1	6	6 7
Switch Phase												
Minimum Initial (s)	5.0	10.0	10.0	5.0	10.0	10.0	5.0	10.0	10.0	5.0	10.0	
Minimum Split (s)	11.9	31.9	31.9	11.9	31.9	31.9	11.9	31.9	31.9	11.9	31.9	
Total Split (s)	25.0	45.0	45.0	12.0	32.0	32.0	12.0	33.6	33.6	12.0	33.6	58.6
Total Split (%)	24.4%	43.9%	43.9%	11.7%	31.2%	31.2%	11.7%	32.7%	32.7%	11.7%	32.7%	57.1%
Yellow Time (s)	4.6	4.6	4.6	4.6	4.6	4.6	4.6	4.6	4.6	4.6	4.6	4.6
All-Red Time (s)	2.3	2.3	2.3	2.3	2.3	2.3	2.3	2.3	2.3	2.3	2.3	2.3
Lost Time Adjust (s)	-1.0	-1.0	-1.0	-1.0	-1.0	-1.0	-1.0	-1.0	-1.0	-1.0	-1.0	-1.0
Total Lost Time (s)	5.9	5.9	5.9	5.9	5.9	5.9	5.9	5.9	5.9	5.9	5.9	5.9
Lead/Lag	Lead	Lag	Lag	Lead	Lag	Lag	Lead	Lag	Lag	Lead	Lag	
Lead-Lag Optimize?	Yes	Yes	Yes	Yes	Yes	Yes	Yes	Yes	Yes	Yes	Yes	Yes
Recall Mode	None	None	None	None	None	None	None	C-Max	C-Max	None	C-Max	
v/c Ratio	0.68	0.05	0.31	0.29	0.67	0.08	0.27	0.08	0.03	0.30	0.14	0.38
Control Delay	45.9	23.9	4.8	47.5	42.0	11.8	46.6	25.7	11.7	46.8	25.6	8.8
Queue Delay	0.0	0.0	0.0	0.0	0.0	0.0	0.0	0.0	0.0	0.0	0.0	0.0
Total Delay	45.9	23.9	4.8	47.5	42.0	11.8	46.6	25.7	11.7	46.8	25.6	8.8
Queue Length 50th (m)	37.7	4.3	0.0	5.9	33.1	0.0	7.2	7.6	0.0	8.1	12.9	24.3
Queue Length 95th (m)	52.8	8.3	13.9	12.2	41.0	5.0	14.0	14.7	5.6	15.6	22.4	41.7
Internal Link Dist (m)		131.0			113.3			120.8			61.2	
Turn Bay Length (m)	100.0		50.0	30.0		50.0	50.0		50.0	50.0		100.0
Base Capacity (vph)	639	1349	724	204	900	421	277	1262	578	285	1269	1769
Starvation Cap Reductn	0	0	0	0	0	0	0	0	0	0	0	0
Spillback Cap Reductn	0	0	0	0	0	0	0	0	0	0	0	0
Storage Cap Reductn	0	0	0	0	0	0	0	0	0	0	0	0
Reduced v/c Ratio	0.63	0.04	0.27	0.29	0.48	0.06	0.27	0.08	0.03	0.30	0.14	0.38

Intersection Summary

Cycle Length: 102.6
 Actuated Cycle Length: 102.6
 Offset: 28 (27%), Referenced to phase 2:NBT and 6:SBT, Start of Green
 Natural Cycle: 90
 Control Type: Actuated-Coordinated

























Splits and Phases: 3: Earl Armstrong & Limebank



HCM Signalized Intersection Capacity Analysis

3: Earl Armstrong & Limebank

Future Background Traffic-2016
Weekday PM Peak Hour Unconstrained

												
Movement	EBL	EBT	EBR	WBL	WBT	WBR	NBL	NBT	NBR	SBL	SBT	SBR
Lane Configurations												
Volume (vph)	400	60	195	60	435	25	75	105	20	85	175	665
Ideal Flow (vphpl)	1900	1900	1900	1900	1900	1900	1900	1900	1900	1900	1900	1900
Total Lost time (s)	5.9	5.9	5.9	5.9	5.9	5.9	5.9	5.9	5.9	5.9	5.9	5.9
Lane Util. Factor	0.97	0.95	1.00	0.97	0.95	1.00	0.97	0.95	1.00	0.97	0.95	0.88
Frt	1.00	1.00	0.85	1.00	1.00	0.85	1.00	1.00	0.85	1.00	1.00	0.85
Flt Protected	0.95	1.00	1.00	0.95	1.00	1.00	0.95	1.00	1.00	0.95	1.00	1.00
Satd. Flow (prot)	3433	3539	1583	3433	3539	1583	3433	3539	1583	3433	3539	2787
Flt Permitted	0.95	1.00	1.00	0.95	1.00	1.00	0.95	1.00	1.00	0.95	1.00	1.00
Satd. Flow (perm)	3433	3539	1583	3433	3539	1583	3433	3539	1583	3433	3539	2787
Peak-hour factor, PHF	1.00	1.00	1.00	1.00	1.00	1.00	1.00	1.00	1.00	1.00	1.00	1.00
Adj. Flow (vph)	400	60	195	60	435	25	75	105	20	85	175	665
RTOR Reduction (vph)	0	0	133	0	0	20	0	0	13	0	0	100
Lane Group Flow (vph)	400	60	62	60	435	5	75	105	7	85	175	565
Turn Type	Prot		Perm	Prot		Perm	Prot		Perm	Prot		custom
Protected Phases	7	4		3	8		5	2		1	6	6
Permitted Phases			4			8			2			6
Actuated Green, G (s)	16.6	31.7	31.7	4.1	19.2	19.2	6.1	32.9	32.9	6.3	33.1	56.6
Effective Green, g (s)	17.6	32.7	32.7	5.1	20.2	20.2	7.1	33.9	33.9	7.3	34.1	57.6
Actuated g/C Ratio	0.17	0.32	0.32	0.05	0.20	0.20	0.07	0.33	0.33	0.07	0.33	0.56
Clearance Time (s)	6.9	6.9	6.9	6.9	6.9	6.9	6.9	6.9	6.9	6.9	6.9	6.9
Vehicle Extension (s)	3.0	3.0	3.0	3.0	3.0	3.0	3.0	3.0	3.0	3.0	3.0	3.0
Lane Grp Cap (vph)	589	1128	505	171	697	312	238	1169	523	244	1176	1565
v/s Ratio Prot	c0.12	0.02		0.02	c0.12		0.02	0.03		c0.02	0.05	c0.20
v/s Ratio Perm			0.04			0.00			0.00			
v/c Ratio	0.68	0.05	0.12	0.35	0.62	0.02	0.32	0.09	0.01	0.35	0.15	0.36
Uniform Delay, d1	39.9	24.2	24.8	47.1	37.7	33.2	45.4	23.7	23.1	45.4	24.1	12.4
Progression Factor	1.00	1.00	1.00	0.94	0.95	0.91	1.00	1.00	1.00	1.00	1.00	1.00
Incremental Delay, d2	3.1	0.0	0.1	1.2	1.7	0.0	0.8	0.2	0.0	0.9	0.3	0.1
Delay (s)	43.0	24.2	24.9	45.7	37.5	30.2	46.2	23.9	23.1	46.2	24.3	12.5
Level of Service	D	C	C	D	D	C	D	C	C	D	C	B
Approach Delay (s)		35.9			38.1			32.2			17.9	
Approach LOS		D			D			C			B	
Intersection Summary												
HCM Average Control Delay			28.8	HCM Level of Service				C				
HCM Volume to Capacity ratio			0.48									
Actuated Cycle Length (s)			102.6	Sum of lost time (s)				17.7				
Intersection Capacity Utilization			55.6%	ICU Level of Service				B				
Analysis Period (min)			15									
c Critical Lane Group												

Queues
6: Earl Armstrong & Proposed New Road

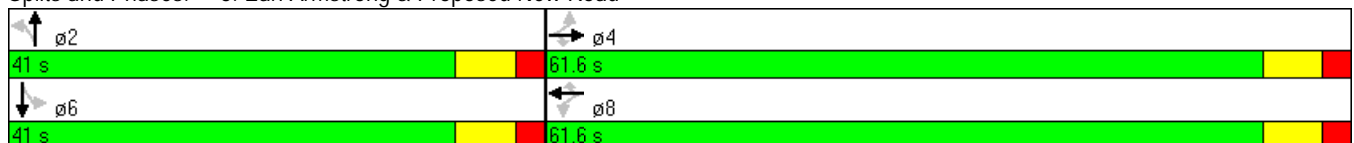
Future Background Traffic-2016
Weekday PM Peak Hour Unconstrained

Lane Group	EBL	EBT	WBT	WBR	SBT	ø2
Lane Configurations						
Volume (vph)	95	75	430	10	0	
Lane Group Flow (vph)	95	75	430	10	90	
Turn Type	Perm			Perm		
Protected Phases		4	8		6	2
Permitted Phases	4			8		
Detector Phase	4	4	8	8	6	
Switch Phase						
Minimum Initial (s)	10.0	10.0	10.0	10.0	10.0	10.0
Minimum Split (s)	31.9	31.9	31.9	31.9	31.9	31.9
Total Split (s)	61.6	61.6	61.6	61.6	41.0	41.0
Total Split (%)	60.0%	60.0%	60.0%	60.0%	40.0%	40%
Yellow Time (s)	4.6	4.6	4.6	4.6	4.6	4.6
All-Red Time (s)	2.3	2.3	2.3	2.3	2.3	2.3
Lost Time Adjust (s)	-1.0	-1.0	-1.0	-1.0	-1.0	
Total Lost Time (s)	5.9	5.9	5.9	5.9	5.9	
Lead/Lag						
Lead-Lag Optimize?						
Recall Mode	C-Max	C-Max	C-Max	C-Max	None	None
v/c Ratio	0.12	0.03	0.15	0.01	0.17	
Control Delay	1.7	0.4	2.7	1.4	0.7	
Queue Delay	0.0	0.0	0.0	0.0	0.0	
Total Delay	1.7	0.4	2.7	1.4	0.7	
Queue Length 50th (m)	0.5	0.2	9.0	0.0	0.0	
Queue Length 95th (m)	0.9	0.3	12.5	1.0	0.0	
Internal Link Dist (m)		96.0	43.9		67.0	
Turn Bay Length (m)	30.0			30.0		
Base Capacity (vph)	769	2910	2910	1303	799	
Starvation Cap Reductn	0	0	0	0	0	
Spillback Cap Reductn	0	0	0	0	0	
Storage Cap Reductn	0	0	0	0	0	
Reduced v/c Ratio	0.12	0.03	0.15	0.01	0.11	

Intersection Summary

Cycle Length: 102.6
 Actuated Cycle Length: 102.6
 Offset: 100 (97%), Referenced to phase 4:EBTL and 8:WBTL, Start of Green
 Natural Cycle: 65
 Control Type: Actuated-Coordinated





























Splits and Phases: 6: Earl Armstrong & Proposed New Road



HCM Signalized Intersection Capacity Analysis







6: Earl Armstrong & Proposed New Road

Future Background Traffic-2016
Weekday PM Peak Hour Unconstrained

												
Movement	EBL	EBT	EBR	WBL	WBT	WBR	NBL	NBT	NBR	SBL	SBT	SBR
Lane Configurations		 			 			 			 	
Volume (vph)	95	75	0	0	430	10	0	0	0	0	0	90
Ideal Flow (vphpl)	1900	1900	1900	1900	1900	1900	1900	1900	1900	1900	1900	1900
Total Lost time (s)	5.9	5.9			5.9	5.9						5.9
Lane Util. Factor	1.00	0.95			0.95	1.00						1.00
Frt	1.00	1.00			1.00	0.85						0.85
Flt Protected	0.95	1.00			1.00	1.00						1.00
Satd. Flow (prot)	1770	3539			3539	1583						1583
Flt Permitted	0.50	1.00			1.00	1.00						1.00
Satd. Flow (perm)	934	3539			3539	1583						1583
Peak-hour factor, PHF	1.00	1.00	1.00	1.00	1.00	1.00	1.00	1.00	1.00	1.00	1.00	1.00
Adj. Flow (vph)	95	75	0	0	430	10	0	0	0	0	0	90
RTOR Reduction (vph)	0	0	0	0	0	2	0	0	0	0	82	0
Lane Group Flow (vph)	95	75	0	0	430	8	0	0	0	0	8	0
Turn Type	Perm		Perm	Perm		Perm	Perm				Perm	
Protected Phases		4			8			2				6
Permitted Phases	4		4	8		8	2			6		
Actuated Green, G (s)	80.8	80.8			80.8	80.8						8.0
Effective Green, g (s)	81.8	81.8			81.8	81.8						9.0
Actuated g/C Ratio	0.80	0.80			0.80	0.80						0.09
Clearance Time (s)	6.9	6.9			6.9	6.9						6.9
Vehicle Extension (s)	3.0	3.0			3.0	3.0						3.0
Lane Grp Cap (vph)	745	2822			2822	1262						139
v/s Ratio Prot		0.02			c0.12							c0.00
v/s Ratio Perm	0.10					0.01						
v/c Ratio	0.13	0.03			0.15	0.01						0.06
Uniform Delay, d1	2.3	2.2			2.4	2.1						42.9
Progression Factor	0.49	0.14			1.00	1.00						1.00
Incremental Delay, d2	0.4	0.0			0.1	0.0						0.2
Delay (s)	1.5	0.3			2.5	2.1						43.1
Level of Service	A	A			A	A						D
Approach Delay (s)		1.0			2.5			0.0				43.1
Approach LOS		A			A			A				D
Intersection Summary												
HCM Average Control Delay			7.4				HCM Level of Service				A	
HCM Volume to Capacity ratio			0.14									
Actuated Cycle Length (s)			102.6				Sum of lost time (s)			11.8		
Intersection Capacity Utilization			43.3%				ICU Level of Service			A		
Analysis Period (min)			15									
c Critical Lane Group												












HCM Unsignalized Intersection Capacity Analysis
 9: Earl Armstrong & RIRO Site Access

Future Background Traffic-2016
 Weekday PM Peak Hour Unconstrained

						
Movement	EBT	EBR	WBL	WBT	NBL	NBR
Lane Configurations	↑↑			↑↑		↗
Volume (veh/h)	170	0	0	520	0	0
Sign Control	Free			Free	Stop	
Grade	0%			0%	0%	
Peak Hour Factor	1.00	1.00	1.00	1.00	1.00	1.00
Hourly flow rate (vph)	170	0	0	520	0	0
Pedestrians						
Lane Width (m)						
Walking Speed (m/s)						
Percent Blockage						
Right turn flare (veh)						
Median type	None		None			
Median storage (veh)						
Upstream signal (m)	137			120		
pX, platoon unblocked					0.99	
vC, conflicting volume			170		430	85
vC1, stage 1 conf vol						
vC2, stage 2 conf vol						
vCu, unblocked vol			170		407	85
tC, single (s)			4.1		6.8	6.9
tC, 2 stage (s)						
tF (s)			2.2		3.5	3.3
p0 queue free %			100		100	100
cM capacity (veh/h)			1405		567	957
Direction, Lane #	EB 1	EB 2	WB 1	WB 2	NB 1	
Volume Total	113	57	260	260	0	
Volume Left	0	0	0	0	0	
Volume Right	0	0	0	0	0	
cSH	1700	1700	1700	1700	1700	
Volume to Capacity	0.07	0.03	0.15	0.15	0.00	
Queue Length 95th (m)	0.0	0.0	0.0	0.0	0.0	
Control Delay (s)	0.0	0.0	0.0	0.0	0.0	
Lane LOS					A	
Approach Delay (s)	0.0		0.0		0.0	
Approach LOS					A	
Intersection Summary						
Average Delay			0.0			
Intersection Capacity Utilization			17.7%	ICU Level of Service	A	
Analysis Period (min)			15			










HCM Unsignalized Intersection Capacity Analysis
 11: Site Access & Limebank

Future Background Traffic-2016
 Weekday PM Peak Hour Unconstrained

							
Movement	WBL	WBR	NBT	NBR	SBL	SBT	
Lane Configurations							
Volume (veh/h)	0	0	195	0	0	430	
Sign Control	Stop		Free			Free	
Grade	0%		0%			0%	
Peak Hour Factor	1.00	1.00	1.00	1.00	1.00	1.00	
Hourly flow rate (vph)	0	0	195	0	0	430	
Pedestrians							
Lane Width (m)							
Walking Speed (m/s)							
Percent Blockage							
Right turn flare (veh)							
Median type	None			None			
Median storage (veh)							
Upstream signal (m)							145
pX, platoon unblocked	0.99						
vC, conflicting volume	410	98			195		
vC1, stage 1 conf vol							
vC2, stage 2 conf vol							
vCu, unblocked vol	377	98			195		
tC, single (s)	6.8	6.9			4.1		
tC, 2 stage (s)							
tF (s)	3.5	3.3			2.2		
p0 queue free %	100	100			100		
cM capacity (veh/h)	590	940			1375		
Direction, Lane #	WB 1	WB 2	NB 1	NB 2	SB 1	SB 2	SB 3
Volume Total	0	0	130	65	0	215	215
Volume Left	0	0	0	0	0	0	0
Volume Right	0	0	0	0	0	0	0
cSH	1700	1700	1700	1700	1700	1700	1700
Volume to Capacity	0.00	0.00	0.08	0.04	0.00	0.13	0.13
Queue Length 95th (m)	0.0	0.0	0.0	0.0	0.0	0.0	0.0
Control Delay (s)	0.0	0.0	0.0	0.0	0.0	0.0	0.0
Lane LOS	A	A					
Approach Delay (s)	0.0	0.0		0.0			
Approach LOS	A						
Intersection Summary							
Average Delay			0.0				
Intersection Capacity Utilization			15.2%	ICU Level of Service			A
Analysis Period (min)	15						










HCM Unsignalized Intersection Capacity Analysis
 13: N. Site Access & Proposed New Road

Future Background Traffic-2016
 Weekday PM Peak Hour Unconstrained

						
Movement	EBL	EBR	NBL	NBT	SBT	SBR
Lane Configurations						
Volume (veh/h)	0	0	0	0	0	0
Sign Control	Stop			Free	Free	
Grade	0%			0%	0%	
Peak Hour Factor	1.00	1.00	1.00	1.00	1.00	1.00
Hourly flow rate (vph)	0	0	0	0	0	0
Pedestrians						
Lane Width (m)						
Walking Speed (m/s)						
Percent Blockage						
Right turn flare (veh)						
Median type				None	None	
Median storage (veh)						
Upstream signal (m)					96	
pX, platoon unblocked						
vC, conflicting volume	0	0	0			
vC1, stage 1 conf vol						
vC2, stage 2 conf vol						
vCu, unblocked vol	0	0	0			
tC, single (s)	6.4	6.2	4.1			
tC, 2 stage (s)						
tF (s)	3.5	3.3	2.2			
p0 queue free %	100	100	100			
cM capacity (veh/h)	1023	1085	1623			
Direction, Lane #	EB 1	NB 1	SB 1			
Volume Total	0	0	0			
Volume Left	0	0	0			
Volume Right	0	0	0			
cSH	1700	1700	1700			
Volume to Capacity	0.00	0.00	0.00			
Queue Length 95th (m)	0.0	0.0	0.0			
Control Delay (s)	0.0	0.0	0.0			
Lane LOS	A					
Approach Delay (s)	0.0	0.0	0.0			
Approach LOS	A					
Intersection Summary						
Average Delay			0.0			
Intersection Capacity Utilization			0.0%	ICU Level of Service		A
Analysis Period (min)			15			

HCM Unsignalized Intersection Capacity Analysis
 15: S. Site Access & Proposed New Road

Future Background Traffic-2016
 Weekday PM Peak Hour Unconstrained

						
Movement	EBL	EBR	NBL	NBT	SBT	SBR
Lane Configurations						
Volume (veh/h)	0	0	0	0	0	0
Sign Control	Stop			Free	Free	
Grade	0%			0%	0%	
Peak Hour Factor	1.00	1.00	1.00	1.00	1.00	1.00
Hourly flow rate (vph)	0	0	0	0	0	0
Pedestrians						
Lane Width (m)						
Walking Speed (m/s)						
Percent Blockage						
Right turn flare (veh)						
Median type				None	None	
Median storage (veh)						
Upstream signal (m)					187	
pX, platoon unblocked						
vC, conflicting volume	0	0	0			
vC1, stage 1 conf vol						
vC2, stage 2 conf vol						
vCu, unblocked vol	0	0	0			
tC, single (s)	6.4	6.2	4.1			
tC, 2 stage (s)						
tF (s)	3.5	3.3	2.2			
p0 queue free %	100	100	100			
cM capacity (veh/h)	1023	1085	1623			
Direction, Lane #	EB 1	NB 1	SB 1			
Volume Total	0	0	0			
Volume Left	0	0	0			
Volume Right	0	0	0			
cSH	1700	1700	1700			
Volume to Capacity	0.00	0.00	0.00			
Queue Length 95th (m)	0.0	0.0	0.0			
Control Delay (s)	0.0	0.0	0.0			
Lane LOS	A					
Approach Delay (s)	0.0	0.0	0.0			
Approach LOS	A					
Intersection Summary						
Average Delay			0.0			
Intersection Capacity Utilization			0.0%	ICU Level of Service		A
Analysis Period (min)			15			

APPENDIX E: Synchro Analysis – Future Total 2016 zero interaction



Queues

3: Earl Armstrong & Limebank

Future Total Traffic-2016

Weekday AM Peak Hour Zero Interaction

Lane Group	EBL	EBT	EBR	WBL	WBT	WBR	NBL	NBT	NBR	SBL	SBT	SBR
Lane Configurations												
Volume (vph)	160	60	70	10	30	15	140	190	5	55	130	125
Lane Group Flow (vph)	160	60	70	10	30	15	140	190	5	55	130	125
Turn Type	Prot		Perm	Prot		Perm	Prot		Perm	Prot		custom
Protected Phases	7	4		3	8		5	2		1	6	6 7
Permitted Phases			4			8			2			6
Detector Phase	7	4	4	3	8	8	5	2	2	1	6	6 7
Switch Phase												
Minimum Initial (s)	5.0	10.0	10.0	5.0	10.0	10.0	5.0	10.0	10.0	5.0	10.0	
Minimum Split (s)	11.9	31.9	31.9	11.9	31.9	31.9	11.9	31.9	31.9	11.9	31.9	
Total Split (s)	22.0	40.0	40.0	14.0	32.0	32.0	21.0	42.6	42.6	16.0	37.6	59.6
Total Split (%)	19.5%	35.5%	35.5%	12.4%	28.4%	28.4%	18.7%	37.8%	37.8%	14.2%	33.4%	52.9%
Yellow Time (s)	4.6	4.6	4.6	4.6	4.6	4.6	4.6	4.6	4.6	4.6	4.6	4.6
All-Red Time (s)	2.3	2.3	2.3	2.3	2.3	2.3	2.3	2.3	2.3	2.3	2.3	2.3
Lost Time Adjust (s)	-1.0	-1.0	-1.0	-1.0	-1.0	-1.0	-1.0	-1.0	-1.0	-1.0	-1.0	-1.0
Total Lost Time (s)	5.9	5.9	5.9	5.9	5.9	5.9	5.9	5.9	5.9	5.9	5.9	5.9
Lead/Lag	Lead	Lag	Lag	Lead	Lag	Lag	Lead	Lag	Lag	Lead	Lag	
Lead-Lag Optimize?	Yes	Yes	Yes	Yes	Yes	Yes	Yes	Yes	Yes	Yes	Yes	Yes
Recall Mode	None	None	None	None	None	None	None	C-Max	C-Max	None	C-Max	
v/c Ratio	0.43	0.10	0.21	0.05	0.09	0.09	0.42	0.09	0.01	0.22	0.07	0.06
Control Delay	50.5	37.5	10.8	50.0	46.1	20.9	51.3	12.8	9.2	50.8	14.8	1.5
Queue Delay	0.0	0.0	0.0	0.0	0.0	0.0	0.0	0.0	0.0	0.0	0.0	0.0
Total Delay	50.5	37.5	10.8	50.0	46.1	20.9	51.3	12.8	9.2	50.8	14.8	1.5
Queue Length 50th (m)	17.1	5.2	0.0	1.0	3.1	0.0	15.0	10.6	0.0	5.9	7.5	0.0
Queue Length 95th (m)	26.7	11.9	12.1	3.2	7.7	6.3	24.0	18.1	2.0	12.0	14.0	3.6
Internal Link Dist (m)		131.0			112.8			120.2			61.2	
Turn Bay Length (m)	100.0		50.0	30.0		50.0	50.0		50.0	50.0		100.0
Base Capacity (vph)	491	1072	528	247	820	378	460	2101	942	308	1938	2103
Starvation Cap Reductn	0	0	0	0	0	0	0	0	0	0	0	0
Spillback Cap Reductn	0	0	0	0	0	0	0	0	0	0	0	0
Storage Cap Reductn	0	0	0	0	0	0	0	0	0	0	0	0
Reduced v/c Ratio	0.33	0.06	0.13	0.04	0.04	0.04	0.30	0.09	0.01	0.18	0.07	0.06

Intersection Summary

Cycle Length: 112.6

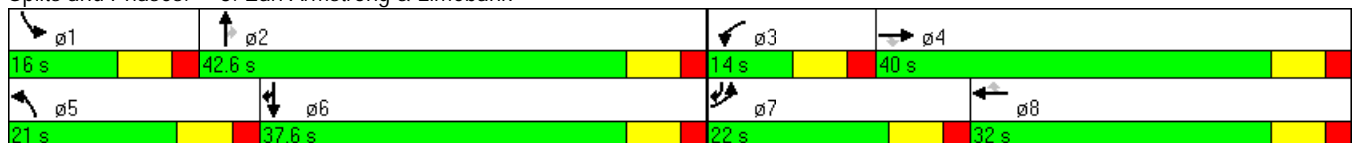
Actuated Cycle Length: 112.6

Offset: 72 (64%), Referenced to phase 2:NBT and 6:SBT, Start of Green

Natural Cycle: 90

Control Type: Actuated-Coordinated

























Splits and Phases: 3: Earl Armstrong & Limebank



HCM Signalized Intersection Capacity Analysis















3: Earl Armstrong & Limebank

Future Total Traffic-2016
Weekday AM Peak Hour Zero Interaction

												
Movement	EBL	EBT	EBR	WBL	WBT	WBR	NBL	NBT	NBR	SBL	SBT	SBR
Lane Configurations												
Volume (vph)	160	60	70	10	30	15	140	190	5	55	130	125
Ideal Flow (vphpl)	1900	1900	1900	1900	1900	1900	1900	1900	1900	1900	1900	1900
Total Lost time (s)	5.9	5.9	5.9	5.9	5.9	5.9	5.9	5.9	5.9	5.9	5.9	5.9
Lane Util. Factor	0.97	0.95	1.00	0.97	0.95	1.00	0.97	0.95	1.00	0.97	0.95	0.88
Frt	1.00	1.00	0.85	1.00	1.00	0.85	1.00	1.00	0.85	1.00	1.00	0.85
Flt Protected	0.95	1.00	1.00	0.95	1.00	1.00	0.95	1.00	1.00	0.95	1.00	1.00
Satd. Flow (prot)	3433	3539	1583	3433	3539	1583	3433	3539	1583	3433	3539	2787
Flt Permitted	0.95	1.00	1.00	0.95	1.00	1.00	0.95	1.00	1.00	0.95	1.00	1.00
Satd. Flow (perm)	3433	3539	1583	3433	3539	1583	3433	3539	1583	3433	3539	2787
Peak-hour factor, PHF	1.00	1.00	1.00	1.00	1.00	1.00	1.00	1.00	1.00	1.00	1.00	1.00
Adj. Flow (vph)	160	60	70	10	30	15	140	190	5	55	130	125
RTOR Reduction (vph)	0	0	58	0	0	14	0	0	2	0	0	43
Lane Group Flow (vph)	160	60	12	10	30	1	140	190	3	55	130	82
Turn Type	Prot		Perm	Prot		Perm	Prot		Perm	Prot		custom
Protected Phases	7	4		3	8		5	2		1	6	6
Permitted Phases			4			8			2			6
Actuated Green, G (s)	11.2	18.6	18.6	1.3	8.7	8.7	9.9	59.0	59.0	6.1	55.2	73.3
Effective Green, g (s)	12.2	19.6	19.6	2.3	9.7	9.7	10.9	60.0	60.0	7.1	56.2	74.3
Actuated g/C Ratio	0.11	0.17	0.17	0.02	0.09	0.09	0.10	0.53	0.53	0.06	0.50	0.66
Clearance Time (s)	6.9	6.9	6.9	6.9	6.9	6.9	6.9	6.9	6.9	6.9	6.9	
Vehicle Extension (s)	3.0	3.0	3.0	3.0	3.0	3.0	3.0	3.0	3.0	3.0	3.0	
Lane Grp Cap (vph)	372	616	276	70	305	136	332	1886	844	216	1766	1839
v/s Ratio Prot	c0.05	c0.02		0.00	0.01		c0.04	c0.05		0.02	0.04	0.03
v/s Ratio Perm			0.01			0.00			0.00			
v/c Ratio	0.43	0.10	0.04	0.14	0.10	0.01	0.42	0.10	0.00	0.25	0.07	0.04
Uniform Delay, d1	46.9	39.1	38.7	54.2	47.4	47.1	47.9	13.0	12.3	50.2	14.7	6.7
Progression Factor	1.00	1.00	1.00	1.00	0.98	0.96	1.00	1.00	1.00	1.00	1.00	1.00
Incremental Delay, d2	0.8	0.1	0.1	0.9	0.1	0.0	0.9	0.1	0.0	0.6	0.1	0.0
Delay (s)	47.7	39.1	38.8	55.1	46.7	45.2	48.7	13.1	12.3	50.9	14.7	6.7
Level of Service	D	D	D	E	D	D	D	B	B	D	B	A
Approach Delay (s)		43.8			47.8			28.0			17.9	
Approach LOS		D			D			C			B	
Intersection Summary												
HCM Average Control Delay			30.6									C
HCM Volume to Capacity ratio			0.18									
Actuated Cycle Length (s)			112.6							17.7		
Intersection Capacity Utilization			38.5%									A
Analysis Period (min)			15									
c Critical Lane Group												

Queues
6: Earl Armstrong & Proposed New Road

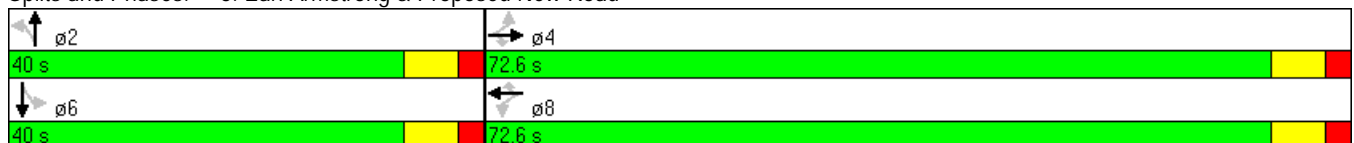
Future Total Traffic-2016
 Weekday AM Peak Hour Zero Interaction

							
Lane Group	EBL	EBT	WBL	WBT	WBR	NBT	SBT
Lane Configurations							
Volume (vph)	35	65	5	40	2	0	0
Lane Group Flow (vph)	35	65	5	40	2	2	15
Turn Type	Perm		Perm		Perm		
Protected Phases		4		8		2	6
Permitted Phases	4		8		8		
Detector Phase	4	4	8	8	8	2	6
Switch Phase							
Minimum Initial (s)	10.0	10.0	10.0	10.0	10.0	10.0	10.0
Minimum Split (s)	31.9	31.9	31.9	31.9	31.9	31.9	31.9
Total Split (s)	72.6	72.6	72.6	72.6	72.6	40.0	40.0
Total Split (%)	64.5%	64.5%	64.5%	64.5%	64.5%	35.5%	35.5%
Yellow Time (s)	4.6	4.6	4.6	4.6	4.6	4.6	4.6
All-Red Time (s)	2.3	2.3	2.3	2.3	2.3	2.3	2.3
Lost Time Adjust (s)	-1.0	-1.0	-1.0	-1.0	-1.0	-1.0	-1.0
Total Lost Time (s)	5.9	5.9	5.9	5.9	5.9	5.9	5.9
Lead/Lag							
Lead-Lag Optimize?							
Recall Mode	C-Max	C-Max	C-Max	C-Max	C-Max	None	None
v/c Ratio	0.03	0.02	0.00	0.01	0.00	0.00	0.01
Control Delay	0.1	0.1	2.0	1.6	1.5	0.0	0.0
Queue Delay	0.0	0.0	0.0	0.0	0.0	0.0	0.0
Total Delay	0.1	0.1	2.0	1.6	1.5	0.0	0.0
Queue Length 50th (m)	0.0	0.0	0.0	0.0	0.0	0.0	0.0
Queue Length 95th (m)	0.2	0.1	0.8	1.6	0.4	0.0	0.0
Internal Link Dist (m)		95.8		43.9		72.0	67.0
Turn Bay Length (m)	30.0		30.0		30.0		
Base Capacity (vph)	1250	3252	1219	3252	1455	1141	1177
Starvation Cap Reductn	0	0	0	0	0	0	0
Spillback Cap Reductn	0	0	0	0	0	0	0
Storage Cap Reductn	0	0	0	0	0	0	0
Reduced v/c Ratio	0.03	0.02	0.00	0.01	0.00	0.00	0.01

Intersection Summary

Cycle Length: 112.6
 Actuated Cycle Length: 112.6
 Offset: 0 (0%), Referenced to phase 4:EBTL and 8:WBTL, Start of Green
 Natural Cycle: 65
 Control Type: Actuated-Coordinated



























Splits and Phases: 6: Earl Armstrong & Proposed New Road



HCM Signalized Intersection Capacity Analysis












6: Earl Armstrong & Proposed New Road

Future Total Traffic-2016
Weekday AM Peak Hour Zero Interaction

												
Movement	EBL	EBT	EBR	WBL	WBT	WBR	NBL	NBT	NBR	SBL	SBT	SBR
Lane Configurations		 			 			 			 	
Volume (vph)	35	65	0	5	40	2	0	0	2	0	0	15
Ideal Flow (vphpl)	1900	1900	1900	1900	1900	1900	1900	1900	1900	1900	1900	1900
Total Lost time (s)	5.9	5.9		5.9	5.9	5.9		5.9			5.9	
Lane Util. Factor	1.00	0.95		1.00	0.95	1.00		1.00			1.00	
Frt	1.00	1.00		1.00	1.00	0.85		0.85			0.85	
Flt Protected	0.95	1.00		0.95	1.00	1.00		1.00			1.00	
Satd. Flow (prot)	1770	3539		1770	3539	1583		1583			1583	
Flt Permitted	0.73	1.00		0.71	1.00	1.00		1.00			1.00	
Satd. Flow (perm)	1359	3539		1327	3539	1583		1583			1583	
Peak-hour factor, PHF	1.00	1.00	1.00	1.00	1.00	1.00	1.00	1.00	1.00	1.00	1.00	1.00
Adj. Flow (vph)	35	65	0	5	40	2	0	0	2	0	0	15
RTOR Reduction (vph)	0	0	0	0	0	0	0	2	0	0	14	0
Lane Group Flow (vph)	35	65	0	5	40	2	0	0	0	0	1	0
Turn Type	Perm		Perm	Perm		Perm	Perm			Perm		
Protected Phases		4			8			2			6	
Permitted Phases	4		4	8		8	2			6		
Actuated Green, G (s)	94.8	94.8		94.8	94.8	94.8		4.0			4.0	
Effective Green, g (s)	95.8	95.8		95.8	95.8	95.8		5.0			5.0	
Actuated g/C Ratio	0.85	0.85		0.85	0.85	0.85		0.04			0.04	
Clearance Time (s)	6.9	6.9		6.9	6.9	6.9		6.9			6.9	
Vehicle Extension (s)	3.0	3.0		3.0	3.0	3.0		3.0			3.0	
Lane Grp Cap (vph)	1156	3011		1129	3011	1347		70			70	
v/s Ratio Prot		0.02			0.01			0.00			c0.00	
v/s Ratio Perm	c0.03			0.00		0.00						
v/c Ratio	0.03	0.02		0.00	0.01	0.00		0.00			0.01	
Uniform Delay, d1	1.3	1.3		1.3	1.3	1.3		51.4			51.4	
Progression Factor	0.05	0.05		1.00	1.00	1.00		1.00			1.00	
Incremental Delay, d2	0.0	0.0		0.0	0.0	0.0		0.0			0.1	
Delay (s)	0.1	0.1		1.3	1.3	1.3		51.4			51.5	
Level of Service	A	A		A	A	A		D			D	
Approach Delay (s)		0.1			1.3			51.4			51.5	
Approach LOS		A			A			D			D	
Intersection Summary												
HCM Average Control Delay			5.8				HCM Level of Service			A		
HCM Volume to Capacity ratio			0.03									
Actuated Cycle Length (s)			112.6				Sum of lost time (s)			11.8		
Intersection Capacity Utilization			39.8%				ICU Level of Service			A		
Analysis Period (min)			15									
c Critical Lane Group												













HCM Unsignalized Intersection Capacity Analysis
 9: Earl Armstrong & RIRO Site Access

Future Total Traffic-2016
 Weekday AM Peak Hour Zero Interaction

						
Movement	EBT	EBR	WBL	WBT	NBL	NBR
Lane Configurations	 			 		
Volume (veh/h)	100	20	0	55	0	1
Sign Control	Free			Free	Stop	
Grade	0%			0%	0%	
Peak Hour Factor	1.00	1.00	1.00	1.00	1.00	1.00
Hourly flow rate (vph)	100	20	0	55	0	1
Pedestrians						
Lane Width (m)						
Walking Speed (m/s)						
Percent Blockage						
Right turn flare (veh)						
Median type	None		None			
Median storage (veh)						
Upstream signal (m)	137			120		
pX, platoon unblocked						
vC, conflicting volume			120		138	60
vC1, stage 1 conf vol						
vC2, stage 2 conf vol						
vCu, unblocked vol			120		138	60
tC, single (s)			4.1		6.8	6.9
tC, 2 stage (s)						
tF (s)			2.2		3.5	3.3
p0 queue free %			100		100	100
cM capacity (veh/h)			1466		842	993
Direction, Lane #	EB 1	EB 2	WB 1	WB 2	NB 1	
Volume Total	67	53	28	28	1	
Volume Left	0	0	0	0	0	
Volume Right	0	20	0	0	1	
cSH	1700	1700	1700	1700	993	
Volume to Capacity	0.04	0.03	0.02	0.02	0.00	
Queue Length 95th (m)	0.0	0.0	0.0	0.0	0.0	
Control Delay (s)	0.0	0.0	0.0	0.0	8.6	
Lane LOS					A	
Approach Delay (s)	0.0		0.0		8.6	
Approach LOS					A	
Intersection Summary						
Average Delay			0.0			
Intersection Capacity Utilization			13.4%		ICU Level of Service	A
Analysis Period (min)	15					










HCM Unsignalized Intersection Capacity Analysis
 11: Site Access & Limebank

Future Total Traffic-2016
 Weekday AM Peak Hour Zero Interaction

							
Movement	WBL	WBR	NBT	NBR	SBL	SBT	
Lane Configurations							
Volume (veh/h)	20	45	290	35	50	155	
Sign Control	Stop		Free			Free	
Grade	0%		0%			0%	
Peak Hour Factor	1.00	1.00	1.00	1.00	1.00	1.00	
Hourly flow rate (vph)	20	45	290	35	50	155	
Pedestrians							
Lane Width (m)							
Walking Speed (m/s)							
Percent Blockage							
Right turn flare (veh)							
Median type			None			None	
Median storage (veh)							
Upstream signal (m)						144	
pX, platoon unblocked							
vC, conflicting volume	485	162			325		
vC1, stage 1 conf vol							
vC2, stage 2 conf vol							
vCu, unblocked vol	485	162			325		
tC, single (s)	6.8	6.9			4.1		
tC, 2 stage (s)							
tF (s)	3.5	3.3			2.2		
p0 queue free %	96	95			96		
cM capacity (veh/h)	490	854			1231		
Direction, Lane #	WB 1	WB 2	NB 1	NB 2	SB 1	SB 2	SB 3
Volume Total	20	45	193	132	50	78	78
Volume Left	20	0	0	0	50	0	0
Volume Right	0	45	0	35	0	0	0
cSH	490	854	1700	1700	1231	1700	1700
Volume to Capacity	0.04	0.05	0.11	0.08	0.04	0.05	0.05
Queue Length 95th (m)	1.0	1.3	0.0	0.0	1.0	0.0	0.0
Control Delay (s)	12.7	9.5	0.0	0.0	8.0	0.0	0.0
Lane LOS	B	A			A		
Approach Delay (s)	10.4		0.0		2.0		
Approach LOS	B						
Intersection Summary							
Average Delay			1.8				
Intersection Capacity Utilization			25.8%		ICU Level of Service		A
Analysis Period (min)			15				










HCM Unsignalized Intersection Capacity Analysis
 13: N. Site Access & Proposed New Road

Future Total Traffic-2016
 Weekday AM Peak Hour Zero Interaction

						
Movement	EBL	EBR	NBL	NBT	SBT	SBR
Lane Configurations						
Volume (veh/h)	2	0	0	0	0	5
Sign Control	Stop			Free	Free	
Grade	0%			0%	0%	
Peak Hour Factor	1.00	1.00	1.00	1.00	1.00	1.00
Hourly flow rate (vph)	2	0	0	0	0	5
Pedestrians						
Lane Width (m)						
Walking Speed (m/s)						
Percent Blockage						
Right turn flare (veh)						
Median type				None	None	
Median storage (veh)						
Upstream signal (m)					96	
pX, platoon unblocked						
vC, conflicting volume	2	2	5			
vC1, stage 1 conf vol						
vC2, stage 2 conf vol						
vCu, unblocked vol	2	2	5			
tC, single (s)	6.4	6.2	4.1			
tC, 2 stage (s)						
tF (s)	3.5	3.3	2.2			
p0 queue free %	100	100	100			
cM capacity (veh/h)	1020	1082	1616			
Direction, Lane #	EB 1	NB 1	SB 1			
Volume Total	2	0	5			
Volume Left	2	0	0			
Volume Right	0	0	5			
cSH	1020	1700	1700			
Volume to Capacity	0.00	0.00	0.00			
Queue Length 95th (m)	0.0	0.0	0.0			
Control Delay (s)	8.5	0.0	0.0			
Lane LOS	A					
Approach Delay (s)	8.5	0.0	0.0			
Approach LOS	A					
Intersection Summary						
Average Delay			2.4			
Intersection Capacity Utilization		13.3%		ICU Level of Service		A
Analysis Period (min)			15			

HCM Unsignalized Intersection Capacity Analysis
 15: S. Site Access & Proposed New Road

Future Total Traffic-2016
 Weekday AM Peak Hour Zero Interaction

						
Movement	EBL	EBR	NBL	NBT	SBT	SBR
Lane Configurations						
Volume (veh/h)	0	0	0	0	0	0
Sign Control	Stop			Free	Free	
Grade	0%			0%	0%	
Peak Hour Factor	1.00	1.00	1.00	1.00	1.00	1.00
Hourly flow rate (vph)	0	0	0	0	0	0
Pedestrians						
Lane Width (m)						
Walking Speed (m/s)						
Percent Blockage						
Right turn flare (veh)						
Median type				None	None	
Median storage (veh)						
Upstream signal (m)					186	
pX, platoon unblocked						
vC, conflicting volume	0	0	0			
vC1, stage 1 conf vol						
vC2, stage 2 conf vol						
vCu, unblocked vol	0	0	0			
tC, single (s)	6.4	6.2	4.1			
tC, 2 stage (s)						
tF (s)	3.5	3.3	2.2			
p0 queue free %	100	100	100			
cM capacity (veh/h)	1023	1085	1623			
Direction, Lane #	EB 1	NB 1	SB 1			
Volume Total	0	0	0			
Volume Left	0	0	0			
Volume Right	0	0	0			
cSH	1700	1700	1700			
Volume to Capacity	0.00	0.00	0.00			
Queue Length 95th (m)	0.0	0.0	0.0			
Control Delay (s)	0.0	0.0	0.0			
Lane LOS						
Approach Delay (s)	0.0	0.0	0.0			
Approach LOS	A					
Intersection Summary						
Average Delay			0.0			
Intersection Capacity Utilization			0.0%	ICU Level of Service		A
Analysis Period (min)			15			

Queues

3: Earl Armstrong & Limebank

Future Total Traffic-2016

Weekday PM Peak Hour IZero Interaction

Lane Group	EBL	EBT	EBR	WBL	WBT	WBR	NBL	NBT	NBR	SBL	SBT	SBR
Lane Configurations												
Volume (vph)	255	80	120	60	65	25	135	195	20	100	245	280
Lane Group Flow (vph)	255	80	120	60	65	25	135	195	20	100	245	280
Turn Type	Prot		Perm	Prot		Perm	Prot		Perm	Prot		custom
Protected Phases	7	4		3	8		5	2		1	6	6 7
Permitted Phases			4			8			2			6
Detector Phase	7	4	4	3	8	8	5	2	2	1	6	6 7
Switch Phase												
Minimum Initial (s)	5.0	10.0	10.0	5.0	10.0	10.0	5.0	10.0	10.0	5.0	10.0	
Minimum Split (s)	11.9	31.9	31.9	11.9	31.9	31.9	11.9	31.9	31.9	11.9	31.9	
Total Split (s)	20.0	40.0	40.0	12.0	32.0	32.0	15.0	36.6	36.6	14.0	35.6	55.6
Total Split (%)	19.5%	39.0%	39.0%	11.7%	31.2%	31.2%	14.6%	35.7%	35.7%	13.6%	34.7%	54.2%
Yellow Time (s)	4.6	4.6	4.6	4.6	4.6	4.6	4.6	4.6	4.6	4.6	4.6	4.6
All-Red Time (s)	2.3	2.3	2.3	2.3	2.3	2.3	2.3	2.3	2.3	2.3	2.3	2.3
Lost Time Adjust (s)	-1.0	-1.0	-1.0	-1.0	-1.0	-1.0	-1.0	-1.0	-1.0	-1.0	-1.0	-1.0
Total Lost Time (s)	5.9	5.9	5.9	5.9	5.9	5.9	5.9	5.9	5.9	5.9	5.9	5.9
Lead/Lag	Lead	Lag	Lag	Lead	Lag	Lag	Lead	Lag	Lag	Lead	Lag	
Lead-Lag Optimize?	Yes	Yes	Yes	Yes	Yes	Yes	Yes	Yes	Yes	Yes	Yes	Yes
Recall Mode	None	None	None	None	None	None	None	C-Max	C-Max	None	C-Max	
v/c Ratio	0.58	0.14	0.33	0.29	0.17	0.13	0.39	0.11	0.02	0.32	0.15	0.15
Control Delay	47.7	36.0	9.4	49.2	41.2	16.3	46.0	16.7	7.5	45.9	17.8	1.3
Queue Delay	0.0	0.0	0.0	0.0	0.0	0.0	0.0	0.0	0.0	0.0	0.0	0.0
Total Delay	47.7	36.0	9.4	49.2	41.2	16.3	46.0	16.7	7.5	45.9	17.8	1.3
Queue Length 50th (m)	24.4	7.0	0.0	5.7	5.8	0.3	12.9	11.7	0.0	9.6	15.2	0.0
Queue Length 95th (m)	36.7	13.3	14.4	11.9	12.0	7.0	21.4	19.3	4.4	17.0	24.2	5.2
Internal Link Dist (m)		131.0			113.3			120.8			61.2	
Turn Bay Length (m)	100.0		50.0	30.0		50.0	50.0		50.0	50.0		100.0
Base Capacity (vph)	472	1176	606	204	900	421	355	1777	805	321	1653	1940
Starvation Cap Reductn	0	0	0	0	0	0	0	0	0	0	0	0
Spillback Cap Reductn	0	0	0	0	0	0	0	0	0	0	0	0
Storage Cap Reductn	0	0	0	0	0	0	0	0	0	0	0	0
Reduced v/c Ratio	0.54	0.07	0.20	0.29	0.07	0.06	0.38	0.11	0.02	0.31	0.15	0.14

Intersection Summary

Cycle Length: 102.6

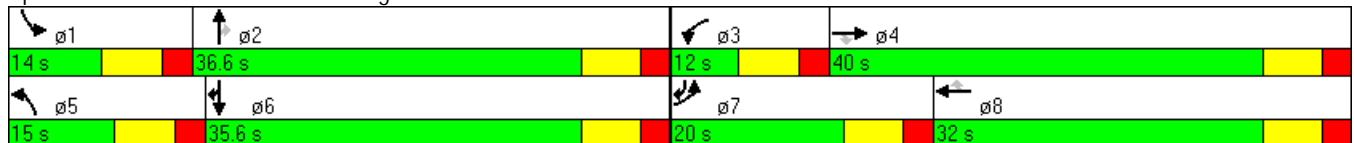
Actuated Cycle Length: 102.6

Offset: 37 (36%), Referenced to phase 2:NBT and 6:SBT, Start of Green

Natural Cycle: 90

Control Type: Actuated-Coordinated

























Splits and Phases: 3: Earl Armstrong & Limebank



HCM Signalized Intersection Capacity Analysis

3: Earl Armstrong & Limebank

Future Total Traffic-2016
Weekday PM Peak Hour IZero Interaction

													
Movement	EBL	EBT	EBR	WBL	WBT	WBR	NBL	NBT	NBR	SBL	SBT	SBR	
Lane Configurations													
Volume (vph)	255	80	120	60	65	25	135	195	20	100	245	280	
Ideal Flow (vphpl)	1900	1900	1900	1900	1900	1900	1900	1900	1900	1900	1900	1900	
Total Lost time (s)	5.9	5.9	5.9	5.9	5.9	5.9	5.9	5.9	5.9	5.9	5.9	5.9	
Lane Util. Factor	0.97	0.95	1.00	0.97	0.95	1.00	0.97	0.95	1.00	0.97	0.95	0.88	
Frt	1.00	1.00	0.85	1.00	1.00	0.85	1.00	1.00	0.85	1.00	1.00	0.85	
Flt Protected	0.95	1.00	1.00	0.95	1.00	1.00	0.95	1.00	1.00	0.95	1.00	1.00	
Satd. Flow (prot)	3433	3539	1583	3433	3539	1583	3433	3539	1583	3433	3539	2787	
Flt Permitted	0.95	1.00	1.00	0.95	1.00	1.00	0.95	1.00	1.00	0.95	1.00	1.00	
Satd. Flow (perm)	3433	3539	1583	3433	3539	1583	3433	3539	1583	3433	3539	2787	
Peak-hour factor, PHF	1.00	1.00	1.00	1.00	1.00	1.00	1.00	1.00	1.00	1.00	1.00	1.00	
Adj. Flow (vph)	255	80	120	60	65	25	135	195	20	100	245	280	
RTOR Reduction (vph)	0	0	100	0	0	23	0	0	11	0	0	101	
Lane Group Flow (vph)	255	80	20	60	65	2	135	195	9	100	245	179	
Turn Type	Prot		Perm	Prot		Perm	Prot		Perm	Prot		custom	
Protected Phases	7	4		3	8		5	2		1	6	6	
Permitted Phases			4			8			2			6	
Actuated Green, G (s)	12.1	16.0	16.0	4.1	8.0	8.0	9.4	47.7	47.7	7.2	45.5	64.5	
Effective Green, g (s)	13.1	17.0	17.0	5.1	9.0	9.0	10.4	48.7	48.7	8.2	46.5	65.5	
Actuated g/C Ratio	0.13	0.17	0.17	0.05	0.09	0.09	0.10	0.47	0.47	0.08	0.45	0.64	
Clearance Time (s)	6.9	6.9	6.9	6.9	6.9	6.9	6.9	6.9	6.9	6.9	6.9	6.9	
Vehicle Extension (s)	3.0	3.0	3.0	3.0	3.0	3.0	3.0	3.0	3.0	3.0	3.0	3.0	
Lane Grp Cap (vph)	438	586	262	171	310	139	348	1680	751	274	1604	1779	
v/s Ratio Prot	c0.07	0.02		0.02	c0.02		c0.04	0.06		0.03	c0.07	0.06	
v/s Ratio Perm			0.01			0.00			0.01				
v/c Ratio	0.58	0.14	0.08	0.35	0.21	0.02	0.39	0.12	0.01	0.36	0.15	0.10	
Uniform Delay, d1	42.2	36.5	36.2	47.1	43.5	42.8	43.1	15.0	14.2	44.7	16.5	7.2	
Progression Factor	1.00	1.00	1.00	0.98	0.96	0.92	1.00	1.00	1.00	1.00	1.00	1.00	
Incremental Delay, d2	2.0	0.1	0.1	1.2	0.3	0.0	0.7	0.1	0.0	0.8	0.2	0.0	
Delay (s)	44.1	36.6	36.3	47.4	42.1	39.2	43.8	15.1	14.3	45.6	16.7	7.2	
Level of Service	D	D	D	D	D	D	D	B	B	D	B	A	
Approach Delay (s)		40.8			43.7			26.2			17.1		
Approach LOS		D			D			C			B		
Intersection Summary													
HCM Average Control Delay			28.4									HCM Level of Service	C
HCM Volume to Capacity ratio			0.26										
Actuated Cycle Length (s)			102.6									Sum of lost time (s)	23.6
Intersection Capacity Utilization			41.2%									ICU Level of Service	A
Analysis Period (min)			15										
c Critical Lane Group													

Queues

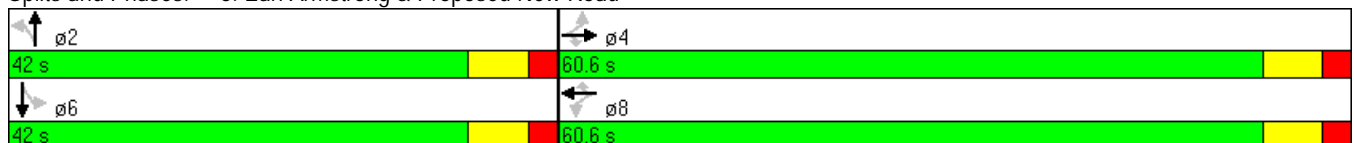
6: Earl Armstrong & Proposed New Road

Lane Group	EBL	EBT	WBL	WBT	WBR	NBL	NBT	SBT
Lane Configurations								
Volume (vph)	95	70	20	50	10	10	0	0
Lane Group Flow (vph)	95	70	20	50	10	10	5	90
Turn Type	Perm		Perm		Perm	Perm		
Protected Phases		4		8			2	6
Permitted Phases	4		8		8	2		
Detector Phase	4	4	8	8	8	2	2	6
Switch Phase								
Minimum Initial (s)	10.0	10.0	10.0	10.0	10.0	10.0	10.0	10.0
Minimum Split (s)	31.9	31.9	31.9	31.9	31.9	31.9	31.9	31.9
Total Split (s)	60.6	60.6	60.6	60.6	60.6	42.0	42.0	42.0
Total Split (%)	59.1%	59.1%	59.1%	59.1%	59.1%	40.9%	40.9%	40.9%
Yellow Time (s)	4.6	4.6	4.6	4.6	4.6	4.6	4.6	4.6
All-Red Time (s)	2.3	2.3	2.3	2.3	2.3	2.3	2.3	2.3
Lost Time Adjust (s)	-1.0	-1.0	-1.0	-1.0	-1.0	-1.0	-1.0	-1.0
Total Lost Time (s)	5.9	5.9	5.9	5.9	5.9	5.9	5.9	5.9
Lead/Lag								
Lead-Lag Optimize?								
Recall Mode	C-Max	C-Max	C-Max	C-Max	C-Max	None	None	None
v/c Ratio	0.09	0.02	0.02	0.02	0.01	0.07	0.01	0.09
Control Delay	0.8	0.7	2.6	2.6	1.4	42.7	0.0	0.2
Queue Delay	0.0	0.0	0.0	0.0	0.0	0.0	0.0	0.0
Total Delay	0.8	0.7	2.6	2.6	1.4	42.7	0.0	0.2
Queue Length 50th (m)	0.9	0.3	0.7	0.9	0.0	1.8	0.0	0.0
Queue Length 95th (m)	1.6	0.6	2.1	2.0	1.0	6.8	0.0	0.0
Internal Link Dist (m)		96.0		43.9			72.0	67.0
Turn Bay Length (m)	30.0		30.0		30.0	30.0		
Base Capacity (vph)	1108	2910	1086	2910	1303	458	1156	1184
Starvation Cap Reductn	0	0	0	0	0	0	0	0
Spillback Cap Reductn	0	0	0	0	0	0	0	0
Storage Cap Reductn	0	0	0	0	0	0	0	0
Reduced v/c Ratio	0.09	0.02	0.02	0.02	0.01	0.02	0.00	0.08

Intersection Summary

Cycle Length: 102.6
 Actuated Cycle Length: 102.6
 Offset: 0 (0%), Referenced to phase 4:EBTL and 8:WBTL, Start of Green
 Natural Cycle: 65
 Control Type: Actuated-Coordinated





























Splits and Phases: 6: Earl Armstrong & Proposed New Road



HCM Signalized Intersection Capacity Analysis

6: Earl Armstrong & Proposed New Road

Future Total Traffic-2016
Weekday PM Peak Hour IZero Interaction

												
Movement	EBL	EBT	EBR	WBL	WBT	WBR	NBL	NBT	NBR	SBL	SBT	SBR
Lane Configurations		 			 			 			 	
Volume (vph)	95	70	0	20	50	10	10	0	5	0	0	90
Ideal Flow (vphpl)	1900	1900	1900	1900	1900	1900	1900	1900	1900	1900	1900	1900
Total Lost time (s)	5.9	5.9		5.9	5.9	5.9	5.9	5.9				5.9
Lane Util. Factor	1.00	0.95		1.00	0.95	1.00	1.00	1.00				1.00
Flt	1.00	1.00		1.00	1.00	0.85	1.00	0.85				0.85
Flt Protected	0.95	1.00		0.95	1.00	1.00	0.95	1.00				1.00
Satd. Flow (prot)	1770	3539		1770	3539	1583	1770	1583				1583
Flt Permitted	0.72	1.00		0.71	1.00	1.00	0.70	1.00				1.00
Satd. Flow (perm)	1346	3539		1321	3539	1583	1301	1583				1583
Peak-hour factor, PHF	1.00	1.00	1.00	1.00	1.00	1.00	1.00	1.00	1.00	1.00	1.00	1.00
Adj. Flow (vph)	95	70	0	20	50	10	10	0	5	0	0	90
RTOR Reduction (vph)	0	0	0	0	0	2	0	5	0	0	82	0
Lane Group Flow (vph)	95	70	0	20	50	8	10	0	0	0	8	0
Turn Type	Perm		Perm	Perm		Perm	Perm			Perm		
Protected Phases		4			8			2				6
Permitted Phases	4		4	8		8	2			6		
Actuated Green, G (s)	80.8	80.8		80.8	80.8	80.8	8.0	8.0				8.0
Effective Green, g (s)	81.8	81.8		81.8	81.8	81.8	9.0	9.0				9.0
Actuated g/C Ratio	0.80	0.80		0.80	0.80	0.80	0.09	0.09				0.09
Clearance Time (s)	6.9	6.9		6.9	6.9	6.9	6.9	6.9				6.9
Vehicle Extension (s)	3.0	3.0		3.0	3.0	3.0	3.0	3.0				3.0
Lane Grp Cap (vph)	1073	2822		1053	2822	1262	114	139				139
v/s Ratio Prot		0.02			0.01			0.00				0.00
v/s Ratio Perm	c0.07			0.02		0.01	c0.01					
v/c Ratio	0.09	0.02		0.02	0.02	0.01	0.09	0.00				0.06
Uniform Delay, d1	2.3	2.2		2.1	2.1	2.1	43.0	42.7				42.9
Progression Factor	0.26	0.26		1.00	1.00	1.00	1.00	1.00				1.00
Incremental Delay, d2	0.2	0.0		0.0	0.0	0.0	0.3	0.0				0.2
Delay (s)	0.8	0.6		2.2	2.2	2.1	43.4	42.7				43.1
Level of Service	A	A		A	A	A	D	D				D
Approach Delay (s)		0.7			2.2			43.1				43.1
Approach LOS		A			A			D				D
Intersection Summary												
HCM Average Control Delay			13.7				HCM Level of Service			B		
HCM Volume to Capacity ratio			0.09									
Actuated Cycle Length (s)			102.6				Sum of lost time (s)			11.8		
Intersection Capacity Utilization			39.8%				ICU Level of Service			A		
Analysis Period (min)			15									
c Critical Lane Group												

HCM Unsignalized Intersection Capacity Analysis












9: Earl Armstrong & RIRO Site Access

Future Total Traffic-2016
Weekday PM Peak Hour IZero Interaction

	→	↘	↙	←	↖	↗
Movement	EBT	EBR	WBL	WBT	NBL	NBR
Lane Configurations	↑↑			↑↑		↗
Volume (veh/h)	135	65	0	150	0	30
Sign Control	Free			Free	Stop	
Grade	0%			0%	0%	
Peak Hour Factor	1.00	1.00	1.00	1.00	1.00	1.00
Hourly flow rate (vph)	135	65	0	150	0	30
Pedestrians						
Lane Width (m)						
Walking Speed (m/s)						
Percent Blockage						
Right turn flare (veh)						
Median type	None			None		
Median storage (veh)						
Upstream signal (m)	137				120	
pX, platoon unblocked						
vC, conflicting volume			200			242
vC1, stage 1 conf vol						
vC2, stage 2 conf vol						
vCu, unblocked vol			200			242
tC, single (s)			4.1			6.8
tC, 2 stage (s)						
tF (s)			2.2			3.5
p0 queue free %			100			100
cM capacity (veh/h)			1370			725
Direction, Lane #	EB 1	EB 2	WB 1	WB 2	NB 1	
Volume Total	90	110	75	75	30	
Volume Left	0	0	0	0	0	
Volume Right	0	65	0	0	30	
cSH	1700	1700	1700	1700	936	
Volume to Capacity	0.05	0.06	0.04	0.04	0.03	
Queue Length 95th (m)	0.0	0.0	0.0	0.0	0.7	
Control Delay (s)	0.0	0.0	0.0	0.0	9.0	
Lane LOS						A
Approach Delay (s)	0.0				9.0	
Approach LOS						A
Intersection Summary						
Average Delay			0.7			
Intersection Capacity Utilization			15.8%	ICU Level of Service	A	
Analysis Period (min)			15			










HCM Unsignalized Intersection Capacity Analysis
 11: Site Access & Limebank

Future Total Traffic-2016
 Weekday PM Peak Hour IZero Interaction

							
Movement	WBL	WBR	NBT	NBR	SBL	SBT	
Lane Configurations							
Volume (veh/h)	120	180	165	90	145	280	
Sign Control	Stop		Free			Free	
Grade	0%		0%			0%	
Peak Hour Factor	1.00	1.00	1.00	1.00	1.00	1.00	
Hourly flow rate (vph)	120	180	165	90	145	280	
Pedestrians							
Lane Width (m)							
Walking Speed (m/s)							
Percent Blockage							
Right turn flare (veh)							
Median type	None			None			
Median storage (veh)							
Upstream signal (m)							145
pX, platoon unblocked							
vC, conflicting volume	640	128			255		
vC1, stage 1 conf vol							
vC2, stage 2 conf vol							
vCu, unblocked vol	640	128			255		
tC, single (s)	6.8	6.9			4.1		
tC, 2 stage (s)							
tF (s)	3.5	3.3			2.2		
p0 queue free %	67	80			89		
cM capacity (veh/h)	363	899			1307		
Direction, Lane #	WB 1	WB 2	NB 1	NB 2	SB 1	SB 2	SB 3
Volume Total	120	180	110	145	145	140	140
Volume Left	120	0	0	0	145	0	0
Volume Right	0	180	0	90	0	0	0
cSH	363	899	1700	1700	1307	1700	1700
Volume to Capacity	0.33	0.20	0.06	0.09	0.11	0.08	0.08
Queue Length 95th (m)	10.6	5.6	0.0	0.0	2.8	0.0	0.0
Control Delay (s)	19.8	10.0	0.0	0.0	8.1	0.0	0.0
Lane LOS	C	B			A		
Approach Delay (s)	13.9		0.0		2.8		
Approach LOS	B						
Intersection Summary							
Average Delay			5.5				
Intersection Capacity Utilization			32.1%	ICU Level of Service	A		
Analysis Period (min)			15				










HCM Unsignalized Intersection Capacity Analysis
 13: N, Site Access & Proposed New Road

Future Total Traffic-2016
 Weekday PM Peak Hour IZero Interaction

						
Movement	EBL	EBR	NBL	NBT	SBT	SBR
Lane Configurations						
Volume (veh/h)	15	0	0	1	1	25
Sign Control	Stop			Free	Free	
Grade	0%			0%	0%	
Peak Hour Factor	1.00	1.00	1.00	1.00	1.00	1.00
Hourly flow rate (vph)	15	0	0	1	1	25
Pedestrians						
Lane Width (m)						
Walking Speed (m/s)						
Percent Blockage						
Right turn flare (veh)						
Median type				None	None	
Median storage (veh)						
Upstream signal (m)					96	
pX, platoon unblocked						
vC, conflicting volume	14	14	26			
vC1, stage 1 conf vol						
vC2, stage 2 conf vol						
vCu, unblocked vol	14	14	26			
tC, single (s)	6.4	6.2	4.1			
tC, 2 stage (s)						
tF (s)	3.5	3.3	2.2			
p0 queue free %	99	100	100			
cM capacity (veh/h)	1004	1067	1588			
Direction, Lane #	EB 1	NB 1	SB 1			
Volume Total	15	1	26			
Volume Left	15	0	0			
Volume Right	0	0	25			
cSH	1004	1588	1700			
Volume to Capacity	0.01	0.00	0.02			
Queue Length 95th (m)	0.3	0.0	0.0			
Control Delay (s)	8.6	0.0	0.0			
Lane LOS	A					
Approach Delay (s)	8.6	0.0	0.0			
Approach LOS	A					
Intersection Summary						
Average Delay			3.1			
Intersection Capacity Utilization		13.3%		ICU Level of Service		A
Analysis Period (min)			15			

HCM Unsignalized Intersection Capacity Analysis
 15: S. Site Access & Proposed New Road

Future Total Traffic-2016
 Weekday PM Peak Hour IZero Interaction

						
Movement	EBL	EBR	NBL	NBT	SBT	SBR
Lane Configurations						
Volume (veh/h)	1	0	0	0	0	1
Sign Control	Stop			Free	Free	
Grade	0%			0%	0%	
Peak Hour Factor	1.00	1.00	1.00	1.00	1.00	1.00
Hourly flow rate (vph)	1	0	0	0	0	1
Pedestrians						
Lane Width (m)						
Walking Speed (m/s)						
Percent Blockage						
Right turn flare (veh)						
Median type				None	None	
Median storage (veh)						
Upstream signal (m)					180	
pX, platoon unblocked						
vC, conflicting volume	0	0	1			
vC1, stage 1 conf vol						
vC2, stage 2 conf vol						
vCu, unblocked vol	0	0	1			
tC, single (s)	6.4	6.2	4.1			
tC, 2 stage (s)						
tF (s)	3.5	3.3	2.2			
p0 queue free %	100	100	100			
cM capacity (veh/h)	1023	1084	1622			
Direction, Lane #	EB 1	NB 1	SB 1			
Volume Total	1	0	1			
Volume Left	1	0	0			
Volume Right	0	0	1			
cSH	1023	1700	1700			
Volume to Capacity	0.00	0.00	0.00			
Queue Length 95th (m)	0.0	0.0	0.0			
Control Delay (s)	8.5	0.0	0.0			
Lane LOS						
Approach Delay (s)	8.5	0.0	0.0			
Approach LOS	A					
Intersection Summary						
Average Delay			4.3			
Intersection Capacity Utilization		13.3%		ICU Level of Service		A
Analysis Period (min)			15			

APPENDIX F: Synchro Analysis – Future Total 2016 unconstrained interaction



Queues

3: Earl Armstrong & Limebank

Future Total Traffic-2016

Weekday AM Peak Hour Unconstrained

Lane Group	EBL	EBT	EBR	WBL	WBT	WBR	NBL	NBT	NBR	SBL	SBT	SBR
Lane Configurations												
Volume (vph)	545	440	75	10	80	15	195	190	5	55	130	325
Lane Group Flow (vph)	545	440	75	10	80	15	195	190	5	55	130	325
Turn Type	Prot		Perm	Prot		Perm	Prot		Perm	Prot		custom
Protected Phases	7	4		3	8		5	2		1	6	6 7
Permitted Phases			4			8			2			6
Detector Phase	7	4	4	3	8	8	5	2	2	1	6	6 7
Switch Phase												
Minimum Initial (s)	5.0	10.0	10.0	5.0	10.0	10.0	5.0	10.0	10.0	5.0	10.0	
Minimum Split (s)	11.9	31.9	31.9	11.9	31.9	31.9	11.9	31.9	31.9	11.9	31.9	
Total Split (s)	31.0	51.0	51.0	11.9	31.9	31.9	17.0	37.8	37.8	11.9	32.7	63.7
Total Split (%)	27.5%	45.3%	45.3%	10.6%	28.3%	28.3%	15.1%	33.6%	33.6%	10.6%	29.0%	56.6%
Yellow Time (s)	4.6	4.6	4.6	4.6	4.6	4.6	4.6	4.6	4.6	4.6	4.6	4.6
All-Red Time (s)	2.3	2.3	2.3	2.3	2.3	2.3	2.3	2.3	2.3	2.3	2.3	2.3
Lost Time Adjust (s)	-1.0	-1.0	-1.0	-1.0	-1.0	-1.0	-1.0	-1.0	-1.0	-1.0	-1.0	-1.0
Total Lost Time (s)	5.9	5.9	5.9	5.9	5.9	5.9	5.9	5.9	5.9	5.9	5.9	5.9
Lead/Lag	Lead	Lag	Lag	Lead	Lag	Lag	Lead	Lag	Lag	Lead	Lag	
Lead-Lag Optimize?	Yes	Yes	Yes	Yes	Yes	Yes	Yes	Yes	Yes	Yes	Yes	Yes
Recall Mode	None	None	None	None	None	None	None	C-Max	C-Max	None	C-Max	
v/c Ratio	0.78	0.41	0.14	0.05	0.23	0.09	0.50	0.11	0.01	0.22	0.09	0.17
Control Delay	50.4	32.2	7.4	49.8	47.7	20.0	51.2	20.4	13.0	50.8	23.9	1.2
Queue Delay	0.0	0.0	0.0	0.0	0.0	0.0	0.0	0.0	0.0	0.0	0.0	0.0
Total Delay	50.4	32.2	7.4	49.8	47.7	20.0	51.2	20.4	13.0	50.8	23.9	1.2
Queue Length 50th (m)	56.9	35.8	0.0	0.9	8.5	0.0	20.8	13.5	0.0	5.9	9.7	0.0
Queue Length 95th (m)	75.0	57.3	10.8	3.3	16.1	6.3	31.1	21.7	2.4	12.0	17.2	5.6
Internal Link Dist (m)		131.0			112.8			120.2			61.2	
Turn Bay Length (m)	100.0		50.0	30.0		50.0	50.0		50.0	50.0		100.0
Base Capacity (vph)	765	1417	679	183	817	377	397	1654	743	250	1435	2001
Starvation Cap Reductn	0	0	0	0	0	0	0	0	0	0	0	0
Spillback Cap Reductn	0	0	0	0	0	0	0	0	0	0	0	0
Storage Cap Reductn	0	0	0	0	0	0	0	0	0	0	0	0
Reduced v/c Ratio	0.71	0.31	0.11	0.05	0.10	0.04	0.49	0.11	0.01	0.22	0.09	0.16

Intersection Summary

Cycle Length: 112.6

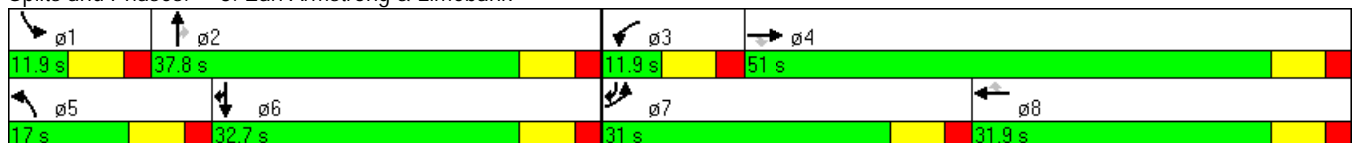
Actuated Cycle Length: 112.6

Offset: 73 (65%), Referenced to phase 2:NBT and 6:SBT, Start of Green

Natural Cycle: 90

Control Type: Actuated-Coordinated

























Splits and Phases: 3: Earl Armstrong & Limebank



HCM Signalized Intersection Capacity Analysis















3: Earl Armstrong & Limebank

Future Total Traffic-2016
Weekday AM Peak Hour Unconstrained

												
Movement	EBL	EBT	EBR	WBL	WBT	WBR	NBL	NBT	NBR	SBL	SBT	SBR
Lane Configurations												
Volume (vph)	545	440	75	10	80	15	195	190	5	55	130	325
Ideal Flow (vphpl)	1900	1900	1900	1900	1900	1900	1900	1900	1900	1900	1900	1900
Total Lost time (s)	5.9	5.9	5.9	5.9	5.9	5.9	5.9	5.9	5.9	5.9	5.9	5.9
Lane Util. Factor	0.97	0.95	1.00	0.97	0.95	1.00	0.97	0.95	1.00	0.97	0.95	0.88
Frt	1.00	1.00	0.85	1.00	1.00	0.85	1.00	1.00	0.85	1.00	1.00	0.85
Flt Protected	0.95	1.00	1.00	0.95	1.00	1.00	0.95	1.00	1.00	0.95	1.00	1.00
Satd. Flow (prot)	3433	3539	1583	3433	3539	1583	3433	3539	1583	3433	3539	2787
Flt Permitted	0.95	1.00	1.00	0.95	1.00	1.00	0.95	1.00	1.00	0.95	1.00	1.00
Satd. Flow (perm)	3433	3539	1583	3433	3539	1583	3433	3539	1583	3433	3539	2787
Peak-hour factor, PHF	1.00	1.00	1.00	1.00	1.00	1.00	1.00	1.00	1.00	1.00	1.00	1.00
Adj. Flow (vph)	545	440	75	10	80	15	195	190	5	55	130	325
RTOR Reduction (vph)	0	0	52	0	0	13	0	0	3	0	0	126
Lane Group Flow (vph)	545	440	23	10	80	2	195	190	2	55	130	199
Turn Type	Prot		Perm	Prot		Perm	Prot		Perm	Prot		custom
Protected Phases	7	4		3	8		5	2		1	6	6
Permitted Phases			4			8			2			6
Actuated Green, G (s)	22.0	33.2	33.2	1.0	12.2	12.2	11.7	44.7	44.7	6.1	39.1	68.0
Effective Green, g (s)	23.0	34.2	34.2	2.0	13.2	13.2	12.7	45.7	45.7	7.1	40.1	69.0
Actuated g/C Ratio	0.20	0.30	0.30	0.02	0.12	0.12	0.11	0.41	0.41	0.06	0.36	0.61
Clearance Time (s)	6.9	6.9	6.9	6.9	6.9	6.9	6.9	6.9	6.9	6.9	6.9	6.9
Vehicle Extension (s)	3.0	3.0	3.0	3.0	3.0	3.0	3.0	3.0	3.0	3.0	3.0	3.0
Lane Grp Cap (vph)	701	1075	481	61	415	186	387	1436	642	216	1260	1708
v/s Ratio Prot	c0.16	c0.12		0.00	0.02		c0.06	c0.05		0.02	0.04	0.07
v/s Ratio Perm			0.01			0.00			0.00			
v/c Ratio	0.78	0.41	0.05	0.16	0.19	0.01	0.50	0.13	0.00	0.25	0.10	0.12
Uniform Delay, d1	42.4	31.2	27.7	54.5	44.9	43.9	47.0	21.0	19.9	50.2	24.2	9.1
Progression Factor	1.00	1.00	1.00	0.97	0.98	0.92	1.00	1.00	1.00	1.00	1.00	1.00
Incremental Delay, d2	5.4	0.3	0.0	1.3	0.2	0.0	1.0	0.2	0.0	0.6	0.2	0.0
Delay (s)	47.8	31.4	27.7	54.0	44.1	40.4	48.0	21.2	19.9	50.9	24.4	9.1
Level of Service	D	C	C	D	D	D	D	C	B	D	C	A
Approach Delay (s)		39.6			44.5			34.6			17.5	
Approach LOS		D			D			C			B	
Intersection Summary												
HCM Average Control Delay			33.4				HCM Level of Service			C		
HCM Volume to Capacity ratio			0.38									
Actuated Cycle Length (s)			112.6				Sum of lost time (s)		17.7			
Intersection Capacity Utilization			50.9%				ICU Level of Service		A			
Analysis Period (min)			15									
c Critical Lane Group												

Queues
6: Earl Armstrong & Proposed New Road





Future Total Traffic-2016
Weekday AM Peak Hour Unconstrained

							
Lane Group	EBL	EBT	WBL	WBT	WBR	NBT	SBT
Lane Configurations							
Volume (vph)	35	445	5	85	2	0	0
Lane Group Flow (vph)	35	445	5	85	2	2	15
Turn Type	Perm		Perm		Perm		
Protected Phases		4		8		2	6
Permitted Phases	4		8		8		
Detector Phase	4	4	8	8	8	2	6
Switch Phase							
Minimum Initial (s)	10.0	10.0	10.0	10.0	10.0	10.0	10.0
Minimum Split (s)	31.9	31.9	31.9	31.9	31.9	31.9	31.9
Total Split (s)	72.6	72.6	72.6	72.6	72.6	40.0	40.0
Total Split (%)	64.5%	64.5%	64.5%	64.5%	64.5%	35.5%	35.5%
Yellow Time (s)	4.6	4.6	4.6	4.6	4.6	4.6	4.6
All-Red Time (s)	2.3	2.3	2.3	2.3	2.3	2.3	2.3
Lost Time Adjust (s)	-1.0	-1.0	-1.0	-1.0	-1.0	-1.0	-1.0
Total Lost Time (s)	5.9	5.9	5.9	5.9	5.9	5.9	5.9
Lead/Lag							
Lead-Lag Optimize?							
Recall Mode	C-Max	C-Max	C-Max	C-Max	C-Max	None	None
v/c Ratio	0.03	0.14	0.01	0.03	0.00	0.00	0.02
Control Delay	0.1	0.1	2.0	1.5	1.5	0.0	0.0
Queue Delay	0.0	0.0	0.0	0.0	0.0	0.0	0.0
Total Delay	0.1	0.1	2.0	1.5	1.5	0.0	0.0
Queue Length 50th (m)	0.0	0.0	0.0	0.0	0.0	0.0	0.0
Queue Length 95th (m)	0.0	0.1	0.8	2.9	0.4	0.0	0.0
Internal Link Dist (m)		95.8		43.9		72.0	67.0
Turn Bay Length (m)	30.0		30.0		30.0		
Base Capacity (vph)	1196	3252	846	3252	1455	768	1113
Starvation Cap Reductn	0	0	0	0	0	0	0
Spillback Cap Reductn	0	0	0	0	0	0	0
Storage Cap Reductn	0	0	0	0	0	0	0
Reduced v/c Ratio	0.03	0.14	0.01	0.03	0.00	0.00	0.01

Intersection Summary

Cycle Length: 112.6
 Actuated Cycle Length: 112.6
 Offset: 0 (0%), Referenced to phase 4:EBTL and 8:WBTL, Start of Green
 Natural Cycle: 65
 Control Type: Actuated-Coordinated





























Splits and Phases: 6: Earl Armstrong & Proposed New Road

 ø2	 ø4
40 s	72.6 s
 ø6	 ø8
40 s	72.6 s

HCM Signalized Intersection Capacity Analysis

6: Earl Armstrong & Proposed New Road

Future Total Traffic-2016
Weekday AM Peak Hour Unconstrained

												
Movement	EBL	EBT	EBR	WBL	WBT	WBR	NBL	NBT	NBR	SBL	SBT	SBR
Lane Configurations		 			 			 			 	
Volume (vph)	35	445	0	5	85	2	0	0	2	0	0	15
Ideal Flow (vphpl)	1900	1900	1900	1900	1900	1900	1900	1900	1900	1900	1900	1900
Total Lost time (s)	5.9	5.9		5.9	5.9	5.9		5.9			5.9	
Lane Util. Factor	1.00	0.95		1.00	0.95	1.00		1.00			1.00	
Flt	1.00	1.00		1.00	1.00	0.85		0.85			0.85	
Flt Protected	0.95	1.00		0.95	1.00	1.00		1.00			1.00	
Satd. Flow (prot)	1770	3539		1770	3539	1583		1583			1583	
Flt Permitted	0.70	1.00		0.49	1.00	1.00		1.00			1.00	
Satd. Flow (perm)	1302	3539		921	3539	1583		1583			1583	
Peak-hour factor, PHF	1.00	1.00	1.00	1.00	1.00	1.00	1.00	1.00	1.00	1.00	1.00	1.00
Adj. Flow (vph)	35	445	0	5	85	2	0	0	2	0	0	15
RTOR Reduction (vph)	0	0	0	0	0	0	0	2	0	0	14	0
Lane Group Flow (vph)	35	445	0	5	85	2	0	0	0	0	1	0
Turn Type	Perm		Perm	Perm		Perm	Perm			Perm		
Protected Phases		4			8			2				6
Permitted Phases	4		4	8		8	2			6		
Actuated Green, G (s)	94.8	94.8		94.8	94.8	94.8		4.0				4.0
Effective Green, g (s)	95.8	95.8		95.8	95.8	95.8		5.0				5.0
Actuated g/C Ratio	0.85	0.85		0.85	0.85	0.85		0.04				0.04
Clearance Time (s)	6.9	6.9		6.9	6.9	6.9		6.9				6.9
Vehicle Extension (s)	3.0	3.0		3.0	3.0	3.0		3.0				3.0
Lane Grp Cap (vph)	1108	3011		784	3011	1347		70				70
v/s Ratio Prot		c0.13			0.02			0.00				c0.00
v/s Ratio Perm	0.03			0.01		0.00						
v/c Ratio	0.03	0.15		0.01	0.03	0.00		0.00				0.01
Uniform Delay, d1	1.3	1.4		1.3	1.3	1.3		51.4				51.4
Progression Factor	0.01	0.01		1.00	1.00	1.00		1.00				1.00
Incremental Delay, d2	0.1	0.1		0.0	0.0	0.0		0.0				0.1
Delay (s)	0.1	0.1		1.3	1.3	1.3		51.4				51.5
Level of Service	A	A		A	A	A		D				D
Approach Delay (s)		0.1			1.3			51.4				51.5
Approach LOS		A			A			D				D
Intersection Summary												
HCM Average Control Delay			1.8				HCM Level of Service				A	
HCM Volume to Capacity ratio			0.14									
Actuated Cycle Length (s)			112.6				Sum of lost time (s)			11.8		
Intersection Capacity Utilization			39.8%				ICU Level of Service			A		
Analysis Period (min)			15									
c Critical Lane Group												














HCM Unsignalized Intersection Capacity Analysis
 9: Earl Armstrong & RIRO Site Access

Future Total Traffic-2016
 Weekday AM Peak Hour Unconstrained

	→	↘	↙	←	↖	↗
Movement	EBT	EBR	WBL	WBT	NBL	NBR
Lane Configurations	↑↑			↑↑		↗
Volume (veh/h)	480	20	0	100	0	1
Sign Control	Free			Free	Stop	
Grade	0%			0%	0%	
Peak Hour Factor	1.00	1.00	1.00	1.00	1.00	1.00
Hourly flow rate (vph)	480	20	0	100	0	1
Pedestrians						
Lane Width (m)						
Walking Speed (m/s)						
Percent Blockage						
Right turn flare (veh)						
Median type	None			None		
Median storage (veh)						
Upstream signal (m)	137			120		
pX, platoon unblocked			0.91		0.91	0.91
vC, conflicting volume			500		540	250
vC1, stage 1 conf vol						
vC2, stage 2 conf vol						
vCu, unblocked vol			242		286	0
tC, single (s)			4.1		6.8	6.9
tC, 2 stage (s)						
tF (s)			2.2		3.5	3.3
p0 queue free %			100		100	100
cM capacity (veh/h)			1198		617	983
Direction, Lane #	EB 1	EB 2	WB 1	WB 2	NB 1	
Volume Total	320	180	50	50	1	
Volume Left	0	0	0	0	0	
Volume Right	0	20	0	0	1	
cSH	1700	1700	1700	1700	983	
Volume to Capacity	0.19	0.11	0.03	0.03	0.00	
Queue Length 95th (m)	0.0	0.0	0.0	0.0	0.0	
Control Delay (s)	0.0	0.0	0.0	0.0	8.7	
Lane LOS						A
Approach Delay (s)	0.0		0.0		8.7	
Approach LOS						A
Intersection Summary						
Average Delay			0.0			
Intersection Capacity Utilization			23.9%		ICU Level of Service	A
Analysis Period (min)			15			










HCM Unsignalized Intersection Capacity Analysis
 11: Site Access & Limebank

Future Total Traffic-2016
 Weekday AM Peak Hour Unconstrained

							
Movement	WBL	WBR	NBT	NBR	SBL	SBT	
Lane Configurations			 			 	
Volume (veh/h)	20	45	345	35	50	160	
Sign Control	Stop		Free			Free	
Grade	0%		0%			0%	
Peak Hour Factor	1.00	1.00	1.00	1.00	1.00	1.00	
Hourly flow rate (vph)	20	45	345	35	50	160	
Pedestrians							
Lane Width (m)							
Walking Speed (m/s)							
Percent Blockage							
Right turn flare (veh)							
Median type			None			None	
Median storage (veh)							
Upstream signal (m)						144	
pX, platoon unblocked							
vC, conflicting volume	542	190			380		
vC1, stage 1 conf vol							
vC2, stage 2 conf vol							
vCu, unblocked vol	542	190			380		
tC, single (s)	6.8	6.9			4.1		
tC, 2 stage (s)							
tF (s)	3.5	3.3			2.2		
p0 queue free %	96	95			96		
cM capacity (veh/h)	450	820			1175		
Direction, Lane #	WB 1	WB 2	NB 1	NB 2	SB 1	SB 2	SB 3
Volume Total	20	45	230	150	50	80	80
Volume Left	20	0	0	0	50	0	0
Volume Right	0	45	0	35	0	0	0
cSH	450	820	1700	1700	1175	1700	1700
Volume to Capacity	0.04	0.05	0.14	0.09	0.04	0.05	0.05
Queue Length 95th (m)	1.0	1.3	0.0	0.0	1.0	0.0	0.0
Control Delay (s)	13.4	9.6	0.0	0.0	8.2	0.0	0.0
Lane LOS	B	A			A		
Approach Delay (s)	10.8		0.0		2.0		
Approach LOS	B						
Intersection Summary							
Average Delay			1.7				
Intersection Capacity Utilization			27.3%		ICU Level of Service		A
Analysis Period (min)			15				










HCM Unsignalized Intersection Capacity Analysis
 13: N. Site Access & Proposed New Road

Future Total Traffic-2016
 Weekday AM Peak Hour Unconstrained

						
Movement	EBL	EBR	NBL	NBT	SBT	SBR
Lane Configurations						
Volume (veh/h)	2	0	0	0	0	5
Sign Control	Stop			Free	Free	
Grade	0%			0%	0%	
Peak Hour Factor	1.00	1.00	1.00	1.00	1.00	1.00
Hourly flow rate (vph)	2	0	0	0	0	5
Pedestrians						
Lane Width (m)						
Walking Speed (m/s)						
Percent Blockage						
Right turn flare (veh)						
Median type				None	None	
Median storage (veh)						
Upstream signal (m)					96	
pX, platoon unblocked						
vC, conflicting volume	2	2	5			
vC1, stage 1 conf vol						
vC2, stage 2 conf vol						
vCu, unblocked vol	2	2	5			
tC, single (s)	6.4	6.2	4.1			
tC, 2 stage (s)						
tF (s)	3.5	3.3	2.2			
p0 queue free %	100	100	100			
cM capacity (veh/h)	1020	1082	1616			
Direction, Lane #	EB 1	NB 1	SB 1			
Volume Total	2	0	5			
Volume Left	2	0	0			
Volume Right	0	0	5			
cSH	1020	1700	1700			
Volume to Capacity	0.00	0.00	0.00			
Queue Length 95th (m)	0.0	0.0	0.0			
Control Delay (s)	8.5	0.0	0.0			
Lane LOS						
Approach Delay (s)	8.5	0.0	0.0			
Approach LOS	A					
Intersection Summary						
Average Delay			2.4			
Intersection Capacity Utilization		13.3%		ICU Level of Service		A
Analysis Period (min)			15			

HCM Unsignalized Intersection Capacity Analysis
 15: S. Site Access & Proposed New Road

Future Total Traffic-2016
 Weekday AM Peak Hour Unconstrained

						
Movement	EBL	EBR	NBL	NBT	SBT	SBR
Lane Configurations						
Volume (veh/h)	0	0	0	0	0	0
Sign Control	Stop			Free	Free	
Grade	0%			0%	0%	
Peak Hour Factor	1.00	1.00	1.00	1.00	1.00	1.00
Hourly flow rate (vph)	0	0	0	0	0	0
Pedestrians						
Lane Width (m)						
Walking Speed (m/s)						
Percent Blockage						
Right turn flare (veh)						
Median type				None	None	
Median storage (veh)						
Upstream signal (m)					186	
pX, platoon unblocked						
vC, conflicting volume	0	0	0			
vC1, stage 1 conf vol						
vC2, stage 2 conf vol						
vCu, unblocked vol	0	0	0			
tC, single (s)	6.4	6.2	4.1			
tC, 2 stage (s)						
tF (s)	3.5	3.3	2.2			
p0 queue free %	100	100	100			
cM capacity (veh/h)	1023	1085	1623			
Direction, Lane #	EB 1	NB 1	SB 1			
Volume Total	0	0	0			
Volume Left	0	0	0			
Volume Right	0	0	0			
cSH	1700	1700	1700			
Volume to Capacity	0.00	0.00	0.00			
Queue Length 95th (m)	0.0	0.0	0.0			
Control Delay (s)	0.0	0.0	0.0			
Lane LOS						
Approach Delay (s)	0.0	0.0	0.0			
Approach LOS	A					
Intersection Summary						
Average Delay			0.0			
Intersection Capacity Utilization			0.0%	ICU Level of Service		A
Analysis Period (min)			15			

Queues
3: Earl Armstrong & Limebank

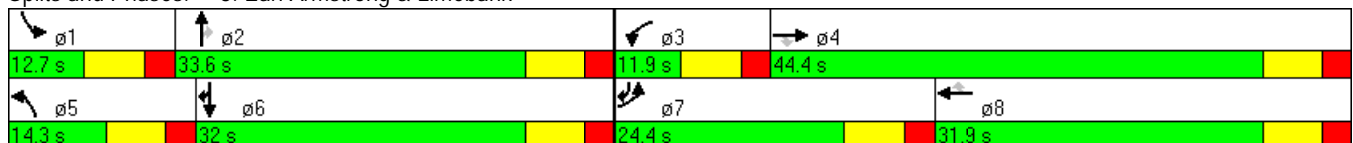
Future Total Traffic-2016
 Weekday PM Peak Hour Unconstrained

Lane Group	EBL	EBT	EBR	WBL	WBT	WBR	NBL	NBT	NBR	SBL	SBT	SBR
Lane Configurations												
Volume (vph)	400	90	220	60	435	25	135	195	20	100	245	665
Lane Group Flow (vph)	400	90	220	60	435	25	135	195	20	100	245	665
Turn Type	Prot		Perm	Prot		Perm	Prot		Perm	Prot		custom
Protected Phases	7	4		3	8		5	2		1	6	6 7
Permitted Phases			4			8			2			6
Detector Phase	7	4	4	3	8	8	5	2	2	1	6	6 7
Switch Phase												
Minimum Initial (s)	5.0	10.0	10.0	5.0	10.0	10.0	5.0	10.0	10.0	5.0	10.0	
Minimum Split (s)	11.9	31.9	31.9	11.9	31.9	31.9	11.9	31.9	31.9	11.9	31.9	
Total Split (s)	24.4	44.4	44.4	11.9	31.9	31.9	14.3	33.6	33.6	12.7	32.0	56.4
Total Split (%)	23.8%	43.3%	43.3%	11.6%	31.1%	31.1%	13.9%	32.7%	32.7%	12.4%	31.2%	55.0%
Yellow Time (s)	4.6	4.6	4.6	4.6	4.6	4.6	4.6	4.6	4.6	4.6	4.6	4.6
All-Red Time (s)	2.3	2.3	2.3	2.3	2.3	2.3	2.3	2.3	2.3	2.3	2.3	2.3
Lost Time Adjust (s)	-1.0	-1.0	-1.0	-1.0	-1.0	-1.0	-1.0	-1.0	-1.0	-1.0	-1.0	-1.0
Total Lost Time (s)	5.9	5.9	5.9	5.9	5.9	5.9	5.9	5.9	5.9	5.9	5.9	5.9
Lead/Lag	Lead	Lag	Lag	Lead	Lag	Lag	Lead	Lag	Lag	Lead	Lag	
Lead-Lag Optimize?	Yes	Yes	Yes	Yes	Yes	Yes	Yes	Yes	Yes	Yes	Yes	Yes
Recall Mode	None	None	None	None	None	None	None	C-Max	C-Max	None	C-Max	
v/c Ratio	0.69	0.08	0.34	0.30	0.67	0.08	0.40	0.15	0.03	0.33	0.22	0.41
Control Delay	46.8	24.5	4.8	51.1	40.2	10.6	46.9	25.8	11.7	46.9	27.8	10.6
Queue Delay	0.0	0.0	0.0	0.0	0.0	0.0	0.0	0.0	0.0	0.0	0.0	0.0
Total Delay	46.8	24.5	4.8	51.1	40.2	10.6	46.9	25.8	11.7	46.9	27.8	10.6
Queue Length 50th (m)	37.9	6.6	0.0	5.9	36.5	0.3	12.9	14.5	0.0	9.6	18.8	27.5
Queue Length 95th (m)	53.2	11.4	14.9	12.4	45.6	4.9	21.9	24.5	5.6	17.4	30.7	46.1
Internal Link Dist (m)		131.0			113.3			120.8			61.2	
Turn Bay Length (m)	100.0		50.0	30.0		50.0	50.0		50.0	50.0		100.0
Base Capacity (vph)	619	1328	731	201	897	420	338	1261	577	299	1135	1645
Starvation Cap Reductn	0	0	0	0	0	0	0	0	0	0	0	0
Spillback Cap Reductn	0	0	0	0	0	0	0	0	0	0	0	0
Storage Cap Reductn	0	0	0	0	0	0	0	0	0	0	0	0
Reduced v/c Ratio	0.65	0.07	0.30	0.30	0.48	0.06	0.40	0.15	0.03	0.33	0.22	0.40

Intersection Summary

Cycle Length: 102.6
 Actuated Cycle Length: 102.6
 Offset: 27 (26%), Referenced to phase 2:NBT and 6:SBT, Start of Green
 Natural Cycle: 90
 Control Type: Actuated-Coordinated

































Splits and Phases: 3: Earl Armstrong & Limebank



HCM Signalized Intersection Capacity Analysis

3: Earl Armstrong & Limebank

Future Total Traffic-2016
Weekday PM Peak Hour Unconstrained

												
Movement	EBL	EBT	EBR	WBL	WBT	WBR	NBL	NBT	NBR	SBL	SBT	SBR
Lane Configurations	 	 		 	 		 	 		 	 	
Volume (vph)	400	90	220	60	435	25	135	195	20	100	245	665
Ideal Flow (vphpl)	1900	1900	1900	1900	1900	1900	1900	1900	1900	1900	1900	1900
Total Lost time (s)	5.9	5.9	5.9	5.9	5.9	5.9	5.9	5.9	5.9	5.9	5.9	5.9
Lane Util. Factor	0.97	0.95	1.00	0.97	0.95	1.00	0.97	0.95	1.00	0.97	0.95	0.88
Frt	1.00	1.00	0.85	1.00	1.00	0.85	1.00	1.00	0.85	1.00	1.00	0.85
Flt Protected	0.95	1.00	1.00	0.95	1.00	1.00	0.95	1.00	1.00	0.95	1.00	1.00
Satd. Flow (prot)	3433	3539	1583	3433	3539	1583	3433	3539	1583	3433	3539	2787
Flt Permitted	0.95	1.00	1.00	0.95	1.00	1.00	0.95	1.00	1.00	0.95	1.00	1.00
Satd. Flow (perm)	3433	3539	1583	3433	3539	1583	3433	3539	1583	3433	3539	2787
Peak-hour factor, PHF	1.00	1.00	1.00	1.00	1.00	1.00	1.00	1.00	1.00	1.00	1.00	1.00
Adj. Flow (vph)	400	90	220	60	435	25	135	195	20	100	245	665
RTOR Reduction (vph)	0	0	150	0	0	20	0	0	13	0	0	94
Lane Group Flow (vph)	400	90	70	60	435	5	135	195	7	100	245	571
Turn Type	Prot		Perm	Prot		Perm	Prot		Perm	Prot		custom
Protected Phases	7	4		3	8		5	2		1	6	6
Permitted Phases			4			8			2			6
Actuated Green, G (s)	16.3	31.5	31.5	4.0	19.2	19.2	9.0	32.8	32.8	6.7	30.5	53.7
Effective Green, g (s)	17.3	32.5	32.5	5.0	20.2	20.2	10.0	33.8	33.8	7.7	31.5	54.7
Actuated g/C Ratio	0.17	0.32	0.32	0.05	0.20	0.20	0.10	0.33	0.33	0.08	0.31	0.53
Clearance Time (s)	6.9	6.9	6.9	6.9	6.9	6.9	6.9	6.9	6.9	6.9	6.9	6.9
Vehicle Extension (s)	3.0	3.0	3.0	3.0	3.0	3.0	3.0	3.0	3.0	3.0	3.0	3.0
Lane Grp Cap (vph)	579	1121	501	167	697	312	335	1166	521	258	1087	1486
v/s Ratio Prot	c0.12	0.03		0.02	c0.12		c0.04	0.06		0.03	0.07	c0.20
v/s Ratio Perm			0.04			0.00			0.00			
v/c Ratio	0.69	0.08	0.14	0.36	0.62	0.02	0.40	0.17	0.01	0.39	0.23	0.38
Uniform Delay, d1	40.1	24.6	25.1	47.2	37.7	33.2	43.5	24.4	23.2	45.2	26.5	14.1
Progression Factor	1.00	1.00	1.00	1.02	0.90	0.81	1.00	1.00	1.00	1.00	1.00	1.00
Incremental Delay, d2	3.5	0.0	0.1	1.3	1.7	0.0	0.8	0.3	0.0	1.0	0.5	0.2
Delay (s)	43.7	24.6	25.2	49.3	35.8	26.9	44.3	24.7	23.2	46.2	26.9	14.2
Level of Service	D	C	C	D	D	C	D	C	C	D	C	B
Approach Delay (s)		35.5			36.9			32.2			20.5	
Approach LOS		D			D			C			C	
Intersection Summary												
HCM Average Control Delay			29.5				HCM Level of Service			C		
HCM Volume to Capacity ratio			0.53									
Actuated Cycle Length (s)			102.6				Sum of lost time (s)		23.6			
Intersection Capacity Utilization			55.6%				ICU Level of Service			B		
Analysis Period (min)			15									
c Critical Lane Group												

Queues
6: Earl Armstrong & Proposed New Road

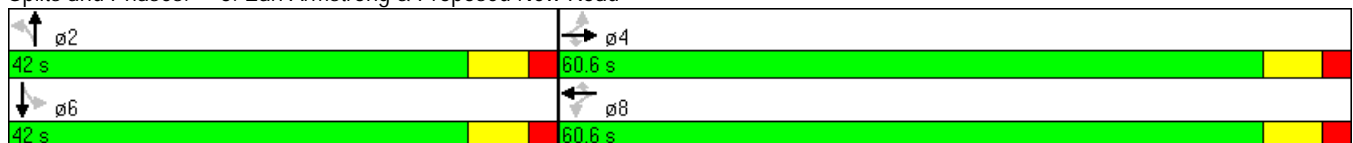
Future Total Traffic-2016
Weekday PM Peak Hour Unconstrained

Lane Group	EBL	EBT	WBL	WBT	WBR	NBL	NBT	SBT
Lane Configurations								
Volume (vph)	95	80	55	385	10	45	0	0
Lane Group Flow (vph)	95	80	55	385	10	45	5	90
Turn Type	Perm		Perm		Perm	Perm		
Protected Phases		4		8			2	6
Permitted Phases	4		8		8	2		
Detector Phase	4	4	8	8	8	2	2	6
Switch Phase								
Minimum Initial (s)	10.0	10.0	10.0	10.0	10.0	10.0	10.0	10.0
Minimum Split (s)	31.9	31.9	31.9	31.9	31.9	31.9	31.9	31.9
Total Split (s)	60.6	60.6	60.6	60.6	60.6	42.0	42.0	42.0
Total Split (%)	59.1%	59.1%	59.1%	59.1%	59.1%	40.9%	40.9%	40.9%
Yellow Time (s)	4.6	4.6	4.6	4.6	4.6	4.6	4.6	4.6
All-Red Time (s)	2.3	2.3	2.3	2.3	2.3	2.3	2.3	2.3
Lost Time Adjust (s)	-1.0	-1.0	-1.0	-1.0	-1.0	-1.0	-1.0	-1.0
Total Lost Time (s)	5.9	5.9	5.9	5.9	5.9	5.9	5.9	5.9
Lead/Lag								
Lead-Lag Optimize?								
Recall Mode	C-Max	C-Max	C-Max	C-Max	C-Max	None	None	None
v/c Ratio	0.12	0.03	0.05	0.13	0.01	0.30	0.01	0.16
Control Delay	1.3	0.6	3.1	2.9	1.7	47.1	0.0	0.6
Queue Delay	0.0	0.0	0.0	0.0	0.0	0.0	0.0	0.0
Total Delay	1.3	0.6	3.1	2.9	1.7	47.1	0.0	0.6
Queue Length 50th (m)	0.7	0.3	2.0	7.9	0.0	8.3	0.0	0.0
Queue Length 95th (m)	1.4	0.5	5.1	13.1	1.1	18.5	0.0	0.0
Internal Link Dist (m)		96.0		43.9			72.0	67.0
Turn Bay Length (m)	30.0		30.0		30.0	30.0		
Base Capacity (vph)	796	2887	1067	2887	1293	458	1142	836
Starvation Cap Reductn	0	0	0	0	0	0	0	0
Spillback Cap Reductn	0	0	0	0	0	0	0	0
Storage Cap Reductn	0	0	0	0	0	0	0	0
Reduced v/c Ratio	0.12	0.03	0.05	0.13	0.01	0.10	0.00	0.11

Intersection Summary



























Cycle Length: 102.6
 Actuated Cycle Length: 102.6
 Offset: 0 (0%), Referenced to phase 4:EBTL and 8:WBTL, Start of Green
 Natural Cycle: 65
 Control Type: Actuated-Coordinated

Splits and Phases: 6: Earl Armstrong & Proposed New Road









HCM Signalized Intersection Capacity Analysis
6: Earl Armstrong & Proposed New Road

Future Total Traffic-2016
Weekday PM Peak Hour Unconstrained

												
Movement	EBL	EBT	EBR	WBL	WBT	WBR	NBL	NBT	NBR	SBL	SBT	SBR
Lane Configurations		 			 			 				
Volume (vph)	95	80	0	55	385	10	45	0	5	0	0	90
Ideal Flow (vphpl)	1900	1900	1900	1900	1900	1900	1900	1900	1900	1900	1900	1900
Total Lost time (s)	5.9	5.9		5.9	5.9	5.9	5.9	5.9			5.9	
Lane Util. Factor	1.00	0.95		1.00	0.95	1.00	1.00	1.00			1.00	
Frt	1.00	1.00		1.00	1.00	0.85	1.00	0.85			0.85	
Flt Protected	0.95	1.00		0.95	1.00	1.00	0.95	1.00			1.00	
Satd. Flow (prot)	1770	3539		1770	3539	1583	1770	1583			1583	
Flt Permitted	0.52	1.00		0.70	1.00	1.00	0.70	1.00			1.00	
Satd. Flow (perm)	976	3539		1308	3539	1583	1301	1583			1583	
Peak-hour factor, PHF	1.00	1.00	1.00	1.00	1.00	1.00	1.00	1.00	1.00	1.00	1.00	1.00
Adj. Flow (vph)	95	80	0	55	385	10	45	0	5	0	0	90
RTOR Reduction (vph)	0	0	0	0	0	2	0	5	0	0	81	0
Lane Group Flow (vph)	95	80	0	55	385	8	45	0	0	0	9	0
Turn Type	Perm		Perm	Perm		Perm	Perm			Perm		
Protected Phases		4			8			2			6	
Permitted Phases	4		4	8		8	2			6		
Actuated Green, G (s)	80.1	80.1		80.1	80.1	80.1	8.7	8.7			8.7	
Effective Green, g (s)	81.1	81.1		81.1	81.1	81.1	9.7	9.7			9.7	
Actuated g/C Ratio	0.79	0.79		0.79	0.79	0.79	0.09	0.09			0.09	
Clearance Time (s)	6.9	6.9		6.9	6.9	6.9	6.9	6.9			6.9	
Vehicle Extension (s)	3.0	3.0		3.0	3.0	3.0	3.0	3.0			3.0	
Lane Grp Cap (vph)	771	2797		1034	2797	1251	123	150			150	
v/s Ratio Prot		0.02			c0.11			0.00			0.01	
v/s Ratio Perm	0.10			0.04		0.00	c0.03					
v/c Ratio	0.12	0.03		0.05	0.14	0.01	0.37	0.00			0.06	
Uniform Delay, d1	2.5	2.3		2.4	2.5	2.3	43.6	42.1			42.3	
Progression Factor	0.33	0.19		1.00	1.00	1.00	1.00	1.00			1.00	
Incremental Delay, d2	0.3	0.0		0.1	0.1	0.0	1.8	0.0			0.2	
Delay (s)	1.1	0.4		2.4	2.6	2.3	45.4	42.1			42.4	
Level of Service	A	A		A	A	A	D	D			D	
Approach Delay (s)		0.8			2.6			45.1			42.4	
Approach LOS		A			A			D			D	
Intersection Summary												
HCM Average Control Delay			9.7				HCM Level of Service				A	
HCM Volume to Capacity ratio			0.16									
Actuated Cycle Length (s)			102.6				Sum of lost time (s)				11.8	
Intersection Capacity Utilization			42.9%				ICU Level of Service				A	
Analysis Period (min)			15									
c Critical Lane Group												












HCM Unsignalized Intersection Capacity Analysis
 9: Earl Armstrong & RIRO Site Access

Future Total Traffic-2016
 Weekday PM Peak Hour Unconstrained

						
Movement	EBT	EBR	WBL	WBT	NBL	NBR
Lane Configurations	↑↑			↑↑		↗
Volume (veh/h)	155	55	0	520	0	20
Sign Control	Free			Free	Stop	
Grade	0%			0%	0%	
Peak Hour Factor	1.00	1.00	1.00	1.00	1.00	1.00
Hourly flow rate (vph)	155	55	0	520	0	20
Pedestrians						
Lane Width (m)						
Walking Speed (m/s)						
Percent Blockage						
Right turn flare (veh)						
Median type	None		None			
Median storage (veh)						
Upstream signal (m)	137			120		
pX, platoon unblocked					1.00	
vC, conflicting volume			210		442	105
vC1, stage 1 conf vol						
vC2, stage 2 conf vol						
vCu, unblocked vol			210		431	105
tC, single (s)			4.1		6.8	6.9
tC, 2 stage (s)						
tF (s)			2.2		3.5	3.3
p0 queue free %			100		100	98
cM capacity (veh/h)			1358		550	929
Direction, Lane #	EB 1	EB 2	WB 1	WB 2	NB 1	
Volume Total	103	107	260	260	20	
Volume Left	0	0	0	0	0	
Volume Right	0	55	0	0	20	
cSH	1700	1700	1700	1700	929	
Volume to Capacity	0.06	0.06	0.15	0.15	0.02	
Queue Length 95th (m)	0.0	0.0	0.0	0.0	0.5	
Control Delay (s)	0.0	0.0	0.0	0.0	9.0	
Lane LOS					A	
Approach Delay (s)	0.0		0.0		9.0	
Approach LOS					A	
Intersection Summary						
Average Delay			0.2			
Intersection Capacity Utilization			17.7%		ICU Level of Service	A
Analysis Period (min)			15			










HCM Unsignalized Intersection Capacity Analysis
 11: Site Access & Limebank

Future Total Traffic-2016
 Weekday PM Peak Hour Unconstrained

							
Movement	WBL	WBR	NBT	NBR	SBL	SBT	
Lane Configurations							
Volume (veh/h)	110	170	175	80	135	390	
Sign Control	Stop		Free			Free	
Grade	0%		0%			0%	
Peak Hour Factor	1.00	1.00	1.00	1.00	1.00	1.00	
Hourly flow rate (vph)	110	170	175	80	135	390	
Pedestrians							
Lane Width (m)							
Walking Speed (m/s)							
Percent Blockage							
Right turn flare (veh)							
Median type			None			None	
Median storage (veh)							
Upstream signal (m)						145	
pX, platoon unblocked	0.99						
vC, conflicting volume	680	128			255		
vC1, stage 1 conf vol							
vC2, stage 2 conf vol							
vCu, unblocked vol	666	128			255		
tC, single (s)	6.8	6.9			4.1		
tC, 2 stage (s)							
tF (s)	3.5	3.3			2.2		
p0 queue free %	69	81			90		
cM capacity (veh/h)	350	899			1307		
Direction, Lane #	WB 1	WB 2	NB 1	NB 2	SB 1	SB 2	SB 3
Volume Total	110	170	117	138	135	195	195
Volume Left	110	0	0	0	135	0	0
Volume Right	0	170	0	80	0	0	0
cSH	350	899	1700	1700	1307	1700	1700
Volume to Capacity	0.31	0.19	0.07	0.08	0.10	0.11	0.11
Queue Length 95th (m)	9.9	5.2	0.0	0.0	2.6	0.0	0.0
Control Delay (s)	19.9	9.9	0.0	0.0	8.1	0.0	0.0
Lane LOS	C	A			A		
Approach Delay (s)	13.9		0.0		2.1		
Approach LOS	B						
Intersection Summary							
Average Delay			4.7				
Intersection Capacity Utilization			31.0%		ICU Level of Service		A
Analysis Period (min)			15				










HCM Unsignalized Intersection Capacity Analysis
 13: N. Site Access & Proposed New Road

Future Total Traffic-2016
 Weekday PM Peak Hour Unconstrained

						
Movement	EBL	EBR	NBL	NBT	SBT	SBR
Lane Configurations						
Volume (veh/h)	50	0	0	1	1	55
Sign Control	Stop			Free	Free	
Grade	0%			0%	0%	
Peak Hour Factor	1.00	1.00	1.00	1.00	1.00	1.00
Hourly flow rate (vph)	50	0	0	1	1	55
Pedestrians						
Lane Width (m)						
Walking Speed (m/s)						
Percent Blockage						
Right turn flare (veh)						
Median type				None	None	
Median storage (veh)						
Upstream signal (m)					96	
pX, platoon unblocked						
vC, conflicting volume	30	28	56			
vC1, stage 1 conf vol						
vC2, stage 2 conf vol						
vCu, unblocked vol	30	28	56			
tC, single (s)	6.4	6.2	4.1			
tC, 2 stage (s)						
tF (s)	3.5	3.3	2.2			
p0 queue free %	95	100	100			
cM capacity (veh/h)	985	1046	1549			
Direction, Lane #	EB 1	NB 1	SB 1			
Volume Total	50	1	56			
Volume Left	50	0	0			
Volume Right	0	0	55			
cSH	985	1549	1700			
Volume to Capacity	0.05	0.00	0.03			
Queue Length 95th (m)	1.2	0.0	0.0			
Control Delay (s)	8.9	0.0	0.0			
Lane LOS	A					
Approach Delay (s)	8.9	0.0	0.0			
Approach LOS	A					
Intersection Summary						
Average Delay			4.1			
Intersection Capacity Utilization		13.5%		ICU Level of Service		A
Analysis Period (min)			15			

HCM Unsignalized Intersection Capacity Analysis
 15: S. Site Accesses & Proposed New Road

Future Total Traffic-2016
 Weekday PM Peak Hour Unconstrained

						
Movement	EBL	EBR	NBL	NBT	SBT	SBR
Lane Configurations						
Volume (veh/h)	1	0	0	0	0	1
Sign Control	Stop			Free	Free	
Grade	0%			0%	0%	
Peak Hour Factor	1.00	1.00	1.00	1.00	1.00	1.00
Hourly flow rate (vph)	1	0	0	0	0	1
Pedestrians						
Lane Width (m)						
Walking Speed (m/s)						
Percent Blockage						
Right turn flare (veh)						
Median type				None	None	
Median storage (veh)						
Upstream signal (m)					187	
pX, platoon unblocked						
vC, conflicting volume	0	0	1			
vC1, stage 1 conf vol						
vC2, stage 2 conf vol						
vCu, unblocked vol	0	0	1			
tC, single (s)	6.4	6.2	4.1			
tC, 2 stage (s)						
tF (s)	3.5	3.3	2.2			
p0 queue free %	100	100	100			
cM capacity (veh/h)	1023	1084	1622			
Direction, Lane #	EB 1	NB 1	SB 1			
Volume Total	1	0	1			
Volume Left	1	0	0			
Volume Right	0	0	1			
cSH	1023	1700	1700			
Volume to Capacity	0.00	0.00	0.00			
Queue Length 95th (m)	0.0	0.0	0.0			
Control Delay (s)	8.5	0.0	0.0			
Lane LOS						
Approach Delay (s)	8.5	0.0	0.0			
Approach LOS	A					
Intersection Summary						
Average Delay			4.3			
Intersection Capacity Utilization		13.3%		ICU Level of Service		A
Analysis Period (min)			15			

**APPENDIX G: Synchro Analysis – Future Background & Future
Total 2021 zero interaction**



Queues

Future Background Traffic-2021

3: Earl Armstrong & Limebank

Weekday AM Peak Hour Zero Interaction

Lane Group	EBL	EBT	EBR	WBL	WBT	WBR	NBL	NBT	NBR	SBL	SBT	SBR
Lane Configurations												
Volume (vph)	435	325	70	45	355	100	130	190	20	95	105	285
Lane Group Flow (vph)	435	325	70	45	355	100	130	190	20	95	105	285
Turn Type	Prot		Perm	Prot		Perm	Prot		Perm	Prot		custom
Protected Phases	7	4		3	8		5	2		1	6	6 7
Permitted Phases			4			8			2			6
Detector Phase	7	4	4	3	8	8	5	2	2	1	6	6 7
Switch Phase												
Minimum Initial (s)	5.0	10.0	10.0	5.0	10.0	10.0	5.0	10.0	10.0	5.0	10.0	
Minimum Split (s)	11.9	31.9	31.9	11.9	31.9	31.9	11.9	31.9	31.9	11.9	31.9	
Total Split (s)	31.9	51.9	51.9	11.9	31.9	31.9	16.9	36.9	36.9	11.9	31.9	63.8
Total Split (%)	28.3%	46.1%	46.1%	10.6%	28.3%	28.3%	15.0%	32.8%	32.8%	10.6%	28.3%	56.7%
Yellow Time (s)	4.6	4.6	4.6	4.6	4.6	4.6	4.6	4.6	4.6	4.6	4.6	4.6
All-Red Time (s)	2.3	2.3	2.3	2.3	2.3	2.3	2.3	2.3	2.3	2.3	2.3	2.3
Lost Time Adjust (s)	-1.0	-1.0	-1.0	-1.0	-1.0	-1.0	-1.0	-1.0	-1.0	-1.0	-1.0	-1.0
Total Lost Time (s)	5.9	5.9	5.9	5.9	5.9	5.9	5.9	5.9	5.9	5.9	5.9	5.9
Lead/Lag	Lead	Lag	Lag	Lead	Lag	Lag	Lead	Lag	Lag	Lead	Lag	
Lead-Lag Optimize?	Yes	Yes	Yes	Yes	Yes	Yes	Yes	Yes	Yes	Yes	Yes	Yes
Recall Mode	None	None	None	None	None	None	None	C-Max	C-Max	None	C-Max	
v/c Ratio	0.69	0.30	0.13	0.25	0.64	0.30	0.40	0.15	0.03	0.34	0.08	0.16
Control Delay	48.4	30.0	6.4	57.1	42.7	6.8	51.3	26.3	11.8	51.9	27.4	2.1
Queue Delay	0.0	0.0	0.0	0.0	0.0	0.0	0.0	0.0	0.0	0.0	0.0	0.0
Total Delay	48.4	30.0	6.4	57.1	42.7	6.8	51.3	26.3	11.8	51.9	27.4	2.1
Queue Length 50th (m)	46.0	29.2	0.0	4.9	33.8	0.0	13.9	14.3	0.0	10.2	7.8	0.8
Queue Length 95th (m)	58.6	36.1	8.9	10.8	41.3	6.8	22.6	25.7	5.8	18.1	16.3	7.6
Internal Link Dist (m)		131.0			112.8			120.2			61.2	
Turn Bay Length (m)	100.0		50.0	30.0		50.0	50.0		50.0	50.0		100.0
Base Capacity (vph)	793	1446	688	183	817	442	353	1304	596	280	1259	1878
Starvation Cap Reductn	0	0	0	0	0	0	0	0	0	0	0	0
Spillback Cap Reductn	0	0	0	0	0	0	0	0	0	0	0	0
Storage Cap Reductn	0	0	0	0	0	0	0	0	0	0	0	0
Reduced v/c Ratio	0.55	0.22	0.10	0.25	0.43	0.23	0.37	0.15	0.03	0.34	0.08	0.15

Intersection Summary

Cycle Length: 112.6

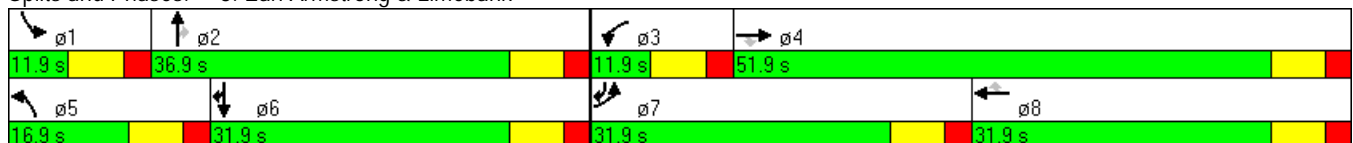
Actuated Cycle Length: 112.6

Offset: 28 (25%), Referenced to phase 2:NBT and 6:SBT, Start of Green

Natural Cycle: 90

Control Type: Actuated-Coordinated

Splits and Phases: 3: Earl Armstrong & Limebank



HCM Signalized Intersection Capacity Analysis

3: Earl Armstrong & Limebank

Future Background Traffic-2021
Weekday AM Peak Hour Zero Interaction

Movement	EBL	EBT	EBR	WBL	WBT	WBR	NBL	NBT	NBR	SBL	SBT	SBR
Lane Configurations												
Volume (vph)	435	325	70	45	355	100	130	190	20	95	105	285
Ideal Flow (vphpl)	1900	1900	1900	1900	1900	1900	1900	1900	1900	1900	1900	1900
Total Lost time (s)	5.9	5.9	5.9	5.9	5.9	5.9	5.9	5.9	5.9	5.9	5.9	5.9
Lane Util. Factor	0.97	0.95	1.00	0.97	0.95	1.00	0.97	0.95	1.00	0.97	0.95	0.88
Frt	1.00	1.00	0.85	1.00	1.00	0.85	1.00	1.00	0.85	1.00	1.00	0.85
Flt Protected	0.95	1.00	1.00	0.95	1.00	1.00	0.95	1.00	1.00	0.95	1.00	1.00
Satd. Flow (prot)	3433	3539	1583	3433	3539	1583	3433	3539	1583	3433	3539	2787
Flt Permitted	0.95	1.00	1.00	0.95	1.00	1.00	0.95	1.00	1.00	0.95	1.00	1.00
Satd. Flow (perm)	3433	3539	1583	3433	3539	1583	3433	3539	1583	3433	3539	2787
Peak-hour factor, PHF	1.00	1.00	1.00	1.00	1.00	1.00	1.00	1.00	1.00	1.00	1.00	1.00
Adj. Flow (vph)	435	325	70	45	355	100	130	190	20	95	105	285
RTOR Reduction (vph)	0	0	48	0	0	83	0	0	13	0	0	112
Lane Group Flow (vph)	435	325	22	45	355	17	130	190	7	95	105	173
Turn Type	Prot		Perm	Prot		Perm	Prot		Perm	Prot		custom
Protected Phases	7	4		3	8		5	2		1	6	6
Permitted Phases			4			8			2			6
Actuated Green, G (s)	19.8	33.7	33.7	4.0	17.9	17.9	9.6	39.1	39.1	8.2	37.7	64.4
Effective Green, g (s)	20.8	34.7	34.7	5.0	18.9	18.9	10.6	40.1	40.1	9.2	38.7	65.4
Actuated g/C Ratio	0.18	0.31	0.31	0.04	0.17	0.17	0.09	0.36	0.36	0.08	0.34	0.58
Clearance Time (s)	6.9	6.9	6.9	6.9	6.9	6.9	6.9	6.9	6.9	6.9	6.9	6.9
Vehicle Extension (s)	3.0	3.0	3.0	3.0	3.0	3.0	3.0	3.0	3.0	3.0	3.0	3.0
Lane Grp Cap (vph)	634	1091	488	152	594	266	323	1260	564	280	1216	1619
v/s Ratio Prot	c0.13	0.09		0.01	c0.10		c0.04	c0.05		0.03	0.03	0.06
v/s Ratio Perm			0.01			0.01			0.00			
v/c Ratio	0.69	0.30	0.04	0.30	0.60	0.06	0.40	0.15	0.01	0.34	0.09	0.11
Uniform Delay, d1	42.9	29.7	27.3	52.1	43.3	39.4	48.0	24.7	23.4	48.8	25.0	10.5
Progression Factor	1.00	1.00	1.00	1.05	0.84	0.57	1.00	1.00	1.00	1.00	1.00	1.00
Incremental Delay, d2	3.1	0.2	0.0	1.1	1.6	0.1	0.8	0.3	0.0	0.7	0.1	0.0
Delay (s)	45.9	29.8	27.4	55.7	38.0	22.4	48.8	24.9	23.5	49.6	25.1	10.6
Level of Service	D	C	C	E	D	C	D	C	C	D	C	B
Approach Delay (s)		38.1			36.4			34.0			21.4	
Approach LOS		D			D			C			C	
Intersection Summary												
HCM Average Control Delay			33.3				HCM Level of Service			C		
HCM Volume to Capacity ratio			0.38									
Actuated Cycle Length (s)			112.6				Sum of lost time (s)		17.7			
Intersection Capacity Utilization			54.4%				ICU Level of Service		A			
Analysis Period (min)			15									
c Critical Lane Group												

Queues
6: Earl Armstrong & Proposed New Road

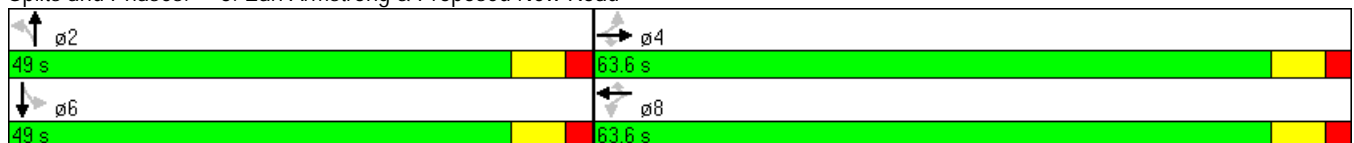
Future Background Traffic-2021
 Weekday AM Peak Hour Zero Interaction

Lane Group	EBL	EBT	EBR	WBL	WBT	WBR	NBL	NBT	SBT
Lane Configurations									
Volume (vph)	35	330	50	5	410	2	75	0	0
Lane Group Flow (vph)	35	330	50	5	410	2	75	30	15
Turn Type	Perm		Perm	Perm		Perm	Perm		
Protected Phases		4			8			2	6
Permitted Phases	4		4	8		8	2		
Detector Phase	4	4	4	8	8	8	2	2	6
Switch Phase									
Minimum Initial (s)	10.0	10.0	10.0	10.0	10.0	10.0	10.0	10.0	10.0
Minimum Split (s)	31.9	31.9	31.9	31.9	31.9	31.9	31.9	31.9	31.9
Total Split (s)	63.6	63.6	63.6	63.6	63.6	63.6	49.0	49.0	49.0
Total Split (%)	56.5%	56.5%	56.5%	56.5%	56.5%	56.5%	43.5%	43.5%	43.5%
Yellow Time (s)	4.6	4.6	4.6	4.6	4.6	4.6	4.6	4.6	4.6
All-Red Time (s)	2.3	2.3	2.3	2.3	2.3	2.3	2.3	2.3	2.3
Lost Time Adjust (s)	-1.0	-1.0	-1.0	-1.0	-1.0	-1.0	-1.0	-1.0	-1.0
Total Lost Time (s)	5.9	5.9	5.9	5.9	5.9	5.9	5.9	5.9	5.9
Lead/Lag									
Lead-Lag Optimize?									
Recall Mode	C-Max	C-Max	C-Max	C-Max	C-Max	C-Max	None	None	None
v/c Ratio	0.04	0.11	0.04	0.01	0.14	0.00	0.45	0.05	0.03
Control Delay	0.2	0.2	0.1	3.6	3.2	2.5	54.7	0.2	0.1
Queue Delay	0.0	0.0	0.0	0.0	0.0	0.0	0.0	0.0	0.0
Total Delay	0.2	0.2	0.1	3.6	3.2	2.5	54.7	0.2	0.1
Queue Length 50th (m)	0.1	0.3	0.0	0.2	9.2	0.0	15.6	0.0	0.0
Queue Length 95th (m)	0.1	0.3	0.0	1.2	16.3	0.6	28.9	0.0	0.0
Internal Link Dist (m)		95.8			43.9			72.0	67.0
Turn Bay Length (m)	30.0		30.0	30.0		30.0	30.0		
Base Capacity (vph)	778	2893	1303	842	2893	1294	533	900	845
Starvation Cap Reductn	0	0	0	0	0	0	0	0	0
Spillback Cap Reductn	0	0	0	0	0	0	0	0	0
Storage Cap Reductn	0	0	0	0	0	0	0	0	0
Reduced v/c Ratio	0.04	0.11	0.04	0.01	0.14	0.00	0.14	0.03	0.02

Intersection Summary

Cycle Length: 112.6
 Actuated Cycle Length: 112.6
 Offset: 0 (0%), Referenced to phase 4:EBTL and 8:WBTL, Start of Green
 Natural Cycle: 65
 Control Type: Actuated-Coordinated





























Splits and Phases: 6: Earl Armstrong & Proposed New Road



HCM Signalized Intersection Capacity Analysis

6: Earl Armstrong & Proposed New Road

Future Background Traffic-2021
Weekday AM Peak Hour Zero Interaction

												
Movement	EBL	EBT	EBR	WBL	WBT	WBR	NBL	NBT	NBR	SBL	SBT	SBR
Lane Configurations		 			 			 			 	
Volume (vph)	35	330	50	5	410	2	75	0	30	0	0	15
Ideal Flow (vphpl)	1900	1900	1900	1900	1900	1900	1900	1900	1900	1900	1900	1900
Total Lost time (s)	5.9	5.9	5.9	5.9	5.9	5.9	5.9	5.9			5.9	
Lane Util. Factor	1.00	0.95	1.00	1.00	0.95	1.00	1.00	1.00			1.00	
Frt	1.00	1.00	0.85	1.00	1.00	0.85	1.00	0.85			0.85	
Flt Protected	0.95	1.00	1.00	0.95	1.00	1.00	0.95	1.00			1.00	
Satd. Flow (prot)	1770	3539	1583	1770	3539	1583	1770	1583			1583	
Flt Permitted	0.51	1.00	1.00	0.55	1.00	1.00	0.75	1.00			1.00	
Satd. Flow (perm)	953	3539	1583	1029	3539	1583	1393	1583			1583	
Peak-hour factor, PHF	1.00	1.00	1.00	1.00	1.00	1.00	1.00	1.00	1.00	1.00	1.00	1.00
Adj. Flow (vph)	35	330	50	5	410	2	75	0	30	0	0	15
RTOR Reduction (vph)	0	0	10	0	0	0	0	27	0	0	13	0
Lane Group Flow (vph)	35	330	40	5	410	2	75	3	0	0	2	0
Turn Type	Perm		Perm	Perm		Perm	Perm			Perm		
Protected Phases		4			8			2				6
Permitted Phases	4		4	8		8	2			6		
Actuated Green, G (s)	88.5	88.5	88.5	88.5	88.5	88.5	10.3	10.3			10.3	
Effective Green, g (s)	89.5	89.5	89.5	89.5	89.5	89.5	11.3	11.3			11.3	
Actuated g/C Ratio	0.79	0.79	0.79	0.79	0.79	0.79	0.10	0.10			0.10	
Clearance Time (s)	6.9	6.9	6.9	6.9	6.9	6.9	6.9	6.9			6.9	
Vehicle Extension (s)	3.0	3.0	3.0	3.0	3.0	3.0	3.0	3.0			3.0	
Lane Grp Cap (vph)	757	2813	1258	818	2813	1258	140	159			159	
v/s Ratio Prot		0.09			c0.12			0.00			0.00	
v/s Ratio Perm	0.04		0.03	0.00		0.00	c0.05					
v/c Ratio	0.05	0.12	0.03	0.01	0.15	0.00	0.54	0.02			0.01	
Uniform Delay, d1	2.5	2.6	2.4	2.4	2.7	2.4	48.2	45.7			45.6	
Progression Factor	0.04	0.04	0.00	1.00	1.00	1.00	1.00	1.00			1.00	
Incremental Delay, d2	0.1	0.1	0.0	0.0	0.1	0.0	3.9	0.0			0.0	
Delay (s)	0.2	0.2	0.0	2.4	2.8	2.4	52.1	45.7			45.6	
Level of Service	A	A	A	A	A	A	D	D			D	
Approach Delay (s)		0.2			2.8			50.2			45.6	
Approach LOS		A			A			D			D	
Intersection Summary												
HCM Average Control Delay			7.6				HCM Level of Service				A	
HCM Volume to Capacity ratio			0.19									
Actuated Cycle Length (s)			112.6				Sum of lost time (s)			11.8		
Intersection Capacity Utilization			45.2%				ICU Level of Service			A		
Analysis Period (min)			15									
c Critical Lane Group												












HCM Unsignalized Intersection Capacity Analysis
 9: Earl Armstrong & RIRO Site Access

Future Background Traffic-2021
 Weekday AM Peak Hour Zero Interaction

	→	↘	↙	←	↖	↗
Movement	EBT	EBR	WBL	WBT	NBL	NBR
Lane Configurations	↑↑			↑↑		↗
Volume (veh/h)	415	25	0	500	0	1
Sign Control	Free			Free	Stop	
Grade	0%			0%	0%	
Peak Hour Factor	1.00	1.00	1.00	1.00	1.00	1.00
Hourly flow rate (vph)	415	25	0	500	0	1
Pedestrians						
Lane Width (m)						
Walking Speed (m/s)						
Percent Blockage						
Right turn flare (veh)						
Median type	None			None		
Median storage (veh)						
Upstream signal (m)	137			120		
pX, platoon unblocked			0.94		0.94	0.94
vC, conflicting volume			440		678	220
vC1, stage 1 conf vol						
vC2, stage 2 conf vol						
vCu, unblocked vol			271		489	36
tC, single (s)			4.1		6.8	6.9
tC, 2 stage (s)						
tF (s)			2.2		3.5	3.3
p0 queue free %			100		100	100
cM capacity (veh/h)			1210		479	964
Direction, Lane #	EB 1	EB 2	WB 1	WB 2	NB 1	
Volume Total	277	163	250	250	1	
Volume Left	0	0	0	0	0	
Volume Right	0	25	0	0	1	
cSH	1700	1700	1700	1700	964	
Volume to Capacity	0.16	0.10	0.15	0.15	0.00	
Queue Length 95th (m)	0.0	0.0	0.0	0.0	0.0	
Control Delay (s)	0.0	0.0	0.0	0.0	8.7	
Lane LOS						A
Approach Delay (s)	0.0		0.0		8.7	
Approach LOS						A
Intersection Summary						
Average Delay			0.0			
Intersection Capacity Utilization			22.3%	ICU Level of Service	A	
Analysis Period (min)			15			










HCM Unsignalized Intersection Capacity Analysis
 11: Site Access & Limebank

Future Background Traffic-2021
 Weekday AM Peak Hour Zero Interaction

							
Movement	WBL	WBR	NBT	NBR	SBL	SBT	
Lane Configurations							
Volume (veh/h)	25	55	285	40	65	155	
Sign Control	Stop		Free			Free	
Grade	0%		0%			0%	
Peak Hour Factor	1.00	1.00	1.00	1.00	1.00	1.00	
Hourly flow rate (vph)	25	55	285	40	65	155	
Pedestrians							
Lane Width (m)							
Walking Speed (m/s)							
Percent Blockage							
Right turn flare (veh)							
Median type			None			None	
Median storage (veh)							
Upstream signal (m)						144	
pX, platoon unblocked							
vC, conflicting volume	512	162			325		
vC1, stage 1 conf vol							
vC2, stage 2 conf vol							
vCu, unblocked vol	512	162			325		
tC, single (s)	6.8	6.9			4.1		
tC, 2 stage (s)							
tF (s)	3.5	3.3			2.2		
p0 queue free %	95	94			95		
cM capacity (veh/h)	465	854			1231		
Direction, Lane #	WB 1	WB 2	NB 1	NB 2	SB 1	SB 2	SB 3
Volume Total	25	55	190	135	65	78	78
Volume Left	25	0	0	0	65	0	0
Volume Right	0	55	0	40	0	0	0
cSH	465	854	1700	1700	1231	1700	1700
Volume to Capacity	0.05	0.06	0.11	0.08	0.05	0.05	0.05
Queue Length 95th (m)	1.3	1.5	0.0	0.0	1.3	0.0	0.0
Control Delay (s)	13.2	9.5	0.0	0.0	8.1	0.0	0.0
Lane LOS	B	A			A		
Approach Delay (s)	10.7		0.0		2.4		
Approach LOS	B						
Intersection Summary							
Average Delay			2.2				
Intersection Capacity Utilization			26.1%		ICU Level of Service		A
Analysis Period (min)			15				










HCM Unsignalized Intersection Capacity Analysis
 13: N. Site Access & Proposed New Road

Future Background Traffic-2021
 Weekday AM Peak Hour Zero Interaction

						
Movement	EBL	EBR	NBL	NBT	SBT	SBR
Lane Configurations						
Volume (veh/h)	2	0	5	105	50	5
Sign Control	Stop			Free	Free	
Grade	0%			0%	0%	
Peak Hour Factor	1.00	1.00	1.00	1.00	1.00	1.00
Hourly flow rate (vph)	2	0	5	105	50	5
Pedestrians						
Lane Width (m)						
Walking Speed (m/s)						
Percent Blockage						
Right turn flare (veh)						
Median type				None	None	
Median storage (veh)						
Upstream signal (m)					96	
pX, platoon unblocked						
vC, conflicting volume	168	52	55			
vC1, stage 1 conf vol						
vC2, stage 2 conf vol						
vCu, unblocked vol	168	52	55			
tC, single (s)	6.4	6.2	4.1			
tC, 2 stage (s)						
tF (s)	3.5	3.3	2.2			
p0 queue free %	100	100	100			
cM capacity (veh/h)	820	1015	1550			
Direction, Lane #	EB 1	NB 1	SB 1			
Volume Total	2	110	55			
Volume Left	2	5	0			
Volume Right	0	0	5			
cSH	820	1550	1700			
Volume to Capacity	0.00	0.00	0.03			
Queue Length 95th (m)	0.1	0.1	0.0			
Control Delay (s)	9.4	0.4	0.0			
Lane LOS	A	A				
Approach Delay (s)	9.4	0.4	0.0			
Approach LOS	A					
Intersection Summary						
Average Delay			0.3			
Intersection Capacity Utilization		19.6%		ICU Level of Service	A	
Analysis Period (min)			15			

HCM Unsignalized Intersection Capacity Analysis
 15: S. Site Access & Proposed New Road

Future Background Traffic-2021
 Weekday AM Peak Hour Zero Interaction

						
Movement	EBL	EBR	NBL	NBT	SBT	SBR
Lane Configurations						
Volume (veh/h)	5	0	1	105	50	1
Sign Control	Stop			Free	Free	
Grade	0%			0%	0%	
Peak Hour Factor	1.00	1.00	1.00	1.00	1.00	1.00
Hourly flow rate (vph)	5	0	1	105	50	1
Pedestrians						
Lane Width (m)						
Walking Speed (m/s)						
Percent Blockage						
Right turn flare (veh)						
Median type				None	None	
Median storage (veh)						
Upstream signal (m)					185	
pX, platoon unblocked						
vC, conflicting volume	158	50	51			
vC1, stage 1 conf vol						
vC2, stage 2 conf vol						
vCu, unblocked vol	158	50	51			
tC, single (s)	6.4	6.2	4.1			
tC, 2 stage (s)						
tF (s)	3.5	3.3	2.2			
p0 queue free %	99	100	100			
cM capacity (veh/h)	833	1018	1555			
Direction, Lane #	EB 1	NB 1	SB 1			
Volume Total	5	106	51			
Volume Left	5	1	0			
Volume Right	0	0	1			
cSH	833	1555	1700			
Volume to Capacity	0.01	0.00	0.03			
Queue Length 95th (m)	0.1	0.0	0.0			
Control Delay (s)	9.3	0.1	0.0			
Lane LOS	A	A				
Approach Delay (s)	9.3	0.1	0.0			
Approach LOS	A					
Intersection Summary						
Average Delay			0.3			
Intersection Capacity Utilization		16.3%		ICU Level of Service		A
Analysis Period (min)			15			

Queues

Future Background Traffic-2021

3: Earl Armstrong & Limebank

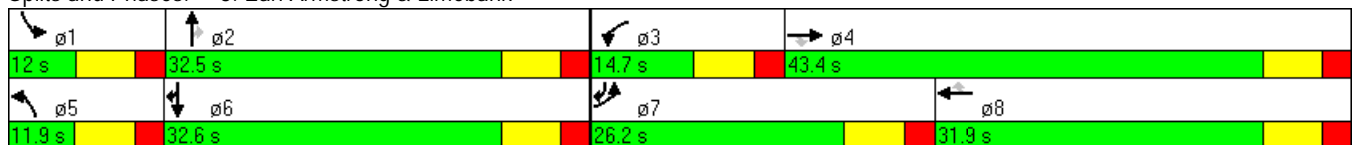
Weekday PM Peak Hour Zero Interaction

Lane Group	EBL	EBT	EBR	WBL	WBT	WBR	NBL	NBT	NBR	SBL	SBT	SBR
Lane Configurations												
Volume (vph)	640	600	105	95	595	155	75	135	55	245	205	755
Lane Group Flow (vph)	640	600	105	95	595	155	75	135	55	245	205	755
Turn Type	Prot		Perm	Prot		Perm	Prot		Perm	Prot		custom
Protected Phases	7	4		3	8		5	2		1	6	6 7
Permitted Phases			4			8			2			6
Detector Phase	7	4	4	3	8	8	5	2	2	1	6	6 7
Switch Phase												
Minimum Initial (s)	5.0	10.0	10.0	5.0	10.0	10.0	5.0	10.0	10.0	5.0	10.0	
Minimum Split (s)	11.9	31.9	31.9	11.9	31.9	31.9	11.9	31.9	31.9	11.9	31.9	
Total Split (s)	26.2	43.4	43.4	14.7	31.9	31.9	11.9	32.5	32.5	12.0	32.6	58.8
Total Split (%)	25.5%	42.3%	42.3%	14.3%	31.1%	31.1%	11.6%	31.7%	31.7%	11.7%	31.8%	57.3%
Yellow Time (s)	4.6	4.6	4.6	4.6	4.6	4.6	4.6	4.6	4.6	4.6	4.6	
All-Red Time (s)	2.3	2.3	2.3	2.3	2.3	2.3	2.3	2.3	2.3	2.3	2.3	
Lost Time Adjust (s)	-1.0	-1.0	-1.0	-1.0	-1.0	-1.0	-1.0	-1.0	-1.0	-1.0	-1.0	-1.0
Total Lost Time (s)	5.9	5.9	5.9	5.9	5.9	5.9	5.9	5.9	5.9	5.9	5.9	5.9
Lead/Lag	Lead	Lag	Lag	Lead	Lag	Lag	Lead	Lag	Lag	Lead	Lag	
Lead-Lag Optimize?	Yes	Yes	Yes	Yes	Yes	Yes	Yes	Yes	Yes	Yes	Yes	Yes
Recall Mode	None	None	None	None	None	None	None	C-Max	C-Max	None	C-Max	
v/c Ratio	0.94	0.46	0.16	0.34	0.75	0.33	0.33	0.15	0.12	0.81	0.19	0.47
Control Delay	64.4	26.5	5.1	50.0	36.5	4.3	50.0	29.8	8.9	69.4	28.8	13.1
Queue Delay	0.0	0.0	0.0	0.0	0.0	0.0	0.0	0.0	0.0	0.0	0.0	0.0
Total Delay	64.4	26.5	5.1	50.0	36.5	4.3	50.0	29.8	8.9	69.4	28.8	13.1
Queue Length 50th (m)	64.4	48.3	0.0	9.4	45.0	0.6	7.3	10.7	0.0	25.1	16.6	43.2
Queue Length 95th (m)	#97.1	62.2	10.4	17.3	56.4	8.0	14.4	18.2	9.0	#54.2	26.1	60.0
Internal Link Dist (m)		131.0			113.3			120.8			61.2	
Turn Bay Length (m)	100.0		50.0	30.0		50.0	50.0		50.0	50.0		100.0
Base Capacity (vph)	679	1340	665	294	897	517	230	918	451	302	1078	1617
Starvation Cap Reductn	0	0	0	0	0	0	0	0	0	0	0	0
Spillback Cap Reductn	0	0	0	0	0	0	0	0	0	0	0	0
Storage Cap Reductn	0	0	0	0	0	0	0	0	0	0	0	0
Reduced v/c Ratio	0.94	0.45	0.16	0.32	0.66	0.30	0.33	0.15	0.12	0.81	0.19	0.47

Intersection Summary

Cycle Length: 102.6
 Actuated Cycle Length: 102.6
 Offset: 24 (23%), Referenced to phase 2:NBT and 6:SBT, Start of Green
 Natural Cycle: 100
 Control Type: Actuated-Coordinated
 # 95th percentile volume exceeds capacity, queue may be longer.
 Queue shown is maximum after two cycles.

Splits and Phases: 3: Earl Armstrong & Limebank



HCM Signalized Intersection Capacity Analysis

3: Earl Armstrong & Limebank

Future Background Traffic-2021
Weekday PM Peak Hour Zero Interaction

Movement	EBL	EBT	EBR	WBL	WBT	WBR	NBL	NBT	NBR	SBL	SBT	SBR
Lane Configurations												
Volume (vph)	640	600	105	95	595	155	75	135	55	245	205	755
Ideal Flow (vphpl)	1900	1900	1900	1900	1900	1900	1900	1900	1900	1900	1900	1900
Total Lost time (s)	5.9	5.9	5.9	5.9	5.9	5.9	5.9	5.9	5.9	5.9	5.9	5.9
Lane Util. Factor	0.97	0.95	1.00	0.97	0.95	1.00	0.97	0.95	1.00	0.97	0.95	0.88
Frt	1.00	1.00	0.85	1.00	1.00	0.85	1.00	1.00	0.85	1.00	1.00	0.85
Flt Protected	0.95	1.00	1.00	0.95	1.00	1.00	0.95	1.00	1.00	0.95	1.00	1.00
Satd. Flow (prot)	3433	3539	1583	3433	3539	1583	3433	3539	1583	3433	3539	2787
Flt Permitted	0.95	1.00	1.00	0.95	1.00	1.00	0.95	1.00	1.00	0.95	1.00	1.00
Satd. Flow (perm)	3433	3539	1583	3433	3539	1583	3433	3539	1583	3433	3539	2787
Peak-hour factor, PHF	1.00	1.00	1.00	1.00	1.00	1.00	1.00	1.00	1.00	1.00	1.00	1.00
Adj. Flow (vph)	640	600	105	95	595	155	75	135	55	245	205	755
RTOR Reduction (vph)	0	0	67	0	0	118	0	0	41	0	0	60
Lane Group Flow (vph)	640	600	38	95	595	37	75	135	14	245	205	695
Turn Type	Prot		Perm	Prot		Perm	Prot		Perm	Prot		custom
Protected Phases	7	4		3	8		5	2		1	6	6
Permitted Phases			4			8			2			6
Actuated Green, G (s)	19.3	36.6	36.6	6.1	23.4	23.4	4.7	24.3	24.3	8.0	27.6	53.8
Effective Green, g (s)	20.3	37.6	37.6	7.1	24.4	24.4	5.7	25.3	25.3	9.0	28.6	54.8
Actuated g/C Ratio	0.20	0.37	0.37	0.07	0.24	0.24	0.06	0.25	0.25	0.09	0.28	0.53
Clearance Time (s)	6.9	6.9	6.9	6.9	6.9	6.9	6.9	6.9	6.9	6.9	6.9	6.9
Vehicle Extension (s)	3.0	3.0	3.0	3.0	3.0	3.0	3.0	3.0	3.0	3.0	3.0	3.0
Lane Grp Cap (vph)	679	1297	580	238	842	376	191	873	390	301	987	1489
v/s Ratio Prot	c0.19	0.17		0.03	c0.17		0.02	0.04		c0.07	0.06	c0.25
v/s Ratio Perm			0.02			0.02			0.01			
v/c Ratio	0.94	0.46	0.07	0.40	0.71	0.10	0.39	0.15	0.03	0.81	0.21	0.47
Uniform Delay, d1	40.6	24.8	21.1	45.7	35.8	30.5	46.8	30.3	29.4	46.0	28.3	14.8
Progression Factor	1.00	1.00	1.00	1.05	0.82	0.47	1.00	1.00	1.00	1.00	1.00	1.00
Incremental Delay, d2	21.5	0.3	0.0	1.1	2.7	0.1	1.3	0.4	0.2	15.4	0.5	0.2
Delay (s)	62.1	25.1	21.2	49.1	32.2	14.5	48.1	30.7	29.5	61.4	28.8	15.1
Level of Service	E	C	C	D	C	B	D	C	C	E	C	B
Approach Delay (s)		42.4			30.8			35.4			26.8	
Approach LOS		D			C			D			C	
Intersection Summary												
HCM Average Control Delay			34.1				HCM Level of Service			C		
HCM Volume to Capacity ratio			0.74									
Actuated Cycle Length (s)			102.6				Sum of lost time (s)		23.6			
Intersection Capacity Utilization			69.7%				ICU Level of Service		C			
Analysis Period (min)			15									
c Critical Lane Group												

Queues
6: Earl Armstrong & Proposed New Road

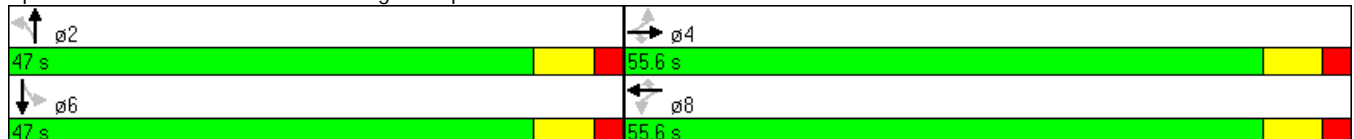
Future Background Traffic-2021
 Weekday PM Peak Hour Zero Interaction

Lane Group	EBL	EBT	EBR	WBL	WBT	WBR	NBL	NBT	SBT
Lane Configurations									
Volume (vph)	95	650	105	25	645	10	110	5	5
Lane Group Flow (vph)	95	650	105	25	645	10	110	55	95
Turn Type	Perm		Perm	Perm		Perm	Perm		
Protected Phases		4			8			2	6
Permitted Phases	4		4	8		8	2		
Detector Phase	4	4	4	8	8	8	2	2	6
Switch Phase									
Minimum Initial (s)	10.0	10.0	10.0	10.0	10.0	10.0	10.0	10.0	10.0
Minimum Split (s)	31.9	31.9	31.9	31.9	31.9	31.9	31.9	31.9	31.9
Total Split (s)	55.6	55.6	55.6	55.6	55.6	55.6	47.0	47.0	47.0
Total Split (%)	54.2%	54.2%	54.2%	54.2%	54.2%	54.2%	45.8%	45.8%	45.8%
Yellow Time (s)	4.6	4.6	4.6	4.6	4.6	4.6	4.6	4.6	4.6
All-Red Time (s)	2.3	2.3	2.3	2.3	2.3	2.3	2.3	2.3	2.3
Lost Time Adjust (s)	-1.0	-1.0	-1.0	-1.0	-1.0	-1.0	-1.0	-1.0	-1.0
Total Lost Time (s)	5.9	5.9	5.9	5.9	5.9	5.9	5.9	5.9	5.9
Lead/Lag									
Lead-Lag Optimize?									
Recall Mode	C-Max	C-Max	C-Max	C-Max	C-Max	C-Max	None	None	None
v/c Ratio	0.17	0.25	0.09	0.05	0.25	0.01	0.56	0.19	0.30
Control Delay	1.0	0.6	0.1	5.1	5.2	2.8	50.4	13.1	11.0
Queue Delay	0.0	0.0	0.0	0.0	0.0	0.0	0.0	0.0	0.0
Total Delay	1.0	0.6	0.1	5.1	5.2	2.8	50.4	13.1	11.0
Queue Length 50th (m)	0.4	1.4	0.0	1.1	18.0	0.0	20.4	0.9	0.9
Queue Length 95th (m)	m0.8	m2.0	m0.0	4.2	31.3	1.6	35.0	10.4	13.3
Internal Link Dist (m)		96.0			43.9			72.0	67.0
Turn Bay Length (m)	30.0		30.0	30.0		30.0	30.0		
Base Capacity (vph)	552	2593	1188	549	2593	1162	519	675	694
Starvation Cap Reductn	0	0	0	0	0	0	0	0	0
Spillback Cap Reductn	0	0	0	0	0	0	0	0	0
Storage Cap Reductn	0	0	0	0	0	0	0	0	0
Reduced v/c Ratio	0.17	0.25	0.09	0.05	0.25	0.01	0.21	0.08	0.14

Intersection Summary

Cycle Length: 102.6
 Actuated Cycle Length: 102.6
 Offset: 0 (0%), Referenced to phase 4:EBTL and 8:WBTL, Start of Green
 Natural Cycle: 65
 Control Type: Actuated-Coordinated
 m Volume for 95th percentile queue is metered by upstream signal.





























Splits and Phases: 6: Earl Armstrong & Proposed New Road



HCM Signalized Intersection Capacity Analysis

6: Earl Armstrong & Proposed New Road

Future Background Traffic-2021
Weekday PM Peak Hour Zero Interaction

												
Movement	EBL	EBT	EBR	WBL	WBT	WBR	NBL	NBT	NBR	SBL	SBT	SBR
Lane Configurations		 			 			 			 	
Volume (vph)	95	650	105	25	645	10	110	5	50	0	5	90
Ideal Flow (vphpl)	1900	1900	1900	1900	1900	1900	1900	1900	1900	1900	1900	1900
Total Lost time (s)	5.9	5.9	5.9	5.9	5.9	5.9	5.9	5.9			5.9	
Lane Util. Factor	1.00	0.95	1.00	1.00	0.95	1.00	1.00	1.00			1.00	
Frt	1.00	1.00	0.85	1.00	1.00	0.85	1.00	0.86			0.86	
Flt Protected	0.95	1.00	1.00	0.95	1.00	1.00	0.95	1.00			1.00	
Satd. Flow (prot)	1770	3539	1583	1770	3539	1583	1770	1609			1598	
Flt Permitted	0.40	1.00	1.00	0.40	1.00	1.00	0.70	1.00			1.00	
Satd. Flow (perm)	753	3539	1583	749	3539	1583	1295	1609			1598	
Peak-hour factor, PHF	1.00	1.00	1.00	1.00	1.00	1.00	1.00	1.00	1.00	1.00	1.00	1.00
Adj. Flow (vph)	95	650	105	25	645	10	110	5	50	0	5	90
RTOR Reduction (vph)	0	0	28	0	0	3	0	42	0	0	76	0
Lane Group Flow (vph)	95	650	77	25	645	7	110	13	0	0	19	0
Turn Type	Perm		Perm	Perm		Perm	Perm			Perm		
Protected Phases		4			8			2				6
Permitted Phases	4		4	8		8	2			6		
Actuated Green, G (s)	74.2	74.2	74.2	74.2	74.2	74.2	14.6	14.6			14.6	
Effective Green, g (s)	75.2	75.2	75.2	75.2	75.2	75.2	15.6	15.6			15.6	
Actuated g/C Ratio	0.73	0.73	0.73	0.73	0.73	0.73	0.15	0.15			0.15	
Clearance Time (s)	6.9	6.9	6.9	6.9	6.9	6.9	6.9	6.9			6.9	
Vehicle Extension (s)	3.0	3.0	3.0	3.0	3.0	3.0	3.0	3.0			3.0	
Lane Grp Cap (vph)	552	2594	1160	549	2594	1160	197	245			243	
v/s Ratio Prot		c0.18			0.18			0.01			0.01	
v/s Ratio Perm	0.13		0.05	0.03		0.00	c0.08					
v/c Ratio	0.17	0.25	0.07	0.05	0.25	0.01	0.56	0.05			0.08	
Uniform Delay, d1	4.2	4.5	3.8	3.8	4.5	3.7	40.3	37.2			37.3	
Progression Factor	0.07	0.08	0.00	1.00	1.00	1.00	1.00	1.00			1.00	
Incremental Delay, d2	0.6	0.2	0.1	0.2	0.2	0.0	3.4	0.1			0.1	
Delay (s)	0.9	0.6	0.1	3.9	4.7	3.7	43.7	37.3			37.5	
Level of Service	A	A	A	A	A	A	D	D			D	
Approach Delay (s)		0.5			4.7			41.6			37.5	
Approach LOS		A			A			D			D	
Intersection Summary												
HCM Average Control Delay			7.8				HCM Level of Service				A	
HCM Volume to Capacity ratio			0.30									
Actuated Cycle Length (s)			102.6				Sum of lost time (s)			11.8		
Intersection Capacity Utilization			53.8%				ICU Level of Service				A	
Analysis Period (min)			15									
c Critical Lane Group												

HCM Unsignalized Intersection Capacity Analysis














9: Earl Armstrong & RIRO Site Access

Future Background Traffic-2021
Weekday PM Peak Hour Zero Interaction

	→	↘	↙	←	↖	↗
Movement	EBT	EBR	WBL	WBT	NBL	NBR
Lane Configurations	↑↑			↑↑		↗
Volume (veh/h)	820	80	0	845	0	30
Sign Control	Free			Free	Stop	
Grade	0%			0%	0%	
Peak Hour Factor	1.00	1.00	1.00	1.00	1.00	1.00
Hourly flow rate (vph)	820	80	0	845	0	30
Pedestrians						
Lane Width (m)						
Walking Speed (m/s)						
Percent Blockage						
Right turn flare (veh)						
Median type	None			None		
Median storage (veh)						
Upstream signal (m)	137			120		
pX, platoon unblocked			0.87		0.90	0.87
vC, conflicting volume			900		1282	450
vC1, stage 1 conf vol						
vC2, stage 2 conf vol						
vCu, unblocked vol			598		828	83
tC, single (s)			4.1		6.8	6.9
tC, 2 stage (s)						
tF (s)			2.2		3.5	3.3
p0 queue free %			100		100	96
cM capacity (veh/h)			852		279	839
Direction, Lane #	EB 1	EB 2	WB 1	WB 2	NB 1	
Volume Total	547	353	422	422	30	
Volume Left	0	0	0	0	0	
Volume Right	0	80	0	0	30	
cSH	1700	1700	1700	1700	839	
Volume to Capacity	0.32	0.21	0.25	0.25	0.04	
Queue Length 95th (m)	0.0	0.0	0.0	0.0	0.8	
Control Delay (s)	0.0	0.0	0.0	0.0	9.4	
Lane LOS						A
Approach Delay (s)	0.0		0.0		9.4	
Approach LOS						A
Intersection Summary						
Average Delay			0.2			
Intersection Capacity Utilization			35.2%		ICU Level of Service	A
Analysis Period (min)			15			










HCM Unsignalized Intersection Capacity Analysis
 11: Site Access & Limebank

Future Background Traffic-2021
 Weekday PM Peak Hour Zero Interaction

							
Movement	WBL	WBR	NBT	NBR	SBL	SBT	
Lane Configurations			 			 	
Volume (veh/h)	135	230	40	110	185	220	
Sign Control	Stop		Free			Free	
Grade	0%		0%			0%	
Peak Hour Factor	1.00	1.00	1.00	1.00	1.00	1.00	
Hourly flow rate (vph)	135	230	40	110	185	220	
Pedestrians							
Lane Width (m)							
Walking Speed (m/s)							
Percent Blockage							
Right turn flare (veh)							
Median type			None			None	
Median storage (veh)							
Upstream signal (m)						145	
pX, platoon unblocked							
vC, conflicting volume	575	75			150		
vC1, stage 1 conf vol							
vC2, stage 2 conf vol							
vCu, unblocked vol	575	75			150		
tC, single (s)	6.8	6.9			4.1		
tC, 2 stage (s)							
tF (s)	3.5	3.3			2.2		
p0 queue free %	65	76			87		
cM capacity (veh/h)	390	971			1429		
Direction, Lane #	WB 1	WB 2	NB 1	NB 2	SB 1	SB 2	SB 3
Volume Total	135	230	27	123	185	110	110
Volume Left	135	0	0	0	185	0	0
Volume Right	0	230	0	110	0	0	0
cSH	390	971	1700	1700	1429	1700	1700
Volume to Capacity	0.35	0.24	0.02	0.07	0.13	0.06	0.06
Queue Length 95th (m)	11.4	6.9	0.0	0.0	3.3	0.0	0.0
Control Delay (s)	19.0	9.9	0.0	0.0	7.9	0.0	0.0
Lane LOS	C	A			A		
Approach Delay (s)	13.2		0.0		3.6		
Approach LOS	B						
Intersection Summary							
Average Delay			6.8				
Intersection Capacity Utilization			32.4%		ICU Level of Service		A
Analysis Period (min)			15				










HCM Unsignalized Intersection Capacity Analysis
 13: N. Site Access & Proposed New Road

Future Background Traffic-2021
 Weekday PM Peak Hour Zero Interaction

						
Movement	EBL	EBR	NBL	NBT	SBT	SBR
Lane Configurations						
Volume (veh/h)	20	5	5	145	110	25
Sign Control	Stop			Free	Free	
Grade	0%			0%	0%	
Peak Hour Factor	1.00	1.00	1.00	1.00	1.00	1.00
Hourly flow rate (vph)	20	5	5	145	110	25
Pedestrians						
Lane Width (m)						
Walking Speed (m/s)						
Percent Blockage						
Right turn flare (veh)						
Median type				None	None	
Median storage (veh)						
Upstream signal (m)					96	
pX, platoon unblocked						
vC, conflicting volume	278	122	135			
vC1, stage 1 conf vol						
vC2, stage 2 conf vol						
vCu, unblocked vol	278	122	135			
tC, single (s)	6.4	6.2	4.1			
tC, 2 stage (s)						
tF (s)	3.5	3.3	2.2			
p0 queue free %	97	99	100			
cM capacity (veh/h)	710	929	1449			
Direction, Lane #	EB 1	NB 1	SB 1			
Volume Total	25	150	135			
Volume Left	20	5	0			
Volume Right	5	0	25			
cSH	745	1449	1700			
Volume to Capacity	0.03	0.00	0.08			
Queue Length 95th (m)	0.8	0.1	0.0			
Control Delay (s)	10.0	0.3	0.0			
Lane LOS	B	A				
Approach Delay (s)	10.0	0.3	0.0			
Approach LOS	B					
Intersection Summary						
Average Delay			0.9			
Intersection Capacity Utilization		21.7%		ICU Level of Service		A
Analysis Period (min)			15			

HCM Unsignalized Intersection Capacity Analysis
 15: S. Site Access & Proposed New Road

Future Background Traffic-2021
 Weekday PM Peak Hour Zero Interaction

						
Movement	EBL	EBR	NBL	NBT	SBT	SBR
Lane Configurations						
Volume (veh/h)	5	10	10	145	110	5
Sign Control	Stop			Free	Free	
Grade	0%			0%	0%	
Peak Hour Factor	1.00	1.00	1.00	1.00	1.00	1.00
Hourly flow rate (vph)	5	10	10	145	110	5
Pedestrians						
Lane Width (m)						
Walking Speed (m/s)						
Percent Blockage						
Right turn flare (veh)						
Median type				None	None	
Median storage (veh)						
Upstream signal (m)					185	
pX, platoon unblocked						
vC, conflicting volume	278	112	115			
vC1, stage 1 conf vol						
vC2, stage 2 conf vol						
vCu, unblocked vol	278	112	115			
tC, single (s)	6.4	6.2	4.1			
tC, 2 stage (s)						
tF (s)	3.5	3.3	2.2			
p0 queue free %	99	99	99			
cM capacity (veh/h)	707	940	1474			
Direction, Lane #	EB 1	NB 1	SB 1			
Volume Total	15	155	115			
Volume Left	5	10	0			
Volume Right	10	0	5			
cSH	847	1474	1700			
Volume to Capacity	0.02	0.01	0.07			
Queue Length 95th (m)	0.4	0.2	0.0			
Control Delay (s)	9.3	0.5	0.0			
Lane LOS	A	A				
Approach Delay (s)	9.3	0.5	0.0			
Approach LOS	A					
Intersection Summary						
Average Delay			0.8			
Intersection Capacity Utilization		24.9%		ICU Level of Service		A
Analysis Period (min)			15			

Queues

3: Earl Armstrong & Limebank

Future Total Traffic-2021

Weekday AM Peak Hour Zero Interaction

Lane Group	EBL	EBT	EBR	WBL	WBT	WBR	NBL	NBT	NBR	SBL	SBT	SBR
Lane Configurations												
Volume (vph)	435	325	70	45	355	100	130	190	25	90	110	285
Lane Group Flow (vph)	435	325	70	45	355	100	130	190	25	90	110	285
Turn Type	Prot		Perm	Prot		Perm	Prot		Perm	Prot		custom
Protected Phases	7	4		3	8		5	2		1	6	6 7
Permitted Phases			4			8			2			6
Detector Phase	7	4	4	3	8	8	5	2	2	1	6	6 7
Switch Phase												
Minimum Initial (s)	5.0	10.0	10.0	5.0	10.0	10.0	5.0	10.0	10.0	5.0	10.0	
Minimum Split (s)	11.9	31.9	31.9	11.9	31.9	31.9	11.9	31.9	31.9	11.9	31.9	
Total Split (s)	31.9	51.9	51.9	11.9	31.9	31.9	16.9	36.9	36.9	11.9	31.9	63.8
Total Split (%)	28.3%	46.1%	46.1%	10.6%	28.3%	28.3%	15.0%	32.8%	32.8%	10.6%	28.3%	56.7%
Yellow Time (s)	4.6	4.6	4.6	4.6	4.6	4.6	4.6	4.6	4.6	4.6	4.6	4.6
All-Red Time (s)	2.3	2.3	2.3	2.3	2.3	2.3	2.3	2.3	2.3	2.3	2.3	2.3
Lost Time Adjust (s)	-1.0	-1.0	-1.0	-1.0	-1.0	-1.0	-1.0	-1.0	-1.0	-1.0	-1.0	-1.0
Total Lost Time (s)	5.9	5.9	5.9	5.9	5.9	5.9	5.9	5.9	5.9	5.9	5.9	5.9
Lead/Lag	Lead	Lag	Lag	Lead	Lag	Lag	Lead	Lag	Lag	Lead	Lag	
Lead-Lag Optimize?	Yes	Yes	Yes	Yes	Yes	Yes	Yes	Yes	Yes	Yes	Yes	Yes
Recall Mode	None	None	None	None	None	None	None	C-Max	C-Max	None	C-Max	
v/c Ratio	0.69	0.30	0.13	0.25	0.64	0.30	0.40	0.14	0.04	0.33	0.09	0.16
Control Delay	48.4	30.0	6.4	57.8	42.4	6.4	51.3	25.6	11.0	51.8	27.4	2.1
Queue Delay	0.0	0.0	0.0	0.0	0.0	0.0	0.0	0.0	0.0	0.0	0.0	0.0
Total Delay	48.4	30.0	6.4	57.8	42.4	6.4	51.3	25.6	11.0	51.8	27.4	2.1
Queue Length 50th (m)	46.0	29.2	0.0	5.0	33.9	0.0	13.9	14.3	0.0	9.6	8.2	0.8
Queue Length 95th (m)	58.6	36.1	8.9	10.8	41.4	8.6	22.6	25.7	6.5	17.3	17.0	7.6
Internal Link Dist (m)		131.0			112.8			120.2			61.2	
Turn Bay Length (m)	100.0		50.0	30.0		50.0	50.0		50.0	50.0		100.0
Base Capacity (vph)	793	1446	688	183	817	442	353	1390	637	276	1259	1878
Starvation Cap Reductn	0	0	0	0	0	0	0	0	0	0	0	0
Spillback Cap Reductn	0	0	0	0	0	0	0	0	0	0	0	0
Storage Cap Reductn	0	0	0	0	0	0	0	0	0	0	0	0
Reduced v/c Ratio	0.55	0.22	0.10	0.25	0.43	0.23	0.37	0.14	0.04	0.33	0.09	0.15

Intersection Summary

Cycle Length: 112.6

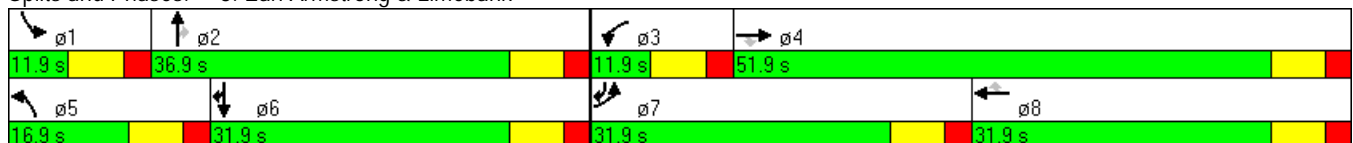
Actuated Cycle Length: 112.6

Offset: 28 (25%), Referenced to phase 2:NBT and 6:SBT, Start of Green

Natural Cycle: 90

Control Type: Actuated-Coordinated

























Splits and Phases: 3: Earl Armstrong & Limebank



HCM Signalized Intersection Capacity Analysis

3: Earl Armstrong & Limebank

Future Total Traffic-2021
Weekday AM Peak Hour Zero Interaction

												
Movement	EBL	EBT	EBR	WBL	WBT	WBR	NBL	NBT	NBR	SBL	SBT	SBR
Lane Configurations												
Volume (vph)	435	325	70	45	355	100	130	190	25	90	110	285
Ideal Flow (vphpl)	1900	1900	1900	1900	1900	1900	1900	1900	1900	1900	1900	1900
Total Lost time (s)	5.9	5.9	5.9	5.9	5.9	5.9	5.9	5.9	5.9	5.9	5.9	5.9
Lane Util. Factor	0.97	0.95	1.00	0.97	0.95	1.00	0.97	0.95	1.00	0.97	0.95	0.88
Frt	1.00	1.00	0.85	1.00	1.00	0.85	1.00	1.00	0.85	1.00	1.00	0.85
Flt Protected	0.95	1.00	1.00	0.95	1.00	1.00	0.95	1.00	1.00	0.95	1.00	1.00
Satd. Flow (prot)	3433	3539	1583	3433	3539	1583	3433	3539	1583	3433	3539	2787
Flt Permitted	0.95	1.00	1.00	0.95	1.00	1.00	0.95	1.00	1.00	0.95	1.00	1.00
Satd. Flow (perm)	3433	3539	1583	3433	3539	1583	3433	3539	1583	3433	3539	2787
Peak-hour factor, PHF	1.00	1.00	1.00	1.00	1.00	1.00	1.00	1.00	1.00	1.00	1.00	1.00
Adj. Flow (vph)	435	325	70	45	355	100	130	190	25	90	110	285
RTOR Reduction (vph)	0	0	48	0	0	83	0	0	16	0	0	112
Lane Group Flow (vph)	435	325	22	45	355	17	130	190	9	90	110	173
Turn Type	Prot		Perm	Prot		Perm	Prot		Perm	Prot		custom
Protected Phases	7	4		3	8		5	2		1	6	6
Permitted Phases			4			8			2			6
Actuated Green, G (s)	19.8	33.7	33.7	4.0	17.9	17.9	9.6	40.5	40.5	6.8	37.7	64.4
Effective Green, g (s)	20.8	34.7	34.7	5.0	18.9	18.9	10.6	41.5	41.5	7.8	38.7	65.4
Actuated g/C Ratio	0.18	0.31	0.31	0.04	0.17	0.17	0.09	0.37	0.37	0.07	0.34	0.58
Clearance Time (s)	6.9	6.9	6.9	6.9	6.9	6.9	6.9	6.9	6.9	6.9	6.9	6.9
Vehicle Extension (s)	3.0	3.0	3.0	3.0	3.0	3.0	3.0	3.0	3.0	3.0	3.0	3.0
Lane Grp Cap (vph)	634	1091	488	152	594	266	323	1304	583	238	1216	1619
v/s Ratio Prot	c0.13	0.09		0.01	c0.10		c0.04	c0.05		0.03	0.03	0.06
v/s Ratio Perm			0.01			0.01			0.01			
v/c Ratio	0.69	0.30	0.04	0.30	0.60	0.06	0.40	0.15	0.02	0.38	0.09	0.11
Uniform Delay, d1	42.9	29.7	27.3	52.1	43.3	39.4	48.0	23.7	22.6	50.1	25.0	10.5
Progression Factor	1.00	1.00	1.00	1.06	0.83	0.52	1.00	1.00	1.00	1.00	1.00	1.00
Incremental Delay, d2	3.1	0.2	0.0	1.1	1.6	0.1	0.8	0.2	0.0	1.0	0.1	0.0
Delay (s)	45.9	29.8	27.4	56.3	37.6	20.4	48.8	24.0	22.6	51.1	25.2	10.6
Level of Service	D	C	C	E	D	C	D	C	C	D	C	B
Approach Delay (s)		38.1			35.9			33.2			21.4	
Approach LOS		D			D			C			C	
Intersection Summary												
HCM Average Control Delay			33.0				HCM Level of Service			C		
HCM Volume to Capacity ratio			0.40									
Actuated Cycle Length (s)			112.6				Sum of lost time (s)		23.6			
Intersection Capacity Utilization			54.4%				ICU Level of Service		A			
Analysis Period (min)			15									
c Critical Lane Group												

Queues
6: Earl Armstrong & Proposed New Road

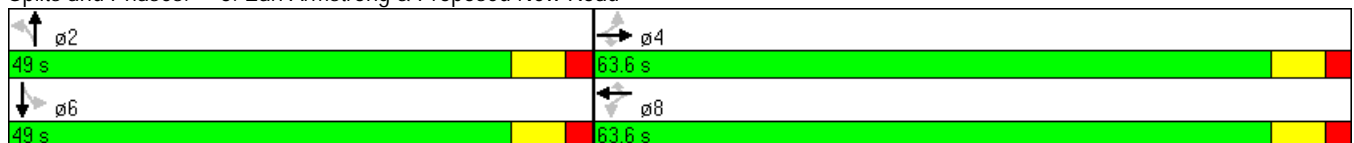
Future Total Traffic-2021
 Weekday AM Peak Hour Zero Interaction

Lane Group	EBL	EBT	EBR	WBL	WBT	WBR	NBL	NBT	SBT
Lane Configurations									
Volume (vph)	35	330	50	10	410	2	75	5	10
Lane Group Flow (vph)	35	330	50	10	410	2	75	40	25
Turn Type	Perm		Perm	Perm		Perm	Perm		
Protected Phases		4			8			2	6
Permitted Phases	4		4	8		8	2		
Detector Phase	4	4	4	8	8	8	2	2	6
Switch Phase									
Minimum Initial (s)	10.0	10.0	10.0	10.0	10.0	10.0	10.0	10.0	10.0
Minimum Split (s)	31.9	31.9	31.9	31.9	31.9	31.9	31.9	31.9	31.9
Total Split (s)	63.6	63.6	63.6	63.6	63.6	63.6	49.0	49.0	49.0
Total Split (%)	56.5%	56.5%	56.5%	56.5%	56.5%	56.5%	43.5%	43.5%	43.5%
Yellow Time (s)	4.6	4.6	4.6	4.6	4.6	4.6	4.6	4.6	4.6
All-Red Time (s)	2.3	2.3	2.3	2.3	2.3	2.3	2.3	2.3	2.3
Lost Time Adjust (s)	-1.0	-1.0	-1.0	-1.0	-1.0	-1.0	-1.0	-1.0	-1.0
Total Lost Time (s)	5.9	5.9	5.9	5.9	5.9	5.9	5.9	5.9	5.9
Lead/Lag									
Lead-Lag Optimize?									
Recall Mode	C-Max	C-Max	C-Max	C-Max	C-Max	C-Max	None	None	None
v/c Ratio	0.04	0.11	0.04	0.01	0.14	0.00	0.46	0.18	0.12
Control Delay	0.3	0.3	0.1	3.5	3.2	2.5	54.7	18.1	26.2
Queue Delay	0.0	0.0	0.0	0.0	0.0	0.0	0.0	0.0	0.0
Total Delay	0.3	0.3	0.1	3.5	3.2	2.5	54.7	18.1	26.2
Queue Length 50th (m)	0.1	0.4	0.0	0.4	9.3	0.0	15.6	1.0	2.0
Queue Length 95th (m)	0.2	0.6	0.0	1.8	16.3	0.6	28.9	10.3	9.5
Internal Link Dist (m)		95.8			43.9			72.0	67.0
Turn Bay Length (m)	30.0		30.0	30.0		30.0	30.0		
Base Capacity (vph)	778	2891	1302	841	2891	1294	528	641	658
Starvation Cap Reductn	0	0	0	0	0	0	0	0	0
Spillback Cap Reductn	0	0	0	0	0	0	0	0	0
Storage Cap Reductn	0	0	0	0	0	0	0	0	0
Reduced v/c Ratio	0.04	0.11	0.04	0.01	0.14	0.00	0.14	0.06	0.04

Intersection Summary

Cycle Length: 112.6
 Actuated Cycle Length: 112.6
 Offset: 0 (0%), Referenced to phase 4:EBTL and 8:WBTL, Start of Green
 Natural Cycle: 65
 Control Type: Actuated-Coordinated





























Splits and Phases: 6: Earl Armstrong & Proposed New Road



HCM Signalized Intersection Capacity Analysis

6: Earl Armstrong & Proposed New Road

Future Total Traffic-2021
Weekday AM Peak Hour Zero Interaction

												
Movement	EBL	EBT	EBR	WBL	WBT	WBR	NBL	NBT	NBR	SBL	SBT	SBR
Lane Configurations		 			 			 			 	
Volume (vph)	35	330	50	10	410	2	75	5	35	0	10	15
Ideal Flow (vphpl)	1900	1900	1900	1900	1900	1900	1900	1900	1900	1900	1900	1900
Total Lost time (s)	5.9	5.9	5.9	5.9	5.9	5.9	5.9	5.9			5.9	
Lane Util. Factor	1.00	0.95	1.00	1.00	0.95	1.00	1.00	1.00			1.00	
Frt	1.00	1.00	0.85	1.00	1.00	0.85	1.00	0.87			0.91	
Flt Protected	0.95	1.00	1.00	0.95	1.00	1.00	0.95	1.00			1.00	
Satd. Flow (prot)	1770	3539	1583	1770	3539	1583	1770	1618			1695	
Flt Permitted	0.51	1.00	1.00	0.55	1.00	1.00	0.74	1.00			1.00	
Satd. Flow (perm)	953	3539	1583	1029	3539	1583	1380	1618			1695	
Peak-hour factor, PHF	1.00	1.00	1.00	1.00	1.00	1.00	1.00	1.00	1.00	1.00	1.00	1.00
Adj. Flow (vph)	35	330	50	10	410	2	75	5	35	0	10	15
RTOR Reduction (vph)	0	0	10	0	0	0	0	31	0	0	13	0
Lane Group Flow (vph)	35	330	40	10	410	2	75	9	0	0	12	0
Turn Type	Perm		Perm	Perm		Perm	Perm			Perm		
Protected Phases		4			8			2			6	
Permitted Phases	4		4	8		8	2			6		
Actuated Green, G (s)	88.4	88.4	88.4	88.4	88.4	88.4	10.4	10.4			10.4	
Effective Green, g (s)	89.4	89.4	89.4	89.4	89.4	89.4	11.4	11.4			11.4	
Actuated g/C Ratio	0.79	0.79	0.79	0.79	0.79	0.79	0.10	0.10			0.10	
Clearance Time (s)	6.9	6.9	6.9	6.9	6.9	6.9	6.9	6.9			6.9	
Vehicle Extension (s)	3.0	3.0	3.0	3.0	3.0	3.0	3.0	3.0			3.0	
Lane Grp Cap (vph)	757	2810	1257	817	2810	1257	140	164			172	
v/s Ratio Prot		0.09			c0.12			0.01			0.01	
v/s Ratio Perm	0.04		0.03	0.01		0.00	c0.05					
v/c Ratio	0.05	0.12	0.03	0.01	0.15	0.00	0.54	0.05			0.07	
Uniform Delay, d1	2.5	2.6	2.5	2.4	2.7	2.4	48.1	45.7			45.8	
Progression Factor	0.06	0.06	0.00	1.00	1.00	1.00	1.00	1.00			1.00	
Incremental Delay, d2	0.1	0.1	0.0	0.0	0.1	0.0	3.9	0.1			0.2	
Delay (s)	0.3	0.2	0.0	2.4	2.8	2.4	52.0	45.9			46.0	
Level of Service	A	A	A	A	A	A	D	D			D	
Approach Delay (s)		0.2			2.8			49.9			46.0	
Approach LOS		A			A			D			D	
Intersection Summary												
HCM Average Control Delay			8.3				HCM Level of Service				A	
HCM Volume to Capacity ratio			0.19									
Actuated Cycle Length (s)			112.6				Sum of lost time (s)			11.8		
Intersection Capacity Utilization			45.2%				ICU Level of Service				A	
Analysis Period (min)			15									
c Critical Lane Group												












HCM Unsignalized Intersection Capacity Analysis
 9: Earl Armstrong & RIRO Site Access

Future Total Traffic-2021
 Weekday AM Peak Hour Zero Interaction

	→	↘	↙	←	↖	↗
Movement	EBT	EBR	WBL	WBT	NBL	NBR
Lane Configurations	↑↑			↑↑		↗
Volume (veh/h)	415	30	0	500	0	1
Sign Control	Free			Free	Stop	
Grade	0%			0%	0%	
Peak Hour Factor	1.00	1.00	1.00	1.00	1.00	1.00
Hourly flow rate (vph)	415	30	0	500	0	1
Pedestrians						
Lane Width (m)						
Walking Speed (m/s)						
Percent Blockage						
Right turn flare (veh)						
Median type	None			None		
Median storage (veh)						
Upstream signal (m)	137			120		
pX, platoon unblocked			0.94		0.94	0.94
vC, conflicting volume			445		680	222
vC1, stage 1 conf vol						
vC2, stage 2 conf vol						
vCu, unblocked vol			276		491	39
tC, single (s)			4.1		6.8	6.9
tC, 2 stage (s)						
tF (s)			2.2		3.5	3.3
p0 queue free %			100		100	100
cM capacity (veh/h)			1204		478	961
Direction, Lane #	EB 1	EB 2	WB 1	WB 2	NB 1	
Volume Total	277	168	250	250	1	
Volume Left	0	0	0	0	0	
Volume Right	0	30	0	0	1	
cSH	1700	1700	1700	1700	961	
Volume to Capacity	0.16	0.10	0.15	0.15	0.00	
Queue Length 95th (m)	0.0	0.0	0.0	0.0	0.0	
Control Delay (s)	0.0	0.0	0.0	0.0	8.8	
Lane LOS						A
Approach Delay (s)	0.0		0.0		8.8	
Approach LOS						A
Intersection Summary						
Average Delay			0.0			
Intersection Capacity Utilization			22.4%	ICU Level of Service	A	
Analysis Period (min)			15			










HCM Unsignalized Intersection Capacity Analysis
 11: Site Access & Limebank

Future Total Traffic-2021
 Weekday AM Peak Hour Zero Interaction

							
Movement	WBL	WBR	NBT	NBR	SBL	SBT	
Lane Configurations							
Volume (veh/h)	15	55	295	30	70	155	
Sign Control	Stop		Free			Free	
Grade	0%		0%			0%	
Peak Hour Factor	1.00	1.00	1.00	1.00	1.00	1.00	
Hourly flow rate (vph)	15	55	295	30	70	155	
Pedestrians							
Lane Width (m)							
Walking Speed (m/s)							
Percent Blockage							
Right turn flare (veh)							
Median type			None			None	
Median storage (veh)							
Upstream signal (m)						144	
pX, platoon unblocked							
vC, conflicting volume	528	162			325		
vC1, stage 1 conf vol							
vC2, stage 2 conf vol							
vCu, unblocked vol	528	162			325		
tC, single (s)	6.8	6.9			4.1		
tC, 2 stage (s)							
tF (s)	3.5	3.3			2.2		
p0 queue free %	97	94			94		
cM capacity (veh/h)	453	854			1231		
Direction, Lane #	WB 1	WB 2	NB 1	NB 2	SB 1	SB 2	SB 3
Volume Total	15	55	197	128	70	78	78
Volume Left	15	0	0	0	70	0	0
Volume Right	0	55	0	30	0	0	0
cSH	453	854	1700	1700	1231	1700	1700
Volume to Capacity	0.03	0.06	0.12	0.08	0.06	0.05	0.05
Queue Length 95th (m)	0.8	1.5	0.0	0.0	1.4	0.0	0.0
Control Delay (s)	13.2	9.5	0.0	0.0	8.1	0.0	0.0
Lane LOS	B	A			A		
Approach Delay (s)	10.3		0.0		2.5		
Approach LOS	B						
Intersection Summary							
Average Delay			2.1				
Intersection Capacity Utilization			26.3%		ICU Level of Service		A
Analysis Period (min)			15				










HCM Unsignalized Intersection Capacity Analysis
 13: N. Site Access & Proposed New Road

Future Total Traffic-2021
 Weekday AM Peak Hour Zero Interaction

						
Movement	EBL	EBR	NBL	NBT	SBT	SBR
Lane Configurations						
Volume (veh/h)	5	5	10	110	60	10
Sign Control	Stop			Free	Free	
Grade	0%			0%	0%	
Peak Hour Factor	1.00	1.00	1.00	1.00	1.00	1.00
Hourly flow rate (vph)	5	5	10	110	60	10
Pedestrians						
Lane Width (m)						
Walking Speed (m/s)						
Percent Blockage						
Right turn flare (veh)						
Median type				None	None	
Median storage (veh)						
Upstream signal (m)					96	
pX, platoon unblocked						
vC, conflicting volume	195	65	70			
vC1, stage 1 conf vol						
vC2, stage 2 conf vol						
vCu, unblocked vol	195	65	70			
tC, single (s)	6.4	6.2	4.1			
tC, 2 stage (s)						
tF (s)	3.5	3.3	2.2			
p0 queue free %	99	99	99			
cM capacity (veh/h)	789	999	1531			
Direction, Lane #	EB 1	NB 1	SB 1			
Volume Total	10	120	70			
Volume Left	5	10	0			
Volume Right	5	0	10			
cSH	881	1531	1700			
Volume to Capacity	0.01	0.01	0.04			
Queue Length 95th (m)	0.3	0.1	0.0			
Control Delay (s)	9.1	0.7	0.0			
Lane LOS	A	A				
Approach Delay (s)	9.1	0.7	0.0			
Approach LOS	A					
Intersection Summary						
Average Delay			0.9			
Intersection Capacity Utilization		23.0%		ICU Level of Service		A
Analysis Period (min)			15			

HCM Unsignalized Intersection Capacity Analysis
 15: S. Site Access & Proposed New Road

Future Total Traffic-2021
 Weekday AM Peak Hour Zero Interaction

						
Movement	EBL	EBR	NBL	NBT	SBT	SBR
Lane Configurations						
Volume (veh/h)	5	10	20	115	55	5
Sign Control	Stop			Free	Free	
Grade	0%			0%	0%	
Peak Hour Factor	1.00	1.00	1.00	1.00	1.00	1.00
Hourly flow rate (vph)	5	10	20	115	55	5
Pedestrians						
Lane Width (m)						
Walking Speed (m/s)						
Percent Blockage						
Right turn flare (veh)						
Median type				None	None	
Median storage (veh)						
Upstream signal (m)					185	
pX, platoon unblocked						
vC, conflicting volume	212	58	60			
vC1, stage 1 conf vol						
vC2, stage 2 conf vol						
vCu, unblocked vol	212	58	60			
tC, single (s)	6.4	6.2	4.1			
tC, 2 stage (s)						
tF (s)	3.5	3.3	2.2			
p0 queue free %	99	99	99			
cM capacity (veh/h)	766	1009	1544			
Direction, Lane #	EB 1	NB 1	SB 1			
Volume Total	15	135	60			
Volume Left	5	20	0			
Volume Right	10	0	5			
cSH	912	1544	1700			
Volume to Capacity	0.02	0.01	0.04			
Queue Length 95th (m)	0.4	0.3	0.0			
Control Delay (s)	9.0	1.2	0.0			
Lane LOS	A	A				
Approach Delay (s)	9.0	1.2	0.0			
Approach LOS	A					
Intersection Summary						
Average Delay			1.4			
Intersection Capacity Utilization		23.8%		ICU Level of Service		A
Analysis Period (min)			15			

Queues

3: Earl Armstrong & Limebank

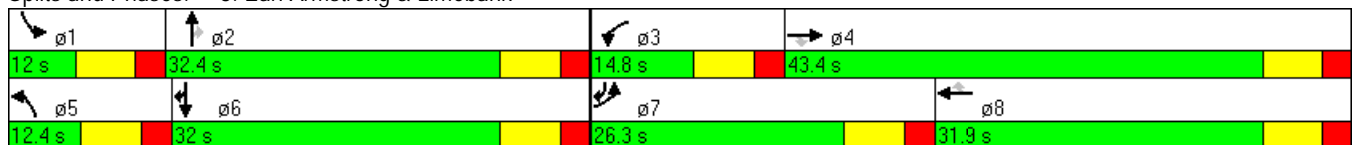
Future Total Traffic-2021
Weekday PM Peak Hour Zero Interaction

Lane Group	EBL	EBT	EBR	WBL	WBT	WBR	NBL	NBT	NBR	SBL	SBT	SBR
Lane Configurations												
Volume (vph)	640	605	110	95	595	155	90	155	65	245	220	755
Lane Group Flow (vph)	640	605	110	95	595	155	90	155	65	245	220	755
Turn Type	Prot		Perm	Prot		Perm	Prot		Perm	Prot		custom
Protected Phases	7	4		3	8		5	2		1	6	6 7
Permitted Phases			4			8			2			6
Detector Phase	7	4	4	3	8	8	5	2	2	1	6	6 7
Switch Phase												
Minimum Initial (s)	5.0	10.0	10.0	5.0	10.0	10.0	5.0	10.0	10.0	5.0	10.0	
Minimum Split (s)	11.9	31.9	31.9	11.9	31.9	31.9	11.9	31.9	31.9	11.9	31.9	
Total Split (s)	26.3	43.4	43.4	14.8	31.9	31.9	12.4	32.4	32.4	12.0	32.0	58.3
Total Split (%)	25.6%	42.3%	42.3%	14.4%	31.1%	31.1%	12.1%	31.6%	31.6%	11.7%	31.2%	56.8%
Yellow Time (s)	4.6	4.6	4.6	4.6	4.6	4.6	4.6	4.6	4.6	4.6	4.6	4.6
All-Red Time (s)	2.3	2.3	2.3	2.3	2.3	2.3	2.3	2.3	2.3	2.3	2.3	2.3
Lost Time Adjust (s)	-1.0	-1.0	-1.0	-1.0	-1.0	-1.0	-1.0	-1.0	-1.0	-1.0	-1.0	-1.0
Total Lost Time (s)	5.9	5.9	5.9	5.9	5.9	5.9	5.9	5.9	5.9	5.9	5.9	5.9
Lead/Lag	Lead	Lag	Lag	Lead	Lag	Lag	Lead	Lag	Lag	Lead	Lag	
Lead-Lag Optimize?	Yes	Yes	Yes	Yes	Yes	Yes	Yes	Yes	Yes	Yes	Yes	Yes
Recall Mode	None	None	None	None	None	None	None	C-Max	C-Max	None	C-Max	
v/c Ratio	0.94	0.47	0.17	0.34	0.75	0.33	0.37	0.17	0.14	0.81	0.21	0.47
Control Delay	63.4	26.6	5.0	55.3	35.4	3.9	50.2	30.1	8.4	69.4	29.4	13.5
Queue Delay	0.0	0.0	0.0	0.0	0.0	0.0	0.0	0.0	0.0	0.0	0.0	0.0
Total Delay	63.4	26.6	5.0	55.3	35.4	3.9	50.2	30.1	8.4	69.4	29.4	13.5
Queue Length 50th (m)	64.3	48.8	0.0	9.6	43.6	1.8	8.7	12.4	0.0	25.1	18.1	44.6
Queue Length 95th (m)	#96.7	62.8	10.5	17.8	54.3	7.1	16.6	20.5	9.9	#54.2	28.0	61.5
Internal Link Dist (m)		131.0			113.3			120.8			61.2	
Turn Bay Length (m)	100.0		50.0	30.0		50.0	50.0		50.0	50.0		100.0
Base Capacity (vph)	683	1341	668	298	897	517	245	914	457	302	1061	1603
Starvation Cap Reductn	0	0	0	0	0	0	0	0	0	0	0	0
Spillback Cap Reductn	0	0	0	0	0	0	0	0	0	0	0	0
Storage Cap Reductn	0	0	0	0	0	0	0	0	0	0	0	0
Reduced v/c Ratio	0.94	0.45	0.16	0.32	0.66	0.30	0.37	0.17	0.14	0.81	0.21	0.47

Intersection Summary

Cycle Length: 102.6
 Actuated Cycle Length: 102.6
 Offset: 31 (30%), Referenced to phase 2:NBT and 6:SBT, Start of Green
 Natural Cycle: 100
 Control Type: Actuated-Coordinated
 # 95th percentile volume exceeds capacity, queue may be longer.
 Queue shown is maximum after two cycles.

























Splits and Phases: 3: Earl Armstrong & Limebank



HCM Signalized Intersection Capacity Analysis

3: Earl Armstrong & Limebank

Future Total Traffic-2021
Weekday PM Peak Hour Zero Interaction

												
Movement	EBL	EBT	EBR	WBL	WBT	WBR	NBL	NBT	NBR	SBL	SBT	SBR
Lane Configurations												
Volume (vph)	640	605	110	95	595	155	90	155	65	245	220	755
Ideal Flow (vphpl)	1900	1900	1900	1900	1900	1900	1900	1900	1900	1900	1900	1900
Total Lost time (s)	5.9	5.9	5.9	5.9	5.9	5.9	5.9	5.9	5.9	5.9	5.9	5.9
Lane Util. Factor	0.97	0.95	1.00	0.97	0.95	1.00	0.97	0.95	1.00	0.97	0.95	0.88
Frt	1.00	1.00	0.85	1.00	1.00	0.85	1.00	1.00	0.85	1.00	1.00	0.85
Flt Protected	0.95	1.00	1.00	0.95	1.00	1.00	0.95	1.00	1.00	0.95	1.00	1.00
Satd. Flow (prot)	3433	3539	1583	3433	3539	1583	3433	3539	1583	3433	3539	2787
Flt Permitted	0.95	1.00	1.00	0.95	1.00	1.00	0.95	1.00	1.00	0.95	1.00	1.00
Satd. Flow (perm)	3433	3539	1583	3433	3539	1583	3433	3539	1583	3433	3539	2787
Peak-hour factor, PHF	1.00	1.00	1.00	1.00	1.00	1.00	1.00	1.00	1.00	1.00	1.00	1.00
Adj. Flow (vph)	640	605	110	95	595	155	90	155	65	245	220	755
RTOR Reduction (vph)	0	0	70	0	0	118	0	0	49	0	0	56
Lane Group Flow (vph)	640	605	40	95	595	37	90	155	16	245	220	699
Turn Type	Prot		Perm	Prot		Perm	Prot		Perm	Prot		custom
Protected Phases	7	4		3	8		5	2		1	6	6
Permitted Phases			4			8			2			6
Actuated Green, G (s)	19.4	36.7	36.7	6.2	23.5	23.5	5.1	24.1	24.1	8.0	27.0	53.3
Effective Green, g (s)	20.4	37.7	37.7	7.2	24.5	24.5	6.1	25.1	25.1	9.0	28.0	54.3
Actuated g/C Ratio	0.20	0.37	0.37	0.07	0.24	0.24	0.06	0.24	0.24	0.09	0.27	0.53
Clearance Time (s)	6.9	6.9	6.9	6.9	6.9	6.9	6.9	6.9	6.9	6.9	6.9	
Vehicle Extension (s)	3.0	3.0	3.0	3.0	3.0	3.0	3.0	3.0	3.0	3.0	3.0	
Lane Grp Cap (vph)	683	1300	582	241	845	378	204	866	387	301	966	1475
v/s Ratio Prot	c0.19	0.17		0.03	c0.17		0.03	0.04		c0.07	0.06	c0.25
v/s Ratio Perm			0.03			0.02			0.01			
v/c Ratio	0.94	0.47	0.07	0.39	0.70	0.10	0.44	0.18	0.04	0.81	0.23	0.47
Uniform Delay, d1	40.5	24.8	21.1	45.6	35.7	30.4	46.6	30.6	29.6	46.0	28.9	15.2
Progression Factor	1.00	1.00	1.00	1.17	0.79	0.40	1.00	1.00	1.00	1.00	1.00	1.00
Incremental Delay, d2	20.3	0.3	0.1	1.0	2.6	0.1	1.5	0.5	0.2	15.4	0.5	0.2
Delay (s)	60.8	25.0	21.1	54.5	30.9	12.2	48.1	31.1	29.8	61.4	29.5	15.4
Level of Service	E	C	C	D	C	B	D	C	C	E	C	B
Approach Delay (s)		41.6			30.2			35.7			27.2	
Approach LOS		D			C			D			C	
Intersection Summary												
HCM Average Control Delay			33.8				HCM Level of Service			C		
HCM Volume to Capacity ratio			0.74									
Actuated Cycle Length (s)			102.6				Sum of lost time (s)		23.6			
Intersection Capacity Utilization			69.7%				ICU Level of Service		C			
Analysis Period (min)			15									
c Critical Lane Group												

Queues
6: Earl Armstrong & Proposed New Road

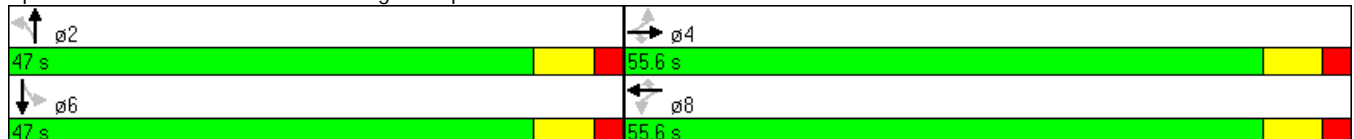
Future Total Traffic-2021
 Weekday PM Peak Hour Zero Interaction

Lane Group	EBL	EBT	EBR	WBL	WBT	WBR	NBL	NBT	SBT
Lane Configurations									
Volume (vph)	95	650	105	80	600	10	155	20	25
Lane Group Flow (vph)	95	650	105	80	600	10	155	80	115
Turn Type	Perm		Perm	Perm		Perm	Perm		
Protected Phases		4			8			2	6
Permitted Phases	4		4	8		8	2		
Detector Phase	4	4	4	8	8	8	2	2	6
Switch Phase									
Minimum Initial (s)	10.0	10.0	10.0	10.0	10.0	10.0	10.0	10.0	10.0
Minimum Split (s)	31.9	31.9	31.9	31.9	31.9	31.9	31.9	31.9	31.9
Total Split (s)	55.6	55.6	55.6	55.6	55.6	55.6	47.0	47.0	47.0
Total Split (%)	54.2%	54.2%	54.2%	54.2%	54.2%	54.2%	45.8%	45.8%	45.8%
Yellow Time (s)	4.6	4.6	4.6	4.6	4.6	4.6	4.6	4.6	4.6
All-Red Time (s)	2.3	2.3	2.3	2.3	2.3	2.3	2.3	2.3	2.3
Lost Time Adjust (s)	-1.0	-1.0	-1.0	-1.0	-1.0	-1.0	-1.0	-1.0	-1.0
Total Lost Time (s)	5.9	5.9	5.9	5.9	5.9	5.9	5.9	5.9	5.9
Lead/Lag									
Lead-Lag Optimize?									
Recall Mode	C-Max	C-Max	C-Max	C-Max	C-Max	C-Max	None	None	None
v/c Ratio	0.17	0.26	0.09	0.15	0.24	0.01	0.66	0.22	0.30
Control Delay	1.5	1.0	0.1	7.4	6.5	3.7	51.0	13.6	12.4
Queue Delay	0.0	0.0	0.0	0.0	0.0	0.0	0.0	0.0	0.0
Total Delay	1.5	1.0	0.1	7.4	6.5	3.7	51.0	13.6	12.4
Queue Length 50th (m)	0.7	2.7	0.0	4.6	19.6	0.0	28.6	3.3	4.1
Queue Length 95th (m)	m1.6	m4.2	m0.0	12.8	34.4	1.9	44.8	13.8	16.6
Internal Link Dist (m)		96.0			43.9			72.0	67.0
Turn Bay Length (m)	30.0		30.0	30.0		30.0	30.0		
Base Capacity (vph)	548	2475	1138	518	2475	1110	510	699	713
Starvation Cap Reductn	0	0	0	0	0	0	0	0	0
Spillback Cap Reductn	0	0	0	0	0	0	0	0	0
Storage Cap Reductn	0	0	0	0	0	0	0	0	0
Reduced v/c Ratio	0.17	0.26	0.09	0.15	0.24	0.01	0.30	0.11	0.16

Intersection Summary





























Cycle Length: 102.6
 Actuated Cycle Length: 102.6
 Offset: 0 (0%), Referenced to phase 4:EBTL and 8:WBTL, Start of Green
 Natural Cycle: 65
 Control Type: Actuated-Coordinated
 m Volume for 95th percentile queue is metered by upstream signal.

Splits and Phases: 6: Earl Armstrong & Proposed New Road



HCM Signalized Intersection Capacity Analysis
6: Earl Armstrong & Proposed New Road

Future Total Traffic-2021
Weekday PM Peak Hour Zero Interaction

												
Movement	EBL	EBT	EBR	WBL	WBT	WBR	NBL	NBT	NBR	SBL	SBT	SBR
Lane Configurations		 			 			 			 	
Volume (vph)	95	650	105	80	600	10	155	20	60	0	25	90
Ideal Flow (vphpl)	1900	1900	1900	1900	1900	1900	1900	1900	1900	1900	1900	1900
Total Lost time (s)	5.9	5.9	5.9	5.9	5.9	5.9	5.9	5.9			5.9	
Lane Util. Factor	1.00	0.95	1.00	1.00	0.95	1.00	1.00	1.00			1.00	
Frt	1.00	1.00	0.85	1.00	1.00	0.85	1.00	0.89			0.88	
Flt Protected	0.95	1.00	1.00	0.95	1.00	1.00	0.95	1.00			1.00	
Satd. Flow (prot)	1770	3539	1583	1770	3539	1583	1770	1653			1644	
Flt Permitted	0.42	1.00	1.00	0.40	1.00	1.00	0.68	1.00			1.00	
Satd. Flow (perm)	785	3539	1583	740	3539	1583	1272	1653			1644	
Peak-hour factor, PHF	1.00	1.00	1.00	1.00	1.00	1.00	1.00	1.00	1.00	1.00	1.00	1.00
Adj. Flow (vph)	95	650	105	80	600	10	155	20	60	0	25	90
RTOR Reduction (vph)	0	0	31	0	0	3	0	49	0	0	73	0
Lane Group Flow (vph)	95	650	74	80	600	7	155	31	0	0	42	0
Turn Type	Perm		Perm	Perm		Perm	Perm			Perm		
Protected Phases		4			8			2			6	
Permitted Phases	4		4	8		8	2			6		
Actuated Green, G (s)	70.8	70.8	70.8	70.8	70.8	70.8	18.0	18.0			18.0	
Effective Green, g (s)	71.8	71.8	71.8	71.8	71.8	71.8	19.0	19.0			19.0	
Actuated g/C Ratio	0.70	0.70	0.70	0.70	0.70	0.70	0.19	0.19			0.19	
Clearance Time (s)	6.9	6.9	6.9	6.9	6.9	6.9	6.9	6.9			6.9	
Vehicle Extension (s)	3.0	3.0	3.0	3.0	3.0	3.0	3.0	3.0			3.0	
Lane Grp Cap (vph)	549	2477	1108	518	2477	1108	236	306			304	
v/s Ratio Prot		c0.18			0.17			0.02			0.03	
v/s Ratio Perm	0.12		0.05	0.11		0.00	c0.12					
v/c Ratio	0.17	0.26	0.07	0.15	0.24	0.01	0.66	0.10			0.14	
Uniform Delay, d1	5.3	5.7	4.8	5.2	5.6	4.6	38.8	34.7			34.9	
Progression Factor	0.13	0.12	0.00	1.00	1.00	1.00	1.00	1.00			1.00	
Incremental Delay, d2	0.6	0.2	0.1	0.6	0.2	0.0	6.4	0.1			0.2	
Delay (s)	1.3	0.9	0.1	5.8	5.8	4.7	45.2	34.9			35.2	
Level of Service	A	A	A	A	A	A	D	C			D	
Approach Delay (s)		0.9			5.8			41.7			35.2	
Approach LOS		A			A			D			D	
Intersection Summary												
HCM Average Control Delay			9.8				HCM Level of Service				A	
HCM Volume to Capacity ratio			0.35									
Actuated Cycle Length (s)			102.6				Sum of lost time (s)				11.8	
Intersection Capacity Utilization			56.3%				ICU Level of Service				B	
Analysis Period (min)			15									
c Critical Lane Group												












HCM Unsignalized Intersection Capacity Analysis
 9: Earl Armstrong & RIRO Site Access

Future Total Traffic-2021
 Weekday PM Peak Hour Zero Interaction

	→	↘	↙	←	↖	↗
Movement	EBT	EBR	WBL	WBT	NBL	NBR
Lane Configurations	↑↑			↑↑		↗
Volume (veh/h)	775	140	0	845	0	75
Sign Control	Free			Free	Stop	
Grade	0%			0%	0%	
Peak Hour Factor	1.00	1.00	1.00	1.00	1.00	1.00
Hourly flow rate (vph)	775	140	0	845	0	75
Pedestrians						
Lane Width (m)						
Walking Speed (m/s)						
Percent Blockage						
Right turn flare (veh)						
Median type	None		None			
Median storage (veh)						
Upstream signal (m)	137			120		
pX, platoon unblocked			0.87		0.90	0.87
vC, conflicting volume			915		1268	458
vC1, stage 1 conf vol						
vC2, stage 2 conf vol						
vCu, unblocked vol			612		802	87
tC, single (s)			4.1		6.8	6.9
tC, 2 stage (s)						
tF (s)			2.2		3.5	3.3
p0 queue free %			100		100	91
cM capacity (veh/h)			841		289	832
Direction, Lane #	EB 1	EB 2	WB 1	WB 2	NB 1	
Volume Total	517	398	422	422	75	
Volume Left	0	0	0	0	0	
Volume Right	0	140	0	0	75	
cSH	1700	1700	1700	1700	832	
Volume to Capacity	0.30	0.23	0.25	0.25	0.09	
Queue Length 95th (m)	0.0	0.0	0.0	0.0	2.2	
Control Delay (s)	0.0	0.0	0.0	0.0	9.8	
Lane LOS						A
Approach Delay (s)	0.0		0.0		9.8	
Approach LOS						A
Intersection Summary						
Average Delay			0.4			
Intersection Capacity Utilization			37.2%	ICU Level of Service	A	
Analysis Period (min)			15			










HCM Unsignalized Intersection Capacity Analysis
 11: Site Access & Limebank

Future Total Traffic-2021
 Weekday PM Peak Hour Zero Interaction

							
Movement	WBL	WBR	NBT	NBR	SBL	SBT	
Lane Configurations							
Volume (veh/h)	90	215	95	70	175	250	
Sign Control	Stop		Free			Free	
Grade	0%		0%			0%	
Peak Hour Factor	1.00	1.00	1.00	1.00	1.00	1.00	
Hourly flow rate (vph)	90	215	95	70	175	250	
Pedestrians							
Lane Width (m)							
Walking Speed (m/s)							
Percent Blockage							
Right turn flare (veh)							
Median type			None			None	
Median storage (veh)							
Upstream signal (m)						145	
pX, platoon unblocked							
vC, conflicting volume	605	82			165		
vC1, stage 1 conf vol							
vC2, stage 2 conf vol							
vCu, unblocked vol	605	82			165		
tC, single (s)	6.8	6.9			4.1		
tC, 2 stage (s)							
tF (s)	3.5	3.3			2.2		
p0 queue free %	76	78			88		
cM capacity (veh/h)	376	961			1411		
Direction, Lane #	WB 1	WB 2	NB 1	NB 2	SB 1	SB 2	SB 3
Volume Total	90	215	63	102	175	125	125
Volume Left	90	0	0	0	175	0	0
Volume Right	0	215	0	70	0	0	0
cSH	376	961	1700	1700	1411	1700	1700
Volume to Capacity	0.24	0.22	0.04	0.06	0.12	0.07	0.07
Queue Length 95th (m)	6.9	6.4	0.0	0.0	3.2	0.0	0.0
Control Delay (s)	17.6	9.8	0.0	0.0	7.9	0.0	0.0
Lane LOS	C	A			A		
Approach Delay (s)	12.1		0.0		3.3		
Approach LOS	B						
Intersection Summary							
Average Delay			5.7				
Intersection Capacity Utilization			29.6%		ICU Level of Service		A
Analysis Period (min)			15				










HCM Unsignalized Intersection Capacity Analysis
 13: N. Site Access & Proposed New Road

Future Total Traffic-2021
 Weekday PM Peak Hour Zero Interaction

						
Movement	EBL	EBR	NBL	NBT	SBT	SBR
Lane Configurations						
Volume (veh/h)	75	15	25	160	125	80
Sign Control	Stop			Free	Free	
Grade	0%			0%	0%	
Peak Hour Factor	1.00	1.00	1.00	1.00	1.00	1.00
Hourly flow rate (vph)	75	15	25	160	125	80
Pedestrians						
Lane Width (m)						
Walking Speed (m/s)						
Percent Blockage						
Right turn flare (veh)						
Median type				None	None	
Median storage (veh)						
Upstream signal (m)					96	
pX, platoon unblocked						
vC, conflicting volume	375	165	205			
vC1, stage 1 conf vol						
vC2, stage 2 conf vol						
vCu, unblocked vol	375	165	205			
tC, single (s)	6.4	6.2	4.1			
tC, 2 stage (s)						
tF (s)	3.5	3.3	2.2			
p0 queue free %	88	98	98			
cM capacity (veh/h)	615	879	1366			
Direction, Lane #	EB 1	NB 1	SB 1			
Volume Total	90	185	205			
Volume Left	75	25	0			
Volume Right	15	0	80			
cSH	647	1366	1700			
Volume to Capacity	0.14	0.02	0.12			
Queue Length 95th (m)	3.6	0.4	0.0			
Control Delay (s)	11.5	1.2	0.0			
Lane LOS	B	A				
Approach Delay (s)	11.5	1.2	0.0			
Approach LOS	B					
Intersection Summary						
Average Delay			2.6			
Intersection Capacity Utilization		36.3%		ICU Level of Service		A
Analysis Period (min)			15			

HCM Unsignalized Intersection Capacity Analysis
 15: S. Site Access & Proposed New Road

Future Total Traffic-2021
 Weekday PM Peak Hour Zero Interaction

						
Movement	EBL	EBR	NBL	NBT	SBT	SBR
Lane Configurations						
Volume (veh/h)	20	35	45	165	125	15
Sign Control	Stop			Free	Free	
Grade	0%			0%	0%	
Peak Hour Factor	1.00	1.00	1.00	1.00	1.00	1.00
Hourly flow rate (vph)	20	35	45	165	125	15
Pedestrians						
Lane Width (m)						
Walking Speed (m/s)						
Percent Blockage						
Right turn flare (veh)						
Median type				None	None	
Median storage (veh)						
Upstream signal (m)					185	
pX, platoon unblocked						
vC, conflicting volume	388	132	140			
vC1, stage 1 conf vol						
vC2, stage 2 conf vol						
vCu, unblocked vol	388	132	140			
tC, single (s)	6.4	6.2	4.1			
tC, 2 stage (s)						
tF (s)	3.5	3.3	2.2			
p0 queue free %	97	96	97			
cM capacity (veh/h)	597	917	1443			
Direction, Lane #	EB 1	NB 1	SB 1			
Volume Total	55	210	140			
Volume Left	20	45	0			
Volume Right	35	0	15			
cSH	767	1443	1700			
Volume to Capacity	0.07	0.03	0.08			
Queue Length 95th (m)	1.7	0.7	0.0			
Control Delay (s)	10.1	1.8	0.0			
Lane LOS	B	A				
Approach Delay (s)	10.1	1.8	0.0			
Approach LOS	B					
Intersection Summary						
Average Delay			2.3			
Intersection Capacity Utilization		32.0%		ICU Level of Service		A
Analysis Period (min)			15			

**APPENDIX H: Synchro Analysis – Future Background & Future
Total 2021 unconstrained interaction**

Queues
3: Earl Armstrong & Limebank

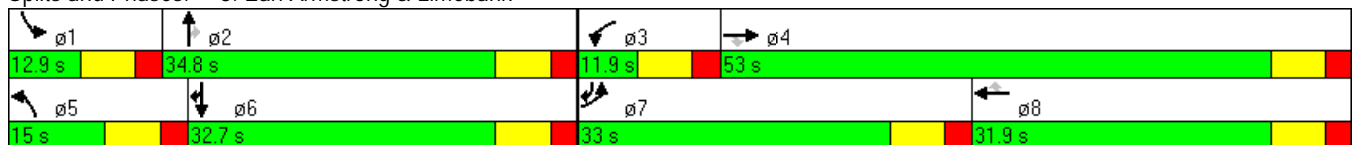
Future Background Traffic-2021
 Weekday AM Peak Hour Unconstrained

Lane Group	EBL	EBT	EBR	WBL	WBT	WBR	NBL	NBT	NBR	SBL	SBT	SBR
Lane Configurations												
Volume (vph)	660	925	80	45	510	100	185	190	20	95	105	285
Lane Group Flow (vph)	660	925	80	45	510	100	185	190	20	95	105	285
Turn Type	Prot		Perm	Prot		Perm	Prot		Perm	Prot		custom
Protected Phases	7	4		3	8		5	2		1	6	6 7
Permitted Phases			4			8			2			6
Detector Phase	7	4	4	3	8	8	5	2	2	1	6	6 7
Switch Phase												
Minimum Initial (s)	5.0	10.0	10.0	5.0	10.0	10.0	5.0	10.0	10.0	5.0	10.0	
Minimum Split (s)	11.9	31.9	31.9	11.9	31.9	31.9	11.9	31.9	31.9	11.9	31.9	
Total Split (s)	33.0	53.0	53.0	11.9	31.9	31.9	15.0	34.8	34.8	12.9	32.7	65.7
Total Split (%)	29.3%	47.1%	47.1%	10.6%	28.3%	28.3%	13.3%	30.9%	30.9%	11.5%	29.0%	58.3%
Yellow Time (s)	4.6	4.6	4.6	4.6	4.6	4.6	4.6	4.6	4.6	4.6	4.6	4.6
All-Red Time (s)	2.3	2.3	2.3	2.3	2.3	2.3	2.3	2.3	2.3	2.3	2.3	2.3
Lost Time Adjust (s)	-1.0	-1.0	-1.0	-1.0	-1.0	-1.0	-1.0	-1.0	-1.0	-1.0	-1.0	-1.0
Total Lost Time (s)	5.9	5.9	5.9	5.9	5.9	5.9	5.9	5.9	5.9	5.9	5.9	5.9
Lead/Lag	Lead	Lag	Lag	Lead	Lag	Lag	Lead	Lag	Lag	Lead	Lag	
Lead-Lag Optimize?	Yes	Yes	Yes	Yes	Yes	Yes	Yes	Yes	Yes	Yes	Yes	Yes
Recall Mode	None	None	None	None	None	None	None	C-Max	C-Max	None	C-Max	
v/c Ratio	0.84	0.66	0.12	0.25	0.73	0.25	0.59	0.18	0.04	0.39	0.11	0.18
Control Delay	51.8	30.5	6.7	55.8	42.9	5.8	57.3	31.8	12.9	55.0	33.0	8.8
Queue Delay	0.0	0.0	0.0	0.0	0.0	0.0	0.0	0.0	0.0	0.0	0.0	0.0
Total Delay	51.8	30.5	6.7	55.8	42.9	5.8	57.3	31.8	12.9	55.0	33.0	8.8
Queue Length 50th (m)	69.7	86.6	1.5	5.0	43.1	0.0	19.7	16.8	0.0	10.2	9.4	11.0
Queue Length 95th (m)	90.4	102.3	10.2	10.8	52.6	8.1	#32.5	26.5	6.0	18.7	16.5	18.6
Internal Link Dist (m)		131.0			112.8			120.2			61.2	
Turn Bay Length (m)	100.0		50.0	30.0		50.0	50.0		50.0	50.0		100.0
Base Capacity (vph)	826	1480	702	183	817	442	316	1033	476	245	960	1615
Starvation Cap Reductn	0	0	0	0	0	0	0	0	0	0	0	0
Spillback Cap Reductn	0	0	0	0	0	0	0	0	0	0	0	0
Storage Cap Reductn	0	0	0	0	0	0	0	0	0	0	0	0
Reduced v/c Ratio	0.80	0.63	0.11	0.25	0.62	0.23	0.59	0.18	0.04	0.39	0.11	0.18

Intersection Summary

Cycle Length: 112.6
 Actuated Cycle Length: 112.6
 Offset: 36 (32%), Referenced to phase 2:NBT and 6:SBT, Start of Green
 Natural Cycle: 100
 Control Type: Actuated-Coordinated
 # 95th percentile volume exceeds capacity, queue may be longer.
 Queue shown is maximum after two cycles.

























Splits and Phases: 3: Earl Armstrong & Limebank



HCM Signalized Intersection Capacity Analysis

3: Earl Armstrong & Limebank

Future Background Traffic-2021
Weekday AM Peak Hour Unconstrained

												
Movement	EBL	EBT	EBR	WBL	WBT	WBR	NBL	NBT	NBR	SBL	SBT	SBR
Lane Configurations												
Volume (vph)	660	925	80	45	510	100	185	190	20	95	105	285
Ideal Flow (vphpl)	1900	1900	1900	1900	1900	1900	1900	1900	1900	1900	1900	1900
Total Lost time (s)	5.9	5.9	5.9	5.9	5.9	5.9	5.9	5.9	5.9	5.9	5.9	5.9
Lane Util. Factor	0.97	0.95	1.00	0.97	0.95	1.00	0.97	0.95	1.00	0.97	0.95	0.88
Frt	1.00	1.00	0.85	1.00	1.00	0.85	1.00	1.00	0.85	1.00	1.00	0.85
Flt Protected	0.95	1.00	1.00	0.95	1.00	1.00	0.95	1.00	1.00	0.95	1.00	1.00
Satd. Flow (prot)	3433	3539	1583	3433	3539	1583	3433	3539	1583	3433	3539	2787
Flt Permitted	0.95	1.00	1.00	0.95	1.00	1.00	0.95	1.00	1.00	0.95	1.00	1.00
Satd. Flow (perm)	3433	3539	1583	3433	3539	1583	3433	3539	1583	3433	3539	2787
Peak-hour factor, PHF	1.00	1.00	1.00	1.00	1.00	1.00	1.00	1.00	1.00	1.00	1.00	1.00
Adj. Flow (vph)	660	925	80	45	510	100	185	190	20	95	105	285
RTOR Reduction (vph)	0	0	42	0	0	79	0	0	14	0	0	45
Lane Group Flow (vph)	660	925	38	45	510	21	185	190	6	95	105	240
Turn Type	Prot		Perm	Prot		Perm	Prot		Perm	Prot		custom
Protected Phases	7	4		3	8		5	2		1	6	6
Permitted Phases			4			8			2			6
Actuated Green, G (s)	24.9	43.5	43.5	4.0	22.6	22.6	9.4	30.5	30.5	7.0	28.1	59.9
Effective Green, g (s)	25.9	44.5	44.5	5.0	23.6	23.6	10.4	31.5	31.5	8.0	29.1	60.9
Actuated g/C Ratio	0.23	0.40	0.40	0.04	0.21	0.21	0.09	0.28	0.28	0.07	0.26	0.54
Clearance Time (s)	6.9	6.9	6.9	6.9	6.9	6.9	6.9	6.9	6.9	6.9	6.9	
Vehicle Extension (s)	3.0	3.0	3.0	3.0	3.0	3.0	3.0	3.0	3.0	3.0	3.0	
Lane Grp Cap (vph)	790	1399	626	152	742	332	317	990	443	244	915	1507
v/s Ratio Prot	c0.19	c0.26		0.01	0.14		c0.05	c0.05		0.03	0.03	0.09
v/s Ratio Perm			0.02			0.01			0.00			
v/c Ratio	0.84	0.66	0.06	0.30	0.69	0.06	0.58	0.19	0.01	0.39	0.11	0.16
Uniform Delay, d1	41.3	27.9	21.1	52.1	41.1	35.6	49.0	30.9	29.3	50.0	31.9	13.0
Progression Factor	1.00	1.00	1.00	1.02	0.86	0.60	1.00	1.00	1.00	1.00	1.00	1.00
Incremental Delay, d2	7.6	1.2	0.0	1.1	2.6	0.1	2.7	0.4	0.1	1.0	0.3	0.0
Delay (s)	49.0	29.1	21.1	54.4	38.1	21.3	51.8	31.3	29.4	51.0	32.2	13.0
Level of Service	D	C	C	D	D	C	D	C	C	D	C	B
Approach Delay (s)		36.6			36.7			40.8			24.6	
Approach LOS		D			D			D			C	
Intersection Summary												
HCM Average Control Delay			35.3				HCM Level of Service			D		
HCM Volume to Capacity ratio			0.51									
Actuated Cycle Length (s)			112.6				Sum of lost time (s)		11.8			
Intersection Capacity Utilization			66.2%				ICU Level of Service		C			
Analysis Period (min)			15									
c Critical Lane Group												

Queues
6: Earl Armstrong & Proposed New Road

Future Background Traffic-2021
 Weekday AM Peak Hour Unconstrained

Lane Group	EBL	EBT	EBR	WBL	WBT	WBR	NBL	NBT	SBT
Lane Configurations									
Volume (vph)	35	930	50	5	565	2	75	0	2
Lane Group Flow (vph)	35	930	50	5	565	2	75	30	17
Turn Type	Perm		Perm	Perm		Perm	Perm		
Protected Phases		4			8			2	6
Permitted Phases	4		4	8		8	2		
Detector Phase	4	4	4	8	8	8	2	2	6
Switch Phase									
Minimum Initial (s)	10.0	10.0	10.0	10.0	10.0	10.0	10.0	10.0	10.0
Minimum Split (s)	31.9	31.9	31.9	31.9	31.9	31.9	31.9	31.9	31.9
Total Split (s)	73.6	73.6	73.6	73.6	73.6	73.6	39.0	39.0	39.0
Total Split (%)	65.4%	65.4%	65.4%	65.4%	65.4%	65.4%	34.6%	34.6%	34.6%
Yellow Time (s)	4.6	4.6	4.6	4.6	4.6	4.6	4.6	4.6	4.6
All-Red Time (s)	2.3	2.3	2.3	2.3	2.3	2.3	2.3	2.3	2.3
Lost Time Adjust (s)	-1.0	-1.0	-1.0	-1.0	-1.0	-1.0	-1.0	-1.0	-1.0
Total Lost Time (s)	5.9	5.9	5.9	5.9	5.9	5.9	5.9	5.9	5.9
Lead/Lag									
Lead-Lag Optimize?									
Recall Mode	C-Max	C-Max	C-Max	C-Max	C-Max	C-Max	None	None	None
v/c Ratio	0.05	0.32	0.04	0.01	0.20	0.00	0.46	0.10	0.08
Control Delay	0.2	0.3	0.0	3.6	3.3	2.5	54.8	0.6	21.2
Queue Delay	0.0	0.0	0.0	0.0	0.0	0.0	0.0	0.0	0.0
Total Delay	0.2	0.3	0.0	3.6	3.3	2.5	54.8	0.6	21.2
Queue Length 50th (m)	0.0	0.3	0.0	0.2	13.4	0.0	15.6	0.0	0.4
Queue Length 95th (m)	m0.0	0.3	m0.0	1.2	22.5	0.6	28.9	0.0	6.7
Internal Link Dist (m)		95.8			43.9			72.0	67.0
Turn Bay Length (m)	30.0		30.0	30.0		30.0	30.0		
Base Capacity (vph)	671	2894	1302	454	2894	1295	409	566	486
Starvation Cap Reductn	0	0	0	0	0	0	0	0	0
Spillback Cap Reductn	0	0	0	0	0	0	0	0	0
Storage Cap Reductn	0	0	0	0	0	0	0	0	0
Reduced v/c Ratio	0.05	0.32	0.04	0.01	0.20	0.00	0.18	0.05	0.03

Intersection Summary

Cycle Length: 112.6
 Actuated Cycle Length: 112.6
 Offset: 0 (0%), Referenced to phase 4:EBTL and 8:WBTL, Start of Green
 Natural Cycle: 65
 Control Type: Actuated-Coordinated
 m Volume for 95th percentile queue is metered by upstream signal.





























Splits and Phases: 6: Earl Armstrong & Proposed New Road



HCM Signalized Intersection Capacity Analysis

6: Earl Armstrong & Proposed New Road

Future Background Traffic-2021
Weekday AM Peak Hour Unconstrained

												
Movement	EBL	EBT	EBR	WBL	WBT	WBR	NBL	NBT	NBR	SBL	SBT	SBR
Lane Configurations		 			 			 			 	
Volume (vph)	35	930	50	5	565	2	75	0	30	0	2	15
Ideal Flow (vphpl)	1900	1900	1900	1900	1900	1900	1900	1900	1900	1900	1900	1900
Total Lost time (s)	5.9	5.9	5.9	5.9	5.9	5.9	5.9	5.9			5.9	
Lane Util. Factor	1.00	0.95	1.00	1.00	0.95	1.00	1.00	1.00			1.00	
Frt	1.00	1.00	0.85	1.00	1.00	0.85	1.00	0.85			0.87	
Flt Protected	0.95	1.00	1.00	0.95	1.00	1.00	0.95	1.00			1.00	
Satd. Flow (prot)	1770	3539	1583	1770	3539	1583	1770	1583			1616	
Flt Permitted	0.44	1.00	1.00	0.30	1.00	1.00	0.75	1.00			1.00	
Satd. Flow (perm)	819	3539	1583	555	3539	1583	1390	1583			1616	
Peak-hour factor, PHF	1.00	1.00	1.00	1.00	1.00	1.00	1.00	1.00	1.00	1.00	1.00	1.00
Adj. Flow (vph)	35	930	50	5	565	2	75	0	30	0	2	15
RTOR Reduction (vph)	0	0	8	0	0	0	0	27	0	0	13	0
Lane Group Flow (vph)	35	930	42	5	565	2	75	3	0	0	4	0
Turn Type	Perm		Perm	Perm		Perm	Perm			Perm		
Protected Phases		4			8			2			6	
Permitted Phases	4		4	8		8	2			6		
Actuated Green, G (s)	88.5	88.5	88.5	88.5	88.5	88.5	10.3	10.3			10.3	
Effective Green, g (s)	89.5	89.5	89.5	89.5	89.5	89.5	11.3	11.3			11.3	
Actuated g/C Ratio	0.79	0.79	0.79	0.79	0.79	0.79	0.10	0.10			0.10	
Clearance Time (s)	6.9	6.9	6.9	6.9	6.9	6.9	6.9	6.9			6.9	
Vehicle Extension (s)	3.0	3.0	3.0	3.0	3.0	3.0	3.0	3.0			3.0	
Lane Grp Cap (vph)	651	2813	1258	441	2813	1258	139	159			162	
v/s Ratio Prot		c0.26			0.16			0.00			0.00	
v/s Ratio Perm	0.04		0.03	0.01		0.00	c0.05					
v/c Ratio	0.05	0.33	0.03	0.01	0.20	0.00	0.54	0.02			0.02	
Uniform Delay, d1	2.5	3.2	2.4	2.4	2.8	2.4	48.2	45.7			45.7	
Progression Factor	0.02	0.03	0.00	1.00	1.00	1.00	1.00	1.00			1.00	
Incremental Delay, d2	0.1	0.3	0.0	0.0	0.2	0.0	4.0	0.0			0.1	
Delay (s)	0.2	0.3	0.0	2.4	3.0	2.4	52.2	45.7			45.7	
Level of Service	A	A	A	A	A	A	D	D			D	
Approach Delay (s)		0.3			3.0			50.3			45.7	
Approach LOS		A			A			D			D	
Intersection Summary												
HCM Average Control Delay			4.7				HCM Level of Service				A	
HCM Volume to Capacity ratio			0.35									
Actuated Cycle Length (s)			112.6				Sum of lost time (s)				11.8	
Intersection Capacity Utilization			49.7%				ICU Level of Service				A	
Analysis Period (min)			15									
c Critical Lane Group												












HCM Unsignalized Intersection Capacity Analysis
 9: Earl Armstrong & RIRO Site Access

Future Background Traffic-2021
 Weekday AM Peak Hour Unconstrained

	→	↘	↙	←	↖	↗
Movement	EBT	EBR	WBL	WBT	NBL	NBR
Lane Configurations	↑↑			↑↑		↗
Volume (veh/h)	1015	25	0	655	0	1
Sign Control	Free			Free	Stop	
Grade	0%			0%	0%	
Peak Hour Factor	1.00	1.00	1.00	1.00	1.00	1.00
Hourly flow rate (vph)	1015	25	0	655	0	1
Pedestrians						
Lane Width (m)						
Walking Speed (m/s)						
Percent Blockage						
Right turn flare (veh)						
Median type	None			None		
Median storage (veh)						
Upstream signal (m)	137			120		
pX, platoon unblocked			0.78		0.80	0.78
vC, conflicting volume			1040		1355	520
vC1, stage 1 conf vol						
vC2, stage 2 conf vol						
vCu, unblocked vol			501		779	0
tC, single (s)			4.1		6.8	6.9
tC, 2 stage (s)						
tF (s)			2.2		3.5	3.3
p0 queue free %			100		100	100
cM capacity (veh/h)			831		266	851
Direction, Lane #	EB 1	EB 2	WB 1	WB 2	NB 1	
Volume Total	677	363	328	328	1	
Volume Left	0	0	0	0	0	
Volume Right	0	25	0	0	1	
cSH	1700	1700	1700	1700	851	
Volume to Capacity	0.40	0.21	0.19	0.19	0.00	
Queue Length 95th (m)	0.0	0.0	0.0	0.0	0.0	
Control Delay (s)	0.0	0.0	0.0	0.0	9.2	
Lane LOS						A
Approach Delay (s)	0.0		0.0		9.2	
Approach LOS						A
Intersection Summary						
Average Delay			0.0			
Intersection Capacity Utilization			38.9%	ICU Level of Service	A	
Analysis Period (min)			15			










HCM Unsignalized Intersection Capacity Analysis
 11: Site Access & Limebank

Future Background Traffic-2021
 Weekday AM Peak Hour Unconstrained

							
Movement	WBL	WBR	NBT	NBR	SBL	SBT	
Lane Configurations							
Volume (veh/h)	25	55	340	40	65	165	
Sign Control	Stop		Free			Free	
Grade	0%		0%			0%	
Peak Hour Factor	1.00	1.00	1.00	1.00	1.00	1.00	
Hourly flow rate (vph)	25	55	340	40	65	165	
Pedestrians							
Lane Width (m)							
Walking Speed (m/s)							
Percent Blockage							
Right turn flare (veh)							
Median type			None			None	
Median storage (veh)							
Upstream signal (m)						144	
pX, platoon unblocked							
vC, conflicting volume	572	190			380		
vC1, stage 1 conf vol							
vC2, stage 2 conf vol							
vCu, unblocked vol	572	190			380		
tC, single (s)	6.8	6.9			4.1		
tC, 2 stage (s)							
tF (s)	3.5	3.3			2.2		
p0 queue free %	94	93			94		
cM capacity (veh/h)	425	820			1175		
Direction, Lane #	WB 1	WB 2	NB 1	NB 2	SB 1	SB 2	SB 3
Volume Total	25	55	227	153	65	82	82
Volume Left	25	0	0	0	65	0	0
Volume Right	0	55	0	40	0	0	0
cSH	425	820	1700	1700	1175	1700	1700
Volume to Capacity	0.06	0.07	0.13	0.09	0.06	0.05	0.05
Queue Length 95th (m)	1.4	1.6	0.0	0.0	1.3	0.0	0.0
Control Delay (s)	14.0	9.7	0.0	0.0	8.2	0.0	0.0
Lane LOS	B	A			A		
Approach Delay (s)	11.0		0.0		2.3		
Approach LOS	B						
Intersection Summary							
Average Delay			2.1				
Intersection Capacity Utilization			27.6%		ICU Level of Service		A
Analysis Period (min)			15				










HCM Unsignalized Intersection Capacity Analysis
 13: N. Site Access & Proposed New Road

Future Background Traffic-2021
 Weekday AM Peak Hour Unconstrained

						
Movement	EBL	EBR	NBL	NBT	SBT	SBR
Lane Configurations						
Volume (veh/h)	2	0	5	105	50	5
Sign Control	Stop			Free	Free	
Grade	0%			0%	0%	
Peak Hour Factor	1.00	1.00	1.00	1.00	1.00	1.00
Hourly flow rate (vph)	2	0	5	105	50	5
Pedestrians						
Lane Width (m)						
Walking Speed (m/s)						
Percent Blockage						
Right turn flare (veh)						
Median type				None	None	
Median storage (veh)						
Upstream signal (m)					96	
pX, platoon unblocked						
vC, conflicting volume	168	52	55			
vC1, stage 1 conf vol						
vC2, stage 2 conf vol						
vCu, unblocked vol	168	52	55			
tC, single (s)	6.4	6.2	4.1			
tC, 2 stage (s)						
tF (s)	3.5	3.3	2.2			
p0 queue free %	100	100	100			
cM capacity (veh/h)	820	1015	1550			
Direction, Lane #	EB 1	NB 1	SB 1			
Volume Total	2	110	55			
Volume Left	2	5	0			
Volume Right	0	0	5			
cSH	820	1550	1700			
Volume to Capacity	0.00	0.00	0.03			
Queue Length 95th (m)	0.1	0.1	0.0			
Control Delay (s)	9.4	0.4	0.0			
Lane LOS	A	A				
Approach Delay (s)	9.4	0.4	0.0			
Approach LOS	A					
Intersection Summary						
Average Delay			0.3			
Intersection Capacity Utilization		19.6%		ICU Level of Service	A	
Analysis Period (min)			15			

HCM Unsignalized Intersection Capacity Analysis
 15: S. Site Access & Proposed New Road

Future Background Traffic-2021
 Weekday AM Peak Hour Unconstrained

						
Movement	EBL	EBR	NBL	NBT	SBT	SBR
Lane Configurations						
Volume (veh/h)	0	2	5	110	50	2
Sign Control	Stop			Free	Free	
Grade	0%			0%	0%	
Peak Hour Factor	1.00	1.00	1.00	1.00	1.00	1.00
Hourly flow rate (vph)	0	2	5	110	50	2
Pedestrians						
Lane Width (m)						
Walking Speed (m/s)						
Percent Blockage						
Right turn flare (veh)						
Median type				None	None	
Median storage (veh)						
Upstream signal (m)					186	
pX, platoon unblocked						
vC, conflicting volume	171	51	52			
vC1, stage 1 conf vol						
vC2, stage 2 conf vol						
vCu, unblocked vol	171	51	52			
tC, single (s)	6.4	6.2	4.1			
tC, 2 stage (s)						
tF (s)	3.5	3.3	2.2			
p0 queue free %	100	100	100			
cM capacity (veh/h)	816	1017	1554			
Direction, Lane #	EB 1	NB 1	SB 1			
Volume Total	2	115	52			
Volume Left	0	5	0			
Volume Right	2	0	2			
cSH	1017	1554	1700			
Volume to Capacity	0.00	0.00	0.03			
Queue Length 95th (m)	0.0	0.1	0.0			
Control Delay (s)	8.5	0.3	0.0			
Lane LOS	A	A				
Approach Delay (s)	8.5	0.3	0.0			
Approach LOS	A					
Intersection Summary						
Average Delay			0.3			
Intersection Capacity Utilization		19.9%		ICU Level of Service		A
Analysis Period (min)			15			

Queues
3: Earl Armstrong & Limebank

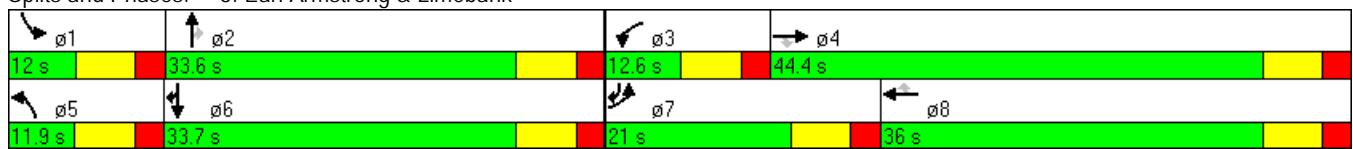
Future Background Traffic-2021
 Weekday PM Peak Hour Unconstrained

Lane Group	EBL	EBT	EBR	WBL	WBT	WBR	NBL	NBT	NBR	SBL	SBT	SBR
Lane Configurations												
Volume (vph)	730	680	215	95	1200	155	75	135	55	245	205	955
Lane Group Flow (vph)	730	680	215	95	1200	155	75	135	55	245	205	955
Turn Type	Prot		Perm	Prot		Perm	Prot		Perm	Prot		custom
Protected Phases	7	4		3	8		5	2		1	6	6 7
Permitted Phases			4			8			2			6
Detector Phase	7	4	4	3	8	8	5	2	2	1	6	6 7
Switch Phase												
Minimum Initial (s)	5.0	10.0	10.0	5.0	10.0	10.0	5.0	10.0	10.0	5.0	10.0	
Minimum Split (s)	11.9	31.9	31.9	11.9	31.9	31.9	11.9	31.9	31.9	11.9	31.9	
Total Split (s)	21.0	44.4	44.4	12.6	36.0	36.0	11.9	33.6	33.6	12.0	33.7	54.7
Total Split (%)	20.5%	43.3%	43.3%	12.3%	35.1%	35.1%	11.6%	32.7%	32.7%	11.7%	32.8%	53.3%
Yellow Time (s)	4.6	4.6	4.6	4.6	4.6	4.6	4.6	4.6	4.6	4.6	4.6	4.6
All-Red Time (s)	2.3	2.3	2.3	2.3	2.3	2.3	2.3	2.3	2.3	2.3	2.3	2.3
Lost Time Adjust (s)	-1.0	-1.0	-1.0	-1.0	-1.0	-1.0	-1.0	-1.0	-1.0	-1.0	-1.0	-1.0
Total Lost Time (s)	5.9	5.9	5.9	5.9	5.9	5.9	5.9	5.9	5.9	5.9	5.9	5.9
Lead/Lag	Lead	Lag	Lag	Lead	Lag	Lag	Lead	Lag	Lag	Lead	Lag	
Lead-Lag Optimize?	Yes	Yes	Yes	Yes	Yes	Yes	Yes	Yes	Yes	Yes	Yes	Yes
Recall Mode	None	None	None	None	None	None	None	C-Max	C-Max	None	C-Max	
v/c Ratio	1.45	0.48	0.28	0.42	1.16	0.29	0.37	0.14	0.12	1.20	0.20	0.67
Control Delay	245.2	25.1	4.1	54.5	110.8	9.8	52.1	29.0	8.6	170.1	28.8	21.7
Queue Delay	0.0	0.0	0.0	0.0	0.0	0.0	0.0	0.0	0.0	0.0	0.0	0.0
Total Delay	245.2	25.1	4.1	54.5	110.8	9.8	52.1	29.0	8.6	170.1	28.8	21.7
Queue Length 50th (m)	~101.1	53.6	0.0	9.3	~148.6	4.1	7.4	10.6	0.0	~30.3	16.4	76.6
Queue Length 95th (m)	#135.8	70.2	13.9	17.4	#182.5	16.0	14.4	18.0	8.8	#54.2	25.7	101.5
Internal Link Dist (m)		131.0			113.3			120.8			61.2	
Turn Bay Length (m)	100.0		50.0	30.0		50.0	50.0		50.0	50.0		100.0
Base Capacity (vph)	505	1415	762	224	1038	530	201	955	468	204	1041	1419
Starvation Cap Reductn	0	0	0	0	0	0	0	0	0	0	0	0
Spillback Cap Reductn	0	0	0	0	0	0	0	0	0	0	0	0
Storage Cap Reductn	0	0	0	0	0	0	0	0	0	0	0	0
Reduced v/c Ratio	1.45	0.48	0.28	0.42	1.16	0.29	0.37	0.14	0.12	1.20	0.20	0.67

Intersection Summary

Cycle Length: 102.6
 Actuated Cycle Length: 102.6
 Offset: 43 (42%), Referenced to phase 2:NBT and 6:SBT, Start of Green
 Natural Cycle: 130
 Control Type: Actuated-Coordinated
 ~ Volume exceeds capacity, queue is theoretically infinite.
 Queue shown is maximum after two cycles.
 # 95th percentile volume exceeds capacity, queue may be longer.
 Queue shown is maximum after two cycles.

























Splits and Phases: 3: Earl Armstrong & Limebank



HCM Signalized Intersection Capacity Analysis

3: Earl Armstrong & Limebank

Future Background Traffic-2021
Weekday PM Peak Hour Unconstrained

												
Movement	EBL	EBT	EBR	WBL	WBT	WBR	NBL	NBT	NBR	SBL	SBT	SBR
Lane Configurations												
Volume (vph)	730	680	215	95	1200	155	75	135	55	245	205	955
Ideal Flow (vphpl)	1900	1900	1900	1900	1900	1900	1900	1900	1900	1900	1900	1900
Total Lost time (s)	5.9	5.9	5.9	5.9	5.9	5.9	5.9	5.9	5.9	5.9	5.9	5.9
Lane Util. Factor	0.97	0.95	1.00	0.97	0.95	1.00	0.97	0.95	1.00	0.97	0.95	0.88
Frt	1.00	1.00	0.85	1.00	1.00	0.85	1.00	1.00	0.85	1.00	1.00	0.85
Flt Protected	0.95	1.00	1.00	0.95	1.00	1.00	0.95	1.00	1.00	0.95	1.00	1.00
Satd. Flow (prot)	3433	3539	1583	3433	3539	1583	3433	3539	1583	3433	3539	2787
Flt Permitted	0.95	1.00	1.00	0.95	1.00	1.00	0.95	1.00	1.00	0.95	1.00	1.00
Satd. Flow (perm)	3433	3539	1583	3433	3539	1583	3433	3539	1583	3433	3539	2787
Peak-hour factor, PHF	1.00	1.00	1.00	1.00	1.00	1.00	1.00	1.00	1.00	1.00	1.00	1.00
Adj. Flow (vph)	730	680	215	95	1200	155	75	135	55	245	205	955
RTOR Reduction (vph)	0	0	129	0	0	64	0	0	41	0	0	31
Lane Group Flow (vph)	730	680	86	95	1200	91	75	135	14	245	205	924
Turn Type	Prot		Perm	Prot		Perm	Prot		Perm	Prot		custom
Protected Phases	7	4		3	8		5	2		1	6	6
Permitted Phases			4			8			2			6
Actuated Green, G (s)	14.1	40.0	40.0	4.6	30.5	30.5	4.0	25.3	25.3	5.1	26.4	47.4
Effective Green, g (s)	15.1	41.0	41.0	5.6	31.5	31.5	5.0	26.3	26.3	6.1	27.4	48.4
Actuated g/C Ratio	0.15	0.40	0.40	0.05	0.31	0.31	0.05	0.26	0.26	0.06	0.27	0.47
Clearance Time (s)	6.9	6.9	6.9	6.9	6.9	6.9	6.9	6.9	6.9	6.9	6.9	
Vehicle Extension (s)	3.0	3.0	3.0	3.0	3.0	3.0	3.0	3.0	3.0	3.0	3.0	
Lane Grp Cap (vph)	505	1414	633	187	1087	486	167	907	406	204	945	1315
v/s Ratio Prot	c0.21	0.19		0.03	c0.34		0.02	0.04		c0.07	0.06	c0.33
v/s Ratio Perm			0.05			0.06			0.01			
v/c Ratio	1.45	0.48	0.14	0.51	1.10	0.19	0.45	0.15	0.03	1.20	0.22	0.70
Uniform Delay, d1	43.8	22.9	19.6	47.2	35.5	26.1	47.5	29.5	28.6	48.2	29.3	21.4
Progression Factor	1.00	1.00	1.00	1.06	0.85	0.69	1.00	1.00	1.00	1.00	1.00	1.00
Incremental Delay, d2	211.5	0.3	0.1	2.0	59.4	0.2	1.9	0.3	0.2	127.8	0.5	1.7
Delay (s)	255.2	23.2	19.7	52.0	89.7	18.3	49.4	29.8	28.8	176.0	29.8	23.1
Level of Service	F	C	B	D	F	B	D	C	C	F	C	C
Approach Delay (s)		126.9			79.6			35.2			50.8	
Approach LOS		F			E			D			D	

Intersection Summary

HCM Average Control Delay	84.8	HCM Level of Service	F
HCM Volume to Capacity ratio	1.01		
Actuated Cycle Length (s)	102.6	Sum of lost time (s)	17.7
Intersection Capacity Utilization	89.0%	ICU Level of Service	E
Analysis Period (min)	15		
c Critical Lane Group			

Queues
6: Earl Armstrong & Proposed New Road

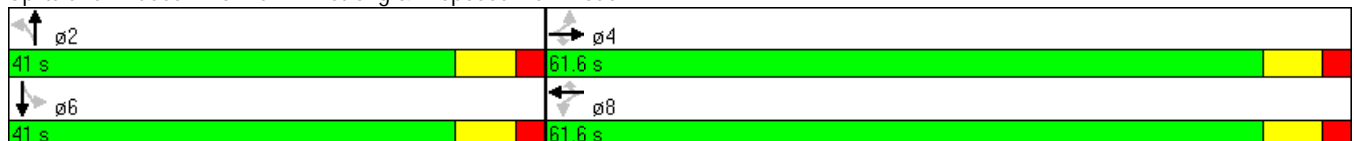
Future Background Traffic-2021
 Weekday PM Peak Hour Unconstrained

Lane Group	EBL	EBT	EBR	WBL	WBT	WBR	NBL	NBT	SBT
Lane Configurations									
Volume (vph)	95	730	105	60	1215	10	145	5	5
Lane Group Flow (vph)	95	730	105	60	1215	10	145	55	95
Turn Type	Perm		Perm	Perm		Perm	Perm		
Protected Phases		4			8			2	6
Permitted Phases	4		4	8		8	2		
Detector Phase	4	4	4	8	8	8	2	2	6
Switch Phase									
Minimum Initial (s)	10.0	10.0	10.0	10.0	10.0	10.0	10.0	10.0	10.0
Minimum Split (s)	31.9	31.9	31.9	31.9	31.9	31.9	31.9	31.9	31.9
Total Split (s)	61.6	61.6	61.6	61.6	61.6	61.6	41.0	41.0	41.0
Total Split (%)	60.0%	60.0%	60.0%	60.0%	60.0%	60.0%	40.0%	40.0%	40.0%
Yellow Time (s)	4.6	4.6	4.6	4.6	4.6	4.6	4.6	4.6	4.6
All-Red Time (s)	2.3	2.3	2.3	2.3	2.3	2.3	2.3	2.3	2.3
Lost Time Adjust (s)	-1.0	-1.0	-1.0	-1.0	-1.0	-1.0	-1.0	-1.0	-1.0
Total Lost Time (s)	5.9	5.9	5.9	5.9	5.9	5.9	5.9	5.9	5.9
Lead/Lag									
Lead-Lag Optimize?									
Recall Mode	C-Max	C-Max	C-Max	C-Max	C-Max	C-Max	None	None	None
v/c Ratio	0.36	0.29	0.09	0.12	0.48	0.01	0.64	0.17	0.29
Control Delay	6.8	0.8	0.1	6.8	8.0	4.4	51.4	11.9	19.0
Queue Delay	0.0	0.0	0.0	0.0	0.0	0.0	0.0	0.0	0.0
Total Delay	6.8	0.8	0.1	6.8	8.0	4.4	51.4	11.9	19.0
Queue Length 50th (m)	0.4	1.4	0.0	3.2	48.1	0.2	26.8	0.8	6.9
Queue Length 95th (m)	m4.1	m3.9	m0.1	9.6	78.5	2.0	43.0	9.9	18.8
Internal Link Dist (m)		96.0			43.9			72.0	67.0
Turn Bay Length (m)	30.0		30.0	30.0		30.0	30.0		
Base Capacity (vph)	262	2513	1154	480	2513	1126	443	583	582
Starvation Cap Reductn	0	0	0	0	0	0	0	0	0
Spillback Cap Reductn	0	0	0	0	0	0	0	0	0
Storage Cap Reductn	0	0	0	0	0	0	0	0	0
Reduced v/c Ratio	0.36	0.29	0.09	0.13	0.48	0.01	0.33	0.09	0.16

Intersection Summary

Cycle Length: 102.6
 Actuated Cycle Length: 102.6
 Offset: 100 (97%), Referenced to phase 4:EBTL and 8:WBTL, Start of Green
 Natural Cycle: 75
 Control Type: Actuated-Coordinated
 m Volume for 95th percentile queue is metered by upstream signal.





























Splits and Phases: 6: Earl Armstrong & Proposed New Road



HCM Signalized Intersection Capacity Analysis

6: Earl Armstrong & Proposed New Road

Future Background Traffic-2021
Weekday PM Peak Hour Unconstrained

												
Movement	EBL	EBT	EBR	WBL	WBT	WBR	NBL	NBT	NBR	SBL	SBT	SBR
Lane Configurations		 			 			 			 	
Volume (vph)	95	730	105	60	1215	10	145	5	50	0	5	90
Ideal Flow (vphpl)	1900	1900	1900	1900	1900	1900	1900	1900	1900	1900	1900	1900
Total Lost time (s)	5.9	5.9	5.9	5.9	5.9	5.9	5.9	5.9			5.9	
Lane Util. Factor	1.00	0.95	1.00	1.00	0.95	1.00	1.00	1.00			1.00	
Frt	1.00	1.00	0.85	1.00	1.00	0.85	1.00	0.86			0.86	
Flt Protected	0.95	1.00	1.00	0.95	1.00	1.00	0.95	1.00			1.00	
Satd. Flow (prot)	1770	3539	1583	1770	3539	1583	1770	1609			1598	
Flt Permitted	0.20	1.00	1.00	0.36	1.00	1.00	0.70	1.00			1.00	
Satd. Flow (perm)	369	3539	1583	677	3539	1583	1295	1609			1598	
Peak-hour factor, PHF	1.00	1.00	1.00	1.00	1.00	1.00	1.00	1.00	1.00	1.00	1.00	1.00
Adj. Flow (vph)	95	730	105	60	1215	10	145	5	50	0	5	90
RTOR Reduction (vph)	0	0	30	0	0	2	0	41	0	0	45	0
Lane Group Flow (vph)	95	730	75	60	1215	8	145	14	0	0	50	0
Turn Type	Perm		Perm	Perm		Perm	Perm			Perm		
Protected Phases		4			8			2				6
Permitted Phases	4		4	8		8	2			6		
Actuated Green, G (s)	71.9	71.9	71.9	71.9	71.9	71.9	16.9	16.9			16.9	
Effective Green, g (s)	72.9	72.9	72.9	72.9	72.9	72.9	17.9	17.9			17.9	
Actuated g/C Ratio	0.71	0.71	0.71	0.71	0.71	0.71	0.17	0.17			0.17	
Clearance Time (s)	6.9	6.9	6.9	6.9	6.9	6.9	6.9	6.9			6.9	
Vehicle Extension (s)	3.0	3.0	3.0	3.0	3.0	3.0	3.0	3.0			3.0	
Lane Grp Cap (vph)	262	2515	1125	481	2515	1125	226	281			279	
v/s Ratio Prot		0.21			c0.34			0.01			0.03	
v/s Ratio Perm	0.26		0.05	0.09		0.01	c0.11					
v/c Ratio	0.36	0.29	0.07	0.12	0.48	0.01	0.64	0.05			0.18	
Uniform Delay, d1	5.8	5.4	4.5	4.7	6.5	4.3	39.4	35.3			36.1	
Progression Factor	0.46	0.10	0.00	1.00	1.00	1.00	1.00	1.00			1.00	
Incremental Delay, d2	3.0	0.2	0.1	0.5	0.7	0.0	6.1	0.1			0.3	
Delay (s)	5.7	0.8	0.1	5.2	7.2	4.3	45.5	35.3			36.4	
Level of Service	A	A	A	A	A	A	D	D			D	
Approach Delay (s)		1.2			7.1			42.7			36.4	
Approach LOS		A			A			D			D	
Intersection Summary												
HCM Average Control Delay			8.9				HCM Level of Service				A	
HCM Volume to Capacity ratio			0.51									
Actuated Cycle Length (s)			102.6				Sum of lost time (s)				11.8	
Intersection Capacity Utilization			71.4%				ICU Level of Service				C	
Analysis Period (min)			15									
c Critical Lane Group												

HCM Unsignalized Intersection Capacity Analysis












9: Earl Armstrong & RIRO Site Access

Future Background Traffic-2021
Weekday PM Peak Hour Unconstrained

	→	↘	↙	←	↖	↗
Movement	EBT	EBR	WBL	WBT	NBL	NBR
Lane Configurations	↑↑			↑↑		↗
Volume (veh/h)	910	70	0	1450	0	20
Sign Control	Free			Free	Stop	
Grade	0%			0%	0%	
Peak Hour Factor	1.00	1.00	1.00	1.00	1.00	1.00
Hourly flow rate (vph)	910	70	0	1450	0	20
Pedestrians						
Lane Width (m)						
Walking Speed (m/s)						
Percent Blockage						
Right turn flare (veh)						
Median type	None		None			
Median storage (veh)						
Upstream signal (m)	137			120		
pX, platoon unblocked			0.86		0.91	0.86
vC, conflicting volume			980		1670	490
vC1, stage 1 conf vol						
vC2, stage 2 conf vol						
vCu, unblocked vol			650		848	80
tC, single (s)			4.1		6.8	6.9
tC, 2 stage (s)						
tF (s)			2.2		3.5	3.3
p0 queue free %			100		100	98
cM capacity (veh/h)			801		274	829
Direction, Lane #	EB 1	EB 2	WB 1	WB 2	NB 1	
Volume Total	607	373	725	725	20	
Volume Left	0	0	0	0	0	
Volume Right	0	70	0	0	20	
cSH	1700	1700	1700	1700	829	
Volume to Capacity	0.36	0.22	0.43	0.43	0.02	
Queue Length 95th (m)	0.0	0.0	0.0	0.0	0.6	
Control Delay (s)	0.0	0.0	0.0	0.0	9.4	
Lane LOS						A
Approach Delay (s)	0.0		0.0		9.4	
Approach LOS						A
Intersection Summary						
Average Delay			0.1			
Intersection Capacity Utilization			43.4%	ICU Level of Service	A	
Analysis Period (min)			15			










HCM Unsignalized Intersection Capacity Analysis
 11: Site Access & Limebank

Future Background Traffic-2021
 Weekday PM Peak Hour Unconstrained

							
Movement	WBL	WBR	NBT	NBR	SBL	SBT	
Lane Configurations							
Volume (veh/h)	125	220	50	100	175	340	
Sign Control	Stop		Free			Free	
Grade	0%		0%			0%	
Peak Hour Factor	1.00	1.00	1.00	1.00	1.00	1.00	
Hourly flow rate (vph)	125	220	50	100	175	340	
Pedestrians							
Lane Width (m)							
Walking Speed (m/s)							
Percent Blockage							
Right turn flare (veh)							
Median type			None			None	
Median storage (veh)							
Upstream signal (m)						145	
pX, platoon unblocked							
vC, conflicting volume	620	75			150		
vC1, stage 1 conf vol							
vC2, stage 2 conf vol							
vCu, unblocked vol	620	75			150		
tC, single (s)	6.8	6.9			4.1		
tC, 2 stage (s)							
tF (s)	3.5	3.3			2.2		
p0 queue free %	66	77			88		
cM capacity (veh/h)	368	971			1429		
Direction, Lane #	WB 1	WB 2	NB 1	NB 2	SB 1	SB 2	SB 3
Volume Total	125	220	33	117	175	170	170
Volume Left	125	0	0	0	175	0	0
Volume Right	0	220	0	100	0	0	0
cSH	368	971	1700	1700	1429	1700	1700
Volume to Capacity	0.34	0.23	0.02	0.07	0.12	0.10	0.10
Queue Length 95th (m)	11.0	6.5	0.0	0.0	3.1	0.0	0.0
Control Delay (s)	19.7	9.8	0.0	0.0	7.9	0.0	0.0
Lane LOS	C	A			A		
Approach Delay (s)	13.4		0.0		2.7		
Approach LOS	B						
Intersection Summary							
Average Delay			5.9				
Intersection Capacity Utilization			31.2%		ICU Level of Service		A
Analysis Period (min)			15				










HCM Unsignalized Intersection Capacity Analysis
 13: N. Site Access & Proposed New Road

Future Background Traffic-2021
 Weekday PM Peak Hour Unconstrained

						
Movement	EBL	EBR	NBL	NBT	SBT	SBR
Lane Configurations						
Volume (veh/h)	55	5	5	145	110	60
Sign Control	Stop			Free	Free	
Grade	0%			0%	0%	
Peak Hour Factor	1.00	1.00	1.00	1.00	1.00	1.00
Hourly flow rate (vph)	55	5	5	145	110	60
Pedestrians						
Lane Width (m)						
Walking Speed (m/s)						
Percent Blockage						
Right turn flare (veh)						
Median type				None	None	
Median storage (veh)						
Upstream signal (m)					96	
pX, platoon unblocked						
vC, conflicting volume	295	140	170			
vC1, stage 1 conf vol						
vC2, stage 2 conf vol						
vCu, unblocked vol	295	140	170			
tC, single (s)	6.4	6.2	4.1			
tC, 2 stage (s)						
tF (s)	3.5	3.3	2.2			
p0 queue free %	92	99	100			
cM capacity (veh/h)	694	908	1407			
Direction, Lane #	EB 1	NB 1	SB 1			
Volume Total	60	150	170			
Volume Left	55	5	0			
Volume Right	5	0	60			
cSH	707	1407	1700			
Volume to Capacity	0.08	0.00	0.10			
Queue Length 95th (m)	2.1	0.1	0.0			
Control Delay (s)	10.6	0.3	0.0			
Lane LOS	B	A				
Approach Delay (s)	10.6	0.3	0.0			
Approach LOS	B					
Intersection Summary						
Average Delay			1.8			
Intersection Capacity Utilization		21.7%		ICU Level of Service		A
Analysis Period (min)			15			

HCM Unsignalized Intersection Capacity Analysis
 15: S. Site Access & Proposed New Road

Future Background Traffic-2021
 Weekday PM Peak Hour Unconstrained

						
Movement	EBL	EBR	NBL	NBT	SBT	SBR
Lane Configurations						
Volume (veh/h)	5	10	10	145	110	5
Sign Control	Stop			Free	Free	
Grade	0%			0%	0%	
Peak Hour Factor	1.00	1.00	1.00	1.00	1.00	1.00
Hourly flow rate (vph)	5	10	10	145	110	5
Pedestrians						
Lane Width (m)						
Walking Speed (m/s)						
Percent Blockage						
Right turn flare (veh)						
Median type				None	None	
Median storage (veh)						
Upstream signal (m)					187	
pX, platoon unblocked						
vC, conflicting volume	278	112	115			
vC1, stage 1 conf vol						
vC2, stage 2 conf vol						
vCu, unblocked vol	278	112	115			
tC, single (s)	6.4	6.2	4.1			
tC, 2 stage (s)						
tF (s)	3.5	3.3	2.2			
p0 queue free %	99	99	99			
cM capacity (veh/h)	707	940	1474			
Direction, Lane #	EB 1	NB 1	SB 1			
Volume Total	15	155	115			
Volume Left	5	10	0			
Volume Right	10	0	5			
cSH	847	1474	1700			
Volume to Capacity	0.02	0.01	0.07			
Queue Length 95th (m)	0.4	0.2	0.0			
Control Delay (s)	9.3	0.5	0.0			
Lane LOS	A	A				
Approach Delay (s)	9.3	0.5	0.0			
Approach LOS	A					
Intersection Summary						
Average Delay			0.8			
Intersection Capacity Utilization		24.9%		ICU Level of Service		A
Analysis Period (min)			15			

Queues
3: Earl Armstrong & Limebank

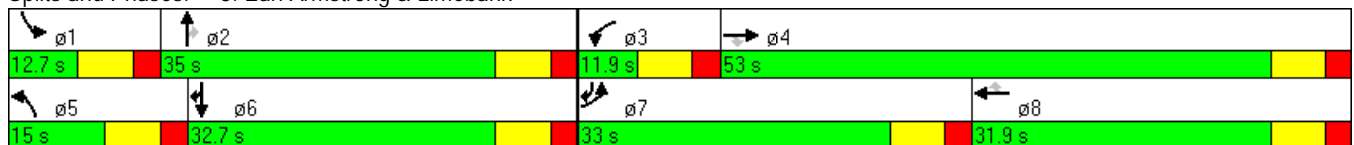
Future Total Traffic-2021
 Weekday AM Peak Hour Unconstrained

Lane Group	EBL	EBT	EBR	WBL	WBT	WBR	NBL	NBT	NBR	SBL	SBT	SBR
Lane Configurations												
Volume (vph)	660	925	80	45	510	100	185	190	25	90	110	285
Lane Group Flow (vph)	660	925	80	45	510	100	185	190	25	90	110	285
Turn Type	Prot		Perm	Prot		Perm	Prot		Perm	Prot		custom
Protected Phases	7	4		3	8		5	2		1	6	6 7
Permitted Phases			4			8			2			6
Detector Phase	7	4	4	3	8	8	5	2	2	1	6	6 7
Switch Phase												
Minimum Initial (s)	5.0	10.0	10.0	5.0	10.0	10.0	5.0	10.0	10.0	5.0	10.0	
Minimum Split (s)	11.9	31.9	31.9	11.9	31.9	31.9	11.9	31.9	31.9	11.9	31.9	
Total Split (s)	33.0	53.0	53.0	11.9	31.9	31.9	15.0	35.0	35.0	12.7	32.7	65.7
Total Split (%)	29.3%	47.1%	47.1%	10.6%	28.3%	28.3%	13.3%	31.1%	31.1%	11.3%	29.0%	58.3%
Yellow Time (s)	4.6	4.6	4.6	4.6	4.6	4.6	4.6	4.6	4.6	4.6	4.6	4.6
All-Red Time (s)	2.3	2.3	2.3	2.3	2.3	2.3	2.3	2.3	2.3	2.3	2.3	2.3
Lost Time Adjust (s)	-1.0	-1.0	-1.0	-1.0	-1.0	-1.0	-1.0	-1.0	-1.0	-1.0	-1.0	-1.0
Total Lost Time (s)	5.9	5.9	5.9	5.9	5.9	5.9	5.9	5.9	5.9	5.9	5.9	5.9
Lead/Lag	Lead	Lag	Lag	Lead	Lag	Lag	Lead	Lag	Lag	Lead	Lag	
Lead-Lag Optimize?	Yes	Yes	Yes	Yes	Yes	Yes	Yes	Yes	Yes	Yes	Yes	Yes
Recall Mode	None	None	None	None	None	None	None	C-Max	C-Max	None	C-Max	
v/c Ratio	0.84	0.66	0.12	0.25	0.73	0.25	0.59	0.17	0.05	0.38	0.11	0.18
Control Delay	51.8	30.5	6.7	56.0	42.8	5.8	57.3	30.9	12.0	55.0	33.0	8.8
Queue Delay	0.0	0.0	0.0	0.0	0.0	0.0	0.0	0.0	0.0	0.0	0.0	0.0
Total Delay	51.8	30.5	6.7	56.0	42.8	5.8	57.3	30.9	12.0	55.0	33.0	8.8
Queue Length 50th (m)	69.7	86.6	1.5	5.0	43.0	0.0	19.7	16.8	0.0	9.6	9.8	11.0
Queue Length 95th (m)	90.4	102.3	10.2	10.8	52.7	8.1	#32.5	26.4	6.6	17.9	17.2	18.6
Internal Link Dist (m)		131.0			112.8			120.2			61.2	
Turn Bay Length (m)	100.0		50.0	30.0		50.0	50.0		50.0	50.0		100.0
Base Capacity (vph)	826	1480	702	183	817	442	316	1121	519	239	960	1615
Starvation Cap Reductn	0	0	0	0	0	0	0	0	0	0	0	0
Spillback Cap Reductn	0	0	0	0	0	0	0	0	0	0	0	0
Storage Cap Reductn	0	0	0	0	0	0	0	0	0	0	0	0
Reduced v/c Ratio	0.80	0.63	0.11	0.25	0.62	0.23	0.59	0.17	0.05	0.38	0.11	0.18

Intersection Summary

Cycle Length: 112.6
 Actuated Cycle Length: 112.6
 Offset: 36 (32%), Referenced to phase 2:NBT and 6:SBT, Start of Green
 Natural Cycle: 100
 Control Type: Actuated-Coordinated
 # 95th percentile volume exceeds capacity, queue may be longer.
 Queue shown is maximum after two cycles.

























Splits and Phases: 3: Earl Armstrong & Limebank



HCM Signalized Intersection Capacity Analysis

3: Earl Armstrong & Limebank

Future Total Traffic-2021
Weekday AM Peak Hour Unconstrained

												
Movement	EBL	EBT	EBR	WBL	WBT	WBR	NBL	NBT	NBR	SBL	SBT	SBR
Lane Configurations												
Volume (vph)	660	925	80	45	510	100	185	190	25	90	110	285
Ideal Flow (vphpl)	1900	1900	1900	1900	1900	1900	1900	1900	1900	1900	1900	1900
Total Lost time (s)	5.9	5.9	5.9	5.9	5.9	5.9	5.9	5.9	5.9	5.9	5.9	5.9
Lane Util. Factor	0.97	0.95	1.00	0.97	0.95	1.00	0.97	0.95	1.00	0.97	0.95	0.88
Frt	1.00	1.00	0.85	1.00	1.00	0.85	1.00	1.00	0.85	1.00	1.00	0.85
Flt Protected	0.95	1.00	1.00	0.95	1.00	1.00	0.95	1.00	1.00	0.95	1.00	1.00
Satd. Flow (prot)	3433	3539	1583	3433	3539	1583	3433	3539	1583	3433	3539	2787
Flt Permitted	0.95	1.00	1.00	0.95	1.00	1.00	0.95	1.00	1.00	0.95	1.00	1.00
Satd. Flow (perm)	3433	3539	1583	3433	3539	1583	3433	3539	1583	3433	3539	2787
Peak-hour factor, PHF	1.00	1.00	1.00	1.00	1.00	1.00	1.00	1.00	1.00	1.00	1.00	1.00
Adj. Flow (vph)	660	925	80	45	510	100	185	190	25	90	110	285
RTOR Reduction (vph)	0	0	42	0	0	79	0	0	18	0	0	45
Lane Group Flow (vph)	660	925	38	45	510	21	185	190	7	90	110	240
Turn Type	Prot		Perm	Prot		Perm	Prot		Perm	Prot		custom
Protected Phases	7	4		3	8		5	2		1	6	6
Permitted Phases			4			8			2			6
Actuated Green, G (s)	24.9	43.5	43.5	4.0	22.6	22.6	9.4	31.9	31.9	5.6	28.1	59.9
Effective Green, g (s)	25.9	44.5	44.5	5.0	23.6	23.6	10.4	32.9	32.9	6.6	29.1	60.9
Actuated g/C Ratio	0.23	0.40	0.40	0.04	0.21	0.21	0.09	0.29	0.29	0.06	0.26	0.54
Clearance Time (s)	6.9	6.9	6.9	6.9	6.9	6.9	6.9	6.9	6.9	6.9	6.9	
Vehicle Extension (s)	3.0	3.0	3.0	3.0	3.0	3.0	3.0	3.0	3.0	3.0	3.0	
Lane Grp Cap (vph)	790	1399	626	152	742	332	317	1034	463	201	915	1507
v/s Ratio Prot	c0.19	c0.26		0.01	0.14		c0.05	c0.05		0.03	0.03	0.09
v/s Ratio Perm			0.02			0.01			0.00			
v/c Ratio	0.84	0.66	0.06	0.30	0.69	0.06	0.58	0.18	0.02	0.45	0.12	0.16
Uniform Delay, d1	41.3	27.9	21.1	52.1	41.1	35.6	49.0	29.8	28.3	51.2	32.0	13.0
Progression Factor	1.00	1.00	1.00	1.03	0.86	0.60	1.00	1.00	1.00	1.00	1.00	1.00
Incremental Delay, d2	7.6	1.2	0.0	1.1	2.6	0.1	2.7	0.4	0.1	1.6	0.3	0.0
Delay (s)	49.0	29.1	21.1	54.6	38.1	21.5	51.8	30.2	28.4	52.8	32.2	13.0
Level of Service	D	C	C	D	D	C	D	C	C	D	C	B
Approach Delay (s)		36.6			36.7			40.1			24.8	
Approach LOS		D			D			D			C	
Intersection Summary												
HCM Average Control Delay			35.2	HCM Level of Service				D				
HCM Volume to Capacity ratio			0.54									
Actuated Cycle Length (s)			112.6	Sum of lost time (s)				17.7				
Intersection Capacity Utilization			66.2%	ICU Level of Service				C				
Analysis Period (min)			15									
c Critical Lane Group												

Queues
6: Earl Armstrong & Proposed New Road

Future Total Traffic-2021
 Weekday AM Peak Hour Unconstrained

Lane Group	EBL	EBT	EBR	WBL	WBT	WBR	NBL	NBT	SBT
Lane Configurations									
Volume (vph)	35	930	50	10	565	2	75	5	10
Lane Group Flow (vph)	35	930	50	10	565	2	75	40	25
Turn Type	Perm		Perm	Perm		Perm	Perm		
Protected Phases		4			8			2	6
Permitted Phases	4		4	8		8	2		
Detector Phase	4	4	4	8	8	8	2	2	6
Switch Phase									
Minimum Initial (s)	10.0	10.0	10.0	10.0	10.0	10.0	10.0	10.0	10.0
Minimum Split (s)	31.9	31.9	31.9	31.9	31.9	31.9	31.9	31.9	31.9
Total Split (s)	73.6	73.6	73.6	73.6	73.6	73.6	39.0	39.0	39.0
Total Split (%)	65.4%	65.4%	65.4%	65.4%	65.4%	65.4%	34.6%	34.6%	34.6%
Yellow Time (s)	4.6	4.6	4.6	4.6	4.6	4.6	4.6	4.6	4.6
All-Red Time (s)	2.3	2.3	2.3	2.3	2.3	2.3	2.3	2.3	2.3
Lost Time Adjust (s)	-1.0	-1.0	-1.0	-1.0	-1.0	-1.0	-1.0	-1.0	-1.0
Total Lost Time (s)	5.9	5.9	5.9	5.9	5.9	5.9	5.9	5.9	5.9
Lead/Lag									
Lead-Lag Optimize?									
Recall Mode	C-Max	C-Max	C-Max	C-Max	C-Max	C-Max	None	None	None
v/c Ratio	0.05	0.32	0.04	0.02	0.20	0.00	0.46	0.18	0.12
Control Delay	0.2	0.4	0.0	3.6	3.4	2.5	54.8	18.1	26.3
Queue Delay	0.0	0.0	0.0	0.0	0.0	0.0	0.0	0.0	0.0
Total Delay	0.2	0.4	0.0	3.6	3.4	2.5	54.8	18.1	26.3
Queue Length 50th (m)	0.0	0.5	0.0	0.4	13.5	0.0	15.6	1.0	2.0
Queue Length 95th (m)	m0.0	0.6	m0.0	1.8	22.6	0.6	28.9	10.4	9.6
Internal Link Dist (m)		95.8			43.9			72.0	67.0
Turn Bay Length (m)	30.0		30.0	30.0		30.0	30.0		
Base Capacity (vph)	670	2892	1301	454	2892	1294	406	501	509
Starvation Cap Reductn	0	0	0	0	0	0	0	0	0
Spillback Cap Reductn	0	0	0	0	0	0	0	0	0
Storage Cap Reductn	0	0	0	0	0	0	0	0	0
Reduced v/c Ratio	0.05	0.32	0.04	0.02	0.20	0.00	0.18	0.08	0.05

Intersection Summary

Cycle Length: 112.6
 Actuated Cycle Length: 112.6
 Offset: 0 (0%), Referenced to phase 4:EBTL and 8:WBTL, Start of Green
 Natural Cycle: 65
 Control Type: Actuated-Coordinated
 m Volume for 95th percentile queue is metered by upstream signal.





























Splits and Phases: 6: Earl Armstrong & Proposed New Road



HCM Signalized Intersection Capacity Analysis

6: Earl Armstrong & Proposed New Road

Future Total Traffic-2021
Weekday AM Peak Hour Unconstrained

												
Movement	EBL	EBT	EBR	WBL	WBT	WBR	NBL	NBT	NBR	SBL	SBT	SBR
Lane Configurations		 			 			 			 	
Volume (vph)	35	930	50	10	565	2	75	5	35	0	10	15
Ideal Flow (vphpl)	1900	1900	1900	1900	1900	1900	1900	1900	1900	1900	1900	1900
Total Lost time (s)	5.9	5.9	5.9	5.9	5.9	5.9	5.9	5.9			5.9	
Lane Util. Factor	1.00	0.95	1.00	1.00	0.95	1.00	1.00	1.00			1.00	
Frt	1.00	1.00	0.85	1.00	1.00	0.85	1.00	0.87			0.91	
Flt Protected	0.95	1.00	1.00	0.95	1.00	1.00	0.95	1.00			1.00	
Satd. Flow (prot)	1770	3539	1583	1770	3539	1583	1770	1618			1695	
Flt Permitted	0.44	1.00	1.00	0.30	1.00	1.00	0.74	1.00			1.00	
Satd. Flow (perm)	819	3539	1583	555	3539	1583	1380	1618			1695	
Peak-hour factor, PHF	1.00	1.00	1.00	1.00	1.00	1.00	1.00	1.00	1.00	1.00	1.00	1.00
Adj. Flow (vph)	35	930	50	10	565	2	75	5	35	0	10	15
RTOR Reduction (vph)	0	0	8	0	0	0	0	31	0	0	13	0
Lane Group Flow (vph)	35	930	42	10	565	2	75	9	0	0	12	0
Turn Type	Perm		Perm	Perm		Perm	Perm			Perm		
Protected Phases		4			8			2				6
Permitted Phases	4		4	8		8	2			6		
Actuated Green, G (s)	88.5	88.5	88.5	88.5	88.5	88.5	10.3	10.3			10.3	
Effective Green, g (s)	89.5	89.5	89.5	89.5	89.5	89.5	11.3	11.3			11.3	
Actuated g/C Ratio	0.79	0.79	0.79	0.79	0.79	0.79	0.10	0.10			0.10	
Clearance Time (s)	6.9	6.9	6.9	6.9	6.9	6.9	6.9	6.9			6.9	
Vehicle Extension (s)	3.0	3.0	3.0	3.0	3.0	3.0	3.0	3.0			3.0	
Lane Grp Cap (vph)	651	2813	1258	441	2813	1258	138	162			170	
v/s Ratio Prot		c0.26			0.16			0.01			0.01	
v/s Ratio Perm	0.04		0.03	0.02		0.00	c0.05					
v/c Ratio	0.05	0.33	0.03	0.02	0.20	0.00	0.54	0.05			0.07	
Uniform Delay, d1	2.5	3.2	2.4	2.4	2.8	2.4	48.2	45.8			45.9	
Progression Factor	0.02	0.03	0.00	1.00	1.00	1.00	1.00	1.00			1.00	
Incremental Delay, d2	0.1	0.3	0.0	0.1	0.2	0.0	4.3	0.1			0.2	
Delay (s)	0.2	0.4	0.0	2.5	3.0	2.4	52.5	45.9			46.0	
Level of Service	A	A	A	A	A	A	D	D			D	
Approach Delay (s)		0.3			3.0			50.2			46.0	
Approach LOS		A			A			D			D	
Intersection Summary												
HCM Average Control Delay			5.2				HCM Level of Service				A	
HCM Volume to Capacity ratio			0.35									
Actuated Cycle Length (s)			112.6				Sum of lost time (s)				11.8	
Intersection Capacity Utilization			49.7%				ICU Level of Service				A	
Analysis Period (min)			15									
c Critical Lane Group												














HCM Unsignalized Intersection Capacity Analysis
 9: Earl Armstrong & RIRO Site Access

Future Total Traffic-2021
 Weekday AM Peak Hour Unconstrained

	→	↘	↙	←	↖	↗
Movement	EBT	EBR	WBL	WBT	NBL	NBR
Lane Configurations	↑↑			↑↑		↗
Volume (veh/h)	1015	30	0	655	0	1
Sign Control	Free			Free	Stop	
Grade	0%			0%	0%	
Peak Hour Factor	1.00	1.00	1.00	1.00	1.00	1.00
Hourly flow rate (vph)	1015	30	0	655	0	1
Pedestrians						
Lane Width (m)						
Walking Speed (m/s)						
Percent Blockage						
Right turn flare (veh)						
Median type	None			None		
Median storage (veh)						
Upstream signal (m)	137				120	
pX, platoon unblocked			0.78		0.80	0.78
vC, conflicting volume			1045		1358	522
vC1, stage 1 conf vol						
vC2, stage 2 conf vol						
vCu, unblocked vol			508		782	0
tC, single (s)			4.1		6.8	6.9
tC, 2 stage (s)						
tF (s)			2.2		3.5	3.3
p0 queue free %			100		100	100
cM capacity (veh/h)			826		265	851
Direction, Lane #	EB 1	EB 2	WB 1	WB 2	NB 1	
Volume Total	677	368	328	328	1	
Volume Left	0	0	0	0	0	
Volume Right	0	30	0	0	1	
cSH	1700	1700	1700	1700	851	
Volume to Capacity	0.40	0.22	0.19	0.19	0.00	
Queue Length 95th (m)	0.0	0.0	0.0	0.0	0.0	
Control Delay (s)	0.0	0.0	0.0	0.0	9.2	
Lane LOS					A	
Approach Delay (s)	0.0	0.0			9.2	
Approach LOS					A	
Intersection Summary						
Average Delay			0.0			
Intersection Capacity Utilization			39.0%	ICU Level of Service	A	
Analysis Period (min)			15			










HCM Unsignalized Intersection Capacity Analysis
 11: Site Access & Limebank

Future Total Traffic-2021
 Weekday AM Peak Hour Unconstrained

							
Movement	WBL	WBR	NBT	NBR	SBL	SBT	
Lane Configurations			 			 	
Volume (veh/h)	15	55	350	30	70	165	
Sign Control	Stop		Free			Free	
Grade	0%		0%			0%	
Peak Hour Factor	1.00	1.00	1.00	1.00	1.00	1.00	
Hourly flow rate (vph)	15	55	350	30	70	165	
Pedestrians							
Lane Width (m)							
Walking Speed (m/s)							
Percent Blockage							
Right turn flare (veh)							
Median type			None			None	
Median storage (veh)							
Upstream signal (m)						144	
pX, platoon unblocked							
vC, conflicting volume	588	190			380		
vC1, stage 1 conf vol							
vC2, stage 2 conf vol							
vCu, unblocked vol	588	190			380		
tC, single (s)	6.8	6.9			4.1		
tC, 2 stage (s)							
tF (s)	3.5	3.3			2.2		
p0 queue free %	96	93			94		
cM capacity (veh/h)	414	820			1175		
Direction, Lane #	WB 1	WB 2	NB 1	NB 2	SB 1	SB 2	SB 3
Volume Total	15	55	233	147	70	82	82
Volume Left	15	0	0	0	70	0	0
Volume Right	0	55	0	30	0	0	0
cSH	414	820	1700	1700	1175	1700	1700
Volume to Capacity	0.04	0.07	0.14	0.09	0.06	0.05	0.05
Queue Length 95th (m)	0.8	1.6	0.0	0.0	1.4	0.0	0.0
Control Delay (s)	14.0	9.7	0.0	0.0	8.3	0.0	0.0
Lane LOS	B	A			A		
Approach Delay (s)	10.6		0.0		2.5		
Approach LOS	B						
Intersection Summary							
Average Delay			1.9				
Intersection Capacity Utilization			27.8%		ICU Level of Service		A
Analysis Period (min)			15				










HCM Unsignalized Intersection Capacity Analysis
 13: N. Site Access & Proposed New Road

Future Total Traffic-2021
 Weekday AM Peak Hour Unconstrained

						
Movement	EBL	EBR	NBL	NBT	SBT	SBR
Lane Configurations						
Volume (veh/h)	5	5	10	110	60	10
Sign Control	Stop			Free	Free	
Grade	0%			0%	0%	
Peak Hour Factor	1.00	1.00	1.00	1.00	1.00	1.00
Hourly flow rate (vph)	5	5	10	110	60	10
Pedestrians						
Lane Width (m)						
Walking Speed (m/s)						
Percent Blockage						
Right turn flare (veh)						
Median type				None	None	
Median storage (veh)						
Upstream signal (m)					96	
pX, platoon unblocked						
vC, conflicting volume	195	65	70			
vC1, stage 1 conf vol						
vC2, stage 2 conf vol						
vCu, unblocked vol	195	65	70			
tC, single (s)	6.4	6.2	4.1			
tC, 2 stage (s)						
tF (s)	3.5	3.3	2.2			
p0 queue free %	99	99	99			
cM capacity (veh/h)	789	999	1531			
Direction, Lane #	EB 1	NB 1	SB 1			
Volume Total	10	120	70			
Volume Left	5	10	0			
Volume Right	5	0	10			
cSH	881	1531	1700			
Volume to Capacity	0.01	0.01	0.04			
Queue Length 95th (m)	0.3	0.1	0.0			
Control Delay (s)	9.1	0.7	0.0			
Lane LOS	A	A				
Approach Delay (s)	9.1	0.7	0.0			
Approach LOS	A					
Intersection Summary						
Average Delay			0.9			
Intersection Capacity Utilization		23.0%		ICU Level of Service		A
Analysis Period (min)			15			

HCM Unsignalized Intersection Capacity Analysis
 15: S. Site Access & Proposed New Road

Future Total Traffic-2021
 Weekday AM Peak Hour Unconstrained

						
Movement	EBL	EBR	NBL	NBT	SBT	SBR
Lane Configurations						
Volume (veh/h)	5	10	20	115	55	5
Sign Control	Stop			Free	Free	
Grade	0%			0%	0%	
Peak Hour Factor	1.00	1.00	1.00	1.00	1.00	1.00
Hourly flow rate (vph)	5	10	20	115	55	5
Pedestrians						
Lane Width (m)						
Walking Speed (m/s)						
Percent Blockage						
Right turn flare (veh)						
Median type				None	None	
Median storage (veh)						
Upstream signal (m)					186	
pX, platoon unblocked						
vC, conflicting volume	212	58	60			
vC1, stage 1 conf vol						
vC2, stage 2 conf vol						
vCu, unblocked vol	212	58	60			
tC, single (s)	6.4	6.2	4.1			
tC, 2 stage (s)						
tF (s)	3.5	3.3	2.2			
p0 queue free %	99	99	99			
cM capacity (veh/h)	766	1009	1544			
Direction, Lane #	EB 1	NB 1	SB 1			
Volume Total	15	135	60			
Volume Left	5	20	0			
Volume Right	10	0	5			
cSH	912	1544	1700			
Volume to Capacity	0.02	0.01	0.04			
Queue Length 95th (m)	0.4	0.3	0.0			
Control Delay (s)	9.0	1.2	0.0			
Lane LOS	A	A				
Approach Delay (s)	9.0	1.2	0.0			
Approach LOS	A					
Intersection Summary						
Average Delay			1.4			
Intersection Capacity Utilization		23.8%		ICU Level of Service		A
Analysis Period (min)			15			

Queues
3: Earl Armstrong & Limebank

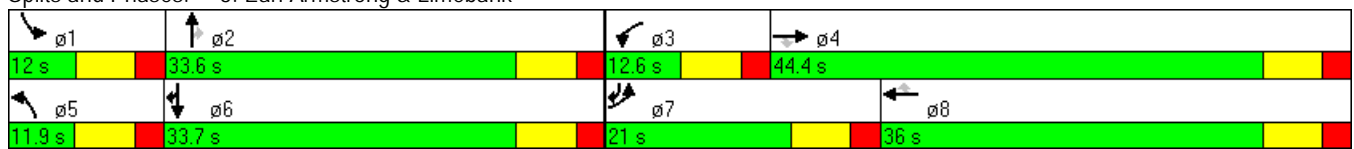
Future Total Traffic-2021
 Weekday PM Peak Hour Unconstrained

Lane Group	EBL	EBT	EBR	WBL	WBT	WBR	NBL	NBT	NBR	SBL	SBT	SBR
Lane Configurations												
Volume (vph)	730	685	220	95	1200	155	90	155	65	245	220	955
Lane Group Flow (vph)	730	685	220	95	1200	155	90	155	65	245	220	955
Turn Type	Prot		Perm	Prot		Perm	Prot		Perm	Prot		custom
Protected Phases	7	4		3	8		5	2		1	6	6 7
Permitted Phases			4			8			2			6
Detector Phase	7	4	4	3	8	8	5	2	2	1	6	6 7
Switch Phase												
Minimum Initial (s)	5.0	10.0	10.0	5.0	10.0	10.0	5.0	10.0	10.0	5.0	10.0	
Minimum Split (s)	11.9	31.9	31.9	11.9	31.9	31.9	11.9	31.9	31.9	11.9	31.9	
Total Split (s)	21.0	44.4	44.4	12.6	36.0	36.0	11.9	33.6	33.6	12.0	33.7	54.7
Total Split (%)	20.5%	43.3%	43.3%	12.3%	35.1%	35.1%	11.6%	32.7%	32.7%	11.7%	32.8%	53.3%
Yellow Time (s)	4.6	4.6	4.6	4.6	4.6	4.6	4.6	4.6	4.6	4.6	4.6	4.6
All-Red Time (s)	2.3	2.3	2.3	2.3	2.3	2.3	2.3	2.3	2.3	2.3	2.3	2.3
Lost Time Adjust (s)	-1.0	-1.0	-1.0	-1.0	-1.0	-1.0	-1.0	-1.0	-1.0	-1.0	-1.0	-1.0
Total Lost Time (s)	5.9	5.9	5.9	5.9	5.9	5.9	5.9	5.9	5.9	5.9	5.9	5.9
Lead/Lag	Lead	Lag	Lag	Lead	Lag	Lag	Lead	Lag	Lag	Lead	Lag	
Lead-Lag Optimize?	Yes	Yes	Yes	Yes	Yes	Yes	Yes	Yes	Yes	Yes	Yes	Yes
Recall Mode	None	None	None	None	None	None	None	C-Max	C-Max	None	C-Max	
v/c Ratio	1.45	0.48	0.29	0.42	1.16	0.29	0.45	0.16	0.14	1.20	0.21	0.68
Control Delay	245.2	25.1	4.1	54.3	110.9	10.3	54.1	29.2	8.1	170.1	29.0	22.2
Queue Delay	0.0	0.0	0.0	0.0	0.0	0.0	0.0	0.0	0.0	0.0	0.0	0.0
Total Delay	245.2	25.1	4.1	54.3	110.9	10.3	54.1	29.2	8.1	170.1	29.0	22.2
Queue Length 50th (m)	~101.1	54.1	0.0	9.3	~148.5	4.3	9.0	12.2	0.0	~30.3	17.6	78.0
Queue Length 95th (m)	#135.8	70.8	14.2	17.4	#182.6	17.2	16.7	20.1	9.7	#54.2	27.3	103.0
Internal Link Dist (m)		131.0			113.3			120.8			61.2	
Turn Bay Length (m)	100.0		50.0	30.0		50.0	50.0		50.0	50.0		100.0
Base Capacity (vph)	505	1415	765	224	1038	530	201	955	475	204	1041	1412
Starvation Cap Reductn	0	0	0	0	0	0	0	0	0	0	0	0
Spillback Cap Reductn	0	0	0	0	0	0	0	0	0	0	0	0
Storage Cap Reductn	0	0	0	0	0	0	0	0	0	0	0	0
Reduced v/c Ratio	1.45	0.48	0.29	0.42	1.16	0.29	0.45	0.16	0.14	1.20	0.21	0.68

Intersection Summary

Cycle Length: 102.6
 Actuated Cycle Length: 102.6
 Offset: 43 (42%), Referenced to phase 2:NBT and 6:SBT, Start of Green
 Natural Cycle: 130
 Control Type: Actuated-Coordinated
 ~ Volume exceeds capacity, queue is theoretically infinite.
 Queue shown is maximum after two cycles.
 # 95th percentile volume exceeds capacity, queue may be longer.
 Queue shown is maximum after two cycles.

























Splits and Phases: 3: Earl Armstrong & Limebank



HCM Signalized Intersection Capacity Analysis

3: Earl Armstrong & Limebank

Future Total Traffic-2021
Weekday PM Peak Hour Unconstrained

													
Movement	EBL	EBT	EBR	WBL	WBT	WBR	NBL	NBT	NBR	SBL	SBT	SBR	
Lane Configurations													
Volume (vph)	730	685	220	95	1200	155	90	155	65	245	220	955	
Ideal Flow (vphpl)	1900	1900	1900	1900	1900	1900	1900	1900	1900	1900	1900	1900	
Total Lost time (s)	5.9	5.9	5.9	5.9	5.9	5.9	5.9	5.9	5.9	5.9	5.9	5.9	
Lane Util. Factor	0.97	0.95	1.00	0.97	0.95	1.00	0.97	0.95	1.00	0.97	0.95	0.88	
Frt	1.00	1.00	0.85	1.00	1.00	0.85	1.00	1.00	0.85	1.00	1.00	0.85	
Flt Protected	0.95	1.00	1.00	0.95	1.00	1.00	0.95	1.00	1.00	0.95	1.00	1.00	
Satd. Flow (prot)	3433	3539	1583	3433	3539	1583	3433	3539	1583	3433	3539	2787	
Flt Permitted	0.95	1.00	1.00	0.95	1.00	1.00	0.95	1.00	1.00	0.95	1.00	1.00	
Satd. Flow (perm)	3433	3539	1583	3433	3539	1583	3433	3539	1583	3433	3539	2787	
Peak-hour factor, PHF	1.00	1.00	1.00	1.00	1.00	1.00	1.00	1.00	1.00	1.00	1.00	1.00	
Adj. Flow (vph)	730	685	220	95	1200	155	90	155	65	245	220	955	
RTOR Reduction (vph)	0	0	132	0	0	64	0	0	48	0	0	23	
Lane Group Flow (vph)	730	685	88	95	1200	91	90	155	17	245	220	932	
Turn Type	Prot		Perm	Prot		Perm	Prot		Perm	Prot		custom	
Protected Phases	7	4		3	8		5	2		1	6	6	
Permitted Phases			4			8			2			6	
Actuated Green, G (s)	14.1	40.0	40.0	4.6	30.5	30.5	4.0	25.3	25.3	5.1	26.4	47.4	
Effective Green, g (s)	15.1	41.0	41.0	5.6	31.5	31.5	5.0	26.3	26.3	6.1	27.4	48.4	
Actuated g/C Ratio	0.15	0.40	0.40	0.05	0.31	0.31	0.05	0.26	0.26	0.06	0.27	0.47	
Clearance Time (s)	6.9	6.9	6.9	6.9	6.9	6.9	6.9	6.9	6.9	6.9	6.9	6.9	
Vehicle Extension (s)	3.0	3.0	3.0	3.0	3.0	3.0	3.0	3.0	3.0	3.0	3.0	3.0	
Lane Grp Cap (vph)	505	1414	633	187	1087	486	167	907	406	204	945	1315	
v/s Ratio Prot	c0.21	0.19		0.03	c0.34		0.03	0.04		c0.07	0.06	c0.33	
v/s Ratio Perm			0.06			0.06			0.01				
v/c Ratio	1.45	0.48	0.14	0.51	1.10	0.19	0.54	0.17	0.04	1.20	0.23	0.71	
Uniform Delay, d1	43.8	22.9	19.6	47.2	35.5	26.1	47.7	29.7	28.7	48.2	29.4	21.5	
Progression Factor	1.00	1.00	1.00	1.05	0.86	0.73	1.00	1.00	1.00	1.00	1.00	1.00	
Incremental Delay, d2	211.5	0.3	0.1	2.0	59.3	0.2	3.3	0.4	0.2	127.8	0.6	1.8	
Delay (s)	255.2	23.2	19.7	51.7	89.8	19.3	51.0	30.1	28.9	176.0	30.0	23.3	
Level of Service	F	C	B	D	F	B	D	C	C	F	C	C	
Approach Delay (s)		126.3			79.7			35.9			50.7		
Approach LOS		F			E			D			D		
Intersection Summary													
HCM Average Control Delay			84.2									HCM Level of Service	F
HCM Volume to Capacity ratio			1.01										
Actuated Cycle Length (s)			102.6									Sum of lost time (s)	17.7
Intersection Capacity Utilization			89.0%									ICU Level of Service	E
Analysis Period (min)			15										
c Critical Lane Group													

Queues
6: Earl Armstrong & Proposed New Road

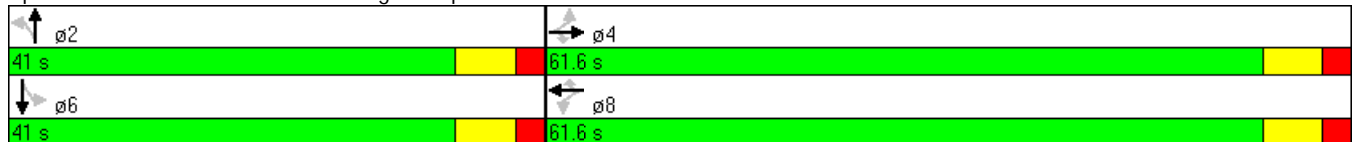
Future Total Traffic-2021
 Weekday PM Peak Hour Unconstrained

Lane Group	EBL	EBT	EBR	WBL	WBT	WBR	NBL	NBT	SBT
Lane Configurations									
Volume (vph)	95	730	105	80	1205	10	155	20	25
Lane Group Flow (vph)	95	730	105	80	1205	10	155	80	115
Turn Type	Perm		Perm	Perm		Perm	Perm		
Protected Phases		4			8			2	6
Permitted Phases	4		4	8		8	2		
Detector Phase	4	4	4	8	8	8	2	2	6
Switch Phase									
Minimum Initial (s)	10.0	10.0	10.0	10.0	10.0	10.0	10.0	10.0	10.0
Minimum Split (s)	31.9	31.9	31.9	31.9	31.9	31.9	31.9	31.9	31.9
Total Split (s)	61.6	61.6	61.6	61.6	61.6	61.6	41.0	41.0	41.0
Total Split (%)	60.0%	60.0%	60.0%	60.0%	60.0%	60.0%	40.0%	40.0%	40.0%
Yellow Time (s)	4.6	4.6	4.6	4.6	4.6	4.6	4.6	4.6	4.6
All-Red Time (s)	2.3	2.3	2.3	2.3	2.3	2.3	2.3	2.3	2.3
Lost Time Adjust (s)	-1.0	-1.0	-1.0	-1.0	-1.0	-1.0	-1.0	-1.0	-1.0
Total Lost Time (s)	5.9	5.9	5.9	5.9	5.9	5.9	5.9	5.9	5.9
Lead/Lag									
Lead-Lag Optimize?									
Recall Mode	C-Max	C-Max	C-Max	C-Max	C-Max	C-Max	None	None	None
v/c Ratio	0.37	0.29	0.09	0.17	0.49	0.01	0.66	0.23	0.33
Control Delay	7.0	1.2	0.1	7.6	8.5	4.7	51.5	13.7	20.7
Queue Delay	0.0	0.0	0.0	0.0	0.0	0.0	0.0	0.0	0.0
Total Delay	7.0	1.2	0.1	7.6	8.5	4.7	51.5	13.7	20.7
Queue Length 50th (m)	0.8	2.8	0.0	4.7	49.6	0.3	28.6	3.3	9.9
Queue Length 95th (m)	m4.6	m6.1	m0.2	13.0	81.4	2.1	45.0	13.9	22.6
Internal Link Dist (m)		96.0			43.9			72.0	67.0
Turn Bay Length (m)	30.0		30.0	30.0		30.0	30.0		
Base Capacity (vph)	259	2480	1141	472	2480	1111	435	605	600
Starvation Cap Reductn	0	0	0	0	0	0	0	0	0
Spillback Cap Reductn	0	0	0	0	0	0	0	0	0
Storage Cap Reductn	0	0	0	0	0	0	0	0	0
Reduced v/c Ratio	0.37	0.29	0.09	0.17	0.49	0.01	0.36	0.13	0.19

Intersection Summary





























Cycle Length: 102.6
 Actuated Cycle Length: 102.6
 Offset: 100 (97%), Referenced to phase 4:EBTL and 8:WBTL, Start of Green
 Natural Cycle: 75
 Control Type: Actuated-Coordinated
 m Volume for 95th percentile queue is metered by upstream signal.

Splits and Phases: 6: Earl Armstrong & Proposed New Road



HCM Signalized Intersection Capacity Analysis
6: Earl Armstrong & Proposed New Road

Future Total Traffic-2021
Weekday PM Peak Hour Unconstrained

												
Movement	EBL	EBT	EBR	WBL	WBT	WBR	NBL	NBT	NBR	SBL	SBT	SBR
Lane Configurations		 			 			 			 	
Volume (vph)	95	730	105	80	1205	10	155	20	60	0	25	90
Ideal Flow (vphpl)	1900	1900	1900	1900	1900	1900	1900	1900	1900	1900	1900	1900
Total Lost time (s)	5.9	5.9	5.9	5.9	5.9	5.9	5.9	5.9			5.9	
Lane Util. Factor	1.00	0.95	1.00	1.00	0.95	1.00	1.00	1.00			1.00	
Frt	1.00	1.00	0.85	1.00	1.00	0.85	1.00	0.89			0.88	
Flt Protected	0.95	1.00	1.00	0.95	1.00	1.00	0.95	1.00			1.00	
Satd. Flow (prot)	1770	3539	1583	1770	3539	1583	1770	1653			1644	
Flt Permitted	0.20	1.00	1.00	0.36	1.00	1.00	0.68	1.00			1.00	
Satd. Flow (perm)	370	3539	1583	674	3539	1583	1272	1653			1644	
Peak-hour factor, PHF	1.00	1.00	1.00	1.00	1.00	1.00	1.00	1.00	1.00	1.00	1.00	1.00
Adj. Flow (vph)	95	730	105	80	1205	10	155	20	60	0	25	90
RTOR Reduction (vph)	0	0	31	0	0	2	0	49	0	0	46	0
Lane Group Flow (vph)	95	730	74	80	1205	8	155	31	0	0	69	0
Turn Type	Perm		Perm	Perm		Perm	Perm			Perm		
Protected Phases		4			8			2				6
Permitted Phases	4		4	8		8	2			6		
Actuated Green, G (s)	70.9	70.9	70.9	70.9	70.9	70.9	17.9	17.9			17.9	
Effective Green, g (s)	71.9	71.9	71.9	71.9	71.9	71.9	18.9	18.9			18.9	
Actuated g/C Ratio	0.70	0.70	0.70	0.70	0.70	0.70	0.18	0.18			0.18	
Clearance Time (s)	6.9	6.9	6.9	6.9	6.9	6.9	6.9	6.9			6.9	
Vehicle Extension (s)	3.0	3.0	3.0	3.0	3.0	3.0	3.0	3.0			3.0	
Lane Grp Cap (vph)	259	2480	1109	472	2480	1109	234	305			303	
v/s Ratio Prot		0.21			c0.34			0.02			0.04	
v/s Ratio Perm	0.26		0.05	0.12		0.01	c0.12					
v/c Ratio	0.37	0.29	0.07	0.17	0.49	0.01	0.66	0.10			0.23	
Uniform Delay, d1	6.2	5.8	4.8	5.2	7.0	4.6	38.9	34.8			35.6	
Progression Factor	0.42	0.15	0.01	1.00	1.00	1.00	1.00	1.00			1.00	
Incremental Delay, d2	3.2	0.2	0.1	0.8	0.7	0.0	6.9	0.1			0.4	
Delay (s)	5.8	1.1	0.1	6.0	7.6	4.6	45.8	34.9			36.0	
Level of Service	A	A	A	A	A	A	D	C			D	
Approach Delay (s)		1.5			7.5			42.1			36.0	
Approach LOS		A			A			D			D	
Intersection Summary												
HCM Average Control Delay			9.8				HCM Level of Service				A	
HCM Volume to Capacity ratio			0.52									
Actuated Cycle Length (s)			102.6				Sum of lost time (s)				11.8	
Intersection Capacity Utilization			71.6%				ICU Level of Service				C	
Analysis Period (min)			15									
c Critical Lane Group												












HCM Unsignalized Intersection Capacity Analysis
 9: Earl Armstrong & RIRO Site Access

Future Total Traffic-2021
 Weekday PM Peak Hour Unconstrained

	→	↘	↙	←	↖	↗
Movement	EBT	EBR	WBL	WBT	NBL	NBR
Lane Configurations	↑↑			↑↑		↗
Volume (veh/h)	855	140	0	1450	0	75
Sign Control	Free			Free	Stop	
Grade	0%			0%	0%	
Peak Hour Factor	1.00	1.00	1.00	1.00	1.00	1.00
Hourly flow rate (vph)	855	140	0	1450	0	75
Pedestrians						
Lane Width (m)						
Walking Speed (m/s)						
Percent Blockage						
Right turn flare (veh)						
Median type	None		None			
Median storage (veh)						
Upstream signal (m)	137			120		
pX, platoon unblocked			0.86		0.91	0.86
vC, conflicting volume			995		1650	498
vC1, stage 1 conf vol						
vC2, stage 2 conf vol						
vCu, unblocked vol			663		814	84
tC, single (s)			4.1		6.8	6.9
tC, 2 stage (s)						
tF (s)			2.2		3.5	3.3
p0 queue free %			100		100	91
cM capacity (veh/h)			791		287	823
Direction, Lane #	EB 1	EB 2	WB 1	WB 2	NB 1	
Volume Total	570	425	725	725	75	
Volume Left	0	0	0	0	0	
Volume Right	0	140	0	0	75	
cSH	1700	1700	1700	1700	823	
Volume to Capacity	0.34	0.25	0.43	0.43	0.09	
Queue Length 95th (m)	0.0	0.0	0.0	0.0	2.2	
Control Delay (s)	0.0	0.0	0.0	0.0	9.8	
Lane LOS						A
Approach Delay (s)	0.0		0.0		9.8	
Approach LOS						A
Intersection Summary						
Average Delay			0.3			
Intersection Capacity Utilization			43.4%	ICU Level of Service	A	
Analysis Period (min)			15			










HCM Unsignalized Intersection Capacity Analysis
 11: Site Access & Limebank

Future Total Traffic-2021
 Weekday PM Peak Hour Unconstrained

							
Movement	WBL	WBR	NBT	NBR	SBL	SBT	
Lane Configurations							
Volume (veh/h)	90	215	95	70	175	360	
Sign Control	Stop		Free			Free	
Grade	0%		0%			0%	
Peak Hour Factor	1.00	1.00	1.00	1.00	1.00	1.00	
Hourly flow rate (vph)	90	215	95	70	175	360	
Pedestrians							
Lane Width (m)							
Walking Speed (m/s)							
Percent Blockage							
Right turn flare (veh)							
Median type			None			None	
Median storage (veh)							
Upstream signal (m)						145	
pX, platoon unblocked							
vC, conflicting volume	660	82			165		
vC1, stage 1 conf vol							
vC2, stage 2 conf vol							
vCu, unblocked vol	660	82			165		
tC, single (s)	6.8	6.9			4.1		
tC, 2 stage (s)							
tF (s)	3.5	3.3			2.2		
p0 queue free %	74	78			88		
cM capacity (veh/h)	347	961			1411		
Direction, Lane #	WB 1	WB 2	NB 1	NB 2	SB 1	SB 2	SB 3
Volume Total	90	215	63	102	175	180	180
Volume Left	90	0	0	0	175	0	0
Volume Right	0	215	0	70	0	0	0
cSH	347	961	1700	1700	1411	1700	1700
Volume to Capacity	0.26	0.22	0.04	0.06	0.12	0.11	0.11
Queue Length 95th (m)	7.6	6.4	0.0	0.0	3.2	0.0	0.0
Control Delay (s)	19.0	9.8	0.0	0.0	7.9	0.0	0.0
Lane LOS	C	A			A		
Approach Delay (s)	12.5		0.0		2.6		
Approach LOS	B						
Intersection Summary							
Average Delay			5.2				
Intersection Capacity Utilization			29.6%		ICU Level of Service		A
Analysis Period (min)			15				










HCM Unsignalized Intersection Capacity Analysis
 13: N. Site Access & Proposed New Road

Future Total Traffic-2021
 Weekday PM Peak Hour Unconstrained

						
Movement	EBL	EBR	NBL	NBT	SBT	SBR
Lane Configurations						
Volume (veh/h)	75	15	25	160	125	80
Sign Control	Stop			Free	Free	
Grade	0%			0%	0%	
Peak Hour Factor	1.00	1.00	1.00	1.00	1.00	1.00
Hourly flow rate (vph)	75	15	25	160	125	80
Pedestrians						
Lane Width (m)						
Walking Speed (m/s)						
Percent Blockage						
Right turn flare (veh)						
Median type				None	None	
Median storage (veh)						
Upstream signal (m)					96	
pX, platoon unblocked						
vC, conflicting volume	375	165	205			
vC1, stage 1 conf vol						
vC2, stage 2 conf vol						
vCu, unblocked vol	375	165	205			
tC, single (s)	6.4	6.2	4.1			
tC, 2 stage (s)						
tF (s)	3.5	3.3	2.2			
p0 queue free %	88	98	98			
cM capacity (veh/h)	615	879	1366			
Direction, Lane #	EB 1	NB 1	SB 1			
Volume Total	90	185	205			
Volume Left	75	25	0			
Volume Right	15	0	80			
cSH	647	1366	1700			
Volume to Capacity	0.14	0.02	0.12			
Queue Length 95th (m)	3.6	0.4	0.0			
Control Delay (s)	11.5	1.2	0.0			
Lane LOS	B	A				
Approach Delay (s)	11.5	1.2	0.0			
Approach LOS	B					
Intersection Summary						
Average Delay			2.6			
Intersection Capacity Utilization		36.3%		ICU Level of Service		A
Analysis Period (min)			15			

HCM Unsignalized Intersection Capacity Analysis
 15: S. Site Access & Proposed New Road

Future Total Traffic-2021
 Weekday PM Peak Hour Unconstrained

						
Movement	EBL	EBR	NBL	NBT	SBT	SBR
Lane Configurations						
Volume (veh/h)	20	35	45	165	125	14
Sign Control	Stop			Free	Free	
Grade	0%			0%	0%	
Peak Hour Factor	1.00	1.00	1.00	1.00	1.00	1.00
Hourly flow rate (vph)	20	35	45	165	125	14
Pedestrians						
Lane Width (m)						
Walking Speed (m/s)						
Percent Blockage						
Right turn flare (veh)						
Median type				None	None	
Median storage (veh)						
Upstream signal (m)					187	
pX, platoon unblocked						
vC, conflicting volume	387	132	139			
vC1, stage 1 conf vol						
vC2, stage 2 conf vol						
vCu, unblocked vol	387	132	139			
tC, single (s)	6.4	6.2	4.1			
tC, 2 stage (s)						
tF (s)	3.5	3.3	2.2			
p0 queue free %	97	96	97			
cM capacity (veh/h)	597	917	1445			
Direction, Lane #	EB 1	NB 1	SB 1			
Volume Total	55	210	139			
Volume Left	20	45	0			
Volume Right	35	0	14			
cSH	768	1445	1700			
Volume to Capacity	0.07	0.03	0.08			
Queue Length 95th (m)	1.7	0.7	0.0			
Control Delay (s)	10.1	1.8	0.0			
Lane LOS	B	A				
Approach Delay (s)	10.1	1.8	0.0			
Approach LOS	B					
Intersection Summary						
Average Delay			2.3			
Intersection Capacity Utilization		31.9%		ICU Level of Service		A
Analysis Period (min)			15			

APPENDIX I: Sensitivity Analysis - Future Background & Future Total 2021 Zero & Unconstrained interaction

Queues

Future Background Traffic-2021

3: Earl Armstrong & Limebank

Weekday AM Peak Hour Zero Interaction

Lane Group	EBL	EBT	EBR	WBL	WBT	WBR	NBL	NBT	NBR	SBL	SBT	SBR
Lane Configurations												
Volume (vph)	435	335	50	45	355	100	125	185	25	130	60	285
Lane Group Flow (vph)	435	335	50	45	355	100	125	185	25	130	60	285
Turn Type	Prot		Perm	Prot		Perm	Prot		Perm	Prot		custom
Protected Phases	7	4		3	8		5	2		1	6	6 7
Permitted Phases			4			8			2			6
Detector Phase	7	4	4	3	8	8	5	2	2	1	6	6 7
Switch Phase												
Minimum Initial (s)	5.0	10.0	10.0	5.0	10.0	10.0	5.0	10.0	10.0	5.0	10.0	
Minimum Split (s)	11.9	31.9	31.9	11.9	31.9	31.9	11.9	31.9	31.9	11.9	31.9	
Total Split (s)	31.9	51.9	51.9	11.9	31.9	31.9	16.9	36.9	36.9	11.9	31.9	63.8
Total Split (%)	28.3%	46.1%	46.1%	10.6%	28.3%	28.3%	15.0%	32.8%	32.8%	10.6%	28.3%	56.7%
Yellow Time (s)	4.6	4.6	4.6	4.6	4.6	4.6	4.6	4.6	4.6	4.6	4.6	4.6
All-Red Time (s)	2.3	2.3	2.3	2.3	2.3	2.3	2.3	2.3	2.3	2.3	2.3	2.3
Lost Time Adjust (s)	-1.0	-1.0	-1.0	-1.0	-1.0	-1.0	-1.0	-1.0	-1.0	-1.0	-1.0	-1.0
Total Lost Time (s)	5.9	5.9	5.9	5.9	5.9	5.9	5.9	5.9	5.9	5.9	5.9	5.9
Lead/Lag	Lead	Lag	Lag	Lead	Lag	Lag	Lead	Lag	Lag	Lead	Lag	
Lead-Lag Optimize?	Yes	Yes	Yes	Yes	Yes	Yes	Yes	Yes	Yes	Yes	Yes	Yes
Recall Mode	None	None	None	None	None	None	None	C-Max	C-Max	None	C-Max	
v/c Ratio	0.69	0.31	0.10	0.25	0.64	0.30	0.39	0.15	0.04	0.42	0.05	0.16
Control Delay	48.4	30.1	7.2	57.8	42.4	6.4	51.3	26.9	11.2	52.5	27.7	2.0
Queue Delay	0.0	0.0	0.0	0.0	0.0	0.0	0.0	0.0	0.0	0.0	0.0	0.0
Total Delay	48.4	30.1	7.2	57.8	42.4	6.4	51.3	26.9	11.2	52.5	27.7	2.0
Queue Length 50th (m)	46.0	30.2	0.0	5.0	33.9	0.0	13.4	14.2	0.0	13.9	4.4	0.6
Queue Length 95th (m)	58.6	37.1	7.5	10.8	41.4	8.6	22.0	25.3	6.5	23.4	10.5	7.3
Internal Link Dist (m)		131.0			112.8			120.2			61.2	
Turn Bay Length (m)	100.0		50.0	30.0		50.0	50.0		50.0	50.0		100.0
Base Capacity (vph)	793	1446	676	183	817	442	350	1272	585	310	1264	1883
Starvation Cap Reductn	0	0	0	0	0	0	0	0	0	0	0	0
Spillback Cap Reductn	0	0	0	0	0	0	0	0	0	0	0	0
Storage Cap Reductn	0	0	0	0	0	0	0	0	0	0	0	0
Reduced v/c Ratio	0.55	0.23	0.07	0.25	0.43	0.23	0.36	0.15	0.04	0.42	0.05	0.15

Intersection Summary

Cycle Length: 112.6

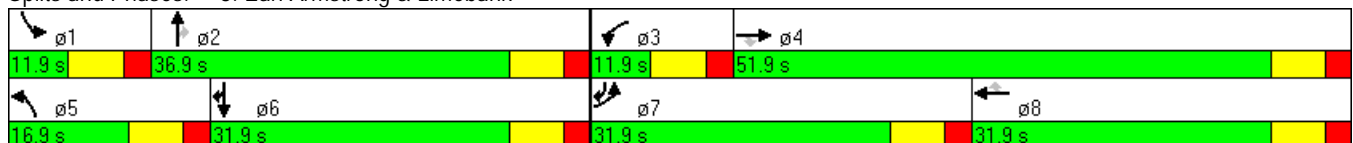
Actuated Cycle Length: 112.6

Offset: 28 (25%), Referenced to phase 2:NBT and 6:SBT, Start of Green

Natural Cycle: 90

Control Type: Actuated-Coordinated

Splits and Phases: 3: Earl Armstrong & Limebank



HCM Signalized Intersection Capacity Analysis
3: Earl Armstrong & Limebank

Future Background Traffic-2021
Weekday AM Peak Hour Zero Interaction

Movement	EBL	EBT	EBR	WBL	WBT	WBR	NBL	NBT	NBR	SBL	SBT	SBR
Lane Configurations												
Volume (vph)	435	335	50	45	355	100	125	185	25	130	60	285
Ideal Flow (vphpl)	1900	1900	1900	1900	1900	1900	1900	1900	1900	1900	1900	1900
Total Lost time (s)	5.9	5.9	5.9	5.9	5.9	5.9	5.9	5.9	5.9	5.9	5.9	5.9
Lane Util. Factor	0.97	0.95	1.00	0.97	0.95	1.00	0.97	0.95	1.00	0.97	0.95	0.88
Frt	1.00	1.00	0.85	1.00	1.00	0.85	1.00	1.00	0.85	1.00	1.00	0.85
Flt Protected	0.95	1.00	1.00	0.95	1.00	1.00	0.95	1.00	1.00	0.95	1.00	1.00
Satd. Flow (prot)	3433	3539	1583	3433	3539	1583	3433	3539	1583	3433	3539	2787
Flt Permitted	0.95	1.00	1.00	0.95	1.00	1.00	0.95	1.00	1.00	0.95	1.00	1.00
Satd. Flow (perm)	3433	3539	1583	3433	3539	1583	3433	3539	1583	3433	3539	2787
Peak-hour factor, PHF	1.00	1.00	1.00	1.00	1.00	1.00	1.00	1.00	1.00	1.00	1.00	1.00
Adj. Flow (vph)	435	335	50	45	355	100	125	185	25	130	60	285
RTOR Reduction (vph)	0	0	35	0	0	83	0	0	16	0	0	113
Lane Group Flow (vph)	435	335	15	45	355	17	125	185	9	130	60	172
Turn Type	Prot		Perm	Prot		Perm	Prot		Perm	Prot		custom
Protected Phases	7	4		3	8		5	2		1	6	6
Permitted Phases			4			8			2			6
Actuated Green, G (s)	19.8	33.7	33.7	4.0	17.9	17.9	9.4	38.1	38.1	9.2	37.9	64.6
Effective Green, g (s)	20.8	34.7	34.7	5.0	18.9	18.9	10.4	39.1	39.1	10.2	38.9	65.6
Actuated g/C Ratio	0.18	0.31	0.31	0.04	0.17	0.17	0.09	0.35	0.35	0.09	0.35	0.58
Clearance Time (s)	6.9	6.9	6.9	6.9	6.9	6.9	6.9	6.9	6.9	6.9	6.9	6.9
Vehicle Extension (s)	3.0	3.0	3.0	3.0	3.0	3.0	3.0	3.0	3.0	3.0	3.0	3.0
Lane Grp Cap (vph)	634	1091	488	152	594	266	317	1229	550	311	1223	1624
v/s Ratio Prot	c0.13	0.09		0.01	c0.10		0.04	c0.05		c0.04	0.02	0.06
v/s Ratio Perm			0.01			0.01			0.01			
v/c Ratio	0.69	0.31	0.03	0.30	0.60	0.06	0.39	0.15	0.02	0.42	0.05	0.11
Uniform Delay, d1	42.9	29.8	27.2	52.1	43.3	39.4	48.1	25.3	24.1	48.4	24.5	10.5
Progression Factor	1.00	1.00	1.00	1.06	0.83	0.52	1.00	1.00	1.00	1.00	1.00	1.00
Incremental Delay, d2	3.1	0.2	0.0	1.1	1.6	0.1	0.8	0.3	0.1	0.9	0.1	0.0
Delay (s)	45.9	29.9	27.2	56.3	37.6	20.4	48.9	25.6	24.2	49.3	24.6	10.5
Level of Service	D	C	C	E	D	C	D	C	C	D	C	B
Approach Delay (s)		38.3			35.9			34.2			22.9	
Approach LOS		D			D			C			C	
Intersection Summary												
HCM Average Control Delay			33.6				HCM Level of Service			C		
HCM Volume to Capacity ratio			0.38									
Actuated Cycle Length (s)			112.6				Sum of lost time (s)		17.7			
Intersection Capacity Utilization			54.4%				ICU Level of Service		A			
Analysis Period (min)			15									
c Critical Lane Group												

Queues
6: Earl Armstrong & Proposed New Road

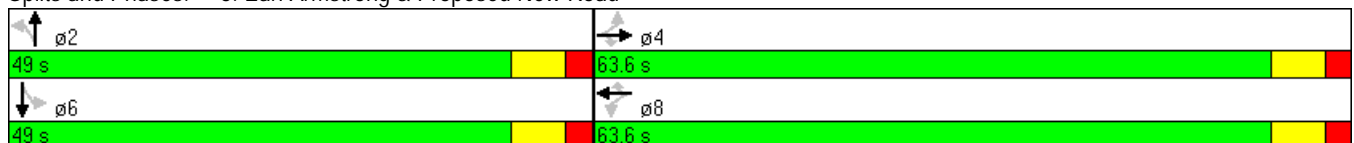
Future Background Traffic-2021
 Weekday AM Peak Hour Zero Interaction

Lane Group	EBL	EBT	EBR	WBL	WBT	WBR	NBL	NBT	SBT
Lane Configurations									
Volume (vph)	35	330	50	10	410	2	75	5	10
Lane Group Flow (vph)	35	330	50	10	410	2	75	40	25
Turn Type	Perm		Perm	Perm		Perm	Perm		
Protected Phases		4			8			2	6
Permitted Phases	4		4	8		8	2		
Detector Phase	4	4	4	8	8	8	2	2	6
Switch Phase									
Minimum Initial (s)	10.0	10.0	10.0	10.0	10.0	10.0	10.0	10.0	10.0
Minimum Split (s)	31.9	31.9	31.9	31.9	31.9	31.9	31.9	31.9	31.9
Total Split (s)	63.6	63.6	63.6	63.6	63.6	63.6	49.0	49.0	49.0
Total Split (%)	56.5%	56.5%	56.5%	56.5%	56.5%	56.5%	43.5%	43.5%	43.5%
Yellow Time (s)	4.6	4.6	4.6	4.6	4.6	4.6	4.6	4.6	4.6
All-Red Time (s)	2.3	2.3	2.3	2.3	2.3	2.3	2.3	2.3	2.3
Lost Time Adjust (s)	-1.0	-1.0	-1.0	-1.0	-1.0	-1.0	-1.0	-1.0	-1.0
Total Lost Time (s)	5.9	5.9	5.9	5.9	5.9	5.9	5.9	5.9	5.9
Lead/Lag									
Lead-Lag Optimize?									
Recall Mode	C-Max	C-Max	C-Max	C-Max	C-Max	C-Max	None	None	None
v/c Ratio	0.04	0.11	0.04	0.01	0.14	0.00	0.46	0.18	0.12
Control Delay	0.3	0.2	0.1	3.5	3.2	2.5	54.7	18.1	26.2
Queue Delay	0.0	0.0	0.0	0.0	0.0	0.0	0.0	0.0	0.0
Total Delay	0.3	0.2	0.1	3.5	3.2	2.5	54.7	18.1	26.2
Queue Length 50th (m)	0.1	0.4	0.0	0.4	9.3	0.0	15.6	1.0	2.0
Queue Length 95th (m)	0.2	0.5	0.0	1.8	16.3	0.6	28.9	10.3	9.5
Internal Link Dist (m)		95.8			43.9			72.0	67.0
Turn Bay Length (m)	30.0		30.0	30.0		30.0	30.0		
Base Capacity (vph)	778	2891	1302	841	2891	1294	528	641	658
Starvation Cap Reductn	0	0	0	0	0	0	0	0	0
Spillback Cap Reductn	0	0	0	0	0	0	0	0	0
Storage Cap Reductn	0	0	0	0	0	0	0	0	0
Reduced v/c Ratio	0.04	0.11	0.04	0.01	0.14	0.00	0.14	0.06	0.04

Intersection Summary

Cycle Length: 112.6
 Actuated Cycle Length: 112.6
 Offset: 0 (0%), Referenced to phase 4:EBTL and 8:WBTL, Start of Green
 Natural Cycle: 65
 Control Type: Actuated-Coordinated



























Splits and Phases: 6: Earl Armstrong & Proposed New Road



HCM Signalized Intersection Capacity Analysis

6: Earl Armstrong & Proposed New Road

Future Background Traffic-2021
Weekday AM Peak Hour Zero Interaction

												
Movement	EBL	EBT	EBR	WBL	WBT	WBR	NBL	NBT	NBR	SBL	SBT	SBR
Lane Configurations		 			 			 				
Volume (vph)	35	330	50	10	410	2	75	5	35	0	10	15
Ideal Flow (vphpl)	1900	1900	1900	1900	1900	1900	1900	1900	1900	1900	1900	1900
Total Lost time (s)	5.9	5.9	5.9	5.9	5.9	5.9	5.9	5.9			5.9	
Lane Util. Factor	1.00	0.95	1.00	1.00	0.95	1.00	1.00	1.00			1.00	
Frt	1.00	1.00	0.85	1.00	1.00	0.85	1.00	0.87			0.91	
Flt Protected	0.95	1.00	1.00	0.95	1.00	1.00	0.95	1.00			1.00	
Satd. Flow (prot)	1770	3539	1583	1770	3539	1583	1770	1618			1695	
Flt Permitted	0.51	1.00	1.00	0.55	1.00	1.00	0.74	1.00			1.00	
Satd. Flow (perm)	953	3539	1583	1029	3539	1583	1380	1618			1695	
Peak-hour factor, PHF	1.00	1.00	1.00	1.00	1.00	1.00	1.00	1.00	1.00	1.00	1.00	1.00
Adj. Flow (vph)	35	330	50	10	410	2	75	5	35	0	10	15
RTOR Reduction (vph)	0	0	10	0	0	0	0	31	0	0	13	0
Lane Group Flow (vph)	35	330	40	10	410	2	75	9	0	0	12	0
Turn Type	Perm		Perm	Perm		Perm	Perm			Perm		
Protected Phases		4			8			2			6	
Permitted Phases	4		4	8		8	2			6		
Actuated Green, G (s)	88.4	88.4	88.4	88.4	88.4	88.4	10.4	10.4			10.4	
Effective Green, g (s)	89.4	89.4	89.4	89.4	89.4	89.4	11.4	11.4			11.4	
Actuated g/C Ratio	0.79	0.79	0.79	0.79	0.79	0.79	0.10	0.10			0.10	
Clearance Time (s)	6.9	6.9	6.9	6.9	6.9	6.9	6.9	6.9			6.9	
Vehicle Extension (s)	3.0	3.0	3.0	3.0	3.0	3.0	3.0	3.0			3.0	
Lane Grp Cap (vph)	757	2810	1257	817	2810	1257	140	164			172	
v/s Ratio Prot		0.09			c0.12			0.01			0.01	
v/s Ratio Perm	0.04		0.03	0.01		0.00	c0.05					
v/c Ratio	0.05	0.12	0.03	0.01	0.15	0.00	0.54	0.05			0.07	
Uniform Delay, d1	2.5	2.6	2.5	2.4	2.7	2.4	48.1	45.7			45.8	
Progression Factor	0.06	0.05	0.00	1.00	1.00	1.00	1.00	1.00			1.00	
Incremental Delay, d2	0.1	0.1	0.0	0.0	0.1	0.0	3.9	0.1			0.2	
Delay (s)	0.3	0.2	0.0	2.4	2.8	2.4	52.0	45.9			46.0	
Level of Service	A	A	A	A	A	A	D	D			D	
Approach Delay (s)		0.2			2.8			49.9			46.0	
Approach LOS		A			A			D			D	
Intersection Summary												
HCM Average Control Delay			8.3				HCM Level of Service			A		
HCM Volume to Capacity ratio			0.19									
Actuated Cycle Length (s)			112.6				Sum of lost time (s)			11.8		
Intersection Capacity Utilization			45.2%				ICU Level of Service			A		
Analysis Period (min)			15									
c Critical Lane Group												

HCM Unsignalized Intersection Capacity Analysis

9: Earl Armstrong & RIRO Site Access












Future Background Traffic-2021
Weekday AM Peak Hour Zero Interaction



Movement	EBT	EBR	WBL	WBT	NBL	NBR
Lane Configurations	↑↑			↑↑		↗
Volume (veh/h)	415	80	0	500	0	1
Sign Control	Free			Free	Stop	
Grade	0%			0%	0%	
Peak Hour Factor	1.00	1.00	1.00	1.00	1.00	1.00
Hourly flow rate (vph)	415	80	0	500	0	1
Pedestrians						
Lane Width (m)						
Walking Speed (m/s)						
Percent Blockage						
Right turn flare (veh)						
Median type	None			None		
Median storage (veh)						
Upstream signal (m)	137			120		
pX, platoon unblocked			0.94		0.94	0.94
vC, conflicting volume			495		705	248
vC1, stage 1 conf vol						
vC2, stage 2 conf vol						
vCu, unblocked vol			322		510	57
tC, single (s)			4.1		6.8	6.9
tC, 2 stage (s)						
tF (s)			2.2		3.5	3.3
p0 queue free %			100		100	100
cM capacity (veh/h)			1155		463	932
Direction, Lane #	EB 1	EB 2	WB 1	WB 2	NB 1	
Volume Total	277	218	250	250	1	
Volume Left	0	0	0	0	0	
Volume Right	0	80	0	0	1	
cSH	1700	1700	1700	1700	932	
Volume to Capacity	0.16	0.13	0.15	0.15	0.00	
Queue Length 95th (m)	0.0	0.0	0.0	0.0	0.0	
Control Delay (s)	0.0	0.0	0.0	0.0	8.9	
Lane LOS					A	
Approach Delay (s)	0.0		0.0		8.9	
Approach LOS					A	
Intersection Summary						
Average Delay			0.0			
Intersection Capacity Utilization			24.0%	ICU Level of Service	A	
Analysis Period (min)			15			










HCM Unsignalized Intersection Capacity Analysis
 11: Site Access & Limebank

Future Background Traffic-2021
 Weekday AM Peak Hour Zero Interaction

						
Movement	WBL	WBR	NBT	NBR	SBL	SBT
Lane Configurations			 			 
Volume (veh/h)	0	40	290	25	0	155
Sign Control	Stop		Free			Free
Grade	0%		0%			0%
Peak Hour Factor	1.00	1.00	1.00	1.00	1.00	1.00
Hourly flow rate (vph)	0	40	290	25	0	155
Pedestrians						
Lane Width (m)						
Walking Speed (m/s)						
Percent Blockage						
Right turn flare (veh)						
Median type			None			None
Median storage (veh)						
Upstream signal (m)						144
pX, platoon unblocked						
vC, conflicting volume	380	158			315	
vC1, stage 1 conf vol						
vC2, stage 2 conf vol						
vCu, unblocked vol	380	158			315	
tC, single (s)	6.8	6.9			4.1	
tC, 2 stage (s)						
tF (s)	3.5	3.3			2.2	
p0 queue free %	100	95			100	
cM capacity (veh/h)	595	860			1242	
Direction, Lane #	WB 1	NB 1	NB 2	SB 1	SB 2	
Volume Total	40	193	122	78	78	
Volume Left	0	0	0	0	0	
Volume Right	40	0	25	0	0	
cSH	860	1700	1700	1700	1700	
Volume to Capacity	0.05	0.11	0.07	0.05	0.05	
Queue Length 95th (m)	1.1	0.0	0.0	0.0	0.0	
Control Delay (s)	9.4	0.0	0.0	0.0	0.0	
Lane LOS	A					
Approach Delay (s)	9.4	0.0		0.0		
Approach LOS	A					
Intersection Summary						
Average Delay			0.7			
Intersection Capacity Utilization			18.8%		ICU Level of Service	A
Analysis Period (min)			15			










HCM Unsignalized Intersection Capacity Analysis
 13: N. Site Access & Proposed New Road

Future Background Traffic-2021
 Weekday AM Peak Hour Zero Interaction

						
Movement	EBL	EBR	NBL	NBT	SBT	SBR
Lane Configurations						
Volume (veh/h)	5	2	10	105	60	10
Sign Control	Stop			Free	Free	
Grade	0%			0%	0%	
Peak Hour Factor	1.00	1.00	1.00	1.00	1.00	1.00
Hourly flow rate (vph)	5	2	10	105	60	10
Pedestrians						
Lane Width (m)						
Walking Speed (m/s)						
Percent Blockage						
Right turn flare (veh)						
Median type				None	None	
Median storage (veh)						
Upstream signal (m)					96	
pX, platoon unblocked						
vC, conflicting volume	190	65	70			
vC1, stage 1 conf vol						
vC2, stage 2 conf vol						
vCu, unblocked vol	190	65	70			
tC, single (s)	6.4	6.2	4.1			
tC, 2 stage (s)						
tF (s)	3.5	3.3	2.2			
p0 queue free %	99	100	99			
cM capacity (veh/h)	794	999	1531			
Direction, Lane #	EB 1	NB 1	SB 1			
Volume Total	7	115	70			
Volume Left	5	10	0			
Volume Right	2	0	10			
cSH	843	1531	1700			
Volume to Capacity	0.01	0.01	0.04			
Queue Length 95th (m)	0.2	0.1	0.0			
Control Delay (s)	9.3	0.7	0.0			
Lane LOS	A	A				
Approach Delay (s)	9.3	0.7	0.0			
Approach LOS	A					
Intersection Summary						
Average Delay			0.8			
Intersection Capacity Utilization		22.7%		ICU Level of Service		A
Analysis Period (min)			15			

HCM Unsignalized Intersection Capacity Analysis
 15: S. Site Access & Proposed New Road

Future Background Traffic-2021
 Weekday AM Peak Hour Zero Interaction

						
Movement	EBL	EBR	NBL	NBT	SBT	SBR
Lane Configurations						
Volume (veh/h)	2	5	15	115	55	5
Sign Control	Stop			Free	Free	
Grade	0%			0%	0%	
Peak Hour Factor	1.00	1.00	1.00	1.00	1.00	1.00
Hourly flow rate (vph)	2	5	15	115	55	5
Pedestrians						
Lane Width (m)						
Walking Speed (m/s)						
Percent Blockage						
Right turn flare (veh)						
Median type				None	None	
Median storage (veh)						
Upstream signal (m)					185	
pX, platoon unblocked						
vC, conflicting volume	202	58	60			
vC1, stage 1 conf vol						
vC2, stage 2 conf vol						
vCu, unblocked vol	202	58	60			
tC, single (s)	6.4	6.2	4.1			
tC, 2 stage (s)						
tF (s)	3.5	3.3	2.2			
p0 queue free %	100	100	99			
cM capacity (veh/h)	778	1009	1544			
Direction, Lane #	EB 1	NB 1	SB 1			
Volume Total	7	130	60			
Volume Left	2	15	0			
Volume Right	5	0	5			
cSH	930	1544	1700			
Volume to Capacity	0.01	0.01	0.04			
Queue Length 95th (m)	0.2	0.2	0.0			
Control Delay (s)	8.9	0.9	0.0			
Lane LOS	A	A				
Approach Delay (s)	8.9	0.9	0.0			
Approach LOS	A					
Intersection Summary						
Average Delay			0.9			
Intersection Capacity Utilization		23.5%		ICU Level of Service		A
Analysis Period (min)		15				

Queues

Future Background Traffic-2021

3: Earl Armstrong & Limebank

Weekday PM Peak Hour Zero Interaction

Lane Group	EBL	EBT	EBR	WBL	WBT	WBR	NBL	NBT	NBR	SBL	SBT	SBR
Lane Configurations												
Volume (vph)	640	635	70	115	595	155	75	135	60	365	85	755
Lane Group Flow (vph)	640	635	70	115	595	155	75	135	60	365	85	755
Turn Type	Prot		Perm	Prot		Perm	Prot		Perm	Prot		custom
Protected Phases	7	4		3	8		5	2		1	6	6 7
Permitted Phases			4			8			2			6
Detector Phase	7	4	4	3	8	8	5	2	2	1	6	6 7
Switch Phase												
Minimum Initial (s)	5.0	10.0	10.0	5.0	10.0	10.0	5.0	10.0	10.0	5.0	10.0	
Minimum Split (s)	11.9	31.9	31.9	11.9	31.9	31.9	11.9	31.9	31.9	11.9	31.9	
Total Split (s)	22.0	40.7	40.7	13.2	31.9	31.9	11.9	32.7	32.7	16.0	36.8	58.8
Total Split (%)	21.4%	39.7%	39.7%	12.9%	31.1%	31.1%	11.6%	31.9%	31.9%	15.6%	35.9%	57.3%
Yellow Time (s)	4.6	4.6	4.6	4.6	4.6	4.6	4.6	4.6	4.6	4.6	4.6	4.6
All-Red Time (s)	2.3	2.3	2.3	2.3	2.3	2.3	2.3	2.3	2.3	2.3	2.3	2.3
Lost Time Adjust (s)	-1.0	-1.0	-1.0	-1.0	-1.0	-1.0	-1.0	-1.0	-1.0	-1.0	-1.0	-1.0
Total Lost Time (s)	5.9	5.9	5.9	5.9	5.9	5.9	5.9	5.9	5.9	5.9	5.9	5.9
Lead/Lag	Lead	Lag	Lag	Lead	Lag	Lag	Lead	Lag	Lag	Lead	Lag	
Lead-Lag Optimize?	Yes	Yes	Yes	Yes	Yes	Yes	Yes	Yes	Yes	Yes	Yes	Yes
Recall Mode	None	None	None	None	None	None	None	C-Max	C-Max	None	C-Max	
v/c Ratio	1.19	0.58	0.13	0.47	0.75	0.33	0.33	0.15	0.13	0.84	0.07	0.47
Control Delay	140.7	31.7	6.5	57.1	36.7	4.3	50.0	29.7	8.6	63.2	25.3	13.1
Queue Delay	0.0	0.0	0.0	0.0	0.0	0.0	0.0	0.0	0.0	0.0	0.0	0.0
Total Delay	140.7	31.7	6.5	57.1	36.7	4.3	50.0	29.7	8.6	63.2	25.3	13.1
Queue Length 50th (m)	~78.5	54.0	0.0	11.8	45.3	0.6	7.3	10.7	0.0	37.1	6.2	43.2
Queue Length 95th (m)	#112.0	69.2	9.0	20.8	56.6	8.5	14.4	18.2	9.4	#69.2	11.8	60.0
Internal Link Dist (m)		131.0			113.3			120.8			61.2	
Turn Bay Length (m)	100.0		50.0	30.0		50.0	50.0		50.0	50.0		100.0
Base Capacity (vph)	539	1200	583	244	897	517	230	924	458	436	1223	1617
Starvation Cap Reductn	0	0	0	0	0	0	0	0	0	0	0	0
Spillback Cap Reductn	0	0	0	0	0	0	0	0	0	0	0	0
Storage Cap Reductn	0	0	0	0	0	0	0	0	0	0	0	0
Reduced v/c Ratio	1.19	0.53	0.12	0.47	0.66	0.30	0.33	0.15	0.13	0.84	0.07	0.47

Intersection Summary

Cycle Length: 102.6

Actuated Cycle Length: 102.6

Offset: 28 (27%), Referenced to phase 2:NBT and 6:SBT, Start of Green

Natural Cycle: 100

Control Type: Actuated-Coordinated

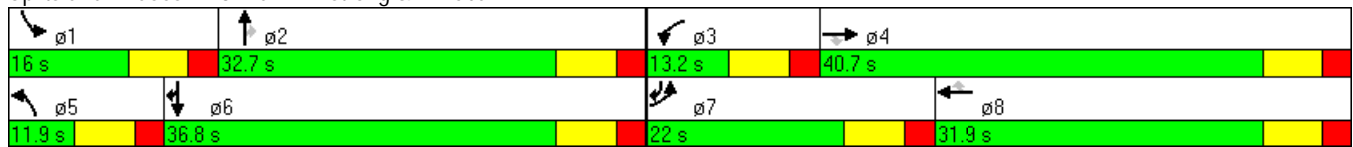
~ Volume exceeds capacity, queue is theoretically infinite.

Queue shown is maximum after two cycles.

95th percentile volume exceeds capacity, queue may be longer.

Queue shown is maximum after two cycles.

























Splits and Phases: 3: Earl Armstrong & Limebank



HCM Signalized Intersection Capacity Analysis

3: Earl Armstrong & Limebank

Future Background Traffic-2021
Weekday PM Peak Hour Zero Interaction

												
Movement	EBL	EBT	EBR	WBL	WBT	WBR	NBL	NBT	NBR	SBL	SBT	SBR
Lane Configurations												
Volume (vph)	640	635	70	115	595	155	75	135	60	365	85	755
Ideal Flow (vphpl)	1900	1900	1900	1900	1900	1900	1900	1900	1900	1900	1900	1900
Total Lost time (s)	5.9	5.9	5.9	5.9	5.9	5.9	5.9	5.9	5.9	5.9	5.9	5.9
Lane Util. Factor	0.97	0.95	1.00	0.97	0.95	1.00	0.97	0.95	1.00	0.97	0.95	0.88
Frt	1.00	1.00	0.85	1.00	1.00	0.85	1.00	1.00	0.85	1.00	1.00	0.85
Flt Protected	0.95	1.00	1.00	0.95	1.00	1.00	0.95	1.00	1.00	0.95	1.00	1.00
Satd. Flow (prot)	3433	3539	1583	3433	3539	1583	3433	3539	1583	3433	3539	2787
Flt Permitted	0.95	1.00	1.00	0.95	1.00	1.00	0.95	1.00	1.00	0.95	1.00	1.00
Satd. Flow (perm)	3433	3539	1583	3433	3539	1583	3433	3539	1583	3433	3539	2787
Peak-hour factor, PHF	1.00	1.00	1.00	1.00	1.00	1.00	1.00	1.00	1.00	1.00	1.00	1.00
Adj. Flow (vph)	640	635	70	115	595	155	75	135	60	365	85	755
RTOR Reduction (vph)	0	0	48	0	0	120	0	0	44	0	0	58
Lane Group Flow (vph)	640	635	22	115	595	35	75	135	16	365	85	697
Turn Type	Prot		Perm	Prot		Perm	Prot		Perm	Prot		custom
Protected Phases	7	4		3	8		5	2		1	6	6
Permitted Phases			4			8			2			6
Actuated Green, G (s)	15.1	30.9	30.9	6.3	22.1	22.1	4.7	25.8	25.8	12.0	33.1	55.1
Effective Green, g (s)	16.1	31.9	31.9	7.3	23.1	23.1	5.7	26.8	26.8	13.0	34.1	56.1
Actuated g/C Ratio	0.16	0.31	0.31	0.07	0.23	0.23	0.06	0.26	0.26	0.13	0.33	0.55
Clearance Time (s)	6.9	6.9	6.9	6.9	6.9	6.9	6.9	6.9	6.9	6.9	6.9	6.9
Vehicle Extension (s)	3.0	3.0	3.0	3.0	3.0	3.0	3.0	3.0	3.0	3.0	3.0	3.0
Lane Grp Cap (vph)	539	1100	492	244	797	356	191	924	413	435	1176	1524
v/s Ratio Prot	c0.19	0.18		0.03	c0.17		0.02	0.04		c0.11	0.02	c0.25
v/s Ratio Perm			0.01			0.02			0.01			
v/c Ratio	1.19	0.58	0.04	0.47	0.75	0.10	0.39	0.15	0.04	0.84	0.07	0.46
Uniform Delay, d1	43.2	29.7	24.7	45.8	37.0	31.5	46.8	29.1	28.3	43.8	23.4	14.1
Progression Factor	1.00	1.00	1.00	1.10	0.83	0.49	1.00	1.00	1.00	1.00	1.00	1.00
Incremental Delay, d2	101.8	0.7	0.0	1.4	3.8	0.1	1.3	0.3	0.2	13.3	0.1	0.2
Delay (s)	145.1	30.4	24.7	51.9	34.4	15.5	48.1	29.4	28.5	57.1	23.5	14.3
Level of Service	F	C	C	D	C	B	D	C	C	E	C	B
Approach Delay (s)		84.7			33.3			34.4			27.9	
Approach LOS		F			C			C			C	
Intersection Summary												
HCM Average Control Delay			50.4				HCM Level of Service				D	
HCM Volume to Capacity ratio			0.73									
Actuated Cycle Length (s)			102.6				Sum of lost time (s)				17.7	
Intersection Capacity Utilization			73.1%				ICU Level of Service				D	
Analysis Period (min)			15									
c Critical Lane Group												

Queues
6: Earl Armstrong & Proposed New Road

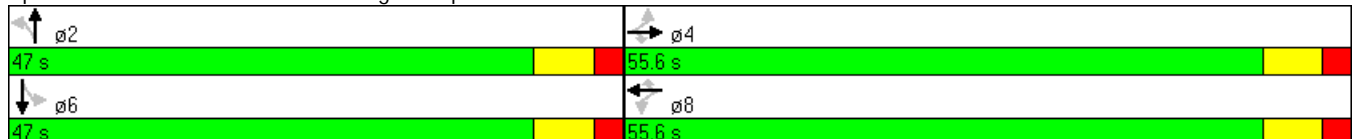
Future Background Traffic-2021
 Weekday PM Peak Hour Zero Interaction

Lane Group	EBL	EBT	EBR	WBL	WBT	WBR	NBL	NBT	SBT
Lane Configurations									
Volume (vph)	95	650	105	25	645	10	110	5	5
Lane Group Flow (vph)	95	650	105	25	645	10	110	55	95
Turn Type	Perm		Perm	Perm		Perm	Perm		
Protected Phases		4			8			2	6
Permitted Phases	4		4	8		8	2		
Detector Phase	4	4	4	8	8	8	2	2	6
Switch Phase									
Minimum Initial (s)	10.0	10.0	10.0	10.0	10.0	10.0	10.0	10.0	10.0
Minimum Split (s)	31.9	31.9	31.9	31.9	31.9	31.9	31.9	31.9	31.9
Total Split (s)	55.6	55.6	55.6	55.6	55.6	55.6	47.0	47.0	47.0
Total Split (%)	54.2%	54.2%	54.2%	54.2%	54.2%	54.2%	45.8%	45.8%	45.8%
Yellow Time (s)	4.6	4.6	4.6	4.6	4.6	4.6	4.6	4.6	4.6
All-Red Time (s)	2.3	2.3	2.3	2.3	2.3	2.3	2.3	2.3	2.3
Lost Time Adjust (s)	-1.0	-1.0	-1.0	-1.0	-1.0	-1.0	-1.0	-1.0	-1.0
Total Lost Time (s)	5.9	5.9	5.9	5.9	5.9	5.9	5.9	5.9	5.9
Lead/Lag									
Lead-Lag Optimize?									
Recall Mode	C-Max	C-Max	C-Max	C-Max	C-Max	C-Max	None	None	None
v/c Ratio	0.17	0.25	0.09	0.05	0.25	0.01	0.56	0.19	0.30
Control Delay	0.9	0.5	0.1	5.1	5.2	2.8	50.4	13.1	11.0
Queue Delay	0.0	0.0	0.0	0.0	0.0	0.0	0.0	0.0	0.0
Total Delay	0.9	0.5	0.1	5.1	5.2	2.8	50.4	13.1	11.0
Queue Length 50th (m)	0.4	1.3	0.0	1.1	18.0	0.0	20.4	0.9	0.9
Queue Length 95th (m)	m0.7	m2.0	m0.0	4.2	31.3	1.6	35.0	10.4	13.3
Internal Link Dist (m)		96.0			43.9			72.0	67.0
Turn Bay Length (m)	30.0		30.0	30.0		30.0	30.0		
Base Capacity (vph)	552	2593	1188	549	2593	1162	519	675	694
Starvation Cap Reductn	0	0	0	0	0	0	0	0	0
Spillback Cap Reductn	0	0	0	0	0	0	0	0	0
Storage Cap Reductn	0	0	0	0	0	0	0	0	0
Reduced v/c Ratio	0.17	0.25	0.09	0.05	0.25	0.01	0.21	0.08	0.14

Intersection Summary

Cycle Length: 102.6
 Actuated Cycle Length: 102.6
 Offset: 0 (0%), Referenced to phase 4:EBTL and 8:WBTL, Start of Green
 Natural Cycle: 65
 Control Type: Actuated-Coordinated
 m Volume for 95th percentile queue is metered by upstream signal.





























Splits and Phases: 6: Earl Armstrong & Proposed New Road



HCM Signalized Intersection Capacity Analysis

6: Earl Armstrong & Proposed New Road

Future Background Traffic-2021
Weekday PM Peak Hour Zero Interaction

												
Movement	EBL	EBT	EBR	WBL	WBT	WBR	NBL	NBT	NBR	SBL	SBT	SBR
Lane Configurations		 			 			 			 	
Volume (vph)	95	650	105	25	645	10	110	5	50	0	5	90
Ideal Flow (vphpl)	1900	1900	1900	1900	1900	1900	1900	1900	1900	1900	1900	1900
Total Lost time (s)	5.9	5.9	5.9	5.9	5.9	5.9	5.9	5.9			5.9	
Lane Util. Factor	1.00	0.95	1.00	1.00	0.95	1.00	1.00	1.00			1.00	
Frt	1.00	1.00	0.85	1.00	1.00	0.85	1.00	0.86			0.86	
Flt Protected	0.95	1.00	1.00	0.95	1.00	1.00	0.95	1.00			1.00	
Satd. Flow (prot)	1770	3539	1583	1770	3539	1583	1770	1609			1598	
Flt Permitted	0.40	1.00	1.00	0.40	1.00	1.00	0.70	1.00			1.00	
Satd. Flow (perm)	753	3539	1583	749	3539	1583	1295	1609			1598	
Peak-hour factor, PHF	1.00	1.00	1.00	1.00	1.00	1.00	1.00	1.00	1.00	1.00	1.00	1.00
Adj. Flow (vph)	95	650	105	25	645	10	110	5	50	0	5	90
RTOR Reduction (vph)	0	0	28	0	0	3	0	42	0	0	76	0
Lane Group Flow (vph)	95	650	77	25	645	7	110	13	0	0	19	0
Turn Type	Perm		Perm	Perm		Perm	Perm			Perm		
Protected Phases		4			8			2			6	
Permitted Phases	4		4	8		8	2			6		
Actuated Green, G (s)	74.2	74.2	74.2	74.2	74.2	74.2	14.6	14.6			14.6	
Effective Green, g (s)	75.2	75.2	75.2	75.2	75.2	75.2	15.6	15.6			15.6	
Actuated g/C Ratio	0.73	0.73	0.73	0.73	0.73	0.73	0.15	0.15			0.15	
Clearance Time (s)	6.9	6.9	6.9	6.9	6.9	6.9	6.9	6.9			6.9	
Vehicle Extension (s)	3.0	3.0	3.0	3.0	3.0	3.0	3.0	3.0			3.0	
Lane Grp Cap (vph)	552	2594	1160	549	2594	1160	197	245			243	
v/s Ratio Prot		c0.18			0.18			0.01			0.01	
v/s Ratio Perm	0.13		0.05	0.03		0.00	c0.08					
v/c Ratio	0.17	0.25	0.07	0.05	0.25	0.01	0.56	0.05			0.08	
Uniform Delay, d1	4.2	4.5	3.8	3.8	4.5	3.7	40.3	37.2			37.3	
Progression Factor	0.07	0.07	0.00	1.00	1.00	1.00	1.00	1.00			1.00	
Incremental Delay, d2	0.5	0.2	0.1	0.2	0.2	0.0	3.4	0.1			0.1	
Delay (s)	0.8	0.5	0.1	3.9	4.7	3.7	43.7	37.3			37.5	
Level of Service	A	A	A	A	A	A	D	D			D	
Approach Delay (s)		0.5			4.7			41.6			37.5	
Approach LOS		A			A			D			D	
Intersection Summary												
HCM Average Control Delay			7.8				HCM Level of Service				A	
HCM Volume to Capacity ratio			0.30									
Actuated Cycle Length (s)			102.6				Sum of lost time (s)			11.8		
Intersection Capacity Utilization			53.8%				ICU Level of Service				A	
Analysis Period (min)			15									
c Critical Lane Group												

HCM Unsignalized Intersection Capacity Analysis
 9: Earl Armstrong & RIRO Site Access












Future Background Traffic-2021
 Weekday PM Peak Hour Zero Interaction



Movement	EBT	EBR	WBL	WBT	NBL	NBR
Lane Configurations	↑↑			↑↑		↗
Volume (veh/h)	820	80	0	845	0	30
Sign Control	Free			Free	Stop	
Grade	0%			0%	0%	
Peak Hour Factor	1.00	1.00	1.00	1.00	1.00	1.00
Hourly flow rate (vph)	820	80	0	845	0	30
Pedestrians						
Lane Width (m)						
Walking Speed (m/s)						
Percent Blockage						
Right turn flare (veh)						
Median type	None		None			
Median storage (veh)						
Upstream signal (m)	137			120		
pX, platoon unblocked			0.87		0.89	0.87
vC, conflicting volume			900		1282	450
vC1, stage 1 conf vol						
vC2, stage 2 conf vol						
vCu, unblocked vol			579		812	61
tC, single (s)			4.1		6.8	6.9
tC, 2 stage (s)						
tF (s)			2.2		3.5	3.3
p0 queue free %			100		100	97
cM capacity (veh/h)			859		283	861
Direction, Lane #	EB 1	EB 2	WB 1	WB 2	NB 1	
Volume Total	547	353	422	422	30	
Volume Left	0	0	0	0	0	
Volume Right	0	80	0	0	30	
cSH	1700	1700	1700	1700	861	
Volume to Capacity	0.32	0.21	0.25	0.25	0.03	
Queue Length 95th (m)	0.0	0.0	0.0	0.0	0.8	
Control Delay (s)	0.0	0.0	0.0	0.0	9.3	
Lane LOS						A
Approach Delay (s)	0.0		0.0		9.3	
Approach LOS						A
Intersection Summary						
Average Delay			0.2			
Intersection Capacity Utilization			35.2%	ICU Level of Service	A	
Analysis Period (min)			15			










HCM Unsignalized Intersection Capacity Analysis
 11: Site Access & Limebank

Future Background Traffic-2021
 Weekday PM Peak Hour Zero Interaction

						
Movement	WBL	WBR	NBT	NBR	SBL	SBT
Lane Configurations			 			 
Volume (veh/h)	0	230	45	95	0	270
Sign Control	Stop		Free			Free
Grade	0%		0%			0%
Peak Hour Factor	1.00	1.00	1.00	1.00	1.00	1.00
Hourly flow rate (vph)	0	230	45	95	0	270
Pedestrians						
Lane Width (m)						
Walking Speed (m/s)						
Percent Blockage						
Right turn flare (veh)						
Median type			None			None
Median storage (veh)						
Upstream signal (m)						145
pX, platoon unblocked						
vC, conflicting volume	228	70			140	
vC1, stage 1 conf vol						
vC2, stage 2 conf vol						
vCu, unblocked vol	228	70			140	
tC, single (s)	6.8	6.9			4.1	
tC, 2 stage (s)						
tF (s)	3.5	3.3			2.2	
p0 queue free %	100	76			100	
cM capacity (veh/h)	740	978			1441	
Direction, Lane #	WB 1	NB 1	NB 2	SB 1	SB 2	
Volume Total	230	30	110	135	135	
Volume Left	0	0	0	0	0	
Volume Right	230	0	95	0	0	
cSH	978	1700	1700	1700	1700	
Volume to Capacity	0.24	0.02	0.06	0.08	0.08	
Queue Length 95th (m)	6.8	0.0	0.0	0.0	0.0	
Control Delay (s)	9.8	0.0	0.0	0.0	0.0	
Lane LOS	A					
Approach Delay (s)	9.8	0.0		0.0		
Approach LOS	A					
Intersection Summary						
Average Delay			3.5			
Intersection Capacity Utilization			25.2%		ICU Level of Service	A
Analysis Period (min)			15			










HCM Unsignalized Intersection Capacity Analysis
 13: N. Site Access & Proposed New Road

Future Background Traffic-2021
 Weekday PM Peak Hour Zero Interaction

						
Movement	EBL	EBR	NBL	NBT	SBT	SBR
Lane Configurations						
Volume (veh/h)	20	5	5	145	110	25
Sign Control	Stop			Free	Free	
Grade	0%			0%	0%	
Peak Hour Factor	1.00	1.00	1.00	1.00	1.00	1.00
Hourly flow rate (vph)	20	5	5	145	110	25
Pedestrians						
Lane Width (m)						
Walking Speed (m/s)						
Percent Blockage						
Right turn flare (veh)						
Median type				None	None	
Median storage (veh)						
Upstream signal (m)					96	
pX, platoon unblocked						
vC, conflicting volume	278	122	135			
vC1, stage 1 conf vol						
vC2, stage 2 conf vol						
vCu, unblocked vol	278	122	135			
tC, single (s)	6.4	6.2	4.1			
tC, 2 stage (s)						
tF (s)	3.5	3.3	2.2			
p0 queue free %	97	99	100			
cM capacity (veh/h)	710	929	1449			
Direction, Lane #	EB 1	NB 1	SB 1			
Volume Total	25	150	135			
Volume Left	20	5	0			
Volume Right	5	0	25			
cSH	745	1449	1700			
Volume to Capacity	0.03	0.00	0.08			
Queue Length 95th (m)	0.8	0.1	0.0			
Control Delay (s)	10.0	0.3	0.0			
Lane LOS	B	A				
Approach Delay (s)	10.0	0.3	0.0			
Approach LOS	B					
Intersection Summary						
Average Delay			0.9			
Intersection Capacity Utilization		21.7%		ICU Level of Service		A
Analysis Period (min)			15			

HCM Unsignalized Intersection Capacity Analysis
 15: S. Site Access & Proposed New Road

Future Background Traffic-2021
 Weekday PM Peak Hour Zero Interaction

						
Movement	EBL	EBR	NBL	NBT	SBT	SBR
Lane Configurations						
Volume (veh/h)	5	10	10	145	110	5
Sign Control	Stop			Free	Free	
Grade	0%			0%	0%	
Peak Hour Factor	1.00	1.00	1.00	1.00	1.00	1.00
Hourly flow rate (vph)	5	10	10	145	110	5
Pedestrians						
Lane Width (m)						
Walking Speed (m/s)						
Percent Blockage						
Right turn flare (veh)						
Median type				None	None	
Median storage (veh)						
Upstream signal (m)					185	
pX, platoon unblocked						
vC, conflicting volume	278	112	115			
vC1, stage 1 conf vol						
vC2, stage 2 conf vol						
vCu, unblocked vol	278	112	115			
tC, single (s)	6.4	6.2	4.1			
tC, 2 stage (s)						
tF (s)	3.5	3.3	2.2			
p0 queue free %	99	99	99			
cM capacity (veh/h)	707	940	1474			
Direction, Lane #	EB 1	NB 1	SB 1			
Volume Total	15	155	115			
Volume Left	5	10	0			
Volume Right	10	0	5			
cSH	847	1474	1700			
Volume to Capacity	0.02	0.01	0.07			
Queue Length 95th (m)	0.4	0.2	0.0			
Control Delay (s)	9.3	0.5	0.0			
Lane LOS	A	A				
Approach Delay (s)	9.3	0.5	0.0			
Approach LOS	A					
Intersection Summary						
Average Delay			0.8			
Intersection Capacity Utilization		24.9%		ICU Level of Service		A
Analysis Period (min)			15			

Queues

3: Earl Armstrong & Limebank

Future Background Traffic-2021

Weekday AM Peak Hour Unconstrained

Lane Group	EBL	EBT	EBR	WBL	WBT	WBR	NBL	NBT	NBR	SBL	SBT	SBR
Lane Configurations												
Volume (vph)	660	935	60	45	510	100	180	185	25	130	60	285
Lane Group Flow (vph)	660	935	60	45	510	100	180	185	25	130	60	285
Turn Type	Prot		Perm	Prot		Perm	Prot		Perm	Prot		custom
Protected Phases	7	4		3	8		5	2		1	6	6 7
Permitted Phases			4			8			2			6
Detector Phase	7	4	4	3	8	8	5	2	2	1	6	6 7
Switch Phase												
Minimum Initial (s)	5.0	10.0	10.0	5.0	10.0	10.0	5.0	10.0	10.0	5.0	10.0	
Minimum Split (s)	11.9	31.9	31.9	11.9	31.9	31.9	11.9	31.9	31.9	11.9	31.9	
Total Split (s)	33.0	53.0	53.0	11.9	31.9	31.9	15.0	33.2	33.2	14.5	32.7	65.7
Total Split (%)	29.3%	47.1%	47.1%	10.6%	28.3%	28.3%	13.3%	29.5%	29.5%	12.9%	29.0%	58.3%
Yellow Time (s)	4.6	4.6	4.6	4.6	4.6	4.6	4.6	4.6	4.6	4.6	4.6	4.6
All-Red Time (s)	2.3	2.3	2.3	2.3	2.3	2.3	2.3	2.3	2.3	2.3	2.3	2.3
Lost Time Adjust (s)	-1.0	-1.0	-1.0	-1.0	-1.0	-1.0	-1.0	-1.0	-1.0	-1.0	-1.0	-1.0
Total Lost Time (s)	5.9	5.9	5.9	5.9	5.9	5.9	5.9	5.9	5.9	5.9	5.9	5.9
Lead/Lag	Lead	Lag	Lag	Lead	Lag	Lag	Lead	Lag	Lag	Lead	Lag	
Lead-Lag Optimize?	Yes	Yes	Yes	Yes	Yes	Yes	Yes	Yes	Yes	Yes	Yes	Yes
Recall Mode	None	None	None	None	None	None	None	C-Max	C-Max	None	C-Max	
v/c Ratio	0.84	0.67	0.09	0.25	0.73	0.25	0.58	0.19	0.05	0.46	0.06	0.18
Control Delay	51.8	30.7	7.3	56.0	42.8	5.8	57.1	32.8	12.6	55.0	32.9	8.7
Queue Delay	0.0	0.0	0.0	0.0	0.0	0.0	0.0	0.0	0.0	0.0	0.0	0.0
Total Delay	51.8	30.7	7.3	56.0	42.8	5.8	57.1	32.8	12.6	55.0	32.9	8.7
Queue Length 50th (m)	69.7	88.0	1.2	5.0	43.0	0.0	19.2	16.6	0.0	13.9	5.3	10.9
Queue Length 95th (m)	90.4	103.7	8.8	10.8	52.7	8.1	31.3	26.5	6.8	23.7	10.7	18.5
Internal Link Dist (m)		131.0			112.8			120.2			61.2	
Turn Bay Length (m)	100.0		50.0	30.0		50.0	50.0		50.0	50.0		100.0
Base Capacity (vph)	826	1480	692	183	817	442	312	996	463	285	963	1619
Starvation Cap Reductn	0	0	0	0	0	0	0	0	0	0	0	0
Spillback Cap Reductn	0	0	0	0	0	0	0	0	0	0	0	0
Storage Cap Reductn	0	0	0	0	0	0	0	0	0	0	0	0
Reduced v/c Ratio	0.80	0.63	0.09	0.25	0.62	0.23	0.58	0.19	0.05	0.46	0.06	0.18

Intersection Summary

Cycle Length: 112.6

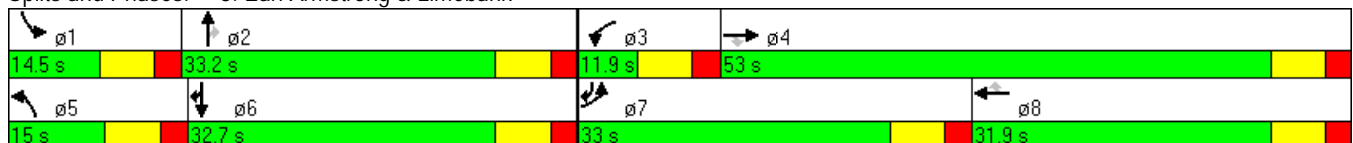
Actuated Cycle Length: 112.6

Offset: 36 (32%), Referenced to phase 2:NBT and 6:SBT, Start of Green

Natural Cycle: 100

Control Type: Actuated-Coordinated

























Splits and Phases: 3: Earl Armstrong & Limebank



HCM Signalized Intersection Capacity Analysis

3: Earl Armstrong & Limebank

Future Background Traffic-2021
Weekday AM Peak Hour Unconstrained

												
Movement	EBL	EBT	EBR	WBL	WBT	WBR	NBL	NBT	NBR	SBL	SBT	SBR
Lane Configurations												
Volume (vph)	660	935	60	45	510	100	180	185	25	130	60	285
Ideal Flow (vphpl)	1900	1900	1900	1900	1900	1900	1900	1900	1900	1900	1900	1900
Total Lost time (s)	5.9	5.9	5.9	5.9	5.9	5.9	5.9	5.9	5.9	5.9	5.9	5.9
Lane Util. Factor	0.97	0.95	1.00	0.97	0.95	1.00	0.97	0.95	1.00	0.97	0.95	0.88
Frt	1.00	1.00	0.85	1.00	1.00	0.85	1.00	1.00	0.85	1.00	1.00	0.85
Flt Protected	0.95	1.00	1.00	0.95	1.00	1.00	0.95	1.00	1.00	0.95	1.00	1.00
Satd. Flow (prot)	3433	3539	1583	3433	3539	1583	3433	3539	1583	3433	3539	2787
Flt Permitted	0.95	1.00	1.00	0.95	1.00	1.00	0.95	1.00	1.00	0.95	1.00	1.00
Satd. Flow (perm)	3433	3539	1583	3433	3539	1583	3433	3539	1583	3433	3539	2787
Peak-hour factor, PHF	1.00	1.00	1.00	1.00	1.00	1.00	1.00	1.00	1.00	1.00	1.00	1.00
Adj. Flow (vph)	660	935	60	45	510	100	180	185	25	130	60	285
RTOR Reduction (vph)	0	0	31	0	0	79	0	0	18	0	0	45
Lane Group Flow (vph)	660	935	29	45	510	21	180	185	7	130	60	240
Turn Type	Prot		Perm	Prot		Perm	Prot		Perm	Prot		custom
Protected Phases	7	4		3	8		5	2		1	6	6
Permitted Phases			4			8			2			6
Actuated Green, G (s)	24.9	43.5	43.5	4.0	22.6	22.6	9.2	29.3	29.3	8.2	28.3	60.1
Effective Green, g (s)	25.9	44.5	44.5	5.0	23.6	23.6	10.2	30.3	30.3	9.2	29.3	61.1
Actuated g/C Ratio	0.23	0.40	0.40	0.04	0.21	0.21	0.09	0.27	0.27	0.08	0.26	0.54
Clearance Time (s)	6.9	6.9	6.9	6.9	6.9	6.9	6.9	6.9	6.9	6.9	6.9	
Vehicle Extension (s)	3.0	3.0	3.0	3.0	3.0	3.0	3.0	3.0	3.0	3.0	3.0	
Lane Grp Cap (vph)	790	1399	626	152	742	332	311	952	426	280	921	1512
v/s Ratio Prot	c0.19	c0.26		0.01	0.14		c0.05	c0.05		0.04	0.02	0.09
v/s Ratio Perm			0.02			0.01			0.00			
v/c Ratio	0.84	0.67	0.05	0.30	0.69	0.06	0.58	0.19	0.02	0.46	0.07	0.16
Uniform Delay, d1	41.3	28.0	21.0	52.1	41.1	35.6	49.1	31.7	30.2	49.3	31.3	12.9
Progression Factor	1.00	1.00	1.00	1.03	0.86	0.60	1.00	1.00	1.00	1.00	1.00	1.00
Incremental Delay, d2	7.6	1.2	0.0	1.1	2.6	0.1	2.6	0.5	0.1	1.2	0.1	0.0
Delay (s)	49.0	29.2	21.0	54.6	38.1	21.5	51.7	32.2	30.3	50.6	31.5	12.9
Level of Service	D	C	C	D	D	C	D	C	C	D	C	B
Approach Delay (s)		36.8			36.7			41.1			25.6	
Approach LOS		D			D			D			C	
Intersection Summary												
HCM Average Control Delay			35.6				HCM Level of Service				D	
HCM Volume to Capacity ratio			0.50									
Actuated Cycle Length (s)			112.6				Sum of lost time (s)			11.8		
Intersection Capacity Utilization			66.1%				ICU Level of Service			C		
Analysis Period (min)			15									
c Critical Lane Group												

Queues
6: Earl Armstrong & Proposed New Road

Future Background Traffic-2021
 Weekday AM Peak Hour Unconstrained

Lane Group	EBL	EBT	EBR	WBL	WBT	WBR	NBL	NBT	SBT
Lane Configurations									
Volume (vph)	35	935	50	10	565	2	75	5	10
Lane Group Flow (vph)	35	935	50	10	565	2	75	40	25
Turn Type	Perm		Perm	Perm		Perm	Perm		
Protected Phases		4			8			2	6
Permitted Phases	4		4	8		8	2		
Detector Phase	4	4	4	8	8	8	2	2	6
Switch Phase									
Minimum Initial (s)	10.0	10.0	10.0	10.0	10.0	10.0	10.0	10.0	10.0
Minimum Split (s)	31.9	31.9	31.9	31.9	31.9	31.9	31.9	31.9	31.9
Total Split (s)	73.6	73.6	73.6	73.6	73.6	73.6	39.0	39.0	39.0
Total Split (%)	65.4%	65.4%	65.4%	65.4%	65.4%	65.4%	34.6%	34.6%	34.6%
Yellow Time (s)	4.6	4.6	4.6	4.6	4.6	4.6	4.6	4.6	4.6
All-Red Time (s)	2.3	2.3	2.3	2.3	2.3	2.3	2.3	2.3	2.3
Lost Time Adjust (s)	-1.0	-1.0	-1.0	-1.0	-1.0	-1.0	-1.0	-1.0	-1.0
Total Lost Time (s)	5.9	5.9	5.9	5.9	5.9	5.9	5.9	5.9	5.9
Lead/Lag									
Lead-Lag Optimize?									
Recall Mode	C-Max	C-Max	C-Max	C-Max	C-Max	C-Max	None	None	None
v/c Ratio	0.05	0.32	0.04	0.02	0.20	0.00	0.46	0.18	0.12
Control Delay	0.2	0.3	0.0	3.6	3.4	2.5	54.8	18.1	26.3
Queue Delay	0.0	0.0	0.0	0.0	0.0	0.0	0.0	0.0	0.0
Total Delay	0.2	0.3	0.0	3.6	3.4	2.5	54.8	18.1	26.3
Queue Length 50th (m)	0.0	0.5	0.0	0.4	13.5	0.0	15.6	1.0	2.0
Queue Length 95th (m)	m0.1	0.5	m0.0	1.8	22.6	0.6	28.9	10.4	9.6
Internal Link Dist (m)		95.8			43.9			72.0	67.0
Turn Bay Length (m)	30.0		30.0	30.0		30.0	30.0		
Base Capacity (vph)	670	2892	1301	450	2892	1294	406	501	509
Starvation Cap Reductn	0	0	0	0	0	0	0	0	0
Spillback Cap Reductn	0	0	0	0	0	0	0	0	0
Storage Cap Reductn	0	0	0	0	0	0	0	0	0
Reduced v/c Ratio	0.05	0.32	0.04	0.02	0.20	0.00	0.18	0.08	0.05

Intersection Summary

Cycle Length: 112.6
 Actuated Cycle Length: 112.6
 Offset: 0 (0%), Referenced to phase 4:EBTL and 8:WBTL, Start of Green
 Natural Cycle: 65
 Control Type: Actuated-Coordinated
 m Volume for 95th percentile queue is metered by upstream signal.





























Splits and Phases: 6: Earl Armstrong & Proposed New Road



HCM Signalized Intersection Capacity Analysis

6: Earl Armstrong & Proposed New Road

Future Background Traffic-2021
Weekday AM Peak Hour Unconstrained

												
Movement	EBL	EBT	EBR	WBL	WBT	WBR	NBL	NBT	NBR	SBL	SBT	SBR
Lane Configurations		 			 			 			 	
Volume (vph)	35	935	50	10	565	2	75	5	35	0	10	15
Ideal Flow (vphpl)	1900	1900	1900	1900	1900	1900	1900	1900	1900	1900	1900	1900
Total Lost time (s)	5.9	5.9	5.9	5.9	5.9	5.9	5.9	5.9			5.9	
Lane Util. Factor	1.00	0.95	1.00	1.00	0.95	1.00	1.00	1.00			1.00	
Frt	1.00	1.00	0.85	1.00	1.00	0.85	1.00	0.87			0.91	
Flt Protected	0.95	1.00	1.00	0.95	1.00	1.00	0.95	1.00			1.00	
Satd. Flow (prot)	1770	3539	1583	1770	3539	1583	1770	1618			1695	
Flt Permitted	0.44	1.00	1.00	0.30	1.00	1.00	0.74	1.00			1.00	
Satd. Flow (perm)	819	3539	1583	552	3539	1583	1380	1618			1695	
Peak-hour factor, PHF	1.00	1.00	1.00	1.00	1.00	1.00	1.00	1.00	1.00	1.00	1.00	1.00
Adj. Flow (vph)	35	935	50	10	565	2	75	5	35	0	10	15
RTOR Reduction (vph)	0	0	8	0	0	0	0	31	0	0	13	0
Lane Group Flow (vph)	35	935	42	10	565	2	75	9	0	0	12	0
Turn Type	Perm		Perm	Perm		Perm	Perm			Perm		
Protected Phases		4			8			2			6	
Permitted Phases	4		4	8		8	2			6		
Actuated Green, G (s)	88.5	88.5	88.5	88.5	88.5	88.5	10.3	10.3			10.3	
Effective Green, g (s)	89.5	89.5	89.5	89.5	89.5	89.5	11.3	11.3			11.3	
Actuated g/C Ratio	0.79	0.79	0.79	0.79	0.79	0.79	0.10	0.10			0.10	
Clearance Time (s)	6.9	6.9	6.9	6.9	6.9	6.9	6.9	6.9			6.9	
Vehicle Extension (s)	3.0	3.0	3.0	3.0	3.0	3.0	3.0	3.0			3.0	
Lane Grp Cap (vph)	651	2813	1258	439	2813	1258	138	162			170	
v/s Ratio Prot		c0.26			0.16			0.01			0.01	
v/s Ratio Perm	0.04		0.03	0.02		0.00	c0.05					
v/c Ratio	0.05	0.33	0.03	0.02	0.20	0.00	0.54	0.05			0.07	
Uniform Delay, d1	2.5	3.2	2.4	2.4	2.8	2.4	48.2	45.8			45.9	
Progression Factor	0.02	0.03	0.00	1.00	1.00	1.00	1.00	1.00			1.00	
Incremental Delay, d2	0.1	0.3	0.0	0.1	0.2	0.0	4.3	0.1			0.2	
Delay (s)	0.2	0.4	0.0	2.5	3.0	2.4	52.5	45.9			46.0	
Level of Service	A	A	A	A	A	A	D	D			D	
Approach Delay (s)		0.3			3.0			50.2			46.0	
Approach LOS		A			A			D			D	
Intersection Summary												
HCM Average Control Delay			5.2				HCM Level of Service				A	
HCM Volume to Capacity ratio			0.36									
Actuated Cycle Length (s)			112.6				Sum of lost time (s)			11.8		
Intersection Capacity Utilization			49.7%				ICU Level of Service			A		
Analysis Period (min)			15									
c Critical Lane Group												

HCM Unsignalized Intersection Capacity Analysis












9: Earl Armstrong & RIRO Site Access

Future Background Traffic-2021
Weekday AM Peak Hour Unconstrained

	→	↘	↙	←	↖	↗
Movement	EBT	EBR	WBL	WBT	NBL	NBR
Lane Configurations	↑↑			↑↑		↗
Volume (veh/h)	1015	75	0	655	0	1
Sign Control	Free			Free	Stop	
Grade	0%			0%	0%	
Peak Hour Factor	1.00	1.00	1.00	1.00	1.00	1.00
Hourly flow rate (vph)	1015	75	0	655	0	1
Pedestrians						
Lane Width (m)						
Walking Speed (m/s)						
Percent Blockage						
Right turn flare (veh)						
Median type	None			None		
Median storage (veh)						
Upstream signal (m)	137			120		
pX, platoon unblocked			0.78		0.80	0.78
vC, conflicting volume			1090		1380	545
vC1, stage 1 conf vol						
vC2, stage 2 conf vol						
vCu, unblocked vol			555		801	0
tC, single (s)			4.1		6.8	6.9
tC, 2 stage (s)						
tF (s)			2.2		3.5	3.3
p0 queue free %			100		100	100
cM capacity (veh/h)			790		256	847
Direction, Lane #	EB 1	EB 2	WB 1	WB 2	NB 1	
Volume Total	677	413	328	328	1	
Volume Left	0	0	0	0	0	
Volume Right	0	75	0	0	1	
cSH	1700	1700	1700	1700	847	
Volume to Capacity	0.40	0.24	0.19	0.19	0.00	
Queue Length 95th (m)	0.0	0.0	0.0	0.0	0.0	
Control Delay (s)	0.0	0.0	0.0	0.0	9.3	
Lane LOS						A
Approach Delay (s)	0.0		0.0		9.3	
Approach LOS						A
Intersection Summary						
Average Delay			0.0			
Intersection Capacity Utilization			40.4%	ICU Level of Service	A	
Analysis Period (min)			15			










HCM Unsignalized Intersection Capacity Analysis
 11: Site Access & Limebank

Future Background Traffic-2021
 Weekday AM Peak Hour Unconstrained

						
Movement	WBL	WBR	NBT	NBR	SBL	SBT
Lane Configurations			 			 
Volume (veh/h)	0	40	350	30	0	165
Sign Control	Stop		Free			Free
Grade	0%		0%			0%
Peak Hour Factor	1.00	1.00	1.00	1.00	1.00	1.00
Hourly flow rate (vph)	0	40	350	30	0	165
Pedestrians						
Lane Width (m)						
Walking Speed (m/s)						
Percent Blockage						
Right turn flare (veh)						
Median type			None			None
Median storage (veh)						
Upstream signal (m)						144
pX, platoon unblocked						
vC, conflicting volume	448	190			380	
vC1, stage 1 conf vol						
vC2, stage 2 conf vol						
vCu, unblocked vol	448	190			380	
tC, single (s)	6.8	6.9			4.1	
tC, 2 stage (s)						
tF (s)	3.5	3.3			2.2	
p0 queue free %	100	95			100	
cM capacity (veh/h)	540	820			1175	
Direction, Lane #	WB 1	NB 1	NB 2	SB 1	SB 2	
Volume Total	40	233	147	82	82	
Volume Left	0	0	0	0	0	
Volume Right	40	0	30	0	0	
cSH	820	1700	1700	1700	1700	
Volume to Capacity	0.05	0.14	0.09	0.05	0.05	
Queue Length 95th (m)	1.2	0.0	0.0	0.0	0.0	
Control Delay (s)	9.6	0.0	0.0	0.0	0.0	
Lane LOS	A					
Approach Delay (s)	9.6	0.0		0.0		
Approach LOS	A					
Intersection Summary						
Average Delay			0.7			
Intersection Capacity Utilization			20.6%		ICU Level of Service	A
Analysis Period (min)			15			










HCM Unsignalized Intersection Capacity Analysis
 13: N. Site Access & Proposed New Road

Future Background Traffic-2021
 Weekday AM Peak Hour Unconstrained

						
Movement	EBL	EBR	NBL	NBT	SBT	SBR
Lane Configurations						
Volume (veh/h)	5	5	10	105	60	10
Sign Control	Stop			Free	Free	
Grade	0%			0%	0%	
Peak Hour Factor	1.00	1.00	1.00	1.00	1.00	1.00
Hourly flow rate (vph)	5	5	10	105	60	10
Pedestrians						
Lane Width (m)						
Walking Speed (m/s)						
Percent Blockage						
Right turn flare (veh)						
Median type				None	None	
Median storage (veh)						
Upstream signal (m)					96	
pX, platoon unblocked						
vC, conflicting volume	190	65	70			
vC1, stage 1 conf vol						
vC2, stage 2 conf vol						
vCu, unblocked vol	190	65	70			
tC, single (s)	6.4	6.2	4.1			
tC, 2 stage (s)						
tF (s)	3.5	3.3	2.2			
p0 queue free %	99	99	99			
cM capacity (veh/h)	794	999	1531			
Direction, Lane #	EB 1	NB 1	SB 1			
Volume Total	10	115	70			
Volume Left	5	10	0			
Volume Right	5	0	10			
cSH	885	1531	1700			
Volume to Capacity	0.01	0.01	0.04			
Queue Length 95th (m)	0.3	0.1	0.0			
Control Delay (s)	9.1	0.7	0.0			
Lane LOS	A	A				
Approach Delay (s)	9.1	0.7	0.0			
Approach LOS	A					
Intersection Summary						
Average Delay			0.9			
Intersection Capacity Utilization			22.7%	ICU Level of Service		A
Analysis Period (min)			15			

HCM Unsignalized Intersection Capacity Analysis
 15: S. Site Access & Proposed New Road

Future Background Traffic-2021
 Weekday AM Peak Hour Unconstrained

						
Movement	EBL	EBR	NBL	NBT	SBT	SBR
Lane Configurations						
Volume (veh/h)	2	5	15	115	55	10
Sign Control	Stop			Free	Free	
Grade	0%			0%	0%	
Peak Hour Factor	1.00	1.00	1.00	1.00	1.00	1.00
Hourly flow rate (vph)	2	5	15	115	55	10
Pedestrians						
Lane Width (m)						
Walking Speed (m/s)						
Percent Blockage						
Right turn flare (veh)						
Median type				None	None	
Median storage (veh)						
Upstream signal (m)					186	
pX, platoon unblocked						
vC, conflicting volume	205	60	65			
vC1, stage 1 conf vol						
vC2, stage 2 conf vol						
vCu, unblocked vol	205	60	65			
tC, single (s)	6.4	6.2	4.1			
tC, 2 stage (s)						
tF (s)	3.5	3.3	2.2			
p0 queue free %	100	100	99			
cM capacity (veh/h)	776	1005	1537			
Direction, Lane #	EB 1	NB 1	SB 1			
Volume Total	7	130	65			
Volume Left	2	15	0			
Volume Right	5	0	10			
cSH	927	1537	1700			
Volume to Capacity	0.01	0.01	0.04			
Queue Length 95th (m)	0.2	0.2	0.0			
Control Delay (s)	8.9	0.9	0.0			
Lane LOS	A	A				
Approach Delay (s)	8.9	0.9	0.0			
Approach LOS	A					
Intersection Summary						
Average Delay			0.9			
Intersection Capacity Utilization		23.5%		ICU Level of Service		A
Analysis Period (min)		15				

Queues
3: Earl Armstrong & Limebank

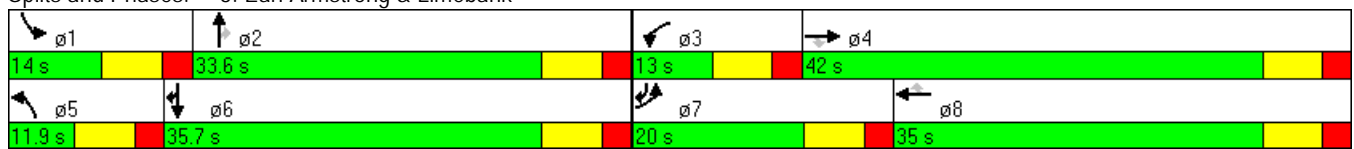
Future Background Traffic-2021
 Weekday PM Peak Hour Unconstrained

Lane Group	EBL	EBT	EBR	WBL	WBT	WBR	NBL	NBT	NBR	SBL	SBT	SBR
Lane Configurations												
Volume (vph)	730	715	180	110	1200	155	75	135	60	360	90	955
Lane Group Flow (vph)	730	715	180	110	1200	155	75	135	60	360	90	955
Turn Type	Prot		Perm	Prot		Perm	Prot		Perm	Prot		custom
Protected Phases	7	4		3	8		5	2		1	6	6 7
Permitted Phases			4			8			2			6
Detector Phase	7	4	4	3	8	8	5	2	2	1	6	6 7
Switch Phase												
Minimum Initial (s)	5.0	10.0	10.0	5.0	10.0	10.0	5.0	10.0	10.0	5.0	10.0	
Minimum Split (s)	11.9	31.9	31.9	11.9	31.9	31.9	11.9	31.9	31.9	11.9	31.9	
Total Split (s)	20.0	42.0	42.0	13.0	35.0	35.0	11.9	33.6	33.6	14.0	35.7	55.7
Total Split (%)	19.5%	40.9%	40.9%	12.7%	34.1%	34.1%	11.6%	32.7%	32.7%	13.6%	34.8%	54.3%
Yellow Time (s)	4.6	4.6	4.6	4.6	4.6	4.6	4.6	4.6	4.6	4.6	4.6	4.6
All-Red Time (s)	2.3	2.3	2.3	2.3	2.3	2.3	2.3	2.3	2.3	2.3	2.3	2.3
Lost Time Adjust (s)	-1.0	-1.0	-1.0	-1.0	-1.0	-1.0	-1.0	-1.0	-1.0	-1.0	-1.0	-1.0
Total Lost Time (s)	5.9	5.9	5.9	5.9	5.9	5.9	5.9	5.9	5.9	5.9	5.9	5.9
Lead/Lag	Lead	Lag	Lag	Lead	Lag	Lag	Lead	Lag	Lag	Lead	Lag	
Lead-Lag Optimize?	Yes	Yes	Yes	Yes	Yes	Yes	Yes	Yes	Yes	Yes	Yes	Yes
Recall Mode	None	None	None	None	None	None	None	C-Max	C-Max	None	C-Max	
v/c Ratio	1.55	0.57	0.27	0.46	1.20	0.30	0.37	0.14	0.13	1.33	0.08	0.66
Control Delay	288.5	29.2	4.6	54.5	127.4	11.8	52.1	29.0	8.4	209.1	26.5	20.8
Queue Delay	0.0	0.0	0.0	0.0	0.0	0.0	0.0	0.0	0.0	0.0	0.0	0.0
Total Delay	288.5	29.2	4.6	54.5	127.4	11.8	52.1	29.0	8.4	209.1	26.5	20.8
Queue Length 50th (m)	~104.6	59.4	0.0	10.8	~152.8	4.4	7.4	10.6	0.0	~47.5	6.7	74.9
Queue Length 95th (m)	#139.4	77.5	13.5	19.6	#186.5	20.7	14.4	18.0	9.3	#75.3	12.5	99.2
Internal Link Dist (m)		131.0			113.3			120.8			61.2	
Turn Bay Length (m)	100.0		50.0	30.0		50.0	50.0		50.0	50.0		100.0
Base Capacity (vph)	472	1245	674	238	1004	515	201	955	471	271	1110	1446
Starvation Cap Reductn	0	0	0	0	0	0	0	0	0	0	0	0
Spillback Cap Reductn	0	0	0	0	0	0	0	0	0	0	0	0
Storage Cap Reductn	0	0	0	0	0	0	0	0	0	0	0	0
Reduced v/c Ratio	1.55	0.57	0.27	0.46	1.20	0.30	0.37	0.14	0.13	1.33	0.08	0.66

Intersection Summary

Cycle Length: 102.6
 Actuated Cycle Length: 102.6
 Offset: 43 (42%), Referenced to phase 2:NBT and 6:SBT, Start of Green
 Natural Cycle: 150
 Control Type: Actuated-Coordinated
 ~ Volume exceeds capacity, queue is theoretically infinite.
 Queue shown is maximum after two cycles.
 # 95th percentile volume exceeds capacity, queue may be longer.
 Queue shown is maximum after two cycles.

























Splits and Phases: 3: Earl Armstrong & Limebank



HCM Signalized Intersection Capacity Analysis

3: Earl Armstrong & Limebank

Future Background Traffic-2021
Weekday PM Peak Hour Unconstrained

												
Movement	EBL	EBT	EBR	WBL	WBT	WBR	NBL	NBT	NBR	SBL	SBT	SBR
Lane Configurations												
Volume (vph)	730	715	180	110	1200	155	75	135	60	360	90	955
Ideal Flow (vphpl)	1900	1900	1900	1900	1900	1900	1900	1900	1900	1900	1900	1900
Total Lost time (s)	5.9	5.9	5.9	5.9	5.9	5.9	5.9	5.9	5.9	5.9	5.9	5.9
Lane Util. Factor	0.97	0.95	1.00	0.97	0.95	1.00	0.97	0.95	1.00	0.97	0.95	0.88
Frt	1.00	1.00	0.85	1.00	1.00	0.85	1.00	1.00	0.85	1.00	1.00	0.85
Flt Protected	0.95	1.00	1.00	0.95	1.00	1.00	0.95	1.00	1.00	0.95	1.00	1.00
Satd. Flow (prot)	3433	3539	1583	3433	3539	1583	3433	3539	1583	3433	3539	2787
Flt Permitted	0.95	1.00	1.00	0.95	1.00	1.00	0.95	1.00	1.00	0.95	1.00	1.00
Satd. Flow (perm)	3433	3539	1583	3433	3539	1583	3433	3539	1583	3433	3539	2787
Peak-hour factor, PHF	1.00	1.00	1.00	1.00	1.00	1.00	1.00	1.00	1.00	1.00	1.00	1.00
Adj. Flow (vph)	730	715	180	110	1200	155	75	135	60	360	90	955
RTOR Reduction (vph)	0	0	117	0	0	66	0	0	44	0	0	30
Lane Group Flow (vph)	730	715	63	110	1200	89	75	135	16	360	90	925
Turn Type	Prot		Perm	Prot		Perm	Prot		Perm	Prot		custom
Protected Phases	7	4		3	8		5	2		1	6	6
Permitted Phases			4			8			2			6
Actuated Green, G (s)	13.1	35.1	35.1	6.1	28.1	28.1	4.0	26.7	26.7	7.1	29.8	49.8
Effective Green, g (s)	14.1	36.1	36.1	7.1	29.1	29.1	5.0	27.7	27.7	8.1	30.8	50.8
Actuated g/C Ratio	0.14	0.35	0.35	0.07	0.28	0.28	0.05	0.27	0.27	0.08	0.30	0.50
Clearance Time (s)	6.9	6.9	6.9	6.9	6.9	6.9	6.9	6.9	6.9	6.9	6.9	6.9
Vehicle Extension (s)	3.0	3.0	3.0	3.0	3.0	3.0	3.0	3.0	3.0	3.0	3.0	3.0
Lane Grp Cap (vph)	472	1245	557	238	1004	449	167	955	427	271	1062	1380
v/s Ratio Prot	c0.21	0.20		0.03	c0.34		0.02	0.04		c0.10	0.03	c0.33
v/s Ratio Perm			0.04			0.06			0.01			
v/c Ratio	1.55	0.57	0.11	0.46	1.20	0.20	0.45	0.14	0.04	1.33	0.08	0.67
Uniform Delay, d1	44.2	27.0	22.4	45.9	36.8	27.9	47.5	28.4	27.6	47.2	25.8	19.6
Progression Factor	1.00	1.00	1.00	1.05	0.86	0.82	1.00	1.00	1.00	1.00	1.00	1.00
Incremental Delay, d2	256.3	0.6	0.1	1.3	96.8	0.2	1.9	0.3	0.2	171.0	0.2	1.3
Delay (s)	300.6	27.7	22.5	49.7	128.6	23.1	49.4	28.7	27.8	218.3	25.9	20.9
Level of Service	F	C	C	D	F	C	D	C	C	F	C	C
Approach Delay (s)		149.7			111.5			34.3			71.8	
Approach LOS		F			F			C			E	
Intersection Summary												
HCM Average Control Delay			108.4				HCM Level of Service				F	
HCM Volume to Capacity ratio			1.14									
Actuated Cycle Length (s)			102.6				Sum of lost time (s)			23.6		
Intersection Capacity Utilization			92.3%				ICU Level of Service			F		
Analysis Period (min)			15									
c Critical Lane Group												

Queues
6: Earl Armstrong & Proposed New Road

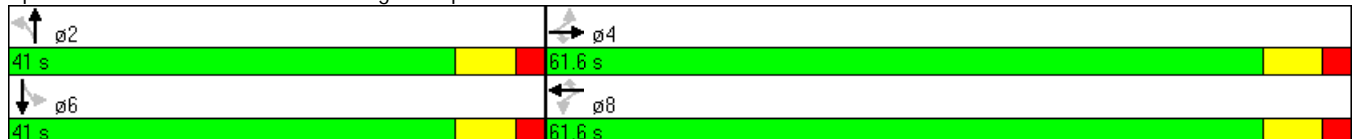
Future Background Traffic-2021
 Weekday PM Peak Hour Unconstrained

Lane Group	EBL	EBT	EBR	WBL	WBT	WBR	NBL	NBT	SBT
Lane Configurations									
Volume (vph)	95	730	105	75	1200	10	175	5	5
Lane Group Flow (vph)	95	730	105	75	1200	10	175	60	95
Turn Type	Perm		Perm	Perm		Perm	Perm		
Protected Phases		4			8			2	6
Permitted Phases	4		4	8		8	2		
Detector Phase	4	4	4	8	8	8	2	2	6
Switch Phase									
Minimum Initial (s)	10.0	10.0	10.0	10.0	10.0	10.0	10.0	10.0	10.0
Minimum Split (s)	31.9	31.9	31.9	31.9	31.9	31.9	31.9	31.9	31.9
Total Split (s)	61.6	61.6	61.6	61.6	61.6	61.6	41.0	41.0	41.0
Total Split (%)	60.0%	60.0%	60.0%	60.0%	60.0%	60.0%	40.0%	40.0%	40.0%
Yellow Time (s)	4.6	4.6	4.6	4.6	4.6	4.6	4.6	4.6	4.6
All-Red Time (s)	2.3	2.3	2.3	2.3	2.3	2.3	2.3	2.3	2.3
Lost Time Adjust (s)	-1.0	-1.0	-1.0	-1.0	-1.0	-1.0	-1.0	-1.0	-1.0
Total Lost Time (s)	5.9	5.9	5.9	5.9	5.9	5.9	5.9	5.9	5.9
Lead/Lag									
Lead-Lag Optimize?									
Recall Mode	C-Max	C-Max	C-Max	C-Max	C-Max	C-Max	None	None	None
v/c Ratio	0.38	0.30	0.09	0.16	0.49	0.01	0.68	0.17	0.26
Control Delay	6.8	0.9	0.1	8.2	9.2	5.1	51.0	10.5	16.5
Queue Delay	0.0	0.0	0.0	0.0	0.0	0.0	0.0	0.0	0.0
Total Delay	6.8	0.9	0.1	8.2	9.2	5.1	51.0	10.5	16.5
Queue Length 50th (m)	0.5	1.6	0.0	4.6	52.0	0.3	32.2	0.8	6.2
Queue Length 95th (m)	m3.9	m3.8	m0.0	12.9	84.7	2.2	49.5	10.0	17.5
Internal Link Dist (m)		96.0			43.9			72.0	67.0
Turn Bay Length (m)	30.0		30.0	30.0		30.0	30.0		
Base Capacity (vph)	252	2433	1121	460	2433	1090	443	586	584
Starvation Cap Reductn	0	0	0	0	0	0	0	0	0
Spillback Cap Reductn	0	0	0	0	0	0	0	0	0
Storage Cap Reductn	0	0	0	0	0	0	0	0	0
Reduced v/c Ratio	0.38	0.30	0.09	0.16	0.49	0.01	0.40	0.10	0.16

Intersection Summary

Cycle Length: 102.6
 Actuated Cycle Length: 102.6
 Offset: 100 (97%), Referenced to phase 4:EBTL and 8:WBTL, Start of Green
 Natural Cycle: 75
 Control Type: Actuated-Coordinated
 m Volume for 95th percentile queue is metered by upstream signal.





























Splits and Phases: 6: Earl Armstrong & Proposed New Road



HCM Signalized Intersection Capacity Analysis

6: Earl Armstrong & Proposed New Road

Future Background Traffic-2021
Weekday PM Peak Hour Unconstrained

												
Movement	EBL	EBT	EBR	WBL	WBT	WBR	NBL	NBT	NBR	SBL	SBT	SBR
Lane Configurations		 			 			 			 	
Volume (vph)	95	730	105	75	1200	10	175	5	55	0	5	90
Ideal Flow (vphpl)	1900	1900	1900	1900	1900	1900	1900	1900	1900	1900	1900	1900
Total Lost time (s)	5.9	5.9	5.9	5.9	5.9	5.9	5.9	5.9			5.9	
Lane Util. Factor	1.00	0.95	1.00	1.00	0.95	1.00	1.00	1.00			1.00	
Frt	1.00	1.00	0.85	1.00	1.00	0.85	1.00	0.86			0.86	
Flt Protected	0.95	1.00	1.00	0.95	1.00	1.00	0.95	1.00			1.00	
Satd. Flow (prot)	1770	3539	1583	1770	3539	1583	1770	1607			1598	
Flt Permitted	0.20	1.00	1.00	0.36	1.00	1.00	0.70	1.00			1.00	
Satd. Flow (perm)	366	3539	1583	669	3539	1583	1295	1607			1598	
Peak-hour factor, PHF	1.00	1.00	1.00	1.00	1.00	1.00	1.00	1.00	1.00	1.00	1.00	1.00
Adj. Flow (vph)	95	730	105	75	1200	10	175	5	55	0	5	90
RTOR Reduction (vph)	0	0	33	0	0	2	0	44	0	0	46	0
Lane Group Flow (vph)	95	730	72	75	1200	8	175	16	0	0	49	0
Turn Type	Perm		Perm	Perm		Perm	Perm			Perm		
Protected Phases		4			8			2				6
Permitted Phases	4		4	8		8	2			6		
Actuated Green, G (s)	69.5	69.5	69.5	69.5	69.5	69.5	19.3	19.3			19.3	
Effective Green, g (s)	70.5	70.5	70.5	70.5	70.5	70.5	20.3	20.3			20.3	
Actuated g/C Ratio	0.69	0.69	0.69	0.69	0.69	0.69	0.20	0.20			0.20	
Clearance Time (s)	6.9	6.9	6.9	6.9	6.9	6.9	6.9	6.9			6.9	
Vehicle Extension (s)	3.0	3.0	3.0	3.0	3.0	3.0	3.0	3.0			3.0	
Lane Grp Cap (vph)	251	2432	1088	460	2432	1088	256	318			316	
v/s Ratio Prot		0.21			c0.34			0.01			0.03	
v/s Ratio Perm	0.26		0.05	0.11		0.01	c0.14					
v/c Ratio	0.38	0.30	0.07	0.16	0.49	0.01	0.68	0.05			0.16	
Uniform Delay, d1	6.8	6.3	5.3	5.7	7.6	5.0	38.2	33.3			34.1	
Progression Factor	0.43	0.09	0.00	1.00	1.00	1.00	1.00	1.00			1.00	
Incremental Delay, d2	2.7	0.2	0.1	0.8	0.7	0.0	7.3	0.1			0.2	
Delay (s)	5.6	0.8	0.1	6.4	8.3	5.1	45.5	33.4			34.3	
Level of Service	A	A	A	A	A	A	D	C			C	
Approach Delay (s)		1.2			8.2			42.4			34.3	
Approach LOS		A			A			D			C	
Intersection Summary												
HCM Average Control Delay			9.8				HCM Level of Service				A	
HCM Volume to Capacity ratio			0.54									
Actuated Cycle Length (s)			102.6				Sum of lost time (s)				11.8	
Intersection Capacity Utilization			72.6%				ICU Level of Service				C	
Analysis Period (min)			15									
c Critical Lane Group												

HCM Unsignalized Intersection Capacity Analysis












9: Earl Armstrong & RIRO Site Access

Future Background Traffic-2021
Weekday PM Peak Hour Unconstrained

	→	↘	↙	←	↖	↗
Movement	EBT	EBR	WBL	WBT	NBL	NBR
Lane Configurations	↑↑			↑↑		↗
Volume (veh/h)	905	230	0	1465	0	25
Sign Control	Free			Free	Stop	
Grade	0%			0%	0%	
Peak Hour Factor	1.00	1.00	1.00	1.00	1.00	1.00
Hourly flow rate (vph)	905	230	0	1465	0	25
Pedestrians						
Lane Width (m)						
Walking Speed (m/s)						
Percent Blockage						
Right turn flare (veh)						
Median type	None		None			
Median storage (veh)						
Upstream signal (m)	137			120		
pX, platoon unblocked			0.84		0.91	0.84
vC, conflicting volume			1135		1752	568
vC1, stage 1 conf vol						
vC2, stage 2 conf vol						
vCu, unblocked vol			773		836	96
tC, single (s)			4.1		6.8	6.9
tC, 2 stage (s)						
tF (s)			2.2		3.5	3.3
p0 queue free %			100		100	97
cM capacity (veh/h)			702		280	789
Direction, Lane #	EB 1	EB 2	WB 1	WB 2	NB 1	
Volume Total	603	532	732	732	25	
Volume Left	0	0	0	0	0	
Volume Right	0	230	0	0	25	
cSH	1700	1700	1700	1700	789	
Volume to Capacity	0.35	0.31	0.43	0.43	0.03	
Queue Length 95th (m)	0.0	0.0	0.0	0.0	0.7	
Control Delay (s)	0.0	0.0	0.0	0.0	9.7	
Lane LOS						A
Approach Delay (s)	0.0		0.0		9.7	
Approach LOS						A
Intersection Summary						
Average Delay			0.1			
Intersection Capacity Utilization			43.8%	ICU Level of Service	A	
Analysis Period (min)			15			










HCM Unsignalized Intersection Capacity Analysis
 11: Site Access & Limebank

Future Background Traffic-2021
 Weekday PM Peak Hour Unconstrained

						
Movement	WBL	WBR	NBT	NBR	SBL	SBT
Lane Configurations			 			 
Volume (veh/h)	0	210	65	75	0	380
Sign Control	Stop		Free			Free
Grade	0%		0%			0%
Peak Hour Factor	1.00	1.00	1.00	1.00	1.00	1.00
Hourly flow rate (vph)	0	210	65	75	0	380
Pedestrians						
Lane Width (m)						
Walking Speed (m/s)						
Percent Blockage						
Right turn flare (veh)						
Median type			None			None
Median storage (veh)						
Upstream signal (m)						145
pX, platoon unblocked						
vC, conflicting volume	292	70			140	
vC1, stage 1 conf vol						
vC2, stage 2 conf vol						
vCu, unblocked vol	292	70			140	
tC, single (s)	6.8	6.9			4.1	
tC, 2 stage (s)						
tF (s)	3.5	3.3			2.2	
p0 queue free %	100	79			100	
cM capacity (veh/h)	675	978			1441	
Direction, Lane #	WB 1	NB 1	NB 2	SB 1	SB 2	
Volume Total	210	43	97	190	190	
Volume Left	0	0	0	0	0	
Volume Right	210	0	75	0	0	
cSH	978	1700	1700	1700	1700	
Volume to Capacity	0.21	0.03	0.06	0.11	0.11	
Queue Length 95th (m)	6.1	0.0	0.0	0.0	0.0	
Control Delay (s)	9.7	0.0	0.0	0.0	0.0	
Lane LOS	A					
Approach Delay (s)	9.7	0.0		0.0		
Approach LOS	A					
Intersection Summary						
Average Delay			2.8			
Intersection Capacity Utilization			23.9%		ICU Level of Service	A
Analysis Period (min)			15			










HCM Unsignalized Intersection Capacity Analysis
 13: N. Site Access & Proposed New Road

Future Background Traffic-2021
 Weekday PM Peak Hour Unconstrained

						
Movement	EBL	EBR	NBL	NBT	SBT	SBR
Lane Configurations						
Volume (veh/h)	80	5	15	155	120	65
Sign Control	Stop			Free	Free	
Grade	0%			0%	0%	
Peak Hour Factor	1.00	1.00	1.00	1.00	1.00	1.00
Hourly flow rate (vph)	80	5	15	155	120	65
Pedestrians						
Lane Width (m)						
Walking Speed (m/s)						
Percent Blockage						
Right turn flare (veh)						
Median type				None	None	
Median storage (veh)						
Upstream signal (m)					96	
pX, platoon unblocked						
vC, conflicting volume	338	152	185			
vC1, stage 1 conf vol						
vC2, stage 2 conf vol						
vCu, unblocked vol	338	152	185			
tC, single (s)	6.4	6.2	4.1			
tC, 2 stage (s)						
tF (s)	3.5	3.3	2.2			
p0 queue free %	88	99	99			
cM capacity (veh/h)	651	894	1390			
Direction, Lane #	EB 1	NB 1	SB 1			
Volume Total	85	170	185			
Volume Left	80	15	0			
Volume Right	5	0	65			
cSH	662	1390	1700			
Volume to Capacity	0.13	0.01	0.11			
Queue Length 95th (m)	3.3	0.2	0.0			
Control Delay (s)	11.2	0.8	0.0			
Lane LOS	B	A				
Approach Delay (s)	11.2	0.8	0.0			
Approach LOS	B					
Intersection Summary						
Average Delay			2.5			
Intersection Capacity Utilization		32.0%		ICU Level of Service		A
Analysis Period (min)			15			

HCM Unsignalized Intersection Capacity Analysis
 15: S. Site Access & Proposed New Road

Future Background Traffic-2021
 Weekday PM Peak Hour Unconstrained

						
Movement	EBL	EBR	NBL	NBT	SBT	SBR
Lane Configurations						
Volume (veh/h)	15	10	30	155	110	10
Sign Control	Stop			Free	Free	
Grade	0%			0%	0%	
Peak Hour Factor	1.00	1.00	1.00	1.00	1.00	1.00
Hourly flow rate (vph)	15	10	30	155	110	10
Pedestrians						
Lane Width (m)						
Walking Speed (m/s)						
Percent Blockage						
Right turn flare (veh)						
Median type				None	None	
Median storage (veh)						
Upstream signal (m)					187	
pX, platoon unblocked						
vC, conflicting volume	330	115	120			
vC1, stage 1 conf vol						
vC2, stage 2 conf vol						
vCu, unblocked vol	330	115	120			
tC, single (s)	6.4	6.2	4.1			
tC, 2 stage (s)						
tF (s)	3.5	3.3	2.2			
p0 queue free %	98	99	98			
cM capacity (veh/h)	651	937	1468			
Direction, Lane #	EB 1	NB 1	SB 1			
Volume Total	25	185	120			
Volume Left	15	30	0			
Volume Right	10	0	10			
cSH	742	1468	1700			
Volume to Capacity	0.03	0.02	0.07			
Queue Length 95th (m)	0.8	0.5	0.0			
Control Delay (s)	10.0	1.4	0.0			
Lane LOS	B	A				
Approach Delay (s)	10.0	1.4	0.0			
Approach LOS	B					
Intersection Summary						
Average Delay			1.5			
Intersection Capacity Utilization		26.5%		ICU Level of Service		A
Analysis Period (min)			15			

Queues

3: Earl Armstrong & Limebank

Future Total Traffic-2021

Weekday AM Peak Hour Zero Interaction

Lane Group	EBL	EBT	EBR	WBL	WBT	WBR	NBL	NBT	NBR	SBL	SBT	SBR
Lane Configurations												
Volume (vph)	435	345	50	45	355	100	130	190	25	140	60	285
Lane Group Flow (vph)	435	345	50	45	355	100	130	190	25	140	60	285
Turn Type	Prot		Perm	Prot		Perm	Prot		Perm	Prot		custom
Protected Phases	7	4		3	8		5	2		1	6	6 7
Permitted Phases			4			8			2			6
Detector Phase	7	4	4	3	8	8	5	2	2	1	6	6 7
Switch Phase												
Minimum Initial (s)	5.0	10.0	10.0	5.0	10.0	10.0	5.0	10.0	10.0	5.0	10.0	
Minimum Split (s)	11.9	31.9	31.9	11.9	31.9	31.9	11.9	31.9	31.9	11.9	31.9	
Total Split (s)	31.9	51.9	51.9	11.9	31.9	31.9	16.9	36.9	36.9	11.9	31.9	63.8
Total Split (%)	28.3%	46.1%	46.1%	10.6%	28.3%	28.3%	15.0%	32.8%	32.8%	10.6%	28.3%	56.7%
Yellow Time (s)	4.6	4.6	4.6	4.6	4.6	4.6	4.6	4.6	4.6	4.6	4.6	4.6
All-Red Time (s)	2.3	2.3	2.3	2.3	2.3	2.3	2.3	2.3	2.3	2.3	2.3	2.3
Lost Time Adjust (s)	-1.0	-1.0	-1.0	-1.0	-1.0	-1.0	-1.0	-1.0	-1.0	-1.0	-1.0	-1.0
Total Lost Time (s)	5.9	5.9	5.9	5.9	5.9	5.9	5.9	5.9	5.9	5.9	5.9	5.9
Lead/Lag	Lead	Lag	Lag	Lead	Lag	Lag	Lead	Lag	Lag	Lead	Lag	
Lead-Lag Optimize?	Yes	Yes	Yes	Yes	Yes	Yes	Yes	Yes	Yes	Yes	Yes	Yes
Recall Mode	None	None	None	None	None	None	None	C-Max	C-Max	None	C-Max	
v/c Ratio	0.69	0.32	0.10	0.25	0.64	0.30	0.40	0.15	0.04	0.44	0.05	0.16
Control Delay	48.4	30.2	7.2	57.8	42.4	6.4	51.3	27.2	11.2	52.5	27.9	2.1
Queue Delay	0.0	0.0	0.0	0.0	0.0	0.0	0.0	0.0	0.0	0.0	0.0	0.0
Total Delay	48.4	30.2	7.2	57.8	42.4	6.4	51.3	27.2	11.2	52.5	27.9	2.1
Queue Length 50th (m)	46.0	31.2	0.0	5.0	33.9	0.0	13.9	14.7	0.0	14.9	4.4	0.8
Queue Length 95th (m)	58.6	38.1	7.5	10.8	41.4	8.6	22.6	25.7	6.5	24.9	10.6	7.6
Internal Link Dist (m)		131.0			112.8			120.2			61.2	
Turn Bay Length (m)	100.0		50.0	30.0		50.0	50.0		50.0	50.0		100.0
Base Capacity (vph)	793	1446	676	183	817	442	353	1261	580	321	1259	1878
Starvation Cap Reductn	0	0	0	0	0	0	0	0	0	0	0	0
Spillback Cap Reductn	0	0	0	0	0	0	0	0	0	0	0	0
Storage Cap Reductn	0	0	0	0	0	0	0	0	0	0	0	0
Reduced v/c Ratio	0.55	0.24	0.07	0.25	0.43	0.23	0.37	0.15	0.04	0.44	0.05	0.15

Intersection Summary

Cycle Length: 112.6

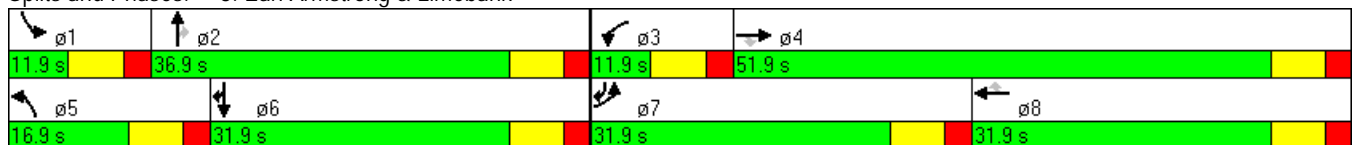
Actuated Cycle Length: 112.6

Offset: 28 (25%), Referenced to phase 2:NBT and 6:SBT, Start of Green

Natural Cycle: 90

Control Type: Actuated-Coordinated

























Splits and Phases: 3: Earl Armstrong & Limebank



HCM Signalized Intersection Capacity Analysis

3: Earl Armstrong & Limebank

Future Total Traffic-2021
Weekday AM Peak Hour Zero Interaction

												
Movement	EBL	EBT	EBR	WBL	WBT	WBR	NBL	NBT	NBR	SBL	SBT	SBR
Lane Configurations												
Volume (vph)	435	345	50	45	355	100	130	190	25	140	60	285
Ideal Flow (vphpl)	1900	1900	1900	1900	1900	1900	1900	1900	1900	1900	1900	1900
Total Lost time (s)	5.9	5.9	5.9	5.9	5.9	5.9	5.9	5.9	5.9	5.9	5.9	5.9
Lane Util. Factor	0.97	0.95	1.00	0.97	0.95	1.00	0.97	0.95	1.00	0.97	0.95	0.88
Frt	1.00	1.00	0.85	1.00	1.00	0.85	1.00	1.00	0.85	1.00	1.00	0.85
Flt Protected	0.95	1.00	1.00	0.95	1.00	1.00	0.95	1.00	1.00	0.95	1.00	1.00
Satd. Flow (prot)	3433	3539	1583	3433	3539	1583	3433	3539	1583	3433	3539	2787
Flt Permitted	0.95	1.00	1.00	0.95	1.00	1.00	0.95	1.00	1.00	0.95	1.00	1.00
Satd. Flow (perm)	3433	3539	1583	3433	3539	1583	3433	3539	1583	3433	3539	2787
Peak-hour factor, PHF	1.00	1.00	1.00	1.00	1.00	1.00	1.00	1.00	1.00	1.00	1.00	1.00
Adj. Flow (vph)	435	345	50	45	355	100	130	190	25	140	60	285
RTOR Reduction (vph)	0	0	35	0	0	83	0	0	16	0	0	112
Lane Group Flow (vph)	435	345	15	45	355	17	130	190	9	140	60	173
Turn Type	Prot		Perm	Prot		Perm	Prot		Perm	Prot		custom
Protected Phases	7	4		3	8		5	2		1	6	6
Permitted Phases			4			8			2			6
Actuated Green, G (s)	19.8	33.7	33.7	4.0	17.9	17.9	9.6	37.8	37.8	9.5	37.7	64.4
Effective Green, g (s)	20.8	34.7	34.7	5.0	18.9	18.9	10.6	38.8	38.8	10.5	38.7	65.4
Actuated g/C Ratio	0.18	0.31	0.31	0.04	0.17	0.17	0.09	0.34	0.34	0.09	0.34	0.58
Clearance Time (s)	6.9	6.9	6.9	6.9	6.9	6.9	6.9	6.9	6.9	6.9	6.9	
Vehicle Extension (s)	3.0	3.0	3.0	3.0	3.0	3.0	3.0	3.0	3.0	3.0	3.0	
Lane Grp Cap (vph)	634	1091	488	152	594	266	323	1219	545	320	1216	1619
v/s Ratio Prot	c0.13	0.10		0.01	c0.10		0.04	c0.05		c0.04	0.02	0.06
v/s Ratio Perm			0.01			0.01			0.01			
v/c Ratio	0.69	0.32	0.03	0.30	0.60	0.06	0.40	0.16	0.02	0.44	0.05	0.11
Uniform Delay, d1	42.9	29.9	27.2	52.1	43.3	39.4	48.0	25.6	24.3	48.3	24.7	10.5
Progression Factor	1.00	1.00	1.00	1.06	0.83	0.52	1.00	1.00	1.00	1.00	1.00	1.00
Incremental Delay, d2	3.1	0.2	0.0	1.1	1.6	0.1	0.8	0.3	0.1	1.0	0.1	0.0
Delay (s)	45.9	30.0	27.2	56.3	37.6	20.4	48.8	25.8	24.4	49.2	24.7	10.6
Level of Service	D	C	C	E	D	C	D	C	C	D	C	B
Approach Delay (s)		38.2			35.9			34.4			23.5	
Approach LOS		D			D			C			C	
Intersection Summary												
HCM Average Control Delay			33.8				HCM Level of Service			C		
HCM Volume to Capacity ratio			0.38									
Actuated Cycle Length (s)			112.6				Sum of lost time (s)		17.7			
Intersection Capacity Utilization			54.4%				ICU Level of Service		A			
Analysis Period (min)			15									
c Critical Lane Group												

Queues
6: Earl Armstrong & Proposed New Road

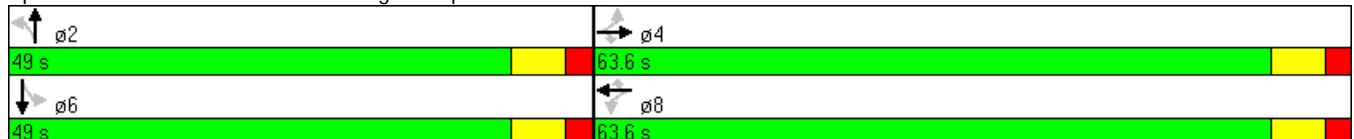
Future Total Traffic-2021
 Weekday AM Peak Hour Zero Interaction

Lane Group	EBL	EBT	EBR	WBL	WBT	WBR	NBL	NBT	SBT
Lane Configurations									
Volume (vph)	35	330	50	10	410	2	75	5	10
Lane Group Flow (vph)	35	330	50	10	410	2	75	40	25
Turn Type	Perm		Perm	Perm		Perm	Perm		
Protected Phases		4			8			2	6
Permitted Phases	4		4	8		8	2		
Detector Phase	4	4	4	8	8	8	2	2	6
Switch Phase									
Minimum Initial (s)	10.0	10.0	10.0	10.0	10.0	10.0	10.0	10.0	10.0
Minimum Split (s)	31.9	31.9	31.9	31.9	31.9	31.9	31.9	31.9	31.9
Total Split (s)	63.6	63.6	63.6	63.6	63.6	63.6	49.0	49.0	49.0
Total Split (%)	56.5%	56.5%	56.5%	56.5%	56.5%	56.5%	43.5%	43.5%	43.5%
Yellow Time (s)	4.6	4.6	4.6	4.6	4.6	4.6	4.6	4.6	4.6
All-Red Time (s)	2.3	2.3	2.3	2.3	2.3	2.3	2.3	2.3	2.3
Lost Time Adjust (s)	-1.0	-1.0	-1.0	-1.0	-1.0	-1.0	-1.0	-1.0	-1.0
Total Lost Time (s)	5.9	5.9	5.9	5.9	5.9	5.9	5.9	5.9	5.9
Lead/Lag									
Lead-Lag Optimize?									
Recall Mode	C-Max	C-Max	C-Max	C-Max	C-Max	C-Max	None	None	None
v/c Ratio	0.04	0.11	0.04	0.01	0.14	0.00	0.46	0.18	0.12
Control Delay	0.3	0.2	0.1	3.5	3.2	2.5	54.7	18.1	26.2
Queue Delay	0.0	0.0	0.0	0.0	0.0	0.0	0.0	0.0	0.0
Total Delay	0.3	0.2	0.1	3.5	3.2	2.5	54.7	18.1	26.2
Queue Length 50th (m)	0.1	0.4	0.0	0.4	9.3	0.0	15.6	1.0	2.0
Queue Length 95th (m)	m0.2	0.5	0.0	1.8	16.3	0.6	28.9	10.3	9.5
Internal Link Dist (m)		95.8			43.9			72.0	67.0
Turn Bay Length (m)	30.0		30.0	30.0		30.0	30.0		
Base Capacity (vph)	778	2891	1302	841	2891	1294	528	641	658
Starvation Cap Reductn	0	0	0	0	0	0	0	0	0
Spillback Cap Reductn	0	0	0	0	0	0	0	0	0
Storage Cap Reductn	0	0	0	0	0	0	0	0	0
Reduced v/c Ratio	0.04	0.11	0.04	0.01	0.14	0.00	0.14	0.06	0.04

Intersection Summary


























Cycle Length: 112.6
 Actuated Cycle Length: 112.6
 Offset: 0 (0%), Referenced to phase 4:EBTL and 8:WBTL, Start of Green
 Natural Cycle: 65
 Control Type: Actuated-Coordinated
 m Volume for 95th percentile queue is metered by upstream signal.

Splits and Phases: 6: Earl Armstrong & Proposed New Road



HCM Signalized Intersection Capacity Analysis
6: Earl Armstrong & Proposed New Road

Future Total Traffic-2021
Weekday AM Peak Hour Zero Interaction

												
Movement	EBL	EBT	EBR	WBL	WBT	WBR	NBL	NBT	NBR	SBL	SBT	SBR
Lane Configurations		 			 							
Volume (vph)	35	330	50	10	410	2	75	5	35	0	10	15
Ideal Flow (vphpl)	1900	1900	1900	1900	1900	1900	1900	1900	1900	1900	1900	1900
Total Lost time (s)	5.9	5.9	5.9	5.9	5.9	5.9	5.9	5.9			5.9	
Lane Util. Factor	1.00	0.95	1.00	1.00	0.95	1.00	1.00	1.00			1.00	
Frt	1.00	1.00	0.85	1.00	1.00	0.85	1.00	0.87			0.91	
Flt Protected	0.95	1.00	1.00	0.95	1.00	1.00	0.95	1.00			1.00	
Satd. Flow (prot)	1770	3539	1583	1770	3539	1583	1770	1618			1695	
Flt Permitted	0.51	1.00	1.00	0.55	1.00	1.00	0.74	1.00			1.00	
Satd. Flow (perm)	953	3539	1583	1029	3539	1583	1380	1618			1695	
Peak-hour factor, PHF	1.00	1.00	1.00	1.00	1.00	1.00	1.00	1.00	1.00	1.00	1.00	1.00
Adj. Flow (vph)	35	330	50	10	410	2	75	5	35	0	10	15
RTOR Reduction (vph)	0	0	10	0	0	0	0	31	0	0	13	0
Lane Group Flow (vph)	35	330	40	10	410	2	75	9	0	0	12	0
Turn Type	Perm		Perm	Perm		Perm	Perm			Perm		
Protected Phases		4			8			2			6	
Permitted Phases	4		4	8		8	2			6		
Actuated Green, G (s)	88.4	88.4	88.4	88.4	88.4	88.4	10.4	10.4			10.4	
Effective Green, g (s)	89.4	89.4	89.4	89.4	89.4	89.4	11.4	11.4			11.4	
Actuated g/C Ratio	0.79	0.79	0.79	0.79	0.79	0.79	0.10	0.10			0.10	
Clearance Time (s)	6.9	6.9	6.9	6.9	6.9	6.9	6.9	6.9			6.9	
Vehicle Extension (s)	3.0	3.0	3.0	3.0	3.0	3.0	3.0	3.0			3.0	
Lane Grp Cap (vph)	757	2810	1257	817	2810	1257	140	164			172	
v/s Ratio Prot		0.09			c0.12			0.01			0.01	
v/s Ratio Perm	0.04		0.03	0.01		0.00	c0.05					
v/c Ratio	0.05	0.12	0.03	0.01	0.15	0.00	0.54	0.05			0.07	
Uniform Delay, d1	2.5	2.6	2.5	2.4	2.7	2.4	48.1	45.7			45.8	
Progression Factor	0.06	0.05	0.00	1.00	1.00	1.00	1.00	1.00			1.00	
Incremental Delay, d2	0.1	0.1	0.0	0.0	0.1	0.0	3.9	0.1			0.2	
Delay (s)	0.3	0.2	0.0	2.4	2.8	2.4	52.0	45.9			46.0	
Level of Service	A	A	A	A	A	A	D	D			D	
Approach Delay (s)		0.2			2.8			49.9			46.0	
Approach LOS		A			A			D			D	
Intersection Summary												
HCM Average Control Delay			8.3				HCM Level of Service			A		
HCM Volume to Capacity ratio			0.19									
Actuated Cycle Length (s)			112.6				Sum of lost time (s)			11.8		
Intersection Capacity Utilization			45.2%				ICU Level of Service			A		
Analysis Period (min)			15									
c Critical Lane Group												

HCM Unsignalized Intersection Capacity Analysis












9: Earl Armstrong & RIRO Site Access

Future Total Traffic-2021
Weekday AM Peak Hour Zero Interaction

	→	↘	↙	←	↖	↗
Movement	EBT	EBR	WBL	WBT	NBL	NBR
Lane Configurations	↑↑			↑↑		↗
Volume (veh/h)	415	100	0	500	0	1
Sign Control	Free			Free	Stop	
Grade	0%			0%	0%	
Peak Hour Factor	1.00	1.00	1.00	1.00	1.00	1.00
Hourly flow rate (vph)	415	100	0	500	0	1
Pedestrians						
Lane Width (m)						
Walking Speed (m/s)						
Percent Blockage						
Right turn flare (veh)						
Median type	None			None		
Median storage (veh)						
Upstream signal (m)	137			120		
pX, platoon unblocked			0.93		0.94	0.93
vC, conflicting volume			515		715	258
vC1, stage 1 conf vol						
vC2, stage 2 conf vol						
vCu, unblocked vol			336		514	59
tC, single (s)			4.1		6.8	6.9
tC, 2 stage (s)						
tF (s)			2.2		3.5	3.3
p0 queue free %			100		100	100
cM capacity (veh/h)			1138		460	927
Direction, Lane #	EB 1	EB 2	WB 1	WB 2	NB 1	
Volume Total	277	238	250	250	1	
Volume Left	0	0	0	0	0	
Volume Right	0	100	0	0	1	
cSH	1700	1700	1700	1700	927	
Volume to Capacity	0.16	0.14	0.15	0.15	0.00	
Queue Length 95th (m)	0.0	0.0	0.0	0.0	0.0	
Control Delay (s)	0.0	0.0	0.0	0.0	8.9	
Lane LOS						A
Approach Delay (s)	0.0		0.0		8.9	
Approach LOS						A
Intersection Summary						
Average Delay			0.0			
Intersection Capacity Utilization			24.7%	ICU Level of Service	A	
Analysis Period (min)			15			










HCM Unsignalized Intersection Capacity Analysis
 11: Site Access & Limebank

Future Total Traffic-2021
 Weekday AM Peak Hour Zero Interaction

						
Movement	WBL	WBR	NBT	NBR	SBL	SBT
Lane Configurations			 			 
Volume (veh/h)	0	55	295	30	0	155
Sign Control	Stop		Free			Free
Grade	0%		0%			0%
Peak Hour Factor	1.00	1.00	1.00	1.00	1.00	1.00
Hourly flow rate (vph)	0	55	295	30	0	155
Pedestrians						
Lane Width (m)						
Walking Speed (m/s)						
Percent Blockage						
Right turn flare (veh)						
Median type			None			None
Median storage (veh)						
Upstream signal (m)						144
pX, platoon unblocked						
vC, conflicting volume	388	162			325	
vC1, stage 1 conf vol						
vC2, stage 2 conf vol						
vCu, unblocked vol	388	162			325	
tC, single (s)	6.8	6.9			4.1	
tC, 2 stage (s)						
tF (s)	3.5	3.3			2.2	
p0 queue free %	100	94			100	
cM capacity (veh/h)	588	854			1231	
Direction, Lane #	WB 1	NB 1	NB 2	SB 1	SB 2	
Volume Total	55	197	128	78	78	
Volume Left	0	0	0	0	0	
Volume Right	55	0	30	0	0	
cSH	854	1700	1700	1700	1700	
Volume to Capacity	0.06	0.12	0.08	0.05	0.05	
Queue Length 95th (m)	1.5	0.0	0.0	0.0	0.0	
Control Delay (s)	9.5	0.0	0.0	0.0	0.0	
Lane LOS	A					
Approach Delay (s)	9.5	0.0		0.0		
Approach LOS	A					
Intersection Summary						
Average Delay			1.0			
Intersection Capacity Utilization			19.2%	ICU Level of Service		A
Analysis Period (min)			15			










HCM Unsignalized Intersection Capacity Analysis
 13: N. Site Access & Proposed New Road

Future Total Traffic-2021
 Weekday AM Peak Hour Zero Interaction

						
Movement	EBL	EBR	NBL	NBT	SBT	SBR
Lane Configurations						
Volume (veh/h)	5	5	10	110	60	10
Sign Control	Stop			Free	Free	
Grade	0%			0%	0%	
Peak Hour Factor	1.00	1.00	1.00	1.00	1.00	1.00
Hourly flow rate (vph)	5	5	10	110	60	10
Pedestrians						
Lane Width (m)						
Walking Speed (m/s)						
Percent Blockage						
Right turn flare (veh)						
Median type				None	None	
Median storage (veh)						
Upstream signal (m)					96	
pX, platoon unblocked						
vC, conflicting volume	195	65	70			
vC1, stage 1 conf vol						
vC2, stage 2 conf vol						
vCu, unblocked vol	195	65	70			
tC, single (s)	6.4	6.2	4.1			
tC, 2 stage (s)						
tF (s)	3.5	3.3	2.2			
p0 queue free %	99	99	99			
cM capacity (veh/h)	789	999	1531			
Direction, Lane #	EB 1	NB 1	SB 1			
Volume Total	10	120	70			
Volume Left	5	10	0			
Volume Right	5	0	10			
cSH	881	1531	1700			
Volume to Capacity	0.01	0.01	0.04			
Queue Length 95th (m)	0.3	0.1	0.0			
Control Delay (s)	9.1	0.7	0.0			
Lane LOS	A	A				
Approach Delay (s)	9.1	0.7	0.0			
Approach LOS	A					
Intersection Summary						
Average Delay			0.9			
Intersection Capacity Utilization		23.0%		ICU Level of Service		A
Analysis Period (min)			15			

HCM Unsignalized Intersection Capacity Analysis
 15: S. Site Access & Proposed New Road

Future Total Traffic-2021
 Weekday AM Peak Hour Zero Interaction

						
Movement	EBL	EBR	NBL	NBT	SBT	SBR
Lane Configurations						
Volume (veh/h)	5	10	20	115	55	5
Sign Control	Stop			Free	Free	
Grade	0%			0%	0%	
Peak Hour Factor	1.00	1.00	1.00	1.00	1.00	1.00
Hourly flow rate (vph)	5	10	20	115	55	5
Pedestrians						
Lane Width (m)						
Walking Speed (m/s)						
Percent Blockage						
Right turn flare (veh)						
Median type				None	None	
Median storage (veh)						
Upstream signal (m)					185	
pX, platoon unblocked						
vC, conflicting volume	212	58	60			
vC1, stage 1 conf vol						
vC2, stage 2 conf vol						
vCu, unblocked vol	212	58	60			
tC, single (s)	6.4	6.2	4.1			
tC, 2 stage (s)						
tF (s)	3.5	3.3	2.2			
p0 queue free %	99	99	99			
cM capacity (veh/h)	766	1009	1544			
Direction, Lane #	EB 1	NB 1	SB 1			
Volume Total	15	135	60			
Volume Left	5	20	0			
Volume Right	10	0	5			
cSH	912	1544	1700			
Volume to Capacity	0.02	0.01	0.04			
Queue Length 95th (m)	0.4	0.3	0.0			
Control Delay (s)	9.0	1.2	0.0			
Lane LOS	A	A				
Approach Delay (s)	9.0	1.2	0.0			
Approach LOS	A					
Intersection Summary						
Average Delay			1.4			
Intersection Capacity Utilization		23.8%		ICU Level of Service		A
Analysis Period (min)			15			

Queues

3: Earl Armstrong & Limebank

Future Total Traffic-2021

Weekday PM Peak Hour Zero Interaction

Lane Group	EBL	EBT	EBR	WBL	WBT	WBR	NBL	NBT	NBR	SBL	SBT	SBR
Lane Configurations												
Volume (vph)	640	645	70	100	595	155	90	155	65	360	100	755
Lane Group Flow (vph)	640	645	70	100	595	155	90	155	65	360	100	755
Turn Type	Prot		Perm	Prot		Perm	Prot		Perm	Prot		custom
Protected Phases	7	4		3	8		5	2		1	6	6 7
Permitted Phases			4			8			2			6
Detector Phase	7	4	4	3	8	8	5	2	2	1	6	6 7
Switch Phase												
Minimum Initial (s)	5.0	10.0	10.0	5.0	10.0	10.0	5.0	10.0	10.0	5.0	10.0	
Minimum Split (s)	11.9	31.9	31.9	11.9	31.9	31.9	11.9	31.9	31.9	11.9	31.9	
Total Split (s)	23.7	43.4	43.4	12.2	31.9	31.9	12.4	33.0	33.0	14.0	34.6	58.3
Total Split (%)	23.1%	42.3%	42.3%	11.9%	31.1%	31.1%	12.1%	32.2%	32.2%	13.6%	33.7%	56.8%
Yellow Time (s)	4.6	4.6	4.6	4.6	4.6	4.6	4.6	4.6	4.6	4.6	4.6	4.6
All-Red Time (s)	2.3	2.3	2.3	2.3	2.3	2.3	2.3	2.3	2.3	2.3	2.3	2.3
Lost Time Adjust (s)	-1.0	-1.0	-1.0	-1.0	-1.0	-1.0	-1.0	-1.0	-1.0	-1.0	-1.0	-1.0
Total Lost Time (s)	5.9	5.9	5.9	5.9	5.9	5.9	5.9	5.9	5.9	5.9	5.9	5.9
Lead/Lag	Lead	Lag	Lag	Lead	Lag	Lag	Lead	Lag	Lag	Lead	Lag	
Lead-Lag Optimize?	Yes	Yes	Yes	Yes	Yes	Yes	Yes	Yes	Yes	Yes	Yes	Yes
Recall Mode	None	None	None	None	None	None	None	C-Max	C-Max	None	C-Max	
v/c Ratio	1.07	0.51	0.11	0.47	0.75	0.33	0.37	0.17	0.14	0.98	0.09	0.47
Control Delay	99.5	27.5	5.9	61.3	35.3	3.8	50.2	29.7	8.2	89.5	26.8	13.5
Queue Delay	0.0	0.0	0.0	0.0	0.0	0.0	0.0	0.0	0.0	0.0	0.0	0.0
Total Delay	99.5	27.5	5.9	61.3	35.3	3.8	50.2	29.7	8.2	89.5	26.8	13.5
Queue Length 50th (m)	~72.5	52.7	0.0	10.3	43.5	1.9	8.7	12.3	0.0	~40.8	7.6	44.3
Queue Length 95th (m)	#105.9	67.3	8.6	19.0	54.0	7.2	16.6	20.3	9.8	#75.3	13.8	61.3
Internal Link Dist (m)		131.0			113.3			120.8			61.2	
Turn Bay Length (m)	100.0		50.0	30.0		50.0	50.0		50.0	50.0		100.0
Base Capacity (vph)	596	1323	636	211	897	517	245	935	466	369	1151	1604
Starvation Cap Reductn	0	0	0	0	0	0	0	0	0	0	0	0
Spillback Cap Reductn	0	0	0	0	0	0	0	0	0	0	0	0
Storage Cap Reductn	0	0	0	0	0	0	0	0	0	0	0	0
Reduced v/c Ratio	1.07	0.49	0.11	0.47	0.66	0.30	0.37	0.17	0.14	0.98	0.09	0.47

Intersection Summary

Cycle Length: 102.6

Actuated Cycle Length: 102.6

Offset: 33 (32%), Referenced to phase 2:NBT and 6:SBT, Start of Green

Natural Cycle: 100

Control Type: Actuated-Coordinated

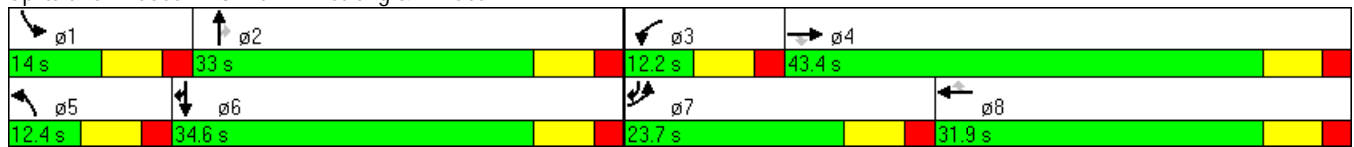
~ Volume exceeds capacity, queue is theoretically infinite.

Queue shown is maximum after two cycles.

95th percentile volume exceeds capacity, queue may be longer.

Queue shown is maximum after two cycles.

























Splits and Phases: 3: Earl Armstrong & Limebank



HCM Signalized Intersection Capacity Analysis

3: Earl Armstrong & Limebank

Future Total Traffic-2021
Weekday PM Peak Hour Zero Interaction

												
Movement	EBL	EBT	EBR	WBL	WBT	WBR	NBL	NBT	NBR	SBL	SBT	SBR
Lane Configurations												
Volume (vph)	640	645	70	100	595	155	90	155	65	360	100	755
Ideal Flow (vphpl)	1900	1900	1900	1900	1900	1900	1900	1900	1900	1900	1900	1900
Total Lost time (s)	5.9	5.9	5.9	5.9	5.9	5.9	5.9	5.9	5.9	5.9	5.9	5.9
Lane Util. Factor	0.97	0.95	1.00	0.97	0.95	1.00	0.97	0.95	1.00	0.97	0.95	0.88
Frt	1.00	1.00	0.85	1.00	1.00	0.85	1.00	1.00	0.85	1.00	1.00	0.85
Flt Protected	0.95	1.00	1.00	0.95	1.00	1.00	0.95	1.00	1.00	0.95	1.00	1.00
Satd. Flow (prot)	3433	3539	1583	3433	3539	1583	3433	3539	1583	3433	3539	2787
Flt Permitted	0.95	1.00	1.00	0.95	1.00	1.00	0.95	1.00	1.00	0.95	1.00	1.00
Satd. Flow (perm)	3433	3539	1583	3433	3539	1583	3433	3539	1583	3433	3539	2787
Peak-hour factor, PHF	1.00	1.00	1.00	1.00	1.00	1.00	1.00	1.00	1.00	1.00	1.00	1.00
Adj. Flow (vph)	640	645	70	100	595	155	90	155	65	360	100	755
RTOR Reduction (vph)	0	0	45	0	0	118	0	0	49	0	0	57
Lane Group Flow (vph)	640	645	25	100	595	37	90	155	16	360	100	698
Turn Type	Prot		Perm	Prot		Perm	Prot		Perm	Prot		custom
Protected Phases	7	4		3	8		5	2		1	6	6
Permitted Phases			4			8			2			6
Actuated Green, G (s)	16.8	36.0	36.0	4.2	23.4	23.4	5.1	24.8	24.8	10.0	29.7	53.4
Effective Green, g (s)	17.8	37.0	37.0	5.2	24.4	24.4	6.1	25.8	25.8	11.0	30.7	54.4
Actuated g/C Ratio	0.17	0.36	0.36	0.05	0.24	0.24	0.06	0.25	0.25	0.11	0.30	0.53
Clearance Time (s)	6.9	6.9	6.9	6.9	6.9	6.9	6.9	6.9	6.9	6.9	6.9	
Vehicle Extension (s)	3.0	3.0	3.0	3.0	3.0	3.0	3.0	3.0	3.0	3.0	3.0	
Lane Grp Cap (vph)	596	1276	571	174	842	376	204	890	398	368	1059	1478
v/s Ratio Prot	c0.19	0.18		0.03	c0.17		0.03	0.04		c0.10	0.03	c0.25
v/s Ratio Perm			0.02			0.02			0.01			
v/c Ratio	1.07	0.51	0.04	0.57	0.71	0.10	0.44	0.17	0.04	0.98	0.09	0.47
Uniform Delay, d1	42.4	25.6	21.3	47.6	35.8	30.5	46.6	30.1	29.0	45.7	25.9	15.1
Progression Factor	1.00	1.00	1.00	1.15	0.79	0.40	1.00	1.00	1.00	1.00	1.00	1.00
Incremental Delay, d2	58.3	0.3	0.0	4.5	2.7	0.1	1.5	0.4	0.2	40.6	0.2	0.2
Delay (s)	100.7	26.0	21.3	59.3	31.0	12.2	48.1	30.5	29.2	86.3	26.1	15.3
Level of Service	F	C	C	E	C	B	D	C	C	F	C	B
Approach Delay (s)		61.0			30.9			35.3			37.3	
Approach LOS		E			C			D			D	
Intersection Summary												
HCM Average Control Delay			44.3				HCM Level of Service			D		
HCM Volume to Capacity ratio			0.78									
Actuated Cycle Length (s)			102.6				Sum of lost time (s)		23.6			
Intersection Capacity Utilization			73.0%				ICU Level of Service		C			
Analysis Period (min)			15									
c Critical Lane Group												

Queues
6: Earl Armstrong & Proposed New Road

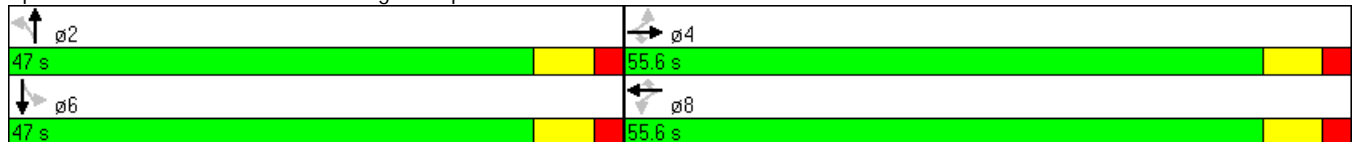
Future Total Traffic-2021
 Weekday PM Peak Hour Zero Interaction

Lane Group	EBL	EBT	EBR	WBL	WBT	WBR	NBL	NBT	SBT
Lane Configurations									
Volume (vph)	95	650	105	80	600	10	160	20	25
Lane Group Flow (vph)	95	650	105	80	600	10	160	80	115
Turn Type	Perm		Perm	Perm		Perm	Perm		
Protected Phases		4			8			2	6
Permitted Phases	4		4	8		8	2		
Detector Phase	4	4	4	8	8	8	2	2	6
Switch Phase									
Minimum Initial (s)	10.0	10.0	10.0	10.0	10.0	10.0	10.0	10.0	10.0
Minimum Split (s)	31.9	31.9	31.9	31.9	31.9	31.9	31.9	31.9	31.9
Total Split (s)	55.6	55.6	55.6	55.6	55.6	55.6	47.0	47.0	47.0
Total Split (%)	54.2%	54.2%	54.2%	54.2%	54.2%	54.2%	45.8%	45.8%	45.8%
Yellow Time (s)	4.6	4.6	4.6	4.6	4.6	4.6	4.6	4.6	4.6
All-Red Time (s)	2.3	2.3	2.3	2.3	2.3	2.3	2.3	2.3	2.3
Lost Time Adjust (s)	-1.0	-1.0	-1.0	-1.0	-1.0	-1.0	-1.0	-1.0	-1.0
Total Lost Time (s)	5.9	5.9	5.9	5.9	5.9	5.9	5.9	5.9	5.9
Lead/Lag									
Lead-Lag Optimize?									
Recall Mode	C-Max	C-Max	C-Max	C-Max	C-Max	C-Max	None	None	None
v/c Ratio	0.17	0.26	0.09	0.16	0.24	0.01	0.66	0.22	0.30
Control Delay	1.6	1.2	0.1	7.6	6.7	3.8	50.9	13.4	12.2
Queue Delay	0.0	0.0	0.0	0.0	0.0	0.0	0.0	0.0	0.0
Total Delay	1.6	1.2	0.1	7.6	6.7	3.8	50.9	13.4	12.2
Queue Length 50th (m)	0.8	2.8	0.0	4.7	19.9	0.0	29.4	3.3	4.1
Queue Length 95th (m)	m1.9	m5.2	m0.1	13.0	35.0	1.9	46.0	13.7	16.5
Internal Link Dist (m)		96.0			43.9			72.0	67.0
Turn Bay Length (m)	30.0		30.0	30.0		30.0	30.0		
Base Capacity (vph)	545	2461	1133	515	2461	1104	510	699	713
Starvation Cap Reductn	0	0	0	0	0	0	0	0	0
Spillback Cap Reductn	0	0	0	0	0	0	0	0	0
Storage Cap Reductn	0	0	0	0	0	0	0	0	0
Reduced v/c Ratio	0.17	0.26	0.09	0.16	0.24	0.01	0.31	0.11	0.16

Intersection Summary

Cycle Length: 102.6
 Actuated Cycle Length: 102.6
 Offset: 0 (0%), Referenced to phase 4:EBTL and 8:WBTL, Start of Green
 Natural Cycle: 65
 Control Type: Actuated-Coordinated
 m Volume for 95th percentile queue is metered by upstream signal.





























Splits and Phases: 6: Earl Armstrong & Proposed New Road



HCM Signalized Intersection Capacity Analysis

6: Earl Armstrong & Proposed New Road

Future Total Traffic-2021
Weekday PM Peak Hour Zero Interaction

												
Movement	EBL	EBT	EBR	WBL	WBT	WBR	NBL	NBT	NBR	SBL	SBT	SBR
Lane Configurations		 			 			 			 	
Volume (vph)	95	650	105	80	600	10	160	20	60	0	25	90
Ideal Flow (vphpl)	1900	1900	1900	1900	1900	1900	1900	1900	1900	1900	1900	1900
Total Lost time (s)	5.9	5.9	5.9	5.9	5.9	5.9	5.9	5.9			5.9	
Lane Util. Factor	1.00	0.95	1.00	1.00	0.95	1.00	1.00	1.00			1.00	
Frt	1.00	1.00	0.85	1.00	1.00	0.85	1.00	0.89			0.88	
Flt Protected	0.95	1.00	1.00	0.95	1.00	1.00	0.95	1.00			1.00	
Satd. Flow (prot)	1770	3539	1583	1770	3539	1583	1770	1653			1644	
Flt Permitted	0.42	1.00	1.00	0.40	1.00	1.00	0.68	1.00			1.00	
Satd. Flow (perm)	784	3539	1583	739	3539	1583	1272	1653			1644	
Peak-hour factor, PHF	1.00	1.00	1.00	1.00	1.00	1.00	1.00	1.00	1.00	1.00	1.00	1.00
Adj. Flow (vph)	95	650	105	80	600	10	160	20	60	0	25	90
RTOR Reduction (vph)	0	0	32	0	0	3	0	49	0	0	73	0
Lane Group Flow (vph)	95	650	73	80	600	7	160	31	0	0	42	0
Turn Type	Perm		Perm	Perm		Perm	Perm			Perm		
Protected Phases		4			8			2			6	
Permitted Phases	4		4	8		8	2			6		
Actuated Green, G (s)	70.4	70.4	70.4	70.4	70.4	70.4	18.4	18.4			18.4	
Effective Green, g (s)	71.4	71.4	71.4	71.4	71.4	71.4	19.4	19.4			19.4	
Actuated g/C Ratio	0.70	0.70	0.70	0.70	0.70	0.70	0.19	0.19			0.19	
Clearance Time (s)	6.9	6.9	6.9	6.9	6.9	6.9	6.9	6.9			6.9	
Vehicle Extension (s)	3.0	3.0	3.0	3.0	3.0	3.0	3.0	3.0			3.0	
Lane Grp Cap (vph)	546	2463	1102	514	2463	1102	241	313			311	
v/s Ratio Prot		c0.18			0.17			0.02			0.03	
v/s Ratio Perm	0.12		0.05	0.11		0.00	c0.13					
v/c Ratio	0.17	0.26	0.07	0.16	0.24	0.01	0.66	0.10			0.14	
Uniform Delay, d1	5.4	5.8	5.0	5.3	5.7	4.8	38.6	34.4			34.6	
Progression Factor	0.15	0.14	0.00	1.00	1.00	1.00	1.00	1.00			1.00	
Incremental Delay, d2	0.6	0.2	0.1	0.6	0.2	0.0	6.7	0.1			0.2	
Delay (s)	1.4	1.0	0.1	6.0	5.9	4.8	45.3	34.5			34.8	
Level of Service	A	A	A	A	A	A	D	C			C	
Approach Delay (s)		1.0			5.9			41.7			34.8	
Approach LOS		A			A			D			C	
Intersection Summary												
HCM Average Control Delay			10.0				HCM Level of Service				A	
HCM Volume to Capacity ratio			0.35									
Actuated Cycle Length (s)			102.6				Sum of lost time (s)			11.8		
Intersection Capacity Utilization			56.6%				ICU Level of Service				B	
Analysis Period (min)			15									
c Critical Lane Group												

HCM Unsignalized Intersection Capacity Analysis












9: Earl Armstrong & RIRO Site Access

Future Total Traffic-2021
Weekday PM Peak Hour Zero Interaction

	→	↘	↙	←	↖	↗
Movement	EBT	EBR	WBL	WBT	NBL	NBR
Lane Configurations	↑↑			↑↑		↗
Volume (veh/h)	770	305	0	850	0	80
Sign Control	Free			Free	Stop	
Grade	0%			0%	0%	
Peak Hour Factor	1.00	1.00	1.00	1.00	1.00	1.00
Hourly flow rate (vph)	770	305	0	850	0	80
Pedestrians						
Lane Width (m)						
Walking Speed (m/s)						
Percent Blockage						
Right turn flare (veh)						
Median type	None			None		
Median storage (veh)						
Upstream signal (m)	137			120		
pX, platoon unblocked			0.86		0.89	0.86
vC, conflicting volume			1075		1348	538
vC1, stage 1 conf vol						
vC2, stage 2 conf vol						
vCu, unblocked vol			762		857	137
tC, single (s)			4.1		6.8	6.9
tC, 2 stage (s)						
tF (s)			2.2		3.5	3.3
p0 queue free %			100		100	90
cM capacity (veh/h)			728		263	762
Direction, Lane #	EB 1	EB 2	WB 1	WB 2	NB 1	
Volume Total	513	562	425	425	80	
Volume Left	0	0	0	0	0	
Volume Right	0	305	0	0	80	
cSH	1700	1700	1700	1700	762	
Volume to Capacity	0.30	0.33	0.25	0.25	0.10	
Queue Length 95th (m)	0.0	0.0	0.0	0.0	2.6	
Control Delay (s)	0.0	0.0	0.0	0.0	10.3	
Lane LOS						B
Approach Delay (s)	0.0		0.0		10.3	
Approach LOS						B
Intersection Summary						
Average Delay			0.4			
Intersection Capacity Utilization			42.7%		ICU Level of Service	A
Analysis Period (min)			15			










HCM Unsignalized Intersection Capacity Analysis
 11: Site Access & Limebank

Future Total Traffic-2021
 Weekday PM Peak Hour Zero Interaction

						
Movement	WBL	WBR	NBT	NBR	SBL	SBT
Lane Configurations			 			 
Volume (veh/h)	0	225	85	80	0	270
Sign Control	Stop		Free			Free
Grade	0%		0%			0%
Peak Hour Factor	1.00	1.00	1.00	1.00	1.00	1.00
Hourly flow rate (vph)	0	225	85	80	0	270
Pedestrians						
Lane Width (m)						
Walking Speed (m/s)						
Percent Blockage						
Right turn flare (veh)						
Median type			None			None
Median storage (veh)						
Upstream signal (m)						145
pX, platoon unblocked						
vC, conflicting volume	260	82			165	
vC1, stage 1 conf vol						
vC2, stage 2 conf vol						
vCu, unblocked vol	260	82			165	
tC, single (s)	6.8	6.9			4.1	
tC, 2 stage (s)						
tF (s)	3.5	3.3			2.2	
p0 queue free %	100	77			100	
cM capacity (veh/h)	707	961			1411	
Direction, Lane #	WB 1	NB 1	NB 2	SB 1	SB 2	
Volume Total	225	57	108	135	135	
Volume Left	0	0	0	0	0	
Volume Right	225	0	80	0	0	
cSH	961	1700	1700	1700	1700	
Volume to Capacity	0.23	0.03	0.06	0.08	0.08	
Queue Length 95th (m)	6.8	0.0	0.0	0.0	0.0	
Control Delay (s)	9.9	0.0	0.0	0.0	0.0	
Lane LOS	A					
Approach Delay (s)	9.9	0.0		0.0		
Approach LOS	A					
Intersection Summary						
Average Delay			3.4			
Intersection Capacity Utilization			25.5%	ICU Level of Service	A	
Analysis Period (min)			15			










HCM Unsignalized Intersection Capacity Analysis
 13: N. Site Access & Proposed New Road

Future Total Traffic-2021
 Weekday PM Peak Hour Zero Interaction

						
Movement	EBL	EBR	NBL	NBT	SBT	SBR
Lane Configurations						
Volume (veh/h)	75	15	25	165	130	75
Sign Control	Stop			Free	Free	
Grade	0%			0%	0%	
Peak Hour Factor	1.00	1.00	1.00	1.00	1.00	1.00
Hourly flow rate (vph)	75	15	25	165	130	75
Pedestrians						
Lane Width (m)						
Walking Speed (m/s)						
Percent Blockage						
Right turn flare (veh)						
Median type				None	None	
Median storage (veh)						
Upstream signal (m)					96	
pX, platoon unblocked						
vC, conflicting volume	382	168	205			
vC1, stage 1 conf vol						
vC2, stage 2 conf vol						
vCu, unblocked vol	382	168	205			
tC, single (s)	6.4	6.2	4.1			
tC, 2 stage (s)						
tF (s)	3.5	3.3	2.2			
p0 queue free %	88	98	98			
cM capacity (veh/h)	609	877	1366			
Direction, Lane #	EB 1	NB 1	SB 1			
Volume Total	90	190	205			
Volume Left	75	25	0			
Volume Right	15	0	75			
cSH	641	1366	1700			
Volume to Capacity	0.14	0.02	0.12			
Queue Length 95th (m)	3.6	0.4	0.0			
Control Delay (s)	11.5	1.1	0.0			
Lane LOS	B	A				
Approach Delay (s)	11.5	1.1	0.0			
Approach LOS	B					
Intersection Summary						
Average Delay			2.6			
Intersection Capacity Utilization		36.6%		ICU Level of Service		A
Analysis Period (min)			15			

HCM Unsignalized Intersection Capacity Analysis
 15: S. Site Access & Proposed New Road

Future Total Traffic-2021
 Weekday PM Peak Hour Zero Interaction

						
Movement	EBL	EBR	NBL	NBT	SBT	SBR
Lane Configurations						
Volume (veh/h)	25	35	45	165	125	20
Sign Control	Stop			Free	Free	
Grade	0%			0%	0%	
Peak Hour Factor	1.00	1.00	1.00	1.00	1.00	1.00
Hourly flow rate (vph)	25	35	45	165	125	20
Pedestrians						
Lane Width (m)						
Walking Speed (m/s)						
Percent Blockage						
Right turn flare (veh)						
Median type				None	None	
Median storage (veh)						
Upstream signal (m)					185	
pX, platoon unblocked						
vC, conflicting volume	390	135	145			
vC1, stage 1 conf vol						
vC2, stage 2 conf vol						
vCu, unblocked vol	390	135	145			
tC, single (s)	6.4	6.2	4.1			
tC, 2 stage (s)						
tF (s)	3.5	3.3	2.2			
p0 queue free %	96	96	97			
cM capacity (veh/h)	595	914	1437			
Direction, Lane #	EB 1	NB 1	SB 1			
Volume Total	60	210	145			
Volume Left	25	45	0			
Volume Right	35	0	20			
cSH	747	1437	1700			
Volume to Capacity	0.08	0.03	0.09			
Queue Length 95th (m)	2.0	0.7	0.0			
Control Delay (s)	10.2	1.8	0.0			
Lane LOS	B	A				
Approach Delay (s)	10.2	1.8	0.0			
Approach LOS	B					
Intersection Summary						
Average Delay			2.4			
Intersection Capacity Utilization		32.5%		ICU Level of Service		A
Analysis Period (min)			15			

Queues
3: Earl Armstrong & Limebank

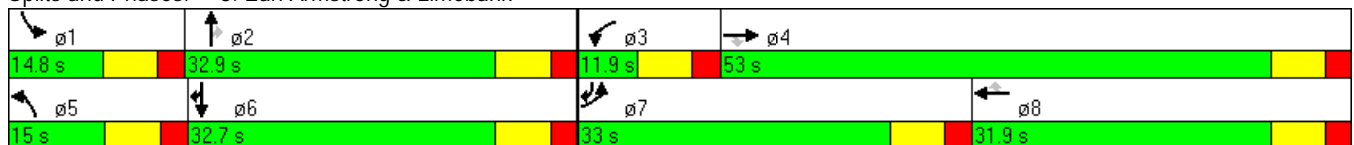
Future Total Traffic-2021
 Weekday AM Peak Hour Unconstrained

Lane Group	EBL	EBT	EBR	WBL	WBT	WBR	NBL	NBT	NBR	SBL	SBT	SBR
Lane Configurations												
Volume (vph)	660	945	60	45	510	100	185	190	30	140	60	285
Lane Group Flow (vph)	660	945	60	45	510	100	185	190	30	140	60	285
Turn Type	Prot		Perm	Prot		Perm	Prot		Perm	Prot		custom
Protected Phases	7	4		3	8		5	2		1	6	6 7
Permitted Phases			4			8			2			6
Detector Phase	7	4	4	3	8	8	5	2	2	1	6	6 7
Switch Phase												
Minimum Initial (s)	5.0	10.0	10.0	5.0	10.0	10.0	5.0	10.0	10.0	5.0	10.0	
Minimum Split (s)	11.9	31.9	31.9	11.9	31.9	31.9	11.9	31.9	31.9	11.9	31.9	
Total Split (s)	33.0	53.0	53.0	11.9	31.9	31.9	15.0	32.9	32.9	14.8	32.7	65.7
Total Split (%)	29.3%	47.1%	47.1%	10.6%	28.3%	28.3%	13.3%	29.2%	29.2%	13.1%	29.0%	58.3%
Yellow Time (s)	4.6	4.6	4.6	4.6	4.6	4.6	4.6	4.6	4.6	4.6	4.6	4.6
All-Red Time (s)	2.3	2.3	2.3	2.3	2.3	2.3	2.3	2.3	2.3	2.3	2.3	2.3
Lost Time Adjust (s)	-1.0	-1.0	-1.0	-1.0	-1.0	-1.0	-1.0	-1.0	-1.0	-1.0	-1.0	-1.0
Total Lost Time (s)	5.9	5.9	5.9	5.9	5.9	5.9	5.9	5.9	5.9	5.9	5.9	5.9
Lead/Lag	Lead	Lag	Lag	Lead	Lag	Lag	Lead	Lag	Lag	Lead	Lag	
Lead-Lag Optimize?	Yes	Yes	Yes	Yes	Yes	Yes	Yes	Yes	Yes	Yes	Yes	Yes
Recall Mode	None	None	None	None	None	None	None	C-Max	C-Max	None	C-Max	
v/c Ratio	0.84	0.68	0.09	0.25	0.73	0.25	0.59	0.19	0.06	0.48	0.06	0.18
Control Delay	51.8	30.9	7.3	56.0	42.8	5.8	57.3	33.1	11.9	55.2	33.0	8.8
Queue Delay	0.0	0.0	0.0	0.0	0.0	0.0	0.0	0.0	0.0	0.0	0.0	0.0
Total Delay	51.8	30.9	7.3	56.0	42.8	5.8	57.3	33.1	11.9	55.2	33.0	8.8
Queue Length 50th (m)	69.7	89.1	1.2	5.0	43.0	0.0	19.7	17.2	0.0	15.0	5.3	11.0
Queue Length 95th (m)	90.4	105.2	8.8	10.8	52.7	8.1	#32.5	27.1	7.3	25.2	10.7	18.6
Internal Link Dist (m)		131.0			112.8			120.2			61.2	
Turn Bay Length (m)	100.0		50.0	30.0		50.0	50.0		50.0	50.0		100.0
Base Capacity (vph)	826	1480	692	183	817	442	316	987	463	294	960	1615
Starvation Cap Reductn	0	0	0	0	0	0	0	0	0	0	0	0
Spillback Cap Reductn	0	0	0	0	0	0	0	0	0	0	0	0
Storage Cap Reductn	0	0	0	0	0	0	0	0	0	0	0	0
Reduced v/c Ratio	0.80	0.64	0.09	0.25	0.62	0.23	0.59	0.19	0.06	0.48	0.06	0.18

Intersection Summary

Cycle Length: 112.6
 Actuated Cycle Length: 112.6
 Offset: 36 (32%), Referenced to phase 2:NBT and 6:SBT, Start of Green
 Natural Cycle: 100
 Control Type: Actuated-Coordinated
 # 95th percentile volume exceeds capacity, queue may be longer.
 Queue shown is maximum after two cycles.

































Splits and Phases: 3: Earl Armstrong & Limebank



HCM Signalized Intersection Capacity Analysis

3: Earl Armstrong & Limebank

Future Total Traffic-2021
Weekday AM Peak Hour Unconstrained

												
Movement	EBL	EBT	EBR	WBL	WBT	WBR	NBL	NBT	NBR	SBL	SBT	SBR
Lane Configurations	 	 		 	 		 	 		 	 	
Volume (vph)	660	945	60	45	510	100	185	190	30	140	60	285
Ideal Flow (vphpl)	1900	1900	1900	1900	1900	1900	1900	1900	1900	1900	1900	1900
Total Lost time (s)	5.9	5.9	5.9	5.9	5.9	5.9	5.9	5.9	5.9	5.9	5.9	5.9
Lane Util. Factor	0.97	0.95	1.00	0.97	0.95	1.00	0.97	0.95	1.00	0.97	0.95	0.88
Frt	1.00	1.00	0.85	1.00	1.00	0.85	1.00	1.00	0.85	1.00	1.00	0.85
Flt Protected	0.95	1.00	1.00	0.95	1.00	1.00	0.95	1.00	1.00	0.95	1.00	1.00
Satd. Flow (prot)	3433	3539	1583	3433	3539	1583	3433	3539	1583	3433	3539	2787
Flt Permitted	0.95	1.00	1.00	0.95	1.00	1.00	0.95	1.00	1.00	0.95	1.00	1.00
Satd. Flow (perm)	3433	3539	1583	3433	3539	1583	3433	3539	1583	3433	3539	2787
Peak-hour factor, PHF	1.00	1.00	1.00	1.00	1.00	1.00	1.00	1.00	1.00	1.00	1.00	1.00
Adj. Flow (vph)	660	945	60	45	510	100	185	190	30	140	60	285
RTOR Reduction (vph)	0	0	31	0	0	79	0	0	22	0	0	45
Lane Group Flow (vph)	660	945	29	45	510	21	185	190	8	140	60	240
Turn Type	Prot		Perm	Prot		Perm	Prot		Perm	Prot		custom
Protected Phases	7	4		3	8		5	2		1	6	6
Permitted Phases			4			8			2			6
Actuated Green, G (s)	24.9	43.5	43.5	4.0	22.6	22.6	9.4	29.0	29.0	8.5	28.1	59.9
Effective Green, g (s)	25.9	44.5	44.5	5.0	23.6	23.6	10.4	30.0	30.0	9.5	29.1	60.9
Actuated g/C Ratio	0.23	0.40	0.40	0.04	0.21	0.21	0.09	0.27	0.27	0.08	0.26	0.54
Clearance Time (s)	6.9	6.9	6.9	6.9	6.9	6.9	6.9	6.9	6.9	6.9	6.9	
Vehicle Extension (s)	3.0	3.0	3.0	3.0	3.0	3.0	3.0	3.0	3.0	3.0	3.0	
Lane Grp Cap (vph)	790	1399	626	152	742	332	317	943	422	290	915	1507
v/s Ratio Prot	c0.19	c0.27		0.01	0.14		c0.05	c0.05		0.04	0.02	0.09
v/s Ratio Perm			0.02			0.01			0.01			
v/c Ratio	0.84	0.68	0.05	0.30	0.69	0.06	0.58	0.20	0.02	0.48	0.07	0.16
Uniform Delay, d1	41.3	28.1	21.0	52.1	41.1	35.6	49.0	32.0	30.5	49.2	31.5	13.0
Progression Factor	1.00	1.00	1.00	1.03	0.86	0.60	1.00	1.00	1.00	1.00	1.00	1.00
Incremental Delay, d2	7.6	1.3	0.0	1.1	2.6	0.1	2.7	0.5	0.1	1.3	0.1	0.0
Delay (s)	49.0	29.4	21.0	54.6	38.1	21.5	51.8	32.5	30.5	50.5	31.6	13.0
Level of Service	D	C	C	D	D	C	D	C	C	D	C	B
Approach Delay (s)		36.8			36.7			41.1			26.1	
Approach LOS		D			D			D			C	
Intersection Summary												
HCM Average Control Delay			35.7				HCM Level of Service			D		
HCM Volume to Capacity ratio			0.51									
Actuated Cycle Length (s)			112.6				Sum of lost time (s)		11.8			
Intersection Capacity Utilization			66.2%				ICU Level of Service		C			
Analysis Period (min)			15									
c Critical Lane Group												

Queues
6: Earl Armstrong & Proposed New Road

Future Total Traffic-2021
 Weekday AM Peak Hour Unconstrained

Lane Group	EBL	EBT	EBR	WBL	WBT	WBR	NBL	NBT	SBT
Lane Configurations									
Volume (vph)	35	935	50	10	565	2	75	5	10
Lane Group Flow (vph)	35	935	50	10	565	2	75	40	25
Turn Type	Perm		Perm	Perm		Perm	Perm		
Protected Phases		4			8			2	6
Permitted Phases	4		4	8		8	2		
Detector Phase	4	4	4	8	8	8	2	2	6
Switch Phase									
Minimum Initial (s)	10.0	10.0	10.0	10.0	10.0	10.0	10.0	10.0	10.0
Minimum Split (s)	31.9	31.9	31.9	31.9	31.9	31.9	31.9	31.9	31.9
Total Split (s)	73.6	73.6	73.6	73.6	73.6	73.6	39.0	39.0	39.0
Total Split (%)	65.4%	65.4%	65.4%	65.4%	65.4%	65.4%	34.6%	34.6%	34.6%
Yellow Time (s)	4.6	4.6	4.6	4.6	4.6	4.6	4.6	4.6	4.6
All-Red Time (s)	2.3	2.3	2.3	2.3	2.3	2.3	2.3	2.3	2.3
Lost Time Adjust (s)	-1.0	-1.0	-1.0	-1.0	-1.0	-1.0	-1.0	-1.0	-1.0
Total Lost Time (s)	5.9	5.9	5.9	5.9	5.9	5.9	5.9	5.9	5.9
Lead/Lag									
Lead-Lag Optimize?									
Recall Mode	C-Max	C-Max	C-Max	C-Max	C-Max	C-Max	None	None	None
v/c Ratio	0.05	0.32	0.04	0.02	0.20	0.00	0.46	0.18	0.12
Control Delay	0.2	0.4	0.0	3.6	3.4	2.5	54.8	18.1	26.3
Queue Delay	0.0	0.0	0.0	0.0	0.0	0.0	0.0	0.0	0.0
Total Delay	0.2	0.4	0.0	3.6	3.4	2.5	54.8	18.1	26.3
Queue Length 50th (m)	0.0	0.6	0.0	0.4	13.5	0.0	15.6	1.0	2.0
Queue Length 95th (m)	m0.1	0.6	m0.0	1.8	22.6	0.6	28.9	10.4	9.6
Internal Link Dist (m)		95.8			43.9			72.0	67.0
Turn Bay Length (m)	30.0		30.0	30.0		30.0	30.0		
Base Capacity (vph)	670	2892	1301	450	2892	1294	406	501	509
Starvation Cap Reductn	0	0	0	0	0	0	0	0	0
Spillback Cap Reductn	0	0	0	0	0	0	0	0	0
Storage Cap Reductn	0	0	0	0	0	0	0	0	0
Reduced v/c Ratio	0.05	0.32	0.04	0.02	0.20	0.00	0.18	0.08	0.05

Intersection Summary

Cycle Length: 112.6
 Actuated Cycle Length: 112.6
 Offset: 0 (0%), Referenced to phase 4:EBTL and 8:WBTL, Start of Green
 Natural Cycle: 65
 Control Type: Actuated-Coordinated
 m Volume for 95th percentile queue is metered by upstream signal.



























Splits and Phases: 6: Earl Armstrong & Proposed New Road



HCM Signalized Intersection Capacity Analysis

6: Earl Armstrong & Proposed New Road

Future Total Traffic-2021
Weekday AM Peak Hour Unconstrained

												
Movement	EBL	EBT	EBR	WBL	WBT	WBR	NBL	NBT	NBR	SBL	SBT	SBR
Lane Configurations		 			 			 				
Volume (vph)	35	935	50	10	565	2	75	5	35	0	10	15
Ideal Flow (vphpl)	1900	1900	1900	1900	1900	1900	1900	1900	1900	1900	1900	1900
Total Lost time (s)	5.9	5.9	5.9	5.9	5.9	5.9	5.9	5.9			5.9	
Lane Util. Factor	1.00	0.95	1.00	1.00	0.95	1.00	1.00	1.00			1.00	
Frt	1.00	1.00	0.85	1.00	1.00	0.85	1.00	0.87			0.91	
Flt Protected	0.95	1.00	1.00	0.95	1.00	1.00	0.95	1.00			1.00	
Satd. Flow (prot)	1770	3539	1583	1770	3539	1583	1770	1618			1695	
Flt Permitted	0.44	1.00	1.00	0.30	1.00	1.00	0.74	1.00			1.00	
Satd. Flow (perm)	819	3539	1583	552	3539	1583	1380	1618			1695	
Peak-hour factor, PHF	1.00	1.00	1.00	1.00	1.00	1.00	1.00	1.00	1.00	1.00	1.00	1.00
Adj. Flow (vph)	35	935	50	10	565	2	75	5	35	0	10	15
RTOR Reduction (vph)	0	0	8	0	0	0	0	31	0	0	13	0
Lane Group Flow (vph)	35	935	42	10	565	2	75	9	0	0	12	0
Turn Type	Perm		Perm	Perm		Perm	Perm			Perm		
Protected Phases		4			8			2			6	
Permitted Phases	4		4	8		8	2			6		
Actuated Green, G (s)	88.5	88.5	88.5	88.5	88.5	88.5	10.3	10.3			10.3	
Effective Green, g (s)	89.5	89.5	89.5	89.5	89.5	89.5	11.3	11.3			11.3	
Actuated g/C Ratio	0.79	0.79	0.79	0.79	0.79	0.79	0.10	0.10			0.10	
Clearance Time (s)	6.9	6.9	6.9	6.9	6.9	6.9	6.9	6.9			6.9	
Vehicle Extension (s)	3.0	3.0	3.0	3.0	3.0	3.0	3.0	3.0			3.0	
Lane Grp Cap (vph)	651	2813	1258	439	2813	1258	138	162			170	
v/s Ratio Prot		c0.26			0.16			0.01			0.01	
v/s Ratio Perm	0.04		0.03	0.02		0.00	c0.05					
v/c Ratio	0.05	0.33	0.03	0.02	0.20	0.00	0.54	0.05			0.07	
Uniform Delay, d1	2.5	3.2	2.4	2.4	2.8	2.4	48.2	45.8			45.9	
Progression Factor	0.02	0.03	0.00	1.00	1.00	1.00	1.00	1.00			1.00	
Incremental Delay, d2	0.1	0.3	0.0	0.1	0.2	0.0	4.3	0.1			0.2	
Delay (s)	0.2	0.4	0.0	2.5	3.0	2.4	52.5	45.9			46.0	
Level of Service	A	A	A	A	A	A	D	D			D	
Approach Delay (s)		0.3			3.0			50.2			46.0	
Approach LOS		A			A			D			D	
Intersection Summary												
HCM Average Control Delay			5.2				HCM Level of Service				A	
HCM Volume to Capacity ratio			0.36									
Actuated Cycle Length (s)			112.6				Sum of lost time (s)			11.8		
Intersection Capacity Utilization			49.7%				ICU Level of Service			A		
Analysis Period (min)			15									
c Critical Lane Group												












HCM Unsignalized Intersection Capacity Analysis
 9: Earl Armstrong & RIRO Site Access

Future Total Traffic-2021
 Weekday AM Peak Hour Unconstrained

	→	↘	↙	←	↖	↗
Movement	EBT	EBR	WBL	WBT	NBL	NBR
Lane Configurations	↑↑			↑↑		↗
Volume (veh/h)	1015	100	0	655	0	1
Sign Control	Free			Free	Stop	
Grade	0%			0%	0%	
Peak Hour Factor	1.00	1.00	1.00	1.00	1.00	1.00
Hourly flow rate (vph)	1015	100	0	655	0	1
Pedestrians						
Lane Width (m)						
Walking Speed (m/s)						
Percent Blockage						
Right turn flare (veh)						
Median type	None		None			
Median storage (veh)						
Upstream signal (m)	137			120		
pX, platoon unblocked			0.78		0.79	0.78
vC, conflicting volume			1115		1392	558
vC1, stage 1 conf vol						
vC2, stage 2 conf vol						
vCu, unblocked vol			576		808	0
tC, single (s)			4.1		6.8	6.9
tC, 2 stage (s)						
tF (s)			2.2		3.5	3.3
p0 queue free %			100		100	100
cM capacity (veh/h)			772		253	843
Direction, Lane #	EB 1	EB 2	WB 1	WB 2	NB 1	
Volume Total	677	438	328	328	1	
Volume Left	0	0	0	0	0	
Volume Right	0	100	0	0	1	
cSH	1700	1700	1700	1700	843	
Volume to Capacity	0.40	0.26	0.19	0.19	0.00	
Queue Length 95th (m)	0.0	0.0	0.0	0.0	0.0	
Control Delay (s)	0.0	0.0	0.0	0.0	9.3	
Lane LOS					A	
Approach Delay (s)	0.0		0.0		9.3	
Approach LOS					A	
Intersection Summary						
Average Delay			0.0			
Intersection Capacity Utilization			41.2%	ICU Level of Service	A	
Analysis Period (min)			15			










HCM Unsignalized Intersection Capacity Analysis
 11: Site Access & Limebank

Future Total Traffic-2021
 Weekday AM Peak Hour Unconstrained

						
Movement	WBL	WBR	NBT	NBR	SBL	SBT
Lane Configurations			 			 
Volume (veh/h)	0	55	350	35	0	165
Sign Control	Stop		Free			Free
Grade	0%		0%			0%
Peak Hour Factor	1.00	1.00	1.00	1.00	1.00	1.00
Hourly flow rate (vph)	0	55	350	35	0	165
Pedestrians						
Lane Width (m)						
Walking Speed (m/s)						
Percent Blockage						
Right turn flare (veh)						
Median type			None			None
Median storage (veh)						
Upstream signal (m)						144
pX, platoon unblocked						
vC, conflicting volume	450	192			385	
vC1, stage 1 conf vol						
vC2, stage 2 conf vol						
vCu, unblocked vol	450	192			385	
tC, single (s)	6.8	6.9			4.1	
tC, 2 stage (s)						
tF (s)	3.5	3.3			2.2	
p0 queue free %	100	93			100	
cM capacity (veh/h)	538	817			1170	
Direction, Lane #	WB 1	NB 1	NB 2	SB 1	SB 2	
Volume Total	55	233	152	82	82	
Volume Left	0	0	0	0	0	
Volume Right	55	0	35	0	0	
cSH	817	1700	1700	1700	1700	
Volume to Capacity	0.07	0.14	0.09	0.05	0.05	
Queue Length 95th (m)	1.6	0.0	0.0	0.0	0.0	
Control Delay (s)	9.7	0.0	0.0	0.0	0.0	
Lane LOS	A					
Approach Delay (s)	9.7	0.0		0.0		
Approach LOS	A					
Intersection Summary						
Average Delay			0.9			
Intersection Capacity Utilization			20.9%		ICU Level of Service	A
Analysis Period (min)			15			










HCM Unsignalized Intersection Capacity Analysis
 13: N. Site Access & Proposed New Road

Future Total Traffic-2021
 Weekday AM Peak Hour Unconstrained

						
Movement	EBL	EBR	NBL	NBT	SBT	SBR
Lane Configurations						
Volume (veh/h)	5	5	10	110	60	10
Sign Control	Stop			Free	Free	
Grade	0%			0%	0%	
Peak Hour Factor	1.00	1.00	1.00	1.00	1.00	1.00
Hourly flow rate (vph)	5	5	10	110	60	10
Pedestrians						
Lane Width (m)						
Walking Speed (m/s)						
Percent Blockage						
Right turn flare (veh)						
Median type				None	None	
Median storage (veh)						
Upstream signal (m)					96	
pX, platoon unblocked						
vC, conflicting volume	195	65	70			
vC1, stage 1 conf vol						
vC2, stage 2 conf vol						
vCu, unblocked vol	195	65	70			
tC, single (s)	6.4	6.2	4.1			
tC, 2 stage (s)						
tF (s)	3.5	3.3	2.2			
p0 queue free %	99	99	99			
cM capacity (veh/h)	789	999	1531			
Direction, Lane #	EB 1	NB 1	SB 1			
Volume Total	10	120	70			
Volume Left	5	10	0			
Volume Right	5	0	10			
cSH	881	1531	1700			
Volume to Capacity	0.01	0.01	0.04			
Queue Length 95th (m)	0.3	0.1	0.0			
Control Delay (s)	9.1	0.7	0.0			
Lane LOS	A	A				
Approach Delay (s)	9.1	0.7	0.0			
Approach LOS	A					
Intersection Summary						
Average Delay			0.9			
Intersection Capacity Utilization		23.0%		ICU Level of Service		A
Analysis Period (min)			15			

HCM Unsignalized Intersection Capacity Analysis
 15: S. Site Access & Proposed New Road

Future Total Traffic-2021
 Weekday AM Peak Hour Unconstrained

						
Movement	EBL	EBR	NBL	NBT	SBT	SBR
Lane Configurations						
Volume (veh/h)	5	10	20	115	55	10
Sign Control	Stop			Free	Free	
Grade	0%			0%	0%	
Peak Hour Factor	1.00	1.00	1.00	1.00	1.00	1.00
Hourly flow rate (vph)	5	10	20	115	55	10
Pedestrians						
Lane Width (m)						
Walking Speed (m/s)						
Percent Blockage						
Right turn flare (veh)						
Median type				None	None	
Median storage (veh)						
Upstream signal (m)					186	
pX, platoon unblocked						
vC, conflicting volume	215	60	65			
vC1, stage 1 conf vol						
vC2, stage 2 conf vol						
vCu, unblocked vol	215	60	65			
tC, single (s)	6.4	6.2	4.1			
tC, 2 stage (s)						
tF (s)	3.5	3.3	2.2			
p0 queue free %	99	99	99			
cM capacity (veh/h)	763	1005	1537			
Direction, Lane #	EB 1	NB 1	SB 1			
Volume Total	15	135	65			
Volume Left	5	20	0			
Volume Right	10	0	10			
cSH	909	1537	1700			
Volume to Capacity	0.02	0.01	0.04			
Queue Length 95th (m)	0.4	0.3	0.0			
Control Delay (s)	9.0	1.2	0.0			
Lane LOS	A	A				
Approach Delay (s)	9.0	1.2	0.0			
Approach LOS	A					
Intersection Summary						
Average Delay			1.4			
Intersection Capacity Utilization		23.8%		ICU Level of Service		A
Analysis Period (min)			15			

Queues
3: Earl Armstrong & Limebank

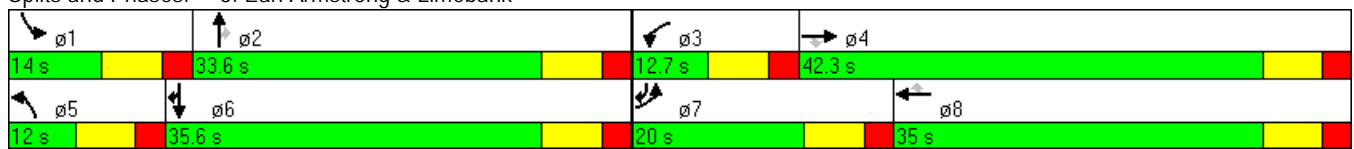
Future Total Traffic-2021
 Weekday PM Peak Hour Unconstrained

Lane Group	EBL	EBT	EBR	WBL	WBT	WBR	NBL	NBT	NBR	SBL	SBT	SBR
Lane Configurations												
Volume (vph)	730	725	180	100	1200	155	90	155	65	360	100	955
Lane Group Flow (vph)	730	725	180	100	1200	155	90	155	65	360	100	955
Turn Type	Prot		Perm	Prot		Perm	Prot		Perm	Prot		custom
Protected Phases	7	4		3	8		5	2		1	6	6 7
Permitted Phases			4			8			2			6
Detector Phase	7	4	4	3	8	8	5	2	2	1	6	6 7
Switch Phase												
Minimum Initial (s)	5.0	10.0	10.0	5.0	10.0	10.0	5.0	10.0	10.0	5.0	10.0	
Minimum Split (s)	11.9	31.9	31.9	11.9	31.9	31.9	11.9	31.9	31.9	11.9	31.9	
Total Split (s)	20.0	42.3	42.3	12.7	35.0	35.0	12.0	33.6	33.6	14.0	35.6	55.6
Total Split (%)	19.5%	41.2%	41.2%	12.4%	34.1%	34.1%	11.7%	32.7%	32.7%	13.6%	34.7%	54.2%
Yellow Time (s)	4.6	4.6	4.6	4.6	4.6	4.6	4.6	4.6	4.6	4.6	4.6	4.6
All-Red Time (s)	2.3	2.3	2.3	2.3	2.3	2.3	2.3	2.3	2.3	2.3	2.3	2.3
Lost Time Adjust (s)	-1.0	-1.0	-1.0	-1.0	-1.0	-1.0	-1.0	-1.0	-1.0	-1.0	-1.0	-1.0
Total Lost Time (s)	5.9	5.9	5.9	5.9	5.9	5.9	5.9	5.9	5.9	5.9	5.9	5.9
Lead/Lag	Lead	Lag	Lag	Lead	Lag	Lag	Lead	Lag	Lag	Lead	Lag	
Lead-Lag Optimize?	Yes	Yes	Yes	Yes	Yes	Yes	Yes	Yes	Yes	Yes	Yes	Yes
Recall Mode	None	None	None	None	None	None	None	C-Max	C-Max	None	C-Max	
v/c Ratio	1.55	0.54	0.25	0.44	1.20	0.30	0.44	0.16	0.14	1.33	0.09	0.66
Control Delay	288.5	27.5	4.5	54.9	127.0	11.2	53.7	29.2	8.1	209.1	26.6	21.3
Queue Delay	0.0	0.0	0.0	0.0	0.0	0.0	0.0	0.0	0.0	0.0	0.0	0.0
Total Delay	288.5	27.5	4.5	54.9	127.0	11.2	53.7	29.2	8.1	209.1	26.6	21.3
Queue Length 50th (m)	~104.6	60.2	0.0	10.0	~152.5	4.2	8.9	12.2	0.0	~47.5	7.5	76.3
Queue Length 95th (m)	#139.4	78.2	13.4	18.1	#186.4	19.3	16.7	20.1	9.7	#75.3	13.6	100.9
Internal Link Dist (m)		131.0			113.3			120.8			61.2	
Turn Bay Length (m)	100.0		50.0	30.0		50.0	50.0		50.0	50.0		100.0
Base Capacity (vph)	472	1344	713	228	1004	515	204	955	475	271	1107	1437
Starvation Cap Reductn	0	0	0	0	0	0	0	0	0	0	0	0
Spillback Cap Reductn	0	0	0	0	0	0	0	0	0	0	0	0
Storage Cap Reductn	0	0	0	0	0	0	0	0	0	0	0	0
Reduced v/c Ratio	1.55	0.54	0.25	0.44	1.20	0.30	0.44	0.16	0.14	1.33	0.09	0.66

Intersection Summary

Cycle Length: 102.6
 Actuated Cycle Length: 102.6
 Offset: 51 (50%), Referenced to phase 2:NBT and 6:SBT, Start of Green
 Natural Cycle: 150
 Control Type: Actuated-Coordinated
 ~ Volume exceeds capacity, queue is theoretically infinite.
 Queue shown is maximum after two cycles.
 # 95th percentile volume exceeds capacity, queue may be longer.
 Queue shown is maximum after two cycles.


































Splits and Phases: 3: Earl Armstrong & Limebank



HCM Signalized Intersection Capacity Analysis

3: Earl Armstrong & Limebank

Future Total Traffic-2021
Weekday PM Peak Hour Unconstrained

												
Movement	EBL	EBT	EBR	WBL	WBT	WBR	NBL	NBT	NBR	SBL	SBT	SBR
Lane Configurations	 	 		 	 		 	 		 	 	 
Volume (vph)	730	725	180	100	1200	155	90	155	65	360	100	955
Ideal Flow (vphpl)	1900	1900	1900	1900	1900	1900	1900	1900	1900	1900	1900	1900
Total Lost time (s)	5.9	5.9	5.9	5.9	5.9	5.9	5.9	5.9	5.9	5.9	5.9	5.9
Lane Util. Factor	0.97	0.95	1.00	0.97	0.95	1.00	0.97	0.95	1.00	0.97	0.95	0.88
Frt	1.00	1.00	0.85	1.00	1.00	0.85	1.00	1.00	0.85	1.00	1.00	0.85
Flt Protected	0.95	1.00	1.00	0.95	1.00	1.00	0.95	1.00	1.00	0.95	1.00	1.00
Satd. Flow (prot)	3433	3539	1583	3433	3539	1583	3433	3539	1583	3433	3539	2787
Flt Permitted	0.95	1.00	1.00	0.95	1.00	1.00	0.95	1.00	1.00	0.95	1.00	1.00
Satd. Flow (perm)	3433	3539	1583	3433	3539	1583	3433	3539	1583	3433	3539	2787
Peak-hour factor, PHF	1.00	1.00	1.00	1.00	1.00	1.00	1.00	1.00	1.00	1.00	1.00	1.00
Adj. Flow (vph)	730	725	180	100	1200	155	90	155	65	360	100	955
RTOR Reduction (vph)	0	0	112	0	0	65	0	0	48	0	0	23
Lane Group Flow (vph)	730	725	68	100	1200	90	90	155	17	360	100	932
Turn Type	Prot		Perm	Prot		Perm	Prot		Perm	Prot		custom
Protected Phases	7	4		3	8		5	2		1	6	6
Permitted Phases			4			8			2			6
Actuated Green, G (s)	13.1	37.9	37.9	4.6	29.4	29.4	4.1	25.4	25.4	7.1	28.4	48.4
Effective Green, g (s)	14.1	38.9	38.9	5.6	30.4	30.4	5.1	26.4	26.4	8.1	29.4	49.4
Actuated g/C Ratio	0.14	0.38	0.38	0.05	0.30	0.30	0.05	0.26	0.26	0.08	0.29	0.48
Clearance Time (s)	6.9	6.9	6.9	6.9	6.9	6.9	6.9	6.9	6.9	6.9	6.9	
Vehicle Extension (s)	3.0	3.0	3.0	3.0	3.0	3.0	3.0	3.0	3.0	3.0	3.0	
Lane Grp Cap (vph)	472	1342	600	187	1049	469	171	911	407	271	1014	1342
v/s Ratio Prot	c0.21	0.20		0.03	c0.34		0.03	0.04		c0.10	0.03	c0.33
v/s Ratio Perm			0.04			0.06			0.01			
v/c Ratio	1.55	0.54	0.11	0.53	1.14	0.19	0.53	0.17	0.04	1.33	0.10	0.69
Uniform Delay, d1	44.2	24.9	20.7	47.2	36.1	26.9	47.6	29.6	28.6	47.2	26.9	20.7
Progression Factor	1.00	1.00	1.00	1.07	0.85	0.77	1.00	1.00	1.00	1.00	1.00	1.00
Incremental Delay, d2	256.3	0.4	0.1	2.6	75.3	0.2	2.9	0.4	0.2	171.0	0.2	1.6
Delay (s)	300.6	25.3	20.8	52.9	105.9	21.0	50.5	30.0	28.8	218.3	27.1	22.3
Level of Service	F	C	C	D	F	C	D	C	C	F	C	C
Approach Delay (s)		147.7			93.3			35.7			72.5	
Approach LOS		F			F			D			E	
Intersection Summary												
HCM Average Control Delay			101.9				HCM Level of Service			F		
HCM Volume to Capacity ratio			1.14									
Actuated Cycle Length (s)			102.6				Sum of lost time (s)		23.6			
Intersection Capacity Utilization			92.3%				ICU Level of Service		F			
Analysis Period (min)			15									
c Critical Lane Group												

Queues
6: Earl Armstrong & Proposed New Road

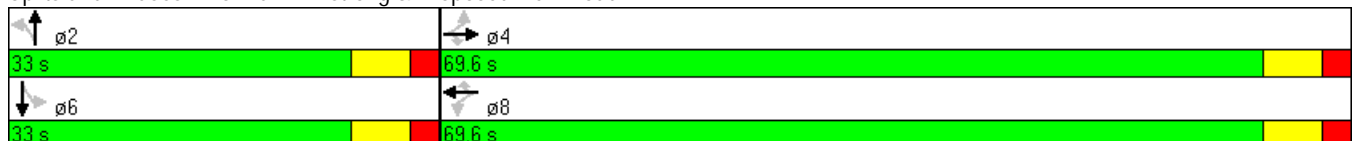
Future Total Traffic-2021
 Weekday PM Peak Hour Unconstrained

Lane Group	EBL	EBT	EBR	WBL	WBT	WBR	NBL	NBT	SBT
Lane Configurations									
Volume (vph)	95	730	105	100	1185	10	180	20	25
Lane Group Flow (vph)	95	730	105	100	1185	10	180	80	115
Turn Type	Perm		Perm	Perm		Perm	Perm		
Protected Phases		4			8			2	6
Permitted Phases	4		4	8		8	2		
Detector Phase	4	4	4	8	8	8	2	2	6
Switch Phase									
Minimum Initial (s)	10.0	10.0	10.0	10.0	10.0	10.0	10.0	10.0	10.0
Minimum Split (s)	31.9	31.9	31.9	31.9	31.9	31.9	31.9	31.9	31.9
Total Split (s)	69.6	69.6	69.6	69.6	69.6	69.6	33.0	33.0	33.0
Total Split (%)	67.8%	67.8%	67.8%	67.8%	67.8%	67.8%	32.2%	32.2%	32.2%
Yellow Time (s)	4.6	4.6	4.6	4.6	4.6	4.6	4.6	4.6	4.6
All-Red Time (s)	2.3	2.3	2.3	2.3	2.3	2.3	2.3	2.3	2.3
Lost Time Adjust (s)	-1.0	-1.0	-1.0	-1.0	-1.0	-1.0	-1.0	-1.0	-1.0
Total Lost Time (s)	5.9	5.9	5.9	5.9	5.9	5.9	5.9	5.9	5.9
Lead/Lag									
Lead-Lag Optimize?									
Recall Mode	C-Max	C-Max	C-Max	C-Max	C-Max	C-Max	None	None	None
v/c Ratio	0.37	0.30	0.09	0.22	0.49	0.01	0.71	0.21	0.29
Control Delay	6.6	1.1	0.1	8.6	9.1	4.7	53.3	13.1	12.6
Queue Delay	0.0	0.0	0.0	0.0	0.0	0.0	0.0	0.0	0.0
Total Delay	6.6	1.1	0.1	8.6	9.1	4.7	53.3	13.1	12.6
Queue Length 50th (m)	0.7	2.7	0.0	6.5	51.7	0.2	33.2	3.2	4.7
Queue Length 95th (m)	m4.4	m5.3	m0.1	16.5	80.6	2.1	52.0	13.8	17.3
Internal Link Dist (m)		96.0			43.9			72.0	67.0
Turn Bay Length (m)	30.0		30.0	30.0		30.0	30.0		
Base Capacity (vph)	256	2430	1120	459	2430	1089	336	481	498
Starvation Cap Reductn	0	0	0	0	0	0	0	0	0
Spillback Cap Reductn	0	0	0	0	0	0	0	0	0
Storage Cap Reductn	0	0	0	0	0	0	0	0	0
Reduced v/c Ratio	0.37	0.30	0.09	0.22	0.49	0.01	0.54	0.17	0.23

Intersection Summary

Cycle Length: 102.6
 Actuated Cycle Length: 102.6
 Offset: 100 (97%), Referenced to phase 4:EBTL and 8:WBTL, Start of Green
 Natural Cycle: 75
 Control Type: Actuated-Coordinated
 m Volume for 95th percentile queue is metered by upstream signal.





























Splits and Phases: 6: Earl Armstrong & Proposed New Road



HCM Signalized Intersection Capacity Analysis

6: Earl Armstrong & Proposed New Road

Future Total Traffic-2021
Weekday PM Peak Hour Unconstrained

												
Movement	EBL	EBT	EBR	WBL	WBT	WBR	NBL	NBT	NBR	SBL	SBT	SBR
Lane Configurations		 			 			 			 	
Volume (vph)	95	730	105	100	1185	10	180	20	60	0	25	90
Ideal Flow (vphpl)	1900	1900	1900	1900	1900	1900	1900	1900	1900	1900	1900	1900
Total Lost time (s)	5.9	5.9	5.9	5.9	5.9	5.9	5.9	5.9			5.9	
Lane Util. Factor	1.00	0.95	1.00	1.00	0.95	1.00	1.00	1.00			1.00	
Frt	1.00	1.00	0.85	1.00	1.00	0.85	1.00	0.89			0.88	
Flt Protected	0.95	1.00	1.00	0.95	1.00	1.00	0.95	1.00			1.00	
Satd. Flow (prot)	1770	3539	1583	1770	3539	1583	1770	1653			1644	
Flt Permitted	0.20	1.00	1.00	0.36	1.00	1.00	0.68	1.00			1.00	
Satd. Flow (perm)	373	3539	1583	669	3539	1583	1272	1653			1644	
Peak-hour factor, PHF	1.00	1.00	1.00	1.00	1.00	1.00	1.00	1.00	1.00	1.00	1.00	1.00
Adj. Flow (vph)	95	730	105	100	1185	10	180	20	60	0	25	90
RTOR Reduction (vph)	0	0	33	0	0	2	0	48	0	0	69	0
Lane Group Flow (vph)	95	730	72	100	1185	8	180	32	0	0	46	0
Turn Type	Perm		Perm	Perm		Perm	Perm			Perm		
Protected Phases		4			8			2			6	
Permitted Phases	4		4	8		8	2			6		
Actuated Green, G (s)	69.4	69.4	69.4	69.4	69.4	69.4	19.4	19.4			19.4	
Effective Green, g (s)	70.4	70.4	70.4	70.4	70.4	70.4	20.4	20.4			20.4	
Actuated g/C Ratio	0.69	0.69	0.69	0.69	0.69	0.69	0.20	0.20			0.20	
Clearance Time (s)	6.9	6.9	6.9	6.9	6.9	6.9	6.9	6.9			6.9	
Vehicle Extension (s)	3.0	3.0	3.0	3.0	3.0	3.0	3.0	3.0			3.0	
Lane Grp Cap (vph)	256	2428	1086	459	2428	1086	253	329			327	
v/s Ratio Prot		0.21			c0.33			0.02			0.03	
v/s Ratio Perm	0.25		0.05	0.15		0.00	c0.14					
v/c Ratio	0.37	0.30	0.07	0.22	0.49	0.01	0.71	0.10			0.14	
Uniform Delay, d1	6.8	6.4	5.3	5.9	7.6	5.1	38.4	33.6			33.9	
Progression Factor	0.39	0.13	0.00	1.00	1.00	1.00	1.00	1.00			1.00	
Incremental Delay, d2	2.8	0.2	0.1	1.1	0.7	0.0	9.1	0.1			0.2	
Delay (s)	5.5	1.1	0.1	7.0	8.3	5.1	47.4	33.7			34.1	
Level of Service	A	A	A	A	A	A	D	C			C	
Approach Delay (s)		1.4			8.2			43.2			34.1	
Approach LOS		A			A			D			C	
Intersection Summary												
HCM Average Control Delay			10.4				HCM Level of Service				B	
HCM Volume to Capacity ratio			0.54									
Actuated Cycle Length (s)			102.6				Sum of lost time (s)			11.8		
Intersection Capacity Utilization			72.5%				ICU Level of Service			C		
Analysis Period (min)			15									
c Critical Lane Group												












HCM Unsignalized Intersection Capacity Analysis
 9: Earl Armstrong & RIRO Site Access

Future Total Traffic-2021
 Weekday PM Peak Hour Unconstrained

	→	↘	↙	←	↖	↗
Movement	EBT	EBR	WBL	WBT	NBL	NBR
Lane Configurations	↑↑			↑↑		↗
Volume (veh/h)	865	290	0	1455	0	65
Sign Control	Free			Free	Stop	
Grade	0%			0%	0%	
Peak Hour Factor	1.00	1.00	1.00	1.00	1.00	1.00
Hourly flow rate (vph)	865	290	0	1455	0	65
Pedestrians						
Lane Width (m)						
Walking Speed (m/s)						
Percent Blockage						
Right turn flare (veh)						
Median type	None			None		
Median storage (veh)						
Upstream signal (m)	137			120		
pX, platoon unblocked			0.84		0.92	0.84
vC, conflicting volume			1155		1738	578
vC1, stage 1 conf vol						
vC2, stage 2 conf vol						
vCu, unblocked vol			808		841	121
tC, single (s)			4.1		6.8	6.9
tC, 2 stage (s)						
tF (s)			2.2		3.5	3.3
p0 queue free %			100		100	91
cM capacity (veh/h)			684		278	763
Direction, Lane #	EB 1	EB 2	WB 1	WB 2	NB 1	
Volume Total	577	578	728	728	65	
Volume Left	0	0	0	0	0	
Volume Right	0	290	0	0	65	
cSH	1700	1700	1700	1700	763	
Volume to Capacity	0.34	0.34	0.43	0.43	0.09	
Queue Length 95th (m)	0.0	0.0	0.0	0.0	2.1	
Control Delay (s)	0.0	0.0	0.0	0.0	10.2	
Lane LOS						B
Approach Delay (s)	0.0		0.0		10.2	
Approach LOS						B
Intersection Summary						
Average Delay			0.2			
Intersection Capacity Utilization			43.9%		ICU Level of Service	A
Analysis Period (min)			15			










HCM Unsignalized Intersection Capacity Analysis
 11: Site Access & Limebank

Future Total Traffic-2021
 Weekday PM Peak Hour Unconstrained

						
Movement	WBL	WBR	NBT	NBR	SBL	SBT
Lane Configurations			 			 
Volume (veh/h)	0	220	90	75	0	380
Sign Control	Stop		Free			Free
Grade	0%		0%			0%
Peak Hour Factor	1.00	1.00	1.00	1.00	1.00	1.00
Hourly flow rate (vph)	0	220	90	75	0	380
Pedestrians						
Lane Width (m)						
Walking Speed (m/s)						
Percent Blockage						
Right turn flare (veh)						
Median type	None			None		
Median storage (veh)						
Upstream signal (m)						145
pX, platoon unblocked						
vC, conflicting volume	318	82			165	
vC1, stage 1 conf vol						
vC2, stage 2 conf vol						
vCu, unblocked vol	318	82			165	
tC, single (s)	6.8	6.9			4.1	
tC, 2 stage (s)						
tF (s)	3.5	3.3			2.2	
p0 queue free %	100	77			100	
cM capacity (veh/h)	651	961			1411	
Direction, Lane #	WB 1	NB 1	NB 2	SB 1	SB 2	
Volume Total	220	60	105	190	190	
Volume Left	0	0	0	0	0	
Volume Right	220	0	75	0	0	
cSH	961	1700	1700	1700	1700	
Volume to Capacity	0.23	0.04	0.06	0.11	0.11	
Queue Length 95th (m)	6.6	0.0	0.0	0.0	0.0	
Control Delay (s)	9.9	0.0	0.0	0.0	0.0	
Lane LOS	A					
Approach Delay (s)	9.9	0.0			0.0	
Approach LOS	A					
Intersection Summary						
Average Delay			2.8			
Intersection Capacity Utilization			25.2%		ICU Level of Service	A
Analysis Period (min)	15					










HCM Unsignalized Intersection Capacity Analysis
 13: N. Site Access & Proposed New Road

Future Total Traffic-2021
 Weekday PM Peak Hour Unconstrained

						
Movement	EBL	EBR	NBL	NBT	SBT	SBR
Lane Configurations						
Volume (veh/h)	95	15	25	165	130	95
Sign Control	Stop			Free	Free	
Grade	0%			0%	0%	
Peak Hour Factor	1.00	1.00	1.00	1.00	1.00	1.00
Hourly flow rate (vph)	95	15	25	165	130	95
Pedestrians						
Lane Width (m)						
Walking Speed (m/s)						
Percent Blockage						
Right turn flare (veh)						
Median type				None	None	
Median storage (veh)						
Upstream signal (m)					96	
pX, platoon unblocked						
vC, conflicting volume	392	178	225			
vC1, stage 1 conf vol						
vC2, stage 2 conf vol						
vCu, unblocked vol	392	178	225			
tC, single (s)	6.4	6.2	4.1			
tC, 2 stage (s)						
tF (s)	3.5	3.3	2.2			
p0 queue free %	84	98	98			
cM capacity (veh/h)	600	866	1344			
Direction, Lane #	EB 1	NB 1	SB 1			
Volume Total	110	190	225			
Volume Left	95	25	0			
Volume Right	15	0	95			
cSH	627	1344	1700			
Volume to Capacity	0.18	0.02	0.13			
Queue Length 95th (m)	4.7	0.4	0.0			
Control Delay (s)	12.0	1.2	0.0			
Lane LOS	B	A				
Approach Delay (s)	12.0	1.2	0.0			
Approach LOS	B					
Intersection Summary						
Average Delay			2.9			
Intersection Capacity Utilization		38.9%		ICU Level of Service		A
Analysis Period (min)			15			

HCM Unsignalized Intersection Capacity Analysis
 15: S. Site Access & Proposed New Road

Future Total Traffic-2021
 Weekday PM Peak Hour Unconstrained

						
Movement	EBL	EBR	NBL	NBT	SBT	SBR
Lane Configurations						
Volume (veh/h)	25	35	45	165	125	20
Sign Control	Stop			Free	Free	
Grade	0%			0%	0%	
Peak Hour Factor	1.00	1.00	1.00	1.00	1.00	1.00
Hourly flow rate (vph)	25	35	45	165	125	20
Pedestrians						
Lane Width (m)						
Walking Speed (m/s)						
Percent Blockage						
Right turn flare (veh)						
Median type				None	None	
Median storage (veh)						
Upstream signal (m)					187	
pX, platoon unblocked						
vC, conflicting volume	390	135	145			
vC1, stage 1 conf vol						
vC2, stage 2 conf vol						
vCu, unblocked vol	390	135	145			
tC, single (s)	6.4	6.2	4.1			
tC, 2 stage (s)						
tF (s)	3.5	3.3	2.2			
p0 queue free %	96	96	97			
cM capacity (veh/h)	595	914	1437			
Direction, Lane #	EB 1	NB 1	SB 1			
Volume Total	60	210	145			
Volume Left	25	45	0			
Volume Right	35	0	20			
cSH	747	1437	1700			
Volume to Capacity	0.08	0.03	0.09			
Queue Length 95th (m)	2.0	0.7	0.0			
Control Delay (s)	10.2	1.8	0.0			
Lane LOS	B	A				
Approach Delay (s)	10.2	1.8	0.0			
Approach LOS	B					
Intersection Summary						
Average Delay			2.4			
Intersection Capacity Utilization		32.5%		ICU Level of Service		A
Analysis Period (min)			15			