

**McINTOSH
PERRY**



ENVIRONMENTAL IMPACT STATEMENT

210 & 220 MAPLE CREEK COURT, CITY OF OTTAWA, ONTARIO

Prepared for:

Mark Kauhanen
BBS Construction Ltd.
1805 Woodward Drive
Ottawa, ON
K2C 0P9

Prepared by:

McIntosh Perry Consulting Engineers Ltd.
115 Walgreen Road, R.R. 3
Carp, ON
K0A 1L0

January 20, 2017

ENVIRONMENTAL IMPACT STATEMENT

210 & 220 MAPLE CREEK COURT, CITY OF OTTAWA, ONTARIO

Prepared for:

Mark Kauhanen
BBS Construction Ltd.
1805 Woodward Drive
Ottawa, ON, K2C 0P9

Prepared by:



McIntosh Perry Consulting Engineers Ltd.
115 Walgreen Road, R.R. 3
Carp, ON, K0A 1L0
Phone (613) 836-2184

January 20, 2017

A handwritten signature in blue ink, appearing to read 'Heather Lunn', is written over a horizontal line.

Heather Lunn, B.A.
Terrestrial Ecologist
McIntosh Perry Consulting Engineers Ltd.

A handwritten signature in black ink, appearing to read 'Chris Heffernan', is written over a horizontal line.

Chris Heffernan
Fish and Wildlife Biologist
McIntosh Perry Consulting Engineers Ltd.

Table of Contents

1.0 PROPERTY INFORMATION	1
2.0 METHODOLOGY	3
3.0 DESCRIPTION OF THE SITE AND THE NATURAL ENVIRONMENT	4
3.1 Landforms, Soils and Geology	6
3.2 Surface Water, Groundwater and Fish Habitat	6
3.3 Vegetation Cover	6
3.4 Wildlife	8
3.5 Habitat for Species at Risk	9
4.0 DESCRIPTION OF THE PROPOSED PROJECT	11
5.0 IMPACT ASSESSMENT	13
5.1 Identifying Cumulative Impacts	14
6.0 MITIGATION	15
7.0 MONITORING	17
8.0 SUMMARY AND RECOMMENDATIONS	18
9.0 REFERENCES	19
10.0 LIMITATIONS	20

LIST OF TABLES

Table 1: Summary of Site Visits	3
Table 2: Vegetation Species List	7
Table 3: Wildlife Observations	8
Table 4: Species at Risk Potentially Present within the Study Area	9

LIST OF FIGURES

Figure 1: Key Plan	2
Figure 2: Natural Environment Map	5
Figure 3: Site Plan	12

APPENDICES

Appendix A: Photographs

Appendix B: Clean Equipment Protocol for Industry

Appendix C: Native Tree and Shrub Species Appropriate for Plantings

Appendix D: Protocol for Wildlife Protection during Construction





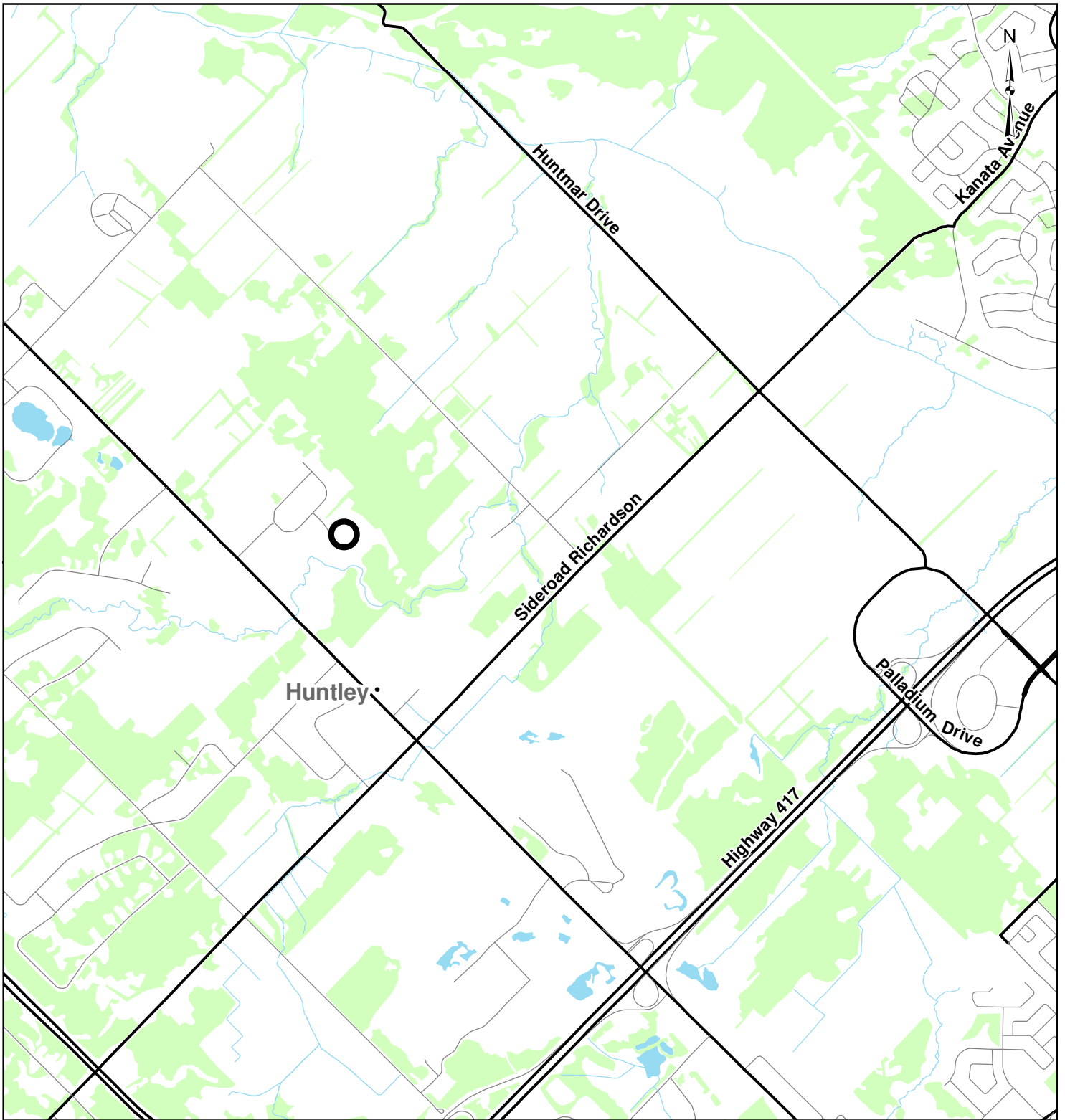

Appendix E: Résumés of Contributors

1.0 PROPERTY INFORMATION

The subject properties are owned by Mr. Jamie Wall. They are located at 210 and 220 Maple Creek Court, within the approved Reis Road Industrial Park. The properties are described as Parts 4 & 5, Plan 27R-17169 Geographic Township of Huntley, Part Lot 7 Concession 2, City of Ottawa, Property Identification Numbers 045370626 and 045370625. The subject properties cover approximately 3.47 ha, and are located at the end of the roundabout on Maple Creek Court. The current planning designation is *Carp Road Corridor Rural Employment Area*. The zoning is *Rural General Industrial (RG5)*.

Based on an analysis of Google Earth and geoOttawa aerial imagery, historically the subject properties were partially forested, while adjacent lands were utilized for agricultural purposes and also forested. The existing properties are currently undeveloped. There are no buildings or infrastructure located on or under the existing site.



- LEGEND**
-  Site Location
 -  Local Road
 -  Major Road
 -  Watercourse
 -  Waterbody
 -  Wooded Area

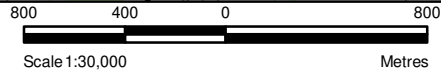

REFERENCE
 GIS Data provided by the Ontario Ministry of Natural Resources and Forestry, 2017.

CLIENT: BBS CONSTRUCTION (ONTARIO) LTD.	
PROJECT: 210 MAPLE CREEK COURT	
TITLE: KEY PLAN	
PROJECT NO: CP15-0429	FIGURE: 1
Date	Jan., 18, 2017
GIS	JD
Checked By	HL



115 Walgreen Rd., RR#3, Carp, ON K0A1L0
 Tel: 613-836-2184 Fax: 613-836-3742

Document Path: H:\01 - Projects - Proposals\2015 - Jobs\CP\0CP-15-0429 - BBS - Site Plan - 210 Maple Creek Court\GIS\mxd\CP150429_01KeyPlan.mxd

2.0 METHODOLOGY

In order to partially satisfy survey requirements outlined in the City of Ottawa’s *Environmental Impact Statement Guidelines* (October 2015), a field investigation was conducted on January 16, 2017, by H. Lunn of McIntosh Perry Consulting Engineers Ltd. (McIntosh Perry). The City of Ottawa’s *Environmental Impact Statement Guidelines* (October 2015) indicate that “*site visit(s) will occur during the growing season rather than in winter, when snow cover and normal seasonal dormancy severely limit potential observations*”. **Therefore, the survey completed for this Environmental Impact Statement (EIS) is considered preliminary, with the expectation that an addendum to this report will be completed, containing information gathered during a minimum of one (1) additional field investigation completed within the growing season (i.e., between early May and mid-September, of any year).**

The field investigation completed on January 16, 2017 included the following:

- Full walk-through of the proposed development area, and visual observations of adjacent habitat;
- Identification and confirmation of the presence of natural heritage features, including watercourses, waterbodies, Provincially Significant Wetlands, Significant Woodlands and Significant Wildlife Habitat;
- Tree and other plant identification, where site conditions/snow coverage allowed;
- Butternut tree location(s) (if observed);
- Bird and other wildlife identification (non-migratory species only, due to timing of field investigation); and,
- Identification and assessment of wildlife habitat, potential breeding, nesting and feeding areas, where site conditions/snow coverage allowed.

Assessed vegetation was classified and mapped using the Ministry of Natural Resources and Forestry’s (MNRF) Ecological Land Classification (ELC) vegetation community codes.

Wildlife species noted during the field investigations were identified by signs, visual observations, and vocalizations. For the purpose of this assessment, all wildlife observed within and adjacent to the study limits were recorded and considered to be residents or visitors of the area.

Photographs were taken of the subject property during the field investigation, and have been included in **Appendix A** of this report.

Table 1: Summary of Site Visits

Date	Surveyors	Time On Parcel	Temperature	Weather Conditions	Purpose of Visit
January 16, 2017	H. Lunn	8:00 a.m. – 11:00 a.m.	-6°C	Sunny, moderate wind, no precipitation	Natural features evaluation, species at risk (SAR)/SAR habitat screening, vegetation and wildlife inventory.

3.0 DESCRIPTION OF THE SITE AND THE NATURAL ENVIRONMENT



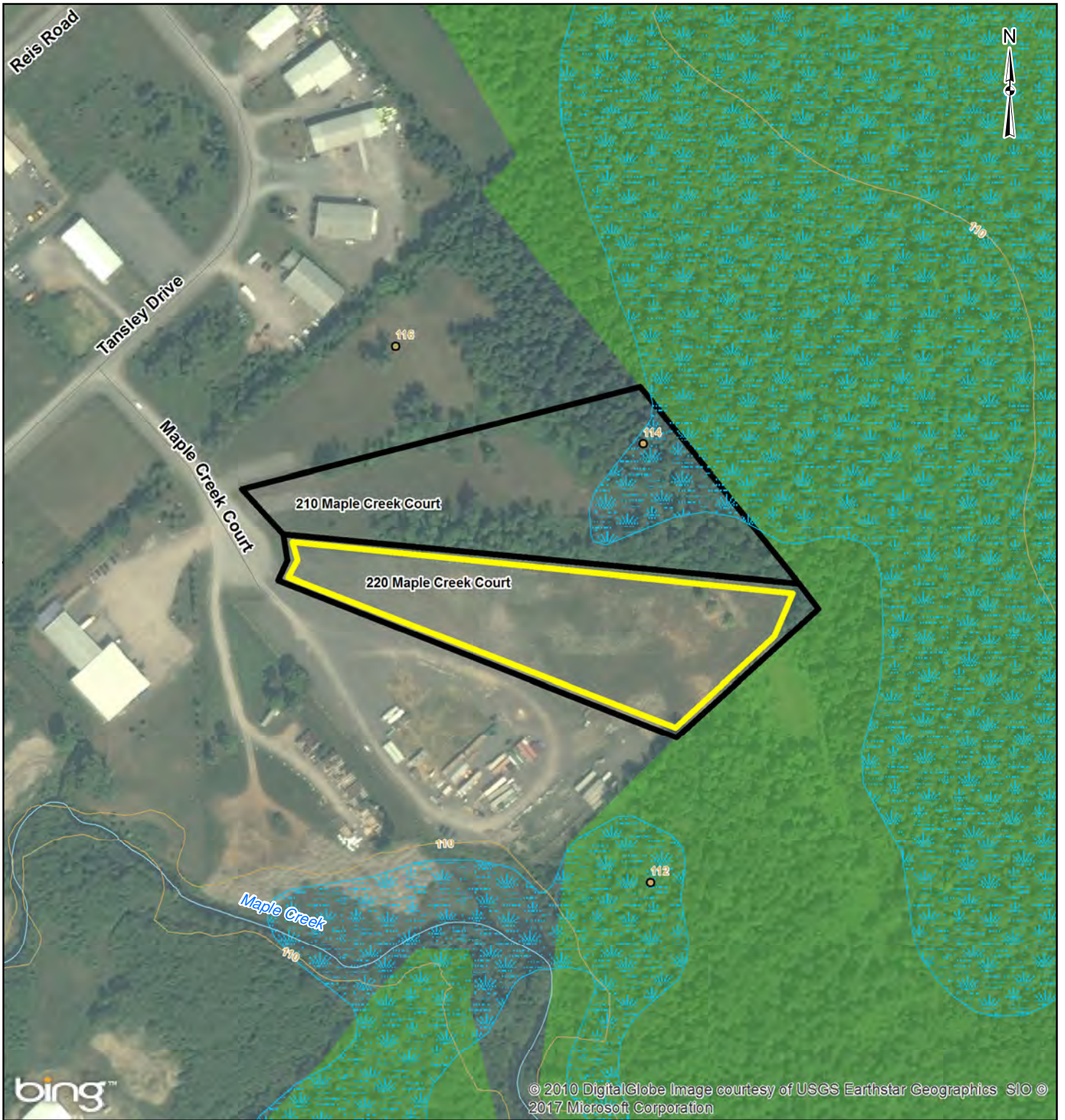





The following sections (3.1 to 3.5, inclusive), provide a description of the ecological functions provided by the site, and identify any functions that contribute to the area being identified as “significant”. **Figure 2 – Natural Environment Map** identifies all terrestrial and aquatic natural features, natural ecosystems, vegetation communities, and potential SAR habitat observed to be present on site, and adjacent to the site, based on the January 16, 2017 field investigation and desktop review. Information provided in the following sections was gathered during the January 16, 2107 field investigation and through background information sources [e.g., Land Information Ontario database (LIO), Atlas of the Breeding Birds of Ontario (ABBO), Ontario Nature’s Ontario Reptile and Amphibian Atlas (ORAA), etc.]. ***In order to fully evaluate the natural environment of the site, a minimum of one (1) additional field investigation should be completed during the growing season, as per the City of Ottawa’s EIS guidelines (2015). The field investigation completed by McIntosh Perry on January 16, 2017 should be considered preliminary only.***



bing™

© 2010 DigitalGlobe Image courtesy of USGS Earthstar Geographics SIO © 2017 Microsoft Corporation

LEGEND

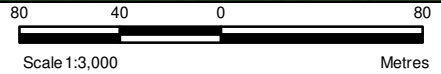

-  Property Boundary
-  Cultural Meadow (CUM) and Potential Bobolink/Eastern Meadowlark/Grasshopper Sparrow Habitat
-  Significant Woodland
-  Spot Height (masl)
-  Contour (masl)
-  Local Road
-  Major Road
-  Watercourse
-  Unevaluated Wetland



REFERENCE

GIS Data provided by the Ontario Ministry of Natural Resources and Forestry, 2017.

CLIENT:		BBS CONSTRUCTION (ONTARIO) LTD.	
PROJECT:		210 MAPLE CREEK COURT	
TITLE:		NATURAL ENVIRONMENT	
PROJECT NO: CP15-0429		FIGURE:	
Date	Jan., 19, 2017	2	
GIS	JD		
Checked By	HL		

115 Walgreen Rd., RR#3, Carp, ON K0A1L0
Tel: 613-836-2184 Fax: 613-836-3742

Document Path: H:\01_Proposals\2015_Proposals\CP15-0429_BBS_Site Plan_210 Maple Creek Court\GIS\mxd\CP150429_02NaturalEnvironment.mxd

3.1 Landforms, Soils and Geology

The general topography of the study area was nearly level. *Soils of the Regional Municipality of Ottawa-Carleton (Excluding the Ottawa Urban Fringe) Ontario Soil Survey Report No. 58* identified the soils on the subject property as from the Jockvale series; fine sandy loam, loamy fine sand, or fine sand (Schut et al., 1987). These soils have imperfect drainage (Schut et al., 1987).

A hydrogeological study is proposed to be completed for the subject property. The report outlining the findings of the hydrogeological study was not available at the writing of this EIS.

3.2 Surface Water, Groundwater and Fish Habitat

Background information indicated that a watercourse, Maple Creek, is present approximately 120 metres south of the subject properties (**Figure 2**). Background information and observations made during the field survey did not suggest any surface water was present within the subject property. However, it should be noted that the subject property was entirely snow-covered at the time of the field investigation, and any surface water features would have been difficult to detect. In addition, any herbaceous vegetation that would have suggested the presence of surface water, would have been dead and/or snow-covered.

Though surface water was not observed, Schedule 2 of the City of Ottawa's *Carp Road Corridor Community Design Plan* indicates that the subject property is located in a High Recharge Area. This is an area where surface water is known to infiltrate the ground. In addition GIS layers from geoOttawa maps indicate that a portion of unevaluated wetland has the potential to be present on the property at 210 Maple Creek Court (**Figure 2**). Wetland habitat was not observed on either subject property during the field investigation. However, as noted in the previous paragraph, snow coverage made features, such as wetland habitat, difficult to detect.

3.3 Vegetation Cover

At the time of the January 16, 2017 field investigation, the majority of the subject property at 210 Maple Creek Court was devoid of woody vegetation (**Photos 1, 2, 3, 4, 8, & 12**). Due to the timing of the field investigation, and the amount of snow cover present, a determination of herbaceous vegetation communities using ELC was not possible on this property. Two trees (non-native species), were observed at the west end of the property, closest to Maple Creek Court: Scot's pine (*Pinus sylvestris*) and white fir (*Abies concolor*). No other woody vegetation was present on the 210 Maple Creek Court subject property. Snow cover prevented any observations of herbaceous vegetation on this property.

Given vegetation species observed poking through the snow cover on the subject property at 220 Maple Creek Court, the vegetation community present was determined to be a Meadow (ME) (**Figure 2, Photos 2, 3, 5, 6, 7, 9, 10, 11, 12, & 13**). Vegetation species composition in the Meadow included less than 5% woody species cover. Woody vegetation species observed within the Meadow (concentrated within the boundary between the

subject properties 210 and 220 Maple Creek Court), included mature speckled alder (*Alnus incana*) and red-osier dogwood (*Cornus sericea*), and balsam poplar (*Populus balsamifera*) and eastern white cedar (*Thuja occidentalis*) saplings (**Photo 12**). Herbaceous vegetation species observed included: Queen Anne’s lace (*Daucus carota*), white sweet-clover (*Melilotus albus*), goldenrod sp. (*Solidago* sp.), aster sp. (*Asteraceae* sp.), common mullein (*Verbascum thapsus*), European reed grass (*Phragmites australis*), evening primrose (*Oenothera biennis*), and black-eyed Susan (*Rudbeckia hirta*). According to *Vascular Plants of the City of Ottawa, with Identification of Significant Species* (Brunton, 2005), all vegetation species observed in this community are common in the surrounding area, and none are considered to be rare on the landscape.

A full listing of vegetation species observed on 210 and 220 Maple Creek Court can be found in **Table 2**.

Table 2: Vegetation Species List

Common Name	Scientific Name	Status According to Brunton (2005)
Scot’s pine	<i>Pinus sylvestris</i>	Rare [frequently planted]
White fir	<i>Abies concolor</i>	N/A
Speckled alder	<i>Alnus incana</i>	Common
Red-osier dogwood	<i>Cornus sericea</i>	Common
Balsam poplar	<i>Populus balsamifera</i>	Common
Black cherry	<i>Prunus serotina</i>	Common
Eastern white cedar	<i>Thuja occidentalis</i>	Common
Green ash	<i>Fraxinus pennsylvanica</i>	Common
Sugar maple	<i>Acer saccharum</i>	Common
American beech	<i>Fagus grandifolia</i>	Common
Ironwood	<i>Ostrya virginiana</i>	Common
Queen Anne’s lace	<i>Daucus carota</i>	Common
White sweet-clover	<i>Melilotus alba</i>	Common
Goldenrod sp	<i>Solidago</i> sp.	Unknown (likely common species)
Aster sp.	<i>Asteraceae</i> sp.	Unknown (likely common species)
Common mullein	<i>Verbascum thapsus</i>	Common
European Reed Grass	<i>Phragmites australis</i>	Uncommon (locally abundant adventive)
Evening primrose	<i>Oenothera biennis</i>	Common
Black-eyed Susan	<i>Rudbeckia hirta</i>	Common

The City of Ottawa identified Significant Woodland as present within the subject properties. The field investigation confirmed that Significant Woodland is not present within either subject property. As noted in Section 1.0 of this report, no forested habitat exists within the subject properties. However, forested habitat was observed to be present adjacent to the subject properties (east and south). This habitat is also identified by the City of Ottawa as Significant Woodland (**Figure 2**). Observations of the adjacent forested habitat were made during the field investigation (**Photos 1, 2, 5, 6, 7, 8, 9, 10, & 13**). In addition, recent aerial photography from Google Earth (9/5/2016) was analysed. These sources were utilized to confirm that the forested habitat adjacent to the subject properties has characteristics of Significant Woodland, consistent with those outlined

in Appendix 8 of *Environmental Impact Statement Guidelines* (City of Ottawa, October 2015). These characteristics include the following:

- Mature stands of trees 80 years of age or older; and,
- Interior forest habitat located more than 100 m inside the edge of a forest patch; and,
- Woodland adjacent to a surface water feature such as a river, stream, drain, pond, or wetland, or any groundwater feature including springs, seepage areas, or areas of groundwater upwelling.

The field investigation confirmed that the adjacent forested habitat consisted of a mature stand of deciduous/mixed forest. Dominant species observed included: black cherry (*Prunus serotina*), green ash (*Fraxinus pennsylvanica*), sugar maple (*Acer saccharum*), eastern white cedar (*Thuja occidentalis*), American beech (*Fagus grandifolia*) and ironwood (*Ostrya virginiana*). Google Earth aerial photographs (9/5/2016) depict continuous forest, with interior forest habitat located more than 100 m inside the edge of the forest patch. In addition, GIS layers from geoOttawa maps show unevaluated wetland habitat and Maple Creek are present within the patch of forest adjacent to the subject properties. These observations and information confirm that the forested habitat adjacent to the subject properties is Significant Woodland. Therefore, the subject properties would be considered to be present on what the *Natural Heritage Reference Manual for Natural Heritage Policies of the Provincial Policy Statement, 2005* (2010) refers to as “Adjacent Lands” (i.e., lands within 120 m of Significant Woodlands where impacts must be considered).

3.4 Wildlife

The subject property is located in the St. Lawrence Lowlands Ecozone within the Mixed Plains Ecozone (National Ecological Framework for Canada, 1995). Characteristic wildlife within this Ecozone includes: black bear, moose, deer, wolf, hare, chipmunk, other small mammals, waterfowl, turtles, snakes and various bird species. A complete list of wildlife species observed during the field investigation can be found in **Table 3**. Due to the time of year during which the field investigation was conducted (January), observations of wildlife species were limited, and species of wildlife that would be considered “migratory” or which hibernate, could not be observed.

Table 3: Wildlife Observations

Species Name	Resident/Visitor	Evidence	Abundance on Site	Site Use
Coyote (<i>Canis latrans</i>)	Resident	Tracks	Common	Foraging
Red Fox (<i>Vulpes vulpes</i>)	Resident	Tracks	Common	Foraging
Common Raven (<i>Corvus corax</i>)	Resident	Call	Common	Foraging

3.5 Habitat for Species at Risk

Information obtained from background sources (i.e., LIO, ABBO, ORAA), indicated that there was the potential for SAR and SAR habitat to be present on the subject properties. SAR with the potential for habitat to be present on the subject properties are listed below in **Table 4**.

Table 4: Species at Risk Potentially Present within the Study Area

Species Name	Scientific Name	Provincial Status	SAR Habitat Potentially Present on Subject Properties & Adjacent Lands	Source
Bird Species				
Loggerhead Shrike	<i>Lanius ludovicianus</i>	Endangered	No	LIO
Eastern Whip-poor-will	<i>Caprimulgus vociferus</i>	Threatened	Yes (adjacent forested lands only)	LIO
Eastern Meadowlark	<i>Sturnella magna</i>	Threatened	Yes (within Meadow)	LIO
Bobolink	<i>Dolichonyx oryzivorus</i>	Threatened	Yes (within Meadow)	LIO
Least Bittern	<i>Ixobrychus exilis</i>	Threatened	No	ABBO
Bald Eagle	<i>Haliaeetus leucocephalus</i>	Special Concern	No	ABBO
Peregrine Falcon	<i>Falco peregrinus</i>	Special Concern	No	ABBO
Black Tern	<i>Chlidonias niger</i>	Special Concern	No	ABBO
Short-eared Owl	<i>Asio Flammeus</i>	Special Concern	No	ABBO
Common Nighthawk	<i>Chordeiles minor</i>	Special Concern	No	ABBO
Chimney Swift	<i>Chaetura pelagica</i>	Threatened	No	ABBO
Red-headed Woodpecker	<i>Melanerpes erythrocephalus</i>	Special Concern	No	ABBO
Olive-sided Flycatcher	<i>Contopus cooperi</i>	Special Concern	No	ABBO
Eastern Wood-Pewee	<i>Contopus virens</i>	Special Concern	Yes (adjacent forested lands only)	ABBO
Bank Swallow	<i>Riparia riparia</i>	Threatened	No	ABBO
Barn Swallow	<i>Hirundo rustica</i>	Threatened	No	ABBO
Wood Thrush	<i>Hylocichla mustelina</i>	Special Concern	Yes (adjacent forested lands only)	ABBO
Golden-winged Warbler	<i>Vermivora chrysoptera</i>	Special Concern	No	ABBO
Cerulean Warbler	<i>Setophaga cerulea</i>	Threatened	No	ABBO
Canada Warbler	<i>Cardellina canadensis</i>	Special Concern	Yes (adjacent forested lands only)	ABBO
Grasshopper Sparrow	<i>Ammodramus savannarum</i>	Special Concern	Yes (within Meadow)	ABBO
Vegetation Species				
Butternut	<i>Juglans cinerea</i>	Endangered	Yes (none observed)	LIO

Species Name	Scientific Name	Provincial Status	SAR Habitat Potentially Present on Subject Properties & Adjacent Lands	Source
Reptile Species				
Snapping Turtle	<i>Chelydra serpentina</i>	Special Concern	Yes (Maple Creek and unevaluated wetlands only)	LIO, ORAA
Blanding's Turtle	<i>Emydoidea blandingii</i>	Threatened	No (Maple Creek and unevaluated wetlands only)	LIO, ORAA
Mammal Species				
Little Brown Myotis	<i>Myotis lucifugus</i>	Endangered	Yes (adjacent forested lands only)	General range

Potential habitat for the Bobolink, Eastern Meadowlark and Grasshopper Sparrow was observed to be present within the Meadow habitat on the subject property at 220 Maple Creek Court (**Photos 5, 6, 7, 10, & 11**). Due to the time of year in which the field investigation was conducted, confirmation of species presence could not be made. These species are migratory and can only be accurately detected during the breeding season (June – July). The Bobolink, Eastern Meadowlark and Grasshopper Sparrow are classified as grassland species. The Bobolink breeds in hayfields and other grasslands with relatively tall vegetation. Eastern Meadowlarks prefer open human-modified landscapes, including hayfields, pasture land, meadows and other grassland types. The Grasshopper Sparrow prefers drier sites to those of the Bobolink and Eastern Meadowlark. It is found mainly in sparsely vegetated grasslands, with a varying amount of forb and shrub growth. They occasionally are also found in cultivated cereal crop or hay fields. The Bobolink and Eastern Meadowlark are threatened species in Ontario, with habitat and species protection afforded under the *Endangered Species Act, 2007* (ESA). The Grasshopper Sparrow is a species of special concern, with protection afforded under the *Migratory Birds Convention Act, 1994*.

No butternut trees were observed on or within 50 m of the subject property boundaries, during the 2017 field investigation. Therefore, it can be concluded that the species is not present at this time within subject property boundaries, and will not be impacted by the proposed development.

It should be noted that the adjacent Significant Woodland (**Figure 2**) provides potential habitat for the following species: Eastern Whip-poor-will, Eastern Wood-Pewee, Wood Thrush, Canada Warbler, and Little Brown Myotis. In addition, the adjacent unevaluated wetland and Maple Creek (**Figure 2**) provide potential habitat for the Snapping Turtle and Blanding's Turtle. Habitat for any of these species was not observed to be present within subject property boundaries. Habitat for all other species listed in **Table 4** was not observed to be present within subject property boundaries or on adjacent lands, during the January 16, 2017 field investigation.

4.0 DESCRIPTION OF THE PROPOSED PROJECT

The proposed development will consist of four (4) warehouse buildings approximately 1,865 m² in size. The proposed development will be completed in phases. Parking and drive aisles will be provided throughout the site, with landscaping located around the perimeter of the site. **Figure 3** provides a site plan for the proposed development.

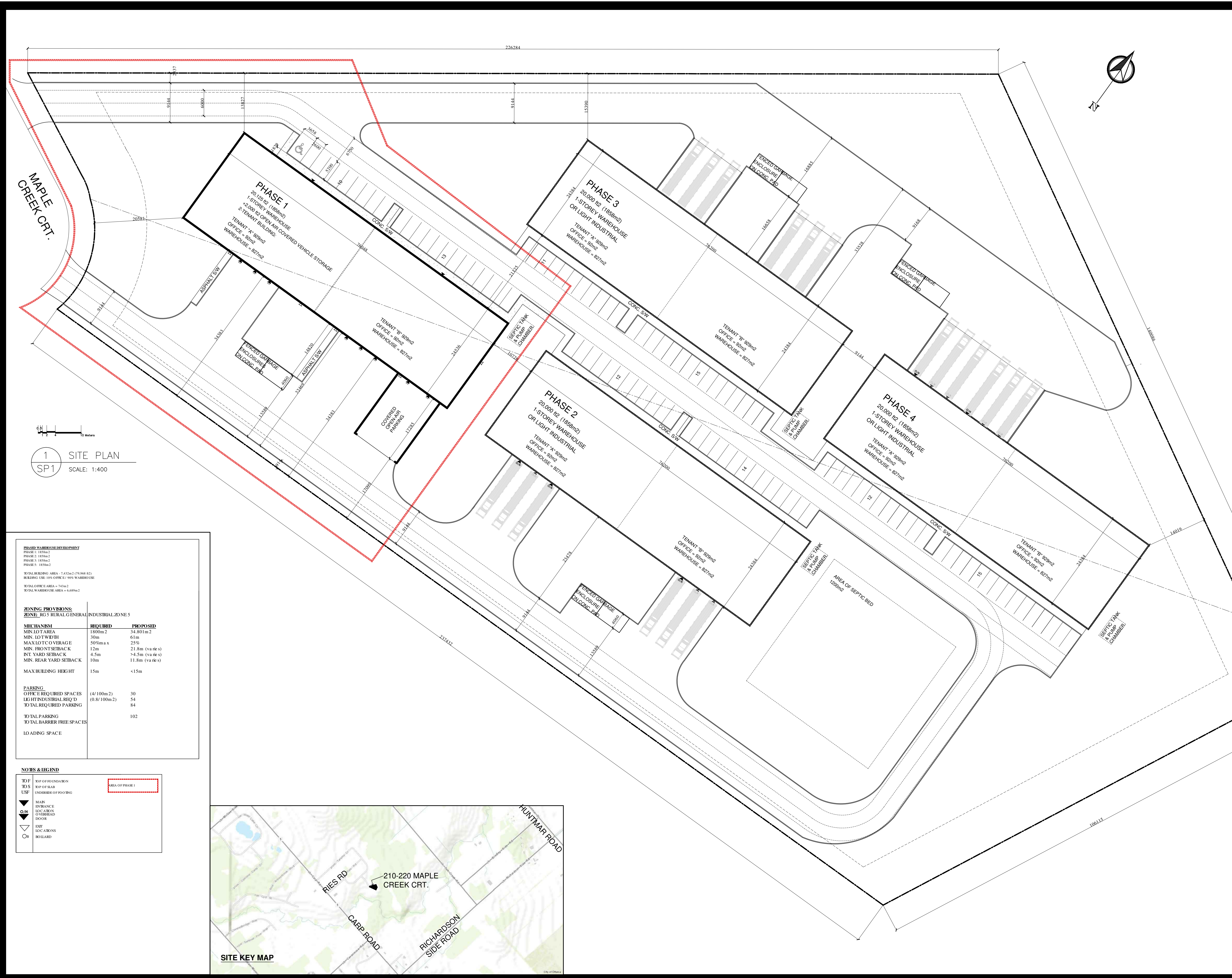

REVISION		
NO.	DATE	REVISION
1		
2		
3		
4		
5		

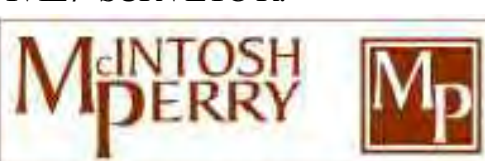
CIVIL / SURVEYOR:

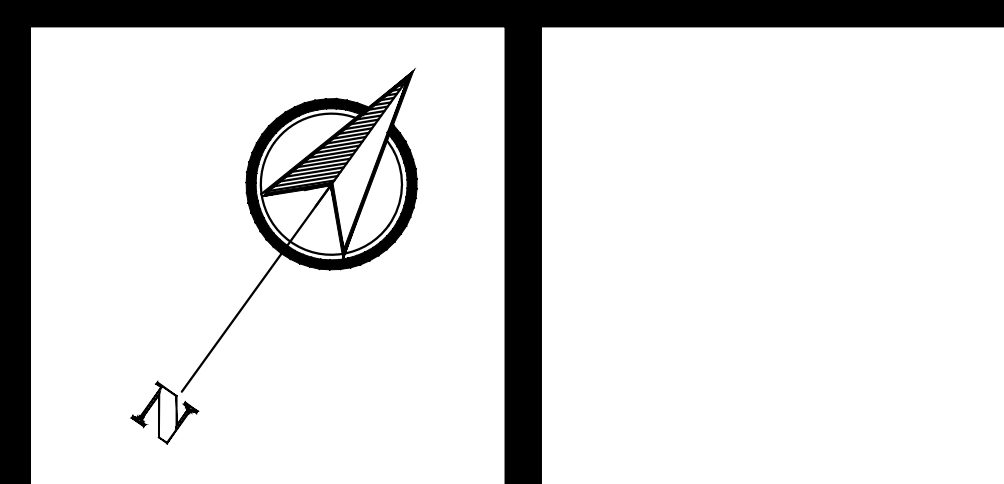
 ARCHITECT:



BBS
 BUILDING A REPUTATION ON EXCELLENCE
 BBS CONSTRUCTION (ONTARIO) LTD.
 1805 WOODWARD DRIVE,
 OTTAWA, ON K2C 0P9
 TEL: 613-226-8830 FAX: 613-226-7709
 www.bbsconstruction.ca

wall
 sound-lighting-staging
 WALL SOUND
 2434894 Ontario Inc.

PROJECT:
 WALL SOUND - PHASED
 OFFICE / WAREHOUSE PROJECT
 210 / 220 MAPLE CREEK COURT

DRAWING TITLE:
 SITE PLAN

PROJECT N°: 397-16 DRAWING NO.
 SCALE: AS NOTED
 DRAWN BY: MK
 DATE: 24/10/2016

SP1

1 SITE PLAN
 SP1 SCALE: 1:400

PHASED WAREHOUSE DEVELOPMENT

PHASE 1: 185,800 sq ft
 PHASE 2: 185,800 sq ft
 PHASE 3: 185,800 sq ft
 PHASE 4: 185,800 sq ft

TOTAL BUILDING AREA: 747,120 sq ft (7,908,820 sq ft)
 BUILDING USE: 10% OFFICE / 90% WAREHOUSE
 TOTAL OFFICE AREA: 74,712 sq ft
 TOTAL WAREHOUSE AREA: 6,724,080 sq ft

ZONING PROVISIONS:
 ZONE: RG 5 RURAL GENERAL INDUSTRIAL ZONE 5

MEASUREMENT	REQUIRED	PROPOSED
MIN. LOT AREA	1800m ²	34,800m ²
MIN. LOT WIDTH	30m	61m
MAX. LOT COVERAGE	50% max	25%
MIN. FRONT SETBACK	12m	21.8m (varies)
INT. YARD SETBACK	4.5m	24.5m (varies)
MIN. REAR YARD SETBACK	10m	11.8m (varies)
MAX. BUILDING HEIGHT	15m	<15m

PARKING:
 OFFICE REQUIRED SPACES (47/100m²): 30
 LIGHT INDUSTRIAL REQ'D (0.8/100m²): 54
 TOTAL REQUIRED PARKING: 84

TOTAL PARKING: 102
 TOTAL BARRIER FREE SPACES: 102
 LOADING SPACE

NOBS & LEGEND

DF	TOP OF FOUNDATION
FS	TOP OF FINISH
USE	UNDERLINE OF FOOTING
MAN	MAN ENTRANCE
OVH	OVERHEAD DOOR
ENT	ENTRANCE
OB	BOLLARD

AREA OF PHASE 1 (indicated by a red dashed line)

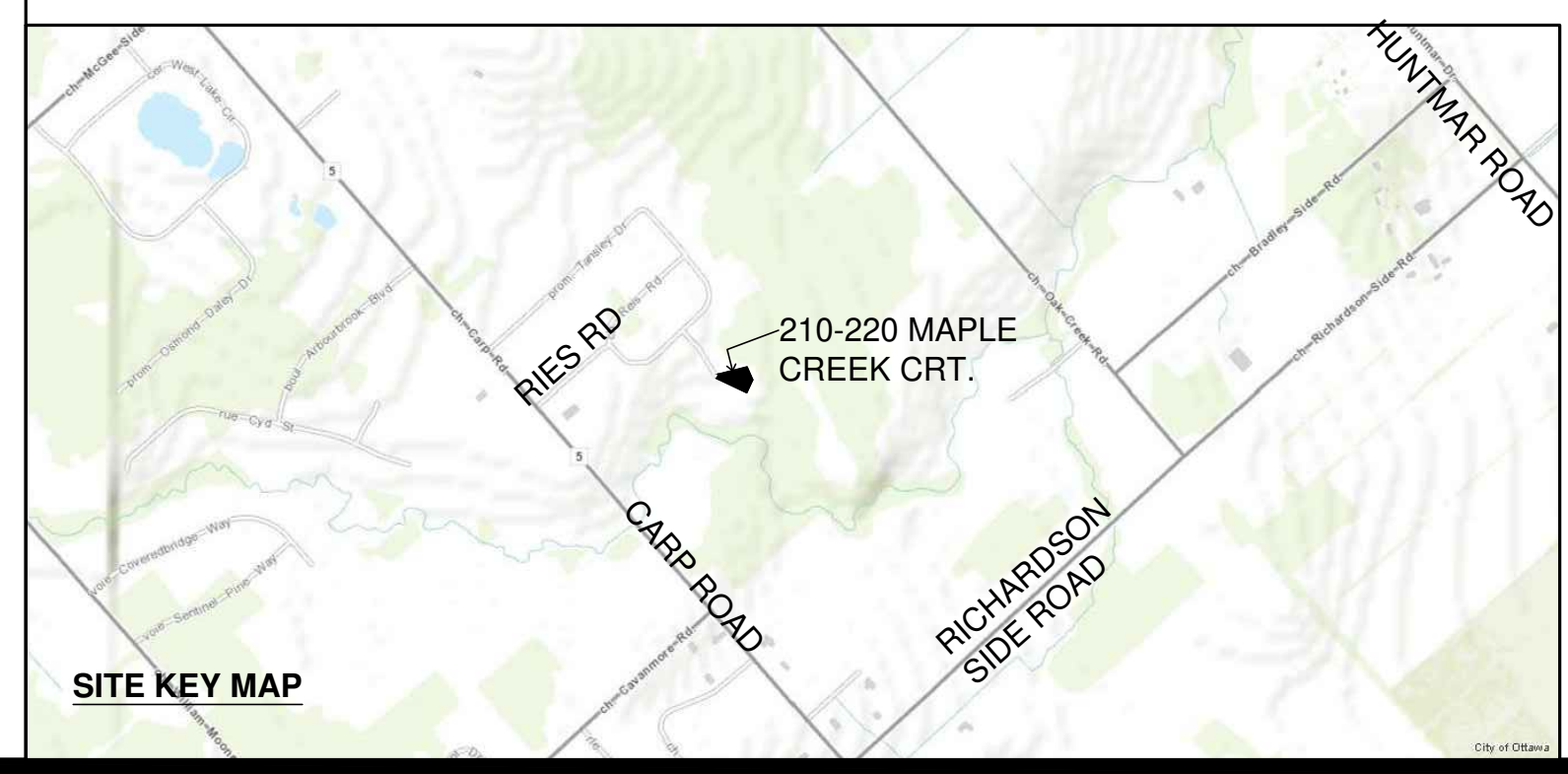

5.0 IMPACT ASSESSMENT

Potential impacts that may be associated with the proposed development, cannot be fully assessed until such time as a minimum of one (1) additional survey has been completed on the subject properties, during the growing season. Additional targeted SAR surveys may also be required during the appropriate seasons. Therefore, the following section should be considered a preliminary examination of the potential impacts that the proposed development may have on various natural heritage features present on, or adjacent to, the subject property.

Though ELC vegetation communities could not be fully assessed, it is not anticipated that the proposed development will have significant negative impact to terrestrial vegetation present on the subject property. The proposed development is located within an industrial park, within Meadow and previously cleared area, which does not appear contain sensitive, rare or significant vegetation species. In addition, there is less than 5% woody vegetation coverage on the subject properties, and vegetation species observed are considered common in the area.

Based on the current site plan, negative impacts that could occur to the adjacent Significant Woodland as a result of the proposed development include effects such as introduction of invasive species, and damage to root systems/critical root zone of trees. The site plan (**Figure 3**) depicts one area where the pavement is proposed to be placed within 1.54 m of the edge of the Significant Woodland. The remaining development maintains a 10 m or greater buffer from the Significant Woodland edge. Development in close proximity to the Significant Woodland may cause the introduction of non-native and/or invasive species into this habitat. In addition, development this close to mature trees may cause negative impacts to the critical root zone of trees directly adjacent to the area, and potentially create hazards in the form of dead falling trees. Aside from the select trees directly adjacent to the proposed development, overall habitat within the Significant Woodland is not anticipated to be negatively impacted by the proposed development.

The subject properties currently provide foraging habitat for common mammals within the area (e.g., red fox, coyote, etc.). The few trees, shrubs and Meadow habitat found on the subject properties, would also provide nesting habitat for migratory birds during the breeding/nesting season (mid-April to mid-August, of any year). The development will remove a small amount of these types of habitat from the surrounding area. Mitigation measures are outlined in Section 6.0 to avoid impacts to wildlife species during construction.

Due to the time of year the field investigation was conducted (January), confirmation of SAR habitat could not be made. However, given vegetation species observed through the snow (i.e., characteristic Meadow species), there is the potential for Bobolink, Eastern Meadowlark, and Grasshopper Sparrow to utilize the Meadow as breeding habitat (**Figure 2**). ***Therefore, Three (3) presence/absence surveys are recommended to be conducted as per MNR protocol during the appropriate season (i.e., between June 1 and the end of the first week in July, of any year), to confirm whether these species are present within the subject properties. Impacts to***

these species and appropriate mitigation/compensation requirements can be evaluated after additional surveys have been conducted.

5.1 Identifying Cumulative Impacts

A comprehensive examination of cumulative impacts is not possible until all factors that have potential to be impacted by the proposed development, are known (e.g., SAR habitat, migratory bird habitat, rare herbaceous vegetation species, etc.). Additional survey(s) are recommended in order to complete the examination of, and identify cumulative impacts to the subject properties and surrounding habitat.

It is recommended that the current site plan be re-evaluated to accommodate the existing critical root zone of adjacent trees within the Significant Woodland, in order to prevent cumulative impacts to this feature through the loss of mature trees. If this can be accommodated, then by following the recommended mitigation measures outlined in Section 6.0 of this report, cumulative impacts should be avoided to the Significant Woodland. Alternatively, the critical root zones of the trees that have the potential to be impacted by the current site plan could be determined and their loss could be off-set by re-planting additional native tree species elsewhere on the property. A list of suitable species can be found in **Appendix C**.

6.0 MITIGATION

In order to minimize or eliminate environmental impacts from construction and development, the following mitigation measures are recommended. ***Additional mitigation measures may be determined to be required after the additional survey(s) have been completed. Therefore, this list should not be considered a complete list of mitigation measures applicable to the proposed development.***

- To prevent the introduction and spread of invasive plant species into the site and adjacent Significant Woodland, equipment utilized during construction should be inspected and cleaned in accordance with the *Clean Equipment Protocol for Industry (Appendix B)*.
- In order to prevent negative impacts to the adjacent Significant Woodland and the sensitive habitat present within, it is recommended that a vegetated buffer be maintained, at minimum, within the critical root zone of trees along the woodland edge, between the proposed development and the adjacent Significant Woodland. Planting native species within this buffer and all associated “landscaped” areas is encouraged, as they will be better adapted to the local site conditions and provide contributory function to the Significant Woodland located adjacent to the subject property. A list of suitable species can be found in **Appendix C**.
- In accordance with Appendix 10 of the *Environmental Impact Statement Guidelines* for the City of Ottawa, no clearing of any vegetation should occur between April 15 and August 15, unless a qualified biologist has determined that no nesting is occurring within 5 days prior to the clearing. Note: these dates are based upon breeding bird nesting data for eastern Ontario, provided by Environment Canada. The nests and eggs of many species are protected under the federal and/or provincial legislation (i.e., *Migratory Birds Convention Act, Fish and Wildlife Conservation Act*).
- In accordance with the *Protocol for Wildlife Protection during Construction (Appendix D)*, reduce potential wildlife usage of the Meadow habitat (**Figure 2**) by mowing outside of the breeding season (i.e., before April 15), then maintain as mowed grass until on-site work begins. This activity should **NOT** occur until it has been determined whether the Meadow habitat represents SAR habitat protected under the ESA (e.g., after targeted Bobolink/Eastern Meadowlark surveys have been undertaken).
- Should any SAR be discovered throughout the course of the work, and/or should any SAR or their habitat be potentially impacted by on-site activities, the MNRF should be contacted immediately and operations modified to avoid any negative impacts to SAR or their habitat, until further direction is provided by the MNRF.
- In accordance with recommendations regarding trees and woodlands found in Appendix 10 of the *Environmental Impact Statement Guidelines* for the City of Ottawa, the following mitigation measures should be employed to avoid negative impacts to the trees present within the adjacent Significant Woodland:

- Erect a fence at the outer limit of the critical root zone (CRZ) of trees on the edge of the Significant Woodland. The CRZ is defined as the distance around the tree at a radius of 10 times the diameter of the tree (at breast height);
- Do not place any material or equipment within the CRZ of the trees on the edge of the Significant Woodland;
- Do not attach any signs, notices or posters to any tree;
- Do not raise or lower the existing grade within the CRZ of the trees on the edge of the Significant Woodland without approval from the City of Ottawa;
- Tunnel or bore when digging within the CRZ of the trees on the edge of the Significant Woodland; and,
- Ensure that exhaust fumes from all equipment are not directed towards any tree's canopy on the edge of the Significant Woodland.

7.0 MONITORING

At this time, there are no recommended monitoring requirements for the site. However, dependent on the results of the recommended additional survey(s), there may be monitoring requirements for during, or after construction. ***Therefore, this section should not be considered complete until such time as additional survey(s) have been completed, and any applicable monitoring requirements have been determined.***

8.0 SUMMARY AND RECOMMENDATIONS

Additional survey(s) completed during the growing season are recommended in order to adequately address negative impacts that have the potential to occur as a result of the proposed development. Residual negative impacts on natural features and ecological functions of the site cannot be addressed until such time as additional survey(s) have been completed.

Negative impacts to vegetation and wildlife species present on the subject property can be moderated by implementing the recommended mitigation measures found in Section 6.0 of this report. Given the current site plan, minor negative impacts are anticipated to select mature trees at the periphery of the Significant Woodland where the proposed development is to occur within 1.54 m of the woodland edge. If the site plan is not amended to accommodate these trees, the critical root zones of these trees could be determined and their loss could be off-set by re-planting additional native tree species elsewhere on the property. Impacts to SAR cannot be evaluated properly until targeted survey(s) have been completed during the growing season.

9.0 REFERENCES

Brunton, D.F. 2005. *Vascular Plants of the City of Ottawa, with Identification of Significant Species*. Appendix A of Ottawa's Urban Natural Areas Environmental Evaluation Study. City of Ottawa, March 2005.

Cadman, M.D., D.A. Sutherland, G.G. Beck, D. Lepage, and A.R. Couturier, eds. *Atlas of the Breeding Birds of Ontario, 2007*. Bird Studies Canada, Environment Canada, Ontario Field Ornithologists, Ontario Ministry of Natural Resources, and Ontario Nature, Toronto.

City of Ottawa. May 2003. *Official Plan*.

City of Ottawa. June 2004. *Carp Road Corridor Community Design Plan*.

City of Ottawa. August 2015. *Protocol for Wildlife Protection during Construction*.

City of Ottawa. October 2015. *Environmental Impact Statement Guidelines*.

Ecological Stratification Working Group. 1996. *A National Ecological Framework for Canada*. Agriculture and Agri-Food Canada, Research Branch, Centre for Land and Biological Resources Research, and Environment Canada. State of the Environment Directorate; Ecozone Analysis Branch, Ottawa/Hull.

Endangered Species Act, 2007 (S.O. 2007, c. 6)

Fish and Wildlife Act, 1997 (S.O. 1997, c. 41)

geoOttawa. (2017, January 18). Retrieved from <http://maps.ottawa.ca/geottawa/>.

Lee, HT, WD Bakowsky, J Riley, J Bowles, M Puddister, P Uhlig and S McMurray. 1998. *Ecological Land Classification for Southern Ontario: First Approximation and its Application*. Ontario Ministry of Natural Resources, South Central Science Section, Science Development and Transfer Branch. SCSS Field Guide FG-02.

Migratory Birds Convention Act, 1994. (S.C. 1994, c. 22)

Ontario Ministry of Natural Resources. March 2010. *Natural Heritage Reference Manual for Natural Heritage Policies of the Provincial Policy Statement, 2005. Second Edition*. Toronto: Queen's Printer for Ontario. 248 pp.

Provincial Policy Statement. 2012. Toronto: Ministry of Municipal Affairs and Housing.

Schut, L.W., Wilson, E.A. 1987. *Soils of the Regional Municipality of Ottawa-Carleton (Excluding the Ottawa Urban Fringe) Ontario Soil Survey Report No. 58*. Agriculture Canada & Ministry of Agriculture and Food Ontario.

10.0 LIMITATIONS

The investigations undertaken by McIntosh Perry with respect to this report and any conclusions or recommendations made in this report reflect McIntosh Perry's judgment based on the site conditions observed at the time of the site inspection on the date set out in this report, and on information available at the time of the preparation of this report.

This report has been prepared for specific application to this site and it is based, in part, upon visual observation of the site, and terrestrial investigations at various locations during a specific time interval, as described in this report. Unless otherwise stated, the findings cannot be extended to previous or future site conditions, or portions of the site which were unavailable for direct investigation.

If site conditions or applicable standards change or if any additional information becomes available at a future date, modifications to the findings, conclusions and recommendations in this report may be necessary.

If you have any question, comments, or concerns, please do not hesitate to contact the undersigned at McIntosh Perry at 613-836-2184 (Ext. 2277).

Sincerely,
McIntosh Perry Consulting Engineers Ltd.



Heather Lunn, B.A.
Terrestrial Ecologist

Appendix A – Photographs



Photo 1: Subject property at 210 Maple Creek Court, adjacent Significant Woodland, facing east, January 16, 2017.



Photo 2: Subject properties at 210 and 220 Maple Creek Court, adjacent Significant Woodland, facing southeast, January 16, 2017.



Photo 3: Subject properties at 210 and 220 Maple Creek Court, facing west towards Maple Creek Court, January 16, 2017.



Photo 4: Subject property at 210 Maple Creek Court, facing west towards Maple Creek Court, January 16, 2017.



Photo 5: Subject property at 220 Maple Creek Court, Meadow habitat and adjacent Significant Woodland, facing south, January 16, 2017.



Photo 6: Subject property at 220 Maple Creek Court, Meadow Habitat and adjacent Significant Woodland, facing southeast, January 16, 2017.



Photo 7: Subject property at 220 Maple Creek Court, Meadow habitat and adjacent Significant Woodland, facing east, January 16, 2017.



Photo 8: Subject property at 210 Maple Creek Court and adjacent Significant Woodland, facing east, January 16, 2017.



Photo 9: Subject property 220 Maple Creek Court and adjacent Significant Woodland, facing southeast, January 16, 2017.



Photo 10: Meadow habitat on 220 Maple Creek Court and adjacent Significant Woodland, facing north, January 16, 2017.



Photo 11: Meadow habitat on 220 Maple Creek Court, facing northwest, January 16, 2017.



Photo 12: Eastern white cedar saplings, red-osier dogwood, property boundary between 210 and 220 Maple Creek Court, facing west, January 16, 2017.



Photo 13: Periphery of adjacent Significant Woodland at the back of 220 Maple Creek Court, facing southeast, January 16, 2017.

Appendix B - Clean Equipment Protocol for Industry

Clean Equipment Protocol for Industry

Inspecting and cleaning equipment for the purposes of invasive species prevention



Publication Information

Halloran, Joe, Anderson, Hayley and Tassie, Danielle. 2013. Clean Equipment Protocol for Industry. Peterborough Stewardship Council and Ontario Invasive Plant Council. Peterborough, ON.

Printed April 2013
Peterborough, Ontario

ISBN: (to be confirmed)

This document was prepared for the Canada-Ontario Invasive Species Centre and the Ontario Ministry of Natural Resources by the Peterborough Stewardship Council and the Ontario Invasive Plant Council.

Inquiries regarding this document can be directed to the Ontario Invasive Plant Council
PO Box 2800, 4601 Guthrie Drive
Peterborough, ON
K9J 8L5

Phone: (705) 748-6324
Email: info@ontarioinvasiveplants.ca

For more information on invasive plants in Ontario, visit www.ontario.ca/invasivespecies,
www.ontarioinvasiveplants.ca, www.invadingspecies.com or www.invasivespeciescentre.ca

Table Of Contents

Introduction	1
Why Cleaning Vehicles and Equipment is Important	3
Impacts of Invasive Species on Industry	4
Construction	4
Forestry/Agriculture	4
Land Management (Trail Use/Maintenance).....	4
Roadsides/Utilities	4
Steps to Prevent the Unintentional Introduction of Invasive Species from Equipment	5
When to Inspect	5
How to Inspect	5
When to Clean.....	6
Where to Clean	6
How to Clean Inside	6
How to Clean Outside	6
Final Inspection Checklist	7
Equipment Required	7
Inspection and Cleaning Diagrams and Checklists	8
2WD and 4WD Vehicles.....	8
Excavator	9
Backhoe.....	10
Bulldozer	11
Contacts and Resources	12
Appendix A: Identification of Invasive Plants found in Ontario	13

Introduction

Why Invasive Plants are a Problem

Invasive alien species are “a growing environmental and economic threat to Ontario. Alien species are plants, animals and microorganisms that have been accidentally or deliberately introduced into areas beyond their normal range. Invasive species are defined as harmful alien species whose introduction or spread threatens the environment, the economy, or society, including human health (Government of Canada 2004).” (Ontario Invasive Species Strategic Plan, 2012). The great majority of plant invasions occur in habitats that have been disturbed either naturally or by humans (Rejmanek 1989; Hobbs and Huenneke 1992; Hobbs 2000).

The ecological effects of invasive species are often irreversible and, once established, they are extremely difficult and costly to control or eradicate. According to Pimental et al. (1999), invasive species in the U.S. cause economic and environmental damages totalling over \$138 billion per year, with agricultural weed control and crop losses totalling approximately \$34 billion per year. Exact figures for the total economic and environmental damages are not available for Canada. In Ontario however, the costs of dealing with just one invasive species is astonishing; Zebra Mussels cost Ontario power producers who draw water from the lake \$6.4 million per year in increased control/operating costs and about \$1 million per year in research costs (Colautti et al. 2006).

Invasive species can spread to new areas when contaminated mud, gravel, water, soil and plant material are unknowingly moved by equipment used on different sites. This method of spread is called an unintentional introduction, and is one of the four major pathways for invasive species introduction into a new area of Ontario (Ontario Invasive Species Strategic Plan, 2012).



Buckthorn removal, Lynde Shores Conservation Area.

Photo by: Central Lake Ontario Conservation Authority

Invasive plant seed and propagules (plant material, i.e. rhizomes) have the ability to travel sight unseen in mud attached to or lodged in various parts and spaces between parts of vehicles, machinery and other mechanical equipment. A recent study at Montana State University found that most seeds (99% on paved roads and 96% on unpaved roads) stayed attached to the vehicle after traveling 160 miles (257 km) under dry conditions.

Invasive plant species are commonly transported on or in vehicles and construction equipment when they are moved to new locations. Those vehicles include four-wheel drives, excavators, tractors, loaders, water trucks and all-terrain vehicles. Failure to properly clean vehicles and machinery of soils, mud, and contaminated water that may contain invasive species seed and propagules can result in permanent, irreversible environmental impacts. These impacts can mean substantial cost to the landowner, land manager and/or the user. Businesses may also face liability issues for activities and operations that result in the introduction of invasive species.

Some of the invasive species in Ontario which have been known to spread through equipment transfer include:

- **Common Buckthorn** (*Rhamnus cathartica*)
- **Dog-strangling Vine** (*Cynanchum rossicum*)
- **Garlic Mustard** (*Alliaria petiolata*)
- **Giant Hogweed** (*Heracleum mantegazzianum*)
- **Glossy Buckthorn** (*Frangula alnus*)
- **Japanese Knotweed** (*Polygonum cuspidatum*)
- **Miscanthus or Chinese Silver Grass** (*Miscanthus sinensis*)
- **Phragmites or Common Reed** (*Phragmites australis* subsp. *australis*)
- **Reed Canary Grass** (*Phalaris arundinacea*)
- **Wild Parsnip** (*Pastinaca sativa*)
- **Wild Chervil** (*Anthriscus sylvestri*)



Dog-strangling vine
(*Cynanchum rossicum*)
Photo by: Hayley Anderson



Garlic Mustard
(*Alliaria petiolata*)
Photo by: Ken Towle



Phragmites
(*Phragmites australis* subsp. *Australis*)
Photo by: Michael Irvine

These plants impact biodiversity by out-competing native species for space, sunlight, and nutrients. They can also have impacts on road and driver safety by physically blocking intersection sightlines, and in the case of Phragmites and Miscanthus, may fuel intense grass fires if ignited, which can damage utility stations and hydro lines.

The harmful effects of invasive species include:

- Physical and structural damage to infrastructure
- Human health hazards (i.e. Giant Hogweed and Wild Parsnip exposure)
- Delays and increased cost in construction activities
- Environmental damage (i.e. erosion)
- Aesthetic degradation
- Loss of biodiversity
- Reduced property values
- Loss of productivity in woodlots and agriculture

Why Cleaning Vehicles and Equipment is Important

Passenger and recreational vehicles as well as heavy machinery are major vectors for spreading terrestrial invasive species into new areas.

It is much more costly to control invasive species after their establishment and spread than it is to prevent their spread. The spread of invasive species through unintentional introduction can be minimized significantly by the diligent cleaning of vehicles and equipment when leaving one site and moving to the next. In the case of large properties, cleaning before moving to a new site is recommended, even if it is within the same property.

This guide has been developed for the construction, agriculture, forestry and other land management industries, to provide equipment operators and practitioners with tools and techniques to identify and prevent the unintentional introduction of invasive species. It establishes a standard for cleaning vehicles and equipment and provides a guide where current codes of practice, industry standards or other environmental management plans are not already in place.

Passenger and recreational vehicles include:

- 2WD and 4WD cars
- 2WD and 4WD trucks
- All Terrain Vehicles (ATV's)
- Motorbikes
- Snowmobiles

Heavy machinery includes:

- Trucks
 - Tractors
 - Mowers
 - Slashers
 - Trailers
 - Backhoes
 - Graders
 - Dozers
 - Excavators
 - Skidders
 - Loaders
 - Water Tankers and Trucks
-



Dog-strangling Vine plants attached to ATV.

Photo by: Francine Macdonald



Plant material attached to bobcat.

Photo by: TH9 Outdoor Services

Impacts of Invasive Species on Industry

Construction

In the UK, Japanese Knotweed (*Polygonum cuspidatum* or *Fallopia japonica*) is classified as a hazardous material. When construction occurs in established Japanese Knotweed stands workers sift the soil to remove root fragments and institute treatment plans to ensure that the Knotweed does not re-sprout, as it can damage housing foundations by growing through concrete and asphalt. The contractors must also thoroughly clean their equipment, and dispose of the contaminated soil at biohazard waste sites. While we do not have these requirements in Ontario, Japanese Knotweed is present here.

Invasive plant species can also increase site preparation and weed control costs, and reduce property values. For example, in Vermont the presence of the aquatic invasive plant Eurasian Watermilfoil (*Myriophyllum spicatum*) depressed shoreline residence property value by as much as 16.4% (Zhang and Boyle, 2010).

Forestry/Agriculture

Invasive plant species which become established in forests will out-compete native species and prevent forest re-generation after logging or natural disturbance. Dog-strangling Vine (*Cynanchum rossicum*) is of particular concern in conifer plantations. This species thrives in the filtered light and open soils of mature plantations, and suppresses seedling establishment of native hardwoods. If its invasion continues, very few juvenile trees will survive to fill the shrinking canopy of over-mature pines. Reforestation sites are also susceptible; the thick mats of vegetation and aggressive competition from Dog-strangling Vine decrease available planting space and increase costs as more mature vegetation needs to be planted in order to ensure the new vegetation can outcompete the invasive plant. As a result, expensive control programs are often required.

Land Management (Trail Use/Maintenance)

Recreational trail use and the maintenance of trails can facilitate the transport of invasive plant material and seeds, and create open and disturbed sites that are prime locations for the establishment of invasive species. Studies have proven that trails act as corridors which assist in the spread of invasive plant species. Humans, their pets, and vehicles such as ATV's can be vectors of invasion along trails because seeds and plant pieces can be carried on equipment and clothing. In addition, frequent trampling along trails alters soil properties, limits the growth of some native species, and creates conditions that may favour the growth of non-native species (Kuss et al. 1985; Marion et al. 1985; Yorks et al. 1997).

Roadsides/Utilities

Invasive species can increase the cost of roadside and utility maintenance by requiring additional maintenance and control efforts. The presence of invasive species can also provide a safety hazard. In the case of Phragmites and Miscanthus (invasive grass species), along with interrupting sight lines, the dead stalks which remain standing each autumn also provide combustible material. Fires in these stands burn intensely, and can damage utilities and hydro lines. Phragmites along roadsides is generally assumed to be spread through the transport and burial of rhizome fragments through ditching, ploughing, and other human activities that transport rhizomes on machinery. Studies have shown that vehicles and road-fill operations can transport invasive plant seeds into uninfested areas, and road construction and maintenance operations provide optimal disturbed sites for seed germination and seedling establishment (Schmidt 1989; Lonsdale & Lane 1994; Greenberg et al. 1997; Trombulak & Frissell 2000).

Steps to Prevent the Unintentional Introduction of Invasive Species from Equipment

Inspection and cleaning of all machinery and equipment should be performed in accordance with the procedures, checklists and diagrams provided in this protocol.

When visiting more than one site, always schedule work in the sites that are the least disturbed and free of known invasive species first, and visit sites with known invasive species infestations last. This will greatly reduce the risk of transferring plants to new locations.

When to Inspect

Inspection should be done before:

- Moving vehicles out of a local area of operation
- Moving machinery between properties or sites within the same property where invasive species may be present in one area, and not in another
- Using machinery along roadsides, in ditches, and along watercourses
- Vehicles using unformed dirt roads, trails or off road conditions
- Using machinery to transport soil and quarry materials
- Visiting remote areas where access by vehicles is limited

Inspection should be done after:

- Operating in areas known to have terrestrial invasive plants or are in high risk areas (i.e. recently disturbed areas near known invaded areas)
- Transporting material (i.e. soil) that is known to contain, or has the potential to contain, invasive species
- Operating in an area or transporting material that you are uncertain contain invasive species
- In the event of rain. If mud contains seeds, they can travel indefinitely until it rains or the road surface is wet, allowing for long distance transport. This may result in transporting seeds to areas where those species did not previously exist

How to Inspect

- Inspect the vehicle thoroughly inside and out for where dirt, plant material and seeds may be lodged or adhering to interior and exterior surfaces.
- Remove any guards, covers or plates that are easy to remove.
- Attention should be paid to the underside of the vehicle, radiators, spare tires, foot wells and bumper bars.

If clods of dirt, seed or other plant material are found, removal should take place immediately, using the techniques outlined below.

When to Clean

Vehicles and heavy equipment that stay on formed and sealed roads have a low risk of spreading invasive species. Cleaning is only required when inspection identifies visible dirt clods and plant material or when moving from one area to another.

Depending on the invasive species present, vehicles may need to be cleaned even when deep snow is present. Phragmites, for example, can still be spread, even in packed snow because the seed heads are usually above the surface of the snow. Other plants, such as Dog-strangling vine, will be contained beneath deep snow.

**Regular inspection of vehicles and machinery will identify if any soil or plant material has been collected on or in vehicles and machinery.*

Where to Clean

Clean the vehicle/equipment in an area where contamination and seed spread is not possible (or limited). The site should be:

- Ideally, mud free, gravel covered or a hard surface. If this option is not available, choose a well maintained (i.e. regularly mowed) grassy area.
- Gently sloping to assist in draining water and material away from the vehicle or equipment. Care should be taken to ensure that localized erosion will not be created, and that water runs back into the area where contamination occurred.
- At least 30m away from any watercourse, water body and natural vegetation.
- Large enough to allow for adequate movement of larger vehicles and equipment.

**Safely locate the vehicle and equipment away from any hazards. If mechanized, ensure engine is off and the vehicle or equipment is immobilized.*

How to Clean Inside

Clean the interior of the vehicle by sweeping, vacuuming or using a compressed air device. Particular attention should be paid to the floor, foot wells, pedals, seats and under the seats.

How to Clean Outside

Knock off all large clods of dirt. Use a pry bar or other device if necessary.

Identify areas that may require cleaning with compressed air rather than water such as radiators and grills. Clean these areas first prior to using water.

Clean the vehicle with a high pressure hose in combination with a stiff brush and/or pry bar to further assist the removal of dirt clods.

Start cleaning from the top of the vehicle and work down to the bottom.

Emphasis should be placed on the undersides, wheels, wheel arches, guards, chassis, engine bays, radiator, grills and other attachments.

When the cleaning is finished avoid driving through the waste water when removing the vehicle or equipment from the cleaning site.

For equipment such as water trucks that may be exposed to aquatic invasive species, trucks should be disinfected with bleach solution before conducting work in a new area. For further information please refer to the Invading Species Awareness Program's Technical Guidelines listed under Contacts and Resources.



Hosing down a vehicle in Queensland Australia

Photo by: TH9 Outdoor Services

Final Inspection Checklist

Conduct a final inspection to ensure the following general clean standard has been achieved:

- No clods of dirt should be visible after wash down.
- Radiators, grills and the interiors of vehicles should be free of accumulations of seed, soil, mud and plant material parts including seeds, roots, flowers, fruit and or stems.

Diagrams have been provided to assist in quickly identifying key areas to inspect and clean on a variety of vehicles associated with the targeted industries. These can be used in combination with vehicle checklists to ensure all areas of the vehicles have been inspected and cleaned.

Equipment Required

- A pump and high pressure hose OR High pressure water unit
- Minimum water pressure for vehicle cleaning should be at least 90 pounds per square inch. Water can be supplied as high volume/low pressure or low volume/high pressure (NOAA Fisheries Service).
- Air compressor and blower OR Vacuum
- Shovel
- Pry bar
- Stiff brush or broom



Cleaning station at construction site.

Photo by: Mark Heaton, OMNR

Inspection and Cleaning Diagrams and Checklists

2WD and 4WD Vehicles

4WD VEHICLE WITH KEY SPOTS TO CHECK AND CLEAN

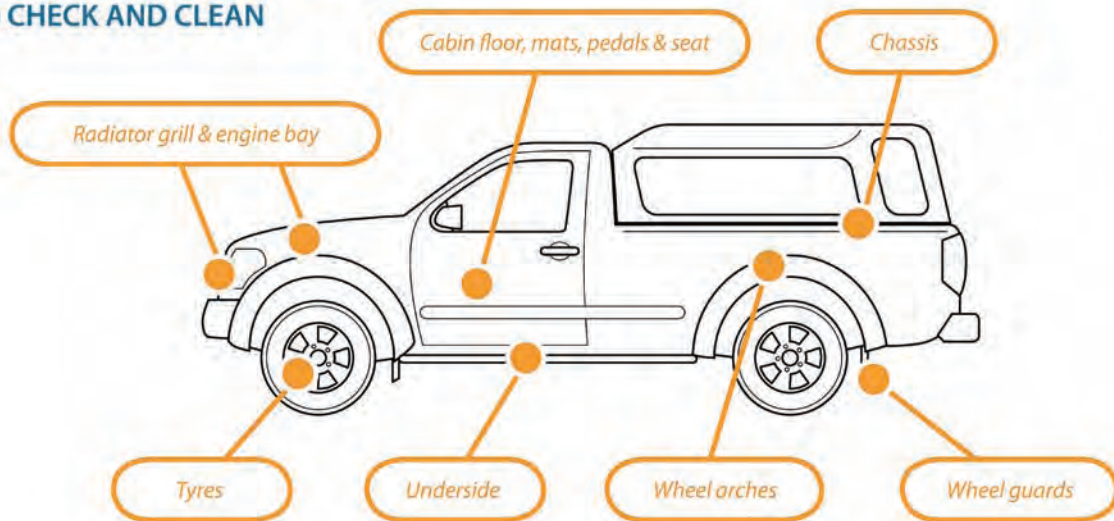

		✓
Cabin	Floor, mats, pedals, seats	
Engine	Radiators, engine bay, grill	
Body	Underside, chassis, crevices, ledges, bumper bars	
Wheels	All wheels (including spare), wheel arches, guards	
Tray	Floor, canopy (if included)	

Excavator

EXCAVATOR WITH KEY SPOTS TO CHECK AND CLEAN

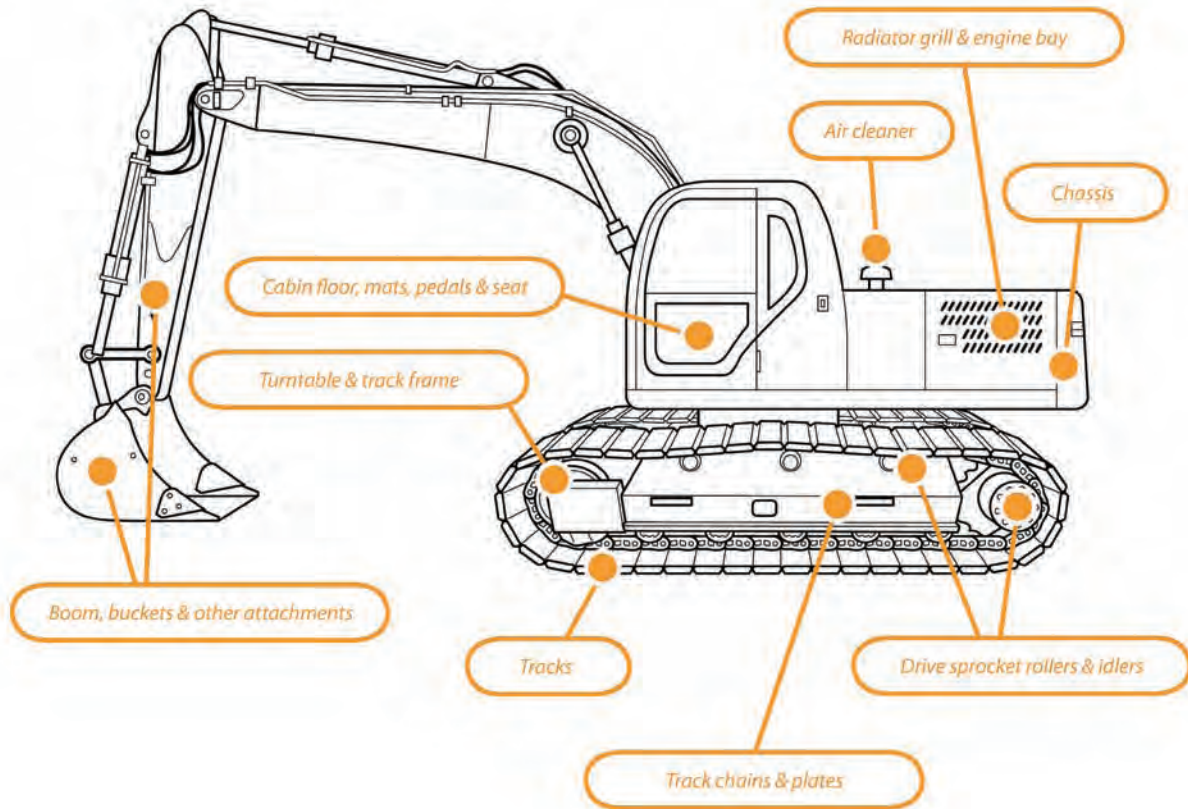

		✓
Cabin	Floor, mats, pedals, seats	
Engine	Radiators, engine bay, grill, air cleaner	
Tracks	Tracks, track frame, drive sprocket rollers, idlers	
Body Plates	Plates of cabin	
Body	Ledges, channels	
Bucket		
Booms		
Turret Pivot		

Backhoe

BACKHOE WITH KEY SPOTS TO CHECK AND CLEAN

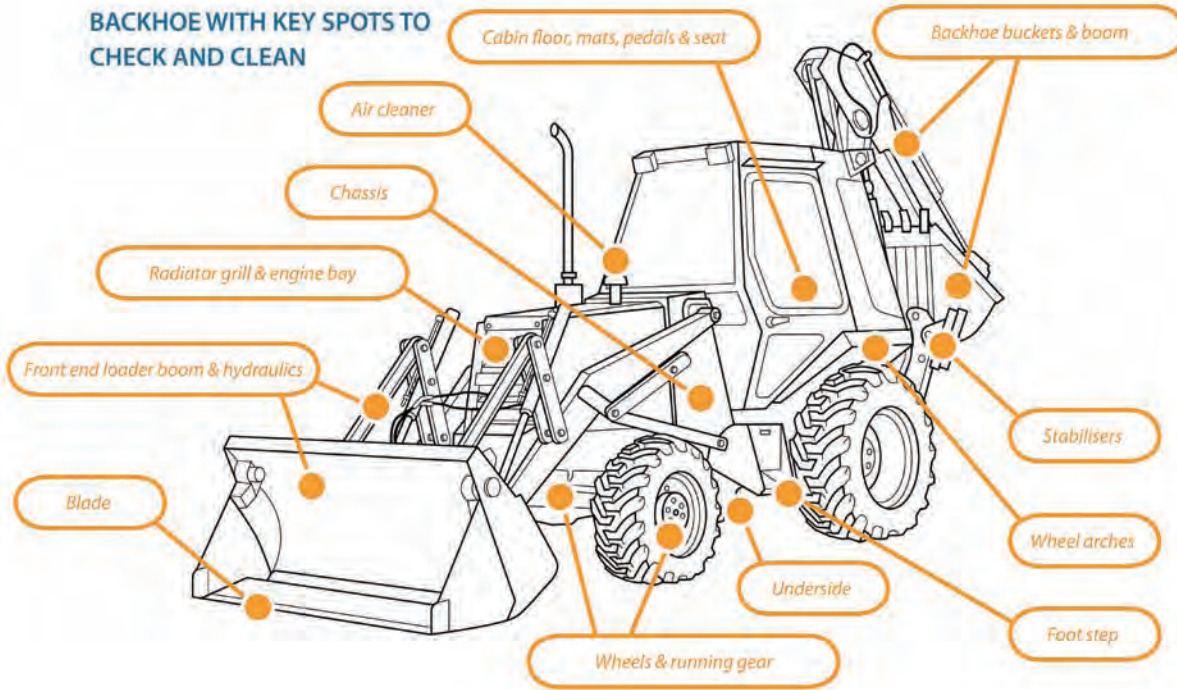

		✓
Cabin	Floor, mats, pedals, seats, foot step	
Engine	Radiators, engine bay, grill, air cleaner	
Wheels	All wheels (including spare), wheel arches, guards	
Front end loader	Blade, hydraulics, booms	
Backhoe	Buckets, boom, hydraulics, stabilizers	

Bulldozer

BULLDOZER WITH KEY SPOTS TO CHECK AND CLEAN

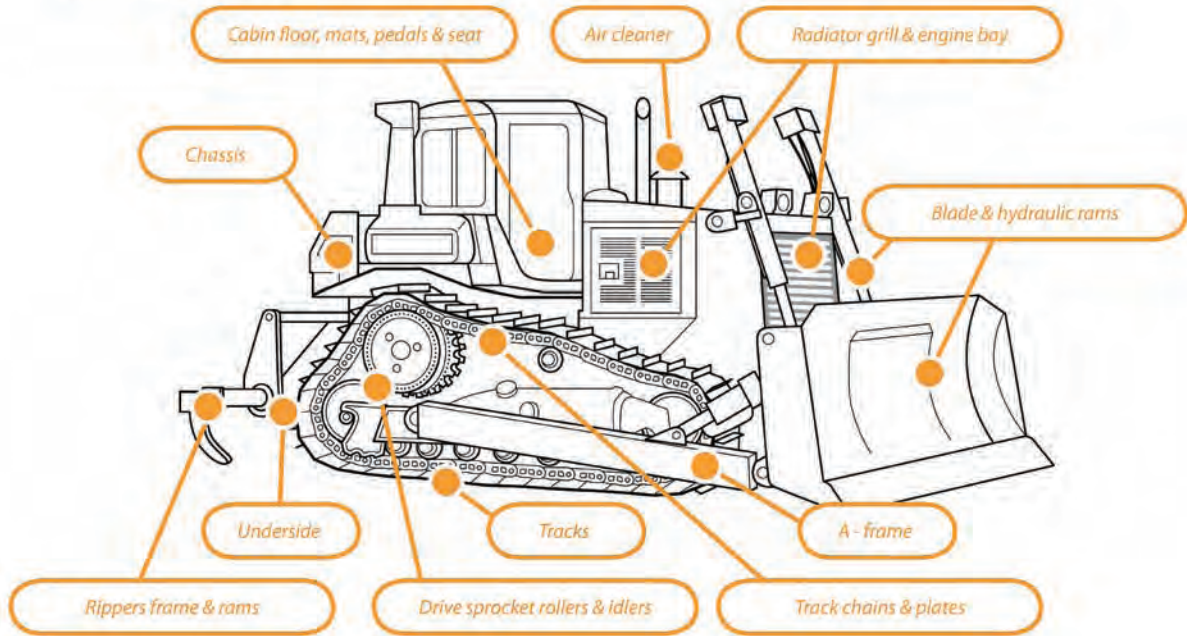

		✓
Cabin	Floor, mats, pedals, seats	
Engine	Radiators, engine bay, grill, air cleaner	
Tracks	Tracks, track frame, drive sprocket rollers, idlers	
Body Plates	Belly plates and rear plates	
Body	Ledges, channels	
Blade	Pivot points, hydraulic rams, a-frame	
Ripper	Ripper frame, ripper points	

Contacts and Resources

Ontario Invasive Species Strategic Plan 2012. Government of Ontario. Online, accessed May 8, 2012.

http://www.mnr.gov.on.ca/stdprodconsume/groups/lr/@mnr/@biodiversity/documents/document/stdprod_097634.pdf

Invasive Species Management for Infrastructure Managers and the Construction Industry 2008. Wade, M. Booy, O. and White, V. Online, accessed April 27, 2012

http://www.ciria.org/service/Web_Site/AM/ContentManagerNet/ContentDisplay.aspx?Section=Web_Site&ContentID=9001

T.I.P.S (Targeted Invasive Plant Solutions) Highway Operations. British Columbia Invasive Species Council. Online, accessed May 8, 2012

http://www.bcinvvasiveplants.com/iscbc/publications/TIPS/Highways_Operations_TIPS.pdf

Invading Species Awareness Program Workshop Manual: Aquatic Invasive Species: An Introduction to Identification, Collection and Reporting of Aquatic Invasive Species in Ontario Waters (includes information on decontaminating equipment).

<http://www.invadingspecies.com/download/publications/manuals/WorkshopManual.pdf>

Reporting Invasive Species

To report invasive species, or view maps of existing records, visit the Invading Species Awareness Program website www.invadingspecies.com/report/ or www.eddmaps.org/Ontario.

Or call the OFAH/MNR Invading Species Awareness Program Hotline at **1-800-563-7711**

Acknowledgements

We gratefully acknowledge NRM South (Tasmania, Australia) for allowing the use of their artwork and text from their “Keeping it Clean – A Tasmanian Field Hygiene Manual to Prevent the Spread of Freshwater Pests and Pathogens”.

We also sincerely thank the Clean Equipment Protocol Working Group and the Ontario Invasive Plant Council Committees and Board of Directors for their ongoing support and valuable input into this document, and the Canada-Ontario Invasive Species Centre and Ontario Ministry of Natural Resources for the support in creating this protocol.

Clean Equipment Protocol Working Group:

Diana Shermet, Central Lake Ontario Conservation Authority; Paula Berketo, Ontario Ministry of Transportation; Travis Cameron, Ontario Ministry of Natural Resources; Jennifer Hoare, Ontario Parks; Michael Irvine, Ontario Ministry of Natural Resources; Alison Kirkpatrick, OFAH/MNR Invading Species Awareness Program; Erika Weisz, Ontario Ministry of Natural Resources; Amanda Chad, Ontario Power Generation; Nancy Vidler, Lambton Shores Phragmites Community Group; Nigel Buffone, Du Pont Canada Company; Ewa Bednarczuk, Lower Trent Conservation Authority

We also gratefully acknowledge the input and direction from Francine MacDonald, James Rockwood, Anne-Marie Roussy, Stephen Smith, Caroline Mach, Patricia Lowe, John Bowen, Karen Hartley, and the Southern Ontario Community Forest Managers group.

More Information:

Ontario Invasive Plant Council: www.ontarioinvasiveplants.ca

Appendix A: Identification of Invasive Plants found in Ontario

- **Common Buckthorn** (*Rhamnus cathartica*) and **Glossy Buckthorn** (*Frangula alnus*)
- **Dog-strangling Vine** (*Cynanchum rossicum*)
- **Garlic Mustard** (*Alliaria petiolata*)
- **Japanese Knotweed** (*Polygonum cuspidatum*)
- **Phragmites or Common Reed** (*Phragmites australis subsp. australis*)
- **Giant Hogweed** (*Heracleum mantegazzianum*)

common & glossy buckthorn

(*Rhamnus cathartica* & *R. frangula*)



Plant type: Shrub/small tree

Arrangement: Common buckthorn are sub-opposite (almost opposite). Glossy buckthorn are alternate.

Leaf: The common buckthorn leaf is egg shaped, edge of the leaf is “pebbled” (small rounded teeth). Veins converging toward leaf top. The glossy buckthorn leaf is more slender (tear drop shaped) and smooth margined.

Bark: Smooth, young bark with prominent raised patches or lenticels; rough texture and peeling bark when mature.

Seed/Flowers: Flowers are green-yellowish, small and inconspicuous. Green berries becoming purplish/black in late summer, berry > 1 cm in diameter.

Buds/Twigs: Common buckthorn has thorn-like tip on many twigs. Glossy buckthorn buds have no bud scales and lack thorny tips to twigs.

Habitat: Various - forest, thickets, meadows, dry to moist soils.

Similar native species: Native dogwoods, which lack the thorny “tip”. Native dogwoods are truly opposite in arrangement of twigs; only alternate leaved (pagoda) dogwood has alternate branching.

dog-strangling vine

(*Cynanchum rossicum* & *C. nigrum*)

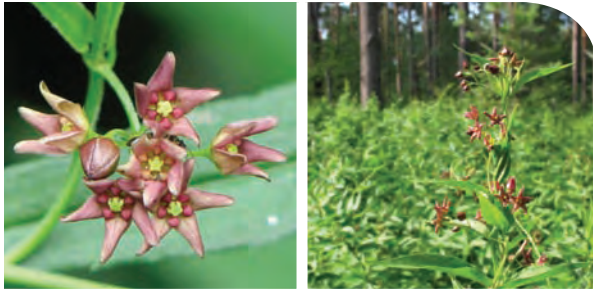

Plant type: Herb, twining vine

Arrangement: Opposite

Leaf: Lance shaped, smooth margin (edge)

Bark: n/a

Seed/Flowers: Bean shaped seed pod with seeds attached to downy 'umbrellas'. Flowers - pink (*C. rossicum*) or purple (*C. nigrum*) with five petals.

Buds/Twigs: n/a

Habitat: Dry to moist soils; more dominant in meadows and woodland edges.

Similar native species: Swamp milkweed (*Asclepias incarnata* spp.), is an upright plant, typically found in wetland habitats.

garlic mustard

(*Alliaria petiolata*)



Plant type: Herb

Arrangement: Alternate

Leaf: Saw tooth like edge, elongated heart shape. Garlic/onion smell when crushed. Leaves are kidney shaped with prominent veins.

Bark: n/a

Seed/Flowers: Cluster of small white flowers with four petals. Small black < 1 mm rounded seed found in elongated 'tube-like' seed pods (similar to a bean pod).

Buds/Twigs: n/a

Habitat: Various – dry to moist soils, in all habitat types, less often in meadows.

Similar native species: n/a

japanese knotweed

(*Polygonum cuspidatum*)



Plant type: Herb, 2 - 4 m in height.

Arrangement: Alternate

Leaf: Tear drop shaped, sharp pointed, dark green, flattened at base.

Bark: n/a

Seed/Flowers: Flowering stalk of many small greenish-white flowers.

Buds/Twigs: Large plant with a 'bamboo-like' stem. Stem light green maturing to tan colour.

Habitat: Moist to wet soils found in wetlands, water-courses and roadside ditches.

Similar native species: None.

common reed

(*Phragmites australis*)



Plant type: Grass

Arrangement: Alternate

Leaf: Broad leaf > 1 cm wide.

Bark: n/a

Seed/Flowers: Dense cascading 'broom-like' flower head. 'Cottony' in appearance when mature.

Buds/Twigs: Stems rough and ridged, ligule a densely hairy band. Mature plants > 3 m tall.

Habitat: Moist to wet soils. Found in wetlands, water-courses and road side ditches.

Similar native species: Species of mannagrass (*Glyceria* sp) including tall northern, eastern and rattlesnake grass. A native common reed exists but has a smooth stem and the ligule is not hairy. It is also quite rare.

giant hogweed

(*Heracleum mantegazzianum*)



Plant type: Herb. Mature plants can be over 3m tall.

Arrangement: Alternate

Leaf: Lobed leaf 1-2 m wide, lobes sharp-pointed.

Bark: n/a

Seed/Flowers: Small, white flowers in a large umbrella-shaped cluster, .75 m wide.

Buds/Twigs: Hairy stem with purple spots.

Habitat: Fresh to wet soils in forests, swamps, meadows, marshes.

Similar native species: Cow parsnip (*Heracleum maximum*) – has smaller flowers, no purple spots on stems. Angelica (*Angelica atropurpurea*) has a rounded-topped flower cluster and leaves divided into many leaflets.

Do not touch this plant because it is poisonous. If you do, wash your skin immediately in cool soapy water and do not expose the area to sunlight.

Seek professional advice before removing.

Identification of Invasive Plants found in Ontario Photos by:

Credit Valley Conservation, Greg Bales, Ken Towle, Patrick Hodge,
Ontario Federation of Anglers and Hunters, Francine Macdonald, Matt Smith

Appendix C: Native Tree and Shrub Species Appropriate for Planting

Common Name	Latin Name	Plant Description	Growing Conditions
Tree Species			
Eastern white cedar	<i>Thuja occidentalis</i>	- up to 15 m in height - excellent windbreaker when planted in buffer strips	Full sun to partial shade; shallow, moist or dry, non-acidic soil; tolerant of flooding
Sugar maple	<i>Acer saccharum</i>	- up to 35 m in height	Prefers deep, rich, moist soil; can tolerate shade but grows better in full sun
Black cherry	<i>Prunus serotina</i>	- up to 22 m in height	Tolerates different moisture levels and a variety of soils; full sun
Shrub Species			
Speckled alder	<i>Alnus incana</i>	- up to 6 m in height - habitat for nesting migratory birds - food source for birds	Various soil types; tolerant of flooding, full sun to partial shade
Red-osier dogwood	<i>Cornus stolonifera</i>	- 1 to 2 m in height - valuable wildlife food	Moist soil; tolerant of flooding, full sun to partial shade

Appendix D – Protocol for Wildlife Protection during Construction

Protocol for Wildlife Protection during Construction



City of Ottawa Protocol for Wildlife Protection during Construction

Contents

PREAMBLE	3
1 Introduction	3
1.1 Application of protocol	4
1.2 Other Legislative Requirements	4
1.3 Wildlife Expertise	4
2 Best Practices	5
2.1 Project-specific Wildlife Protocol.....	5
2.2 Sensitive Timing Windows.....	5
2.3 Pre-stressing	6
2.4 Site Clearing	9
2.5 Construction Site Management	10
2.6 Wildlife Encounters.....	11
2.7 Wildlife-proofing.....	12
2.8 Owner Awareness	13
3 Conclusion	13
4 Additional Resources	14

Tables

Table 1: Sensitive times for wildlife in various habitats, with recommendations for reducing impacts of construction.....	7
---	---

Appendices

Appendix 1: Example of On-site Reference Handout.....	16
---	----

City of Ottawa Protocol for Wildlife Protection during Construction

PREAMBLE

The updated City of Ottawa Protocol for Wildlife Protection during Construction has been developed in response to a direction provided by Council on July 17, 2013, as part of the City's Wildlife Strategy. The protocol is a compilation of best practices that serves as a guide and a common frame of reference for the City and the development industry in addressing wildlife protection during construction. The protocol also serves as a guide and frame of reference for City staff involved in planning and carrying out capital projects or other activities that may affect wildlife and wildlife habitat. The protocol itself is not intended to define new requirements for wildlife protection during construction, nor does the protocol provide for proponents of development a means to not adhere to other applicable legislation such as the *Endangered Species Act, 2007* or the *Migratory Birds Convention Act*. The techniques and methods to provide for wildlife protection will continue to be identified by proponents of development through studies that are required as set out in the Official Plan (e.g., Environmental Impact Statements, Tree Conservation Reports) to meet legislative requirements and with consideration to best practices as compiled within this document. Specific requirements for wildlife protection will continue to be defined by staff in consultation with proponents and their consultants, and included as conditions of approval where appropriate through subdivision, condominium and site plans.

1 Introduction

This protocol is intended to help reduce the direct impacts of development on wildlife that occur during construction. It also provides some guidance on how to help reduce conflicts between residents and wildlife in newly-constructed neighbourhoods, through better wildlife-proofing and awareness. The protocol complements and supports the City's Environmental Impact Statement (EIS) Guidelines, which address impact assessment and mitigation in a more general way during the development planning and review process, and the Tree Conservation Report (TCR) Guidelines, which address impact assessment and mitigation for trees. The protocol promotes best management practices relating to sensitive timing windows for clearing, pre-stressing, site clearing, construction site management, wildlife encounters, wildlife-proofing, and owner awareness.

1.1 Application of protocol

This protocol may be used to guide wildlife protection planning in plans of subdivision, plans of condominium, and site control plans for properties that include or are located adjacent to wildlife habitat, including:

- areas of tall grass;
- shrubs;
- trees or woodlands;
- watercourses;
- wetlands; or,
- complex features such as rock piles, junk heaps, or vacant structures.

Applicants will be advised of the protocol's relevance to their site at pre-consultation.

If a proposed development requires an Environmental Impact Statement or a Tree Conservation Report under the policies of the Official Plan, any recommendations in the EIS/TCR related to mitigating impacts to wildlife from construction activity will be expected to meet or exceed the standard of protection established in this protocol. The recommendations from the EIS/TCR will be used by City staff during the development review process to develop conditions of approval for the project.

This protocol also provides useful information for City staff and members of the public, which can be referred to when planning other projects and activities, such as the development of single lots under a building permit, the construction of new infrastructure, or in non-development related vegetation clearing.

1.2 Other Legislative Requirements

This protocol provides guidance on best practices to protect Ottawa's wildlife during construction and related activities. There are several legislative requirements for the protection of various species or groups of wildlife (e.g., provincial *Fish and Wildlife Conservation Act, 1997* and *Endangered Species Act, 2007*; federal *Species at Risk Act, Migratory Birds Convention Act, and Fisheries Act*). It remains the responsibility of the property owners and their agents to ensure that their actions comply with all applicable legal requirements.

1.3 Wildlife Expertise

Project proponents will typically rely on professional biologists or environmental consultants to advise them with respect to wildlife. Other potential sources of information and advice on wildlife include wildlife service providers, wildlife rehabilitators and other local experts, as well as relevant agency staff (e.g., Ministry of Natural Resources and Forestry, Canadian Wildlife Service). Links to various sources of additional information that may be useful in wildlife protection planning are provided in Section 4 of this protocol.

Wildlife rehabilitators provide care for orphaned or recuperating wildlife, with the aim of returning them to the wild when they are able to care for themselves. Rehabilitators must receive authorisation from the Ministry of Natural Resources and Forestry (and/or Environment Canada, for migratory birds) on an annual basis. There are very few authorised rehabilitators in the Ottawa area (see links in Section 4). By making pre-arrangements with wildlife rehabilitators, as recommended in this protocol, project proponents can help rehabilitators to

determine whether local capacity exists to handle their potential needs. Rehabilitators and other local experts can also advise proponents on ways to avoid injuring or orphaning wildlife, thus reducing the need for rehabilitation. Similarly, pre-arrangements should be made with local veterinarians to ensure that they are able to treat injured wildlife.

2 Best Practices

2.1 Project-specific Wildlife Protocol

For some projects where an EIS has identified large areas of wildlife habitat, or particularly sensitive areas of wildlife habitat, a project-specific wildlife protocol may be needed to ensure that the recommendations in the EIS are appropriately implemented during construction. The following information should be clearly conveyed to the on-site staff as part of the project-specific wildlife protocol, via notes on plans, handouts and/or on-site briefings:

- Schedule for pre-construction activities such as inspections for wildlife, installation of protective fencing, pre-stressing, and on-site briefings for contractors;
- Description of wildlife mitigation measures to be used during construction, including;
 - Identification of any natural areas, trees or other features to be retained;
 - Placement and specifications of required protection measures (e.g., fencing, signs);
 - Phasing and direction of site clearing activities;
 - Any recommendations regarding internal access routes for vehicles and other heavy equipment, vehicle parking, materials staging and stockpiling, fuel storage and handling, etc.; and,
- Guidance on how to deal with wildlife encounters, including any species at risk that may be present, and arrangements for dealing with injured or orphaned wildlife. This guidance should be summarized in a handout suitable for quick reference by on-site staff (see example in Appendix 1).

When a project-specific wildlife protocol is needed, it should typically be developed close to or following approval of the project, when the plans have been finalized and more information on scheduling is available. For projects involving early servicing or other site preparation activities in advance of approval, the EIS consultant should provide appropriate advice on wildlife protection measures prior to the commencement of on-site activities. This can be done in conjunction with the Tree Conservation Report requirements, where applicable.

2.2 Sensitive Timing Windows

The greatest disruption to wildlife generally occurs when a site is cleared, removing the existing habitat. The timing of site clearing should be carefully considered, because the impacts to wildlife will be greater during sensitive times of the year. During the winter, overwintering and hibernating wildlife may be physically unable to escape from the site, or may freeze or starve to death if forced to leave their dens and food caches. In the spring and summer, most species are more mobile, but mothers will be laying eggs or bearing young. The most profound impacts to wildlife occur when they are displaced from their habitat at such critical times during their life cycle. Table 1 identifies sensitive times of the year for various habitat types and wildlife. This information can be used to determine what time(s) of year may be sensitive at a particular site, based on which types of habitat and wildlife are actually

present. Where possible, site clearing should be planned to occur outside of the applicable sensitive time(s); otherwise, additional mitigation measures should be employed to reduce the impacts.

These timing windows are provided for guidance only, and should not be relied upon in cases where legislated restrictions apply (e.g., under the *Endangered Species Act, 2007*). The federal *Migratory Birds Convention Act* prohibits the unauthorized killing or harassment of migratory birds and the disturbance or taking of their nests and eggs, but does not refer to specific timing windows. The Canadian Wildlife Service (Environment Canada) provides information on how to avoid impacts to migratory birds and their nests during construction, including the timing of bird breeding seasons in Canada (see list of Additional Resources in Section 4.0 below) in order to assist proponents in their project planning; however, these are not legislated dates, and the federal prohibitions apply throughout the year.

All sites should be inspected by a biologist prior to clearing, to identify any potential wildlife issues (e.g., hibernating animals or nursing mothers and their young, etc.) and to inform or adjust mitigation planning as needed. The timing and scope of this inspection will vary depending on the type and extent of habitat to be affected, the availability of existing information about the wildlife on the site (from an EIS or other sources), and the anticipated timing for site clearing. Table 1 includes recommendations for specific habitat searches that should be included in the scope of the EIS, where applicable, or the site inspection. For more information about the timing of site inspections and associated pre-stressing activities that should occur prior to clearing, see Section 2.3, Pre-stressing below.

In cases where site clearing needs to occur during sensitive times of the year (and no regulated restrictions apply) additional mitigation measures may be needed to reduce impacts to wildlife. Potential mitigation measures include:

- More intensive pre-stressing to encourage resident wildlife to leave the site;
- Installation of appropriate nesting boxes around the periphery of the site, to compensate for nesting sites (e.g., cavity trees, squirrel dreys) that will be removed;
- In some cases, where winter food caches will be lost and other sources of food are scarce, supplemental food sources may need to be temporarily provided in safe locations away from the work space;
- Retention of qualified agents to provide on-site monitoring during site clearing, and/or on-call advice and assistance;
- Pre-arrangements made with wildlife rehabilitators and qualified veterinarians to ensure appropriate care of orphaned or injured wildlife.

2.3 Pre-stressing

“Pre-stressing” is a term used to describe actions taken to encourage wildlife to move away from a site prior to the onset of construction. Common methods of pre-stressing include having one or more people walk the site while talking loudly or playing loud music, or placing pieces of cloth or other objects that carry a strong human scent into animal dens. To be effective, these measures may need to be combined and repeated several times over the course of two to three weeks. Some common pre-construction activities, such as surveying, or installing protective fencing, can contribute to pre-stressing. In urban areas where wildlife are already accustomed to human presence, pre-stressing using human sounds and scents may be less effective; other repellants may be needed.

Table 1: Sensitive times for wildlife in various habitats, with recommendations for reducing impacts of construction*

Habitat Type	Wildlife	Sensitive time(s)	Recommendations
Grasslands and old fields	<p>Migratory birds and raptors</p> <p>Small mammals and other wildlife</p> <p>Note: several Species at Risk birds use grasslands and open habitats; consult Ministry of Natural Resources and Forestry (MNR).</p>	<p>April through mid-August (breeding season for most species)</p> <p>Mid-October through March (for overwintering woodchucks, if present)</p>	<p>Reduce potential wildlife usage by mowing outside of breeding season, then maintain as mowed grass until on-site work begins.</p> <p>Woodchucks, if present, may persist on mowed sites. Avoid impacting burrows during sensitive times for this species, where possible.</p>
Shrubs or trees (growing as individuals or in small clumps or hedgerows)	<p>Migratory birds and raptors</p> <p>Small mammals and other wildlife</p>	<p>The following only apply if wildlife are actually using the habitat:</p> <p>March through mid-August (breeding season for most species)</p> <p>Mid-October through March (for cavity trees or other den sites)</p>	<p>Retain a biologist to inspect habitat. If no active nests or dens are present, clearing should be done within a few days of inspection (during sensitive times of year, clearing should occur the same day if possible).</p>
Thickets or woodlands	<p>Migratory birds and raptors</p> <p>Mammals and other wildlife</p> <p>Note: several Species at Risk use thicket, edge and woodland habitats; consult MNR.</p>	<p>March through mid-August (breeding season for most species)</p> <p>Mid-October through March (for overwintering wildlife)</p>	<p>Do not clear during sensitive times of the year, unless mitigation measures are used to reduce risks to wildlife.</p> <p>The Canadian Wildlife Service does not support relying on inspections for migratory bird nests in such habitats, due to the difficulty of locating all nests and the risk to the birds.</p>
Complex features (e.g., piles of	Mammals and other wildlife (e.g., snakes)	March through July (breeding season for most	Retain a biologist to inspect habitat prior to removal. In cases where

*NOTE: The information in this Table can be used to determine what time(s) of year may be sensitive at a particular site, based on which types of habitat and wildlife are actually present. Where possible, site clearing should be planned to occur outside of the applicable sensitive time(s); otherwise, additional mitigation measures should be employed to reduce the impacts. The recommendations provided do not address Species at Risk requirements under the *Endangered Species Act, 2007*. For situations involving Species at Risk, regulated timing restrictions, mitigation measures or compensation requirements may apply (consult the Ministry of Natural Resources and Forestry for more information).

Table 1: Sensitive times for wildlife in various habitats, with recommendations for reducing impacts of construction*

Habitat Type	Wildlife	Sensitive time(s) species)	Recommendations
rock or wood, stone walls, derelict vehicles, junk heaps, etc.)		<p>species)</p> <p>October through March (for overwintering wildlife, including snakes)</p>	<p>presence of wildlife is confirmed or uncertain, disassemble slowly, outside of relevant sensitive time(s), to reduce potential impacts and allow wildlife time to relocate.</p>
Vacant buildings or other structures	<p>Some birds</p> <p>Small mammals and other wildlife (e.g., snakes)</p> <p>Note: some Species at Risk, including barn swallows and little brown bats, use buildings and other structures; consult MNRF.</p>	<p>March through mid-August (breeding season for most species)</p> <p>Mid-October through March (for overwintering wildlife)</p>	<p>Retain a biologist to inspect habitat prior to removal. In cases where presence of wildlife is confirmed or uncertain, demolition may need to be done in controlled stages, outside of relevant sensitive time(s), to reduce potential impacts and allow wildlife time to relocate.</p>
Wetlands and waterbodies	<p>Migratory birds, including waterfowl</p> <p>Mammals</p> <p>Aquatic reptiles and amphibians</p> <p>Fish</p> <p>Note: many Species at Risk use wetlands and other aquatic habitats; consult MNRF.</p>	<p>March through August (breeding season for most species); note that this includes regulated in-water timing restriction for warmwater fishes (March 15 to June 30)</p> <p>August through October (emergence of hatchling turtles, if turtle nests are present)</p> <p>Mid-October through March (for overwintering wildlife, including turtles)</p>	<p>Do not clear during sensitive times of the year, except in cases where exclusion fencing or other mitigation measures can be used to reduce risks to wildlife.</p> <p>Exclusion fencing can be useful when working in or around these habitats, to prevent wildlife (especially turtles) from entering work areas.</p> <p>Fish and other highly aquatic wildlife such as turtles and frogs may need to be relocated prior to commencing work (permits required from MNRF for relocation).</p>

*NOTE: The information in this Table can be used to determine what time(s) of year may be sensitive at a particular site, based on which types of habitat and wildlife are actually present. Where possible, site clearing should be planned to occur outside of the applicable sensitive time(s); otherwise, additional mitigation measures should be employed to reduce the impacts. The recommendations provided do not address Species at Risk requirements under the *Endangered Species Act, 2007*. For situations involving Species at Risk, regulated timing restrictions, mitigation measures or compensation requirements may apply (consult the Ministry of Natural Resources and Forestry for more information).

Timing and frequency of pre-stressing activities will vary depending on the site context, the amount of information known about wildlife at the site, and the proposed schedule for site clearing. Suggested site inspection and pre-stressing schedules are as follows:

- For sites with good wildlife information and/or little habitat to be affected, that will be cleared outside of any applicable sensitive timing windows (low risk of impacts): one site inspection combined with pre-stressing within a few days prior to clearing.
- For sites with poor wildlife information and/or larger areas of habitat being affected, that will be cleared outside of any known sensitive timing windows (moderate risk of impacts): first site inspection 2-3 weeks in advance, with pre-stressing and follow up inspections as needed based on results; final inspection/pre-stressing on the day before clearing for each phase.
- For sites that will be cleared during sensitive times of the year (high risk of impacts): first site inspection 3+ weeks in advance with multiple pre-stressing and follow up inspections; final inspection/pre-stressing on the day before clearing for each phase.

Note: for sites located within or adjacent to existing developed areas, nearby residents should be informed about the onset of pre-stressing activities and the potential for increased encounters with wildlife dispersing from the site. Sources of information on avoiding conflicts with wildlife should be provided (see Section 4). The City's Noise By-law needs to be respected.

2.4 Site Clearing

Vegetation removal (including mowing of tall grass) and other site clearing activities should proceed in phases, generally moving from the most disturbed part of the site (closest to existing development) towards the least disturbed part of the site. Even on small sites that can be cleared in a single day, it is important to follow this pattern in order to "herd" wildlife out of the site into adjacent undisturbed habitat, or towards the nearest habitat. Some examples of possible scenarios are provided below. Site clearing should be timed to avoid disturbance of habitat areas during sensitive times of the year (see Section 2.2) where possible.

Scenario 1: The work space directly abuts a natural area or open space that will be protected and retained.

Site clearing activities should begin at the far side of the property from the retained natural area and proceed towards it. The goal is to ensure that any wildlife within the work space can retreat into the retained natural area without having to cross cleared lands.

Scenario 2: There is an existing natural connection (stream corridor, hedgerow or other natural linkage) between the work site and a nearby natural area.

Site clearing activities should be phased to funnel wildlife towards the existing connection. Areas of habitat within the work space should not become isolated from the connection until the final stages of this process.

Scenario 3: The site includes one or more isolated areas of habitat to be cleared, with no existing connection to other natural areas nearby.

One or more open “escape routes” between the habitat and the edge of the site should be maintained until the final phases of vegetation clearing are completed. These escape routes should be defined on the site with fencing to ensure they stay open, and to help channel wildlife movement. Clearing should begin at the far side of the habitat and proceed towards the designated escape route.

In all cases, each area to be cleared should be inspected (and, if necessary, pre-stressed) by the project biologist one more time the day before clearing, to determine whether any trees or other habitat features are still being used by wildlife. Any occupied trees/features should be flagged for temporary retention for at least one additional day, to allow wildlife a last chance to move out. In cases where occupancy is uncertain, the same precaution should apply. If they do not leave on their own, then it may be necessary to have a professional wildlife service provider relocate them, in accordance with applicable laws (e.g., *Fish and Wildlife Conservation Act, 1997* for most commonly encountered wildlife species). Relocation is not an option for some species; for example, if a migratory bird is nesting on site, a protected buffer zone may need to be established and maintained until the birds are finished nesting (the width of such buffer zones varies depending on the species, and should be determined by the project biologist in consultation with Environment Canada). This may affect the phasing or overall schedule for site clearing and subsequent on-site activities.

Any fencing between the work space and the natural habitat to which wildlife are being directed during site clearing must allow for wildlife passage; otherwise, wildlife may be unable to escape from the site. Acceptable fencing options are those which provide low gaps at the bottom of the fence to permit passage by small to medium species, and which are no more than 1.2 m high for larger species such as deer to leap over. Plastic snow fencing can be used, if suitable gaps are provided at intervals along the bottom edge (these can be cut out, or natural gaps caused by uneven terrain at the base of the fence). Once the work space has been cleared, these gaps should be closed or a more secure perimeter fence can be installed to reduce the risk of wildlife returning to the site.

2.5 Construction Site Management

Construction sites are normally managed to promote safety, efficiency and legal compliance. Site management is a key factor in reducing the overall environmental impact of the project, by controlling the risks of environmental contamination, soil compaction, and damage to trees and other natural features intended for retention. It also helps to reduce the risks to wildlife, by controlling the activities on-site that could directly or indirectly harm them.

All personnel should be briefed about wildlife protection measures at the outset of the project, in order to ensure that these measures are clearly understood and appropriately implemented. The briefing needs to provide an overview of the mitigation measures that are being used at the site, as well as instructions on what to do if and when wildlife are encountered during the work. It should also include information on any species at risk that may be present, and what to do if one is seen. A laminated handout summarising key information on wildlife protection should be kept on-site at all times for reference by staff (see example of a handout in Appendix 1). The handout should be tailored to suit the needs of each specific project, but should address the following subjects:

- General provisions – e.g., do not harm, feed or unnecessarily harass wildlife; drive slowly and avoid hitting wildlife where possible; keep site tidy and secure
- Species at risk – basic identification tips and recommendations (needs to be modified to address species most likely to be encountered at the site)
- Contact information for:
 - Project biologist / wildlife service provider
 - Ministry of Natural Resources and Forestry, Kemptville (for species at risk)
 - Wildlife rehabilitators and veterinarians (for orphaned or injured wildlife)

The management of the site needs to specifically address how to avoid attracting wildlife to the work space. Although on-site activities will generally discourage wildlife from entering the work space during the day, they may be drawn to the site at night (or on weekends) if it appears to provide sources of food, water or shelter. The following common attractants should be controlled or eliminated:

- Food wastes and other garbage – effective mitigation measures include waste control (prevent littering); keeping all trash secured in wildlife-proof containers, and prompt removal from the site (especially in warm weather).
- Water – effective mitigation measures include ensuring proper site drainage to limit standing pools of water; fencing off temporary storm ponds and other waterbodies within the work space (and not permitting wildlife access to any potentially contaminated waterbodies); and, use appropriate sediment and erosion control measures to protect the quality of surface water adjacent to or downstream of the work space.
- Shelter – effective mitigation measures include covering or containing piles of soil, fill, brush, rocks and other loose materials; capping ends of pipes where necessary to keep wildlife out; ensuring that trailers, bins, boxes, and vacant buildings are secured at the end of each work day to prevent access by wildlife.

While all personnel need to be aware of the wildlife protection measures, one or more people should be specifically tasked with ensuring that those measures are properly implemented, by performing the following duties:

- Checking the work site (including previously cleared areas) for wildlife, prior to beginning work each day;
- Regularly inspecting protective fencing or other installed measures to ensure their integrity and continued function; and,
- Monitoring construction activities to ensure compliance with the project-specific protocol (where applicable) or any other requirements.

For simple, low-risk projects, construction staff may be able to undertake this work (with help from contracted professionals if any issues arise). Large-scale or complex projects may benefit from the presence of a part or full time specialist such as an environmental officer, biologist or wildlife service provider, particularly during site clearing. Professional expertise is strongly recommended in cases where site clearing is being carried out during sensitive times of the year.

2.6 Wildlife Encounters

Ideally, the mitigation measures described above would allow all local wildlife to vacate the site before it was cleared, and no wildlife would return until the project was completed. In reality, however, it is very likely that wildlife will be encountered on-site at some point during the construction process. Wildlife may return to the site after dark, seeking the habitat that used to

be there. They may also be attracted to the site if it appears to provide food, water or shelter, as previously described in Section 2.5. Proper site management will reduce the risk of wildlife trying to move back onto the site, while daily inspections before work begins will reduce the risk of harm to any wildlife that has wandered in overnight.

Any wildlife encountered during site clearing or subsequent construction activities should be allowed to exit the site on their own, via safe routes. Construction staff should not attempt to capture or handle most kinds of wildlife, unless an animal is in imminent peril or is injured and cannot wait for rescue by qualified personnel. Improper handling can result in injuries to both workers and wildlife, and may in some cases contravene provincial or federal legislation. Removal and relocation of mammals, in particular, should only be done by qualified wildlife service providers working in accordance with applicable laws (i.e., *Fish and Wildlife Conservation Act, 1997*).

If young birds or mammals are discovered on a site, contact the project biologist, a wildlife rehabilitator, or other wildlife expert for advice. In most cases, they should be left alone. The mother is very likely nearby and will return if given the chance. For primarily nocturnal species like raccoons and skunks, she may wait until evening to move her family to a safe location.

Useful equipment for wildlife encounters:

- Work gloves, to reduce the risk of injury from bites or scratches
- Push broom for gently redirecting small mammals, reptiles or amphibians
- Clean (uncontaminated) towels or blankets and assorted containers such as plastic sweaterboxes, cat carriers, and a large bin or garbage can for capturing and transporting injured or orphaned wildlife (note: small cardboard boxes or unwaxed paper bags are best for small birds)

Scratches and bites from animals, whether domestic or wild, can result in serious infections and/or transmit diseases. Immediate medical treatment should be sought for any person injured by an animal.

2.7 Wildlife-proofing

Wildlife can cause significant property damage and even health and safety issues when they seek shelter in, on or under buildings. Wildlife-proofing measures have been developed to address these problems, but many of these measures are typically installed by building owners in response to an issue, rather than being installed proactively during the construction of the building. The Ontario Building Code (OBC) does not address the subject of wildlife-proofing in great detail. It does require that sources of natural ventilation (other than windows) be constructed to provide protection from insects and weather, and that outdoor air intakes and exhaust outlets should be screened to prevent entry of animals and insects. However, these requirements alone may not protect a building from wildlife determined to find a way in. The most common access points are through vents, chimneys, roofs and eaves; wildlife will also frequently seek shelter underneath porches, stairs and raised decks.

Builders and contractors are encouraged to go beyond the requirements of the OBC and provide their clients with additional built-in protection against wildlife. This could include upgrading materials to use more wildlife-resistant metal components instead of plastic. Heavy screening or other exclusion measures could be installed to keep wildlife out of crawl spaces under porches or exterior stairs, including below grade to deter digging animals. Quality

assurance programs should include checking for any loose external fittings or gaps that could allow access by wildlife.

Buildings which feature large windows or other expanses of glass may need a different type of wildlife-proofing. These buildings can pose a risk to birds, which may not recognise the glass as a barrier. Many birds are injured and killed in collisions with glass each year, especially during spring and fall migration. Several major cities across North America, including Toronto and Vancouver, have introduced bird-friendly design guidelines to address this issue. FLAP Canada also provides advice on how to reduce risks to birds on its website (see Section 4, Additional Resources, below). Architects are encouraged to consider the potential risks to birds when designing buildings with glass exteriors or large banks of windows, and to take steps to reduce those risks.

2.8 Owner Awareness

Once construction has been completed, the potential conflicts between people and wildlife living in the new development can generally be best handled through education. “Owner Awareness Packages” are commonly required as a mitigation measure for new developments in or adjacent to natural areas. These packages are intended to inform residents about the environmental significance and sensitivities of the natural areas, and also to provide guidance on how to avoid having (or causing) problems, including conflicts with wildlife. There are many available sources of information to draw upon when assembling such packages (see Section 4). The finished product may consist of a simple brochure or one-pager, or may be a more comprehensive handbook. It should include:

- Basic information about common wildlife that may be expected to occur in the area;
- Information about any species at risk that residents should be aware of, and the legal protections associated with these species;
- Information on potential implications of allowing pets to roam unattended (including possible impacts to pets and/or wildlife, as well as legal restrictions under municipal and provincial regulations);
- Recommendations for maintenance of any wildlife-proofing measures included in the building;
- Suggestions on other ways to avoid or reduce human-wildlife conflicts; and,
- Sources of additional information.

3 Conclusion

By following this protocol and planning ahead for wildlife protection, project proponents should be able to reduce construction-related impacts on Ottawa’s wildlife, remain compliant with federal and provincial legislation, and help residents to avoid problems with wildlife in the longer term.

4 Additional Resources

City of Ottawa – information on Ottawa’s wildlife and conflict avoidance at <http://ottawa.ca/en/residents/water-and-environment/animals-ottawas-wildlife>

Environment Canada (Canadian Wildlife Service) – information on avoiding incidental take of migratory birds at <http://www.ec.gc.ca/paom-itmb/default.asp?lang=En&n=C51C415F-1>

Environment Canada (Canadian Wildlife Service) – general nesting periods of migratory birds in Canada at <http://www.ec.gc.ca/paom-itmb/default.asp?lang=En&n=4F39A78F-1>

FLAP Canada – information on how to reduce building-related risks to birds, including links to various cities’ bird-friendly design guidelines, at <http://www.flap.org/index.php>

Government of Canada – Species at Risk Public Registry, including information on all federally listed species at risk, at <http://www.registrelep-sararegistry.gc.ca/default.asp?lang=en&n=24F7211B-1>

Ministry of Natural Resources and Forestry – information on Species at Risk in Ontario at <http://www.ontario.ca/environment-and-energy/species-risk>

Ministry of Natural Resources and Forestry – contact information for authorized wildlife rehabilitators at <http://www.ontario.ca/environment-and-energy/find-wildlife-rehabilitator>

Ministry of Natural Resources and Forestry – illustrated instructions on safe handling of turtles, snakes, amphibians and birds, as well as directions on appropriate relocation and reporting of species at risk encounters, in the “Ontario Species at Risk Handling Manual: For Endangered Species Act Authorization Holders” at http://files.ontario.ca/environment-and-energy/species-at-risk/mnr_sar_tx_sar_hnd_mnl_en.pdf

Ministry of Natural Resources and Forestry – Species at Risk Branch Best Practices Technical Note on Reptile and Amphibian Exclusion Fencing, at http://files.ontario.ca/environment-and-energy/species-at-risk/mnr_sar_tx_rptl_amp_fnc_en.pdf

Ottawa-Carleton Wildlife Centre – information on commonly encountered species and conflict avoidance at <http://wildlifeinfo.ca/index.html>

Ottawa Humane Society – emergency response for injured wildlife, guidance on common wildlife issues, and information on wildlife service providers at <http://www.ottawahumane.ca/protection/wildlifeissues.cfm>

Ottawa Stewardship Council – Species at Risk Handbook for Ottawa at <http://www.ottawastewardship.org>

Rideau Valley Wildlife Sanctuary – wildlife rehabilitation centre; information on what to do for apparently orphaned or injured wildlife at <http://www.rideauwildlife.org/index.html>

Wild Bird Care Centre – wild bird rehabilitation centre; information on avoiding conflicts with birds and what to do for apparently orphaned or injured birds at <http://wildbirdcarecentre.org/index.php>

Appendix 1: Example of On-site Reference Handout

General Provisions:

- Watch out for wildlife while driving, and avoid hitting them, provided that it is safe to do so.
- Ensure sediment and erosion control measures (i.e., silt fencing) and other protective measures are in place prior to beginning work. Inspect them regularly, and particularly after storm events, to ensure their continued effectiveness.
- Prior to beginning work each day, check for wildlife by conducting a thorough visual inspection of the work space and immediate surroundings.
- Restrict all activities, vehicles and materials to the designated work space. Do not disturb areas identified for retention.
- Secure stockpiled materials, vehicles and structures against wildlife entry.
- Litter and other waste materials must be appropriately contained and promptly disposed of.
- Do not feed any wildlife or leave food out where it could attract them.

For health and safety reasons, and for protection of animals, removal and relocation of mammals must only be done by qualified and properly equipped personnel. Call the wildlife service provider [NAME] at (613) XXX-XXXX for assistance.

For injured wildlife, call the Ottawa Humane Society Emergency Services at (613) 725-1532. For injured birds, call the Wild Bird Care Centre at (613) 828-2849.

Scratches and bites from animals, whether domestic or wild, can result in serious infections and/or transmit diseases. Seek medical treatment immediately for any person injured by an animal.

Wildlife Encounters:

- **Do not harm any wildlife.** Many species are protected under provincial and/or federal legislation. Legal protection of egg-laying species applies to their eggs as well. Penalties for contravening these Acts can be severe.
- **Stand back** and allow the animal to leave the site. Wildlife may be encouraged to move away from the work area by shouting, waving of arms, clapping of hands or gentle redirection using a push broom. Contact project biologist / wildlife service provider for assistance if needed (e.g., if young animals are found). Do not unnecessarily harass any wildlife.
- **Turtles** may need to be helped to safety. Our most common species, Painted and Snapping Turtles, are protected under the Fish and Wildlife Conservation Act, 1997. If one of these turtles is found in the work area, it can be gently removed to a safe location nearby. Wear gloves, or use a broom to steer the turtle into a bucket or other container. Handle with care to avoid injury to the turtle or yourself, particularly when dealing with Snapping Turtles, which may bite or scratch. Turtles may also wet themselves when handled.
- Most of Ottawa's **snakes** are protected under the Fish and Wildlife Conservation Act, 1997. None of them are venomous, but bites may cause infections. Some produce a foul-smelling musk when handled, instead of biting. Snakes will usually try to escape or hide when disturbed, and only defend themselves when trapped. If a snake is found in the work area, it should be gently herded out to a safe location.
- **Stop work immediately** if any species protected under the Endangered Species Act, 2007 are seen in or near the work site (see attached sheet for tips on identifying some commonly encountered species). Take a photograph if possible, to confirm the sighting, and contact the project biologist at (613) XXX-XXXX and the Ontario Ministry of Natural Resources and Forestry – Kemptville District, at (613) 258-8204 or sar.kemptville@ontario.ca. Additional measures to avoid impacts may be required by the Ministry before work can restart.

Commonly Encountered Species Protected under the Endangered Species Act, 2007

For more information on Ottawa's species at risk, refer to <http://www.ottawastewardship.org>

Barn Swallow

Dark metallic blue above, buff to orange below. Long, deeply forked tail and pointed wings. Very quick and agile in flight. Cup-shaped nests built of mud and plant fibres on buildings and other structures, including bridge supports and culverts.



Male



Female



Nest

Bank Swallows are similar in shape to Barn Swallows, but do not have such long, deeply forked tails. They are dull brown above and white underneath, with a brownish band across the chest. They nest in burrows dug in exposed soils on steep slopes (e.g., sand pits, fill piles).

Blanding's Turtle

Bright yellow chin and throat. Highly domed, speckled shell up to 28 cm (11 in) in length.

Eggs small, oval and white. Usually less than 12 eggs per nest.



^ Photo courtesy of R. van de Lande

Bobolink

Males black with white back and cream hood during spring and summer breeding season. Females and non-breeding males streaky brown. Nests on the ground in open grasslands and hayfields.



All photos by A. MacPherson unless otherwise specified.

Butternut

Also known as White Walnut. Each leaf has several pairs of leaflets on either side of the main stalk, and one leaflet at the tip. Leaves and twigs grow in an alternating pattern along the branches. The nuts resemble limes or lemons in shape, and have greenish-yellow fuzzy rinds covering a hard, brown, ridged shell.



Butternut tree (centre)



Butternut leaves and fruit



Opened shell of butternut (without rind)

The closely related Black Walnut, which is not a species at risk, has round nuts like tennis balls. Its leaves are very similar to Butternut's leaves, but the terminal leaflet at the tip of each leaf is often much smaller than the other leaflets, or missing entirely. Ash trees may also appear similar to Butternut at first, with very similar leaves, but ash leaves and twigs grow in opposite pairs rather than alternating.

Eastern Meadowlark

Streaky grayish-brown bird with bright yellow front marked by black "V." Short tail has white edges on each side. Nests on the ground in open grassy areas; often seen perching on fence posts or shrubs.



All photos by A. MacPherson unless otherwise specified.

Appendix E – Résumés of Contributors

Chris Heffernan, Fish and Wildlife Biologist

Experience

14 Years total, 6 Years with McIntosh Perry

- *Certified as Fisheries Assessment Specialist with the MTO Registry of Appraisal and Qualification System (RAQS)*
- *Electrofishing Crew Leader (2nd Class) Backpack*
- *Certified Wetland Evaluator (MNR)*
- *Trained in Ecological Land Classification (MNR)*
- *Environmental impact and assessment (Provincial and Municipal)*
- *GPS mapping and monitoring techniques*
- *Desktop habitat review of wildlife and SAR habitat*
- *Water quality monitoring*
- *Working knowledge of current environmental legislation and policies (federal, provincial and municipal)*
- *Vegetation identification*
- *Fish species identification*
- *Bird identification and census: breeding, staging and wintering populations*
- *Bat identification and survey methodology*

Education

- Fish and Wildlife Technologist Diploma, Sir Sanford Fleming College, 2004
- Fish and Wildlife Technician Diploma, Sir Sanford Fleming College, 2003

Affiliations

- Ontario Field Ornithologists
- Kingston Field Naturalists

Chris is a Fish and Wildlife Biologist with over 10 years of experience carrying out environmental field investigation and assessment including terrestrial, fisheries, wildlife and species at risk inventories and reporting and water quality assessment. Mr. Heffernan has undertaken many terrestrial and aquatic assessments and inventories relating to development and has determined the impacts associated with such. Mr. Heffernan has numerous projects with emphasis on Species at Risk and their habitat and has been involved in various aspects of the implementation of the ESA including: Inventory, habitat modeling, mitigation, avoidance, recovery, overall benefit and permitting requirements (authorizations, registrations, permits and avoidance).

Project Experience

Municipal and Class Environmental Assessment and Remediation

Environmental Assessments incorporate historical research, interviews, fisheries, water quality, vegetation, terrestrial and aquatic analysis and wildlife and resources enhancement recommendations. Remediation projects including the analysis, assessment and remediation of terrestrial and aquatic sites. Specifically, these studies have included:

- Design Build: Rehabilitation of Highway 28, Bancroft to Hardwood Lake DB-2015-4023
- Detailed Design Services for the rehabilitation of the Cameron Lake Bridge on Highway 35 GWP 4045-10-00
- Design Build: Highway 531 – from Highway 17 southerly to Bonfield (3.7 km) and Highway 533 – from 1.0 km North of Highway 17 (Mattawa North Limits) to 0.2 km North of Highway 656 (4.2km) DB-2014-5009
- Design Build: Rehabilitation of the Steventown Creek and Replacement of the Mud Creek structural culverts on Highway 401 DB-2014-4016
- Detailed Design Services for the rehabilitation of 8 Bridges on Highway 400 and 11; two culverts on Highway 89 and 12 and the pavement of a portion of Highway 89 GWP 2183-13-00
- Detailed Design Services for the rehabilitation of the Ventnor Road Underpass on Highway 416. WP 4229-13-01 and WP 4230-13-01
- Detailed Design Services for the rehabilitation of the County Road 44 Underpass on Highway 416. WP 4227-13-01 and WP 4228-13-01
- Detailed Design Services for the rehabilitation of the Mississippi River Bridge on Highway 7. G.W.P4156-13-00
- Design Build: Rehabilitation of culvert crossing on Highway 11 8.5 km north of Bracebridge GWP 5242-10-00
- Detailed Design Services for the rehabilitation of the Gilmore Road and Beck Road Underpass's on the QEW. G.W.P. 2339-09-00,
- Detailed Design Services for the rehabilitation of the Lundy's Lane, Sodom Road Underpasses on the QEW. G.W.P. 2057-12-00
- Detailed Design Services for the rehabilitation of the Baker Road, Netherby Road and Townline Road Underpasses on the QEW. G.W.P. 2184-08-00

- Detailed Design Services for the rehabilitation of the Thompson Road and Concession Road Overpasses' on the QEW. G.W.P. 2058-12-00
- Detailed Design Services for the repair of the Christie Street and Maple Avenue Bridges on the QEW. G.W.P. 2191-10-00
- Detailed Design Services for the repair of the Oakes Road, Casablanca Blvd. Maple Avenue CNR and Bartlett Avenue CNR bridges. G.W.P. 2191-10-01
- Detailed Design Services for Brock Road bridge rehabilitation on Highway 401. G.W.P. 2128-11-00
- Detailed Design Services for the replacement of the Rainbow Creek Culvert on Highway 556. G.W.P. 5075-06-00
- Detailed Design Services for the replacement of the West Beaton and Cedar Creek Culverts on Highway 631 G.W.P. 5270-08-00
- Detailed Design Services for the replacement of the Machine Shop Creek Highway 546, Johnson Creek Highway 17 and Wharncliffe Creek Highway 129 Culverts G.W.P. 5271-08-00
- Detailed Design Services for the replacement of the Picnic Lake Creek Culvert on Highway 17 G.W.P. 5270-08-00
- Detailed Design Services for the replacement of the Borden Lake Culvert on Highway 101 G.W.P. 5077-08-00
- Detailed Design Services for Highway 7 from 0.4 km East of Reesor Road to 0.1 km West of Sideline 16, 10.1 km Agreement # 2010-E-0045
- Detailed Design Services for Highway 9 from Simcoe Road 27 (Schomberg) to 0.3 km West of Simcoe Road 10, 10 km Agreement # 2010-E-0045
- Detailed Design Services for Highway 11 from Lacile Street to Regional Road 38 (South Sparrow Lake Road), 10.6 km Agreement # 2010-E-0045
- Detailed Design Services for Highway 48 from 0.5 km South of York Road 9 to 4.0 Km North of York Road 9, 4.5 km Agreement # 2010-E-0045
- Detailed Design Services for Highway 400 from Simcoe Road 19 to North Junction of Highway 12/Simcoe Road 16. North and South Bound Lanes, 11.3 km Agreement # 2010-E-0045
- Detailed Design Services for Highway 403 from Central Parkway Overpass to 1.0 km West of Winston Churchill Blvd, 10.5 km Agreement # 2010-E-0045
- Detailed Design Services for Highway 404 from Stouffville Road North to Wellington Street East/Aurora Road, North and South Bound Lanes, 8 km Agreement # 2010-E-0045
- Detailed Design Services for the Rehabilitation of the Skye Road Bridge Underpass on Highway 417 Assignment # 4010-E-0007
- Detailed Design Services for Rehabilitation of Leeburn Creek Highway 638 and Stokely Creek Highway 7045 Bridge Structures GWP 5194-09-00
- Detailed Design Services for the Rehabilitation of the Algoma Central Rail Overhead on Highway 17 GWP 5142-06-00
- Detailed Design Services for Rehabilitation of Kilworthy & South Kakshe Lake Road Underpass and Sparrow Lake Road Underpass on Highway 11, Agreement # 5009-E-0069
- Detailed Design Services for Highway 7A from Nesbitt Line to N Junc Durham Road 57, 7.9km, GWP 2005-10-00
- Detailed Design Services for Highway 11 from Hoile's Creek Bridge east for 25.7 km GWP 547-00-00 (2009-2010)
- Detailed Design Services for Highway 9 from 2.4km west of Peel Road 50, westerly to 1.0km west of Peel Road 7, GWP 2080-09-00
- Detailed Design Services for Highway 10 from Highway 410 connection to Peel Road 9, 5.0km, GWP 2081-09-00
- Detailed Design Services for Highway 11 from highway 93 to Oro Medonte Line 5, 8.7km, GWP 2082-09-00
- Detailed Design Services for Highway 11 from Oro Medonte Line 5 to Memorial Ave (Simco Rd. 49 IC), 16.0km, CWP 2083-09-00

Chris Heffernan, Fish and Wildlife Biologist

- Detailed Design Services for Highway 140 from Highway 3, northerly 6.2 km, GWP 2490-04-00 (2009)
- Detailed Design Services for Highway 614 from Highway 17 northerly 26 km, GWP 335-99-00 (2009-2010)
- Detailed Design Services for Highway 17 Robert Creek Culvert Repair/Replacement 1.9 km west of Highway 575, Verner, GWP 5066-07-00 (2009)
- Bayview Bog Wetland Study neat the town of Amherstview Ontario, for Loyalist Township, (2005-2009)

Individual Environmental Assessments

Environmental assessments completed incorporated fisheries, water quality, vegetation, wildlife and resource enhancement, examples of projects are:

- Environmental Impact Assessment – Private lot severance Limoges (2015)
- Avian Screening Kanata - Nicholas Caragianis Architect Inc. (2015)
- Environmental Impact Assessment – Private severance and re-zoning Kingston (2015)
- Level 2 Natural Environment Study: LA Knapp Quarry, Mallorytown (2015)
- Environmental Impact Assessment – Private road construction, Swagger’s Lake (2015)
- Environmental Impact Assessment – GO Transit Davenport Diamond line Toronto (2014)
- Environmental Assessment of two bridge crossings on McKenzie Creek – 6 Nations (2014-2015)
- Environmental Impact Assessment – Proposed boat storage facility near Rockport (2014)
- Environmental Impact Assessment – Private severance near Carp (2014)
- Environmental Impact Assessment – Private site plan development near Smith’s Falls (2014)
- Environmental Impact Assessment – Private severance on Otter Lake (2014)
- MTO – Environmental Assessment of 42 Interchange Locations on Highway 401, 416 and 417 (2014)
- Environmental Impact Assessment – GO Transit Bus Depot expansion Burlington (2014)
- Wetland Evaluation for Public Works and Government Services Canada on Carling Avenue (2013)
- Baseline desktop wetland evaluation of CFB Borden (2012)
- Environmental Impact Assessment – Private development on Devil Lake (2012)
- Environmental Impact Assessment– Private severance near Kingston (2012)
- Environmental Impact Assessment – Private severance near Perth (2012)
- Tree inventory and significant tree identification for Gilchak Holdings Proposed Solar Development near Kingston (2012)
- Environmental Impact Assessment - Private severance near Westport (2012)
- Environmental Impact Assessment for Minto Barhaven proposed Phase 1 development (2012)
- Environmental Impact Assessment– Maple Reindeer Public Storage (2011 -2012)
- Environmental Impact Assessment - Private severance near Portland (2011)
- Environmental Impact Assessment - Proposed soil treatment facility near Napanee (2011-2012)
- Environmental Impact Assessment - Private severance near Perth Ontario (2011-2012)
- MTO Highway 7 construction at Aston Station screening for nesting migratory birds (2010)
- Environmental Impact Assessment of the YMCA/YWCA Bonenfant Outdoors Centre, Ottawa (2010)
- Breeding bird and vegetation assessment for Perth Golf Course development (2010)
- Breeding bird and vegetation assessment for Glen Tay subdivision development (2010)
- Murphy’s Point Provincial Park Annual breeding bird census (2010)
- Environmental Impact Assessment and breeding bird survey for Jock River Phase II, Richmond (2009)
- Environmental Impact Assessment for SACA Condos, Limoges (2009)
- MTO Hurd’s Creek Bridge Removal Preliminary Fisheries and Terrestrial Assessment (2009)

Chris Heffernan, Fish and Wildlife Biologist

- Mid-Winter Waterfowl Survey (2007-2010)
- Ontario Grassland Bird Survey, Smith's Falls Region (2009)
- Ontario Herpetofaunal Summary Atlas (2009-2010)
- Natural Resource Inventory and Assessment for the Mahogany Communities development, Manotick Breeding Bird and vegetation survey(2006-2008)
- Ontario Breeding Bird Atlas (2001-2005)
- Western University Winter Waterfowl Ecology Study (2004)
- Migration Monitoring Network Haldimand Bird Observatory banding operations and hawk count (2003)
- Waterfowl Check Station at Hullet Marsh (2003)
- Wildlife, fisheries and vegetative Inventory and Assessment for Dam Removal, Sheldon's Creek, Portland, Ontario (2002)
- Loon Monitoring Study on Big Rideau Lake, Portland (2002)
- Amphibian and Reptile Population Survey, Portland (2002)
- National Audubon Society Christmas Bird Count (2002-2007)

Fisheries Inventory and Assessment

- 6 Nations – Comprehensive Fish and Fish Habitat Assessment of two bridge crossings on McKenzie Creek (2014-2015)
- MTO GWP 2183-13-00 – Comprehensive two season Fisheries Assessment for a culvert on Highway 12 and a culvert on Highway 89 (2014-2015)
- MTO Agreement 2010-E-0058 Assignment # 2 – Comprehensive three season Fisheries Assessment for three culverts on Highway 26 (2012-2013)
- MTO Agreement 2010-E-0058 Assignment # 3 – Comprehensive three season Fisheries Assessment for all watercourses along Highway 26 from West of Mosey Street to 6th Line (2012-2013)
- MTO Agreement 2010-E-0058 Assignment # 4 – Comprehensive two season Fisheries Assessment for two culverts on Highway 26 (2013)
- MTO Highway 11 Design Build for the Replacement of Centreline Culvert by Trenchless Technologies, G.W.P 5242-10-00 (2012)
- Comprehensive Fisheries Assessment for Gilmore Road and Beck Road Underpass's on the QEW. G.W.P. 2339-09-00,
- Comprehensive Fisheries Assessment for Lundy's Lane, Sodom Road Underpasses on the QEW. G.W.P. 2057-12-00
- Comprehensive Fisheries Assessment for Baker Road, Netherby Road and Townline Road Underpasses on the QEW. G.W.P. 2184-08-00
- Comprehensive Fisheries Assessment for Thompson Road and Concession Road Overpasses' on the QEW. G.W.P. 2058-12-00
- Comprehensive Fisheries Assessment for the Christie Street and Maple Avenue Bridges on the QEW. G.W.P. 2191-10-00
- Comprehensive Fisheries Assessment for the Oakes Road, Casablanca Blvd. Maple Avenue CNR and Bartlett Avenue CNR bridges. G.W.P. 2191-10-01
- MTO Agreement 4010-E-0041 Assignment # 2 – Comprehensive Fisheries Assessment for 7 Culverts Along Highway 62 and 118 (2011-2012)
- MTO Agreement 4010-E-0041 Assignment # 4 – Comprehensive Fisheries Assessment for 19 Storm water Ponds along Highway 401 (2011-2012)
- MTO Agreement 4010-E-0041 Assignment # 8 – Comprehensive Fisheries Assessment for Trout Creek Bridge Highway 7A (2011-2012)

- MTO Agreement 4010-E-0041 Assignment # 9 –Scugog River Bridge Hwy 7 Post Construction Monitoring (2012)
- MTO Agreement 4010-E-0041 Assignment # 10 – Comprehensive Fisheries Assessment for 15 Culvert Locations along Highways 401, 7, 28, 35, 60 and 416 (2012-2013)
- MTO Ottawa Comprehensive Fisheries Study carried out on 1 culvert on Highway 417 (2010)
- MTO Agreement 4009-E-0004 Assignment #1 – Comprehensive Fisheries Assessment for 23 culverts along Hwy 28 (2010)
- MTO Agreement 4009-E-0004 Assignment #2 Comprehensive Fisheries Assessment for 10 culverts along Highway 401 and 1 Culvert along Hwy 62 (2010)
- MTO Agreement 4009-E-0004 Assignment #3 – Preliminary Fisheries Assessment for Hurd’s Creek Bridge Removal (2010)
- MTO Agreement 4009-E-0004 Assignment #4 – Comprehensive Fisheries Assessment for 15 Storm Water Management Ponds along Highway 401 (2011)
- MTO Agreement 4009-E-0004 Assignment #5 – Comprehensive Fisheries Assessment of 12 Culverts along Highway 401 (2010)
- MTO Agreement 4009-E-0004 Assignment #7 – Comprehensive Fisheries Assessment for 21 Culverts along Highway 401 and 1 on Highway 416 (2011-2012)
- MTO Agreement 4009-E-0004 Assignment #10 – Comprehensive Fisheries Assessment for 7 Culverts on Highway 28 and 7 Culverts on Highway 118 (2011-2012)
- MTO Agreement 4009-E-0004 Assignment #11 – Compressive Fisheries Assessment for 1 Culvert on Highway 416, 7 Culverts on Highway 35, 7 Culverts on Highway 41 and 2 Culverts on Highway 401 (2011-2012)
- MTO Agreement 4009-E-0004 Assignment #
- MTO Ottawa Fisheries Studies carried out on 7 separate culvert locations on Highway 17, 417 and 15 (2009)
- MTO Bancroft Comprehensive Fisheries Study carried out on 1 culvert on Highway 62 (2009)
- MTO Post-Construction Monitoring of Highway 2 locations as required under Fisheries Act Authorization, 4007-E-0048 (2009)
- Fisheries Studies for Amherstview Bayview Bog Wetland Project (2007-2009)
- Elevator Bay Fish and Fish Habitat Study (2008)
- Kingston Waterfront Fisheries Assessment and Nocturnal Survey From the Kingston Water Purification Plant East to Emily Street (2007)
- Coastal Fisheries and Habitat Usage Study, Lake Ontario (2004-2006)

Species at Risk Inventory, Impact Assessment and Mitigation

- Preparation of Redside Dace Mitigation Plan for the rehabilitation of the McLaren Road Bridge, Caledon under O.reg 176/13 *Aquatic Species – Activities in the habitat of certain fish or mussels*
- Preparation of Barn Swallow Mitigation Plan and Kiosk Design for the rehabilitation of the Cameron Lake Bridge on Highway 35 under O.reg 176/13 *Barn Swallow and Chimney Swift – Activities in built structures that are habitat (2015)*
- Ontario Ministry of Natural Resources and Forestry: Strategic and Aboriginal Policy Branch, Land Claims and Treaties Section: Species at Risk Assessment for 12 proposed settlement lands identified in the Algonquins of Ontario Proposed Agreement-in-Principle - Region 1 (2015)
- Ontario Ministry of Natural Resources and Forestry: Strategic and Aboriginal Policy Branch, Land Claims and Treaties Section: Species at Risk Assessment for 7 proposed settlement lands identified in the Algonquins of Ontario Proposed Agreement-in-Principle Region 3 (2015)

- Ontario Ministry of Natural Resources and Forestry: Strategic and Aboriginal Policy Branch, Land Claims and Treaties Section: Species at Risk Assessment for 7 proposed settlement lands identified in the Algonquins of Ontario Proposed Agreement-in-Principle Region 4,5 (2015)
- At risk bat acoustic monitoring – Erskine Dredge and Associates Architects Inc. Pioneer House Ottawa (2015)
- Gray Ratsnake, Eastern Whip-poor-will and butternut inventory; and at risk bat acoustic monitoring Camp IAWAH (2015)
- Eastern Whip-poor-will, butternut, bat acoustic monitoring, Bobolink/Eastern Meadowlark and Gray Ratsnake inventory, LA Knapp Quarry, Mallorytown (2015)
- Gray Ratsnake, Eastern Whip-poor-will and butternut inventory and impact assessment; as well as Pugnose Shiner critical habitat mapping – private severance and re-zoning Kingston (2015)
- Barn Swallow inventory – Brissenden Pit (2015)
- 6 Nations – design of Barn Swallow mitigation kiosk (2014-2015)
- Preparation of Blanding’s Turtle Mitigation Plan for a private development, Rockport under O.reg 242/08 *Newly Listed and Transition Species – Development in an area designated as a site plan control area under subsection 41(2) of the Planning Act*
- Butternut presence/absence survey for proposed private development near Cornwall (2014)
- Preliminary SAR site screening for the City of Pembroke (2014)
- Eastern Whip-poor-will inventory, bat acoustic inventory and impact assessment for private development near Smith’s Falls (2014)
- Eastern Whip-poor-will inventory and impact assessment for private development near Carp (2014)
- Gray Ratsnake survey, habitat assessment, impact assessment and mitigation for private cottage development on Otter Lake (2014)
- Eastern Whip-poor-will, Bobolink, Eastern Meadowlark, Barn Swallow inventory and impact assessment for Go Transit bus terminal expansion Burlington (2014)
- At risk bat acoustic monitoring of County Road 44 underpass structure Highway 416 (2014)
- Eastern Whip-poor-will and Blanding’s Turtle habitat inventory and impact assessment for school board development near Kemptville (2014)
- Eastern Whip-poor-will, Bobolink and Eastern Meadowlark inventory and impact assessment for private development near Westport (2014)
- CFB Borden Forest Nesting Songbird field study (2014)
- City of Kingston Turtle mitigation measures to reduce road mortality (2013)
- Environment Canada – Deloro Mine Rehabilitation Turtle Exclusion Measures (2013)
- CFB Borden baseline Forest Nesting Songbird field study (2013)
- CFB Borden baseline grassland bird field study which included Henslow’s Sparrow, Loggerhead Shrike, Bobolink, Eastern Meadowlark and Short-eared Owl (2013)
- CFB Borden baseline turtle field study which included Blanding’s Turtle, Snapping Turtle, Spotted Turtle, Wood Turtle, Eastern Musk Turtle and Northern Map Turtle (2013)
- Barn Swallow screening of Mariposa Creek culvert repair Hwy 7 (2013)
- Species at Risk pre-screening for private development in Belleville (2013)
- Whip-poor-will inventory and impact assessment for a private development on March Road Ottawa (2013)
- Bobolink, Eastern Meadowlark and Whip-poor-will inventory and impact assessment for a private development near Carleton place (2013)

- Bobolink, Eastern Meadowlark and Whip-poor-will inventory and impact assessment for a private development near Carleton place (2013)
- Whip-poor-will inventory and impact assessment for a private development near Cornwall (2013)
- Sun Edison Whip-poor-will Mitigation Training (2012/2013)
- Preparation of Butternut Planting Plan for private development under O.reg 294/11 (2013)
- Canadian Solar Species at Risk Screening (2012)
- Baseline Desktop Species at Risk Study for CFB Borden to provide compliance with SARA (2012/2013)
- Butternut Health Assessment, Bobolink and Whip-poor-will inventory– Private severance near Kingston (2012)
- Butternut Health Assessment and Whip-poor-will inventory and mitigation – Private severance near Perth (2012)
- Bobolink, Eastern Meadowlark, Whip-poor-will, Common Nighthawk and Milksnake inventory and assessment for Gilchak Holdings Proposed Solar Development near Kingston (2012)
- Whip-poor-will inventory and impact assessment for a private severance near Westport (2012)
- Species at Risk inventory and assessment: Whip-poor-will, Eastern Meadowlark and Bobolink for Minto Barhaven proposed Phase 1 development (2012)
- MTO Agreement 4010-E-0041 Assignment # 2 – Species at Risk Assessment for Highway 62 and 118 (2011-2012)
- MTO Agreement 4010-E-0041 Assignment # 4 – Species at Risk Assessment for 19 Storm water Ponds along Highway 401 (2011-2012)
- MTO Agreement 4010-E-0041 Assignment # 8 – Species at Risk Assessment for Trout Creek Bridge Highway 7A (2011-2012)
- MTO Agreement 4010-E-0041 Assignment # 10 – Species at Risk Assessment for 15 Culvert Locations along Highways 401, 7, 28, 35, 60 and 416 (2012-2013)
- MTO Agreement 4010-E-0041 Assignment # 13 –Rock Cuts and Storm Water Ponds along Highway 401 (2012)
- Species at Risk Assessment for Eastern Meadowlark and Bobolink MTO Eastern Region Patrol Yards – Young’s Point and Madoc (2012)
- Bobolink, Eastern Meadowlark and Whip-poor-will Inventory and Assessment for Mahogany Communities development, Manotick (2011-2012)
- Species at Risk Assessment for Bobolink – Maple Reindeer Public Storage (2011 -2012)
- Bobolink habitat assessment and inventory for Minto Avalon Subdivision Development Orleans (2011)
- Species at Risk assessment for private severance near Portland (2011)
- Butternut Health Assessment and Species at Risk Assessment: Bobolink, Eastern Meadowlark, Loggerhead Shrike, Common Nighthawk and Whip-poor-will for a proposed soil treatment facility near Napanee (2011-2012)
- Whip-poor-will and Common Nighthawk inventory and impact assessment for private severance near Perth Ontario (2011-2012)
- Whip-poor-will, Bobolink, Eastern Meadowlark and Least Bittern inventory and assessment for a proposed subdivision near Perth (2010-2011)
- Whip-poor-will, Bobolink and Eastern Meadowlark Inventory and Assessment for a proposed aggregate pit near Carleton Place (2011)
- Whip-poor-will, Bobolink and Eastern Meadowlark Inventory and Assessment for propose development of a site near Stitsville (2011)
- Whip-poor-will Inventory and Assessment for a proposed development near Stitsville (2011)
- MTO Agreement 4009-E-0004 Assignment #1 – Species at Risk Assessment for 23 culverts along Hwy 28 (2010)
- MTO Agreement 4009-E-0004 Assignment #2 - Species at Risk Assessment for 10 culverts along Highway 401 and 1 Culvert along Hwy 62 (2010)

- MTO Agreement 4009-E-0004 Assignment #3 – Species at Risk Assessment for Hurd’s Creek Bridge Removal (2010)
- MTO Agreement 4009-E-0004 Assignment #4 – Species at Risk Assessment for 15 Storm Water Management Ponds along Highway 401 (2011)
- MTO Agreement 4009-E-0004 Assignment #5 – Species at Risk Assessment of 12 Culverts along Highway 401 (2010)
- MTO Agreement 4009-E-0004 Assignment #7 – Species at Risk Assessment for 21 Culverts along Highway 401 and 1 on Highway 416 (2011-2012)
- MTO Agreement 4009-E-0004 Assignment #8 – Species at Risk Assessment for Highway 62 at Moira Lake (2010)
- MTO Agreement 4009-E-0004 Assignment #10 – Species at Risk Assessment for 7 Culverts on Highway 28 and 7 Culverts on Highway 118 (2011-2012)
- MTO Agreement 4009-E-0004 Assignment #11 – Species at Risk Assessment for 1 Culvert on Highway 416, 7 Culverts on Highway 35, 7 Culverts on Highway 41 and 2 Culverts on Highway 401 (2011-2012)
- Meadows of Perth Subdivision, Bobolink mitigation, management and compensation measures, Perth (2010-2011)
- MTO Eastern Region Fisheries and Species-at-Risk Retainer carried out species at risk inventory and assessment of Highway 62 realignment archaeological investigation area (2010)
- MTO Eastern Region Fisheries and Species-at-risk Retainer including screening for the presence of Species-at-Risk at 15 storm Water management ponds along Highway 401 (2010)
- Environment Canada – Deloro Mine Rehabilitation Species at Risk Mitigation (2010-2012)
- Preparation of Overall Benefit Permit (C Permit) for Butternut Mahogany Communities development, Manotick (2011)
- MTO Highway 7 Least Bittern nest Monitoring and species at risk screening (2010)
- Butternut Health Assessment and species-at-risk screening for the YMCA/YWCA Bonenfant Outdoors Centre, Ottawa including mitigation of impacts to Whip-poor-will and their habitat (2010)
- Butternut Health Assessment Campbell Quarry Development, Smith’s Falls (2010)
- Species-at-risk assessment for Perth Golf Course development (2010)
- Butternut Health Assessment survey for Jock River Phase II, Richmond (2009)
- Butternut Health Assessment for Mahogany Communities development, Manotick (2008-present)

Construction Monitoring Projects

- National Capital Commission Avian Management Plan for Pinecrest Creek Culvert Rehabilitation, Ottawa (2015)
- Springwood Wind Farm Bird and Bat Mortality Monitoring - Northwind Solutions (2015-2017)
- Whittington Wind Farm Bird and Bat Mortality Monitoring - Northwind Solutions (2015-2017)
- MTO migratory bird and turtle screening of Corben Creek culvert repair HWY 35 (2013)
- MTO migratory bird and turtle screening of Martin Creek culvert repair HWY 35 (2013)
- MTO Migratory bird and turtle screening of Mariposa Creek culvert repair Hwy 7 (2013)
- MTO Agreement 2010-E-0058 Assignment # 1 – Highway 48 fisheries construction monitoring (2012)
- MTO Highway 11 migratory bird screening for the Replacement of Centreline Culvert (2012)
- MTO Highway 7 migratory bird screening (2010)

Guidance Documents

- Transportation Association of Canada (TAC) - Beneficial Practices for Compliance with the Migratory Birds Convention Act and Regulations (Phase 1) (2015-2016)
- CFB Connaught - Wildlife Management Plan: Groundhog Management Option Analysis (2015).
- Ontario Ministry of Natural Resources and Forestry – Best Management Practice Document for Vegetation Management Activities near 224 Species at Risk and Their Habitat (2014-2015)

Chris Heffernan, Fish and Wildlife Biologist

Rehabilitation Projects

- Ministry of Northern Development and Mines - Kam Kotia Mine Re-vegetation Design (2012-2013)
- Environment Canada – Deloro Mine Rehabilitation and Re-vegetation Design (2010-2012)

Specialized Environmental Training

- Ecological Land Classification Certification - MNR
- Certified as Fisheries Assessment Specialist with the MTO Registry of Appraisal and Qualification System (RAQS)
- Certified Butternut Health Assessor – MNR
- Commercial Vessel Operations Certificate – MED A3
- Wetland Evaluation Certification – MNR
- Bat Detector Training – Wildlife Acoustics
- Royal Ontario Museum Fish Identification Workshop
- Class 2 Electrofishing Certificate – MNR
- Trained in Ontario Benthic Bio monitoring Network (OBBN) methodology
- Fish and Wildlife Guardian - MNR
- Recreational Diving Certificate - PADI
- St John's Ambulance Level 1 First Aid and C.P.R. - Heart Saver Cert.
- Pleasure Craft Operators Card - FNCC
- Fur Management and Conservation Course
- Hunter's Safety Course

Heather C. Lunn, B.A. Psychology, Intermediate Ecologist

Experience

15 Years total (all with Species at Risk experience), over 6 Years with McIntosh Perry Consulting Engineers Ltd.

- Environmental Assessment
- Terrestrial Ecosystems Assessments and Inventories
- Species at Risk Inventory and Assessment
- Construction Environmental Inspections
- Fisheries and Aquatic Ecosystems Inventories and Assessments

Education

- *Bachelor of Arts, Psychology, Wilfrid Laurier University, Waterloo, On 2005*
- *Post Graduate Certificate in Environmental Conservation, University of Guelph, Guelph, On 2006*

Certifications

- *Butternut Health Assessment Certification (MNRF)*
- *Ecological Land Classification (MNRF)*
- *Backpack Electrofisher Certification (MNRF)*
- *Royal Ontario Museum Fish Identification Training*
- *MTO / DFO / MNRF Fisheries Contract and Habitat Specialist Training*
- *St. John's Ambulance Standard and C.P.R. Administration*
- *WHIMIS*

Heather Lunn is an Intermediate Ecologist with over fifteen years' experience working in the field of Environmental Science. Ms. Lunn has extensive experience throughout Ontario with flora and fauna inventories and monitoring, including species at risk (SAR). While employed with MNRF (Ontario Parks), Ms. Lunn was involved in, and led teams for tracking SAR, including Gray Ratsnake and Eastern Musk Turtle. Ms. Lunn has coordinated and conducted targeted field surveys for SAR bats, SAR turtles and multiple SAR birds (e.g. Eastern Whip-poor-will, Least Bittern, Eastern Meadowlark, Bobolink, Henslow's Sparrow, Kirtland's Warbler, etc.). These surveys utilized MNRF protocols, where applicable. Ms. Lunn has experience in obtaining Overall Benefit Permits under clause 17(2)(c) of the Endangered Species Act, 2007 (Butternut & Blanding's Turtle), in addition to registering projects with the MNRF that have the potential to cause harm to SAR (i.e. Barn Swallows). She has completed over 40 Environmental Impact Statements, the majority of which include breeding bird surveys that follow Bird Studies Canada's Forest Bird Monitoring Program methodology. She is also proficient with communications and outreach. Heather has the skill set required to effectively undertake technical report writing and liaisons with regulatory agencies.

Relevant Project Experience

Species at Risk Screening (2014 & 2015) – 900 infrastructure rehabilitation project locations (roads, culverts, bridges, etc.) within the City of Ottawa

This project involved 3 phases of screening for SAR at over 900 infrastructure rehabilitation project locations within the City of Ottawa. Phase 1 of the screening utilized tables prepared specifically for the project to self-screen project locations for potential SAR and their habitat. The tables included targeted questions that would eliminate any projects that posed no risk to SAR or their habitat (e.g. is the project adjacent to a wetland?). Phase 1 also included desktop screening of the project locations by use of aerial photos and background information. Field investigations were completed in Phase 1 for any projects where confirmation of SAR habitat was not able to be made through desktop screening (e.g. Barn Swallow nesting). Phase 2 of the project constituted a risk assessment of all projects where SAR habitat was deemed in Phase 1, to be potentially present. In Phase 3 recommendations and mitigation measures were proposed for those projects that posed moderate or high risk to SAR and/or their habitat.

SAR Snake Monitoring Program (2005 – 2008) – Ontario Parks, Murphys Point Provincial Park

Ms. Lunn took part in a 4-year hibernacula monitoring and on-going tracking study, in order to determine population status of SAR snakes (e.g. Gray Ratsnake), within Park boundaries. The monitoring studies included multi-year hibernacula studies where snakes were observed, and location and physical information was recorded. The tracking studies included the use of passive integrated transponder (PIT) tags inserted into Gray Ratsnakes, to maintain a record of individual snakes present within the park. Any Gray Ratsnake observed within Park boundaries during the spring and summer months was inserted with a PIT tag, and physical information about the snake was recorded. The project was carried out as part of the Park's management strategy.

Heather C. Lunn, B.A. Psychology, Intermediate Ecologist

Class Environmental Assessment Projects

Environmental Assessments incorporate historical research, interviews, fisheries, water quality, vegetation, terrestrial and aquatic analysis and wildlife and resources enhancement recommendations. Remediation projects include the analysis, assessment and remediation of terrestrial and aquatic sites. The following are examples of Class Environmental Assessment Projects completed by Ms. Lunn.

Selected Projects:

- Detail Design Group 'C' for Highway 28 culvert, pavement, guiderail and shoulder rehabilitations, from 1.2 km south of Long Lake Road to Peterborough Road 504 (2016)
- Detail Design Group 'C' for pavement rehabilitation of Highway 401 eastbound and westbound lanes, from Lake Road to Northumberland County Road 26 (2016).
- Detail Design Class 'C' bridge rehabilitation, Cameron Lake Bridge Structure, Highway 35, Fenlon Falls (2015)
- Detail Design Class 'C' for the rehabilitation of 7 structural culverts and one bridge structure on Highway 148, from the Quebec/Ontario border, 5 km to the Pembroke City limits (2012)
- Preliminary Design Class 'B' for the repair or replacement of a CPR structure on Highway 148, 5 km to the Pembroke City limits (2011)
- Municipal Class Environmental Assessment (MCEA) Schedule 'B' for the replacement of Structure 14 over the Bear Creek, St. Clair Township (2010)

Environmental Impact Assessments and Inventories

Environmental assessments completed by Ms. Lunn have incorporated fisheries, water quality, vegetation, wildlife, and natural resource enhancement. Ms. Lunn has been the Terrestrial Ecologist and Field Technician on large scale and small scale Environmental Assessment Assignments in both the public and private industry over the past 5 years. These projects have involved providing natural resource inventories, species at risk inventory/assessment, baseline environmental studies, habitat studies, and ecological/environmental assessments. Specifically, the studies have included:

- *Breeding bird surveys* which identify species by sight, call and physical evidence, such as prints and nests;
- *Collection of terrestrial field data* using Ecological Land Classification (ELC) training and soil augers to determine the terrestrial system, community class, series, ecosite and vegetation type. Identification of terrestrial species is undertaken by sight, sound, scat in all seasons and includes identification of rare and invasive species; and
- *Species-at-risk surveys* including contacting the concerned agencies, conducting field surveys during the appropriate season and time of day (including nocturnal surveys), assessing the impacts of the project on species at risk (SAR), presenting mitigation, preparing compensation measures and acquiring SAR permits.

Selected Projects:

- Environmental Impact Statement, 3400 Old Montreal Road, City of Ottawa (2015)
- Environmental Impact Statement, 2822, 2826, 2869, 2876 & 2880 Carp Road, City of Ottawa (2015)
- Scoped Environmental Impact Statement, 5797 Prince of Wales Drive, City of Ottawa (2015)
- Scoped Environmental Impact Statement, Lot 18, Concession 12, City of Ottawa (2015)
- Environmental Impact Statement, 528 March Road, City of Ottawa (2014)
- Environmental Impact Statement, Part Lot 24, Concession 3, Township of Beckwith (2014)
- Environmental Impact Statement, Part Lot 22, Concession 11, Geographic Township of Bedford (2014)
- Scoped Environmental Impact Statement, 1980 Bear Hill Road, City of Ottawa (2014)
- Environmental Impact Statement, Lot 8, Concession 4, City of Ottawa (2014)
- Environmental Impact Statement, Lot 18, Concession 2, Township of Rideau Lakes (2014)

Heather C. Lunn, B.A. Psychology, Intermediate Ecologist

- Scoped Environmental Impact Statement, 3735 St. Joseph Blvd, City of Ottawa (2014)
- Scoped Environmental Impact Statement, Part Lot 1, Concession 2, Geographic Township of Goulbourn (2014)
- Level 1 Natural Environment Report, Part Lot 7, Concession 12, Township of North Dundas (2013)
- Environmental Impact Statement, Dean's Island Bridge and Causeway, Township of Rideau Lakes (2013)
- Environmental Impact Statement, Part Lot 1, Concession 4, Township of Huntley (2013)
- Environmental Impact Statement, Part Lot 13, Concession 10, Township of Beckwith, County of Lanark (2013)
- Environmental Impact Statement, Lot 1, Concession B, Geographic Township of McNab, Town of Arnprior (2013)
- Scoped Environmental Impact Statement, Lot 5, Concession 6, Geographic Township of West Carleton (2013)
- Environmental Impact Statement & Tree Conservation Report, Part Lot 15, Concession 5, City of Ottawa (2013)
- Environmental Impact Statement, Lot 21, Concession 8, Township of Beckwith, County of Lanark (2013)
- Environmental Impact Statement, Part Lot 9, Concession 9, Township of Beckwith, County of Lanark (2013)
- Environmental Impact Statement, Part Lot 19, Concession 7, Township of McNab/Braeside, County of Renfrew (2012)
- Scoped Environmental Impact Statement, Part Lot 9, Concession 2, Geographic Township of Osgoode (2012)
- Environmental Impact Statement, Lot 1 & 2 Concession 4 Geographic Township of Goulbourn, City of Ottawa (2012)
- Level 1 & 2 Natural Environment Report, Carroll Pit, Herbert Corners, Ontario (2012)
- Environmental Impact Statement Part Lot 7, 8 & 9 Concession 5 Township of Tay Valley, Lanark County (2012)
- Environmental Impact Statement Resting Paws Pet Cemetery & Crematorium, 3395 Torbolton Ridge Road, Ottawa (2012)
- Tree Conservation Plan for Lots 73 and 74, Carleton Place, Ontario (2010)
- Environmental Impact Assessment for Part Lot 19, Concession 5, Merrickville-Wolford Township, Ontario (2010)
- Scoped Environmental Impact Assessment for Lot 24, Concession 1, March Township, Ontario (2010)
- Environmental Impact Assessment and Tree Conservation Plan for Part of Lot 23, Concession 2, City of Clarence Rockland, United Counties of Prescott and Russell, Ontario (2010)
- Environmental Impact Assessment for Part Lot 26 and 27, Concession 1 and 2, Perth, Ontario (2010)
- Environmental Impact Assessment for Part Lot 12, Concession 10, Beckwith Township, Lanark County, Ontario (2010)
- Environmental Impact Statement for Lots 21 and 22, Glen Tay, Tay Valley Township, Ontario (2010)
- Environmental Impact Assessment for Part Lot 11, Concession 6, Tay Valley Township (2010)
- Environmental Impact Assessment and Tree Conservation Plan for Part of Lot 1, Concession 4, Geographic Township of Huntley, Formerly Township of West Carleton, City of Ottawa, Ontario (2010)
- Environmental Impact Statement for Part of Lots 18 and 19, Concession 9, Frontenac County (2009)
- Scoped Environmental Impact Statement for Part of Lot 4, Concession 2, City of Ottawa (2009)
- Environmental Impact Statement for East Part of Lot 29, Concession 3, District of Cambridge, Limoges, Ontario (2009)
- White-tailed Deer Impact Monitoring Study, Murphys Point Provincial Park, Ontario (2007-09)
- Vegetation Inventory, NCC Historic Portage Site, Gatineau, Quebec (2007)
- Vegetation Surveys, St. Lawrence Islands National Park, Ontario (2006)
- Breeding Bird Monitoring, Lanark County, Ontario (2005)
- Frog Monitoring Study, Murphys Point Provincial Park, Ontario (2004)
- Amphibian Population Survey, Lombardy, Ontario (2003)

Avian Screenings

These projects have involved the screening of locations for breeding migratory birds and their nests, prior to vegetation removal. As a qualified Avian Biologist, Ms. Lunn would identify all bird species present in the specified area, by sight and/or call, and determines the level (if any) of breeding activity exhibited by any birds observed.

Selected Projects:

- Avian Screening, Highway 7 Culvert Replacement, Goldie Mohr (2016)
- Avian Screening, OLRT Construction, Cyrville Road, City of Ottawa, OLRT (2016)
- Avian Screening, OLRT Construction, Present St/Albert St, City of Ottawa, Cavanagh Construction (2016)
- Avian Screening, Hurdman Bridge, City of Ottawa, Cavanagh Construction (2016)
- Avian Screening, Hwy 60, Renfrew (2016)
- Avian Screening, Silver Seven Road, City of Ottawa (2015)
- Avian Screening, Main Street, City of Ottawa (2015)
- Avian Screening, Walkley Road, City of Ottawa (2015)
- Avian Screening, Highway 62, between County Road 620 and the Town of Bancroft (2015)
- Avian Screening, Highway 127, 70 m north of the intersection with Highway 127 and Highway 62, Bancroft (2015)
- Avian Screening, Hampton Park, City of Ottawa Ottawa (2014)
- Avian Screening, Scheel Drive at Highway 17, Renfrew County (2013)

Construction Supervision, Administration and Environmental Inspection

These projects have involved the inspection and compliance review of construction projects for highways, roads and bridges. Inspection duties included, but were not limited to, fisheries and species at risk habitat protection, erosion and sedimentation control and excess material management. Compliance duties ensured that construction projects were in conformity with federal, provincial, and municipal environmental regulations and protocol.

Selected Projects:

- Mitigation Measure Monitoring (Barn Swallow) for culvert renewal, Walkley Road, City of Ottawa (2016)
- Environmental Inspection, culvert replacement (SAR Turtles), Lester Road, City of Ottawa (2015)
- Mitigation Measure Monitoring, bridge replacement (Barn Swallow, SAR Turtles), Sand Road, City of Ottawa (2015)
- Mitigation Measure Monitoring (SAR Turtles) for culvert replacement, Dwyer Hill Road, City of Ottawa (2015)
- Mitigation Measure Monitoring (Barn Swallow, SAR Turtles) for culvert renewal, Spruce Ridge Road & Walkley Road, City of Ottawa (2015)
- Mitigation Measure Monitoring (Barn Swallow, SAR Turtles) for bridge renewal, John Shaw Road, City of Ottawa (2015)
- Mitigation Measure Monitoring (Barn Swallow, SAR Turtles) for culvert renewal, Etienne Road & Kinburn Side Road, City of Ottawa (2015)
- Mitigation Measure Monitoring (SAR Turtles) for culvert renewal, Ashton Station Road, City of Ottawa (2015)
- Mitigation Measure Monitoring (SAR Turtles) for culvert renewal, Shea Road, City of Ottawa (2015)
- Environmental Inspection (SAR Turtles, fish) for culvert replacement, Old Montreal Road, City of Ottawa (2015)
- Mitigation Measure Monitoring (SAR Turtles) for culvert replacement, Dwyer Hill Road, City of Ottawa (2015)
- Mitigation Measure Monitoring (Barn Swallow) for culvert renewal, Prince of Wales Drive, City of Ottawa (2015)
- Mitigation Measure Monitoring (SAR Turtles) for culvert replacement, Thomas A. Dolan Parkway, City of Ottawa (2014)
- Mitigation Measure Monitoring (Barn Swallow) for Muskrat and Indian River Bridge Rehabilitations, Pembroke (2014)
- Mitigation Measure Monitoring (SAR Turtles, Barn Swallow) 13 infrastructure renewal projects, City of Ottawa (2014)
- Environmental Inspection (Fisheries) for Highway 417 culvert replacements, City of Ottawa, Ontario (2012)
- Environmental Inspection (Fisheries) for fish habitat compensation on the Rideau River at the Chapman Mills Conservation Area within the City of Ottawa (2011)
- Construction Administration and Environmental Inspection (Fisheries), Earl Armstrong road widening, City of Ottawa (2010)
- Construction Administration and Environmental Inspection (Blanding's Turtle Habitat) for Highway 7 from 0.3 km West of Jinkinson Road Westerly to 3.9 km west of Ashton Station Road including service Roads, Contract 2007-4007 (2010)

Heather C. Lunn, B.A. Psychology, Intermediate Ecologist

- Construction Administration and Environmental Inspection (Blanding's Turtle Habitat) for Highway 7 at Dwyer Hill intersection, Contract 2007-4007 (2010)
- Construction Administration and Environmental Inspection (Fisheries) Highway 417 at Arnprior, Contract 2009-4016 (2010)

Species at Risk Inspection and Inventory

Species at risk assessments completed by Ms. Lunn include assessment of study areas for the presence/absence of SAR and their habitat. This often goes hand in hand with Environmental Impact Assessments and Construction Projects. Specific activities related to SAR have included pre-screening field inventories prior to construction activities in areas of concern; nocturnal field assessments for Common Nighthawk and Whip-poor-will; Blanding's turtle overwintering habitat suitability sampling using oxygen metres and water depth as indicators; butternut field assessments using MNRF protocols as a certified Butternut Health Assessor; and tracking of Eastern Musk Turtles by use of radio transmitters to determine hibernacula locations. Ms. Lunn was also involved in a 4-year field investigation at Murphys Point Provincial Park, located south of Perth, ON, monitoring populations of Gray Ratsnakes (threatened species). The monitoring involved spring emergence surveys and incidental observations during the summer months. Also at Murphys Point Provincial Park, Ms. Lunn took part in a population field survey for Golden-winged Warblers (special concern species) and their habitat within Park boundaries.

Selected Projects:

- Species at Risk Screening Report, Plantagenet, County Road 17, United Counties of Prescott & Russell (2016)
- Species at Risk Screening Report, Paul Martin Drive, Pembroke (2016)
- Species at Risk Screening Report, Town of Petawawa Salt Dome (2015)
- Species at Risk and Existing Conditions Screening Report, Blossom Park, City of Ottawa (2015)
- Species at Risk Screening Report, culvert renewal, Bank Street, City of Ottawa (2015)
- Species at Risk Screening Report, 15 road rehabilitation projects, 38 buildings/parks locations, City of Ottawa (2015)
- Species at Risk Screening Report, Goshen Road, 200 m south of Highway 17 to Calabogie Road (County Road 508), Township of McNab/Braeside (2015)
- Species at Risk Screening for 11 Culverts, City of Ottawa (2015)
- Species at Risk Screening, culvert replacement, Ramsayville Road, City of Ottawa (2014)
- Species at Risk Screening for culvert replacement, Ridgetop Road, City of Ottawa (2014)
- Species at Risk Screening, culvert replacements, Lester Road and Marvelville Road, City of Ottawa (2014)
- Species at Risk Screening, culvert renewal, Big Horn Way, City of Ottawa (2014)
- Species at Risk Screening Report, Lot 26, Concession 7, Township of Laurentian Valley (2014)
- Species at Risk Natural Science Report, 44 Small Culverts, City of Ottawa (2013)
- Species at Risk Screening Field Surveys, Canadian Forces Base Borden (2013)
- Species at Risk Pre-screening Report, for 13 sections of road, 24 bridges, 110 culverts, City of Ottawa (2013)
- Species at Risk Natural Science Report, Part Lot 12 Concession 5 Township of South Stormont, County of Stormont (2013)
- Species at Risk Screening Report, Part Lot 10, Concession 10, Beckwith Township, County of Lanark (2012)
- Terrestrial Species at Risk Screening Document, Paquette Road and Highway 17, Petawawa, W.P. 4040-12-00 (2012)
- Species at Risk Screening Survey, Culvert Replacements, Highway 17, Pembroke, Ontario (2012)
- Butternut Inventory and Assessment, Part Lot 21, Concession 2, 2720 Richmond Road, City of Ottawa, Ontario (2012)
- Species at Risk Natural Sciences Report, Culvert Replacements at 22 Locations, City of Ottawa, Ontario (2012)
- Species at Risk and Migratory Bird Screening Survey, Structure 55, Brodie Road, City of Ottawa, Ontario (2012)
- Species at Risk Natural Sciences Report, Queenswood Heights Nature Trail Bridge SN 891320, City of Ottawa (2012)

Heather C. Lunn, B.A. Psychology, Intermediate Ecologist

- Species at Risk Natural Sciences Report, Culvert Replacements at Four Locations, City of Ottawa, Ontario (2012)
- Species at Risk and Migratory Bird Screening Survey, Madoc and Young's Point MTO Patrol Yards (2012)
- Species at Risk and Migratory Bird Screening Survey, Part Lot 9 & 10 Concession 6, The Nation Municipality (2012)
- Species at Risk Screening Letter, Lot 11, Concession 10, Goulbourn Ward, City of Ottawa, Ontario (2011)
- Species at Risk Screening, Lot 20, Concession 2, Huntley, Ontario (2011)
- Species at Risk Screening Letter, Lot 35, Concession 7, Bob's Lake, Ontario (2010)
- Species at Risk Screening Report, Lot 6, Concession 1, Hawkesbury, Ontario (2010)
- Construction Administration and Environmental Inspection (Blanding's Turtle Habitat) for Highway 7 at Dwyer Hill intersection, Contract 2007-4007 (2010)
- Construction Administration and Environmental Inspection (Blanding's Turtle Habitat and other Species at Risk) for Highway 7 from 0.3 km West of Jinkinson Road Westerly to 3.9 km west of Ashton Station Road including service Roads, Contract 2007-4007 (2010)
- Golden-winged Warbler Habitat Inventory, Murphys Point Provincial Park, Ontario (2009)
- Radio Telemetry Tracking Survey for Stinkpot Turtles at Charleston Lake Provincial Park, Ontario (2007)
- Gray Ratsnake Monitoring Study, Murphys Point Provincial Park, Ontario (2004-2009)

Professional Experience

Ecologist - Environmental Science & Engineering. *McIntosh Perry Consulting Engineers Ltd.* (2009 – Present)

- See above details.

Natural Heritage Education Interpreter. *Murphys Point Provincial Park* (2001-2005, 2007-2009)

- Established deer impact monitoring plots;
- Compiled Gray Ratsnake, Butternut, and species at risk bird monitoring data;
- Assisted in compilation of Park's Life Sciences Inventory;
- Classified critical habitat in the park through use of ELC method;
- Interpretation of Park Visitor Centre;
- Developed and presented natural heritage education programs; and
- Developed and guided natural and cultural heritage hikes.

Species at Risk Education Coordinator. *Eastern Ontario Model Forest.* (2007-2008)

- Researched and developed a plain language guidebook on species at risk in eastern Ontario;
- Developed a series of PowerPoint presentations on species at risk and the Endangered Species Act, 2007 to accommodate specific groups; and coordinated with, and delivered presentations to, local partners through existing networks.

Biological Consultant. *Charleston Lake Provincial Park.* (2007)

- Attached radio transmitters to select Eastern Musk Turtles (Threatened Species)
- Tracked select Eastern Musk Turtles through radio telemetry; and
- Recorded data regarding on Eastern Musk Turtle habits and habitat.

Resource Conservation Technician. *St. Lawrence Islands National Park* (2006-2007)

- Identified and assessed vegetation and soil samples on predetermined plots using the ELC method;
- Interacted with private property owners where assessments were conducted; and
- Navigated to plots using GPS technology.