



Kinaxis Office Development 8700 Campeau Drive

TIA Report



**Kinaxis Office Development
8700 Campeau Drive**

TIA Report

prepared for:
Taggart Realty Management
225 Metcalfe St, Suite 708
Ottawa, ON K2P 1P9

prepared by:
PARSONS
1223 Michael Street North
Suite 100
Ottawa, ON K1J 7T2

October 28, 2019

477190-02000

Document Control Page

CLIENT:	Taggart Realty Management
PROJECT NAME:	Transportation Impact Assessment – Kinaxis Office Development
REPORT TITLE:	Kinaxis Office Development – TIA Report
PARSONS PROJECT NO.:	477190-02000
VERSION:	Final
DIGITAL MASTER:	H:\ISO\477190\2000\DOCS\Step 5 - Submission #2 10.28.19\TRM Kinaxis_STEP 5 Report-10.28.2019.docx
ORIGINATOR	Basel Ansari, E.I.T.
REVIEWER:	Austin Shih, M.A.Sc., P.Eng.
AUTHORIZATION:	City of Ottawa
CIRCULATION LIST:	Josiane Gervais, P.Eng.
HISTORY:	TIA Steps 1 & 2 (Screening & Scoping Report) – Submitted on June 18, 2019 TIA Step 3 (Forecasting Report) – Submitted on June 24, 2019 TIA Step 4 (Strategy Report) – Submitted on July 15, 2019 TIA Step 5 – Resubmitted on Sep 16, 2019 TIA Step 5 Second Submission – Submitted on October 29, 2019



TIA Plan Reports

On 14 June 2017, the Council of the City of Ottawa adopted new Transportation Impact Assessment (TIA) Guidelines. In adopting the guidelines, Council established a requirement for those preparing and delivering transportation impact assessments and reports to sign a letter of certification.

Individuals submitting TIA reports will be responsible for all aspects of development-related transportation assessment and reporting, and undertaking such work, in accordance and compliance with the City of Ottawa's Official Plan, the Transportation Master Plan and the Transportation Impact Assessment (2017) Guidelines.

By submitting the attached TIA report (and any associated documents) and signing this document, the individual acknowledges that s/he meets the four criteria listed below.

CERTIFICATION

1. I have reviewed and have a sound understanding of the objectives, needs and requirements of the City of Ottawa's Official Plan, Transportation Master Plan and the Transportation Impact Assessment (2017) Guidelines;
2. I have a sound knowledge of industry standard practice with respect to the preparation of transportation impact assessment reports, including multi modal level of service review;
3. I have substantial experience (more than 5 years) in undertaking and delivering transportation impact studies (analysis, reporting and geometric design) with strong background knowledge in transportation planning, engineering or traffic operations; and
4. I am either a licensed¹ or registered² professional in good standing, whose field of expertise [check appropriate field(s)] is either transportation engineering or transportation planning .

1,2 License of registration body that oversees the profession is required to have a code of conduct and ethics guidelines that will ensure appropriate conduct and representation for transportation planning and/or transportation engineering works.

City Of Ottawa
Infrastructure Services and Community
Sustainability
Planning and Growth Management
110 Laurier Avenue West, 4th fl.
Ottawa, ON K1P 1J1
Tel. : 613-580-2424
Fax: 613-560-6006

Ville d'Ottawa
Services d'infrastructure et Viabilité des
collectivités
Urbanisme et Gestion de la croissance
110, avenue Laurier Ouest
Ottawa (Ontario) K1P 1J1
Tél. : 613-580-2424
Télécopieur: 613-560-6006

Dated at Ottawa this 28 day of October, 2019.
(City)

Name: Austin Shih
(Please Print)

Professional Title: Senior Project Manager



Signature of Individual certifier that s/he meets the above four criteria

Office Contact Information (Please Print)
Address: 1223 Michael Street North, Suite 100
City / Postal Code: Ottawa, Ontario, K1J 7T2
Telephone / Extension: 613-738-4160
E-Mail Address: Austin.shih@parsons.com

Table of Contents

- 1. SCREENING FORM..... 1
- 2. SCOPING REPORT..... 1
 - 2.1. EXISTING AND PLANNED CONDITIONS..... 1
 - 2.1.1. Proposed Development 1
 - 2.1.2. Existing Conditions..... 2
 - 2.1.3. Planned Conditions..... 7
 - 2.2. STUDY AREA AND TIME PERIODS 10
 - 2.3. EXEMPTION REVIEW 11
- 3. FORECASTING..... 11
 - 3.1. DEVELOPMENT GENERATED TRAVEL DEMAND..... 11
 - 3.1.1. Trip Generation and Mode Shares 11
 - 3.1.2. Trip Distribution and Assignment..... 12
 - 3.2. BACKGROUND NETWORK TRAFFIC 13
 - 3.2.1. Transportation Network Plans..... 13
 - 3.2.2. Background Growth 13
 - 3.2.3. Other Developments 14
 - 3.2.4. Total background traffic..... 15
 - 3.3. DEMAND RATIONALIZATION 17
- 4. ANALYSIS 17
 - 4.1. DEVELOPMENT DESIGN 17
 - 4.1.1. Design for Sustainable Modes 17
 - 4.1.2. Circulation and Access..... 17
 - 4.2. PARKING..... 18
 - 4.2.1. Parking Supply..... 18
 - 4.3. BOUNDARY STREET DESIGN 18
 - 4.4. ACCESS INTERSECTION DESIGN..... 19
 - 4.4.1. Location and Design of Access 19
 - 4.4.2. Intersection Control and Design..... 20
 - 4.5. TRANSPORTATION DEMAND MANAGEMENT 20
 - 4.6. NEIGHBOURHOOD TRAFFIC MANAGEMENT..... 20
 - 4.7. TRANSIT..... 20
 - 4.8. REVIEW OF NETWORK CONCEPT 20
 - 4.9. INTERSECTION DESIGN 20
 - 4.9.1. INTERSECTION CONTROL 20
 - 4.9.2. INTERSECTION DESIGN 20
- 5. FINDINGS, CONCLUSIONS AND RECOMMENDATIONS..... 25

List of Figures

Figure 1: Local Context 1
 Figure 2: Site Plan 2
 Figure 3: Area Transit Network..... 6
 Figure 4: Bus Stop Locations..... 6
 Figure 5: Existing Peak Hour Traffic Volumes..... 7
 Figure 6: Kanata West Business Park 8
 Figure 7: Other Area Developments 9
 Figure 8: Study Area 10
 Figure 9: Kinaxis Office Development Site-Generated Traffic 12
 Figure 10: Future Background 2021 13
 Figure 11: Future Background 2026 14
 Figure 12: Other Area Developments Total Traffic Volumes..... 15
 Figure 13: Total Future Background 2021 Traffic Volumes 16
 Figure 14: Total Future Background 2026 Traffic Volumes 16
 Figure 15: Total Projected 2021 Traffic Volumes 22
 Figure 16: Total Projected 2026 Traffic Volumes 24

List of Tables

Table 1: Exemptions Review Summary 11
 Table 2: Office Building ITE Trip Generation Trip Rates 11
 Table 3: Person Trips Generated by the Office Building 11
 Table 4: Mode Shares for the Office Building Development 12
 Table 5: MMLOS – Boundary Road Analysis 19
 Table 6: Existing Conditions Intersection Performance 21
 Table 7: Total Future Background 2021 Intersection Performance 21
 Table 8: Total Future Background 2026 Intersection Performance 22
 Table 9: Total Projected 2021 Performance at Study Area Intersections 23
 Table 10: Total Projected 2026 Performance at Study Area Intersections 24

List of Appendices

- APPENDIX A – City Comments and Screening Form
- APPENDIX B – Transit Route Maps
- APPENDIX C – City of Ottawa Traffic Data
- APPENDIX D – City of Ottawa Collision Data
- APPENDIX E – Boundary Street MMLOS Analysis
- APPENDIX F – Truck Turning Templates
- APPENDIX G – SimTraffic Reports
- APPENDIX H – TDM Checklist
- APPENDIX I – Synchro and Sidra Analysis Reports

TIA Report

Parsons has been retained by Taggart Realty Management to prepare a TIA in support of a Site Plan application for a proposed office building development in Ward 4: Kanata North. The following report represents Step 5 of the TIA process. In a previous submission, the gross leasable floor area of the development building was proposed to be 150,000 ft². However, in the most recent site plan provided by the architect, the gross leasable floor area of the building was reduced to 135,000 ft². In accordance with the previous submissions, the gross leasable floor area was kept as 150,000 ft² to reflect a more conservative scenario. City comments, which have been addressed from previous submissions, have been provided in **Appendix A**.

1. SCREENING FORM

The Screening Form was submitted to the City of Ottawa for review and verification of the need to complete a Transportation Impact Assessment (TIA). The Trip Generation and Safety triggers were both met due to the size of the development and its proximity to the roundabout at Campeau/Palladium. As such, a TIA Report was deemed required. The Screening Form is provided in **Appendix A**.

2. SCOPING REPORT

2.1. EXISTING AND PLANNED CONDITIONS

2.1.1. PROPOSED DEVELOPMENT

The proposed development is located at 8700 Campeau Dr and is expected to occupy blocks 24, 25 and 28 of the Kanata West Business Park. The development will be implemented in a single phase and will consist of a five-storey office building with a gross floor area of 150,000 ft². The anticipated year of full buildout is 2021. The subject site is currently vacant and zoned as IP – Business Park Industrial Zone. **Figure 1** below provides the local context of the development site, while **Figure 2** provides the current site plan.

Figure 1: Local Context



Figure 2: Site Plan

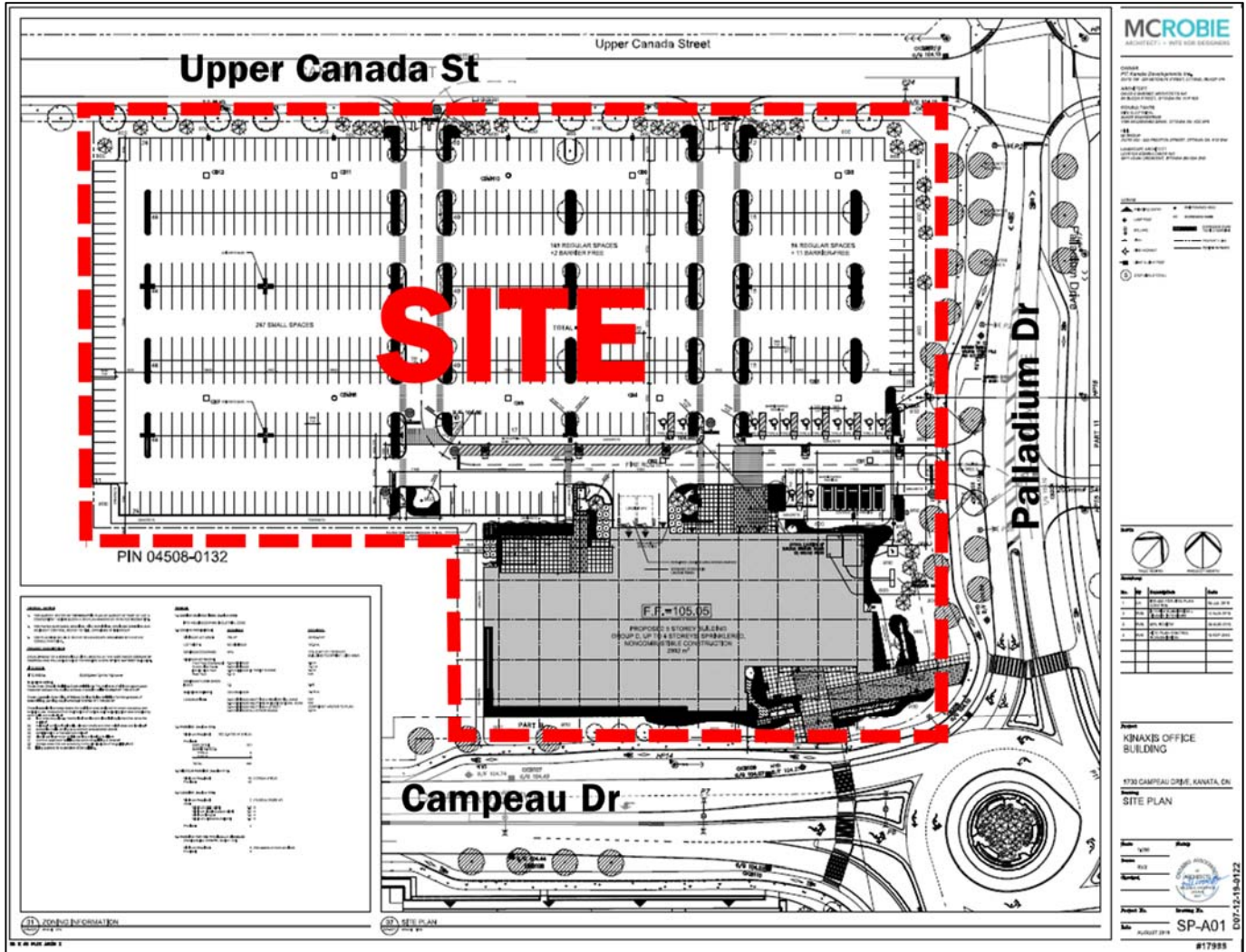

The development site provides a total of 534 vehicle parking spaces (including 13 accessible spaces) and 54 bike parking spaces to be used mainly by staff and employees. Three accesses have been proposed. Two site accesses will be located at the north end of the site, along Upper Canada St. The third access is located off Palladium Dr. All accesses will permit all-turn movements.

2.1.2. EXISTING CONDITIONS

Area Road Network

Campeau Drive is an east-west arterial roadway within the City of Ottawa that currently extends from approximately 650 m west of Palladium Dr to Eagleson Rd/March Rd in the east. Within the study area, Campeau Dr has a four-lane cross section with a posted speed limit of 60 km/h.

Palladium Drive is an arterial roadway within the City of Ottawa that currently extends from approximately 270 m north of Campeau Dr to south of the Hwy 417 EB Off Ramp, where it curves east and continues until Terry Fox Dr. East of Terry Fox Dr, Palladium Dr continues as Katimavik Rd. The roadway consists of a four-lane cross section and a posted speed limit of 60 km/h north of the Hwy 417 WB On-Off Ramps, and 70 km/h south of the ramps.

Existing Study Area Intersections

Kanata West Centre/Campeau

The Kanata West Centre/Campeau intersection is a 'T' intersection with STOP Control on the south leg of the intersection. The east leg consists of a thru lane and an auxiliary left-turn lane, while the west and south legs consist of a single shared movement lane. There are no restricted movements at this intersection.



Campeau/Palladium

The Campeau/Palladium intersection is a four-legged roundabout intersection consisting of two approach lanes on each leg. The west and south legs consist of a single shared movement lane and a right-turn slip lane. The north leg consists of one shared thru and right-turn lane and one shared thru and left-turn lane. The east leg consists of one shared all movement lane and one left-turn lane. There are no prohibited movements at this intersection.



Journeyman/Campeau

The Journeyman/Campeau intersection is a signalized four-legged intersection with a single thru lane and auxiliary right and left turn lanes on the north, south and west legs of the intersection. The east leg consists of an auxiliary left-turn lane, an exclusive thru-lane and a shared thru/right-turn lane. There are no restricted movements at this intersection.



PARSONS

Huntmar/Campeau

The Huntmar/Campeau intersection is a four-legged roundabout intersection with three approach lanes on each leg of the intersection. The south leg consists of an exclusive left and right turn lanes and a shared thru/left-turn lane. The north leg consists of exclusive thru, left and right turn lanes. The east leg consists of exclusive thru and right-turn lanes and a shared thru/left-turn lane. The west leg consists of a right-turn slip lane, an exclusive thru lane and a shared thru-/left-turn lane. There are no prohibited movements at this intersection.



Cabela's/Palladium

The Cabela's/Palladium intersection is a 'T' intersection with STOP Control on the west leg of the intersection. The north leg of the intersection consists of a thru lane and a shared thru/right-turn lane. The south leg consists of two thru lanes and an auxiliary left-turn lane. The west leg consists of a single right-turn lane. There is no left-turn movement coming from the west leg of the intersection.



Hwy 417 WB On-Off Ramps/Palladium

The Hwy 417 Wb On-Off Ramps/Palladium intersection is a signalized 'T' intersection consisting of north, south and east legs. The north leg of the intersection consists of two thru lanes and an auxiliary left-turn lane. The south leg of the intersection consists of two thru lanes and the east leg of the intersection consists of two left-turn lanes and an auxiliary right-turn lane. There are no restricted movements at this intersection.



PARSONS

Hwy 417 EB Off Ramp/Palladium

The Hwy 417 EB Off ramp/Palladium intersection is a 'T' intersection with STOP Control on the west leg of the intersection. The north and south legs of the intersection consist of two thru lanes, while the west leg consists of a single left-turn lane and an auxiliary right-turn lane.



Existing Driveways to Adjacent Developments

An adjacent development access exists approximately 175m north of the proposed access along Palladium Dr. This adjacent development access serves a small medical facility.

Existing Area Traffic Management Measures

Below are the existing area traffic management measures along both Palladium Dr and Campeau Dr:

- Roundabouts;
- Medians;
- Sidewalks;
- Streetscaping;
- Separated bike lanes; and,
- Zebra crosswalks at most major intersections.

Pedestrian/Cycling Network

Within the study area, starting from the Kanata West Centre Dr, sidewalks are provided along the north and south sides of Campeau Dr, with the exception of the segment between Journeyman St and Huntmar Dr, where no sidewalk are provided on north side. Sidewalks are provided on the east and west sides of Palladium Dr up to the Hwy 417 WB On-Off Ramps. Sidewalks are provided along the east side only of the Kanata West Centre Dr. Along Journeyman St, sidewalks are provided on the west side only, north of Campeau Dr, and on both sides south of Campeau Dr. Finally, sidewalks are provided on both sides of the roadway along Huntmar Dr between Campeau and the Tanger Outlets Shopping Centre access and on the east side only to the north of Campeau Dr.

With regards to the cycling network, bike lanes are provided along side the aforementioned sidewalk facilities within the study area, as physically separated and raised unidirectional bike lanes. However, bike lanes were not provided along either of Kanata West Centre Dr or Journeyman St. Furthermore, bike signals are provided on the north and south sides of the intersection of Journeyman/Campeau, for cyclists travelling east and west along Campeau Dr.

Transit Network

The following OC Transpo routes currently operate along Campeau Dr and Palladium Dr:

- **Route #62 (St-Laurent, Hurdman <-> Terry Fox, Stittsville):** identified by OC Transpo as a “Rapid Route”, Route #62 operates 7 days a week, at an average rate of every 30 minutes during weekday peak hour periods. The nearest bus stops to the site are available at the intersection of Journeyman/Campeau.
- **Route #162 (Terry Fox <-> Stittsville):** identified by OC Transpo as a “Local Route”, this route provides customized routing and scheduling to serve local destinations. Route #162 operates at an hourly rate

between 1 and 3 pm and between 7:30 and 10:30 pm on weekdays. The nearest bus stops to the site are available at the intersection of Journeyman/Campeau.

The noted OC Transpo route maps have been provided in **Appendix B**. **Figure 3** below illustrates the area transit network, while **Figure 4** provides the nearest bus stop locations to the development site.

Figure 3: Area Transit Network

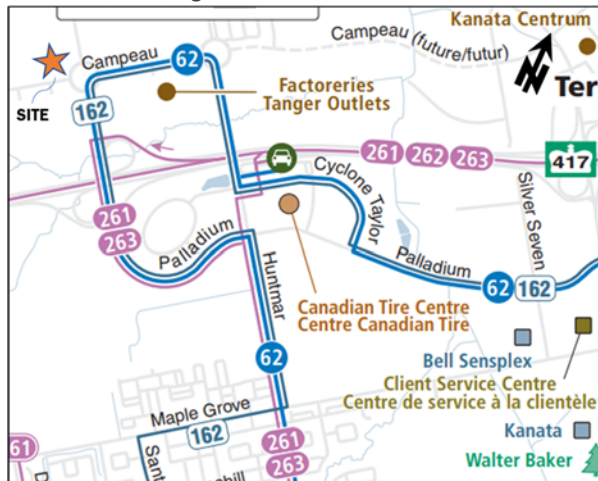
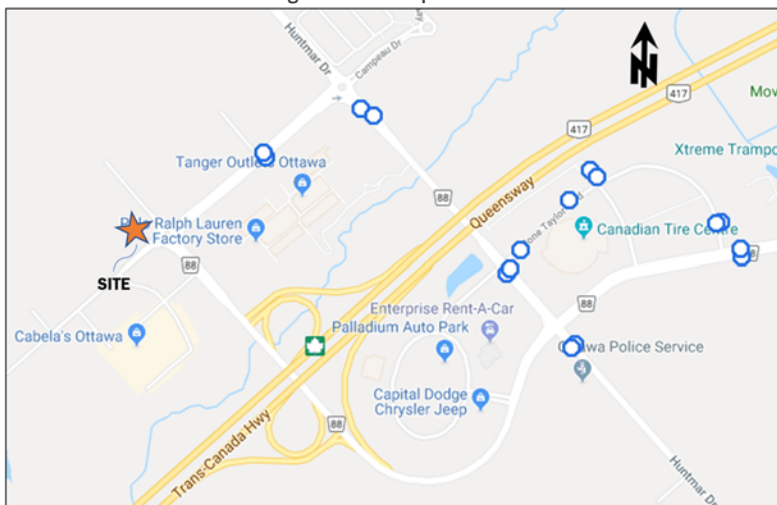

Figure 4: Bus Stop Locations



Peak Hour Travel Demand

Traffic counts at the Hwy 417 Ramps were obtained from MTO (dated April 2018), while counts at other study area intersections were conducted recently by Parsons. The existing peak hour traffic volumes are illustrated in **Figure 5**. Note that the traffic volumes at the Hwy 417 Ramps were balanced using the volumes at the Cabela's/Palladium intersection. The raw peak hour traffic volume count data has been provided in **Appendix C**.

Figure 5: Existing Peak Hour Traffic Volumes

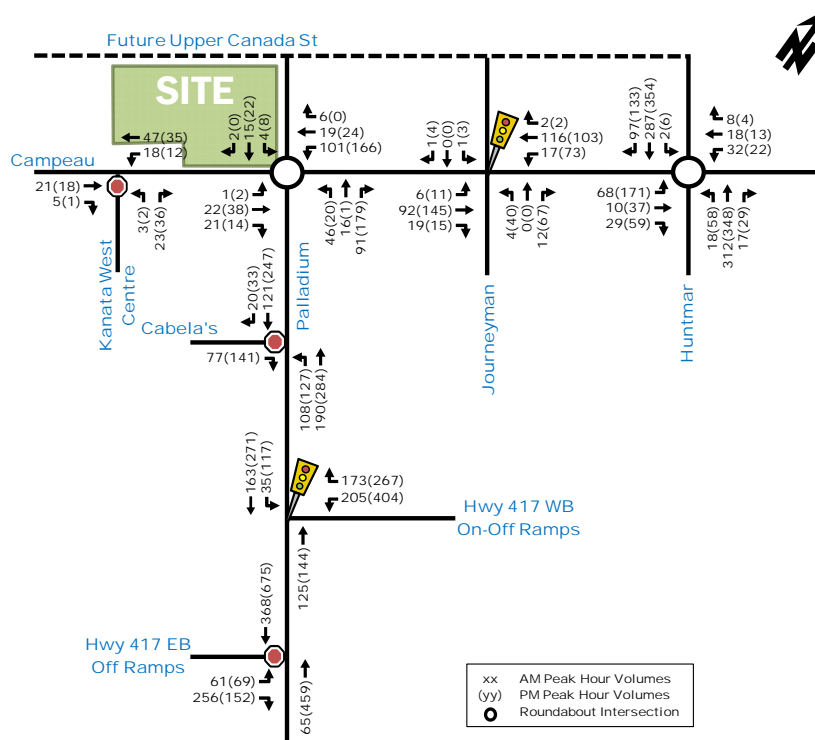

Existing Road Safety Conditions

Although many features of the surrounding road network are relatively new (i.e. some intersections were recently constructed), a five-year collision history data was requested and obtained from the City of Ottawa, which shows a total of 31 collisions occurring in the past five years at all intersections and road segments within the study area. Note that 29 of the collisions recorded resulted in property damage only and 2 resulted in a non-fatal injury.

Of the 31 collisions that occurred within the study area, 14 were at the intersection of Huntmar/Campeau alone, 7 of which were due to sideswipe collisions and 6 of which were due to angle collisions. Since the roundabout was opened to traffic in late 2014, collisions of this nature are expected to be encountered in the first few years due to the unfamiliarity of drivers with the intersection configuration. As such, the number of collisions is not necessarily indicative of future trends at this intersection.

There were 7 collisions at the intersection of Palladium/Hwy 417 WB On-Off Ramps, however, there are no particular collision trends taking place. The remaining 10 collisions that occurred at various intersections and road segments within the study area show no particular trends in collision patterns either. It is worth noting that no collisions were recorded at the roundabout intersection of Campeau/Palladium. This is likely due to the recent opening of the intersection to traffic in 2017, as well as the relatively low current traffic volumes.

The collision data as provided by the City of Ottawa is attached as **Appendix D**.

2.1.3. PLANNED CONDITIONS

Planned Study Area Transportation Network Changes

Shown in **Figure 6** below is the future plan of the Kanata West Business Park. A substantial portion of the road network has been constructed over the past few years. Future additions and improvements to the road network include the construction of a new roadway named Upper Canada St directly north of the proposed Kinaxis development site. Upper

Canada St will extend from Huntmar Dr in the east to connect to Campeau Dr in the west, where it continues as Nippising Way south of Campeau Dr and terminates in a cul-de-sac. Furthermore, Journeyman St would extend north to connect to the future Upper Canada St.

Figure 6: Kanata West Business Park



Slightly further south, the intersection of Hwy 417 EB off Ramp/Palladium is planned to be realigned along with the future realignment of Palladium Dr. The purpose of the realignment is to accommodate a future adjacent area development at 195 Huntmar Dr, by providing it with better connectivity through an east-west collector roadway. A detailed discussion regarding the realignment can be found in a letter submitted by Parsons to the City in May 2018, as an addendum to a Community Transportation Study (CTS) that was prepared for the future development at 195 Huntmar Dr.

With regards to transit, the City of Ottawa Transportation Master Plan (TMP) does not identify any future changes to the existing transit network.

Other Area Developments

Figure 7 below illustrates the other area developments described in this section, relative to the location of the proposed Kinaxis development site. The 1-km limit cited in the City of Ottawa TIA Guidelines to consider adjacent developments is also shown. A summary has been provided for these developments based on the latest available information from the City regarding adjacent site development applications.

Figure 7: Other Area Developments

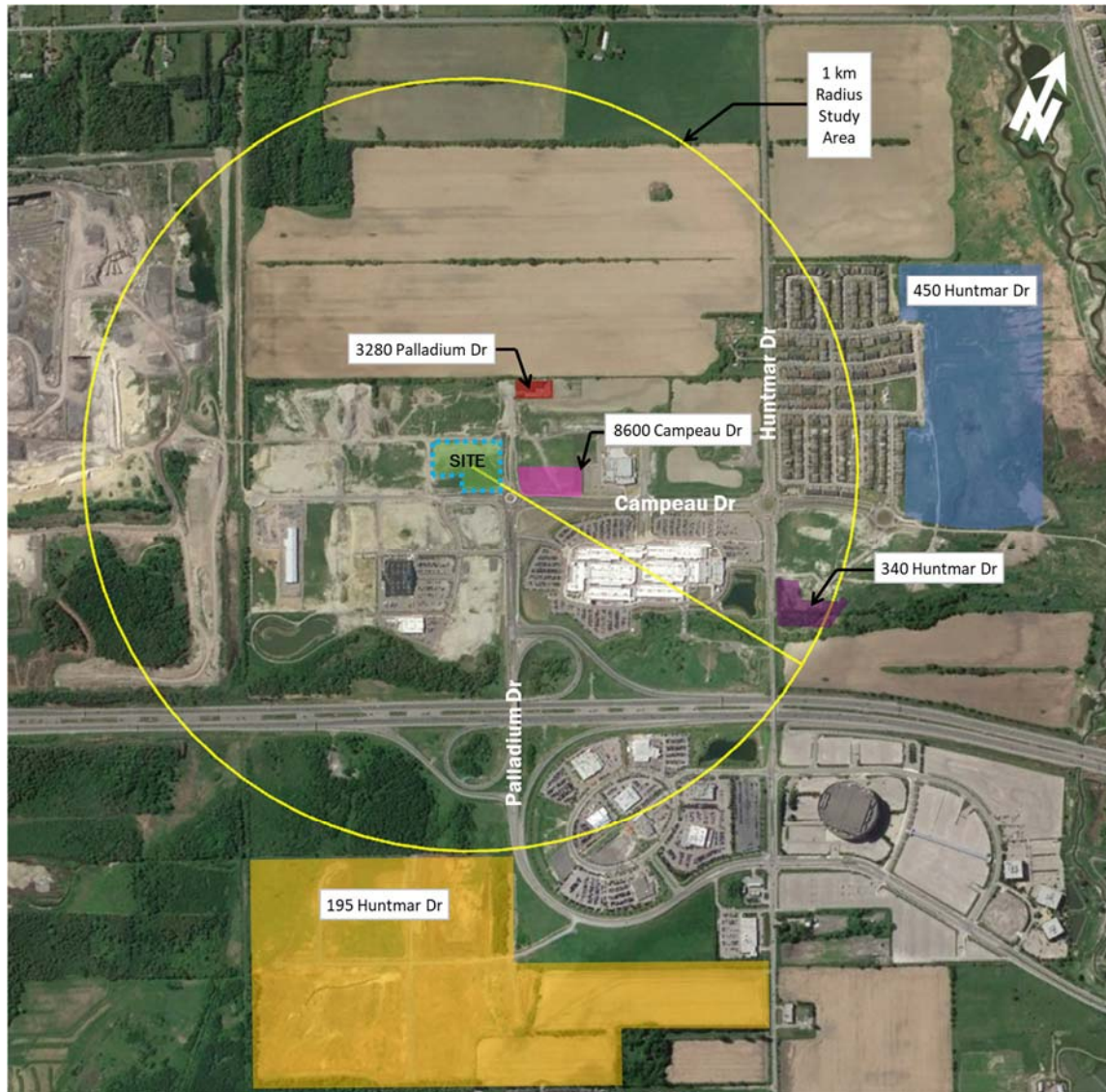

Kanata West Business Park

The Kanata West Business Park (shown in **Figure 6**) is a major development node in Ottawa’s west end. It contains a mix of retail, office and lodging developments, some of which have already been constructed in recent years. A Community Transportation Study (CTS) was prepared in December 2011 by Parsons (previously Delcan) depicting the transportation requirements of the road network based on trip generation of the various future developments. To keep up with development changes being made to the area and provide proper recommendations from a transportation perspective, 12 Addendums were submitted by Parsons to the City after the initial CTS, with the latest Addendum submitted in May 2017.

8600 Campeau Dr (Wingate Hotel)

A Transportation Impact Assessment (TIA) was submitted by the IBI Group in May 2018 in support of a proposed hotel development to be located at 8600 Campeau Dr (northeast corner of the Campeau/Palladium intersection shown in **Figure 7**). The proposed hotel will consist of 20 hotel rooms within a four-storey building and is anticipated to generate up to 56 vehicles/hour during the respective peak hour period. This development was included in the future analysis.

PARSONS

3280 Palladium Dr (Medical Office Building)

Located in the northeast corner of Palladium Dr and the future Upper Canada St (see **Figure 7**), the medical office building was constructed in 2018 and traffic from this site would be accounted for in the existing traffic counts.

340 Huntmar Dr (Hotel Development)

A Transportation Impact Assessment (TIA) was submitted by Parsons in April 2018, in support of a four-storey hotel development to be constructed on the east side of Huntmar Dr, approximately 170 m south of the Huntmar/Campeau intersection. The anticipated occupancy date of this development is 2020. This development was included in the future analysis.

450 Huntmar Dr (Residential Development)

A Transportation Brief was prepared by Parsons in January 2017, addressing the transportation implications and requirements of Stages 3 and 4 of the Arcadia Subdivision. The residential development will be located on the north side of Campeau Dr, approximately 450 m east of the Huntmar/Campeau intersection and will consist of a total of 146 Single Family Units and 255 Townhome Units. Due to the significance of this development with regards to the traffic volumes it generates within the study area, it was included in the future analysis despite being located outside the 1 km radius.

195 Huntmar Dr (mixed uses)

A development consisting of residential units, commercial retail and office uses is planned to the south of the Hwy 417 EB Off Ramp. A Community Transportation Study (CTS) was prepared by Parsons in July 2016, which was followed by an Addendum with updated development land uses in May 2018. Although noted herein, the 195 Huntmar Dr development was not included in the future analysis conducted in this report, due to its location outside of the 1 km radius study area, as well as the uncertainty of its timeline. A more detailed explanation is provided in **Section 3.3** of the report, as a response to a comment from the City.

2.2. STUDY AREA AND TIME PERIODS

Figure 8: Study Area



- Kanata West Centre/Campeau intersection;
- Campeau/Palladium intersection;
- Journeyman/Campeau intersection;
- Huntmar/Campeau;
- Cabela's/Palladium;
- Hwy 417 WB On-Off Ramps/Palladium intersection; and,
- Hwy 417 EB Off Ramp/Palladium intersection.

Since the proposed development consists of an office building, the peak time periods to be assessed are the weekday morning and afternoon peak hour periods. Furthermore, the horizon years to be analyzed are the year of full-buildout of

the development (2021) and five years after full-buildout (2026), as per the requirements of the TIA Guidelines. The proposed study area is outlined below and highlighted in **Figure 8**

2.3. EXEMPTION REVIEW

Based on the City's TIA guidelines and the subject site, the following modules/elements of the TIA process, summarized in **Table 1**, are recommended to be exempt in the subsequent steps of the TIA process:

Table 1: Exemptions Review Summary

Module	Element	Exemption Consideration
4.1 Development Design	4.1.3 New Streets Network	This element is only required for plans of subdivision.
4.2 Parking	4.2.2 Spillover Parking	Parking is anticipated to meet the development's demand.
4.6 Neighbourhood Traffic Management	4.6.1 Adjacent Neighbourhoods	The development relies on arterial roads for access.
4.8 Review of Network Concept	All elements	The site is not expected to generate 200 trips more than the established zoning. This will be confirmed in Step 3.

3. FORECASTING

3.1. DEVELOPMENT GENERATED TRAVEL DEMAND

3.1.1. TRIP GENERATION AND MODE SHARES

The proposed development will consist of a five-storey office building, with a gross floor area of 150,000 ft². Appropriate trip generation trip rates (in vehicles/h) have been obtained from the ITE Trip Generation Manual (10th edition) and are summarized in **Table 2**.

Table 2: Office Building ITE Trip Generation Trip Rates

Land Use	Data Source	Trip Rates (Fitted Curve Equations)	
		AM Peak	PM Peak
General Office Building	ITE 710	$T = 0.94(X) + 26.49;$	$\ln(T) = 0.95\ln(X) + 0.36;$
Notes: $T =$ Average Vehicle Trip Ends $X =$ 1000 Sq. ft GFA			

The ITE vehicle trip rates shown in **Table 2** were then multiplied by a factor of 1.28, which was calculated by assuming a default 10% non-auto mode share and an average vehicle occupancy of 1.15, in order to convert the vehicle trips provided by the ITE manual to person trips. The resulting person trips/h are provided in **Table 3** below. Note that the percentages of in and out traffic was obtained from the ITE Trip Generation Manual.

Table 3: Person Trips Generated by the Office Building

Land Use	Area (ft ²)	AM Peak (Person Trips/h)			PM Peak (Person Trips/h)		
		In	Out	Total	In	Out	Total
General Office Building	150,000	184	30	214	34	180	214

As shown in **Table 3**, the total person trips/h expected to be generated by the future Kinaxis office building development, is 214 person trips/h during both morning and afternoon weekday peak hour periods. Travel modes and their associated mode share percentages were then obtained from the 2011 NCR Household Origin-Destination Survey for the Kanata/Stittsville district. **Table 4** provides the projected person trips/h for each of the travel modes.

Table 4: Mode Shares for the Office Building Development

Travel Mode	Mode Share	AM Peak (Person Trips/h)			PM Peak (Person Trips/h)		
		In	Out	Total	In	Out	Total
Auto Driver	60%	111	18	129	21	108	129
Auto Passenger	15%	28	5	33	5	27	32
Transit	10%	18	3	21	3	18	21
Non-motorized	15%	27	4	31	5	27	32
Total Person Trips	100%	184	30	214	34	180	214
Total 'New' Auto Trips		111	18	129	21	108	129

As shown in **Table 4**, the number of Total Person Trips and number of 'New' Auto Trips expected to be generated by the proposed development are approximately 214 person trips/h and 129 vehicle trips/h, respectively, during both the morning and afternoon weekday peak hour periods.

3.1.2. TRIP DISTRIBUTION AND ASSIGNMENT

Based on the 2011 NCR Household Origin-Destination Survey (Kanata – Stittsville district) and the location of adjacent arterial roadways and neighbourhoods, the distribution of site-generated traffic volumes was estimated as follows:

- 25% to/from the north;
- 10% to/from the south;
- 60% to/from the east; and,
- 5% to/from the west.

The expected site-generated auto trips in **Table 4** were then assigned to the road networks as shown in **Figure 9** below, based on existing traffic volumes, estimated travel times and engineering judgement.

Figure 9: Kinaxis Office Development Site-Generated Traffic

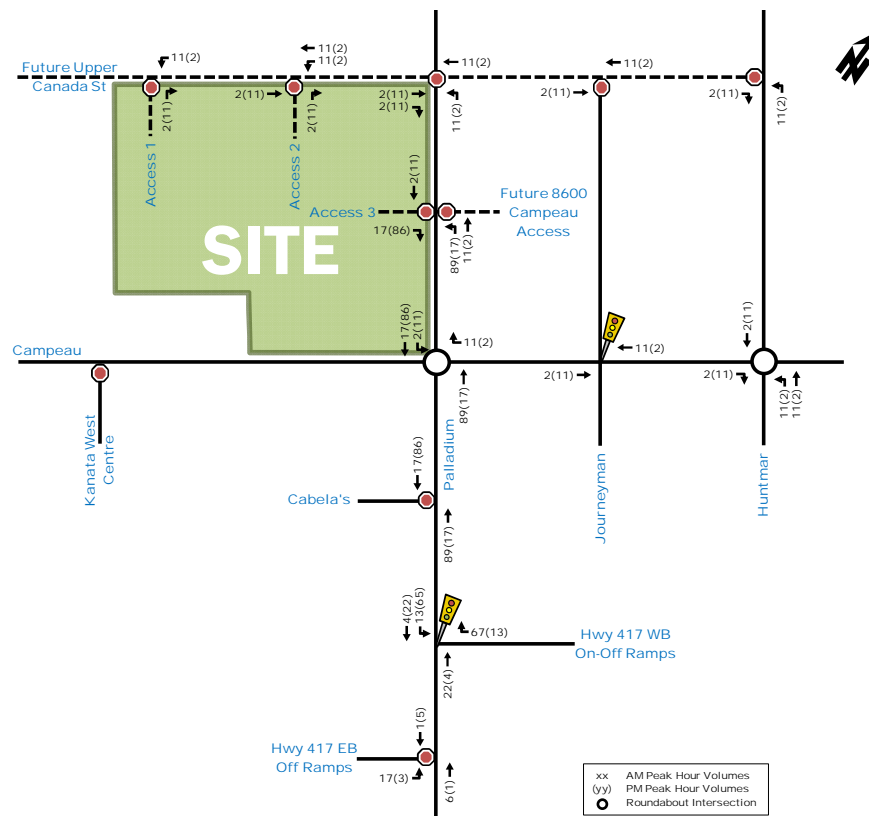

It was assumed that 25% of site traffic would travel to/from Huntmar Rd, while 75% would use Hwy 417 WB and EB ramp intersections. The majority of the site traffic (80%) was anticipated to use Site Access 3, along Palladium Dr, to enter and exit the development site. The remainder would use the accesses on Upper Canada St.

3.2. BACKGROUND NETWORK TRAFFIC

3.2.1. TRANSPORTATION NETWORK PLANS

Refer to **Section 2.1.3: Planned Study Area Transportation Network Changes.**

3.2.2. BACKGROUND GROWTH

A large portion of the Kanata West Business Park and the ultimate road network to support it (see **Figure 6**) has already been constructed. Therefore, the existing traffic counts recently conducted by Parsons at study area intersections account for the current buildout. As previously noted, planned adjacent developments will be accounted for separately in this analysis. However, a 1% background growth rate was still applied to the existing traffic volumes to represent more conservative future buildout conditions.

The resulting future background traffic volumes for horizon years 2021 and 2026 are illustrated in **Figure 10** and **Figure 11**.

Figure 10: Future Background 2021

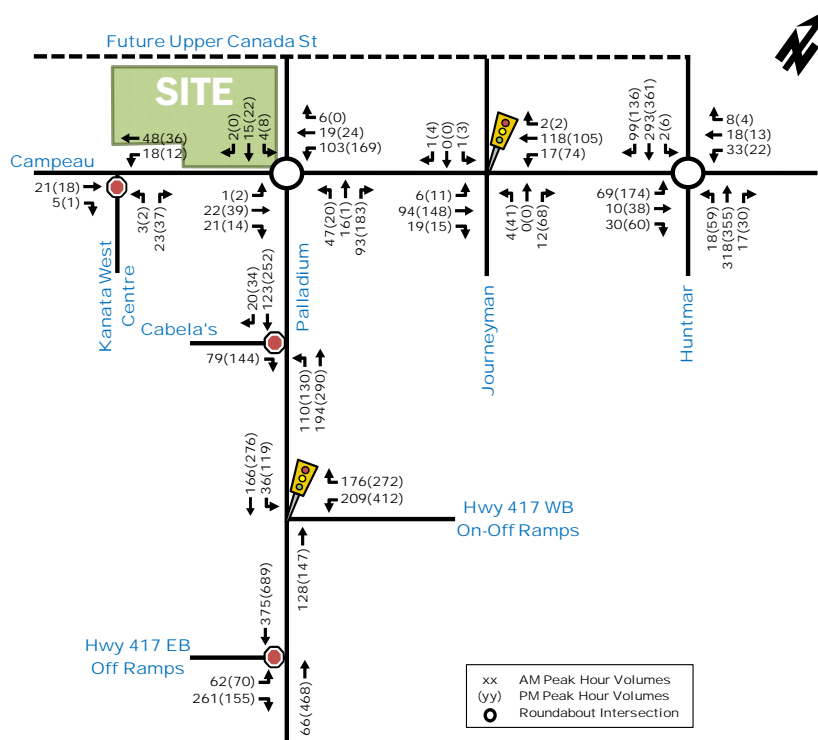
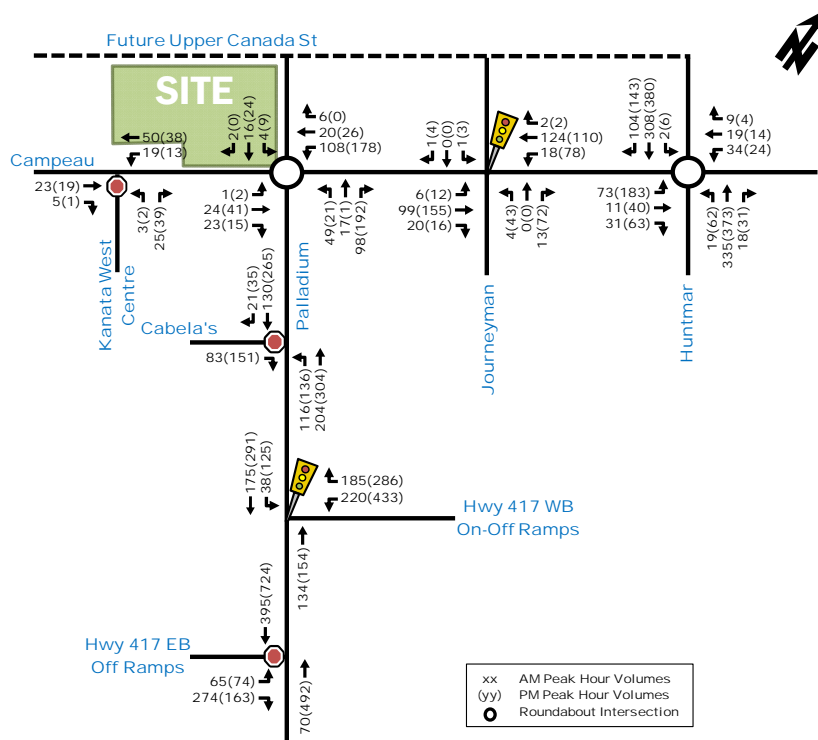

Figure 11: Future Background 2026



3.2.3. OTHER DEVELOPMENTS

Other developments that have initiated the City’s development application process were outlined in **Section 2.1.3: Other Area Developments**. Based on the previous discussion, traffic volumes generated by the following other area developments were considered in future analysis (to be conducted in the Strategy section of the TIA process):

- 8600 Campeau Dr (Wingate Hotel)
- 340 Huntmar Dr (Hotel)
- 450 Huntmar Dr (Residential Subdivision)

The 340 Huntmar Dr development traffic volumes were accounted for in the background growth percentage applied in **Section 3.2.2** based on its location and low volume generation. The 8600 Campeau Dr and the 450 Huntmar Dr development traffic volumes were added separately based on their respective TIA submissions. **Figure 12** illustrates the anticipated traffic volumes, generated within the study area by other area developments.

Figure 12: Other Area Developments Total Traffic Volumes

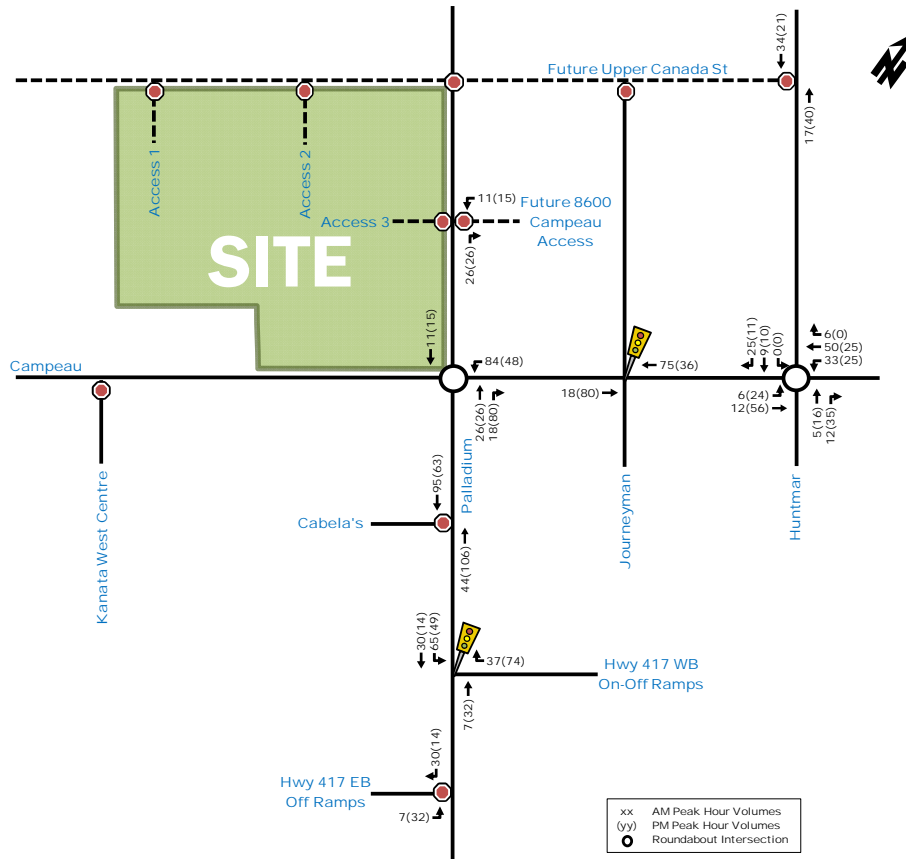

3.2.4. TOTAL BACKGROUND TRAFFIC

Total background traffic represents the summation of background traffic growth (based on the 1% growth rate) in **Figure 10** and **Figure 11** and adjacent development traffic in **Figure 12**. The resulting total background traffic volumes for horizon years 2021 and 2026 are illustrated in **Figure 13** and **Figure 14**.

Figure 13: Total Future Background 2021 Traffic Volumes

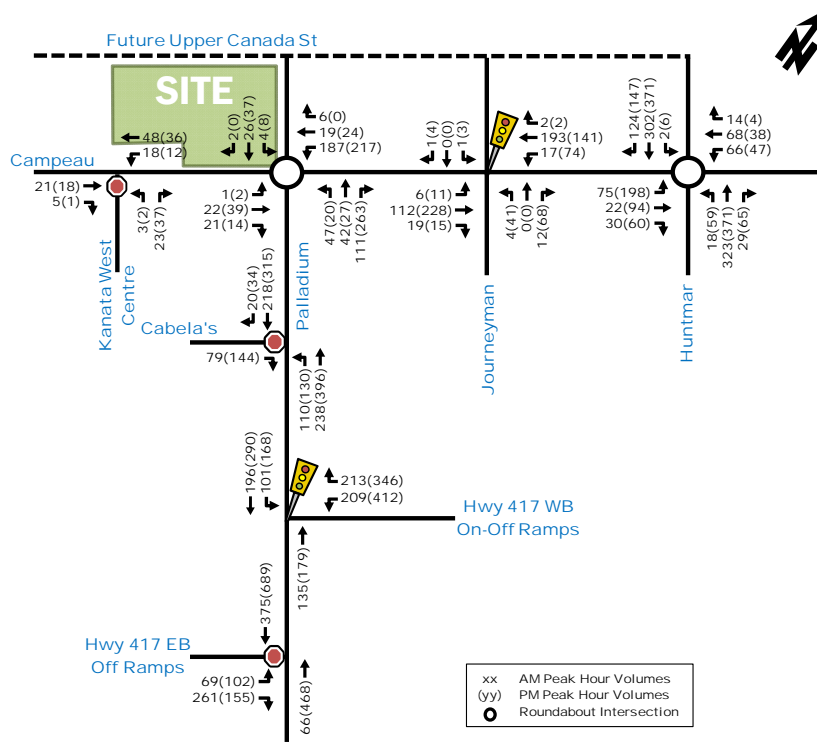
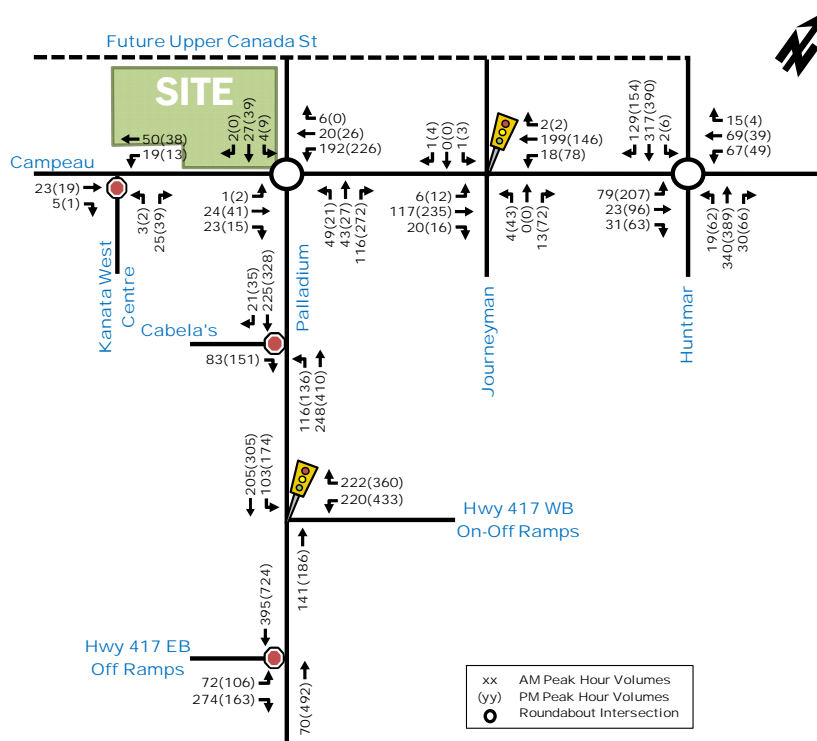

Figure 14: Total Future Background 2026 Traffic Volumes



3.3. DEMAND RATIONALIZATION

The study area road network is expected to accommodate projected volumes. There are currently no anticipated capacity issues. The capacity of the roadways will be further explored in a more detailed review of the total projected traffic volumes and intersection design in the following Analysis Section of the Report.

Regarding the future development at 195 Huntmar Dr, traffic volumes generated by this development were excluded from analysis in the report for the following reasons:

- The status and timeline of this development are currently unknown. Based on the City of Ottawa website, the plan of subdivision application submitted for this development has yet to be approved.
- In order to accommodate this development, changes to the road network are expected to take place south of the Hwy 417 EB Ramps. However, there is uncertainty surrounding the design and scale of these changes, which is important to estimate future traffic intensity and routing.
- Given its location south of the Hwy 417, as well as outside the 1 km radius of the proposed Kinaxis development, traffic volumes generated by the 195 Huntmar Dr development are expected to influence mainly the intersections of Palladium Dr with the Hwy 417 EB and WB Ramps. As such, its impact on the proposed Kinaxis boundary streets would be minimal.

4. ANALYSIS

4.1. DEVELOPMENT DESIGN

4.1.1. DESIGN FOR SUSTAINABLE MODES

Pedestrians and cyclists can access the development site through the series of sidewalks and unidirectional bike lanes that are currently provided throughout the study area. Sidewalks facilities will also be provided along both sides of the future Upper Canada St, but there are no plans currently for bike lanes.

With regards to transit, two bus routes currently operate along Campeau Dr and Palladium Dr, as previously mentioned in **Section 2.1.2**. Furthermore, the nearest bus stop to the development site is along Campeau Dr, within approximately 400-450 m walking distance. Providing a closer bus stop, via existing transit service, either along Campeau Dr or along Palladium Dr, would be of more convenience to employees of the subject site and may further incentivise the use of transit. The location of future bus stops will be confirmed by OC Transpo.

4.1.2. CIRCULATION AND ACCESS

There are no anticipated issues with vehicle accessibility to parking areas on site. The Palladium Dr access is located approximately 50m north of the Campeau/Palladium roundabout, while the two Upper Canada St accesses will be approximately 50m and 120m west of the future intersection of Upper Canada St/Palladium Dr. The loading bay area for trucks is located approximately 75m west of the edge of the Palladium Dr access and not across any of the driveway aisles or parking spaces, so as to minimize any potential traffic disturbance. The fire route is proposed to enter through the Palladium Dr access and exit through the west access along the future Upper Canada St.

Furthermore, the main entrance to the building is on the north side of the building for employees and on the south side of the building for visitors. Sidewalks and crosswalks throughout the site allow employees to arrive at the entrance and maneuver within the parking lot safely.

Design review provided in **Section 4.4.1**.

4.2. PARKING

4.2.1. PARKING SUPPLY

Vehicle Parking

A total of 534 vehicle parking spaces are expected to be provided for the planned development, 13 of which are designated as barrier free parking spaces (i.e. accessible parking). The number of parking spaces provided exceeds the minimum parking space rates set by the City of Ottawa parking provisions. The parking spaces are 5.2 m long and 2.6 m wide, with nearly 50% reduced to 2.4 m wide, as permitted by the City of Ottawa's parking provisions By-Law.

Bicycle Parking

A total of 54 bicycle parking spaces are provided, which meets the requirement set by the City of Ottawa's bike parking provisions. Furthermore, the bike parking will be located in a covered storage area near the proposed building's entrance.

4.3. BOUNDARY STREET DESIGN

The boundary streets today are Campeau Dr and Palladium Dr. In the future, a new roadway, Upper Canada St, will be constructed to the north of the development site. Since there are no anticipated changes to the existing Campeau Dr and Palladium Dr in future conditions, a Multi-Modal Level of Service (MMLoS) analysis was conducted for all three boundary streets, based on future conditions.

Campeau Dr's and *Palladium Dr's* (Arterial Roads) geometry along the frontage of the proposed site consist of similar design features, as follows:

- 1 vehicle travel lane in each direction;
- 2.0 m sidewalks on both sides of the roadway;
- 2.0 m physically separated bike lanes on both sides of the roadway;
- Less than 3000 avg daily curb lane traffic volumes;
- Posted speed limit of 60 km/h; and
- 3.5 m wide lanes.

The geometry of the future *Upper Canada St* (Local Road) consists of the following features:

- 1 vehicle travel lane in each direction;
- 2.0 m sidewalks on the south side of the roadway;
- No planned bike lanes;
- Less than 3000 avg daily curb lane traffic volumes;
- Assumed posted speed limit of 50 km/h; and
- Approximately 4.0 m wide lanes.

The multi-modal level of service analysis for the adjacent road segments of Campeau Dr, Palladium Dr and Upper Canada St is summarized in **Table 5**, with detailed analysis provided in **Appendix E**. The table also identifies the target LOS, with respect to each mode, based on the land-use designation and road classification of the development site and the boundary streets. The Transportation Master Plan (TMP) of the City of Ottawa identifies the land-use designation of the development site as an Urban Employment Area. The road classifications of each of the boundary streets are noted above.

Table 5: MMLOS - Boundary Road Analysis

Road Segment	Level of Service							
	Pedestrian (PLOS)		Bicycle (BLOS)		Transit (TLOS)		Truck (TkLOS)	
	PLOS	Target	BLOS	Target	TLOS	Target	TKLOS	Target
Campeau Dr	A	C	A	E	D	No target	C	D
Palladium Dr	A	C	A	E	D	No target	C	D
Upper Canada St	A	C	B	No target	D	No target	B	E

Blue letters in the table above indicate that the respective LOS result meets its respective LOS target set by the MMLOS Guidelines. As such, all travel modes pertaining to each of the road segments are anticipated to meet the MMLOS requirements. Note that no targets are set for the Transit LOS as there is no transit corridor or transit priority area along the boundary streets.

4.4. ACCESS INTERSECTION DESIGN

4.4.1. LOCATION AND DESIGN OF ACCESS

As previously mentioned, three future accesses are planned to be provided for the future development. Based on information provided by the site plan (Figure 2), the location and design of each of the accesses is described as follows:

- An 9 m wide, full-movement driveway connection to Palladium Dr, on the east end of the site.
 - The corner clearance of this access to the Campeau/Palladium roundabout is approximately 65-70 m, which is sufficient based on TAC access guidelines.
 - The throat length was measured from the first parking lot aisle (minus the crosswalk) of the site, to the end of the driveway curb. The length was determined to be approximately 49 m. However, as illustrated by the site plan in Figure 2, two accessible perpendicular parking spaces are proposed on the south side of the driveway, between Palladium Dr and the first parking lot aisle, providing a clear throat length of 30 m from the Palladium Dr access, thereby meeting the minimum requirement based on TAC guidelines.
- A 6.7 m wide, full-movement driveway connection to the future Upper Canada St, on the north end of the site.
- A 7 m wide, full-movement driveway connection to the future Upper Canada St, on the north end of the site.

Furthermore, truck turning templates are provided in Appendix F, which illustrate the movement of trucks within the site, between the loading dock and the Palladium Dr access. Medium sized trucks (MSU) are the largest trucks expected to access the loading dock of the site. Large sized trucks (HSU), such as firetrucks, are expected to travel through the site’s fire route only.

It should be noted that a full-movement access to an adjacent area development will be located across from the Palladium Dr access of the Kinaxis development. In order for traffic to access the two driveway connections along the future Upper Canada St, an intersection will be formed between Upper Canada St and the existing Palladium Dr.

The City noted a potential concern with the proposed all-turns access off Palladium Dr. A “worst-case scenario” analysis was conducted using SimTraffic and total projected 2026 traffic volumes (Figure 16) to ensure that inbound queues do not spill back to the full-movement access at Palladium Dr, which may impact the operations of the Campeau/Palladium roundabout. The focus of the simulation was on the first parking lot aisle that traffic approaches from the Palladium Dr access. An all-way STOP control pseudo-intersection was formed in Synchro at the parking lot aisle, with conservative estimates entered for bike and pedestrian volumes crossing this intersection during peak hours. Traffic volumes at the intersection were balanced and distributed based on the inbound and outbound volumes at the Palladium Dr access. Multiple runs were conducted using SimTraffic in order to provide an average 95th percentile queue length. The resulting queue lengths of the WB movement of the pseudo-intersection was approximately 16 m in the morning peak and 11 m in

the afternoon peak. As such, there are no anticipated queuing issues caused by allowing full-movements of traffic at the Palladium Dr access. SimTraffic reports of this analysis are provided in **Appendix G**.

4.4.2. INTERSECTION CONTROL AND DESIGN

At each of the proposed development's accesses, STOP control will be provided for traffic exiting the site. At the future intersection of Upper Canada/Palladium, an All-Way STOP control is anticipated to be provided and all legs of the intersection will consist of single, full-movement lanes. Intersection control at the existing study area intersections will remain unchanged.

Furthermore, MMLoS analysis at signalized intersections is required to be provided for existing and future conditions of travel demands. However, since there are no signalized intersections at the frontage of the development site, this analysis cannot be provided.

4.5. TRANSPORTATION DEMAND MANAGEMENT

The TDM checklist is provided in **Appendix H**.

4.6. NEIGHBOURHOOD TRAFFIC MANAGEMENT

Exempt – see **Section 2.3**.

4.7. TRANSIT

Refer to **Section 2.1.2: Transit Network**, for a description of the existing bus services within the study area. Based on the City of Ottawa TMP, there are no planned changes to the study area with regards to the transit network.

4.8. REVIEW OF NETWORK CONCEPT

Exempt – see **Section 2.3**.

4.9. INTERSECTION DESIGN

4.9.1. INTERSECTION CONTROL

Refer to **Section 4.4.2: Intersection Control and Design**.

4.9.2. INTERSECTION DESIGN

Existing Conditions

Table 6 below summarizes traffic operational results of the signalized, unsignalized and roundabout intersections within the study area, based on existing conditions traffic volumes (see **Figure 5**). Signalized and unsignalized intersections were assessed using the Synchro 10 Trafficware, while roundabouts were assessed using the Sidra 7.0 Intersection software. Critical movements at each intersection are identified based on the movement providing either the highest volume-to-capacity (v/c) ratio (signalized intersections), or the highest average delay (unsignalized and roundabout intersections) at its respective intersection. It should be noted that, as per the TIA Guidelines, the Peak Hour Factor (PHF) was set to 0.90 for existing conditions analysis and to 1.0 for all future analysis scenarios. All Synchro and Sidra analysis outputs for existing and future conditions have been provided in **Appendix I**.

Table 6: Existing Conditions Intersection Performance

Intersection	Weekday AM Peak (PM Peak)					
	Critical Movement			Intersection 'As a Whole'		
	LOS	max. v/c or avg. delay (s)	Movement	Delay (s)	LOS	v/c
Journeyman St/Campeau Dr (S)	A(A)	0.43(0.52)	WBT(EBT)	25.7(23.0)	A(A)	0.37(0.38)
Palladium Dr/Hwy 417 WB On-Off Ramps (S)	A(A)	0.31(0.43)	WBR(WBR)	16.0(17.1)	A(A)	0.21(0.30)
Kanata West Centre Dr/Campeau Dr (U)	A(A)	8.6(8.6)	NB(NB)	3.0(4.0)	-	-
Cabelas Way/Palladium Dr (U)	A(B)	9.1(10.1)	EB(EB)	3.0(3.0)	-	-
Palladium Dr/Hwy 417 EB Off Ramp (U)	B(C)	12.1(17.4)	EB(EB)	5.1(2.8)	-	-
Campeau Dr/Palladium Dr (R)	A(A)	9.7(9.8)	SBL(SBL)	6.1(5.9)	-	-
Huntmar Dr/Palladium Dr (R)	A(B)	10.0(10.2)	WBL(WBL)	4.6(5.3)	-	-

Note: Analysis of signalized intersections assumes a PHF of 0.90 and a saturation flow rate of 1800 veh/h/lane.
(S) - Signalized intersection.
(U) - Unsignalized intersection.
(R) - Roundabout intersection.

As shown in **Table 6**, all critical movements at study area intersections are anticipated to result in a Level of Service (LOS) 'C' or better during morning and afternoon weekday peak hour periods. The signalized intersections 'as a whole' result in a LOS 'A' during both morning and afternoon weekday peak hour periods.

Total Future Background 2021 Conditions

Analysis of total future background 2021 was based on the traffic volumes shown in **Figure 13**. **Table 7** below provides a summary of the analysis results.

Table 7: Total Future Background 2021 Intersection Performance

Intersection	Weekday AM Peak (PM Peak)					
	Critical Movement			Intersection 'As a Whole'		
	LOS	max. v/c or avg. delay (s)	Movement	Delay (s)	LOS	v/c
Journeyman St/Campeau Dr (S)	A(A)	0.47(0.52)	WBT(EBT)	23.8(21.4)	A(A)	0.43(0.41)
Palladium Dr/Hwy 417 WB On-Off Ramps (S)	A(A)	0.31(0.45)	WBR(WBR)	13.5(14.7)	A(A)	0.21(0.31)
Kanata West Centre Dr/Campeau Dr (U)	A(A)	8.6(8.6)	NB(NB)	3.0(4.0)	-	-
Cabelas Way/Palladium Dr (U)	A(B)	9.3(10.2)	EB(EB)	2.4(2.5)	-	-
Palladium Dr/Hwy 417 EB Off Ramp (U)	B(C)	11.8(18.0)	EB(EB)	4.8(3.2)	-	-
Campeau Dr/Palladium Dr (R)	A(A)	9.9(9.9)	SBL(SBL)	6.5(5.7)	-	-
Huntmar Dr/Palladium Dr (R)	B(B)	10.3(10.2)	WBL(WBL)	4.9(5.4)	-	-

Note: Analysis of signalized intersections assumes a PHF of 1.0 and a saturation flow rate of 1800 veh/h/lane.
(S) - Signalized intersection.
(U) - Unsignalized intersection.
(R) - Roundabout intersection.

As shown in **Table 7**, the study area intersections are anticipated to operate similar to existing conditions, with slight improvements to delays and v/c ratios due to increasing the PHF parameter to 1.0.

Total Future Background 2026 Conditions

Analysis of total future background 2026 was based on the traffic volumes shown in **Figure 14**. **Table 8** below provides a summary of the analysis results.

Table 8: Total Future Background 2026 Intersection Performance

Intersection	Weekday AM Peak (PM Peak)					
	Critical Movement			Intersection 'As a Whole'		
	LOS	max. v/c or avg. delay (s)	Movement	Delay (s)	LOS	v/c
Journeyman St/Campeau Dr (S)	A(A)	0.48(0.53)	WBT(EBT)	23.8(21.4)	A(A)	0.44(0.41)
Palladium Dr/Hwy 417 WB On-Off Ramps (S)	A(A)	0.33(0.46)	WBR(WBR)	13.6(14.8)	A(A)	0.22(0.32)
Kanata West Centre Dr/Campeau Dr (U)	A(A)	8.6(8.6)	NB(NB)	3.0(4.0)	-	-
Cabelas Way/Palladium Dr (U)	A(B)	9.4(10.3)	EB(EB)	2.5(2.5)	-	-
Palladium Dr/Hwy 417 EB Off Ramp (U)	B(C)	12.1(19.5)	EB(EB)	5.0(3.5)	-	-
Campeau Dr/Palladium Dr (R)	A(A)	9.9(10.0)	SBL(SBL)	6.4(5.7)	-	-
Huntmar Dr/Palladium Dr (R)	B(B)	10.3(10.2)	WBL(WBL)	4.9(5.5)	-	-

Note: Analysis of signalized intersections assumes a PHF of 1.0 and a saturation flow rate of 1800 veh/h/lane.
 (S) - Signalized intersection.
 (U) - Unsignalized intersection.
 (R) - Roundabout intersection.

The results show very slight increase in delays and v/c ratios at some intersections, in comparison to total future background 2021 analysis results.

Total Projected 2021 Conditions – Full Build-Out

The total projected 2021 traffic volumes were derived by superimposing the site-generated traffic volumes (Figure 9) onto total future background 2021 traffic volumes (Figure 13). The resulting total projected traffic volumes are illustrated in Figure 15.

Figure 15: Total Projected 2021 Traffic Volumes

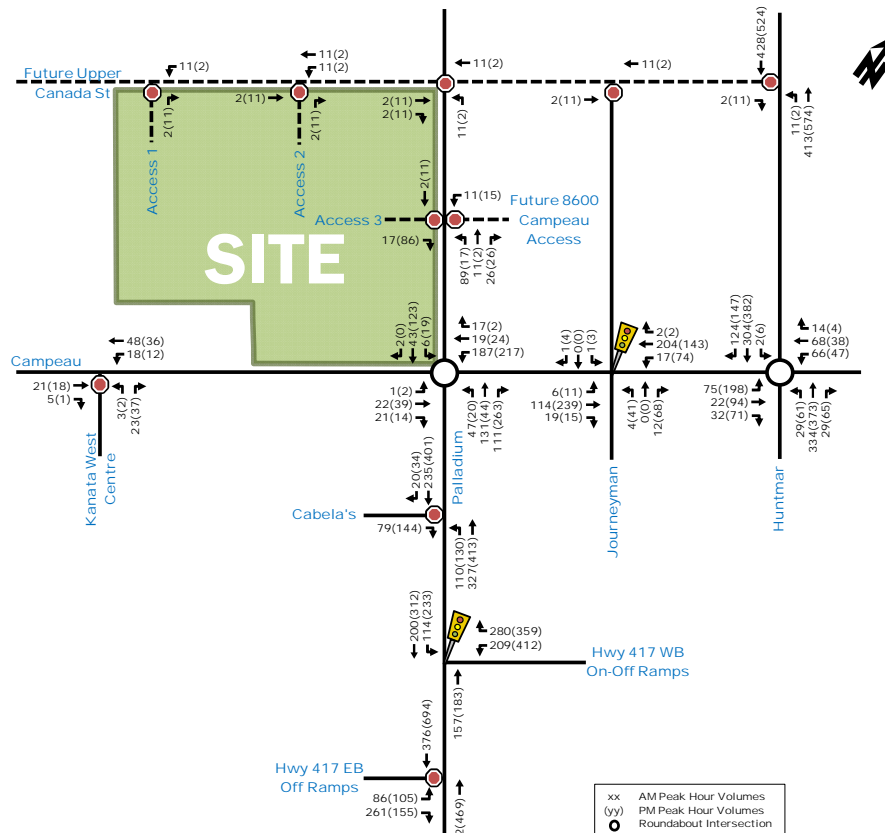

As mentioned previously, three new accesses are proposed to be used by the future development, two along the future Upper Canada St and one along Palladium Dr. This allows a new intersection to form between Palladium Dr and the future Upper Canada St. As such, four new unsignalized intersections are added to the analysis.

Table 9 below provides a summary of the critical Synchro analysis results at intersections within the study area, based on total projected 2021 traffic volumes.

Table 9: Total Projected 2021 Performance at Study Area Intersections

Intersection	Weekday AM Peak (PM Peak)					
	Critical Movement			Intersection 'As a Whole'		
	LOS	max. v/c or avg. delay (s)	Movement	Delay (s)	LOS	v/c
Journeyman St/Campeau Dr (S)	A(A)	0.49(0.53)	WBT(EBT)	24.0(21.5)	A(A)	0.45(0.42)
Palladium Dr/Hwy 417 WB On-Off Ramps (S)	A(A)	0.39(0.46)	WBR(WBR)	13.0(14.5)	A(A)	0.26(0.34)
Kanata West Centre Dr/Campeau Dr (U)	A(A)	8.6(8.6)	NB(NB)	3.0(4.0)	-	-
Cabelas Way/Palladium Dr (U)	A(B)	9.4(10.6)	EB(EB)	2.1(2.4)	-	-
Palladium Dr/Hwy 417 EB Off Ramp (U)	B(C)	11.9(18.4)	EB(EB)	5.0(3.3)	-	-
Palladium Dr/Future Upper Canada St (U)	A(A)	7.2(7.2)	NB(NB)	7.0(6.8)	-	-
Future Upper Canada St/Access 1 (U)	A(A)	8.3(8.4)	NB(NB)	7.4(8.2)	-	-
Future Upper Canada St/Access 2 (U)	A(A)	8.3(8.4)	NB(NB)	3.7(4.1)	-	-
Palladium Dr/Access 3/8600 Campeau (U)	B(A)	10.3(9.9)	WB(WB)	5.9(6.5)	-	-
Campeau Dr/Palladium Dr (R)	A(A)	9.9(10.0)	SBL(SBL)	6.1(5.6)	-	-
Huntmar Dr/Palladium Dr (R)	B(B)	10.3(10.2)	WBL(WBL)	4.9(5.4)	-	-

Note: Analysis of signalized intersections assumes a PHF of 1.0 and a saturation flow rate of 1800 veh/h/lane.
(S) - Signalized intersection.
(U) - Unsignalized intersection.
(R) - Roundabout intersection.

As shown in **Table 9**, all critical movements at study area intersections operate at a LOS 'C' or better during morning and afternoon weekday peak hour periods. The signalized intersections 'as a whole' result in a LOS 'A' during both morning and afternoon weekday peak hour periods.

Total Projected 2026 Conditions –Build-Out plus Five Years

The total projected 2026 traffic volumes shown in **Figure 16**, were derived by superimposing the site-generated traffic volumes (**Figure 9**) onto total future 2026 background traffic volumes (**Figure 14**).

Figure 16: Total Projected 2026 Traffic Volumes

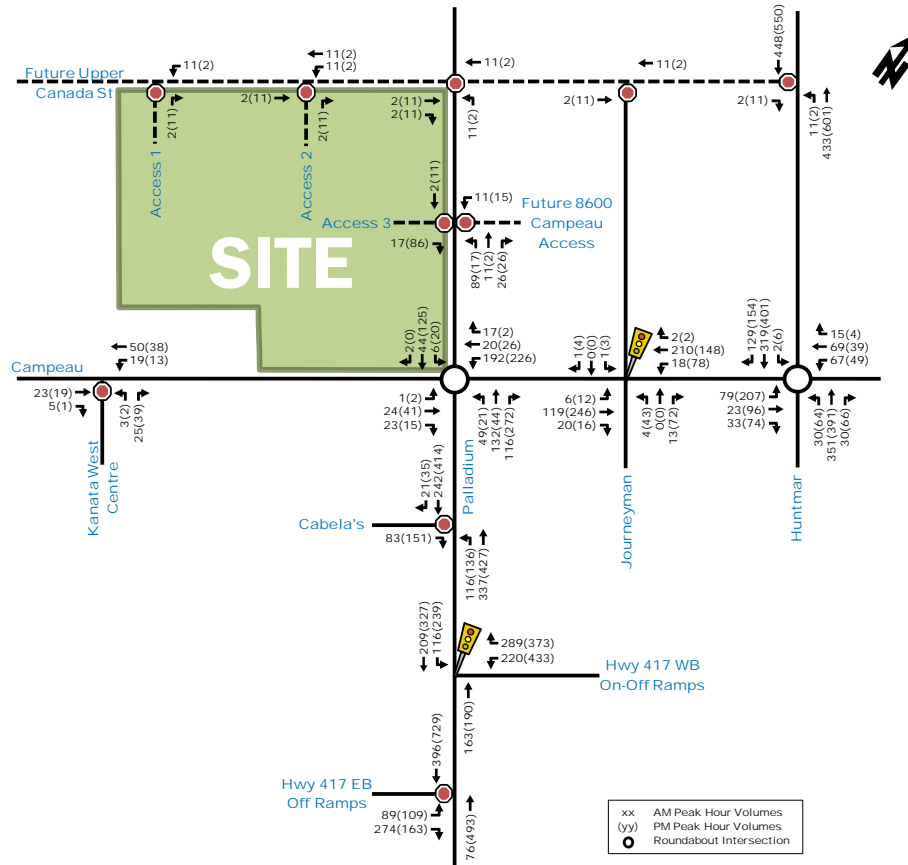

Table 10 below provides a summary of the critical Synchro analysis results at intersections within the study area, based on total projected 2026 traffic volumes.

Table 10: Total Projected 2026 Performance at Study Area Intersections

Intersection	Weekday AM Peak (PM Peak)					
	Critical Movement			Intersection 'As a Whole'		
	LOS	max. v/c or avg. delay (s)	Movement	Delay (s)	LOS	v/c
Journeyman St/Campeau Dr (S)	A(A)	0.50(0.54)	WBT(EBT)	23.9(21.6)	A(A)	0.46(0.43)
Palladium Dr/Hwy 417 WB On-Off Ramps (S)	A(A)	0.40(0.48)	WBR(WBR)	13.1(14.7)	A(A)	0.27(0.35)
Kanata West Centre Dr/Campeau Dr (U)	A(A)	8.6(8.6)	NB(NB)	3.0(4.0)	-	-
Cabelas Way/Palladium Dr (U)	A(B)	9.4(10.7)	EB(EB)	2.1(2.4)	-	-
Palladium Dr/Hwy 417 EB Off Ramp (U)	B(C)	12.2(20.0)	EB(EB)	5.1(3.6)	-	-
Palladium Dr/Future Upper Canada St (U)	A(A)	7.2(7.2)	NB(NB)	7.0(6.8)	-	-
Future Upper Canada St/Access 1 (U)	A(A)	8.3(8.4)	NB(NB)	7.4(8.2)	-	-
Future Upper Canada St/Access 2 (U)	A(A)	8.3(8.4)	NB(NB)	3.7(4.1)	-	-
Palladium Dr/Access 3/8600 Campeau (U)	B(A)	10.3(9.9)	WB(WB)	5.9(6.5)	-	-
Campeau Dr/Palladium Dr (R)	A(B)	9.9(10.0)	WBL(SBL)	6.1(5.6)	-	-
Huntmar Dr/Palladium Dr (R)	B(B)	10.4(10.2)	WBL(WBL)	4.9(5.5)	-	-

Note: Analysis of signalized intersections assumes a PHF of 1.0 and a saturation flow rate of 1800 veh/h/lane.
 (S) - Signalized intersection.
 (U) - Unsignalized intersection.
 (R) - Roundabout intersection.

As shown in **Table 10**, the study area intersections are anticipated to operate similar to total projected 2021 conditions, with slight increase in delays and v/c ratios at some intersections.

5. FINDINGS, CONCLUSIONS AND RECOMMENDATIONS

Based on the results summarized herein the following transportation related conclusions are offered:

Proposed Development

- The proposed single-phase development will consist of a five-storey office building with a total building area of 150,000 ft². The anticipated buildout year of the development is 2021.
- The development is planned to provide a total of 534 vehicle parking spaces (including 13 accessible spaces) and 54 bicycle parking spaces, both of which meet what is required by the City of Ottawa's parking provisions.
- Three new accesses are proposed to serve the development. Two accesses will be located along the future Upper Canada St, on the north end of the site, while one accesses will be located along Palladium Dr, on the east end of the site. All access will permit all-turn movements.
- The projected number of vehicle trips anticipated to be generated by the development is 129 veh/h during both morning and afternoon weekday peak hour periods.

Existing and Background Conditions

- All existing study area intersections were projected to operate at a LOS 'C' or better during morning and afternoon weekday peak hour periods.
- Background traffic growth rate was assumed to be 1% per year at all existing study area intersections.
- The operational analysis of total future background 2021 and 2026 conditions indicated the following:
 - Study area intersections operate similar to existing conditions, with a LOS 'C' or better during morning and afternoon weekday peak hour periods; and,
 - MMLoS analysis of boundary streets was conducted based on future conditions of the study area. The boundary streets analyzed were Campeau Dr, Palladium Dr and the future Upper Canada St. The analysis indicated that all MMLoS targets were met, with respect to each travel mode and boundary street.

Projected Conditions

- In total projected 2021 and 2026 conditions, analysis was extended to include the three proposed accesses to the development, as well the intersection of future Upper Canada St/Palladium Dr.
- Based on the analysis, all study area intersections in total projected 2021 and 2026 conditions are projected to operate at a LOS 'C' or better during morning and afternoon weekday peak hour periods.

Design Review

- The following design requirements were reviewed:
 - Corner clearance was measured between the Palladium Dr access and the Campeau/Palladium roundabout and was determined to be approximately 65-70 m, which meets minimum requirement of the TAC guidelines.
 - Throat length of Palladium Dr access was found to meet TAC guidelines requirements, with a length of approximately 30 m.
 - As per the City of Ottawa parking provisions, the driveway aisles of the development's parking lot are at least 6.7 m wide.
 - Truck turning templates indicated that there are no issues regarding truck movements throughout the site.

PARSONS

- Additional analysis was also conducted using SimTraffic to simulate the internal queuing of the site at the development's first parking lot aisle, when approaching from the Palladium Dr access. The analysis indicated that there are no anticipated queuing issues, with a maximum queue of 16 m during the morning peak hour, meaning there is low risk of queue spillback impacting Palladium Dr traffic operations.

Based on the foregoing, the proposed Kinaxis office development can be well accommodated by the adjacent transportation network and is recommended to proceed from a transportation perspective.

Prepared By:



Basel Ansari, EIT.
Transportation Planner

Reviewed By:



Austin Shih, M.A.Sc., P.Eng.
Senior Transportation Engineer

Appendix A

City Comments and Screening Form

City of Ottawa 2017 TIA Guidelines

Date

13-Jun-19

TIA Screening Form

Project

TRM Kinaxis

Project Number

908489-50052

Results of Screening	Yes/No
Development Satisfies the Trip Generation Trigger	Yes
Development Satisfies the Location Trigger	No
Development Satisfies the Safety Trigger	Yes

Module 1.1 - Description of Proposed Development	
Municipal Address	8700 Campeau Drive
Description of location	NW corner of Campeau Drive and Palladium Drive roundabout
Land Use	Office
Development Size	13935 sq.m GFA
Number of Accesses and Locations	2 accesses off Upper Canada Street 1 access off Palladium Drive
Development Phasing	1 Phase
Buildout Year	Anticipated Full-Buildout 2021
Sketch Plan / Site Plan	See attached

Module 1.2 - Trip Generation Trigger		
Land Use Type	Office	
Development Size	13935	sq. m
Trip Generation Trigger Met?	Yes	

Module 1.3 - Location Triggers	
Development Proposes a new driveway to a boundary street that is designated as part of the City's Transit Priority, Rapid Transit, or Spine Bicycle Networks (See Sheet 3)	No
Development is in a Design Priority Area (DPA) or Transit-oriented Development (TOD) zone. (See Sheet 3)	No
Location Trigger Met?	No

Module 1.4 - Safety Triggers		
Posted Speed Limit on any boundary road	<80	km/h
Horizontal / Vertical Curvature on a boundary street limits sight lines at a proposed driveway	No	
A proposed driveway is within the area of influence of an adjacent traffic signal or roundabout (i.e. within 300 m of intersection in rural conditions, or within 150 m of intersection in urban/ suburban conditions) or within auxiliary lanes of an intersection;	Yes	
A proposed driveway makes use of an existing median break that serves an existing site	No	
There is a documented history of traffic operations or safety concerns on the boundary streets within 500 m of the development	No	
The development includes a drive-thru facility	No	
Safety Trigger Met?	Yes	

**Step 5 Report -
Submission #1
Comments**

28 October 2019

City of Ottawa
Development Review Services
110 Laurier Avenue West
Ottawa, ON K1P 1J1

Attention: Josiane Gervais

Dear Josiane:

**Re: 8700 Campeau Drive Kinaxis Development
Step 5 – Comment and Response Form Second Submission**

This comment and response form has been prepared to address the comments received from the City of Ottawa on October 21st, 2019, with corresponding responses from Parsons.

TRAFFIC SIGNAL OPERATIONS

Comment 1: *For Palladium Drive and HWY417 WB ramp intersection, what split time does phase 6 receive in Synchro?*

Response 1: The phase 6 split time in Synchro was equivalent to 61s. Note, we adjusted the City's existing signal timing plan that cited a 39s phase 6 (the SBT movement). We assume this was an error because phase 6 must equal the sum of the protected SBL and NBT timings, which is 61s. This timing was used in all existing and future scenario analysis.

DEVELOPMENT REVIEW TRANSPORTATION ENGINEERING SERVICES

Comment 2: *Update Appendix F Turning Movements to show HSU turning movements.*

Response 2: Appendix F updated to include HSU turning movements.

Strategy Report Comments

16 September 2019

City of Ottawa
Development Review Services
110 Laurier Avenue West
Ottawa, ON K1P 1J1

Attention: Rosanna Baggs

Dear Rosanna:

**Re: 8700 Campeau Dr
Step 4 – Comment and Response Form**

This comment and response form has been prepared to address the comments received from the City of Ottawa on August 26th, 2019, with corresponding responses from Taggart and Parsons.

DEVELOPMENT REVIEW – TRANSPORTATION ENGINEERING SERVICES

Comment 1: *Include access design parameters such as access width, clear throat, access grade, curb radii, location of any parking gates, etc. for both accesses on the site plan.*

Response 1: These have been included on the revised Site Plan.

Comment 2: *Parking within the throat length on the access is not permitted.*

Response 2: Accessible parking spaces north of the building that were previously within the throat length have been relocated to achieve a 30 meter clear throat length from the Palladium access, which is the minimum requirement for a 15,000m² office development off an arterial road based on TAC.

Comment 3: *Confirm the largest vehicle accessing the site is an HSU. Reduce the width of the access on Palladium Drive and relocating the truck access to Upper Canada Street fire route access. Tighten the curb radii as much as possible at this access.*

Response 3: The largest vehicle intended to access the site is a heavy single unit (HSU) truck. No freight trucks or trucks larger than garbage trucks will have access. Trucks will be directed to access the site from Upper Canada Street. The width of the access from Palladium is 9 meters to enable feasible operation of the aisle accessing the loading bays and for fire route access. Curb radii at the Palladium Drive access have been tightened.

Comment 4: *Replace any trees removed for construction of the accesses.*

Response 4: See Landscape Plan. Proposed relocation of three trees is indicated along Palladium Drive.

Comment 5: *Provide a sidewalk connection (small piece missing) from the employee entrance to Palladium Drive.*

Response 5: See Site Plan. A continuous sidewalk connection is now provided from Palladium Drive to the employee entrance.

Comment 6: *Provide electronic existing and proposed "Pavement Markings and Signage" drawings following acceptance of the final design to Amir Zahabi at amir.zahabi@ottawa.ca for review. The drawings should show all roadway markings and signs within the construction limits (and beyond if affected - i.e. warning signs that are no longer applicable).*

Response 6: Noted. Pavement Markings and Signage drawings will be provided.

TRAFFIC SIGNAL DESIGN

Comment 7: *Synchro: phasing is incorrect; total split times are incorrect. Resubmit.*

Response 7: This has been revised within the TIA. This change did not affect the results or recommendations of the TIA.

Forecasting Report Comments

Ansari, Basel

Subject: RE: 8700 Campeau Dr - Transportation Impact Assessment (TIA) Forecasting

From: Shih, Austin <Austin.Shih@parsons.com>

Sent: July 10, 2019 9:57 AM

To: Baggs, Rosanna <Rosanna.Baggs@ottawa.ca>

Cc: McCreight, Laurel <Laurel.McCreight@ottawa.ca>; Ansari, Basel <Basel.Ansari@parsons.com>

Subject: RE: 8700 Campeau Dr - Transportation Impact Assessment (TIA) Forecasting

CAUTION: This email originated from an External Sender. Please do not click links or open attachments unless you recognize the source.

ATTENTION : Ce courriel provient d'un expéditeur externe. Ne cliquez sur aucun lien et n'ouvrez pas de pièce jointe, excepté si vous connaissez l'expéditeur.

Hi Rosanna,

See responses below. We will revise the appropriate sections for the Strategy Report submission. Please confirm.

Thanks!

Austin Shih

PARSONS

From: Baggs, Rosanna <Rosanna.Baggs@ottawa.ca>

Sent: Tuesday, July 9, 2019 4:04 PM

To: Shih, Austin <Austin.Shih@parsons.com>

Cc: McCreight, Laurel <Laurel.McCreight@ottawa.ca>

Subject: [EXTERNAL] RE: 8700 Campeau Dr - Transportation Impact Assessment (TIA) Forecasting

Hi Austin,

Please see the comments for the forecasting report:

Transportation Engineering Services

1. Section 3.2.3 should include volumes from 195 and 450 Huntmar Drive given the size of these developments and their effect on the study area's road network. Please include demand rationalization if required.

Acknowledged, we will include the 450 Huntmar development in our background, but we consider 195 Huntmar to be overly conservative given its location, size and uncertainty. We will add a demand rationalization as requested to explain further.

2. Consider using traffic counts from the Palladium Drive/417 ramps as well to calibrate the study area traffic counts.

Acknowledged, we will calibrate the volumes at the 417 ramps.

3. There are transposition errors between the report's appended traffic counts and what is shown on Figure 5. Please adjust these volumes.

Acknowledged, we will update in the Strategy Report.

4. Figure 9 does not show volumes at the Upper Canada Street and Huntmar Drive intersection despite 25% to/from north assignment. Please correct this.

Acknowledged, we will update in the Strategy Report.

5. Section 2.1.3 could include the Campeau Drive extension, which will provide a more direct connection to the Kanata Centrum area. Consider reassigning a small portion of the EB 417 volumes to Campeau Drive as a result.

The timing of the Campeau Drive extension is uncertain, and until it is confirmed, we believe it is more appropriate to assume the worst case scenario, i.e. traffic will continue to use the 417 ramp intersection to travel east of Huntmar.

Please address these concerns before proceeding to the strategy report.

Rosanna Baggs, C.E.T.

Project Manager, Infrastructure Approvals | GPRJ Approbation demandes infrastructure

Development Review West Branch | Dir Services d'exam des dem d'amgt

Tel | Tél. : 613-580- 2424 ext. | poste 26388

Scoping Report Comments

Ansari, Basel

Subject: RE: 8700 Campeau Dr - Transportation Impact Assessment (TIA) Step 1&2 - TPM Comments

From: Baggs, Rosanna <Rosanna.Baggs@ottawa.ca>

Sent: Thursday, June 20, 2019 2:38 PM

To: Shih, Austin <Austin.Shih@parsons.com>

Cc: McCreight, Laurel <Laurel.McCreight@ottawa.ca>

Subject: [EXTERNAL] 8700 Campeau Dr - Transportation Impact Assessment (TIA) Step 1&2 - TPM Comments

Hi Austin,

Please see my comments related to your submission of Step 1-2 of the Traffic Impact Assessment.

Please include the following:

Module 2.1 - Existing and Planned Conditions

Element 2.1.1 - Proposed Development

Provide the following:

- Access points: note any restrictions (e.g., full movements, right-in/right-out, turning restrictions, etc.)

Report updated.

Element 2.1.2 - Existing Conditions

Provide the following:

- Existing roads: note jurisdiction

Report updated.

Element 2.1.3 - Planned Conditions

Identify the following:

- Changes to the study area transportation network
 - You may want to note that the intersection of the Hwy 417 EB Off Ramp/Palladium will be realigned as part of the 195 Huntmar development.2

Noted, report updated.

- Other developments within the study area
 - 340 Huntmar Dr
 - 450 Huntmar Dr Ph 3-5
 - 3280 Palladium Drive
 - 195 Huntmar

Other developments included in the report.

If the above can be incorporated into the next submission, please proceed with Step 3. Otherwise, please discuss responses prior to proceeding.

Rosanna Baggs, C.E.T.

Project Manager, Infrastructure Approvals | GPRJ Approbation demandes infrastructure
Development Review West Branch | Dir Services d'examen des demandes

City of Ottawa | Ville d'Ottawa

Tel | Tél. : 613-580- 2424 ext. | poste 26388

web | Site Web : www.ottawa.ca [ottawa.ca]

This e-mail originates from the City of Ottawa e-mail system. Any distribution, use or copying of this e-mail or the information it contains by other than the intended recipient(s) is unauthorized. Thank you.

Le présent courriel a été expédié par le système de courriels de la Ville d'Ottawa. Toute distribution, utilisation ou reproduction du courriel ou des renseignements qui s'y trouvent par une personne autre que son destinataire prévu est interdite. Je vous remercie de votre collaboration.

'NOTICE: This email message and all attachments transmitted with it may contain privileged and confidential information, and information that is protected by, and proprietary to, Parsons Corporation, and is intended solely for the use of the addressee for the specific purpose set forth in this communication. If the reader of this message is not the intended recipient, you are hereby notified that any reading, dissemination, distribution, copying, or other use of this message or its attachments is strictly prohibited, and you should delete this message and all copies and backups thereof. The recipient may not further distribute or use any of the information contained herein without the express written authorization of the sender. If you have received this message in error, or if you have any questions regarding the use of the proprietary information contained therein, please contact the sender of this message immediately, and the sender will provide you with further instructions.'

Appendix B

Transit Route Maps



Rapid^e

**TERRY FOX
STITTSVILLE**

TUNNEY'S PASTURE

7 days a week / 7 jours par semaine

All day service

Service toute la journée

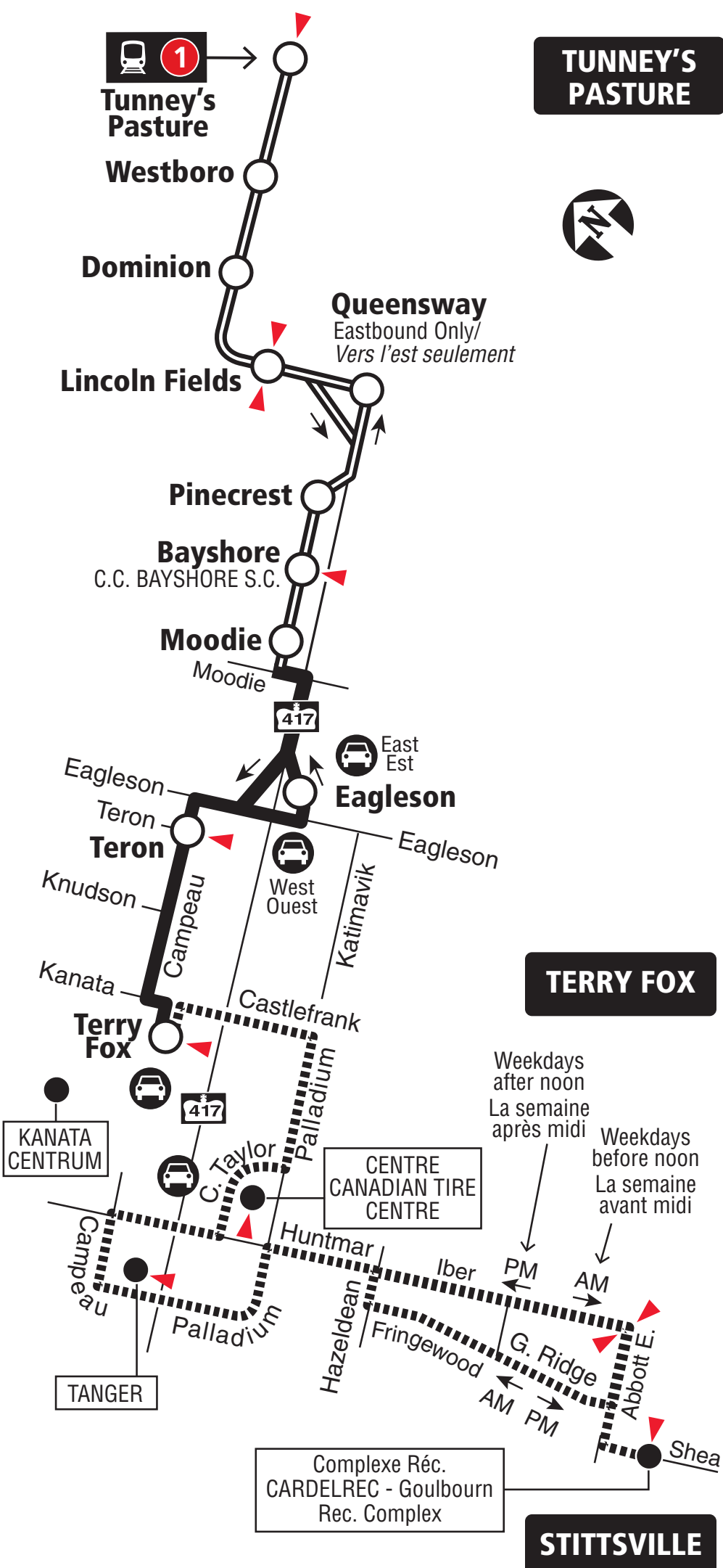

TUNNEY'S PASTURE

TERRY FOX

STITTSVILLE

- Transitway & Station
- Monday to Friday only (limited evening service)
Lundi au vendredi seulement (service de soirée limité)
- Park & Ride / Parc-o-bus
- Timepoint / Heures de passage

2019.07



**Starting July 14, 2019
À partir du 14 juillet 2019**

Lost and Found / Objets perdus..... **613-563-4011**

Security / Sécurité **613-741-2478**



INFO 613-741-4390
octranspo.com



162



TERRY FOX STITTSVILLE

Local

Monday to Friday / Lundi au vendredi

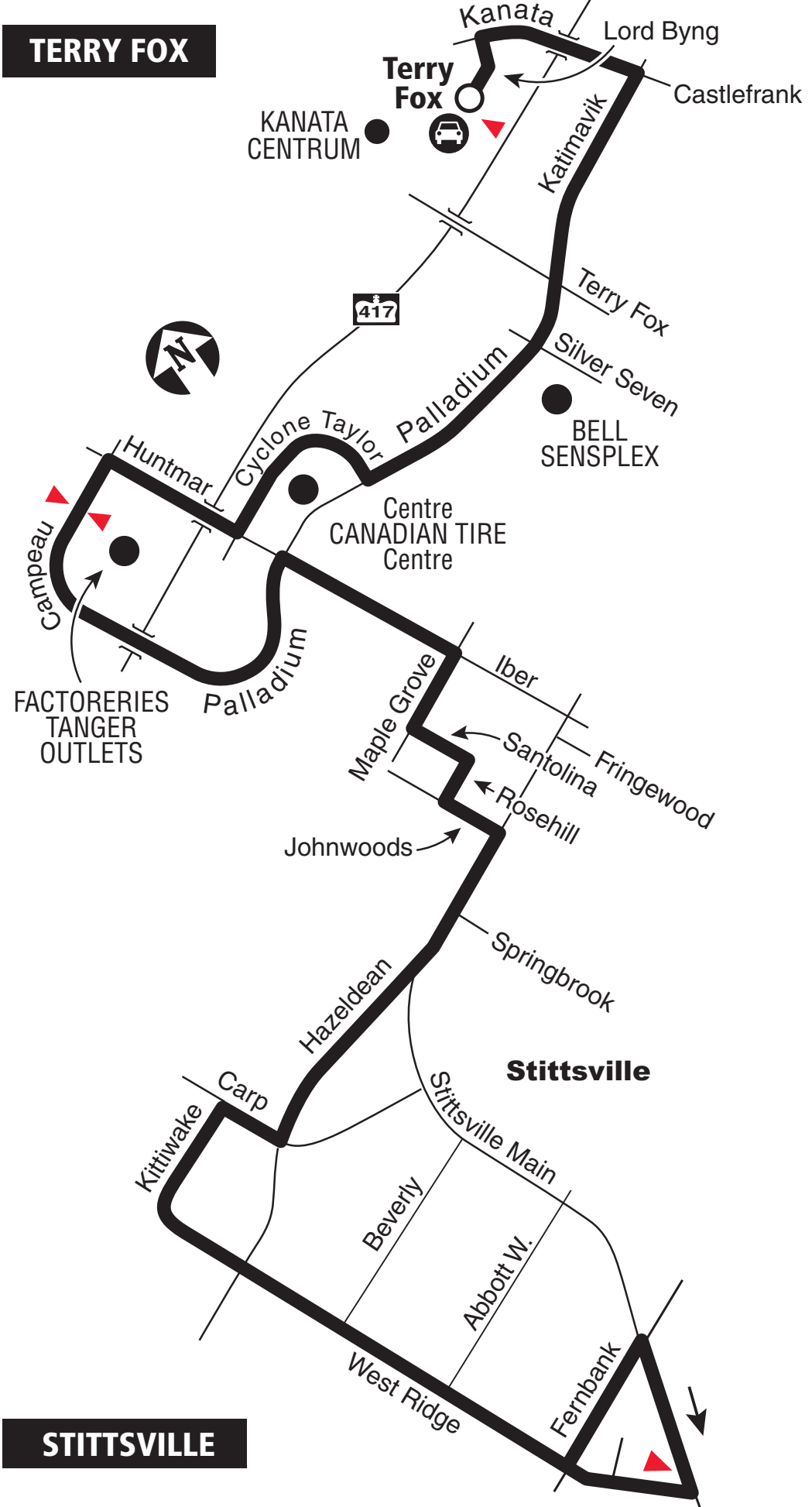
Selected trips Mon. to Fri. All day on weekends /
Service limité du lun. au ven. Toute la journée les
fins de semaine



-  Transitway Station / Station du Transitway
-  Park & Ride / Parc-o-bus
-  Timepoint / Heures de passage

2019.06



Schedule / Horaire.....613-560-1000

Text / Texto560560

plus your four digit bus stop number / plus votre numéro d'arrêt à quatre chiffres

Customer Service
Service à la clientèle **613-741-4390**

Lost and Found / Objets perdus..... **613-563-4011**

Security / Sécurité **613-741-2478**

Effective November 15, 2017
En vigueur 15 novembre 2017



INFO 613-741-4390
octranspo.com

Appendix C

Traffic Data



Turning Movement Count Summary, AM and PM Peak Hour Flow Diagrams

Automobiles, Taxis, Light Trucks, Vans, SUV's, Motorcycles, Heavy Trucks, Buses, and School Buses

Cabela's Way & Palladium Drive

Kanata, ON

All Vehicles
(Except Bicycles & Electric Scooters)

Thursday, 23 May 2019
0700-0900 & 1600-1800
4 Hour Survey
City of Ottawa Ward 4

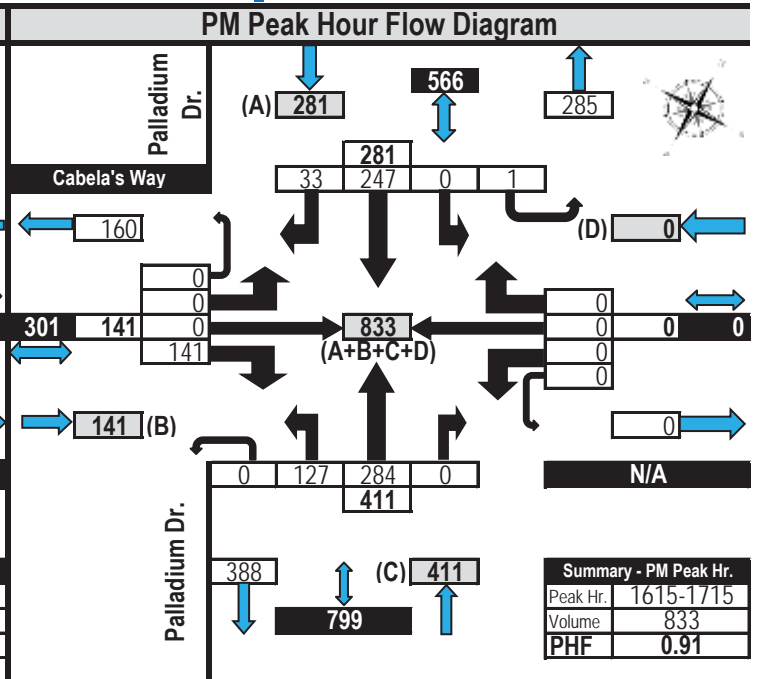
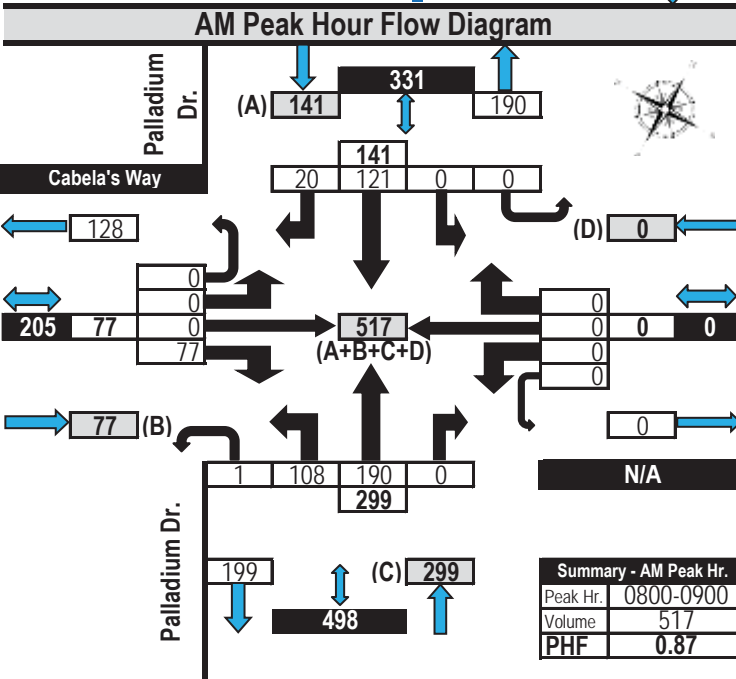
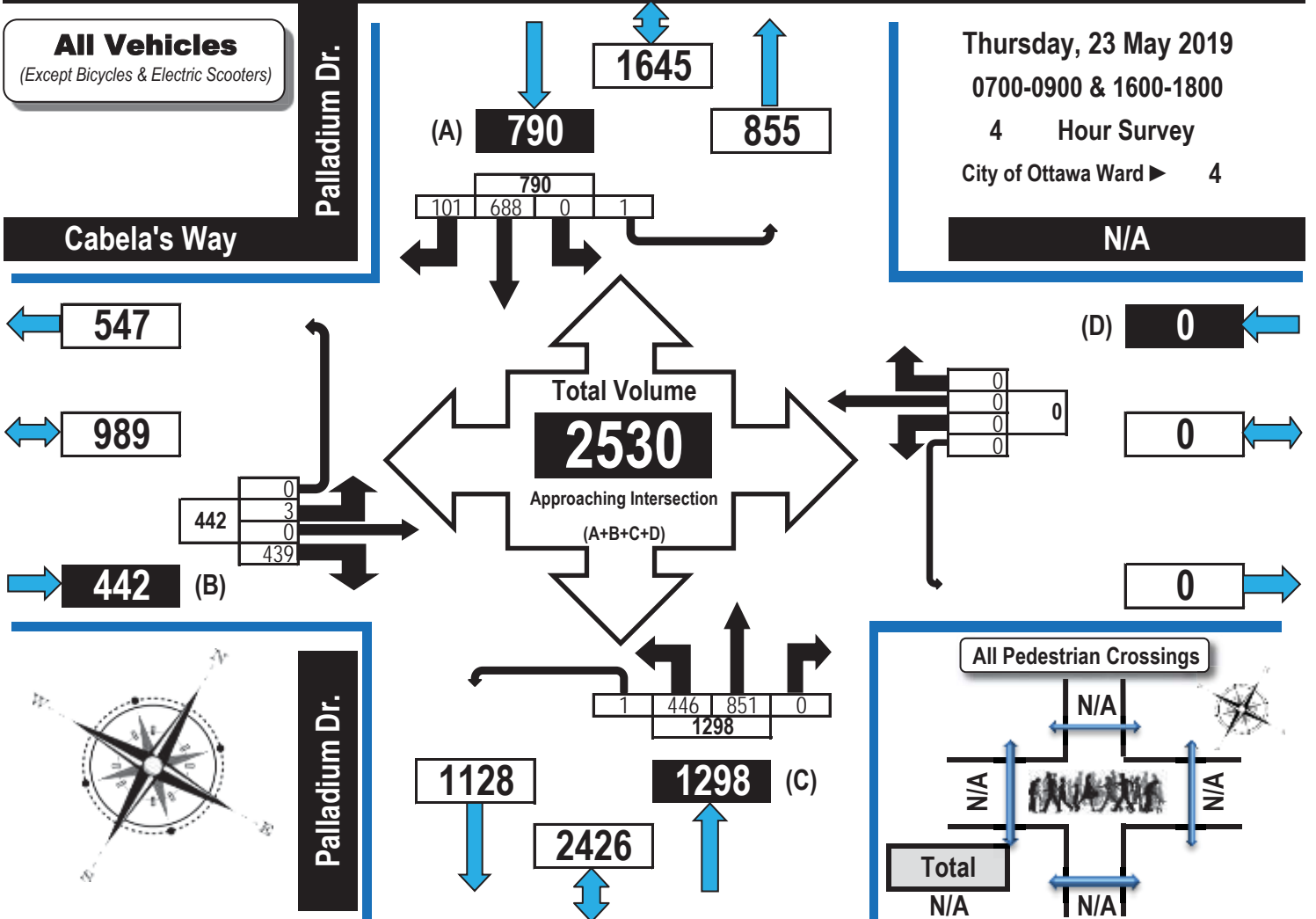



Turning Movement Count Summary, AM and PM Peak Hour Flow Diagrams

Automobiles, Taxis, Light Trucks, Vans, SUV's, Motorcycles, Heavy Trucks, Buses, and School Buses

Campeau Drive & Huntmar Drive (ROUNDBABOUT) Kanata, ON

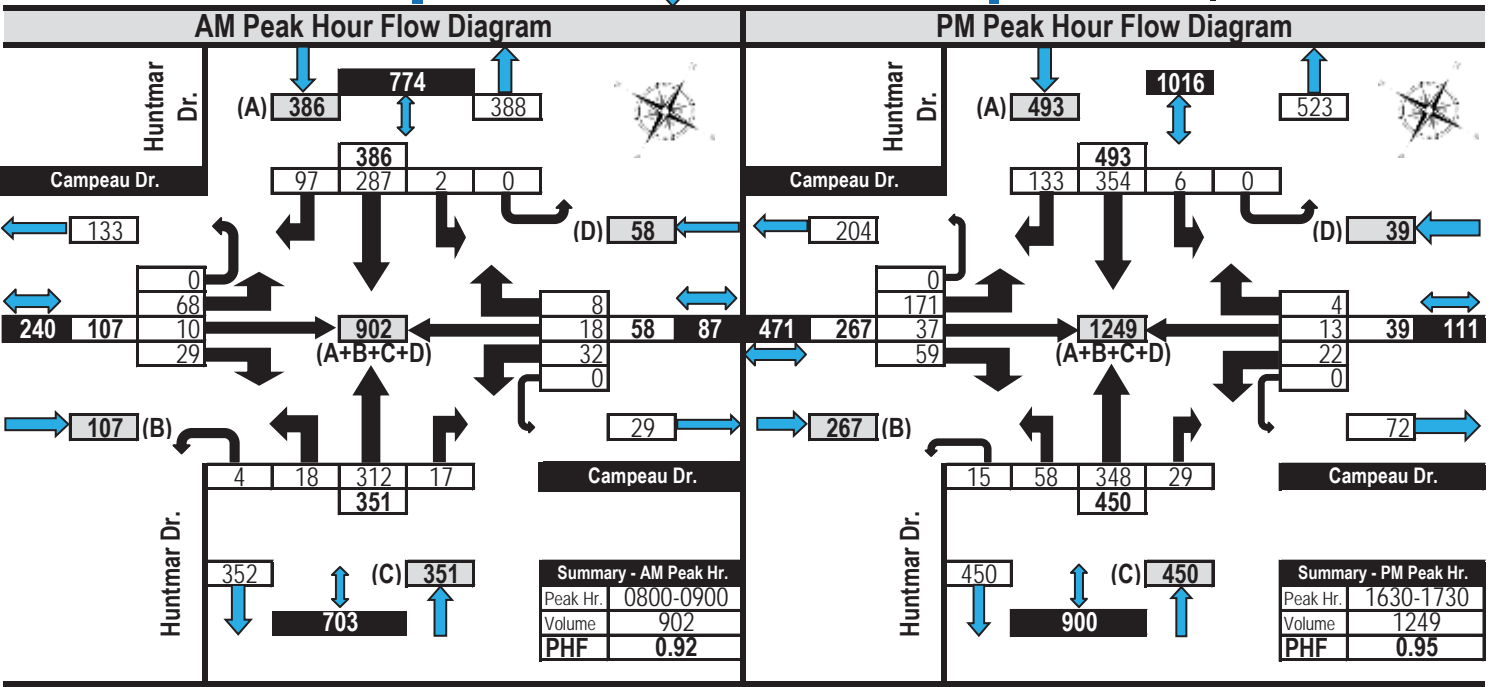
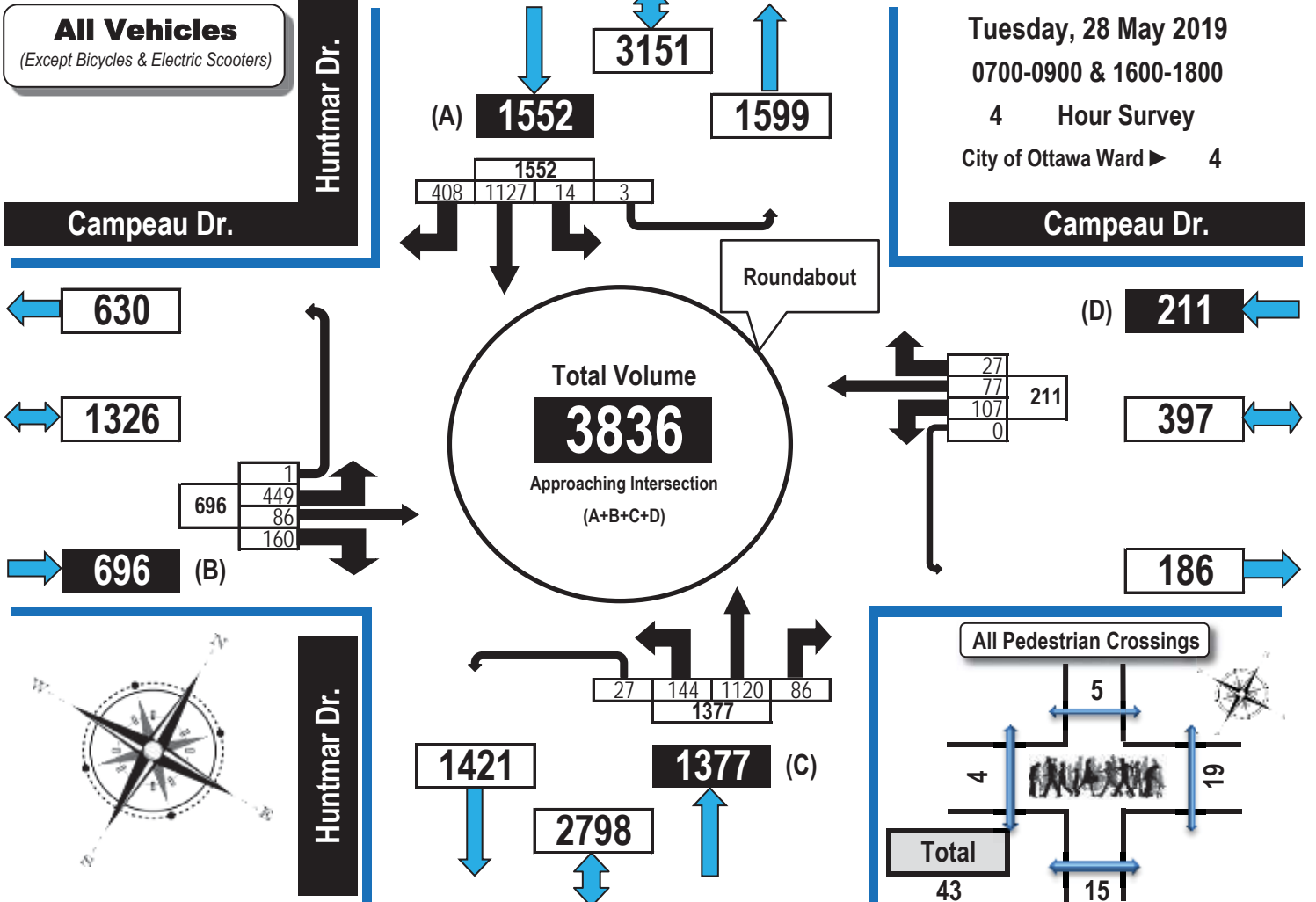



Turning Movement Count Summary, AM and PM Peak Hour Flow Diagrams

Automobiles, Taxis, Light Trucks, Vans, SUV's, Motorcycles, Heavy Trucks, Buses, and School Buses

Campeau Drive & Journeyman Street/Tanger Outlet Kanata, ON

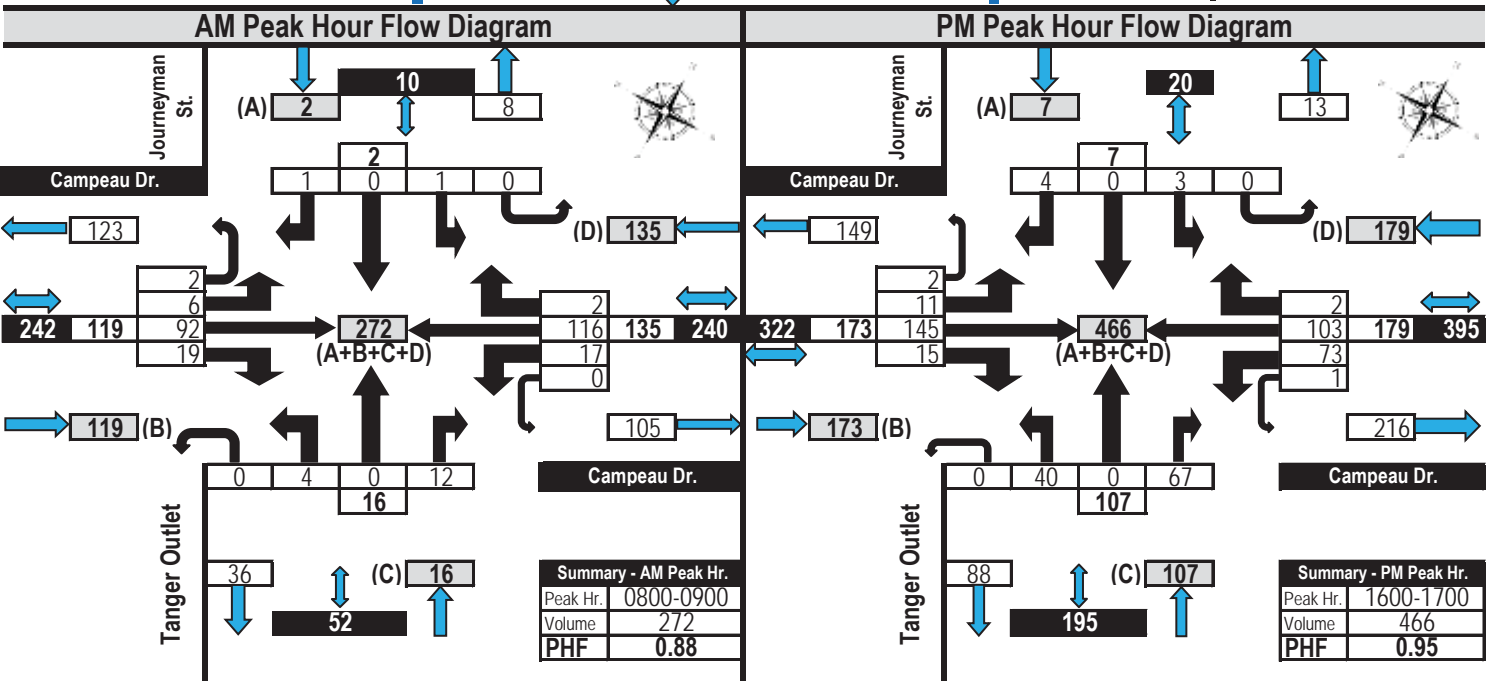
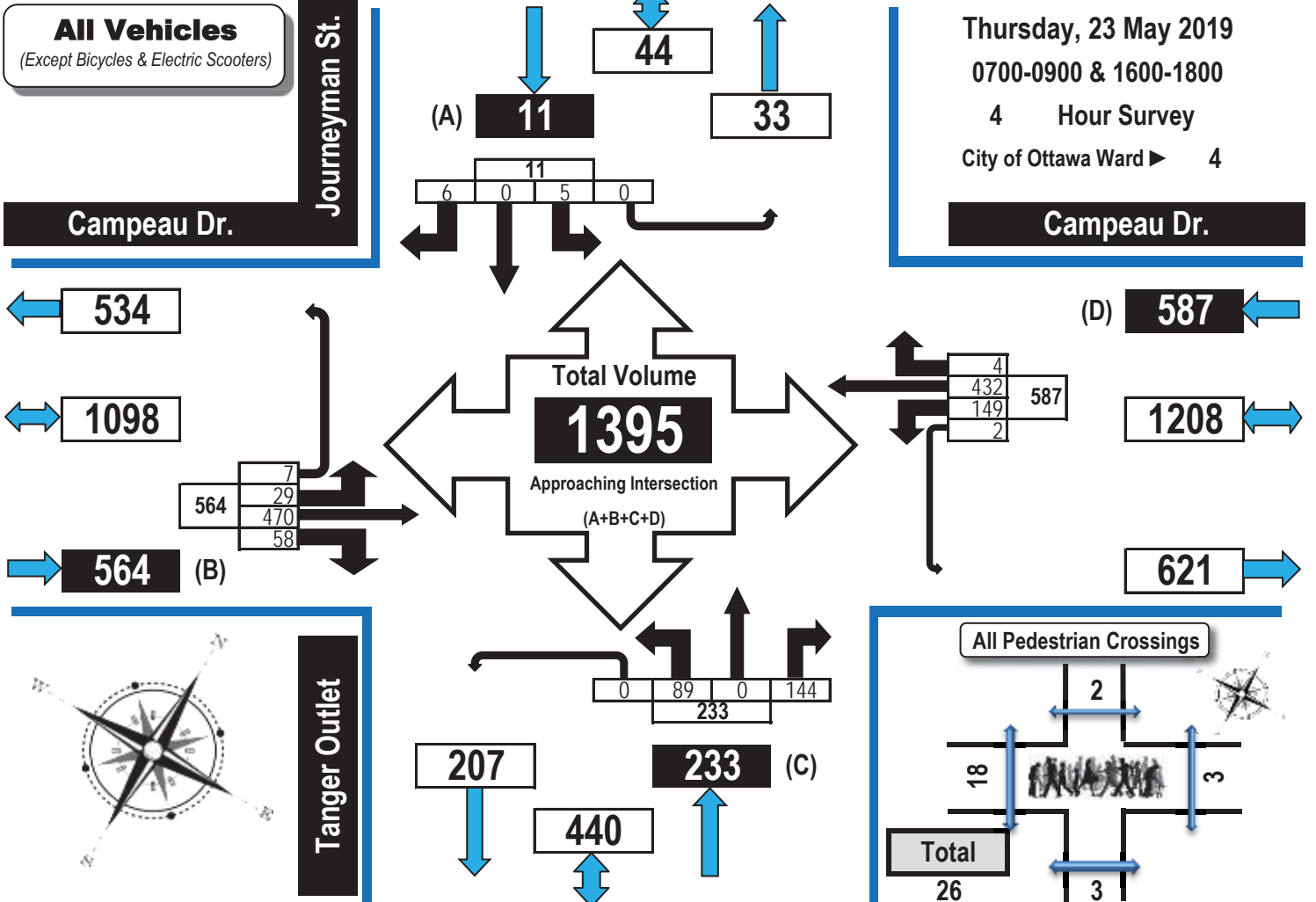



Turning Movement Count Summary, AM and PM Peak Hour Flow Diagrams

Automobiles, Taxis, Light Trucks, Vans, SUV's, Motorcycles, Heavy Trucks, Buses, and School Buses

Campeau Drive & Kanata West Centre Drive Kanata, ON

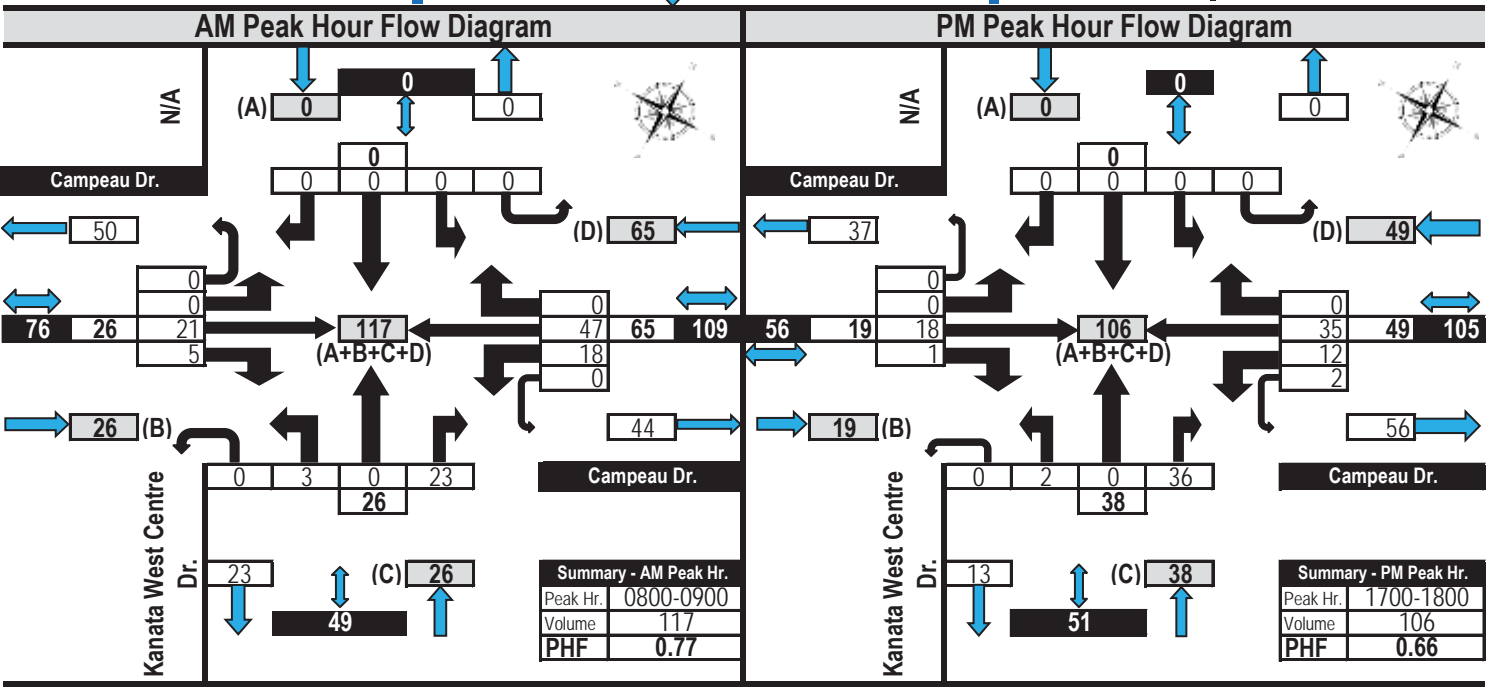
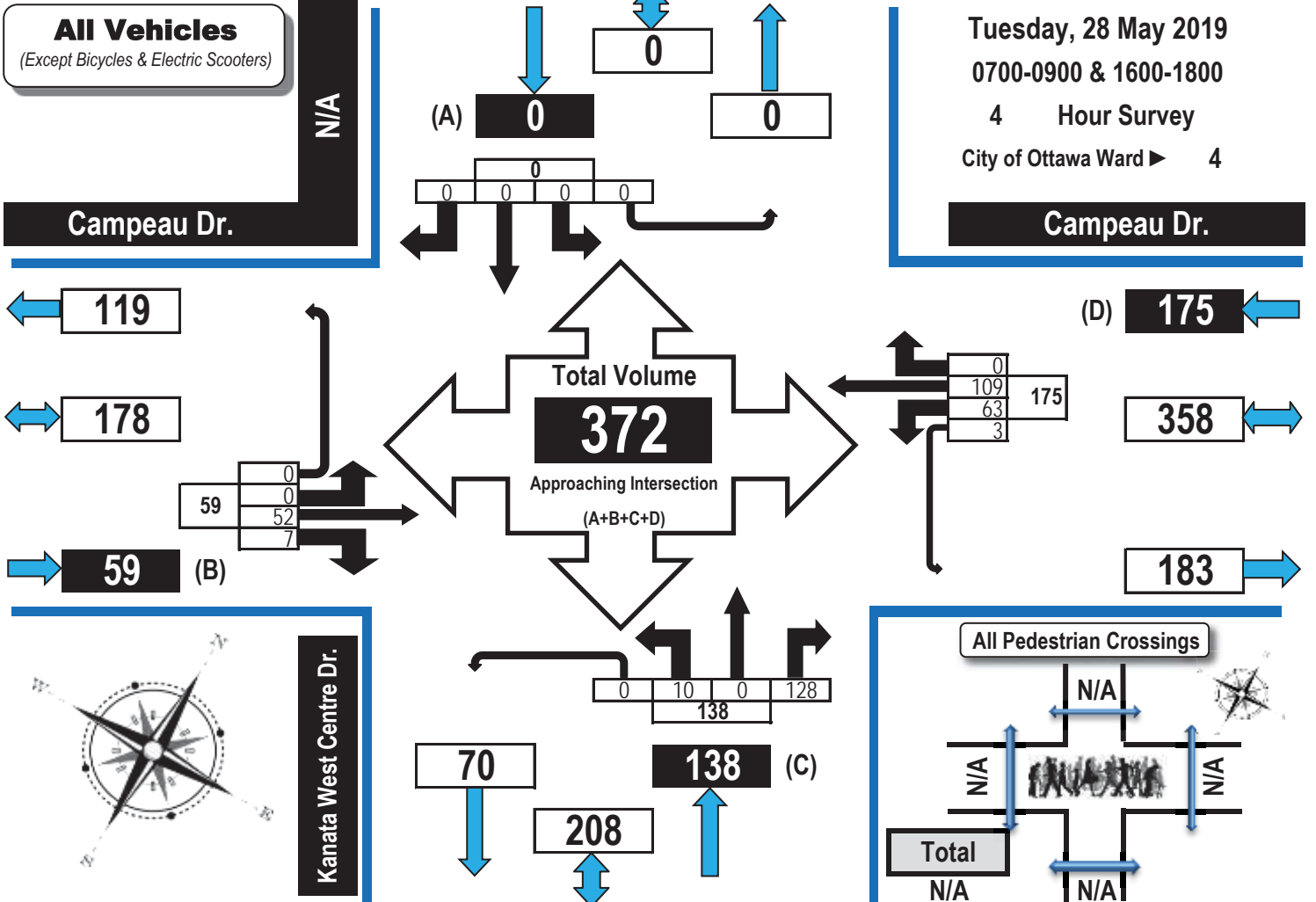



Turning Movement Count Summary, AM and PM Peak Hour Flow Diagrams

Automobiles, Taxis, Light Trucks, Vans, SUV's, Motorcycles, Heavy Trucks, Buses, and School Buses

Campeau Drive & Palladium Drive (ROUNDBABOUT)

Kanata, ON

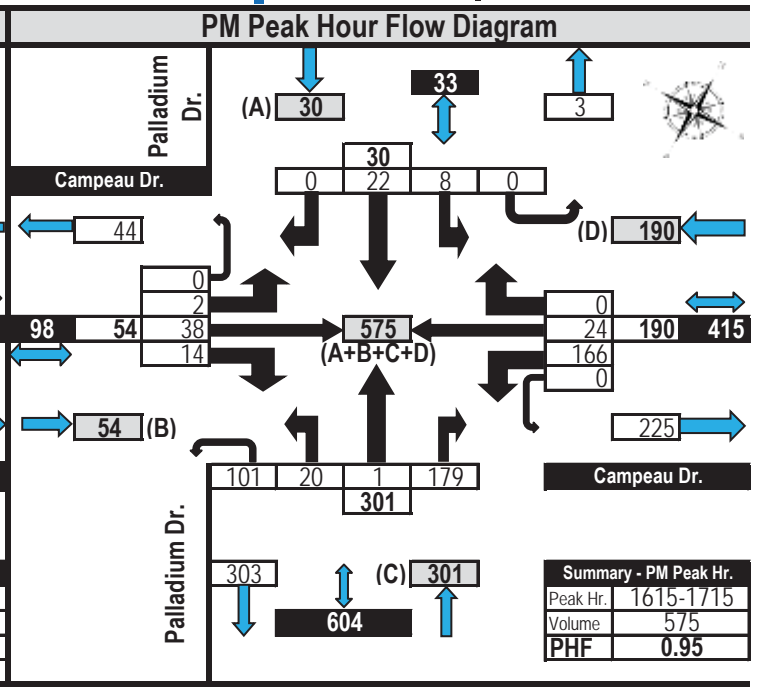
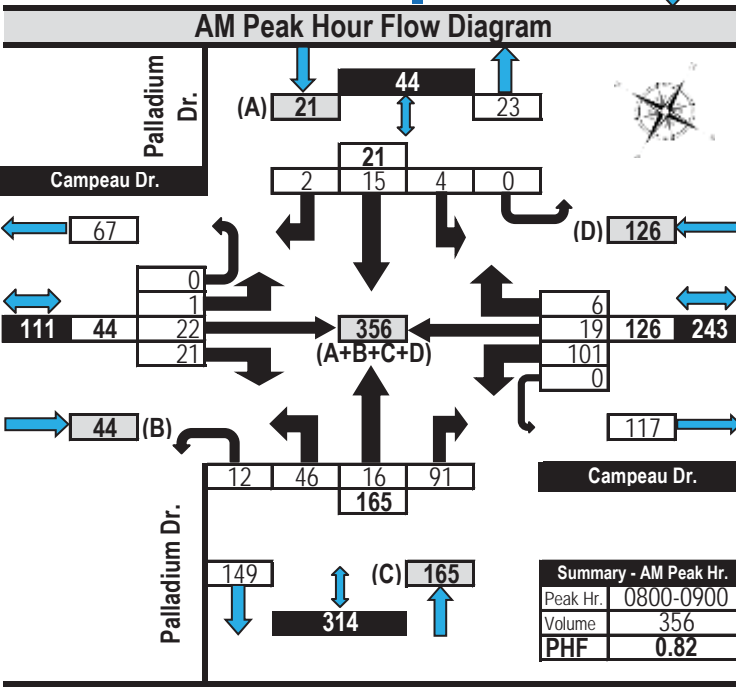
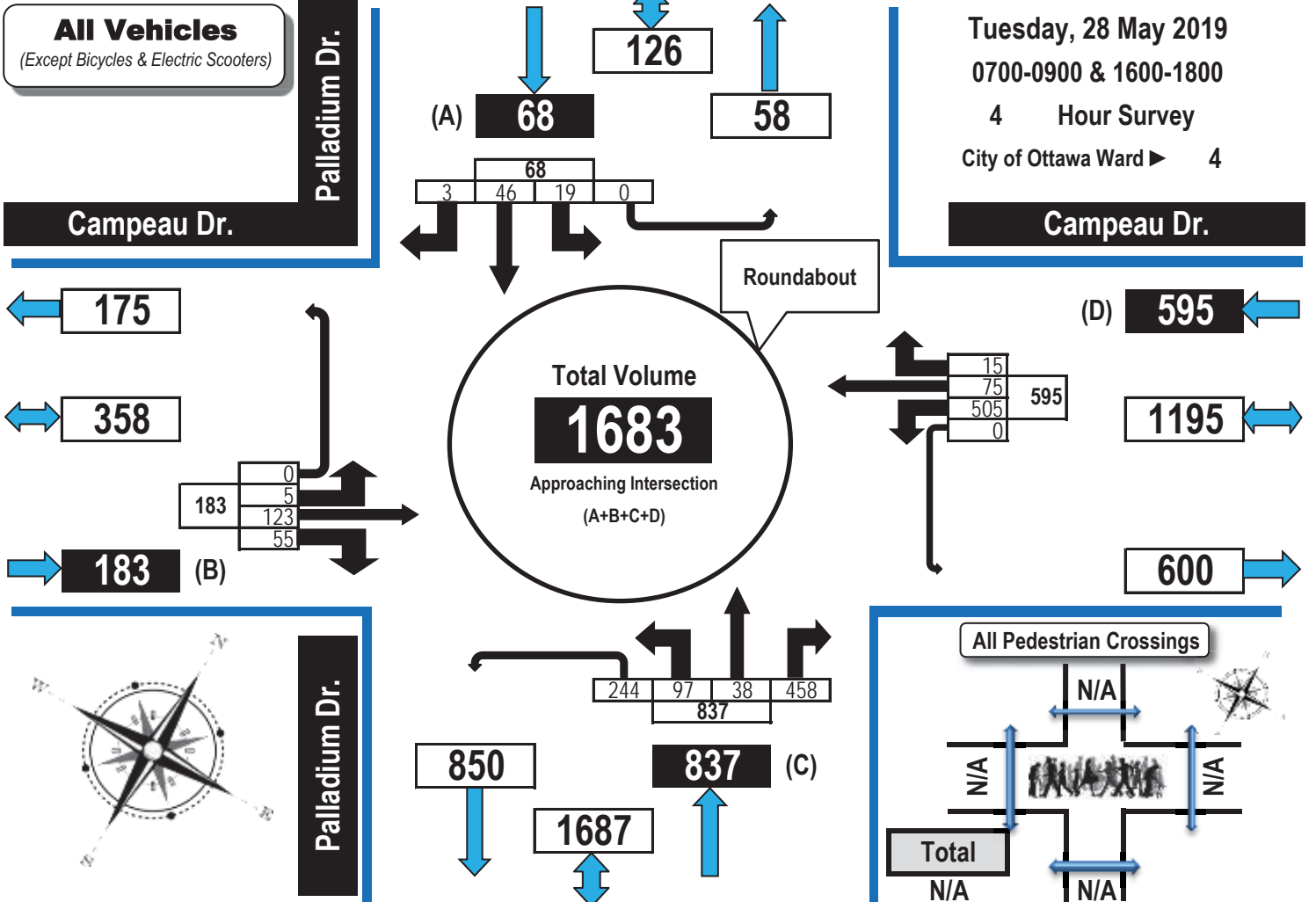

15 MIN REPORT

Intersection ID:495620000(--S--)

Hwy 417 @ PALLADIUM DR IC-142

Municipality: Eastern

Date: 24-Apr-2018

Time	NORTH APPROACH					EAST APPROACH					SOUTH APPROACH					WEST APPROACH					Total															
	Cars		Trucks		Heavies	Ped	Cars		Trucks		Heavies	Ped	Cars		Trucks		Heavies	Ped	Cars			Trucks		Heavies	Ped											
	Left	Thru Right	Left	Thru Right	Left		Thru Right	Left	Thru Right	Left	Thru Right		Left	Thru Right	Left	Thru Right	Left		Thru Right	Left		Thru Right	Left	Thru Right		Left	Thru Right	Left	Thru Right							
Period1																																				
14:15	0	70	44	0	0	1	0	2	1	0	0	0	0	0	0	0	0	0	0	0	0	1	1	0	12	0	23	0	0	0	0	0	0	1	0	245
14:30	0	76	40	0	1	1	0	3	0	0	0	0	0	0	0	0	0	0	0	0	0	0	0	0	10	0	33	1	0	0	0	0	0	1	0	266
14:45	0	82	57	0	0	0	0	3	1	0	0	0	0	0	0	0	0	0	0	0	0	0	0	13	0	24	0	0	0	0	0	0	0	0	0	288
15:00	0	65	36	0	0	2	0	2	0	0	0	0	0	0	0	0	0	0	0	0	0	0	0	12	0	32	0	0	0	0	0	0	3	0	258	
15:15	0	99	47	0	1	1	0	7	0	0	0	0	0	0	0	0	0	0	0	0	0	0	0	13	0	23	1	0	1	0	0	3	0	312		
15:30	0	104	39	0	1	3	0	5	0	0	0	0	0	0	0	0	0	0	0	0	0	0	11	0	26	0	0	2	0	0	0	0	0	0	321	
15:45	0	75	44	0	0	0	0	3	1	0	0	0	0	0	0	0	0	0	0	0	0	0	11	0	20	0	0	0	0	0	0	1	0	294		
16:00	0	125	27	0	0	0	0	4	0	0	0	0	0	0	0	0	0	0	0	0	0	0	14	0	29	0	0	1	0	0	0	0	0	0	338	
16:15	0	109	43	0	2	0	0	5	1	0	0	0	0	0	0	0	0	0	0	0	0	0	14	0	18	1	0	0	1	0	0	0	0	0	371	
16:30	0	131	43	0	1	1	0	5	1	0	0	0	0	0	0	0	0	0	0	0	0	0	14	0	35	1	0	0	1	0	0	0	0	0	394	
16:45	0	113	46	0	0	1	0	6	0	0	0	0	0	0	0	0	0	0	0	0	0	0	18	0	32	0	0	1	0	0	0	0	0	0	391	
17:00	0	111	42	0	0	0	0	4	1	0	0	0	0	0	0	0	0	0	0	0	0	21	0	42	1	0	1	0	0	0	0	0	0	0	362	
17:15	0	109	43	0	0	1	0	5	0	0	0	0	0	0	0	0	0	0	0	0	0	13	0	40	0	0	0	0	0	1	0	0	0	0	392	
17:30	0	107	35	0	0	0	0	2	0	0	0	0	0	0	0	0	0	0	0	0	0	25	0	29	0	0	0	0	0	0	0	0	0	0	333	
17:45	0	97	37	0	0	0	0	1	0	0	0	0	0	0	0	0	0	0	0	0	0	17	0	41	0	0	0	0	0	0	0	0	0	0	319	
18:00	0	81	42	0	1	0	0	2	1	0	0	0	0	0	0	0	0	0	0	0	0	10	0	22	0	0	0	0	0	0	0	0	0	0	247	
Period2																																				
7:15	0	34	24	0	0	1	0	0	0	0	0	0	0	0	0	0	0	0	0	0	0	12	0	58	0	0	0	2	0	1	0	0	0	243		
7:30	0	50	16	0	0	0	0	1	0	0	0	0	0	0	0	0	0	0	0	0	0	8	0	52	0	0	0	0	0	0	0	0	0	0	230	
7:45	0	50	19	0	0	0	0	2	0	0	0	0	0	0	0	0	0	0	0	0	0	20	0	81	0	0	3	0	0	1	0	0	0	283		
8:00	0	62	13	0	1	0	0	3	0	0	0	0	0	0	0	0	0	0	0	0	0	16	0	60	1	0	0	2	0	0	0	0	0	263		
8:15	0	35	23	0	1	0	0	2	1	0	0	0	0	0	0	0	0	0	0	0	0	14	0	40	1	0	0	1	0	0	0	0	0	222		
8:30	0	45	15	0	0	1	0	4	2	0	0	0	0	0	0	0	0	0	0	0	0	10	0	66	0	0	2	2	0	2	0	2	0	241		
8:45	0	54	18	0	3	0	0	3	1	0	0	0	0	0	0	0	0	0	0	0	0	10	0	44	0	0	0	1	0	0	0	0	0	216		
9:00	0	60	16	0	0	0	0	3	1	0	0	0	0	0	0	0	0	0	0	0	0	24	0	51	0	0	0	0	0	0	0	0	0	0	238	
9:15	0	52	17	0	0	0	0	1	0	0	0	0	0	0	0	0	0	0	0	0	0	14	0	58	0	0	0	0	0	1	0	0	0	208		
9:30	0	55	7	0	4	0	0	4	0	0	0	0	0	0	0	0	0	0	0	0	0	9	0	37	0	0	0	0	0	0	0	0	0	0	176	
9:45	0	50	20	0	1	1	0	4	1	0	0	0	0	0	0	0	0	0	0	0	0	18	0	31	1	0	0	0	0	0	0	0	0	0	196	
10:00	0	45	15	0	1	1	0	1	0	0	0	0	0	0	0	0	0	0	0	0	0	23	0	48	1	0	0	0	0	3	0	0	0	194		
10:15	0	32	17	0	2	0	0	3	0	0	0	0	0	0	0	0	0	0	0	0	0	11	0	45	0	0	0	0	0	1	0	0	0	163		
10:30	0	52	26	0	1	1	0	3	0	0	0	0	0	0	0	0	0	0	0	0	0	22	0	47	0	0	1	0	0	0	0	0	0	234		
10:45	0	48	23	0	2	0	0	3	1	0	0	0	0	0	0	0	0	0	0	0	0	17	0	34	0	0	2	1	0	0	0	0	0	207		
11:00	0	47	25	0	2	1	0	2	0	0	0	0	0	0	0	0	0	0	0	0	0	17	0	34	0	0	1	0	0	0	0	0	0	211		

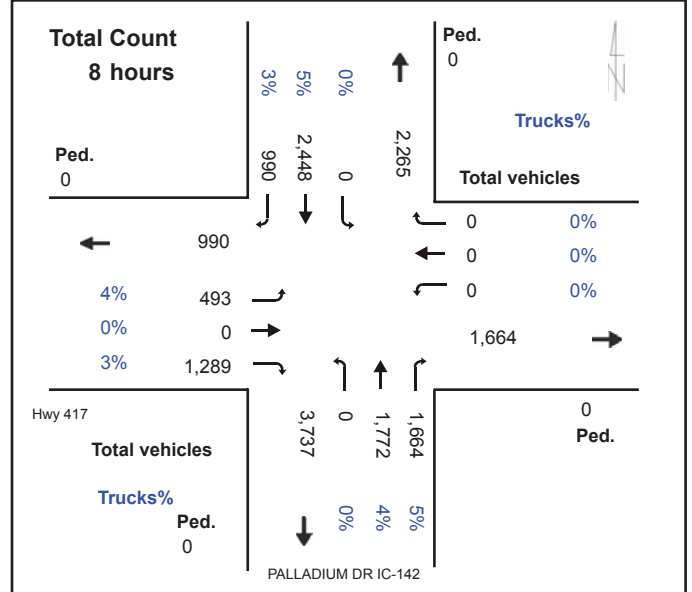
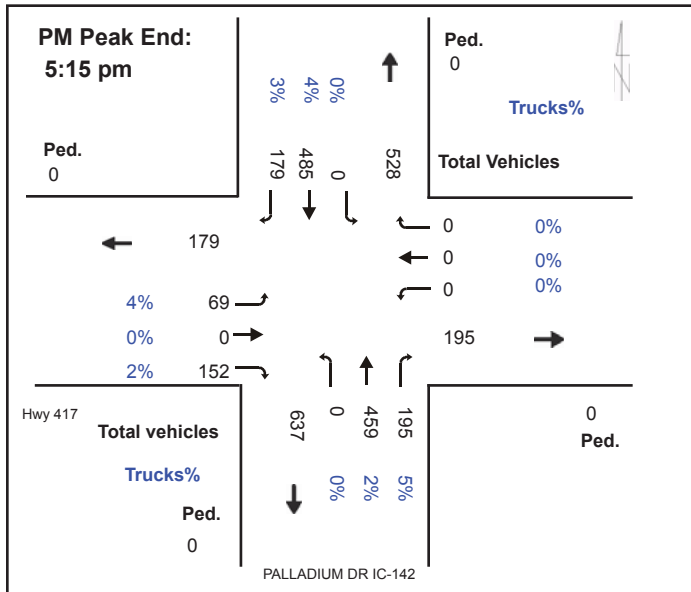
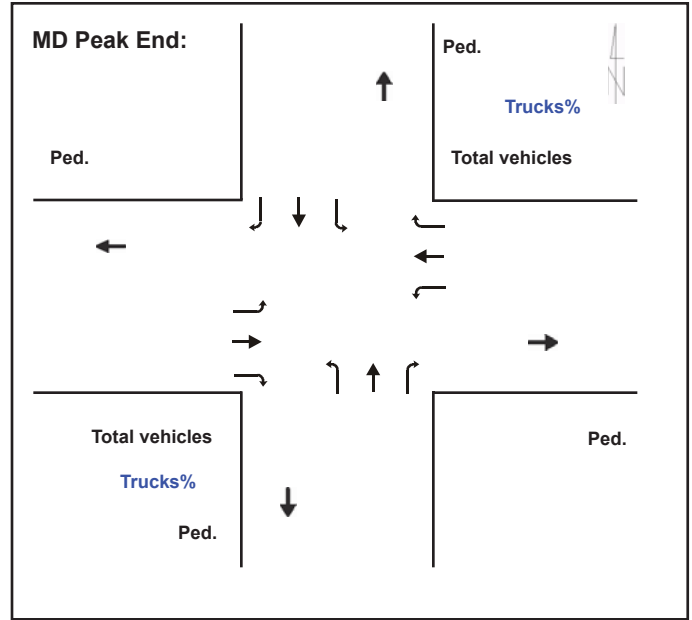
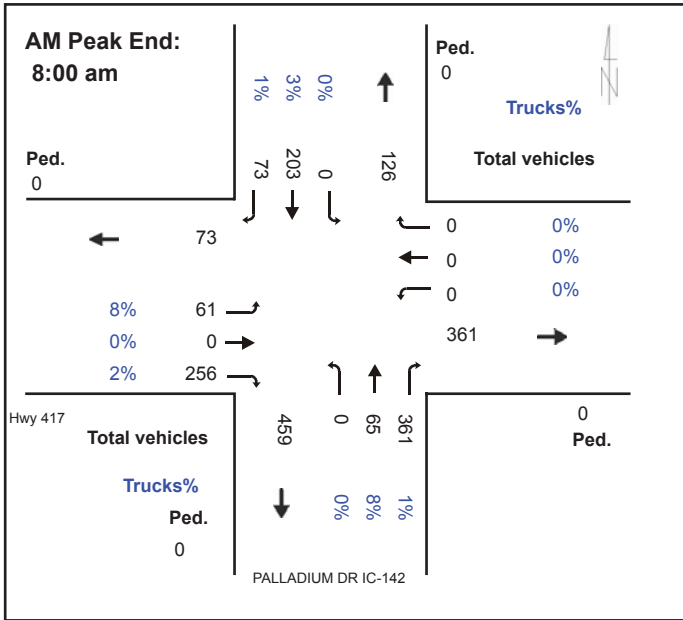

15 MIN REPORT

Intersection ID:495620000(--N--S

Hwy 417 @ PALLADIUM DR IC-142

Municipality: Eastern

Date: 24-Apr-2018

Time	NORTH APPROACH								EAvt APPROACH								vOUTH APPROACH								WEvT APPROACH								Total								
	Cars			Trucds			Heakies		Pem	Cars			Trucds			Heakies		Pem	Cars			Trucds			Heakies		Pem	Cars			Trucds			Heakies		Pem					
	Left	Thru	Right	Left	Thru	Right	Left	Right		Left	Thru	Right	Left	Thru	Right	Left	Right		Left	Thru	Right	Left	Thru	Right	Left	Right		Left	Thru	Right	Left	Thru		Right	Left		Right				
Period1																																									
14:15	13	60	0	0	1	0	0	3	0	0	54	0	59	0	0	1	0	0	0	0	0	27	41	0	0	0	0	0	1	0	0	0	0	0	0	0	0	0	0	0	260
14:30	22	54	0	0	1	0	0	0	0	0	60	0	55	1	0	1	3	0	0	0	0	29	38	0	0	0	0	1	2	0	0	0	0	0	0	0	0	0	0	0	267
14:45	27	77	0	2	0	0	0	2	0	0	60	0	44	0	0	2	2	0	0	0	0	22	49	0	0	1	0	0	1	0	0	0	0	0	0	0	0	0	0	0	289
15:00	24	47	0	0	1	0	0	1	0	0	56	0	56	1	0	0	3	0	0	0	0	22	56	0	1	1	0	2	0	0	0	0	0	0	0	0	0	0	0	0	271
15:15	21	65	0	0	1	0	0	2	0	0	78	0	48	0	0	0	4	0	0	0	0	23	53	0	1	0	0	0	1	0	0	0	0	0	0	0	0	0	0	0	297
15:30	13	54	0	0	2	0	0	1	0	0	86	0	57	1	0	0	5	0	3	0	0	26	61	0	0	0	0	1	0	0	0	0	0	0	0	0	0	0	0	0	310
15:45	15	62	0	0	2	0	0	2	0	0	66	0	65	0	0	0	2	0	0	1	0	25	71	0	0	0	0	1	1	0	0	0	0	0	0	0	0	0	0	0	313
16:00	35	52	0	0	0	0	1	1	0	0	105	0	48	0	0	1	4	0	0	0	0	31	72	0	0	0	0	1	1	0	0	0	0	0	0	0	0	0	0	0	352
16:15	26	63	0	0	3	0	0	0	0	0	83	0	62	0	0	0	5	0	0	0	0	27	96	0	1	1	0	1	1	0	0	0	0	0	0	0	0	0	0	0	369
16:30	32	59	0	1	1	0	1	1	0	0	113	0	68	0	0	0	5	0	0	0	0	32	93	0	0	2	0	1	3	0	0	0	0	0	0	0	0	0	0	0	412
16:45	33	67	0	1	1	0	0	1	0	0	96	0	53	0	0	0	5	0	0	0	0	35	98	0	1	1	0	0	0	0	0	0	0	0	0	0	0	0	0	0	392
17:00	23	53	0	0	0	0	0	1	0	0	94	0	63	0	0	0	4	0	0	0	0	27	83	0	1	0	0	1	3	0	0	0	0	0	0	0	0	0	0	0	353
17:15	21	72	0	0	0	0	0	2	0	0	83	0	64	0	0	0	4	0	0	0	0	36	106	0	0	1	0	0	1	0	0	0	0	0	0	0	0	0	0	0	390
17:30	24	47	0	0	1	0	0	0	0	2	97	0	65	0	0	0	2	0	0	0	0	38	73	0	0	0	0	1	2	0	0	0	0	0	0	0	0	0	0	0	352
17:45	33	51	0	1	0	0	0	0	0	2	83	0	67	0	0	0	1	0	0	0	0	25	63	0	0	0	0	0	0	0	0	0	0	0	0	0	0	0	0	0	326
18:00	16	49	0	0	0	0	0	0	0	0	76	0	49	1	0	0	3	0	0	0	0	23	42	0	0	0	0	1	0	0	0	0	0	0	0	0	0	0	0	0	260
Period2																																									
7:15	3	31	0	0	0	0	0	1	0	0	35	0	14	1	0	0	0	0	0	0	0	11	9	0	0	1	0	2	0	0	0	0	0	0	0	0	0	0	0	0	108
7:30	2	15	0	0	0	0	0	0	0	0	47	0	17	0	0	1	1	0	0	0	0	10	9	0	0	0	0	0	0	0	0	0	0	0	0	0	0	0	0	0	102
7:45	6	27	0	0	0	0	0	0	0	0	46	0	12	0	0	0	2	0	0	0	0	24	15	0	0	0	0	0	0	0	0	0	0	0	0	0	0	0	0	0	132
8:00	6	21	0	1	0	0	0	0	0	0	56	0	20	1	0	1	3	0	1	0	0	19	12	0	1	2	0	2	0	0	0	0	0	0	0	0	0	0	0	0	146
8:15	2	26	0	0	0	0	0	2	0	0	32	0	14	1	0	0	1	0	2	0	0	18	14	0	1	2	0	1	1	0	0	0	0	0	0	0	0	0	0	0	117
8:30	4	26	0	0	0	0	1	2	0	0	45	0	17	1	0	1	4	0	0	0	0	16	12	0	0	0	0	2	1	0	0	0	0	0	0	0	0	0	0	0	132
8:45	5	17	0	0	1	0	0	1	0	0	46	0	26	1	0	0	2	0	0	0	0	13	20	0	0	3	0	1	0	0	0	0	0	0	0	0	0	0	0	0	136
9:00	8	23	0	0	1	0	0	0	0	0	54	0	34	0	0	1	3	0	0	0	0	28	10	0	1	1	0	0	2	0	0	0	0	0	0	0	0	0	0	0	166
9:15	2	25	0	0	0	0	1	1	0	0	49	0	31	0	0	0	0	0	0	0	0	18	11	0	0	0	0	1	2	0	0	0	0	0	0	0	0	0	0	0	141
9:30	1	22	0	0	1	0	1	0	0	0	46	0	39	3	0	0	4	0	1	0	0	22	7	0	0	2	0	0	1	0	0	0	0	0	0	0	0	0	0	0	150
9:45	3	21	0	0	1	0	1	2	0	0	44	0	40	1	0	1	3	0	0	0	0	24	14	0	0	3	0	0	0	0	0	0	0	0	0	0	0	0	0	0	158
10:00	4	24	0	1	2	0	1	0	0	0	34	0	41	0	0	4	1	0	1	0	0	40	8	0	1	0	0	1	0	0	0	0	0	0	0	0	0	0	0	0	163
10:15	9	28	0	1	1	0	0	0	0	0	23	0	41	2	0	0	3	0	0	0	0	29	14	0	0	0	0	0	0	0	0	0	0	0	0	0	0	0	0	0	151
10:30	8	36	0	0	1	0	0	1	0	1	41	0	59	1	0	0	2	0	0	1	0	30	20	0	2	0	0	1	1	0	0	0	0	0	0	0	0	0	0	0	205
10:45	15	45	0	0	2	0	2	0	0	0	33	0	42	0	0	2	2	0	0	0	0	29	26	0	1	0	0	2	1	0	0	0	0	0	0	0	0	0	0	0	202
11:00	15	43	0	1	3	0	0	0	0	0	36	0	54	1	0	1	2	0	0	0	0	33	20	0	3	0	0	0	1	0	0	0	0	0	0	0	0	0	0	0	213



Hwy 417 @ PALLADIUM DR IC-142

Eastern

Intersection ID:495620000(--N--)

Count Day: Tuesday

Count Date: 24-Apr-2018

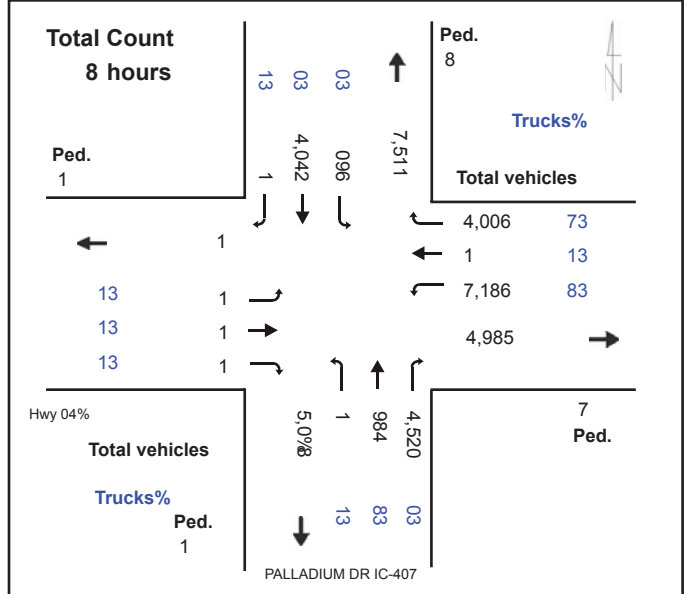
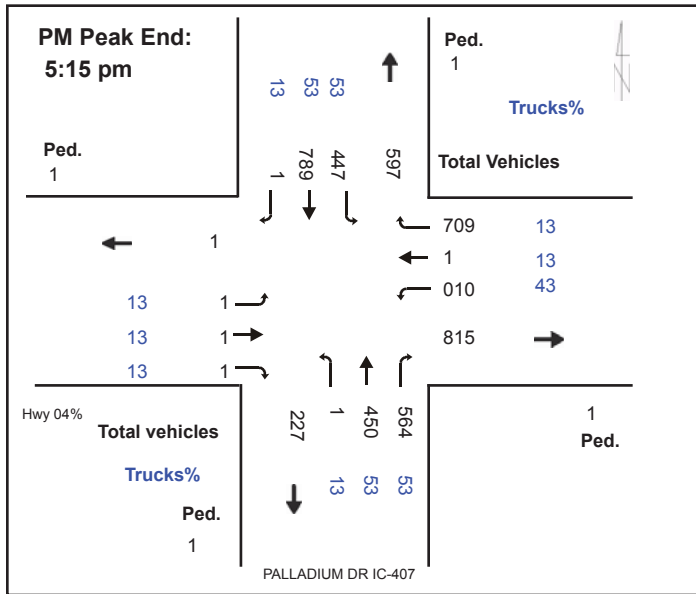
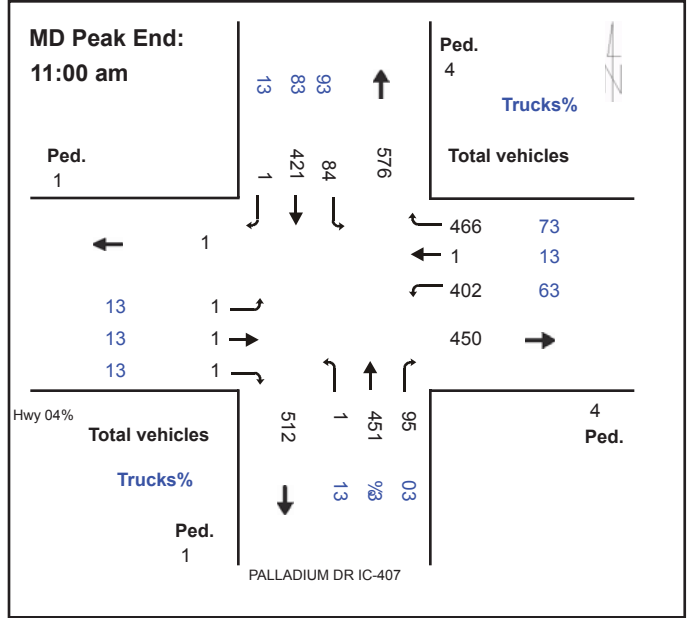
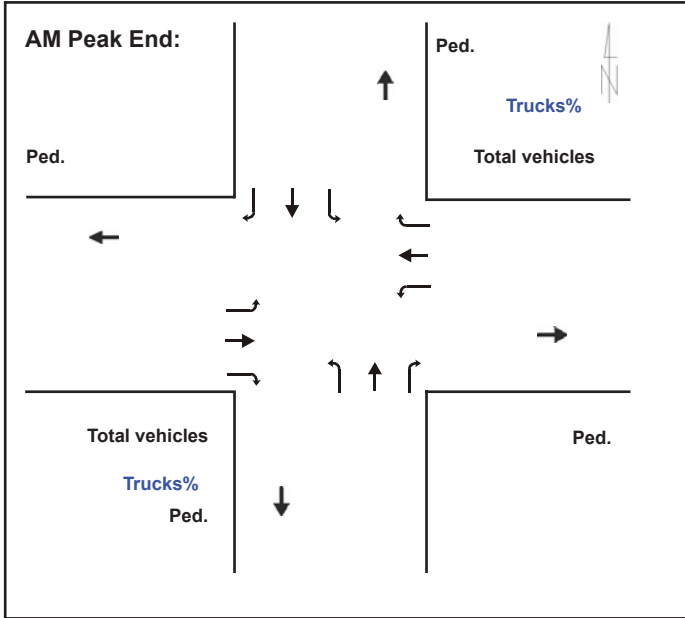

Appendix D

City of Ottawa Collision Data



City Operations - Transportation Services

Collision Details Report - Public Version

From: January 1, 2013 **To:** December 31, 2017

Location: CAMPEAU DR @ HUNTMAR DR

Traffic Control: Roundabout

Total Collisions: 14

Date/Day/Time	Environment	Impact Type	Classification	Surface Cond'n	Veh. Dir	Vehicle Manoeuvre	Vehicle type	First Event	No. Ped
2014-Oct-17, Fri,10:50	Clear	Rear end	P.D. only	Dry	North	Going ahead	Automobile, station wagon	Other motor vehicle	
					North	Slowing or stopping	Pick-up truck	Other motor vehicle	
2014-Oct-17, Fri,14:04	Rain	Sideswipe	Non-fatal injury	Wet	North	Going ahead	Automobile, station wagon	Other motor vehicle	
					North	Going ahead	Automobile, station wagon	Other motor vehicle	
2014-Dec-06, Sat,10:00	Clear	Angle	P.D. only	Dry	South	Merging	Automobile, station wagon	Other motor vehicle	
					West	Going ahead	Automobile, station wagon	Other motor vehicle	
2015-May-12, Tue,07:38	Clear	Angle	P.D. only	Dry	East	Going ahead	Delivery van	Other motor vehicle	
					South	Going ahead	Automobile, station wagon	Other motor vehicle	
2015-Mar-14, Sat,13:27	Rain	Angle	P.D. only	Wet	North	Going ahead	Automobile, station wagon	Other motor vehicle	
					East	Going ahead	Automobile, station wagon	Other motor vehicle	
2015-Apr-29, Wed,18:22	Clear	Sideswipe	P.D. only	Dry	North	Going ahead	Automobile, station wagon	Other motor vehicle	

					North	Going ahead	Automobile, station wagon	Other motor vehicle
2015-Jan-04, Sun,22:34	Freezing Rain	Sideswipe	P.D. only	Slush	West	Going ahead	Automobile, station wagon	Other motor vehicle
					West	Going ahead	Automobile, station wagon	Other motor vehicle
2014-Dec-26, Fri,13:11	Clear	Sideswipe	P.D. only	Dry	South	Going ahead	Automobile, station wagon	Other motor vehicle
					South	Going ahead	Automobile, station wagon	Other motor vehicle
2015-Jul-14, Tue,09:09	Clear	Angle	P.D. only	Dry	South	Merging	Pick-up truck	Other motor vehicle
					West	Going ahead	Automobile, station wagon	Other motor vehicle
2016-May-24, Tue,17:27	Clear	Sideswipe	P.D. only	Dry	North	Overtaking	Automobile, station wagon	Other motor vehicle
					North	Going ahead	Farm tractor	Other motor vehicle
2016-Sep-12, Mon,18:14	Clear	Angle	P.D. only	Dry	East	Going ahead	Pick-up truck	Other motor vehicle
					North	Going ahead	Automobile, station wagon	Other motor vehicle
2017-Oct-02, Mon,07:36	Clear	Angle	P.D. only	Dry	South	Merging	Automobile, station wagon	Other motor vehicle
					West	Going ahead	Automobile, station wagon	Other motor vehicle
2017-Jun-14, Wed,09:50	Clear	Sideswipe	P.D. only	Dry	West	Going ahead	Automobile, station wagon	Other motor vehicle
					West	Going ahead	Automobile, station wagon	Other motor vehicle

2017-Jul-10, Mon,17:47	Clear	Sideswipe	P.D. only	Dry	North	Going ahead	Automobile, station wagon	Other motor vehicle
					North	Going ahead	Pick-up truck	Other motor vehicle

Location: CAMPEAU DR @ JOURNEYMAN ST

Traffic Control: Traffic signal

Total Collisions: 1

Date/Day/Time	Environment	Impact Type	Classification	Surface Cond'n	Veh. Dir	Vehicle Manoeuver	Vehicle type	First Event	No. Ped
2015-Dec-26, Sat,11:05	Clear	Sideswipe	P.D. only	Dry	West	Changing lanes	Pick-up truck	Other motor vehicle	
					West	Going ahead	Automobile, station wagon	Other motor vehicle	

Location: HUNTMAR DR @ PALLADIUM DR N

Traffic Control: Stop sign

Total Collisions: 2

Date/Day/Time	Environment	Impact Type	Classification	Surface Cond'n	Veh. Dir	Vehicle Manoeuver	Vehicle type	First Event	No. Ped
2014-Jan-30, Thu,19:30	Clear	Rear end	P.D. only	Loose snow	South	Going ahead	Automobile, station wagon	Other motor vehicle	
					South	Slowing or stopping	Automobile, station wagon	Other motor vehicle	
2016-Dec-18, Sun,15:12	Clear	SMV other	P.D. only	Slush	North	Going ahead	Automobile, station wagon	Curb	

Location: HWY 417 PALLADI IC142R36 @ PALLADIUM DR

Traffic Control: Traffic signal

Total Collisions: 7

Date/Day/Time	Environment	Impact Type	Classification	Surface Cond'n	Veh. Dir	Vehicle Manoeuver	Vehicle type	First Event	No. Ped
2014-Mar-19, Wed,10:30	Clear	Rear end	P.D. only	Dry	South	Slowing or stopping	Automobile, station wagon	Other motor vehicle	
					South	Slowing or stopping	Automobile, station wagon	Other motor vehicle	

2016-May-07, Sat,14:32	Clear	Turning movement	P.D. only	Dry	South	Turning left	Automobile, station wagon	Other motor vehicle
					South	Going ahead	Pick-up truck	Other motor vehicle
2016-Sep-21, Wed,17:30	Clear	Sideswipe	P.D. only	Dry	South	Turning left	Pick-up truck	Other motor vehicle
					South	Turning left	Pick-up truck	Other motor vehicle
2016-Dec-19, Mon,16:35	Clear	Other	P.D. only	Wet	East	Reversing	Pick-up truck	Other motor vehicle
					West	Turning left	Pick-up truck	Other motor vehicle
2017-Nov-01, Wed,17:18	Rain	Turning movement	P.D. only	Wet	South	Turning left	Automobile, station wagon	Other motor vehicle
					North	Going ahead	Automobile, station wagon	Other motor vehicle
2017-Dec-29, Fri,14:40	Clear	Sideswipe	P.D. only	Dry	South	Making "U" turn	Pick-up truck	Other motor vehicle
					South	Going ahead	Automobile, station wagon	Other motor vehicle
2017-Dec-08, Fri,12:04	Clear	Angle	P.D. only	Dry	West	Turning right	Automobile, station wagon	Other motor vehicle
					North	Going ahead	Automobile, station wagon	Other motor vehicle

Location: PALLADIUM DR btwn HWY417 IC142 RAMP52 & HWY417 IC142 RAMP53

Traffic Control: No control

Total Collisions: 1

Date/Day/Time	Environment	Impact Type	Classification	Surface Cond'n	Veh. Dir	Vehicle Manoeuver	Vehicle type	First Event	No. Ped
2017-Nov-24, Fri,16:16	Clear	Turning movement	Non-fatal injury	Dry	South	Making "U" turn	Automobile, station wagon	Other motor vehicle	

South Going ahead Automobile, station wagon Other motor vehicle

Location: PALLADIUM DR btwn HWY417 IC142 RAMP53 & HWY417 IC142 RAMP25

Traffic Control: No control

Total Collisions: 2

Date/Day/Time	Environment	Impact Type	Classification	Surface Cond'n	Veh. Dir	Vehicle Manoeuver	Vehicle type	First Event	No. Ped
2014-Nov-09, Sun,17:36	Clear	Rear end	P.D. only	Wet	East	Slowing or stopping	Automobile, station wagon	Other motor vehicle	
					East	Stopped	Pick-up truck	Other motor vehicle	
2013-Feb-25, Mon,19:00	Clear	Rear end	P.D. only	Wet	South	Going ahead	Automobile, station wagon	Other motor vehicle	
					South	Stopped	Automobile, station wagon	Other motor vehicle	

Location: PALLADIUM DR btwn HWY417 IC142 RAMP62 & HUNTMAR DR

Traffic Control: No control

Total Collisions: 3

Date/Day/Time	Environment	Impact Type	Classification	Surface Cond'n	Veh. Dir	Vehicle Manoeuver	Vehicle type	First Event	No. Ped
2014-Oct-17, Fri,10:50	Clear	Sideswipe	P.D. only	Dry	East	Changing lanes	Automobile, station wagon	Other motor vehicle	
					East	Changing lanes	Pick-up truck	Other motor vehicle	
2015-Jul-26, Sun,15:15	Clear	Turning movement	P.D. only	Dry	North	Making "U" turn	Automobile, station wagon	Other motor vehicle	
					North	Going ahead	Motorcycle	Other motor vehicle	
2016-Nov-24, Thu,08:09	Snow	Rear end	P.D. only	Loose snow	North	Going ahead	Pick-up truck	Other motor vehicle	
					North	Making "U" turn	Automobile, station wagon	Other motor vehicle	

Location: PALLADIUM DR/HWY 417 PALLADIU IC142R52 @ HWY 4

Traffic Control: Stop sign

Total Collisions: 1

Date/Day/Time	Environment	Impact Type	Classification	Surface Cond'n	Veh. Dir	Vehicle Manoeuver	Vehicle type	First Event	No. Ped
2017-Mar-18, Sat,17:31	Clear	Rear end	P.D. only	Dry	South	Making "U" turn	Pick-up truck	Other motor vehicle	
					South	Going ahead	Automobile, station wagon	Other motor vehicle	

Appendix E

Boundary Street MMLOS Analysis

Multi-Modal Level of Service - Segments Form

Consultant
Scenario
Comments

Parsons
Future

Project
Date

477190 - 01000
26-Jun-19

SEGMENTS		Street	Campeau	Palladium	Upper Canada
			1	2	3
Pedestrian	Sidewalk Width	-	≥ 2 m	≥ 2 m	≥ 2 m
	Boulevard Width		0.5 - 2 m	> 2 m	0.5 - 2 m
	Avg Daily Curb Lane Traffic Volume		≤ 3000	≤ 3000	≤ 3000
	Operating Speed		> 50 to 60 km/h	> 50 to 60 km/h	> 30 to 50 km/h
	On-Street Parking		no	no	no
	Exposure to Traffic PLoS		A	A	A
	Effective Sidewalk Width				
Pedestrian Volume					
Crowding PLoS	-	-	-		
Level of Service	-	-	-		
Bicycle	Type of Cycling Facility	B	Physically Separated	Physically Separated	Mixed Traffic
	Number of Travel Lanes				≤ 2 (no centreline)
	Operating Speed				>40 to <50 km/h
	# of Lanes & Operating Speed LoS		-	-	B
	Bike Lane (+ Parking Lane) Width				
	Bike Lane Width LoS		-	-	-
	Bike Lane Blockages				
	Blockage LoS		-	-	-
	Median Refuge Width (no median = < 1.8 m)				< 1.8 m refuge
	No. of Lanes at Unsignalized Crossing				≤ 3 lanes
Sidestreet Operating Speed			>40 to 50 km/h		
Unsignalized Crossing - Lowest LoS	A	A	B		
Level of Service	A	A	B		
Transit	Facility Type	D	Mixed Traffic	Mixed Traffic	Mixed Traffic
	Friction or Ratio Transit:Posted Speed		Vt/Vp ≥ 0.8	Vt/Vp ≥ 0.8	Vt/Vp ≥ 0.8
	Level of Service		D	D	D
Truck	Truck Lane Width	C	≤ 3.5 m	≤ 3.5 m	> 3.7 m
	Travel Lanes per Direction		1	1	1
	Level of Service		C	C	B

Appendix F

Truck Turning Templates

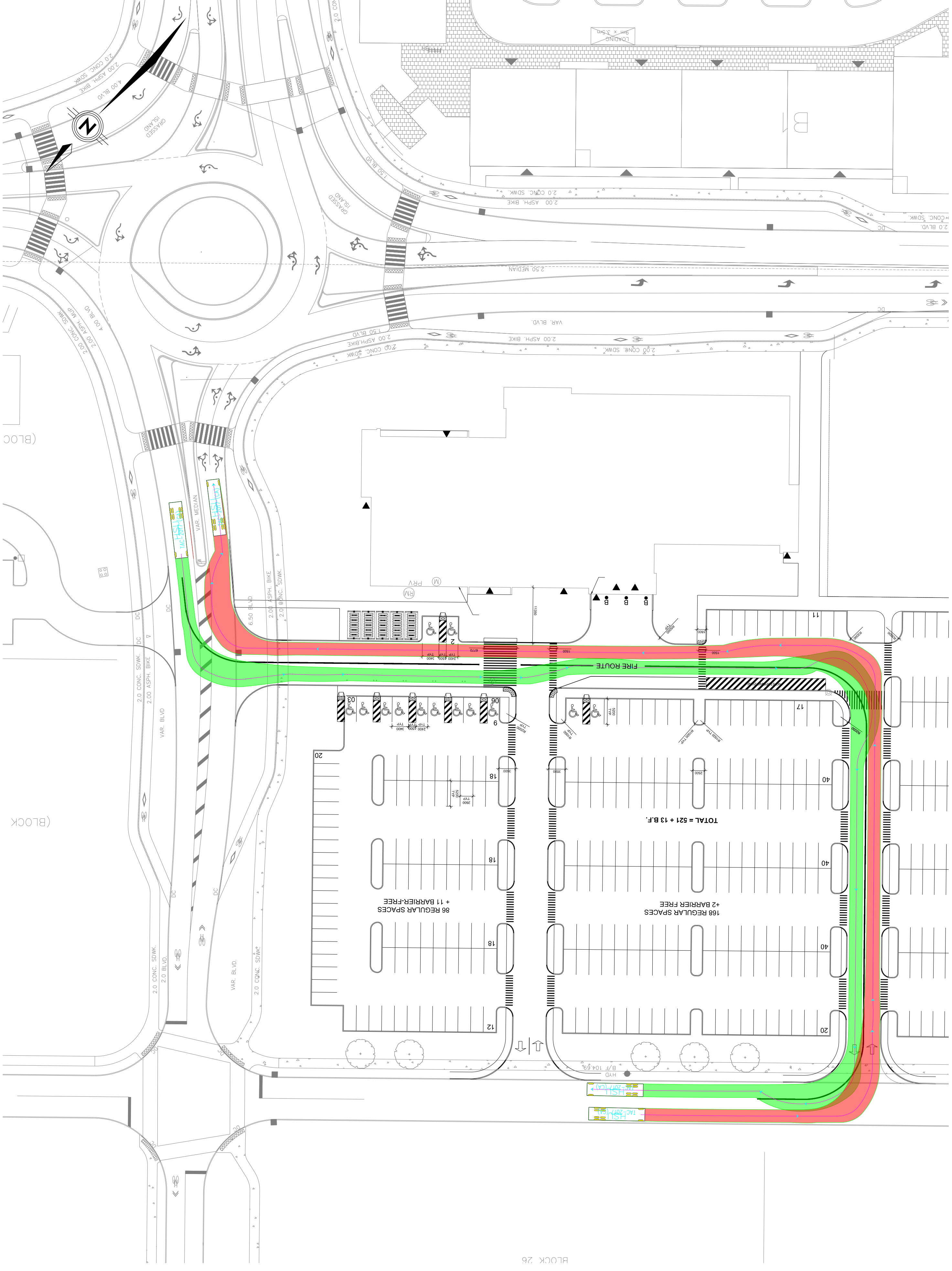

TURNING TEMPLATES
HSU

KANATA WEST BUSINESS PARK
KINAXIS OFFICE DEVELOPMENT



Scale: HORIZONTAL
0m 2.5 5 10

Rev. No. _____
Draw. No. SK-001

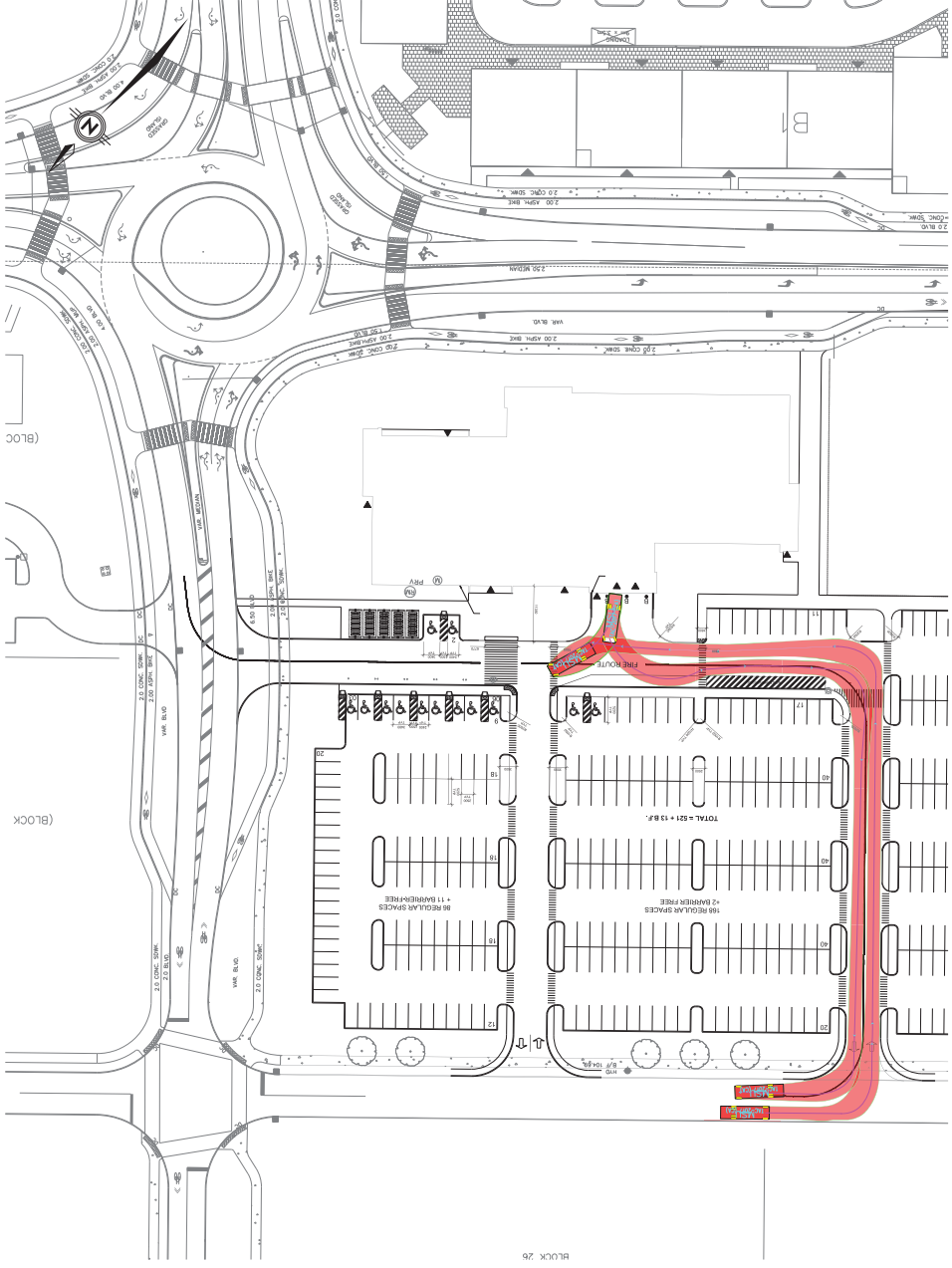

PARSONS CONSULTING ENGINEERS 1000 RIVERVIEW AVENUE SUITE 200 OAKLAND, CA 94612 TEL: 415.779.4500 FAX: 415.779.4501 WWW.PARSONS.COM	TURNING TEMPLATES MSU
	KANATA WEST BUSINESS PARK KANATA OFFICE DEVELOPMENT

Appendix G

SimTraffic Reports

Intersection: 31: Access 3 & Parking Aisle

Movement	EB	WB	SB
Directions Served	LT	TR	LR
Maximum Queue (m)	8.9	20.5	9.2
Average Queue (m)	2.2	9.8	1.7
95th Queue (m)	8.4	15.8	7.6
Link Distance (m)	33.5	49.3	37.6
Upstream Blk Time (%)			
Queuing Penalty (veh)			
Storage Bay Dist (m)			
Storage Blk Time (%)			
Queuing Penalty (veh)			

Zone Summary

Zone wide Queuing Penalty: 0

Intersection: 31: Access 3 & Parking Aisle

Movement	EB	WB	SB
Directions Served	LT	TR	LR
Maximum Queue (m)	17.0	9.8	15.8
Average Queue (m)	8.4	3.9	6.2
95th Queue (m)	15.7	11.3	14.5
Link Distance (m)	34.2	48.4	37.7
Upstream Blk Time (%)			
Queuing Penalty (veh)			
Storage Bay Dist (m)			
Storage Blk Time (%)			
Queuing Penalty (veh)			

Zone Summary

Zone wide Queuing Penalty: 0

Appendix H

TDM Checklist

TDM-Supportive Development Design and Infrastructure Checklist:
Non-Residential Developments (office, institutional, retail or industrial)

Legend	
REQUIRED	The Official Plan or Zoning By-law provides related guidance that must be followed
BASIC	The measure is generally feasible and effective, and in most cases would benefit the development and its users
BETTER	The measure could maximize support for users of sustainable modes, and optimize development performance

TDM-supportive design & infrastructure measures: <i>Non-residential developments</i>		Check if completed & add descriptions, explanations or plan/drawing references
1. WALKING & CYCLING: ROUTES		
1.1 Building location & access points		
BASIC	1.1.1 Locate building close to the street, and do not locate parking areas between the street and building entrances	<input type="checkbox"/>
BASIC	1.1.2 Locate building entrances in order to minimize walking distances to sidewalks and transit stops/stations	<input type="checkbox"/>
BASIC	1.1.3 Locate building doors and windows to ensure visibility of pedestrians from the building, for their security and comfort	<input type="checkbox"/>
1.2 Facilities for walking & cycling		
REQUIRED	1.2.1 Provide convenient, direct access to stations or major stops along rapid transit routes within 600 metres; minimize walking distances from buildings to rapid transit; provide pedestrian-friendly, weather-protected (where possible) environment between rapid transit accesses and building entrances; ensure quality linkages from sidewalks through building entrances to integrated stops/stations (<i>see Official Plan policy 4.3.3</i>)	<input checked="" type="checkbox"/>
REQUIRED	1.2.2 Provide safe, direct and attractive pedestrian access from public sidewalks to building entrances through such measures as: reducing distances between public sidewalks and major building entrances; providing walkways from public streets to major building entrances; within a site, providing walkways along the front of adjoining buildings, between adjacent buildings, and connecting areas where people may congregate, such as courtyards and transit stops; and providing weather protection through canopies, colonnades, and other design elements wherever possible (<i>see Official Plan policy 4.3.12</i>)	<input checked="" type="checkbox"/>

TDM-supportive design & infrastructure measures: <i>Non-residential developments</i>		Check if completed & add descriptions, explanations or plan/drawing references
REQUIRED	1.2.3 Provide sidewalks of smooth, well-drained walking surfaces of contrasting materials or treatments to differentiate pedestrian areas from vehicle areas, and provide marked pedestrian crosswalks at intersection sidewalks (<i>see Official Plan policy 4.3.10</i>)	<input checked="" type="checkbox"/>
REQUIRED	1.2.4 Make sidewalks and open space areas easily accessible through features such as gradual grade transition, depressed curbs at street corners and convenient access to extra-wide parking spaces and ramps (<i>see Official Plan policy 4.3.10</i>)	<input checked="" type="checkbox"/>
REQUIRED	1.2.5 Include adequately spaced inter-block/street cycling and pedestrian connections to facilitate travel by active transportation. Provide links to the existing or planned network of public sidewalks, multi-use pathways and on-road cycle routes. Where public sidewalks and multi-use pathways intersect with roads, consider providing traffic control devices to give priority to cyclists and pedestrians (<i>see Official Plan policy 4.3.11</i>)	<input checked="" type="checkbox"/>
BASIC	1.2.6 Provide safe, direct and attractive walking routes from building entrances to nearby transit stops	<input type="checkbox"/>
BASIC	1.2.7 Ensure that walking routes to transit stops are secure, visible, lighted, shaded and wind-protected wherever possible	<input type="checkbox"/>
BASIC	1.2.8 Design roads used for access or circulation by cyclists using a target operating speed of no more than 30 km/h, or provide a separated cycling facility	<input type="checkbox"/>
1.3 Amenities for walking & cycling		
BASIC	1.3.1 Provide lighting, landscaping and benches along walking and cycling routes between building entrances and streets, sidewalks and trails	<input type="checkbox"/>
BASIC	1.3.2 Provide wayfinding signage for site access (where required, e.g. when multiple buildings or entrances exist) and egress (where warranted, such as when directions to reach transit stops/stations, trails or other common destinations are not obvious)	<input type="checkbox"/>

TDM-supportive design & infrastructure measures: <i>Non-residential developments</i>		Check if completed & add descriptions, explanations or plan/drawing references
2. WALKING & CYCLING: END-OF-TRIP FACILITIES		
2.1 Bicycle parking		
REQUIRED	2.1.1 Provide bicycle parking in highly visible and lighted areas, sheltered from the weather wherever possible (see <i>Official Plan policy 4.3.6</i>)	<input checked="" type="checkbox"/>
REQUIRED	2.1.2 Provide the number of bicycle parking spaces specified for various land uses in different parts of Ottawa; provide convenient access to main entrances or well-used areas (see <i>Zoning By-law Section 111</i>)	<input checked="" type="checkbox"/>
REQUIRED	2.1.3 Ensure that bicycle parking spaces and access aisles meet minimum dimensions; that no more than 50% of spaces are vertical spaces; and that parking racks are securely anchored (see <i>Zoning By-law Section 111</i>)	<input checked="" type="checkbox"/>
BASIC	2.1.4 Provide bicycle parking spaces equivalent to the expected number of commuter cyclists (assuming the cycling mode share target is met), plus the expected peak number of customer/visitor cyclists	<input type="checkbox"/>
BETTER	2.1.5 Provide bicycle parking spaces equivalent to the expected number of commuter and customer/visitor cyclists, plus an additional buffer (e.g. 25 percent extra) to encourage other cyclists and ensure adequate capacity in peak cycling season	<input type="checkbox"/>
2.2 Secure bicycle parking		
REQUIRED	2.2.1 Where more than 50 bicycle parking spaces are provided for a single office building, locate at least 25% of spaces within a building/structure, a secure area (e.g. supervised parking lot or enclosure) or bicycle lockers (see <i>Zoning By-law Section 111</i>)	<input checked="" type="checkbox"/>
BETTER	2.2.2 Provide secure bicycle parking spaces equivalent to the expected number of commuter cyclists (assuming the cycling mode share target is met)	<input type="checkbox"/>
2.3 Shower & change facilities		
BASIC	2.3.1 Provide shower and change facilities for the use of active commuters	<input type="checkbox"/>
BETTER	2.3.2 In addition to shower and change facilities, provide dedicated lockers, grooming stations, drying racks and laundry facilities for the use of active commuters	<input type="checkbox"/>
2.4 Bicycle repair station		
BETTER	2.4.1 Provide a permanent bike repair station, with commonly used tools and an air pump, adjacent to the main bicycle parking area (or secure bicycle parking area, if provided)	<input type="checkbox"/>

TDM-supportive design & infrastructure measures: <i>Non-residential developments</i>		Check if completed & add descriptions, explanations or plan/drawing references
3. TRANSIT		
3.1 Customer amenities		
BASIC	3.1.1 Provide shelters, lighting and benches at any on-site transit stops	<input type="checkbox"/>
BASIC	3.1.2 Where the site abuts an off-site transit stop and insufficient space exists for a transit shelter in the public right-of-way, protect land for a shelter and/or install a shelter	<input type="checkbox"/>
BETTER	3.1.3 Provide a secure and comfortable interior waiting area by integrating any on-site transit stops into the building	<input type="checkbox"/>
4. RIDESHARING		
4.1 Pick-up & drop-off facilities		
BASIC	4.1.1 Provide a designated area for carpool drivers (plus taxis and ride-hailing services) to drop off or pick up passengers without using fire lanes or other no-stopping zones	<input type="checkbox"/>
4.2 Carpool parking		
BASIC	4.2.1 Provide signed parking spaces for carpools in a priority location close to a major building entrance, sufficient in number to accommodate the mode share target for carpools	<input type="checkbox"/>
BETTER	4.2.2 At large developments, provide spaces for carpools in a separate, access-controlled parking area to simplify enforcement	<input type="checkbox"/>
5. CARSHARING & BIKESHARING		
5.1 Carshare parking spaces		
BETTER	5.1.1 Provide carshare parking spaces in permitted non-residential zones, occupying either required or provided parking spaces (<i>see Zoning By-law Section 94</i>)	<input type="checkbox"/>
5.2 Bikeshare station location		
BETTER	5.2.1 Provide a designated bikeshare station area near a major building entrance, preferably lighted and sheltered with a direct walkway connection	<input type="checkbox"/>

TDM-supportive design & infrastructure measures: <i>Non-residential developments</i>		Check if completed & add descriptions, explanations or plan/drawing references
6. PARKING		
6.1 Number of parking spaces		
REQUIRED	6.1.1 Do not provide more parking than permitted by zoning, nor less than required by zoning, unless a variance is being applied for	<input checked="" type="checkbox"/>
BASIC	6.1.2 Provide parking for long-term and short-term users that is consistent with mode share targets, considering the potential for visitors to use off-site public parking	<input type="checkbox"/>
BASIC	6.1.3 Where a site features more than one use, provide shared parking and reduce the cumulative number of parking spaces accordingly (<i>see Zoning By-law Section 104</i>)	<input type="checkbox"/>
BETTER	6.1.4 Reduce the minimum number of parking spaces required by zoning by one space for each 13 square metres of gross floor area provided as shower rooms, change rooms, locker rooms and other facilities for cyclists in conjunction with bicycle parking (<i>see Zoning By-law Section 111</i>)	<input type="checkbox"/>
6.2 Separate long-term & short-term parking areas		
BETTER	6.2.1 Separate short-term and long-term parking areas using signage or physical barriers, to permit access controls and simplify enforcement (i.e. to discourage employees from parking in visitor spaces, and vice versa)	<input type="checkbox"/>
7. OTHER		
7.1 On-site amenities to minimize off-site trips		
BETTER	7.1.1 Provide on-site amenities to minimize mid-day or mid-commute errands	<input type="checkbox"/>

Appendix I

Synchro and Sidra Analysis Reports

Existing Conditions

MOVEMENT SUMMARY

 Site: 101 [Huntmar / Campeau Existing AM]

New Site
Roundabout

Movement Performance - Vehicles												
Mov ID	OD Mov	Demand Total veh/h	Flows HV %	Deg. Satn v/c	Average Delay sec	Level of Service	95% Back of Queue Vehicles veh	Queue Distance m	Prop. Queued	Effective Stop Rate per veh	Average Speed km/h	
South: Huntmar Dr												
1	L2	20	2.0	0.016	9.5	LOS A	0.1	0.5	0.20	0.60	53.5	
2	T1	347	2.0	0.201	3.7	LOS A	1.0	7.1	0.20	0.36	57.4	
3	R2	19	2.0	0.016	4.2	LOS A	0.1	0.4	0.20	0.43	55.3	
Approach		386	2.0	0.201	4.1	LOS A	1.0	7.1	0.20	0.38	57.0	
East: Campeau Dr												
4	L2	36	2.0	0.024	10.0	LOS A	0.1	0.7	0.37	0.63	52.9	
5	T1	20	2.0	0.017	4.7	LOS A	0.1	0.5	0.40	0.45	56.3	
6	R2	9	2.0	0.008	5.1	LOS A	0.0	0.2	0.40	0.50	54.5	
Approach		64	2.0	0.024	7.7	LOS A	0.1	0.7	0.38	0.56	54.1	
North: Huntmar Dr												
7	L2	2	2.0	0.002	9.5	LOS A	0.0	0.0	0.18	0.59	53.6	
8	T1	319	2.0	0.183	3.7	LOS A	0.9	6.2	0.18	0.36	57.5	
9	R2	108	2.0	0.083	4.1	LOS A	0.3	2.5	0.18	0.44	55.4	
Approach		429	2.0	0.183	3.8	LOS A	0.9	6.2	0.18	0.38	56.9	
West: Campeau Dr												
10	L2	76	2.0	0.049	9.9	LOS A	0.2	1.5	0.35	0.63	53.0	
11	T1	11	2.0	0.010	4.6	LOS A	0.0	0.3	0.37	0.43	56.4	
12	R2	32	2.0	0.017	3.3	LOS A	0.0	0.0	0.00	0.42	56.8	
Approach		119	2.0	0.049	7.6	LOS A	0.2	1.5	0.26	0.55	54.3	
All Vehicles		998	2.0	0.201	4.6	LOS A	1.0	7.1	0.21	0.41	56.4	

Site Level of Service (LOS) Method: Delay (SIDRA). Site LOS Method is specified in the Parameter Settings dialog (Site tab).

Roundabout LOS Method: SIDRA Roundabout LOS.

Vehicle movement LOS values are based on average delay per movement.

Intersection and Approach LOS values are based on average delay for all vehicle movements.

Roundabout Capacity Model: SIDRA Standard.

SIDRA Standard Delay Model is used. Control Delay includes Geometric Delay.

Gap-Acceptance Capacity: SIDRA Standard (Akçelik M3D).

HV (%) values are calculated for All Movement Classes of All Heavy Vehicle Model Designation.

MOVEMENT SUMMARY

 Site: 101 [Huntmar / Campeau Existing PM]

New Site
Roundabout

Movement Performance - Vehicles												
Mov ID	OD Mov	Demand Total veh/h	Flows HV %	Deg. Satn v/c	Average Delay sec	Level of Service	95% Back of Queue Vehicles veh	Queue Distance m	Prop. Queued	Effective Stop Rate per veh	Average Speed km/h	
South: Huntmar Dr												
1	L2	64	2.0	0.058	10.0	LOS B	0.2	1.7	0.34	0.63	53.0	
2	T1	387	2.0	0.245	4.1	LOS A	1.3	8.9	0.35	0.40	56.5	
3	R2	32	2.0	0.029	4.6	LOS A	0.1	0.8	0.33	0.48	54.8	
Approach		483	2.0	0.245	4.9	LOS A	1.3	8.9	0.35	0.44	55.9	
East: Campeau Dr												
4	L2	24	2.0	0.017	10.2	LOS B	0.1	0.5	0.44	0.64	52.7	
5	T1	14	2.0	0.014	5.0	LOS A	0.1	0.4	0.46	0.49	55.9	
6	R2	4	2.0	0.004	5.3	LOS A	0.0	0.1	0.46	0.52	54.3	
Approach		43	2.0	0.017	7.9	LOS A	0.1	0.5	0.45	0.58	53.9	
North: Huntmar Dr												
7	L2	7	2.0	0.006	9.5	LOS A	0.0	0.1	0.20	0.59	53.5	
8	T1	393	2.0	0.229	3.8	LOS A	1.1	7.8	0.21	0.37	57.3	
9	R2	148	2.0	0.113	4.2	LOS A	0.5	3.4	0.22	0.45	55.2	
Approach		548	2.0	0.229	4.0	LOS A	1.1	7.8	0.21	0.40	56.7	
West: Campeau Dr												
10	L2	190	2.0	0.128	10.2	LOS B	0.6	4.3	0.41	0.66	52.8	
11	T1	41	2.0	0.039	4.9	LOS A	0.2	1.1	0.42	0.48	56.1	
12	R2	66	2.0	0.035	3.3	LOS A	0.0	0.0	0.00	0.42	56.8	
Approach		297	2.0	0.128	7.9	LOS A	0.6	4.3	0.32	0.58	54.0	
All Vehicles		1371	2.0	0.245	5.3	LOS A	1.3	8.9	0.29	0.46	55.7	

Site Level of Service (LOS) Method: Delay (SIDRA). Site LOS Method is specified in the Parameter Settings dialog (Site tab).

Roundabout LOS Method: SIDRA Roundabout LOS.

Vehicle movement LOS values are based on average delay per movement.

Intersection and Approach LOS values are based on average delay for all vehicle movements.

Roundabout Capacity Model: SIDRA Standard.

SIDRA Standard Delay Model is used. Control Delay includes Geometric Delay.

Gap-Acceptance Capacity: SIDRA Standard (Akçelik M3D).

HV (%) values are calculated for All Movement Classes of All Heavy Vehicle Model Designation.

MOVEMENT SUMMARY

 Site: 101 [Campeau / Palladium Existing AM]

New Site
Roundabout

Movement Performance - Vehicles											
Mov ID	OD Mov	Demand Total veh/h	Flows HV %	Deg. Satn v/c	Average Delay sec	Level of Service	95% Back of Queue Vehicles veh	Queue Distance m	Prop. Queued	Effective Stop Rate per veh	Average Speed km/h
South: Campeau Dr											
1	L2	51	2.0	0.039	9.3	LOS A	0.2	1.4	0.11	0.56	55.0
2	T1	18	2.0	0.039	3.6	LOS A	0.2	1.4	0.11	0.56	54.6
3	R2	101	2.0	0.053	3.1	LOS A	0.0	0.0	0.00	0.40	57.1
Approach		170	2.0	0.053	5.0	LOS A	0.2	1.4	0.04	0.47	56.2
East: Palladium Dr											
4	L2	112	2.0	0.045	9.4	LOS A	0.2	1.5	0.18	0.57	54.2
5	T1	21	2.0	0.045	3.7	LOS A	0.2	1.5	0.17	0.54	54.9
6	R2	7	2.0	0.045	3.8	LOS A	0.2	1.5	0.17	0.54	53.2
Approach		140	2.0	0.045	8.3	LOS A	0.2	1.5	0.18	0.56	54.3
North: Campeau Dr											
7	L2	4	2.0	0.009	9.7	LOS A	0.0	0.2	0.26	0.49	55.8
8	T1	17	2.0	0.009	4.0	LOS A	0.0	0.2	0.25	0.43	56.4
9	R2	2	2.0	0.009	4.1	LOS A	0.0	0.2	0.25	0.38	55.3
Approach		23	2.0	0.009	5.1	LOS A	0.0	0.2	0.25	0.43	56.2
West: Palladium Dr											
10	L2	1	2.0	0.018	9.5	LOS A	0.1	0.5	0.21	0.38	57.5
11	T1	24	2.0	0.018	3.9	LOS A	0.1	0.5	0.21	0.38	57.1
12	R2	23	2.0	0.017	3.7	LOS A	0.1	0.4	0.21	0.42	55.9
Approach		49	2.0	0.018	3.9	LOS A	0.1	0.5	0.21	0.40	56.6
All Vehicles		382	2.0	0.053	6.1	LOS A	0.2	1.5	0.13	0.49	55.5

Site Level of Service (LOS) Method: Delay (SIDRA). Site LOS Method is specified in the Parameter Settings dialog (Site tab).

Roundabout LOS Method: SIDRA Roundabout LOS.

Vehicle movement LOS values are based on average delay per movement.

Intersection and Approach LOS values are based on average delay for all vehicle movements.

Roundabout Capacity Model: SIDRA Standard.

SIDRA Standard Delay Model is used. Control Delay includes Geometric Delay.

Gap-Acceptance Capacity: SIDRA Standard (Akçelik M3D).

HV (%) values are calculated for All Movement Classes of All Heavy Vehicle Model Designation.

MOVEMENT SUMMARY

 Site: 101 [Campeau / Palladium Existing PM]

New Site
Roundabout

Movement Performance - Vehicles											
Mov ID	OD Mov	Demand Total veh/h	Flows HV %	Deg. Satn v/c	Average Delay sec	Level of Service	95% Back of Queue Vehicles veh	Queue Distance m	Prop. Queued	Effective Stop Rate per veh	Average Speed km/h
South: Campeau Dr											
1	L2	22	2.0	0.014	9.3	LOS A	0.1	0.5	0.15	0.59	53.9
2	T1	1	2.0	0.014	3.7	LOS A	0.1	0.5	0.15	0.59	53.6
3	R2	199	2.0	0.105	3.1	LOS A	0.0	0.0	0.00	0.40	57.1
Approach		222	2.0	0.105	3.8	LOS A	0.1	0.5	0.02	0.42	56.7
East: Palladium Dr											
4	L2	184	2.0	0.065	9.3	LOS A	0.3	2.3	0.10	0.59	54.4
5	T1	27	2.0	0.065	3.6	LOS A	0.3	2.3	0.10	0.57	54.6
6	R2	1	2.0	0.065	3.7	LOS A	0.3	2.3	0.10	0.57	52.9
Approach		212	2.0	0.065	8.5	LOS A	0.3	2.3	0.10	0.59	54.4
North: Campeau Dr											
7	L2	9	2.0	0.014	9.8	LOS A	0.0	0.3	0.29	0.54	55.1
8	T1	24	2.0	0.014	4.1	LOS A	0.0	0.3	0.28	0.44	56.3
9	R2	1	2.0	0.014	4.2	LOS A	0.0	0.3	0.28	0.39	55.1
Approach		34	2.0	0.014	5.6	LOS A	0.0	0.3	0.28	0.46	55.9
West: Palladium Dr											
10	L2	2	2.0	0.033	9.7	LOS A	0.1	0.9	0.27	0.41	57.1
11	T1	42	2.0	0.033	4.1	LOS A	0.1	0.9	0.27	0.41	56.8
12	R2	16	2.0	0.012	3.9	LOS A	0.0	0.3	0.26	0.43	55.7
Approach		60	2.0	0.033	4.2	LOS A	0.1	0.9	0.27	0.42	56.5
All Vehicles		529	2.0	0.105	5.9	LOS A	0.3	2.3	0.10	0.49	55.7

Site Level of Service (LOS) Method: Delay (SIDRA). Site LOS Method is specified in the Parameter Settings dialog (Site tab).

Roundabout LOS Method: SIDRA Roundabout LOS.

Vehicle movement LOS values are based on average delay per movement.

Intersection and Approach LOS values are based on average delay for all vehicle movements.

Roundabout Capacity Model: SIDRA Standard.

SIDRA Standard Delay Model is used. Control Delay includes Geometric Delay.

Gap-Acceptance Capacity: SIDRA Standard (Akçelik M3D).

HV (%) values are calculated for All Movement Classes of All Heavy Vehicle Model Designation.

Existing AM
1: Kanata West Centre Dr & Campeau Dr

08/27/2019



Movement	EBT	EBR	WBL	WBT	NBL	NBR
Lane Configurations	↻		↻	↻	↻	
Traffic Volume (veh/h)	21	5	18	47	3	23
Future Volume (Veh/h)	21	5	18	47	3	23
Sign Control	Free		Free		Stop	
Grade	0%		0%		0%	
Peak Hour Factor	0.90	0.90	0.90	0.90	0.90	0.90
Hourly flow rate (vph)	23	6	20	52	3	26
Pedestrians						
Lane Width (m)						
Walking Speed (m/s)						
Percent Blockage						
Right turn flare (veh)						
Median type	None		None			
Median storage veh)						
Upstream signal (m)						
pX, platoon unblocked						
vC, conflicting volume			29		118	26
vC1, stage 1 conf vol						
vC2, stage 2 conf vol						
vCu, unblocked vol			29		118	26
tC, single (s)			4.1		6.4	6.2
tC, 2 stage (s)						
tF (s)			2.2		3.5	3.3
p0 queue free %			99		100	98
cM capacity (veh/h)			1584		867	1050
Direction, Lane #	EB 1	WB 1	WB 2	NB 1		
Volume Total	29	20	52	29		
Volume Left	0	20	0	3		
Volume Right	6	0	0	26		
cSH	1700	1584	1700	1027		
Volume to Capacity	0.02	0.01	0.03	0.03		
Queue Length 95th (m)	0.0	0.3	0.0	0.7		
Control Delay (s)	0.0	7.3	0.0	8.6		
Lane LOS	A		A			
Approach Delay (s)	0.0	2.0	8.6			
Approach LOS	A		A			
Intersection Summary						
Average Delay			3.0			
Intersection Capacity Utilization			17.7%	ICU Level of Service	A	
Analysis Period (min)			15			

Existing AM
3: Journeyman St & Campeau Dr

08/27/2019

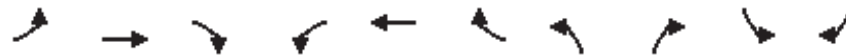

Lane Group	EBL	EBT	EBR	WBL	WBT	WBR	NBL	NBR	SBL	SBR
Lane Configurations										
Traffic Volume (vph)	6	92	19	17	116	2	4	12	1	1
Future Volume (vph)	6	92	19	17	116	2	4	12	1	1
Lane Group Flow (vph)	7	102	21	19	129	2	4	13	1	1
Turn Type	Perm	NA	Perm	Perm	NA	Perm	Perm	Perm	Perm	Perm
Protected Phases		4			8					
Permitted Phases	4		4	8		8	2	2	6	6
Detector Phase	4	4	4	8	8	8	2	2	6	6
Switch Phase										
Minimum Initial (s)	10.0	10.0	10.0	10.0	10.0	10.0	10.0	10.0	10.0	10.0
Minimum Split (s)	44.5	44.5	44.5	44.5	44.5	44.5	39.8	39.8	39.8	39.8
Total Split (s)	39.0	39.0	39.0	39.0	39.0	39.0	51.0	51.0	51.0	51.0
Total Split (%)	43.3%	43.3%	43.3%	43.3%	43.3%	43.3%	56.7%	56.7%	56.7%	56.7%
Yellow Time (s)	4.2	4.2	4.2	4.2	4.2	4.2	3.3	3.3	3.3	3.3
All-Red Time (s)	2.3	2.3	2.3	2.3	2.3	2.3	3.5	3.5	3.5	3.5
Lost Time Adjust (s)	0.0	0.0	0.0	0.0	0.0	0.0	0.0	0.0	0.0	0.0
Total Lost Time (s)	6.5	6.5	6.5	6.5	6.5	6.5	6.8	6.8	6.8	6.8
Lead/Lag										
Lead-Lag Optimize?										
Recall Mode	None	None	None	None	None	None	Max	Max	Max	Max
Act Effct Green (s)	10.9	10.9	10.9	10.9	10.9	10.9	49.0	49.0	49.0	49.0
Actuated g/C Ratio	0.16	0.16	0.16	0.16	0.16	0.16	0.72	0.72	0.72	0.72
v/c Ratio	0.03	0.34	0.07	0.09	0.43	0.01	0.00	0.01	0.00	0.00
Control Delay	24.3	29.0	3.6	25.5	30.8	0.0	4.8	0.0	5.0	0.0
Queue Delay	0.0	0.0	0.0	0.0	0.0	0.0	0.0	0.0	0.0	0.0
Total Delay	24.3	29.0	3.6	25.5	30.8	0.0	4.8	0.0	5.0	0.0
LOS	C	C	A	C	C	A	A	A	A	A
Approach Delay		24.6			29.7					
Approach LOS		C			C					
Queue Length 50th (m)	0.8	11.7	0.0	2.1	15.1	0.0	0.2	0.0	0.0	0.0
Queue Length 95th (m)	3.8	24.1	2.4	7.2	29.4	0.0	1.1	0.0	0.5	0.0
Internal Link Dist (m)		319.9			296.6					
Turn Bay Length (m)	45.0			50.0			20.0		45.0	
Base Capacity (vph)	603	895	785	618	895	785	1021	1362	1021	1342
Starvation Cap Reductn	0	0	0	0	0	0	0	0	0	0
Spillback Cap Reductn	0	0	0	0	0	0	0	0	0	0
Storage Cap Reductn	0	0	0	0	0	0	0	0	0	0
Reduced v/c Ratio	0.01	0.11	0.03	0.03	0.14	0.00	0.00	0.01	0.00	0.00

Intersection Summary

Cycle Length: 90	
Actuated Cycle Length: 68.4	
Natural Cycle: 85	
Control Type: Semi Act-Uncoord	
Maximum v/c Ratio: 0.43	
Intersection Signal Delay: 25.7	Intersection LOS: C
Intersection Capacity Utilization 41.8%	ICU Level of Service A
Analysis Period (min) 15	

Existing AM
3: Journeyman St & Campeau Dr

08/27/2019

Splits and Phases: 3: Journeyman St & Campeau Dr

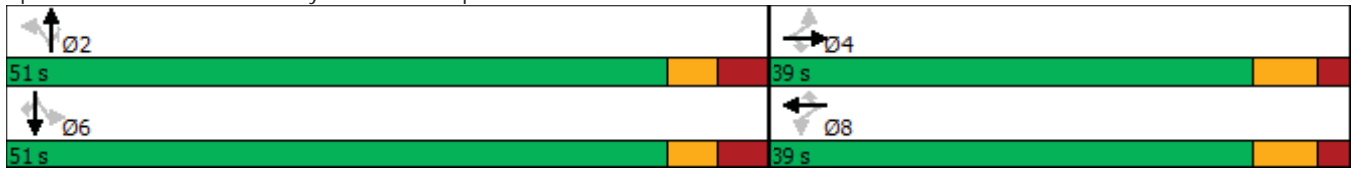

Existing AM
5: Palladium Dr & Cabela's Way

08/27/2019



Movement	EBL	EBR	NBL	NBT	SBT	SBR
Lane Configurations		↗	↖	↑↑	↑↑	
Traffic Volume (veh/h)	0	77	108	190	121	20
Future Volume (Veh/h)	0	77	108	190	121	20
Sign Control	Stop			Free	Free	
Grade	0%			0%	0%	
Peak Hour Factor	0.90	0.90	0.90	0.90	0.90	0.90
Hourly flow rate (vph)	0	86	120	211	134	22
Pedestrians						
Lane Width (m)						
Walking Speed (m/s)						
Percent Blockage						
Right turn flare (veh)						
Median type				None	None	
Median storage veh						
Upstream signal (m)	207					
pX, platoon unblocked						
vC, conflicting volume	490	78	156			
vC1, stage 1 conf vol						
vC2, stage 2 conf vol						
vCu, unblocked vol	490	78	156			
tC, single (s)	6.8	6.9	4.1			
tC, 2 stage (s)						
tF (s)	3.5	3.3	2.2			
p0 queue free %	100	91	92			
cM capacity (veh/h)	464	967	1422			
Direction, Lane #	EB 1	NB 1	NB 2	NB 3	SB 1	SB 2
Volume Total	86	120	106	106	89	67
Volume Left	0	120	0	0	0	0
Volume Right	86	0	0	0	0	22
cSH	967	1422	1700	1700	1700	1700
Volume to Capacity	0.09	0.08	0.06	0.06	0.05	0.04
Queue Length 95th (m)	2.2	2.1	0.0	0.0	0.0	0.0
Control Delay (s)	9.1	7.8	0.0	0.0	0.0	0.0
Lane LOS	A	A				
Approach Delay (s)	9.1	2.8	0.0			
Approach LOS	A					
Intersection Summary						
Average Delay	3.0					
Intersection Capacity Utilization	16.6%		ICU Level of Service		A	
Analysis Period (min)	15					

Existing AM
6: Palladium Dr & Hwy 417 WB On-Off Ramps

08/27/2019



Lane Group	WBL	WBR	NBT	SBL	SBT
Lane Configurations	↔↔	↗	↕↕	↘	↕↕
Traffic Volume (vph)	205	173	125	35	163
Future Volume (vph)	205	173	125	35	163
Lane Group Flow (vph)	228	192	139	39	181
Turn Type	Prot	Perm	NA	pm+pt	NA
Protected Phases	8		2	1	6
Permitted Phases		8		6	
Detector Phase	8	8	2	1	6
Switch Phase					
Minimum Initial (s)	10.0	10.0	10.0	5.0	10.0
Minimum Split (s)	32.7	32.7	39.0	12.0	25.0
Total Split (s)	36.7	36.7	39.0	22.0	39.0
Total Split (%)	37.6%	37.6%	39.9%	22.5%	39.9%
Yellow Time (s)	3.3	3.3	3.7	3.7	3.7
All-Red Time (s)	3.4	3.4	3.3	3.3	3.3
Lost Time Adjust (s)	0.0	0.0	0.0	0.0	0.0
Total Lost Time (s)	6.7	6.7	7.0	7.0	7.0
Lead/Lag			Lag	Lead	
Lead-Lag Optimize?			Yes	Yes	
Recall Mode	Max	Max	Max	Max	Max
Act Effct Green (s)	30.0	30.0	32.0	54.0	54.0
Actuated g/C Ratio	0.31	0.31	0.33	0.55	0.55
v/c Ratio	0.21	0.31	0.12	0.06	0.09
Control Delay	25.8	5.2	23.4	10.3	10.5
Queue Delay	0.0	0.0	0.0	0.0	0.0
Total Delay	25.8	5.2	23.4	10.3	10.5
LOS	C	A	C	B	B
Approach Delay	16.4		23.4		10.4
Approach LOS	B		C		B
Queue Length 50th (m)	16.3	0.0	9.5	3.2	8.0
Queue Length 95th (m)	25.4	14.7	16.3	7.7	12.9
Internal Link Dist (m)	322.5		403.5		183.1
Turn Bay Length (m)		125.0		115.0	
Base Capacity (vph)	1065	624	1172	684	1978
Starvation Cap Reductn	0	0	0	0	0
Spillback Cap Reductn	0	0	0	0	0
Storage Cap Reductn	0	0	0	0	0
Reduced v/c Ratio	0.21	0.31	0.12	0.06	0.09

Intersection Summary

Cycle Length: 97.7	
Actuated Cycle Length: 97.7	
Natural Cycle: 85	
Control Type: Actuated-Uncoordinated	
Maximum v/c Ratio: 0.31	
Intersection Signal Delay: 16.0	Intersection LOS: B
Intersection Capacity Utilization 38.1%	ICU Level of Service A
Analysis Period (min) 15	

Existing AM
6: Palladium Dr & Hwy 417 WB On-Off Ramps

08/27/2019

Splits and Phases: 6: Palladium Dr & Hwy 417 WB On-Off Ramps

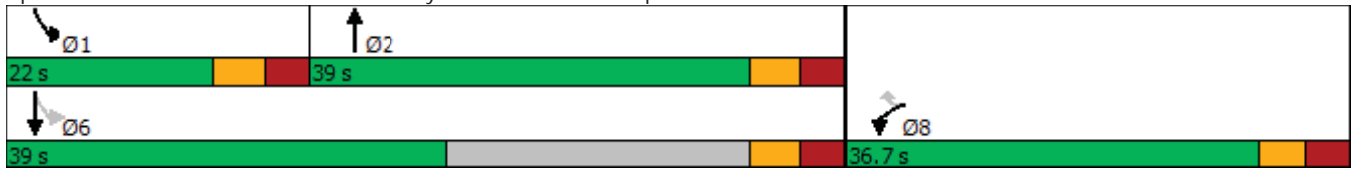

Existing AM
7: Palladium Dr & Hwy 417 EB Off Ramp

08/27/2019



Movement	EBL	EBR	NBL	NBT	SBT	SBR
Lane Configurations						
Traffic Volume (veh/h)	61	256	0	65	368	0
Future Volume (Veh/h)	61	256	0	65	368	0
Sign Control	Stop			Free		Free
Grade	0%			0%	0%	
Peak Hour Factor	0.90	0.90	0.90	0.90	0.90	0.90
Hourly flow rate (vph)	68	284	0	72	409	0
Pedestrians						
Lane Width (m)						
Walking Speed (m/s)						
Percent Blockage						
Right turn flare (veh)	3					
Median type				None	None	
Median storage veh						
Upstream signal (m)						
pX, platoon unblocked						
vC, conflicting volume	445	204	409			
vC1, stage 1 conf vol						
vC2, stage 2 conf vol						
vCu, unblocked vol	445	204	409			
tC, single (s)	6.8	6.9	4.1			
tC, 2 stage (s)						
tF (s)	3.5	3.3	2.2			
p0 queue free %	87	65	100			
cM capacity (veh/h)	542	802	1146			
Direction, Lane #	EB 1	NB 1	NB 2	SB 1	SB 2	
Volume Total	352	36	36	204	204	
Volume Left	68	0	0	0	0	
Volume Right	284	0	0	0	0	
cSH	994	1700	1700	1700	1700	
Volume to Capacity	0.35	0.02	0.02	0.12	0.12	
Queue Length 95th (m)	12.3	0.0	0.0	0.0	0.0	
Control Delay (s)	12.1	0.0	0.0	0.0	0.0	
Lane LOS	B					
Approach Delay (s)	12.1	0.0	0.0			
Approach LOS	B					
Intersection Summary						
Average Delay	5.1					
Intersection Capacity Utilization	32.7%			ICU Level of Service	A	
Analysis Period (min)	15					

Existing PM
1: Kanata West Centre Dr & Campeau Dr

08/27/2019



Movement	EBT	EBR	WBL	WBT	NBL	NBR
Lane Configurations						
Traffic Volume (veh/h)	18	1	12	35	2	36
Future Volume (Veh/h)	18	1	12	35	2	36
Sign Control	Free			Free	Stop	
Grade	0%			0%	0%	
Peak Hour Factor	0.90	0.90	0.90	0.90	0.90	0.90
Hourly flow rate (vph)	20	1	13	39	2	40
Pedestrians						
Lane Width (m)						
Walking Speed (m/s)						
Percent Blockage						
Right turn flare (veh)						
Median type	None		None			
Median storage veh						
Upstream signal (m)						
pX, platoon unblocked						
vC, conflicting volume			21		86	20
vC1, stage 1 conf vol						
vC2, stage 2 conf vol						
vCu, unblocked vol			21		86	20
tC, single (s)			4.1		6.4	6.2
tC, 2 stage (s)						
tF (s)			2.2		3.5	3.3
p0 queue free %			99		100	96
cM capacity (veh/h)			1595		908	1057
Direction, Lane #	EB 1	WB 1	WB 2	NB 1		
Volume Total	21	13	39	42		
Volume Left	0	13	0	2		
Volume Right	1	0	0	40		
cSH	1700	1595	1700	1049		
Volume to Capacity	0.01	0.01	0.02	0.04		
Queue Length 95th (m)	0.0	0.2	0.0	1.0		
Control Delay (s)	0.0	7.3	0.0	8.6		
Lane LOS	A		A			
Approach Delay (s)	0.0	1.8	8.6			
Approach LOS	A					
Intersection Summary						
Average Delay			4.0			
Intersection Capacity Utilization			17.3%	ICU Level of Service	A	
Analysis Period (min)			15			

Existing PM
3: Journeyman St & Campeau Dr

08/27/2019

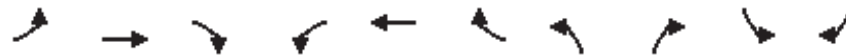

Lane Group	EBL	EBT	EBR	WBL	WBT	WBR	NBL	NBR	SBL	SBR
Lane Configurations										
Traffic Volume (vph)	11	145	15	73	103	2	40	67	3	4
Future Volume (vph)	11	145	15	73	103	2	40	67	3	4
Lane Group Flow (vph)	12	161	17	81	114	2	44	74	3	4
Turn Type	Perm	NA	Perm	Perm	NA	Perm	Perm	Perm	Perm	Perm
Protected Phases		4			8					
Permitted Phases	4		4	8		8	2	2	6	6
Detector Phase	4	4	4	8	8	8	2	2	6	6
Switch Phase										
Minimum Initial (s)	10.0	10.0	10.0	10.0	10.0	10.0	10.0	10.0	10.0	10.0
Minimum Split (s)	44.5	44.5	44.5	44.5	44.5	44.5	39.8	39.8	39.8	39.8
Total Split (s)	39.0	39.0	39.0	39.0	39.0	39.0	51.0	51.0	51.0	51.0
Total Split (%)	43.3%	43.3%	43.3%	43.3%	43.3%	43.3%	56.7%	56.7%	56.7%	56.7%
Yellow Time (s)	4.2	4.2	4.2	4.2	4.2	4.2	3.3	3.3	3.3	3.3
All-Red Time (s)	2.3	2.3	2.3	2.3	2.3	2.3	3.5	3.5	3.5	3.5
Lost Time Adjust (s)	0.0	0.0	0.0	0.0	0.0	0.0	0.0	0.0	0.0	0.0
Total Lost Time (s)	6.5	6.5	6.5	6.5	6.5	6.5	6.8	6.8	6.8	6.8
Lead/Lag										
Lead-Lag Optimize?										
Recall Mode	None	None	None	None	None	None	Max	Max	Max	Max
Act Effct Green (s)	11.8	11.8	11.8	11.8	11.8	11.8	46.7	46.7	46.7	46.7
Actuated g/C Ratio	0.16	0.16	0.16	0.16	0.16	0.16	0.65	0.65	0.65	0.65
v/c Ratio	0.06	0.52	0.06	0.40	0.37	0.01	0.05	0.06	0.00	0.00
Control Delay	24.3	32.9	2.1	31.8	29.2	0.0	5.4	0.1	5.3	0.0
Queue Delay	0.0	0.0	0.0	0.0	0.0	0.0	0.0	0.0	0.0	0.0
Total Delay	24.3	32.9	2.1	31.8	29.2	0.0	5.4	0.1	5.3	0.0
LOS	C	C	A	C	C	A	A	A	A	A
Approach Delay		29.6			29.9					
Approach LOS		C			C					
Queue Length 50th (m)	1.3	19.1	0.0	9.4	13.2	0.0	1.8	0.0	0.2	0.0
Queue Length 95th (m)	5.3	35.4	1.4	21.0	26.2	0.0	5.6	0.0	1.0	0.0
Internal Link Dist (m)		319.9			296.6					
Turn Bay Length (m)	45.0			50.0			20.0		45.0	
Base Capacity (vph)	584	854	751	559	854	751	926	1256	926	1295
Starvation Cap Reductn	0	0	0	0	0	0	0	0	0	0
Spillback Cap Reductn	0	0	0	0	0	0	0	0	0	0
Storage Cap Reductn	0	0	0	0	0	0	0	0	0	0
Reduced v/c Ratio	0.02	0.19	0.02	0.14	0.13	0.00	0.05	0.06	0.00	0.00

Intersection Summary

Cycle Length: 90	
Actuated Cycle Length: 71.9	
Natural Cycle: 85	
Control Type: Semi Act-Uncoord	
Maximum v/c Ratio: 0.52	
Intersection Signal Delay: 23.0	Intersection LOS: C
Intersection Capacity Utilization 42.0%	ICU Level of Service A
Analysis Period (min) 15	

Existing PM
3: Journeyman St & Campeau Dr

08/27/2019

Splits and Phases: 3: Journeyman St & Campeau Dr

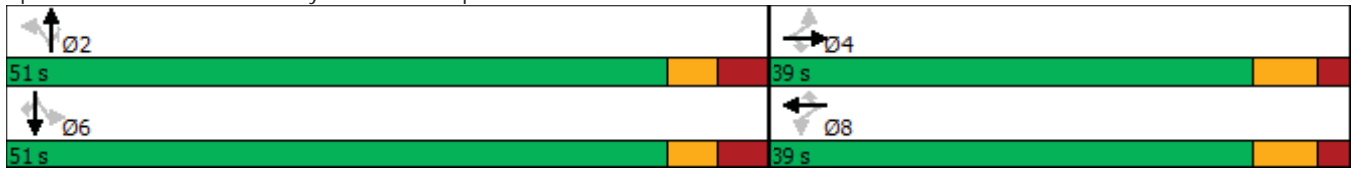

Existing PM
5: Palladium Dr & Cabela's Way

08/27/2019



Movement	EBL	EBR	NBL	NBT	SBT	SBR
Lane Configurations						
Traffic Volume (veh/h)	0	141	127	284	247	33
Future Volume (Veh/h)	0	141	127	284	247	33
Sign Control	Stop			Free	Free	
Grade	0%			0%	0%	
Peak Hour Factor	0.90	0.90	0.90	0.90	0.90	0.90
Hourly flow rate (vph)	0	157	141	316	274	37
Pedestrians						
Lane Width (m)						
Walking Speed (m/s)						
Percent Blockage						
Right turn flare (veh)						
Median type				None	None	
Median storage veh						
Upstream signal (m)	207					
pX, platoon unblocked						
vC, conflicting volume	732	156	311			
vC1, stage 1 conf vol						
vC2, stage 2 conf vol						
vCu, unblocked vol	732	156	311			
tC, single (s)	6.8	6.9	4.1			
tC, 2 stage (s)						
tF (s)	3.5	3.3	2.2			
p0 queue free %	100	82	89			
cM capacity (veh/h)	316	862	1246			
Direction, Lane #	EB 1	NB 1	NB 2	NB 3	SB 1	SB 2
Volume Total	157	141	158	158	183	128
Volume Left	0	141	0	0	0	0
Volume Right	157	0	0	0	0	37
cSH	862	1246	1700	1700	1700	1700
Volume to Capacity	0.18	0.11	0.09	0.09	0.11	0.08
Queue Length 95th (m)	5.0	2.9	0.0	0.0	0.0	0.0
Control Delay (s)	10.1	8.3	0.0	0.0	0.0	0.0
Lane LOS	B	A				
Approach Delay (s)	10.1	2.5	0.0			
Approach LOS	B					
Intersection Summary						
Average Delay	3.0					
Intersection Capacity Utilization	23.3%			ICU Level of Service	A	
Analysis Period (min)	15					

Existing PM
6: Palladium Dr & Hwy 417 WB On-Off Ramps

08/27/2019



Lane Group	WBL	WBR	NBT	SBL	SBT
Lane Configurations					
Traffic Volume (vph)	404	267	144	117	271
Future Volume (vph)	404	267	144	117	271
Lane Group Flow (vph)	449	297	160	130	301
Turn Type	Prot	Perm	NA	pm+pt	NA
Protected Phases	8		2	1	6
Permitted Phases		8		6	
Detector Phase	8	8	2	1	6
Switch Phase					
Minimum Initial (s)	10.0	10.0	10.0	5.0	10.0
Minimum Split (s)	32.7	32.7	39.0	12.0	25.0
Total Split (s)	36.7	36.7	39.0	22.0	39.0
Total Split (%)	37.6%	37.6%	39.9%	22.5%	39.9%
Yellow Time (s)	3.3	3.3	3.7	3.7	3.7
All-Red Time (s)	3.4	3.4	3.3	3.3	3.3
Lost Time Adjust (s)	0.0	0.0	0.0	0.0	0.0
Total Lost Time (s)	6.7	6.7	7.0	7.0	7.0
Lead/Lag			Lag	Lead	
Lead-Lag Optimize?			Yes	Yes	
Recall Mode	Max	Max	Max	Max	Max
Act Effct Green (s)	30.0	30.0	32.0	54.0	54.0
Actuated g/C Ratio	0.31	0.31	0.33	0.55	0.55
v/c Ratio	0.42	0.43	0.14	0.19	0.15
Control Delay	28.4	5.2	23.5	11.4	10.9
Queue Delay	0.0	0.0	0.0	0.0	0.0
Total Delay	28.4	5.2	23.5	11.4	10.9
LOS	C	A	C	B	B
Approach Delay	19.2		23.5		11.1
Approach LOS	B		C		B
Queue Length 50th (m)	34.6	0.0	11.1	11.2	13.7
Queue Length 95th (m)	48.2	17.7	18.3	20.0	20.3
Internal Link Dist (m)	322.5		403.5		183.1
Turn Bay Length (m)		125.0		115.0	
Base Capacity (vph)	1065	697	1172	676	1978
Starvation Cap Reductn	0	0	0	0	0
Spillback Cap Reductn	0	0	0	0	0
Storage Cap Reductn	0	0	0	0	0
Reduced v/c Ratio	0.42	0.43	0.14	0.19	0.15

Intersection Summary

Cycle Length: 97.7	
Actuated Cycle Length: 97.7	
Natural Cycle: 85	
Control Type: Actuated-Uncoordinated	
Maximum v/c Ratio: 0.43	
Intersection Signal Delay: 17.1	Intersection LOS: B
Intersection Capacity Utilization 43.6%	ICU Level of Service A
Analysis Period (min) 15	

Existing PM
6: Palladium Dr & Hwy 417 WB On-Off Ramps

08/27/2019

Splits and Phases: 6: Palladium Dr & Hwy 417 WB On-Off Ramps

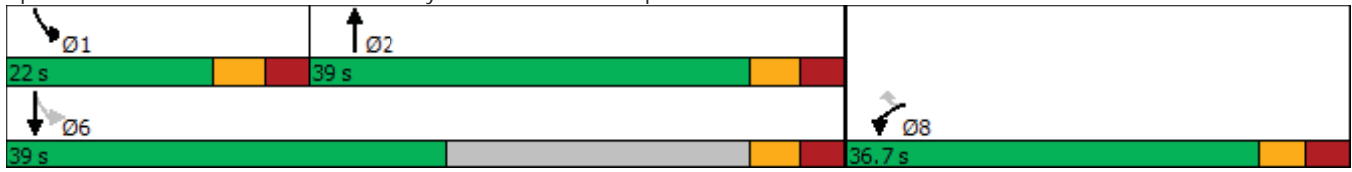

Existing PM
7: Palladium Dr & Hwy 417 EB Off Ramp

08/27/2019



Movement	EBL	EBR	NBL	NBT	SBT	SBR
Lane Configurations						
Traffic Volume (veh/h)	69	152	0	459	675	0
Future Volume (Veh/h)	69	152	0	459	675	0
Sign Control	Stop			Free	Free	
Grade	0%			0%	0%	
Peak Hour Factor	0.90	0.90	0.90	0.90	0.90	0.90
Hourly flow rate (vph)	77	169	0	510	750	0
Pedestrians						
Lane Width (m)						
Walking Speed (m/s)						
Percent Blockage						
Right turn flare (veh)	3					
Median type				None	None	
Median storage veh						
Upstream signal (m)						
pX, platoon unblocked						
vC, conflicting volume	1005	375	750			
vC1, stage 1 conf vol						
vC2, stage 2 conf vol						
vCu, unblocked vol	1005	375	750			
tC, single (s)	6.8	6.9	4.1			
tC, 2 stage (s)						
tF (s)	3.5	3.3	2.2			
p0 queue free %	68	73	100			
cM capacity (veh/h)	238	623	855			
Direction, Lane #	EB 1	NB 1	NB 2	SB 1	SB 2	
Volume Total	246	255	255	375	375	
Volume Left	77	0	0	0	0	
Volume Right	169	0	0	0	0	
cSH	760	1700	1700	1700	1700	
Volume to Capacity	0.32	0.15	0.15	0.22	0.22	
Queue Length 95th (m)	10.7	0.0	0.0	0.0	0.0	
Control Delay (s)	17.4	0.0	0.0	0.0	0.0	
Lane LOS	C					
Approach Delay (s)	17.4	0.0		0.0		
Approach LOS	C					
Intersection Summary						
Average Delay	2.8					
Intersection Capacity Utilization	34.7%			ICU Level of Service	A	
Analysis Period (min)	15					

Future Background 2021

MOVEMENT SUMMARY

 Site: 101 [Huntmar / Campeau FB2021 AM]

New Site
Roundabout

Movement Performance - Vehicles												
Mov ID	OD Mov	Demand Total veh/h	Flows HV %	Deg. Satn v/c	Average Delay sec	Level of Service	95% Back of Queue Vehicles veh	Queue Distance m	Prop. Queued	Effective Stop Rate per veh	Average Speed km/h	
South: Huntmar Dr												
1	L2	18	2.0	0.015	9.5	LOS A	0.1	0.4	0.21	0.59	53.5	
2	T1	323	2.0	0.189	3.8	LOS A	0.9	6.6	0.21	0.37	57.3	
3	R2	29	2.0	0.024	4.2	LOS A	0.1	0.7	0.21	0.44	55.3	
Approach		370	2.0	0.189	4.1	LOS A	0.9	6.6	0.21	0.38	56.9	
East: Campeau Dr												
4	L2	66	2.0	0.055	10.3	LOS B	0.2	1.6	0.39	0.66	52.8	
5	T1	68	2.0	0.045	4.3	LOS A	0.2	1.3	0.36	0.42	56.4	
6	R2	14	2.0	0.013	5.1	LOS A	0.0	0.4	0.39	0.51	54.5	
Approach		148	2.0	0.055	7.0	LOS A	0.2	1.6	0.38	0.54	54.6	
North: Huntmar Dr												
7	L2	2	2.0	0.002	9.7	LOS A	0.0	0.0	0.25	0.58	53.3	
8	T1	302	2.0	0.182	3.9	LOS A	0.8	6.0	0.26	0.38	57.0	
9	R2	124	2.0	0.097	4.3	LOS A	0.4	2.9	0.27	0.47	55.0	
Approach		428	2.0	0.182	4.0	LOS A	0.8	6.0	0.26	0.41	56.4	
West: Campeau Dr												
10	L2	75	2.0	0.049	9.9	LOS A	0.2	1.5	0.35	0.63	53.0	
11	T1	22	2.0	0.020	4.6	LOS A	0.1	0.6	0.38	0.45	56.3	
12	R2	30	2.0	0.016	3.3	LOS A	0.0	0.0	0.00	0.42	56.8	
Approach		127	2.0	0.049	7.4	LOS A	0.2	1.5	0.28	0.55	54.4	
All Vehicles		1073	2.0	0.189	4.9	LOS A	0.9	6.6	0.26	0.43	56.1	

Site Level of Service (LOS) Method: Delay (SIDRA). Site LOS Method is specified in the Parameter Settings dialog (Site tab).

Roundabout LOS Method: SIDRA Roundabout LOS.

Vehicle movement LOS values are based on average delay per movement.

Intersection and Approach LOS values are based on average delay for all vehicle movements.

Roundabout Capacity Model: SIDRA Standard.

SIDRA Standard Delay Model is used. Control Delay includes Geometric Delay.

Gap-Acceptance Capacity: SIDRA Standard (Akçelik M3D).

HV (%) values are calculated for All Movement Classes of All Heavy Vehicle Model Designation.

MOVEMENT SUMMARY

 Site: 101 [Huntmar / Campeau FB2021 PM]

New Site
Roundabout

Movement Performance - Vehicles												
Mov ID	OD Mov	Demand Total veh/h	Flows HV %	Deg. Satn v/c	Average Delay sec	Level of Service	95% Back of Queue Vehicles veh	Queue Distance m	Prop. Queued	Effective Stop Rate per veh	Average Speed km/h	
South: Huntmar Dr												
1	L2	59	2.0	0.054	10.1	LOS B	0.2	1.6	0.37	0.65	52.9	
2	T1	371	2.0	0.240	4.2	LOS A	1.2	8.5	0.38	0.41	56.3	
3	R2	65	2.0	0.060	4.8	LOS A	0.2	1.7	0.37	0.52	54.6	
Approach		495	2.0	0.240	5.0	LOS A	1.2	8.5	0.38	0.46	55.7	
East: Campeau Dr												
4	L2	47	2.0	0.034	10.2	LOS B	0.1	1.0	0.44	0.66	52.8	
5	T1	38	2.0	0.034	5.0	LOS A	0.1	1.0	0.46	0.50	55.8	
6	R2	4	2.0	0.004	5.3	LOS A	0.0	0.1	0.46	0.52	54.3	
Approach		89	2.0	0.034	7.7	LOS A	0.1	1.0	0.45	0.58	54.1	
North: Huntmar Dr												
7	L2	6	2.0	0.005	9.7	LOS A	0.0	0.1	0.25	0.59	53.4	
8	T1	371	2.0	0.222	3.9	LOS A	1.1	7.6	0.25	0.38	57.1	
9	R2	147	2.0	0.115	4.3	LOS A	0.5	3.4	0.26	0.47	55.1	
Approach		524	2.0	0.222	4.1	LOS A	1.1	7.6	0.26	0.41	56.4	
West: Campeau Dr												
10	L2	198	2.0	0.134	10.1	LOS B	0.6	4.4	0.41	0.66	52.8	
11	T1	94	2.0	0.083	4.8	LOS A	0.4	2.5	0.42	0.47	56.1	
12	R2	60	2.0	0.032	3.3	LOS A	0.0	0.0	0.00	0.42	56.8	
Approach		352	2.0	0.134	7.5	LOS A	0.6	4.4	0.34	0.57	54.3	
All Vehicles		1460	2.0	0.240	5.4	LOS A	1.2	8.5	0.33	0.47	55.5	

Site Level of Service (LOS) Method: Delay (SIDRA). Site LOS Method is specified in the Parameter Settings dialog (Site tab).

Roundabout LOS Method: SIDRA Roundabout LOS.

Vehicle movement LOS values are based on average delay per movement.

Intersection and Approach LOS values are based on average delay for all vehicle movements.

Roundabout Capacity Model: SIDRA Standard.

SIDRA Standard Delay Model is used. Control Delay includes Geometric Delay.

Gap-Acceptance Capacity: SIDRA Standard (Akçelik M3D).

HV (%) values are calculated for All Movement Classes of All Heavy Vehicle Model Designation.

MOVEMENT SUMMARY

 Site: 101 [Campeau / Palladium FB2021 AM]

New Site
Roundabout

Movement Performance - Vehicles											
Mov ID	OD Mov	Demand Total veh/h	Flows HV %	Deg. Satn v/c	Average Delay sec	Level of Service	95% Back of Queue Vehicles veh	Queue Distance m	Prop. Queued	Effective Stop Rate per veh	Average Speed km/h
South: Campeau Dr											
1	L2	47	2.0	0.050	9.3	LOS A	0.3	1.8	0.10	0.51	55.9
2	T1	42	2.0	0.050	3.6	LOS A	0.3	1.8	0.10	0.51	55.6
3	R2	111	2.0	0.058	3.1	LOS A	0.0	0.0	0.00	0.40	57.1
Approach		200	2.0	0.058	4.7	LOS A	0.3	1.8	0.05	0.45	56.5
East: Palladium Dr											
4	L2	187	2.0	0.069	9.5	LOS A	0.3	2.4	0.21	0.58	53.9
5	T1	19	2.0	0.069	3.8	LOS A	0.3	2.4	0.20	0.57	54.1
6	R2	6	2.0	0.069	3.9	LOS A	0.3	2.4	0.20	0.57	52.5
Approach		212	2.0	0.069	8.8	LOS A	0.3	2.4	0.21	0.58	53.9
North: Campeau Dr											
7	L2	4	2.0	0.013	9.9	LOS A	0.0	0.3	0.31	0.48	56.1
8	T1	26	2.0	0.013	4.2	LOS A	0.0	0.3	0.30	0.43	56.4
9	R2	2	2.0	0.013	4.2	LOS A	0.0	0.3	0.29	0.40	55.0
Approach		32	2.0	0.013	4.9	LOS A	0.0	0.3	0.30	0.44	56.3
West: Palladium Dr											
10	L2	1	2.0	0.017	9.7	LOS A	0.1	0.5	0.27	0.40	57.1
11	T1	22	2.0	0.017	4.1	LOS A	0.1	0.5	0.27	0.40	56.8
12	R2	21	2.0	0.016	3.9	LOS A	0.1	0.4	0.27	0.44	55.7
Approach		44	2.0	0.017	4.1	LOS A	0.1	0.5	0.27	0.42	56.3
All Vehicles		488	2.0	0.069	6.5	LOS A	0.3	2.4	0.16	0.50	55.3

Site Level of Service (LOS) Method: Delay (SIDRA). Site LOS Method is specified in the Parameter Settings dialog (Site tab).

Roundabout LOS Method: SIDRA Roundabout LOS.

Vehicle movement LOS values are based on average delay per movement.

Intersection and Approach LOS values are based on average delay for all vehicle movements.

Roundabout Capacity Model: SIDRA Standard.

SIDRA Standard Delay Model is used. Control Delay includes Geometric Delay.

Gap-Acceptance Capacity: SIDRA Standard (Akçelik M3D).

HV (%) values are calculated for All Movement Classes of All Heavy Vehicle Model Designation.

MOVEMENT SUMMARY

 Site: 101 [Campeau / Palladium FB2021 PM]

New Site
Roundabout

Movement Performance - Vehicles											
Mov ID	OD Mov	Demand Total veh/h	Flows HV %	Deg. Satn v/c	Average Delay sec	Level of Service	95% Back of Queue Vehicles veh	Queue Distance m	Prop. Queued	Effective Stop Rate per veh	Average Speed km/h
South: Campeau Dr											
1	L2	20	2.0	0.028	9.3	LOS A	0.1	1.0	0.15	0.48	56.2
2	T1	27	2.0	0.028	3.7	LOS A	0.1	1.0	0.15	0.48	55.8
3	R2	263	2.0	0.139	3.2	LOS A	0.0	0.0	0.00	0.40	57.1
Approach		310	2.0	0.139	3.6	LOS A	0.1	1.0	0.02	0.41	56.9
East: Palladium Dr											
4	L2	217	2.0	0.076	9.4	LOS A	0.4	2.7	0.15	0.59	54.1
5	T1	24	2.0	0.076	3.7	LOS A	0.4	2.7	0.15	0.57	54.2
6	R2	1	2.0	0.076	3.8	LOS A	0.4	2.7	0.15	0.57	52.6
Approach		242	2.0	0.076	8.8	LOS A	0.4	2.7	0.15	0.59	54.1
North: Campeau Dr											
7	L2	8	2.0	0.019	9.9	LOS A	0.1	0.5	0.31	0.51	55.7
8	T1	37	2.0	0.019	4.2	LOS A	0.1	0.5	0.30	0.44	56.3
9	R2	1	2.0	0.019	4.2	LOS A	0.1	0.5	0.30	0.40	55.0
Approach		46	2.0	0.019	5.2	LOS A	0.1	0.5	0.30	0.45	56.2
West: Palladium Dr											
10	L2	2	2.0	0.032	9.8	LOS A	0.1	0.8	0.30	0.42	57.0
11	T1	39	2.0	0.032	4.2	LOS A	0.1	0.8	0.30	0.42	56.6
12	R2	14	2.0	0.011	4.0	LOS A	0.0	0.3	0.29	0.44	55.6
Approach		55	2.0	0.032	4.3	LOS A	0.1	0.8	0.30	0.43	56.4
All Vehicles		653	2.0	0.139	5.7	LOS A	0.4	2.7	0.11	0.48	55.7

Site Level of Service (LOS) Method: Delay (SIDRA). Site LOS Method is specified in the Parameter Settings dialog (Site tab).

Roundabout LOS Method: SIDRA Roundabout LOS.

Vehicle movement LOS values are based on average delay per movement.

Intersection and Approach LOS values are based on average delay for all vehicle movements.

Roundabout Capacity Model: SIDRA Standard.

SIDRA Standard Delay Model is used. Control Delay includes Geometric Delay.

Gap-Acceptance Capacity: SIDRA Standard (Akçelik M3D).

HV (%) values are calculated for All Movement Classes of All Heavy Vehicle Model Designation.

Future Background 2021 AM
 1: Kanata West Centre Dr & Campeau Dr

08/27/2019



Movement	EBT	EBR	WBL	WBT	NBL	NBR
Lane Configurations	↔		↔	↔	↔	
Traffic Volume (veh/h)	21	5	18	48	3	23
Future Volume (Veh/h)	21	5	18	48	3	23
Sign Control	Free		Free		Stop	
Grade	0%		0%		0%	
Peak Hour Factor	1.00	1.00	1.00	1.00	1.00	1.00
Hourly flow rate (vph)	21	5	18	48	3	23
Pedestrians						
Lane Width (m)						
Walking Speed (m/s)						
Percent Blockage						
Right turn flare (veh)						
Median type	None		None			
Median storage veh						
Upstream signal (m)						
pX, platoon unblocked						
vC, conflicting volume			26		108	24
vC1, stage 1 conf vol						
vC2, stage 2 conf vol						
vCu, unblocked vol			26		108	24
tC, single (s)			4.1		6.4	6.2
tC, 2 stage (s)						
tF (s)			2.2		3.5	3.3
p0 queue free %			99		100	98
cM capacity (veh/h)			1588		880	1053
Direction, Lane #	EB 1	WB 1	WB 2	NB 1		
Volume Total	26	18	48	26		
Volume Left	0	18	0	3		
Volume Right	5	0	0	23		
cSH	1700	1588	1700	1030		
Volume to Capacity	0.02	0.01	0.03	0.03		
Queue Length 95th (m)	0.0	0.3	0.0	0.6		
Control Delay (s)	0.0	7.3	0.0	8.6		
Lane LOS	A		A			
Approach Delay (s)	0.0	2.0	8.6			
Approach LOS					A	
Intersection Summary						
Average Delay			3.0			
Intersection Capacity Utilization			17.7%	ICU Level of Service	A	
Analysis Period (min)			15			

Future Background 2021 AM
3: Journeyman St & Campeau Dr

08/27/2019



Lane Group	EBL	EBT	EBR	WBL	WBT	WBR	NBL	NBR	SBL	SBR
Lane Configurations	↖	↗	↖	↖	↗	↖	↖	↖	↖	↖
Traffic Volume (vph)	6	112	19	17	193	2	4	12	1	1
Future Volume (vph)	6	112	19	17	193	2	4	12	1	1
Lane Group Flow (vph)	6	112	19	17	193	2	4	12	1	1
Turn Type	Perm	NA	Perm	Perm	NA	Perm	Perm	Perm	Perm	Perm
Protected Phases		4			8					
Permitted Phases	4		4	8		8	2	2	6	6
Detector Phase	4	4	4	8	8	8	2	2	6	6
Switch Phase										
Minimum Initial (s)	10.0	10.0	10.0	10.0	10.0	10.0	10.0	10.0	10.0	10.0
Minimum Split (s)	44.5	44.5	44.5	44.5	44.5	44.5	39.8	39.8	39.8	39.8
Total Split (s)	39.0	39.0	39.0	39.0	39.0	39.0	51.0	51.0	51.0	51.0
Total Split (%)	43.3%	43.3%	43.3%	43.3%	43.3%	43.3%	56.7%	56.7%	56.7%	56.7%
Yellow Time (s)	4.2	4.2	4.2	4.2	4.2	4.2	3.3	3.3	3.3	3.3
All-Red Time (s)	2.3	2.3	2.3	2.3	2.3	2.3	3.5	3.5	3.5	3.5
Lost Time Adjust (s)	-2.8	-2.8	-2.8	-2.8	-2.8	-2.8	-2.5	-2.5	-2.5	-2.5
Total Lost Time (s)	3.7	3.7	3.7	3.7	3.7	3.7	4.3	4.3	4.3	4.3
Lead/Lag										
Lead-Lag Optimize?										
Recall Mode	None	None	None	None	None	None	Max	Max	Max	Max
Act Effct Green (s)	15.6	15.6	15.6	15.6	15.6	15.6	48.6	48.6	48.6	48.6
Actuated g/C Ratio	0.22	0.22	0.22	0.22	0.22	0.22	0.67	0.67	0.67	0.67
v/c Ratio	0.03	0.28	0.05	0.06	0.47	0.01	0.00	0.01	0.00	0.00
Control Delay	21.2	24.5	2.4	21.6	28.2	0.0	4.8	0.0	5.0	0.0
Queue Delay	0.0	0.0	0.0	0.0	0.0	0.0	0.0	0.0	0.0	0.0
Total Delay	21.2	24.5	2.4	21.6	28.2	0.0	4.8	0.0	5.0	0.0
LOS	C	C	A	C	C	A	A	A	A	A
Approach Delay		21.3			27.4					
Approach LOS		C			C					
Queue Length 50th (m)	0.6	12.2	0.0	1.8	22.1	0.0	0.2	0.0	0.0	0.0
Queue Length 95th (m)	3.3	24.3	1.7	6.2	39.2	0.0	1.1	0.0	0.5	0.0
Internal Link Dist (m)		319.9			296.6					
Turn Bay Length (m)	45.0			50.0			20.0		45.0	
Base Capacity (vph)	470	921	806	628	921	806	959	1325	959	1267
Starvation Cap Reductn	0	0	0	0	0	0	0	0	0	0
Spillback Cap Reductn	0	0	0	0	0	0	0	0	0	0
Storage Cap Reductn	0	0	0	0	0	0	0	0	0	0
Reduced v/c Ratio	0.01	0.12	0.02	0.03	0.21	0.00	0.00	0.01	0.00	0.00

Intersection Summary

Cycle Length: 90	
Actuated Cycle Length: 72.3	
Natural Cycle: 85	
Control Type: Semi Act-Uncoord	
Maximum v/c Ratio: 0.47	
Intersection Signal Delay: 23.8	Intersection LOS: C
Intersection Capacity Utilization 37.3%	ICU Level of Service A
Analysis Period (min) 15	

Splits and Phases: 3: Journeyman St & Campeau Dr

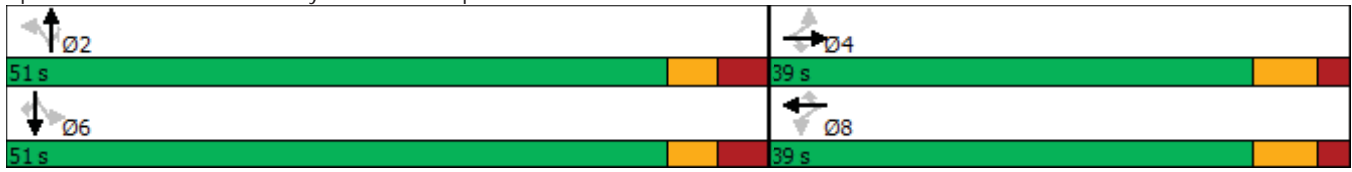

Future Background 2021 AM
5: Palladium Dr & Cabela's Way

08/27/2019



Movement	EBL	EBR	NBL	NBT	SBT	SBR
Lane Configurations						
Traffic Volume (veh/h)	0	79	110	238	218	20
Future Volume (Veh/h)	0	79	110	238	218	20
Sign Control	Stop			Free	Free	
Grade	0%			0%	0%	
Peak Hour Factor	1.00	1.00	1.00	1.00	1.00	1.00
Hourly flow rate (vph)	0	79	110	238	218	20
Pedestrians						
Lane Width (m)						
Walking Speed (m/s)						
Percent Blockage						
Right turn flare (veh)						
Median type				None	None	
Median storage veh						
Upstream signal (m)	207					
pX, platoon unblocked						
vC, conflicting volume	567	119	238			
vC1, stage 1 conf vol						
vC2, stage 2 conf vol						
vCu, unblocked vol	567	119	238			
tC, single (s)	6.8	6.9	4.1			
tC, 2 stage (s)						
tF (s)	3.5	3.3	2.2			
p0 queue free %	100	91	92			
cM capacity (veh/h)	416	910	1326			
Direction, Lane #	EB 1	NB 1	NB 2	NB 3	SB 1	SB 2
Volume Total	79	110	119	119	145	93
Volume Left	0	110	0	0	0	0
Volume Right	79	0	0	0	0	20
cSH	910	1326	1700	1700	1700	1700
Volume to Capacity	0.09	0.08	0.07	0.07	0.09	0.05
Queue Length 95th (m)	2.2	2.1	0.0	0.0	0.0	0.0
Control Delay (s)	9.3	8.0	0.0	0.0	0.0	0.0
Lane LOS	A	A				
Approach Delay (s)	9.3	2.5	0.0			
Approach LOS	A					
Intersection Summary						
Average Delay			2.4			
Intersection Capacity Utilization			19.4%	ICU Level of Service	A	
Analysis Period (min)			15			

Future Background 2021 AM
6: Palladium Dr & Hwy 417 WB On-Off Ramps

08/27/2019



Lane Group	WBL	WBR	NBT	SBL	SBT
Lane Configurations					
Traffic Volume (vph)	209	213	135	101	196
Future Volume (vph)	209	213	135	101	196
Lane Group Flow (vph)	209	213	135	101	196
Turn Type	Prot	Perm	NA	pm+pt	NA
Protected Phases	8		2	1	6
Permitted Phases		8		6	
Detector Phase	8	8	2	1	6
Switch Phase					
Minimum Initial (s)	10.0	10.0	10.0	5.0	10.0
Minimum Split (s)	32.7	32.7	39.0	12.0	25.0
Total Split (s)	36.7	36.7	39.0	22.0	39.0
Total Split (%)	37.6%	37.6%	39.9%	22.5%	39.9%
Yellow Time (s)	3.3	3.3	3.7	3.7	3.7
All-Red Time (s)	3.4	3.4	3.3	3.3	3.3
Lost Time Adjust (s)	-2.7	-2.7	-3.0	-3.0	-3.0
Total Lost Time (s)	4.0	4.0	4.0	4.0	4.0
Lead/Lag			Lag	Lead	
Lead-Lag Optimize?			Yes	Yes	
Recall Mode	Max	Max	Max	Max	Max
Act Effct Green (s)	32.7	32.7	35.0	57.0	57.0
Actuated g/C Ratio	0.33	0.33	0.36	0.58	0.58
v/c Ratio	0.18	0.31	0.11	0.13	0.09
Control Delay	23.5	4.7	21.2	9.5	9.1
Queue Delay	0.0	0.0	0.0	0.0	0.0
Total Delay	23.5	4.7	21.2	9.5	9.1
LOS	C	A	C	A	A
Approach Delay	14.0		21.2		9.2
Approach LOS	B		C		A
Queue Length 50th (m)	14.2	0.0	8.8	7.8	8.0
Queue Length 95th (m)	22.4	14.7	15.2	14.7	12.7
Internal Link Dist (m)	322.5		403.5		183.1
Turn Bay Length (m)		125.0		115.0	
Base Capacity (vph)	1161	677	1282	779	2088
Starvation Cap Reductn	0	0	0	0	0
Spillback Cap Reductn	0	0	0	0	0
Storage Cap Reductn	0	0	0	0	0
Reduced v/c Ratio	0.18	0.31	0.11	0.13	0.09

Intersection Summary

Cycle Length: 97.7	
Actuated Cycle Length: 97.7	
Natural Cycle: 85	
Control Type: Actuated-Uncoordinated	
Maximum v/c Ratio: 0.31	
Intersection Signal Delay: 13.5	Intersection LOS: B
Intersection Capacity Utilization 32.3%	ICU Level of Service A
Analysis Period (min) 15	

Splits and Phases: 6: Palladium Dr & Hwy 417 WB On-Off Ramps

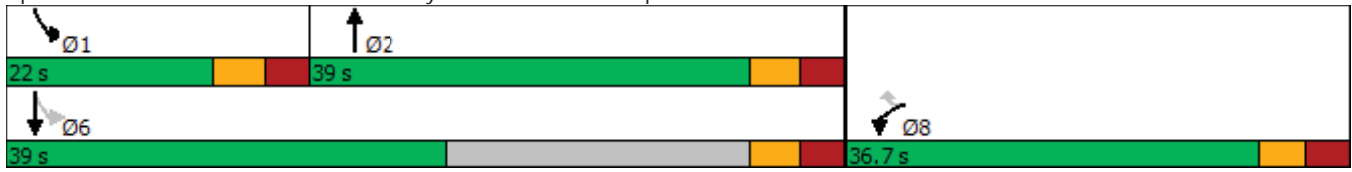

Future Background 2021 AM
7: Palladium Dr & Hwy 417 EB Off Ramp

08/27/2019



Movement	EBL	EBR	NBL	NBT	SBT	SBR
Lane Configurations						
Traffic Volume (veh/h)	69	261	0	66	375	30
Future Volume (Veh/h)	69	261	0	66	375	30
Sign Control	Stop			Free	Free	
Grade	0%			0%	0%	
Peak Hour Factor	1.00	1.00	1.00	1.00	1.00	1.00
Hourly flow rate (vph)	69	261	0	66	375	30
Pedestrians						
Lane Width (m)						
Walking Speed (m/s)						
Percent Blockage						
Right turn flare (veh)	3					
Median type				None	None	
Median storage veh						
Upstream signal (m)						
pX, platoon unblocked						
vC, conflicting volume	423	202	405			
vC1, stage 1 conf vol						
vC2, stage 2 conf vol						
vCu, unblocked vol	423	202	405			
tC, single (s)	6.8	6.9	4.1			
tC, 2 stage (s)						
tF (s)	3.5	3.3	2.2			
p0 queue free %	88	68	100			
cM capacity (veh/h)	559	805	1150			
Direction, Lane #	EB 1	NB 1	NB 2	SB 1	SB 2	
Volume Total	330	33	33	250	155	
Volume Left	69	0	0	0	0	
Volume Right	261	0	0	0	30	
cSH	1017	1700	1700	1700	1700	
Volume to Capacity	0.32	0.02	0.02	0.15	0.09	
Queue Length 95th (m)	10.8	0.0	0.0	0.0	0.0	
Control Delay (s)	11.8	0.0	0.0	0.0	0.0	
Lane LOS	B					
Approach Delay (s)	11.8	0.0		0.0		
Approach LOS	B					
Intersection Summary						
Average Delay	4.8					
Intersection Capacity Utilization	34.1%			ICU Level of Service	A	
Analysis Period (min)	15					

Future Background 2021 PM
 1: Kanata West Centre Dr & Campeau Dr

08/27/2019



Movement	EBT	EBR	WBL	WBT	NBL	NBR
Lane Configurations	↻		↻	↻	↻	
Traffic Volume (veh/h)	18	1	12	36	2	37
Future Volume (Veh/h)	18	1	12	36	2	37
Sign Control	Free			Free	Stop	
Grade	0%			0%	0%	
Peak Hour Factor	1.00	1.00	1.00	1.00	1.00	1.00
Hourly flow rate (vph)	18	1	12	36	2	37
Pedestrians						
Lane Width (m)						
Walking Speed (m/s)						
Percent Blockage						
Right turn flare (veh)						
Median type	None			None		
Median storage veh						
Upstream signal (m)						
pX, platoon unblocked						
vC, conflicting volume			19		78	18
vC1, stage 1 conf vol						
vC2, stage 2 conf vol						
vCu, unblocked vol			19		78	18
tC, single (s)			4.1		6.4	6.2
tC, 2 stage (s)						
tF (s)			2.2		3.5	3.3
p0 queue free %			99		100	97
cM capacity (veh/h)			1597		917	1060
Direction, Lane #	EB 1	WB 1	WB 2	NB 1		
Volume Total	19	12	36	39		
Volume Left	0	12	0	2		
Volume Right	1	0	0	37		
cSH	1700	1597	1700	1051		
Volume to Capacity	0.01	0.01	0.02	0.04		
Queue Length 95th (m)	0.0	0.2	0.0	0.9		
Control Delay (s)	0.0	7.3	0.0	8.6		
Lane LOS	A		A			
Approach Delay (s)	0.0	1.8	8.6			
Approach LOS	A		A			
Intersection Summary						
Average Delay			4.0			
Intersection Capacity Utilization			17.3%	ICU Level of Service	A	
Analysis Period (min)			15			

Future Background 2021 PM
3: Journeyman St & Campeau Dr

08/27/2019



Lane Group	EBL	EBT	EBR	WBL	WBT	WBR	NBL	NBR	SBL	SBR
Lane Configurations	↖	↗	↖	↖	↗	↖	↖	↖	↖	↖
Traffic Volume (vph)	11	228	15	74	141	2	41	68	3	4
Future Volume (vph)	11	228	15	74	141	2	41	68	3	4
Lane Group Flow (vph)	11	228	15	74	141	2	41	68	3	4
Turn Type	Perm	NA	Perm	Perm	NA	Perm	Perm	Perm	Perm	Perm
Protected Phases		4			8					
Permitted Phases	4		4	8		8	2	2	6	6
Detector Phase	4	4	4	8	8	8	2	2	6	6
Switch Phase										
Minimum Initial (s)	10.0	10.0	10.0	10.0	10.0	10.0	10.0	10.0	10.0	10.0
Minimum Split (s)	44.5	44.5	44.5	44.5	44.5	44.5	39.8	39.8	39.8	39.8
Total Split (s)	39.0	39.0	39.0	39.0	39.0	39.0	51.0	51.0	51.0	51.0
Total Split (%)	43.3%	43.3%	43.3%	43.3%	43.3%	43.3%	56.7%	56.7%	56.7%	56.7%
Yellow Time (s)	4.2	4.2	4.2	4.2	4.2	4.2	3.3	3.3	3.3	3.3
All-Red Time (s)	2.3	2.3	2.3	2.3	2.3	2.3	3.5	3.5	3.5	3.5
Lost Time Adjust (s)	-2.8	-2.8	-2.8	-2.8	-2.8	-2.8	-2.5	-2.5	-2.5	-2.5
Total Lost Time (s)	3.7	3.7	3.7	3.7	3.7	3.7	4.3	4.3	4.3	4.3
Lead/Lag										
Lead-Lag Optimize?										
Recall Mode	None	None	None	None	None	None	Max	Max	Max	Max
Act Effct Green (s)	16.8	16.8	16.8	16.8	16.8	16.8	47.3	47.3	47.3	47.3
Actuated g/C Ratio	0.23	0.23	0.23	0.23	0.23	0.23	0.66	0.66	0.66	0.66
v/c Ratio	0.04	0.52	0.04	0.37	0.32	0.00	0.04	0.06	0.00	0.00
Control Delay	20.8	28.4	0.8	28.5	24.6	0.0	5.4	0.1	5.3	0.0
Queue Delay	0.0	0.0	0.0	0.0	0.0	0.0	0.0	0.0	0.0	0.0
Total Delay	20.8	28.4	0.8	28.5	24.6	0.0	5.4	0.1	5.3	0.0
LOS	C	C	A	C	C	A	A	A	A	A
Approach Delay		26.5			25.7					
Approach LOS		C			C					
Queue Length 50th (m)	1.2	26.7	0.0	8.3	15.7	0.0	1.7	0.0	0.2	0.0
Queue Length 95th (m)	4.6	45.5	0.7	19.3	29.4	0.0	5.6	0.0	1.1	0.0
Internal Link Dist (m)		319.9			296.6					
Turn Bay Length (m)	45.0			50.0			20.0		45.0	
Base Capacity (vph)	579	923	808	423	923	808	935	1227	935	1287
Starvation Cap Reductn	0	0	0	0	0	0	0	0	0	0
Spillback Cap Reductn	0	0	0	0	0	0	0	0	0	0
Storage Cap Reductn	0	0	0	0	0	0	0	0	0	0
Reduced v/c Ratio	0.02	0.25	0.02	0.17	0.15	0.00	0.04	0.06	0.00	0.00

Intersection Summary

Cycle Length: 90	
Actuated Cycle Length: 72.1	
Natural Cycle: 85	
Control Type: Semi Act-Uncoord	
Maximum v/c Ratio: 0.52	
Intersection Signal Delay: 21.4	Intersection LOS: C
Intersection Capacity Utilization 39.5%	ICU Level of Service A
Analysis Period (min) 15	

Splits and Phases: 3: Journeyman St & Campeau Dr

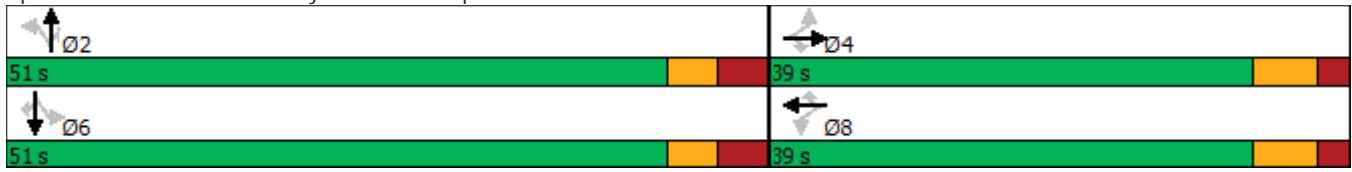

Future Background 2021 PM
5: Palladium Dr & Cabela's Way

08/27/2019



Movement	EBL	EBR	NBL	NBT	SBT	SBR
Lane Configurations						
Traffic Volume (veh/h)	0	144	130	396	315	34
Future Volume (Veh/h)	0	144	130	396	315	34
Sign Control	Stop			Free	Free	
Grade	0%			0%	0%	
Peak Hour Factor	1.00	1.00	1.00	1.00	1.00	1.00
Hourly flow rate (vph)	0	144	130	396	315	34
Pedestrians						
Lane Width (m)						
Walking Speed (m/s)						
Percent Blockage						
Right turn flare (veh)						
Median type				None	None	
Median storage veh						
Upstream signal (m)	207					
pX, platoon unblocked						
vC, conflicting volume	790	174	349			
vC1, stage 1 conf vol						
vC2, stage 2 conf vol						
vCu, unblocked vol	790	174	349			
tC, single (s)	6.8	6.9	4.1			
tC, 2 stage (s)						
tF (s)	3.5	3.3	2.2			
p0 queue free %	100	83	89			
cM capacity (veh/h)	292	839	1207			
Direction, Lane #	EB 1	NB 1	NB 2	NB 3	SB 1	SB 2
Volume Total	144	130	198	198	210	139
Volume Left	0	130	0	0	0	0
Volume Right	144	0	0	0	0	34
cSH	839	1207	1700	1700	1700	1700
Volume to Capacity	0.17	0.11	0.12	0.12	0.12	0.08
Queue Length 95th (m)	4.7	2.7	0.0	0.0	0.0	0.0
Control Delay (s)	10.2	8.3	0.0	0.0	0.0	0.0
Lane LOS	B	A				
Approach Delay (s)	10.2	2.1	0.0			
Approach LOS	B					
Intersection Summary						
Average Delay	2.5					
Intersection Capacity Utilization	25.4%			ICU Level of Service		A
Analysis Period (min)	15					

Future Background 2021 PM
6: Palladium Dr & Hwy 417 WB On-Off Ramps

08/27/2019



Lane Group	WBL	WBR	NBT	SBL	SBT
Lane Configurations					
Traffic Volume (vph)	412	346	179	168	290
Future Volume (vph)	412	346	179	168	290
Lane Group Flow (vph)	412	346	179	168	290
Turn Type	Prot	Perm	NA	pm+pt	NA
Protected Phases	8		2	1	6
Permitted Phases		8		6	
Detector Phase	8	8	2	1	6
Switch Phase					
Minimum Initial (s)	10.0	10.0	10.0	5.0	10.0
Minimum Split (s)	32.7	32.7	39.0	12.0	25.0
Total Split (s)	36.7	36.7	39.0	22.0	39.0
Total Split (%)	37.6%	37.6%	39.9%	22.5%	39.9%
Yellow Time (s)	3.3	3.3	3.7	3.7	3.7
All-Red Time (s)	3.4	3.4	3.3	3.3	3.3
Lost Time Adjust (s)	-2.7	-2.7	-3.0	-3.0	-3.0
Total Lost Time (s)	4.0	4.0	4.0	4.0	4.0
Lead/Lag			Lag	Lead	
Lead-Lag Optimize?			Yes	Yes	
Recall Mode	Max	Max	Max	Max	Max
Act Effct Green (s)	32.7	32.7	35.0	57.0	57.0
Actuated g/C Ratio	0.33	0.33	0.36	0.58	0.58
v/c Ratio	0.35	0.45	0.14	0.22	0.14
Control Delay	25.6	4.7	21.6	10.2	9.4
Queue Delay	0.0	0.0	0.0	0.0	0.0
Total Delay	25.6	4.7	21.6	10.2	9.4
LOS	C	A	C	B	A
Approach Delay	16.1		21.6		9.7
Approach LOS	B		C		A
Queue Length 50th (m)	30.0	0.0	11.8	13.6	12.1
Queue Length 95th (m)	42.3	18.1	19.3	23.0	18.0
Internal Link Dist (m)	322.5		403.5		183.1
Turn Bay Length (m)		125.0		115.0	
Base Capacity (vph)	1161	766	1282	760	2088
Starvation Cap Reductn	0	0	0	0	0
Spillback Cap Reductn	0	0	0	0	0
Storage Cap Reductn	0	0	0	0	0
Reduced v/c Ratio	0.35	0.45	0.14	0.22	0.14

Intersection Summary

Cycle Length: 97.7	
Actuated Cycle Length: 97.7	
Natural Cycle: 85	
Control Type: Actuated-Uncoordinated	
Maximum v/c Ratio: 0.45	
Intersection Signal Delay: 14.7	Intersection LOS: B
Intersection Capacity Utilization 39.4%	ICU Level of Service A
Analysis Period (min) 15	

Splits and Phases: 6: Palladium Dr & Hwy 417 WB On-Off Ramps

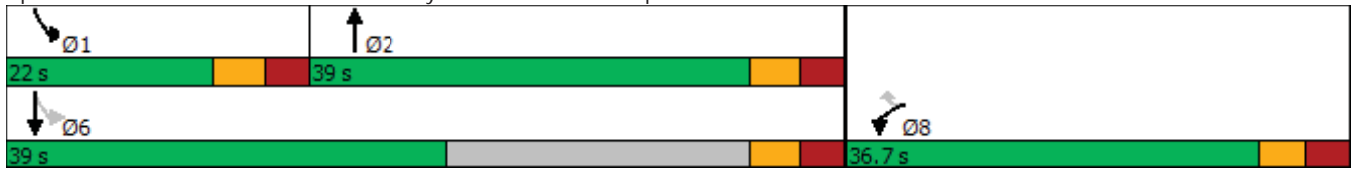

Future Background 2021 PM
7: Palladium Dr & Hwy 417 EB Off Ramp

08/27/2019



Movement	EBL	EBR	NBL	NBT	SBT	SBR
Lane Configurations						
Traffic Volume (veh/h)	102	155	0	468	689	14
Future Volume (Veh/h)	102	155	0	468	689	14
Sign Control	Stop			Free	Free	
Grade	0%			0%	0%	
Peak Hour Factor	1.00	1.00	1.00	1.00	1.00	1.00
Hourly flow rate (vph)	102	155	0	468	689	14
Pedestrians						
Lane Width (m)						
Walking Speed (m/s)						
Percent Blockage						
Right turn flare (veh)	3					
Median type				None	None	
Median storage (veh)						
Upstream signal (m)						
pX, platoon unblocked						
vC, conflicting volume	930	352	703			
vC1, stage 1 conf vol						
vC2, stage 2 conf vol						
vCu, unblocked vol	930	352	703			
tC, single (s)	6.8	6.9	4.1			
tC, 2 stage (s)						
tF (s)	3.5	3.3	2.2			
p0 queue free %	62	76	100			
cM capacity (veh/h)	266	645	890			
Direction, Lane #	EB 1	NB 1	NB 2	SB 1	SB 2	
Volume Total	257	234	234	459	244	
Volume Left	102	0	0	0	0	
Volume Right	155	0	0	0	14	
cSH	670	1700	1700	1700	1700	
Volume to Capacity	0.38	0.14	0.14	0.27	0.14	
Queue Length 95th (m)	13.7	0.0	0.0	0.0	0.0	
Control Delay (s)	18.0	0.0	0.0	0.0	0.0	
Lane LOS	C					
Approach Delay (s)	18.0	0.0		0.0		
Approach LOS	C					
Intersection Summary						
Average Delay	3.2					
Intersection Capacity Utilization	35.8%			ICU Level of Service	A	
Analysis Period (min)	15					

Future Background 2026

MOVEMENT SUMMARY

 Site: 101 [Huntmar / Campeau FB2026 AM]

New Site
Roundabout

Movement Performance - Vehicles												
Mov ID	OD Mov	Demand Total veh/h	Flows HV %	Deg. Satn v/c	Average Delay sec	Level of Service	95% Back of Queue Vehicles veh	of Queue Distance m	Prop. Queued	Effective Stop Rate per veh	Average Speed km/h	
South: Huntmar Dr												
1	L2	19	2.0	0.016	9.6	LOS A	0.1	0.4	0.22	0.60	53.5	
2	T1	340	2.0	0.199	3.8	LOS A	1.0	7.0	0.22	0.37	57.3	
3	R2	30	2.0	0.025	4.2	LOS A	0.1	0.7	0.22	0.44	55.2	
Approach		389	2.0	0.199	4.1	LOS A	1.0	7.0	0.22	0.39	56.9	
East: Campeau Dr												
4	L2	67	2.0	0.057	10.3	LOS B	0.2	1.6	0.40	0.66	52.8	
5	T1	69	2.0	0.046	4.3	LOS A	0.2	1.4	0.38	0.43	56.4	
6	R2	15	2.0	0.014	5.1	LOS A	0.1	0.4	0.40	0.52	54.5	
Approach		151	2.0	0.057	7.1	LOS A	0.2	1.6	0.39	0.54	54.5	
North: Huntmar Dr												
7	L2	2	2.0	0.002	9.7	LOS A	0.0	0.0	0.26	0.58	53.3	
8	T1	317	2.0	0.192	3.9	LOS A	0.9	6.4	0.26	0.38	57.0	
9	R2	129	2.0	0.101	4.4	LOS A	0.4	3.0	0.27	0.47	55.0	
Approach		448	2.0	0.192	4.0	LOS A	0.9	6.4	0.26	0.41	56.4	
West: Campeau Dr												
10	L2	79	2.0	0.052	9.9	LOS A	0.2	1.6	0.36	0.64	52.9	
11	T1	23	2.0	0.021	4.6	LOS A	0.1	0.6	0.39	0.45	56.3	
12	R2	31	2.0	0.016	3.3	LOS A	0.0	0.0	0.00	0.42	56.8	
Approach		133	2.0	0.052	7.5	LOS A	0.2	1.6	0.28	0.55	54.3	
All Vehicles		1121	2.0	0.199	4.9	LOS A	1.0	7.0	0.27	0.44	56.1	

Site Level of Service (LOS) Method: Delay (SIDRA). Site LOS Method is specified in the Parameter Settings dialog (Site tab).

Roundabout LOS Method: SIDRA Roundabout LOS.

Vehicle movement LOS values are based on average delay per movement.

Intersection and Approach LOS values are based on average delay for all vehicle movements.

Roundabout Capacity Model: SIDRA Standard.

SIDRA Standard Delay Model is used. Control Delay includes Geometric Delay.

Gap-Acceptance Capacity: SIDRA Standard (Akçelik M3D).

HV (%) values are calculated for All Movement Classes of All Heavy Vehicle Model Designation.

MOVEMENT SUMMARY

 Site: 101 [Huntmar / Campeau FB2026 PM]

New Site
Roundabout

Movement Performance - Vehicles											
Mov ID	OD Mov	Demand Total veh/h	Flows HV %	Deg. Satn v/c	Average Delay sec	Level of Service	95% Back of Queue Vehicles veh	Queue Distance m	Prop. Queued	Effective Stop Rate per veh	Average Speed km/h
South: Huntmar Dr											
1	L2	62	2.0	0.057	10.2	LOS B	0.2	1.6	0.38	0.65	52.9
2	T1	389	2.0	0.253	4.2	LOS A	1.3	9.1	0.39	0.42	56.3
3	R2	66	2.0	0.061	4.8	LOS A	0.2	1.8	0.38	0.53	54.6
Approach		517	2.0	0.253	5.0	LOS A	1.3	9.1	0.39	0.46	55.6
East: Campeau Dr											
4	L2	48	2.0	0.036	10.2	LOS B	0.1	1.0	0.45	0.66	52.8
5	T1	39	2.0	0.036	5.0	LOS A	0.1	1.0	0.47	0.50	55.7
6	R2	4	2.0	0.004	5.4	LOS A	0.0	0.1	0.47	0.52	54.3
Approach		91	2.0	0.036	7.8	LOS A	0.1	1.0	0.46	0.59	54.0
North: Huntmar Dr											
7	L2	6	2.0	0.005	9.7	LOS A	0.0	0.1	0.25	0.59	53.3
8	T1	390	2.0	0.234	3.9	LOS A	1.1	8.1	0.26	0.38	57.0
9	R2	154	2.0	0.121	4.4	LOS A	0.5	3.6	0.27	0.47	55.0
Approach		550	2.0	0.234	4.1	LOS A	1.1	8.1	0.26	0.41	56.4
West: Campeau Dr											
10	L2	207	2.0	0.141	10.2	LOS B	0.7	4.7	0.42	0.67	52.7
11	T1	96	2.0	0.086	4.9	LOS A	0.4	2.6	0.43	0.48	56.0
12	R2	63	2.0	0.033	3.3	LOS A	0.0	0.0	0.00	0.42	56.8
Approach		366	2.0	0.141	7.6	LOS A	0.7	4.7	0.35	0.58	54.2
All Vehicles		1524	2.0	0.253	5.5	LOS A	1.3	9.1	0.34	0.48	55.5

Site Level of Service (LOS) Method: Delay (SIDRA). Site LOS Method is specified in the Parameter Settings dialog (Site tab).

Roundabout LOS Method: SIDRA Roundabout LOS.

Vehicle movement LOS values are based on average delay per movement.

Intersection and Approach LOS values are based on average delay for all vehicle movements.

Roundabout Capacity Model: SIDRA Standard.

SIDRA Standard Delay Model is used. Control Delay includes Geometric Delay.

Gap-Acceptance Capacity: SIDRA Standard (Akçelik M3D).

HV (%) values are calculated for All Movement Classes of All Heavy Vehicle Model Designation.

MOVEMENT SUMMARY

 Site: 101 [Campeau / Palladium FB2026 AM]

New Site
Roundabout

Movement Performance - Vehicles											
Mov ID	OD Mov	Demand Total veh/h	Flows HV %	Deg. Satn v/c	Average Delay sec	Level of Service	95% Back of Queue Vehicles veh	Queue Distance m	Prop. Queued	Effective Stop Rate per veh	Average Speed km/h
South: Campeau Dr											
1	L2	49	2.0	0.052	9.3	LOS A	0.3	1.9	0.11	0.52	55.9
2	T1	43	2.0	0.052	3.6	LOS A	0.3	1.9	0.11	0.52	55.5
3	R2	116	2.0	0.061	3.1	LOS A	0.0	0.0	0.00	0.40	57.1
Approach		208	2.0	0.061	4.7	LOS A	0.3	1.9	0.05	0.45	56.5
East: Palladium Dr											
4	L2	192	2.0	0.071	9.5	LOS A	0.4	2.5	0.22	0.58	53.9
5	T1	20	2.0	0.071	3.8	LOS A	0.4	2.5	0.21	0.57	54.1
6	R2	6	2.0	0.071	3.9	LOS A	0.4	2.5	0.21	0.57	52.5
Approach		218	2.0	0.071	8.8	LOS A	0.4	2.5	0.22	0.58	53.9
North: Campeau Dr											
7	L2	4	2.0	0.013	9.9	LOS A	0.0	0.3	0.31	0.48	56.1
8	T1	27	2.0	0.013	4.2	LOS A	0.0	0.4	0.30	0.44	56.4
9	R2	2	2.0	0.013	4.2	LOS A	0.0	0.4	0.30	0.40	55.0
Approach		33	2.0	0.013	4.9	LOS A	0.0	0.4	0.30	0.44	56.3
West: Palladium Dr											
10	L2	1	2.0	0.019	9.7	LOS A	0.1	0.5	0.28	0.40	57.1
11	T1	24	2.0	0.019	4.1	LOS A	0.1	0.5	0.28	0.40	56.8
12	R2	23	2.0	0.017	3.9	LOS A	0.1	0.5	0.28	0.44	55.7
Approach		48	2.0	0.019	4.1	LOS A	0.1	0.5	0.28	0.42	56.2
All Vehicles		507	2.0	0.071	6.4	LOS A	0.4	2.5	0.16	0.50	55.3

Site Level of Service (LOS) Method: Delay (SIDRA). Site LOS Method is specified in the Parameter Settings dialog (Site tab).

Roundabout LOS Method: SIDRA Roundabout LOS.

Vehicle movement LOS values are based on average delay per movement.

Intersection and Approach LOS values are based on average delay for all vehicle movements.

Roundabout Capacity Model: SIDRA Standard.

SIDRA Standard Delay Model is used. Control Delay includes Geometric Delay.

Gap-Acceptance Capacity: SIDRA Standard (Akçelik M3D).

HV (%) values are calculated for All Movement Classes of All Heavy Vehicle Model Designation.

MOVEMENT SUMMARY

 Site: 101 [Campeau / Palladium FB2026 PM]

New Site
Roundabout

Movement Performance - Vehicles											
Mov ID	OD Mov	Demand Total veh/h	Flows HV %	Deg. Satn v/c	Average Delay sec	Level of Service	95% Back of Queue Vehicles veh	Queue Distance m	Prop. Queued	Effective Stop Rate per veh	Average Speed km/h
South: Campeau Dr											
1	L2	21	2.0	0.028	9.3	LOS A	0.1	1.0	0.15	0.48	56.1
2	T1	27	2.0	0.028	3.7	LOS A	0.1	1.0	0.15	0.48	55.8
3	R2	272	2.0	0.143	3.2	LOS A	0.0	0.0	0.00	0.40	57.1
Approach		320	2.0	0.143	3.6	LOS A	0.1	1.0	0.02	0.41	56.9
East: Palladium Dr											
4	L2	226	2.0	0.079	9.4	LOS A	0.4	2.8	0.16	0.59	54.1
5	T1	26	2.0	0.079	3.7	LOS A	0.4	2.8	0.15	0.57	54.2
6	R2	1	2.0	0.079	3.8	LOS A	0.4	2.8	0.15	0.57	52.6
Approach		253	2.0	0.079	8.8	LOS A	0.4	2.8	0.15	0.58	54.1
North: Campeau Dr											
7	L2	9	2.0	0.020	10.0	LOS A	0.1	0.5	0.31	0.52	55.6
8	T1	39	2.0	0.020	4.2	LOS A	0.1	0.5	0.31	0.45	56.2
9	R2	1	2.0	0.020	4.3	LOS A	0.1	0.5	0.30	0.41	55.0
Approach		49	2.0	0.020	5.3	LOS A	0.1	0.5	0.31	0.46	56.1
West: Palladium Dr											
10	L2	2	2.0	0.033	9.9	LOS A	0.1	0.9	0.30	0.43	56.9
11	T1	41	2.0	0.033	4.2	LOS A	0.1	0.9	0.30	0.43	56.6
12	R2	15	2.0	0.012	4.0	LOS A	0.0	0.3	0.30	0.45	55.6
Approach		58	2.0	0.033	4.3	LOS A	0.1	0.9	0.30	0.43	56.4
All Vehicles		680	2.0	0.143	5.7	LOS A	0.4	2.8	0.12	0.48	55.7

Site Level of Service (LOS) Method: Delay (SIDRA). Site LOS Method is specified in the Parameter Settings dialog (Site tab).

Roundabout LOS Method: SIDRA Roundabout LOS.

Vehicle movement LOS values are based on average delay per movement.

Intersection and Approach LOS values are based on average delay for all vehicle movements.

Roundabout Capacity Model: SIDRA Standard.

SIDRA Standard Delay Model is used. Control Delay includes Geometric Delay.

Gap-Acceptance Capacity: SIDRA Standard (Akçelik M3D).

HV (%) values are calculated for All Movement Classes of All Heavy Vehicle Model Designation.

Future Background 2026 AM
 1: Kanata West Centre Dr & Campeau Dr

08/27/2019



Movement	EBT	EBR	WBL	WBT	NBL	NBR
Lane Configurations						
Traffic Volume (veh/h)	23	5	19	50	3	25
Future Volume (Veh/h)	23	5	19	50	3	25
Sign Control	Free			Free	Stop	
Grade	0%			0%	0%	
Peak Hour Factor	1.00	1.00	1.00	1.00	1.00	1.00
Hourly flow rate (vph)	23	5	19	50	3	25
Pedestrians						
Lane Width (m)						
Walking Speed (m/s)						
Percent Blockage						
Right turn flare (veh)						
Median type	None			None		
Median storage veh						
Upstream signal (m)						
pX, platoon unblocked						
vC, conflicting volume			28		114	26
vC1, stage 1 conf vol						
vC2, stage 2 conf vol						
vCu, unblocked vol			28		114	26
tC, single (s)			4.1		6.4	6.2
tC, 2 stage (s)						
tF (s)			2.2		3.5	3.3
p0 queue free %			99		100	98
cM capacity (veh/h)			1585		872	1050
Direction, Lane #	EB 1	WB 1	WB 2	NB 1		
Volume Total	28	19	50	28		
Volume Left	0	19	0	3		
Volume Right	5	0	0	25		
cSH	1700	1585	1700	1028		
Volume to Capacity	0.02	0.01	0.03	0.03		
Queue Length 95th (m)	0.0	0.3	0.0	0.6		
Control Delay (s)	0.0	7.3	0.0	8.6		
Lane LOS	A		A			
Approach Delay (s)	0.0	2.0	8.6			
Approach LOS	A		A			
Intersection Summary						
Average Delay			3.0			
Intersection Capacity Utilization			17.7%	ICU Level of Service	A	
Analysis Period (min)			15			

Future Background 2026 AM
3: Journeyman St & Campeau Dr

08/27/2019



Lane Group	EBL	EBT	EBR	WBL	WBT	WBR	NBL	NBR	SBL	SBR
Lane Configurations										
Traffic Volume (vph)	6	117	20	18	199	2	4	13	1	1
Future Volume (vph)	6	117	20	18	199	2	4	13	1	1
Lane Group Flow (vph)	6	117	20	18	199	2	4	13	1	1
Turn Type	Perm	NA	Perm	Perm	NA	Perm	Perm	Perm	Perm	Perm
Protected Phases		4			8					
Permitted Phases	4		4	8		8	2	2	6	6
Detector Phase	4	4	4	8	8	8	2	2	6	6
Switch Phase										
Minimum Initial (s)	10.0	10.0	10.0	10.0	10.0	10.0	10.0	10.0	10.0	10.0
Minimum Split (s)	44.5	44.5	44.5	44.5	44.5	44.5	39.8	39.8	39.8	39.8
Total Split (s)	39.0	39.0	39.0	39.0	39.0	39.0	51.0	51.0	51.0	51.0
Total Split (%)	43.3%	43.3%	43.3%	43.3%	43.3%	43.3%	56.7%	56.7%	56.7%	56.7%
Yellow Time (s)	4.2	4.2	4.2	4.2	4.2	4.2	3.3	3.3	3.3	3.3
All-Red Time (s)	2.3	2.3	2.3	2.3	2.3	2.3	3.5	3.5	3.5	3.5
Lost Time Adjust (s)	-2.8	-2.8	-2.8	-2.8	-2.8	-2.8	-2.5	-2.5	-2.5	-2.5
Total Lost Time (s)	3.7	3.7	3.7	3.7	3.7	3.7	4.3	4.3	4.3	4.3
Lead/Lag										
Lead-Lag Optimize?										
Recall Mode	None	None	None	None	None	None	Max	Max	Max	Max
Act Effct Green (s)	15.8	15.8	15.8	15.8	15.8	15.8	48.4	48.4	48.4	48.4
Actuated g/C Ratio	0.22	0.22	0.22	0.22	0.22	0.22	0.67	0.67	0.67	0.67
v/c Ratio	0.03	0.28	0.05	0.06	0.48	0.01	0.00	0.01	0.00	0.00
Control Delay	21.2	24.5	2.6	21.6	28.2	0.0	5.0	0.0	5.0	0.0
Queue Delay	0.0	0.0	0.0	0.0	0.0	0.0	0.0	0.0	0.0	0.0
Total Delay	21.2	24.5	2.6	21.6	28.2	0.0	5.0	0.0	5.0	0.0
LOS	C	C	A	C	C	A	A	A	A	A
Approach Delay		21.3			27.4					
Approach LOS		C			C					
Queue Length 50th (m)	0.6	12.8	0.0	1.9	22.9	0.0	0.2	0.0	0.0	0.0
Queue Length 95th (m)	3.3	25.1	1.9	6.4	40.3	0.0	1.2	0.0	0.5	0.0
Internal Link Dist (m)		319.9			296.6					
Turn Bay Length (m)	45.0			50.0			20.0		45.0	
Base Capacity (vph)	462	922	807	621	922	807	955	1318	955	1260
Starvation Cap Reductn	0	0	0	0	0	0	0	0	0	0
Spillback Cap Reductn	0	0	0	0	0	0	0	0	0	0
Storage Cap Reductn	0	0	0	0	0	0	0	0	0	0
Reduced v/c Ratio	0.01	0.13	0.02	0.03	0.22	0.00	0.00	0.01	0.00	0.00

Intersection Summary

Cycle Length: 90	
Actuated Cycle Length: 72.2	
Natural Cycle: 85	
Control Type: Semi Act-Uncoord	
Maximum v/c Ratio: 0.48	
Intersection Signal Delay: 23.8	Intersection LOS: C
Intersection Capacity Utilization 37.6%	ICU Level of Service A
Analysis Period (min) 15	

Splits and Phases: 3: Journeyman St & Campeau Dr

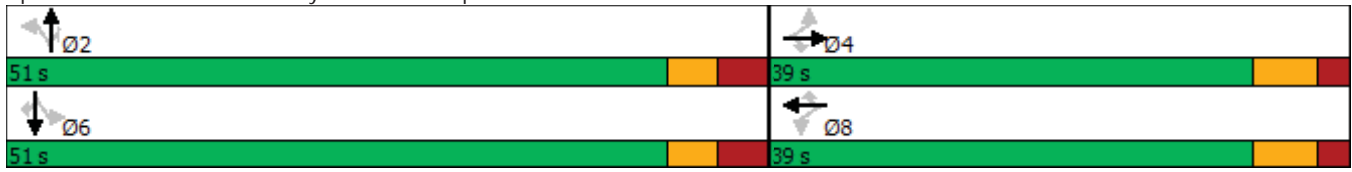

Future Background 2026 AM
5: Palladium Dr & Cabela's Way

08/27/2019



Movement	EBL	EBR	NBL	NBT	SBT	SBR
Lane Configurations						
Traffic Volume (veh/h)	0	83	116	248	225	21
Future Volume (Veh/h)	0	83	116	248	225	21
Sign Control	Stop			Free	Free	
Grade	0%			0%	0%	
Peak Hour Factor	1.00	1.00	1.00	1.00	1.00	1.00
Hourly flow rate (vph)	0	83	116	248	225	21
Pedestrians						
Lane Width (m)						
Walking Speed (m/s)						
Percent Blockage						
Right turn flare (veh)						
Median type				None	None	
Median storage veh						
Upstream signal (m)	207					
pX, platoon unblocked						
vC, conflicting volume	592	123	246			
vC1, stage 1 conf vol						
vC2, stage 2 conf vol						
vCu, unblocked vol	592	123	246			
tC, single (s)	6.8	6.9	4.1			
tC, 2 stage (s)						
tF (s)	3.5	3.3	2.2			
p0 queue free %	100	91	91			
cM capacity (veh/h)	399	905	1317			
Direction, Lane #	EB 1	NB 1	NB 2	NB 3	SB 1	SB 2
Volume Total	83	116	124	124	150	96
Volume Left	0	116	0	0	0	0
Volume Right	83	0	0	0	0	21
cSH	905	1317	1700	1700	1700	1700
Volume to Capacity	0.09	0.09	0.07	0.07	0.09	0.06
Queue Length 95th (m)	2.3	2.2	0.0	0.0	0.0	0.0
Control Delay (s)	9.4	8.0	0.0	0.0	0.0	0.0
Lane LOS	A	A				
Approach Delay (s)	9.4	2.5	0.0			
Approach LOS	A					
Intersection Summary						
Average Delay			2.5			
Intersection Capacity Utilization			20.0%	ICU Level of Service	A	
Analysis Period (min)			15			

Future Background 2026 AM
6: Palladium Dr & Hwy 417 WB On-Off Ramps

08/27/2019



Lane Group	WBL	WBR	NBT	SBL	SBT
Lane Configurations					
Traffic Volume (vph)	220	222	141	103	205
Future Volume (vph)	220	222	141	103	205
Lane Group Flow (vph)	220	222	141	103	205
Turn Type	Prot	Perm	NA	pm+pt	NA
Protected Phases	8		2	1	6
Permitted Phases		8		6	
Detector Phase	8	8	2	1	6
Switch Phase					
Minimum Initial (s)	10.0	10.0	10.0	5.0	10.0
Minimum Split (s)	32.7	32.7	39.0	12.0	25.0
Total Split (s)	36.7	36.7	39.0	22.0	39.0
Total Split (%)	37.6%	37.6%	39.9%	22.5%	39.9%
Yellow Time (s)	3.3	3.3	3.7	3.7	3.7
All-Red Time (s)	3.4	3.4	3.3	3.3	3.3
Lost Time Adjust (s)	-2.7	-2.7	-3.0	-3.0	-3.0
Total Lost Time (s)	4.0	4.0	4.0	4.0	4.0
Lead/Lag			Lag	Lead	
Lead-Lag Optimize?			Yes	Yes	
Recall Mode	Max	Max	Max	Max	Max
Act Effct Green (s)	32.7	32.7	35.0	57.0	57.0
Actuated g/C Ratio	0.33	0.33	0.36	0.58	0.58
v/c Ratio	0.19	0.33	0.11	0.13	0.10
Control Delay	23.6	4.7	21.3	9.5	9.2
Queue Delay	0.0	0.0	0.0	0.0	0.0
Total Delay	23.6	4.7	21.3	9.5	9.2
LOS	C	A	C	A	A
Approach Delay	14.1		21.3		9.3
Approach LOS	B		C		A
Queue Length 50th (m)	15.1	0.0	9.2	8.0	8.3
Queue Length 95th (m)	23.5	15.0	15.7	15.0	13.2
Internal Link Dist (m)	322.5		403.5		183.1
Turn Bay Length (m)		125.0		115.0	
Base Capacity (vph)	1161	683	1282	777	2088
Starvation Cap Reductn	0	0	0	0	0
Spillback Cap Reductn	0	0	0	0	0
Storage Cap Reductn	0	0	0	0	0
Reduced v/c Ratio	0.19	0.33	0.11	0.13	0.10

Intersection Summary

Cycle Length: 97.7	
Actuated Cycle Length: 97.7	
Natural Cycle: 85	
Control Type: Actuated-Uncoordinated	
Maximum v/c Ratio: 0.33	
Intersection Signal Delay: 13.6	Intersection LOS: B
Intersection Capacity Utilization 32.4%	ICU Level of Service A
Analysis Period (min) 15	

Splits and Phases: 6: Palladium Dr & Hwy 417 WB On-Off Ramps

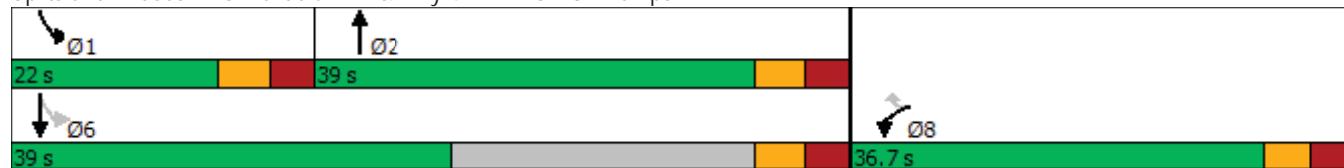

Future Background 2026 AM
7: Palladium Dr & Hwy 417 EB Off Ramp

08/27/2019



Movement	EBL	EBR	NBL	NBT	SBT	SBR
Lane Configurations						
Traffic Volume (veh/h)	72	274	0	70	395	30
Future Volume (Veh/h)	72	274	0	70	395	30
Sign Control	Stop			Free	Free	
Grade	0%			0%	0%	
Peak Hour Factor	1.00	1.00	1.00	1.00	1.00	1.00
Hourly flow rate (vph)	72	274	0	70	395	30
Pedestrians						
Lane Width (m)						
Walking Speed (m/s)						
Percent Blockage						
Right turn flare (veh)	3					
Median type				None	None	
Median storage veh						
Upstream signal (m)						
pX, platoon unblocked						
vC, conflicting volume	445	212	425			
vC1, stage 1 conf vol						
vC2, stage 2 conf vol						
vCu, unblocked vol	445	212	425			
tC, single (s)	6.8	6.9	4.1			
tC, 2 stage (s)						
tF (s)	3.5	3.3	2.2			
p0 queue free %	87	65	100			
cM capacity (veh/h)	542	793	1131			
Direction, Lane #	EB 1	NB 1	NB 2	SB 1	SB 2	
Volume Total	346	35	35	263	162	
Volume Left	72	0	0	0	0	
Volume Right	274	0	0	0	30	
cSH	1001	1700	1700	1700	1700	
Volume to Capacity	0.35	0.02	0.02	0.15	0.10	
Queue Length 95th (m)	11.8	0.0	0.0	0.0	0.0	
Control Delay (s)	12.1	0.0	0.0	0.0	0.0	
Lane LOS	B					
Approach Delay (s)	12.1	0.0		0.0		
Approach LOS	B					
Intersection Summary						
Average Delay	5.0					
Intersection Capacity Utilization	35.5%			ICU Level of Service	A	
Analysis Period (min)	15					

Future Background 2026 PM
 1: Kanata West Centre Dr & Campeau Dr

08/27/2019



Movement	EBT	EBR	WBL	WBT	NBL	NBR
Lane Configurations	↔		↔	↔	↔	
Traffic Volume (veh/h)	19	1	13	38	2	39
Future Volume (Veh/h)	19	1	13	38	2	39
Sign Control	Free			Free	Stop	
Grade	0%			0%	0%	
Peak Hour Factor	1.00	1.00	1.00	1.00	1.00	1.00
Hourly flow rate (vph)	19	1	13	38	2	39
Pedestrians						
Lane Width (m)						
Walking Speed (m/s)						
Percent Blockage						
Right turn flare (veh)						
Median type	None			None		
Median storage veh						
Upstream signal (m)						
pX, platoon unblocked						
vC, conflicting volume			20		84	20
vC1, stage 1 conf vol						
vC2, stage 2 conf vol						
vCu, unblocked vol			20		84	20
tC, single (s)			4.1		6.4	6.2
tC, 2 stage (s)						
tF (s)			2.2		3.5	3.3
p0 queue free %			99		100	96
cM capacity (veh/h)			1596		911	1058
Direction, Lane #	EB 1	WB 1	WB 2	NB 1		
Volume Total	20	13	38	41		
Volume Left	0	13	0	2		
Volume Right	1	0	0	39		
cSH	1700	1596	1700	1050		
Volume to Capacity	0.01	0.01	0.02	0.04		
Queue Length 95th (m)	0.0	0.2	0.0	0.9		
Control Delay (s)	0.0	7.3	0.0	8.6		
Lane LOS		A		A		
Approach Delay (s)	0.0	1.9		8.6		
Approach LOS				A		
Intersection Summary						
Average Delay			4.0			
Intersection Capacity Utilization			17.4%		ICU Level of Service	A
Analysis Period (min)			15			

Future Background 2026 PM
3: Journeyman St & Campeau Dr

08/27/2019



Lane Group	EBL	EBT	EBR	WBL	WBT	WBR	NBL	NBR	SBL	SBR
Lane Configurations										
Traffic Volume (vph)	12	235	16	78	146	2	43	72	3	4
Future Volume (vph)	12	235	16	78	146	2	43	72	3	4
Lane Group Flow (vph)	12	235	16	78	146	2	43	72	3	4
Turn Type	Perm	NA	Perm	Perm	NA	Perm	Perm	Perm	Perm	Perm
Protected Phases		4			8					
Permitted Phases	4		4	8		8	2	2	6	6
Detector Phase	4	4	4	8	8	8	2	2	6	6
Switch Phase										
Minimum Initial (s)	10.0	10.0	10.0	10.0	10.0	10.0	10.0	10.0	10.0	10.0
Minimum Split (s)	44.8	44.8	44.8	44.8	44.8	44.8	39.8	39.8	39.8	39.8
Total Split (s)	39.0	39.0	39.0	39.0	39.0	39.0	51.0	51.0	51.0	51.0
Total Split (%)	43.3%	43.3%	43.3%	43.3%	43.3%	43.3%	56.7%	56.7%	56.7%	56.7%
Yellow Time (s)	4.2	4.2	4.2	4.2	4.2	4.2	3.3	3.3	3.3	3.3
All-Red Time (s)	2.3	2.3	2.3	2.3	2.3	2.3	3.5	3.5	3.5	3.5
Lost Time Adjust (s)	-2.8	-2.8	-2.8	-2.8	-2.8	-2.8	-2.5	-2.5	-2.5	-2.5
Total Lost Time (s)	3.7	3.7	3.7	3.7	3.7	3.7	4.3	4.3	4.3	4.3
Lead/Lag										
Lead-Lag Optimize?										
Recall Mode	None	None	None	None	None	None	Max	Max	Max	Max
Act Effct Green (s)	17.0	17.0	17.0	17.0	17.0	17.0	47.1	47.1	47.1	47.1
Actuated g/C Ratio	0.24	0.24	0.24	0.24	0.24	0.24	0.65	0.65	0.65	0.65
v/c Ratio	0.04	0.53	0.04	0.39	0.33	0.00	0.05	0.06	0.00	0.00
Control Delay	20.8	28.4	1.1	29.1	24.5	0.0	5.6	0.1	5.7	0.0
Queue Delay	0.0	0.0	0.0	0.0	0.0	0.0	0.0	0.0	0.0	0.0
Total Delay	20.8	28.4	1.1	29.1	24.5	0.0	5.6	0.1	5.7	0.0
LOS	C	C	A	C	C	A	A	A	A	A
Approach Delay		26.4			25.9					
Approach LOS		C			C					
Queue Length 50th (m)	1.2	27.6	0.0	8.8	16.3	0.0	1.8	0.0	0.2	0.0
Queue Length 95th (m)	4.9	46.7	0.9	20.1	30.2	0.0	5.9	0.0	1.0	0.0
Internal Link Dist (m)		319.9			296.6					
Turn Bay Length (m)	45.0			50.0			20.0		45.0	
Base Capacity (vph)	571	922	807	413	922	807	930	1220	930	1280
Starvation Cap Reductn	0	0	0	0	0	0	0	0	0	0
Spillback Cap Reductn	0	0	0	0	0	0	0	0	0	0
Storage Cap Reductn	0	0	0	0	0	0	0	0	0	0
Reduced v/c Ratio	0.02	0.25	0.02	0.19	0.16	0.00	0.05	0.06	0.00	0.00

Intersection Summary

Cycle Length: 90	
Actuated Cycle Length: 72.1	
Natural Cycle: 85	
Control Type: Semi Act-Uncoord	
Maximum v/c Ratio: 0.53	
Intersection Signal Delay: 21.4	Intersection LOS: C
Intersection Capacity Utilization 40.0%	ICU Level of Service A
Analysis Period (min) 15	

Splits and Phases: 3: Journeyman St & Campeau Dr

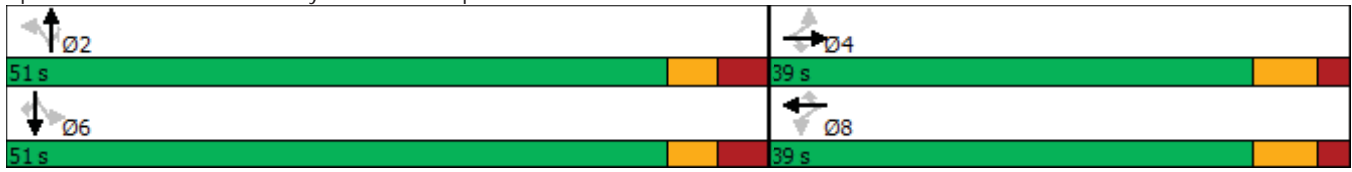

Future Background 2026 PM
5: Palladium Dr & Cabela's Way

08/27/2019



Movement	EBL	EBR	NBL	NBT	SBT	SBR
Lane Configurations						
Traffic Volume (veh/h)	0	151	136	410	328	35
Future Volume (Veh/h)	0	151	136	410	328	35
Sign Control	Stop			Free	Free	
Grade	0%			0%	0%	
Peak Hour Factor	1.00	1.00	1.00	1.00	1.00	1.00
Hourly flow rate (vph)	0	151	136	410	328	35
Pedestrians						
Lane Width (m)						
Walking Speed (m/s)						
Percent Blockage						
Right turn flare (veh)						
Median type				None	None	
Median storage veh						
Upstream signal (m)	207					
pX, platoon unblocked						
vC, conflicting volume	822	182	363			
vC1, stage 1 conf vol						
vC2, stage 2 conf vol						
vCu, unblocked vol	822	182	363			
tC, single (s)	6.8	6.9	4.1			
tC, 2 stage (s)						
tF (s)	3.5	3.3	2.2			
p0 queue free %	100	82	89			
cM capacity (veh/h)	276	830	1192			
Direction, Lane #	EB 1	NB 1	NB 2	NB 3	SB 1	SB 2
Volume Total	151	136	205	205	219	144
Volume Left	0	136	0	0	0	0
Volume Right	151	0	0	0	0	35
cSH	830	1192	1700	1700	1700	1700
Volume to Capacity	0.18	0.11	0.12	0.12	0.13	0.08
Queue Length 95th (m)	5.0	2.9	0.0	0.0	0.0	0.0
Control Delay (s)	10.3	8.4	0.0	0.0	0.0	0.0
Lane LOS	B	A				
Approach Delay (s)	10.3	2.1	0.0			
Approach LOS	B					
Intersection Summary						
Average Delay			2.5			
Intersection Capacity Utilization			26.2%	ICU Level of Service	A	
Analysis Period (min)			15			

Future Background 2026 PM
6: Palladium Dr & Hwy 417 WB On-Off Ramps

08/27/2019



Lane Group	WBL	WBR	NBT	SBL	SBT
Lane Configurations					
Traffic Volume (vph)	433	360	186	174	305
Future Volume (vph)	433	360	186	174	305
Lane Group Flow (vph)	433	360	186	174	305
Turn Type	Prot	Perm	NA	pm+pt	NA
Protected Phases	8		2	1	6
Permitted Phases		8		6	
Detector Phase	8	8	2	1	6
Switch Phase					
Minimum Initial (s)	10.0	10.0	10.0	5.0	10.0
Minimum Split (s)	32.7	32.7	39.0	12.0	25.0
Total Split (s)	36.7	36.7	39.0	22.0	39.0
Total Split (%)	37.6%	37.6%	39.9%	22.5%	39.9%
Yellow Time (s)	3.3	3.3	3.7	3.7	3.7
All-Red Time (s)	3.4	3.4	3.3	3.3	3.3
Lost Time Adjust (s)	-2.7	-2.7	-3.0	-3.0	-3.0
Total Lost Time (s)	4.0	4.0	4.0	4.0	4.0
Lead/Lag			Lag	Lead	
Lead-Lag Optimize?			Yes	Yes	
Recall Mode	Max	Max	Max	Max	Max
Act Effct Green (s)	32.7	32.7	35.0	57.0	57.0
Actuated g/C Ratio	0.33	0.33	0.36	0.58	0.58
v/c Ratio	0.37	0.46	0.15	0.23	0.15
Control Delay	25.9	4.8	21.6	10.3	9.5
Queue Delay	0.0	0.0	0.0	0.0	0.0
Total Delay	25.9	4.8	21.6	10.3	9.5
LOS	C	A	C	B	A
Approach Delay	16.3		21.6		9.8
Approach LOS	B		C		A
Queue Length 50th (m)	31.8	0.0	12.3	14.1	12.8
Queue Length 95th (m)	44.4	18.2	19.8	23.8	18.8
Internal Link Dist (m)	322.5		403.5		183.1
Turn Bay Length (m)		125.0		115.0	
Base Capacity (vph)	1161	775	1282	758	2088
Starvation Cap Reductn	0	0	0	0	0
Spillback Cap Reductn	0	0	0	0	0
Storage Cap Reductn	0	0	0	0	0
Reduced v/c Ratio	0.37	0.46	0.15	0.23	0.15

Intersection Summary

Cycle Length: 97.7	
Actuated Cycle Length: 97.7	
Natural Cycle: 85	
Control Type: Actuated-Uncoordinated	
Maximum v/c Ratio: 0.46	
Intersection Signal Delay: 14.8	Intersection LOS: B
Intersection Capacity Utilization 40.3%	ICU Level of Service A
Analysis Period (min) 15	

Splits and Phases: 6: Palladium Dr & Hwy 417 WB On-Off Ramps

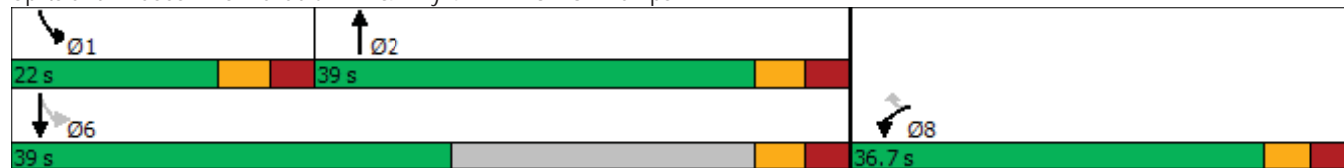

Future Background 2026 PM
7: Palladium Dr & Hwy 417 EB Off Ramp

08/27/2019



Movement	EBL	EBR	NBL	NBT	SBT	SBR
Lane Configurations						
Traffic Volume (veh/h)	106	163	0	492	724	14
Future Volume (Veh/h)	106	163	0	492	724	14
Sign Control	Stop			Free	Free	
Grade	0%			0%	0%	
Peak Hour Factor	1.00	1.00	1.00	1.00	1.00	1.00
Hourly flow rate (vph)	106	163	0	492	724	14
Pedestrians						
Lane Width (m)						
Walking Speed (m/s)						
Percent Blockage						
Right turn flare (veh)	3					
Median type				None	None	
Median storage veh						
Upstream signal (m)						
pX, platoon unblocked						
vC, conflicting volume	977	369	738			
vC1, stage 1 conf vol						
vC2, stage 2 conf vol						
vCu, unblocked vol	977	369	738			
tC, single (s)	6.8	6.9	4.1			
tC, 2 stage (s)						
tF (s)	3.5	3.3	2.2			
p0 queue free %	57	74	100			
cM capacity (veh/h)	248	628	864			
Direction, Lane #	EB 1	NB 1	NB 2	SB 1	SB 2	
Volume Total	269	246	246	483	255	
Volume Left	106	0	0	0	0	
Volume Right	163	0	0	0	14	
cSH	630	1700	1700	1700	1700	
Volume to Capacity	0.43	0.14	0.14	0.28	0.15	
Queue Length 95th (m)	16.2	0.0	0.0	0.0	0.0	
Control Delay (s)	19.5	0.0	0.0	0.0	0.0	
Lane LOS	C					
Approach Delay (s)	19.5	0.0		0.0		
Approach LOS	C					
Intersection Summary						
Average Delay	3.5					
Intersection Capacity Utilization	37.2%			ICU Level of Service	A	
Analysis Period (min)	15					

Total Projected 2021

MOVEMENT SUMMARY

 Site: 101 [Huntmar / Campeau FT2021 AM]

New Site
Roundabout

Movement Performance - Vehicles											
Mov ID	OD Mov	Demand Total veh/h	Flows HV %	Deg. Satn v/c	Average Delay sec	Level of Service	95% Back of Queue Vehicles veh	Queue Distance m	Prop. Queued	Effective Stop Rate per veh	Average Speed km/h
South: Huntmar Dr											
1	L2	29	2.0	0.024	9.5	LOS A	0.1	0.7	0.21	0.60	53.5
2	T1	334	2.0	0.195	3.8	LOS A	1.0	6.8	0.21	0.37	57.3
3	R2	29	2.0	0.024	4.2	LOS A	0.1	0.7	0.21	0.44	55.3
Approach		392	2.0	0.195	4.2	LOS A	1.0	6.8	0.21	0.39	56.8
East: Campeau Dr											
4	L2	66	2.0	0.056	10.3	LOS B	0.2	1.6	0.40	0.66	52.8
5	T1	68	2.0	0.045	4.3	LOS A	0.2	1.3	0.37	0.43	56.4
6	R2	14	2.0	0.013	5.1	LOS A	0.0	0.4	0.40	0.51	54.5
Approach		148	2.0	0.056	7.1	LOS A	0.2	1.6	0.39	0.54	54.5
North: Huntmar Dr											
7	L2	2	2.0	0.002	9.7	LOS A	0.0	0.0	0.26	0.58	53.3
8	T1	304	2.0	0.184	3.9	LOS A	0.9	6.1	0.26	0.38	57.0
9	R2	124	2.0	0.098	4.4	LOS A	0.4	2.9	0.27	0.48	55.0
Approach		430	2.0	0.184	4.1	LOS A	0.9	6.1	0.27	0.41	56.4
West: Campeau Dr											
10	L2	75	2.0	0.049	9.9	LOS A	0.2	1.5	0.36	0.63	53.0
11	T1	22	2.0	0.020	4.6	LOS A	0.1	0.6	0.38	0.45	56.3
12	R2	32	2.0	0.017	3.3	LOS A	0.0	0.0	0.00	0.42	56.8
Approach		129	2.0	0.049	7.4	LOS A	0.2	1.5	0.27	0.55	54.4
All Vehicles		1099	2.0	0.195	4.9	LOS A	1.0	6.8	0.26	0.44	56.0

Site Level of Service (LOS) Method: Delay (SIDRA). Site LOS Method is specified in the Parameter Settings dialog (Site tab).

Roundabout LOS Method: SIDRA Roundabout LOS.

Vehicle movement LOS values are based on average delay per movement.

Intersection and Approach LOS values are based on average delay for all vehicle movements.

Roundabout Capacity Model: SIDRA Standard.

SIDRA Standard Delay Model is used. Control Delay includes Geometric Delay.

Gap-Acceptance Capacity: SIDRA Standard (Akçelik M3D).

HV (%) values are calculated for All Movement Classes of All Heavy Vehicle Model Designation.

MOVEMENT SUMMARY

 Site: 101 [Huntmar / Campeau FT2021 PM]

New Site
Roundabout

Movement Performance - Vehicles												
Mov ID	OD Mov	Demand Total veh/h	Flows HV %	Deg. Satn v/c	Average Delay sec	Level of Service	95% Back of Queue Vehicles veh	Queue Distance m	Prop. Queued	Effective Stop Rate per veh	Average Speed km/h	
South: Huntmar Dr												
1	L2	61	2.0	0.056	10.1	LOS B	0.2	1.6	0.37	0.65	52.9	
2	T1	373	2.0	0.242	4.2	LOS A	1.2	8.5	0.38	0.41	56.3	
3	R2	65	2.0	0.060	4.8	LOS A	0.2	1.7	0.37	0.52	54.6	
Approach		499	2.0	0.242	5.0	LOS A	1.2	8.5	0.38	0.46	55.7	
East: Campeau Dr												
4	L2	47	2.0	0.034	10.2	LOS B	0.1	1.0	0.44	0.66	52.8	
5	T1	38	2.0	0.034	5.0	LOS A	0.1	1.0	0.46	0.50	55.7	
6	R2	4	2.0	0.004	5.3	LOS A	0.0	0.1	0.46	0.52	54.3	
Approach		89	2.0	0.034	7.7	LOS A	0.1	1.0	0.45	0.58	54.1	
North: Huntmar Dr												
7	L2	6	2.0	0.005	9.7	LOS A	0.0	0.1	0.25	0.59	53.4	
8	T1	382	2.0	0.229	3.9	LOS A	1.1	7.8	0.26	0.38	57.0	
9	R2	147	2.0	0.116	4.4	LOS A	0.5	3.5	0.26	0.47	55.1	
Approach		535	2.0	0.229	4.1	LOS A	1.1	7.8	0.26	0.41	56.4	
West: Campeau Dr												
10	L2	198	2.0	0.134	10.1	LOS B	0.6	4.4	0.42	0.67	52.7	
11	T1	94	2.0	0.084	4.8	LOS A	0.4	2.5	0.43	0.47	56.1	
12	R2	71	2.0	0.037	3.3	LOS A	0.0	0.0	0.00	0.42	56.8	
Approach		363	2.0	0.134	7.4	LOS A	0.6	4.4	0.34	0.57	54.3	
All Vehicles		1486	2.0	0.242	5.4	LOS A	1.2	8.5	0.33	0.47	55.5	

Site Level of Service (LOS) Method: Delay (SIDRA). Site LOS Method is specified in the Parameter Settings dialog (Site tab).

Roundabout LOS Method: SIDRA Roundabout LOS.

Vehicle movement LOS values are based on average delay per movement.

Intersection and Approach LOS values are based on average delay for all vehicle movements.

Roundabout Capacity Model: SIDRA Standard.

SIDRA Standard Delay Model is used. Control Delay includes Geometric Delay.

Gap-Acceptance Capacity: SIDRA Standard (Akçelik M3D).

HV (%) values are calculated for All Movement Classes of All Heavy Vehicle Model Designation.

MOVEMENT SUMMARY

 Site: 101 [Campeau / Palladium FT2021 AM]

New Site
Roundabout

Movement Performance - Vehicles											
Mov ID	OD Mov	Demand Total veh/h	Flows HV %	Deg. Satn v/c	Average Delay sec	Level of Service	95% Back of Queue Vehicles veh	Queue Distance m	Prop. Queued	Effective Stop Rate per veh	Average Speed km/h
South: Campeau Dr											
1	L2	47	2.0	0.100	9.3	LOS A	0.5	3.8	0.11	0.43	57.0
2	T1	131	2.0	0.100	3.6	LOS A	0.5	3.8	0.11	0.43	56.7
3	R2	111	2.0	0.058	3.1	LOS A	0.0	0.0	0.00	0.40	57.1
Approach		289	2.0	0.100	4.4	LOS A	0.5	3.8	0.07	0.42	56.9
East: Palladium Dr											
4	L2	187	2.0	0.077	9.8	LOS A	0.4	2.8	0.31	0.59	53.7
5	T1	19	2.0	0.077	4.1	LOS A	0.4	2.8	0.30	0.57	54.1
6	R2	17	2.0	0.077	4.2	LOS A	0.4	2.8	0.30	0.57	52.5
Approach		223	2.0	0.077	8.9	LOS A	0.4	2.8	0.31	0.59	53.6
North: Campeau Dr											
7	L2	6	2.0	0.021	9.9	LOS A	0.1	0.6	0.31	0.48	56.1
8	T1	43	2.0	0.021	4.2	LOS A	0.1	0.6	0.31	0.44	56.4
9	R2	2	2.0	0.021	4.2	LOS A	0.1	0.6	0.30	0.41	55.0
Approach		51	2.0	0.021	4.9	LOS A	0.1	0.6	0.31	0.44	56.3
West: Palladium Dr											
10	L2	1	2.0	0.018	9.8	LOS A	0.1	0.5	0.29	0.41	57.0
11	T1	22	2.0	0.018	4.1	LOS A	0.1	0.5	0.29	0.41	56.7
12	R2	21	2.0	0.016	3.9	LOS A	0.1	0.4	0.29	0.44	55.6
Approach		44	2.0	0.018	4.1	LOS A	0.1	0.5	0.29	0.42	56.2
All Vehicles		607	2.0	0.100	6.1	LOS A	0.5	3.8	0.19	0.48	55.5

Site Level of Service (LOS) Method: Delay (SIDRA). Site LOS Method is specified in the Parameter Settings dialog (Site tab).

Roundabout LOS Method: SIDRA Roundabout LOS.

Vehicle movement LOS values are based on average delay per movement.

Intersection and Approach LOS values are based on average delay for all vehicle movements.

Roundabout Capacity Model: SIDRA Standard.

SIDRA Standard Delay Model is used. Control Delay includes Geometric Delay.

Gap-Acceptance Capacity: SIDRA Standard (Akçelik M3D).

HV (%) values are calculated for All Movement Classes of All Heavy Vehicle Model Designation.

MOVEMENT SUMMARY

 Site: 101 [Campeau / Palladium FT2021 PM]

New Site
Roundabout

Movement Performance - Vehicles											
Mov ID	OD Mov	Demand Total veh/h	Flows HV %	Deg. Satn v/c	Average Delay sec	Level of Service	95% Back of Queue Vehicles veh	Queue Distance m	Prop. Queued	Effective Stop Rate per veh	Average Speed km/h
South: Campeau Dr											
1	L2	20	2.0	0.038	9.4	LOS A	0.2	1.3	0.17	0.45	56.6
2	T1	44	2.0	0.038	3.7	LOS A	0.2	1.3	0.17	0.45	56.2
3	R2	263	2.0	0.139	3.2	LOS A	0.0	0.0	0.00	0.40	57.1
Approach		327	2.0	0.139	3.6	LOS A	0.2	1.3	0.03	0.41	56.9
East: Palladium Dr											
4	L2	217	2.0	0.077	9.4	LOS A	0.4	2.8	0.18	0.58	54.0
5	T1	24	2.0	0.077	3.7	LOS A	0.4	2.8	0.18	0.57	54.2
6	R2	2	2.0	0.077	3.8	LOS A	0.4	2.8	0.18	0.57	52.5
Approach		243	2.0	0.077	8.8	LOS A	0.4	2.8	0.18	0.58	54.0
North: Campeau Dr											
7	L2	19	2.0	0.058	10.0	LOS A	0.2	1.5	0.32	0.50	56.0
8	T1	123	2.0	0.058	4.2	LOS A	0.2	1.5	0.31	0.45	56.3
9	R2	1	2.0	0.058	4.3	LOS A	0.2	1.5	0.31	0.41	54.9
Approach		143	2.0	0.058	5.0	LOS A	0.2	1.5	0.31	0.46	56.3
West: Palladium Dr											
10	L2	2	2.0	0.033	10.0	LOS B	0.1	0.8	0.34	0.44	56.7
11	T1	39	2.0	0.033	4.4	LOS A	0.1	0.8	0.34	0.44	56.4
12	R2	14	2.0	0.011	4.1	LOS A	0.0	0.3	0.33	0.46	55.5
Approach		55	2.0	0.033	4.5	LOS A	0.1	0.8	0.34	0.45	56.2
All Vehicles		768	2.0	0.139	5.6	LOS A	0.4	2.8	0.15	0.48	55.8

Site Level of Service (LOS) Method: Delay (SIDRA). Site LOS Method is specified in the Parameter Settings dialog (Site tab).

Roundabout LOS Method: SIDRA Roundabout LOS.

Vehicle movement LOS values are based on average delay per movement.

Intersection and Approach LOS values are based on average delay for all vehicle movements.

Roundabout Capacity Model: SIDRA Standard.

SIDRA Standard Delay Model is used. Control Delay includes Geometric Delay.

Gap-Acceptance Capacity: SIDRA Standard (Akçelik M3D).

HV (%) values are calculated for All Movement Classes of All Heavy Vehicle Model Designation.

Total Projected 2021 AM
1: Kanata West Centre Dr & Campeau Dr

08/27/2019



Movement	EBT	EBR	WBL	WBT	NBL	NBR
Lane Configurations						
Traffic Volume (veh/h)	21	5	18	48	3	23
Future Volume (Veh/h)	21	5	18	48	3	23
Sign Control	Free			Free	Stop	
Grade	0%			0%	0%	
Peak Hour Factor	1.00	1.00	1.00	1.00	1.00	1.00
Hourly flow rate (vph)	21	5	18	48	3	23
Pedestrians						
Lane Width (m)						
Walking Speed (m/s)						
Percent Blockage						
Right turn flare (veh)						
Median type	None		None			
Median storage veh						
Upstream signal (m)						
pX, platoon unblocked						
vC, conflicting volume			26		108	24
vC1, stage 1 conf vol						
vC2, stage 2 conf vol						
vCu, unblocked vol			26		108	24
tC, single (s)			4.1		6.4	6.2
tC, 2 stage (s)						
tF (s)			2.2		3.5	3.3
p0 queue free %			99		100	98
cM capacity (veh/h)			1588		880	1053
Direction, Lane #	EB 1	WB 1	WB 2	NB 1		
Volume Total	26	18	48	26		
Volume Left	0	18	0	3		
Volume Right	5	0	0	23		
cSH	1700	1588	1700	1030		
Volume to Capacity	0.02	0.01	0.03	0.03		
Queue Length 95th (m)	0.0	0.3	0.0	0.6		
Control Delay (s)	0.0	7.3	0.0	8.6		
Lane LOS	A		A			
Approach Delay (s)	0.0	2.0	8.6			
Approach LOS	A					
Intersection Summary						
Average Delay			3.0			
Intersection Capacity Utilization			17.7%	ICU Level of Service	A	
Analysis Period (min)			15			

Total Projected 2021 AM
3: Journeyman St & Campeau Dr

08/27/2019



Lane Group	EBL	EBT	EBR	WBL	WBT	WBR	NBL	NBR	SBL	SBR
Lane Configurations										
Traffic Volume (vph)	6	114	19	17	204	2	4	12	1	1
Future Volume (vph)	6	114	19	17	204	2	4	12	1	1
Lane Group Flow (vph)	6	114	19	17	204	2	4	12	1	1
Turn Type	Perm	NA	Perm	Perm	NA	Perm	Perm	Perm	Perm	Perm
Protected Phases		4			8					
Permitted Phases	4		4	8		8	2	2	6	6
Detector Phase	4	4	4	8	8	8	2	2	6	6
Switch Phase										
Minimum Initial (s)	10.0	10.0	10.0	10.0	10.0	10.0	10.0	10.0	10.0	10.0
Minimum Split (s)	44.5	44.5	44.5	44.5	44.5	44.5	39.8	39.8	39.8	39.8
Total Split (s)	39.0	39.0	39.0	39.0	39.0	39.0	51.0	51.0	51.0	51.0
Total Split (%)	43.3%	43.3%	43.3%	43.3%	43.3%	43.3%	56.7%	56.7%	56.7%	56.7%
Yellow Time (s)	4.2	4.2	4.2	4.2	4.2	4.2	3.3	3.3	3.3	3.3
All-Red Time (s)	2.3	2.3	2.3	2.3	2.3	2.3	3.5	3.5	3.5	3.5
Lost Time Adjust (s)	-2.8	-2.8	-2.8	-2.8	-2.8	-2.8	-2.5	-2.5	-2.5	-2.5
Total Lost Time (s)	3.7	3.7	3.7	3.7	3.7	3.7	4.3	4.3	4.3	4.3
Lead/Lag										
Lead-Lag Optimize?										
Recall Mode	None	None	None	None	None	None	Max	Max	Max	Max
Act Effect Green (s)	16.0	16.0	16.0	16.0	16.0	16.0	48.3	48.3	48.3	48.3
Actuated g/C Ratio	0.22	0.22	0.22	0.22	0.22	0.22	0.67	0.67	0.67	0.67
v/c Ratio	0.03	0.27	0.05	0.06	0.49	0.01	0.00	0.01	0.00	0.00
Control Delay	21.0	24.3	2.4	21.5	28.3	0.0	5.0	0.0	5.0	0.0
Queue Delay	0.0	0.0	0.0	0.0	0.0	0.0	0.0	0.0	0.0	0.0
Total Delay	21.0	24.3	2.4	21.5	28.3	0.0	5.0	0.0	5.0	0.0
LOS	C	C	A	C	C	A	A	A	A	A
Approach Delay		21.2			27.5					
Approach LOS		C			C					
Queue Length 50th (m)	0.6	12.5	0.0	1.8	23.5	0.0	0.2	0.0	0.0	0.0
Queue Length 95th (m)	3.3	24.6	1.7	6.2	41.1	0.0	1.2	0.0	0.5	0.0
Internal Link Dist (m)		319.9			296.6					
Turn Bay Length (m)	45.0			50.0			20.0		45.0	
Base Capacity (vph)	453	920	806	625	920	806	952	1319	952	1255
Starvation Cap Reductn	0	0	0	0	0	0	0	0	0	0
Spillback Cap Reductn	0	0	0	0	0	0	0	0	0	0
Storage Cap Reductn	0	0	0	0	0	0	0	0	0	0
Reduced v/c Ratio	0.01	0.12	0.02	0.03	0.22	0.00	0.00	0.01	0.00	0.00

Intersection Summary

Cycle Length: 90	
Actuated Cycle Length: 72.3	
Natural Cycle: 85	
Control Type: Semi Act-Uncoord	
Maximum v/c Ratio: 0.49	
Intersection Signal Delay: 24.0	Intersection LOS: C
Intersection Capacity Utilization 37.9%	ICU Level of Service A
Analysis Period (min) 15	

Splits and Phases: 3: Journeyman St & Campeau Dr



Total Projected 2021 AM
5: Palladium Dr & Cabela's Way

08/27/2019



Movement	EBL	EBR	NBL	NBT	SBT	SBR
Lane Configurations						
Traffic Volume (veh/h)	0	79	110	327	235	20
Future Volume (Veh/h)	0	79	110	327	235	20
Sign Control	Stop			Free	Free	
Grade	0%			0%	0%	
Peak Hour Factor	1.00	1.00	1.00	1.00	1.00	1.00
Hourly flow rate (vph)	0	79	110	327	235	20
Pedestrians						
Lane Width (m)						
Walking Speed (m/s)						
Percent Blockage						
Right turn flare (veh)						
Median type				None	None	
Median storage veh						
Upstream signal (m)	207					
pX, platoon unblocked						
vC, conflicting volume	628	128	255			
vC1, stage 1 conf vol						
vC2, stage 2 conf vol						
vCu, unblocked vol	628	128	255			
tC, single (s)	6.8	6.9	4.1			
tC, 2 stage (s)						
tF (s)	3.5	3.3	2.2			
p0 queue free %	100	91	92			
cM capacity (veh/h)	380	899	1307			
Direction, Lane #	EB 1	NB 1	NB 2	NB 3	SB 1	SB 2
Volume Total	79	110	164	164	157	98
Volume Left	0	110	0	0	0	0
Volume Right	79	0	0	0	0	20
cSH	899	1307	1700	1700	1700	1700
Volume to Capacity	0.09	0.08	0.10	0.10	0.09	0.06
Queue Length 95th (m)	2.2	2.1	0.0	0.0	0.0	0.0
Control Delay (s)	9.4	8.0	0.0	0.0	0.0	0.0
Lane LOS	A	A				
Approach Delay (s)	9.4	2.0	0.0			
Approach LOS	A					
Intersection Summary						
Average Delay			2.1			
Intersection Capacity Utilization			19.9%	ICU Level of Service	A	
Analysis Period (min)			15			

Total Projected 2021 AM
6: Palladium Dr & Hwy 417 WB On-Off Ramps

08/27/2019



Lane Group	WBL	WBR	NBT	SBL	SBT
Lane Configurations					
Traffic Volume (vph)	209	280	157	114	200
Future Volume (vph)	209	280	157	114	200
Lane Group Flow (vph)	209	280	157	114	200
Turn Type	Prot	Perm	NA	pm+pt	NA
Protected Phases	8		2	1	6
Permitted Phases		8		6	
Detector Phase	8	8	2	1	6
Switch Phase					
Minimum Initial (s)	10.0	10.0	10.0	5.0	10.0
Minimum Split (s)	32.7	32.7	39.0	12.0	25.0
Total Split (s)	36.7	36.7	39.0	22.0	39.0
Total Split (%)	37.6%	37.6%	39.9%	22.5%	39.9%
Yellow Time (s)	3.3	3.3	3.7	3.7	3.7
All-Red Time (s)	3.4	3.4	3.3	3.3	3.3
Lost Time Adjust (s)	-2.7	-2.7	-3.0	-3.0	-3.0
Total Lost Time (s)	4.0	4.0	4.0	4.0	4.0
Lead/Lag			Lag	Lead	
Lead-Lag Optimize?			Yes	Yes	
Recall Mode	Max	Max	Max	Max	Max
Act Effct Green (s)	32.7	32.7	35.0	57.0	57.0
Actuated g/C Ratio	0.33	0.33	0.36	0.58	0.58
v/c Ratio	0.18	0.39	0.12	0.15	0.10
Control Delay	23.5	4.6	21.4	9.6	9.1
Queue Delay	0.0	0.0	0.0	0.0	0.0
Total Delay	23.5	4.6	21.4	9.6	9.1
LOS	C	A	C	A	A
Approach Delay	12.7		21.4		9.3
Approach LOS	B		C		A
Queue Length 50th (m)	14.2	0.0	10.3	8.9	8.1
Queue Length 95th (m)	22.4	16.5	17.2	16.4	12.9
Internal Link Dist (m)	322.5		403.5		183.1
Turn Bay Length (m)		125.0		115.0	
Base Capacity (vph)	1161	722	1282	770	2088
Starvation Cap Reductn	0	0	0	0	0
Spillback Cap Reductn	0	0	0	0	0
Storage Cap Reductn	0	0	0	0	0
Reduced v/c Ratio	0.18	0.39	0.12	0.15	0.10

Intersection Summary

Cycle Length: 97.7	
Actuated Cycle Length: 97.7	
Natural Cycle: 85	
Control Type: Actuated-Uncoordinated	
Maximum v/c Ratio: 0.39	
Intersection Signal Delay: 13.0	Intersection LOS: B
Intersection Capacity Utilization 33.0%	ICU Level of Service A
Analysis Period (min) 15	

Total Projected 2021 AM
6: Palladium Dr & Hwy 417 WB On-Off Ramps

08/27/2019

Splits and Phases: 6: Palladium Dr & Hwy 417 WB On-Off Ramps

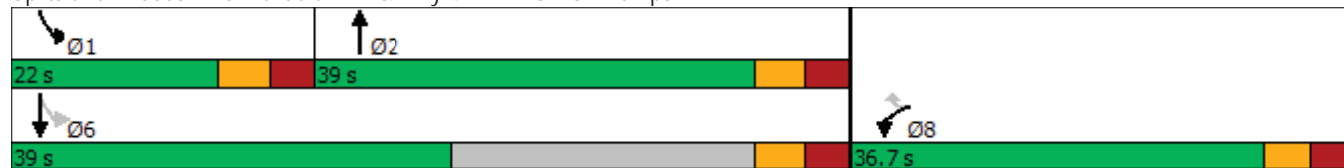

Total Projected 2021 AM
7: Palladium Dr & Hwy 417 EB Off Ramp

08/27/2019



Movement	EBL	EBR	NBL	NBT	SBT	SBR
Lane Configurations	↙	↙		↑↑	↑↑	
Traffic Volume (veh/h)	86	261	0	72	376	30
Future Volume (Veh/h)	86	261	0	72	376	30
Sign Control	Stop			Free	Free	
Grade	0%			0%	0%	
Peak Hour Factor	1.00	1.00	1.00	1.00	1.00	1.00
Hourly flow rate (vph)	86	261	0	72	376	30
Pedestrians						
Lane Width (m)						
Walking Speed (m/s)						
Percent Blockage						
Right turn flare (veh)	3					
Median type				None	None	
Median storage veh						
Upstream signal (m)						
pX, platoon unblocked						
vC, conflicting volume	427	203	406			
vC1, stage 1 conf vol						
vC2, stage 2 conf vol						
vCu, unblocked vol	427	203	406			
tC, single (s)	6.8	6.9	4.1			
tC, 2 stage (s)						
tF (s)	3.5	3.3	2.2			
p0 queue free %	85	68	100			
cM capacity (veh/h)	556	804	1149			
Direction, Lane #	EB 1	NB 1	NB 2	SB 1	SB 2	
Volume Total	347	36	36	251	155	
Volume Left	86	0	0	0	0	
Volume Right	261	0	0	0	30	
cSH	1069	1700	1700	1700	1700	
Volume to Capacity	0.32	0.02	0.02	0.15	0.09	
Queue Length 95th (m)	10.8	0.0	0.0	0.0	0.0	
Control Delay (s)	11.9	0.0	0.0	0.0	0.0	
Lane LOS	B					
Approach Delay (s)	11.9	0.0		0.0		
Approach LOS	B					
Intersection Summary						
Average Delay	5.0					
Intersection Capacity Utilization	34.2%			ICU Level of Service	A	
Analysis Period (min)	15					

Total Projected 2021 AM
8: Palladium Dr & Upper Canada St

08/27/2019



Movement	EBL	EBT	EBR	WBL	WBT	WBR	NBL	NBT	NBR	SBL	SBT	SBR
Lane Configurations		↕			↕			↕			↕	
Sign Control		Stop			Stop			Stop			Stop	
Traffic Volume (vph)	0	2	2	0	11	0	11	0	0	0	0	0
Future Volume (vph)	0	2	2	0	11	0	11	0	0	0	0	0
Peak Hour Factor	1.00	1.00	1.00	1.00	1.00	1.00	1.00	1.00	1.00	1.00	1.00	1.00
Hourly flow rate (vph)	0	2	2	0	11	0	11	0	0	0	0	0

Direction, Lane #	EB 1	WB 1	NB 1	SB 1
Volume Total (vph)	4	11	11	0
Volume Left (vph)	0	0	11	0
Volume Right (vph)	2	0	0	0
Hadj (s)	-0.27	0.03	0.23	0.00
Departure Headway (s)	3.7	4.0	4.2	3.9
Degree Utilization, x	0.00	0.01	0.01	0.00
Capacity (veh/h)	970	901	848	900
Control Delay (s)	6.7	7.0	7.2	6.9
Approach Delay (s)	6.7	7.0	7.2	0.0
Approach LOS	A	A	A	A

Intersection Summary			
Delay		7.0	
Level of Service		A	
Intersection Capacity Utilization	13.3%	ICU Level of Service	A
Analysis Period (min)	15		

Total Projected 2021 AM
9: Access 1 & Upper Canada St

08/27/2019



Movement	EBT	EBR	WBL	WBT	NBL	NBR
Lane Configurations	↻			↻	↻	
Traffic Volume (veh/h)	0	0	11	0	0	2
Future Volume (Veh/h)	0	0	11	0	0	2
Sign Control	Free			Free	Stop	
Grade	0%			0%	0%	
Peak Hour Factor	1.00	1.00	1.00	1.00	1.00	1.00
Hourly flow rate (vph)	0	0	11	0	0	2
Pedestrians						
Lane Width (m)						
Walking Speed (m/s)						
Percent Blockage						
Right turn flare (veh)						
Median type	None			None		
Median storage (veh)						
Upstream signal (m)						
pX, platoon unblocked						
vC, conflicting volume			0	22	0	
vC1, stage 1 conf vol						
vC2, stage 2 conf vol						
vCu, unblocked vol			0	22	0	
tC, single (s)			4.1	6.4	6.2	
tC, 2 stage (s)						
tF (s)			2.2	3.5	3.3	
p0 queue free %			99	100	100	
cM capacity (veh/h)			1623	988	1085	
Direction, Lane #	EB 1	WB 1	NB 1			
Volume Total	0	11	2			
Volume Left	0	11	0			
Volume Right	0	0	2			
cSH	1700	1623	1085			
Volume to Capacity	0.00	0.01	0.00			
Queue Length 95th (m)	0.0	0.2	0.0			
Control Delay (s)	0.0	7.2	8.3			
Lane LOS			A	A		
Approach Delay (s)	0.0	7.2	8.3			
Approach LOS			A	A		
Intersection Summary						
Average Delay			7.4			
Intersection Capacity Utilization			13.3%	ICU Level of Service	A	
Analysis Period (min)			15			

Total Projected 2021 AM
10: Access 2 & Upper Canada St

08/27/2019



Movement	EBT	EBR	WBL	WBT	NBL	NBR
Lane Configurations	↔			↔	↔	
Traffic Volume (veh/h)	2	0	11	11	0	2
Future Volume (Veh/h)	2	0	11	11	0	2
Sign Control	Free		Free		Stop	
Grade	0%		0%		0%	
Peak Hour Factor	1.00	1.00	1.00	1.00	1.00	1.00
Hourly flow rate (vph)	2	0	11	11	0	2
Pedestrians						
Lane Width (m)						
Walking Speed (m/s)						
Percent Blockage						
Right turn flare (veh)						
Median type	None		None			
Median storage veh						
Upstream signal (m)						
pX, platoon unblocked						
vC, conflicting volume			2		35	2
vC1, stage 1 conf vol						
vC2, stage 2 conf vol						
vCu, unblocked vol			2		35	2
tC, single (s)			4.1		6.4	6.2
tC, 2 stage (s)						
tF (s)			2.2		3.5	3.3
p0 queue free %			99		100	100
cM capacity (veh/h)			1620		971	1082
Direction, Lane #	EB 1	WB 1	NB 1			
Volume Total	2	22	2			
Volume Left	0	11	0			
Volume Right	0	0	2			
cSH	1700	1620	1082			
Volume to Capacity	0.00	0.01	0.00			
Queue Length 95th (m)	0.0	0.2	0.0			
Control Delay (s)	0.0	3.6	8.3			
Lane LOS		A	A			
Approach Delay (s)	0.0	3.6	8.3			
Approach LOS			A			
Intersection Summary						
Average Delay			3.7			
Intersection Capacity Utilization			17.9%	ICU Level of Service	A	
Analysis Period (min)			15			

Total Projected 2021 AM
 11: Palladium Dr & Access 3/8600 Campeau

08/27/2019



Movement	EBL	EBT	EBR	WBL	WBT	WBR	NBL	NBT	NBR	SBL	SBT	SBR
Lane Configurations		↕			↕			↕			↕	
Traffic Volume (veh/h)	0	0	17	11	0	0	89	11	26	0	2	0
Future Volume (Veh/h)	0	0	17	11	0	0	89	11	26	0	2	0
Sign Control		Stop			Stop			Free			Free	
Grade		0%			0%			0%			0%	
Peak Hour Factor	1.00	1.00	1.00	1.00	1.00	1.00	1.00	1.00	1.00	1.00	1.00	1.00
Hourly flow rate (vph)	0	0	17	11	0	0	89	11	26	0	2	0
Pedestrians												
Lane Width (m)												
Walking Speed (m/s)												
Percent Blockage												
Right turn flare (veh)												
Median type												
Median storage veh												
Upstream signal (m)												
pX, platoon unblocked												
vC, conflicting volume	204	217	2	221	204	24	2			37		
vC1, stage 1 conf vol												
vC2, stage 2 conf vol												
vCu, unblocked vol	204	217	2	221	204	24	2			37		
tC, single (s)	7.1	6.5	6.2	7.1	6.5	6.2	4.1			4.1		
tC, 2 stage (s)												
tF (s)	3.5	4.0	3.3	3.5	4.0	3.3	2.2			2.2		
p0 queue free %	100	100	98	98	100	100	95			100		
cM capacity (veh/h)	722	644	1082	693	654	1052	1620			1574		
Direction, Lane #	EB 1	WB 1	NB 1	SB 1								
Volume Total	17	11	126	2								
Volume Left	0	11	89	0								
Volume Right	17	0	26	0								
cSH	1082	693	1620	1574								
Volume to Capacity	0.02	0.02	0.05	0.00								
Queue Length 95th (m)	0.4	0.4	1.3	0.0								
Control Delay (s)	8.4	10.3	5.3	0.0								
Lane LOS	A	B	A									
Approach Delay (s)	8.4	10.3	5.3	0.0								
Approach LOS	A	B										
Intersection Summary												
Average Delay			5.9									
Intersection Capacity Utilization			27.7%		ICU Level of Service					A		
Analysis Period (min)			15									

Total Projected 2021 PM
1: Kanata West Centre Dr & Campeau Dr

08/27/2019



Movement	EBT	EBR	WBL	WBT	NBL	NBR
Lane Configurations						
Traffic Volume (veh/h)	18	1	12	36	2	37
Future Volume (Veh/h)	18	1	12	36	2	37
Sign Control	Free			Free	Stop	
Grade	0%			0%	0%	
Peak Hour Factor	1.00	1.00	1.00	1.00	1.00	1.00
Hourly flow rate (vph)	18	1	12	36	2	37
Pedestrians						
Lane Width (m)						
Walking Speed (m/s)						
Percent Blockage						
Right turn flare (veh)						
Median type	None		None			
Median storage veh						
Upstream signal (m)						
pX, platoon unblocked						
vC, conflicting volume			19		78	18
vC1, stage 1 conf vol						
vC2, stage 2 conf vol						
vCu, unblocked vol			19		78	18
tC, single (s)			4.1		6.4	6.2
tC, 2 stage (s)						
tF (s)			2.2		3.5	3.3
p0 queue free %			99		100	97
cM capacity (veh/h)			1597		917	1060
Direction, Lane #	EB 1	WB 1	WB 2	NB 1		
Volume Total	19	12	36	39		
Volume Left	0	12	0	2		
Volume Right	1	0	0	37		
cSH	1700	1597	1700	1051		
Volume to Capacity	0.01	0.01	0.02	0.04		
Queue Length 95th (m)	0.0	0.2	0.0	0.9		
Control Delay (s)	0.0	7.3	0.0	8.6		
Lane LOS	A		A			
Approach Delay (s)	0.0	1.8	8.6			
Approach LOS	A					
Intersection Summary						
Average Delay			4.0			
Intersection Capacity Utilization			17.3%	ICU Level of Service	A	
Analysis Period (min)	15					

Total Projected 2021 PM
3: Journeyman St & Campeau Dr

08/27/2019



Lane Group	EBL	EBT	EBR	WBL	WBT	WBR	NBL	NBR	SBL	SBR
Lane Configurations										
Traffic Volume (vph)	11	239	15	74	143	2	41	68	3	4
Future Volume (vph)	11	239	15	74	143	2	41	68	3	4
Lane Group Flow (vph)	11	239	15	74	143	2	41	68	3	4
Turn Type	Perm	NA	Perm	Perm	NA	Perm	Perm	Perm	Perm	Perm
Protected Phases		4			8					
Permitted Phases	4		4	8		8	2	2	6	6
Detector Phase	4	4	4	8	8	8	2	2	6	6
Switch Phase										
Minimum Initial (s)	10.0	10.0	10.0	10.0	10.0	10.0	10.0	10.0	10.0	10.0
Minimum Split (s)	44.5	44.5	44.5	44.5	44.5	44.5	39.8	39.8	39.8	39.8
Total Split (s)	39.0	39.0	39.0	39.0	39.0	39.0	51.0	51.0	51.0	51.0
Total Split (%)	43.3%	43.3%	43.3%	43.3%	43.3%	43.3%	56.7%	56.7%	56.7%	56.7%
Yellow Time (s)	4.2	4.2	4.2	4.2	4.2	4.2	3.3	3.3	3.3	3.3
All-Red Time (s)	2.3	2.3	2.3	2.3	2.3	2.3	3.5	3.5	3.5	3.5
Lost Time Adjust (s)	-2.8	-2.8	-2.8	-2.8	-2.8	-2.8	-2.5	-2.5	-2.5	-2.5
Total Lost Time (s)	3.7	3.7	3.7	3.7	3.7	3.7	4.3	4.3	4.3	4.3
Lead/Lag										
Lead-Lag Optimize?										
Recall Mode	None	None	None	None	None	None	Max	Max	Max	Max
Act Effct Green (s)	17.2	17.2	17.2	17.2	17.2	17.2	47.1	47.1	47.1	47.1
Actuated g/C Ratio	0.24	0.24	0.24	0.24	0.24	0.24	0.65	0.65	0.65	0.65
v/c Ratio	0.04	0.53	0.04	0.37	0.32	0.00	0.04	0.06	0.00	0.00
Control Delay	20.6	28.5	0.8	28.6	24.4	0.0	5.6	0.1	5.7	0.0
Queue Delay	0.0	0.0	0.0	0.0	0.0	0.0	0.0	0.0	0.0	0.0
Total Delay	20.6	28.5	0.8	28.6	24.4	0.0	5.6	0.1	5.7	0.0
LOS	C	C	A	C	C	A	A	A	A	A
Approach Delay		26.6			25.6					
Approach LOS		C			C					
Queue Length 50th (m)	1.2	28.1	0.0	8.4	15.9	0.0	1.7	0.0	0.2	0.0
Queue Length 95th (m)	4.6	47.6	0.6	19.5	29.5	0.0	5.7	0.0	1.1	0.0
Internal Link Dist (m)		319.9			296.6					
Turn Bay Length (m)	45.0			50.0			20.0		45.0	
Base Capacity (vph)	575	920	806	406	920	806	928	1216	928	1281
Starvation Cap Reductn	0	0	0	0	0	0	0	0	0	0
Spillback Cap Reductn	0	0	0	0	0	0	0	0	0	0
Storage Cap Reductn	0	0	0	0	0	0	0	0	0	0
Reduced v/c Ratio	0.02	0.26	0.02	0.18	0.16	0.00	0.04	0.06	0.00	0.00

Intersection Summary

Cycle Length: 90	
Actuated Cycle Length: 72.3	
Natural Cycle: 85	
Control Type: Semi Act-Uncoord	
Maximum v/c Ratio: 0.53	
Intersection Signal Delay: 21.5	Intersection LOS: C
Intersection Capacity Utilization 40.1%	ICU Level of Service A
Analysis Period (min) 15	

Splits and Phases: 3: Journeyman St & Campeau Dr

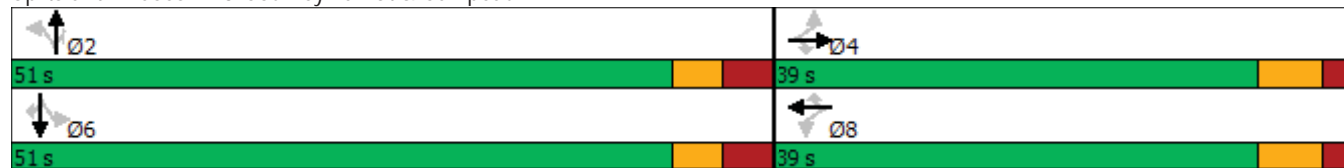

Total Projected 2021 PM
5: Palladium Dr & Cabela's Way

08/27/2019



Movement	EBL	EBR	NBL	NBT	SBT	SBR
Lane Configurations						
Traffic Volume (veh/h)	0	144	130	413	401	34
Future Volume (Veh/h)	0	144	130	413	401	34
Sign Control	Stop			Free	Free	
Grade	0%			0%	0%	
Peak Hour Factor	1.00	1.00	1.00	1.00	1.00	1.00
Hourly flow rate (vph)	0	144	130	413	401	34
Pedestrians						
Lane Width (m)						
Walking Speed (m/s)						
Percent Blockage						
Right turn flare (veh)						
Median type				None	None	
Median storage veh						
Upstream signal (m)				207		
pX, platoon unblocked						
vC, conflicting volume	884	218	435			
vC1, stage 1 conf vol						
vC2, stage 2 conf vol						
vCu, unblocked vol	884	218	435			
tC, single (s)	6.8	6.9	4.1			
tC, 2 stage (s)						
tF (s)	3.5	3.3	2.2			
p0 queue free %	100	82	88			
cM capacity (veh/h)	252	787	1121			
Direction, Lane #	EB 1	NB 1	NB 2	NB 3	SB 1	SB 2
Volume Total	144	130	206	206	267	168
Volume Left	0	130	0	0	0	0
Volume Right	144	0	0	0	0	34
cSH	787	1121	1700	1700	1700	1700
Volume to Capacity	0.18	0.12	0.12	0.12	0.16	0.10
Queue Length 95th (m)	5.1	3.0	0.0	0.0	0.0	0.0
Control Delay (s)	10.6	8.6	0.0	0.0	0.0	0.0
Lane LOS	B	A				
Approach Delay (s)	10.6	2.1			0.0	
Approach LOS	B					
Intersection Summary						
Average Delay			2.4			
Intersection Capacity Utilization			27.8%	ICU Level of Service		A
Analysis Period (min)			15			

Total Projected 2021 PM
6: Palladium Dr & Hwy 417 WB On-Off Ramps

08/27/2019



Lane Group	WBL	WBR	NBT	SBL	SBT
Lane Configurations					
Traffic Volume (vph)	412	359	183	233	312
Future Volume (vph)	412	359	183	233	312
Lane Group Flow (vph)	412	359	183	233	312
Turn Type	Prot	Perm	NA	pm+pt	NA
Protected Phases	8		2	1	6
Permitted Phases		8		6	
Detector Phase	8	8	2	1	6
Switch Phase					
Minimum Initial (s)	10.0	10.0	10.0	5.0	10.0
Minimum Split (s)	32.7	32.7	39.0	12.0	25.0
Total Split (s)	36.7	36.7	39.0	22.0	39.0
Total Split (%)	37.6%	37.6%	39.9%	22.5%	39.9%
Yellow Time (s)	3.3	3.3	3.7	3.7	3.7
All-Red Time (s)	3.4	3.4	3.3	3.3	3.3
Lost Time Adjust (s)	-2.7	-2.7	-3.0	-3.0	-3.0
Total Lost Time (s)	4.0	4.0	4.0	4.0	4.0
Lead/Lag			Lag	Lead	
Lead-Lag Optimize?			Yes	Yes	
Recall Mode	Max	Max	Max	Max	Max
Act Effct Green (s)	32.7	32.7	35.0	57.0	57.0
Actuated g/C Ratio	0.33	0.33	0.36	0.58	0.58
v/c Ratio	0.35	0.46	0.14	0.31	0.15
Control Delay	25.6	4.8	21.6	11.0	9.5
Queue Delay	0.0	0.0	0.0	0.0	0.0
Total Delay	25.6	4.8	21.6	11.0	9.5
LOS	C	A	C	B	A
Approach Delay	15.9		21.6		10.1
Approach LOS	B		C		B
Queue Length 50th (m)	30.0	0.0	12.1	19.6	13.1
Queue Length 95th (m)	42.3	18.3	19.5	31.5	19.3
Internal Link Dist (m)	322.5		403.5		183.1
Turn Bay Length (m)		125.0		115.0	
Base Capacity (vph)	1161	774	1282	758	2088
Starvation Cap Reductn	0	0	0	0	0
Spillback Cap Reductn	0	0	0	0	0
Storage Cap Reductn	0	0	0	0	0
Reduced v/c Ratio	0.35	0.46	0.14	0.31	0.15

Intersection Summary

Cycle Length: 97.7
 Actuated Cycle Length: 97.7
 Natural Cycle: 85
 Control Type: Actuated-Uncoordinated
 Maximum v/c Ratio: 0.46
 Intersection Signal Delay: 14.5
 Intersection Capacity Utilization 43.0%
 Analysis Period (min) 15
 Intersection LOS: B
 ICU Level of Service A

Total Projected 2021 PM
6: Palladium Dr & Hwy 417 WB On-Off Ramps

08/27/2019

Splits and Phases: 6: Palladium Dr & Hwy 417 WB On-Off Ramps

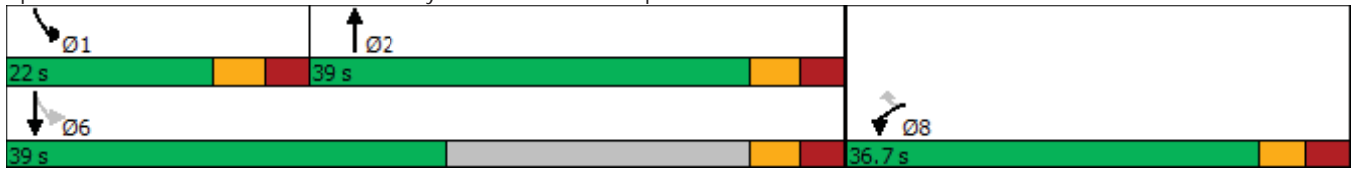

Total Projected 2021 PM
7: Palladium Dr & Hwy 417 EB Off Ramp

08/27/2019



Movement	EBL	EBR	NBL	NBT	SBT	SBR
Lane Configurations						
Traffic Volume (veh/h)	105	155	0	469	694	14
Future Volume (Veh/h)	105	155	0	469	694	14
Sign Control	Stop			Free	Free	
Grade	0%			0%	0%	
Peak Hour Factor	1.00	1.00	1.00	1.00	1.00	1.00
Hourly flow rate (vph)	105	155	0	469	694	14
Pedestrians						
Lane Width (m)						
Walking Speed (m/s)						
Percent Blockage						
Right turn flare (veh)	3					
Median type				None	None	
Median storage veh						
Upstream signal (m)						
pX, platoon unblocked						
vC, conflicting volume	936	354	708			
vC1, stage 1 conf vol						
vC2, stage 2 conf vol						
vCu, unblocked vol	936	354	708			
tC, single (s)	6.8	6.9	4.1			
tC, 2 stage (s)						
tF (s)	3.5	3.3	2.2			
p0 queue free %	60	76	100			
cM capacity (veh/h)	264	642	887			
Direction, Lane #	EB 1	NB 1	NB 2	SB 1	SB 2	
Volume Total	260	234	234	463	245	
Volume Left	105	0	0	0	0	
Volume Right	155	0	0	0	14	
cSH	653	1700	1700	1700	1700	
Volume to Capacity	0.40	0.14	0.14	0.27	0.14	
Queue Length 95th (m)	14.5	0.0	0.0	0.0	0.0	
Control Delay (s)	18.4	0.0	0.0	0.0	0.0	
Lane LOS	C					
Approach Delay (s)	18.4	0.0		0.0		
Approach LOS	C					
Intersection Summary						
Average Delay	3.3					
Intersection Capacity Utilization	35.9%			ICU Level of Service	A	
Analysis Period (min)	15					

Total Projected 2021 PM
8: Palladium Dr & Upper Canada St

08/27/2019



Movement	EBL	EBT	EBR	WBL	WBT	WBR	NBL	NBT	NBR	SBL	SBT	SBR
Lane Configurations		↕			↕			↕			↕	
Sign Control		Stop			Stop			Stop			Stop	
Traffic Volume (vph)	0	11	11	0	2	0	2	0	0	0	0	0
Future Volume (vph)	0	11	11	0	2	0	2	0	0	0	0	0
Peak Hour Factor	1.00	1.00	1.00	1.00	1.00	1.00	1.00	1.00	1.00	1.00	1.00	1.00
Hourly flow rate (vph)	0	11	11	0	2	0	2	0	0	0	0	0
Direction, Lane #	EB 1	WB 1	NB 1	SB 1								
Volume Total (vph)	22	2	2	0								
Volume Left (vph)	0	0	2	0								
Volume Right (vph)	11	0	0	0								
Hadj (s)	-0.27	0.03	0.23	0.00								
Departure Headway (s)	3.6	4.0	4.2	3.9								
Degree Utilization, x	0.02	0.00	0.00	0.00								
Capacity (veh/h)	981	903	843	900								
Control Delay (s)	6.7	7.0	7.2	6.9								
Approach Delay (s)	6.7	7.0	7.2	0.0								
Approach LOS	A	A	A	A								
Intersection Summary												
Delay			6.8									
Level of Service			A									
Intersection Capacity Utilization			13.3%	ICU Level of Service								A
Analysis Period (min)			15									

Total Projected 2021 PM
9: Access 1 & Upper Canada St

08/27/2019



Movement	EBT	EBR	WBL	WBT	NBL	NBR
Lane Configurations						
Traffic Volume (veh/h)	0	0	2	0	0	11
Future Volume (Veh/h)	0	0	2	0	0	11
Sign Control	Free			Free	Stop	
Grade	0%			0%	0%	
Peak Hour Factor	1.00	1.00	1.00	1.00	1.00	1.00
Hourly flow rate (vph)	0	0	2	0	0	11
Pedestrians						
Lane Width (m)						
Walking Speed (m/s)						
Percent Blockage						
Right turn flare (veh)						
Median type	None		None			
Median storage veh						
Upstream signal (m)						
pX, platoon unblocked						
vC, conflicting volume			0		4	0
vC1, stage 1 conf vol						
vC2, stage 2 conf vol						
vCu, unblocked vol			0		4	0
tC, single (s)			4.1		6.4	6.2
tC, 2 stage (s)						
tF (s)			2.2		3.5	3.3
p0 queue free %			100		100	99
cM capacity (veh/h)			1623		1017	1085
Direction, Lane #	EB 1	WB 1	NB 1			
Volume Total	0	2	11			
Volume Left	0	2	0			
Volume Right	0	0	11			
cSH	1700	1623	1085			
Volume to Capacity	0.00	0.00	0.01			
Queue Length 95th (m)	0.0	0.0	0.2			
Control Delay (s)	0.0	7.2	8.4			
Lane LOS			A			
Approach Delay (s)	0.0	7.2	8.4			
Approach LOS			A			
Intersection Summary						
Average Delay			8.2			
Intersection Capacity Utilization			13.3%	ICU Level of Service		A
Analysis Period (min)			15			

Total Projected 2021 PM
10: Access 2 & Upper Canada St

08/27/2019



Movement	EBT	EBR	WBL	WBT	NBL	NBR
Lane Configurations	↔			↔	↔	
Traffic Volume (veh/h)	11	0	2	2	0	11
Future Volume (Veh/h)	11	0	2	2	0	11
Sign Control	Free			Free	Stop	
Grade	0%			0%	0%	
Peak Hour Factor	1.00	1.00	1.00	1.00	1.00	1.00
Hourly flow rate (vph)	11	0	2	2	0	11
Pedestrians						
Lane Width (m)						
Walking Speed (m/s)						
Percent Blockage						
Right turn flare (veh)						
Median type	None			None		
Median storage veh						
Upstream signal (m)						
pX, platoon unblocked						
vC, conflicting volume			11		17	11
vC1, stage 1 conf vol						
vC2, stage 2 conf vol						
vCu, unblocked vol			11		17	11
tC, single (s)			4.1		6.4	6.2
tC, 2 stage (s)						
tF (s)			2.2		3.5	3.3
p0 queue free %			100		100	99
cM capacity (veh/h)			1608		1000	1070
Direction, Lane #	EB 1	WB 1	NB 1			
Volume Total	11	4	11			
Volume Left	0	2	0			
Volume Right	0	0	11			
cSH	1700	1608	1070			
Volume to Capacity	0.01	0.00	0.01			
Queue Length 95th (m)	0.0	0.0	0.2			
Control Delay (s)	0.0	3.6	8.4			
Lane LOS		A	A			
Approach Delay (s)	0.0	3.6	8.4			
Approach LOS			A			
Intersection Summary						
Average Delay			4.1			
Intersection Capacity Utilization			13.3%	ICU Level of Service		A
Analysis Period (min)			15			

Total Projected 2021 PM
 11: Palladium Dr & Access 3/8600 Campeau

08/27/2019



Movement	EBL	EBT	EBR	WBL	WBT	WBR	NBL	NBT	NBR	SBL	SBT	SBR
Lane Configurations		↕			↕			↕			↕	
Traffic Volume (veh/h)	0	0	86	15	0	0	17	2	26	0	11	0
Future Volume (Veh/h)	0	0	86	15	0	0	17	2	26	0	11	0
Sign Control		Stop			Stop			Free			Free	
Grade		0%			0%			0%			0%	
Peak Hour Factor	1.00	1.00	1.00	1.00	1.00	1.00	1.00	1.00	1.00	1.00	1.00	1.00
Hourly flow rate (vph)	0	0	86	15	0	0	17	2	26	0	11	0
Pedestrians												
Lane Width (m)												
Walking Speed (m/s)												
Percent Blockage												
Right turn flare (veh)												
Median type												
Median storage veh												
Upstream signal (m)												
pX, platoon unblocked												
vC, conflicting volume	60	73	11	146	60	15	11			28		
vC1, stage 1 conf vol												
vC2, stage 2 conf vol												
vCu, unblocked vol	60	73	11	146	60	15	11			28		
tC, single (s)	7.1	6.5	6.2	7.1	6.5	6.2	4.1			4.1		
tC, 2 stage (s)												
tF (s)	3.5	4.0	3.3	3.5	4.0	3.3	2.2			2.2		
p0 queue free %	100	100	92	98	100	100	99			100		
cM capacity (veh/h)	928	809	1070	750	822	1065	1608			1585		
Direction, Lane #	EB 1	WB 1	NB 1	SB 1								
Volume Total	86	15	45	11								
Volume Left	0	15	17	0								
Volume Right	86	0	26	0								
cSH	1070	750	1608	1585								
Volume to Capacity	0.08	0.02	0.01	0.00								
Queue Length 95th (m)	2.0	0.5	0.2	0.0								
Control Delay (s)	8.7	9.9	2.8	0.0								
Lane LOS	A	A	A									
Approach Delay (s)	8.7	9.9	2.8	0.0								
Approach LOS	A	A										
Intersection Summary												
Average Delay			6.5									
Intersection Capacity Utilization			23.5%		ICU Level of Service				A			
Analysis Period (min)			15									

Total Projected 2026

MOVEMENT SUMMARY

 Site: 101 [Huntmar / Campeau FT2026 AM]

New Site
Roundabout

Movement Performance - Vehicles												
Mov ID	OD Mov	Demand Total veh/h	Flows HV %	Deg. Satn v/c	Average Delay sec	Level of Service	95% Back of Queue Vehicles veh	of Queue Distance m	Prop. Queued	Effective Stop Rate per veh	Average Speed km/h	
South: Huntmar Dr												
1	L2	30	2.0	0.025	9.6	LOS A	0.1	0.7	0.22	0.60	53.5	
2	T1	351	2.0	0.206	3.8	LOS A	1.0	7.3	0.22	0.37	57.2	
3	R2	30	2.0	0.025	4.2	LOS A	0.1	0.7	0.22	0.44	55.2	
Approach		411	2.0	0.206	4.2	LOS A	1.0	7.3	0.22	0.39	56.8	
East: Campeau Dr												
4	L2	67	2.0	0.057	10.4	LOS B	0.2	1.6	0.41	0.67	52.8	
5	T1	69	2.0	0.047	4.4	LOS A	0.2	1.4	0.38	0.43	56.3	
6	R2	15	2.0	0.014	5.2	LOS A	0.1	0.4	0.41	0.52	54.5	
Approach		151	2.0	0.057	7.1	LOS A	0.2	1.6	0.40	0.54	54.5	
North: Huntmar Dr												
7	L2	2	2.0	0.002	9.7	LOS A	0.0	0.0	0.27	0.58	53.3	
8	T1	319	2.0	0.194	3.9	LOS A	0.9	6.4	0.27	0.38	57.0	
9	R2	129	2.0	0.102	4.4	LOS A	0.4	3.0	0.28	0.48	55.0	
Approach		450	2.0	0.194	4.1	LOS A	0.9	6.4	0.27	0.41	56.4	
West: Campeau Dr												
10	L2	79	2.0	0.052	9.9	LOS A	0.2	1.6	0.37	0.64	52.9	
11	T1	23	2.0	0.021	4.6	LOS A	0.1	0.6	0.39	0.45	56.3	
12	R2	33	2.0	0.017	3.3	LOS A	0.0	0.0	0.00	0.42	56.8	
Approach		135	2.0	0.052	7.4	LOS A	0.2	1.6	0.28	0.55	54.4	
All Vehicles		1147	2.0	0.206	4.9	LOS A	1.0	7.3	0.27	0.44	56.0	

Site Level of Service (LOS) Method: Delay (SIDRA). Site LOS Method is specified in the Parameter Settings dialog (Site tab).

Roundabout LOS Method: SIDRA Roundabout LOS.

Vehicle movement LOS values are based on average delay per movement.

Intersection and Approach LOS values are based on average delay for all vehicle movements.

Roundabout Capacity Model: SIDRA Standard.

SIDRA Standard Delay Model is used. Control Delay includes Geometric Delay.

Gap-Acceptance Capacity: SIDRA Standard (Akçelik M3D).

HV (%) values are calculated for All Movement Classes of All Heavy Vehicle Model Designation.

MOVEMENT SUMMARY

 Site: 101 [Huntmar / Campeau FT2026 PM]

New Site
Roundabout

Movement Performance - Vehicles												
Mov ID	OD Mov	Demand Total veh/h	Flows HV %	Deg. Satn v/c	Average Delay sec	Level of Service	95% Back of Queue Vehicles veh	Queue Distance m	Prop. Queued	Effective Stop Rate per veh	Average Speed km/h	
South: Huntmar Dr												
1	L2	64	2.0	0.059	10.2	LOS B	0.2	1.7	0.38	0.65	52.9	
2	T1	391	2.0	0.255	4.2	LOS A	1.3	9.1	0.39	0.42	56.3	
3	R2	66	2.0	0.061	4.8	LOS A	0.2	1.8	0.38	0.53	54.6	
Approach		521	2.0	0.255	5.0	LOS A	1.3	9.1	0.39	0.46	55.6	
East: Campeau Dr												
4	L2	49	2.0	0.036	10.2	LOS B	0.1	1.1	0.45	0.66	52.7	
5	T1	39	2.0	0.036	5.0	LOS A	0.1	1.1	0.47	0.50	55.7	
6	R2	4	2.0	0.004	5.4	LOS A	0.0	0.1	0.47	0.52	54.3	
Approach		92	2.0	0.036	7.8	LOS A	0.1	1.1	0.46	0.59	54.0	
North: Huntmar Dr												
7	L2	6	2.0	0.005	9.7	LOS A	0.0	0.1	0.25	0.59	53.3	
8	T1	401	2.0	0.241	3.9	LOS A	1.2	8.4	0.27	0.38	57.0	
9	R2	154	2.0	0.122	4.4	LOS A	0.5	3.7	0.27	0.47	55.0	
Approach		561	2.0	0.241	4.1	LOS A	1.2	8.4	0.27	0.41	56.4	
West: Campeau Dr												
10	L2	207	2.0	0.142	10.2	LOS B	0.7	4.8	0.43	0.67	52.7	
11	T1	96	2.0	0.087	4.9	LOS A	0.4	2.6	0.44	0.48	56.0	
12	R2	74	2.0	0.039	3.3	LOS A	0.0	0.0	0.00	0.42	56.8	
Approach		377	2.0	0.142	7.5	LOS A	0.7	4.8	0.35	0.57	54.3	
All Vehicles		1551	2.0	0.255	5.5	LOS A	1.3	9.1	0.34	0.48	55.5	

Site Level of Service (LOS) Method: Delay (SIDRA). Site LOS Method is specified in the Parameter Settings dialog (Site tab).

Roundabout LOS Method: SIDRA Roundabout LOS.

Vehicle movement LOS values are based on average delay per movement.

Intersection and Approach LOS values are based on average delay for all vehicle movements.

Roundabout Capacity Model: SIDRA Standard.

SIDRA Standard Delay Model is used. Control Delay includes Geometric Delay.

Gap-Acceptance Capacity: SIDRA Standard (Akçelik M3D).

HV (%) values are calculated for All Movement Classes of All Heavy Vehicle Model Designation.

MOVEMENT SUMMARY

 Site: 101 [Campeau / Palladium FT2026 AM]

New Site
Roundabout

Movement Performance - Vehicles											
Mov ID	OD Mov	Demand Total veh/h	Flows HV %	Deg. Satn v/c	Average Delay sec	Level of Service	95% Back of Queue Vehicles veh	Queue Distance m	Prop. Queued	Effective Stop Rate per veh	Average Speed km/h
South: Campeau Dr											
1	L2	49	2.0	0.102	9.3	LOS A	0.5	3.9	0.12	0.44	57.0
2	T1	132	2.0	0.102	3.6	LOS A	0.5	3.9	0.12	0.44	56.6
3	R2	116	2.0	0.061	3.1	LOS A	0.0	0.0	0.00	0.40	57.1
Approach		297	2.0	0.102	4.4	LOS A	0.5	3.9	0.07	0.42	56.9
East: Palladium Dr											
4	L2	192	2.0	0.080	9.9	LOS A	0.4	2.9	0.32	0.59	53.7
5	T1	20	2.0	0.080	4.1	LOS A	0.4	2.9	0.30	0.57	54.1
6	R2	17	2.0	0.080	4.2	LOS A	0.4	2.9	0.30	0.57	52.4
Approach		229	2.0	0.080	8.9	LOS A	0.4	2.9	0.31	0.59	53.6
North: Campeau Dr											
7	L2	6	2.0	0.021	9.9	LOS A	0.1	0.6	0.32	0.48	56.1
8	T1	44	2.0	0.021	4.2	LOS A	0.1	0.6	0.31	0.44	56.4
9	R2	2	2.0	0.021	4.3	LOS A	0.1	0.6	0.31	0.41	54.9
Approach		52	2.0	0.021	4.9	LOS A	0.1	0.6	0.31	0.44	56.3
West: Palladium Dr											
10	L2	1	2.0	0.019	9.8	LOS A	0.1	0.5	0.30	0.41	57.0
11	T1	24	2.0	0.019	4.1	LOS A	0.1	0.5	0.30	0.41	56.7
12	R2	23	2.0	0.018	3.9	LOS A	0.1	0.5	0.29	0.45	55.6
Approach		48	2.0	0.019	4.1	LOS A	0.1	0.5	0.29	0.43	56.2
All Vehicles		626	2.0	0.102	6.1	LOS A	0.5	3.9	0.20	0.49	55.5

Site Level of Service (LOS) Method: Delay (SIDRA). Site LOS Method is specified in the Parameter Settings dialog (Site tab).

Roundabout LOS Method: SIDRA Roundabout LOS.

Vehicle movement LOS values are based on average delay per movement.

Intersection and Approach LOS values are based on average delay for all vehicle movements.

Roundabout Capacity Model: SIDRA Standard.

SIDRA Standard Delay Model is used. Control Delay includes Geometric Delay.

Gap-Acceptance Capacity: SIDRA Standard (Akçelik M3D).

HV (%) values are calculated for All Movement Classes of All Heavy Vehicle Model Designation.

MOVEMENT SUMMARY

 Site: 101 [Campeau / Palladium FT2026 PM]

New Site
Roundabout

Movement Performance - Vehicles											
Mov ID	OD Mov	Demand Total veh/h	Flows HV %	Deg. Satn v/c	Average Delay sec	Level of Service	95% Back of Queue Vehicles veh	Queue Distance m	Prop. Queued	Effective Stop Rate per veh	Average Speed km/h
South: Campeau Dr											
1	L2	21	2.0	0.039	9.4	LOS A	0.2	1.4	0.17	0.45	56.5
2	T1	44	2.0	0.039	3.7	LOS A	0.2	1.4	0.17	0.45	56.2
3	R2	272	2.0	0.143	3.2	LOS A	0.0	0.0	0.00	0.40	57.1
Approach		337	2.0	0.143	3.6	LOS A	0.2	1.4	0.03	0.41	56.9
East: Palladium Dr											
4	L2	226	2.0	0.081	9.4	LOS A	0.4	2.9	0.19	0.58	54.0
5	T1	26	2.0	0.081	3.7	LOS A	0.4	2.9	0.18	0.57	54.2
6	R2	2	2.0	0.081	3.8	LOS A	0.4	2.9	0.18	0.57	52.5
Approach		254	2.0	0.081	8.8	LOS A	0.4	2.9	0.18	0.58	54.0
North: Campeau Dr											
7	L2	20	2.0	0.059	10.0	LOS B	0.2	1.6	0.33	0.51	55.9
8	T1	125	2.0	0.059	4.3	LOS A	0.2	1.6	0.32	0.45	56.3
9	R2	1	2.0	0.059	4.3	LOS A	0.2	1.6	0.31	0.42	54.9
Approach		146	2.0	0.059	5.1	LOS A	0.2	1.6	0.32	0.46	56.2
West: Palladium Dr											
10	L2	2	2.0	0.035	10.1	LOS B	0.1	0.9	0.35	0.45	56.7
11	T1	41	2.0	0.035	4.4	LOS A	0.1	0.9	0.35	0.45	56.4
12	R2	15	2.0	0.012	4.2	LOS A	0.0	0.3	0.33	0.46	55.4
Approach		58	2.0	0.035	4.5	LOS A	0.1	0.9	0.34	0.45	56.1
All Vehicles		795	2.0	0.143	5.6	LOS A	0.4	2.9	0.16	0.48	55.7

Site Level of Service (LOS) Method: Delay (SIDRA). Site LOS Method is specified in the Parameter Settings dialog (Site tab).

Roundabout LOS Method: SIDRA Roundabout LOS.

Vehicle movement LOS values are based on average delay per movement.

Intersection and Approach LOS values are based on average delay for all vehicle movements.

Roundabout Capacity Model: SIDRA Standard.

SIDRA Standard Delay Model is used. Control Delay includes Geometric Delay.

Gap-Acceptance Capacity: SIDRA Standard (Akçelik M3D).

HV (%) values are calculated for All Movement Classes of All Heavy Vehicle Model Designation.

Total Projected 2026 AM
1: Kanata West Centre Dr & Campeau Dr

08/27/2019



Movement	EBT	EBR	WBL	WBT	NBL	NBR
Lane Configurations						
Traffic Volume (veh/h)	23	5	19	50	3	25
Future Volume (Veh/h)	23	5	19	50	3	25
Sign Control	Free			Free	Stop	
Grade	0%			0%	0%	
Peak Hour Factor	1.00	1.00	1.00	1.00	1.00	1.00
Hourly flow rate (vph)	23	5	19	50	3	25
Pedestrians						
Lane Width (m)						
Walking Speed (m/s)						
Percent Blockage						
Right turn flare (veh)						
Median type	None		None			
Median storage veh						
Upstream signal (m)						
pX, platoon unblocked						
vC, conflicting volume			28		114	26
vC1, stage 1 conf vol						
vC2, stage 2 conf vol						
vCu, unblocked vol			28		114	26
tC, single (s)			4.1		6.4	6.2
tC, 2 stage (s)						
tF (s)			2.2		3.5	3.3
p0 queue free %			99		100	98
cM capacity (veh/h)			1585		872	1050
Direction, Lane #	EB 1	WB 1	WB 2	NB 1		
Volume Total	28	19	50	28		
Volume Left	0	19	0	3		
Volume Right	5	0	0	25		
cSH	1700	1585	1700	1028		
Volume to Capacity	0.02	0.01	0.03	0.03		
Queue Length 95th (m)	0.0	0.3	0.0	0.6		
Control Delay (s)	0.0	7.3	0.0	8.6		
Lane LOS	A		A			
Approach Delay (s)	0.0	2.0	8.6			
Approach LOS					A	
Intersection Summary						
Average Delay			3.0			
Intersection Capacity Utilization			17.7%	ICU Level of Service	A	
Analysis Period (min)	15					

Total Projected 2026 AM
3: Journeyman St & Campeau Dr

08/27/2019



Lane Group	EBL	EBT	EBR	WBL	WBT	WBR	NBL	NBR	SBL	SBR
Lane Configurations										
Traffic Volume (vph)	6	119	20	18	210	2	4	13	1	1
Future Volume (vph)	6	119	20	18	210	2	4	13	1	1
Lane Group Flow (vph)	6	119	20	18	210	2	4	13	1	1
Turn Type	Perm	NA	Perm	Perm	NA	Perm	Perm	Perm	Perm	Perm
Protected Phases		4			8					
Permitted Phases	4		4	8		8	2	2	6	6
Detector Phase	4	4	4	8	8	8	2	2	6	6
Switch Phase										
Minimum Initial (s)	10.0	10.0	10.0	10.0	10.0	10.0	10.0	10.0	10.0	10.0
Minimum Split (s)	44.5	44.5	44.5	44.5	44.5	44.5	39.8	39.8	39.8	39.8
Total Split (s)	39.0	39.0	39.0	39.0	39.0	39.0	51.0	51.0	51.0	51.0
Total Split (%)	43.3%	43.3%	43.3%	43.3%	43.3%	43.3%	56.7%	56.7%	56.7%	56.7%
Yellow Time (s)	4.2	4.2	4.2	4.2	4.2	4.2	3.3	3.3	3.3	3.3
All-Red Time (s)	2.3	2.3	2.3	2.3	2.3	2.3	3.5	3.5	3.5	3.5
Lost Time Adjust (s)	-2.8	-2.8	-2.8	-2.8	-2.8	-2.8	-2.5	-2.5	-2.5	-2.5
Total Lost Time (s)	3.7	3.7	3.7	3.7	3.7	3.7	4.3	4.3	4.3	4.3
Lead/Lag										
Lead-Lag Optimize?										
Recall Mode	None	None	None	None	None	None	Max	Max	Max	Max
Act Effct Green (s)	16.2	16.2	16.2	16.2	16.2	16.2	48.0	48.0	48.0	48.0
Actuated g/C Ratio	0.22	0.22	0.22	0.22	0.22	0.22	0.66	0.66	0.66	0.66
v/c Ratio	0.03	0.28	0.05	0.06	0.50	0.01	0.00	0.01	0.00	0.00
Control Delay	21.0	24.3	2.5	21.4	28.3	0.0	5.2	0.0	5.0	0.0
Queue Delay	0.0	0.0	0.0	0.0	0.0	0.0	0.0	0.0	0.0	0.0
Total Delay	21.0	24.3	2.5	21.4	28.3	0.0	5.2	0.0	5.0	0.0
LOS	C	C	A	C	C	A	A	A	A	A
Approach Delay		21.1			27.5					
Approach LOS		C			C					
Queue Length 50th (m)	0.6	13.1	0.0	1.9	24.3	0.0	0.2	0.0	0.0	0.0
Queue Length 95th (m)	3.3	25.5	1.9	6.4	42.2	0.0	1.2	0.0	0.5	0.0
Internal Link Dist (m)		319.9			296.6					
Turn Bay Length (m)	45.0			50.0			20.0		45.0	
Base Capacity (vph)	446	921	806	616	921	806	947	1312	947	1248
Starvation Cap Reductn	0	0	0	0	0	0	0	0	0	0
Spillback Cap Reductn	0	0	0	0	0	0	0	0	0	0
Storage Cap Reductn	0	0	0	0	0	0	0	0	0	0
Reduced v/c Ratio	0.01	0.13	0.02	0.03	0.23	0.00	0.00	0.01	0.00	0.00

Intersection Summary

Cycle Length: 90	
Actuated Cycle Length: 72.2	
Natural Cycle: 85	
Control Type: Semi Act-Uncoord	
Maximum v/c Ratio: 0.50	
Intersection Signal Delay: 23.9	Intersection LOS: C
Intersection Capacity Utilization 38.2%	ICU Level of Service A
Analysis Period (min) 15	

Splits and Phases: 3: Journeyman St & Campeau Dr



Total Projected 2026 AM
5: Palladium Dr & Cabela's Way

08/27/2019



Movement	EBL	EBR	NBL	NBT	SBT	SBR
Lane Configurations						
Traffic Volume (veh/h)	0	83	116	337	242	21
Future Volume (Veh/h)	0	83	116	337	242	21
Sign Control	Stop			Free	Free	
Grade	0%			0%	0%	
Peak Hour Factor	1.00	1.00	1.00	1.00	1.00	1.00
Hourly flow rate (vph)	0	83	116	337	242	21
Pedestrians						
Lane Width (m)						
Walking Speed (m/s)						
Percent Blockage						
Right turn flare (veh)						
Median type				None	None	
Median storage veh						
Upstream signal (m)	207					
pX, platoon unblocked						
vC, conflicting volume	653	132	263			
vC1, stage 1 conf vol						
vC2, stage 2 conf vol						
vCu, unblocked vol	653	132	263			
tC, single (s)	6.8	6.9	4.1			
tC, 2 stage (s)						
tF (s)	3.5	3.3	2.2			
p0 queue free %	100	91	91			
cM capacity (veh/h)	364	894	1298			
Direction, Lane #	EB 1	NB 1	NB 2	NB 3	SB 1	SB 2
Volume Total	83	116	168	168	161	102
Volume Left	0	116	0	0	0	0
Volume Right	83	0	0	0	0	21
cSH	894	1298	1700	1700	1700	1700
Volume to Capacity	0.09	0.09	0.10	0.10	0.09	0.06
Queue Length 95th (m)	2.3	2.2	0.0	0.0	0.0	0.0
Control Delay (s)	9.4	8.0	0.0	0.0	0.0	0.0
Lane LOS	A	A				
Approach Delay (s)	9.4	2.1	0.0			
Approach LOS	A					
Intersection Summary						
Average Delay			2.1			
Intersection Capacity Utilization			20.5%	ICU Level of Service	A	
Analysis Period (min)			15			

Total Projected 2026 AM
6: Palladium Dr & Hwy 417 WB On-Off Ramps

08/27/2019



Lane Group	WBL	WBR	NBT	SBL	SBT
Lane Configurations					
Traffic Volume (vph)	220	289	163	116	209
Future Volume (vph)	220	289	163	116	209
Lane Group Flow (vph)	220	289	163	116	209
Turn Type	Prot	Perm	NA	pm+pt	NA
Protected Phases	8		2	1	6
Permitted Phases		8		6	
Detector Phase	8	8	2	1	6
Switch Phase					
Minimum Initial (s)	10.0	10.0	10.0	5.0	10.0
Minimum Split (s)	32.7	32.7	39.0	12.0	25.0
Total Split (s)	36.7	36.7	39.0	22.0	39.0
Total Split (%)	37.6%	37.6%	39.9%	22.5%	39.9%
Yellow Time (s)	3.3	3.3	3.7	3.7	3.7
All-Red Time (s)	3.4	3.4	3.3	3.3	3.3
Lost Time Adjust (s)	-2.7	-2.7	-3.0	-3.0	-3.0
Total Lost Time (s)	4.0	4.0	4.0	4.0	4.0
Lead/Lag			Lag	Lead	
Lead-Lag Optimize?			Yes	Yes	
Recall Mode	Max	Max	Max	Max	Max
Act Effct Green (s)	32.7	32.7	35.0	57.0	57.0
Actuated g/C Ratio	0.33	0.33	0.36	0.58	0.58
v/c Ratio	0.19	0.40	0.13	0.15	0.10
Control Delay	23.6	4.7	21.4	9.6	9.2
Queue Delay	0.0	0.0	0.0	0.0	0.0
Total Delay	23.6	4.7	21.4	9.6	9.2
LOS	C	A	C	A	A
Approach Delay	12.9		21.4		9.3
Approach LOS	B		C		A
Queue Length 50th (m)	15.1	0.0	10.7	9.1	8.5
Queue Length 95th (m)	23.5	16.8	17.7	16.7	13.4
Internal Link Dist (m)	322.5		403.5		183.1
Turn Bay Length (m)		125.0		115.0	
Base Capacity (vph)	1161	728	1282	767	2088
Starvation Cap Reductn	0	0	0	0	0
Spillback Cap Reductn	0	0	0	0	0
Storage Cap Reductn	0	0	0	0	0
Reduced v/c Ratio	0.19	0.40	0.13	0.15	0.10

Intersection Summary

Cycle Length: 97.7	
Actuated Cycle Length: 97.7	
Natural Cycle: 85	
Control Type: Actuated-Uncoordinated	
Maximum v/c Ratio: 0.40	
Intersection Signal Delay: 13.1	Intersection LOS: B
Intersection Capacity Utilization 33.1%	ICU Level of Service A
Analysis Period (min) 15	

Total Projected 2026 AM
6: Palladium Dr & Hwy 417 WB On-Off Ramps

08/27/2019

Splits and Phases: 6: Palladium Dr & Hwy 417 WB On-Off Ramps

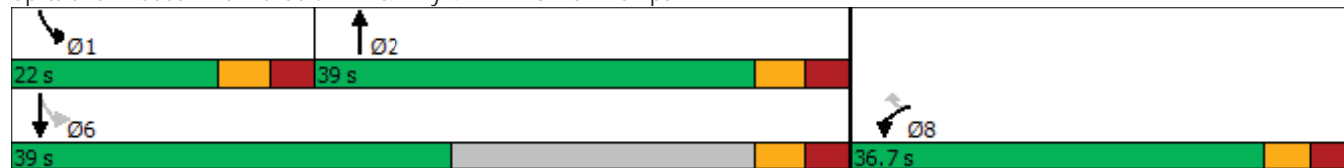

Total Projected 2026 AM
7: Palladium Dr & Hwy 417 EB Off Ramp

08/27/2019



Movement	EBL	EBR	NBL	NBT	SBT	SBR
Lane Configurations						
Traffic Volume (veh/h)	89	274	0	76	396	30
Future Volume (Veh/h)	89	274	0	76	396	30
Sign Control	Stop			Free	Free	
Grade	0%			0%	0%	
Peak Hour Factor	1.00	1.00	1.00	1.00	1.00	1.00
Hourly flow rate (vph)	89	274	0	76	396	30
Pedestrians						
Lane Width (m)						
Walking Speed (m/s)						
Percent Blockage						
Right turn flare (veh)	3					
Median type				None	None	
Median storage veh						
Upstream signal (m)						
pX, platoon unblocked						
vC, conflicting volume	449	213	426			
vC1, stage 1 conf vol						
vC2, stage 2 conf vol						
vCu, unblocked vol	449	213	426			
tC, single (s)	6.8	6.9	4.1			
tC, 2 stage (s)						
tF (s)	3.5	3.3	2.2			
p0 queue free %	83	65	100			
cM capacity (veh/h)	538	792	1130			
Direction, Lane #	EB 1	NB 1	NB 2	SB 1	SB 2	
Volume Total	363	38	38	264	162	
Volume Left	89	0	0	0	0	
Volume Right	274	0	0	0	30	
cSH	1049	1700	1700	1700	1700	
Volume to Capacity	0.35	0.02	0.02	0.16	0.10	
Queue Length 95th (m)	11.8	0.0	0.0	0.0	0.0	
Control Delay (s)	12.2	0.0	0.0	0.0	0.0	
Lane LOS	B					
Approach Delay (s)	12.2	0.0		0.0		
Approach LOS	B					
Intersection Summary						
Average Delay	5.1					
Intersection Capacity Utilization	35.5%			ICU Level of Service	A	
Analysis Period (min)	15					

Total Projected 2026 AM
8: Palladium Dr & Upper Canada St

08/27/2019



Movement	EBL	EBT	EBR	WBL	WBT	WBR	NBL	NBT	NBR	SBL	SBT	SBR
Lane Configurations		↕			↕			↕			↕	
Sign Control		Stop			Stop			Stop			Stop	
Traffic Volume (vph)	0	2	2	0	11	0	11	0	0	0	0	0
Future Volume (vph)	0	2	2	0	11	0	11	0	0	0	0	0
Peak Hour Factor	1.00	1.00	1.00	1.00	1.00	1.00	1.00	1.00	1.00	1.00	1.00	1.00
Hourly flow rate (vph)	0	2	2	0	11	0	11	0	0	0	0	0

Direction, Lane #	EB 1	WB 1	NB 1	SB 1
Volume Total (vph)	4	11	11	0
Volume Left (vph)	0	0	11	0
Volume Right (vph)	2	0	0	0
Hadj (s)	-0.27	0.03	0.23	0.00
Departure Headway (s)	3.7	4.0	4.2	3.9
Degree Utilization, x	0.00	0.01	0.01	0.00
Capacity (veh/h)	970	901	848	900
Control Delay (s)	6.7	7.0	7.2	6.9
Approach Delay (s)	6.7	7.0	7.2	0.0
Approach LOS	A	A	A	A

Intersection Summary			
Delay		7.0	
Level of Service		A	
Intersection Capacity Utilization	13.3%		ICU Level of Service A
Analysis Period (min)		15	

Total Projected 2026 AM
9: Access 1 & Upper Canada St

08/27/2019



Movement	EBT	EBR	WBL	WBT	NBL	NBR
Lane Configurations	↑			↑	↑	
Traffic Volume (veh/h)	0	0	11	0	0	2
Future Volume (Veh/h)	0	0	11	0	0	2
Sign Control	Free			Free	Stop	
Grade	0%			0%	0%	
Peak Hour Factor	1.00	1.00	1.00	1.00	1.00	1.00
Hourly flow rate (vph)	0	0	11	0	0	2
Pedestrians						
Lane Width (m)						
Walking Speed (m/s)						
Percent Blockage						
Right turn flare (veh)						
Median type	None			None		
Median storage veh						
Upstream signal (m)						
pX, platoon unblocked						
vC, conflicting volume			0	22	0	
vC1, stage 1 conf vol						
vC2, stage 2 conf vol						
vCu, unblocked vol			0	22	0	
tC, single (s)			4.1	6.4	6.2	
tC, 2 stage (s)						
tF (s)			2.2	3.5	3.3	
p0 queue free %			99	100	100	
cM capacity (veh/h)			1623	988	1085	
Direction, Lane #	EB 1	WB 1	NB 1			
Volume Total	0	11	2			
Volume Left	0	11	0			
Volume Right	0	0	2			
cSH	1700	1623	1085			
Volume to Capacity	0.00	0.01	0.00			
Queue Length 95th (m)	0.0	0.2	0.0			
Control Delay (s)	0.0	7.2	8.3			
Lane LOS			A			
Approach Delay (s)	0.0	7.2	8.3			
Approach LOS			A			
Intersection Summary						
Average Delay			7.4			
Intersection Capacity Utilization			13.3%	ICU Level of Service	A	
Analysis Period (min)			15			

Total Projected 2026 AM
10: Access 2 & Upper Canada St

08/27/2019



Movement	EBT	EBR	WBL	WBT	NBL	NBR
Lane Configurations	↑			↑	↑	
Traffic Volume (veh/h)	2	0	11	11	0	2
Future Volume (Veh/h)	2	0	11	11	0	2
Sign Control	Free			Free	Stop	
Grade	0%			0%	0%	
Peak Hour Factor	1.00	1.00	1.00	1.00	1.00	1.00
Hourly flow rate (vph)	2	0	11	11	0	2
Pedestrians						
Lane Width (m)						
Walking Speed (m/s)						
Percent Blockage						
Right turn flare (veh)						
Median type	None		None			
Median storage veh						
Upstream signal (m)						
pX, platoon unblocked						
vC, conflicting volume			2		35	2
vC1, stage 1 conf vol						
vC2, stage 2 conf vol						
vCu, unblocked vol			2		35	2
tC, single (s)			4.1		6.4	6.2
tC, 2 stage (s)						
tF (s)			2.2		3.5	3.3
p0 queue free %			99		100	100
cM capacity (veh/h)			1620		971	1082
Direction, Lane #	EB 1	WB 1	NB 1			
Volume Total	2	22	2			
Volume Left	0	11	0			
Volume Right	0	0	2			
cSH	1700	1620	1082			
Volume to Capacity	0.00	0.01	0.00			
Queue Length 95th (m)	0.0	0.2	0.0			
Control Delay (s)	0.0	3.6	8.3			
Lane LOS			A			
Approach Delay (s)	0.0	3.6	8.3			
Approach LOS			A			
Intersection Summary						
Average Delay			3.7			
Intersection Capacity Utilization			17.9%	ICU Level of Service		A
Analysis Period (min)			15			

Total Projected 2026 AM
 11: Palladium Dr & Access 3/8600 Campeau

08/27/2019



Movement	EBL	EBT	EBR	WBL	WBT	WBR	NBL	NBT	NBR	SBL	SBT	SBR
Lane Configurations		↕			↕			↕			↕	
Traffic Volume (veh/h)	0	0	17	11	0	0	89	11	26	0	2	0
Future Volume (Veh/h)	0	0	17	11	0	0	89	11	26	0	2	0
Sign Control		Stop			Stop			Free			Free	
Grade		0%			0%			0%			0%	
Peak Hour Factor	1.00	1.00	1.00	1.00	1.00	1.00	1.00	1.00	1.00	1.00	1.00	1.00
Hourly flow rate (vph)	0	0	17	11	0	0	89	11	26	0	2	0
Pedestrians												
Lane Width (m)												
Walking Speed (m/s)												
Percent Blockage												
Right turn flare (veh)												
Median type												
Median storage veh												
Upstream signal (m)												
pX, platoon unblocked												
vC, conflicting volume	204	217	2	221	204	24	2			37		
vC1, stage 1 conf vol												
vC2, stage 2 conf vol												
vCu, unblocked vol	204	217	2	221	204	24	2			37		
tC, single (s)	7.1	6.5	6.2	7.1	6.5	6.2	4.1			4.1		
tC, 2 stage (s)												
tF (s)	3.5	4.0	3.3	3.5	4.0	3.3	2.2			2.2		
p0 queue free %	100	100	98	98	100	100	95			100		
cM capacity (veh/h)	722	644	1082	693	654	1052	1620			1574		
Direction, Lane #	EB 1	WB 1	NB 1	SB 1								
Volume Total	17	11	126	2								
Volume Left	0	11	89	0								
Volume Right	17	0	26	0								
cSH	1082	693	1620	1574								
Volume to Capacity	0.02	0.02	0.05	0.00								
Queue Length 95th (m)	0.4	0.4	1.3	0.0								
Control Delay (s)	8.4	10.3	5.3	0.0								
Lane LOS	A	B	A									
Approach Delay (s)	8.4	10.3	5.3	0.0								
Approach LOS	A	B										
Intersection Summary												
Average Delay			5.9									
Intersection Capacity Utilization			27.7%		ICU Level of Service					A		
Analysis Period (min)			15									

Total Projected 2026 PM
1: Kanata West Centre Dr & Campeau Dr

08/27/2019



Movement	EBT	EBR	WBL	WBT	NBL	NBR
Lane Configurations	↔		↔	↔	↔	
Traffic Volume (veh/h)	19	1	13	38	2	39
Future Volume (Veh/h)	19	1	13	38	2	39
Sign Control	Free			Free	Stop	
Grade	0%			0%	0%	
Peak Hour Factor	1.00	1.00	1.00	1.00	1.00	1.00
Hourly flow rate (vph)	19	1	13	38	2	39
Pedestrians						
Lane Width (m)						
Walking Speed (m/s)						
Percent Blockage						
Right turn flare (veh)						
Median type	None			None		
Median storage veh						
Upstream signal (m)						
pX, platoon unblocked						
vC, conflicting volume			20		84	20
vC1, stage 1 conf vol						
vC2, stage 2 conf vol						
vCu, unblocked vol			20		84	20
tC, single (s)			4.1		6.4	6.2
tC, 2 stage (s)						
tF (s)			2.2		3.5	3.3
p0 queue free %			99		100	96
cM capacity (veh/h)			1596		911	1058
Direction, Lane #	EB 1	WB 1	WB 2	NB 1		
Volume Total	20	13	38	41		
Volume Left	0	13	0	2		
Volume Right	1	0	0	39		
cSH	1700	1596	1700	1050		
Volume to Capacity	0.01	0.01	0.02	0.04		
Queue Length 95th (m)	0.0	0.2	0.0	0.9		
Control Delay (s)	0.0	7.3	0.0	8.6		
Lane LOS		A		A		
Approach Delay (s)	0.0	1.9		8.6		
Approach LOS				A		
Intersection Summary						
Average Delay			4.0			
Intersection Capacity Utilization			17.4%		ICU Level of Service	A
Analysis Period (min)			15			

Total Projected 2026 PM
3: Journeyman St & Campeau Dr

08/27/2019



Lane Group	EBL	EBT	EBR	WBL	WBT	WBR	NBL	NBR	SBL	SBR
Lane Configurations										
Traffic Volume (vph)	12	246	16	78	148	2	43	72	3	4
Future Volume (vph)	12	246	16	78	148	2	43	72	3	4
Lane Group Flow (vph)	12	246	16	78	148	2	43	72	3	4
Turn Type	Perm	NA	Perm	Perm	NA	Perm	Perm	Perm	Perm	Perm
Protected Phases		4			8					
Permitted Phases	4		4	8		8	2	2	6	6
Detector Phase	4	4	4	8	8	8	2	2	6	6
Switch Phase										
Minimum Initial (s)	10.0	10.0	10.0	10.0	10.0	10.0	10.0	10.0	10.0	10.0
Minimum Split (s)	44.5	44.5	44.5	44.5	44.5	44.5	39.8	39.8	39.8	39.8
Total Split (s)	39.0	39.0	39.0	39.0	39.0	39.0	51.0	51.0	51.0	51.0
Total Split (%)	43.3%	43.3%	43.3%	43.3%	43.3%	43.3%	56.7%	56.7%	56.7%	56.7%
Yellow Time (s)	4.2	4.2	4.2	4.2	4.2	4.2	3.3	3.3	3.3	3.3
All-Red Time (s)	2.3	2.3	2.3	2.3	2.3	2.3	3.5	3.5	3.5	3.5
Lost Time Adjust (s)	-2.8	-2.8	-2.8	-2.8	-2.8	-2.8	-2.5	-2.5	-2.5	-2.5
Total Lost Time (s)	3.7	3.7	3.7	3.7	3.7	3.7	4.3	4.3	4.3	4.3
Lead/Lag										
Lead-Lag Optimize?										
Recall Mode	None	None	None	None	None	None	Max	Max	Max	Max
Act Effct Green (s)	17.4	17.4	17.4	17.4	17.4	17.4	46.9	46.9	46.9	46.9
Actuated g/C Ratio	0.24	0.24	0.24	0.24	0.24	0.24	0.65	0.65	0.65	0.65
v/c Ratio	0.04	0.54	0.04	0.40	0.33	0.00	0.05	0.06	0.00	0.00
Control Delay	20.6	28.6	1.1	29.3	24.4	0.0	5.8	0.1	5.7	0.0
Queue Delay	0.0	0.0	0.0	0.0	0.0	0.0	0.0	0.0	0.0	0.0
Total Delay	20.6	28.6	1.1	29.3	24.4	0.0	5.8	0.1	5.7	0.0
LOS	C	C	A	C	C	A	A	A	A	A
Approach Delay		26.6			25.8					
Approach LOS		C			C					
Queue Length 50th (m)	1.2	29.1	0.0	8.9	16.5	0.0	1.8	0.0	0.2	0.0
Queue Length 95th (m)	4.9	49.0	0.9	20.3	30.5	0.0	5.9	0.0	1.1	0.0
Internal Link Dist (m)		319.9			296.6					
Turn Bay Length (m)	45.0			50.0			20.0		45.0	
Base Capacity (vph)	566	920	805	397	920	805	924	1209	924	1274
Starvation Cap Reductn	0	0	0	0	0	0	0	0	0	0
Spillback Cap Reductn	0	0	0	0	0	0	0	0	0	0
Storage Cap Reductn	0	0	0	0	0	0	0	0	0	0
Reduced v/c Ratio	0.02	0.27	0.02	0.20	0.16	0.00	0.05	0.06	0.00	0.00

Intersection Summary

Cycle Length: 90	
Actuated Cycle Length: 72.4	
Natural Cycle: 85	
Control Type: Semi Act-Uncoord	
Maximum v/c Ratio: 0.54	
Intersection Signal Delay: 21.6	Intersection LOS: C
Intersection Capacity Utilization 40.6%	ICU Level of Service A
Analysis Period (min) 15	

Splits and Phases: 3: Journeyman St & Campeau Dr

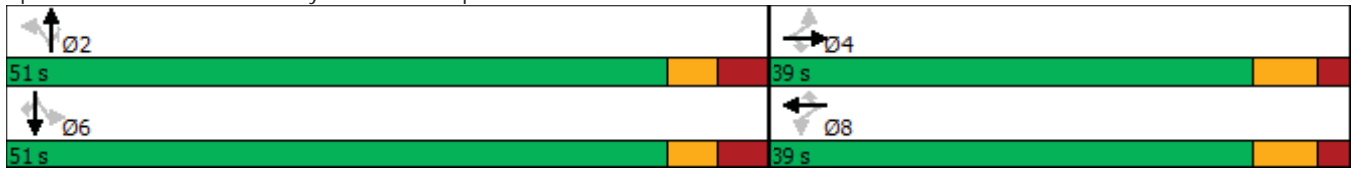

Total Projected 2026 PM
5: Palladium Dr & Cabela's Way

08/27/2019



Movement	EBL	EBR	NBL	NBT	SBT	SBR
Lane Configurations						
Traffic Volume (veh/h)	0	151	136	427	414	35
Future Volume (Veh/h)	0	151	136	427	414	35
Sign Control	Stop			Free	Free	
Grade	0%			0%	0%	
Peak Hour Factor	1.00	1.00	1.00	1.00	1.00	1.00
Hourly flow rate (vph)	0	151	136	427	414	35
Pedestrians						
Lane Width (m)						
Walking Speed (m/s)						
Percent Blockage						
Right turn flare (veh)						
Median type				None	None	
Median storage veh						
Upstream signal (m)	207					
pX, platoon unblocked						
vC, conflicting volume	917	224	449			
vC1, stage 1 conf vol						
vC2, stage 2 conf vol						
vCu, unblocked vol	917	224	449			
tC, single (s)	6.8	6.9	4.1			
tC, 2 stage (s)						
tF (s)	3.5	3.3	2.2			
p0 queue free %	100	81	88			
cM capacity (veh/h)	238	779	1108			
Direction, Lane #	EB 1	NB 1	NB 2	NB 3	SB 1	SB 2
Volume Total	151	136	214	214	276	173
Volume Left	0	136	0	0	0	0
Volume Right	151	0	0	0	0	35
cSH	779	1108	1700	1700	1700	1700
Volume to Capacity	0.19	0.12	0.13	0.13	0.16	0.10
Queue Length 95th (m)	5.4	3.2	0.0	0.0	0.0	0.0
Control Delay (s)	10.7	8.7	0.0	0.0	0.0	0.0
Lane LOS	B	A				
Approach Delay (s)	10.7	2.1	0.0			
Approach LOS	B					
Intersection Summary						
Average Delay			2.4			
Intersection Capacity Utilization			28.6%	ICU Level of Service	A	
Analysis Period (min)			15			

Total Projected 2026 PM
6: Palladium Dr & Hwy 417 WB On-Off Ramps

08/27/2019



Lane Group	WBL	WBR	NBT	SBL	SBT
Lane Configurations					
Traffic Volume (vph)	433	373	190	239	327
Future Volume (vph)	433	373	190	239	327
Lane Group Flow (vph)	433	373	190	239	327
Turn Type	Prot	Perm	NA	pm+pt	NA
Protected Phases	8		2	1	6
Permitted Phases		8		6	
Detector Phase	8	8	2	1	6
Switch Phase					
Minimum Initial (s)	10.0	10.0	10.0	5.0	10.0
Minimum Split (s)	32.7	32.7	39.0	12.0	25.0
Total Split (s)	36.7	36.7	39.0	22.0	39.0
Total Split (%)	37.6%	37.6%	39.9%	22.5%	39.9%
Yellow Time (s)	3.3	3.3	3.7	3.7	3.7
All-Red Time (s)	3.4	3.4	3.3	3.3	3.3
Lost Time Adjust (s)	-2.7	-2.7	-3.0	-3.0	-3.0
Total Lost Time (s)	4.0	4.0	4.0	4.0	4.0
Lead/Lag			Lag	Lead	
Lead-Lag Optimize?			Yes	Yes	
Recall Mode	Max	Max	Max	Max	Max
Act Effct Green (s)	32.7	32.7	35.0	57.0	57.0
Actuated g/C Ratio	0.33	0.33	0.36	0.58	0.58
v/c Ratio	0.37	0.48	0.15	0.32	0.16
Control Delay	25.9	4.8	21.7	11.1	9.6
Queue Delay	0.0	0.0	0.0	0.0	0.0
Total Delay	25.9	4.8	21.7	11.1	9.6
LOS	C	A	C	B	A
Approach Delay	16.1		21.7		10.2
Approach LOS	B		C		B
Queue Length 50th (m)	31.8	0.0	12.6	20.2	13.8
Queue Length 95th (m)	44.4	18.5	20.2	32.3	20.1
Internal Link Dist (m)	322.5		403.5		183.1
Turn Bay Length (m)		125.0		115.0	
Base Capacity (vph)	1161	784	1282	755	2088
Starvation Cap Reductn	0	0	0	0	0
Spillback Cap Reductn	0	0	0	0	0
Storage Cap Reductn	0	0	0	0	0
Reduced v/c Ratio	0.37	0.48	0.15	0.32	0.16

Intersection Summary

Cycle Length: 97.7	
Actuated Cycle Length: 97.7	
Natural Cycle: 85	
Control Type: Actuated-Uncoordinated	
Maximum v/c Ratio: 0.48	
Intersection Signal Delay: 14.7	Intersection LOS: B
Intersection Capacity Utilization 43.9%	ICU Level of Service A
Analysis Period (min) 15	

Total Projected 2026 PM
6: Palladium Dr & Hwy 417 WB On-Off Ramps

08/27/2019

Splits and Phases: 6: Palladium Dr & Hwy 417 WB On-Off Ramps

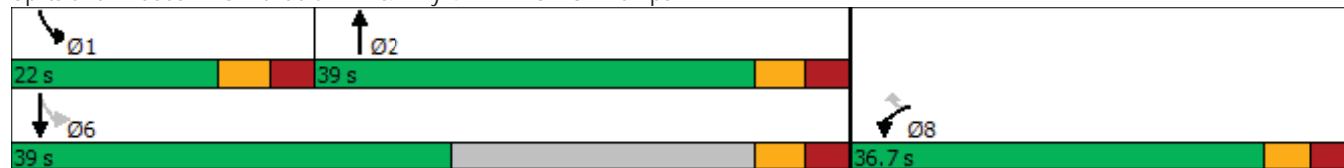

Total Projected 2026 PM
7: Palladium Dr & Hwy 417 EB Off Ramp

08/27/2019



Movement	EBL	EBR	NBL	NBT	SBT	SBR
Lane Configurations						
Traffic Volume (veh/h)	109	163	0	493	729	14
Future Volume (Veh/h)	109	163	0	493	729	14
Sign Control	Stop			Free	Free	
Grade	0%			0%	0%	
Peak Hour Factor	1.00	1.00	1.00	1.00	1.00	1.00
Hourly flow rate (vph)	109	163	0	493	729	14
Pedestrians						
Lane Width (m)						
Walking Speed (m/s)						
Percent Blockage						
Right turn flare (veh)	3					
Median type				None	None	
Median storage veh						
Upstream signal (m)						
pX, platoon unblocked						
vC, conflicting volume	982	372	743			
vC1, stage 1 conf vol						
vC2, stage 2 conf vol						
vCu, unblocked vol	982	372	743			
tC, single (s)	6.8	6.9	4.1			
tC, 2 stage (s)						
tF (s)	3.5	3.3	2.2			
p0 queue free %	56	74	100			
cM capacity (veh/h)	246	626	860			
Direction, Lane #	EB 1	NB 1	NB 2	SB 1	SB 2	
Volume Total	272	246	246	486	257	
Volume Left	109	0	0	0	0	
Volume Right	163	0	0	0	14	
cSH	614	1700	1700	1700	1700	
Volume to Capacity	0.44	0.14	0.14	0.29	0.15	
Queue Length 95th (m)	17.2	0.0	0.0	0.0	0.0	
Control Delay (s)	20.0	0.0	0.0	0.0	0.0	
Lane LOS	C					
Approach Delay (s)	20.0	0.0		0.0		
Approach LOS	C					
Intersection Summary						
Average Delay	3.6					
Intersection Capacity Utilization	37.4%			ICU Level of Service	A	
Analysis Period (min)	15					

Total Projected 2026 PM
8: Palladium Dr & Upper Canada St

08/27/2019



Movement	EBL	EBT	EBR	WBL	WBT	WBR	NBL	NBT	NBR	SBL	SBT	SBR
Lane Configurations		↕			↕			↕			↕	
Sign Control		Stop			Stop			Stop			Stop	
Traffic Volume (vph)	0	11	11	0	2	0	2	0	0	0	0	0
Future Volume (vph)	0	11	11	0	2	0	2	0	0	0	0	0
Peak Hour Factor	1.00	1.00	1.00	1.00	1.00	1.00	1.00	1.00	1.00	1.00	1.00	1.00
Hourly flow rate (vph)	0	11	11	0	2	0	2	0	0	0	0	0

Direction, Lane #	EB 1	WB 1	NB 1	SB 1
Volume Total (vph)	22	2	2	0
Volume Left (vph)	0	0	2	0
Volume Right (vph)	11	0	0	0
Hadj (s)	-0.27	0.03	0.23	0.00
Departure Headway (s)	3.6	4.0	4.2	3.9
Degree Utilization, x	0.02	0.00	0.00	0.00
Capacity (veh/h)	981	903	843	900
Control Delay (s)	6.7	7.0	7.2	6.9
Approach Delay (s)	6.7	7.0	7.2	0.0
Approach LOS	A	A	A	A

Intersection Summary			
Delay		6.8	
Level of Service		A	
Intersection Capacity Utilization	13.3%	ICU Level of Service	A
Analysis Period (min)	15		

Total Projected 2026 PM
9: Access 1 & Upper Canada St

08/27/2019



Movement	EBT	EBR	WBL	WBT	NBL	NBR
Lane Configurations	↑			↑	↑	
Traffic Volume (veh/h)	0	0	2	0	0	11
Future Volume (Veh/h)	0	0	2	0	0	11
Sign Control	Free			Free	Stop	
Grade	0%			0%	0%	
Peak Hour Factor	1.00	1.00	1.00	1.00	1.00	1.00
Hourly flow rate (vph)	0	0	2	0	0	11
Pedestrians						
Lane Width (m)						
Walking Speed (m/s)						
Percent Blockage						
Right turn flare (veh)						
Median type	None			None		
Median storage (veh)						
Upstream signal (m)						
pX, platoon unblocked						
vC, conflicting volume			0		4	0
vC1, stage 1 conf vol						
vC2, stage 2 conf vol						
vCu, unblocked vol			0		4	0
tC, single (s)			4.1		6.4	6.2
tC, 2 stage (s)						
tF (s)			2.2		3.5	3.3
p0 queue free %			100		100	99
cM capacity (veh/h)			1623		1017	1085
Direction, Lane #	EB 1	WB 1	NB 1			
Volume Total	0	2	11			
Volume Left	0	2	0			
Volume Right	0	0	11			
cSH	1700	1623	1085			
Volume to Capacity	0.00	0.00	0.01			
Queue Length 95th (m)	0.0	0.0	0.2			
Control Delay (s)	0.0	7.2	8.4			
Lane LOS		A	A			
Approach Delay (s)	0.0	7.2	8.4			
Approach LOS			A			
Intersection Summary						
Average Delay			8.2			
Intersection Capacity Utilization			13.3%	ICU Level of Service	A	
Analysis Period (min)			15			

Total Projected 2026 PM
10: Access 2 & Upper Canada St

08/27/2019



Movement	EBT	EBR	WBL	WBT	NBL	NBR
Lane Configurations	↔			↔	↔	
Traffic Volume (veh/h)	11	0	2	2	0	11
Future Volume (Veh/h)	11	0	2	2	0	11
Sign Control	Free			Free	Stop	
Grade	0%			0%	0%	
Peak Hour Factor	1.00	1.00	1.00	1.00	1.00	1.00
Hourly flow rate (vph)	11	0	2	2	0	11
Pedestrians						
Lane Width (m)						
Walking Speed (m/s)						
Percent Blockage						
Right turn flare (veh)						
Median type	None			None		
Median storage veh						
Upstream signal (m)						
pX, platoon unblocked						
vC, conflicting volume			11		17	11
vC1, stage 1 conf vol						
vC2, stage 2 conf vol						
vCu, unblocked vol			11		17	11
tC, single (s)			4.1		6.4	6.2
tC, 2 stage (s)						
tF (s)			2.2		3.5	3.3
p0 queue free %			100		100	99
cM capacity (veh/h)			1608		1000	1070
Direction, Lane #	EB 1	WB 1	NB 1			
Volume Total	11	4	11			
Volume Left	0	2	0			
Volume Right	0	0	11			
cSH	1700	1608	1070			
Volume to Capacity	0.01	0.00	0.01			
Queue Length 95th (m)	0.0	0.0	0.2			
Control Delay (s)	0.0	3.6	8.4			
Lane LOS		A	A			
Approach Delay (s)	0.0	3.6	8.4			
Approach LOS			A			
Intersection Summary						
Average Delay			4.1			
Intersection Capacity Utilization			13.3%	ICU Level of Service		A
Analysis Period (min)			15			

Total Projected 2026 PM
 11: Palladium Dr & Access 3/8600 Campeau

08/27/2019



Movement	EBL	EBT	EBR	WBL	WBT	WBR	NBL	NBT	NBR	SBL	SBT	SBR
Lane Configurations		↕			↕			↕			↕	
Traffic Volume (veh/h)	0	0	86	15	0	0	17	2	26	0	11	0
Future Volume (Veh/h)	0	0	86	15	0	0	17	2	26	0	11	0
Sign Control		Stop			Stop			Free			Free	
Grade		0%			0%			0%			0%	
Peak Hour Factor	1.00	1.00	1.00	1.00	1.00	1.00	1.00	1.00	1.00	1.00	1.00	1.00
Hourly flow rate (vph)	0	0	86	15	0	0	17	2	26	0	11	0
Pedestrians												
Lane Width (m)												
Walking Speed (m/s)												
Percent Blockage												
Right turn flare (veh)												
Median type												
Median storage veh												
Upstream signal (m)												
pX, platoon unblocked												
vC, conflicting volume	60	73	11	146	60	15	11			28		
vC1, stage 1 conf vol												
vC2, stage 2 conf vol												
vCu, unblocked vol	60	73	11	146	60	15	11			28		
tC, single (s)	7.1	6.5	6.2	7.1	6.5	6.2	4.1			4.1		
tC, 2 stage (s)												
tF (s)	3.5	4.0	3.3	3.5	4.0	3.3	2.2			2.2		
p0 queue free %	100	100	92	98	100	100	99			100		
cM capacity (veh/h)	928	809	1070	750	822	1065	1608			1585		
Direction, Lane #	EB 1	WB 1	NB 1	SB 1								
Volume Total	86	15	45	11								
Volume Left	0	15	17	0								
Volume Right	86	0	26	0								
cSH	1070	750	1608	1585								
Volume to Capacity	0.08	0.02	0.01	0.00								
Queue Length 95th (m)	2.0	0.5	0.2	0.0								
Control Delay (s)	8.7	9.9	2.8	0.0								
Lane LOS	A	A	A									
Approach Delay (s)	8.7	9.9	2.8	0.0								
Approach LOS	A	A										
Intersection Summary												
Average Delay			6.5									
Intersection Capacity Utilization			23.5%		ICU Level of Service				A			
Analysis Period (min)			15									