



Engineers, Planners & Landscape Architects

Engineering

- Land / Site Development
- Municipal Infrastructure
- Environmental / Water Resources
- Traffic / Transportation
- Structural
- Recreational

Planning

- Land / Site Development
- Planning Application Management
- Municipal Planning Documents & Studies
- Expert Witness (OMB)
- Wireless Industry

Landscape Architecture

- Urban Design & Streetscapes
- Open Space, Parks & Recreation Planning
- Community & Residential Developments
- Commercial & Institutional Sites
- Environmental Restoration



**24-30 Pretoria Avenue
Ottawa, Ontario**

**Servicing and
Stormwater Management Report**

Engineering excellence. Planning precision. Inspired landscapes.

SERVICING AND STORMWATER MANAGEMENT REPORT

**24-30 PRETORIA AVENUE
OTTAWA, ONTARIO**

Prepared by:

NOVATECH
Suite 200, 240 Michael Cowpland Drive
Kanata, Ontario
K2M 1P6

Prepared: July 3, 2019
Revised: January 28, 2020
Revised: March 24, 2020

Novatech File: 119011
Ref No. R-2019-116

March 24, 2020

Planning and Infrastructure Approvals
City of Ottawa
110 Laurier Avenue West
Ottawa, Ontario, K1P 1J1

Attention: Jean-Charles Renaud, MCIP/MICU, RPP/UPC

Dear Mr. Renaud:

**Reference: 24-30 Pretoria Avenue, Ottawa, ON
Servicing and Stormwater Management Report
Our File No.: 119011**

Please find enclosed the 'Servicing and Stormwater Management Report' for the above noted project. This report has been revised per the City of Ottawa comments and is resubmitted for review and approval.

Should you have any questions or require additional information, please contact the undersigned.

Yours truly,

NOVATECH



Cara Ruddle, P.Eng.
Senior Project Manager | Land Development Engineering

cc:

TABLE OF CONTENTS

1.0 INTRODUCTION 1

2.0 EXISTING CONDITIONS 1

3.0 PROPOSED DEVELOPMENT 1

4.0 SITE CONSTRAINTS..... 1

5.0 WATER SERVICING..... 2

6.0 SANITARY SERVICING 3

7.0 STORM SERVICING..... 4

8.0 STORMWATER MANAGEMENT 4

8.1 Stormwater Management Criteria..... 4

8.2 Existing Site Drainage..... 4

8.3 Quantity Control 4

8.4 Quality Control..... 5

8.5 Major Overland Flow Route 6

9.0 EROSION AND SEDIMENT CONTROL 6

9.1 Temporary Measures..... 6

10.0 CONCLUSIONS AND RECOMMENDATIONS 6

LIST OF FIGURES

Figure 1 Key Plan

Figure 2 Existing Conditions Plan

Figure 3 Site Plan

Figure A4 Pre Development Drainage Area Plan

Figure A5 Post Development Drainage Area Plan

LIST OF APPENDICIES

Appendix A Correspondence

Appendix B Water Servicing Information

Appendix C Sanitary Servicing Information

Appendix D Stormwater Management Calculations

Appendix E Development Servicing Study Checklist

Appendix F Drawings

LIST OF ENGINEERING DRAWINGS

General Plan of Services (119011-GP)

Grading & Erosion Sediment Control Plan (119011-GR)

1.0 INTRODUCTION

Novatech has been retained to prepare a Servicing and Stormwater Management Report for the proposed development located at 24-30 Pretoria Avenue within the City of Ottawa. This report will support a Site Plan Application for the subject development. **Figure 1** Key Plan shows the site location.

2.0 EXISTING CONDITIONS

The existing four properties have a combine area of approximately 0.11 hectares. There is currently a detached residential dwelling on lots 28 and 30 and a semi-detached dwelling on lots 24 and 26. The legal description of the property is identified as Lots 1, 2 and 3 (South Pretoria Avenue), Registered Plan 53786, City of Ottawa. The property is bound by Pretoria Avenue to the North, adjacent residential dwellings to the south and west, and a commercial development to the east. The topography of the site slopes towards Pretoria Avenue (south to north). **Figure 2** shows the existing site conditions.

3.0 PROPOSED DEVELOPMENT

It is proposed to develop a 6-storey, 49-unit apartment building with 1-storey of underground parking. There will be amenity areas for the residents provided in the building on the ground floor level. The total building footprint is approximately 630m² at the ground floor level. Access to the underground parking garage is proposed from Pretoria Avenue. A small landscape area is proposed at the rear of the building on top of the underground parking garage roof. Refer to **Figure 3** for the proposed site layout.

A pre-consultation meeting was held with the City of Ottawa on January 16, 2019, at which time the client was advised of the general submission requirements. Refer to **Appendix A** for a copy of the correspondence from the City of Ottawa.

4.0 SITE CONSTRAINTS

A geotechnical investigation was completed for the subject development. A report entitled 'Geotechnical Investigation Proposed Multi-Story Building 28-30 Pretoria Avenue Ottawa, Ontario' prepared by Paterson Group Inc. dated April 22, 2019 indicates that bedrock in the area ranges from 30 to 50 meters below the surface. A permissible grade raise restriction of 1.5 meters has been determined for the site. The long-term groundwater level is expected at a depth ranging from 3.5 to 4.5 meters below existing grade. During construction a temporary Category 3 permit to take water (PTTW) may be required if pumping volumes exceed 400,000L/day.

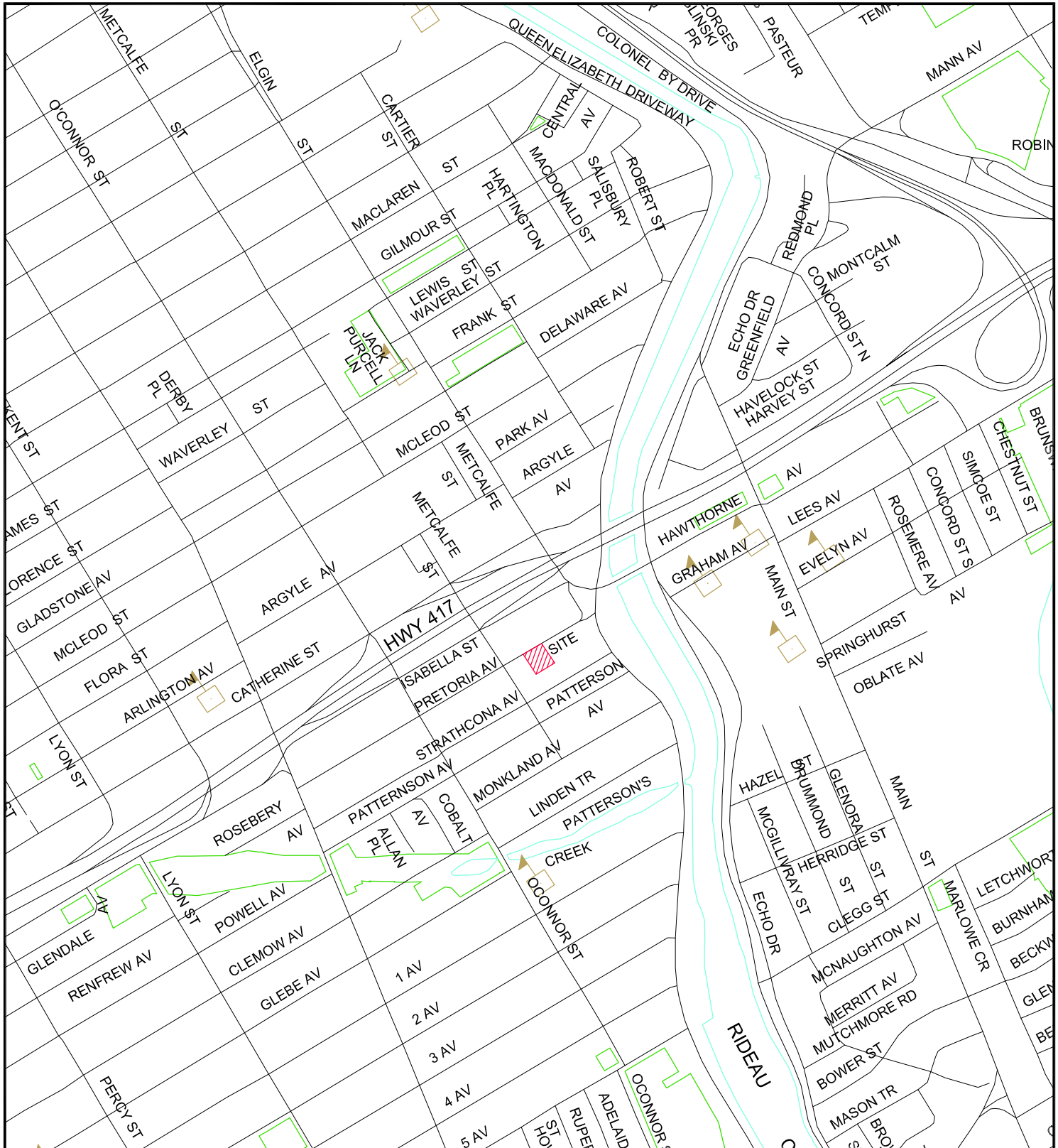

M:\2019\119011\CAD\Design\Figures\119011-KP FIG 1.dwg, KP, Mar 19, 2019 - 4:16pm, mhrehoriatk



Engineers, Planners & Landscape Architects
 Suite 200, 240 Michael Cowpland Drive
 Ottawa, Ontario, Canada K2M 1P6

Telephone (613) 254-9643
 Facsimile (613) 254-5867
 Website www.novatech-eng.com



24-30 PRETORIA AVENUE

KEYPLAN

SCALE	N.T.S		
DATE	JUNE 2019	JOB	119011
FIGURE	1		



M:\2019\119011\CAD\Design\Figures\119011-EX FIG 2.dwg, PR, Mar 13, 2019 - 6:17pm, mhrehorjak



Engineers, Planners & Landscape Architects
 Suite 200, 240 Michael Cowpland Drive
 Ottawa, Ontario, Canada K2M 1P6

Telephone (613) 254-9643
 Facsimile (613) 254-5867
 Website www.novatech-eng.com

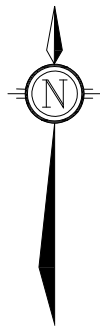

24-30 PRETORIA AVENUE

EXISTING CONDITIONS
 PLAN

SCALE		N.T.S	
DATE	JUNE 2019	JOB	119011
FIGURE			2

PRETORIA AVENUE

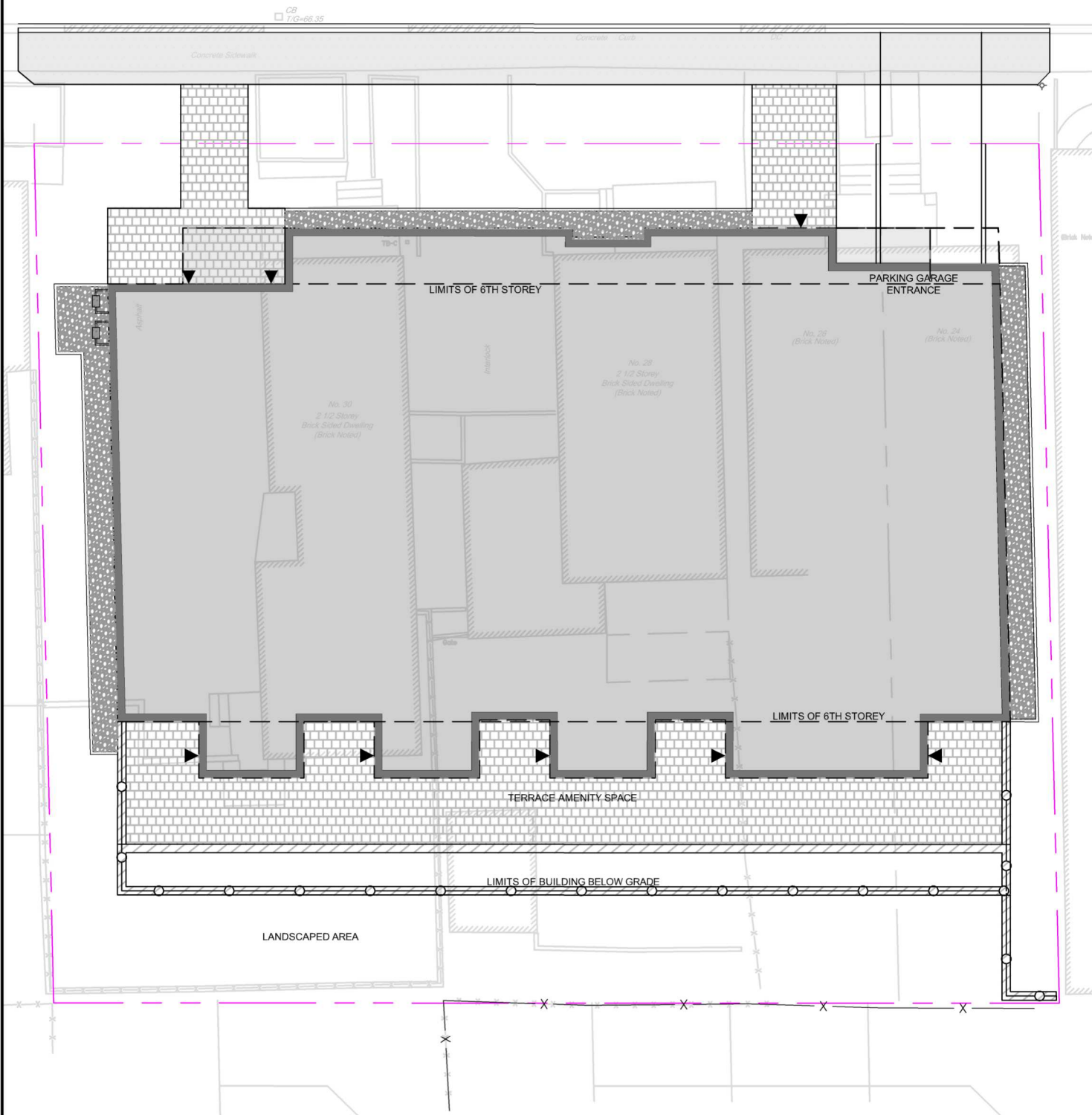

M:\2019\119011\CAD\Design\Figures\119011-PR FIG 3.dwg, PR, Jan 28, 2020 - 4:31pm, mhrehorziak



Engineers, Planners & Landscape Architects
 Suite 200, 240 Michael Cowpland Drive
 Ottawa, Ontario, Canada K2M 1P6

Telephone (613) 254-9643
 Facsimile (613) 254-5867
 Website www.novatech-eng.com



24-30 PRETORIA AVENUE

SITE PLAN



DATE	JOB	FIGURE
MAR 2020	119011	3

5.0 WATER SERVICING

The proposed development is in the 1W pressure zone of the City of Ottawa water distribution network. There is an existing 200mm diameter watermain located in the Pretoria Avenue right-of-way which will provide service for the proposed development. A portion of the City sewer mapping is included in **Appendix B** for reference.

The proposed 6-storey apartment building will be serviced by a new 150mm diameter water service with a connection to the existing 200mm diameter watermain along Pretoria Avenue. The proposed water service will be sized to provide both the required domestic water demand and fire flow. A shut-off valve will be located on the proposed service at the property line and a water meter and remote water meter will be provided. Refer to the General Plan of Services (119011-GP) for details.

The City of Ottawa design criteria for Water Distribution systems were used to calculate the theoretical water demand for the proposed 6-storey residence building. The water demand has been calculated based on a population of 71 people from a total of 49 units. A summary of the water demand criteria is provided below in **Table 5.1**.

Table 5.1 Water Demand Summary

	Proposed Development
Water Demand Rate	Residential - 350 L/person/day
Units/Area	5 - Bach, 40 - 1 Bed, 4 - 2 Bed,
Density	1.4 ppu – Bach & 1 Bed, 2.1 ppu – 2 Bed,
Peaking Factors (MOE Table 3.3)	Residential - MD=7.9 x avg day, PH=11.9 x avg day
Average Day Demand (L/s)	0.29
Maximum Daily Demand (L/s)	2.28
Peak Hour Demand (L/s)	3.43
FUS Fire Flow Requirement (L/s)	67.0
Max Day+Fire Flow (L/s)	69.28

The required fire demand was calculated using the Fire Underwriters Survey (FUS) Guidelines. The proposed building is to be sprinklered with the Siamese connection located by the parking garage entrance. Existing hydrants within the Pretoria Avenue right-of-way will also provide fire protection for the proposed development. The required fire demand was calculated to be 1,057 USGPM (or 4,000 L/min). Refer to **Appendix B** for a copy of the water calculations.

This water demand info was submitted to the City and boundary conditions provided from the City's water model. The boundary conditions are provided in **Table 5.2**.

Table 5.2 Water Boundary Conditions

Criteria	Head (m)
Connection Pretoria Avenue	
Minimum HGL	106.2
Maximum HGL	114.8
Max Day + Fire Flow HGL	105.0

These boundary conditions were used to analyze the performance of the proposed watermain for three theoretical conditions: 1) High Pressure check under Average Day conditions 2) Peak Hour demand 3) Maximum Day + Fire Flow demand. The following **Table 5.3** summarizes the results from the hydraulic water analysis.

Table 5.3 Water Analysis Results Summary

Condition	Demand (L/s)	Min/Max Allowable Operating Pressures (psi)	Limits of Design Operating Pressures (psi)
High Pressure	2.06	80psi (Max)	68.4
Max Day + Fire Flow	138.14	20psi (Min)	54.5
Peak Hour	11.29	40psi (Min)	56.2

Based on the proceeding analysis it can be concluded that the watermain, as designed, will provide adequate flow and pressures for the fire flow + maximum day demand and peak hour demand. Refer to **Appendix B** for detailed hydraulic calculations and City of Ottawa boundary conditions.

6.0 SANITARY SERVICING

There is an existing 375mm diameter sanitary sewer located in the Pretoria Avenue right-of-way which will service the proposed development. The existing 375mm diameter sanitary sewer flows to the east along Pretoria Avenue where it connects into a 750mm diameter combined sewer at Queen Elizabeth Drive. A portion of the City sewer mapping is included in **Appendix C** for reference which shows the existing sanitary sewer infrastructure.

The proposed 6-storey apartment building will be serviced by a new 150mm diameter sanitary service with a connection to the existing 375mm diameter sewer mentioned above. Refer to the General Plan of Services (119011-GP) for details.

Sanitary flows for the proposed development were calculated from criteria in Section 4 of the City of Ottawa Sewer Design Guidelines and are based on a population of 71 people from a total of 49 units. The peak sanitary flow was calculated to be 0.82 L/s based on an average domestic

demand of 280 L/day/person. Detailed sanitary flow calculations are provided in **Appendix C** for reference.

The City of Ottawa Water Resources Department has indicated that there are no capacity concerns with the existing sewer infrastructure and the proposed development (refer to email in **Appendix C**). Therefore, there is adequate capacity in the existing sanitary infrastructure to service the proposed development.

7.0 STORM SERVICING

There is an existing 525mm diameter storm sewer in Pretoria Avenue which is the storm sewer outlets for the subject site. The proposed 6-storey apartment building will be serviced by two new 200mm storm services with connections to the existing 525mm diameter in Pretoria Avenue. The first 200mm diameter service will convey controlled roof flows and foundation drainage. The second 200mm diameter storm service will convey controlled flows from the stormwater storage tank. The existing 525mm diameter storm sewer flows east along Pretoria Avenue where it connects into a 750mm diameter combined sewer at Queen Elizabeth Drive. A portion of the City sewer mapping is included in **Appendix D** for reference which shows the existing storm sewer infrastructure.

8.0 STORMWATER MANAGEMENT

8.1 Stormwater Management Criteria

The following Stormwater Management criteria was provided by the City of Ottawa:

- Control post-development flow from the site to the 1:2-year predevelopment level for all storm events up to and including 1:100-year storm.
- Pre-development flow to be calculated using a runoff coefficient of 0.4.
- Calculated Time of Concentration (no less than 10 minutes).
- Quality control is not required, stormwater outlets to a combined sewer downstream of the subject site, (refer to correspondence with RVCA for quality control requirements in **Appendix A**)

8.2 Existing Site Drainage

As indicated previously the site is currently comprised of four individual lots which are developed with 2 detached and 1 semidetached residential dwelling. In the existing site condition stormwater sheet drains across the properties towards the Pretoria Avenue right-of-way and is collected in existing road catchbasins and conveyed to the existing storm sewer system. Refer to Figure A4 Pre-Development Drainage Area Plan in **Appendix D**.

8.3 Quantity Control

As previously mentioned stormwater from the proposed development for storms up to and including the 100-year storm event will be controlled to the 2-year level based on a run-off coefficient of 0.4 and a calculated time of concentration to be no less than 10 minutes. The allowable release to the existing Pretoria Avenue storm sewer was calculated to be 9.3 L/s.

The site has been divided into three different drainage areas for the post development condition. The catchment areas are based on the proposed grading design for the site. The drainage areas are as follows:

Area A-1

- The front and west side yard area surrounding the building will sheet drain uncontrolled directly to Pretoria Avenue.

Area A-2

- Flows from the roof terraces, rear landscaped amenity space and east side yard will be conveyed to the existing storm sewer in Pretoria Avenue. These flows will be captured by area deck drains and landscape drains and will be conveyed to a stormwater storage tank under the driveway to the covered parking garage. Flows from the storage tank to the existing sewer in Pretoria Avenue will be attenuated by an inlet control device. Storage will be provided for storms up to and including the 100-year event within the storage tank. Flows in excess of the 100-year event will overflow through the vented lid on the tank and will be conveyed directly to the Pretoria Avenue right-of-way.

Area A-3

- Flows from roof will also be conveyed to the existing storm sewer in Pretoria Avenue. These flows will be captured by flow control roof drains and will be conveyed directly to the existing storm sewer in Pretoria Avenue. These flows will bypass the storage tank as storage will be provided for storms up to and including the 100-year event on the roof area.

Table 8.1 below summarizes the flow, storage required, and storage provided for each of the site drainage areas.

Table 8.1 Stormwater Management Summary

Area ID	Area (ha)	1:5 Year Weighted Cw	Orifice Size & Type	5 Year Storm Event			100 Year Storm Event		
				Flow (L/s)	Req Vol (cu.m)	Max. Vol. Provided (cu.m.)	Flow (L/s)	Req Vol (cu.m)	Max. Vol. Provided (cu.m.)
A-1	0.017	0.36	N/A	1.8	N/A	N/A	3.6	N/A	N/A
A-2	0.043	0.51	LMF 45	1.2	5.5	17.8	1.9	13.8	17.8
A-3	0.049	0.90	RD-100-A-ADJ	2.5	7.4	24.9	3.8	15.7	24.9
Post-Development Release Rate				5.5			9.3		
Allowable Release Rate				9.3			9.3		
Pre-Development Release Rate				18.7			36.2		

Refer to **Appendix D** for Rational and Modified Method calculations, stormwater management model results and Figure A5 Post Development Drainage Area Plan.

8.4 Quality Control

Quality control of stormwater for the site development will not be required as the storm sewer outlet for the site drains into a combined sewer downstream.

8.5 Major Overland Flow Route

A major overland flow route will be provided for storms greater than the 100-year storm event. Stormwater from the rear of the site will be directed to the Pretoria Avenue right-of-way as per existing conditions. Stormwater from the front of the building will sheet drain directly to the Pretoria Avenue right-of-way as per existing conditions. The major overland system is shown on the Grading Plan (119011-GR).

9.0 EROSION AND SEDIMENT CONTROL

9.1 Temporary Measures

Temporary erosion and sediment control measures will be required on-site during construction in accordance with the Best Management Practices for Erosion and Sediment Control. This includes the following temporary measures:

- Filter bags will be placed under the grates of nearby catchbasins, manholes and will remain in place until vegetation has been established and construction is completed.
- Silt fencing will be placed per OPSS 577 and OPSD 219.110 along the surrounding construction limits;
- A mud mat will be installed at the site entrance off Pretoria Avenue.
- Street sweeping, and cleaning will be performed, as required, to suppress dust and to provide safe and clean roadways adjacent to the construction site.
- On-site dewatering is to be directed to a sediment trap and/or gravel splash pad and discharged safely to an approved outlet as directed by the engineer.

These measures will be implemented prior to the commencement of construction and maintained in good order until vegetation has been established. Refer to the Grading Plans (119011-GR) for additional information.

10.0 CONCLUSIONS AND RECOMMENDATIONS

- Water servicing for the proposed development will be provided by a single 150mm diameter service connection to the existing 200mm diameter watermain Pretoria Avenue. The existing watermain infrastructure can provide adequate domestic flows and pressure for fire protection.
- The proposed building will be serviced by a single 150mm diameter sanitary service which will connect to the existing 375mm diameter sanitary sewer in Pretoria Avenue. The proposed building service will include an internal test port in the P1 level of the parking garage. The existing sanitary sewer has adequate excess capacity to service the development.
- The proposed building will be serviced by two 200mm diameter storm services which will connect to the existing 525mm diameter storm sewer in Pretoria Avenue. Quantity control of stormwater will be provided by a stormwater storage tank with an inlet control device and flow-controlled roof drains to attenuate flows to the existing storm sewer in Pretoria Avenue. Stormwater will be controlled to the 2-year level for storms up to and including the 100-year event. The allowable release rate for the site is 9.3 L/s and the post-

development stormwater release rates are 5.5 L/s and 9.3 L/s for the 5 and 100 year events respectively.

- Quality control of stormwater will is not required as the storm sewer on Pretoria Avenue outlets to a combined sewer system downstream of the development.
- An overland flow route is provided;
- Erosion and sediment control measures will be implemented prior to and during construction.

NOVATECH

Prepared by:



Matthew Hrehoriak, P.Eng.
Project Engineer
Land Development Engineering

Reviewed by:

A handwritten signature in blue ink, appearing to read "Cara Ruddle".

Cara Ruddle, P. Eng.
Senior Project Manager
Land Development Engineering

APPENDIX A

Correspondence

Matthew Hrehoriak

From: Cara Ruddle
Sent: Tuesday, March 12, 2019 3:48 PM
To: Matthew Hrehoriak
Subject: FW: 28 Pretoria SWM Criteria and Misc. Info

Cara Ruddle, P.Eng., Senior Project Manager | Land Development Engineering

NOVATECH Engineers, Planners & Landscape Architects

240 Michael Cowpland Drive, Suite 200, Ottawa, ON, K2M 1P6 | Tel: 613.254.9643 Ext: 220 | Cell: 613.261.7719 | Fax: 613.254.5867

The information contained in this email message is confidential and is for exclusive use of the addressee.

From: Wessel, Shawn <shawn.wessel@ottawa.ca>
Sent: Tuesday, March 12, 2019 3:44 PM
To: Cara Ruddle <c.ruddle@novatech-eng.com>
Subject: 28 Pretoria SWM Criteria and Misc. Info

Good afternoon again Ms. Ruddle.

Further to our conversation today regarding the zoning application proposed for 28 Pretoria, please find the requested SWM Criteria for your information and use:

Although the sewers are separated on this street, they connect to a combined sewer system downstream and are thereby considered partially separated.

The following apply to this site and any development within a combined sewer area:

- Total (San & Stm) allowable release rate will be 2 year pre-development rate.
- Coefficient (C) of runoff will need to be determined **as per existing conditions** but in no case more than 0.4
- TC = 20 minutes or can be calculated
TC should be not be less than 10 minutes, since IDF curves become unrealistic at less than 10 min.
- Any storm events greater than 2 year, up to 100 year, and including 100 year storm event must be detained on site.
- Two separate sewer laterals (one for sanitary and other for storm) will be required.
*Please note:
Foundation drains are to be independently connected to sewermain unless being pumped with appropriate back up power, sufficient sized pump and back flow prevention. Pumped is recommended for this development due to reported sanitary flooding from neighbouring properties.
- Roof drains are to be connected downstream of any incorporated ICD within the SWM system.
- The sanitary and storm sewers in this area has been identified to have capacity for the proposed 6 storey, 21 unit, residential apartment building by our Water Resources Dept.

Due to combined sewer connection, an MECP Environmental Compliance Approval (ECA) is required, Direct Submission.

For MECP ECA:

Please provide one copy of the following:

- MECP ECA Application Form - Direct Sub tied to SPC Application.
- Fees - Certified Cheque made out to "Minister of Finance" in accordance to completed application.
- Proof of Applicant's Identification (Copy of Passport or Drivers Lic.(Both Sides) – in colour)
- Certificate of Incorporation (if Applicable)
- NAICS Code (If Applicable)
- Plan & Profile
- Grading and Servicing Plans
- Survey Plan
- Pipe Data Form
- Draft ECA (City of Ottawa Expanded Works Form)
- Source Protection Policy Screening & Significant Threat Report
- Sewer Drainage Area Plan
- SWM Report
- Services Report
- Geotechnical Report & any other supportive documentation
- Correspondence: City of Ottawa including ROW, Water Resources Dept., ISD etc., MNR, Conservation Authority (RCVA) & MECP.

Please note that once the review has been completed 3 final copies including 3 CD Rom disks will be required to accompany the applications with MECP and for City of Ottawa records.

In addition, you are welcome to contact Eric Tousignant (Water Resources Dept.) in regards to modeling, HGL, ponding and freeboard information for this or any other project, as this is the City's preference – particularly when looking at proposing sunken or reverse sloped driveways and UG parking scenarios.

If you require additional information or clarification, please do not hesitate to contact me anytime.

Thank you

Regards,

Shawn Wessel, A.Sc.T.,rcji
Project Manager - Infrastructure Approvals
Gestionnaire de projet – Approbation des demandes d'infrastructures

Development Review Central Branch | Direction de l'examen des projets d'aménagement, Centrale
Planning, Infrastructure and Economic Development Department | Direction générale de la planification
de l'infrastructure et du développement économique
City of Ottawa | Ville d'Ottawa

110 Laurier Ave. W. | 110, avenue Laurier Ouest, Ottawa ON K1P 1J1
(613) 580 2424 Ext. | Poste 33017
Int. Mail Code | Code de Courrier Interne 01-14
shawn.wessel@ottawa.ca

 Please consider the environment before printing this email

This e-mail originates from the City of Ottawa e-mail system. Any distribution, use or copying of this e-mail or the information it contains by other than the intended recipient(s) is unauthorized. Thank you.

Le présent courriel a été expédié par le système de courriels de la Ville d'Ottawa. Toute distribution, utilisation ou reproduction du courriel ou des renseignements qui s'y trouvent par une personne autre que son destinataire prévu est interdite. Je vous remercie de votre collaboration.

Matthew Hrehoriak

From: Eric Lalande <eric.lalande@rvca.ca>
Sent: Thursday, January 31, 2019 10:50 AM
To: Francois Thauvette
Subject: Re: RVCA Pre-consultation - Proposed residential development 28 & 30 Pretoria Ave

Hi Francois,

You are correct, The RVCA has no objections to the stormwater connection to the combined sewer. The RVCA does not require an approval for the connection. Water quality mitigation is expected to be provided through municipal infrastructure. No quality control measures will be required.

Thank you,

Eric Lalande, MCIP, RPP
Planner, RVCA
613-692-3571 x1137

From: Francois Thauvette <f.thauvette@novatech-eng.com>
Sent: January 31, 2019 10:45 AM
To: Eric Lalande
Subject: RVCA Pre-consultation - Proposed residential development 28 & 30 Pretoria Ave

Hi Eric,

We are working on a proposed 6-storey residential development located at 28 & 30 Pretoria Avenue, in the City of Ottawa.

There are separate sanitary and storm sewers in front of the property, however the storm sewer drains into a combined sewer at the east end of the block. Based on past experience, on-site stormwater quality control is not required. Furthermore, RVCA approval is not required as the storm flows are ultimately being directed into a combined sewer. Please review and advise if these assumption are correct.

On a similar development, the RVCA's response was as follows: "The RVCA has no objections to the stormwater connection to the combined sewer. The RVCA does not require an approval for the connection."

Please note however that we will be applying for a MECP ECA (per O. Reg. 525/98).

Regards,

François Thauvette, P. Eng., Senior Project Manager | Land Development & Public Sector Engineering
NOVATECH Engineers, Planners & Landscape Architects
240 Michael Cowpland Drive, Suite 200, Ottawa, ON, K2M 1P6 | Tel: 613.254.9643 Ext: 219 | Cell: 613.276.0310 | Fax: 613.254.5867
The information contained in this email message is confidential and is for exclusive use of the addressee.

APPENDIX B
Watermain Servicing Information

24-30 Pretoria Water Servicing



March 12, 2019

- Property Parcels
- Water Labels / Étiquettes**
- Valves / Vannes**
 - Valve / Vanne
 - TVS, A, D
- Water Fittings / Raccords de conduite d'eau**
 - Cap / bouchon

- ◀ Reducer / réducteur
- Hydrants / Bornes-fontaines
- Hydrant Laterals / Branchements de borne-fontaine
- Water Mains / Conduites d'eau principales**
 - Private / Branchement privé
 - Public / Branchement public

- Misc. Water Structures / Structures d'aqueduc - divers**
 - Pumping Station / Station de pompage des eaux
 - Well Supply / Alimentation par puits
 - Elevated Tank / Château d'eau
 - In Ground Tank / Réservoir souterrain
 - Water Treatment Plant / Usine d'épuration des eaux

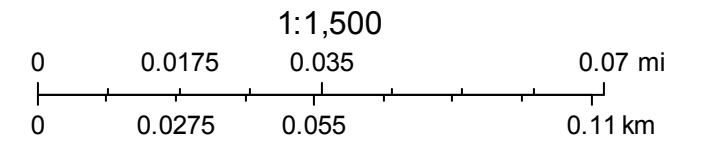

City of Ottawa

24-30 PRETORIA AVE WATER DEMANDS

	Unit Type			Total	Residential Demand (L/s)		
	Bachelor	1 Bed Apartment	2 Bed Apartment		Avg Day	Max. Daily	Peak Hour
No. Units	5	40	4	49	0.29	2.28	3.43
Unit Population	7	56	8	71			

Design Parameters:

- Bachelor Apartment = 1.4 persons/unit
- 1 Bed Apartment = 1.4 persons/unit
- 2 Bed Apartment = 2.1 persons/unit

Section 4.0 Ottawa Sewer Design Guidelines

- Average Domestic Flow 350 L/person/day

Peaking Factors: Table 3-3 Moe Guideline for Drinking Water systems (pop < 500)

Max. Daily Demand:

- Residential 7.9 x Avg Day

Peak Hourly Demand:

- Residential 11.9 xAvg Day

FUS - Fire Flow Calculations

As per 1999 Fire Underwriter's Survey Guidelines



Engineers, Planners & Landscape Architects

Novatech Project #: 119011
 Project Name: 24-30 Pretoria Avenue
 Date: 6/20/2019
 Input By: Matt Hrehoriak
 Reviewed By: Cara Ruddle

Legend

Input by User

No Information or Input Required

Building Description: 6 Storey Apartment Building
 Fire Resistive Construction

Step		Choose		Value Used	Total Fire Flow (L/min)	
Base Fire Flow						
1	Construction Material		Multiplier			
	Coefficient related to type of construction C	Wood frame		1.5		0.6
		Ordinary construction		1		
		Non-combustible construction		0.8		
		Modified Fire resistive construction (2 hrs)	Yes	0.6		
Fire resistive construction (> 3 hrs)			0.6			
2	Floor Area					
	A	Building Footprint (m ²)	630			
		Number of Floors/Storeys	6			
		Protected Openings (1 hr)	Yes			
		Area of structure considered (m ²)		945		
F	Base fire flow without reductions			4,000		
	$F = 220 C (A)^{0.5}$					
Reductions or Surcharges						
3	Occupancy hazard reduction or surcharge		Reduction/Surcharge		3,400	
	(1)	Non-combustible		-25%		-15%
		Limited combustible	Yes	-15%		
		Combustible		0%		
		Free burning		15%		
Rapid burning			25%			
4	Sprinkler Reduction		Reduction		-1,700	
	(2)	Adequately Designed System (NFPA 13)	Yes	-30%		-30%
		Standard Water Supply	Yes	-10%		-10%
		Fully Supervised System	Yes	-10%		-10%
Cumulative Total			-50%			
5	Exposure Surcharge (cumulative %)		Surcharge		2,550	
	(3)	North Side	10.1 - 20 m			15%
		East Side	0 - 3 m			25%
		South Side	3.1 - 10 m			20%
		West Side	0 - 3 m			25%
Cumulative Total			75%			
Results						
6	(1) + (2) + (3)	Total Required Fire Flow, rounded to nearest 1000L/min		L/min	4,000	
		(2,000 L/min < Fire Flow < 45,000 L/min)	or	L/s	67	
			or	USGPM	1,057	
7	Storage Volume	Required Duration of Fire Flow (hours)		Hours	1.5	
		Required Volume of Fire Flow (m ³)		m ³	360	

Boundary Condition for 28-30 Pretoria

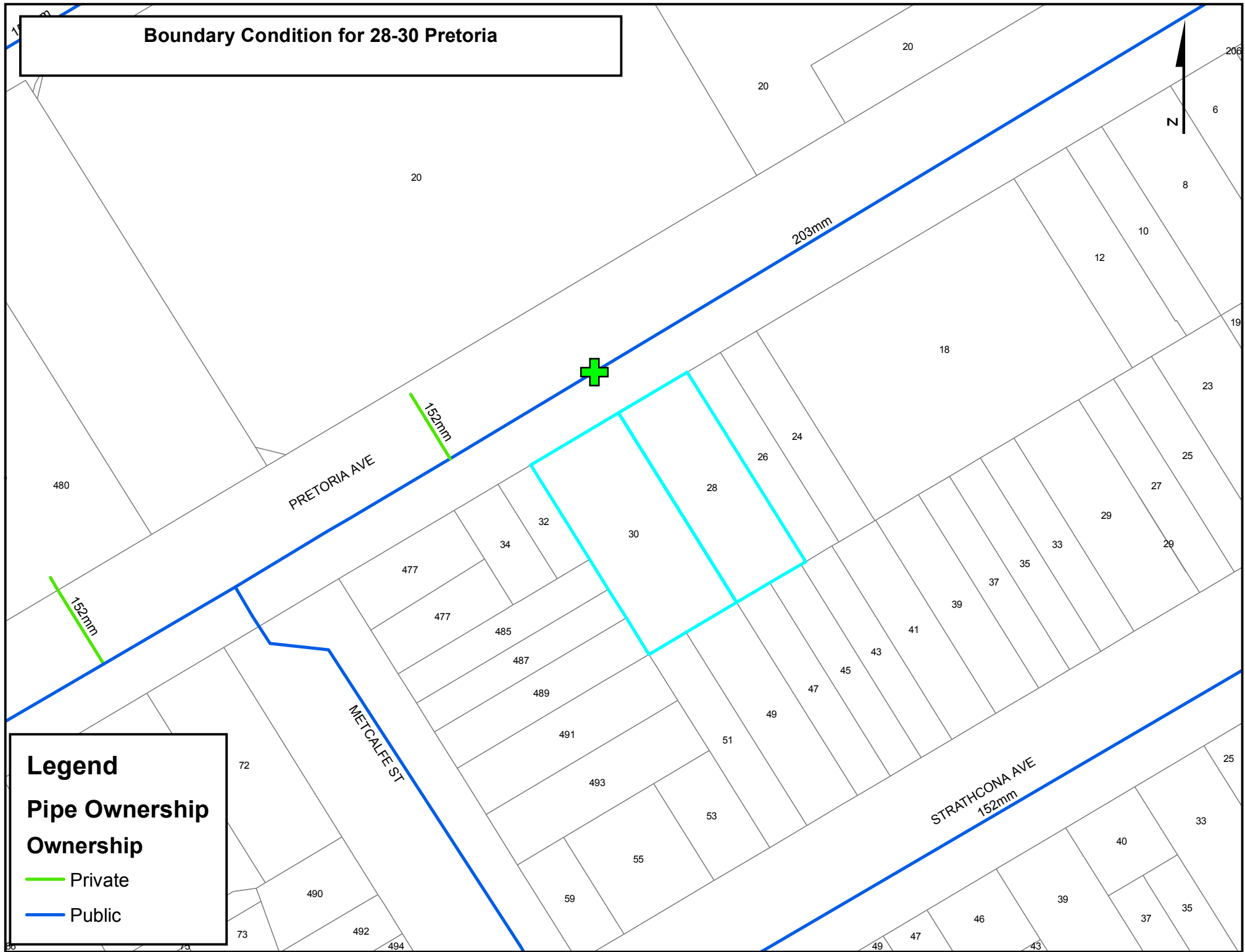

Legend

Pipe Ownership

- Ownership
- Private
- Public

Matthew Hrehoriak

From: Wessel, Shawn <shawn.wessel@ottawa.ca>
Sent: Tuesday, June 25, 2019 4:40 PM
To: Matthew Hrehoriak
Subject: RE: 24-30 Pretoria Ave Boundary Condition Request
Attachments: 28-30 Pretoria June 2019.pdf

Good afternoon Mr. Hrehoriak.

Please find boundary conditions below:

The following are boundary conditions, HGL, for hydraulic analysis at 28-30 Pretoria (zone 1W) assumed to be connected to the 203mm on Pretoria (see attached PDF for location).

Minimum HGL = 106.2m

Maximum HGL = 114.8m

Max Day + Fire Flow (67 L/s) = 105.0m

These are for current conditions and are based on computer model simulation.

Disclaimer: The boundary condition information is based on current operation of the city water distribution system. The computer model simulation is based on the best information available at the time. The operation of the water distribution system can change on a regular basis, resulting in a variation in boundary conditions. The physical properties of watermains deteriorate over time, as such must be assumed in the absence of actual field test data. The variation in physical watermain properties can therefore alter the results of the computer model simulation.

If you require additional information or clarification, please do not hesitate to contact me anytime.

Thank you

Regards,

Shawn Wessel, A.Sc.T.,rcji

Project Manager - Infrastructure Approvals

Gestionnaire de projet – Approbation des demandes d’infrastructures

Development Review Central Branch | Direction de l’examen des projets d’aménagement, Centrale
Planning, Infrastructure and Economic Development Department | Direction générale de la planification
de l’infrastructure et du développement économique
City of Ottawa | Ville d’Ottawa
110 Laurier Ave. W. | 110, avenue Laurier Ouest, Ottawa ON K1P 1J1

CALCULATED WATER DEMANDS:

PROPOSED DEVELOPMENT (6 STOREY BUILDING)

AVERAGE DAY = 0.29 L/s
MAXIMUM DAY = 2.28 L/s
PEAK HOUR = 3.43 L/s
MAX DAY + FIRE = 69.28 L/s

CITY OF OTTAWA BOUNDARY CONDITIONS:

BOUNDARY CONDITIONS BASED ON (ZONE 1W) CONNECTION TO 203mm DIA. WATERMAIN ON PRETORIA AVENUE.

MINIMUM HGL = 106.2 m
MAXIMUM HGL = 114.8 m
MAX DAY + FIRE = 105 m

WATERMAIN ANALYSIS:

24-30 PRETORIA AVE WATERMAIN CONNECTIONS

FINISHED FLOOR GROUND ELEVATION = 66.70 m

HIGH PRESSURE TEST = MAX HGL - AVG GROUND ELEV x 1.42197 PSI/m < 80 PSI

HIGH PRESSURE = 68.4 PSI

LOW PRESSURE TEST = MIN HGL - AVG GROUND ELEV x 1.42197 PSI/m > 40 PSI

LOW PRESSURE = 56.2 PSI

MAX DAY + FIRE TEST = MAX DAY + FIRE - AVG GROUND ELEV x 1.42197 PSI/m > 20 PSI

LOW PRESSURE = 54.5 PSI

APPENDIX C
Sanitary Servicing Information

28-30 Pretoria Sanitary Servicing



March 12, 2019

- Property Parcels
- Sanitary Pipe Details / Détails de la conduite de réseau d'égout domestique**
- Sewer Fittings / Raccords**
- Cap / bouchon
- Tee / raccord en T
- Sanitary Manholes / Regards d'égout domestique

- Sanitary Pipes / Conduites d'égout domestique**
- - - Private / Branchement privé
- Public / Branchement public
- Sanitary Pump Stations and Treatment Plants / Installations d'infrastructure**
- Sanitary Pump Station / Station de pompage des eaux usées
- Wastewater Treatment Plant / Usine d'épuration des eaux usées
- Upstream Invert / Radier amont

- Downstream Invert / Radier aval
- Combined Pipe Details / Détails de la conduite d'égout unitaire**
- - - Combined Manholes / Regards d'égout unitaire
- Combined Pipes / Conduites d'égout unitaire**
- + Public / Branchement public
- - - Private / Branchement privé

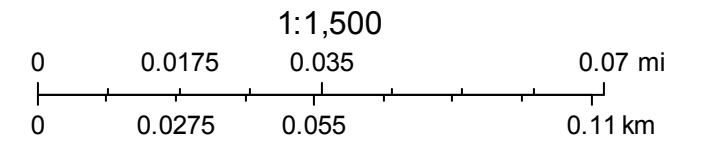

City of Ottawa

24-30 PRETORIA AVE SANITARY FLOWS

LOCATION			RESIDENTIAL							INFILTRATION			Total Flow (l/s)	PIPE						
AREA	FROM	TO	Unit Type				TOTAL			Total Area (ha)	Accum. Area (ha)	Infiltr. Flow (l/s)		Size (mm)	Slope (%)	Length (m)	Capacity (l/s)	Full Flow Vel. (m/s)	Q/Q _{full} (%)	
			Bachelor	1 Bed Units	2 Bed Units	Pop.	Pop.	Accum. Pop.	Peak Factor											Peak Flow (l/s)
	BLDG	EX	5	40	4	71	71	71	3.4	0.79	0.109	0.109	0.04	0.82	150	2.00	N/a	21.5	1.22	3.8%
Existing Sewer Capacity															375	0.50	84.0	123.9	1.12	

Design Parameters:

- 1 Bachelor = 1.4 persons/unit
- 1 Bed Apartment = 1.4 persons/unit
- 2 Bed Apartment = 2.1 persons/unit

Section 4.0 Ottawa Sewer Design Guidelines

- Average Domestic Flow 280 L/person/day
- Extraneous Flows 0.33 l/s/ha

Residential Peaking Factor Harmon Equation

Matthew Hrehoriak

To: Cara Ruddle
Subject: RE: 28 Pretoria SWM Criteria and Misc. Info

From: Wessel, Shawn <shawn.wessel@ottawa.ca>
Sent: Thursday, March 14, 2019 11:28 AM
To: Cara Ruddle <c.ruddle@novatech-eng.com>
Subject: RE: 28 Pretoria SWM Criteria and Misc. Info

Good morning Ms. Ruddle.

I can confirm that our Water Resources Dept. reviewed the proposal and determined there is sufficient capacity for both sanitary and storm sewer service connections for this development. Additionally, and as mentioned prior, we recommend pumping the storm and sanitary as there has been reported flooding in this area.

Please feel free to reference this and previous email (below) for the Re-Zoning Application through Serviceability Report and for the required MECP ECA application and expected Site Plan Control Application.

If you require additional information or clarification, please do not hesitate to contact me anytime.

Thank you

Regards,

Shawn Wessel, A.Sc.T.,rcji
Project Manager - Infrastructure Approvals
Gestionnaire de projet – Approbation des demandes d’infrastructures

Development Review Central Branch | Direction de l'examen des projets d'aménagement, Centrale
Planning, Infrastructure and Economic Development Department | Direction générale de la planification
de l'infrastructure et du développement économique
City of Ottawa | Ville d'Ottawa
110 Laurier Ave. W. | 110, avenue Laurier Ouest, Ottawa ON K1P 1J1
(613) 580 2424 Ext. | Poste 33017
Int. Mail Code | Code de Courrier Interne 01-14
shawn.wessel@ottawa.ca

 Please consider the environment before printing this email

From: Cara Ruddle <c.ruddle@novatech-eng.com>
Sent: March 14, 2019 11:17 AM
To: Wessel, Shawn <shawn.wessel@ottawa.ca>
Subject: RE: 28 Pretoria SWM Criteria and Misc. Info

Thanks Shawn. Your email below indicates there is adequate capacity in the existing storm and sanitary sewers for the proposed development. Can you please confirm that this email can be referenced in a Serviceability Report and is acceptable to support a Re-Zoning Application? I understand that more detailed calculations and coordination with the Water Resources Department would be required during the detailed design to support a Site Plan Application.

Thanks.

Cara Ruddle, P.Eng., Senior Project Manager | Land Development Engineering

NOVATECH Engineers, Planners & Landscape Architects

240 Michael Cowpland Drive, Suite 200, Ottawa, ON, K2M 1P6 | Tel: 613.254.9643 Ext: 220 | Cell: 613.261.7719 | Fax: 613.254.5867
The information contained in this email message is confidential and is for exclusive use of the addressee.

From: Wessel, Shawn <shawn.wessel@ottawa.ca>
Sent: Tuesday, March 12, 2019 3:44 PM
To: Cara Ruddle <c.ruddle@novatech-eng.com>
Subject: 28 Pretoria SWM Criteria and Misc. Info

Good afternoon again Ms. Ruddle.

Further to our conversation today regarding the zoning application proposed for 28 Pretoria, please find the requested SWM Criteria for your information and use:

Although the sewers are separated on this street, they connect to a combined sewer system downstream and are thereby considered partially separated.

The following apply to this site and any development within a combined sewer area:

- Total (San & Stm) allowable release rate will be 2 year pre-development rate.
- Coefficient (C) of runoff will need to be determined **as per existing conditions** but in no case more than 0.4
- TC = 20 minutes or can be calculated
TC should be not be less than 10 minutes, since IDF curves become unrealistic at less than 10 min.
- Any storm events greater than 2 year, up to 100 year, and including 100 year storm event must be detained on site.
- Two separate sewer laterals (one for sanitary and other for storm) will be required.
*Please note:
Foundation drains are to be independently connected to sewermain unless being pumped with appropriate back up power, sufficient sized pump and back flow prevention. Pumped is recommended for this development due to reported sanitary flooding from neighbouring properties.
- Roof drains are to be connected downstream of any incorporated ICD within the SWM system.
- The sanitary and storm sewers in this area has been identified to have capacity for the proposed 6 storey, 21 unit, residential apartment building by our Water Resources Dept.

Due to combined sewer connection, an MECP Environmental Compliance Approval (ECA) is required, Direct Submission.

For MECP ECA:

Please provide one copy of the following:

MECP ECA Application Form - Direct Sub tied to SPC Application.

Fees - Certified Cheque made out to "Minister of Finance" in accordance to completed application.

Proof of Applicant's Identification (Copy of Passport or Drivers Lic.(Both Sides) – in colour)

Certificate of Incorporation (if Applicable)

NAICS Code (If Applicable)

Plan & Profile

Grading and Servicing Plans

Survey Plan

Pipe Data Form

Draft ECA (City of Ottawa Expanded Works Form)

Source Protection Policy Screening & Significant Threat Report

Sewer Drainage Area Plan

SWM Report

Services Report

Geotechnical Report & any other supportive documentation

Correspondence: City of Ottawa including ROW, Water Resources Dept., ISD etc., MNR, Conservation Authority (RCVA) & MECP.

Please note that once the review has been completed 3 final copies including 3 CD Rom disks will be required to accompany the applications with MECP and for City of Ottawa records.

In addition, you are welcome to contact Eric Tousignant (Water Resources Dept.) in regards to modeling, HGL, ponding and freeboard information for this or any other project, as this is the City's preference – particularly when looking at proposing sunken or reverse sloped driveways and UG parking scenarios.

If you require additional information or clarification, please do not hesitate to contact me anytime.

Thank you

Regards,

Shawn Wessel, A.Sc.T.,rcji

Project Manager - Infrastructure Approvals

Gestionnaire de projet – Approbation des demandes d'infrastructures

Development Review Central Branch | Direction de l'examen des projets d'aménagement, Centrale
Planning, Infrastructure and Economic Development Department | Direction générale de la planification
de l'infrastructure et du développement économique
City of Ottawa | Ville d'Ottawa

APPENDIX D
Storm Servicing and Stormwater Management Calculations

APPENDIX 5-A

OTTAWA INTENSITY DURATION FREQUENCY (IDF) CURVE

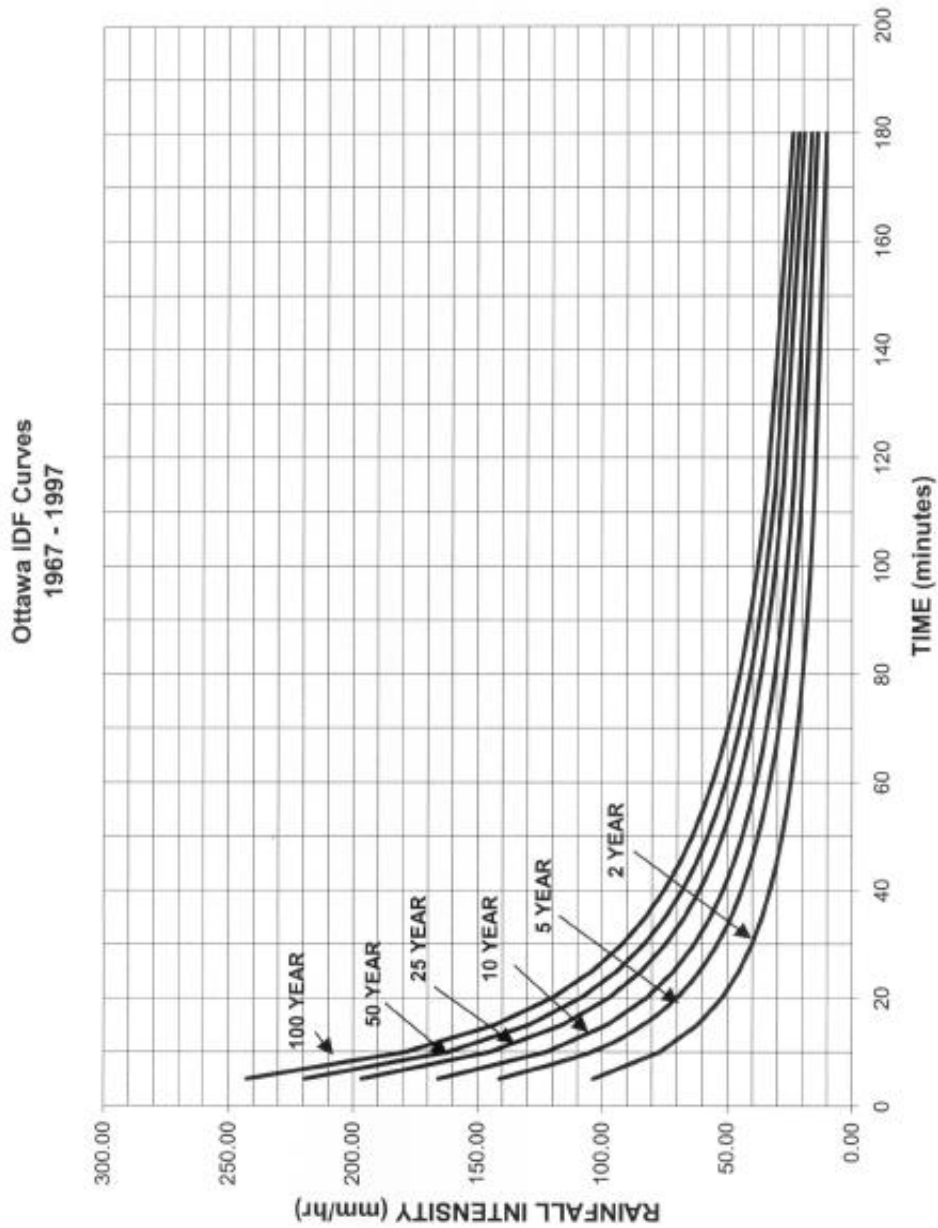

RATIONAL METHOD

The Rational Method was used to determine both the allowable runoff as well as the post-development runoff for the proposed site. The equation is as follows:

$$Q=2.78 CIA$$

Where:

Q is the runoff in L/s

C is the weighted runoff coefficient*

I is the rainfall intensity in mm/hr**

A is the area in hectares

*The weighted runoff coefficient is determined for each of the catchment areas as follows:

$$C = \frac{(A_p \times C_p) + (A_{imp} \times C_{imp})}{A_{tot}}$$

Where:

A_p is the pervious area in hectares

C_p is the pervious area runoff coefficient ($C_{perv}=0.20$)

A_{imp} is the impervious area in hectares

C_{imp} is the impervious area runoff coefficient ($C_{imp}=0.90$)

A_{tot} is the catchment area ($A_{perv} + A_{imp}$) in hectares

** The rainfall intensity is taken from the City of Ottawa IDF Curves using a time of concentration (t_c) of 10 minutes resulting in a rainfall intensity of 104.2mm/hr and 178.6mm/hr for the 1:5 year and 1:100 year design events respectively.

Note: The post-development C values are to be increased by 25% for the 1:100 year event (max. $C_{imp}=1.0$).

24-30 Pretoria Storm Servicing

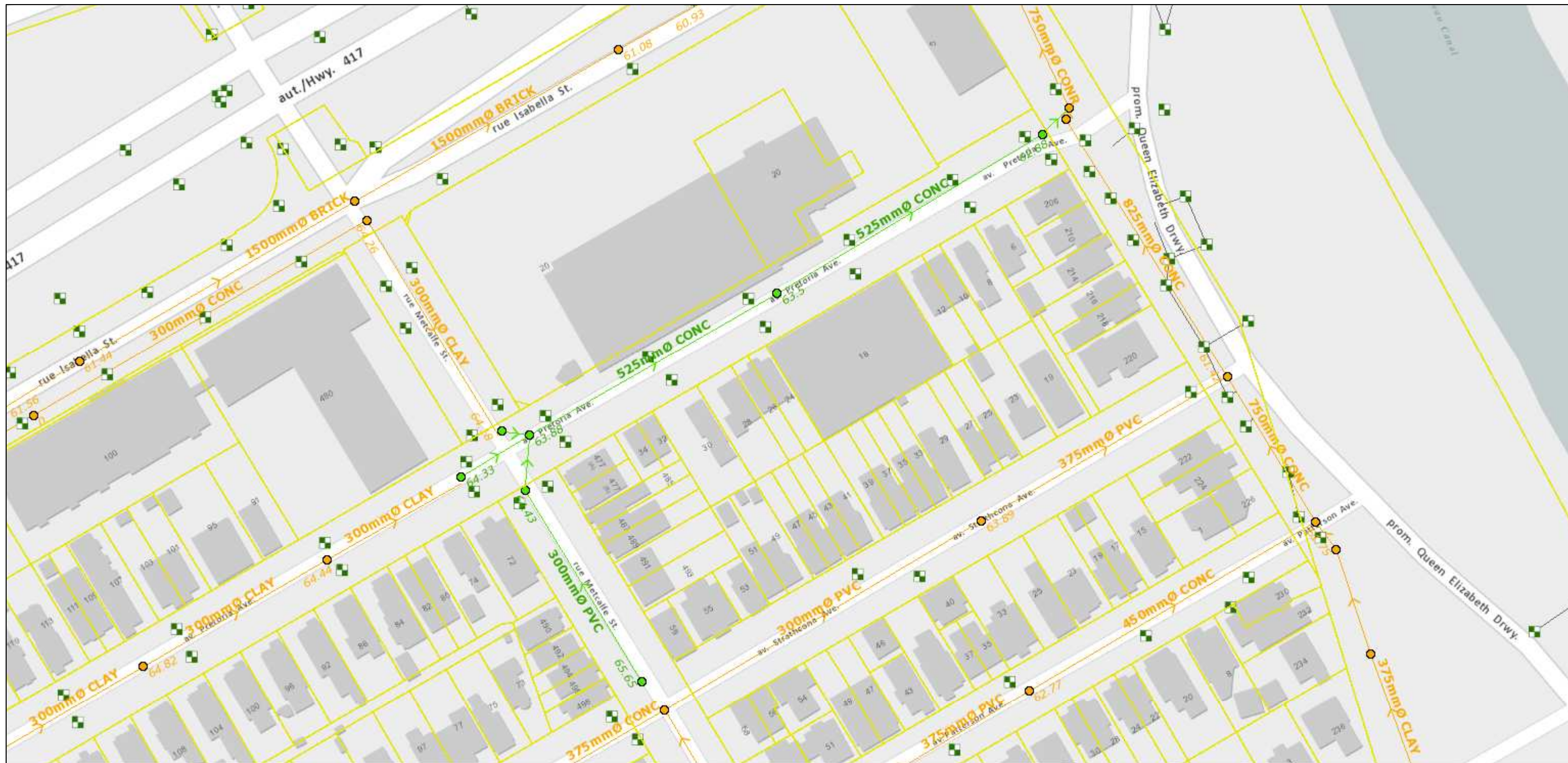

March 12, 2019

- Property Parcels
- Storm Manholes / Regards de conduites d'eaux pluviales
- Storm Inlet Leads / Avaloirs des prises d'entrée des eaux pluviales
- Storm Pipes / Conduites d'eaux pluviales
 - Private / Branchement privé
 - Public / Branchement public
- Storm Pump Stations / Stations de pompage des eaux pluviales
- ▲ Storm Pump Station / Station de pompage des eaux pluviales
- ▲ Storm Inlets / Prises d'entrée des eaux pluviales
- ▲ Storm Outlets / Prises de sortie des eaux pluviales
- Upstream Invert / Radier amont
- Downstream Invert / Radier aval
- + Combined Pipe Details / Détails de la conduite d'égout unitaire
 - + Combined Manholes / Regards d'égout unitaire
 - + Public / Branchement public
 - + Private / Branchement privé

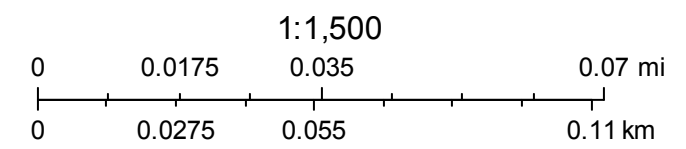

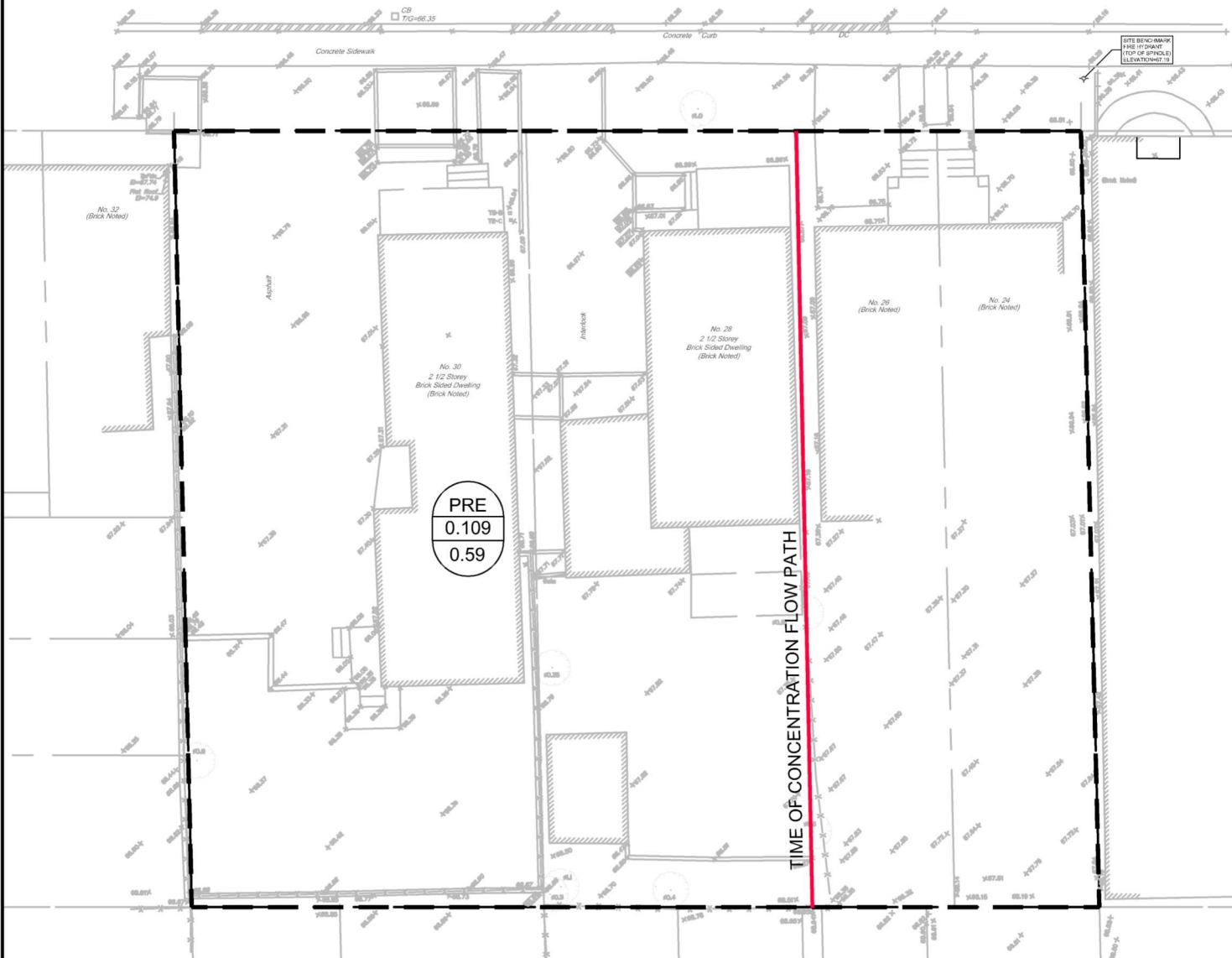

City of Ottawa

5756 BENCHMARK
PIPE 110 DIA
TOP OF SINKHOLE
ELEVATION 407.19

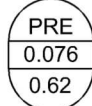

LEGEND

-  EXISTING STORM DRAINAGE AREA
-  DRAINAGE AREA ID
DRAINAGE AREA (HA)
RUNOFF COEFFICIENT
-  EXISTING STORM SEWER c/w MANHOLE



Engineers, Planners & Landscape Architects
Suite 200, 240 Michael Cowpland Drive
Ottawa, Ontario, Canada K2M 1P6

Telephone (613) 254-9643
Facsimile (613) 254-5867
Website www.novatech-eng.com



24-30 PRETORIA AVENUE

EXISTING STORM DRAINAGE AREA PLAN

SCALE 1 : 250 

DATE	JUNE 2019	JOB	119011	FIGURE	A4
------	-----------	-----	--------	--------	----

PRETORIA AVENUE

T/SAN=63.55
B/S/TM=64.20

T/WM=63.95
B/S/TM=64.25

BITE BENCH-MARK
FEE: 175.00MM
(TOP OF BENCHMARK)
ELEVATION=67.19

A-1
0.017
0.36

INCLUDED AS PART
OF AREA A-2

6TH FLOOR DECK AREA
UNCONTROLLED ROOF RAINS
TO STORAGE TANK

200mm PVC
STM @ 1.0%
LD 2
T/G=66.45
N/V=65.65

STORMWATER
STORAGE TANK
TANK LID
T/G=66.45

PROPOSED 6 STOREY
APARTMENT BUILDING
FFE= 66.65
USF= 62.75

6TH FLOOR ROOF AREA
CONTROLLED ROOF RAINS TO
BYPASS STORAGE TANK

A-3
0.049
0.90

INCLUDED AS PART
OF AREA A-2



GROUND FLOOR PATIOS
TERRACE AREAS TO FLOW
UNCONTROLLED TO
STORAGE TANK

200mm PVC
STM @ 1.0%
LD 1
T/G=68.55

A-2
0.043
0.51

200mm PVC
STM @ 1.0%
LD 2
T/G=68.55

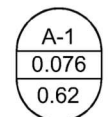
LEGEND

-  EXISTING STORM DRAINAGE AREA
-  DRAINAGE AREA ID
DRAINAGE AREA (HA)
RUNOFF COEFFICIENT
-  PROPOSED STORM SEWER



Engineers, Planners & Landscape Architects
Suite 200, 240 Michael Cowpland Drive
Ottawa, Ontario, Canada K2M 1P6

Telephone (613) 254-9643
Facsimile (613) 254-5867
Website www.novatech-eng.com



24-30 PRETORIA AVENUE

POST-DEVELOPMENT
DRAINAGE AREA PLAN

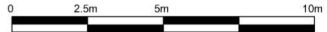
SCALE 1 : 250 

DATE JAN 2020 JOB 119011 FIGURE A5

M:\2019\119011\CAD\Design\119011-SWM.dwg, Jan 10, 2020 - 4:21pm, mhrehorjak

Time to Peak Calculations - Existing Conditions

TABLE 1A: Time of Concentration (Uplands Overland Flow Method)

Area ID	Overland Flow						Channel Flow			Overall	
	Length	Elevation U/S	Elevation D/S	Slope	Velocity (Uplands)	Travel Time	Length	Velocity *	Travel Time	Time of Concentration	Time to Peak
	(m)	(m)	(m)	(%)	(m/s)	(min)	(m)	(m/s)	(min)	(min)	(min)
PRE	30	N/A	N/A	2.0%	0.3	2	N/A	N/A	N/A	2	1

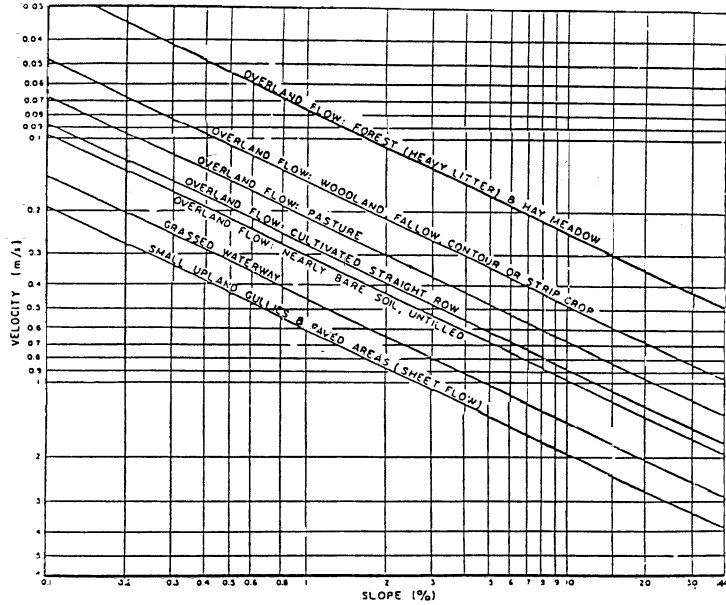

Figure A.5.2: Upland Method for Estimating Time of Concentration (SCS National Engineering Handbook, 1971)

TABLE 2A: Pre-Development Runoff Coefficient "C" - PRE

Area	Surface	Ha	"C"	C _{avg}	*C ₁₀₀	Runoff Coefficient Equation
Total	Hard	0.061	0.90	0.59	0.67	C = (A _{hard} x 0.9 + A _{soft} x 0.2)/A _{Tot} * Runoff
0.109	Soft	0.048	0.20			

TABLE 2B: Pre-Development Flows

Outlet Options	Area (ha)	C _{avg}	Tc (min)	Q _{2 Year} (L/s)	Q _{5 Year} (L/s)	Q _{100 Year} (L/s)
Pretoria Ave	0.109	0.59	10	13.8	18.7	36.2

Time of Concentration Tc= 10 min
 Intensity (2 Year Event) I₂= 76.81 mm/hr
 Intensity (5 Year Event) I₅= 104.19 mm/hr
 Intensity (100 Year Event) I₁₀₀= 178.56 mm/hr

Equations:
 Flow Equation
 Q = 2.78 x C x I x A
 Where:

C is the runoff coefficient
 I is the rainfall intensity, City of Ottawa IDF
 A is the total drainage area

100 year Intensity = 1735.688 / (Time in min + 6.014)^{0.820}
 5 year Intensity = 998.071 / (Time in min + 6.053)^{0.814}
 2 year Intensity = 732.951 / (Time in min + 6.199)^{0.810}

TABLE 3A: Allowable Runoff Coefficient "C"

Area	"C"
Total	0.40
0.109	

TABLE 3B: Allowable Flows

Outlet Options	Area (ha)	"C"	Tc (min)	Q _{2 Year} (L/s)
Pretoria Ave	0.109	0.40	10	9.3

Time of Concentration T_c= 10 min
 Intensity (2 Year Event) I₂= 76.81 mm/hr
 Intensity (5 Year Event) I₅= 104.19 mm/hr
 Intensity (100 Year Event) I₁₀₀= 178.56 mm/hr

100 year Intensity = $1735.688 / (\text{Time in min} + 6.014)^{0.820}$
 5 year Intensity = $998.071 / (\text{Time in min} + 6.053)^{0.814}$

Equations:
 Flow Equation
 $Q = 2.78 \times C \times I \times A$

Where:
 C is the runoff coefficient
 I is the rainfall intensity, City of Ottawa IDF
 A is the total drainage area

TABLE 4A: Post-Development Runoff Coefficient "C" - A-1

Area	Surface	Ha	"C"	C _{avg}	*C ₁₀₀
Total	Hard	0.004	0.90	0.36	0.43
0.017	Soft	0.013	0.20		

Runoff Coefficient Equation
 $C = (A_{hard} \times 0.9 + A_{soft} \times 0.2) / A_{tot}$
 * Runoff Coefficient increases by 25% up to a maximum value of 1.00 for the 100-Year event

TABLE 4B: Post-Development A-1 Flows

Outlet Options	Area (ha)	C _{avg}	Tc (min)	Q _{2 Year} (L/s)	Q _{5 Year} (L/s)	Q _{100 Year} (L/s)
Pretoria Ave	0.017	0.36	10	1.3	1.8	3.6

Time of Concentration Tc= 10 min
 Intensity (2 Year Event) I₂= 76.81 mm/hr
 Intensity (5 Year Event) I₅= 104.19 mm/hr
 Intensity (100 Year Event) I₁₀₀= 178.56 mm/hr

Equations:
 Flow Equation
 $Q = 2.78 \times C \times I \times A$

Where:
 C is the runoff coefficient
 I is the rainfall intensity, City of Ottawa IDF
 A is the total drainage area

100 year Intensity = $1735.688 / (\text{Time in min} + 6.014)^{0.820}$
 5 year Intensity = $998.071 / (\text{Time in min} + 6.053)^{0.814}$
 2 year Intensity = $732.951 / (\text{Time in min} + 6.199)^{0.810}$

TABLE 5A: Post-Development Runoff Coefficient "C" - A-3

Area	0.4	Ha	5 Year Event		100 Year Event	
			"C"	C _{avg}	"C" + 25%	*C _{avg}
Total	Hard	0.000	0.90	0.90	1.00	1.00
0.049	Roof	0.049	0.90			
	Soft	0.000	0.20			

TABLE 5B: 2 YEAR EVENT QUANTITY STORAGE REQUIREMENT - A-3

0.049 =Area (ha)
 0.90 = C

Return Period	Time (min)	Intensity (mm/hr)	Flow Q (L/s)	Allowable Runoff (L/s)	Net Flow to be Stored (L/s)	Storage Req'd (m ³)
2 YEAR	15	61.77	7.57	1.9	5.67	5.11
	20	52.03	6.38	1.9	4.48	5.37
	25	45.17	5.54	1.9	3.64	5.46
	30	40.04	4.91	1.9	3.01	5.42
	35	36.06	4.42	1.9	2.52	5.29

TABLE 5C: 5 YEAR EVENT QUANTITY STORAGE REQUIREMENT - A-3

0.049 =Area (ha)
 0.90 = C

Return Period	Time (min)	Intensity (mm/hr)	Flow Q (L/s)	Allowable Runoff (L/s)	Net Flow to be Stored (L/s)	Storage Req'd (m ³)
5 YEAR	15	83.56	10.24	2.5	7.72	6.95
	20	70.25	8.61	2.5	6.09	7.31
	25	60.90	7.47	2.5	4.95	7.42
	30	53.93	6.61	2.5	4.09	7.36
	35	48.52	5.95	2.5	3.43	7.20

TABLE 5D: 100 YEAR EVENT QUANTITY STORAGE REQUIREMENT - A-3

0.049 =Area (ha)
 1.00 = C

Return Period	Time (min)	Intensity (mm/hr)	Flow Q (L/s)	Allowable Runoff (L/s)	Net Flow to be Stored (L/s)	Storage Req'd (m ³)
100 YEAR	20	119.95	16.34	3.8	12.54	15.05
	25	103.85	14.15	3.8	10.35	15.52
	30	91.87	12.51	3.8	8.71	15.69
	35	82.58	11.25	3.8	7.45	15.64
	40	75.15	10.24	3.8	6.44	15.45

Equations:

Flow Equation

$$Q = 2.78 \times C \times I \times A$$

Where:

C is the runoff coefficient

I is the rainfall intensity, City of Ottawa IDF

A is the total drainage area

Runoff Coefficient Equation

$$C_s = (A_{\text{hard}} \times 0.9 + A_{\text{soft}} \times 0.2) / A_{\text{Tot}}$$

$$C_{100} = (A_{\text{hard}} \times 1.0 + A_{\text{soft}} \times 0.25) / A_{\text{Tot}}$$

Table 5E: Roof Drain Flows

Roof Drains		
Roof Area	490	m ²
Qty	4	
Type	Accutrol RD-100-A-ADJ	
Setting	1/2 Open	
Design Head	0.05-0.15	m
Design Flow 1" of head	0.32	L/s (ea)
Design Flow 2" of head	0.63	L/s (ea)
Design Flow 3" of head	0.79	L/s (ea)
Design Flow 4" of head	0.95	L/s (ea)
Design Flow 5" of head	1.10	L/s (ea)
Design Flow 6" of head	1.26	L/s (ea)

Table 5F: Total Roof Storage

Storm Event	# Roof Drains	Avg Area Per Roof Drain (m ²)	Avg Ponding Depth Per Roof Drain (m)	*Total Volume (m ³)	Total Volume (m ³) Required
2 Year	4	122.5	0.0381	6.22	5.46
5 Year	4	122.5	0.0508	8.30	7.42
100 Year	4	122.5	0.1016	16.59	15.69
Max Storage	4	122.5	0.1524	24.89	

*NOTE: Ponding volumes for A-3 calculated using cone equation:

$$V = \frac{\text{Area} \times \text{Depth}}{3}$$

Table 6: Post-Development Stormwater Mangement Summary

Area ID	Area (ha)	1:5 Year Weighted Cw	Outlet Location	Orifice	2 Year Storm Event				5 Year Storm Event				100 Year Storm Event			
					Release (L/s)	Head (m)	Req'd Vol (cu.m)	Max. Vol. Provided (cu.m.)	Release (L/s)	Head (m)	Req'd Vol (cu.m)	Max. Vol. Provided (cu.m.)	Release (L/s)	Head (m)	Req'd Vol (cu.m)	Max. Vol. Provided (cu.m.)
A-1	0.017	0.36	Pretoria Ave	N/A	1.3	N/A	N/A	N/A	1.8	N/A	N/A	N/A	3.6	N/A	N/A	N/A
A-2	0.043	0.51	Pretoria Ave	LMF 45	0.9	0.18	3.05	17.82	1.2	0.41	5.54	17.82	1.9	1.18	13.80	17.82
A-3	0.049	0.90	Pretoria Ave	RD-100-A-ADJ	1.9	0.04	5.46	24.89	2.5	0.05	7.42	24.89	3.8	0.10	15.69	24.89
Total					4.1				5.5				9.3			
Allowable					9.3				9.3				9.3			

* Notes - Area A-2 flows and stroage requirements calculated using PCSWMM 2019.

EPA STORM WATER MANAGEMENT MODEL - VERSION 5.1 (Build 5.1.013)

```

*****
Element Count
*****
Number of rain gages ..... 1
Number of subcatchments ... 1
Number of nodes ..... 3
Number of links ..... 2
Number of pollutants ..... 0
Number of land uses ..... 0
    
```

```

*****
Raingage Summary
*****
    
```

Name	Data Source	Data Type	Recording Interval
RG-1	C3HR-100YR	INTENSITY	10 min.

```

*****
Subcatchment Summary
*****
    
```

Name	Area	Width	%Imperv	%Slope	Rain Gage	Outlet
A-2	0.04	36.00	44.00	2.0000	RG-1	TANK

```

*****
Node Summary
*****
    
```

Name	Type	Invert Elev.	Max. Depth	Ponded Area	External Inflow
STM	JUNCTION	64.35	2.10	0.0	
525STM2	OUTFALL	63.90	0.50	0.0	
TANK	STORAGE	64.35	2.10	0.0	

```

*****
Link Summary
    
```

Name	From Node	To Node	Type	Length	%Slope	Roughness
STM2	STM	525STM2	CONDUIT	10.0	1.5002	0.0130
TEMPESTICD	TANK	STM	ORIFICE			

Cross Section Summary

Conduit	Shape	Full Depth	Full Area	Hyd. Rad.	Max. Width	No. of Barrels	Full Flow
STM2	CIRCULAR	0.20	0.03	0.05	0.20	1	40.17

NOTE: The summary statistics displayed in this report are based on results found at every computational time step, not just on results from each reporting time step.

Analysis Options

Flow Units LPS

Process Models:

Rainfall/Runoff YES

RDII NO

Snowmelt NO

Groundwater NO

Flow Routing YES

Ponding Allowed YES

Water Quality NO

Infiltration Method HORTON

Flow Routing Method DYNWAVE

Surcharge Method EXTRAN

Starting Date 01/10/2020 00:00:00

Ending Date 01/17/2020 00:00:00

Antecedent Dry Days 0.0

Report Time Step 00:05:00

Wet Time Step 00:05:00

Dry Time Step 01:00:00

Routing Time Step 2.00 sec

Variable Time Step YES

Maximum Trials 8
 Number of Threads 1
 Head Tolerance 0.001500 m

 Control Actions Taken

*****	Volume	Depth
Runoff Quantity Continuity	hectare-m	mm
*****	-----	-----
Initial LID Storage	0.000	0.691
Total Precipitation	0.003	71.667
Evaporation Loss	0.000	0.000
Infiltration Loss	0.001	24.700
Surface Runoff	0.002	48.337
Final Storage	0.000	0.691
Continuity Error (%)	-1.894	

*****	Volume	Volume
Flow Routing Continuity	hectare-m	10^6 ltr
*****	-----	-----
Dry Weather Inflow	0.000	0.000
Wet Weather Inflow	0.002	0.021
Groundwater Inflow	0.000	0.000
RDII Inflow	0.000	0.000
External Inflow	0.000	0.000
External Outflow	0.002	0.021
Flooding Loss	0.000	0.000
Evaporation Loss	0.000	0.000
Exfiltration Loss	0.000	0.000
Initial Stored Volume	0.000	0.000
Final Stored Volume	0.000	0.000
Continuity Error (%)	0.000	

 Time-Step Critical Elements

 None

Highest Flow Instability Indexes

Link TEMPESTICD (2)

Routing Time Step Summary

Minimum Time Step : 1.50 sec
 Average Time Step : 2.00 sec
 Maximum Time Step : 2.00 sec
 Percent in Steady State : 0.00
 Average Iterations per Step : 2.00
 Percent Not Converging : 0.00

Subcatchment Runoff Summary

Subcatchment	Total Precip mm	Total Runon mm	Total Evap mm	Total Infil mm	Imperv Runoff mm	Perv Runoff mm	Total Runoff mm	Total Runoff 10 ⁶ ltr	Peak Runoff LPS	Runoff Coeff
A-2	71.67	0.00	0.00	24.70	31.75	16.59	48.34	0.02	18.68	0.674

Node Depth Summary

Node	Type	Average Depth Meters	Maximum Depth Meters	Maximum HGL Meters	Time of Max Occurrence days hr:min	Reported Max Depth Meters
STM	JUNCTION	0.00	0.03	64.38	0 01:33	0.03
525STM2	OUTFALL	0.15	0.15	64.05	0 00:00	0.15
TANK	STORAGE	0.02	1.28	65.63	0 01:33	1.28

Node Inflow Summary

Node	Type	Maximum Lateral Inflow LPS	Maximum Total Inflow LPS	Time of Max Occurrence days hr:min	Lateral Inflow Volume 10^6 ltr	Total Inflow Volume 10^6 ltr	Flow Balance Error Percent
STM	JUNCTION	0.00	1.86	0 01:33	0	0.021	-0.065
525STM2	OUTFALL	0.00	1.86	0 01:34	0	0.0209	0.000
TANK	STORAGE	18.68	18.68	0 01:10	0.0209	0.021	0.064

Node Surcharge Summary

No nodes were surcharged.

Node Flooding Summary

No nodes were flooded.

Storage Volume Summary

Storage Unit	Average Volume 1000 m3	Avg Pcnt Full	Evap Pcnt Loss	Exfil Pcnt Loss	Maximum Volume 1000 m3	Max Pcnt Full	Time of Max Occurrence days hr:min	Maximum Outflow LPS
TANK	0.000	1	0	0	0.014	61	0 01:33	1.86

Outfall Loading Summary

Outfall Node	Flow Freq Pcnt	Avg Flow LPS	Max Flow LPS	Total Volume 10^6 ltr
--------------	----------------	--------------	--------------	-----------------------

525STM2	3.69	0.93	1.86	0.021
-----	-----	-----	-----	-----
System	3.69	0.93	1.86	0.021

Link Flow Summary

Link	Type	Maximum Flow LPS	Time of Max Occurrence days hr:min	Maximum Veloc m/sec	Max/ Full Flow	Max/ Full Depth
STM2	CONDUIT	1.86	0 01:34	0.63	0.05	0.15
TEMPESTICD	ORIFICE	1.86	0 01:33			1.00

Flow Classification Summary

Conduit	Adjusted /Actual Length	Fraction of Time in Flow Class								
		Dry	Up Dry	Down Dry	Sub Crit	Sup Crit	Up Crit	Down Crit	Norm Ltd	Inlet Ctrl
STM2	1.00	0.00	0.00	0.00	0.00	0.00	0.00	1.00	0.00	0.00

Conduit Surcharge Summary

No conduits were surcharged.

Analysis begun on: Tue Jan 14 15:36:03 2020
Analysis ended on: Tue Jan 14 15:36:04 2020
Total elapsed time: 00:00:01

Overall Model Schematic

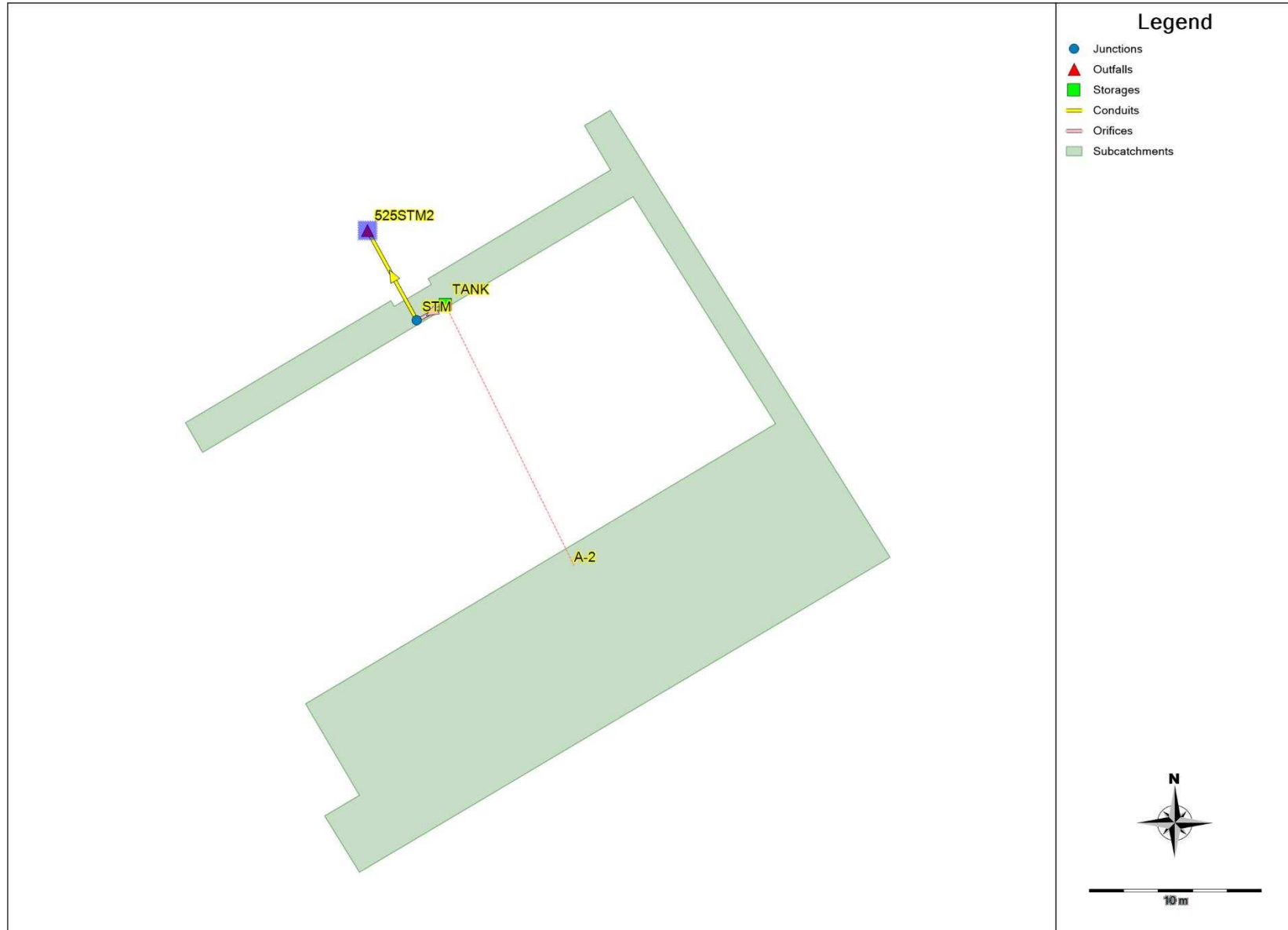

Volume III: TEMPEST™ INLET CONTROL DEVICES

Municipal Technical
Manual Series

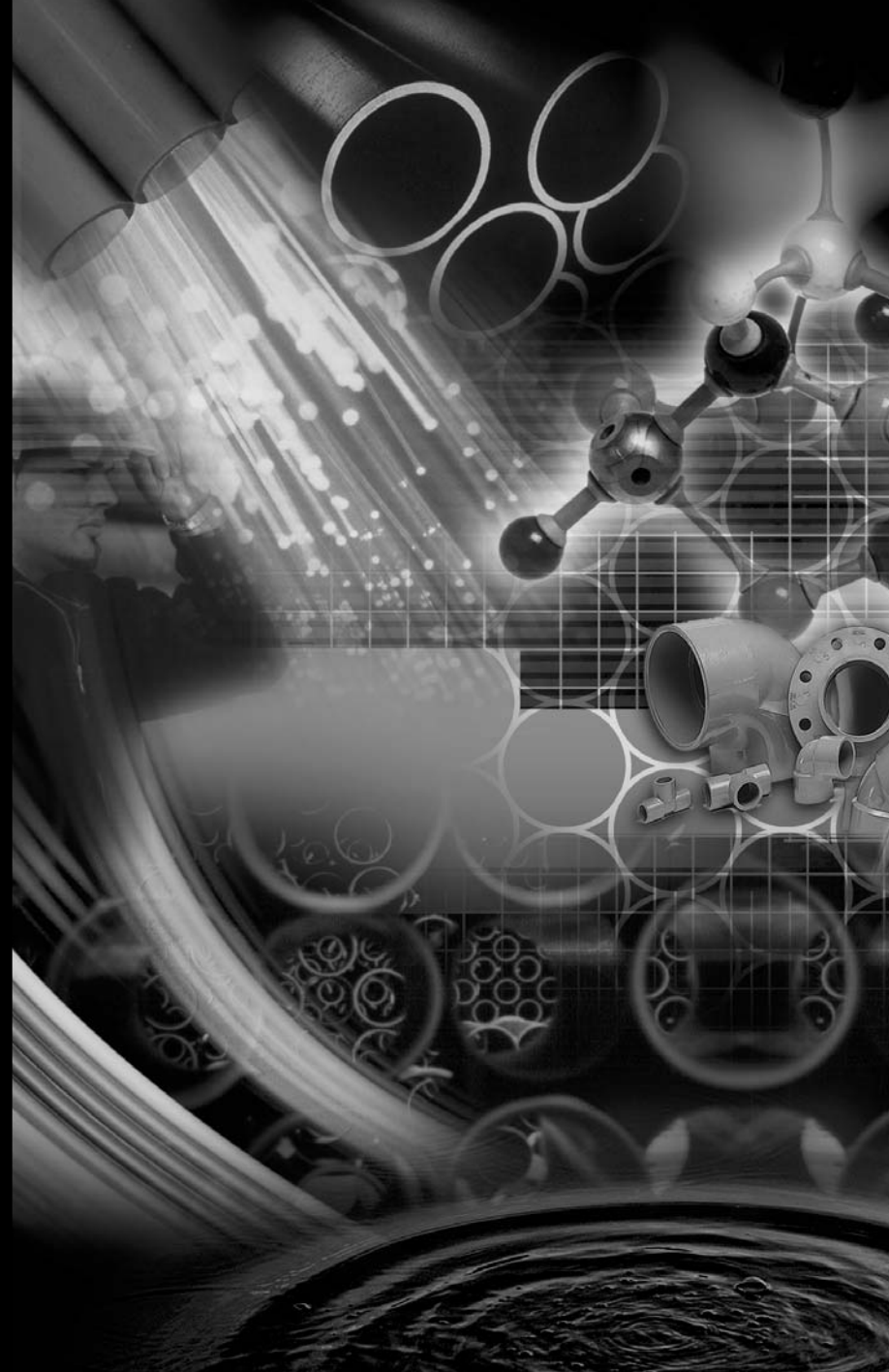

SECOND EDITION

LMF (Low to Medium Flow) ICD

HF (High Flow) ICD

MHF (Medium to High Flow) ICD



IPEX

PRODUCT INFORMATION: TEMPEST LOW, MEDIUM FLOW (LMF) ICD

Purpose

To control the amount of storm water runoff entering a sewer system by allowing a specified flow volume out of a catch basin or manhole at a specified head. This approach conserves pipe capacity so that catch basins downstream do not become uncontrollably surcharged, which can lead to basement floods, flash floods and combined sewer overflows.

Product Description

Our LMF ICD is designed to accommodate catch basins or manholes with sewer outlet pipes 6" in diameter and larger. Any storm sewer larger than 12" may require custom modification. However, IPEX can custom build a TEMPEST device to accommodate virtually any storm sewer size.

Available in 14 preset flow curves, the LMF ICD has the ability to provide flow rates: 2lps – 17lps (31gpm – 270gpm)

Product Function

The LMF ICD vortex flow action allows the LMF ICD to provide a narrower flow curve using a larger orifice than a conventional orifice plate ICD, making it less likely to clog. When comparing flows at the same head level, the LMF ICD has the ability to restrict more flow than a conventional ICD during a rain event, preserving greater sewer capacity.

Product Construction

Constructed from durable PVC, the LMF ICD is light weight 8.9 Kg (19.7 lbs).

Product Applications

Will accommodate both square and round applications:

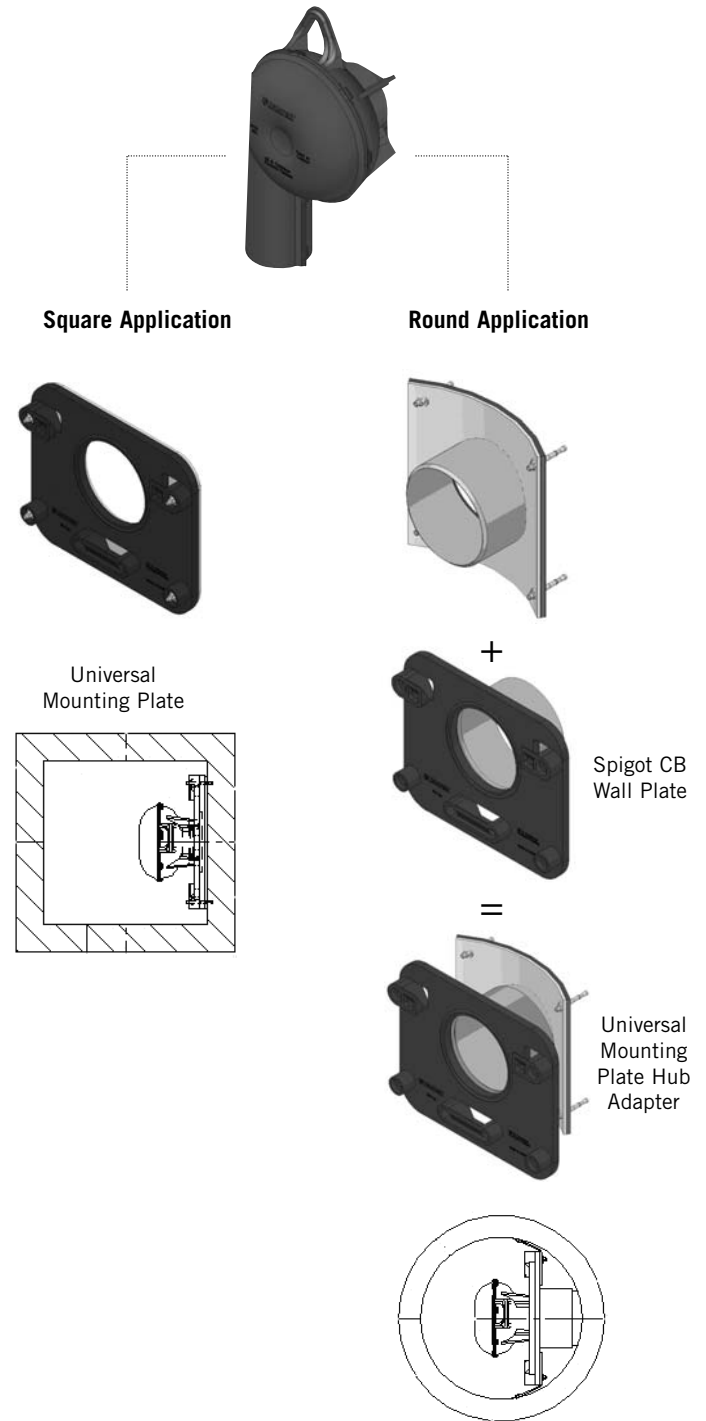

Chart 1: LMF 14 Preset Flow Curves

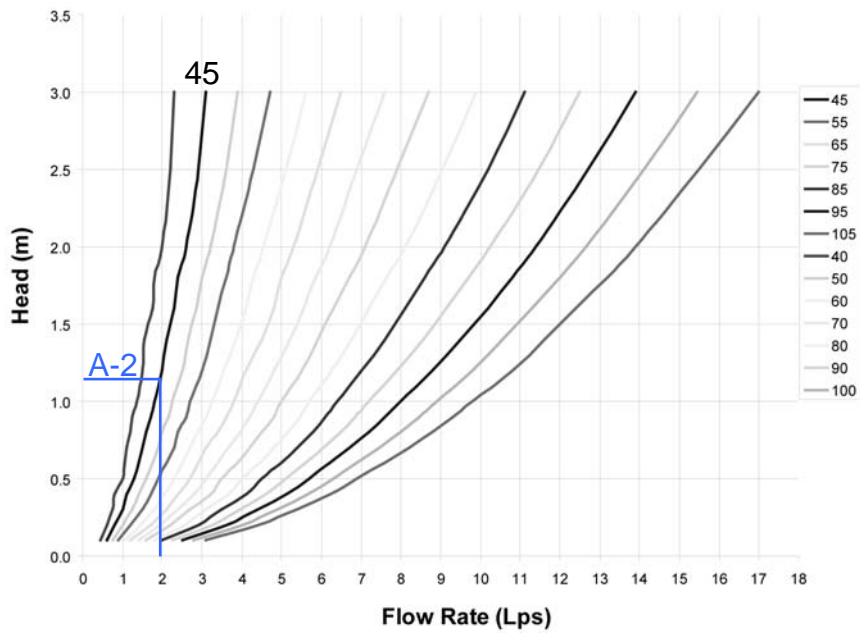
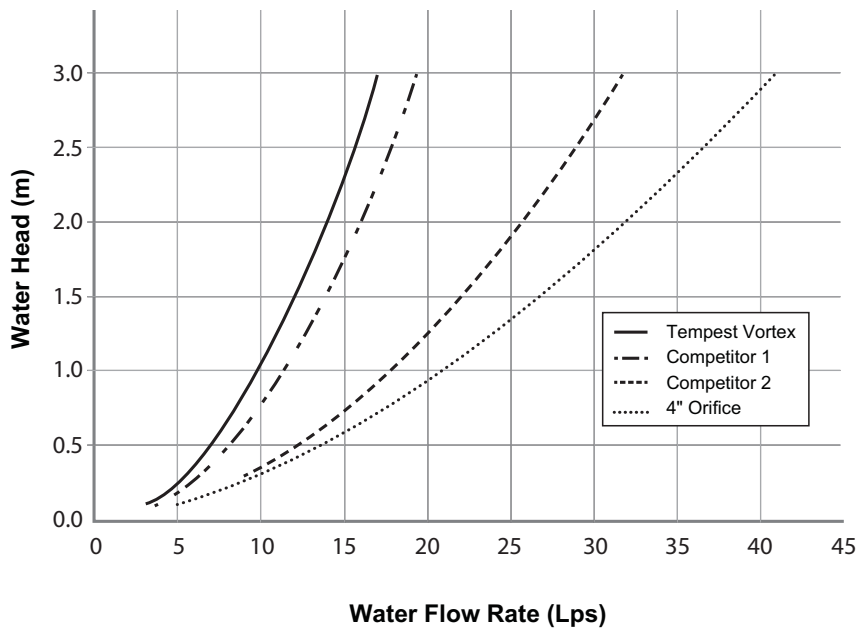

Chart 2: LMF Flow vs. ICD Alternatives



PRODUCT INSTALLATION

Instructions to assemble a TEMPEST LMF ICD into a Square Catch Basin:

STEPS:

1. Materials and tooling verification:
 - Tooling: impact drill, 3/8" concrete bit, torque wrench for 9/16" nut, hand hammer, level, and marker.
 - Material: (4) concrete anchor 3/8 x 3-1/2, (4) washers, (4) nuts, universal mounting plate, ICD device.
2. Use the mounting wall plate to locate and mark the hole (4) pattern on the catch basin wall. You should use a level to ensure that the plate is at the horizontal.
3. Use an impact drill with a 3/8" concrete bit to make the four holes at a minimum of 1-1/2" depth up to 2-1/2". Clean the concrete dust from the holes.
4. Install the anchors (4) in the holes by using a hammer. Thread the nuts on the top of the anchors to protect the threads when you hit the anchors with the hammer. Remove the nuts from the ends of the anchors.
5. Install the universal mounting plate on the anchors and screw the 4 nuts in place with a maximum torque of 40 N.m (30 lbf-ft). There should be no gap between the wall mounting plate and the catch basin wall.
6. From the ground above using a reach bar, lower the ICD device by hooking the end of the reach bar to the handle of the ICD device. Align the triangular plate portion into the mounting wall plate. Push down the device to be sure it has centered in to the universal mounting plate and has created a seal.



WARNING

- Verify that the outlet pipe doesn't protrude into the catch basin. If it does, cut down the pipe flush to the catch basin wall.
- Call your IPEX representative for more information or if you have any questions about our products.

Instructions to assemble a TEMPEST LMF ICD into a Round Catch Basin:

STEPS:

1. Materials and tooling verification.
 - Tooling: impact drill, 3/8" concrete bit, torque wrench for 9/16" nut, hand hammer, level and marker.
 - Material: (4) concrete anchor 3/8 x 3-1/2, (4) washers and (4) nuts, spigot CB wall plate, universal mounting plate hub adapter, ICD device.
2. Use the spigot catch basin wall plate to locate and mark the hole (4) pattern on the catch basin wall. You should use a level to ensure that the plate is at the horizontal.
3. Use an impact drill with a 3/8" concrete bit to make the four holes at a depth between 1-1/2" to 2-1/2". Clean the concrete dust from the holes.
4. Install the anchors (4) in the holes by using a hammer. Thread the nuts on the top of the anchors to protect the threads when you hit the anchors with the hammer. Remove the nuts from the ends of the anchors.
5. Install the CB spigot wall plate on the anchors and screw the 4 nuts in place with a maximum torque of 40 N.m (30 lbf-ft). There should be no gap between the spigot wall plate and the catch basin wall.
6. Apply solvent cement on the hub of the universal mounting plate, hub adapter and the spigot of the CB wall plate, then slide the hub over the spigot. Make sure the universal mounting plate is at the horizontal and its hub is completely inserted onto the spigot. Normally, the corners of the universal mounting plate hub adapter should touch the catch basin wall.
7. From ground above using a reach bar, lower the ICD device by hooking the end of the reach bar to the handle of the ICD device. Align the triangular plate portion into the mounting wall plate. Push down the device to be sure it has centered in to the mounting plate and has created a seal.



WARNING

- Verify that the outlet pipe doesn't protrude into the catch basin. If it does, cut back the pipe flush to the catch basin wall.
- The solvent cement which is used in this installation is to be approved for PVC.
- The solvent cement should not be used below 0°C (32°F) or in a high humidity environment. Refer to the IPEX solvent cement guide to confirm the required curing time or visit the IPEX Online Solvent Cement Training Course available at www.ipexinc.com.
- Call your IPEX representative for more information or if you have any questions about our products.

PRODUCT TECHNICAL SPECIFICATION

General

Inlet control devices (ICD's) are designed to provide flow control at a specified rate for a given water head level and also provide odour and floatable control. All ICD's will be IPEX Tempest or approved equal.

All devices shall be removable from a universal mounting plate. An operator from street level using only a T-bar with a hook will be able to retrieve the device while leaving the universal mounting plate secured to the catch basin wall face. The removal of the TEMPEST devices listed above must not require any unbolting or special manipulation or any special tools.

High Flow (HF) Sump devices will consist of a removable threaded cap which can be accessible from street level with out entry into the catchbasin (CB). The removal of the threaded cap shall not require any special tools other than the operator's hand.

ICD's shall have no moving parts.

Materials

ICD's are to be manufactured from Polyvinyl Chloride (PVC) or Polyurethane material, designed to be durable enough to withstand multiple freeze-thaw cycles and exposure to harsh elements.

The inner ring seal will be manufactured using a Buna or Nitrile material with hardness between Duro 50 and Duro 70.

The wall seal is to be comprised of a 3/8" thick Neoprene Closed Cell Sponge gasket which is attached to the back of the wall plate.

All hardware will be made from 304 stainless steel.

Dimensioning

The Low Medium Flow (LMF), High Flow (HF) and the High Flow (HF) Sump shall allow for a minimum outlet pipe diameter of 200mm with a 600mm deep Catch Basin sump.

Installation

Contractor shall be responsible for securing, supporting and connecting the ICD's to the existing influent pipe and catchbasin/manhole structure as specified and designed by the Engineer.



Adjustable Accutrol Weir

Tag: RD-100-A-ADJ

**Adjustable Flow Control
for Roof Drains**

ADJUSTABLE ACCUTROL(for Large Sump Roof Drains only)

For more flexibility in controlling flow with heads deeper than 2", Watts Drainage offers the Adjustable Accutrol. The Adjustable Accutrol Weir is designed with a single parabolic opening that can be covered to restrict flow above 2" of head to less than 5 gpm per inch, up to 6" of head. To adjust the flow rate for depths over 2" of head, set the slot in the adjustable upper cone according to the flow rate required. Refer to Table 1 below.

Note: Flow rates are directly proportional to the amount of weir opening that is exposed.

EXAMPLE:

For example, if the adjustable upper cone is set to cover 1/2 of the weir opening, flow rates above 2" of head will be restricted to 2-1/2 gpm per inch of head.

Therefore, at 3" of head, the flow rate through the Accutrol Weir that has 1/2 the slot exposed will be:
 [5 gpm(per inch of head) x 2 inches of head] + 2-1/2 gpm(for the third inch of head) = 12-1/2 gpm.

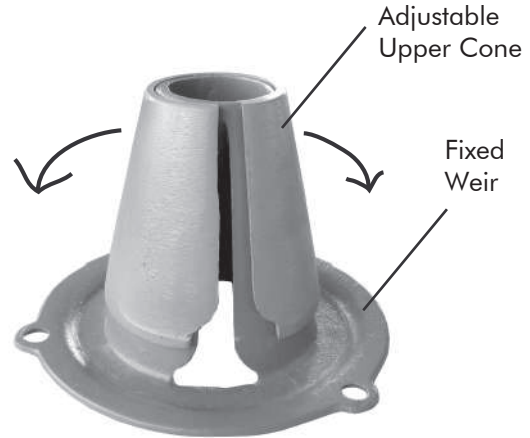
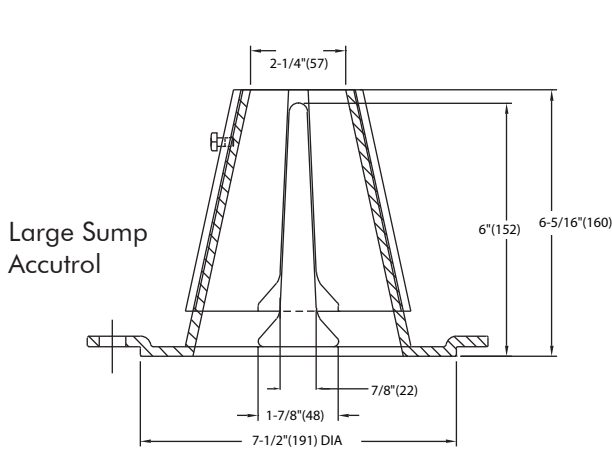

1/2 Weir Opening Exposed Shown Above

TABLE 1. Adjustable Accutrol Flow Rate Settings

Weir Opening Exposed	Head of Water					
	1"	2"	3"	4"	5"	6"
	Flow Rate (gallons per minute)					
Fully Exposed	5	10	15	20	25	30
3/4	5	10	13.75	17.5	21.25	25
1/2	5	10	12.5	15	17.5	20
1/4	5	10	11.25	12.5	13.75	15
Closed	5	10	10	10	10	10

Job Name _____ Contractor _____

Job Location _____ Contractor's P.O. No. _____

Engineer _____ Representative _____

WATTS Drainage reserves the right to modify or change product design or construction without prior notice and without incurring any obligation to make similar changes and modifications to products previously or subsequently sold. See your WATTS Drainage representative for any clarification. Dimensions are subject to manufacturing tolerances.



CANADA: 5435 North Service Road, Burlington, ON, L7L 5H7 TEL: 905-332-6718 TOLL-FREE: 1-888-208-8927 Website: www.wattsdrainage.ca



Storm Sewer Design Sheet

LOCATION		AREA (Ha)			FLOW					PROPOSED SEWER							
FROM	TO	TOTAL AREA	R= 0.2	R= 0.9	INDIV 2.78 AR	ACCUM 2.78 AR	TIME OF CONC.	RAINFALL INTENSITY I	* PEAK FLOW Q (l/s)	PIPE SIZE (mm)	PIPE SLOPE (%)	LENGTH (m)	CAPACITY (l/s)	FULL FLOW VELOCITY (m/s)	TIME OF FLOW (min.)	EXCESS CAPACITY (l/s)	Q/Qfull
TANK	EX SEWER	0.043	0.024	0.019	0.06	0.06	10.00	104.19	6.34	200.0	1.50	11.9	40.21	1.28	0.16	33.87	0.16
BLDG	EX SEWER	0.049	0.000	0.049	0.12	0.12	10.00	104.19	12.77	200.0	2.00	12.9	46.43	1.48	0.15	33.66	0.28

*Note: Storm sewer design sheet flows are peak uncontrolled flows. Flows will be attenuated with ICD's

Definitions

Q = 2.78 AIR
 Q = Peak Flow, in Litres per second (L/s)
 A = Area in hectares (ha)
 I = 5 YEAR Rainfall Intensity (mm/h)
 R = Runoff Coefficient

Notes:

- 1) Ottawa Rainfall-Intensity Curve
- 2) Min Velocity = 0.76 m/sec.
- 3) 5 Year intensity = $998.071 / (\text{time} + 6.053)^{0.814}$
 10 Year intensity = $1174.184 / (\text{time} + 6.014)^{0.816}$
 100 Year intensity = $1735.688 / (\text{time} + 6.014)^{0.820}$

APPENDIX E
Development Servicing Study Checklist

**24-30 PRETORIA AVENUE, OTTAWA
DEVELOPMENT SERVICING STUDY CHECKLIST**

4.1 General Content	Addressed (Y/N/NA)	Comments
Executive Summary (for larger reports only).	N/A	
Date and revision number of the report.	Y	
Location map and plan showing municipal address, boundary, and layout of proposed development.	Y	Refer to Report Figures
Plan showing the site and location of all existing services.	Y	Refer to Grading and Servicing Plans
Development statistics, land use, density, adherence to zoning and official plan, and reference to applicable subwatershed and watershed plans that provide context to which individual developments must adhere.	Y	Refer to Site Plan
Summary of Pre-consultation Meetings with City and other approval agencies.	Y	
Reference and confirm conformance to higher level studies and reports (Master Servicing Studies, Environmental Assessments, Community Design Plans), or in the case where it is not in conformance, the proponent must provide justification and develop a defensible design criteria.	N/A	
Statement of objectives and servicing criteria.	Y	Report Sections: 5.0 Water Servicing , 6.0 Sanitary Servicing, 7.0 Storm Servicing
Identification of existing and proposed infrastructure available in the immediate area.	Y	
Identification of Environmentally Significant Areas, watercourses and Municipal Drains potentially impacted by the proposed development (Reference can be made to the Natural Heritage Studies, if available).	N/A	
Concept level master grading plan to confirm existing and proposed grades in the development. This is required to confirm the feasibility of proposed stormwater management and drainage, soil removal and fill constraints, and potential impacts to neighboring properties. This is also required to confirm that the proposed grading will not impede existing major system flow paths.	Y	Refer to Grading Plan

**24-30 PRETORIA AVENUE, OTTAWA
DEVELOPMENT SERVICING STUDY CHECKLIST**

4.1 General Content	Addressed (Y/N/NA)	Comments
Identification of potential impacts of proposed piped services on private services (such as wells and septic fields on adjacent lands) and mitigation required to address potential impacts.	N/A	
Proposed phasing of the development, if applicable.	N/A	
Reference to geotechnical studies and recommendations concerning servicing.	Y	Report Section 4.0 Site Constraints
All preliminary and formal site plan submissions should have the following information:		
Metric scale	Y	
North arrow (including construction	Y	
Key plan	Y	
Name and contact information of applicant and property owner	Y	
Property limits including bearings and dimensions	Y	
Existing and proposed structures and parking areas	Y	
Easements, road widening and rights-of-	Y	
Adjacent street names	Y	

**24-30 PRETORIA AVENUE, OTTAWA
DEVELOPMENT SERVICING STUDY CHECKLIST**

4.2 Water	Addressed (Y/N/NA)	Comments
Confirm consistency with Master Servicing Study, if available.	N/A	
Availability of public infrastructure to service proposed development.	Y	Report Sections: 5.0 Water Servicing , 6.0 Sanitary Servicing, 7.0 Storm Servicing
Identification of system constraints.	N/A	
Identify boundary conditions.	Y	Provided by City of Ottawa
Confirmation of adequate domestic supply and pressure.	Y	Refer to Appendix B
Confirmation of adequate fire flow protection and confirmation that fire flow is calculated as per the Fire Underwriter's Survey. Output should show available fire flow at locations throughout the development.	Y	Refer to Appendix B
Provide a check of high pressures. If pressure is found to be high, an assessment is required to confirm the application of pressure reducing valves.	Y	Refer to Appendix B
Definition of phasing constraints. Hydraulic modeling is required to confirm servicing for all defined phases of the project including the ultimate design.	N/A	
Address reliability requirements such as appropriate location of shut-off valves.	Y	Refer to Appendix B
Check on the necessity of a pressure zone boundary modification.	N/A	
Reference to water supply analysis to show that major infrastructure is capable of delivering sufficient water for the proposed land use. This includes data that shows that the expected demands under average day, peak hour and fire flow conditions provide water within the required pressure range.	Y	Report Section 5.0 Water Servicing
Description of the proposed water distribution network, including locations of proposed connections to the existing system, provisions for necessary looping, and appurtenances (valves, pressure reducing valves, valve chambers, and fire hydrants) including special metering provisions.	Y	Report Section 5.0 Water Servicing
Description of off-site required feeder mains, booster pumping stations, and other water infrastructure that will be ultimately required to service proposed development, including financing, interim facilities, and timing of implementation.	N/A	
Confirmation that water demands are calculated based on the City of Ottawa Design Guidelines.	Y	Report Section 5.0 Water Servicing
Provision of a model schematic showing the boundary conditions locations, streets, parcels, and building locations for reference.	N/A	

**24-30 PRETORIA AVENUE, OTTAWA
DEVELOPMENT SERVICING STUDY CHECKLIST**

4.3 Wastewater	Addressed (Y/N/NA)	Comments
Summary of proposed design criteria (Note: Wet-weather flow criteria should not deviate from the City of Ottawa Sewer Design Guidelines. Monitored flow data from relatively new infrastructure cannot be used to justify capacity requirements for proposed	Y	Report Section 6.0 Sanitary Servicing
Confirm consistency with Master Servicing Study and/or justifications for deviations.	N/A	
Consideration of local conditions that may contribute to extraneous flows that are higher than the recommended flows in the guidelines. This includes groundwater and soil conditions, and age and condition of sewers.	N/A	
Description of existing sanitary sewer available for discharge of wastewater from proposed development.	Y	Report Section 6.0 Sanitary Servicing
Verify available capacity in downstream sanitary sewer and/or identification of upgrades necessary to service the proposed development. (Reference can be made to previously completed Master Servicing Study if applicable)	y	Refer to Appendix C
Calculations related to dry-weather and wet-weather flow rates from the development in standard MOE sanitary sewer design table (Appendix 'C') format.	N/A	
Description of proposed sewer network including sewers, pumping stations, and forcemains.	Y	Report Section 6.0 Sanitary Servicing
Discussion of previously identified environmental constraints and impact on servicing (environmental constraints are related to limitations imposed on the development in order to preserve the physical condition of watercourses, vegetation, soil cover, as well as protecting against water quantity and quality).	N/A	
Pumping stations: impacts of proposed development on existing pumping stations or requirements for new pumping station to service development.	N/A	
Forcemain capacity in terms of operational redundancy, surge pressure and maximum flow velocity.	N/A	
Identification and implementation of the emergency overflow from sanitary pumping stations in relation to the hydraulic grade line to protect against basement flooding.	N/A	
Special considerations such as contamination, corrosive environment etc.	N/A	

**24-30 PRETORIA AVENUE, OTTAWA
DEVELOPMENT SERVICING STUDY CHECKLIST**

4.4 Stormwater	Addressed (Y/N/NA)	Comments
Description of drainage outlets and downstream constraints including legality of outlet (i.e. municipal drain, right-of-way, watercourse, or private property).	Y	Report Sections 7.0 Storm Servicing and Section 8.0 Stormwater Management
Analysis of the available capacity in existing public infrastructure.	N/A	The allowable flow was provided by the City of Ottawa.
A drawing showing the subject lands, its surroundings, the receiving watercourse, existing drainage patterns and proposed drainage patterns.	Y	Refer to Post-Development Drainage Area Plan
Water quantity control objective (e.g. controlling post-development peak flows to pre-development level for storm events ranging from the 2 or 5 year event (dependent on the receiving sewer design) to 100 year return period); if other objectives are being applied, a rationale must be included with reference to hydrologic analyses of the potentially affected subwatersheds, taking into account long-term cumulative effects.	Y	Report Section 8.0 Stormwater Management
Water Quality control objective (basic, normal or enhanced level of protection based on the sensitivities of the receiving watercourse) and storage requirements.	Y	Report Section 8.0 Stormwater Management
Description of stormwater management concept with facility locations and descriptions with references and supporting information.	Y	Report Section 8.0 Stormwater Management
Set-back from private sewage disposal systems.	N/A	
Watercourse and hazard lands setbacks.	N/A	
Record of pre-consultation with the Ontario Ministry of Environment and the Conservation Authority that has jurisdiction on the affected watershed.	N/A	
Confirm consistency with sub-watershed and Master Servicing Study, if applicable study exists.	N/A	
Storage requirements (complete with calcs) and conveyance capacity for 5 yr and 100 yr events.	Y	Refer to Appendix D
Identification of watercourse within the proposed development and how watercourses will be protected, or, if necessary, altered by the proposed development with applicable approvals.	N/A	
Calculate pre and post development peak flow rates including a description of existing site conditions and proposed impervious areas and drainage catchments in comparison to existing conditions.	Y	Refer to Appendix D
Any proposed diversion of drainage catchment areas from one outlet to another.	N/A	
Proposed minor and major systems including locations and sizes of stormwater trunk sewers, and SWM	N/A	
If quantity control is not proposed, demonstration that downstream system has adequate capacity for the post-development flows up to and including the 100-year return period storm event.	N/A	

**24-30 PRETORIA AVENUE, OTTAWA
DEVELOPMENT SERVICING STUDY CHECKLIST**

4.4 Stormwater	Addressed (Y/N/NA)	Comments
Identification of potential impacts to receiving watercourses.	N/A	
Identification of municipal drains and related approval requirements.	N/A	
Description of how the conveyance and storage capacity will be achieved for the development.	Y	Report Section 8.0 Stormwater Management
100 year flood levels and major flow routing to protect proposed development from flooding for establishing minimum building elevations (MBE) and overall grading.	Y	Refer to Post-Development Drainage Area Plan
Inclusion of hydraulic analysis including HGL elevations.	N/A	
Description of approach to erosion and sediment control during construction for the protection of receiving watercourse or drainage corridors.	Y	Report Section 9.0 Erosion and Sediment Control
Identification of floodplains – proponent to obtain relevant floodplain information from the appropriate Conservation Authority. The proponent may be required to delineate floodplain elevations to the satisfaction of the Conservation Authority if such information is not available or if information does not match current conditions.	N/A	
Identification of fill constrains related to floodplain and geotechnical investigation.	N/A	

4.5 Approval and Permit Requirements	Addressed (Y/N/NA)	Comments
Conservation Authority as the designated approval agency for modification of floodplain, potential impact on fish habitat, proposed works in or adjacent to a watercourse, cut/fill permits and Approval under Lakes and Rivers Improvement Act. The Conservation Authority is not the approval authority for the Lakes and Rivers Improvement Act. Where there are Conservation Authority regulations in place, approval under the Lakes and Rivers Improvement Act is not required, except in cases of dams as defined in the Act.	Y	Refer to Appendix A
Application for Certificate of Approval (CofA) under the Ontario Water Resources Act.	N/A	
Changes to Municipal Drains.	N/A	
Other permits (National Capital Commission, Parks Canada, Public Works and Government Services Canada, Ministry of Transportation etc.)	N/A	

4.6 Conclusion	Addressed (Y/N/NA)	Comments
Clearly stated conclusions and recommendations.	Y	Report Section 10.0 Conclusions and Recommendations
Comments received from review agencies including the City of Ottawa and information on how the comments were addressed. Final sign-off from the responsible reviewing agency.	N/A	T.B.D.
All draft and final reports shall be signed and stamped by a professional Engineer registered in Ontario.	Y	Noted

APPENDIX F

Drawings