



MORRISON HERSHFIELD

Site Servicing and Stormwater Management Design Brief

1050&1060 Bank Street, Mixed-Use Development

Ottawa, Ontario

Presented to:

Dominic Santaguida
2641723 Ontario Inc.

Shawn Wessel
Project Manager - Infrastructure Approvals at City of
Ottawa

Project: 190500700

December 3, 2019

\\MH.LOCAL\DATA\PROJ\2019\190500700-1050-1060 BANK STREET-CIVIL\08.
WORKING\MUNICIPAL\BANK&AYLMER CIVIL DESIGN BRIEF_120319.DOCX

TABLE OF CONTENTS

	Page	
1	INTRODUCTION	2
1.1	Site Description and Proposed Development	2
1.2	Background Documents	3
1.3	Consultation and Permits	3
1.4	Available Existing Infrastructure	3
2	GEOTECHNICAL STUDY	4
3	WATER SERVICES	4
3.1	Design Criteria	4
3.2	Adequacy of Supply for Domestic and Fire Flows	5
3.3	Check of High Pressures	6
3.4	Reliability Requirements	6
3.5	Summary and Conclusions	6
4	SANITARY SERVICING	6
4.1	Background and Existing Infrastructure	6
4.2	Review of Ground Water and Soil Conditions	6
4.3	Proposed Servicing and Calculations	6
4.4	Summary and Conclusions	7
5	STORM SERVICING AND STORMWATER MANAGEMENT	7
5.1	Background	7
5.2	Storm Servicing Strategy including Analysis of Existing Infrastructure	8
5.3	Proposed Storm Servicing	8
5.4	Grading	12
5.5	Erosion and Sediment Control	12
6	CONCLUSIONS	13
7	APPENDICES	14

1 Introduction

1.1 Site Description and Proposed Development

This report describes the site servicing and stormwater management design and calculations pertaining to a 6 storey mixed-use development proposed at 1050&1050 Bank Street. The existing site houses a parking lot and single-storey commercial/retail buildings.

Proposed grading and servicing is shown on the drawings included in **Appendix A**.

The format of this report matches that of the development servicing study checklist found in Section 4 of the City of Ottawa’s Servicing Study Guidelines for Development Applications. A completed copy of the checklist is provided in **Appendix F**.

1.1.1 Statement of Objectives and Servicing Criteria

The objective of this Site Servicing and Stormwater Management Report is to demonstrate that the proposed design meets the servicing requirements for the proposed development, while adhering to the appropriate regulatory requirements.

1.1.2 Location Map and Plan

The location of the site is illustrated in **Figure 1**. A detailed site layout is provided within the drawings in **Appendix A**.

Figure 1- Key Plan

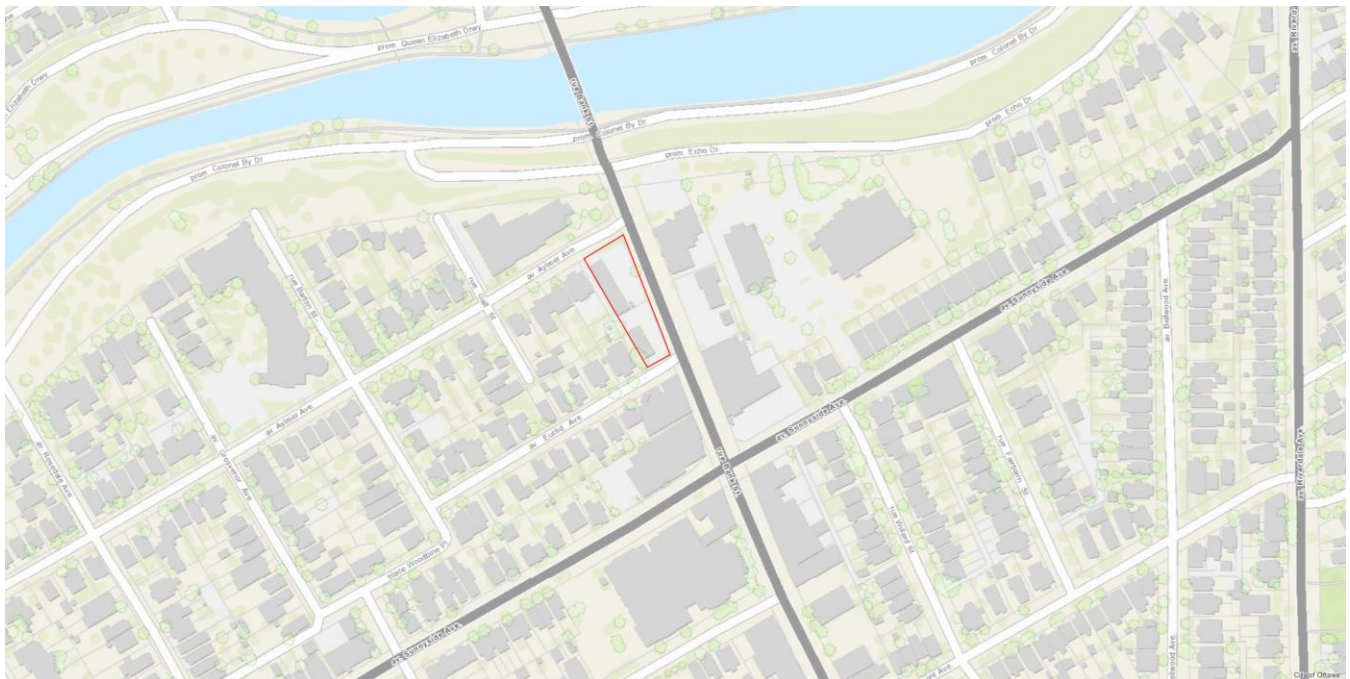

The site is currently zoned TM2 H (15) – Traditional Main Street zone.

A portion of the existing land is currently used as commercial/retail stores, while the remainder used as parking lot/storage area.

1.2 Background Documents

Existing conditions are shown on the Topographic and Legal Survey (**Appendix G**).

1.3 Consultation and Permits

1.3.1 Pre-consultation Meetings

A pre-consultation meeting was held with representatives of the City of Ottawa and the consultant design team on October 18th, 2018. The resulting comments that would affect this report are as follows:

- Excavation: Please note that a pre and post construction CCTV scan and report is required prior to approvals and if blasting is proposed - Constructability and Vibration Reports are required, including monitoring devices on all public infrastructure located within the ROW. Assess the condition of the existing storm and sanitary sewer via CCTV to determine that the existing sewer are in good condition and thereby viable candidates for drainage of the proposed addition.
- Control post-development flow from the site to the 1:5 year predevelopment level for all storm events up to and including 1:100 year storm.
- Pre-development flow to be calculated using the smaller of a runoff coefficient of 0.5 or the actual existing runoff coefficient. Use either a T_c of 20 minutes or calculated the pre-development T_c but not less than 10 minutes
- Maximum ponding on the public and private roadways and parking lot surfaces during 1:100 year storm event = 350mm max.
- Consult with the RVCA regarding storm water quality/restrictions
- Determine the total water demand based on maximum demand and required fire flow for water boundary conditions.

The full comments regarding site-servicing and stormwater management-specific requirements can be found in **Appendix B**.

1.3.2 Adherence to Zoning and Related Requirements

The property is zoned as a Traditional Main Street.

1.4 Available Existing Infrastructure

Sewer and watermain mapping collected from the City of Ottawa indicate that the following services exist across the property frontages within the adjacent municipal rights-of-way.

Aylmer Street

- 203mm diameter UCI watermain
- 300 mm diameter PVC sanitary sewer main discharging into Bank St
- 300 mm diameter PVC storm sewer

Bank Street

- 305mm diameter PVC watermain
- 300mm diameter PVC sanitary sewer discharging to the Rideau River interceptor
- 375mm diameter Conc. storm sewer

Euclid Street

- 152mm diameter UCI watermain
- 300 mm diameter PVC sanitary sewer discharging into Bank St. 1200 mm diameter Brick Collector south of Grove Ave
- 300 mm diameter Conc. storm sewer

2 Geotechnical Study

A Geotechnical Investigation was undertaken by Paterson Group and is documented in Report No. PG4506-1 dated August 20, 2018.

Two boreholes were drilled to a depth of 14.6 m below the existing ground surface. A third borehole was terminated on practical refusal to augering at a depth of approximately 13.7 m. The subsurface profile at the borehole locations consists of a pavement structure underlain by a fill layer to approximately 1.4 to 2.4 m depth. The fill was generally observed to consist of a loose, brown sand with some silt, gravel, and asphalt. The fill was underlain by deposits of compact to very dense sand and very dense silty sand to sandy silt.

Based on available geological mapping, the subject site is located in an area where the bedrock consists of interbedded limestone and shale of the Verulam formation.

Groundwater was encountered at depths of 11-12 m below the existing ground surface.

The geotechnical report provides recommendations for excavation, backfill, pavement structure and pipe bedding and backfill.

3 Water Services

3.1 Design Criteria

The water service will be designed in accordance with the 2010 City of Ottawa Water Design Guidelines as well as MOE Design Guidelines for Drinking Water Systems. The proposed development lies within the City of Ottawa 1W pressure zone as shown by the Pressure Zone map in **Appendix B**

The required domestic water demand and pressure design parameters for the development has been calculated based in **Table 1**:

Table 1– Summary of Water Demand Parameters

Design Parameter	Value	
	Residential	Retail
Average Daily Demand	350 L/d/P ¹	2500 L/(1000m ² /d)
Max. Daily Peaking Factor	7.5 x Average Daily ²	1.5 x Average Daily ³
Max. Hourly Peaking Factor	11.25 x Average Daily ²	1.8 x Max Daily ³
Minimum Watermain Size	150mm diameter	
Minimum Depth of Cover	2.4m from top of watermain to finished grade	
Desired pressure range during normal operating conditions	350kPa and 480kPa	
Min. pressure during normal operating conditions	275kPa	
Max. pressure during normal operating conditions	552kPa	



Min. pressure during maximum hourly demand	276kPa
Min. pressure during maximum daily demand + fire flow	140kPa
¹ Daily average based on Appendix 4-A from Water Supply Guidelines ² Residential Max. Daily and Max. Hourly peaking factors per MOE Guidelines for Drinking-Water Systems Table 3-3 for 0 to 500 persons ³ Retail/Commercial Max. Daily and Max. Hourly peaking factors per from Water Supply Guidelines, Table 4.2 – Shopping Center	

Table 2 summarizes the water demand/fire flow for the development based on the **Ottawa Design Guidelines (2010 incl. Technical Bulletins)** and the **Fire Underwriters Survey (1999)**:

Table 2– Summarization of Water Demand Calculations

Design Parameter	Water Demand (L/s)	
	Residential	Retail
Average Daily Demand	0.36	0.025
Maximum Daily Demand	3.78	0.038
Maximum Hourly Demand	2.51	0.068
Fire Flow	90.10	
Total Max Daily Demand + Fire Flow	92.65	
Max Hourly Demand	3.85	

Domestic and fire flow calculations are provided in **Appendix C**. Supporting correspondence from the Architect is provided in **Appendix A**.

3.2 Adequacy of Supply for Domestic and Fire Flows

Based on the boundary conditions provided by the City (**Appendix B**), the pressure limits described in **Table 1** are met. **Table 3** illustrates the calculated pressures:

Table 3 – Summarization of Situational Boundary Conditions

Design Parameter	Calculated Demand (L/min)	Boundary Conditions (m Head/kPa)	Calculated Pressure at Finished Floor Elev. (m Head/kPa)
Average Daily Demand	23.1	Max HGL 114.7m/1125.2kPa	43.1m/422.8kPa
Max Hourly Demand	231	Min HGL 104.3m/1023.2kPa	32.7m/320.8kPa
Total Max Daily Demand + Fire Flow	8135.1	104.0m/1020.2kPa	32.4m/317.8kPa

Using these boundary conditions and the provided finished floor elevation of 71.56m, the resulting pressure falls between 423 kPa and 321 kPa, the latter occurring under maximum hourly conditions. The pressure during maximum daily demand + fire flow is 318 kPa.



A 200 mm diameter water service is proposed. **Table 4** summarizes the water demands, boundary conditions, and residual pressure at the service entry, and demonstrates that the pressure constraints described in **Table 1** are met under all analyzed conditions:

Table 4 – Summarization of Water Demand Calculations based on the Boundary Conditions

	Scenario		Source of Data
	Max Day + Fire	Max Hourly	
Flow Demand (L/s)	135.1	3.85	Calculated (full calculations included in Appendix E)
Boundary Condition: Available Pressure under Current Conditions (kPa)	317.8	320.8	Provided by the City of Ottawa
Residual Pressure at Service Entry including pipe losses (200mm diameter pipe) (kPa)	298.6	320.7	Calculated (full calculations included in Appendix E)
Minimum Allowable Pressure (kPa)	170	276	City of Ottawa Water Design Guidelines

3.3 Check of High Pressures

The site is within Pressure Zone 1W, which operates at a maximum head of 115 m (City of Ottawa Water Master Plan, 2013). This would result in a maximum pressure above the finished floor elevation of approximately 426kPa, which falls under the maximum 552kPa defined in the guidelines.

3.4 Reliability Requirements

A shut off valve for the water service will be provided at the property line.

3.5 Summary and Conclusions

The proposed building will be serviced by a 200 mm diameter water service connected to the existing 305 mm diameter watermain in Bank Street.

4 Sanitary Servicing

4.1 Background and Existing Infrastructure

The sanitary service will be designed in accordance with the 2012 Ottawa City Sewer Design Guidelines. The surrounding municipal sanitary services are described in detail in **Section 1.4**. The site is serviced by separated storm and sanitary sewers.

4.2 Review of Ground Water and Soil Conditions

Recommendations regarding the installation of piped services that are provided in the geotechnical report will be incorporated into the contract specifications.

All proposed sewers will be installed above the groundwater table.

4.3 Proposed Servicing and Calculations

The proposed development will require a new 150mm diameter PVC sanitary service. The new 150mm diameter PVC sanitary service will extend from the east side of the building and connect to an existing 300mm diameter sanitary sewer in Bank Street. The sanitary servicing design parameters are defined in **Table 5**.

Table 5– Summarization of Sanitary Servicing Design Parameters

Design Parameter	Value
Residential Single Home	3.4 P/unit
Residential Townhouse	2.7 P/unit
Average Residential Apartment	1.8 P/unit
Residential Average Flow	28'000 L/ha/d
Residential Peaking Factor	Based on the Harmon Equation $P.F. = 1 + \left(\frac{14}{4 + \left(\frac{P}{1000} \right)^{\frac{1}{2}}} \right) * K$
Commercial Average Flow	28'000 L/ha/d
Commercial Peaking Factor	1.5 if commercial contribution > 20%, else 1.0
Institutional Average Flow	28'000 L/ha/d
Institutional Peaking Factor	1.5 if institutional contribution > 20%, else 1.0
Infiltration and Inflow Allowance	0.33 L/ha/s
Sanitary Sewer Sizing Based on the Manning's Equation	$Q = \frac{1}{n} \pi A R^{2/3} S^{1/2}$
Manning's Coefficient 'n'	0.013
Minimum Depth of Cover	2.5m from obvert of sewer to grade
Minimum Full Flowing Velocity	0.6m/s
Maximum Full Flowing Velocity	3.0m/s

As per Sections 4 and 6 of the City of Ottawa Sewer Design Guidelines, October 2012 incl. all Tech. Bulletins as of November 2019

The proposed building will produce a sanitary flow of 0.35 L/s as determined by the City of Ottawa 2012 Sewer Design Guidelines. The proposed service lateral has a maximum capacity of 16.8 L/s. This is sufficient for the calculated sanitary flow.

Analysis of the catchment area shows that the estimated peak flow rate in the 300 mm sanitary sewer in Bank Street under existing conditions is 14.5 L/s. This will be increased by 0.35 L/s by the proposed development. The existing sewer has sufficient capacity accommodate this calculated flow. Full calculations can be found in **Appendix D**.

4.4 Summary and Conclusions

In conclusion the proposed development meets all required servicing constraints and associated design criteria/requirements.

5 Storm Servicing and Stormwater Management

5.1 Background

The majority of parking lot presently drains to two catch basins, which connect to the storm sewers draining the existing buildings. All storm water drained from this site is assumed to flow uncontrolled into STM 38050 in Bank Str. which travels via Sunnyside Ave. and Leonard Ave. where it then



discharges into the Rideau River via a 1350mm storm sewer located on the southern boundary of Leonard Ave. (ID STM37913).

The City of Ottawa's Sewer Design Guidelines require more stringent control for the proposed development: the 100-year post-development storm flow is to be restricted to the 5-year pre-development run-off with an assumed pre-development coefficient no greater than 0.5.

For the proposed development, quantity control meeting the City of Ottawa requirements will be provided through the use of on-site detention and flow control devices.

5.2 Storm Servicing Strategy including Analysis of Existing Infrastructure

The proposed stormwater management system will provide the necessary detention storage on site to meet the stormwater management requirements. Quantity control will be provided at the source within each catchment to the extent possible.

The local pre-development drainage patterns will remain consistent post-development. As described in **Section 1.3.1**, all flows beyond the pre-development 5-year event will be controlled via local storage and controlled flow devices.

5.3 Proposed Storm Servicing

A new 250 mm diameter storm service will extend from the east side of the proposed development to connect to STM38050. In addition, the two existing catch basins (which currently drain the existing parking lot area) will be removed. The proposed pre-development and post-development catchment areas, runoff coefficients and catchment total areas are indicated in **Appendix E**.

5.3.1 Design Criteria (Minor and Major Systems)

For the design of stormwater management (SWM), the City of Ottawa's criteria for a Commercial/ Institutional/ Industrial development in an existing area will be applied (Section 8.3.7.3 of the City of Ottawa Sewer Design Guidelines). The key SWM requirements are:

- On-site SWM measures required to avoid impact on downstream system (i.e. existing storm sewers).
- Runoff to be controlled to the 5-year pre-development level as directed by the City.
- Pre-development flow to be calculated using the smaller of a runoff coefficient of 0.5 or the actual existing runoff coefficient. Use either a T_c of 20 minutes or calculated the pre-development T_c but not less than 10 minutes.
- All flow depths must be controlled on-site (i.e. no spill to adjacent properties or rights-of-way for flows up to the 100-year event).
- The design should consider the 100-year return period event, address performance for specified historical storms, and be stress tested for Climate Change using design storms calculated on the basis of a 20% increase of the City's IDF curves for rainfall events. Any instances of severe flooding identified through the stress test must be rectified.

Key drainage design requirements from the City of Ottawa Sewer Design Guidelines include:

- The minor system (underground storm sewers) is designed to capture the 2-year event (minimum). Inlet Control Devices should be utilized to minimize surcharging during the 100-year event.



- The minor system is designed to convey the 2-year event, with the hydraulic grade line (HGL) below the crown of the pipe (except where impacted by boundary conditions – in which case the HGL shall not exceed 0.3m below the underside of the footings during the 100-year event).
- For events greater than the 100 year return period, spillage is directed to a public ROW and not to neighbouring private property.
- The site grading ensures that the property being developed is higher than the spill elevation of the adjacent municipal ROW. This is considered especially critical if underground parking is being proposed. The grading ensures sufficient positive drainage away from the building, with a minimum slope from the building to the street of 2% and building openings a minimum of 0.3m above the 100-year ponding level. If reduced lot grading is considered for an increase in travel time and infiltration, the 2% minimum grade is still maintained for at least 4m from the building.
- The maximum water depth on streets (public, private and parking lots), static or dynamic, is 350 mm.
- Where underground storage is utilized, the design must ensure that backwater from the downstream system does not impact the required storage.

In addition to the City of Ottawa’s guidelines, requirements for storm water quality control will be considered. The Rideau Valley Conservation Authority (RVCA) has been consulted (**Appendix B**) and indicated as follows:

- Building roof areas can be excluded from storm water quality treatment systems due to the “clean” water being discharged from the roof as opposed to that being discharged from ground surface areas.
- The remaining setback areas contains fewer than 6 parking spaces, and therefore do not require quality control.
- The RVCA recommends opportunities and options for suitable source and conveyance controls to be considered, including LID techniques, that will assist with managing/improving the quality of runoff from this site

5.3.2 Stormwater Quantity Control

5.3.2.1 Runoff Coefficient and Peak Flows

Table 6 indicates the run-off coefficient for each catchment. The 100-year run-off coefficients include a 25% increase (to a maximum of 1.0) as required by the City of Ottawa Sewer Design Guidelines Section 5.4.5.2.1.

Table 6– Pre-development Run-off Coefficients

Storm Event	Pre-Development Run-off Coefficients	
	5-Year Storm	100-Year Storm
Site Area (in ha)	0.159	0.159
Run-off Coefficients	0.90	1.0

Intensity (i) is calculated using the formula

$$i = \frac{A}{(T_d + C)^B}$$



where A, B and C are all factors of the IDF Return Period, T_d being the time of concentration and A the drainage area (Detailed calculations provided in **Appendix E**).

Time of concentration is determined using the inlet time graph (Appendix 5D Ottawa City Sewer Design Guidelines) which results in a values less than 10 minutes. Therefore 10 minutes will be used to calculate peak flows. With the pre and post-development run-off coefficients and rainfall intensity, the peak flows for each drainage area can be calculated using the Rational Method. The results (using actual run-off coefficients) are summarized in **Table 7**.

Table 7– Pre-Development Peak Flows

Storm Event	Pre-Development Peak Flows (actual run-off coefficients)	
	5-Year Storm	100-Year Storm
Intensity (mm/hr)	104.2	178.6
Peak Flow (L/s)	41.6	79.1

Since the pre-development run-off coefficient exceeds 0.5, a value of 0.5 will be assumed for calculation of the allowable release rate. Considering time of concentration of 10 minutes, site area of 0.159 hectares and a 5 year storm, **the allowable release rate is 23.1 L/s**.

The project will result in all catchments remaining covered with impervious surfaces. The post-development run-off coefficients are indicated in **Table 8**:

Table 8– Overall Post-Development Run-off Coefficients

Storm Event	Overall Post-Development Run-off Coefficients	
	5-Year Storm	100-Year Storm
Project Area (in ha)	0.159	0.159
Weighted Run-Off Coefficient	0.90	1.00

5.3.2.2 Stormwater Management Concept

Uncontrolled Drainage Areas (RAMP, SB1, SB3)

It is not feasible to control run-off from the setback areas along Aylmer Ave. and Bank Str., as such these area will release uncontrolled to the adjacent ROW.

The base of the access ramp to the underground parking area is too low to drain by gravity to the existing storm sewers. Run-off from the ramp will therefore be captured and pumped. So as to allow one set of pumps to service both the ramp and the foundation drains, the pump discharge will be directed downstream of the ICD and released uncontrolled.

Table 9– Post-Development Uncontrolled Release

Storm Event	Post-Development Uncontrolled Release	
	5-Year Storm	100-Year Storm
Drainage area (ha)	0.042	0.042
Run-off Coefficient	0.9	1.0
Peak Flow (L/s)	10.8	20.7

This leaves a remaining allowable release rate of **2.4 L/s**.

The pumps will be located inside the building and will be designed by the mechanical engineer. The pumps will be sized to provide capacity equal to the peak run-off from the ramp during the 100 year storm (i.e. 6.4 L/s).

Controlled Drainage Areas BLDG1, BLDG2, SB2, SB4

The drainage from the roof, western setback (rear parking area) and southern setback (Euclid Ave.) will be captured and directed to an underground storage tank located in the western setback. The tank will outlet to a catchbasin maintenance hole outfitted with an ICD. Downstream of the ICD the storm service will outlet to the existing 375mm storm sewer in Bank Str..

As indicated by the proposed storage calculations, the required underground storage is 59m³. This will be provided using a rectangular plastic geocellular stormwater storage tank. Assuming a void ratio of 0.95 (as per documentation for a typical tank in **Appendix E**), the required tank dimensions are 21.6m long by 2.4m wide by 1.2m tall.

Based on the orifice calculation, the outlet will require a vortex inlet control device. Using an allowable release rate of 2.4L/s and a head of 1.33m, the “*IPEX Tempest LMF ICD*” meets the requirements at a preset of 50. The ICD design chart is provided in **Appendix E**.

Summary

Table 10 summarizes the proposed release rates and confirms that the total release rate does not exceed the allowable release rate.

Table 10 – Post-Development Controlled Peak Flows

	Post-Development Controlled Peak Flows (L/s)
Allowable Release Rate	23.1
Release Rate from Uncontrolled Drainage Areas	20.7
Release Rate from Controlled Drainage Areas	2.4
Total Release Rate	23.1

5.3.2.3 Impact on Existing Stormwater Infrastructure

An existing 375 mm storm sewer with a slope of 0.5% services Bank Street between Aylmer Avenue and Euclid Avenue. **Table 11** summarizes the existing flows to the public storm sewer.

Table 11 – Pre-Development Peak Flows vs. Post-Development Controlled Peak Flows

	Pre-Development Peak Flow	Post-Development Controlled Peak Flow
Storm Event	5-Year Storm	5-Year Storm
Peak Flow / Reduced Release Rate (L/s)	41.6	23.1
Total run-off (L/s)	41.6	23.1

This shows a reduction in total run-off of 64.6% when compared to the uncontrolled pre-development peak flow.

Sewer Design Calculations are provided in **Appendix E**.

5.3.3 Storm Water Quality Control

As indicated in **Section 5.3.1** above, the RVCA considers run-off from building roof areas to be “clean”, and therefore not require quality control.



As there are fewer than 6 proposed parking spaces parallel to the municipal laneway, this area does not require quality control.

The RVCA correspondence regarding water quality has been included in **Appendix B**.

5.3.4 Pre-Consultation with the Ontario Ministry of the Environment and Conservation and Parks, and Conservation Authority

The Ministry of Environment, Conservation and Parks (MECP) has been contacted and has confirmed that no ECA is required for this site. Correspondence is provided in **Appendix B**.

5.3.5 Minor and Major Systems

The minor storm sewer system consists of the sewers described above. The major system consists of flow north along Bank Street toward the Rideau Canal. The site will be graded to direct run-off from storms in excess of the 100-year event to Bank Street. Run-off from the rear of the site will reach Bank Street via the rear passage (laneway), and Aylmer or Euclid Avenue.

5.3.6 Impacts to Receiving Watercourses

No negative impacts to receiving watercourses are anticipated.

5.3.7 100 Year Flood Levels and Major Flow Routing

The site is not within a 100-year floodplain.

5.4 Grading

The proposed grading plan is shown in Drawing C002 in **Appendix A**. The development will be tied into existing sidewalk grades along Bank Street, Aylmer Avenue and Euclid Avenue.

The west side of the site fronts a City-owned rear passage (laneway). It is apparent that the rear passage was previously partially excavated to provide access from 1060 Bank Street to a property west of the rear passage with PIN 041430324 (also identified as 1060 Bank Street, though not fronting onto Bank Street). As a result of this excavation, it is currently not possible to drive along the rear passage from Aylmer Avenue to Euclid Avenue. During construction of the proposed development, the rear passage will be reinstated by the developer. To maintain drainage, the previously-excavated portion of PIN 041430324 will be filled to slope towards the rear passage. No other development of PIN 041430324 is proposed at this time.

The proposed setback/parking area on the west side of the proposed development will be graded away from the rear passage to prevent run-off onto the rear passage. The rear passage will be graded with a crossfall to the west and longitudinal slopes from a high point towards Aylmer Avenue and Euclid Avenue to maintain drainage of the properties to the west, including PIN 041430324.

5.5 Erosion and Sediment Control

As described in the servicing guidelines, an erosion and sediment control plan is required for implementation during the construction phase. To minimize the migration of sediments, items such as silt fencing and sediment capture devices for catch-basins downstream of the site and around the building are to be installed to capture and retain sediment. Additionally, all stockpiles are to be covered.

During construction, all erosion control features shall be maintained and repaired as necessary and adjacent roadways kept free of construction debris and sediment this responsibility falls under the purview of the Contractor.



6 Conclusions

In conclusion the proposed development meets all required servicing constraints and associated design criteria/requirements as well as the additional City of Ottawa requirements identified in the pre-consultation phase. It is recommended that this report be submitted to the City of Ottawa in support of the application for site plan approval.

Sincerely,

Morrison Hershfield Limited



James Fookes, P.Eng., C.Eng.
Senior Water and Wastewater Engineer

A handwritten signature in blue ink that reads "Daniel Glauser".

Daniel Glauser, B.Eng.
Municipal Designer

7 Appendices

- Appendix A Site Servicing, Grading and Erosion and Sediment Control, Catchments Plans and Details
- Appendix B RVCA and City of Ottawa Specific Requirements Correspondence
- Appendix C Water Demand and FUS Calculations
- Appendix D Sanitary Flow Calculations
- Appendix E Storm Sewer Design Calculations
- Appendix F Site Servicing Checklist
- Appendix G Topographic and Legal Survey

Appendix A

Site Servicing, Grading and Erosion and Sediment Control, Catchments Plans and Details

Drawing Frame: 790mm x 544mm City of Ottawa 2008 (Rev.0)
 Tuesday, December 02, 2015 10:42:58 AM
 Monday, December 02, 2019 4:53:13 PM
 Last Saved:

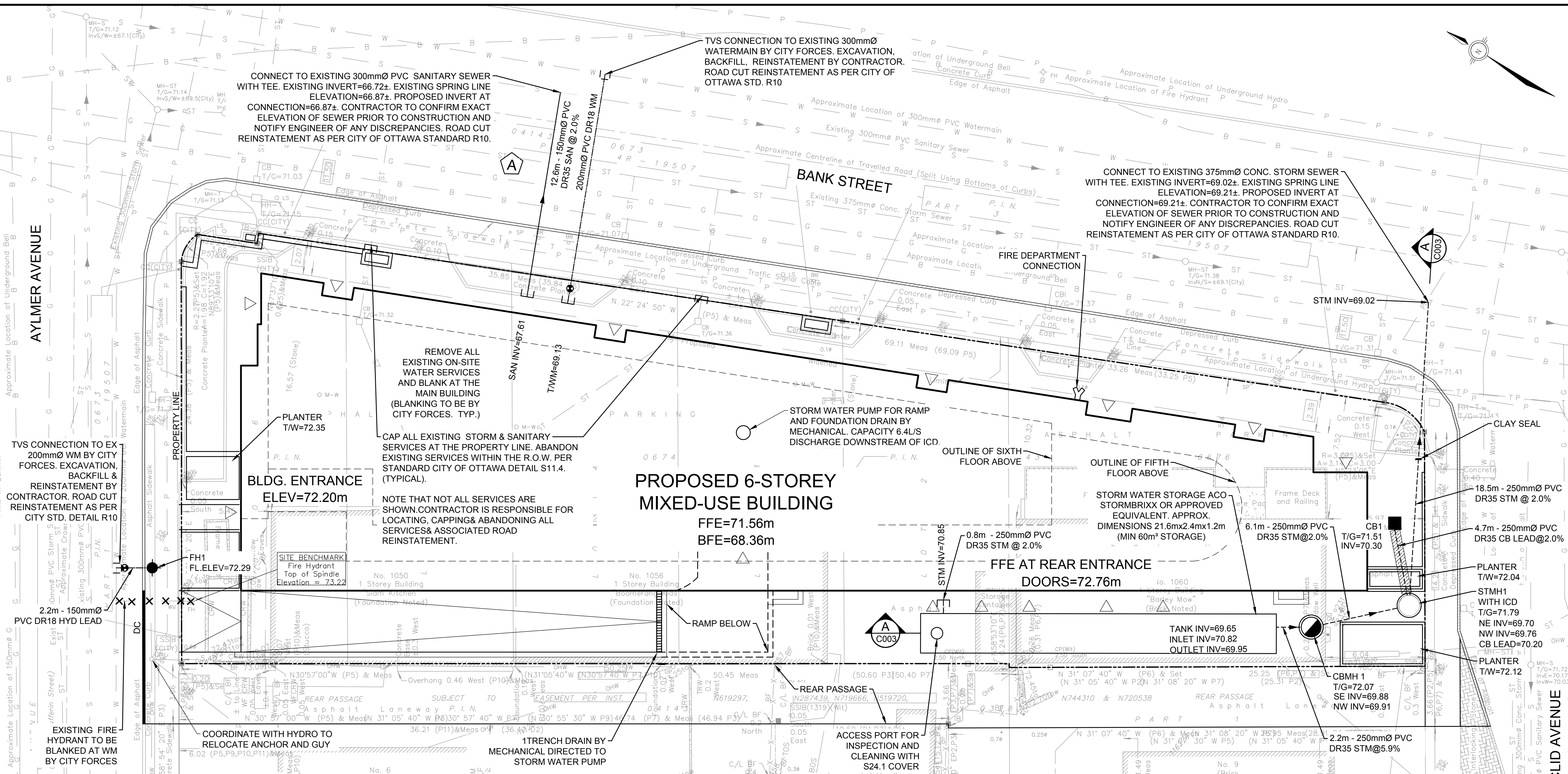

PROPOSED MIXED-USE RETAIL & RENTAL APARTMENT BUILDING
 1050&1060 BANK STREET
 OTTAWA, ON

SITE SERVICING PLAN

Contract No. C001
 Drawing No. C001
 Sheet No. 1 of 5
 Asset No.
 Asset Group

Des: DG Chk'd: JF
 Dwn: NI Chk'd: JF
 Utility Circulation No.: CTY---
 Construction Inspector:

Scale: 1:150
 0m HORIZONTAL 2.5 5

PROFESSIONAL ENGINEER
 J. B. FROOKES
 1012/2820
 Dec 02, 2019
 PROVINCE OF ONTARIO

NOTE:
 The location of utilities is approximate only, the exact location should be determined by consulting the municipal authorities and utility companies concerned. The contractor shall prove the location of utilities and shall be responsible for adequate protection from damage.

No.	Description	By	Date (dd/mm/yyyy)
0	ISSUED FOR SITE PLAN APPROVAL	J.F.	02/12/19

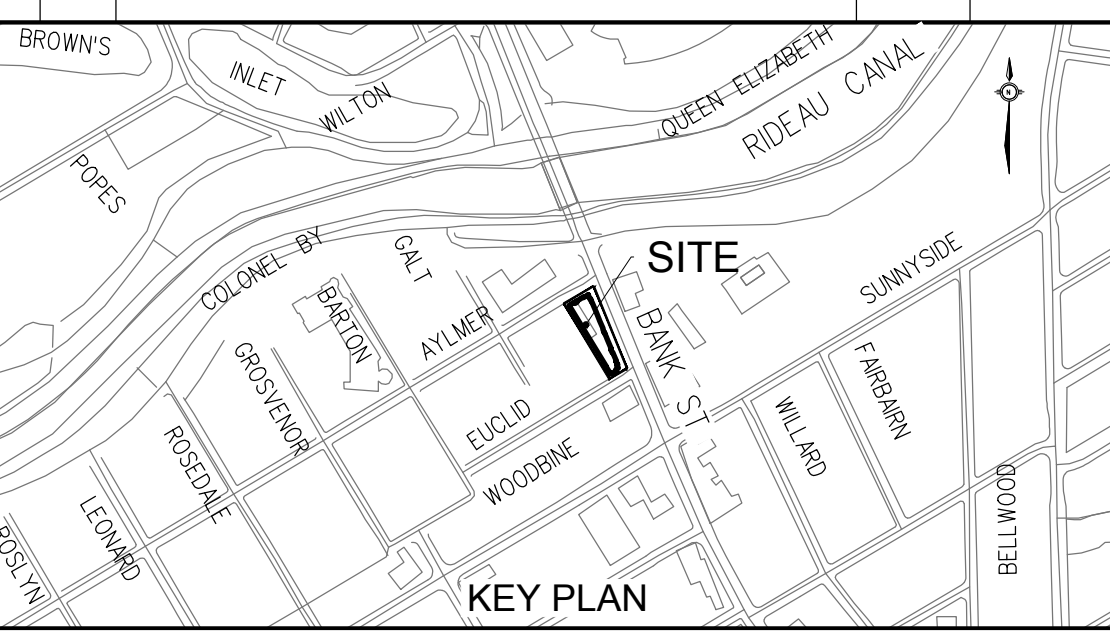

LEGEND

- NEW WATERMAIN
- NEW SANITARY SEWER
- NEW STORM SEWER
- NEW MANHOLE
- VB NEW VALVE AND VALVE BOX
- NEW HYDRANT
- NEW CAP
- NEW CATCH BASIN
- NEW STORM CB LEAD
- ▽ NEW ENTRANCE
- NEW FIRE DEPARTMENT CONNECTION
- NEW THERMAL INSULATION FOR SHALLOW SEWERS
- EXISTING STORM SEWER
- EXISTING SANITARY SEWER
- EXISTING WATERMAIN

NOTES:
GENERAL

- COORDINATES ARE IN MTM ZONE 9 (76°30' WEST LONGITUDE) NAD-83 (ORIGINAL)
- OBTAIN ALL NECESSARY PERMITS AND APPROVALS FROM THE CITY OF OTTAWA PRIOR TO STARTING CONSTRUCTION
- SERVICES ARE TO BE CONSTRUCTED TO 1.0m FROM FACE OF BUILDING.
- REFER TO "SITE SERVICING AND STORMWATER MANAGEMENT DESIGN BRIEF, 1050&1060 BANK STREET, MIXED-USE DEVELOPMENT" PREPARED BY MORRISON HERSHFIELD FOR SITE SERVICING REPORT
- REFER TO GEOTECHNICAL INVESTIGATION REPORT (NO. PG4506-1 DATED AUGUST 20, 2018) PREPARED BY PATERSON GROUP FOR SUBSURFACE CONDITIONS, CONSTRUCTION RECOMMENDATIONS AND GEOTECHNICAL INSPECTION REQUIREMENTS. THE GEOTECHNICAL CONSULTANT SHALL REVIEW EXCAVATIONS PRIOR TO THE PLACEMENT OF GRANULAR MATERIAL.
- CONTRACTOR TO VERIFY ALL EXISTING UTILITY ELEVATIONS AT CONNECTION AND CROSSING LOCATIONS PRIOR TO CONSTRUCTION AND ADVISE THE ENGINEER OF ANY DISCREPANCIES.
- UNLESS DIRECTED OTHERWISE ANY DAMAGED ASPHALT OR CURB (REGARDLESS OF WHETHER WITHIN OR EXTERNAL TO THE SITE) SHALL BE REINSTATED IN ACCORDANCE WITH CITY STD. DET. R10 AND S1.
- UNLESS DIRECTED OTHERWISE THE CONTRACTOR SHALL REINSTATE ALL SIGNS, LIGHTING AND OTHER STREET FURNITURE DISTURBED BY THE WORK.
- THE CONTRACTOR SHALL DEVELOP AND IMPLEMENT TRAFFIC MANAGEMENT PLANS FOR WORK IN RIGHT OF WAY IN ACCORDANCE WITH OTM BOOK 7.
- CLAY SEALS SHALL BE IN ACCORDANCE WITH CITY OF OTTAWA

STANDARD DETAIL S8 AND SHALL BE INSTALLED AT 50m INTERVALS IN ALL PIPE TRENCHES. CLAY SEAL TO EXTEND FULL TRENCH WIDTH AND FROM BOTTOM OF TRENCH EXCAVATION TO UNDERSIDE OF ROAD STRUCTURE, WITH A MINIMUM THICKNESS OF 1m ALONG PIPE.

11. LOCATE AND CAP ALL EXISTING STORM, SANITARY AND WATER SERVICES AT THE PROPERTY LINE. ABANDON EXISTING SERVICES WITHIN THE R.O.W. PER STANDARD CITY OF OTTAWA DETAIL S11.4. (TYPICAL)

SEWERS

- ALL STORM SEWERS, SANITARY SEWERS AND CATCH BASINS LEADS SHALL BE PVC DR 35 UNLESS OTHERWISE SPECIFIED.
- REFER TO DETAIL 1 ON DRAWING C003 FOR SEWER INSTALLATION.
- MAINTENANCE HOLES AND CATCH BASIN MAINTENANCE HOLES ON STORM SEWERS LESS THAN 900mm DIAMETER SHALL BE CONSTRUCTED WITH A 300mm SUMP. BENCHING SHALL BE INSTALLED IN MAINTENANCE HOLES ON STORM SEWERS 900mm AND ABOVE.
- STORM SEWER MAINTENANCE HOLE COVERS SHALL BE IN ACCORDANCE WITH CITY OF OTTAWA STANDARD DETAIL S24.1 ON FRAMES TO DETAIL S25.
- CONTRACTOR SHALL MAINTAIN EXISTING SEWER FLOWS DURING CONSTRUCTION IN ACCORDANCE WITH CITY OF OTTAWA SPECIFICATIONS.
- ALL MAINTENANCE HOLES, CATCHBASINS AND CLEANOUTS SHALL BE ADJUSTED TO POST-CONSTRUCTION GRADE.
- CCTV INSPECTION OF ALL SEWERS SHALL BE COMPLETED AS PER CITY OF OTTAWA SPECIFICATIONS PRIOR TO THE INSTALLATION OF BASE COURSE ASPHALT.

WATERMAINS

- REFER TO DETAIL 1 ON DRAWING C003 FOR WATERMAIN INSTALLATION.
- ALL WATERMAIN MATERIALS AND CONSTRUCTION METHODS SHALL BE IN ACCORDANCE WITH THE 2019 EDITION OF THE CITY OF OTTAWA STANDARD SPECIFICATIONS AND STANDARD DRAWINGS. PVC PIPE TO BE CLASS 150 DR18 TO LATEST EDITION OF A.W.W.A. SPECIFICATION C900 AND CSA B137.3 LATEST AMENDMENT WITH GASKETED BELL AND SPIGOT COUPLINGS.
- THE CONTRACTOR SHALL BE RESPONSIBLE FOR OBTAINING A WATER PERMIT AS REQUIRED FROM THE CITY OF OTTAWA, AND COMPLYING WITH ALL CITY OF OTTAWA REQUIREMENTS. THE CITY MAY REQUIRE THAT CERTAIN ACTIVITIES (E.G. VALVE OPERATION, CONNECTION OF NEW WATER SERVICE TO EXISTING WATERMAIN, DISINFECTION) BE CARRIED OUT ONLY BY CITY FORCES.
- ALL VALVES 300mm DIAMETER AND SMALLER SHALL INCLUDE A VALVE BOX AS PER W24.
- THE NEW WATERMAIN IS TO BE INSTALLED WITH A MINIMUM OF 2.4m COVER (INCLUDING HYDRANT LEAD). WHERE 2.4m COVER IS NOT POSSIBLE, PROVIDE INSULATION IN ACCORDANCE WITH CITY OF OTTAWA STANDARD DETAILS W22 & W23.
- THRUST RESTRAINT SHALL BE PROVIDED BY BOTH RESTRAINING/RETAINING RINGS AND THRUST BLOCKS AT ALL DEAD END CAPS, PLUGS, VALVES, BENDS AND REDUCERS AS PER CITY OF OTTAWA STANDARD DETAILS W25.3, W25.4, W25.5 AND W25.6. ALL TEMPORARY THRUST RESTRAINTS ARE THE RESPONSIBILITY OF THE CONTRACTOR.
- TRACER WIRE SHALL BE PROVIDED FOR ALL NEW PVC WATERMAINS IN ACCORDANCE WITH THE SPECIFICATIONS AND CITY OF OTTAWA STANDARD DETAIL W36.
- CATHODIC PROTECTION SHALL BE PROVIDED FOR ALL NEW WATERMAINS IN ACCORDANCE WITH THE SPECIFICATIONS AND CITY OF OTTAWA STANDARD DETAILS W39, W40, W41, W42 AND W47. CATHODIC PROTECTION OF EXISTING WATERMAINS SHALL ALSO BE PROVIDED AT CONNECTIONS BETWEEN EXISTING AND NEW WATERMAINS.
- ADJUST ALL VALVE CHAMBERS, VALVE BOXES AND HYDRANTS TO FINISHED GRADE.

UTILITY NOTE

- THE POSITION OF POLE LINES, CONDUITS, WATERMAINS, SEWERS AND OTHER UNDERGROUND AND OVERGROUND UTILITIES AND STRUCTURES IS NOT NECESSARILY SHOWN ON THE CONTRACT DRAWING, AND, WHERE SHOWN, THE ACCURACY OF THE POSITION OF SUCH UTILITIES AND STRUCTURES IS NOT GUARANTEED. BEFORE STARTING WORK THE CONTRACTOR SHALL INFORM HIMSELF OF THE EXACT LOCATION OF ALL SUCH UTILITIES AND STRUCTURES, AND SHALL ASSUME ALL LIABILITY FOR DAMAGE TO THEM. THE CONTRACTOR WILL BE RESPONSIBLE FOR SUPPORTING AND PROTECTING ANY EXISTING UTILITIES, AS REQUIRED, IN ACCORDANCE WITH THE UTILITY OWNERS' REQUIREMENTS. CONTRACTOR IS REQUIRED TO OBTAIN LOCATES, IN ADVANCE OF EXCAVATION WORK, AND FORWARD COPIES OF THE LOCATES TO THE CONSULTANT AND THE OWNER PRIOR TO EXCAVATION.
- ALL CROSSING OF EX. UTILITIES TO BE IN ACCORDANCE WITH CITY STD. DET. S10

PIPE CROSSING TABLE

CROSSING	LOWER PIPE	HIGHER PIPE	CLEARANCE	SURFACE ELEVATION
A	150mmØ SAN OBV=66.94	375mmØ STM INV=69.28	2.3m±	71.09m

PROPOSED HYDRANT LEAD TABLE

STATION	SURFACE ELEVATION	T/WM ELEVATION	COMMENTS
0+000	72.04	69.64±	TVS CONNECTION TO EXISTING 200mmØ WATERMAIN
0+001.5	72.18	69.78±	200mmØ VALVE AND VALVE BOX
0+003.0	72.23	69.83±	HYDRANT

PROPOSED WATER SERVICE TABLE

STATION	SURFACE ELEVATION	T/WM ELEVATION	COMMENTS
0+000	71.70	68.70±	TVS CONNECTION TO EXISTING 300mmØ WATERMAIN
0+001.5	71.11	68.71±	CROSS ABOVE 300mmØ SAN (1.7m± CLEARANCE)
0+005.9	71.10	68.70±	CROSS ABOVE 375mmØ STM (0.6m± CLEARANCE)
0+013.0	71.48	69.08±	200mmØ VALVE AND VALVE BOX
0+014.6	71.53	69.13±	CAP 1.0m FROM BUILDING FACE

*) TVS CONNECTION TO EXISTING 300mmØ WATERMAIN. EXACT ELEVATION TO BE FIELD DETERMINED.

NEW STORM STRUCTURE

STRUCTURE	STRUCTURE TYPE	COVER TYPE	TOP OF GRATE	INVERT	NORTHING	EASTING	NOTES
MHST1	701.010	S24.1	71.79	69.70 (NE) 69.76 (NW)	5028642.69	368689.09	WITH ICD
CBMH1	701.010	S19	72.07	69.91 (NW) 69.88 (SE)	5028647.12	368684.90	
CB1	705.010	S19	71.51	70.30 (SW)	5028646.01	368692.92	

INLET CONTROL DEVICE DATA TABLE - STMH1

DESIGN EVENT	ICD TYPE	DIAMETER OF OUTLET PIPE (mm)	DESIGN FLOW (L/s)	WATER ELEVATION (m)	REQUIRED VOLUME (m³)	TOTAL VOLUME PROVIDED
1:5 YR	IPEX Tempest LMF 50	250mmØ PVC	2.0	70.73	31.9	60m³
1:100 YR	IPEX Tempest LMF 50	250mmØ PVC	2.4	71.16	59.0	

Drawing Frame: 790mm x 554mm City of Ottawa 2008 (Rev.0)
 Last Saved: Friday, November 29, 2019 5:11:17 PM
 Plot Date: Monday, December 02, 2019 4:51:26 PM
 Consultants' Information: C:\2019\1916050700-1050-1060 Bank Street-Civil\08_CAD\07_Sheets\Grading_Plan.dwg

PROPOSED MIXED-USE RETAIL & RENTAL APARTMENT BUILDING
 1050&1060 BANK STREET
 OTTAWA, ON

GRADING AND EROSION AND SEDIMENT CONTROL PLAN

Contract No. C002
 Sheet No. 2 of 5
 Asset No.
 Asset Group

Des: DG Chk'd: JF
 Dwn: NI Chk'd: JF
 Utility Circulation No.: CTY---
 Construction Inspector:

Scale: 1:150
 HORIZONTAL
 0m 2.5 5

NOTE:
 The location of utilities is approximate only, the exact location should be determined by consulting the municipal authorities and utility companies concerned. The contractor shall prove the location of utilities and shall be responsible for adequate protection from damage.

MORRISON HERSHFIELD
 200-2932 BASELINE RD.
 OTTAWA, ON K2H 1B1

No.	Description	By	Date (dd/mm/yyyy)
0	ISSUED FOR SITE PLAN APPROVAL	J.F.	02/12/19

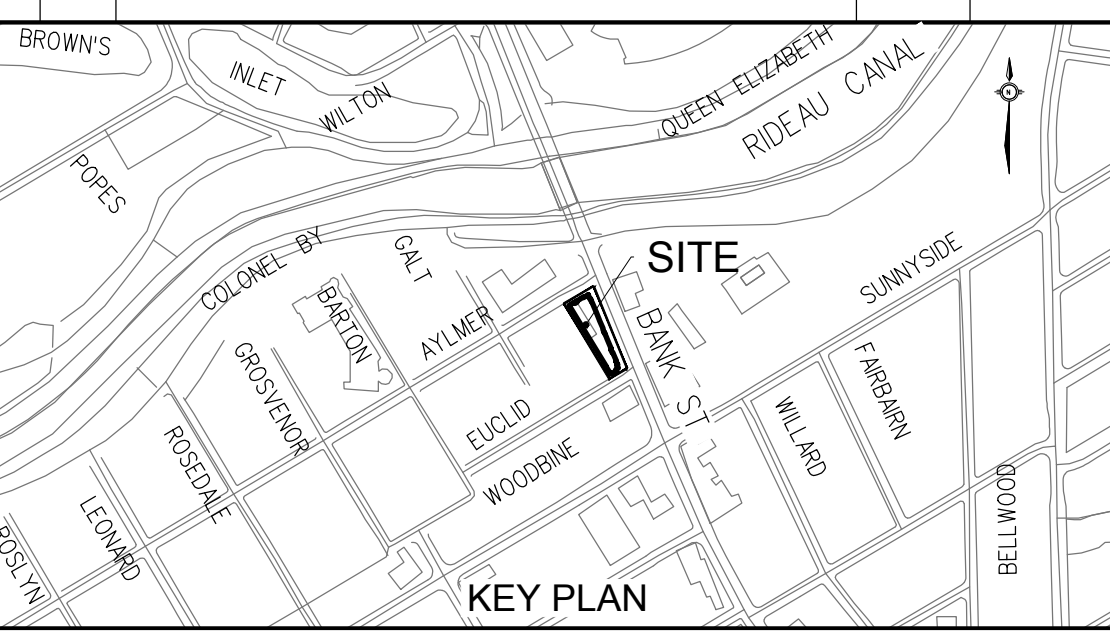

LEGEND

- × (71.40) PROPOSED ELEVATION
- × 71.65 EXISTING ELEVATION
- × (71.40T) PROPOSED FINISH GRADE AT TOP OF WALL OR STEP
- × (71.40B) PROPOSED FINISH GRADE AT BOTTOM OF WALL OR STEP
- × (71.40TC) PROPOSED TOP OF CURB ELEVATION
- ↘ 2.0% PROPOSED SLOPE DIRECTION
- ➔ DIRECTION OF MAJOR OVERLAND FLOW
- PROPOSED CURB
- DC PROPOSED DEPRESSED CURB
- LIGHT DUTY SILT FENCE
- HEAVY DUTY PAVEMENT
- LIGHT DUTY PAVEMENT

SEE DRAWING C003 FOR DETAILS

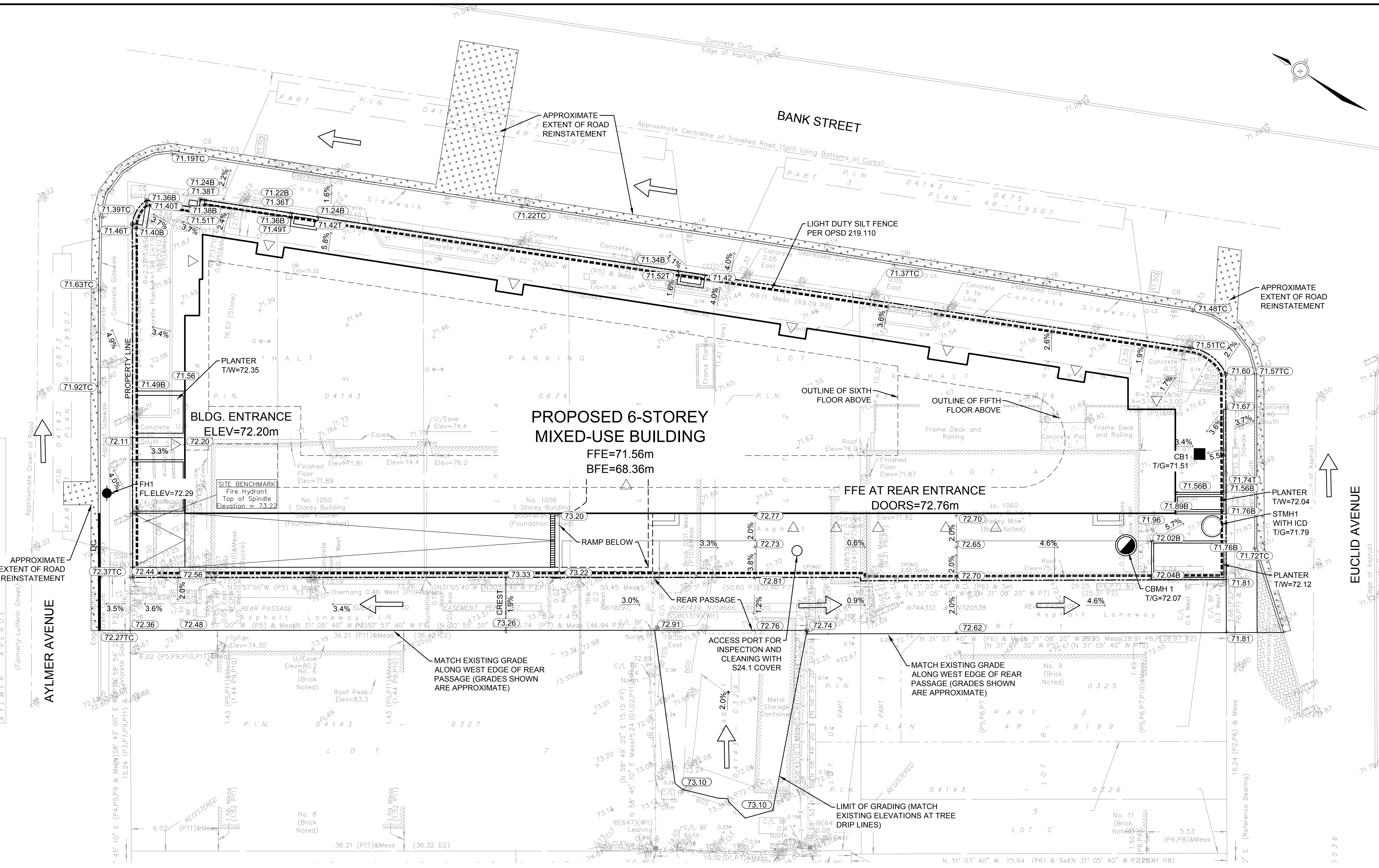

NOTES:
GRADING

- ALL ELEVATIONS ARE GEODETIC.
- REFER TO ARCHITECTURAL AND LANDSCAPE DRAWINGS FOR LAYOUT, DIMENSIONS AND SURFACE FINISHES.
- THIS DRAWING SHALL BE READ IN CONJUNCTION WITH ALL OTHER DRAWINGS.
- ALL ELEVATIONS BY CURBS ARE EDGE OF PAVEMENT UNLESS OTHERWISE INDICATED.
- REFER TO GEOTECHNICAL INVESTIGATION REPORT (NO. PG4506-1 DATED AUGUST 20, 2018) PREPARED BY PATERSON GROUP FOR SUBSURFACE CONDITIONS, CONSTRUCTION RECOMMENDATIONS AND GEOTECHNICAL INSPECTION REQUIREMENTS. THE GEOTECHNICAL CONSULTANT SHALL REVIEW EXCAVATIONS PRIOR TO THE PLACEMENT OF GRANULAR MATERIAL.
- REINSTATE ALL DISTURBED/DAMAGED AREAS TO THEIR ORIGINAL CONDITION OR BETTER.
- PROVIDE POSITIVE DRAINAGE, MATCHING EXISTING OVERALL DRAINAGE PATTERN INDICATED.
- ALL WORK AND MATERIALS SHALL BE IN ACCORDANCE WITH CITY OF OTTAWA AND/OR ONTARIO PROVINCIAL STANDARDS.
- ALL TOPSOIL, ORGANIC OR DELETERIOUS MATERIAL MUST BE ENTIRELY REMOVED FROM BENEATH THE PROPOSED PAVED AREAS AS DIRECTED BY THE OWNER'S REPRESENTATIVE.
- ALL AREAS SHALL DRAIN AT A MINIMUM OF 1% ANY DISCREPANCIES PREVENTING THIS SHALL BE REPORTED TO THE ENGINEER PRIOR TO CONTINUING WORK.

- BLEND NEW EARTHWORK INTO EXISTING, PROVIDING VERTICAL CURVES OR ROUNDING AT ALL TOP AND BOTTOM OF SLOPES.
- CONCRETE SIDEWALKS SHALL BE IN ACCORDANCE WITH CITY OF OTTAWA STANDARD DRAWING SC1.4 AND SC4.
- CONCRETE BARRIER CURBS SHALL BE IN ACCORDANCE WITH CITY OF OTTAWA STANDARD DRAWING SC1.1.
- ALL SIDEWALKS CONSTRUCTED IN CITY ROW, SHALL BE MONOLITHIC CONCRETE CURB AND SIDEWALK PER STD. DETAIL SC 2 UNLESS OTHERWISE INDICATED.
- SAW CUT AND KEY GRIND ASPHALT AT ALL TIE-INS PER CITY OF OTTAWA STANDARD R10.
- PROVIDE LINE PAINTING.
- SNOW IS TO BE REMOVED FROM THE SITE. ON SITE SNOW STORAGE IS NOT PROPOSED.

EROSION AND SEDIMENT CONTROL

- THE CONTRACTOR SHALL IMPLEMENT BEST MANAGEMENT PRACTICES, TO PROVIDE FOR PROTECTION OF THE AREA DRAINAGE SYSTEM AND THE RECEIVING WATERCOURSE, DURING CONSTRUCTION ACTIVITIES. THIS INCLUDES LIMITING THE AMOUNT OF EXPOSED SOIL, USING FILTER CLOTH UNDER THE GRATES OF CATCHBASINS AND MANHOLES, AND INSTALLING SILT FENCES AND OTHER EFFECTIVE SEDIMENT TRAPS. THE CONTRACTOR ACKNOWLEDGES THAT FAILURE TO IMPLEMENT APPROPRIATE EROSION AND SEDIMENT CONTROL MEASURES MAY BE SUBJECT TO PENALTIES IMPOSED BY ANY APPLICABLE REGULATORY AGENCY.
- THE SEDIMENT CONTROL MEASURES SHALL ONLY BE REMOVED

- WHEN, IN THE OPINION OF THE ENGINEER, THE MEASURES ARE NO LONGER REQUIRED, NO CONTROL MEASURES MAY BE PERMANENTLY REMOVED WITHOUT PRIOR AUTHORIZATION FROM THE ENGINEER.
- REGULAR INSPECTION AND MAINTENANCE OF THE EROSION AND SEDIMENT MEASURES SHALL BE UNDERTAKEN, THE IMPLEMENTATION AND ADJUSTMENT AND/OR CORRECTIVE MAINTENANCE OF THE EROSION AND SEDIMENT MEASURES IS AN INTEGRAL PART OF THE PLAN AND MUST BE PERFORMED.
 - GEOTEXTILE FILTER FABRIC SHALL BE PLACED BETWEEN THE STRUCTURE FRAME AND COVER FOR ALL MANHOLES, CATCHBASINS, AND CATCHBASIN MANHOLES IN THE VICINITY OF WORK.
 - THE CONTRACTOR SHALL MAINTAIN ADJACENT ROADS IN A CLEAN CONDITION AT ALL TIMES.

UTILITY NOTE

- THE POSITION OF POLE LINES, CONDUITS, WATERMANS, SEWERS AND OTHER UNDERGROUND AND OVERGROUND UTILITIES AND STRUCTURES IS NOT NECESSARILY SHOWN ON THE CONTRACT DRAWING, AND, WHERE SHOWN, THE ACCURACY OF THE POSITION OF SUCH UTILITIES AND STRUCTURES IS NOT GUARANTEED. BEFORE STARTING WORK THE CONTRACTOR SHALL INFORM HIMSELF OF THE EXACT LOCATION OF ALL SUCH UTILITIES AND STRUCTURES, AND SHALL ASSUME ALL LIABILITY FOR DAMAGE TO THEM. THE CONTRACTOR WILL BE RESPONSIBLE FOR SUPPORTING AND PROTECTING ANY EXISTING UTILITIES, AS REQUIRED, IN ACCORDANCE WITH THE

UTILITY OWNERS' REQUIREMENTS. CONTRACTOR IS REQUIRED TO OBTAIN LOCATES, IN ADVANCE OF EXCAVATION WORK, AND FORWARD COPIES OF THE LOCATES TO THE CONSULTANT AND THE OWNER PRIOR TO EXCAVATION. HAND EXCAVATION IS REQUIRED PER UTILITY OWNERS REQUIREMENTS.

PROPOSED MIXED-USE RETAIL & RENTAL APARTMENT BUILDING
1050&1060 BANK STREET
OTTAWA, ON

Contract No. Drawing No. C003

Sheet No. 3 of 5

Asset No.

Asset Group

Des: DG Chk'd: JF
Dwn: NI Chk'd: JF
Utility Circulation No.: CTY---
Construction Inspector:

Scale:



NOTE:
The location of utilities is approximate only, the exact location should be determined by consulting the municipal authorities and utility companies concerned. The contractor shall prove the location of utilities and shall be responsible for adequate protection from damage.

MORRISON HERSHFIELD
200-2932 BASELINE RD.
OTTAWA, ON K2H 1B1

No.	Description	By	Date (dd/mm/yy)
0	ISSUED FOR SITE PLAN APPROVAL	J.F.	02/12/19

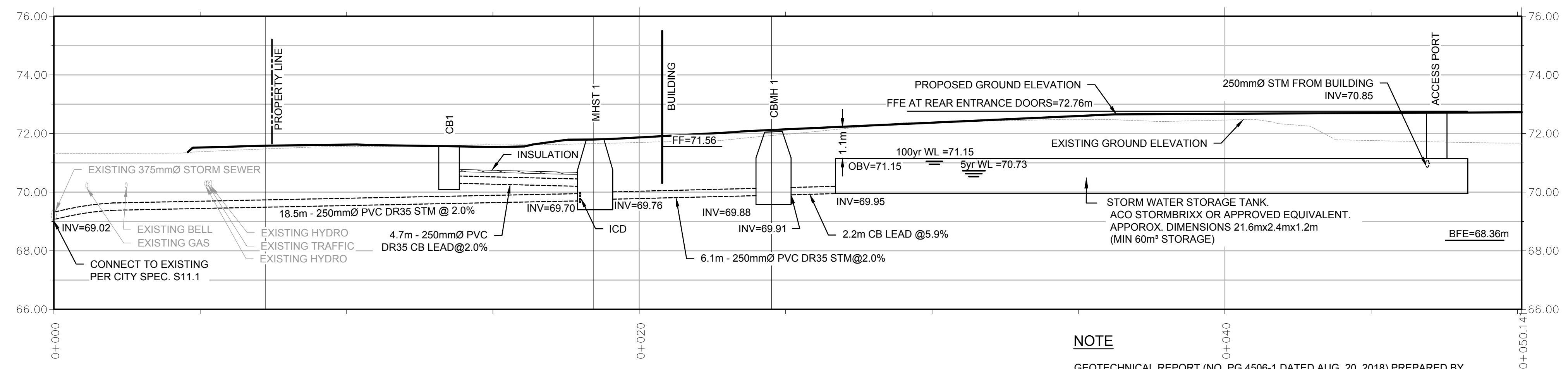
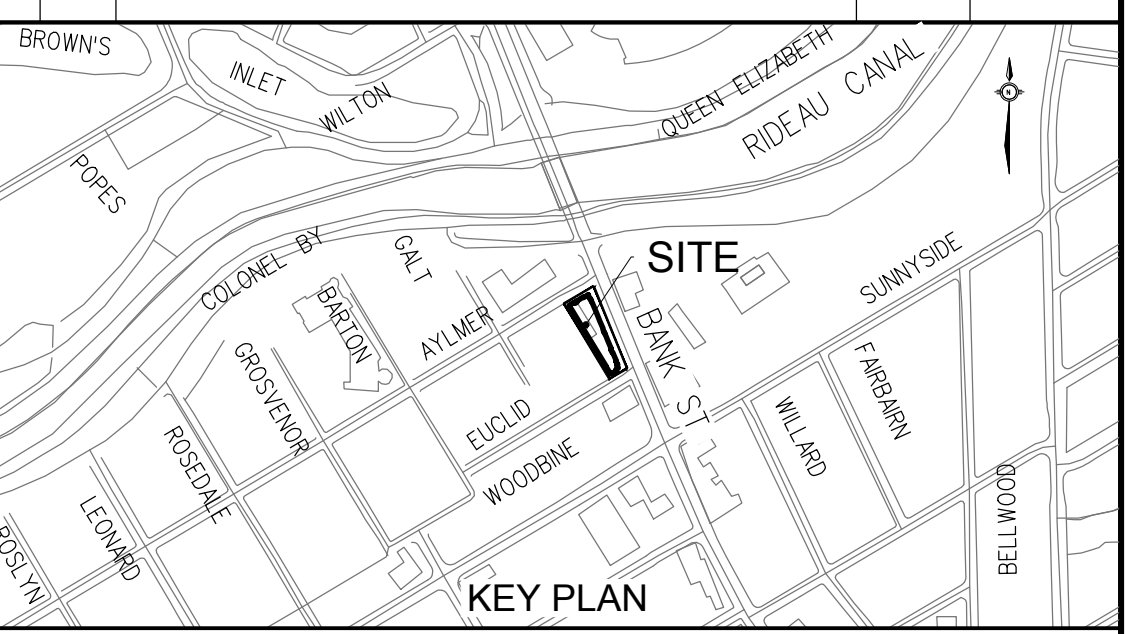

NOTE
GEO TECHNICAL REPORT (NO. PG 4506-1 DATED AUG. 20, 2018) PREPARED BY PATERSON GROUP, INDICATES GROUNDWATER TO BE 11-12m BELOW GRADE. HOWEVER AN IMPERMEABLE LINER IS REQUIRED FOR THE STORM WATER STORAGE TANK TO PREVENT EXFILTRATION FROM THE TANK IN THE VICINITY OF THE PERIMETER FOUNDATION DRAIN OF THE PROPOSED BUILDING.

SECTION A - A
SCALE 1:100

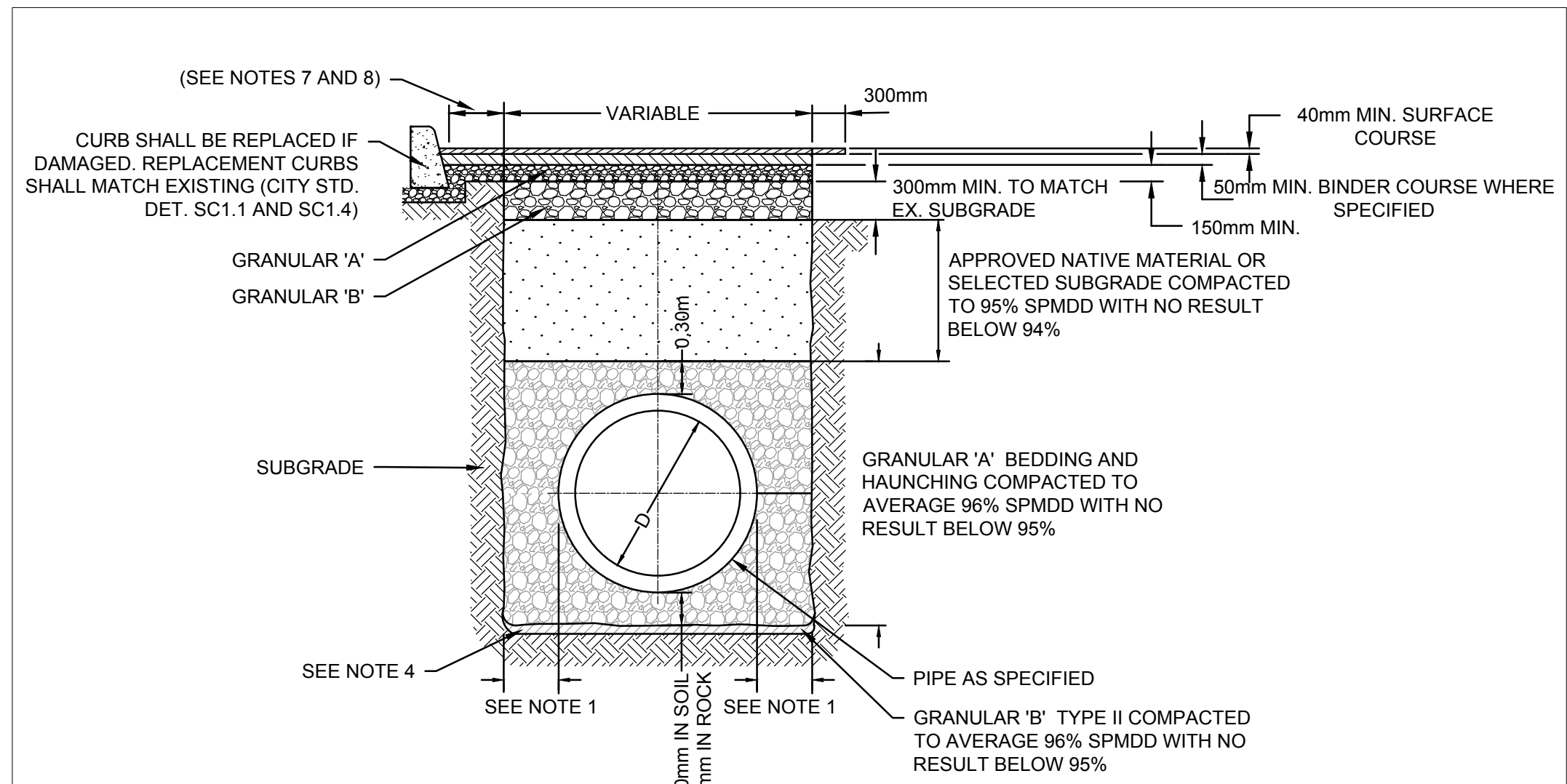

NOTES:

PIPE INSIDE DIAMETER (mm)	CLEARANCE (mm)
900 OR LESS	CONC 450 PVC 450
OVER 900	500

- FINAL BACKFILL - APPROVED NATIVE MATERIAL OR SELECT SUBGRADE
- ALL DIMENSION ARE IN MILLIMETERS UNLESS SHOWN OTHERWISE.
- WHEN NECESSARY POOR SOILS SHALL BE EXCAVATED TO CREATE A FOUNDATION THAT SHALL BE FILLED TO THE BOTTOM OF THE BEDDING WITH GRANULAR 'B'.
- THE USE OF CLEAR CRUSHED STONE AS A BEDDING LAYER IS NOT PERMITTED ANYWHERE ON THIS SITE.
- ALL EXISTING ASPHALT AND CONCRETE REMOVAL LIMITS TO BE SAWCUT.
- 300 MM KEY TO BE SAWCUT AND REMOVED OR MILLED.
- ROAD REINSTATEMENT ON THE CURB SIDE OF THE TRENCH EXCAVATION SHALL EXTEND TO THE CURB FACE.
- TACK COAT SHALL BE APPLIED TO ALL MILLED SURFACES

1 WATERMAIN AND SEWER INSTALLATION
TYPICAL DETAIL
N.T.S.

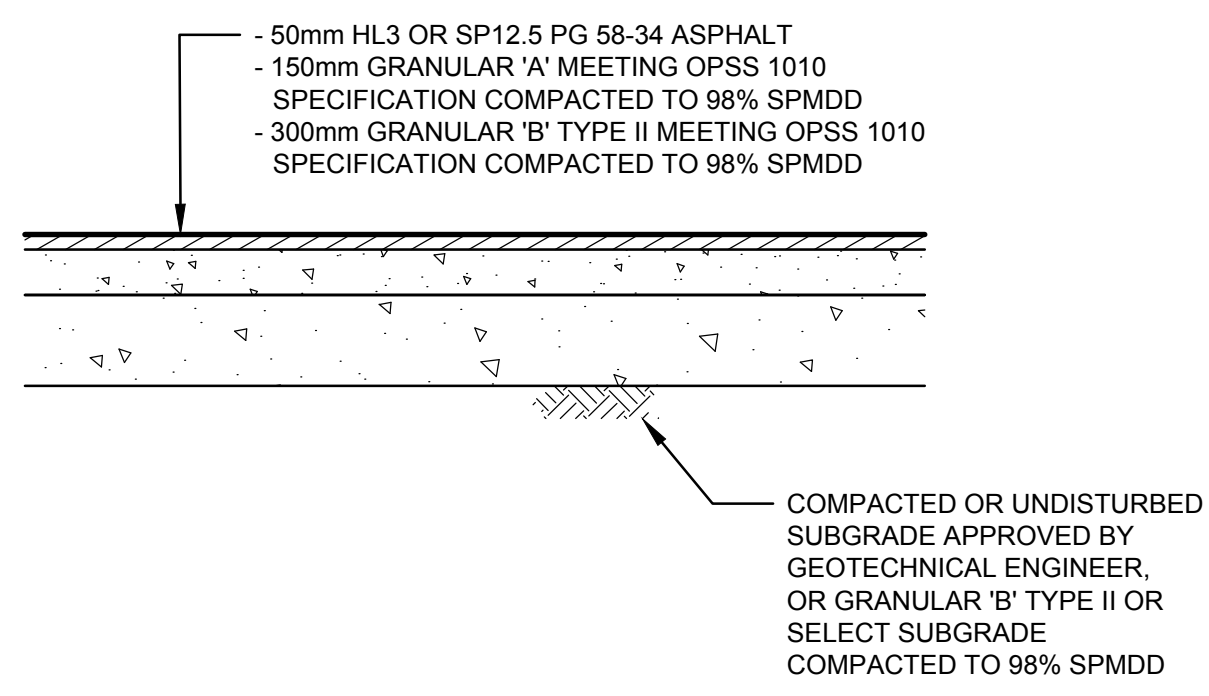

LIGHT DUTY PAVEMENT
N.T.S.

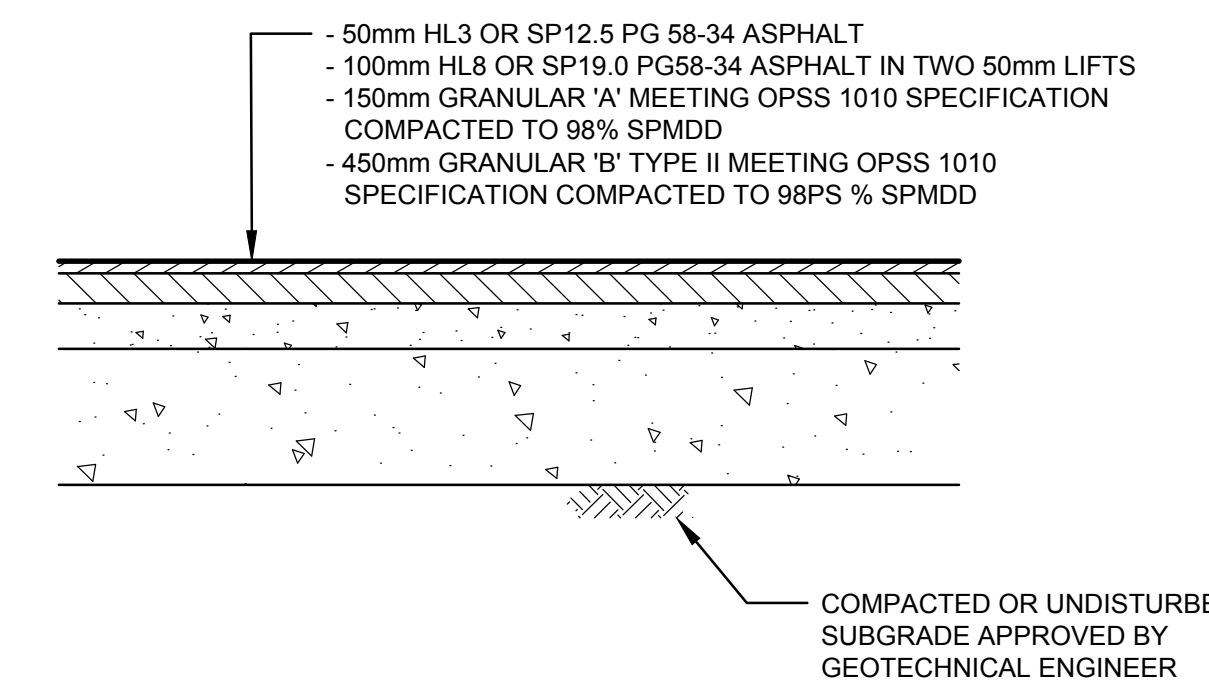

HEAVY DUTY PAVEMENT
N.T.S.

INSULATION NOTE

THE THICKNESS OF SEWER INSULATION SHALL BE THE EQUIVALENT OF 25mm FOR EVERY 300mm REDUCTION IN THE REQUIRED DEPTH OF COVER LESS THAN 1500mm (SEE TABLE BELOW)

TI=THICKNESS OF INSULATION (mm)
H=DEPTH OF COVER
W=D+300 (1000 MIN.)
W=WIDTH OF INSULATION (mm)
D=O.D. OF PIPE (mm)

COVER (mm)	INSULATION THICKNESS (mm)
1500-1200	75
1200-900	100
900-600	125

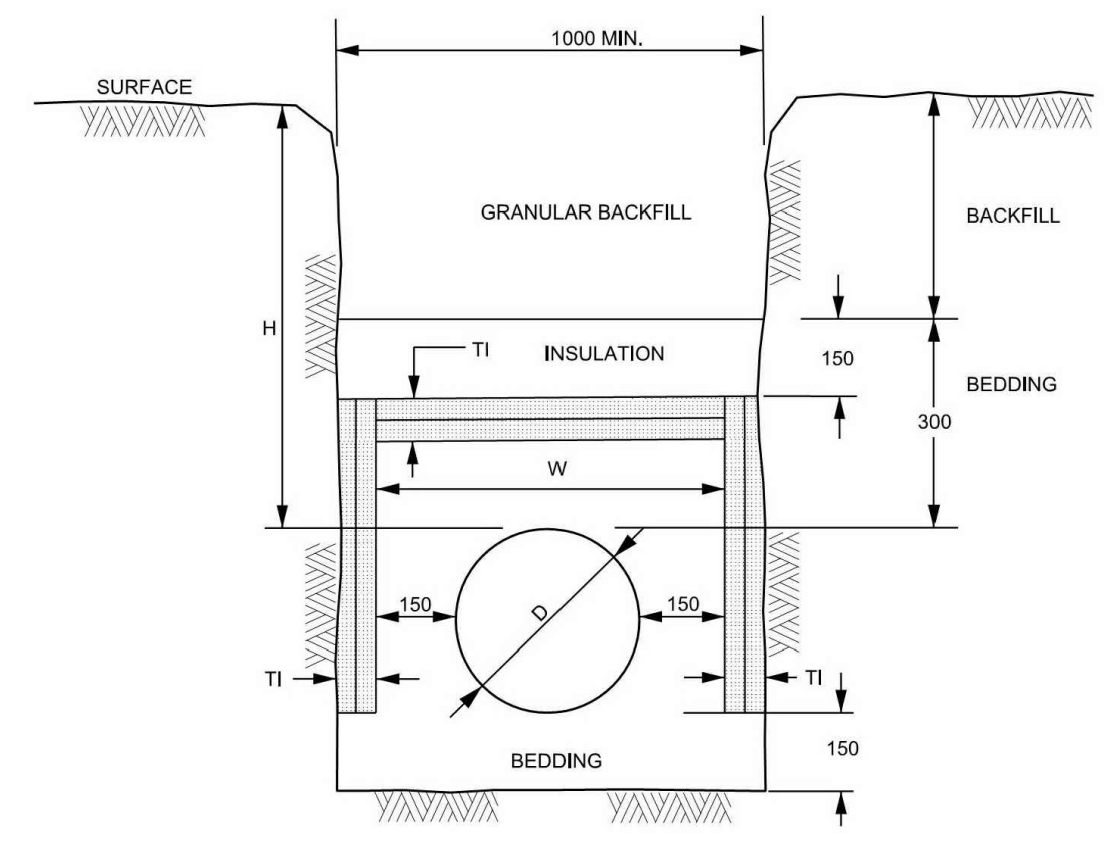

INSULATION DETAIL FOR SHALLOW SEWERS
N.T.S.

MORRISON HERSHFIELD



1050 AND 1060 BANK STREET EXISTING STORM DRAINAGE AREA PLAN

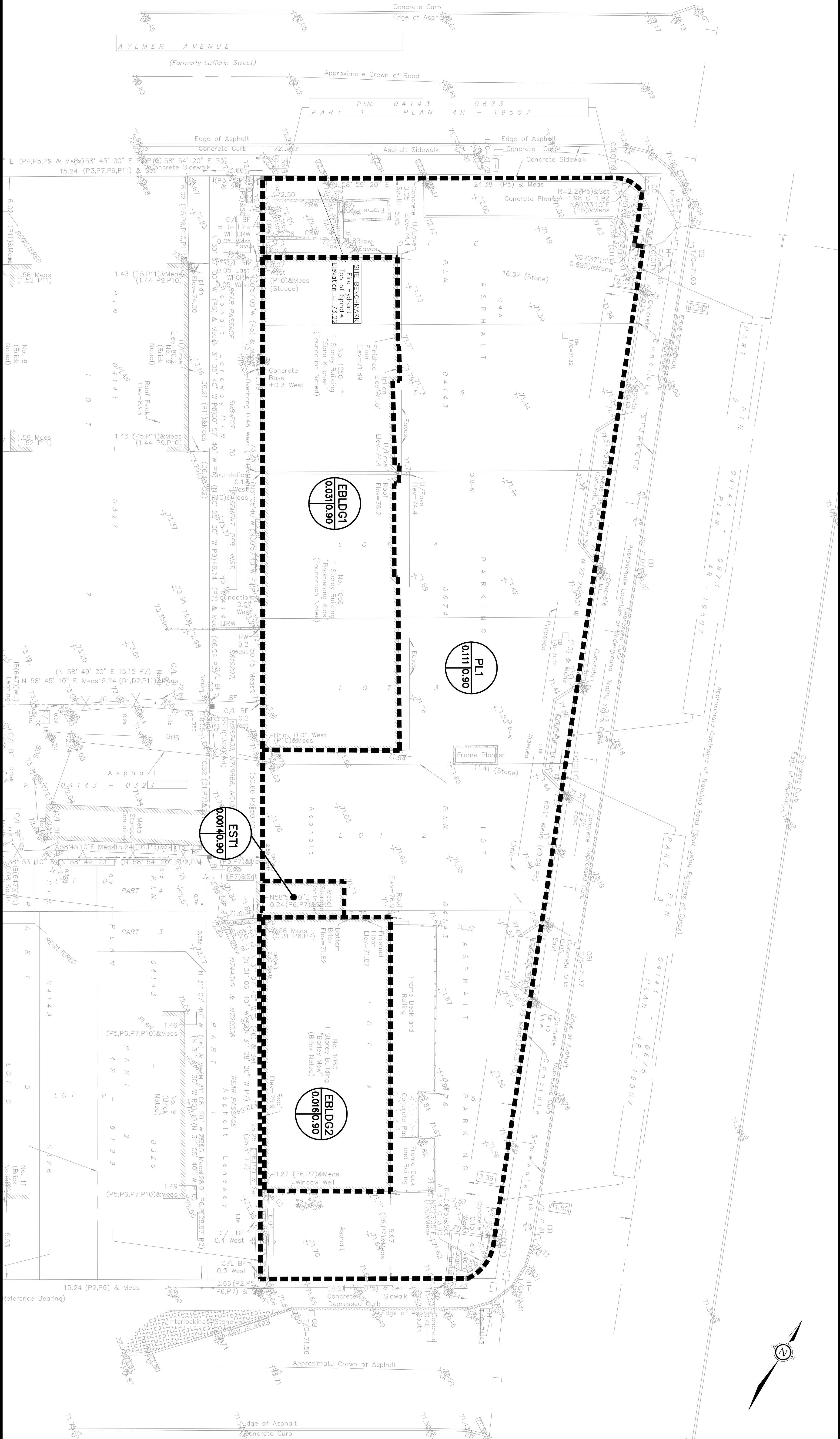

LEGEND

AREA ID	DRAINAGE AREA CHARACTERISTICS
	AREA CHARACTERISTICS
	AREA CHARACTERISTICS
	AREA CHARACTERISTICS
	AREA CHARACTERISTICS

C004

DATE: 2019-12-02

SCALE: N.T.S.

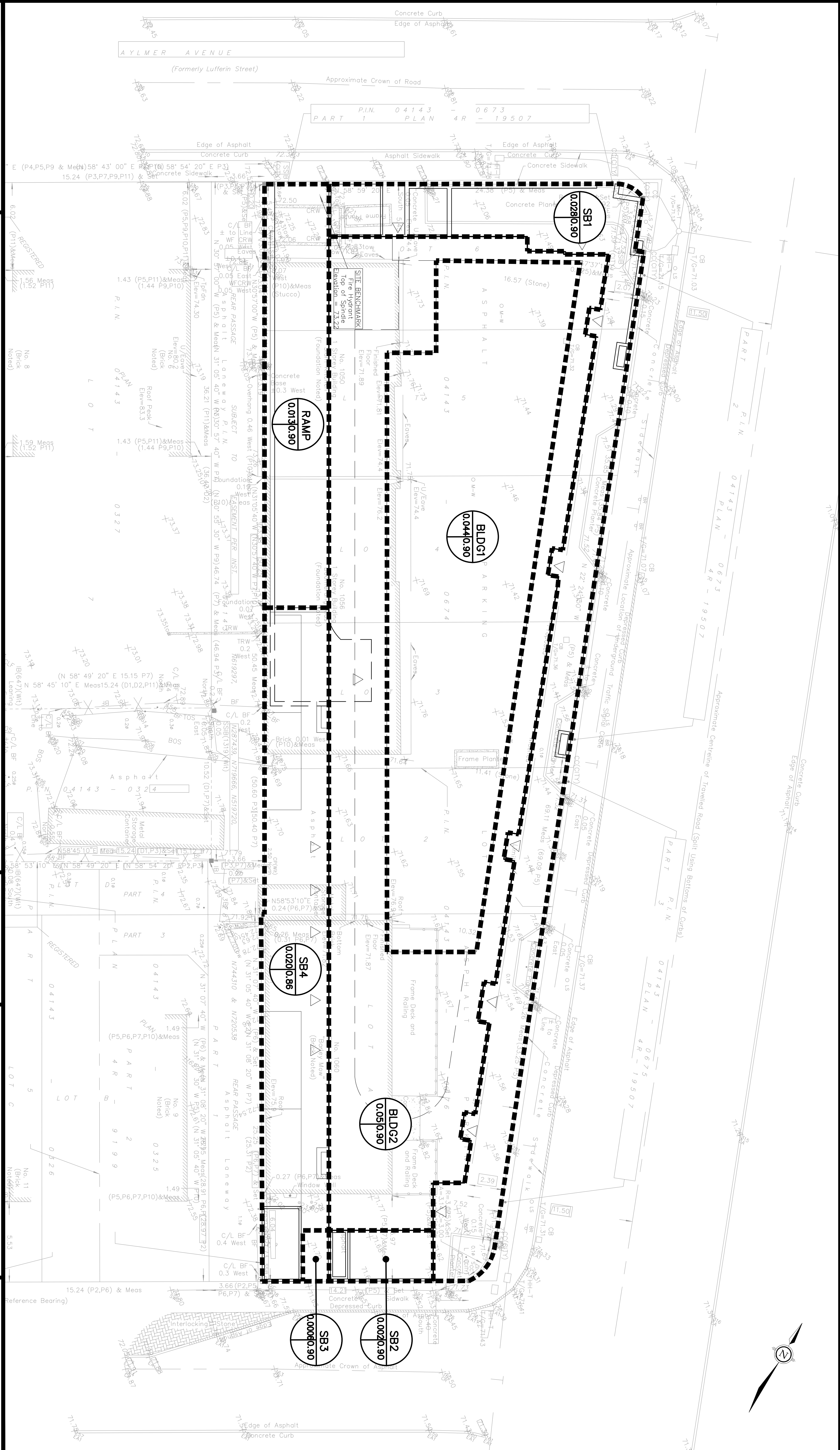

MORRISON HERSHFIELD

**1050 AND 1060 BANK STREET
PROPOSED STORM DRAINAGE AREA PLAN**



LEGEND

AREA ID	DRAINAGE AREA CHARACTERISTICS
	Runoff Coefficient %
	Area ha

C005
DATE: 2019-12-02
SCALE: N.T.S.

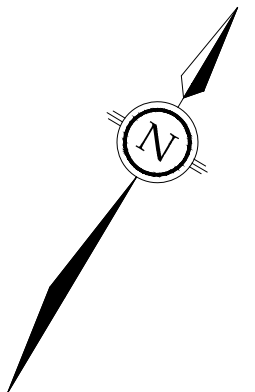

Appendix B

RVCA and City of Ottawa Specific Requirements Correspondence

Daniel Glauser

From: Wessel, Shawn <shawn.wessel@ottawa.ca>
Sent: Thursday, November 28, 2019 11:22 AM
To: Daniel Glauser
Cc: James Fookes
Subject: RE: 1050+1060 Bank Street; Boundary Conditions for Water Demand
Attachments: 1050-1060 Bank Sept 2019.pdf

Good morning, Mr. Glauser.

Further to your request, please find the boundary conditions below:

The following are boundary conditions, HGL, for hydraulic analysis at 1050-1060 Bank (zone 1W) assumed to be connected to the 305mm on Bank (see attached PDF for location).

Minimum HGL = 104.3m

Maximum HGL = 114.7m

MaxDay + FireFlow (135L/s) = 104.0m

These are for current conditions and are based on computer model simulation.

Disclaimer: The boundary condition information is based on current operation of the city water distribution system. The computer model simulation is based on the best information available at the time. The operation of the water distribution system can change on a regular basis, resulting in a variation in boundary conditions. The physical properties of watermains deteriorate over time, as such must be assumed in the absence of actual field test data. The variation in physical watermain properties can therefore alter the results of the computer model simulation.

If you require additional information or clarification, please do not hesitate to contact me anytime.

Thank you

Regards,

Shawn Wessel, A.Sc.T.,rcji

Project Manager - Infrastructure Approvals

Gestionnaire de projet – Approbation des demandes d’infrastructures

Development Review Central Branch | Direction de l’examen des projets d’aménagement, Centrale
Planning, Infrastructure and Economic Development Department | Direction générale de la planification
de l’infrastructure et du développement économique

 Please consider the environment before printing this email

From: Daniel Glauser <DGlauser@morrisonhershfield.com>
Sent: November 26, 2019 11:08 AM
To: Wessel, Shawn <shawn.wessel@ottawa.ca>
Cc: James Fookes <JFookes@morrisonhershfield.com>
Subject: FW: 1050+1060 Bank Street; Boundary Conditions for Water Demand

CAUTION: This email originated from an External Sender. Please do not click links or open attachments unless you recognize the source.

ATTENTION : Ce courriel provient d'un expéditeur externe. Ne cliquez sur aucun lien et n'ouvrez pas de pièce jointe, excepté si vous connaissez l'expéditeur.

Hi Shawn,

With regards to the project "Mixed-Use Development, 1050+1060 Bank Street" KWC has retained us to aide with the site servicing and grading elements of the site plan approval process. We had asked form boundary conditions based on the preliminary design, however some of the conditions have changed with the most recent set of plans. This has changed our fire flow requirements for the proposed development.

The following table outlines the updated design parameters/criteria and the corresponding calculated values (updated numbers are bolded and underlined):

Design Parameter	Value (L/s)	Design Criteria
Residential Average Daily Demand	0.36	350 L/d/P ¹
Residential Maximum Daily Demand	2.51	7.5 x Average Daily ²
Residential Maximum Hourly Demand	3.78	11.25 x Average Daily ²
Retail/Commercial Average Daily Demand	0.025	2500 L/(1000m ² /d)
Retail/Commercial Maximum Daily Demand	0.038	1.5 x Average Daily ³
Retail/Commercial Maximum Hourly Demand	0.068	1.8 x Max Daily ³
<u>Fire Flow</u>	<u>135.2</u>	<u>Based on the FUS</u>

We ask that you provide the boundary conditions based on the proposed water service connection (See attached plan)

Design Parameter	Calculated Demand (L/min)	Boundary Conditions (kPa)
Average Daily Demand	23.1	
<u>Total Max Daily + Fire Flow</u>	<u>8135.1</u>	
Max Hourly	231	

I apologize for the inconvenience.

Kind Regards

Daniel Glauser

Municipal Designer - Infrastructure Ottawa

Office: 613 739 2910 Ext. 1022201

DGlauser@morrisonhershfield.com



MORRISON HERSHFIELD
People • Culture • Capabilities

Did You Know? Same smart people. Shiny new office

[200 – 2932 Baseline Road | Ottawa, ON K2H 1B1 Canada](#)

Dir: [613 739 2910](tel:6137392910) x1022201 | Fax: [613 739 4926](tel:6137394926)

morrisonhershfield.com

This e-mail originates from the City of Ottawa e-mail system. Any distribution, use or copying of this e-mail or the information it contains by other than the intended recipient(s) is unauthorized. Thank you.

Le présent courriel a été expédié par le système de courriels de la Ville d'Ottawa. Toute distribution, utilisation ou reproduction du courriel ou des renseignements qui s'y trouvent par une personne autre que son destinataire prévu est interdite. Je vous remercie de votre collaboration.

Daniel Glauser

From: Maurizio Martignago <mmartignago@kwc-arch.ca>
Sent: Thursday, September 19, 2019 2:21 PM
To: Daniel Glauser
Cc: James Fookes
Subject: RE: Bank and Aylmer questions for Maurizio

Hi Daniel.
Not expecting any hazardous materials.

We are going to fall under OBC 3.2.2.43 Group C, Up to 6 Storeys, **Sprinklered**, Noncombustible Construction.

Thanks.

Maurizio Martignago B.Arch, OAA, MRAIC, *LEED AP*
Partner / Principal

KWC Architects Inc.

383 Parkdale Avenue Suite 201, Ottawa, Ontario K1Y 4R4
T: 613-238-2117 ext. 230 F: 613-238-6595 E: mmartignago@kwc-arch.com

From: Daniel Glauser <DGlauser@morrisonhershfield.com>
Sent: September-19-19 12:27 PM
To: Maurizio Martignago <mmartignago@kwc-arch.ca>
Cc: James Fookes <JFookes@morrisonhershfield.com>
Subject: RE: Bank and Aylmer questions for Maurizio

Hi Maurizio,

Thanks for the info, this should help define out water/fire flow and stormwater storage.

“Can you confirm the building isn’t expected to house any combustible material. KWC – no combustible material however can you give an example your thinking of.”

The FUS has a loose definition that covers a broad range of “High Hazard Occupancies”. Generally it refers to manufacturing or chemical applications, however they do refer to paint and varnish as being high hazard.

If we can say that the retail portion of the shops are predicted to be restaurants or clothing shops then we can reduce the required flow by up to 25%. I’ve attached the appendix below. I think it’s safe to assume that there won’t be any hazardous material in these areas.

Examples of High Hazard Occupancies:

Aircraft Hangars	Pyrotechnics Manufacturing Shade
Cereal, Feed, Flour and	Cloth Manufacturing
Grist Mills Chemical Works -	Foamed Plastics, Storage or
High Hazard	use in Manufacturing
Cotton Picker and Opening	High Piled Combustibles
Operations Explosives &	Storage in excess of 6.5
	metres high
Linseed Oil Mills	
Match Manufacturing	
Oil Refineries	
Paint Shops	
Pyroxylin Plastic Manufacturing & Processing Solvent Extracting	
Varnish and Paint Works	
Woodworking with Flammable Finishing Linoleum and Oilcloth	
Manufacturing	

Other occupancies involving processing, mixing storage and dispensing flammable and/or combustible liquids. Generally, occupancies falling in National Building Code Group F, Divisions 1 and 2 would be in this class.

For other occupancies, good judgement should be used, and the percentage increase will not necessarily be the same for all buildings that are in the same general category - for example "Colleges and Universities"; this could range from a 25% decrease for buildings used only as dormitories to an increase for a chemical laboratory. Even when considering high schools, the decrease should be less if they have extensive shops.

It is expected that in commercial buildings no percentage increase or decrease for occupancy will be applied in most of the fire flow determinations. In general, percentage increase or decrease will not be at the limits of plus or minus 25%.

Kind Regards

Daniel Glauser

Municipal Designer - Infrastructure Ottawa

Office: 613 739 2910 Ext. 1022201

DGlauser@morrisonhershfield.com



MORRISON HERSHFIELD
People • Culture • Capabilities

Did You Know? Same smart people. Shiny new office

[200 – 2932 Baseline Road | Ottawa, ON K2H 1B1 Canada](#)

Dir: [613 739 2910](tel:6137392910) x1022201 | Fax: [613 739 4926](tel:6137394926)

morrisonhershfield.com

From: Maurizio Martignago [<mailto:mmartignago@kwc-arch.ca>]

Sent: Thursday, September 19, 2019 12:06 PM

To: Daniel Glauser <DGlauser@morrisonhershfield.com>

Cc: James Fookes <JFookes@morrisonhershfield.com>

Subject: RE: Bank and Aylmer questions for Maurizio

Hi Daniel,

See below, responses in red.

Ground Floor: 10401sqft

2nd Floor: 11053 sqft

3rd Floor: 11053 sqft

4th Floor: 11053 sqft
5th Floor: 6487 sqft
6th Floor: 4802 sqft

Maurizio Martignago B.Arch, OAA, MRAIC, LEED AP
Partner / Principal

KWC Architects Inc.

383 Parkdale Avenue Suite 201, Ottawa, Ontario K1Y 4R4
T: 613-238-2117 ext. 230 F: 613-238-6595 E: mmartignago@kwc-arch.com

From: Daniel Glauser <DGlauser@morrisonhershfield.com>
Sent: September-18-19 9:43 AM
To: Maurizio Martignago <mmartignago@kwc-arch.ca>
Subject: Bank and Aylmer questions for Maurizio

Hi Maurizio

I've made some of the following assumptions for the water demand/fire flow and stormwater management:

1. Can you confirm the amount of expected apartments of the following type (based on estimates in preliminary design drawings), **KWC -This is correct**

Apartments:	Number
Bach/Studio	6
1 Bedroom	18
2 Bedroom	13
3 Bedroom	7

2. Can you confirm the square meterage of the building excluding the basement is approximately 4350m² or 47100ft²
3. Can you confirm the what type of construction the proposed building is (wood frame construction (structure essentially all combustible), ordinary (brick or other masonry walls, combustible floor and interior), non-combustible (unprotected metal structural components, masonry or metal walls) or fire-resistive (fully protected frame, floors, roof)). **KWC – the building will be concrete frame, non combustible construction (no wood framing is anticipated).**
4. Can you confirm the building isn't expected to house any combustible material. **KWC – no combustible material however can you give an example your thinking of.**
5. Can you confirm that an automatic sprinkler system with a standard siamese connection is proposed for the new building. Additionally will the system be fully supervised? **KWC – will get back to you on this one.**
6. Is it safe to assume maximum 150mm stormwater pooling on the roof above the 5th floor? If so what area can we assume for storage? **KWC – we can assume roof storage for now. This will become a question for the structural engineer when they come on board.**

We are just following up with Shawn from the city regarding the pre-consultation notes he had.

Kind Regards

Daniel Glauser
Municipal Designer - Infrastructure Ottawa

Office: 613 739 2910 Ext. 1022201
DGlauser@morrisonhershfield.com



Did You Know? Same smart people. Shiny new office
[200 – 2932 Baseline Road | Ottawa, ON K2H 1B1 Canada](#)
Dir: [613 739 2910](tel:6137392910) [x1022201](tel:6137392910) | Fax: [613 739 4926](tel:6137394926)
morrisonhershfield.com

Daniel Glauser

From: Des Rochers, Christina (MECP) <Christina.Desrochers@ontario.ca>
Sent: Thursday, September 26, 2019 9:25 AM
To: James Fookes
Cc: Daniel Glauser
Subject: RE: 1050-1060 Bank Street

Thanks James,

Based on the information provided below, the local office does not believe an ECA is required for the proposed project.

Regards.

Christina Des Rochers

Water Inspector | Inspectrice de l'eau

Safe Drinking Water Branch | Direction du contrôle de la qualité de l'eau potable

Ministry of the Environment, Conservation and Parks | Ministère de l'Environnement, de la Protection de la nature et des Parcs

Tel. 613-521-3450 ex. 231

Fax. 613-521-5437

Spills Action Centre | Centre d'intervention en cas de déversement 1-800-268-6060

Please consider the environment before printing this email note

From: James Fookes <JFookes@morrisonhershfield.com>
Sent: September-25-19 12:39 PM
To: Des Rochers, Christina (MECP) <Christina.Desrochers@ontario.ca>
Cc: Daniel Glauser <DGlauser@morrisonhershfield.com>
Subject: 1050-1060 Bank Street

Hi Christina,

We are designing site servicing for a mixed-use Development located at 1050-1060 Bank Street ([Link to Map location](#)). The proposed development consists of a six story mixed-use building, where floors 2-5 are residential, floor 1 is retail and the parking garage in the basement. The existing single-story commercial buildings on the site will be demolished. Behind the building there will be a few parking spaces located in a municipal laneway. Stormwater from the site will be directed into an existing storm sewer in Bank Street which outlets to the Rideau River via Sunnyside Avenue (existing 1350 Conc. storm sewer on the south boundary of Leonard Ave.). I've attached an overview of the municipal storm sewers with the proposed site in red and the drainage route in orange. Sanitary servicing will be via the existing sanitary sewer on Bank Street.

The City has requested that we obtain confirmation from the MECP of whether an ECA is required for the development. I believe that the reason they are asking for this is because a section of the trunk sanitary sewer downstream of the site is shown in orange on GeoOttawa (indicating classification as a combined sewer – shown in the attached jpg). However, the site is not in a combined sewer area, and storm drainage is by a separated sewer to the Rideau River.

The RVCA has confirmed that stormwater quality control is not required for the site.

The owner will consolidate the two property parcels into one before proceeding with the development. We intend to design the grading and drainage so that drainage of the lane at the rear of the property is separate to drainage of the property.

Our understanding is therefore that an ECA will not be required. Please confirm whether this is correct.

Thanks and regards,
James

James Fookes, P.Eng.

Department Manager, Municipal Infrastructure
jfookes@morrisonhershfield.com



200 – 2932 Baseline Road | Ottawa, ON K2H 1B1 Canada
Dir: 613 739 2910 x1022225 | Cell: 613 869 9592 | Fax: 613 739 4926
morrisonhershfield.com

Did You Know? Same smart people. Shiny new office. Take a peek inside our new Ottawa office at 200 - 2932 Baseline Road, Ottawa, ON K2H 1B1. [Watch video.](#)

Daniel Glauser

From: Jamie Batchelor <jamie.batchelor@rvca.ca>
Sent: Wednesday, September 25, 2019 10:46 AM
To: Daniel Glauser
Cc: James Fookes
Subject: RE: Mixed-Use Development; 1050-1060 Bank Str.

Good Morning Daniel,

Based on the plans provided, majority of the parking is in an underground parking garage. There is only a few exterior parking spaces proposed in the municipal laneway (less than 6). Therefore, this redevelopment will be primarily roof top area receiving rainwater. Roofs and landscaped areas, for the purpose of protecting surface water and aquatic habitat, are considered clean. The RVCA therefore accepts that the stormwater runoff from this site does not require any additional water quality measures.

Jamie Batchelor, MCIP, RPP
Planner, ext. 1191

[Jamie.batchelor@rvca.ca](mailto:jamie.batchelor@rvca.ca)



3889 Rideau Valley Drive
PO Box 599, Manotick ON K4M 1A5
T 613-692-3571 | 1-800-267-3504 F 613-692-0831 | www.rvca.ca

This message may contain information that is privileged or confidential and is intended to be for the use of the individual(s) or entity named. If you are not the intended recipient of this e-mail, any use, review, revision, retransmission, distribution, dissemination, copying, printing or taking of any action in reliance upon this e-mail, is strictly prohibited. If you have received this e-mail in error, please contact the sender and any copy of the e-mail and any printout thereof, immediately. Your cooperation is appreciated.

From: Daniel Glauser <DGlauser@morrisonhershfield.com>
Sent: Wednesday, September 18, 2019 3:26 PM
To: Glen McDonald <glen.mcdonald@rvca.ca>
Cc: James Fookes <JFookes@morrisonhershfield.com>
Subject: Mixed-Use Development; 1050-1060 Bank Str.

Hi Glen

We are designing a mixed-use Development located at 1050-1060 Bank Street ([Link to Map location](#)). The proposed development consists of a six story mixed-use building, where floors 2-5 are residential, floor 1 is retail and the parking garage in the basement. Behind the building there are a few parking spaces located in a municipal laneway. Stormwater from the site will be directed into an existing storm sewer in Bank Street which outlets in Rideau River via Sunnyside Ave. (existing 1350 Conc. storm sewer on the south boundary of Leonard Ave.). I've attached an overview municipal storm sewers with the proposed site in red and the drainage route in orange.

The current 0.16 ha site consists two areas, approx. 0.11ha of parking lot and 0.05 ha of existing commercial buildings. I've also attached a some preliminary design drawing to show the proposed development.

Please could you confirm whether on-site quality control is required for this site, and if required, what treatment level is required.

Kind Regards

Daniel Glauser

Municipal Designer - Infrastructure Ottawa

Office: 613 739 2910 Ext. 1022201

DGlauser@morrisonhershfield.com



Did You Know? Same smart people. Shiny new office

[200 – 2932 Baseline Road](#) | [Ottawa, ON K2H 1B1 Canada](#)

Dir: [613 739 2910](tel:6137392910) x1022201 | Fax: [613 739 4926](tel:6137394926)

morrisonhershfield.com

Appendix C

Water Demand and FUS Calculations

1050 + 1060 Bank Street Water Demand Calculations

Project Name Site Servicing 1050+1060 Bank Street
Project Number 190500700
Site Address 1050+1060 Bank Street
Completed By DG
Date 9/12/2019

Excerpt from the MOE Design Guidelines for Drinking-Water System, Table 3-3

Dwelling Units Served	Equivalent Population	Night Minimum Hour Demand	Maximum Daily Factor	Peak Hour Factor
10	30	0.1	9.5	14.3
50	150	0.1	4.9	7.4
100	300	0.2	3.6	5.4
150	450	0.3	3	4.5
167	500	0.4	2.9	4.3

MAXIMUM DAILY DEMAND	
Actual Population	Corresponding Factor (Interpolated)
83	7.468

MAXIMUM HOURLY DEMAND	
Actual Population	Corresponding Factor (Interpolated)
83	11.2525

Average Daily Demand	29050.0 L/day
Maximum Daily Demand	216955.1 L/day
Maximum Hourly Demand	326885.1 L/day

1050 + 1060 Bank Street Water Demand Calculations

Project Name Site Servicing 1050+1060 Bank Street
Project Number 190500700
Site Address 1050+1060 Bank Street
Completed By DG
Date

(Per Fire Underwriters Survey, Water Supply for Public Fire Protection, 1999)

1. Determine Estimated Fire Flow based on Building Floor Area

$F = 220 C \sqrt{A}$
 $F =$ Required flow in litres / minute
 $A =$ Total floor area in m^2
 $C =$ Coefficient related to Construction
 = 1.5 for wood frame construction
 = 1.0 for ordinary construction
 = 0.8 for non-combustible construction
 = 0.6 for fire-resistive construction

$C =$	0.8
$A =$	4660 m^2

$F =$ 12014.5 L/min

2. Adjust flow based on Fire hazard and contents

A	Non-combustible	-25%
B	Limited Combustible	-15%
C	Combustible	0%
D	Free Burning	15%
E	Rapid Burning	25%

Type of Construction (A,B,C,D)	A
Adjustment Factor	-25%
Flow From 1.	12014.5 L/min
Adjusted Flow	9010.9 L/min
Minimum Flow (2000 L/min)	9010.9 L/min
Flow	9010.9 L/min

3. Reduce flow from No. 2. based on automatic sprinkler protection

Flow from 2.	9010.9 L/min
Complete Automatic Sprinkler Protection (yes/no)	Yes
Reduction	30%
Sprinkler system is standard for fire department hose lines (yes/no)	Yes
Additional Reduction	10%
Sprinkler System is fully supervised (yes/no)	no
Additional Reduction	0%
Total Reduction	40%
Flow after Sprinkler Reduction	5406.5 L/min

4. Adjacent Structures / Fire Separation with other buildings

Flow from 3.	5406.5 L/min
A 0m-3m	25%
B 3.1m - 10m	20%
C 10.1m to 20m	15%
D 20.1m to 30m	10%
E 30.1 m to 45m	5%
F 45m +	0%

	Distance to Adjacent Building	Flow Increase	Distance
North	E	5%	32
East	D	10%	23
South	C	15%	13
West	B	20%	4

Cumulative Increase (Max 75%) 50%

Flow Increased for Adjacent Structures	8109.8 L/min
Maximum Permitted Flow (45 000 L/min)	8109.8 L/min
Minimum Permitted Flow (2 000 L/min)	8109.8 L/min

1050 + 1060 Bank Street Water Demand Calculations

Project Name Site Servicing 1050+1060 Bank Street
Project Number 190500700
Site Address 1050+1060 Bank Street
Completed By DG

From City of Ottawa Water Distribution Systems Guidelines

Occupancy Preliminary Design

				ea.
			Bachelor/Studio	6
			1 Bedroom	18
			2 Bedroom	13
			3 Bedroom	7
			Retail	869.1
			Retail 1	94.9
			Retail 02	649.5
			Remain gr. area	124.8
Building Occupancy	83 people	Posted per Preliminary Design		
Total Gross Building Area (Retail)	870 m ²	Posted per Preliminary Design		
<u>Residential</u>	83 persons			
Per Capita Flow	350 l/per/d	City of Ottawa Water Design Guidelines Table 4.2 - residential		
Daily average flow	29050 l/d			
Daily average flow	0.336227 l/s			
<u>Commercial (Water Demand)</u>	2500 L/(1000m ² /d)	City of Ottawa Water Design Guidelines Table 4.2 - Shopping Center		
Daily average flow	2175 l/d			
Daily average flow	0.025174 l/s			
Total Daily Demand	31225 L/day			
	31.225 m ³ /d			
	5.728314 GPM			
	0.3614 L/s			
<u>Residential portion</u>				
Maximum Daily Demand Peak				
Peak Factor	7.47 x average day	MOE Design Guidelines for Drinking-Water System, Table 3-3		
Peak Flow	2.51 l/s			
	39.80 GPM		1 GPM	1
			0.0630902 L/s	5450.993
Maximum Hourly Demand Peak				
Peak Factor	11.25 x average day	MOE Design Guidelines for Drinking-Water System, Table 3-3		
Peak Flow	3.78 l/s			

1050 + 1060 Bank Street Water Demand Calculations

$P_{\text{Road}} = 46.09$ (psi) Dynamic pressure

$P_{\text{Road}} = 317.77949$ (kPa)

Existing Service at node 262

Length

L= 15 (m)
49 (ft)

Size

d= 200 (mm)
8 (in)

Flow

Q = 0.1350 (m³/s)
2140 (Usg/min)

Velocity

$$V = \frac{1.274Q}{d^2}$$

V= 4.30 (m/s)

Head Loss

$$P_d = \frac{4.52Q^{1.85}}{C^{1.85}d^{4.87}}$$

$$P = 0.434hSG$$

SG= specific gravity of water
= 1

C = 100

$P_d = 0.05647424$ (psi)

h= 0.130125 (ft/ft)

6.4038 (ft)

Pressure Loss

$P_{\text{ROAD}} = 46.09$ (psi)

$P_L = 2.78$ (psi)

$P_{\text{AT METER}} = 43.31$ (psi)

$P_{\text{AT METER}} = 298.6173253$ (kPa)

1050 + 1060 Bank Street Water Demand Calculations

$P_{\text{Road}} = 46.52$ (psi) Dynamic pressure

$P_{\text{Road}} = 320.74424$ (kpa)

Existing Service at node 262

Length

$L = 15$ (m)
 49 (ft)

Size

$d = 200$ (mm)
 8 (in)

Flow

$Q = 0.0039$ (m³/s)
 61 (Usg/min)

Velocity

$$V = \frac{1.274Q}{d^2}$$

$V = 0.12$ (m/s)

Head Loss

$$P_d = \frac{4.52Q^{1.85}}{C^{1.85}d^{4.87}}$$

$$P = 0.434hSG$$

SG= specific gravity of water
= 1

$C = 100$

$P_d = 7.83133E-05$ (psi)

$h = 0.000180$ (ft/ft)

0.0089 (ft)

Pressure Loss

$P_{\text{ROAD}} = 46.52$ (psi)

$P_L = 0.00$ (psi)

$P_{\text{AT METER}} = 46.52$ (psi)

$P_{\text{AT METER}} = 320.72$ (kpa)

1050 + 1060 Bank Street Water Demand Calculations

Key Plan showing surrounding hydrants and offset's to surrounding structures



Boundary Condition for 1050-1060 Bank



Legend

Pipe Ownership

Ownership

— Private

— Public

City of Ottawa - Water Distribution System Facilities & Feeder mains

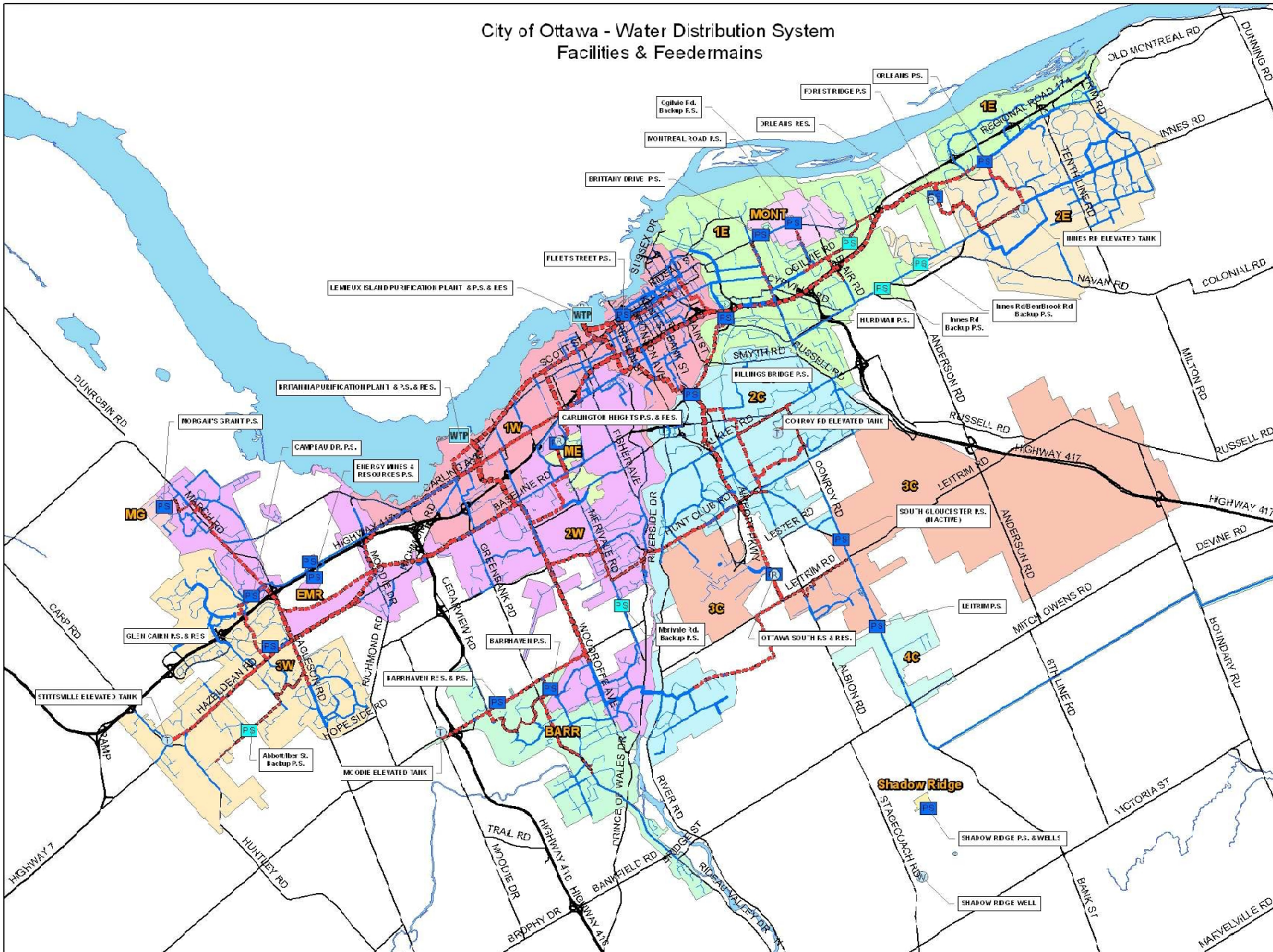

Legend

Water System Structure

- Pump Station
- Backup Pump Station
- Water Treatment Plant
- Well
- Elevated Tank
- Reservoir

WATERMANS
Priority, Internal Diameter

- Backbone 154mm - 198mm
- Backbone 107mm - 137mm
- Backbone 81mm - 91mm
- Backbone 40mm - 50mm
- Backbone 152mm - 35mm
- Distribution 152mm - 35mm
- Distribution 107mm - 137mm
- Distribution 81mm - 91mm
- Distribution 40mm - 50mm
- Distribution 35mm - 38mm

PRESSURE ZONES

- 1E
- 1A
- 2C
- 2E
- 2K
- 3C
- 3A
- 4C
- BARR
- ENR
- ME
- MW
- MONT
- SPAD

Shadow Ridge

- SHADOW RIDGE P.S. & WELLS
- SHADOW RIDGE WELL

Ottawa
Infrastructure Services & Community Sustainability
Infrastructure Services

Scale: 0 to 6,000 Meters

FIGURE 5.1

DATE: 02/14/2011

Appendix D

Sanitary Flow Calculations

EXISTING SANITARY SEWER CALCULATION SHEET

Proposed Development - 1050-1060 Bank Str.

LOCATION				RESIDENTIAL AREA AND POPULATION										COMMERCIAL			INSTITUTIONAL			INDUSTRIAL				INFILTRATION			TOTAL	EXISTING SEWER													
Area ID	LIP	Down	Area	Number of Units					Pop.	Cumulative	Qres	Peak	Qres	Area	Accu	Qc	Area	Accu	Qins	Area	Accu	Qind	QC+I	Total	Accu.	Flow	Flow	Length	Size	Area	Grade	Minimum Slope	Full Capacity	Full Velocity	Time of Flow	Reserve Capacity	Otot/Ocull	Notes			
				By Type					area	pop.	avg.	Fact.	(-)	(L/s)	(ha)	(ha)	(L/s)	(ha)	(ha)	(L/s)	(ha)	(ha)	(L/s)	(L/s)	(ha)	(ha)	(L/s)	(L/s)	(m)	(mm)	(m²)	(%)	(%)	(L/s)	(m/s)	(min)	(L/s)	(-)			
			(ha)	Singles	Semi's	Town's	Apt's	P	(ha)	(ha)	(L/s)	(-)	(L/s)	(ha)	(ha)	(L/s)	(ha)	(ha)	(L/s)	(ha)	(ha)	(L/s)	(L/s)	(ha)	(ha)	(L/s)	(L/s)	(m)	(mm)	(m²)	(%)	(%)	(L/s)	(m/s)	(min)	(L/s)	(-)				
101	1	2	2.22	26		7	84	250	2.220	250	0.838	3.71	3.110	0.120	0.120	0.039	0.450	0.450	0.146					0.000	0.000	0.277	2.79	2.79	0.921	4.308											
102	2	3	1.56	15				51	3.78	310	1.003	3.70	3.707	0.280	0.400	0.130	2.340	2.79	0.994					0.00	0.000	1.551	4.18	6.97	2.300	7.558	90.7	300	0.071	0.440	0.34	64.1	0.91	1.67	56.6	0.12	
103	3	4	0					0	3.78	310	1.003	3.70	3.707	0.610	1.010	0.327		2.79	0.994					0.000	0.000	1.947	0.61	7.58	2.521	8.055	68.5	300	0.071	0.550	0.34	71.7	1.61	1.13	63.7	0.11	
104	4	5	0	17				58	3.78	367	1.190	3.68	4.377	0.770	1.780	0.577	0.490	3.28	1.063					0.00	0.000	2.460	1.26	8.84	2.917	9.754	82.4	375	0.110	1.040	0.25	178.8	1.62	0.85	169.0	0.05	
105	5	6	2.06					0	5.84	367	1.190	3.68	4.377	0.560	2.340	0.758		3.28	1.063					0.000	0.000	2.732	2.62	11.46	3.782	10.891	79.6	375	0.110	4.000	0.25	350.7	3.17	0.42	339.8	0.03	
106	7	0	0					0	5.84	367	1.190	3.68	4.377	0.560	2.340	0.758		3.28	1.063					0.00	0.000	2.732	0.00	11.46	3.782	10.891	13.6	375	0.110	4.410	0.25	368.2	3.33	0.07	357.3	0.03	
107	7	8	2.45	57				194	8.29	561	1.818	3.62	6.576	0.220	2.560	0.830	0.140	3.42	1.108					0.000	0.000	2.907	2.81	14.27	4.709	14.192	24.1	375	0.110	4.230	0.25	360.6	3.26	0.12	346.4	0.04	
108	8	9	0					0	8.29	561	1.818	3.62	6.576	0.330	2.890	0.937		3.42	1.108					0.00	0.000	3.067	0.33	14.60	4.818	14.462	24.1	375	0.110	4.230	0.25	360.6	3.26	0.12	346.1	0.04	

Design Parameters Avg. Daily Flow Res. 280 L/s/d Avg. Daily Flow Comm. 28000 Lha/d Avg. Daily Flow Instit. 28000 Lha/d Avg. Daily Flow Indust 55000 Lha/d	Peak Fact. Res. Harmon's Equation Commercial Contribution 24% Peak Fact. Comm. 1.5 Institutional Contribution 29% Peak Fact. Instit. 1.5 Peak Fact. Indust per MOE Graph	Infiltration / Inflow 0.33 L/s/ha Min. Pipe Velocity 0.06 L/s Max. Pipe Velocity 3.00 L/s Mannings Roughness Coefficient 0.013	Prepared By: Daniel Glauser Checked by: James Fookes Date: November 21, 2019	Project No. 190530700
--	---	---	--	-----------------------

1050 + 1060 Bank Street Sanitary Catchments

The figure below displays the assumed catchment areas. This is meant to clarify the calculations found in the "EXISTING SANITARY SEWER CALCULATION SHEET"

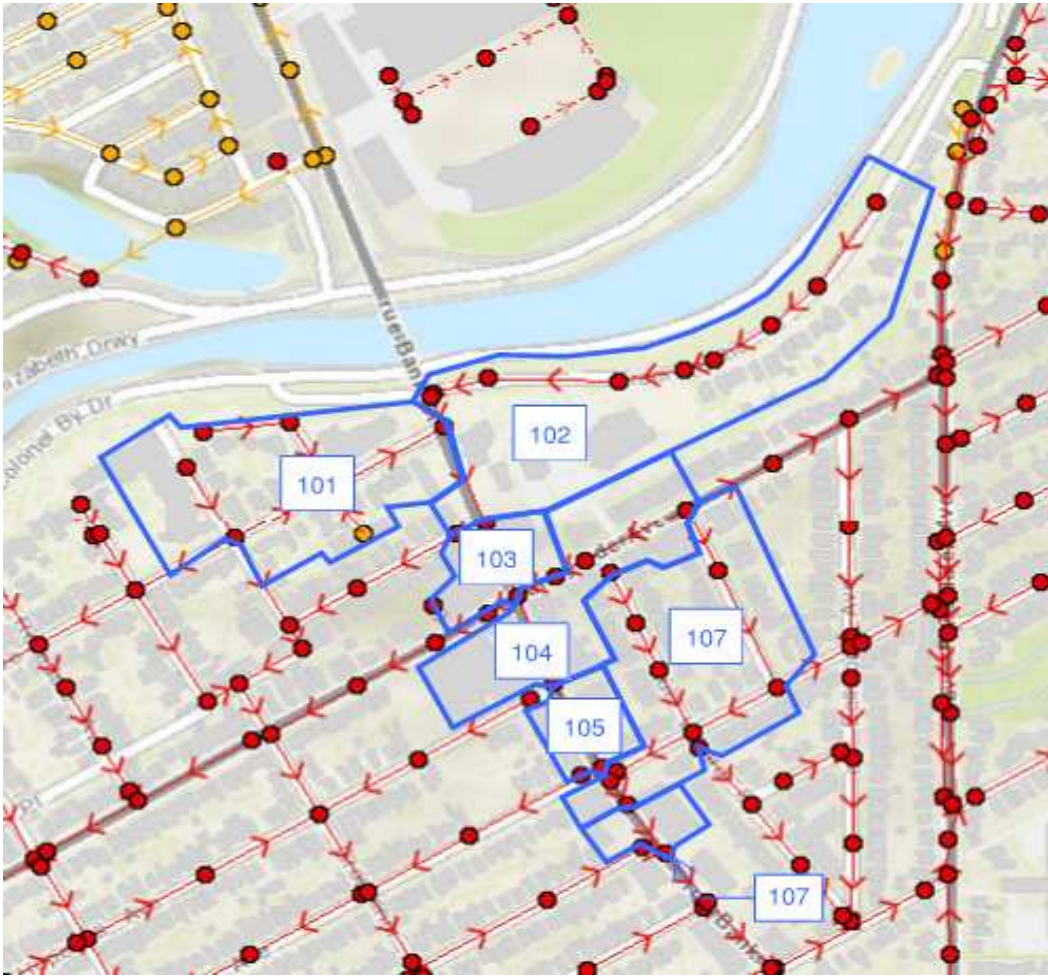

1050+1060 Bank Sanitary Flow Estimate

Occupancy Based Calculation

Occupancy	83	persons	(Per Preliminary design drawings)
Per Capita Flow	280	l/c.d	(Sewer Design Guidelines, Figure 4.3)
Daily average flow	23 240	l/d	
	23.24	m ³ /d	
Peak Factor	3.6		(Sewer Design Guidelines, Figure 4.3; Harmon Equation)
Peak Flow	0.97	l/s	
Site Area	0.16	ha	
Infiltration allowance	0.28	l/s.gross ha	
Infiltration flow	0.0448	l/s	
Peak Flow	1.02	l/s	

$$P.F. = 1 + \left(\frac{14}{4 + \left(\frac{P}{1000} \right)^{\frac{1}{2}}} \right) * K$$

Building Use Peak Flow

Gross Area	0.16	ha
commercial Average Flow	28 000	L/ha/d
Peaking Factor	1.5	
Peak Extraneous Flows	0.28	L/s/effective gross ha
Peak Flow	4 480	L/day
	0.05	L/s

Designed: D. Glauser		Project: Proposed Development 1050+1060 Bank Street Proposed Servicing	
Checked: J. Fookes	Date: November 29, 2019	Location: 1050+1060 Bank Street	
Dwg Reference: C-001	File Ref: 190500700	Sheet No.:	1 of 1

Appendix E

Storm Sewer Design Calculations

1. Existing Conditions & Release Rate

Proposed Development - 1050-1060 Bank Str.

Project No.	190500700
Date	Nov 25, 2019
Prepared By:	D Glauser
Checked By	J Fookes

Existing Drainage Area Characteristics

Drainage Area	Area, A (ha)	Runoff Coefficient, R
EBLDG1	0.031	0.90
EBLDG2	0.016	0.90
PL1	0.111	0.90
EST1	0.0014	0.90
Total	0.159	0.90

Asphalt Area:	R = 0.90
Grassy Area:	R = 0.30
Building Area:	R = 0.90
Gravel Area:	R = 0.50
Concrete Area:	R = 0.90

Existing Conditions

Q = RAIN where Q = runoff rate (L/s)

R = runoff coefficient
i = rainfall intensity (mm/hr)
A = drainage area (ha)
N = 2.78

and
$$i = \frac{A}{(T_d + C)^B}$$

T_d = Time of Concentration = 10 (min)

Return Period (Years)	A	B	C	Intensity, I (mm/hr)	Area (ha)	Runoff Coefficient, R (Note 1)	Runoff Rate, Q (L/s)
5	998.071	0.814	6.053	104.2	0.159	0.90	41.6
100	1735.688	0.82	6.014	178.6	0.159	1.00	79.1

Note 1: For 100-year event, Runoff Coefficient is increased by 25% to a maximum of 1.0.

Allowable Release Rate

Criteria for calculation of allowable release rate:

Return Period 5 year
Maximum Runoff Coefficient 0.5
Time of Concentration 10 minutes

Return Period (Years)	A	B	C	Intensity, I (mm/hr)	Area (ha)	Runoff Coefficient, R	Runoff Rate, Q (L/s)
5	998.071	0.814	6.053	104.2	0.159	0.50	23.1

Allowable release rate from site in 100-year storm is 23.1 L/s

2. Proposed Uncontrolled Flow

Proposed Development - 1050-1060 Bank Str.

Project No.	190500700
Date	Nov 25, 2019
Prepared By:	D Glauser
Checked By	J Fookes

Proposed Uncontrolled Drainage Area Characteristics

Drainage Area	Area, A (ha)	Runoff Coefficient, R (5-year event)	Runoff Coefficient, R (100-year event, Note 1)
RAMP	0.013	0.90	1.00
SB1	0.028	0.90	1.00
SB3	0.0006	0.90	1.00
Total	0.042	0.90	1.00

(Refer to Proposed Storm Drainage Area Plan)

Note 1: For 100-year event, Runoff Coefficient is increased by 25% to a maximum of 1.0.

Runoff coefficients used in calculations:

Asphalt Area:	R = 0.90
Grassy Area:	R = 0.30
Building Area:	R = 0.90
Gravel Area:	R = 0.50
Concrete Area:	R = 0.90

Proposed Uncontrolled Runoff

Q = RAIN where Q = runoff rate (L/s)

R = runoff coefficient
i = rainfall intensity (mm/hr)
A = drainage area (ha)
N = 2.78

and
$$i = \frac{A}{(T_d + C)^B}$$

T_d = Time of Concentration = 10 (min)

Return Period (Years)	A	B	C	Intensity, I (mm/hr)	Area (ha)	Runoff Coefficient, R	Runoff Rate, Q (L/s)
5	998.071	0.814	6.053	104.2	0.042	0.90	10.8
100	1735.688	0.82	6.014	178.6	0.042	1.00	20.7

Remaining Allowable Release Rate

Total Allowable Release Rate 23.1 (L/s)
Uncontrolled Runoff (100 year) 20.7 (L/s)
Remaining Allowable Release Rate 2.4 (L/s)

Runoff from remaining drainage areas in 100-year event will be controlled to 2.4 L/s

3. Proposed Storage

Proposed Development - 1050-1060 Bank Str.

Project No.	190500700
Date	Nov 25, 2019
Prepared By:	D Glauser
Checked By	J Fookes

Proposed Controlled Drainage Area Characteristics

Drainage Area	Area, A (ha)	Runoff Coefficient, R (5-year event)	Runoff Coefficient, R (100-year event, Note 1)
BLDG1	0.05	0.90	1.00
BLDG2	0.04	0.90	1.00
SB2	0.002	0.90	1.00
SB4	0.02	0.86	1.00
Total	0.112	0.89	1.00

(Refer to Proposed Storm Drainage Area Plan)

Note 1: For 100-year event, Runoff Coefficient is increased by 25% to a maximum of 1.0.

Allowable Release Rate from storage (100-year event) = 2.39 (L/s)
 Average release rate for calculation of storage volume = 1.19 (L/s) (Conservatively estimated as 50% of allowable release rate)

Orifice Sizing

$Q = CA(2gH)^{0.5}$
 $C = 0.61$
 Design Flow Rate = 2.4 (L/s)
 Proposed 100-year tank depth = 1.20 (m)
 Proposed 100-year head above centreline of orifice = 1.33 (m)
 Orifice Area = 766 (mm²)
 Orifice diameter = 31 (mm) (if <75mm then vortex ICD required)
 Refer to Sheet 5 for Vortex ICD selection

Release Rates during 5-year event

Water depth during 5-year event = 0.65 (m) (based on result of Req. Storage Vol. calc below)
 Proposed 5-year head above centreline of orifice = 0.78 (m)
 Maximum release rate during 5-year event = 2.00 (L/s) (based on ICD performance, see Sheet 5)
 Average release rate during 5-year event = 1.00 (L/s) (Refer to attached calculation sheet)

Required Storage Volume (using Modified Rational Method)

Q = RAIN

$Q = \text{runoff rate (L/s)}$
 $R = \text{runoff coefficient}$
 $i = \text{rainfall intensity (mm/hr)}$
 $A = \text{drainage area (ha)}$
 $N = 2.78$

$i = \frac{A}{(T_d + C)^B}$ where $i = \text{Rainfall Intensity (mm/hr)}$
 $T_d = \text{Time of Concentration (min)}$

Time, Td (min)	5-Year Event				100-Year Event			
	Intensity (mm/hr)	Peak Flow (L/s)	Average Release Rate (L/s)	Storage Volume (m ³)	Intensity (mm/hr)	Peak Flow (L/s)	Average Release Rate (L/s)	Storage Volume (m ³)
10	104.19	29.0	1.00	16.8	178.56	49.6	1.19	29.1
15	83.56	23.2	1.00	20.0	142.89	39.7	1.19	34.7
20	70.25	19.5	1.00	22.2	119.95	33.3	1.19	38.6
25	60.90	16.9	1.00	23.9	103.85	28.9	1.19	41.5
30	53.93	15.0	1.00	25.2	91.87	25.5	1.19	43.8
40	44.18	12.3	1.00	27.1	75.15	20.9	1.19	47.3
50	37.65	10.5	1.00	28.4	63.95	17.8	1.19	49.8
60	32.94	9.2	1.00	29.4	55.89	15.5	1.19	51.6
80	26.56	7.4	1.00	30.6	44.99	12.5	1.19	54.3
100	22.41	6.2	1.00	31.4	37.90	10.5	1.19	56.1
120	19.47	5.4	1.00	31.8	32.89	9.1	1.19	57.3
140	17.27	4.8	1.00	31.9	29.15	8.1	1.19	58.1
160	15.56	4.3	1.00	31.9	26.24	7.3	1.19	58.6
180	14.18	3.9	1.00	31.8	23.90	6.6	1.19	58.9
200	13.05	3.6	1.00	31.5	21.98	6.1	1.19	59.0

220	12.10	3.4	1.00	31.2	20.37	5.7	1.19	59.0
240	11.29	3.1	1.00	30.8	19.01	5.3	1.19	58.9
260	10.60	2.9	1.00	30.4	17.83	5.0	1.19	58.7
280	9.99	2.8	1.00	29.9	16.80	4.7	1.19	58.4
300	9.46	2.6	1.00	29.3	15.89	4.4	1.19	58.1
320	8.98	2.5	1.00	28.7	15.09	4.2	1.19	57.6
340	8.56	2.4	1.00	28.1	14.37	4.0	1.19	57.2

minimum time = time of concentration

Storage volume used	31.9 m ³	Storage volume used	59.0 m ³
---------------------	---------------------	---------------------	---------------------

A storage tank with a minimum volume of 59 m³ is required.

4. Tank Draindown Time

Proposed Development - 1050-1060 Bank Str.

Release Rate from Storage Tank

Equation 4.10 from MOE Stormwater Design Guidelines:

$$t = \frac{2A_p}{C A_p (2g)^{0.5}} (h_1^{0.5} - h_2^{0.5})$$

where:

Tank Volume 59.0 cu.m
 Water depth when full, h1 1.3 m
 Water depth when empty, h2 0.0 m
 Orifice coefficient, C 0.61
 Acceleration due to gravity, g 9.81 m/s²
 Tank Area, Ap 44.4 sq.m (rectangular tank with vertical sides)

Project No.	190500700
Date	Nov 25, 2019
Prepared By:	D Glauser
Checked By	J Fookes

Incremental draindown calculation (100-year event), based on equivalent orifice to proposed ICD:

Water depth at start of step, h1 (m)	Water depth at end of step, h1 (m)	Duration of step, t (s)	Release rate (L/s)
1.33	1.28	939	2.4
1.28	1.23	957	2.3
1.23	1.18	977	2.3
1.18	1.13	998	2.2
1.13	1.08	1,020	2.2
1.08	1.03	1,044	2.1
1.03	0.98	1,070	2.1
0.98	0.93	1,097	2.0
0.93	0.88	1,127	2.0
0.88	0.83	1,160	1.9
0.83	0.78	1,195	1.9
0.78	0.73	1,234	1.8
0.73	0.68	1,277	1.7
0.68	0.63	1,325	1.7
0.63	0.58	1,379	1.6
0.58	0.53	1,440	1.5
0.53	0.48	1,509	1.5
0.48	0.43	1,590	1.4
0.43	0.38	1,686	1.3
0.38	0.33	1,801	1.2
0.33	0.28	1,943	1.1
0.28	0.23	2,126	1.0
0.23	0.18	2,373	0.9
0.18	0.13	2,732	0.8
0.13	0.08	3,333	0.7

Total draindown duration 37,332 seconds
 10 hours

Average release rate (by water depth)

1.7 L/s

Incremental drawdown calculation (5-year event), based on equivalent orifice to proposed ICD:

Water depth at start of step, h1 (m)	Water depth at end of step, h1 (m)	Duration of step, t (s)	Release rate (L/s)
0.78	0.73	1,234	1.8
0.73	0.68	1,277	1.7
0.68	0.63	1,325	1.7
0.63	0.58	1,379	1.6
0.58	0.53	1,440	1.5
0.53	0.48	1,509	1.5
0.48	0.43	1,590	1.4
0.43	0.38	1,686	1.3
0.38	0.33	1,801	1.2
0.33	0.28	1,943	1.1
0.28	0.23	2,126	1.0
0.23	0.18	2,373	0.9
0.18	0.13	2,732	0.8
0.13	0.00	15,464	0.4

Total drawdown duration 37,879 seconds
 11 hours

Average release rate (by water depth) 1.3 L/s

5. Vortex ICD Sizing

Proposed Development - 1050-1060 Bank Str.

Project No.	190500700
Date	Nov 25, 2019
Prepared By:	D Glauser
Checked By	J Fookes

ICD sizing

100-yr elevation	71.15 m
Cover elevation	71.79 m
Invert elevation	69.70 m
Outlet pipe dia	250 mm

Orifice Sizing:

100-yr depth	1.33 m (depth above centreline of orifice)
Design flow	2.4 l/s
Orifice area	783 mm ² (calculated by Orifice Equation: $Q=CA(2gh)^{0.5}$ where $C=0.61$)
Orifice diameter	32 mm (if less than 75mm then vortex ICD required)

MHST1				
DESIGN EVENT	DIAMETER OF OUTLET PIPE	ICD	DESIGN FLOW (l/s)	UPSTREAM HEAD (m)
1:100 YR	250mm	IPEX Tempest LMF 50	2.4	1.33

IPEX Tempest ICD Design Chart:

Chart 1: LMF 14 Preset Flow Curves

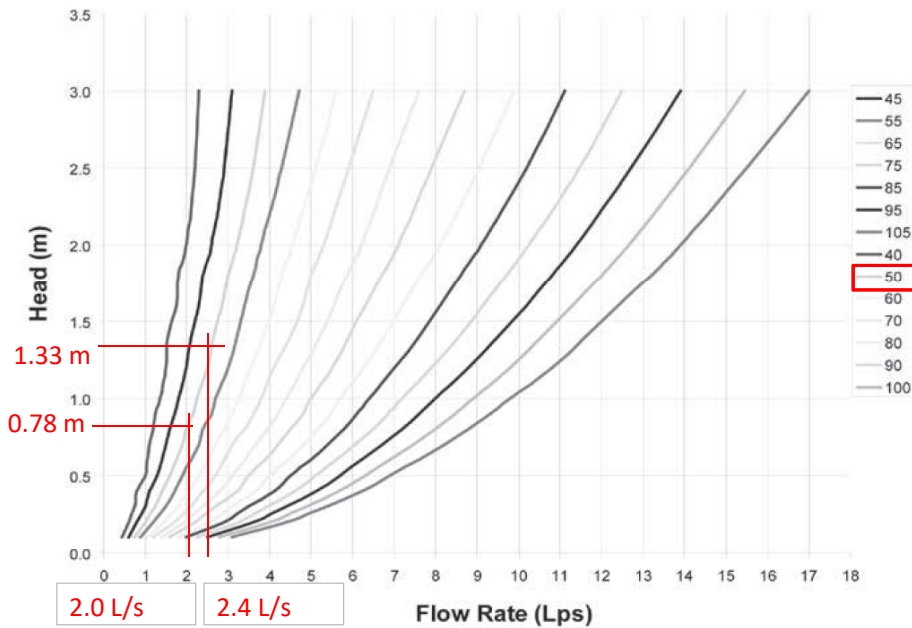

TEMPEST
LMF ICD

6. PROPOSED STORM SEWER CALCULATION SHEET

Proposed Development - 1050-1060 Bank Str.

LOCATION					INDIVIDUAL								CUMULATIVE		DESIGN				PROPOSED SEWER													
Description	From	Top of Cover (m)	To	Top of Cover (m)	Asphalt Area (ha)	Lawn Areas (ha)	Bldg. Area (ha)	Gravel Area (ha)	Conc. Area (ha)	Total (ha)	R*A*N	Area (ha)	R*A*N	Time of Conc. (min.)	Storm Event Return Period (year)	Rainfall Intensity (mm/hr)	Peak Flow (L/s)	Peak Flow (m³/s)	Length (m)	Size (mm)	Area (m²)	Grade (%)	Minimum Slope (%)	Full Capacity (L/s)	Full Velocity (m/s)	Time of Flow (min)	Reserve Capacity (L/s)	Upstream Invert (m)	Downstream Invert (m)	Notes		
																															Proposed Development	BLDG1&2
Setback 2	CB1	71.51	CBMH1	71.79	0.002					0.002	0.005	0.002	0.005	10.00	5.00	104.19	0.5	0.001	4.7	250	0.049	2.128	0.43	86.7	1.77	0.04	86.2	70.30	70.20			
	CBMH1	71.79	MHST1	72.07	0.024	0.001				0.025	0.070	0.122	0.312	10.04	5.00	103.96	32.5	0.032	6	250	0.049	2.000	0.43	84.1	1.71	0.06	51.6	69.88	69.76			
	MHST1	72.07	Existing STM		0.013					0.013	0.032	0.135	0.344	10.10	5.00	103.65	35.7	0.036	18.4	250	0.049	4.022	0.43	119.3	2.43	0.13	83.6	69.76	69.02			
Q = RAIN, where					Q = Peak flow (L/s) R = Runoff coefficient A = Area (ha) I = Rainfall Intensity (mm/hr) N = 2.78				Asphalt Area: R = 0.90 Grassy Area: R = 0.30 Building Area: R = 0.90 Gravel Area: R = 0.50 Concrete Area: R = 0.90				Manning's Roughness Coefficient = 0.013				Prepared By: Daniel Glauser Checked by: James Fookes Date: November 25, 2019											Project No. 190500700				

StormBrixx® HD

StormBrixx® HD is ACO's heavy duty plastic geocellular surface water management system. It consists of a single, recyclable, polypropylene body that can be assembled in a variety of ways to form an open bonded structure.

50
YEARS
OF
LIFE



- 1 4.5 Half bodies per cubic metre
- 2 Functional design combined with an intelligent snap-lock system make for easy handling and rapid installation
- 3 High void ratio of 97% of total volume available for storage
- 4 Height of 1 layer: 24" (610mm)
- 5 Min. cover depth (see image above): 19.7" (0.5m)
- 6 StormBrixx® units can be cut in half to allow integration into the overall system
- 7 The open structure of StormBrixx® allows inspection cameras and cleaning devices to have free passage through the system

Appendix F

Site Servicing Checklist

4. Development Servicing Study Checklist

The following section describes the checklist of the required content of servicing studies. It is expected that the proponent will address each one of the following items for the study to be deemed complete and ready for review by City of Ottawa Infrastructure Approvals staff.

The level of required detail in the Servicing Study will increase depending on the type of application. For example, for Official Plan amendments and re-zoning applications, the main issues will be to determine the capacity requirements for the proposed change in land use and confirm this against the existing capacity constraint, and to define the solutions, phasing of works and the financing of works to address the capacity constraint. For subdivisions and site plans, the above will be required with additional detailed information supporting the servicing within the development boundary.

4.1 General Content

- N/A Executive Summary (for larger reports only).
- Date and revision number of the report.
- Location map and plan showing municipal address, boundary, and layout of proposed development.
- Plan showing the site and location of all existing services.
- Development statistics, land use, density, adherence to zoning and official plan, and reference to applicable subwatershed and watershed plans that provide context to which individual developments must adhere.
- Summary of Pre-consultation Meetings with City and other approval agencies.
- N/A Reference and confirm conformance to higher level studies and reports (Master Servicing Studies, Environmental Assessments, Community Design Plans), or in the case where it is not in conformance, the proponent must provide justification and develop a defensible design criteria.
- Statement of objectives and servicing criteria.
- Identification of existing and proposed infrastructure available in the immediate area.
- N/A Identification of Environmentally Significant Areas, watercourses and Municipal Drains potentially impacted by the proposed development (Reference can be made to the Natural Heritage Studies, if available).

- Concept level master grading plan to confirm existing and proposed grades in the development. This is required to confirm the feasibility of proposed stormwater management and drainage, soil removal and fill constraints, and potential impacts to neighbouring properties. This is also required to confirm that the proposed grading will not impede existing major system flow paths.
- N/A Identification of potential impacts of proposed piped services on private services (such as wells and septic fields on adjacent lands) and mitigation required to address potential impacts.
- Proposed phasing of the development, if applicable.
- Reference to geotechnical studies and recommendations concerning servicing.
- All preliminary and formal site plan submissions should have the following information:
- Metric scale
 - North arrow (including construction North)
 - Key plan
 - Name and contact information of applicant and property owner
 - Property limits including bearings and dimensions
 - Existing and proposed structures and parking areas
 - Easements, road widening and rights-of-way
 - Adjacent street names

4.2 Development Servicing Report: Water

- N/A Confirm consistency with Master Servicing Study, if available
- Availability of public infrastructure to service proposed development
- Identification of system constraints
- Identify boundary conditions
- Confirmation of adequate domestic supply and pressure
- Confirmation of adequate fire flow protection and confirmation that fire flow is calculated as per the Fire Underwriter's Survey. Output should show available fire flow at locations throughout the development.
- Provide a check of high pressures. If pressure is found to be high, an assessment is required to confirm the application of pressure reducing valves.
- N/A Definition of phasing constraints. Hydraulic modeling is required to confirm servicing for all defined phases of the project including the ultimate design
- Address reliability requirements such as appropriate location of shut-off valves
- N/A Check on the necessity of a pressure zone boundary modification.

- Reference to water supply analysis to show that major infrastructure is capable of delivering sufficient water for the proposed land use. This includes data that shows that the expected demands under average day, peak hour and fire flow conditions provide water within the required pressure range
- Description of the proposed water distribution network, including locations of proposed connections to the existing system, provisions for necessary looping, and appurtenances (valves, pressure reducing valves, valve chambers, and fire hydrants) including special metering provisions.
- N/A Description of off-site required feeder mains, booster pumping stations, and other water infrastructure that will be ultimately required to service proposed development, including financing, interim facilities, and timing of implementation.
- Confirmation that water demands are calculated based on the City of Ottawa Design Guidelines.
- Provision of a model schematic showing the boundary conditions locations, streets, parcels, and building locations for reference.

4.3 Development Servicing Report: Wastewater

- Summary of proposed design criteria (Note: Wet-weather flow criteria should not deviate from the City of Ottawa Sewer Design Guidelines. Monitored flow data from relatively new infrastructure cannot be used to justify capacity requirements for proposed infrastructure).
- N/A Confirm consistency with Master Servicing Study and/or justifications for deviations.
- Consideration of local conditions that may contribute to extraneous flows that are higher than the recommended flows in the guidelines. This includes groundwater and soil conditions, and age and condition of sewers.
- Description of existing sanitary sewer available for discharge of wastewater from proposed development.
- Verify available capacity in downstream sanitary sewer and/or identification of upgrades necessary to service the proposed development. (Reference can be made to previously completed Master Servicing Study if applicable)
- N/A Calculations related to dry-weather and wet-weather flow rates from the development in standard MOE sanitary sewer design table (Appendix 'C') format.
- N/A Description of proposed sewer network including sewers, pumping stations, and forcemains.

- Discussion of previously identified environmental constraints and impact on servicing (environmental constraints are related to limitations imposed on the development in order to preserve the physical condition of watercourses, vegetation, soil cover, as well as protecting against water quantity and quality).
- N/A Pumping stations: impacts of proposed development on existing pumping stations or requirements for new pumping station to service development.
- N/A Forcemain capacity in terms of operational redundancy, surge pressure and maximum flow velocity.
- N/A Identification and implementation of the emergency overflow from sanitary pumping stations in relation to the hydraulic grade line to protect against basement flooding.
- Special considerations such as contamination, corrosive environment etc.

4.4 Development Servicing Report: Stormwater Checklist

- Description of drainage outlets and downstream constraints including legality of outlets (i.e. municipal drain, right-of-way, watercourse, or private property)
- Analysis of available capacity in existing public infrastructure.
- A drawing showing the subject lands, its surroundings, the receiving watercourse, existing drainage patterns, and proposed drainage pattern.
- Water quantity control objective (e.g. controlling post-development peak flows to pre-development level for storm events ranging from the 2 or 5 year event (dependent on the receiving sewer design) to 100 year return period); if other objectives are being applied, a rationale must be included with reference to hydrologic analyses of the potentially affected subwatersheds, taking into account long-term cumulative effects.
- Water Quality control objective (basic, normal or enhanced level of protection based on the sensitivities of the receiving watercourse) and storage requirements.
- Description of the stormwater management concept with facility locations and descriptions with references and supporting information.
- N/A Set-back from private sewage disposal systems.
- N/A Watercourse and hazard lands setbacks.
- Record of pre-consultation with the Ontario Ministry of Environment and the Conservation Authority that has jurisdiction on the affected watershed.
- N/A Confirm consistency with sub-watershed and Master Servicing Study, if applicable study exists.

- Storage requirements (complete with calculations) and conveyance capacity for minor events (1:5 year return period) and major events (1:100 year return period).
- N/A Identification of watercourses within the proposed development and how watercourses will be protected, or, if necessary, altered by the proposed development with applicable approvals.
- Calculate pre and post development peak flow rates including a description of existing site conditions and proposed impervious areas and drainage catchments in comparison to existing conditions.
- N/A Any proposed diversion of drainage catchment areas from one outlet to another.
- Proposed minor and major systems including locations and sizes of stormwater trunk sewers, and stormwater management facilities.
- N/A If quantity control is not proposed, demonstration that downstream system has adequate capacity for the post-development flows up to and including the 100-year return period storm event.
- N/A Identification of potential impacts to receiving watercourses
- N/A Identification of municipal drains and related approval requirements.
- Descriptions of how the conveyance and storage capacity will be achieved for the development.
- 100 year flood levels and major flow routing to protect proposed development from flooding for establishing minimum building elevations (MBE) and overall grading.
- N/A Inclusion of hydraulic analysis including hydraulic grade line elevations.
- Description of approach to erosion and sediment control during construction for the protection of receiving watercourse or drainage corridors.
- N/A Identification of floodplains – proponent to obtain relevant floodplain information from the appropriate Conservation Authority. The proponent may be required to delineate floodplain elevations to the satisfaction of the Conservation Authority if such information is not available or if information does not match current conditions.
- N/A Identification of fill constraints related to floodplain and geotechnical investigation.

4.5 Approval and Permit Requirements: Checklist

The Servicing Study shall provide a list of applicable permits and regulatory approvals necessary for the proposed development as well as the relevant issues affecting each approval. The approval and permitting shall include but not be limited to the following:

- Conservation Authority as the designated approval agency for modification of floodplain, potential impact on fish habitat, proposed works in or adjacent to a watercourse, cut/fill permits and Approval under Lakes and Rivers Improvement Act. The Conservation Authority is not the approval authority for the Lakes and Rivers Improvement Act. Where there are Conservation Authority regulations in place, approval under the Lakes and Rivers Improvement Act is not required, except in cases of dams as defined in the Act.
- N/A Application for Certificate of Approval (CofA) under the Ontario Water Resources Act.
- N/A Changes to Municipal Drains.
- Other permits (National Capital Commission, Parks Canada, Public Works and Government Services Canada, Ministry of Transportation etc.)

4.6 Conclusion Checklist

- Clearly stated conclusions and recommendations
- Comments received from review agencies including the City of Ottawa and information on how the comments were addressed. Final sign-off from the responsible reviewing agency.
- All draft and final reports shall be signed and stamped by a professional Engineer registered in Ontario

Appendix G

Topographic and Legal Survey

TOPOGRAPHIC PLAN OF SURVEY OF

PART OF LOTS 2, 3, 4, 5, 6 AND 7 REGISTERED PLAN 101126 AND PART OF LOT A REGISTERED PLAN 116274 CITY OF OTTAWA

Scale 1: 150

FARLEY, SMITH & DENIS SURVEYING LTD. 2018

Metric Note Distances and coordinates on this plan are in metres and can be converted to feet by dividing by 0.3048.

Distance Note Distances shown on this plan are ground distances and can be converted to grid distances by multiplying by the combined scale factor of 0.99945.

Bearing Note Bearings are grid and are derived from the northerly limit of Euclid Avenue having a bearing of N 58° 54' 20" E as shown on Plan 4R-19507. Bearings are referred to the Central Meridian (76°30' West Longitude) MTM NAD-83 (Original) Zone 9.

For bearing comparisons, a rotation of 0°38'40" counter-clockwise was applied to bearings on P1, P2, P3, P6, P7, P8 and P10.

For bearing comparisons, a rotation of 0°48'16" counter-clockwise was applied to bearings on P4.

For bearing comparisons, a rotation of 0°03'00" clockwise was applied to bearings on P9.

Elevation Notes 1. Elevations shown are geodetic and are referred to Geodetic Datum CGVD-1978. 2. Elevations are derived from a site benchmark shown on a plan of survey by (1692) dated May 20th, 2016 having a published elevation of 76.87 metres. (FSD File No. 116-16.) 3. It is the responsibility of the user of this information to verify that the job benchmark has not been altered or disturbed and that it's relative elevation and description agrees with the information shown on this drawing.

Utility Notes 1. This drawing cannot be accepted as acknowledging all of the utilities and it will be the responsibility of the user to contact the respective utility authorities for confirmation. 2. Only visible surface utilities were located. 3. Underground utility data derived from City of Ottawa utility sheets reference H-12-11, plan no. 2538 sheet 7 of 7, drawing 11617p&pi0 and drawing 11617p&pi6. 4. Sanitary and storm sewer grades and inverts were compiled from field measurement and City of Ottawa utility sheets. 5. A field location of underground plant by the pertinent utility authority is mandatory before any work involving breaking ground, probing, excavating etc.

Notes & Legend

Table with 2 columns: Denotes (symbols) and Survey Monument Planted (descriptions). Includes symbols for SSB, IB, CC, CP, Wit, Meas, (P1)-(P7), (P8)-(P10), (D1)-(D2), MH-ST, MH-T, ST, S, W, U, OW, T, G, CP, AN, LS, BS, PH, WV, SP, T/G, TB-T, B, S, BR, O-M-W, OF, CRW, SRW, TRW, WF, C/L, T/Fdn, U/Eave, TOS, Elev, Bot, +65.00, +65.00, Deciduous Tree.

Surveyor's Certificate I certify that: 1. This survey and plan are correct and in accordance with the Surveys Act, the Surveyors Act and the Regulations made under them. 2. The survey was completed on the 11th day of September, 2018.

Date Daniel Robinson Ontario Land Surveyor

FARLEY, SMITH & DENIS SURVEYING LTD. ONTARIO LAND SURVEYORS CANADA LAND SURVEYORS

190 COLONNADE ROAD, OTTAWA, ONTARIO K2E 7J5 TEL: (613) 727-8226 FAX: (613) 727-1826

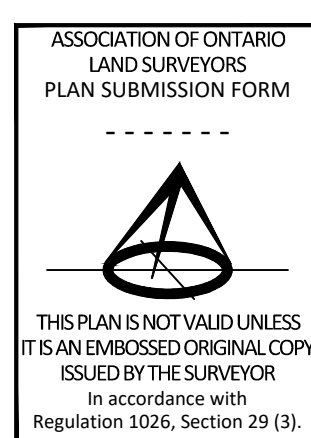
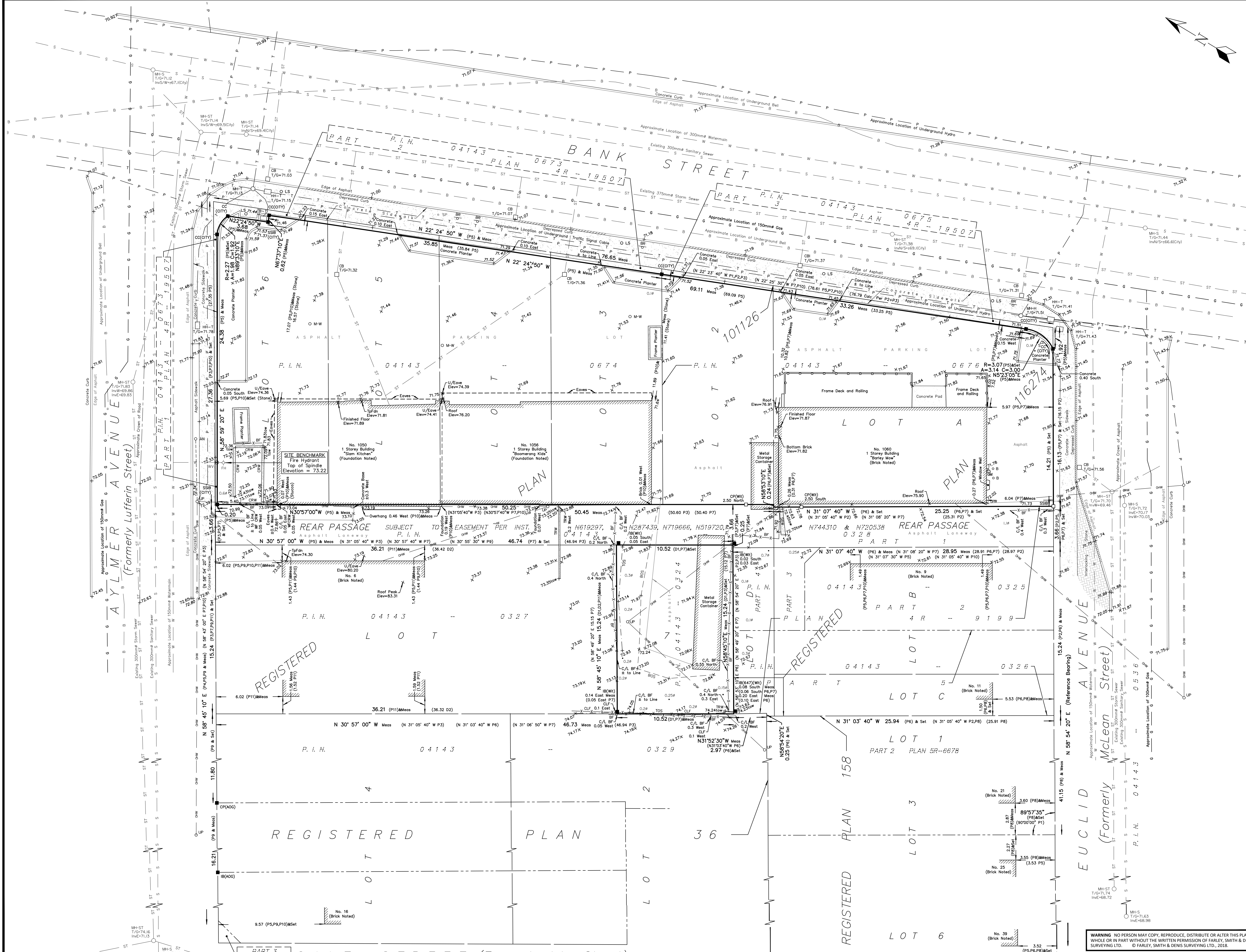

THIS PLAN IS NOT VALID UNLESS IT IS AN EMBOSSED ORIGINAL COPY ISSUED BY THE SURVEYOR In accordance with Regulation 1026, Section 23 (3).

WARNING: NO PERSON MAY COPY, REPRODUCE, DISTRIBUTE OR ALTER THIS PLAN IN WHOLE OR IN PART WITHOUT THE WRITTEN PERMISSION OF FARLEY, SMITH & DENIS SURVEYING LTD. © FARLEY, SMITH & DENIS SURVEYING LTD., 2018.