



1243 Teron Road, Kanata Ontario
Megha Holdings Inc.

Transportation Impact Assessment

January 17, 2020

Table of Contents

Introduction.....	1
1 Screening.....	2
1.1 Summary of Development.....	2
1.2 Trip Generation Triggers.....	2
1.3 Location Triggers.....	3
1.4 Safety Triggers	3
1.5 Summary.....	3
2 Scoping	4
2.1 Existing and Planned Conditions	4
2.2 Study Area and Time Period	11
2.3 Exemption Review	11
3 Forecasting	12
3.1 Development-Generated Travel Demand	12
3.2 Background Network Travel Demand	15
3.3 Demand Rationalization	16
4 Analysis.....	18
4.1 Development Design	18
4.2 Parking.....	20
4.3 Boundary Street Design	20
4.4 Access Intersection Design	22
4.5 Transportation Demand Management (TDM)	23
4.6 Neighbourhood Traffic Management.....	24
4.7 Transit	24
4.8 Review of Network Concept.....	25
4.9 Intersection Design	25
Conclusion	37
Recommendations.....	38

List of Figures

Figure 1: Project Location..... 1
Figure 2: Public Transportation Network near the Project Site 5
Figure 3: Sidewalk and Pathways near the Project Site 6
Figure 4: Existing Turning Movement Volumes, AM (PM) Peak Hour 7
Figure 5: Number of Collisions per Year at March Road / Teron Road 9
Figure 6: Types of Collisions at March Road / Teron Road 9
Figure 7: Intersection Collision Diagram – March Road / Teron Road..... 10
Figure 8: Auto Trip Generation, AM (PM) Peak Hour 14
Figure 9: 2025 Background Turning Movement Volumes, AM (PM) Peak Hour 15
Figure 10: Background Development Traffic, AM (PM) Peak Hour 16
Figure 11: 2025 Total Projected Turning Movement Volumes, AM (PM) Peak Hour 17
Figure 12: Swept Path Analysis – WB-19 Trucks Accessing Loading Bays and Leaving the Site 19
Figure 13: Swept Path Analysis – WB-19 Trucks Entering the Site 19
Figure 14: Left-Turn Lane Warrant Chart – Proposed Access on Teron Road, 2025 Total Traffic..... 23
Figure 15: Left-Turn Lane Warrant Chart – Carling Avenue Westbound at Teron Road,
2025 Background Traffic 25

List of Tables

Table 1: Description of Proposed Development 2
Table 2: Trip Generation Triggers..... 2
Table 3: Location Triggers 3
Table 4: Safety Triggers 3
Table 5: Summary of TIA Triggers 4
Table 6: Possible TIA Exemptions 12
Table 7: Trip Generation..... 13
Table 8: Target Level of Services for Road Segment 20
Table 9: Pedestrian Level of Service on Teron Road 21
Table 10: Truck Level of Service on Teron Road 22
Table 11: Auto Levels of Service at the Proposed Site Access 23
Table 12: Existing or Planned Road Classes and Designations for each Transportation Mode 26
Table 13: Target LOS for each Transportation Mode..... 26
Table 14: Pedestrian Levels of Service at Signalized Intersections 27
Table 15: Bicycle Levels of Service at Signalized Intersections 29
Table 16: Transit Levels of Service at Signalized Intersections 31
Table 17: Truck Levels of Service at Signalized Intersections 32
Table 18: Auto Levels of Service at Signalized Intersections 33
Table 19: Auto Levels of Service at a Stop-Controlled Intersection..... 36

Appendices

Appendix A TIA Certification
Appendix B Site Plan
Appendix C Traffic Count Reports
Appendix D Collision Details Report
Appendix E O-D Survey – Kanata-Stittsville
Appendix F TRANS Regional Model
Appendix G TDM Checklists
Appendix H Traffic Signal Warrant Analysis
Appendix I Synchro Traffic Analysis Reports

Introduction

The purpose of this report is to assess the transportation impact of a proposed industrial building located at 1243 Teron Road, on the south side of Teron Road near March Road in Kanata, Ottawa, Ontario. The project site is shown on **Figure 1**.



Figure 1: Project Location

The format of this report is consistent with the City of Ottawa's Transportation Impact Assessment (TIA) Guidelines (2017).

1 Screening

1.1 Summary of Development

Table 1 presents a description of the proposed development. A detailed layout is included in **Appendix B**.

Table 1: Description of Proposed Development

Municipal Address	1243 Teron Road, Kanata, K2K 1X2
Description of Location	South side of Teron Road, halfway (approx. 300 m) between March Road and Carling Avenue
Land Use Classification	General Industrial Zone, IG6 Subzone
Development Size (units)	n/a
Development Size (m ²)	9,281 m ²
Number of Accesses and Locations	1 proposed full access on Teron Road
Phase of Development	Phase 1 of 1
Buildout Year	2020

1.2 Trip Generation Triggers

A TIA is warranted if the proposed development is anticipated to generate a significant number of person-trips that may affect the performance of the transportation network. **Table 2** presents the trip generation triggers.

Table 2: Trip Generation Triggers

Land Use Type	Minimum Development Size	Proposed Development Size
Single-family homes	40 units	–
Townhomes or apartments	90 units	–
Office	3,500 m ²	–
Industrial	5,000 m ²	9,281 m ²
Fast-food restaurant or coffee shop	100 m ²	–
Destination retail	1,000 m ²	–
Gas station or convenience market	75 m ²	–

The proposed land uses exceed the trip generation threshold for an industrial development. Therefore, a TIA is **warranted** based on trip generation.

1.3 Location Triggers

A TIA may be warranted based on location. **Table 3** presents the location triggers.

Table 3: Location Triggers

Location Trigger	Yes/No
Does the development propose a new driveway to a boundary street that is designated as part of the City’s Transit Priority, Rapid Transit or Spine Bicycle Networks?	No
Is the development in a Design Priority Area (DPA) or Transit-oriented Development (TOD) zone?	No

Based on the information above, a TIA is **not warranted** based on location.

1.4 Safety Triggers

A TIA may be warranted based on safety. **Table 4** presents the safety triggers.

Table 4: Safety Triggers

Safety Trigger	Yes/No
Are posted speed limits on a boundary street 80 km/hr or greater?	No
Are there any horizontal/vertical curvatures on a boundary street which limit sight lines at a proposed driveway?	No
Is the proposed driveway within the area of influence of an adjacent traffic signal or roundabout (i.e. within 300 m of intersection in rural conditions, or within 150 m of intersection in urban/suburban conditions)?	No
Is the proposed driveway within the auxiliary lanes of an intersection?	No
Does the proposed driveway make use of an existing median break that serves an existing site?	No
Is there is a documented history of traffic operations or safety concerns on the boundary streets within 500 m of the development?	No
Does the development include a drive-thru facility?	No

Based on the information above, a TIA is **not warranted** based on safety.

1.5 Summary

A TIA is warranted if any of the justifications in **Table 5** are met.

Table 5: Summary of TIA Triggers

Trigger Category	Yes/No
Does the development satisfy one of the trip generation triggers?	Yes
Does the development satisfy one of the location triggers?	No
Does the development satisfy one of the safety triggers?	No

Based on the information above, a TIA is **warranted**.

2 Scoping

2.1 Existing and Planned Conditions

2.1.1 Proposed Development

The project consists of the construction of a 1-storey industrial building with a total area of 9,281 m² (99,900 sq. ft.) and an off-street parking lot with a capacity of 90 spaces. A site plan is provided in **Appendix B**.

The building is expected to serve as a warehouse with some office use. The estimated year of occupancy is 2020.

The project site will be accessed by a single full-access driveway on Teron Road, located as shown on the site plan. A sidewalk will be built from the building to the edge of the roadway.

2.1.2 Existing Conditions

2.1.2.1 Roadways

Between March Road and Carling Avenue, Teron Road is a rural 2-lane undivided local roadway in a light industrial setting. The intersection with March Road is fully signalized while the intersection with Carling Avenue is Stop-controlled on the northbound approach. Beyond March Road, Teron Road becomes an urban residential collector road. The posted speed limit is 50 km/h.

March Road is a divided multi-lane arterial roadway and truck route serving Kanata North and connecting to Highway 417. Its posted speed limit is 80 km/h. Beyond Highway 417, March Road becomes Eagleson Road, a divided arterial road serving Kanata South.

Near the study area, Carling Avenue is an undivided arterial roadway extending from March Road through the Greenbelt. It is also a truck route with restricted loads. Beyond Moodie Drive, Carling Road becomes a multi-lane arterial extending to the city core and connecting to several north-south arterials.

2.1.2.2 Public Transportation

Figure 2 illustrates the available public transportation service near the project site. There is no service in front of the project site but several major bus routes are present at walking distance, including Rapid bus Route 63 and local bus Route 64, both providing frequent service in both directions between Kanata North and the LRT at Tunney’s Pasture. Connexion bus 266 also provides a fast service between Kanata North and Tunney’s Pasture, but only during peak hours in peak directions (toward downtown in the morning, Kanata North in the afternoon). The nearest bus stops to access bus routes 63, 64 and 266 in any direction are located on March Road just north of Teron Road, at a walking distance of 420 to 440 m from the proposed development.

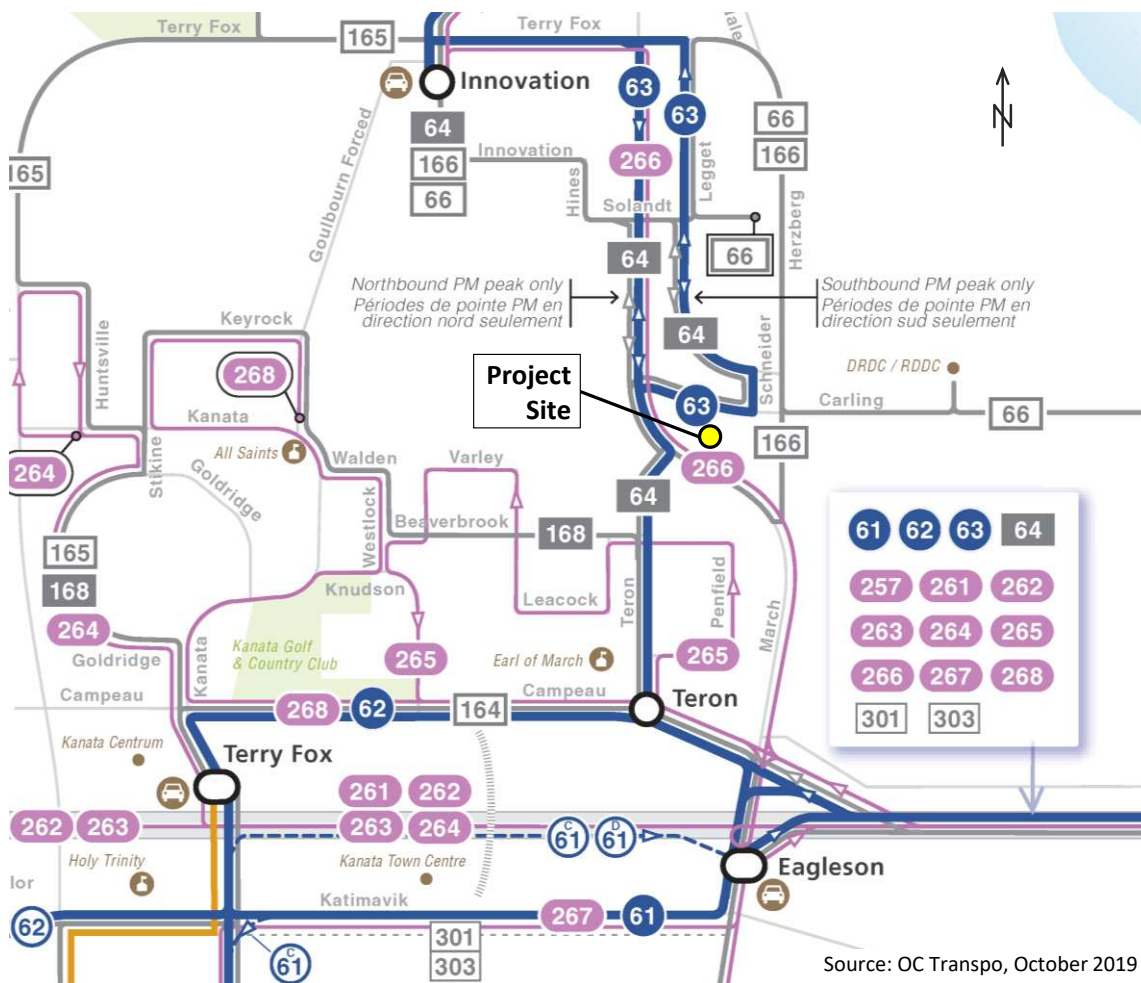

Figure 2: Public Transportation Network near the Project Site

Two local bus routes are also available on nearby Herzberg Road: Route 66, connecting to Tunney’s Pasture via Carling Avenue and Moodie Station, and Route 166, connecting to Eagleson Station. These 2 routes operate only during peak hours in the peak direction (both toward Kanata North in the morning).

2.1.2.3 Active Transportation Network

As shown on **Figure 3**, there is no sidewalk provided on Teron Road between March Road and Carling Avenue and a sidewalk is provided only on a segment of Carling Avenue near March Road.

Sidewalks are provided on March Road north of Teron Road and on Teron Road west of March Road. A pathway also exists along March Road south of Teron Road, providing an additional access to the residential community west of March Road.

Bicycle lanes and paved shoulders are provided on March Road, Carling Avenue, Herzberg Road and Teron Road west of March Road. NCC's Watts Creek Pathway and Greenbelt Pathway can both be accessed via Carling Avenue east of Herzberg Road.



Figure 3: Sidewalk and Pathways near the Project Site

2.1.2.4 Existing Traffic Volumes

Traffic count reports were acquired from the City of Ottawa for the following intersections:

- March Road / Herzberg Road (August 10, 2016);
- March Road / Teron Road (April 11, 2017);
- March Road / Carling Avenue (August 10, 2016);
- Carling Avenue / Teron Road (June 23, 2010); and
- Carling Avenue / Herzberg Road (August 10, 2016).

The traffic data for the intersection at Carling Avenue / Teron Road is 9 years old. Therefore, BTE conducted a turning movement count at that location on November 19, 2019, capturing the morning and afternoon peak hours.

Figure 4 presents the existing traffic volumes near the project site. Traffic count reports are provided in **Appendix C**.

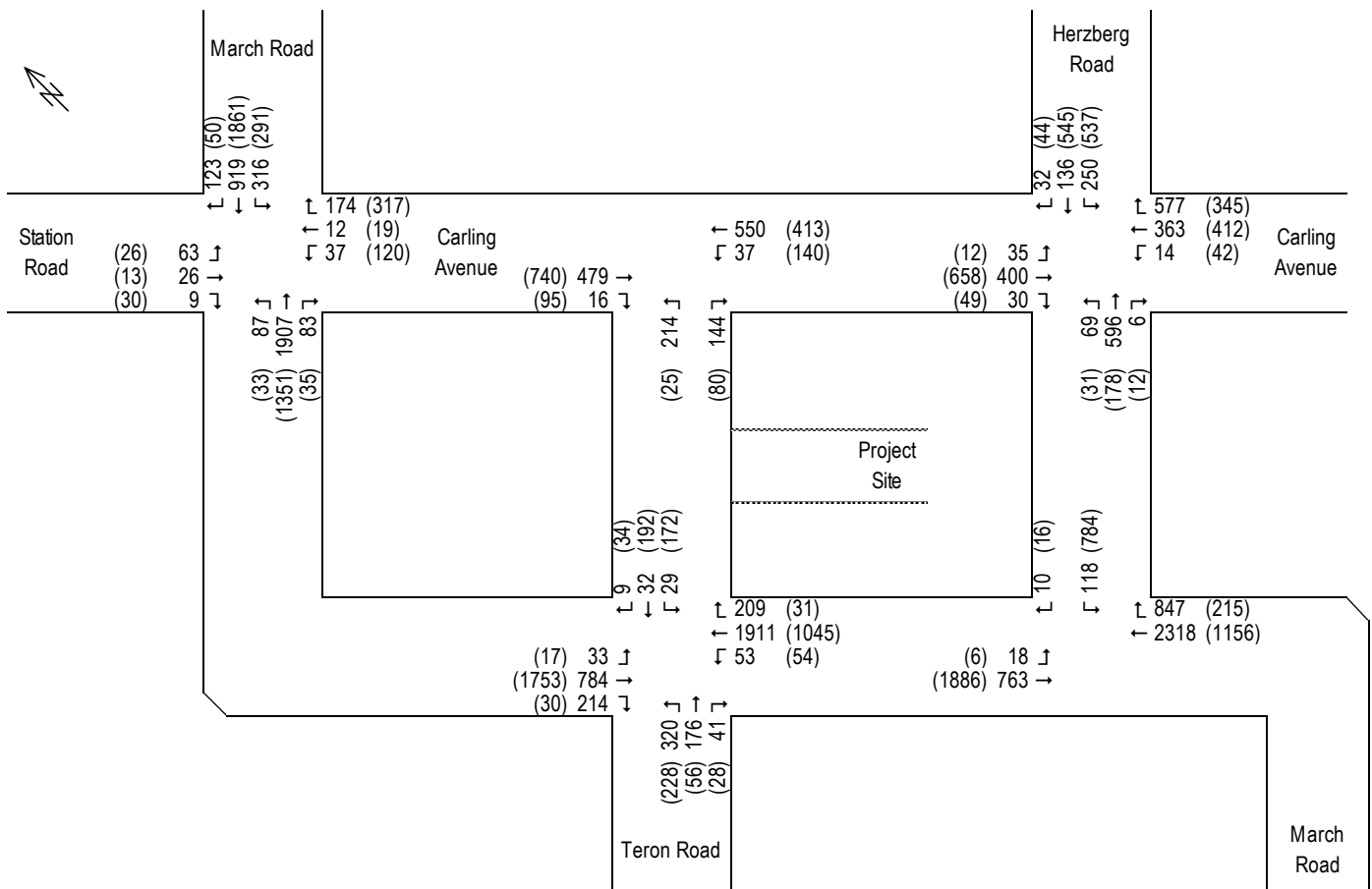

Figure 4: Existing Turning Movement Volumes, AM (PM) Peak Hour

It was observed during the traffic count at Carling Avenue / Teron Road that the northbound left-turn movement is busier than anticipated during the morning peak hour, with a queue that lasted the entire peak hour. It is suspected that Teron Road is used as a bypass route by drivers coming from the south and heading toward the Kanata North Business Park.

The traffic count reports reveal that pedestrian and cycling volumes are generally very low (less than 10), with the following exceptions:

- March Road / Carling Avenue: 18 northbound cyclists and 20 pedestrians on the east crosswalk were counted during the morning peak hour, and 10 southbound cyclists during the afternoon peak hour;
- Carling Avenue / Herzberg Road: 32 westbound cyclists were counted during the morning peak hour, and 29 eastbound and 19 southbound cyclists during the afternoon peak hour.

2.1.2.5 Collision History

The City of Ottawa provided a detailed collision report for the area near the project site, including Teron Road between March Road and Carling Avenue, for a 5-year period from January 1, 2014 to December 31, 2018. No fatal collisions were recorded during that period. A detailed collision history report is available in **Appendix D**.

Only 3 collisions were reported on Teron Road between March Road and Carling Avenue, 2 of them involving an improper turning movement (one causing injury) and a third one involving only one vehicle.

Five collisions were reported at the intersection of Carling Avenue / Teron Road. Two of them involved injuries. Three collisions were rear ends, one involved a turning vehicle, and one involved only one vehicle.

Thirty-two (32) collisions were reported at the intersection of March Road / Teron Road, an average of 6.4 per year. **Figure 5** illustrates the number of collisions per year. **Figure 6** illustrates the number of collisions for each different type recorded at this intersection.

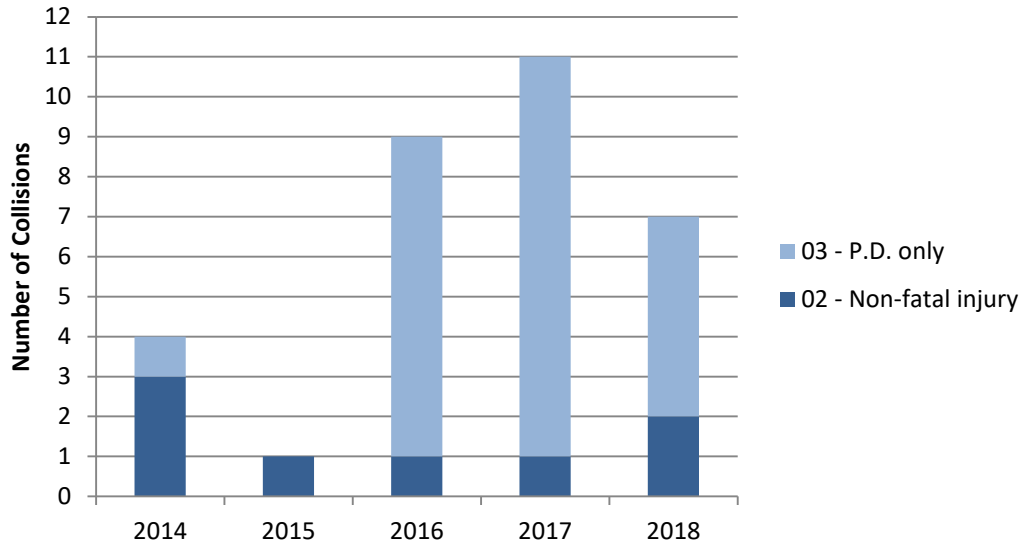

Figure 5: Number of Collisions per Year at March Road / Teron Road

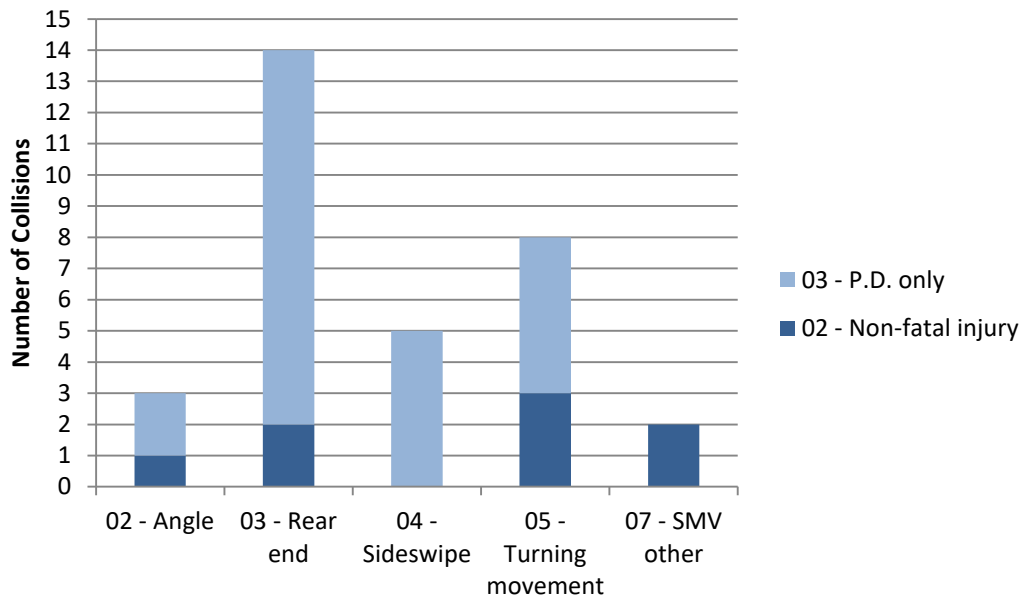

Figure 6: Types of Collisions at March Road / Teron Road

Figure 7 illustrates the types of collisions and the direction of the involved vehicles for each collision at the intersection of March Road / Teron Road.

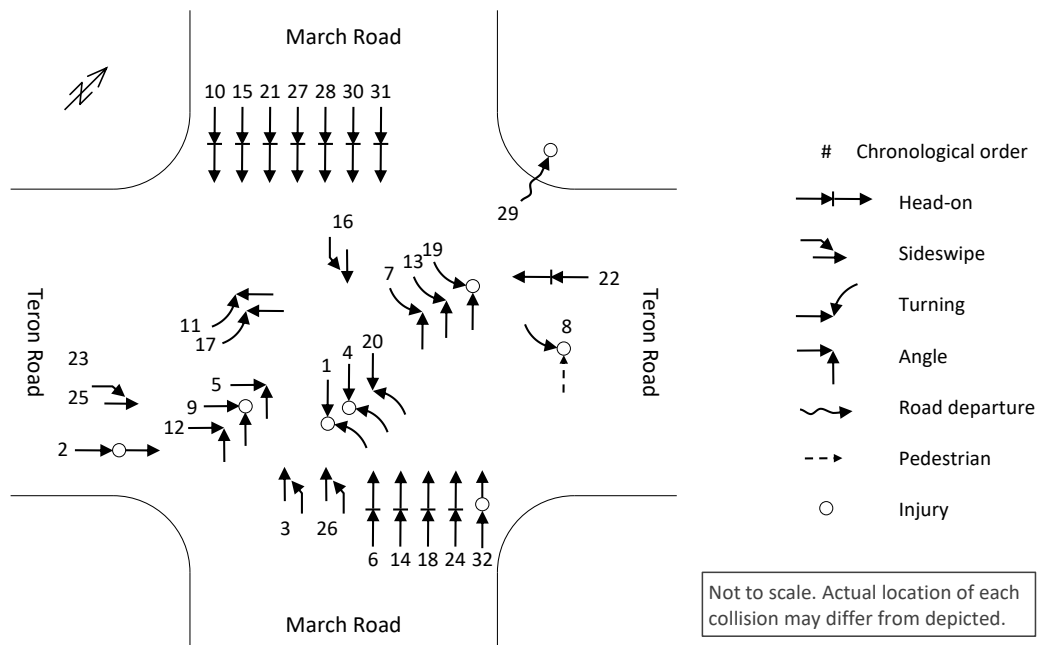

Figure 7: Intersection Collision Diagram – March Road / Teron Road

The vast majority of collisions occurred during clear weather (only 1 instance with snow, 5 with rain) and during daytime. Two collisions involved only one vehicle, including one collision with a pedestrian causing injury.

The number of collisions at March Road / Teron Road appears to have increased from 2014 to 2018, albeit not consistently. The number of rear-end collisions is higher than any other type of collision, but this is not unusual for a signalized intersection. It is noted that this intersection is located on a curve and that March Road has a high posted speed limit (80 km/h). Otherwise, no discernable pattern is evident that would indicate a deficiency.

2.1.3 Planned Conditions

2.1.3.1 Background Developments

According to the City of Ottawa’s Development Application Search tool, several developments are planned in the vicinity of the project site.

One proposed development, submitted in 2014, consists of 2 light industrial/office buildings located at 1285 Teron Road but no details are available at this time.

A 3-unit commercial building is also planned at the corner of March Road and Teron Road (329 March Road) and a 2-story office building with a 1,600 m² footprint is planned at 56 Steacie Drive. These two projects are not expected to have a significant impact on traffic near the project site.

A residential development and a mixed-use development totalling 139 residential units and 1,068 m² (11,500 sq. ft.) of commercial floor area including a sit-down restaurant are planned at 1131 and 1151

Teron Road, respectively. The project's transportation impact assessment concludes that these developments will not have a major influence on the performance on the nearby intersections.

2.1.3.2 Roadways

The 2013 Transportation Master Plan indicates that no change to the road capacity is planned near the project site within the 2031 planning horizon.

2.1.3.3 Public Transportation

The 2013 Transportation Master Plan identifies March Road as a bus rapid transit (BRT) corridor as part of the 2031 Affordable Network, with a planned bus station at the intersection of March Road and Teron Road.

2.1.3.4 Active Transportation

No cycling or pedestrian facilities are currently planned near the project site.

2.2 Study Area and Time Period

2.2.1 Study Area

For the purpose of this analysis, the study area includes the project site driveways as well as the following intersections:

- March Road / Herzberg Road;
- March Road / Teron Road;
- March Road / Carling Avenue;
- Carling Avenue / Teron Road; and
- Carling Avenue / Herzberg Road.

2.2.2 Time Periods

The proposed development is expected to be in operation during normal business hours. The critical peak periods are expected to be the weekday morning and afternoon peak hours.

2.2.3 Horizon Year

The buildout year of the project is 2020. Therefore, the year 2025 (5 years after buildout) is used as a reference for analysis.

2.3 Exemption Review

Table 6 presents the elements of the TIA Guidelines that can be exempted from the analysis.

Table 6: Possible TIA Exemptions

Element	Exemption	Exempt?
4.1.2 Circulation and Access	Only required for site plans	No
4.1.3 New Street Networks	Only required for plans of subdivision	Yes
4.2.1 Parking Supply	Only required for site plans	No
4.2.2 Spillover Parking	Only required for site plans where parking supply is 15% below unconstrained demand	Yes
4.5 Transportation Demand Management	Not required for site plans expected to have fewer than 60 employees and/or students on location at any given time	No
4.6.1 Adjacent Neighbourhoods	Only required when the development relies on local or collector streets for access and total volumes exceed ATM capacity thresholds	Yes (note below)
4.8 Network Concept	Only required when the proposed development generates more than 200 person-trips during the peak hour in excess of the equivalent volume permitted by established zoning	Yes

Note: The proposed development’s only access is on a roadway classified as a local street. However, the item “4.6.1 Adjacent Neighbourhoods” is considered exempt because the development is consistent with the industrial character of the neighbourhood (akin to developing a residential building on a residential street) and because the anticipated trip demand is not high enough to significantly impact the safety and quality of life of the other road users. In fact, the addition of a single driveway on Teron Road would actually reinforce its purpose as a “local street” (i.e. to facilitate access), compared to the purpose of an arterial roadway (to facilitate movement).

3 Forecasting

3.1 Development-Generated Travel Demand

3.1.1 Trip Generation and Mode Shares

3.1.1.1 Employees

The developer has indicated that the proposed development will have up to 75 employees. According to the Institute of Transportation Engineers’ (ITE) Trip Generation Manual 10th Edition, a warehouse (ITE code 150), described as primarily devoted to the storage of materials but occasionally provided with office and maintenance areas, is expected to generate 0.61 and 0.66 vehicular trips per employee, i.e. 45 and 50 vehicular trips, during the morning and the afternoon peak hours respectively.

Assuming a 10% non-auto mode share and an average vehicle occupancy of 1.15, these values amount to 59 and 63 person trips during the morning and the afternoon peak hours respectively.

The information contained in the 2011 TRANS O-D Survey Report for the Kanata-Stittsville district (provided in **Appendix E**) has been used to determine the modal distribution for an average peak period. The resulting number of trips for each peak hour is presented in **Table 7**. The proportions of entering and exiting trips are based on the ITE Trip Generation Manual.

Table 7: Trip Generation

Mode	Modal Distribution	Morning Peak Hour Trips			Afternoon Peak Hour Trips		
		Total	Entering (72%)	Exiting (28%)	Total	Entering (36%)	Exiting (65%)
Auto Driver	64%	37	27	10	41	15	26
Auto Passenger	17%	10	7	3	11	4	7
Transit User	11%	7	5	2	7	2	5
Cyclist	1%	0	0	0	0	0	0
Pedestrian	7%	4	3	1	4	1	3
Total	100%	59	42	16	63	23	41

3.1.1.2 Trucks

The developer has indicated that there will be an average of 2 truck deliveries per day and a maximum of 5 truck deliveries per day. For the purpose of this assessment, it is assumed that 2 trucks will be entering the site and 2 will be exiting the site during the morning and the afternoon peak hour.

3.1.2 Trip Distribution and Assignment

3.1.2.1 Employees

The 2011 TRANS O-D Survey was used to determine the trip distribution of car drivers (see **Appendix E**). It was determined that 50% of trips would be to/from east of Kanata, 10% would be to/from the rural west and 40% would be local, i.e. made within the Kanata-Stittsville area.

The vast majority of the auto trips to/from east of Kanata are expected to travel on Highway 417, while a small proportion would likely travel on Carling Avenue. Trips to/from the rural west will likely travel on Highway 417 as well, but some trips may be made on March Road north of the project site. The Kanata-Stittsville area is very large and includes various residential communities located north, south and west of the project site.

In consideration of the above, and of the road network configuration, the following car trip assignments were assumed:

- 10% via Carling Avenue east of Herzberg Road;
- 10% via Herzberg Road north of Carling Avenue;
- 10% via March Road north of Teron Road;

- 10% via Teron Road west of March Road; and
- 60% via March Road south of Teron Road.

Regarding non-auto modes, considering that the nearest residential area is located west of March Road, that all major bus routes are found on March Road and that no pedestrian facilities are provided on Teron Road and on Carling Avenue, it is anticipated that the totality of non-auto trips (11 trips during each peak hours) will be travelling via the intersection of March Road / Teron Road. Both pedestrian and transit users are expected to walk along the roadway between March Road and the project site.

Figure 8 presents the number of auto trips generated by the proposed development during the morning and the afternoon peak hours.

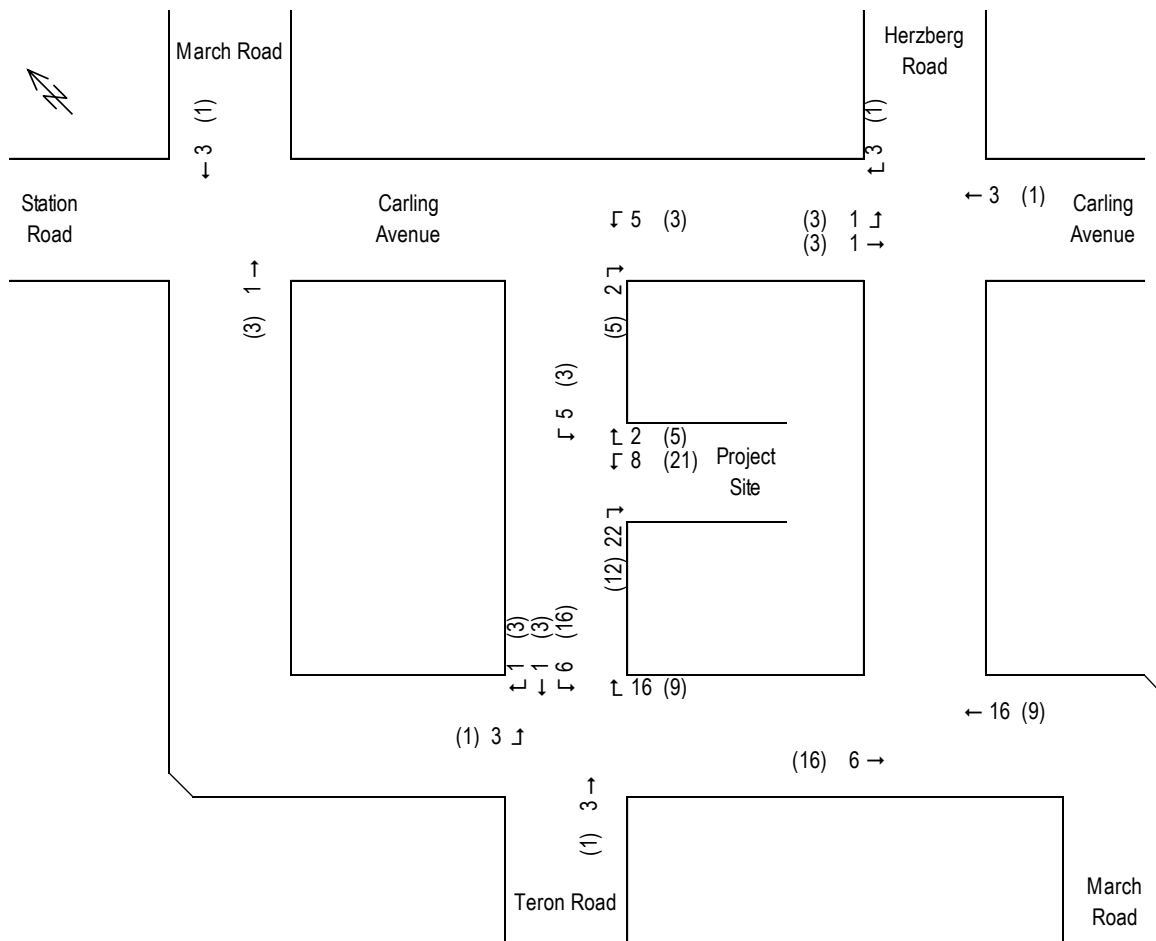

Figure 8: Auto Trip Generation, AM (PM) Peak Hour

3.1.2.2 Trucks

Truck trips are anticipated to be regional. For the purpose of this assessment, all trucks are assumed to be travelling via March Road south of Teron Road.

3.2 Background Network Travel Demand

3.2.1 Transportation Network Plans

As indicated in **Section 2.1.3**, no changes to the road capacity or to the active transportation network are planned near the project site within the 2031 planning horizon.

March Road is identified as a BRT corridor with a planned bus station at the intersection of March Road and Teron Road.

3.2.2 Background Growth

A review of the City's Strategic Long Range Model, comparing snapshots of the TRANS regional model for the 2011 AM base scenario and the 2031 AM affordable network (provided in **Appendix F**) was conducted. An annual growth rate within the 0% to 0.8% range is anticipated on Teron Road, March Road and Carling Avenue near the project site. Therefore, a 0.5% annual background growth rate has been applied.

Figure 9 presents the background traffic volumes for the 2025 horizon year within the study area.

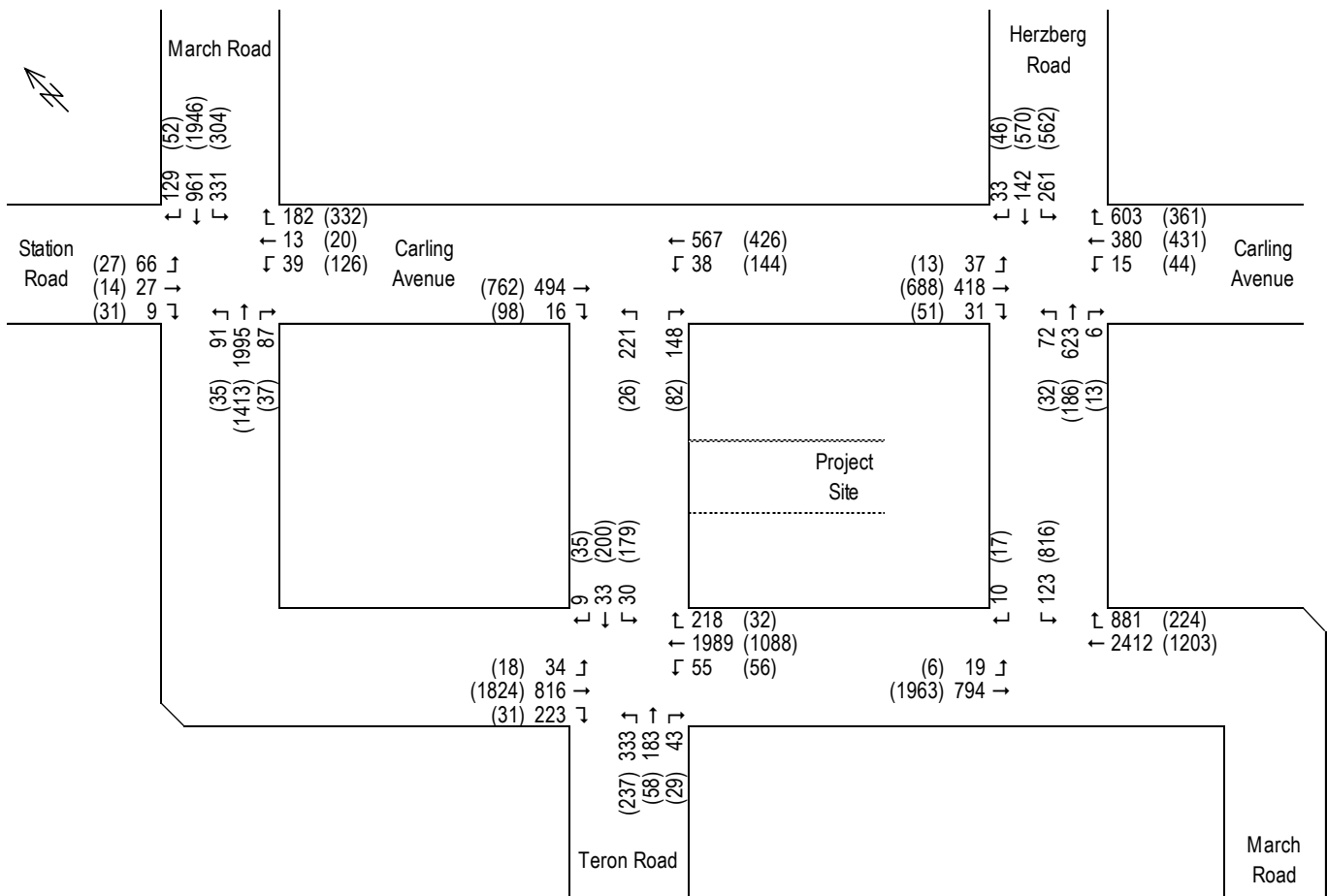

Figure 9: 2025 Background Turning Movement Volumes, AM (PM) Peak Hour

3.2.3 Other Developments

As indicated in **Section 2.1.3**, no planned development, on its own, is expected to have a significant impact on traffic near the project site.

Nevertheless, as requested by the City of Ottawa, the planned developments at 329 March Road and at 1131/1151 Teron Road were included as part of the background travel demand which is presented in **Figure 10**.

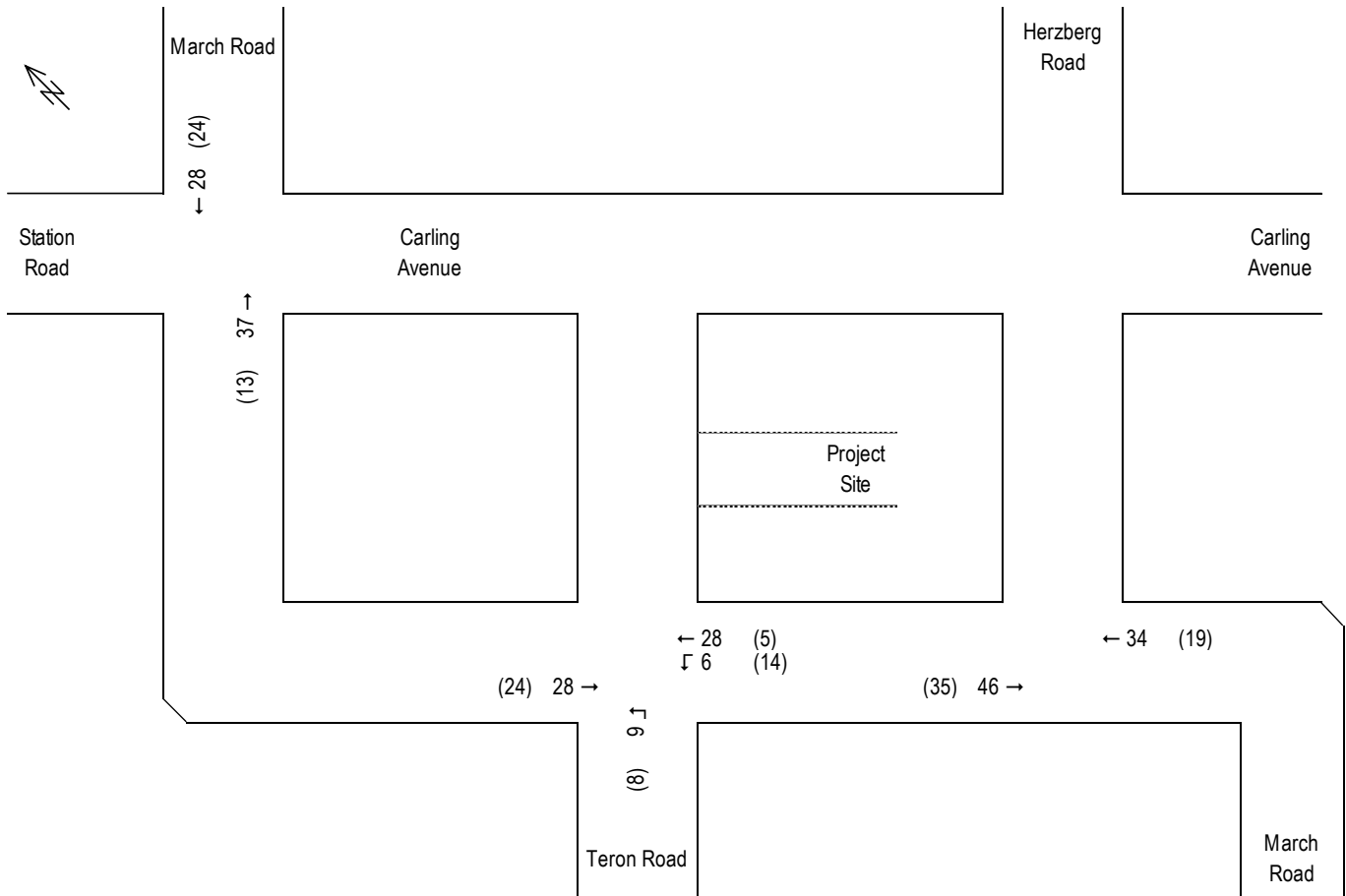

Figure 10: Background Development Traffic, AM (PM) Peak Hour

3.3 Demand Rationalization

Figure 11 shows the total traffic volumes anticipated for the 2025 horizon year, based on the traffic background growth and trip generation rates discussed above.

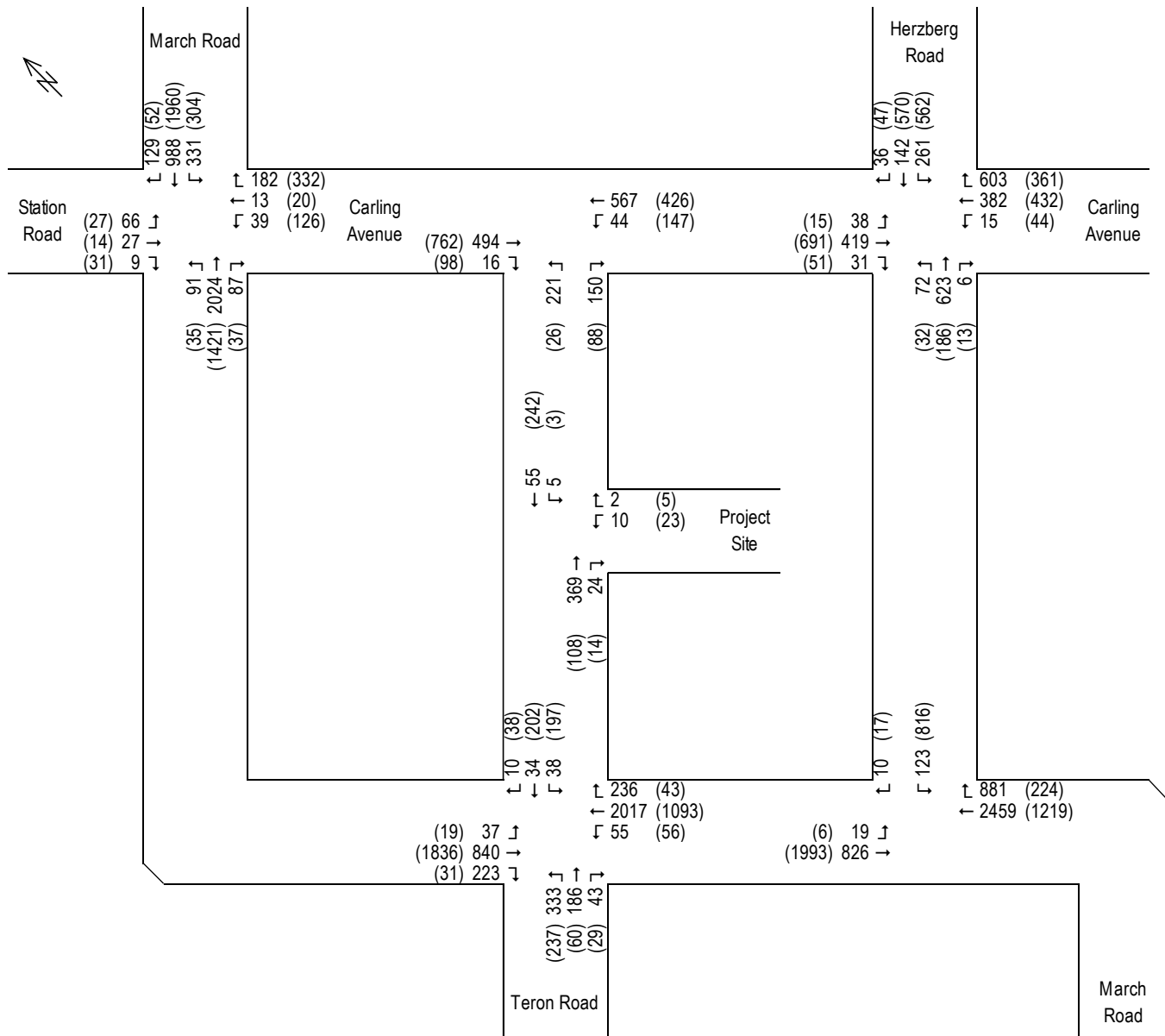

Figure 11: 2025 Total Projected Turning Movement Volumes, AM (PM) Peak Hour

The anticipated auto trip generation by the proposed development is considered very low and unlikely to significantly affect existing traffic operations. The planned BRT on March Road will undoubtedly increase the public transportation’s modal share. However, it may not be completed before 2025, and therefore no adjustment to the anticipated modal distribution has been made to reflect its addition to the transportation network.

As indicated in **Section 4.9.2** of this report, the road network is currently experiencing congestion. Nevertheless, it is reasonable to expect that many of the future employees will still opt to drive to work. While the City clearly aims to increase non-auto mode shares as stated in their 2031 Transportation Master Plan, the modal distribution presented in **Table 7** is considered reasonable.

4 Analysis

4.1 Development Design

4.1.1 Design for Sustainable Modes

A review of the Transportation Demand Management (TDM) – Supportive Development Design and Infrastructure Checklist has been conducted. A copy of the checklist is included in **Appendix G**.

4.1.1.1 Pedestrians

The proposed development includes a sidewalk along the access to the parking lot and along the front of the building. Walking paths will surround the proposed parking lot for the benefit of drivers.

4.1.1.2 Bicycles

Bicycle spaces will be provided along the building for the occasional cyclist. Access is not expected to be an issue for cyclists as the operating speed on the parking lot access will be low.

4.1.1.3 Transit

The proposed development is located within 600 m of the nearest transit service. Frequent service is provided on March Road by Rapid bus Route 63 and local bus Route 64 during working hours and express service is provided by Connexion Route 266 during peak hours. Therefore, no mitigation measure is recommended with respect to public transportation.

4.1.1.4 Autos

All the parking stalls will be located along the west side of the building (the street side is facing north) and will be surrounded by clearly identified walkways, allowing drivers to safely travel between their cars and the building. Accessible parking stalls will be provided near the building entrances, complete with recessed curbs.

4.1.2 Circulation and Access

Based on the site plan, the loading bays are expected to be used by WB-19 tractor trailers. **Figures 12 and 13** present a swept path analysis using a WB-19 tractor trailer template as a design vehicle. As shown, access to and from the loading bays is not expected to be an issue, nor is access to and from Teron Road. However, a minimum corner radius of 12 m must be provided at Teron Road to ensure that the design vehicle does not overlap the edge of pavement.

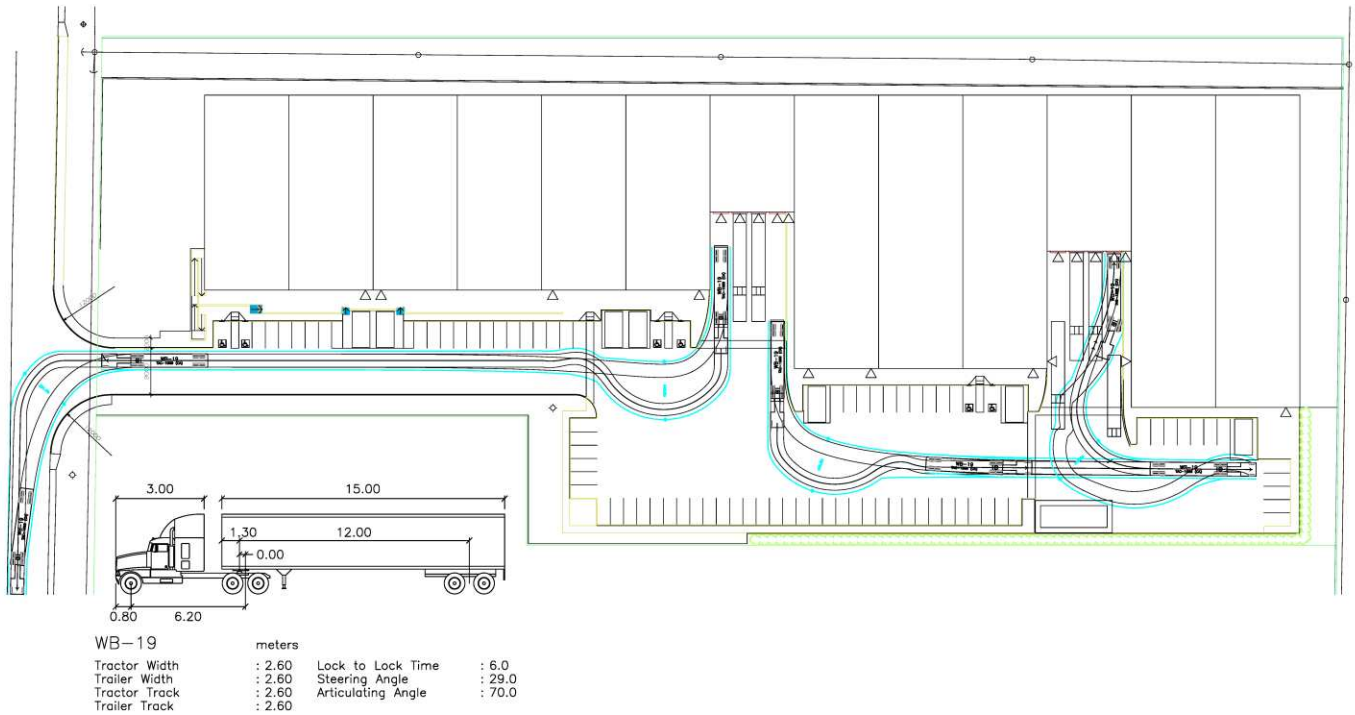

Figure 12: Swept Path Analysis – WB-19 Trucks Accessing Loading Bays and Leaving the Site

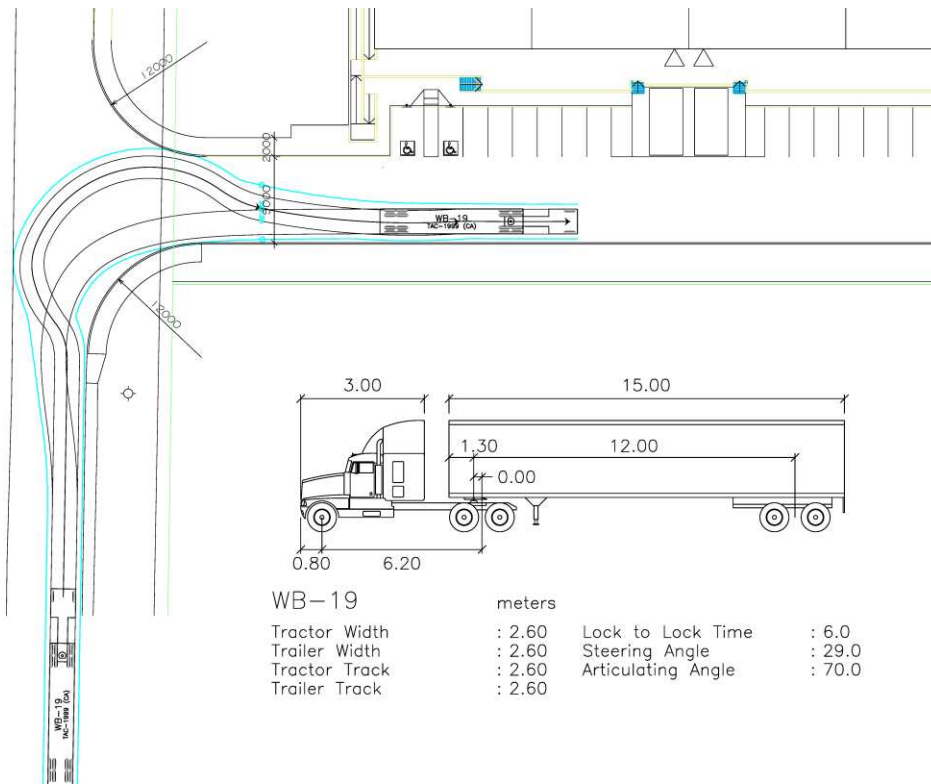

Figure 13: Swept Path Analysis – WB-19 Trucks Entering the Site

4.1.3 New Street Networks

[Exempt.]

4.2 Parking

4.2.1 Parking Supply

The proposed parking lot will contain 90 parking stalls, which exceeds the Zoning By-law requirement (0.8 stall per 100 m² of gross floor area, or a total of 75 stalls) and the anticipated number of employees (up to 75).

Three (3) Type 'A' and 3 Type 'B' accessible parking spaces will be provided, consistent with the City's Accessibility Design Standards.

Ten (10) bicycle parking spaces will be provided, exceeding the Zoning By-law requirement (1 space per 2,000 m² of gross floor area, or a total of 5 stalls).

4.2.2 Spillover Parking

[Exempt.]

4.3 Boundary Street Design

The 2015 Multi-Modal Level of Service (MMLOS) Guidelines and its 2017 Addendum were used to evaluate the levels of service on Teron Road for each mode of transportation. Schedule B of the City's Official Plan identifies the project site as being within the Urban Employment Area. Exhibit 22 of the MMLOS Guidelines is used to determine the target LOS of each non-auto mode; these targets are presented in **Table 8**.

Table 8: Target Level of Services for Road Segment

Pedestrian LOS	Bicycle LOS	Transit LOS	Truck LOS
C	No Target	No Target	E

Because the proposed development is located on a local street that is not part of a bicycle route and is not served by transit, no target is provided for these two modes of transportation.

The operating speed of the boundary street is assumed as 10 km/h above the posted speed limit or, in this case, 60 km/h.

According to the 2017 Addendum, the "Average Daily Curb Lane Traffic Volume" (ADCLTV) is used as a traffic criterion for the pedestrian LOS analysis. The ADCLTV in this case is assumed as 10 times the average peak hour volume in the direction adjacent to the pedestrian facility. For this calculation, heavy vehicles are accounted for using a passenger car equivalent of 2.0. According to the 2025 total projected

turning movement volumes (**Figure 11**), the ADCLTV within the 2025 horizon on Teron Road in the northbound direction is expected to vary from 2,400 to 3,000 vehicles per day.

4.3.1 Pedestrian Level of Service (PLOS)

For the proposed development, the City of Ottawa requested that the existing gravel shoulder be upgraded to a paved shoulder along the site frontage. The results of the segment PLOS analysis are summarized in **Table 9**.

Table 9: Pedestrian Level of Service on Teron Road

Parameter	Existing	Proposed
Sidewalk width	No sidewalk, gravel shoulder	1.3 m paved shoulder
Boulevard width	n/a	n/a
Average Daily Curb Lane Traffic Volume (ADCLTV)	≤ 3,000 veh/d	
Presence of on-street parking	No	
Operating speed	60 km/h	
Pedestrian level of service	F	F

The absence of a pedestrian facility combined with a moderately high operating speed automatically yields a PLOS F.

The MMLOS Guidelines recognize that a paved shoulder may be an appropriate pedestrian facility in certain cases but recommend that the resulting PLOS be adjusted down one grade to acknowledge its lower safety and lesser convenience compared to a sidewalk.

It is noted that a paved shoulder would yield a PLOS F if less than 1.8 m wide, regardless of the other parameters. At 1.8 m or wider, a paved shoulder would yield a PLOS D if the operational speed is maintained at 60 km/h and PLOS C if the operational speed is reduced to 50 km/h (i.e. posted speed limit of 40 km/h).

A sidewalk of the same width would yield a PLOS C and a PLOS B respectively. However, the City has noted that a sidewalk along the site frontage would cause an issue with drainage, and therefore this solution has not been carried forward.

Although no bicycle LOS target is defined, a paved shoulder would improve cycling access to the site.

4.3.2 Truck Level of Service (TkLOS)

The results of the segment TkLOS analysis are summarized in **Table 10**.

Table 10: Truck Level of Service on Teron Road

Parameter	Value
Curb lane width	> 3.7 m
Number of travel lanes	1 per direction
Truck level of service	B

The target TkLOS is met in this case.

4.3.3 Road Safety

As noted in **Section 2.1.2.5**, no discernable collision pattern is evident that would indicate a deficiency on Teron Road. Therefore, no measures are required to address road safety.

4.4 Access Intersection Design

The access to the proposed development consists of a full movement, 3-way intersection on Teron Road. The proposed driveway is 9 m wide with a clear throat length of 19 m. However, the driveway width at the property line is 10 m, which exceeds the standard 9 m width. This is to accommodate the 12 m corner radii that are required to ensure that tractor-trailers can access the site, as discussed in **Section 4.1.2**.

The proposed driveway is located at approximately 40 m east of Brewer Hunt Way. There are 2 existing driveways east of the project site, one at 1260 Teron Road on the north side at a distance of 40 m, and one at 1283-1285 Teron Road on the south side at a distance of 60 m.

Based on MTO's left-turn lane warrant methodology, it was determined that a left-turn lane was clearly not warranted on Teron Road, as illustrated in **Figure 14**.

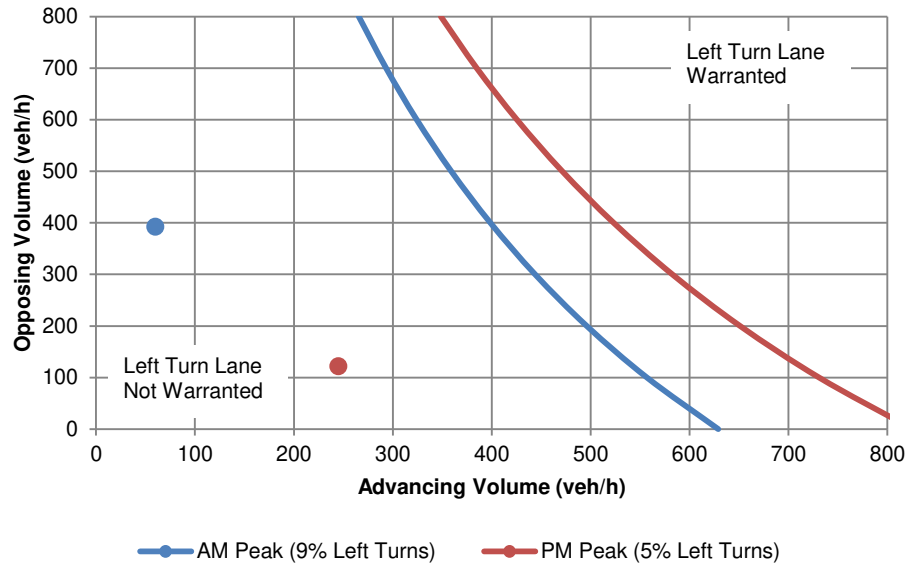

Figure 14: Left-Turn Lane Warrant Chart – Proposed Access on Teron Road, 2025 Total Traffic

A traffic capacity analysis has been performed using the analytical software tool Synchro. The results of the analysis for the 2025 horizon year with the access in place are presented in **Table 11**.

Table 11: Auto Levels of Service at the Proposed Site Access

Intersection	Impeded Movement	Morning Peak Hour				Afternoon Peak Hour			
		V/C	Delay (s)	LOS	95th Queue (m)	V/C	Delay (s)	LOS	95th Queue (m)
Teron Road / site access	WBL/R	0.02	12	B	0	0.05	11	B	1
	SBL/T	0.00	1	A	0	0.00	0	A	0
	Overall	B				B			

The traffic analysis of the proposed site access indicates that the new access will operate satisfactorily 5 years after build-out.

4.5 Transportation Demand Management (TDM)

The proposed development is located in a low-density industrial area which is appropriate for a warehouse but not typically conducive to a high modal share for active transportation, transit or carpooling. On the other hand, it is located near a residential community (Beaverbrook) and to a future rapid transit station. Additionally, occupants of the proposed development may also be encouraged to move to Kanata North to reduce their commuting distance.

As mentioned above, the road network is currently operating near or above capacity. While the proposed development is not expected to have a significant impact on traffic, it is important that the occupants be aware of the different available travel options, including cycling, public transit and carpooling, so to limit the impact on traffic delays.

Among the different TDM strategies suggested by the City of Ottawa, the following are recommended:

- Designate a TDM coordinator (role can be added to an existing position in parking, real estate, human resources or environmental management);
- Display local area maps with walking/cycling access routes and key destinations at the main entrances;
- Display relevant transit schedules and route maps at the main entrances;
- Provide online links to OC Transpo information;
- Provide a dedicated ride-matching portal at OttawaRideMatch.com; and
- Encourage flexible work hours.

A copy of the TDM checklist is provided in **Appendix G**.

4.6 Neighbourhood Traffic Management

[Exempt.]

4.7 Transit

Based on the trip generation estimates presented in **Section 3.1.1**, the proposed development is anticipated to generate 7 transit trips during both the morning and the afternoon peak hours. This transit review applies the trip distribution assumptions described in **Section 3.1.2**. The transit trips generated by the proposed development are therefore distributed as follows:

Morning peak hour:

- Stop #0858 (March/Teron northbound): 3 passengers alighting Route 63 or 64;
- Stop #1600 (March/Teron southbound): 2 passengers boarding and 1 alighting Route 63, 64 or 266;
and
- Stop #7980 (Teron/Steacie northbound): 1 passenger boarding Route 166.

Afternoon peak hour:

- Stop #0858 (March/Teron northbound): 1 passenger boarding and 2 alighting Route 63, 64 or 266;
- Stop #1600 (March/Teron southbound): 3 passengers boarding Route 63 or 64; and
- Stop #0868 (Teron/Steacie southbound): 1 passenger boarding Route 166.

Based on the projected passenger volumes, no capacity problems are anticipated on the bus routes or at the bus stops listed above.

4.8 Review of Network Concept

[Exempt.]

4.9 Intersection Design

4.9.1 Intersection Control

All intersections within the study area are already signalized and provided with exclusive turning lanes, except the intersection at Carling Avenue / Teron Road.

4.9.1.1 Carling Avenue / Teron Road

Several issues are observed with the intersection at Carling Avenue / Teron Road:

- Observed queuing on Teron Road (Stop-controlled approach);
- No left-turn lane on Carling Avenue;
- Railway crossing on Teron Road adjacent to Carling Avenue; and
- Acute intersection skew angle (45°).

Based on MTO's left-turn lane warrant methodology, it has been determined that a left-turn lane is warranted on Carling Avenue, as illustrated in **Figure 15**. This warrant is met **without** the proposed development in place.

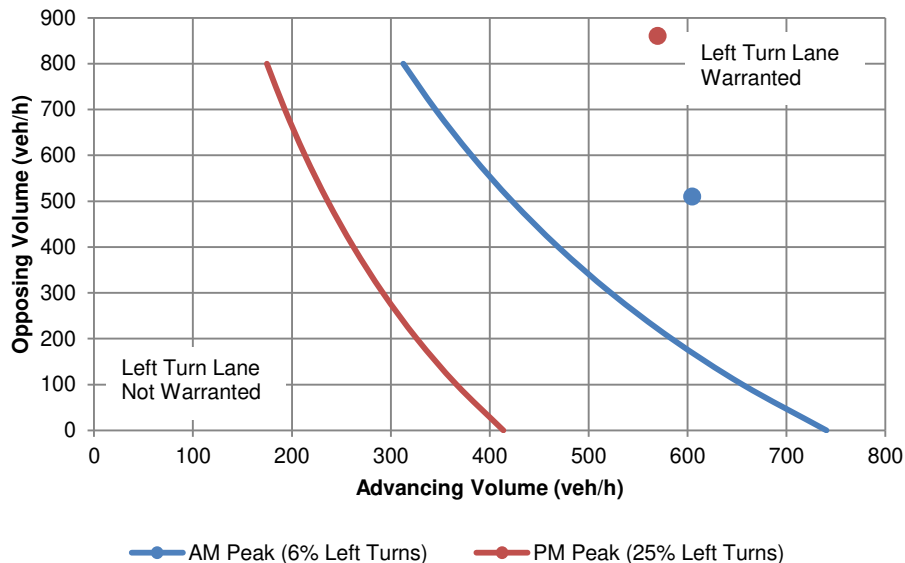

Figure 15: Left-Turn Lane Warrant Chart – Carling Avenue Westbound at Teron Road, 2025 Background Traffic

A traffic signal warrant analysis was performed based on the Ontario Traffic Manual (OTM) Book 12's Justification 7 methodology. The analysis, provided in **Appendix H**, indicates that traffic signals are not warranted at this location within the 2025 horizon with or without the proposed development in place.

Some of the observed design issues at this intersection could be mitigated by the City in several ways without encouraging non-local traffic, including conversion to a right-in/right-out access, conversion to a cul-de-sac (i.e. road closure, at least for autos) or roadway realignment.

4.9.2 Intersection Design

The MMLOS Guidelines were used to evaluate the levels of service of all the intersections within the study area for each mode of transportation. Schedule B of the City’s Official Plan identifies the study area as being within the Urban Employment Area. Exhibit 22 of the MMLOS Guidelines was used to determine the target LOS for each mode of transportation, based on the road class and relevant designations, as presented in **Table 12**. The target levels of service used for analysis are presented in **Table 13**.

Table 12: Existing or Planned Road Classes and Designations for each Transportation Mode

Roadway	Road	Bicycle	Transit	Truck
March Road	Arterial	Spine Route	Rapid Transit Corridor	Truck Route
Carling Avenue	Arterial	Spine Route	N/A	Truck Route
Herzberg Road	Collector	Spine Route	N/A	Truck Route

Table 13: Target LOS for each Transportation Mode

Roadway	Pedestrian LOS	Bicycle LOS	Transit LOS	Truck LOS	Auto LOS
March Road	C	C	B	B	D
Carling Avenue	C	C	No target	B	D
Herzberg Road	C	C	No target	B	D

4.9.2.1 Pedestrian Level of Service (PLOS)

The PLOS analysis is based on the PETS I scoring system as presented in Exhibit 5 of the MMLOS Guidelines. The results of the signalized intersection PLOS analysis are summarized in **Table 14**.

Table 14: Pedestrian Levels of Service at Signalized Intersections

	Category	Parameter	East Approach	West Approach	North Approach	South Approach
March Road / Herzberg Road	Crossing Conditions	Total travel lanes crossed	6	N/A	3	N/A
		Median (> 2.4 m)	No		No	
	Signal Features	Left turn conflict	Protected		Protected	
		Right turn conflict	No		Yield	
		Right turn on red	No		No	
		Leading pedestrian interval	No		No	
	Corner Radius		–		Smart channel	
	Crosswalk Treatment		Standard		Standard	
	Pedestrian Score (LOS)		42 (E)		89 (B)	
Intersection PLOS			E			
March Road / Teron Road	Crossing Conditions	Total travel lanes crossed	6	6	3	3
		Median (> 2.4 m)	No	No	No	No
	Signal Features	Left turn conflict	Protected	Protected	Prot/Perm	Prot/Perm
		Right turn conflict	Yield	Yield	Yield	Yield
		Right turn on red	No	No	No	No
		Leading pedestrian interval	No	No	No	No
	Corner Radius		Channel with receiving lane			
	Crosswalk Treatment		Standard			
Pedestrian Score (LOS)		76 (B)	76 (B)	34 (E)	34 (E)	
Intersection PLOS			E			
March Road / Carling Avenue / Station Road	Crossing Conditions	Total travel lanes crossed	4	2	7	7
		Median (> 2.4 m)	No	No	No	No
	Signal Features	Left turn conflict	Permissive	Permissive	Protected	Protected
		Right turn conflict	Yield	Yield	Permissive	Yield
		Right turn on red	No	No	Yes	No
		Leading pedestrian interval	No	No	No	No
	Corner Radius		Channel with receiving lane	Channel with receiving lane	15 to 25 m	Channel with receiving lane
	Crosswalk Treatment		Standard			
Pedestrian Score (LOS)		59 (D)	91 (A)	10 (F)	22 (F)	
Intersection PLOS			F			

Table 14: Pedestrian Levels of Service at Signalized Intersections (continued)

	Category	Parameter	East Approach	West Approach	North Approach	South Approach
Carling Avenue / Herzberg Road	Crossing Conditions	Total travel lanes crossed	4	3	3	2
		Median (> 2.4 m)	No	No	No	No
	Signal Features	Left turn conflict	Prot/Perm	Permissive	Prot/Perm	Permissive
		Right turn conflict	Permissive	Permissive	Permissive	Permissive
		Right turn on red	Yes	Yes	Yes	No
		Leading pedestrian interval	No	No	No	No
	Corner Radius		15 to 25 m	15 to 25 m	15 to 25 m	15 to 25 m
	Crosswalk Treatment		Standard			
	Pedestrian Score (LOS)		51 (D)	68 (C)	68 (C)	86 (B)
	Intersection PLOS		D			

The PLOS analysis indicates that none of the signalized intersections within the study area currently meet target PLOS C. This is mainly due to the high number of lanes that pedestrians need to cross to get to the other side of the roadway, especially on March Road where pedestrians need to cross up to 7 lanes.

This could be partially mitigated by converting existing channelization islands into smaller “smart channels” with yield control, which encourage drivers to slow down, instead of acceleration lanes, which encourage hasty departures. The implementation of fully-protected left-turn signals would also increase the PLOS as well as the overall intersection safety for drivers as it reduces the risks of angle collisions, although it is noted that this measure also tends to reduce the left-turn movement capacity.

4.9.2.2 Bicycle Level of Service (BLOS)

The results of the signalized intersection BLOS analysis are summarized in **Table 15**.

Table 15: Bicycle Levels of Service at Signalized Intersections

	Parameter	East Approach	West Approach	North Approach	South Approach	
March Road / Herzberg Road	Type of bikeway	Bike lane	Bike lane	Cycle track	MUP	
	Bike Through vs Right Turn Traffic	Right-turn storage lane	–	–	–	–
		Right-turn speed	–	–	–	–
		Type of right turn	–	–	–	–
	Through BLOS		A	A	A	A
	Bike Left Turn vs Through Traffic	Two-stage area?	Yes	Yes	Yes	Yes
		Required lane changes	–	–	–	–
		Through speed	–	–	–	–
		Dual left turn?	–	–	–	–
	Left-Turn BLOS		A	A	A	A
Intersection BLOS		A				
March Road / Teron Road	Type of bikeway	Pocket lane	Pocket lane	Mixed	Mixed	
	Bike Through vs Right Turn Traffic	Right-turn storage lane	> 50 m	> 50 m	> 50 m	> 50 m
		Right-turn speed	≤ 30 km/h	≤ 30 km/h	≤ 25 km/h	≤ 25 km/h
		Type of right turn	Single	Single	Single	Single
	Through BLOS		D	D	F	F
	Bike Left Turn vs Through Traffic	Two-stage area?	No	No	No	No
		Required lane changes	2	2	1	1
		Through speed	90 km/h	90 km/h	60 km/h	60 km/h
		Dual left turn?	No	No	No	No
	Left-Turn BLOS		F	F	F	F
Intersection BLOS		F				

Table 15: Bicycle Levels of Service at Signalized Intersections (continued)

	Parameter	East Approach	West Approach	North Approach	South Approach	
March Road / Carling Avenue / Station Road	Type of bikeway	Pocket lane	Mixed	Pocket lane	Pocket lane	
	Bike Through vs Right Turn Traffic	Right-turn storage lane	> 50 m	≤ 50 m	≤ 50 m	> 50 m
		Right-turn speed	≤ 30 km/h	≤ 25 km/h	≤ 25 km/h	≤ 30 km/h
		Type of right turn	Single	Single	Single	Single
	Through BLOS	D	D	B	D	
	Bike Left Turn vs Through Traffic	Two-stage area?	No	No	No	No
		Required lane changes	0	0	2	2
		Through speed	60 km/h	60 km/h	90 km/h	90 km/h
		Dual left turn?	No	No	Yes	No
	Left-Turn BLOS	C	D	F	F	
Intersection BLOS		F				
Carling Avenue / Herzberg Road	Type of bikeway	Pocket lane	Bike lane	Bike lane	Bike lane	
	Bike Through vs Right Turn Traffic	Right-turn storage lane	> 50 m	–	–	–
		Right-turn speed	≤ 30 km/h	≤ 25 km/h	≤ 25 km/h	≤ 25 km/h
		Type of right turn	Single	Shared	Shared	Shared
	Through BLOS	D	A	A	A	
	Bike Left Turn vs Through Traffic	Two-stage area?	No	No	No	No
		Required lane changes	1	1	1	0
		Through speed	70 km/h	70 km/h	60 km/h	60 km/h
Dual left turn?		No	No	No	No	
Left-Turn BLOS	E	E	E	C		
Intersection BLOS		E				

The BLOS analysis indicates that March Road / Herzberg Road is the only the signalized intersection within the study area that satisfies the target BLOS. This intersection has been recently reconfigured as a “protected intersection”, including fully segregated bicycle lanes. The benefits of such design are:

- No weaving between through cyclists and right-turning drivers – cyclists remain to the right and cross the right-turn movement’s path where right-turning drivers are moving slowly; and
- Dedicated areas where cyclists can safely wait for signals to perform a 2-stage left-turn instead of weaving through fast-moving traffic to use the left-turn lane.

The poor BLOS at the other locations are mainly attributed to pocket lanes, which result in cyclists riding between two fast-moving auto lanes over a certain distance, and to the lack of an adequate space to perform a 2-stage left turn.

4.9.2.3 Transit Level of Service (TLOS)

The results of the signalized intersection TLOS analysis are summarized in **Table 16**. The turning movements in the table are those performed by buses on the existing bus routes.

Table 16: Transit Levels of Service at Signalized Intersections

Intersection	Turning Movement	Average Delay (s) ¹		TLOS	Intersection TLOS
		Morning Peak Hour	Afternoon Peak Hour		
March Road / Herzberg Road	Eastbound left turn	88	86	F	F
	Southbound right turn	26	19	D	
March Road / Teron Road	Eastbound right turn	4	0	B	F
	Westbound left turn	66	62	F	
	Northbound left turn	186	154	F	
	Northbound right turn	1	1	B	
March Road / Carling Avenue / Station Road	Westbound left turn	–	73	F	F
	Northbound through	–	31	E	
	Northbound right turn	5	–	B	
	Southbound through	16	–	C	

¹Based on **Table 18**.

The implementation of the planned BRT on March Road will significantly improve the efficiency of the bus service. It could also be an opportunity for the City to rebuild the intersections on March Road as protected intersections (leading to BLOS A) with island refuges for pedestrians (better PLOS).

4.9.2.4 Truck Level of Service (TkLOS)

The results of the signalized intersection TLOS analysis are summarized in **Table 17**.

Table 17: Truck Levels of Service at Signalized Intersections

Intersection	Approach	Turning Radius (m)	Number of Receiving Lanes	Approach TkLOS	Intersection TkLOS
March Road / Herzberg Road	Westbound	> 15 m	1	C	C
	Southbound	10 to 15 m	2	B	
March Road / Teron Road	Eastbound	> 15 m	2	A	A
	Westbound	> 15 m	2	A	
	Northbound	> 15 m	3	A	
	Southbound	> 15 m	3	A	
March Road / Carling Avenue	Eastbound	> 15 m	3	A	C
	Westbound	> 15 m	3	A	
	Northbound	> 15 m	2	A	
	Southbound	> 15 m	1	C	
Carling Avenue / Herzberg Road	Eastbound	> 15 m	1	C	C
	Westbound	> 15 m	1	C	
	Northbound	> 15 m	1	C	
	Southbound	> 15 m	1	C	

The intersection at March Road / Teron Road exceeds the target TkLOS B while the other signalized intersections do not. However, this is simply due to the TkLOS methodology which requires 2 receiving lanes in order to yield a TkLOS B or A. It is noted that at locations with a TkLOS C, the wide corner radii facilitate the movement of large trucks. It is assumed that all truck trips to and from the proposed development will travel along March Road and Highway 417. For these trips, March Road provides a TkLOS A.

4.9.2.5 Auto Level of Service

A traffic capacity analysis was performed using Synchro. The existing intersection configuration and signal settings were assumed and the timing at each location was optimized for capacity. Three measures of effectiveness are used for comparison: the volume-to-capacity ratio (V/C), the average delay in seconds and the 95th percentile queue length in metres.

Consistent with the MMLOS Guidelines, the auto LOS at signalized intersections is based on the V/C ratio. LOS A is attributed to a V/C ratio of 0.60 or less while LOS F is attributed to a V/C ratio of more than 1.00 (i.e. above capacity).

The auto LOS at unsignalized intersections is based on the average delay. LOS A is attributed to a delay of 10 seconds or less while LOS F is attributed to a delay of more than 50 seconds.

The results of the signalized intersection TLOS analysis are summarized in **Table 18** for signalized intersections and **Table 19** for the unsignalized intersection at Carling Avenue / Teron Road. By default,

the values presented in these tables represent 2025 traffic conditions with **and** without the proposed development. Where there is a difference, the values within brackets represent the 2025 traffic conditions with the proposed development.

Table 18: Auto Levels of Service at Signalized Intersections

Intersection	Turning Movement	Morning Peak Hour				Afternoon Peak Hour			
		V/C	LOS	Delay (s)	95th Queue (m)	V/C	LOS	Delay (s)	95th Queue (m)
March Road / Herzberg Road	EBL	0.23	A	88 [91]	8	0.10	A	86 [85]	1
	EBT	0.23	A	3 [2]	1	0.75 [0.76]	C	4 [5]	18 [23]
	WBT	1.06 [1.07]	F	54 [57]	#368 [#371]	0.68 [0.69]	B	23	144 [146]
	WBR	0.77	C	10	117	0.25	A	4	16
	SBL	0.47	A	62	21	0.87	D	53	103
	SBR	0.08	A	26	5	0.04	A	19	6
	Overall		1.06 [1.07]	F	35 [37]	–	0.87	D	19

95th percentile volume exceeds capacity; queue may be longer.

Table 18: Auto Levels of Service at Signalized Intersections (continued)

Intersection	Turning Movement	Morning Peak Hour				Afternoon Peak Hour			
		V/C	LOS	Delay (s)	95th Queue (m)	V/C	LOS	Delay (s)	95th Queue (m)
March Road / Teron Road	EBL	0.34 [0.36]	A	66	16	0.24 [0.25]	A	66 [67]	11
	EBT	0.51 [0.54]	A	23 [25]	94	1.19	F	124	#296
	EBR	0.26 [0.27]	A	4	12	0.04	A	0	0
	WBL	0.44 [0.45]	A	66	11	0.54 [0.55]	A	62 [63]	#31
	WBT	1.13 [1.19]	F	77 [105]	#297	0.60 [0.62]	A [B]	22 [25]	152
	WBR	0.26 [0.29]	A	3 [4]	10 [11]	0.04 [0.05]	A	1	0
	NBL	1.27 [1.17]	F	186 [144]	#90 [#83]	1.17	F	154 [153]	#82
	NBT	0.72 [0.71]	C	66 [65]	56 [57]	0.23	A	47	20 [21]
	NBR	0.14 [0.13]	A	1	0	0.09	A	1	0
	SBL	0.18 [0.19]	A	38 [35]	11	0.64 [0.69]	B	51 [54]	46 [51]
	SBT	0.19	A	54	14	0.75	C	67	60
	SBR	0.04	A	0	0	0.11	A	1	0
		Overall	1.27 [1.19]	F	65 [75]	-	1.19	F	84 [85]

95th percentile volume exceeds capacity; queue may be longer.

Table 18: Auto Levels of Service at Signalized Intersections (continued)

Intersection	Turning Movement	Morning Peak Hour				Afternoon Peak Hour			
		V/C	LOS	Delay (s)	95th Queue (m)	V/C	LOS	Delay (s)	95th Queue (m)
March Road / Carling Avenue / Station Road	EBL/T	0.64	B	72	33	0.21	A	47	15
	EBR	0.04	A	0	0	0.09	A	1	0
	WBL/T	0.42	A	61	21	0.76	C	73	47
	WBR	0.13	A	0	0	0.24	A	0	0
	NBL	0.59	B	70	33	0.40	A	72	#19
	NBT	1.23	F	138 [139]	#326	0.84 [0.85]	D	31	#178 [#179]
	NBR	0.12	A	5	8	0.05	A	0	0
	SBL	0.59	A	54	49	0.76	C	66	#55
	SBT	0.51 [0.52]	A	16	92	0.99	E	41	#293
	SBR	0.15	A	6	14	0.06	A	1	3
	Overall	1.23	F	83	-	0.99	E	37	-
Carling Avenue / Herzberg Road	EBL	0.24	A	36	14	0.06 [0.07]	A	24	5 [6]
	EBT/R	0.84	D	54	#134	1.09	F	95 [97]	#242 [#244]
	WBL	0.14	A	34	7	0.87	D	129	#29
	WBT	0.70	B	45	102	0.63	B	34	102
	WBR	1.00	E	61	#157	0.46	A	4	15
	NBL/T/R	0.99	E	65	#217	1.00	E	110	#94
	SBL	0.88	D	48	#58	1.10	F	98	#172
	SBT/R	0.20	A	13	26	0.79	C	37	152
	Overall	1.00	E	54	-	1.10	F	65 [66]	-

95th percentile volume exceeds capacity; queue may be longer.

Table 19: Auto Levels of Service at a Stop-Controlled Intersection

Intersection	Impeded Movement	Morning Peak Hour				Afternoon Peak Hour			
		V/C	Delay (s)	LOS	95th Queue (m)	V/C	Delay (s)	LOS	95th Queue (m)
Carling Avenue / Teron Road	WBL/T	0.04	1	A	1	0.21 [0.22]	5	A	5
	NBL/R	1.78	>5 min	F	164	0.65 [0.67]	55 [57]	F	22 [24]
	Overall	F				F			

The results above indicate that all the intersections operate near or above capacity during both peak hours with generally long average delays.

The traditional approach of increasing the auto capacity by adding more lanes will deteriorate the level of service of the active modes of transportation and is known to encourage traffic growth associated with induced demand and urban sprawl. Instead, the provision of a rapid bus service, as planned in the Transportation Master Plan will more efficiently increase the **people** capacity of the March Road corridor and provide commuters with a way to avoid car congestion.

The results also indicate that the proposed development will have a minor impact on the traffic operations, as delays and queues will increase slightly for certain turning movements, but will not, in itself, trigger any requirement for mitigation.

Conclusion

The proposed development consists of a 9,281 m² industrial building located at 1243 Teron Road in Kanata. The project site will be accessed by a single full-access driveway on Teron Road. The building is expected to serve as a warehouse with some office use. The estimated year of occupancy is 2020.

The project site is located in a General Industrial Zone, IG6 Subzone. At this location, Teron Road is classified as a local street but connects to March Road and to Carling Avenue, both classified as arterial roadways and truck routes, although the latter has a load restriction. March Road represents a direct route to Highway 417 to the south. The development is consistent with the industrial character of the neighbourhood and will reinforce the function of Teron Road as a “local street”.

According to the developer, there will be an average of 2 truck deliveries per day and a maximum of 5 truck deliveries per day. The loading bays are designed to be used by WB-19 tractor-trailers. A swept path analysis shows that the design vehicle (WB-19 truck) will be capable of accessing all loading bays. The design vehicle will also be able to enter and exit the project site provided that the corner radii at the entrance are at least 12.0 m. As a consequence, the driveway width at the property line is 10.0 m, which is slightly larger than the standard 9.0 m.

The boundary street (Teron Road) meets the target level of service for trucks. A paved shoulder is required by the City of Ottawa along the frontage to improve pedestrian access to the site.

The parking lot included in the project site will provide more car and bicycle parking spaces than required by the Zoning By-law, i.e. 90 car spaces instead of 75 and 10 bicycle spaces instead of 5. The project site will also include 6 accessible parking spaces, consistent with the City’s Accessibility Design Standards.

The developer has indicated that the proposed development will have up to 75 employees. For the purpose of this study, the origin-destination and the modal distribution of the trips generated by the development were assumed to be consistent with the current distribution in the Kanata-Stittsville area.

The multi-modal transportation analysis of the intersections in the study area indicates that the level of service is currently poor for all modes of transportation, with the exception of delivery trucks. The auto trips generated by the development will contribute to the capacity issues currently experienced at the signalized intersections within the study area, but will not trigger any requirement for traffic-related mitigation.

On the other hand, the development is located near a residential community (Beaverbrook) and bus stops with frequent bus services. Additionally, occupants of the proposed development may also be encouraged to move to Kanata North to reduce their commuting distance. Finally, the construction of the planned rapid bus service along March Road has the potential of encouraging potential drivers to commute by transit instead.

Recommendations

For the purpose of the proposed development, the following features are recommended:

- Pave the existing gravel shoulder along the frontage of the project site to improve pedestrian and cycling access; and
- Design the access on Teron Road with 12 m corner radii to facilitate the circulation of WB-19 tractor trailers.

Both recommended features are shown on the site plan in **Appendix B**.

Among the different transportation demand management strategies suggested by the City of Ottawa, the following are recommended:

- Designate a TDM coordinator (role can be added to an existing position in parking, real estate, human resources or environmental management);
- Display local area maps with walking/cycling access routes and key destinations at the main entrances;
- Display relevant transit schedules and route maps at the main entrances;
- Provide online links to OC Transpo information;
- Provide a dedicated ride-matching portal at OttawaRideMatch.com; and
- Encourage flexible work hours.

A copy of the TDM checklist is provided in **Appendix G**.

Appendix A

TIA Certification



TIA Plan Reports

On 14 June 2017, the Council of the City of Ottawa adopted new Transportation Impact Assessment (TIA) Guidelines. In adopting the guidelines, Council established a requirement for those preparing and delivering transportation impact assessments and reports to sign a letter of certification.

Individuals submitting TIA reports will be responsible for all aspects of development-related transportation assessment and reporting, and undertaking such work, in accordance and compliance with the City of Ottawa's Official Plan, the Transportation Master Plan and the Transportation Impact Assessment (2017) Guidelines.

By submitting the attached TIA report (and any associated documents) and signing this document, the individual acknowledges that s/he meets the four criteria listed below.

CERTIFICATION

1. I have reviewed and have a sound understanding of the objectives, needs and requirements of the City of Ottawa's Official Plan, Transportation Master Plan and the Transportation Impact Assessment (2017) Guidelines;
2. I have a sound knowledge of industry standard practice with respect to the preparation of transportation impact assessment reports, including multi modal level of service review;
3. I have substantial experience (more than 5 years) in undertaking and delivering transportation impact studies (analysis, reporting and geometric design) with strong background knowledge in transportation planning, engineering or traffic operations; and
4. I am either a licensed¹ or registered² professional in good standing, whose field of expertise [check appropriate field(s)] is either transportation engineering or transportation planning .

1,2 License of registration body that oversees the profession is required to have a code of conduct and ethics guidelines that will ensure appropriate conduct and representation for transportation planning and/or transportation engineering works.

City Of Ottawa
Infrastructure Services and Community
Sustainability
Planning and Growth Management
110 Laurier Avenue West, 4th fl.
Ottawa, ON K1P 1J1
Tel. : 613-580-2424
Fax: 613-560-6006

Ville d'Ottawa
Services d'infrastructure et Viabilité des
collectivités
Urbanisme et Gestion de la croissance
110, avenue Laurier Ouest
Ottawa (Ontario) K1P 1J1
Tél. : 613-580-2424
Télécopieur: 613-560-6006



Dated at Ottawa this 7th day of November, 2019.
(City)

Name: Daniel Riendeau
(Please Print)

Professional Title: Transportation Engineer

Signature of Individual certifier that s/he meets the above four criteria

Office Contact Information (Please Print)
Address: 100 Craig Henry Drive, Suite 201
City / Postal Code: Ottawa, ON K2G 5W3
Telephone / Extension: 613-228-4813
E-Mail Address: daniel.riendeau@bteng.ca



Appendix B

Site Plan

Project Zoning Review/Statistics
 Municipality: City of Ottawa
 Municipal Address: 1243 Teron Road
 Registered Owner: Megha Holdings Inc.
 Lot Area: 21,994 sq.m. (236,739 sq.ft.) (5.44 acres)
 Zoning Analysis: Ottawa
 Zoning By-law: 2008-250
 Zone: IG5 - General Industrial Zone
 Proposed Use: Warehouse

Building Areas	Gross (out-to-out)	
	Sq.m.	Sq.ft.
Proposed Warehouse	9,281	99,900
Proposed Development	9,281	99,900
Grand Total	9,281	99,900

Development Standards	Required	Provided
	Minimum Lot Area	4,000 sq.m.
Minimum Lot Width	45m	74.25m
Minimum Required Yard		
Front Yard (min.)	12m	20.2m
Corner Side Yard (min.)	12m	N/A
Interior Side Yard (min.)	7.5m	11.45m (not abutting residential zone)
Rear Yard (min.)	7.5m	7.65m (not abutting residential zone)
Maximum Building Height	22m	10m
Minimum Width of Landscaped Area		
Abutting a residential or institutional zone	3m	N/A
Abutting a street	3m	20.2m
Around a parking lot	1.5m	2.2m
All other cases	No min.	2.2m

Parking, Loading, Queuing	Area C Schedule 1A	
	Required	Provided
Parking Spaces (2.6m x 5.2m)		
Warehouse (0.8 spaces/100 sq.m.)	Required: 75	Provided: 90
Accessible Parking	Required: 3 (1 Type 'A' & 2 Type 'B')	Provided: 6 (3 Type 'A' & 3 Type 'B')
Bicycle Parking (0.6m x 1.8m) (Warehouse: 1/2000 sq.m.)	Required: 10 (Table 111A)	Provided: 10
Standard Loading Spaces (3.5m x 7m)	Required: 1 (Table 113A)	Provided: 7
Oversized Loading Spaces (4.3m x 13m)	Required: 1 (Table 113C)	Provided: 1

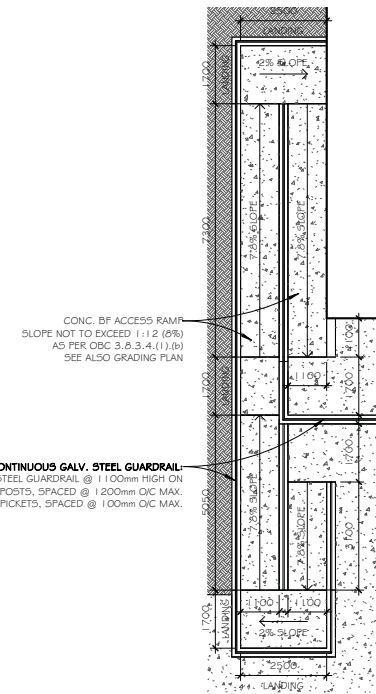

5 BF RAMP DETAIL
SCALE 1:100



1 LOCATION PLAN
SCALE N.T.S.

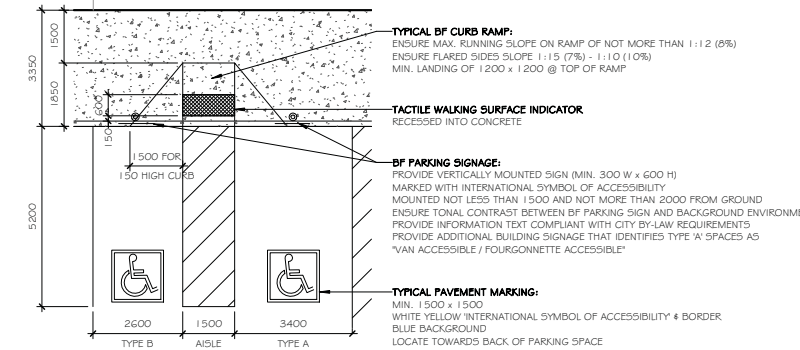

3 BF PARKING DETAIL
SCALE 1:100

ICON	DESCRIPTION
[Symbol]	Concrete
[Symbol]	Landscape Area
[Symbol]	Proposed Buildings
[Symbol]	Concrete Curb
[Symbol]	Depressed Curb
[Symbol]	Overhead Wires
[Symbol]	Property Lines
[Symbol]	Existing Fence
[Symbol]	Fence
[Symbol]	Signage
[Symbol]	BF Parking Space
[Symbol]	6m Wide Fire Route (12m centreline radius on all turns, TYP.)
[Symbol]	Principal Entrance Door
[Symbol]	Exterior Door ("OH" indicates Overhead Door)

SITE PLAN NOTES

Note #	Note Text
(E)FH	Existing Fire Hydrant
(E)GS	Existing Gravel Shoulder
(E)UP	Existing Utility Pole
AS	Paved Asphalt Shoulder, flush with road surface, to replace existing gravel shoulder. Width of asphalt to match width of existing gravel shoulder
BR	Bicycle Rack
CC	Concrete Curb
CR	Concrete Ramp
CRW	Concrete Retaining Wall
CS	Concrete Stair
CSW	Concrete Sidewalk; 2m wide, as per City Standard Details; See Civil
CW	Concrete Walkway
DC	Depressed Curb
FH	Fire Hydrant
GCD	Grooved Concrete Driveway
GSR	Galvanized Steel Guardrail
LZ	Loading Zone, Painted Lines
PB	Painted Bollard
RCW	Recessed Concrete Walkway

PLAN OF SURVEY OF PART OF LOT 5 CONCESSION 4 GEOGRAPHIC TOWNSHIP OF MARCH CITY OF OTTAWA
 PREPARED BY FARHALL, MOFFATT & WOODLAND LIMITED
 OTTAWA LAND SURVEYORS
 NOVEMBER 11, 2019

plot scale 1:1

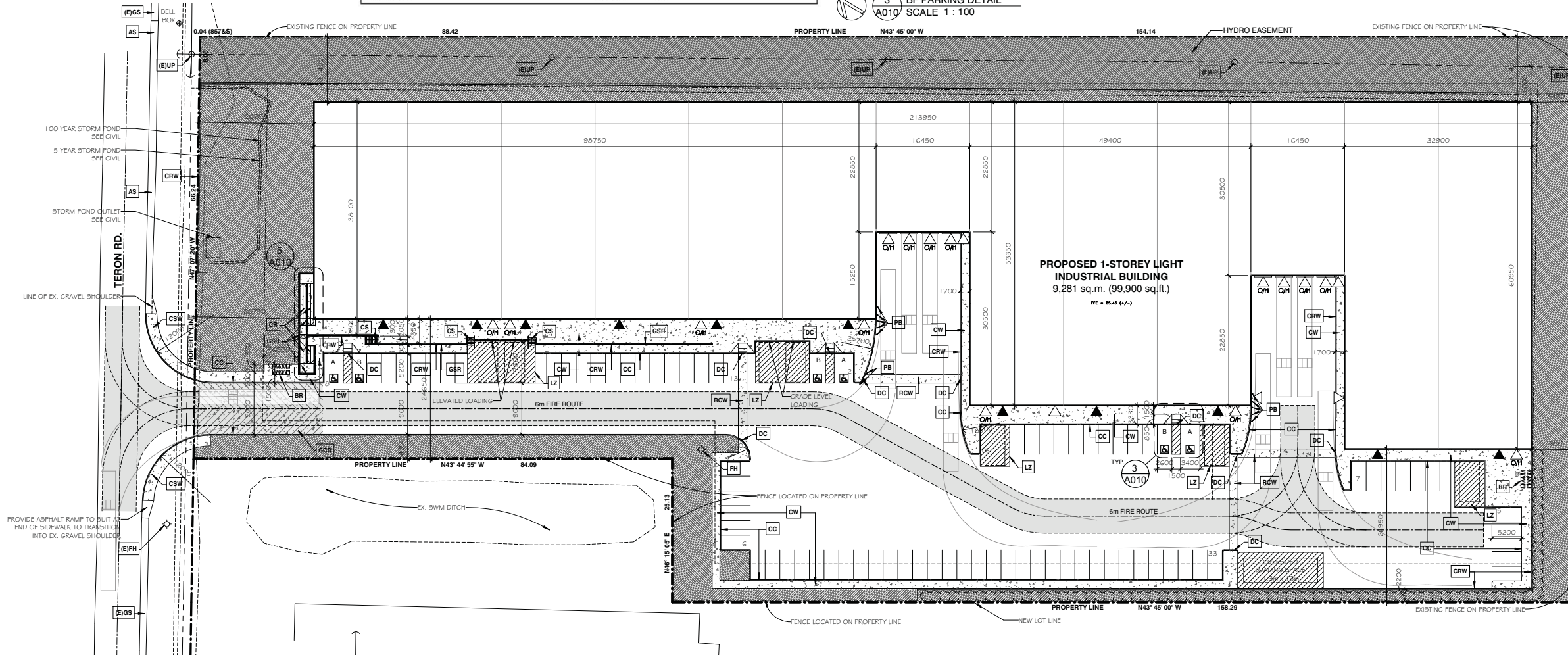

2 SITE PLAN
SCALE 1:400

NOTES:
 Contractor shall check and verify all dimensions on site and report any discrepancies to the Architect before proceeding.

- GENERAL SITE PLAN NOTES:**
- Exterior site lighting shall be directed onto the site away from adjacent properties. See Electrical Drawings.
 - Read this drawing in conjunction with the Landscape Drawings, Civil Engineering Drawings and Electrical Drawings.

no.	revision	date
0	ISSUED FOR SITE PLAN APPROVAL	16 JAN 2020

383 Parkdale Avenue, Suite 201
 Ottawa Ontario Canada K1Y 4R4
KWC ARCHITECTS INC.
 PHONE (613) 238-2117
 FAX (613) 238-6595
 E MAIL kwc@kwc-arch.com

detail no.	1	détail no.
sheet no.	A1	feuille no.

PROPOSED WAREHOUSE
 1243 TERON RD.
 OTTAWA, ON.

designed by	KWC	approved by	
drawn by	AK/TC	project no.	1943
date	16 JANUARY 2020	scale	as noted
drawing / dessin			

**SITE PLAN,
 SITE PLAN DETAILS**

revision
 sheet no. **A010**
 no. de feuille

Appendix C

Traffic Count Reports

Survey Date: Thursday, March 30, 2017

Start Time: 07:00

WO No: 36819

Device: Miovision

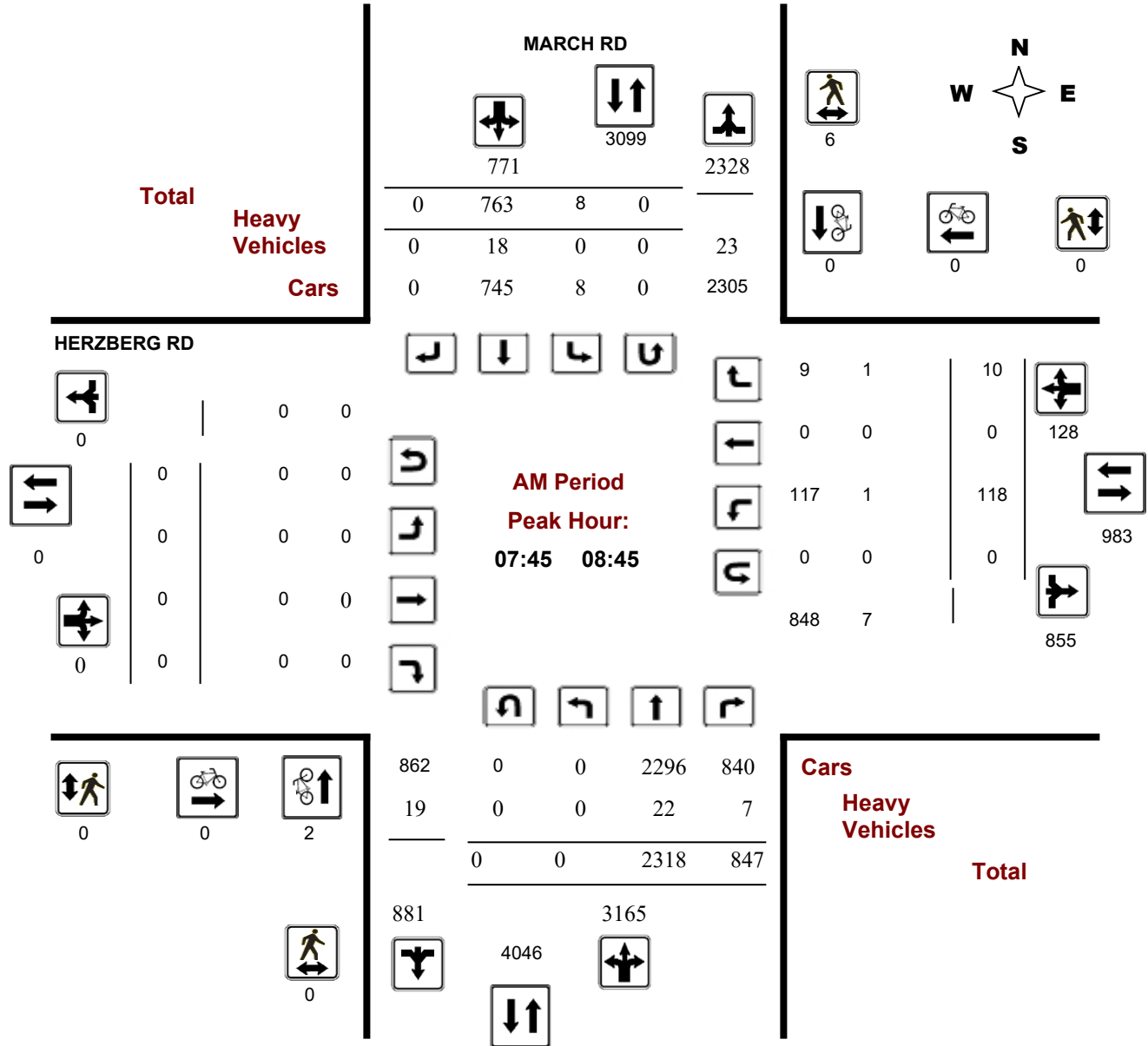

Comments

Survey Date: Thursday, March 30, 2017

Start Time: 07:00

WO No: 36819

Device: Miovision

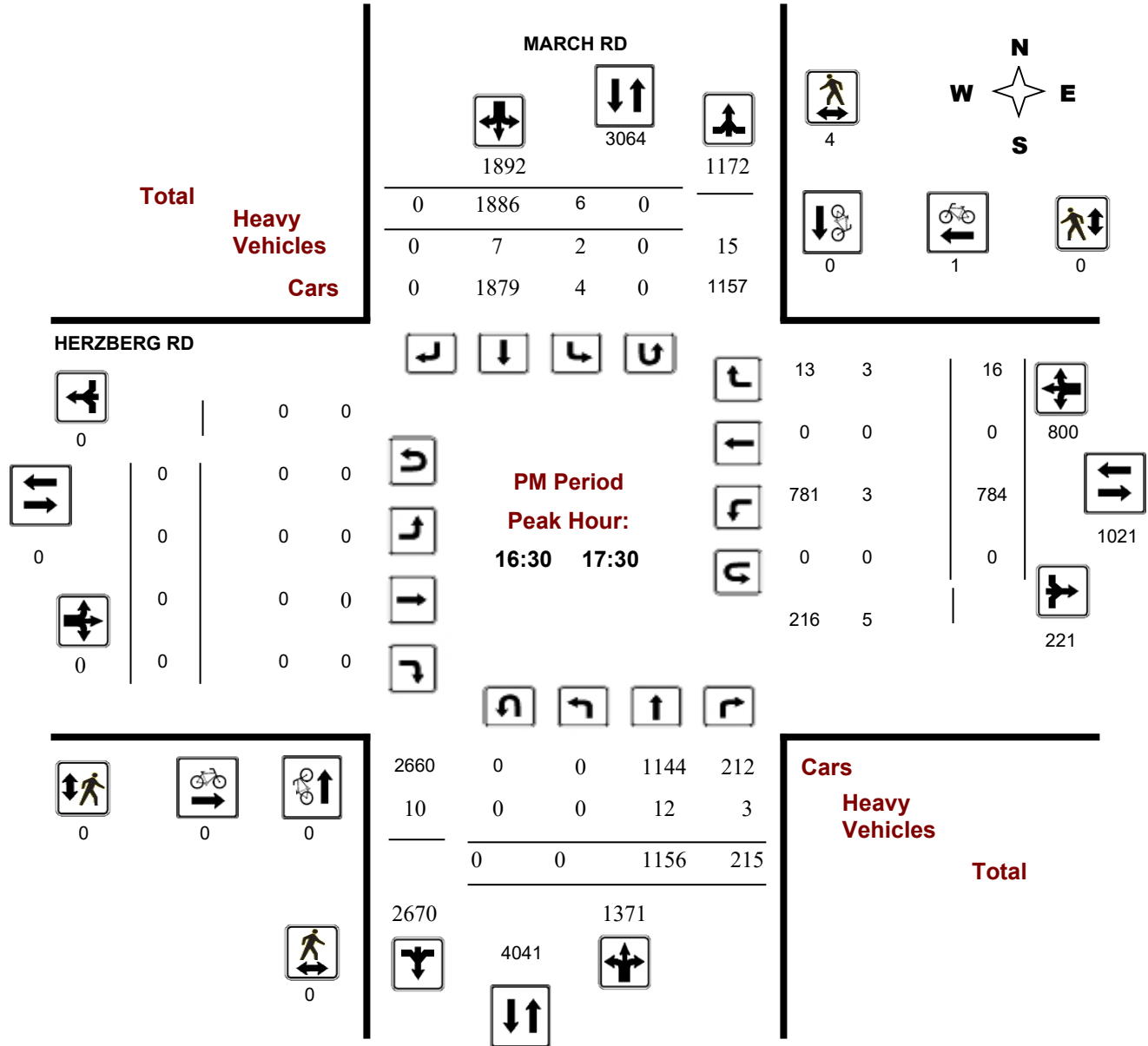



Transportation Services - Traffic Services

Turning Movement Count - Full Study Peak Hour Diagram

MARCH RD @ RICHARDSON SIDE RD

Survey Date: Tuesday, April 11, 2017

Start Time: 07:00

WO No: 36820

Device: Miovision

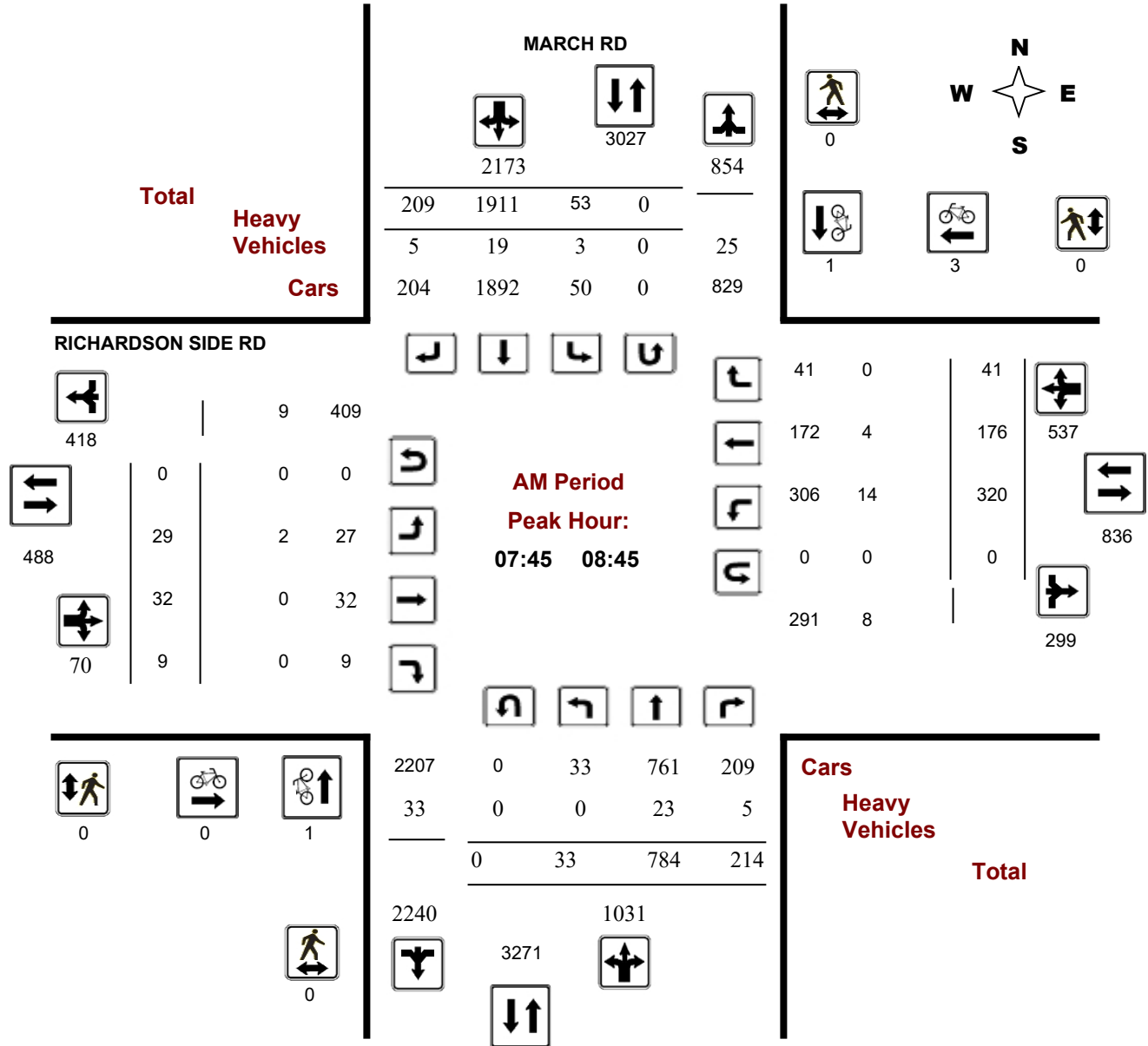

Survey Date: Tuesday, April 11, 2017

Start Time: 07:00

WO No: 36820

Device: Miovision

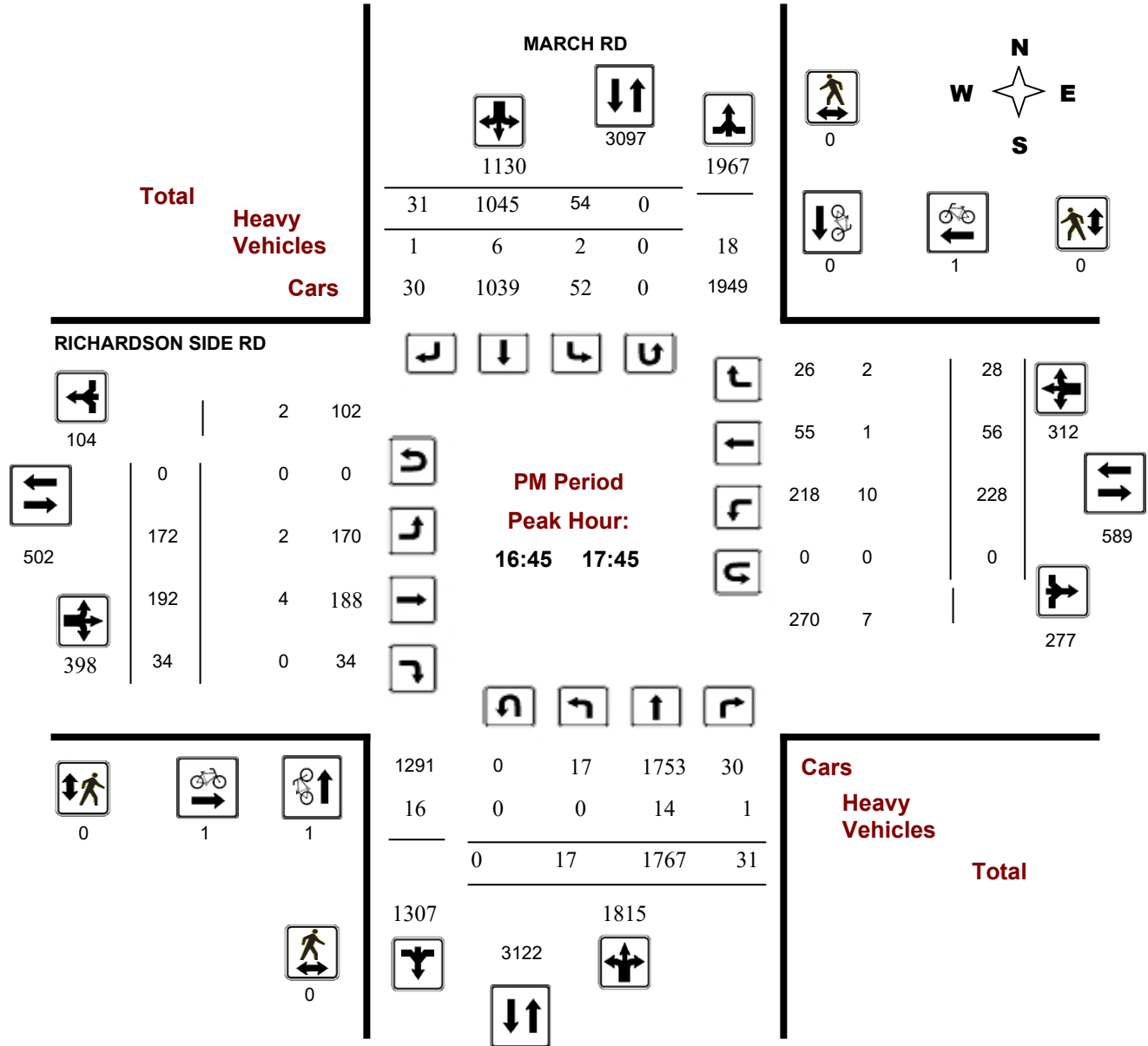

Survey Date: Wednesday, August 10, 2016

Start Time: 07:00

WO No: 36154

Device: Miovision

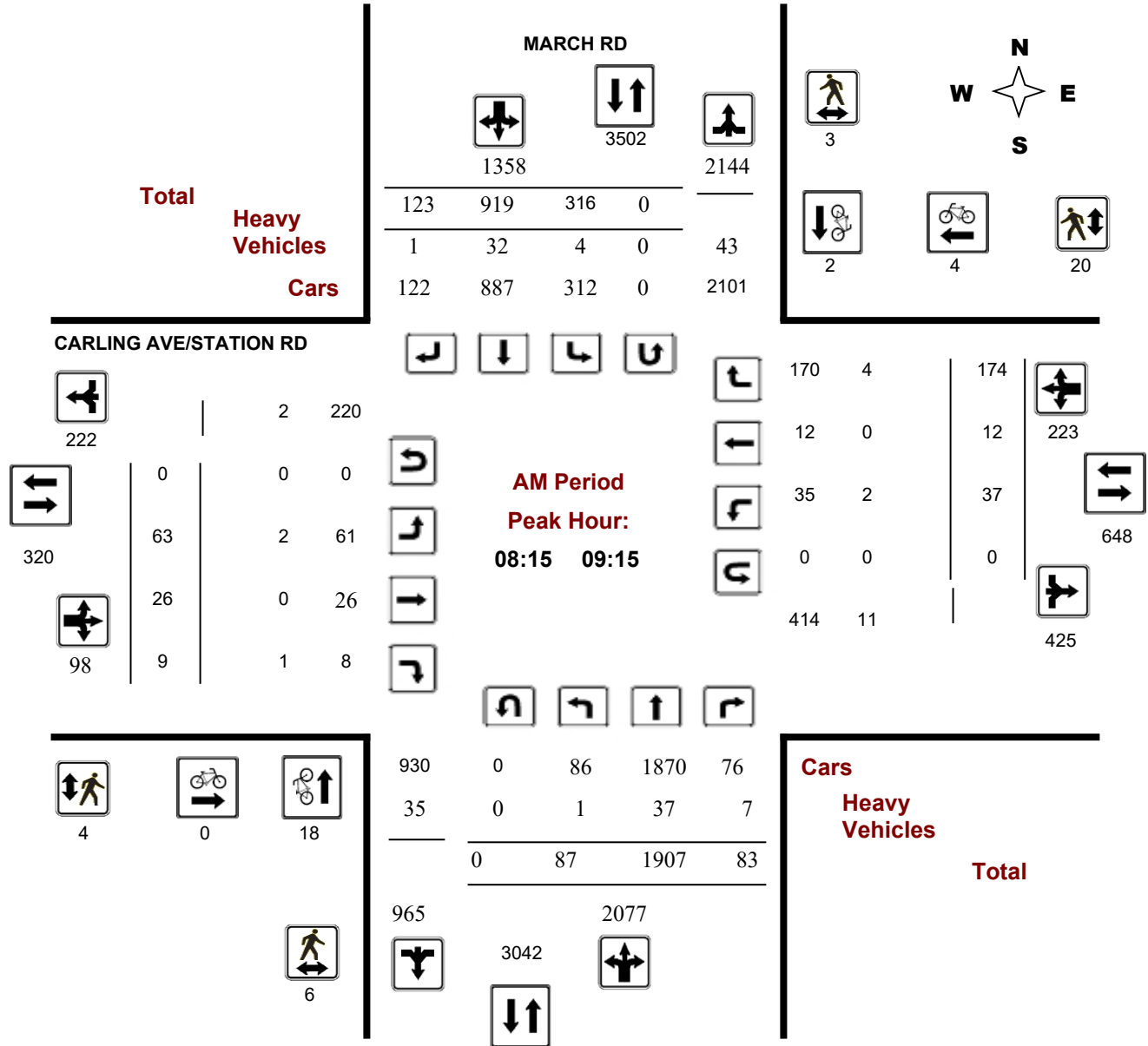

Turning Movement Count - Full Study Peak Hour Diagram

CARLING AVE/STATION RD @ MARCH RD

Survey Date: Wednesday, August 10, 2016

Start Time: 07:00

WO No: 36154

Device: Miovision

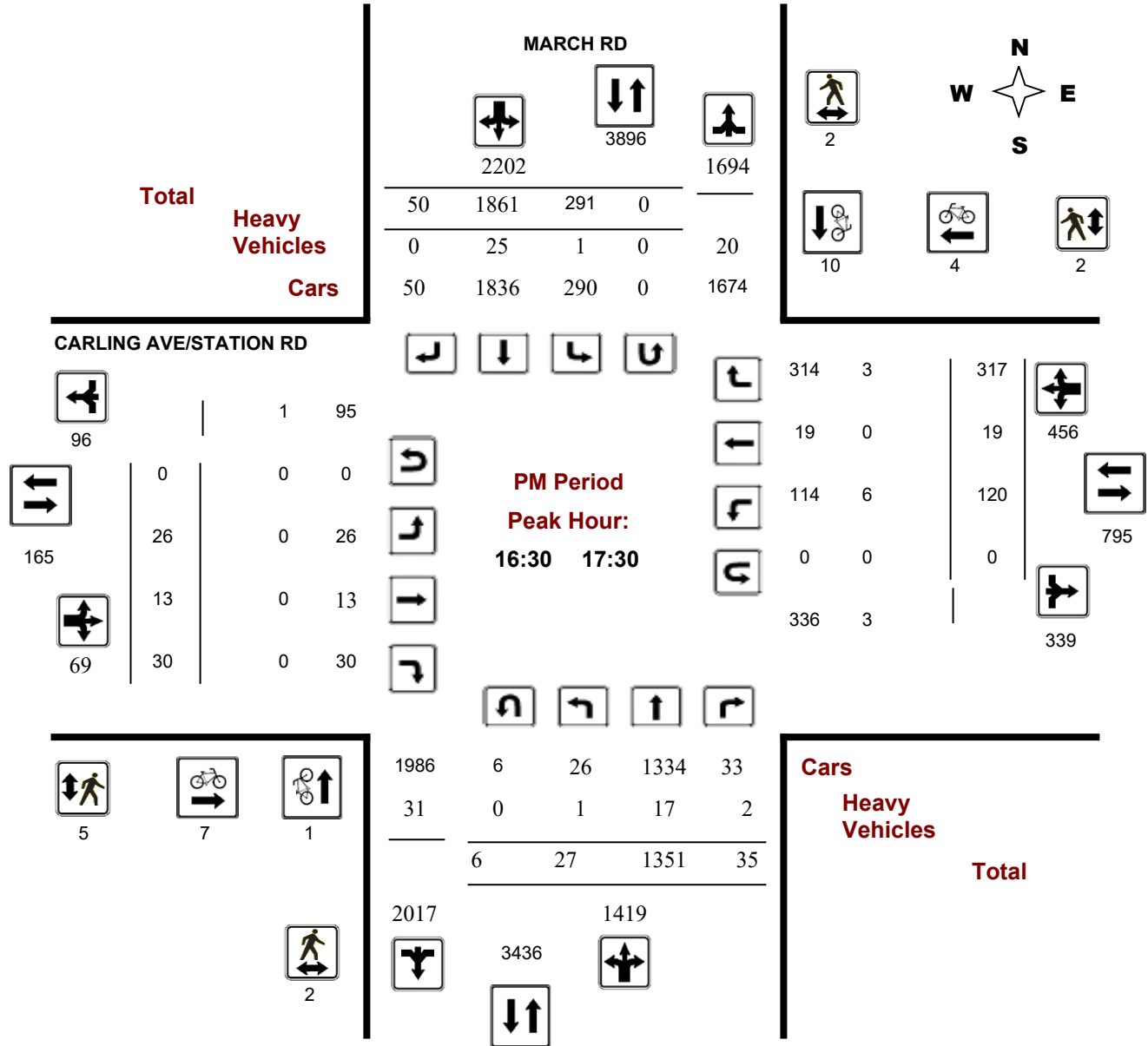

Survey Date: Wednesday, June 23, 2010

WO No: 28296

Start Time: 07:00

Device:

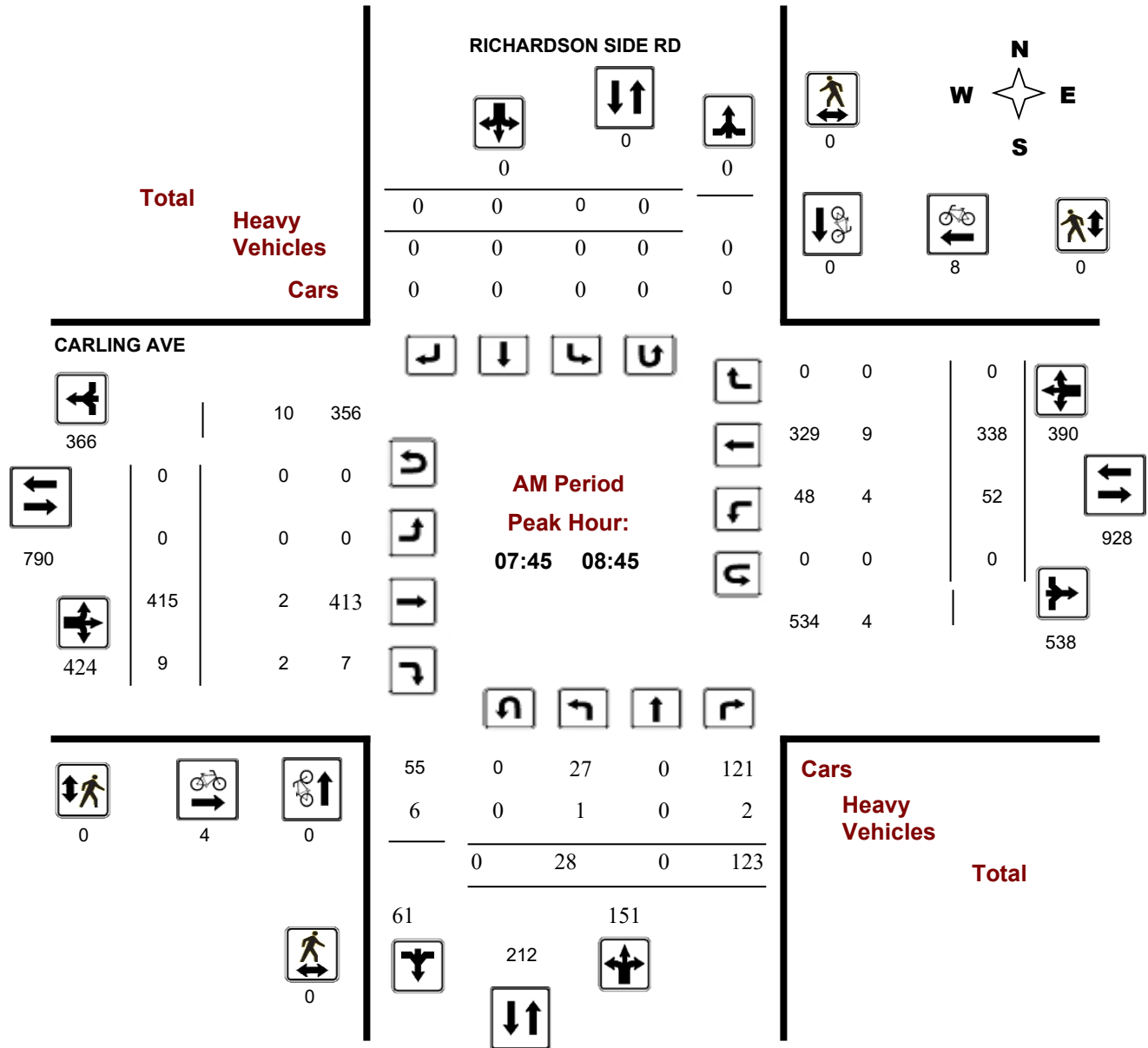

Comments

Survey Date: Wednesday, June 23, 2010

WO No: 28296

Start Time: 07:00

Device:

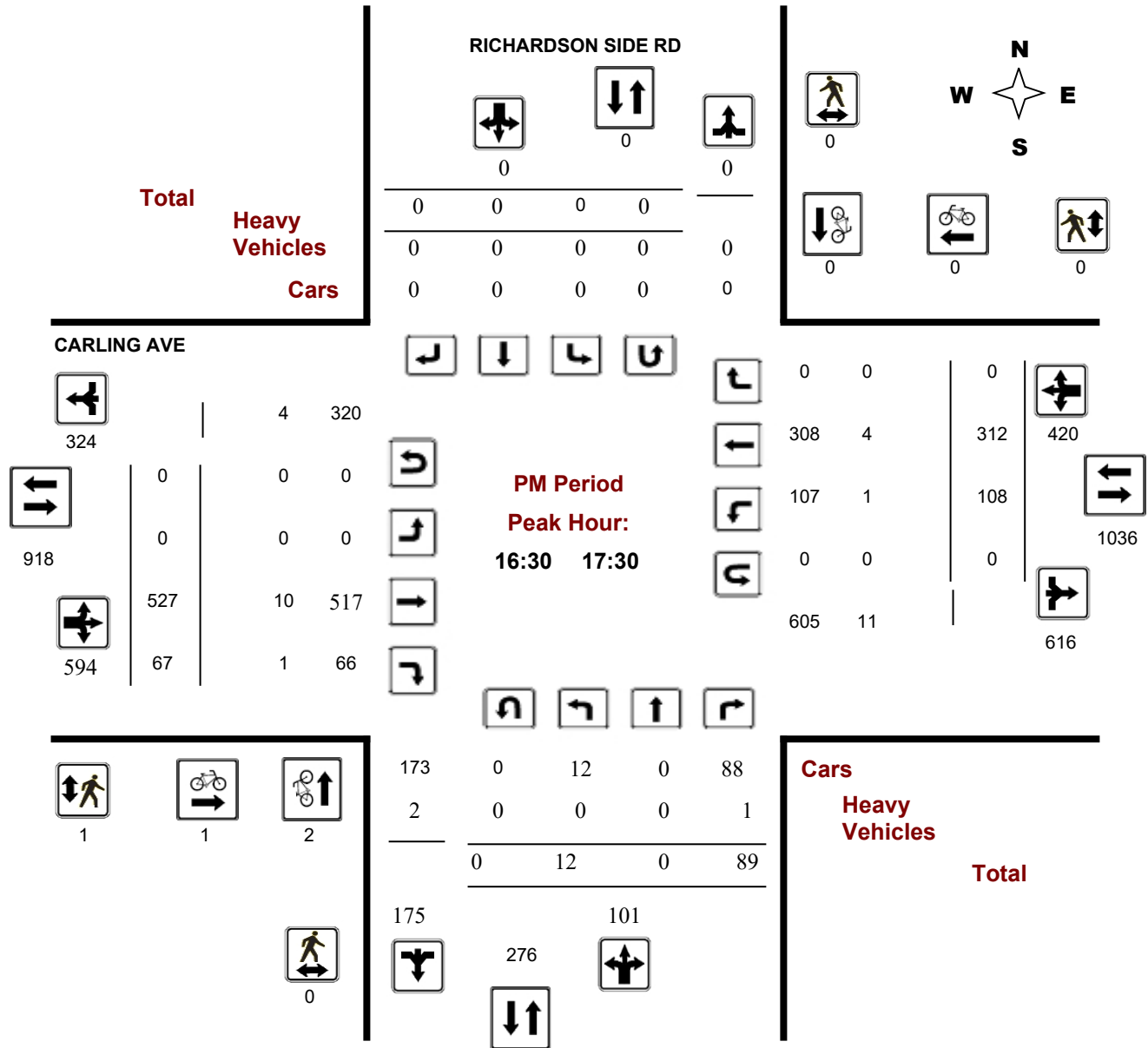

Survey Date: Wednesday, August 10, 2016

Start Time: 07:00

WO No: 36155

Device: Miovision

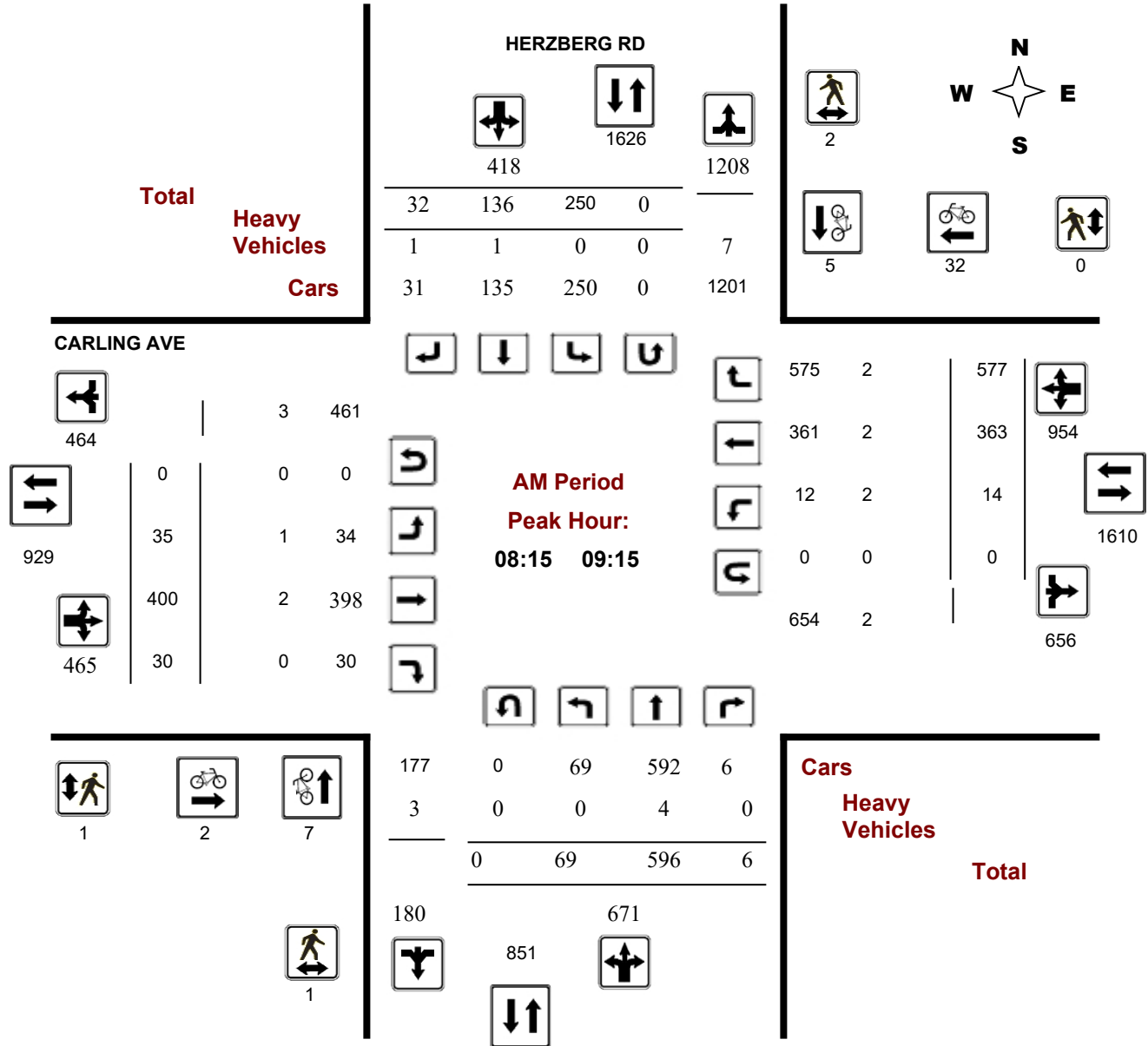

Comments

Survey Date: Wednesday, August 10, 2016

Start Time: 07:00

WO No: 36155

Device: Miovision

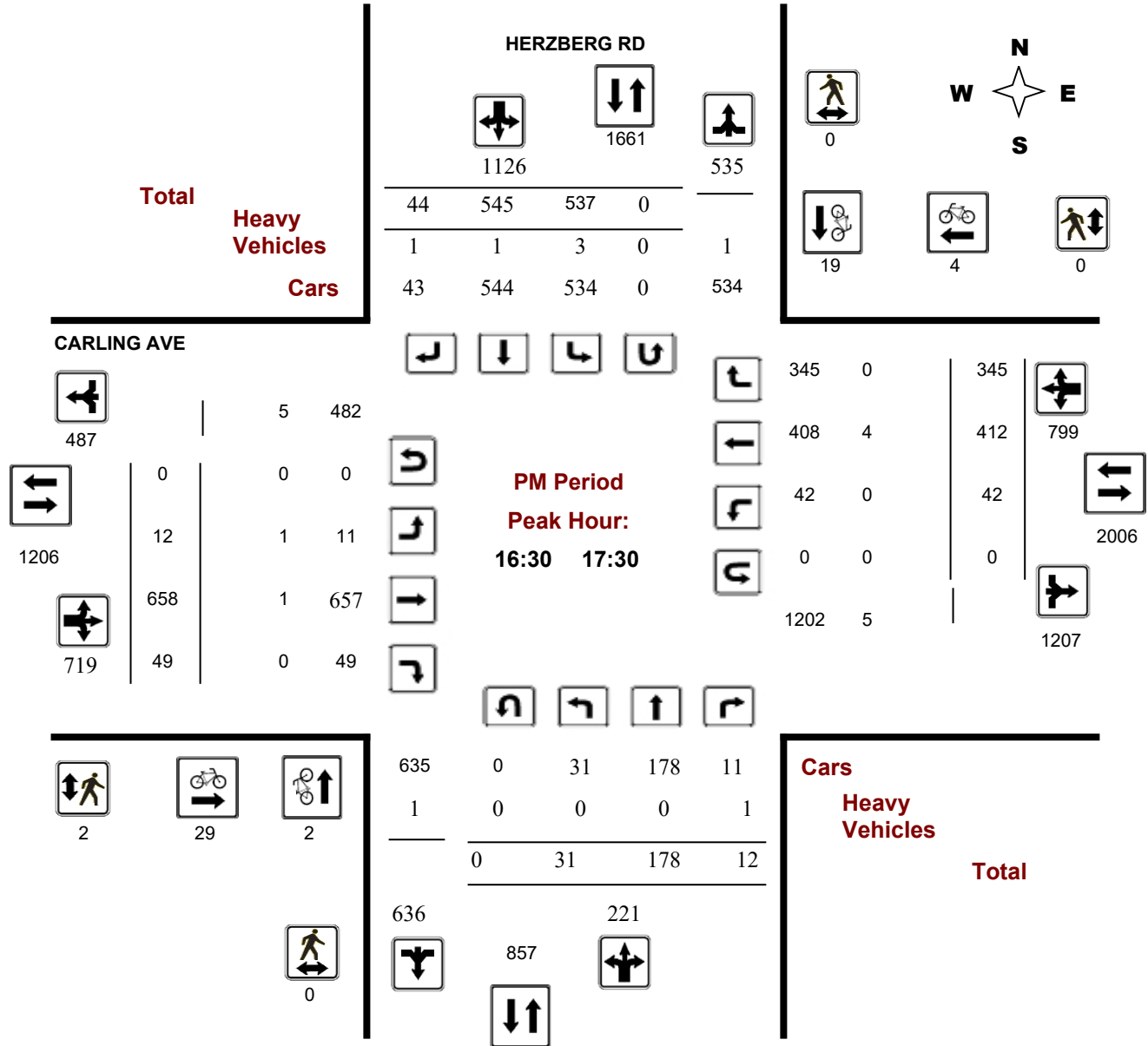

Vehicular Turning Movements – All Vehicles and Pedestrians

CARLING AVENUE and TERON ROAD in Ottawa, ON

Survey Date: Tuesday, 19 November 2019
Performed By: BTE



Full Period (4 hours)

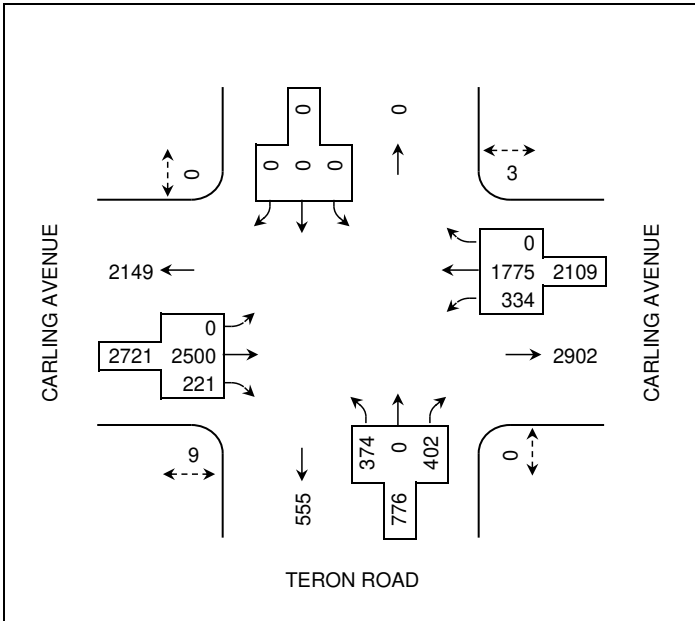

Midday Peak (11:30–12:30)

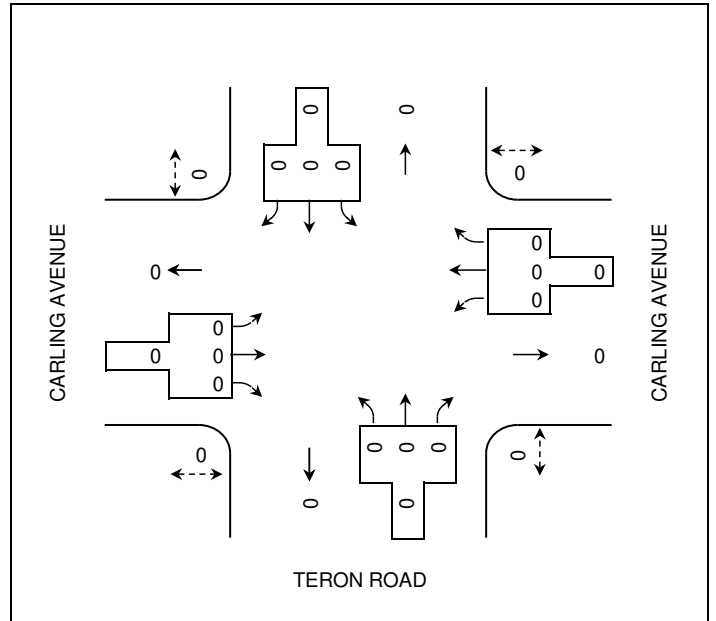

Morning Peak (8:00–9:00)

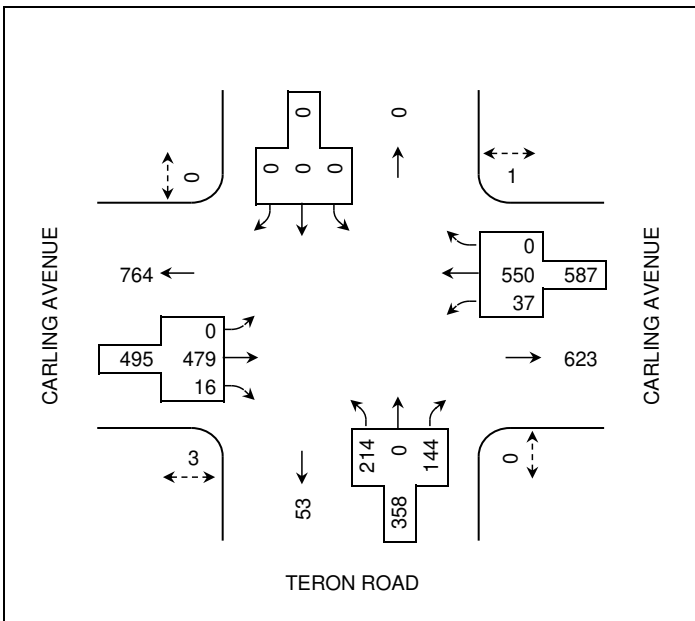

Afternoon Peak (16:00–17:00)

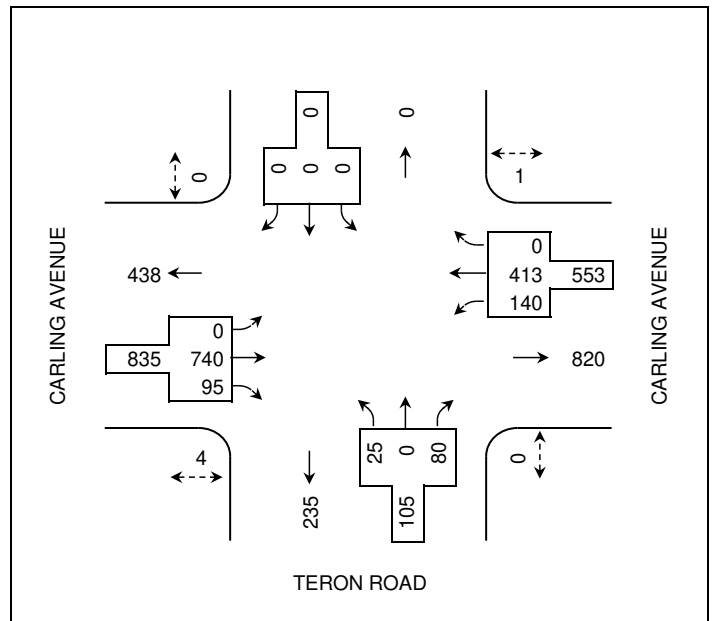

Note:
Volumes above include **cars** and **heavy vehicles**.
Cars include motorcycles, passenger cars, pick-up trucks (including "heavy-duty"), full-size vans (i.e. Econoline), and any of these with a trailer.

Vehicular Turning Movements – Heavy Vehicles

CARLING AVENUE and TERON ROAD in Ottawa, ON

Survey Date: Tuesday, 19 November 2019
 Performed By: BTE



Full Period (4 hours)

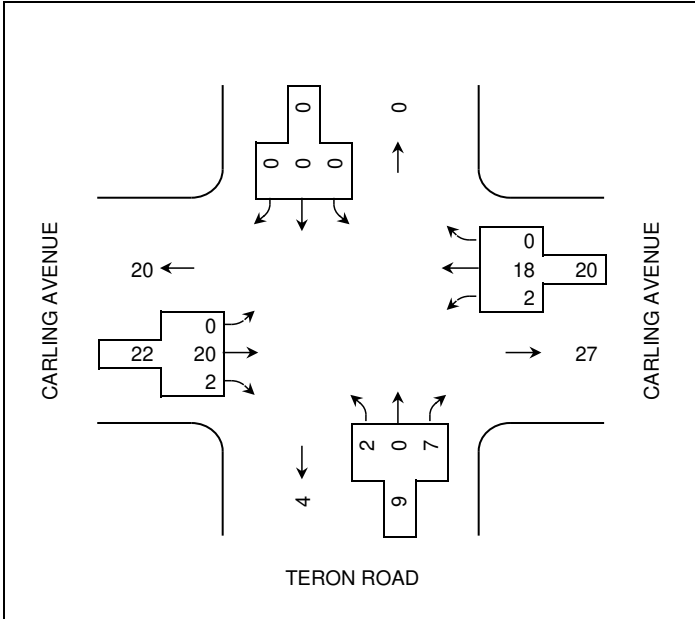

Midday Peak (11:30–12:30)

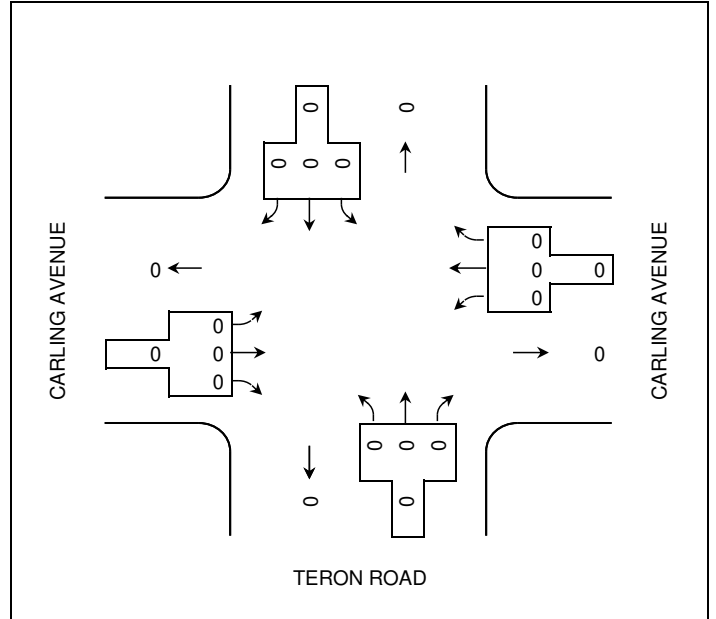

Morning Peak (8:00–9:00)

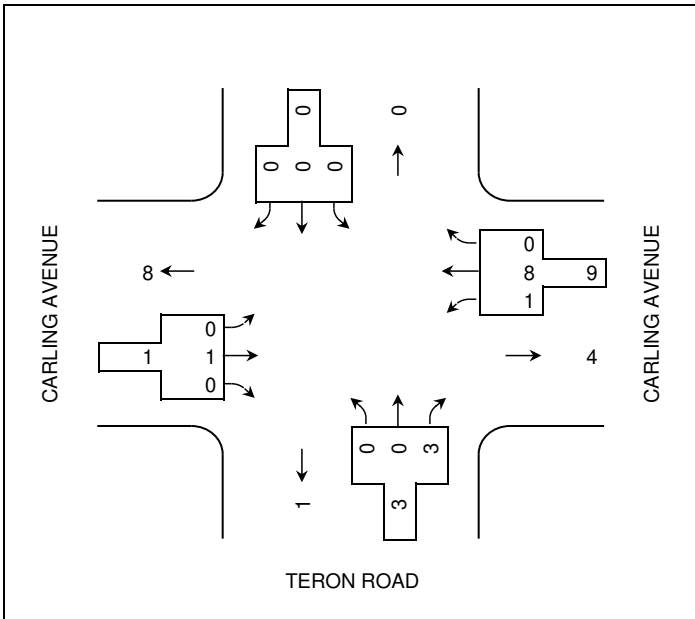

Afternoon Peak (16:00–17:00)

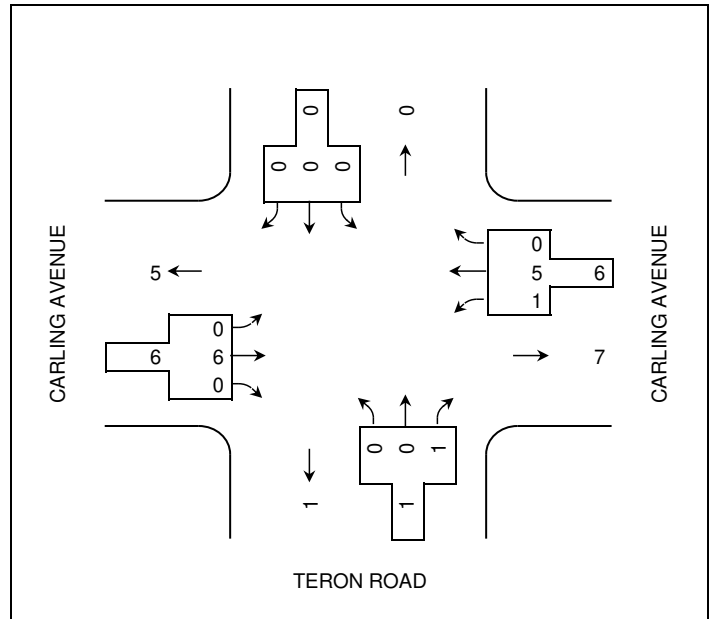

Note:
Heavy vehicles include vehicles with more than 2 axles (with the exception of cars with trailers).

Vehicular Turning Movements (15 Min. Volumes) – All Vehicles

CARLING AVENUE and TERON ROAD in Ottawa, ON

Survey Date: Tuesday, 19 November 2019

Performed By: BTE

Grey = Peak Hour

Time Period	TERON ROAD					CARLING AVENUE					CARLING AVENUE					GRAND TOTAL			
	Northbound				Southbound					Eastbound				Westbound					
	L	T	R	SUB TOT	L	T	R	SUB TOT	STR TOT	L	T	R	SUB TOT	L	T		R	SUB TOT	STR TOT
7:30 – 7:45	8	0	27	35	0	0	0	0	35	0	202	8	210	14	77	0	91	301	336
7:45 – 8:00	10	0	45	55	0	0	0	0	55	0	172	5	177	9	65	0	74	251	306
8:00 – 8:15	40	0	46	86	0	0	0	0	86	0	121	4	125	11	120	0	131	256	342
8:15 – 8:30	49	0	35	84	0	0	0	0	84	0	121	3	124	11	148	0	159	283	367
8:30 – 8:45	70	0	39	109	0	0	0	0	109	0	115	3	118	8	102	0	110	228	337
8:45 – 9:00	55	0	24	79	0	0	0	0	79	0	122	6	128	7	180	0	187	315	394
9:00 – 9:15	49	0	27	76	0	0	0	0	76	0	122	8	130	13	204	0	217	347	423
9:15 – 9:30	32	0	19	51	0	0	0	0	51	0	120	6	126	7	117	0	124	250	301
16:00 – 16:15	6	0	33	39	0	0	0	0	39	0	212	23	235	43	84	0	127	362	401
16:15 – 16:30	4	0	11	15	0	0	0	0	15	0	201	20	221	37	99	0	136	357	372
16:30 – 16:45	7	0	21	28	0	0	0	0	28	0	163	31	194	29	118	0	147	341	369
16:45 – 17:00	8	0	15	23	0	0	0	0	23	0	164	21	185	31	112	0	143	328	351
17:00 – 17:15	5	0	9	14	0	0	0	0	14	0	171	23	194	25	106	0	131	325	339
17:15 – 17:30	10	0	22	32	0	0	0	0	32	0	165	20	185	39	88	0	127	312	344
17:30 – 17:45	11	0	10	21	0	0	0	0	21	0	186	21	207	32	93	0	125	332	353
17:45 – 18:00	10	0	19	29	0	0	0	0	29	0	143	19	162	18	62	0	80	242	271
TOTAL	374	0	402	776	0	0	0	0	776	0	2500	221	2721	334	1775	0	2109	4830	5606

Vehicular Turning Movements (15 Min. Volumes) – Heavy Vehicles

CARLING AVENUE and TERON ROAD in Ottawa, ON

Survey Date: Tuesday, 19 November 2019

Performed By: BTE

Time Period	TERON ROAD					CARLING AVENUE					CARLING AVENUE					GRAND TOTAL			
	Northbound				Southbound					Eastbound				Westbound					
	L	T	R	SUB TOT	L	T	R	SUB TOT	STR TOT	L	T	R	SUB TOT	L	T		R	SUB TOT	STR TOT
7:30 – 7:45	0	0	0	0	0	0	0	0	0	0	0	0	0	0	0	0	0	0	0
7:45 – 8:00	0	0	0	0	0	0	0	0	0	0	4	0	4	0	2	0	2	6	6
8:00 – 8:15	0	0	1	1	0	0	0	0	1	0	1	0	1	1	4	0	5	6	7
8:15 – 8:30	0	0	1	1	0	0	0	0	1	0	0	0	0	0	2	0	2	2	3
8:30 – 8:45	0	0	1	1	0	0	0	0	1	0	0	0	0	0	2	0	2	2	3
8:45 – 9:00	0	0	0	0	0	0	0	0	0	0	0	0	0	0	0	0	0	0	0
9:00 – 9:15	0	0	2	2	0	0	0	0	2	0	1	0	1	0	0	0	0	1	3
9:15 – 9:30	2	0	0	2	0	0	0	0	2	0	6	0	6	0	1	0	1	7	9
16:00 – 16:15	0	0	0	0	0	0	0	0	0	0	2	0	2	0	4	0	4	6	6
16:15 – 16:30	0	0	0	0	0	0	0	0	0	0	2	0	2	0	0	0	0	2	2
16:30 – 16:45	0	0	1	1	0	0	0	0	1	0	0	0	0	1	1	0	2	2	3
16:45 – 17:00	0	0	0	0	0	0	0	0	0	0	2	0	2	0	0	0	0	2	2
17:00 – 17:15	0	0	1	1	0	0	0	0	1	0	0	1	1	0	0	0	0	1	2
17:15 – 17:30	0	0	0	0	0	0	0	0	0	0	1	0	1	0	0	0	0	1	1
17:30 – 17:45	0	0	0	0	0	0	0	0	0	0	0	1	1	0	2	0	2	3	3
17:45 – 18:00	0	0	0	0	0	0	0	0	0	0	1	0	1	0	0	0	0	1	1
TOTAL	2	0	7	9	0	0	0	0	9	0	20	2	22	2	18	0	20	42	51

Vehicular Turning Movements (15 Min. Volumes) – Pedestrians

CARLING AVENUE and TERON ROAD in Ottawa, ON

Survey Date: Tuesday, 19 November 2019

Performed By: BTE

Time Period	TERON ROAD Parallel Crossing		STREET TOTAL	CARLING AVENUE Parallel Crossing		STREET TOTAL	GRAND TOTAL
	East	West		South	North		
7:30 – 7:45	0	0	0	0	0	0	0
7:45 – 8:00	0	0	0	0	0	0	0
8:00 – 8:15	0	0	0	1	0	1	1
8:15 – 8:30	0	0	0	0	1	1	1
8:30 – 8:45	0	0	0	0	0	0	0
8:45 – 9:00	0	0	0	2	0	2	2
9:00 – 9:15	0	0	0	0	0	0	0
9:15 – 9:30	0	0	0	0	0	0	0
16:00 – 16:15	0	0	0	1	0	1	1
16:15 – 16:30	0	0	0	3	0	3	3
16:30 – 16:45	0	0	0	0	0	0	0
16:45 – 17:00	0	0	0	0	1	1	1
17:00 – 17:15	0	0	0	1	1	2	2
17:15 – 17:30	0	0	0	0	0	0	0
17:30 – 17:45	0	0	0	1	0	1	1
17:45 – 18:00	0	0	0	0	0	0	0
TOTAL	0	0	0	9	3	12	12

Appendix D

Collision Details Report



City Operations - Transportation Services

Collision Details Report - Public Version

From: January 1, 2014 **To:** December 31, 2018

Location: CARLING AVE @ RICHARDSON SIDE RD

Traffic Control: Stop sign

Total Collisions: 5

Date/Day/Time	Environment	Impact Type	Classification	Surface Cond'n	Veh. Dir	Vehicle Manoeuvre	Vehicle type	First Event	No. Ped
2014-Aug-28, Thu,10:29	Clear	Rear end	Non-fatal injury	Dry	West	Slowing or stopping	Automobile, station wagon	Other motor vehicle	
					West	Turning left	Automobile, station wagon	Other motor vehicle	
2015-Apr-21, Tue,07:48	Rain	Rear end	P.D. only	Wet	North	Turning right	Passenger van	Other motor vehicle	
					North	Turning right	Automobile, station wagon	Other motor vehicle	
2016-Feb-13, Sat,02:00	Clear	SMV other	P.D. only	Loose snow	Unknown	Turning right	Unknown	Pole (sign, parking meter)	
2017-Jun-07, Wed,17:13	Clear	Turning movement	Non-fatal injury	Dry	West	Turning left	Automobile, station wagon	Cyclist	
					East	Going ahead	Bicycle	Other motor vehicle	
2017-Nov-15, Wed,16:00	Clear	Rear end	P.D. only	Dry	West	Slowing or stopping	Automobile, station wagon	Other motor vehicle	
					West	Turning left	Automobile, station wagon	Other motor vehicle	

Location: MARCH RD @ RICHARDSON SIDE RD

Traffic Control: Traffic signal

Total Collisions: 32

Date/Day/Time	Environment	Impact Type	Classification	Surface Cond'n	Veh. Dir	Vehicle Manoeuvre	Vehicle type	First Event	No. Ped
---------------	-------------	-------------	----------------	----------------	----------	-------------------	--------------	-------------	---------

2014-Mar-04, Tue,16:05	Rain	Turning movement	Non-fatal injury	Wet	North	Turning left	Automobile, station wagon	Other motor vehicle
					South	Going ahead	Automobile, station wagon	Other motor vehicle
2014-Oct-03, Fri,09:34	Clear	Rear end	Non-fatal injury	Dry	East	Turning left	Municipal transit bus	Other motor vehicle
					East	Turning left	Automobile, station wagon	Other motor vehicle
2014-Sep-06, Sat,16:11	Rain	Sideswipe	P.D. only	Wet	North	Changing lanes	Automobile, station wagon	Other motor vehicle
					North	Turning left	Unknown	Other motor vehicle
2014-Nov-04, Tue,18:03	Rain	Turning movement	Non-fatal injury	Wet	South	Going ahead	Automobile, station wagon	Other motor vehicle
					North	Turning left	Automobile, station wagon	Other motor vehicle
2016-Feb-24, Wed,09:47	Snow	Angle	P.D. only	Loose snow	East	Slowing or stopping	Automobile, station wagon	Other motor vehicle
					North	Going ahead	Pick-up truck	Other motor vehicle
2016-Mar-09, Wed,17:30	Clear	Rear end	P.D. only	Dry	North	Going ahead	Automobile, station wagon	Other motor vehicle
					North	Slowing or stopping	Pick-up truck	Other motor vehicle
2016-Oct-28, Fri,15:31	Clear	Turning movement	P.D. only	Dry	South	Turning left	Automobile, station wagon	Other motor vehicle
					North	Going ahead	Automobile, station wagon	Other motor vehicle

2015-Dec-11, Fri,18:42	Rain	SMV other	Non-fatal injury	Wet	South	Turning left	Automobile, station wagon	Pedestrian	1
2016-Feb-18, Thu,13:20	Clear	Angle	Non-fatal injury	Wet	East	Going ahead	Automobile, station wagon	Other motor vehicle	
					North	Turning left	Automobile, station wagon	Other motor vehicle	
2016-Apr-14, Thu,16:10	Clear	Rear end	P.D. only	Dry	South	Turning right	Automobile, station wagon	Other motor vehicle	
					South	Turning right	Pick-up truck	Other motor vehicle	
2016-Apr-07, Thu,12:56	Clear	Turning movement	P.D. only	Dry	East	Turning left	Pick-up truck	Other motor vehicle	
					West	Going ahead	Automobile, station wagon	Other motor vehicle	
2016-Apr-09, Sat,19:43	Clear	Angle	P.D. only	Dry	North	Going ahead	Automobile, station wagon	Other motor vehicle	
					East	Going ahead	Automobile, station wagon	Other motor vehicle	
2016-Apr-15, Fri,09:08	Clear	Turning movement	P.D. only	Dry	North	Going ahead	Automobile, station wagon	Other motor vehicle	
					South	Turning left	Pick-up truck	Other motor vehicle	
2017-Aug-16, Wed,09:55	Clear	Rear end	P.D. only	Dry	North	Going ahead	Automobile, station wagon	Other motor vehicle	
					North	Slowing or stopping	Automobile, station wagon	Other motor vehicle	
2017-Aug-21, Mon,09:00	Clear	Rear end	P.D. only	Dry	South	Slowing or stopping	Automobile, station wagon	Other motor vehicle	

					South	Stopped	Automobile, station wagon	Other motor vehicle
2017-Jan-16, Mon,17:49	Clear	Sideswipe	P.D. only	Dry	South	Going ahead	Unknown	Other motor vehicle
					South	Going ahead	Automobile, station wagon	Other motor vehicle
2016-Dec-06, Tue,07:27	Clear	Turning movement	P.D. only	Dry	East	Turning left	Passenger van	Other motor vehicle
					West	Going ahead	Pick-up truck	Other motor vehicle
2017-Feb-06, Mon,08:30	Clear	Rear end	P.D. only	Ice	North	Slowing or stopping	Automobile, station wagon	Other motor vehicle
					North	Stopped	Pick-up truck	Other motor vehicle
2017-Mar-30, Thu,09:09	Clear	Turning movement	Non-fatal injury	Dry	South	Turning left	Automobile, station wagon	Other motor vehicle
					North	Going ahead	Pick-up truck	Other motor vehicle
2017-Apr-28, Fri,17:20	Clear	Turning movement	P.D. only	Dry	North	Turning left	Automobile, station wagon	Other motor vehicle
					South	Going ahead	Automobile, station wagon	Other motor vehicle
2017-May-29, Mon,20:00	Rain	Rear end	P.D. only	Wet	South	Going ahead	Unknown	Other motor vehicle
					South	Stopped	Automobile, station wagon	Other motor vehicle
2017-Jun-24, Sat,16:55	Clear	Rear end	P.D. only	Dry	West	Going ahead	Motor home	Other motor vehicle

					West	Stopped	Automobile, station wagon	Other motor vehicle
2017-Apr-11, Tue,12:00	Clear	Sideswipe	P.D. only	Dry	East	Changing lanes	Automobile, station wagon	Other motor vehicle
					East	Going ahead	Automobile, station wagon	Other motor vehicle
2017-Jun-16, Fri,23:05	Clear	Rear end	P.D. only	Dry	North	Going ahead	Automobile, station wagon	Other motor vehicle
					North	Stopped	Pick-up truck	Other motor vehicle
2017-Oct-12, Thu,08:54	Clear	Sideswipe	P.D. only	Dry	East	Going ahead	Passenger van	Other motor vehicle
					East	Going ahead	Automobile, station wagon	Other motor vehicle
2018-Mar-12, Mon,09:00	Clear	Sideswipe	P.D. only	Dry	North	Changing lanes	Passenger van	Other motor vehicle
					North	Going ahead	Automobile, station wagon	Other motor vehicle
2018-Mar-07, Wed,06:30	Rain	Rear end	P.D. only	Slush	South	Slowing or stopping	Passenger van	Other motor vehicle
					South	Slowing or stopping	Automobile, station wagon	Other motor vehicle
2018-Feb-27, Tue,14:40	Clear	Rear end	P.D. only	Dry	South	Going ahead	Automobile, station wagon	Other motor vehicle
					South	Stopped	Automobile, station wagon	Other motor vehicle
2018-Apr-05, Thu,19:35	Clear	SMV other	Non-fatal injury	Dry	North	Going ahead	Automobile, station wagon	Pole (utility, power)

2018-May-24, Thu,15:56	Clear	Rear end	P.D. only	Dry	South	Going ahead	Automobile, station wagon	Other motor vehicle
					South	Slowing or stopping	Automobile, station wagon	Other motor vehicle

2018-Aug-10, Fri,12:20	Clear	Rear end	P.D. only	Dry	South	Going ahead	Automobile, station wagon	Other motor vehicle
					South	Stopped	Automobile, station wagon	Other motor vehicle

2018-Aug-16, Thu,17:25	Clear	Rear end	Non-fatal injury	Dry	North	Going ahead	Automobile, station wagon	Other motor vehicle
					North	Stopped	Automobile, station wagon	Other motor vehicle

Location: RICHARDSON SIDE RD btwn BREWER HUNT WAY & CARLING AVE

Traffic Control: No control

Total Collisions: 2

Date/Day/Time	Environment	Impact Type	Classification	Surface Cond'n	Veh. Dir	Vehicle Manoeuver	Vehicle type	First Event	No. Ped
2015-Nov-10, Tue,12:06	Clear	SMV other	P.D. only	Dry	West	Turning right	Truck - dump	Other	
2016-Mar-03, Thu,17:37	Clear	Angle	Non-fatal injury	Dry	East	Turning left	Automobile, station wagon	Other motor vehicle	
					South	Going ahead	Automobile, station wagon	Other motor vehicle	

Location: RICHARDSON SIDE RD btwn MARCH RD & BREWER HUNT WAY

Traffic Control: No control

Total Collisions: 1

Date/Day/Time	Environment	Impact Type	Classification	Surface Cond'n	Veh. Dir	Vehicle Manoeuver	Vehicle type	First Event	No. Ped
2015-Dec-05, Sat,16:00	Clear	Turning movement	P.D. only	Dry	West	Making "U" turn	Passenger van	Other motor vehicle	
					East	Going ahead	Pick-up truck	Other motor vehicle	

Appendix E

O-D Survey – Kanata-Stittsville

Kanata - Stittsville

Demographic Characteristics

Population	105,210	Actively Travelled	83,460
Employed Population	49,640	Number of Vehicles	64,540
Households	38,010	Area (km ²)	82.6

Occupation Status (age 5+)	Male	Female	Total
Full Time Employed	24,670	19,590	44,260
Part Time Employed	1,540	3,840	5,380
Student	13,630	13,410	27,040
Retiree	6,480	8,350	14,820
Unemployed	850	940	1,790
Homemaker	160	3,310	3,470
Other	350	1,010	1,360
Total:	47,690	50,440	98,120

Traveller Characteristics	Male	Female	Total
Transit Pass Holders	5,940	6,920	12,860
Licensed Drivers	36,280	36,790	73,070
Telecommuters	200	380	580
Trips made by residents	135,300	143,330	278,630

Selected Indicators	
Daily Trips per Person (age 5+)	2.84
Vehicles per Person	0.61
Number of Persons per Household	2.77
Daily Trips per Household	7.33
Vehicles per Household	1.70
Workers per Household	1.31
Population Density (Pop/km ²)	1270

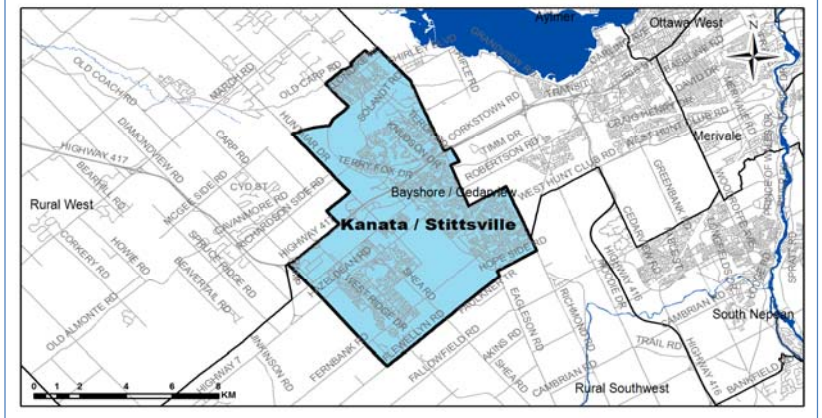

Household Size		
1 person	5,810	15%
2 persons	11,660	31%
3 persons	7,490	20%
4 persons	8,890	23%
5+ persons	4,160	11%
Total:	38,010	100%

Households by Vehicle Availability		
0 vehicles	1,050	3%
1 vehicle	14,090	37%
2 vehicles	19,110	50%
3 vehicles	3,000	8%
4+ vehicles	770	2%
Total:	38,010	100%

Households by Dwelling Type		
Single-detached	21,610	57%
Semi-detached	3,890	10%
Townhouse	10,550	28%
Apartment/Condo	1,960	5%
Total:	38,010	100%

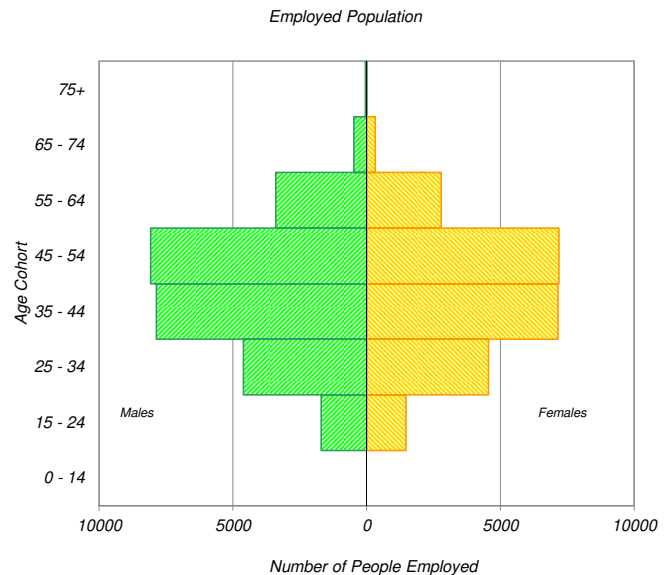
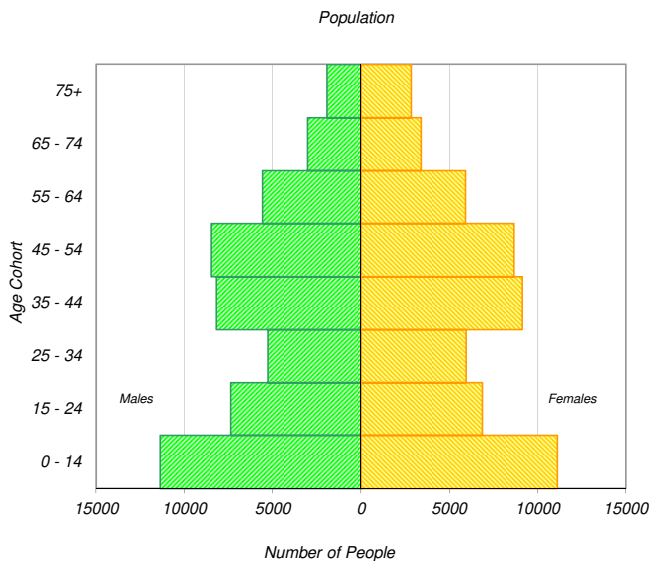

* In 2005 data was only collected for household members aged 11+ therefore these results cannot be compared to the 2011 data.

Travel Patterns

Top Five Destinations of Trips from Kanata - Stittsville

AM Peak Period

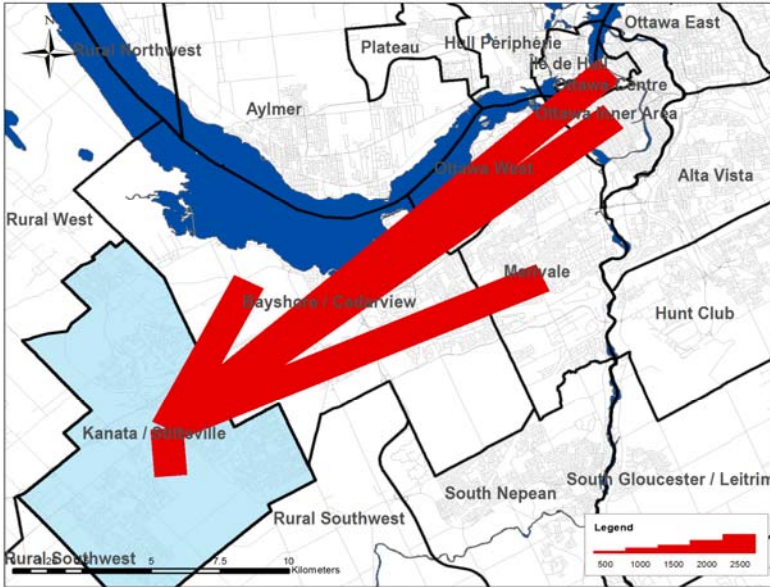

Summary of Trips to and from Kanata - Stittsville

AM Peak Period (6:30 - 8:59)

Districts	Destinations of Trips From		Origins of Trips To	
	District	% Total	District	% Total
Ottawa Centre	4,560	8%	140	0%
Ottawa Inner Area	3,350	6%	970	2%
Ottawa East	660	1%	260	1%
Beacon Hill	280	0%	170	0%
Alta Vista	1,810	3%	660	1%
Hunt Club	490	1%	420	1%
Merivale	3,410	6%	1,200	3%
Ottawa West	2,020	4%	840	2%
Bayshore / Cedarview	5,010	9%	2,420	5%
Orléans	290	1%	500	1%
Rural East	100	0%	30	0%
Rural Southeast	50	0%	260	1%
South Gloucester / Leitrim	60	0%	140	0%
South Nepean	690	1%	1,800	4%
Rural Southwest	1,130	2%	1,850	4%
Kanata / Stittsville	30,360	54%	30,360	66%
Rural West	1,050	2%	3,250	7%
Île de Hull	670	1%	30	0%
Hull Périphérie	160	0%	30	0%
Plateau	100	0%	230	0%
Aylmer	0	0%	190	0%
Rural Northwest	20	0%	60	0%
Pointe Gatineau	20	0%	80	0%
Gatineau Est	0	0%	60	0%
Rural Northeast	30	0%	50	0%
Buckingham / Masson-Angers	30	0%	10	0%
Ontario Sub-Total:	55,320	98%	45,270	98%
Québec Sub-Total:	1,030	2%	740	2%
Total:	56,350	100%	46,010	100%

Trips by Trip Purpose

24 Hours	From District		To District		Within District	
Work or related	27,180	29%	17,020	18%	14,550	9%
School	7,070	7%	2,500	3%	15,110	9%
Shopping	6,070	6%	9,150	10%	22,480	14%
Leisure	8,450	9%	10,590	11%	17,090	11%
Medical	2,520	3%	1,170	1%	2,660	2%
Pick-up / drive passenger	6,570	7%	5,470	6%	15,190	9%
Return Home	33,610	35%	45,620	48%	65,770	41%
Other	3,560	4%	3,590	4%	8,440	5%
Total:	95,030	100%	95,110	100%	161,290	100%

AM Peak (06:30 - 08:59)	From District		To District		Within District	
Work or related	18,030	69%	11,020	70%	7,430	24%
School	4,890	19%	2,280	15%	11,740	39%
Shopping	170	1%	320	2%	760	3%
Leisure	340	1%	400	3%	780	3%
Medical	330	1%	230	1%	350	1%
Pick-up / drive passenger	1,260	5%	580	4%	4,760	16%
Return Home	290	1%	380	2%	1,980	7%
Other	670	3%	430	3%	2,560	8%
Total:	25,980	100%	15,640	100%	30,360	100%

PM Peak (15:30 - 17:59)	From District		To District		Within District	
Work or related	390	2%	350	1%	930	2%
School	370	2%	0	0%	90	0%
Shopping	1,030	5%	1,910	7%	5,100	14%
Leisure	2,140	11%	3,080	11%	4,130	11%
Medical	230	1%	180	1%	400	1%
Pick-up / drive passenger	1,980	10%	1,980	7%	3,410	9%
Return Home	12,130	64%	20,550	71%	21,560	58%
Other	680	4%	860	3%	1,850	5%
Total:	18,950	100%	28,910	100%	37,470	100%

Peak Period (%)	Total:	% of 24 Hours	Within District (%)
24 Hours	351,430		46%
AM Peak Period	71,980	20%	42%
PM Peak Period	85,330	24%	44%

Trips by Primary Travel Mode

24 Hours	From District		To District		Within District	
Auto Driver	63,470	67%	63,830	67%	92,190	57%
Auto Passenger	15,220	16%	14,920	16%	31,880	20%
Transit	12,200	13%	12,270	13%	4,050	3%
Bicycle	360	0%	410	0%	960	1%
Walk	40	0%	50	0%	21,080	13%
Other	3,730	4%	3,660	4%	11,130	7%
Total:	95,020	100%	95,140	100%	161,290	100%

AM Peak (06:30 - 08:59)	From District		To District		Within District	
Auto Driver	15,360	59%	11,530	74%	13,630	45%
Auto Passenger	2,450	9%	1,160	7%	5,050	17%
Transit	6,230	24%	1,290	8%	1,210	4%
Bicycle	30	0%	80	1%	220	1%
Walk	0	0%	40	0%	5,730	19%
Other	1,900	7%	1,560	10%	4,510	15%
Total:	25,970	100%	15,660	100%	30,350	100%

PM Peak (15:30 - 17:59)	From District		To District		Within District	
Auto Driver	13,850	73%	17,660	61%	21,240	57%
Auto Passenger	3,240	17%	4,270	15%	8,570	23%
Transit	1,270	7%	5,980	21%	670	2%
Bicycle	40	0%	100	0%	260	1%
Walk	40	0%	0	0%	4,570	12%
Other	520	3%	910	3%	2,160	6%
Total:	18,960	100%	28,920	100%	37,470	100%

Avg Vehicle Occupancy	From District		To District		Within District	
24 Hours	1.24		1.23		1.35	
AM Peak Period	1.16		1.10		1.37	
PM Peak Period	1.23		1.24		1.40	

Transit Modal Split	From District		To District		Within District	
24 Hours	13%		13%		3%	
AM Peak Period	26%		9%		6%	
PM Peak Period	7%		21%		2%	

Appendix F

TRANS Regional Model

TRANS Regional Model

Version 1.13 - Assigned March 6, 2019

AM Peak Hour Total Traffic Volume Shirley's Brook - Kanata

2011 - Base Scenario

User Initials: SG
Plot Prepared: March 6, 2019
EMME Scenario: 11132



Legend

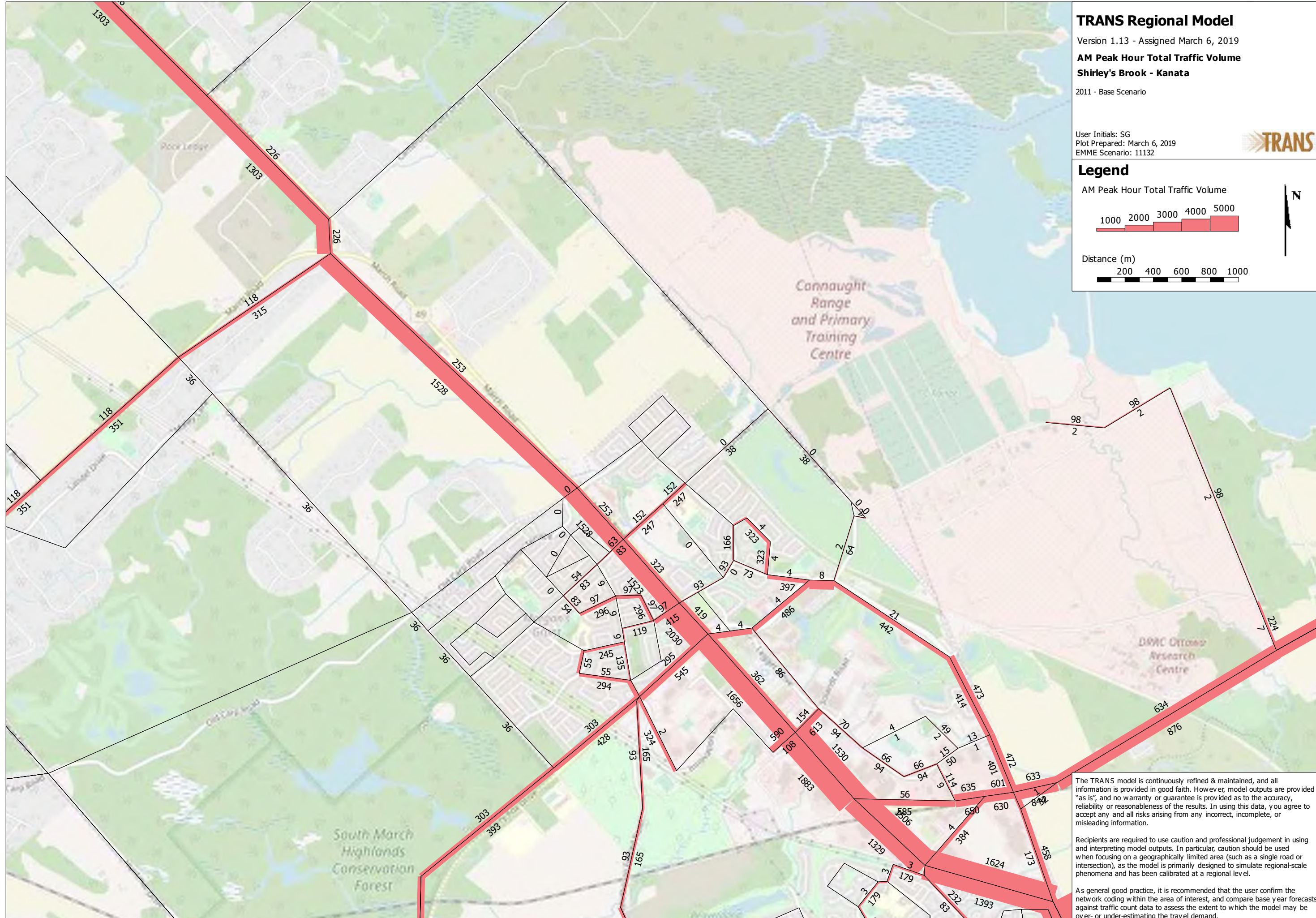
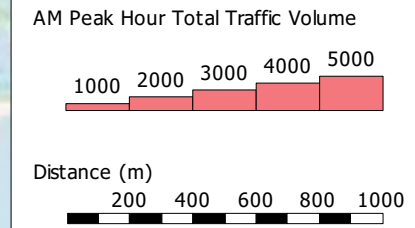

The TRANS model is continuously refined & maintained, and all information is provided in good faith. However, model outputs are provided "as is", and no warranty or guarantee is provided as to the accuracy, reliability or reasonableness of the results. In using this data, you agree to accept any and all risks arising from any incorrect, incomplete, or misleading information.

Recipients are required to use caution and professional judgement in using and interpreting model outputs. In particular, caution should be used when focusing on a geographically limited area (such as a single road or intersection), as the model is primarily designed to simulate regional-scale phenomena and has been calibrated at a regional level.

As a general good practice, it is recommended that the user confirm the network coding within the area of interest, and compare base year forecasts against traffic count data to assess the extent to which the model may be over- or under-estimating the travel demand.

TRANS Regional Model

Version 1.14 - Assigned March 5, 2019

AM Peak Hour Total Traffic Volume Shirley's Brook - Kanata

2031 - Base Scenario
TMP Affordable Road & Transit Network

User Initials: SG
Plot Prepared: March 6, 2018
EMME Scenario: 14311



Legend

AM Peak Hour Total Traffic Volume

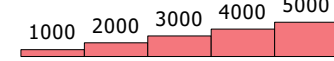

Distance (m)

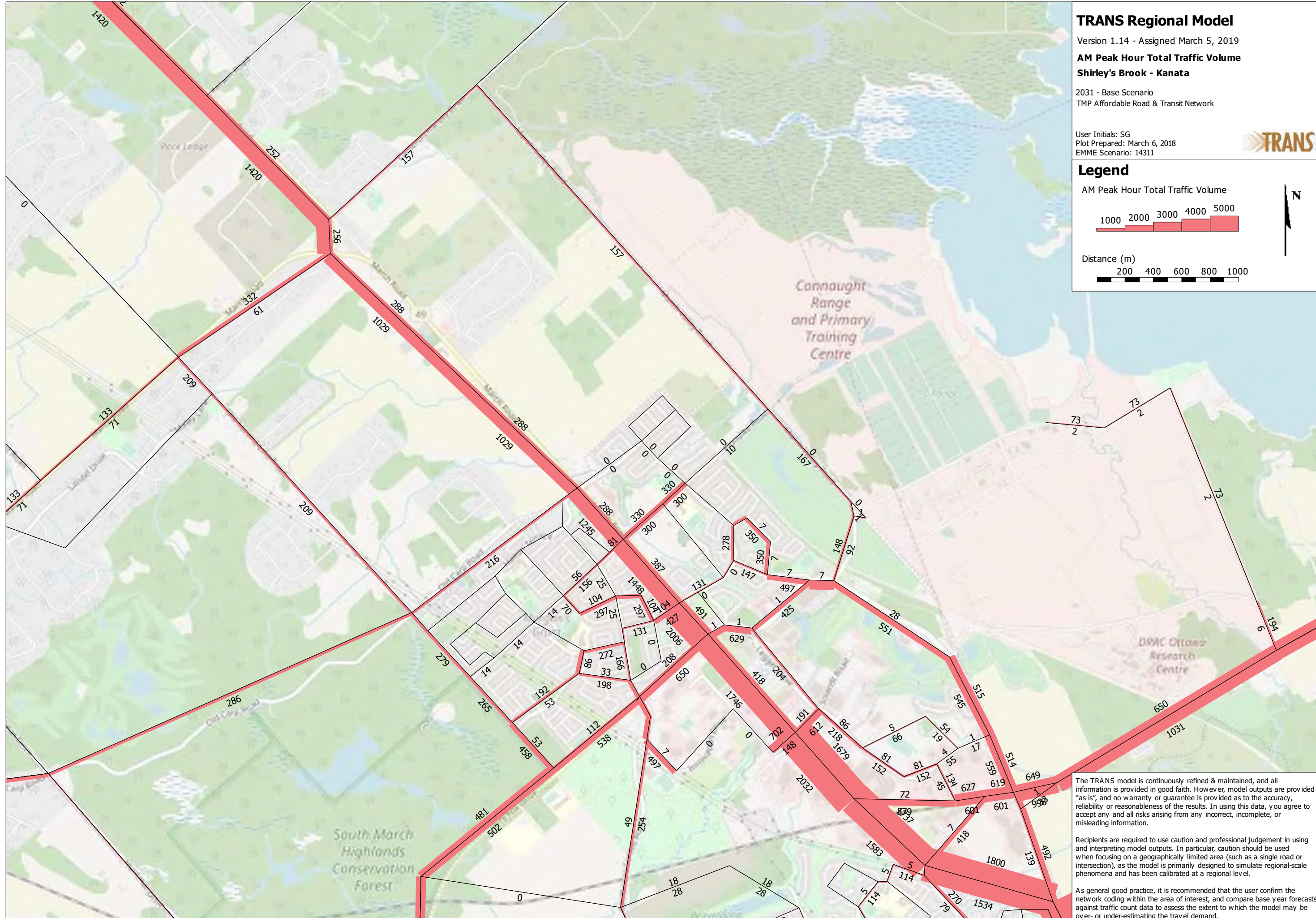
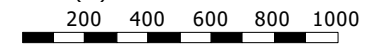

The TRANS model is continuously refined & maintained, and all information is provided in good faith. However, model outputs are provided "as is", and no warranty or guarantee is provided as to the accuracy, reliability or reasonableness of the results. In using this data, you agree to accept any and all risks arising from any incorrect, incomplete, or misleading information.

Recipients are required to use caution and professional judgement in using and interpreting model outputs. In particular, caution should be used when focusing on a geographically limited area (such as a single road or intersection), as the model is primarily designed to simulate regional-scale phenomena and has been calibrated at a regional level.

As a general good practice, it is recommended that the user confirm the network coding within the area of interest, and compare base year forecasts against traffic count data to assess the extent to which the model may be over- or under-estimating the travel demand.

Appendix G

TDM Checklists

TDM-Supportive Development Design and Infrastructure Checklist:
Non-Residential Developments (office, institutional, retail or industrial)

Legend	
REQUIRED	The Official Plan or Zoning By-law provides related guidance that must be followed
BASIC	The measure is generally feasible and effective, and in most cases would benefit the development and its users
BETTER	The measure could maximize support for users of sustainable modes, and optimize development performance

TDM-supportive design & infrastructure measures: <i>Non-residential developments</i>		Check if completed & add descriptions, explanations or plan/drawing references
1. WALKING & CYCLING: ROUTES		
1.1 Building location & access points		
BASIC	1.1.1 Locate building close to the street, and do not locate parking areas between the street and building entrances	<input checked="" type="checkbox"/>
BASIC	1.1.2 Locate building entrances in order to minimize walking distances to sidewalks and transit stops/stations	<input checked="" type="checkbox"/>
BASIC	1.1.3 Locate building doors and windows to ensure visibility of pedestrians from the building, for their security and comfort	<input checked="" type="checkbox"/>
1.2 Facilities for walking & cycling		
REQUIRED	1.2.1 Provide convenient, direct access to stations or major stops along rapid transit routes within 600 metres; minimize walking distances from buildings to rapid transit; provide pedestrian-friendly, weather-protected (where possible) environment between rapid transit accesses and building entrances; ensure quality linkages from sidewalks through building entrances to integrated stops/stations <i>(see Official Plan policy 4.3.3)</i>	<input checked="" type="checkbox"/>
REQUIRED	1.2.2 Provide safe, direct and attractive pedestrian access from public sidewalks to building entrances through such measures as: reducing distances between public sidewalks and major building entrances; providing walkways from public streets to major building entrances; within a site, providing walkways along the front of adjoining buildings, between adjacent buildings, and connecting areas where people may congregate, such as courtyards and transit stops; and providing weather protection through canopies, colonnades, and other design elements wherever possible <i>(see Official Plan policy 4.3.12)</i>	<input checked="" type="checkbox"/>

TDM-supportive design & infrastructure measures: Non-residential developments		Check if completed & add descriptions, explanations or plan/drawing references
REQUIRED	1.2.3 Provide sidewalks of smooth, well-drained walking surfaces of contrasting materials or treatments to differentiate pedestrian areas from vehicle areas, and provide marked pedestrian crosswalks at intersection sidewalks (<i>see Official Plan policy 4.3.10</i>)	<input checked="" type="checkbox"/>
REQUIRED	1.2.4 Make sidewalks and open space areas easily accessible through features such as gradual grade transition, depressed curbs at street corners and convenient access to extra-wide parking spaces and ramps (<i>see Official Plan policy 4.3.10</i>)	<input checked="" type="checkbox"/>
REQUIRED	1.2.5 Include adequately spaced inter-block/street cycling and pedestrian connections to facilitate travel by active transportation. Provide links to the existing or planned network of public sidewalks, multi-use pathways and on-road cycle routes. Where public sidewalks and multi-use pathways intersect with roads, consider providing traffic control devices to give priority to cyclists and pedestrians (<i>see Official Plan policy 4.3.11</i>)	<input checked="" type="checkbox"/>
BASIC	1.2.6 Provide safe, direct and attractive walking routes from building entrances to nearby transit stops	<input type="checkbox"/>
BASIC	1.2.7 Ensure that walking routes to transit stops are secure, visible, lighted, shaded and wind-protected wherever possible	<input type="checkbox"/>
BASIC	1.2.8 Design roads used for access or circulation by cyclists using a target operating speed of no more than 30 km/h, or provide a separated cycling facility	<input type="checkbox"/>
1.3 Amenities for walking & cycling		
BASIC	1.3.1 Provide lighting, landscaping and benches along walking and cycling routes between building entrances and streets, sidewalks and trails	<input type="checkbox"/>
BASIC	1.3.2 Provide wayfinding signage for site access (where required, e.g. when multiple buildings or entrances exist) and egress (where warranted, such as when directions to reach transit stops/stations, trails or other common destinations are not obvious)	<input type="checkbox"/>

TDM-supportive design & infrastructure measures: <i>Non-residential developments</i>		Check if completed & add descriptions, explanations or plan/drawing references
2. WALKING & CYCLING: END-OF-TRIP FACILITIES		
2.1 Bicycle parking		
REQUIRED	2.1.1 Provide bicycle parking in highly visible and lighted areas, sheltered from the weather wherever possible (see <i>Official Plan policy 4.3.6</i>)	<input checked="" type="checkbox"/>
REQUIRED	2.1.2 Provide the number of bicycle parking spaces specified for various land uses in different parts of Ottawa; provide convenient access to main entrances or well-used areas (see <i>Zoning By-law Section 111</i>)	<input checked="" type="checkbox"/>
REQUIRED	2.1.3 Ensure that bicycle parking spaces and access aisles meet minimum dimensions; that no more than 50% of spaces are vertical spaces; and that parking racks are securely anchored (see <i>Zoning By-law Section 111</i>)	<input checked="" type="checkbox"/>
BASIC	2.1.4 Provide bicycle parking spaces equivalent to the expected number of commuter cyclists (assuming the cycling mode share target is met), plus the expected peak number of customer/visitor cyclists	<input checked="" type="checkbox"/>
BETTER	2.1.5 Provide bicycle parking spaces equivalent to the expected number of commuter and customer/visitor cyclists, plus an additional buffer (e.g. 25 percent extra) to encourage other cyclists and ensure adequate capacity in peak cycling season	<input type="checkbox"/>
2.2 Secure bicycle parking		
REQUIRED	2.2.1 Where more than 50 bicycle parking spaces are provided for a single office building, locate at least 25% of spaces within a building/structure, a secure area (e.g. supervised parking lot or enclosure) or bicycle lockers (see <i>Zoning By-law Section 111</i>)	<input type="checkbox"/> n/a
BETTER	2.2.2 Provide secure bicycle parking spaces equivalent to the expected number of commuter cyclists (assuming the cycling mode share target is met)	<input type="checkbox"/>
2.3 Shower & change facilities		
BASIC	2.3.1 Provide shower and change facilities for the use of active commuters	<input type="checkbox"/>
BETTER	2.3.2 In addition to shower and change facilities, provide dedicated lockers, grooming stations, drying racks and laundry facilities for the use of active commuters	<input type="checkbox"/>
2.4 Bicycle repair station		
BETTER	2.4.1 Provide a permanent bike repair station, with commonly used tools and an air pump, adjacent to the main bicycle parking area (or secure bicycle parking area, if provided)	<input type="checkbox"/>

TDM-supportive design & infrastructure measures: <i>Non-residential developments</i>		Check if completed & add descriptions, explanations or plan/drawing references
3. TRANSIT		
3.1 Customer amenities		
BASIC	3.1.1 Provide shelters, lighting and benches at any on-site transit stops	<input type="checkbox"/>
BASIC	3.1.2 Where the site abuts an off-site transit stop and insufficient space exists for a transit shelter in the public right-of-way, protect land for a shelter and/or install a shelter	<input type="checkbox"/>
BETTER	3.1.3 Provide a secure and comfortable interior waiting area by integrating any on-site transit stops into the building	<input type="checkbox"/>
4. RIDESHARING		
4.1 Pick-up & drop-off facilities		
BASIC	4.1.1 Provide a designated area for carpool drivers (plus taxis and ride-hailing services) to drop off or pick up passengers without using fire lanes or other no-stopping zones	<input type="checkbox"/>
4.2 Carpool parking		
BASIC	4.2.1 Provide signed parking spaces for carpools in a priority location close to a major building entrance, sufficient in number to accommodate the mode share target for carpools	<input type="checkbox"/>
BETTER	4.2.2 At large developments, provide spaces for carpools in a separate, access-controlled parking area to simplify enforcement	<input type="checkbox"/>
5. CARSHARING & BIKESHARING		
5.1 Carshare parking spaces		
BETTER	5.1.1 Provide carshare parking spaces in permitted non-residential zones, occupying either required or provided parking spaces (<i>see Zoning By-law Section 94</i>)	<input type="checkbox"/>
5.2 Bikeshare station location		
BETTER	5.2.1 Provide a designated bikeshare station area near a major building entrance, preferably lighted and sheltered with a direct walkway connection	<input type="checkbox"/>

TDM-supportive design & infrastructure measures: <i>Non-residential developments</i>		Check if completed & add descriptions, explanations or plan/drawing references
6. PARKING		
6.1 Number of parking spaces		
REQUIRED	6.1.1 Do not provide more parking than permitted by zoning, nor less than required by zoning, unless a variance is being applied for	<input checked="" type="checkbox"/>
BASIC	6.1.2 Provide parking for long-term and short-term users that is consistent with mode share targets, considering the potential for visitors to use off-site public parking	<input type="checkbox"/>
BASIC	6.1.3 Where a site features more than one use, provide shared parking and reduce the cumulative number of parking spaces accordingly (<i>see Zoning By-law Section 104</i>)	<input type="checkbox"/>
BETTER	6.1.4 Reduce the minimum number of parking spaces required by zoning by one space for each 13 square metres of gross floor area provided as shower rooms, change rooms, locker rooms and other facilities for cyclists in conjunction with bicycle parking (<i>see Zoning By-law Section 111</i>)	<input type="checkbox"/>
6.2 Separate long-term & short-term parking areas		
BETTER	6.2.1 Separate short-term and long-term parking areas using signage or physical barriers, to permit access controls and simplify enforcement (i.e. to discourage employees from parking in visitor spaces, and vice versa)	<input type="checkbox"/>
7. OTHER		
7.1 On-site amenities to minimize off-site trips		
BETTER	7.1.1 Provide on-site amenities to minimize mid-day or mid-commute errands	<input type="checkbox"/>

TDM Measures Checklist:
Non-Residential Developments (office, institutional, retail or industrial)

Legend	
BASIC	The measure is generally feasible and effective, and in most cases would benefit the development and its users
BETTER	The measure could maximize support for users of sustainable modes, and optimize development performance
★	The measure is one of the most dependably effective tools to encourage the use of sustainable modes

TDM measures: <i>Non-residential developments</i>		Check if proposed & add descriptions
1. TDM PROGRAM MANAGEMENT		
1.1 Program coordinator		
BASIC	★	1.1.1 Designate an internal coordinator, or contract with an external coordinator <input checked="" type="checkbox"/>
1.2 Travel surveys		
BETTER		1.2.1 Conduct periodic surveys to identify travel-related behaviours, attitudes, challenges and solutions, and to track progress <input type="checkbox"/>
2. WALKING AND CYCLING		
2.1 Information on walking/cycling routes & destinations		
BASIC		2.1.1 Display local area maps with walking/cycling access routes and key destinations at major entrances <input checked="" type="checkbox"/>
2.2 Bicycle skills training		
<i>Commuter travel</i>		
BETTER	★	2.2.1 Offer on-site cycling courses for commuters, or subsidize off-site courses <input type="checkbox"/>
2.3 Valet bike parking		
<i>Visitor travel</i>		
BETTER		2.3.1 Offer secure valet bike parking during public events when demand exceeds fixed supply (e.g. for festivals, concerts, games) <input type="checkbox"/>

TDM measures: <i>Non-residential developments</i>		Check if proposed & add descriptions
3. TRANSIT		
3.1 Transit information		
BASIC	3.1.1 Display relevant transit schedules and route maps at entrances	<input checked="" type="checkbox"/>
BASIC	3.1.2 Provide online links to OC Transpo and STO information	<input checked="" type="checkbox"/>
BETTER	3.1.3 Provide real-time arrival information display at entrances	<input type="checkbox"/>
3.2 Transit fare incentives		
<i>Commuter travel</i>		
BETTER	3.2.1 Offer preloaded PRESTO cards to encourage commuters to use transit	<input type="checkbox"/>
BETTER ★	3.2.2 Subsidize or reimburse monthly transit pass purchases by employees	<input type="checkbox"/>
<i>Visitor travel</i>		
BETTER	3.2.3 Arrange inclusion of same-day transit fare in price of tickets (e.g. for festivals, concerts, games)	<input type="checkbox"/>
3.3 Enhanced public transit service		
<i>Commuter travel</i>		
BETTER	3.3.1 Contract with OC Transpo to provide enhanced transit services (e.g. for shift changes, weekends)	<input type="checkbox"/>
<i>Visitor travel</i>		
BETTER	3.3.2 Contract with OC Transpo to provide enhanced transit services (e.g. for festivals, concerts, games)	<input type="checkbox"/>
3.4 Private transit service		
<i>Commuter travel</i>		
BETTER	3.4.1 Provide shuttle service when OC Transpo cannot offer sufficient quality or capacity to serve demand (e.g. for shift changes, weekends)	<input type="checkbox"/>
<i>Visitor travel</i>		
BETTER	3.4.2 Provide shuttle service when OC Transpo cannot offer sufficient quality or capacity to serve demand (e.g. for festivals, concerts, games)	<input type="checkbox"/>

TDM measures: <i>Non-residential developments</i>		Check if proposed & add descriptions
4. RIDESHARING		
4.1 Ridematching service		
<i>Commuter travel</i>		
BASIC ★	4.1.1 Provide a dedicated ridematching portal at OttawaRideMatch.com	<input checked="" type="checkbox"/>
4.2 Carpool parking price incentives		
<i>Commuter travel</i>		
BETTER	4.2.1 Provide discounts on parking costs for registered carpools	<input type="checkbox"/>
4.3 Vanpool service		
<i>Commuter travel</i>		
BETTER	4.3.1 Provide a vanpooling service for long-distance commuters	<input type="checkbox"/>
5. CARSHARING & BIKESHARING		
5.1 Bikeshare stations & memberships		
BETTER	5.1.1 Contract with provider to install on-site bikeshare station for use by commuters and visitors	<input type="checkbox"/>
<i>Commuter travel</i>		
BETTER	5.1.2 Provide employees with bikeshare memberships for local business travel	<input type="checkbox"/>
5.2 Carshare vehicles & memberships		
<i>Commuter travel</i>		
BETTER	5.2.1 Contract with provider to install on-site carshare vehicles and promote their use by tenants	<input type="checkbox"/>
BETTER	5.2.2 Provide employees with carshare memberships for local business travel	<input type="checkbox"/>
6. PARKING		
6.1 Priced parking		
<i>Commuter travel</i>		
BASIC ★	6.1.1 Charge for long-term parking (daily, weekly, monthly)	<input type="checkbox"/>
BASIC	6.1.2 Unbundle parking cost from lease rates at multi-tenant sites	<input type="checkbox"/>
<i>Visitor travel</i>		
BETTER	6.1.3 Charge for short-term parking (hourly)	<input type="checkbox"/>

TDM measures: <i>Non-residential developments</i>		Check if proposed & add descriptions
7. TDM MARKETING & COMMUNICATIONS		
7.1 Multimodal travel information		
<i>Commuter travel</i>		
BASIC ★	7.1.1	Provide a multimodal travel option information package to new/relocating employees and students <input type="checkbox"/>
<i>Visitor travel</i>		
BETTER ★	7.1.2	Include multimodal travel option information in invitations or advertising that attract visitors or customers (e.g. for festivals, concerts, games) <input type="checkbox"/>
7.2 Personalized trip planning		
<i>Commuter travel</i>		
BETTER ★	7.2.1	Offer personalized trip planning to new/relocating employees <input type="checkbox"/>
7.3 Promotions		
<i>Commuter travel</i>		
BETTER	7.3.1	Deliver promotions and incentives to maintain awareness, build understanding, and encourage trial of sustainable modes <input type="checkbox"/>
8. OTHER INCENTIVES & AMENITIES		
8.1 Emergency ride home		
<i>Commuter travel</i>		
BETTER ★	8.1.1	Provide emergency ride home service to non-driving commuters <input type="checkbox"/>
8.2 Alternative work arrangements		
<i>Commuter travel</i>		
BASIC ★	8.2.1	Encourage flexible work hours <input checked="" type="checkbox"/>
BETTER	8.2.2	Encourage compressed workweeks <input type="checkbox"/>
BETTER ★	8.2.3	Encourage telework <input type="checkbox"/>
8.3 Local business travel options		
<i>Commuter travel</i>		
BASIC ★	8.3.1	Provide local business travel options that minimize the need for employees to bring a personal car to work <input type="checkbox"/>
8.4 Commuter incentives		
<i>Commuter travel</i>		
BETTER	8.4.1	Offer employees a taxable, mode-neutral commuting allowance <input type="checkbox"/>
8.5 On-site amenities		
<i>Commuter travel</i>		
BETTER	8.5.1	Provide on-site amenities/services to minimize mid-day or mid-commute errands <input type="checkbox"/>

Appendix H

Traffic Signal Warrant Analysis

Intersection: **Carling Avenue / Teron Road**
Scenario: 2025 Total Projection

Project 19-032
2019-12-15

Date of Traffic Count: Tuesday, 19 November 2019

Conditions

Main road oriented north-south? No
Two lanes or more per approach on main road? No
Intersection with only 3 approaches (T)? Yes
Urban setting (restricted flow)? Yes
Future intersection or roadway(s)? No

Hourly Traffic Volumes (pc/h)

Peak Hour	Eastbound (Main)			Northbound (Minor)			Westbound (Main)			Southbound (Minor)			Peds Crossing Main Road
	Left	Through	Right	Left	Through	Right	Left	Through	Right	Left	Through	Right	
AM		494	16	221		150	44	567					
PM		762	98	26		88	147	426					
Average Hourly Volume (AHV)	0	314	29	62	0	60	48	248	0	0	0	0	0

Justification 7

	Justification	Threshold (pc/h)	Volume (pc/h)		Average Hourly Volume (pc/h)	Percentage of Threshold	Justification Met to 120%?
			AM	PM			
Volume	1A Total Traffic	720	1491	1547	759	105%	No
	1B Sidestreet Traffic	255	371	113	121	47%	
Delay	2A Main Road Traffic	720	1120	1433	638	89%	No
	2B Crossing Traffic & Pedestrians	75	221	99	62	82%	

Result

Traffic signals are not warranted

Appendix I

Synchro Traffic Analysis Reports

19-032 1243 Teron Road
Lanes, Volumes, Timings

1: March Rd & Herzberg Rd
2025 Background AM

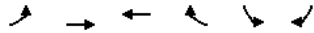

Lane Group	EBL	EBT	WBT	WBR	SBL	SBR
Lane Configurations	↔	↕↕↕	↕↕	↔	↕↕	↔
Traffic Volume (vph)	19	840	2446	881	123	10
Future Volume (vph)	19	840	2446	881	123	10
Ideal Flow (vphpl)	1800	1800	1800	1800	1800	1800
Lane Width (m)	3.6	3.6	3.6	3.6	3.6	3.6
Grade (%)		0%	0%		0%	
Storage Length (m)	75.0			0.0	0.0	30.0
Storage Lanes	1			1	2	1
Taper Length (m)	40.0				7.5	
Lane Util. Factor	1.00	0.91	0.95	1.00	0.97	1.00
Ped Bike Factor						
Frt				0.850		0.850
Fit Protected	0.950				0.950	
Satd. Flow (prot)	1676	4818	3353	1500	3252	1500
Fit Permitted	0.950				0.950	
Satd. Flow (perm)	1676	4818	3353	1500	3252	1500
Right Turn on Red				Yes		Yes
Satd. Flow (RTOR)				509		11
Link Speed (k/h)		80	80		50	
Link Distance (m)		149.3	160.9		125.0	
Travel Time (s)		6.7	7.2		9.0	
Confl. Peds. (#/hr)						
Confl. Bikes (#/hr)						
Peak Hour Factor	0.92	0.92	0.92	0.92	0.92	0.92
Growth Factor	100%	100%	100%	100%	100%	100%
Heavy Vehicles (%)	2%	2%	2%	2%	2%	2%
Bus Blockages (#/hr)	0	0	0	0	0	0
Parking (#/hr)						
Mid-Block Traffic (%)		0%	0%		0%	
Adj. Flow (vph)	21	913	2659	958	134	11
Shared Lane Traffic (%)						
Lane Group Flow (vph)	21	913	2659	958	134	11
Turn Type	Prot	NA	NA	Perm	Prot	Perm
Protected Phases	5	2	6	6	4	4
Permitted Phases				6		4
Detector Phase	5	2	6	6	4	4
Switch Phase						
Minimum Initial (s)	5.0	20.0	20.0	20.0	10.0	10.0
Minimum Split (s)	12.0	27.0	27.0	27.0	35.0	35.0
Total Split (s)	12.0	95.0	83.0	83.0	35.0	35.0
Total Split (%)	9.2%	73.1%	63.8%	63.8%	26.9%	26.9%
Yellow Time (s)	4.6	4.6	4.6	4.6	3.3	3.3
All-Red Time (s)	1.8	1.7	1.7	1.7	2.8	2.8
Lost Time Adjust (s)	0.0	0.0	0.0	0.0	0.0	0.0
Total Lost Time (s)	6.4	6.3	6.3	6.3	6.1	6.1
Lead/Lag	Lead		Lag	Lag		
Lead-Lag Optimize?						
Recall Mode	None	C-Max	C-Max	C-Max	None	None
Act Effct Green (s)	7.2	106.2	97.5	97.5	11.4	11.4

19-032 1243 Teron Road
Lanes, Volumes, Timings

1: March Rd & Herzberg Rd
2025 Background AM

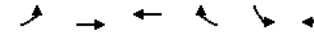

Lane Group	EBL	EBT	WBT	WBR	SBL	SBR
Actuated g/C Ratio	0.06	0.82	0.75	0.75	0.09	0.09
v/c Ratio	0.23	0.23	1.06	0.77	0.47	0.08
Control Delay	88.3	3.1	54.0	10.0	61.7	25.9
Queue Delay	0.0	0.0	0.0	0.0	0.0	0.0
Total Delay	88.3	3.1	54.0	10.0	61.7	25.9
LOS	F	A	D	A	E	C
Approach Delay		5.1	42.3		59.0	
Approach LOS		A	D		E	
Queue Length 50th (m)	3.5	0.4	~321.9	49.8	13.6	0.0
Queue Length 95th (m)	m8.4	0.7	#367.6	116.5	21.3	4.7
Internal Link Dist (m)		125.3	136.9		101.0	
Turn Bay Length (m)	75.0					30.0
Base Capacity (vph)	93	3935	2513	1252	722	342
Starvation Cap Reductn	0	0	0	0	0	0
Spillback Cap Reductn	0	0	0	0	0	0
Storage Cap Reductn	0	0	0	0	0	0
Reduced v/c Ratio	0.23	0.23	1.06	0.77	0.19	0.03

Intersection Summary

Area Type: Other
 Cycle Length: 130
 Actuated Cycle Length: 130
 Offset: 12 (9%), Referenced to phase 2:EBT and 6:WBT, Start of Green
 Natural Cycle: 150
 Control Type: Actuated-Coordinated
 Maximum v/c Ratio: 1.06
 Intersection Signal Delay: 35.4
 Intersection Capacity Utilization 90.0%
 Analysis Period (min) 15
 ~ Volume exceeds capacity, queue is theoretically infinite.
 Queue shown is maximum after two cycles.
 # 95th percentile volume exceeds capacity, queue may be longer.
 Queue shown is maximum after two cycles.
 m Volume for 95th percentile queue is metered by upstream signal.

Splits and Phases: 1: March Rd & Herzberg Rd

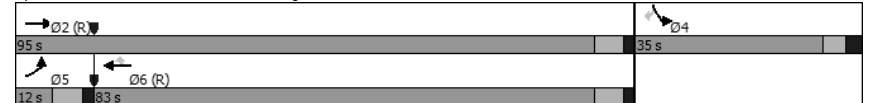

19-032 1243 Teron Road
Lanes, Volumes, Timings

2: Teron Rd & March Rd
2025 Background AM

Lane Group	EBL	EBT	EBR	WBL	WBT	WBR	NBL	NBT	NBR	SBL	SBT	SBR
Lane Configurations	↔	↔↔	↔	↔	↔↔	↔	↔	↔	↔	↔	↔	↔
Traffic Volume (vph)	34	844	223	61	2017	218	342	183	43	30	33	9
Future Volume (vph)	34	844	223	61	2017	218	342	183	43	30	33	9
Ideal Flow (vphpl)	1800	1800	1800	1800	1800	1800	1800	1800	1800	1800	1800	1800
Lane Width (m)	3.6	3.6	3.6	3.6	3.6	3.6	3.6	3.6	3.6	3.6	3.6	3.6
Grade (%)	0%		0%		0%		0%		0%		0%	
Storage Length (m)	75.0		75.0		75.0		0.0		40.0		40.0	
Storage Lanes	1		1		1		1		1		1	
Taper Length (m)	50.0		50.0		7.5		40.0					
Lane Util. Factor	1.00	0.95	1.00	1.00	0.95	1.00	1.00	1.00	1.00	1.00	1.00	1.00
Ped Bike Factor	0.850		0.850		0.850		0.850		0.850		0.850	
Fit Protected	0.950		0.950		0.950		0.950		0.950		0.950	
Satd. Flow (prot)	1676	3353	1500	1676	3353	1500	1676	1765	1500	1676	1765	1500
Fit Permitted	0.950		0.950		0.450		0.633					
Satd. Flow (perm)	1676	3353	1500	1676	3353	1500	794	1765	1500	1117	1765	1500
Right Turn on Red	Yes		Yes		Yes		Yes		Yes		Yes	
Satd. Flow (RTOR)	242		135		133		133		133		133	
Link Speed (k/h)	80		80		80		50		50		50	
Link Distance (m)	220.0		806.6		79.5		112.5					
Travel Time (s)	9.9		36.3		5.7		8.1					
Confl. Peds. (#/hr)												
Confl. Bikes (#/hr)												
Peak Hour Factor	0.92	0.92	0.92	0.92	0.92	0.92	0.92	0.92	0.92	0.92	0.92	0.92
Growth Factor	100%	100%	100%	100%	100%	100%	100%	100%	100%	100%	100%	100%
Heavy Vehicles (%)	2%	2%	2%	2%	2%	2%	2%	2%	2%	2%	2%	2%
Bus Blockages (#/hr)	0	0	0	0	0	0	0	0	0	0	0	0
Parking (#/hr)												
Mid-Block Traffic (%)	0%		0%		0%		0%		0%		0%	
Adj. Flow (vph)	37	917	242	66	2192	237	372	199	47	33	36	10
Shared Lane Traffic (%)												
Lane Group Flow (vph)	37	917	242	66	2192	237	372	199	47	33	36	10
Turn Type	Prot	NA	Perm	Prot	NA	Perm	pm+pt	NA	Perm	pm+pt	NA	Perm
Protected Phases	5	2		1	6		3	8		7	4	
Permitted Phases			2			6	8		8	4		4
Detector Phase	5	2	2	1	6	6	3	8	8	7	4	4
Switch Phase												
Minimum Initial (s)	5.0	20.0	20.0	5.0	20.0	20.0	5.0	10.0	10.0	5.0	10.0	10.0
Minimum Split (s)	12.0	27.0	27.0	12.0	27.0	27.0	12.0	35.0	35.0	12.0	35.0	35.0
Total Split (s)	12.0	61.0	61.0	12.0	61.0	61.0	22.0	35.0	35.0	22.0	35.0	35.0
Total Split (%)	9.2%	46.9%	46.9%	9.2%	46.9%	46.9%	16.9%	26.9%	26.9%	16.9%	26.9%	26.9%
Yellow Time (s)	4.6	4.6	4.6	4.6	4.6	4.6	3.3	3.3	3.3	3.3	3.3	3.3
All-Red Time (s)	1.8	1.7	1.7	1.8	1.7	1.7	2.8	3.3	3.3	2.8	3.3	3.3
Lost Time Adjust (s)	0.0	0.0	0.0	0.0	0.0	0.0	0.0	0.0	0.0	0.0	0.0	0.0
Total Lost Time (s)	6.4	6.3	6.3	6.4	6.3	6.3	6.1	6.6	6.6	6.1	6.6	6.6
Lead/Lag	Lead	Lag	Lag	Lead	Lag	Lag	Lead	Lag	Lag	Lead	Lag	Lag
Lead-Lag Optimize?												
Recall Mode	None	C-Max	C-Max	None	C-Max	C-Max	None	None	None	None	None	None
Act Effct Green (s)	8.4	69.7	69.7	11.6	75.3	75.3	29.9	20.5	20.5	17.7	13.7	13.7

19-032 1243 Teron Road
Lanes, Volumes, Timings

2: Teron Rd & March Rd
2025 Background AM

Lane Group	EBL	EBT	EBR	WBL	WBT	WBR	NBL	NBT	NBR	SBL	SBT	SBR
Actuated g/C Ratio	0.06	0.54	0.54	0.09	0.58	0.58	0.23	0.16	0.16	0.14	0.11	0.11
v/c Ratio	0.34	0.51	0.26	0.44	1.13	0.26	1.27	0.72	0.14	0.18	0.19	0.04
Control Delay	65.8	22.9	3.5	66.0	77.0	3.2	185.6	66.1	0.8	37.8	53.5	0.2
Queue Delay	0.0	0.0	0.0	0.0	0.0	0.0	0.0	0.0	0.0	0.0	0.0	0.0
Total Delay	65.8	22.9	3.5	66.0	77.0	3.2	185.6	66.1	0.8	37.8	53.5	0.2
LOS	E	C	A	E	E	A	F	E	A	D	D	A
Approach Delay	20.3		69.7		133.1		40.2					
Approach LOS	C		E		F		D					
Queue Length 50th (m)	7.3	65.5	0.0	12.2	~288.1	7.0	~85.8	38.8	0.0	5.0	6.9	0.0
Queue Length 95th (m)	16.0	94.4	12.0	m11.3m#296.7	m9.6	#89.9	56.0	0.0	10.6	14.2	0.0	0.0
Internal Link Dist (m)	196.0		782.6		55.5		88.5					
Turn Bay Length (m)	75.0		75.0		75.0		40.0		40.0		40.0	
Base Capacity (vph)	108	1797	916	149	1941	925	292	385	431	290	385	431
Starvation Cap Reductn	0	0	0	0	0	0	0	0	0	0	0	0
Spillback Cap Reductn	0	0	0	0	0	0	0	0	0	0	0	0
Storage Cap Reductn	0	0	0	0	0	0	0	0	0	0	0	0
Reduced v/c Ratio	0.34	0.51	0.26	0.44	1.13	0.26	1.27	0.52	0.11	0.11	0.09	0.02

Intersection Summary

Area Type: Other
 Cycle Length: 130
 Actuated Cycle Length: 130
 Offset: 77 (59%), Referenced to phase 2:EBT and 6:WBT, Start of Green
 Natural Cycle: 150
 Control Type: Actuated-Coordinated
 Maximum v/c Ratio: 1.27
 Intersection Signal Delay: 64.7
 Intersection Capacity Utilization 103.0%
 Intersection LOS: E
 ICU Level of Service G
 Analysis Period (min) 15
 ~ Volume exceeds capacity, queue is theoretically infinite.
 Queue shown is maximum after two cycles.
 # 95th percentile volume exceeds capacity, queue may be longer.
 Queue shown is maximum after two cycles.
 m Volume for 95th percentile queue is metered by upstream signal.

Splits and Phases: 2: Teron Rd & March Rd



19-032 1243 Teron Road
Lanes, Volumes, Timings

3: March Rd & Station Rd/Carling Ave

2025 Background AM

Lane Group	EBL	EBT	EBR	WBL	WBT	WBR	NBL	NBT	NBR	SBL	SBT	SBR	
Lane Configurations		↑	↑		↑	↑		↑↑	↑	↑	↑↑	↑	
Traffic Volume (vph)	66	27	9	39	13	182	91	2032	87	331	989	129	
Future Volume (vph)	66	27	9	39	13	182	91	2032	87	331	989	129	
Ideal Flow (vphpl)	1800	1800	1800	1800	1800	1800	1800	1800	1800	1800	1800	1800	
Lane Width (m)	3.6	3.6	3.6	3.6	3.6	3.6	3.6	3.6	3.6	3.6	3.6	3.6	
Grade (%)	0%			0%			0%			0%			
Storage Length (m)	0.0		25.0	0.0		0.0	75.0		75.0	175.0		25.0	
Storage Lanes	0		1	0		1	1		1	2		1	
Taper Length (m)	7.5			7.5			50.0			75.0			
Lane Util. Factor	1.00	1.00	1.00	1.00	1.00	1.00	1.00	0.95	1.00	0.97	0.95	1.00	
Ped Bike Factor	1.00		0.98	0.99		0.99	1.00	0.94		1.00	0.97		
Frt	0.850			0.850			0.850			0.850			
Fit Protected	0.966		0.964		0.950		0.950		0.950		0.950		
Satd. Flow (prot)	0	1705	1500	0	1701	1500	1676	3353	1500	3252	3353	1500	
Fit Permitted	0.753		0.636		0.950		0.950		0.950		0.950		
Satd. Flow (perm)	0	1323	1463	0	1113	1481	1671	3353	1415	3241	3353	1449	
Right Turn on Red			Yes		Yes		Yes		Yes		Yes		
Satd. Flow (RTOR)	103			198			80			80			
Link Speed (k/h)	50			60			80			80			
Link Distance (m)	131.4			60.0			183.7			281.3			
Travel Time (s)	9.5			3.6			8.3			12.7			
Confl. Peds. (#/hr)	3		6	6		3	4		21	21		4	
Confl. Bikes (#/hr)													
Peak Hour Factor	0.92	0.92	0.92	0.92	0.92	0.92	0.92	0.92	0.92	0.92	0.92	0.92	
Growth Factor	100%	100%	100%	100%	100%	100%	100%	100%	100%	100%	100%	100%	
Heavy Vehicles (%)	2%	2%	2%	2%	2%	2%	2%	2%	2%	2%	2%	2%	
Bus Blockages (#/hr)	0	0	0	0	0	0	0	0	0	0	0	0	
Parking (#/hr)													
Mid-Block Traffic (%)	0%			0%			0%			0%			
Adj. Flow (vph)	72	29	10	42	14	198	99	2209	95	360	1075	140	
Shared Lane Traffic (%)													
Lane Group Flow (vph)	0	101	10	0	56	198	99	2209	95	360	1075	140	
Turn Type	Perm	NA	Perm	Perm	NA	Free	Prot	NA	Perm	Prot	NA	Perm	
Protected Phases	4			8			5			2			
Permitted Phases	4		4	8		Free			2			6	
Detector Phase	4	4	4	8	8		5	2	2	1	6	6	
Switch Phase													
Minimum Initial (s)	10.0	10.0	10.0	10.0	10.0		5.0	20.0	20.0	5.0	20.0	20.0	
Minimum Split (s)	35.0	35.0	35.0	35.0	35.0		13.0	28.0	28.0	13.0	28.0	28.0	
Total Split (s)	35.0	35.0	35.0	35.0	35.0		22.0	76.0	76.0	19.0	73.0	73.0	
Total Split (%)	26.9%	26.9%	26.9%	26.9%	26.9%		16.9%	58.5%	58.5%	14.6%	56.2%	56.2%	
Yellow Time (s)	3.3	3.3	3.3	3.3	3.3		4.6	4.6	4.6	4.6	4.6	4.6	
All-Red Time (s)	1.8	1.8	1.8	1.8	1.8		2.8	3.3	3.3	2.8	3.3	3.3	
Lost Time Adjust (s)	0.0		0.0		0.0		0.0		0.0		0.0		
Total Lost Time (s)	5.1		5.1		5.1		7.4		7.9		7.9		
Lead/Lag							Lead	Lag	Lag	Lead	Lag	Lag	
Lead-Lag Optimize?													
Recall Mode	None	None	None	None	None		None	C-Max	C-Max	None	C-Max	C-Max	
Act Effct Green (s)	15.5		15.5		15.5		130.0	13.0	69.6	69.6	24.5	81.1	81.1

19-032 1243 Teron Road
Lanes, Volumes, Timings

3: March Rd & Station Rd/Carling Ave

2025 Background AM

Lane Group	EBL	EBT	EBR	WBL	WBT	WBR	NBL	NBT	NBR	SBL	SBT	SBR	
Actuated g/C Ratio	0.12	0.12			0.12	1.00	0.10	0.54	0.54	0.19	0.62	0.62	
v/c Ratio	0.64	0.04			0.42	0.13	0.59	1.23	0.12	0.59	0.51	0.15	
Control Delay	72.0	0.2			61.4	0.2	69.8	138.4	4.7	53.5	15.8	6.1	
Queue Delay	0.0	0.0			0.0	0.0	0.0	0.0	0.0	0.0	0.0	0.0	
Total Delay	72.0	0.2			61.4	0.2	69.8	138.4	4.7	53.5	15.8	6.1	
LOS	E	A			E	A	E	F	A	D	B	A	
Approach Delay	65.5				13.7		130.3				23.6		
Approach LOS	E				B		F				C		
Queue Length 50th (m)	19.8	0.0			10.7	0.0	19.5	~286.8	1.4	34.9	59.2	4.5	
Queue Length 95th (m)	33.0	0.0			20.6	0.0	32.7	#326.3	8.0	49.4	91.5	13.8	
Internal Link Dist (m)	107.4				36.0		159.7				257.3		
Turn Bay Length (m)				25.0			75.0			175.0			25.0
Base Capacity (vph)	304	415			255	1481	198	1794	794	612	2091	934	
Starvation Cap Reductn	0	0			0	0	0	0	0	0	0	0	
Spillback Cap Reductn	0	0			0	0	0	0	0	0	0	0	
Storage Cap Reductn	0	0			0	0	0	0	0	0	0	0	
Reduced v/c Ratio	0.33	0.02			0.22	0.13	0.50	1.23	0.12	0.59	0.51	0.15	

Intersection Summary

Area Type: Other
 Cycle Length: 130
 Actuated Cycle Length: 130
 Offset: 22 (17%), Referenced to phase 2:NBT and 6:SBT, Start of Green
 Natural Cycle: 150
 Control Type: Actuated-Coordinated
 Maximum v/c Ratio: 1.23
 Intersection Signal Delay: 83.1 Intersection LOS: F
 Intersection Capacity Utilization 98.8% ICU Level of Service F
 Analysis Period (min) 15
 ~ Volume exceeds capacity, queue is theoretically infinite.
 Queue shown is maximum after two cycles.
 # 95th percentile volume exceeds capacity, queue may be longer.
 Queue shown is maximum after two cycles.

Splits and Phases: 3: March Rd & Station Rd/Carling Ave

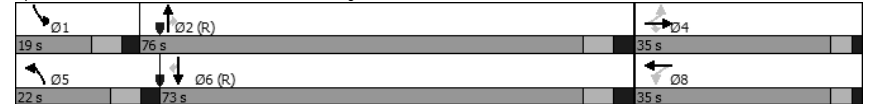

19-032 1243 Teron Road
Lanes, Volumes, Timings

4: Teron Rd & Carling Ave
2025 Background AM

	→	↖	↗	←	↖	↗
Lane Group	EBT	EBR	WBL	WBT	NBL	NBR
Lane Configurations	↑	↑		↑	↑	
Traffic Volume (vph)	494	16	38	567	221	148
Future Volume (vph)	494	16	38	567	221	148
Ideal Flow (vphpl)	1800	1800	1800	1800	1800	1800
Lane Width (m)	3.6	3.6	3.6	3.6	3.6	3.6
Grade (%)	0%			0%	0%	
Storage Length (m)		20.0	0.0		0.0	0.0
Storage Lanes		1	0		1	0
Taper Length (m)			7.5		7.5	
Lane Util. Factor	1.00	1.00	1.00	1.00	1.00	1.00
Ped Bike Factor						
Frt		0.850			0.946	
Fit Protected				0.997	0.971	
Satd. Flow (prot)	1765	1500	0	1759	1621	0
Fit Permitted				0.997	0.971	
Satd. Flow (perm)	1765	1500	0	1759	1621	0
Link Speed (k/h)	60			60	50	
Link Distance (m)	194.0			213.2	38.0	
Travel Time (s)	11.6			12.8	2.7	
Confl. Peds. (#/hr)		3	3			
Confl. Bikes (#/hr)						
Peak Hour Factor	0.92	0.92	0.92	0.92	0.92	0.92
Growth Factor	100%	100%	100%	100%	100%	100%
Heavy Vehicles (%)	2%	2%	2%	2%	2%	2%
Bus Blockages (#/hr)	0	0	0	0	0	0
Parking (#/hr)						
Mid-Block Traffic (%)	0%			0%	0%	
Adj. Flow (vph)	537	17	41	616	240	161
Shared Lane Traffic (%)						
Lane Group Flow (vph)	537	17	0	657	401	0
Sign Control	Free			Free	Stop	

Intersection Summary

Area Type:	Other
Control Type:	Unsignalized
Intersection Capacity Utilization	93.6%
ICU Level of Service	F
Analysis Period (min)	15

19-032 1243 Teron Road
HCM Unsignalized Intersection Capacity Analysis

4: Teron Rd & Carling Ave
2025 Background AM

	→	↖	↗	←	↖	↗
Movement	EBT	EBR	WBL	WBT	NBL	NBR
Lane Configurations	↑	↑		↑	↑	
Traffic Volume (veh/h)	494	16	38	567	221	148
Future Volume (Veh/h)	494	16	38	567	221	148
Sign Control	Free			Free	Stop	
Grade	0%			0%	0%	
Peak Hour Factor	0.92	0.92	0.92	0.92	0.92	0.92
Hourly flow rate (vph)	537	17	41	616	240	161
Pedestrians					3	
Lane Width (m)					3.6	
Walking Speed (m/s)					1.2	
Percent Blockage					0	
Right turn flare (veh)						
Median type	None			None		
Median storage (veh)						
Upstream signal (m)				213		
pX, platoon unblocked					0.80	
vC, conflicting volume			557		1238	540
vC1, stage 1 conf vol						
vC2, stage 2 conf vol						
vCu, unblocked vol			557		1171	540
tC, single (s)			4.1		6.4	6.2
tC, 2 stage (s)						
tF (s)			2.2		3.5	3.3
p0 queue free %			96		0	70
cM capacity (veh/h)			1011		162	540

Direction, Lane #	EB 1	EB 2	WB 1	NB 1
Volume Total	537	17	657	401
Volume Left	0	0	41	240
Volume Right	0	17	0	161
cSH	1700	1700	1011	226
Volume to Capacity	0.32	0.01	0.04	1.78
Queue Length 95th (m)	0.0	0.0	0.8	164.4
Control Delay (s)	0.0	0.0	1.1	403.9
Lane LOS			A	F
Approach Delay (s)	0.0		1.1	403.9
Approach LOS				F

Intersection Summary

Average Delay	100.9
Intersection Capacity Utilization	93.6%
ICU Level of Service	F
Analysis Period (min)	15

19-032 1243 Teron Road
Lanes, Volumes, Timings

5: Herzberg Rd & Carling Ave
2025 Background AM

Lane Group	EBL	EBT	EBR	WBL	WBT	WBR	NBL	NBT	NBR	SBL	SBT	SBR
Lane Configurations	↔	↔	↔	↔	↔	↔	↔	↔	↔	↔	↔	↔
Traffic Volume (vph)	37	418	31	15	380	603	72	623	6	261	142	33
Future Volume (vph)	37	418	31	15	380	603	72	623	6	261	142	33
Ideal Flow (vphpl)	1800	1800	1800	1800	1800	1800	1800	1800	1800	1800	1800	1800
Lane Width (m)	3.6	3.6	3.6	3.6	3.6	3.6	3.6	3.6	3.6	3.6	3.6	3.6
Grade (%)	0%			0%			0%			0%		
Storage Length (m)	0.0		75.0	100.0	100.0		0.0	0.0		0.0	0.0	
Storage Lanes	1		1	1	1		0	0		1	0	
Taper Length (m)	7.5		75.0			7.5			7.5			
Lane Util. Factor	1.00	1.00	1.00	1.00	1.00	1.00	1.00	1.00	1.00	1.00	1.00	1.00
Ped Bike Factor	1.00		0.97			1.00			1.00			
Frt	0.990		0.850			0.999			0.972			
Fit Protected	0.950		0.950			0.995			0.950			
Satd. Flow (prot)	1676	1744	0	1676	1765	1500	0	1754	0	1676	1708	0
Fit Permitted	0.290		0.199			0.940			0.258			
Satd. Flow (perm)	512	1744	0	351	1765	1459	0	1657	0	455	1708	0
Right Turn on Red	Yes		Yes			Yes			Yes			
Satd. Flow (RTOR)	3		256			15			15			
Link Speed (k/h)	60		60			50			50			
Link Distance (m)	213.2		282.2			126.1			120.3			
Travel Time (s)	12.8		16.9			9.1			8.7			
Confl. Peds. (#/hr)	2	1	1	2	1	1	1	1	1	1	1	1
Confl. Bikes (#/hr)												
Peak Hour Factor	0.92	0.92	0.92	0.92	0.92	0.92	0.92	0.92	0.92	0.92	0.92	0.92
Growth Factor	100%	100%	100%	100%	100%	100%	100%	100%	100%	100%	100%	100%
Heavy Vehicles (%)	2%	2%	2%	2%	2%	2%	2%	2%	2%	2%	2%	2%
Bus Blockages (#/hr)	0	0	0	0	0	0	0	0	0	0	0	0
Parking (#/hr)												
Mid-Block Traffic (%)	0%		0%			0%			0%			
Adj. Flow (vph)	40	454	34	16	413	655	78	677	7	284	154	36
Shared Lane Traffic (%)												
Lane Group Flow (vph)	40	488	0	16	413	655	0	762	0	284	190	0
Turn Type	Perm	NA	Perm	NA	Perm	Perm	NA	pm+pt	NA	NA	NA	NA
Protected Phases	2		6			8			4			
Permitted Phases	2		6			8			4			
Detector Phase	2		6			8			4			
Switch Phase												
Minimum Initial (s)	20.0	20.0	20.0	20.0	20.0	10.0	10.0	5.0	10.0	10.0	10.0	10.0
Minimum Split (s)	27.0	27.0	27.0	27.0	27.0	25.0	25.0	12.0	25.0	12.0	25.0	25.0
Total Split (s)	50.0	50.0	50.0	50.0	50.0	67.0	67.0	13.0	80.0	13.0	80.0	80.0
Total Split (%)	38.5%	38.5%	38.5%	38.5%	38.5%	51.5%	51.5%	10.0%	61.5%	10.0%	61.5%	61.5%
Yellow Time (s)	3.3	3.3	3.3	3.3	3.3	3.3	3.3	3.3	3.3	3.3	3.3	3.3
All-Red Time (s)	3.3	3.3	3.3	3.3	3.3	3.3	3.3	2.8	3.3	2.8	3.3	3.3
Lost Time Adjust (s)	0.0	0.0	0.0	0.0	0.0	0.0	0.0	0.0	0.0	0.0	0.0	0.0
Total Lost Time (s)	6.6	6.6	6.6	6.6	6.6	6.6	6.6	6.1	6.6	6.1	6.6	6.6
Lead/Lag							Lag	Lag	Lead			
Lead-Lag Optimize?												
Recall Mode	Max	Max	Max	Max	Max	None	None	None	None	None	None	None
Act Effct Green (s)	43.4	43.4	43.4	43.4	43.4	60.4	60.4	73.9	73.9	73.4	73.4	73.4

19-032 1243 Teron Road
Lanes, Volumes, Timings

5: Herzberg Rd & Carling Ave
2025 Background AM

Lane Group	EBL	EBT	EBR	WBL	WBT	WBR	NBL	NBT	NBR	SBL	SBT	SBR
Actuated g/C Ratio	0.33	0.33	0.33	0.33	0.33	0.33	0.46	0.46	0.57	0.56	0.57	0.56
v/c Ratio	0.24	0.84	0.14	0.70	1.00	0.99	0.88	0.20	0.88	0.20	0.88	0.20
Control Delay	36.0	53.8	34.1	45.2	61.0	65.2	47.8	13.3	47.8	13.3	47.8	13.3
Queue Delay	0.0	0.0	0.0	0.0	0.0	0.0	0.0	0.0	0.0	0.0	0.0	0.0
Total Delay	36.0	53.8	34.1	45.2	61.0	65.2	47.8	13.3	47.8	13.3	47.8	13.3
LOS	D	D	C	D	E	E	D	B	D	B	D	B
Approach Delay	52.4		54.6			65.2			34.0			
Approach LOS	D		D			E			C			
Queue Length 50th (m)	5.8	90.5	2.3	72.4	92.7	149.5	28.6	16.5	28.6	16.5	28.6	16.5
Queue Length 95th (m)	13.9	#133.7	7.1	101.8	#157.3	#216.8	#58.0	26.4	#58.0	26.4	#58.0	26.4
Internal Link Dist (m)	189.2		258.2			102.1			96.3			
Turn Bay Length (m)	100.0			100.0			100.0			100.0		
Base Capacity (vph)	170	584	117	589	657	769	323	970	323	970	323	970
Starvation Cap Reductn	0	0	0	0	0	0	0	0	0	0	0	0
Spillback Cap Reductn	0	0	0	0	0	0	0	0	0	0	0	0
Storage Cap Reductn	0	0	0	0	0	0	0	0	0	0	0	0
Reduced v/c Ratio	0.24	0.84	0.14	0.70	1.00	0.99	0.88	0.20	0.88	0.20	0.88	0.20

Intersection Summary

Area Type:	Other
Cycle Length:	130
Actuated Cycle Length:	130
Natural Cycle:	100
Control Type:	Semi Act-Uncoord
Maximum v/c Ratio:	1.00
Intersection Signal Delay:	53.6
Intersection LOS:	D
Intersection Capacity Utilization:	112.0%
ICU Level of Service:	H
Analysis Period (min):	15
#	95th percentile volume exceeds capacity, queue may be longer.
	Queue shown is maximum after two cycles.

Splits and Phases: 5: Herzberg Rd & Carling Ave

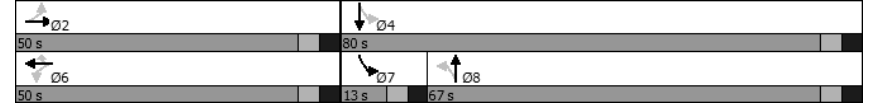

19-032 1243 Teron Road
Lanes, Volumes, Timings

6: Teron Rd & Project Site
2025 Background AM

Lane Group	WBL	WBR	NBT	NBR	SBL	SBT
Lane Configurations						
Traffic Volume (vph)	0	0	369	0	0	55
Future Volume (vph)	0	0	369	0	0	55
Ideal Flow (vphpl)	1800	1800	1800	1800	1800	1800
Lane Width (m)	3.6	3.6	3.6	3.6	3.6	3.6
Grade (%)	0%		0%			0%
Storage Length (m)	0.0	0.0		0.0	0.0	
Storage Lanes	1	0		0	0	
Taper Length (m)	7.5			7.5		
Lane Util. Factor	1.00	1.00	1.00	1.00	1.00	1.00
Ped Bike Factor						
Frt						
Fit Protected						
Satd. Flow (prot)	1765	0	1765	0	0	1765
Fit Permitted						
Satd. Flow (perm)	1765	0	1765	0	0	1765
Link Speed (k/h)	50		50			50
Link Distance (m)	78.8		108.3			300.6
Travel Time (s)	5.7		7.8			21.6
Confl. Peds. (#/hr)						
Confl. Bikes (#/hr)						
Peak Hour Factor	0.92	0.92	0.92	0.92	0.92	0.92
Growth Factor	100%	100%	100%	100%	100%	100%
Heavy Vehicles (%)	2%	2%	2%	2%	2%	2%
Bus Blockages (#/hr)	0	0	0	0	0	0
Parking (#/hr)						
Mid-Block Traffic (%)	0%		0%			0%
Adj. Flow (vph)	0	0	401	0	0	60
Shared Lane Traffic (%)						
Lane Group Flow (vph)	0	0	401	0	0	60
Sign Control	Stop		Free			Free

Intersection Summary

Area Type:	Other
Control Type:	Unsignalized
Intersection Capacity Utilization	23.8%
Analysis Period (min)	15
	ICU Level of Service A

19-032 1243 Teron Road
HCM Unsignalized Intersection Capacity Analysis

6: Teron Rd & Project Site
2025 Background AM

Movement	WBL	WBR	NBT	NBR	SBL	SBT
Lane Configurations						
Traffic Volume (veh/h)	0	0	369	0	0	55
Future Volume (Veh/h)	0	0	369	0	0	55
Sign Control	Stop		Free			Free
Grade	0%		0%			0%
Peak Hour Factor	0.92	0.92	0.92	0.92	0.92	0.92
Hourly flow rate (vph)	0	0	401	0	0	60
Pedestrians						
Lane Width (m)						
Walking Speed (m/s)						
Percent Blockage						
Right turn flare (veh)						
Median type			None			None
Median storage (veh)						
Upstream signal (m)						
pX, platoon unblocked						
vC, conflicting volume	461	401			401	
vC1, stage 1 conf vol						
vC2, stage 2 conf vol						
vCu, unblocked vol	461	401			401	
tC, single (s)	6.4	6.2			4.1	
tC, 2 stage (s)						
tF (s)	3.5	3.3			2.2	
p0 queue free %	100	100			100	
cM capacity (veh/h)	559	649			1158	

Direction, Lane #	WB 1	NB 1	SB 1
Volume Total	0	401	60
Volume Left	0	0	0
Volume Right	0	0	0
cSH	1700	1700	1158
Volume to Capacity	0.00	0.24	0.00
Queue Length 95th (m)	0.0	0.0	0.0
Control Delay (s)	0.0	0.0	0.0
Lane LOS	A		
Approach Delay (s)	0.0	0.0	0.0
Approach LOS	A		

Intersection Summary

Average Delay		0.0	
Intersection Capacity Utilization	23.8%	ICU Level of Service	A
Analysis Period (min)	15		

19-032 1243 Teron Road
Lanes, Volumes, Timings

1: March Rd & Herzberg Rd
2025 Background PM

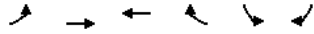

Lane Group	EBL	EBT	WBT	WBR	SBL	SBR
Lane Configurations	↔	↑↑↑	↑↑	↔	↔	↔
Traffic Volume (vph)	6	1998	1222	224	816	17
Future Volume (vph)	6	1998	1222	224	816	17
Ideal Flow (vphpl)	1800	1800	1800	1800	1800	1800
Lane Width (m)	3.6	3.6	3.6	3.6	3.6	3.6
Grade (%)		0%	0%		0%	
Storage Length (m)	75.0			0.0	0.0	30.0
Storage Lanes	1			1	2	1
Taper Length (m)	40.0				7.5	
Lane Util. Factor	1.00	0.91	0.95	1.00	0.97	1.00
Ped Bike Factor						
Frt				0.850		0.850
Fit Protected	0.950				0.950	
Satd. Flow (prot)	1693	4865	3386	1515	3285	1515
Fit Permitted	0.950				0.950	
Satd. Flow (perm)	1693	4865	3386	1515	3285	1515
Right Turn on Red				Yes		Yes
Satd. Flow (RTOR)				202		10
Link Speed (k/h)		80	80		50	
Link Distance (m)		149.3	160.9		125.0	
Travel Time (s)		6.7	7.2		9.0	
Confl. Peds. (#/hr)						
Confl. Bikes (#/hr)						
Peak Hour Factor	0.92	0.92	0.92	0.92	0.92	0.92
Growth Factor	100%	100%	100%	100%	100%	100%
Heavy Vehicles (%)	1%	1%	1%	1%	1%	1%
Bus Blockages (#/hr)	0	0	0	0	0	0
Parking (#/hr)						
Mid-Block Traffic (%)		0%	0%		0%	
Adj. Flow (vph)	7	2172	1328	243	887	18
Shared Lane Traffic (%)						
Lane Group Flow (vph)	7	2172	1328	243	887	18
Turn Type	Prot	NA	NA	Perm	Prot	Perm
Protected Phases	5	2	6		4	
Permitted Phases				6		4
Detector Phase	5	2	6	6	4	4
Switch Phase						
Minimum Initial (s)	5.0	20.0	20.0	20.0	10.0	10.0
Minimum Split (s)	12.0	27.0	27.0	27.0	35.0	35.0
Total Split (s)	12.0	80.0	68.0	68.0	50.0	50.0
Total Split (%)	9.2%	61.5%	52.3%	52.3%	38.5%	38.5%
Yellow Time (s)	4.6	4.6	4.6	4.6	3.3	3.3
All-Red Time (s)	1.8	1.7	1.7	1.7	2.8	2.8
Lost Time Adjust (s)	0.0	0.0	0.0	0.0	0.0	0.0
Total Lost Time (s)	6.4	6.3	6.3	6.3	6.1	6.1
Lead/Lag	Lead		Lag	Lag		
Lead-Lag Optimize?						
Recall Mode	None	C-Max	C-Max	C-Max	None	None
Act Effct Green (s)	5.6	77.3	74.9	74.9	40.3	40.3

19-032 1243 Teron Road
Lanes, Volumes, Timings

1: March Rd & Herzberg Rd
2025 Background PM

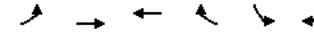

Lane Group	EBL	EBT	WBT	WBR	SBL	SBR
Actuated g/C Ratio	0.04	0.59	0.58	0.58	0.31	0.31
v/c Ratio	0.10	0.75	0.68	0.25	0.87	0.04
Control Delay	85.7	4.4	22.9	4.4	52.5	18.9
Queue Delay	0.0	0.0	0.0	0.0	0.0	0.0
Total Delay	85.7	4.4	22.9	4.4	52.5	18.9
LOS	F	A	C	A	D	B
Approach Delay		4.7	20.1		51.8	
Approach LOS		A	C		D	
Queue Length 50th (m)	1.3	8.0	92.3	3.4	85.9	1.1
Queue Length 95th (m)	m1.1	m18.3	143.5	15.9	103.4	5.5
Internal Link Dist (m)		125.3	136.9		101.0	
Turn Bay Length (m)	75.0					30.0
Base Capacity (vph)	73	2893	1951	958	1109	518
Starvation Cap Reductn	0	0	0	0	0	0
Spillback Cap Reductn	0	0	0	0	0	0
Storage Cap Reductn	0	0	0	0	0	0
Reduced v/c Ratio	0.10	0.75	0.68	0.25	0.80	0.03

Intersection Summary

Area Type: Other
 Cycle Length: 130
 Actuated Cycle Length: 130
 Offset: 12 (9%), Referenced to phase 2:EBT and 6:WBT, Start of Green
 Natural Cycle: 90
 Control Type: Actuated-Coordinated
 Maximum v/c Ratio: 0.87
 Intersection Signal Delay: 19.0
 Intersection Capacity Utilization 75.7%
 Intersection LOS: B
 ICU Level of Service D
 Analysis Period (min) 15
 m Volume for 95th percentile queue is metered by upstream signal.

Splits and Phases: 1: March Rd & Herzberg Rd

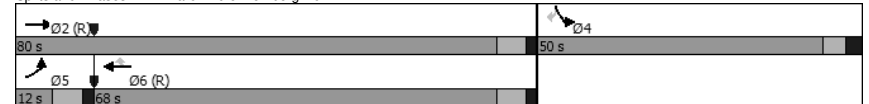

19-032 1243 Teron Road
Lanes, Volumes, Timings

2: Teron Rd & March Rd
2025 Background PM

Lane Group	EBL	EBT	EBR	WBL	WBT	WBR	NBL	NBT	NBR	SBL	SBT	SBR
Lane Configurations	↔	↕	↔	↔	↕	↔	↔	↕	↔	↔	↕	↔
Traffic Volume (vph)	18	1848	31	70	1093	32	245	58	29	179	200	35
Future Volume (vph)	18	1848	31	70	1093	32	245	58	29	179	200	35
Ideal Flow (vphpl)	1800	1800	1800	1800	1800	1800	1800	1800	1800	1800	1800	1800
Lane Width (m)	3.6	3.6	3.6	3.6	3.6	3.6	3.6	3.6	3.6	3.6	3.6	3.6
Grade (%)	0%		0%		0%		0%		0%		0%	
Storage Length (m)	75.0		75.0		75.0		0.0		40.0		40.0	
Storage Lanes	1		1		1		1		1		1	
Taper Length (m)	50.0		50.0		7.5		40.0					
Lane Util. Factor	1.00	0.95	1.00	1.00	0.95	1.00	1.00	1.00	1.00	1.00	1.00	1.00
Ped Bike Factor	0.850		0.850		0.850		0.850		0.850		0.850	
Fit Protected	0.950		0.950		0.950		0.950		0.950		0.950	
Satd. Flow (prot)	1693	3386	1515	1693	3386	1515	1693	1782	1515	1693	1782	1515
Fit Permitted	0.950		0.950		0.486		0.585					
Satd. Flow (perm)	1693	3386	1515	1693	3386	1515	866	1782	1515	1043	1782	1515
Right Turn on Red	Yes		Yes		Yes		Yes		Yes		Yes	
Satd. Flow (RTOR)	135		135		133		133		133		133	
Link Speed (k/h)	80		80		80		50		50		50	
Link Distance (m)	220.0		806.6		79.5		112.5					
Travel Time (s)	9.9		36.3		5.7		8.1					
Confl. Peds. (#/hr)												
Confl. Bikes (#/hr)												
Peak Hour Factor	0.92	0.92	0.92	0.92	0.92	0.92	0.92	0.92	0.92	0.92	0.92	0.92
Growth Factor	100%	100%	100%	100%	100%	100%	100%	100%	100%	100%	100%	100%
Heavy Vehicles (%)	1%	1%	1%	1%	1%	1%	1%	1%	1%	1%	1%	1%
Bus Blockages (#/hr)	0	0	0	0	0	0	0	0	0	0	0	0
Parking (#/hr)												
Mid-Block Traffic (%)	0%		0%		0%		0%		0%		0%	
Adj. Flow (vph)	20	2009	34	76	1188	35	266	63	32	195	217	38
Shared Lane Traffic (%)												
Lane Group Flow (vph)	20	2009	34	76	1188	35	266	63	32	195	217	38
Turn Type	Prot	NA	Perm	Prot	NA	Perm	pm+pt	NA	Perm	pm+pt	NA	Perm
Protected Phases	5	2		1	6		3	8		7	4	
Permitted Phases			2			6	8		8	4		4
Detector Phase	5	2	2	1	6	6	3	8	8	7	4	4
Switch Phase												
Minimum Initial (s)	5.0	20.0	20.0	5.0	20.0	20.0	5.0	10.0	10.0	5.0	10.0	10.0
Minimum Split (s)	12.0	27.0	27.0	12.0	27.0	27.0	12.0	35.0	35.0	12.0	35.0	35.0
Total Split (s)	12.0	69.0	69.0	12.0	69.0	69.0	14.0	35.0	35.0	14.0	35.0	35.0
Total Split (%)	9.2%	53.1%	53.1%	9.2%	53.1%	53.1%	10.8%	26.9%	26.9%	10.8%	26.9%	26.9%
Yellow Time (s)	4.6	4.6	4.6	4.6	4.6	4.6	3.3	3.3	3.3	3.3	3.3	3.3
All-Red Time (s)	1.8	1.7	1.7	1.8	1.7	1.7	2.8	3.3	3.3	2.8	3.3	3.3
Lost Time Adjust (s)	0.0	0.0	0.0	0.0	0.0	0.0	0.0	0.0	0.0	0.0	0.0	0.0
Total Lost Time (s)	6.4	6.3	6.3	6.4	6.3	6.3	6.1	6.6	6.6	6.1	6.6	6.6
Lead/Lag	Lead	Lag	Lag	Lead	Lag	Lag	Lead	Lag	Lag	Lead	Lag	Lag
Lead-Lag Optimize?												
Recall Mode	None	C-Max	C-Max	None	C-Max	C-Max	None	None	None	None	None	None
Act Effct Green (s)	6.5	64.7	64.7	10.8	76.6	76.6	26.7	20.4	20.4	30.8	21.2	21.2

19-032 1243 Teron Road
Lanes, Volumes, Timings

2: Teron Rd & March Rd
2025 Background PM

Lane Group	EBL	EBT	EBR	WBL	WBT	WBR	NBL	NBT	NBR	SBL	SBT	SBR
Actuated g/C Ratio	0.05	0.50	0.50	0.08	0.59	0.59	0.21	0.16	0.16	0.24	0.16	0.16
v/c Ratio	0.24	1.19	0.04	0.54	0.60	0.04	1.17	0.23	0.09	0.64	0.75	0.11
Control Delay	66.4	123.6	0.1	62.1	22.4	0.5	154.2	47.3	0.5	50.6	67.3	0.6
Queue Delay	0.0	0.0	0.0	0.0	0.0	0.0	0.0	0.0	0.0	0.0	0.0	0.0
Total Delay	66.4	123.6	0.1	62.1	22.4	0.5	154.2	47.3	0.5	50.6	67.3	0.6
LOS	E	F	A	E	C	A	F	D	A	D	E	A
Approach Delay	121.0				24.1		121.9				54.5	
Approach LOS	F				C		F				D	
Queue Length 50th (m)	3.9	~263.6	0.0	12.0	113.0	0.0	~50.9	11.2	0.0	32.4	42.3	0.0
Queue Length 95th (m)	10.8	#296.4	0.0	m#30.6	152.2	m0.0	#81.8	20.4	0.0	46.2	60.2	0.0
Internal Link Dist (m)	196.0				782.6		55.5				88.5	
Turn Bay Length (m)	75.0		75.0		75.0		75.0		40.0		40.0	
Base Capacity (vph)	84	1685	822	140	1995	948	227	389	434	307	389	434
Starvation Cap Reductn	0	0	0	0	0	0	0	0	0	0	0	0
Spillback Cap Reductn	0	0	0	0	0	0	0	0	0	0	0	0
Storage Cap Reductn	0	0	0	0	0	0	0	0	0	0	0	0
Reduced v/c Ratio	0.24	1.19	0.04	0.54	0.60	0.04	1.17	0.16	0.07	0.64	0.56	0.09

Intersection Summary

Area Type: Other
 Cycle Length: 130
 Actuated Cycle Length: 130
 Offset: 83 (64%), Referenced to phase 2:EBT and 6:WBT, Start of Green
 Natural Cycle: 150
 Control Type: Actuated-Coordinated
 Maximum v/c Ratio: 1.19
 Intersection Signal Delay: 83.8
 Intersection Capacity Utilization 102.7%
 Analysis Period (min) 15
 ~ Volume exceeds capacity, queue is theoretically infinite.
 Queue shown is maximum after two cycles.
 # 95th percentile volume exceeds capacity, queue may be longer.
 Queue shown is maximum after two cycles.
 m Volume for 95th percentile queue is metered by upstream signal.

Splits and Phases: 2: Teron Rd & March Rd

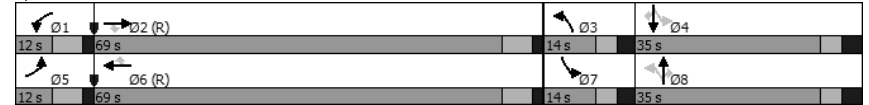

19-032 1243 Teron Road
Lanes, Volumes, Timings

3: March Rd & Station Rd/Carling Ave
2025 Background PM

Lane Group	EBL	EBT	EBR	WBL	WBT	WBR	NBL	NBT	NBR	SBL	SBT	SBR
Lane Configurations		↖	↗		↖	↗	↖	↗	↖	↗	↖	↗
Traffic Volume (vph)	27	14	31	126	20	332	35	1426	37	304	1970	52
Future Volume (vph)	27	14	31	126	20	332	35	1426	37	304	1970	52
Ideal Flow (vphpl)	1800	1800	1800	1800	1800	1800	1800	1800	1800	1800	1800	1800
Lane Width (m)	3.6	3.6	3.6	3.6	3.6	3.6	3.6	3.6	3.6	3.6	3.6	3.6
Grade (%)		0%			0%			0%				0%
Storage Length (m)	0.0		25.0	0.0		0.0	75.0		75.0	175.0		25.0
Storage Lanes	0		1	0		1	1		1	2		1
Taper Length (m)	7.5			7.5			50.0			75.0		
Lane Util. Factor	1.00	1.00	1.00	1.00	1.00	1.00	1.00	0.95	1.00	0.97	0.95	1.00
Ped Bike Factor		1.00	0.98		0.99	0.99	1.00		0.94	0.99		0.97
Frt			0.850			0.850			0.850			0.850
Fit Protected		0.968			0.959		0.950			0.950		
Satd. Flow (prot)	0	1725	1515	0	1709	1515	1693	3386	1515	3285	3386	1515
Fit Permitted		0.705			0.724		0.950			0.950		
Satd. Flow (perm)	0	1253	1477	0	1277	1495	1692	3386	1429	3256	3386	1463
Right Turn on Red			Yes		Yes	Yes		Yes	Yes		Yes	Yes
Satd. Flow (RTOR)			165			358			142			80
Link Speed (k/h)		50			60			80				80
Link Distance (m)		131.4			60.0			183.7				281.3
Travel Time (s)		9.5			3.6			8.3				12.7
Confl. Peds. (#/hr)	3		6	6		3	4		21	21		4
Confl. Bikes (#/hr)												
Peak Hour Factor	0.92	0.92	0.92	0.92	0.92	0.92	0.92	0.92	0.92	0.92	0.92	0.92
Growth Factor	100%	100%	100%	100%	100%	100%	100%	100%	100%	100%	100%	100%
Heavy Vehicles (%)	1%	1%	1%	1%	1%	1%	1%	1%	1%	1%	1%	1%
Bus Blockages (#/hr)	0	0	0	0	0	0	0	0	0	0	0	0
Parking (#/hr)												
Mid-Block Traffic (%)		0%			0%			0%				0%
Adj. Flow (vph)	29	15	34	137	22	361	38	1550	40	330	2141	57
Shared Lane Traffic (%)												
Lane Group Flow (vph)	0	44	34	0	159	361	38	1550	40	330	2141	57
Turn Type	Perm	NA	Perm	Perm	NA	Free	Prot	NA	Perm	Prot	NA	Perm
Protected Phases		4			8		8		2		1	6
Permitted Phases	4		4	8		Free			2			6
Detector Phase	4	4	4	8	8		5	2	2	1	6	6
Switch Phase												
Minimum Initial (s)	10.0	10.0	10.0	10.0	10.0		5.0	20.0	20.0	5.0	20.0	20.0
Minimum Split (s)	35.0	35.0	35.0	35.0	35.0		13.0	28.0	28.0	13.0	28.0	28.0
Total Split (s)	35.0	35.0	35.0	35.0	35.0		13.0	73.0	73.0	22.0	82.0	82.0
Total Split (%)	26.9%	26.9%	26.9%	26.9%	26.9%		10.0%	56.2%	56.2%	16.9%	63.1%	63.1%
Yellow Time (s)	3.3	3.3	3.3	3.3	3.3		4.6	4.6	4.6	4.6	4.6	4.6
All-Red Time (s)	1.8	1.8	1.8	1.8	1.8		2.8	3.3	3.3	2.8	3.3	3.3
Lost Time Adjust (s)		0.0	0.0		0.0		0.0	0.0	0.0	0.0	0.0	0.0
Total Lost Time (s)		5.1	5.1		5.1		7.4	7.9	7.9	7.4	7.9	7.9
Lead/Lag							Lead	Lag	Lag	Lead	Lag	Lag
Lead-Lag Optimize?												
Recall Mode	None	None	None	None	None		None	C-Max	C-Max	None	C-Max	C-Max
Act Effct Green (s)		21.5	21.5		21.5	130.0	7.3	71.0	71.0	17.2	83.4	83.4

19-032 1243 Teron Road
Lanes, Volumes, Timings

3: March Rd & Station Rd/Carling Ave
2025 Background PM

Lane Group	EBL	EBT	EBR	WBL	WBT	WBR	NBL	NBT	NBR	SBL	SBT	SBR
Actuated g/C Ratio		0.17	0.17		0.17	1.00	0.06	0.55	0.55	0.13	0.64	0.64
v/c Ratio		0.21	0.09		0.76	0.24	0.40	0.84	0.05	0.76	0.99	0.06
Control Delay		46.7	0.5		72.8	0.4	71.7	31.2	0.1	66.4	40.9	1.3
Queue Delay		0.0	0.0		0.0	0.0	0.0	0.0	0.0	0.0	0.0	0.0
Total Delay		46.7	0.5		72.8	0.4	71.7	31.2	0.1	66.4	40.9	1.3
LOS		D	A		E	A	E	C	A	E	D	A
Approach Delay		26.6			22.5			31.3			43.4	
Approach LOS		C			C			C			D	
Queue Length 50th (m)		7.8	0.0		31.0	0.0	7.5	138.7	0.0	32.9	~244.2	0.0
Queue Length 95th (m)		15.4	0.0		46.7	0.0	#18.9	#178.2	0.0	#54.6	#292.5	2.5
Internal Link Dist (m)		107.4			36.0			159.7			257.3	
Turn Bay Length (m)			25.0				75.0		75.0	175.0		25.0
Base Capacity (vph)	288	466			293	1495	95	1848	844	433	2172	967
Starvation Cap Reductn	0	0			0	0	0	0	0	0	0	0
Spillback Cap Reductn	0	0			0	0	0	0	0	0	0	0
Storage Cap Reductn	0	0			0	0	0	0	0	0	0	0
Reduced v/c Ratio		0.15	0.07		0.54	0.24	0.40	0.84	0.05	0.76	0.99	0.06

Intersection Summary

Area Type: Other
 Cycle Length: 130
 Actuated Cycle Length: 130
 Offset: 22 (17%), Referenced to phase 2:NBT and 6:SBT, Start of Green
 Natural Cycle: 140
 Control Type: Actuated-Coordinated
 Maximum v/c Ratio: 0.99
 Intersection Signal Delay: 36.7
 Intersection Capacity Utilization 93.8%
 ICU Level of Service F
 Analysis Period (min) 15
 ~ Volume exceeds capacity, queue is theoretically infinite.
 Queue shown is maximum after two cycles.
 # 95th percentile volume exceeds capacity, queue may be longer.
 Queue shown is maximum after two cycles.

Splits and Phases: 3: March Rd & Station Rd/Carling Ave

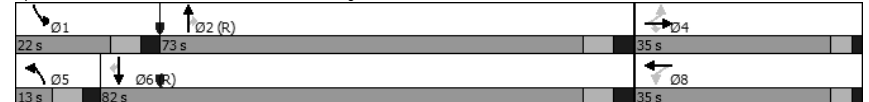

19-032 1243 Teron Road
Lanes, Volumes, Timings

4: Teron Rd & Carling Ave
2025 Background PM

	→	↖	↗	←	↖	↗
Lane Group	EBT	EBR	WBL	WBT	NBL	NBR
Lane Configurations	↑	↑		↑	↑	↑
Traffic Volume (vph)	762	98	144	426	26	82
Future Volume (vph)	762	98	144	426	26	82
Ideal Flow (vphpl)	1800	1800	1800	1800	1800	1800
Lane Width (m)	3.6	3.6	3.6	3.6	3.6	3.6
Grade (%)	0%			0%	0%	
Storage Length (m)		20.0	0.0		0.0	0.0
Storage Lanes		1	0		1	0
Taper Length (m)			7.5		7.5	
Lane Util. Factor	1.00	1.00	1.00	1.00	1.00	1.00
Ped Bike Factor						
Frt		0.850			0.897	
Fit Protected				0.987	0.988	
Satd. Flow (prot)	1782	1515	0	1759	1579	0
Fit Permitted				0.987	0.988	
Satd. Flow (perm)	1782	1515	0	1759	1579	0
Link Speed (k/h)	60			60	50	
Link Distance (m)	194.0			213.2	38.0	
Travel Time (s)	11.6			12.8	2.7	
Confl. Peds. (#/hr)		3	3			
Confl. Bikes (#/hr)						
Peak Hour Factor	0.92	0.92	0.92	0.92	0.92	0.92
Growth Factor	100%	100%	100%	100%	100%	100%
Heavy Vehicles (%)	1%	1%	1%	1%	1%	1%
Bus Blockages (#/hr)	0	0	0	0	0	0
Parking (#/hr)						
Mid-Block Traffic (%)	0%			0%	0%	
Adj. Flow (vph)	828	107	157	463	28	89
Shared Lane Traffic (%)						
Lane Group Flow (vph)	828	107	0	620	117	0
Sign Control	Free			Free	Stop	

Intersection Summary

Area Type:	Other
Control Type:	Unsignalized
Intersection Capacity Utilization	91.3%
ICU Level of Service	F
Analysis Period (min)	15

19-032 1243 Teron Road
HCM Unsignalized Intersection Capacity Analysis

4: Teron Rd & Carling Ave
2025 Background PM

	→	↖	↗	←	↖	↗
Movement	EBT	EBR	WBL	WBT	NBL	NBR
Lane Configurations	↑	↑		↑	↑	↑
Traffic Volume (veh/h)	762	98	144	426	26	82
Future Volume (Veh/h)	762	98	144	426	26	82
Sign Control	Free			Free	Stop	
Grade	0%			0%	0%	
Peak Hour Factor	0.92	0.92	0.92	0.92	0.92	0.92
Hourly flow rate (vph)	828	107	157	463	28	89
Pedestrians					3	
Lane Width (m)					3.6	
Walking Speed (m/s)					1.2	
Percent Blockage					0	
Right turn flare (veh)						
Median type	None			None		
Median storage (veh)						
Upstream signal (m)				213		
pX, platoon unblocked					0.79	
vC, conflicting volume			938		1608	831
vC1, stage 1 conf vol						
vC2, stage 2 conf vol						
vCu, unblocked vol			938		1637	831
tC, single (s)			4.1		6.4	6.2
tC, 2 stage (s)						
tF (s)			2.2		3.5	3.3
p0 queue free %			79		59	76
cM capacity (veh/h)			733		69	370

Direction, Lane #	EB 1	EB 2	WB 1	NB 1
Volume Total	828	107	620	117
Volume Left	0	0	157	28
Volume Right	0	107	0	89
cSH	1700	1700	733	181
Volume to Capacity	0.49	0.06	0.21	0.65
Queue Length 95th (m)	0.0	0.0	4.9	22.4
Control Delay (s)	0.0	0.0	5.3	55.4
Lane LOS			A	F
Approach Delay (s)	0.0		5.3	55.4
Approach LOS				F

Intersection Summary

Average Delay	5.8
Intersection Capacity Utilization	91.3%
ICU Level of Service	F
Analysis Period (min)	15

19-032 1243 Teron Road
Lanes, Volumes, Timings

5: Herzberg Rd & Carling Ave
2025 Background PM

Lane Group	EBL	EBT	EBR	WBL	WBT	WBR	NBL	NBT	NBR	SBL	SBT	SBR
Lane Configurations	↔	↔	↔	↔	↔	↔	↔	↔	↔	↔	↔	↔
Traffic Volume (vph)	13	688	51	44	431	361	32	186	13	562	570	46
Future Volume (vph)	13	688	51	44	431	361	32	186	13	562	570	46
Ideal Flow (vphpl)	1800	1800	1800	1800	1800	1800	1800	1800	1800	1800	1800	1800
Lane Width (m)	3.6	3.6	3.6	3.6	3.6	3.6	3.6	3.6	3.6	3.6	3.6	3.6
Grade (%)	0%		0%		0%		0%		0%		0%	
Storage Length (m)	0.0		75.0	100.0		100.0	0.0		0.0	0.0		0.0
Storage Lanes	1		1	1		1	0		0	1		0
Taper Length (m)	7.5			75.0			7.5			7.5		
Lane Util. Factor	1.00	1.00	1.00	1.00	1.00	1.00	1.00	1.00	1.00	1.00	1.00	1.00
Ped Bike Factor	1.00				0.97		1.00				1.00	
Frt	0.990				0.850		0.992				0.989	
Fit Protected	0.950			0.950			0.993			0.950		
Satd. Flow (prot)	1693	1762	0	1693	1782	1515	0	1756	0	1693	1759	0
Fit Permitted	0.313			0.074			0.821			0.285		
Satd. Flow (perm)	558	1762	0	132	1782	1474	0	1451	0	508	1759	0
Right Turn on Red			Yes			Yes		Yes			Yes	
Satd. Flow (RTOR)	4				392		2				4	
Link Speed (k/h)	60				60		50				50	
Link Distance (m)	213.2				282.2		126.1				120.3	
Travel Time (s)	12.8				16.9		9.1				8.7	
Confl. Peds. (#/hr)	2		1	1		2	1					1
Confl. Bikes (#/hr)												
Peak Hour Factor	0.92	0.92	0.92	0.92	0.92	0.92	0.92	0.92	0.92	0.92	0.92	0.92
Growth Factor	100%	100%	100%	100%	100%	100%	100%	100%	100%	100%	100%	100%
Heavy Vehicles (%)	1%	1%	1%	1%	1%	1%	1%	1%	1%	1%	1%	1%
Bus Blockages (#/hr)	0	0	0	0	0	0	0	0	0	0	0	0
Parking (#/hr)												
Mid-Block Traffic (%)	0%				0%		0%				0%	
Adj. Flow (vph)	14	748	55	48	468	392	35	202	14	611	620	50
Shared Lane Traffic (%)												
Lane Group Flow (vph)	14	803	0	48	468	392	0	251	0	611	670	0
Turn Type	Perm	NA		Perm	NA	Perm	Perm	NA		pm+pt	NA	
Protected Phases	2				6		8				4	
Permitted Phases	2				6		8				4	
Detector Phase	2		2		6		6		6		8	
Switch Phase												
Minimum Initial (s)	20.0	20.0		20.0	20.0	20.0	10.0	10.0		5.0	10.0	
Minimum Split (s)	27.0	27.0		27.0	27.0	27.0	25.0	25.0		12.0	25.0	
Total Split (s)	61.0	61.0		61.0	61.0	61.0	29.0	29.0		40.0	69.0	
Total Split (%)	46.9%	46.9%		46.9%	46.9%	46.9%	22.3%	22.3%		30.8%	53.1%	
Yellow Time (s)	3.3	3.3		3.3	3.3	3.3	3.3	3.3		3.3	3.3	
All-Red Time (s)	3.3	3.3		3.3	3.3	3.3	3.3	3.3		2.8	3.3	
Lost Time Adjust (s)	0.0	0.0		0.0	0.0	0.0	0.0	0.0		0.0	0.0	
Total Lost Time (s)	6.6	6.6		6.6	6.6	6.6	6.6	6.6		6.1	6.6	
Lead/Lag							Lag	Lag		Lead		
Lead-Lag Optimize?												
Recall Mode	Max	Max		Max	Max	Max	None	None		None	None	
Act Effct Green (s)	54.4	54.4		54.4	54.4	54.4	22.4	22.4		62.9	62.4	

19-032 1243 Teron Road
Lanes, Volumes, Timings

5: Herzberg Rd & Carling Ave
2025 Background PM

Lane Group	EBL	EBT	EBR	WBL	WBT	WBR	NBL	NBT	NBR	SBL	SBT	SBR
Actuated g/C Ratio	0.42	0.42		0.42	0.42	0.42		0.17			0.48	0.48
v/c Ratio	0.06	1.09		0.87	0.63	0.46		1.00			1.10	0.79
Control Delay	23.6	95.4		129.0	34.4	4.2		110.1			97.9	36.6
Queue Delay	0.0	0.0		0.0	0.0	0.0		0.0			0.0	0.0
Total Delay	23.6	95.4		129.0	34.4	4.2		110.1			97.9	36.6
LOS	C	F		F	C	A		F			F	D
Approach Delay	94.2				26.4		110.1				65.8	
Approach LOS	F				C		F				E	
Queue Length 50th (m)	1.7	~181.9		8.8	73.7	0.0		51.0			~116.0	110.5
Queue Length 95th (m)	5.1	#241.7		#29.2	102.4	14.5		#94.1			#172.3	151.6
Internal Link Dist (m)	189.2				258.2		102.1				96.3	
Turn Bay Length (m)			100.0		100.0							
Base Capacity (vph)	233	739		55	745	844		251			554	846
Starvation Cap Reductn	0	0		0	0	0		0			0	0
Spillback Cap Reductn	0	0		0	0	0		0			0	0
Storage Cap Reductn	0	0		0	0	0		0			0	0
Reduced v/c Ratio	0.06	1.09		0.87	0.63	0.46		1.00			1.10	0.79

Intersection Summary

Area Type:	Other
Cycle Length:	130
Actuated Cycle Length:	130
Natural Cycle:	130
Control Type:	Semi Act-Uncoord
Maximum v/c Ratio:	1.10
Intersection Signal Delay:	65.4
Intersection LOS:	E
Intersection Capacity Utilization:	105.6%
ICU Level of Service:	G
Analysis Period (min):	15
~ Volume exceeds capacity, queue is theoretically infinite.	
Queue shown is maximum after two cycles.	
# 95th percentile volume exceeds capacity, queue may be longer.	
Queue shown is maximum after two cycles.	

Splits and Phases: 5: Herzberg Rd & Carling Ave

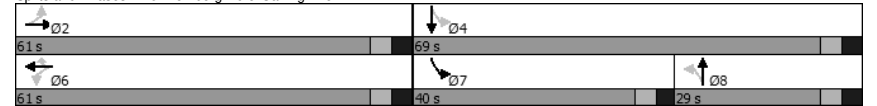

19-032 1243 Teron Road
Lanes, Volumes, Timings

6: Teron Rd & Project Site
2025 Background PM



Lane Group	WBL	WBR	NBT	NBR	SBL	SBT
Lane Configurations	↔	↔	↕	↕	↕	↕
Traffic Volume (vph)	0	0	108	0	0	242
Future Volume (vph)	0	0	108	0	0	242
Ideal Flow (vphpl)	1800	1800	1800	1800	1800	1800
Lane Width (m)	3.6	3.6	3.6	3.6	3.6	3.6
Grade (%)	0%		0%			0%
Storage Length (m)	0.0	0.0		0.0	0.0	
Storage Lanes	1	0		0	0	
Taper Length (m)	7.5			7.5		
Lane Util. Factor	1.00	1.00	1.00	1.00	1.00	1.00
Ped Bike Factor						
Frt						
Fit Protected						
Satd. Flow (prot)	1782	0	1782	0	0	1782
Fit Permitted						
Satd. Flow (perm)	1782	0	1782	0	0	1782
Link Speed (k/h)	50		50			50
Link Distance (m)	78.8		108.3			300.6
Travel Time (s)	5.7		7.8			21.6
Confl. Peds. (#/hr)						
Confl. Bikes (#/hr)						
Peak Hour Factor	0.92	0.92	0.92	0.92	0.92	0.92
Growth Factor	100%	100%	100%	100%	100%	100%
Heavy Vehicles (%)	1%	1%	1%	1%	1%	1%
Bus Blockages (#/hr)	0	0	0	0	0	0
Parking (#/hr)						
Mid-Block Traffic (%)	0%		0%			0%
Adj. Flow (vph)	0	0	117	0	0	263
Shared Lane Traffic (%)						
Lane Group Flow (vph)	0	0	117	0	0	263
Sign Control	Stop		Free			Free

Intersection Summary

Area Type:	Other
Control Type:	Unsignalized
Intersection Capacity Utilization	16.8%
ICU Level of Service	A
Analysis Period (min)	15

19-032 1243 Teron Road
HCM Unsignalized Intersection Capacity Analysis

6: Teron Rd & Project Site
2025 Background PM



Movement	WBL	WBR	NBT	NBR	SBL	SBT
Lane Configurations	↔	↔	↕	↕	↕	↕
Traffic Volume (veh/h)	0	0	108	0	0	242
Future Volume (Veh/h)	0	0	108	0	0	242
Sign Control	Stop		Free			Free
Grade	0%		0%			0%
Peak Hour Factor	0.92	0.92	0.92	0.92	0.92	0.92
Hourly flow rate (vph)	0	0	117	0	0	263
Pedestrians						
Lane Width (m)						
Walking Speed (m/s)						
Percent Blockage						
Right turn flare (veh)						
Median type			None			None
Median storage (veh)						
Upstream signal (m)						
pX, platoon unblocked						
vC, conflicting volume	380	117			117	
vC1, stage 1 conf vol						
vC2, stage 2 conf vol						
vCu, unblocked vol	380	117			117	
tC, single (s)	6.4	6.2			4.1	
tC, 2 stage (s)						
tF (s)	3.5	3.3			2.2	
p0 queue free %	100	100			100	
cM capacity (veh/h)	624	938			1478	

Direction, Lane #	WB 1	NB 1	SB 1
Volume Total	0	117	263
Volume Left	0	0	0
Volume Right	0	0	0
cSH	1700	1700	1478
Volume to Capacity	0.00	0.07	0.00
Queue Length 95th (m)	0.0	0.0	0.0
Control Delay (s)	0.0	0.0	0.0
Lane LOS	A		
Approach Delay (s)	0.0	0.0	0.0
Approach LOS	A		

Intersection Summary

Average Delay		0.0	
Intersection Capacity Utilization		16.8%	ICU Level of Service A
Analysis Period (min)		15	

19-032 1243 Teron Road
Lanes, Volumes, Timings

1: March Rd & Herzberg Rd
2025 Total AM

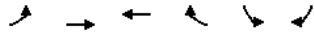

Lane Group	EBL	EBT	WBT	WBR	SBL	SBR
Lane Configurations	↔	↑↑↑	↑↑	↔	↔	↔
Traffic Volume (vph)	19	848	2465	881	123	10
Future Volume (vph)	19	848	2465	881	123	10
Ideal Flow (vphpl)	1800	1800	1800	1800	1800	1800
Lane Width (m)	3.6	3.6	3.6	3.6	3.6	3.6
Grade (%)		0%	0%		0%	
Storage Length (m)		75.0		0.0	0.0	30.0
Storage Lanes		1		1	2	1
Taper Length (m)		40.0			7.5	
Lane Util. Factor	1.00	0.91	0.95	1.00	0.97	1.00
Ped Bike Factor						
Frt				0.850		0.850
Fit Protected	0.950				0.950	
Satd. Flow (prot)	1676	4818	3353	1500	3252	1500
Fit Permitted	0.950				0.950	
Satd. Flow (perm)	1676	4818	3353	1500	3252	1500
Right Turn on Red				Yes		Yes
Satd. Flow (RTOR)				505		11
Link Speed (k/h)		80	80		50	
Link Distance (m)		149.3	160.9		125.0	
Travel Time (s)		6.7	7.2		9.0	
Confl. Peds. (#/hr)						
Confl. Bikes (#/hr)						
Peak Hour Factor	0.92	0.92	0.92	0.92	0.92	0.92
Growth Factor	100%	100%	100%	100%	100%	100%
Heavy Vehicles (%)	2%	2%	2%	2%	2%	2%
Bus Blockages (#/hr)	0	0	0	0	0	0
Parking (#/hr)						
Mid-Block Traffic (%)		0%	0%		0%	
Adj. Flow (vph)	21	922	2679	958	134	11
Shared Lane Traffic (%)						
Lane Group Flow (vph)	21	922	2679	958	134	11
Turn Type	Prot	NA	NA	Perm	Prot	Perm
Protected Phases	5	2	6	6	4	4
Permitted Phases				6		4
Detector Phase	5	2	6	6	4	4
Switch Phase						
Minimum Initial (s)	5.0	20.0	20.0	20.0	10.0	10.0
Minimum Split (s)	12.0	27.0	27.0	27.0	35.0	35.0
Total Split (s)	12.0	95.0	83.0	83.0	35.0	35.0
Total Split (%)	9.2%	73.1%	63.8%	63.8%	26.9%	26.9%
Yellow Time (s)	4.6	4.6	4.6	4.6	3.3	3.3
All-Red Time (s)	1.8	1.7	1.7	1.7	2.8	2.8
Lost Time Adjust (s)	0.0	0.0	0.0	0.0	0.0	0.0
Total Lost Time (s)	6.4	6.3	6.3	6.3	6.1	6.1
Lead/Lag	Lead		Lag	Lag		
Lead-Lag Optimize?						
Recall Mode	None	C-Max	C-Max	C-Max	None	None
Act Effct Green (s)	7.2	106.2	97.5	97.5	11.4	11.4

19-032 1243 Teron Road
Lanes, Volumes, Timings

1: March Rd & Herzberg Rd
2025 Total AM

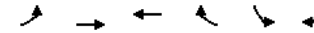

Lane Group	EBL	EBT	WBT	WBR	SBL	SBR
Actuated g/C Ratio	0.06	0.82	0.75	0.75	0.09	0.09
v/c Ratio	0.23	0.23	1.07	0.77	0.47	0.08
Control Delay	91.2	1.8	57.0	10.0	61.7	25.9
Queue Delay	0.0	0.0	0.0	0.0	0.0	0.0
Total Delay	91.2	1.8	57.0	10.0	61.7	25.9
LOS	F	A	E	B	E	C
Approach Delay		3.8	44.6		59.0	
Approach LOS		A	D		E	
Queue Length 50th (m)	3.5	0.4	~326.3	50.3	13.6	0.0
Queue Length 95th (m)	m8.0	0.8	#371.8	117.5	21.3	4.7
Internal Link Dist (m)		125.3	136.9		101.0	
Turn Bay Length (m)	75.0					30.0
Base Capacity (vph)	93	3935	2513	1251	722	342
Starvation Cap Reductn	0	0	0	0	0	0
Spillback Cap Reductn	0	0	0	0	0	0
Storage Cap Reductn	0	0	0	0	0	0
Reduced v/c Ratio	0.23	0.23	1.07	0.77	0.19	0.03

Intersection Summary

Area Type: Other
 Cycle Length: 130
 Actuated Cycle Length: 130
 Offset: 12 (9%), Referenced to phase 2:EBT and 6:WBT, Start of Green
 Natural Cycle: 150
 Control Type: Actuated-Coordinated
 Maximum v/c Ratio: 1.07
 Intersection Signal Delay: 36.9
 Intersection Capacity Utilization 90.6%
 Intersection LOS: D
 ICU Level of Service E
 Analysis Period (min) 15
 ~ Volume exceeds capacity, queue is theoretically infinite.
 Queue shown is maximum after two cycles.
 # 95th percentile volume exceeds capacity, queue may be longer.
 Queue shown is maximum after two cycles.
 m Volume for 95th percentile queue is metered by upstream signal.

Splits and Phases: 1: March Rd & Herzberg Rd

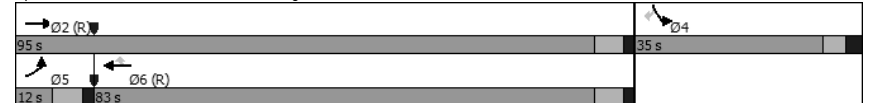

19-032 1243 Teron Road
Lanes, Volumes, Timings

2: Teron Rd & March Rd
2025 Total AM

Lane Group	EBL	EBT	EBR	WBL	WBT	WBR	NBL	NBT	NBR	SBL	SBT	SBR
Lane Configurations	↔	↔↔	↔	↔	↔↔	↔	↔	↔	↔	↔	↔	↔
Traffic Volume (vph)	37	844	223	61	2017	236	342	186	43	38	34	10
Future Volume (vph)	37	844	223	61	2017	236	342	186	43	38	34	10
Ideal Flow (vphpl)	1800	1800	1800	1800	1800	1800	1800	1800	1800	1800	1800	1800
Lane Width (m)	3.6	3.6	3.6	3.6	3.6	3.6	3.6	3.6	3.6	3.6	3.6	3.6
Grade (%)	0%		0%		0%		0%		0%		0%	
Storage Length (m)	75.0		75.0		75.0		0.0		40.0		40.0	
Storage Lanes	1		1		1		1		1		1	
Taper Length (m)	50.0		50.0		7.5		40.0					
Lane Util. Factor	1.00	0.95	1.00	1.00	0.95	1.00	1.00	1.00	1.00	1.00	1.00	1.00
Ped Bike Factor	0.850		0.850		0.850		0.850		0.850		0.850	
Fit Protected	0.950		0.950		0.950		0.950		0.950		0.950	
Satd. Flow (prot)	1676	3353	1500	1676	3353	1500	1676	1765	1500	1676	1765	1500
Fit Permitted	0.950		0.950		0.489		0.631					
Satd. Flow (perm)	1676	3353	1500	1676	3353	1500	863	1765	1500	1114	1765	1500
Right Turn on Red	Yes		Yes		Yes		Yes		Yes		Yes	
Satd. Flow (RTOR)	242		144		133		133		133		133	
Link Speed (k/h)	80		80		50		50		50		50	
Link Distance (m)	220.0		806.6		79.5		112.5					
Travel Time (s)	9.9		36.3		5.7		8.1					
Confl. Peds. (#/hr)												
Confl. Bikes (#/hr)												
Peak Hour Factor	0.92	0.92	0.92	0.92	0.92	0.92	0.92	0.92	0.92	0.92	0.92	0.92
Growth Factor	100%	100%	100%	100%	100%	100%	100%	100%	100%	100%	100%	100%
Heavy Vehicles (%)	2%	2%	2%	2%	2%	2%	2%	2%	2%	2%	2%	2%
Bus Blockages (#/hr)	0	0	0	0	0	0	0	0	0	0	0	0
Parking (#/hr)												
Mid-Block Traffic (%)	0%		0%		0%		0%		0%		0%	
Adj. Flow (vph)	40	917	242	66	2192	257	372	202	47	41	37	11
Shared Lane Traffic (%)												
Lane Group Flow (vph)	40	917	242	66	2192	257	372	202	47	41	37	11
Turn Type	Prot	NA	Perm	Prot	NA	Perm	pm+pt	NA	Perm	pm+pt	NA	Perm
Protected Phases	5	2		1	6		3	8		7	4	
Permitted Phases			2			6	8		8	4		4
Detector Phase	5	2	2	1	6	6	3	8	8	7	4	4
Switch Phase												
Minimum Initial (s)	5.0	20.0	20.0	5.0	20.0	20.0	5.0	10.0	10.0	5.0	10.0	10.0
Minimum Split (s)	12.0	27.0	27.0	12.0	27.0	27.0	12.0	35.0	35.0	12.0	35.0	35.0
Total Split (s)	12.0	61.0	61.0	12.0	61.0	61.0	22.0	35.0	35.0	22.0	35.0	35.0
Total Split (%)	9.2%	46.9%	46.9%	9.2%	46.9%	46.9%	16.9%	26.9%	26.9%	16.9%	26.9%	26.9%
Yellow Time (s)	4.6	4.6	4.6	4.6	4.6	4.6	3.3	3.3	3.3	3.3	3.3	3.3
All-Red Time (s)	1.8	1.7	1.7	1.8	1.7	1.7	2.8	3.3	3.3	2.8	3.3	3.3
Lost Time Adjust (s)	0.0	0.0	0.0	0.0	0.0	0.0	0.0	0.0	0.0	0.0	0.0	0.0
Total Lost Time (s)	6.4	6.3	6.3	6.4	6.3	6.3	6.1	6.6	6.6	6.1	6.6	6.6
Lead/Lag	Lead	Lag	Lag	Lead	Lag	Lag	Lead	Lag	Lag	Lead	Lag	Lag
Lead-Lag Optimize?												
Recall Mode	None	C-Max	C-Max	None	C-Max	C-Max	None	None	None	None	None	None
Act Effct Green (s)	8.7	66.5	66.5	11.4	71.6	71.6	33.2	21.0	21.0	20.7	14.2	14.2

19-032 1243 Teron Road
Lanes, Volumes, Timings

2: Teron Rd & March Rd
2025 Total AM

Lane Group	EBL	EBT	EBR	WBL	WBT	WBR	NBL	NBT	NBR	SBL	SBT	SBR
Actuated g/C Ratio	0.07	0.51	0.51	0.09	0.55	0.55	0.26	0.16	0.16	0.16	0.11	0.11
v/c Ratio	0.36	0.54	0.27	0.45	1.19	0.29	1.17	0.71	0.13	0.19	0.19	0.04
Control Delay	66.1	24.8	3.5	65.8	105.1	3.9	143.6	65.2	0.8	35.3	52.7	0.3
Queue Delay	0.0	0.0	0.0	0.0	0.0	0.0	0.0	0.0	0.0	0.0	0.0	0.0
Total Delay	66.1	24.8	3.5	65.8	105.1	3.9	143.6	65.2	0.8	35.3	52.7	0.3
LOS	E	C	A	E	F	A	F	E	A	D	D	A
Approach Delay	21.9				93.7		107.3				38.2	
Approach LOS	C				F		F				D	
Queue Length 50th (m)	7.9	66.4	0.0	12.2	~291.1	8.3	~81.5	39.4	0.0	6.2	7.0	0.0
Queue Length 95th (m)	17.0	94.4	12.0	m11.5m	#297.3	m11.0	#83.0	56.7	0.0	12.0	14.4	0.0
Internal Link Dist (m)	196.0				782.6		55.5				88.5	
Turn Bay Length (m)	75.0		75.0		75.0		75.0		40.0		40.0	
Base Capacity (vph)	112	1714	885	146	1845	890	319	385	431	312	385	431
Starvation Cap Reductn	0	0	0	0	0	0	0	0	0	0	0	0
Spillback Cap Reductn	0	0	0	0	0	0	0	0	0	0	0	0
Storage Cap Reductn	0	0	0	0	0	0	0	0	0	0	0	0
Reduced v/c Ratio	0.36	0.54	0.27	0.45	1.19	0.29	1.17	0.52	0.11	0.13	0.10	0.03

Intersection Summary

Area Type: Other
 Cycle Length: 130
 Actuated Cycle Length: 130
 Offset: 77 (59%), Referenced to phase 2:EBT and 6:WBT, Start of Green
 Natural Cycle: 150
 Control Type: Actuated-Coordinated
 Maximum v/c Ratio: 1.19
 Intersection Signal Delay: 75.0 Intersection LOS: E
 Intersection Capacity Utilization 103.0% ICU Level of Service G
 Analysis Period (min) 15
 ~ Volume exceeds capacity, queue is theoretically infinite.
 Queue shown is maximum after two cycles.
 # 95th percentile volume exceeds capacity, queue may be longer.
 Queue shown is maximum after two cycles.
 m Volume for 95th percentile queue is metered by upstream signal.

Splits and Phases: 2: Teron Rd & March Rd



19-032 1243 Teron Road
Lanes, Volumes, Timings

3: March Rd & Station Rd/Carling Ave
2025 Total AM

Lane Group	EBL	EBT	EBR	WBL	WBT	WBR	NBL	NBT	NBR	SBL	SBT	SBR
Lane Configurations		↖	↗		↖	↗		↖	↗	↖	↗	↖
Traffic Volume (vph)	66	27	9	39	13	182	91	2033	87	331	992	129
Future Volume (vph)	66	27	9	39	13	182	91	2033	87	331	992	129
Ideal Flow (vphpl)	1800	1800	1800	1800	1800	1800	1800	1800	1800	1800	1800	1800
Lane Width (m)	3.6	3.6	3.6	3.6	3.6	3.6	3.6	3.6	3.6	3.6	3.6	3.6
Grade (%)	0%		0%		0%		0%		0%		0%	
Storage Length (m)	0.0		25.0	0.0		0.0	75.0		75.0	175.0		25.0
Storage Lanes	0		1	0		1	1		1	2		1
Taper Length (m)	7.5			7.5			50.0			75.0		
Lane Util. Factor	1.00	1.00	1.00	1.00	1.00	1.00	1.00	0.95	1.00	0.97	0.95	1.00
Ped Bike Factor	1.00		0.98		0.99		0.99		1.00		0.97	
Frt	0.850			0.850			0.850			0.850		
Fit Protected	0.966				0.964		0.950				0.950	
Satd. Flow (prot)	0	1705	1500	0	1701	1500	1676	3353	1500	3252	3353	1500
Fit Permitted	0.753				0.636		0.950				0.950	
Satd. Flow (perm)	0	1323	1463	0	1113	1481	1671	3353	1415	3241	3353	1449
Right Turn on Red	Yes			Yes			Yes			Yes		
Satd. Flow (RTOR)	103			198			80			80		
Link Speed (k/h)	50			60			80			80		
Link Distance (m)	131.4			60.0			183.7			281.3		
Travel Time (s)	9.5			3.6			8.3			12.7		
Confl. Peds. (#/hr)	3		6	6		3	4		21	21		4
Confl. Bikes (#/hr)												
Peak Hour Factor	0.92	0.92	0.92	0.92	0.92	0.92	0.92	0.92	0.92	0.92	0.92	0.92
Growth Factor	100%	100%	100%	100%	100%	100%	100%	100%	100%	100%	100%	100%
Heavy Vehicles (%)	2%	2%	2%	2%	2%	2%	2%	2%	2%	2%	2%	2%
Bus Blockages (#/hr)	0	0	0	0	0	0	0	0	0	0	0	0
Parking (#/hr)												
Mid-Block Traffic (%)	0%				0%		0%				0%	
Adj. Flow (vph)	72	29	10	42	14	198	99	2210	95	360	1078	140
Shared Lane Traffic (%)												
Lane Group Flow (vph)	0	101	10	0	56	198	99	2210	95	360	1078	140
Turn Type	Perm	NA	Perm	Perm	NA	Free	Prot	NA	Perm	Prot	NA	Perm
Protected Phases	4			8			8			5		
Permitted Phases	4		4	8		Free			2			6
Detector Phase	4	4	4	8	8		5	2	2	1	6	6
Switch Phase												
Minimum Initial (s)	10.0	10.0	10.0	10.0	10.0		5.0	20.0	20.0	5.0	20.0	20.0
Minimum Split (s)	35.0	35.0	35.0	35.0	35.0		13.0	28.0	28.0	13.0	28.0	28.0
Total Split (s)	35.0	35.0	35.0	35.0	35.0		22.0	76.0	76.0	19.0	73.0	73.0
Total Split (%)	26.9%	26.9%	26.9%	26.9%	26.9%		16.9%	58.5%	58.5%	14.6%	56.2%	56.2%
Yellow Time (s)	3.3	3.3	3.3	3.3	3.3		4.6	4.6	4.6	4.6	4.6	4.6
All-Red Time (s)	1.8	1.8	1.8	1.8	1.8		2.8	3.3	3.3	2.8	3.3	3.3
Lost Time Adjust (s)	0.0	0.0	0.0	0.0	0.0		0.0	0.0	0.0	0.0	0.0	0.0
Total Lost Time (s)	5.1	5.1	5.1	5.1	5.1		7.4	7.9	7.9	7.4	7.9	7.9
Lead/Lag							Lead	Lag	Lag	Lead	Lag	Lag
Lead-Lag Optimize?												
Recall Mode	None	None	None	None	None		None	C-Max	C-Max	None	C-Max	C-Max
Act Effct Green (s)		15.5	15.5		15.5	130.0	13.0	69.6	69.6	24.5	81.1	81.1

19-032 1243 Teron Road
Lanes, Volumes, Timings

3: March Rd & Station Rd/Carling Ave
2025 Total AM

Lane Group	EBL	EBT	EBR	WBL	WBT	WBR	NBL	NBT	NBR	SBL	SBT	SBR
Actuated g/C Ratio	0.12	0.12		0.12	1.00	0.10	0.54	0.54	0.19	0.62	0.62	
v/c Ratio	0.64	0.04		0.42	0.13	0.59	1.23	0.12	0.59	0.52	0.15	
Control Delay	72.0	0.2		61.4	0.2	69.8	138.6	4.7	53.5	15.9	6.1	
Queue Delay	0.0	0.0		0.0	0.0	0.0	0.0	0.0	0.0	0.0	0.0	
Total Delay	72.0	0.2		61.4	0.2	69.8	138.6	4.7	53.5	15.9	6.1	
LOS	E	A		E	A	E	F	A	D	B	A	
Approach Delay	65.5			13.7		130.5				23.6		
Approach LOS	E			B		F				C		
Queue Length 50th (m)	19.8	0.0		10.7	0.0	19.5	~287.1	1.4	34.9	59.5	4.5	
Queue Length 95th (m)	33.0	0.0		20.6	0.0	32.7	#326.5	8.0	49.4	91.8	13.8	
Internal Link Dist (m)	107.4				36.0		159.7				257.3	
Turn Bay Length (m)	25.0						75.0			175.0		
Base Capacity (vph)	304	415		255	1481	198	1794	794	612	2091	934	
Starvation Cap Reductn	0	0		0	0	0	0	0	0	0	0	
Spillback Cap Reductn	0	0		0	0	0	0	0	0	0	0	
Storage Cap Reductn	0	0		0	0	0	0	0	0	0	0	
Reduced v/c Ratio	0.33	0.02		0.22	0.13	0.50	1.23	0.12	0.59	0.52	0.15	
Intersection Summary												
Area Type: Other												
Cycle Length: 130												
Actuated Cycle Length: 130												
Offset: 22 (17%), Referenced to phase 2:NBT and 6:SBT, Start of Green												
Natural Cycle: 150												
Control Type: Actuated-Coordinated												
Maximum v/c Ratio: 1.23												
Intersection Signal Delay: 83.2						Intersection LOS: F						
Intersection Capacity Utilization 98.8%						ICU Level of Service F						
Analysis Period (min) 15												
~ Volume exceeds capacity, queue is theoretically infinite.												
Queue shown is maximum after two cycles.												
# 95th percentile volume exceeds capacity, queue may be longer.												
Queue shown is maximum after two cycles.												
Splits and Phases: 3: March Rd & Station Rd/Carling Ave												

19-032 1243 Teron Road
Lanes, Volumes, Timings

4: Teron Rd & Carling Ave
2025 Total AM

	→	↖	↗	←	↖	↗
Lane Group	EBT	EBR	WBL	WBT	NBL	NBR
Lane Configurations	↑	↑		↑	↑	
Traffic Volume (vph)	494	16	44	567	221	150
Future Volume (vph)	494	16	44	567	221	150
Ideal Flow (vphpl)	1800	1800	1800	1800	1800	1800
Lane Width (m)	3.6	3.6	3.6	3.6	3.6	3.6
Grade (%)	0%			0%	0%	
Storage Length (m)		20.0	0.0		0.0	0.0
Storage Lanes		1	0		1	0
Taper Length (m)			7.5		7.5	
Lane Util. Factor	1.00	1.00	1.00	1.00	1.00	1.00
Ped Bike Factor						
Frt		0.850			0.945	
Fit Protected				0.996	0.971	
Satd. Flow (prot)	1765	1500	0	1758	1619	0
Fit Permitted				0.996	0.971	
Satd. Flow (perm)	1765	1500	0	1758	1619	0
Link Speed (k/h)	60			60	50	
Link Distance (m)	194.0			213.2	38.0	
Travel Time (s)	11.6			12.8	2.7	
Confl. Peds. (#/hr)		3	3			
Confl. Bikes (#/hr)						
Peak Hour Factor	0.92	0.92	0.92	0.92	0.92	0.92
Growth Factor	100%	100%	100%	100%	100%	100%
Heavy Vehicles (%)	2%	2%	2%	2%	2%	2%
Bus Blockages (#/hr)	0	0	0	0	0	0
Parking (#/hr)						
Mid-Block Traffic (%)	0%			0%	0%	
Adj. Flow (vph)	537	17	48	616	240	163
Shared Lane Traffic (%)						
Lane Group Flow (vph)	537	17	0	664	403	0
Sign Control	Free			Free	Stop	

Intersection Summary

Area Type:	Other
Control Type:	Unsignalized
Intersection Capacity Utilization	94.1%
ICU Level of Service	F
Analysis Period (min)	15

19-032 1243 Teron Road
HCM Unsignalized Intersection Capacity Analysis

4: Teron Rd & Carling Ave
2025 Total AM

	→	↖	↗	←	↖	↗
Movement	EBT	EBR	WBL	WBT	NBL	NBR
Lane Configurations	↑	↑		↑	↑	
Traffic Volume (veh/h)	494	16	44	567	221	150
Future Volume (Veh/h)	494	16	44	567	221	150
Sign Control	Free			Free	Stop	
Grade	0%			0%	0%	
Peak Hour Factor	0.92	0.92	0.92	0.92	0.92	0.92
Hourly flow rate (vph)	537	17	48	616	240	163
Pedestrians					3	
Lane Width (m)					3.6	
Walking Speed (m/s)					1.2	
Percent Blockage					0	
Right turn flare (veh)						
Median type	None			None		
Median storage (veh)						
Upstream signal (m)				213		
pX, platoon unblocked					0.80	
vC, conflicting volume			557		1252	540
vC1, stage 1 conf vol						
vC2, stage 2 conf vol						
vCu, unblocked vol			557		1188	540
tC, single (s)			4.1		6.4	6.2
tC, 2 stage (s)						
tF (s)			2.2		3.5	3.3
p0 queue free %			95		0	70
cM capacity (veh/h)			1011		157	540

Direction, Lane #	EB 1	EB 2	WB 1	NB 1
Volume Total	537	17	664	403
Volume Left	0	0	48	240
Volume Right	0	17	0	163
cSH	1700	1700	1011	220
Volume to Capacity	0.32	0.01	0.05	1.83
Queue Length 95th (m)	0.0	0.0	0.9	169.2
Control Delay (s)	0.0	0.0	1.2	427.8
Lane LOS			A	F
Approach Delay (s)	0.0		1.2	427.8
Approach LOS				F

Intersection Summary

Average Delay	106.9
Intersection Capacity Utilization	94.1%
ICU Level of Service	F
Analysis Period (min)	15

19-032 1243 Teron Road
Lanes, Volumes, Timings

5: Herzberg Rd & Carling Ave
2025 Total AM

Lane Group	EBL	EBT	EBR	WBL	WBT	WBR	NBL	NBT	NBR	SBL	SBT	SBR
Lane Configurations	↔	↔	↔	↔	↔	↔	↔	↔	↔	↔	↔	↔
Traffic Volume (vph)	38	419	31	15	382	603	72	623	6	261	142	36
Future Volume (vph)	38	419	31	15	382	603	72	623	6	261	142	36
Ideal Flow (vphpl)	1800	1800	1800	1800	1800	1800	1800	1800	1800	1800	1800	1800
Lane Width (m)	3.6	3.6	3.6	3.6	3.6	3.6	3.6	3.6	3.6	3.6	3.6	3.6
Grade (%)	0%			0%			0%			0%		
Storage Length (m)	0.0			75.0			100.0			0.0		
Storage Lanes	1			1			1			0		
Taper Length (m)	7.5			75.0			7.5			7.5		
Lane Util. Factor	1.00	1.00	1.00	1.00	1.00	1.00	1.00	1.00	1.00	1.00	1.00	1.00
Ped Bike Factor	1.00			0.97			1.00			1.00		
Frt	0.990			0.850			0.999			0.970		
Fit Protected	0.950			0.950			0.995			0.950		
Satd. Flow (prot)	1676	1744	0	1676	1765	1500	0	1754	0	1676	1704	0
Fit Permitted	0.288			0.198			0.940			0.258		
Satd. Flow (perm)	508	1744	0	349	1765	1459	0	1657	0	455	1704	0
Right Turn on Red	Yes			Yes			Yes			Yes		
Satd. Flow (RTOR)	3			256			16			16		
Link Speed (k/h)	60			60			50			50		
Link Distance (m)	213.2			282.2			126.1			120.3		
Travel Time (s)	12.8			16.9			9.1			8.7		
Confl. Peds. (#/hr)	2	1	1	2	1	1	2	1	1	2	1	1
Confl. Bikes (#/hr)												
Peak Hour Factor	0.92	0.92	0.92	0.92	0.92	0.92	0.92	0.92	0.92	0.92	0.92	0.92
Growth Factor	100%	100%	100%	100%	100%	100%	100%	100%	100%	100%	100%	100%
Heavy Vehicles (%)	2%	2%	2%	2%	2%	2%	2%	2%	2%	2%	2%	2%
Bus Blockages (#/hr)	0	0	0	0	0	0	0	0	0	0	0	0
Parking (#/hr)												
Mid-Block Traffic (%)	0%			0%			0%			0%		
Adj. Flow (vph)	41	455	34	16	415	655	78	677	7	284	154	39
Shared Lane Traffic (%)												
Lane Group Flow (vph)	41	489	0	16	415	655	0	762	0	284	193	0
Turn Type	Perm	NA	Perm	NA	Perm	Perm	NA	pm+pt	NA	NA	NA	NA
Protected Phases	2			6			8			4		
Permitted Phases	2			6			8			4		
Detector Phase	2			6			8			4		
Switch Phase												
Minimum Initial (s)	20.0	20.0	20.0	20.0	20.0	10.0	10.0	5.0	10.0	10.0	10.0	10.0
Minimum Split (s)	27.0	27.0	27.0	27.0	27.0	25.0	25.0	12.0	25.0	12.0	25.0	25.0
Total Split (s)	50.0	50.0	50.0	50.0	50.0	67.0	67.0	13.0	80.0	13.0	80.0	80.0
Total Split (%)	38.5%	38.5%	38.5%	38.5%	38.5%	51.5%	51.5%	10.0%	61.5%	10.0%	61.5%	61.5%
Yellow Time (s)	3.3	3.3	3.3	3.3	3.3	3.3	3.3	3.3	3.3	3.3	3.3	3.3
All-Red Time (s)	3.3	3.3	3.3	3.3	3.3	3.3	3.3	2.8	3.3	2.8	3.3	3.3
Lost Time Adjust (s)	0.0	0.0	0.0	0.0	0.0	0.0	0.0	0.0	0.0	0.0	0.0	0.0
Total Lost Time (s)	6.6	6.6	6.6	6.6	6.6	6.6	6.6	6.1	6.6	6.1	6.6	6.6
Lead/Lag							Lag	Lag	Lead			
Lead-Lag Optimize?												
Recall Mode	Max	Max	Max	Max	Max	None	None	None	None	None	None	None
Act Effct Green (s)	43.4	43.4	43.4	43.4	43.4	60.4	60.4	73.9	73.9	73.4	73.4	73.4

19-032 1243 Teron Road
Lanes, Volumes, Timings

5: Herzberg Rd & Carling Ave
2025 Total AM

Lane Group	EBL	EBT	EBR	WBL	WBT	WBR	NBL	NBT	NBR	SBL	SBT	SBR
Actuated g/C Ratio	0.33	0.33	0.33	0.33	0.33	0.33	0.46	0.57	0.56	0.57	0.56	0.56
v/c Ratio	0.24	0.84	0.14	0.70	1.00	0.99	0.88	0.20	0.20	0.88	0.20	0.20
Control Delay	36.3	53.9	34.2	45.4	61.0	65.2	47.8	13.3	13.3	47.8	13.3	13.3
Queue Delay	0.0	0.0	0.0	0.0	0.0	0.0	0.0	0.0	0.0	0.0	0.0	0.0
Total Delay	36.3	53.9	34.2	45.4	61.0	65.2	47.8	13.3	13.3	47.8	13.3	13.3
LOS	D	D	C	D	E	E	D	B	B	D	B	B
Approach Delay	52.6			54.7			65.2			33.8		
Approach LOS	D			D			E			C		
Queue Length 50th (m)	6.0	90.7	2.3	72.9	92.7	149.5	28.6	16.7	16.7	28.6	16.7	16.7
Queue Length 95th (m)	13.9	#134.2	7.1	102.4	#157.3	#216.8	#58.0	26.7	26.7	#58.0	26.7	26.7
Internal Link Dist (m)	189.2			258.2			102.1			96.3		
Turn Bay Length (m)				100.0			100.0					
Base Capacity (vph)	169	584	116	589	657	769	323	969	969	323	969	969
Starvation Cap Reductn	0	0	0	0	0	0	0	0	0	0	0	0
Spillback Cap Reductn	0	0	0	0	0	0	0	0	0	0	0	0
Storage Cap Reductn	0	0	0	0	0	0	0	0	0	0	0	0
Reduced v/c Ratio	0.24	0.84	0.14	0.70	1.00	0.99	0.88	0.20	0.20	0.88	0.20	0.20

Intersection Summary

Area Type: Other
 Cycle Length: 130
 Actuated Cycle Length: 130
 Natural Cycle: 100
 Control Type: Semi Act-Uncoord
 Maximum v/c Ratio: 1.00
 Intersection Signal Delay: 53.6
 Intersection LOS: D
 Intersection Capacity Utilization 112.0%
 ICU Level of Service H
 Analysis Period (min) 15
 # 95th percentile volume exceeds capacity, queue may be longer.
 Queue shown is maximum after two cycles.

Splits and Phases: 5: Herzberg Rd & Carling Ave

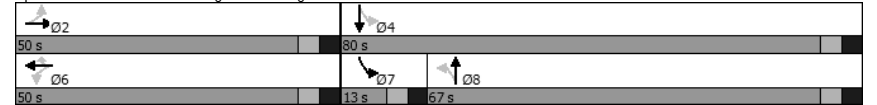

19-032 1243 Teron Road
Lanes, Volumes, Timings

6: Teron Rd & Project Site
2025 Total AM

Lane Group	WBL	WBR	NBT	NBR	SBL	SBT
Lane Configurations	↔	↔	↕	↕	↔	↔
Traffic Volume (vph)	10	2	369	24	5	55
Future Volume (vph)	10	2	369	24	5	55
Ideal Flow (vphpl)	1800	1800	1800	1800	1800	1800
Lane Width (m)	3.6	3.6	3.6	3.6	3.6	3.6
Grade (%)	0%		0%			0%
Storage Length (m)	0.0	0.0		0.0	0.0	
Storage Lanes	1	0		0	0	
Taper Length (m)	7.5			7.5		
Lane Util. Factor	1.00	1.00	1.00	1.00	1.00	1.00
Ped Bike Factor						
Frt	0.979		0.992			
Fit Protected	0.959				0.996	
Satd. Flow (prot)	1657	0	1751	0	0	1758
Fit Permitted	0.959				0.996	
Satd. Flow (perm)	1657	0	1751	0	0	1758
Link Speed (k/h)	50		50		50	
Link Distance (m)	78.8		108.3		300.6	
Travel Time (s)	5.7		7.8		21.6	
Confl. Peds. (#/hr)						
Confl. Bikes (#/hr)						
Peak Hour Factor	0.92	0.92	0.92	0.92	0.92	0.92
Growth Factor	100%	100%	100%	100%	100%	100%
Heavy Vehicles (%)	2%	2%	2%	2%	2%	2%
Bus Blockages (#/hr)	0	0	0	0	0	0
Parking (#/hr)						
Mid-Block Traffic (%)	0%		0%		0%	
Adj. Flow (vph)	11	2	401	26	5	60
Shared Lane Traffic (%)						
Lane Group Flow (vph)	13	0	427	0	0	65
Sign Control	Stop		Free			Free

Intersection Summary	
Area Type:	Other
Control Type:	Unsignalized
Intersection Capacity Utilization	32.0%
ICU Level of Service	A
Analysis Period (min)	15

19-032 1243 Teron Road
HCM Unsignalized Intersection Capacity Analysis

6: Teron Rd & Project Site
2025 Total AM

Movement	WBL	WBR	NBT	NBR	SBL	SBT
Lane Configurations	↔	↔	↕	↕	↔	↔
Traffic Volume (veh/h)	10	2	369	24	5	55
Future Volume (Veh/h)	10	2	369	24	5	55
Sign Control	Stop		Free			Free
Grade	0%		0%			0%
Peak Hour Factor	0.92	0.92	0.92	0.92	0.92	0.92
Hourly flow rate (vph)	11	2	401	26	5	60
Pedestrians						
Lane Width (m)						
Walking Speed (m/s)						
Percent Blockage						
Right turn flare (veh)						
Median type			None		None	
Median storage (veh)						
Upstream signal (m)						
pX, platoon unblocked						
vC, conflicting volume	484	414			427	
vC1, stage 1 conf vol						
vC2, stage 2 conf vol						
vCu, unblocked vol	484	414			427	
tC, single (s)	6.4	6.2			4.1	
tC, 2 stage (s)						
tF (s)	3.5	3.3			2.2	
p0 queue free %	98	100			100	
cM capacity (veh/h)	539	638			1132	

Direction, Lane #	WB 1	NB 1	SB 1
Volume Total	13	427	65
Volume Left	11	0	5
Volume Right	2	26	0
cSH	553	1700	1132
Volume to Capacity	0.02	0.25	0.00
Queue Length 95th (m)	0.4	0.0	0.1
Control Delay (s)	11.7	0.0	0.7
Lane LOS	B		A
Approach Delay (s)	11.7	0.0	0.7
Approach LOS	B		

Intersection Summary			
Average Delay		0.4	
Intersection Capacity Utilization	32.0%	ICU Level of Service	A
Analysis Period (min)		15	

19-032 1243 Teron Road
Lanes, Volumes, Timings

1: March Rd & Herzberg Rd
2025 Total PM

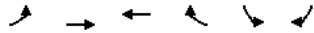

Lane Group	EBL	EBT	WBT	WBR	SBL	SBR
Lane Configurations	↔	↑↑↑	↑↑	↔	↔	↔
Traffic Volume (vph)	6	2016	1233	224	816	17
Future Volume (vph)	6	2016	1233	224	816	17
Ideal Flow (vphpl)	1800	1800	1800	1800	1800	1800
Lane Width (m)	3.6	3.6	3.6	3.6	3.6	3.6
Grade (%)		0%	0%		0%	
Storage Length (m)		75.0		0.0	0.0	30.0
Storage Lanes		1		1	2	1
Taper Length (m)		40.0			7.5	
Lane Util. Factor	1.00	0.91	0.95	1.00	0.97	1.00
Ped Bike Factor						
Frt				0.850		0.850
Flt Protected	0.950				0.950	
Satd. Flow (prot)	1693	4865	3386	1515	3285	1515
Flt Permitted	0.950				0.950	
Satd. Flow (perm)	1693	4865	3386	1515	3285	1515
Right Turn on Red				Yes		Yes
Satd. Flow (RTOR)				200		10
Link Speed (k/h)		80	80		50	
Link Distance (m)		149.3	160.9		125.0	
Travel Time (s)		6.7	7.2		9.0	
Confl. Peds. (#/hr)						
Confl. Bikes (#/hr)						
Peak Hour Factor	0.92	0.92	0.92	0.92	0.92	0.92
Growth Factor	100%	100%	100%	100%	100%	100%
Heavy Vehicles (%)	1%	1%	1%	1%	1%	1%
Bus Blockages (#/hr)	0	0	0	0	0	0
Parking (#/hr)						
Mid-Block Traffic (%)		0%	0%		0%	
Adj. Flow (vph)	7	2191	1340	243	887	18
Shared Lane Traffic (%)						
Lane Group Flow (vph)	7	2191	1340	243	887	18
Turn Type	Prot	NA	NA	Perm	Prot	Perm
Protected Phases	5	2	6		4	
Permitted Phases				6		4
Detector Phase	5	2	6	6	4	4
Switch Phase						
Minimum Initial (s)	5.0	20.0	20.0	20.0	10.0	10.0
Minimum Split (s)	12.0	27.0	27.0	27.0	35.0	35.0
Total Split (s)	12.0	80.0	68.0	68.0	50.0	50.0
Total Split (%)	9.2%	61.5%	52.3%	52.3%	38.5%	38.5%
Yellow Time (s)	4.6	4.6	4.6	4.6	3.3	3.3
All-Red Time (s)	1.8	1.7	1.7	1.7	2.8	2.8
Lost Time Adjust (s)	0.0	0.0	0.0	0.0	0.0	0.0
Total Lost Time (s)	6.4	6.3	6.3	6.3	6.1	6.1
Lead/Lag	Lead		Lag	Lag		
Lead-Lag Optimize?						
Recall Mode	None	C-Max	C-Max	C-Max	None	None
Act Effct Green (s)	5.6	77.3	74.9	74.9	40.3	40.3

19-032 1243 Teron Road
Lanes, Volumes, Timings

1: March Rd & Herzberg Rd
2025 Total PM

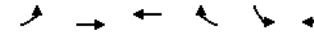

Lane Group	EBL	EBT	WBT	WBR	SBL	SBR
Actuated g/C Ratio	0.04	0.59	0.58	0.58	0.31	0.31
v/c Ratio	0.10	0.76	0.69	0.25	0.87	0.04
Control Delay	84.8	4.9	23.1	4.4	52.5	18.9
Queue Delay	0.0	0.0	0.0	0.0	0.0	0.0
Total Delay	84.8	4.9	23.1	4.4	52.5	18.9
LOS	F	A	C	A	D	B
Approach Delay		5.2	20.3		51.8	
Approach LOS		A	C		D	
Queue Length 50th (m)	1.3	9.5	93.6	3.6	85.9	1.1
Queue Length 95th (m)	m1.1	m22.8	145.6	16.2	103.4	5.5
Internal Link Dist (m)		125.3	136.9		101.0	
Turn Bay Length (m)		75.0				30.0
Base Capacity (vph)	73	2893	1951	957	1109	518
Starvation Cap Reductn	0	0	0	0	0	0
Spillback Cap Reductn	0	0	0	0	0	0
Storage Cap Reductn	0	0	0	0	0	0
Reduced v/c Ratio	0.10	0.76	0.69	0.25	0.80	0.03

Intersection Summary

Area Type: Other
 Cycle Length: 130
 Actuated Cycle Length: 130
 Offset: 12 (9%), Referenced to phase 2:EBT and 6:WBT, Start of Green
 Natural Cycle: 90
 Control Type: Actuated-Coordinated
 Maximum v/c Ratio: 0.87
 Intersection Signal Delay: 19.3
 Intersection Capacity Utilization 76.0%
 Intersection LOS: B
 ICU Level of Service D
 Analysis Period (min) 15
 m Volume for 95th percentile queue is metered by upstream signal.

Splits and Phases: 1: March Rd & Herzberg Rd

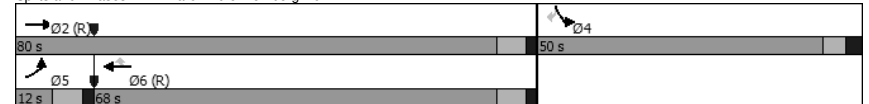

19-032 1243 Teron Road
Lanes, Volumes, Timings

2: Teron Rd & March Rd
2025 Total PM

Lane Group	EBL	EBT	EBR	WBL	WBT	WBR	NBL	NBT	NBR	SBL	SBT	SBR
Lane Configurations	↔	↔↔	↔	↔	↔↔	↔	↔	↔	↔	↔	↔	↔
Traffic Volume (vph)	19	1848	31	70	1093	43	245	60	29	197	202	38
Future Volume (vph)	19	1848	31	70	1093	43	245	60	29	197	202	38
Ideal Flow (vphpl)	1800	1800	1800	1800	1800	1800	1800	1800	1800	1800	1800	1800
Lane Width (m)	3.6	3.6	3.6	3.6	3.6	3.6	3.6	3.6	3.6	3.6	3.6	3.6
Grade (%)	0%		0%		0%		0%		0%		0%	
Storage Length (m)	75.0		75.0		75.0		0.0		40.0		40.0	
Storage Lanes	1		1		1		1		1		1	
Taper Length (m)	50.0		50.0		7.5		40.0					
Lane Util. Factor	1.00	0.95	1.00	1.00	0.95	1.00	1.00	1.00	1.00	1.00	1.00	1.00
Ped Bike Factor	0.850		0.850		0.850		0.850		0.850		0.850	
Fit Protected	0.950		0.950		0.950		0.950		0.950		0.950	
Satd. Flow (prot)	1693	3386	1515	1693	3386	1515	1693	1782	1515	1693	1782	1515
Fit Permitted	0.950		0.950		0.483		0.583					
Satd. Flow (perm)	1693	3386	1515	1693	3386	1515	861	1782	1515	1039	1782	1515
Right Turn on Red	Yes		Yes		Yes		Yes		Yes		Yes	
Satd. Flow (RTOR)	135		135		133		133		133		133	
Link Speed (k/h)	80		80		80		50		50		50	
Link Distance (m)	220.0		806.6		79.5		112.5					
Travel Time (s)	9.9		36.3		5.7		8.1					
Confl. Peds. (#/hr)												
Confl. Bikes (#/hr)												
Peak Hour Factor	0.92	0.92	0.92	0.92	0.92	0.92	0.92	0.92	0.92	0.92	0.92	0.92
Growth Factor	100%	100%	100%	100%	100%	100%	100%	100%	100%	100%	100%	100%
Heavy Vehicles (%)	1%	1%	1%	1%	1%	1%	1%	1%	1%	1%	1%	1%
Bus Blockages (#/hr)	0	0	0	0	0	0	0	0	0	0	0	0
Parking (#/hr)												
Mid-Block Traffic (%)	0%		0%		0%		0%		0%		0%	
Adj. Flow (vph)	21	2009	34	76	1188	47	266	65	32	214	220	41
Shared Lane Traffic (%)												
Lane Group Flow (vph)	21	2009	34	76	1188	47	266	65	32	214	220	41
Turn Type	Prot	NA	Perm	Prot	NA	Perm	pm+pt	NA	Perm	pm+pt	NA	Perm
Protected Phases	5	2		1	6		3	8		7	4	
Permitted Phases			2			6	8		8	4		4
Detector Phase	5	2	2	1	6	6	3	8	8	7	4	4
Switch Phase												
Minimum Initial (s)	5.0	20.0	20.0	5.0	20.0	20.0	5.0	10.0	10.0	5.0	10.0	10.0
Minimum Split (s)	12.0	27.0	27.0	12.0	27.0	27.0	12.0	35.0	35.0	12.0	35.0	35.0
Total Split (s)	12.0	69.0	69.0	12.0	69.0	69.0	14.0	35.0	35.0	14.0	35.0	35.0
Total Split (%)	9.2%	53.1%	53.1%	9.2%	53.1%	53.1%	10.8%	26.9%	26.9%	10.8%	26.9%	26.9%
Yellow Time (s)	4.6	4.6	4.6	4.6	4.6	4.6	3.3	3.3	3.3	3.3	3.3	3.3
All-Red Time (s)	1.8	1.7	1.7	1.8	1.7	1.7	2.8	3.3	3.3	2.8	3.3	3.3
Lost Time Adjust (s)	0.0	0.0	0.0	0.0	0.0	0.0	0.0	0.0	0.0	0.0	0.0	0.0
Total Lost Time (s)	6.4	6.3	6.3	6.4	6.3	6.3	6.1	6.6	6.6	6.1	6.6	6.6
Lead/Lag	Lead	Lag	Lag	Lead	Lag	Lag	Lead	Lag	Lag	Lead	Lag	Lag
Lead-Lag Optimize?												
Recall Mode	None	C-Max	C-Max	None	C-Max	C-Max	None	None	None	None	None	None
Act Effct Green (s)	6.4	64.6	64.6	10.6	73.7	73.7	26.9	20.6	20.6	31.0	21.4	21.4

19-032 1243 Teron Road
Lanes, Volumes, Timings

2: Teron Rd & March Rd
2025 Total PM

Lane Group	EBL	EBT	EBR	WBL	WBT	WBR	NBL	NBT	NBR	SBL	SBT	SBR
Actuated g/C Ratio	0.05	0.50	0.50	0.08	0.57	0.57	0.21	0.16	0.16	0.24	0.16	0.16
v/c Ratio	0.25	1.19	0.04	0.55	0.62	0.05	1.17	0.23	0.09	0.69	0.75	0.11
Control Delay	67.0	124.2	0.1	62.6	25.2	1.3	153.3	47.3	0.5	54.1	67.1	0.6
Queue Delay	0.0	0.0	0.0	0.0	0.0	0.0	0.0	0.0	0.0	0.0	0.0	0.0
Total Delay	67.0	124.2	0.1	62.6	25.2	1.3	153.3	47.3	0.5	54.1	67.1	0.6
LOS	E	F	A	E	C	A	F	D	A	D	E	A
Approach Delay	121.6			26.5			120.9			55.5		
Approach LOS	F			C			F			E		
Queue Length 50th (m)	4.2	~263.6	0.0	12.1	134.6	0.0	~50.5	11.5	0.0	35.9	42.9	0.0
Queue Length 95th (m)	11.2	#296.4	0.0	m#30.8	152.2	m0.4	#81.6	20.9	0.0	50.7	60.5	0.0
Internal Link Dist (m)	196.0		782.6		55.5		88.5					
Turn Bay Length (m)	75.0		75.0		75.0		40.0		40.0		40.0	
Base Capacity (vph)	84	1683	821	138	1920	917	228	389	434	308	389	434
Starvation Cap Reductn	0	0	0	0	0	0	0	0	0	0	0	0
Spillback Cap Reductn	0	0	0	0	0	0	0	0	0	0	0	0
Storage Cap Reductn	0	0	0	0	0	0	0	0	0	0	0	0
Reduced v/c Ratio	0.25	1.19	0.04	0.55	0.62	0.05	1.17	0.17	0.07	0.69	0.57	0.09

Intersection Summary

Area Type: Other
 Cycle Length: 130
 Actuated Cycle Length: 130
 Offset: 83 (64%), Referenced to phase 2:EBT and 6:WBT, Start of Green
 Natural Cycle: 150
 Control Type: Actuated-Coordinated
 Maximum v/c Ratio: 1.19
 Intersection Signal Delay: 84.5 Intersection LOS: F
 Intersection Capacity Utilization 102.8% ICU Level of Service G
 Analysis Period (min) 15
 ~ Volume exceeds capacity, queue is theoretically infinite.
 Queue shown is maximum after two cycles.
 # 95th percentile volume exceeds capacity, queue may be longer.
 Queue shown is maximum after two cycles.
 m Volume for 95th percentile queue is metered by upstream signal.

Splits and Phases: 2: Teron Rd & March Rd

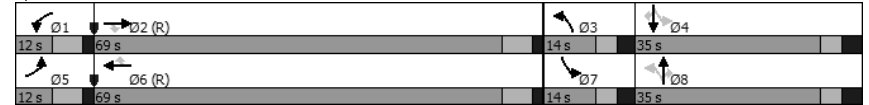

19-032 1243 Teron Road
Lanes, Volumes, Timings

3: March Rd & Station Rd/Carling Ave
2025 Total PM

Lane Group	EBL	EBT	EBR	WBL	WBT	WBR	NBL	NBT	NBR	SBL	SBT	SBR
Lane Configurations		↖	↗		↖	↗		↖	↗		↖	↗
Traffic Volume (vph)	27	14	31	126	20	332	35	1429	37	304	1972	52
Future Volume (vph)	27	14	31	126	20	332	35	1429	37	304	1972	52
Ideal Flow (vphpl)	1800	1800	1800	1800	1800	1800	1800	1800	1800	1800	1800	1800
Lane Width (m)	3.6	3.6	3.6	3.6	3.6	3.6	3.6	3.6	3.6	3.6	3.6	3.6
Grade (%)		0%			0%			0%			0%	
Storage Length (m)	0.0		25.0	0.0		0.0	75.0		75.0	175.0		25.0
Storage Lanes	0		1	0		1	1		1	2		1
Taper Length (m)	7.5			7.5			50.0			75.0		
Lane Util. Factor	1.00	1.00	1.00	1.00	1.00	1.00	1.00	0.95	1.00	0.97	0.95	1.00
Ped Bike Factor		1.00	0.98		0.99	0.99	1.00		0.94	0.99		0.97
Frt			0.850			0.850			0.850			0.850
Fit Protected		0.968			0.959		0.950			0.950		
Satd. Flow (prot)	0	1725	1515	0	1709	1515	1693	3386	1515	3285	3386	1515
Fit Permitted		0.705			0.724		0.950			0.950		
Satd. Flow (perm)	0	1253	1477	0	1277	1495	1692	3386	1429	3256	3386	1463
Right Turn on Red			Yes		Yes	Yes		Yes	Yes		Yes	Yes
Satd. Flow (RTOR)			165			358			142			80
Link Speed (k/h)		50			60			80			80	
Link Distance (m)		131.4			60.0			183.7			281.3	
Travel Time (s)		9.5			3.6			8.3			12.7	
Confl. Peds. (#/hr)	3		6	6		3	4		21	21		4
Confl. Bikes (#/hr)												
Peak Hour Factor	0.92	0.92	0.92	0.92	0.92	0.92	0.92	0.92	0.92	0.92	0.92	0.92
Growth Factor	100%	100%	100%	100%	100%	100%	100%	100%	100%	100%	100%	100%
Heavy Vehicles (%)	1%	1%	1%	1%	1%	1%	1%	1%	1%	1%	1%	1%
Bus Blockages (#/hr)	0	0	0	0	0	0	0	0	0	0	0	0
Parking (#/hr)												
Mid-Block Traffic (%)		0%			0%			0%			0%	
Adj. Flow (vph)	29	15	34	137	22	361	38	1553	40	330	2143	57
Shared Lane Traffic (%)												
Lane Group Flow (vph)	0	44	34	0	159	361	38	1553	40	330	2143	57
Turn Type	Perm	NA	Perm	Perm	NA	Free	Prot	NA	Perm	Prot	NA	Perm
Protected Phases		4			8		8		2		1	6
Permitted Phases	4		4	8		Free			2			6
Detector Phase	4	4	4	8	8		5	2	2	1	6	6
Switch Phase												
Minimum Initial (s)	10.0	10.0	10.0	10.0	10.0		5.0	20.0	20.0	5.0	20.0	20.0
Minimum Split (s)	35.0	35.0	35.0	35.0	35.0		13.0	28.0	28.0	13.0	28.0	28.0
Total Split (s)	35.0	35.0	35.0	35.0	35.0		13.0	73.0	73.0	22.0	82.0	82.0
Total Split (%)	26.9%	26.9%	26.9%	26.9%	26.9%		10.0%	56.2%	56.2%	16.9%	63.1%	63.1%
Yellow Time (s)	3.3	3.3	3.3	3.3	3.3		4.6	4.6	4.6	4.6	4.6	4.6
All-Red Time (s)	1.8	1.8	1.8	1.8	1.8		2.8	3.3	3.3	2.8	3.3	3.3
Lost Time Adjust (s)		0.0	0.0		0.0		0.0	0.0	0.0	0.0	0.0	0.0
Total Lost Time (s)		5.1	5.1		5.1		7.4	7.9	7.9	7.4	7.9	7.9
Lead/Lag							Lead	Lag	Lag	Lead	Lag	Lag
Lead-Lag Optimize?												
Recall Mode	None	None	None	None	None		None	C-Max	C-Max	None	C-Max	C-Max
Act Effct Green (s)		21.5	21.5		21.5	130.0	7.3	71.0	71.0	17.2	83.4	83.4

19-032 1243 Teron Road
Lanes, Volumes, Timings

3: March Rd & Station Rd/Carling Ave
2025 Total PM

Lane Group	EBL	EBT	EBR	WBL	WBT	WBR	NBL	NBT	NBR	SBL	SBT	SBR
Actuated g/C Ratio		0.17	0.17		0.17	1.00	0.06	0.55	0.55	0.13	0.64	0.64
v/c Ratio		0.21	0.09		0.76	0.24	0.40	0.84	0.05	0.76	0.99	0.06
Control Delay		46.7	0.5		72.8	0.4	71.7	31.3	0.1	66.4	41.2	1.3
Queue Delay		0.0	0.0		0.0	0.0	0.0	0.0	0.0	0.0	0.0	0.0
Total Delay		46.7	0.5		72.8	0.4	71.7	31.3	0.1	66.4	41.2	1.3
LOS		D	A		E	A	E	C	A	E	D	A
Approach Delay		26.6			22.5			31.4			43.6	
Approach LOS		C			C			C			D	
Queue Length 50th (m)		7.8	0.0		31.0	0.0	7.5	139.3	0.0	32.9	~244.6	0.0
Queue Length 95th (m)		15.4	0.0		46.7	0.0	#18.9	#179.4	0.0	#54.6	#293.0	2.5
Internal Link Dist (m)		107.4			36.0			159.7			257.3	
Turn Bay Length (m)			25.0				75.0		75.0	175.0		25.0
Base Capacity (vph)		288	466		293	1495	95	1848	844	433	2172	967
Starvation Cap Reductn		0	0		0	0	0	0	0	0	0	0
Spillback Cap Reductn		0	0		0	0	0	0	0	0	0	0
Storage Cap Reductn		0	0		0	0	0	0	0	0	0	0
Reduced v/c Ratio		0.15	0.07		0.54	0.24	0.40	0.84	0.05	0.76	0.99	0.06

Intersection Summary

Area Type: Other
 Cycle Length: 130
 Actuated Cycle Length: 130
 Offset: 22 (17%), Referenced to phase 2:NBT and 6:SBT, Start of Green
 Natural Cycle: 140
 Control Type: Actuated-Coordinated
 Maximum v/c Ratio: 0.99
 Intersection Signal Delay: 36.8
 Intersection Capacity Utilization 93.8%
 Intersection LOS: D
 ICU Level of Service F
 Analysis Period (min) 15
 ~ Volume exceeds capacity, queue is theoretically infinite.
 Queue shown is maximum after two cycles.
 # 95th percentile volume exceeds capacity, queue may be longer.
 Queue shown is maximum after two cycles.

Splits and Phases: 3: March Rd & Station Rd/Carling Ave

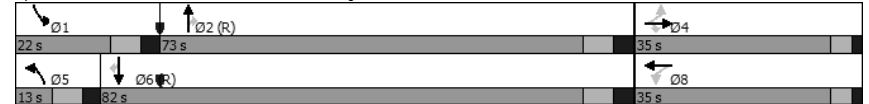

19-032 1243 Teron Road
Lanes, Volumes, Timings

4: Teron Rd & Carling Ave
2025 Total PM

	→	↖	↗	←	↙	↘
Lane Group	EBT	EBR	WBL	WBT	NBL	NBR
Lane Configurations	↑	↑		↑	↑	
Traffic Volume (vph)	762	98	147	426	26	88
Future Volume (vph)	762	98	147	426	26	88
Ideal Flow (vphpl)	1800	1800	1800	1800	1800	1800
Lane Width (m)	3.6	3.6	3.6	3.6	3.6	3.6
Grade (%)	0%			0%	0%	
Storage Length (m)		20.0	0.0		0.0	0.0
Storage Lanes		1	0		1	0
Taper Length (m)			7.5		7.5	
Lane Util. Factor	1.00	1.00	1.00	1.00	1.00	1.00
Ped Bike Factor						
Frt		0.850			0.895	
Fit Protected				0.987	0.989	
Satd. Flow (prot)	1782	1515	0	1759	1578	0
Fit Permitted				0.987	0.989	
Satd. Flow (perm)	1782	1515	0	1759	1578	0
Link Speed (k/h)	60			60	50	
Link Distance (m)	194.0			213.2	38.0	
Travel Time (s)	11.6			12.8	2.7	
Confl. Peds. (#/hr)		3	3			
Confl. Bikes (#/hr)						
Peak Hour Factor	0.92	0.92	0.92	0.92	0.92	0.92
Growth Factor	100%	100%	100%	100%	100%	100%
Heavy Vehicles (%)	1%	1%	1%	1%	1%	1%
Bus Blockages (#/hr)	0	0	0	0	0	0
Parking (#/hr)						
Mid-Block Traffic (%)	0%			0%	0%	
Adj. Flow (vph)	828	107	160	463	28	96
Shared Lane Traffic (%)						
Lane Group Flow (vph)	828	107	0	623	124	0
Sign Control	Free			Free	Stop	

Intersection Summary

Area Type:	Other
Control Type:	Unsignalized
Intersection Capacity Utilization	91.8%
ICU Level of Service	F
Analysis Period (min)	15

19-032 1243 Teron Road
HCM Unsignalized Intersection Capacity Analysis

4: Teron Rd & Carling Ave
2025 Total PM

	→	↖	↗	←	↙	↘
Movement	EBT	EBR	WBL	WBT	NBL	NBR
Lane Configurations	↑	↑		↑	↑	
Traffic Volume (veh/h)	762	98	147	426	26	88
Future Volume (Veh/h)	762	98	147	426	26	88
Sign Control	Free			Free	Stop	
Grade	0%			0%	0%	
Peak Hour Factor	0.92	0.92	0.92	0.92	0.92	0.92
Hourly flow rate (vph)	828	107	160	463	28	96
Pedestrians					3	
Lane Width (m)					3.6	
Walking Speed (m/s)					1.2	
Percent Blockage					0	
Right turn flare (veh)						
Median type	None			None		
Median storage (veh)						
Upstream signal (m)				213		
pX, platoon unblocked					0.79	
vC, conflicting volume			938		1614	831
vC1, stage 1 conf vol						
vC2, stage 2 conf vol						
vCu, unblocked vol			938		1644	831
tC, single (s)			4.1		6.4	6.2
tC, 2 stage (s)						
tF (s)			2.2		3.5	3.3
p0 queue free %			78		59	74
cM capacity (veh/h)			733		68	370

Direction, Lane #	EB 1	EB 2	WB 1	NB 1
Volume Total	828	107	623	124
Volume Left	0	0	160	28
Volume Right	0	107	0	96
cSH	1700	1700	733	184
Volume to Capacity	0.49	0.06	0.22	0.67
Queue Length 95th (m)	0.0	0.0	5.0	24.1
Control Delay (s)	0.0	0.0	5.4	57.3
Lane LOS			A	F
Approach Delay (s)	0.0		5.4	57.3
Approach LOS				F

Intersection Summary

Average Delay	6.2
Intersection Capacity Utilization	91.8%
ICU Level of Service	F
Analysis Period (min)	15

19-032 1243 Teron Road
Lanes, Volumes, Timings

5: Herzberg Rd & Carling Ave
2025 Total PM

Lane Group	EBL	EBT	EBR	WBL	WBT	WBR	NBL	NBT	NBR	SBL	SBT	SBR
Lane Configurations	↔	↔	↔	↔	↔	↔	↔	↔	↔	↔	↔	↔
Traffic Volume (vph)	15	691	51	44	432	361	32	186	13	562	570	47
Future Volume (vph)	15	691	51	44	432	361	32	186	13	562	570	47
Ideal Flow (vphpl)	1800	1800	1800	1800	1800	1800	1800	1800	1800	1800	1800	1800
Lane Width (m)	3.6	3.6	3.6	3.6	3.6	3.6	3.6	3.6	3.6	3.6	3.6	3.6
Grade (%)	0%		0%		0%		0%		0%		0%	
Storage Length (m)	0.0		75.0	100.0		100.0	0.0		0.0	0.0		0.0
Storage Lanes	1		1	1		1	0		0	1		0
Taper Length (m)	7.5			75.0		7.5			7.5			
Lane Util. Factor	1.00	1.00	1.00	1.00	1.00	1.00	1.00	1.00	1.00	1.00	1.00	1.00
Ped Bike Factor	1.00				0.97		1.00				1.00	
Frt	0.990				0.850		0.992				0.989	
Fit Protected	0.950		0.950				0.993		0.950			
Satd. Flow (prot)	1693	1762	0	1693	1782	1515	0	1756	0	1693	1759	0
Fit Permitted	0.311		0.074				0.821		0.285			
Satd. Flow (perm)	554	1762	0	132	1782	1474	0	1451	0	508	1759	0
Right Turn on Red			Yes				Yes		Yes		Yes	
Satd. Flow (RTOR)	3				392		2		4			
Link Speed (k/h)	60		60		50		50		50			
Link Distance (m)	213.2		282.2		126.1		120.3					
Travel Time (s)	12.8		16.9		9.1		8.7					
Confl. Peds. (#/hr)	2		1	1		2	1					1
Confl. Bikes (#/hr)												
Peak Hour Factor	0.92	0.92	0.92	0.92	0.92	0.92	0.92	0.92	0.92	0.92	0.92	0.92
Growth Factor	100%	100%	100%	100%	100%	100%	100%	100%	100%	100%	100%	100%
Heavy Vehicles (%)	1%	1%	1%	1%	1%	1%	1%	1%	1%	1%	1%	1%
Bus Blockages (#/hr)	0	0	0	0	0	0	0	0	0	0	0	0
Parking (#/hr)												
Mid-Block Traffic (%)	0%		0%		0%		0%		0%			
Adj. Flow (vph)	16	751	55	48	470	392	35	202	14	611	620	51
Shared Lane Traffic (%)												
Lane Group Flow (vph)	16	806	0	48	470	392	0	251	0	611	671	0
Turn Type	Perm	NA		Perm	NA	Perm	Perm	NA		pm+pt	NA	
Protected Phases	2				6		8		8		4	
Permitted Phases	2		6		6		8		4		4	
Detector Phase	2		6		6		8		8		7	
Switch Phase												
Minimum Initial (s)	20.0	20.0		20.0	20.0	20.0	10.0	10.0		5.0	10.0	
Minimum Split (s)	27.0	27.0		27.0	27.0	27.0	25.0	25.0		12.0	25.0	
Total Split (s)	61.0	61.0		61.0	61.0	61.0	29.0	29.0		40.0	69.0	
Total Split (%)	46.9%	46.9%		46.9%	46.9%	46.9%	22.3%	22.3%		30.8%	53.1%	
Yellow Time (s)	3.3	3.3		3.3	3.3	3.3	3.3	3.3		3.3	3.3	
All-Red Time (s)	3.3	3.3		3.3	3.3	3.3	3.3	3.3		2.8	3.3	
Lost Time Adjust (s)	0.0	0.0		0.0	0.0	0.0	0.0	0.0		0.0	0.0	
Total Lost Time (s)	6.6	6.6		6.6	6.6	6.6	6.6	6.6		6.1	6.6	
Lead/Lag							Lag	Lag		Lead		
Lead-Lag Optimize?												
Recall Mode	Max	Max		Max	Max	Max	None	None		None	None	
Act Effct Green (s)	54.4	54.4		54.4	54.4	54.4	22.4	22.4		62.9	62.4	

19-032 1243 Teron Road
Lanes, Volumes, Timings

5: Herzberg Rd & Carling Ave
2025 Total PM

Lane Group	EBL	EBT	EBR	WBL	WBT	WBR	NBL	NBT	NBR	SBL	SBT	SBR
Actuated g/C Ratio	0.42	0.42		0.42	0.42	0.42		0.17		0.48	0.48	
v/c Ratio	0.07	1.09		0.87	0.63	0.46		1.00		1.10	0.79	
Control Delay	23.9	96.8		129.0	34.5	4.2		110.1		97.9	36.6	
Queue Delay	0.0	0.0		0.0	0.0	0.0		0.0		0.0	0.0	
Total Delay	23.9	96.8		129.0	34.5	4.2		110.1		97.9	36.6	
LOS	C	F		F	C	A		F		F	D	
Approach Delay	95.4				26.5		110.1		65.9			
Approach LOS	F				C		F		E			
Queue Length 50th (m)	1.9	~183.5		8.8	74.1	0.0		51.0		~116.0	110.7	
Queue Length 95th (m)	5.8	#243.6		#29.2	103.0	14.5		#94.1		#172.3	152.0	
Internal Link Dist (m)	189.2				258.2		102.1		96.3			
Turn Bay Length (m)			100.0		100.0							
Base Capacity (vph)	231	739		55	745	844		251		554	846	
Starvation Cap Reductn	0	0		0	0	0		0		0	0	
Spillback Cap Reductn	0	0		0	0	0		0		0	0	
Storage Cap Reductn	0	0		0	0	0		0		0	0	
Reduced v/c Ratio	0.07	1.09		0.87	0.63	0.46		1.00		1.10	0.79	

Intersection Summary

Area Type:	Other
Cycle Length:	130
Actuated Cycle Length:	130
Natural Cycle:	120
Control Type:	Semi Act-Uncoord
Maximum v/c Ratio:	1.10
Intersection Signal Delay:	65.7
Intersection Capacity Utilization:	105.9%
ICU Level of Service:	G
Analysis Period (min):	15
~ Volume exceeds capacity, queue is theoretically infinite.	
Queue shown is maximum after two cycles.	
# 95th percentile volume exceeds capacity, queue may be longer.	
Queue shown is maximum after two cycles.	

Splits and Phases: 5: Herzberg Rd & Carling Ave

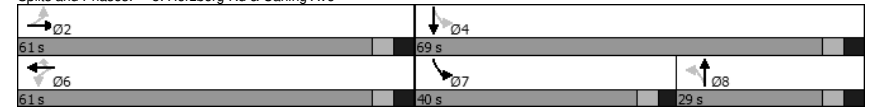

19-032 1243 Teron Road
Lanes, Volumes, Timings

6: Teron Rd & Project Site
2025 Total PM

Lane Group	WBL	WBR	NBT	NBR	SBL	SBT
Lane Configurations	↔	↔	↕	↕	↔	↔
Traffic Volume (vph)	23	5	108	14	3	242
Future Volume (vph)	23	5	108	14	3	242
Ideal Flow (vphpl)	1800	1800	1800	1800	1800	1800
Lane Width (m)	3.6	3.6	3.6	3.6	3.6	3.6
Grade (%)	0%		0%			0%
Storage Length (m)	0.0	0.0		0.0	0.0	
Storage Lanes	1	0		0	0	
Taper Length (m)	7.5			7.5		
Lane Util. Factor	1.00	1.00	1.00	1.00	1.00	1.00
Ped Bike Factor						
Frt	0.977		0.985			
Fit Protected	0.960					0.999
Satd. Flow (prot)	1672	0	1755	0	0	1780
Fit Permitted	0.960					0.999
Satd. Flow (perm)	1672	0	1755	0	0	1780
Link Speed (k/h)	50		50			50
Link Distance (m)	78.8		108.3			300.6
Travel Time (s)	5.7		7.8			21.6
Confl. Peds. (#/hr)						
Confl. Bikes (#/hr)						
Peak Hour Factor	0.92	0.92	0.92	0.92	0.92	0.92
Growth Factor	100%	100%	100%	100%	100%	100%
Heavy Vehicles (%)	1%	1%	1%	1%	1%	1%
Bus Blockages (#/hr)	0	0	0	0	0	0
Parking (#/hr)						
Mid-Block Traffic (%)	0%		0%			0%
Adj. Flow (vph)	25	5	117	15	3	263
Shared Lane Traffic (%)						
Lane Group Flow (vph)	30	0	132	0	0	266
Sign Control	Stop		Free			Free

Intersection Summary

Area Type:	Other
Control Type:	Unsignalized
Intersection Capacity Utilization	26.0%
ICU Level of Service	A
Analysis Period (min)	15

19-032 1243 Teron Road
HCM Unsignalized Intersection Capacity Analysis

6: Teron Rd & Project Site
2025 Total PM

Movement	WBL	WBR	NBT	NBR	SBL	SBT
Lane Configurations	↔	↔	↕	↕	↔	↔
Traffic Volume (veh/h)	23	5	108	14	3	242
Future Volume (Veh/h)	23	5	108	14	3	242
Sign Control	Stop		Free			Free
Grade	0%		0%			0%
Peak Hour Factor	0.92	0.92	0.92	0.92	0.92	0.92
Hourly flow rate (vph)	25	5	117	15	3	263
Pedestrians						
Lane Width (m)						
Walking Speed (m/s)						
Percent Blockage						
Right turn flare (veh)						
Median type			None			None
Median storage (veh)						
Upstream signal (m)						
pX, platoon unblocked						
vC, conflicting volume	394	124			132	
vC1, stage 1 conf vol						
vC2, stage 2 conf vol						
vCu, unblocked vol	394	124			132	
tC, single (s)	6.4	6.2			4.1	
tC, 2 stage (s)						
tF (s)	3.5	3.3			2.2	
p0 queue free %	96	99			100	
cM capacity (veh/h)	612	929			1459	

Direction, Lane #	WB 1	NB 1	SB 1
Volume Total	30	132	266
Volume Left	25	0	3
Volume Right	5	15	0
cSH	649	1700	1459
Volume to Capacity	0.05	0.08	0.00
Queue Length 95th (m)	0.9	0.0	0.0
Control Delay (s)	10.8	0.0	0.1
Lane LOS	B		A
Approach Delay (s)	10.8	0.0	0.1
Approach LOS	B		

Intersection Summary

Average Delay		0.8	
Intersection Capacity Utilization		26.0%	ICU Level of Service A
Analysis Period (min)		15	