

11061917 Canada Inc.

Traffic Impact Assessment

Type of Document:
Final Report

Project Name:
365 Forest Street

Project Number:
OTT-00252570-A0

Prepared By:
EXP Services Inc.
2650 Queensview Drive, Suite 100
Ottawa, ON K2B 8H6

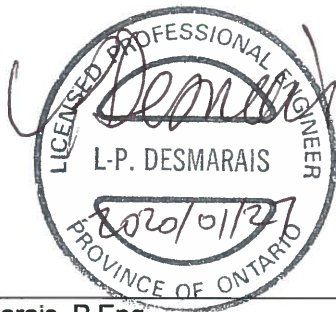

Phil Desmarais, P.Eng.
Senior Project Manager
Infrastructure Services

A handwritten signature in black ink, appearing to read "JG", positioned above a horizontal line.

Joseph Gowrie, P.Eng.
Project Engineer
Transportation Planning

Date Submitted:
January 2020

Legal Notification

This report was prepared by EXP Services Inc. for the account of **11061917 Canada Inc.**

Any use which a third party makes of this report, or any reliance on or decisions to be made based on it, are the responsibility of such third parties. EXP Services Inc. accepts no responsibility for damages, if any, suffered by any third party as a result of decisions made or actions based on this project



Table of Contents

	Page
1 Screening Form.....	1
2 Scoping Report.....	1
2.1 Proposed Development	1
2.2 Study Area.....	2
2.3 Time Periods	3
2.4 Horizon Years.....	3
2.5 Existing Conditions	4
2.5.1 Area Road Network.....	4
2.5.2 Existing Study Area Intersections.....	4
2.5.3 Existing Area Traffic Measures	6
2.5.4 Existing Driveways to Adjacent Developments.....	6
2.5.5 Pedestrian/Cycling Network	7
2.5.6 Transit Network.....	7
2.5.7 Existing Road Safety Conditions	10
2.6 Exemptions Review	10
3 Forecasting.....	10
3.1 Proposed Development	10
3.1.1 Development-generated Travel Demand.....	10
3.1.2 Mode Share	11
3.1.3 Trip Distribution.....	11
3.1.4 Trip Assignment.....	12
3.2 Background Network Travel Demands.....	13
3.2.1 Transportation Network Plans	13
3.2.2 Background Traffic Growth.....	13
3.2.3 Other Developments	14
3.3 Demand Rationalization.....	15
3.3.1 Future (2024) Background Traffic.....	15
3.3.2 Future (2029) Background Traffic.....	16

4	Analysis	18
4.1	Development Design	18
4.2	Parking	18
4.3	Boundary Streets	18
4.4	Access Intersections.....	18
4.5	Transportation Demand Management.....	18
4.6	Neighbourhood Traffic Management.....	19
4.7	Transit	19
4.8	Network Concept	19
4.9	Network Intersections	19
4.9.1	Vehicular Level of Service.....	19
4.9.1.1	Future (2024) Total Traffic	19
4.9.1.2	Future (2029) Total Traffic	22
4.9.2	Multi-Modal Level of Service	23
4.9.3	Intersection Safety	24
4.9.3.1	Carling Avenue / Alpine Avenue	24
4.9.3.2	Carling Avenue / Croyden Avenue	25
4.9.3.3	Richmond Road / Croyden Avenue.....	26
5	Conclusion and Recommendations	28

List of Appendices

Appendix A – TIA Screening Form

Appendix B – Site Plan

Appendix C – Existing Turning Movement Counts

Appendix D – Existing Traffic Level of Service Calculations

Appendix E – Future (2024) Background Level of Service Calculations

Appendix F – Future (2029) Background Level of Service Calculations

Appendix G – Future (2024) Total Traffic Level of Service Calculations

Appendix H – Future (2029) Total Traffic Level of Service Calculations

Appendix I – Intersection Collision Diagrams

List of Tables

	Page
Table 1 – Existing Traffic Level of Service Calculations	9
Table 2 – ITE Trip Generation – Subject Site	10
Table 3 – Existing Travel Modes	11
Table 4 – Subject Site Trip Generation by Mode.....	11
Table 5 – Trip Distribution – Existing Traffic	12
Table 6 – Adjusted Trip Distribution	12
Table 7 – Future (2024) Background Traffic Analysis	16
Table 8 – Future (2029) Background Traffic Analysis	17
Table 9 – MultiModal Level of Service	18
Table 10 – Future (2024) Total Traffic Analysis	21
Table 11 – Future (2024) Total Traffic Analysis	23
Table 12 – Intersection Multi-Modal Level of Service Analysis	23

List of Figures

	Page
Figure 1 – Site Plan	1
Figure 2 – Proposed Study Area	3
Figure 2 – Existing Traffic Control and Lane Configuration	5
Figure 3 – Existing OC Transpo Area Network	8
Figure 4 – Existing Traffic Volumes.....	9
Figure 5 – Site Traffic – Subject Site.....	13
Figure 6 – Future (2024) Background Traffic Volumes	15
Figure 7 – Future (2029) Background Traffic Volumes	16
Figure 8 – Future (2024) Total Traffic Volumes.....	20
Figure 9 – Future (2029) Total Traffic Volumes.....	22
Figure 10 – Carling Avenue / Alpine Avenue Intersection	24
Figure 11 – Carling Avenue / Croyden Avenue Intersection.....	26
Figure 12 – Richmond Road / Croyden Avenue Intersection	27

1 Screening Form

EXP completed a TIA screening form for the proposed development and submitted to City of Ottawa staff for review and confirmation of the need for completion of a Traffic Impact Assessment (TIA). A copy of the completed screening form is attached to this report as **Appendix A**.

The proposed development satisfies all three triggers (Trip Generation, Location and Safety) due to the size of the development, the development being located in a Design Priority Area (DPA) and Transit-Oriented Development (TOD) zone and the proximity of the proposed access to the existing signalized intersection of Alpine Drive and Carling Avenue. We have received confirmation to proceed with the Scoping Report (Step 2).

2 Scoping Report

2.1 Proposed Development

Canada 11061917 Inc. is proposing a mixed-use development consisting of 387 residential units split between two buildings (Building A – 183 units, Building B – 204 units), up to 12 and stories high storeys high, located on 365 Forest Street between Bond Street and Richmond Road. The development will provide 434 parking spaces located in the proposed underground parking lot. A concept site plan is shown in **Figure 1** and is provided in full-size in **Appendix B**.



Figure 1 – Site Plan



The proposed development is located in a General Urban Area (Section 3.6.1 of the Official Plan) and spans multiple properties which are all located within Zone Arterial Mainstreet Subzone AM10:

- **1420 Richmond Road** is currently a gravel parking lot on the southeast corner of the Forest Street and Richmond Road intersection;
- **365 Forest Street** houses an automotive garage located in a 1-storey building on the property. The property also contains an asphalt parking lot; and
- **2583 Bond Street and 2589 Bond Street** are currently vacant and previously housed a used tire shop. An existing 1-storey building is located on the 2589 Bond Street property with exterior storage provided on the 2583 Bond Street property.

The Arterial Mainstreet zoning of the properties permits the proposed land use as per Part 10, Section 186 of the City of Ottawa Zoning Bylaw. The proposed development is to be phased with construction of one power and the underground parking in Phase 1 and the second tower to follow in Phase 2. Construction is scheduled to begin in 2020 and be completed by 2024.

The proposed development adheres to the Transit-Oriented Development goals in support of facilitating transit use. Direct pedestrian access is proposed to the existing Richmond Road sidewalk via the proposed sidewalk area. Pedestrian access is provided to Forest Street and Bond Street via proposed sidewalk surrounding the exterior of both buildings however due to the lack of existing sidewalk and walkways on Forest Street and Bond Street, pedestrian traffic will be primarily directed to Richmond Road.

Vehicular access to the proposed development will be provided from the proposed entrance on Forest Street located approximately 70m south of the intersection with Richmond Road.

2.2 Study Area

The proposed study area is as outlined and highlighted in **Figure 2**:

- Carling Avenue and Alpine Street Intersection;
- Richmond Road and Croydon Avenue Intersection;
- Carling Avenue and Croydon Avenue Intersection; and
- All boundary roads to the proposed development (Carling Avenue, Richmond Road, Croydon Avenue, Forest Street and Bond Street).

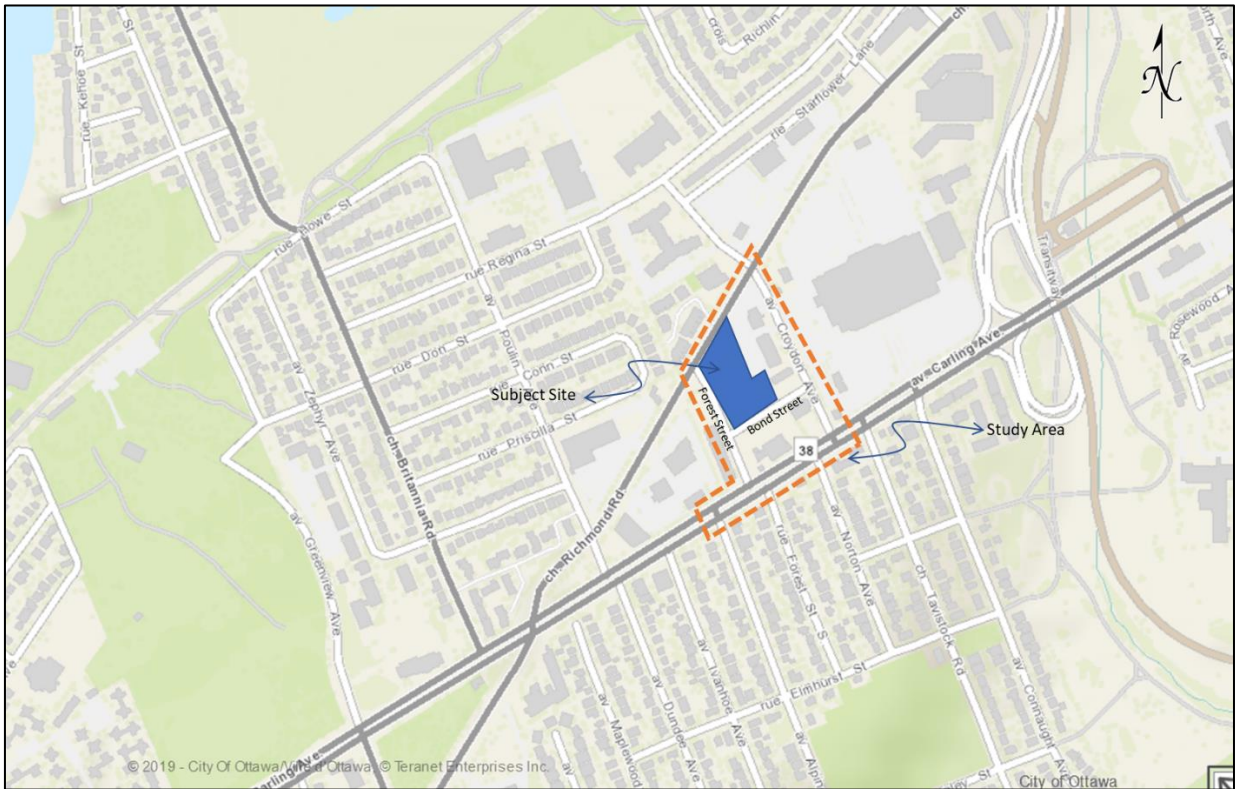

Figure 2 – Proposed Study Area

2.3 Time Periods

It is proposed that the residential development will generate peak traffic volumes during the weekday in the AM and PM peak periods.

2.4 Horizon Years

Based upon the anticipated size of the proposed residential development (387 residential units) and the impact of the proposed adjacent developments, it is anticipated both of the horizon periods (full occupancy and 5 years following full occupancy) will be required for analysis.

2.5 Existing Conditions

2.5.1 Area Road Network

Carling Avenue is an east-west, City-owned, arterial roadway which extends from March Road to the west to Bronson Avenue to the east. It provides access from Highway 49 in Kanata to the Glebe south of Highway 417. Within the study area, Carling Avenue is a six-lane divided cross-section with auxiliary turning lanes at major intersections. West-bound traffic occupies the northern lanes and east-bound traffic occupies the southern lanes. The posted speed limit is 60km/hr.

Richmond Road is an east-west, City-owned, arterial roadway which extends from Baseline Road in the west (where it continues as Robertson Road) to Island Park Drive in the east (where it continues as Wellington Street West). Within the study area, Richmond Road has a two-lane undivided cross-section with a bike lane and parking permitted on the north side of the roadway and a separate bike lane provided adjacent to the sidewalk on the north side of the roadway. Auxiliary turn lanes are provided at major intersections. The posted speed limit is 50km/hr.

Croydon Avenue is a north-south, City-owned local roadway which extends between Carling Avenue to the south and Regina Street to the north. Within the study area, Croydon Avenue is a two-lane, undivided cross-section with no parking permitted on either side of the roadway. The posted speed limit is 40km/hr.

Forest Street is a north-south, City-owned, local roadway which extends between Carling Avenue to the south and Richmond Road to the north. Forest Street is a two-lane undivided cross-section with parking permitted on both sides of the roadway. The roadway intersects with Richmond Road and Carling Avenue at unsignalized intersections. The posted speed limit is 50km/hr.

Bond Street is an east-west, City-owned, local roadway that extends between Forest Street to the east and Croydon Street to the west. Bond Street is a two-lane, undivided cross-section which intersects Forest Street and Croydon Avenue at unsignalized intersections. There is no parking permitted on either side of the roadway. The posted speed limit is 50km/hr.

2.5.2 Existing Study Area Intersections

Carling Avenue/Alpine Street

The Carling Avenue/Alpine Street intersection is a signalized four-way intersection. The eastbound approach consists of three through lanes and one auxiliary left-turn lane. The westbound approach consists of three through lanes and one auxiliary left-turn lane. The northbound approach consists of one full-movement lane into a commercial plaza. The southbound approach consists of one full-movement lane. There are no cycle lanes provided.

Carling Avenue/Croydon Avenue

The Carling Avenue/Croydon Avenue intersection is a signalized three-way intersection. The eastbound approach consists of three through lanes with one auxiliary left-turn lane. The westbound approach consists of three through lanes. The southbound approach consists of one auxiliary left-turn lane and one shared left and right-turn lane. There are no cycle lanes provided.

Richmond Road/Croydon Avenue

The Richmond Road/Croydon Avenue intersection is a signalized four-way intersection. The eastbound approach consists of one through lane and one auxiliary left-turn lane. The westbound approach consists of one through lane and one auxiliary left-turn lane. The northbound and southbound approaches consist of one single full-movement lane. There are cycle lanes provided east and westbound along Richmond Road on both sides of the roadway.

There are additional three-leg, one-way, stop-controlled intersections located within the proposed development at Forest Street/Carling Avenue, Forest Street/Richmond Road, Bond Street/Forest Street and at Bond Street/Croydon Avenue.

The existing control and lane configuration at each intersection is shown below in **Figure 2**.

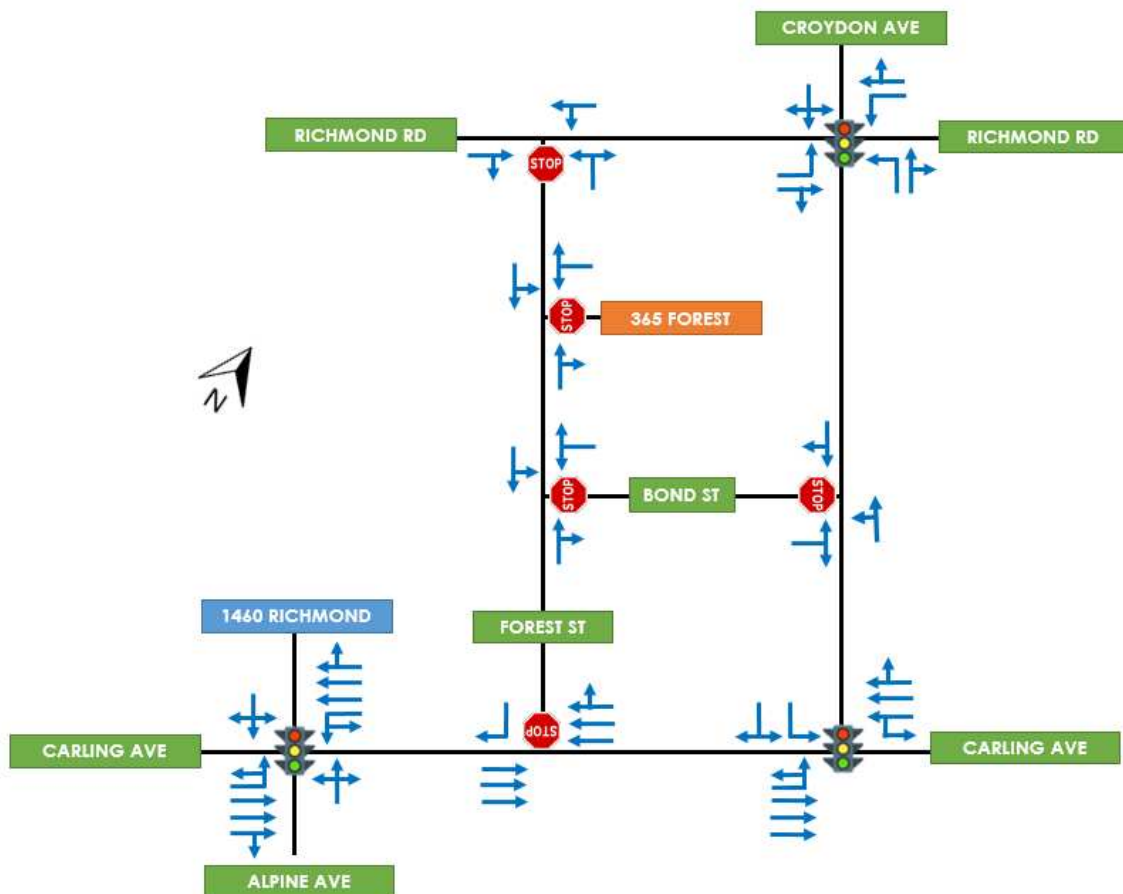

Figure 2 – Existing Traffic Control and Lane Configuration

2.5.3 Existing Area Traffic Measures

The existing traffic control measures for each of the boundary streets are as follows:

Carling Avenue

- Center Median
- Stop Signs at 3-way Intersections
- Sidewalks (North and South)
- Traffic Signals at Alpine Street and Croydon Avenue

Richmond Road

- Stop Signs at 3-way Intersections
- Sidewalks (North and South)
- Bike Lanes
- Traffic Signal at Croydon Avenue

Croydon Avenue

- Sidewalk (West)
- Stop Sign at 3-way Intersections
- Traffic Signals at Carling and Richmond Road

Forest Street

- Stop Signs at 3-way Intersections
- Asphalt Walkway

2.5.4 Existing Driveways to Adjacent Developments

There are existing residential apartment driveways located on Forest Street approximately 45m and 70m south of Richmond Road. They provide access to the apartment parking lot for the building located on the west side of Forest Street located to the west of the proposed development.

There are existing apartment driveways located on Croydon Avenue approximately 75m and 125m south of the Richmond Road intersection. They provide access to the rear parking lot (75m) and underground parking lot (125m) for the existing apartment building located to the east of the proposed development.

There is a commercial driveway entrance to a restaurant parking lot located approximately 60m southwest of the Richmond Road/Croydon Avenue intersection on Richmond Road to the northeast of the proposed development.

There is an existing commercial driveway entrance to the Albatool Fatima Association parking lot located approximately 30m west of Croydon Street on Bond Street to the southeast of the proposed development.

There are commercial driveway entrances located approximately 15m, 35m and 65m south of Richmond Road on Croydon Avenue. These driveways provide access to the existing CIBC bank (15m and 35m) and the adjacent commercial plaza located to the east of the proposed development.

There is a residential entrance to Winthrop Court Community House located approximately 105m southwest of the Richmond Road/Croydon Avenue intersection on the north side of Richmond Road.

There is a commercial plaza driveway entrance located approximately 25m north of Carling Avenue on Croydon Avenue to the southeast of the proposed development

There is an apartment building currently under construction immediately to the south of the proposed development which appears to provide access to both Bond Street and Forest Street. The proposed driveway locations are not established at this time and have therefore not been included in this report.

There are additional driveway entrances located within 200m of the proposed site driveway however these entrances are located along arterial roadways and should remain unaffected by the proposed development.

2.5.5 Pedestrian/Cycling Network

With respect to pedestrian traffic, sidewalks in the vicinity of the proposed development are provided along both sides of Carling Avenue and Richmond Road and along the west side of Croydon Avenue. An asphalt walkway is provided along the west side of Forest Street and there are no existing sidewalks on Bond Street.

With respect to cyclists, according to the City of Ottawa Cycling Plan, both Richmond Road and Carling Avenue are classified as “Spine” cycling routes while Forest Street, Croydon Avenue and Bond Street are not classified. Cycling facilities are currently provided on Richmond Road in the form of painted bike lanes however there are currently no bike lanes provided on Carling Avenue resulting in cyclists operating in mixed-traffic.

2.5.6 Transit Network

Transit service within the vicinity of the site is currently provided by OC Transpo Routes #11, #16, #85, #97 and #153. The current bus stops are as follows:

<u>Roadway Name</u>	<u>OC Transpo Route Nos.</u>	<u>Stop Location</u>
Carling Avenue	#85, #97	Carling Avenue/Alpine Street Intersection
Carling Avenue	#11, #16, #85, #97, #153	Carling Avenue/Tavistock Road Intersection
Richmond Road	#16, #153	Richmond Road (Winthrop Court Community House)
Croydon Avenue	#16	Croydon Avenue/Richmond Road Intersection
Croydon Avenue	#11, #16, #153	Croydon Avenue – Lincoln Fields Mall
Croydon Avenue	#11, #16, #153	Croydon Avenue/Bond Street Intersection

A detailed map of the approximate stop locations has been provided below in **Figure 3** for reference.



Figure 3 – Existing OC Transpo Area Network

Peak Hour Travel Demands

The existing peak hour traffic volumes were collected by the City of Ottawa on the following dates:

- Croyden Avenue / Richmond Road – August 2016;
- Carling Avenue / Croyden Road – August 2016; and,
- Carling Avenue / Alpine Avenue – January 2018.

The peak hour traffic volume count data is illustrated in **Figure 4** and is included in **Appendix C**.

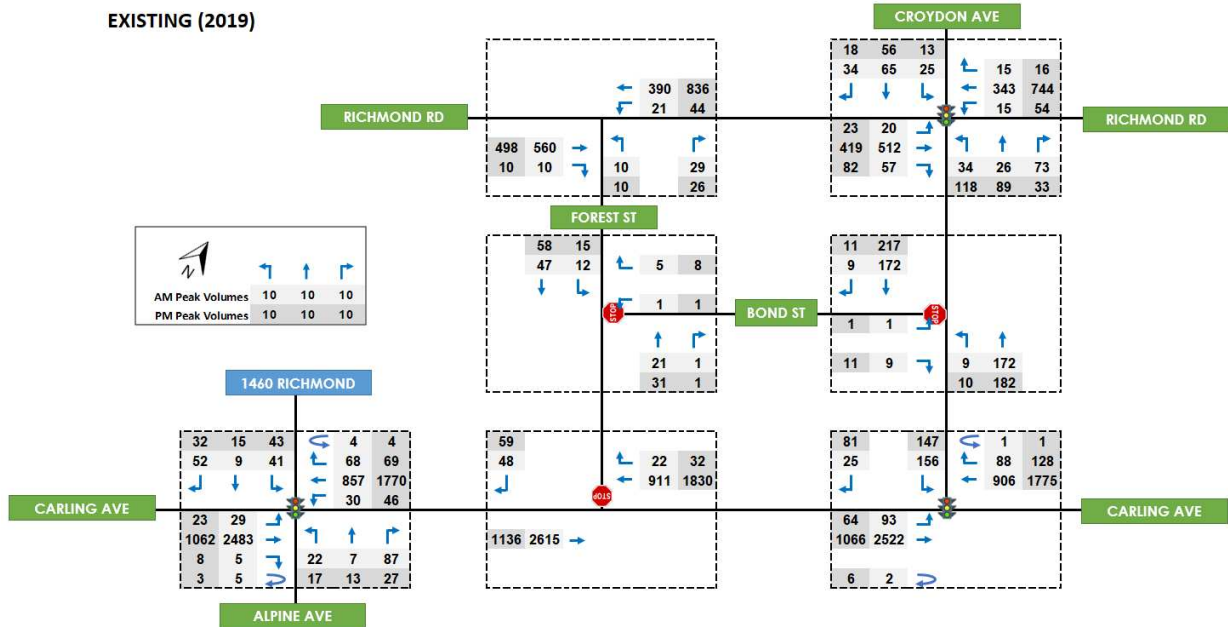

Figure 4 – Existing Traffic Volumes

The existing traffic operations were assessed using Synchro software and the results provided in **Appendix D** summarized in **Table 1**.

Table 1 – Existing Traffic Level of Service Calculations

Intersection	Weekday AM Peak (PM Peak)					
	Critical Movement			Intersection 'as a whole'		
	LoS	v/c	Movement	Delay (s)	LoS	v/c
Signalized						
Croydon Ave / Richmond Rd				11.4 (15.5)	0.56 (0.72)	B (B)
Alpine Ave / Carling Ave	E	0.47	NBTLR	14.9 (9.0)	0.77 (0.57)	B (A)
	E (E)	0.69 (0.56)	SBLTR			
Carling Ave / Croydon Ave	E	0.59	SBLR	6.7 (9.0)	0.76 (0.57)	A (A)
Unsignalized						
Carling Ave / Forest St	-	-	-	0.1 (0.2)	B (A)	-
Croydon Ave / Bond St	-	-	-	0.5 (0.5)	A (A)	-
Forest St / Bond St	-	-	-	1.6 (1.7)	A (A)	-
Forest St / Richmond Rd	-	-	-	0.9 (1.7)	-	-

2.5.7 Existing Road Safety Conditions

Collision history for the study area intersections (2014-2018, inclusive) was obtained from the City of Ottawa.

2.6 Exemptions Review

The proposed development satisfies the Trip Generation Trigger, the Location Trigger and the Safety Trigger. Based upon Table 4 in the City of Ottawa Traffic Impact Assessment Guidelines, there are no exemptions identified for the proposed development.

3 Forecasting

3.1 Proposed Development

3.1.1 Development-generated Travel Demand

Trip generation for the proposed development were derived from the Institute of Transportation Engineer's (ITE) *Trip Generation Manual 10th Edition* for the Multifamily Residential (High-Rise) land use (Land Use Code 222). The trip generation is summarized in **Table 2**. The auto trips forecasted in the *Trip Generation Manual 10th Edition* are converted into person trips by multiplying by a factor of 1.28 which reflects the typical suburban nature of the ITE surveys.

Table 2 – ITE Trip Generation – Subject Site

Land Use	Size	Parameter	AM Peak		PM Peak	
			In	Out	In	Out
Multifamily Residential (High-Rise)	387 Dwelling Units	Scenario	Peak Hour of Adjacent Street Traffic		Peak Hour of Adjacent Street Traffic	
		Rate / Eq.	$T = 0.28(X) + 12.86$		$T = 0.34(X) + 8.56$	
		Total Trips	121		140	
		Person Trips (x1.28)	155		179	
		Distribution	24%	76%	61%	39%
		New Trips	37	118	109	70

The proposed development is expected to generate 155 two-way person trips during the AM peak hour and 179 two-way person trips during the PM peak hour.

3.1.2 Mode Share

The subject development is located within the Bayshore/Cedarview neighbourhood and its trips are distributed as shown in **Table 3**.

Table 3 – Existing Travel Modes

24 Hours	From District	To District	Within District	Total	Proportion
Auto Driver	73150	73010	34470	180630	60%
Auto Passenger	18520	18710	10600	47830	16%
Transit	17480	17570	5270	40320	13%
Bicycle	1200	1130	1160	3490	1%
Walk	1210	1120	15610	17940	6%
Other	3150	3270	5710	12130	4%
Total	114710	114810	72820	302340	100%

The subject area has a non-auto modal split of approximately 40% resulting in the trip generation of the subject site in **Table 4**.

Table 4 – Subject Site Trip Generation by Mode

Land Use	Travel Mode	Proportion	AM Peak			PM Peak		
			In	Out	Total	In	Out	Total
Multifamily Residential (High-Rise)	Auto Driver	60%	23	72	95	66	42	108
	Auto Passenger	16%	6	19	25	17	11	28
	Transit	13%	5	15	20	14	9	23
	Bicycle	1%	0	1	1	1	1	2
	Walk	6%	2	7	9	7	4	11
	Other	4%	1	4	5	4	3	7
	Total	100%	37	118	155	109	70	179

3.1.3 Trip Distribution

The trip distribution for the proposed development is based on existing AM and PM peak hour traffic volumes and summarized in **Table 5**.

Table 5 – Trip Distribution – Existing Traffic

Direction	Via (To / From)	In	Out
North	Croyden Avenue	2%	2%
South	--	--	--
East	Richmond Road	12%	12%
	Carling Avenue	39%	39%
West	Richmond Road	15%	15%
	Carling Avenue	31%	31%

Upon review of the trip assignment, it was noted that there are capacity constraints for the northbound left turn from Forest Street to Richmond Road. However, upon review of the roadway geometry, Richmond Road runs south-west to north-east and intersects Carling Avenue approximately 360 meters west of Forest Street. As a result, it is expected that westbound traffic from the site will utilize Carling Avenue instead of Richmond Road. The revised trip distribution is provided in **Table 6**.

Table 6 – Adjusted Trip Distribution

Direction	Via (To / From)	In	Out
North	Croyden Avenue	2%	2%
South	--	--	--
East	Richmond Road	12%	12%
	Carling Avenue	39%	39%
West	Richmond Road	15%	0%
	Carling Avenue	31%	46%

3.1.4 Trip Assignment

The site traffic for the proposed development is provided in **Figure 5**.

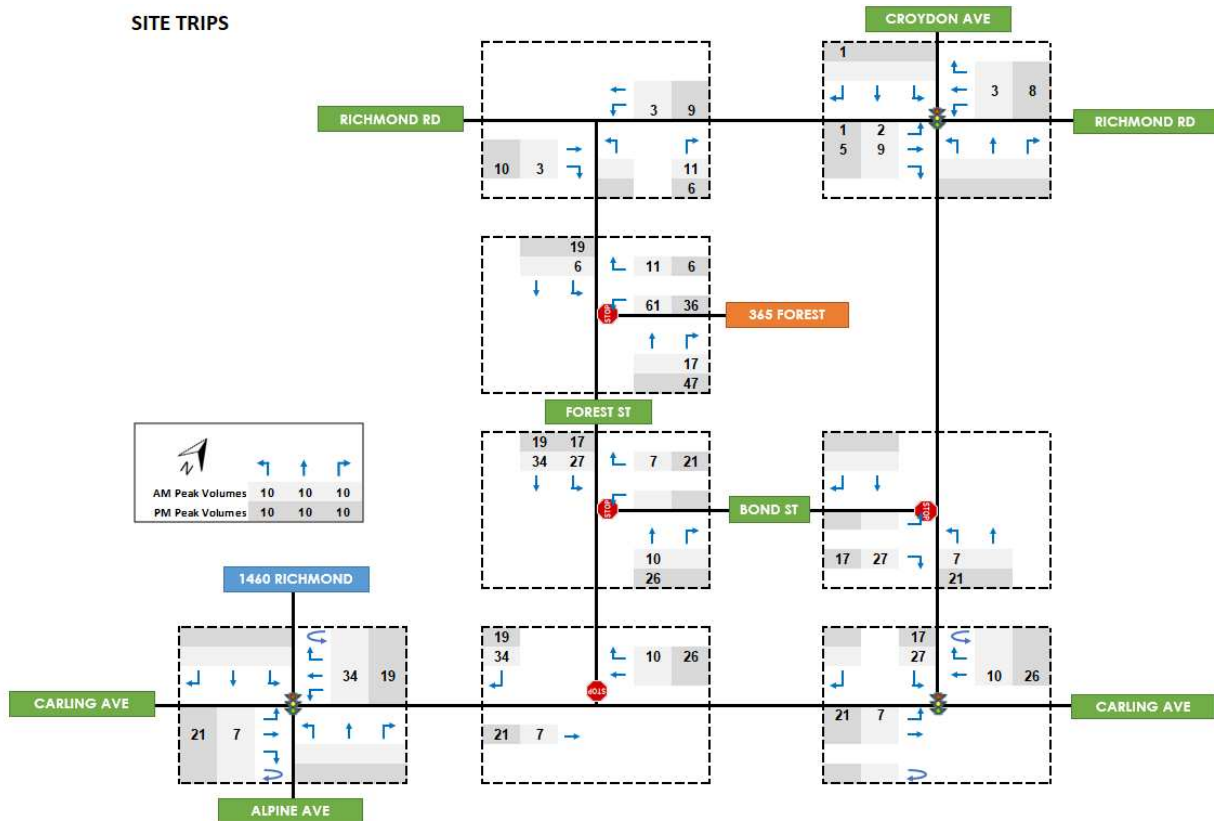

Figure 5 – Site Traffic – Subject Site

3.2 Background Network Travel Demands

3.2.1 Transportation Network Plans

Arterial road widening is proposed on Richmond Road between Highway 417 and Carling Avenue as identified on the 2031 Road Network Concept (Map 10 of the City of Ottawa Transportation Master Plan).

A transit rail station is proposed at the Carling/Sir John A. Macdonald Parkway as identified on the Rapid Transit and Transit Priority – 2031 Network Concept and Affordable Network Plans (Maps 4 and 5 of the City of Ottawa Transportation Master Plan).

3.2.2 Background Traffic Growth

Background traffic growth for the study area was obtained from the *RioCan – 2525 Carling Avenue – Lincoln Fields Shopping Centre Traffic Impact Assessment Report* (prepared by Parsons) which uses a 2% per annum growth rate for the study area. This growth rate was not applied to Forest Street or Bond Street due to their very short nature which does not allow for traffic from outside the study area.

3.2.3 Other Developments

Based on our review of the study area, the proposed developments located near the study area are as follows:

- **2525 Carling Avenue** - Site Plan Control application for 2525 Carling Avenue has been submitted for the proposed demolition of the existing shopping centre located at to facilitate the construction of a new shopping centre surrounding the future LRT station proposed at Lincoln Fields. The proposed development consists of two, two-storey retail buildings which are approximately 28,300sqft and 16,800sqft in Gross Floor Area. The proposed development is located on the east side of Croydon Avenue adjacent to the proposed development. The *RioCan – 2525 Carling Avenue – Lincoln Fields Shopping Centre Traffic Impact Assessment Report* (prepared by Parsons) indicates the proposed development is projected to generate approximately 30 vehicles/hour and 451 vehicles/hour during the morning and afternoon peak hours, respectively.
- **2583 Carling Avenue & 2599 Carling Avenue** - Site Plan Control and Zoning Bylaw Amendment application for the 2583 and 2599 Carling Avenue has been submitted for a proposed Dymon self-storage facility which is comprised of a 136,000 sqft storage facility with an additional 10,000sqft retail space. The proposed development will be accessed via Carling Avenue, Forest Street and Bond Street. Based upon the proposed use of the facility and anticipated traffic volumes from the site, the overall traffic impacts are considered negligible.
- **351 Croydon Avenue** - Site Plan Control Application for 351 Croydon Avenue has been submitted for a proposed residential building. The proposed building is 3-storeys and contains 8 residential units. Based upon the limited size of this development, a Traffic Impact Study was not completed for the development and it is anticipated the overall traffic impacts are considered negligible.

3.3 Demand Rationalization

3.3.1 Future (2024) Background Traffic

The future (2024) background traffic volumes are provided in **Figure 6**.

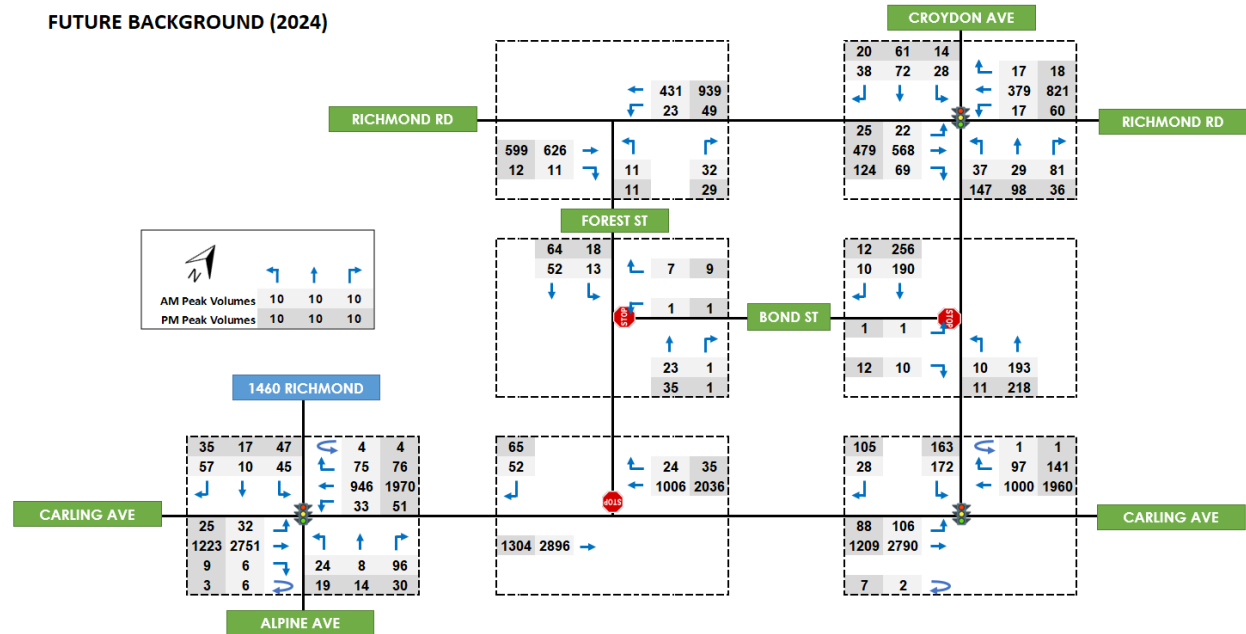

Figure 6 – Future (2024) Background Traffic Volumes

The future (2024) background traffic analysis is assessed using Synchro software and is the outputs provided in **Appendix E** and summarized in **Table 7**.

Table 7 – Future (2024) Background Traffic Analysis

Intersection	Weekday AM Peak (PM Peak)					
	Critical Movement			Intersection 'as a whole'		
	LoS	v/c	Movement	Delay (s)	LoS	v/c
Signalized						
Croyden Ave / Richmond Rd	-	-	-	11.4 (16.3)	0.57 (0.73)	B (B)
Alpine Ave / Carling Ave	E	0.47	NBLTR	14.7 (9.2)	0.47 (0.57)	B (A)
	E (E)	0.67 (0.55)	SBLTR			
Carling Ave / Croyden Ave	E (E)	0.58 (0.59)	SBLR	6.6 (13.5)	0.75 (0.67)	A (B)
Unsignalized						
Carling Ave / Forest St	-	-	-	0.1 (0.2)	B (A)	-
Croyden Ave / Bond St	-	-	-	0.5 (0.5)	A (A)	-
Forest St / Bond St	-	-	-	1.7 (1.8)	A (A)	-
Forest St / Richmond Rd	-	-	-	0.9 (1.8)	A (A)	-

3.3.2 Future (2029) Background Traffic

The future (2029) background traffic volumes are provided in **Figure 7**.

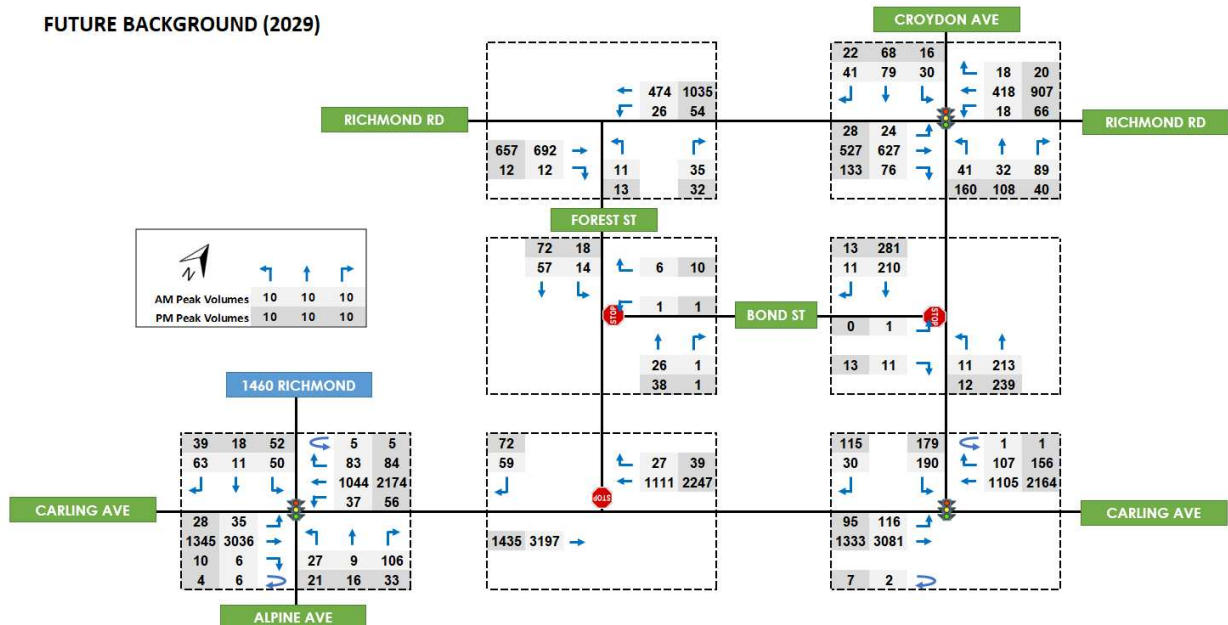

Figure 7 – Future (2029) Background Traffic Volumes



The future (2029) background traffic analysis is assessed using Synchro software and is the outputs provided in **Appendix F** and summarized in **Table 8**

Table 8 – Future (2029) Background Traffic Analysis

Intersection	Weekday AM Peak (PM Peak)					
	Critical Movement			Intersection 'as a whole'		
	LoS	v/c	Movement	Delay (s)	LoS	v/c
Signalized						
Croyden Ave / Richmond Rd	-	-	-	12.2 (19.7)	0.63 (0.81)	B (B)
Alpine Ave / Carling Ave	E	0.36	WBL	18.7 (10.4)	0.86 (0.63)	B (B)
	E	0.55	NBLTR			
	F (E)	0.76 (0.59)	SBLTR			
Carling Ave / Croyden Ave	(E)	(0.61)	EBL	8.0 (16.0)	0.83 (0.75)	A (B)
	E (E)	0.62 (0.63)	SBLR			
Unsignalized						
Carling Ave / Forest St	-	-	-	0.1 (0.2)	C (B)	-
Croyden Ave / Bond St	-	-	-	0.5 (0.5)	A (A)	-
Forest St / Bond St	-	-	-	1.6 (1.7)	A (A)	-
Forest St / Richmond Rd	-	-	-	1.0 (4.8)	B (A)	-

The southbound approach at the Alpine Avenue / Carling Avenue intersection is expected to operate at level of service F with v/c ratio of 0.76. It is expected that this failing level of service can be accommodated through signal timing changes, but it is recommended that this be re-evaluated at a later date.

4 Analysis

4.1 Development Design

The proposed development is to have a single driveway access on Forest Street located approximately 70 meters south of Richmond Road. The access is located on a low volume street and provides driveway access to the underground parking garage. There is also a proposed lay-by located on Forest Street to allow pick up and drop offs.

4.2 Parking

The proposed development is providing 434 parking spaces in an underground parking garage as well as four short-term lay-by parking spaces on Forest Street.

4.3 Boundary Streets

The boundary streets of the development include Richmond Road, Carling Avenue, Croydon Avenue, Forest Street and Bond Street. The proposed development is not expected to change the configuration of the boundary street roads. The MultiModal Level of Service for the boundary road segments are summarized in **Table 9**.

Table 9 – MultiModal Level of Service

Segment	Pedestrian	Cycling	Transit	Truck
Richmond between Forest/Croydon	B	A	D	C
Croydon between Richmond/Carling	C	D	D	-
Carling between Alpine/Croydon	D	D	D	A
Forest between Richmond/Carling	B	B	-	-
Bond between Forest/Croydon	F	B	-	-

The Pedestrian level of service can be improved along Bond Street by installing a sidewalk along its length.

4.4 Access Intersections

The proposed access has a 6.5 meter throat and a reduced 2 meter radius located in the recessed parking lay-by lane approximately 70 meters south of Richmond Road. This driveway width is sufficient to serve two-way traffic and the reduced curb radius reduces the speed of vehicles entering and exiting the driveway.

4.5 Transportation Demand Management

The proposed development is expected to have a non-auto modal split of 40% due to the availability of transit and other facilities in the area. As a result, the development is installing sidewalks on-site to connect the development to the City's sidewalk network as well as providing 197 bicycle parking spaces.

4.6 Neighbourhood Traffic Management

All site traffic is expected to be accommodated on Forest Street and Bond Street. No modifications are required to limit impact to the surrounding neighbourhoods.

4.7 Transit

This development is not expected to increase the transit requirements of the area. However, the future Confederation Line West and redeveloped Lincoln Fields Station will considerably increase transit availability in the area.

4.8 Network Concept

The road network is not expected to change within the duration of this report.

4.9 Network Intersections

4.9.1 Vehicular Level of Service

4.9.1.1 Future (2024) Total Traffic

The future (2024) total traffic volumes are provided in **Figure 8**.

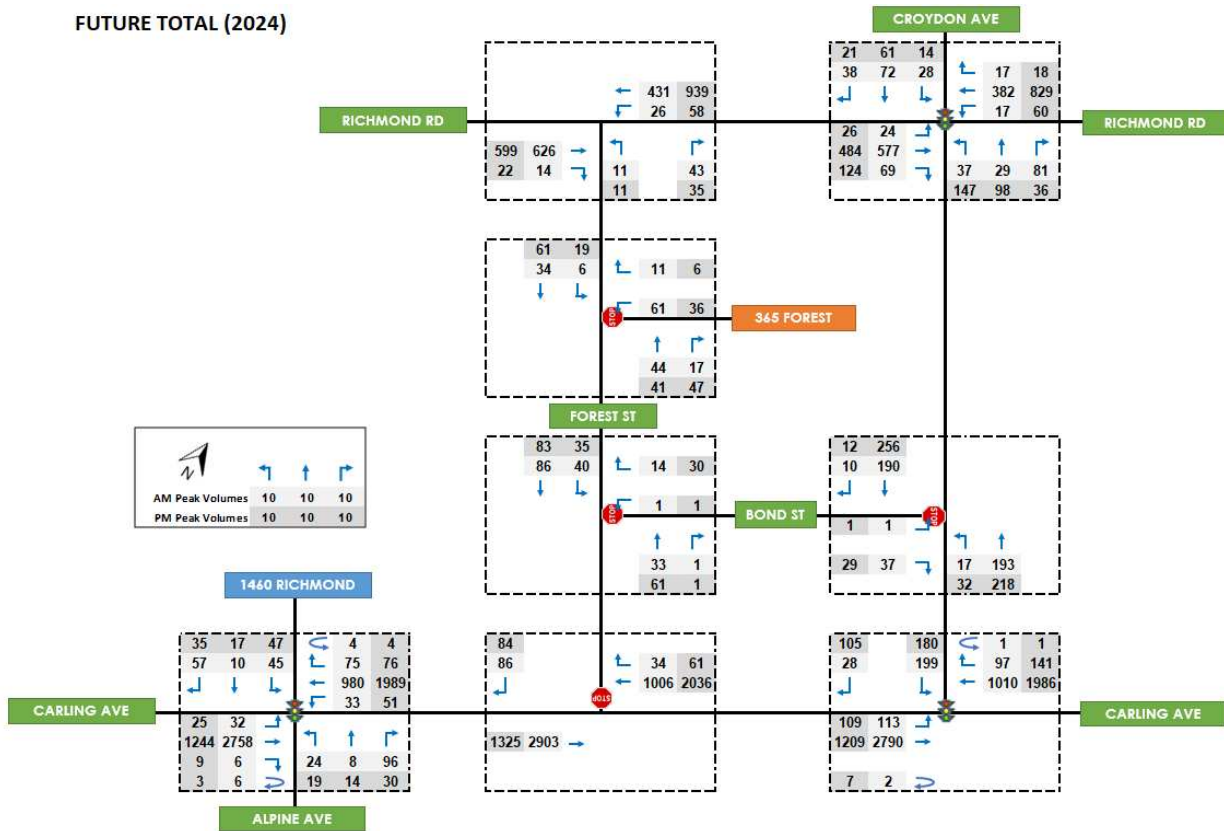

Figure 8 – Future (2024) Total Traffic Volumes

The future (2024) total traffic volumes were assessed using Synchro software. The results of the analysis are provided in **Appendix G** and summarized in **Table 10**.

Table 10 – Future (2024) Total Traffic Analysis

Intersection	Weekday AM Peak (PM Peak)					
	Critical Movement			Intersection 'as a whole'		
	LoS	v/c	Movement	Delay (s)	LoS	v/c
Signalized						
Croyden Ave / Richmond Rd	-	-	-	11.4 (16.5)	0.57 (0.74)	B (B)
Alpine Ave / Carling Ave	E	0.47	NBLTR	14.7 (9.5)	0.77 (0.57)	B (A)
	E (E)	0.67 (0.55)	SBLTR			
Carling Ave / Croyden Ave	(E)	(0.59)	EBL	7.2 (15.7)	0.76 (0.70)	A (B)
	E (E)	0.76 (0.59)	SBLR			
Unsignalized						
Carling Ave / Forest St	-	-	-	0.2 (0.2)	B (B)	-
Croyden Ave / Bond St	-	-	-	1.2 (1.1)	A (A)	-
Forest St / Bond St	-	-	-	2.5 (2.6)	A (A)	-
Forest St / Richmond Rd	-	-	-	1.1 (2.1)	A (A)	-
Forest St / Access	-	-	-	4.2 (2.6)	A (A)	-

The future (2024) total traffic condition shows little change between the future (2024) background and total conditions, showing that the proposed development has little impact on the surrounding road network.

4.9.1.2 Future (2029) Total Traffic

The future (2029) total traffic volumes are provided in **Figure 9**.

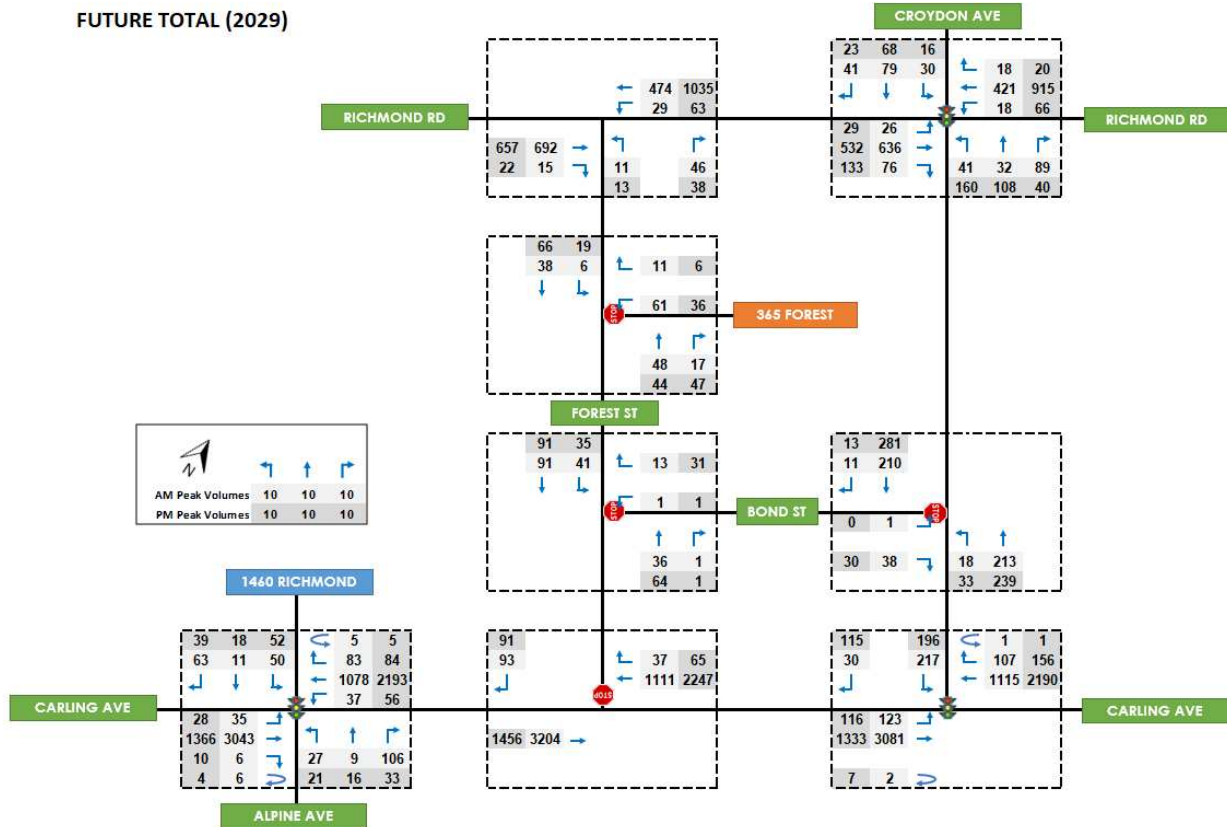

Figure 9 – Future (2029) Total Traffic Volumes

The future (2029) total traffic volumes were assessed using Synchro software. The results of the analysis are provided in **Appendix H** and summarized in **Table 11**.

Table 11 – Future (2024) Total Traffic Analysis

Intersection	Weekday AM Peak (PM Peak)					
	Critical Movement			Intersection 'as a whole'		
	LoS	v/c	Movement	Delay (s)	LoS	v/c
Signalized						
Croyden Ave / Richmond Rd	-	-	-	12.2 (19.9)	0.63 (0.82)	B (B)
Alpine Ave / Carling Ave	E	0.36	WBL	18.7 (10.8)	0.86 (0.64)	B (B)
	E	0.55	NBLTR			
	F (E)	0.76 (0.59)	SBLTR			
Carling Ave / Croyden Ave	(E)	(0.63)	EBL	8.6 (16.0)	0.84 (0.75)	A (B)
	E (E)	0.65 (0.63)	SBLR			
Unsignalized						
Carling Ave / Forest St	-	-	-	0.2 (0.3)	C (B)	-
Croyden Ave / Bond St	-	-	-	1.1 (1.1)	A (A)	-
Forest St / Bond St	-	-	-	2.4 (2.5)	A (A)	-
Forest St / Richmond Rd	-	-	-	1.2 (6.1)	B (A)	-
Forest St / Access	-	-	-	4.0 (2.5)	A (A)	-

Again, the future (2029) total traffic condition is expected to operate at levels of service similar to the existing traffic condition. The southbound approach at the Alpine Avenue / Carling Avenue intersection is expected to operate at level of service F with v/c ratio of 0.76. It is expected that this failing level of service can be accommodated through signal timing changes, but it is recommended that this be re-evaluated at a later date.

4.9.2 Multi-Modal Level of Service

A multi-modal level of service was conducted at the signalized intersections within the study area and the results summarized in **Table 12**.

Table 12 – Intersection Multi-Modal Level of Service Analysis

Intersection	Pedestrian	Cycling	Transit	Truck	Auto
Richmond & Croydon	D	A	C	-	B
Carling & Croydon	F	F	A	-	B
Carling & Alpine	F	F	E	-	B

Although the pedestrian and cycling operate level of service F along Carling Avenue, major reconstruction of Carling Avenue would be required improve these scores, which is beyond the scope of this project.

4.9.3 Intersection Safety

A safety review of the study area was conducted for the signalized intersections using five years of collision data. The collision diagrams are provided in **Appendix I**; however, each intersection is reviewed.

4.9.3.1 Carling Avenue / Alpine Avenue

The Carling Avenue / Alpine Avenue intersection has a total of 4 collisions with 11 of those collisions being eastbound left turns as well as 15 rear end collisions (6 eastbound and 9 westbound). The intersection is presented in **Figure 10**.



Figure 10 – Carling Avenue / Alpine Avenue Intersection

The clearance interval was reviewed using the *Ontario Traffic Manual Book 12 Traffic Signals* and it was determined that the required clearance interval for the eastbound and westbound traffic is 5.95 seconds where there are 5.9 seconds. It is unclear if this is contributing to the rear end collisions or if it is aggressive driving as most of the collisions occur during the PM peak period (between 3:00 p.m. and 6:00 p.m.).

With respect to the eastbound left turning collisions, it is likely that the view of left turning motorists is obstructed due to the misalignment of the eastbound and westbound left turn lanes and high opposing through volumes. The westbound left turning vehicle blocks the view of the eastbound left turning vehicle, and then due to the high westbound through volume, the driver gets impatient and tries to fit through an unacceptable gap. In order to improve the sight line for left turning vehicles, the left turn lanes and median will need to be redesigned / reconstructed.

4.9.3.2 Carling Avenue / Croyden Avenue

The Carling Avenue / Croyden Avenue intersection has a total of 42 collisions, with 6 westbound rear end collisions and 13 collisions involving eastbound left turning vehicles. The intersection is presented in **Figure 11**.

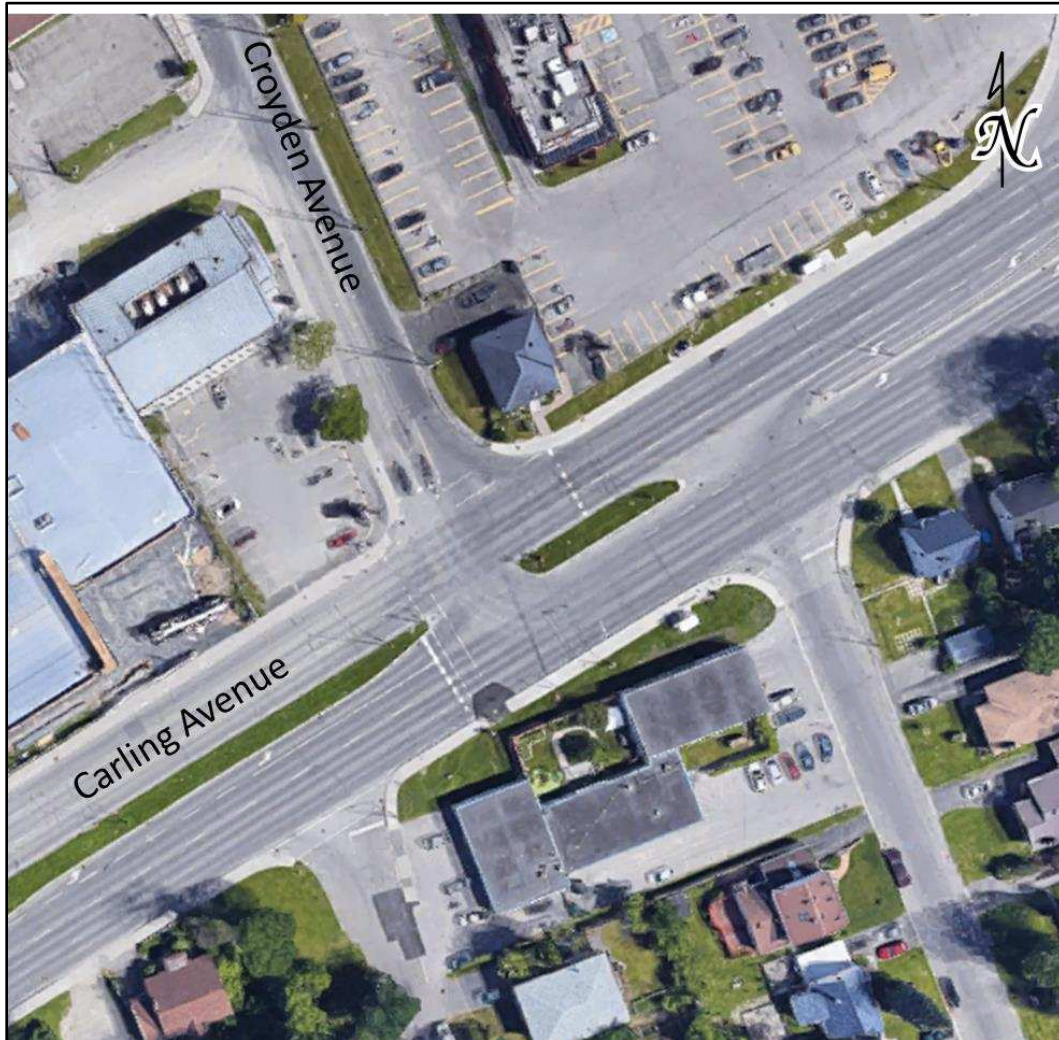

Figure 11 – Carling Avenue / Croyden Avenue Intersection

Based on review of the clearance interval, there is sufficient clearance time for eastbound and westbound through vehicles. Given that there are no issues with sight lines, as the road is relatively flat and straight. It is believed that drivers are being aggressive or following too closely.

With respect to the left turn collisions, it is expected that, again, there is poor sight distance due to the left turn lane being offser from the centreline. In order to improve the safety of this left turn movement, the left turn lane and median will need to be redesigned / reconstructed, which is outside the scope of this project.

4.9.3.3 Richmond Road / Croyden Avenue

The Richmond Road / Croyden Avenue intersection has had a total of 27 collisions within the last five year, with a 10 of those collisions being rear end collisions (five eastbound and five westbound). The intersection is provided in **Figure 12** for reference.



Figure 12 – Richmond Road / Croyden Avenue Intersection

Generally, rear end collisions are a result of aggressive driving or following too closely.

5 Conclusion and Recommendations

Based on the analysis, our conclusions and recommendations are as follows:

- The development proposal is for a total of 387 residential units with a single access to Forest Street;
- Based on our review of the area, the site is well served by transit and experiences a non-auto modal split of 40%;
- The 2525 Carling Avenue redevelopment is the only significant background development in the area and is included in our study;
- A 2% growth rate was applied to the study area road network;
- The proposed development is expected to generate a total 155 person trips during the AM peak hour and 179 person trips during the PM peak hour;
- The proposed development is providing sidewalk connections to Richmond Street;
- The multimodal level of service analysis outlines failing levels of service for pedestrian and cyclists on the boundary road network. This is primarily a result of large cross-sections and high operating speeds. Major works will be required along Carling Avenue to improve the levels of service;
- The vehicular level of service operates similarly in all analysis periods and horizons, showing that the proposed development has minimal impact on the surrounding neighbourhood;
- The safety review identifies a potential issue with eastbound left turning vehicles on Carling Avenue. When this street needs rehabilitation, there may be the need for a redesign of the street.

Appendix A – TIA Screening Form

City of Ottawa 2017 TIA Guidelines Screening Form

1. Description of Proposed Development

Municipal Address	1420 Richmond Rd, 365 Forest St & 2583-2589 Bond St
Description of Location	Mixed-Use (commercial 3555 m ² , residential 223 units)
Land Use Classification	AM10
Development Size (units)	223 Units
Development Size (m ²)	3555
Number of Accesses and Locations	1 main entrance - Bond St.
Phase of Development	Site Plan Approval
Buildout Year	2019-2020

If available, please attach a sketch of the development or site plan to this form.

2. Trip Generation Trigger

Considering the Development's Land Use type and Size (as filled out in the previous section), please refer to the Trip Generation Trigger checks below.

Land Use Type	Minimum Development Size
Single-family homes	40 units
Townhomes or apartments	90 units < 228
Office	3,500 m ²
Industrial	5,000 m ²
Fast-food restaurant or coffee shop	100 m ²
Destination retail	1,000 m ²
Gas station or convenience market	75 m ²

** If the development has a land use type other than what is presented in the table above, estimates of person-trip generation may be made based on average trip generation characteristics represented in the current edition of the Institute of Transportation Engineers (ITE) Trip Generation Manual.*

If the proposed development size is greater than the sizes identified above, the Trip Generation Trigger is satisfied.

3. Location Triggers

	Yes	No
Does the development propose a new driveway to a boundary street that is designated as part of the City's Transit Priority, Rapid Transit or Spine Bicycle Networks?		X
Is the development in a Design Priority Area (DPA) or Transit-oriented Development (TOD) zone?*	X	

*DPA and TOD are identified in the City of Ottawa Official Plan (DPA in Section 2.5.1 and Schedules A and B; TOD in Annex 6). See Chapter 4 for a list of City of Ottawa Planning and Engineering documents that support the completion of TIA).

If any of the above questions were answered with 'Yes,' the Location Trigger is satisfied.

4. Safety Triggers

	Yes	No
Are posted speed limits on a boundary street are 80 km/hr or greater?		X
Are there any horizontal/vertical curvatures on a boundary street limits sight lines at a proposed driveway?		X
Is the proposed driveway within the area of influence of an adjacent traffic signal or roundabout (i.e. within 300 m of intersection in rural conditions, or within 150 m of intersection in urban/ suburban conditions)?	X	
Is the proposed driveway within auxiliary lanes of an intersection?		X
Does the proposed driveway make use of an existing median break that serves an existing site?		X
Is there is a documented history of traffic operations or safety concerns on the boundary streets within 500 m of the development?		X
Does the development include a drive-thru facility?		X

If any of the above questions were answered with 'Yes,' the Safety Trigger is satisfied.

5. Summary

	Yes	No
Does the development satisfy the Trip Generation Trigger?	X	
Does the development satisfy the Location Trigger?	X	
Does the development satisfy the Safety Trigger?	X	

If none of the triggers are satisfied, the TIA Study is complete. If one or more of the triggers is satisfied, the TIA Study must continue into the next stage (Screening and Scoping).

Appendix B – Site Plan

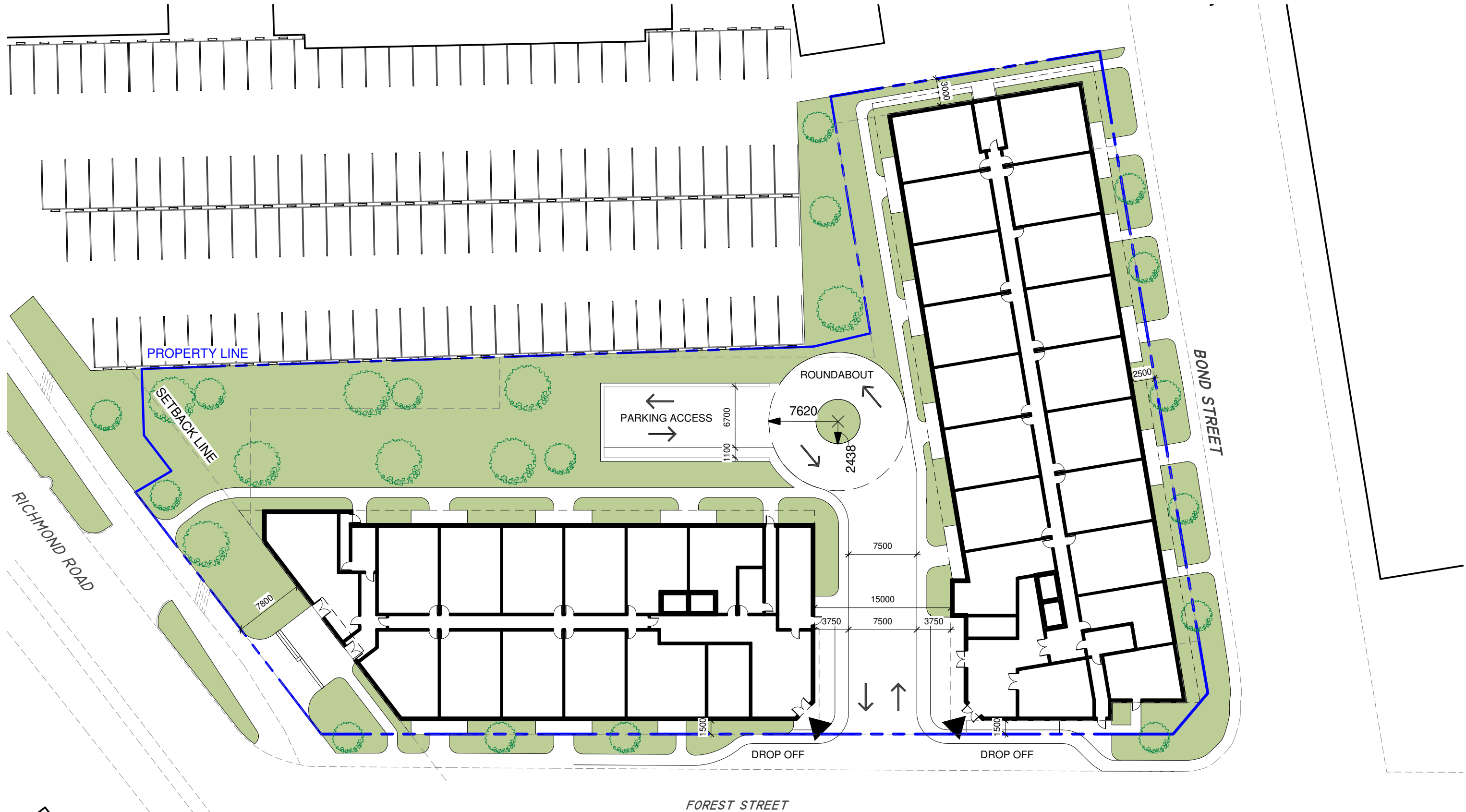

TOWER A & B - SITE LEVEL 1

GROUP HEAFEY



Dessiné par : Author
 Conçu par : Designer

53 blvd Saint-Raymond, Suite 200-A
 Gatineau, QC J8Y 1R8
 www.lrarch.ca

365 Forest Street
 Ottawa, ON K2B 7Z7
 1 : 400

1887-2303-19

ES02
 2020.01.08

Appendix C – Existing Turning Movement Counts

Survey Date: Wednesday, January 17, 2018

Start Time: 07:00

WO No: 37422

Device: Miovision

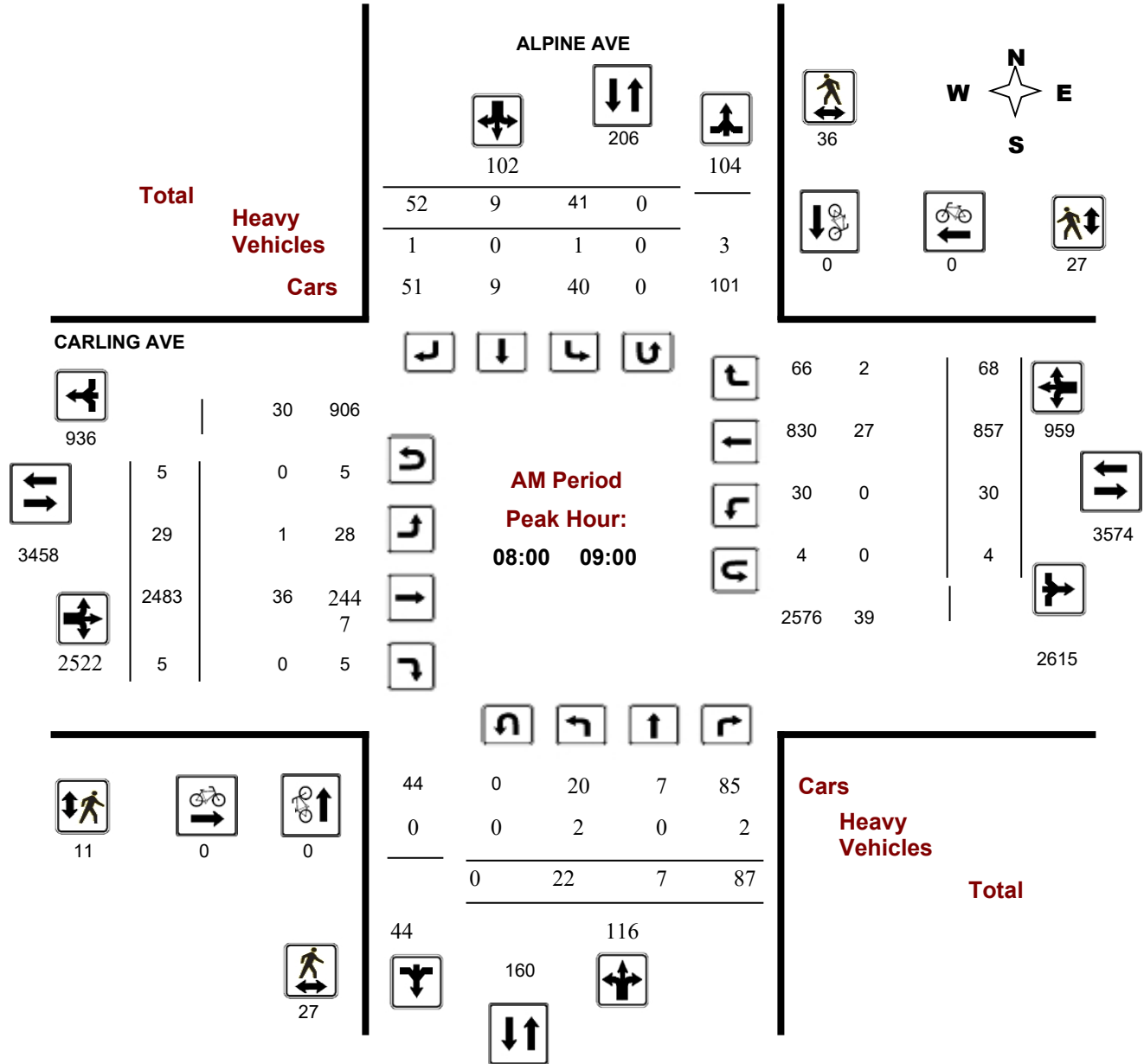

Survey Date: Wednesday, January 17, 2018

Start Time: 07:00

WO No: 37422

Device: Miovision

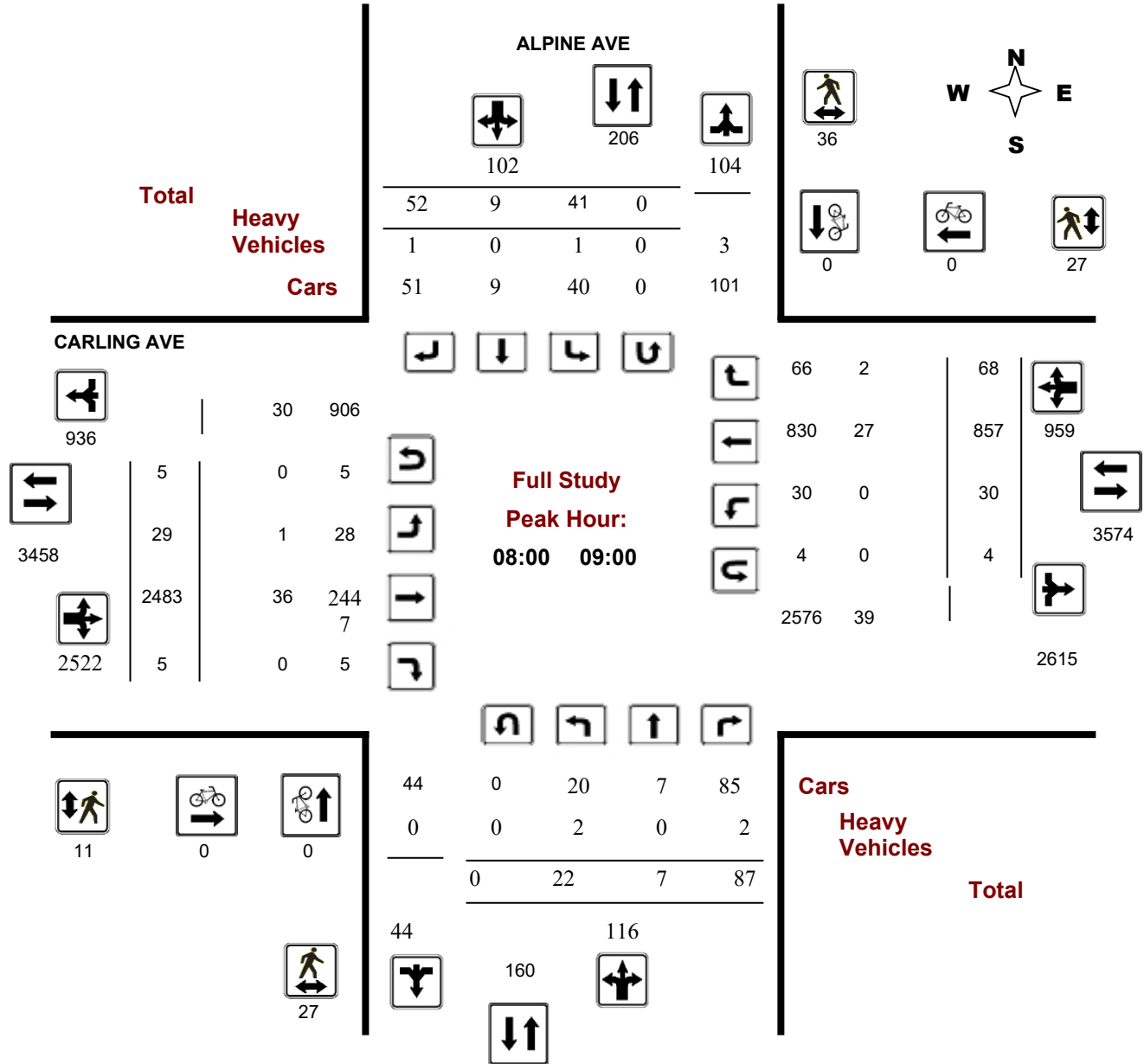

Survey Date: Wednesday, January 17, 2018

Start Time: 07:00

WO No: 37422

Device: Miovision

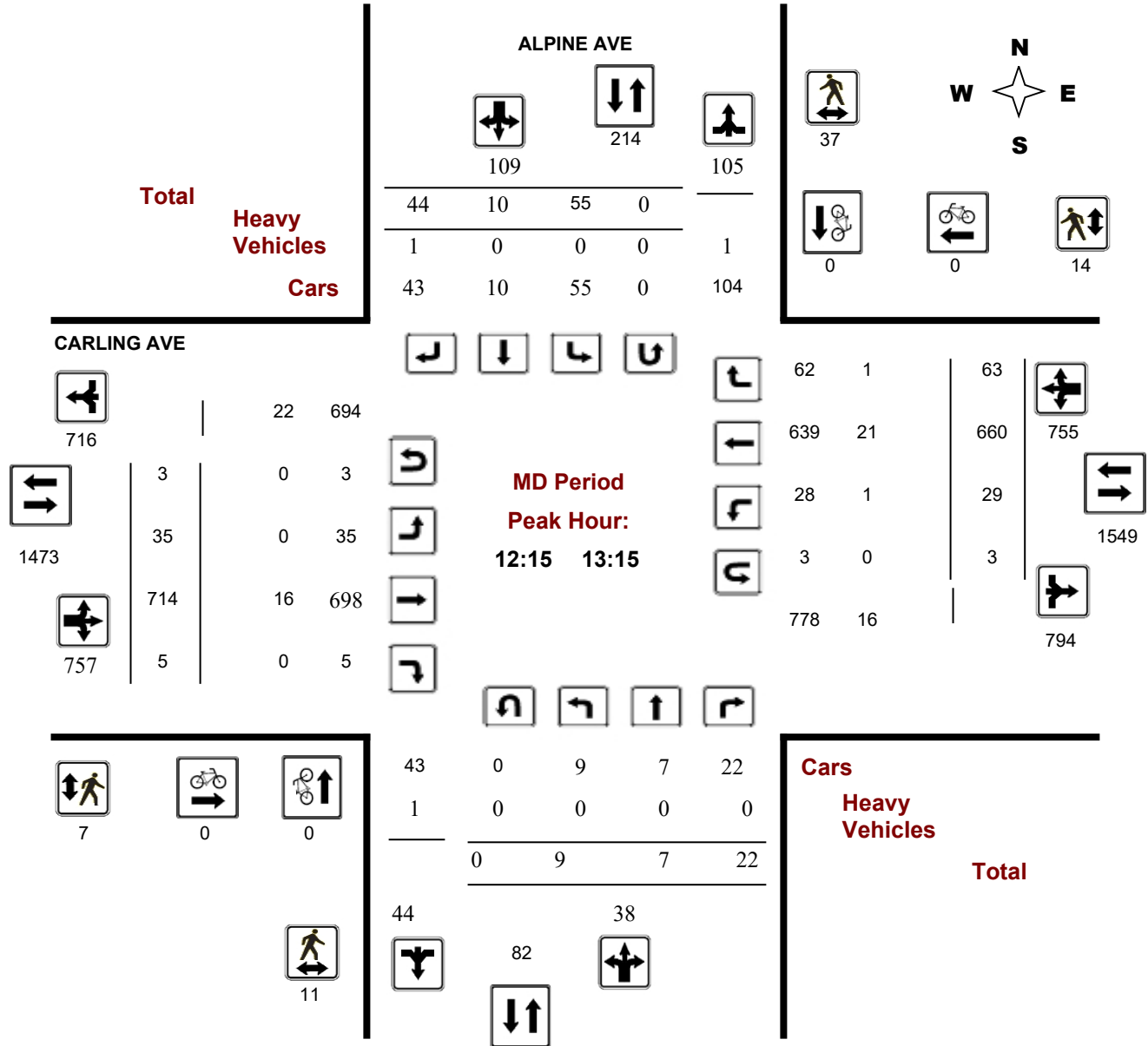

Survey Date: Wednesday, January 17, 2018

Start Time: 07:00

WO No: 37422

Device: Miovision

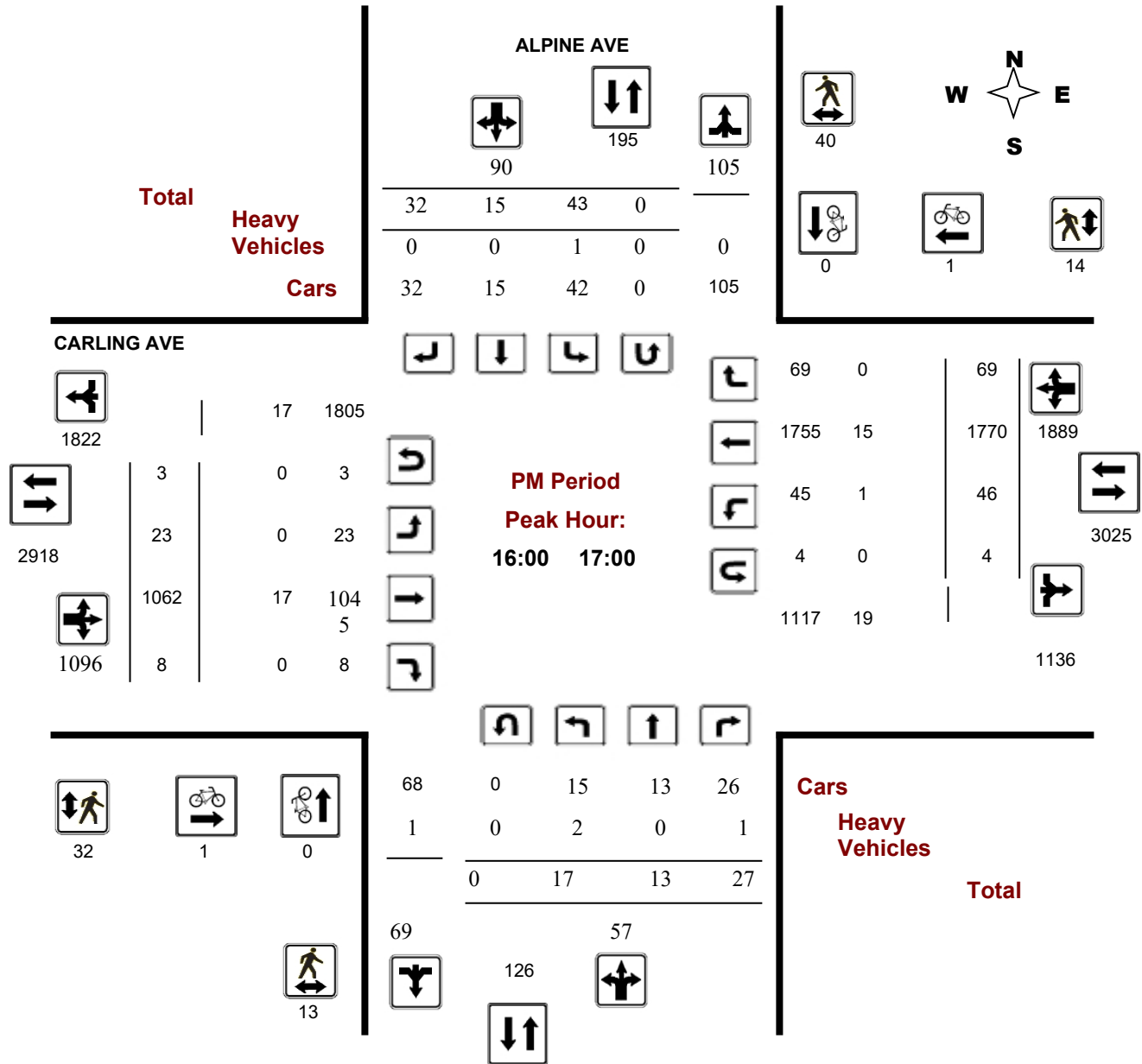



Turning Movement Count - Full Study Summary Report

ALPINE AVE @ CARLING AVE

Survey Date: Wednesday, January 17, 201

Total Observed U-Turns

Northbound: 0 Southbound: 0
Eastbound: 29 Westbound: 28

AADT Factor

1.00

Full Study

Period	ALPINE AVE								CARLING AVE								Grand Total		
	Northbound				Southbound				Eastbound				Westbound						
	LT	ST	RT	NB TOT	LT	ST	RT	SB TOT	STR TOT	LT	ST	RT	EB TOT	LT	ST	RT	WB TOT	STR TOT	
07:00 08:00	11	10	63	84	41	6	34	81	165	30	2586	3	2619	9	601	57	667	3286	3451
08:00 09:00	22	7	87	116	41	9	52	102	218	29	2483	5	2517	30	857	68	955	3472	3690
09:00 10:00	24	12	40	76	40	13	37	90	166	34	1566	7	1607	27	684	59	770	2377	2543
11:30 12:30	11	10	33	54	48	14	49	111	165	47	658	9	714	24	659	66	749	1463	1628
12:30 13:30	9	6	12	27	51	9	46	106	133	31	728	3	762	32	654	58	744	1506	1639
15:00 16:00	18	9	33	60	31	12	45	88	148	27	1074	4	1105	50	1544	76	1670	2775	2923
16:00 17:00	17	13	27	57	43	15	32	90	147	23	1062	8	1093	46	1770	69	1885	2978	3125
17:00 18:00	16	14	27	57	46	20	34	100	157	31	944	10	985	59	1535	76	1670	2655	2812
Sub Total	128	81	322	531	341	98	329	768	1299	252	11101	49	11402	277	8304	529	9110	20512	21811
U Turns				0				0	0				29				28	57	57
Total	128	81	322	531	341	98	329	768	1299	252	11101	49	11431	277	8304	529	9138	20569	21868
EQ 12Hr	178	113	448	738	474	136	457	1068	1806	350	15430	68	15889	385	11543	735	12702	28591	30397
Note: These values are calculated by multiplying the totals by the appropriate expansion factor.													1.39						
AVG 12Hr	178	113	448	738	474	136	457	1068	1806	350	15430	68	15889	385	11543	735	12702	28591	30397
Note: These volumes are calculated by multiplying the Equivalent 12 hr. totals by the AADT factor.													1.00						
AVG 24Hr	233	147	586	967	621	178	599	1398	2365	459	20214	89	20815	504	15121	963	16639	37454	39819
Note: These volumes are calculated by multiplying the Average Daily 12 hr. totals by 12 to 24 expansion factor.													1.31						

Comments:

Note: U-Turns provided for approach totals. Refer to 'U-Turn' Report for specific breakdown.



Turning Movement Count - 15 Minute Summary Report

ALPINE AVE @ CARLING AVE

Survey Date: Wednesday, January 17, 2018

Total Observed U-Turns

Northbound: 0 Southbound: 0
Eastbound: 29 Westbound: 28

Table with columns for Time Period, Northbound (LT, ST, RT, N TOT), Southbound (LT, ST, RT, S TOT, STR TOT), Eastbound (LT, ST, RT, E TOT), Westbound (LT, ST, RT, W TOT, STR TOT), and Grand Total. Rows represent 15-minute intervals from 07:00 to 18:00.

Note: U-Turns are included in Totals.

Comment:



Transportation Services - Traffic Services

Turning Movement Count - Cyclist Volume Report

Work Order
37422

ALPINE AVE @ CARLING AVE

Count Date: Wednesday, January 17, 2018

Start Time: 07:00

Time Period	ALPINE AVE			CARLING AVE			Grand Total
	Northbound	Southbound	Street Total	Eastbound	Westbound	Street Total	
07:00 08:00	1	1	2	0	1	1	3
08:00 09:00	0	0	0	0	0	0	0
09:00 10:00	0	0	0	0	0	0	0
11:30 12:30	0	0	0	0	0	0	0
12:30 13:30	0	0	0	0	0	0	0
15:00 16:00	0	0	0	0	0	0	0
16:00 17:00	0	0	0	1	1	2	2
17:00 18:00	0	1	1	0	0	0	1
Total	1	2	3	1	2	3	6

Comment:

Note: These volumes consists of bicycles only (no mopeds or motorcycles) and ARE NOT included in the Turning Movement Count Summary.



Transportation Services - Traffic Services

W.O.
37422

Turning Movement Count - Heavy Vehicle Report

ALPINE AVE @ CARLING AVE

Survey Date: Wednesday, January 17, 2018

Time Period	ALPINE AVE									CARLING AVE									Grand Total	
	Northbound			Southbound			S TOT	STR TOT	Eastbound			Westbound			W TOT	STR TOT				
	LT	ST	RT	N TOT	LT	ST			RT	LT	ST	RT	E TOT	LT			ST	RT		
07:00 08:00	0	0	0	0	0	0	0	0	0	0	2	21	0	23	0	14	1	15	38	38
08:00 09:00	2	0	2	4	1	0	1	2	6	1	36	0	37	0	27	2	29	66	72	
09:00 10:00	0	0	2	2	1	0	2	3	5	0	39	0	39	1	21	0	22	61	66	
11:30 12:30	1	0	0	1	0	0	2	2	3	1	14	0	15	1	16	0	17	32	35	
12:30 13:30	0	0	0	0	0	0	1	1	1	0	21	0	21	1	22	1	24	45	46	
15:00 16:00	1	0	2	3	0	0	2	2	5	0	18	0	18	1	22	1	24	42	47	
16:00 17:00	2	0	1	3	1	0	0	1	4	0	17	0	17	1	15	0	16	33	37	
17:00 18:00	0	0	0	0	0	0	0	0	0	0	13	0	13	0	19	0	19	32	32	
Sub Total	6	0	7	13	3	0	8	11	24	4	179	0	183	5	156	5	166	349	373	
U-Turns (Heavy Vehicles)				0				0	0				0				0	0	0	
Total	6	0	7	0	3	0	8	11	24	4	179	0	183	5	156	5	166	349	373	

Heavy Vehicles include Buses, Single-Unit Trucks and Articulated Trucks. Further, they ARE included in the Turning Movement Count Summary.



Transportation Services - Traffic Services

Work Order

37422

Turning Movement Count - Pedestrian Volume Report

ALPINE AVE @ CARLING AVE

Count Date: Wednesday, January 17, 2018

Start Time: 07:00

Time Period	NB Approach (E or W Crossing)	SB Approach (E or W Crossing)	Total	EB Approach (N or S Crossing)	WB Approach (N or S Crossing)	Total	Grand Total
07:00 07:15	0	4	4	0	1	1	5
07:15 07:30	1	4	5	0	3	3	8
07:30 07:45	5	6	11	1	6	7	18
07:45 08:00	8	7	15	1	5	6	21
07:00 08:00	14	21	35	2	15	17	52
08:00 08:15	3	6	9	4	5	9	18
08:15 08:30	8	13	21	1	10	11	32
08:30 08:45	12	7	19	3	3	6	25
08:45 09:00	4	10	14	3	9	12	26
08:00 09:00	27	36	63	11	27	38	101
09:00 09:15	4	2	6	2	2	4	10
09:15 09:30	4	3	7	0	4	4	11
09:30 09:45	1	9	10	2	5	7	17
09:45 10:00	1	8	9	2	1	3	12
09:00 10:00	10	22	32	6	12	18	50
11:30 11:45	0	5	5	2	6	8	13
11:45 12:00	0	9	9	2	0	2	11
12:00 12:15	2	11	13	4	3	7	20
12:15 12:30	3	9	12	4	1	5	17
11:30 12:30	5	34	39	12	10	22	61
12:30 12:45	0	4	4	1	3	4	8
12:45 13:00	3	8	11	1	6	7	18
13:00 13:15	5	16	21	1	4	5	26
13:15 13:30	2	13	15	0	5	5	20
12:30 13:30	10	41	51	3	18	21	72
15:00 15:15	3	12	15	4	2	6	21
15:15 15:30	8	17	25	9	15	24	49
15:30 15:45	13	8	21	2	8	10	31
15:45 16:00	3	14	17	7	6	13	30
15:00 16:00	27	51	78	22	31	53	131
16:00 16:15	2	14	16	10	5	15	31
16:15 16:30	4	10	14	7	2	9	23
16:30 16:45	2	9	11	10	5	15	26
16:45 17:00	5	7	12	5	2	7	19
16:00 17:00	13	40	53	32	14	46	99
17:00 17:15	8	11	19	8	16	24	43
17:15 17:30	6	18	24	10	7	17	41
17:30 17:45	3	6	9	10	3	13	22
17:45 18:00	5	5	10	4	11	15	25
17:00 18:00	22	40	62	32	37	69	131
Total	128	285	413	120	164	284	697

Comment:

Turning Movement Count - 15 Min U-Turn Total Report

ALPINE AVE @ CARLING AVE

Survey Date: Wednesday, January 17, 2018

Time Period		Northbound U-Turn Total	Southbound U-Turn Total	Eastbound U-Turn Total	Westbound U-Turn Total	Total
07:00	07:15	0	0	0	0	0
07:15	07:30	0	0	1	2	3
07:30	07:45	0	0	2	0	2
07:45	08:00	0	0	0	0	0
08:00	08:15	0	0	2	0	2
08:15	08:30	0	0	0	1	1
08:30	08:45	0	0	2	2	4
08:45	09:00	0	0	1	1	2
09:00	09:15	0	0	1	1	2
09:15	09:30	0	0	0	0	0
09:30	09:45	0	0	0	1	1
09:45	10:00	0	0	1	0	1
11:30	11:45	0	0	0	0	0
11:45	12:00	0	0	0	1	1
12:00	12:15	0	0	1	0	1
12:15	12:30	0	0	1	2	3
12:30	12:45	0	0	0	0	0
12:45	13:00	0	0	0	1	1
13:00	13:15	0	0	2	0	2
13:15	13:30	0	0	1	2	3
15:00	15:15	0	0	2	2	4
15:15	15:30	0	0	2	0	2
15:30	15:45	0	0	0	1	1
15:45	16:00	0	0	2	0	2
16:00	16:15	0	0	0	1	1
16:15	16:30	0	0	1	0	1
16:30	16:45	0	0	0	2	2
16:45	17:00	0	0	2	1	3
17:00	17:15	0	0	0	2	2
17:15	17:30	0	0	0	1	1
17:30	17:45	0	0	4	2	6
17:45	18:00	0	0	1	2	3
Total		0	0	29	28	57

Survey Date: Thursday, August 25, 2016

Start Time: 07:00

WO No: 36243

Device: Miovision

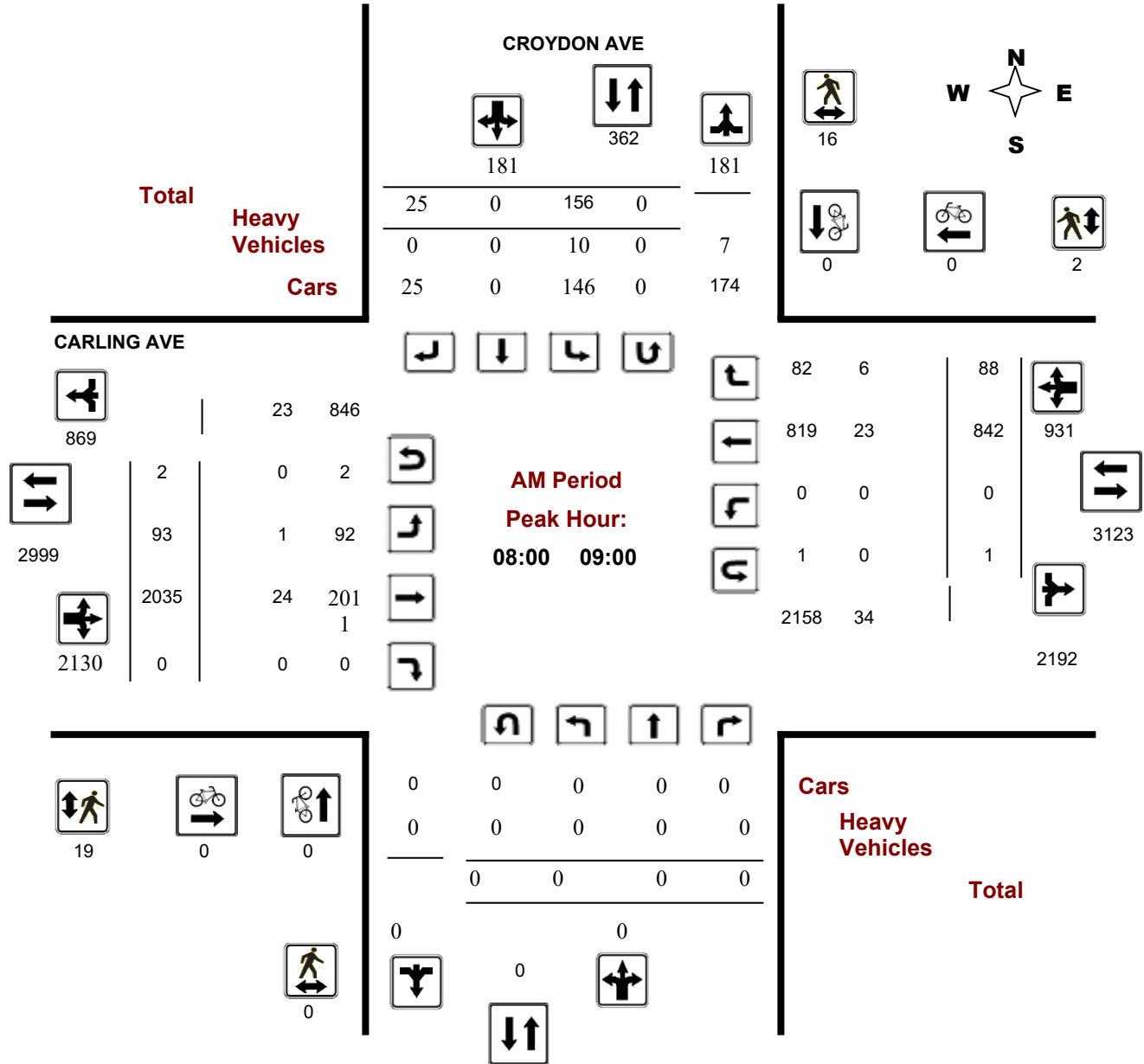

Survey Date: Thursday, August 25, 2016

Start Time: 07:00

WO No: 36243

Device: Miovision

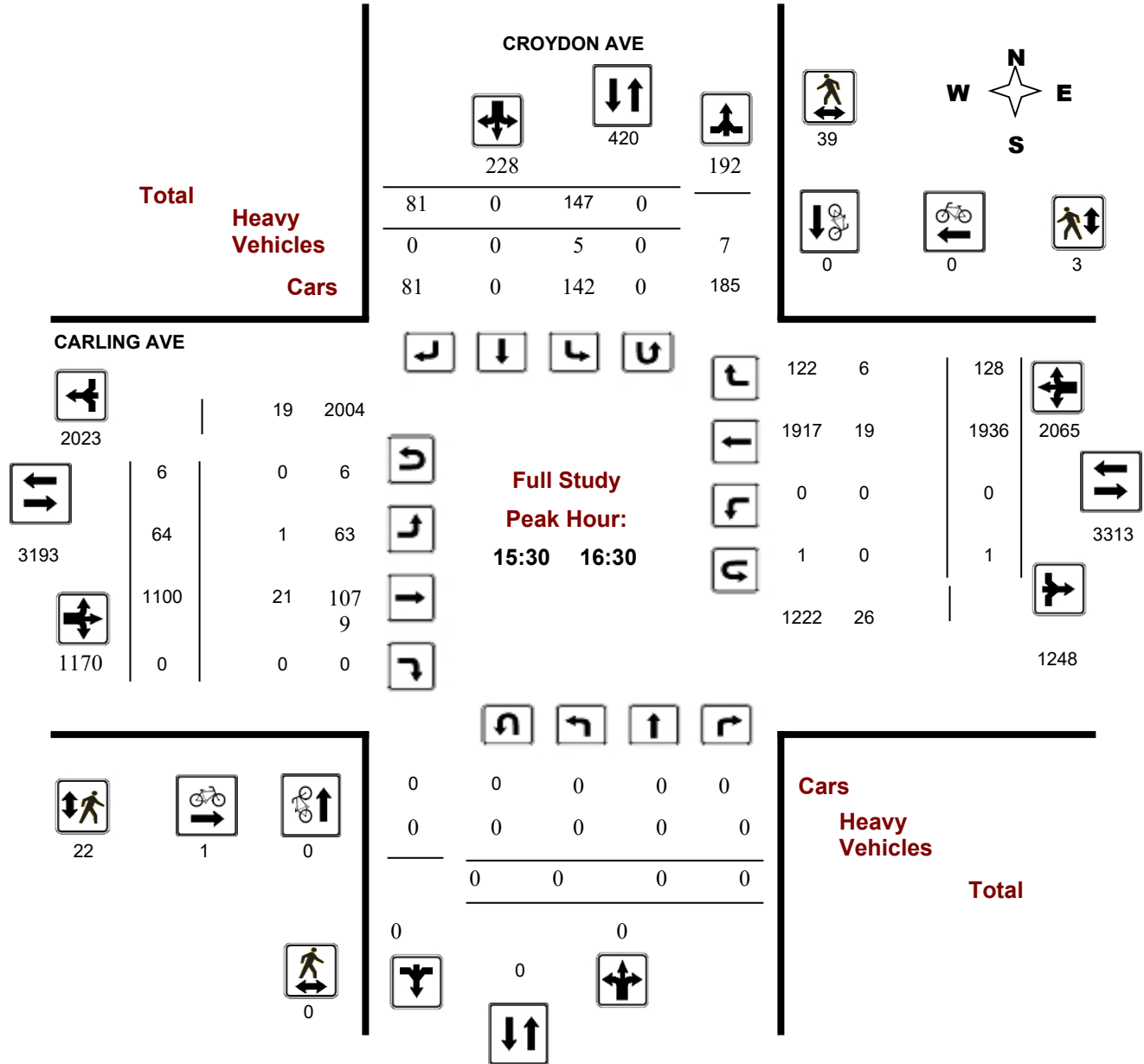

Comments



Transportation Services - Traffic Services

Turning Movement Count - Full Study Peak Hour Diagram

CARLING AVE @ CROYDON AVE

Survey Date: Thursday, August 25, 2016

Start Time: 07:00

WO No: 36243

Device: Miovision

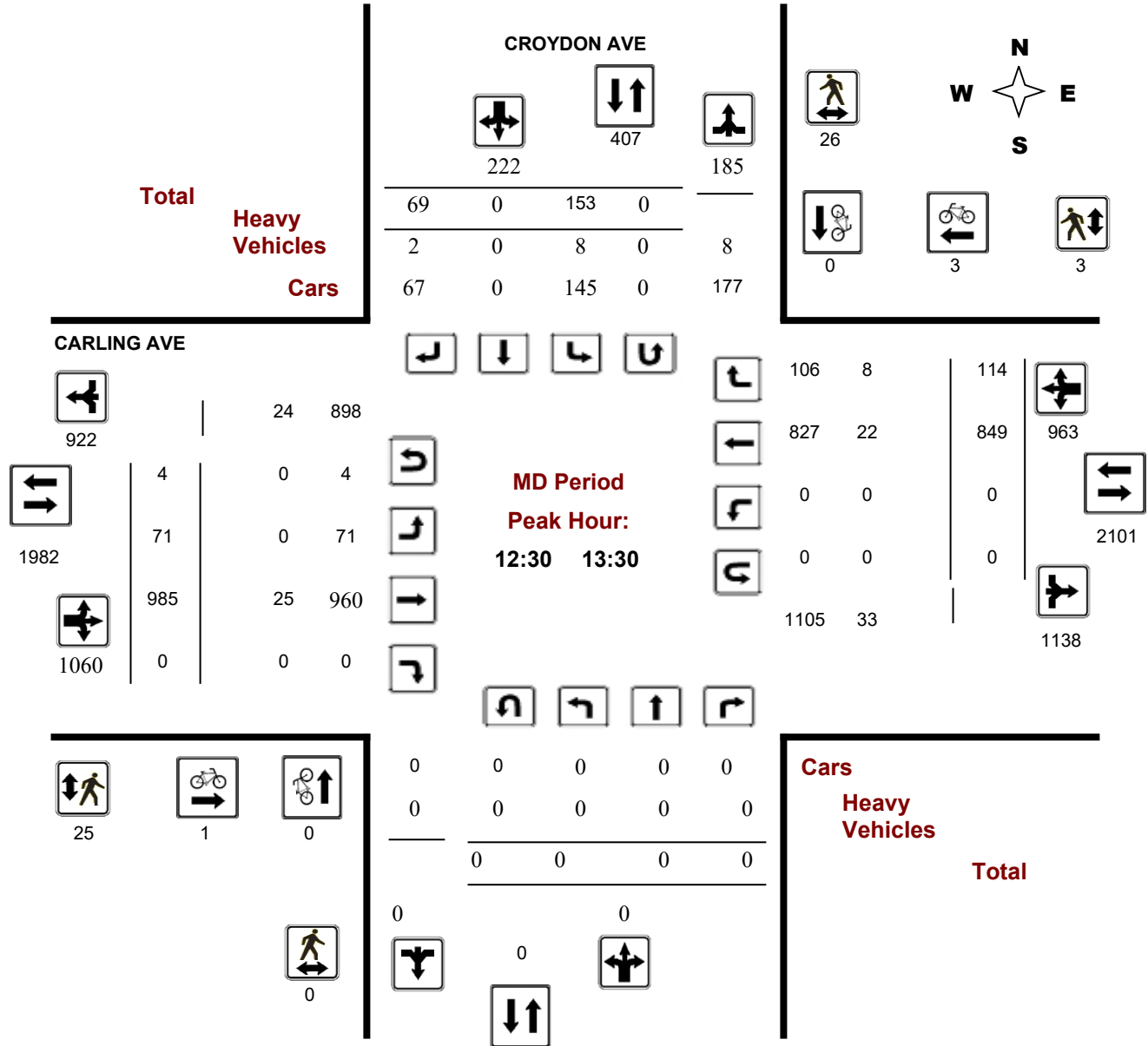

Survey Date: Thursday, August 25, 2016

Start Time: 07:00

WO No: 36243

Device: Miovision

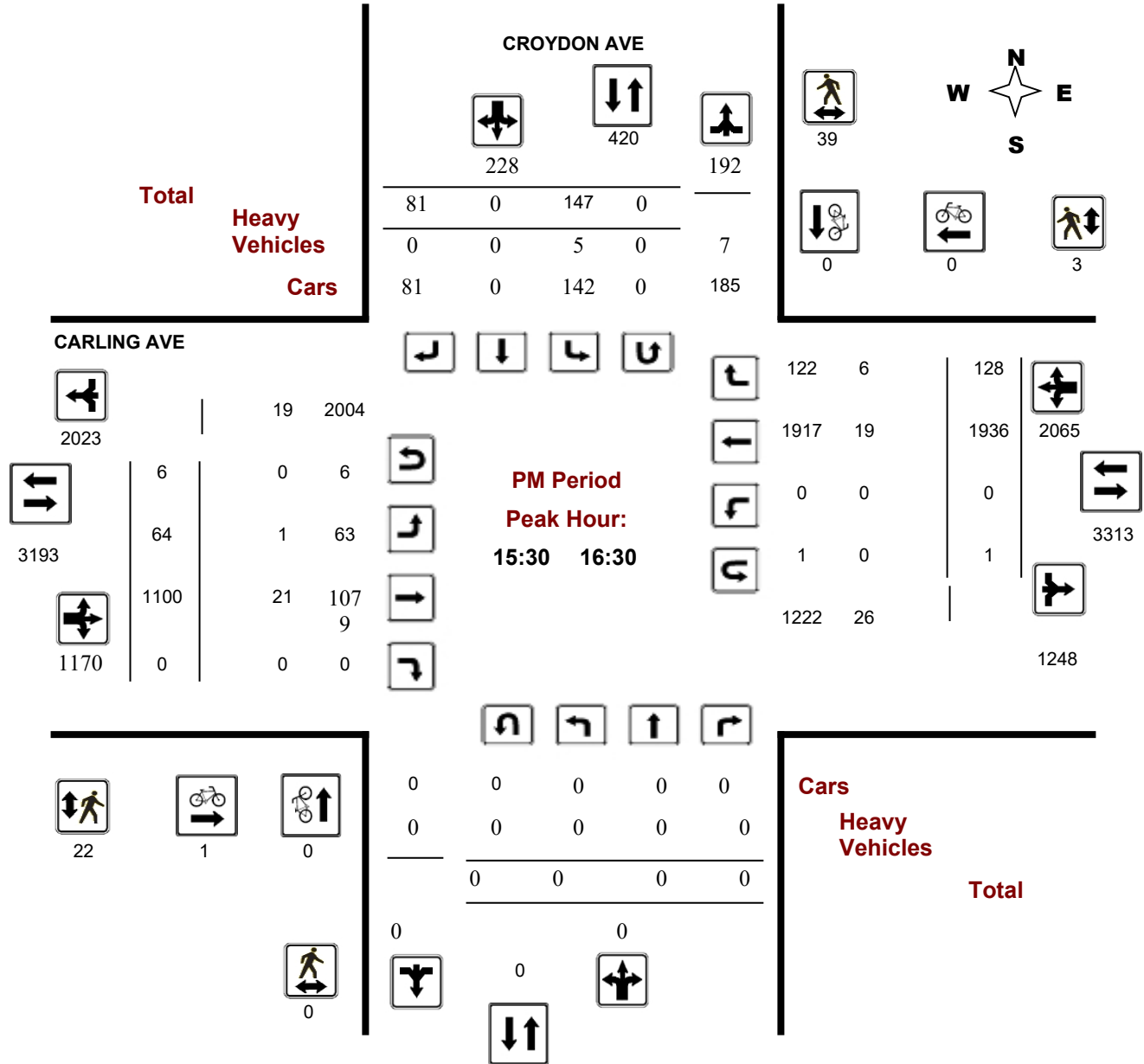

Transportation Services - Traffic Services

Turning Movement Count - Full Study Diagram

CARLING AVE @ CROYDON AVE

Survey Date: Thursday, August 25, 2016

WO#: 36243
Device: Miovision

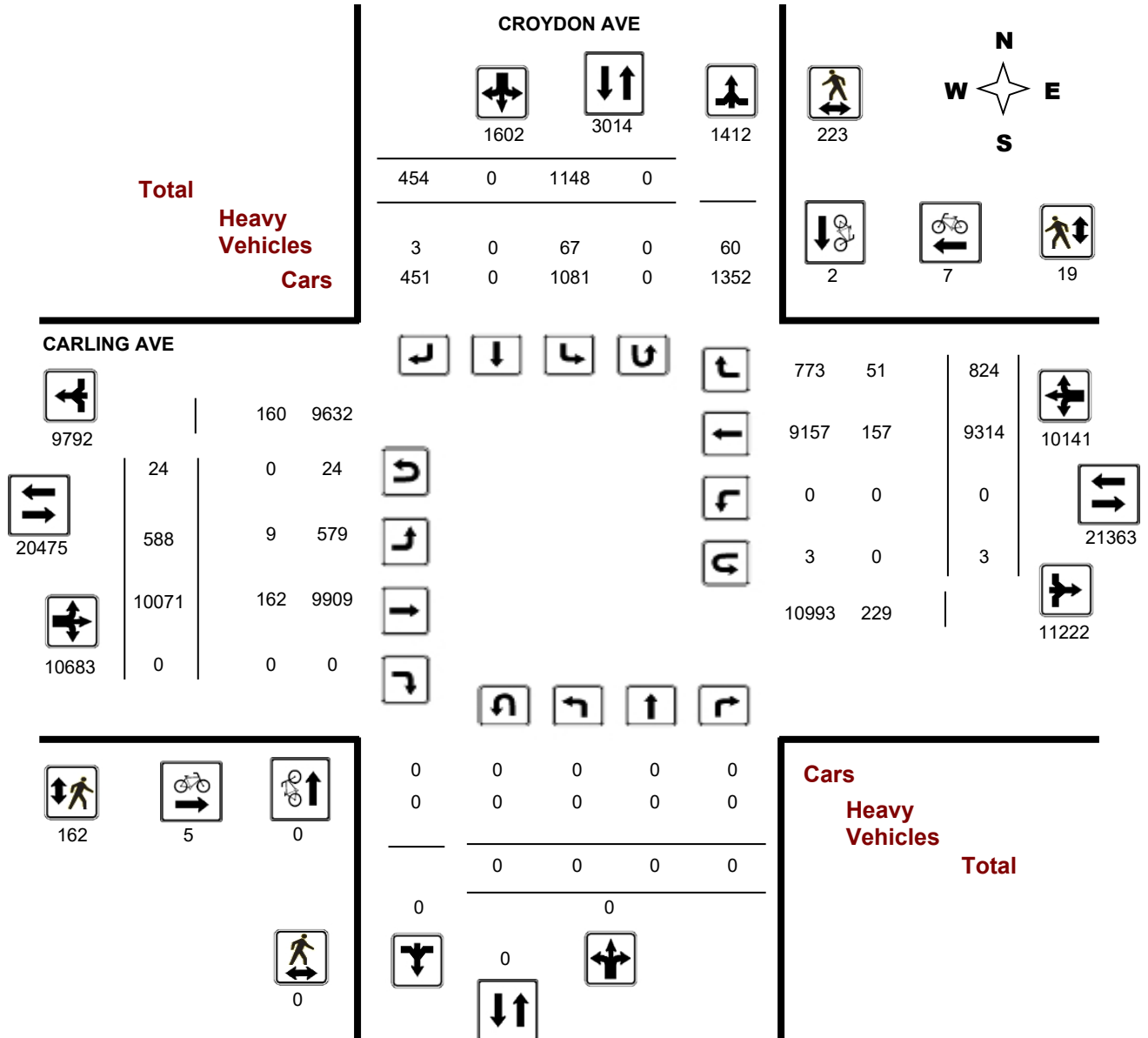



Turning Movement Count - Full Study Summary Report

CARLING AVE @ CROYDON AVE

Survey Date: Thursday, August 25, 2016

Total Observed U-Turns

Northbound: 0 Southbound: 0
Eastbound: 24 Westbound: 3

AADT Factor

.90

Full Study

Period	CROYDON AVE								CARLING AVE								STR TOT	Grand Total	
	Northbound				Southbound				Eastbound				Westbound						
	LT	ST	RT	NB TOT	LT	ST	RT	SB TOT	LT	ST	RT	EB TOT	LT	ST	RT	WB TOT			
07:00 08:00	0	0	0	0	109	0	15	124	124	69	1911	0	1980	0	675	50	725	2705	2829
08:00 09:00	0	0	0	0	156	0	25	181	181	93	2035	0	2128	0	842	88	930	3058	3239
09:00 10:00	0	0	0	0	155	0	48	203	203	65	1063	0	1128	0	751	93	844	1972	2175
11:30 12:30	0	0	0	0	141	0	66	207	207	82	765	0	847	0	800	111	911	1758	1965
12:30 13:30	0	0	0	0	153	0	69	222	222	71	985	0	1056	0	849	114	963	2019	2241
15:00 16:00	0	0	0	0	136	0	75	211	211	69	1056	0	1125	0	1716	124	1840	2965	3176
16:00 17:00	0	0	0	0	145	0	78	223	223	73	1101	0	1174	0	1893	116	2009	3183	3406
17:00 18:00	0	0	0	0	153	0	78	231	231	66	1155	0	1221	0	1788	128	1916	3137	3368
Sub Total	0	0	0	0	1148	0	454	1602	1602	588	10071	0	10659	0	9314	824	10138	20797	22399
U Turns				0				0	0				24				3	27	27
Total	0	0	0	0	1148	0	454	1602	1602	588	10071	0	10683	0	9314	824	10141	20824	22426
EQ 12Hr	0	0	0	0	1596	0	631	2227	2227	817	13999	0	14849	0	12946	1145	14096	28945	31172
Note: These values are calculated by multiplying the totals by the appropriate expansion factor.																	1.39		
AVG 12Hr	0	0	0	0	1436	0	568	2004	2004	736	12599	0	13364	0	11652	1031	12686	26050	28054
Note: These volumes are calculated by multiplying the Equivalent 12 hr. totals by the AADT factor.																	.90		
AVG 24Hr	0	0	0	0	1881	0	744	2625	2625	964	16504	0	17507	0	15264	1350	16619	34126	36751
Note: These volumes are calculated by multiplying the Average Daily 12 hr. totals by 12 to 24 expansion factor.																	1.31		

Comments:

Note: U-Turns provided for approach totals. Refer to 'U-Turn' Report for specific breakdown.



Turning Movement Count - 15 Minute Summary Report

CARLING AVE @ CROYDON AVE

Survey Date: Thursday, August 25, 2016

Total Observed U-Turns

Northbound: 0 Southbound: 0
Eastbound: 24 Westbound: 3

CROYDON AVE

CARLING AVE

Time Period	Northbound			Southbound			Eastbound			Westbound			Grand Total						
	LT	ST	RT	N TOT	LT	ST	RT	S TOT	STR TOT	LT	ST	RT		E TOT	LT	ST	RT	W TOT	STR TOT
07:00 07:15	0	0	0	0	24	0	3	27	27	11	362	0	374	0	147	6	153	527	554
07:15 07:30	0	0	0	0	19	0	5	24	24	25	457	0	482	0	164	8	172	654	678
07:30 07:45	0	0	0	0	40	0	5	45	45	14	541	0	555	0	188	13	201	756	801
07:45 08:00	0	0	0	0	26	0	2	28	28	19	551	0	570	0	176	23	199	769	797
08:00 08:15	0	0	0	0	43	0	7	50	50	19	502	0	521	0	193	19	212	733	783
08:15 08:30	0	0	0	0	37	0	3	40	40	25	517	0	542	0	198	24	222	764	804
08:30 08:45	0	0	0	0	44	0	4	48	48	25	522	0	549	0	226	21	248	797	845
08:45 09:00	0	0	0	0	32	0	11	43	43	24	494	0	518	0	225	24	249	767	810
09:00 09:15	0	0	0	0	46	0	6	52	52	16	329	0	348	0	219	26	245	593	645
09:15 09:30	0	0	0	0	27	0	12	39	39	20	312	0	334	0	175	19	194	528	567
09:30 09:45	0	0	0	0	40	0	17	57	57	12	232	0	245	0	184	27	211	456	513
09:45 10:00	0	0	0	0	42	0	13	55	55	17	190	0	208	0	173	21	194	402	457
11:30 11:45	0	0	0	0	39	0	14	53	53	20	173	0	194	0	188	19	207	401	454
11:45 12:00	0	0	0	0	40	0	18	58	58	18	186	0	206	0	208	27	235	441	499
12:00 12:15	0	0	0	0	25	0	18	43	43	23	201	0	224	0	204	31	235	459	502
12:15 12:30	0	0	0	0	37	0	16	53	53	21	205	0	226	0	200	34	234	460	513
12:30 12:45	0	0	0	0	43	0	18	61	61	13	211	0	224	0	213	23	236	460	521
12:45 13:00	0	0	0	0	46	0	19	65	65	16	227	0	243	0	227	28	255	498	563
13:00 13:15	0	0	0	0	31	0	17	48	48	20	274	0	295	0	197	30	227	522	570
13:15 13:30	0	0	0	0	33	0	15	48	48	22	273	0	298	0	212	33	245	543	591
15:00 15:15	0	0	0	0	29	0	9	38	38	13	259	0	272	0	346	27	374	646	684
15:15 15:30	0	0	0	0	43	0	22	65	65	20	264	0	284	0	405	31	436	720	785
15:30 15:45	0	0	0	0	31	0	18	49	49	16	276	0	293	0	491	27	519	812	861
15:45 16:00	0	0	0	0	33	0	26	59	59	20	257	0	278	0	474	39	513	791	850
16:00 16:15	0	0	0	0	37	0	19	56	56	14	263	0	281	0	484	36	520	801	857
16:15 16:30	0	0	0	0	46	0	18	64	64	14	304	0	318	0	487	26	513	831	895
16:30 16:45	0	0	0	0	34	0	15	49	49	22	273	0	295	0	459	28	487	782	831
16:45 17:00	0	0	0	0	28	0	26	54	54	23	261	0	284	0	463	26	489	773	827
17:00 17:15	0	0	0	0	44	0	22	66	66	20	270	0	290	0	431	22	453	743	809
17:15 17:30	0	0	0	0	37	0	22	59	59	15	302	0	317	0	450	34	484	801	860
17:30 17:45	0	0	0	0	43	0	18	61	61	17	307	0	325	0	474	39	513	838	899
17:45 18:00	0	0	0	0	29	0	16	45	45	14	276	0	290	0	433	33	466	756	801
TOTAL:	0	0	0	0	1148	0	454	1602	1602	588	10071	0	10683	0	9314	824	10141	20824	22426

Note: U-Turns are included in Totals.

Comment:



Transportation Services - Traffic Services

Turning Movement Count - Cyclist Volume Report

Work Order
36243

CARLING AVE @ CROYDON AVE

Count Date: Thursday, August 25, 2016

Start Time: 07:00

Time Period	CROYDON AVE			CARLING AVE			Grand Total
	Northbound	Southbound	Street Total	Eastbound	Westbound	Street Total	
07:00 08:00	0	1	1	0	0	0	1
08:00 09:00	0	0	0	0	0	0	0
09:00 10:00	0	0	0	1	2	3	3
11:30 12:30	0	0	0	0	0	0	0
12:30 13:30	0	0	0	1	3	4	4
15:00 16:00	0	0	0	1	0	1	1
16:00 17:00	0	1	1	0	0	0	1
17:00 18:00	0	0	0	2	2	4	4
Total	0	2	2	5	7	12	14

Comment:

Note: These volumes consists of bicycles only (no mopeds or motorcycles) and ARE NOT included in the Turning Movement Count Summary.



Transportation Services - Traffic Services

W.O.
36243

Turning Movement Count - Heavy Vehicle Report

CARLING AVE @ CROYDON AVE

Survey Date: Thursday, August 25, 2016

Time Period	CROYDON AVE									CARLING AVE									Grand Total
	Northbound			N TOT	Southbound			S TOT	STR TOT	Eastbound			E TOT	Westbound			W TOT	STR TOT	
	LT	ST	RT		LT	ST	RT			LT	ST	RT		LT	ST	RT			
07:00 08:00	0	0	0	0	6	0	0	6	6	2	23	0	25	0	20	3	23	48	54
08:00 09:00	0	0	0	0	10	0	0	10	10	1	24	0	25	0	23	6	29	54	64
09:00 10:00	0	0	0	0	9	0	0	9	9	2	27	0	29	0	22	6	28	57	66
11:30 12:30	0	0	0	0	11	0	0	11	11	2	16	0	18	0	18	10	28	46	57
12:30 13:30	0	0	0	0	8	0	2	10	10	0	25	0	25	0	22	8	30	55	65
15:00 16:00	0	0	0	0	9	0	0	9	9	0	18	0	18	0	19	5	24	42	51
16:00 17:00	0	0	0	0	7	0	0	7	7	1	17	0	18	0	16	7	23	41	48
17:00 18:00	0	0	0	0	7	0	1	8	8	1	12	0	13	0	17	6	23	36	44
Sub Total	0	0	0	0	67	0	3	70	70	9	162	0	171	0	157	51	208	379	449
U-Turns (Heavy Vehicles)				0				0	0				0				0	0	0
Total	0	0	0	0	67	0	3	70	70	9	162	0	171	0	157	51	208	379	449

Heavy Vehicles include Buses, Single-Unit Trucks and Articulated Trucks. Further, they ARE included in the Turning Movement Count Summary.



Transportation Services - Traffic Services

Work Order

36243

Turning Movement Count - Pedestrian Volume Report

CARLING AVE @ CROYDON AVE

Count Date: Thursday, August 25, 2016

Start Time: 07:00

Time Period	NB Approach (E or W Crossing)	SB Approach (E or W Crossing)	Total	EB Approach (N or S Crossing)	WB Approach (N or S Crossing)	Total	Grand Total
07:00 07:15	0	1	1	4	0	4	5
07:15 07:30	0	3	3	1	0	1	4
07:30 07:45	0	4	4	5	0	5	9
07:45 08:00	0	1	1	2	0	2	3
07:00 08:00	0	9	9	12	0	12	21
08:00 08:15	0	0	0	6	0	6	6
08:15 08:30	0	3	3	3	0	3	6
08:30 08:45	0	9	9	6	0	6	15
08:45 09:00	0	4	4	4	2	6	10
08:00 09:00	0	16	16	19	2	21	37
09:00 09:15	0	5	5	3	0	3	8
09:15 09:30	0	10	10	4	0	4	14
09:30 09:45	0	8	8	1	0	1	9
09:45 10:00	0	8	8	3	1	4	12
09:00 10:00	0	31	31	11	1	12	43
11:30 11:45	0	1	1	4	0	4	5
11:45 12:00	0	12	12	7	1	8	20
12:00 12:15	0	2	2	3	0	3	5
12:15 12:30	0	5	5	6	1	7	12
11:30 12:30	0	20	20	20	2	22	42
12:30 12:45	0	7	7	8	2	10	17
12:45 13:00	0	9	9	9	1	10	19
13:00 13:15	0	5	5	4	0	4	9
13:15 13:30	0	5	5	4	0	4	9
12:30 13:30	0	26	26	25	3	28	54
15:00 15:15	0	5	5	2	5	7	12
15:15 15:30	0	3	3	3	0	3	6
15:30 15:45	0	8	8	4	0	4	12
15:45 16:00	0	9	9	9	2	11	20
15:00 16:00	0	25	25	18	7	25	50
16:00 16:15	0	9	9	3	1	4	13
16:15 16:30	0	13	13	6	0	6	19
16:30 16:45	0	11	11	7	0	7	18
16:45 17:00	0	17	17	4	1	5	22
16:00 17:00	0	50	50	20	2	22	72
17:00 17:15	0	10	10	6	0	6	16
17:15 17:30	0	16	16	7	0	7	23
17:30 17:45	0	12	12	14	2	16	28
17:45 18:00	0	8	8	10	0	10	18
17:00 18:00	0	46	46	37	2	39	85
Total	0	223	223	162	19	181	404

Comment:

Turning Movement Count - 15 Min U-Turn Total Report

CARLING AVE @ CROYDON AVE

Survey Date: Thursday, August 25, 2016

Time Period		Northbound U-Turn Total	Southbound U-Turn Total	Eastbound U-Turn Total	Westbound U-Turn Total	Total
07:00	07:15	0	0	1	0	1
07:15	07:30	0	0	0	0	0
07:30	07:45	0	0	0	0	0
07:45	08:00	0	0	0	0	0
08:00	08:15	0	0	0	0	0
08:15	08:30	0	0	0	0	0
08:30	08:45	0	0	2	1	3
08:45	09:00	0	0	0	0	0
09:00	09:15	0	0	3	0	3
09:15	09:30	0	0	2	0	2
09:30	09:45	0	0	1	0	1
09:45	10:00	0	0	1	0	1
11:30	11:45	0	0	1	0	1
11:45	12:00	0	0	2	0	2
12:00	12:15	0	0	0	0	0
12:15	12:30	0	0	0	0	0
12:30	12:45	0	0	0	0	0
12:45	13:00	0	0	0	0	0
13:00	13:15	0	0	1	0	1
13:15	13:30	0	0	3	0	3
15:00	15:15	0	0	0	1	1
15:15	15:30	0	0	0	0	0
15:30	15:45	0	0	1	1	2
15:45	16:00	0	0	1	0	1
16:00	16:15	0	0	4	0	4
16:15	16:30	0	0	0	0	0
16:30	16:45	0	0	0	0	0
16:45	17:00	0	0	0	0	0
17:00	17:15	0	0	0	0	0
17:15	17:30	0	0	0	0	0
17:30	17:45	0	0	1	0	1
17:45	18:00	0	0	0	0	0
Total		0	0	24	3	27



Transportation Services - Traffic Services

Turning Movement Count - Full Study Peak Hour Diagram

CROYDON AVE @ RICHMOND RD

Survey Date: Thursday, August 11, 2016

Start Time: 07:00

WO No: 36184

Device: Miovision

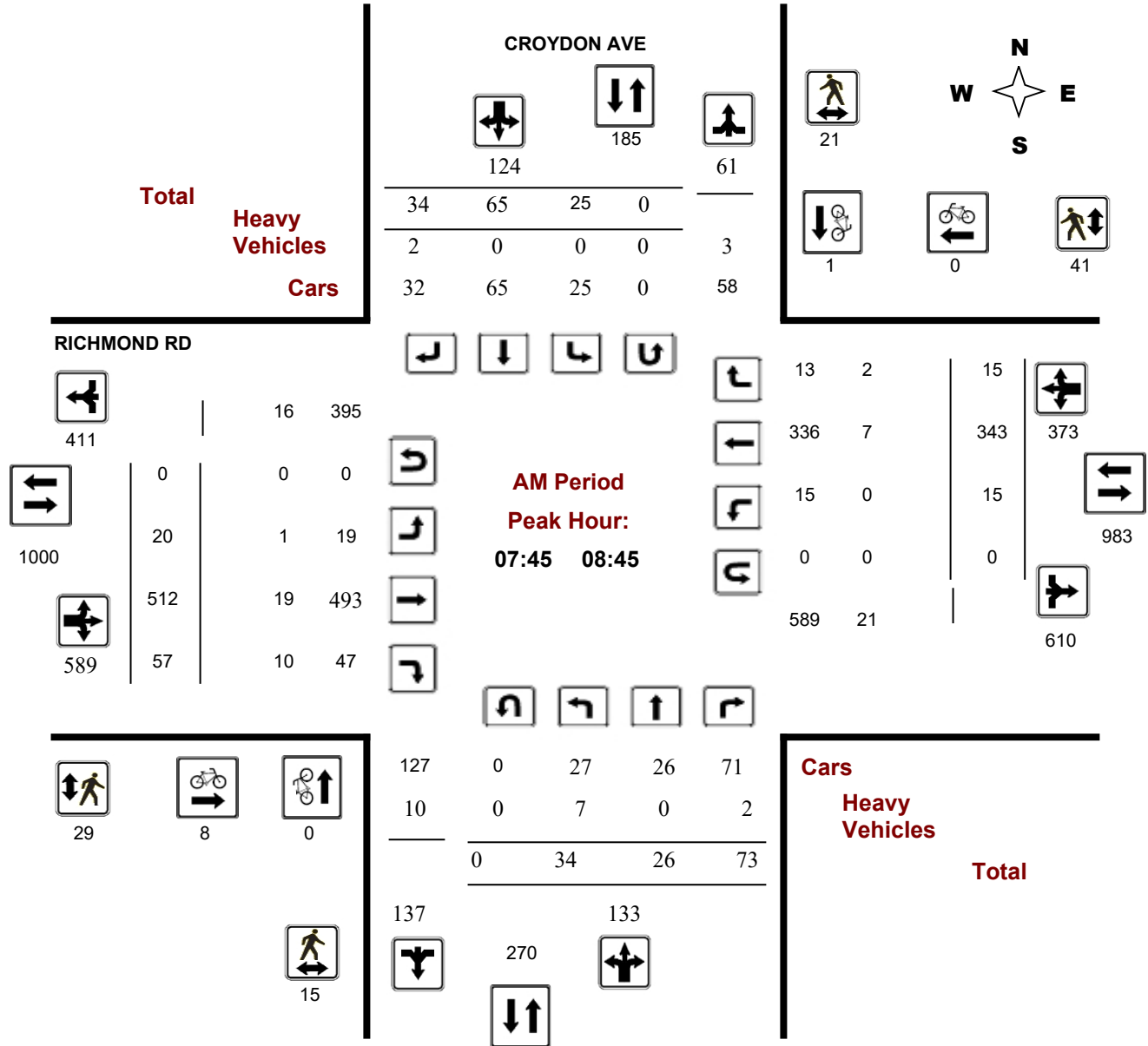

Survey Date: Thursday, August 11, 2016

Start Time: 07:00

WO No: 36184

Device: Miovision

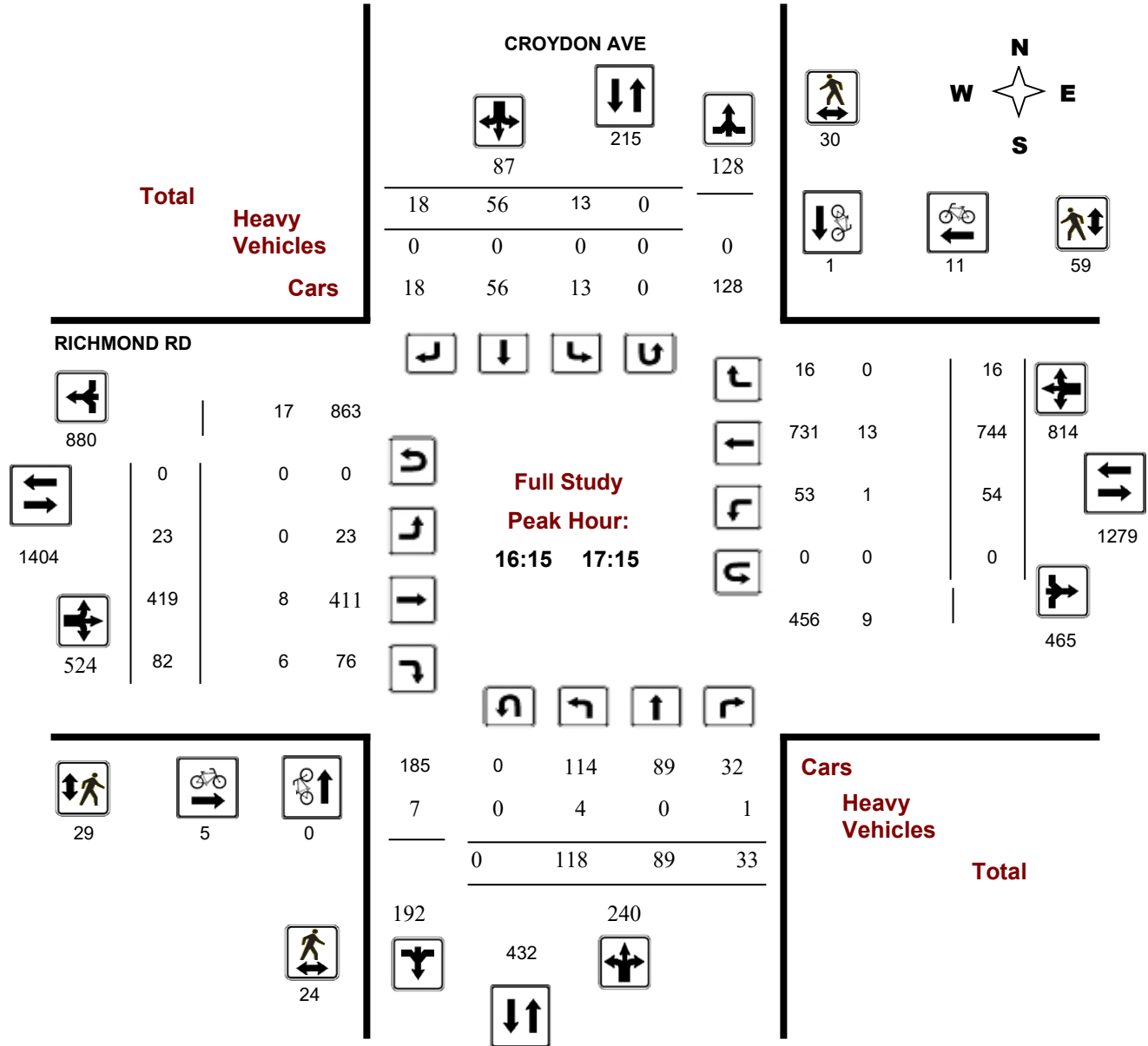

Comments



Transportation Services - Traffic Services

Turning Movement Count - Full Study Peak Hour Diagram

CROYDON AVE @ RICHMOND RD

Survey Date: Thursday, August 11, 2016

Start Time: 07:00

WO No: 36184

Device: Miovision

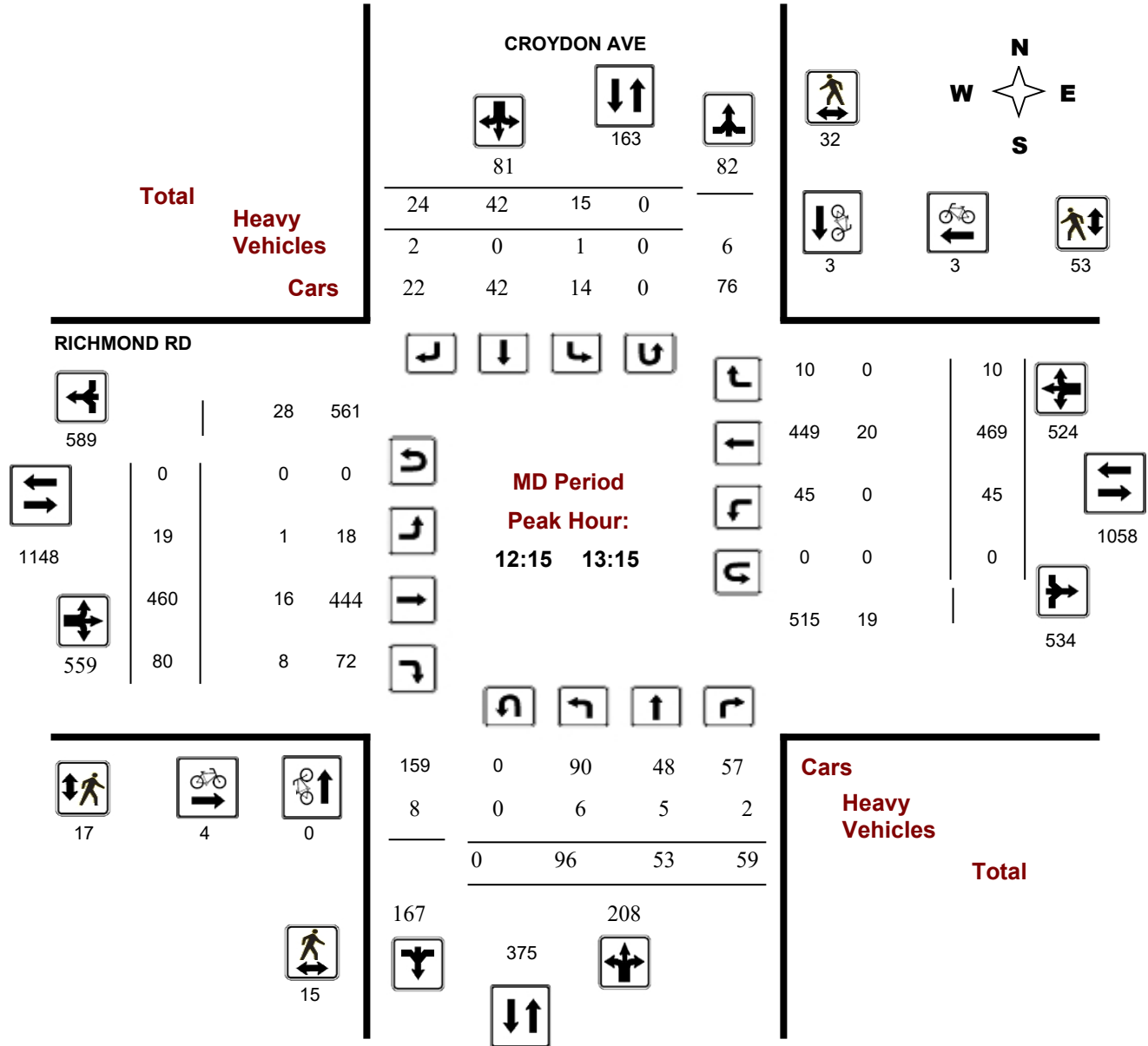

Comments

Survey Date: Thursday, August 11, 2016

Start Time: 07:00

WO No: 36184

Device: Miovision

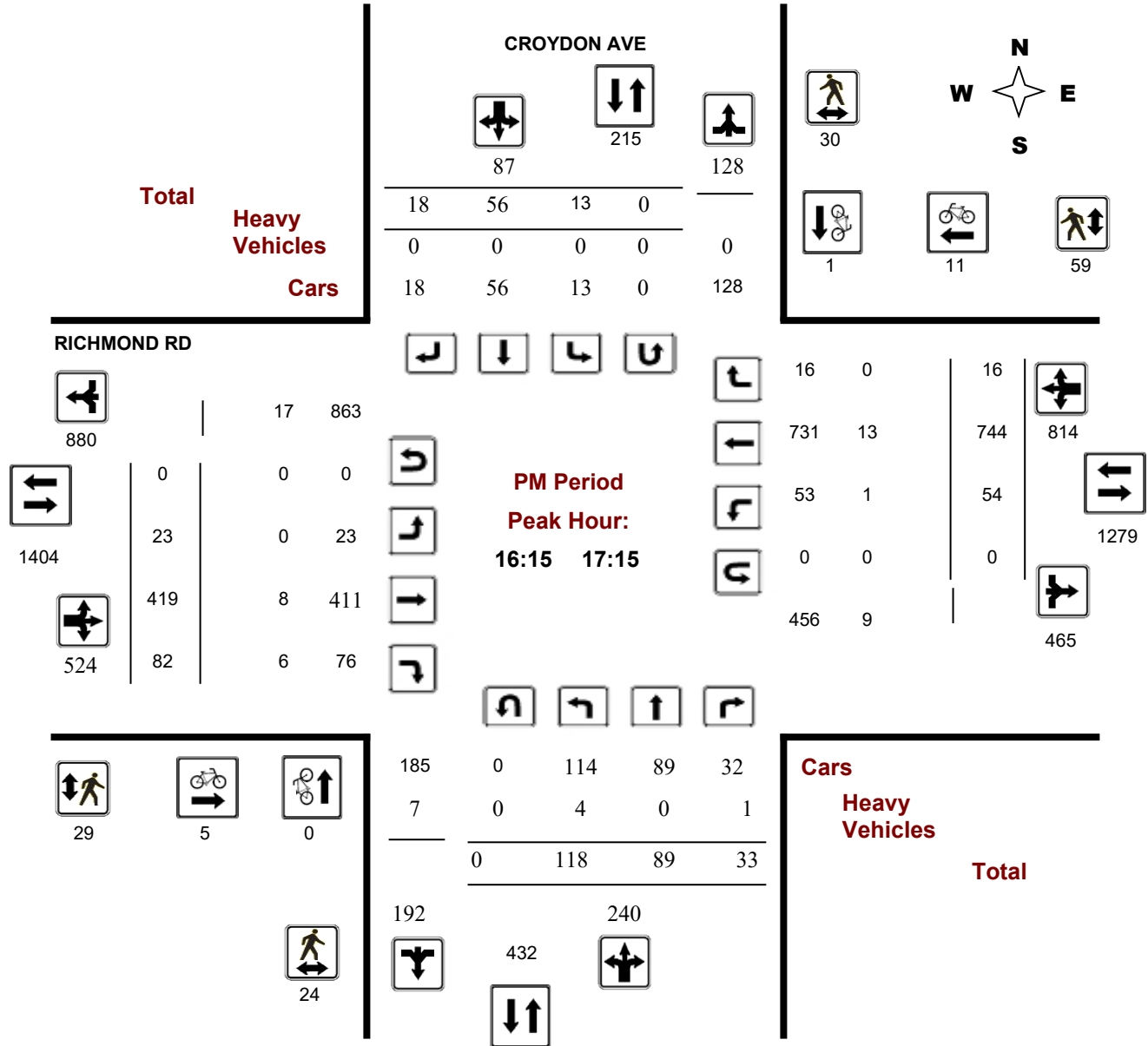

Transportation Services - Traffic Services

Turning Movement Count - Full Study Diagram

CROYDON AVE @ RICHMOND RD

Survey Date: Thursday, August 11, 2016

WO#: 36184
Device: Miovision

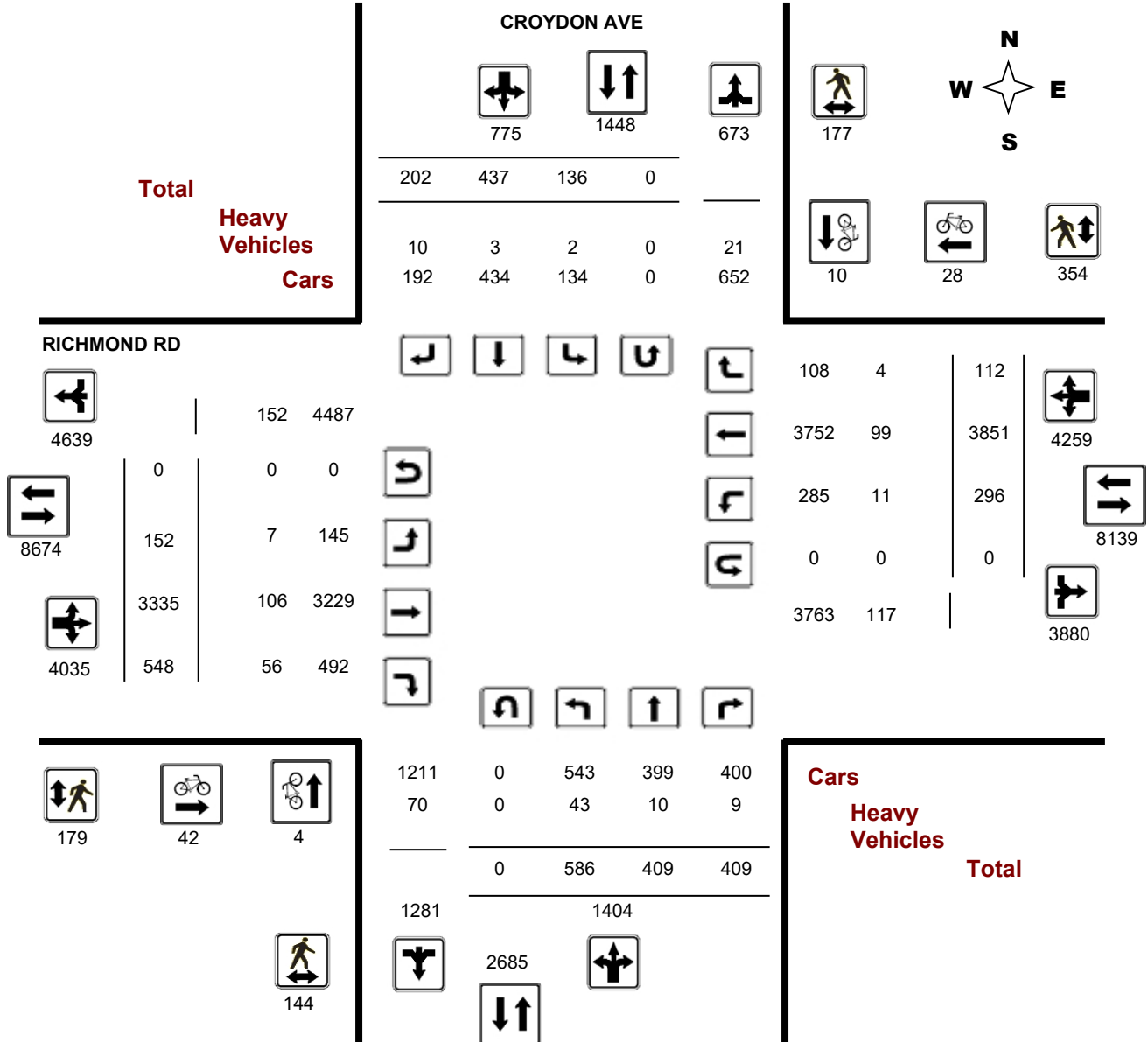

Comments

Turning Movement Count - Full Study Summary Report

CROYDON AVE @ RICHMOND RD

Survey Date: Thursday, August 11, 2016

Total Observed U-Turns

Northbound: 0 Southbound: 0
Eastbound: 0 Westbound: 0

AADT Factor

.90

Full Study

Period	CROYDON AVE									RICHMOND RD									Grand Total	
	Northbound			NB TOT	Southbound			SB TOT	STR TOT	Eastbound			EB TOT	Westbound			WB TOT	STR TOT		
	LT	ST	RT		LT	ST	RT			LT	ST	RT		LT	ST	RT				
07:00 08:00	25	21	59	105	11	50	18	79	184	19	440	51	510	14	236	7	257	767	951	
08:00 09:00	35	23	68	126	28	69	38	135	261	19	502	54	575	19	345	16	380	955	1216	
09:00 10:00	46	34	48	128	21	61	20	102	230	16	363	65	444	36	353	14	403	847	1077	
11:30 12:30	72	48	46	166	12	56	15	83	249	12	396	73	481	56	439	13	508	989	1238	
12:30 13:30	95	53	63	211	19	33	30	82	293	20	435	79	534	39	456	11	506	1040	1333	
15:00 16:00	93	63	43	199	17	54	30	101	300	20	373	75	468	42	644	24	710	1178	1478	
16:00 17:00	114	72	36	222	16	60	23	99	321	22	419	84	525	47	711	14	772	1297	1618	
17:00 18:00	106	95	46	247	12	54	28	94	341	24	407	67	498	43	667	13	723	1221	1562	
Sub Total	586	409	409	1404	136	437	202	775	2179	152	3335	548	4035	296	3851	112	4259	8294	10473	
U Turns				0				0	0				0				0	0	0	0
Total	586	409	409	1404	136	437	202	775	2179	152	3335	548	4035	296	3851	112	4259	8294	10473	
EQ 12Hr	815	569	569	1952	189	607	281	1077	3029	211	4636	762	5609	411	5353	156	5920	11529	14558	
Note: These values are calculated by multiplying the totals by the appropriate expansion factor.													1.39							
AVG 12Hr	733	512	512	1756	170	547	253	970	2726	190	4172	686	5048	370	4818	140	5328	10376	13102	
Note: These volumes are calculated by multiplying the Equivalent 12 hr. totals by the AADT factor.													.90							
AVG 24Hr	960	670	670	2301	223	716	331	1270	3571	249	5465	898	6613	485	6311	184	6980	13593	17164	
Note: These volumes are calculated by multiplying the Average Daily 12 hr. totals by 12 to 24 expansion factor.													1.31							

Comments:

Note: U-Turns provided for approach totals. Refer to 'U-Turn' Report for specific breakdown.



Turning Movement Count - 15 Minute Summary Report

CROYDON AVE @ RICHMOND RD

Survey Date: Thursday, August 11, 2016

Total Observed U-Turns

Northbound: 0 Southbound: 0
Eastbound: 0 Westbound: 0

CROYDON AVE

RICHMOND RD

Table with columns for Time Period, Northbound (LT, ST, RT, N TOT), Southbound (LT, ST, RT, S TOT, STR TOT), Eastbound (LT, ST, RT, E TOT), Westbound (LT, ST, RT, W TOT, STR TOT), and Grand Total. Rows represent 15-minute intervals from 07:00 to 18:00.

Note: U-Turns are included in Totals.

Comment:



Transportation Services - Traffic Services

Turning Movement Count - Cyclist Volume Report

Work Order
36184

CROYDON AVE @ RICHMOND RD

Count Date: Thursday, August 11, 2016

Start Time: 07:00

Time Period	CROYDON AVE			RICHMOND RD			Grand Total
	Northbound	Southbound	Street Total	Eastbound	Westbound	Street Total	
07:00 08:00	1	1	2	5	2	7	9
08:00 09:00	0	0	0	7	0	7	7
09:00 10:00	0	0	0	8	2	10	10
11:30 12:30	0	4	4	2	4	6	10
12:30 13:30	0	1	1	4	1	5	6
15:00 16:00	2	0	2	3	3	6	8
16:00 17:00	0	1	1	8	11	19	20
17:00 18:00	1	3	4	5	5	10	14
Total	4	10	14	42	28	70	84

Comment:

Note: These volumes consists of bicycles only (no mopeds or motorcycles) and ARE NOT included in the Turning Movement Count Summary.



Transportation Services - Traffic Services

W.O.
36184

Turning Movement Count - Heavy Vehicle Report

CROYDON AVE @ RICHMOND RD

Survey Date: Thursday, August 11, 2016

Time Period	CROYDON AVE									RICHMOND RD									Grand Total
	Northbound			Southbound			S TOT	STR TOT	Eastbound			Westbound			W TOT	STR TOT			
	LT	ST	RT	N TOT	LT	ST			RT	LT	ST	RT	E TOT	LT			ST	RT	
07:00 08:00	8	0	1	9	1	0	1	2	11	1	18	11	30	2	5	1	8	38	49
08:00 09:00	8	0	2	10	0	0	2	2	12	1	19	8	28	0	6	2	8	36	48
09:00 10:00	4	0	0	4	0	0	1	1	5	1	20	11	32	2	17	0	19	51	56
11:30 12:30	4	3	3	10	1	1	1	3	13	1	12	8	21	3	18	0	21	42	55
12:30 13:30	5	4	1	10	0	0	3	3	13	1	14	5	20	1	18	0	19	39	52
15:00 16:00	6	2	1	9	0	2	2	4	13	1	9	3	13	0	11	0	11	24	37
16:00 17:00	4	0	1	5	0	0	0	0	5	1	8	4	13	2	13	0	15	28	33
17:00 18:00	4	1	0	5	0	0	0	0	5	0	6	6	12	1	11	1	13	25	30
Sub Total	43	10	9	62	2	3	10	15	77	7	106	56	169	11	99	4	114	283	360
U-Turns (Heavy Vehicles)				0				0	0				0				0	0	0
Total	43	10	9	0	2	3	10	15	77	7	106	56	169	11	99	4	114	283	360

Heavy Vehicles include Buses, Single-Unit Trucks and Articulated Trucks. Further, they ARE included in the Turning Movement Count Summary.



Transportation Services - Traffic Services

Work Order

36184

Turning Movement Count - Pedestrian Volume Report

CROYDON AVE @ RICHMOND RD

Count Date: Thursday, August 11, 2016

Start Time: 07:00

Time Period	NB Approach (E or W Crossing)	SB Approach (E or W Crossing)	Total	EB Approach (N or S Crossing)	WB Approach (N or S Crossing)	Total	Grand Total
07:00 07:15	3	1	4	4	11	15	19
07:15 07:30	2	1	3	5	4	9	12
07:30 07:45	1	5	6	2	8	10	16
07:45 08:00	3	4	7	8	11	19	26
07:00 08:00	9	11	20	19	34	53	73
08:00 08:15	1	0	1	6	12	18	19
08:15 08:30	5	13	18	8	9	17	35
08:30 08:45	6	4	10	7	9	16	26
08:45 09:00	11	5	16	3	12	15	31
08:00 09:00	23	22	45	24	42	66	111
09:00 09:15	5	1	6	3	11	14	20
09:15 09:30	2	0	2	4	12	16	18
09:30 09:45	1	1	2	5	8	13	15
09:45 10:00	2	4	6	8	16	24	30
09:00 10:00	10	6	16	20	47	67	83
11:30 11:45	6	2	8	3	5	8	16
11:45 12:00	3	4	7	4	6	10	17
12:00 12:15	5	15	20	4	22	26	46
12:15 12:30	6	9	15	4	17	21	36
11:30 12:30	20	30	50	15	50	65	115
12:30 12:45	2	3	5	4	7	11	16
12:45 13:00	4	8	12	2	15	17	29
13:00 13:15	3	12	15	7	14	21	36
13:15 13:30	3	3	6	2	7	9	15
12:30 13:30	12	26	38	15	43	58	96
15:00 15:15	5	4	9	6	7	13	22
15:15 15:30	6	3	9	6	10	16	25
15:30 15:45	3	16	19	10	17	27	46
15:45 16:00	8	5	13	4	10	14	27
15:00 16:00	22	28	50	26	44	70	120
16:00 16:15	9	6	15	13	14	27	42
16:15 16:30	6	9	15	4	21	25	40
16:30 16:45	7	9	16	12	18	30	46
16:45 17:00	9	4	13	5	10	15	28
16:00 17:00	31	28	59	34	63	97	156
17:00 17:15	2	8	10	8	10	18	28
17:15 17:30	5	6	11	7	7	14	25
17:30 17:45	5	8	13	7	9	16	29
17:45 18:00	5	4	9	4	5	9	18
17:00 18:00	17	26	43	26	31	57	100
Total	144	177	321	179	354	533	854

Comment:

Turning Movement Count - 15 Min U-Turn Total Report

CROYDON AVE @ RICHMOND RD





















Survey Date: Thursday, August 11, 2016

Time Period		Northbound U-Turn Total	Southbound U-Turn Total	Eastbound U-Turn Total	Westbound U-Turn Total	Total
07:00	07:15	0	0	0	0	0
07:15	07:30	0	0	0	0	0
07:30	07:45	0	0	0	0	0
07:45	08:00	0	0	0	0	0
08:00	08:15	0	0	0	0	0
08:15	08:30	0	0	0	0	0
08:30	08:45	0	0	0	0	0
08:45	09:00	0	0	0	0	0
09:00	09:15	0	0	0	0	0
09:15	09:30	0	0	0	0	0
09:30	09:45	0	0	0	0	0
09:45	10:00	0	0	0	0	0
11:30	11:45	0	0	0	0	0
11:45	12:00	0	0	0	0	0
12:00	12:15	0	0	0	0	0
12:15	12:30	0	0	0	0	0
12:30	12:45	0	0	0	0	0
12:45	13:00	0	0	0	0	0
13:00	13:15	0	0	0	0	0
13:15	13:30	0	0	0	0	0
15:00	15:15	0	0	0	0	0
15:15	15:30	0	0	0	0	0
15:30	15:45	0	0	0	0	0
15:45	16:00	0	0	0	0	0
16:00	16:15	0	0	0	0	0
16:15	16:30	0	0	0	0	0
16:30	16:45	0	0	0	0	0
16:45	17:00	0	0	0	0	0
17:00	17:15	0	0	0	0	0
17:15	17:30	0	0	0	0	0
17:30	17:45	0	0	0	0	0
17:45	18:00	0	0	0	0	0
Total		0	0	0	0	0

Appendix D – Existing Traffic Level of Service Calculations

HCM Signalized Intersection Capacity Analysis
1: Croydon Ave & Richmond Rd/Richmond St

Existing (2019)
AM Peak Hour

												
Movement	EBL	EBT	EBR	WBL	WBT	WBR	NBL	NBT	NBR	SBL	SBT	SBR
Lane Configurations												
Traffic Volume (vph)	20	512	57	15	343	15	34	26	73	25	65	34
Future Volume (vph)	20	512	57	15	343	15	34	26	73	25	65	34
Ideal Flow (vphpl)	1800	1800	1800	1800	1800	1800	1800	1800	1800	1800	1800	1800
Lane Width	3.4	3.4	3.7	3.0	3.4	3.7	3.5	3.5	3.7	3.7	4.8	3.7
Total Lost time (s)	6.4	6.4		6.4	6.4		6.1	6.1			6.1	
Lane Util. Factor	1.00	1.00		1.00	1.00		1.00	1.00			1.00	
Frbp, ped/bikes	1.00	1.00		1.00	1.00		1.00	0.94			0.98	
Flpb, ped/bikes	0.98	1.00		0.99	1.00		0.97	1.00			0.99	
Frt	1.00	0.99		1.00	0.99		1.00	0.89			0.96	
Flt Protected	0.95	1.00		0.95	1.00		0.95	1.00			0.99	
Satd. Flow (prot)	1559	1598		1581	1613		1545	1429			1827	
Flt Permitted	0.53	1.00		0.38	1.00		0.68	1.00			0.90	
Satd. Flow (perm)	865	1598		629	1613		1113	1429			1662	
Peak-hour factor, PHF	0.90	0.90	0.90	0.90	0.90	0.90	0.90	0.90	0.90	0.90	0.90	0.90
Adj. Flow (vph)	22	569	63	17	381	17	38	29	81	28	72	38
RTOR Reduction (vph)	0	3	0	0	1	0	0	70	0	0	26	0
Lane Group Flow (vph)	22	629	0	17	397	0	38	40	0	0	112	0
Confl. Peds. (#/hr)	21		15	15		21	29		41	41		29
Heavy Vehicles (%)	5%	3%	10%	0%	4%	0%	6%	9%	3%	7%	0%	8%
Bus Blockages (#/hr)	0	10	0	0	10	0	0	0	0	0	0	0
Turn Type	Perm	NA		Perm	NA		Perm	NA		Perm	NA	
Protected Phases		2			6			8			4	
Permitted Phases	2			6			8			4		
Actuated Green, G (s)	48.3	48.3		48.3	48.3		9.2	9.2			9.2	
Effective Green, g (s)	48.3	48.3		48.3	48.3		9.2	9.2			9.2	
Actuated g/C Ratio	0.69	0.69		0.69	0.69		0.13	0.13			0.13	
Clearance Time (s)	6.4	6.4		6.4	6.4		6.1	6.1			6.1	
Vehicle Extension (s)	3.0	3.0		3.0	3.0		3.0	3.0			3.0	
Lane Grp Cap (vph)	596	1102		434	1112		146	187			218	
v/s Ratio Prot		c0.39			0.25			0.03				
v/s Ratio Perm	0.03			0.03			0.03				c0.07	
v/c Ratio	0.04	0.57		0.04	0.36		0.26	0.21			0.51	
Uniform Delay, d1	3.5	5.5		3.5	4.5		27.3	27.2			28.3	
Progression Factor	1.00	1.00		1.00	1.00		1.00	1.00			1.00	
Incremental Delay, d2	0.1	2.1		0.2	0.9		1.0	0.6			2.0	
Delay (s)	3.6	7.7		3.6	5.4		28.3	27.7			30.4	
Level of Service	A	A		A	A		C	C			C	
Approach Delay (s)		7.6			5.3			27.9			30.4	
Approach LOS		A			A			C			C	
Intersection Summary												
HCM 2000 Control Delay			11.4				HCM 2000 Level of Service				B	
HCM 2000 Volume to Capacity ratio			0.56									
Actuated Cycle Length (s)			70.0				Sum of lost time (s)			12.5		
Intersection Capacity Utilization			61.1%				ICU Level of Service			B		
Analysis Period (min)			15									

c Critical Lane Group

HCM Signalized Intersection Capacity Analysis
2: Alpine Ave/1460 Richmond & Carling Ave

Existing (2019)
AM Peak Hour



Movement	EBU	EBL	EBT	EBR	WBU	WBL	WBT	WBR	NBL	NBT	NBR	SBL
Lane Configurations		↔	↑↑↑			↔	↑↑↑			↔		
Traffic Volume (vph)	5	29	2483	5	4	30	857	68	22	7	87	41
Future Volume (vph)	5	29	2483	5	4	30	857	68	22	7	87	41
Ideal Flow (vphpl)	1800	1800	1800	1800	1800	1800	1800	1800	1800	1800	1800	1800
Lane Width	3.7	3.0	3.6	3.7	3.7	3.0	3.7	3.7	3.7	4.8	3.7	3.7
Total Lost time (s)		5.9	5.9			5.9	5.9			6.7		
Lane Util. Factor		1.00	0.91			1.00	0.91			1.00		
Frbp, ped/bikes		1.00	1.00			1.00	0.99			0.96		
Flpb, ped/bikes		0.97	1.00			1.00	1.00			1.00		
Frt		1.00	1.00			1.00	0.99			0.90		
Flt Protected		0.95	1.00			0.95	1.00			0.99		
Satd. Flow (prot)		1516	4811			1596	4684			1689		
Flt Permitted		0.27	1.00			0.04	1.00			0.88		
Satd. Flow (perm)		425	4811			68	4684			1498		
Peak-hour factor, PHF	0.90	0.90	0.90	0.90	0.90	0.90	0.90	0.90	0.90	0.90	0.90	0.90
Adj. Flow (vph)	6	32	2759	6	4	33	952	76	24	8	97	46
RTOR Reduction (vph)	0	0	0	0	0	0	4	0	0	56	0	0
Lane Group Flow (vph)	0	38	2765	0	0	37	1024	0	0	73	0	0
Confl. Peds. (#/hr)	11	36		27	27	27		36	11		27	27
Heavy Vehicles (%)	0%	3%	1%	0%	0%	0%	3%	3%	9%	0%	2%	2%
Bus Blockages (#/hr)	0	0	8	0	0	0	8	0	0	0	0	0
Turn Type	Perm	Perm	NA		Perm	pm+pt	NA		Perm	NA		Perm
Protected Phases			2			1	6			8		
Permitted Phases	2	2			6	6			8			4
Actuated Green, G (s)		92.8	92.8			103.8	103.8			13.6		
Effective Green, g (s)		92.8	92.8			103.8	103.8			13.6		
Actuated g/C Ratio		0.71	0.71			0.80	0.80			0.10		
Clearance Time (s)		5.9	5.9			5.9	5.9			6.7		
Vehicle Extension (s)		3.0	3.0			3.0	3.0			3.0		
Lane Grp Cap (vph)		303	3434			114	3739			156		
v/s Ratio Prot			c0.57			0.01	c0.22					
v/s Ratio Perm		0.09				0.25				0.05		
v/c Ratio		0.13	0.81			0.32	0.27			0.47		
Uniform Delay, d1		5.8	12.5			14.9	3.4			54.8		
Progression Factor		1.00	1.00			3.52	0.82			1.00		
Incremental Delay, d2		0.9	2.1			1.6	0.2			2.2		
Delay (s)		6.7	14.6			54.1	3.0			57.1		
Level of Service		A	B			D	A			E		
Approach Delay (s)			14.5				4.7			57.1		
Approach LOS			B				A			E		
Intersection Summary												
HCM 2000 Control Delay			14.9									B
HCM 2000 Volume to Capacity ratio			0.77									
Actuated Cycle Length (s)			130.0							18.5		
Intersection Capacity Utilization			79.2%									D
Analysis Period (min)			15									

c Critical Lane Group

HCM Signalized Intersection Capacity Analysis
 2: Alpine Ave/1460 Richmond & Carling Ave

Existing (2019)
 AM Peak Hour



Movement	SBT	SBR
Lane Configurations	↕	
Traffic Volume (vph)	9	52
Future Volume (vph)	9	52
Ideal Flow (vphpl)	1800	1800
Lane Width	3.6	3.7
Total Lost time (s)	6.7	
Lane Util. Factor	1.00	
Frbp, ped/bikes	0.99	
Flpb, ped/bikes	0.99	
Frt	0.93	
Flt Protected	0.98	
Satd. Flow (prot)	1576	
Flt Permitted	0.68	
Satd. Flow (perm)	1088	
Peak-hour factor, PHF	0.90	0.90
Adj. Flow (vph)	10	58
RTOR Reduction (vph)	36	0
Lane Group Flow (vph)	78	0
Confl. Peds. (#/hr)		11
Heavy Vehicles (%)	0%	2%
Bus Blockages (#/hr)	0	0
Turn Type	NA	
Protected Phases	4	
Permitted Phases		
Actuated Green, G (s)	13.6	
Effective Green, g (s)	13.6	
Actuated g/C Ratio	0.10	
Clearance Time (s)	6.7	
Vehicle Extension (s)	3.0	
Lane Grp Cap (vph)	113	
v/s Ratio Prot		
v/s Ratio Perm	c0.07	
v/c Ratio	0.69	
Uniform Delay, d1	56.2	
Progression Factor	1.00	
Incremental Delay, d2	16.7	
Delay (s)	72.9	
Level of Service	E	
Approach Delay (s)	72.9	
Approach LOS	E	
Intersection Summary		

HCM Signalized Intersection Capacity Analysis
3: Carling Ave & Croydon Ave

Existing (2019)
AM Peak Hour



Movement	EBU	EBL	EBT	WBU	WBT	WBR	SBL	SBR
Lane Configurations		↔	↑↑↑		↑↑↑		↔	
Traffic Volume (vph)	2	93	2522	1	906	88	156	25
Future Volume (vph)	2	93	2522	1	906	88	156	25
Ideal Flow (vphpl)	1800	1800	1800	1800	1800	1800	1800	1800
Lane Width	3.7	2.8	3.6	3.7	3.7	3.7	3.7	3.3
Total Lost time (s)		5.9	5.9		5.9		6.3	
Lane Util. Factor		1.00	0.91		0.91		0.97	
Frbp, ped/bikes		1.00	1.00		0.99		1.00	
Flpb, ped/bikes		1.00	1.00		1.00		1.00	
Frt		1.00	1.00		0.99		0.98	
Flt Protected		0.95	1.00		1.00		0.96	
Satd. Flow (prot)		1539	4742		4597		3145	
Flt Permitted		0.22	1.00		0.94		0.96	
Satd. Flow (perm)		352	4742		4306		3145	
Peak-hour factor, PHF	0.90	0.90	0.90	0.90	0.90	0.90	0.90	0.90
Adj. Flow (vph)	2	103	2802	1	1007	98	173	28
RTOR Reduction (vph)	0	0	0	0	6	0	12	0
Lane Group Flow (vph)	0	105	2802	0	1100	0	189	0
Confl. Peds. (#/hr)	19	16		2		16	19	2
Heavy Vehicles (%)	0%	1%	1%	0%	3%	7%	6%	0%
Bus Blockages (#/hr)	0	0	19	0	19	0	0	0
Turn Type	Perm	pm+pt	NA	Perm	NA		Prot	
Protected Phases		5	2		6		7	
Permitted Phases	2	2		6				
Actuated Green, G (s)		104.5	104.5		91.2		13.3	
Effective Green, g (s)		104.5	104.5		91.2		13.3	
Actuated g/C Ratio		0.80	0.80		0.70		0.10	
Clearance Time (s)		5.9	5.9		5.9		6.3	
Vehicle Extension (s)		3.0	3.0		3.0		3.0	
Lane Grp Cap (vph)		350	3811		3020		321	
v/s Ratio Prot		0.02	c0.59				c0.06	
v/s Ratio Perm		0.22			0.26			
v/c Ratio		0.30	0.74		0.36		0.59	
Uniform Delay, d1		3.3	6.1		7.8		55.7	
Progression Factor		0.59	0.28		1.00		1.00	
Incremental Delay, d2		0.3	0.8		0.3		2.8	
Delay (s)		2.3	2.5		8.1		58.5	
Level of Service		A	A		A		E	
Approach Delay (s)			2.5		8.1		58.5	
Approach LOS			A		A		E	
Intersection Summary								
HCM 2000 Control Delay			6.7		HCM 2000 Level of Service			A
HCM 2000 Volume to Capacity ratio			0.76					
Actuated Cycle Length (s)			130.0		Sum of lost time (s)			18.1
Intersection Capacity Utilization			96.7%		ICU Level of Service			F
Analysis Period (min)			15					

c Critical Lane Group

HCM Unsignalized Intersection Capacity Analysis
4: Carling Ave & Forest St

Existing (2019)
AM Peak Hour



Movement	EBL	EBT	WBT	WBR	SBL	SBR	
Lane Configurations		↑↑↑	↑↑↑			↗	
Traffic Volume (veh/h)	0	2615	911	22	0	48	
Future Volume (Veh/h)	0	2615	911	22	0	48	
Sign Control		Free	Free		Stop		
Grade		0%	0%		0%		
Peak Hour Factor	0.90	0.90	0.90	0.90	0.90	0.90	
Hourly flow rate (vph)	0	2906	1012	24	0	53	
Pedestrians						36	
Lane Width (m)						4.8	
Walking Speed (m/s)						1.0	
Percent Blockage						5	
Right turn flare (veh)							
Median type		None	None				
Median storage (veh)							
Upstream signal (m)		55	141				
pX, platoon unblocked	0.93				0.64	0.93	
vC, conflicting volume	1072				2029	385	
vC1, stage 1 conf vol							
vC2, stage 2 conf vol							
vCu, unblocked vol	794				0	52	
tC, single (s)	4.1				6.8	6.9	
tC, 2 stage (s)							
tF (s)	2.2				3.5	3.3	
p0 queue free %	100				100	94	
cM capacity (veh/h)	736				625	891	
Direction, Lane #	EB 1	EB 2	EB 3	WB 1	WB 2	WB 3	SB 1
Volume Total	969	969	969	405	405	226	53
Volume Left	0	0	0	0	0	0	0
Volume Right	0	0	0	0	0	24	53
cSH	1700	1700	1700	1700	1700	1700	891
Volume to Capacity	0.57	0.57	0.57	0.24	0.24	0.13	0.06
Queue Length 95th (m)	0.0	0.0	0.0	0.0	0.0	0.0	1.4
Control Delay (s)	0.0	0.0	0.0	0.0	0.0	0.0	9.3
Lane LOS							A
Approach Delay (s)	0.0			0.0			9.3
Approach LOS							A
Intersection Summary							
Average Delay			0.1				
Intersection Capacity Utilization			56.7%		ICU Level of Service		B
Analysis Period (min)			15				

HCM Unsignalized Intersection Capacity Analysis
5: Croydon Ave & Bond St

Existing (2019)
AM Peak Hour



Movement	EBL	EBR	NBL	NBT	SBT	SBR
Lane Configurations						
Traffic Volume (veh/h)	1	9	9	172	172	9
Future Volume (Veh/h)	1	9	9	172	172	9
Sign Control	Stop			Free	Free	
Grade	0%			0%	0%	
Peak Hour Factor	0.90	0.90	0.90	0.90	0.90	0.90
Hourly flow rate (vph)	1	10	10	191	191	10
Pedestrians	24					
Lane Width (m)	4.3					
Walking Speed (m/s)	1.0					
Percent Blockage	3					
Right turn flare (veh)						
Median type				None	None	
Median storage (veh)						
Upstream signal (m)				78	181	
pX, platoon unblocked						
vC, conflicting volume	431	220	225			
vC1, stage 1 conf vol						
vC2, stage 2 conf vol						
vCu, unblocked vol	431	220	225			
tC, single (s)	6.4	6.2	4.1			
tC, 2 stage (s)						
tF (s)	3.5	3.3	2.2			
p0 queue free %	100	99	99			
cM capacity (veh/h)	564	801	1317			
Direction, Lane #	EB 1	NB 1	SB 1			
Volume Total	11	201	201			
Volume Left	1	10	0			
Volume Right	10	0	10			
cSH	772	1317	1700			
Volume to Capacity	0.01	0.01	0.12			
Queue Length 95th (m)	0.3	0.2	0.0			
Control Delay (s)	9.7	0.4	0.0			
Lane LOS	A	A				
Approach Delay (s)	9.7	0.4	0.0			
Approach LOS	A					
Intersection Summary						
Average Delay			0.5			
Intersection Capacity Utilization			27.3%	ICU Level of Service	A	
Analysis Period (min)			15			

HCM Unsignalized Intersection Capacity Analysis
6: Forest St & Bond St

Existing (2019)
AM Peak Hour



Movement	WBL	WBR	NBT	NBR	SBL	SBT
Lane Configurations	W		T	R		L
Traffic Volume (veh/h)	1	5	21	1	12	47
Future Volume (Veh/h)	1	5	21	1	12	47
Sign Control	Stop		Free		Free	
Grade	0%		0%		0%	
Peak Hour Factor	0.90	0.90	0.90	0.90	0.90	0.90
Hourly flow rate (vph)	1	6	23	1	13	52
Pedestrians	10					
Lane Width (m)	3.5					
Walking Speed (m/s)	1.0					
Percent Blockage	1					
Right turn flare (veh)						
Median type	None			None		
Median storage (veh)						
Upstream signal (m)						
pX, platoon unblocked						
vC, conflicting volume	112	34			34	
vC1, stage 1 conf vol						
vC2, stage 2 conf vol						
vCu, unblocked vol	112	34			34	
tC, single (s)	6.4	6.2			4.1	
tC, 2 stage (s)						
tF (s)	3.5	3.3			2.2	
p0 queue free %	100	99			99	
cM capacity (veh/h)	874	1035			1575	
Direction, Lane #	WB 1	NB 1	SB 1			
Volume Total	7	24	65			
Volume Left	1	0	13			
Volume Right	6	1	0			
cSH	1009	1700	1575			
Volume to Capacity	0.01	0.01	0.01			
Queue Length 95th (m)	0.2	0.0	0.2			
Control Delay (s)	8.6	0.0	1.5			
Lane LOS	A		A			
Approach Delay (s)	8.6	0.0	1.5			
Approach LOS	A					
Intersection Summary						
Average Delay			1.6			
Intersection Capacity Utilization			20.0%	ICU Level of Service	A	
Analysis Period (min)			15			

HCM Unsignalized Intersection Capacity Analysis
7: Forest St & Richmond Rd





















Existing (2019)
AM Peak Hour



Movement	EBT	EBR	WBL	WBT	NBL	NBR
Lane Configurations	→			←	↙	↘
Traffic Volume (veh/h)	560	10	21	390	10	29
Future Volume (Veh/h)	560	10	21	390	10	29
Sign Control	Free			Free	Stop	
Grade	0%			0%	0%	
Peak Hour Factor	0.90	0.90	0.90	0.90	0.90	0.90
Hourly flow rate (vph)	622	11	23	433	11	32
Pedestrians					10	
Lane Width (m)					4.7	
Walking Speed (m/s)					1.0	
Percent Blockage					1	
Right turn flare (veh)						
Median type	None			None		
Median storage veh						
Upstream signal (m)				154		
pX, platoon unblocked					0.93	
vC, conflicting volume			643		1116 638	
vC1, stage 1 conf vol						
vC2, stage 2 conf vol						
vCu, unblocked vol			643		1088 638	
tC, single (s)			4.1		6.4 6.2	
tC, 2 stage (s)						
tF (s)			2.2		3.5 3.3	
p0 queue free %			98		95 93	
cM capacity (veh/h)			939		216 474	
Direction, Lane #	EB 1	WB 1	NB 1			
Volume Total	633	456	43			
Volume Left	0	23	11			
Volume Right	11	0	32			
cSH	1700	939	363			
Volume to Capacity	0.37	0.02	0.12			
Queue Length 95th (m)	0.0	0.6	3.0			
Control Delay (s)	0.0	0.7	16.2			
Lane LOS			A		C	
Approach Delay (s)	0.0	0.7	16.2			
Approach LOS			C			
Intersection Summary						
Average Delay			0.9			
Intersection Capacity Utilization			49.8%		ICU Level of Service A	
Analysis Period (min)			15			

HCM Signalized Intersection Capacity Analysis
 1: Croydon Ave & Richmond Rd/Richmond St

Existing (2019)
 PM Peak Hour

												
Movement	EBL	EBT	EBR	WBL	WBT	WBR	NBL	NBT	NBR	SBL	SBT	SBR
Lane Configurations												
Traffic Volume (vph)	23	419	82	54	744	16	118	89	33	13	56	18
Future Volume (vph)	23	419	82	54	744	16	118	89	33	13	56	18
Ideal Flow (vphpl)	1800	1800	1800	1800	1800	1800	1800	1800	1800	1800	1800	1800
Lane Width	3.4	3.4	3.7	3.0	3.4	3.7	3.5	3.5	3.7	3.7	4.8	3.7
Total Lost time (s)	6.4	6.4		6.4	6.4		6.1	6.1			6.1	
Lane Util. Factor	1.00	1.00		1.00	1.00		1.00	1.00			1.00	
Frpb, ped/bikes	1.00	0.99		1.00	1.00		1.00	0.97			0.99	
Flpb, ped/bikes	0.99	1.00		0.98	1.00		0.96	1.00			0.99	
Fr _t	1.00	0.98		1.00	1.00		1.00	0.96			0.97	
Fl _t Protected	0.95	1.00		0.95	1.00		0.95	1.00			0.99	
Satd. Flow (prot)	1653	1585		1533	1649		1573	1639			1917	
Fl _t Permitted	0.24	1.00		0.41	1.00		0.76	1.00			0.94	
Satd. Flow (perm)	424	1585		663	1649		1258	1639			1813	
Peak-hour factor, PHF	0.90	0.90	0.90	0.90	0.90	0.90	0.90	0.90	0.90	0.90	0.90	0.90
Adj. Flow (vph)	26	466	91	60	827	18	131	99	37	14	62	20
RTOR Reduction (vph)	0	6	0	0	1	0	0	18	0	0	13	0
Lane Group Flow (vph)	26	551	0	60	844	0	131	118	0	0	83	0
Confl. Peds. (#/hr)	30		24	24		30	29		59	59		29
Heavy Vehicles (%)	0%	2%	7%	2%	2%	0%	3%	0%	3%	0%	0%	0%
Bus Blockages (#/hr)	0	10	0	0	10	0	0	0	0	0	0	0
Turn Type	Perm	NA		Perm	NA		Perm	NA		Perm	NA	
Protected Phases		2			6			8			4	
Permitted Phases	2			6			8			4		
Actuated Green, G (s)	58.0	58.0		58.0	58.0		14.5	14.5			14.5	
Effective Green, g (s)	58.0	58.0		58.0	58.0		14.5	14.5			14.5	
Actuated g/C Ratio	0.68	0.68		0.68	0.68		0.17	0.17			0.17	
Clearance Time (s)	6.4	6.4		6.4	6.4		6.1	6.1			6.1	
Vehicle Extension (s)	3.0	3.0		3.0	3.0		3.0	3.0			3.0	
Lane Grp Cap (vph)	289	1081		452	1125		214	279			309	
v/s Ratio Prot		0.35			c0.51			0.07				
v/s Ratio Perm	0.06			0.09			c0.10				0.05	
v/c Ratio	0.09	0.51		0.13	0.75		0.61	0.42			0.27	
Uniform Delay, d1	4.6	6.6		4.7	8.8		32.6	31.5			30.6	
Progression Factor	1.00	1.00		1.00	1.00		1.00	1.00			1.00	
Incremental Delay, d2	0.6	1.7		0.6	4.6		5.1	1.0			0.5	
Delay (s)	5.2	8.3		5.3	13.4		37.8	32.5			31.1	
Level of Service	A	A		A	B		D	C			C	
Approach Delay (s)		8.2			12.9			35.1			31.1	
Approach LOS		A			B			D			C	
Intersection Summary												
HCM 2000 Control Delay			15.5				HCM 2000 Level of Service				B	
HCM 2000 Volume to Capacity ratio			0.72									
Actuated Cycle Length (s)			85.0				Sum of lost time (s)			12.5		
Intersection Capacity Utilization			77.6%				ICU Level of Service			D		
Analysis Period (min)			15									

c Critical Lane Group

HCM Signalized Intersection Capacity Analysis
 2: Alpine Ave/1460 Richmond & Carling Ave

Existing (2019)
 PM Peak Hour

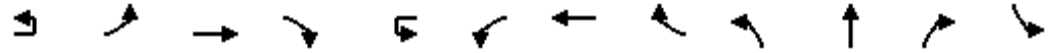

Movement	EBU	EBL	EBT	EBR	WBU	WBL	WBT	WBR	NBL	NBT	NBR	SBL
Lane Configurations												
Traffic Volume (vph)	3	23	1062	8	4	46	1770	69	17	13	27	43
Future Volume (vph)	3	23	1062	8	4	46	1770	69	17	13	27	43
Ideal Flow (vphpl)	1800	1800	1800	1800	1800	1800	1800	1800	1800	1800	1800	1800
Lane Width	3.7	3.0	3.6	3.7	3.7	3.0	3.7	3.7	3.7	4.8	3.7	3.7
Total Lost time (s)		5.9	5.9			5.9	5.9			6.7		
Lane Util. Factor		1.00	0.91			1.00	0.91			1.00		
Frbp, ped/bikes		1.00	1.00			1.00	1.00			0.98		
Flpb, ped/bikes		1.00	1.00			1.00	1.00			0.99		
Frt		1.00	1.00			1.00	0.99			0.94		
Flt Protected		0.95	1.00			0.95	1.00			0.99		
Satd. Flow (prot)		1596	4760			1564	4821			1740		
Flt Permitted		0.07	1.00			0.21	1.00			0.85		
Satd. Flow (perm)		122	4760			340	4821			1509		
Peak-hour factor, PHF	0.90	0.90	0.90	0.90	0.90	0.90	0.90	0.90	0.90	0.90	0.90	0.90
Adj. Flow (vph)	3	26	1180	9	4	51	1967	77	19	14	30	48
RTOR Reduction (vph)	0	0	0	0	0	0	2	0	0	27	0	0
Lane Group Flow (vph)	0	29	1189	0	0	55	2042	0	0	36	0	0
Confl. Peds. (#/hr)	32	40		13	14	13		40	32		14	14
Heavy Vehicles (%)	0%	0%	2%	0%	0%	2%	1%	0%	12%	0%	4%	2%
Bus Blockages (#/hr)	0	0	8	0	0	0	8	0	0	0	0	0
Turn Type	Perm	pm+pt	NA		Perm	pm+pt	NA		Perm	NA		Perm
Protected Phases		5	2			1	6			8		
Permitted Phases	2	2			6	6			8			4
Actuated Green, G (s)		96.2	92.4			99.4	94.0			13.7		
Effective Green, g (s)		96.2	92.4			99.4	94.0			13.7		
Actuated g/C Ratio		0.74	0.71			0.76	0.72			0.11		
Clearance Time (s)		5.9	5.9			5.9	5.9			6.7		
Vehicle Extension (s)		3.0	3.0			3.0	3.0			3.0		
Lane Grp Cap (vph)		133	3383			310	3485			159		
v/s Ratio Prot		0.01	0.25			c0.01	c0.42					
v/s Ratio Perm		0.15				0.13				0.02		
v/c Ratio		0.22	0.35			0.18	0.59			0.23		
Uniform Delay, d1		6.0	7.2			4.0	8.6			53.3		
Progression Factor		1.00	1.00			0.94	0.64			1.00		
Incremental Delay, d2		0.8	0.3			0.2	0.6			0.7		
Delay (s)		6.9	7.5			4.0	6.1			54.0		
Level of Service		A	A			A	A			D		
Approach Delay (s)			7.5				6.1			54.0		
Approach LOS			A				A			D		
Intersection Summary												
HCM 2000 Control Delay			9.0				HCM 2000 Level of Service			A		
HCM 2000 Volume to Capacity ratio			0.57									
Actuated Cycle Length (s)			130.0				Sum of lost time (s)			18.5		
Intersection Capacity Utilization			77.4%				ICU Level of Service			D		
Analysis Period (min)			15									

c Critical Lane Group

HCM Signalized Intersection Capacity Analysis
 2: Alpine Ave/1460 Richmond & Carling Ave

Existing (2019)
 PM Peak Hour



Movement	SBT	SBR
Lane Configurations	↕	
Traffic Volume (vph)	15	32
Future Volume (vph)	15	32
Ideal Flow (vphpl)	1800	1800
Lane Width	3.6	3.7
Total Lost time (s)	6.7	
Lane Util. Factor	1.00	
Frbp, ped/bikes	0.98	
Flpb, ped/bikes	0.99	
Frt	0.95	
Flt Protected	0.98	
Satd. Flow (prot)	1616	
Flt Permitted	0.85	
Satd. Flow (perm)	1406	
Peak-hour factor, PHF	0.90	0.90
Adj. Flow (vph)	17	36
RTOR Reduction (vph)	19	0
Lane Group Flow (vph)	82	0
Confl. Peds. (#/hr)		32
Heavy Vehicles (%)	0%	0%
Bus Blockages (#/hr)	0	0
Turn Type	NA	
Protected Phases	4	
Permitted Phases		
Actuated Green, G (s)	13.7	
Effective Green, g (s)	13.7	
Actuated g/C Ratio	0.11	
Clearance Time (s)	6.7	
Vehicle Extension (s)	3.0	
Lane Grp Cap (vph)	148	
v/s Ratio Prot		
v/s Ratio Perm	c0.06	
v/c Ratio	0.56	
Uniform Delay, d1	55.3	
Progression Factor	1.00	
Incremental Delay, d2	4.5	
Delay (s)	59.7	
Level of Service	E	
Approach Delay (s)	59.7	
Approach LOS	E	
Intersection Summary		

HCM Signalized Intersection Capacity Analysis
3: Carling Ave & Croydon Ave

Existing (2019)
PM Peak Hour



Movement	EBU	EBL	EBT	WBU	WBT	WBR	SBL	SBR
Lane Configurations		↔	↑↑↑		↑↑↑		↔	
Traffic Volume (vph)	6	64	1066	1	1775	128	147	81
Future Volume (vph)	6	64	1066	1	1775	128	147	81
Ideal Flow (vphpl)	1800	1800	1800	1800	1800	1800	1800	1800
Lane Width	3.7	2.8	3.6	3.7	3.7	3.7	3.7	3.3
Total Lost time (s)		5.9	5.9		5.9		6.3	
Lane Util. Factor		1.00	0.91		0.91		0.97	
Frbp, ped/bikes		1.00	1.00		0.99		0.99	
Flpb, ped/bikes		1.00	1.00		1.00		1.00	
Frt		1.00	1.00		0.99		0.95	
Flt Protected		0.95	1.00		1.00		0.97	
Satd. Flow (prot)		1530	4696		4693		3132	
Flt Permitted		0.06	1.00		0.94		0.97	
Satd. Flow (perm)		95	4696		4410		3132	
Peak-hour factor, PHF	0.90	0.90	0.90	0.90	0.90	0.90	0.90	0.90
Adj. Flow (vph)	7	71	1184	1	1972	142	163	90
RTOR Reduction (vph)	0	0	0	0	4	0	74	0
Lane Group Flow (vph)	0	78	1184	0	2111	0	179	0
Confl. Peds. (#/hr)	22	39		3		39	3	22
Heavy Vehicles (%)	0%	2%	2%	0%	1%	5%	3%	0%
Bus Blockages (#/hr)	0	0	19	0	19	0	0	0
Turn Type	Perm	pm+pt	NA	Perm	NA		Prot	
Protected Phases		5	2		6		7	
Permitted Phases	2	2		6				
Actuated Green, G (s)		104.8	104.8		92.1		13.0	
Effective Green, g (s)		104.8	104.8		92.1		13.0	
Actuated g/C Ratio		0.81	0.81		0.71		0.10	
Clearance Time (s)		5.9	5.9		5.9		6.3	
Vehicle Extension (s)		3.0	3.0		3.0		3.0	
Lane Grp Cap (vph)		151	3785		3124		313	
v/s Ratio Prot		c0.03	0.25				c0.06	
v/s Ratio Perm		0.39			c0.48			
v/c Ratio		0.52	0.31		0.68		0.57	
Uniform Delay, d1		10.1	3.3		10.6		55.8	
Progression Factor		3.11	0.30		1.00		1.00	
Incremental Delay, d2		2.8	0.2		1.2		2.5	
Delay (s)		34.2	1.2		11.8		58.4	
Level of Service		C	A		B		E	
Approach Delay (s)			3.2		11.8		58.4	
Approach LOS			A		B		E	
Intersection Summary								
HCM 2000 Control Delay			12.1		HCM 2000 Level of Service			B
HCM 2000 Volume to Capacity ratio			0.65					
Actuated Cycle Length (s)			130.0		Sum of lost time (s)		18.1	
Intersection Capacity Utilization			89.0%		ICU Level of Service			E
Analysis Period (min)			15					

c Critical Lane Group

HCM Unsignalized Intersection Capacity Analysis
4: Carling Ave & Forest St

Existing (2019)
PM Peak Hour



Movement	EBL	EBT	WBT	WBR	SBL	SBR	
Lane Configurations		↑↑↑	↑↑↑			↑	
Traffic Volume (veh/h)	0	1136	1830	32	0	59	
Future Volume (Veh/h)	0	1136	1830	32	0	59	
Sign Control		Free	Free		Stop		
Grade		0%	0%		0%		
Peak Hour Factor	0.90	0.90	0.90	0.90	0.90	0.90	
Hourly flow rate (vph)	0	1262	2033	36	0	66	
Pedestrians					40		
Lane Width (m)					4.8		
Walking Speed (m/s)					1.0		
Percent Blockage					5		
Right turn flare (veh)							
Median type		None	None				
Median storage (veh)							
Upstream signal (m)		55	141				
pX, platoon unblocked	0.77				0.81	0.77	
vC, conflicting volume	2109				2512	736	
vC1, stage 1 conf vol							
vC2, stage 2 conf vol							
vCu, unblocked vol	1388				1292	0	
tC, single (s)	4.1				6.8	6.9	
tC, 2 stage (s)							
tF (s)	2.2				3.5	3.3	
p0 queue free %	100				100	92	
cM capacity (veh/h)	363				121	793	
Direction, Lane #	EB 1	EB 2	EB 3	WB 1	WB 2	WB 3	SB 1
Volume Total	421	421	421	813	813	443	66
Volume Left	0	0	0	0	0	0	0
Volume Right	0	0	0	0	0	36	66
cSH	1700	1700	1700	1700	1700	1700	793
Volume to Capacity	0.25	0.25	0.25	0.48	0.48	0.26	0.08
Queue Length 95th (m)	0.0	0.0	0.0	0.0	0.0	0.0	2.1
Control Delay (s)	0.0	0.0	0.0	0.0	0.0	0.0	9.9
Lane LOS							A
Approach Delay (s)	0.0			0.0			9.9
Approach LOS							A
Intersection Summary							
Average Delay			0.2				
Intersection Capacity Utilization			48.7%		ICU Level of Service		A
Analysis Period (min)			15				

HCM Unsignalized Intersection Capacity Analysis
5: Croydon Ave & Bond St

Existing (2019)
PM Peak Hour



Movement	EBL	EBR	NBL	NBT	SBT	SBR
Lane Configurations						
Traffic Volume (veh/h)	1	11	10	182	217	11
Future Volume (Veh/h)	1	11	10	182	217	11
Sign Control	Stop			Free	Free	
Grade	0%			0%	0%	
Peak Hour Factor	0.90	0.90	0.90	0.90	0.90	0.90
Hourly flow rate (vph)	1	12	11	202	241	12
Pedestrians	26					
Lane Width (m)	4.3					
Walking Speed (m/s)	1.0					
Percent Blockage	3					
Right turn flare (veh)						
Median type				None	None	
Median storage (veh)						
Upstream signal (m)				78	181	
pX, platoon unblocked						
vC, conflicting volume	497	273	279			
vC1, stage 1 conf vol						
vC2, stage 2 conf vol						
vCu, unblocked vol	497	273	279			
tC, single (s)	6.4	6.2	4.1			
tC, 2 stage (s)						
tF (s)	3.5	3.3	2.2			
p0 queue free %	100	98	99			
cM capacity (veh/h)	515	747	1255			
Direction, Lane #	EB 1	NB 1	SB 1			
Volume Total	13	213	253			
Volume Left	1	11	0			
Volume Right	12	0	12			
cSH	722	1255	1700			
Volume to Capacity	0.02	0.01	0.15			
Queue Length 95th (m)	0.4	0.2	0.0			
Control Delay (s)	10.1	0.5	0.0			
Lane LOS	B	A				
Approach Delay (s)	10.1	0.5	0.0			
Approach LOS	B					
Intersection Summary						
Average Delay			0.5			
Intersection Capacity Utilization			28.7%	ICU Level of Service	A	
Analysis Period (min)			15			

HCM Unsignalized Intersection Capacity Analysis
6: Forest St & Bond St

Existing (2019)
PM Peak Hour



Movement	WBL	WBR	NBT	NBR	SBL	SBT
Lane Configurations						
Traffic Volume (veh/h)	1	8	31	1	15	58
Future Volume (Veh/h)	1	8	31	1	15	58
Sign Control	Stop		Free			Free
Grade	0%		0%			0%
Peak Hour Factor	0.90	0.90	0.90	0.90	0.90	0.90
Hourly flow rate (vph)	1	9	34	1	17	64
Pedestrians	10					
Lane Width (m)	3.5					
Walking Speed (m/s)	1.0					
Percent Blockage	1					
Right turn flare (veh)						
Median type			None			None
Median storage (veh)						
Upstream signal (m)						
pX, platoon unblocked						
vC, conflicting volume	142	44			45	
vC1, stage 1 conf vol						
vC2, stage 2 conf vol						
vCu, unblocked vol	142	44			45	
tC, single (s)	6.4	6.2			4.1	
tC, 2 stage (s)						
tF (s)	3.5	3.3			2.2	
p0 queue free %	100	99			99	
cM capacity (veh/h)	837	1021			1561	
Direction, Lane #	WB 1	NB 1	SB 1			
Volume Total	10	35	81			
Volume Left	1	0	17			
Volume Right	9	1	0			
cSH	999	1700	1561			
Volume to Capacity	0.01	0.02	0.01			
Queue Length 95th (m)	0.2	0.0	0.3			
Control Delay (s)	8.6	0.0	1.6			
Lane LOS	A		A			
Approach Delay (s)	8.6	0.0	1.6			
Approach LOS	A					
Intersection Summary						
Average Delay			1.7			
Intersection Capacity Utilization			20.8%		ICU Level of Service	A
Analysis Period (min)			15			

HCM Unsignalized Intersection Capacity Analysis
7: Forest St & Richmond Rd

Existing (2019)
PM Peak Hour























Movement	EBT	EBR	WBL	WBT	NBL	NBR
Lane Configurations	→	↘	↙	←	↖	↗
Traffic Volume (veh/h)	498	10	44	836	10	26
Future Volume (Veh/h)	498	10	44	836	10	26
Sign Control	Free			Free	Stop	
Grade	0%			0%	0%	
Peak Hour Factor	0.90	0.90	0.90	0.90	0.90	0.90
Hourly flow rate (vph)	553	11	49	929	11	29
Pedestrians					10	
Lane Width (m)					4.7	
Walking Speed (m/s)					1.0	
Percent Blockage					1	
Right turn flare (veh)						
Median type	None			None		
Median storage veh						
Upstream signal (m)				154		
pX, platoon unblocked					0.60	
vC, conflicting volume			574		1596 568	
vC1, stage 1 conf vol						
vC2, stage 2 conf vol						
vCu, unblocked vol			574		1660 568	
tC, single (s)			4.1		6.4 6.2	
tC, 2 stage (s)						
tF (s)			2.2		3.5 3.3	
p0 queue free %			95		82 94	
cM capacity (veh/h)			996		61 519	
Direction, Lane #	EB 1	WB 1	NB 1			
Volume Total	564	978	40			
Volume Left	0	49	11			
Volume Right	11	0	29			
cSH	1700	996	169			
Volume to Capacity	0.33	0.05	0.24			
Queue Length 95th (m)	0.0	1.2	6.7			
Control Delay (s)	0.0	1.3	32.8			
Lane LOS			A		D	
Approach Delay (s)	0.0	1.3	32.8			
Approach LOS			D			
Intersection Summary						
Average Delay			1.7			
Intersection Capacity Utilization			90.7%		ICU Level of Service E	
Analysis Period (min)			15			

Appendix E – Future (2024) Background Level of Service Calculations

HCM Signalized Intersection Capacity Analysis
1: Croydon Ave & Richmond Rd/Richmond St

Future Background (2024)
AM Peak Hour

												
Movement	EBL	EBT	EBR	WBL	WBT	WBR	NBL	NBT	NBR	SBL	SBT	SBR
Lane Configurations												
Traffic Volume (vph)	22	568	69	17	379	17	37	29	81	28	72	38
Future Volume (vph)	22	568	69	17	379	17	37	29	81	28	72	38
Ideal Flow (vphpl)	1800	1800	1800	1800	1800	1800	1800	1800	1800	1800	1800	1800
Lane Width	3.4	3.4	3.7	3.0	3.4	3.7	3.5	3.5	3.7	3.7	4.8	3.7
Total Lost time (s)	6.4	6.4		6.4	6.4		6.1	6.1			6.1	
Lane Util. Factor	1.00	1.00		1.00	1.00		1.00	1.00			1.00	
Frbp, ped/bikes	1.00	0.99		1.00	1.00		1.00	0.94			0.98	
Flpb, ped/bikes	0.98	1.00		0.99	1.00		0.97	1.00			0.99	
Frnt	1.00	0.98		1.00	0.99		1.00	0.89			0.96	
Flt Protected	0.95	1.00		0.95	1.00		0.95	1.00			0.99	
Satd. Flow (prot)	1555	1593		1579	1613		1540	1423			1823	
Flt Permitted	0.53	1.00		0.37	1.00		0.68	1.00			0.90	
Satd. Flow (perm)	865	1593		623	1613		1109	1423			1658	
Peak-hour factor, PHF	1.00	1.00	1.00	1.00	1.00	1.00	1.00	1.00	1.00	1.00	1.00	1.00
Adj. Flow (vph)	22	568	69	17	379	17	37	29	81	28	72	38
RTOR Reduction (vph)	0	4	0	0	1	0	0	70	0	0	26	0
Lane Group Flow (vph)	22	633	0	17	395	0	37	40	0	0	112	0
Confl. Peds. (#/hr)	23		17	17		23	32		45	45		32
Heavy Vehicles (%)	5%	3%	10%	0%	4%	0%	6%	9%	3%	7%	0%	8%
Bus Blockages (#/hr)	0	10	0	0	10	0	0	0	0	0	0	0
Turn Type	Perm	NA		Perm	NA		Perm	NA		Perm	NA	
Protected Phases		2			6			8			4	
Permitted Phases	2			6			8			4		
Actuated Green, G (s)	48.3	48.3		48.3	48.3		9.2	9.2			9.2	
Effective Green, g (s)	48.3	48.3		48.3	48.3		9.2	9.2			9.2	
Actuated g/C Ratio	0.69	0.69		0.69	0.69		0.13	0.13			0.13	
Clearance Time (s)	6.4	6.4		6.4	6.4		6.1	6.1			6.1	
Vehicle Extension (s)	3.0	3.0		3.0	3.0		3.0	3.0			3.0	
Lane Grp Cap (vph)	596	1099		429	1112		145	187			217	
v/s Ratio Prot		c0.40			0.24			0.03				
v/s Ratio Perm	0.03			0.03			0.03				c0.07	
v/c Ratio	0.04	0.58		0.04	0.35		0.26	0.21			0.52	
Uniform Delay, d1	3.5	5.6		3.5	4.5		27.3	27.2			28.3	
Progression Factor	1.00	1.00		1.00	1.00		1.00	1.00			1.00	
Incremental Delay, d2	0.1	2.2		0.2	0.9		0.9	0.6			2.1	
Delay (s)	3.6	7.8		3.6	5.3		28.3	27.7			30.4	
Level of Service	A	A		A	A		C	C			C	
Approach Delay (s)		7.6			5.3			27.9			30.4	
Approach LOS		A			A			C			C	
Intersection Summary												
HCM 2000 Control Delay			11.4				HCM 2000 Level of Service				B	
HCM 2000 Volume to Capacity ratio			0.57									
Actuated Cycle Length (s)			70.0				Sum of lost time (s)				12.5	
Intersection Capacity Utilization			65.6%				ICU Level of Service				C	
Analysis Period (min)			15									

c Critical Lane Group

HCM Signalized Intersection Capacity Analysis
 2: Alpine Ave/1460 Richmond & Carling Ave

Future Background (2024)
 AM Peak Hour

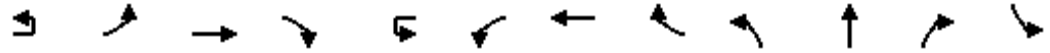

Movement	EBU	EBL	EBT	EBR	WBU	WBL	WBT	WBR	NBL	NBT	NBR	SBL
Lane Configurations		↔	↑↑↑			↔	↑↑↑			↔		
Traffic Volume (vph)	6	32	2751	6	4	33	946	75	24	8	96	45
Future Volume (vph)	6	32	2751	6	4	33	946	75	24	8	96	45
Ideal Flow (vphpl)	1800	1800	1800	1800	1800	1800	1800	1800	1800	1800	1800	1800
Lane Width	3.7	3.0	3.6	3.7	3.7	3.0	3.7	3.7	3.7	4.8	3.7	3.7
Total Lost time (s)		5.9	5.9			5.9	5.9			6.7		
Lane Util. Factor		1.00	0.91			1.00	0.91			1.00		
Frbp, ped/bikes		1.00	1.00			1.00	0.99			0.96		
Flpb, ped/bikes		0.97	1.00			1.00	1.00			1.00		
Frt		1.00	1.00			1.00	0.99			0.90		
Flt Protected		0.95	1.00			0.95	1.00			0.99		
Satd. Flow (prot)		1511	4811			1596	4681			1683		
Flt Permitted		0.27	1.00			0.04	1.00			0.88		
Satd. Flow (perm)		427	4811			68	4681			1495		
Peak-hour factor, PHF	1.00	1.00	1.00	1.00	1.00	1.00	1.00	1.00	1.00	1.00	1.00	1.00
Adj. Flow (vph)	6	32	2751	6	4	33	946	75	24	8	96	45
RTOR Reduction (vph)	0	0	0	0	0	0	4	0	0	55	0	0
Lane Group Flow (vph)	0	38	2757	0	0	37	1017	0	0	73	0	0
Confl. Peds. (#/hr)	12	40		30	30	30		40	12		30	30
Heavy Vehicles (%)	0%	3%	1%	0%	0%	0%	3%	3%	9%	0%	2%	2%
Bus Blockages (#/hr)	0	0	8	0	0	0	8	0	0	0	0	0
Turn Type	Perm	Perm	NA		Perm	pm+pt	NA		Perm	NA		Perm
Protected Phases			2			1	6			8		
Permitted Phases	2	2			6	6			8			4
Actuated Green, G (s)		92.9	92.9			103.8	103.8			13.6		
Effective Green, g (s)		92.9	92.9			103.8	103.8			13.6		
Actuated g/C Ratio		0.71	0.71			0.80	0.80			0.10		
Clearance Time (s)		5.9	5.9			5.9	5.9			6.7		
Vehicle Extension (s)		3.0	3.0			3.0	3.0			3.0		
Lane Grp Cap (vph)		305	3438			113	3737			156		
v/s Ratio Prot			c0.57			0.01	c0.22					
v/s Ratio Perm		0.09				0.25				0.05		
v/c Ratio		0.12	0.80			0.33	0.27			0.47		
Uniform Delay, d1		5.8	12.4			14.8	3.4			54.8		
Progression Factor		1.00	1.00			3.34	0.82			1.00		
Incremental Delay, d2		0.8	2.1			1.6	0.2			2.2		
Delay (s)		6.6	14.5			50.9	2.9			57.0		
Level of Service		A	B			D	A			E		
Approach Delay (s)			14.4				4.6			57.0		
Approach LOS			B				A			E		
Intersection Summary												
HCM 2000 Control Delay			14.7			HCM 2000 Level of Service				B		
HCM 2000 Volume to Capacity ratio			0.77									
Actuated Cycle Length (s)			130.0			Sum of lost time (s)				18.5		
Intersection Capacity Utilization			85.9%			ICU Level of Service				E		
Analysis Period (min)			15									

c Critical Lane Group

HCM Signalized Intersection Capacity Analysis
 2: Alpine Ave/1460 Richmond & Carling Ave

Future Background (2024)
 AM Peak Hour



Movement	SBT	SBR
Lane Configurations	↕	
Traffic Volume (vph)	10	57
Future Volume (vph)	10	57
Ideal Flow (vphpl)	1800	1800
Lane Width	3.6	3.7
Total Lost time (s)	6.7	
Lane Util. Factor	1.00	
Frbp, ped/bikes	0.99	
Flpb, ped/bikes	0.99	
Frt	0.93	
Flt Protected	0.98	
Satd. Flow (prot)	1573	
Flt Permitted	0.68	
Satd. Flow (perm)	1093	
Peak-hour factor, PHF	1.00	1.00
Adj. Flow (vph)	10	57
RTOR Reduction (vph)	36	0
Lane Group Flow (vph)	76	0
Confl. Peds. (#/hr)		12
Heavy Vehicles (%)	0%	2%
Bus Blockages (#/hr)	0	0
Turn Type	NA	
Protected Phases	4	
Permitted Phases		
Actuated Green, G (s)	13.6	
Effective Green, g (s)	13.6	
Actuated g/C Ratio	0.10	
Clearance Time (s)	6.7	
Vehicle Extension (s)	3.0	
Lane Grp Cap (vph)	114	
v/s Ratio Prot		
v/s Ratio Perm	c0.07	
v/c Ratio	0.67	
Uniform Delay, d1	56.0	
Progression Factor	1.00	
Incremental Delay, d2	13.9	
Delay (s)	69.9	
Level of Service	E	
Approach Delay (s)	69.9	
Approach LOS	E	
Intersection Summary		

HCM Signalized Intersection Capacity Analysis

3: Carling Ave & Croydon Ave

Future Background (2024)
AM Peak Hour



Movement	EBU	EBL	EBT	WBU	WBT	WBR	SBL	SBR
Lane Configurations								
Traffic Volume (vph)	2	106	2790	1	999	97	172	28
Future Volume (vph)	2	106	2790	1	999	97	172	28
Ideal Flow (vphpl)	1800	1800	1800	1800	1800	1800	1800	1800
Lane Width	3.7	2.8	3.6	3.7	3.7	3.7	3.7	3.3
Total Lost time (s)		5.9	5.9		5.9		6.3	
Lane Util. Factor		1.00	0.91		0.91		0.97	
Frbp, ped/bikes		1.00	1.00		0.99		1.00	
Flpb, ped/bikes		1.00	1.00		1.00		1.00	
Frt		1.00	1.00		0.99		0.98	
Flt Protected		0.95	1.00		1.00		0.96	
Satd. Flow (prot)		1538	4742		4595		3145	
Flt Permitted		0.22	1.00		0.94		0.96	
Satd. Flow (perm)		355	4742		4304		3145	
Peak-hour factor, PHF	1.00	1.00	1.00	1.00	1.00	1.00	1.00	1.00
Adj. Flow (vph)	2	106	2790	1	999	97	172	28
RTOR Reduction (vph)	0	0	0	0	6	0	13	0
Lane Group Flow (vph)	0	108	2790	0	1091	0	187	0
Confl. Peds. (#/hr)	21	18		2		18	21	2
Heavy Vehicles (%)	0%	1%	1%	0%	3%	7%	6%	0%
Bus Blockages (#/hr)	0	0	19	0	19	0	0	0
Turn Type	Perm	pm+pt	NA	Perm	NA		Prot	
Protected Phases		5	2		6		7	
Permitted Phases	2	2		6				
Actuated Green, G (s)		104.5	104.5		91.1		13.3	
Effective Green, g (s)		104.5	104.5		91.1		13.3	
Actuated g/C Ratio		0.80	0.80		0.70		0.10	
Clearance Time (s)		5.9	5.9		5.9		6.3	
Vehicle Extension (s)		3.0	3.0		3.0		3.0	
Lane Grp Cap (vph)		353	3811		3016		321	
v/s Ratio Prot		0.02	c0.59				c0.06	
v/s Ratio Perm		0.23			0.25			
v/c Ratio		0.31	0.73		0.36		0.58	
Uniform Delay, d1		3.3	6.1		7.8		55.7	
Progression Factor		0.58	0.28		1.00		1.00	
Incremental Delay, d2		0.3	0.8		0.3		2.7	
Delay (s)		2.2	2.5		8.1		58.4	
Level of Service		A	A		A		E	
Approach Delay (s)			2.5		8.1		58.4	
Approach LOS			A		A		E	
Intersection Summary								
HCM 2000 Control Delay			6.6		HCM 2000 Level of Service			A
HCM 2000 Volume to Capacity ratio			0.75					
Actuated Cycle Length (s)			130.0		Sum of lost time (s)			18.1
Intersection Capacity Utilization			104.3%		ICU Level of Service			G
Analysis Period (min)			15					

c Critical Lane Group

HCM Unsignalized Intersection Capacity Analysis
4: Carling Ave & Forest St

Future Background (2024)
AM Peak Hour



Movement	EBL	EBT	WBT	WBR	SBL	SBR	
Lane Configurations		↑↑↑	↑↑↑			↗	
Traffic Volume (veh/h)	0	2896	1006	24	0	52	
Future Volume (Veh/h)	0	2896	1006	24	0	52	
Sign Control		Free	Free		Stop		
Grade		0%	0%		0%		
Peak Hour Factor	1.00	1.00	1.00	1.00	1.00	1.00	
Hourly flow rate (vph)	0	2896	1006	24	0	52	
Pedestrians					40		
Lane Width (m)					4.8		
Walking Speed (m/s)					1.0		
Percent Blockage					5		
Right turn flare (veh)							
Median type		None	None				
Median storage (veh)							
Upstream signal (m)		55	141				
pX, platoon unblocked	0.93				0.64	0.93	
vC, conflicting volume	1070				2023	387	
vC1, stage 1 conf vol							
vC2, stage 2 conf vol							
vCu, unblocked vol	795				0	57	
tC, single (s)	4.1				6.8	6.9	
tC, 2 stage (s)							
tF (s)	2.2				3.5	3.3	
p0 queue free %	100				100	94	
cM capacity (veh/h)	732				625	879	
Direction, Lane #	EB 1	EB 2	EB 3	WB 1	WB 2	WB 3	SB 1
Volume Total	965	965	965	402	402	225	52
Volume Left	0	0	0	0	0	0	0
Volume Right	0	0	0	0	0	24	52
cSH	1700	1700	1700	1700	1700	1700	879
Volume to Capacity	0.57	0.57	0.57	0.24	0.24	0.13	0.06
Queue Length 95th (m)	0.0	0.0	0.0	0.0	0.0	0.0	1.4
Control Delay (s)	0.0	0.0	0.0	0.0	0.0	0.0	9.4
Lane LOS							A
Approach Delay (s)	0.0			0.0			9.4
Approach LOS							A
Intersection Summary							
Average Delay			0.1				
Intersection Capacity Utilization			62.4%		ICU Level of Service		B
Analysis Period (min)			15				

HCM Unsignalized Intersection Capacity Analysis
5: Croydon Ave & Bond St

Future Background (2024)
AM Peak Hour



Movement	EBL	EBR	NBL	NBT	SBT	SBR
Lane Configurations						
Traffic Volume (veh/h)	1	10	10	193	190	10
Future Volume (Veh/h)	1	10	10	193	190	10
Sign Control	Stop			Free	Free	
Grade	0%			0%	0%	
Peak Hour Factor	1.00	1.00	1.00	1.00	1.00	1.00
Hourly flow rate (vph)	1	10	10	193	190	10
Pedestrians	26					
Lane Width (m)	4.3					
Walking Speed (m/s)	1.0					
Percent Blockage	3					
Right turn flare (veh)						
Median type				None	None	
Median storage (veh)						
Upstream signal (m)				78	181	
pX, platoon unblocked						
vC, conflicting volume	434	221	226			
vC1, stage 1 conf vol						
vC2, stage 2 conf vol						
vCu, unblocked vol	434	221	226			
tC, single (s)	6.4	6.2	4.1			
tC, 2 stage (s)						
tF (s)	3.5	3.3	2.2			
p0 queue free %	100	99	99			
cM capacity (veh/h)	560	798	1312			
Direction, Lane #	EB 1	NB 1	SB 1			
Volume Total	11	203	200			
Volume Left	1	10	0			
Volume Right	10	0	10			
cSH	768	1312	1700			
Volume to Capacity	0.01	0.01	0.12			
Queue Length 95th (m)	0.3	0.2	0.0			
Control Delay (s)	9.8	0.4	0.0			
Lane LOS	A	A				
Approach Delay (s)	9.8	0.4	0.0			
Approach LOS	A					
Intersection Summary						
Average Delay			0.5			
Intersection Capacity Utilization			29.3%	ICU Level of Service	A	
Analysis Period (min)			15			

HCM Unsignalized Intersection Capacity Analysis
6: Forest St & Bond St

Future Background (2024)
AM Peak Hour



Movement	WBL	WBR	NBT	NBR	SBL	SBT
Lane Configurations						
Traffic Volume (veh/h)	1	7	23	1	13	52
Future Volume (Veh/h)	1	7	23	1	13	52
Sign Control	Stop		Free		Free	
Grade	0%		0%		0%	
Peak Hour Factor	1.00	1.00	1.00	1.00	1.00	1.00
Hourly flow rate (vph)	1	7	23	1	13	52
Pedestrians	11					
Lane Width (m)	3.5					
Walking Speed (m/s)	1.0					
Percent Blockage	1					
Right turn flare (veh)						
Median type	None			None		
Median storage (veh)						
Upstream signal (m)						
pX, platoon unblocked						
vC, conflicting volume	112	34			35	
vC1, stage 1 conf vol						
vC2, stage 2 conf vol						
vCu, unblocked vol	112	34			35	
tC, single (s)	6.4	6.2			4.1	
tC, 2 stage (s)						
tF (s)	3.5	3.3			2.2	
p0 queue free %	100	99			99	
cM capacity (veh/h)	872	1033			1572	
Direction, Lane #	WB 1	NB 1	SB 1			
Volume Total	8	24	65			
Volume Left	1	0	13			
Volume Right	7	1	0			
cSH	1010	1700	1572			
Volume to Capacity	0.01	0.01	0.01			
Queue Length 95th (m)	0.2	0.0	0.2			
Control Delay (s)	8.6	0.0	1.5			
Lane LOS	A		A			
Approach Delay (s)	8.6	0.0	1.5			
Approach LOS	A					
Intersection Summary						
Average Delay			1.7			
Intersection Capacity Utilization			20.3%	ICU Level of Service		A
Analysis Period (min)			15			

HCM Unsignalized Intersection Capacity Analysis
7: Forest St & Richmond Rd

Future Background (2024)
AM Peak Hour

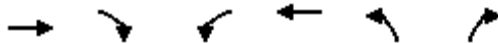

Movement	EBT	EBR	WBL	WBT	NBL	NBR
Lane Configurations	→			←	←	←
Traffic Volume (veh/h)	626	11	23	431	11	32
Future Volume (Veh/h)	626	11	23	431	11	32
Sign Control	Free			Free	Stop	
Grade	0%			0%	0%	
Peak Hour Factor	1.00	1.00	1.00	1.00	1.00	1.00
Hourly flow rate (vph)	626	11	23	431	11	32
Pedestrians						11
Lane Width (m)						4.7
Walking Speed (m/s)						1.0
Percent Blockage						1
Right turn flare (veh)						
Median type	None			None		
Median storage veh						
Upstream signal (m)				154		
pX, platoon unblocked					0.93	
vC, conflicting volume			648		1120	642
vC1, stage 1 conf vol						
vC2, stage 2 conf vol						
vCu, unblocked vol			648		1092	642
tC, single (s)			4.1		6.4	6.2
tC, 2 stage (s)						
tF (s)			2.2		3.5	3.3
p0 queue free %			98		95	93
cM capacity (veh/h)			934		215	471
Direction, Lane #	EB 1	WB 1	NB 1			
Volume Total	637	454	43			
Volume Left	0	23	11			
Volume Right	11	0	32			
cSH	1700	934	361			
Volume to Capacity	0.37	0.02	0.12			
Queue Length 95th (m)	0.0	0.6	3.1			
Control Delay (s)	0.0	0.7	16.3			
Lane LOS			A			C
Approach Delay (s)	0.0	0.7	16.3			
Approach LOS				C		
Intersection Summary						
Average Delay			0.9			
Intersection Capacity Utilization			53.7%	ICU Level of Service	A	
Analysis Period (min)			15			

HCM Signalized Intersection Capacity Analysis
 1: Croydon Ave & Richmond Rd/Richmond St

Future Background (2024)
 PM Peak Hour



Movement	EBL	EBT	EBR	WBL	WBT	WBR	NBL	NBT	NBR	SBL	SBT	SBR
Lane Configurations												
Traffic Volume (vph)	25	479	124	60	821	18	147	98	36	14	61	20
Future Volume (vph)	25	479	124	60	821	18	147	98	36	14	61	20
Ideal Flow (vphpl)	1800	1800	1800	1800	1800	1800	1800	1800	1800	1800	1800	1800
Lane Width	3.4	3.4	3.7	3.0	3.4	3.7	3.5	3.5	3.7	3.7	4.8	3.7
Total Lost time (s)	6.4	6.4		6.4	6.4		6.1	6.1			6.1	
Lane Util. Factor	1.00	1.00		1.00	1.00		1.00	1.00			1.00	
Frbp, ped/bikes	1.00	0.98		1.00	1.00		1.00	0.97			0.98	
Flpb, ped/bikes	0.99	1.00		0.98	1.00		0.95	1.00			0.99	
Frt	1.00	0.97		1.00	1.00		1.00	0.96			0.97	
Flt Protected	0.95	1.00		0.95	1.00		0.95	1.00			0.99	
Satd. Flow (prot)	1652	1565		1535	1649		1565	1636			1911	
Flt Permitted	0.24	1.00		0.38	1.00		0.76	1.00			0.94	
Satd. Flow (perm)	415	1565		609	1649		1258	1636			1812	
Peak-hour factor, PHF	1.00	1.00	1.00	1.00	1.00	1.00	1.00	1.00	1.00	1.00	1.00	1.00
Adj. Flow (vph)	25	479	124	60	821	18	147	98	36	14	61	20
RTOR Reduction (vph)	0	8	0	0	1	0	0	18	0	0	13	0
Lane Group Flow (vph)	25	595	0	60	838	0	147	116	0	0	82	0
Confl. Peds. (#/hr)	33		26	26		33	32		65	65		32
Heavy Vehicles (%)	0%	2%	7%	2%	2%	0%	3%	0%	3%	0%	0%	0%
Bus Blockages (#/hr)	0	10	0	0	10	0	0	0	0	0	0	0
Turn Type	Perm	NA		Perm	NA		Perm	NA		Perm	NA	
Protected Phases		2			6			8				4
Permitted Phases	2			6			8			4		
Actuated Green, G (s)	56.9	56.9		56.9	56.9		15.6	15.6			15.6	
Effective Green, g (s)	56.9	56.9		56.9	56.9		15.6	15.6			15.6	
Actuated g/C Ratio	0.67	0.67		0.67	0.67		0.18	0.18			0.18	
Clearance Time (s)	6.4	6.4		6.4	6.4		6.1	6.1			6.1	
Vehicle Extension (s)	3.0	3.0		3.0	3.0		3.0	3.0			3.0	
Lane Grp Cap (vph)	277	1047		407	1103		230	300			332	
v/s Ratio Prot		0.38			c0.51			0.07				
v/s Ratio Perm	0.06			0.10			c0.12				0.05	
v/c Ratio	0.09	0.57		0.15	0.76		0.64	0.39			0.25	
Uniform Delay, d1	4.9	7.5		5.2	9.5		32.1	30.5			29.7	
Progression Factor	1.00	1.00		1.00	1.00		1.00	1.00			1.00	
Incremental Delay, d2	0.6	2.2		0.8	4.9		5.7	0.8			0.4	
Delay (s)	5.6	9.7		5.9	14.4		37.8	31.3			30.1	
Level of Service	A	A		A	B		D	C			C	
Approach Delay (s)		9.6			13.8			34.7			30.1	
Approach LOS		A			B			C			C	
Intersection Summary												
HCM 2000 Control Delay			16.3			HCM 2000 Level of Service			B			
HCM 2000 Volume to Capacity ratio			0.73									
Actuated Cycle Length (s)			85.0			Sum of lost time (s)		12.5				
Intersection Capacity Utilization			83.2%			ICU Level of Service			E			
Analysis Period (min)			15									

c Critical Lane Group

HCM Signalized Intersection Capacity Analysis

2: Alpine Ave/1460 Richmond & Carling Ave

Future Background (2024)
PM Peak Hour



Movement	EBU	EBL	EBT	EBR	WBU	WBL	WBT	WBR	NBL	NBT	NBR	SBL
Lane Configurations		↔	↑↑↑			↔	↑↑↑			↔		
Traffic Volume (vph)	3	25	1223	9	4	51	1971	76	19	14	30	47
Future Volume (vph)	3	25	1223	9	4	51	1971	76	19	14	30	47
Ideal Flow (vphpl)	1800	1800	1800	1800	1800	1800	1800	1800	1800	1800	1800	1800
Lane Width	3.7	3.0	3.6	3.7	3.7	3.0	3.7	3.7	3.7	4.8	3.7	3.7
Total Lost time (s)		5.9	5.9			5.9	5.9			6.7		
Lane Util. Factor		1.00	0.91			1.00	0.91			1.00		
Frbp, ped/bikes		1.00	1.00			1.00	1.00			0.98		
Flpb, ped/bikes		1.00	1.00			1.00	1.00			0.99		
Frt		1.00	1.00			1.00	0.99			0.94		
Flt Protected		0.95	1.00			0.95	1.00			0.99		
Satd. Flow (prot)		1596	4760			1564	4820			1737		
Flt Permitted		0.07	1.00			0.20	1.00			0.85		
Satd. Flow (perm)		122	4760			324	4820			1507		
Peak-hour factor, PHF	1.00	1.00	1.00	1.00	1.00	1.00	1.00	1.00	1.00	1.00	1.00	1.00
Adj. Flow (vph)	3	25	1223	9	4	51	1971	76	19	14	30	47
RTOR Reduction (vph)	0	0	0	0	0	0	2	0	0	27	0	0
Lane Group Flow (vph)	0	28	1232	0	0	55	2045	0	0	36	0	0
Confl. Peds. (#/hr)	35	44		14	15	14		44	35		15	15
Heavy Vehicles (%)	0%	0%	2%	0%	0%	2%	1%	0%	12%	0%	4%	2%
Bus Blockages (#/hr)	0	0	8	0	0	0	8	0	0	0	0	0
Turn Type	Perm	pm+pt	NA		Perm	pm+pt	NA		Perm	NA		Perm
Protected Phases		5	2			1	6			8		
Permitted Phases	2	2			6	6			8			4
Actuated Green, G (s)		96.4	92.6			99.6	94.2			13.5		
Effective Green, g (s)		96.4	92.6			99.6	94.2			13.5		
Actuated g/C Ratio		0.74	0.71			0.77	0.72			0.10		
Clearance Time (s)		5.9	5.9			5.9	5.9			6.7		
Vehicle Extension (s)		3.0	3.0			3.0	3.0			3.0		
Lane Grp Cap (vph)		133	3390			299	3492			156		
v/s Ratio Prot		0.01	0.26			c0.01	c0.42					
v/s Ratio Perm		0.15				0.13				0.02		
v/c Ratio		0.21	0.36			0.18	0.59			0.23		
Uniform Delay, d1		6.0	7.3			4.0	8.6			53.5		
Progression Factor		1.00	1.00			1.04	0.69			1.00		
Incremental Delay, d2		0.8	0.3			0.2	0.5			0.8		
Delay (s)		6.8	7.6			4.4	6.5			54.2		
Level of Service		A	A			A	A			D		
Approach Delay (s)			7.5				6.4			54.2		
Approach LOS			A				A			D		
Intersection Summary												
HCM 2000 Control Delay			9.2				HCM 2000 Level of Service			A		
HCM 2000 Volume to Capacity ratio			0.57									
Actuated Cycle Length (s)			130.0				Sum of lost time (s)			18.5		
Intersection Capacity Utilization			82.7%				ICU Level of Service			E		
Analysis Period (min)			15									

c Critical Lane Group

HCM Signalized Intersection Capacity Analysis
 2: Alpine Ave/1460 Richmond & Carling Ave

Future Background (2024)
 PM Peak Hour



Movement	SBT	SBR
Lane Configurations	↕	
Traffic Volume (vph)	17	35
Future Volume (vph)	17	35
Ideal Flow (vphpl)	1800	1800
Lane Width	3.6	3.7
Total Lost time (s)	6.7	
Lane Util. Factor	1.00	
Frbp, ped/bikes	0.98	
Flpb, ped/bikes	0.99	
Frt	0.95	
Flt Protected	0.98	
Satd. Flow (prot)	1614	
Flt Permitted	0.85	
Satd. Flow (perm)	1405	
Peak-hour factor, PHF	1.00	1.00
Adj. Flow (vph)	17	35
RTOR Reduction (vph)	19	0
Lane Group Flow (vph)	80	0
Confl. Peds. (#/hr)		35
Heavy Vehicles (%)	0%	0%
Bus Blockages (#/hr)	0	0
Turn Type	NA	
Protected Phases	4	
Permitted Phases		
Actuated Green, G (s)	13.5	
Effective Green, g (s)	13.5	
Actuated g/C Ratio	0.10	
Clearance Time (s)	6.7	
Vehicle Extension (s)	3.0	
Lane Grp Cap (vph)	145	
v/s Ratio Prot		
v/s Ratio Perm	c0.06	
v/c Ratio	0.55	
Uniform Delay, d1	55.4	
Progression Factor	1.00	
Incremental Delay, d2	4.5	
Delay (s)	59.9	
Level of Service	E	
Approach Delay (s)	59.9	
Approach LOS	E	
Intersection Summary		

HCM Signalized Intersection Capacity Analysis

3: Carling Ave & Croydon Ave

Future Background (2024)
PM Peak Hour



Movement	EBU	EBL	EBT	WBU	WBT	WBR	SBL	SBR
Lane Configurations								
Traffic Volume (vph)	7	88	1209	1	1960	141	163	105
Future Volume (vph)	7	88	1209	1	1960	141	163	105
Ideal Flow (vphpl)	1800	1800	1800	1800	1800	1800	1800	1800
Lane Width	3.7	2.8	3.6	3.7	3.7	3.7	3.7	3.3
Total Lost time (s)		5.9	5.9		5.9		6.3	
Lane Util. Factor		1.00	0.91		0.91		0.97	
Frbp, ped/bikes		1.00	1.00		0.99		0.98	
Flpb, ped/bikes		1.00	1.00		1.00		1.00	
Frt		1.00	1.00		0.99		0.94	
Flt Protected		0.95	1.00		1.00		0.97	
Satd. Flow (prot)		1530	4696		4690		3116	
Flt Permitted		0.06	1.00		0.94		0.97	
Satd. Flow (perm)		93	4696		4407		3116	
Peak-hour factor, PHF	1.00	1.00	1.00	1.00	1.00	1.00	1.00	1.00
Adj. Flow (vph)	7	88	1209	1	1960	141	163	105
RTOR Reduction (vph)	0	0	0	0	4	0	81	0
Lane Group Flow (vph)	0	95	1209	0	2098	0	187	0
Confl. Peds. (#/hr)	24	43		3		43	3	24
Heavy Vehicles (%)	0%	2%	2%	0%	1%	5%	3%	0%
Bus Blockages (#/hr)	0	0	19	0	19	0	0	0
Turn Type	Perm	pm+pt	NA	Perm	NA		Prot	
Protected Phases		5	2		6		7	
Permitted Phases	2	2		6				
Actuated Green, G (s)		104.5	104.5		89.3		13.3	
Effective Green, g (s)		104.5	104.5		89.3		13.3	
Actuated g/C Ratio		0.80	0.80		0.69		0.10	
Clearance Time (s)		5.9	5.9		5.9		6.3	
Vehicle Extension (s)		3.0	3.0		3.0		3.0	
Lane Grp Cap (vph)		177	3774		3027		318	
v/s Ratio Prot		c0.04	0.26				c0.06	
v/s Ratio Perm		0.39			c0.48			
v/c Ratio		0.54	0.32		0.69		0.59	
Uniform Delay, d1		14.8	3.4		12.2		55.7	
Progression Factor		2.64	0.29		1.00		1.00	
Incremental Delay, d2		3.0	0.2		1.3		2.8	
Delay (s)		42.0	1.2		13.5		58.5	
Level of Service		D	A		B		E	
Approach Delay (s)			4.2		13.5		58.5	
Approach LOS			A		B		E	
Intersection Summary								
HCM 2000 Control Delay			13.5		HCM 2000 Level of Service		B	
HCM 2000 Volume to Capacity ratio			0.67					
Actuated Cycle Length (s)			130.0		Sum of lost time (s)		18.1	
Intersection Capacity Utilization			101.7%		ICU Level of Service		G	
Analysis Period (min)			15					

c Critical Lane Group

HCM Unsignalized Intersection Capacity Analysis
4: Carling Ave & Forest St

Future Background (2024)
PM Peak Hour



Movement	EBL	EBT	WBT	WBR	SBL	SBR	
Lane Configurations		↑↑↑	↑↑↑			↗	
Traffic Volume (veh/h)	0	1304	2036	35	0	65	
Future Volume (Veh/h)	0	1304	2036	35	0	65	
Sign Control		Free	Free		Stop		
Grade		0%	0%		0%		
Peak Hour Factor	1.00	1.00	1.00	1.00	1.00	1.00	
Hourly flow rate (vph)	0	1304	2036	35	0	65	
Pedestrians					44		
Lane Width (m)					4.8		
Walking Speed (m/s)					1.0		
Percent Blockage					6		
Right turn flare (veh)							
Median type		None	None				
Median storage (veh)							
Upstream signal (m)		55	141				
pX, platoon unblocked	0.75				0.80	0.75	
vC, conflicting volume	2115				2532	740	
vC1, stage 1 conf vol							
vC2, stage 2 conf vol							
vCu, unblocked vol	1334				1231	0	
tC, single (s)	4.1				6.8	6.9	
tC, 2 stage (s)							
tF (s)	2.2				3.5	3.3	
p0 queue free %	100				100	92	
cM capacity (veh/h)	371				130	774	
Direction, Lane #	EB 1	EB 2	EB 3	WB 1	WB 2	WB 3	SB 1
Volume Total	435	435	435	814	814	442	65
Volume Left	0	0	0	0	0	0	0
Volume Right	0	0	0	0	0	35	65
cSH	1700	1700	1700	1700	1700	1700	774
Volume to Capacity	0.26	0.26	0.26	0.48	0.48	0.26	0.08
Queue Length 95th (m)	0.0	0.0	0.0	0.0	0.0	0.0	2.1
Control Delay (s)	0.0	0.0	0.0	0.0	0.0	0.0	10.1
Lane LOS							B
Approach Delay (s)	0.0			0.0			10.1
Approach LOS							B
Intersection Summary							
Average Delay			0.2				
Intersection Capacity Utilization			53.3%		ICU Level of Service		A
Analysis Period (min)			15				

HCM Unsignalized Intersection Capacity Analysis
5: Croydon Ave & Bond St









Future Background (2024)
PM Peak Hour



Movement	EBL	EBR	NBL	NBT	SBT	SBR
Lane Configurations						
Traffic Volume (veh/h)	1	12	11	218	256	12
Future Volume (Veh/h)	1	12	11	218	256	12
Sign Control	Stop			Free	Free	
Grade	0%			0%	0%	
Peak Hour Factor	1.00	1.00	1.00	1.00	1.00	1.00
Hourly flow rate (vph)	1	12	11	218	256	12
Pedestrians	29					
Lane Width (m)	4.3					
Walking Speed (m/s)	1.0					
Percent Blockage	3					
Right turn flare (veh)						
Median type				None	None	
Median storage veh						
Upstream signal (m)				78	181	
pX, platoon unblocked						
vC, conflicting volume	531	291	297			
vC1, stage 1 conf vol						
vC2, stage 2 conf vol						
vCu, unblocked vol	531	291	297			
tC, single (s)	6.4	6.2	4.1			
tC, 2 stage (s)						
tF (s)	3.5	3.3	2.2			
p0 queue free %	100	98	99			
cM capacity (veh/h)	490	727	1232			
Direction, Lane #	EB 1	NB 1	SB 1			
Volume Total	13	229	268			
Volume Left	1	11	0			
Volume Right	12	0	12			
cSH	701	1232	1700			
Volume to Capacity	0.02	0.01	0.16			
Queue Length 95th (m)	0.4	0.2	0.0			
Control Delay (s)	10.2	0.5	0.0			
Lane LOS	B	A				
Approach Delay (s)	10.2	0.5	0.0			
Approach LOS	B					
Intersection Summary						
Average Delay			0.5			
Intersection Capacity Utilization			31.6%	ICU Level of Service	A	
Analysis Period (min)			15			

HCM Unsignalized Intersection Capacity Analysis
6: Forest St & Bond St

Future Background (2024)
PM Peak Hour

						
Movement	WBL	WBR	NBT	NBR	SBL	SBT
Lane Configurations						
Traffic Volume (veh/h)	1	9	35	1	18	64
Future Volume (Veh/h)	1	9	35	1	18	64
Sign Control	Stop		Free			Free
Grade	0%		0%			0%
Peak Hour Factor	1.00	1.00	1.00	1.00	1.00	1.00
Hourly flow rate (vph)	1	9	35	1	18	64
Pedestrians	11					
Lane Width (m)	3.5					
Walking Speed (m/s)	1.0					
Percent Blockage	1					
Right turn flare (veh)						
Median type			None			None
Median storage veh						
Upstream signal (m)						
pX, platoon unblocked						
vC, conflicting volume	146	46			47	
vC1, stage 1 conf vol						
vC2, stage 2 conf vol						
vCu, unblocked vol	146	46			47	
tC, single (s)	6.4	6.2			4.1	
tC, 2 stage (s)						
tF (s)	3.5	3.3			2.2	
p0 queue free %	100	99			99	
cM capacity (veh/h)	832	1018			1557	
Direction, Lane #	WB 1	NB 1	SB 1			
Volume Total	10	36	82			
Volume Left	1	0	18			
Volume Right	9	1	0			
cSH	995	1700	1557			
Volume to Capacity	0.01	0.02	0.01			
Queue Length 95th (m)	0.2	0.0	0.3			
Control Delay (s)	8.7	0.0	1.7			
Lane LOS	A		A			
Approach Delay (s)	8.7	0.0	1.7			
Approach LOS	A					
Intersection Summary						
Average Delay			1.8			
Intersection Capacity Utilization			21.3%		ICU Level of Service	A
Analysis Period (min)			15			

HCM Unsignalized Intersection Capacity Analysis
7: Forest St & Richmond Rd

Future Background (2024)
PM Peak Hour























Movement	EBT	EBR	WBL	WBT	NBL	NBR
Lane Configurations	→			←	←	←
Traffic Volume (veh/h)	599	12	49	939	11	29
Future Volume (Veh/h)	599	12	49	939	11	29
Sign Control	Free			Free	Stop	
Grade	0%			0%	0%	
Peak Hour Factor	1.00	1.00	1.00	1.00	1.00	1.00
Hourly flow rate (vph)	599	12	49	939	11	29
Pedestrians					11	
Lane Width (m)					4.7	
Walking Speed (m/s)					1.0	
Percent Blockage					1	
Right turn flare (veh)						
Median type	None			None		
Median storage (veh)						
Upstream signal (m)					154	
pX, platoon unblocked					0.58	
vC, conflicting volume			622			616
vC1, stage 1 conf vol						
vC2, stage 2 conf vol						
vCu, unblocked vol			622			616
tC, single (s)			4.1			6.2
tC, 2 stage (s)						
tF (s)			2.2			3.3
p0 queue free %			95			94
cM capacity (veh/h)			955			487
Direction, Lane #	EB 1	WB 1	NB 1			
Volume Total	611	988	40			
Volume Left	0	49	11			
Volume Right	12	0	29			
cSH	1700	955	144			
Volume to Capacity	0.36	0.05	0.28			
Queue Length 95th (m)	0.0	1.2	8.1			
Control Delay (s)	0.0	1.4	39.2			
Lane LOS			A			E
Approach Delay (s)	0.0	1.4	39.2			
Approach LOS			E			
Intersection Summary						
Average Delay			1.8			
Intersection Capacity Utilization			102.4%	ICU Level of Service	G	
Analysis Period (min)			15			

Appendix F – Future (2029) Background Level of Service Calculations

HCM Signalized Intersection Capacity Analysis
1: Croydon Ave & Richmond Rd/Richmond St

Future Background (2029)
AM Peak Hour

												
Movement	EBL	EBT	EBR	WBL	WBT	WBR	NBL	NBT	NBR	SBL	SBT	SBR
Lane Configurations												
Traffic Volume (vph)	24	627	76	18	418	18	41	32	89	30	79	41
Future Volume (vph)	24	627	76	18	418	18	41	32	89	30	79	41
Ideal Flow (vphpl)	1800	1800	1800	1800	1800	1800	1800	1800	1800	1800	1800	1800
Lane Width	3.4	3.4	3.7	3.0	3.4	3.7	3.5	3.5	3.7	3.7	4.8	3.7
Total Lost time (s)	6.4	6.4		6.4	6.4		6.1	6.1			6.1	
Lane Util. Factor	1.00	1.00		1.00	1.00		1.00	1.00			1.00	
Frbp, ped/bikes	1.00	0.99		1.00	1.00		1.00	0.93			0.98	
Flpb, ped/bikes	0.98	1.00		0.99	1.00		0.96	1.00			0.99	
Frft	1.00	0.98		1.00	0.99		1.00	0.89			0.96	
Flt Protected	0.95	1.00		0.95	1.00		0.95	1.00			0.99	
Satd. Flow (prot)	1553	1593		1581	1613		1536	1415			1821	
Flt Permitted	0.50	1.00		0.33	1.00		0.65	1.00			0.90	
Satd. Flow (perm)	822	1593		556	1613		1047	1415			1653	
Peak-hour factor, PHF	1.00	1.00	1.00	1.00	1.00	1.00	1.00	1.00	1.00	1.00	1.00	1.00
Adj. Flow (vph)	24	627	76	18	418	18	41	32	89	30	79	41
RTOR Reduction (vph)	0	4	0	0	1	0	0	77	0	0	26	0
Lane Group Flow (vph)	24	699	0	18	435	0	41	44	0	0	124	0
Confl. Peds. (#/hr)	26		18	18		26	35		50	50		35
Heavy Vehicles (%)	5%	3%	10%	0%	4%	0%	6%	9%	3%	7%	0%	8%
Bus Blockages (#/hr)	0	10	0	0	10	0	0	0	0	0	0	0
Turn Type	Perm	NA		Perm	NA		Perm	NA		Perm	NA	
Protected Phases		2			6			8			4	
Permitted Phases	2			6			8			4		
Actuated Green, G (s)	48.0	48.0		48.0	48.0		9.5	9.5			9.5	
Effective Green, g (s)	48.0	48.0		48.0	48.0		9.5	9.5			9.5	
Actuated g/C Ratio	0.69	0.69		0.69	0.69		0.14	0.14			0.14	
Clearance Time (s)	6.4	6.4		6.4	6.4		6.1	6.1			6.1	
Vehicle Extension (s)	3.0	3.0		3.0	3.0		3.0	3.0			3.0	
Lane Grp Cap (vph)	563	1092		381	1106		142	192			224	
v/s Ratio Prot		c0.44			0.27			0.03				
v/s Ratio Perm	0.03			0.03			0.04				c0.08	
v/c Ratio	0.04	0.64		0.05	0.39		0.29	0.23			0.55	
Uniform Delay, d1	3.6	6.2		3.6	4.7		27.2	27.0			28.3	
Progression Factor	1.00	1.00		1.00	1.00		1.00	1.00			1.00	
Incremental Delay, d2	0.1	2.9		0.2	1.1		1.1	0.6			2.9	
Delay (s)	3.7	9.0		3.8	5.8		28.3	27.6			31.2	
Level of Service	A	A		A	A		C	C			C	
Approach Delay (s)		8.9			5.7			27.8			31.2	
Approach LOS		A			A			C			C	
Intersection Summary												
HCM 2000 Control Delay			12.2				HCM 2000 Level of Service				B	
HCM 2000 Volume to Capacity ratio			0.63									
Actuated Cycle Length (s)			70.0				Sum of lost time (s)			12.5		
Intersection Capacity Utilization			86.6%				ICU Level of Service			E		
Analysis Period (min)			15									

c Critical Lane Group

HCM Signalized Intersection Capacity Analysis
 2: Alpine Ave/1460 Richmond & Carling Ave

Future Background (2029)
 AM Peak Hour

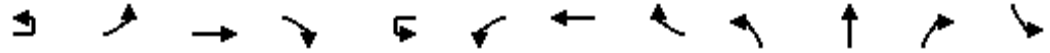

Movement	EBU	EBL	EBT	EBR	WBU	WBL	WBT	WBR	NBL	NBT	NBR	SBL
Lane Configurations												
Traffic Volume (vph)	6	35	3036	6	5	37	1044	83	27	9	106	50
Future Volume (vph)	6	35	3036	6	5	37	1044	83	27	9	106	50
Ideal Flow (vphpl)	1800	1800	1800	1800	1800	1800	1800	1800	1800	1800	1800	1800
Lane Width	3.7	3.0	3.6	3.7	3.7	3.0	3.7	3.7	3.7	4.8	3.7	3.7
Total Lost time (s)		5.9	5.9			5.9	5.9			6.7		
Lane Util. Factor		1.00	0.91			1.00	0.91			1.00		
Frbp, ped/bikes		1.00	1.00			1.00	0.99			0.95		
Flpb, ped/bikes		0.97	1.00			1.00	1.00			1.00		
Frt		1.00	1.00			1.00	0.99			0.90		
Flt Protected		0.95	1.00			0.95	1.00			0.99		
Satd. Flow (prot)		1513	4811			1596	4678			1678		
Flt Permitted		0.24	1.00			0.04	1.00			0.87		
Satd. Flow (perm)		383	4811			69	4678			1470		
Peak-hour factor, PHF	1.00	1.00	1.00	1.00	1.00	1.00	1.00	1.00	1.00	1.00	1.00	1.00
Adj. Flow (vph)	6	35	3036	6	5	37	1044	83	27	9	106	50
RTOR Reduction (vph)	0	0	0	0	0	0	4	0	0	52	0	0
Lane Group Flow (vph)	0	41	3042	0	0	42	1123	0	0	90	0	0
Confl. Peds. (#/hr)	13	44		33	33	33		44	13		33	33
Heavy Vehicles (%)	0%	3%	1%	0%	0%	0%	3%	3%	9%	0%	2%	2%
Bus Blockages (#/hr)	0	0	8	0	0	0	8	0	0	0	0	0
Turn Type	Perm	Perm	NA		Perm	pm+pt	NA		Perm	NA		Perm
Protected Phases			2			1	6			8		
Permitted Phases	2	2			6	6			8			4
Actuated Green, G (s)		91.7	91.7			102.9	102.9			14.5		
Effective Green, g (s)		91.7	91.7			102.9	102.9			14.5		
Actuated g/C Ratio		0.71	0.71			0.79	0.79			0.11		
Clearance Time (s)		5.9	5.9			5.9	5.9			6.7		
Vehicle Extension (s)		3.0	3.0			3.0	3.0			3.0		
Lane Grp Cap (vph)		270	3393			116	3702			163		
v/s Ratio Prot			c0.63			0.01	c0.24					
v/s Ratio Perm		0.11				0.27				0.06		
v/c Ratio		0.15	0.90			0.36	0.30			0.55		
Uniform Delay, d1		6.3	15.3			22.0	3.7			54.7		
Progression Factor		1.00	1.00			3.01	0.79			1.00		
Incremental Delay, d2		1.2	4.2			1.8	0.2			3.8		
Delay (s)		7.5	19.6			68.0	3.1			58.4		
Level of Service		A	B			E	A			E		
Approach Delay (s)			19.4				5.5			58.4		
Approach LOS			B				A			E		
Intersection Summary												
HCM 2000 Control Delay			18.7			HCM 2000 Level of Service				B		
HCM 2000 Volume to Capacity ratio			0.86									
Actuated Cycle Length (s)			130.0			Sum of lost time (s)				18.5		
Intersection Capacity Utilization			92.8%			ICU Level of Service				F		
Analysis Period (min)			15									

c Critical Lane Group

HCM Signalized Intersection Capacity Analysis
 2: Alpine Ave/1460 Richmond & Carling Ave

Future Background (2029)
 AM Peak Hour



Movement	SBT	SBR
Lane Configurations	↕	
Traffic Volume (vph)	11	63
Future Volume (vph)	11	63
Ideal Flow (vphpl)	1800	1800
Lane Width	3.6	3.7
Total Lost time (s)	6.7	
Lane Util. Factor	1.00	
Frbp, ped/bikes	0.99	
Flpb, ped/bikes	0.99	
Frt	0.93	
Flt Protected	0.98	
Satd. Flow (prot)	1571	
Flt Permitted	0.65	
Satd. Flow (perm)	1044	
Peak-hour factor, PHF	1.00	1.00
Adj. Flow (vph)	11	63
RTOR Reduction (vph)	36	0
Lane Group Flow (vph)	88	0
Confl. Peds. (#/hr)		13
Heavy Vehicles (%)	0%	2%
Bus Blockages (#/hr)	0	0
Turn Type	NA	
Protected Phases	4	
Permitted Phases		
Actuated Green, G (s)	14.5	
Effective Green, g (s)	14.5	
Actuated g/C Ratio	0.11	
Clearance Time (s)	6.7	
Vehicle Extension (s)	3.0	
Lane Grp Cap (vph)	116	
v/s Ratio Prot		
v/s Ratio Perm	c0.08	
v/c Ratio	0.76	
Uniform Delay, d1	56.1	
Progression Factor	1.00	
Incremental Delay, d2	25.2	
Delay (s)	81.3	
Level of Service	F	
Approach Delay (s)	81.3	
Approach LOS	F	
Intersection Summary		

HCM Signalized Intersection Capacity Analysis
3: Carling Ave & Croydon Ave

Future Background (2029)
AM Peak Hour



Movement	EBU	EBL	EBT	WBU	WBT	WBR	SBL	SBR
Lane Configurations		↔	↑↑↑		↑↑↑		↔	
Traffic Volume (vph)	2	116	3081	1	1105	107	190	30
Future Volume (vph)	2	116	3081	1	1105	107	190	30
Ideal Flow (vphpl)	1800	1800	1800	1800	1800	1800	1800	1800
Lane Width	3.7	2.8	3.6	3.7	3.7	3.7	3.7	3.3
Total Lost time (s)		5.9	5.9		5.9		6.3	
Lane Util. Factor		1.00	0.91		0.91		0.97	
Frbp, ped/bikes		1.00	1.00		0.99		1.00	
Flpb, ped/bikes		1.00	1.00		1.00		1.00	
Frt		1.00	1.00		0.99		0.98	
Flt Protected		0.95	1.00		1.00		0.96	
Satd. Flow (prot)		1539	4742		4593		3146	
Flt Permitted		0.19	1.00		0.94		0.96	
Satd. Flow (perm)		308	4742		4298		3146	
Peak-hour factor, PHF	1.00	1.00	1.00	1.00	1.00	1.00	1.00	1.00
Adj. Flow (vph)	2	116	3081	1	1105	107	190	30
RTOR Reduction (vph)	0	0	0	0	6	0	12	0
Lane Group Flow (vph)	0	118	3081	0	1207	0	208	0
Confl. Peds. (#/hr)	23	20		2		20	23	2
Heavy Vehicles (%)	0%	1%	1%	0%	3%	7%	6%	0%
Bus Blockages (#/hr)	0	0	19	0	19	0	0	0
Turn Type	Perm	pm+pt	NA	Perm	NA		Prot	
Protected Phases		5	2		6		7	
Permitted Phases	2	2		6				
Actuated Green, G (s)		103.9	103.9		90.3		13.9	
Effective Green, g (s)		103.9	103.9		90.3		13.9	
Actuated g/C Ratio		0.80	0.80		0.69		0.11	
Clearance Time (s)		5.9	5.9		5.9		6.3	
Vehicle Extension (s)		3.0	3.0		3.0		3.0	
Lane Grp Cap (vph)		319	3789		2985		336	
v/s Ratio Prot		0.02	c0.65				c0.07	
v/s Ratio Perm		0.27			0.28			
v/c Ratio		0.37	0.81		0.40		0.62	
Uniform Delay, d1		3.8	7.5		8.4		55.5	
Progression Factor		0.60	0.43		1.00		1.00	
Incremental Delay, d2		0.4	1.0		0.4		3.5	
Delay (s)		2.6	4.2		8.8		59.1	
Level of Service		A	A		A		E	
Approach Delay (s)			4.2		8.8		59.1	
Approach LOS			A		A		E	
Intersection Summary								
HCM 2000 Control Delay			8.0		HCM 2000 Level of Service			A
HCM 2000 Volume to Capacity ratio			0.83					
Actuated Cycle Length (s)			130.0		Sum of lost time (s)			18.1
Intersection Capacity Utilization			112.6%		ICU Level of Service			H
Analysis Period (min)			15					

c Critical Lane Group

HCM Unsignalized Intersection Capacity Analysis
4: Carling Ave & Forest St

Future Background (2029)
AM Peak Hour



Movement	EBL	EBT	WBT	WBR	SBL	SBR	
Lane Configurations		↑↑↑	↑↑↑			↗	
Traffic Volume (veh/h)	0	3197	1111	27	0	59	
Future Volume (Veh/h)	0	3197	1111	27	0	59	
Sign Control		Free	Free		Stop		
Grade		0%	0%		0%		
Peak Hour Factor	1.00	1.00	1.00	1.00	1.00	1.00	
Hourly flow rate (vph)	0	3197	1111	27	0	59	
Pedestrians					44		
Lane Width (m)					4.8		
Walking Speed (m/s)					1.0		
Percent Blockage					6		
Right turn flare (veh)							
Median type		None	None				
Median storage (veh)							
Upstream signal (m)		55	141				
pX, platoon unblocked	0.91				0.35	0.91	
vC, conflicting volume	1182				2234	428	
vC1, stage 1 conf vol							
vC2, stage 2 conf vol							
vCu, unblocked vol	851				0	21	
tC, single (s)	4.1				6.8	6.9	
tC, 2 stage (s)							
tF (s)	2.2				3.5	3.3	
p0 queue free %	100				100	93	
cM capacity (veh/h)	682				340	905	
Direction, Lane #	EB 1	EB 2	EB 3	WB 1	WB 2	WB 3	SB 1
Volume Total	1066	1066	1066	444	444	249	59
Volume Left	0	0	0	0	0	0	0
Volume Right	0	0	0	0	0	27	59
cSH	1700	1700	1700	1700	1700	1700	905
Volume to Capacity	0.63	0.63	0.63	0.26	0.26	0.15	0.07
Queue Length 95th (m)	0.0	0.0	0.0	0.0	0.0	0.0	1.6
Control Delay (s)	0.0	0.0	0.0	0.0	0.0	0.0	9.3
Lane LOS							A
Approach Delay (s)	0.0			0.0			9.3
Approach LOS							A
Intersection Summary							
Average Delay			0.1				
Intersection Capacity Utilization			68.5%		ICU Level of Service		C
Analysis Period (min)			15				

HCM Unsignalized Intersection Capacity Analysis
5: Croydon Ave & Bond St









Future Background (2029)
AM Peak Hour



Movement	EBL	EBR	NBL	NBT	SBT	SBR
Lane Configurations						
Traffic Volume (veh/h)	1	11	11	213	210	11
Future Volume (Veh/h)	1	11	11	213	210	11
Sign Control	Stop			Free	Free	
Grade	0%			0%	0%	
Peak Hour Factor	1.00	1.00	1.00	1.00	1.00	1.00
Hourly flow rate (vph)	1	11	11	213	210	11
Pedestrians	29					
Lane Width (m)	4.3					
Walking Speed (m/s)	1.0					
Percent Blockage	3					
Right turn flare (veh)						
Median type				None	None	
Median storage veh						
Upstream signal (m)				78	181	
pX, platoon unblocked						
vC, conflicting volume	480	244	250			
vC1, stage 1 conf vol						
vC2, stage 2 conf vol						
vCu, unblocked vol	480	244	250			
tC, single (s)	6.4	6.2	4.1			
tC, 2 stage (s)						
tF (s)	3.5	3.3	2.2			
p0 queue free %	100	99	99			
cM capacity (veh/h)	525	772	1281			
Direction, Lane #	EB 1	NB 1	SB 1			
Volume Total	12	224	221			
Volume Left	1	11	0			
Volume Right	11	0	11			
cSH	743	1281	1700			
Volume to Capacity	0.02	0.01	0.13			
Queue Length 95th (m)	0.4	0.2	0.0			
Control Delay (s)	9.9	0.5	0.0			
Lane LOS	A	A				
Approach Delay (s)	9.9	0.5	0.0			
Approach LOS	A					
Intersection Summary						
Average Delay			0.5			
Intersection Capacity Utilization			31.3%	ICU Level of Service	A	
Analysis Period (min)			15			

HCM Unsignalized Intersection Capacity Analysis
6: Forest St & Bond St

Future Background (2029)
AM Peak Hour

						
Movement	WBL	WBR	NBT	NBR	SBL	SBT
Lane Configurations						
Traffic Volume (veh/h)	1	6	26	1	14	57
Future Volume (Veh/h)	1	6	26	1	14	57
Sign Control	Stop		Free			Free
Grade	0%		0%			0%
Peak Hour Factor	1.00	1.00	1.00	1.00	1.00	1.00
Hourly flow rate (vph)	1	6	26	1	14	57
Pedestrians	12					
Lane Width (m)	3.5					
Walking Speed (m/s)	1.0					
Percent Blockage	1					
Right turn flare (veh)						
Median type			None			None
Median storage veh						
Upstream signal (m)						
pX, platoon unblocked						
vC, conflicting volume	124	38			39	
vC1, stage 1 conf vol						
vC2, stage 2 conf vol						
vCu, unblocked vol	124	38			39	
tC, single (s)	6.4	6.2			4.1	
tC, 2 stage (s)						
tF (s)	3.5	3.3			2.2	
p0 queue free %	100	99			99	
cM capacity (veh/h)	858	1027			1566	
Direction, Lane #	WB 1	NB 1	SB 1			
Volume Total	7	27	71			
Volume Left	1	0	14			
Volume Right	6	1	0			
cSH	999	1700	1566			
Volume to Capacity	0.01	0.02	0.01			
Queue Length 95th (m)	0.2	0.0	0.2			
Control Delay (s)	8.6	0.0	1.5			
Lane LOS	A		A			
Approach Delay (s)	8.6	0.0	1.5			
Approach LOS	A					
Intersection Summary						
Average Delay			1.6			
Intersection Capacity Utilization			20.7%		ICU Level of Service	A
Analysis Period (min)			15			

HCM Unsignalized Intersection Capacity Analysis
7: Forest St & Richmond Rd

Future Background (2029)
AM Peak Hour

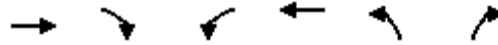

Movement	EBT	EBR	WBL	WBT	NBL	NBR
Lane Configurations	→			←	←	↗
Traffic Volume (veh/h)	692	12	26	474	11	35
Future Volume (Veh/h)	692	12	26	474	11	35
Sign Control	Free			Free	Stop	
Grade	0%			0%	0%	
Peak Hour Factor	1.00	1.00	1.00	1.00	1.00	1.00
Hourly flow rate (vph)	692	12	26	474	11	35
Pedestrians						12
Lane Width (m)						4.7
Walking Speed (m/s)						1.0
Percent Blockage						2
Right turn flare (veh)						
Median type	None			None		
Median storage (veh)						
Upstream signal (m)				154		
pX, platoon unblocked					0.91	
vC, conflicting volume			716	1236	710	
vC1, stage 1 conf vol						
vC2, stage 2 conf vol						
vCu, unblocked vol			716	1210	710	
tC, single (s)			4.1	6.4	6.2	
tC, 2 stage (s)						
tF (s)			2.2	3.5	3.3	
p0 queue free %			97	94	92	
cM capacity (veh/h)			880	177	430	
Direction, Lane #	EB 1	WB 1	NB 1			
Volume Total	704	500	46			
Volume Left	0	26	11			
Volume Right	12	0	35			
cSH	1700	880	321			
Volume to Capacity	0.41	0.03	0.14			
Queue Length 95th (m)	0.0	0.7	3.8			
Control Delay (s)	0.0	0.8	18.1			
Lane LOS			A	C		
Approach Delay (s)	0.0	0.8	18.1			
Approach LOS			C			
Intersection Summary						
Average Delay			1.0			
Intersection Capacity Utilization			58.7%	ICU Level of Service		B
Analysis Period (min)			15			

HCM Signalized Intersection Capacity Analysis
1: Croydon Ave & Richmond Rd/Richmond St

Future Background (2029)
PM Peak Hour

Movement	EBL	EBT	EBR	WBL	WBT	WBR	NBL	NBT	NBR	SBL	SBT	SBR
Lane Configurations												
Traffic Volume (vph)	28	527	133	66	907	20	160	108	40	16	68	22
Future Volume (vph)	28	527	133	66	907	20	160	108	40	16	68	22
Ideal Flow (vphpl)	1800	1800	1800	1800	1800	1800	1800	1800	1800	1800	1800	1800
Lane Width	3.4	3.4	3.7	3.0	3.4	3.7	3.5	3.5	3.7	3.7	4.8	3.7
Total Lost time (s)	6.4	6.4		6.4	6.4		6.1	6.1			6.1	
Lane Util. Factor	1.00	1.00		1.00	1.00		1.00	1.00			1.00	
Frbp, ped/bikes	1.00	0.98		1.00	1.00		1.00	0.96			0.98	
Flpb, ped/bikes	1.00	1.00		0.98	1.00		0.95	1.00			0.98	
Frt	1.00	0.97		1.00	1.00		1.00	0.96			0.97	
Flt Protected	0.95	1.00		0.95	1.00		0.95	1.00			0.99	
Satd. Flow (prot)	1672	1565		1536	1648		1560	1630			1907	
Flt Permitted	0.18	1.00		0.33	1.00		0.73	1.00			0.94	
Satd. Flow (perm)	313	1565		541	1648		1206	1630			1803	
Peak-hour factor, PHF	1.00	1.00	1.00	1.00	1.00	1.00	1.00	1.00	1.00	1.00	1.00	1.00
Adj. Flow (vph)	28	527	133	66	907	20	160	108	40	16	68	22
RTOR Reduction (vph)	0	8	0	0	1	0	0	18	0	0	13	0
Lane Group Flow (vph)	28	652	0	66	926	0	160	130	0	0	93	0
Confl. Peds. (#/hr)	37		29	29		37	35		72	72		35
Heavy Vehicles (%)	0%	2%	7%	2%	2%	0%	3%	0%	3%	0%	0%	0%
Bus Blockages (#/hr)	0	10	0	0	10	0	0	0	0	0	0	0
Turn Type	Perm	NA		Perm	NA		Perm	NA		Perm	NA	
Protected Phases		2			6			8			4	
Permitted Phases	2			6			8			4		
Actuated Green, G (s)	55.5	55.5		55.5	55.5		17.0	17.0			17.0	
Effective Green, g (s)	55.5	55.5		55.5	55.5		17.0	17.0			17.0	
Actuated g/C Ratio	0.65	0.65		0.65	0.65		0.20	0.20			0.20	
Clearance Time (s)	6.4	6.4		6.4	6.4		6.1	6.1			6.1	
Vehicle Extension (s)	3.0	3.0		3.0	3.0		3.0	3.0			3.0	
Lane Grp Cap (vph)	204	1021		353	1076		241	326			360	
v/s Ratio Prot		0.42			c0.56			0.08				
v/s Ratio Perm	0.09			0.12			c0.13				0.05	
v/c Ratio	0.14	0.64		0.19	0.86		0.66	0.40			0.26	
Uniform Delay, d1	5.6	8.8		5.8	11.7		31.4	29.6			28.7	
Progression Factor	1.00	1.00		1.00	1.00		1.00	1.00			1.00	
Incremental Delay, d2	1.4	3.1		1.2	9.0		6.7	0.8			0.4	
Delay (s)	7.0	11.8		7.0	20.7		38.1	30.4			29.1	
Level of Service	A	B		A	C		D	C			C	
Approach Delay (s)		11.6			19.8			34.4			29.1	
Approach LOS		B			B			C			C	
Intersection Summary												
HCM 2000 Control Delay			19.7				HCM 2000 Level of Service				B	
HCM 2000 Volume to Capacity ratio			0.81									
Actuated Cycle Length (s)			85.0			Sum of lost time (s)			12.5			
Intersection Capacity Utilization			89.1%			ICU Level of Service					E	
Analysis Period (min)			15									

c Critical Lane Group

HCM Signalized Intersection Capacity Analysis
 2: Alpine Ave/1460 Richmond & Carling Ave

Future Background (2029)
 PM Peak Hour

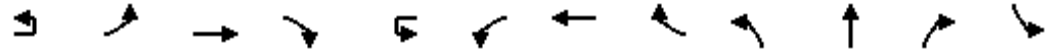

Movement	EBU	EBL	EBT	EBR	WBU	WBL	WBT	WBR	NBL	NBT	NBR	SBL
Lane Configurations		↔	↑↑↑			↔	↑↑↑			↔		
Traffic Volume (vph)	4	28	1345	10	5	56	2174	84	21	16	33	52
Future Volume (vph)	4	28	1345	10	5	56	2174	84	21	16	33	52
Ideal Flow (vphpl)	1800	1800	1800	1800	1800	1800	1800	1800	1800	1800	1800	1800
Lane Width	3.7	3.0	3.6	3.7	3.7	3.0	3.7	3.7	3.7	4.8	3.7	3.7
Total Lost time (s)		5.9	5.9			5.9	5.9			6.7		
Lane Util. Factor		1.00	0.91			1.00	0.91			1.00		
Frbp, ped/bikes		1.00	1.00			1.00	1.00			0.98		
Flpb, ped/bikes		1.00	1.00			1.00	1.00			0.99		
Frt		1.00	1.00			1.00	0.99			0.94		
Flt Protected		0.95	1.00			0.95	1.00			0.99		
Satd. Flow (prot)		1596	4760			1565	4818			1735		
Flt Permitted		0.05	1.00			0.17	1.00			0.85		
Satd. Flow (perm)		89	4760			276	4818			1495		
Peak-hour factor, PHF	1.00	1.00	1.00	1.00	1.00	1.00	1.00	1.00	1.00	1.00	1.00	1.00
Adj. Flow (vph)	4	28	1345	10	5	56	2174	84	21	16	33	52
RTOR Reduction (vph)	0	0	0	0	0	0	2	0	0	29	0	0
Lane Group Flow (vph)	0	32	1355	0	0	61	2256	0	0	41	0	0
Confl. Peds. (#/hr)	39	49		16	17	16		49	39		17	17
Heavy Vehicles (%)	0%	0%	2%	0%	0%	2%	1%	0%	12%	0%	4%	2%
Bus Blockages (#/hr)	0	0	8	0	0	0	8	0	0	0	0	0
Turn Type	Perm	pm+pt	NA		Perm	pm+pt	NA		Perm	NA		Perm
Protected Phases		5	2			1	6			8		
Permitted Phases	2	2			6	6			8			4
Actuated Green, G (s)		95.3	91.4			98.7	93.1			14.5		
Effective Green, g (s)		95.3	91.4			98.7	93.1			14.5		
Actuated g/C Ratio		0.73	0.70			0.76	0.72			0.11		
Clearance Time (s)		5.9	5.9			5.9	5.9			6.7		
Vehicle Extension (s)		3.0	3.0			3.0	3.0			3.0		
Lane Grp Cap (vph)		110	3346			265	3450			166		
v/s Ratio Prot		0.01	0.28			c0.01	c0.47					
v/s Ratio Perm		0.20				0.16				0.03		
v/c Ratio		0.29	0.40			0.23	0.65			0.25		
Uniform Delay, d1		7.7	8.0			4.4	9.8			52.8		
Progression Factor		1.00	1.00			1.20	0.74			1.00		
Incremental Delay, d2		1.5	0.4			0.3	0.6			0.8		
Delay (s)		9.2	8.4			5.6	7.9			53.5		
Level of Service		A	A			A	A			D		
Approach Delay (s)			8.4				7.9			53.5		
Approach LOS			A				A			D		
Intersection Summary												
HCM 2000 Control Delay			10.4				HCM 2000 Level of Service			B		
HCM 2000 Volume to Capacity ratio			0.63									
Actuated Cycle Length (s)			130.0				Sum of lost time (s)			18.5		
Intersection Capacity Utilization			89.1%				ICU Level of Service			E		
Analysis Period (min)			15									

c Critical Lane Group

HCM Signalized Intersection Capacity Analysis
 2: Alpine Ave/1460 Richmond & Carling Ave

Future Background (2029)
 PM Peak Hour



Movement	SBT	SBR
Lane Configurations	↕	
Traffic Volume (vph)	18	39
Future Volume (vph)	18	39
Ideal Flow (vphpl)	1800	1800
Lane Width	3.6	3.7
Total Lost time (s)	6.7	
Lane Util. Factor	1.00	
Frbp, ped/bikes	0.98	
Flpb, ped/bikes	0.99	
Frt	0.95	
Flt Protected	0.98	
Satd. Flow (prot)	1608	
Flt Permitted	0.84	
Satd. Flow (perm)	1378	
Peak-hour factor, PHF	1.00	1.00
Adj. Flow (vph)	18	39
RTOR Reduction (vph)	19	0
Lane Group Flow (vph)	90	0
Confl. Peds. (#/hr)		39
Heavy Vehicles (%)	0%	0%
Bus Blockages (#/hr)	0	0
Turn Type	NA	
Protected Phases	4	
Permitted Phases		
Actuated Green, G (s)	14.5	
Effective Green, g (s)	14.5	
Actuated g/C Ratio	0.11	
Clearance Time (s)	6.7	
Vehicle Extension (s)	3.0	
Lane Grp Cap (vph)	153	
v/s Ratio Prot		
v/s Ratio Perm	c0.07	
v/c Ratio	0.59	
Uniform Delay, d1	54.9	
Progression Factor	1.00	
Incremental Delay, d2	6.0	
Delay (s)	60.9	
Level of Service	E	
Approach Delay (s)	60.9	
Approach LOS	E	
Intersection Summary		

HCM Signalized Intersection Capacity Analysis
3: Carling Ave & Croydon Ave

Future Background (2029)
PM Peak Hour



Movement	EBU	EBL	EBT	WBU	WBT	WBR	SBL	SBR
Lane Configurations		↔	↑↑↑		↑↑↑		↔	
Traffic Volume (vph)	7	95	1333	1	2164	156	179	115
Future Volume (vph)	7	95	1333	1	2164	156	179	115
Ideal Flow (vphpl)	1800	1800	1800	1800	1800	1800	1800	1800
Lane Width	3.7	2.8	3.6	3.7	3.7	3.7	3.7	3.3
Total Lost time (s)		5.9	5.9		5.9		6.3	
Lane Util. Factor		1.00	0.91		0.91		0.97	
Frbp, ped/bikes		1.00	1.00		0.99		0.98	
Flpb, ped/bikes		1.00	1.00		1.00		1.00	
Frt		1.00	1.00		0.99		0.94	
Flt Protected		0.95	1.00		1.00		0.97	
Satd. Flow (prot)		1530	4696		4685		3111	
Flt Permitted		0.04	1.00		0.94		0.97	
Satd. Flow (perm)		69	4696		4403		3111	
Peak-hour factor, PHF	1.00	1.00	1.00	1.00	1.00	1.00	1.00	1.00
Adj. Flow (vph)	7	95	1333	1	2164	156	179	115
RTOR Reduction (vph)	0	0	0	0	5	0	76	0
Lane Group Flow (vph)	0	102	1333	0	2316	0	218	0
Confl. Peds. (#/hr)	27	48		4		48	4	27
Heavy Vehicles (%)	0%	2%	2%	0%	1%	5%	3%	0%
Bus Blockages (#/hr)	0	0	19	0	19	0	0	0
Turn Type	Perm	pm+pt	NA	Perm	NA		Prot	
Protected Phases		5	2		6		7	
Permitted Phases	2	2		6				
Actuated Green, G (s)		103.4	103.4		87.5		14.4	
Effective Green, g (s)		103.4	103.4		87.5		14.4	
Actuated g/C Ratio		0.80	0.80		0.67		0.11	
Clearance Time (s)		5.9	5.9		5.9		6.3	
Vehicle Extension (s)		3.0	3.0		3.0		3.0	
Lane Grp Cap (vph)		167	3735		2963		344	
v/s Ratio Prot		c0.05	0.28				c0.07	
v/s Ratio Perm		0.44			c0.53			
v/c Ratio		0.61	0.36		0.78		0.63	
Uniform Delay, d1		29.9	3.8		14.7		55.3	
Progression Factor		2.05	0.27		1.00		1.00	
Incremental Delay, d2		6.1	0.3		2.1		3.8	
Delay (s)		67.3	1.3		16.8		59.0	
Level of Service		E	A		B		E	
Approach Delay (s)			6.0		16.8		59.0	
Approach LOS			A		B		E	
Intersection Summary								
HCM 2000 Control Delay			16.0		HCM 2000 Level of Service			B
HCM 2000 Volume to Capacity ratio			0.75					
Actuated Cycle Length (s)			130.0		Sum of lost time (s)			18.1
Intersection Capacity Utilization			109.8%		ICU Level of Service			H
Analysis Period (min)			15					

c Critical Lane Group

HCM Unsignalized Intersection Capacity Analysis
4: Carling Ave & Forest St

Future Background (2029)
PM Peak Hour



Movement	EBL	EBT	WBT	WBR	SBL	SBR	
Lane Configurations		↑↑↑	↑↑↑			↗	
Traffic Volume (veh/h)	0	1435	2247	39	0	72	
Future Volume (Veh/h)	0	1435	2247	39	0	72	
Sign Control		Free	Free		Stop		
Grade		0%	0%		0%		
Peak Hour Factor	1.00	1.00	1.00	1.00	1.00	1.00	
Hourly flow rate (vph)	0	1435	2247	39	0	72	
Pedestrians					49		
Lane Width (m)					4.8		
Walking Speed (m/s)					1.0		
Percent Blockage					7		
Right turn flare (veh)							
Median type		None	None				
Median storage (veh)							
Upstream signal (m)		55	141				
pX, platoon unblocked	0.68				0.74	0.68	
vC, conflicting volume	2335				2794	818	
vC1, stage 1 conf vol							
vC2, stage 2 conf vol							
vCu, unblocked vol	1333				1152	0	
tC, single (s)	4.1				6.8	6.9	
tC, 2 stage (s)							
tF (s)	2.2				3.5	3.3	
p0 queue free %	100				100	90	
cM capacity (veh/h)	335				135	697	
Direction, Lane #	EB 1	EB 2	EB 3	WB 1	WB 2	WB 3	SB 1
Volume Total	478	478	478	899	899	488	72
Volume Left	0	0	0	0	0	0	0
Volume Right	0	0	0	0	0	39	72
cSH	1700	1700	1700	1700	1700	1700	697
Volume to Capacity	0.28	0.28	0.28	0.53	0.53	0.29	0.10
Queue Length 95th (m)	0.0	0.0	0.0	0.0	0.0	0.0	2.6
Control Delay (s)	0.0	0.0	0.0	0.0	0.0	0.0	10.8
Lane LOS							B
Approach Delay (s)	0.0			0.0			10.8
Approach LOS							B
Intersection Summary							
Average Delay			0.2				
Intersection Capacity Utilization			58.2%		ICU Level of Service		B
Analysis Period (min)			15				

HCM Unsignalized Intersection Capacity Analysis
5: Croydon Ave & Bond St









Future Background (2029)
PM Peak Hour



Movement	EBL	EBR	NBL	NBT	SBT	SBR
Lane Configurations						
Traffic Volume (veh/h)	0	13	12	239	281	13
Future Volume (Veh/h)	0	13	12	239	281	13
Sign Control	Stop			Free	Free	
Grade	0%			0%	0%	
Peak Hour Factor	1.00	1.00	1.00	1.00	1.00	1.00
Hourly flow rate (vph)	0	13	12	239	281	13
Pedestrians	32					
Lane Width (m)	4.3					
Walking Speed (m/s)	1.0					
Percent Blockage	4					
Right turn flare (veh)						
Median type				None	None	
Median storage veh						
Upstream signal (m)				78	181	
pX, platoon unblocked						
vC, conflicting volume	582	320	326			
vC1, stage 1 conf vol						
vC2, stage 2 conf vol						
vCu, unblocked vol	582	320	326			
tC, single (s)	6.4	6.2	4.1			
tC, 2 stage (s)						
tF (s)	3.5	3.3	2.2			
p0 queue free %	100	98	99			
cM capacity (veh/h)	455	698	1197			
Direction, Lane #	EB 1	NB 1	SB 1			
Volume Total	13	251	294			
Volume Left	0	12	0			
Volume Right	13	0	13			
cSH	698	1197	1700			
Volume to Capacity	0.02	0.01	0.17			
Queue Length 95th (m)	0.4	0.2	0.0			
Control Delay (s)	10.3	0.5	0.0			
Lane LOS	B	A				
Approach Delay (s)	10.3	0.5	0.0			
Approach LOS	B					
Intersection Summary						
Average Delay			0.5			
Intersection Capacity Utilization			33.6%	ICU Level of Service	A	
Analysis Period (min)			15			

HCM Unsignalized Intersection Capacity Analysis
6: Forest St & Bond St

Future Background (2029)
PM Peak Hour

						
Movement	WBL	WBR	NBT	NBR	SBL	SBT
Lane Configurations						
Traffic Volume (veh/h)	1	10	38	1	18	72
Future Volume (Veh/h)	1	10	38	1	18	72
Sign Control	Stop		Free		Free	
Grade	0%		0%		0%	
Peak Hour Factor	1.00	1.00	1.00	1.00	1.00	1.00
Hourly flow rate (vph)	1	10	38	1	18	72
Pedestrians	12					
Lane Width (m)	3.5					
Walking Speed (m/s)	1.0					
Percent Blockage	1					
Right turn flare (veh)						
Median type	None			None		
Median storage veh						
Upstream signal (m)						
pX, platoon unblocked						
vC, conflicting volume	158	50			51	
vC1, stage 1 conf vol						
vC2, stage 2 conf vol						
vCu, unblocked vol	158	50			51	
tC, single (s)	6.4	6.2			4.1	
tC, 2 stage (s)						
tF (s)	3.5	3.3			2.2	
p0 queue free %	100	99			99	
cM capacity (veh/h)	818	1011			1550	
Direction, Lane #	WB 1	NB 1	SB 1			
Volume Total	11	39	90			
Volume Left	1	0	18			
Volume Right	10	1	0			
cSH	990	1700	1550			
Volume to Capacity	0.01	0.02	0.01			
Queue Length 95th (m)	0.3	0.0	0.3			
Control Delay (s)	8.7	0.0	1.5			
Lane LOS	A		A			
Approach Delay (s)	8.7	0.0	1.5			
Approach LOS	A					
Intersection Summary						
Average Delay			1.7			
Intersection Capacity Utilization			21.7%	ICU Level of Service		A
Analysis Period (min)			15			

HCM Unsignalized Intersection Capacity Analysis
7: Forest St & Richmond Rd

Future Background (2029)
PM Peak Hour

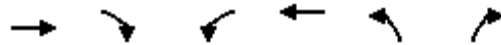





















Movement	EBT	EBR	WBL	WBT	NBL	NBR
Lane Configurations	→			←	↘	↙
Traffic Volume (veh/h)	657	12	54	1035	13	32
Future Volume (Veh/h)	657	12	54	1035	13	32
Sign Control	Free			Free	Stop	
Grade	0%			0%	0%	
Peak Hour Factor	1.00	1.00	1.00	1.00	1.00	1.00
Hourly flow rate (vph)	657	12	54	1035	13	32
Pedestrians						12
Lane Width (m)						4.7
Walking Speed (m/s)						1.0
Percent Blockage						2
Right turn flare (veh)						
Median type	None			None		
Median storage (veh)						
Upstream signal (m)				154		
pX, platoon unblocked					0.45	
vC, conflicting volume			681	1818	675	
vC1, stage 1 conf vol						
vC2, stage 2 conf vol						
vCu, unblocked vol			681	2214	675	
tC, single (s)			4.1	6.4	6.2	
tC, 2 stage (s)						
tF (s)			2.2	3.5	3.3	
p0 queue free %			94	36	93	
cM capacity (veh/h)			907	20	450	
Direction, Lane #	EB 1	WB 1	NB 1			
Volume Total	669	1089	45			
Volume Left	0	54	13			
Volume Right	12	0	32			
cSH	1700	907	63			
Volume to Capacity	0.39	0.06	0.72			
Queue Length 95th (m)	0.0	1.4	23.9			
Control Delay (s)	0.0	1.8	148.4			
Lane LOS			A	F		
Approach Delay (s)	0.0	1.8	148.4			
Approach LOS			F			
Intersection Summary						
Average Delay			4.8			
Intersection Capacity Utilization			111.3%	ICU Level of Service	H	
Analysis Period (min)			15			

Appendix G – Future (2024) Total Traffic Level of Service Calculations

HCM Signalized Intersection Capacity Analysis
 1: Croydon Ave & Richmond Rd/Richmond St

Future Total (2024)
 AM Peak Hour

													
Movement	EBL	EBT	EBR	WBL	WBT	WBR	NBL	NBT	NBR	SBL	SBT	SBR	
Lane Configurations													
Traffic Volume (vph)	24	577	69	17	382	17	37	29	81	28	72	38	
Future Volume (vph)	24	577	69	17	382	17	37	29	81	28	72	38	
Ideal Flow (vphpl)	1800	1800	1800	1800	1800	1800	1800	1800	1800	1800	1800	1800	
Lane Width	3.4	3.4	3.7	3.0	3.4	3.7	3.5	3.5	3.7	3.7	4.8	3.7	
Total Lost time (s)	6.4	6.4		6.4	6.4		6.1	6.1				6.1	
Lane Util. Factor	1.00	1.00		1.00	1.00		1.00	1.00				1.00	
Frbp, ped/bikes	1.00	0.99		1.00	1.00		1.00	0.94				0.98	
Flpb, ped/bikes	0.98	1.00		0.99	1.00		0.97	1.00				0.99	
Frtp	1.00	0.98		1.00	0.99		1.00	0.89				0.96	
Fltp Protected	0.95	1.00		0.95	1.00		0.95	1.00				0.99	
Satd. Flow (prot)	1556	1594		1579	1613		1540	1423				1823	
Fltp Permitted	0.53	1.00		0.37	1.00		0.68	1.00				0.90	
Satd. Flow (perm)	863	1594		614	1613		1109	1423				1658	
Peak-hour factor, PHF	1.00	1.00	1.00	1.00	1.00	1.00	1.00	1.00	1.00	1.00	1.00	1.00	
Adj. Flow (vph)	24	577	69	17	382	17	37	29	81	28	72	38	
RTOR Reduction (vph)	0	3	0	0	1	0	0	70	0	0	26	0	
Lane Group Flow (vph)	24	643	0	17	398	0	37	40	0	0	112	0	
Confl. Peds. (#/hr)	23		17	17		23	32		45	45		32	
Heavy Vehicles (%)	5%	3%	10%	0%	4%	0%	6%	9%	3%	7%	0%	8%	
Bus Blockages (#/hr)	0	10	0	0	10	0	0	0	0	0	0	0	
Turn Type	Perm	NA		Perm	NA		Perm	NA		Perm	NA		
Protected Phases		2			6			8				4	
Permitted Phases	2			6			8			4			
Actuated Green, G (s)	48.3	48.3		48.3	48.3		9.2	9.2				9.2	
Effective Green, g (s)	48.3	48.3		48.3	48.3		9.2	9.2				9.2	
Actuated g/C Ratio	0.69	0.69		0.69	0.69		0.13	0.13				0.13	
Clearance Time (s)	6.4	6.4		6.4	6.4		6.1	6.1				6.1	
Vehicle Extension (s)	3.0	3.0		3.0	3.0		3.0	3.0				3.0	
Lane Grp Cap (vph)	595	1099		423	1112		145	187				217	
v/s Ratio Prot		c0.40			0.25			0.03					
v/s Ratio Perm	0.03			0.03			0.03					c0.07	
v/c Ratio	0.04	0.58		0.04	0.36		0.26	0.21				0.52	
Uniform Delay, d1	3.5	5.6		3.5	4.5		27.3	27.2				28.3	
Progression Factor	1.00	1.00		1.00	1.00		1.00	1.00				1.00	
Incremental Delay, d2	0.1	2.3		0.2	0.9		0.9	0.6				2.1	
Delay (s)	3.6	7.9		3.6	5.4		28.3	27.7				30.4	
Level of Service	A	A		A	A		C	C				C	
Approach Delay (s)		7.8			5.3			27.9				30.4	
Approach LOS		A			A			C				C	
Intersection Summary													
HCM 2000 Control Delay			11.4				HCM 2000 Level of Service					B	
HCM 2000 Volume to Capacity ratio			0.57										
Actuated Cycle Length (s)			70.0				Sum of lost time (s)				12.5		
Intersection Capacity Utilization			66.1%				ICU Level of Service					C	
Analysis Period (min)			15										

c Critical Lane Group

HCM Signalized Intersection Capacity Analysis
2: Alpine Ave/1460 Richmond & Carling Ave

Future Total (2024)
AM Peak Hour



Movement	EBU	EBL	EBT	EBR	WBU	WBL	WBT	WBR	NBL	NBT	NBR	SBL
Lane Configurations												
Traffic Volume (vph)	6	32	2758	6	4	33	980	75	24	8	96	45
Future Volume (vph)	6	32	2758	6	4	33	980	75	24	8	96	45
Ideal Flow (vphpl)	1800	1800	1800	1800	1800	1800	1800	1800	1800	1800	1800	1800
Lane Width	3.7	3.0	3.6	3.7	3.7	3.0	3.7	3.7	3.7	4.8	3.7	3.7
Total Lost time (s)		5.9	5.9			5.9	5.9			6.7		
Lane Util. Factor		1.00	0.91			1.00	0.91			1.00		
Frbp, ped/bikes		1.00	1.00			1.00	0.99			0.96		
Flpb, ped/bikes		0.97	1.00			1.00	1.00			1.00		
Frt		1.00	1.00			1.00	0.99			0.90		
Flt Protected		0.95	1.00			0.95	1.00			0.99		
Satd. Flow (prot)		1513	4811			1596	4684			1683		
Flt Permitted		0.26	1.00			0.04	1.00			0.88		
Satd. Flow (perm)		413	4811			68	4684			1495		
Peak-hour factor, PHF	1.00	1.00	1.00	1.00	1.00	1.00	1.00	1.00	1.00	1.00	1.00	1.00
Adj. Flow (vph)	6	32	2758	6	4	33	980	75	24	8	96	45
RTOR Reduction (vph)	0	0	0	0	0	0	4	0	0	55	0	0
Lane Group Flow (vph)	0	38	2764	0	0	37	1051	0	0	73	0	0
Confl. Peds. (#/hr)	12	40		30	30	30		40	12		30	30
Heavy Vehicles (%)	0%	3%	1%	0%	0%	0%	3%	3%	9%	0%	2%	2%
Bus Blockages (#/hr)	0	0	8	0	0	0	8	0	0	0	0	0
Turn Type	Perm	Perm	NA		Perm	pm+pt	NA		Perm	NA		Perm
Protected Phases			2			1	6			8		
Permitted Phases	2	2			6	6			8			4
Actuated Green, G (s)		92.9	92.9			103.8	103.8			13.6		
Effective Green, g (s)		92.9	92.9			103.8	103.8			13.6		
Actuated g/C Ratio		0.71	0.71			0.80	0.80			0.10		
Clearance Time (s)		5.9	5.9			5.9	5.9			6.7		
Vehicle Extension (s)		3.0	3.0			3.0	3.0			3.0		
Lane Grp Cap (vph)		295	3438			113	3739			156		
v/s Ratio Prot			c0.57			0.01	c0.22					
v/s Ratio Perm		0.09				0.25				0.05		
v/c Ratio		0.13	0.80			0.33	0.28			0.47		
Uniform Delay, d1		5.8	12.4			14.9	3.4			54.8		
Progression Factor		1.00	1.00			3.27	0.82			1.00		
Incremental Delay, d2		0.9	2.1			1.6	0.2			2.2		
Delay (s)		6.7	14.5			50.3	3.0			57.0		
Level of Service		A	B			D	A			E		
Approach Delay (s)			14.4				4.6			57.0		
Approach LOS			B				A			E		
Intersection Summary												
HCM 2000 Control Delay			14.7									B
HCM 2000 Volume to Capacity ratio			0.77									
Actuated Cycle Length (s)			130.0							18.5		
Intersection Capacity Utilization			86.1%									E
Analysis Period (min)			15									

c Critical Lane Group

HCM Signalized Intersection Capacity Analysis
 2: Alpine Ave/1460 Richmond & Carling Ave

Future Total (2024)
 AM Peak Hour



Movement	SBT	SBR
Lane Configurations	↕	
Traffic Volume (vph)	10	57
Future Volume (vph)	10	57
Ideal Flow (vphpl)	1800	1800
Lane Width	3.6	3.7
Total Lost time (s)	6.7	
Lane Util. Factor	1.00	
Frbp, ped/bikes	0.99	
Flpb, ped/bikes	0.99	
Frt	0.93	
Flt Protected	0.98	
Satd. Flow (prot)	1573	
Flt Permitted	0.68	
Satd. Flow (perm)	1093	
Peak-hour factor, PHF	1.00	1.00
Adj. Flow (vph)	10	57
RTOR Reduction (vph)	36	0
Lane Group Flow (vph)	76	0
Confl. Peds. (#/hr)		12
Heavy Vehicles (%)	0%	2%
Bus Blockages (#/hr)	0	0
Turn Type	NA	
Protected Phases	4	
Permitted Phases		
Actuated Green, G (s)	13.6	
Effective Green, g (s)	13.6	
Actuated g/C Ratio	0.10	
Clearance Time (s)	6.7	
Vehicle Extension (s)	3.0	
Lane Grp Cap (vph)	114	
v/s Ratio Prot		
v/s Ratio Perm	c0.07	
v/c Ratio	0.67	
Uniform Delay, d1	56.0	
Progression Factor	1.00	
Incremental Delay, d2	13.9	
Delay (s)	69.9	
Level of Service	E	
Approach Delay (s)	69.9	
Approach LOS	E	
Intersection Summary		

HCM Signalized Intersection Capacity Analysis
3: Carling Ave & Croydon Ave

Future Total (2024)
AM Peak Hour



Movement	EBU	EBL	EBT	WBU	WBT	WBR	SBL	SBR
Lane Configurations		↔	↑↑↑		↑↑↑		↔	
Traffic Volume (vph)	2	113	2790	1	1010	97	199	28
Future Volume (vph)	2	113	2790	1	1010	97	199	28
Ideal Flow (vphpl)	1800	1800	1800	1800	1800	1800	1800	1800
Lane Width	3.7	2.8	3.6	3.7	3.7	3.7	3.7	3.3
Total Lost time (s)		5.9	5.9		5.9		6.3	
Lane Util. Factor		1.00	0.91		0.91		0.97	
Frbp, ped/bikes		1.00	1.00		0.99		1.00	
Flpb, ped/bikes		1.00	1.00		1.00		1.00	
Frt		1.00	1.00		0.99		0.98	
Flt Protected		0.95	1.00		1.00		0.96	
Satd. Flow (prot)		1538	4742		4596		3148	
Flt Permitted		0.22	1.00		0.94		0.96	
Satd. Flow (perm)		348	4742		4305		3148	
Peak-hour factor, PHF	1.00	1.00	1.00	1.00	1.00	1.00	1.00	1.00
Adj. Flow (vph)	2	113	2790	1	1010	97	199	28
RTOR Reduction (vph)	0	0	0	0	6	0	11	0
Lane Group Flow (vph)	0	115	2790	0	1102	0	216	0
Confl. Peds. (#/hr)	21	18		2		18	21	2
Heavy Vehicles (%)	0%	1%	1%	0%	3%	7%	6%	0%
Bus Blockages (#/hr)	0	0	19	0	19	0	0	0
Turn Type	Perm	pm+pt	NA	Perm	NA		Prot	
Protected Phases		5	2		6		7	
Permitted Phases	2	2		6				
Actuated Green, G (s)		103.5	103.5		89.9		14.3	
Effective Green, g (s)		103.5	103.5		89.9		14.3	
Actuated g/C Ratio		0.80	0.80		0.69		0.11	
Clearance Time (s)		5.9	5.9		5.9		6.3	
Vehicle Extension (s)		3.0	3.0		3.0		3.0	
Lane Grp Cap (vph)		347	3775		2977		346	
v/s Ratio Prot		0.02	c0.59				c0.07	
v/s Ratio Perm		0.24			0.26			
v/c Ratio		0.33	0.74		0.37		0.63	
Uniform Delay, d1		3.7	6.6		8.3		55.3	
Progression Factor		0.56	0.27		1.00		1.00	
Incremental Delay, d2		0.3	0.8		0.4		3.5	
Delay (s)		2.4	2.6		8.7		58.8	
Level of Service		A	A		A		E	
Approach Delay (s)			2.6		8.7		58.8	
Approach LOS			A		A		E	
Intersection Summary								
HCM 2000 Control Delay			7.2		HCM 2000 Level of Service		A	
HCM 2000 Volume to Capacity ratio			0.76					
Actuated Cycle Length (s)			130.0		Sum of lost time (s)		18.1	
Intersection Capacity Utilization			104.5%		ICU Level of Service		G	
Analysis Period (min)			15					

c Critical Lane Group

HCM Unsignalized Intersection Capacity Analysis
4: Carling Ave & Forest St

Future Total (2024)
AM Peak Hour



Movement	EBL	EBT	WBT	WBR	SBL	SBR	
Lane Configurations		↑↑↑	↑↑↑			↗	
Traffic Volume (veh/h)	0	2903	1006	34	0	86	
Future Volume (Veh/h)	0	2903	1006	34	0	86	
Sign Control		Free	Free		Stop		
Grade		0%	0%		0%		
Peak Hour Factor	1.00	1.00	1.00	1.00	1.00	1.00	
Hourly flow rate (vph)	0	2903	1006	34	0	86	
Pedestrians					40		
Lane Width (m)					4.8		
Walking Speed (m/s)					1.0		
Percent Blockage					5		
Right turn flare (veh)							
Median type		None	None				
Median storage (veh)							
Upstream signal (m)		55	141				
pX, platoon unblocked	0.92				0.64	0.92	
vC, conflicting volume	1080				2031	392	
vC1, stage 1 conf vol							
vC2, stage 2 conf vol							
vCu, unblocked vol	788				0	42	
tC, single (s)	4.1				6.8	6.9	
tC, 2 stage (s)							
tF (s)	2.2				3.5	3.3	
p0 queue free %	100				100	90	
cM capacity (veh/h)	733				625	895	
Direction, Lane #	EB 1	EB 2	EB 3	WB 1	WB 2	WB 3	SB 1
Volume Total	968	968	968	402	402	235	86
Volume Left	0	0	0	0	0	0	0
Volume Right	0	0	0	0	0	34	86
cSH	1700	1700	1700	1700	1700	1700	895
Volume to Capacity	0.57	0.57	0.57	0.24	0.24	0.14	0.10
Queue Length 95th (m)	0.0	0.0	0.0	0.0	0.0	0.0	2.4
Control Delay (s)	0.0	0.0	0.0	0.0	0.0	0.0	9.4
Lane LOS							A
Approach Delay (s)	0.0			0.0			9.4
Approach LOS							A
Intersection Summary							
Average Delay			0.2				
Intersection Capacity Utilization			62.5%		ICU Level of Service		B
Analysis Period (min)			15				

HCM Unsignalized Intersection Capacity Analysis
5: Croydon Ave & Bond St

Future Total (2024)
AM Peak Hour



Movement	EBL	EBR	NBL	NBT	SBT	SBR
Lane Configurations						
Traffic Volume (veh/h)	1	37	17	193	190	10
Future Volume (Veh/h)	1	37	17	193	190	10
Sign Control	Stop			Free	Free	
Grade	0%			0%	0%	
Peak Hour Factor	1.00	1.00	1.00	1.00	1.00	1.00
Hourly flow rate (vph)	1	37	17	193	190	10
Pedestrians	26					
Lane Width (m)	4.3					
Walking Speed (m/s)	1.0					
Percent Blockage	3					
Right turn flare (veh)						
Median type				None	None	
Median storage veh						
Upstream signal (m)				78	181	
pX, platoon unblocked						
vC, conflicting volume	448	221	226			
vC1, stage 1 conf vol						
vC2, stage 2 conf vol						
vCu, unblocked vol	448	221	226			
tC, single (s)	6.4	6.2	4.1			
tC, 2 stage (s)						
tF (s)	3.5	3.3	2.2			
p0 queue free %	100	95	99			
cM capacity (veh/h)	547	798	1312			
Direction, Lane #	EB 1	NB 1	SB 1			
Volume Total	38	210	200			
Volume Left	1	17	0			
Volume Right	37	0	10			
cSH	789	1312	1700			
Volume to Capacity	0.05	0.01	0.12			
Queue Length 95th (m)	1.2	0.3	0.0			
Control Delay (s)	9.8	0.7	0.0			
Lane LOS	A	A				
Approach Delay (s)	9.8	0.7	0.0			
Approach LOS	A					
Intersection Summary						
Average Delay			1.2			
Intersection Capacity Utilization			35.6%	ICU Level of Service	A	
Analysis Period (min)			15			

HCM Unsignalized Intersection Capacity Analysis
6: Forest St & Bond St

Future Total (2024)
AM Peak Hour



Movement	WBL	WBR	NBT	NBR	SBL	SBT
Lane Configurations						
Traffic Volume (veh/h)	1	14	33	1	40	86
Future Volume (Veh/h)	1	14	33	1	40	86
Sign Control	Stop		Free		Free	
Grade	0%		0%		0%	
Peak Hour Factor	1.00	1.00	1.00	1.00	1.00	1.00
Hourly flow rate (vph)	1	14	33	1	40	86
Pedestrians	11					
Lane Width (m)	3.5					
Walking Speed (m/s)	1.0					
Percent Blockage	1					
Right turn flare (veh)						
Median type	None			None		
Median storage veh						
Upstream signal (m)						
pX, platoon unblocked						
vC, conflicting volume	210	44			45	
vC1, stage 1 conf vol						
vC2, stage 2 conf vol						
vCu, unblocked vol	210	44			45	
tC, single (s)	6.4	6.2			4.1	
tC, 2 stage (s)						
tF (s)	3.5	3.3			2.2	
p0 queue free %	100	99			97	
cM capacity (veh/h)	754	1020			1559	
Direction, Lane #	WB 1	NB 1	SB 1			
Volume Total	15	34	126			
Volume Left	1	0	40			
Volume Right	14	1	0			
cSH	997	1700	1559			
Volume to Capacity	0.02	0.02	0.03			
Queue Length 95th (m)	0.3	0.0	0.6			
Control Delay (s)	8.7	0.0	2.5			
Lane LOS	A		A			
Approach Delay (s)	8.7	0.0	2.5			
Approach LOS	A					
Intersection Summary						
Average Delay			2.5			
Intersection Capacity Utilization			23.8%	ICU Level of Service	A	
Analysis Period (min)			15			

HCM Unsignalized Intersection Capacity Analysis
7: Forest St & Richmond Rd









Future Total (2024)
AM Peak Hour



Movement	EBT	EBR	WBL	WBT	NBL	NBR
Lane Configurations	→			←	←	←
Traffic Volume (veh/h)	626	14	26	431	11	43
Future Volume (Veh/h)	626	14	26	431	11	43
Sign Control	Free			Free	Stop	
Grade	0%			0%	0%	
Peak Hour Factor	1.00	1.00	1.00	1.00	1.00	1.00
Hourly flow rate (vph)	626	14	26	431	11	43
Pedestrians					11	
Lane Width (m)					4.7	
Walking Speed (m/s)					1.0	
Percent Blockage					1	
Right turn flare (veh)						
Median type	None			None		
Median storage veh						
Upstream signal (m)					154	
pX, platoon unblocked					0.93	
vC, conflicting volume			651	1127	644	
vC1, stage 1 conf vol						
vC2, stage 2 conf vol						
vCu, unblocked vol			651	1099	644	
tC, single (s)			4.1	6.4	6.2	
tC, 2 stage (s)						
tF (s)			2.2	3.5	3.3	
p0 queue free %			97	95	91	
cM capacity (veh/h)			931	211	470	
Direction, Lane #	EB 1	WB 1	NB 1			
Volume Total	640	457	54			
Volume Left	0	26	11			
Volume Right	14	0	43			
cSH	1700	931	376			
Volume to Capacity	0.38	0.03	0.14			
Queue Length 95th (m)	0.0	0.7	3.8			
Control Delay (s)	0.0	0.8	16.2			
Lane LOS			A	C		
Approach Delay (s)	0.0	0.8	16.2			
Approach LOS			C			
Intersection Summary						
Average Delay			1.1			
Intersection Capacity Utilization			56.5%	ICU Level of Service	B	
Analysis Period (min)			15			



















HCM Unsignalized Intersection Capacity Analysis
8: Forest St & 365 Forest

Future Total (2024)
AM Peak Hour

						
Movement	WBL	WBR	NBT	NBR	SBL	SBT
Lane Configurations						
Traffic Volume (veh/h)	61	11	44	17	6	34
Future Volume (Veh/h)	61	11	44	17	6	34
Sign Control	Stop		Free		Free	
Grade	0%		0%		0%	
Peak Hour Factor	1.00	1.00	1.00	1.00	1.00	1.00
Hourly flow rate (vph)	61	11	44	17	6	34
Pedestrians	11					
Lane Width (m)	3.7					
Walking Speed (m/s)	1.0					
Percent Blockage	1					
Right turn flare (veh)						
Median type	None			None		
Median storage (veh)						
Upstream signal (m)						
pX, platoon unblocked						
vC, conflicting volume	110	64			72	
vC1, stage 1 conf vol						
vC2, stage 2 conf vol						
vCu, unblocked vol	110	64			72	
tC, single (s)	6.4	6.2			4.1	
tC, 2 stage (s)						
tF (s)	3.5	3.3			2.2	
p0 queue free %	93	99			100	
cM capacity (veh/h)	879	995			1524	
Direction, Lane #	WB 1	NB 1	SB 1			
Volume Total	72	61	40			
Volume Left	61	0	6			
Volume Right	11	17	0			
cSH	895	1700	1524			
Volume to Capacity	0.08	0.04	0.00			
Queue Length 95th (m)	2.0	0.0	0.1			
Control Delay (s)	9.4	0.0	1.1			
Lane LOS	A		A			
Approach Delay (s)	9.4	0.0	1.1			
Approach LOS	A					
Intersection Summary						
Average Delay			4.2			
Intersection Capacity Utilization			18.2%	ICU Level of Service	A	
Analysis Period (min)			15			

HCM Signalized Intersection Capacity Analysis
 1: Croydon Ave & Richmond Rd/Richmond St

Future Total (2024)
 PM Peak Hour

												
Movement	EBL	EBT	EBR	WBL	WBT	WBR	NBL	NBT	NBR	SBL	SBT	SBR
Lane Configurations												
Traffic Volume (vph)	26	484	124	60	829	18	147	98	36	14	61	21
Future Volume (vph)	26	484	124	60	829	18	147	98	36	14	61	21
Ideal Flow (vphpl)	1800	1800	1800	1800	1800	1800	1800	1800	1800	1800	1800	1800
Lane Width	3.4	3.4	3.7	3.0	3.4	3.7	3.5	3.5	3.7	3.7	4.8	3.7
Total Lost time (s)	6.4	6.4		6.4	6.4		6.1	6.1			6.1	
Lane Util. Factor	1.00	1.00		1.00	1.00		1.00	1.00			1.00	
Frbp, ped/bikes	1.00	0.98		1.00	1.00		1.00	0.97			0.98	
Flpb, ped/bikes	0.99	1.00		0.98	1.00		0.95	1.00			0.99	
Frft	1.00	0.97		1.00	1.00		1.00	0.96			0.97	
Flt Protected	0.95	1.00		0.95	1.00		0.95	1.00			0.99	
Satd. Flow (prot)	1653	1566		1535	1649		1566	1636			1908	
Flt Permitted	0.23	1.00		0.37	1.00		0.76	1.00			0.94	
Satd. Flow (perm)	406	1566		603	1649		1253	1636			1810	
Peak-hour factor, PHF	1.00	1.00	1.00	1.00	1.00	1.00	1.00	1.00	1.00	1.00	1.00	1.00
Adj. Flow (vph)	26	484	124	60	829	18	147	98	36	14	61	21
RTOR Reduction (vph)	0	8	0	0	1	0	0	18	0	0	14	0
Lane Group Flow (vph)	26	600	0	60	846	0	147	116	0	0	82	0
Confl. Peds. (#/hr)	33		26	26		33	32		65	65		32
Heavy Vehicles (%)	0%	2%	7%	2%	2%	0%	3%	0%	3%	0%	0%	0%
Bus Blockages (#/hr)	0	10	0	0	10	0	0	0	0	0	0	0
Turn Type	Perm	NA		Perm	NA		Perm	NA		Perm	NA	
Protected Phases		2			6			8			4	
Permitted Phases	2			6			8			4		
Actuated Green, G (s)	56.8	56.8		56.8	56.8		15.7	15.7			15.7	
Effective Green, g (s)	56.8	56.8		56.8	56.8		15.7	15.7			15.7	
Actuated g/C Ratio	0.67	0.67		0.67	0.67		0.18	0.18			0.18	
Clearance Time (s)	6.4	6.4		6.4	6.4		6.1	6.1			6.1	
Vehicle Extension (s)	3.0	3.0		3.0	3.0		3.0	3.0			3.0	
Lane Grp Cap (vph)	271	1046		402	1101		231	302			334	
v/s Ratio Prot		0.38			c0.51			0.07				
v/s Ratio Perm	0.06			0.10			c0.12				0.05	
v/c Ratio	0.10	0.57		0.15	0.77		0.64	0.38			0.25	
Uniform Delay, d1	5.0	7.6		5.2	9.6		32.0	30.4			29.6	
Progression Factor	1.00	1.00		1.00	1.00		1.00	1.00			1.00	
Incremental Delay, d2	0.7	2.3		0.8	5.2		5.6	0.8			0.4	
Delay (s)	5.7	9.9		6.0	14.8		37.7	31.2			30.0	
Level of Service	A	A		A	B		D	C			C	
Approach Delay (s)		9.7			14.2			34.6			30.0	
Approach LOS		A			B			C			C	
Intersection Summary												
HCM 2000 Control Delay			16.5				HCM 2000 Level of Service				B	
HCM 2000 Volume to Capacity ratio			0.74									
Actuated Cycle Length (s)			85.0				Sum of lost time (s)				12.5	
Intersection Capacity Utilization			83.2%				ICU Level of Service				E	
Analysis Period (min)			15									

c Critical Lane Group

HCM Signalized Intersection Capacity Analysis
2: Alpine Ave/1460 Richmond & Carling Ave

Future Total (2024)
PM Peak Hour



Movement	EBU	EBL	EBT	EBR	WBU	WBL	WBT	WBR	NBL	NBT	NBR	SBL
Lane Configurations		↔	↑↑↑			↔	↑↑↑			↔		
Traffic Volume (vph)	3	25	1244	9	4	51	1989	76	19	14	30	47
Future Volume (vph)	3	25	1244	9	4	51	1989	76	19	14	30	47
Ideal Flow (vphpl)	1800	1800	1800	1800	1800	1800	1800	1800	1800	1800	1800	1800
Lane Width	3.7	3.0	3.6	3.7	3.7	3.0	3.7	3.7	3.7	4.8	3.7	3.7
Total Lost time (s)		5.9	5.9			5.9	5.9			6.7		
Lane Util. Factor		1.00	0.91			1.00	0.91			1.00		
Frbp, ped/bikes		1.00	1.00			1.00	1.00			0.98		
Flpb, ped/bikes		1.00	1.00			1.00	1.00			0.99		
Frt		1.00	1.00			1.00	0.99			0.94		
Flt Protected		0.95	1.00			0.95	1.00			0.99		
Satd. Flow (prot)		1596	4760			1565	4820			1737		
Flt Permitted		0.07	1.00			0.19	1.00			0.85		
Satd. Flow (perm)		119	4760			315	4820			1507		
Peak-hour factor, PHF	1.00	1.00	1.00	1.00	1.00	1.00	1.00	1.00	1.00	1.00	1.00	1.00
Adj. Flow (vph)	3	25	1244	9	4	51	1989	76	19	14	30	47
RTOR Reduction (vph)	0	0	0	0	0	0	2	0	0	27	0	0
Lane Group Flow (vph)	0	28	1253	0	0	55	2063	0	0	36	0	0
Confl. Peds. (#/hr)	35	44		14	15	14		44	35		15	15
Heavy Vehicles (%)	0%	0%	2%	0%	0%	2%	1%	0%	12%	0%	4%	2%
Bus Blockages (#/hr)	0	0	8	0	0	0	8	0	0	0	0	0
Turn Type	Perm	pm+pt	NA		Perm	pm+pt	NA		Perm	NA		Perm
Protected Phases		5	2			1	6			8		
Permitted Phases	2	2			6	6			8			4
Actuated Green, G (s)		96.4	92.6			99.6	94.2			13.5		
Effective Green, g (s)		96.4	92.6			99.6	94.2			13.5		
Actuated g/C Ratio		0.74	0.71			0.77	0.72			0.10		
Clearance Time (s)		5.9	5.9			5.9	5.9			6.7		
Vehicle Extension (s)		3.0	3.0			3.0	3.0			3.0		
Lane Grp Cap (vph)		131	3390			293	3492			156		
v/s Ratio Prot		0.01	0.26			c0.01	c0.43					
v/s Ratio Perm		0.15				0.14				0.02		
v/c Ratio		0.21	0.37			0.19	0.59			0.23		
Uniform Delay, d1		6.0	7.3			4.0	8.6			53.5		
Progression Factor		1.00	1.00			1.18	0.76			1.00		
Incremental Delay, d2		0.8	0.3			0.2	0.5			0.8		
Delay (s)		6.9	7.6			5.0	7.1			54.2		
Level of Service		A	A			A	A			D		
Approach Delay (s)			7.6				7.0			54.2		
Approach LOS			A				A			D		
Intersection Summary												
HCM 2000 Control Delay			9.5				HCM 2000 Level of Service			A		
HCM 2000 Volume to Capacity ratio			0.57									
Actuated Cycle Length (s)			130.0				Sum of lost time (s)			18.5		
Intersection Capacity Utilization			82.7%				ICU Level of Service			E		
Analysis Period (min)			15									

c Critical Lane Group

HCM Signalized Intersection Capacity Analysis
 2: Alpine Ave/1460 Richmond & Carling Ave

Future Total (2024)
 PM Peak Hour



Movement	SBT	SBR
Lane Configurations	↕	
Traffic Volume (vph)	17	35
Future Volume (vph)	17	35
Ideal Flow (vphpl)	1800	1800
Lane Width	3.6	3.7
Total Lost time (s)	6.7	
Lane Util. Factor	1.00	
Frbp, ped/bikes	0.98	
Flpb, ped/bikes	0.99	
Frt	0.95	
Flt Protected	0.98	
Satd. Flow (prot)	1614	
Flt Permitted	0.85	
Satd. Flow (perm)	1405	
Peak-hour factor, PHF	1.00	1.00
Adj. Flow (vph)	17	35
RTOR Reduction (vph)	19	0
Lane Group Flow (vph)	80	0
Confl. Peds. (#/hr)		35
Heavy Vehicles (%)	0%	0%
Bus Blockages (#/hr)	0	0
Turn Type	NA	
Protected Phases	4	
Permitted Phases		
Actuated Green, G (s)	13.5	
Effective Green, g (s)	13.5	
Actuated g/C Ratio	0.10	
Clearance Time (s)	6.7	
Vehicle Extension (s)	3.0	
Lane Grp Cap (vph)	145	
v/s Ratio Prot		
v/s Ratio Perm	c0.06	
v/c Ratio	0.55	
Uniform Delay, d1	55.4	
Progression Factor	1.00	
Incremental Delay, d2	4.5	
Delay (s)	59.9	
Level of Service	E	
Approach Delay (s)	59.9	
Approach LOS	E	
Intersection Summary		

HCM Signalized Intersection Capacity Analysis
3: Carling Ave & Croydon Ave

Future Total (2024)
PM Peak Hour

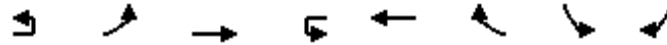

Movement	EBU	EBL	EBT	WBU	WBT	WBR	SBL	SBR
Lane Configurations		↔	↑↑↑		↑↑↑		↔	
Traffic Volume (vph)	7	109	1209	1	1986	141	180	105
Future Volume (vph)	7	109	1209	1	1986	141	180	105
Ideal Flow (vphpl)	1800	1800	1800	1800	1800	1800	1800	1800
Lane Width	3.7	2.8	3.6	3.7	3.7	3.7	3.7	3.3
Total Lost time (s)		5.9	5.9		5.9		6.3	
Lane Util. Factor		1.00	0.91		0.91		0.97	
Frbp, ped/bikes		1.00	1.00		0.99		0.98	
Flpb, ped/bikes		1.00	1.00		1.00		1.00	
Frt		1.00	1.00		0.99		0.94	
Flt Protected		0.95	1.00		1.00		0.97	
Satd. Flow (prot)		1529	4696		4691		3125	
Flt Permitted		0.05	1.00		0.94		0.97	
Satd. Flow (perm)		85	4696		4408		3125	
Peak-hour factor, PHF	1.00	1.00	1.00	1.00	1.00	1.00	1.00	1.00
Adj. Flow (vph)	7	109	1209	1	1986	141	180	105
RTOR Reduction (vph)	0	0	0	0	5	0	80	0
Lane Group Flow (vph)	0	116	1209	0	2123	0	205	0
Confl. Peds. (#/hr)	24	43		3		43	3	24
Heavy Vehicles (%)	0%	2%	2%	0%	1%	5%	3%	0%
Bus Blockages (#/hr)	0	0	19	0	19	0	0	0
Turn Type	Perm	pm+pt	NA	Perm	NA		Prot	
Protected Phases		5	2		6		7	
Permitted Phases	2	2		6				
Actuated Green, G (s)		103.9	103.9		86.5		13.9	
Effective Green, g (s)		103.9	103.9		86.5		13.9	
Actuated g/C Ratio		0.80	0.80		0.67		0.11	
Clearance Time (s)		5.9	5.9		5.9		6.3	
Vehicle Extension (s)		3.0	3.0		3.0		3.0	
Lane Grp Cap (vph)		195	3753		2933		334	
v/s Ratio Prot		c0.05	0.26				c0.07	
v/s Ratio Perm		0.42			c0.48			
v/c Ratio		0.59	0.32		0.72		0.61	
Uniform Delay, d1		25.8	3.5		14.0		55.5	
Progression Factor		2.24	0.28		1.00		1.00	
Incremental Delay, d2		4.6	0.2		1.6		3.3	
Delay (s)		62.5	1.2		15.6		58.8	
Level of Service		E	A		B		E	
Approach Delay (s)			6.6		15.6		58.8	
Approach LOS			A		B		E	
Intersection Summary								
HCM 2000 Control Delay			15.7		HCM 2000 Level of Service		B	
HCM 2000 Volume to Capacity ratio			0.70					
Actuated Cycle Length (s)			130.0		Sum of lost time (s)		18.1	
Intersection Capacity Utilization			102.4%		ICU Level of Service		G	
Analysis Period (min)			15					

c Critical Lane Group

HCM Unsignalized Intersection Capacity Analysis

4: Carling Ave & Forest St

Future Total (2024)
PM Peak Hour



Movement	EBL	EBT	WBT	WBR	SBL	SBR	
Lane Configurations		↑↑↑	↑↑↑			↑	
Traffic Volume (veh/h)	0	1325	2036	61	0	84	
Future Volume (Veh/h)	0	1325	2036	61	0	84	
Sign Control		Free	Free		Stop		
Grade		0%	0%		0%		
Peak Hour Factor	1.00	1.00	1.00	1.00	1.00	1.00	
Hourly flow rate (vph)	0	1325	2036	61	0	84	
Pedestrians					44		
Lane Width (m)					4.8		
Walking Speed (m/s)					1.0		
Percent Blockage					6		
Right turn flare (veh)							
Median type		None	None				
Median storage (veh)							
Upstream signal (m)		55	141				
pX, platoon unblocked	0.73				0.78	0.73	
vC, conflicting volume	2141				2552	753	
vC1, stage 1 conf vol							
vC2, stage 2 conf vol							
vCu, unblocked vol	1265				1140	0	
tC, single (s)	4.1				6.8	6.9	
tC, 2 stage (s)							
tF (s)	2.2				3.5	3.3	
p0 queue free %	100				100	89	
cM capacity (veh/h)	382				145	749	
Direction, Lane #	EB 1	EB 2	EB 3	WB 1	WB 2	WB 3	SB 1
Volume Total	442	442	442	814	814	468	84
Volume Left	0	0	0	0	0	0	0
Volume Right	0	0	0	0	0	61	84
cSH	1700	1700	1700	1700	1700	1700	749
Volume to Capacity	0.26	0.26	0.26	0.48	0.48	0.28	0.11
Queue Length 95th (m)	0.0	0.0	0.0	0.0	0.0	0.0	2.9
Control Delay (s)	0.0	0.0	0.0	0.0	0.0	0.0	10.4
Lane LOS							B
Approach Delay (s)	0.0			0.0			10.4
Approach LOS							B
Intersection Summary							
Average Delay			0.2				
Intersection Capacity Utilization			55.2%		ICU Level of Service		B
Analysis Period (min)			15				

HCM Unsignalized Intersection Capacity Analysis
5: Croydon Ave & Bond St

Future Total (2024)
PM Peak Hour



Movement	EBL	EBR	NBL	NBT	SBT	SBR
Lane Configurations						
Traffic Volume (veh/h)	1	29	32	218	256	12
Future Volume (Veh/h)	1	29	32	218	256	12
Sign Control	Stop			Free	Free	
Grade	0%			0%	0%	
Peak Hour Factor	1.00	1.00	1.00	1.00	1.00	1.00
Hourly flow rate (vph)	1	29	32	218	256	12
Pedestrians	29					
Lane Width (m)	4.3					
Walking Speed (m/s)	1.0					
Percent Blockage	3					
Right turn flare (veh)						
Median type				None	None	
Median storage veh						
Upstream signal (m)				78	181	
pX, platoon unblocked						
vC, conflicting volume	573	291	297			
vC1, stage 1 conf vol						
vC2, stage 2 conf vol						
vCu, unblocked vol	573	291	297			
tC, single (s)	6.4	6.2	4.1			
tC, 2 stage (s)						
tF (s)	3.5	3.3	2.2			
p0 queue free %	100	96	97			
cM capacity (veh/h)	455	727	1232			
Direction, Lane #	EB 1	NB 1	SB 1			
Volume Total	30	250	268			
Volume Left	1	32	0			
Volume Right	29	0	12			
cSH	713	1232	1700			
Volume to Capacity	0.04	0.03	0.16			
Queue Length 95th (m)	1.0	0.6	0.0			
Control Delay (s)	10.3	1.2	0.0			
Lane LOS	B	A				
Approach Delay (s)	10.3	1.2	0.0			
Approach LOS	B					
Intersection Summary						
Average Delay			1.1			
Intersection Capacity Utilization			42.4%	ICU Level of Service	A	
Analysis Period (min)			15			

HCM Unsignalized Intersection Capacity Analysis
6: Forest St & Bond St

Future Total (2024)
PM Peak Hour



Movement	WBL	WBR	NBT	NBR	SBL	SBT
Lane Configurations						
Traffic Volume (veh/h)	1	30	61	1	35	83
Future Volume (Veh/h)	1	30	61	1	35	83
Sign Control	Stop		Free			Free
Grade	0%		0%			0%
Peak Hour Factor	1.00	1.00	1.00	1.00	1.00	1.00
Hourly flow rate (vph)	1	30	61	1	35	83
Pedestrians	11					
Lane Width (m)	3.5					
Walking Speed (m/s)	1.0					
Percent Blockage	1					
Right turn flare (veh)						
Median type			None			None
Median storage (veh)						
Upstream signal (m)						
pX, platoon unblocked						
vC, conflicting volume	226	72			73	
vC1, stage 1 conf vol						
vC2, stage 2 conf vol						
vCu, unblocked vol	226	72			73	
tC, single (s)	6.4	6.2			4.1	
tC, 2 stage (s)						
tF (s)	3.5	3.3			2.2	
p0 queue free %	100	97			98	
cM capacity (veh/h)	741	985			1523	
Direction, Lane #	WB 1	NB 1	SB 1			
Volume Total	31	62	118			
Volume Left	1	0	35			
Volume Right	30	1	0			
cSH	974	1700	1523			
Volume to Capacity	0.03	0.04	0.02			
Queue Length 95th (m)	0.7	0.0	0.5			
Control Delay (s)	8.8	0.0	2.3			
Lane LOS	A		A			
Approach Delay (s)	8.8	0.0	2.3			
Approach LOS	A					
Intersection Summary						
Average Delay			2.6			
Intersection Capacity Utilization			23.3%		ICU Level of Service	A
Analysis Period (min)			15			

HCM Unsignalized Intersection Capacity Analysis
7: Forest St & Richmond Rd









Future Total (2024)
PM Peak Hour



Movement	EBT	EBR	WBL	WBT	NBL	NBR
Lane Configurations	→			←	←	↗
Traffic Volume (veh/h)	599	22	58	939	11	35
Future Volume (Veh/h)	599	22	58	939	11	35
Sign Control	Free			Free	Stop	
Grade	0%			0%	0%	
Peak Hour Factor	1.00	1.00	1.00	1.00	1.00	1.00
Hourly flow rate (vph)	599	22	58	939	11	35
Pedestrians						11
Lane Width (m)						4.7
Walking Speed (m/s)						1.0
Percent Blockage						1
Right turn flare (veh)						
Median type	None			None		
Median storage veh						
Upstream signal (m)				154		
pX, platoon unblocked					0.57	
vC, conflicting volume			632	1676	621	
vC1, stage 1 conf vol						
vC2, stage 2 conf vol						
vCu, unblocked vol			632	1809	621	
tC, single (s)			4.1	6.4	6.2	
tC, 2 stage (s)						
tF (s)			2.2	3.5	3.3	
p0 queue free %			94	76	93	
cM capacity (veh/h)			947	46	484	
Direction, Lane #	EB 1	WB 1	NB 1			
Volume Total	621	997	46			
Volume Left	0	58	11			
Volume Right	22	0	35			
cSH	1700	947	148			
Volume to Capacity	0.37	0.06	0.31			
Queue Length 95th (m)	0.0	1.5	9.4			
Control Delay (s)	0.0	1.7	39.8			
Lane LOS			A	E		
Approach Delay (s)	0.0	1.7	39.8			
Approach LOS			E			
Intersection Summary						
Average Delay			2.1			
Intersection Capacity Utilization			103.6%	ICU Level of Service	G	
Analysis Period (min)			15			

HCM Unsignalized Intersection Capacity Analysis
 8: Forest St & 365 Forest





















Future Total (2024)
 PM Peak Hour

						
Movement	WBL	WBR	NBT	NBR	SBL	SBT
Lane Configurations						
Traffic Volume (veh/h)	36	6	41	47	19	61
Future Volume (Veh/h)	36	6	41	47	19	61
Sign Control	Stop		Free		Free	
Grade	0%		0%		0%	
Peak Hour Factor	1.00	1.00	1.00	1.00	1.00	1.00
Hourly flow rate (vph)	36	6	41	47	19	61
Pedestrians	11					
Lane Width (m)	3.7					
Walking Speed (m/s)	1.0					
Percent Blockage	1					
Right turn flare (veh)						
Median type	None			None		
Median storage (veh)						
Upstream signal (m)						
pX, platoon unblocked						
vC, conflicting volume	174	76			99	
vC1, stage 1 conf vol						
vC2, stage 2 conf vol						
vCu, unblocked vol	174	76			99	
tC, single (s)	6.4	6.2			4.1	
tC, 2 stage (s)						
tF (s)	3.5	3.3			2.2	
p0 queue free %	96	99			99	
cM capacity (veh/h)	800	980			1490	
Direction, Lane #	WB 1	NB 1	SB 1			
Volume Total	42	88	80			
Volume Left	36	0	19			
Volume Right	6	47	0			
cSH	822	1700	1490			
Volume to Capacity	0.05	0.05	0.01			
Queue Length 95th (m)	1.2	0.0	0.3			
Control Delay (s)	9.6	0.0	1.8			
Lane LOS	A		A			
Approach Delay (s)	9.6	0.0	1.8			
Approach LOS	A					
Intersection Summary						
Average Delay			2.6			
Intersection Capacity Utilization			21.2%		ICU Level of Service	A
Analysis Period (min)			15			

Appendix H – Future (2029) Total Traffic Level of Service Calculations

HCM Signalized Intersection Capacity Analysis
 1: Croydon Ave & Richmond Rd/Richmond St

Future Total (2029)
 AM Peak Hour

												
Movement	EBL	EBT	EBR	WBL	WBT	WBR	NBL	NBT	NBR	SBL	SBT	SBR
Lane Configurations												
Traffic Volume (vph)	26	636	76	18	421	18	41	32	89	30	79	41
Future Volume (vph)	26	636	76	18	421	18	41	32	89	30	79	41
Ideal Flow (vphpl)	1800	1800	1800	1800	1800	1800	1800	1800	1800	1800	1800	1800
Lane Width	3.4	3.4	3.7	3.0	3.4	3.7	3.5	3.5	3.7	3.7	4.8	3.7
Total Lost time (s)	6.4	6.4		6.4	6.4		6.1	6.1			6.1	
Lane Util. Factor	1.00	1.00		1.00	1.00		1.00	1.00			1.00	
Frbp, ped/bikes	1.00	0.99		1.00	1.00		1.00	0.93			0.98	
Flpb, ped/bikes	0.98	1.00		0.99	1.00		0.96	1.00			0.99	
Frtp	1.00	0.98		1.00	0.99		1.00	0.89			0.96	
Flt Protected	0.95	1.00		0.95	1.00		0.95	1.00			0.99	
Satd. Flow (prot)	1554	1594		1581	1613		1536	1415			1821	
Flt Permitted	0.50	1.00		0.33	1.00		0.65	1.00			0.90	
Satd. Flow (perm)	819	1594		547	1613		1047	1415			1653	
Peak-hour factor, PHF	1.00	1.00	1.00	1.00	1.00	1.00	1.00	1.00	1.00	1.00	1.00	1.00
Adj. Flow (vph)	26	636	76	18	421	18	41	32	89	30	79	41
RTOR Reduction (vph)	0	3	0	0	1	0	0	77	0	0	26	0
Lane Group Flow (vph)	26	709	0	18	438	0	41	44	0	0	124	0
Confl. Peds. (#/hr)	26		18	18		26	35		50	50		35
Heavy Vehicles (%)	5%	3%	10%	0%	4%	0%	6%	9%	3%	7%	0%	8%
Bus Blockages (#/hr)	0	10	0	0	10	0	0	0	0	0	0	0
Turn Type	Perm	NA		Perm	NA		Perm	NA		Perm	NA	
Protected Phases		2			6			8				4
Permitted Phases	2			6			8			4		
Actuated Green, G (s)	48.0	48.0		48.0	48.0		9.5	9.5			9.5	
Effective Green, g (s)	48.0	48.0		48.0	48.0		9.5	9.5			9.5	
Actuated g/C Ratio	0.69	0.69		0.69	0.69		0.14	0.14			0.14	
Clearance Time (s)	6.4	6.4		6.4	6.4		6.1	6.1			6.1	
Vehicle Extension (s)	3.0	3.0		3.0	3.0		3.0	3.0			3.0	
Lane Grp Cap (vph)	561	1093		375	1106		142	192			224	
v/s Ratio Prot		c0.44			0.27			0.03				
v/s Ratio Perm	0.03			0.03			0.04				c0.08	
v/c Ratio	0.05	0.65		0.05	0.40		0.29	0.23			0.55	
Uniform Delay, d1	3.6	6.2		3.6	4.7		27.2	27.0			28.3	
Progression Factor	1.00	1.00		1.00	1.00		1.00	1.00			1.00	
Incremental Delay, d2	0.2	3.0		0.2	1.1		1.1	0.6			2.9	
Delay (s)	3.7	9.2		3.8	5.8		28.3	27.6			31.2	
Level of Service	A	A		A	A		C	C			C	
Approach Delay (s)		9.0			5.7			27.8			31.2	
Approach LOS		A			A			C			C	
Intersection Summary												
HCM 2000 Control Delay			12.2				HCM 2000 Level of Service				B	
HCM 2000 Volume to Capacity ratio			0.63									
Actuated Cycle Length (s)			70.0				Sum of lost time (s)			12.5		
Intersection Capacity Utilization			87.1%				ICU Level of Service			E		
Analysis Period (min)			15									

c Critical Lane Group

HCM Signalized Intersection Capacity Analysis
 2: Alpine Ave/1460 Richmond & Carling Ave

Future Total (2029)
 AM Peak Hour

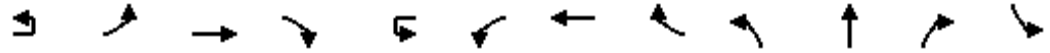

Movement	EBU	EBL	EBT	EBR	WBU	WBL	WBT	WBR	NBL	NBT	NBR	SBL
Lane Configurations		↔	↑↑↑			↔	↑↑↑			↔		
Traffic Volume (vph)	6	35	3043	6	5	37	1078	83	27	9	106	50
Future Volume (vph)	6	35	3043	6	5	37	1078	83	27	9	106	50
Ideal Flow (vphpl)	1800	1800	1800	1800	1800	1800	1800	1800	1800	1800	1800	1800
Lane Width	3.7	3.0	3.6	3.7	3.7	3.0	3.7	3.7	3.7	4.8	3.7	3.7
Total Lost time (s)		5.9	5.9			5.9	5.9			6.7		
Lane Util. Factor		1.00	0.91			1.00	0.91			1.00		
Frbp, ped/bikes		1.00	1.00			1.00	0.99			0.95		
Flpb, ped/bikes		0.97	1.00			1.00	1.00			1.00		
Frt		1.00	1.00			1.00	0.99			0.90		
Flt Protected		0.95	1.00			0.95	1.00			0.99		
Satd. Flow (prot)		1515	4811			1596	4681			1678		
Flt Permitted		0.23	1.00			0.04	1.00			0.87		
Satd. Flow (perm)		370	4811			69	4681			1470		
Peak-hour factor, PHF	1.00	1.00	1.00	1.00	1.00	1.00	1.00	1.00	1.00	1.00	1.00	1.00
Adj. Flow (vph)	6	35	3043	6	5	37	1078	83	27	9	106	50
RTOR Reduction (vph)	0	0	0	0	0	0	4	0	0	52	0	0
Lane Group Flow (vph)	0	41	3049	0	0	42	1157	0	0	90	0	0
Confl. Peds. (#/hr)	13	44		33	33	33		44	13		33	33
Heavy Vehicles (%)	0%	3%	1%	0%	0%	0%	3%	3%	9%	0%	2%	2%
Bus Blockages (#/hr)	0	0	8	0	0	0	8	0	0	0	0	0
Turn Type	Perm	Perm	NA		Perm	pm+pt	NA		Perm	NA		Perm
Protected Phases			2			1	6			8		
Permitted Phases	2	2			6	6			8			4
Actuated Green, G (s)		91.7	91.7			102.9	102.9			14.5		
Effective Green, g (s)		91.7	91.7			102.9	102.9			14.5		
Actuated g/C Ratio		0.71	0.71			0.79	0.79			0.11		
Clearance Time (s)		5.9	5.9			5.9	5.9			6.7		
Vehicle Extension (s)		3.0	3.0			3.0	3.0			3.0		
Lane Grp Cap (vph)		260	3393			116	3705			163		
v/s Ratio Prot			c0.63			0.01	c0.25					
v/s Ratio Perm		0.11				0.27				0.06		
v/c Ratio		0.16	0.90			0.36	0.31			0.55		
Uniform Delay, d1		6.3	15.4			22.2	3.8			54.7		
Progression Factor		1.00	1.00			2.94	0.79			1.00		
Incremental Delay, d2		1.3	4.3			1.8	0.2			3.8		
Delay (s)		7.6	19.7			67.2	3.2			58.4		
Level of Service		A	B			E	A			E		
Approach Delay (s)			19.5				5.4			58.4		
Approach LOS			B				A			E		
Intersection Summary												
HCM 2000 Control Delay			18.7			HCM 2000 Level of Service				B		
HCM 2000 Volume to Capacity ratio			0.86									
Actuated Cycle Length (s)			130.0			Sum of lost time (s)				18.5		
Intersection Capacity Utilization			92.9%			ICU Level of Service				F		
Analysis Period (min)			15									

c Critical Lane Group

HCM Signalized Intersection Capacity Analysis
 2: Alpine Ave/1460 Richmond & Carling Ave

Future Total (2029)
 AM Peak Hour



Movement	SBT	SBR
Lane Configurations	↕	
Traffic Volume (vph)	11	63
Future Volume (vph)	11	63
Ideal Flow (vphpl)	1800	1800
Lane Width	3.6	3.7
Total Lost time (s)	6.7	
Lane Util. Factor	1.00	
Frbp, ped/bikes	0.99	
Flpb, ped/bikes	0.99	
Frt	0.93	
Flt Protected	0.98	
Satd. Flow (prot)	1571	
Flt Permitted	0.65	
Satd. Flow (perm)	1044	
Peak-hour factor, PHF	1.00	1.00
Adj. Flow (vph)	11	63
RTOR Reduction (vph)	36	0
Lane Group Flow (vph)	88	0
Confl. Peds. (#/hr)		13
Heavy Vehicles (%)	0%	2%
Bus Blockages (#/hr)	0	0
Turn Type	NA	
Protected Phases	4	
Permitted Phases		
Actuated Green, G (s)	14.5	
Effective Green, g (s)	14.5	
Actuated g/C Ratio	0.11	
Clearance Time (s)	6.7	
Vehicle Extension (s)	3.0	
Lane Grp Cap (vph)	116	
v/s Ratio Prot		
v/s Ratio Perm	c0.08	
v/c Ratio	0.76	
Uniform Delay, d1	56.1	
Progression Factor	1.00	
Incremental Delay, d2	25.2	
Delay (s)	81.3	
Level of Service	F	
Approach Delay (s)	81.3	
Approach LOS	F	
Intersection Summary		

HCM Signalized Intersection Capacity Analysis
3: Carling Ave & Croydon Ave

Future Total (2029)
AM Peak Hour

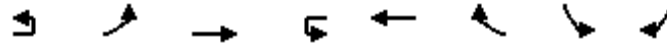

Movement	EBU	EBL	EBT	WBU	WBT	WBR	SBL	SBR
Lane Configurations		↔	↑↑↑		↑↑↑		↔	
Traffic Volume (vph)	2	123	3081	1	1115	107	217	30
Future Volume (vph)	2	123	3081	1	1115	107	217	30
Ideal Flow (vphpl)	1800	1800	1800	1800	1800	1800	1800	1800
Lane Width	3.7	2.8	3.6	3.7	3.7	3.7	3.7	3.3
Total Lost time (s)		5.9	5.9		5.9		6.3	
Lane Util. Factor		1.00	0.91		0.91		0.97	
Frbp, ped/bikes		1.00	1.00		0.99		1.00	
Flpb, ped/bikes		1.00	1.00		1.00		1.00	
Frt		1.00	1.00		0.99		0.98	
Flt Protected		0.95	1.00		1.00		0.96	
Satd. Flow (prot)		1539	4742		4594		3149	
Flt Permitted		0.19	1.00		0.94		0.96	
Satd. Flow (perm)		301	4742		4299		3149	
Peak-hour factor, PHF	1.00	1.00	1.00	1.00	1.00	1.00	1.00	1.00
Adj. Flow (vph)	2	123	3081	1	1115	107	217	30
RTOR Reduction (vph)	0	0	0	0	6	0	10	0
Lane Group Flow (vph)	0	125	3081	0	1217	0	237	0
Confl. Peds. (#/hr)	23	20		2		20	23	2
Heavy Vehicles (%)	0%	1%	1%	0%	3%	7%	6%	0%
Bus Blockages (#/hr)	0	0	19	0	19	0	0	0
Turn Type	Perm	pm+pt	NA	Perm	NA		Prot	
Protected Phases		5	2		6		7	
Permitted Phases	2	2		6				
Actuated Green, G (s)		102.7	102.7		88.8		15.1	
Effective Green, g (s)		102.7	102.7		88.8		15.1	
Actuated g/C Ratio		0.79	0.79		0.68		0.12	
Clearance Time (s)		5.9	5.9		5.9		6.3	
Vehicle Extension (s)		3.0	3.0		3.0		3.0	
Lane Grp Cap (vph)		313	3746		2936		365	
v/s Ratio Prot		0.02	c0.65				c0.08	
v/s Ratio Perm		0.29			0.28			
v/c Ratio		0.40	0.82		0.41		0.65	
Uniform Delay, d1		4.2	8.2		9.1		54.9	
Progression Factor		0.68	0.41		1.00		1.00	
Incremental Delay, d2		0.4	1.1		0.4		4.1	
Delay (s)		3.3	4.4		9.5		59.0	
Level of Service		A	A		A		E	
Approach Delay (s)			4.4		9.5		59.0	
Approach LOS			A		A		E	
Intersection Summary								
HCM 2000 Control Delay			8.6		HCM 2000 Level of Service			A
HCM 2000 Volume to Capacity ratio			0.84					
Actuated Cycle Length (s)			130.0		Sum of lost time (s)		18.1	
Intersection Capacity Utilization			112.8%		ICU Level of Service			H
Analysis Period (min)			15					

c Critical Lane Group

HCM Unsignalized Intersection Capacity Analysis
4: Carling Ave & Forest St

Future Total (2029)
AM Peak Hour

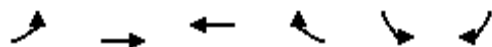

Movement	EBL	EBT	WBT	WBR	SBL	SBR	
Lane Configurations		↑↑↑	↑↑↑			↗	
Traffic Volume (veh/h)	0	3204	1111	37	0	93	
Future Volume (Veh/h)	0	3204	1111	37	0	93	
Sign Control		Free	Free		Stop		
Grade		0%	0%		0%		
Peak Hour Factor	1.00	1.00	1.00	1.00	1.00	1.00	
Hourly flow rate (vph)	0	3204	1111	37	0	93	
Pedestrians					44		
Lane Width (m)					4.8		
Walking Speed (m/s)					1.0		
Percent Blockage					6		
Right turn flare (veh)							
Median type		None	None				
Median storage (veh)							
Upstream signal (m)		55	141				
pX, platoon unblocked	0.90				0.35	0.90	
vC, conflicting volume	1192				2242	433	
vC1, stage 1 conf vol							
vC2, stage 2 conf vol							
vCu, unblocked vol	839				0	0	
tC, single (s)	4.1				6.8	6.9	
tC, 2 stage (s)							
tF (s)	2.2				3.5	3.3	
p0 queue free %	100				100	90	
cM capacity (veh/h)	684				342	928	
Direction, Lane #	EB 1	EB 2	EB 3	WB 1	WB 2	WB 3	SB 1
Volume Total	1068	1068	1068	444	444	259	93
Volume Left	0	0	0	0	0	0	0
Volume Right	0	0	0	0	0	37	93
cSH	1700	1700	1700	1700	1700	1700	928
Volume to Capacity	0.63	0.63	0.63	0.26	0.26	0.15	0.10
Queue Length 95th (m)	0.0	0.0	0.0	0.0	0.0	0.0	2.5
Control Delay (s)	0.0	0.0	0.0	0.0	0.0	0.0	9.3
Lane LOS							A
Approach Delay (s)	0.0			0.0			9.3
Approach LOS							A
Intersection Summary							
Average Delay			0.2				
Intersection Capacity Utilization			68.7%		ICU Level of Service		C
Analysis Period (min)			15				

HCM Unsignalized Intersection Capacity Analysis
5: Croydon Ave & Bond St

Future Total (2029)
AM Peak Hour



Movement	EBL	EBR	NBL	NBT	SBT	SBR
Lane Configurations						
Traffic Volume (veh/h)	1	38	18	213	210	11
Future Volume (Veh/h)	1	38	18	213	210	11
Sign Control	Stop			Free	Free	
Grade	0%			0%	0%	
Peak Hour Factor	1.00	1.00	1.00	1.00	1.00	1.00
Hourly flow rate (vph)	1	38	18	213	210	11
Pedestrians	29					
Lane Width (m)	4.3					
Walking Speed (m/s)	1.0					
Percent Blockage	3					
Right turn flare (veh)						
Median type				None	None	
Median storage veh						
Upstream signal (m)				78	181	
pX, platoon unblocked						
vC, conflicting volume	494	244	250			
vC1, stage 1 conf vol						
vC2, stage 2 conf vol						
vCu, unblocked vol	494	244	250			
tC, single (s)	6.4	6.2	4.1			
tC, 2 stage (s)						
tF (s)	3.5	3.3	2.2			
p0 queue free %	100	95	99			
cM capacity (veh/h)	513	772	1281			
Direction, Lane #	EB 1	NB 1	SB 1			
Volume Total	39	231	221			
Volume Left	1	18	0			
Volume Right	38	0	11			
cSH	762	1281	1700			
Volume to Capacity	0.05	0.01	0.13			
Queue Length 95th (m)	1.2	0.3	0.0			
Control Delay (s)	10.0	0.7	0.0			
Lane LOS	A	A				
Approach Delay (s)	10.0	0.7	0.0			
Approach LOS	A					
Intersection Summary						
Average Delay			1.1			
Intersection Capacity Utilization			37.5%	ICU Level of Service	A	
Analysis Period (min)			15			

HCM Unsignalized Intersection Capacity Analysis
6: Forest St & Bond St

Future Total (2029)
AM Peak Hour



Movement	WBL	WBR	NBT	NBR	SBL	SBT
Lane Configurations						
Traffic Volume (veh/h)	1	13	36	1	41	91
Future Volume (Veh/h)	1	13	36	1	41	91
Sign Control	Stop		Free		Free	
Grade	0%		0%		0%	
Peak Hour Factor	1.00	1.00	1.00	1.00	1.00	1.00
Hourly flow rate (vph)	1	13	36	1	41	91
Pedestrians	12					
Lane Width (m)	3.5					
Walking Speed (m/s)	1.0					
Percent Blockage	1					
Right turn flare (veh)						
Median type	None			None		
Median storage veh						
Upstream signal (m)						
pX, platoon unblocked						
vC, conflicting volume	222	48			49	
vC1, stage 1 conf vol						
vC2, stage 2 conf vol						
vCu, unblocked vol	222	48			49	
tC, single (s)	6.4	6.2			4.1	
tC, 2 stage (s)						
tF (s)	3.5	3.3			2.2	
p0 queue free %	100	99			97	
cM capacity (veh/h)	742	1014			1553	
Direction, Lane #	WB 1	NB 1	SB 1			
Volume Total	14	37	132			
Volume Left	1	0	41			
Volume Right	13	1	0			
cSH	988	1700	1553			
Volume to Capacity	0.01	0.02	0.03			
Queue Length 95th (m)	0.3	0.0	0.6			
Control Delay (s)	8.7	0.0	2.4			
Lane LOS	A		A			
Approach Delay (s)	8.7	0.0	2.4			
Approach LOS	A					
Intersection Summary						
Average Delay			2.4			
Intersection Capacity Utilization			24.1%	ICU Level of Service		A
Analysis Period (min)			15			

HCM Unsignalized Intersection Capacity Analysis
7: Forest St & Richmond Rd

Future Total (2029)
AM Peak Hour



Movement	EBT	EBR	WBL	WBT	NBL	NBR
Lane Configurations	→			←	↘	↙
Traffic Volume (veh/h)	692	15	29	474	11	46
Future Volume (Veh/h)	692	15	29	474	11	46
Sign Control	Free			Free	Stop	
Grade	0%			0%	0%	
Peak Hour Factor	1.00	1.00	1.00	1.00	1.00	1.00
Hourly flow rate (vph)	692	15	29	474	11	46
Pedestrians						12
Lane Width (m)						4.7
Walking Speed (m/s)						1.0
Percent Blockage						2
Right turn flare (veh)						
Median type	None			None		
Median storage (veh)						
Upstream signal (m)				154		
pX, platoon unblocked					0.91	
vC, conflicting volume			719	1244	712	
vC1, stage 1 conf vol						
vC2, stage 2 conf vol						
vCu, unblocked vol			719	1218	712	
tC, single (s)			4.1	6.4	6.2	
tC, 2 stage (s)						
tF (s)			2.2	3.5	3.3	
p0 queue free %			97	94	89	
cM capacity (veh/h)			878	174	429	
Direction, Lane #	EB 1	WB 1	NB 1			
Volume Total	707	503	57			
Volume Left	0	29	11			
Volume Right	15	0	46			
cSH	1700	878	335			
Volume to Capacity	0.42	0.03	0.17			
Queue Length 95th (m)	0.0	0.8	4.6			
Control Delay (s)	0.0	0.9	17.9			
Lane LOS			A	C		
Approach Delay (s)	0.0	0.9	17.9			
Approach LOS			C			
Intersection Summary						
Average Delay			1.2			
Intersection Capacity Utilization			61.7%	ICU Level of Service	B	
Analysis Period (min)			15			

HCM Unsignalized Intersection Capacity Analysis
8: Forest St & 365 Forest





















Future Total (2029)
AM Peak Hour



Movement	WBL	WBR	NBT	NBR	SBL	SBT
Lane Configurations						
Traffic Volume (veh/h)	61	11	48	17	6	38
Future Volume (Veh/h)	61	11	48	17	6	38
Sign Control	Stop		Free		Free	
Grade	0%		0%		0%	
Peak Hour Factor	1.00	1.00	1.00	1.00	1.00	1.00
Hourly flow rate (vph)	61	11	48	17	6	38
Pedestrians	12					
Lane Width (m)	3.7					
Walking Speed (m/s)	1.0					
Percent Blockage	1					
Right turn flare (veh)						
Median type	None			None		
Median storage (veh)						
Upstream signal (m)						
pX, platoon unblocked						
vC, conflicting volume	118	68			77	
vC1, stage 1 conf vol						
vC2, stage 2 conf vol						
vCu, unblocked vol	118	68			77	
tC, single (s)	6.4	6.2			4.1	
tC, 2 stage (s)						
tF (s)	3.5	3.3			2.2	
p0 queue free %	93	99			100	
cM capacity (veh/h)	868	988			1516	
Direction, Lane #	WB 1	NB 1	SB 1			
Volume Total	72	65	44			
Volume Left	61	0	6			
Volume Right	11	17	0			
cSH	884	1700	1516			
Volume to Capacity	0.08	0.04	0.00			
Queue Length 95th (m)	2.0	0.0	0.1			
Control Delay (s)	9.4	0.0	1.0			
Lane LOS	A		A			
Approach Delay (s)	9.4	0.0	1.0			
Approach LOS	A					
Intersection Summary						
Average Delay			4.0			
Intersection Capacity Utilization			18.4%	ICU Level of Service		A
Analysis Period (min)			15			

HCM Signalized Intersection Capacity Analysis
 1: Croydon Ave & Richmond Rd/Richmond St

Future Total (2029)
 PM Peak Hour

												
Movement	EBL	EBT	EBR	WBL	WBT	WBR	NBL	NBT	NBR	SBL	SBT	SBR
Lane Configurations												
Traffic Volume (vph)	29	532	133	66	915	20	160	108	40	16	68	23
Future Volume (vph)	29	532	133	66	915	20	160	108	40	16	68	23
Ideal Flow (vphpl)	1800	1800	1800	1800	1800	1800	1800	1800	1800	1800	1800	1800
Lane Width	3.4	3.4	3.7	3.0	3.4	3.7	3.5	3.5	3.7	3.7	4.8	3.7
Total Lost time (s)	6.4	6.4		6.4	6.4		6.1	6.1			6.1	
Lane Util. Factor	1.00	1.00		1.00	1.00		1.00	1.00			1.00	
Frbp, ped/bikes	1.00	0.98		1.00	1.00		1.00	0.96			0.98	
Flpb, ped/bikes	1.00	1.00		0.98	1.00		0.95	1.00			0.99	
Frt	1.00	0.97		1.00	1.00		1.00	0.96			0.97	
Flt Protected	0.95	1.00		0.95	1.00		0.95	1.00			0.99	
Satd. Flow (prot)	1672	1566		1537	1648		1561	1630			1904	
Flt Permitted	0.18	1.00		0.33	1.00		0.73	1.00			0.94	
Satd. Flow (perm)	309	1566		539	1648		1201	1630			1800	
Peak-hour factor, PHF	1.00	1.00	1.00	1.00	1.00	1.00	1.00	1.00	1.00	1.00	1.00	1.00
Adj. Flow (vph)	29	532	133	66	915	20	160	108	40	16	68	23
RTOR Reduction (vph)	0	8	0	0	1	0	0	18	0	0	13	0
Lane Group Flow (vph)	29	657	0	66	934	0	160	130	0	0	94	0
Confl. Peds. (#/hr)	37		29	29		37	35		72	72		35
Heavy Vehicles (%)	0%	2%	7%	2%	2%	0%	3%	0%	3%	0%	0%	0%
Bus Blockages (#/hr)	0	10	0	0	10	0	0	0	0	0	0	0
Turn Type	Perm	NA		Perm	NA		Perm	NA		Perm	NA	
Protected Phases		2			6			8				4
Permitted Phases	2			6			8			4		
Actuated Green, G (s)	55.8	55.8		55.8	55.8		16.7	16.7			16.7	
Effective Green, g (s)	55.8	55.8		55.8	55.8		16.7	16.7			16.7	
Actuated g/C Ratio	0.66	0.66		0.66	0.66		0.20	0.20			0.20	
Clearance Time (s)	6.4	6.4		6.4	6.4		6.1	6.1			6.1	
Vehicle Extension (s)	3.0	3.0		3.0	3.0		3.0	3.0			3.0	
Lane Grp Cap (vph)	202	1028		353	1081		235	320			353	
v/s Ratio Prot		0.42			c0.57			0.08				
v/s Ratio Perm	0.09			0.12			c0.13				0.05	
v/c Ratio	0.14	0.64		0.19	0.86		0.68	0.41			0.27	
Uniform Delay, d1	5.5	8.6		5.7	11.6		31.7	29.8			29.0	
Progression Factor	1.00	1.00		1.00	1.00		1.00	1.00			1.00	
Incremental Delay, d2	1.5	3.0		1.2	9.2		7.9	0.8			0.4	
Delay (s)	7.0	11.7		6.9	20.8		39.5	30.7			29.4	
Level of Service	A	B		A	C		D	C			C	
Approach Delay (s)		11.5			19.9			35.3			29.4	
Approach LOS		B			B			D			C	
Intersection Summary												
HCM 2000 Control Delay			19.9				HCM 2000 Level of Service				B	
HCM 2000 Volume to Capacity ratio			0.82									
Actuated Cycle Length (s)			85.0				Sum of lost time (s)			12.5		
Intersection Capacity Utilization			89.1%				ICU Level of Service			E		
Analysis Period (min)			15									

c Critical Lane Group

HCM Signalized Intersection Capacity Analysis
 2: Alpine Ave/1460 Richmond & Carling Ave

Future Total (2029)
 PM Peak Hour



Movement	EBU	EBL	EBT	EBR	WBU	WBL	WBT	WBR	NBL	NBT	NBR	SBL
Lane Configurations		↔	↑↑↑			↔	↑↑↑			↔		
Traffic Volume (vph)	4	28	1366	10	5	56	2193	84	21	16	33	52
Future Volume (vph)	4	28	1366	10	5	56	2193	84	21	16	33	52
Ideal Flow (vphpl)	1800	1800	1800	1800	1800	1800	1800	1800	1800	1800	1800	1800
Lane Width	3.7	3.0	3.6	3.7	3.7	3.0	3.7	3.7	3.7	4.8	3.7	3.7
Total Lost time (s)		5.9	5.9			5.9	5.9			6.7		
Lane Util. Factor		1.00	0.91			1.00	0.91			1.00		
Frbp, ped/bikes		1.00	1.00			1.00	1.00			0.98		
Flpb, ped/bikes		1.00	1.00			1.00	1.00			0.99		
Frt		1.00	1.00			1.00	0.99			0.94		
Flt Protected		0.95	1.00			0.95	1.00			0.99		
Satd. Flow (prot)		1596	4760			1566	4818			1735		
Flt Permitted		0.05	1.00			0.16	1.00			0.85		
Satd. Flow (perm)		86	4760			269	4818			1495		
Peak-hour factor, PHF	1.00	1.00	1.00	1.00	1.00	1.00	1.00	1.00	1.00	1.00	1.00	1.00
Adj. Flow (vph)	4	28	1366	10	5	56	2193	84	21	16	33	52
RTOR Reduction (vph)	0	0	0	0	0	0	2	0	0	29	0	0
Lane Group Flow (vph)	0	32	1376	0	0	61	2275	0	0	41	0	0
Confl. Peds. (#/hr)	39	49		16	17	16		49	39		17	17
Heavy Vehicles (%)	0%	0%	2%	0%	0%	2%	1%	0%	12%	0%	4%	2%
Bus Blockages (#/hr)	0	0	8	0	0	0	8	0	0	0	0	0
Turn Type	Perm	pm+pt	NA		Perm	pm+pt	NA		Perm	NA		Perm
Protected Phases		5	2			1	6			8		
Permitted Phases	2	2			6	6			8			4
Actuated Green, G (s)		95.3	91.4			98.7	93.1			14.5		
Effective Green, g (s)		95.3	91.4			98.7	93.1			14.5		
Actuated g/C Ratio		0.73	0.70			0.76	0.72			0.11		
Clearance Time (s)		5.9	5.9			5.9	5.9			6.7		
Vehicle Extension (s)		3.0	3.0			3.0	3.0			3.0		
Lane Grp Cap (vph)		108	3346			260	3450			166		
v/s Ratio Prot		0.01	0.29			c0.01	c0.47					
v/s Ratio Perm		0.21				0.17				0.03		
v/c Ratio		0.30	0.41			0.23	0.66			0.25		
Uniform Delay, d1		7.8	8.1			4.5	9.9			52.8		
Progression Factor		1.00	1.00			1.33	0.81			1.00		
Incremental Delay, d2		1.5	0.4			0.3	0.6			0.8		
Delay (s)		9.4	8.4			6.2	8.7			53.5		
Level of Service		A	A			A	A			D		
Approach Delay (s)			8.5				8.6			53.5		
Approach LOS			A				A			D		
Intersection Summary												
HCM 2000 Control Delay			10.8				HCM 2000 Level of Service			B		
HCM 2000 Volume to Capacity ratio			0.64									
Actuated Cycle Length (s)			130.0				Sum of lost time (s)			18.5		
Intersection Capacity Utilization			89.1%				ICU Level of Service			E		
Analysis Period (min)			15									

c Critical Lane Group

HCM Signalized Intersection Capacity Analysis
 2: Alpine Ave/1460 Richmond & Carling Ave

Future Total (2029)
 PM Peak Hour



Movement	SBT	SBR
Lane Configurations	↕	
Traffic Volume (vph)	18	39
Future Volume (vph)	18	39
Ideal Flow (vphpl)	1800	1800
Lane Width	3.6	3.7
Total Lost time (s)	6.7	
Lane Util. Factor	1.00	
Frbp, ped/bikes	0.98	
Flpb, ped/bikes	0.99	
Frt	0.95	
Flt Protected	0.98	
Satd. Flow (prot)	1608	
Flt Permitted	0.84	
Satd. Flow (perm)	1378	
Peak-hour factor, PHF	1.00	1.00
Adj. Flow (vph)	18	39
RTOR Reduction (vph)	19	0
Lane Group Flow (vph)	90	0
Confl. Peds. (#/hr)		39
Heavy Vehicles (%)	0%	0%
Bus Blockages (#/hr)	0	0
Turn Type	NA	
Protected Phases	4	
Permitted Phases		
Actuated Green, G (s)	14.5	
Effective Green, g (s)	14.5	
Actuated g/C Ratio	0.11	
Clearance Time (s)	6.7	
Vehicle Extension (s)	3.0	
Lane Grp Cap (vph)	153	
v/s Ratio Prot		
v/s Ratio Perm	c0.07	
v/c Ratio	0.59	
Uniform Delay, d1	54.9	
Progression Factor	1.00	
Incremental Delay, d2	6.0	
Delay (s)	60.9	
Level of Service	E	
Approach Delay (s)	60.9	
Approach LOS	E	
Intersection Summary		

HCM Signalized Intersection Capacity Analysis
3: Carling Ave & Croydon Ave

Future Total (2029)
PM Peak Hour



Movement	EBU	EBL	EBT	WBU	WBT	WBR	SBL	SBR
Lane Configurations		↔	↑↑↑		↑↑↑		↔	
Traffic Volume (vph)	7	116	1333	1	2190	156	196	115
Future Volume (vph)	7	116	1333	1	2190	156	196	115
Ideal Flow (vphpl)	1800	1800	1800	1800	1800	1800	1800	1800
Lane Width	3.7	2.8	3.6	3.7	3.7	3.7	3.7	3.3
Total Lost time (s)		5.9	5.9		5.9		6.3	
Lane Util. Factor		1.00	0.91		0.91		0.97	
Frbp, ped/bikes		1.00	1.00		0.99		0.98	
Flpb, ped/bikes		1.00	1.00		1.00		1.00	
Frt		1.00	1.00		0.99		0.94	
Flt Protected		0.95	1.00		1.00		0.97	
Satd. Flow (prot)		1529	4696		4686		3120	
Flt Permitted		0.04	1.00		0.94		0.97	
Satd. Flow (perm)		71	4696		4404		3120	
Peak-hour factor, PHF	1.00	1.00	1.00	1.00	1.00	1.00	1.00	1.00
Adj. Flow (vph)	7	116	1333	1	2190	156	196	115
RTOR Reduction (vph)	0	0	0	0	5	0	76	0
Lane Group Flow (vph)	0	123	1333	0	2342	0	235	0
Confl. Peds. (#/hr)	27	48		4		48	4	27
Heavy Vehicles (%)	0%	2%	2%	0%	1%	5%	3%	0%
Bus Blockages (#/hr)	0	0	19	0	19	0	0	0
Turn Type	Perm	pm+pt	NA	Perm	NA		Prot	
Protected Phases		5	2		6		7	
Permitted Phases	2	2		6				
Actuated Green, G (s)		102.8	102.8		84.4		15.0	
Effective Green, g (s)		102.8	102.8		84.4		15.0	
Actuated g/C Ratio		0.79	0.79		0.65		0.12	
Clearance Time (s)		5.9	5.9		5.9		6.3	
Vehicle Extension (s)		3.0	3.0		3.0		3.0	
Lane Grp Cap (vph)		196	3713		2859		360	
v/s Ratio Prot		c0.06	0.28				c0.08	
v/s Ratio Perm		0.43			c0.53			
v/c Ratio		0.63	0.36		0.82		0.65	
Uniform Delay, d1		33.8	4.0		17.1		55.0	
Progression Factor		1.95	0.27		1.00		1.00	
Incremental Delay, d2		5.8	0.3		2.8		4.2	
Delay (s)		71.6	1.3		19.8		59.2	
Level of Service		E	A		B		E	
Approach Delay (s)			7.3		19.8		59.2	
Approach LOS			A		B		E	
Intersection Summary								
HCM 2000 Control Delay			18.4		HCM 2000 Level of Service			B
HCM 2000 Volume to Capacity ratio			0.78					
Actuated Cycle Length (s)			130.0		Sum of lost time (s)		18.1	
Intersection Capacity Utilization			110.5%		ICU Level of Service			H
Analysis Period (min)			15					

c Critical Lane Group

HCM Unsignalized Intersection Capacity Analysis
4: Carling Ave & Forest St

Future Total (2029)
PM Peak Hour



Movement	EBL	EBT	WBT	WBR	SBL	SBR	
Lane Configurations		↑↑↑	↑↑↑			↗	
Traffic Volume (veh/h)	0	1456	2247	65	0	91	
Future Volume (Veh/h)	0	1456	2247	65	0	91	
Sign Control		Free	Free		Stop		
Grade		0%	0%		0%		
Peak Hour Factor	1.00	1.00	1.00	1.00	1.00	1.00	
Hourly flow rate (vph)	0	1456	2247	65	0	91	
Pedestrians					49		
Lane Width (m)					4.8		
Walking Speed (m/s)					1.0		
Percent Blockage					7		
Right turn flare (veh)							
Median type		None	None				
Median storage (veh)							
Upstream signal (m)		55	141				
pX, platoon unblocked	0.65				0.71	0.65	
vC, conflicting volume	2361				2814	830	
vC1, stage 1 conf vol							
vC2, stage 2 conf vol							
vCu, unblocked vol	1219				1012	0	
tC, single (s)	4.1				6.8	6.9	
tC, 2 stage (s)							
tF (s)	2.2				3.5	3.3	
p0 queue free %	100				100	86	
cM capacity (veh/h)	353				159	665	
Direction, Lane #	EB 1	EB 2	EB 3	WB 1	WB 2	WB 3	SB 1
Volume Total	485	485	485	899	899	514	91
Volume Left	0	0	0	0	0	0	0
Volume Right	0	0	0	0	0	65	91
cSH	1700	1700	1700	1700	1700	1700	665
Volume to Capacity	0.29	0.29	0.29	0.53	0.53	0.30	0.14
Queue Length 95th (m)	0.0	0.0	0.0	0.0	0.0	0.0	3.6
Control Delay (s)	0.0	0.0	0.0	0.0	0.0	0.0	11.3
Lane LOS							B
Approach Delay (s)	0.0			0.0			11.3
Approach LOS							B
Intersection Summary							
Average Delay			0.3				
Intersection Capacity Utilization			60.1%		ICU Level of Service		B
Analysis Period (min)			15				

HCM Unsignalized Intersection Capacity Analysis
5: Croydon Ave & Bond St









Future Total (2029)
PM Peak Hour



Movement	EBL	EBR	NBL	NBT	SBT	SBR
Lane Configurations						
Traffic Volume (veh/h)	0	30	33	239	281	13
Future Volume (Veh/h)	0	30	33	239	281	13
Sign Control	Stop			Free	Free	
Grade	0%			0%	0%	
Peak Hour Factor	1.00	1.00	1.00	1.00	1.00	1.00
Hourly flow rate (vph)	0	30	33	239	281	13
Pedestrians	32					
Lane Width (m)	4.3					
Walking Speed (m/s)	1.0					
Percent Blockage	4					
Right turn flare (veh)						
Median type				None	None	
Median storage veh						
Upstream signal (m)				78	181	
pX, platoon unblocked						
vC, conflicting volume	624	320	326			
vC1, stage 1 conf vol						
vC2, stage 2 conf vol						
vCu, unblocked vol	624	320	326			
tC, single (s)	6.4	6.2	4.1			
tC, 2 stage (s)						
tF (s)	3.5	3.3	2.2			
p0 queue free %	100	96	97			
cM capacity (veh/h)	423	698	1197			
Direction, Lane #	EB 1	NB 1	SB 1			
Volume Total	30	272	294			
Volume Left	0	33	0			
Volume Right	30	0	13			
cSH	698	1197	1700			
Volume to Capacity	0.04	0.03	0.17			
Queue Length 95th (m)	1.0	0.6	0.0			
Control Delay (s)	10.4	1.2	0.0			
Lane LOS	B	A				
Approach Delay (s)	10.4	1.2	0.0			
Approach LOS	B					
Intersection Summary						
Average Delay			1.1			
Intersection Capacity Utilization			45.1%	ICU Level of Service	A	
Analysis Period (min)			15			

HCM Unsignalized Intersection Capacity Analysis
6: Forest St & Bond St

Future Total (2029)
PM Peak Hour

						
Movement	WBL	WBR	NBT	NBR	SBL	SBT
Lane Configurations						
Traffic Volume (veh/h)	1	31	64	1	35	91
Future Volume (Veh/h)	1	31	64	1	35	91
Sign Control	Stop		Free			Free
Grade	0%		0%			0%
Peak Hour Factor	1.00	1.00	1.00	1.00	1.00	1.00
Hourly flow rate (vph)	1	31	64	1	35	91
Pedestrians	12					
Lane Width (m)	3.5					
Walking Speed (m/s)	1.0					
Percent Blockage	1					
Right turn flare (veh)						
Median type			None			None
Median storage veh						
Upstream signal (m)						
pX, platoon unblocked						
vC, conflicting volume	238	76			77	
vC1, stage 1 conf vol						
vC2, stage 2 conf vol						
vCu, unblocked vol	238	76			77	
tC, single (s)	6.4	6.2			4.1	
tC, 2 stage (s)						
tF (s)	3.5	3.3			2.2	
p0 queue free %	100	97			98	
cM capacity (veh/h)	729	979			1517	
Direction, Lane #	WB 1	NB 1	SB 1			
Volume Total	32	65	126			
Volume Left	1	0	35			
Volume Right	31	1	0			
cSH	968	1700	1517			
Volume to Capacity	0.03	0.04	0.02			
Queue Length 95th (m)	0.8	0.0	0.5			
Control Delay (s)	8.8	0.0	2.2			
Lane LOS	A		A			
Approach Delay (s)	8.8	0.0	2.2			
Approach LOS	A					
Intersection Summary						
Average Delay			2.5			
Intersection Capacity Utilization			23.8%		ICU Level of Service	A
Analysis Period (min)			15			

HCM Unsignalized Intersection Capacity Analysis
7: Forest St & Richmond Rd









Future Total (2029)
PM Peak Hour



Movement	EBT	EBR	WBL	WBT	NBL	NBR
Lane Configurations	→			←	←	↗
Traffic Volume (veh/h)	657	22	63	1035	13	38
Future Volume (Veh/h)	657	22	63	1035	13	38
Sign Control	Free			Free	Stop	
Grade	0%			0%	0%	
Peak Hour Factor	1.00	1.00	1.00	1.00	1.00	1.00
Hourly flow rate (vph)	657	22	63	1035	13	38
Pedestrians						12
Lane Width (m)						4.7
Walking Speed (m/s)						1.0
Percent Blockage						2
Right turn flare (veh)						
Median type	None			None		
Median storage (veh)						
Upstream signal (m)	154					
pX, platoon unblocked					0.44	
vC, conflicting volume				691	1841	680
vC1, stage 1 conf vol						
vC2, stage 2 conf vol						
vCu, unblocked vol				691	2280	680
tC, single (s)				4.1	6.4	6.2
tC, 2 stage (s)						
tF (s)				2.2	3.5	3.3
p0 queue free %				93	27	92
cM capacity (veh/h)				899	18	447
Direction, Lane #	EB 1	WB 1	NB 1			
Volume Total	679	1098	51			
Volume Left	0	63	13			
Volume Right	22	0	38			
cSH	1700	899	63			
Volume to Capacity	0.40	0.07	0.82			
Queue Length 95th (m)	0.0	1.7	28.2			
Control Delay (s)	0.0	2.1	172.3			
Lane LOS	A		F			
Approach Delay (s)	0.0	2.1	172.3			
Approach LOS	F					
Intersection Summary						
Average Delay	6.1					
Intersection Capacity Utilization	112.5%			ICU Level of Service	H	
Analysis Period (min)	15					

HCM Unsignalized Intersection Capacity Analysis
 8: Forest St & 365 Forest

Future Total (2029)
 PM Peak Hour

						
Movement	WBL	WBR	NBT	NBR	SBL	SBT
Lane Configurations						
Traffic Volume (veh/h)	36	6	44	47	19	66
Future Volume (Veh/h)	36	6	44	47	19	66
Sign Control	Stop		Free		Free	
Grade	0%		0%		0%	
Peak Hour Factor	1.00	1.00	1.00	1.00	1.00	1.00
Hourly flow rate (vph)	36	6	44	47	19	66
Pedestrians	12					
Lane Width (m)	3.7					
Walking Speed (m/s)	1.0					
Percent Blockage	1					
Right turn flare (veh)						
Median type	None			None		
Median storage (veh)						
Upstream signal (m)						
pX, platoon unblocked						
vC, conflicting volume	184	80			103	
vC1, stage 1 conf vol						
vC2, stage 2 conf vol						
vCu, unblocked vol	184	80			103	
tC, single (s)	6.4	6.2			4.1	
tC, 2 stage (s)						
tF (s)	3.5	3.3			2.2	
p0 queue free %	95	99			99	
cM capacity (veh/h)	790	974			1483	
Direction, Lane #	WB 1	NB 1	SB 1			
Volume Total	42	91	85			
Volume Left	36	0	19			
Volume Right	6	47	0			
cSH	812	1700	1483			
Volume to Capacity	0.05	0.05	0.01			
Queue Length 95th (m)	1.2	0.0	0.3			
Control Delay (s)	9.7	0.0	1.7			
Lane LOS	A		A			
Approach Delay (s)	9.7	0.0	1.7			
Approach LOS	A					
Intersection Summary						
Average Delay			2.5			
Intersection Capacity Utilization			21.4%		ICU Level of Service	A
Analysis Period (min)			15			

Appendix I – Intersection Collision Diagrams



COLLISION DIAGRAM

LOCATION: Alpine Avenue and Carling Avenue
 CITY: Ottawa, ON
 PERIOD: January 2014 to December 2018

DATE: Nov 11, 2019
 PREPARED BY: M.C.

1460 Richmond



Carling Avenue

Carling Avenue

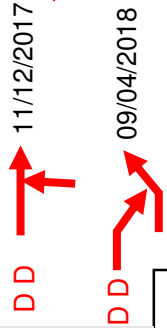
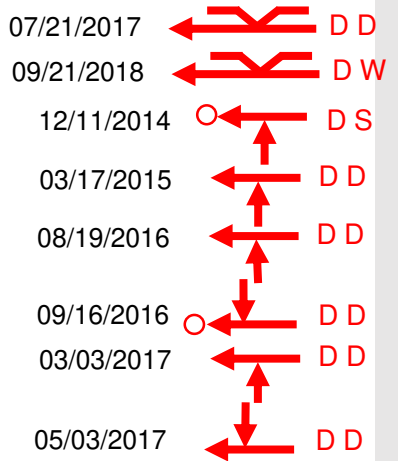
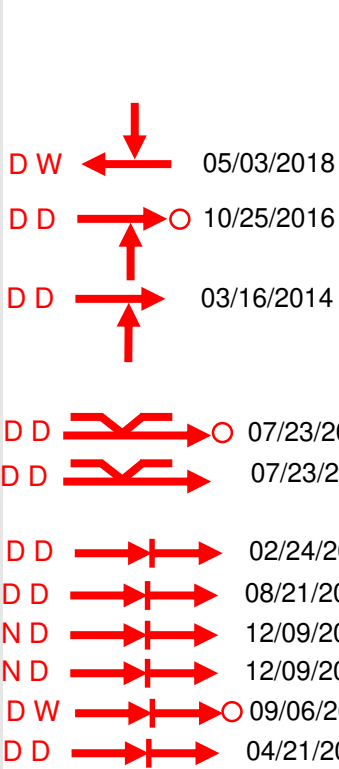
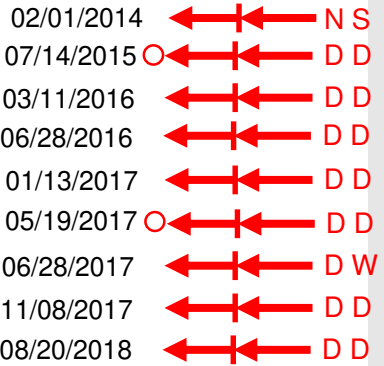
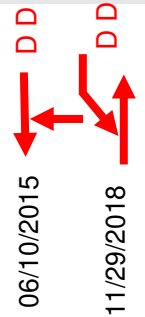

Alpine Avenue

LEGEND

- Vehicle Path
- Pedestrian Path
- Fixed Object
- Personal Injury
- Fatality

- Rear-end Collision
- Head-on Collision
- Side Swipe
- Out Of Control
- Right-turning Vehicle
- Left-turning Vehicle

Conditions

D W

Time of Day

D – Daytime
 N – Nighttime

Roadway

D – Dry W – Wet
 I – Icy S – Snow



COLLISION DIAGRAM

LOCATION: Croydon Avenue and Richmond Road
 CITY: Ottawa, ON
 PERIOD: January 2014 to December 2018

DATE: Nov 11, 2019
 PREPARED BY: M.C.

Croydon Avenue



Richmond Road

Richmond Road

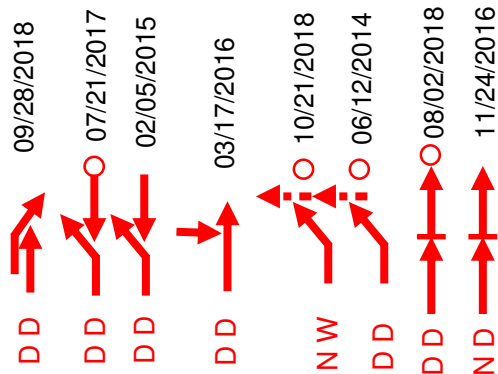
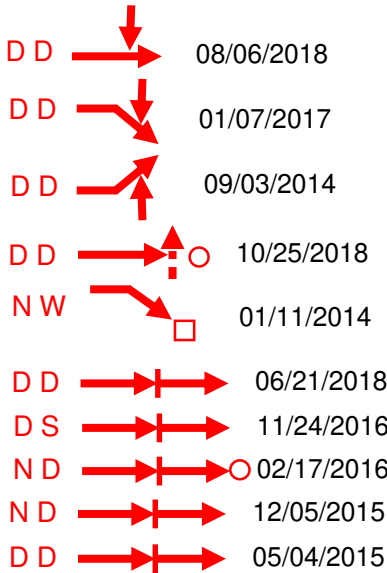
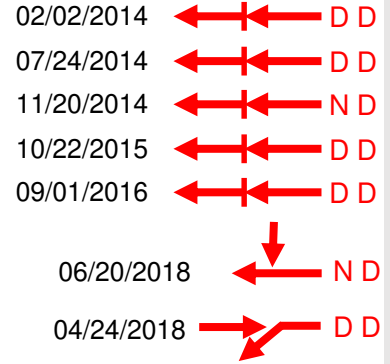
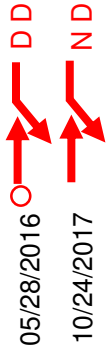

Croydon Avenue

LEGEND

- Vehicle Path
- Pedestrian Path
- Fixed Object
- Personal Injury
- Fatality

- Rear-end Collision
- Head-on Collision
- Side Swipe
- Out Of Control
- Right-turning Vehicle
- Left-turning Vehicle

Conditions

D W

Time of Day

D – Daytime
 N – Nighttime

Roadway

D – Dry W – Wet
 I – Icy S – Snow



COLLISION DIAGRAM

LOCATION: Croydon Avenue and Carling Avenue
 CITY: Ottawa, ON
 PERIOD: January 2014 to December 2018

DATE: Nov 11, 2019
 PREPARED BY: M.C.

Croydon Avenue



Carling Avenue

Carling Avenue

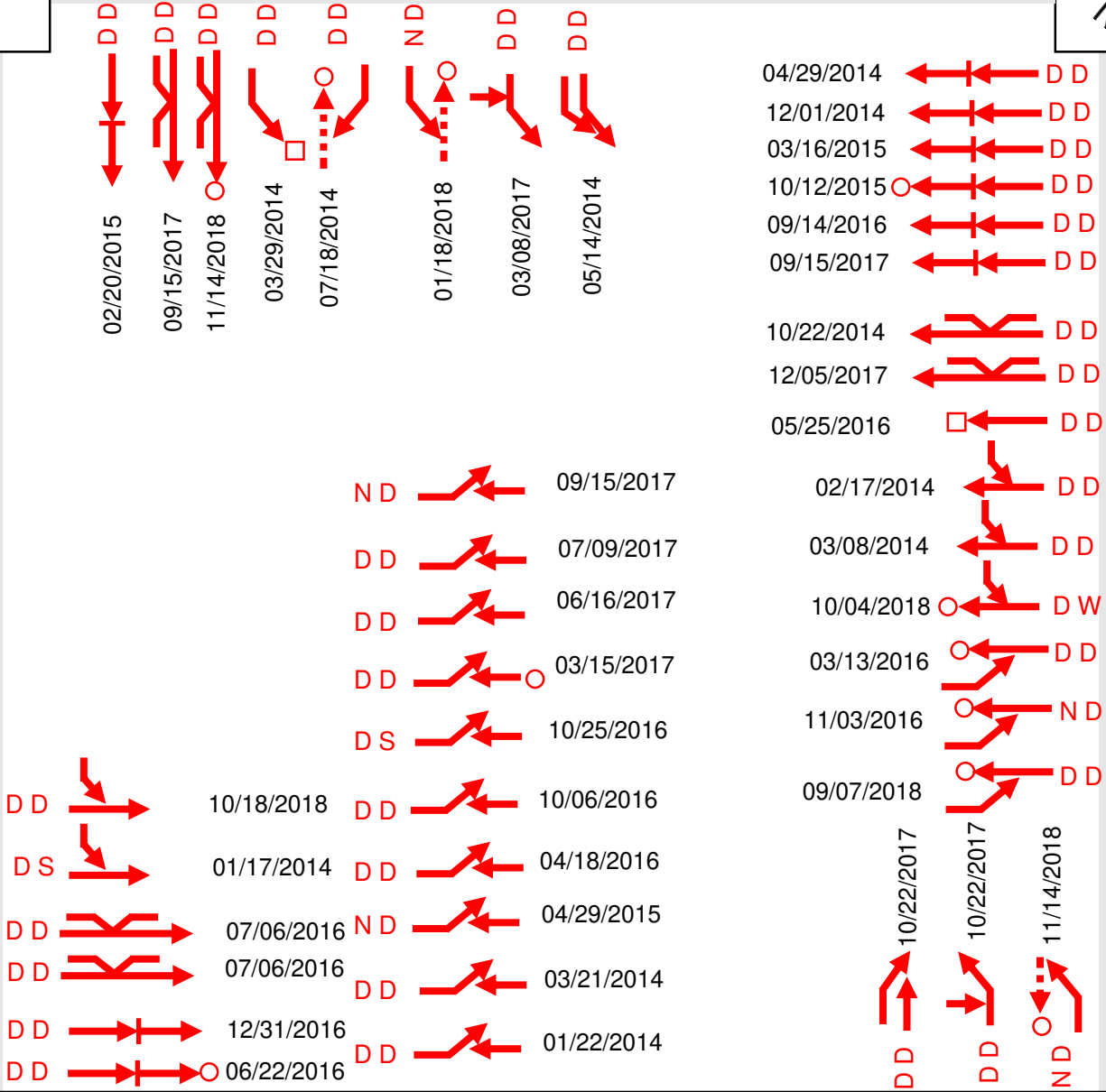

LEGEND

- Vehicle Path
- Pedestrian Path
- Fixed Object
- Personal Injury
- Fatality

- Rear-end Collision
- Head-on Collision
- Side Swipe
- Out Of Control
- Right-turning Vehicle
- Left-turning Vehicle

Conditions

- D W**
- Time of Day Roadway
- D – Daytime
 - N – Nighttime
 - D – Dry
 - I – Icy
 - W – Wet
 - S – Snow