

NOVATECH

Engineers, Planners & Landscape Architects

Engineering

Land / Site
Development

Municipal
Infrastructure

Environmental /
Water Resources

Traffic /
Transportation

Structural

Recreational

Planning

Land / Site
Development

Planning Application
Management

Municipal Planning
Documents &
Studies

Expert Witness
(OMB)

Wireless Industry

Landscape Architecture

Urban Design &
Streetscapes

Open Space, Parks &
Recreation Planning

Community &
Residential
Developments

Commercial &
Institutional Sites

Environmental
Restoration

37
Years

**200 Baribeau Street
Ottawa, Ontario**

Servicing Design Brief

Engineering excellence. Planning precision. Inspired landscapes.

**200 BARIBEAU STREET
OTTAWA, ONTARIO**

SERVICING DESIGN BRIEF

Prepared For:

Parkriver Properties



Prepared By:



NOVATECH

Suite 200, 240 Michael Cowpland Drive
Ottawa, Ontario
K2M 1P6

August 24, 2020
Revised: October 23, 2020
Revised: February 5, 2021
Revised: June 8, 2021

Novatech File: 119068
Ref: R-2020-104

June 8, 2021

City of Ottawa
Infrastructure Services and Community Sustainability
110 Laurier Avenue West, 4th Floor
Ottawa, ON K1P 1J1

Attention: Jean-Charles Renaud, Planner II

**Reference: 200 Baribeau Street
Servicing Design Brief
Our File No.: 119068**

Enclosed for your review and approval is the Servicing Design Brief for the proposed 200 Baribeau Street development.

If you have any questions or comments, please do not hesitate to contact us.

Sincerely,

NOVATECH

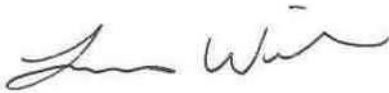

Lucas Wilson, P.Eng.
Project Coordinator

TABLE OF CONTENTS

1.0	INTRODUCTION.....	1
1.1	BACKGROUND.....	1
1.2	LAND USE.....	2
2.0	ROADWAYS.....	3
2.1	EXISTING CONDITIONS.....	3
2.2	PROPOSED CONDITIONS.....	3
2.3	ROADWAY DESIGN.....	3
3.0	GRADING.....	3
3.1	EXISTING CONDITIONS.....	3
3.2	PROPOSED CONDITIONS.....	3
4.0	EROSION AND SEDIMENT CONTROL.....	4
5.0	SANITARY SEWERS.....	5
5.1	EXISTING CONDITIONS.....	5
5.2	PROPOSED CONDITIONS.....	5
6.0	STORMWATER MANAGEMENT.....	8
6.1	STORMWATER MANAGEMENT CRITERIA.....	8
6.1.1	<i>Allowable Release Rate.....</i>	<i>8</i>
6.2	EXISTING CONDITIONS.....	8
6.3	PROPOSED CONDITIONS.....	8
6.3.1	<i>Minor System Design.....</i>	<i>9</i>
6.3.2	<i>Major System Design.....</i>	<i>11</i>
6.4	HYDROLOGIC & HYDRAULIC MODELING.....	11
6.4.1	<i>Stormwater Storage.....</i>	<i>14</i>
6.5	RESULTS OF HYDROLOGIC / HYDRAULIC ANALYSIS.....	15
6.5.1	<i>Minor System.....</i>	<i>15</i>
6.5.2	<i>Major System.....</i>	<i>17</i>
6.5.3	<i>Hydraulic Grade Line.....</i>	<i>17</i>
6.5.4	<i>Peak Flows.....</i>	<i>18</i>
7.0	WATER.....	19
7.1	EXISTING CONDITIONS.....	19
7.2	PROPOSED CONDITIONS.....	19
8.0	CONCLUSIONS AND RECOMMENDATIONS.....	23

List of Tables

Table 2-1: Roadway Structure
Table 5-1: Proposed Sanitary Sewer Design Parameters
Table 6-1: Storm Sewer Design Parameters
Table 6-2: Runoff Coefficients
Table 6-3: Subcatchment Model Parameters
Table 6-4: Total Storage Provided (Surface and Underground)
Table 6-5: Inlet Control Devices & Design Flows
Table 6-6: Overland Flow Results (100-year Event)
Table 6-7: 100-year HGL Elevations
Table 6-8: Summary of Peak Flows
Table 7-1: Watermain Design Criteria
Table 7-2: Water Flow Summary
Table 7-3: Summary of Hydraulic Model Results - Maximum Day + Fire Flow
Table 7-4: Summary of Hydraulic Model Results - Peak Hour Demand
Table 7-5: Summary of Hydraulic Model Results – Maximum Pressure Check

List of Figures

Figure 1: Key Plan
Figure 2: Site Plan
Figure 3: Sanitary Sewer Network
Figure 4: Storm Sewer Network
Figure 5: Watermain Layout

Appendices

Appendix A: Design Sheets
Appendix B: SWM Calculations
Appendix C: Drawings
Appendix D: DSS Checklist
Emergency Overland Flow Route Documentation

1.0 INTRODUCTION

1.1 Background

Novatech has been retained to prepare a Servicing Design Brief for the 200 Baribeau Street Development, located in the City of Ottawa. The site will be developed by Parkriver Properties.

The development is located in the Vanier neighborhood, on the west side of Baribeau Street and consists of the property located at 200 Baribeau Street. **Figure 1** shows the location of the development lands.

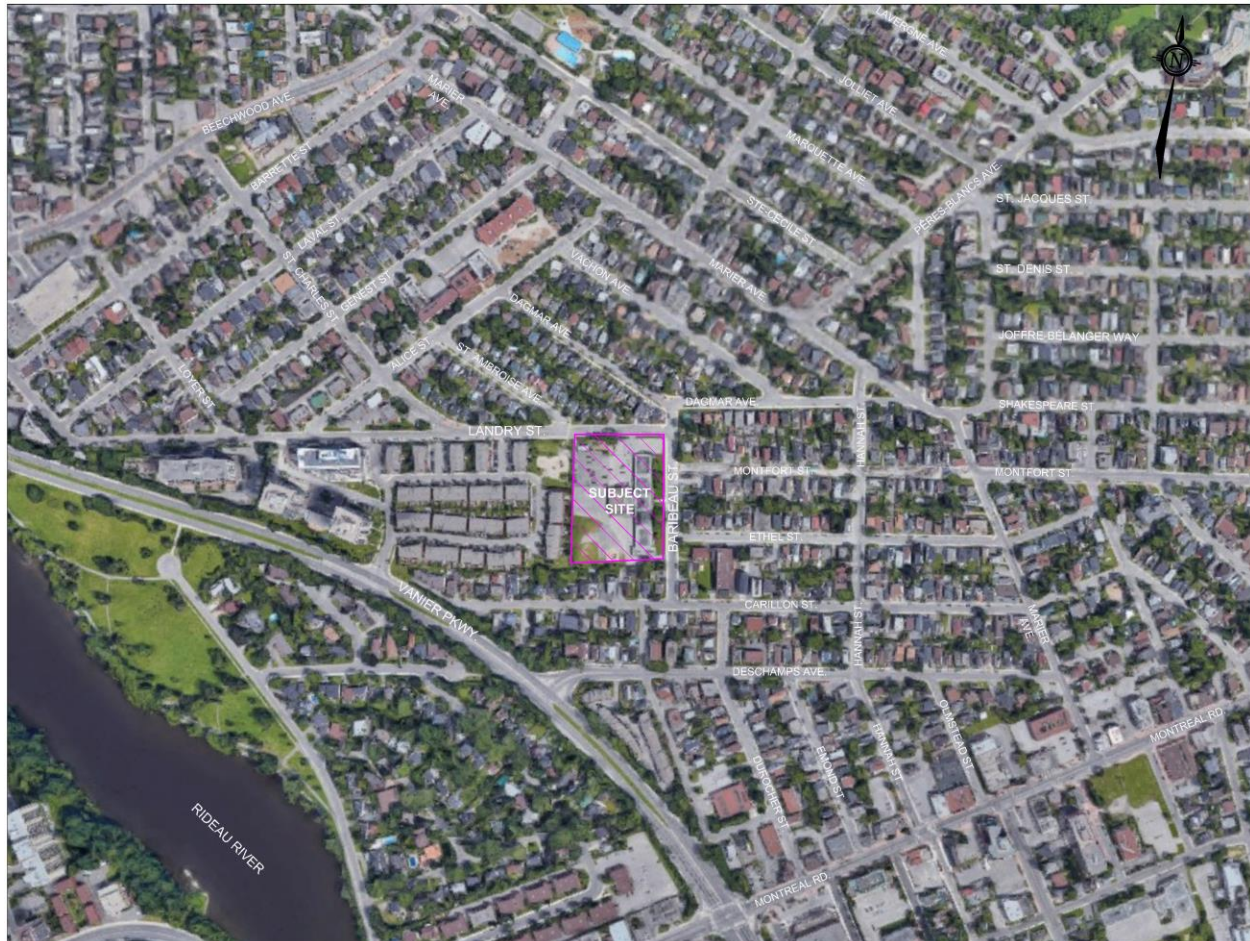

Figure 1: Key Plan

The proposed site is approximately 1.27ha and will be bordered by Landry Street to the north, Baribeau Street to the east and existing residential to the west and south.

This Servicing Design Brief provides information on the considerations and approach by which Novatech has analyzed the existing site information for the 200 Baribeau Street development, and details how the development lands will be serviced while meeting the City requirements and all other relevant regulations.

This report should be read in conjunction with the following:

- Geotechnical Investigation, Proposed Residential Development, 200 Baribeau Street - Ottawa, Ontario prepared by Paterson Group, dated July 15, 2019 (Project:PG4951-1).

1.2 Land Use

The site will consist of twelve townhome buildings with a total of 85 units. The proposed Site Plan is shown below in **Figure 2**.

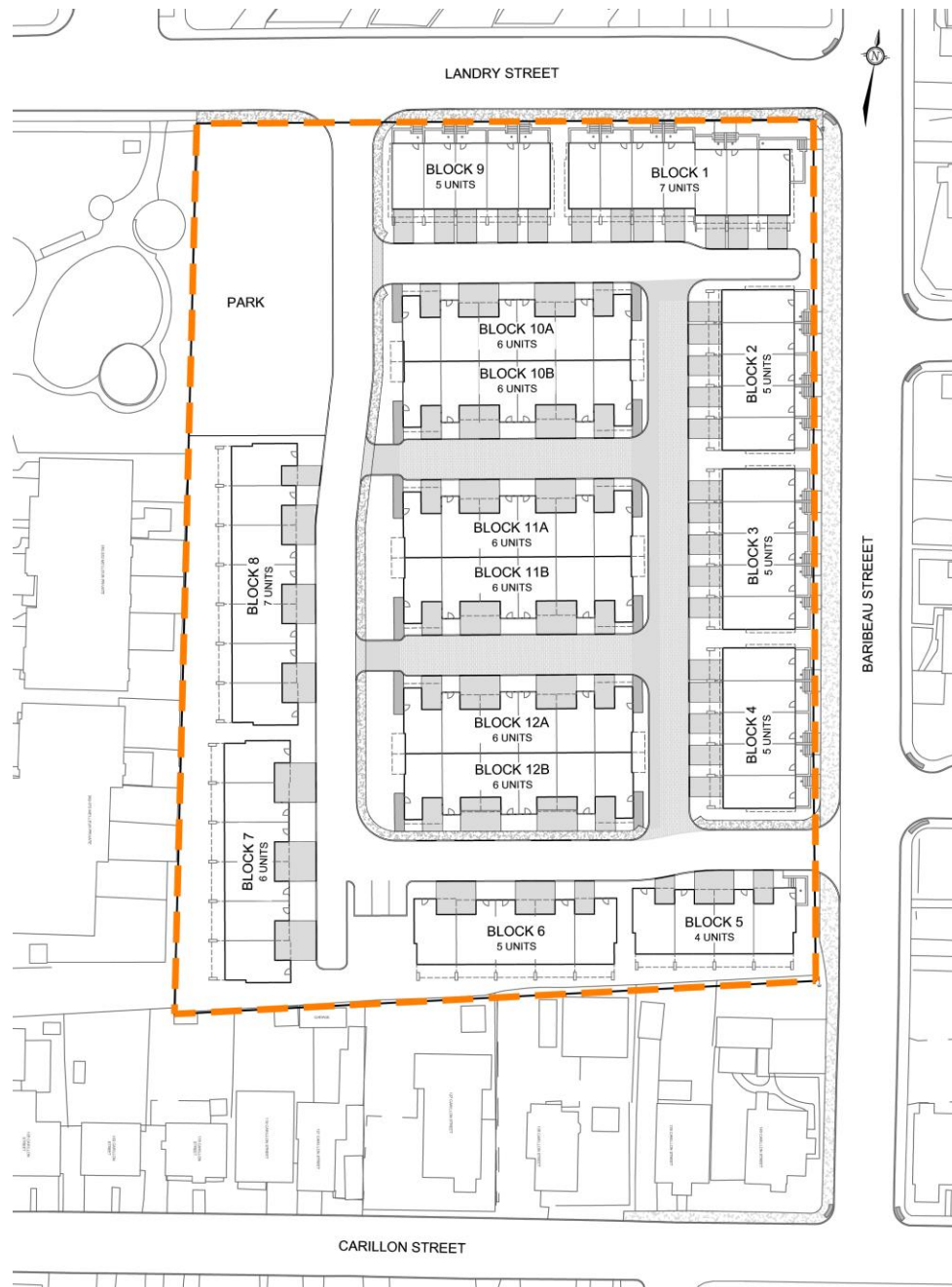

Figure 2: Site Plan

2.0 ROADWAYS

2.1 Existing Conditions

Currently the site can be accessed from Landry Street and Baribeau Street, all classified as local roadways in the 2013 City of Ottawa Transportation Master Plan (TMP).

2.2 Proposed Conditions

The development will be accessed from entrances off Landry Street and Baribeau Street. The site contains a series of 6.0m private roads.

2.3 Roadway Design

Paterson Group has prepared a Geotechnical Investigation report for the development (July 15th, 2019) that provides recommendations for roadway structure, servicing and foundations. The recommended roadway structure is as follows:

Table 2-1: Roadway Structure

Roadway Material Description	Pavement Structure
	Layer Thickness (mm)
Private Road	
Asphalt Wear Course: Superpave 12.5 (Class B)	40
Asphalt Binder Course: Superpave 19.0 (Class B)	50
Base: Granular A	150
Sub-Base: Granular B – Type II	400
Total	640

3.0 GRADING

3.1 Existing Conditions

The lands along the north and east property lines at 200 Baribeau Street slope towards the adjacent public roadways (Landry Street and Baribeau Street). The remaining portion of the subject lands are directed to an existing catchbasin located within the playing field.

A geotechnical investigation was carried out by Paterson Group, practical refusal was encountered at 6.4m below ground surface at borehole 4. Groundwater was recorded between 0.82m and 1.55m below the ground surface, on April 25th, 2019.

3.2 Proposed Conditions

The site will be graded to ensure the minimum clearances are provided per the City of Ottawa and RVCA policies listed below:

- Underside of slab must have a minimum of 0.30m clearance above the 100-year flood level of 56.44m;
- All building openings, including garage, must be at least 0.30m above the 100-year flood level;
- Terracing grades at proposed buildings must be a minimum of 0.15m above the 100-year flood level.

The front yards located along Landry Street and Baribeau Street will tie into the back of curb and existing back of sidewalk. The rear-yards of Blocks 5, 6, 7, 8 and 9 and the park lands will tie into the existing grades along the south and west property lines. For detailed grading refer to drawing 119068-GR.

The proposed grading will fall within these ranges:

- Landscaped Area: Minimum 2% - Maximum 6%
- Rearyard Swales: Minimum 1.5% (1.0% with subdrain)
- Maximum Terracing Grade of 3H:1V

4.0 EROSION AND SEDIMENT CONTROL

Erosion and sediment control measures will be implemented during construction in accordance with the "Guidelines on Erosion and Sediment Control for Urban Construction Sites" (Government of Ontario, May 1987). Typical erosion and sediment control measures recommended include, but are not limited to, the use of silt fences around perimeter of site, filter fabric or inserts under catch basin/maintenance hole lids, heavy duty silt fence barrier, straw bale check dams, rock check dams, turbidity curtain, dewatering trap, temporary water passage system, riprap, mud mats, silt bags for dewatering operations, topsoil and sod to disturbed areas and natural grassed waterways. Dewatering and sediment control techniques will be developed for the individual situations based on the above guidelines and utilizing typical measures to ensure erosion and sediment control is controlled in an acceptable manner and there is no negative impact to adjacent lands, water bodies or water treatment/conveyance facilities.

The following erosion and sediment control measures will be implemented during construction. Details are provided on the Erosion and Sediment Control Plan.

- All erosion and sediment control measures are to be installed to the satisfaction of the engineer, the municipality and the conservation authority prior to undertaking any site alterations (filling, grading, removal of vegetation, etc.) and remain present during all phases of site preparation and construction.
- A qualified inspector should conduct daily visits during construction to ensure that the contractor is working in accordance with the design drawings and that mitigation measures are being implemented as specified.
 - A light duty silt fence barrier is to be installed in the locations shown on the Erosion and Sediment Control & Removals Plan (**119068-ESC**).

- Terrafix Siltsoxx are to be placed under all new and existing catchbasins and storm manhole covers as shown on Erosion and Sediment Control & Removals Plan (**119068-ESC**).
- After complete build-out, all sewers are to be inspected and cleaned and all sediment and construction fencing shall be removed.
- The contractor shall ensure that proper dust control is provided with the application of water (and if required, calcium chloride) during dry periods.
- The contractor shall immediately report to the engineer or inspector any accidental discharges of sediment material into any ditch or sewer system. Appropriate response measures shall be carried out by the contractor without delay.
- The contractor acknowledges that failure to implement erosion and sediment control measures may result in penalties imposed by any applicable regulatory agency.

Temporary erosion and sediment control measures would be implemented both prior to commencement and during construction in accordance with the “Guidelines on Erosion and Sediment Control for Urban Construction Sites”, (Government of Ontario, May 1987).

5.0 SANITARY SEWERS

5.1 Existing Conditions

An existing 250mm diameter sanitary sewer runs along Baribeau Street and outlets to a 750mm trunk sanitary sewer in Carillon Street.

5.2 Proposed Conditions

The peak design flow parameters in **Table 5-1** have been used in the sewer capacity analysis.

Unit and population densities and all other design parameters are specified in the City of Ottawa Sewer Design Guidelines.

Sanitary flow from the site is proposed to connect into the 250mm diameter sanitary sewer in Baribeau Street. The sanitary sewer layout is shown on 119068-GP (**Appendix C**), and the design sheet is attached in **Appendix A**. The site (approx. 1.27ha) will outlet to the 250mm sanitary sewer (Baribeau Street) with a peak design flow of 3.0 L/s.

Table 5-1: Proposed Sanitary Sewer Design Parameters

Parameter	Design Parameter
Town Unit Population	2.7 people/unit
Existing Apartment Unit Population (127 Carillon Street)	1.8 people/unit
Residential Flow Rate, Average Daily	280 L/cap/day
Residential Peaking Factor	Harmon Equation (min=2.0, max=4.0)
Infiltration Rate	0.33 L/s/ha
Minimum Pipe Size	200 mm
Minimum Velocity	0.6 m/s
Maximum Velocity	3.0 m/s

The existing school demand of 60 L/person/day was calculated using Appendix 4-A in the City of Ottawa Sewer Design Guidelines. The school contains 18 classrooms with 22 students per class (396 students). With one teacher per classroom an estimate of 415 people was used to determine an accurate existing peak flow:

$$Q_{POP} = (415 \text{ ppl} * 60 \text{ L/day}) / 86400 = 0.29 \text{ L/s}$$

With the inclusion of infiltration, the total design flow from the existing school is calculated as:

$$Q_{PK \text{ DESIGN}} = (0.33 \text{ L/s/ha} * 1.27 \text{ ha}) + 0.29 \text{ L/s} = 0.71 \text{ L/s}$$

The proposed peak design flow of 3.0 L/s represents an increase of 2.3 L/s being directed to the existing 250mm diameter sanitary sewer in Baribeau Street. The attached sanitary design sheet in Appendix A shows the available capacity in the 250mm diameter sanitary sewer in Baribeau Street at the point of connection. With the additional flows from the site, there is still adequate capacity remaining in the existing sanitary sewer as the Q/Q_{FULL} is at 26%.

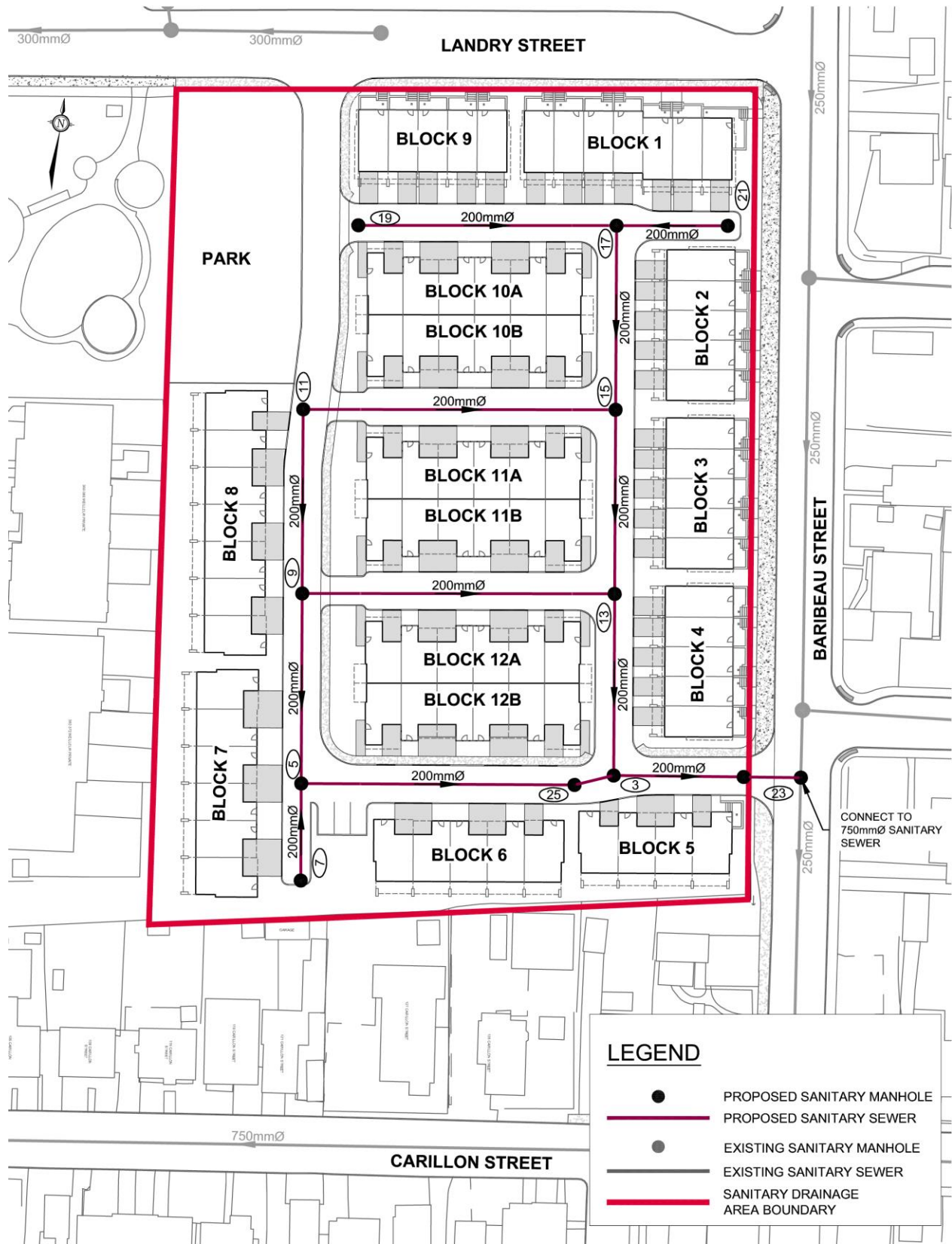

Figure 3: Sanitary Sewer Network

6.0 STORMWATER MANAGEMENT

6.1 Stormwater Management Criteria

The following stormwater management criteria for the proposed development were prepared in accordance with the City of Ottawa Sewer Design Guidelines (October 2012) and RVCA policies.

- Provide a dual drainage system (i.e. minor and major system flows);
- Control the runoff to the existing storm system in Carillon Street to the allowable release rates Specified in **Section 6.1.1** using on-site storage;
- Ensure that ponding is confined within the parking areas at a maximum depth of 0.30 m for both static ponding and dynamic flow;
- Ensure no surface ponding occurs during the 2-year storm event;
- Provide guidelines to ensure that site preparation and construction is in accordance with the current Best Management Practices for Erosion and Sediment Control.

6.1.1 Allowable Release Rate

The allowable release rate for the development has been calculated using the Rational Method with the following parameters:

- Drainage Area
 - 1.27 ha (site boundary)
- Runoff Coefficient
 - 0.50 (based on City of Ottawa criteria)
- Rainfall Intensity
 - Based on City of Ottawa IDF data (Ottawa Sewer Design Guidelines)
 - Time-of-Concentration = 10 minutes

The allowable release rate based on the above parameters is 135.6 L/s for all storms up to and including the 100-year storm event.

6.2 Existing Conditions

The development is located within the Rideau Valley Conservation Authority jurisdiction and is within the 100-year floodplain zone. Under existing conditions, the area fronting onto Baribeau Street and the parking area adjacent to Landry Street flow directly to the public roadways. The remainder of the site is directed to a catchbasin located within the playing field directing flows to the existing storm sewer system in the public roadways. A 525mm diameter storm sewer is located within Landry Street, storm sewers ranging from 600mm to 900mm are located within Baribeau Street and 1050mm diameter storm sewers are located within Carillon Street.

6.3 Proposed Conditions

Catch basins located within the private roadway and landscaped areas will be controlled with inlet control devices (ICDs). Runoff from the site will be routed to the 1050mm diameter storm sewer in Carillon Street through the property at 127 Carillon Street. A 6.0m easement will be

provided through the property to access the existing 1050mm storm sewer. Catch basins located within the private roadway and landscaped areas will be controlled with inlet control devices (ICDs) in order to meet the allowable release rate in **Section 6.1.1**. Underground storage will be provided using StormTech STC-310 storage chambers.

The site grading uses a maximum static ponding depth of 150mm in the private roadways to ensure that the dynamic ponding depth during the 100-year event do not exceed 300mm. The underside of slab elevation for each building has been set at least 300mm above the 100-year floodplain level of 56.44m. In addition, all building opening have been set a minimum of 300mm above the 100-year floodplain level.

Figure 5 outlines the proposed storm sewer system layout, and how it will connect to the existing network along Carillon Street.

6.3.1 Minor System Design

The storm sewers comprising the minor system have been designed based on the criteria outlined in the Ottawa Sewer Design Guidelines using the principles of dual drainage. The design criteria used in sizing the storm sewers are summarized in **Table 6-1** and **Table 6-2**.

The proposed storm sewers have been designed using the Rational Method to convey peak flow associated with a 2-year rainfall event. The storm sewer design sheets are provided in **Appendix A**. The corresponding Storm Drainage Area Plan (Drawing 119068-STM) is provided in **Appendix C**.

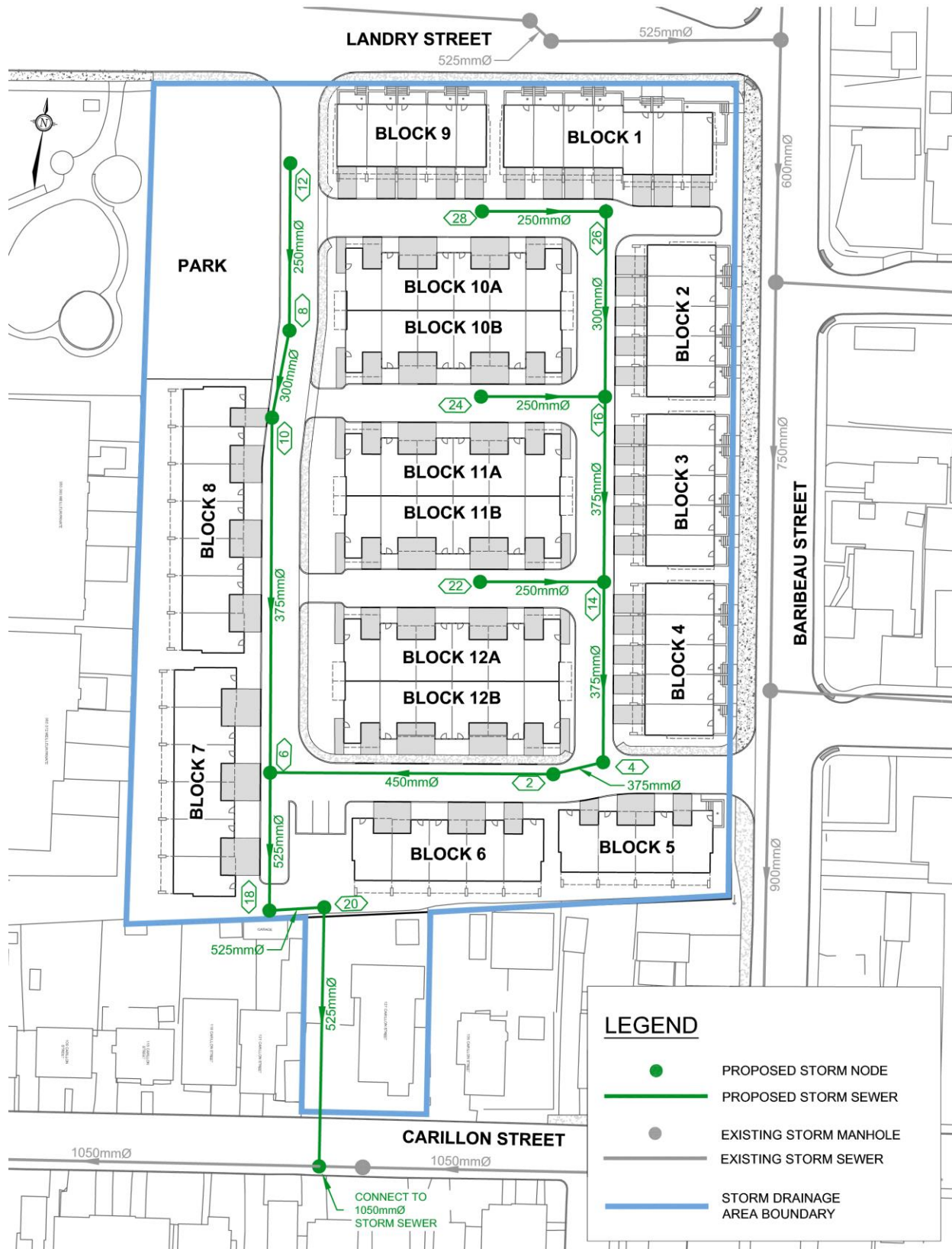

Figure 4: Storm Sewer Network

Table 6-1: Storm Sewer Design Parameters

Parameter	Design Criteria
Private Roads	2 Year Return Period
Storm Sewer Design	Rational Method/AutoDesk Storm Analysis
IDF Rainfall Data	Ottawa Sewer Design Guidelines
Initial Time of Concentration (T_c)	10 min
Minimum Velocity	0.8 m/s
Maximum Velocity	3.0 m/s
Minimum Diameter	250 mm

Table 6-2: Runoff Coefficients

Land Use	Runoff Coefficient
Hard Surface	0.90
Soft Surface	0.20

6.3.2 Major System Design

The site has been designed to convey runoff from storms that exceed the minor system capacity to the approved major system outlet within the existing pathway easement in the southwest corner of the site leading to Kipp Street. The roadway area has been graded to ensure that the 100-year peak overland flows are confined within the site at a maximum flow depth of 300mm. The design of the major system conforms to the design standards outlined in Section 5.5 (Major System Considerations) of the City of Ottawa Sewer Design Guidelines (October 2012).

The existing site provides an emergency overland flow route for Landry Street and Baribeau Street. The proposed site grading will maintain these emergency overland flow routes through the park land and rear-yards of Blocks 8 and 9 for Landry Street and through the rear-yards of Blocks 5 and 6 for Baribeau Street. Prior discussion with the City of Ottawa regarding the design of the emergency overland flow routes is provided in **Appendix D**.

6.4 Hydrologic & Hydraulic Modeling

The *City of Ottawa Sewer Design Guidelines* (October 2012) require hydrologic modelling for all dual drainage systems. The performance of the proposed storm drainage system for the site was evaluated using the *PCWMM* hydrologic/hydraulic modeling software.

Design Storms

The hydrologic analysis was completed using the following synthetic design storms and historical storms. The IDF parameters used to generate the design storms were taken from the Sewer Design Guidelines.

3 Hour Chicago Storms:

25mm 3-hr Chicago storm
 2-year 3hr Chicago storm
 5-year 3hr Chicago storm
 100-year 3hr Chicago storm

12 Hour SCS Storms:

2-year 12-hr SCS storm
 5-year 24hr Chicago storm
 100-year 24hr Chicago storm

The 3-hour Chicago distribution generates the highest peak flows for both the minor and major systems and was determined to be the critical storm distribution for the design of the storm drainage system.

The proposed drainage system has also been stress tested using a 3-hour Chicago design storm that has a 20% higher intensity and total volume compared to the 100-year event.

Model Development

The PCSWMM model accounts for both minor and major system flows (*dual drainage*), including the routing of flows through the storm sewer network (*minor system*), and overland along the road network (*major system*). The results of the analysis were used to;

- Determine the total major and minor system runoff from the site;
- Size the ICDs for each inlet to the storm sewer system;
- Calculate the storm sewer hydraulic grade line (HGL) for the 100-year storm event; and
- Ensure no ponding occurs during the 2-year storm event.

The model is capable of accounting for both static and dynamic storage within the private roadways and landscaped areas, including the overland flow across all high points. The 100-year flow depths computed by the model represent the total (static + dynamic) ponding depths at low points for areas in road sags.

Storm Drainage Area Plan & Subcatchment Parameters

The development has been divided into subcatchments based on the drainage areas tributary to each inlet of the proposed storm sewer system. The catchment areas are shown on the Storm Drainage Area Plan provided as drawing **119068-STM** in **Appendix C**.

The hydrologic parameters for each subcatchment were developed based on the Site Plan (**Figure 2**) and the Storm Drainage Area Plan specified above. Subcatchment parameters are outlined in **Table 6-3**.

Table 6-3: Subcatchment Model Parameters

Area ID	Catchment Area (ha)	Runoff Coefficient (C)	Percent Impervious (%)	Zero Imperv. (%)	Flow Length (m)	Equivalent Width (m)	Average Slope (%)
A-01	0.040	0.20	0.0	0.0	15	27	1.5
A-02	0.040	0.67	67.5	29.6	15	27	1.5
A-03	0.101	0.81	87.1	59.1	20	51	1.5
A-04	0.073	0.80	86.3	52.4	15	49	1.5
A-05	0.073	0.78	82.2	50.0	15	49	1.5
A-06	0.093	0.85	92.5	57.0	15	62	1.5
A-07	0.066	0.65	63.6	23.8	15	44	1.5
A-08	0.038	0.20	0.0	0.0	15	25	1.5
A-09	0.032	0.51	43.8	100.0	10	32	1.5
A-10	0.030	0.46	36.7	100.0	10	30	1.5
A-11	0.082	0.67	67.1	29.1	15	55	1.5
A-12	0.094	0.85	92.6	57.5	15	63	1.5

Area ID	Catchment Area (ha)	Runoff Coefficient (C)	Percent Impervious (%)	Zero Imperv. (%)	Flow Length (m)	Equivalent Width (m)	Average Slope (%)
A-13	0.082	0.78	82.9	50.0	15	55	1.5
A-14	0.088	0.80	85.2	44.0	15	59	1.5
A-15	0.060	0.83	90.0	48.1	15	40	1.5
A-16	0.070	0.72	74.3	23.1	15	47	1.5
A-17	0.030	0.48	40.0	100.0	10	30	1.5
A-18	0.025	0.31	16.0	100.0	10	25	1.5
A-19	0.020	0.59	55.0	100.0	10	20	1.5
A-20	0.028	0.50	42.9	100.0	10	28	1.5
A-21	0.009	0.33	18.9	100.0	10	9	1.5
B-01	0.042	0.54	48.8	0.0	10	35	1.5
B-02	0.050	0.43	33.0	0.0	10	51	1.5
TOTAL	1.27 ha	0.68	69%	-	-	-	-

Infiltration

Infiltration losses for all catchment areas were modeled using Horton's infiltration equation, which defines the infiltration capacity of the soil over the duration of a precipitation event using a decay function that ranges from an initial maximum infiltration rate to a minimum rate as the storm progresses. The default values for the Sewer Design Guidelines were used for all catchments.

Horton's Equation:
 $f(t) = f_c + (f_o - f_c)e^{-k(t)}$

Initial infiltration rate: $f_o = 76.2$ mm/hr
 Final infiltration rate: $f_c = 13.2$ mm/hr
 Decay Coefficient: $k = 4.14$ /hr

Depression Storage

The default values for depression storage in the Sewer Design Guidelines were used for all catchments. Residential rooftops were assumed to provide no depression storage.

- Depression Storage (pervious areas): 4.67 mm
- Depression Storage (impervious areas): 1.57 mm

Equivalent Width

'Equivalent Width' refers to the width of the sub-catchment flow path. This parameter is calculated as described in the Sewer Design Guidelines, Section 5.4.5.6. The flow paths used to calculate the equivalent widths are shown on the PCSWMM schematics provided in **Appendix B**.

Impervious Values

Impervious (TIMP) values for each subcatchment area were calculated based on the proposed Site Plan (**Figure 2**) and correspond to the Runoff Coefficients used in the Rational Method calculations using the equation:

$$\%imp = \frac{C - 0.2}{0.7}$$

6.4.1 Stormwater Storage

Underground and surface storage are represented in the PCSWMM model using storage nodes and storage curves. Refer to **Appendix B** for additional details.

Underground Storage

Underground storage will be provided using StormTech STC-310 (arch type) storage chambers connected to all roadway CB's to ensure no 2-year ponding occurs. The underground storage chambers are also required to prevent major system flow being directed off-site.

The StormTech chambers have the following dimensions:

- Stone foundation depth = 150mm (min)
- Stone cover = 230mm
- Stone porosity = 40%
- Size (L x W x H) = 2170mm x 864mm x 406mm
- Chamber / minimum installed storage = 0.40 m³ / 0.90 m³

The storage volumes were determined using the StormTech design calculator based on the configurations shown on the General Plan of Services (Drawing 119068-GP). Documentation for the StormTech storage chambers is provided in **Appendix B**.

Surface Storage

In addition to the underground storage provided, surface storage will be provided to attenuate peak flows to the allowable release rates. Surface storage will consist of ponding above each catchbasin within the private roadways and landscaped areas.

A summary of the underground and surface storage is provided in **Table 6-4**. The extent of surface ponding is shown on the Storm Drainage Area Plan (119068-STM).

Table 6-4: Total Storage Provided (Surface and Underground)

Structure ID	STM Area ID	Max Static Ponding Depth (m)	Storage Provided (m ³)			Number of StormTech STC-310 Storage Chambers
			Underground ¹	Surface ²	TOTAL	
<i>Catchbasins within Private Roadway</i>						
CB01	A14	0.15	8	10	18	6
CB02	A15	0.15	8	6	14	6
CB03	A11	0.15	5	14	19	4
CB04	A07	0.15	5	10	15	4
CB05	A02	0.15	5	6	11	4
CB06	A13	0.15	8	10	18	4
CB07	A12	0.15	21	13	34	16
CB08	A05	0.15	8	8	16	6
CB09	A06	0.15	21	12	33	16
CB10	A04	0.15	8	10	18	6
CB11	A03	0.15	21	10	31	16
CB12	A16	0.12	21	10	31	16

Inlet Control Devices (ICDs)

All catch basins will be fitted with Ipex Tempest LMF ICDs as specified in the Tempest documentation package provided in **Appendix B** and shown on the General Plan of Services (119068-GP).

6.5 Results of Hydrologic / Hydraulic Analysis

The model was used to evaluate the performance of the proposed storm drainage system for 200 Baribeau Street.

6.5.1 Minor System

Inflows to the storm sewer were modeled based on the characteristics of each inlet. All the catch basins in the roadways are located at low points. Inflows to the storm sewer are based on the ICD specified for the inlet and the maximum depth of ponding. ICDs have been sized to limit the outlet peak flows to the allowable release rate of 135.6 L/s. All catch basins will be fitted with Ipex Tempest LMF ICDs as specified in the Tempest documentation package provided in **Appendix B** and shown on the General Plan of Services (119068-GP). Details are outlined as follows in **Table 6.4**.

The Rational Method design sheets (**Appendix B**) were used to calculate the required storm sewer sizes based on capturing the peak flow at each inlet to the storm sewer for a 2-year design return period.

Table 6-5: Inlet Control Devices & Design Flows

Structure ID	ICD Size & Inlet Rate						
	ICD Type	T/G (m)	Orifice Invert (m)	100-year Head on Orifice (m)	2-year Orifice Peak Flow* (L/s)	5-year Orifice Peak Flow* (L/s)	100-year Orifice Peak Flow* (L/s)
CB01	Tempest LMF (Vortex 84)	57.43	55	1.65	5.0	7.4	7.8
CB02	Tempest LMF (Vortex 84)	57.38	54.95	1.67	4.5	5.0	7.8
CB03	Tempest LMF (Vortex 75)	57.43	55	1.60	5.2	5.9	6.1
CB04	Tempest LMF (Vortex 74)	57.5	55.07	1.57	3.7	5.8	6.0
CB05	Tempest LMF (Vortex 74)	57.56	55.13	1.56	3.1	3.7	6.0
CB06	Tempest LMF (Vortex 76)	57.48	55.05	1.64	4.1	6.1	6.4
CB07	Tempest LMF (Vortex 74)	57.57	55.14	1.58	3.5	3.9	6.0
CB08	Tempest LMF (Vortex 76)	57.55	55.12	1.62	4.0	6.1	6.4
CB09	Tempest LFM (Vortex 74)	57.61	55.18	1.61	3.5	3.9	6.1
CB10	Tempest LMF (Vortex 74)	57.63	55.2	1.61	3.9	5.8	6.1
CB11	Tempest LMF (Vortex 74)	57.67	55.24	1.62	3.5	3.9	6.1
CB12	Tempest LMF (Vortex 76)	57.38	54.95	1.55	3.0	3.5	6.2
RYCB1	Tempest LMF (Vortex 76)	56.65	54.32	1.51	2.6	4.5	6.2
RYCB3	Tempest LMF (Vortex 87)	56.59	54.03	1.77	4.6	6.6	8.8
RYCB6	Tempest LMF (Vortex 83)	56.39	53.77	1.80	5.9	8.7	8.0

*PCSWMM model results for a 3-hour Chicago storm distribution.

6.5.2 Major System

The major system network was evaluated using the PCSWMM model to ensure that the ponding depths conform to City standards. A summary of ponding depths at each inlet for the 2-year, 5-year, 100-year and 100-year (+20%) events are provided in **Appendix B**. The maximum static and dynamic ponding depths within the roadways are less than 0.3m during all events.

Table 6-6: Overland Flow Results (100-year Event)

Structure	T/G (m)	Max. Static Ponding (Spill Depth)		100-yr Event (3hr)			
		Elev. (m)	Depth (m)	Elev. (m)	Depth (m)	Cascading Flow?	Cascade Depth (m)
CB01	56.43	56.58	0.15	56.65	0.22	Y	0.07
CB02	56.38	56.53	0.15	56.62	0.24	Y	0.09
CB03	56.43	56.58	0.15	56.60	0.17	Y	0.02
CB04	56.50	56.65	0.15	56.64	0.14	N	0.00
CB05	56.56	56.71	0.15	56.69	0.13	N	0.00
CB06	56.48	56.63	0.15	56.69	0.21	Y	0.06
CB07	56.57	56.72	0.15	56.72	0.15	N	0.00
CB08	56.55	56.70	0.15	56.74	0.19	Y	0.04
CB09	56.61	56.76	0.15	56.79	0.18	Y	0.03
CB10	56.63	56.78	0.15	56.81	0.18	Y	0.03
CB11	56.67	56.82	0.15	56.86	0.19	Y	0.04
CB12	56.38	56.50	0.12	56.50	0.12	N	0.00

An expanded table of the ponding depths at low points in the roadway (including the stress-test event) is provided in **Appendix B**. Based on these results, the proposed storm drainage system will not experience any adverse flooding even with a 20% increase to the 100-year event.

6.5.3 Hydraulic Grade Line

The results of the analysis were used to determine if there would be any surcharging from the storm sewer system during the 100-year storm event. **Appendix B** provides a summary of the 100-year HGL elevation at each storm manhole within the proposed development, as well as a summary of the HGL elevations for a 20% increase (rainfall intensity and total precipitation) in the 100-year design event. The results of the HGL analysis and the stress testing indicates that the storm sewer does surcharge during the 100-year event and 100-year+20% storm event.

The results of the HGL analysis were used to ensure that a minimum freeboard of 0.50m is provided between the 100-year HGL and the designed underside of slab elevations (all buildings are slab on grade). The 100-year HGL elevations at each storm manhole with respect to the lowest adjacent underside of slab elevation are provided in **Table 6-7**.

Table 6-7: 100-year HGL Elevations

Manhole ID	MH Invert Elevation (m)	T/G Elevation (m)	HGL Elevation - 100yr3hr (m)	Design USS (m)	Clearance (100yr) (m)
MH02	52.74	56.47	55.14	56.86	1.7
MH04	52.88	56.51	55.15	56.86	1.7
MH06	52.33	56.43	55.12	56.80	1.7
MH08	53.26	56.62	55.14	56.85	1.7
MH10	53.05	56.57	55.13	56.85	1.7
MH12	53.58	56.73	55.14	57.06	1.9
MH14	53.08	56.51	55.16	56.90	1.7
MH16	53.23	56.59	55.17	56.96	1.8
MH18	52.08	55.44	55.10	56.80	1.7
MH20	51.94	55.61	55.09	-	-
MH22	53.34	56.63	55.16	56.90	1.7
MH24	53.56	56.66	55.17	57.03	1.9
MH26	53.53	56.69	55.17	57.06	1.9
MH28	53.78	56.73	55.18	57.06	1.9

**Downstream 'fixed' outfall condition set at 55.05m (Based on profile provided by the City of Ottawa located in Appendix B). Initial depths based on fixed outfall elevation of 55.05m.*

An expanded table showing the results of the stress test (100-year +20% event) and the HGL elevations is provided in **Appendix B**. The stress test indicates that the HGL elevations will be below the USS elevations for this event.

6.5.4 Peak Flows

The overall release rates from the controlled and uncontrolled areas were added to determine the overall release rate from the site. The results of this analysis indicate that the allowable release rate will be met for each storm event. Refer to **Table 6-8** for the modelled peak flows for each storm event.

The results of the PCSWMM analysis indicate that outflows from the proposed development will not exceed the allowable release rate for all storm events.

Table 6-8: Summary of Peak Flows

Design Event	Allowable Release Rate (L/s)	Controlled Minor System Release Rate (L/s)	Uncontrolled Minor System Release Rate (L/s)	Total Minor System Release Rate (L/s)
2-year	135.6	57.6	7.5	65.1
5-year		79.6	15.2	94.8
100-year		99.1	36.4	135.5
100-year (+20%)	-	96.6	46.0	142.6

**PCSWMM Model results for a 3-hr Chicago storm distribution.*

As mentioned above in **Section 6.3.2**, the existing site provides an emergency overland flow route for Landry Street (through the park land and rear-yards of Blocks 8 and 9) and Baribeau Street (through the rear-yards of Block 5 and 6), outletting to the pathway block connecting to Kipp Street. Through coordination with the City of Ottawa (**Appendix D**) Novatech has assumed potential 100-year overland flows of 190 L/s from Landry Street and 1,000 L/s from Baribeau Street. With the combination of surface storage and underground storage chambers, most of the major system from the 100-year storm event is contained on-site. During the 100-year storm event 48.5 L/s of major system flow from the rear-yards is directed to Kipp Street at RYCB5. The overland flow at RYCB5 is the result of maintaining the grade of the existing overland flow route through the rear-yards as we are unable to raise the existing grade enough to provide additional storage. The additional 48.5 L/s from the site is insignificant compared to the assumed flows from Landry Street and Baribeau Street.

7.0 WATER

7.1 Existing Conditions

The proposed development is located inside the 1E Pressure Zone. A 300mm diameter watermain runs along Landry Street, a 200mm diameter watermain runs along Baribeau Street and a 150mm diameter watermain runs along Carillon Street.

7.2 Proposed Conditions

The site will have two connection points to the existing watermains, one to the 300mm watermain in Landry Street and one to the 200 mm watermain in Baribeau Street.

A series of 150mm and 200mm diameter watermains are proposed and will provide capacity to maintain appropriate pressures and fire flows throughout the development. **Figure 5** provides a high-level schematic of the proposed water distribution system.

The watermain boundary conditions below were obtained from the City of Ottawa (July 2020) and has been included in **Appendix A**:

Boundary Condition 1 – Landry Street (300mm watermain)

Max Day + FF of 183 L/s = 110.0m

Max Day + FF of 333 L/s = 104.0m

Peak Hour = 109.5m

Maximum HGL = 118.5m

Boundary Condition 2 – Baribeau Street (200mm watermain)

Max Day + FF of 183 L/s = 109.0m

Max Day + FF of 333 L/s = 101.0m

Peak Hour = 109.5m

Maximum HGL = 118.5m

City of Ottawa watermain design criteria are outlined in **Table 7.1**.

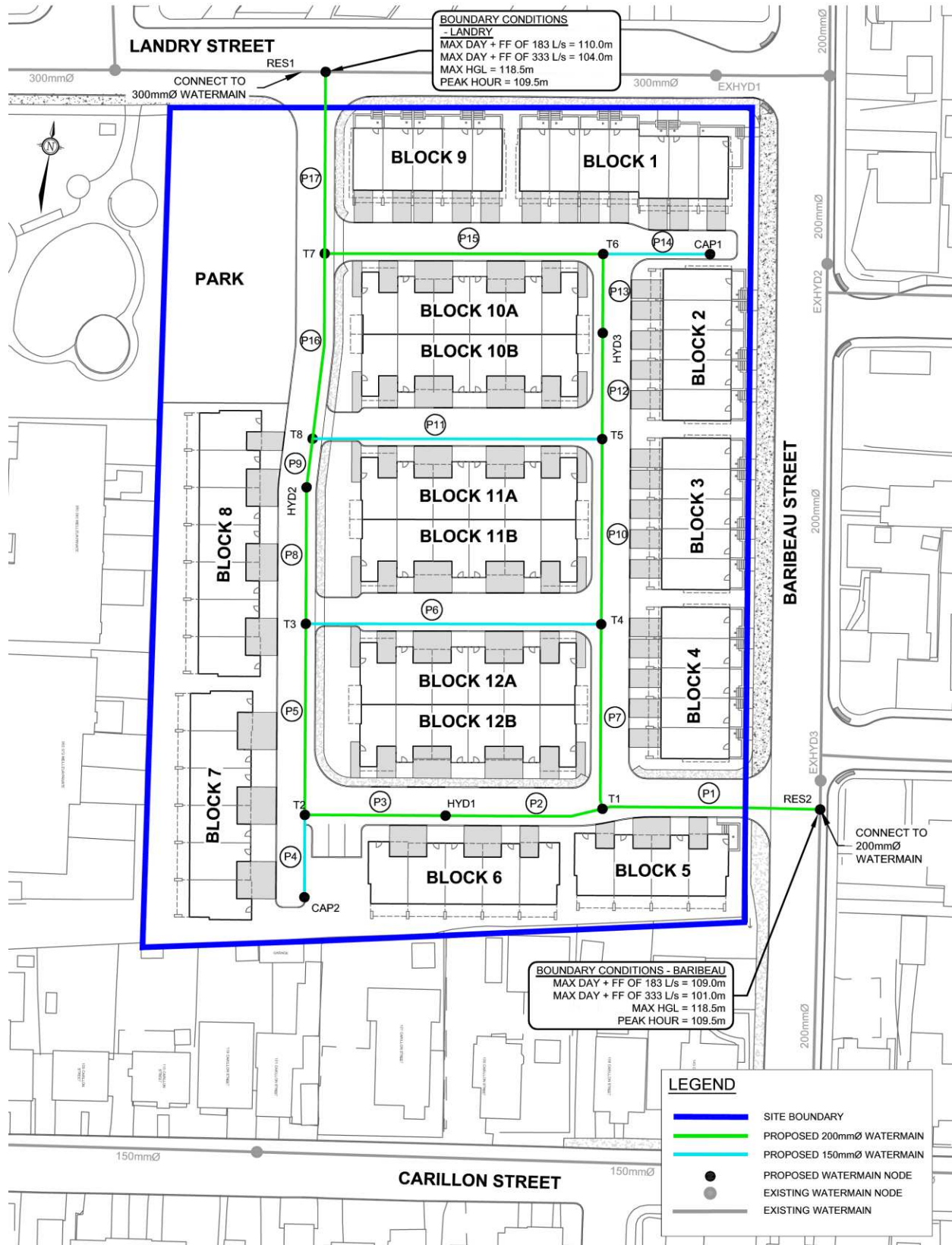

Figure 5: Watermain Layout

Table 7-1: Watermain Design Criteria

Design Parameter	Design Criteria
Town Population	2.7 people/unit
Residential Demand	280 L/c/d
Maximum Day Demand	2.5 x Average Day
Peak Hour Demand	2.2 x Maximum Day
Fire Demand	183 to 300 L/s
Maximum Pressure	690 kPa (100psi) unoccupied areas
Maximum Pressure	552 kPa (80psi) occupied areas outside of ROW
Minimum Pressure	275 kPa (40 psi) except during fire flow
Minimum Pressure	140 kPa (20 psi) fire flow conditions

Table 7-2: Water Flow Summary

	Units	Population	Average Day Demand (L/s)	Maximum Day Demand (L/s)	Peak Hour Demand (L/s)
Back-to-Back Towns	85	230	0.744	1.859	4.091
Total	85	230	0.744	1.859	4.091

Based on the fire underwriters survey, the fire flows were calculated as 183 L/s (Block 9), 200 L/s (Blocks 5), 217 L/s (Blocks 2, 3, 4, and 6), 233 L/s (Blocks 1, 7 and 8) and 300 L/s (Blocks 10, 11 and 12). Hydrant grades and distances to structures are illustrated on the Fire Hydrant Coverage Plan in **Appendix A**. Fire flow calculations are provided in **Appendix A**.

The proposed watermain was modeled using EPANET 2 (See 119068-GP for detailed watermain layout).

A summary of the model results is shown below in **Table 7.3**, **Table 7.4** and **Table 7.5**. Full model results are included in **Appendix A**.

Table 7-3: Summary of Hydraulic Model Results - Maximum Day + Fire Flow

Operating Condition	Minimum Pressure
233 L/s at Block 1	481.18 kPa (HYD3)
217 L/s at Block 2	489.03 kPa (HYD3)
217 L/s at Block 3 & 4	472.45 kPa (HYD3)
200 L/s at Block 5	498.15 kPa (HYD1)
217 L/s at Block 6	470.49 kPa (HYD1)
233 L/s at Block 7	467.74 kPa (HYD1)
233 L/s at Block 8	459.70 kPa (HYD1)
183 L/s at Block 9	491.78 kPa (HYD3)
300 L/s at Block 10	427.81 kPa (HYD3)
300 L/s at Block 11 & 12	416.24 kPa (HYD2)

Table 7-4: Summary of Hydraulic Model Results - Peak Hour Demand

Operating Condition	Maximum Pressure	Minimum Pressure
4.091 L/s through system	520.52 kPa (T2)	517.38 kPa (T6)

The hydraulic modelling summarized above highlights the maximum and minimum system pressures during Peak Hour conditions, and the minimum system pressures during the Maximum Day + Fire condition. Since the Maximum Day + Fire Flow pressures are above the minimum 140 kPa, and the Peak Hour Pressures onsite fall within the normal operating pressure range (345 kPa to 552 kPa) we conclude the proposed water design will adequately service the development.

Table 7-5: Summary of Hydraulic Model Results – Maximum Pressure Check

Operating Condition	Maximum Pressure	Minimum Pressure
0.744 L/s through system	608.81 kPa (T2)	605.67 kPa (T6)

The average day pressures throughout the system are above 552 kPa, therefore pressure reducing valves are required.

Water retention was analyzed at each node during average day demand. The maximum age throughout the system is within City standards.

8.0 CONCLUSIONS AND RECOMMENDATIONS

The report conclusions are as follows:

- 1) The proposed storm system will control post-development flow to the allowable release rate of 135.6 L/s.
- 2) The proposed sanitary sewer conforms to City design criteria and provides a gravity outlet for the development site. There is capacity in the downstream sanitary sewers to accommodate the design flow into the Baribeau Street sanitary sewers.
- 3) Connection to the watermains in Baribeau Street and Landry Street will provide municipal water service to the development.
- 4) There is adequate fire protection for the proposed development, in accordance with the Fire Underwriter's Survey.
- 5) The proposed infrastructure (sanitary, storm and water) complies with City of Ottawa design standards.
- 6) The proposed grading provides a minimum 0.30m clearance between the RVCA regulatory flood level of 56.44m and the underside of slab of all living levels.

This report is respectfully submitted for review and approval. Please contact the undersigned should you have questions or require additional information.

Sincerely,

NOVATECH

Prepared By:

Reviewed By:



Lucas Wilson, P.Eng.
Project Coordinator



Mark Bissett, P.Eng.
Senior Project Manager

APPENDIX A: Design Sheets

Storm Sewer Design Sheet (Rational Method)

Sanitary Sewer Design Sheet

Watermain Boundary Conditions

Watermain Modelling

Fire Flow Calculations

Fire Hydrant Coverage Plan

STORM SEWER DESIGN SHEET

FLOW RATES BASED ON RATIONAL METHOD



LOCATION				AREA (ha)			FLOW							TOTAL FLOW	SEWER DATA								
Street	Catchment ID	From Manhole	To Manhole	Area (ha)	C	AC (ha)	Indiv 2.78 AC	Accum 2.78 AC	Time of Concentration	Rainfall Intensity 2 Year (mm/hr)	Rainfall Intensity 5 Year (mm/hr)	Rainfall Intensity 10 Year (mm/hr)	Peak Flow (L/s)	Total Peak Flow, Q (L/s)	Dia. (m) Actual	Dia. (mm)	Type	Slope (%)	Length (m)	Capacity (L/s)	Velocity (m/s)	Flow Time (min)	Ratio Q/Q full
	A2	MH12	MH8	0.040	0.67	0.03	0.075	0.075	10.00	76.81			5.7	5.7	0.254	250	PVC	1.00	26.9	62.0	1.22	0.37	9%
	A1, A7, A8, A9	MH8	MH10	0.176	0.42	0.07	0.205	0.280	10.37	75.43			21.1	21.1	0.305	300	PVC	1.00	14.3	100.8	1.38	0.17	21%
	A11	MH10	MH6	0.082	0.67	0.05	0.153	0.433	10.54	74.80			32.4	32.4	0.381	375	PVC	1.00	57.1	182.8	1.60	0.59	18%
	A3, A4	MH26	MH16	0.174	0.81	0.14	0.392	0.392	10.00	76.81			30.1	30.1	0.305	300	PVC	0.75	29.8	87.3	1.20	0.42	34%
	A5, A6	MH16	MH14	0.166	0.82	0.14	0.378	0.770	10.42	75.25			58.0	58.0	0.381	375	PVC	0.50	29.8	129.2	1.13	0.44	45%
	A12, A13	MH14	MH4	0.176	0.82	0.14	0.401	1.171	10.85	73.68			86.3	86.3	0.381	375	PVC	0.50	29.0	129.2	1.13	0.43	67%
	A14, A15	MH4	MH2			0.00	0.000	1.171	11.28	72.22			84.6	84.6	0.381	375	PVC	0.75	8.3	158.3	1.39	0.10	53%
	A14, A15	MH2	MH6	0.148	0.81	0.12	0.333	1.505	11.38	71.89			108.2	108.2	0.457	450	Conc	0.75	45.5	257.4	1.57	0.48	42%
	A16	MH6	MH18	0.070	0.72	0.05	0.140	2.078	11.86	70.32			146.1	146.1	0.533	525	Conc	0.85	22.2	413.4	1.85	0.20	35%
	A10, A17, A18, A21	MH18	MH20	0.094	0.41	0.04	0.107	2.185	12.06	69.70			152.3	152.3	0.533	525	Conc	0.85	8.8	413.4	1.85	0.08	37%
	A19, A20	MH20	MH30	0.048	0.54	0.03	0.072	2.257	12.14	69.45			156.7	156.7	0.533	525	Conc	0.85	41.7	413.4	1.85	0.38	38%

Q = 2.78 AIC, where
 Q = Peak Flow in Litres per Second (L/s)
 A = Area in hectares (ha)
 I = Rainfall Intensity (mm/hr), 2 year storm
 C = Runoff Coefficient



Consultant:	Novatech
Date:	June 4, 2021
Design By:	Lucas Wilson
Client:	
Parkriver Properties	
Dwg. Reference:	Checked By:
119068-STM	MAB

200 Baribeau Street - Sanitary Sewer Design Sheet

AREA			RESIDENTIAL							INFILTRATION			Total Flow (l/s)	PIPE												
ID	From	To	SINGLES		Towns		Accum. Pop.	Peak Factor	Peak Flow (l/s)	Total Area (ha)	Accum. Area (ha)	Infil. Flow (l/s)		Size (mm)	Slope (%)	Length (m)	Capacity (l/s)	Full Flow Vel. (m/s)	Actual Vel. (m/s)	Q/Q _{full} (%)	d/D					
			Units	Pop.	Units	Pop.																				
200 BARIBEAU STREET																										
	19	17	0	0.0	14	37.8	37.8	3.7	0.4	0.15	0.15	0.0	0.5	200	0.65	41.8	27.6	0.85	0.28	1.8%	0.077					
	21	17	0	0.0	4	10.8	10.8	3.7	0.1	0.04	0.04	0.0	0.1	200	0.65	18.0	27.6	0.85	0.19	0.5%	0.000					
	17	15	0	0.0	5	13.5	62.1	3.6	0.7	0.06	0.25	0.1	0.8	200	0.35	29.8	20.2	0.62	0.26	4.0%	0.153					
	11	15	0	0.0	12	32.4	32.4	3.7	0.4	0.11	0.11	0.0	0.4	200	0.65	50.6	27.6	0.85	0.26	1.5%	0.077					
	15	13	0	0.0	5	13.5	108.0	3.6	1.3	0.07	0.43	0.1	1.4	200	0.35	29.8	20.2	0.62	0.30	6.9%	0.187					
	9	13	0	0.0	12	32.4	32.4	3.7	0.4	0.11	0.11	0.0	0.4	200	0.65	50.6	27.6	0.85	0.26	1.5%	0.077					
	13	3	0	0.0	5	13.5	153.9	3.5	1.8	0.06	0.60	0.2	2.0	200	0.35	29.4	20.2	0.62	0.33	9.7%	0.077					
	11	9	0	0.0	6	16.2	16.2	3.7	0.2	0.08	0.08	0.0	0.2	200	0.65	29.8	27.6	0.85	0.21	0.8%	0.077					
	9	5	0	0.0	4	10.8	27.0	3.7	0.3	0.07	0.15	0.0	0.4	200	0.35	30.8	20.2	0.62	0.20	1.8%	0.077					
	7	5	0	0.0	3	8.1	8.1	3.7	0.1	0.04	0.04	0.0	0.1	200	0.65	15.7	27.6	0.85	0.16	0.4%	0.077					
	5	25	0	0.0	11	29.7	64.8	3.6	0.8	0.12	0.31	0.1	0.9	200	0.35	44.2	20.2	0.62	0.26	4.3%	0.077					
	25	3	0	0.0	1	2.7	67.5	3.6	0.8	0.10	0.41	0.1	0.9	200	0.35	6.5	20.2	0.62	0.27	4.6%	0.077					
	3	23	0	0.0	3	8.1	229.5	3.5	2.6	0.04	1.05	0.3	3.0	200	0.35	30.3	20.2	0.62	0.37	14.6%	0.077					
Design Parameters:			Avg Flow/Person = 280 l/day			Comm./Inst. Flow = 28000 l/ha/day			Infiltration = 0.33 l/s/ha			Pipe Friction n = 0.013			Residential Peaking Factor = Harmon Equation (max 4, min 2)			Population Density:			Project: 200 Baribeau Street (119068)					
			ppl/unit			units/net ha												Designed: LRW			Checked: MAB			Date: June 4, 2021		
			Apartment 1.80			Singles 3.40			Towns 2.70																	



200 Baribeau Street - Sanitary Sewer Design Sheet

AREA			RESIDENTIAL							ICI				INFILTRATION			PIPE											
Street	From	To	SINGLES		Apartments		Accum. Pop.	Peak Factor	Peak Flow (l/s)	Commercial Area (ha)	Institutional Area (ha)	Accum. Area (ha)	Peak Flow (l/s)	Total Area (ha)	Accum. Area (ha)	Infil. Flow (l/s)	Total Flow (l/s)	Size (mm)	Slope (%)	Length (m)	Capacity (l/s)	Full Flow Vel. (m/s)	Actual Vel. (m/s)	Q/Q _{full} (%)	d/D			
			Units	Pop.	Units	Pop.																						
Existing																												
Dagmar Ave.	EXSANMH1	EXSANMH2	7	23.8	12	21.6	45.4	3.7	0.5	0.00	0.00	0.00	0.0	0.52	0.52	0.2	0.7	250	0.45	108.7	41.6	0.82	0.27	1.7%	0.077			
Dagmar Ave.	EXSANMH2	EXSANMH3	0	0.0		0.0	45.4	3.7	0.5	0.00	0.00	0.00	0.0	0.00	0.52	0.2	0.7	250	0.28	7.1	32.8	0.65	0.22	2.2%	0.108			
Dagmar Ave.	EXSANMH5	EXSANMH4	14	47.6	3	5.4	53.0	3.6	0.6	0.00	0.00	0.00	0.0	0.69	0.69	0.2	0.9	250	1.00	99.2	62.0	1.22	0.38	1.4%	0.077			
Dagmar Ave.	EXSANMH4	EXSANMH3	16	54.4		0.0	107.4	3.6	1.2	0.00	0.00	0.00	0.0	0.77	1.46	0.5	1.7	250	0.81	110.5	55.8	1.10	0.42	3.1%	0.132			
Baribeau St.	EXSANMH3	EXSANMH6	0	0.0	3	5.4	158.2	3.5	1.8	0.00	0.00	0.00	0.0	0.08	2.06	0.7	2.5	250	0.51	61.0	44.3	0.87	0.40	5.6%	0.171			
Montfort St.	EXSANMH8	EXSANMH7	11	37.4	15	27.0	64.4	3.6	0.8	0.00	0.00	0.00	0.0	0.65	0.65	0.2	1.0	250	0.39	86.6	38.7	0.76	0.28	2.5%	0.108			
Montfort St.	EXSANMH7	EXSANMH6	14	47.6		0.0	112.0	3.6	1.3	0.00	0.00	0.00	0.0	0.61	1.26	0.4	1.7	250	0.19	95.7	27.0	0.53	0.25	6.3%	0.077			
Baribeau St.	EXSANMH6	EXSANMH9	2	6.8		0.0	277.0	3.5	3.1	0.00	0.00	0.00	0.0	0.14	3.46	1.1	4.3	250	0.37	70.4	37.7	0.74	0.41	11.3%	0.077			
Ethel St.	EXSANMH11	EXSANMH10	11	37.4	5	9.0	46.4	3.7	0.5	0.00	0.00	0.00	0.0	0.58	0.58	0.2	0.7	250	0.40	84.7	39.2	0.77	0.25	1.9%	0.077			
Ethel St.	EXSANMH10	EXSANMH9	5	17.0	3	5.4	68.8	3.6	0.8	0.00	0.28	0.28	0.1	0.54	1.12	0.4	1.3	250	0.41	68.8	39.7	0.78	0.30	3.3%	0.077			
200 Baribeau Street										229.5	3.5	2.6		0.00	0.00	0.00	0.0											
Baribeau St.	EXSANMH9	EXSANMH12	0	0.0		0.0	575.3	3.4	6.3	0.00	0.00	0.28	0.1	1.37	7.00	2.3	8.7	250	0.30	71.8	34.0	0.67	0.47	25.6%	0.077			
Design Parameters:			Population Density:										Project: 200 Baribeau Street (119068)															
Avg Flow/Person =			280 l/day					ppl/unit		units/net ha																		
Comm./Inst. Flow =			28000 l/ha/day					Apartment 1.80		90																		
Infiltration =			0.33 l/s/ha					Singles 3.40																				
Pipe Friction n =			0.013					Towns 2.70		60																		
Residential Peaking Factor = Harmon Equation (max 4, min 2)																												
Institutional Peaking Factor			1.5																									
																								Designed: LRW				
																								Checked: MAB				
																								Date: June 4, 2021				



M:\2019\119068\CAD\Design\Figures\Design Brief\119068-XSAN.dwg, 11x17 portrait, Jun 04, 2021 - 12:06pm, IWilson

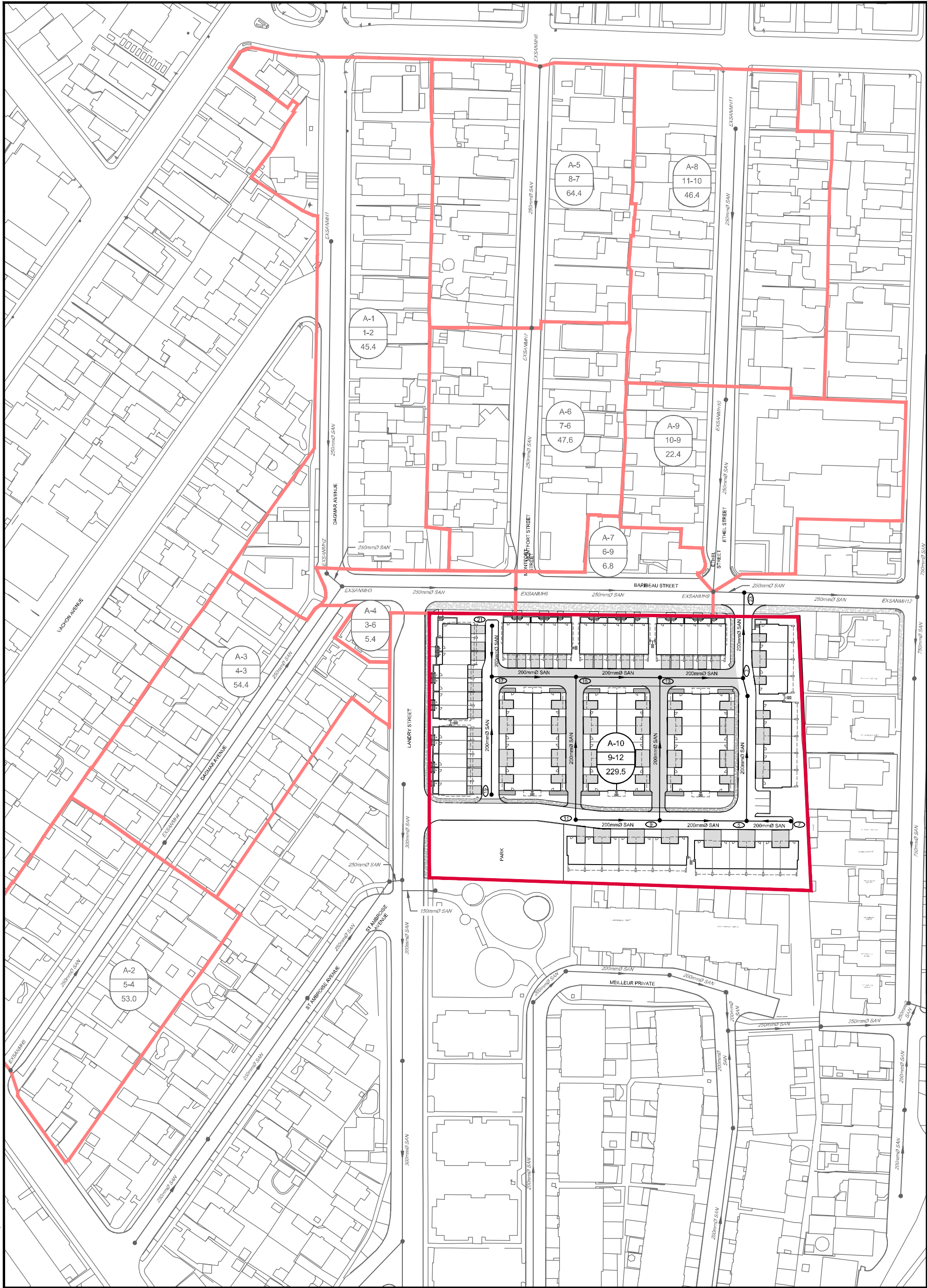

NOVATECH
 Engineers, Planners & Landscape Architects
 Suite 200, 240 Michael Cowpland Drive
 Ottawa, Ontario, Canada K2M 1P6
 Telephone (613) 254-9643
 Facsimile (613) 254-5867
 Website www.novatech-eng.com

LEGEND

	EXISTING AREA I.D.		EXISTING SANITARY NETWORK
	EXISTING MANHOLE RUN		PROPOSED SANITARY NETWORK
	EXISTING POPULATION		EXISTING SANITARY DRAINAGE AREA
	PROPOSED AREA I.D.		PROPOSED SANITARY DRAINAGE AREA
	PROPOSED MANHOLE RUN		
	PROPOSED POPULATION		

CITY OF OTTAWA
200 BARIBEAU STREET
OFF-SITE SANITARY NETWORK

SCALE 1 : 1250

DATE JUN 2021 JOB 119068 FIGURE SAN

Boundary Condition for 200 Baribeau

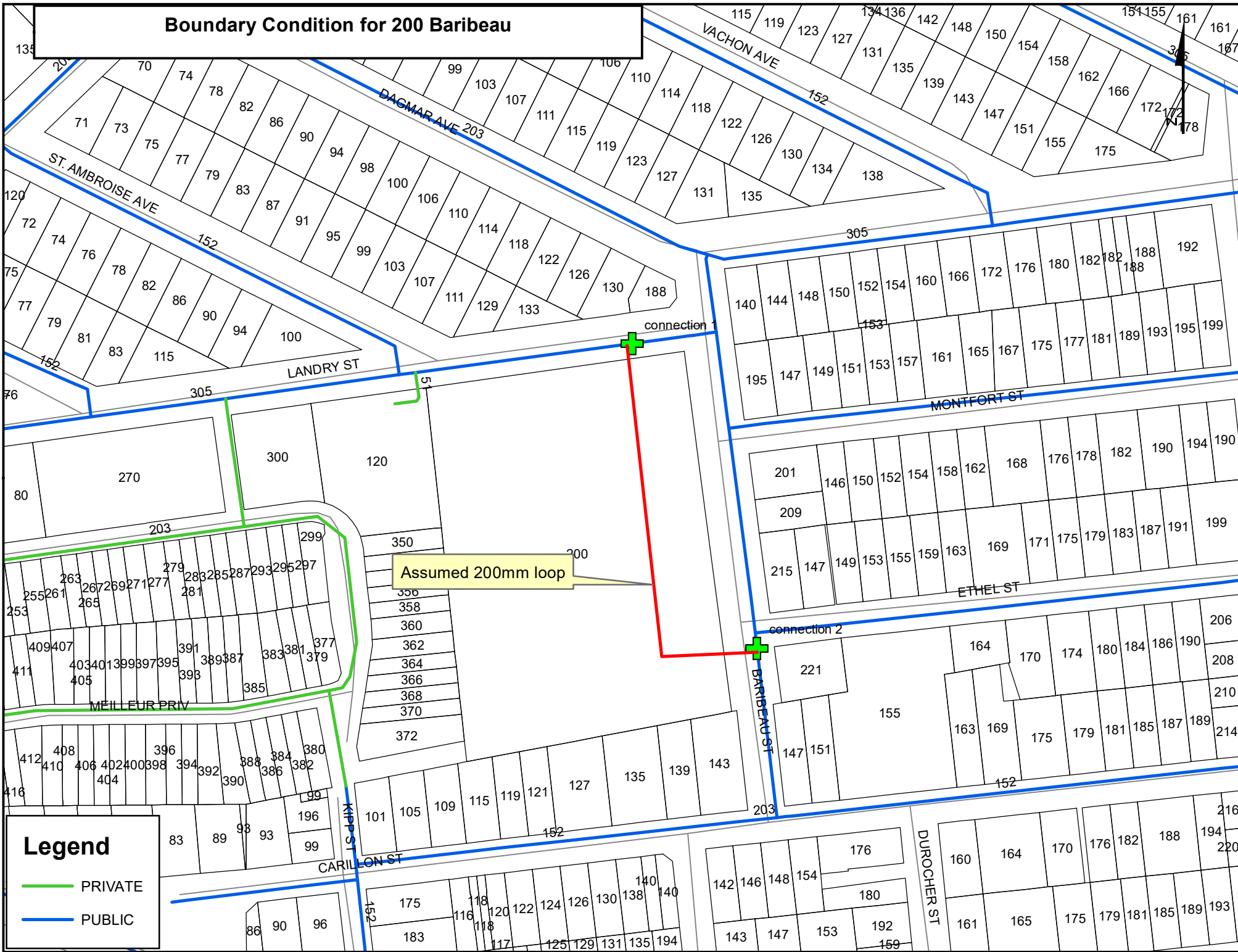

Assumed 200mm loop

Legend

- PRIVATE
- PUBLIC

Lucas Wilson

From: Wu, John <John.Wu@ottawa.ca>
Sent: Monday, July 27, 2020 12:17 PM
To: Lucas Wilson
Subject: RE: Fir flow and boundary condition for 200 Baribeau
Attachments: 200 Baribeau July 2020.pdf

The following are boundary conditions, HGL, for hydraulic analysis at 200 Baribeau (zone 1E) assumed to be connected to the 305mm on Landry and 203mm on Baribeau (see attached PDF for location).

A 200mm private watermain was assumed between both connections as requested.

	305mm on Landry	203mm on Baribeau
Minimum HGL	109.5m	109.5m
Maximum HGL	118.5m*	118.5m*
MaxDay + Fireflow (183 L/s)	110.0m	109.0m
MaxDay + Fireflow (333L/s)	104.0m	101.0m

The maximum pressure is estimated to be above 80 psi. A pressure check at completion of construction is recommended to determine if pressure control is required.

These are for current conditions and are based on computer model simulation.

Disclaimer: The boundary condition information is based on current operation of the city water distribution system. The computer model simulation is based on the best information available at the time. The operation of the water distribution system can change on a regular basis, resulting in a variation in boundary conditions. The physical properties of watermains deteriorate over time, as such must be assumed in the absence of actual field test data. The variation in physical watermain properties can therefore alter the results of the computer model simulation.

John

From: Lucas Wilson <l.wilson@novatech-eng.com>
Sent: July 27, 2020 8:32 AM
To: Wu, John <John.Wu@ottawa.ca>
Subject: RE: Fir flow and boundary condition for 200 Baribeau

CAUTION: This email originated from an External Sender. Please do not click links or open attachments unless you recognize the source.

ATTENTION : Ce courriel provient d'un expéditeur externe. Ne cliquez sur aucun lien et n'ouvrez pas de pièce jointe, excepté si vous connaissez l'expéditeur.

Good morning John,

Just wanted to follow up on 200 Baribeau and if you've heard anything from water modelling in regards to the boundary conditions.

Thanks,

Lucas Wilson, P.Eng., Project Coordinator | Engineering

NOVATECH Engineers, Planners & Landscape Architects

240 Michael Cowpland Drive, Suite 200, Ottawa, ON K2M 1P6 | Tel: 613.254.9643 Ext: 282 | Fax: 613.254.5867

The information contained in this email message is confidential and is for exclusive use of the addressee.

From: Lucas Wilson

Sent: Monday, July 13, 2020 10:17 AM

To: 'John.Wu@ottawa.ca' <John.Wu@ottawa.ca>

Cc: Mark Bissett <m.bissett@novatech-eng.com>

Subject: RE: Fir flow and boundary condition for 200 Baribeau

John,

Thanks for the quick response. The link between the two connection points is a 200mm diameter watermain approximately 175m in length. We will be using a range of fire flows depending on the Block being modelled. Block 1 has the lowest fire flow of 183 L/s and Block 10 being the highest with a fire flow of 333 L/s. The City typically provides the pressures for the highest and lowest fire flows and requests that we interpolate for the remaining fire flows.

Thanks,

Lucas Wilson, P.Eng., Project Coordinator | Engineering

NOVATECH Engineers, Planners & Landscape Architects

240 Michael Cowpland Drive, Suite 200, Ottawa, ON K2M 1P6 | Tel: 613.254.9643 Ext: 282 | Fax: 613.254.5867

The information contained in this email message is confidential and is for exclusive use of the addressee.

From: Wu, John <John.Wu@ottawa.ca>

Sent: Monday, July 13, 2020 9:14 AM

To: Mark Bissett <m.bissett@novatech-eng.com>; Mark Bissett <m.bissett@novatech-eng.com>

Cc: Renaud, Jean-Charles <Jean-Charles.Renaud@ottawa.ca>

Subject: Fir flow and boundary condition for 200 Baribeau

Hi, Lucas:

Please let me know which Fire flow you try to use and what kind of link(size of water main and distance) between the two connection points

I can forward to City's Model group to do the boundary condition for you.

Thanks.

John Wu, P.Eng.

Project Manager, Infrastructure Approval

Development Review (Urban Services)

Gestionnaire de projet, Approbation de L'infrastructure
Examen des projets d'aménagement (Services urbains)
Planning, Infrastructure and Economic Development Department
Services de planification, d'infrastructure et de développement économique
City of Ottawa | Ville d'Ottawa
110 Laurier Avenue West. Ottawa, ON | 110, avenue. Laurier Ouest. Ottawa (Ontario) K1P 1J1
613.580.2424 ext./poste 27734, fax/télec:613-560-6006, john.wu@ottawa.ca

'
This e-mail originates from the City of Ottawa e-mail system. Any distribution, use or copying of this e-mail or the information it contains by other than the intended recipient(s) is unauthorized. Thank you.

Le présent courriel a été expédié par le système de courriels de la Ville d'Ottawa. Toute distribution, utilisation ou reproduction du courriel ou des renseignements qui s'y trouvent par une personne autre que son destinataire prévu est interdite. Je vous remercie de votre collaboration.

'
'
This e-mail originates from the City of Ottawa e-mail system. Any distribution, use or copying of this e-mail or the information it contains by other than the intended recipient(s) is unauthorized. Thank you.

Le présent courriel a été expédié par le système de courriels de la Ville d'Ottawa. Toute distribution, utilisation ou reproduction du courriel ou des renseignements qui s'y trouvent par une personne autre que son destinataire prévu est interdite. Je vous remercie de votre collaboration.

**200 Baribeau Street
Water Demand**

	Area (ha)	Units	Population	Average Day Demand (L/s)	Maximum Day Demand (L/s)	Peak Hour Demand (L/s)
Towns	N/A	85	230	0.744	1.859	4.091
Total	0.00	85	230	0.744	1.859	4.091

Water Demand Parameters

Towns	2.7	ppl/unit
Residential Demand	280	L/c/day
Residential Max Day	2.5	x Avg Day
Residential Peak Hour	2.2	x Max Day
Residential Fire Flow	183 - 300	L/s

200 Baribeau Street - Watermain Demand

Node	Towns	Total Population	Average Day Residential Demand (L/s)	Maximum Day Residential Demand (L/s)	Peak Hour Residential Demand (L/s)
HYD1	11	30	0.096	0.241	0.529
HYD2	3	8	0.026	0.066	0.144
HYD3	3	8	0.026	0.066	0.144
CAP1	3	8	0.026	0.066	0.144
CAP2	2	5	0.018	0.044	0.096
T1	6	16	0.053	0.131	0.289
T2	4	11	0.035	0.088	0.193
T3	10	27	0.088	0.219	0.481
T4	11	30	0.096	0.241	0.529
T5	11	30	0.096	0.241	0.529
T6	8	22	0.070	0.175	0.385
T7	7	19	0.061	0.153	0.337
T8	6	16	0.053	0.131	0.289
Total	85	230	0.744	1.859	4.091

Water Demand Parameters

Singles	3.4	ppl/unit	Residential Max Day	2.5	x Avg Day
Towns	2.7	ppl/unit	Residential Peak Hour	2.2	x Max Day
Residential Demand	280	L/c/day	Residential Fire Flow	183 - 300	L/s

200 Baribeau Street - Watermain Analysis

Network Table - Nodes - (Peak Hour)

Node ID	Elevation m	Demand LPS	Head m	Pressure m	Pressure kPa	Pressure psi
Junc HYD1	56.52	0.53	109.5	52.98	519.73	75.38
Junc HYD2	56.64	0.14	109.5	52.86	518.56	75.21
Junc HYD3	56.74	0.14	109.5	52.76	517.58	75.07
Junc T1	56.54	0.29	109.5	52.96	519.54	75.35
Junc T2	56.44	0.19	109.5	53.06	520.52	75.49
Junc T3	56.47	0.48	109.5	53.03	520.22	75.45
Junc T4	56.59	0.53	109.5	52.91	519.05	75.28
Junc T5	56.66	0.53	109.5	52.84	518.36	75.18
Junc T6	56.76	0.38	109.5	52.74	517.38	75.04
Junc T7	56.64	0.34	109.5	52.86	518.56	75.21
Junc T8	56.56	0.29	109.5	52.94	519.34	75.32
Junc CAP1	56.75	0.14	109.5	52.75	517.48	75.05
Junc CAP2	56.54	0.1	109.5	52.96	519.54	75.35
Resvr RES1	109.5	-2.1	109.5	0	0.00	0.00
Resvr RES2	109.5	-1.99	109.5	0	0.00	0.00

Network Table - Links - (Peak Hour)

Link ID	Length m	Diameter mm	Roughness	Flow LPS	Velocity m/s	Headloss m/km	Friction Factor
Pipe P1	35	204	110	1.99	0.06	0.04	0.044
Pipe P2	25	204	110	0.87	0.03	0.01	0.048
Pipe P3	23	204	110	0.34	0.01	0.00	0.061
Pipe P4	13	155	100	0.10	0.01	0.00	0.083
Pipe P5	31	204	110	0.05	0.00	0.00	0.000
Pipe P6	48	155	100	-0.07	0.00	0.00	0.089
Pipe P7	30	204	110	0.83	0.03	0.01	0.048
Pipe P8	22	204	110	-0.36	0.01	0.00	0.055
Pipe P9	8	204	110	-0.51	0.02	0.00	0.059
Pipe P10	30	204	110	0.23	0.01	0.00	0.074
Pipe P11	47	155	100	0.15	0.01	0.00	0.080
Pipe P12	17	204	110	-0.15	0.00	0.00	0.106
Pipe P13	13	204	110	-0.29	0.01	0.00	0.037
Pipe P14	17	155	100	-0.14	0.01	0.00	0.057
Pipe P15	45	204	110	-0.82	0.03	0.01	0.050
Pipe P16	30	204	110	-0.94	0.03	0.01	0.048
Pipe P17	29	204	110	-2.10	0.06	0.04	0.044

200 Baribeau Street - Watermain Analysis

Network Table - Nodes - (Max Pressure Check)

Node ID	Elevation m	Demand LPS	Head m	Pressure m	Pressure kPa	Pressure psi	Age Hours
Junc HYD1	56.52	0.1	118.5	61.98	608.02	88.19	2.34
Junc HYD2	56.64	0.03	118.5	61.86	606.85	88.02	3.05
Junc HYD3	56.74	0.03	118.5	61.76	605.87	87.87	5.58
Junc T1	56.54	0.05	118.5	61.96	607.83	88.16	0.88
Junc T2	56.44	0.04	118.5	62.06	608.81	88.30	5.68
Junc T3	56.47	0.09	118.5	62.03	608.51	88.26	11.54
Junc T4	56.59	0.1	118.5	61.91	607.34	88.09	2.67
Junc T5	56.66	0.1	118.5	61.84	606.65	87.99	10.37
Junc T6	56.76	0.07	118.5	61.74	605.67	87.84	3.42
Junc T7	56.64	0.06	118.5	61.86	606.85	88.02	0.69
Junc T8	56.56	0.05	118.5	61.94	607.63	88.13	2.27
Junc CAP1	56.75	0.03	118.5	61.75	605.77	87.86	6.88
Junc CAP2	56.54	0.02	118.5	61.96	607.83	88.16	9.52
Resvr RES1	118.5	-0.38	118.5	0	0.00	0.00	0
Resvr RES2	118.5	-0.36	118.5	0	0.00	0.00	0

Network Table - Links - (Max Pressure Check)

Link ID	Length m	Diameter mm	Roughness	Flow LPS	Velocity m/s	Headloss m/km	Friction Factor
Pipe P1	35	204	110	0.36	0.01	0.00	0.061
Pipe P2	25	204	110	0.16	0.00	0.00	0.063
Pipe P3	23	204	110	0.06	0.00	0.00	0.000
Pipe P4	13	155	100	0.02	0.00	0.00	0.000
Pipe P5	31	204	110	0.01	0.00	0.00	0.000
Pipe P6	48	155	100	-0.01	0.00	0.00	0.000
Pipe P7	30	204	110	0.15	0.00	0.00	0.059
Pipe P8	22	204	110	-0.07	0.00	0.00	0.000
Pipe P9	8	204	110	-0.09	0.00	0.00	0.591
Pipe P10	30	204	110	0.04	0.00	0.00	0.000
Pipe P11	47	155	100	0.03	0.00	0.00	0.306
Pipe P12	17	204	110	-0.03	0.00	0.00	0.000
Pipe P13	13	204	110	-0.05	0.00	0.00	0.000
Pipe P14	17	155	100	-0.03	0.00	0.00	0.000
Pipe P15	45	204	110	-0.15	0.00	0.00	0.080
Pipe P16	30	204	110	-0.17	0.01	0.00	0.045
Pipe P17	29	204	110	-0.38	0.01	0.00	0.056

200 Baribeau Street - Watermain Analysis

Network Table - Nodes - (Fire Flow Summary)

Fire Flow		Minimum Pressure		
LOCATION	Flow (L/s)	Pressure (kPa)	Pressure (PSI)	Node
B1	233	481.18	69.79	HYD3
B2	217	489.03	70.93	HYD3
B3/B4	217	472.45	68.52	HYD3
B5	200	498.15	72.25	HYD1
B6	217	470.49	68.24	HYD1
B7	233	467.74	67.84	HYD1
B8	233	459.70	66.67	HYD1
B9	183	491.78	71.33	HYD3
B10	300	427.81	62.05	HYD3
B11/B12	300	416.24	60.37	HYD2

200 Baribeau Street - Watermain Analysis

Network Table - Nodes (Max Day + FF 'Block 1')

Node ID	Elevation m	Demand LPS	Head m	Pressure m	Pressure kPa	Pressure psi
Junc HYD1	56.52	0.24	106.29	49.77	488.24	70.81
Junc HYD2	56.64	0.07	106.41	49.77	488.24	70.81
Junc HYD3	56.74	95.07	105.79	49.05	481.18	69.79
Junc EXHYD1	56.43	95	107.08	50.65	496.88	72.07
Junc EXHYD2	56.05	43	106.33	50.28	493.25	71.54
Junc EXHYD3	55.72	0	106.3	50.58	496.19	71.97
Junc T1	56.54	0.13	106.27	49.73	487.85	70.76
Junc T2	56.44	0.09	106.32	49.88	489.32	70.97
Junc T3	56.47	0.22	106.34	49.87	489.22	70.96
Junc T4	56.59	0.24	106.19	49.6	486.58	70.57
Junc T5	56.66	0.24	106.01	49.35	484.12	70.22
Junc T6	56.76	0.17	105.99	49.23	482.95	70.05
Junc T7	56.64	0.15	106.7	50.06	491.09	71.23
Junc T8	56.56	0.13	106.43	49.87	489.22	70.96
Junc CAP1	56.75	0.07	105.99	49.24	483.04	70.06
Junc CAP2	56.54	0.04	106.32	49.78	488.34	70.83
Resvr RES1	108	-231.34	108	0	0.00	0.00
Resvr RES2	106.3	-3.52	106.3	0	0.00	0.00

Network Table - Links (Max Day + FF 'Block 1')

Link ID	Length m	Diameter mm	Roughness	Flow LPS	Velocity m/s	Headloss m/km	Friction Factor
Pipe P1	35	204	110	9.72	0.30	0.77	0.035
Pipe P2	25	204	110	-10.35	0.32	0.86	0.034
Pipe P3	23	204	110	-10.59	0.32	0.90	0.034
Pipe P4	13	155	100	0.04	0.00	0.00	0.000
Pipe P5	31	204	110	-10.72	0.33	0.92	0.034
Pipe P6	48	155	100	9.44	0.50	3.29	0.040
Pipe P7	30	204	110	19.94	0.61	2.89	0.031
Pipe P8	22	204	110	-20.38	0.62	3.01	0.031
Pipe P9	8	204	110	-20.44	0.63	3.03	0.031
Pipe P10	30	204	110	29.14	0.89	5.84	0.029
Pipe P11	47	155	100	16.28	0.86	9.03	0.037
Pipe P12	17	204	110	45.17	1.38	13.15	0.028
Pipe P13	13	204	110	-49.89	1.53	15.81	0.027
Pipe P14	17	155	100	-0.07	0.00	0.00	0.000
Pipe P15	45	204	110	-50.13	1.53	15.95	0.027
Pipe P16	30	204	110	-36.85	1.13	9.02	0.028
Pipe P17	29	204	110	-87.14	2.67	44.40	0.025

200 Baribeau Street - Watermain Analysis

Network Table - Nodes (Max Day + FF 'Block 2')

Node ID	Elevation m	Demand LPS	Head m	Pressure m	Pressure kPa	Pressure psi
Junc HYD1	56.52	0.24	107.15	50.63	496.68	72.04
Junc HYD2	56.64	0.07	107.22	50.58	496.19	71.97
Junc HYD3	56.74	95.07	106.59	49.85	489.03	70.93
Junc EXHYD1	56.43	27	108.17	51.74	507.57	73.62
Junc EXHYD2	56.05	95	106.78	50.73	497.66	72.18
Junc EXHYD3	55.72	0	107.18	51.46	504.82	73.22
Junc T1	56.54	0.13	107.14	50.6	496.39	71.99
Junc T2	56.44	0.09	107.16	50.72	497.56	72.17
Junc T3	56.47	0.22	107.17	50.7	497.37	72.14
Junc T4	56.59	0.24	107.03	50.44	494.82	71.77
Junc T5	56.66	0.24	106.83	50.17	492.17	71.38
Junc T6	56.76	0.17	106.78	50.02	490.70	71.17
Junc T7	56.64	0.15	107.45	50.81	498.45	72.29
Junc T8	56.56	0.13	107.24	50.68	497.17	72.11
Junc CAP1	56.75	0.07	106.78	50.03	490.79	71.18
Junc CAP2	56.54	0.04	107.16	50.62	496.58	72.02
Resvr RES1	108.6	-177.25	108.6	0	0.00	0.00
Resvr RES2	107.2	-41.61	107.2	0	0.00	0.00

Network Table - Links (Max Day + FF 'Block 2')

Link ID	Length m	Diameter mm	Roughness	Flow LPS	Velocity m/s	Headloss m/km	Friction Factor
Pipe P1	35	204	110	15.36	0.47	1.78	0.032
Pipe P2	25	204	110	-7.17	0.22	0.44	0.036
Pipe P3	23	204	110	-7.41	0.23	0.46	0.036
Pipe P4	13	155	100	0.04	0.00	0.00	0.394
Pipe P5	31	204	110	-7.54	0.23	0.48	0.036
Pipe P6	48	155	100	8.99	0.48	3.01	0.040
Pipe P7	30	204	110	22.40	0.69	3.59	0.031
Pipe P8	22	204	110	-16.75	0.51	2.10	0.032
Pipe P9	8	204	110	-16.82	0.51	2.11	0.032
Pipe P10	30	204	110	31.15	0.95	6.61	0.029
Pipe P11	47	155	100	15.90	0.84	8.64	0.037
Pipe P12	17	204	110	46.80	1.43	14.05	0.027
Pipe P13	13	204	110	-48.26	1.48	14.87	0.027
Pipe P14	17	155	100	-0.07	0.00	0.00	0.134
Pipe P15	45	204	110	-48.50	1.48	15.00	0.027
Pipe P16	30	204	110	-32.85	1.00	7.29	0.029
Pipe P17	29	204	110	-81.50	2.49	39.23	0.025

200 Baribeau Street - Watermain Analysis

Network Table - Nodes (Max Day + FF 'Block 3 & 4')

Node ID	Elevation m	Demand LPS	Head m	Pressure m	Pressure kPa	Pressure psi
Junc HYD1	56.52	95.24	104.74	48.22	473.04	68.61
Junc HYD2	56.64	27.07	105.2	48.56	476.37	69.09
Junc HYD3	56.74	95.07	104.9	48.16	472.45	68.52
Junc EXHYD1	56.43	0	108.52	52.09	511.00	74.11
Junc EXHYD2	56.05	0	108.05	52	510.12	73.99
Junc EXHYD3	55.72	0	107.25	51.53	505.51	73.32
Junc T1	56.54	0.13	105.37	48.83	479.02	69.48
Junc T2	56.44	0.09	104.89	48.45	475.29	68.94
Junc T3	56.47	0.22	105.1	48.63	477.06	69.19
Junc T4	56.59	0.24	105.18	48.59	476.67	69.13
Junc T5	56.66	0.24	105.05	48.39	474.71	68.85
Junc T6	56.76	0.17	105.17	48.41	474.90	68.88
Junc T7	56.64	0.15	106.11	49.47	485.30	70.39
Junc T8	56.56	0.13	105.33	48.77	478.43	69.39
Junc CAP1	56.75	0.07	105.17	48.42	475.00	68.89
Junc CAP2	56.54	0.04	104.89	48.35	474.31	68.79
Resvr RES1	108.6	-162.17	108.6	0	0.00	0.00
Resvr RES2	107.2	-56.69	107.2	0	0.00	0.00

Network Table - Links (Max Day + FF 'Block 3 & 4')

Link ID	Length m	Diameter mm	Roughness	Flow LPS	Velocity m/s	Headloss m/km	Friction Factor
Pipe P1	35	204	110	94.97	2.91	52.08	0.025
Pipe P2	25	204	110	63.86	1.95	24.97	0.026
Pipe P3	23	204	110	-31.38	0.96	6.70	0.029
Pipe P4	13	155	100	0.04	0.00	0.00	0.000
Pipe P5	31	204	110	-31.51	0.96	6.75	0.029
Pipe P6	48	155	100	-6.55	0.35	1.67	0.042
Pipe P7	30	204	110	30.97	0.95	6.54	0.029
Pipe P8	22	204	110	-25.18	0.77	4.46	0.030
Pipe P9	8	204	110	-52.25	1.60	17.22	0.027
Pipe P10	30	204	110	24.19	0.74	4.14	0.030
Pipe P11	47	155	100	13.01	0.69	5.96	0.038
Pipe P12	17	204	110	36.95	1.13	9.07	0.028
Pipe P13	13	204	110	-58.11	1.78	20.97	0.027
Pipe P14	17	155	100	-0.07	0.00	0.00	0.000
Pipe P15	45	204	110	-58.35	1.79	21.13	0.027
Pipe P16	30	204	110	-65.39	2.00	26.09	0.026
Pipe P17	29	204	110	-123.89	3.79	85.21	0.024

200 Baribeau Street - Watermain Analysis

Network Table - Nodes (Max Day + FF 'Block 5')

Node ID	Elevation m	Demand LPS	Head m	Pressure m	Pressure kPa	Pressure psi
Junc HYD1	56.52	95.24	107.3	50.78	498.15	72.25
Junc HYD2	56.64	0.07	108.02	51.38	504.04	73.10
Junc HYD3	56.74	10.07	108.07	51.33	503.55	73.03
Junc EXHYD1	56.43	0	109.22	52.79	517.87	75.11
Junc EXHYD2	56.05	0	108.77	52.72	517.18	75.01
Junc EXHYD3	55.72	95	108	52.28	512.87	74.39
Junc T1	56.54	0.13	107.8	51.26	502.86	72.93
Junc T2	56.44	0.09	107.53	51.09	501.19	72.69
Junc T3	56.47	0.22	107.84	51.37	503.94	73.09
Junc T4	56.59	0.24	107.89	51.3	503.25	72.99
Junc T5	56.66	0.24	108.02	51.36	503.84	73.08
Junc T6	56.76	0.17	108.14	51.38	504.04	73.10
Junc T7	56.64	0.15	108.41	51.77	507.86	73.66
Junc T8	56.56	0.13	108.09	51.53	505.51	73.32
Junc CAP1	56.75	0.07	108.14	51.39	504.14	73.12
Junc CAP2	56.54	0.04	107.53	50.99	500.21	72.55
Resvr RES1	109.3	-108.31	109.3	0	0.00	0.00
Resvr RES2	108.1	-93.55	108.1	0	0.00	0.00

Network Table - Links (Max Day + FF 'Block 5')

Link ID	Length m	Diameter mm	Roughness	Flow LPS	Velocity m/s	Headloss m/km	Friction Factor
Pipe P1	35	204	110	35.94	1.10	8.61	0.029
Pipe P2	25	204	110	56.04	1.71	19.61	0.027
Pipe P3	23	204	110	-39.20	1.20	10.11	0.028
Pipe P4	13	155	100	0.04	0.00	0.00	0.000
Pipe P5	31	204	110	-39.33	1.20	10.18	0.028
Pipe P6	48	155	100	-4.73	0.25	0.92	0.044
Pipe P7	30	204	110	-20.23	0.62	2.97	0.031
Pipe P8	22	204	110	-34.82	1.07	8.12	0.029
Pipe P9	8	204	110	-34.88	1.07	8.15	0.029
Pipe P10	30	204	110	-25.21	0.77	4.47	0.030
Pipe P11	47	155	100	6.00	0.32	1.42	0.043
Pipe P12	17	204	110	-19.45	0.60	2.76	0.031
Pipe P13	13	204	110	-29.52	0.90	5.98	0.029
Pipe P14	17	155	100	-0.07	0.00	0.00	0.000
Pipe P15	45	204	110	-29.76	0.91	6.07	0.029
Pipe P16	30	204	110	-41.01	1.25	11.00	0.028
Pipe P17	29	204	110	-70.92	2.17	30.33	0.026

200 Baribeau Street - Watermain Analysis

Network Table - Nodes (Max Day + FF 'Block 6')

Node ID	Elevation m	Demand LPS	Head m	Pressure m	Pressure kPa	Pressure psi
Junc HYD1	56.52	95.24	104.48	47.96	470.49	68.24
Junc HYD2	56.64	95.07	104.61	47.97	470.59	68.25
Junc HYD3	56.74	27.07	105.35	48.61	476.86	69.16
Junc EXHYD1	56.43	0	108.52	52.09	511.00	74.11
Junc EXHYD2	56.05	0	108.05	52	510.12	73.99
Junc EXHYD3	55.72	0	107.25	51.53	505.51	73.32
Junc T1	56.54	0.13	105.38	48.84	479.12	69.49
Junc T2	56.44	0.09	104.54	48.1	471.86	68.44
Junc T3	56.47	0.22	104.61	48.14	472.25	68.49
Junc T4	56.59	0.24	105.31	48.72	477.94	69.32
Junc T5	56.66	0.24	105.31	48.65	477.26	69.22
Junc T6	56.76	0.17	105.52	48.76	478.34	69.38
Junc T7	56.64	0.15	106.11	49.47	485.30	70.39
Junc T8	56.56	0.13	105	48.44	475.20	68.92
Junc CAP1	56.75	0.07	105.52	48.77	478.43	69.39
Junc CAP2	56.54	0.04	104.54	48	470.88	68.30
Resvr RES1	108.6	-162.34	108.6	0	0.00	0.00
Resvr RES2	107.2	-56.52	107.2	0	0.00	0.00

Network Table - Links (Max Day + FF 'Block 6')

Link ID	Length m	Diameter mm	Roughness	Flow LPS	Velocity m/s	Headloss m/km	Friction Factor
Pipe P1	35	204	110	94.80	2.90	51.90	0.025
Pipe P2	25	204	110	77.03	2.36	35.34	0.025
Pipe P3	23	204	110	-18.21	0.56	2.45	0.032
Pipe P4	13	155	100	0.04	0.00	0.00	0.000
Pipe P5	31	204	110	-18.35	0.56	2.48	0.032
Pipe P6	48	155	100	-21.13	1.12	14.64	0.036
Pipe P7	30	204	110	17.64	0.54	2.30	0.032
Pipe P8	22	204	110	2.57	0.08	0.07	0.042
Pipe P9	8	204	110	-92.50	2.83	49.60	0.025
Pipe P10	30	204	110	-3.73	0.11	0.13	0.040
Pipe P11	47	155	100	-13.81	0.73	6.66	0.038
Pipe P12	17	204	110	-17.78	0.54	2.34	0.032
Pipe P13	13	204	110	-44.85	1.37	12.98	0.028
Pipe P14	17	155	100	-0.07	0.00	0.00	0.000
Pipe P15	45	204	110	-45.09	1.38	13.11	0.028
Pipe P16	30	204	110	-78.82	2.41	36.88	0.025
Pipe P17	29	204	110	-124.06	3.80	85.43	0.024

200 Baribeau Street - Watermain Analysis

Network Table - Nodes (Max Day + FF 'Block 7')

Node ID	Elevation m	Demand LPS	Head m	Pressure m	Pressure kPa	Pressure psi
Junc HYD1	56.52	95.24	104.2	47.68	467.74	67.84
Junc HYD2	56.64	95.07	104.35	47.71	468.04	67.88
Junc HYD3	56.74	0.07	105.31	48.57	476.47	69.11
Junc EXHYD1	56.43	0	107.9	51.47	504.92	73.23
Junc EXHYD2	56.05	0	107.31	51.26	502.86	72.93
Junc EXHYD3	55.72	43	106.3	50.58	496.19	71.97
Junc T1	56.54	0.13	105.07	48.53	476.08	69.05
Junc T2	56.44	0.09	104.26	47.82	469.11	68.04
Junc T3	56.47	0.22	104.35	47.88	469.70	68.12
Junc T4	56.59	0.24	105.07	48.48	475.59	68.98
Junc T5	56.66	0.24	105.16	48.5	475.79	69.01
Junc T6	56.76	0.17	105.42	48.66	477.35	69.23
Junc T7	56.64	0.15	105.83	49.19	482.55	69.99
Junc T8	56.56	0.13	104.75	48.19	472.74	68.57
Junc CAP1	56.75	0.07	105.42	48.67	477.45	69.25
Junc CAP2	56.54	0.04	104.26	47.72	468.13	67.90
Resvr RES1	108	-158.32	108	0	0.00	0.00
Resvr RES2	106.3	-76.54	106.3	0	0.00	0.00

Network Table - Links (Max Day + FF 'Block 7')

Link ID	Length m	Diameter mm	Roughness	Flow LPS	Velocity m/s	Headloss m/km	Friction Factor
Pipe P1	35	204	110	76.82	2.35	35.16	0.025
Pipe P2	25	204	110	75.57	2.31	34.11	0.026
Pipe P3	23	204	110	-19.67	0.60	2.82	0.031
Pipe P4	13	155	100	0.04	0.00	0.00	0.000
Pipe P5	31	204	110	-19.80	0.61	2.86	0.031
Pipe P6	48	155	100	-21.41	1.13	15.00	0.035
Pipe P7	30	204	110	1.12	0.03	0.01	0.048
Pipe P8	22	204	110	1.38	0.04	0.02	0.046
Pipe P9	8	204	110	-93.68	2.87	50.78	0.025
Pipe P10	30	204	110	-20.53	0.63	3.05	0.031
Pipe P11	47	155	100	-15.93	0.84	8.67	0.037
Pipe P12	17	204	110	-36.70	1.12	8.95	0.028
Pipe P13	13	204	110	-36.76	1.12	8.98	0.028
Pipe P14	17	155	100	-0.07	0.00	0.00	0.134
Pipe P15	45	204	110	-37.00	1.13	9.09	0.028
Pipe P16	30	204	110	-77.89	2.38	36.07	0.025
Pipe P17	29	204	110	-115.05	3.52	74.28	0.024

200 Baribeau Street - Watermain Analysis

Network Table - Nodes (Max Day + FF 'Block 8')

Node ID	Elevation m	Demand LPS	Head m	Pressure m	Pressure kPa	Pressure psi
Junc HYD1	56.52	95.24	103.38	46.86	459.70	66.67
Junc HYD2	56.64	95.07	103.51	46.87	459.79	66.69
Junc HYD3	56.74	43.07	104.15	47.41	465.09	67.46
Junc EXHYD1	56.43	0	107.9	51.47	504.92	73.23
Junc EXHYD2	56.05	0	107.33	51.28	503.06	72.96
Junc EXHYD3	55.72	0	106.36	50.64	496.78	72.05
Junc T1	56.54	0.13	104.26	47.72	468.13	67.90
Junc T2	56.44	0.09	103.43	46.99	460.97	66.86
Junc T3	56.47	0.22	103.51	47.04	461.46	66.93
Junc T4	56.59	0.24	104.14	47.55	466.47	67.66
Junc T5	56.66	0.24	104.14	47.48	465.78	67.56
Junc T6	56.76	0.17	104.36	47.6	466.96	67.73
Junc T7	56.64	0.15	105.11	48.47	475.49	68.96
Junc T8	56.56	0.13	103.92	47.36	464.60	67.38
Junc CAP1	56.75	0.07	104.36	47.61	467.05	67.74
Junc CAP2	56.54	0.04	103.43	46.89	459.99	66.72
Resvr RES1	108	-176.72	108	0	0.00	0.00
Resvr RES2	106.3	-58.15	106.3	0	0.00	0.00

Network Table - Links (Max Day + FF 'Block 8')

Link ID	Length m	Diameter mm	Roughness	Flow LPS	Velocity m/s	Headloss m/km	Friction Factor
Pipe P1	35	204	110	100.65	3.08	58.00	0.024
Pipe P2	25	204	110	76.65	2.34	35.01	0.025
Pipe P3	23	204	110	-18.60	0.57	2.54	0.031
Pipe P4	13	155	100	0.04	0.00	0.00	0.394
Pipe P5	31	204	110	-18.73	0.57	2.58	0.031
Pipe P6	48	155	100	-20.04	1.06	13.28	0.036
Pipe P7	30	204	110	23.88	0.73	4.04	0.030
Pipe P8	22	204	110	1.09	0.03	0.01	0.048
Pipe P9	8	204	110	-93.97	2.88	51.07	0.025
Pipe P10	30	204	110	3.59	0.11	0.12	0.040
Pipe P11	47	155	100	-11.61	0.62	4.83	0.039
Pipe P12	17	204	110	-8.26	0.25	0.57	0.035
Pipe P13	13	204	110	-51.33	1.57	16.66	0.027
Pipe P14	17	155	100	-0.07	0.00	0.00	0.134
Pipe P15	45	204	110	-51.57	1.58	16.81	0.027
Pipe P16	30	204	110	-82.49	2.52	40.12	0.025
Pipe P17	29	204	110	-134.21	4.11	98.81	0.023

200 Baribeau Street - Watermain Analysis

Network Table - Nodes (Max Day + FF 'Block 9')

Node ID	Elevation m	Demand LPS	Head m	Pressure m	Pressure kPa	Pressure psi
Junc HYD1	56.52	0.24	107.57	51.05	500.80	72.63
Junc HYD2	56.64	95.07	106.99	50.35	493.93	71.64
Junc HYD3	56.74	95.07	106.87	50.13	491.78	71.33
Junc EXHYD1	56.43	0	109.94	53.51	524.93	76.14
Junc EXHYD2	56.05	0	109.61	53.56	525.42	76.21
Junc EXHYD3	55.72	0	109.03	53.31	522.97	75.85
Junc T1	56.54	0.13	107.75	51.21	502.37	72.86
Junc T2	56.44	0.09	107.42	50.98	500.11	72.54
Junc T3	56.47	0.22	107.22	50.75	497.86	72.21
Junc T4	56.59	0.24	107.35	50.76	497.96	72.22
Junc T5	56.66	0.24	107.07	50.41	494.52	71.72
Junc T6	56.76	0.17	107.08	50.32	493.64	71.60
Junc T7	56.64	0.15	107.85	51.21	502.37	72.86
Junc T8	56.56	0.13	107.15	50.59	496.29	71.98
Junc CAP1	56.75	0.07	107.08	50.33	493.74	71.61
Junc CAP2	56.54	0.04	107.42	50.88	499.13	72.39
Resvr RES1	110	-146.31	110	0	0.00	0.00
Resvr RES2	109	-45.55	109	0	0.00	0.00

Network Table - Links (Max Day + FF 'Block 9')

Link ID	Length m	Diameter mm	Roughness	Flow LPS	Velocity m/s	Headloss m/km	Friction Factor
Pipe P1	35	204	110	73.37	2.24	32.29	0.026
Pipe P2	25	204	110	29.97	0.92	6.15	0.029
Pipe P3	23	204	110	29.73	0.91	6.06	0.029
Pipe P4	13	155	100	0.04	0.00	0.00	0.000
Pipe P5	31	204	110	29.60	0.91	6.01	0.029
Pipe P6	48	155	100	-8.07	0.43	2.46	0.041
Pipe P7	30	204	110	43.26	1.32	12.14	0.028
Pipe P8	22	204	110	37.45	1.15	9.29	0.028
Pipe P9	8	204	110	-57.61	1.76	20.64	0.027
Pipe P10	30	204	110	34.95	1.07	8.18	0.029
Pipe P11	47	155	100	6.86	0.36	1.83	0.042
Pipe P12	17	204	110	41.58	1.27	11.28	0.028
Pipe P13	13	204	110	-53.49	1.64	17.98	0.027
Pipe P14	17	155	100	-0.07	0.00	0.00	0.000
Pipe P15	45	204	110	-53.73	1.64	18.14	0.027
Pipe P16	30	204	110	-64.61	1.98	25.52	0.026
Pipe P17	29	204	110	-118.49	3.63	78.46	0.024

200 Baribeau Street - Watermain Analysis

Network Table - Nodes (Max Day + FF 'Block 10')

Node ID	Elevation m	Demand LPS	Head m	Pressure m	Pressure kPa	Pressure psi
Junc HYD1	56.52	55.24	100.31	43.79	429.58	62.31
Junc HYD2	56.64	95.07	100.25	43.61	427.81	62.05
Junc HYD3	56.74	95.07	100.35	43.61	427.81	62.05
Junc EXHYD1	56.43	0	104.99	48.56	476.37	69.09
Junc EXHYD2	56.05	55	103.17	47.12	462.25	67.04
Junc EXHYD3	55.72	0	102.82	47.1	462.05	67.01
Junc T1	56.54	0.13	100.87	44.33	434.88	63.07
Junc T2	56.44	0.09	100.31	43.87	430.36	62.42
Junc T3	56.47	0.22	100.3	43.83	429.97	62.36
Junc T4	56.59	0.24	100.59	44	431.64	62.60
Junc T5	56.66	0.24	100.46	43.8	429.68	62.32
Junc T6	56.76	0.17	100.66	43.9	430.66	62.46
Junc T7	56.64	0.15	101.8	45.16	443.02	64.25
Junc T8	56.56	0.13	100.54	43.98	431.44	62.58
Junc CAP1	56.75	0.07	100.66	43.91	430.76	62.48
Junc CAP2	56.54	0.04	100.31	43.77	429.38	62.28
Resvr RES1	105.3	-228.57	105.3	0	0.00	0.00
Resvr RES2	102.8	-73.29	102.8	0	0.00	0.00

Network Table - Links (Max Day + FF 'Block 10')

Link ID	Length m	Diameter mm	Roughness	Flow LPS	Velocity m/s	Headloss m/km	Friction Factor
Pipe P1	35	204	110	97.80	2.99	54.99	0.025
Pipe P2	25	204	110	59.71	1.83	22.05	0.026
Pipe P3	23	204	110	4.47	0.14	0.18	0.039
Pipe P4	13	155	100	0.04	0.00	0.00	0.000
Pipe P5	31	204	110	4.33	0.13	0.17	0.039
Pipe P6	48	155	100	-13.05	0.69	5.99	0.038
Pipe P7	30	204	110	37.96	1.16	9.53	0.028
Pipe P8	22	204	110	17.16	0.53	2.19	0.032
Pipe P9	8	204	110	-77.90	2.38	36.09	0.025
Pipe P10	30	204	110	24.68	0.75	4.29	0.030
Pipe P11	47	155	100	6.62	0.35	1.70	0.042
Pipe P12	17	204	110	31.05	0.95	6.57	0.029
Pipe P13	13	204	110	-64.01	1.96	25.08	0.026
Pipe P14	17	155	100	-0.07	0.00	0.00	0.134
Pipe P15	45	204	110	-64.26	1.97	25.26	0.026
Pipe P16	30	204	110	-84.65	2.59	42.09	0.025
Pipe P17	29	204	110	-149.06	4.56	120.01	0.023

200 Baribeau Street - Watermain Analysis

Network Table - Nodes (Max Day + FF 'Block 11 & 12')

Node ID	Elevation m	Demand LPS	Head m	Pressure m	Pressure kPa	Pressure psi
Junc HYD1	56.52	95.24	98.97	42.45	416.43	60.40
Junc HYD2	56.64	95.07	99.07	42.43	416.24	60.37
Junc HYD3	56.74	95.07	99.38	42.64	418.30	60.67
Junc EXHYD1	56.43	0	105.16	48.73	478.04	69.33
Junc EXHYD2	56.05	0	104.3	48.25	473.33	68.65
Junc EXHYD3	55.72	15	102.84	47.12	462.25	67.04
Junc T1	56.54	0.13	99.92	43.38	425.56	61.72
Junc T2	56.44	0.09	99.01	42.57	417.61	60.57
Junc T3	56.47	0.22	99.07	42.6	417.91	60.61
Junc T4	56.59	0.24	99.58	42.99	421.73	61.17
Junc T5	56.66	0.24	99.46	42.8	419.87	60.90
Junc T6	56.76	0.17	99.74	42.98	421.63	61.15
Junc T7	56.64	0.15	101.05	44.41	435.66	63.19
Junc T8	56.56	0.13	99.47	42.91	420.95	61.05
Junc CAP1	56.75	0.07	99.74	42.99	421.73	61.17
Junc CAP2	56.54	0.04	99.01	42.47	416.63	60.43
Resvr RES1	105.3	-218.19	105.3	0	0.00	0.00
Resvr RES2	102.8	-83.67	102.8	0	0.00	0.00

Network Table - Links (Max Day + FF 'Block 11 & 12')

Link ID	Length m	Diameter mm	Roughness	Flow LPS	Velocity m/s	Headloss m/km	Friction Factor
Pipe P1	35	204	110	121.45	3.72	82.12	0.024
Pipe P2	25	204	110	79.43	2.43	37.40	0.025
Pipe P3	23	204	110	-15.81	0.48	1.88	0.032
Pipe P4	13	155	100	0.04	0.00	0.00	0.000
Pipe P5	31	204	110	-15.94	0.49	1.91	0.032
Pipe P6	48	155	100	-17.80	0.94	10.66	0.036
Pipe P7	30	204	110	41.89	1.28	11.44	0.028
Pipe P8	22	204	110	1.64	0.05	0.03	0.045
Pipe P9	8	204	110	-93.43	2.86	50.52	0.025
Pipe P10	30	204	110	23.85	0.73	4.03	0.030
Pipe P11	47	155	100	2.27	0.12	0.23	0.049
Pipe P12	17	204	110	25.87	0.79	4.69	0.030
Pipe P13	13	204	110	-69.19	2.12	28.97	0.026
Pipe P14	17	155	100	-0.07	0.00	0.00	0.000
Pipe P15	45	204	110	-69.43	2.12	29.16	0.026
Pipe P16	30	204	110	-95.82	2.93	52.95	0.025
Pipe P17	29	204	110	-165.41	5.06	145.53	0.023

FUS - Fire Flow Calculations

As per 1999 Fire Underwriter's Survey Guidelines



Engineers, Planners & Landscape Architects

Novatech Project #: 119068
 Project Name: 200 Baribeau Street
 Date: 6/7/2021
 Input By: Lucas Wilson
 Reviewed By: Mark Bissett

Legend

No Information or Input Required

Building Description: Block 1 - 7 Units
 Wood frame

Step	Input		Value Used	Total Fire Flow (L/min)		
Base Fire Flow						
1	Construction Material		Multiplier	1.5		
	Coefficient related to type of construction C	Wood frame	Yes		1.5	
		Ordinary construction			1	
		Non-combustible construction			0.8	
		Modified Fire resistive construction (2 hrs)			0.6	
Fire resistive construction (> 3 hrs)			0.6			
2	Floor Area			10,000		
	A	Building Footprint (m ²)	336		1,008	
		Number of Floors/Storeys	3			
		Area of structure considered (m ²)				
F	Base fire flow without reductions					
Reductions or Surcharges						
3	Occupancy hazard reduction or surcharge		Reduction/Surcharge	8,500		
	(1)	Non-combustible			-25%	
		Limited combustible	Yes		-15%	
		Combustible			0%	
		Free burning			15%	
Rapid burning			25%			
4	Sprinkler Reduction		Reduction	0		
	(2)	Adequately Designed System (NFPA 13)			-30%	
		Standard Water Supply			-10%	
		Fully Supervised System			-10%	
Cumulative Total			0%			
5	Exposure Surcharge (cumulative %)		Surcharge	5,100		
	(3)	North Side	20.1 - 30 m		10%	
		East Side	20.1 - 30 m		10%	
		South Side	10.1 - 20 m		15%	
		West Side	0 - 3 m		25%	
Cumulative Total			60%			
Results						
6	(1) + (2) + (3)	Total Required Fire Flow, rounded to nearest 1000L/min		L/min	14,000	
		(2,000 L/min < Fire Flow < 45,000 L/min)		or	L/s	233
				or	USGPM	3,699
7	Storage Volume	Required Duration of Fire Flow (hours)		Hours	3	
		Required Volume of Fire Flow (m ³)		m ³	2520	

FUS - Fire Flow Calculations

As per 1999 Fire Underwriter's Survey Guidelines



Engineers, Planners & Landscape Architects

Novatech Project #: 119068
 Project Name: 200 Baribeau
 Date: 6/7/2021
 Input By: Lucas Wilson
 Reviewed By: Mark Bissett

Legend

Input by User

No Information or Input Required

Building Description: Block 2, 3 & 4 - 5 Units
 Wood frame

Step	Input		Value Used	Total Fire Flow (L/min)		
Base Fire Flow						
1	Construction Material		Multiplier	1.5		
	Coefficient related to type of construction C	Wood frame	Yes		1.5	
		Ordinary construction			1	
		Non-combustible construction			0.8	
		Modified Fire resistive construction (2 hrs)			0.6	
Fire resistive construction (> 3 hrs)			0.6			
2	Floor Area		804	9,000		
	A	Building Footprint (m ²)			268	
		Number of Floors/Storeys			3	
		Area of structure considered (m ²)				
F	Base fire flow without reductions					
Reductions or Surcharges						
3	Occupancy hazard reduction or surcharge		Reduction/Surcharge	7,650		
	(1)	Non-combustible			-25%	
		Limited combustible	Yes		-15%	
		Combustible			0%	
		Free burning			15%	
Rapid burning			25%			
4	Sprinkler Reduction		Reduction	0		
	(2)	Adequately Designed System (NFPA 13)			-30%	
		Standard Water Supply			-10%	
		Fully Supervised System			-10%	
Cumulative Total			0%			
5	Exposure Surcharge (cumulative %)		Surcharge	5,738		
	(3)	North Side	0 - 3 m		25%	
		East Side	20.1 - 30 m		10%	
		South Side	0 - 3 m		25%	
		West Side	10.1 - 20 m		15%	
Cumulative Total			75%			
Results						
6	(1) + (2) + (3)	Total Required Fire Flow, rounded to nearest 1000L/min		L/min	13,000	
		(2,000 L/min < Fire Flow < 45,000 L/min)		or	L/s	217
				or	USGPM	3,435
7	Storage Volume	Required Duration of Fire Flow (hours)		Hours	2.5	
		Required Volume of Fire Flow (m ³)		m ³	1950	

FUS - Fire Flow Calculations

As per 1999 Fire Underwriter's Survey Guidelines



Engineers, Planners & Landscape Architects

Novatech Project #: 119068

Project Name: 200 Baribeau

Date: 6/7/2021

Input By: Lucas Wilson

Reviewed By: Mark Bissett

Legend

Input by User

No Information or Input Required

Building Description: Block 5 - 4 Units

Wood frame

Step	Input		Value Used	Total Fire Flow (L/min)		
Base Fire Flow						
1	Construction Material		Multiplier	1.5		
	Coefficient related to type of construction C	Wood frame	Yes		1.5	
		Ordinary construction			1	
		Non-combustible construction			0.8	
		Modified Fire resistive construction (2 hrs)			0.6	
Fire resistive construction (> 3 hrs)			0.6			
2	Floor Area		645	8,000		
	A	Building Footprint (m ²)			215	
		Number of Floors/Storeys			3	
		Area of structure considered (m ²)				
F	Base fire flow without reductions					
Reductions or Surcharges						
3	Occupancy hazard reduction or surcharge		Reduction/Surcharge	6,800		
	(1)	Non-combustible			-25%	
		Limited combustible	Yes		-15%	
		Combustible			0%	
		Free burning			15%	
Rapid burning			25%			
4	Sprinkler Reduction		Reduction	0		
	(2)	Adequately Designed System (NFPA 13)			-30%	
		Standard Water Supply			-10%	
		Fully Supervised System			-10%	
Cumulative Total			0%			
5	Exposure Surcharge (cumulative %)		Surcharge	4,760		
	(3)	North Side	10.1 - 20 m		15%	
		East Side	20.1 - 30 m		10%	
		South Side	3.1 - 10 m		20%	
		West Side	0 - 3 m		25%	
Cumulative Total			70%			
Results						
6	(1) + (2) + (3)	Total Required Fire Flow, rounded to nearest 1000L/min		L/min	12,000	
		(2,000 L/min < Fire Flow < 45,000 L/min)		or	L/s	200
				or	USGPM	3,170
7	Storage Volume	Required Duration of Fire Flow (hours)		Hours	2.5	
		Required Volume of Fire Flow (m ³)		m ³	1800	

FUS - Fire Flow Calculations

As per 1999 Fire Underwriter's Survey Guidelines



Engineers, Planners & Landscape Architects

Novatech Project #: 119068

Project Name: 200 Baribeau

Date: 6/7/2021

Input By: Lucas Wilson

Reviewed By: Mark Bissett

Legend

No Information or Input Required

Building Description: Block 6 - 5 Units

Wood frame

Step	Input		Value Used	Total Fire Flow (L/min)		
Base Fire Flow						
1	Construction Material		Multiplier	1.5		
	Coefficient related to type of construction C	Wood frame	Yes		1.5	
		Ordinary construction			1	
		Non-combustible construction			0.8	
		Modified Fire resistive construction (2 hrs)			0.6	
Fire resistive construction (> 3 hrs)			0.6			
2	Floor Area			9,000		
	A	Building Footprint (m ²)	268		804	
		Number of Floors/Storeys	3			
		Area of structure considered (m ²)				
F	Base fire flow without reductions					
Reductions or Surcharges						
3	Occupancy hazard reduction or surcharge		Reduction/Surcharge	7,650		
	(1)	Non-combustible			-25%	
		Limited combustible	Yes		-15%	
		Combustible			0%	
		Free burning			15%	
Rapid burning			25%			
4	Sprinkler Reduction		Reduction	0		
	(2)	Adequately Designed System (NFPA 13)			-30%	
		Standard Water Supply			-10%	
		Fully Supervised System			-10%	
Cumulative Total			0%			
5	Exposure Surcharge (cumulative %)		Surcharge	5,355		
	(3)	North Side	10.1 - 20 m		15%	
		East Side	0 - 3 m		25%	
		South Side	3.1 - 10 m		20%	
		West Side	20.1 - 30 m		10%	
Cumulative Total			70%			
Results						
6	(1) + (2) + (3)	Total Required Fire Flow, rounded to nearest 1000L/min		L/min	13,000	
		(2,000 L/min < Fire Flow < 45,000 L/min)		or	L/s	217
				or	USGPM	3,435
7	Storage Volume	Required Duration of Fire Flow (hours)		Hours	2.5	
		Required Volume of Fire Flow (m ³)		m ³	1950	

FUS - Fire Flow Calculations

As per 1999 Fire Underwriter's Survey Guidelines



Engineers, Planners & Landscape Architects

Novatech Project #: 119068
 Project Name: 200 Baribeau
 Date: 6/7/2021
 Input By: Lucas Wilson
 Reviewed By: Mark Bissett

Legend

No Information or Input Required

Building Description: Block 7 - 6 Units
 Wood frame

Step	Input		Value Used	Total Fire Flow (L/min)		
Base Fire Flow						
1	Construction Material		Multiplier	1.5		
	Coefficient related to type of construction C	Wood frame	Yes		1.5	
		Ordinary construction			1	
		Non-combustible construction			0.8	
		Modified Fire resistive construction (2 hrs)			0.6	
Fire resistive construction (> 3 hrs)			0.6			
2	Floor Area		960	10,000		
	A	Building Footprint (m ²)			320	
		Number of Floors/Storeys			3	
		Area of structure considered (m ²)				
F	Base fire flow without reductions					
Reductions or Surcharges						
3	Occupancy hazard reduction or surcharge		Reduction/Surcharge	8,500		
	(1)	Non-combustible			-25%	
		Limited combustible	Yes		-15%	
		Combustible			0%	
		Free burning			15%	
Rapid burning			25%			
4	Sprinkler Reduction		Reduction	0		
	(2)	Adequately Designed System (NFPA 13)			-30%	
		Standard Water Supply			-10%	
		Fully Supervised System			-10%	
Cumulative Total			0%			
5	Exposure Surcharge (cumulative %)		Surcharge	5,950		
	(3)	North Side	0 - 3 m		25%	
		East Side	20.1 - 30 m		10%	
		South Side	3.1 - 10 m		20%	
		West Side	10.1 - 20 m		15%	
Cumulative Total			70%			
Results						
6	(1) + (2) + (3)	Total Required Fire Flow, rounded to nearest 1000L/min		L/min	14,000	
		(2,000 L/min < Fire Flow < 45,000 L/min)		or	L/s	233
				or	USGPM	3,699
7	Storage Volume	Required Duration of Fire Flow (hours)		Hours	3	
		Required Volume of Fire Flow (m ³)		m ³	2520	

FUS - Fire Flow Calculations

As per 1999 Fire Underwriter's Survey Guidelines



Engineers, Planners & Landscape Architects

Novatech Project #: 119068

Project Name: 200 Baribeau

Date: 6/7/2021

Input By: Lucas Wilson

Reviewed By: Mark Bissett

Legend

No Information or Input Required

Building Description: Block 8 - 7 Units

Wood frame

Step	Input		Value Used	Total Fire Flow (L/min)		
Base Fire Flow						
1	Construction Material		Multiplier	1.5		
	Coefficient related to type of construction C	Wood frame	Yes		1.5	
		Ordinary construction			1	
		Non-combustible construction			0.8	
		Modified Fire resistive construction (2 hrs)			0.6	
Fire resistive construction (> 3 hrs)			0.6			
2	Floor Area		1,116	11,000		
	A	Building Footprint (m ²)			372	
		Number of Floors/Storeys			3	
		Area of structure considered (m ²)				
F	Base fire flow without reductions		$F = 220 C (A)^{0.5}$			
Reductions or Surcharges						
3	Occupancy hazard reduction or surcharge		Reduction/Surcharge	9,350		
	(1)	Non-combustible			-25%	
		Limited combustible	Yes		-15%	
		Combustible			0%	
		Free burning			15%	
Rapid burning			25%			
4	Sprinkler Reduction		Reduction	0		
	(2)	Adequately Designed System (NFPA 13)			-30%	
		Standard Water Supply			-10%	
		Fully Supervised System			-10%	
Cumulative Total			0%			
5	Exposure Surcharge (cumulative %)		Surcharge	5,143		
	(3)	North Side	> 45.1m		0%	
		East Side	10.1 - 20 m		15%	
		South Side	0 - 3 m		25%	
		West Side	10.1 - 20 m		15%	
Cumulative Total			55%			
Results						
6	(1) + (2) + (3)	Total Required Fire Flow, rounded to nearest 1000L/min		L/min	14,000	
		(2,000 L/min < Fire Flow < 45,000 L/min)		or	L/s	233
				or	USGPM	3,699
7	Storage Volume	Required Duration of Fire Flow (hours)		Hours	3	
		Required Volume of Fire Flow (m ³)		m ³	2520	

FUS - Fire Flow Calculations

As per 1999 Fire Underwriter's Survey Guidelines



Engineers, Planners & Landscape Architects

Novatech Project #: 119068

Project Name: 200 Baribeau

Date: 6/7/2021

Input By: Lucas Wilson

Reviewed By: Mark Bissett

Legend

Input by User

No Information or Input Required

Building Description: Block 9 - 5 Units

Wood frame

Step	Input		Value Used	Total Fire Flow (L/min)		
Base Fire Flow						
1	Construction Material		Multiplier	1.5		
	Coefficient related to type of construction C	Wood frame	Yes		1.5	
		Ordinary construction			1	
		Non-combustible construction			0.8	
		Modified Fire resistive construction (2 hrs)			0.6	
Fire resistive construction (> 3 hrs)			0.6			
2	Floor Area			9,000		
	A	Building Footprint (m ²)	240			
		Number of Floors/Storeys	3			
		Area of structure considered (m ²)			720	
	F	Base fire flow without reductions				
$F = 220 C (A)^{0.5}$						
Reductions or Surcharges						
3	Occupancy hazard reduction or surcharge		Reduction/Surcharge	7,650		
	(1)	Non-combustible			-25%	
		Limited combustible	Yes		-15%	
		Combustible			0%	
		Free burning			15%	
Rapid burning			25%			
4	Sprinkler Reduction		Reduction	0		
	(2)	Adequately Designed System (NFPA 13)			-30%	
		Standard Water Supply			-10%	
		Fully Supervised System			-10%	
Cumulative Total			0%			
5	Exposure Surcharge (cumulative %)		Surcharge	3,825		
	(3)	North Side	20.1 - 30 m		10%	
		East Side	0 - 3 m		25%	
		South Side	10.1 - 20 m		15%	
		West Side	> 45.1m		0%	
Cumulative Total			50%			
Results						
6	(1) + (2) + (3)	Total Required Fire Flow, rounded to nearest 1000L/min		L/min	11,000	
		(2,000 L/min < Fire Flow < 45,000 L/min)		or	L/s	183
				or	USGPM	2,906
7	Storage Volume	Required Duration of Fire Flow (hours)		Hours	2	
		Required Volume of Fire Flow (m ³)		m³	1320	

FUS - Fire Flow Calculations

As per 1999 Fire Underwriter's Survey Guidelines



Engineers, Planners & Landscape Architects

Novatech Project #: 119068

Project Name: 200 Baribeau

Date: 6/7/2021

Input By: Lucas Wilson

Reviewed By: Mark Bissett

Legend

Input by User

No Information or Input Required

Building Description: Block 10, 11 & 12 - 12 Units

Wood frame

Step	Input		Value Used	Total Fire Flow (L/min)		
Base Fire Flow						
1	Construction Material		Multiplier	1.5		
	Coefficient related to type of construction C	Wood frame	Yes		1.5	
		Ordinary construction			1	
		Non-combustible construction			0.8	
		Modified Fire resistive construction (2 hrs)			0.6	
Fire resistive construction (> 3 hrs)			0.6			
2	Floor Area			13,000		
	A	Building Footprint (m ²)	557			
		Number of Floors/Storeys	3			
		Area of structure considered (m ²)			1,671	
F	Base fire flow without reductions					
Reductions or Surcharges						
3	Occupancy hazard reduction or surcharge		Reduction/Surcharge	11,050		
	(1)	Non-combustible			-25%	
		Limited combustible	Yes		-15%	
		Combustible			0%	
		Free burning			15%	
Rapid burning			25%			
4	Sprinkler Reduction		Reduction	0		
	(2)	Adequately Designed System (NFPA 13)			-30%	
		Standard Water Supply			-10%	
		Fully Supervised System			-10%	
Cumulative Total			0%			
5	Exposure Surcharge (cumulative %)		Surcharge	6,630		
	(3)	North Side	10.1 - 20 m		15%	
		East Side	10.1 - 20 m		15%	
		South Side	10.1 - 20 m		15%	
		West Side	10.1 - 20 m		15%	
Cumulative Total			60%			
Results						
6	(1) + (2) + (3)	Total Required Fire Flow, rounded to nearest 1000L/min		L/min	18,000	
		(2,000 L/min < Fire Flow < 45,000 L/min)		or	L/s	300
				or	USGPM	4,756
7	Storage Volume	Required Duration of Fire Flow (hours)		Hours	4	
		Required Volume of Fire Flow (m ³)		m ³	4320	

LANDRY STREET

EX HYD1
(AA-LIGHT BLUE)
5,700L/min (95L/s)
<75m (B1, B2, B9)

EX HYD2
(AA-LIGHT BLUE)
5,700L/min (95L/s)
<75m (B1, B2, B3, B10)

EX HYD2
(AA-LIGHT BLUE)
3,800L/min (63L/s)
>75m and <150m (B9)

MONTFORT STREET

BARIBEAU STREET

ETHEL STREET

EX HYD3
(AA-LIGHT BLUE)
5,700L/min (95L/s)
<75m (B3, B4, B5, B6, B12)

EX HYD3
(AA-LIGHT BLUE)
3,800L/min (63L/s)
>75m and <150m (B7, B11)

CARILLON STREET

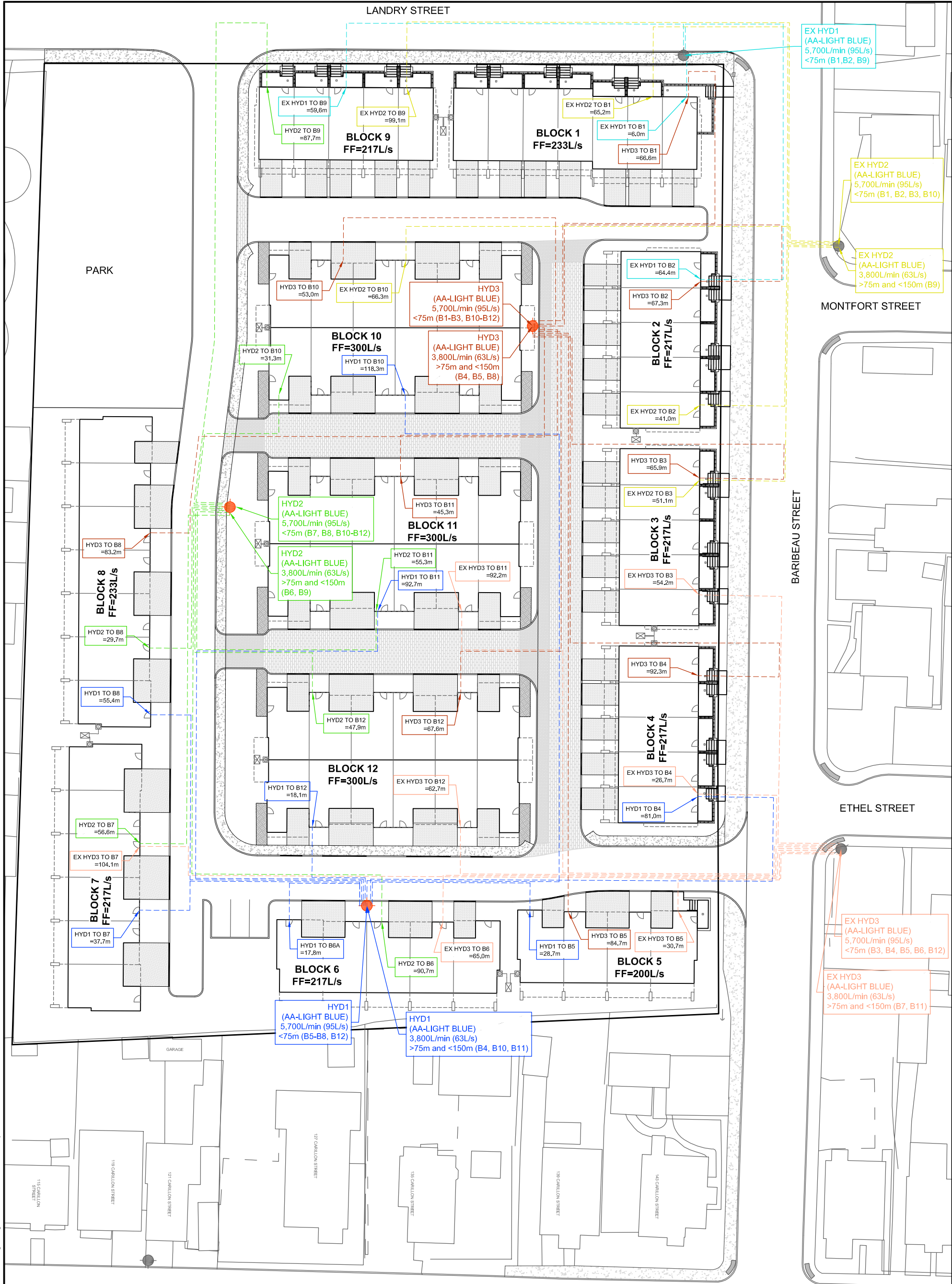

PARK

BLOCK 8
FF=233L/s

BLOCK 7
FF=217L/s

BLOCK 6
FF=217L/s

BLOCK 9
FF=217L/s

BLOCK 10
FF=300L/s

BLOCK 11
FF=300L/s

BLOCK 12
FF=300L/s

BLOCK 1
FF=233L/s

BLOCK 2
FF=217L/s

BLOCK 3
FF=217L/s

BLOCK 4
FF=217L/s

BLOCK 5
FF=200L/s

LEGEND

- ROUTE FROM PROPOSED BUILDING TO HYD 1
- ROUTE FROM PROPOSED BUILDING TO HYD 2
- ROUTE FROM PROPOSED BUILDING TO HYD 3
- ROUTE FROM PROPOSED BUILDING TO EX HYD1
- ROUTE FROM PROPOSED BUILDING TO EX HYD2
- ROUTE FROM PROPOSED BUILDING TO EX HYD3
- FIRE HYDRANT



CITY OF OTTAWA
200 BARIBEAU STREET

FIRE HYDRANT
COVERAGE PLAN

SCALE 1 : 500

DATE JUN 2021 JOB 119068 FIGURE FIG-6



Engineers, Planners & Landscape Architects
Suite 200, 240 Michael Cowpland Drive
Ottawa, Ontario, Canada K2M 1P6

Telephone (613) 254-9643
Facsimile (613) 254-5867
Website www.novatech-eng.com

M:\2019\119068\CAD\Design\Figures\Design Brief\119068-HYD Coverage.dwg, FIG-6, Jun 04, 2021 - 2:34pm, IWilson

APPENDIX B

SWM Calculations

EXISTING CONDITIONS

Existing Catchment Parameters

Catchment ID	Areas (ha)	Runoff Coefficient
	Total	C
TOTAL	1.270	0.50

Pre-Development Peak Flows

Catchment ID	Rainfall Intensity (mm/hr) ¹	Peak Flows (L/s)
	2-year	2-year
Site Boundary (existing conditions)	76.81	135.6

¹ Tc is based on Uplands Method.

Notes:

Rainfall Intensity from City of Ottawa Sewer Design Guidelines (Oct. 2012)

- 100 year Intensity = $1735.688 / (Tc + 6.014)^{0.820}$
- 5 year Intensity = $998.071 / (Tc + 6.053)^{0.814}$
- 2 year Intensity = $732.951 / (Tc + 6.199)^{0.810}$

$Q(\text{peak flow}) = 2.78 \times C \times I \times A$

- C is the runoff coefficient
- I is the rainfall intensity
- A is the total drainage area

200 Baribeau Street (119068) Roadway Cross-Sections



Mountable Curb and Gutter Distance	Elevation
0	1
0.01	0.1
0.99	0.075
1	0
7	0.06
7.01	0.135
7.99	0.155
8	1

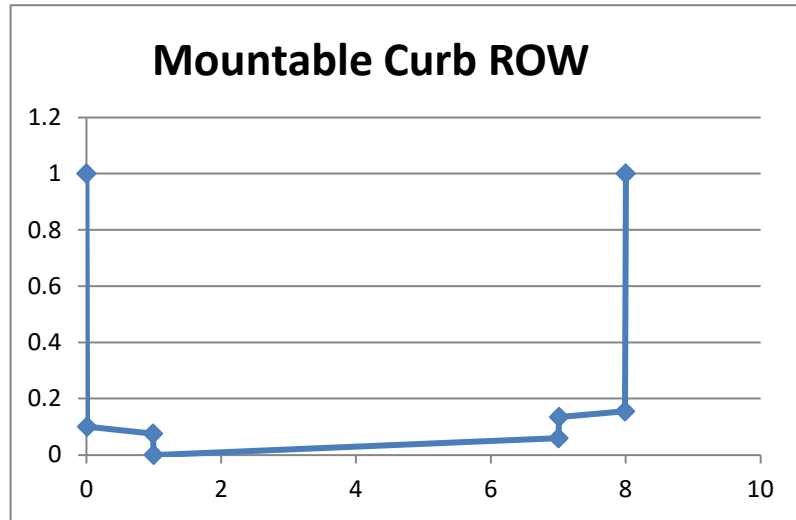

CB1-Storage		
Depth (m)	Area (m ²)	Volume (m ³)
0.00	0.00	0.00
0.64	25.00	8.00
0.65	0.36	8.13
1.28	0.36	8.35
1.43	133.00	18.36
1.44	0.00	19.02
2.28	0.00	19.02

CB2-Storage		
Depth (m)	Area (m ²)	Volume (m ³)
0.00	0.00	0.00
0.64	25.00	8.00
0.65	0.36	8.13
1.28	0.36	8.35
1.43	80.00	14.38
1.44	0.00	14.78
2.28	0.00	14.78

CB3-Storage		
Depth (m)	Area (m ²)	Volume (m ³)
0.00	0.00	0.00
0.64	15.00	4.80
0.65	0.36	4.88
1.28	0.36	5.10
1.43	190.00	19.38
1.44	0.00	20.33
2.28	0.00	20.33

CB4-Storage		
Depth (m)	Area (m ²)	Volume (m ³)
0.00	0.00	0.00
0.64	15.00	4.80
0.65	0.36	4.88
1.28	0.36	5.10
1.43	140.00	15.63
1.44	0.00	16.33
2.28	0.00	16.33

CB5-Storage		
Depth (m)	Area (m ²)	Volume (m ³)
0.00	0.00	0.00
0.64	15.00	4.80
0.65	0.36	4.88
1.28	0.36	5.10
1.43	80.00	11.13
1.44	0.00	11.53
2.28	0.00	11.53

CB6-Storage		
Depth (m)	Area (m ²)	Volume (m ³)
0.00	0.00	0.00
0.64	25.00	8.00
0.65	0.36	8.13
1.28	0.36	8.35
1.43	140.00	18.88
1.44	0.00	19.58
2.28	0.00	19.58

CB7-Storage		
Depth (m)	Area (m ²)	Volume (m ³)
0.00	0.00	0.00
0.64	65.60	20.99
0.65	0.36	21.32
1.28	0.36	21.55
1.43	173.00	34.55
1.44	0.00	35.42
2.28	0.00	35.42

CB8-Storage		
Depth (m)	Area (m ²)	Volume (m ³)
0.00	0.00	0.00
0.64	25.00	8.00
0.65	0.36	8.13
1.28	0.36	8.35
1.43	110.00	16.63
1.44	0.00	17.18
2.28	0.00	17.18

CB9-Storage		
Depth (m)	Area (m ²)	Volume (m ³)
0.00	0.00	0.00
0.64	65.60	20.99
0.65	0.36	21.32
1.28	0.36	21.55
1.43	165.00	33.95
1.44	0.00	34.78
2.28	0.00	34.78

CB10-Storage		
Depth (m)	Area (m ²)	Volume (m ³)
0.00	0.00	0.00
0.64	25.00	8.00
0.65	0.36	8.13
1.28	0.36	8.35
1.43	140.00	18.88
1.44	0.00	19.58
2.28	0.00	19.58

CB11-Storage		
Depth (m)	Area (m ²)	Volume (m ³)
0.00	0.00	0.00
0.64	65.60	20.99
0.65	0.36	21.32
1.28	0.36	21.55
1.43	140.00	32.08
1.44	0.00	32.78
2.28	0.00	32.78

CB12-Storage		
Depth (m)	Area (m ²)	Volume (m ³)
0.00	0.00	0.00
0.64	65.60	20.99
0.65	0.36	21.32
1.28	0.36	21.55
1.40	170.00	31.77
1.41	0.00	32.62
2.28	0.00	32.62

200 Baribeau Street (119068)
 PCSWMM Model Results (Ponding)



CB ID	Invert Elev. (m)	Rim Elev. (m)	Spill Elev. (m)	Ponding Depth (m)	HGL Elev. (m) ¹				Ponding Depth (m)				Spill Depth (m)			
					2-yr	5-yr	100-yr	100-yr (+20%)	2-yr	5-yr	100-yr	100-yr (+20%)	2-yr	5-yr	100-yr	100-yr (+20%)
CB01	55.15	56.43	56.58	0.15	55.79	56.50	56.65	56.70	0.00	0.07	0.22	0.27	0.00	0.00	0.07	0.12
CB02	55.10	56.38	56.53	0.15	55.61	55.74	56.62	56.67	0.00	0.00	0.24	0.29	0.00	0.00	0.09	0.14
CB03	55.15	56.43	56.58	0.15	56.20	56.49	56.60	56.68	0.00	0.06	0.17	0.25	0.00	0.00	0.02	0.10
CB04	55.22	56.50	56.65	0.15	55.78	56.53	56.64	56.73	0.00	0.03	0.14	0.23	0.00	0.00	0.00	0.08
CB05	55.28	56.56	56.71	0.15	55.68	55.82	56.69	56.78	0.00	0.00	0.13	0.22	0.00	0.00	0.00	0.07
CB06	55.20	56.48	56.63	0.15	55.83	56.55	56.69	56.74	0.00	0.07	0.21	0.26	0.00	0.00	0.06	0.11
CB07	55.29	56.57	56.72	0.15	55.79	55.90	56.72	56.79	0.00	0.00	0.15	0.22	0.00	0.00	0.00	0.07
CB08	55.27	56.55	56.70	0.15	55.85	56.59	56.74	56.79	0.00	0.04	0.19	0.24	0.00	0.00	0.04	0.09
CB09	55.33	56.61	56.76	0.15	55.83	55.94	56.79	56.82	0.00	0.00	0.18	0.21	0.00	0.00	0.03	0.06
CB10	55.35	56.63	56.78	0.15	55.96	56.69	56.81	56.85	0.00	0.06	0.18	0.22	0.00	0.00	0.03	0.07
CB11	55.39	56.67	56.82	0.15	55.89	56.01	56.86	56.90	0.00	0.00	0.19	0.23	0.00	0.00	0.04	0.08
CB12	55.10	56.38	56.50	0.12	55.45	55.55	56.50	56.65	0.00	0.00	0.12	0.27	0.00	0.00	0.00	0.15
LCB1	54.26	55.66	55.85	0.19	54.30	54.47	55.81	55.85	0.00	0.00	0.15	0.19	0.00	0.00	0.00	0.00
LCB2	54.25	55.45	55.65	0.20	54.30	54.37	55.63	55.72	0.00	0.00	0.18	0.27	0.00	0.00	0.00	0.07
LCB3	54.55	55.55	55.75	0.20	54.59	54.73	55.82	55.86	0.00	0.00	0.27	0.31	0.00	0.00	0.07	0.11
LCB4	54.50	55.50	55.70	0.20	54.53	54.55	55.66	55.76	0.00	0.00	0.16	0.26	0.00	0.00	0.00	0.06
RYCB1	54.32	55.65	55.80	0.15	54.47	54.73	55.83	55.86	0.00	0.00	0.18	0.21	0.00	0.00	0.03	0.06
RYCB3	54.03	55.59	55.75	0.16	54.26	54.47	55.80	55.83	0.00	0.00	0.21	0.24	0.00	0.00	0.05	0.08
RYCB4	54.65	55.65	55.90	0.25	54.66	54.73	55.83	55.87	0.00	0.00	0.18	0.22	0.00	0.00	0.00	0.00
RYCB5	54.02	55.25	55.50	0.25	54.07	54.37	55.57	55.69	0.00	0.00	0.32	0.44	0.00	0.00	0.07	0.19
RYCB6	53.77	55.39	55.65	0.26	54.06	54.37	55.57	55.79	0.00	0.00	0.18	0.40	0.00	0.00	0.00	0.14

¹ 3-hour Chicago Storm.

200 Baribeau Street (119068)
Summary of Hydraulic Grade Line (HGL) Elevations



MH ID	Obvert Elevation (m)	T/G Elevation (m)	HGL Elevation ¹ (m)	Surcharge (m)	Clearance from T/G (m)	HGL in Stress Test ¹ (m)
MH02	53.19	56.47	55.14	2.0	1.33	55.34
MH04	53.26	56.51	55.15	1.9	1.36	55.34
MH06	52.86	56.43	55.12	2.3	1.31	55.32
MH08	53.56	56.62	55.14	1.6	1.48	55.33
MH10	53.43	56.57	55.13	1.7	1.44	55.33
MH12	53.83	56.73	55.14	1.3	1.59	55.33
MH14	53.46	56.51	55.16	1.7	1.35	55.36
MH16	53.61	56.59	55.17	1.6	1.42	55.36
MH18	52.61	55.44	55.10	2.5	0.34	55.30
MH20	52.47	55.61	55.09	2.6	0.52	55.28
MH22	53.59	56.63	55.16	1.6	1.47	55.36
MH24	53.81	56.66	55.17	1.4	1.49	55.37
MH26	53.83	56.69	55.17	1.3	1.52	55.37
MH28	54.03	56.73	55.18	1.2	1.55	55.37

¹ 3-hour Chicago Storm.

**200 Baribeau Street (119068)
PCSWMM Model Output
100yr 3-hour Chicago Storm**

EPA STORM WATER MANAGEMENT MODEL - VERSION 5.1 (Build 5.1.013)

```

*****
Element Count
*****
Number of rain gages ..... 1
Number of subcatchments ... 23
Number of nodes ..... 59
Number of links ..... 77
Number of pollutants ..... 0
Number of land uses ..... 0
    
```

```

*****
Raingage Summary
*****
    
```

Name	Data Source	Data Type	Recording Interval
RG_1	C3hr-100yr	INTENSITY	10 min.

```

*****
Subcatchment Summary
*****
    
```

Name	Area	Width	%Imperv	%Slope	Rain Gage	Outlet
A-01	0.04	26.67	0.00	1.5000	RG_1	RYCB4
A-02	0.04	26.67	67.50	1.5000	RG_1	CB05
A-03	0.10	50.50	87.10	1.5000	RG_1	CB11
A-04	0.07	48.67	86.30	1.5000	RG_1	CB10
A-05	0.07	48.67	82.20	1.5000	RG_1	CB08
A-06	0.09	62.00	92.50	1.5000	RG_1	CB09
A-07	0.07	44.00	63.60	1.5000	RG_1	CB04
A-08	0.04	25.33	0.00	1.5000	RG_1	HP-RYCB1
A-09	0.03	32.00	43.80	1.5000	RG_1	LCB3
A-10	0.03	30.00	36.70	1.5000	RG_1	LCB4
A-11	0.08	54.67	67.10	1.5000	RG_1	CB03
A-12	0.09	62.67	92.60	1.5000	RG_1	CB07
A-13	0.08	54.67	82.90	1.5000	RG_1	CB06
A-14	0.09	58.67	85.20	1.5000	RG_1	CB01
A-15	0.06	40.00	90.00	1.5000	RG_1	CB02
A-16	0.07	46.67	74.30	1.5000	RG_1	CB12
A-17	0.03	30.00	40.00	1.5000	RG_1	LCB2
A-18	0.03	25.00	16.00	1.5000	RG_1	RYCB6
A-19	0.02	20.00	55.00	1.5000	RG_1	RYCB3
A-20	0.03	28.00	42.90	1.5000	RG_1	LCB1
A-21	0.01	9.00	18.90	1.5000	RG_1	RYCB5
B-01	0.04	35.00	48.80	1.5000	RG_1	OF1
B-02	0.05	51.00	33.00	1.5000	RG_1	OF1

```

*****
Node Summary
*****
    
```

Name	Type	Invert Elev.	Max. Depth	Ponded Area	External Inflow
HP-CB01	JUNCTION	56.58	1.00	0.0	
HP-CB02	JUNCTION	56.53	1.00	0.0	
HP-CB03	JUNCTION	56.58	1.00	0.0	
HP-CB04	JUNCTION	56.65	1.00	0.0	
HP-CB05	JUNCTION	56.71	1.00	0.0	
HP-CB06	JUNCTION	56.63	1.00	0.0	
HP-CB07	JUNCTION	56.72	1.00	0.0	
HP-CB08	JUNCTION	56.70	1.00	0.0	
HP-CB09	JUNCTION	56.76	1.00	0.0	
HP-CB10	JUNCTION	56.78	1.00	0.0	
HP-CB11	JUNCTION	56.82	1.00	0.0	
HP-CB12	JUNCTION	56.50	1.00	0.0	
HP-LCB1	JUNCTION	55.85	1.00	0.0	
HP-LCB2	JUNCTION	55.65	1.00	0.0	
HP-LCB3	JUNCTION	55.75	1.00	0.0	
HP-LCB4	JUNCTION	55.70	1.00	0.0	
HP-LCB6	JUNCTION	55.65	1.00	0.0	
HP-RYCB1	JUNCTION	55.80	1.00	0.0	
HP-RYCB3	JUNCTION	55.75	1.00	0.0	
HP-RYCB4	JUNCTION	55.90	1.00	0.0	

HP-RYCB5	OUTFALL	55.50	1.00	0.0
OF1	OUTFALL	56.00	0.00	0.0
OF2	OUTFALL	51.05	1.07	0.0
CB01	STORAGE	55.15	2.28	0.0
CB02	STORAGE	55.10	2.28	0.0
CB02-Dummy	STORAGE	52.55	3.87	0.0
CB03	STORAGE	55.15	2.28	0.0
CB04	STORAGE	55.22	2.28	0.0
CB05	STORAGE	55.28	2.28	0.0
CB06	STORAGE	55.20	2.28	0.0
CB07	STORAGE	55.29	2.28	0.0
CB08	STORAGE	55.27	2.28	0.0
CB09	STORAGE	55.33	2.28	0.0
CB10	STORAGE	55.35	2.28	0.0
CB11	STORAGE	55.39	2.28	0.0
CB12	STORAGE	55.10	2.28	0.0
LCB1	STORAGE	54.26	2.40	0.0
LCB2	STORAGE	54.25	2.20	0.0
LCB3	STORAGE	54.55	2.00	0.0
LCB4	STORAGE	54.50	2.00	0.0
MH02	STORAGE	52.74	3.73	0.0
MH04	STORAGE	52.88	3.63	0.0
MH06	STORAGE	52.33	4.10	0.0
MH08	STORAGE	53.26	3.36	0.0
MH10	STORAGE	53.05	3.52	0.0
MH12	STORAGE	53.58	3.15	0.0
MH14	STORAGE	53.08	3.43	0.0
MH16	STORAGE	53.23	3.36	0.0
MH18	STORAGE	52.08	3.36	0.0
MH20	STORAGE	51.94	3.67	0.0
MH22	STORAGE	53.34	3.29	0.0
MH24	STORAGE	53.56	3.10	0.0
MH26	STORAGE	53.53	3.16	0.0
MH28	STORAGE	53.78	2.95	0.0
RYCB1	STORAGE	54.21	2.44	0.0
RYCB3	STORAGE	54.03	2.56	0.0
RYCB4	STORAGE	54.65	2.00	0.0
RYCB5	STORAGE	54.02	2.23	0.0
RYCB6	STORAGE	53.77	2.62	0.0

```

*****
Link Summary
*****
    
```

Name	From Node	To Node	Type	Length	%Slope	Roughness
Dummy-MH06	CB02-Dummy	MH06	CONDUIT	20.1	0.7463	0.0130
LCB1-RYCB3	LCB1	RYCB3	CONDUIT	22.5	0.9778	0.0130
LCB3-RYCB1	LCB3	RYCB1	CONDUIT	28.8	1.0070	0.0130
LCB4-LCB5	LCB4	LCB2	CONDUIT	25.0	1.0001	0.0130
LCB5-RYCB5	LCB2	RYCB5	CONDUIT	17.3	0.9827	0.0130
MH02-CB02-Dummy	MH02	CB02-Dummy	CONDUIT	25.5	0.7451	0.0130
MH04-MH02	MH04	MH02	CONDUIT	8.3	0.7229	0.0130
MH06-MH18	MH06	MH18	CONDUIT	22.2	0.8559	0.0130
MH08-MH06	MH10	MH06	CONDUIT	57.1	0.9983	0.0130
MH10-MH8	MH08	MH10	CONDUIT	14.3	0.9791	0.0130
MH12-MH10	MH12	MH08	CONDUIT	26.9	1.0038	0.0130
MH14-MH4	MH14	MH04	CONDUIT	29.0	0.4828	0.0130
MH16-MH14	MH16	MH14	CONDUIT	29.8	0.5034	0.0130
MH18-MH20	MH18	MH20	CONDUIT	8.8	0.9091	0.0130
MH20-OF2	MH20	OF2	CONDUIT	41.7	0.8394	0.0130
MH22-MH14	MH22	MH14	CONDUIT	19.9	1.0051	0.0130
MH24-MH16	MH24	MH16	CONDUIT	19.9	1.0051	0.0130
MH26-MH16	MH26	MH16	CONDUIT	29.8	0.7383	0.0130
MH28-MH26	MH28	MH26	CONDUIT	20.0	1.0001	0.0130
MS-CB01	CB01	HP-CB01	CONDUIT	3.0	-5.0063	0.2500
MS-CB02	CB02	HP-CB02	CONDUIT	3.0	-5.0063	0.2500
MS-CB03	CB03	HP-CB03	CONDUIT	3.0	-5.0063	0.2500
MS-CB04	CB04	HP-CB04	CONDUIT	3.0	-5.0063	0.2500
MS-CB05	CB05	HP-CB05	CONDUIT	3.0	-5.0063	0.2500
MS-CB06	CB06	HP-CB06	CONDUIT	3.0	-5.0063	0.2500
MS-CB07	CB07	HP-CB07	CONDUIT	3.0	-5.0063	0.2500
MS-CB08	CB08	HP-CB08	CONDUIT	3.0	-5.0063	0.2500
MS-CB09	CB09	HP-CB09	CONDUIT	3.0	-5.0063	0.2500
MS-CB10	CB10	HP-CB10	CONDUIT	3.0	-5.0063	0.2500
MS-CB11	CB11	HP-CB11	CONDUIT	3.0	-5.0063	0.2500
MS-CB12	CB12	HP-CB12	CONDUIT	3.0	-4.0032	0.2500
MS-HP-CB01	HP-CB01	CB02	CONDUIT	3.0	6.6815	0.2500
MS-HP-CB02	HP-CB02	CB12	CONDUIT	3.0	5.0063	0.2500
MS-HP-CB03	HP-CB03	CB12	CONDUIT	3.0	6.6815	0.2500
MS-HP-CB04	HP-CB04	CB03	CONDUIT	3.0	7.3531	0.2500
MS-HP-CB05	HP-CB05	CB04	CONDUIT	3.0	7.0172	0.2500

**200 Baribeau Street (119068)
PCSWMM Model Output
100yr 3-hour Chicago Storm**



MS-HP-CB06	HP-CB06	CB01	CONDUIT	3.0	6.6815	0.2500
MS-HP-CB07	HP-CB07	CB03	CONDUIT	3.0	9.7122	0.2500
MS-HP-CB08	HP-CB08	CB06	CONDUIT	3.0	7.3531	0.2500
MS-HP-CB09	HP-CB09	CB04	CONDUIT	3.0	8.6994	0.2500
MS-HP-CB10	HP-CB10	CB08	CONDUIT	3.0	7.6893	0.2500
MS-HP-CB11	HP-CB11	CB05	CONDUIT	3.0	8.6994	0.2500
MS-HP-CB12	HP-CB12	RYCB6	CONDUIT	3.0	39.8264	0.0350
MS-HP-LCB1	HP-LCB1	RYCB3	CONDUIT	10.7	2.4254	0.0350
MS-HP-LCB2	HP-LCB1	LCB3	CONDUIT	17.9	1.3975	0.0350
MS-HP-LCB3	HP-LCB3	LCB4	CONDUIT	15.2	1.6463	0.0350
MS-HP-LCB4	HP-LCB4	LCB2	CONDUIT	15.0	1.6669	0.0350
MS-HP-LCB5	HP-LCB2	RYCB5	CONDUIT	7.3	5.4877	0.0350
MS-HP-LCB6	HP-LCB6	RYCB5	CONDUIT	8.3	4.8307	0.0350
MS-HP-RYCB3	HP-RYCB3	RYCB6	CONDUIT	22.3	1.6169	0.0350
MS-HP-RYCB4	HP-RYCB4	RYCB1	CONDUIT	14.4	1.7396	0.0350
MS-LCB1	LCB1	HP-LCB1	CONDUIT	12.4	-1.5354	0.0350
MS-LCB2	LCB2	HP-LCB2	CONDUIT	10.0	-2.0004	0.0350
MS-LCB3	LCB3	HP-LCB3	CONDUIT	8.5	-2.3555	0.0350
MS-LCB4	LCB4	HP-LCB4	CONDUIT	10.0	-2.0004	0.0350
MS-RYCB01	RYCB1	HP-RYCB1	CONDUIT	11.5	-1.3068	0.0350
MS-RYCB3	RYCB3	HP-RYCB3	CONDUIT	11.6	-1.3779	0.0350
MS-RYCB4	RYCB4	HP-RYCB4	CONDUIT	7.4	-3.3662	0.0350
MS-RYCB5	RYCB5	HP-RYCB5	CONDUIT	3.0	-8.2462	0.0350
MS-RYCB6	RYCB6	HP-LCB6	CONDUIT	13.5	-1.9267	0.0350
RYCB4-LCB2	RYCB4	RYCB1	CONDUIT	21.2	0.9906	0.0130
RYCB5-RYCB6	RYCB5	RYCB6	CONDUIT	20.0	1.0001	0.0130
CB01-ICD	CB01	MH02	ORIFICE			
CB02-ICD	CB02	CB02-Dummy	ORIFICE			
CB03-ICD	CB03	MH10	ORIFICE			
CB04-ICD	CB04	MH08	ORIFICE			
CB05-ICD	CB05	MH12	ORIFICE			
CB06-ICD	CB06	MH14	ORIFICE			
CB07-ICD	CB07	MH22	ORIFICE			
CB08-ICD	CB08	MH16	ORIFICE			
CB09-ICD	CB09	MH24	ORIFICE			
CB10-ICD	CB10	MH26	ORIFICE			
CB11-ICD	CB11	MH28	ORIFICE			
CB12-ICD	CB12	MH06	ORIFICE			
RYCB1-ICD	RYCB1	MH08	ORIFICE			
RYCB3-ICD	RYCB3	MH20	ORIFICE			
RYCB6-ICD	RYCB6	MH18	ORIFICE			

Cross Section Summary

Conduit	Shape	Full Depth	Full Area	Hyd. Rad.	Max. Width	No. of Barrels	Full Flow
Dummy-MH06	CIRCULAR	0.45	0.16	0.11	0.45	1	246.31
LCB1-RYCB3	CIRCULAR	0.25	0.05	0.06	0.25	1	58.81
LCB3-RYCB1	CIRCULAR	0.25	0.05	0.06	0.25	1	59.68
LCB4-LCB5	CIRCULAR	0.25	0.05	0.06	0.25	1	59.47
LCB5-RYCB5	CIRCULAR	0.25	0.05	0.06	0.25	1	58.95
MH02-CB02-Dummy	CIRCULAR	0.45	0.16	0.11	0.45	1	246.12
MH04-MH02	CIRCULAR	0.38	0.11	0.09	0.38	1	149.08
MH06-MH18	CIRCULAR	0.53	0.22	0.13	0.53	1	397.89
MH08-MH06	CIRCULAR	0.38	0.11	0.09	0.38	1	175.19
MH10-MH8	CIRCULAR	0.30	0.07	0.07	0.30	1	95.69
MH12-MH10	CIRCULAR	0.25	0.05	0.06	0.25	1	59.58
MH14-MH4	CIRCULAR	0.38	0.11	0.09	0.38	1	121.83
MH16-MH14	CIRCULAR	0.38	0.11	0.09	0.38	1	124.40
MH18-MH20	CIRCULAR	0.53	0.22	0.13	0.53	1	410.08
MH20-OF2	CIRCULAR	0.53	0.22	0.13	0.53	1	394.03
MH22-MH14	CIRCULAR	0.25	0.05	0.06	0.25	1	59.62
MH24-MH16	CIRCULAR	0.25	0.05	0.06	0.25	1	59.62
MH26-MH16	CIRCULAR	0.30	0.07	0.07	0.30	1	83.09
MH28-MH26	CIRCULAR	0.25	0.05	0.06	0.25	1	59.47
MS-CB01	Road_Transect	1.00	7.58	2.60	8.00	1	12829.66
MS-CB02	Road_Transect	1.00	7.58	2.60	8.00	1	12829.66
MS-CB03	Road_Transect	1.00	7.58	2.60	8.00	1	12829.66
MS-CB04	Road_Transect	1.00	7.58	2.60	8.00	1	12829.66
MS-CB05	Road_Transect	1.00	7.58	2.60	8.00	1	12829.66
MS-CB06	Road_Transect	1.00	7.58	2.60	8.00	1	12829.66
MS-CB07	Road_Transect	1.00	7.58	2.60	8.00	1	12829.66
MS-CB08	Road_Transect	1.00	7.58	2.60	8.00	1	12829.66
MS-CB09	Road_Transect	1.00	7.58	2.60	8.00	1	12829.66
MS-CB10	Road_Transect	1.00	7.58	2.60	8.00	1	12829.66
MS-CB11	Road_Transect	1.00	7.58	2.60	8.00	1	12829.66
MS-CB12	Road_Transect	1.00	7.58	2.60	8.00	1	11472.61
MS-HP-CB01	Road_Transect	1.00	7.58	2.60	8.00	1	14821.65
MS-HP-CB02	Road_Transect	1.00	7.58	2.60	8.00	1	12829.66

MS-HP-CB03	Road_Transect	1.00	7.58	2.60	8.00	1	14821.65
MS-HP-CB04	Road_Transect	1.00	7.58	2.60	8.00	1	15548.72
MS-HP-CB05	Road_Transect	1.00	7.58	2.60	8.00	1	15189.41
MS-HP-CB06	Road_Transect	1.00	7.58	2.60	8.00	1	14821.65
MS-HP-CB07	Road_Transect	1.00	7.58	2.60	8.00	1	17869.66
MS-HP-CB08	Road_Transect	1.00	7.58	2.60	8.00	1	15548.72
MS-HP-CB09	Road_Transect	1.00	7.58	2.60	8.00	1	16912.32
MS-HP-CB10	Road_Transect	1.00	7.58	2.60	8.00	1	15900.17
MS-HP-CB11	Road_Transect	1.00	7.58	2.60	8.00	1	16912.32
MS-HP-CB12	RECT_OPEN	1.00	3.00	0.60	3.00	1	38482.72
MS-HP-LCB1	TRAPEZOIDAL	1.00	3.30	0.50	6.30	1	9227.89
MS-HP-LCB2	TRAPEZOIDAL	1.00	3.30	0.50	6.30	1	7004.61
MS-HP-LCB3	TRAPEZOIDAL	1.00	3.30	0.50	6.30	1	7602.55
MS-HP-LCB4	TRAPEZOIDAL	1.00	3.30	0.50	6.30	1	7650.06
MS-HP-LCB5	TRAPEZOIDAL	1.00	3.30	0.50	6.30	1	13880.50
MS-HP-LCB6	TRAPEZOIDAL	1.00	3.30	0.50	6.30	1	13023.15
MS-HP-RYCB3	TRAPEZOIDAL	1.00	3.30	0.50	6.30	1	7534.41
MS-HP-RYCB4	TRAPEZOIDAL	1.00	3.30	0.50	6.30	1	7815.19
MS-LCB1	TRAPEZOIDAL	1.00	3.30	0.50	6.30	1	7342.14
MS-LCB2	TRAPEZOIDAL	1.00	3.30	0.50	6.30	1	8380.47
MS-LCB3	TRAPEZOIDAL	1.00	3.30	0.50	6.30	1	9094.00
MS-LCB4	TRAPEZOIDAL	1.00	3.30	0.50	6.30	1	8380.47
MS-RYCB01	TRAPEZOIDAL	1.00	3.30	0.50	6.30	1	6773.64
MS-RYCB3	TRAPEZOIDAL	1.00	3.30	0.50	6.30	1	6955.34
MS-RYCB4	TRAPEZOIDAL	1.00	3.30	0.50	6.30	1	10871.25
MS-RYCB5	TRAPEZOIDAL	1.00	3.30	0.50	6.30	1	17015.17
MS-RYCB6	TRAPEZOIDAL	1.00	3.30	0.50	6.30	1	8224.67
RYCB4-LCB2	CIRCULAR	0.25	0.05	0.06	0.25	1	59.19
RYCB5-RYCB6	CIRCULAR	0.25	0.05	0.06	0.25	1	59.47

Transsect Summary

Transsect Road_Transect					
Area:	0.0026	0.0106	0.0238	0.0397	0.0571
	0.0756	0.0941	0.1145	0.1355	0.1566
	0.1777	0.1987	0.2198	0.2408	0.2619
	0.2830	0.3040	0.3251	0.3462	0.3673
	0.3883	0.4094	0.4305	0.4516	0.4726
	0.4937	0.5148	0.5359	0.5570	0.5781
	0.5991	0.6202	0.6413	0.6624	0.6835
	0.7046	0.7257	0.7468	0.7679	0.7890
	0.8101	0.8312	0.8523	0.8734	0.8945
	0.9156	0.9367	0.9578	0.9789	1.0000
Brad:	0.0038	0.0076	0.0114	0.0183	0.0234
	0.0307	0.0381	0.0491	0.0681	0.0910
	0.1162	0.1427	0.1700	0.1977	0.2255
	0.2533	0.2810	0.3084	0.3355	0.3623
	0.3888	0.4148	0.4405	0.4658	0.4906
	0.5151	0.5391	0.5628	0.5861	0.6090
	0.6316	0.6537	0.6756	0.6970	0.7182
	0.7390	0.7595	0.7796	0.7995	0.8191
	0.8384	0.8574	0.8761	0.8945	0.9127
	0.9307	0.9484	0.9658	0.9830	1.0000
Width:	0.2503	0.5007	0.7510	0.7761	0.8744
	0.8748	0.9057	0.9976	0.9976	0.9977
	0.9978	0.9978	0.9979	0.9979	0.9980
	0.9980	0.9981	0.9982	0.9982	0.9983
	0.9983	0.9984	0.9985	0.9985	0.9986
	0.9986	0.9987	0.9987	0.9988	0.9989
	0.9989	0.9990	0.9990	0.9991	0.9991
	0.9992	0.9993	0.9993	0.9994	0.9994
	0.9995	0.9995	0.9996	0.9997	0.9997
	0.9998	0.9998	0.9999	0.9999	1.0000

NOTE: The summary statistics displayed in this report are based on results found at every computational time step, not just on results from each reporting time step.

Analysis Options

Flow Units LPS

**200 Baribeau Street (119068)
PCSWMM Model Output
100yr 3-hour Chicago Storm**



Process Models:
 Rainfall/Runoff YES
 RDII NO
 Snowmelt NO
 Groundwater NO
 Flow Routing YES
 Ponding Allowed NO
 Water Quality NO
 Infiltration Method HORTON
 Flow Routing Method DYNWAVE
 SurchARGE Method EXTRAN
 Starting Date 07/29/2020 00:00:00
 Ending Date 07/30/2020 00:00:00
 Antecedent Dry Days 0.0
 Report Time Step 00:01:00
 Wet Time Step 00:05:00
 Dry Time Step 00:05:00
 Routing Time Step 5.00 sec
 Variable Time Step YES
 Maximum Trials 8
 Number of Threads 4
 Head Tolerance 0.001500 m

	Volume hectare-m	Depth mm
Runoff Quantity Continuity		
Total Precipitation	0.090	71.667
Evaporation Loss	0.000	0.000
Infiltration Loss	0.018	14.237
Surface Runoff	0.073	57.694
Final Storage	0.001	0.550
Continuity Error (%)	-1.136	

	Volume hectare-m	Volume 10^6 ltr
Flow Routing Continuity		
Dry Weather Inflow	0.000	0.000
Wet Weather Inflow	0.073	0.726
Groundwater Inflow	0.000	0.000
RDII Inflow	0.000	0.000
External Inflow	0.000	0.002
External Outflow	0.073	0.734
Flooding Loss	0.000	0.000
Evaporation Loss	0.000	0.000
Exfiltration Loss	0.000	0.000
Initial Stored Volume	0.009	0.086
Final Stored Volume	0.009	0.086
Continuity Error (%)	-0.782	

Highest Continuity Errors

Node RYCB5 (4.61%)
Node CB09 (-3.21%)
Node CB03 (-2.82%)
Node CB01 (-2.40%)
Node CB08 (-2.18%)

Time-Step Critical Elements

Link MS-CB02 (1.64%)

Highest Flow Instability Indexes

Link RYCB6-ICD (126)
Link RYCB3-ICD (120)
Link MH18-MH20 (112)
Link MH06-MH18 (51)
Link RYCB1-ICD (42)

Routing Time Step Summary

Minimum Time Step	: 0.96 sec
-------------------	------------

Average Time Step	: 4.93 sec
Maximum Time Step	: 5.00 sec
Percent in Steady State	: 0.00
Average Iterations per Step	: 2.02
Percent Not Converging	: 0.10

Subcatchment Runoff Summary

Subcatchment	Runoff 10^6 ltr	Peak Runoff LPS	Runoff Coeff	Total Precip mm	Total Runon mm	Total Evap mm	Total Infil mm	Imperv Runoff mm	Perv Runoff mm	Total Runoff mm
A-01	0.01	10.90	0.382	71.67	0.00	0.00	45.35	0.00	27.36	27.36
A-02	0.02	18.50	0.800	71.67	0.00	0.00	14.38	47.72	9.65	57.37
A-03	0.07	49.07	0.922	71.67	0.00	0.00	5.68	62.08	3.99	66.07
A-04	0.05	35.45	0.916	71.67	0.00	0.00	6.02	61.35	4.30	65.66
A-05	0.05	35.17	0.892	71.67	0.00	0.00	7.83	58.40	5.50	63.90
A-06	0.06	45.62	0.953	71.67	0.00	0.00	3.29	65.84	2.42	68.26
A-07	0.04	30.08	0.776	71.67	0.00	0.00	16.14	44.90	10.72	55.62
A-08	0.01	10.36	0.382	71.67	0.00	0.00	45.35	0.00	27.36	27.36
A-09	0.02	13.85	0.669	71.67	0.00	0.00	24.92	31.38	16.53	47.91
A-10	0.01	12.56	0.625	71.67	0.00	0.00	14.56	47.43	9.76	57.19
A-11	0.05	37.88	0.798	71.67	0.00	0.00	3.24	65.92	2.39	68.31
A-12	0.06	46.11	0.953	71.67	0.00	0.00	7.52	58.90	5.30	64.20
A-13	0.05	39.57	0.896	71.67	0.00	0.00	6.50	60.46	4.63	65.08
A-14	0.06	42.65	0.908	71.67	0.00	0.00	4.39	63.93	3.19	67.12
A-15	0.04	29.32	0.937	71.67	0.00	0.00	11.35	52.46	7.75	60.21
A-16	0.04	33.09	0.840	71.67	0.00	0.00	26.64	28.66	17.57	46.23
A-17	0.01	12.76	0.645	71.67	0.00	0.00	37.51	11.46	24.03	35.49
A-18	0.01	9.26	0.495	71.67	0.00	0.00	19.90	39.41	13.43	52.85
A-19	0.01	9.04	0.737	71.67	0.00	0.00	25.33	30.74	16.77	47.51
A-20	0.01	12.07	0.663	71.67	0.00	0.00	36.19	13.54	23.26	36.79
A-21	0.00	3.40	0.513	71.67	0.00	0.00	22.68	34.24	15.15	49.39
B-01	0.02	15.46	0.689	71.67	0.00	0.00	29.80	23.16	19.47	42.62
B-02	0.02	20.95	0.595	71.67	0.00	0.00				

Node Depth Summary

Node	Type	Average Depth Meters	Maximum Depth Meters	Maximum HGL Meters	Time of Max Occurrence days hr:min	Reported Max Depth Meters
HP-CB01	JUNCTION	0.00	0.07	56.65	0 01:14	0.07
HP-CB02	JUNCTION	0.00	0.09	56.62	0 01:16	0.09
HP-CB03	JUNCTION	0.00	0.02	56.60	0 01:24	0.02
HP-CB04	JUNCTION	0.00	0.00	56.65	0 00:00	0.00

**200 Baribeau Street (119068)
PCSWMM Model Output
100yr 3-hour Chicago Storm**



HP-CB05	JUNCTION	0.00	0.00	56.71	0	00:00	0.00		
HP-CB06	JUNCTION	0.00	0.06	56.69	0	01:14	0.06		
HP-CB07	JUNCTION	0.00	0.00	56.72	0	00:00	0.00		
HP-CB08	JUNCTION	0.00	0.04	56.74	0	01:20	0.04		
HP-CB09	JUNCTION	0.00	0.03	56.79	0	01:23	0.03		
HP-CB10	JUNCTION	0.00	0.03	56.81	0	01:20	0.03		
HP-CB11	JUNCTION	0.00	0.04	56.86	0	01:19	0.04		
HP-CB12	JUNCTION	0.00	0.00	56.50	0	01:29	0.00		
HP-LCB1	JUNCTION	0.00	0.00	55.85	0	00:00	0.00		
HP-LCB2	JUNCTION	0.00	0.00	55.65	0	00:00	0.00		
HP-LCB3	JUNCTION	0.00	0.07	55.82	0	01:13	0.07		
HP-LCB4	JUNCTION	0.00	0.00	55.70	0	00:00	0.00		
HP-LCB6	JUNCTION	0.00	0.00	55.65	0	00:00	0.00		
HP-RYCB1	JUNCTION	0.00	0.04	55.84	0	01:10	0.04		
HP-RYCB3	JUNCTION	0.00	0.04	55.79	0	01:12	0.04		
HP-RYCB4	JUNCTION	0.00	0.00	55.90	0	00:00	0.00		
HP-RYCB5	OUTFALL	0.00	0.08	55.58	0	01:10	0.06		
OF1	OUTFALL	0.00	0.00	56.00	0	00:00	0.00		
OF2	OUTFALL	4.00	4.00	55.05	0	00:00	4.00		
CB01	STORAGE	0.11	1.50	56.65	0	01:14	1.50		
CB02	STORAGE	0.09	1.52	56.62	0	01:16	1.52		
CB02-Dummy	STORAGE	2.51	2.58	55.13	0	01:22	2.58		
CB03	STORAGE	0.13	1.45	56.60	0	01:24	1.45		
CB04	STORAGE	0.11	1.42	56.64	0	01:26	1.42		
CB05	STORAGE	0.08	1.41	56.69	0	01:25	1.41		
CB06	STORAGE	0.13	1.49	56.69	0	01:14	1.49		
CB07	STORAGE	0.15	1.43	56.72	0	01:31	1.43		
CB08	STORAGE	0.11	1.47	56.74	0	01:20	1.47		
CB09	STORAGE	0.15	1.46	56.79	0	01:23	1.46		
CB10	STORAGE	0.12	1.46	56.81	0	01:20	1.46		
CB11	STORAGE	0.15	1.47	56.86	0	01:18	1.47		
CB12	STORAGE	0.12	1.40	56.50	0	01:29	1.40		
LCB1	STORAGE	0.81	1.55	55.81	0	01:11	1.55		
LCB2	STORAGE	0.83	1.38	55.63	0	01:14	1.38		
LCB3	STORAGE	0.54	1.27	55.82	0	01:13	1.27		
LCB4	STORAGE	0.58	1.16	55.66	0	01:14	1.16		
MH02	STORAGE	2.32	2.40	55.14	0	01:22	2.40		
MH04	STORAGE	2.18	2.27	55.15	0	01:22	2.27		
MH06	STORAGE	2.72	2.79	55.12	0	01:22	2.79		
MH08	STORAGE	1.80	1.88	55.14	0	01:21	1.88		
MH10	STORAGE	2.01	2.08	55.13	0	01:21	2.08		
MH12	STORAGE	1.48	1.56	55.14	0	01:21	1.56		
MH14	STORAGE	1.98	2.08	55.16	0	01:22	2.08		
MH16	STORAGE	1.83	1.94	55.17	0	01:22	1.94		
MH18	STORAGE	2.97	3.02	55.10	0	01:20	3.02		
MH20	STORAGE	3.11	3.15	55.09	0	01:20	3.15		
MH22	STORAGE	1.72	1.82	55.16	0	01:22	1.82		
MH24	STORAGE	1.50	1.61	55.17	0	01:22	1.61		
MH26	STORAGE	1.53	1.64	55.17	0	01:22	1.64		
MH28	STORAGE	1.28	1.40	55.18	0	01:22	1.40		
RYCB1	STORAGE	0.88	1.62	55.83	0	01:13	1.62		
RYCB3	STORAGE	1.04	1.77	55.80	0	01:11	1.77		
RYCB4	STORAGE	0.44	1.18	55.83	0	01:13	1.18		
RYCB5	STORAGE	1.05	1.55	55.57	0	01:14	1.55		
RYCB6	STORAGE	1.30	1.80	55.57	0	01:13	1.80		

Node Inflow Summary

Node	Type	Maximum Lateral Inflow LPS	Maximum Total Inflow LPS	Time of Max Occurrence days hr:min	Lateral Inflow Volume 10 ⁶ ltr	Total Inflow Volume 10 ⁶ ltr	Flow Balance Error Percent
HP-CB01	JUNCTION	0.00	25.11	0 01:13	0	0.016	-0.056
HP-CB02	JUNCTION	0.00	22.44	0 01:18	0	0.013	2.394
HP-CB03	JUNCTION	0.00	1.15	0 01:21	0	0.000322	-1.088
HP-CB04	JUNCTION	0.00	0.00	0 00:00	0	0	0.000 ltr
HP-CB05	JUNCTION	0.00	0.00	0 00:00	0	0	0.000 ltr
HP-CB06	JUNCTION	0.00	15.64	0 01:14	0	0.00996	0.283
HP-CB07	JUNCTION	0.00	0.00	0 00:00	0	0	0.000 ltr
HP-CB08	JUNCTION	0.00	8.07	0 01:20	0	0.00522	0.363
HP-CB09	JUNCTION	0.00	3.58	0 01:21	0	0.00117	0.982
HP-CB10	JUNCTION	0.00	4.81	0 01:14	0	0.00222	0.895
HP-CB11	JUNCTION	0.00	8.53	0 01:18	0	0.00484	-0.179
HP-CB12	JUNCTION	0.00	0.01	0 01:29	0	9.11e-08	0.091 ltr
HP-LCB1	JUNCTION	0.00	0.00	0 00:00	0	0	0.000 ltr
HP-LCB2	JUNCTION	0.00	0.00	0 00:00	0	0	0.000 ltr
HP-LCB3	JUNCTION	0.00	16.43	0 01:13	0	0.0117	-0.123

HP-LCB4	JUNCTION	0.00	0.00	0 00:00	0	0	0.000 ltr
HP-LCB6	JUNCTION	0.00	0.00	0 00:00	0	0	0.000 ltr
HP-RYCB1	JUNCTION	10.36	10.36	0 01:10	0.0104	0.0104	0.277
HP-RYCB3	JUNCTION	0.00	7.57	0 01:11	0	0.00226	-0.558
HP-RYCB4	JUNCTION	0.00	0.00	0 00:00	0	0	0.000 ltr
HP-RYCB5	OUTFALL	0.00	48.50	0 01:10	0	0.0222	0.000
OF1	OUTFALL	36.41	36.41	0 01:10	0.039	0.039	0.000
OF2	OUTFALL	0.00	99.09	0 01:20	0	0.676	0.000
CB01	STORAGE	42.65	42.65	0 01:10	0.0572	0.0671	-2.347
CB02	STORAGE	29.32	38.95	0 01:13	0.0402	0.0563	-0.325
CB02-Dummy	STORAGE	0.00	52.67	0 01:23	0	0.43	0.000
CB03	STORAGE	37.88	37.88	0 01:10	0.0468	0.0469	-2.746
CB04	STORAGE	30.08	30.08	0 01:10	0.0367	0.0377	-2.007
CB05	STORAGE	18.50	18.50	0 01:10	0.0229	0.0277	-0.190
CB06	STORAGE	39.57	39.57	0 01:10	0.0526	0.0578	-2.030
CB07	STORAGE	46.11	46.11	0 01:10	0.0641	0.0641	0.257
CB08	STORAGE	35.17	35.17	0 01:10	0.0466	0.0487	-2.137
CB09	STORAGE	45.62	45.62	0 01:10	0.0634	0.0635	-3.111
CB10	STORAGE	35.45	35.45	0 01:10	0.0479	0.0479	0.067
CB11	STORAGE	49.07	49.07	0 01:10	0.0666	0.0667	-1.629
CB12	STORAGE	33.09	36.00	0 01:18	0.0421	0.055	-0.063
LCB1	STORAGE	12.07	12.07	0 01:10	0.0133	0.0142	0.024
LCB2	STORAGE	12.76	28.15	0 01:13	0.0138	0.0403	-0.013
LCB3	STORAGE	13.85	19.07	0 01:11	0.0153	0.0245	0.140
LCB4	STORAGE	12.56	23.56	0 01:12	0.0134	0.0257	0.092
MH02	STORAGE	0.00	44.92	0 01:23	0	0.389	0.000
MH04	STORAGE	0.00	37.16	0 01:23	0	0.336	0.000
MH06	STORAGE	0.00	82.99	0 01:24	0	0.628	0.001
MH08	STORAGE	0.00	18.04	0 01:17	0	0.0962	-0.005
MH10	STORAGE	0.00	24.10	0 01:21	0	0.144	0.000
MH12	STORAGE	0.00	5.99	0 01:25	0	0.0301	-0.001
MH14	STORAGE	0.00	37.15	0 01:23	0	0.336	-0.000
MH16	STORAGE	0.00	24.71	0 01:22	0	0.222	-0.000
MH18	STORAGE	0.00	90.72	0 01:23	0	0.659	-0.000
MH20	STORAGE	0.00	99.08	0 01:20	0	0.68	-0.025
MH22	STORAGE	0.00	6.04	0 01:31	0	0.0664	-0.001
MH24	STORAGE	0.00	6.10	0 01:23	0	0.0665	-0.002
MH26	STORAGE	0.00	12.26	0 01:19	0	0.112	0.000
MH28	STORAGE	0.00	6.14	0 01:18	0	0.0649	-0.002
RYCB1	STORAGE	0.00	18.28	0 00:00	0	0.0309	0.780
RYCB3	STORAGE	9.04	18.87	0 01:10	0.0106	0.0263	0.081
RYCB4	STORAGE	10.90	10.90	0 01:10	0.0109	0.0121	0.047
RYCB5	STORAGE	3.40	41.02	0 01:09	0.0033	0.046	4.830
RYCB6	STORAGE	9.26	25.36	0 01:09	0.00885	0.0344	0.583

Node Surcharge Summary

No nodes were surcharged.

Node Flooding Summary

No nodes were flooded.

Storage Volume Summary

Storage Unit	Average Volume 1000 m3	Avg Port Full	Evap Port	Exfil Port	Maximum Volume 1000 m3	Max Port Full	Time of Max Occurrence days hr:min	Maximum Outflow LPS
CB01	0.001	6	0	0	0.019	100	0 01:10	32.91
CB02	0.001	6	0	0	0.015	100	0 01:13	30.23
CB02-Dummy	0.000	65	0	0	0.000	67	0 01:22	52.67
CB03	0.001	7	0	0	0.020	100	0 01:21	7.21
CB04	0.001	5	0	0	0.015	89	0 01:26	6.03
CB05	0.000	4	0	0	0.009	82	0 01:25	5.99
CB06	0.001	7	0	0	0.020	100	0 01:11	22.06
CB07	0.003	9	0	0	0.035	97	0 01:31	6.04
CB08	0.001	7	0	0	0.017	100	0 01:12	14.46
CB09	0.003	10	0	0	0.035	100	0 01:20	9.65
CB10	0.001	7	0	0	0.020	100	0 01:14	10.88
CB11	0.003	10	0	0	0.033	100	0 01:14	14.66
CB12	0.003	8	0	0	0.032	97	0 01:29	6.23

**200 Baribeau Street (119068)
PCSWMM Model Output
100yr 3-hour Chicago Storm**

LCB1	0.000	34	0	0	0.001	64	0	01:11	10.20
LCB2	0.000	38	0	0	0.000	63	0	01:14	27.23
LCB3	0.000	27	0	0	0.000	64	0	01:13	16.43
LCB4	0.000	29	0	0	0.000	58	0	01:14	21.69
MH02	0.003	62	0	0	0.003	64	0	01:22	44.92
MH04	0.002	60	0	0	0.003	62	0	01:22	37.17
MH06	0.003	66	0	0	0.003	68	0	01:22	83.01
MH08	0.002	53	0	0	0.002	56	0	01:21	18.04
MH10	0.002	57	0	0	0.002	59	0	01:21	24.12
MH12	0.002	47	0	0	0.002	49	0	01:21	6.01
MH14	0.002	58	0	0	0.002	61	0	01:22	37.16
MH16	0.002	54	0	0	0.002	58	0	01:22	24.72
MH18	0.003	88	0	0	0.003	90	0	01:20	90.73
MH20	0.004	85	0	0	0.004	86	0	01:20	99.09
MH22	0.002	52	0	0	0.002	55	0	01:22	6.06
MH24	0.002	48	0	0	0.002	52	0	01:22	6.11
MH26	0.002	48	0	0	0.002	52	0	01:22	12.25
MH28	0.001	43	0	0	0.002	47	0	01:22	6.14
RYCB1	0.000	36	0	0	0.001	66	0	01:13	11.82
RYCB3	0.000	41	0	0	0.001	69	0	01:11	16.36
RYCB4	0.000	22	0	0	0.000	59	0	01:13	8.58
RYCB5	0.000	47	0	0	0.001	70	0	01:14	57.06
RYCB6	0.000	50	0	0	0.001	69	0	01:13	18.06

Outfall Loading Summary

Outfall Node	Flow Freq Pcnt	Avg Flow LPS	Max Flow LPS	Total Volume 10 ⁶ ltr
HP-RYCB5	3.10	16.97	48.50	0.022
OF1	13.40	4.66	36.41	0.039
OF2	68.18	13.18	99.09	0.676
System	28.23	34.80	99.09	0.737

Link Flow Summary

Link	Type	Maximum Flow LPS	Time of Max Occurrence days hr:min	Maximum Veloc m/sec	Max/ Full Flow	Max/ Full Depth
Dummy-MH06	CONDUIT	52.67	0 01:23	0.33	0.21	1.00
LCB1-RYCB3	CONDUIT	10.20	0 01:10	0.21	0.17	1.00
LCB3-RYCB1	CONDUIT	8.44	0 01:06	0.17	0.14	1.00
LCB4-LCB5	CONDUIT	21.69	0 01:14	0.44	0.36	1.00
LCB5-RYCB5	CONDUIT	27.23	0 01:14	0.55	0.46	1.00
MH02-CB02-Dummy	CONDUIT	44.92	0 01:23	0.28	0.18	1.00
MH04-MH02	CONDUIT	37.17	0 01:24	0.34	0.25	1.00
MH06-MH18	CONDUIT	83.01	0 01:24	0.38	0.21	1.00
MH08-MH06	CONDUIT	24.12	0 01:24	0.22	0.14	1.00
MH10-MH8	CONDUIT	18.04	0 01:17	0.26	0.19	1.00
MH12-MH10	CONDUIT	6.01	0 01:29	0.12	0.10	1.00
MH14-MH4	CONDUIT	37.16	0 01:23	0.34	0.31	1.00
MH16-MH14	CONDUIT	24.72	0 01:23	0.22	0.20	1.00
MH18-MH18	CONDUIT	90.73	0 01:23	0.42	0.22	1.00
MH20-OF2	CONDUIT	99.09	0 01:20	0.46	0.25	1.00
MH22-MH14	CONDUIT	6.06	0 01:32	0.12	0.10	1.00
MH24-MH16	CONDUIT	6.11	0 01:24	0.12	0.10	1.00
MH26-MH16	CONDUIT	12.25	0 01:19	0.17	0.15	1.00
MH28-MH26	CONDUIT	6.14	0 01:19	0.13	0.10	1.00
MS-CB01	CHANNEL	25.11	0 01:13	0.03	0.00	0.14
MS-CB02	CHANNEL	22.44	0 01:18	0.03	0.00	0.16
MS-CB03	CHANNEL	1.15	0 01:21	0.00	0.00	0.09
MS-CB04	CHANNEL	0.00	0 00:00	0.00	0.00	0.07
MS-CB05	CHANNEL	0.00	0 00:00	0.00	0.00	0.06
MS-CB06	CHANNEL	15.64	0 01:14	0.02	0.00	0.13
MS-CB07	CHANNEL	0.00	0 00:00	0.00	0.00	0.07
MS-CB08	CHANNEL	8.07	0 01:20	0.02	0.00	0.12
MS-CB09	CHANNEL	3.58	0 01:21	0.01	0.00	0.10
MS-CB10	CHANNEL	4.81	0 01:14	0.01	0.00	0.11
MS-CB11	CHANNEL	8.53	0 01:18	0.02	0.00	0.12
MS-CB12	CHANNEL	0.01	0 01:29	0.00	0.00	0.06
MS-HP-CB01	CHANNEL	24.92	0 01:14	0.04	0.00	0.15

MS-HP-CB02	CHANNEL	26.16	0 01:18	0.11	0.00	0.08
MS-HP-CB03	CHANNEL	0.61	0 01:24	0.00	0.00	0.07
MS-HP-CB04	CHANNEL	0.00	0 00:00	0.00	0.00	0.08
MS-HP-CB05	CHANNEL	0.00	0 00:00	0.00	0.00	0.07
MS-HP-CB06	CHANNEL	15.07	0 01:14	0.02	0.00	0.14
MS-HP-CB07	CHANNEL	0.00	0 00:00	0.00	0.00	0.08
MS-HP-CB08	CHANNEL	8.02	0 01:20	0.01	0.00	0.12
MS-HP-CB09	CHANNEL	2.73	0 01:23	0.01	0.00	0.08
MS-HP-CB10	CHANNEL	4.27	0 01:20	0.01	0.00	0.11
MS-HP-CB11	CHANNEL	8.50	0 01:19	0.03	0.00	0.08
MS-HP-CB12	CONDUIT	0.00	0 00:00	0.00	0.00	0.09
MS-HP-LCB1	CONDUIT	0.00	0 00:00	0.00	0.00	0.10
MS-HP-LCB2	CONDUIT	5.13	0 01:10	0.27	0.00	0.15
MS-HP-LCB3	CONDUIT	16.34	0 01:13	0.29	0.00	0.12
MS-HP-LCB4	CONDUIT	0.00	0 00:00	0.00	0.00	0.09
MS-HP-LCB5	CONDUIT	0.00	0 00:00	0.00	0.00	0.16
MS-HP-LCB6	CONDUIT	0.00	0 00:00	0.00	0.00	0.16
MS-HP-RYCB3	CONDUIT	7.05	0 01:12	0.10	0.00	0.11
MS-HP-RYCB4	CONDUIT	0.00	0 00:00	0.00	0.00	0.09
MS-LCB1	CONDUIT	0.00	0 00:00	0.00	0.00	0.07
MS-LCB2	CONDUIT	0.00	0 00:00	0.00	0.00	0.09
MS-LCB3	CONDUIT	16.43	0 01:13	0.12	0.00	0.17
MS-LCB4	CONDUIT	0.00	0 00:00	0.00	0.00	0.08
MS-RYCB01	CONDUIT	4.96	0 01:10	0.28	0.00	0.11
MS-RYCB3	CONDUIT	7.57	0 01:11	0.09	0.00	0.13
MS-RYCB4	CONDUIT	0.00	0 00:00	0.00	0.00	0.09
MS-RYCB5	CONDUIT	48.50	0 01:10	0.41	0.00	0.19
MS-RYCB6	CONDUIT	0.00	0 00:00	0.00	0.00	0.09
RYCB4-LCB2	CONDUIT	8.58	0 00:00	0.17	0.15	1.00
RYCB5-RYCB6	CONDUIT	13.26	0 01:09	0.27	0.22	1.00
CB01-ICD	ORIFICE	7.80	0 01:14			1.00
CB02-ICD	ORIFICE	7.83	0 01:16			1.00
CB03-ICD	ORIFICE	6.08	0 01:24			1.00
CB04-ICD	ORIFICE	6.03	0 01:26			1.00
CB05-ICD	ORIFICE	5.99	0 01:25			1.00
CB06-ICD	ORIFICE	6.42	0 01:14			1.00
CB07-ICD	ORIFICE	6.04	0 01:31			1.00
CB08-ICD	ORIFICE	6.39	0 01:20			1.00
CB09-ICD	ORIFICE	6.10	0 01:23			1.00
CB10-ICD	ORIFICE	6.12	0 01:20			1.00
CB11-ICD	ORIFICE	6.14	0 01:18			1.00
CB12-ICD	ORIFICE	6.22	0 01:29			1.00
RYCB1-ICD	ORIFICE	6.17	0 01:13			1.00
RYCB3-ICD	ORIFICE	8.79	0 01:11			1.00
RYCB6-ICD	ORIFICE	8.04	0 01:10			1.00

Flow Classification Summary

Conduit	Adjusted /Actual Length	Fraction of Time in Flow Class								
		Dry	Up Dry	Down Dry	Sub Crit	Sup Crit	Up Crit	Down Crit	Norm Ltd	Inlet Ctrl
Dummy-MH06	1.00	0.00	0.00	0.00	1.00	0.00	0.00	0.00	0.00	0.00
LCB1-RYCB3	1.00	0.00	0.00	0.00	1.00	0.00	0.00	0.00	0.00	0.00
LCB3-RYCB1	1.00	0.00	0.00	0.00	1.00	0.00	0.00	0.00	0.00	0.00
LCB4-LCB5	1.00	0.00	0.00	0.00	1.00	0.00	0.00	0.00	0.00	0.00
LCB5-RYCB5	1.00	0.00	0.00	0.00	1.00	0.00	0.00	0.00	0.00	0.00
MH02-CB02-Dummy	1.00	0.00	0.00	0.00	1.00	0.00	0.00	0.00	0.00	0.00
MH04-MH02	1.00	0.00	0.00	0.00	1.00	0.00	0.00	0.00	0.00	0.00
MH06-MH18	1.00	0.00	0.00	0.00	1.00	0.00	0.00	0.00	0.00	0.00
MH08-MH06	1.00	0.00	0.00	0.00	1.00	0.00	0.00	0.00	0.00	0.00
MH10-MH8	1.00	0.00	0.00	0.00	1.00	0.00	0.00	0.00	0.00	0.00
MH12-MH10	1.00	0.00	0.00	0.00	1.00	0.00	0.00	0.00	0.00	0.00
MH14-MH4	1.00	0.00	0.00	0.00	1.00	0.00	0.00	0.00	0.00	0.00
MH16-MH14	1.00	0.00	0.00	0.00	1.00	0.00	0.00	0.00	0.00	0.00
MH18-MH20	1.00	0.00	0.00	0.00	1.00	0.00	0.00	0.00	0.00	0.00
MH20-OF2	1.00	0.00	0.00	0.00	1.00	0.00	0.00	0.00	0.00	0.00
MH22-MH14	1.00	0.00	0.00	0.00	1.00	0.00	0.00	0.00	0.00	0.00
MH24-MH16	1.00	0.00	0.00	0.00	1.00	0.00	0.00	0.00	0.00	0.00
MH26-MH16	1.00	0.00	0.00	0.00	1.00	0.00	0.00	0.00	0.00	0.00
MH28-MH26	1.00	0.00	0.00	0.00	1.00	0.00	0.00	0.00	0.00	0.00
MS-CB01	1.00	0.04	0.00	0.00	0.06	0.00	0.00	0.89	0.03	0.00
MS-CB02	1.00	0.05	0.01	0.00	0.04	0.00	0.00	0.90	0.02	0.00
MS-CB03	1.00	0.04	0.01	0.00	0.07	0.00	0.00	0.87	0.05	0.00
MS-CB04	1.00	0.94	0.06	0.00	0.00	0.00	0.00	0.00	0.00	0.00
MS-CB05	1.00	0.96	0.04	0.00	0.00	0.00	0.00	0.00	0.00	0.00
MS-CB06	1.00	0.04	0.00	0.00	0.07	0.00	0.00	0.88	0.04	0.00
MS-CB07	1.00	0.92	0.08	0.00	0.00	0.00	0.00	0.00	0.00	0.00

**200 Baribeau Street (119068)
 PCSWMM Model Output
 100yr 3-hour Chicago Storm**

MS-CB08	1.00	0.05	0.00	0.00	0.06	0.00	0.00	0.89	0.03	0.00
MS-CB09	1.00	0.05	0.01	0.00	0.06	0.00	0.00	0.87	0.05	0.00
MS-CB10	1.00	0.04	0.01	0.00	0.06	0.00	0.00	0.89	0.04	0.00
MS-CB11	1.00	0.05	0.01	0.00	0.07	0.00	0.00	0.88	0.04	0.00
MS-CB12	1.00	0.95	0.05	0.00	0.00	0.00	0.00	0.00	0.94	0.00
MS-HP-CB01	1.00	0.05	0.00	0.00	0.05	0.00	0.00	0.90	0.04	0.00
MS-HP-CB02	1.00	0.05	0.00	0.00	0.05	0.00	0.00	0.90	0.04	0.00
MS-HP-CB03	1.00	0.06	0.00	0.00	0.05	0.00	0.00	0.89	0.04	0.00
MS-HP-CB04	1.00	0.92	0.08	0.00	0.00	0.00	0.00	0.00	0.00	0.00
MS-HP-CB05	1.00	0.94	0.06	0.00	0.00	0.00	0.00	0.00	0.00	0.00
MS-HP-CB06	1.00	0.04	0.00	0.00	0.06	0.00	0.00	0.89	0.05	0.00
MS-HP-CB07	1.00	0.92	0.08	0.00	0.00	0.00	0.00	0.00	0.00	0.00
MS-HP-CB08	1.00	0.04	0.01	0.00	0.07	0.00	0.00	0.88	0.05	0.00
MS-HP-CB09	1.00	0.05	0.02	0.00	0.05	0.00	0.00	0.89	0.04	0.00
MS-HP-CB10	1.00	0.05	0.01	0.00	0.06	0.00	0.00	0.89	0.05	0.00
MS-HP-CB11	1.00	0.05	0.01	0.00	0.04	0.00	0.00	0.91	0.03	0.00
MS-HP-CB12	1.00	0.96	0.04	0.00	0.00	0.00	0.00	0.00	0.00	0.00
MS-HP-LCB1	1.00	0.97	0.03	0.00	0.00	0.00	0.00	0.00	0.00	0.00
MS-HP-LCB2	1.00	0.88	0.00	0.00	0.05	0.00	0.00	0.07	0.04	0.00
MS-HP-LCB3	1.00	0.94	0.00	0.00	0.03	0.00	0.00	0.03	0.01	0.00
MS-HP-LCB4	1.00	0.96	0.04	0.00	0.00	0.00	0.00	0.00	0.00	0.00
MS-HP-LCB5	1.00	0.95	0.05	0.00	0.00	0.00	0.00	0.00	0.00	0.00
MS-HP-LCB6	1.00	0.95	0.05	0.00	0.00	0.00	0.00	0.00	0.00	0.00
MS-HP-RYCB3	1.00	0.93	0.00	0.00	0.04	0.00	0.00	0.03	0.03	0.00
MS-HP-RYCB4	1.00	0.96	0.04	0.00	0.00	0.00	0.00	0.00	0.00	0.00
MS-LCB1	1.00	0.97	0.03	0.00	0.00	0.00	0.00	0.00	0.00	0.00
MS-LCB2	1.00	0.96	0.04	0.00	0.00	0.00	0.00	0.00	0.00	0.00
MS-LCB3	1.00	0.94	0.00	0.00	0.05	0.00	0.00	0.01	0.01	0.00
MS-LCB4	1.00	0.97	0.03	0.00	0.00	0.00	0.00	0.00	0.00	0.00
MS-RYCB01	1.00	0.88	0.00	0.00	0.04	0.00	0.00	0.07	0.03	0.00
MS-RYCB3	1.00	0.93	0.00	0.00	0.03	0.00	0.00	0.04	0.01	0.00
MS-RYCB4	1.00	0.96	0.04	0.00	0.00	0.00	0.00	0.00	0.00	0.00
MS-RYCB5	1.00	0.04	0.00	0.00	0.05	0.00	0.00	0.91	0.02	0.00
MS-RYCB6	1.00	0.96	0.04	0.00	0.00	0.00	0.00	0.00	0.00	0.00
RYCB4-LCB2	1.00	0.00	0.00	0.00	1.00	0.00	0.00	0.00	0.00	0.00
RYCB5-RYCB6	1.00	0.00	0.00	0.00	1.00	0.00	0.00	0.00	0.00	0.00

 Conduit Surcharge Summary

Conduit	Hours Full			Hours	
	Both Ends	Upstream	Dnstream	Above Full Normal Flow	Capacity Limited
Dummy-MH06	24.00	24.00	24.00	0.01	0.01
LCB1-RYCB3	24.00	24.00	24.00	0.01	0.01
LCB3-RYCB1	24.00	24.00	24.00	0.01	0.01
LCB4-LCB5	24.00	24.00	24.00	0.01	0.01
LCB5-RYCB5	24.00	24.00	24.00	0.01	0.01
MH02-CB02-Dummy	24.00	24.00	24.00	0.01	0.01
MH04-MH02	24.00	24.00	24.00	0.01	0.01
MH06-MH18	24.00	24.00	24.00	0.01	0.01
MH08-MH06	24.00	24.00	24.00	0.01	0.01
MH10-MH8	24.00	24.00	24.00	0.01	0.01
MH12-MH10	24.00	24.00	24.00	0.01	0.01
MH14-MH4	24.00	24.00	24.00	0.01	0.01
MH16-MH14	24.00	24.00	24.00	0.01	0.01
MH18-MH20	24.00	24.00	24.00	0.01	0.01
MH20-OF2	24.00	24.00	24.00	0.01	0.01
MH22-MH14	24.00	24.00	24.00	0.01	0.01
MH24-MH16	24.00	24.00	24.00	0.01	0.01
MH26-MH16	24.00	24.00	24.00	0.01	0.01
MH28-MH26	24.00	24.00	24.00	0.01	0.01
RYCB4-LCB2	24.00	24.00	24.00	0.01	0.01
RYCB5-RYCB6	24.00	24.00	24.00	0.01	0.01

Analysis begun on: Fri Jun 4 14:57:29 2021
 Analysis ended on: Fri Jun 4 14:57:31 2021
 Total elapsed time: 00:00:02

Overall Model Schematic



Subcatchment ID's

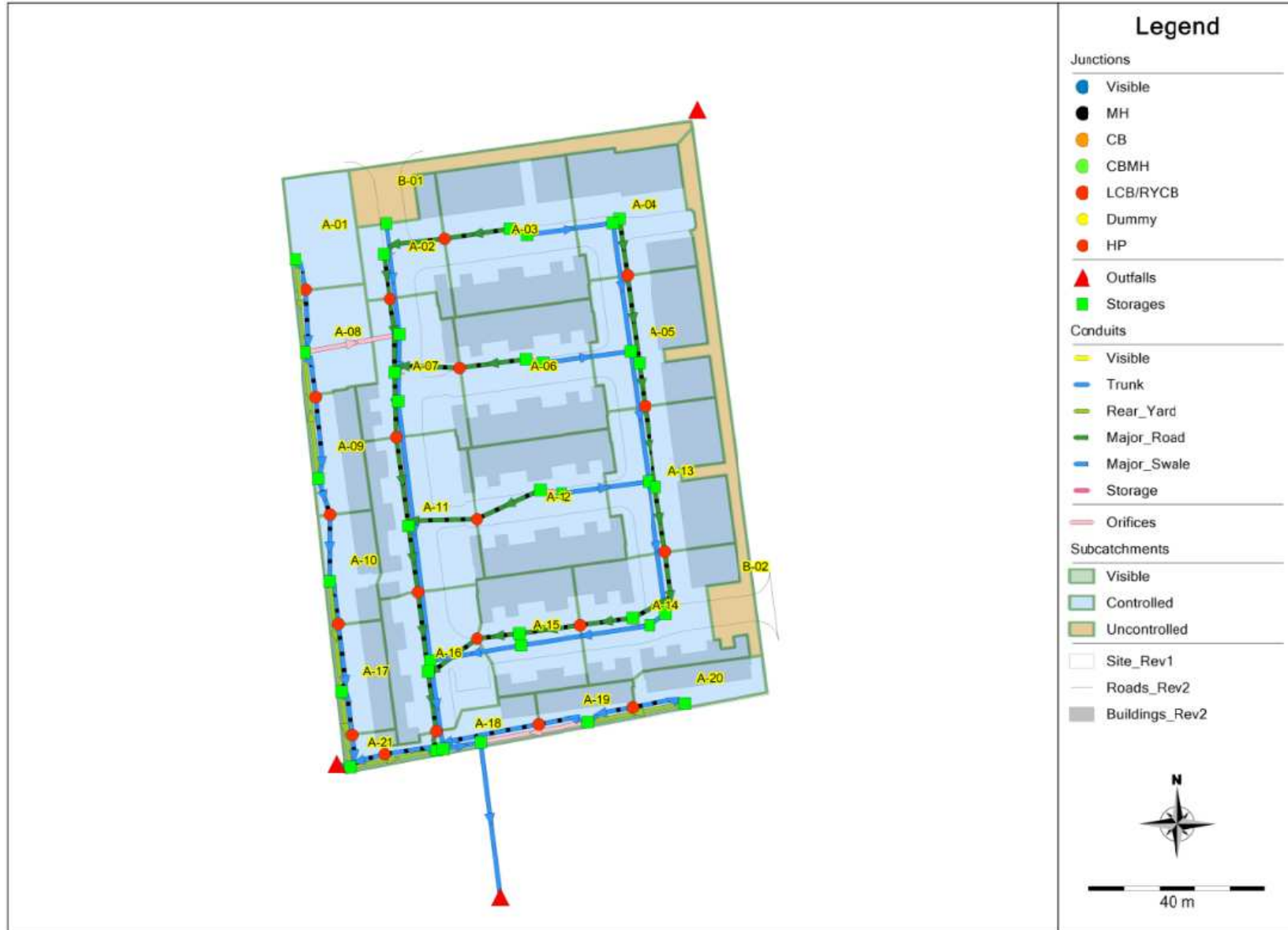

Node ID's

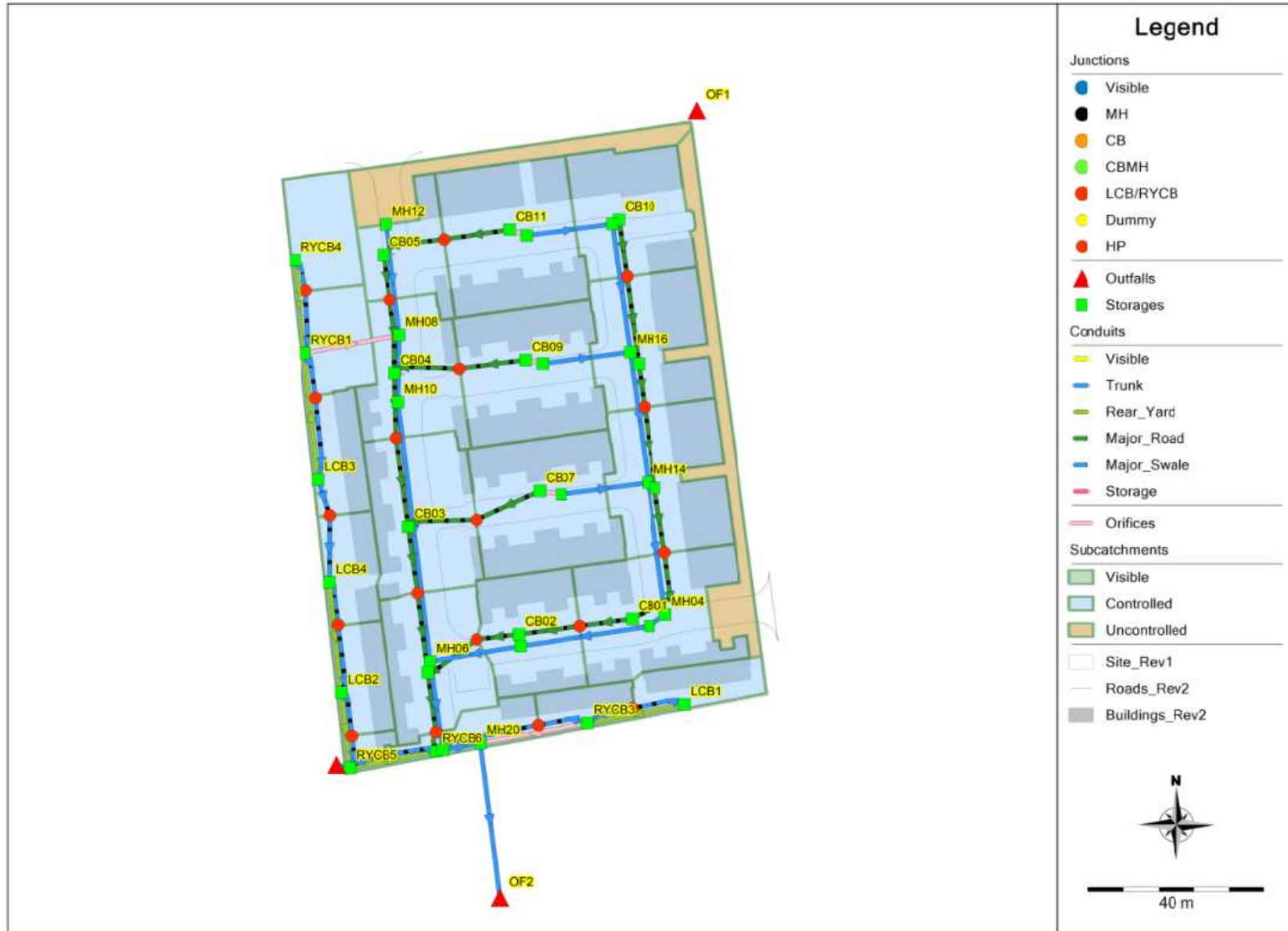

SC-310 CHAMBER

Designed to meet the most stringent industry performance standards for superior structural integrity while providing designers with a cost-effective method to save valuable land and protect water resources. The StormTech system is designed primarily to be used under parking lots, thus maximizing land usage for private (commercial) and public applications. StormTech chambers can also be used in conjunction with Green Infrastructure, thus enhancing the performance and extending the service life of these practices.



STORMTECH SC-310 CHAMBER

(not to scale)

Nominal Chamber Specifications

Size (L x W x H)

85.4" x 34.0" x 16.0"

2,170 mm x 864 mm x 406 mm

Chamber Storage

14.7 ft³ (0.42 m³)

Min. Installed Storage*

31.0 ft³ (0.88 m³)

Weight

37.0 lbs (16.8 kg)

Shipping

41 chambers/pallet

108 end caps/pallet

18 pallets/truck

*Assumes 6" (150 mm) stone above and below chambers and 40% stone porosity.

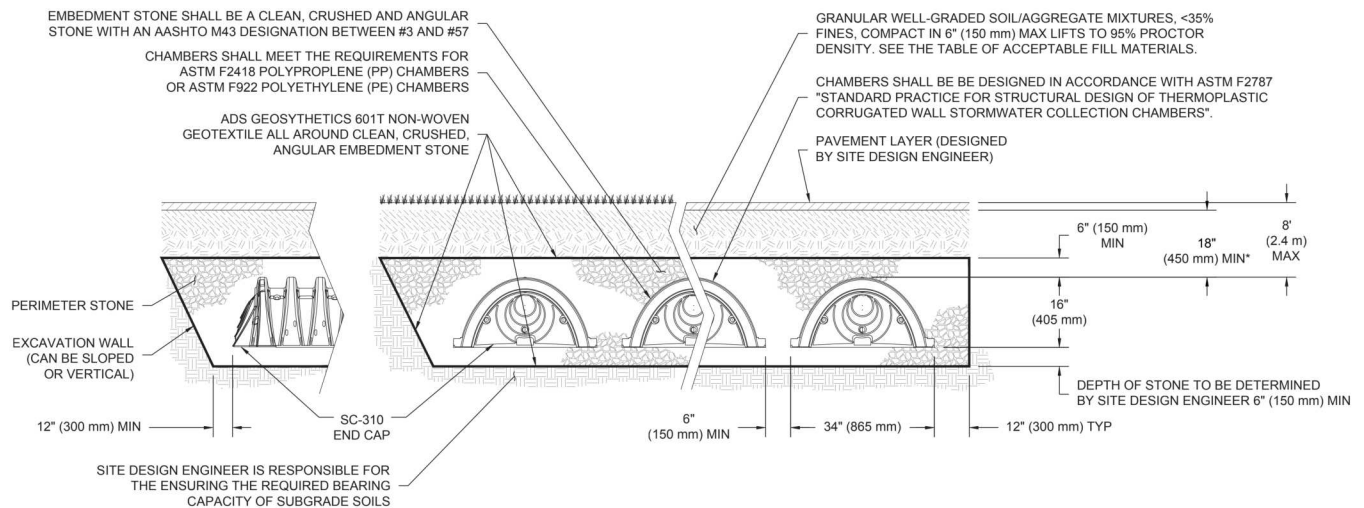
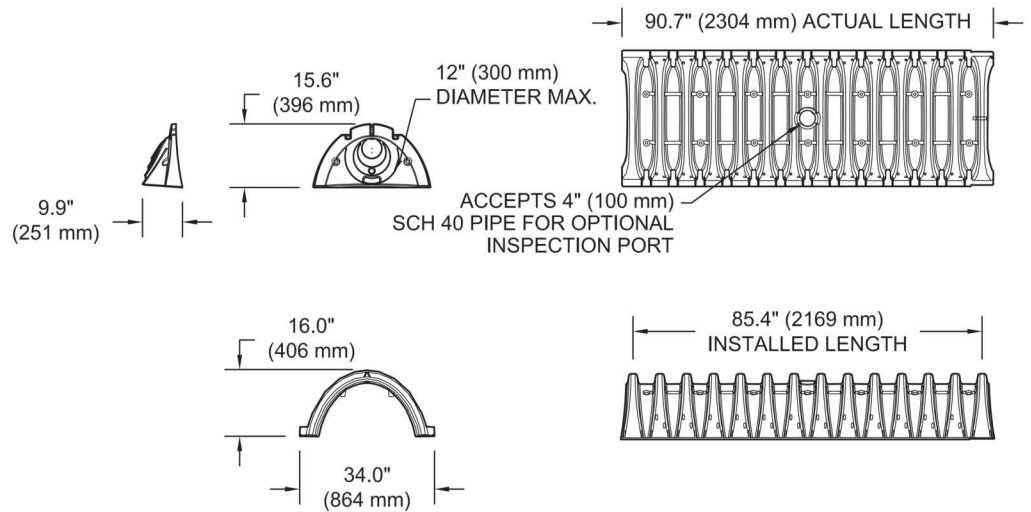

*MINIMUM COVER TO BOTTOM OF FLEXIBLE PAVEMENT. FOR UNPAVED INSTALLATIONS WHERE RUTTING FROM VEHICLES MAY OCCUR, INCREASE COVER TO 24" (600 mm).

SC-310 CUMULATIVE STORAGE VOLUMES PER CHAMBER

Assumes 40% Stone Porosity. Calculations are Based Upon a 6" (150 mm) Stone Base Under Chambers.

Depth of Water in System Inches (mm)	Cumulative Chamber Storage ft ³ (m ³)	Total System Cumulative Storage ft ³ (m ³)
28 (711)	↑ 14.70 (0.416)	31.00 (0.878)
27 (686)	↑ 14.70 (0.416)	30.21 (0.855)
26 (680)	Stone 14.70 (0.416)	29.42 (0.833)
25 (610)	Cover 14.70 (0.416)	28.63 (0.811)
24 (609)	↓ 14.70 (0.416)	27.84 (0.788)
23 (584)	↓ 14.70 (0.416)	27.05 (0.766)
22 (559)	14.70 (0.416)	26.26 (0.748)
21 (533)	14.64 (0.415)	25.43 (0.720)
20 (508)	14.49 (0.410)	24.54 (0.695)
19 (483)	14.22 (0.403)	23.58 (0.668)
18 (457)	13.68 (0.387)	22.47 (0.636)
17 (432)	12.99 (0.368)	21.25 (0.602)
16 (406)	12.17 (0.345)	19.97 (0.566)
15 (381)	11.25 (0.319)	18.62 (0.528)
14 (356)	10.23 (0.290)	17.22 (0.488)
13 (330)	9.15 (0.260)	15.78 (0.447)
12 (305)	7.99 (0.227)	14.29 (0.425)
11 (279)	6.78 (0.192)	12.77 (0.362)
10 (254)	5.51 (0.156)	11.22 (0.318)
9 (229)	4.19 (0.119)	9.64 (0.278)
8 (203)	2.83 (0.081)	8.03 (0.227)
7 (178)	1.43 (0.041)	6.40 (0.181)
6 (152)	↑ 0	4.74 (0.134)
5 (127)	0	3.95 (0.112)
4 (102)	Stone Foundation 0	3.16 (0.090)
3 (76)	0	2.37 (0.067)
2 (51)	0	1.58 (0.046)
1 (25)	↓ 0	0.79 (0.022)

Note: Add 0.79 ft³ (0.022 m³) of storage for each additional inch. (25 mm) of stone foundation.

STORAGE VOLUME PER CHAMBER FT³ (M³)

	Bare Chamber Storage ft ³ (m ³)	Chamber and Stone Foundation Depth in. (mm)		
		6 (150)	12 (300)	18 (450)
StormTech SC-310	14.7 (0.4)	31.0 (0.9)	35.7 (1.0)	40.4 (1.1)

Note: Assumes 6" (150 mm) of stone above chambers, 6" (150 mm) row spacing and 40% stone porosity.

AMOUNT OF STONE PER CHAMBER

ENGLISH TONS (yds ³)	Stone Foundation Depth		
	6"	12"	18"
StormTech SC-310	2.1 (1.5 yd ³)	2.7 (1.9 yd ³)	3.4 (2.4 yd ³)
METRIC KILOGRAMS (m ³)	150 mm	300 mm	450 mm
StormTech SC-310	1830 (1.1 m ³)	2490 (1.5 m ³)	2990 (1.8 m ³)

Note: Assumes 6" (150 mm) of stone above, and between chambers.

VOLUME EXCAVATION PER CHAMBER YD³ (M³)

	Stone Foundation Depth		
	6" (150 mm)	12" (300 mm)	18" (450 mm)
StormTech SC-310	2.9 (2.2)	3.4 (2.6)	3.8 (2.9)

Note: Assumes 6" (150 mm) of row separation and 18" (450 mm) of cover. The volume of excavation will vary as the depth of the cover increases.

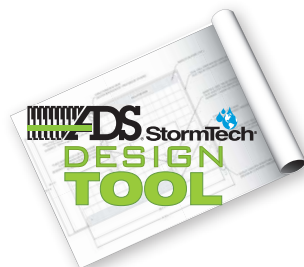

Working on a project?
Visit us at www.stormtech.com
and utilize the StormTech Design Tool

For more information on the StormTech SC-310 Chamber and other ADS products, please contact our Customer Service Representatives at 1-800-821-6710

THE MOST **ADVANCED** NAME IN WATER MANAGEMENT SOLUTIONS™

Advanced Drainage Systems, Inc.
4640 Trueman Blvd., Hilliard, OH 43026
1-800-821-6710 www.ads-pipe.com



User Inputs

Chamber Model:	SC-310
Outlet Control Structure:	No
Project Name:	200 Baribeau
Engineer:	Lucas Wilson
Project Location:	
Measurement Type:	Metric
Required Storage Volume:	2.50 cubic meters.
Stone Porosity:	40%
Stone Foundation Depth:	152 mm.
Stone Above Chambers:	230 mm.
Average Cover Over Chambers:	457 mm.
Design Constraint Dimensions:	(1.50 m. x 5.40 m.)

Results

System Volume and Bed Size

Installed Storage Volume:	2.97 cubic meters.
Storage Volume Per Chamber:	0.42 cubic meters.
Number Of Chambers Required:	2
Number Of End Caps Required:	2
Chamber Rows:	1
Maximum Length:	5.32 m.
Maximum Width:	1.47 m.
Approx. Bed Size Required:	7.83 square meters.

System Components

Amount Of Stone Required:	5.35 cubic meters
Volume Of Excavation (Not Including Fill):	6.18 cubic meters

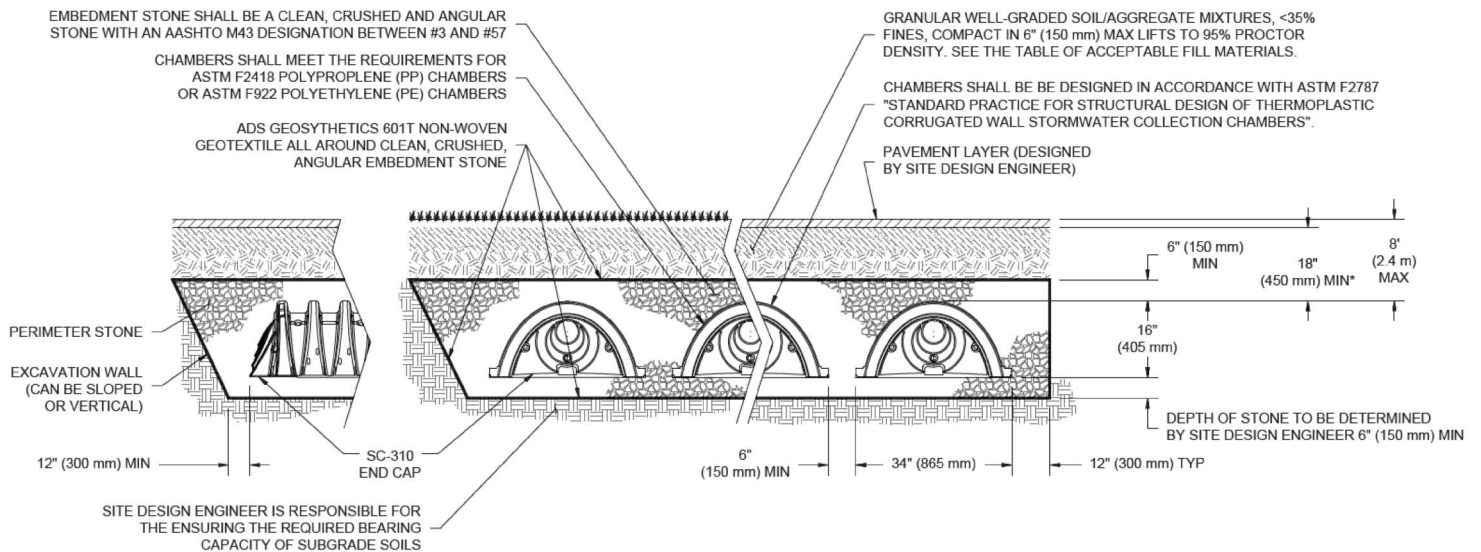

*MINIMUM COVER TO BOTTOM OF FLEXIBLE PAVEMENT. FOR UNPAVED INSTALLATIONS WHERE RUTTING FROM VEHICLES MAY OCCUR, INCREASE COVER TO 24" (600 mm).



User Inputs

Chamber Model:	SC-310
Outlet Control Structure:	No
Project Name:	200 Baribeau
Engineer:	Lucas Wilson
Project Location:	
Measurement Type:	Metric
Required Storage Volume:	4.00 cubic meters.
Stone Porosity:	40%
Stone Foundation Depth:	152 mm.
Stone Above Chambers:	230 mm.
Average Cover Over Chambers:	457 mm.
Design Constraint Dimensions:	(1.50 m. x 7.50 m.)

Results

System Volume and Bed Size

Installed Storage Volume:	4.23 cubic meters.
Storage Volume Per Chamber:	0.42 cubic meters.
Number Of Chambers Required:	3
Number Of End Caps Required:	2
Chamber Rows:	1
Maximum Length:	7.48 m.
Maximum Width:	1.47 m.
Approx. Bed Size Required:	11.03 square meters.

System Components

Amount Of Stone Required:	7.45 cubic meters
Volume Of Excavation (Not Including Fill):	8.70 cubic meters

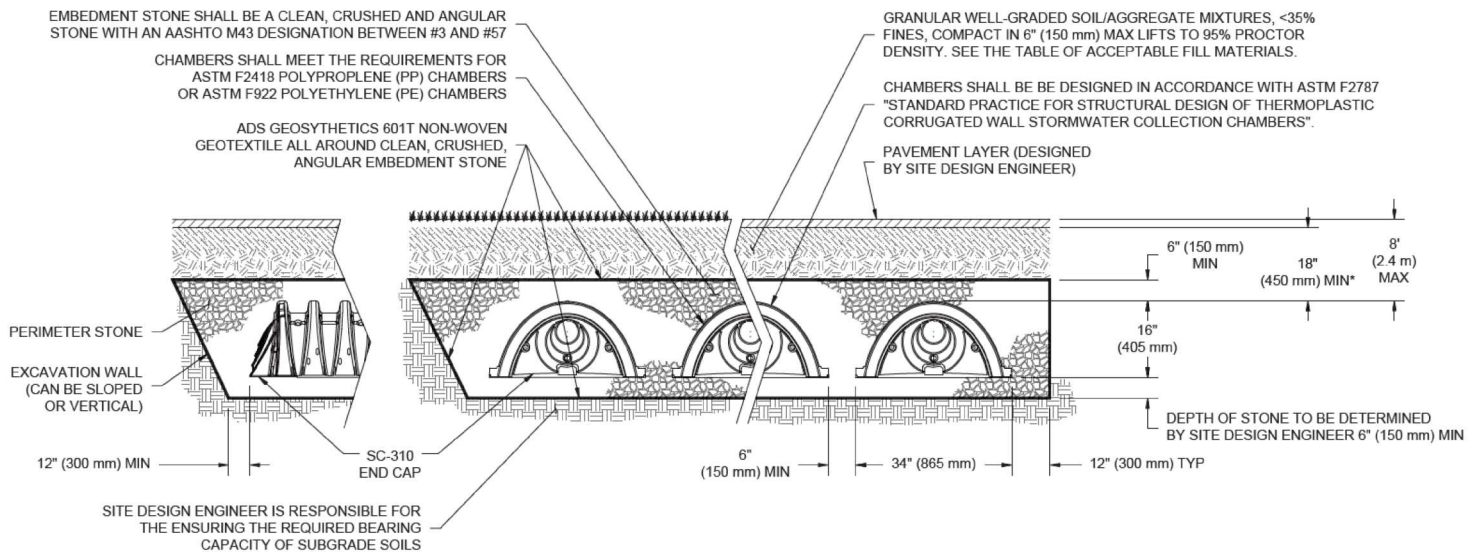

*MINIMUM COVER TO BOTTOM OF FLEXIBLE PAVEMENT. FOR UNPAVED INSTALLATIONS WHERE RUTTING FROM VEHICLES MAY OCCUR, INCREASE COVER TO 24" (600 mm).

User Inputs

Chamber Model:	SC-310
Outlet Control Structure:	No
Project Name:	200 Baribeau
Engineer:	Lucas Wilson
Project Location:	
Measurement Type:	Metric
Required Storage Volume:	8.00 cubic meters.
Stone Porosity:	40%
Stone Foundation Depth:	152 mm.
Stone Above Chambers:	230 mm.
Average Cover Over Chambers:	457 mm.
Design Constraint Dimensions:	(1.50 m. x 14.00 m.)

Results

System Volume and Bed Size

Installed Storage Volume:	8.00 cubic meters.
Storage Volume Per Chamber:	0.42 cubic meters.
Number Of Chambers Required:	6
Number Of End Caps Required:	2
Chamber Rows:	1
Maximum Length:	13.99 m.
Maximum Width:	1.47 m.
Approx. Bed Size Required:	20.61 square meters.

System Components

Amount Of Stone Required:	13.76 cubic meters
Volume Of Excavation (Not Including Fill):	16.26 cubic meters

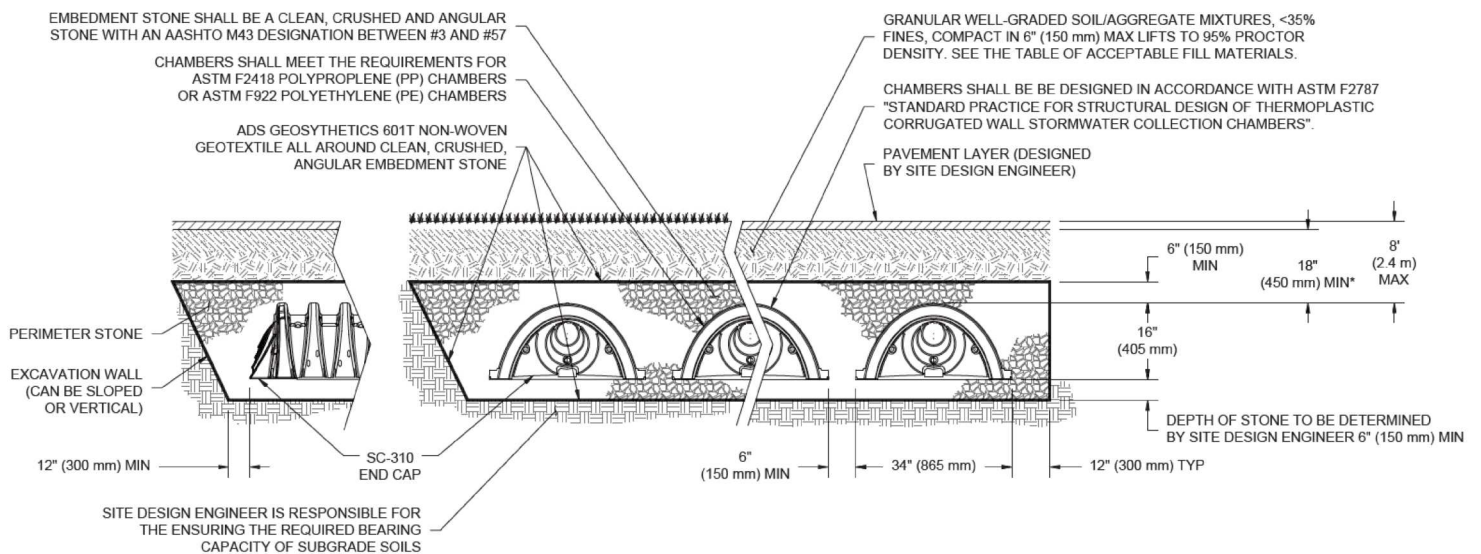

User Inputs

Chamber Model:	SC-310
Outlet Control Structure:	No
Project Name:	200 Baribeau
Engineer:	Lucas Wilson
Project Location:	
Measurement Type:	Metric
Required Storage Volume:	5.00 cubic meters.
Stone Porosity:	40%
Stone Foundation Depth:	152 mm.
Stone Above Chambers:	230 mm.
Average Cover Over Chambers:	457 mm.
Design Constraint Dimensions:	(2.50 m. x 6.50 m.)

Results

System Volume and Bed Size

Installed Storage Volume:	5.97 cubic meters.
Storage Volume Per Chamber:	0.42 cubic meters.
Number Of Chambers Required:	4
Number Of End Caps Required:	4
Chamber Rows:	2
Maximum Length:	6.32 m.
Maximum Width:	2.49 m.
Approx. Bed Size Required:	15.74 square meters.

System Components

Amount Of Stone Required:	10.75 cubic meters
Volume Of Excavation (Not Including Fill):	12.42 cubic meters

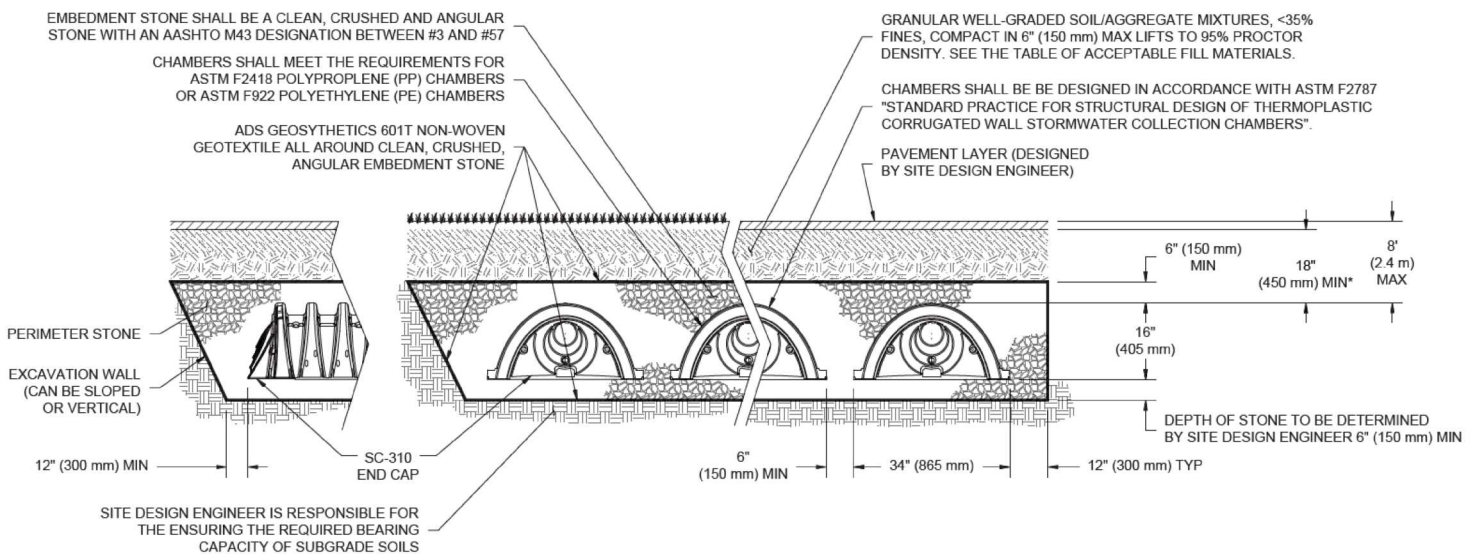

*MINIMUM COVER TO BOTTOM OF FLEXIBLE PAVEMENT. FOR UNPAVED INSTALLATIONS WHERE RUTTING FROM VEHICLES MAY OCCUR, INCREASE COVER TO 24" (600 mm).

User Inputs

Chamber Model:	SC-310
Outlet Control Structure:	No
Project Name:	200 Baribeau
Engineer:	Lucas Wilson
Project Location:	
Measurement Type:	Metric
Required Storage Volume:	10.37 cubic meters.
Stone Porosity:	40%
Stone Foundation Depth:	152 mm.
Stone Above Chambers:	230 mm.
Average Cover Over Chambers:	457 mm.
Design Constraint Dimensions:	(2.50 m. x 10.70 m.)

Results

System Volume and Bed Size

Installed Storage Volume:	10.37 cubic meters.
Storage Volume Per Chamber:	0.42 cubic meters.
Number Of Chambers Required:	8
Number Of End Caps Required:	4
Chamber Rows:	2
Maximum Length:	10.66 m.
Maximum Width:	2.49 m.
Approx. Bed Size Required:	26.54 square meters.

System Components

Amount Of Stone Required:	17.61 cubic meters
Volume Of Excavation (Not Including Fill):	20.94 cubic meters

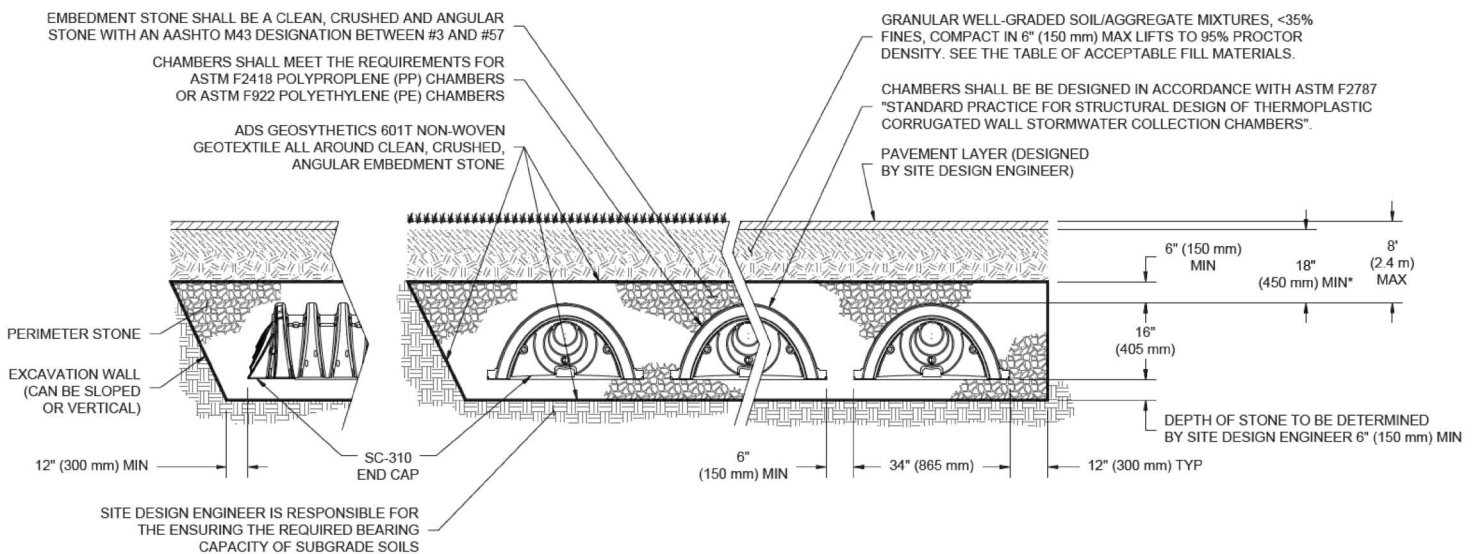

*MINIMUM COVER TO BOTTOM OF FLEXIBLE PAVEMENT. FOR UNPAVED INSTALLATIONS WHERE RUTTING FROM VEHICLES MAY OCCUR, INCREASE COVER TO 24" (600 mm).



User Inputs

Chamber Model:	SC-310
Outlet Control Structure:	Yes
Project Name:	200 Baribeau - 16 Chambers
Engineer:	Lucas Wilson
Project Location:	
Measurement Type:	Metric
Required Storage Volume:	21.00 cubic meters.
Stone Porosity:	40%
Stone Foundation Depth:	152 mm.
Stone Above Chambers:	230 mm.
Average Cover Over Chambers:	457 mm.
Design Constraint Dimensions:	(3.00 m. x 20.00 m.)

Results

System Volume and Bed Size

Installed Storage Volume:	21.75 cubic meters.
Storage Volume Per Chamber:	0.42 cubic meters.
Number Of Chambers Required:	16
Number Of End Caps Required:	4
Chamber Rows:	2
Maximum Length:	19.53 m.
Maximum Width:	2.88 m.
Approx. Bed Size Required:	56.26 square meters.

System Components

Amount Of Stone Required:	37.72 cubic meters
Volume Of Excavation (Not Including Fill):	44.38 cubic meters

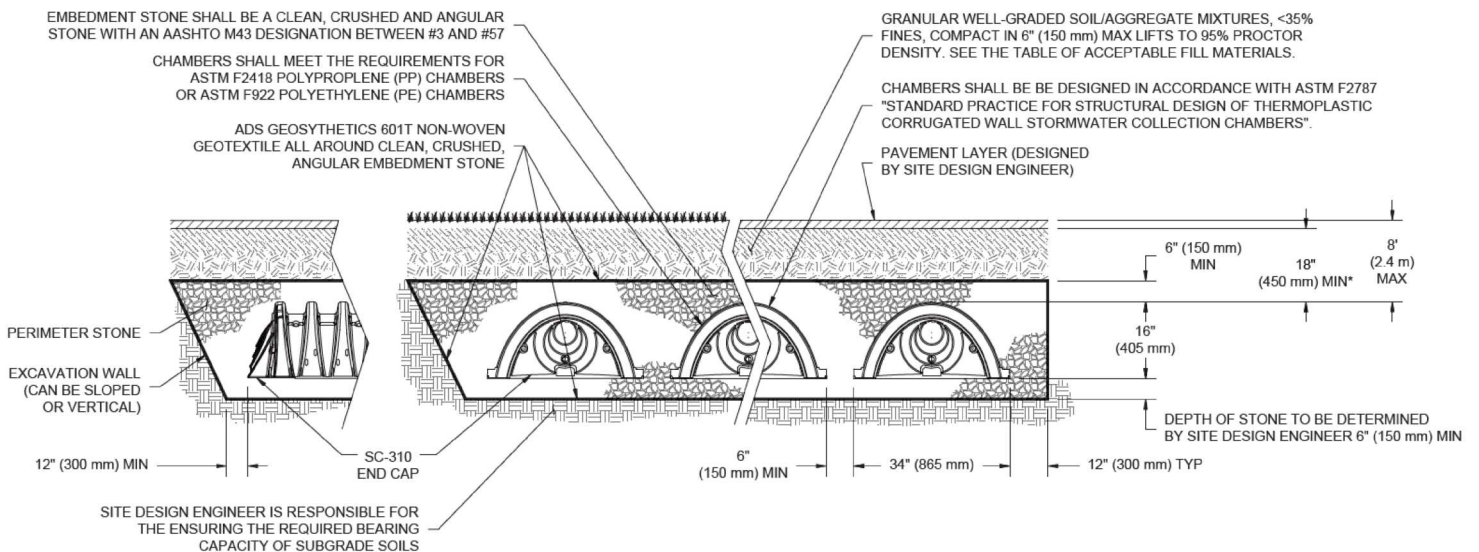

*MINIMUM COVER TO BOTTOM OF FLEXIBLE PAVEMENT. FOR UNPAVED INSTALLATIONS WHERE RUTTING FROM VEHICLES MAY OCCUR, INCREASE COVER TO 24" (600 mm).

TEMPEST Product Submittal Package R2



Date: June 7, 2021

Customer: Novatech

Contact: Lucas Wilson

Location: Ottawa

Project Name: 200 Baribeau St



Tempest LMF ICD Sq Shop Drawing

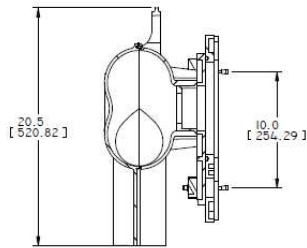
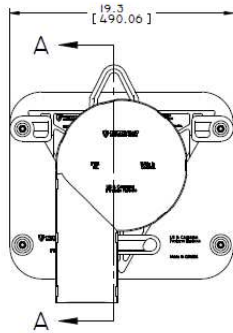
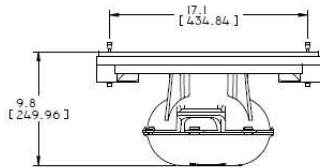

SECTION A-A

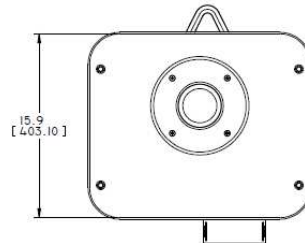

TOLERANCES UNLESS OTHERWISE SPECIFIED: FRACTIONS: ±0.005 (0.15 mm) DECIMALS: ±0.002 (0.05 mm) HOLE POSITION: ±0.005 (0.15 mm) HOLE SIZE: ±0.002 (0.05 mm)		IPEX TECHNOLOGIES INC. PRODUCT DEVELOPMENT DEPARTMENT 25000 LA 100 DRIVE, FORTNEY, SC 29541 COLUMBIA, SC 29910 WWW.IPEX.COM	
PRODUCTION INCHES IN (mm)		FILE LMF SQUARE CB ASSEMBLY	
DRAWN BY: H. M. MARTIN CHECKED BY:	DATE: 2011-07-27	REV: B QUANTITY: 1/8	SHEET: 1 OF 1 DRAWING NUMBER: 55H74_FAS01R03 REV: 3



Tempest LMF ICD Flow Curve

Flow: 7.8 L/s
Head: 1.65 m
CB01

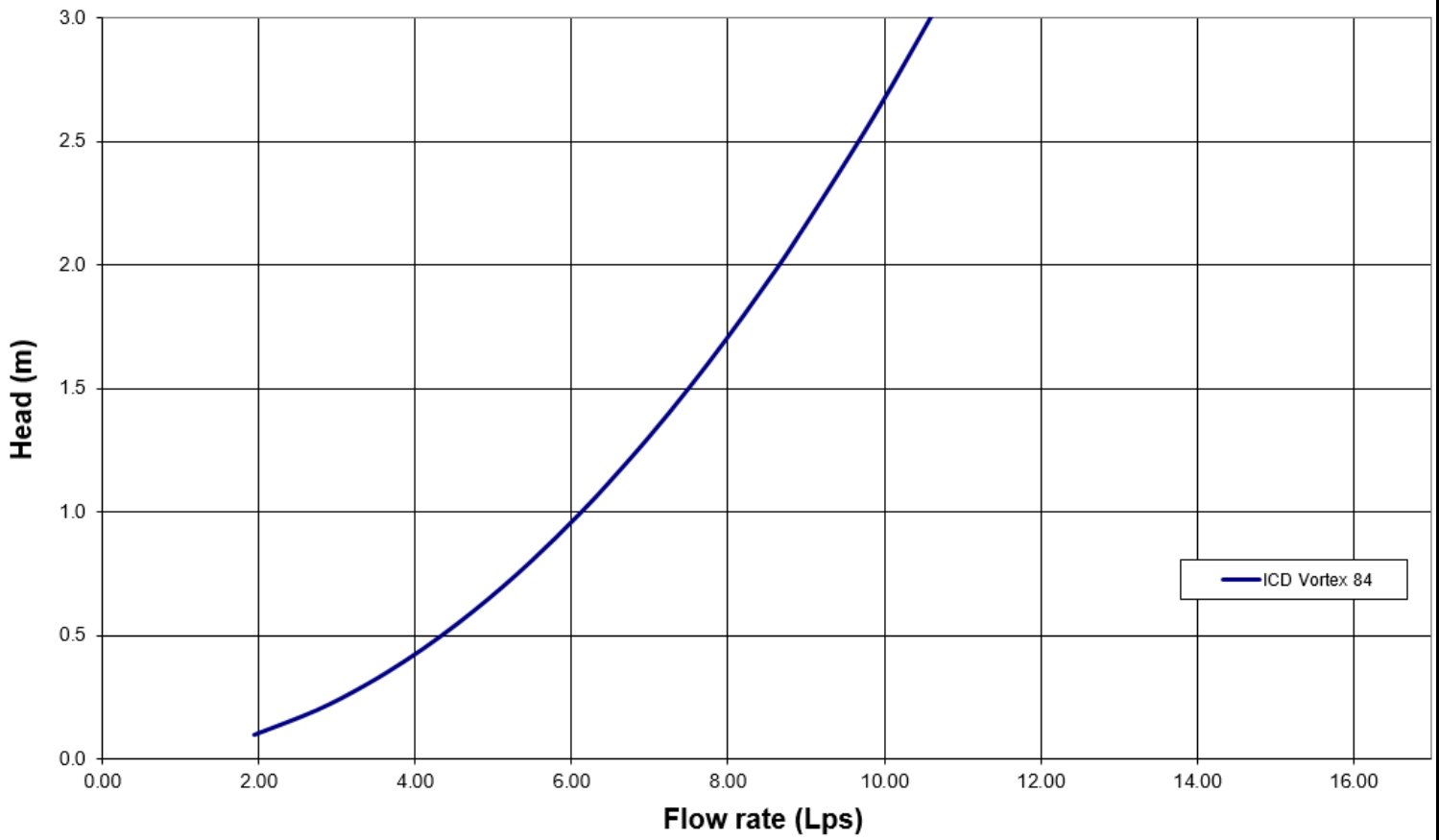

Tempest LMF ICD Flow Curve

Flow: 7.8 L/s
Head: 1.67 m
CB02

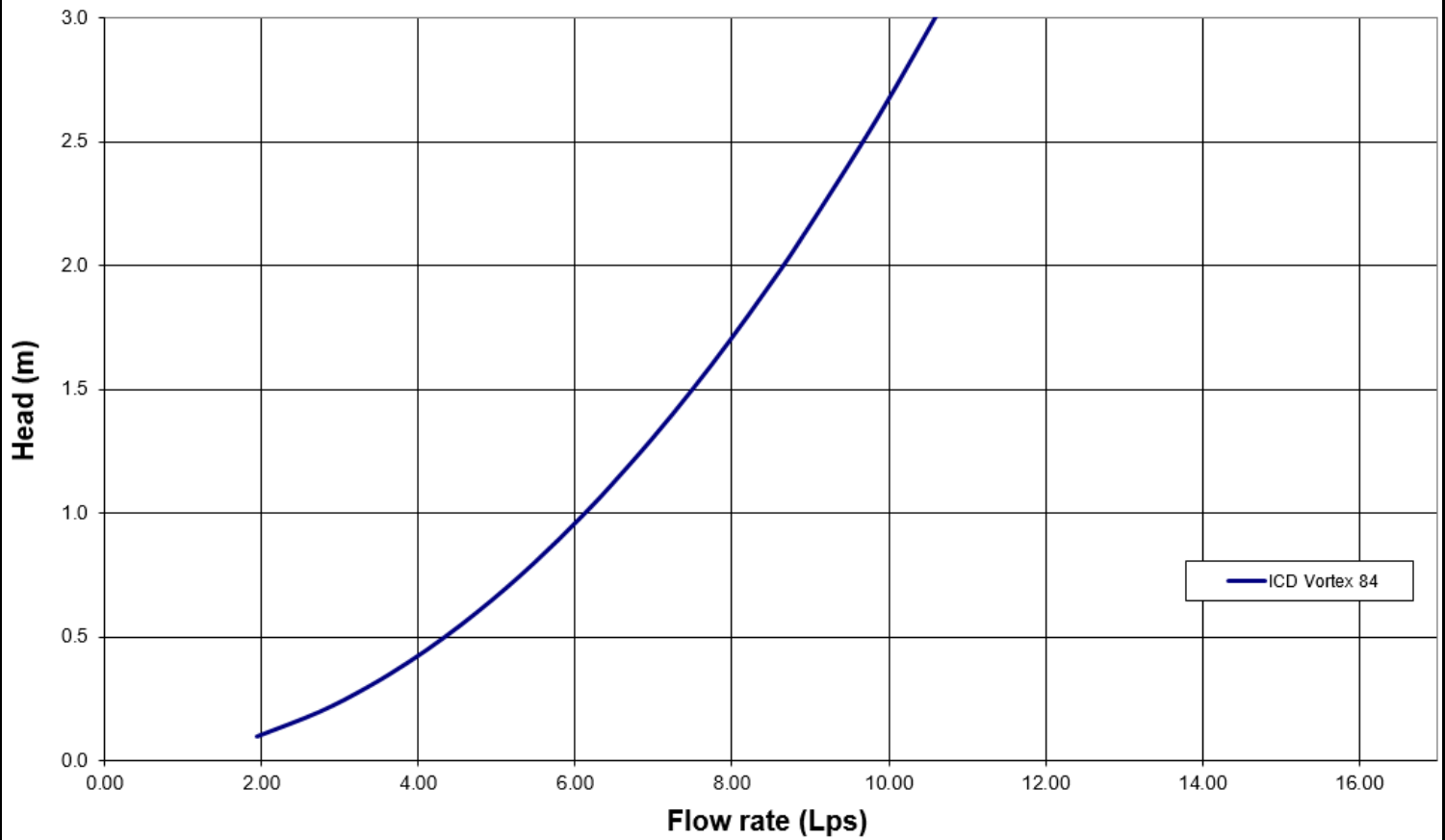

Tempest LMF ICD Flow Curve

Flow: 6.1 L/s
Head: 1.60 m
CB03

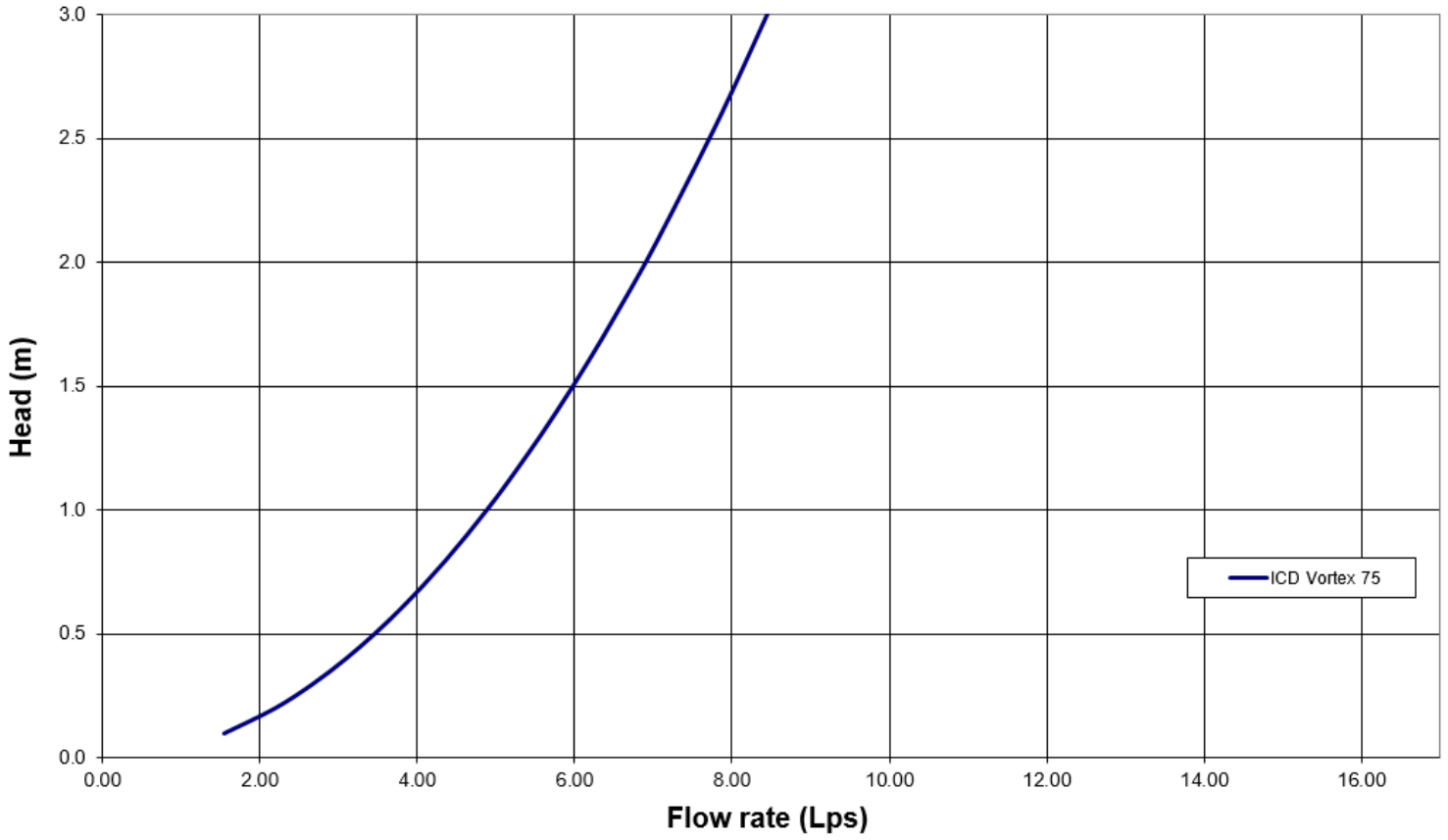

Tempest LMF ICD Flow Curve

Flow: 6 L/s
Head: 1.57 m
CB04

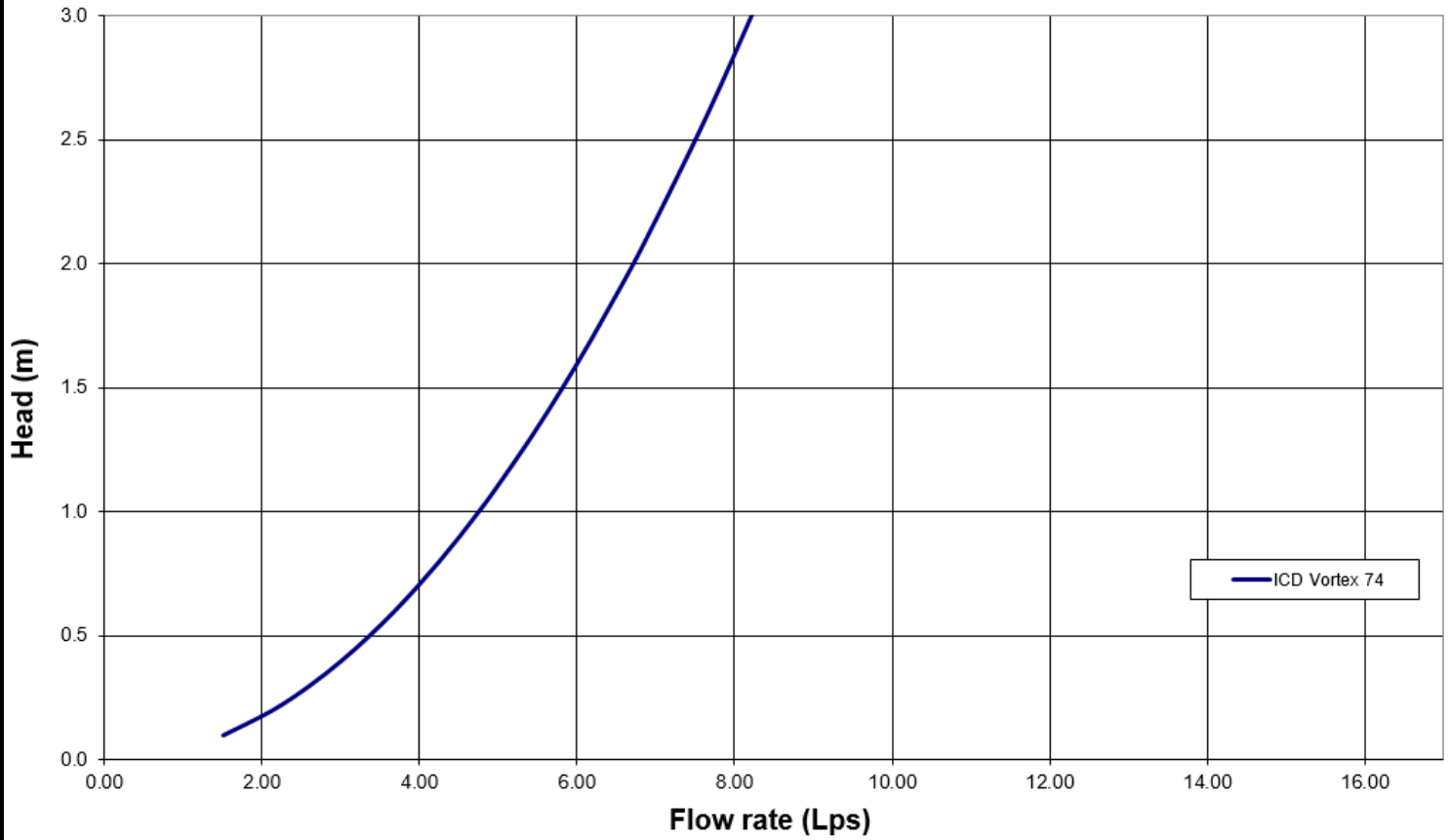

Tempest LMF ICD Flow Curve

Flow: 6 L/s
Head: 1.56 m
CB05

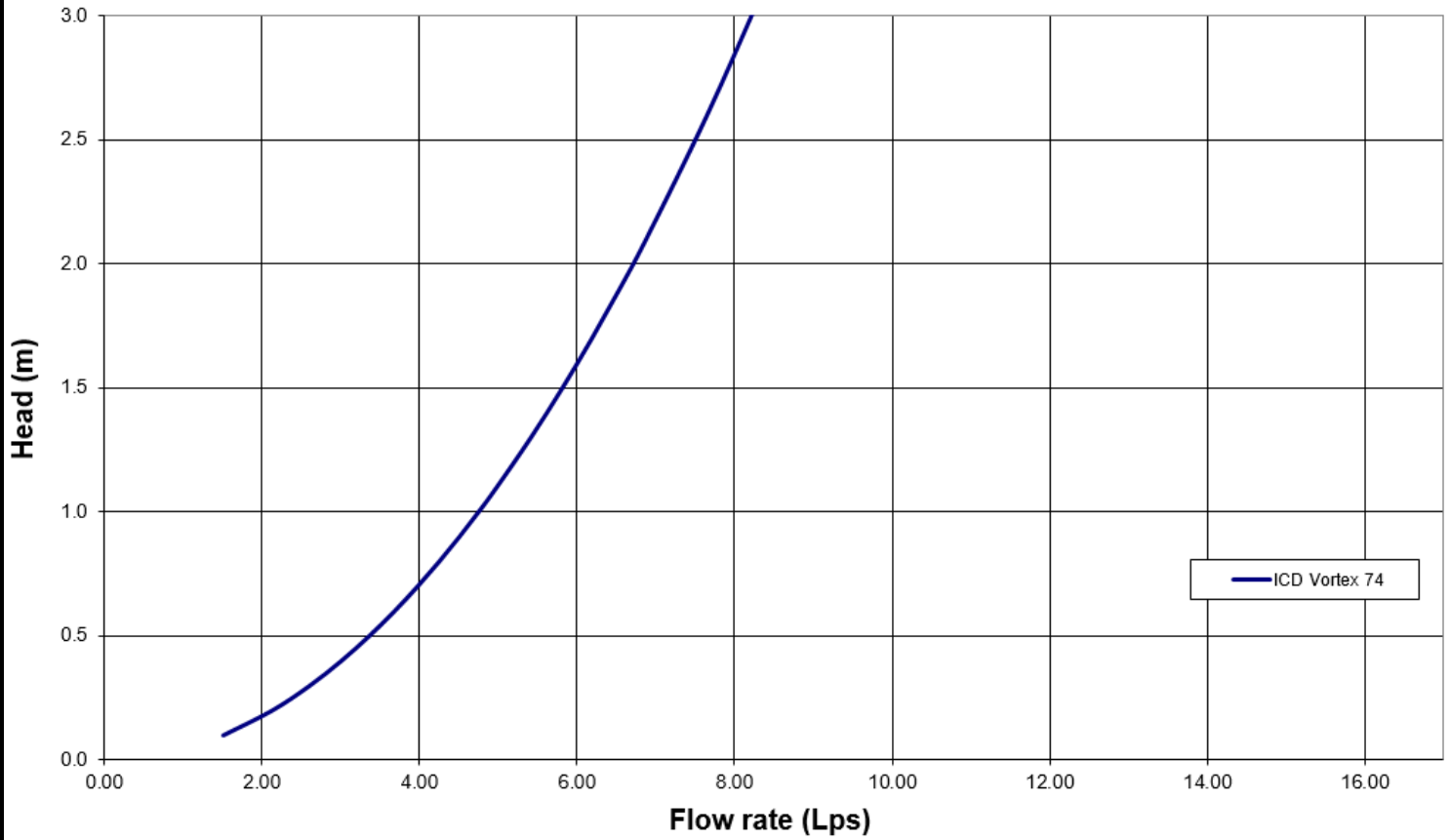

Tempest LMF ICD Flow Curve

Flow: 6.4 L/s
Head: 1.64 m
CB06

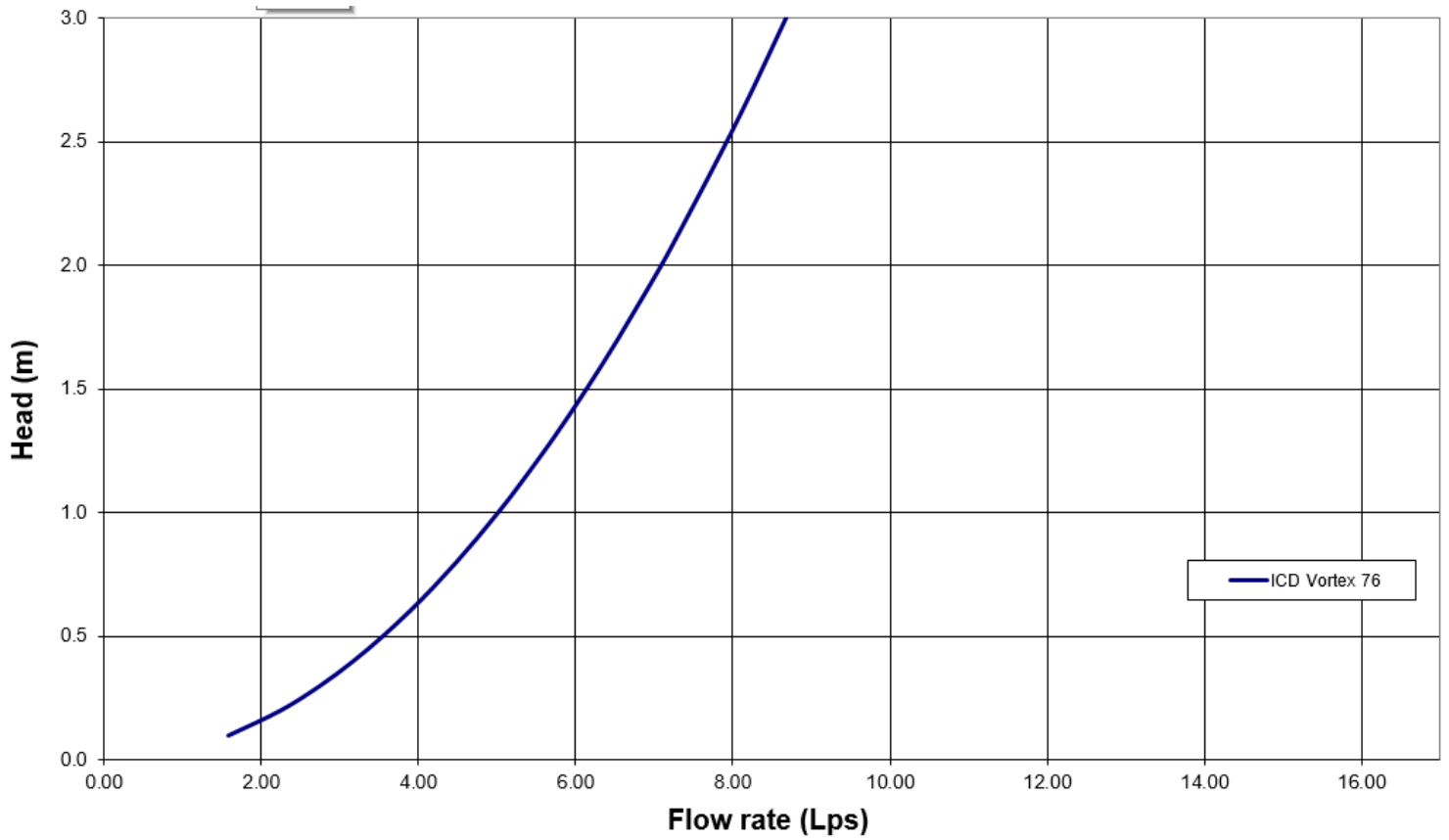

Tempest LMF ICD Flow Curve

Flow: 6 L/s
Head: 1.58 m
CB07

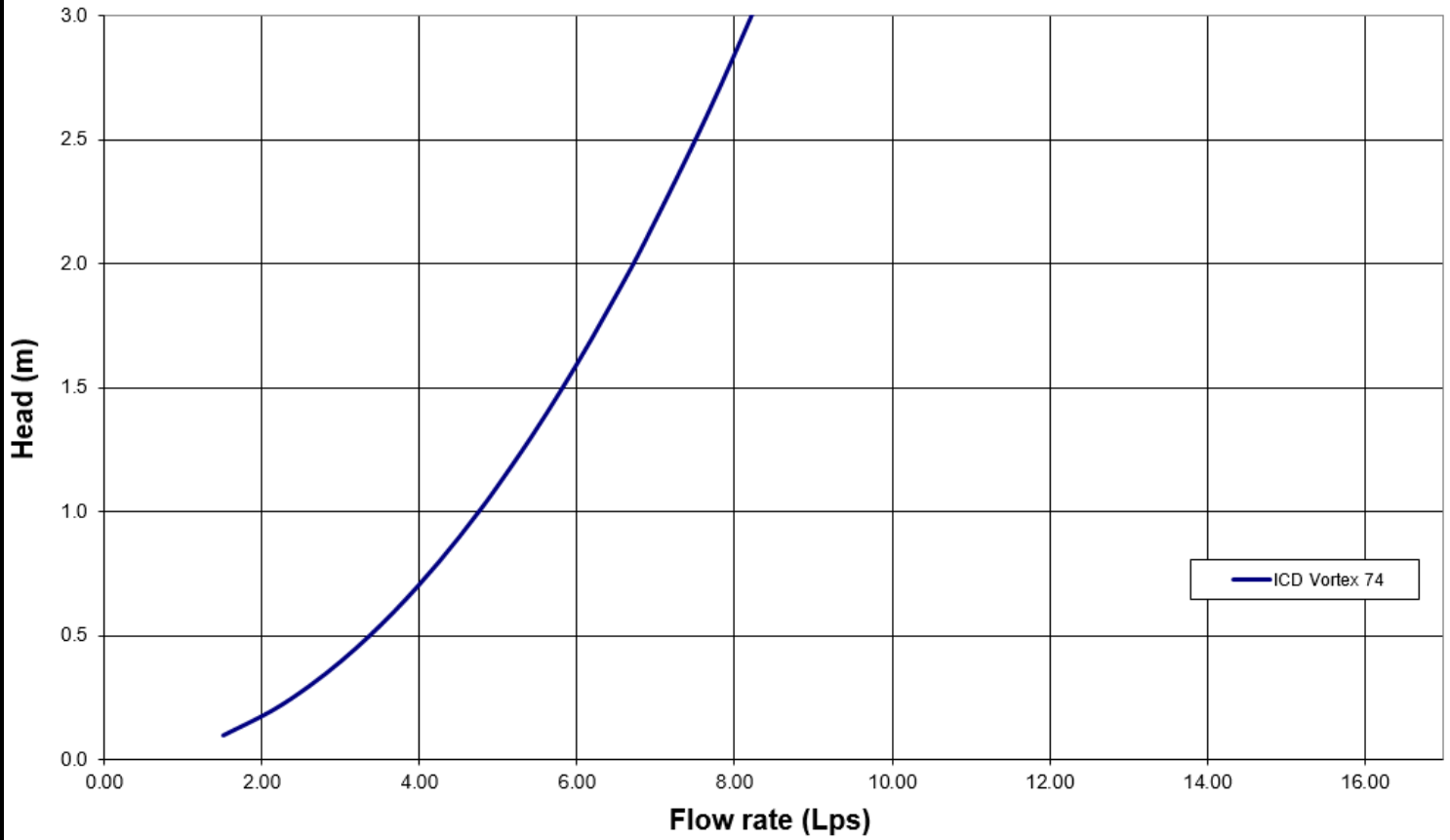

Tempest LMF ICD Flow Curve

Flow: 6.4 L/s
Head: 1.62 m
CB08

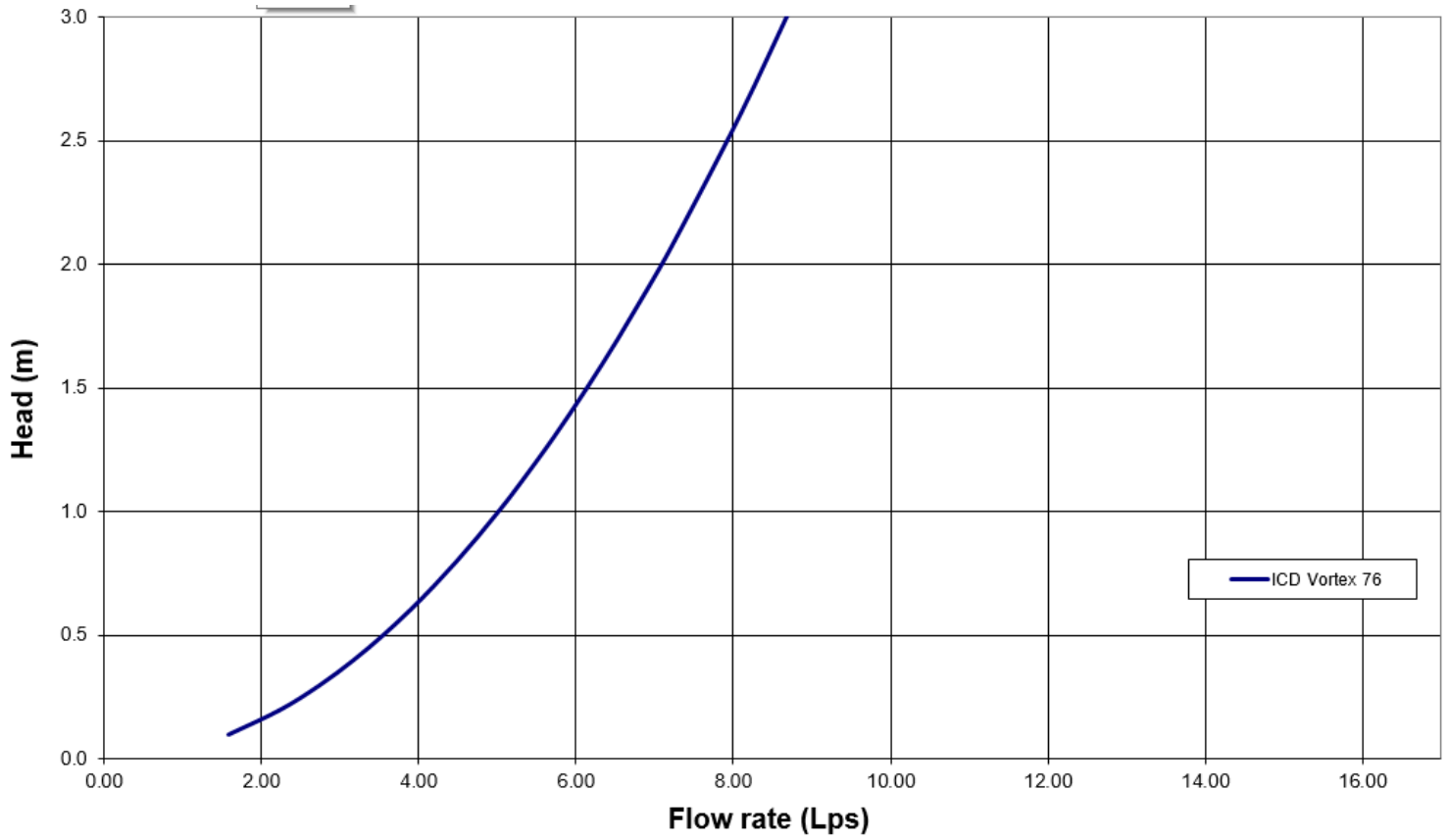

Tempest LMF ICD Flow Curve

Flow: 6.1 L/s
Head: 1.61 m
CB09, 10

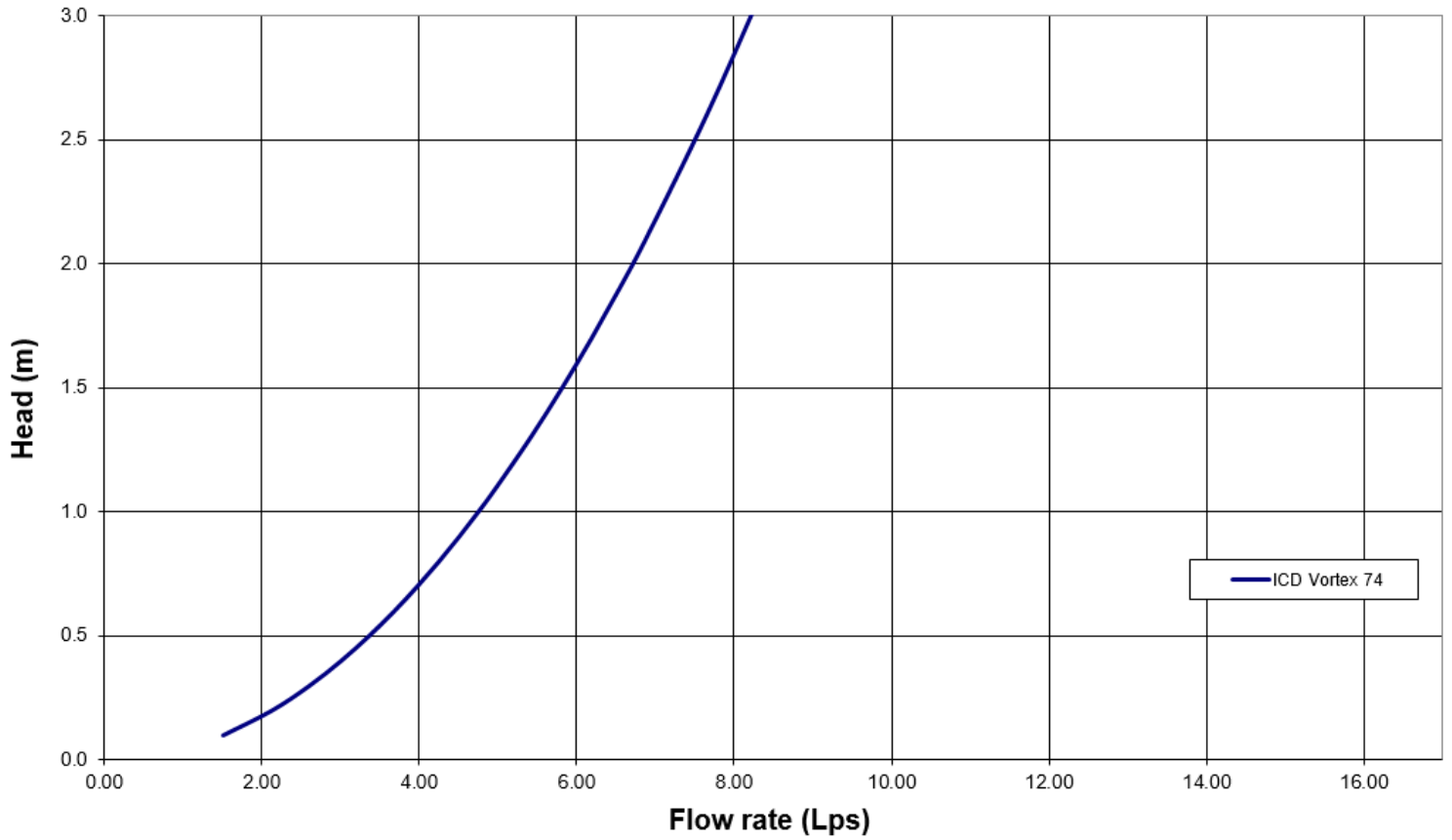

Tempest LMF ICD Flow Curve

Flow: 6.1 L/s
Head: 1.62 m
CB11

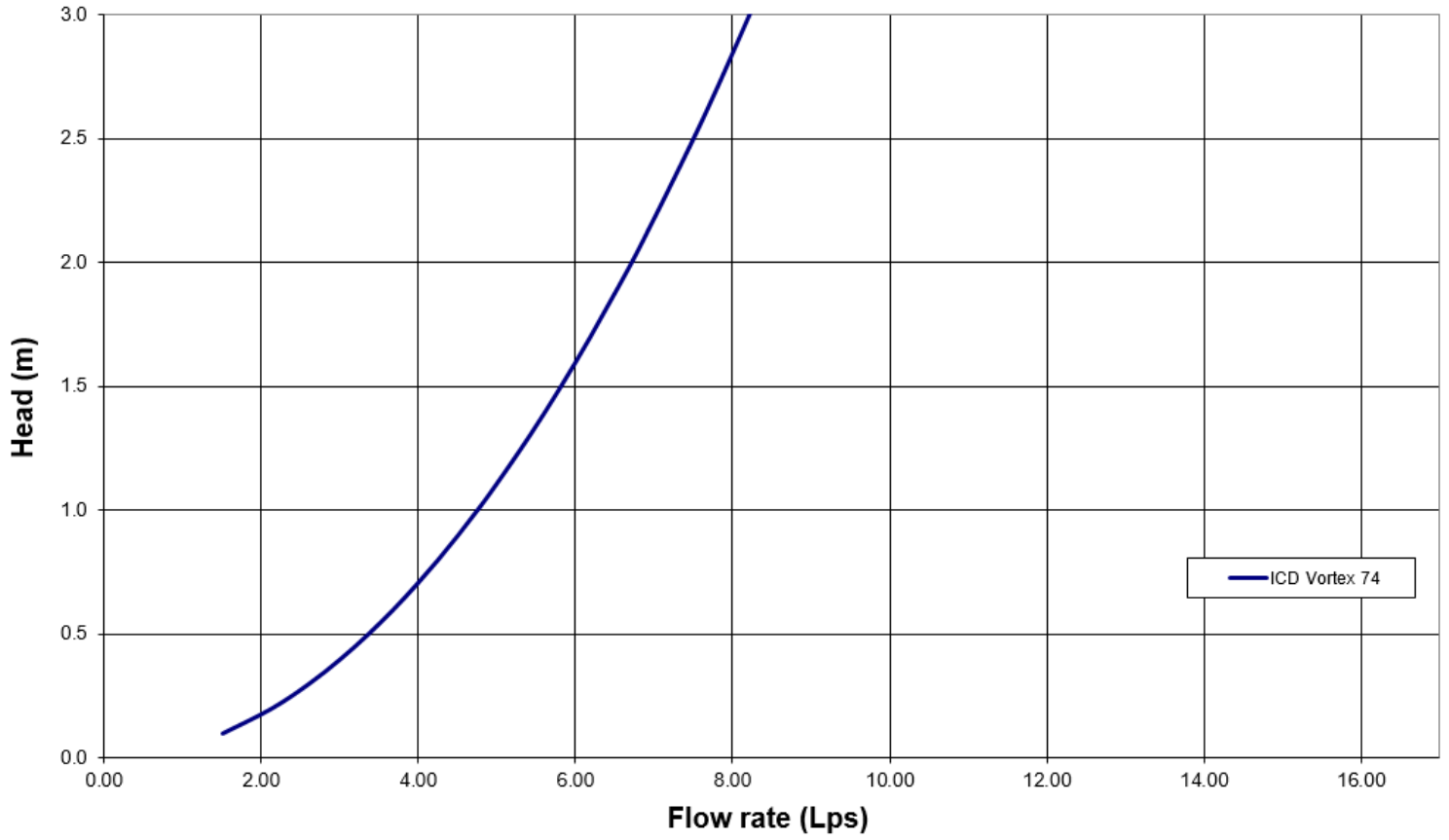

Tempest LMF ICD Flow Curve

Flow: 6.2 L/s
Head: 1.55 m
CB12

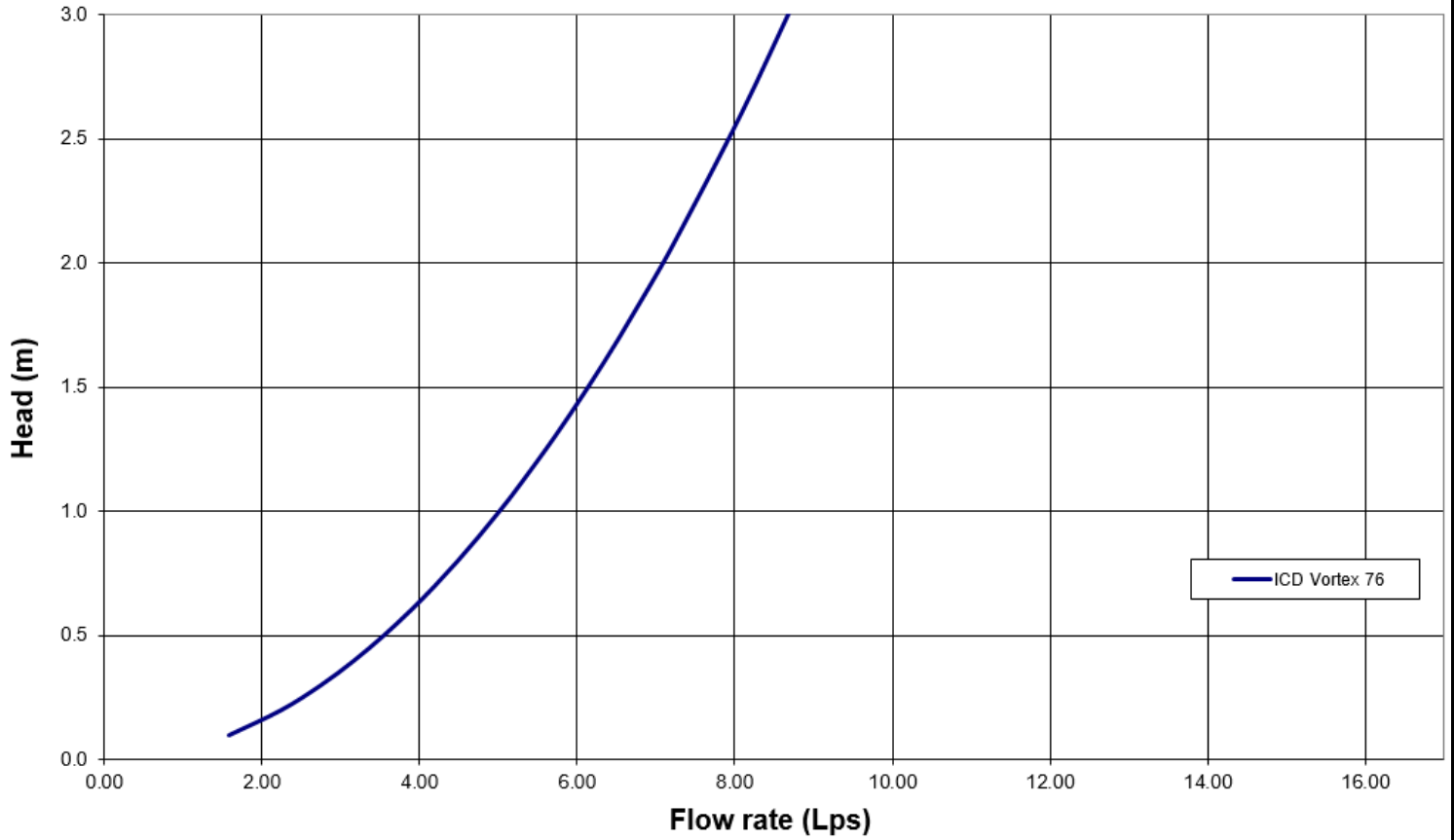

Tempest LMF ICD Flow Curve

Flow: 6.2 L/s
Head: 1.51 m
RYCB1

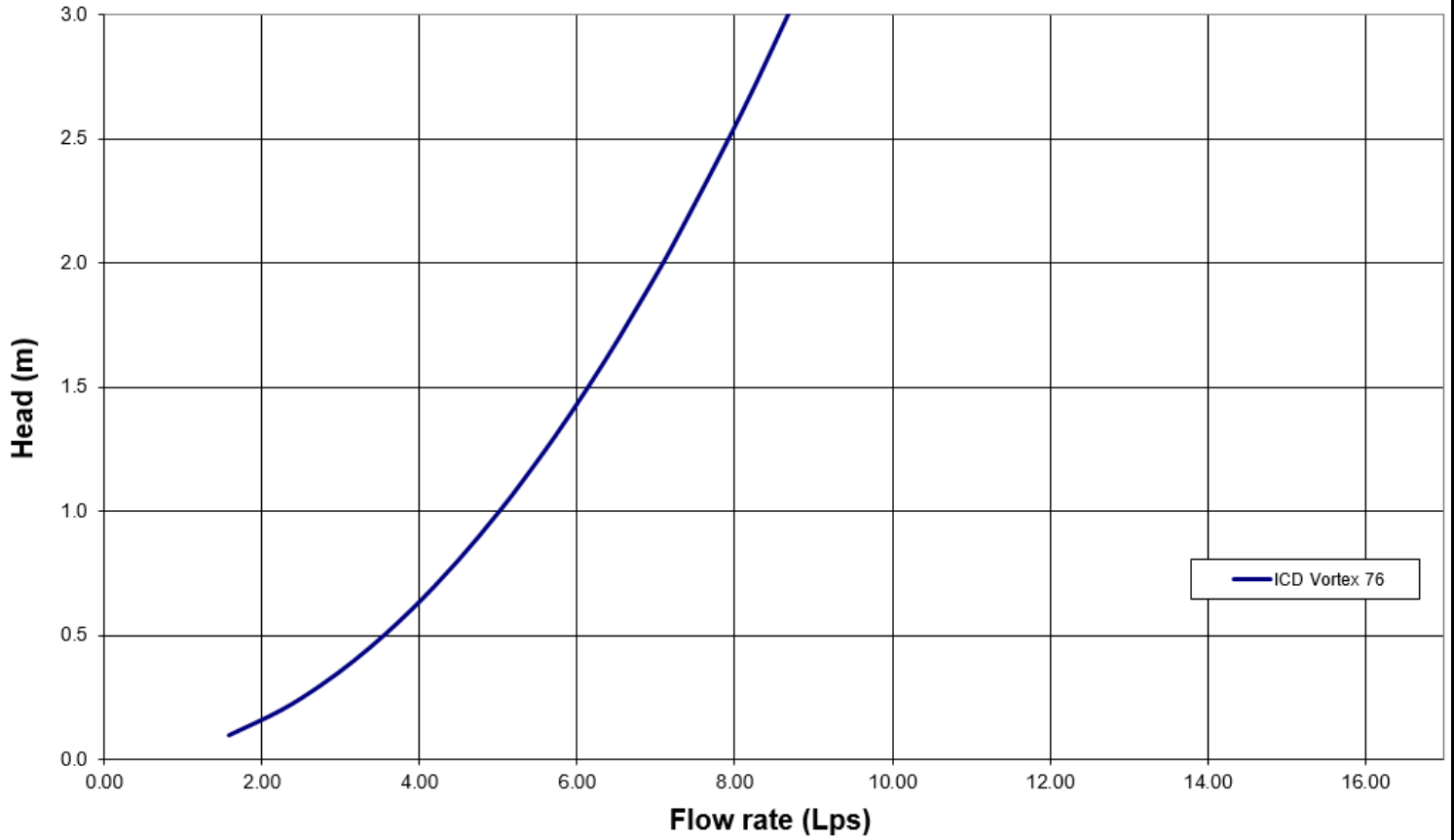

Tempest LMF ICD Flow Curve

Flow: 8.8 L/s
Head: 1.77 m
RYCB3

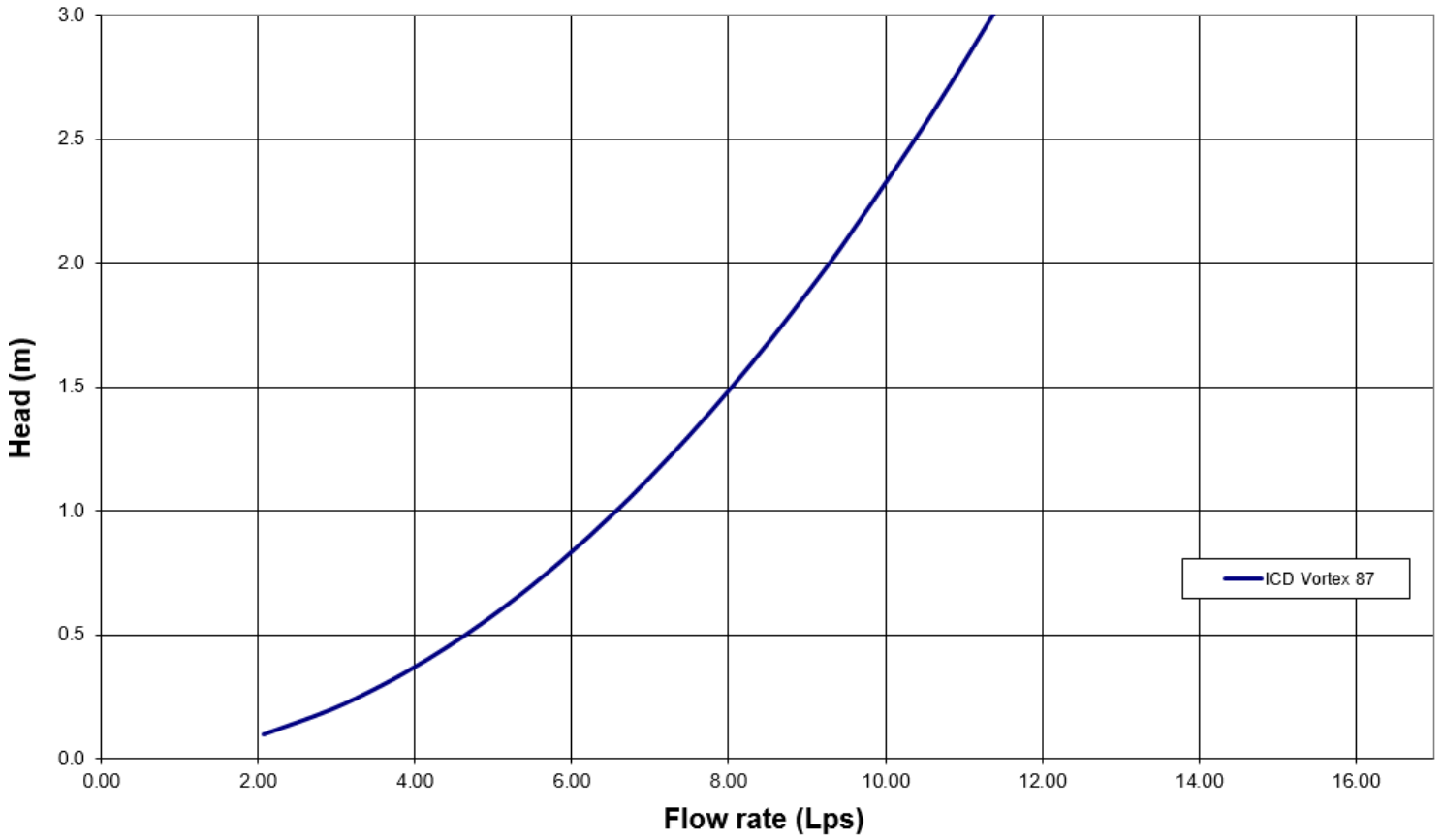

Tempest LMF ICD Flow Curve

Flow: 8.0 L/s
Head: 1.80 m
RYCB6

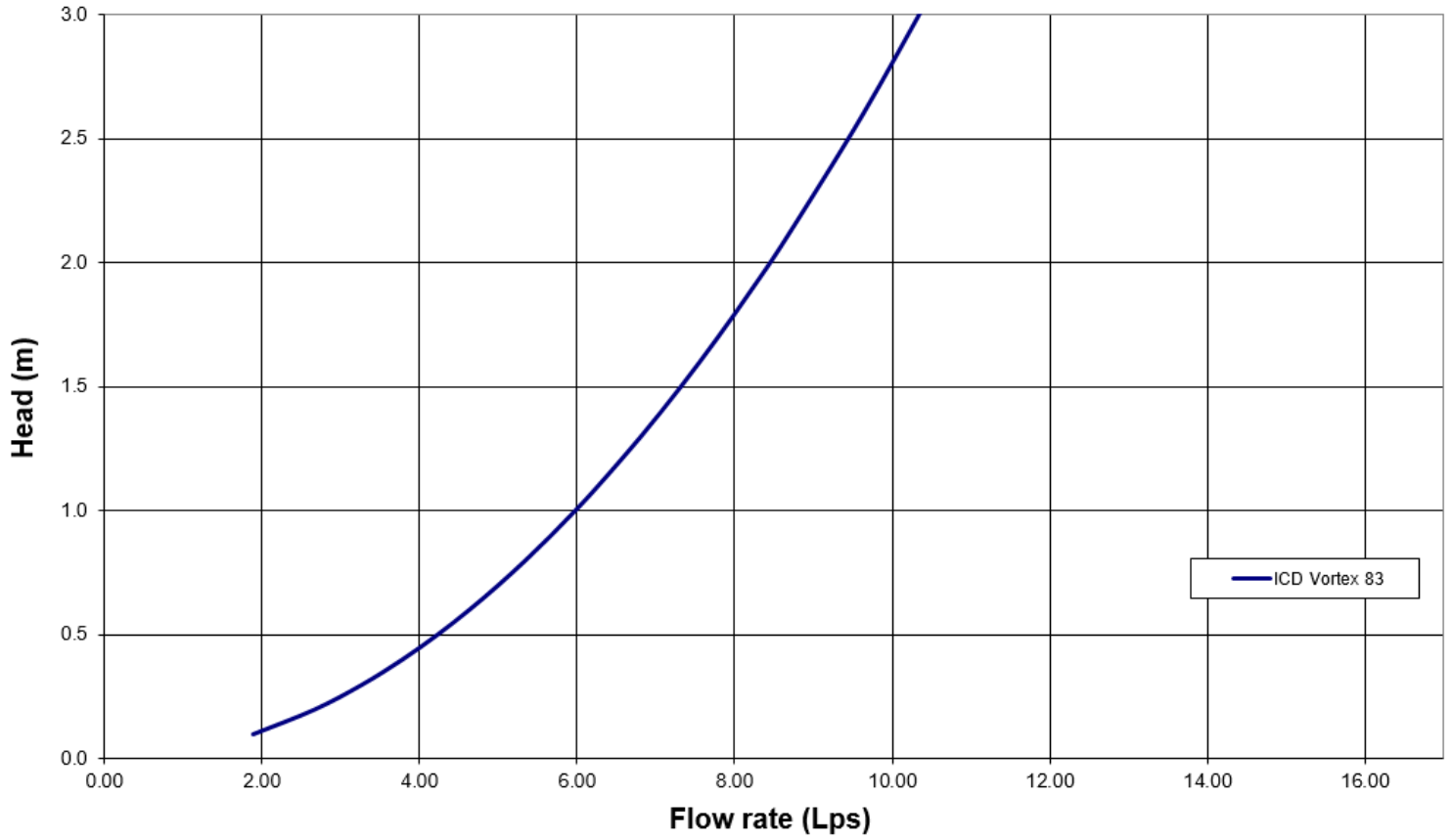

Square CB Installation Notes:

1. Materials and tooling verification:
 - Tooling: impact drill, 3/8'' concrete bit, torque wrench for 9/16'' nut, hand hammer, level, and marker.
 - Material: (4) concrete anchor 3/8x3-1/2, (4) washers, (4) nuts
2. Use the mounting wall plate to locate and mark the hole (4) pattern on the catch basin wall. You should use a level to ensure that the plate is at the horizontal.
3. Use an impact drill with a 3/8'' concrete bit to make the four holes at a minimum of 1-1/2'' depth up to 2-1/2''. Clean the concrete dust from the holes.
4. Install the anchors (4) in the holes by using a hammer. Put the nuts on the top of the anchors to protect the threads when you will hit the anchors with the hammer. Remove the nuts on the ends of the anchors
5. Install the wall mounting plate on the anchors and screw the nut in place with a maximum torque of 40 N.m (30 lbf-ft). There should be no gap between the wall mounting plate and the catch basin wall.
6. From ground above using a reach bar, lower the device by hooking the end of the reach bar to the handle of the LMF device. Align the triangular plate portion into the mounting wall plate. Push down the device to be sure it has centered in to the wall mounting plate and has created a seal.



Round CB Installation Notes: (Refer to square install notes above for steps 1 , 3, & 4)

2. Use spigot catch basin wall plate to locate and mark the hole (4) pattern on the catch basin wall. You should use a level to ensure that the plate is at the horizontal.
5. Install the CB spigot wall plate on the anchors and screw the 4 nuts in place with a maximum torque of 40 N.m (30 lb-ft). There should be no gap between the CB spigot wall plate and the catch basin wall.
6. Apply solvent cement on the hub of the universal mounting plate and the spigot of the spigot CB wall plate. Slide the hub over the spigot. Make sure the universal mounting plate is at the horizontal and its hub is completely inserted onto the spigot. Normally, the corners of the universal mounting plate hub adapter should touch the catch basin wall.
7. From ground above using a reach bar, lower the ICD device by hooking the end of the reach bar to the handle of the ICD device. Align the triangular plate portion into the mounting wall plate. Push down the device to be sure it has centered into the mounting plate and has created a seal.



CAUTION/WARNING/DISCLAIM:

- Verify that the inlet(s) pipe(s) is not protruding into the catch basin. If it is, cut it back so that the inlet pipe is flush with the catch basin wall.
- Any required cement in the installation must be approved for PVC.
- The solvent cement should not be used below 0°C (32°F) or in a high humidity environment. Please refer to the IPEX solvent cement guide to confirm required curing times or attend the IPEX [Online Solvent Cement Training Course](#).
- Call your IPEX representative for more information or if you have any questions about our products.

IPEX TEMPEST Inlet Control Devices Technical Specification

General

Inlet control devices (ICD's) are designed to provide flow control at a specified rate for a given water head level and also provide odour and floatable control where specified. All ICD's will be IPEX Tempest or approved equal.

All devices shall be removable from a universal mounting plate. An operator from street level using only a T-bar with a hook will be able to retrieve the device while leaving the universal mounting plate secured to the catch basin wall face. The removal of the TEMPEST devices listed above must not require any unbolting or special manipulation or any special tools.

High Flow (HF) Sump devices will consist of a removable threaded cap which can be accessible from street level with out entry into the catchbasin (CB). The removal of the threaded cap shall not require any special tools other than the operator's hand.

ICD's must have no moving parts.

Materials

ICD's are to be manufactured from Polyvinyl Chloride (PVC) or Polyurethane material, designed to be durable enough to withstand multiple freeze-thaw cycles and exposure to harsh elements.

The inner ring seal will be manufactured using a Buna or Nitrile material with hardness between Duro 50 and Duro 70.

The wall seal is to be comprised of a 3/8" thick Neoprene Closed Cell Sponge gasket which is attached to the back of the wall plate.

All hardware will be made from 304 stainless steel.

Dimensioning

The Low Medium Flow (LMF), High Flow (HF) and the High Flow (HF) Sump shall allow for a minimum outlet pipe diameter of 200mm with a 600mm deep Catch Basin sump.

Installation

Contractor shall be responsible for securing, supporting and connecting the ICD's to the existing influent pipe and catchbasin/manhole structure as specified and designed by the Engineer.



FRP_Ottawa East_2yr_v2_FF FRP_Ottawa East_100yr_v2 FRP_Ottawa East_50yr_v2 FRP_Ottawa East_25yr_v2 FRP_Ottawa East_10yr_v2 FRP_Ottawa East_5yr_v2 FRP_Ottawa East_2yr_v2

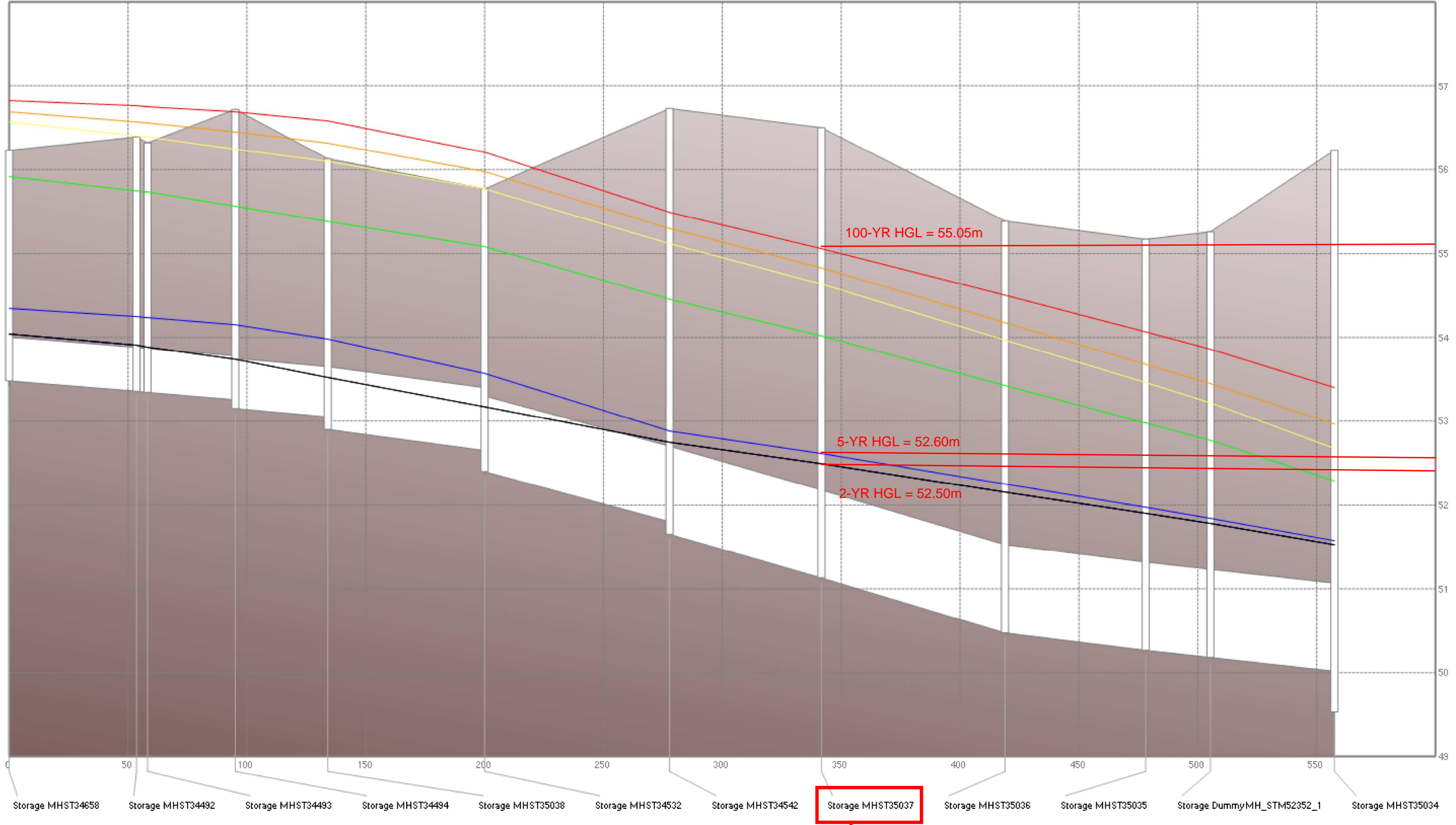

Storage MHST35037

MANHOLE LOCATED AT 127 CARILLON STREET

APPENDIX C: Drawings

119068-GP
119068-GR
119068-STM
119068-ESC

SANITARY MANHOLE TABLE				
MANHOLE ID	SIZE(mm)	T/G ELEV (m)	INVERT (m)	PIPE DIAMETER (mm)
3	1200	56.52	E=53.68 N=53.71 W=53.74	E=200 W=200 N=200
5	1200	56.42	E=53.91 N=53.97 S=53.97	E=200 N=200 S=200
7	1200	56.53	N=54.07	N=200
9	1200	56.46	S=54.08 N=54.09 E=54.23	S=200 N=200 E=200
11	1200	56.55	S=54.34 E=54.34	S=200 E=200
13	1200	56.53	N=53.85 S=53.84 W=53.90	N=200 S=200 W=200
15	1200	56.62	N=53.96 S=53.85 W=54.01	N=200 S=200 W=200
17	1200	56.72	E=54.12 S=54.06 W=54.12	E=200 S=200 W=200
19	1200	56.73	E=54.39	E=200
21	1200	56.77	W=54.24	W=200
23	1200	55.97	W=53.57 N=53.52 S=53.51	W=200 N=200 S=250
25	1200	54.80	W=53.70 E=53.73	W=200 E=200
27	1200	54.51	W=53.60 E=53.60	W=200 E=200

STORM MANHOLE TABLE				
MANHOLE ID	SIZE(mm)	T/G ELEV (m)	INVERT (m)	PIPE DIAMETER (mm)
2	1200	56.47	E=52.62 W=52.74 N=52.72	E=375 W=450 N=200
4	1200	56.51	W=52.88 N=52.94 N=52.94	W=375 N=375 N=375
6	1200	56.43	S=52.33 E=52.40 N=52.48	S=525 E=450 N=375
8	1200	55.11	N=53.31 S=53.29 W=53.99	N=250 S=300 W=300
10	1200	56.57	N=53.12 S=53.05	N=300 S=375
12	1200	56.73	E=54.41 S=53.88 W=53.14	E=200 S=250 W=250
14	1200	56.51	N=53.08 S=53.08 W=53.14	N=375 S=375 W=250
16	1200	56.59	N=53.31 S=53.29 W=53.36	N=300 S=375 W=250
18	1500	55.44	W=52.14 W=53.75 E=52.08	N=525 W=300 E=525
20	1500	55.61	S=51.94 W=52.00 E=53.79	S=525 W=450 E=250
22	1200	56.63	E=53.34 W=55.09	E=250 W=200
24	1200	56.66	E=53.56 W=55.14	E=250 W=200
26	1200	56.69	N=56.22 S=53.23 W=53.58	N=200 S=300 W=250
28	1200	56.73	E=53.78 W=55.20	E=250 W=200
30	1800	56.50	E=51.07 W=51.07 N=51.59	E=1050 W=1050 N=525

REAR YARD CATCHBASIN TABLE				
RYCB No.	T/G ELEVATION	INVERT	I.C.D.	
LCB1	55.66	54.26	-	
LCB2	55.45	54.25	-	
LCB3	55.55	54.55	-	
LCB4	55.50	54.50	-	
RYCB1	55.65	53.91	TEMPEST LMF (VORTEX 76)	
RYCB3	55.59	54.03	TEMPEST LMF (VORTEX 87)	
RYCB4	55.65	54.65	-	
RYCB5	55.25	54.02	-	
RYCB6	55.39	53.77	TEMPEST LMF (VORTEX 83)	

SEWER CROSSING TABLE			
LOCATION	ELEVATIONS	CLEARANCE	
C1	SAN INV=53.51 WM OBV=53.26	0.25m	
C2	WM INV=53.48 STM OBV=53.18	0.30m	
C3	SAN INV=53.58 STM OBV=53.20	0.38m	
C4	SAN INV=53.75 STM OBV=53.24	0.51m	
C5	WM INV=53.89 STM OBV=53.23	0.66m	
C6	WM INV=54.22 SAN OBV=53.92	0.30m	
C7	SAN INV=53.98 STM OBV=52.86	1.12m	
C8	WM INV=54.41 SAN OBV=54.11	0.30m	
C9	WM INV=53.84 STM OBV=53.89	0.95m	
C10	WM INV=53.90 STM OBV=52.17	1.73m	
C11	SAN INV=52.63 STM OBV=52.14	0.49m	
C12	SAN INV=54.22 WM OBV=53.97	0.25m	
C13	SAN INV=54.32 WM OBV=54.07	0.25m	
C14	WM INV=54.41 SAN OBV=54.11	0.30m	
C15	WM INV=53.98 STM OBV=53.43	0.55m	
C16	WM INV=53.86 STM OBV=53.41	0.45m	
C17	WM INV=54.52 SAN OBV=54.22	0.30m	
C18	WM INV=54.07 STM OBV=53.64	0.43m	
C19	SAN INV=53.97 STM OBV=53.63	0.34m	
C20	SAN INV=54.13 STM OBV=53.82	0.31m	
C21	WM INV=54.12 STM OBV=53.81	0.31m	
C22	SAN OBV=54.26 WM INV=54.56	0.30m	

CATCHBASIN TABLE				
CB ID	T/G ELEVATION	INVERT	I.C.D.	
CB1	56.43	55.03	TEMPEST LMF (VORTEX 84)	
CB2	56.38	54.88	TEMPEST LMF (VORTEX 84)	
CB3	56.43	55.03	TEMPEST LMF (VORTEX 75)	
CB4	56.50	55.10	TEMPEST LMF (VORTEX 74)	
CB5	56.56	55.16	TEMPEST LMF (VORTEX 74)	
CB6	56.48	55.08	TEMPEST LMF (VORTEX 76)	
CB7	56.57	55.14	TEMPEST LMF (VORTEX 74)	
CB8	56.55	55.15	TEMPEST LMF (VORTEX 74)	
CB9	56.61	55.18	TEMPEST LMF (VORTEX 74)	
CB10	56.63	55.23	TEMPEST LMF (VORTEX 74)	
CB11	56.67	55.24	TEMPEST LMF (VORTEX 74)	
CB12	56.38	54.95	TEMPEST LMF (VORTEX 76)	

WATERMAIN TABLE				
Station	F/G ELEVATION	TOP OF WATERMAIN	DESCRIPTION	
1+000.00	55.75	53.35	CONNECT TO EXISTING	
1+011.86	56.01	53.61	VB1	
1+025.00	56.61	54.21		
1+033.73	56.54	54.14	H. BEND	
1+035.09	56.54	54.14	200 X 200 TEE	
1+040.25	56.54	54.14	H. BEND	
1+050.00	56.55	54.15		
1+060.50	56.52	54.12	HYD1 TEE	
1+075.00	56.49	54.09		
1+103.00	56.67	54.27		
1+103.81	56.64	54.24	200 X 150 TEE	
1+125.00	56.13	53.73		
1+127.23	55.98	53.58	VB7	
1+133.04	55.99	53.59	200 X 300 TEE	

WATERMAIN TABLE				
Station	F/G ELEVATION	TOP OF WATERMAIN	DESCRIPTION	
2+000.00	56.54	54.14	CAP	
2+013.26	56.44	54.04	H. BEND	
2+019.18	56.45	54.05	VB3	
2+025.00	56.52	54.12		
2+040.02	56.47	54.07	200 X 150 TEE	
2+050.00	56.50	54.10		
2+059.56	56.64	54.24	HYD2 TEE	
2+073.88	56.56	54.16	200 X 150 TEE	
2+075.05	56.57	54.17		
2+100.00	56.67	54.27		
2+103.81	56.64	54.24	200 X 150 TEE	
2+125.00	56.13	53.73		
2+127.23	55.98	53.58	VB7	
2+133.04	55.99	53.59	200 X 300 TEE	

WATERMAIN TABLE				
Station	F/G ELEVATION	TOP OF WATERMAIN	DESCRIPTION	
3+000.00	56.54	54.14	200 X 200 TEE	
3+001.50	56.50	54.10	H. BEND	
3+006.63	56.53	54.13	VB2	
3+025.00	56.55	54.15		
3+029.76	56.56	54.16	200 X 150 TEE	
3+050.00	56.70	54.30		
3+059.56	56.65	54.25	200 X 200 TEE	
3+075.00	56.73	54.33		
3+076.84	56.74	54.34	HYD3 TEE	
3+089.36	56.76	54.36	200 X 150 TEE	

WATERMAIN TABLE				
Station	F/G ELEVATION	TOP OF WATERMAIN	DESCRIPTION	
4+000.00	56.47	54.07	200 X 150 TEE	
4+023.07	56.64	54.24		
4+041.89	56.67	54.27	VB4	
4+047.56	56.56	54.16	200 X 150 TEE	

WATERMAIN TABLE				
Station	F/G ELEVATION	TOP OF WATERMAIN	DESCRIPTION	
5+000.00	56.56	54.16	200 X 150 TEE	
5+022.96	56.68	54.28		
5+043.68	56.74	54.34	VB5	
5+046.63	56.65	54.25	200 X 200 TEE	

WATERMAIN TABLE				
Station	F/G ELEVATION	TOP OF WATERMAIN	DESCRIPTION	
6+000.00	56.64	54.24	200 X 150 TEE	
6+021.19	56.77	54.37		
6+041.89	56.82	54.42	VB6	
6+044.84	56.76	54.36	200 X 150 TEE	
6+046.19	56.74	54.34		
6+062.05	56.75	54.35	CONNECT TO EXISTING	

WATERMAIN TABLE				
Station	F/G ELEVATION	TOP OF WATERMAIN	DESCRIPTION	
7+000.00	56.56	54.16	200 X 150 TEE	
7+022.96	56.68	54.28		
7+043.68	56.74	54.34	VB5	
7+046.63	56.65	54.25	200 X 200 TEE	

WATERMAIN TABLE				
Station	F/G ELEVATION	TOP OF WATERMAIN	DESCRIPTION	
8+000.00	56.56	54.16	200 X 150 TEE	
8+022.96	56.68	54.28		
8+043.68	56.74	54.34	VB5	
8+046.63	56.65	54.25	200 X 200 TEE	

LEGEND				
	SANITARY MANHOLE, SEWER & DIRECTION OF FLOW			
	STORM MANHOLE, SEWER & DIRECTION OF FLOW			
	WATERMAIN AND DIAMETER			
	VALVE & VALVE BOX			
	VALVE & VALVE CHAMBER			
	BEND AND THRUST BLOCK			
	HYDRANT CW VALVE & LEAD			
	CAP			
	ROAD CATCHBASIN			
	ROAD CATCHBASIN WITH ICD			
	LANDSCAPE TYPE CATCHBASIN			
	REAR YARD CATCH BASIN			
	UNDERGROUND STORAGE CHAMBERS WITH SUBDRAIN			

NOTES:
 RIDEAU RIVER REGULATORY FLOOD LEVEL (REDUCED FLOOD RISK) = 56.44
 ALL BUILDINGS ARE SLAB-ON-GRADE

FOR REVIEW ONLY				
6. CITY SUBMISSION	JUN 8/21	MAB	DATE	DTD
5. CITY SUBMISSION	FEB 5/21	MAB	CHECKED	LRW
4. STORM OUTLET VIA 127 CARILLON	OCT 23/20	MAB	DRAWN	DTD
3. SITE PLAN APPLICATION	AUG 24/20	MAB	CHECKED	LRW
2. RVCA APPROVAL IN PRINCIPAL APPLICATION	MAY 29/20	MAB	APPROVED	LRW
1. ISSUED FOR RVCA REVIEW	MAR 26/20	MAB	DATE	BY

SCALE				
1:250				
0 2 4 6 8 10				

NOVATECH				
Engineers, Planners & Landscape Architects				
Suite 200, 240 Michael Copland Drive				
Ottawa, Ontario, Canada K2M 1P6				
Telephone: (613) 254-9643				
Facsimile: (613) 254-5867				
Website: www.novatech-eng.com				

CITY OF OTTAWA
 200 BARIBEAU STREET
 PROJECT NO: 119068
 REV: 119068-GP

NOTE: THE POSITION OF ALL POLE LINES, CONDUITS, WATERMANS, SEWERS AND OTHER UNDERGROUND AND OVERGROUND UTILITIES AND STRUCTURES IS NOT NECESSARILY SHOWN ON THE CONTRACT DRAWINGS, AND WHERE SHOWN, THE ACCURACY OF THE POSITION OF SUCH UTILITIES AND STRUCTURES IS NOT GUARANTEED. BEFORE STARTING WORK, DETERMINE THE EXACT LOCATION OF ALL SUCH UTILITIES AND STRUCTURES AND ASSUME ALL LIABILITY FOR DAMAGE TO THEM.

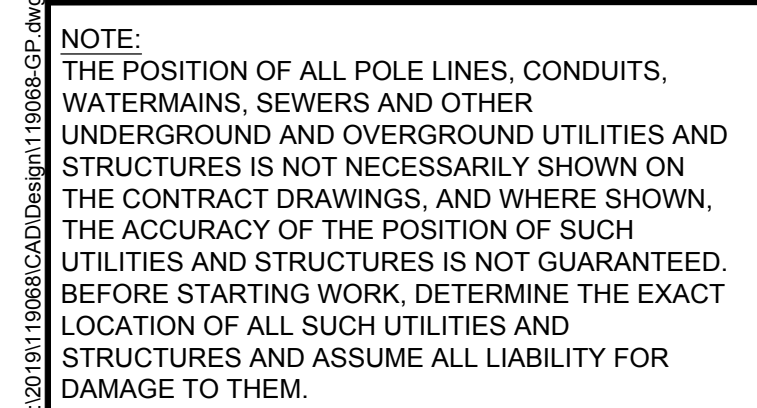

GENERAL NOTES:

1. DIMENSIONS AND LAYOUT INFORMATION SHALL BE CONFIRMED PRIOR TO COMMENCEMENT OF CONSTRUCTION.
2. THE ORIGINAL TOPOGRAPHY AND GROUND ELEVATIONS, SERVICING AND SURVEY INFORMATION SHOWN ON THIS PLAN ARE SUPPLIED FOR INFORMATION PURPOSES ONLY. IT SHALL BE THE RESPONSIBILITY OF THE CONTRACTOR TO VERIFY THE ACCURACY OF ALL INFORMATION OBTAINED FROM THIS PLAN.
3. CO-ORDINATE AND SCHEDULE ALL WORK WITH OTHER TRADES AND CONTRACTORS.
4. BEFORE COMMENCING CONSTRUCTION, PROVIDE PROOF OF COMPREHENSIVE ALL RISK AND OPERATIONAL LIABILITY INSURANCE INCLUDING BLASTING. INSURANCE POLICY TO NAME THE OWNER, ENGINEER AND THE CITY AS CO-INSURED.
5. CONNECT TO EXISTING SYSTEMS AS DETAILLED, INCLUDING ALL RESTORATION WORK NECESSARY TO REINSTATE SURFACES TO EXISTING CONDITIONS OR BETTER.
6. DETERMINE THE EXACT LOCATION, SIZE, MATERIAL AND ELEVATION OF ALL EXISTING UTILITIES PRIOR TO COMMENCING CONSTRUCTION. PROTECT AND ASSUME RESPONSIBILITY FOR ALL EXISTING UTILITIES WHETHER OR NOT SHOWN ON THESE DRAWINGS.
7. OBTAIN AND PAY FOR ALL NECESSARY PERMITS AND APPROVALS BEFORE COMMENCING CONSTRUCTION.
8. RESTORE ALL TRENCHES AND SURFACE FEATURES TO EXISTING CONDITIONS OR BETTER AND TO THE SATISFACTION OF MUNICIPAL AUTHORITIES.
9. REMOVE FROM SITE ALL DEBRIS AND EXCESS EXCAVATED MATERIAL UNLESS OTHERWISE INSTRUCTED BY THE ENGINEER.
10. ALL ELEVATIONS ARE GEODETIC AND UTILIZE METRIC UNITS.
11. REFER TO GEOTECHNICAL INVESTIGATION PA#278-1 (DATED JULY 5, 2016), PREPARED BY PATERSON GROUP INC. FOR SUBSURFACE CONDITIONS AND CONSTRUCTION RECOMMENDATIONS.
12. PERFORATED PIPE SUB-DRAINS TO BE PROVIDED AT SUBGRADE LEVEL EXTENDING FROM THE ROADSIDE CATCHBASIN FOR A DISTANCE OF 3.0m, PARALLEL TO THE CURB IN TWO DIRECTIONS.

SEWER NOTES:

1. SPECIFICATIONS:
 ITEM: CATCHBASIN (600x600mm)
 CATCHBASIN MANHOLE (1200)
 STORM / SANITARY MANHOLE (1200)
 ROADSIDE CB, FRAME & COVER
 CBM FRAME & COVER
 STORM / SANITARY MH FRAME & COVER
 STORM SEWER
 SANITARY SEWER
 CATCHBASIN LEAD
 SPEC. No.: 705.010
 701.010
 701.010
 S24 & S19
 S25 & S28
 S24 / S24 & S25
 PVC DR 35 OR CONC.
 PVC DR 35
 PVC DR 35
 REFERENCE: OPSD
 OPSD
 OPSD
 CITY OF OTTAWA
 CITY OF OTTAWA
 CITY OF OTTAWA
 (CLASS SPECIFIED ON PROFILE DRAWINGS)
2. INSULATE ALL PIPES (SAN/STM) THAT HAVE LESS THAN 1.5m COVER WITH 50mmX1200mm HI-40 INSULATION. PROVIDE 150mm CLEARANCE BETWEEN PIPE AND INSULATION.
3. SERVICES ARE TO BE CONSTRUCTED TO PROPERTY LINE AT MINIMUM SLOPE OF 1.0% (2.0% IS PREFERRED).
4. PIPE BEDDING, COVER AND BACKFILL ARE TO BE COMPACTED TO AT LEAST 95% OF THE STANDARD PROCTOR MAXIMUM DRY DENSITY. THE USE OF CLEAN CRUSHED STONE AS A BEDDING LAYER SHALL NOT BE PERMITTED.
5. SEWER SERVICE CONNECTIONS PER CITY OF OTTAWA DETAILS S11 AND S11.1.
6. THE SITE SERVICING CONTRACTOR SHALL PERFORM FIELD TESTS FOR QUALITY CONTROL OF ALL SANITARY SEWERS. LEAKAGE TESTING SHALL BE COMPLETED IN ACCORDANCE WITH OPSD 410.17.6 AND 407.07.24. DYE TESTING IS TO BE COMPLETED ON ALL SANITARY SERVICES TO CONFIRM PROPER CONNECTION TO THE SANITARY SEWER MAIN. THE FIELD TESTS SHALL BE PERFORMED IN THE PRESENCE OF THE ENGINEER.
7. STORM MANHOLES AND CBMHS SHALL HAVE 300mm SUMPS UNLESS OTHERWISE INDICATED.
8. CONTRACTOR TO TELETYPE (CTV) ALL PROPOSED SEWERS, 300mm OR GREATER PRIOR TO BASE COURSE ASPHALT. UPON COMPLETION OF CONTRACT, THE CONTRACTOR IS RESPONSIBLE TO FLUSH AND CLEAN ALL SEWERS & APPURTENANCES.

WATERMAIN NOTES:

1. GENERAL:
 ITEM: WATERMAIN TRENCHING
 THERMAL INSULATION IN SHALLOW TRENCHES
 WATERMAIN CROSSING BELOW SEWER / OVER SEWER
 DETAIL No.: W17
 W22
 W25 / W25.2
 REFERENCE: CITY OF OTTAWA
 CITY OF OTTAWA
 CITY OF OTTAWA
2. THE WATERMAIN SHALL BE PVC DR 18 IN ACCORDANCE WITH MATERIAL SPECIFICATION MW-18.1, UNLESS OTHERWISE INDICATED.
3. SUPPLY AND CONSTRUCT ALL WATERMANS AND APPURTENANCES IN ACCORDANCE WITH THE CITY OF OTTAWA STANDARDS AND SPECIFICATIONS. EXCAVATION, BACKFILL AND RESTORATION OF ALL WATERMANS BY THE CONTRACTOR. CONNECTIONS AND SHUT-OFFS AT THE MAIN AND CHLORINATION OF THE WATER SYSTEM SHALL BE PERFORMED BY CITY OFFICIALS.
4. WATERMAIN SHALL BE MINIMUM 2.4m DEPTH BELOW GRADE UNLESS OTHERWISE INDICATED.
5. PROVIDE MINIMUM 0.50m CLEARANCE BETWEEN OUTSIDE OF PIPES AT ALL CROSSINGS.
6. WATER SERVICE SHALL BE CONSTRUCTED TO SERVICE POST AT PROPERTY LINE, UNLESS OTHERWISE INDICATED.
7. PRESSURE REDUCING VALVES SHALL

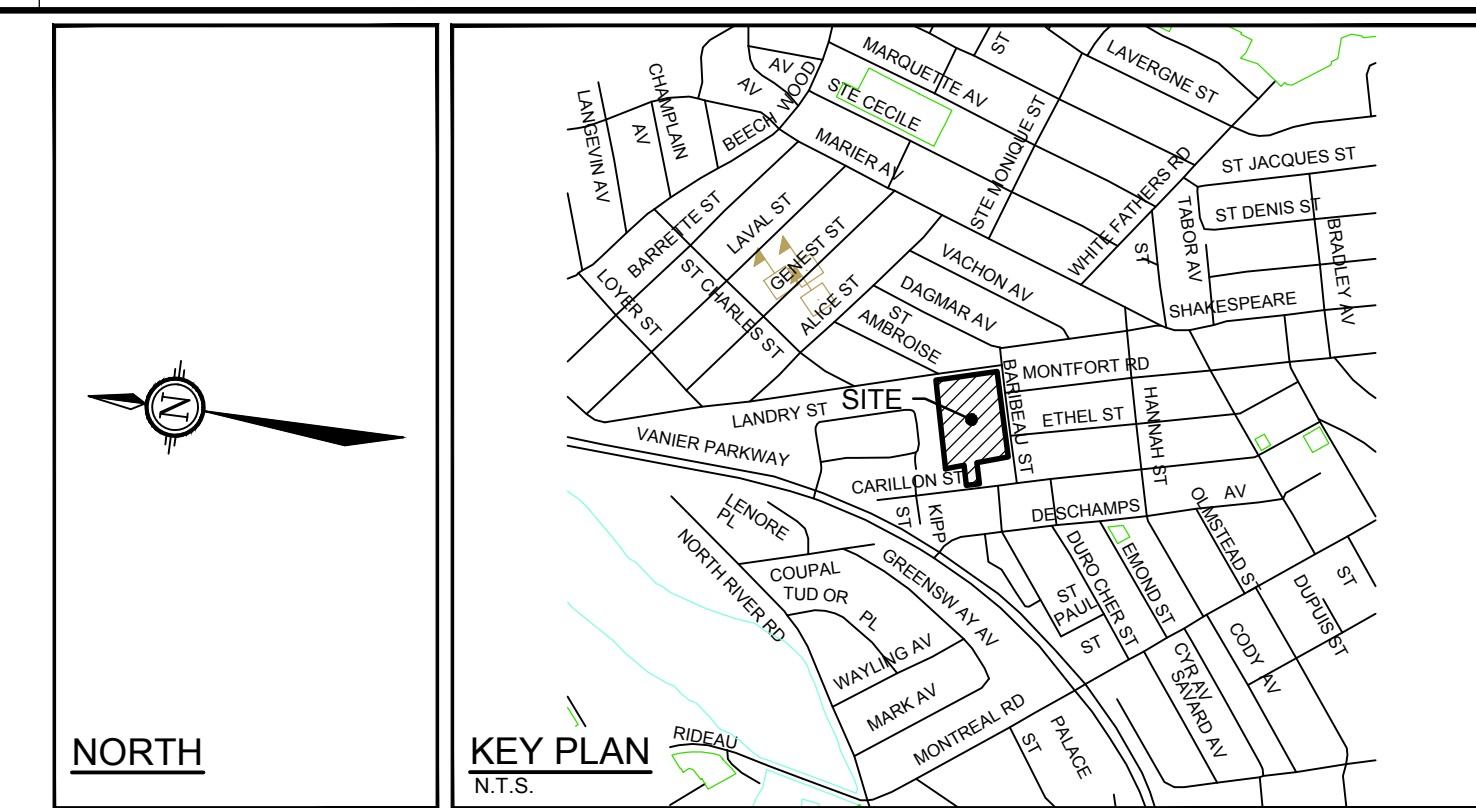
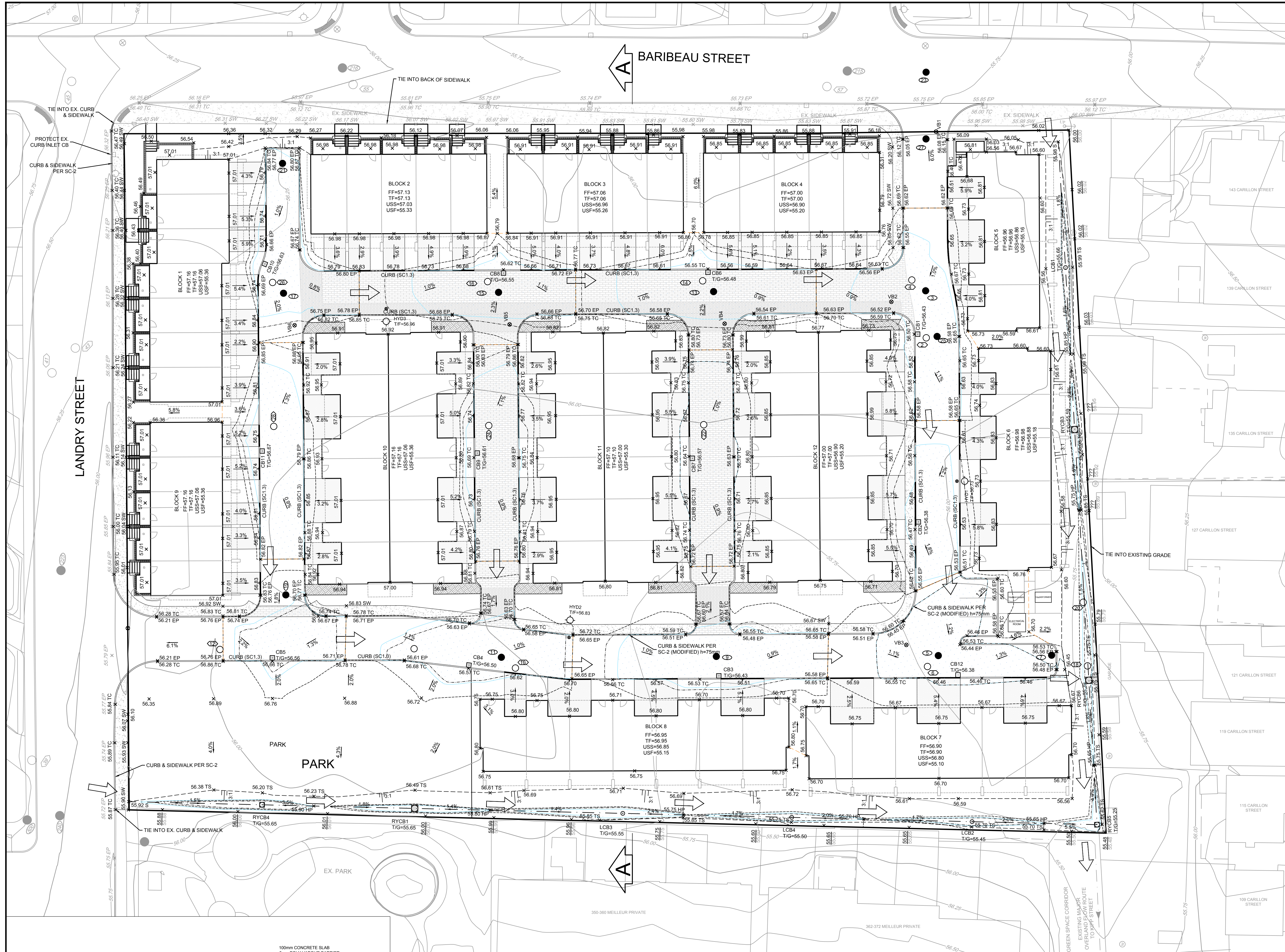

LEGEND

	PROPOSED GRADE AND DIRECTION OF FLOW		HYDRANT WITH TOP OF FLANGE ELEVATION
	PROPOSED ELEVATION AT HIGH POINT		STORM MANHOLE
	PROPOSED ELEVATION EXISTING ELEVATION		CATCHBASIN WITH TOP OF GRATE ELEVATION
	EXISTING SPOT ELEVATION		LANDSCAPE TYPE CATCHBASIN WITH TOP OF GRATE ELEVATION
	EXISTING ELEVATION AT BACK OF SIDEWALK		VALVE & VALVE BOX LOCATION
	EXISTING CONTOUR ELEVATION		FF= FINISHED FLOOR
	UTILITY POLE AND GUY WIRE		TF= TOP OF FOUNDATION
	MAJOR OVERLAND FLOW DIRECTION		USS= UNDERSIDE OF SLAB
	TERRACE GRADE (3:1 MAX)		USF= UNDERSIDE OF FOOTING
	SWALE AND TERRACE		EP= EDGE OF PAVEMENT
	MAX STATIC PONDING LIMITS		TC= TOP OF CURB
	100-YR PONDING LIMITS		
	100-YR +20% PONDING LIMITS		

GENERAL NOTES:

- DIMENSIONS AND LAYOUT INFORMATION SHALL BE CONFIRMED PRIOR TO COMMENCEMENT OF CONSTRUCTION.
- THE ORIGINAL TOPOGRAPHY AND GROUND ELEVATIONS, SERVING AND SURVEY INFORMATION SHOWN ON THIS PLAN ARE SUPPLIED FOR INFORMATION PURPOSES ONLY. IT SHALL BE THE RESPONSIBILITY OF THE CONTRACTOR TO VERIFY THE ACCURACY OF ALL INFORMATION OBTAINED FROM THIS PLAN.
- CO-ORDINATE AND SCHEDULE ALL WORK WITH OTHER TRADES AND CONTRACTORS.
- BEFORE COMMENCING CONSTRUCTION, PROVIDE PROOF OF COMPREHENSIVE ALL RISK AND OPERATIONAL LIABILITY INSURANCE INCLUDING BLASTING, INSURANCE POLICY TO NAME THE OWNER, ENGINEER AND THE CITY AS CO-INSURED. AMOUNT OF INSURANCE TO BE SPECIFIED BY OWNERS AGENT.
- CONNECT TO EXISTING SYSTEMS AS DETAILED, INCLUDING ALL RESTORATION WORK NECESSARY TO REINSTATE SURFACES TO EXISTING CONDITIONS OR BETTER.
- DETERMINE THE EXACT LOCATION, SIZE, MATERIAL AND ELEVATION OF ALL EXISTING UTILITIES PRIOR TO COMMENCING CONSTRUCTION. PROTECT AND ASSUME ALL RESPONSIBILITY FOR ALL EXISTING UTILITIES WHETHER OR NOT SHOWN ON THESE DRAWINGS.
- OBTAIN AND PAY FOR ALL NECESSARY PERMITS AND APPROVALS BEFORE COMMENCING CONSTRUCTION.
- RESTORE ALL TRENCHES AND SURFACE FEATURES TO EXISTING CONDITIONS OR BETTER AND TO THE SATISFACTION OF CITY OF OTTAWA AUTHORITIES.
 - ASPHALT RESTORATION SHALL BE IN ACCORDANCE WITH CITY OF OTTAWA DETAIL R-10.
 - THICKNESS OF GRANULAR MATERIAL AND ASPHALT LAYERS TO MATCH EXISTING.
 - BOULEVARDS SHALL BE REINSTATE WITH 100mm OF TOPSOIL, SEED AND MULCH.
- REMOVE FROM SITE ALL EXCESS EXCAVATED MATERIAL UNLESS OTHERWISE INSTRUCTED BY ENGINEER.
- ALL ELEVATIONS ARE GEODETIC AND UTILIZE METRIC UNITS.
- REFER TO GEOTECHNICAL INVESTIGATION PG4951-1 (DATED JULY 15, 2019), PREPARED BY PATERSON GROUP FOR SUBSURFACE CONDITIONS AND CONSTRUCTION RECOMMENDATIONS.
- PERFORATED PIPE SUB-DRAINS TO BE PROVIDED AT SUBGRADE LEVEL EXTENDING FROM THE ROADSIDE CATCHBASIN FOR A DISTANCE OF 3.0m, PARALLEL TO THE CURB IN TWO DIRECTIONS.

- GRADING AND PAVEMENT NOTES:**
- ALL TOPSOIL, ORGANIC OR DELETERIOUS MATERIAL MUST BE ENTIRELY REMOVED FROM BENEATH THE PROPOSED HARD SURFACE (ie. PAVEMENT, CURB, SIDEWALK, ETC.) AREAS AS DIRECTED BY THE SITE ENGINEER OR GEOTECHNICAL ENGINEER PRIOR TO THE PLACEMENT OF GRANULARS.
 - EXPOSED SUBGRADES IN PROPOSED PAVED AREAS SHOULD BE HEAVILY PROOF ROLLED WITH A LARGE (10 TON) VIBRATORY STEEL DRUM ROLLER UNDER DRY CONDITIONS AND INSPECTED BY THE GEOTECHNICAL ENGINEER PRIOR TO THE PLACEMENT OF GRANULARS.
 - ANY SOFT AREAS EVIDENT FROM THE PROOF ROLLING SHOULD BE SUB-EXCAVATED AND REPLACED WITH SUITABLE MATERIAL THAT IS FROST COMPATIBLE WITH THE EXISTING SOILS AS RECOMMENDED BY THE GEOTECHNICAL ENGINEER.
 - THE GRANULAR BASE SHOULD BE PLACED IN MAXIMUM 300mm LIFTS AND COMPACTED TO AT LEAST 100% OF THE STANDARD PROCTOR MAXIMUM DRY DENSITY VALUE. ANY ADDITIONAL GRANULAR FILL USED BELOW THE PROPOSED PAVEMENT SHOULD BE PLACED IN MAXIMUM 300mm LIFTS AND COMPACTED TO AT LEAST 95% OF THE STANDARD PROCTOR MAXIMUM DRY DENSITY VALUE.
 - ROADWAY SUBGRADE TO BE INSPECTED BY THE GEOTECHNICAL ENGINEER AT THE TIME OF CONSTRUCTION TO REVIEW IF A WOVEN GEOTEXTILE IS REQUIRED BELOW THE GRANULAR MATERIALS, AND TO CONFIRM THE DEPTH AND COMPACTION OF GRANULAR 'B'.
 - PRIOR TO THE PLACEMENT OF TOPLIFT, THE CONTRACTOR SHALL ADJUST ALL STRUCTURES TO FINAL GRADE PER CITY OF OTTAWA STANDARDS.
 - MINIMUM OF 2% GRADE FOR ALL GRASS AREAS UNLESS OTHERWISE NOTED.
 - MAXIMUM TERRACING GRADE TO BE 3:1 UNLESS OTHERWISE NOTED.
 - ALL GRADES BY CURBS ARE EDGE OF PAVEMENT GRADES UNLESS OTHERWISE INDICATED.
 - ALL CURBS SHALL BE MOUNTABLE CURB UNLESS OTHERWISE NOTED AND CONSTRUCTED PER CITY OF OTTAWA STANDARD (SC1.3).
 - REFER TO LANDSCAPE PLAN FOR PLANTING AND OTHER LANDSCAPE FEATURE DETAILS.

PONDING ID	STRUCTURE	PONDING				MAX STATIC PONDING ELEVATION (m)	MAX STATIC PONDING DEPTH (m)
		100 YEAR PONDING ELEVATION	100 YEAR PONDING DEPTH (m)	100 YEAR +20% PONDING ELEVATION	100 YEAR +20% PONDING DEPTH (m)		
P1	CB1	56.55	0.23	56.70	0.27	56.58	0.15
P2	CB2	56.60	0.24	56.67	0.29	56.53	0.15
P3	CB3	56.60	0.17	56.68	0.25	56.58	0.15
P4	CB4	56.64	0.14	56.73	0.23	56.65	0.15
P5	CB5	56.69	0.13	56.78	0.22	56.71	0.15
P6	CB6	56.69	0.21	56.74	0.26	56.63	0.15
P7	CB7	56.72	0.15	56.79	0.22	56.72	0.15
P8	CB8	56.74	0.19	56.79	0.24	56.70	0.15
P9	CB9	56.79	0.18	56.82	0.21	56.76	0.15
P10	CB10	56.81	0.18	56.85	0.22	56.78	0.15
P11	CB11	56.86	0.19	56.90	0.23	56.82	0.15
P12	CB12	56.50	0.12	56.65	0.27	56.50	0.12
P13	RYCB4	55.83	0.18	55.87	0.22	55.90	0.25
P14	RYCB1	55.83	0.18	55.86	0.21	55.80	0.15
P15	LCB3	55.82	0.27	55.86	0.31	55.75	0.20
P16	LCB4	55.66	0.16	55.76	0.26	55.70	0.20
P17	LCB2	55.63	0.18	55.72	0.27	55.65	0.20
P18	RYCB5	55.57	0.32	55.69	0.44	55.50	0.25
P19	RYCB6	55.57	0.18	55.79	0.40	55.65	0.26
P20	RYCB3	55.80	0.21	56.83	0.24	55.75	0.16
P21	LCB1	55.81	0.15	55.85	0.19	55.85	0.19

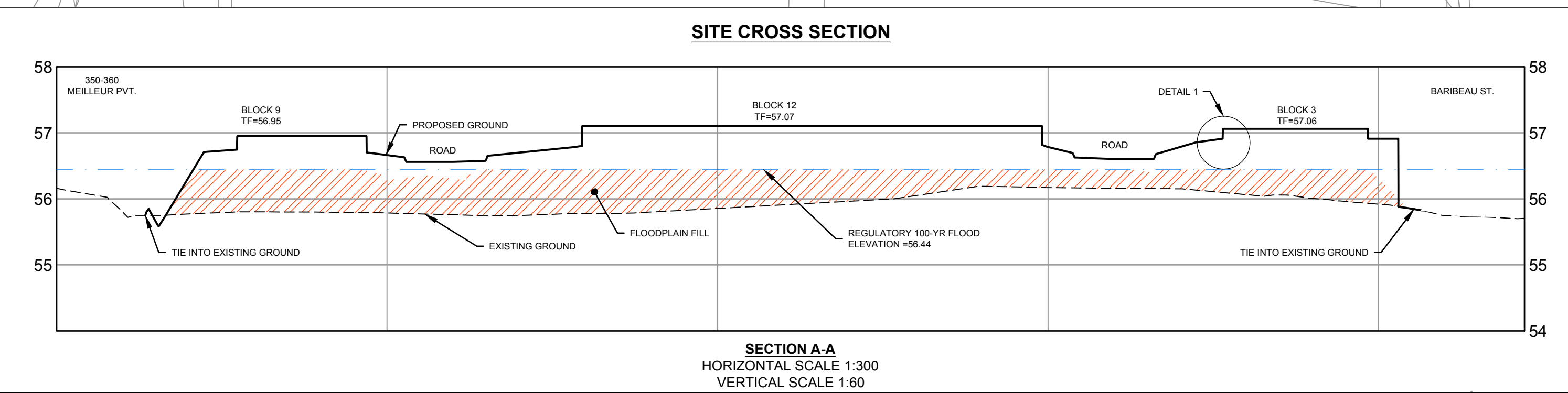
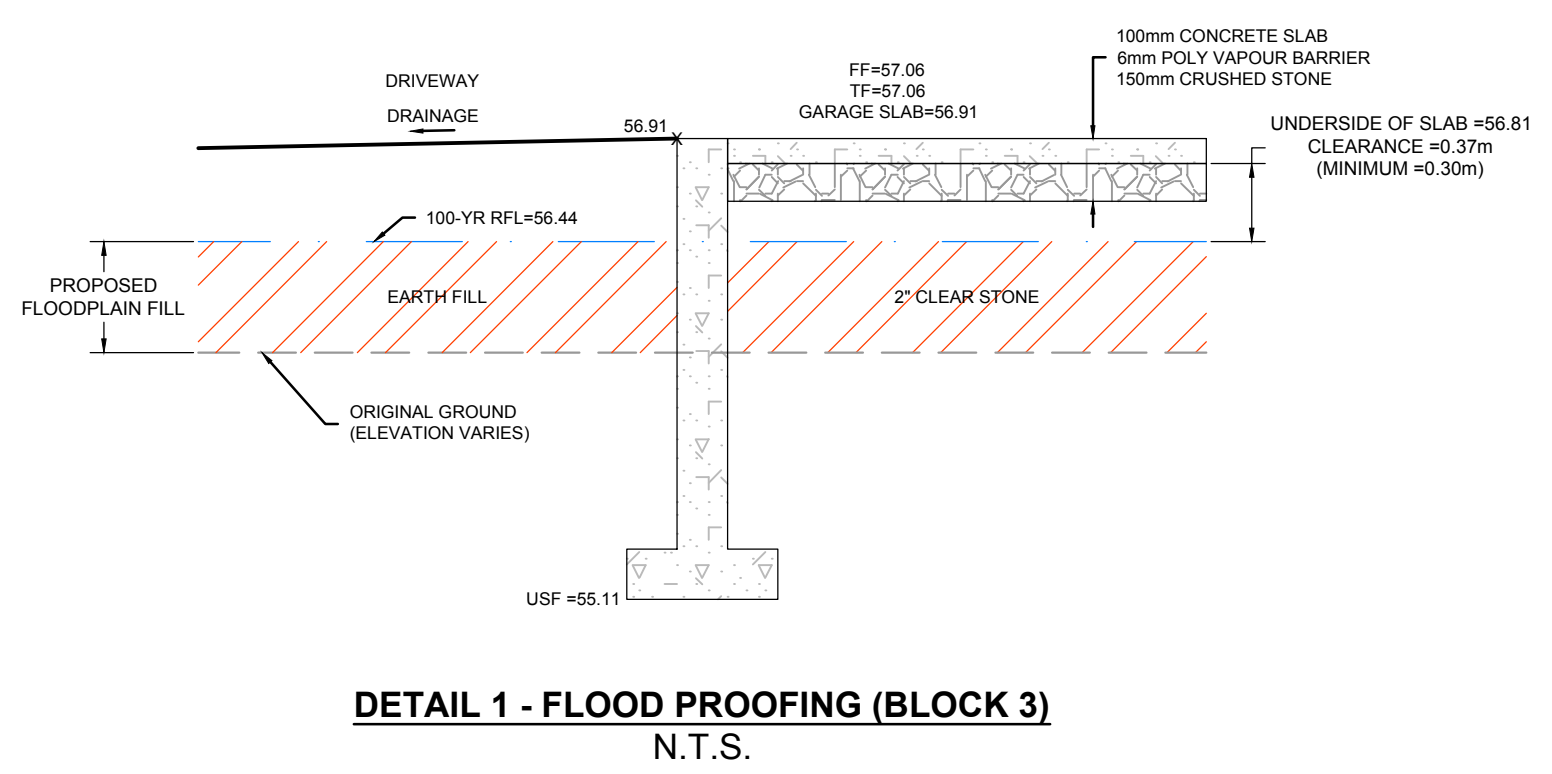

PAVEMENT STRUCTURE:

40mm	ASPHALT SP12.5
50mm	ASPHALT SP19.0
150mm	GRAN 'A'
400mm	GRAN 'B' TYPE II
640mm	TOTAL DEPTH

NOTE: THE POSITION OF ALL POLE LINES, CONDUITS, WATERMANS, SEWERS AND OTHER UNDERGROUND AND OVERGROUND UTILITIES AND STRUCTURES IS NOT NECESSARILY SHOWN ON THE CONTRACT DRAWINGS, AND WHERE SHOWN, THE ACCURACY OF THE POSITION OF SUCH UTILITIES AND STRUCTURES IS NOT GUARANTEED. BEFORE STARTING WORK, DETERMINE THE EXACT LOCATION OF ALL SUCH UTILITIES AND STRUCTURES AND ASSUME ALL LIABILITY FOR DAMAGE TO THEM.



NO.	REVISION	DATE	BY
6.	CITY SUBMISSION	JUN 8/21	MAB
5.	CITY SUBMISSION	FEB 5/21	MAB
4.	STORM OUTLET VIA 127 CARILLON	OCT 23/20	MAB
3.	SITE PLAN APPLICATION	AUG 24/20	MAB
2.	RVCA APPROVAL IN PRINCIPAL APPLICATION	MAY 28/20	MAB
1.	ISSUED FOR RVCA REVIEW	MAR 26/20	MAB

SCALE	DATE	FOR REVIEW ONLY
1:250	DTD	
	LRW	
	DTD	
	LRW	
	MAB	



NOVATECH
Engineers, Planners & Landscape Architects
Suite 200, 240 Michael Cowpland Drive
Ottawa, Ontario, Canada K2M 1P6
Telephone: (613) 254-9643
Facsimile: (613) 254-5867
Website: www.novatech-eng.com

CITY OF OTTAWA
200 BARIBEAU STREET

GRADING PLAN

PROJECT NO: 119068
REV # 6
DRAWING NO: 119068-GR

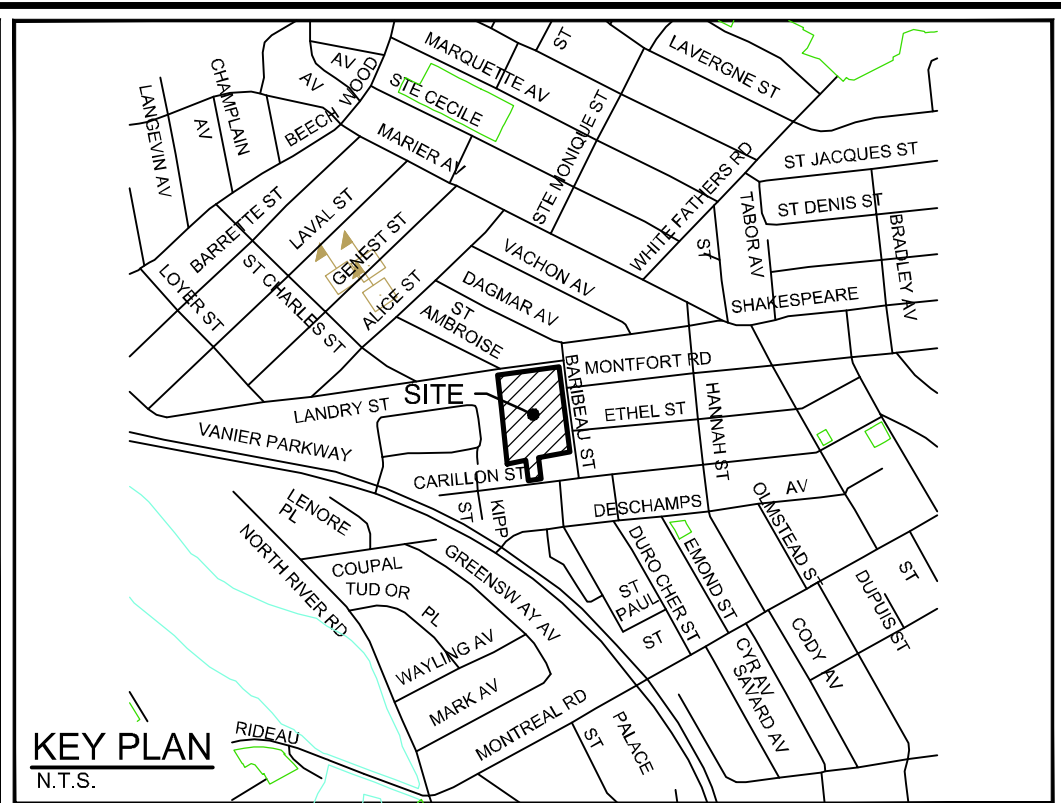
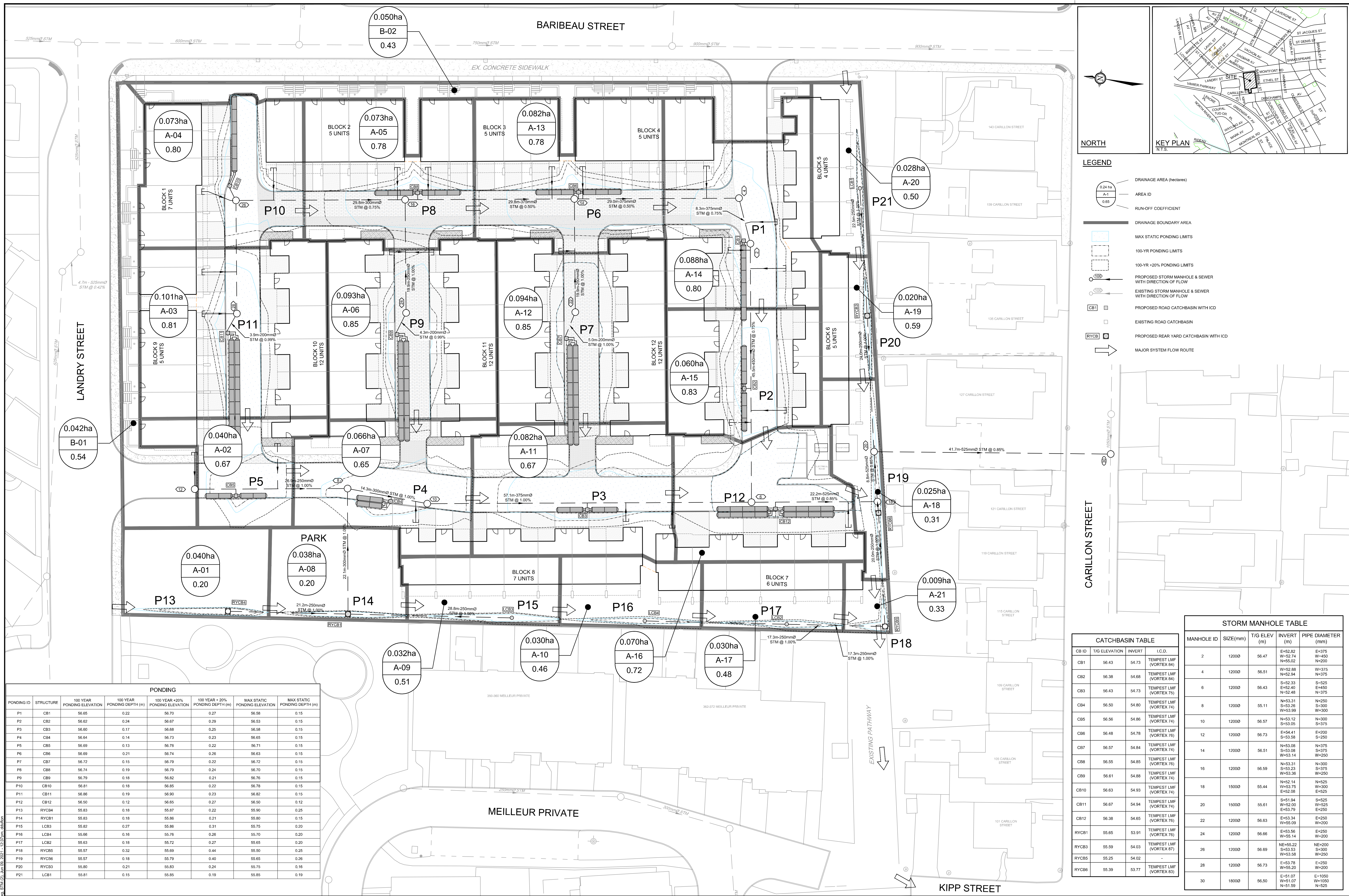

LEGEND

- 0.24 ha DRAINAGE AREA (hectares)
- A-1 AREA ID
- 0.85 RUN-OFF COEFFICIENT
- DRAINAGE BOUNDARY AREA
- MAX STATIC PONDING LIMITS
- 100-YR PONDING LIMITS
- 100-YR +20% PONDING LIMITS
- PROPOSED STORM MANHOLE & SEWER WITH DIRECTION OF FLOW
- EXISTING STORM MANHOLE & SEWER WITH DIRECTION OF FLOW
- CB1 PROPOSED ROAD CATCHBASIN WITH ICD
- EXISTING ROAD CATCHBASIN
- RYCB1 PROPOSED REAR YARD CATCHBASIN WITH ICD
- MAJOR SYSTEM FLOW ROUTE

CATCHBASIN TABLE

CB ID	TIG ELEVATION	INVERT	I.C.D.
CB1	56.43	54.73	TEMPEST LMF (VORTEX 84)
CB2	56.38	54.68	TEMPEST LMF (VORTEX 84)
CB3	56.43	54.73	TEMPEST LMF (VORTEX 75)
CB4	56.50	54.80	TEMPEST LMF (VORTEX 74)
CB5	56.56	54.86	TEMPEST LMF (VORTEX 74)
CB6	56.48	54.78	TEMPEST LMF (VORTEX 76)
CB7	56.57	54.84	TEMPEST LMF (VORTEX 74)
CB8	56.55	54.85	TEMPEST LMF (VORTEX 76)
CB9	56.61	54.88	TEMPEST LMF (VORTEX 74)
CB10	56.63	54.93	TEMPEST LMF (VORTEX 74)
CB11	56.67	54.94	TEMPEST LMF (VORTEX 74)
CB12	56.38	54.65	TEMPEST LMF (VORTEX 76)
RYCB1	55.65	53.91	TEMPEST LMF (VORTEX 74)
RYCB3	55.59	54.03	TEMPEST LMF (VORTEX 87)
RYCB5	55.25	54.02	-
RYCB6	55.39	53.77	TEMPEST LMF (VORTEX 83)

STORM MANHOLE TABLE

MANHOLE ID	SIZE (mm)	TIG ELEV (m)	INVERT (m)	PIPE DIAMETER (mm)
2	1200	56.47	E=52.82 W=52.74 N=55.02	E=375 W=450 N=200
4	1200	56.51	W=52.88 N=52.94	W=375 N=375
6	1200	56.43	S=52.33 E=52.40 N=52.48	S=525 E=450 N=375
8	1200	55.11	N=53.31 S=53.26 W=53.99	N=250 S=300 W=300
10	1200	56.57	N=53.12 S=53.05	N=300 S=375
12	1200	56.73	E=54.41 S=53.58	E=200 S=250
14	1200	56.51	N=53.08 S=53.08 W=53.14	N=375 S=375 W=250
16	1200	56.59	N=53.31 S=53.23 W=53.36	N=300 S=375 W=250
18	1500	55.44	N=52.14 W=53.75 E=52.08	N=525 W=300 E=525
20	1500	55.61	S=51.94 W=52.00 E=53.79	S=425 W=525 E=250
22	1200	56.63	E=53.34 W=55.09	E=250 W=200
24	1200	56.66	E=53.56 W=55.14	E=250 W=200
26	1200	56.69	NE=55.22 S=53.53 W=53.58	NE=200 S=300 W=250
28	1200	56.73	E=53.76 W=55.20	E=250 W=200
30	1800	56.50	E=51.07 W=51.07 N=51.59	E=1050 W=1050 N=525

PONDING

PONDING ID	STRUCTURE	100 YEAR PONDING ELEVATION	100 YEAR PONDING DEPTH (m)	100 YEAR +20% PONDING ELEVATION	100 YEAR +20% PONDING DEPTH (m)	MAX STATIC PONDING ELEVATION	MAX STATIC PONDING DEPTH (m)
P1	CB1	56.65	0.22	56.70	0.27	56.58	0.15
P2	CB2	56.62	0.24	56.67	0.29	56.53	0.15
P3	CB3	56.80	0.17	56.83	0.25	56.58	0.15
P4	CB4	56.84	0.14	56.73	0.23	56.65	0.15
P5	CB5	56.89	0.13	56.78	0.22	56.71	0.15
P6	CB6	56.89	0.21	56.74	0.28	56.63	0.15
P7	CB7	56.72	0.15	56.79	0.22	56.72	0.15
P8	CB8	56.74	0.19	56.79	0.24	56.70	0.15
P9	CB9	56.79	0.18	56.82	0.21	56.76	0.15
P10	CB10	56.81	0.18	56.85	0.22	56.78	0.15
P11	CB11	56.88	0.19	56.90	0.23	56.82	0.15
P12	CB12	56.50	0.12	56.55	0.27	56.50	0.12
P13	RYCB4	55.83	0.18	55.87	0.22	55.90	0.25
P14	RYCB1	55.83	0.18	55.86	0.21	55.80	0.15
P15	LCB3	55.82	0.27	55.86	0.31	55.75	0.20
P16	LCB4	55.86	0.16	55.76	0.26	55.70	0.20
P17	LCB2	55.83	0.18	55.72	0.27	55.65	0.20
P18	RYCB5	55.57	0.32	55.69	0.44	55.50	0.25
P19	RYCB6	55.57	0.18	55.79	0.40	55.65	0.26
P20	RYCB3	55.80	0.21	55.83	0.24	55.75	0.18
P21	LCB1	55.81	0.15	55.85	0.19	55.85	0.19

NOTE: THE POSITION OF ALL POLE LINES, CONDUITS, WATERMANS, SEWERS AND OTHER UNDERGROUND AND OVERGROUND UTILITIES AND STRUCTURES IS NOT NECESSARILY SHOWN ON THE CONTRACT DRAWINGS, AND WHERE SHOWN, THE ACCURACY OF THE POSITION OF SUCH UTILITIES AND STRUCTURES IS NOT GUARANTEED. BEFORE STARTING WORK, DETERMINE THE EXACT LOCATION OF ALL SUCH UTILITIES AND STRUCTURES AND ASSUME ALL LIABILITY FOR DAMAGE TO THEM.

REVISION

No.	REVISION	DATE	BY
6.	CITY SUBMISSION	JUN 8/21	MAB
5.	CITY SUBMISSION	FEB 5/21	MAB
4.	STORM OUTLET VIA 127 CARILLON	OCT 23/20	MAB
3.	SITE PLAN APPLICATION	AUG 24/20	MAB
2.	RVCA APPROVAL IN PRINCIPAL APPLICATION	MAY 28/20	MAB
1.	ISSUED FOR RVCA REVIEW	MAR 26/20	MAB

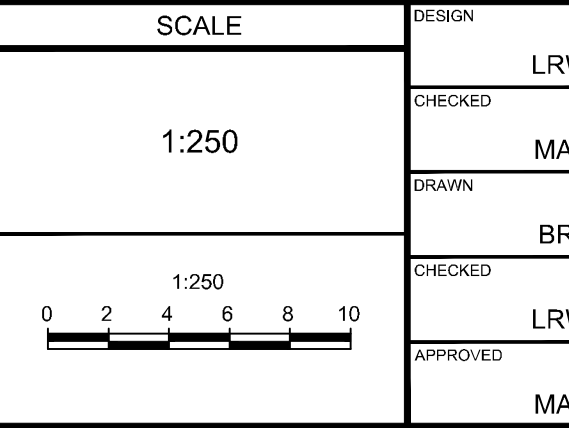

FOR REVIEW ONLY

DESIGN: LRW
CHECKED: MAB
DRAWN: BRF
CHECKED: LRW
APPROVED: MAB

L.R. VILSON
LICENSED PROFESSIONAL ENGINEER
PROVINCE OF ONTARIO
10160955

M.A. BISSETT
LICENSED PROFESSIONAL ENGINEER
PROVINCE OF ONTARIO
2021.06.08

NOVATECH
Engineers, Planners & Landscape Architects
Suite 200, 240 Michael Copland Drive
Ottawa, Ontario, Canada K2M 1P6
Telephone: (613) 254-9643
Facsimile: (613) 254-5867
Website: www.novatech-eng.com

CITY OF OTTAWA
200 BARIBEAU STREET

DRAWING NAME: **STORM DRAINAGE AREA PLAN**

PROJECT NO.: 119068
REV # 6
DRAWING NO.: 119068-STM

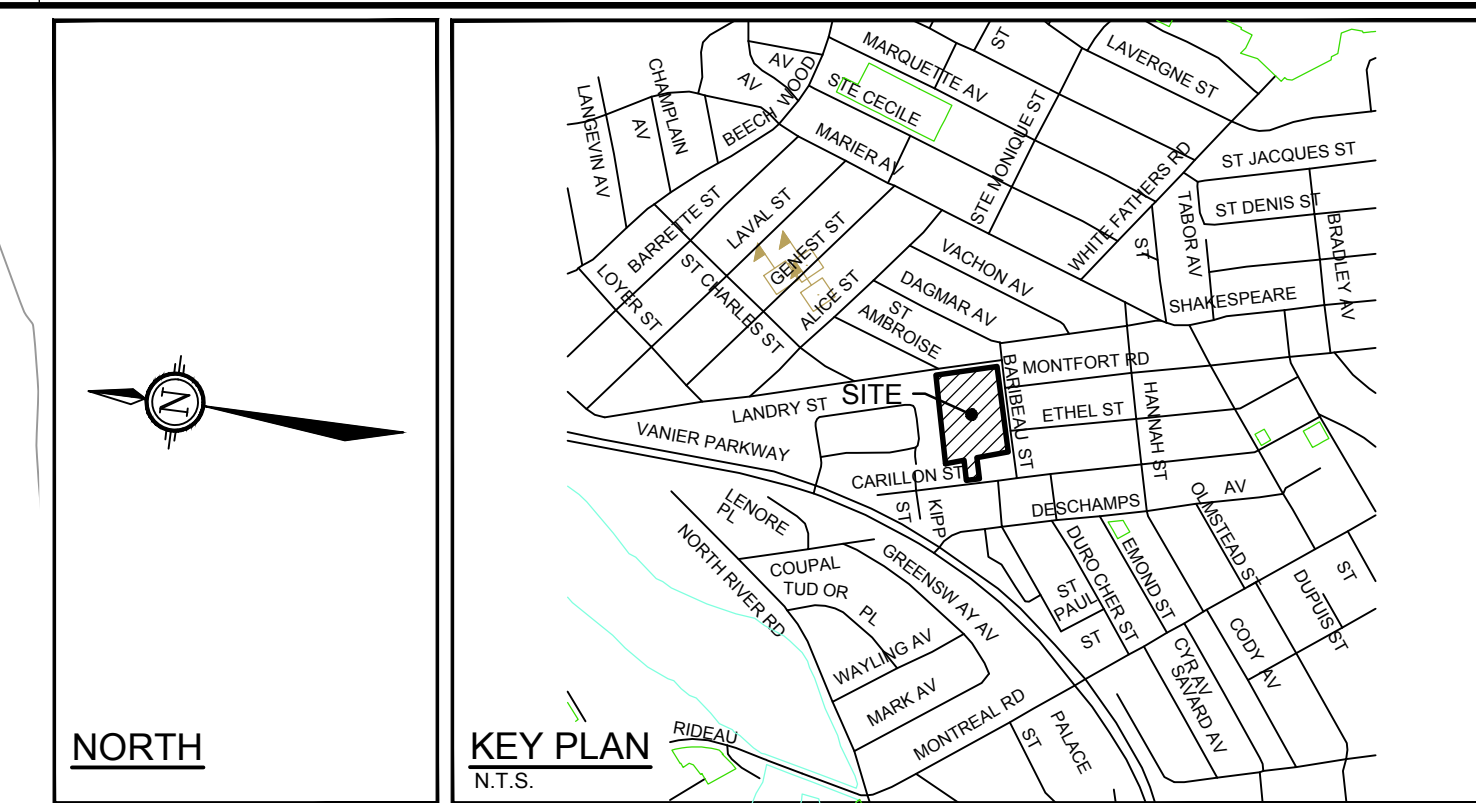
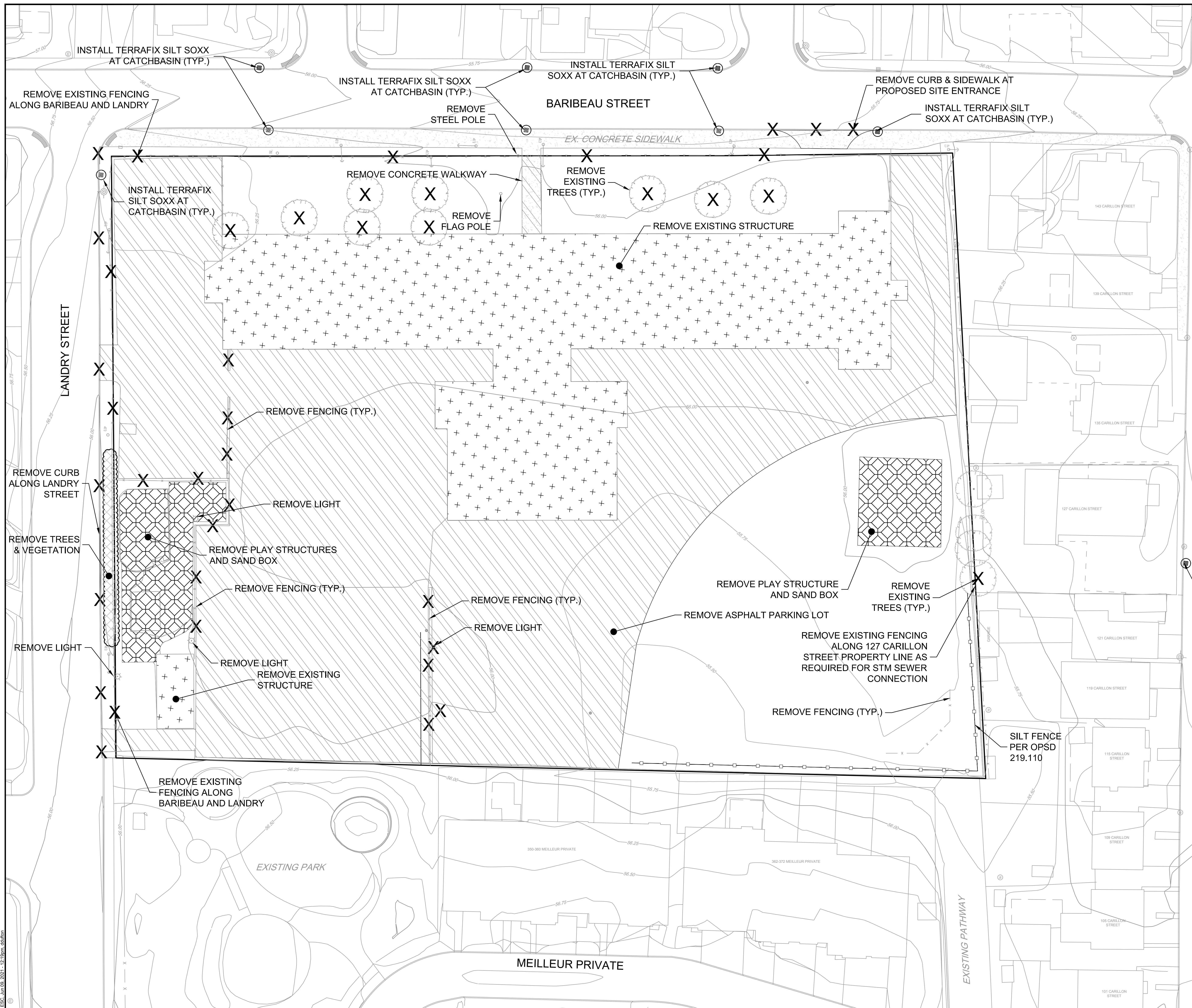

LEGEND

X	REMOVALS		EXISTING GROUND CONTOUR AND LABEL
○	TERRAFIX SILT SOXX INSTALLED AT CATCH BASIN		SILT FENCE PER OPSD 219.110

- EROSION AND SEDIMENT CONTROL NOTES:**
1. ALL EROSION AND SEDIMENT CONTROLS ARE TO BE INSTALLED TO THE SATISFACTION OF THE ENGINEER, THE MUNICIPALITY AND THE CONSERVATION AUTHORITY. THEY ARE TO BE APPROPRIATE TO THE SITE CONDITIONS, PRIOR TO UNDERTAKING ANY SITE ALTERATIONS (FILLING, GRADING, REMOVAL OF VEGETATION, ETC.) AND DURING ALL PHASES OF SITE PREPARATION AND CONSTRUCTION. THESE PRACTICES ARE TO BE IMPLEMENTED IN ACCORDANCE WITH THE CURRENT BEST MANAGEMENT PRACTICES FOR EROSION AND SEDIMENT CONTROL AND SHOULD INCLUDE AS A MINIMUM THOSE MEASURES INDICATED ON THE PLAN.
 2. TO PREVENT SURFACE EROSION FROM ENTERING THE STORM SYSTEM DURING CONSTRUCTION, FILTER SOCKS WILL BE PLACED UNDER GRATES OF ALL PROPOSED AND EXISTING CATCHBASINS AND STRUCTURES. THESE CONTROL MEASURES WILL REMAIN IN PLACE UNTIL VEGETATION HAS BEEN ESTABLISHED AND CONSTRUCTION COMPLETE.
 3. THE CONTRACTOR SHALL INSTALL MUD MATS AT ALL SITE ENTRANCES (100mm GRANULAR 'B' TYPE II).
 4. THE SEDIMENT CONTROL MEASURES SHALL ONLY BE REMOVED WHEN, IN THE OPINION OF THE ENGINEER, THE MEASURES ARE NO LONGER REQUIRED. NO CONTROL MEASURES MAY BE PERMANENTLY REMOVED WITHOUT PRIOR AUTHORIZATION FROM THE ENGINEER.
 5. THE CONTRACTOR SHALL IMMEDIATELY REPORT TO THE ENGINEER ANY ACCIDENTAL DISCHARGES OF SEDIMENT MATERIAL INTO ANY DITCH OR STORM SEWER SYSTEM. APPROPRIATE RESPONSE MEASURES, INCLUDING ANY REPAIRS TO EXISTING CONTROL MEASURES OR THE IMPLEMENTATION OF ADDITIONAL CONTROL MEASURES, SHALL BE CARRIED OUT BY THE CONTRACTOR WITHOUT DELAY.
 6. THE CONTRACTOR ACKNOWLEDGES THAT FAILURE TO IMPLEMENT EROSION AND SEDIMENT CONTROL MEASURES MAY BE SUBJECT TO PENALTIES IMPOSED BY ANY APPLICABLE REGULATORY AGENCY.
 7. THE CONTRACTOR SHALL ENSURE PROPER DUST CONTROL IS PROVIDED WITH THE APPLICATION OF WATER (AND IF REQUIRED, CALCIUM CHLORIDE) DURING DRY PERIODS.
 8. THE CONTRACTOR SHALL PROTECT ALL SURVEY MONUMENTS.
 9. ALL TOPSOIL AND ANY SOFT, WET OR DELETERIOUS MATERIAL SHALL BE REMOVED FROM IMPROVED AREAS UNLESS OTHERWISE DIRECTED BY ENGINEER.

NOTE:
THE POSITION OF ALL POLE LINES, CONDUITS, WATERMANS, SEWERS AND OTHER UNDERGROUND AND OVERGROUND UTILITIES AND STRUCTURES IS NOT NECESSARILY SHOWN ON THE CONTRACT DRAWINGS, AND WHERE SHOWN, THE ACCURACY OF THE POSITION OF SUCH UTILITIES AND STRUCTURES IS NOT GUARANTEED. BEFORE STARTING WORK, DETERMINE THE EXACT LOCATION OF ALL SUCH UTILITIES AND STRUCTURES AND ASSUME ALL LIABILITY FOR DAMAGE TO THEM.



No.	REVISION	DATE	BY
1.	SITE PLAN APPLICATION	AUG 24/20	MAB
2.	STORM OUTLET VIA 127 CARILLON	OCT 23/20	MAB
3.	CITY SUBMISSION	FEB 5/21	MAB
4.	CITY SUBMISSION	JUN 8/21	MAB

SCALE

1:250

FOR REVIEW ONLY

DATE: DTD
CHECKED: LRW
DRAWN: DTD
CHECKED: LRW
APPROVED: MAB

NOVATECH
Engineers, Planners & Landscape Architects
Suite 200, 240 Michael Cowpland Drive
Ottawa, Ontario, Canada K2M 1P6
Telephone: (613) 254-9643
Facsimile: (613) 254-5867
Website: www.novatech-eng.com

CITY OF OTTAWA
200 BARIBEAU STREET

REMOVALS & EROSION AND SEDIMENT CONTROL PLAN

PROJECT No: 119068
REV: #4
DRAWING No: 119068-ESC

C:\Users\11068\OneDrive\Documents\119068-ESC.dwg ESC: Jan 09, 2021 - 12:10pm, dsham

Appendix D:

DSS Checklist

Emergency Overland Flow Route Documentation

**200 BARIBEAU STREET, OTTAWA
DEVELOPMENT SERVICING STUDY CHECKLIST**

4.1 General Content	Addressed (Y/N/NA)	Comments
Executive Summary (for larger reports only).	N/A	
Date and revision number of the report.	Y	
Location map and plan showing municipal address, boundary, and layout of proposed development.	Y	Refer to Report Figures
Plan showing the site and location of all existing services.	Y	Refer to Grading and Servicing Plans
Development statistics, land use, density, adherence to zoning and official plan, and reference to applicable subwatershed and watershed plans that provide context to which individual developments must adhere.	Y	Refer to Site Plan
Summary of Pre-consultation Meetings with City and other approval agencies.	Y	
Reference and confirm conformance to higher level studies and reports (Master Servicing Studies, Environmental Assessments, Community Design Plans), or in the case where it is not in conformance, the proponent must provide justification and develop a defensible design criteria.	Y	
Statement of objectives and servicing criteria.	Y	Refer to Sections: 5.0 Sanitary Sewers, 6.0 Stormwater Management, 7.0 Water
Identification of existing and proposed infrastructure available in the immediate area.	Y	
Identification of Environmentally Significant Areas, watercourses and Municipal Drains potentially impacted by the proposed development (Reference can be made to the Natural Heritage Studies, if available).	N/A	
Concept level master grading plan to confirm existing and proposed grades in the development. This is required to confirm the feasibility of proposed stormwater management and drainage, soil removal and fill constraints, and potential impacts to neighboring properties. This is also required to confirm that the proposed grading will not impede existing major system flow paths.	Y	Refer to Grading Plan and Stormwater Management Plan

**200 BARIBEAU STREET, OTTAWA
DEVELOPMENT SERVICING STUDY CHECKLIST**

4.1 General Content	Addressed (Y/N/NA)	Comments
Identification of potential impacts of proposed piped services on private services (such as wells and septic fields on adjacent lands) and mitigation required to address potential impacts.	N/A	
Proposed phasing of the development, if applicable.	N/A	
Reference to geotechnical studies and recommendations concerning servicing.	Y	Refer to Section 3.0 Grading
All preliminary and formal site plan submissions should have the following information:		
Metric scale	Y	
North arrow (including construction North)	Y	
Key plan	Y	
Name and contact information of applicant and property owner	Y	
Property limits including bearings and dimensions	Y	
Existing and proposed structures and parking areas	Y	
Easements, road widening and rights-of-way	Y	
Adjacent street names	Y	

**200 BARIBEAU STREET, OTTAWA
DEVELOPMENT SERVICING STUDY CHECKLIST**

4.2 Water	Addressed (Y/N/NA)	Comments
Confirm consistency with Master Servicing Study, if available.	Y	
Availability of public infrastructure to service proposed development.	Y	Refer to Sections: 5.0 Sanitary Sewers, 6.0 Stormwater Management, 7.0 Water
Identification of system constraints.	N/A	
Identify boundary conditions.	Y	Provided by City of Ottawa
Confirmation of adequate domestic supply and pressure.	Y	Refer to Appendix A
Confirmation of adequate fire flow protection and confirmation that fire flow is calculated as per the Fire Underwriter's Survey. Output should show available fire flow at locations throughout the development.	Y	Refer to Appendix A
Provide a check of high pressures. If pressure is found to be high, an assessment is required to confirm the application of pressure reducing valves.	Y	Refer to Appendix A
Definition of phasing constraints. Hydraulic modeling is required to confirm servicing for all defined phases of the project including the ultimate design.	N/A	
Address reliability requirements such as appropriate location of shut-off valves.	Y	
Check on the necessity of a pressure zone boundary modification.	N/A	
Reference to water supply analysis to show that major infrastructure is capable of delivering sufficient water for the proposed land use. This includes data that shows that the expected demands under average day, peak hour and fire flow conditions provide water within the required pressure range.	Y	Refer to Section 7.0 Water
Description of the proposed water distribution network, including locations of proposed connections to the existing system, provisions for necessary looping, and appurtenances (valves, pressure reducing valves, valve chambers, and fire hydrants) including special metering provisions.	Y	Refer to Section 7.0 Water
Description of off-site required feeder mains, booster pumping stations, and other water infrastructure that will be ultimately required to service proposed development, including financing, interim facilities, and timing of implementation.	N/A	
Confirmation that water demands are calculated based on the City of Ottawa Design Guidelines.	Y	Refer to Section 7.0 Water
Provision of a model schematic showing the boundary conditions locations, streets, parcels, and building locations for reference.	N/A	

**200 BARIBEAU STREET, OTTAWA
DEVELOPMENT SERVICING STUDY CHECKLIST**

4.3 Wastewater	Addressed (Y/N/NA)	Comments
Summary of proposed design criteria (Note: Wet-weather flow criteria should not deviate from the City of Ottawa Sewer Design Guidelines. Monitored flow data from relatively new infrastructure cannot be used to justify capacity requirements for proposed infrastructure).	Y	Refer to Section 5.0 Sanitary Sewers
Confirm consistency with Master Servicing Study and/or justifications for deviations.	N/A	
Consideration of local conditions that may contribute to extraneous flows that are higher than the recommended flows in the guidelines. This includes groundwater and soil conditions, and age and condition of sewers.	N/A	
Description of existing sanitary sewer available for discharge of wastewater from proposed development.	Y	Refer to Section 5.0 Sanitary Sewers
Verify available capacity in downstream sanitary sewer and/or identification of upgrades necessary to service the proposed development. (Reference can be made to previously completed Master Servicing Study if applicable)	y	Refer to Appendix A
Calculations related to dry-weather and wet-weather flow rates from the development in standard MOE sanitary sewer design table (Appendix 'C') format.	N/A	
Description of proposed sewer network including sewers, pumping stations, and forcemains.	Y	Refer to Section 5.0 Sanitary Sewers
Discussion of previously identified environmental constraints and impact on servicing (environmental constraints are related to limitations imposed on the development in order to preserve the physical condition of watercourses, vegetation, soil cover, as well as protecting against water quantity and quality).	N/A	
Pumping stations: impacts of proposed development on existing pumping stations or requirements for new pumping station to service development.	N/A	
Forcemain capacity in terms of operational redundancy, surge pressure and maximum flow velocity.	N/A	
Identification and implementation of the emergency overflow from sanitary pumping stations in relation to the hydraulic grade line to protect against basement flooding.	N/A	
Special considerations such as contamination, corrosive environment etc.	N/A	

**200 BARIBEAU STREET, OTTAWA
DEVELOPMENT SERVICING STUDY CHECKLIST**

4.4 Stormwater	Addressed (Y/N/NA)	Comments
Description of drainage outlets and downstream constraints including legality of outlet (i.e. municipal drain, right-of-way, watercourse, or private property).	Y	Refer to Section 6.0 Stormwater Management
Analysis of the available capacity in existing public infrastructure.	Y	Refer to Appendix A
A drawing showing the subject lands, its surroundings, the receiving watercourse, existing drainage patterns and proposed drainage patterns.	Y	Refer to Storm Drainage Area Plan (119068-STM)
Water quantity control objective (e.g. controlling post-development peak flows to pre-development level for storm events ranging from the 2 or 5 year event (dependent on the receiving sewer design) to 100 year return period); if other objectives are being applied, a rationale must be included with reference to hydrologic analyses of the potentially affected subwatersheds, taking into account long-term cumulative effects.	Y	Refer to Section 6.0 Stormwater Management
Water Quality control objective (basic, normal or enhanced level of protection based on the sensitivities of the receiving watercourse) and storage requirements.	Y	Refer to Section 6.0 Stormwater Management
Description of stormwater management concept with facility locations and descriptions with references and supporting information.	Y	Refer to Section 6.0 Stormwater Management
Set-back from private sewage disposal systems.	N/A	
Watercourse and hazard lands setbacks.	N/A	
Record of pre-consultation with the Ontario Ministry of Environment and the Conservation Authority that has jurisdiction on the affected watershed.	N/A	
Confirm consistency with sub-watershed and Master Servicing Study, if applicable study exists.	N/A	
Storage requirements (complete with calcs) and conveyance capacity for 5 yr and 100 yr events.	Y	Refer to Appendix B
Identification of watercourse within the proposed development and how watercourses will be protected, or, if necessary, altered by the proposed development with applicable approvals.	N/A	
Calculate pre and post development peak flow rates including a description of existing site conditions and proposed impervious areas and drainage catchments in comparison to existing conditions.	Y	Refer to Appendix B
Any proposed diversion of drainage catchment areas from one outlet to another.	N/A	
Proposed minor and major systems including locations and sizes of stormwater trunk sewers, and SWM facilities.	N/A	
If quantity control is not proposed, demonstration that downstream system has adequate capacity for the post-development flows up to and including the 100-year return period storm event.	N/A	

**200 BARIBEAU STREET, OTTAWA
DEVELOPMENT SERVICING STUDY CHECKLIST**

4.4 Stormwater	Addressed (Y/N/NA)	Comments
Identification of potential impacts to receiving watercourses.	N/A	
Identification of municipal drains and related approval requirements.	N/A	
Description of how the conveyance and storage capacity will be achieved for the development.	Y	Refer to Section 6.0 Stormwater Management
100 year flood levels and major flow routing to protect proposed development from flooding for establishing minimum building elevations (MBE) and overall grading.	Y	Refer to Grading Plan and Storm Drainage Area Plan
Inclusion of hydraulic analysis including HGL elevations.	N/A	
Description of approach to erosion and sediment control during construction for the protection of receiving watercourse or drainage corridors.	Y	Refer to Section 4.0 Erosion Sediment Control
Identification of floodplains – proponent to obtain relevant floodplain information from the appropriate Conservation Authority. The proponent may be required to delineate floodplain elevations to the satisfaction of the Conservation Authority if such information is not available or if information does not match current conditions.	N/A	
Identification of fill constrains related to floodplain and geotechnical investigation.	N/A	

4.5 Approval and Permit Requirements	Addressed (Y/N/NA)	Comments
Conservation Authority as the designated approval agency for modification of floodplain, potential impact on fish habitat, proposed works in or adjacent to a watercourse, cut/fill permits and Approval under Lakes and Rivers Improvement Act. The Conservation Authority is not the approval authority for the Lakes and Rivers Improvement Act. Where there are Conservation Authority regulations in place, approval under the Lakes and Rivers Improvement Act is not required, except in cases of dams as defined in the Act.	N/A	
Application for Certificate of Approval (CofA) under the Ontario Water Resources Act.	N/A	
Changes to Municipal Drains.	N/A	
Other permits (National Capital Commission, Parks Canada, Public Works and Government Services Canada, Ministry of Transportation etc.)	N/A	

4.6 Conclusion	Addressed (Y/N/NA)	Comments
Clearly stated conclusions and recommendations.	Y	Refer to Section 8.0 Conclusions and Recommendations
Comments received from review agencies including the City of Ottawa and information on how the comments were addressed. Final sign-off from the responsible reviewing agency.	Y	
All draft and final reports shall be signed and stamped by a professional Engineer registered in Ontario.	Y	

M E M O R A N D U M

DATE: MAY 4, 2020 **PROJECT:** 119068

TO: ERIC TOUSIGNANT, HIRAN SANDANAYAKE

FROM: MARK BISSETT, LUCAS WILSON, CONRAD STANG

RE: 200 BARIBEAU STREET – SWM MODELLING

CC: KEVIN MCMAHON, PIERRE BOULET, JOHN RIDDELL

Novatech has updated our drainage model to quantify major overland flow routed through the planned development at 200 Baribeau Street. Before we finalize the Concept Plan and expend significant design effort, we request a staff review of the model so we might find consensus on the overland flow accommodation. The magnitude of conveyance informs how we design the site.

Using City 1:1000 topographic mapping we have delineated the drainage boundaries (shown on Figures DSK-2A and 2B) with excellent correlation to the DRAPE 2014 Lidar mapping. There are two overland flow parcels that need consideration and are described below:

Area 1: East of Baribeau Street

There is a large 616ha drainage catchment to the east. Our analysis shows the majority of this parcel is located in a bowl and does not produce overland flow towards 200 Baribeau under any reasonable design storm (we assessed up to the 100-year+20% rainfall event). As such, the effective drainage area contributing overland flow from the east is 29.0ha.

Using the City-suggested criteria a minor system capture rate of 85L/s/ha and surface storage of 100m³/ha we calculate overland flow of $Q_{100}=1,650\text{L/s}$ at Baribeau Street. Interestingly, only minor adjustments to either parameter lower the overland flow at Baribeau Street to $Q_{100}=0\text{L/s}$. We tested model sensitivity by adjusting the inlet capture rate to 100L/s/ha and the surface storage to 125m³/ha. In our opinion, these values are more representative of actual conditions as we understand there is no ICD control, and the topographic modelling supports the increased surface storage.

In all likelihood, we think there will be no overland flow from this upstream area during a 100-year rainfall event due to the probable inlet capture rate and available surface storage. Regardless, we see value in an emergency overland flow route as protection against extreme weather events and/or inlet capture obstruction.

Area 2: Northwest of Landry Street

There is a 6.6ha drainage catchment northwest of the development site with overland flow routed to a parkette on Landry Street (part of a recent development by Claridge Homes). Using a minor system capture rate of 85L/s/ha and surface storage of 100m³/ha we calculate overland flow of $Q_{100}=190\text{L/s}$. Civil design plans indicate the major system flow from Landry Street is routed through the parkette and residential rear yards toward Kipp Street. Novatech will obtain

the as-built design plans and servicing report to confirm the intended conveyance along this corridor.

Similar to Area 1, the modelled overland flow drops to $Q_{100}=0\text{L/s}$ if either of the SWM parameters are modified to reflect the anticipated real-world conditions (i.e. inlet capture of 100L/s/ha , or surface storage of $125\text{m}^3/\text{ha}$). Our conclusion is that Area 2 will not likely experience overland flow from the upstream drainage area during a 100-year design storm. Regardless, a prudent design will provide an emergency overland flow route as protection against extreme events.

Next Steps

In closing, we respectfully ask staff to review our SWM model so we might find a mutually acceptable overland conveyance rate through the development for both Area 1 and Area 2. This value is required to finalize the development concept, design the flow route, and make our submission to the City and RVCA.

Hoping the above is agreeable. Please call with any question or concerns.
Respectfully submitted.

Lucas Wilson

From: Tousignant, Eric <Eric.Tousignant@ottawa.ca>
Sent: Tuesday, June 2, 2020 1:47 PM
To: Mark Bissett
Cc: Sandanayake, Hiran; Lucas Wilson; Conrad Stang
Subject: RE: 200 Baribeau - Community Model

Hi Mark

Given that this is an emergency route and not part of the 100 year design, and not even part of the 20% stress test, I would not be concerned about including it in your final report if you fear it could be an issue. This was more as a check on our part to make sure that should any flow spill onto the property that it could be conveyed to the channel at the rear. This was important because the only way flow will get to the channel is through the property as it cannot spill around it. You have shown that the property can convey 900 L/s should there be some kind of major system spill (i.e. blockage or even less than anticipated storage in the upstream sewershed). It is not our intent to designate this property as an overland flow route, but it is good to know that should it be required, flow can safely make it to the channel.

In short, I am fine with the approach you have taken.

Eric

Eric Tousignant, P.Eng.

Senior Water Resources Engineer
Infrastructure Services
613-580-2424 ext 25129

From: Mark Bissett <m.bissett@novatech-eng.com>
Sent: May 29, 2020 2:28 PM
To: Tousignant, Eric <Eric.Tousignant@ottawa.ca>
Cc: Sandanayake, Hiran <Hiran.Sandanayake@ottawa.ca>; Lucas Wilson <l.wilson@novatech-eng.com>; Conrad Stang <c.stang@novatech-eng.com>
Subject: 200 Baribeau - Community Model

CAUTION: This email originated from an External Sender. Please do not click links or open attachments unless you recognize the source.

ATTENTION : Ce courriel provient d'un expéditeur externe. Ne cliquez sur aucun lien et n'ouvrez pas de pièce jointe, excepté si vous connaissez l'expéditeur.

Eric- I think we've developed a reasonable solution, but want to bounce this off your team one last time. Here's our approach:

- 1) **Existing Conditions:** overland flow from Baribeau Street is routed through the existing school site. We suspect this does not occur during any design storm up to the 100-year+20% event (based on previous modelling), but

agree allowance should be made for safety. The spill point is an access road at elevation 56.00m between the school and garage at 143 Carillon Street. Using the broad-crested weir equation, we calculated flow for various water levels (see PDF-Existing). The trick of course is choosing an appropriate max. spill elevation. We think 56.15m is a reasonable peak water level, as higher elevations suggest extensive community flooding...to our knowledge this is not occurring. At 56.15m there is an emergency overland flow of $Q=908\text{L/s}$ through the existing school block and pathway to Kipp Street (same discharge point as the 100 Landry development).

- 2) **Proposed Conditions:** provide an equivalent emergency overland flow ($Q>908\text{L/s}$) through the proposed development with a maximum water level of 56.15m on Baribeau. It appears this can be achieved...we would prepare a detailed model as part of the submission, but for now using a broad-crested weir at the Baribeau spill point and Manning's open channel through the rear yards suggest about $1,000\text{L/s}$ can be conveyed (see PDF-Proposed).

Hoping your team can advise if you generally agree with this approach. My risk here is that we complete a detail design, submit to RVCA for a Fill Permit (has to go to Executive Committee), and then it all blows up because of the off-site overland flow conveyance. Totally respect that your not giving approval...just guidance. Thanking you in advance, have a great weekend, and my apologies for the long email. Best,

Mark Bissett, P.Eng., Senior Project Manager | Land Development & Municipal

NOVATECH Engineers, Planners & Landscape Architects

240 Michael Cowpland Drive, Suite 200, Ottawa, ON, K2M 1P6 | Tel: 613.254.9643 Ext: 237 | Cell: 613.261.4792

The information contained in this email message is confidential and is for exclusive use of the addressee.

From: Tousignant, Eric <Eric.Tousignant@ottawa.ca>

Sent: Tuesday, May 5, 2020 10:59 AM

To: Mark Bissett <m.bissett@novatech-eng.com>

Cc: Sandanayake, Hiran <Hiran.Sandanayake@ottawa.ca>; Conrad Stang <c.stang@novatech-eng.com>; Lucas Wilson <l.wilson@novatech-eng.com>; Pierre Boulet (Boulet) <pierreb@bouletconstruction.com>; Kevin McMahon <kevin@ulra.ca>; John Riddell <J.Riddell@novatech-eng.com>

Subject: RE: 200 Baribeau - Community Model

Hi Mark

Your analysis appears to be reasonable and in line with previous assessments done in this area. What I would require though, is for you to show that should there be excess external major system flow (i.e due to CB blockages for example), that this flow could be routed through the property to the ditch that was create for the 100 Landry street Development (i.e. emergency overflow route).

Eric

Eric Tousignant, P.Eng.

Senior Water Resources Engineer

Infrastructure Services

613-580-2424 ext 25129

From: Mark Bissett <m.bissett@novatech-eng.com>

Sent: May 04, 2020 12:52 PM

To: Tousignant, Eric <Eric.Tousignant@ottawa.ca>

Cc: Sandanayake, Hiran <Hiran.Sandanayake@ottawa.ca>; Conrad Stang <c.stang@novatech-eng.com>; Lucas Wilson <l.wilson@novatech-eng.com>; Pierre Boulet (Boulet) <pierreb@bouletconstruction.com>; Kevin McMahon <kevin@ulra.ca>; John Riddell <J.Riddell@novatech-eng.com>

Subject: 200 Baribeau - Community Model

CAUTION: This email originated from an External Sender. Please do not click links or open attachments unless you recognize the source.

ATTENTION : Ce courriel provient d'un expéditeur externe. Ne cliquez sur aucun lien et n'ouvrez pas de pièce jointe, excepté si vous connaissez l'expéditeur.

Eric- kindly refer to the attached memo and SWM model for the 200 Baribeau development site.

We're hoping to establish consensus on a reasonable overland conveyance from two upstream parcels that are routed through this site.

We appreciate staff input and assistance with this matter. Sincerely,

Mark Bissett, P.Eng., Senior Project Manager | Land Development & Municipal

NOVATECH Engineers, Planners & Landscape Architects

240 Michael Cowpland Drive, Suite 200, Ottawa, ON, K2M 1P6 | Tel: 613.254.9643 Ext: 237 | Cell: 613.261.4792

The information contained in this email message is confidential and is for exclusive use of the addressee.

From: Tousignant, Eric <Eric.Tousignant@ottawa.ca>

Sent: Monday, April 6, 2020 10:48 AM

To: Mark Bissett <m.bissett@novatech-eng.com>

Subject: FW: 200 Baribeau - Community Model

Hi Mark

Below is a rough idea of the entire overland drainage system that goes through the Property. As you can see, it is very large. Back in 2006-2007, I did a high level estimate of the flow reaching the property just to the west (100 Landry). I have attached some old emails about this. The 100 year estimate was quite high but IBI created a ditch on the property to take the upstream flow. I'm sure that if a more detailed model was created that we would have a lower peak flow, but that would be a huge undertaking at this time.

Now if you only want to account for the 2.2 ha area area, I would do a lumped rational method computation for the 100 year and subtract the 2 year. This should give you a good idea of the overland flow from the 2.2 ha area.

Eric

Eric Tousignant, P.Eng.

Senior Water Resources Engineer

Infrastructure Services

613-580-2424 ext 25129

From: Cooke, Ryan <ryan.cooke@ottawa.ca>
Sent: April 03, 2020 5:48 PM
To: Tousignant, Eric <Eric.Tousignant@ottawa.ca>
Cc: Sandanayake, Hiran <Hiran.Sandanayake@ottawa.ca>
Subject: RE: 200 Baribeau - Community Model

Hi Eric,

Our DEM/streams show that the upstream area is very large, as shown below ('major' upstream drainage area shown, drainage area to low point would be larger).

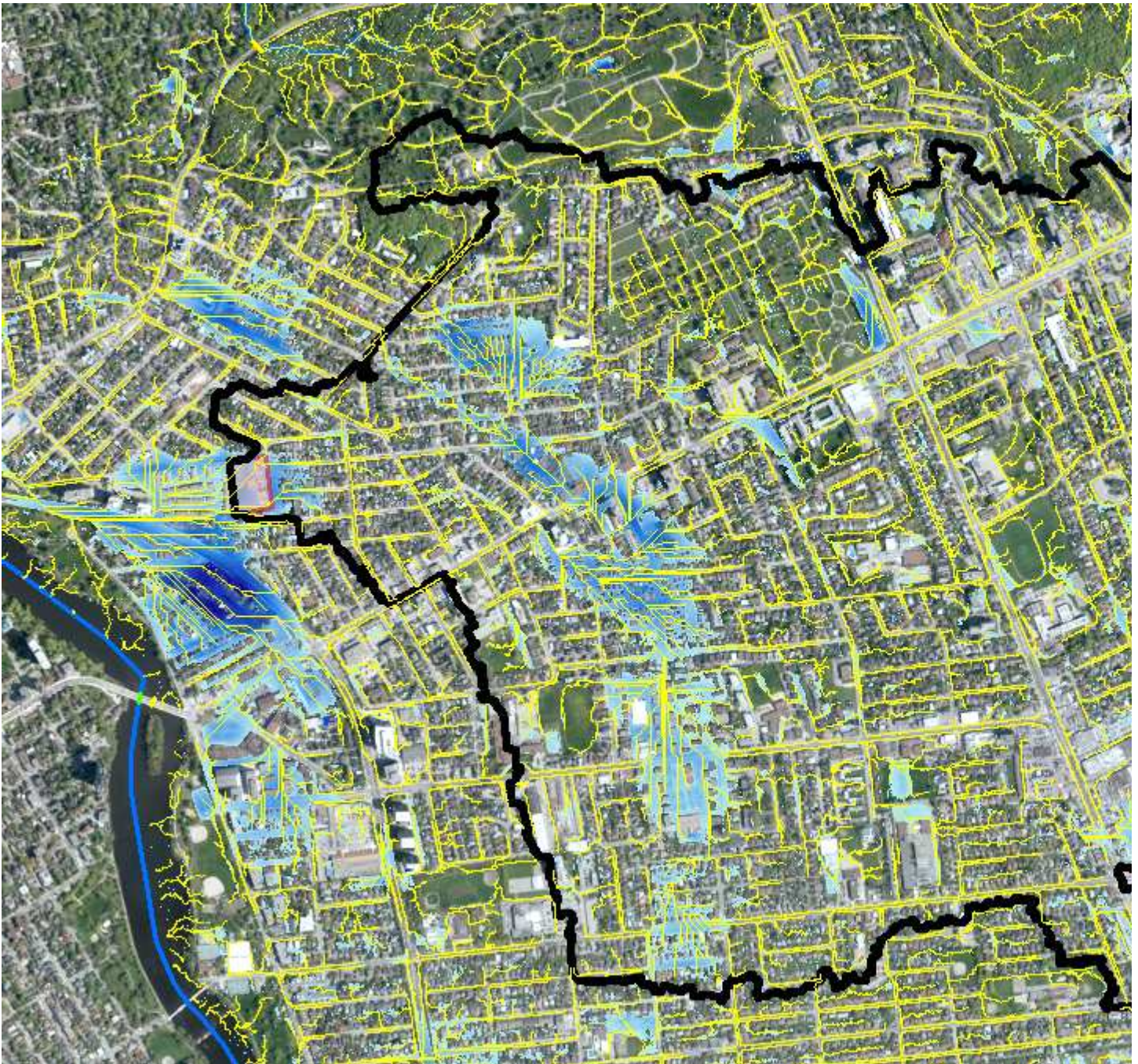

Although not all this drainage area would make its way to the site, the stream lines are also not accurate in this location because it's in a low point.



Unfortunately we don't have a major system model that can provide hydrographs.

Maybe we can discuss further next week?

Thanks,

Ryan

From: Tousignant, Eric <Eric.Tousignant@ottawa.ca>

Sent: April 02, 2020 1:27 PM

To: Sandanayake, Hiran <Hiran.Sandanayake@ottawa.ca>; Cooke, Ryan <ryan.cooke@ottawa.ca>

Subject: FW: 200 Baribeau - Community Model

Gentlemen

Mark Bisette at Novatech is looking at a redevelopment project at 200 Baribeau in Vanier. The attached figure shows a drainage area of approximately 2.2 ha that goes through the site, but I wonder if this was not determined with a high Level DEM. What does our more detailed DEM show? Does it go through the site or does it follow Baribeau Street. If it does go through the site, do we have major system flow/hydrograph and this location from the Major system model?

Thanks

Eric

From: Mark Bissett <m.bissett@novatech-eng.com>

Sent: March 30, 2020 10:39 AM

To: Tousignant, Eric <Eric.Tousignant@ottawa.ca>

Cc: Conrad Stang <c.stang@novatech-eng.com>

Subject: 200 Baribeau - Community Model

CAUTION: This email originated from an External Sender. Please do not click links or open attachments unless you recognize the source.

ATTENTION : Ce courriel provient d'un expéditeur externe. Ne cliquez sur aucun lien et n'ouvrez pas de pièce jointe, excepté si vous connaissez l'expéditeur.

Eric- I'm working on a preliminary design for a site at 200 Baribeau Street in Vanier. The site is currently a private school, which the developer intends to convert to residential units. As part of our preliminary design, it appears that external major system roadway flow is routed through the private site from both the north (10ha parcel near Landry Street & St. Ambroise Avenue) and from the east (25ha parcel near Baribeau Street & Ethel Street). The drainage areas are depicted on the attached Figure DSK-2, generated using the DRAPE 2014 elevation model.

Does the City have modelling information that can be shared to help quantify overland flow conveyed via each upstream parcel? We'd need the catchbasin info and ICD controls (if any), and roadway depression storage. Not sure if this is available...we'd really appreciate any modelling staff might be able to share, or guidance on your experience in this community.

Hope you are keeping well. Stay safe, all the best.

Mark Bissett, P.Eng., Senior Project Manager | Land Development & Municipal

NOVATECH Engineers, Planners & Landscape Architects

240 Michael Cowpland Drive, Suite 200, Ottawa, ON, K2M 1P6 | Tel: 613.254.9643 Ext: 237 | Cell: 613.261.4792

The information contained in this email message is confidential and is for exclusive use of the addressee.

This e-mail originates from the City of Ottawa e-mail system. Any distribution, use or copying of this e-mail or the information it contains by other than the intended recipient(s) is unauthorized. Thank you.

Le présent courriel a été expédié par le système de courriels de la Ville d'Ottawa. Toute distribution, utilisation ou reproduction du courriel ou des renseignements qui s'y trouvent par une personne autre que son destinataire prévu est interdite. Je vous remercie de votre collaboration.

This e-mail originates from the City of Ottawa e-mail system. Any distribution, use or copying of this e-mail or the information it contains by other than the intended recipient(s) is unauthorized. Thank you.

Le présent courriel a été expédié par le système de courriels de la Ville d'Ottawa. Toute distribution, utilisation ou reproduction du courriel ou des renseignements qui s'y trouvent par une personne autre que son destinataire prévu est interdite. Je vous remercie de votre collaboration.

This e-mail originates from the City of Ottawa e-mail system. Any distribution, use or copying of this e-mail or the information it contains by other than the intended recipient(s) is unauthorized. Thank you.

Le présent courriel a été expédié par le système de courriels de la Ville d'Ottawa. Toute distribution, utilisation ou reproduction du courriel ou des renseignements qui s'y trouvent par une personne autre que son destinataire prévu est interdite. Je vous remercie de votre collaboration.

**200 BARIBEAU
EXISTING CONDITIONS
BROAD CRESTED WEIR**

Broad Crested Weir

$Q \text{ (m}^3\text{/s)} = C \times L \times H^{(3/2)}$

Weir Coefficeint	1.84
Bottom Width (m)	8.5
Bottom of Weir Elevation (m)	56.00

Water Level Elevation	Flow Rate Over Weir		Surface Storage
	(m)	(m³/s)	(L/s)
56.00	0.000	0.0	1015
56.05	0.175	174.9	1340
56.10	0.495	494.6	1700
56.15	0.909	908.6	2075
56.20	1.399	1398.9	2500
56.25	1.955	1955.0	2950
56.30	2.570	2569.9	3500

**200 BARIBEAU
PROPOSED CONDITIONS
BROAD CRESTED WEIR**

Broad Crested Weir

$$Q (m^3/s) = C \times L \times H^{(3/2)}$$

Weir Coefficeint	1.84
Bottom Width (m)	10.3
Bottom of Weir Elevation (m)	56.00

Water Level Elevation (m)	Flow Rate Over Weir	
	(m³/s)	(L/s)
56.00	0.000	0.0
56.05	0.212	211.9
56.10	0.599	599.3
56.15	1.101	1101.0
56.20	1.695	1695.1
56.25	2.369	2369.0
56.30	3.114	3114.1

**200 BARIBEAU
PROPOSED CONDITIONS
BLOCK 5 & 6 REARYARD
CONVEYANCE -
MANNINGS EQUATION**

Flat bottom ditch

Depth	m	0.31
Bottom Width	m	4.00
Side slopes	1 to X	1
Top Width	m	4.62
Area	m ²	1.336
Perimeter	m	4.88
R=A/P	m	0.27
n		0.040
Slope	m/m	0.005
Q _{max}	m ³ /s	0.996
V _{max}	m/s	0.746