

SECTION SWALE
N.T.S.

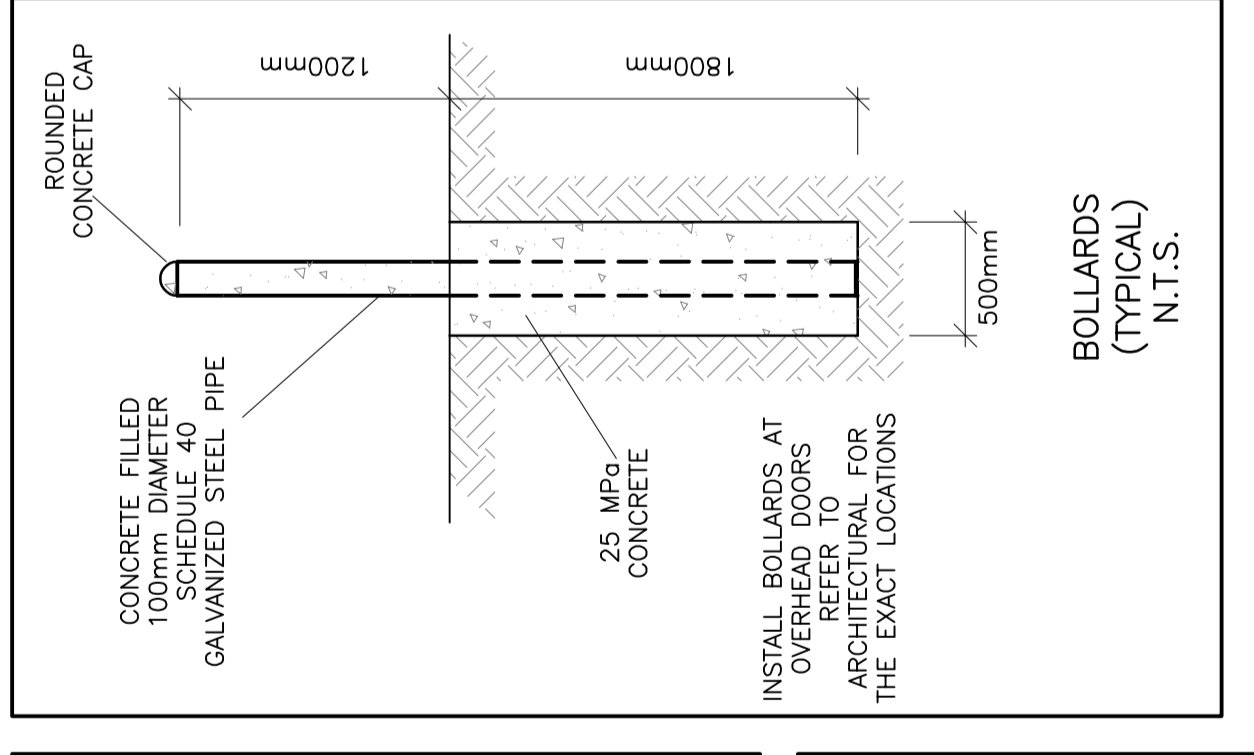

BOLLARDS
(TYPICAL)
N.T.S.

H (DEPTH OF COVER)	INSULATION THICKNESS	W (WIDTH OF INSULATION)
1800 TO 2400mm	50mm	1200mm
1500 TO 1800mm	75mm	1800mm
1200 TO 1500mm	100mm	2400mm

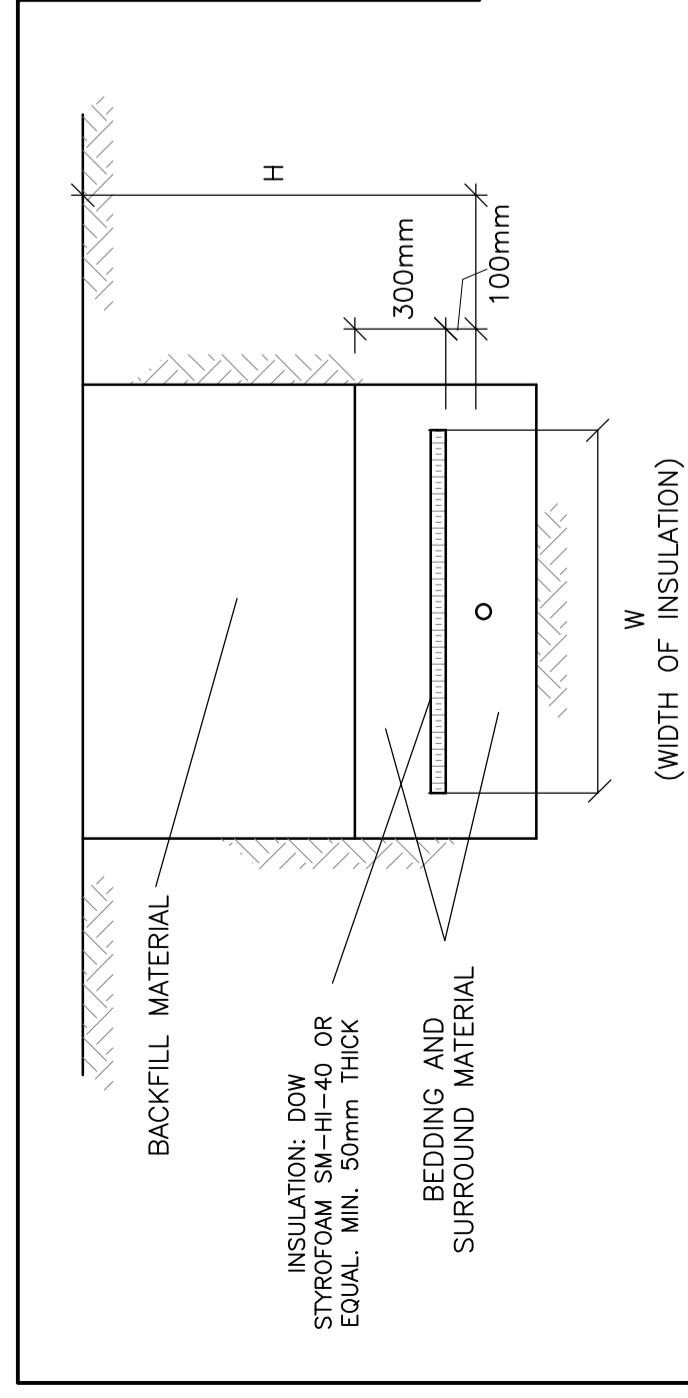

INSULATION OF WELL WATER LINE
SHALLOW TRENCHES
N.T.S.

INSULATE SEWER AS INDICATED AND WHERE DEPTH OF COVER IS LESS THAN 2400mm. CENTER INSULATION OVER PIPE. JOINTS BETWEEN SHEETS OF INSULATION SHALL BE STAGGERED.

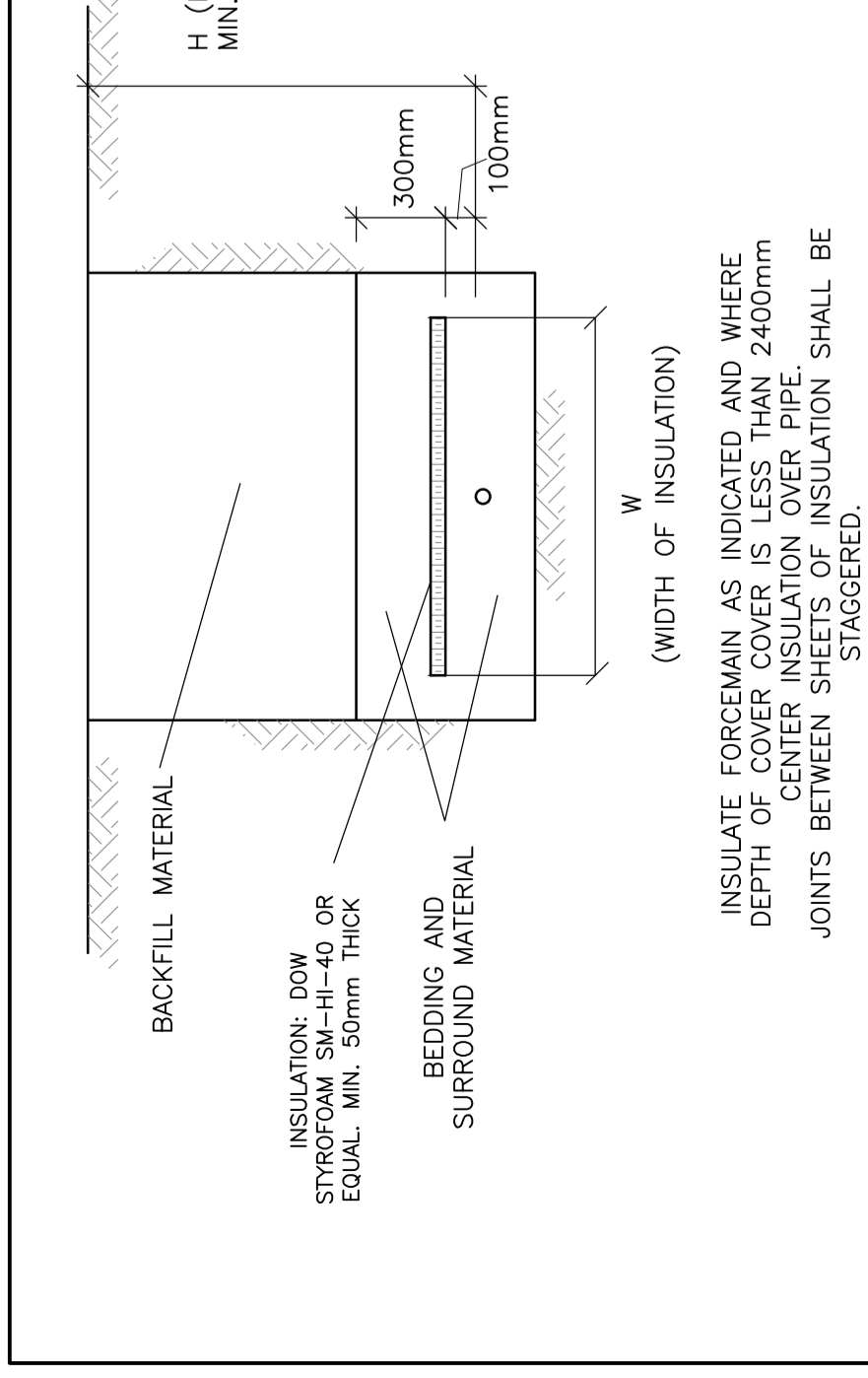

INSULATION OF SANITARY
FORCEMAIN IN SHALLOW TRENCHES
N.T.S.

INSULATE FORCEMAIN AS INDICATED AND WHERE DEPTH OF COVER IS LESS THAN 2400mm. CENTER INSULATION OVER PIPE. JOINTS BETWEEN SHEETS OF INSULATION SHALL BE STAGGERED.

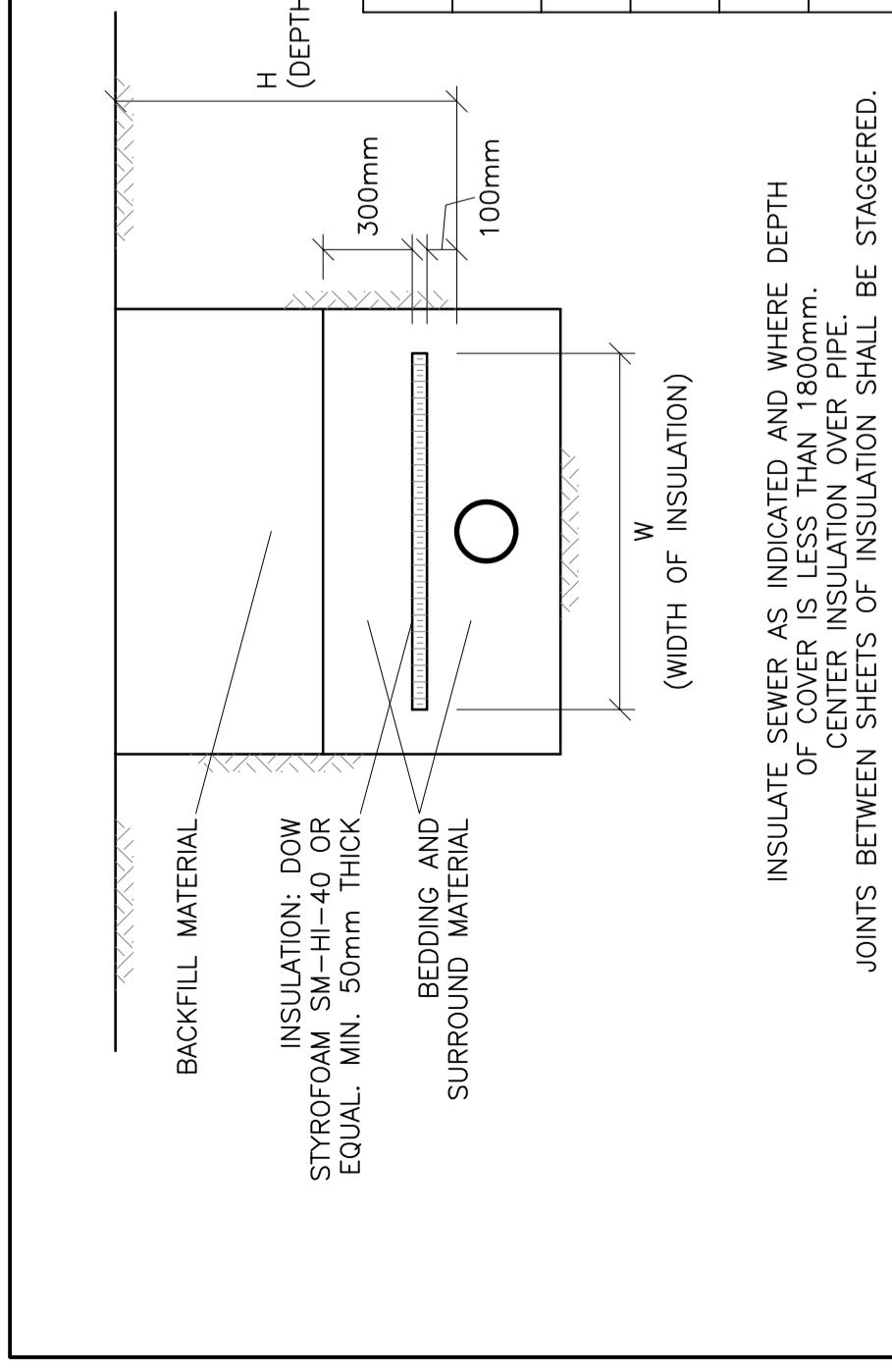

INSULATION OF SEWERS
IN SHALLOW TRENCHES
N.T.S.

INSULATE SEWER AS INDICATED AND WHERE DEPTH OF COVER IS LESS THAN 2400mm. CENTER INSULATION OVER PIPE. JOINTS BETWEEN SHEETS OF INSULATION SHALL BE STAGGERED.

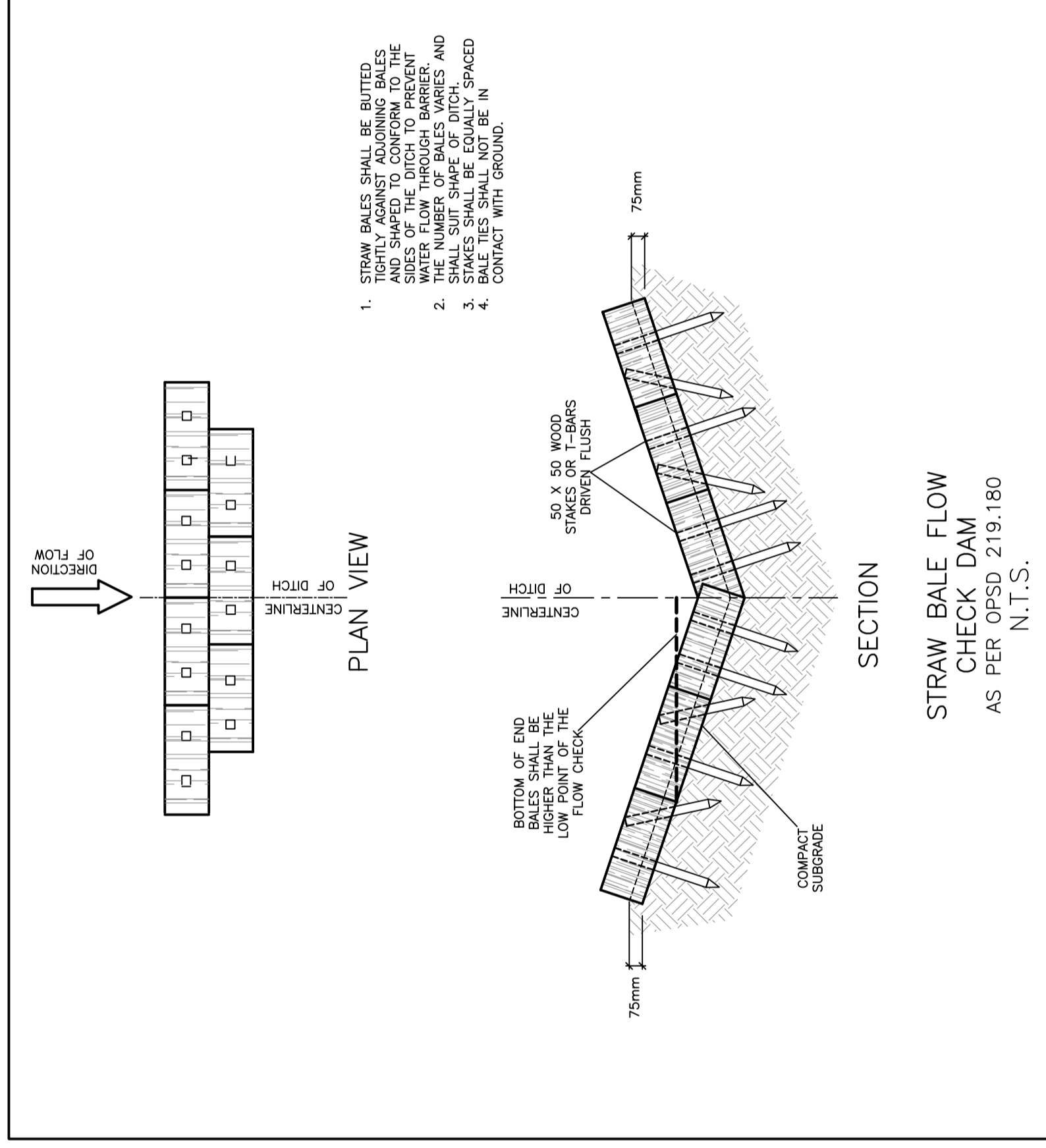

STRAW BALE FLOW
CHECK DAM
AS PER OPSD 219.180
N.T.S.

1. STRAW BALES SHALL BE BITTED AND SHAPED TO CONFORM TO THE WATER FLOW THROUGH BARRIER.
2. STAKES SHALL BE EQUALLY SPACED AND CONTACT WITH GROUND.
3. STAKES SHALL BE EQUALLY SPACED AND CONTACT WITH GROUND.
4. CONTACT WITH GROUND.

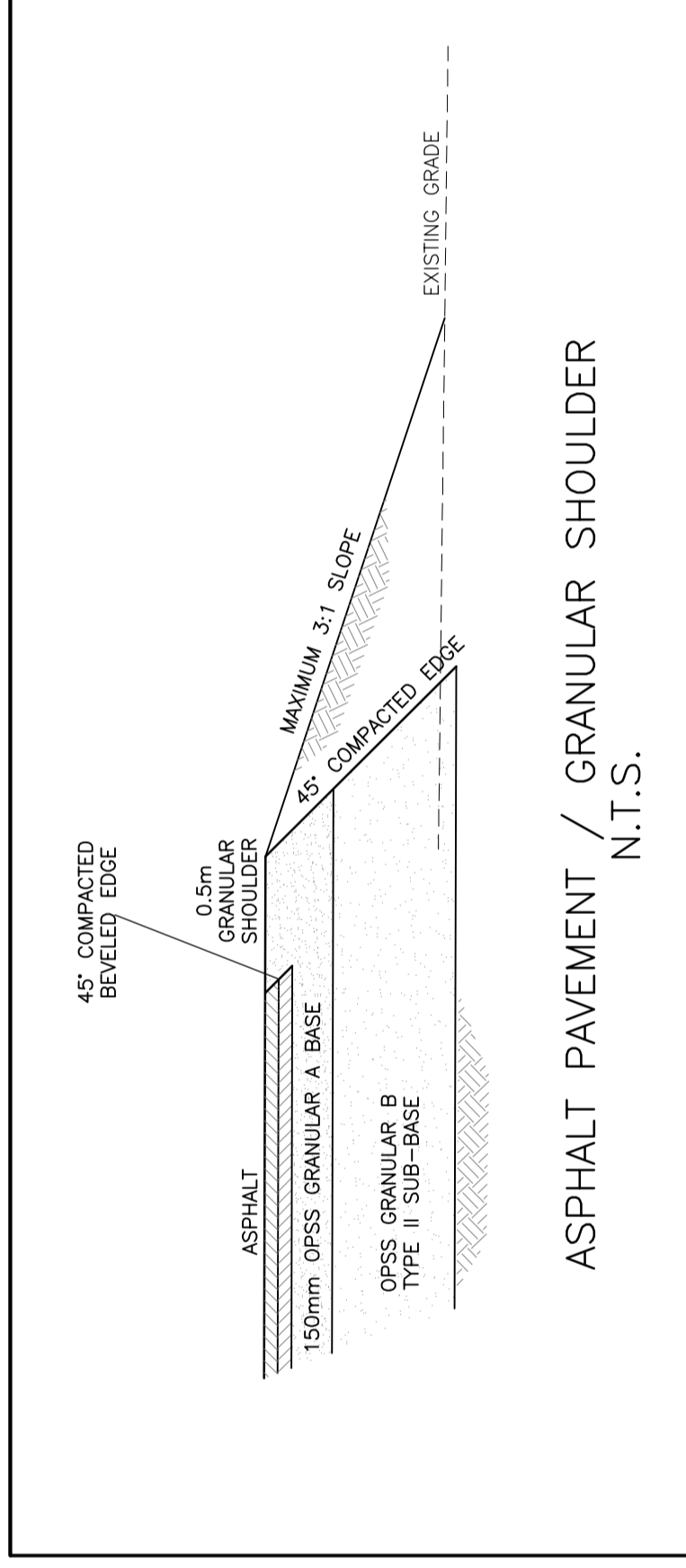

ASPHALT PAVEMENT / GRANULAR SHOULDER
N.T.S.

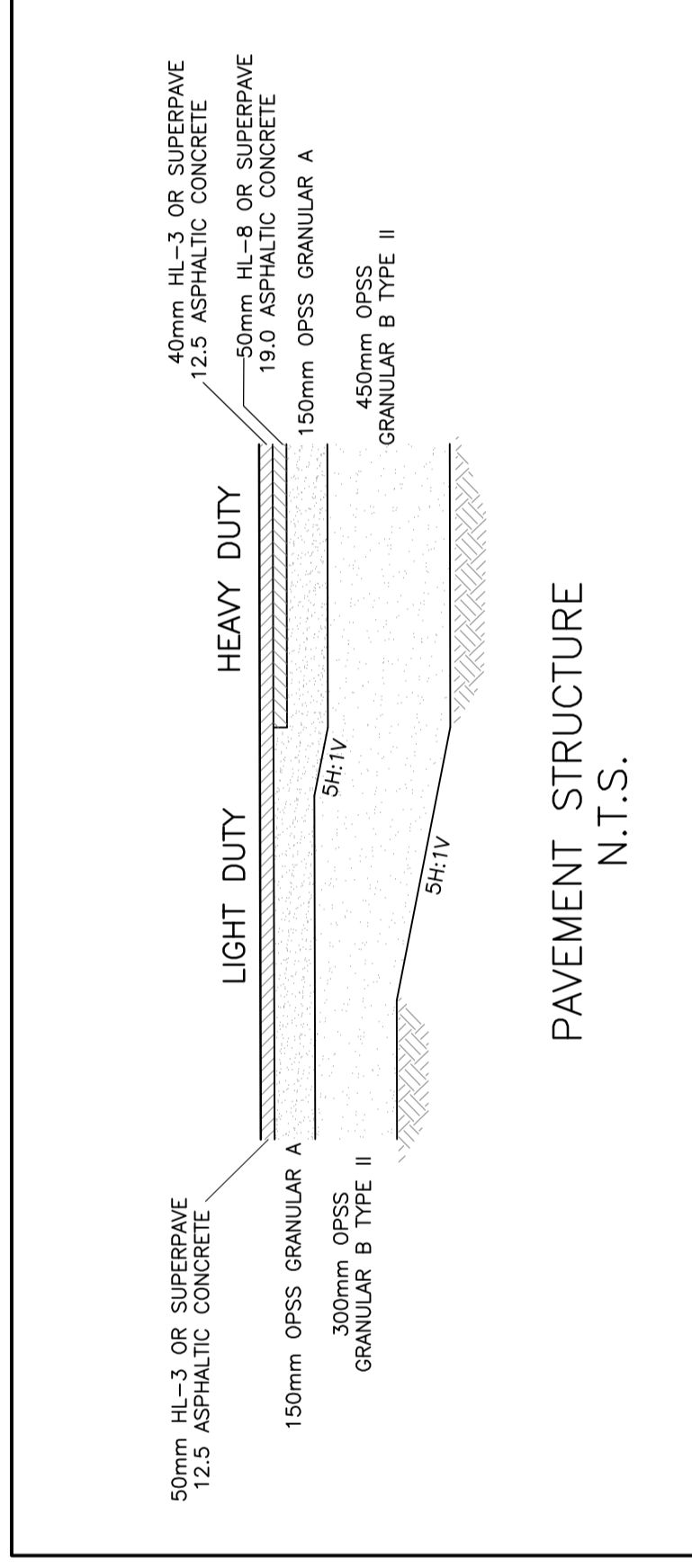

PAVEMENT STRUCTURE
N.T.S.

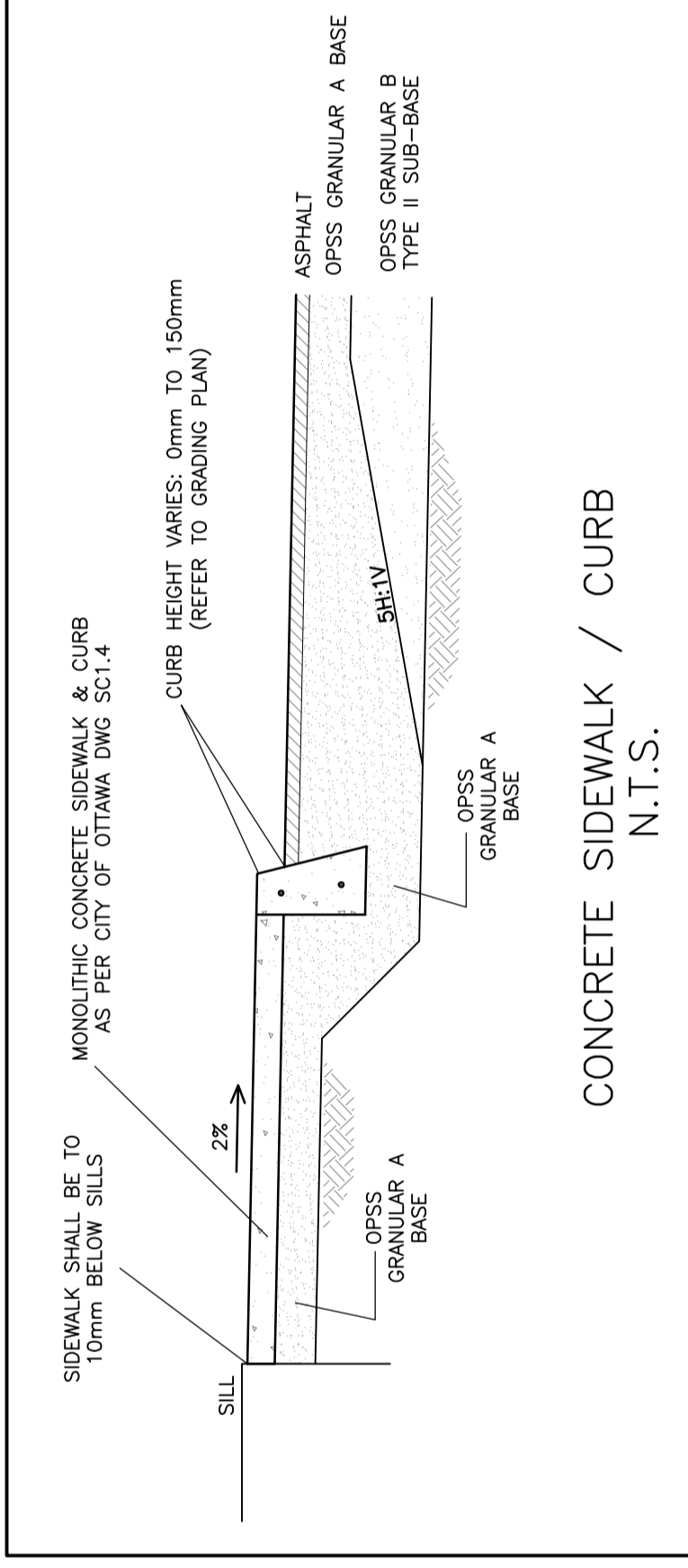

CONCRETE SIDEWALK / CURB
N.T.S.

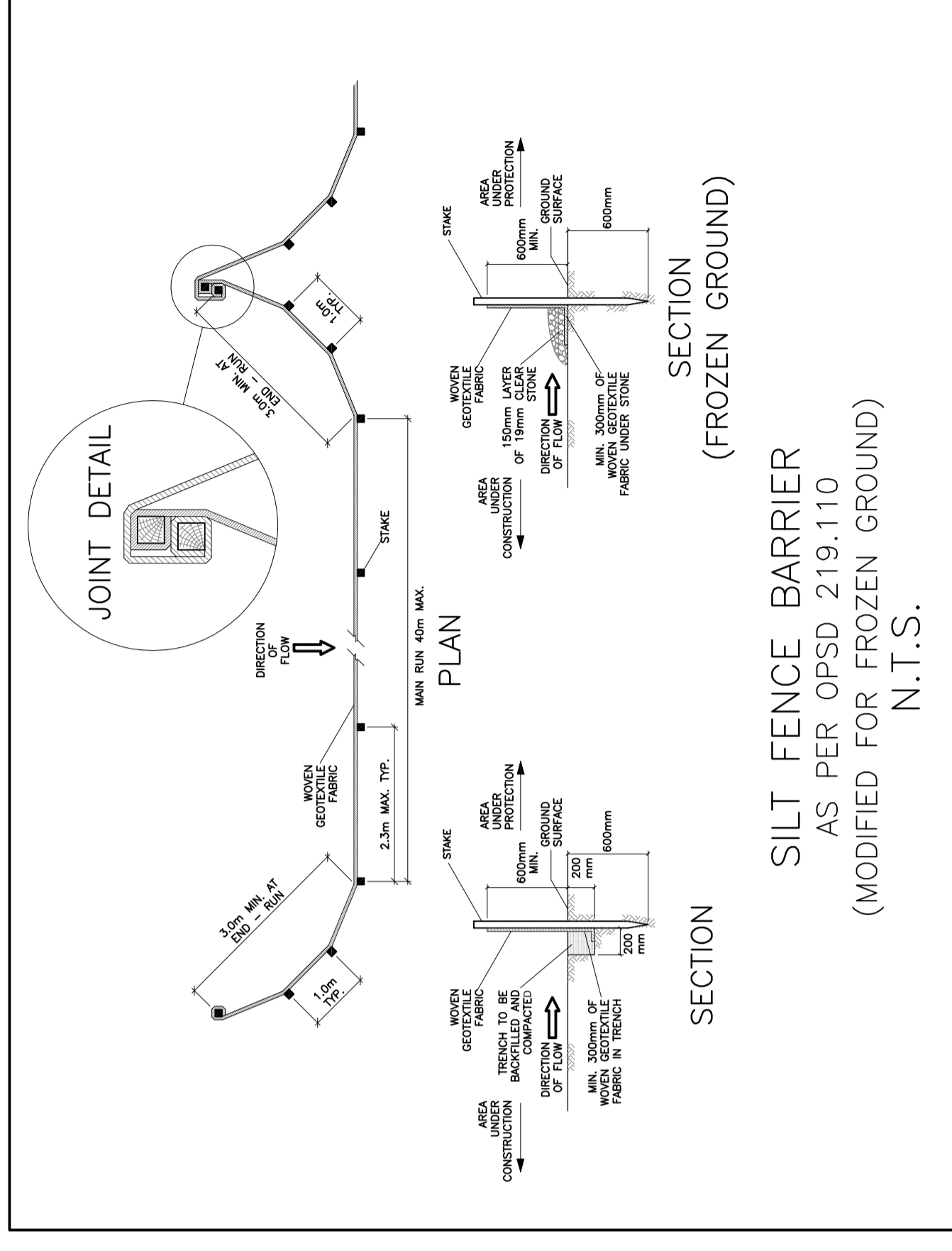

SILT FENCE BARRIER
AS PER OPSD 219.110
(MODIFIED FOR FROZEN GROUND)
N.T.S.

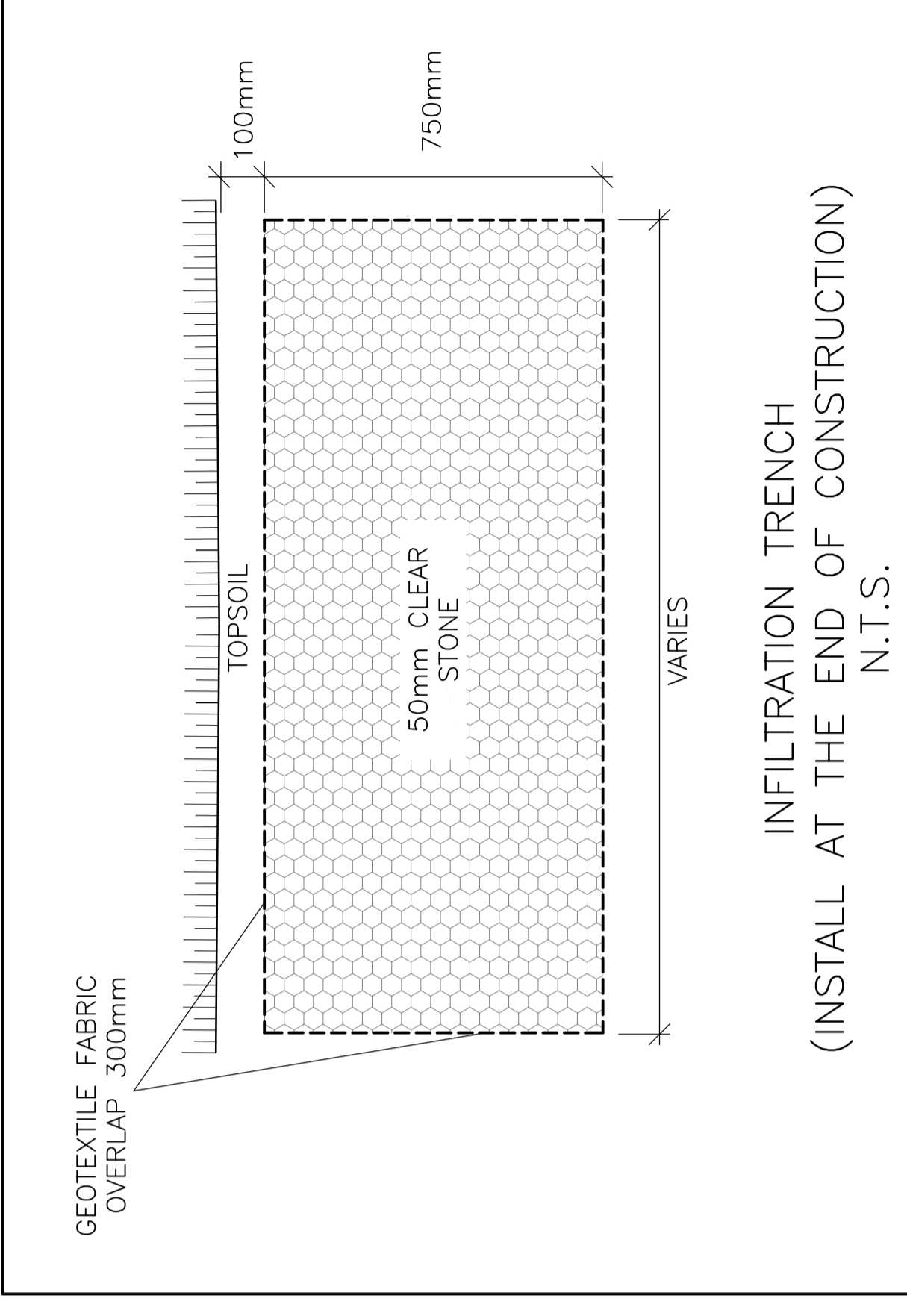

INFILTRATION TRENCH
(INSTALL AT THE END OF CONSTRUCTION)
N.T.S.

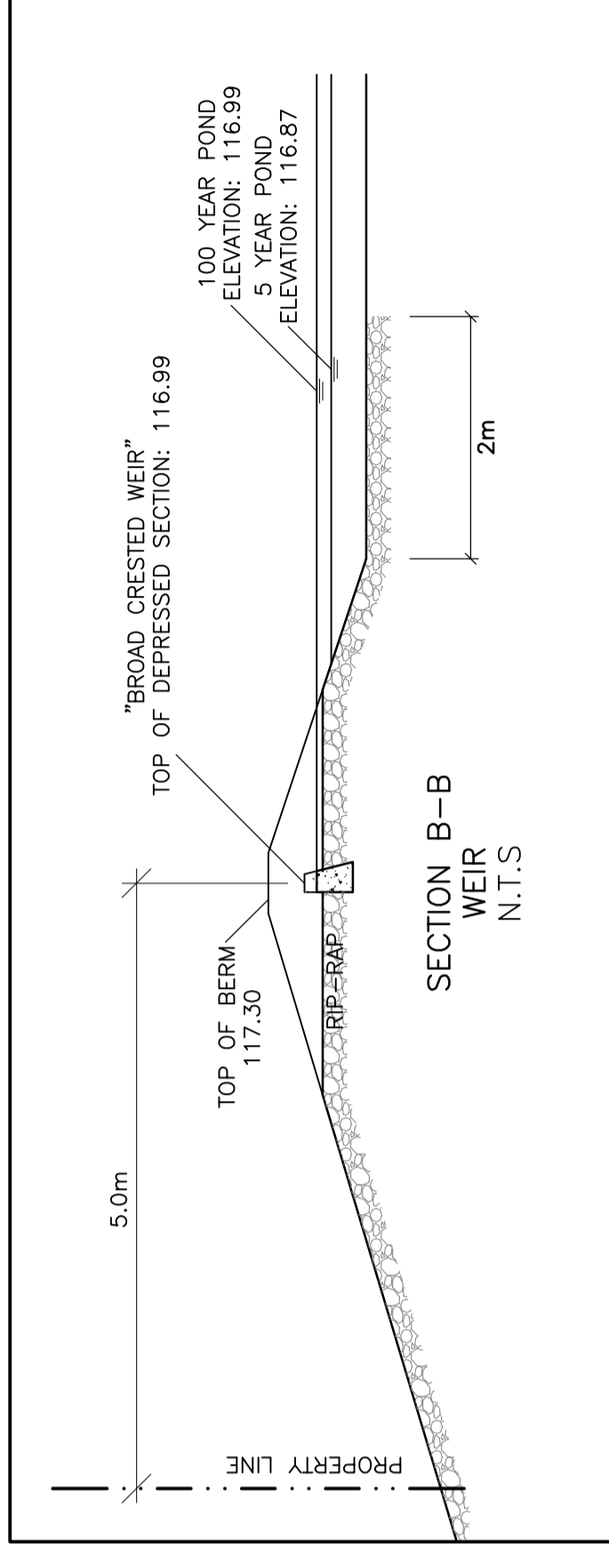

SECTION B-B
WEIR
N.T.S.

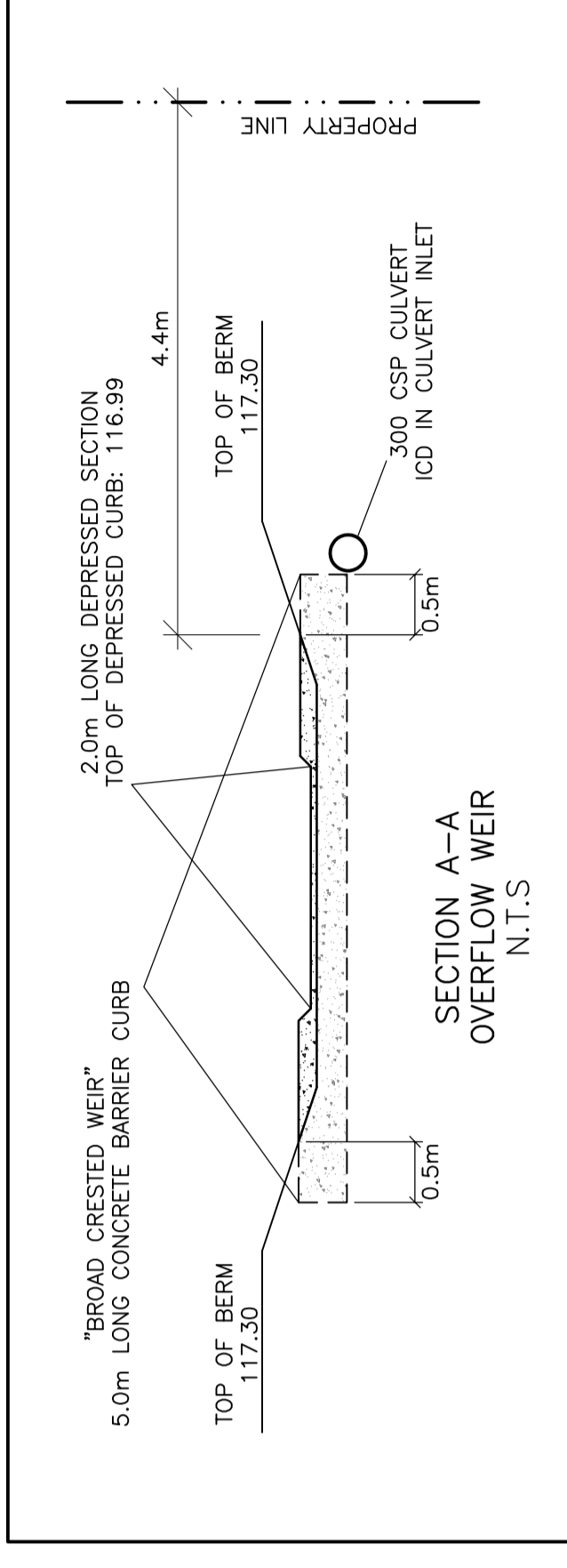

SECTION A-A
OVERFLOW WEIR
N.T.S.

KEY PLAN

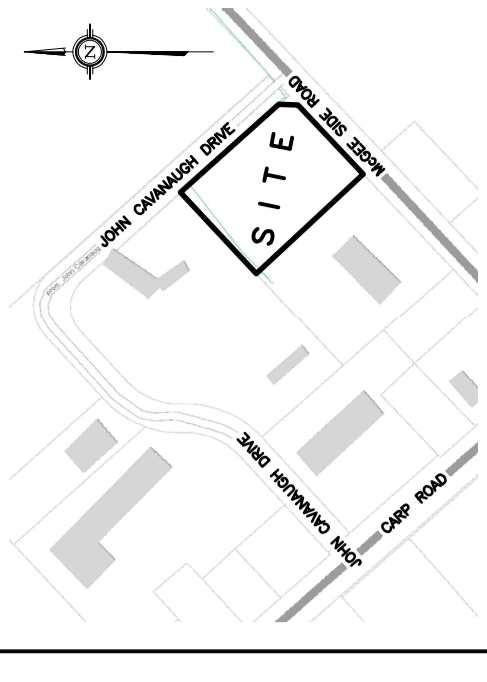

No.	DATE	REVISION
1	JAN 27-21	ISSUED FOR REVIEW & COORDINATION
2	MAR 12-21	ISSUED FOR APPROVAL
3	APR 22-21	ISSUED FOR BUILDING PERMIT
4	JUN 14-21	RE-ISSUED FOR APPROVAL

D. B. GRAY ENGINEERING INC.
700 Long Point Circle
Ottawa, Ontario
4gray@dbgrayengineering.com
613-425-8044

**CLS ROOFING LTD
OFFICE & WAREHOUSE
2167 MCGEE SIDE ROAD
OTTAWA, ONTARIO**

DETAILS

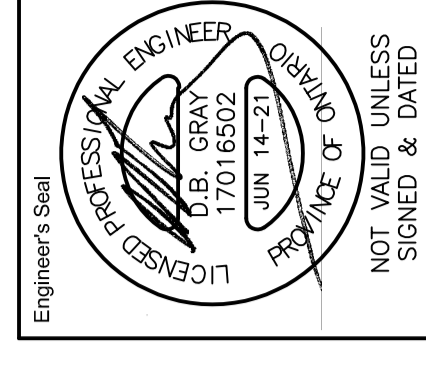

Drawn: D.B.G.
Checked: J.T.S.
Scale: 1:250
Date: NOV 18-20
Rev. No.: 20088

Drawing No. **C-4**
of **6**

#18432

07-12-21-0027